



SOCCER

INDOOR / OUTDOOR ATHLETIC EQUIPMENT



DESIGNED TO PERFORM.
MANUFACTURED TO LAST.™



2 0 2 0



NOVA™ Premiere Goal Package (White)

- 2 NOVA™ Premiere Goals (SGP-600)
- (2) 5mm, 5½" hex mesh white nets (SN-HTTP-W)
- 4 World Cup™ Anchors - 1 Set (SGA-50)
- 1 NOVA™ Goal Wheel Kit (NSGWK)

* Limited Warranties



SGP-600PKGWHI

\$5,845 PKG 598 lbs



NOVA™ Premiere Goal Package (Black/White)

- 2 NOVA™ Premiere Goals (SGP-600)
- (2) 5mm, 5½" hex mesh two-tone black/white nets (SN-2BLKW)
- 4 World Cup™ Anchors - 1 Set (SGA-50)
- 1 NOVA™ Goal Wheel Kit (NSGWK)

* Limited Warranties



SGP-600PKGBLK

\$5,845 PKG 598 lbs



NOVA™ Premiere Goal Package (Blue/White)

- 2 NOVA™ Premiere Goals (SGP-600)
- (2) 5mm, 5½" hex mesh two-tone blue/white nets (SN-2BLUW)
- 4 World Cup™ Anchors - 1 Set (SGA-50)
- 1 NOVA™ Goal Wheel Kit (NSGWK)

* Limited Warranties



SGP-600PKGBLU

\$5,845 PKG 598 lbs



In-ground anchors or appropriate amount of counterweight required per goal. See page 34 for ASTM counterweight requirements for your specific goal.

* Goal: 12 Year Lifetime Warranty, Anchors and Wheel Kit: 3 Year Limited Warranty, Net: 1 Year Limited Warranty

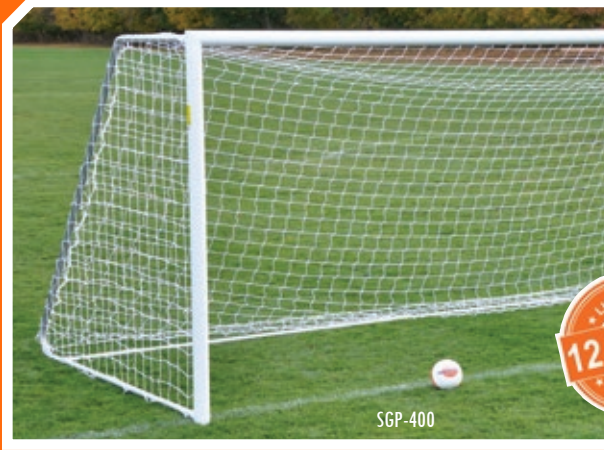

SGP-400



SGP-760

Classic Official Round or Square Goal Package

- 2 Classic Round Official Goals (SGP-400) or 2 Classic Square Official Goals (SGP-760)
- (2) 4mm, 5½" sq. mesh white nets (SND-8)
- 4 Auger Anchors - 1 Set (SAS-95)
- 1 Classic Wheel Kit (CSGWK)



* Limited Warranties



SGP-400PKG	Round Goal	\$3,780 PKG	534 lbs
SGP-760PKG	Square Goal	\$3,780 PKG	557 lbs

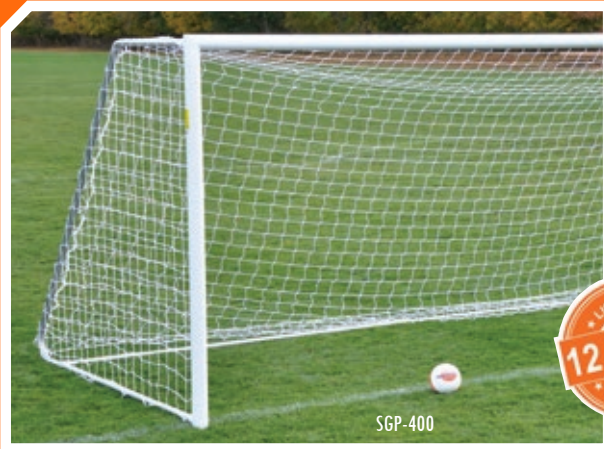

SGP-400



SGP-760

Deluxe Classic Official Round or Square Goal Package

- 2 Classic Round Official Goals (SGP-400) or 2 Classic Square Official Goals (SGP-760)
- (2) 4mm, 5½" sq. mesh white nets (SND-8)
- 4 World Cup™ Anchors - 1 Set (SGA-50)
- 1 Classic Wheel Kit (CSGWK)



* Limited Warranties



SGP-400PKGDX	Round Goal	\$4,000 PKG	538 lbs
SGP-760PKGDX	Square Goal	\$4,000 PKG	558 lbs

In-ground anchors or appropriate amount of counterweight required per goal. See page 34 for ASTM counterweight requirements for your specific goal.

* Goal: 12 Year Lifetime Warranty, Anchors and Wheel Kit: 3 Year Limited Warranty, Net: 1 Year Limited Warranty

NOVA™

SOCCER



SGP-850 shown with optional wheel kits

Features Jaypro Sports flush mount
EASY TRACK™
Net Attachment System



Tension Cable



Upright Brace



Corner Fitting for
Net Stay Pole



ASTM Compliant



NOVA™ World Cup Goal

Features Jaypro Sports flush mount Easy Track™ net attachment system with clips.

- Official size with white powder coat finish
- All aluminum extruded goal
- 4" extruded aluminum goal face with 2" x 4" base frame
- White 2 3/8" steel back net posts (color options available for additional charge - call for details)
- Optional wheel kit (NSGWK) sold separately
- Stainless steel hardware included
- Ground anchors, counterweights and nets (SGP-850N) sold separately
- 24'W x 8'H x 7'B x 8'D



12 Year Lifetime Warranty



SGP-850

\$6,900 PR

450 lbs

In-ground anchors or appropriate amount of counterweight required per goal. See page 34 for ASTM counterweight requirements for your specific goal.

Dealer Rated BEST In Customer Service ★★★★★

JAYPRO.COM 800-243-0533



NOVA™ World Fold-Up Goal

Features Jaypro Sports flush mount Easy Track™ net attachment system with clips.

- Official size international style aluminum goal with white powder coat finish
- Field maintenance friendly with fold-up rear frame can be temporarily pinned or permanently locked in raised position
- 4" extruded aluminum with a 2" x 4" base frame
- 2 $\frac{3}{8}$ " galvanized steel back posts
- Ground sleeves for semi-permanent installation included
- World competition hex net and stainless steel hardware included
- 24'W x 8'H x 6'B x 6'D



12 Year Lifetime Warranty



SGP-660

\$5,290 PR 534 lbs



NOVA™ World Classic Goal

Same as NOVA™ World Fold-Up Goal (SGP-660) except without fold-up rear frame.

- 24'W x 8'H x 6'B x 6'D



12 Year Lifetime Warranty



SGP-550

\$3,755 PR 432 lbs



Features Jaypro Sports flush mount

EASY TRACK™
Net Attachment System

FieldPro™ Soccer Ball Stop System

Stop wasting time chasing missed shots or errant passes during practice and games. Ensure the safety of athletes, coaches, and spectators.

- Designed to fit behind soccer goals
- (4) 4" heavy-walled aluminum uprights with ground sleeves and covers
- #36 knotted black nylon net with 3 $\frac{1}{2}$ " sq. mesh and 1/4" rope border
- Pulley system to raise/lower net included
- Corrosion-resistant hardware included
- 20'H x 65'L

Custom sizes available. See page 132-134 for more FieldPro™ Net System options.

* Limited Warranties



FNSB-65

\$2,390 EA 250 lbs

* System: 3 Year Limited Warranty, Net: 1 Year Limited Warranty





NOVA™ Premiere Goal Packages
See page 20 for package details.



Features Jaypro Sports flush mount
EASY TRACK™
Net Attachment System



Backstays



Cast Corners



ASTM Compliant



NOVA™ Premiere Goal

Features Jaypro Sports flush mount Easy Track™ net attachment system with clips.

- Official size with white powder coat finish
- International style all aluminum goal
- 4" extruded aluminum with a 2" x 4" base frame
- 1.7" aluminum European and auxiliary backstays
- Optional wheel kit (NSGWK) sold separately
- Stainless steel hardware included

- Ground anchors, counterweights, and nets sold separately
- 24'W x 8'H x 4'B x 10'D



12 Year Lifetime Warranty



SGP-600

\$5,200 PR

446 lbs

In-ground anchors or appropriate amount of counterweight required per goal. See page 34 for ASTM counterweight requirements for your specific goal.



NOVA™ Premiere Adjustable Goal Package

- 2 NOVA™ Premiere Adjustable Goals (SGP-600AX)
- (2) 5mm, 5½" hex mesh two-tone blue/white nets (SN-2BLUW)
- 4 World Cup™ Anchors - 1 Set (SGA-50)
- 2 NOVA™ Goal Wheel Kits (NSGWK)

* Limited Warranties



SGP-600AXPKG

\$6,410 PKG

651 lbs



* Goal: 12 Year Lifetime Warranty, Anchors and Wheel Kit: 3 Year Limited Warranty, Net: 1 Year Limited Warranty



Features Jaypro Sports flush mount
EASY TRACK™
Net Attachment System



Adjustable Crossbar



Backstays



ASTM Compliant



NOVA™ Premiere Adjustable Goal

Same as NOVA™ Premiere Goal (SGP-600) except with:

- Infinitely adjustable rear crossbar allows goal to fit under any football goal post
- No fixed settings and no fixed depth on crossbar (bottom bar adjusts from 4' to 8' deep)
- Anchor kits available for football goal post (SFGA-6, SFGA-5 or SFGA-4)

- Optional wheel kit (NSGWK) sold separately
- Stainless steel hardware included
- Ground anchors, counterweights, and nets sold separately
- 24'W x 8'H x 4'B x 10'D

12 Year Lifetime Warranty



SGP-600AX

\$5,380 PR 513 lbs

In-ground anchors or appropriate amount of counterweight required per goal. See page 34 for ASTM counterweight requirements for your specific goal.



Soccer/Football Anchor Kit

- Fastens the soccer goal rear crossbar to a football goal gooseneck

3 Year Limited Warranty



SFGA-6	6 ⁵ / ₈ " OD Gooseneck	\$145 KIT	10 lbs
SFGA-5	5 ¹ / ₁₆ " OD Gooseneck	\$157 KIT	10 lbs
SFGA-4	4 ¹ / ₂ " OD Gooseneck	\$168 KIT	10 lbs



IMPROVED



NOVA™ Wheel Kit

Attaches to any NOVA™ goal base (SGP-600 and NOVA™ club round and square).

- (4) 10" no-flat wheels
- Kit equips 2 goals

3 Year Limited Warranty



NSGWK \$499 KIT 49 lbs



SGP-400 Round



Classic Goal Packages
See page 21 for package details.

SGP-760 Square

Classic Official Goals



Features Jaypro Sports flush mount Easy Track™ net attachment system with clips.

* Limited Warranties



- Official size with white powder coat finish
- 4" round or square extruded aluminum frame with 2" galvanized steel backstays and rear crossbar
- Portable and semi-permanent models
- Wheel kit (CSGWK), ground anchors, counterweights, and net sold separately
- 24'W x 8'H x 4'B x 10'D



Classic Official Round Goal

SGP-400	Portable Goal	\$3,060 PR	478 lbs
SGP-440	Semi-Permanent Goal with Galvanized Steel Backstays	\$2,895 PR	384 lbs
SGP-440EB	Semi-Permanent Goal with European Backstays	\$3,020 PR	306 lbs
SGP-445G	Ground Sleeves for Semi-Permanent Goal (Set of 4)	\$510 SET	20 lbs

Features Jaypro Sports flush mount



Classic Official Square Goal

SGP-760	Portable Goal	\$3,065 PR	478 lbs
SGP-730	Semi-Permanent Goal with Galvanized Steel Backstays	\$3,940 PR	345 lbs
SGP-730EB	Semi-Permanent Goal with European Backstays	\$3,020 PR	241 lbs
SGP-735G	Ground Sleeves for Semi-Permanent Goal (Set of 4)	\$550 SET	18 lbs

In-ground anchors or appropriate amount of counterweight required per goal. See page 34 for ASTM counterweight requirements for your specific goal.

* Goal: 12 Year Lifetime Warranty, Sleeves: 3 Year Limited Warranty



Soccer Goal Cart

Swivel wheel goal carts allow goals to be moved in all directions with ease. Will transport any official or club soccer goal.

3 Year Limited Warranty

SGT-24	\$899 PR	72 lbs
---------------	-----------------	--------



Classic Wheel Kit



Attaches to any goal base (SGP-760, SGP-400, SGP-110 and all Classic Club Round Goals).

- (4) 10" no-flat wheels and equips 2 goals
- No drilling of backstay pipe required

3 Year Limited Warranty



CSGWK	\$429 KIT	40 lbs
--------------	------------------	--------



Team Official Square Goal

Features Jaypro Sports flush mount Easy Track™ net attachment system with clips.

- Official size with white powder coat finish
- 4" x 2" aluminum frame with 2" galvanized steel backstays and rear crossbar
- Backstays run back 10' for more stable base
- Wheel kit (CSGWK), ground anchors, counterweights, and nets sold separately
- 24'W x 8'H x 4'B x 10'D



Features Jaypro Sports flush mount

EASY TRACK™
Net Attachment System



3 Year Limited Warranty



SGP-110

\$2,570 PR 459 lbs

In-ground anchors or appropriate amount of counterweight required per goal. See page 34 for ASTM counterweight requirements for your specific goal.



Team Official Round Goal (Semi-Permanent)

Powder coated aluminum goal that features Jaypro Sports flush mount Easy Track™ net attachment system with clips. Designed without backstays for permanent/semi-permanent installation!

- Official size with white powder coat finish
- 4" crossbar and uprights
- Nets, net clips, and net pegs included
- Aluminum ground sleeves with locking caps sold separately
- 24'W x 8'H



Features Jaypro Sports flush mount

EASY TRACK™
Net Attachment System

* Limited Warranties



SGP-220

\$2,150 PR 432 lbs

SGP-445G Ground Sleeves (Set of 4)

\$510 SET 20 lbs

* Goal, Clips and Pegs: 3 Year Limited Warranty, Net: 1 Year Limited Warranty



EASY TRACK™
Net Attachment System



Auger Anchors



Upright Brace



Cast Corners



NOVA™ Club Round Goals

Features Jaypro Sports flush mount Easy Track™ net attachment system with clips. White powder coat finish!

- 3" extruded aluminum frames with European and auxiliary backstays
- Multiple sizes available
- 4" sq. mesh white nets (SCN-24), net clips, augers, and stainless steel hardware included
- Wheel kit (NSGWK) sold separately



Item	Weight	Counter Weight	Size	Price
RCG-24S	402 lbs	150 lbs	24'W x 8'H x 4'B x 9'D	\$3,859 SET
RCG-21S	378 lbs	170 lbs	21'W x 7'H x 3'B x 8'D	\$3,599 SET
RCG-18S	316 lbs	240 lbs	18½'W x 6½'H x 2'B x 6'D	\$3,399 SET
RCG-12S	306 lbs	240 lbs	12'W x 6½'H x 2'B x 6'D	\$3,259 SET
RCG-9S	218 lbs	*	9'W x 4½'H x 2'B x 5'D	\$2,599 SET
RCG-6S	198 lbs	*	6'W x 4'H x 2'B x 5'D	\$2,299 SET

* Limited Warranties



In-ground anchors or appropriate amount of counterweight required per goal. See page 34 for ASTM counterweight requirements for your specific goal.

* Goal: 12 Year Lifetime Warranty, Net: 1 Year Limited Warranty

Which size goal does your program need?

See page 34 for recommended goal size for your age group and number of players



NOVA™ Wheel Kit

IMPROVED

Attaches to any NOVA™ goal base (SGP-600 and NOVA™ club round and square).

- (4) 10" no-flat wheels
- Quick and easy wheel engagement
- Kit equips 2 goals



3 Year Limited Warranty



NSGWK

\$499 KIT 49 lbs



EASY TRACK
Net Attachment System



Auger Anchors



Cast Corners



Backstays



Classic Club Round Goal

Features Jaypro Sports flush mount Easy Track™ net attachment system with clips. White powder coat and natural finish design!

- 3" extruded aluminum front frames with galvanized steel backstays
- Multiple sizes available (galvanized steel rear crossbars on three largest sizes)
- 4" sq. mesh white nets (SCN-24), net clips, and augers included
- Wheel kit (CSGWK) sold separately



Item	Weight	Counter Weight	Size	Price
CC24S	481 lbs	140 lbs	24'W x 8'H x 4'B x 9'D	\$2,669 SET
CC21S	412 lbs	160 lbs	21'W 7'H x x 3'B x 8'D	\$2,499 SET
CC18S	361 lbs	240 lbs	18½'W x 6½'H x 2'B x 6'D	\$2,299 SET
CC12S	305 lbs	240 lbs	12'W x 6½'H x 2'B x 6'D	\$2,099 SET
CC9S	157 lbs	*	9'W x 4½'H x 2'B x 5'D	\$1,697 SET
CC6S	136 lbs	*	6'W x 4'H x 2'B x 5'D	\$1,597 SET

* Limited Warranties



In-ground anchors or appropriate amount of counterweight required per goal. See page 34 for ASTM counterweight requirements for your specific goal.

* Goal: 12 Year Lifetime Warranty, Net: 1 Year Limited Warranty

Which size goal does your program need?

See page 34 for recommended goal size for your age group and number of players



Classic Wheel Kit

Attaches to any goal base (SGP-760, SGP-400, SGP-110 and all Classic Club Round Goals).

- (4) 10" no-flat wheels
- No drilling of backstay pipe required
- Quick and easy wheel engagement
- Kit equips 2 goals



3 Year Limited Warranty



CSGWK

\$429 KIT

40 lbs

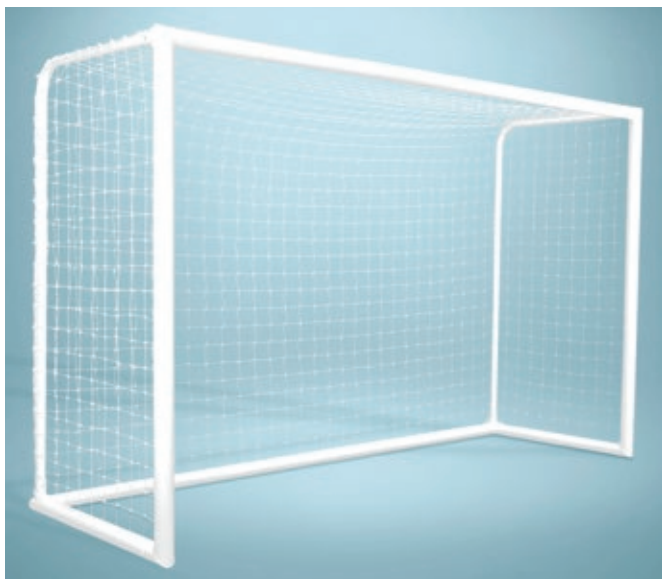

Deluxe Official Futsal Goal

Features Jaypro Sports flush mount Easy Track™ net attachment system with clips.

- 1 official size goal with white powder coat finish
- 3" round aluminum goal face and base with extruded channel
- 1¼" round heavy-walled aluminum backstays
- Polyethylene white net with 4" sq. mesh (FSG67910N)
- Stainless steel hardware included
- Optional NOVA™ Wheel Kit (NSGWK) sold separately
- 9'10"W x 6'7"H x 3'3"D

* Limited Warranties



FSG-1 \$1,648 EA 240 lbs

* Goal: 3 Year Limited Warranty, Net: 1 Year Limited Warranty



Official Futsal Goal

Features Jaypro Sports flush mount Easy Track™ net attachment system with clips.

- 1 portable goal with white powder coat finish
- Extruded aluminum frame
- Official size 9'10"W (3m) x 6'7"H (2m) meets specifications
- (1) 4" sq. mesh net
- Non-marring floor protectors included

* Limited Warranties



FSG-2	Goal	\$1,400 EA	101 lbs
FSG67910NHP	Replacement Net	\$100 EA	5 lbs
FSGWK	Wheel Kit	\$499 KIT	40 lbs

* Goal and Wheel Kit: 3 Year Limited Warranty, Net: 1 Year Limited Warranty



Practice Futsal Goal

- 1 official size goal with white powder coat finish
- Folds for portability and storage
- 1.9" heavy-duty steel galvanized pipe goal face
- 1½" OD steel galvanized pipe backstays
- 4" sq. mesh net held in place with hook-and-loop closure strips
- Non-marring floor protectors
- 9'10"W x 6'7"H x 3'3"D

* Limited Warranties



FPG-23	Goal	\$750 EA	63 lbs
FPG-23N	Replacement Net	\$88 EA	41 lbs

* Goal: 3 Year Limited Warranty, Net: 1 Year Limited Warranty



Indoor/Outdoor Folding Goal

For competitive indoor play and as an outdoor training/youth goal.

- Indoor/outdoor use
- 2" zinc undercoated steel frame powder coated white
- 1 5/16" backstays fold without removing net
- 4" sq. mesh net
- Non-marring floor protectors included
- 12'W x 7'H x 4'D

See pages 34-35 for ground anchors for outdoor use.

* Limited Warranties



SFG-14HP	Goal	\$405 EA	81 lbs
SFG-14NHP	Replacement Net	\$99 EA	4 lbs

* Goal: 3 Year Limited Warranty, Net: 1 Year Limited Warranty



Hook-and-loop net straps eliminate lacing.



Portable Short-Sided Soccer Goals

- 1 5/16" galvanized steel frame powder coated white
- All-welded side frames and rear ground crossbars for increased strength and durability
- Snap pins lock frame in place for added safety
- Folds for easy transport and storage
- 2.5mm twisted net with 4" sq. mesh
- Ground anchors and net ties included
- Optional Floor Protection Kit (PSS-4FT) sold separately to use indoors

* Limited Warranties

For 4 vs 4 Play:

PSS-612	12'W x 6'H x 31"D Goal	\$315 EA	51 lbs
PSS-612N	Replacement Net	\$52 EA	3 lbs
PSS-608	8'W x 6'H x 31"D Goal	\$299 EA	44 lbs
PSS-608N	Replacement Net	\$49 EA	2 lbs
PSS-510	10'W x 5'H x 34"D Goal	\$270 EA	43 lbs
PSS-510N	Replacement Net	\$47 EA	4 lbs

For 3 vs 3 Play:

PSS-406	6'W x 4'H x 24"D Goal	\$260 EA	30 lbs
PSS-406N	Replacement Net	\$40 EA	2 lbs

* Goal: 3 Year Limited Warranty, Net: 1 Year Limited Warranty

Floor Protector Kit

Ideal for using Portable Short-Sided Soccer Goals indoors.

- Help protect gymnasium floor from being scratched or damaged
- Kit includes self-threading screws with 4 rubber feet

3 Year Limited Warranty

PSS-4FT	\$32 KIT	2 lbs
----------------	----------	-------

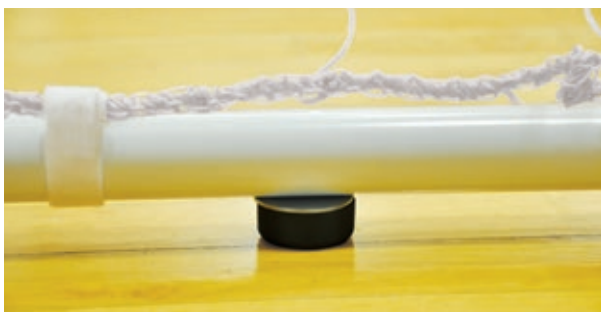

Quick Set-Up Goal

Great for any league or backyard use.

- Sets up in minutes with quick release push-pins
- 2" aluminum frame
- Goal width adjusts to 8', 16' or 24' x 8'H
- Net, 6 net pegs, indoor floor pads and carry bag included

* Limited Warranties



SEYL-824	Goal	\$799 EA	52 lbs
SEYL-24NHP	Replacement Net	\$132 EA	7 lbs

* Goal: 3 Year Limited Warranty, Net: 1 Year Limited Warranty



Rugged Play Goal

For precision shooting drills or short-sided games.

- Quick release push-pins make break down easy
- 2" galvanized steel frame
- 2.5mm orange polyethylene net with 4" sq. mesh
- Includes rubber feet to protect gymnasium floor
- 8'W x 4'H x 4'D

* Limited Warranties

SMG-8HP	Goal	\$264 EA	42 lbs
SMG-8NHP	Replacement Net	\$40 EA	5 lbs

* Goal: 3 Year Limited Warranty, Net: 1 Year Limited Warranty



Two-For-Youth Goal

- Two sizes in one (4' x 6' or flip to 3' x 6')
- Easy quick release push-pin assembly
- 1½" aluminum frame powder coated white
- 1¾" sq. black mesh net
- Hook-and-loop attachment

* Limited Warranties



MPG-46	Goal	\$295 EA	24 lbs
MPG-46N	Replacement Net	\$48 EA	2 lbs

* Goal: 3 Year Limited Warranty, Net: 1 Year Limited Warranty





Soccer Pop-Up Trainers



- Durable and safe lightweight pop-up goals
- Fiberglass rod frame w/steel spring corners and heavy-duty net
- Equipped with anchoring pegs to ensure stability
- Folds down to 1" flat oval
- Available in 2 sizes
- Zipper nylon bag with handles included

1 Year Limited Warranty

SGPU4830R	4'W x 2½'H x 2½'D (Red)	\$63 PR	11 lbs
SGPU7240B	6'W x 3'4"H x 3'4"D (Blue)	\$100 PR	11 lbs



Goal Runner™



- Indoor/outdoor youth use
- Steel frame folds flat for compact storage
- Non-marking front wheels for easy transport
- Durable knotless nylon net with vinyl sleeves
- Hook-and-loop closures (no lacing required)
- Available in 3 sizes

* Limited Warranties

STG-23	Small Goal - 3'W x 2'H	\$133 EA	20 lbs
STG-23N	Replacement Net	\$60 EA	2 lbs
STG-34	Medium Goal - 4'W x 3'H	\$185 EA	28 lbs
STG-34N	Replacement Net	\$75 EA	3 lbs
STG-46	Large Goal - 6'W x 4'H	\$240 EA	38 lbs
STG-46N	Replacement Net	\$98 EA	4 lbs

* Goal: 3 Year Limited Warranty, Net: 1 Year Limited Warranty



Adjustable Soccer Rebounder

- 3 adjustable playback angles
- 1¼" heavy-duty steel frame and support base
- White mesh net with ⅛" cord
- Folds flat for easy transport and storage
- Rebound Surface - 40"W x 40"H

3 Year Limited Warranty

ASR33BK	\$285 EA	27 lbs
----------------	----------	--------

WORLD CUP™ ANCHOR

SOCCER



World Cup™ Anchor

- Tank style anchor has 4¾"W x 3¼"H opening designed to fit over any round or flat rear crossbar
- Hard plastic shell will not crack when filled in the field with 50 lbs. concrete, or 39 lbs. sand
- Built-in carry handle and stackable design for convenient storage
- Bright yellow color for visibility and safety
- 12"W x 8½"H

3 Year Limited Warranty



SGA-50	Set of 4	\$300 SET	12 lbs
SGA-51	Single	\$88 EA	3 lbs



See below for ASTM counterweight requirements for your specific goal.



Multi-Use Soccer Cart

- Heavy-duty utility cart
- Pull by hand or tow by ATV/Utility Tractor
- Fold-down sides for easy loading
- (4) 13" x 5" wide pneumatic turn wheels rated to hold up to 350 lbs.
- Holds up to 16 World Cup™ Anchors (SGA-50)
- 51"L x 26"W

3 Year Limited Warranty



SGA-CART	\$675 EA	65 lbs
-----------------	-----------------	--------

SOCCER GOAL COUNTERWEIGHT REQUIREMENTS

Visit our website for the latest information

www.Jaypro.com/ASTM

Which size goal does your program need?

Age Group	Recommended Goal Size	Maximum Ball Size	Minimum Players/Team
U-13	8' x 24'	5	11 vs 11
U-12	Up to 6½' x 18½'	4	9 vs 9
U-11	Up to 6½' x 18½'	4	9 vs 9
U-10	Up to 6½' x 18½'	4	7 vs 7
U-9	Up to 6½' x 18½'	4	7 vs 7
U-8	Up to 4' x 6'	3	4 vs 4
U-6/U-7	Up to 4' x 6'	3	4 vs 4

Jaypro Sports is committed to safety on the field. Because of this we have created the Secure 4 Safety Program which promotes soccer goal safety.



Sandbag Anchor

- Fill sandbag in the field with 50 lbs. of dry sand
- Choose from steel carry handle or nylon strap design
- Custom colors on orders of 10 or more (SWB-451 only)

3 Year Limited Warranty



SWB-451 w/ Steel Handle \$75 EA 2 lbs
SWB-454 w/ Steel Handle - Set of 4 \$290 SET 8 lbs

SWB-451W w/Nylon Handle \$56 EA 2 lbs
SWB-454W w/Nylon Handle - Set of 4 \$180 SET 6 lbs

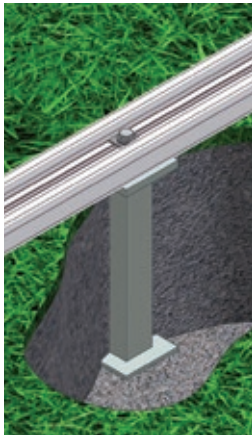

In-Ground Anchor

- Securely anchors any portable NOVA™ goal or existing goal with minor modification
- Will not pull out or slide off the base frame
- Set includes 2 anchors for one goal

3 Year Limited Warranty

SGA-60 \$230 PR 11 lbs

Counterweight Requirements

See page 34 for ASTM counterweight requirements for your specific goal.

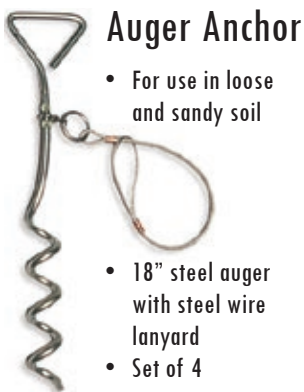

Auger Anchor

- For use in loose and sandy soil
- 18" steel auger with steel wire lanyard
- Set of 4

3 Year Limited Warranty

SAS-95 \$77 SET 5 lbs



J-Hook Stake

- For use in firm and compressed soil
- 18" durable "J" style steel stake with steel wire lanyard
- Set of 4

3 Year Limited Warranty

SGA-91 \$105 SET 16 lbs



Spike Anchor

- For use in firm and tightly compacted soil
- 18" long 3/4" galvanized steel spike with steel wire lanyard
- Set of 4

3 Year Limited Warranty

SS-18 \$117 SET 12 lbs

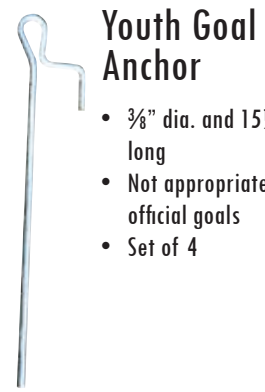

Youth Goal Anchor

- 3/8" dia. and 15 1/2" long
- Not appropriate for official goals
- Set of 4

3 Year Limited Warranty

217RP \$57 SET 2 lbs



2 Tone Hexagon

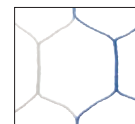

Durable Twisted & Knotted



Durable Braided & Knotted

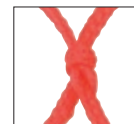

	Item #	Size	Mesh	Twine	Color	Weight	Price
OFFICIAL	SOC-6*	8' x 24' x 4' x 10'	5½" sq.	6mm Braid	WHITE	29 lbs	\$286 PR
	SND-8*	8' x 24' x 4' x 10'	5½" sq.	4mm Braid	WHITE	28 lbs	\$250 PR
	SND-7*	8' x 24' x 4' x 10'	5½" sq.	4mm Braid	ORANGE	30 lbs	\$250 PR
	SN-40B*	8' x 24' x 4' x 10'	5½" sq.	4mm Braid	BLUE	25 lbs	\$340 PR
	SN-40R*	8' x 24' x 4' x 10'	5½" sq.	4mm Braid	RED	20 lbs	\$340 PR
	SN-40Y*	8' x 24' x 4' x 10'	5½" sq.	4mm Braid	YELLOW	20 lbs	\$340 PR
	SGP-850N*	8' x 24' x 6½' x 7½'	4¾" sq.	4mm Braid	WHITE	25 lbs	\$209 PR
	SN-HTTP-W*	8' x 24' x 4' x 10'	5½" hex	5mm Braid	WHITE	29 lbs	\$374 PR
	SGP-550N*	8' x 24' x 6' x 6' Box	5½" hex	5mm Braid	WHITE	22 lbs	\$365 PR
	SN-6BLUW*	8' x 24' x 6' x 6' Box	5½" hex	5mm Braid	WHITE BLUE	25 lbs	\$340 PR
	SN-6GRNW*	8' x 24' x 6' x 6' Box	5½" hex	5mm Braid	WHITE GREEN	25 lbs	\$340 PR
	SN-6REDW*	8' x 24' x 6' x 6' Box	5½" hex	5mm Braid	WHITE RED	25 lbs	\$340 PR
	SN-6BLKW*	8' x 24' x 6' x 6' Box	5½" hex	5mm Braid	WHITE BLACK	25 lbs	\$340 PR
	SN-2BLUW*	8' x 24' x 4' x 10'	5½" hex	5mm Braid	WHITE BLUE	28 lbs	\$295 PR
	SN-2GRNW*	8' x 24' x 4' x 10'	5½" hex	5mm Braid	WHITE GREEN	28 lbs	\$295 PR
SN-2REDW*	8' x 24' x 4' x 10'	5½" hex	5mm Braid	WHITE RED	28 lbs	\$295 PR	
SN-2BLKW*	8' x 24' x 4' x 10'	5½" hex	5mm Braid	WHITE BLACK	28 lbs	\$295 PR	
CLUB	SEYL-24NHP*	8' x 24' x 0' x 8'	5½" sq.	2.5mm Twist	WHITE	7 lbs	\$132 EA
	SCN-24*	8' x 24' x 4' x 10'	4" sq.	3mm Twist	WHITE	24 lbs	\$205 PR
	SCN-21	7' x 21' x 3' x 8'	4" sq.	3mm Twist	WHITE	18 lbs	\$180 PR
	SCN-18	6½' x 18½' x 2' x 6'	4" sq.	3mm Twist	WHITE	10 lbs	\$170 PR
	SCN-12	6½' x 12' x 2' x 6'	4" sq.	3mm Twist	WHITE	10 lbs	\$145 PR
	SCN-9	4½' x 9' x 2' x 5'	4" sq.	3mm Twist	WHITE	7 lbs	\$99 PR
	SCN-6	4½' x 6' x 2' x 5'	4" sq.	3mm Twist	WHITE	6 lbs	\$89 PR
YOUTH	SFG-14NHP	7' x 12' x 1' x 4'	4" sq.	2.5mm Twist	WHITE	4 lbs	\$99 EA
	SMG-8NHP	4' x 8' x 0' x 4'	4" sq.	2.5mm Twist	ORANGE	5 lbs	\$40 EA
	PSS-612N	6' x 12' x 0' x 31"	4" sq.	2.5mm Twist	ORANGE	3 lbs	\$52 EA
	PSS-608N	6' x 8' x 0' x 31"	4" sq.	2.5mm Twist	ORANGE	2 lbs	\$49 EA
	PSS-510N	5' x 10' x 0' x 34"	4" sq.	2.5mm Twist	ORANGE	4 lbs	\$47 EA
	PSS-406N	4' x 6' x 0' x 24"	4" sq.	2.5mm Twist	ORANGE	2 lbs	\$40 EA

* Official Size Nets - Nets: 1 Year Limited Warranty

EASY TRACK™



Easy Track™ Net Clips

- Rigid plastic clips fit securely and flush into Easy Track™ net attachment system so net won't slip
- 100 clips in a bag (enough clips for a pair of goals)

3 Year Limited Warranty

EC-824	White	\$85 BAG	1 lb
EC-824PK	Pink	\$89 BAG	1 lb
EC-824BK	Black	\$89 BAG	1 lb
EC-824RD	Red	\$89 BAG	1 lb
EC-824BL	Blue	\$89 BAG	1 lb

Jaypro Sports Easy Track™ net clips are compatible with other soccer goal brands.

Hook-and-Loop Closure Strips

Convenient hook-and-loop closure strips secure net without lacing.

3 Year Limited Warranty

SINT-20	Kit of 20 - Fits up to 2" tubing	\$40 KIT	2 lbs
SINT-25	Kit of 25 - Fits up to 2" tubing	\$47 KIT	2 lbs
SINT-40	Kit of 40	\$54 KIT	2 lbs
SINT-60	Kit of 60	\$65 KIT	2 lbs

*SINT-20 fits up to (1) 12' goal. SINT-25 fits up to (1) 24' goal.
SINT-40 fits up to (2) 12' goals. SINT-60 fits up to (2) 24' goals.*



Bungees

- (30) 6" long bungees
- Two bags required for Medium Soccer Rebounder (STGRB718)
- Three bags required for the Large Soccer Rebounder (STGRB824)

3 Year Limited Warranty

STGRB718B	30 count	\$33 BAG	2 lbs
-----------	----------	----------	-------



Hook-and-Loop Closure

- Closure roll is 1½" wide x 75' long
- Enough to fit a pair of official goals

3 Year Limited Warranty

VNS-25	\$93 SET	2 lbs
--------	----------	-------



Net Clips

- Treated steel "money clip" design
- For use with existing pre-drilled 5/16" dia. holes
- 70 clips in a kit (enough for a pair of 8' x 24' goals)
- Plastic retainers included

3 Year Limited Warranty

SNT-180	\$74 KIT	2 lbs
---------	----------	-------

- Self-drilling screws for aluminum goals
- Space at 14"

SNT-200	\$59 KIT	2 lbs
---------	----------	-------



Net Pegs

- Prevent balls from passing under net
- Set of 25

3 Year Limited Warranty

NP-25	\$47 SET	3 lbs
-------	----------	-------

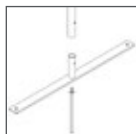

Stable Anchored Base

The powder coated white ground base assembly lies flat on the ground. The ground stake is inserted through the middle of the base to anchor it to the ground. The upright is placed over a sleeve on the base assembly, resulting in a stable goal with no visible anchor to cause a tripping hazard.

Portable Training Goal

- 2" lightweight aluminum frame with stabilizing base plates
- 4" sq. mesh nylon net and carry bag included

* Limited Warranties

STG-718	Medium - 18'W x 7½'H	\$630 EA	52 lbs
STG-718N	Medium Replacement Net	\$50 EA	4 lbs
STG-824	Large - 24'W x 8'H	\$710 EA	62 lbs
STG-824N	Large Replacement Net	\$95 EA	5 lbs

* Goal: 3 Year Limited Warranty, Net: 1 Year Limited Warranty

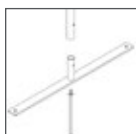

Stable Anchored Base

The powder coated white ground base assembly lies flat on the ground. The ground stake is inserted through the middle of the base to anchor it to the ground. The upright is placed over a sleeve on the base assembly, resulting in a stable goal with no visible anchor to cause a tripping hazard.

Soccer Rebounder

- 2" lightweight aluminum frame with stabilizing base plates
- 1½" sq. mesh net, bottom crossbar, and powder coat finish
- Bungee net attachments and carry bag included

* Limited Warranties

STGRB718	Medium - 18'W x 7½'H	\$796 EA	48 lbs
RB718N	Medium Rebound Net	\$99 EA	6 lbs
STGRB824	Large - 24'W x 8'H	\$940 EA	112 lbs
RB824N	Large Rebound Net	\$122 EA	9 lbs

* Rebounder: 3 Year Limited Warranty, Net: 1 Year Limited Warranty



Equipment Carry Bags

Heavy-duty black bags with reinforced zipper.

- Large - Holds the Quick-Set Up Goal (SEYL-824)
- Medium - Holds Portable Training Goal and Soccer Rebounder
- Small - Holds Two-For-Youth Goal (MPG-46) and other items

1 Year Limited Warranty

ECB-LG	Large Bag - 105" L x 15" dia.	\$94 EA	6 lbs
ECB-MD	Medium Bag - 100" L x 13" dia.	\$84 EA	3 lbs
ECB-SM	Small Bag - 78" L x 11" dia.	\$71 EA	4 lbs



Bungees

- (30) 6" long bungees
- Two bags required for Medium Soccer Rebounder (STGRB718)
- Three bags required for the Large Soccer Rebounder (STGRB824)

1 Year Limited Warranty

STGRB718B	30 count	\$33 BAG	2 lbs
------------------	----------	-----------------	-------



Corner Flags

- Official 5' tall x 1" dia. PVC poles
- Set includes 4 poles, 4 flags and 4 black rubber bases
- Indoor/outdoor

RBF-4 \$251 SET 34 lbs

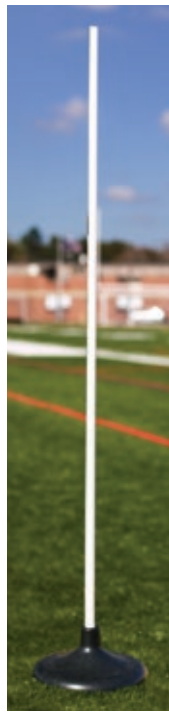

Coaching Sticks

- Official 5' tall x 1" dia. PVC poles
- Each base weighs over 7 lbs.
- 6 poles and 6 black rubber bases
- Indoor/outdoor

RBCS-6 \$299 SET 50 lbs



Corner Flag Bag

- Convenient storage bag carries up to 8 flags
- Constructed of washable black vinyl

CFCB \$73 EA 3 lbs

Training Cone

- Solid plastic stackable cone with perimeter base
- Bright orange for high visibility
- Available in 2 heights



D171 9" Cones \$2.04 EA 1 lb
D175 12" Cones \$3.54 EA 2 lbs

Flag Base Bag



- Vinyl carry bag holds 4 rubber bases
- 12"W x 12"D x 14"H

RBF-BASE \$34 EA 3 lbs

Replacement Flags

- (4) 13½" x 12" red nylon flags

RBF-FLAG \$17 SET 5 lbs

Deluxe Corner Flags

- 60" tall x ¾" thick PVC poles
- Stationary base

DCF-251 Set of 4 \$85 SET 7 lbs

Deluxe Training Flags

- 60" tall x ¾" thick PVC poles
- Flexible spring loaded base

DCF-255 Set of 4 \$94 SET 7 lbs



Disk Cone (Single)

- Highly visible and won't tip over
- 2¼" tall with a 7½" dia. base

D272BL Blue \$.94 EA 1 lb
D272OR Orange \$.94 EA 1 lb
D272RD Red \$.94 EA 1 lb
D272YW Neon Yellow \$.94 EA 1 lb



Disk Cone Carrier

- Durable white vinyl-coated 5mm steel frame
- Holds up to 200 disk cones (not included)
- 7" dia. x 12"H

DCC7 \$8 EA 1 lb



Field ID Marker

- 14" x 14" vinyl marker with corner grommets
- Specify color and numbers when ordering.*

FIM-14 \$49 EA 1 lb

Disk Cone (Set)

- Available in quantities of 100 per set

D272BL-100 Blue \$70 SET 4 lbs
D272OR-100 Orange \$70 SET 4 lbs
D272RD-100 Red \$70 SET 4 lbs
D272YW-100 Neon Yellow \$70 SET 4 lbs



Disk Package

- Disk Cone Carrier (DCC7)
- 30 Cones (D272) of blue, orange, red and neon yellow
- 120 cones in package

3 Year Limited Warranty

DCPKG \$84 PKG 9 lbs

* All Items on this page: 3 Year Limited Warranty, except Field ID Marker: 1Year Limited Warranty



NOVA™ Team Shelter

Used extensively in Europe, team shelters not only provide refuge from the elements, but the sleek look of European styling adds class to any sport facility and a boost to the morale of any program.

- Unbreakable tinted polycarbonate
- Heavy-duty extruded aluminum frame
- Available in five different widths
- 8½" pneumatic wheels only on 8', 12' and 16' widths
- 6'10" tall x 4'8" deep base
- Ground anchors included
- Natural finish anodized aluminum bench

- Add team colors to your bench at no extra cost (specify colors when ordering)
 - Call for details and pricing to add team colors or customized graphics to your shelter
- Call for freight quote.*

3 Year Limited Warranty



POWDER COAT COLORS



Item	Description	Seats	Weight	Price
NTS-8	8' Team Shelter w/Seat	5	600 lbs	\$3,371 EA
NTS-12	12' Team Shelter w/Seat	8	980 lbs	\$4,451 EA
NTS-16	16' Team Shelter w/Seat	10	1,190 lbs	\$6,256 EA
NTS-20	20' Team Shelter w/Seat	13	1,821 lbs	\$7,759 EA
NTS-24	24' Team Shelter w/Seat	16	1,915 lbs	\$9,197 EA

Bleachers • Player Benches • Enclosures



See pages 144-152 for details about Jaypro Sports player and spectator seating.



Soccer Shelter

- Powder coated steel frame with removable polyester top for quick and easy (dis)assembly
- 4 auger stakes for grass or 4 sand bags (filled in the field) for turf anchoring (specify when ordering)
- Wheel kit included
- See page 144-145 for optional player benches
- 17'W x 6'4"H x 5'D

Call for freight quote.

1 Year Limited Warranty



SCSHLT-(X) \$4,360 EA 350 lbs

Item	Color
SCSHLT-G	Gray
SCSHLT-NB	Navy Blue
SCSHLT-B	Royal Blue
SCSHLT-R	Red
SCSHLT-BK	Black
SCSHLT-M	Maroon
SCSHLT-GR	Green

Upgrade your shelter with any of the following options:

1 Year Limited Warranty



Shelter Wind Flap

- Flaps add protection from wind and rain
- 17' x 2' mesh fabric sewn into cover with wind flap added to rear of shelter

SCSHLT-WF \$716 EA

2' x 2' Team Logo

- Sewn on side panel

SCSHLT-LOG022 \$168 EA

3" Team Lettering

- Letters are sewn across front panel

SCSHLT-LTR \$133 EA

4' x 4' Team Logo

- Sewn on rear panel

SCSHLT-LOG044 \$296 EA

Vector files required for team logos. Other file formats require an art charge. Call customer service for additional options.

Referee/Scorekeeper Shelter

- Easy to move and assemble
- Powder coated steel frame
- Removable polyester cover
- Same lettering and logo options listed above are offered
- 8½' x 6½' x 4'8"

Call for freight quote.

1 Year Limited Warranty



RSHLT-(X) \$2,460 EA 350 lbs



Item	Color
RSHLT-G	Gray
RSHLT-NB	Navy Blue
RSHLT-B	Royal Blue
RSHLT-R	Red
RSHLT-BK	Black
RSHLT-M	Maroon
RSHLT-GR	Green



Features Jaypro Sports flush mount

EASY TRACK
Net Attachment System

Deluxe Official Soccer/Football Goal

Ideal for multi-purpose athletic facilities.

- Designed for permanent or semi-permanent installation
- 4" round extruded aluminum soccer uprights and crossbars, powder coated white
- 2" removable soccer backstays
- 2 3/8" aluminum football uprights
- Nets, post padding, and ground sleeves sold separately
- Soccer Dimensions - 8' x 24' x 10' x 4'
- Football Uprights - 10' tall



3 Year Limited Warranty



FBSC-240 Goal w/Standard Backstays \$4,300 PR 500 lbs

FBSC-240EB Goal w/European Backstays \$4,885 PR 470 lbs

Aluminum Ground Sleeves

- Aluminum ground sleeves with locking caps for semi-permanent installation

3 Year Limited Warranty



SGP-445G Set of 4 \$510 SET 20 lbs



Goal

Standard Backstay

European Backstay



Ground Sleeves

- (4) 24" ground sleeves and 4 locking caps included

3 Year Limited Warranty

SGP-722G \$616 SET 18 lbs

Official Soccer/Football Goal

Ideal for shared football and soccer fields.

- Meets high school regulations for competition football and soccer
- Designed for permanent or semi-permanent installation
- Football uprights can be installed at high school (23'4") or collegiate (18'6") widths and removed for soccer play
- 2" x 4" goal support uprights made of 14 gauge steel tubing
- 2" square steel tube football uprights are 10' tall
- "Money Clip" attachments included - ground sleeves (SGP-722G) optional
- Nets and backstays sold separately
- Soccer Dimensions - 8' x 24'

3 Year Limited Warranty



Goal (without Backstays)

- Recommended Portable Combo Goal Net (SEYL-24NHP) sold separately

FBSC-120 \$3,794 PR 650 lbs

Standard Backstay Kit

- Removable soccer backstays made from 1.66" galvanized steel tubing
- Recommended standard official size net (8' x 24' x 4' x 10') sold separately

FBSC-120FBS Set of 4 \$774 SET 140 lbs

European Backstay Kit

- Removable European backstays made from 1.66" galvanized steel tubing with 4' depth
- Recommended standard official size net (8' x 24' x 4' x 10') sold separately

FBSC-120EBS Set of 4 \$774 SET 45 lbs





Portable Practice Football Goal (High School)

- H-frame with double no-flat wheels
- 23'4"W x 20'H

3 Year Limited Warranty  
PPG-4HS \$2,028 EA 375 lbs

Portable Practice Football/Soccer Combo Goal (High School)



- Lightweight and stable
- 2" galvanized steel construction
- Double no-flat wheels for easy transport
- Available in two colors (specify when ordering)
- Net and wind streamers sold separately
- Soccer Dimensions - 8' x 24'
- Football Crossbar - 23'4" wide
- Football Uprights - 10' tall

* Limited Warranties  
PCG-800 \$2,175 EA 331 lbs
PNT-1 White or Yellow Powder Coat \$168 EA
Specify when ordering.
SEYL-24NHP Replacement Net \$132 EA 7 lbs
 * Goal: 3 Year Limited Warranty, Net: 1 Year Limited Warranty

Portable Practice Football Goal (Collegiate)

- H-frame with double no-flat wheels
- 18'6"W x 20'H



3 Year Limited Warranty  
PPG-4C \$2,028 EA 375 lbs



H-Frame Football Goal Post

- Designed for permanent installation
- 4" heavy-walled aluminum tubing
- Uprights extend 10' above crossbar
- Powder coated white
- 23'4"W x 20'H

3 Year Limited Warranty  
HFGP-3 \$3,208 PR 426 lbs

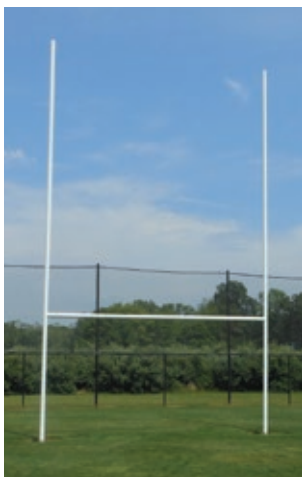

Official Rugby Goal

- Designed for permanent installation
- Official size rugby goal measures 18'4"W (5.6m) x 32'H (9.8m)
- Uprights extend 22' above crossbar and made with 4" Sch 40 aluminum tubing
- Crossbar is 4" aluminum tubing
- Tough powder coated white finish

3 Year Limited Warranty  
RGP-3 Goal \$4,614 PR 580 lbs
RGP-SQP Pad \$707 EA 42 lbs

Rugby Goal Pad

Call customer service for details.

Custom lettering and graphics available. See page 120 for details.





best seller

Economy Paint Marker

- 2" to 4" line marking
- Aerosol paint sold separately

3 Year Limited Warranty

FME-501 \$154 EA 28 lbs



Field Marking Wand

- Lightweight single spray can dispenser
- Aerosol paint sold separately

3 Year Limited Warranty

FMWAND \$66 EA 5 lbs



Athletic Field Marking Dust

- Pure white & NCAA compliant
 - Non-toxic & won't stain uniforms
 - Pallet of (50) 50 lb. bags
- Call for freight quote.



AFMD50 \$445 EA 2,060 lbs



Pro-Stripe Athletic Field Marking Paint

- Concentrate can be diluted with water
- Natural/artificial turf-friendly
- Non-toxic, halogen-free, and won't stain uniforms
- 5 gallon container

FSP-5WT White \$70 EA 52 lbs

FSP-5YW Yellow \$133 EA 52 lbs

Aerosol Paint

Order by case or in bulk!

- Ozone friendly/No CFCs
- Universal spray tip included
- (12) 20 oz. cans per case

best seller



GL-101 White \$60 CASE 18 lbs

GL-107 Royal Blue \$74 CASE 18 lbs

GL-108 Yellow \$74 CASE 18 lbs

GL-110 Red \$74 CASE 18 lbs

Aerosol Paint (Bulk)

- Pallet of 50 cases ((12) 20 oz. cans per case)
- Call for freight and bulk pricing.



PNTPKG-1 White \$2,879 PALLET 1,150 lbs



ProLine Layout & Marking Systems

Quick and economical way to line athletic fields year after year.

- Locators, starting tool, and 600' cord included
- Call for freight quote.

1 Year Limited Warranty

FM-LM1 12 pc. Baseball \$130 SET 8 lbs

FM-LM2 25 pc. Soccer \$228 SET 10 lbs

FM-LM4 14 pc. Lacrosse \$130 SET 4 lbs

FM-LM5 50 pc. Football \$408 SET 5 lbs

FM-LM0 10 pc. Replacement \$104 SET 2 lbs



Portable FieldPro™ Net System Package

Keep balls on the field and ensure the safety of spectators.

- 4 poles with black powder coat finish
- 4 bases with (16) 5 gallon jugs
- 1¾" knotted nylon net
- Red vinyl base covers included
- 60'L x 12'H

* Limited Warranties



PFN-1260PKG

\$3,480 EA 510 lbs

* System: 3 Year Limited Warranty, Net & Covers: 1 Year Limited Warranty

FIELDPRO™ NET SYSTEM



Portable FieldPro™ Net System

Lightweight indoor/outdoor portable net system for fields and courts where in-ground sleeve systems are not an option. Can also be used as a multi-field/court space divider!

- Easy net assembly with cable clamps and sliding rings
- 12' tall x 2¾" dia. aluminum poles on tip-and-roll bases with no-flat tires
- Counterweight containers and corrosion-resistant hardware included
- Optional vinyl base covers (PFN-BCVR) sold separately

Poles can be powder coated black (specify when ordering). Typical pole spacing is 18' apart and should not exceed 20'. Sold per base dependent on overall length needs (specify when ordering). Call for quote.

NOTE: It is the customer's responsibility to fill counterweight containers.

FieldPro™ Net System Base Cover

Vinyl base cover slides over counterweight containers. Standard color is red.

1 Year Limited Warranty



PFN-BCVR Red \$60 EA 1 lb





FieldPro™ Multi-Sport Net System

Ball stop net system for lacrosse, field hockey, and other field sports. Ensure the safety of athletes, coaches, and spectators!

- (4) 4" heavy-walled aluminum uprights, ground sleeves, and covers
 - #36 knotted black nylon net with 1¾" sq. mesh
 - Pulley system and corrosion-resistant hardware included
- Standard upright color is black. Specify preferred pole color when ordering. Call for freight quote.*

* Limited Warranties



FNMB-65 65'W x 15'H \$2,610 EA 225 lbs

* System: 3 Year Limited Warranty, Net: 1 Year Limited Warranty



FieldPro™ Football Net System

Keep field goals and extra point kicks away from spectators and inside the field.

- (2) 6⅝" heavy-walled aluminum uprights, ground sleeves, and covers
- #36 knotted black nylon net with 3½" sq. mesh
- Pulley system and corrosion-resistant hardware included
- 30' and 40' models

Standard upright color is natural finish. Specify preferred pole color when ordering. Call for freight quote.

* Limited Warranties



FNFB-30 40'W x 30'H \$4,770 EA 530 lbs
FNFB-40 40'W x 40'H \$7,434 EA 762 lbs

* System: 3 Year Limited Warranty, Net: 1 Year Limited Warranty



FieldPro™ Soccer Net System

Ensure the safety of athletes, coaches, and spectators.

- (4) 4" heavy-walled aluminum uprights, ground sleeves, and covers
- #36 knotted black nylon net with 3½" sq. mesh
- Pulley system and corrosion-resistant hardware included

Standard upright color is black. Specify preferred pole color when ordering. Call for freight quote.

* Limited Warranties



FNSB-65 65'W x 20'H \$2,390 EA 250 lbs

* System: 3 Year Limited Warranty, Net: 1 Year Limited Warranty

Custom **FIELDPRO**TM NET SYSTEM



Seven Different Heights and Pole Styles

10' Straight Pole with multi-sport net is ideal for use as a Lacrosse and Field Hockey backstop net. The net is clipped at the top and bottom of each pole.

15', 20', 25', 30', and 40' Straight Pole comes with a hoist system allowing quick and easy lowering/removal of the net after the game, season, or before a big storm. Reinstalling the net is a snap - all from ground level with no need for a ladder.

20' Offset Pole provides 3' of offset which is ideal for use around the perimeter of soccer and baseball/softball fields. It's also an added measure of safety from ricocheting balls.

Basic Features

- Pulley system to raise/lower net (excludes 10' poles)
- Ground sleeves facilitate installation and allow for system removal as needed
- Covers for ground sleeves are sold separately

* Limited Warranties



Visit JayproSpecs.com to access detailed specification sheets for FieldProTM Net Systems.

Call for freight quote and pricing.

System: 3 Year Limited Warranty, Net: 1 Year Limited Warranty

Pole	Pole Description	Net	Net Description
FN-10	10' tall straight 2 $\frac{3}{8}$ " OD heavy-walled aluminum pole	FN-A	#36 knotted multi-sport UV treated nylon net with 1 $\frac{3}{4}$ " sq. mesh and $\frac{1}{4}$ " rope border
FN-15	15' tall straight 4" OD heavy-walled aluminum pole	FN-B	#36 knotted soccer/football UV treated nylon net with 3 $\frac{1}{2}$ " sq. mesh and $\frac{1}{4}$ " rope border
FNS-20	20' tall straight 4" OD heavy-walled aluminum pole	FN-C	HTPP knotless UV treated net with 1 $\frac{3}{4}$ " sq. mesh and $\frac{1}{4}$ " rope border
FNS-25	25' tall straight 6 $\frac{5}{8}$ " OD heavy-walled aluminum pole	FN-D	HTPP knotless UV treated net with 4" sq. mesh and $\frac{1}{4}$ " rope border
FNS-30	30' tall straight 6 $\frac{5}{8}$ " OD heavy-walled aluminum pole		
FNS-40	40' tall straight 6 $\frac{5}{8}$ " OD heavy-walled aluminum pole		
FNO-20	20' tall offset 4" OD heavy-walled aluminum pole		
FN-SPECIAL	Custom for your facility		



The Original ToteMaster[™]

Indoor/outdoor all-purpose carrier. No tools required for assembly.

- Holds 20-25 balls
- Lockable hinged top (lock not included)
- 36" L x 24" W x 36" H

3 Year Limited Warranty

TE-2	Royal Blue	\$212 EA	44 lbs
TE-2BK	Black	\$212 EA	44 lbs

Replacement Caster and Insert Kit

- 4 non-marking 3" swivel casters and inserts
Specify push-in or screw-in model needed when ordering.



3 Year Limited Warranty

TE-2HK		\$42 KIT	4 lbs
---------------	--	----------	-------



Mini ToteMaster[™]

Indoor/outdoor all-purpose carrier. No tools required for assembly.

- Holds 10-12 balls
- Lockable hinged top (lock not included)
- 21" L x 21" W x 30" H

3 Year Limited Warranty

TE-30		\$200 EA	24 lbs
--------------	--	----------	--------



ToteMaster[™] Plus

All-purpose carrier with large storage capacity.

- Holds 30-35 balls
- Divider included to separate equipment
- Lockable hinged dual tops (lock not included)
- 60" L x 24" W x 36" H

3 Year Limited Warranty

TE-60		\$350 EA	63 lbs
--------------	--	----------	--------



ToteMaster™ All-Terrain

Durable indoor/outdoor all-purpose carrier.

- 12" all-terrain wheels on rear
- Lockable hinged top (lock not included)
- 36" L x 24" W x 36" H

3 Year Limited Warranty

AT-5 \$300 EA 50 lbs



ToteMaster™ Field

Durable indoor/outdoor all-purpose carrier.

- 20" all-terrain wheels on rear
- Lockable hinged top (lock not included)
- 51" L x 25" W x 48" H

3 Year Limited Warranty

AT-10 \$395 EA 62 lbs



ToteMaster™ Open Top

All-purpose carrier with open top storage baskets.

- Rotating hangers included for jump rope and hoop storage
- Optional side shelf (TE-PESHELF) sold separately
- 48" L x 26" W x 54" H

3 Year Limited Warranty

TE-PE01 \$260 EA 46 lbs



ToteMaster™ Deluxe Open Top

All-purpose carrier with open top storage baskets, rotating hangers, and side shelf.

- All-terrain wheels on rear
- Additional side shelves (TE-PESHELF) sold separately
- 48" L x 26" W x 54" H

3 Year Limited Warranty

TE-PE02 \$320 EA 56 lbs

Atlas Series™ Ball Carts & Lockers

Heavy-duty ball carts and lockers that survive the test of time. Strong enough to store medicine balls!

- 1" thick-walled steel frames with royal blue powder coat finish
- Non-marking swivel casters (Ball Locker & Hamper (BBABL-2) has all-terrain wheels on rear)
- Ball lockers include lockable hinged top (lock not included)

3 Year Limited Warranty



Atlas Series™ Ball Locker

- Holds 25+ balls
- 47"L x 24"W x 37"H

BBABL-1 \$360 EA 55 lbs



Atlas Series™ Ball Locker & Hamper

- Holds 25+ balls
- Mesh hamper liner included for towels/uniforms storage
- 45"L x 24"W x 35"H

BBABL-2 \$380 EA 80 lbs



Atlas Series™ Ball Cart

- Holds 15 balls
- 51½"L x 18"W x 36"H

BBABC-1 \$250 EA 31 lbs



Atlas Series™ Double Ball Cart

- Holds 30 balls
- 51½"L x 24"W x 36"H

BBABC-2 \$340 EA 52 lbs



StackMaster™ Wall Racks

Heavy-duty steel ball racks permanently mount to gymnasium wall.

- Lockable top/bottom bars (lock not included)
- Mounting hardware not included
- Single Wall Rack - 15"W x 66"H x 12"D
- Double Wall Rack - 37"W x 66"H x 12"D

3 Year Limited Warranty

PE-140	Single	\$115 EA	18 lbs
PE-240	Double	\$200 EA	49 lbs



Deluxe Training Ball Rack

Durable steel rack for shooting competitions and free throw practice.

- Holds 19 regulation basketballs (top 7 feed to shooter)
- Non-marking swivel wheels (front 2 lockable)
- 61"L x 18"W x 44"H

3 Year Limited Warranty

DTBR-19

\$225 EA 40 lbs

Premium Ball Carrier

Durable steel frame carrier with side panels for custom graphics on both ends.

- Non-marking swivel wheels
 - 39"L x 22"W x 36"H
- Specify graphics when ordering.*

3 Year Limited Warranty

DTBR-12 \$199 EA 30 lbs

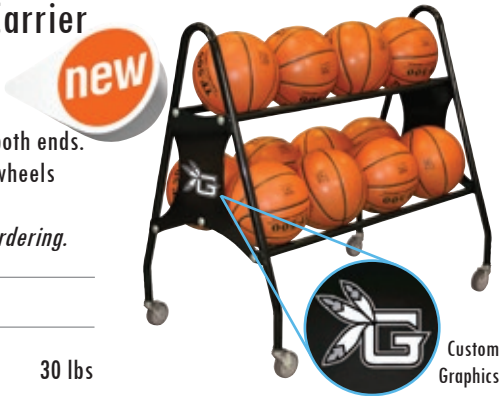

Deluxe Ball Carriers

Durable steel frame carriers hold basketballs, volleyballs, and medicine balls.

- Non-marking swivel wheels
- 12 Ball Carrier - 39"L x 22"W x 36"H
- 18 Ball Carrier - 60"L x 22"W x 36"H

3 Year Limited Warranty

BBC-12RB	12 Ball - Royal Blue	\$134 EA	26 lbs
BBC-12BK	12 Ball - Black	\$134 EA	26 lbs
BBC-12RD	18 Ball - Red	\$134 EA	26 lbs
BBC-18RB	18 Ball - Royal Blue	\$150 EA	41 lbs
BBC-18BK	18 Ball - Black	\$150 EA	41 lbs
BBC-18RD	18 Ball - Red	\$150 EA	41 lbs



Holds
Basketballs
Medicine Balls
Volleyballs



BBC-12RD



BBC-18RB

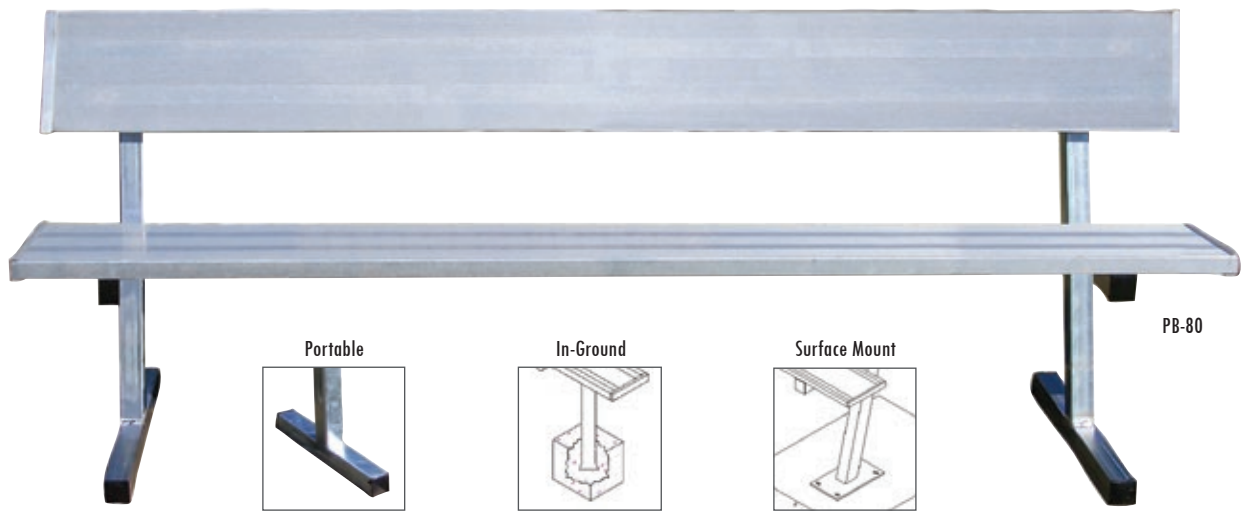

PB-80

Player Bench

Sturdy rust-resistant aluminum bench for athletic fields, public parks, and sport complexes.

- 10" wide non-skid seat planks
 - Heavy-duty rust-resistant steel legs
 - Portable, in-ground, or surface mount installation
 - Floor protection kit (PSS-4FT) for indoor use sold separately
- Specify plank and leg colors when ordering powder coat option.*



PB-75PC

3 Year Limited Warranty



	Length	Weight	Natural Finish			Price	Powder Coat			Price
			Portable	In-Ground	Surface		Portable	In-Ground	Surface	
w/ Seat Back	7½'	60 lbs	PB-80	PB-80PI	PB-80SM	\$350 EA	PB-80PC	PB-80PIPC	PB-80SMPC	\$440 EA
	15'	100 lbs	PB-20	PB-20PI	PB-20SM	\$545 EA	PB-20PC	PB-20PIPC	PB-20SMPC	\$663 EA
	21'	135 lbs	PB-10	PB-10PI	PB-10SM	\$690 EA	PB-10PC	PB-10PIPC	PB-10SMPC	\$950 EA
	27'	175 lbs	PB-90	PB-90PI	PB-90SM	\$808 EA	PB-90PC	PB-90PIPC	PB-90SMPC	\$970 EA
w/o Seat Back	7½'	33 lbs	PB-75	PB-75PI	PB-75SM	\$248 EA	PB-75PC	PB-75PIPC	PB-75SMPC	\$305 EA
	15'	57 lbs	PB-15	PB-15PI	PB-15SM	\$330 EA	PB-15PC	PB-15PIPC	PB-15SMPC	\$445 EA
	21'	79 lbs	PB-5	PB-5PI	PB-5SM	\$460 EA	PB-5PC	PB-5PIPC	PB-5SMPC	\$525 EA
	27'	101 lbs	PB-95	PB-95PI	PB-95SM	\$570 EA	PB-95PC	PB-95PIPC	PB-95SMPC	\$665 EA

169 Possible Color Combinations



Protect Indoor Surfaces



Floor Protection Kit

- Prevents floor marking
- 4 rubber feet and self-threading screws included

3 Year Limited Warranty

PSS-4FT

\$32 KIT

2 lbs



DPB50PC

Courtside Benches

Portable 5' aluminum benches for courtside viewing.

- Durable and rust-resistant
 - Single or double seat plank models
 - Floor protection kit (PSS-4FT) for indoor use sold separately
- Specify plank and leg colors when ordering powder coat option.*

3 Year Limited Warranty

PB40	Natural - w/ Back	\$279 EA	50 lbs
PB40PC	Powder coat -w/ Back	\$310 EA	50 lbs
DPB50	Natural	\$339 EA	55 lbs
DPB50PC	Powder coat	\$399 EA	55 lbs



PBS-20

Player Bench with Shelf

Durable rust-resistant aluminum bench with equipment shelf.

- 20" wide non-skid shelf for helmets, gloves, and other items
 - Non-skid seat planks and rust-resistant steel legs
- Specify plank and leg colors when ordering powder coat option.*

3 Year Limited Warranty



Length	Weight	Natural Finish	Price	Powder Coat	Price
7½'	95 lbs	PBS-80	\$630 EA	PBS-80PC	\$640 EA
15'	130 lbs	PBS-20	\$900 EA	PBS-20PC	\$1,060 EA
21'	185 lbs	PBS-10	\$1,190 EA	PBS-10PC	\$1,460 EA
27'	200 lbs	PBS-90	\$1,889 EA	PBS-90PC	\$2,299 EA



ST75PC

Scorer Table with Bench

Heavy-duty and rust-resistant. Ideal for any outdoor sport.

- 10" wide non-skid seat planks and rust-resistant steel legs
- Tabletop - 7½"L x 19"W

Specify plank and leg colors when ordering powder coat option.

3 Year Limited Warranty



Length	Weight	Natural Finish	Price	Powder Coat	Price
7½'	90 lbs	ST75	\$575 EA	ST75PC	\$691 EA

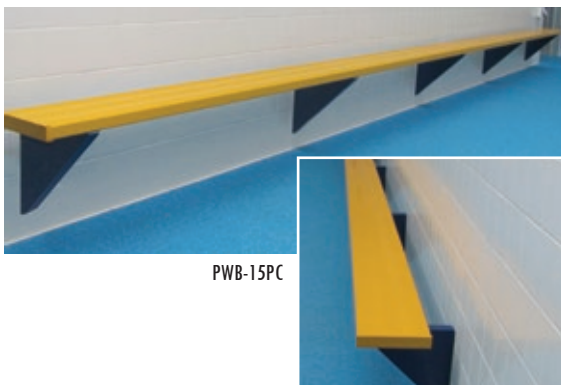

PWB-15PC

Wall-Mounted Player Bench

Rust-resistant aluminum bench ideal for locker rooms, aquatic centers, and outdoor applications.

- 10" wide non-skid seat planks
- Corrosion-resistant understructure

Understructure mounts to wall with stainless steel hardware (provided by local installer). Specify plank and understructure colors when ordering.

Length	Weight	Natural Finish	Price	Powder Coat	Price
7½'	20 lbs	PBW-75	\$340 EA	PBW-75PC	\$389 EA
15'	40 lbs	PBW-15	\$400 EA	PBW-15PC	\$470 EA
21'	60 lbs	PBW-5	\$525 EA	PBW-5PC	\$635 EA
27'	80 lbs	PBW-95	\$595 EA	PBW-95PC	\$744 EA

3 Year Limited Warranty





BLCH-4AL

All Aluminum Bleachers

Lightweight all aluminum bleachers are perfect for outdoor parks and fields.

- 10" wide non-skid seat planks with sturdy understructure
- Single or double foot plank models
- Indoor conversion kit (BLCHICK34) for indoor use sold separately

4 row bleacher does not exceed 30" in height. Guard rails may not be needed (check local codes). Specify plank and leg colors when ordering powder coat option.

3 Year Limited Warranty



BLDP-4AL



	Rows	Length	Seats	Weight	Natural Finish	Price	Powder Coat	Price
Single Foot Plank Bleacher (Standard)	3	15'	30	240 lbs	BLCH-3AL	\$1,423 EA	BLCH-3ALPC	\$1,526 EA
		21'	42	340 lbs	BLCH-321AL	\$1,694 EA	BLCH-321ALPC	\$1,895 EA
		27'	54	440 lbs	BLCH-327AL	\$2,353 EA	BLCH-327ALPC	\$2,568 EA
	4	15'	40	320 lbs	BLCH-4AL	\$1,870 EA	BLCH-4ALPC	\$1,855 EA
		21'	52	440 lbs	BLCH-421AL	\$2,400 EA	BLCH-421ALPC	\$2,459 EA
		27'	70	560 lbs	BLCH-427AL	\$2,827 EA	BLCH-427ALPC	\$3,213 EA
Double Foot Plank Bleacher (Preferred)	3	15'	30	290 lbs	BLDP-3AL	\$1,495 EA	BLDP-3ALPC	\$1,862 EA
		21'	42	415 lbs	BLDP-321AL	\$1,845 EA	BLDP-321ALPC	\$2,300 EA
		27'	54	540 lbs	BLDP-327AL	\$2,476 EA	BLDP-327ALPC	\$2,947 EA
	4	15'	40	395 lbs	BLDP-4AL	\$2,307 EA	BLDP-4ALPC	\$2,697 EA
		21'	52	550 lbs	BLDP-421AL	\$2,770 EA	BLDP-421ALPC	\$3,237 EA
		27'	70	705 lbs	BLDP-427AL	\$3,308 EA	BLDP-427ALPC	\$3,751 EA

169 Possible Color Combinations

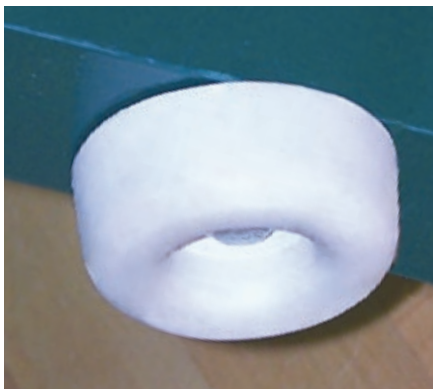

Indoor Conversion Kit

Protect floor surfaces with this outdoor to indoor bleacher conversion kit.

- 12 rubber pad protectors to prevent floor marking
- 7½' Bleacher - Requires 1 kit
- 15'/21' Bleacher - Requires 2 kits
- 27' Bleacher - Requires 3 kits

For 2, 3, and 4 row bleachers at lengths of 7½', 15', 21', and 27'.

3 Year Limited Warranty



BLCHICK34

\$56 SET 4 lbs



BTDP-3



BTBB-3PC

Back-to-Back Bleachers

Place between adjoining fields or indoor courts for spectator viewing from both sides of the bleacher.

- Lightweight 10" wide all aluminum seat planks and sturdy understructure
 - Single or double foot plank models
 - Indoor conversion kit (BLCHICK34) for indoor use sold separately
- Specify plank and leg colors when ordering powder coat option.*

3 Year Limited Warranty



	Rows	Length	Seats	Weight	Natural Finish	Price	Powder Coat	Price
Single Foot Plank Bleacher (Standard)	3	7½'	25	299 lbs	BTBB-375	\$2,087 EA	BTBB-375PC	\$2,276 EA
		15'	50	540 lbs	BTBB-3	\$2,576 EA	BTBB-3PC	\$2,764 EA
		21'	72	668 lbs	BTBB-321	\$3,725 EA	BTBB-321PC	\$3,725 EA
Double Foot Plank Bleacher (Preferred)	3	7½'	25	363 lbs	BTDP-375	\$2,331 EA	BTDP-375PC	\$2,664 EA
		15'	50	670 lbs	BTDP-3	\$2,864 EA	BTDP-3PC	\$3,219 EA
		21'	72	903 lbs	BTDP-321	\$3,553 EA	BTDP-321PC	\$3,940 EA

POWDER COAT COLORS

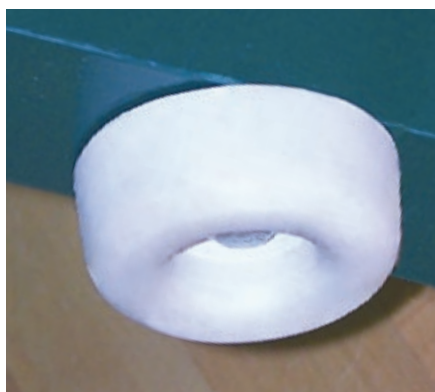

Indoor Conversion Kit

Protect floor surfaces with this outdoor to indoor bleacher conversion kit.

- 12 rubber pad protectors to prevent floor marking
- 7½' Bleacher - Requires 1 kit
- 15'/21' Bleacher - Requires 2 kits
- 27' Bleacher - Requires 3 kits

For 2, 3, and 4 row bleachers at lengths of 7½', 15', 21', and 27'.

3 Year Limited Warranty



BLCHICK34

\$56 SET 4 lbs



Standard Outdoor Bleacher

Heavy-duty outdoor bleacher with dual braces and rear stabilizing bar for increased strength.

- 10" wide aluminum non-skid seat planks
 - Galvanized steel understructure
- 4 row bleacher does not exceed 30" in height. Guard rails may not be needed (check local codes). Specify plank and leg colors when ordering powder coat option.

Rows	Length	Seats	Weight	Natural Finish	Price	Powder Coat	Price
3	15'	30	310 lbs	BLCH-3	\$1,397 EA	BLCH-3PC	\$1,450 EA
	21'	42	425 lbs	BLCH-321	\$1,770 EA	BLCH-321PC	\$2,040 EA
	27'	54	545 lbs	BLCH-327	\$2,211 EA	BLCH-327PC	\$2,504 EA
4	15'	40	390 lbs	BLCH-4	\$1,959 EA	BLCH-4PC	\$2,265 EA
	21'	52	520 lbs	BLCH-421	\$2,430 EA	BLCH-421PC	\$2,648 EA
	27'	70	650 lbs	BLCH-427	\$2,768 EA	BLCH-427PC	\$3,264 EA

3 Year Limited Warranty



Bleacher/Bench Plank Pad

Create comfortable bleacher seating for players and spectators.

- Straps buckle under plank for easy installation
- 7½' Bleacher - Requires 1 pad per row
- 15' Bleacher - Requires 2 pads per row
- 21' Bleacher - Requires 3 pads per row
- 7'L x 10"W x 1⅜"H

For bleachers at lengths of 7½', 15', and 21'. Specify pad color when ordering (Pink, Lime, Kelly Green, Light Blue, Royal Blue, Forest Green, Yellow, Orange, Dark Purple, Burgundy, Beige, Brown, White, Navy Blue, Red, Gray, Charcoal or Black). Call for freight quote (extended lead time may apply). Custom - non-returnable.

1 Year Limited Warranty



PLKPAD7

\$149 EA 5 lbs



Bleacher Transport Kit

Transport bleachers from field to field with ease.

- (2) 4"W x 12"H heavy-duty wheels
- Wheels and tongue easily attach and remove
- Fits any angle framed 2, 3, 4, or 5 row bleachers at lengths of 15', 21', and 27' - Vehicle Mounting Kit sold separately

3 Year Limited Warranty



BLCH-TOW4515	15'	\$864 KIT	120 lbs
BLCH-TOW4521	21' - 27'	\$971 KIT	150 lbs
BLCH-TMKIT	Vehicle Mounting Kit	\$254 KIT	60 lbs



BLCH-10GR



BLCH-521ASGRPC

Enclosed Bleacher

Heavy-duty enclosed bleacher with dual braces and rear stabilizing bar for increased strength.

- 10" wide aluminum non-skid seat planks
- Galvanized steel understructure
- Vertical guardrails or chain-link enclosure
- 5 or 10 row configuration
- Aisle option includes handrail in center of bleacher

Risers and double foot planks added to bleachers over 30" high for code and safety regulations. Specify plank, understructure, and guardrail colors when ordering powder coat option. Powder coat finish not available on chain-link enclosures or 10 row bleachers. Call for freight quote.

3 Year Limited Warranty



POWDER COAT COLORS



Enclosure	Rows	Length	Seats	Weight	Natural Finish	Price	Powder Coat	Price
Guard Rail	5	15'	50	1,172 lbs	BLCH-5GR	\$4,885 EA	BLCH-5GRPC	\$5,824 EA
Chain Link		15'	50	1,012 lbs	BLCH-5C	\$4,429 EA	N/A	N/A
Guard Rail		21'	62	1,452 lbs	BLCH-521GR	\$6,000 EA	BLCH-521GRPC	\$7,547 EA
Chain Link		21'	62	1,252 lbs	BLCH-521C	\$5,220 EA	N/A	N/A
Guard Rail w/Aisle		21'	58	1,500 lbs	BLCH-521ASGR	\$7,570 EA	BLCH-521ASGRPC	\$8,948 EA
Guard Rail		27'	80	1,732 lbs	BLCH-527GR	\$8,007 EA	BLCH-527GRPC	\$8,459 EA
Chain Link		27'	80	1,492 lbs	BLCH-527C	\$6,273 EA	N/A	N/A
Guard Rail	10	15'	100	2,500 lbs	BLCH-10GR	\$12,307 EA	N/A	N/A
Guard Rail		21'	140	2,700 lbs	BLCH-1021GR	\$15,285 EA	N/A	N/A
Guard Rail w/Aisle		21'	114	3,000 lbs	BLCH-1021ASGR	\$16,614 EA	N/A	N/A
Guard Rail		27'	170	3,464 lbs	BLCH-1027GR	\$18,774 EA	N/A	N/A
Guard Rail w/Aisle		27'	134	3,700 lbs	BLCH-1027ASGR	\$19,771 EA	N/A	N/A

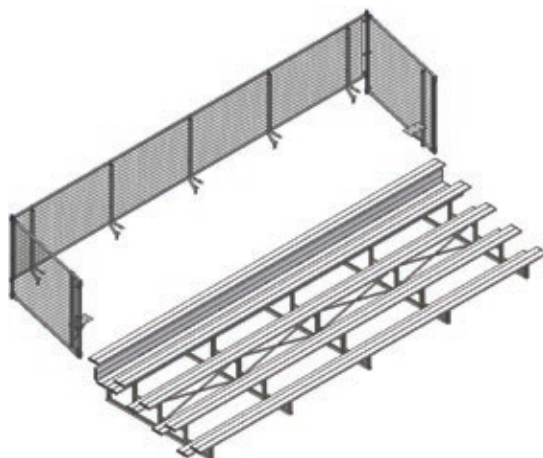

Universal Enclosure

Upgrade 5 row bleachers to comply with local safety codes.

- Enclose bleacher seating higher than 30" (fits most bleacher brands)
- Bolts to 5 row bleachers at lengths of 15', 21', and 27'
- Footboard, kickboard, attachment frame, and hardware kit included

3 Year Limited Warranty



BLCH5CUE15	15' - 5 Row	\$2,491 EA	250 lbs
BLCH5CUE21	21' - 5 Row	\$3,124 EA	275 lbs
BLCH5CUE27	27' - 5 Row	\$3,987 EA	300 lbs



DESIGNED TO PERFORM.
MANUFACTURED TO LAST.™

JAYPRO SPORTS
IS GOING GREEN 

Jaypro Sports, LLC
976 Hartford Turnpike, Waterford, CT 06385

P: 800-243-0533
info@jaypro.com

F: 800-988-3363
www.Jaypro.com