

N75-33004  
Unclas 42571  
CACL 01B G3/02  
(NASA-CR-137691-Vol-2) DESCRIPTION OF  
CASCOMP COMPREHENSIVE AIRSHIP SIZING AND  
PERFORMANCE COMPUTER PROGRAM, VOLUME 2  
(Boeing Vertol Co., Philadelphia, Pa.)  
304 p HC \$9.25

# DESCRIPTION OF CASCOMP COMPREHENSIVE AIRSHIP SIZING AND PERFORMANCE COMPUTER PROGRAM

Volume II

Prepared under Contract Number NAS 2-8693  
(Feasibility Study of Modern Airships, Phase I)

for  
National Aeronautics and Space Administration  
Ames Research Center

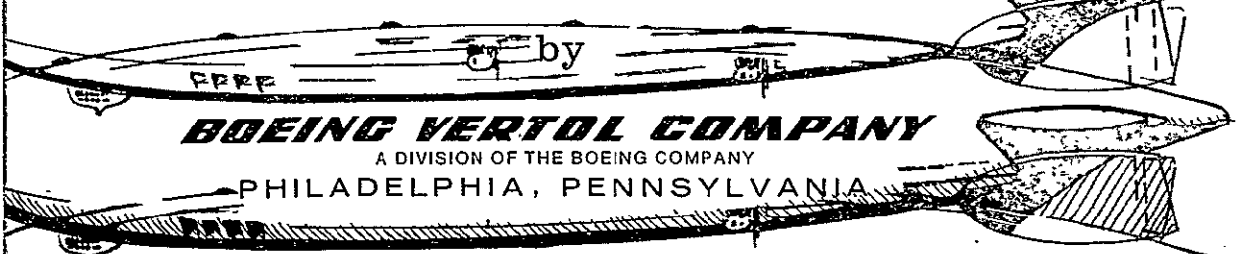

D210-10953-2

May 1975

**DESCRIPTION OF CASCOMP  
COMPREHENSIVE AIRSHIP  
SIZING AND PERFORMANCE  
COMPUTER PROGRAM**

Volume II

Prepared under Contract Number NAS 2-8693  
(Feasibility Study of Modern Airships, Phase I)

for

**National Aeronautics and Space Administration  
Ames Research Center**

by

Jon Davis

***BOEING VERTOL COMPANY***

A DIVISION OF THE BOEING COMPANY

PHILADELPHIA, PENNSYLVANIA

## CONTENTS

<u>Section</u>	<u>Page</u>
1.0 INTRODUCTION	
1.1 Background	1-1
1.2 Application	1-2
2.0 TYPICAL AIRSHIP GEOMETRY	2-1
3.0 GENERAL PROGRAM DESCRIPTION	3-1
3.1 General	3-1
3.2 Options	3-1
3.3 Program Indicators	3-6
3.4 Program Flow	3-9
4.0 DETAILED PROGRAM DESCRIPTION	4-1
4.1 Atmosphere Subroutine	4-1
4.2 Propulsion Systems Characteristics	4-1
4.3 Size Trends Subroutine	4-2
4.4 Engine Sizing Subroutine	4-9
4.5 Aerodynamics Subroutine	4-12
4.6 Lift Subroutine	4-14
4.7 Drag Subroutine	4-20
4.8 Rotor Performance Subroutine	4-21
4.9 Propeller Performance Subroutine(s)	4-23
4.10 Weight Trends Subroutine	4-29
4.11 Performance Calculations Subprogram	4-29
4.11.1 Takeoff, Hover and Landing Calculations Subroutine	4-29
4.11.2 Cruise Calculations Subroutine	4-31
4.11.3 Change of Weight Subroutine	4-32
4.11.4 Transfer Altitude Subroutine	4-32
5.0 PROGRAM INPUT	5-1
5.1 General	5-1
5.2 Specimen Input Sheets	5-5
5.3 Program Input Variables and Indicators	5-21
6.0 SAMPLE CASE	6-1
7.0 COMPLETE PROGRAM LISTING (FORTRAN)	7-1
REFERENCES	

## ILLUSTRATIONS

<u>Figure</u>	<u>Page</u>
2-1 Typical Hull and Fin Geometry - Conventional Hull Airship (HULIND = 1)	2-2
2-1a Typical Hull and Fin Geometry - Megalifter	2-3
2-2 Typical Hull and Fin Geometry - Lifting Hull Airship (HULIND = 2)	2-4
2-3 Typical Hull and Fin Geometry - Helipsoid Airship (HULIND = 3)	2-5
2-4 Typical Hull and Fin Geometry - Disc Shaped Hull Airship (HULIND = 4)	2-6
3-1 CASCOMP Program Flow Diagram	3-10
4-1 Conventional Airship Hull - Volume and Surface Area Relationships - Summary	4-3
4-2 Lifting Body Hull - Volume and Surface Area Relationships - Summary	4-4
4-3 Helipsoid Lifting Body Hull - Volume and Surface Area Relationships - Summary	4-6
4-4 Disc-Shaped Lifting Body Hull - Volume and Surface Area Relationships - Summary	4-7
4-5 Relationships For Sizing Airship Horizontal and Vertical Fins	4-10
4-6 Airship Stability Trends	4-11
4-7 Typical Data Required For Determining Conventional Hull Lift & Drag Characteristics	4-16
4-8 Typical Lift Curve Slope ( $dC_L/d\alpha$ ) Data For Lifting Body Hulls	4-18
4-9 Correlation of Theoretical & Experimental Lift Using Various Values of Cross-Flow Drag Coefficient (CDC)	4-19



<u>Figure</u>		<u>Page</u>
4-10	Comparison of "Short Form Aero" Rotor Performance and Flight Test Data	4-22
4-11	Comparison of "Short Method" and Detailed Calculation for Propeller Hover Efficiency	4-25
4-12	Comparison of "Short Method" and Detailed Calculations for Propeller Cruise Efficiency	4-26
4-13	Weight Trends Subroutine	4-30

### TABLES

<u>Table</u>		<u>Page</u>
1-1	Airship Configurations Which May Be Studied Using CASCOMP	1-3
3-1	Summary of CASCOMP Subroutines	3-11
4-1	Coefficients Used in Conjunction with the Lifting Body Hull Type (HULIND = 2) Illustrated in Figure 4-2.	4-5
4-2	Relationships Required for Determination of Conventional Hull Lift and Drag Characteristics	4-17
4-3	Coefficients for Propeller Equivalent Polars	4-28

## 1.0 INTRODUCTION

### 1.1 BACKGROUND

CASCOMP is an airship sizing and performance computer program very similar in format and operation to VASCOMP II, the V/STOL Aircraft Sizing and Performance Computer Program described in Reference 1. The purpose of the program is to aid comparative design studies of lighter than air vehicles by rapidly providing airship size and mission performance data. The program can be used to define design requirements such as weight breakdown, required propulsive power, and physical dimensions of airships which are designed to meet specified mission requirements. The program is also useful in sensitivity studies involving both design trade-offs and performance trade-offs.

During the formulation of the program, the following guidelines have been followed:

1. Maintain generality and flexibility:

A program of this type must be comprehensive and flexible in order to permit an accurate simulation of virtually any airship configuration. It must be capable of approximating the design process involved in layout and sizing of a wide variety of LTA vehicles and synthesizing their performance.

2. The program should be easy to use:

In order to minimize hand computation of input data, the input to the program primarily consists of a series of single point values specifying, for example, hull overall fineness ratio, number of engines, airship hull and empennage drag coefficients, a description of the mission profile, and weights of fixed equipment, fixed useful load and payload. Where necessary to adequately describe certain functional relationships, the input is in tabular form. However, since preparation of data for tabular input is generally more cumbersome and time consuming, this form of input has been kept to a minimum.

3. Minimize computation time:

In order to minimize computation time, the program makes ample use of optional computation paths. To eliminate large quantities of null arithmetic, the program avoids calculations which do not apply to the particular airship

being studied. This is accomplished by means of a series of input indicators that specify the calculations to be performed.

4. The program should be well balanced:

The program should not be extremely sophisticated in one detail and yet extremely simple in another. To offset the possibility of this occurrence, great care has been taken to examine methods used to describe the airship and its operation.

## 1.2 APPLICATION

The program has two primary independent applications and a third which is a combination of the first two. The program may be used for the sizing of airships for which the type of vehicle and the mission profile are specified. Alternatively, the program may be used for mission calculations for vehicles for which sizing details (gross weight, fuel available, engine power and fuel consumption, etc.) are known. As a combination of these two capabilities, the program may be used to first size an airship for a given mission and then calculate the off-design-point performance for other missions. The option of calculation to be used is specified to the program by means of an input "option indicator."

The program has been written in a manner to make it directly applicable to sensitivity studies to determine the effect of variations in weight, drag, engine characteristics, etc. This is accomplished by use of incremental multiplicative and additive factors applied to the gross weight, component drag and fuel required equations. For the most part, the multiplicative factors are nominally equal to unity and the additive factors are nominally equal to zero. However, to determine the effect, for example, of a 10 percent increase in drive system weight, the appropriate multiplicative factor can be set to 1.10 and the sizing program rerun.

The program contains size trend equations which reflect the variation of airship dimensions with gross weight, detailed statistical weight trends equations, a routine for sizing of engines to match airframe requirements, and several optional procedures for calculating propeller performance.

The program can be used to study a wide variety of lighter-than-air (LTA) vehicles. Table 1-1 illustrates these.

PRECEDING PAGE BEING NOT FILMED

1-3

TABLE 1-1

AIRSHIP CONFIGURATIONS WHICH MAY BE STUDIED USING CASCOMP

Hull Type Type of Dynamic Lift (HULIND) (DYLIND)	CONVENTIONAL (1)	LIFTING BODY (2)	ELLIPTICAL PLANFORM LIFTING BODY (3)	CIRCULAR PLANFORM LIFTING BODY (4)
Hull Only Dynamic Lift (Both partially and Fully Buoyant) (1)	X			
Wing and/or Hull Dynamic Lift (2)	X (Megalifter Type)	X	X	X
Dynamic Lift by Rotors Alone (3)	X			
Dynamic Lift by Rotors, Wing and/or Hull (4)	X (Megalifter Type with Rotors)	X	X	X

## 2.0 TYPICAL AIRSHIP GEOMETRY

Specification of airship characteristics in order to calculate aerodynamic behavior and airship weights is made in a variety of ways; through use of input indicators which specify the types of calculations to be made, through use of weights factors and constants, and through use of configuration geometric information (largely nondimensional).

A typical dimensioning and weighing analysis starts with a given gross weight, a known hull type, a known requirement (or no requirement) for dynamic lift, and a given buoyant fluid (lifting gas). Hull volume is then determined by the interacting requirements of buoyancy ratio, buoyant fluid specific weight and design maximum pressure altitude. The actual hull dimensions, such as overall length or diameter, etc., are obtained by solving the volume relationships for a given hull type using the input values of fineness ratios (in the case of conventional type hulls) or aspect and taper ratios (in the case of the lifting body type hulls). Wing geometry (in the case of a megalifter type airship) is dictated by the requirements to satisfy a given dynamic lift loading and aspect ratio. Tail surface geometry is dictated by tail volume requirements and the location of the airship center of buoyancy.

Figures 2-1, 2-2, 2-3 and 2-4 illustrate the four basic hull forms which may be utilized with this program. Figure 2-1a is simply a special case of the first hull type (shown in Figure 2-1). The geometric information illustrated is typical of that which may be required of the program user. A list of the geometric inputs required is included in the input variable list in Section 5.3.

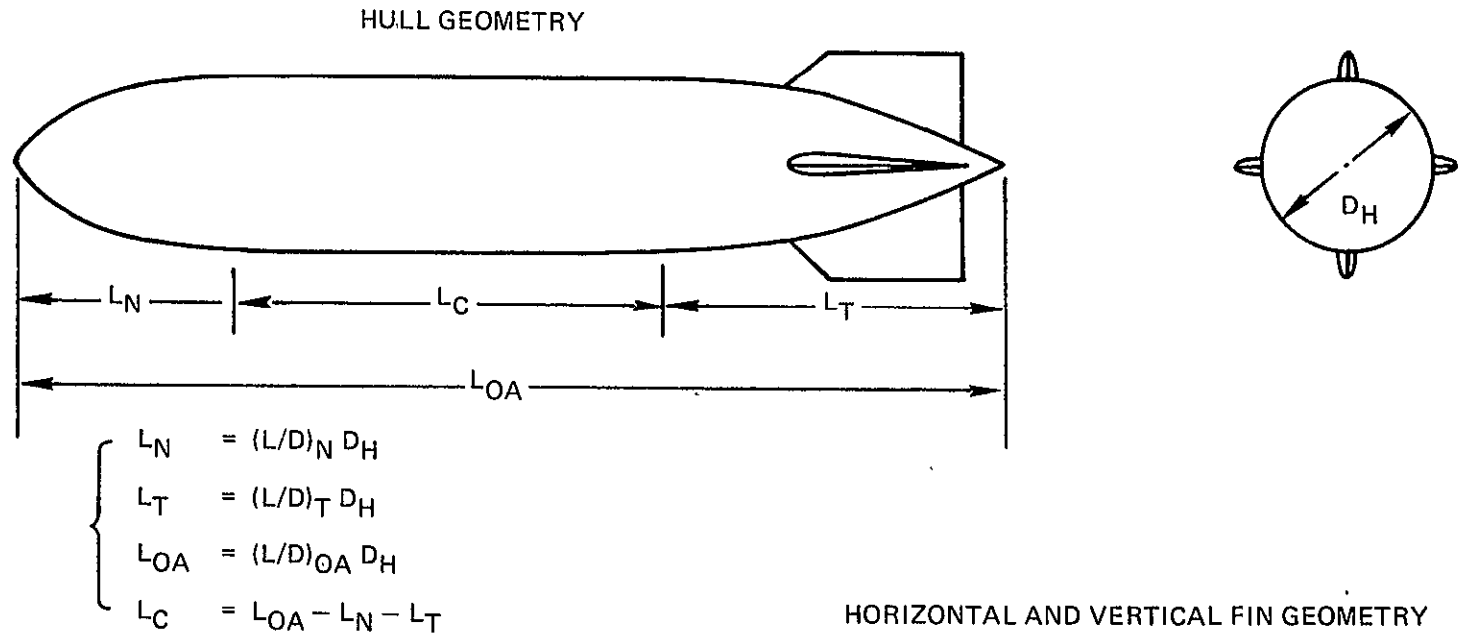

NOTE:  $S_{VT,HT}$  IS 1/2 THE TOTAL FIN AREA REQUIRED (I.E., IT IS INDIVIDUAL FIN AREA)

$$\left\{ \begin{aligned} AR_{VT,HT} &= \frac{b^2_{VT,HT}}{S_{VT,HT}} \\ \lambda_{VT,HT} &= \frac{C_{T_{VT,HT}}}{C_{R_{VT,HT}}} \\ C_{R_{VT,HT}} &= \frac{2b_{VT,HT}}{AR_{VT,HT}(1 + \lambda_{VT,HT})} \end{aligned} \right.$$

HORIZONTAL AND VERTICAL FIN GEOMETRY

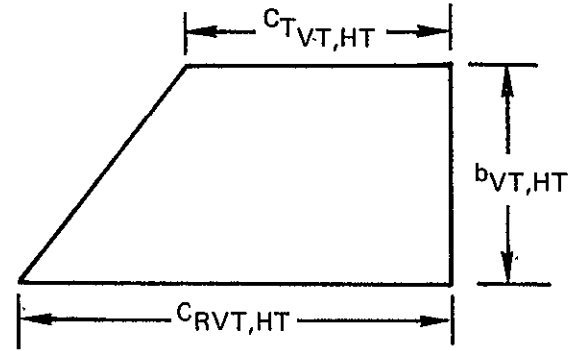
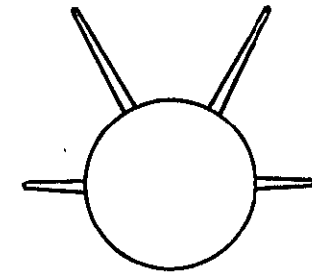
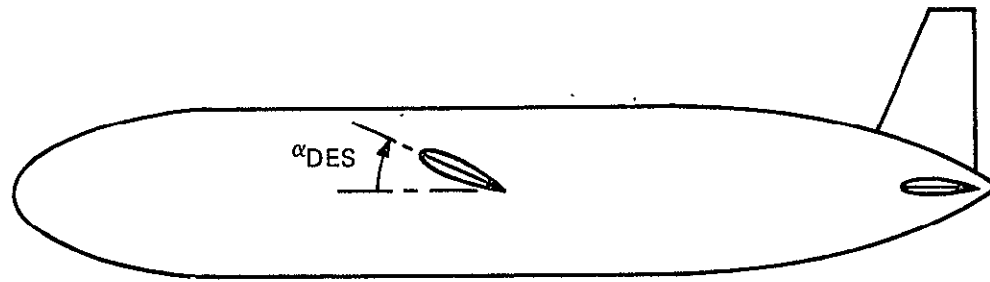
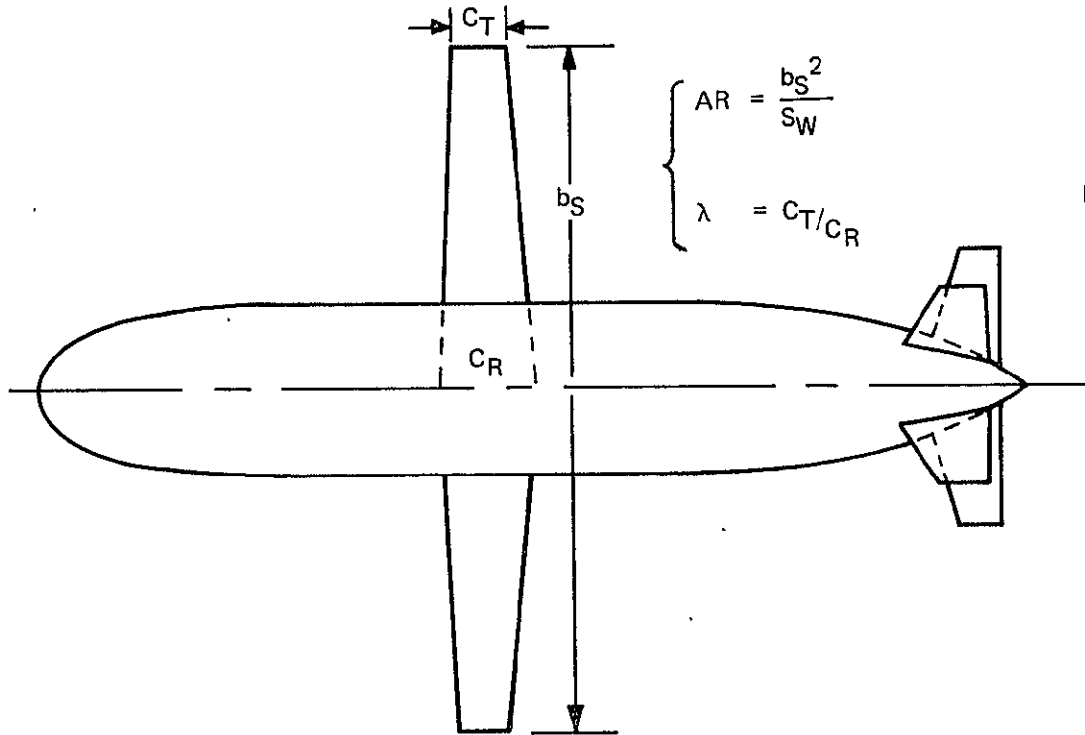

Figure 2-1. Typical Hull and Fin Geometry – Conventional Hull Airship (HULIND = 1)



NOTE: WING OMITTED IN THIS VIEW FOR CLARITY



$$\left\{ \begin{array}{l} AR = \frac{b_S^2}{S_W} \\ \lambda = C_T / C_R \end{array} \right.$$

NOTE: FIN AND HULL DIMENSIONS AND GEOMETRY SAME AS IN CONVENTIONAL HULL AIRSHIP (HULIND = 1)

Figure 2-1a. Typical Hull and Fin Geometry – Megalifter

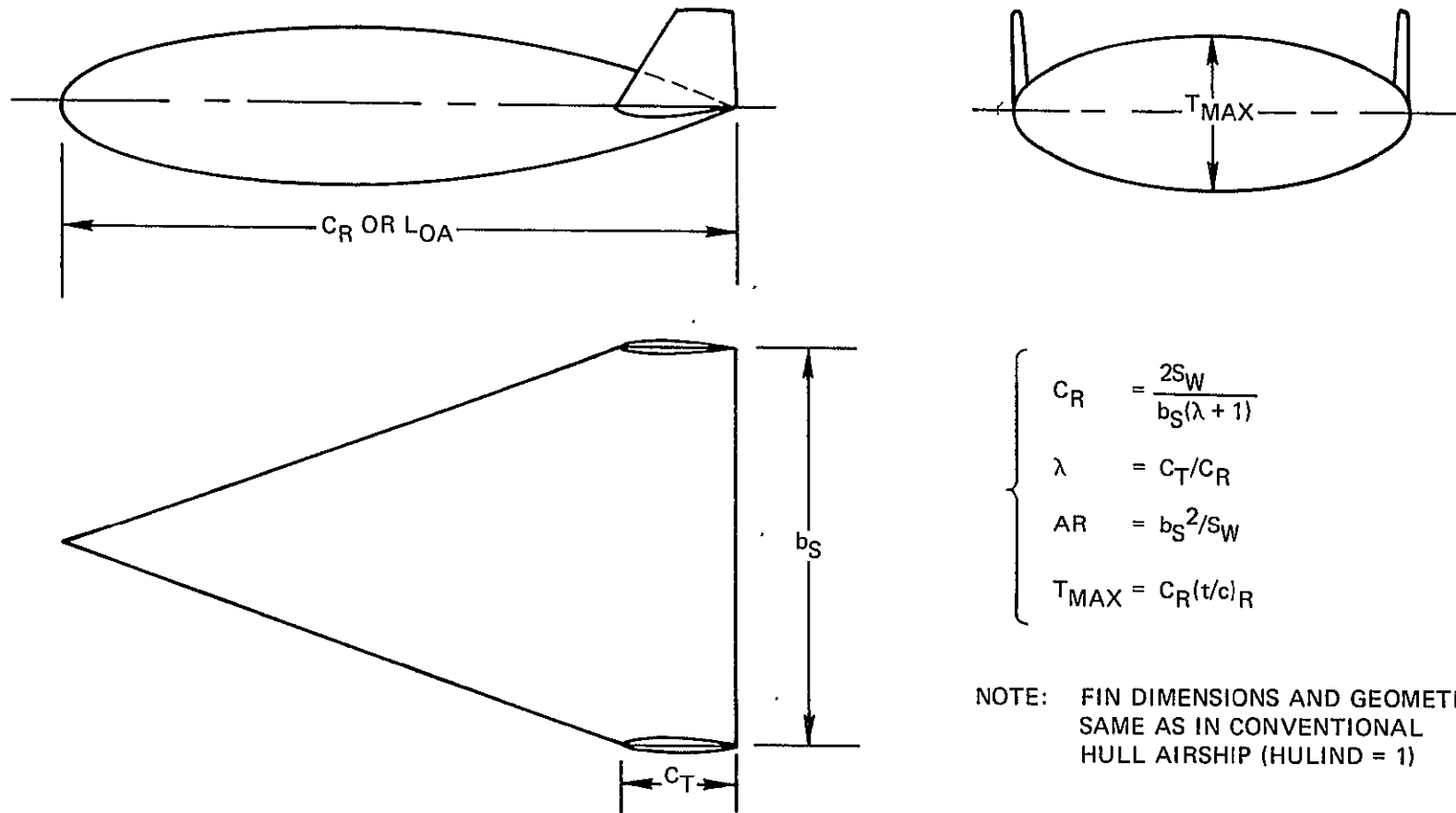

NOTE: FIN DIMENSIONS AND GEOMETRY  
SAME AS IN CONVENTIONAL  
HULL AIRSHIP (HULIND = 1)

Figure 2-2. Typical Hull and Fin Geometry – Lifting Hull Airship (HULIND = 2)



2-5

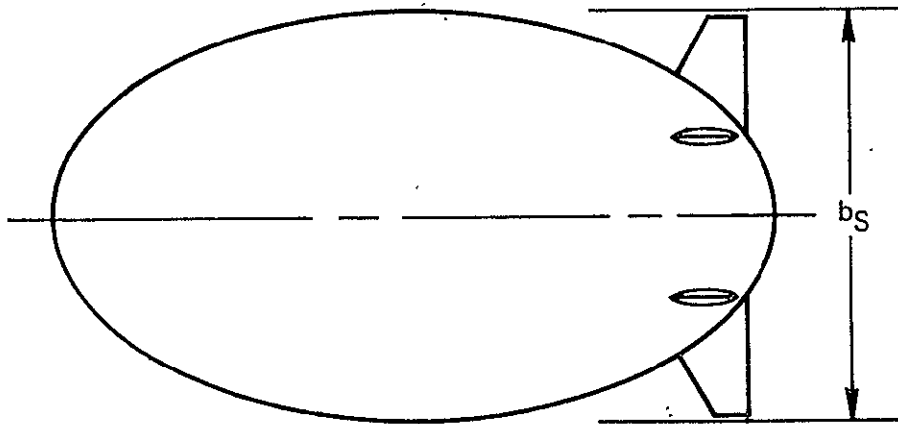
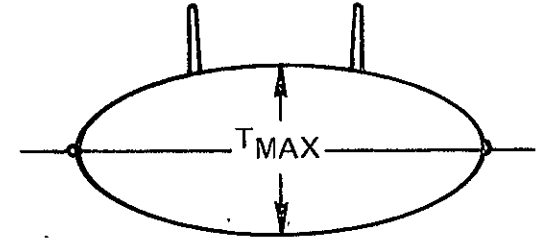
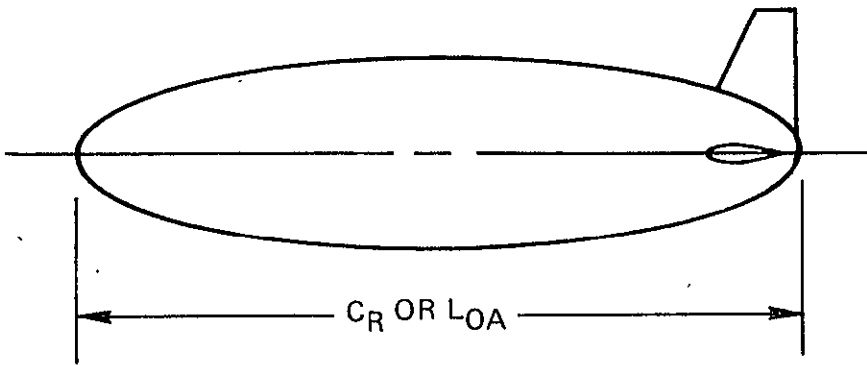

$$\left\{ \begin{array}{l} C_R = \frac{4S_W}{\pi b_S} \\ AR = \frac{4b_S}{\pi C_R} \\ T_{MAX} = C_R(t/c)_R \end{array} \right.$$

NOTE: FIN DIMENSIONS AND GEOMETRY SAME AS IN CONVENTIONAL HULL AIRSHIP (HULIND = 1)

Figure 2-3. Typical Hull and Fin Geometry – Helipsoid Airship (HULIND = 3)

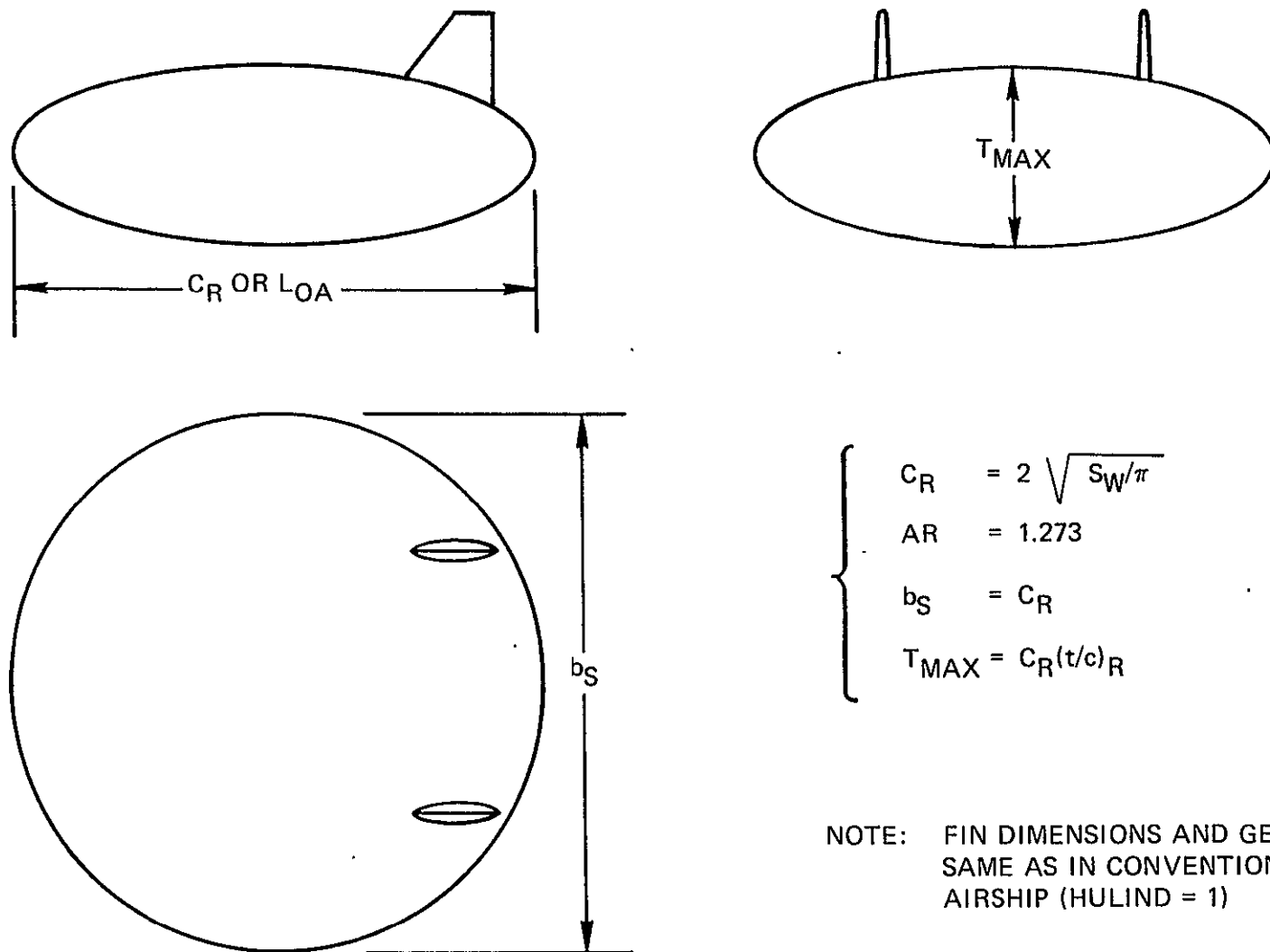

Figure 2-4. Typical Hull and Fin Geometry – Disc Shaped Hull Airship (HULIND = 4)

## 3.0 GENERAL PROGRAM DESCRIPTION

### 3.1 GENERAL

As previously described, the program has two major options. The specific option to be used is selected by means of an input "option indicator" abbreviated OPTIND. Note that throughout this volume, the input data locations (see Specimen Input Sheets, Section 5-2) are referred to by the abbreviation LOC.

### 3.2 OPTIONS

#### OPTIND = 0

This option determines the airship weight breakdown, payload, dimensions, and required power to satisfy a prescribed mission flight profile at a fixed gross weight. In addition to the flight profile, certain characteristics describing the type of airship are specified such as hull type, buoyancy ratio, design altitude, number of propellers, etc.

#### OPTIND = 2

This option is used to calculate the flight performance of an airship for which the dimensions and payload have been determined. In addition to the airship characteristics specified above, the power available, airship dimensions, etc. are input to the program. A flight profile is also specified. The program then calculates the performance history of the airship for the specified mission.

#### Combined Option

This option permits the user to "size" an airship for a "design-point" mission and then to calculate the off-design-point performance of the "sized" airship for a variety of additional missions. Basically, this option causes the program to run OPTIND = 0, save the sizing data generated in that option, and then input this information into the performance option (OPTIND = 2).

### 3.2.1 Description of Mission Profile

The Performance Calculations Subprogram, consisting of four individual subroutines, permits the simulation of airship performance for virtually any mission flight profile. A typical performance analysis is made up of a series of elements which, in building block fashion, allow the user of the program to perform a wide variety of studies. The elements of a typical performance analysis are:

- a. Segment - A segment of a mission profile is a unique portion of the mission such as a cruise or a hover. A segment starts with a set of initial conditions of one or more of the variables of state (altitude, range, weight, etc.) and ends when a terminal condition (or conditions) has been satisfied.
- b. Hop - A hop is defined as a set of segments ending at some logical terminal location (such as ground level at the desired range). Thus, a hop might consist of flying from location "A" to location "B" by means of combining the following segments: Takeoff, Transfer Altitude, Cruise, Transfer Altitude, Cruise, Transfer Altitude, Landing.
- c. Leg - A leg of a mission is herein defined as a set of hops ending in a re-fueling of the airship. Thus, a leg might consist of flying from location "A" to "B", then to "C", at which point the airship is refueled.
- d. Mission - A mission is defined in this program as a set of legs (or hops or segments) which satisfy some specific operational requirement. In this program, the mission is the basic element for which the airship is sized.
- e. Case - A case is a consecutive series of missions for the same airship. This program permits the user to analyze a case which consists of a mission for which an airship is sized, followed by a different mission which the now-sized airship performs, followed by yet additional missions.

The Performance Calculations Subprogram consists of four individual performance segments, specified by means of an input indicator, SGTIND. The segments are takeoff, hover, and landing (SGTIND = 2), cruise (SGTIND = 4), increment in weight of payload (SGTIND = 8), and transfer altitude (SGTIND = 9). The end of the mission is specified by an input SGTIND = 0. An array of segment indicators is input to the program to specify the mission being studied. Thus, a typical array might be:

SGTIND =

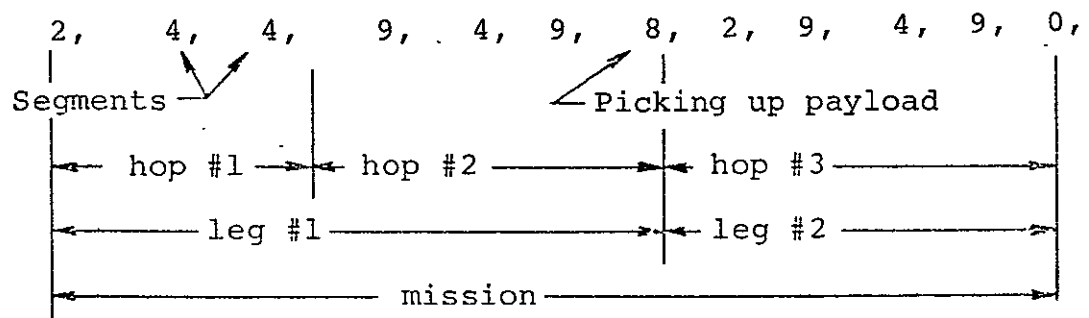

At the end of any leg, the sum of segment fuel required to perform that leg is stored in the computer. At the end of the mission, the largest of these stored values is used to determine the airship sizing requirements when OPTIND = 0. An end of a case is specified by an input SGTIND = 100. Since an end-of-case is also always an end-of-mission, it is not necessary to end a case by a SGTIND = 0 followed by SGTIND = 100. SGTIND = 100 always takes precedence over SGTIND = 0. The distinction between a mission and a case is most useful when it is desired to size an airship for a specified mission followed by analysis of the off-design-point performance of the "sized" airship on other missions. As an example, with OPTIND = 0 (sizing option) the following array of SGTIND might be used:

SGTIND =

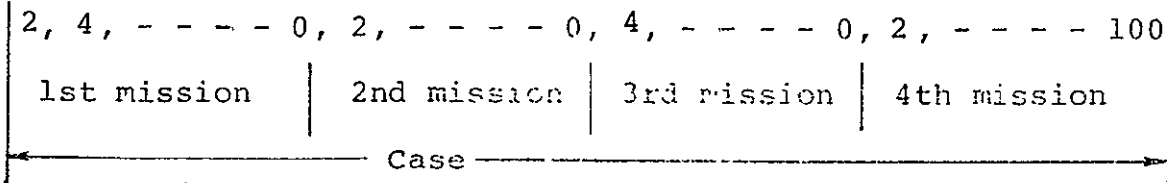

The program will size the airship for the first mission and then analyze the performance of the "sized" airship for the second, third and fourth missions. Up to 12 consecutive segments may be included in a single case, arranged in any arbitrary series of hops, legs, and missions. Up to 5 of any specific segment may be included in any case. Thus, a case might consist of several missions, each mission having several different cruise segments.

Each segment is a discrete element of the mission, independent of any other segment with the exception of the influence on the altitude, range, weight, and time. That is, the first cruise of a case might be at cruise power at standard atmospheric conditions and the second cruise could be at best specific range for a nonstandard day.

At the start of a case, the user inputs values for initial conditions of altitude, range, weight, and time. The first segment of the case uses these values as initial boundary conditions and the segment ends at a specified terminal condition. The final values of altitude, range, weight, and time then become, in turn, the initial values for the following segment.

The final, or terminal, condition varies depending upon the segment. Terminal conditions for each segment, input by the user, are:

Takeoff, Hover, and Landing - increment in time

Cruise - range at end of cruise

Change of Payload Weight - increment in weight  
and increment in  
time

Transfer Altitude - final altitude

Segments 2 and 4 (takeoff, hover, and landing and cruise) require, in addition to terminal conditions on one of the variables of state, an input value for the step size to be used in the calculations. The step size specifies both the increment in the primary variable which is used in the calculations and the increment between successive printouts. Printouts occur at even integral multiples of the primary variable. As the step size is decreased, the program accuracy improves, but the computing time lengthens.

Atmospheric conditions may vary from segment to segment. For example, the first segment may be for a standard atmosphere; the second segment may use a constant increment in temperature above standard, etc.

At the end of the mission, the total fuel required is determined as the sum of mission fuel required plus reserve fuel. Reserve fuel can be specified to the program as an arbitrary percentage of mission fuel or as an arbitrary increment in total fuel required, or as any arbitrary combination of these factors.

Propeller efficiency can be calculated in two different ways for airships with turboshaft engines. The option chosen is specified by means of a propulsive efficiency indicator, ETAINND. The options range from (a) input of a set of point values of efficiency to

(b) automatic calculation of propeller performance. The option chosen will depend on the type of problem being studied as each of the means of calculating prop performance has features which may be desirable under certain conditions. These options are described in more detail in Section 4.9.

### 3.3 PROGRAM INDICATORS

Flexibility of operation and generality of approach have been accomplished by use of many optional computation paths. The path to be used is selected by the user through use of a series of input indicators. Besides the option indicator, previously described, the program indicators fall into four categories: size trends indicators, aerodynamics indicators, propulsion indicators, and mission performance indicators. The indicators and their use are described below.

#### 3.3.1 Size Trends Indicators

- a. HULIND - Four different types of basic airship hull configurations are included in this program. They are the conventional "spindle-shaped" hull, a lifting body hull with a chordwise airfoil profile and a spanwise elliptical cross-section, a lifting body hull with an elliptical planform and chordwise and spanwise elliptical cross-sections and a circular planform (or disc-shaped) hull with chordwise and spanwise elliptical cross-sections. If HULIND is input as 1, the conventional hull is selected. If HULIND is input as 2, the lifting-body hull with the chordwise airfoil profile is selected. If HULIND is input as 3 or 4, the elliptical or circular planform lifting body hulls are selected, respectively.
- b. DYLLIND - This indicator determines the manner in which (or whether) it is desired to utilize dynamic lift for the particular hull configuration selected by the HULIND indicator. There are four options available - DYLLIND = 1, 2, 3, and 4. DYLLIND = 1 is used only in conjunction with HULIND = 1. Its use assumes a conventional hull airship with propellers for propulsion and no type of wings for dynamic lift. If the airship to be studied is



fully buoyant ( $L_B/W_0 = 1.00$ , LOC 0011), it is assumed that the gross weight decrease caused by fuel burnoff is compensated for by water ballast recovery devices, thus negating the need for negative dynamic lift. If the airship is "heavy" ( $L_B/W_0 < 1.00$ ), the dynamic lift of the hull is employed for both lifting and trim. DYLIND = 2 is used in conjunction with all hull types. For the case where HULIND = 1, its use implies a configuration with a conventional hull plus a conventional wing - both of which contribute dynamic lift for both lifting and trimming purposes. When HULIND = 2, 3 or 4, obviously all of the dynamic lift is contributed by the lifting body hull. Use of this indicator further implies the use of propellers for propulsion. DYLIND = 3 is used only in conjunction with HULIND = 1. Its use assumes a partially buoyant ( $L_B/W_0 < 1.0$ ) conventional hull airship utilizing "helicopter-type" rotors for both dynamic lift and propulsion. DYLIND = 4 is used in conjunction with all hull types. When HULIND = 1, its use implies a conventional hull plus a conventional wing plus "helicopter-type" rotor(s) - all three of which contribute dynamic lift, with the rotor additionally supplying propulsive thrust. When HULIND = 2, 3, or 4, the dynamic lift is supplied by the combination of the lifting-body hull and the rotors, with, as before, the rotor(s) also supplying the propulsive thrust.

- c. RDMIND - Propellers or rotors employed by the various airship configurations may be either fixed in diameter and solidity or sized. If RDMIND is input as 1, propeller or rotor diameter (LOC 0074) and propeller Activity Factor (LOC 0077) or rotor solidity (LOC 0075) must be input directly. If RDMIND is input as 2, disc loading (LOC 0073),  $C_T/\sigma$  (LOC 0084), and the propeller/rotor design conditions (LOCS 0085, 0086, 0087) must be input.
- d. PRPIND - This indicator is used in conjunction with DYLIND. It serves to indicate whether propellers or "helicopter-type" rotors are being used, thus PRPIND = 0 for DYLIND = 1 and 2 and PRPIND = 1 for DYLIND = 3 and 4.

### 3.3.2 Aerodynamics Indicators

- a. DRGIND - The method of determining the total parasite drag of the airship is specified to the program by means of the indicator DRGIND. If DRGIND = 1, configuration parasite drag is built up in component fashion, with Reynolds number scaling. This is the only parasite drag option presently available. Future modification could lead to a DRGIND = 2 option permitting parasite drag determination on the basis of a trend based on hull volume.
- b. OSWIND - The span loading efficiency factor (Oswald's efficiency factor) may be calculated by the program from an approximate relationship as a function of wing aspect ratio. If the user prefers, he may input a fixed value of the efficiency factor to the program. An input of OSWIND = 0 permits the user to input a fixed value for efficiency. An input of OSWIND = 1 will cause the program to use this approximate equation to calculate the value for efficiency. Use of the OSWIND indicator is applicable only for HULIND = 1 and DYLLIND = 2 or 4.

### 3.3.3 Propulsion Indicators

- a. FIXIND - Engines selected for airships being studied in the program may be either "fixed" in size or "rubberized". If the engines are "rubberized", the engine sizing subroutine calculates the maximum power of the engines required to satisfy the design cruise flight conditions. If the engines are fixed in size, the user inputs the level of maximum power for the engines and the engine sizing subroutine is bypassed. If FIXIND = 0, the engines are fixed in size. If FIXIND = 1, the engine sizing subroutine is used to calculate the size of the "rubberized" engines.
- b. ETAIND - This indicator permits the user to select one of two different methods for providing propeller performance data. If ETAIND = 0, the user specifies a point value efficiency for takeoff and

a table of efficiency versus flight speed for cruise. An input of ETAIND = 1 will permit the use of an automatic subroutine within the program for calculating prop performance.

### 3.3.4 Mission Performance Indicators

- a. SGTIND - The mission profile flown by the airship may be made up of an arbitrary sequencing of four discrete profile segments. The segment selected is specified by means of the segment indicator, SGTIND. The segments are: takeoff, hover, and landing (SGTIND = 2), cruise (SGTIND = 4), change payload (SGTIND = 8), and transfer altitude (SGTIND = 9). The mission is terminated by an input value of SGTIND = 0. SGTIND = 100 terminates a case.
- b. CRSIND - Three types of cruise missions are included in the program. They are: cruise at fixed cruise power (CRSIND = 1), cruise at constant true airspeed (CRSIND = 2), or cruise at airspeed for best specific range (CRSIND = 3).
- c. TOLIND - The indicator TOLIND is input with each takeoff, hover, and landing and dictates the manner in which power is calculated. If TOLIND = 1, the user inputs the required T/W ratio. If TOLIND = 2, the user inputs required fractions of takeoff power (T/W ratio is computed).

### 3.4 PROGRAM FLOW

Figure 3-1 indicates, conceptually, the operation of the program. Program flow is monitored by a general control loop which controls the operation of a series of peripheral programs. These include six minor subroutines, four major subroutines, a major subprogram, and various internally stored data. The characteristics of these routines are summarized in Table 3-1.

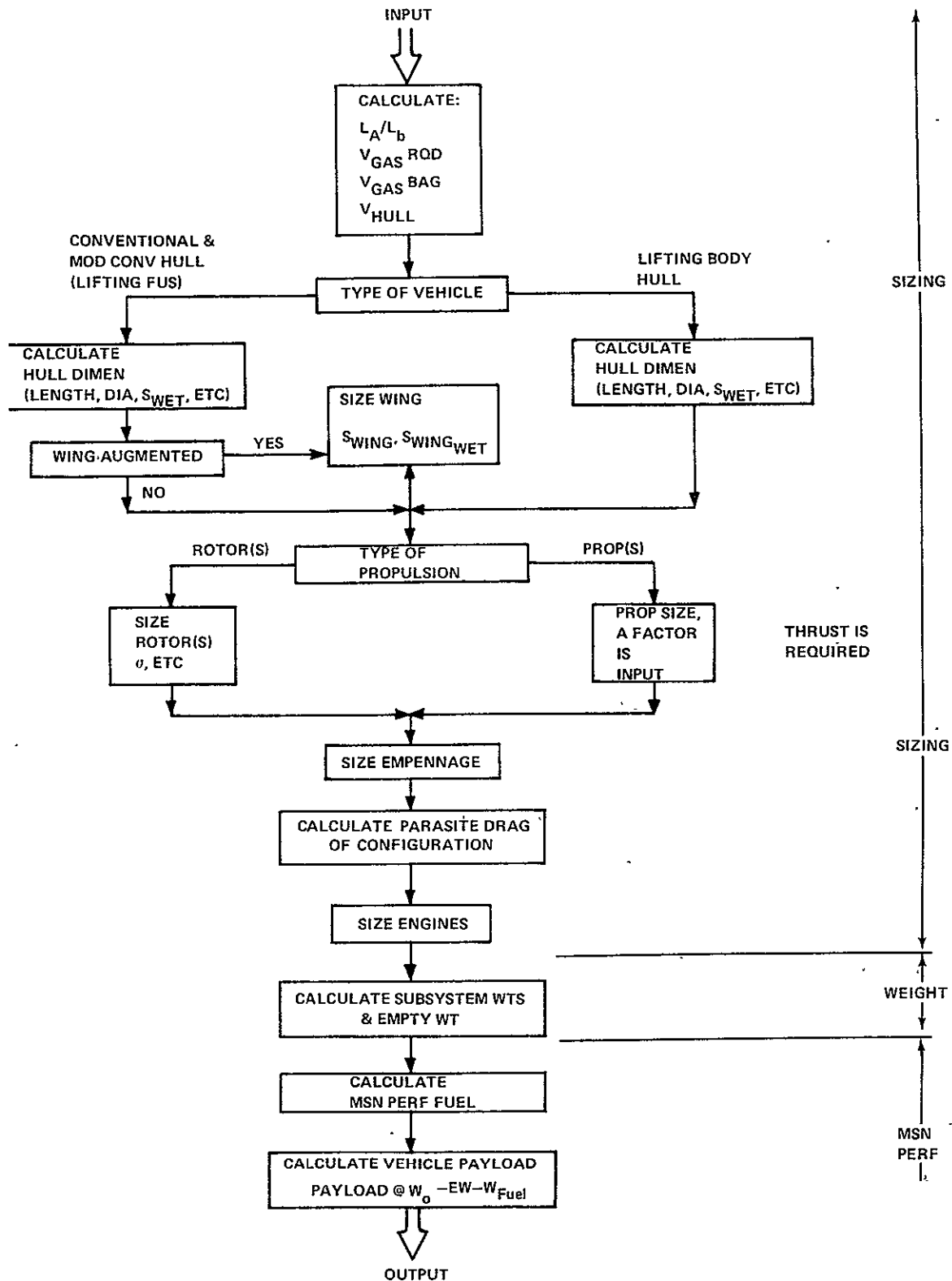

Figure 3-1. CASCOMP Program Flow Diagram

TABLE 3-1  
SUMMARY OF SUBROUTINES

ROUTINE	CALLED BY	PURPOSE
Main Control Loop (MAIN)	- - - -	Monitor program operations.
<u>Minor Subroutines:</u>		
Atmosphere (ATMOS)	Performance subroutines with SGTIND = 2,4, Engine Sizing, and Size Trends	Calculate atmospheric density, pressure, temperature, and speed of sound
Lift Calculations (LIFT)	Performance subroutine SGTIND = 4	Calculate airship buoyant lift, determine hull/wing/rotor dynamic lift split, and deter- mine hull/wing angle of attack to satisfy dynamic lift req'd.
Drag Calculations (DRAG)	Performance subroutine SGTIND = 4 and Engine Sizing	Calculate airship drag
POWER	Performance subroutines with SGTIND = 2,4 and Engine Sizing	Calculate propeller power re- quired when thrust and advance ratio are known
THRUST	Same as POWER	Calculate propeller thrust available when power and ad- vance ratio are known

3-11

TABLE 3-1  
(CONTINUED)

ROUTINE	CALLED BY	PURPOSE
ROTPOW	Performance subroutines with SGTIND = 2,4 and Engine Sizing	Calculates rotor power required for "helicopter-type" rotors
<u>Major Subroutines:</u>		
Size Trends (SIZTR)	MAIN	Calculates airship dimensions which are required for weight breakdown estimate and drag calculation
Aerodynamics (AERO)	MAIN	Performs parasite drag buildup and calculates a series of co- efficients which are used by the drag subroutine to calcu- late airship drag
Engine Sizing (ENGSZ)	MAIN	Calculates engine size (power) required to meet design cruise requirement
Weight Trends (WGHTR)	MAIN	Calculates airship weight summary including propulsion, structures, flight controls, and payload

PRESIDENTIAL PAGE BLANK NOT FILLED

3-13

TABLE 3-1  
(CONTINUED)

ROUTINE	CALLED BY	PURPOSE
<u>Major Subprogram:</u>		
Performance Calculations (PRFRM)	MAIN	Monitors program flow during calculation of mission performance and calculates total fuel required at end of mission
<u>Performance Subroutines:</u>		
Takeoff, Hover, and Landing (TOHL)	PRFRM	Calculate takeoff, hover, or landing performance
Cruise (CRUS1,2,3)	PRFRM	Calculate cruise performance
Change Payload (CHGPL)	PRFRM	Add (or subtract) payload to airship
Transfer Altitude (TRALT)	PRFRM	Changes altitude

## 4.0 DETAILED PROGRAM DESCRIPTION

### 4.1 ATMOSPHERE SUBROUTINE

The atmosphere subroutine will calculate the atmospheric density, pressure, and temperature as a function of altitude. If non-standard temp. conditions are required, the temperature differential between the standard and desired temperature ( $\Delta T_{in}$ ) is input. Thus, atmospheric conditions can be varied individually for each segment of the flight profile and for the engine sizing.

### 4.2 PROPULSION SYSTEM CHARACTERISTICS

The propulsion system input for the CASCOMP computer program consists of tabulated performance data and factors relating the dry weight of the propulsion system to its maximum power output. Only propulsion systems producing shaft transmitted power are considered in the program.

The engine identification number is the first input value, followed by FF, which is a measure of the change in power at ambient temperatures other than standard:

$$\frac{\frac{BHP}{\delta \sqrt{\theta}}}{BHP^*} = \left( \frac{BHP}{\delta \sqrt{\theta}} \right)_{STD} + FF (\theta_{STD} - \theta)$$

Where:

BHP = shaft horsepower

$\delta$  = ambient pressure (psia) divided by 14.696 psia

$\theta$  = ambient temperature ( $^{\circ}$ R) divided by 518.7 $^{\circ}$  R

STD = standard day

\* = sea level static standard day takeoff power setting

Inputs  $k_3$  and  $k_4$  determine the engine dry weight as a function of sea level static standard day takeoff power, viz,

$$\text{Weight (lbs)} = k_3 \frac{BHP^* P}{N_p} + k_4$$

Where  $N_p$  = number of engines



The performance for the engines is input as tabulated data. The power is represented in normalized referred form as  $BHP/BHP*\delta\sqrt{\theta}$ . Two 2-dimensional tables (power versus altitude) are required--one for takeoff power (table 1) and one for cruise power (table 2). Each table contains 10 points.

Specific fuel consumption data is represented by a 2-dimensional table of SFC versus referred power.

#### 4.3 SIZE TRENDS SUBROUTINE

The size trends subroutine calculates the volume of the airship hull based on the following relationship:

$$V_{HULL} = \frac{(L_B/W_0)W_0}{(.076474-LG_{SPWT_0})(\rho/\rho_0)_{HD}(V_{GASB}/V_{HL})}$$

Where:

$L_B/W_0$  = Buoyancy ratio

$W_0$  = Gross Weight

$LG_{SPWT_0}$  = Lifting gas specific weight  
(SL, STD) - lb/ft<sup>3</sup>

$(\rho/\rho_0)_{HD}$  = Atmospheric density ratio at design  
pressure altitude

$V_{GASB}/V_{HL}$  = Ratio of gas cell volume to hull volume

Hull geometric dimensions (such as diameter, overall length, etc.) are obtained by solving the volume relationships for a given hull configuration. Figures 4-1, 4-2, 4-3, and 4-4 illustrate these relationships for the four basic hull types. Table 4-1 lists some coefficients required with the equations of Figure 4-2.

Note that for the conventional hull type (HULIND = 1) the user inputs a series of fineness ratios  $(L/D)_N$ ,  $(L/D)_T$ ,  $(L/D)_{OA}$ , where in the case of the lifting-body hulls (HULIND = 2, 3, and 4) the planform aspect ratio (AR), maximum t/c of the center line section  $(t/c)_R$  and taper ratio ( $\lambda$ ) are input.

In the case of a conventional hull type (HULIND = 1) which exhibits no constant diameter center section ( $l_C$ ), it is sufficient to note that this type of configuration may be represented by insuring that the sum of

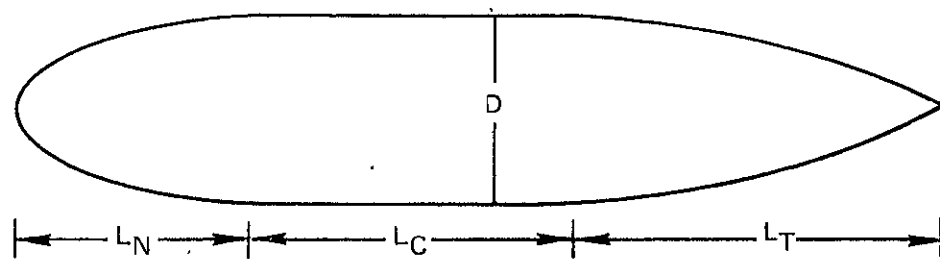

DIMENSIONS

$$L_N = (L/D)_N D$$

$$L_T = (L/D)_T D$$

$$L_C = (L/D)_{OA} D - L_N - L_T$$

$$L_{OA} = (L/D)_{OA} D$$

$$D = \sqrt[3]{\frac{V - \Delta V}{\pi \left[ \frac{(L/D)_{OA}}{4} - \frac{(L/D)_N}{12} - \frac{7(L/D)_T}{60} \right] \left[ 1 + \frac{\Delta V}{V} \right]}}$$

(SEE BELOW)

4-3

VOLUME

$$V = \pi D^3 \left[ \frac{(L/D)_{OA}}{4} - \frac{(L/D)_N}{12} - \frac{7(L/D)_T}{60} \right] \left[ 1 + \frac{\Delta V}{V} \right] + \Delta V$$

$$C_V = \frac{4V}{\pi D^2 L_{OA}}$$

(PRISMATIC COEFFICIENT)

SURFACE (WETTED) AREA

$$S_{WET} = D \left[ 2.40 L_N + 3.14 L_C + 2.07 L_T + .46D \right] \left[ 1 + \frac{\Delta S_{WET}}{S_{WET}} \right] + \Delta S_{WET}$$

Figure 4-1. Conventional Airship Hull – Volume and Surface Area Relationships Summary

THIS HULL ASSUMES:

- 1) DELTA PLANFORM (MODIFIED)
- 2)  $\zeta$  CHORDWISE SECTION REPRESENTATIVE OF NACA 4-DIGIT A/FOIL
- 3) SPANWISE CROSS-SECTION CONSISTS OF ELLIPSES OF VARYING ECCENTRICITY

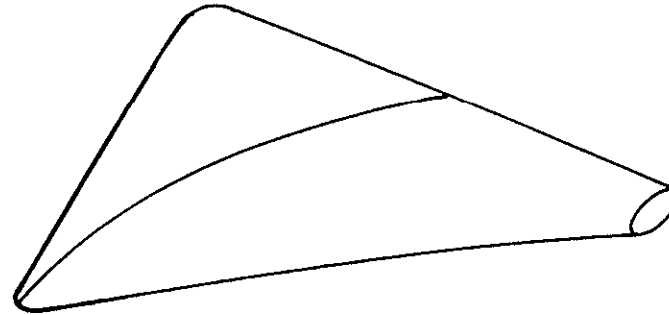

**DIMENSIONS**

$$C_{RT} = \frac{2S_W}{b_S(\lambda + 1)} \quad \left\{ \begin{array}{l} b_S = \text{SPAN} \\ \lambda = C_{TIP}/C_{RT} \\ AR = b_S^2/S_W \end{array} \right. \quad S_W = \left[ \frac{(V - \Delta V) AR^{1/2} (1 + \lambda)^2}{10\pi (t/c)_R (k_1 + k_2) \left[ 1 + \frac{\Delta V}{V} \right]} \right]^{2/3}$$

**VOLUME**

$$V = \frac{10\pi (t/c)_R S_W}{AR^{1/2} (1 + \lambda)^2}^{3/2} \left[ k_1 + k_2 \right] \left( 1 + \frac{\Delta V}{V} \right) + \Delta V$$

**SURFACE (WETTED AREA)**

$$S_{WET} = k_6 \left\{ C_{RT}^3 \frac{(t/c)_R^2}{b_S} k_3 + C_{RT} \frac{3b_S \lambda}{2} + C_{RT} \frac{3b_S}{4} (1 - \lambda) + C_{RT} \frac{(t/c)_R^2}{b_S} (k_4 - k_5) \right\} \left( 1 + \frac{\Delta S_W}{S_W} \right) + \Delta S_W$$

Figure 4-2. Lifting Body Hull - Volume and Surface Area Relationships Summary

TABLE 4-1

COEFFICIENTS USED IN CONJUNCTION WITH THE LIFTING BODY  
HULL TYPE (HULIND = 2) ILLUSTRATED IN FIG. 4-2

$$\begin{aligned}
 k_1 &= 0.13493 - .07917(1-\lambda)^{3/2} + 0.021(1-\lambda)^2 \\
 k_2 &= 0.06642 + 0.0293(1-\lambda)^3 - 0.01422(1-\lambda)^4 + 0.003383(1-\lambda)^5 \\
 k_3 &= 4.4075(1-\lambda)^2 - 2.494(1-\lambda)^{5/2} - 4.1755(1-\lambda)^{7/2} + 2.4115(1-\lambda)^{9/2} - 0.6695(1-\lambda)^{11/2} \\
 &+ 0.3269(1-\lambda)^3 + 1.4765(1-\lambda)^4 + 0.64975(1-\lambda)^5 - 1.7434(1-\lambda)^6 \\
 &+ 1.25835(1-\lambda)^7 - 0.41225(1-\lambda)^8 + 0.06439(1-\lambda)^9 \\
 k_4 &= 5.4915 \\
 k_5 &= 7.4225(1-\lambda)^2 - 1.4965(1-\lambda)^{5/2} - 2.9825(1-\lambda)^{7/2} + 1.87575(1-\lambda)^{9/2} - 0.5479(1-\lambda)^{11/2} \\
 &+ 0.2646(1-\lambda)^3 + 1.10755(1-\lambda)^4 + 0.51975(1-\lambda)^5 - 1.453(1-\lambda)^6 \\
 &+ 1.08715(1-\lambda)^7 - 0.3607(1-\lambda)^8 + 0.0572(1-\lambda)^9 \\
 k_6 &= 1.44513
 \end{aligned}$$

THIS HULL ASSUMES:

- 1) ELLIPTICAL PLANFORM
- 2) SPANWISE AND CHORDWISE CROSS-SECTIONS CONSIST OF ELLIPSES OF DIFFERENT ECCENTRICITY

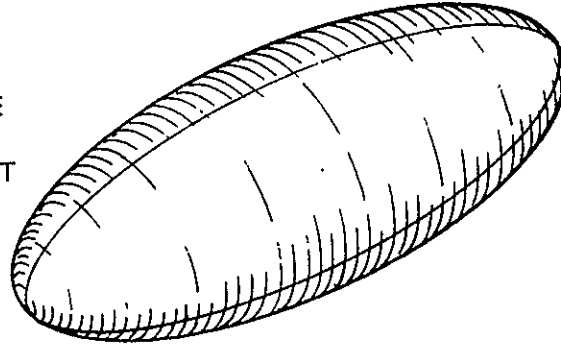

DIMENSIONS

$$C_{RT} = 2 \left[ \frac{3(V - \Delta V)}{\pi^2 AR(t/c)_R \left[ 1 + \frac{\Delta V}{V} \right]} \right]^{1/3}$$

$$b_S = \frac{\pi AR}{4} C_{RT}$$

$$T_{MAX} = (t/c)_R C_{RT}$$

$$S_W = \frac{\pi}{4} C_{RT} b_S$$

VOLUME

$$V = \frac{\pi}{6} C_{RT} b_S T_{MAX} \left( 1 + \frac{\Delta V}{V} \right) + \Delta V$$

SURFACE (WETTED) AREA

$$S_{WET} = \frac{\pi C_{RT} b_S}{2} E \left[ 1 + \frac{\Delta S_{WET}}{S_{WET}} \right] + \Delta S_{WET}$$

$$E = 1.570796 - .44062m + .162986m^2 - .29316m^3$$

$$m = 1 - \left( \frac{T_{MAX}}{b_S} \right)^2$$

Figure 4-3. Helioid Lifting-Body Hull Volume and Surface Area Relationships Summary.

THIS HULL ASSUMES:

- 1) CIRCULAR PLANFORM
- 2) SPANWISE AND CHORDWISE CROSS-SECTIONS CONSIST OF ELLIPSES OF EQUAL ECCENTRICITY

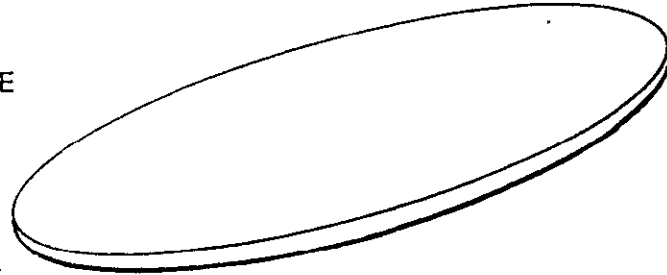

**DIMENSIONS**

$$C_{RT} = 2 \left[ \frac{3[V - \Delta V]}{4\pi(t/c)_R \left[1 + \frac{\Delta V}{V}\right]} \right]^{1/3}$$

$$b_S = C_{RT}$$

$$T_{MAX} = (t/c)_R C_{RT}$$

$$S_W = \frac{\pi}{4} C_{RT}^2$$

$$AR = 1.273$$

**VOLUME**

$$V = \frac{\pi}{3} C_{RT}^2 T_{MAX} \left[ 1 + \frac{\Delta V}{V} \right] + \Delta V$$

**SURFACE (WETTED) AREA**

$$S_{WET} = \left[ \frac{\pi C_{RT}^2}{2} + \frac{\pi T_{MAX}^2}{4 \epsilon} \log_e \left( \frac{1 + \epsilon}{1 - \epsilon} \right) \right] \left[ 1 + \frac{\Delta S_{WET}}{S_{WET}} \right] + \Delta S_{WET}$$

$$\left[ 1 - (t/c)_R^2 \right]^{1/2}$$

4-7

Figure 4-4. Disc-Shaped Lifting-Body Hull – Volume and Surface Area Relationships Summary

$(L/D)_N$  and  $(L/D)_T$  is equal to  $(L/D)_{OA}$ .

Lifting body hulls of the type represented in Figure 4-2 (HULIND = 2) are not necessarily limited to the configuration pictured. If taper ratio ( $\lambda$ ) is equal to 1:0, a rectangular planform hull results. If taper ratio ( $\lambda$ ) is equal to 0.0, a delta planform with sharp pointed wing tips results.

It should be noted that for all hull types it is possible to adjust hull volume and wetted areas to account for hull cross-sections other than those reflected by the hull configuration equations by use of the factors  $\Delta V$ ,  $\Delta V/V$ ,  $\Delta S_{wet}$ , and  $\Delta S_{wet}/S_{wet}$ .

For the airship configuration where a conventional type hull is used in conjunction with a wing (HULIND = 1, DYLLIND = 2 or 4), wing area is calculated from the input wing loading (based on the dynamic lift requirement) and at the design cruise flight requirements (LOCS 0104, 0105, and 0106) used for engine sizing. The relationship used is:

$$S_w = \frac{(1 - LR/L_A)(1 - LB/W_0) W_0}{W/S}$$

Where:

$LR/L_A$  = Design rotor lift/dynamic lift ratio  
(applicable if DYLLIND = 4)

$LB/W_0$  = Buoyancy Ratio

$W_0$  = Gross Weight

$W/S$  = Wing Loading

Note that the wing area defined includes the center section within the hull.

As stated previously, propellers and/or rotors may be either fixed in size (RDMIND = 1) or sized (RDMIND = 2). In the case of the latter situation, the rotor or propeller is sized based on the following equations:

$$L_{RH} = W_0 [1 - (1 - (LB/W_0))]$$

$$D_{MR} = \sqrt{\frac{4L_{RH}}{\pi(W/A) N_R}}$$

$$\sigma_{MR} = \frac{4L_{RH} (T/W)}{\rho \pi D_{MR}^2 N_R V_T^2 (C_T/\sigma)_H}$$

Where:

$N_R$  = No. of rotors or propellers

$V_T$  = Rotor or propeller tip speed (ft/sec)

$(C_T/\sigma)_H$  = Design rotor lift coefficient

$(T/W)$  = Design thrust/weight ratio

The ambient conditions are specified by LOCS 0086 and 0087.

Figure 4-5 illustrates the relationships used for sizing airship empennage. Typical tail volumes are obtained from a trend such as is illustrated in Figure 4-6. Note that all fin dimensions, areas, etc. are based on the portion exposed to the freestream (see Figure 2-1 in Section 2.0).

#### 4.4 ENGINE SIZING SUBROUTINE

Engines selected for airship configurations being studied in the program may be either "fixed" in size or "rubberized." If the engines are "rubberized," the engine sizing subroutine calculates the maximum power of the engines required to satisfy the design cruise flight conditions. If the engines are fixed in size, the user inputs the level of maximum power for the engines and the engine sizing subroutine is bypassed. If FIXIND=0, the engines are fixed in size. If FIXIND=1, the engine sizing subroutine is used to calculate the size of the "rubberized" engines.

If FIXIND = 1, the design sizing conditions are dictated by LOCS 0104, 0105, 0106. The relationship for engine sizing is given by:

$$BHP_P^* = \frac{T V_{CR}}{325.8 n_P n_T \left( \frac{BHP}{BHP^* \delta \sqrt{\theta}} \right) \delta \sqrt{\theta}}$$



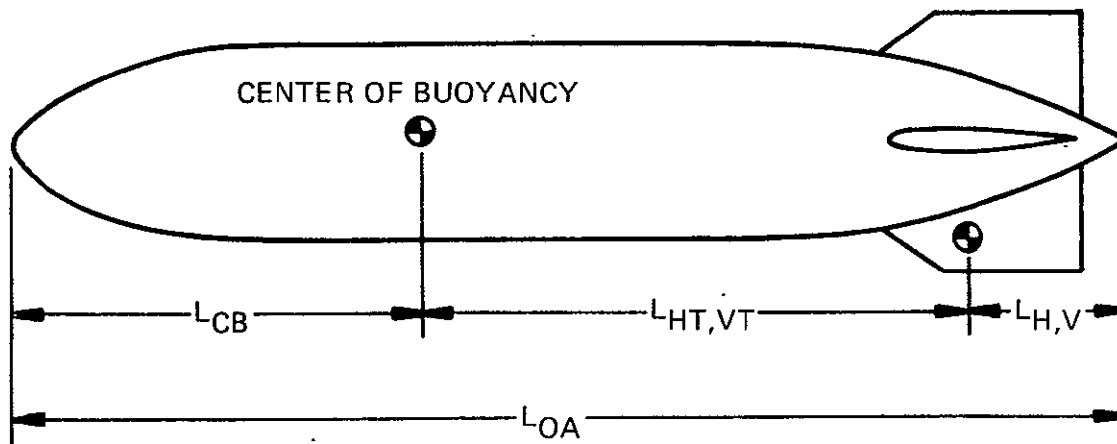

$$L_{HT,VT} = \left[ 1 - \left( \frac{L_{CB}}{L_{OA}} + \frac{L_{H,V}}{L_{OA}} \right) \right] L_{OA}$$

$$S_{HT} = \frac{\bar{V}_H V_{HULL}}{L_{HT}}$$

$$S_{VT} = \frac{\bar{V}_V V_{HULL}}{L_{VT}}$$

NOTE:

- 1)  $S_{HT}$  IS THE TOTAL AREA OF 2 HORIZONTAL FINS
- 2)  $S_{VT}$  IS THE TOTAL AREA OF 2 VERTICAL FINS
- 3)  $V_{HULL}$  IS THE TOTAL HULL VOLUME

Figure 4-5. Relationships for Sizing Airship Horizontal and Vertical Fins

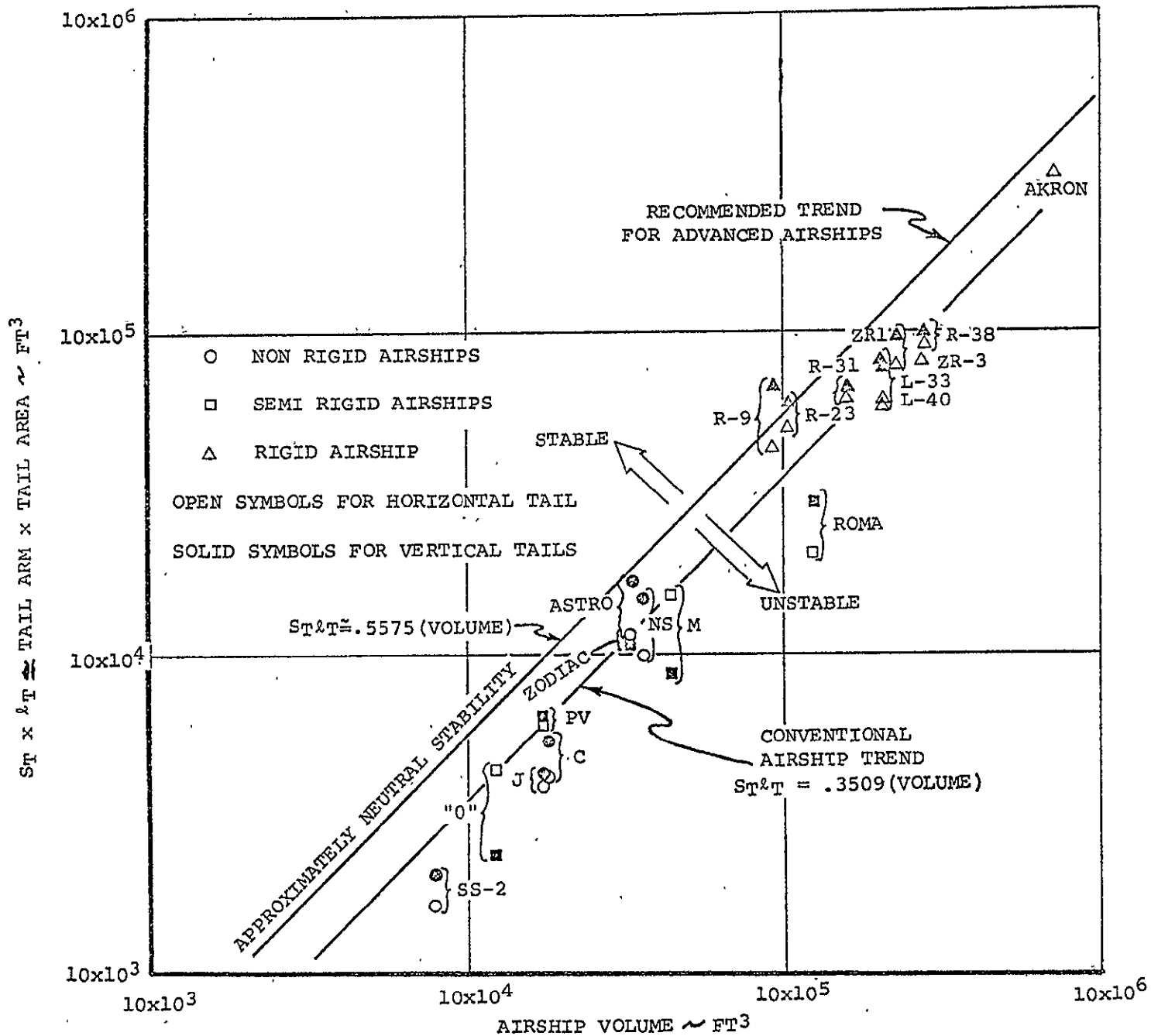

FIGURE 4-6 AIRSHIP STABILITY TRENDS.

Where:

T = Airship thrust required

V<sub>CR</sub> = Design cruise speed (kts)

$\eta_P$  = Propulsive efficiency

$\eta_T$  = Transmission efficiency

$\left(\frac{\text{BHP}}{\text{BHP} * \delta \sqrt{\theta}}\right)$  = Referred cruise power available at design altitude

$\delta$  = Atmospheric pressure ratio at design altitude

$\theta$  = Atmospheric temperature ratio at design altitude

It should be noted that in the case of a conventional hull airship combined with a wing, the drag for engine sizing is based on the premise that the hull is at a level attitude (and therefore contributing no dynamic lift) and the wing is at its design angle of attack ( $\alpha_{DES}$ ).

#### 4.5 AERODYNAMICS SUBROUTINE

This subroutine performs the parasite drag buildup and calculates other coefficients for use by the DRAG subroutine. The overall expression for parasite drag which obtains is:

$$F_e = F_{eHULL} + \Delta F_e + F_{eHT} + F_{eVT} + F_{eW}$$

Where:

$$F_{eHT} = K_{HT} C_{DHT} S_{HT} f_{HT} (Re)$$

$$F_{eVT} = K_{VT} C_{DVT} S_{VT} f_{VT} (Re)$$

$$F_{eW} = a_6 C_{DW1} S_W \text{ (obviously this expression is equal to 0 when HULIND = 1, DYLIND = 1 or 3)}$$

Further:

$$a_6 = K_W f_W (Re)$$

$$a_7 = \frac{1}{\pi A Re}$$

For a conventional hull. (HULIND = 1)

$$F_{eHULL} = .00287 K_{FSwetHULL} f_F (Re)$$

For a lifting body hull of the type indicated by  
HULIND = .3

$$F_{eHULL} = .00287 K_{FSwetHULL} f_F (Re)$$

$$F_{eW} = 0$$

For lifting body hulls of the type indicated by  
HULIND = 2 or 4.

$$F_{eHULL} = a_6 C_{DWI} S_W$$

$$F_{eW} = 0$$

The terms  $f_W(Re)$ ,  $f_F(Re)$ ,  $f_{VT}(Re)$ , etc., are Reynolds' number functions for the wing, hull, vertical tail, etc., which reflect the variation of skin friction coefficient with Reynolds' number. The function which is used is a normalized form of the Prandtl-Schlichting turbulent flat plate skin friction equation:

$$f(Re) = \frac{C_f}{C_{fRe=10^7}} = [1 + \frac{1}{7} \log_{10} \frac{Re}{10^7}]^{-2.6}$$

The program user inputs a value for average Reynolds number per foot for the mission and the program then calculates the Reynolds' number for each component of the aircraft and uses the Reynolds' number functions  $f_W(Re)$ ,  $f_F(Re)$ , etc., to determine the variation in component drag as the aircraft dimensions change during the iteration on gross weight. The individual profile drag coefficients,  $C_{DVT}$ ,  $C_{DHT}$ , etc., are input at a Reference Reynolds' number of  $10^7$ .

The user inputs values for the profile drag coefficients ( $C_{DVTi}$ ,  $C_{DWi}$ , etc.), for the interference factors ( $K_F$ ,  $K_W$ , etc.), for the mean Reynolds' number per foot, ( $Re/\bar{q}$ ), and for the efficiency factor,  $e$  (the program will calculate  $e$  if OSWIND is input as unity). The program then calculates the values for  $a_6$  and  $a_7$  for use in the drag calculations subroutine.

#### 4.6 LIFT SUBROUTINE

The lift subroutine calculates the buoyant and dynamic lift of the airship during the mission performance calculations. Buoyant lift is defined by the following relationship:

$$L_B = \left[ \frac{.076474(t/T - 1)}{(.076474 - LGSPWT_0)} + 1 \right] \left( \frac{L_B}{W_0} \right) W_0$$

Where:

$t/T$  = Superheat ratio (ratio of lifting gas temperature to ambient atmospheric temperature)

$LGSPWT_0$  = Lifting gas specific weight (SL, STD) - lb/ft<sup>3</sup>

$L_B/W_0$  = Buoyancy ratio

$W_0$  = Gross weight

This relationship is based on the following assumptions:

- 1) The airship is operating at or below the maximum design altitude
- 2) Until application of superheat, the outside air and lifting gas are at equal temperatures and pressures.
- 3) Application of superheat results in a change of lifting gas density.

Note that the option available to the user, namely; that of being able to specify  $t/T$  in the various performance segments, allows the study of various schemes for modifying buoyant lift by modifying the lifting gas temperature.

The conventional hull and/or lifting body hull dynamic lift is related to hull angle of attack by the following relationship:

$$C_L = \left( \frac{dC_L}{d\alpha} \right) \alpha_{RAD} + C_{DC} \alpha_{RAD} \left| \alpha_{RAD} \right|$$

Where:

$\frac{dC_L}{d\alpha}$  = Lift curve slope of conventional and/or lifting body hull (RAD<sup>-1</sup>)

$\alpha_{RAD}$  = Hull angle of attack (radians)

$C_{DC}$  = Hull cross flow drag coefficient

Figure 4-7 and Table 4-2 illustrate typical values of and procedures for obtaining  $dC_L/d\alpha$  and  $C_{DC}$  for conventional hulls. Figure 4-8 and Figure 4-9 show typical values of  $dC_L/d\alpha$  and  $C_{DC}$  for lifting body hulls.

For the conventional hull, the hull lift is defined by:

$$L_{HULL} = q D_H L_{OA} C_L$$

For a conventional hull and wing combination, the total lift is defined by:

$$L_{Hull} + Wing = q \left[ D_H L_{OA} C_L + 6.28 S_W (\alpha_{RAD} + \alpha_{Des}) \right]$$

Where:

$D_H$  = Hull diameter (ft)

$L_{OA}$  = Overall length of hull

$S_W$  = Wing planform area

$\alpha_{DES}$  = Wing design angle of attack (Rad.)

For a lifting body hull, the lift is defined by:

$$L_{HULL} = q S_W C_L$$

Thus for a given dynamic lift requirement, this subroutine determines the required hull angle of attack for use in calculating the induced drag of the configuration.

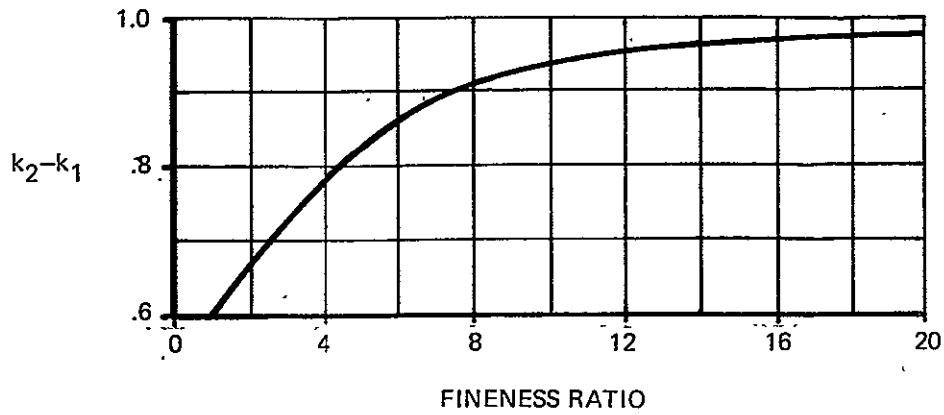

Figure 4-7a. Typical Data Required for Determining Conventional Hull Lift and Drag Characteristics

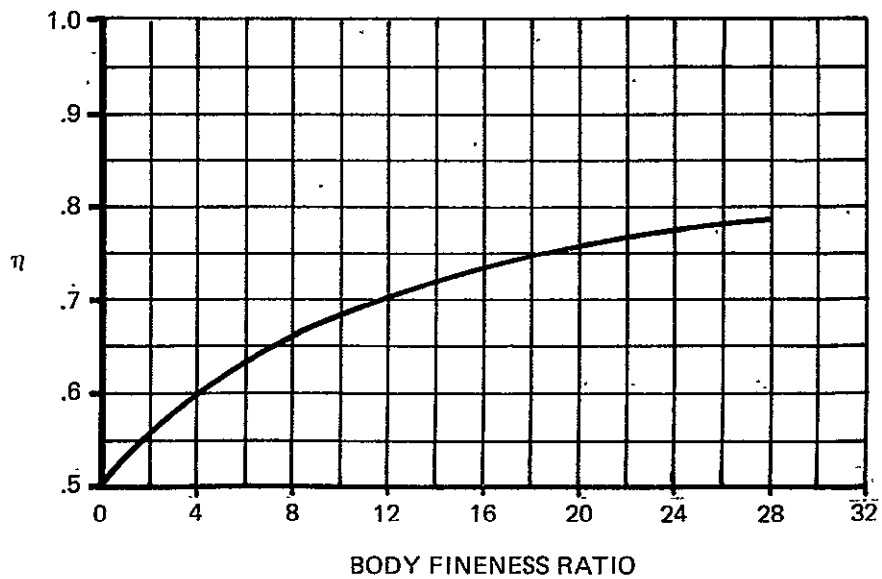

Figure 4-7b. Ratio of the Drag Coefficient of a Circular Cylinder of Finite Length to That of a Cylinder of Infinite Length

TABLE 4-2

RELATIONSHIPS REQUIRED  
FOR  
DETERMINATION OF CONVENTIONAL  
HULL LIFT & DRAG CHARACTERISTICS

1 general:

$$C_L = \left( \frac{dC_L}{d\alpha} \right) \alpha + C_{DC} \alpha^2$$

where:

$$\left( \frac{dC_L}{d\alpha} \right) = \frac{2(k_2 - k_1)S_O}{S_{PLAN}}$$

$$C_{DC} = \frac{2}{S_{PLAN}} \int_{X_O}^{L_{OA}} \pi r C_{dc} dx$$

For the case of a hull with a circular cross-section:

$$S_O = \frac{\pi D_H^2}{4}$$

$$S_{PLAN} = L_{OA} D_H$$

$$C_{dc} = 1.2$$

$$X_O = 0.5 L_{OA}$$

$$r = D_H/2 \text{ (CONSTANT WITH X)}$$

This reduces to:

$$\left( \frac{dC_L}{d\alpha} \right) = \frac{(k_2 - k_1)\pi}{2(L/D)_{OA}}, \quad C_{DC} = 0.6\eta$$

where  $(k_2 - k_1)$ ,  $\eta$  are  $f(L/D)_{OA}$  (See Fig. 4-7)



LIFT CURVE SLOPE vs ASPECT RATIO FOR RECTANGULAR WINGS

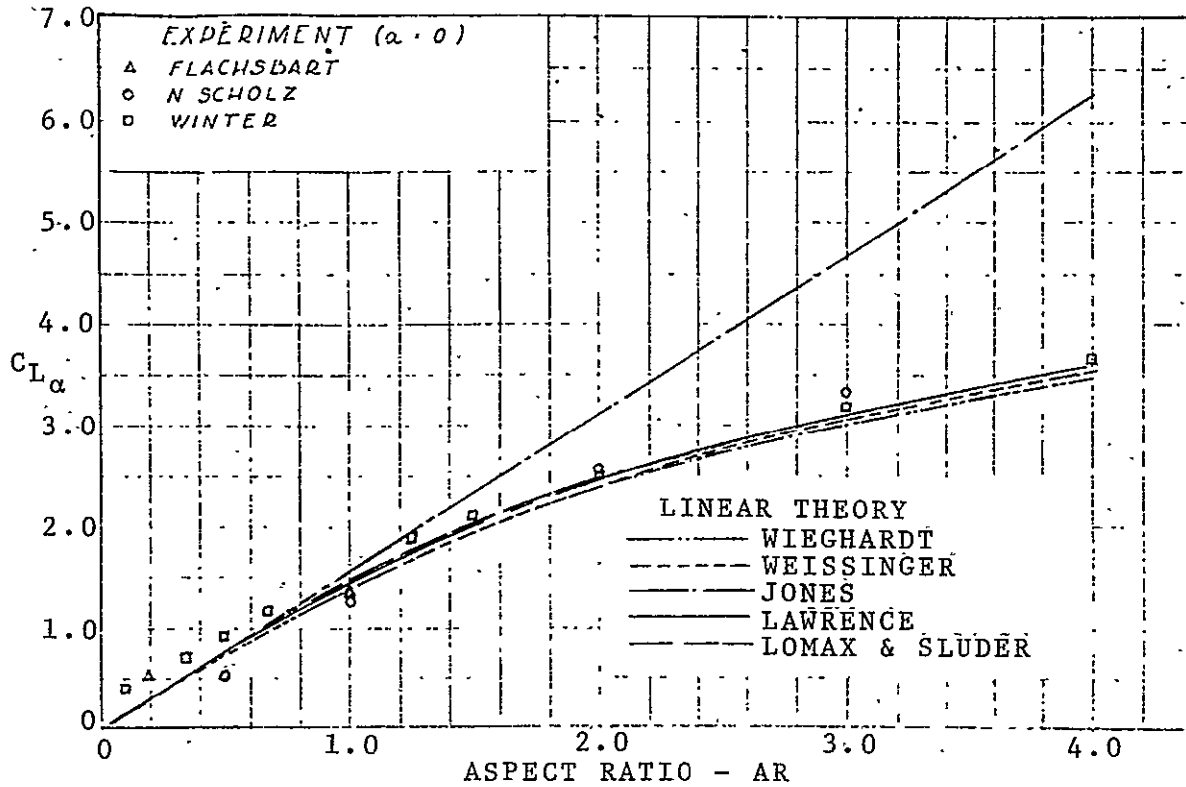

FIGURE 4-8a

LIFT CURVE SLOPE vs ASPECT RATIO FOR DELTA WINGS

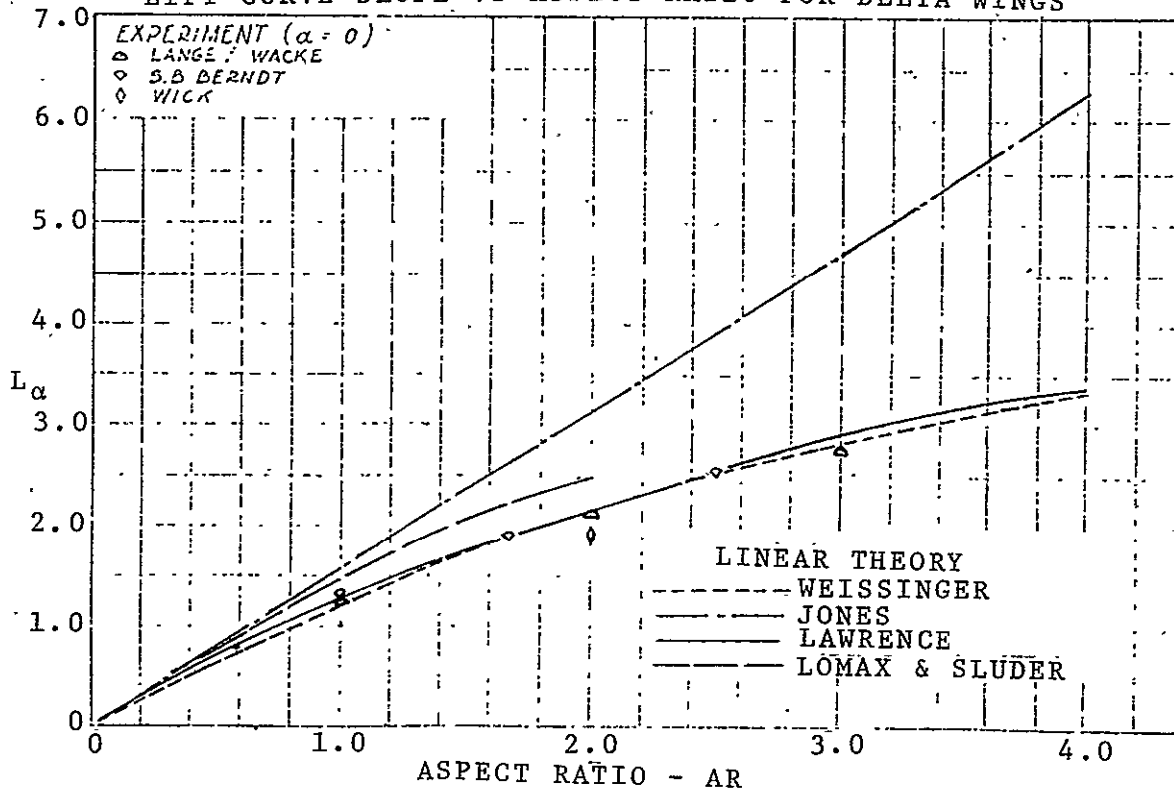

FIGURE 4-8b

FIGURE 4-8. TYPICAL LIFT CURVE SLOPE ( $dC_L/d\alpha$ ) DATA FOR LIFTING BODY HULLS.

COMPARISON OF THEORETICAL & EXPERIMENTAL LIFT OF  
RECTANGULAR AIRFOIL WITH ROUND & SHARP SIDE EDGES

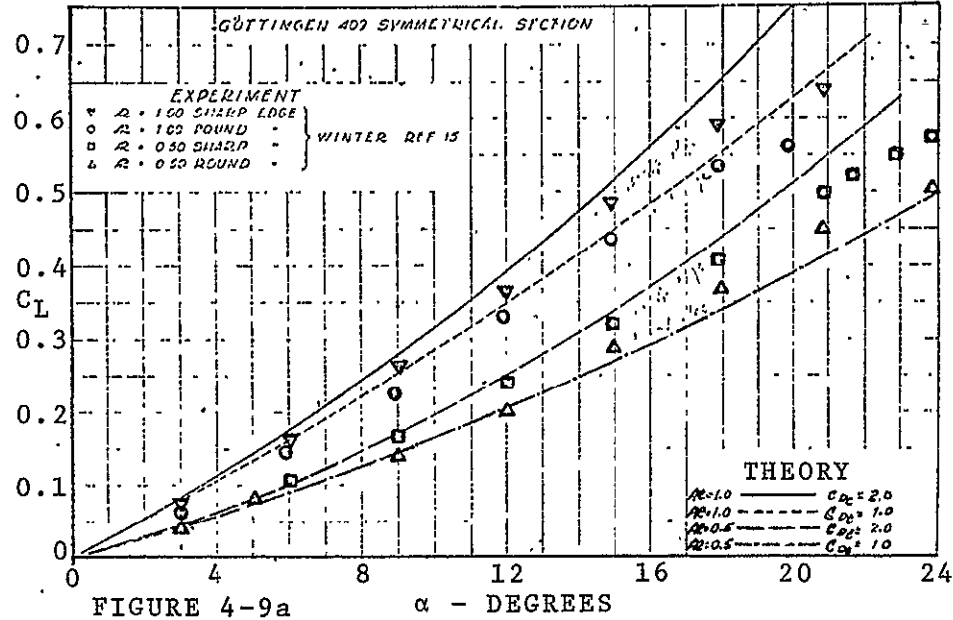

FIGURE 4-9a

4-19

COMPARISON OF THEORETICAL & EXPERIMENTAL LIFT  
FOR BLUNT AIRFOIL DELTA WINGS

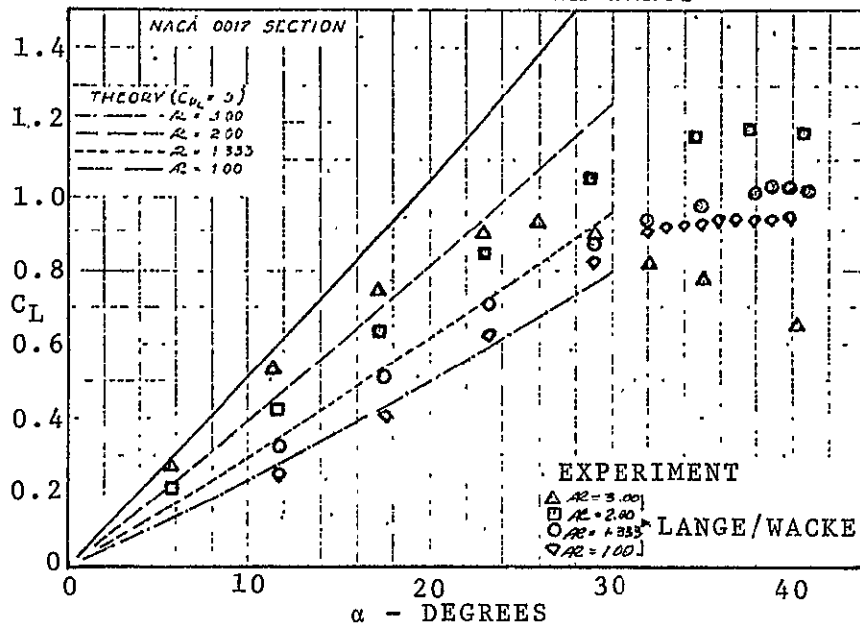

FIGURE 4-9c

COMPARISON OF THEORETICAL & EXPERIMENTAL LIFT  
FOR AIRFOIL DELTA WINGS WITH ROUNDED EDGES

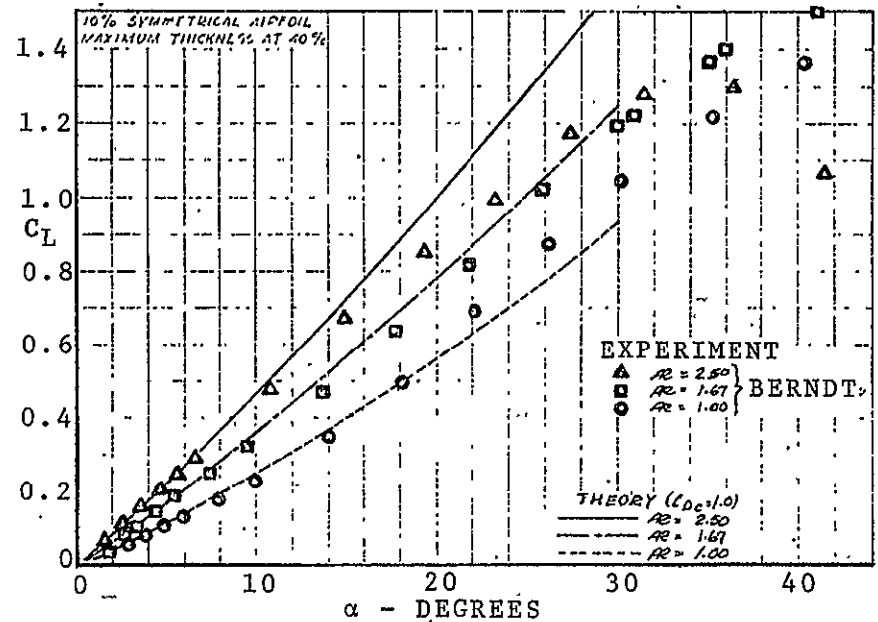

FIGURE 4-9. CORRELATION OF THEORETICAL & EXPERIMENTAL LIFT USING VARIOUS VALUES OF CROSS-FLOW DRAG COEFFICIENT ( $C_{Dc}$ ).

#### 4.7 DRAG SUBROUTINE

The drag subroutine calculates the total airship drag during the mission performance calculations. This includes parasite, profile and induced drag.

The conventional hull and/or lifting body induced drag is given by:

$$C_{Di} = \left( \frac{dC_L}{d\bar{\alpha}} \right) \bar{\alpha}_{RAD}^2 + C_{DC} \bar{\alpha}_{RAD}^2 \left| \bar{\alpha}_{RAD} \right|$$

Where  $\bar{\alpha}_{RAD}$  was determined by the LIFT subroutine and  $(dC_L/d\bar{\alpha})$  and  $C_{DC}$  are input values as defined in Section 4.6.

The conventional hull airship total drag is given by:

$$D = qF_e + qD_{H^{LOA}} C_{Di}$$

For a conventional hull plus wing this becomes:

$$D = qF_e + qD_{H^{LOA}} C_{Di} + qC_{DWI} S_w a_6 + qC_{LW}^2 S_w a_7$$

Where:

$F_e$  = Parasite drag area of hull + empennage

$C_{DWI}$  = Wing profile drag coefficient

$C_{LW}$  = Wing lift coefficient

$a_6, a_7$  = Coefficients calculated in AERO subroutine

For lifting body hulls defined by HULIND = 2 or 4.

$$D = qF_e + qC_{DWS} S_w a_6 + qS_w C_{Di}$$

Where:

$F_e$  = Parasite drag area of empennage

$S_w$  = Hull planform area

For lifting body hulls defined by HULIND = 3.

$$D = qF_e + qS_w C_{Di}$$

Where:

$F_e$  = Parasite drag area of hull + empennage.

#### 4.8 ROTOR PERFORMANCE SUBROUTINE

This subroutine calculates the rotor power required for airship configurations using helicopter "type" rotors for providing all or part of the dynamic lift and all of the propulsive thrust. It employs a Boeing developed method known as the "short form" aero methodology which allows the user to calculate rotor performance for a wide range of rotors with a minimum amount of input.

The short form aero methodology, developed at Boeing (References 2, 3 and 4) combines momentum theory and empirical corrections through coefficients found in the rotor cycles. The data used in this approach has been derived and correlated for rotors operating within the following parametric ranges:

Blade Number	=	2 - 6
Blade Twist	=	0 - -15°
Blade Root Cutout	=	0.20R
Rotor Solidity	=	0.055 - 0.150
Rotor Advance Ratio ( $\mu$ )	=	0 - 0.4

No appreciable loss in accuracy is likely for cases involving more than six blades, less than 20 percent root cutout or a solidity lower than 0.055. The level of confidence will be reduced, however, for those cases in which the rotor parameters greatly exceed the ranges shown above. Figure 4-10 illustrates a typical comparison of short form aero predicted performance and flight test data.

The quantity ALPHA D/L printed out in all forward flight performance segments reflects the propulsive thrust-lift vector of the main rotor. The simple sketch below illustrates the sign convention employed.

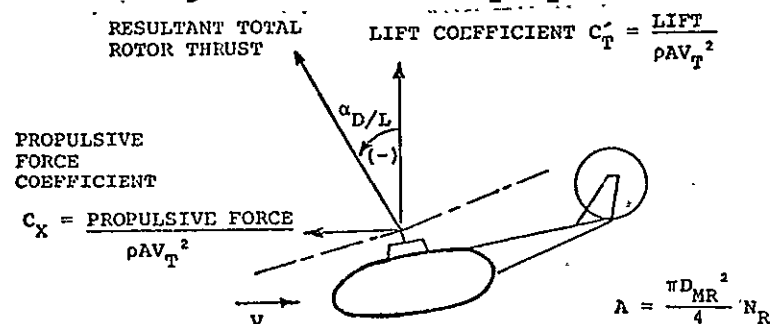

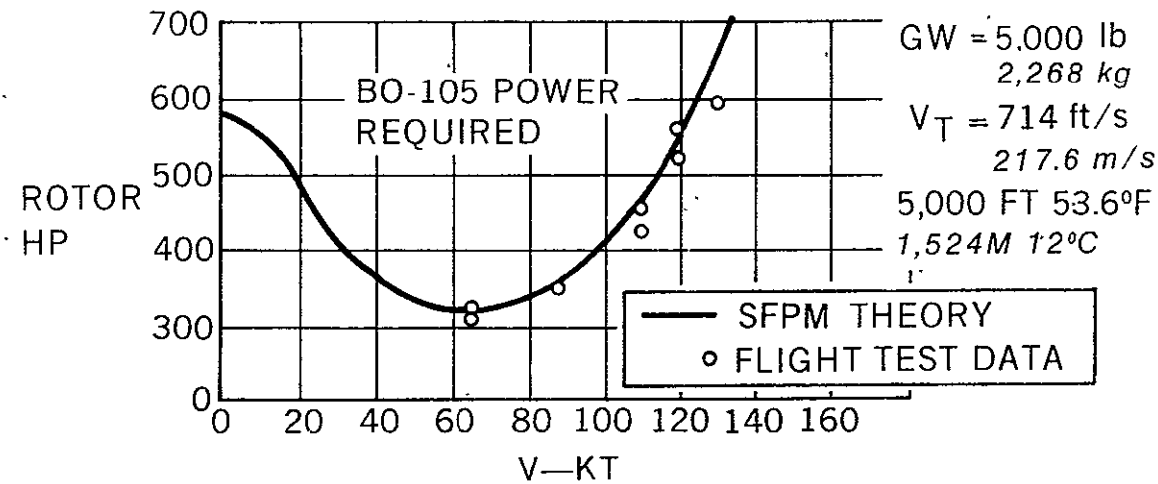
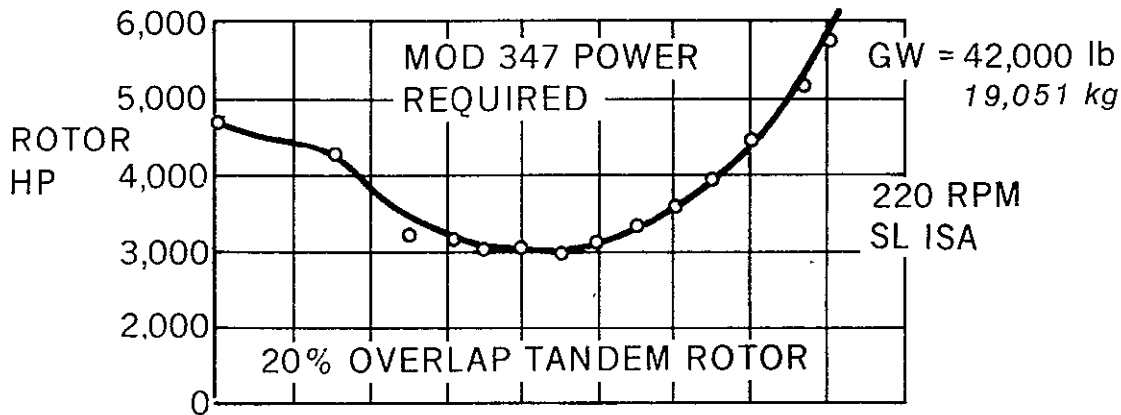
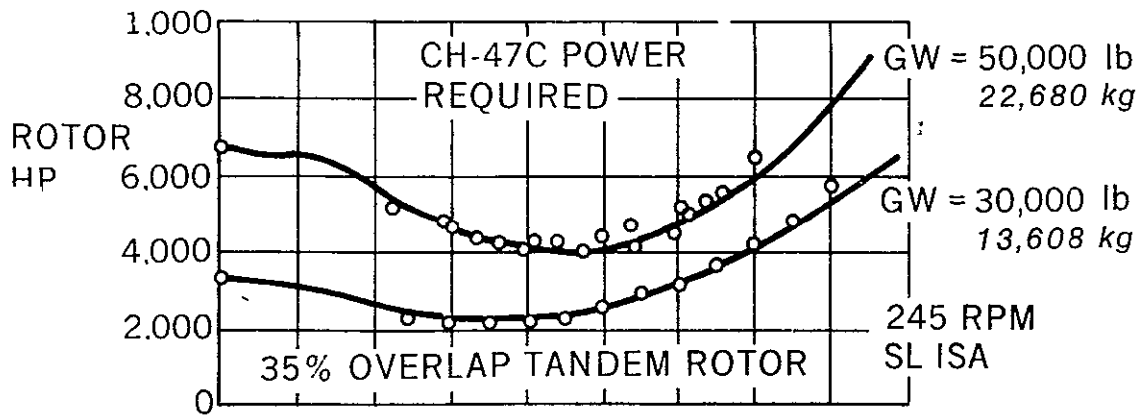

CONVERSION FACTOR: 1 kt = 0.514 m/s

Figure 4-10. Comparison of "Short Form Aero" Rotor Performance and Flight Test Data

#### 4.9 PROPELLER PERFORMANCE SUBROUTINE(S)

Two options are available for representing the performance of propellers when using shaft power producing engines. The option to be used is specified to the program by means of a prop efficiency indicator "ETAIND"

ETAIND = 0 - The user inputs a set of point values for the prop efficiency for takeoff and a table of efficiency as a function of flight speed for cruise. The following input is required:

$\eta_{P2}$  - The static propeller efficiency (Figure of Merit) to be used in calculation of takeoff, hover and landing (SGTIND=2) is input as a single point value.

$\eta_{P4}$  - A table is input of prop efficiency during cruise (SGTIND=4) as a function of flight speed.

The primary advantage of this option of propeller performance representation is that it permits rapid evaluation of the sensitivity of airship performance and size to changes in propeller performance. For example, a series of runs with different values of  $\eta_{P2}$  and  $\eta_{P4}$  will quickly show the tradeoff between Figure of Merit and cruise efficiency for a family of propellers. It may also prove desirable to use this option in early conceptual studies when a specific prop has not been picked and it is desired to use "reasonable" values of efficiency.

ETAIND = 1 - Through use of this option the program will automatically calculate the performance of a wide variety of V/STOL propellers. The user need only specify the number of blades (3 or 4), the activity factor per blade, and the integrated lift coefficient,  $C_{L_i}$ . The method used for the calculation of propeller performance is the "short method" originated at the Curtiss-Wright Corporation's Propeller Division (Reference 14). The method involves the use of a set of equations which can be developed from strip theory. These equations permit the propeller performance maps ( $C_p$ ,  $C_T$ ,  $J$ ) to be transformed into an "equivalent" lift-drag polar for the propeller. Conversely, the lift-drag polars, once developed, can be used with the equations to predict the propeller performance. For incompressible flow, the "equivalent" lift-drag polar which is used depends only on the value of  $C_{L_i}$  being considered. That is, for a given  $C_{L_i}$  the same polar can be used to accurately

represent the performance of props with a wide variation in activity factor and number of blades and for a wide range of  $C_p$  and  $J$ . For compressible flow conditions, the curves correlate very well on the basis of the value of helical Mach number at the  $3/4$  radial station. The equivalent lift-drag polars which are contained in the program were developed from detailed strip analysis calculations for cruise and from calculations using an explicit vortex-influence technique in hover. These detailed calculations covered the following range of parameters:

No. of blades: 3 and 4  
 Activity factor/blade: 60  $\rightarrow$  220  
 Integrated lift coefficient,  $C_{L_i}$ : 0.15  $\rightarrow$  0.7

Although the user is permitted to input values of activity factor and  $C_{L_i}$  greater than (or less than) those shown above, the level of confidence in the predictions is reduced when values for those parameters are outside the range used in the detailed calculations.

Figures 4-11 and 4-12 are characteristic of the level of accuracy obtained from the short method when compared to the detailed calculations.

This option will calculate the propeller performance for all mission performance segments.

Subroutine thrust calculates the propeller thrust available for known values of power and flight speed. Subroutine power calculates the power required for a specified thrust and flight speed. These subroutines make use of propeller equivalent lift-drag polars, as mentioned above, to calculate the performance of the propeller. The polars are developed in the main control loop for the particular value of integrated lift coefficient,  $C_{L_i}$ , being studied from the following equations:

$$\gamma = \tan^{-1} (C_D/C_L) = \text{function of } M_H, C_L, C_{L_i}$$

$M_H$  = helical Mach No. at  $3/4$  r/R

$C_L$  = equivalent lift coefficient at which prop is operating

$C_{L_i}$  = integrated lift coefficient of prop

FIGURE OF MERIT  
%

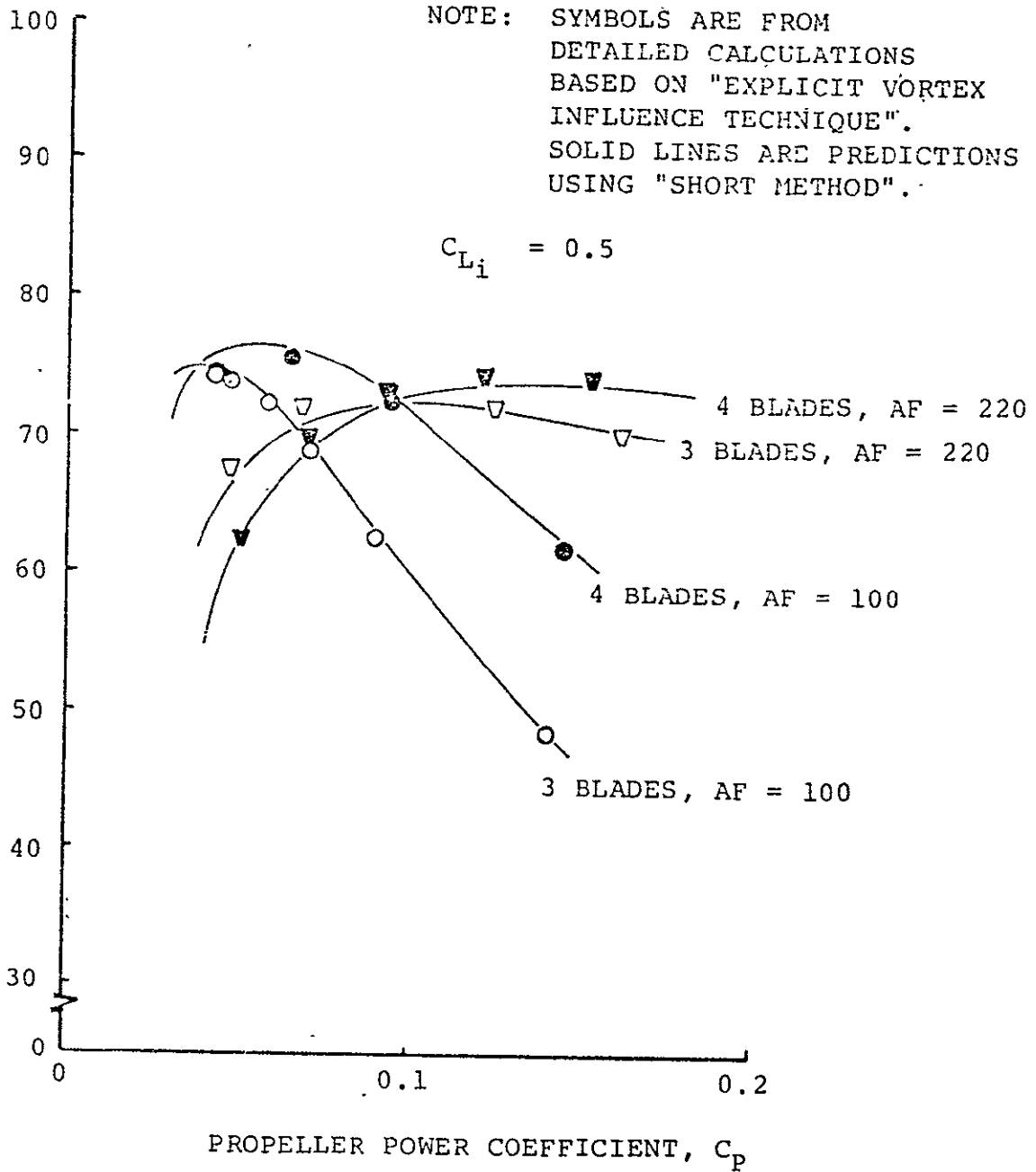

FIGURE 4-11. Comparison of "Short Method" and Detailed Calculation for Propeller Hover Efficiency.



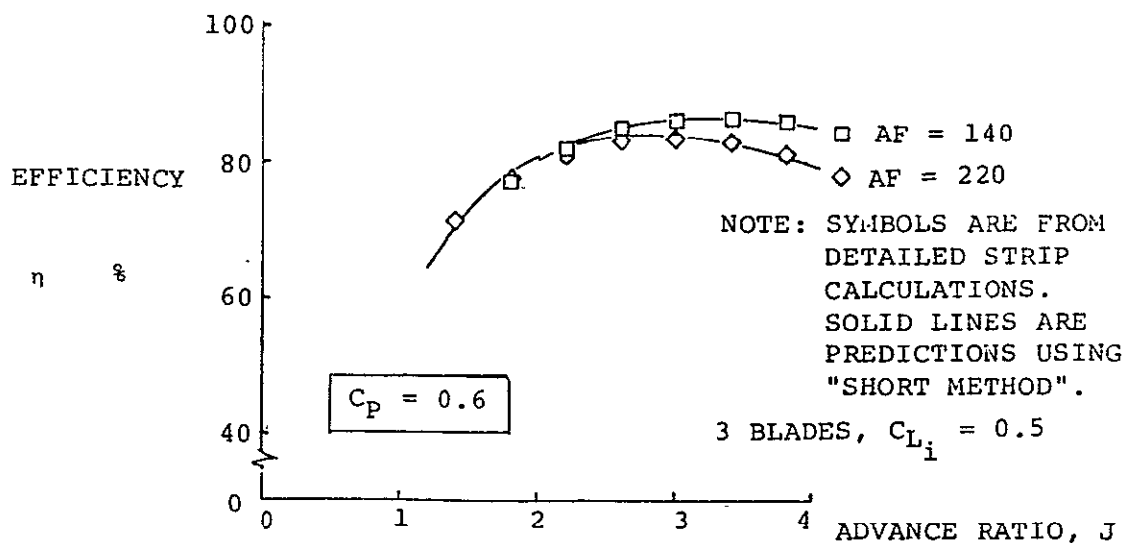
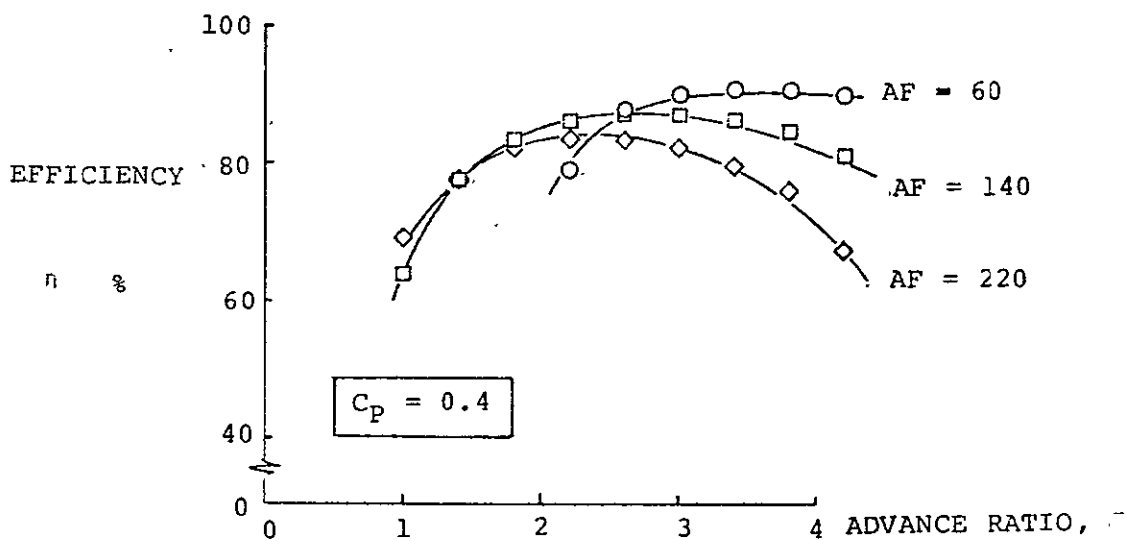
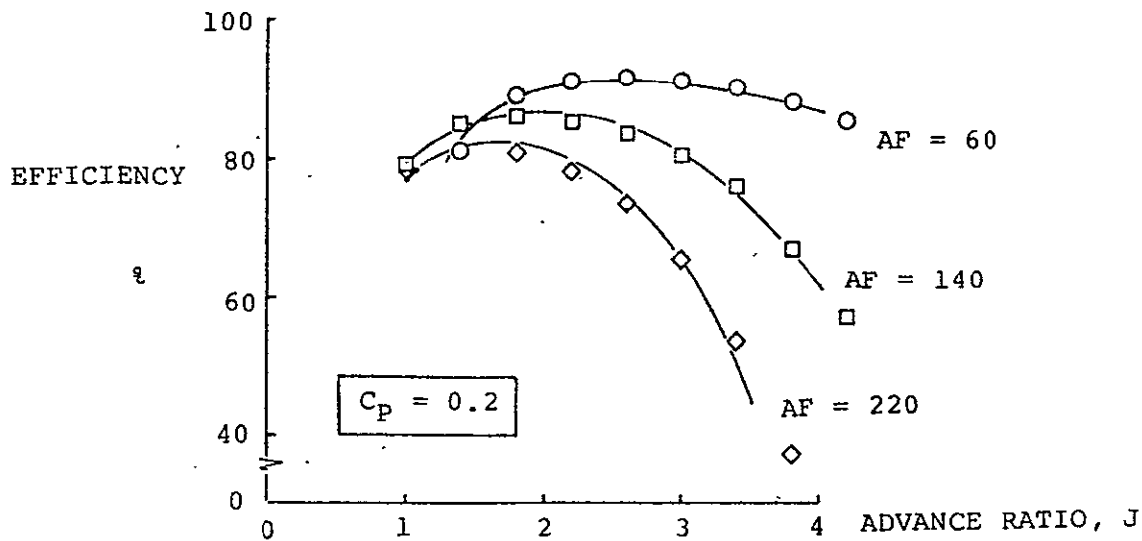

Figure 4-12 Comparison of "Short Method" and Detailed Calculations for Propeller Cruise Efficiency.

For cruise

$$\bar{\gamma} = a_0 + a_1 C_{Li} + a_2 C_{Li}^2$$

$a_0$ ,  $a_1$ , and  $a_2$  are coefficients stored in the program and are functions of  $M_H$  and  $C_L$

For hover:

$$\bar{\gamma} = b_0 + b_1 C_{Li} + b_2 C_{Li}^2$$

$b_0$ ,  $b_1$ , and  $b_2$  are coefficients stored in the program and are functions of  $C_L$ .

The coefficients  $a_0$ ,  $a_1$ ,  $a_2$ ,  $b_0$ ,  $b_1$ ,  $b_2$  are listed in Table 4-3.

TABLE 4-3

## COEFFICIENTS FOR PROPELLER EQUIVALENT POLARS

COEFFICIENTS FOR HOVER:

$C_L$	$b_1$	$b_2$	$b_3$
0	90	0	0
.15	2.68	-5.4836	13.5125
.2	1.9141	-2.9393	8.012
.3	1.513	-2.7523	5.8118
.4	1.5304	-3.0648	4.8132
.5	1.9611	-4.5374	5.3846
.6	2.7089	-6.8293	6.8072
.7	3.8237	-10.0965	9.3267
.8	5.051	-12.558	10.7333
.9	7.3796	-18.5171	15.8002
1.0	9.13	-19.35	15.5

COEFFICIENTS FOR CRUISE:

$C_L$	$M_H$	$a_0$	$a_1$	$a_2$	$M_H$	$a_0$	$a_1$	$a_2$	$M_H$	$a_0$	$a_1$	$a_2$
0	0.7	90.	0.	0.	0.8	90.	0	0	0.9	90.	0.	0.
.05		7.0392	1.9949	61.2416		10.2148	2.4433	86.4731		11.3227	40.9515	21.9481
.10		4.8350	-4.1639	19.2195		8.3106	-22.6338	56.0		11.3355	-14.062	62.0142
.15		3.2218	-1.7030	8.291		5.4623	-14.9997	35.3636		8.3676	-12.2425	36.0889
.20		2.7551	-2.5322	7.0366		4.0458	-9.9837	23.0606		6.5856	-9.574	25.9573
.3		2.481	-4.5422	7.3774		3.9439	-13.0524	22.0028		5.3862	-8.9808	18.6439
.4		2.4521	-5.4949	7.4251		3.6769	-11.7146	17.3803		5.2054	-9.3153	16.4063
.5		2.8149	-7.092	8.3401		3.8766	-12.0044	16.0882		6.1902	-14.7567	23.2672
.6		3.8725	-10.861	11.4678		4.5901	-13.8756	17.2451		8.153	-25.0375	39.117
.7		5.6653	-16.2691	15.8093		6.1044	-18.2607	21.8349		10.1745	-30.7342	51.0509
.8		8.5799	-24.8115	22.6773		8.9031	-26.0958	30.7056		13.0822	-33.2211	58.1494
.9		12.25	-33.6185	28.7271		12.2042	-29.4588	34.1515		16.5344	-34.9378	64.3529
1.0		17.0496	-43.061	33.8798		17.0398	-37.3809	43.697		20.8089	-40.6314	76.3927
1.1		21.8332	-47.8821	33.6322		22.784	-47.3791	55.5455		25.6453	-49.145	94.4326
1.2		31.7062	-49.6246	26.4923		28.7851	-57.8217	68.2121		33.5049	-77.6449	144.4176

ORIGINAL PAGE IS  
OF POOR QUALITY

4-28

#### 4.10 WEIGHT TRENDS SUBROUTINE

The weight trends subroutine calculates the group weights for the propulsion system, the structures system, and the flight control system. These weights are then combined with input values of the weight of fixed useful load, fixed equipment, and payload in order to determine the weight of fuel available (Figure 4-13). The subroutine uses detailed statistical weight equations as used at the Boeing Vertol Company. The group weights are not directly added, but rather are combined by the use of incremental multiplicative and additive weight factors; these factors are useful for sensitivity studies for the airship. For example, if it is desired to determine the effect of an additional 300 pounds of propulsion system weight, the factor  $\Delta W_p$  is input as 300. Similarly, if it is desired to investigate the effect of a 15-percent increase in the weight of the engines, the factor  $K_5$  is input as 1.15.

In order to calculate the weight of the airship structure, the weight trends subroutine must determine the limiting design load factor. It does this by comparing the magnitude of the input maneuver load factor with the value calculated for gust load factor.

A detailed explanation of the weight trend methodology as used in CASCOMP in this study is contained in Vol. I, Section 5.4.2.

#### 4.11 PERFORMANCE CALCULATIONS SUBPROGRAM

This subroutine monitors the flow during calculation of mission performance data and calculates the total fuel required at the end of the mission.

##### 4.11.1 Takeoff, Hover and Landing Calculations Subroutine

The takeoff, hover and landing calculations subroutine (specified by SGTIND = 2) will calculate the power required and corresponding fuel flow rates during simulated takeoff/hover/landing operations. Two options are available, specified by the input indicator TOLIND:

TOLIND = 1 - Input required thrust-weight ratio. Program will calculate required power fractions.

TOLIND = 2 - Input the required power fraction. Program will calculate thrust-weight ratio.

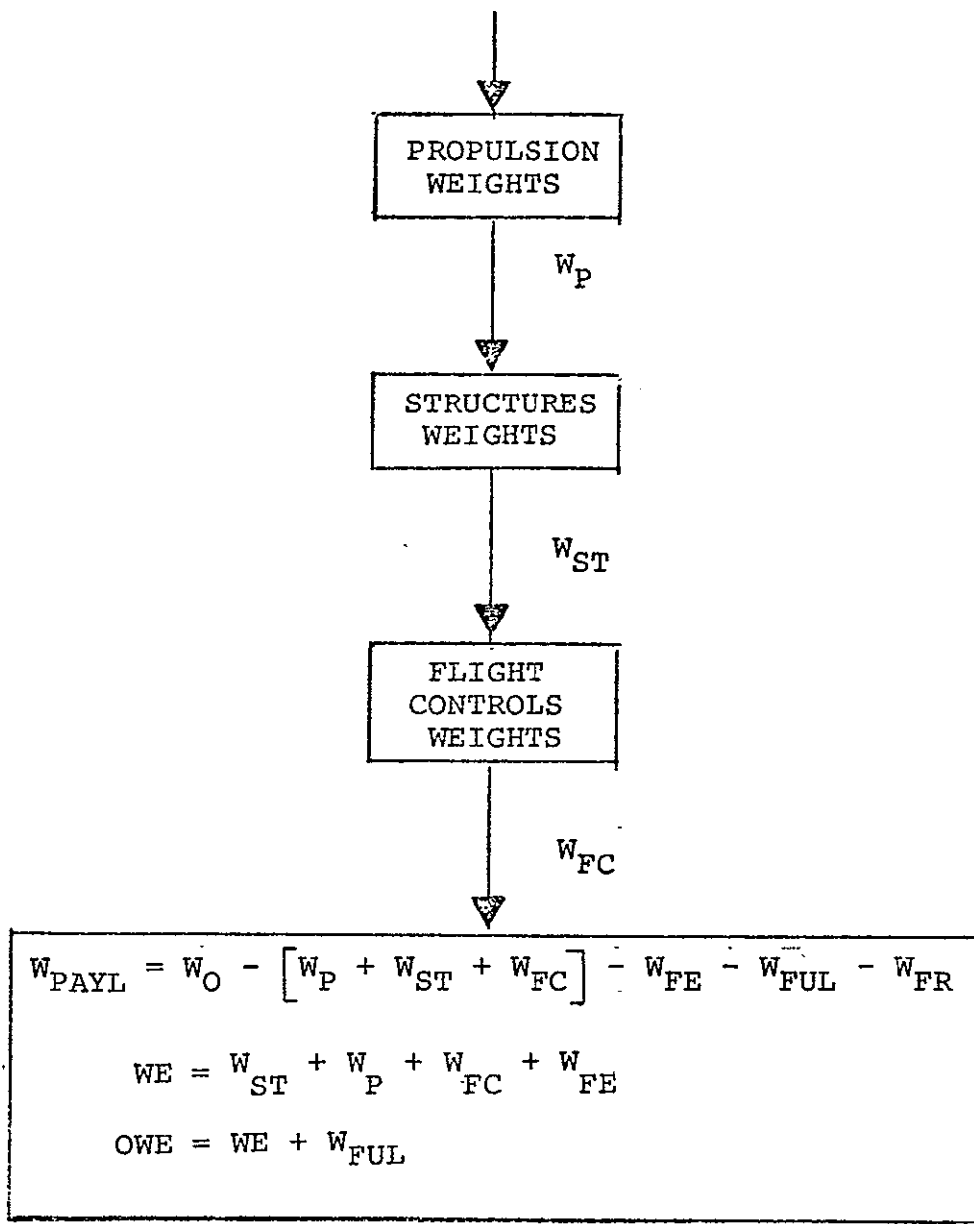

FIGURE 4-13. Weight Trends Subroutine.

In all cases, the program will print out the power fraction and thrust-weight ratio. The program will permit operation at power fractions greater than 1.0 (more than 100 percent of available power) in order to make it easier to perform studies in which engine power is being varied parametrically to satisfy specified takeoff or landing requirements as a site. The program will, however, print a cautionary note that power fraction exceeds 100 percent.

#### 4.11.2 Cruise Calculations Subroutine

This performance segment calculates airship cruise performance. Three separate options specifying the type of cruise desired for the airship are determined by an input cruise indicator, CRSIND.

- a. CRSIND = 1 - This is a calculation of airship cruise performance at a fixed cruise power setting and at a constant altitude, constrained by limiting airspeed. This option calculates the true airspeed, specific range, and reduction in gross weight during cruise.
- b. CRSIND = 2 - This option will calculate the cruise performance of the airship at constant airspeed, constant altitude, and constrained by cruise power and by limiting airspeed. The program will calculate the power setting required, true airspeed, specific range, and corresponding reduction in gross weight of the airship during cruise.
- c. CRSIND = 3 - This option calculates the airspeed during cruise required for best specific range, constrained by cruise power setting and by limiting airspeed. Flight is at constant altitude.

This subroutine permits simulation of cruise performance of an airship with an arbitrary number of engines shut down. The program user specifies the number of engines shut down and a corresponding increment in airship  $\Delta F_e$ .

The input for the cruise calculations subroutine consists of the value for CRSIND, the lifting gas superheat ratio, the increment in atmospheric temperature, the step size (incremental range), the final range for cruise, the increment in parasite drag area, number of engines shut down, and if CRSIND = 2, the cruise airspeed.

#### 4.11.3 Change of Weight Subroutine

This performance segment represents an incremental change in weight of payload. This option would be used to simulate loading or unloading of passengers or other payload. The input to the subroutine consists of the increment in weight and a corresponding increment in time.

#### 4.11.4 Transfer Altitude Subroutine

This performance segment provides a discontinuous change in altitude. The only required input is the altitude to which the airship is to be transferred.

## 5.0 PROGRAM INPUT

### 5.1 GENERAL

Input to the program is made by means of a standard set of input sheets. Although there are large quantities of possible input, necessitated by the requirement to keep the program flexible and general, the input sheets have been configured to give maximum visibility and reduce the tediousness of inputting the data. This has been accomplished through several means:

- a. All input of a similar nature has been grouped together. Thus, all dimensional information is on the same input sheet, regardless of whether it is used in the size trends subroutine or elsewhere.
- b. The input sheets have been color-coded to distinguish between the data required in the weighing and dimensioning option (OPTIND = 0) and the much smaller amount of data required for performance calculations (OPTIND = 2).
- c. Footnotes on the input sheets call attention to input which is not required due to selection of one of the optional paths of computation.
- d. For parametric studies where only one or two variables are being changed from case to case, a special supplementary input sheet may be used, thus reducing the quantity of paper work.

Altogether there are nine different input sheets which can be loosely grouped into five categories: general information, airship descriptive information, mission profile information, engine cycle information, and supplementary information. A specimen copy of each input sheet is included in this report on pages 5-5 to 5-19. Descriptions of input variables and indicators are given in sections 5.3.1 and 5.3.2. The use of the various input sheets is discussed below in 5.1.1 and 5.1.2.



### 5.1.1 General Information

Input all primary program indicators (except those for specific mission segments, such as CRSIND), mission initial conditions, reserve fuel factors, and maneuver load factor.

### 5.1.2 Airship Description Information

5.1.2.1 Dimensional Information - Input characteristic geometric information for airship being studied.

5.1.2.2 Propulsion Information - Input data for propulsive efficiencies, numbers of engines, propellers (and/or rotors), and critical engine sizing conditions.

5.1.2.3 Aerodynamics Information - Input airship hull and empennage drag characteristics - and in the case of the hybrid airships both lift and drag characteristics.

5.1.2.4 Weight Information - Input the factors and constants for weight trends calculations.

### 5.1.3 Mission Profile Information

There are three input sheets for mission profile information. They are:

- a. Takeoff, Hover, and Landing Information
- b. Cruise Information
- c. Change of Payload Weight and Transfer Altitude Information

Each input variable on the mission profile sheets is represented by an array of five input locations. The data for these locations is filled in sequentially by rows as the particular mission segment is used. For example, the first time that cruise is used in a particular case, the required input information is filled in on the first row of the input sheet. Data for the second cruise of a case is filled in on the second row and so on. Thus, up to five of any particular segment may be used in a case.

5.1.4 Engine Cycle Information - Input engine lapse rate and weight information, take-off and cruise power data (referred), and fuel consumption (SFC) data. All tables must be filled out completely on this sheet.

5.1.5 Supplementary Information

The supplementary input sheet may be used for the second and subsequent cases of a parametric study. For example, if the user wishes to change both the propeller (or rotor) tip speed (Location 0083 - see dimensional information sheet) and the number of engines (location 0102 - see propulsion information sheet), these locations and their new values may be filled in on the supplementary input sheet.

GENERAL INFORMATION

TITLE CARD (72) (DIGITS)	7	10	13	16	19	22	25	28	31	34	37	40	42
	4	46	49	52	55	58	61	64	67	70	73	76	78

OPTION INDICATOR

VARIABLE	UNIT	LOC	VALUE
OPTIND		0001	

{ 0 = WEIGH & DIMENSION  
2 = PERF. ONLY

SIZE TREND INDICATORS

HULLIND		0002	
WINGIND		0003	

{ 1 = CONV., 2 = LIFTING BODY,  
3 = HELIPSOID, 4 = DISC  
1 = HULL (ONLY), 2 = WING  
3 = ROTOR(S), 4 = WING + ROTOR(S)

MISSION PROFILE INFORMATION  
MAXIMUM OF 12 CONSECUTIVE SEGMENTS

AERODYNAMICS INDICATORS

DRGIND		0004	
OSWIND		0005	

{ 1 = COMPONENT DRAG  
2 = DRAG TREND  
0 = INPUT e  
1 = PROG, CALC e

VALUES OF SGTIND

0 = END OF MISSION  
2 = T.O., HOVER, LAND  
4 = CRUISE  
8 = CHANGE PAYLOAD  
9 = TRANSFER ALTITUDE  
100 = END OF CASE

PROPULSION & SIZE TRENDS INDICATORS

FIXIND		0006	
RDMIND		0007	
PRPIND		0008	
ETAIND		0009	

{ 0 = INPUT FIXED SIZE ENGINES  
1 = PROGRAM SIZE ENGINES  
1 = INPUT DMR,  $\sigma(AF)$   
2 = INPUT W/A,  $C_T/\sigma$   
0 = PROPELLER  
1 = HELICOPTER "TYPE" ROTOR  
0 = INPUT  $\eta P'S$   
1 = PROG. CALC. PROP. PERF

$W_g$	LB	0010	
$LB/W_g$		0011	
$L/D$		0012	
$V_{GASBAG}/V_{HULL}$		0013	
$LG_{SPWT}$	LB/FT <sup>3</sup>	0014	
$H_{MAXD}$	FT	0015	
$\rho/\rho_0$		0016	

GROSS WEIGHT  
BUOYANCY RATIO  
DESIGN ROTOR LIFT/DYN LIFT  
GASBAG VOL./HULL VOL  
LIFTING GAS SPECIFIC WT (SL, STD)  
HULL DESIGN ALT  
ATMOS. DENSITY RATIO AT DESIGN ALT

$V_{MO}$	KTS EAS	0017	
$M_{LF}$		0018	

LIMITING SPEED  
MANEUVER LOAD FACTOR

RESERVE FUEL FACTORS

$K_f$		0019	
$\Delta W_f$	LB	0020	
$K_{FF}$		0021	

NOM = 1.0  
NOM = 0.0  
FUEL FLOW MULTIPLIER (NOM = 1.0)

$V_{DIVE}$	KTS EAS	0022	
------------	---------	------	--

INITIAL CONDITIONS

$R_g$	FT	0023	
$R_D$	N.M.	0024	
$T_D$	HR	0025	

NOTE: WHEN OPTIND = 2  
CONSIDER ONLY THOSE  
ITEMS IN THE SHADED BLOCKS

	LOC	VALUE
1 <sup>ST</sup>	0031	
2 <sup>ND</sup>	0032	
3 <sup>RD</sup>	0033	
4 <sup>TH</sup>	0034	
5 <sup>TH</sup>	0035	
6 <sup>TH</sup>	0036	
7 <sup>TH</sup>	0037	
8 <sup>TH</sup>	0038	
9 <sup>TH</sup>	0039	
10 <sup>TH</sup>	0040	
11 <sup>TH</sup>	0041	
12 <sup>TH</sup>	0042	

SHEET NO.	CASE NO.
OF	

NOTE WHEN OPTIND = 2  
CONSIDER ONLY THOSE  
ITEMS IN THE SHADED  
BLOCKS

AIRSHIP DIMENSIONAL INFORMATION

WING OR HULL

NOTE	VARIABLE	UNIT	LOC	VALUE
a	AR		0051	
	W/S	PSF	0052	
a	(t/c)R		0053	
	(t/c)T		0054	
a	$\lambda$		0055	

HOR. TAIL

	AR <sub>HT</sub>		0056	
	(t/c) <sub>HT</sub>		0057	
	$\bar{V}_H$		0058	
	$\lambda_H$		0059	

VERT. TAIL

	AR <sub>VT</sub>		0060	
	(t/c) <sub>VT</sub>		0061	
	$\bar{V}_V$		0062	
	$\lambda_V$		0063	

TAIL A.C. POSN

	L <sub>H</sub> /L <sub>OA</sub>		0043	
	L <sub>V</sub> /L <sub>OA</sub>		0044	

HULL

b	(L/D) <sub>N</sub>		0064	
b	(L/D) <sub>T</sub>		0065	
b	(L/D) <sub>OA</sub>		0066	
	$\Delta S_{WET}/S_{WET}$		0067	
	$\Delta S_{WET}$	FT <sup>2</sup>	0068	
	$\Delta VOL/VOL$		0069	
	$\Delta VOL$	FT <sup>3</sup>	0070	
	C <sub>BUOY</sub> /L <sub>OA</sub>		0071	

ROTOR(S) OR PROPELLER

NOTE	VARIABLE	UNIT	LOC	VALUE
	N <sub>R</sub>		0072	
c	W/A	PSF	0073	
d	D <sub>MR</sub>	FT	0074	
d	$\sigma_{MR}$		0075	
	b <sub>MR</sub>		0076	
e	AF		0077	
e	C <sub>Q</sub>		0078	
f	$\theta_{TMR}$	DEG	0079	
f	X <sub>TMR</sub>		0080	
	X <sub>MR</sub>		0081	
f	(t/c) <sub>.25 MR</sub>		0082	
	V <sub>TIP</sub>	FT/SEC	0083	
c	C <sub>T</sub> /σ		0084	
	(T/M) <sub>0</sub>		0085	
	h <sub>DSN</sub>	FT	0086	
	$\Delta T_{INC_{DSN}}$	°F	0087	

VALUES OF AERODYNAMIC EFFICIENCY  
(SEE NOTE g)

g	$\eta_p$		0088	
---	----------	--	------	--

NO. OF PAIRS IN $\eta_p$ TABLE		0089	
--------------------------------	--	------	--

V	LOC	VALUE	V	LOC	VALUE
A	0090		A	0095	
L	0091		L	0096	
V	0092		V	0097	
E	0093		E	0098	
S	0094		S	0099	
OF			OF		
V			$\eta_p$		

NOTE a IF HULIND = 2,3,4, INPUT THESE VALUES  
INSTEAD OF THOSE NOTED IN b.

INPUT NOT NECESSARY WHEN

b. HULIND = 2,3,4  
c. RDMIND = 1

d. RDMIND = 2  
e. DYLIND = 3,4

f. DYLIND = 1,2  
g. DYLIND = 3,4 OR ETAIND = 1

SHEET NO.	CASE NO.
OF	

AIRSHIP PROPULSION INFORMATION

NOTE	VARIABLE	LOC	VALUE
b	$SHP_p$	0101	
	$N_p$	0102	
	$\eta$	0103	

ENGINE DATA

NOTE: WHEN OPTIND = 2  
CONSIDER ONLY THOSE  
ITEMS IN THE SHADED  
BLOCKS

a	$h_{CR}$	0104	
a	$V_{CR}$	0105	
a	$\Delta T_{IN_{CR}}$	0106	

CRUISE  
CONDITIONS  
FOR  
ENGINE SIZING

AIRSHIP AERODYNAMICS INFORMATION

NOTE	VARIABLE	LOC	VALUE
	$C_{DVT}$	0107	
	$C_{DHT}$	0108	
c	$\Delta F_e$	0109	
	$\Delta F_e$	0110	
d	$F_{eDRG}$	0111	
d	EDRAG	0112	
e	$C_{DC}$	0113	
e	$C_{D_{RAD-1}}$	0114	

NOTE	VARIABLE	LOC	VALUE
	$K_{VT}$	0115	
	$K_{HT}$	0116	
f	$K_F$	0117	
g	$K_W$	0118	

(Re/0)	0119
--------	------

WING PROFILE DRAG AS FUNCTION OF  $C_L$  (g)

NO. OF PAIRS IN TABLE	0120
--------------------------	------

NOTE.

a THESE CONDITIONS ARE USED FOR  
WING SIZING ALSO IN THE CASE OF  
HULIND = 1, DYLAND = 1 OR 3

INPUT NOT NECESSARY WHEN.

- b. FIXIND = 1
- c. OSWIND = 1
- d. DRGIND = 1
- e. DYLAND = 3
- f. HULIND = 2 OR 4
- g. HULIND = 1, DYLAND = 1 OR 3 OR HULIND = 3

$C_{LW(1)}$	0121
$C_{LW(2)}$	0122
$C_{LW(3)}$	0123
$C_{LW(4)}$	0124
$C_{LW(5)}$	0125
$C_{LW(6)}$	0126
$C_{LW(7)}$	0127
$C_{LW(8)}$	0128

$C_{DW(1)}$	0129
$C_{DW(2)}$	0130
$C_{DW(3)}$	0131
$C_{DW(4)}$	0132
$C_{DW(5)}$	0133
$C_{DW(6)}$	0134
$C_{DW(7)}$	0135
$C_{DW(8)}$	0136

SHEET NO.	CASE NO.
or	

AIRSHIP WEIGHT INFORMANTION

VARIABLE	LOC.	VALUE
W <sub>FE</sub>	0141	
W <sub>FUL</sub>	0142	

INCREMENTAL GROUP WEIGHTS (NOM = 0)

VARIABLE	LOC.	VALUE
ΔW <sub>FC</sub>	0143	
ΔW <sub>p</sub>	0144	
ΔW <sub>ST</sub>	0145	



GROUP WEIGHT INFORMATION

FLIGHT CONTROLS

k <sub>CC</sub>	0146	
k <sub>RC</sub>	0147	
k <sub>SC</sub>	0148	
k <sub>FW</sub>	0149	
k <sub>TM</sub>	0150	
k <sub>RCA</sub>	0151	
k <sub>SCA</sub>	0152	
k <sub>MC</sub>	0153	
k <sub>AC</sub>	0154	

STRUCTURAL

k <sub>HL</sub>	0155	
k <sub>ENV1</sub>	0156	
k <sub>ENV2</sub>	0157	
k <sub>GB1</sub>	0158	
k <sub>GB2</sub>	0159	
k <sub>BLNT</sub>	0160	
k <sub>BAL</sub>	0161	
k <sub>LG</sub>	0162	
k <sub>WW</sub>	0163	
LF	0164	
RM <sub>1</sub>	0165	
k <sub>WP</sub>	0166	
k <sub>HT</sub>	0167	
k <sub>VT</sub>	0168	

PROPULSION

k <sub>PRB</sub>	0169	
k <sub>RBF</sub>	0170	
k <sub>PH</sub>	0171	
k <sub>amd</sub>	0172	
k <sub>AR</sub>	0173	
k <sub>PA</sub>	0174	
k <sub>VTAR</sub>	0175	
k <sub>PDS</sub>	0176	
k <sub>PDSZ</sub>	0177	
k <sub>T</sub>	0178	
k <sub>FS</sub>	0179	
k <sub>PEI</sub>	0180	
k <sub>PES</sub>	0181	

MULTIPLICATIVE FACTORS  
NOMINALLY = 1.0

K <sub>1</sub>	0182	
K <sub>2</sub>	0183	
K <sub>3</sub>	0184	
K <sub>4</sub>	0185	
K <sub>5</sub>	0186	

K <sub>6</sub>	0187	
K <sub>7</sub>	0188	
K <sub>8</sub>	0189	
K <sub>9</sub>	0190	
K <sub>10</sub>	0191	

K <sub>11</sub>	0192	
K <sub>12</sub>	0193	
K <sub>13</sub>	0194	
K <sub>14</sub>	0195	
K <sub>15</sub>	0196	

\* INPUT USED ONLY WHEN OPTIND = 2

NOTE: WHEN OPTIND = 2  
CONSIDER ONLY THOSE  
ITEMS IN THE SHADED BLOCKS

SHEET NO.	CASE NO.
OF	

EOFF, HOVER AND LANDING INFORMATION

SGTIND = 2

	TOLIND		(t/T)H		$\Delta T_{IN} (^{\circ}F)$		T/W	
	LOC	VALUE	LOC	VALUE	LOC	VALUE	LOC	VALUE
1 <sup>ST</sup>	0201		0206		0211		0216	
2 <sup>ND</sup>	0202		0207		0212		0217	
3 <sup>RD</sup>	0203		0208		0213		0218	
4 <sup>TH</sup>	0204		0209		0214		0219	
5 <sup>TH</sup>	0205		0210		0215		0220	

1 = INPUT T/W  
2 = INPUT PEHF

NOM = 1.0

INPUT NOT NECESSARY WHEN TOLIND = 2

	PEHF		$\Delta t_H$ (HR)		$t_H$ (HR)	
	LOC	VALUE	LOC	VALUE	LOC	VALUE
1 <sup>ST</sup>	0221		0226		0231	
2 <sup>ND</sup>	0222		0227		0232	
3 <sup>RD</sup>	0223		0228		0233	
4 <sup>TH</sup>	0224		0229		0234	
5 <sup>TH</sup>	0225		0230		0235	

INPUT NOT NECESSARY WHEN TOLIND = 1

SHEET NO	CASE NO

CRUISE INFORMATION

SGTIND = 4

CRSIND

	LOC	VALUE
1 <sup>ST</sup>	0236	
2 <sup>ND</sup>	0237	
3 <sup>RD</sup>	0238	
4 <sup>TH</sup>	0239	
5 <sup>TH</sup>	0240	

$(t/T)_{CR}$

	LOC	VALUE
	0241	
	0242	
	0243	
	0244	
	0245	

$\Delta T_{IN} (^{\circ}F)$

	LOC	VALUE
	0246	
	0247	
	0248	
	0249	
	0250	

$V_{KTS}$

	LOC	VALUE
	0251	
	0252	
	0253	
	0254	
	0255	

1 = SPECIFIED POWER  
 2 = CONSTANT TAS  
 3 = BEST NMPP

NOM = 1.0

INPUT NOT NECESSARY WHEN CRSIND = 1,3

$\Delta R$  (N.M.)

	LOC	VALUE
1 <sup>ST</sup>	0256	
2 <sup>ND</sup>	0257	
3 <sup>RD</sup>	0258	
4 <sup>TH</sup>	0259	
5 <sup>TH</sup>	0260	

$R_{MAX}$  (N.M.)

	LOC	VALUE
	0261	
	0262	
	0263	
	0264	
	0265	

$\Delta F_{eCR}$  (FT<sup>2</sup>)

	LOC	VALUE
	0266	
	0267	
	0268	
	0269	
	0270	

$N_{PSD_{CR}}$

	LOC	VALUE
	0271	
	0272	
	0273	
	0274	
	0275	

PRECEDING PAGE BLANK NOT FILMED



SHEET NO.	CASE NO.
27	

VARIABLE	LOC	VALUE
CYCLE NO.	0301	
FF	0302	
$k_3$	0303	
$k_4$	0304	

NOTE (a)  
(a)

ALL TABLES MUST BE COMPLETE

TAKE OFF POWER

CRUISE POWER

VALUES OF h, FT		
	LOC	VALUE
$h_1$	0306	
$h_2$	0306	
$h_3$	0307	
$h_4$	0308	
$h_5$	0309	

VALUES OF REF. PWR		
	LOC	VALUE
$P_1$	0310	
$P_2$	0311	
$P_3$	0312	
$P_4$	0313	
$P_5$	0314	

VALUES OF h, FT		
	LOC	VALUE
$h_1$	0315	
$h_2$	0316	
$h_3$	0317	
$h_4$	0318	
$h_5$	0319	

VALUES OF REF. PWR		
	LOC	VALUE
$P_1$	0320	
$P_2$	0321	
$P_3$	0322	
$P_4$	0323	
$P_5$	0324	

SPECIFIC FUEL CONSUMPTION

VALUES OF SFC		
	LOC	VALUE
SFC <sub>1</sub>	0325	
SFC <sub>2</sub>	0326	
SFC <sub>3</sub>	0327	
SFC <sub>4</sub>	0328	
SFC <sub>5</sub>	0329	
SFC <sub>6</sub>	0330	
SFC <sub>7</sub>	0331	
SFC <sub>8</sub>	0332	

VALUES OF REF. PWR		
	LOC	VALUE
$P_1$	0333	
$P_2$	0334	
$P_3$	0335	
$P_4$	0336	
$P_5$	0337	
$P_6$	0338	
$P_7$	0339	
$P_8$	0340	

(a)  $k_3$  IS IN LB/HP,  $k_4$  IS IN LB

CHANGE IN PAYLOAD WEIGHT

SGTIND = 8

$\Delta W_{PL}$  (LB)

	LOC	VALUE
1 <sup>ST</sup>	0276	
2 <sup>ND</sup>	0277	
3 <sup>RD</sup>	0278	
4 <sup>TH</sup>	0279	
5 <sup>TH</sup>	0280	

$t_{PW}$  (HR)

	LOC	VALUE
	0281	
	0282	
	0283	
	0284	
	0285	

TRANSFER ALTITUDE

SGTIND = 9

$H_{FINAL}$  (FT)

	LOC	VALUE
1 <sup>ST</sup>	0286	
2 <sup>ND</sup>	0287	
3 <sup>RD</sup>	0288	
4 <sup>TH</sup>	0289	
5 <sup>TH</sup>	0290	

### 5.3 PROGRAM INPUT

#### 5.3.1 Program Variables

AF	Activity Factor (per blade) of propeller
AR	Wing Aspect Ratio (Lifting body hull . aspect ratio when HULIND = 2,3,4)
AR <sub>HT</sub>	Horizontal tail fin aspect ratio (this is per fin and is based on exposed fin area)
AR <sub>VT</sub>	Vertical tail fin aspect ratio (this is per fin and is based on exposed fin area)
BHP* <sub>P</sub>	Total configuration installed power
b <sub>MR</sub>	Number of blades per propeller or rotor
C <sub>BUOY</sub> /l <sub>OA</sub>	Position of airship center of buoyancy divided by overall airship length
C <sub>DC</sub>	Hull/lifting body cross flow drag coefficient
C <sub>DHT</sub>	Profile drag coefficient of horizontal tail at Re = 10 <sup>7</sup>
C <sub>DVT</sub>	Profile drag coefficient of vertical tail at Re = 10 <sup>7</sup>
C <sub>DW</sub>	Profile drag coefficient of wing (based on wing planform area)
C <sub>LW</sub>	Wing lift coefficient (based on wing planform area)
C <sub>Li</sub>	Propeller integrated design lift coefficient
C <sub>2</sub> <sub>α</sub>	Hull/lifting body lift curve slope (Rad <sup>-1</sup> )

CT/σ	Ratio of thrust coefficient to rotor solidity (helicopter $C_T = \text{Thrust} / \rho AV_{\text{TIP}}^2$ ) - this value used for sizing rotor/propeller solidity when RDMIND = 2
CYCLE NO.	Propulsion cycle number
D <sub>MR</sub>	Rotor or propeller diameter (ft) input if RDMIND = 1
	Span loading efficiency factor
EDRAG	} Factors used in conjunction with drag trend
F <sub>eDRG</sub>	
ΔF <sub>e</sub>	Increment in equivalent flat plate area parasite drag - ft <sup>2</sup>
ΔF <sub>e CR</sub>	Increment in equivalent flat plate area parasite drag (cruise performance segment) - ft <sup>2</sup> .
FF	Temperature accountability (lapse rate) factor for engines (rate of change of referred power with respect to temperature ratio)
h <sub>0</sub>	Initial altitude at start of mission (ft)
h <sub>CR</sub>	Cruise altitude for sizing engines (ft)
h <sub>FINAL</sub>	Final altitude for transfer altitude segment (SGTIND = 9) (ft)
H <sub>MAXD</sub>	Hull design altitude (ft)
K <sub>F</sub>	Hull multiplicative drag factor
K <sub>FF</sub>	Fuel flow multiplicative factor

K <sub>HT</sub>		Horizontal tail multiplicative drag factor
K <sub>VT</sub>		Vertical tail multiplicative drag factor
K <sub>W</sub>		Wing multiplicative drag factor
K <sub>1</sub> (LOC 0019)		Reserve fuel multiplicative factor
k <sub>3</sub>	}	Engine weight factors
k <sub>4</sub>		
k <sub>CC</sub>		Cockpit controls weight factor
k <sub>RRC*</sub>		Rotor controls weight factor
k <sub>SC*</sub>		Rotor system controls weight factor
k <sub>FW</sub>		Fixed wing controls weight factor (Fraction of airship gross weight)
k <sub>TM**</sub>		Tilt mechanism weight factor (Fraction of propeller weight)
k <sub>RCA**</sub>		Propeller controls weight factor
k <sub>SCA**</sub>		Propeller system controls weight factor
k <sub>MC</sub>		Miscellaneous controls weight factor (lb.)
k <sub>AC</sub>		Airship controls weight factor (Fraction of airship gross weight)
k <sub>HL</sub>		Hull primary structure weight factor (If airship is non-rigid, this coefficient is not used)

$k_{ENV1}$  Main envelope (skin) weight factors  
 (If airship is rigid,  $k_{ENV1}$  is input  
 as 0.)

$k_{ENV2}$

$k_{GB1}$  Gas cell weight factors

$k_{GB2}$

$k_{BLNT}$  Ballonet weight factor ( $\text{lb}/\text{ft}^2$ )  
 ( $k_{BLNT}$  input as 0 for rigid airships).

$k_{BAL}$  Ballast weight factor (Fraction of  
 airship gross weight)

$k_{LG}$  Landing gear weight factor  
 (Fraction of airship gross weight)

$k_{WW}$  Wing weight factor (used if it is  
 desired to account for wing relief  
 loads, etc.)

$k_{WP}$  Wing weight factor ( $\text{lb}/\text{ft}^2$ ) (If this  
 factor is used, set  $k_{WW} = 0.$ )

$k_{HT}$  Horizontal tail weight factor  
 ( $\text{lb}/\text{ft}^2$ )

$k_{VT}$  Vertical tail weight factor ( $\text{lb}/\text{ft}^2$ )

$k_{PRB*}$  Rotor blade weight factors

$k_{RBF*}$

$k_{PH*}$  Rotor hub weight factor

$k_{amd*}$  Rotor weight factor

$k_{AR**}$  Propeller weight factor

$k_{PA**}$  Propeller weight factor (NOM = 1.0)

$k_{VTAR**}$  Propeller weight factor (NOM = 1.0)

$k_{PDS}$	Primary drive system weight factor
$k_{PDSZ}$	Primary drive system weight factor (number of gears in system)
$k_T$	Primary drive system weight factor
$k_{FS}$	Fuel system weight factor (Fraction of fuel required)
$k_{PEI}$	Engine installation weight factor (Fraction of bare engine weight) (If $k_{PEI}$ is greater than 1.0, program assumes $k_{PEI} = W_{PEI}$ (lbs.))
$k_{PES}$	Engine section weight factor (Fraction of bare engine weight)
$K_1$	Rotor blade weight multiplicative factor
$K_2$	Rotor blade hub multiplicative factor
$K_3$	Propeller weight multiplicative factor
$K_4$	Primary drive system multiplicative factor
$K_5$	Engine weight multiplicative factor
$K_6$	Total hull weight multiplicative factor
$K_7$	Gas cell weight multiplicative factor
$K_8$	Wing weight multiplicative factor
$K_9$	Horizontal tail weight multiplicative factor
$K_{10}$	Vertical tail weight multiplicative factor
$K_{11}$	Landing gear weight multiplicative factor

K12	Rotor controls weight multiplicative factor
K13	Rotor system controls weight multiplicative factor
K14	Fixed wing controls weight multiplicative factor
K15	Total propeller controls weight multiplicative factor

NOTE:

\* Input only if DYLLIND = 3 or 4. This corresponds to a hybrid airship which utilizes helicopter "type" rotors for all or a portion of its dynamic lift.

\*\* Input only if DYLLIND = 1 or 2. This corresponds to a fully buoyant conventional airship or a hybrid airship with wings which uses propeller(s) for propulsion and tilts same for low speed/hover control.

$L_B/W_O$	Airship buoyancy ratio (ratio of buoyant lift to gross weight)
$(L/D)_N$	Fineness ratio of airship nose section
$(L/D)_T$	Fineness ratio of airship tail section
$(L/D)_{OA}$	Overall fineness ratio of hull
LF	Wing unloading factor
$L_{G_{SPWT_0}}$	Lifting gas (buoyant fluid) specific weight at SL, STD conditions ( $lb/ft^3$ )



$L_H/LOA$	Position of horizontal tail fin aerodynamic center as a fraction of overall hull length (forward of stern)
$L_R/LA$	Design rotor lift as a fraction of design dynamic lift requirement
$L_V/LOA$	Position of vertical tail fin aerodynamic center as a fraction of overall hull length (forward of stern)
$M_{LF}$	Maneuver load factor (g's)
$N_P$	Number of engines
$\dot{N}_{PSD_{CR}}$	Number of engines shut down during cruise
$N_R$	Number of rotors or propellers
$PEHF$	Engine power fraction
$Re/\ell$	Mean Reynolds number per foot for mission
$R_{MAX}$	Range at end of cruise (n.mi)
$RM_I$	Wing relief as fraction of wing lift (used with $k_{WW}$ input)
$R_0$	Initial range at start of mission (nautical miles)
$\Delta R$	Step size for cruise (nautical miles)
$\Delta S_{wet}$	Incremental wetted area of airship hull (ft <sup>2</sup> )
$\Delta S_{wet}/S_{wet}$	Incremental wetted area of airship hull divided by hull wetted area
$(t/c)_R$	Wing root thickness to chord ratio
$(t/c)_T$	Wing tip thickness to chord ratio

$(t/c)_{HT}$	Horizontal tail mean thickness to chord ratio
$(t/c)_{VT}$	Vertical tail mean thickness to chord ratio
$(t/c)_{.25R}$	Rotor blade thickness to chord ratio @ 0.25 rotor radius
$t_H$	Incremental time for hover (hours)
$\Delta t_H$	Step size for hover (hours)
$\Delta T_{IN}$	Increment in ambient temperature during mission ( $^{\circ}F$ )
$\Delta T_{IN_{CR}}$	Increment in ambient temperature for engine sizing at cruise condition ( $^{\circ}F$ )
$\Delta T_{IN_{DSN}}$	Increment in ambient temperature for rotor or propeller sizing at takeoff condition ( $^{\circ}F$ )
$t_0$	Initial time at start of mission (hours)
$t_{PW}$	Incremental time for change of payload weight (hours)
$(t/T)_H$	Ratio of lifting gas temperature to ambient temperature (superheat ratio) in hover segment
$(t/T)_{CR}$	Ratio of lifting gas temperature to ambient temperature (superheat ratio) in cruise segment
$T/W$	Configuration thrust/weight ratio (hover)
$(T/W)_D$	Configuration design thrust/weight ratio for sizing rotor or propeller in hover
$V_{CR}$	Design cruise speed for engine sizing (kts)
$V_{DIVE}$	Dive speed (knots EAS)

$V_{GASB}/V_{HL}$	Ratio of gas cell volume to total hull volume
$\bar{V}_H$	Horizontal tail volume coefficient
$V_{KTS}$	Mission cruise speed (kts)
$V_{MO}$	Maximum operating equivalent airspeed (kt)
$V_{TIP}$	Rotor or propeller tip speed (fps)
$\bar{V}_V$	Vertical tail volume coefficient
$\Delta Vol$	Incremental volume of airship hull (ft <sup>3</sup> )
$\Delta Vol/Vol$	Incremental volume of airship hull divided by hull volume
$W_{FE}$	Weight of fixed equipment (lb.)
$W_{FUL}$	Weight of fixed useful load (lb.)
$W_O$	Airship gross weight (lb.)
$W_{PAYL}$	Payload weight (lbs.) - input only if OPTIND = 2
$W/A$	Rotor or propeller disc loading (psf) (based on difference between gross weight and buoyant lift)
$W/S$	Wing loading based on actual lift carried (difference between gross weight and buoyant lift) (psf)
$\Delta W_{FC}$	Flight controls group incremental weight (lb.)
$\Delta W_P$	Propulsion group incremental weight (lb.)
$\Delta W_{ST}$	Structures group incremental weight (lb.)

$\Delta W_{PL}$	Increment in payload weight during change of payload weight subroutine (lb.)
$X_{CMR}$	Rotor blade cutout (end of blade shank, beginning of rotor airfoil sections) position as a fraction of rotor radius
$X_{MR}$	Rotor blade attachment point as a fraction of rotor radius
$\delta_{WF}$	Fuel required additive reserve factor
$\eta_{P2}$	Propeller propulsive efficiency for hover
$\eta_{P4}$	Propeller propulsive efficiency for cruise
$\eta_T$	Transmission efficiency
$\theta_{TMR}$	Rotor blade twist (deg)
	Taper ratio of wing
$\lambda_H$	Taper ratio of horizontal tail
$\lambda_V$	Taper ratio of vertical tail
$(\rho/\rho_0)$	Ratio of atmospheric density at hull design altitude to that at SL, STD
$\sigma_{MR}$	Rotor or propeller solidity

### 5.3.2 Program Indicators

#### Option Indicators

OPTIND      0 = Weigh & dimension airship  
             2 = Calculate performance

#### Size Trends Indicators

HULIND      1 = Conventional hull  
             2 = Lifting body hull  
             3 = Helipsoid  
             4 = Disk (circular planform) hull

DYLIND      1 = Dynamic lift by hull alone  
             2 = Dynamic lift by wing and hull  
             3 = Dynamic lift by rotor(s) only  
             4 = Dynamic lift by wing and rotor(s)

NOTE:      For HULIND = 2, 3, or 4, only DYLIND = 2  
             or 4 are used.

RDMIND      1 = Input  $D_{MR}$  or  $\sigma$  (or AF, if PROPIND = 1)  
             2 = Input  $W/A$ ,  $C_T/\sigma$

PRPIND      0 = Propeller used  
             1 = Helicopter "type" rotor used

#### Aerodynamics Indicators

DRGIND      1 = Component drag buildup

OSWIND      0 = Input span loading efficiency factor ( $e$ )  
             1 = Program calculates  $e$

### Propulsion Indicators

FIXIND      0 = Input fixed sized engines  
            1 = Program sizes engines based on cruise  
                    flight design conditions

ETAIND      0 = Input propulsive efficiencies for  
                    takeoff and cruise

            1 = Program calculates propeller performance

### Mission Performance Indicators

SGTIND      0 = End of mission  
            2 = Takeoff, hover, and landing  
            4 = Cruise  
            8 = Change payload  
            9 = Transfer altitude  
           100 = End of case

TOLIND      1 = Takeoff, hover, or land at input  $T/W$   
            2 = Takeoff, hover, or land at input power  
                    setting (PEHF)

CRSIND      1 = Cruise at cruise power  
            2 = Cruise at constant true airspeed  
            3 = Cruise at speed for best specific range

## 6.0 SAMPLE CASE

This section contains a filled out sample input sheet and a complete sample case.

PRECEDING PAGE BLANK NOT FILMED



GENERAL INFORMATION

TITLE CARD (72) (DIGITS)	CONVENTIONAL RIGID AIRSHIP PARAMETRIC STUDY												
	7	10	13	16	19	22	25	28	31	34	37	40	42
	43	46	49	52	55	58	61	64	67	70	73	76	78

OPTION INDICATOR

VARIABLE	UNIT	LOC	VALUE
OPTIND		0001	0.

{ 0 = WEIGH & DIMENSION  
2 = PERF. ONLY

SIZE TREND INDICATORS

HULIND		0002	1.
DYIND		0003	1.

{ 1 = CONV., 2 = LIFTING BODY,  
3 = HELIPSOID, 4 = DISC  
1 = HULL (ONLY), 2 = WING  
3 = ROTOR(S), 4 = WING + ROTOR(S)

MISSION PROFILE INFORMATION  
MAXIMUM OF 12 CONSECUTIVE SEGMENTS

AERODYNAMICS INDICATORS

DRGIND		0004	1.
OSWIND		0005	1.

{ 1 = COMPONENT DRAG  
2 = DRAG TREND  
0 = INPUT e  
1 = PROG. CALC e

VALUES OF SGTIND

0 = END OF MISSION  
2 = T.O., HOVER, LAND  
4 = CRUISE  
8 = CHANGE PAYLOAD  
9 = TRANSFER ALTITUDE  
100 = END OF CASE

PROPULSION & SIZE TRENDS INDICATORS

FIXIND		0006	1.
RDMIND		0007	1.
PRPIND		0008	0.
ETAIND		0009	0.

{ 0 = INPUT FIXED SIZE ENGINES  
1 = PROGRAM SIZE ENGINES  
1 = INPUT DMR, σ(AF)  
2 = INPUT W/A, C<sub>T</sub>/σ  
0 = PROPELLER  
1 = HELICOPTER "TYPE" ROTOR  
0 = INPUT η P'S  
1 = PROG. CALC. PROP. PERF

W <sub>g</sub>	LB	0010	60000.
LB/W <sub>g</sub>		0011	1.0
L <sub>R</sub> /L <sub>A</sub>		0012	0.
V <sub>GASB</sub> /V <sub>HL</sub>		0013	.925
L <sub>G</sub> SP WT	LB/FT <sup>3</sup>	0014	.01251
H <sub>MAX D</sub>	FT	0015	5000.
(ρ <sub>g</sub> ) <sub>HD</sub>		0016	.8617

GROSS WEIGHT  
BUOYANCY RATIO  
DESIGN ROTOR LIFT/DYN LIFT  
GASBAG VOL./HULL VOL  
LIFTING GAS SPECIFIC WT (SL, STD)  
HULL DESIGN ALT  
ATMOS DENSITY RATIO AT DESIGN ALT

V <sub>MD</sub>	KTS EAS	0017	60.
M <sub>LF</sub>		0018	1.3

LIMITING SPEED  
MANEUVER LOAD FACTOR

RESERVE FUEL FACTORS

K <sub>f</sub>		0019	1.00
SW <sub>F</sub>	LBS	0020	0.0
K <sub>FF</sub>		0021	1.00

NOM = 1.0  
NOM = 0.0  
FUEL FLOW MULTIPLIER (NOM = 1.0)

V <sub>DIVE</sub>	KTS EAS	0022	55.7
-------------------	---------	------	------

INITIAL CONDITIONS

h <sub>g</sub>	FT	0023	2000.
R <sub>g</sub>	N.M.	0024	0.
T <sub>g</sub>	HR	0025	0.

NOTE: WHEN OPTIND = 2  
CONSIDER ONLY THOSE  
ITEMS IN THE SHADED BLOCKS

	LOC	VALUE
1 <sup>ST</sup>	0031	4.
2 <sup>ND</sup>	0032	4.
3 <sup>RD</sup>	0033	2.
4 <sup>TH</sup>	0034	100.
5 <sup>TH</sup>	0035	
6 <sup>TH</sup>	0036	
7 <sup>TH</sup>	0037	
8 <sup>TH</sup>	0038	
9 <sup>TH</sup>	0039	
10 <sup>TH</sup>	0040	
11 <sup>TH</sup>	0041	
12 <sup>TH</sup>	0042	

PRECEDING PAGE BLANK NOT FILMED

PRECEDING PAGE BLANK NOT FILMED

NOTE: WHEN OPTIND = 2  
CONSIDER ONLY THOSE  
ITEMS IN THE SHADED  
BLOCKS

AIRSHIP DIMENSIONAL INFORMATION

WING OR HULL

NOTE	VARIABLE	UNIT	LOC	VALUE
a	AR		0051	
	W/S	PSF	0052	
a	(t/c)R		0053	
	(t/c)T		0054	
a	$\lambda$		0055	

HOR. TAIL

	AR <sub>HT</sub>		0056	0.5
	(t/c) <sub>HT</sub>		0057	0.10
	$\bar{V}_H$		0058	.3509
	$\lambda_H$		0059	.60

VERT. TAIL

	AR <sub>VT</sub>		0060	0.5
	(t/c) <sub>VT</sub>		0061	0.10
	$\bar{V}_V$		0062	.3509
	$\lambda_V$		0063	.60

TAIL A.C. POSN

	L <sub>H</sub> /L <sub>OA</sub>		0043	.10
	L <sub>V</sub> /L <sub>OA</sub>		0044	.10

HULL

b	(L/D) <sub>N</sub>		0064	1.519
b	(L/D) <sub>T</sub>		0065	2.126
b	(L/D) <sub>OA</sub>		0066	4.496
	$\Delta S_{WET}/S_{WET}$		0067	0.
	$\Delta S_{WET}$	FT <sup>2</sup>	0068	0.
	$\Delta VOL/VOL$		0069	0.
	$\Delta VOL$	FT <sup>3</sup>	0070	0.
	C <sub>BUOY</sub> /L <sub>OA</sub>		0071	.455

NOTE	VARIABLE	UNIT	LOC	VALUE
	N <sub>R</sub>		0072	4.
c	W/A	PSF	0073	
d	D <sub>MR</sub>	FT	0074	10.
d	$\sigma_{MR}$		0075	
	b <sub>MR</sub>		0076	4.
e	AF		0077	140.
e	C <sub>g</sub>		0078	.5
f	$\theta_{TMR}$	DEG	0079	
f	X <sub>C<sub>MR</sub></sub>		0080	
	X <sub>MR</sub>		0081	.08
f	(t/c) <sub>25 MR</sub>		0082	.10
	V <sub>TIP</sub>	FT/SEC	0083	900.
c	C <sub>T/O</sub>		0084	
	(T/M) <sub>D</sub>		0085	
	h <sub>DSN</sub>	FT	0086	
	$\Delta T_{INC}$ <sub>DSN</sub>	°F	0087	

VALUES OF AERODYNAMIC EFFICIENCY  
(SEE NOTE g)

g	$\eta_{p2}$		0088	0.7035
---	-------------	--	------	--------

	NO. OF PAIRS IN $\eta_{p4}$ TABLE		0089	5.0
--	-----------------------------------	--	------	-----

VALUES OF V	LOC	VALUE	VALUES OF $\eta_{p4}$	LOC	VALUE
	0090	0.		0095	0.7035
0091	40.	0096	0.42		
0092	80.	0097	0.67		
0093	140.	0098	0.825		
0094	240.	0099	0.88		

NOTE: a. IF HULIND = 2,3,4, INPUT THESE VALUES  
INSTEAD OF THOSE NOTED IN b.

INPUT NOT NECESSARY WHEN:

b. HULIND = 2,3,4  
c. RDMIND = 1

d. RDMIND = 2  
e. DYLIND = 3,4

f. DYLIND = 1,2  
g. DYLIND = 3,4 OR ETAINED = 1

AIRSHIP PROPULSION INFORMATION

NOTE	VARIABLE	LOC	VALUE
b	BHP <sub>p</sub>	0101	
	N <sub>p</sub>	0102	4.
	η <sub>T</sub>	0103	0.97

ENGINE DATA

NOTE: WHEN OPTIND = 2  
CONSIDER ONLY THOSE  
ITEMS IN THE SHADED  
BLOCKS.

a	n <sub>CR</sub>	0104	5000.
a	V <sub>CR</sub>	0105	50.
a	ΔT <sub>INCR</sub>	0106	0.

CRUISE  
CONDITIONS  
FOR  
ENGINE SIZING

AIRSHIP AERODYNAMICS INFORMATION

NOTE	VARIABLE	LOC	VALUE
	C <sub>DVT</sub>	0107	.00287
	C <sub>DHT</sub>	0108	.00287
c	e	0109	
	ΔF <sub>e</sub>	0110	25.
d	F <sub>eDRG</sub>	0111	
d	EDRAG	0112	
e	C <sub>DC</sub>	0113	
e	C <sub>DRAD-1</sub>	0114	

NOTE	VARIABLE	LOC	VALUE
	K <sub>VT</sub>	0115	2.80
	K <sub>HT</sub>	0116	2.80
f	K <sub>F</sub>	0117	1.3463
g	K <sub>W</sub>	0118	

(Re/ρ)	0119	4.743
		X 10 <sup>5</sup>

WING PROFILE DRAG AS FUNCTION OF C<sub>L</sub> (g)

NO. OF PAIRS IN TABLE	0120	
--------------------------	------	--

NOTE:

a. THESE CONDITIONS ARE USED FOR  
WING SIZING ALSO IN THE CASE OF  
HULIND = 1, DYLAND = 1 OR 3

INPUT NOT NECESSARY WHEN:

- b. FIXIND = 1
- c. OSWIND = 1
- d. DRGIND = 1
- e. DYLAND = 3
- f. HULIND = 2 OR 4
- g. HULIND = 1, DYLAND = 1 OR 3 OR HULIND = 3

C <sub>LW</sub> (1)	0121	
C <sub>LW</sub> (2)	0122	
C <sub>LW</sub> (3)	0123	
C <sub>LW</sub> (4)	0124	
C <sub>LW</sub> (5)	0125	
C <sub>LW</sub> (6)	0126	
C <sub>LW</sub> (7)	0127	
C <sub>LW</sub> (8)	0128	

C <sub>DW</sub> (1)	0129	
C <sub>DW</sub> (2)	0130	
C <sub>DW</sub> (3)	0131	
C <sub>DW</sub> (4)	0132	
C <sub>DW</sub> (5)	0133	
C <sub>DW</sub> (6)	0134	
C <sub>DW</sub> (7)	0135	
C <sub>DW</sub> (8)	0136	

AIRSHIP WEIGHT INFORMANTION

VARIABLE	LOC.	VALUE
W <sub>FE</sub>	0141	5820.
W <sub>FUL</sub>	0142	1050.

INCREMENTAL GROUP WEIGHTS (NOM = 0)

VARIABLE	LOC.	VALUE
ΔW <sub>FC</sub>	0143	200.
ΔW <sub>p</sub>	0144	0.
ΔW <sub>ST</sub>	0145	1000.

W <sub>PAYL</sub>	0197	
-------------------	------	--

GROUP WEIGHT INFORMATION

FLIGHT CONTROLS

k <sub>CC</sub>	0146	48.
k <sub>RC</sub>	0147	0.
k <sub>SC</sub>	0148	0.
k <sub>FW</sub>	0149	0.
k <sub>TM</sub>	0150	0.26
k <sub>RCA</sub>	0151	0.4
k <sub>SCA</sub>	0152	38.
k <sub>MC</sub>	0153	0.
k <sub>AC</sub>	0154	0.009

STRUCTURAL

k <sub>HL</sub>	0155	0.406
k <sub>ENV1</sub>	0156	0.
k <sub>ENV2</sub>	0157	0.038
k <sub>GB1</sub>	0158	0.049
k <sub>GB2</sub>	0159	0.939
k <sub>BLNT</sub>	0160	0.
k <sub>BAL</sub>	0161	0.046
k <sub>LG</sub>	0162	0.013
k <sub>WW</sub>	0163	0.
LF	0164	0.
RM <sub>1</sub>	0165	0.
k <sub>WP</sub>	0166	0.
k <sub>HT</sub>	0167	1.084
k <sub>VT</sub>	0168	1.084

PROPULSION

k <sub>PRB</sub>	0169	0.
k <sub>RBF</sub>	0170	0.
k <sub>PH</sub>	0171	0.
k <sub>amd</sub>	0172	0.
k <sub>AR</sub>	0173	17.3
k <sub>PA</sub>	0174	1.0
k <sub>VTAR</sub>	0175	1.0
k <sub>PDS</sub>	0176	250.
k <sub>PDSZ</sub>	0177	3.
k <sub>T</sub>	0178	.25
k <sub>FS</sub>	0179	.07
k <sub>PEI</sub>	0180	0.27
k <sub>PES</sub>	0181	2.5

MULTIPLICATIVE FACTORS  
NOMINALLY = 1.0

K <sub>1</sub>	0182	1.0
K <sub>2</sub>	0183	1.0
K <sub>3</sub>	0184	1.0
K <sub>4</sub>	0185	4.0
K <sub>5</sub>	0186	1.0

K <sub>6</sub>	0187	1.0
K <sub>7</sub>	0188	1.0
K <sub>8</sub>	0189	1.0
K <sub>9</sub>	0190	1.0
K <sub>10</sub>	0191	1.0

K <sub>11</sub>	0192	1.0
K <sub>12</sub>	0193	1.0
K <sub>13</sub>	0194	1.0
K <sub>14</sub>	0195	1.0
K <sub>15</sub>	0196	1.0

\* INPUT USED ONLY WHEN OPTIND = 2

NOTE: WHEN OPTIND = 2  
CONSIDER ONLY THOSE  
ITEMS IN THE SHADED BLOCKS

TAKEOFF, HOVER AND LANDING INFORMATION

SGTINO = 2

TOLIND

	LOC	VALUE
1 <sup>ST</sup>	0201	2
2 <sup>ND</sup>	0202	
3 <sup>RD</sup>	0203	
4 <sup>TH</sup>	0204	
5 <sup>TH</sup>	0205	

1 = INPUT T/W  
2 = INPUT PEHF

(t/T)H

LOC	VALUE
0206	1.00
0207	
0208	
0209	
0210	

NOM = 1.0

$\Delta T_{IN} (^{\circ}F)$

LOC	VALUE
0211	0.
0212	
0213	
0214	
0215	

T/W

LOC	VALUE
0216	
0217	
0218	
0219	
0220	

INPUT NOT NECESSARY WHEN TOLIND = 2

PEHF

	LOC	VALUE
1 <sup>ST</sup>	0221	0.01
2 <sup>ND</sup>	0222	
3 <sup>RD</sup>	0223	
4 <sup>TH</sup>	0224	
5 <sup>TH</sup>	0225	

INPUT NOT NECESSARY WHEN TOLIND = 1

$\Delta t_H$  (HR)

LOC	VALUE
0226	0.2
0227	
0228	
0229	
0230	

$t_H$  (HR)

LOC	VALUE
0231	2.0
0232	
0233	
0234	
0235	

SHEET NO. 6 or 7	CASE NO.
---------------------	----------

CRUISE INFORMATION

SGTIND = 4

	CRSIND		$(\dot{W}/T)_{CR}$		$\Delta T_{IN} (^{\circ}F)$		$V_{KTS}$	
	LOC	VALUE	LOC	VALUE	LOC	VALUE	LOC	VALUE
1 <sup>ST</sup>	0236	2.	0241	1.0	0246	0.	0251	50.
2 <sup>ND</sup>	0237	2.	0242	1.0	0247	0.	0252	50.
3 <sup>RD</sup>	0238		0243		0248		0253	
4 <sup>TH</sup>	0239		0244		0249		0254	
5 <sup>TH</sup>	0240		0245		0250		0255	

1 = SPECIFIED POWER  
2 = CONSTANT TAS  
3 = BEST NMPP

NOM = 1.0

INPUT NOT NECESSARY WHEN CRSIND = 1,3

	$\Delta R$ (N.M.)		$R_{MAX}$ (N.M.)		$\Delta Fe_{CR}$ (FT <sup>2</sup> )		$N_{PSDCR}$	
	LOC	VALUE	LOC	VALUE	LOC	VALUE	LOC	VALUE
1 <sup>ST</sup>	0256	20.	0261	300.	0266	0.	0271	0.
2 <sup>ND</sup>	0257	5.	0262	350.	0267	0.	0272	0.
3 <sup>RD</sup>	0258		0263		0268		0273	
4 <sup>TH</sup>	0259		0264		0269		0274	
5 <sup>TH</sup>	0260		0265		0270		0275	

VARIABLE	LOC	VALUE
CYCLE NO.	0301	1.0
FF	0302	2.58
$k_3$	0303	0.15
$k_4$	0304	0.

NOTE (a)  
(a)

ALL TABLES MUST BE COMPLETE

TAKE OFF POWER

CRUISE POWER

VALUES OF h, FT		
	LOC	VALUE
$h_1$	0305	0.
$h_2$	0306	5000.
$h_3$	0307	10000.
$h_4$	0308	15000.
$h_5$	0309	17000.

VALUES OF REF. PWR		
	LOC	VALUE
$P_1$	0310	1.00
$P_2$	0311	1.09
$P_3$	0312	1.18
$P_4$	0313	1.27
$P_5$	0314	1.306

VALUES OF h, FT		
	LOC	VALUE
$h_1$	0315	0.
$h_2$	0316	5000.
$h_3$	0317	10000.
$h_4$	0318	15000.
$h_5$	0319	17000.

VALUES OF REF. PWR		
	LOC	VALUE
$P_1$	0320	0.848
$P_2$	0321	0.938
$P_3$	0322	1.027
$P_4$	0323	1.116
$P_5$	0324	1.150

SPECIFIC FUEL CONSUMPTION

VALUES OF SFC		
	LOC	VALUE
SFC <sub>1</sub>	0325	16.3
SFC <sub>2</sub>	0326	0.695
SFC <sub>3</sub>	0327	0.556
SFC <sub>4</sub>	0328	0.495
SFC <sub>5</sub>	0329	0.440
SFC <sub>6</sub>	0330	0.418
SFC <sub>7</sub>	0331	0.408
SFC <sub>8</sub>	0332	0.400

VALUES OF REF. PWR		
	LOC	VALUE
$P_1$	0333	0.005
$P_2$	0334	0.20
$P_3$	0335	0.30
$P_4$	0336	0.40
$P_5$	0337	0.60
$P_6$	0338	0.80
$P_7$	0339	1.00
$P_8$	0340	2.00

(a)  $k_3$  IS IN LB/HP,  $k_4$  IS IN LB



C A S C O M P  
 COMPREHENSIVE AIRSHIP SIZING COMPUTER PROGRAM B-81

THE FOLLOWING IS A CARD BY CARD REPRODUCTION OF THE INPUT DECK FOR THIS CASE

LOC. CORRESPONDS TO LOCATION NUMBER GIVEN ON INPUT SHEET  
 NUM STANDS FOR THE NUMBER OF SEQUENTIAL INPUT VALUES STARTING WITH LOC. (MAX. =5)  
 VAL EQUALS VALUE FOR VARIABLE CORRESPONDING TO LOC.  
 VAL1 VALUE CORRESPONDING TO LOC.+0001  
 VAL2 VALUE CORRESPONDING TO LOC.+0002  
 ETC.

LOC.	NUM	VAL	VAL1	VAL2	VAL3	VAL4
------	-----	-----	------	------	------	------

NOTE : IN USING AUXILIARY ENGINES ; AUXILIARY ENGINE CYCLE INPUT LOCATIONS CAN BE CREATED BY PLACING A 66666 CARD IN FRONT AND BEHIND A STANDARD ENGINE CYCLE

1	5	0.0	1.0000	1.0000	1.0000	1.0000
6	4	1.0000	1.0000	0.0	0.0	
10	5	60000.	1.0000	0.0	0.92500	0.12510E-01
15	2	5000.0	0.86170			
17	2	60.000	1.3000			
19	3	1.0000	0.0	1.0000		
22	1	55.700				
23	3	2000.0	0.0	0.0		
31	4	4.0000	4.0000	2.0000	100.00	
56	4	0.50000	0.10000E 00	0.35090	0.60000	
60	4	0.50000	0.10000E 00	0.35090	0.60000	
43	2	0.10000E 00	0.10000E 00			
64	5	1.5190	2.1260	4.4960	0.0	0.0
69	3	0.0	0.0	0.45500		
72	1	4.0000				
74	1	10.000				
76	3	4.0000	140.00	0.50000		
81	3	0.80000E-01	0.10000E 00	900.00		
88	1	0.70350				
89	1	5.0000				
90	5	0.0	40.000	80.000	140.00	240.00
95	5	0.70350	0.42000	0.67000	0.82500	0.88000
102	2	4.0000	0.97000			
104	3	5000.0	50.000	0.0		
107	2	0.28700E-02	0.28700E-02			
110	1	25.000				
113	1	1.2000				
115	3	2.8000	2.8000	1.3463		
119	1	0.47430E 06				
120	1	0.0				
141	2	5820.0	1050.0			
143	3	200.00	0.0	1000.0		
146	5	48.000	0.0	0.0	0.0	0.26000
151	4	0.40000	38.000	0.0	0.90000E-02	
155	5	0.40600	0.0	0.38000E-01	0.49000E-01	0.93900
160	5	0.0	0.46000E-01	0.13000E-01	0.0	0.0
165	4	0.0	0.0	1.0840	1.0840	
169	5	0.0	0.0	0.0	0.0	17.300

PRECEDING PAGE BLANK NOT FILMED

6-17

ORIGINAL PAGE IS  
 OF POOR QUALITY

174	5	1.0000	1.0000	250.00	3.0000	0.25000
179	3	0.70000E-01	0.27000	2.5000		
182	5	1.0000	1.0000	1.0000	4.0000	1.0000
187	5	1.0000	1.0000	1.0000	1.0000	1.0000
192	5	1.0000	1.0000	1.0000	1.0000	1.0000
201	1	2.0000				
206	1	1.0000				
211	1	0.0				
221	1	0.10000E-01				
226	1	0.20000				
231	1	2.0000				
236	2	2.0000	2.0000			
241	2	1.0000	1.0000			
246	2	0.0	0.0			
251	2	50.000	50.000			
256	2	20.000	5.0000			
261	2	300.00	350.00			
266	4	0.0	0.0	0.0	0.0	
271	4	0.0	0.0	0.0	0.0	
301	4	1.0000	2.5800	0.15000	0.0	
305	5	0.0	5000.0	10000.	15000.	17000.
310	5	1.0000	1.0900	1.1800	1.2700	1.3060
315	5	0.0	5000.0	10000.	15000.	17000.
320	5	0.84800	0.93800	1.0270	1.1160	1.1500
325	5	16.300	0.69500	0.55600	0.49500	0.44000
330	3	0.41800	0.40800	0.40000		
333	5	0.50000E-02	0.20000	0.30000	0.40000	0.60000
338	3	0.80000	1.0000	2.0000		

INSUFFICIENT POWER AVAILABLE FOR CRUISE(CRUS2)A  
INSUFFICIENT POWER AVAILABLE FOR CRUISE(CRUS2)A

HULLNO = 1 CONVENTIONAL HULL

6-18

\*\*\* DIMENSIONAL DATA

GROSS WEIGHT = 60000. POUNDS

\*\*\* HULL

DISPLACEMENT	DSPLMT	89998.	POUNDS
LENGTH(OVERALL)	ELOA	355.3	FEET
LENGTH(NOSE)	ELN	120.0	FEET
LENGTH(TAIL)	ELT	168.0	FEET
DIAMETER	DH	79.0	FEET
VOLUME(HULL)	VHL	1176841.	CUBIC FEET
VOLUME(GAS)	VGASR	938028.	CUBIC FEET
WETTED AREA	SF	69796.	SQUARE FEET
PRISMATIC COEFFICIENT	CV	0.68	
CENTER OF BUOYANCY	CB	161.6	

\*\*\*\*\*

\*\*\* HORIZONTAL TAIL

ASPECT RATIO	ARHT	0.50	
AREA	SHT	2612.1	SQUARE FEET
SPAN	BHT	25.55	FEET
MEAN CHORD	CBARHT	51.11	FEET
TAPER RATIO	SLMH	0.600	

\*\*\*\*\*

\*\*\* VERTICAL TAIL

ASPECT RATIO	ARVT	0.50	
AREA	SVT	2612.1	SQUARE FEET
SPAN	BVT	25.55	FEET
MEAN CHORD	CBARVT	51.11	FEET
TAPER RATIO	SLMVT	0.600	

\*\*\*\*\*

\*\*\* PROPELLERS - DYLLIND = 1 OR 2

DIAMETER	DMR	10.00	FEET
ACTIVITY FACTOR PER BLADE	AF	140.	
SOLIDITY	SIGMR	0.229	
NO. OF PROPELLERS	ENR	4.	
NO. OF BLADES PER PROP	BMR	4.	
TIP SPEED	VT	900.	FT/SEC

\*\*\*\*\*

ORIGINAL PAGE IS  
OF POOR QUALITY

\*\*\* WEIGHTS DATA IN LBS  
 GUST LOAD FACTOR GLF 0.0  
 MANEUVER LOAD FACTOR EMLF 1.300  
 ULTIMATE LOAD FACTOR ULF 1.950

PROPULSION GROUP

TOTAL MAIN ROTOR GROUP	WPRG	0.	
MAIN ROTOR BLADE	SKI*WPRB		0.
MAIN ROTOR HUB	SK2*WPH		0.
PROPELLER GROUP	DK3*WPRP	472.	
DRIVE SYSTEM	DK4*WPDS	271.	
ENGINES	SK5*WEP	112.	
ENGINE INSTALLATION	WPEI	30.	
FUEL SYSTEM	WFS	141.	
PROPULSION GROUP WEIGHT INCREMENT	DELWP	0.	
* TOTAL PROPULSION GROUP WEIGHT	WPSTR		1026.

STRUCTURES GROUP

TOTAL HULL STRUCTURE WEIGHT		7053.	
HULL STRUCTURE	SK6*WHL		4401.
HULL ENVELOPE (SKIN)	SK6*WENV		2652.
GAS CELLS	SK7*WGSB	9283.	
BALLONETS	WBALNT	0.	
WING	SK8*WW	0.	
HORIZONTAL TAIL	SK9*WHT	2832.	
VERTICAL TAIL	SK10*WVT	2832.	
LANDING GEAR	SK11*WLG	780.	
ENGINE SECTION	WES	280.	
STRUCTURES WEIGHT INCREMENT	DELWST	1000.	
* TOTAL STRUCTURE WEIGHT	WST		24059.

6-20

FLIGHT CONTROLS GROUP

PRIMARY FLIGHT CONTROLS	WPFC	4317.	
COCKPIT CONTROLS	WCC		257.
AIRSHIP CONTROLS	WAC		540.
ROTOR CONTROLS	SK12*WRC		0.
ROTOR SYSTEMS CONTROLS	SK13*WSC		0.
FIXED WING CONTROLS	SK14*WFW		0.
TILT MECHANISM	WTM		123.
PROPELLER CONTROLS	SK15*WPC	637.	
BALLAST	WBAL		2760.
MISCELLANEOUS CONTROLS	WMC		0.
CONTROL WEIGHT INCREMENT	DELWFC	200.	
* TOTAL CONTROL WEIGHT	WFC		4517.
* WEIGHT OF FIXED EQUIPMENT	WFE		5820.
* WEIGHT EMPTY	WE		35422.
* FIXED USEFUL LOAD	WFUL		1050.
* OPERATING WEIGHT EMPTY	OWE		36472.
* PAYLOAD	WPL		21518.
* FUEL	WFR		2010.

\*\*\* GROSS WEIGHT WD 60000.  
 \* \* \* \* \*

\*\*\* PROPULSION DATA

PROPULSION CYCLE NUMRER 1.000 WAS EMPLOYED

TOTAL POWER FOR 4. ENGINE(S); ( BHP \* ) 746. HORSEPOWER

ENGINE(S) SIZED FOR CRUISE AT VC= 50.0 KNOTS,  
 HC= 5000. FT, TEMPERATURE= 41.2 DEG F.

\*\*\*\*\*

\*\*\* AERODYNAMICS DATA

TOTAL EFFECTIVE FLAT PLATE AREA	FE	238.8	SQ.FT
TOTAL WETTED AREA	SWET	80413.8	SQ.FT
MEAN SKIN FRICTION COEFFICIENT	CBARF	0.002969	
DRAG COEFFICIENT BASED ON VOLUME	CDV	0.021410	

\*\*\* DRAG BREAKDOWN

WING FE	FEW	0.0	SQ.FT
HULL FE	FEH	177.2	SQ.FT
VERTICAL TAIL FE	FEVT	18.3	SQ.FT
HORIZONTAL TAIL FE	FEHT	18.3	SQ.FT
INCREMENTAL FE	DELTA FE	25.0	SQ.FT
*** WING LIFT EFFICIENCY FACTOR	E	1.0000	

\*\*\*\*\*

MISSION PERFORMANCE DATA

CRUISE AT 50.0 KNOTS TAS

TIME (HOURS)	RANGE (N.MI)	FUEL USED (POUNDS)	WEIGHT (POUNDS)	ALT. (FEET)	TEMP (DEG.F)	TAS (KT)	B.R.	PEHF	BHPR	ETAP	NMPP	R.N.	CL
			HULL LIFT (POUNDS)				ROTOR LIFT (POUNDS)		ALPHA H (DEG)			ALPHA D/L (DEG)	

INSUFFICIENT POWER AVAILABLE FOR CRUISE (CRUS2) A  
 CRUISE AT CRUISE POWER

TIME (HOURS)	RANGE (N.MI)	FUEL USED (POUNDS)	WEIGHT (POUNDS)	ALT. (FEET)	TEMP (DEG.F)	TAS (KT)	B.R.	PEHF	BHPR	ETAP	NMPP	R.N.	CL
0.0	0.0	0.	60000. 0.	2000.	51.87 0.	49.4	1.000 0.	1.000	609. 0.0	0.48	0.196212	0.0 -90.0	0.0
0.40	20.0	102.	59898. 0.	2000.	51.87 0.	49.4	1.002 0.	1.000	609. 0.0	0.48	0.196212	0.0 -90.0	0.0

ORIGINAL PAGE IS OF POOR QUALITY

6-21

7-53148-0200

0.81	40.0	204.	59796. 0.	2000.	51.87 0.	49.4	1.003 0.	1.000	609. 0.0	0.48	0.196212	0.0 -90.0	0.0
1.21	60.0	306.	59694. 0.	2000.	51.87 0.	49.4	1.005 0.	1.000	609. 0.0	0.48	0.196212	0.0 -90.0	0.0
1.62	80.0	408.	59592. 0.	2000.	51.87 0.	49.4	1.007 0.	1.000	609. 0.0	0.48	0.196212	0.0 -90.0	0.0
2.02	100.0	510.	59490. 0.	2000.	51.87 0.	49.4	1.009 0.	1.000	609. 0.0	0.48	0.196212	0.0 -90.0	0.0
2.43	120.0	612.	59388. 0.	2000.	51.87 0.	49.4	1.010 0.	1.000	609. 0.0	0.48	0.196212	0.0 -90.0	0.0
2.83	140.0	714.	59286. 0.	2000.	51.87 0.	49.4	1.012 0.	1.000	609. 0.0	0.48	0.196212	0.0 -90.0	0.0
3.24	160.0	815.	59185. 0.	2000.	51.87 0.	49.4	1.014 0.	1.000	609. 0.0	0.48	0.196212	0.0 -90.0	0.0
3.64	180.0	917.	59083. 0.	2000.	51.87 0.	49.4	1.016 0.	1.000	609. 0.0	0.48	0.196212	0.0 -90.0	0.0
4.05	200.0	1019.	58981. 0.	2000.	51.87 0.	49.4	1.017 0.	1.000	609. 0.0	0.48	0.196212	0.0 -90.0	0.0
4.45	220.0	1121.	58879. 0.	2000.	51.87 0.	49.4	1.019 0.	1.000	609. 0.0	0.48	0.196212	0.0 -90.0	0.0
4.85	240.0	1223.	58777. 0.	2000.	51.87 0.	49.4	1.021 0.	1.000	609. 0.0	0.48	0.196212	0.0 -90.0	0.0
5.26	260.0	1325.	58675. 0.	2000.	51.87 0.	49.4	1.023 0.	1.000	609. 0.0	0.48	0.196212	0.0 -90.0	0.0
5.66	280.0	1427.	58573. 0.	2000.	51.87 0.	49.4	1.024 0.	1.000	609. 0.0	0.48	0.196212	0.0 -90.0	0.0
6.07	300.0	1529.	58471. 0.	2000.	51.87 0.	49.4	1.026 0.	1.000	609. 0.0	0.48	0.196212	0.0 -90.0	0.0

CRUISE AT 50.0 KNOTS TAS

TIME (HOURS)	RANGE (N.MI)	FUEL USED (POUNDS)	WEIGHT (POUNDS)	ALT. (FEET)	TEMP (DEG.F)	TAS (KT)	B.R.	PEHF	BHPR	ETAP	NMPP	R.N.	CL
-----------------	-----------------	-----------------------	--------------------	----------------	-----------------	-------------	------	------	------	------	------	------	----

HULL LIFT  
(POUNDS)

WING LIFT  
(POUNDS)

ROTOR LIFT  
(POUNDS)

ALPHA H  
(DEG)

ALPHA D/L  
(DEG)

INSUFFICIENT POWER AVAILABLE FOR CRUISE(CRUS2)A  
CRUISE AT CRUISE POWER

TIME (HOURS)	RANGE (N.MI)	FUEL USED (POUNDS)	WEIGHT (POUNDS)	ALT. (FEET)	TEMP (DEG.F)	TAS (KT)	B.R.	PEHF	BHPR	ETAP	NMPP	R.N.	CL
-----------------	-----------------	-----------------------	--------------------	----------------	-----------------	-------------	------	------	------	------	------	------	----

HULL LIFT

WING LIFT

ROTOR LIFT

ALPHA H

ALPHA D/L

	(POUNDS)	(POUNDS)	(POUNDS)	(DEG)	(DEG)								
6.07	300.0	1529.	58471. 0.	2000.	51.87 0.	49.4	1.026 0.	1.000	609. 0.0	0.48	0.196212	0.0 -90.0	0.0
6.17	305.0	1554.	58446. 0.	2000.	51.87 0.	49.4	1.027 0.	1.000	609. 0.0	0.48	0.196212	0.0 -90.0	0.0
6.27	310.0	1580.	58420. 0.	2000.	51.87 0.	49.4	1.027 0.	1.000	609. 0.0	0.48	0.196212	0.0 -90.0	0.0
6.37	315.0	1605.	58395. 0.	2000.	51.87 0.	49.4	1.027 0.	1.000	609. 0.0	0.48	0.196212	0.0 -90.0	0.0
6.47	320.0	1631.	58369. 0.	2000.	51.87 0.	49.4	1.028 0.	1.000	609. 0.0	0.48	0.196212	0.0 -90.0	0.0
6.57	325.0	1656.	58344. 0.	2000.	51.87 0.	49.4	1.028 0.	1.000	609. 0.0	0.48	0.196212	0.0 -90.0	0.0
6.68	330.0	1682.	58318. 0.	2000.	51.87 0.	49.4	1.029 0.	1.000	609. 0.0	0.48	0.196212	0.0 -90.0	0.0
6.78	335.0	1707.	58293. 0.	2000.	51.87 0.	49.4	1.029 0.	1.000	609. 0.0	0.48	0.196212	0.0 -90.0	0.0
6.88	340.0	1733.	58267. 0.	2000.	51.87 0.	49.4	1.030 0.	1.000	609. 0.0	0.48	0.196212	0.0 -90.0	0.0
6.98	345.0	1758.	58242. 0.	2000.	51.87 0.	49.4	1.030 0.	1.000	609. 0.0	0.48	0.196212	0.0 -90.0	0.0
7.08	350.0	1784.	58216. 0.	2000.	51.87 0.	49.4	1.031 0.	1.000	609. 0.0	0.48	0.196212	0.0 -90.0	0.0

6-23

TAKEOFF, HOVER, OR LAND AT PEHF = 0.010 FOR 2.000 HRS.													
TIME HOURS	RANGE (N.MI.)	FUEL USED (POUNDS)	WEIGHT (POUNDS)	ALT. FEET	TEMP (DEG.F)	TAS (KTS)	B.R.	PEHF	BHPR	FM	T/W	THRUST (POUNDS)	FUEL FLOW (LB/HR)
7.08	350.0	1784.	58216.	2000.	51.87	0.0	1.031	0.010	7.	0.70	0.004	-60000.	113.
7.28	350.0	1806.	58194.	2000.	51.87	0.0	1.031	0.010	7.	0.70	0.004	-60000.	113.
7.48	350.0	1829.	58171.	2000.	51.87	0.0	1.031	0.010	7.	0.70	0.004	-60000.	113.
7.68	350.0	1852.	58148.	2000.	51.87	0.0	1.032	0.010	7.	0.70	0.004	-60000.	113.
7.88	350.0	1874.	58126.	2000.	51.87	0.0	1.032	0.010	7.	0.70	0.004	-60000.	113.
8.08	350.0	1897.	58103.	2000.	51.87	0.0	1.033	0.010	7.	0.70	0.004	-60000.	113.
8.28	350.0	1920.	58080.	2000.	51.87	0.0	1.033	0.010	7.	0.70	0.004	-60000.	113.
8.48	350.0	1942.	58058.	2000.	51.87	0.0	1.033	0.010	7.	0.70	0.004	-60000.	113.
8.68	350.0	1965.	58035.	2000.	51.87	0.0	1.034	0.010	7.	0.70	0.004	-60000.	113.
8.88	350.0	1988.	58012.	2000.	51.87	0.0	1.034	0.010	7.	0.70	0.004	-60000.	113.
9.08	350.0	2010.	57990.	2000.	51.87	0.0	1.035	0.010	7.	0.70	0.004	-60000.	113.
9.08	350.0	2010.	57990.	2000.	51.87	0.0	1.035	0.010	7.	0.70	0.004	-60000.	113.

MISSION FUEL REQUIRED = 2010.  
 RESERVE FUEL REQUIRED = 0.  
 TOTAL FUEL REQUIRED = 2010.

## 7.0 COMPLETE PROGRAM LISTING (FORTRAN)

This section contains a complete FORTRAN listing of the CASCOMP computer program.

C2

7-1

C-2



F88-LEVEL LINKAGE EDITOR OPTIONS SPECIFIED XREF,LIST,LET,OVLY  
 DEFAULT OPTION(S) USED - SIZE=(100352,14336)

IEW0000 INCLUDE SYSOBJ  
 IEW0000 INCLUDE SYSLMOD1(B8100)  
 IEW0000 ENTRY MAIN  
 IEW0000 NAME B8100(R)  
 IEW0201  
 \*\*\*\*B8100 NOW REPLACED IN DATA SET

CROSS REFERENCE TABLE

CONTROL SECTION				ENTRY							
NAME	ORIGIN	LENGTH	SEG. NO.	NAME	LOCATION	NAME	LOCATION	NAME	LOCATION	NAME	LOCATION
DRAG	00	41E	1								
RUTPOW	420	FD8	1								
ENGSZ	13F8	922	1								
LIFT	1D20	816	1								
AERO	2538	8BA	1								
MAIN	2DF8	2342	1								
CRUS1	5140	8D8	1								
CRUS3	5D18	C60	1								
SIZTR	6978	11DA	1								
THRUST	7858	CAC	1								
WGHR	8808	DD6	1								
ATMOS	95E0	316	1								
BIV	98F8	58C	1								
ODD	9E88	814	1								
RTPOW	A6A0	26C	1								
CHGPL	A910	2C4	1								
CRUS2	ABD8	A66	1								
FACTR	B640	126	1								
LOADER	B768	85A	1								
POWER	BFC8	8DC	1								
PRFRM	C8A8	570	1								
TABLE	CE18	46E	1								
TOHL	D288	C06	1								
TRALT	DE90	26C	1								
XLINT	E100	474	1								
XLKUP	E578	854	1								
IHC SLOG	EDD0	186	1								
IHCSSCN	EF88	1D9	1	ALOG10	EDD0	ALOG	EDE8				
IHC FEX IT	F168	1C	1	COS	EF88	SIN	EFA0				
IHCSEXP	F188	192	1	EXIT	F168						
IHC FRXPR	F320	183	1	EXP	F188						
IHCNAMEL	F4A8	AC3	1	FRXPR#	F320						
				FRDNL#	F4A8	FWRNL#	FAAC				

7-2

ORIGINAL PAGE IS  
 OF POOR QUALITY

NAME	ORIGIN	LENGTH	SEG. NO.	NAME	LOCATION	NAME	LOCATION	NAME	LOCATION	NAME	LOCATION
IHCECOMH	FF70	F61	1	IBCOM#	FF70	FDIOCS#	1002C	INTSWTCH	10EB6		
IHCMMH2	10ED8	65D	1	SEQDASD	11250						
IHCSSQRT	11538	145	1	SQRT	11538						
IHCFCVTH	11680	119D	1	ADCON#	11680	FCVAOUTP	1172A	FCVLOUTP	117BA	FCVZOUTP	1190A
				FCVIOUTP	11CB8	FCVEOUTP	121BA	FCVCOUTP	123D4	INT6SWCH	126BB
IHCENFTH	12820	542	1	ARITH#	12820	ADJSWTCH	12B8C				
IHC SATN2	12D68	1CB	1	ATAN2	12D68	ATAN	12D7C				
IHCSTNCT	12F38	266	1	COTAN	12F38	TAN	12F4E	QTAN	130C0		
IHC FIOS	131A0	F28	1	FIOCS#	131A0	FIOCSBEP	131A6				
IHC FIOS2	140C8	52E	1								
IHCERRM	145F8	5D4	1	ERRMON	145F8	IHCERRE	14610				
IHCUDPT	14BD0	300	1								
IHCETRCH	14ED0	28E	1	IHCTRCH	14ED0	ERRTRA	14ED8				
IHC UATBL	15160	638	1								
\$BLANKCOM	15798	9DC	1								

ORIGINAL PAGE IS  
OF POOR QUALITY

7-3

LOCATION	REFERS TO SYMBOL	IN CONTROL SECTION	SEG. NO.	LOCATION	REFERS TO SYMBOL	IN CONTROL SECTION	SEG. NO.
100			1	104	XLINT	XLINT	1
108	IBCOM#	IHCECOMH	1	11C			1
12C			1	13C			1
14C			1	15C			1
16C			1	17C			1
18C			1	1AC			1
18C			1	1CC			1
1DC			1	9C			1
A0			1	A4			1
910			1	914	RTPOW	RTPOW	1
918	XLINT	XLINT	1	91C	XLKUP	XLKUP	1
920	EXXPR#	IHCERXPR	1	924	COS	IHCSSCN	1
928	SIN	IHCSSCN	1	92C	ATAN	IHC SATN2	1
930	SQRT	IHCSSQRT	1	934	IBCOM#	IHCECOMH	1
9A8			1	9B8			1
9D8			1	9E8			1
9F8			1	A08			1
A18			1	A28			1
A58			1	A68			1
A78			1	680	RTPOW	RTPOW	1
6B4	RTPOW	RTPOW	1	6CB			1
6CC	RTPOW	RTPOW	1	6D4	RTPOW	RTPOW	1

LOCATION	REFERS TO SYMBOL	IN CONTROL SECTION	SEG. NO.	LOCATION	REFERS TO SYMBOL	IN CONTROL SECTION	SEG. NO.
6DC	RTPOW	RTPOW	1	6F8	RTPOW	RTPOW	1
700	RTPOW	RTPOW	1	708	RTPOW	RTPOW	1
724	RTPOW	RTPOW	1	728	RTPOW	RTPOW	1
72C			1	25E0			1
25E4			1	25F4			1
26D0			1	26D4	XLINT	XLINT	1
26D8	FRXPR#	IHCFRXPR	1	26D0	ALOGIO	IHCSLOG	1
26F4			1	2704			1
2714			1	2724			1
2734			1	2744			1
2754			1	2764			1
2774			1	2784			1
2794			1	27A4			1
27B4			1	27C4			1
1618			1	161C	DRAG	DRAG	1
1620	ATMOS	ATMOS	1	1624	FACTR	FACTR	1
162B	XLINT	XLINT	1	162C	IBCOM#	IHCECOMH	1
1630	ROTPOW	ROTPOW	1	1634	THRUST	THRUST	1
1648			1	16B8			1
16E8			1	16F8			1
1708			1	1728			1
1738			1	1758			1
152C			1	1530			1
1534			1	1538			1
153C			1	1540			1
154C			1	1550			1
1560			1	1568			1
156C			1	1570			1
1E30			1	1E44			1
1E54			1	1E64			1
1E74			1	1E84			1
1F74			1	1F84			1
2884			1	26E0	IBCOM#	IHCECOMH	1
262C			1	4608			1
460C			1	4610	ODD	ODD	1
4614	AERO	AERO	1	4618	ATMOS	ATMOS	1
461C	ENGSZ	ENGSZ	1	4620	PRFRM	PRFRM	1
4624	SIZTR	SIZTR	1	4628	WGTR	WGTR	1
462C	FRXPR#	IHCFRXPR	1	4630	IBCOM#	IHCECOMH	1
4634	LOADER	LOADER	1	44FC			1
4504			1	450d			1
5588			1	558C	DRAG	DRAG	1
5590	LIFT	LIFT	1	5594	ATMOS	ATMOS	1
5598	FACTR	FACTR	1	559C	POWER	POWER	1
55A0	XLINT	XLINT	1	55A4	FWRNL#	IHCNAMEL	1
55A8	IBCOM#	IHCECOMH	1	55AC	ROTPOW	ROTPOW	1
55E0			1	55F0			1
5600			1	5610			1
5620			1	5630			1
5640			1	5650			1
5660			1	5670			1
5680			1	5690			1

7-4

LOCATION	REFERS TO SYMBOL	IN CONTROL SECTION	SEG. NO.	LOCATION	REFERS TO SYMBOL	IN CONTROL SECTION	SEG. NO.
56A0			1	56F0			1
5700			1	5710			1
5720			1	5730			1
5484			1	548C			1
5490			1	5494			1
5498			1	54A4			1
54A8			1	54AC			1
54B8			1	54C0			1
54C4			1	54C8			1
54CC			1	54D0			1
607C			1	6084			1
6088			1	608C			1
6090			1	609C			1
60A0			1	60A4			1
60B0			1	60B8			1
60BC			1	60C0			1
60C4			1	60C8			1
6178			1	617C	DRAG	DRAG	1
62E0			1	6180	LIFT	LIFT	1
6184	ATMOS	ATMOS	1	6188	FACTR	FACTR	1
618C	POWER	POWER	1	6190	XLINT	XLINT	1
6194	FWRNL#	IHCNAMEL	1	6198	IBCOM#	IHCCEOMH	1
619C	ROTPOW	ROTPOW	1	61F0			1
6200			1	6210			1
6220			1	6230			1
6240			1	6250			1
6260			1	6270			1
6280			1	6290			1
62A0			1	62B0			1
62E0			1	6300			1
6310			1	6EB4			1
6EC4			1	6ED4			1
6EE4			1	6EF4			1
6F04			1	6F14			1
6F34			1	6F44			1
6F64			1	6F84			1
6F94			1	6FA4			1
6FB4			1	6FC4			1
6FD4			1	6FE4			1
6FF4			1	7004			1
7014			1	7024			1
7034			1	7084			1
7094			1	69FC			1
6D24			1	6A50			1
6A54			1	6A5C			1
6A60			1	6C40			1
6C44	ATMOS	ATMOS	1	6C48	ALOG	IHCSLOG	1
6C4C	SQRT	IHCSSQRT	1	6C50	FRXPR#	IHCERXPR	1
6C64			1	6C74			1
6C84			1	6C94			1
6CA4			1	6CB4			1
6CC4			1	6CD4			1

7  
5

LOCATION REFERS TO SYMBOL IN CONTROL SECTION SEG. NO. LOCATION REFERS TO SYMBOL IN CONTROL SECTION SEG. NO.

6CE4			1	6CF4			1
6D04			1	6D14			1
6D34			1	6D44			1
6D54			1	6D64			1
6D74			1	6D84			1
6D94			1	6DA4			1
6E54			1	6E64			1
6E74			1	7ED8			1
7EDC	ODD	ODD	1	7EE0	BIV	BIV	1
7EE4	TABLE	TABLE	1	7EE8	XLINT	XLINT	1
7EEC	FRXPR#	IHCFRXPR	1	7EF0	COTAN	IHCSTNCT	1
7EF4	TAN	IHCSTNCT	1	7EF8	COS	IHCSSCN	1
7EFC	SIN	IHCSSCN	1	7F00	ATAN	IHCSTN2	1
7F04	SQRT	IHCSSQRT	1	7F08	FWRNL#	IHCNAMEL	1
7F0C	IBCOM#	IHCECOMH	1	7F20			1
7F30			1	7F40			1
7F50			1	7F60			1
7F70			1	8070			1
7C80			1	7CB4			1
7CB8	ODD	ODD	1	7CBC	ODD	ODD	1
7CC0	ODD	ODD	1	7CD4			1
7CD8			1	7CDC	ODD	ODD	1
7CE0	ODD	ODD	1	7CE4	ODD	ODD	1
7D14	ODD	ODD	1	7D18	ODD	ODD	1
7D1C			1	7D40	ODD	ODD	1
7D44	ODD	ODD	1	7D48			1
7D68	ODD	ODD	1	7D6C	ODD	ODD	1
7D70			1	7D7C	ODD	ODD	1
7D80	ODD	ODD	1	7D84			1
7DA8	ODD	ODD	1	7DAC			1
7DC8	ODD	ODD	1	7DCC			1
7DE8			1	8A20			1
8A24	ALOG10	IHCSLOG	1	8A28	SQRT	IHCSSQRT	1
8A2C	FRXPR#	IHCFRXPR	1	8A40			1
8A50			1	8A60			1
8A70			1	8A80			1
8A90			1	8AA0			1
8AB0			1	8AC0			1
8AD0			1	8AE0			1
8AF0			1	8B00			1
8B10			1	8B20			1
8B30			1	8B40			1
8B50			1	8B60			1
8B70			1	8B80			1
8B90			1	8BA0			1
8B80			1	8BC0			1
8BD0			1	8BE0			1
8BF0			1	8C00			1
8C10			1	8C20			1
8C30			1	8C40			1
8C50			1	8C60			1
8C70			1	8C80			1

7-6

LOCATION REFERS TO SYMBOL IN CONTROL SECTION SEG. NO. LOCATION REFERS TO SYMBOL IN CONTROL SECTION SEG. NO.

8C90			1	88AC			1
88BC			1	88DC			1
88E4			1	88E8			1
8904			1	890C			1
8910			1	9688			1
968C	EXP	IHCSEXP	1	96C0	FR XPR#	IHCFRXPR	1
96C4	SQRT	IHCSSQRT	1	96D8			1
96E8			1	96F8			1
9708			1	9718			1
9728			1	9738			1
9748			1	9758			1
9768			1	9654			1
9668			1	AA88			1
AA8C	IBCOM#	IHCCEOMH	1	AFD8			1
AFDC	DRAG	DRAG	1	AFF0	LIFT	LIFT	1
AFF4	ATMOS	ATMOS	1	AFF8	CRUS1	CRUS1	1
AFFC	FACTR	FACTR	1	AFF0	POWER	POWER	1
AFF4	XLINT	XLINT	1	AFF8	IBCOM#	IHCCEOMH	1
AFFC	ROTPOW	ROTPOW	1	B020			1
B030			1	B040			1
B050			1	B060			1
B070			1	B080			1
B090			1	B0A0			1
B0B0			1	B0C0			1
B0D0			1	B0E0			1
B0F0			1	B100			1
B110			1	B120			1
AEF4			1	AEFC			1
AF00			1	AF04			1
AF08			1	AE14			1
AF18			1	AF1C			1
AF28			1	AF30			1
AF34			1	AF38			1
AF3C			1	AF40			1
BCB8	EXIT	IHCSEXIT	1	BC8C	IBCOM#	IHCCEOMH	1
C290			1	C294	FACTR	FACTR	1
C298	TABLE	TABLE	1	C29C	XLINT	XLINT	1
C2A0	SQRT	IHCSSQRT	1	C2A4	FR XPR#	IHCFRXPR	1
C2A8	EWRN1 #	IHCNAME1	1	C2AC	IBCOM#	IHCCEOMH	1
C280	THRUST	THRUST	1	C2C4			1
C2D4			1	C2E4			1
C2F4			1	C304			1
C314			1	C324			1
C334			1	C344			1
C354			1	C364			1
C394			1	COE4			1
COE8			1	COF8			1
C100			1	C104			1
C108			1	C10C			1
C11C			1	C120			1
C124			1	C128			1
CAF0			1	CAF4	TOHL	TOHL	1

7-7

ORIGINAL PAGE IS  
OF POOR QUALITY

LOCATION REFERS TO SYMBOL IN CONTROL SECTION SEG. NO. LOCATION REFERS TO SYMBOL IN CONTROL SECTION SEG. NO.

CAF8	CHGPL	CHGPL	1	CAFC	CRUS1	CRUS1	1
CB00	CRUS2	CRUS2	1	CB04	CRUS3	CRUS3	1
CB08	TRALT	TRALT	1	CB0C	IBCOM#	IHCCEOMH	1
CA90			1	D618			1
D61C	ATMOS	ATMOS	1	D620	FACTR	FACTR	1
D624	POWER	POWER	1	D628	XLINT	XLINT	1
D62C	SQRT	IHCSSQRT	1	D630	FRXPR#	IHCFRXPR	1
D634	IBCOM#	IHCCEOMH	1	D638	ROTPOW	ROTPOW	1
D64C			1	D65C			1
D66C			1	D67C			1
D68C			1	D69C			1
D6AC			1	D68C			1
D6CC			1	D6DC			1
D6EC			1	D6FC			1
D70C			1	D71C			1
D72C			1	D73C			1
D74C			1	D77C			1
D78C			1	D7CC			1
D524			1	D528			1
D538			1	D540			1
D544			1	D548			1
D55C			1	D560			1
D564			1	D560			1
DFEC	IBCOM#	IHCCEOMH	1	D560			1
EA10	BIV	BIV	1	DFE8			1
EEF8	IBCOM#	IHCCEOMH	1	E330	IBCOM#	IHCCEOMH	1
FO88	IBCOM#	IHCCEOMH	1	EA2C	IBCOM#	IHCCEOMH	1
F180	IBCOM#	IHCCEOMH	1	EF34	IHCERRM	IHCERRM	1
F28C	IHCERRM	IHCERRM	1	F0FC	IHCERRM	IHCERRM	1
F434	IHCERRM	IHCERRM	1	F290	IBCOM#	IHCCEOMH	1
F42C	EXP	IHCSEXP	1	F430	IBCOM#	IHCCEOMH	1
FD44	ADCON#	IHCFCVTH	1	F428	ALOG	IHC SLOG	1
FE28	IHCERRM	IHCERRM	1	FD3C	IBCOM#	IHCCEOMH	1
1008C	ADCON#	IHCFCVTH	1	FD40	FIOCS#	IHC FIOS	1
100C0	ARITH#	IHC FNTH	1	1002C	SEQDASD	IHCCEOMH2	1
100DC	IHC UOPT	IHC UOPT	1	10084	FIOCS#	IHC FIOS	1
10DC8	FCVLOUTP	IHCFCVTH	1	10DE0	ADJSWCH	IHC FNTH	1
10DD0	FCVOUTP	IHCFCVTH	1	10DC4	FCVEQUTP	IHCFCVTH	1
10DD8	FCV2OUTP	IHCFCVTH	1	10DC	FCVIOU TP	IHCFCVTH	1
10D94	IHCCEOMH2	IHCCEOMH2	1	10DD4	FCVAOUTP	IHCFCVTH	1
10D6C	IHCCEOMH2	IHCCEOMH2	1	10D63	IHCERRE	IHCERRM	1
10D74	IHCCEOMH2	IHCCEOMH2	1	10D98	IHCERRM	IHCERRM	1
11175	IHCCEOMH	IHCCEOMH	1	10D70	IHCCEOMH2	IHCCEOMH2	1
10F20	IHCERRM	IHCERRM	1	10D78	IHCCEOMH2	IHCCEOMH2	1
11395	IHCCEOMH	IHCCEOMH	1	11178	IHCCEOMH	IHCCEOMH	1
11385	IHCCEOMH	IHCCEOMH	1	10F1C	IBCOM#	IHCCEOMH	1
11630	IHCERRM	IHCERRM	1	113A5	IHCCEOMH	IHCCEOMH	1
12678	IHCERRM	IHCERRM	1	11608	IBCOM#	IHCCEOMH	1
12C10	INTSWTCH	IHCCEOMH	1	1267C	IBCOM#	IHCCEOMH	1
12884	IHC UOPT	IHC UOPT	1	12C0C	IBCOM#	IHCCEOMH	1
12C14	FIOCS#	IHC FIOS	1	12888	INT6SWCH	IHCFCVTH	1
12EA8	IBCOM#	IHCCEOMH	1	12C18	ADCON#	IHCFCVTH	1
				12C84	IHCERRM	IHCERRM	1
				12EF4	IHCERRM	IHCERRM	1

7-8

LOCATION	REFERS TO SYMBOL	IN CONTROL SECTION	SEG. NO.	LOCATION	REFERS TO SYMBOL	IN CONTROL SECTION	SEG. NO.
130C4	IBCOM#	IHCCEOMH	1	130D8	IHCERRM	IHCERRM	1
13308	IHCERRM	IHCERRM	1	1330C	IHCFIOS2	IHCFIOS2	1
13F18	IHCUATBL	IHCUATBL	1	13F24	IBCOM#	IHCCEOMH	1
13F39	IHCFIOS2	IHCFIOS2	1	13F50	IHCFIOS2	IHCFIOS2	1
140C1	IHCFIOS2	IHCFIOS2	1	148BC	IHCLOPT	IHCLOPT	1
14BC0	IBCOM#	IHCCEOMH	1	14BC4	IHCTRCH	IHCETRCH	1
14BC8	FIOCSBEP	IHCCEFIOS	1	15044	IBCOM#	IHCCEOMH	1
15048	ADCON#	IHCFCVTH	1	1504C	FIOCSBEP	IHCCEFIOS	1
ENTRY ADDRESS	2DF8						
TOTAL LENGTH	16178						

DIAGNOSTIC MESSAGE DIRECTORY

IEW0201 WARNING - OVERLAY STRUCTURE CONTAINS ONLY ONE SEGMENT -- OVERLAY OPTION CANCELED.

ORIGINAL PAGE IS  
OF POOR QUALITY



CCMPILER CPTICNS - NAME= MAIN,OPT=C2,LINECNT=54,SIZE=000CK,  
 SCLRCE,EBCCIC,NCLIST,NODECK,LCAC,MAP,NGEDIT, ID,NOXREF

ISN 0002	SUBROUTINE AERC						00010000	
	C**** MEMBER NAME B81AERO						00020000	
	C	PAGE 1	INPUT	LCC 001 THRU 0050			00030000	
ISN 0003		CCMMON	CPTINC	,FLINC	,DYIND	,ERGIND	,OSWIND	,00040000
		1FIXIND	,RCMINC	,FFFINC	,ETAIND	,WC	,XLBWD	,00050000
		2XLRLA	,VGBCVH	,XLC	,HMAXD	,RFRHO	,VMC	,00060000
		3EMLF	,CK1	,EELWF	,CKFF	,VCIVE	,HCC	,00070000
		4RCO	,TOG	,CAP1(5)	,SGTIND(12)	,ELHLOA	,ELVLOA	,00080000
		5GAP2(6)						,00090000
ISN 0004	C	PAGE 2	INPUT	LCC 001 THRU 0100			00100000	
		CCMMON	AR	,VS	,TCR	,TCT	,SLM	,00110000
		1ARHT	,TCHT	,VEZRH	,SLMH	,ARVT	,TCVT	,00120000
		2VBARV	,SLMVT	,ELCA	,ELDT	,ELDOA	,DLSWSH	,00130000
		3DSKET	,CLVFL	,CVCL	,CBYLCA	,ENR	,WVA	,00140000
		4CAM1	,CAM2	,EMF	,DAM3	,CLEVE	,THETMR	,00150000
		5XC	,XMR	,TVCNR	,VT	,CTSIGH	,TVK	,00160000
		6FES	,TINY	,ETAP2	,ETAP4N	,TBEM5(5)	,TB8AP4(5)	,00170000
		7GAP3						,00180000
ISN 0005	C	PAGE 3	INPUT	LCC 011 THRU 140			00190000	
		CCMMON	CAN4	,EAF	,ETAT	,FC	,VC	,00200000
		1ATMIY	,CDVT	,CCHT	,DAM5	,CLTAFE	,FECRAG	,00210000
		2EXPDRG	,CDC	,CLALP	,CKVT	,CKHT	,CKF	,00220000
		3CKW	,RELI	,ICLN	,TBCL1(8)	,TBCDWI(8)	,GAP4(4)	,00230000
ISN 0006	C	PAGE 4	INPUT	LCC 141 THRU 200	WEIGHT DATA		00240000	
		CCMMON	WFE	,WFL	,DELWFC	,DELWST		,00250000
		1SKCC	,SKRC	,SKSC	,SKFW	,SKTM	,SKRCA	,00260000
		2SKSCA	,SKPC	,SKAC	,SKHL	,SKENV1	,SKENV2	,00270000
		3SKGB1	,SKGB2	,SKBLNT	,SKBAL	,SKLG	,SKW	,00280000
		4ELF	,RMI	,SKWP	,SKVT	,SKPRB		,00290000
		5SKRBF	,SKPF	,SKAND	,SKAR	,SKPA	,SKVTAR	,00300000
		6SKPDS	,SKPCSZ	,SKT	,SKFS	,SKPEI	,SKPES	,00310000
		7SK1	,SK2	,SK3	,SK4	,SK5	,SK6	,00320000
		8SK7	,SK8	,SK9	,SK10	,SK11	,SK12	,00330000
		9SK13	,SK14	,SK15	,PLIN	,GAP5(3)		,00340000
ISN 0007	C	PAGE 5	INPUT	LCC 201 THRU 300			00350000	
		CCMMON	TCLINC(5)	,TETA2(5)	,TIN2(5)	,TWTW(5)	,PFET2(5)	,00360000
		1DELTH(5)	,STH(5)	,CRSINC(5)	,XTGTA4(5)	,TIN4(5)	,VIN(5)	,00370000
		2DELR(5)	,RYAX(5)	,DELCR(5)	,ENPCR(5)	,DELWPL(5)	,STPW(5)	,00380000
		3FIN(5)	,GAP6(10)					,00390000
ISN 0008	C	PAGE 6	INPUT	LCC 301 THRU 400			00400000	
		CCMMON	CYCFRL	,FF	,SK3	,SK4	,TBP1(5)	,00410000
		1TBT0(5)	,TBH2(5)	,TECRP(5)	,TBSFC(8)	,TBPOW(8)	,GAP7(60)	,00420000
ISN 0009	C	WORKING	CCMPCA				00430000	
		CCMMON	ALFCE,ALFCL,ALFF,AMU,				00440000	
		1	BPA,BFR,BHSCF,BHT,BLP,BR,BS,BVT,				00450000	
		2	CBARF,CEARHT,CEARVT,CEARW,CCP,CCT,CDV,CLW,CPIND,CPNUD,CPPAR,CPPRC				00460000	
		3	CPTOT,CRT,CTP,CV,CX,CLCES,CE,				00470000	
		4	DELRT,DELTA,DF,CSPLMT,	ELC,ELHT,ELN,ELCA,ELT,ELVT,EN,ETAP,			00480000	
		5	FEH,FEHI,FEHL,FEHT,FEI,FETCT,FEVT,FEW,FEWH,FEWI,FM,FP,ETAP4				00490000	
ISN 0010		CCMMON	GAND11(3,15),GLF,GYDC1(16),H,				00500000	

OT-10

		7 ICRUS, INCRU, INCRG, INCDYL, INDETA, INDFIX, INCHUL, INDOPT, INCOSW, ...	005100CC
		8 INDOPOW, INDRPF, INCRDM, IPPINT	005200CC
ISN 0011		CCOMON LTHL, NCCFF, NCXP, CWE, PEHF, PI, Q, RHC, REALJ, RHPMR, R, RA	005300CC
ISN 0012		CCOMON SA, SA5, SA6, SA7, SFC, SHPA, SHPR, SHT, SHTE, SHTW, SIGMA, SSIGMA, ST,	005400CC
		1STFETA, STMAX, SVT, SVTE, SVTW, SW, SWETH, SWEXP, SWTT, SWWET, SZRHC	005500CC
ISN 0013		CCOMON T, TAF, TCFAR, TFETA, TMAX, TMP, TPRCP, TR, ULF, VGASB, VGASR, VHL, V	005600CC
ISN 0014		CCOMON W, WBAL, WEAINT, WCC, WE, WEP, WES, WF, WFC, WFR, WFS, WFW,	005700CC
		1 WGSB, WFL, WHT, WLG, WMC, WPAYL, WPC, WPDS, WPEI, WPH, WPRB, WPRG, WPRP, WPSTR	005800CC
		2, WRC, WRCA, WSC, WSCA, WST, WTM, WVT, WW, WPAYLG, WAC, WENV	005900CC
ISN 0015		COMMON XLALB, XLE, XLBF, XLF, XLR, XLW, YLS2, TOVW	006000CC
ISN 0016		COMMON DMF, SIGFR, ZF, EFP, SEE	006000CC
ISN 0017	10C2	FCRMT(22X, 34HT) IS ERROR IS IN THE CL, CDWI TABLE)	006000CC
ISN 0018		NAMLIST /NAERC/ FEH, FEHL, FEVL, FEHT, FEGL, SWIT, CBARF, CDV, SA5,	006200CC
		1 SA6, SA7, SWWET, SEE, CLTAFE, FNWRE, FNVRE, FNHRE,	006300CC
		2 FHLRE, REH, REF, REVT, REHT, REHL, CKKH, SWETH	006400CC
ISN 0019		NTCL = TCLN + C.1	006500CC
ISN 0020		FEH=0.0	006600CC
ISN 0021		IF (INCDYL.EQ.1.CR.INCDYL.EQ.3) GO TO 3	006700CC
ISN 0023		IF (INCHUL.GT.1) GO TO 2	006800CC
ISN 0025		REH=RELI*CBARH	006900CC
ISN 0026		ARGG=1.CE-C7*REH	007000CC
ISN 0027		FNWRE=(1.C+ALCG10(ARGG)/7.0)**(-2.6)	007100CC
ISN 0028		CDWI=XLINT(TBCL1, TBCDWI, C., ATCL, M)	007200CC
ISN 0029		IF (M.NE.C) WRITE(6, 10C2)	007300CC
ISN 0031		FEH=CKH*CDWI*SW*FNWRE	007400CC
ISN 0032		IF (INCCSW.EQ.C) GC TC 3	007500CC
ISN 0034		SEE=0.94-C.45*AR**0.68	007600CC
ISN 0035		GC TO 3	007700CC
ISN 0036	2	SWWET=C.	007800CC
ISN 0037	3	IF (INCRG.EQ.2) GC TC 15	007900CC
ISN 0039		REF=RELI*ELCA	008000CC
ISN 0040		REVT=RELI*CBARVT	008100CC
ISN 0041		REHT=RELI*CBARHT	008200CC
ISN 0042		ARGG=1.CE-C7*REF	008300CC
ISN 0043		FNWRE=(1.C+ALOG10(ARGG)/7.0)**(-2.6)	008400CC
ISN 0044		ARGG=1.CE-C7*REVT	008500CC
ISN 0045		IF (ARGG.GT.C.) GC TC 17	008501CC
ISN 0047		FNWRE=0.	008502CC
ISN 0048		GC TO 18	008503CC
ISN 0049	17	FNWRE=(1.C+ALCG10(ARGG)/7.0)**(-2.6)	008600CC
ISN 0050	18	ARGG=1.CE-C7*REHT	008700CC
ISN 0051		IF (ARGG.GT.C.) GO TC 15	008701CC
ISN 0053		FNWRE=0.	008702CC
ISN 0054		GC TO 20	008703CC
ISN 0055	19	FNWRE=(1.C+ALCG10(ARGG)/7.0)**(-2.6)	008800CC
ISN 0056	20	IF (INDHUL.GT.1) GC TC 4	008900CC
ISN 0058		FEHL=0.CC287*CKH*SWETH*FNWRE	009000CC
ISN 0059		GC TO 5	009100CC
ISN 0060	4	IF (INCHUL.EQ.3) GO TC 16	009101CC
ISN 0062		REHL=RELI*CBARH	009200CC
ISN 0063		ARGG=1.CE-C7*REHL	009300CC
ISN 0064		FHLRE=(1.C+ALCG10(ARGG)/7.0)**(-2.6)	009400CC

7-11

ORIGINAL PAGE IS  
OF POOR QUALITY

ISN 0065	CDWI=XLINT(TBCL1,TBCDWI,C.,NTCL,M)	00950000
ISN 0066	IF (M.NE.C) WRITE(6,ICC2)	00960000
ISN 0068	FEFL=CKW*CDWI*SW*FHLRE	00970000
ISN 0069	FEW=0.C	00980000
ISN 0070	SEE=0.C	00990000
ISN 0071	SWWET=C.C	01000000
ISN 0072	5 FEVT=CKVT*CCVT*SVT*FNVFE	01010000
ISN 0073	FEHT=CKHT*CCHT*SHT*FNHFE	01020000
ISN 0074	FETOT=FEHL+FEW+FEVT+FEHT+DLTAFE	01030000
ISN 0075	6 SWTT=SWETH+SWWET+SVTW+SHTW	01040000
ISN 0076	CBARF=FETCT/SWTT	01050000
ISN 0077	CCV=FETCT/VFL**C.6667	01060000
ISN 0078	IF (INDHUL.GT.1) GC TO 8	01070000
ISN 0080	SA5=FEHL+FEVT+FEHT+DLTAFE	01080000
ISN 0081	IF (INDCYL.EQ.2.OR.INDCYL.EQ.4) GO TO 7	01090000
ISN 0083	SA6=0.C	01100000
ISN 0084	SA7=0.C	01110000
ISN 0085	GC TO 15	01120000
ISN 0086	7 SA6=CKW*FNWRE	01130000
ISN 0087	SA7=1/(PI*SEE*AR)	01140000
ISN 0088	GC TO 15	01150000
ISN 0089	8 SA7=0.C	01160000
ISN 0090	IF (INDCRG.EQ.2) GC TO 9	01170000
ISN 0092	SA5=FEVT+FEHT+DLTAFE	01180000
ISN 0093	SA6=CKW*FHLRE	01190000
ISN 0094	IF (INDHUL.EC.3) SA6=0.C	01190100
ISN 0096	IF (INDHUL.EC.3) SA5=FEFL+FEVT+FEHT+DLTAFE	01190200
ISN 0098	GC TO 15	01200000
ISN 0099	16 REFL=RELI*ELCA	01201000
ISN 0100	ARGG=1.0E-C7*REFL	01202000
ISN 0101	FHLRE=(1.C+ALGG10(ARGG)/7.0)**(-2.6)	01203000
ISN 0102	FEFL=0.CC287*CKF*SWETH*FHLRE	01204000
ISN 0103	FEW=0.0	01205000
ISN 0104	SEE=0.0	01206000
ISN 0105	SWWET=C.C	01207000
ISN 0106	GC TO 5	01208000
ISN 0107	9 CDWI=XLINT(TBCL1,TBCDWI,C.,NTCL,M)	01210000
ISN 0108	IF (M.NE.C) WRITE(6,10C2)	01220000
ISN 0110	CKKW=FEHL/(CDWI*SW)	01230000
ISN 0111	SA5=0.C	01240000
ISN 0112	SA6=CKKW	01250000
ISN 0113	SA7=0.C	01260000
ISN 0114	15 CCNTINUE	01270000
ISN 0115	RETURN	01290000
ISN 0116	END	01300000

NAME	TAG	TYPE	ADD.	NAME	TAG	TYPE	ADD.	NAME	TAG	TYPE	ADD.	NAME	TAG	TYPE	ADD.
H		C	R*4 N.R.	M		I*4	000158	Q		C	R*4 N.R.	R		C	R*4 N.R.
T		C	R*4 N.R.	V		C	R*4 N.R.	W		C	R*4 N.R.	AF		C	R*4 N.R.
AR	F	C	R*4 000GC8	BR		C	R*4 N.R.	BS		C	R*4 N.R.	CB		C	R*4 N.R.
CV		C	R*4 N.R.	CX		C	R*4 N.R.	DH		C	R*4 N.R.	EN		C	R*4 N.R.
FF		C	R*4 N.R.	FM		C	R*4 N.R.	FP		C	R*4 N.R.	HC		C	R*4 N.R.
PI	F	C	R*4 000E64	RN		C	R*4 N.R.	SA		C	R*4 N.R.	ST		C	R*4 N.R.
SW	F	C	R*4 0008C8	TR		C	R*4 N.R.	VC		C	R*4 N.R.	VT		C	R*4 N.R.
WE		C	R*4 N.R.	WF		C	R*4 N.R.	WD		C	R*4 N.R.	WS		C	R*4 N.R.
WW		C	R*4 N.R.	XC		C	R*4 N.R.	AMU		C	R*4 N.R.	BHT		C	R*4 N.P.
BLP		C	R*4 N.R.	BMR		C	R*4 N.R.	BVT		C	R*4 N.R.	CCP		C	R*4 N.R.
CCT		C	R*4 N.R.	CDC		C	R*4 N.R.	CDV	S	C	R*4 000688	CKF	F	C	R*4 0001D0
CKH	F	C	R*4 0001D4	CK1		C	R*4 N.R.	CLW		C	R*4 N.R.	CRT		C	R*4 N.R.
CTP		C	R*4 N.R.	EK3		C	R*4 N.R.	DK4		C	R*4 N.R.	DMR		C	R*4 N.R.
ELC		C	R*4 N.R.	ELF		C	R*4 N.R.	ELN		C	R*4 N.R.	ELT		C	R*4 N.R.
ENP		C	R*4 N.R.	ENR		C	R*4 N.R.	FEH		C	R*4 N.R.	FET		C	R*4 N.R.
FEW	SF	C	R*4 0007C8	GLF		C	R*4 N.R.	HES		C	R*4 N.R.	HCC		C	R*4 N.R.
QWE		C	R*4 N.R.	REF	SF	C	R*4 00015C	REW	SF	C	R*4 000160	RHO		C	R*4 N.R.
RMI		C	R*4 N.R.	RCC		C	R*4 N.R.	SA5	S	C	R*4 000884	SA6	S	C	R*4 CC0888
SA7	S	C	R*4 00088C	SEE	SF	C	R*4 0009D8	SFC		C	R*4 N.R.	SHT	F	C	R*4 00089C
SKT		C	R*4 N.R.	SK1		C	R*4 N.R.	SK2		C	R*4 N.R.	SK3		C	R*4 N.R.
SK4		C	R*4 N.R.	SK5		C	R*4 N.R.	SK6		C	R*4 N.R.	SK7		C	R*4 N.R.
SK8		C	R*4 N.R.	SK9		C	R*4 N.R.	SLM		C	R*4 N.R.	STH		C	R*4 N.R.
SVT	F	C	R*4 0008BC	TAF		C	R*4 N.R.	TCR		C	R*4 N.R.	TCT		C	R*4 N.R.
TMP		C	R*4 N.R.	TGG		C	R*4 N.R.	TVW		C	R*4 N.R.	ULF		C	R*4 N.R.
VHL	F	C	R*4 0009CC	VIN		C	R*4 N.R.	VMO		C	R*4 N.R.	WAC		C	R*4 N.R.
WCC		C	R*4 N.R.	WEP		C	R*4 N.R.	WES		C	R*4 N.R.	WFC		C	R*4 N.R.
WFE		C	R*4 N.R.	WFR		C	R*4 N.R.	WFS		C	R*4 N.R.	WFW		C	R*4 N.R.
WHL		C	R*4 N.R.	WHT		C	R*4 N.R.	WLG		C	R*4 N.R.	WMC		C	R*4 N.R.
WPC		C	R*4 N.R.	WPH		C	R*4 N.R.	WRC		C	R*4 N.R.	WSC		C	R*4 N.R.
WST		C	R*4 N.R.	WTM		C	R*4 N.R.	WVA		C	R*4 N.R.	WVT		C	R*4 N.R.
XLB		C	R*4 N.R.	XLR		C	R*4 N.R.	XLW		C	R*4 N.R.	XMR		C	R*4 N.R.
AERO			R*4 000164	ALFR		C	R*4 N.R.	ARGG	SFA		R*4 000168	ARHT		C	R*4 N.R.
ARVT		C	R*4 N.R.	BHPA		C	R*4 N.R.	BHPP		C	R*4 N.R.	BHPR		C	R*4 N.R.
CDHT	F	C	R*4 0001AC	CDVT	F	C	R*4 0001A8	CDWI	SF	C	R*4 00016C	CKFF		C	R*4 N.R.
CKHT	F	C	R*4 0001CC	CKKH	SF	C	R*4 00017C	CKVT	F	C	R*4 0001C8	CAMI		C	R*4 N.R.
DAM2		C	R*4 N.R.	LAM3		C	R*4 N.R.	CAM4		C	R*4 N.R.	CAM5		C	R*4 N.R.
DELR		C	R*4 N.R.	CVOL		C	R*4 N.R.	ELDN		C	R*4 N.R.	ELDT		C	R*4 N.R.
ELHT		C	R*4 N.R.	ELCA	F	C	R*4 0006D8	ELVT		C	R*4 N.R.	EMLF		C	R*4 N.R.
ETAP		C	R*4 N.R.	ETAT		C	R*4 N.R.	FEHI		C	R*4 N.R.	FEHL	SF	C	R*4 0006F4
FEHT	SF	C	R*4 0006F8	FEVT	SF	C	R*4 000704	FEWH		C	R*4 N.R.	FEWI		C	R*4 N.R.
GAP1		C	R*4 N.R.	GAP2		C	R*4 N.R.	GAP3		C	R*4 N.R.	GAP4		C	R*4 N.R.
GAP5		C	R*4 N.R.	GAP6		C	R*4 N.R.	GAP7		C	R*4 N.R.	HFIN		C	R*4 N.R.
LTHL		C	I*4 N.R.	NTCL	SFA		I*4 000174	PEHF		C	R*4 N.R.	PLIN		C	R*4 N.R.
REHL	SF	C	R*4 000178	FEHT	SF		R*4 00017C	RELI	F	C	R*4 0001D8	REVT	SF		R*4 000180
RMAX		C	R*4 N.R.	SHPA		C	R*4 N.R.	SHPR		C	R*4 N.R.	SHTE		C	R*4 N.R.
SHTW	F	C	R*4 0008A4	SKAC		C	R*4 N.R.	SKAR		C	R*4 N.R.	SKCC		C	R*4 N.R.
SKES		C	R*4 N.R.	SKFW		C	R*4 N.R.	SKHL		C	R*4 N.R.	SKHT		C	R*4 N.R.
SKLG		C	R*4 N.R.	SKMC		C	R*4 N.R.	SKPA		C	R*4 N.R.	SKPH		C	R*4 N.R.
SKRC		C	R*4 N.R.	SKSC		C	R*4 N.R.	SKTM		C	R*4 N.R.	SKVT		C	R*4 N.R.
SKWP		C	R*4 N.R.	SKWH		C	R*4 N.R.	SK10		C	R*4 N.R.	SK11		C	R*4 N.R.

7-13

SK12	C	R*4	N.R.	SK13	C	R*4	N.R.	SK14	C	R*4	N.R.	SK15	C	R*4	N.R.	
SLMH	C	R*4	N.R.	STPK	C	R*4	N.R.	SVTE	C	R*4	N.R.	SVTW	F	C	R*4	0008C4
SWTT SF	C	R*4	0008C4	TBHL	C	R*4	N.R.	TBHT	C	R*4	N.R.	TETC	C	R*4	N.R.	
TGHT	C	R*4	N.R.	TCLN	F	C	R*4	0001DC	C	R*4	N.R.	TINY	C	R*4	N.R.	
TIN2	C	R*4	N.R.	TIN4	C	R*4	N.R.	TCVT	C	R*4	N.R.	TCVW	C	R*4	N.R.	
TWTh	C	R*4	N.R.	WEAL	C	R*4	N.R.	TMAX	C	R*4	N.R.	WFUL	C	R*4	N.R.	
WGSB	C	R*4	N.R.	WPDS	C	R*4	N.R.	WENV	C	R*4	N.R.	WPRB	C	R*4	N.R.	
WPRG	C	R*4	N.R.	WPRP	C	R*4	N.R.	WPEI	C	R*4	N.R.	WSCA	C	R*4	N.R.	
XLBH	C	R*4	N.R.	XLGD	C	R*4	N.R.	WRCA	C	R*4	N.R.	YLS2	C	R*4	N.R.	
ALFDL	C	R*4	N.R.	ATNY	C	R*4	N.R.	XLHL	C	R*4	N.R.	CBARW	F	C	R*4	00067C
CLOES	C	R*4	N.R.	CLEVE	C	R*4	N.R.	CBARF S	C	R*4	000670	CPNUD	C	R*4	N.R.	
CPPAR	C	R*4	N.R.	CFPRC	C	R*4	N.R.	CPIND	C	R*4	N.R.	DELTA	C	R*4	N.R.	
CELTH	C	R*4	N.R.	DELWF	C	R*4	N.R.	CPTOT	C	R*4	N.R.	DSWET	C	R*4	N.R.	
ELDOA	C	R*4	N.R.	ENPCR	C	R*4	N.R.	DELWP	C	R*4	N.R.	ETAP4	C	R*4	N.R.	
FETOT SF	C	R*4	0007C0	FHLRE SF	C	R*4	N.R.	ETAP2	C	R*4	N.R.	FNHRE SF	C	R*4	N.R.	
FNVRE SF	C	R*4	000190	FNAER SF	C	R*4	N.R.	FNFRE SF	C	R*4	000188	FNHRE SF	C	R*4	00018C	
ICRUS	C	I*4	N.R.	MAERG	C	R*4	000000	GMDD1	C	R*4	N.R.	HMAXD	C	R*4	N.R.	
PFET2	C	R*4	N.R.	REALJ	C	R*4	N.R.	NOCPP	C	I*4	N.R.	NCXPJ	C	I*4	N.R.	
SIGMR	C	R*4	N.R.	SKAMD	C	R*4	N.R.	RHPMR	C	R*4	N.R.	SIGMA	C	R*4	N.R.	
SKGB2	C	R*4	N.R.	SKPDS	C	R*4	N.R.	SKBAL	C	R*4	N.R.	SKGB1	C	R*4	N.R.	
SKPRB	C	R*4	N.R.	SKRBF	C	R*4	N.R.	SKPEI	C	R*4	N.R.	SKPES	C	R*4	N.R.	
SLMVT	C	R*4	N.R.	SKMAX	C	R*4	N.R.	SKRCA	C	R*4	N.R.	SKSCA	C	R*4	N.R.	
SWET SF	C	R*4	0008CB	SZRHC	C	R*4	N.R.	SWETH F	C	R*4	0008CC	SWEXP	C	R*4	N.R.	
TBEM5	C	R*4	N.R.	TBPCW	C	R*4	N.R.	TBCLI FA	C	R*4	0001E0	TBCRP	C	R*4	N.R.	
THETA	C	R*4	N.R.	TFFCP	C	R*4	N.R.	TBSFC	C	R*4	N.R.	TCBAR	C	R*4	N.R.	
VBARV	C	R*4	N.R.	VCIVE	C	R*4	N.R.	TVCMR	C	R*4	N.R.	VBARH	C	R*4	N.R.	
WPAYL	C	R*4	N.R.	WPSTR	C	R*4	N.R.	VGASB	C	R*4	N.R.	VGASR	C	R*4	N.R.	
XLINT F XF	C	R*4	0000CC	XLRLA	C	R*4	N.R.	XLALB	C	R*4	N.R.	XLBHD	C	R*4	N.R.	
ALFDES	C	R*4	N.R.	EHFSG	C	R*4	N.R.	FRXPR #	XF	R*4	000000	ALCG10	XF	R*4	000000	
CBYLOA	C	R*4	N.R.	CLALPH	C	R*4	N.R.	CBARHT F	C	R*4	000674	CBARVT	F	C	R*4	000678
CYCPRL	C	R*4	N.R.	CELFCR	C	R*4	N.R.	CRSIND	C	R*4	N.R.	CTSIGH	C	R*4	N.R.	
DELWPL	C	R*4	N.R.	CELWST	C	R*4	N.R.	DELRTH	C	R*4	N.R.	DELWFC	C	R*4	N.R.	
DLVLHL	C	R*4	N.R.	ERGINA	C	R*4	N.R.	DLSSH	C	R*4	N.R.	DLTAFE	F	C	R*4	0001B4
ELHLOA	C	R*4	N.R.	ELVLCA	C	R*4	N.R.	DSPLMT	C	R*4	N.R.	DYLIND	C	R*4	N.R.	
EXPDRG	C	R*4	N.R.	FECRAG	C	R*4	N.R.	ETAIND	C	R*4	N.R.	ETAP4N	C	R*4	N.R.	
HULIND	C	R*4	N.R.	IECCM# F XF	C	I*4	000000	FIXIND	C	R*4	N.R.	GAPD11	C	R*4	N.R.	
IADDYL	C	I*4	000828	INCETA	C	I*4	N.R.	INDCRU	C	I*4	N.R.	INDCRG	C	I*4	000824	
INDOPT	C	I*4	N.R.	INCCSW	C	I*4	00083C	INDFIX	C	I*4	N.R.	INDPUL	C	I*4	000834	
INDRDM	C	I*4	N.R.	IPRINT	C	I*4	N.R.	INDPOW	C	I*4	N.R.	INCPRP	C	I*4	N.R.	
PRPIND	C	R*4	N.R.	REMINC	C	R*4	N.R.	OPTIND	C	R*4	N.R.	OSWIND	C	R*4	N.R.	
SKBLNT	C	R*4	N.R.	SKENVI	C	R*4	N.R.	RHORHO	C	R*4	N.R.	SGTIND	C	R*4	N.R.	
SKVTAR	C	R*4	N.R.	SSIGMA	C	R*4	N.R.	SKENV2	C	R*4	N.R.	SKPDSZ	C	R*4	N.R.	
TBAP4	C	R*4	N.R.	TFETMR	C	R*4	N.R.	STHETA	C	R*4	N.R.	TBCDKI	FA	C	R*4	000200
WBALNT	C	R*4	N.R.	WFAILO	C	R*4	N.R.	TOLIND	C	R*4	N.R.	VGBOVH	C	R*4	N.R.	
								XTGTA2	C	R*4	N.R.	XTGTA4	C	R*4	N.R.	

\*\*\*\*\* COMMON INFORMATION \*\*\*\*\*

NAME OF COMMON BLOCK \* \* SIZE OF BLOCK 0009DC HEXADECIMAL BYTES

VAR. NAME TYPE REL. ADDR. VAR. NAME TYPE REL. ADDR. VAR. NAME TYPE REL. ADDR. VAR. NAME TYPE REL. ADDR.

OPTIND	R*4	N.R.	HULINE	R*4	N.R.	DYLIND	R*4	N.R.	DRGIND	R*4	N.R.
OSWIND	R*4	N.R.	FIXINC	R*4	N.R.	ROMIND	R*4	N.R.	PRPIND	R*4	N.R.
ETAIND	R*4	N.R.	WC	R*4	N.R.	XLBWO	R*4	N.R.	XLRLA	R*4	N.R.
VGBCVH	R*4	N.R.	XLGC	R*4	N.R.	HMAXD	R*4	N.R.	RHORHO	R*4	N.R.
VVC	R*4	N.R.	EMLF	R*4	N.R.	CKI	R*4	N.R.	DELWF	R*4	N.R.
CKFF	R*4	N.R.	VDIVE	R*4	N.R.	HOO	R*4	N.R.	ROO	R*4	N.R.
TCC	R*4	N.R.	GAP1	R*4	N.R.	SGTIND	R*4	N.R.	ELHLCA	R*4	N.R.
ELVLCA	R*4	N.R.	GAP2	R*4	N.R.	AR	R*4	00C0C8	WS	R*4	N.R.
TCR	R*4	N.R.	TCT	R*4	N.R.	SLM	R*4	N.R.	ARHT	R*4	N.R.
TCHT	R*4	N.R.	VEARJ	R*4	N.R.	SLMH	R*4	N.R.	ARVT	R*4	N.R.
TCVT	R*4	N.R.	VEARV	R*4	N.R.	SLMVT	R*4	N.R.	ELDN	R*4	N.R.
ELCT	R*4	N.R.	ELCOA	R*4	N.R.	DLSWSH	R*4	N.R.	DSWET	R*4	N.R.
DLVLFH	R*4	N.R.	EVCL	R*4	N.R.	CBYLOA	R*4	N.R.	ENR	R*4	N.R.
KVA	R*4	N.R.	CAMI	R*4	N.R.	CAM2	R*4	N.R.	BMR	R*4	N.R.
CAM3	R*4	N.R.	CLEYE	R*4	N.R.	THETMR	R*4	N.R.	XC	R*4	N.R.
XMR	R*4	N.R.	TVCMR	R*4	N.R.	VT	R*4	N.R.	CTSIGH	R*4	N.R.
TVW	R*4	N.R.	FES	R*4	N.R.	TINY	R*4	N.R.	ETAP2	R*4	N.R.
ETAP4N	R*4	N.R.	TBENS	R*4	N.R.	TB8AP4	R*4	N.R.	GAP3	R*4	N.R.
CAN4	R*4	N.R.	ENF	R*4	N.R.	ETAT	R*4	N.R.	HC	R*4	N.R.
VC	R*4	N.R.	ATMIY	R*4	N.R.	CDVT	R*4	0001A8	CDHT	R*4	00C1AC
CAN5	R*4	N.R.	CLTAFE	R*4	0001B4	FEDRAG	R*4	N.R.	EXPDRG	R*4	N.R.
CFC	R*4	N.R.	CLALFH	R*4	N.R.	CKVT	R*4	0001C8	CKHT	R*4	0001CC
CKF	R*4	0001C0	CKW	R*4	0001D4	RELI	R*4	0001D8	TCLN	R*4	0001DC
TBCLI	R*4	0001E0	TBCDWI	R*4	000200	GAP4	R*4	N.R.	WFE	R*4	N.R.
WFLH	R*4	N.R.	DELWFC	R*4	N.R.	DELWP	R*4	N.R.	DELWST	R*4	N.R.
SKCC	R*4	N.R.	SKRC	R*4	N.R.	SKSC	R*4	N.R.	SKFW	R*4	N.R.
SKTM	R*4	N.R.	SKRCA	R*4	N.R.	SKSCA	R*4	N.R.	SKMC	R*4	N.R.
SKAC	R*4	N.R.	SKHL	R*4	N.R.	SKENV1	R*4	N.R.	SKENV2	R*4	N.R.
SKGB1	R*4	N.R.	SKGB2	R*4	N.R.	SKBLNT	R*4	N.R.	SKBAL	R*4	N.R.
SKLG	R*4	N.R.	SKHW	R*4	N.R.	ELF	R*4	N.R.	RMI	R*4	N.R.
SKWP	R*4	N.R.	SKHT	R*4	N.R.	SKVT	R*4	N.R.	SKPRB	R*4	N.R.
SKREF	R*4	N.R.	SKPH	R*4	N.R.	SKAMD	R*4	N.R.	SKAR	R*4	N.R.
SKFA	R*4	N.R.	SKVTAR	R*4	N.R.	SKPDS	R*4	N.R.	SKPDSZ	R*4	N.R.
SKT	R*4	N.R.	SKFS	R*4	N.R.	SKPEI	R*4	N.R.	SKPES	R*4	N.R.
SK1	R*4	N.R.	SK2	R*4	N.R.	DK3	R*4	N.R.	DK4	R*4	N.R.
SK5	R*4	N.R.	SK6	R*4	N.R.	SK7	R*4	N.R.	SK8	R*4	N.R.
SK9	R*4	N.R.	SK10	R*4	N.R.	SK11	R*4	N.R.	SK12	R*4	N.R.
SK13	R*4	N.R.	SK14	R*4	N.R.	SK15	R*4	N.R.	PLIN	R*4	N.R.
GAP5	R*4	N.R.	TCLINC	R*4	N.R.	XTGTA2	R*4	N.R.	TIN2	R*4	N.R.
THTH	R*4	N.R.	PEETZ	R*4	N.R.	DELTH	R*4	N.R.	STH	R*4	N.R.
CRSIND	R*4	N.R.	XTCTA4	R*4	N.R.	TIN4	R*4	N.R.	VIN	R*4	N.R.
DELR	R*4	N.R.	RVA	R*4	N.R.	DELFCR	R*4	N.R.	ENPCR	R*4	N.R.
DELWFL	R*4	N.R.	STP	R*4	N.R.	HFIN	R*4	N.R.	GAP6	R*4	N.R.
CYCPFL	R*4	N.R.	FF	R*4	N.R.	SK3	R*4	N.R.	SK4	R*4	N.R.
TBH1	R*4	N.R.	TBTC	R*4	N.R.	TBH2	R*4	N.R.	TBCRP	R*4	N.R.
TBSFC	R*4	N.R.	TBPC	R*4	N.R.	GAP7	R*4	N.R.	ALFDES	R*4	N.R.
ALFCL	R*4	N.R.	ALFR	R*4	N.R.	AMU	R*4	N.R.	BHPA	R*4	N.R.
BHFR	R*4	N.R.	BHFSLF	R*4	N.R.	BHT	R*4	N.R.	BLP	R*4	N.R.
ER	R*4	N.R.	B	R*4	N.R.	BVT	R*4	N.R.	CBARF	R*4	000670
CBARFT	R*4	000674	CBARVT	R*4	000678	CBARW	R*4	00067C	CCP	R*4	N.R.
CCT	R*4	N.R.	CDV	R*4	000688	CLW	R*4	N.R.	CPIND	R*4	N.R.
CPALD	R*4	N.R.	CPPAR	R*4	N.R.	CPPRO	R*4	N.R.	CPTOT	R*4	N.R.

7-15

ORIGINAL PAGE IS  
OF POOR QUALITY

CFT	R*4	N.R.	CTF	R*4	N.R.	CV	R*4	N.R.	CX	R*4	N.R.
CLDES	R*4	N.R.	CE	R*4	N.R.	DELRTH	R*4	N.R.	DELTA	R*4	N.R.
CH	R*4	N.R.	CSPLMT	R*4	N.R.	ELC	R*4	N.R.	ELHT	R*4	N.R.
ELN	R*4	N.R.	ELOA	R*4	0006D8	ELT	R*4	N.R.	ELVT	R*4	N.R.
EN	R*4	N.R.	ETAf	R*4	N.R.	FEH	R*4	N.R.	FEHI	R*4	N.R.
FEFL	R*4	0006F4	FEHT	R*4	0006F8	FET	R*4	N.R.	FETOT	R*4	000700
FEVT	R*4	0007C4	FEW	R*4	000708	FEWH	R*4	N.R.	FEWI	R*4	N.R.
FM	R*4	N.R.	FF	R*4	N.R.	ETAP4	R*4	N.R.	GAMD11	R*4	N.R.
GLF	R*4	N.R.	GMOC1	R*4	N.R.	H	R*4	N.R.	ICRUS	I*4	N.R.
INDCRL	I*4	N.R.	INDCRG	I*4	000824	INDDYL	I*4	000828	INDETA	I*4	N.R.
INDFIX	I*4	N.R.	INDFUL	I*4	000834	INDOPT	I*4	N.R.	INDOSW	I*4	00083C
INDPCW	I*4	N.R.	INDPRP	I*4	N.R.	INDRDM	I*4	N.R.	IPRINT	I*4	N.R.
LTHL	I*4	N.R.	NCCPF	I*4	N.R.	NOXPJ	I*4	N.R.	QWE	R*4	N.R.
PEFF	R*4	N.R.	PI	R*4	000864	Q	R*4	N.R.	RHO	R*4	N.R.
REALJ	R*4	N.R.	RHPMF	R*4	N.R.	R	R*4	N.R.	RN	R*4	N.R.
SA	R*4	N.R.	SAE	R*4	000884	SA6	R*4	000888	SA7	R*4	00088C
SFC	R*4	N.R.	SHPA	R*4	N.R.	SHPR	R*4	N.R.	SHT	R*4	00089C
SFTE	R*4	N.R.	SHTk	R*4	0008A4	SIGMA	R*4	N.R.	SSIGMA	R*4	N.R.
ST	R*4	N.R.	STHETA	R*4	N.R.	STMAX	R*4	N.R.	SVT	R*4	0008BC
SVTE	R*4	N.R.	SVTh	R*4	0008C4	SW	R*4	0008C8	SWETH	R*4	0008CC
SwEXP	R*4	N.R.	SWTT	R*4	0008D4	SWWET	R*4	0008D8	S2RHO	R*4	N.R.
T	R*4	N.R.	TAF	R*4	N.R.	TCBAR	R*4	N.R.	THETA	R*4	N.R.
TMAX	R*4	N.R.	TMP	R*4	N.R.	TPROP	R*4	N.R.	TR	R*4	N.R.
LLF	R*4	N.R.	VGASE	R*4	N.R.	VGASR	R*4	N.R.	VHL	R*4	00090C
V	R*4	N.R.	W	R*4	N.R.	WBAL	R*4	N.R.	WBALNT	R*4	N.R.
WCC	R*4	N.R.	WE	R*4	N.R.	WEP	R*4	N.R.	WES	R*4	N.R.
WF	R*4	N.R.	WFC	R*4	N.R.	WFR	R*4	N.R.	WFS	R*4	N.R.
WFK	R*4	N.R.	WGSE	R*4	N.R.	WHL	R*4	N.R.	WHT	R*4	N.R.
WLG	R*4	N.R.	WMC	R*4	N.R.	WPAYL	R*4	N.R.	WPC	R*4	N.R.
WPCS	R*4	N.R.	WPEI	R*4	N.R.	WPH	R*4	N.R.	WPRB	R*4	N.R.
WPFQ	R*4	N.R.	WPEF	R*4	N.R.	WPSTR	R*4	N.R.	WRC	R*4	N.R.
WRCA	R*4	N.R.	WSC	R*4	N.R.	WSCA	R*4	N.R.	WST	R*4	N.R.
WTM	R*4	N.R.	WVT	R*4	N.R.	WW	R*4	N.R.	WPAYLO	R*4	N.R.
WAC	R*4	N.R.	WENV	R*4	N.R.	XLALB	R*4	N.R.	XLB	R*4	N.R.
XLEH	R*4	N.R.	XLHL	R*4	N.R.	XLR	R*4	N.R.	XLW	R*4	N.R.
YLS2	R*4	N.R.	TCVh	R*4	N.R.	DMR	R*4	N.R.	SIGMR	R*4	N.R.
AF	R*4	N.R.	BHPF	R*4	N.R.	SEE	R*4	0009D8			

7-16

LABEL	ADDR	LABEL	ADDR	LABEL	ADDR	LABEL	ADDR	PAGE
2	0CC4A6	3	CC04AE	17	0C0542	18	00057A	008
19	CCC59E	2C	CCC5CC	4	CC05F0	5	000698	
6	CCC6D8 NR	7	CCC75C	8	CC0776	16	0007D2	
9	CCC83E	15	CCC856					

\*OPTIONS IN EFFECT\* NAME= MAIN,CPT=C2,LINECNT=54,SIZE=C000K,

\*OPTIONS IN EFFECT\* SOURCE,EBCCIC,NGLIST,NODECK,LOAD,MAP,NOEDIT,ID,NOXREF

\*STATISTICS\* SOURCE STATEMENTS = 115 ,PROGRAM SIZE = 2234

\*STATISTICS\* NO DIAGNOSTICS GENERATED

\*\*\*\*\* END OF COMPIATION \*\*\*\*\*

99K BYTES OF CORE NOT USED

7-17

ORIGINAL PAGE IS  
OF POOR QUALITY



COMPILER OPTIONS - NAME= MAIN,OPT=02,LINECNT=54,SIZE=0000K,  
SOURCE,EBCDIC,NOLIST,NODECK,LOAD,MAP,NOEDIT, ID,NOXREF

	C	ENTRY MAIN	CASCOMP				00010000
	C****	MEMBER NAME	B81AMAIN				CCC20000
ISN 0002	C	PAGE 1	INPUT LOC 0001 THRU 0050				00C30000
		COMMON	OPTIND ,HULIND ,DYLIND ,DRGIND ,OSWIND				,00C40000
		1FIXIND	,RDMIND ,PRPIND ,ETAIND ,WD				,00050000
		2XLRLA	,VGBOVH ,XLGD ,HMAXD ,RHDRHO ,VMO				,00C60000
		3EMLF	,CK1 ,DELWF ,CKFF ,VDIVE ,HOO				,00070000
		4ROO	,TOO ,GAP1(5) ,SGTIND(12) ,ELHLOA ,ELVLOA				,00C80000
		5GAP2(6)					00C90000
ISN 0003	C	PAGE 2	INPUT LOC 0051 THRU 0100				00100000
		COMMON	AR ,WS ,TCR ,TCT ,SLM				,00110000
		1ARHT	,TCHT ,VBARH ,SLMH ,ARVT ,TCVT				,00120000
		2VBARV	,SLMVT ,ELDN ,ELDT ,ELDOA ,DLSWSH				,00130000
		3DSWET	,DLVLHL ,DVOL ,CBYLOA ,ENR ,WVA				,00140000
		4DAM1	,DAM2 ,BMR ,DAM3 ,CLEYE ,THETMR				,00150000
		5XC	,XMR ,TVCMR ,VT ,CTSIGH ,TVW				,00160000
		6HES	,TINY ,ETAP2 ,ETAP4N ,TBEM5(5) ,TB8AP4(5)				,00170000
		7GAP3					00180000
ISN 0004	C	PAGE 3	INPUT LOC 0101 THRU 140				00190000
		COMMON	DAM4 ,ENP ,ETAT ,HC ,VC				,00200000
		1ATMIY	,CDVT ,CDHT ,DAMS ,DLTAFE ,FEDRAG				,00210000
		2EXPDRG	,CDC ,CLALPH ,CKVT ,CKHT ,CKF				,00220000
		3CKW	,RELI ,TCLN ,TBCL1(8) ,TBCDWI(8) ,GAP4(4)				00230000
ISN 0005	C	PAGE 4	INPUT LOC 141 THRU 200 WEIGHT DATA				00240000
		COMMON	WFE ,WFUL ,DELWFC ,DELWP ,DELWST				,00250000
		1SKCC	,SKRC ,SKSC ,SKFW ,SKTM ,SKRCA				,00260000
		2SKSCA	,SKMC ,SKAC ,SKHL ,SKENV1 ,SKENV2				,00270000
		3SKGB1	,SKGB2 ,SKBLNT ,SKBAL ,SKLG ,SKWW				,00280000
		4ELF	,RMI ,SKWP ,SKHT ,SKVT ,SKPRB				,00290000
		5SKRBF	,SKPH ,SKAMD ,SKAR ,SKPA ,SKVTAR				,00300000
		6SKPDS	,SKPDSZ ,SKT ,SKFS ,SKPEI ,SKPES				,00310000
		7SK1	,SK2 ,DK3 ,DK4 ,SK5 ,SK6				,00320000
		8SK7	,SK8 ,SK9 ,SK10 ,SK11 ,SK12				,00330000
		9SK13	,SK14 ,SK15 ,PLIN ,GAP5(3)				00340000
ISN 0006	C	PAGE 5	INPUT LOC 201 THRU 300				00350000
		COMMON	TOLIND(5) ,XTGTA2(5) ,TIN2(5) ,TWTW(5) ,PFET2(5)				,00360000
		1DELTH(5)	,STH(5) ,CRSIND(5) ,XTGTA4(5) ,TIN4(5) ,VIN(5)				,00370000
		2DELK(5)	,RMAX(5) ,DELFCR(5) ,ENPCR(5) ,DELWPL(5) ,STPW(5)				,00380000
		3HFIN(5)	,GAP6(10)				00390000
ISN 0007	C	PAGE 6	INPUT LOC 301 THRU 400				00400000
		COMMON	CYCPRL ,FF ,SK3 ,SK4 ,TBH1(5)				,00410000
		1TBTO(5)	,TBH2(5) ,TBCRP(5) ,TBSFC(8) ,TBPOW(8) ,GAP7(60)				00420000
ISN 0008	C	WORKING	COMMON				00430000
		COMMON	ALFDES,ALFDL,ALFR,AMU,				00440000
		1	BHPA,BHPR,BHPSUP,BHT,BLP,BR,BS,BVT,				00450000
		2	CBARF,CBARHT,CBARVT,CBARW,CCP,CCT,CDV,CLW,CPIND,CPNUD,CPPAR,CPPRO				00460000
		3	CPTOT,CRT,CTP,CV,CX,CLDES,CB,				00470000
		4	DELRT,DELTA,DH,DSPLMT, ELC,ELHT,ELN,ELOA,ELT,ELVT,EN,ETAP,				00480000
		5	FEH,FEHI,FEHL,FEHT,FET,FETOT,FEVT,FEW,FEWH,FEWI,FM,FP,ETAP4				00490000
ISN 0009		COMMON	GAMD11(3,15),GLF,GDD1(16),H,				00500000

	7	ICRUS, INDCRU, INDRG, INDDYL, INDETA, INDFIX, INDHUL, INDOPT, INDOSW,	00510000
	8	INDPOW, INDRP, INDRM, IPRINT	00520000
ISN 0010		COMMON LTHL, NOCPP, NUXPJ, OWE, PEHF, PI, Q, RHO, REALJ, RHPMR, R, RN	00530000
ISN 0011		COMMON SA, SA5, SA6, SA7, SFC, SHPA, SHPR, SHT, SHTE, SHTW, SIGMA, SSIGMA, ST,	00540000
	1	STHETA, STMAX, SVT, SVTE, SVTW, SW, SWETH, SWEXP, SWTT, SWWET, S2RHO	00550000
ISN 0012		COMMON T, TAF, TCBAR, THETA, TMAX, TMP, TPROP, TR, ULF, VGASB, VGASR, VHL, V	00560000
ISN 0013		COMMON W, WBAL, WBALNT, WCC, WE, WEP, NES, WF, WFC, WFR, WFS, WFW,	00570000
	1	WGSB, WHL, WHT, WLG, WMC, WPAYL, WPC, WPDS, WPEI, WPH, WPRB, WPRG, WPRP, WPSTR	00580000
	2	WRC, WRCA, WSC, WSCA, WST, WTM, WVT, WW, WPAYLQ, WAC, WENV	00590000
ISN 0014		COMMON XLALB, XLB, XLBH, XLHL, XLR, XLW, YLS2, TOVW	00600000
ISN 0015		COMMON DMK, SIGMR, AF, BHPP, SEE	00600001
ISN 0016		COMMON /ODD/ AO(3,15), A1(3,15), A2(3,15), B80(16), B81(16), B82(16),	00600010
	1	RJ3(10), CPOW3(10), ETAI3(10,10), RJ4(10), CPOW4(10),	00600020
	2	ETAI4(10,10), AMACH(3), CLLL(15), CLGAM(16), CPOW33(20),	00600030
	3	CTI3(20), CTI4(20)	00600040
ISN 0017		DIMENSION DATA(1)	00600100
ISN 0018		EQUIVALENCE (DATA(1), OPTIND)	00610000
		INITIALIZE DATA	00620000
ISN 0019		DO 1 I=1,400	00630000
ISN 0020	1	DATA(I) = 0.	00640000
ISN 0021		DO 2 I=179,193	00650000
ISN 0022	2	DATA(I) = 1.	00660000
ISN 0023		PI = 3.14159	00670000
ISN 0024		DATA(11) = 1.	00680000
ISN 0025		DATA(13) = 1.	00690000
ISN 0026		DATA(16) = 1.	00700000
ISN 0027		DATA(18) = 1.	00710000
ISN 0028		DATA(19) = 1.	00720000
ISN 0029		DATA(21) = 1.	00730000
ISN 0030		DATA(109) = 1.	00740000
ISN 0031		DATA(161) = 1.	00750000
ISN 0032	3	CALL LOADER (DATA,1)	00760000
ISN 0033		INDOPT=OPTIND+0.1	00770000
ISN 0034		INDHUL=HULIND+0.1	00780000
ISN 0035		INDDYL=DYLIND+0.1	00790000
ISN 0036		INDDRG=DRGIND+0.1	00800000
ISN 0037		INDOSW=OSWIND+0.1	00810000
ISN 0038		INDFIX=FIXIND+0.1	00820000
ISN 0039		INDRDM=RDIND+0.1	00830000
ISN 0040		INDPRP=PRPIND+0.1	00840000
ISN 0041		INDETA=ETAIND+0.1	00850000
ISN 0042		WPAYL=PLIN	00850100
ISN 0043		DMR=DAM1	00850200
ISN 0044		SIGMR=DAM2	00850300
ISN 0045		AF=DAM3	00850400
ISN 0046		BHPP=DAM4	00850500
ISN 0047		SEE=DAM5	00850600
ISN 0048		IF(INDDYL.GT.2)GO TO 4	00860000
ISN 0050		IF(INDETA.EQ.0)GO TO 4	00870000
ISN 0052		DO 69 I=1,16	00880000
ISN 0053		GMDD1(I) = B80(I) + CLEYE*(B81(I) + CLEYE * B82(I))	00890000
ISN 0054	59	CONTINUE	00900000

```

ISN 0055      DO 77 J = 1,3                      C0510000
ISN 0056      DO 78 K = 1,15                     00920000
ISN 0057      GAMD11(J,K) = A0(J,K) + CLEYE * ( A1(J,K) + CLEYE * A2(J,K)).  C0530000
ISN 0058      78 CONTINUE                        C0930100
ISN 0059      77 CONTINUE                        CC940000
ISN 0060      4 IF(INDOPT.EQ.0) GO TO 5           00950000
ISN 0062      IF(INDOPT.EQ.1) RETURN             00960000
ISN 0064      GO TO 6                            00970000
ISN 0065      5 CALL SIZTR                        00980000
ISN 0066      CALL AERO                          00990000
ISN 0067      CALL ENGSZ                         01C00000
ISN 0068      IPRINT=0                           01C10000
ISN 0069      CALL PRFRM                         01C20000
ISN 0070      CALL WGHTR                         01C30000
ISN 0071      WRITE(6,2015)                      01030100
ISN 0072      IF(INDHUL.EQ.1)WRITE(6,2003)       C1C40000
ISN 0074      2003 FORMAT(10X,'HULLIND = 1     CONVENTIONAL HULL'//)  01050000
ISN 0075      2015 FORMAT(1H1,10X,'*** DIMENSIONAL DATA',//)  01C70000
ISN 0076      IF(INDHUL.EQ.1)WRITE(6,2001)WD,DSPLMT,ELOA,ELN,ELT,DH,VHL,VGASR,SWO1C80000
                1ETH,CV,CB                      01C90000
ISN 0078      2001 FORMAT(10X,'GROSS WEIGHT = ',F10.0,' POUNDS'//  01100000
                1 10X,'*** HULL'//              01110000
                2 20X,'DISPLACEMENT',12X,'DSPLMT',3X,F10.0,4X,'POUNDS'//  01120000
                3 20X,'LENGTH(OVERALL)',9X,'ELOA',9X,F7.1,3X,'FEET'//  01130000
                4 20X,'LENGTH(NUSE)',12X,'ELN',11X,F7.1,3X,'FEET'//  01140000
                5 20X,'LENGTH(TAIL)',12X,'ELT',11X,F7.1,3X,'FEET'//  01150000
                6 20X,'DIAMETER', 16X,'DH', 12X,F7.1,3X,'FEET'//  01160000
                7 20X,'VOLUME(HULL)',12X,'VHL',5X,F12.0,4X,'CUBIC FEET'//  01170000
                8 20X,'VOLUME(GAS)',12X,'VGASR',2X,F12.0,4X,'CUBIC FEET'//  01180000
                9 20X,'WETTED AREA',13X,'SF',6X,F11.0,4X,'SQUARE FEET'//  01190000
                A 20X,'PRISMATIC COEFFICIENT CV',15X,F6.2, / 01200000
                B 20X,'CENTER OF BUOYANCY CB',14X,F6.1, / 01210000
                C 10X,'* * * * *'//              C1220000
                D* * * * *//)                   01230000
ISN 0079      IF(INDDYL.EQ.1.OR.INDDYL.EQ.3) GO TO 2222 01240000
ISN 0081      ALFDD=ALFDES*57.2957795           01240100
ISN 0082      IF(INDHUL.EQ.1)WRITE(6,2002)AR,SW,BS,CBARW,SLM,CLDES,ALFDD  01250000
ISN 0084      2002 FORMAT(10X,'*** WING'//      01260000
                1 20X,'ASPECT RATIO',12X,'AR',14X,F6.2/ 01270000
                2 20X,'AREA',20X,'SW',11X,F8.1,3X,'SQUARE FEET'//  01280000
                3 20X,'SPAN',20X,'BW',12X,F8.2,2X,'FEET'//  01290000
                4 20X,'MEAN CHORD',14X,'CBARW',10X,F7.2,' FEET'//  01300000
                5 20X,'TAPER RATIO',13X,'LAMBDA',12X,F6.3/ 01310000
                6 20X,'DESIGN LIFT COEFFICIENT',2X,'CLDES',12X,F6.3/ 01320000
                7 20X,'DESIGN ANGLE OF ATTACK',3X,'ALFDES',11X,F6.3,' DEG'// 01320100
                80X,'* * * * *'//              01320200
                9* * * * *//)                   01320300
ISN 0085      2222 IF(INDHUL.EQ.2) WRITE(6,2004) 01330000
ISN 0087      2004 FORMAT(10X,'HULLIND = 2     LIFTING HULL'//)  01340000
ISN 0088      IF(INDHUL.EQ.3) WRITE(6,2019)    01340100
ISN 0090      2019 FORMAT(10X,'HULLIND = 3     LIFTING HULL (ELLIPTICAL PLANFORM)'//)  01340200
ISN 0091      IF(INDHUL.EQ.4) WRITE(6,2020).  01340300

```

ISN 0093	2020	FORMAT(10X,'HULLIND = 4 LIFTING HULL (CIRCULAR PLANFORM)')//)	01340400
ISN 0094		IF(INDHUL.GT.1) WRITE(6,2005)WD,DSPLMT,ELOA,TMAX,AR,BS,TCR,SLM,VHL	01350000
		1,VGASR,SW,SWETH,CLDES,ALFDD,CB	01360000
ISN 0096	2005	FORMAT(10X,'GROSS WEIGHT = ',F10.0,2X,'POUNDS'//10X,'*** HULL'//	01370000
	1	20X,'DISPLACEMENT DSPLMT', 2X,F10.0,6X,'PCOUNDS'//	01380000
	2	20X,'LENGTH(OVERALL) ELOA ', 6X,F7.1 ,5X,'FEET'//	01390000
	3	20X,'MAXIMUM THICKNESS TMAX ', 7X,F6.1 ,5X,'FEET'//	01400000
	4	20X,'ASPECT RATIO AR ', 8X,F6.2//	01410000
	5	20X,'SPAN BS ', 6X,F7.1 ,5X,'FEET'//	01420000
	6	20X,'THICKNESS/CHORD TCR ', 9X,F6.3//	01430000
	7	20X,'TAPER RATIO LAMBDA', 9X,F6.3//	01440000
	8	20X,'VOLUME(HULL) VHL ', F12.0,6X,'CUBIC FEET'//	01450000
	9	20X,'VOLUME(GAS) VGASR ', F12.0,6X,'CUBIC FEET'//	01460000
	A	20X,'PLANFORM AREA SW ', 1X,F11.0,6X,'SQUARE FEET'//	01470000
	B	20X,'WETTED AREA SWETH ', 1X,F11.0,6X,'SQUARE FEET'//	01480000
	C	20X,'DESIGN LIFT COEFFICIENT',1X,'CLDES',2X,F6.3//	01490000
	D	20X,'DESIGN ANGLE OF ATTACK',2X,'ALFDES',1X,F6.3,' DEG'//	01500000
	E	20X,'CENTER OF BUOYANCY CB ', 7X,F6.1 ,5X,'FEET'//10X,' * * * *'	01501000
	F	* * * * * //)	01502000
ISN 0097		WRITE(6,2006)ARHT,SHT,BHT,CBARHT,SLMH	01510000
ISN 0098	2006	FORMAT(10X,'*** HORIZONTAL TAIL'//	01520000
	1	20X,'ASPECT RATIO',12X,'ARHT',12X, F6.2//	01530000
	2	20X,'AREA', 20X,'SHT', 10X, F8.1,3X,'SQUARE FEET'//	01540000
	3	20X,'SPAN', 20X,'BHT', 11X, F8.2,2X,'FEET'//	01550000
	4	20X,'MEAN CHORD', 14X,'CBARHT',9X, F7.2,2X,'FEET'//	01560000
	5	20X,'TAPER RATIO', 13X,'SLMH', 13X, F6.3/10X,'* * * * *'	01570000
	6	* * * * * //)	01580000
ISN 0099		WRITE(6,2007)ARVT,SVT,BVT,CBARVT,SLMVT	01590000
ISN 0100	2007	FORMAT(10X,'*** VERTICAL TAIL'//	01600000
	1	20X,'ASPECT RATIO',12X,'ARVT', 12X, F6.2//	01610000
	2	20X,'AREA', 20X,'SVT', 10X, F8.1,3X,'SQUARE FEET'//	01620000
	3	20X,'SPAN', 20X,'BVT', 11X, F8.2,2X,'FEET'//	01630000
	4	20X,'MEAN CHORD', 14X,'CBARVT', 9X, F7.2,2X,'FEET'//	01640000
	5	20X,'TAPER RATIO', 13X,'SLMVT', 13X, F6.3/10X,'* * * * *'	01650000
	6	* * * * * //)	01660000
ISN 0101		IF(INDDYL.LE.2)WRITE(6,2008)DMR,AF,SIGMR,ENR,BMR,VT	01670000
ISN 0103	2008	FORMAT(10X,'*** PROPELLERS - DYLLIND = 1 OR 2'//	01680000
	1	20X,'DIAMETER', 21X,'DMR', 5X,F7.2,3X,'FEET'//	01690000
	2	20X,'ACTIVITY FACTOR PER BLADE', 4X,'AF', 5X,F6.0//	01700000
	3	20X,'SOLIDITY', 21X,'SIGMR',5X,F6.3//	01710000
	4	20X,'NO. OF PROPELLERS', 12X,'ENR', 6X,F4.0//	01720000
	5	20X,'NO. OF BLADES PER PROP', 7X,'BMR', 6X,F4.0//	01730000
	6	20X,'TIP SPEED', 20X,'VT', 5X,F6.0,5X,'FT/SEC'//	01740000
	7	10X,' * * * * *'	01750000
	8	* * * * * //)	01760000
ISN 0104		IF(INDDYL.GT.2)WRITE(6,2009)DMR,SIGMR,WVA,ENR,BMR,VT	01770000
ISN 0106	2009	FORMAT(10X,'*** ROTOR(S) - DYLLIND = 3 OR 4'//	01780000
	1	20X,'DIAMETER', 21X,'DMR', 5X,F7.2,3X,'FEET'//	01790000
	2	20X,'SOLIDITY', 21X,'SIGMR',5X,F6.3//	01800000
	3	20X,'DISC LOADING', 17X,'WVA', 5X,F6.1,4X,'LB/SQ.FT'//	01810000
	4	20X,'NO. OF ROTORS', 16X,'ENR', 6X,F4.0//	01820000
	5	20X,'NO. OF BLADES PER ROTOR', 6X,'BMR', 6X,F4.0//	01830000

ORIGINAL PAGE IS OF POOR QUALITY

7-22

```

6 20X,'TIP SPEED', 20X,'VT', 5X,F6.0,5X,'FT/SEC'/ 01840000
7 10X,'*****' 20X,'VT', 5X,F6.0,5X,'FT/SEC'/ *C1850000
8 '*/') 01860000
ISN 0107 WRITE(6,2010) GLF,EMLF,ULF 01870000
ISN 0108 2010 FORMAT(1H1,10X,'*** WEIGHTS DATA IN LBS'/ 01880000
1 20X,'GUST LOAD FACTOR GLF ',15X,F7.3/ 01890000
2 20X,'MANEUVER LOAD FACTOR EMLF ',14X,F7.3/ 01900000
3 20X,'ULTIMATE LOAD FACTOR ULF ',15X,F7.3//) 01910000
ISN 0109 WPRBO = SK1 * WPRB 01920000
ISN 0110 WPHO = SK2 * WPH 01930000
ISN 0111 WPRPO = DK3 * WPRP 01940000
ISN 0112 WPDSO = DK4 * WPDS 01950000
ISN 0113 WEPO = SK5 * WEP 01960000
ISN 0114 WHLO = SK6 * WHL 01970000
ISN 0115 WENVO = SK6 * WENV 01980000
ISN 0116 WHLT = WHLO + WENVO 01990000
ISN 0117 WGSBO = SK7 * WGSB 02000000
ISN 0118 WWO = SK8 * WW 02010000
ISN 0119 WHTO = SK9 * WHT 02020000
ISN 0120 WVTO = SK10* WVT 02030000
ISN 0121 WLGO = SK11* WLG 02040000
ISN 0122 WRCO = SK12* WRC 02050000
ISN 0123 WSCO = SK13* WSC 02060000
ISN 0124 WFWO = SK14* WFW 02070000
ISN 0125 WPCO = SK15* WPC 02080000
ISN 0126 WPF = WCC+WRCO+WSCO+WFWO+WTM+WPCO+WBAL+WMC+WAC 02090000
ISN 0127 WFC = WPF + DELWFC 02100000
ISN 0128 WPL=WPAYL 02100100
ISN 0129 WRITE(6,2011)WPRG,WPRBO,WPHO,WPRPO,WPSO,WPEI,WFS,DELWP,WPSTR 02110000
ISN 0130 2011 FORMAT(15X,'PROPULSION GROUP'// 02120000
1 20X,'TOTAL MAIN ROTOR GROUP WPRG ',F10.0/ 02130000
2 20X,' MAIN ROTOR BLADE',17X,'SK1*WPRB',15X,F10.0/ 02140000
3 20X,' MAIN ROTOR HUB',19X,'SK2*WPH',16X,F10.0/ 02150000
4 20X,'PROPELLER GROUP',18X,'DK3*WPRP',8X,F10.0/ 02160000
5 20X,'DRIVE SYSTEM',22X,'DK4*WPDS',8X,F10.0/ 02170000
6 20X,'ENGINES',27X,'SK5*WEP',9X,F10.0/ 02180000
7 20X,'ENGINE INSTALLATION',15X,'WPEI',12X,F10.0/ 02190000
8 20X,'FUEL SYSTEM',23X,'WFS',13X,F10.0/ 02200000
9 20X,'PROPULSION GROUP WEIGHT INCREMENT DELWP',11X,F10.0/ 02210000
A 18X,'* TOTAL PROPULSION GROUP WEIGHT WPSTR',31X,F10.0//) 02220000
ISN 0131 WRITE(6,2012)WHLT,WHLO,WENVO,WGSBO,WBALNT,WWC,WHTO,WVTO,WLGO,WES, 02230000
1 DELWST,WST 02240000
ISN 0132 2012 FORMAT(15X,'STRUCTURES GROUP'// 02250000
1 20X,'TOTAL HULL STRUCTURE WEIGHT',24X,F10.0/ 02260000
B 30X,'HULL STRUCTURE',20X,'SK6*WHL',17X,F10.0/ 02270000
C 30X,'HULL ENVELOPE (SKIN)',14X,'SK6*WENV',16X,F10.0/ 02280000
2 20X,'GAS CELLS',25X,'SK7*WGSB',7X,F10.0/ 02290000
3 20X,'BALLONETS',25X,'WBALNT',9X,F10.0/ 02300000
4 20X,'WING',30X,'SK8*WW',9X,F10.0/ 02310000
5 20X,'HORIZONTAL TAIL',19X,'SK9 *WHT', 8X, F10.0/ 02320000
6 20X,'VERTICAL TAIL',19X,'SK10*WVT', 8X, F10.0/ 02330000
-7 20X,'LANDING GEAR',19X,'SK11*WLG', 8X, F10.0/ 02340000

```



```

      6 10X, '****', 7X, 'WING LIFT EFFICIENCY FACTOR', 10X, 'E', 18X, F7.4/10X, 02820000
      7* * * * * 02830000
      8* * * * * 02840000
      SPRO=WPL*VC/WE 02840100
      WRITE(6,2024)SPRO 02840200
2024 FORMAT(20X,'SPECIFIC PRODUCTIVITY =',2X,F7.2,1X,'TON-KNOTS/TON') 02840300
      IPRINT=1 02850000
      CALL PRFRM 02860000
      GO TO 3 02870000
      6 SA5 = DLTAPE 02880000
      IF(INDDYL.EQ.2.OR.INDDYL.EQ.4) GO TO 7 02890000
      GO TO 8 02900000
      7 SA6 = CKW 02910000
      SW = WD/WS 02920000
      IF(INDHUL.EQ.1)GO TO 9 02930000
      GO TO 8 02940000
      9 CALL ATMOS(HC,ATMIY) 02950000
      Q = 1.42636 * RHO * VC * VC 02960000
      ALFDES = (1. - XLRLA)*(1. - XLBWO)*WO/(Q * SW * CLALPH) 02970000
      VHULL = XLBWO * WO/(RHORHO *VGBOVH*(0.076474 - XLGD)) 02980000
      DENOM = PI * (0.25*ELDOA-ELDN/12. - ELDT*7./60.)*(1.+DLVHL) 02990000
      DH = ((VHULL-DVOL)/DENOM)**(1./3.) 03000000
      ELOA = ELDOA * DH 03010000
      8 IPRINT=1 03020000
      CALL PRFRM 03030000
      GO TO 3 03040000
      END 03060000
ISN 0146
ISN 0147
ISN 0148
ISN 0149
ISN 0150
ISN 0151
ISN 0152
ISN 0153
ISN 0155
ISN 0156
ISN 0157
ISN 0158
ISN 0160
ISN 0161
ISN 0162
ISN 0163
ISN 0164
ISN 0165
ISN 0166
ISN 0167
ISN 0168
ISN 0169
ISN 0170
ISN 0171

```

7-24

NAME	TAG	TYPE	ADD.	NAME	TAG	TYPE	ADD.	NAME	TAG	TYPE	ADD.	NAME	TAG	TYPE	ADD.									
H		C	R#4	N.R.	I	SF	I#4	0017D8	J	SF	I#4	0017DC	K	SF	I#4	0017E0								
Q	SF	C	K#4	000868	R		C	R#4	N.R.	T		C	R#4		N.R.	V		C	R#4	N.R.				
W		C	R#4	N.R.	AF	SF	C	R#4	0009D0	AR	F	C	R#4	0000C8	AO	F	C	R#4	000000	BS	F	C	R#4	000668
A1	F	C	R#4	0000B4	A2	F	C	R#4	000168	BR		C	R#4	N.R.	DH	SF	C	R#4	0006C4	FP		C	R#4	N.R.
CB	F	C	R#4	0006B8	CV	F	C	R#4	0006AC	CX		C	R#4	N.R.	SA		C	R#4	N.R.	VC	F	C	R#4	0001A0
EN		C	R#4	N.R.	FF		C	R#4	N.R.	FM		C	R#4	N.R.	WO	F	C	R#4	000024	AMU		C	R#4	N.R.
HC	SFA	C	R#4	00019C	PI	SF	C	R#4	000864	RN		C	R#4	N.R.	BHT	F	C	R#4	00065C	CCP		C	R#4	N.R.
ST		C	R#4	N.R.	SW	SF	C	R#4	0008C8	TR		C	R#4	N.R.	CKF		C	R#4	N.R.	CRT		C	R#4	N.R.
VT	F	C	R#4	000148	WE	F	C	R#4	000924	WF		C	R#4	N.R.	DMR	SF	C	R#4	0009C8	ELT	F	C	R#4	0006DC
WS	F	C	R#4	0000CC	WW	F	C	R#4	000998	XC		C	R#4	N.R.	FET		C	R#4	N.R.	HOO		C	R#4	N.R.
BRO	F	C	R#4	00021C	BB1	F	C	R#4	00025C	BB2	F	C	R#4	00029C	RJ4		C	R#4	N.R.	SA6	S	C	R#4	000888
BLP		C	R#4	N.R.	BMR	F	C	R#4	00012C	BVT	F	C	R#4	00066C	SA7		C	R#4	N.R.	SHT	F	C	R#4	00089C
CCT		C	R#4	N.R.	CDC		C	R#4	N.R.	CDV	F	C	R#4	000688	SK4		C	R#4	N.R.	SK3		C	R#4	N.R.
CKW	F	C	R#4	0001D4	CK1		C	R#4	N.R.	CLW		C	R#4	N.R.	SK7	F	C	R#4	0002EC	SK7	F	C	R#4	0002EC
CTP		C	R#4	N.R.	DK3	F	C	R#4	0002DC	DK4	F	C	R#4	0002E0	STH		C	R#4	N.R.	SK8	F	C	R#4	0002F0
ELC		C	R#4	N.R.	ELF		C	R#4	N.R.	ELN	F	C	R#4	0006D4	TCT		C	R#4	N.R.	SVT	F	C	R#4	0008BC
ENP	F	C	R#4	000194	ENR	F	C	R#4	00011C	FEH		C	R#4	N.R.	ULF	F	C	R#4	000900	TMP	F	C	R#4	0008F4
FEW	F	C	R#4	000708	GLF	F	C	R#4	0007D4	HES		C	R#4	N.R.	WAC	F	C	R#4	0009A0	VHL	F	C	R#4	00090C
QWE	F	C	K#4	00085C	RHO	F	C	R#4	00086C	RJ3		C	R#4	N.R.	WFC	SF	C	R#4	000934	WCC	F	C	R#4	000920
RMI		C	R#4	N.R.	ROO		C	R#4	N.R.	SA5	S	C	R#4	000884	WFH	F	C	R#4	000940	WFE	F	C	R#4	000230
SA7		C	R#4	N.R.	SEE	SF	C	R#4	0009D8	SFC		C	R#4	N.R.	WMC	F	C	R#4	000954	WHL	F	C	R#4	000948
SKT		C	R#4	N.R.	SK1	F	C	R#4	0002D4	SK2	F	C	R#4	0002D8	WRC	F	C	R#4	00097C	WPC	F	C	R#4	00095C
SK4		C	R#4	N.R.	SK5	F	C	R#4	0002E4	SK6	F	C	R#4	0002E8	WVA	F	C	R#4	000120	WSC	F	C	R#4	000984
SK8	F	C	R#4	0002F0	SK9	F	C	R#4	0002F4	SLM	F	C	R#4	0000D8	XLR		C	R#4	N.R.	WVT	F	C	R#4	000994
SVT	F	C	R#4	0008BC	TAF		C	R#4	N.R.	TCR	F	C	R#4	0000D0	ALFR		C	R#4	N.R.	XLW		C	R#4	N.R.
TMP	F	C	R#4	0008F4	TOO		C	R#4	N.R.	TVW		C	R#4	N.R.	BHPP	SF	C	R#4	0009D4	ARHT	F	C	R#4	0000DC
VHL	F	C	R#4	00090C	VIN		C	R#4	N.R.	VMD		C	R#4	N.R.	CKFF		C	R#4	N.R.	BHPR		C	R#4	N.R.
WCC	F	C	R#4	000920	WEP	F	C	R#4	000928	WES	F	C	R#4	00092C	CTI3		C	R#4	N.R.	CKHT		C	R#4	N.R.
WFE	F	C	R#4	000230	WFR	F	C	R#4	000938	WFS	F	C	R#4	00093C	DAM3	F	C	R#4	000130	CTI4		C	R#4	N.R.
WHL	F	C	R#4	000948	WHT	F	C	R#4	00094C	WLG	F	C	R#4	000950	DELR		C	R#4	N.R.	DAM4	F	C	R#4	000190
WPC	F	C	R#4	00095C	WPH	F	C	R#4	000968	WPL	SF	C	R#4	0017E4	ELHT		C	R#4	N.R.	DVOL	F	C	R#4	000114
WSC	F	C	R#4	000984	WST	F	C	R#4	00098C	WTM	F	C	R#4	000990	ETAP		C	R#4	N.R.	ELUA	SF	C	R#4	0006D8
WVT	F	C	R#4	000994	WVO	SF	C	R#4	0017E8	XLB		C	R#4	N.R.	FEHT	F	C	R#4	0006F8	ETAT		C	R#4	N.R.
XLW		C	R#4	N.R.	XMR		C	R#4	N.R.	AERO	SF	XF	R#4	000000	GAPI		C	R#4	N.R.	FEVT	F	C	R#4	000704
ARHT	F	C	R#4	0000DC	ARVT	F	C	R#4	0000EC	BHPA		C	R#4	N.R.	GAP5		C	R#4	N.R.	GAP2		C	R#4	N.R.
BHPR		C	R#4	N.R.	CDHT		C	R#4	N.R.	CDVT		C	R#4	N.R.	LTHL		C	I#4	N.R.	GAP6		C	R#4	N.R.
CKHT		C	R#4	N.R.	CKVT		C	R#4	N.R.	CLLL		C	R#4	N.R.	RMAX		C	R#4	N.R.	PEHF		C	R#4	N.R.
CTI4		C	R#4	N.R.	DAM1	F	C	R#4	000124	DAM2	F	C	R#4	000128	SHTW		C	R#4	N.R.	SHPA		C	R#4	N.R.
DAM4	F	C	R#4	000190	DAM5	F	C	R#4	0001B0	DATA	SFA	CE	R#4	000000	SKCC		C	R#4	N.R.	SKAC		C	R#4	N.R.
DVOL	F	C	R#4	000114	ELDN	F	C	R#4	0000FC	ELDT	F	C	R#4	000100	SKHT		C	R#4	N.R.	SKFW		C	R#4	N.R.
ELUA	SF	C	R#4	0006D8	ELVT		C	R#4	N.R.	EMLF	F	C	R#4	000044	SKPH		C	R#4	N.R.	SKMC		C	R#4	N.R.
ETAT		C	R#4	N.R.	FEHI		C	R#4	N.R.	FEHL	F	C	R#4	0006F4										
FEVT	F	C	R#4	000704	FEWH		C	R#4	N.R.	FEWI		C	R#4	N.R.										
GAP2		C	R#4	N.R.	GAP3		C	R#4	N.R.	GAP4		C	R#4	N.R.										
GAP6		C	R#4	N.R.	GAP7		C	R#4	N.R.	HF IN		C	R#4	N.R.										
PEHF		C	R#4	N.R.	PLIN	F	C	R#4	000310	RELI		C	R#4	N.R.										
SHPA		C	R#4	N.R.	SHPR		C	R#4	N.R.	SHTC		C	R#4	N.R.										
SKAC		C	R#4	N.R.	SKAR		C	R#4	N.R.	SKCC		C	R#4	N.R.										
SKFW		C	R#4	N.R.	SKHL		C	R#4	N.R.	SKHT		C	R#4	N.R.										
SKMC		C	R#4	N.R.	SKPA		C	R#4	N.R.	SKPH		C	R#4	N.R.										

ORIGINAL PAGE IS  
OF POOR QUALITY



SKSC	C	R#4	N.R.	SKTM	C	R#4	N.R.	SKVT	C	R#4	N.R.	SKWP	C	R#4	N.R.									
SKHW	C	R#4	N.R.	SK10	F	C	R#4	0002F8	SK11	F	C	R#4	0002FC	SK12	F	C	R#4	000300						
SK13	F	C	R#4	000304	SK14	F	C	R#4	000308	SK15	F	C	R#4	00030C	SLMH	F	C	R#4	0003E8					
SPRO	SF	R#4	0017EC	STPW	C	R#4	N.R.	SVTE	C	R#4	N.R.	SVTW	C	R#4	N.R.	SVTH	C	R#4	N.R.					
SWTT	F	C	R#4	0008D4	TBHL	C	R#4	N.R.	TB2	C	R#4	N.R.	TBTO	C	R#4	N.R.	TINY	C	R#4	N.R.				
TCHT	C	R#4	N.R.	TCLN	C	R#4	N.R.	TCVT	C	R#4	N.R.	TOVW	C	R#4	N.R.	TINY	C	R#4	N.R.					
TIN2	C	R#4	N.R.	TIN4	C	R#4	N.R.	TMAX	F	C	R#4	0008FO	TOVW	C	R#4	N.R.	TINY	C	R#4	N.R.				
TWTW	C	R#4	N.R.	WBAL	F	C	R#4	000918	WENV	F	C	R#4	0009A4	WEPO	SF	R#4	0017F0	WEPO	SF	R#4	0017F0			
WFUL	F	C	R#4	000234	WFWO	SF	R#4	0017F4	WGSB	F	C	R#4	000944	WHLO	SF	R#4	0017F8	WHLO	SF	R#4	0017F8			
WHLT	SF	R#4	0017FC	WHTO	SF	R#4	001800	WLGQ	SF	R#4	001804	WPCO	SF	R#4	001808	WPCO	SF	R#4	001808					
WPDS	F	C	R#4	000900	WPEI	F	C	R#4	000964	WPGC	SF	R#4	00180C	WPHO	SF	R#4	001810	WPHO	SF	R#4	001810			
WPKB	F	C	R#4	00096C	WPRG	F	C	R#4	000970	WPRP	F	C	R#4	000974	WRCA	C	R#4	N.R.	WRCA	C	R#4	N.R.		
WRCC	SF	R#4	001814	WSCA	C	R#4	N.R.	WSCO	SF	R#4	001818	WVTO	SF	R#4	00181C	WVTO	SF	R#4	00181C					
XLBH	C	R#4	N.R.	XLGD	F	C	R#4	000034	XLHL	C	R#4	N.R.	YLS2	C	R#4	N.R.	YLS2	C	R#4	N.R.				
ALFDD	SF	R#4	001820	ALFDL	C	R#4	N.R.	AMACH	C	R#4	N.R.	ATMIY	SFA	C	R#4	0001A4	ATMIY	SFA	C	R#4	0001A4			
ATMUS	SF	XF	R#4	000000	CBARF	F	C	R#4	000670	CBARH	F	C	R#4	00067C	CLDES	F	C	R#4	0006B4	CLDES	F	C	R#4	0006B4
CLEVE	F	C	R#4	000134	CLGAM	C	R#4	N.R.	CPIND	C	R#4	N.R.	CPNUD	C	R#4	N.R.	CPNUD	C	R#4	N.R.				
CPW3	C	R#4	N.R.	CPOW4	C	R#4	N.R.	CPPAR	C	R#4	N.R.	CPPRO	C	R#4	N.R.	CPPRO	C	R#4	N.R.					
CPTCT	C	R#4	N.R.	DELTA	C	R#4	N.R.	DELTH	C	R#4	N.R.	DELWF	C	R#4	N.R.	DELWF	C	R#4	N.R.					
DELWP	F	C	R#4	00023C	DENOM	SF	R#4	001824	DSWET	C	R#4	N.R.	ELDOA	F	C	R#4	000104	ELDOA	F	C	R#4	000104		
ENG5Z	SF	XF	R#4	000000	ENPCR	C	R#4	N.R.	ETA13	C	R#4	N.R.	ETA14	C	R#4	N.R.	ETA14	C	R#4	N.R.				
ETAP2	C	R#4	N.R.	ETAP4	C	R#4	N.R.	FETOT	F	C	R#4	000700	GMDD1	S	C	R#4	0007D8	GMDD1	S	C	R#4	0007D8		
HMAXD	C	R#4	N.R.	IGRUS	C	I#4	N.R.	NOCPP	C	I#4	N.R.	NOXPJ	C	I#4	N.R.	NOXPJ	C	I#4	N.R.					
PFET2	C	R#4	N.R.	PRFRM	SF	XF	R#4	000000	REALJ	C	R#4	N.R.	RHPMR	C	R#4	N.R.	RHPMR	C	R#4	N.R.				
SIGMA	C	R#4	N.R.	SIGMR	SF	C	R#4	0009CC	SIZTR	SF	XF	R#4	000000	SKAMD	C	R#4	N.R.	SKAMD	C	R#4	N.R.			
SKBAL	C	R#4	N.R.	SKGB1	C	R#4	N.R.	SKGB2	C	R#4	N.R.	SKPDS	C	R#4	N.R.	SKPDS	C	R#4	N.R.					
SKPEI	C	R#4	N.R.	SKPES	C	R#4	N.R.	SKPRB	C	R#4	N.R.	SKRBF	C	R#4	N.R.	SKRBF	C	R#4	N.R.					
SKRCA	C	R#4	N.R.	SKSCA	C	R#4	N.R.	SLMVT	F	C	R#4	0000F8	STMAX	C	R#4	N.R.	STMAX	C	R#4	N.R.				
SWETH	F	C	R#4	0008CC	SWEXP	C	R#4	N.R.	SWWET	C	R#4	N.R.	S2RHO	C	R#4	N.R.	S2RHO	C	R#4	N.R.				
TBCL1	C	R#4	N.R.	TBCRP	C	R#4	N.R.	TBEM5	C	R#4	N.R.	TBPOW	C	R#4	N.R.	TBPOW	C	R#4	N.R.					
TBSFC	C	R#4	N.R.	TGBAR	C	R#4	N.R.	THETA	C	R#4	N.R.	TPROP	C	R#4	N.R.	TPROP	C	R#4	N.R.					
TVCMR	C	R#4	N.R.	VBARH	C	R#4	N.R.	VBARV	C	R#4	N.R.	VDIVE	C	R#4	N.R.	VDIVE	C	R#4	N.R.					
VGASB	C	R#4	N.R.	VGASR	F	C	R#4	000908	VHULL	SF	R#4	001828	WENVO	SF	R#4	00182C	WENVO	SF	R#4	00182C				
WGHR	SF	XF	R#4	000000	WGSBO	SF	R#4	001830	WPAYL	SF	C	R#4	000958	WPDSO	SF	R#4	001834	WPDSO	SF	R#4	001834			
WPRBU	SF	R#4	001838	WPRPO	SF	R#4	00183C	WPSTR	F	C	R#4	000978	XLALB	C	R#4	N.R.	XLALB	C	R#4	N.R.				
XLAWO	F	C	R#4	000028	XLRLA	F	C	R#4	00002C	FRXPR#	XF	R#4	000000	ALFDES	SF	C	R#4	000640	ALFDES	SF	C	R#4	000640	
BHPSUP	C	R#4	N.R.	CBARHT	F	C	R#4	000674	CBARVT	F	C	R#4	000678	CBYLOA	C	R#4	N.R.	CBYLOA	C	R#4	N.R.			
CLALPH	F	C	R#4	0001C4	CPOW33	C	R#4	N.R.	CRSIND	C	R#4	N.R.	CTSIGH	C	R#4	N.R.	CTSIGH	C	R#4	N.R.				
CYCPR1	F	C	R#4	000480	DELFCR	C	R#4	N.R.	DELRTH	C	R#4	N.R.	DELWFC	F	C	R#4	000238	DELWFC	F	C	R#4	000238		
DELWPL	C	R#4	N.R.	DELWST	F	C	R#4	000240	DLSWSH	C	R#4	N.R.	DLTAFE	F	C	R#4	0001B4	DLTAFE	F	C	R#4	0001B4		
DLVLHL	F	C	R#4	000110	DRGIND	F	C	R#4	00000C	DSPLMT	F	C	R#4	0006C8	DYLIND	F	C	R#4	000008	DYLIND	F	C	R#4	000008
ELHLOA	C	R#4	N.R.	ELVLOA	C	R#4	N.R.	ETAIND	F	C	R#4	000020	ETAP4N	C	R#4	N.R.	ETAP4N	C	R#4	N.R.				
EXPDRG	C	R#4	N.R.	FEDRAG	C	R#4	N.R.	FIXIND	F	C	R#4	000014	GAMD11	S	C	R#4	000720	GAMD11	S	C	R#4	000720		
HULIND	F	C	R#4	000004	IBCOM#	F	XF	R#4	000000	INDCRU	C	I#4	N.R.	INDDRG	S	C	I#4	000824	INDDRG	S	C	I#4	000824	
INDDYL	S	C	I#4	000828	INDETA	S	C	I#4	00082C	INDFIX	S	C	I#4	000830	INDHUL	S	C	I#4	000834	INDHUL	S	C	I#4	000834
INDOPT	S	C	I#4	000838	INDOSW	S	C	I#4	00083C	INDPOW	C	I#4	N.R.	INDPRP	S	C	I#4	000844	INDPRP	S	C	I#4	000844	
INDROM	S	C	I#4	000848	IPRINT	S	C	I#4	00084C	LOADER	SF	XF	I#4	000000	OPTIND	F	CE	R#4	000000	OPTIND	F	CE	R#4	000000
OSWIND	F	C	R#4	000010	PRPIND	F	C	R#4	00001C	ROMIND	F	C	R#4	000018	RHORHO	F	C	R#4	00003C	RHORHO	F	C	R#4	00003C
SGTIND	C	R#4	N.R.	SKBLNT	C	R#4	N.R.	SKENV1	C	R#4	N.R.	SKENV2	C	R#4	N.R.	SKENV2	C	R#4	N.R.	SKENV2	C	R#4	N.R.	
SKPDSZ	C	R#4	N.R.	SKVTAR	C	R#4	N.R.	SSIGMA	C	R#4	N.R.	STHETA	C	R#4	N.R.	STHETA	C	R#4	N.R.	STHETA	C	R#4	N.R.	
TBCDWI	C	R#4	N.R.	TB8AP4	C	R#4	N.R.	THETMR	C	R#4	N.R.	TOLIND	C	R#4	N.R.	TOLIND	C	R#4	N.R.	TOLIND	C	R#4	N.R.	
VGBOVH	F	C	R#4	000030	WBALNT	F	C	R#4	00091C	WPAYLO	C	R#4	N.R.	XTGTA2	C	R#4	N.R.	XTGTA2	C	R#4	N.R.			

XTGTA4 C R\*4 N.R.

\*\*\*\*\* COMMON INFORMATION \*\*\*\*\*

NAME OF COMMON BLOCK \* \* SIZE OF BLOCK 0009DC HEXADECIMAL BYTES

VAR. NAME	TYPE	REL. ADDR.	VAR. NAME	TYPE	REL. ADDR.	VAR. NAME	TYPE	REL. ADDR.	VAR. NAME	TYPE	REL. ADDR.
OPTIND	R*4	000000	HULIND	R*4	000004	DYLIND	R*4	000008	DRGIND	R*4	00000C
OSWIND	R*4	000010	FIXIND	R*4	000014	RDIND	P*4	000018	PRPIND	R*4	00001C
ETAIND	R*4	000020	WD	R*4	000024	XLBWG	R*4	000028	XLRLA	R*4	00002C
VGBQVH	R*4	000030	XLGD	R*4	000034	HMAXD	R*4	N.R.	RHORHO	R*4	00003C
VMO	R*4	N.R.	EMLF	R*4	000044	CK1	R*4	N.R.	DELWF	R*4	N.R.
CKFF	R*4	N.R.	VDIVE	R*4	N.R.	HOO	R*4	N.R.	ROO	R*4	N.R.
TOO	R*4	N.R.	GAP1	R*4	N.R.	SGTIND	R*4	N.R.	ELHLOA	R*4	N.R.
ELVLCR	R*4	N.R.	GAP2	R*4	N.R.	AR	R*4	0000C9	WS	R*4	0000CC
TCR	R*4	0000D0	TCT	R*4	N.R.	SLM	R*4	0J0CDE	ARHT	R*4	0000DC
TCHT	R*4	N.R.	VBARH	R*4	N.R.	SLMH	R*4	0000E8	ARVT	R*4	0000EC
TCVT	R*4	N.R.	VBARV	R*4	N.R.	SLMVT	R*4	0000F8	ELDN	R*4	0000FC
ELDT	R*4	000100	ELDOA	R*4	000104	DLSWSH	R*4	N.R.	DSWET	R*4	N.R.
DLVLHL	R*4	000110	DVOL	R*4	000114	CBYLOA	R*4	N.R.	ENR	R*4	00011C
WVA	R*4	000120	DAMI	R*4	000124	DAM2	R*4	000128	BMR	R*4	00012C
DAM3	R*4	000130	CLEYE	R*4	000134	THETMR	R*4	N.R.	XC	R*4	N.R.
XMR	R*4	N.R.	TVCMR	R*4	N.R.	VT	R*4	000148	CTSI GH	R*4	N.R.
TVW	R*4	N.R.	HES	R*4	N.R.	TINY	R*4	N.R.	ETAP2	R*4	N.R.
ETAP4N	R*4	N.R.	TBEM5	R*4	N.R.	TB8AP4	R*4	N.R.	GAP3	R*4	N.R.
DAM4	R*4	000190	ENP	R*4	000194	ETAT	R*4	N.R.	HC	R*4	00019C
VC	R*4	0001A0	ATMIY	R*4	0001A4	CDVT	R*4	N.R.	CDHT	R*4	N.R.
DAM5	R*4	0001B0	DLTAFE	R*4	0001B4	FEDRAG	R*4	N.R.	EXPDRG	R*4	N.R.
CDC	R*4	N.R.	CLALPH	R*4	0001C4	CKVT	R*4	N.R.	CKHT	R*4	N.R.
CKF	R*4	N.R.	CKW	R*4	0001D4	RELI	R*4	N.R.	TCLN	R*4	N.R.
TBCL1	R*4	N.R.	TBCDWI	R*4	N.R.	GAP4	R*4	N.R.	WFE	R*4	000230
WFUL	R*4	000234	DELWFC	R*4	000238	DELWP	R*4	00023C	DELWST	R*4	000240
SKCC	R*4	N.R.	SKRC	R*4	N.R.	SKSC	R*4	N.R.	SKFW	R*4	N.R.
SKTM	R*4	N.R.	SKRCA	R*4	N.R.	SKSCA	R*4	N.R.	SKMC	R*4	N.R.
SKAC	R*4	N.R.	SKHL	R*4	N.R.	SKENV1	R*4	N.R.	SKENV2	R*4	N.R.
SKGB1	R*4	N.R.	SKGB2	R*4	N.R.	SKBLNT	R*4	N.R.	SKBAL	R*4	N.R.
SKLG	R*4	N.R.	SKWW	R*4	N.R.	ELF	R*4	N.R.	RMI	R*4	N.R.
SKWP	R*4	N.R.	SKHT	R*4	N.R.	SKVT	R*4	N.R.	SKPRB	R*4	N.R.
SKRBF	R*4	N.R.	SKPH	R*4	N.R.	SKAMD	R*4	N.R.	SKAR	R*4	N.R.
SKPA	R*4	N.R.	SKVTAR	R*4	N.R.	SKPDS	R*4	N.R.	SKPDSZ	R*4	N.R.
SKT	R*4	N.R.	SKFS	R*4	N.R.	SKPEI	R*4	N.R.	SKPES	R*4	N.R.
SK1	R*4	0002D4	SK2	R*4	0002D8	DK3	R*4	0002DC	DK4	R*4	0002E0
SK5	R*4	0002E4	SK6	R*4	0002E8	SK7	R*4	0002EC	SK8	R*4	0002F0
SK9	R*4	0002F4	SK10	R*4	0002F8	SK11	R*4	0002FC	SK12	R*4	000300
SK13	R*4	000304	SK14	R*4	000308	SK15	R*4	00030C	PLIN	R*4	000310
GAP5	R*4	N.R.	TOLIND	R*4	N.R.	XTGTA2	R*4	N.R.	TIN2	R*4	N.R.
TWTW	R*4	N.R.	PFET2	R*4	N.R.	DELTH	R*4	N.R.	STH	R*4	N.R.
CRSIND	R*4	N.R.	XTGTA4	R*4	N.R.	TIA4	R*4	N.R.	VIN	R*4	N.R.
DELR	R*4	N.R.	RMAX	R*4	N.R.	DELFCR	R*4	N.R.	ENPCR	R*4	N.R.
DELWPL	R*4	N.R.	STPW	R*4	N.R.	HFIN	R*4	N.R.	GAP6	R*4	N.R.
CYCPRL	R*4	000480	FF	R*4	N.R.	SK3	R*4	N.R.	SK4	R*4	N.R.

ORIGINAL PAGE IS  
OF POOR QUALITY

7-27

TBHI	R*4	N.R.	TBTO	R*4	N.R.	TBF2	R*4	N.R.	TBCRP	R*4	N.R.
TBSFC	R*4	N.R.	TBPOW	R*4	N.R.	GAP7	R*4	N.R.	ALFOES	R*4	000640
ALFDL	R*4	N.R.	ALFR	R*4	N.R.	AMU	R*4	N.R.	BHPA	R*4	N.R.
BHPR	R*4	N.R.	BHPSUP	R*4	N.R.	BHT	R*4	00065C	BLP	R*4	N.R.
BR	R*4	N.R.	BS	R*4	000668	BVT	R*4	00066C	CBARF	R*4	000670
CBARHT	R*4	000674	CBARVT	R*4	000678	CBARW	R*4	00067C	CCP	R*4	N.R.
CCT	R*4	N.R.	CDV	R*4	000688	CLW	R*4	N.R.	CPIND	R*4	N.R.
CPNUD	R*4	N.R.	CPPAR	R*4	N.R.	CPPRO	R*4	N.R.	CPTOT	R*4	N.R.
CKT	R*4	N.R.	CTP	R*4	N.R.	CV	R*4	0006AC	CX	R*4	N.R.
CLDES	R*4	0006B4	CB	R*4	0006B8	DELRTH	R*4	N.R.	DELTA	R*4	N.R.
DH	R*4	0006C4	DSPLMT	R*4	0006C8	ELC	R*4	N.R.	ELHT	R*4	N.R.
ELN	R*4	0006D4	ELDA	R*4	0006D8	ELT	R*4	0006DC	ELVT	R*4	N.R.
EN	R*4	N.R.	ETAP	R*4	N.R.	FEH	R*4	N.R.	FEHI	R*4	N.R.
FEHL	R*4	0006F4	FEHT	R*4	0006F8	FET	R*4	N.R.	FETOT	R*4	000700
FEVT	R*4	000704	FEW	R*4	000708	FEWH	R*4	N.R.	FEWI	R*4	N.R.
FM	R*4	N.R.	FP	R*4	N.R.	ETAP4	R*4	N.R.	GAMD11	R*4	000720
GLF	R*4	0007D4	GMDD1	R*4	0007D8	H	R*4	N.R.	ICRUS	I*4	N.R.
INDCRU	I*4	N.R.	INDDRG	I*4	000824	INDDYL	I*4	000828	INDETA	I*4	00082C
INDFIX	I*4	000830	INDHUL	I*4	000834	INDOPT	I*4	000838	INDOSW	I*4	00083C
INDPOW	I*4	N.R.	INDPRP	I*4	000844	INDRDM	I*4	000848	IPRINT	I*4	00084C
LTHL	I*4	N.R.	NOCPP	I*4	N.R.	NOXPJ	I*4	N.R.	QWE	R*4	00085C
PEHF	R*4	N.R.	PI	R*4	000864	Q	R*4	000868	RHO	R*4	00086C
REALJ	R*4	N.R.	RHPMR	R*4	N.R.	R	R*4	N.R.	RN	R*4	N.R.
SA	R*4	N.R.	SA5	R*4	000884	SA6	R*4	000888	SA7	R*4	N.R.
SFC	R*4	N.R.	SHPA	R*4	N.R.	SHPR	R*4	N.R.	SHT	R*4	00089C
SHT	R*4	N.R.	SHTW	R*4	N.R.	SIGMA	R*4	N.R.	SSIGMA	R*4	N.R.
ST	R*4	N.R.	STHETA	R*4	N.R.	STMAX	R*4	N.R.	SVT	R*4	0008BC
SVTE	R*4	N.R.	SVTW	R*4	N.R.	SW	R*4	0008C8	SWETH	R*4	0008CC
SWEXP	R*4	N.R.	SWTT	R*4	0008D4	SWWET	R*4	N.R.	SZRHO	R*4	N.R.
T	R*4	N.R.	TAF	R*4	N.R.	TCBAR	R*4	N.R.	THETA	R*4	N.R.
TMAX	R*4	0008F0	TMP	R*4	0008F4	TPRCP	R*4	N.R.	TR	R*4	N.R.
ULF	R*4	000900	VGASB	R*4	N.R.	VGASR	R*4	000908	VHL	R*4	00090C
V	R*4	N.R.	W	R*4	N.R.	WBAL	R*4	000918	WBALNT	R*4	00091C
WCC	R*4	000920	WE	R*4	000924	WEP	R*4	000928	WES	R*4	00092C
WF	R*4	N.R.	WFC	R*4	000934	WFR	R*4	000938	WFS	R*4	00093C
WFW	R*4	000940	WGSB	R*4	000944	WHL	R*4	000948	WHT	R*4	00094C
WLG	R*4	000950	WMC	R*4	000954	WPAYL	R*4	000958	WPC	R*4	00095C
WPDS	R*4	000960	WPEI	R*4	000964	WPH	R*4	000968	WPRB	R*4	00096C
WPRG	R*4	000970	WPRP	R*4	000974	WPSIR	R*4	000978	WRC	R*4	00097C
WRCA	R*4	N.R.	WSC	R*4	000984	WSCA	R*4	N.R.	WST	R*4	00098C
WTM	R*4	000990	WVT	R*4	000994	WW	R*4	000998	WPAYLO	R*4	N.R.
WAC	R*4	0009A0	WENV	R*4	0009A4	XLALB	R*4	N.R.	XLB	R*4	N.R.
XLRH	R*4	N.R.	XLHL	R*4	N.R.	XHR	R*4	N.R.	XLW	R*4	N.R.
YLS2	R*4	N.R.	TOVW	R*4	N.R.	DMR	R*4	0009C8	SIGMR	R*4	0009CC
AF	R*4	0009D0	BHPP	R*4	0009D4	SEE	R*4	0009D8			

EQUIVALENCED VARIABLES WITHIN THIS COMMON BLOCK  
 VARIABLE OFFSET  
 DATA 000000

VARIABLE OFFSET

VARIABLE OFFSET

NAME OF COMMON BLOCK \* ODD\* SIZE OF BLOCK 000814 HEXADECIMAL BYTES

VAR. NAME	TYPE	REL. ADDR.	VAR. NAME	TYPE	REL. ADDR.	VAR. NAME	TYPE	REL. ADDR.	VAR. NAME	TYPE	REL. ADDR.
AO	R*4	000000	A1	R*4	000084	A2	R*4	000168	BB0	R*4	00021C
BB1	R*4	00025C	BB2	R*4	00029C	RJ3	R*4	N.R.	CPOW3	R*4	N.R.
ETA13	R*4	N.R.	RJ4	R*4	N.R.	CPOW4	R*4	N.R.	ETA14	R*4	N.R.
AMACH	R*4	N.R.	CLLL	R*4	N.R.	CLGAM	R*4	N.R.	CPOW33	R*4	N.R.
CTI3	R*4	N.R.	CTI4	R*4	N.R.						

LABEL	ADDR	LABEL	ADDR	LABEL	ADDR	LABEL	ADDR
1	0018CC	2	0018E2	3	001916	69	001AB2
78	001AE4	77	001AE8	4	001AEC	5	001B0C
2222	001C78	6	002264	7	002280	9	0022A4
8	002368						

\*OPTIONS IN EFFECT\* NAME= MAIN,DPT=02,LINECNT=54,SIZE=0000K,

\*OPTIONS IN EFFECT\* SOURCE,EBCDIC,NOLIST,NODECK,LOAD,MAP,NOEDIT,NOXREF

\*STATISTICS\* SOURCE STATEMENTS = 170 ,PROGRAM SIZE = 9118

\*STATISTICS\* NO DIAGNOSTICS GENERATED

\*\*\*\*\* END OF COMPILATION \*\*\*\*\*

79K BYTES OF CORE NOT USED

COMPILER OPTICNS - NAME= MAIN,GP1=C2,LINECNT=54,SIZE=0CCCK,

SOURCE,EBCDIC,ACLIST,NODECK,LOAD,MAP,NCEDIT,LD,NOXREF

ISN 0002

SUBROUTINE ATMCS(H,TIN33)

00010000

C\*\*\*\* MEMBER NAME B81ATMCS

00020000

ISN 0003

C PAGE 1 INPLT LCC CCG1 THRU 0050

00030000

CCMMON CPTIND ,FULIND ,OYLIND ,CRGIND ,OSKIND ,00040000  
1FIXIND ,RCMIND ,PFFIND ,ETAIND ,K ,XLBW ,00050000  
2XLRLA ,VGBCVH ,XLCG ,HMAXD ,RFRHO ,VMC ,00060000  
3EMLF ,CK1 ,DELWF ,CKFF ,VCIVE ,HGC ,00070000  
4RCC ,TOC ,GAF1(5) ,SCTIND(12) ,ELHLOA ,ELVLGA ,00080000

ISN 0004

C PAGE 2 INPLT LCC CCG1 THRU 0100

00090000

CCMMON AR ,K ,TCR ,TCT ,SLM ,00100000  
1ARFT ,TCHT ,VBARH ,SLMH ,ARVT ,TCVT ,00120000  
2VBARV ,SLMVT ,ELCN ,ELDT ,ELGOA ,DLSWSH ,00130000  
3DSWET ,DLVLF ,CVCL ,CBLGA ,EAR ,KVA ,00140000  
4CAM1 ,CAM2 ,EMF ,DAM3 ,CLEVE ,TFTMR ,00150000  
5XC ,XMR ,TVCMR ,VT ,CTSIGH ,TVM ,00160000  
CCMMON FES ,00170000

ISN 0005

6 ,TINY ,ETAP2 ,ETAP4N ,TBEM5(5) ,TB8AP4(5) ,00180000

7GAP3 ,00190000

ISN 0006

C PAGE 3 INPUT LCC CCG1 THRU 140

00200000

CCMMON CAM4 ,ENF ,ETAT ,FC ,VC ,00210000  
1ATMIY ,CDVT ,CDHT ,DAM5 ,ELTAFE ,FEDRAG ,00220000  
2EXPDRG ,CDC ,CLALPH ,CKVT ,CKHT ,CKF ,00230000  
3CKW ,RELI ,ICLN ,TBCL1(8) ,TBCDWI(8) ,GAP4(4) ,00240000

ISN 0007

C PAGE 4 INPLT LCC 141 THRU 200 WEIGHT DATA

00250000

CCMMON WFE ,WFL ,DELWFC ,DELWP ,DELWST ,00260000  
1SKCC ,SKRC ,SKSC ,SKFW ,SKTM ,SKRCA ,00270000  
2SKSCA ,SKMC ,SKAC ,SKHL ,SKENV1 ,SKENV2 ,00280000  
3SKGB1 ,SKGE2 ,SKBLNT ,SKBAL ,SKLG ,SKW ,00290000  
4ELF ,RMI ,SKFP ,SKHT ,SKVT ,SKPRB ,00300000  
5SKRBF ,SKPF ,SKAND ,SKAR ,SKPA ,SKVTAR ,00310000  
6SKPDS ,SKFCSZ ,SKT ,SKFS ,SKPEI ,SKPES ,00320000  
7SK1 ,SK2 ,CK3 ,DK4 ,SK5 ,SK6 ,00330000  
8SK7 ,SK8 ,SK9 ,SK10 ,SK11 ,SK12 ,00340000  
9SK13 ,SK14 ,SK15 ,PLIN ,GAP5(3) ,00350000

ISN 0008

C PAGE 5 INPLT LCC 201 THRU 300

00360000

CCMMON TOLIN(5) ,XTA2(5) ,TIN2(5) ,TIN3(5) ,PFET2(5) ,CC370000  
1DELTH(5) ,STH(5) ,CRSINC(5) ,XTGTA4(5) ,TIN4(5) ,VIN(5) ,00380000  
2DELRF(5) ,RMAX(5) ,DELFCR(5) ,ENPCR(5) ,DELWPL(5) ,STPW(5) ,00390000  
3HFIN(5) ,GAP6(10) ,00400000

ISN 0009

C PAGE 6 INPUT LCC 301 THRU 400

00410000

CCMMON CYCFFL ,FF ,SK3 ,SK4 ,TBRI(5) ,00420000  
1TBTO(5) ,TBH2(5) ,TBCRP(5) ,TBSFC(8) ,TBPOW(8) ,GAP7(60) ,00430000  
WORKING CCMMON ,00440000

ISN 0010

CCMMON ALFDES,ALFCL,ALFF,AML, ,00450000

1 BPA,BFR,EHFLP,EHT,BLP,BR,BS,BVT, ,00460000

2 CEARF,CEART,CEARVT,CEARW,CCP,CCT,CDV,CLW,CPIND,CPNUD,CPPAR,CPPRG00470000

3,CPTOT,CRT,CTP,CV,CX,CLDES,CE, ,00480000

4 DELRTH,DELTA,DF,CSPLNT, ELC,ELHT,ELN,ELCA,ELT,ELVT,EN,ETAP, ,00490000

5 FEH,FEHI,FEHL,FEHT,FEI,FETCT,FEVT,FEW,FEWH,FEWI,FM,FP,ETAP4 ,00500000

ORIGINAL PAGE IS OF POOR QUALITY

7-31

ISN 0011	CCMMON CAMD11(3,15),CLF,CMDC1(16),H, 7 ICRUS,INCRU,INCLRG,INCCYL,INDETA,INDFIX,INCHUL,INDOPT,INCOSW, E INDPON,INDPRF,INCFON,IFFIAT	00510000 00520000 00530000
ISN 0012	CCMMON LTHL,NCCFP,NOXP, ,CWE,PEHF,PI,Q,RHC,REALJ,RHPMR,R,RA	00540000
ISN 0013	CCMMON SA,SA5,SA6,SZ7,SFC,STPA,SHPR,SHT,SHTC,SHTW,SIGMA,SSIGMA,ST, 1STHETA,STMAX,SVT,SVTE,SVTH,SW,SWETH,SWEXP,SWTT,SWWET,S2RHC	00550000 00560000
ISN 0014	CCMMON T,TA,TEAF,THEIA,TMAX,TMP,TPRGP,TR,ULF,VGASB,VGASR,VHL,V	00570000
ISN 0015	CCMMON h,kBAL,kEALNT,kCC,kE,kEP,WES,WF,WFC,WFR,WFS,WFW, 1 WGSB,kFL,kHT,kLG,kPC,kPAYL,kPC,WPCS,WPEI,kPF,kPRB,WPRG,WPRP,WPSTR 2,kRC,WRC,kSC,kSCA,kST,kTM,kVT,WW,kPAYLO,WAC,kENV	00580000 00590000 00600000
ISN 0016	CCMMON XLALB,XLE,XLBF,XLFL,XLR,XLW,YLS2,TCVW	00610000
ISN 0017	CCMMON CMR,SIGMR,AF,BFFP,SEE	00610100
ISN 0018	NAMELIST /NATMCS/ THETA,DELTA,SIGMA,SA,RHC,S2RHO,STHETA, 1 SSIGMA,DELRTF,TMP	00620000 00630000
ISN 0019	IF (HH.GT.36089.) GC TC 2	00640000
ISN 0021	THETA=1.C-C.CCCCC6E75*H	00650000
ISN 0022	GC TO 3	00660000
ISN 0023	2 THETA=C.7519	00670000
ISN 0024	3 THETA=THEIA+TIN23/518.65	00680000
ISN 0025	STHETA=SQRT(THETA)	00690000
ISN 0026	IF (HH.GT.36089.) GC TC 4	00700000
ISN 0028	DELTA=(1.C-C.CCCCC6E75*H)**5.2561	00710000
ISN 0029	GC TO 5	00720000
ISN 0030	4 DELTA=0.22336*EXP((36089.-HH)/20786.)	00730000
ISN 0031	5 SIGMA=DELTA/THETA	00740000
ISN 0032	SA=661.7*STHETA	00750000
ISN 0033	RFC=0.0023769*SIGMA	00760000
ISN 0034	S2RHO=SQRT(2.*RFC)	00770000
ISN 0035	SSIGMA=SQRT(SIGMA)	00780000
ISN 0036	DELRTH=DELTA*STHETA	00790000
ISN 0037	TMP=THETA*518.65-459.65	00800000
ISN 0038	RETURN	00820000
ISN 0039	ENC	00830000

NAME	TAG	TYPE	ADD.	NAME	TAG	TYPE	ADD.	NAME	TAG	TYPE	ADD.	NAME	TAG	TYPE	ADD.	
H	C	R*4	N.R.	G	C	R*4	N.R.	R	C	R*4	N.R.	T	C	R*4	N.R.	
V	C	R*4	N.R.	W	C	R*4	N.R.	AF	C	R*4	N.R.	AF	C	R*4	N.R.	
BR	C	R*4	N.R.	ES	C	K*4	N.R.	CB	C	R*4	N.R.	CV	C	R*4	N.R.	
CX	C	R*4	N.R.	DF	C	R*4	N.R.	EN	C	R*4	N.R.	FF	C	R*4	N.R.	
FM	C	R*4	N.R.	FP	C	R*4	N.R.	HC	C	R*4	N.R.	HH	FA	R*4	0C00C4	
PI	C	R*4	N.R.	RA	C	R*4	N.R.	SA	S	C	R*4	00C880	ST	C	R*4	N.R.
SW	C	R*4	N.R.	TR	C	R*4	N.R.	VC	C	R*4	N.R.	VT	C	R*4	N.R.	
WE	C	R*4	N.R.	WF	C	R*4	N.R.	WO	C	R*4	N.R.	WS	C	R*4	N.R.	
WW	C	R*4	N.R.	XC	C	R*4	N.R.	AMU	C	R*4	N.R.	BHT	C	R*4	N.R.	
BLP	C	R*4	N.R.	BMR	C	R*4	N.R.	BVT	C	R*4	N.R.	CCP	C	R*4	N.R.	
CCT	C	R*4	N.R.	CGC	C	R*4	N.R.	CDV	C	R*4	N.R.	CKF	C	R*4	N.R.	
CKW	C	R*4	N.R.	CKI	C	R*4	N.R.	CLW	C	R*4	N.R.	CRT	C	R*4	N.R.	
CTP	C	R*4	N.R.	CKE	C	R*4	N.R.	DK4	C	R*4	N.R.	DMR	C	R*4	N.R.	
ELC	C	R*4	N.R.	ELF	C	R*4	N.R.	ELN	C	R*4	N.R.	ELT	C	R*4	N.R.	
ENP	C	R*4	N.R.	ENR	C	R*4	N.R.	FEH	C	R*4	N.R.	FET	C	R*4	N.R.	
FEW	C	R*4	N.R.	GLF	C	R*4	N.R.	HES	C	R*4	N.R.	HOO	C	R*4	N.R.	
OWE	C	R*4	N.R.	RHC	SFA	C	R*4	00086C	RMI	C	R*4	N.R.	ROO	C	R*4	N.R.
SA5	C	R*4	N.R.	SA6	C	R*4	N.R.	SA7	C	R*4	N.R.	SEE	C	R*4	N.R.	
SFC	C	R*4	N.R.	SHT	C	R*4	N.R.	SKT	C	R*4	N.R.	SK1	C	R*4	N.R.	
SK2	C	R*4	N.R.	SK3	C	R*4	N.R.	SK4	C	R*4	N.R.	SK5	C	R*4	N.R.	
SK6	C	R*4	N.R.	SK7	C	R*4	N.R.	SK8	C	R*4	N.R.	SK9	C	R*4	N.R.	
SLV	C	R*4	N.R.	STH	C	R*4	N.R.	SVT	C	R*4	N.R.	TAF	C	R*4	N.R.	
TCR	C	R*4	N.R.	TCT	C	R*4	N.R.	TMP	S	C	R*4	00C8F4	TCO	C	R*4	N.R.
TVW	C	R*4	N.R.	ULF	C	R*4	N.R.	VHL	C	R*4	N.R.	VIN	C	K*4	N.R.	
VMO	C	R*4	N.R.	WAC	C	R*4	N.R.	WCC	C	R*4	N.R.	WEP	C	R*4	N.R.	
WES	C	R*4	N.R.	WFC	C	R*4	N.R.	WFE	C	R*4	N.R.	WFR	C	R*4	N.R.	
WFS	C	R*4	N.R.	WFK	C	R*4	N.R.	WHL	C	R*4	N.R.	WHY	C	R*4	N.R.	
WLG	C	R*4	N.R.	WMC	C	R*4	N.R.	WPC	C	R*4	N.R.	WPH	C	R*4	N.R.	
WRC	C	R*4	N.R.	WSC	C	R*4	N.R.	WST	C	R*4	N.R.	WTM	C	R*4	N.R.	
WVA	C	R*4	N.R.	WVT	C	R*4	N.R.	XLB	C	R*4	N.R.	XLK	C	R*4	N.R.	
XLW	C	R*4	N.R.	XMR	C	R*4	N.R.	ALFR	C	R*4	N.R.	ARHT	C	R*4	N.R.	
ARVT	C	R*4	N.R.	EHPA	C	R*4	N.R.	BHPP	C	R*4	N.R.	BHPP	C	R*4	N.R.	
CDHT	C	R*4	N.R.	CDVT	C	R*4	N.R.	CKFF	C	R*4	N.R.	CKHT	C	R*4	N.R.	
CKVT	C	R*4	N.R.	CAM1	C	R*4	N.R.	CAM2	C	R*4	N.R.	CAM3	C	R*4	N.R.	
DAM4	C	R*4	N.R.	CAM5	C	R*4	N.R.	DELR	C	R*4	N.R.	DVCL	C	R*4	N.R.	
ELDN	C	R*4	N.R.	ELDT	C	R*4	N.R.	ELHT	C	R*4	N.R.	ELOA	C	R*4	N.R.	
ELVT	C	R*4	N.R.	ELVF	C	R*4	N.R.	ETAP	C	R*4	N.R.	ETAT	C	R*4	N.R.	
FEHI	C	R*4	N.R.	FEHL	C	R*4	N.R.	FEHT	C	R*4	N.R.	FEVT	C	R*4	N.R.	
FEWH	C	R*4	N.R.	FEWI	C	R*4	N.R.	GAP1	C	R*4	N.R.	GAP2	C	R*4	N.R.	
GAP3	C	R*4	N.R.	CAP4	C	R*4	N.R.	GAP5	C	R*4	N.R.	GAP6	C	R*4	N.R.	
GAP7	C	R*4	N.R.	FFIN	C	R*4	N.R.	LTHL	C	I*4	N.R.	PEHF	C	R*4	N.R.	
PLIA	C	R*4	N.R.	FELI	C	R*4	N.R.	RMAX	C	R*4	N.R.	SHPA	C	R*4	N.R.	
SHPR	C	R*4	N.R.	SFTE	C	R*4	N.R.	SHTW	C	R*4	N.R.	SKAC	C	R*4	N.R.	
SKAR	C	R*4	N.R.	SKCC	C	R*4	N.R.	SKFS	C	R*4	N.R.	SKFW	C	R*4	N.R.	
SKHL	C	R*4	N.R.	SKHT	C	R*4	N.R.	SKLG	C	R*4	N.R.	SKMC	C	R*4	N.R.	
SKPA	C	R*4	N.R.	SKPH	C	R*4	N.R.	SKRC	C	R*4	N.R.	SKSC	C	R*4	N.R.	
SKTM	C	R*4	N.R.	SKVT	C	R*4	N.R.	SKWP	C	R*4	N.R.	SKWW	C	R*4	N.R.	
SK10	C	R*4	N.R.	SK11	C	R*4	N.R.	SK12	C	R*4	N.R.	SK13	C	R*4	N.R.	
SK14	C	R*4	N.R.	SK15	C	R*4	N.R.	SLMH	C	R*4	N.R.	STPW	C	R*4	N.R.	
SVTE	C	R*4	N.R.	SVTW	C	R*4	N.R.	SWTT	C	R*4	N.R.	TBHI	C	R*4	N.R.	

7-33



TBH2	C	R*4	N.R.	TBTO	C	R*4	N.R.	TCHT	C	R*4	N.R.	TCLN	C	R*4	N.R.
TCVT	C	R*4	N.R.	TINY	C	R*4	N.R.	TIN2	C	R*4	N.R.	TIN4	C	R*4	N.R.
TMAX	C	R*4	N.R.	TCVW	C	R*4	N.R.	TWTW	C	R*4	N.R.	WBAL	C	R*4	N.R.
WENV	C	R*4	N.R.	WFUL	C	R*4	N.R.	WGSB	C	R*4	N.P.	WPDS	C	R*4	N.R.
WPEI	C	R*4	N.R.	WPRB	C	R*4	N.R.	WPRG	C	R*4	N.R.	WPPP	C	R*4	N.R.
WRCA	C	R*4	N.R.	WSCA	C	R*4	N.R.	XLBH	C	R*4	N.R.	XLGD	C	R*4	N.R.
XLHL	C	R*4	N.R.	YLS2	C	R*4	N.R.	ALFDL	C	R*4	N.R.	ATMIY	C	R*4	N.R.
ATMOS		R*4	0000C8	CEARF	C	R*4	N.R.	CBARW	C	R*4	N.R.	CLDES	C	R*4	N.R.
CLEYE	C	R*4	N.R.	CPIND	C	R*4	N.R.	CPNUD	C	R*4	N.R.	CPPAR	C	R*4	N.R.
CPPRO	C	R*4	N.R.	CFIQT	C	R*4	N.R.	DELTA SF	C	R*4	00C6C0	DELTH	C	R*4	N.R.
DELWF	C	R*4	N.R.	DELWP	C	R*4	N.R.	DSWET	C	R*4	N.R.	ELDCA	C	R*4	N.R.
ENPCR	C	R*4	N.R.	ETAP2	C	R*4	N.R.	ETAP4	C	R*4	N.R.	FETOT	C	R*4	N.R.
GMJDI	C	R*4	N.R.	FMAXC	C	R*4	N.R.	ICRUS	C	I*4	N.R.	NCCPP	C	I*4	N.R.
NOXPJ	C	I*4	N.R.	PFET2	C	R*4	N.R.	REALJ	C	R*4	N.R.	RFPMR	C	R*4	N.R.
SIGMA SFA	C	R*4	0008A8	SIGMR	C	R*4	N.R.	SKAMD	C	R*4	N.R.	SKBAL	C	R*4	N.R.
SKGB1	C	R*4	N.R.	SKGB2	C	R*4	N.R.	SKPDS	C	R*4	N.R.	SKPEI	C	R*4	N.R.
SKPES	C	R*4	N.R.	SKPRE	C	R*4	N.R.	SKRBF	C	R*4	N.R.	SKPCA	C	R*4	N.R.
SKSCA	C	R*4	N.R.	SLMVT	C	R*4	N.R.	STHAX	C	R*4	N.R.	SWETH	C	R*4	N.R.
ShEXP	C	R*4	N.R.	ShNET	C	R*4	N.R.	S2%HO S	C	R*4	00C8DC	TBCL1	C	R*4	N.R.
TBCRP	C	R*4	N.R.	TBEM5	C	R*4	N.R.	TBPOW	C	R*4	N.R.	TBSFC	C	R*4	N.R.
TC3AR	C	R*4	N.R.	TIFETA SFA	C	R*4	0008EC	TIN33 F	C	R*4	00C0CC	TPRCF	C	R*4	N.R.
TVCMR	C	R*4	N.R.	VEARH	C	R*4	N.R.	VBARV	C	R*4	N.R.	VCIVE	C	R*4	N.R.
VGASB	C	R*4	N.R.	VGASK	C	R*4	N.R.	WPAYL	C	R*4	N.R.	WPSTR	C	R*4	N.R.
XLALB	C	R*4	N.R.	XLBWC	C	R*4	N.R.	XLRLA	C	R*4	N.R.	EXP	XF	R*4	0C0000
FRXPR#	XF	R*4	0000CC	SCRT	XF	R*4	0C0000	ALFDES	C	R*4	N.R.	BHPSUP	C	R*4	N.R.
CEARHT	C	R*4	N.R.	CEARVT	C	R*4	N.R.	CBYLOA	C	R*4	N.R.	CLALPH	C	R*4	N.R.
CRSIND	C	R*4	N.R.	CTSIGN	C	R*4	N.R.	CYCPRL	C	R*4	N.R.	DELFCR	C	R*4	N.R.
DELRTH S	C	R*4	0006BC	EELWFC	C	R*4	N.R.	DELWPL	C	R*4	N.R.	DELWST	C	R*4	N.R.
DLWSH	C	R*4	N.R.	ELTAFE	C	R*4	N.R.	DLVLHL	C	R*4	N.R.	CRGIND	C	R*4	N.R.
DSPLMT	C	R*4	N.R.	CYLINC	C	R*4	N.R.	ELHLOA	C	R*4	N.R.	ELVLCA	C	R*4	N.R.
ETAIND	C	R*4	N.R.	ETAFA4N	C	R*4	N.R.	EXPURG	C	R*4	N.R.	FEDPAG	C	R*4	N.R.
FIXIND	C	R*4	N.R.	CAPD11	C	R*4	N.R.	HULIND	C	R*4	N.R.	INDCRU	C	I*4	N.R.
INDDRG	C	I*4	N.R.	INDDYL	C	I*4	N.R.	INDETA	C	I*4	N.R.	INCFIX	C	I*4	N.R.
INDHUL	C	I*4	N.R.	INCCPT	C	I*4	N.R.	INDQSW	C	I*4	N.R.	INDPOW	C	I*4	N.R.
INDPRP	C	I*4	N.R.	INCRDP	C	I*4	N.R.	IPRINT	C	I*4	N.R.	NATHOS			0C0000
OPTINC	C	R*4	N.R.	CSWIND	C	R*4	N.R.	PRPIND	C	R*4	N.R.	RCMIND	C	R*4	N.R.
RHORHO	C	R*4	N.R.	SGTIND	C	R*4	N.R.	SKBLNT	C	R*4	N.R.	SKENVL	C	R*4	N.R.
SKENV2	C	R*4	N.R.	SKFCSZ	C	R*4	N.R.	SKVTAR	C	R*4	N.R.	SSIGMA S	C	R*4	0C08AC
STHETA SF	C	R*4	0008B4	TBCDWI	C	R*4	N.R.	TB8AP4	C	R*4	N.R.	THETMR	C	R*4	N.R.
TCLIND	C	R*4	N.R.	VGECVH	C	R*4	N.R.	WBALNT	C	R*4	N.R.	WPAYLG	C	R*4	N.R.
XTGTA2	C	R*4	N.R.	XTGTA4	C	R*4	N.R.								

\*\*\*\*\* COMMON INFORMATION \*\*\*\*\*

NAME OF COMMON BLOCK * * SIZE OF BLOCK 0009DC HEXADECIMAL BYTES											
VAR. NAME	TYPE	REL.	ADDR.	VAR. NAME	TYPE	REL.	ADDR.	VAR. NAME	TYPE	REL.	ADDR.
OPTINC	R*4		N.R.	HLLINC	R*4		N.R.	CYLIND	R*4		N.R.
OSWIND	R*4		N.R.	FIXINC	R*4		N.R.	RCMIND	R*4		N.R.
ETAIND	R*4		N.R.	hC	R*4		N.R.	XLRLA	R*4		N.R.
VGBCVH	R*4		N.R.	XLGC	R*4		N.R.	RHORHO	R*4		N.R.

VVC	R*4	N.R.	EMLF	R*4	N.R.	CK1	R*4	N.R.	DELWF	R*4	N.R.
CKFF	R*4	N.R.	VDIVE	R*4	N.R.	HOO	R*4	N.R.	RCO	R*4	N.R.
TCC	R*4	N.R.	GAP1	R*4	N.R.	SGTIND	R*4	N.R.	ELHLOA	R*4	N.R.
ELVLC	R*4	N.R.	GAP2	R*4	N.R.	AR	R*4	N.R.	WS	R*4	N.R.
TCR	R*4	N.R.	TCT	R*4	N.R.	SLM	R*4	N.R.	APHT	R*4	N.R.
TCHT	R*4	N.R.	VEARF	R*4	N.R.	SLMH	R*4	N.R.	ARVT	R*4	N.R.
TCVT	R*4	N.R.	VEARV	R*4	N.R.	SLMVT	R*4	N.R.	FLDN	R*4	N.R.
ELCT	R*4	N.R.	ELDCA	R*4	N.R.	DLSWSH	R*4	N.R.	DSKET	R*4	N.R.
DLVLF	R*4	N.R.	DVCL	R*4	N.R.	CBYLOA	R*4	N.R.	ENR	R*4	N.R.
KVA	R*4	N.R.	CAM1	R*4	N.R.	CAM2	R*4	N.R.	BMR	R*4	N.R.
CAY3	R*4	N.R.	CLEYE	R*4	N.R.	THEYMR	R*4	N.R.	XC	R*4	N.R.
XMR	R*4	N.R.	TVCMR	R*4	N.R.	VT	R*4	N.R.	CTSIGH	R*4	N.R.
TVh	R*4	N.R.	FVS	R*4	N.R.	TINY	R*4	N.R.	ETAP2	R*4	N.R.
ETAP4N	R*4	N.R.	TBEM5	R*4	N.R.	TB8AP4	R*4	N.R.	GAP3	R*4	N.R.
CAM4	R*4	N.R.	ENF	R*4	N.R.	ETAT	R*4	N.R.	FC	R*4	N.R.
VC	R*4	N.R.	ATMIY	R*4	N.R.	CDVT	R*4	N.R.	CDHT	R*4	N.R.
CAM5	R*4	N.R.	ELTAFE	R*4	N.R.	FEDRAG	R*4	N.R.	EXPDRG	R*4	N.R.
CCC	R*4	N.R.	CLALP	R*4	N.R.	CKVT	R*4	N.R.	CKHT	R*4	N.R.
CKF	R*4	N.R.	CKh	R*4	N.R.	RELI	R*4	N.R.	TCLN	R*4	N.R.
TBCL1	R*4	N.R.	TBCDWI	R*4	N.R.	GAP4	R*4	N.R.	WFE	R*4	N.R.
WFL	R*4	N.R.	DELWFC	R*4	N.R.	DELWP	R*4	N.R.	DELWST	R*4	N.R.
SKCC	R*4	N.R.	SKRC	R*4	N.R.	SKSCA	R*4	N.R.	SKFW	R*4	N.R.
SKTM	R*4	N.R.	SKRCA	R*4	N.R.	SKSCA	R*4	N.R.	SKMC	R*4	N.R.
SKAC	R*4	N.R.	SKFL	R*4	N.R.	SKENV1	R*4	N.R.	SKENV2	R*4	N.R.
SKGE1	R*4	N.R.	SKGB2	R*4	N.R.	SKBLNT	R*4	N.R.	SKBAL	R*4	N.R.
SKLG	R*4	N.R.	SKW	R*4	N.R.	ELF	R*4	N.R.	KMI	R*4	N.R.
SKVP	R*4	N.R.	SKHT	R*4	N.R.	SKVT	R*4	N.R.	SKPRB	R*4	N.R.
SKREF	R*4	N.R.	SKPT	R*4	N.R.	SKAMD	R*4	N.R.	SKAR	R*4	N.R.
SKPA	R*4	N.R.	SKVTAR	R*4	N.R.	SKPDS	R*4	N.R.	SKPDSZ	R*4	N.R.
SKT	R*4	N.R.	SKFS	R*4	N.R.	SKPEI	R*4	N.R.	SKPES	R*4	N.R.
SK1	R*4	N.R.	SK2	R*4	N.R.	DK3	R*4	N.R.	DK4	R*4	N.R.
SK5	R*4	N.R.	SK6	R*4	N.R.	SK7	R*4	N.R.	SK8	R*4	N.R.
SK9	R*4	N.R.	SK10	R*4	N.R.	SK11	R*4	N.R.	SK12	R*4	N.R.
SK13	R*4	N.R.	SK14	R*4	N.R.	SK15	R*4	N.R.	PLIN	R*4	N.R.
GAF5	R*4	N.R.	TCLINC	R*4	N.R.	XTGTA2	R*4	N.R.	TIN2	R*4	N.R.
T*Th	R*4	N.R.	PFET2	R*4	N.R.	DELTH	R*4	N.R.	STH	R*4	N.R.
CRSIAC	R*4	N.R.	XTGTA4	R*4	N.R.	TIN4	R*4	N.R.	VIN	R*4	N.R.
DELR	R*4	N.R.	RMAX	R*4	N.R.	DELFCR	R*4	N.R.	ENPCR	R*4	N.R.
DELWFL	R*4	N.R.	STP	R*4	N.R.	HFIN	R*4	N.R.	GAP6	R*4	N.R.
CYCPFL	R*4	N.R.	FF	R*4	N.R.	SK3	R*4	N.R.	SK4	R*4	N.R.
TBF1	R*4	N.R.	TBTC	R*4	N.R.	TBH2	R*4	N.R.	TBCPP	R*4	N.R.
TBSFC	R*4	N.R.	TBFCW	R*4	N.R.	GAP7	R*4	N.R.	ALFDES	R*4	N.R.
ALFCL	R*4	N.R.	ALFF	R*4	N.R.	AMU	R*4	N.R.	BHPA	R*4	N.R.
BFFR	R*4	N.R.	EHFSLF	R*4	N.R.	BHT	R*4	N.R.	BLP	R*4	N.R.
BR	R*4	N.R.	BS	R*4	N.R.	BVT	R*4	N.R.	CBARF	R*4	N.R.
CBARFT	R*4	N.R.	CBARVT	R*4	N.R.	CBARW	R*4	N.R.	CCP	R*4	N.R.
CCT	R*4	N.R.	CCV	R*4	N.R.	CLW	R*4	N.R.	CPIND	R*4	N.R.
CPALC	R*4	N.R.	CPPAF	R*4	N.R.	CPPRO	R*4	N.R.	CPTGT	R*4	N.R.
CRT	R*4	N.R.	CTP	R*4	N.R.	CV	R*4	N.R.	CX	R*4	N.R.
CLDES	R*4	N.R.	CB	R*4	N.R.	DELRTH	R*4	0006BC	DELTA	R*4	0006CO
CH	R*4	N.R.	CSPLMT	R*4	N.R.	ELC	R*4	N.R.	ELHT	R*4	N.R.
ELN	R*4	N.R.	ELCA	R*4	N.R.	ELT	R*4	N.R.	ELVT	R*4	N.R.

EA	R*4	N.R.	ETAP	R*4	N.R.	FEH	R*4	N.R.	FEHI	R*4	N.R.
FEFL	R*4	N.R.	FETT	R*4	N.R.	FET	R*4	N.R.	FETOT	R*4	N.R.
FEVT	R*4	N.R.	FEW	R*4	N.R.	FEWH	R*4	N.P.	FEWI	R*4	N.P.
FM	R*4	N.R.	FF	R*4	N.R.	ETAP4	R*4	N.R.	GAMDII	R*4	N.R.
GLF	R*4	N.R.	GMDI	R*4	N.R.	H	R*4	N.R.	ICRUS	I*4	N.R.
INDCRU	I*4	N.R.	INDCRC	I*4	N.R.	INDDYL	I*4	N.R.	INDETA	I*4	N.R.
INDFIX	I*4	N.R.	INDHUL	I*4	N.R.	INDOPT	I*4	N.R.	INDUSW	I*4	N.R.
INDPCH	I*4	N.R.	INCPRF	I*4	N.R.	INDRDM	I*4	N.R.	IPRINT	I*4	N.R.
LTHL	I*4	N.R.	NCCPF	I*4	N.R.	NOXPJ	I*4	N.R.	CWE	R*4	N.R.
PELF	R*4	N.R.	PI	R*4	N.R.	Q	R*4	N.R.	PHO	R*4	0086C
REALJ	R*4	N.R.	RHPMR	R*4	N.R.	R	R*4	N.R.	RN	R*4	N.R.
SA	R*4	000880	SAE	R*4	N.R.	SA6	R*4	N.R.	SAT	R*4	N.R.
SFC	R*4	N.R.	SHPA	R*4	N.R.	SHPR	R*4	N.R.	SHT	R*4	N.R.
SFTE	R*4	N.R.	SHTW	R*4	N.R.	SIGMA	R*4	00CBAB	SSIGPA	R*4	008AC
ST	R*4	N.R.	STFETA	R*4	0008B4	STMAX	R*4	N.R.	SVT	R*4	N.R.
SVTE	R*4	N.R.	SVTW	R*4	N.R.	SW	R*4	N.R.	SWETH	R*4	N.R.
SWEXP	R*4	N.R.	SWTT	R*4	N.R.	SWWET	R*4	N.R.	SZPHO	R*4	0088DC
T	R*4	N.R.	TAF	R*4	N.R.	TCBAR	R*4	N.R.	THETA	R*4	0088EC
TMAX	R*4	N.R.	TMF	R*4	0008F4	TPROP	R*4	N.P.	TR	R*4	N.R.
ULF	R*4	N.R.	VGASE	R*4	N.R.	VGASR	R*4	N.R.	VHL	R*4	N.R.
V	R*4	N.R.	W	R*4	N.R.	WBAL	R*4	N.R.	WBALNT	R*4	N.R.
WCC	R*4	N.R.	WE	R*4	N.R.	WEP	R*4	N.R.	WES	R*4	N.R.
WF	R*4	N.R.	WFC	R*4	N.R.	WFR	R*4	N.R.	WFS	R*4	N.R.
WFH	R*4	N.R.	WGSE	R*4	N.R.	WHL	R*4	N.R.	WHT	R*4	N.R.
WLG	R*4	N.R.	WMC	R*4	N.R.	WPAYL	R*4	N.R.	WPC	R*4	N.R.
WPES	R*4	N.R.	WPEI	R*4	N.R.	WPH	R*4	N.R.	WPRB	R*4	N.R.
WPPG	R*4	N.R.	WPPF	R*4	N.R.	WPSTR	R*4	N.R.	WRC	R*4	N.R.
WRCA	R*4	N.R.	WSC	R*4	N.R.	WSCA	R*4	N.R.	WST	R*4	N.R.
WTM	R*4	N.R.	WVT	R*4	N.R.	WW	R*4	N.R.	WPAYLO	R*4	N.R.
WAC	R*4	N.R.	WENV	R*4	N.R.	XLALB	R*4	N.R.	XLB	R*4	N.R.
XLBH	R*4	N.R.	XLHL	R*4	N.R.	XLR	R*4	N.R.	XLW	R*4	N.R.
YLS2	R*4	N.R.	TOVW	R*4	N.R.	DMR	R*4	N.R.	SIGMR	R*4	N.R.
AF	R*4	N.R.	BHFF	R*4	N.R.	SEE	R*4	N.R.			

LABEL	ACCR	LABEL	ACCR	LABEL	ADDR	LABEL	ADDR	PAGE
2	0CC1CA	3	CCG1DZ	4	CG0230	5	00025E	007
*OPTIONS IN EFFECT*		NAME= MAIN,CPT=C2,LINECNT=54,SIZE=0000K,						
*OPTIONS IN EFFECT*		SOURCE,EBCCIC,NCLIST,NCDECK,LOAD,MAP,NOEDIT,IO,NOXREF						
*STATISTICS*		SCLRCE STATEMENTS = 38 ,PROGRAM SIZE = 790						
*STATISTICS*		NO DIAGNOSTICS GENERATED						
***** END OF CCMPILATION *****				107K BYTES OF CORE NOT USED				

7-37

CCMPILER OPTIONS - NAME= MAIN,OPT=C2,LINECNT=54,SIZE=0000K,

SOURCE,EBCCIC,NCLIST,NODECK,LCAD,MAP,NCEDIT,ID,NCXREF

ISN 0002	FUNCTION BIV(XARG,YARG,XTAB,YTAB,ZTAB,NXARG,NYARG,NXI,NYJ)	00010000
	C**** MEMBER NAME B81EIV	00020000
ISN 0003	VAL(A,B,C,D) = (A*(A-B-C)+B*C)/(D*(D-B-C)+B*C)	00030000
ISN 0004	DIMENSION ZTAE(NXI,NYJ),XTAB(1),YTAB(1)	00040000
	C XTAB AND YTAB DIMENSICNS ARE DUMMY BUT Z IS CRITICAL	00050000
	C IT MUST AGREE WITH THE DIMENSION IN THE CALLING PROGRAM	00060000
	C	00070000
	C	00080000
	C LOCATE THE X VALUE	00090000
	C IS XARG LESS THAN FIRST VALUE IN TABLE	00100000
ISN 0005	1 IF (XARG-XTAB(1))2,3,3	00110000
	C YES-USE FIRST 3 VALUES IN TABLE	00120000
ISN 0006	2 J=1	00130000
ISN 0007	GC TO 9	00140000
	C NC-FIND WHICH 2 ARGUMENTS XARG IS BETWEEN	00150000
ISN 0008	3 DC 5 I=2,NXARG	00160000
ISN 0009	K=I	00170000
ISN 0010	4 IF(XARG-XTAB(I))6,6,5	00180000
ISN 0011	5 CCNTINUE	00190000
	C ARE WE AT END OF TABLE	00200000
ISN 0012	6 I=K	00210000
ISN 0013	IF(I-NXARG) 8,7,8	00220000
	C YES-USE LAST 3 TABLE VALUES	00230000
ISN 0014	7 J=NXARG-2	00240000
ISN 0015	GC TO 9	00250000
	C NC-USE 3 SURROUNDING VALUES	00260000
ISN 0016	8 J=I-1	00270000
	C FIND WHERE YARG LIES IN TABLE	00280000
	C IS YARG LESS THAN FIRST VALUE OF TABLE	00290000
ISN 0017	9 IF (YARG-YTAB(1))10,11,11	00300000
	C YES-USE FIRST 3 VALUES IN TABLE	00310000
ISN 0018	10 L=1	00320000
ISN 0019	GC TO 17	00330000
	C NC-FIND WHERE YARG LIES	00340000
ISN 0020	11 DC 13 I=2,NYARG	00350000
ISN 0021	K=I	00360000
ISN 0022	12 IF (YARG-YTAB(1))14,14,13	00370000
ISN 0023	13 CCNTINUE	00380000
	C ARE WE AT END OF TABLE	00390000
ISN 0024	14 I=K	00400000
ISN 0025	IF(I-NYARG) 16,15,16	00410000
	C YES-USE LAST 3 VALUES IN TABLE	00420000
ISN 0026	15 L=NYARG-2	00430000
ISN 0027	GC TO 17	00440000
	C NO-USE 3 SURROUNDING VALUES	00450000
ISN 0028	16 L=I-1	00460000
	C SET UP FOR INTERPLATION	00470000
ISN 0029	17 JJ=J+1	00480000
ISN 0030	JJJ=J+2	00490000
ISN 0031	LL=L+1	00500000

ISN 0032		LLL=L+2	00510000
	C	EVALUATE FY1(X)	00520000
ISN 0033	18	FY11=VAL(XARG,XTAE(JJ),XTAB(JJJ),XTAB(J))	00530000
ISN 0034		FY12=VAL(XARG,XTAE(J),XTAB(JJJ),XTAB(JJ))	00540000
ISN 0035		FY13=VAL(XARG,XTAE(J),XTAB(JJ),XTAB(JJJ))	00550000
ISN 0036		FY1=FY11*ZTAB(L,L)+FY12*ZTAB(JJ,L)+FY13*ZTAB(JJJ,L)	00560000
	C	EVALUATE FY2(X)	00570000
ISN 0037	19	FY2=FY11*ZTAB(J,LL)+FY12*ZTAB(JJ,LL)+FY13*ZTAB(JJJ,LL)	00580000
	C	EVALUATE FY3(X)	00590000
ISN 0038	20	FY3=FY11*ZTAB(L,LLL)+FY12*ZTAB(JJ,LLL)+FY13*ZTAB(JJJ,LLL)	00600000
	C	EVALUATE F(Y)-FINAL ANSWER	00610000
ISN 0039	21	BIV=(VAL(YARG,YTAB(LL),YTAB(LLL),YTAB(L))*FY1)+	00620000
		1(VAL(YARG,YTAB(L),YTAB(LLL),YTAB(LL))*FY2)+	00630000
		2(VAL(YARG,YTAB(L),YTAB(LL),YTAB(LLL))*FY3)	00640000
ISN 0040		RETURN	00650000
ISN 0041		END	00660000

ORIGINAL PAGE IS  
OF POOR QUALITY

NAME	TAG	TYPE	ADD.	NAME	TAG	TYPE	ADD.	NAME	TAG	TYPE	ADD.	NAME	TAG	TYPE	ADD.
I	SF	I*4	000C80	J	SFA	I*4	000B84	K	SF	I*4	000J88	L	SFA	I*4	0C008C
JJ	SFA	I*4	000G90	LL	SFA	I*4	000094	BIV	S	R*4	00C098	FY1	SF	R*4	0C009C
FY2	SF	R*4	000CA0	FY3	SF	R*4	0000A4	JJJ	SFA	I*4	00CCA8	LLL	SFA	I*4	0C00AC
NXI		I*4	00008C	NYJ		I*4	000084	VAL	S ASF	R*4	000000	FY11	SF	R*4	0000B8
FY12	SF	R*4	00008C	FY13	SF	R*4	0C00C0	XARG	FA	R*4	00GCC4	XTAB	FA XR	R*4	0C0000
YARG	FA	R*4	0000C8	YTAB	FA XR	R*4	000000	ZTAB	F XR	R*4	000000	NXARG	F	I*4	0000CC
NYARG	F	I*4	0000C0												

LABEL	ADDR	LABEL	ADDR	LABEL	ADDR	LABEL	ADDR	PAGE 004
1	OCC128	2	CCC13E	3	CC0144	4	000162 NR	
5	OCC172	6	CCC17C	7	CC018E	8	00019E	
9	OCC1AA	10	CCC18A	11	CC01C6	12	0001E4 NR	
13	OCC1F4	14	CC01FE	15	CC0210	16	000220	
17	CC022C	18	CC025C NR	19	CC0380 NR	20	000386 NR	
21	OCC3E8 NR							

\*OPTIONS IN EFFECT\* NAME= MAIN,CPT=C2,LINECNT=54,SIZE=0000K,

\*OPTIONS IN EFFECT\* SOURCE,EBCDIC,NCLIST,NCDECK,LOAC,MAP,NCEDIT,ID,NOXREF

\*STATISTICS\* SOURCE STATEMENTS = 40 ,PROGRAM SIZE = 1420

\*STATISTICS\* NO DIAGNOSTICS GENERATED

\*\*\*\*\* END OF COMPILE \*\*\*\*\*

115K BYTES OF CORE NOT USED

7-41

ORIGINAL PAGE IS  
OF POOR QUALITY



COMPILER OPTICNS - NAME= MAIN,OPT=C2,LINECNT=54,SIZE=00CCK,

SOURCE,EBCCIC,NCLIST,NQDECK,LGAD,MAP,NCEDIT, ID,NGXREF

ISN 0002	BLCK DATA	00010000
	C**** MEMBER NAME B81ELKCT	00020000
ISN 0003	DIMENSICN AC(3,15),A1(3,15),A2(3,15),B80(16),B81(16),B82(16), 1 RJ3(10),CPGW3(10),ETA13(10,10),RJ4(10),CPW4(10),ETA14(10,10), 2 AMACH(3),CLLL(15),CLGAN(16),CPW33(20),CT13(20),CT14(20)	00030000 00040000 00050000
ISN 0004	DIMENSICN RCTCAT(14)	00070000
ISN 0005	COMMON/CDC/AQ,A1,A2,ABC,EB1,BB2,RJ3,CPGW3,ETA13,RJ4,CPW4, 1 ETA14,AMACH,CLLL,CLCAN,CPW33,CT13,CT14	00080000 00090000
ISN 0006	COMMON /RTPCW/ (TTBLE(12),TFTBLE(5),DKHTB(12,5),AMUTB(20), 1 CKNETB(20),DMCEB(9),CKBLK(9),CTT(10),CKHCVT(10)	00100000 00110000
ISN 0007	DATA AG/ %C.,9C.,90.,7.C392,10.2148,11.3227,4.8350,8.3106, 1 11.3355,2.2218,5.4623,8.3676,2.7551,4.0458,6.5856,2.481, 2 3.9439,5.3862,2.4521,3.6769,5.2054,2.8149,3.8766,6.1902, 3 3.8725,4.5901,8.153,5.6653,6.1044,10.1745,8.5799,8.9031, 4 13.0822,12.25,12.2042,16.5344,17.0496,17.0358,20.8089, 5 21.8332,22.784,25.6453,31.7062,28.7851,33.5049/ DATA AL/ C.O,C.C,C.C,1.9949,2.4433,40.9515,-4.1639,-22.6338, 1 -14.062,-1.7030,-14.9997,-12.2425,-2.5322,-9.9837,-9.574, 2 -4.5422,-13.0524,-8.9808,-5.4949,-11.7146,-9.3153,-7.092, 3 -12.0044,-14.7567,-10.841,-13.8756,-25.0375,-16.2691,-18.2607, 4 -20.7342,-24.8115,-26.0958,-33.2211,-33.6185,-29.4588,-34.9378, 5 -43.061,-37.3809,-40.6314,-47.8821,-47.3791,-49.145,-49.6246, 6 -57.8217,-77.6449/ DATA A2/ C.O,C.C,C.O,61.2416,86.4731,21.9481,19.2195,56.C, 1 62.0142,8.291,35.3636,36.C889,7.0366,23.0606,25.9573,7.3774, 2 22.0028,18.6435,7.4251,17.3803,16.4063,8.3401,16.0882,23.2672, 3 11.4678,17.2451,29.117,15.8093,21.8349,51.0509,22.6773,30.7056, 4 58.1494,28.7271,34.1515,64.3529,33.8798,43.697,76.3927,33.6322, 5 55.5455,44.4326,26.4923,68.2121,144.4176/ DATA BBC/ 9C.,2.68,1.9141,1.513,1.5304,1.9611,2.7089,3.8237, 1 5.051,7.2756,5.12,12.397,17.169,22.392,28.85,38.2/ DATA BB1/ 0.0,-5.4836,-2.9393,-2.7523,-3.0646,-4.5374, 1 -6.8293,-10.0965,-12.558,-18.5171,-19.35,-11.944,-10.883, 2 -5.948,C.C,0.0/ DATA BB2/ 0.0,13.5125,8.C12,5.8118,4.8132,5.3846,6.8072, 1 9.3267,10.7333,15.8002,15.5,6.818,7.879,5.606,C.O,0.0/ DATA RJ3/C.2,1.C,1.2,1.4,1.8,2.2,2.6,3.0,3.4,4.2/ DATA CPCW3/C.C,C.C5,C.1,C.2,C.3,C.4,0.5,C.6,C.75,0.9/ DATA ETA12/10*1.C,C.74,C.937,C.954,0.9662,0.980,0.9862,0.9895, 1 0.9912,0.9924,C.9962,C.621,C.896,C.920,C.939,0.961,0.973,C.9793, 2 C.9827,0.985,C.9906,C.467,C.830,0.866,C.892,C.928,0.949,C.960, 3 C.9664,C.9715,C.9794,C.342,C.772,0.819,C.851,C.856,0.926,C.9415, 4 0.9486,C.956,C.9683,0.262,C.718,C.770,0.810,C.868,0.9044,C.9235, 5 C.935,C.944,C.9575,C.206,0.666,0.728,0.773,C.839,0.882,C.9064, 6 C.9204,C.9305,C.9456,C.168,C.615,0.684,0.736,0.810,0.8615,0.8885, 7 C.906,C.918,C.9345,C.126,0.541,C.615,0.679,C.779,0.830,0.8633, 8 C.8848,C.8988,C.9175,C.956,C.471,C.547,0.620,0.743,0.803,C.8385, 9 C.863,C.880,C.900/ DATA RJ4/C.2,1.0,1.2,1.4,1.8,2.2,2.6,3.0,3.4,4.2/ DATA CPCW4/C.C,C.C5,C.1,C.2,C.3,C.4,0.5,C.6,C.75,0.9/ ISN 0016	00130000 00140000 00150000 00160000 00170000 00180000 00190000 00200000 00210000 00220000 00230000 00240000 00250000 00260000 00270000 00280000 00290000 00300000 00310000 00320000 00330000 00340000 00350000 00360000 00370000 00380000 00390000 00400000 00410000 00420000 00430000 00440000 00450000 00460000 00470000 00480000 00490000 00500000 00510000
ISN 0017		

ORIGINAL PAGE IS  
OF POOR QUALITY

ISN 0018	DATA ETAI4/10*1.0,C.668,C.935,0.959,0.968,0.9822,0.9875,C.9906,	00520000
	1 0.9925,0.9938,C.9956,C.9972,C.898,C.929,0.946,C.9655,0.9755,C.981,	00530000
	2 C.9846,C.987,C.9905,C.4C5,C.834,0.878,0.904,C.9355,0.954,C.964,	00540000
	3 C.9705,C.975,C.982,0.911,C.784,C.834,C.869,C.9095,0.9345,C.9484,	00550000
	4 C.9575,C.9646,C.9736,C.252,C.735,0.793,C.835,C.886,0.916,C.933,	00560000
	5 C.9445,C.9535,C.966,0.2C4,C.690,0.753,C.8025,0.862,0.8974,0.918,	00570000
	6 0.932,0.9436,C.9585,C.170,0.646,0.714,C.772,C.8415,0.8794,0.902,	00580000
	7 C.9195,0.933,C.9513,C.135,C.582,0.657,C.727,C.810,0.853,C.8796,	00590000
	8 C.9007,C.918,C.940,C.11C,0.520,0.601,0.683,C.781,0.828,C.860,	00600000
	9 C.883,C.9C4,C.928/	00610000
ISN 0019	DATA APACF/C.7,C.8,C.9/	00620000
ISN 0020	DATA CLLL / 0.C,C.C5,C.1,C.15,C.2,0.3,0.4,0.5,C.6,0.7,0.8,C.9,	00630000
	1 1.0,1.1,1.2/	00640000
ISN 0021	DATA CLEAT/C.C,C.15,C.2,C.3,C.4,C.5,0.6,0.7,C.8,0.9,1.0,	00650000
	1 1.2,1.4,1.6,1.8,2.0/	00660000
ISN 0022	DATA CPCW33/ C.C,C.CC5,C.C1,C.02,0.03,0.04,0.06,0.08,0.12,C.16,	00670000
	1 0.20,0.24,C.28,C.32,C.36,C.40,0.44,0.48,0.52,C.60/	00680000
ISN 0023	DATA CT13/0.0,C.0223,0.0523,C.082,C.1065,0.127,0.163,0.194,	00690000
	1C.2475,C.2945,C.338,C.372,C.4102,C.4308,0.4637,0.4912,0.517,	00700000
	2 0.539,C.5616,C.5958/	00710000
ISN 0024	DATA CTI4/0.0,C.345,C.345,C.338,0.1073,C.128,C.166,0.201,0.2556,	00720000
	1 C.3026,C.3462,C.3859,C.4208,0.4544,0.4871,0.514,0.539,0.5592,	00730000
	2 C.5824,C.6354/	00740000
ISN 0025	DATA CTTBLE / C.C,0.0C4,C.CC5,0.006,0.007,0.008,0.010,0.012,	00750000
	1 C.C14,C.C18,0.C22,C.C30/	00760000
ISN 0026	DATA THTBLE /-15.C,-9.C,-6.C,-3.0,0.0/	00770000
ISN 0027	DATA DKHTE / -C.219,-C.219,-C.204,-0.195,-0.186,-0.179,-0.164,	00780000
	1 -C.152,-C.144,-C.132,-0.124,-0.120,-0.119,-0.119,	00790000
	2 -C.159,-C.145,-C.134,-0.125,-0.111,-0.100,-0.093,	00800000
	3 -C.084,-C.080,-C.079,-0.135,-0.135,-0.118,-0.106,	00810000
	4 -C.097,-C.090,-C.078,-0.069,-0.063,-0.058,-0.054,	00820000
	5 -0.053,-C.078,-C.078,-0.066,-0.056,-C.052,-C.048,	00830000
	6 -C.041,-C.035,-C.033,-0.029,-0.028,-0.028,12*C.0/	00840000
ISN 0028	DATA AMLTE / C.C,C.C5,C.125,C.2,0.25,0.325,0.36,0.37,0.386,	00850000
	1 C.4,C.425,C.45,C.475,C.525,C.55,C.6,0.7,0.8,	00860000
	2 C.9,1.0/	00870000
ISN 0029	DATA CKNDTE / C.C,0.C,C.C25,C.105,C.205,0.397,C.475,0.48,C.475,	00880000
	1 C.432,C.342,0.33,0.333,0.342,0.355,C.375,0.412,	00890000
	2 C.444,C.474,0.5/	00900000
ISN 0030	DATA DMCBE / C.C20,0.C15,0.C,-0.005,-0.0085,-C.011,-0.013,	00910000
	1 -C.0148,-C.0167/	00920000
ISN 0031	DATA CKBLT / 1.2C,1.C6,1.00,C.955,C.92,0.891,C.867,0.846,	00930000
	1 C.828/	00940000
ISN 0032	DATA CTT / C.C,C.CC4,C.CC7,C.C09,C.010,0.011,C.015,0.012,	00950000
	1 0.C155,C.C22/	00960000
ISN 0033	DATA CKHONT / 1.C18,1.C85,1.154,1.233,1.279,1.314,1.327,1.337,	00970000
	1 1.364,1.397/	00980000
ISN 0034	ENC	00990000

ORIGINAL PAGE IS  
OF POOR QUALITY

NAME	TAG	TYPE	ADD.	NAME	TAG	TYPE	ADD.	NAME	TAG	TYPE	ADD.	NAME	TAG	TYPE	ADD.
A0	C	R*4	N.R.	A1	C	R*4	N.R.	A2	C	R*4	N.R.	BBO	C	R*4	N.R.
BB1	C	R*4	N.R.	BB2	C	R*4	N.R.	CTT	C	R*4	N.R.	PJ3	C	R*4	N.R.
RJ4	C	R*4	N.R.	CLLL	C	R*4	N.R.	CTI3	C	R*4	N.R.	CTI4	C	R*4	N.R.
AMACH	C	R*4	N.R.	AMUTB	C	R*4	N.R.	CKBLH	C	R*4	N.R.	CLGAM	C	R*4	N.R.
CPOW3	C	R*4	N.R.	CPCW4	C	R*4	N.R.	DKHTB	C	R*4	N.R.	CMDBB	C	R*4	N.R.
ETAI3	C	R*4	N.R.	ETAI4	C	R*4	N.R.	CKHOVT	C	R*4	N.R.	CKNDTB	C	R*4	N.R.
CPOW33	C	R*4	N.R.	CTTBLE	C	R*4	N.R.	POTDAT		R*4	N.R.	THTBLE	C	R*4	N.R.

\*\*\*\*\* COMMON INFORMATION \*\*\*\*\*

NAME OF COMMON BLOCK * CDC* SIZE OF BLOCK 000814 HEXADECIMAL BYTES											
VAR. NAME	TYPE	REL. ADDR.	VAR. NAME	TYPE	REL. ADDR.	VAR. NAME	TYPE	REL. ADDR.	VAR. NAME	TYPE	REL. ADDR.
AC	R*4	N.R.	A1	R*4	N.R.	A2	R*4	N.R.	BBO	R*4	N.R.
EEL	R*4	N.R.	EE2	R*4	N.R.	RJ3	R*4	N.R.	CPCW3	R*4	N.R.
ETAI3	R*4	N.R.	RJ4	R*4	N.R.	CPOW4	R*4	N.R.	ETAI4	R*4	N.R.
AMACH	R*4	N.R.	CLLL	R*4	N.R.	CLGAM	R*4	N.R.	CPOW33	R*4	N.R.
CTI3	R*4	N.R.	CTI4	R*4	N.R.						

NAME OF COMMON BLOCK * RTPCW* SIZE OF BLOCK 00026C HEXADECIMAL BYTES											
VAR. NAME	TYPE	REL. ADDR.	VAR. NAME	TYPE	REL. ADDR.	VAR. NAME	TYPE	REL. ADDR.	VAR. NAME	TYPE	REL. ADDR.
CTTBLE	R*4	N.R.	THTBLE	R*4	N.R.	DKHTB	R*4	N.R.	AMUTB	R*4	N.R.
CKNDTB	R*4	N.R.	CMDBB	R*4	N.R.	CKBLH	R*4	N.R.	CTT	R*4	N.R.
CKHOVT	R*4	N.R.									

7-44

\*OPTIONS IN EFFECT\* NAME= MAIN,CPT=02,LINECNT=54,SIZE=0000K,

\*OPTIONS IN EFFECT\* SOURCE,EBCDIC,NCLIST,NODECK,LOAD,MAP,NOEDIT,NOXREF

\*STATISTICS\* SCLRC STATEMENTS = 33 ,PROGRAM SIZE = 8

\*STATISTICS\* NO DIAGNOSTICS GENERATED

\*\*\*\*\* END OF COMPILE \*\*\*\*\* 83K BYTES OF CORE NOT USED

CCMPILER OPTICNS - NAME= PAIN,CPT=C2,LINECNT=54,SIZE=CCGCK,

SCURCE,ECCIC,NCLIST,NODECK,LGAD,MAP,ACEDIT,IC,NOXREF

ISN 0002	SLROUTINE CHCFL (ICHCFL)	00010000
	C**** MEMBER NAME B81CHGPL	00020000
	C PAGE 1 INPT LCC C001 THRU 0050	00030000
ISN 0003	CCMMON CPTIND ,FULINC ,DYLAND ,CRGIND ,OSWIND ,00040000	
	1FIXIND ,RCMINC ,FFFINC ,ETAINC ,AC ,XLBWC ,00050000	
	2XLRLA ,VCBCVH ,XLCG ,HMAXD ,PHCRHO ,VMC ,00060000	
	3EMLF ,CK1 ,DELWF ,CKFF ,VCIVE ,HOC ,00070000	
	4RCC ,TOC ,CAP1(5) ,SGTIND(12) ,ELFLOA ,ELVLOA ,00080000	
	5GAP2(6)	00090000
	C PAGE 2 INPLT LCC C051 THRU 0100	00100000
ISN 0004	CCMMON AR ,AS ,TCR ,TCT ,SLM ,00110000	
	1ARFT ,TCHT ,VEARH ,SLMH ,ARVT ,TCVT ,00120000	
	2VBARV ,SLMVT ,ELCA ,FLDT ,ELCOA ,CLSWSH ,00130000	
	3DSWET ,CLVLF ,CVCL ,CBYLOA ,ENR ,WVA ,00140000	
	4CAN1 ,CAN2 ,EMR ,DAMB ,CLEYE ,TFETMR ,00150000	
	5XC ,XVR ,TVCPR ,VT ,CTSIGH ,TVH ,00160000	
	6RES ,TIAY ,ETAP2 ,ETAP4N ,TBEM5(5) ,TB8AP4(5) ,00170000	
	7GAP3	00180000
	C PAGE 3 INPLT LCC C101 THRU 140	00190000
ISN 0005	CCMMON CAN4 ,ENF ,ETAT ,FC ,VC ,00200000	
	1ATMIY ,CDVT ,COFT ,DAMS ,CLTAFE ,FEERAG ,00210000	
	2EXPDRG ,CCC ,CLZLPF ,CKVT ,CKHT ,CKF ,00220000	
	3CKW ,RELI ,TCLN ,TBCL1(8) ,TBODWI(8) ,GAP4(4) ,00230000	
	4	00240000
	C PAGE 4 INPLT LCC 141 THRU 200 WEIGHT DATA	00250000
ISN 0006	CCMMON WFE ,WFL ,DELWFC ,DELWP ,DELWST ,00250000	
	1SKCC ,SKRC ,SKEC ,SKWF ,SKTM ,SKRCA ,00260000	
	2SKSCA ,SKPC ,SKAC ,SKHL ,SKENVI ,SKENV2 ,00270000	
	3SKGB1 ,SKGB2 ,SKELNT ,SKBAL ,SKLG ,SKW ,00280000	
	4ELF ,RVI ,SKWP ,SKHT ,SKVT ,SKPRB ,00290000	
	5SKRBF ,SKPH ,SKAMD ,SKAR ,SKPA ,SKVTAR ,00300000	
	6SKPDS ,SKPCSZ ,SKT ,SKFS ,SKPEI ,SKPES ,00310000	
	7SK1 ,SK2 ,CK3 ,DK4 ,SK5 ,SK6 ,00320000	
	8SK7 ,SK8 ,SK9 ,SK10 ,SK11 ,SK12 ,00330000	
	9SK13 ,SK14 ,SK15 ,PLIN ,GAP5(3)	00340000
	C PAGE 5 INPLT LCC 201 THRU 300	00350000
ISN 0007	CCMMON TCLIN(5) ,XTGTA2(5) ,TIN2(5) ,TWTW(5) ,PFET2(5) ,00360000	
	1DELTH(5) ,STH(5) ,CRSINC(5) ,XTGTA4(5) ,TIN4(5) ,VIN(5) ,00370000	
	2DELR(5) ,RMAX(5) ,DELFCR(5) ,ENPCR(5) ,DELWPL(5) ,STPW(5) ,00380000	
	3FFIN(5) ,GAP6(10)	00390000
	C PAGE 6 INPLT LCC 301 THRU 400	00400000
ISN 0008	CCMMON CYCPAL ,FF ,SK3 ,SK4 ,TBH1(5) ,00410000	
	1TBTO(5) ,TBH2(5) ,TBCRP(5) ,TBSFC(8) ,TBCPW(8) ,GAP7(60)	00420000
	C WORKING CCMPEN	00430000
ISN 0009	CCMMON ALFCES,ALFDL,ALFR,AML,	00440000
	1 BPPA,BPPR,BHPSLP,BHT,ELP,BR,BS,BVT,	00450000
	2 CBARF,CEARF,CEARVT,CEARW,CCP,CCT,CDV,CLW,CPIND,CPNUD,CPPAR,CPPRO	00460000
	3,CFDIT,CRT,CTP,CV,CX,CLES,CE,	00470000
	4 DELRTH,DELTA,DF,CSPENT, ELC,ELHT,ELN,ELCA,ELT,ELVT,EN,ETAP,	00480000
	5 FEH,FEHI,FEHL,FEHT,FET,FETCT,FEVT,FEW,FEWH,FEWI,FM,FP,ETAP4	00490000
ISN 0010	CCMMON GAMC1(3,15),CLF,GMCC1(16),H,	00500000

7-45

ORIGINAL PAGE IS OF POOR QUALITY

	7	ICRUS,IMCCRU,INCCRG,INCCYL,INDETA,INDFIX,INCFLL,INDOPT,INCOSW,	00510000
	E	INDPOW,INDPRF,INCFOM,IPRINT	00520000
ISN 0011		CCMMON LTHL,NCCFP,NCXP, ,CWE,FEHF,PI,Q,KHC,REALJ,PHPMR,R,RA	00530000
ISN 0012		CCMMON SA,SA5,SA6,SA7,SFC,SFPA,SHPP,SHT,SHTE,SHTW,SIGMA,SSIGMA,ST,	00540000
	1	STHETA,STMAX,SVT,SVTE,SVTH,SW,SWETH,SWEXP,SWTT,SWHET,S2RFC	00550000
ISN 0013		CCMMON T,TAF,TCEAR,THEJA,TMAX,TMP,TPROP,TR,ULF,VGASB,VGASR,VHL,V	00560000
ISN 0014		CCMMON W,WBAL,WALAT,WCC,WEE,WEP,WES,WFC,WFR,WFS,WFW,	00570000
	1	WGSB,WFL,WFT,WLG,WFC,WPAYL,WFC,WPCS,WPEI,WPF,WPRB,WPRG,WPRP,WPSTROO580000	00580000
	2	WRC,WRCB,WSC,WSCA,WST,WTK,WVT,WK,WPAYLC,WAC,WENV	00590000
ISN 0015		CCMMON XLALB,XLE,XLBH,XLFL,XLR,XLW,YLS2,TCVW	00600000
ISN 0016		CCMMON DNR,SIGAR,AF,BFFP,SEE	00600000
ISN 0017		WCLD = W	00610000
ISN 0018		TCLD = ST	00620000
ISN 0019		PLCLD = WPAYLC	00630000
ISN 0020		W = W + DELWFL(ICHGFL)	00640000
ISN 0021		ST = ST + STPW(ICHGFL)	00650000
ISN 0022		WPAYLO = PLCLD + DELWFL(ICHGFL)	00660000
ISN 0023		IF(IPRINT,NE.1)GC TC 3CC	00670000
ISN 0025		WRITE(6,1001) PLCLD,WPAYLC,STPW(ICHGFL)	00680000
ISN 0026	1001	FCRMT(7X,'CHANGE PAYLCAC FRM ',F10.0,4X,'FCUNDS'/25X,'TC ',	00700000
		IF10.0,4X,'PCUNDS',4X,'TAKING',2X,F6.2,2X,'HOURS'/)	00710000
ISN 0027		WRITE(6,1002)	00720000
ISN 0028	1002	FCRMT(7X,'TIME',EX,'RANGE',6X,'FUEL USED',6X,'WEIGHT',7X,'ALT'/	00730000
		17X,'(HOURS)',5X,'(N.MI)',6X,'(POUNDS)',5X,'(FCUNDS)',6X,'FEET'/)	00740000
ISN 0029		WRITE(6,1003)TELC,R,WFC,WCLD,F	00750000
ISN 0030		WRITE(6,1003)ST ,R,WFC,WCLD,F	00760000
ISN 0031	1003	FCRMT(7X,F7.2,4X,F8.1,4X,F9.0,4X,F10.0,4X,F8.0)	00770000
ISN 0032	300	RETURN	00780000
ISN 0033		END	00790000

NAME	TAG	TYPE	ADD.	NAME	TAG	TYPE	ADD.	NAME	TAG	TYPE	ADD.	NAME	TAG	TYPE	ADD.
H	F	C	R*4 000818	Q	C	R*4	N.R.	R	F	C	R*4 00C878	T	C	R*4	N.R.
V	C	R*4	N.R.	W	SF	C	R*4 000914	AF	C	R*4	N.R.	AR	C	R*4	N.R.
BR	C	R*4	N.R.	BS	C	R*4	N.R.	CB	C	R*4	N.R.	CV	C	R*4	N.R.
CX	C	R*4	N.R.	CH	C	R*4	N.R.	EN	C	R*4	N.R.	FF	C	R*4	N.R.
FM	C	R*4	N.R.	FP	C	R*4	N.R.	HC	C	R*4	N.R.	PI	C	R*4	N.R.
RN	C	R*4	N.R.	SA	C	R*4	N.R.	ST	SF	C	R*4 00C8B0	SW	C	R*4	N.R.
TR	C	R*4	N.R.	VC	C	R*4	N.R.	VT	C	R*4	N.R.	WE	C	R*4	N.R.
WF	F	C	R*4 000930	WG	C	R*4	N.R.	WS	C	R*4	N.R.	WW	C	R*4	N.R.
XC	C	R*4	N.R.	AMU	C	R*4	N.R.	BHT	C	R*4	N.R.	BLP	C	R*4	N.R.
BMR	C	R*4	N.R.	BVT	C	R*4	N.R.	CCP	C	R*4	N.R.	CCT	C	R*4	N.R.
CDC	C	R*4	N.R.	CDV	C	R*4	N.R.	CKF	C	R*4	N.R.	CKW	C	R*4	N.R.
CKI	C	R*4	N.R.	CLW	C	R*4	N.R.	CRT	C	R*4	N.R.	CTP	C	R*4	N.R.
DK3	C	R*4	N.R.	CK4	C	R*4	N.R.	DMR	C	R*4	N.R.	ELC	C	R*4	N.R.
ELF	C	R*4	N.R.	ELN	C	R*4	N.R.	ELT	C	R*4	N.R.	ENP	C	R*4	N.R.
ENR	C	R*4	N.R.	FEE	C	R*4	N.R.	FET	C	R*4	N.R.	FEW	C	R*4	N.R.
GLF	C	R*4	N.R.	FES	C	R*4	N.R.	HOO	C	R*4	N.R.	QWE	C	R*4	N.R.
RHC	C	R*4	N.R.	RMI	C	R*4	N.R.	ROO	C	R*4	N.R.	SA5	C	R*4	N.R.
SA6	C	R*4	N.R.	SA7	C	R*4	N.R.	SEE	C	R*4	N.R.	SFC	C	R*4	N.R.
SHT	C	R*4	N.R.	SKT	C	R*4	N.R.	SKI	C	R*4	N.R.	SK2	C	R*4	N.R.
SK3	C	R*4	N.R.	SK4	C	R*4	N.R.	SK5	C	R*4	N.R.	SK6	C	R*4	N.R.
SK7	C	R*4	N.R.	SK8	C	R*4	N.R.	SK9	C	R*4	N.R.	SLM	C	R*4	N.R.
STH	C	R*4	N.R.	SVT	C	R*4	N.R.	TAF	C	R*4	N.R.	TCR	C	R*4	N.R.
TCT	C	R*4	N.R.	TMP	C	R*4	N.R.	TOO	C	R*4	N.R.	TVW	C	R*4	N.R.
ULF	C	R*4	N.R.	VHL	C	R*4	N.R.	VIN	C	R*4	N.R.	VMC	C	R*4	N.R.
WAC	C	R*4	N.R.	WCC	C	R*4	N.R.	WEP	C	R*4	N.R.	WES	C	R*4	N.R.
WFC	C	R*4	N.R.	WFE	C	R*4	N.R.	WFR	C	R*4	N.R.	WFS	C	R*4	N.R.
WFH	C	R*4	N.R.	WHL	C	R*4	N.R.	WHT	C	R*4	N.R.	WLG	C	R*4	N.R.
WMC	C	R*4	N.R.	WPC	C	R*4	N.R.	WPH	C	R*4	N.R.	WRC	C	R*4	N.R.
WSC	C	R*4	N.R.	WST	C	R*4	N.R.	WTM	C	R*4	N.R.	WVA	C	R*4	N.R.
WVT	C	R*4	N.R.	XLB	C	R*4	N.R.	XLR	C	R*4	N.R.	XLW	C	R*4	N.R.
XMR	C	R*4	N.R.	ALFR	C	R*4	N.R.	ARHT	C	R*4	N.R.	ARVT	C	R*4	N.R.
BHPA	C	R*4	N.R.	BHPF	C	R*4	N.R.	BHPR	C	R*4	N.R.	CDHT	C	R*4	N.R.
CDVT	C	R*4	N.R.	CKFF	C	R*4	N.R.	CKHT	C	R*4	N.R.	CKVT	C	R*4	N.R.
DAM1	C	R*4	N.R.	CAM2	C	R*4	N.R.	DAM3	C	R*4	N.R.	DAM4	C	R*4	N.R.
DAM5	C	R*4	N.R.	CELR	C	R*4	N.R.	DVQL	C	R*4	N.R.	ELCN	C	R*4	N.R.
ELDT	C	R*4	N.R.	ELHT	C	R*4	N.R.	ELJA	C	R*4	N.R.	ELVT	C	R*4	N.R.
EMLF	C	R*4	N.R.	ETAP	C	R*4	N.R.	ETAT	C	R*4	N.R.	FEHI	C	R*4	N.R.
FEHL	C	R*4	N.R.	FEHT	C	R*4	N.R.	FEVT	C	R*4	N.R.	FEWH	C	R*4	N.R.
FEWI	C	R*4	N.R.	CAP1	C	R*4	N.R.	GAP2	C	R*4	N.R.	GAP3	C	R*4	N.R.
GAP4	C	R*4	N.R.	CAP5	C	R*4	N.R.	GAP6	C	R*4	N.R.	GAP7	C	R*4	N.R.
HFIN	C	R*4	N.R.	LTHL	C	R*4	N.R.	PEHF	C	R*4	N.R.	PLIN	C	R*4	N.R.
RELI	C	R*4	N.R.	RMAX	C	R*4	N.R.	SHPA	C	R*4	N.R.	SHPK	C	R*4	N.R.
SHTe	C	R*4	N.R.	SHTX	C	R*4	N.R.	SKAC	C	R*4	N.R.	SKAR	C	R*4	N.R.
SKCC	C	R*4	N.R.	SKFS	C	R*4	N.R.	SKFW	C	R*4	N.R.	SKHL	C	R*4	N.R.
SKHT	C	R*4	N.R.	SKLG	C	R*4	N.R.	SKMC	C	R*4	N.R.	SKPA	C	R*4	N.R.
SKPH	C	R*4	N.R.	SKRC	C	R*4	N.R.	SKSC	C	R*4	N.R.	SKTM	C	R*4	N.R.
SKVT	C	R*4	N.R.	SKWP	C	R*4	N.R.	SKWW	C	R*4	N.R.	SK10	C	R*4	N.R.
SK11	C	R*4	N.R.	SK12	C	R*4	N.R.	SK13	C	R*4	N.R.	SK14	C	R*4	N.R.
SK15	C	R*4	N.R.	SLMH	C	R*4	N.R.	STPW	F	C	R*4 000460	SVTE	C	R*4	N.R.
SVTW	C	R*4	N.R.	SKTT	C	R*4	N.R.	TBHI	C	R*4	N.R.	TBHI	C	R*4	N.R.

7-47

TBTC	C	R*4	N.R.	TCHT	C	R*4	N.R.	TCLN	C	R*4	N.R.	TCVT	C	R*4	N.R.	
TINY	C	R*4	N.R.	TIN2	C	R*4	N.R.	TIN4	C	R*4	N.R.	TFAX	C	R*4	N.R.	
TOLD SF		R*4	00016C	TCVW	C	R*4	N.R.	TWTW	C	R*4	N.R.	WBAL	C	R*4	N.R.	
WENV	C	R*4	N.R.	WFL	C	R*4	N.R.	WGSB	C	R*4	N.R.	WCLD SF		R*4	000164	
WPDS	C	R*4	N.R.	WPEI	C	R*4	N.R.	WPRB	C	R*4	N.R.	WPRG	C	R*4	N.R.	
WPRP	C	R*4	N.R.	WRC A	C	R*4	N.R.	WSCA	C	R*4	N.P.	XLBH	C	R*4	N.P.	
XLGD	C	R*4	N.R.	XLHL	C	R*4	N.R.	YLS2	C	R*4	N.R.	ALFCL	C	R*4	N.R.	
ATMIY	C	R*4	N.R.	CEARF	C	R*4	N.R.	CBARW	C	R*4	N.R.	CFGPL		P*4	000168	
CLDES	C	R*4	N.R.	CLEYE	C	R*4	N.R.	CPIND	C	R*4	N.R.	CPNUD	C	R*4	N.R.	
CPPAR	C	R*4	N.R.	CPPRO	C	R*4	N.R.	CPTOT	C	R*4	N.R.	DELTA	C	R*4	N.R.	
DELTH	C	R*4	N.R.	CELWF	C	R*4	N.R.	DELWP	C	R*4	N.R.	DSWET	C	R*4	N.R.	
ELDOA	C	R*4	N.R.	ENPCR	C	R*4	N.R.	ETAP2	C	R*4	N.R.	ETAP4	C	R*4	N.R.	
FETOT	C	R*4	N.R.	GMD1	C	P*4	N.R.	HMAXD	C	R*4	N.R.	ICRUS	C	I*4	N.R.	
NOCPP	C	I*4	N.R.	NCXPJ	C	I*4	N.R.	PFET2	C	R*4	N.R.	PLCLD SF		R*4	00016C	
REALJ	C	R*4	N.R.	RFFMR	C	R*4	N.R.	SIGMA	C	R*4	N.R.	SIGMP	C	R*4	N.R.	
SKAMD	C	R*4	N.R.	SKBAL	C	R*4	N.R.	SKGB1	C	R*4	N.R.	SKGB2	C	R*4	N.R.	
SKPDS	C	R*4	N.R.	SKPEI	C	R*4	N.R.	SKPES	C	R*4	N.R.	SKPPB	C	R*4	N.R.	
SKRBF	C	R*4	N.R.	SKRCA	C	R*4	N.R.	SKSCA	C	R*4	N.R.	SLMVT	C	R*4	N.R.	
STMAX	C	R*4	N.R.	SWETE	C	R*4	N.R.	SWEXP	C	R*4	N.R.	SWJET	C	R*4	N.R.	
S2RHO	C	R*4	N.R.	TECLI	C	R*4	N.R.	TBCRP	C	R*4	N.R.	TBEM5	C	R*4	N.R.	
TBPOW	C	R*4	N.R.	TESFC	C	R*4	N.R.	TGBAR	C	R*4	N.R.	THETA	C	R*4	N.R.	
TPROP	C	R*4	N.R.	TVCMR	C	R*4	N.R.	VBARH	C	R*4	N.R.	VBARV	C	P*4	N.R.	
VDIVE	C	R*4	N.R.	VGASB	C	R*4	N.R.	VGASR	C	R*4	N.R.	WPAYL	C	R*4	N.R.	
WPSTR	C	R*4	N.R.	XLALB	C	R*4	N.R.	XLBWO	C	R*4	N.R.	XLRLA	C	R*4	N.R.	
ALFDES	C	R*4	N.R.	EHFSLP	C	R*4	N.R.	CBARHT	C	R*4	N.R.	CBARVT	C	P*4	N.R.	
CYLOA	C	R*4	N.R.	CLALPH	C	R*4	N.R.	CRSIND	C	R*4	N.R.	CTSIGH	C	R*4	N.R.	
CYCPRL	C	R*4	N.R.	DELFCR	C	R*4	N.R.	DELTRH	C	R*4	N.R.	DELWFC	C	R*4	N.R.	
DELWPL F		C	R*4	DELWST	C	R*4	N.R.	CLSWSH	C	R*4	N.R.	DLTAFE	C	R*4	N.R.	
DLVLHL	C	R*4	N.R.	CRGIND	C	R*4	N.R.	DSPLHT	C	R*4	N.R.	DYLIND	C	P*4	N.R.	
ELHLOA	C	R*4	N.R.	ELVLOA	C	R*4	N.R.	ETAIND	C	R*4	N.R.	ETAP4N	C	P*4	N.R.	
EXPDKG	C	R*4	N.R.	FEECRG	C	R*4	N.R.	FIXIND	C	R*4	N.R.	GAMD11	C	R*4	N.R.	
HULIND	C	R*4	N.R.	IBCCM#	F	XF	I*4	000J00	ICHGPL	F	I*4	000170	INCCRU	C	I*4	N.R.
INDDRG	C	I*4	N.R.	INCCYL	C	I*4	N.R.	INDETA	C	I*4	N.R.	INCFIX	C	I*4	N.R.	
INDHUL	C	I*4	N.R.	INCCPT	C	I*4	N.R.	INDOSW	C	I*4	N.R.	INCPDW	C	I*4	N.R.	
INDPRP	C	I*4	N.R.	INCRDM	C	I*4	N.R.	IPRINT	C	I*4	000B4C	OPTIND	C	R*4	N.R.	
OSWIND	C	R*4	N.R.	FRFIND	C	R*4	N.R.	ROMIND	C	R*4	N.R.	RHCFHO	C	R*4	N.R.	
SCTIND	C	R*4	N.R.	SKBLAT	C	R*4	N.R.	SKENV1	C	R*4	N.R.	SKENV2	C	R*4	N.R.	
SKPDSZ	C	R*4	N.R.	SKVTAR	C	R*4	N.R.	SSIGMA	C	R*4	N.R.	STHETA	C	R*4	N.R.	
TBCDWI	C	R*4	N.R.	TBBAP4	C	R*4	N.R.	THETMR	C	R*4	N.R.	TCLIND	C	R*4	N.R.	
VGBOVH	C	R*4	N.R.	WBALNT	C	R*4	N.R.	WPAYLO SF		C	R*4	00099C	XTGTA2	C	R*4	N.R.
XTGTA4	C	R*4	N.R.													

\*\*\*\*\* COMMON INFORMATICA \*\*\*\*\*

NAME OF COMMON BLOCK * * SIZE OF BLOCK 0009DC HEXADECIMAL BYTES															
VAR. NAME	TYPE	REL.	ACCR.	VAR. NAME	TYPE	REL.	ACCR.	VAR. NAME	TYPE	REL.	ACCR.	VAR. NAME	TYPE	REL.	ACCR.
OPTIND	R*4		N.R.	HULIND	R*4		N.R.	DYLIND	R*4		N.R.	CRGIND	R*4		N.R.
OSWIND	R*4		N.R.	FIXIND	R*4		N.R.	ROMIND	R*4		N.R.	PRPIND	R*4		N.R.
ETAIND	R*4		N.R.	WC	R*4		N.R.	XLBWO	R*4		N.R.	XLRLA	R*4		N.R.
VGBCVT	R*4		N.R.	XLGC	R*4		N.R.	HMAXD	R*4		N.R.	RHCRHO	R*4		N.R.

VMC	R*4	N.R.	EMLF	R*4	N.R.	CK1	R*4	N.R.	DELWF	R*4	N.R.
CKFF	R*4	N.R.	VLIVE	R*4	N.P.	HOO	R*4	N.R.	PCU	R*4	N.R.
TCC	R*4	N.R.	CAF1	R*4	N.R.	SGTIND	R*4	N.R.	ELHLCA	R*4	N.R.
ELVLCA	R*4	N.R.	GAP2	R*4	N.P.	AR	R*4	N.P.	WS	R*4	N.P.
TCR	R*4	N.R.	TCT	R*4	N.R.	SLM	R*4	N.R.	ARHT	R*4	N.R.
TCHT	R*4	N.R.	VBART	R*4	N.R.	SLMH	R*4	N.R.	ARVT	R*4	N.R.
TCVT	R*4	N.R.	VEARV	R*4	N.R.	SLMVT	R*4	N.R.	ELDN	R*4	N.R.
ELCT	R*4	N.R.	ELCCA	R*4	N.R.	CLSWSH	R*4	N.R.	DSWET	R*4	N.R.
DLVLF	R*4	N.R.	CVCL	R*4	N.R.	CBYLOA	R*4	N.R.	ENF	R*4	N.R.
KVA	R*4	N.R.	CAM1	R*4	N.R.	DAM2	R*4	N.P.	BMP	R*4	N.R.
CAM3	R*4	N.R.	CLEVE	R*4	N.P.	THEYMR	R*4	N.R.	XC	R*4	N.P.
XMR	R*4	N.R.	TVCMA	R*4	N.R.	VT	R*4	N.R.	CTSIGH	R*4	N.R.
TVK	R*4	N.R.	FES	R*4	N.R.	TINY	R*4	N.R.	ETAP2	R*4	N.R.
ETAP4N	R*4	N.R.	TBEVS	R*4	N.R.	TBSAP4	R*4	N.R.	GAP3	R*4	N.R.
CAM4	R*4	N.R.	ENF	R*4	N.R.	ETAT	R*4	N.R.	HC	R*4	N.R.
VC	R*4	N.R.	ATMIY	R*4	N.R.	COVT	R*4	N.R.	CDHT	R*4	N.R.
CAM5	R*4	N.R.	CLTAFE	R*4	N.P.	FEDRAG	R*4	N.R.	EXPCRG	R*4	N.R.
CCC	R*4	N.R.	CLALPH	R*4	N.R.	CKVT	R*4	N.R.	CKHT	R*4	N.P.
CKF	R*4	N.R.	CKV	R*4	N.R.	RELI	R*4	N.R.	TCLN	R*4	N.R.
TBCL1	R*4	N.R.	TBCOW	R*4	N.R.	GAP4	R*4	N.R.	WFE	R*4	N.R.
WFLL	R*4	N.R.	DELWFC	R*4	N.R.	DELWP	R*4	N.R.	DELWST	R*4	N.R.
SKCC	R*4	N.R.	SKRC	R*4	N.R.	SKSC	R*4	N.R.	SKFY	R*4	N.R.
SKIM	R*4	N.R.	SKRCA	R*4	N.R.	SKSCA	R*4	N.R.	SKVC	R*4	N.R.
SKAC	R*4	N.R.	SKFL	R*4	N.R.	SKENVI	R*4	N.R.	SKENV2	R*4	N.P.
SKCE1	R*4	N.R.	SKGB2	R*4	N.R.	SKBLNT	R*4	N.R.	SKBAL	R*4	N.R.
SKLG	R*4	N.R.	SKW	R*4	N.R.	ELF	R*4	N.R.	FMI	R*4	N.R.
SKWP	R*4	N.R.	SKFT	R*4	N.R.	SKVT	R*4	N.R.	SKPRB	R*4	N.R.
SKREF	R*4	N.R.	SKPT	R*4	N.R.	SKAMD	R*4	N.R.	SKAR	R*4	N.R.
SKFA	R*4	N.R.	SKVTA	R*4	N.R.	SKPDS	R*4	N.P.	SKPDSZ	R*4	N.R.
SKT	R*4	N.R.	SKFS	R*4	N.R.	SKPEI	R*4	N.R.	SKPES	R*4	N.R.
SK1	R*4	N.R.	SK2	R*4	N.R.	DK3	R*4	N.P.	DK4	R*4	N.R.
SK5	R*4	N.R.	SK6	R*4	N.R.	SK7	R*4	N.R.	SK8	R*4	N.R.
SK9	R*4	N.R.	SK10	R*4	N.R.	SK11	R*4	N.R.	SK12	R*4	N.R.
SK13	R*4	N.R.	SK14	R*4	N.R.	SK15	R*4	N.R.	PLIN	R*4	N.R.
GAF5	R*4	N.R.	TCLINE	R*4	N.R.	XTGTA2	R*4	N.R.	TIN2	R*4	N.R.
TWTH	R*4	N.R.	PFET2	R*4	N.R.	DELTH	R*4	N.R.	STH	R*4	N.R.
CRSINC	R*4	N.R.	XTGTA4	R*4	N.R.	TIN4	R*4	N.R.	VIN	R*4	N.R.
DELK	R*4	N.R.	RMAY	R*4	N.R.	DELFCR	R*4	N.R.	ENPCP	R*4	N.R.
DELWFL	R*4	00044C	STFV	R*4	0C0400	HFIN	R*4	N.R.	GAP6	R*4	N.R.
CYCPFL	R*4	N.R.	FF	R*4	N.R.	SK3	R*4	N.R.	SK4	R*4	N.R.
TBF1	R*4	N.R.	TEYC	R*4	N.R.	TGH2	R*4	N.R.	TBCKP	R*4	N.R.
TBSFC	R*4	N.R.	TBFOW	R*4	N.R.	GAP7	R*4	N.R.	ALFDES	R*4	N.R.
ALFCL	R*4	N.R.	ALFR	R*4	N.R.	AMU	R*4	N.R.	BHPA	R*4	N.R.
BFR	R*4	N.R.	BHPSLF	R*4	N.R.	BHT	R*4	N.R.	BLP	R*4	N.R.
ER	R*4	N.R.	BS	R*4	N.R.	BVT	R*4	N.R.	CBARF	R*4	N.R.
CBARHT	R*4	N.R.	CBARVT	R*4	N.R.	CBARW	R*4	N.R.	CCP	R*4	N.R.
CCT	R*4	N.R.	CCV	R*4	N.R.	CLW	R*4	N.R.	CPIND	R*4	N.P.
CPNLC	R*4	N.R.	CPPAF	R*4	N.R.	CPPRO	R*4	N.R.	CPTOT	R*4	N.R.
CFT	R*4	N.R.	CTP	R*4	N.R.	CV	R*4	N.R.	CX	R*4	N.R.
CLDES	R*4	N.R.	CE	R*4	N.R.	DELRYH	R*4	N.R.	DELTA	R*4	N.R.
CH	R*4	N.R.	CSPLMT	R*4	N.R.	ELC	R*4	N.R.	ELHT	R*4	N.R.
ELN	R*4	N.R.	ELCA	R*4	N.R.	ELT	R*4	N.R.	ELVT	R*4	N.R.



EN	R*4	N.R.	ETAF	R*4	N.R.	FEH	R*4	N.R.	FEH1	R*4	N.R.
FEFL	R*4	N.R.	FEFI	R*4	N.R.	FET	R*4	N.R.	FFCT	R*4	N.R.
FEVT	R*4	N.R.	FEW	R*4	N.R.	FEWH	R*4	N.R.	FEW1	R*4	N.R.
FM	R*4	N.R.	FF	R*4	N.R.	ETAP4	R*4	N.R.	GAMC11	R*4	N.R.
GLF	R*4	N.R.	GMCCI	R*4	N.R.	H	R*4	00C818	ICRUS	I*4	N.R.
INDCFL	I*4	N.R.	INCCRG	I*4	N.R.	INDOYL	I*4	N.R.	INDETA	I*4	N.R.
INDFIX	I*4	N.R.	INDHLL	I*4	N.R.	INDOJPT	I*4	N.R.	INDCS	I*4	N.R.
INDPCW	I*4	N.R.	INDPRF	I*4	N.R.	INDRDM	I*4	N.R.	IPRINT	I*4	00084C
LTHL	I*4	N.R.	NCCFF	I*4	N.R.	NOXPJ	I*4	N.R.	CXE	R*4	N.R.
PEEF	R*4	N.R.	PI	R*4	N.R.	Q	R*4	N.R.	PHQ	R*4	N.R.
REALJ	R*4	N.R.	RFFMR	R*4	N.R.	R	R*4	00C878	RN	R*4	N.R.
SA	R*4	N.R.	SAE	R*4	N.R.	SA6	R*4	N.R.	SA7	R*4	N.R.
SFC	R*4	N.R.	SHPA	R*4	N.R.	SHPR	R*4	N.R.	SHT	R*4	N.R.
SFTE	R*4	N.R.	SHTK	R*4	N.R.	SIGMA	R*4	N.R.	SSIGMA	R*4	N.R.
ST	R*4	0008BC	STFETA	R*4	N.R.	STMAX	R*4	N.R.	SVT	R*4	N.R.
SVTE	R*4	N.R.	SVTK	R*4	N.R.	SU	R*4	N.R.	SWETH	R*4	N.R.
SWEXP	R*4	N.R.	SWTI	R*4	N.R.	SWWET	R*4	N.R.	S2RHG	R*4	N.R.
T	R*4	N.R.	TAF	R*4	N.R.	TCGAR	R*4	N.R.	THETA	R*4	N.R.
TMAX	R*4	N.R.	TMP	R*4	N.R.	TPROP	R*4	N.R.	TR	R*4	N.R.
LLF	R*4	N.R.	VGASE	R*4	N.R.	VGASR	R*4	N.R.	VHL	R*4	N.R.
V	R*4	N.R.	V	R*4	000914	WBAL	R*4	N.R.	WBALNT	R*4	N.R.
WCC	R*4	N.R.	WE	R*4	N.R.	WEP	R*4	N.R.	WES	R*4	N.R.
WF	R*4	000920	WFC	R*4	N.R.	WFR	R*4	N.R.	WFS	R*4	N.R.
WFW	R*4	N.R.	WGSE	R*4	N.R.	WHL	R*4	N.R.	WHT	R*4	N.R.
WLG	R*4	N.R.	WMC	R*4	N.R.	WPAYL	R*4	N.R.	WPC	R*4	N.R.
WPCS	R*4	N.R.	WPEI	R*4	N.R.	WPH	R*4	N.R.	WPRB	R*4	N.R.
WPPG	R*4	N.R.	WPRF	R*4	N.R.	WPSTR	R*4	N.R.	WRC	R*4	N.R.
WRCA	R*4	N.R.	WSC	R*4	N.R.	WSCA	R*4	N.R.	WST	R*4	N.R.
WTM	R*4	N.R.	WVT	R*4	N.R.	WW	R*4	N.R.	WPAYLO	R*4	00099C
WAC	R*4	N.R.	WENV	R*4	N.R.	XLALB	R*4	N.R.	XLB	R*4	N.R.
XLBT	R*4	N.R.	XLHL	R*4	N.R.	XLR	R*4	N.R.	XLW	R*4	N.R.
YLS2	R*4	N.R.	TCVh	R*4	N.R.	DMR	R*4	N.R.	SIGMR	R*4	N.R.
AF	R*4	N.R.	BHPP	R*4	N.R.	SEE	R*4	N.R.			

7-50

LABEL ADDR

LABEL ADDR

LABEL ADDR

LABEL ADDR

PAGE 007

300 GCC294

\*OPTIONS IN EFFECT\* NAME= MAIN,CPT=C2,LINECNT=54,SIZE=0000K,

\*OPTIONS IN EFFECT\* SOURCE,EBCDIC,NCLIST,NCDECK,LOAD,MAP,NOEDIT,IO,NOXREF

\*STATISTICS\* SOURCE STATEMENTS = 32 ,FRCCRAM SIZE = 708

\*STATISTICS\* NO DIAGNOSTICS GENERATED

\*\*\*\*\* END OF COMPILATION \*\*\*\*\*

107K BYTES OF CORE NOT USED

7-51

COMPILER OPTIONS - NAME= MAIN,OPT=C2,LINECNT=54,SIZE=QCOCK,							
SOURCE,ECCIC,ACLIST,NODECK,LOAD,MAP,NCEDIT,ID,NOXREF							
ISN 0002		SLROUTINE CRLS1 (ICRLS)					00010000
	C***	MEMBER NAME B8ICRLS1					00020000
	C	PAGE 1 INPUT LCC OCC1 THRU 0050					00030000
ISN 0003		CCMMON CPTIND ,FULIND ,DYLIND ,CRGIND ,OSWIND ,00040000					
		1FIXIND ,RDMIND ,PRPIND ,ETAIND ,WC ,XLEWQ ,00050000					
		2XLFLA ,VGEVH ,LCC ,HMVXD ,FFORHO ,VMC ,00060000					
		3EMLF ,CK1 ,DELWF ,CKFF ,VCIVE ,HOC ,00070000					
		4RCC ,TCC ,GAF1(5) ,SGTIND(12) ,ELHLOA ,ELVLOA ,00080000					
		5GAP2(6)					00090000
	C	PAGE 2 INPUT LCC CC51 THRU 0100					00100000
ISN 0004		CCMMON AR ,S ,TCR ,TCT ,SLP ,00110000					
		1ARFT ,TCHT ,VEARH ,SLMH ,ARVT ,TCVT ,00120000					
		2VEARV ,SLMT ,ELCN ,ELDT ,ELDOA ,DLSWSH ,00130000					
		3DSWET ,CLVLEL ,CVCL ,CBYLOA ,ENR ,hVA ,00140000					
		4CAM1 ,CAM2 ,EMF ,DAM3 ,CLEYE ,T-ETMR ,00150000					
		5XC ,XMR ,TVCMR ,VT ,CTSIGH ,TVW ,00160000					
		6HES ,TINY ,ETAP2 ,ETAP4N ,TBEM5(5) ,TB8AP4(5) ,00170000					
		7GAP3					00180000
	C	PAGE 3 INPUT LCC C1C1 THRU 140					00190000
ISN 0005		CCMMON DAM4 ,ENF ,ETAT ,tC ,VC ,00200000					
		1ATMIY ,CDVT ,CCHT ,DAM5 ,ELTAFE ,FECRAG ,00210000					
		2EXFDRG ,CDC ,CLALP ,CKVT ,CKHT ,CKF ,00220000					
		3CKW ,RELI ,TCLN ,TECL1(8) ,TECDW1(8) ,GAP4(4) ,00230000					
	C	PAGE 4 INPUT LCC 141 THRU 200 WEIGHT DATA					00240000
ISN 0006		CCMMON WFE ,WFL ,DELWFC ,DELWP ,DELWST ,00250000					
		1SKCC ,SKRC ,SKSC ,SKFW ,SKTM ,SKRCA ,00260000					
		2SKSCA ,SKMC ,SKAC ,SKHL ,SKENV1 ,SKENV2 ,00270000					
		3SKCB1 ,SKGE2 ,SKELNT ,SKBAL ,SKLG ,SKW ,00280000					
		4ELF ,RMI ,SKP ,SKHT ,SKVT ,SKPRB ,00290000					
		5SKRBF ,SKPH ,SKAMD ,SKAR ,SKPA ,SKVTAR ,00300000					
		6SKPDS ,SKPDS2 ,SKT ,SKFS ,SKPEI ,SKPES ,00310000					
		7SK1 ,SK2 ,CK3 ,DK4 ,SK5 ,SK6 ,00320000					
		8SK7 ,SK8 ,SK9 ,SK10 ,SK11 ,SK12 ,00330000					
		9SK13 ,SK14 ,SK15 ,PLIN ,GAP5(3)					00340000
	C	PAGE 5 INPLT LCC 201 THRU 300					00350000
ISN 0007		CCMMON TCLINC(5) ,TCTA2(5) ,TIN2(5) ,TWTW(5) ,PFET2(5) ,00360000					
		1DELTH(5) ,STH(5) ,CRSINC(5) ,XTGTA4(5) ,TIN4(5) ,VIN(5) ,00370000					
		2DELR(5) ,RMAX(5) ,DELFCR(5) ,ENPCR(5) ,DELWPL(5) ,STPW(5) ,00380000					
		3FFIN(5) ,GAP6(10)					00390000
	C	PAGE 6 INPLT LCC 301 THRU 400					00400000
ISN 0008		CCMMON CYCPR ,FF ,SK3 ,SK4 ,TBH1(5) ,00410000					
		1TBTO(5) ,TBH2(5) ,TBCRP(5) ,TBSFC(8) ,TBPOW(8) ,GAP7(60)					00420000
	C	WORKING CCMMON					00430000
ISN 0009		CCMMON ALFDES,ALFCL,ALFF,AML,					00440000
		1 BHPA,EHFR,BFPLP,BHT,BLP,BR,BS,BVT,					00450000
		2 CBARF,CEARFT,CEARVT,CEARW,CCP,CCT,CDV,CLW,CFIND,CPNUD,CPPAR,CPPRO00460000					
		3,CPTOT,CRT,CTP,CV,CX,CLDES,CB,					00470000
		4 DELRT,DELTA,DF,DSPLN1, ELC,ELHT,ELN,ELCA,ELT,ELVT,EN,ETAP,					00480000
		5 FEH,FEH1,FEHL,FEHT,FET,FETCT,FEVT,FEW,FEWH,FEWI,FM,FP,ETAP4					00490000
ISN 0010		CCMMON GAPD11(3,15),GLF,GMCC1(16),H,					00500000

7-52

	7ICUM3, INDCRU, INDEGR, INDCYL, INCETA, INDFIX, INDFUL, INDOPT, INDCSW,	C0510000
	E INDPW, INDCRP, INDCRM, IFFINT	00520000
ISN 0011	CCMON LTHL, ACCFP, ACXP, CWE, PEHF, PI, Q, RHC, REALJ, RHPMR, R, RA	00530000
ISN 0012	CCMON SA, SA5, SA6, SA7, SFC, SFA, SHPP, SHT, SHTE, SHTW, SIGMA, SSIGMA, ST,	C0540000
	1STHETA, STMAX, SVT, SVTE, SVTK, SW, SWETH, SWEXP, SWTT, SWWET, S2RHC	00550000
ISN 0013	CCMON T, TAF, TCEAR, THETA, TMAX, TMP, TPROP, TR, ULF, VGASB, VGASR, VHL, V	00560000
ISN 0014	CCMON W, WBAL, WEA, WELT, WCC, WE, WEP, WES, WF, WFC, WFR, WFS, WFW,	00570000
	1 WCSB, WFL, WFT, WLG, WMC, WPAYL, WPC, WPDS, WPEI, WPH, WPRB, WPRG, WPRP, WPSTRO	00580000
	2, WRC, WRCA, WSC, WSCA, WST, WTM, WVT, WW, WPAYLC, WAC, WENV	00590000
ISN 0015	CCMON XLALB, XLE, XLBT, XLHL, XLR, XLW, YLS2, TGVW	00600000
ISN 0016	CCMON DMR, SIGMR, ZF, EHPP, SEE	C0600001
ISN 0017	NAMELIST /ICRUS1/ LC1, LC3, YLS2, V, T, Q, CX, BHPR, BHPA, BLP,	C0610000
	1 BHPSUP, FP, EN, INCETA, ETAP4, DHP, B1, B2, DELV, V, R, W, WF, ST	00620000
ISN 0018	RTCD=57.2957795	00620100
ISN 0019	H=H	00620200
ISN 0020	NETAP4 = ETAP4A + C.1	00630000
ISN 0021	IF(IPRINT.EC.1) GO TO 3C1	00640000
ISN 0023	3C4 WRITE(6,3C7)	00720000
ISN 0024	3C7 FORMAT(7X, 'CRLISE AT CRLISE PCWER'//)	00730000
ISN 0025	3C1 CONTINUE	00740000
ISN 0026	IF(IPRINT.EC.1) WRITE(6,1C05)	00750000
ISN 0028	IF(IPRINT.EC.1) WRITE(6,1C08)	00750100
ISN 0030	1CC5 FORMAT(2X, 'TIME', 7X, 'RANGE', 5X, 'FUEL USED', 5X, 'WEIGHT', 6X, 'ALT.', 60076000	
	1X, 'TEMP', 5X, 'TAS', 5X, 'E.F.', 4X, 'PEHF', 5X, 'BHFR', 4X, 'ETAP', 5X, 'NMPP00770000	
	2, 6X, 'R.N.', 4X, 'CL'//	00780000
	32X, '(ICRUS) (N.MI) (PCUNDS) (PCUNDS) (FEET) (DEG.F00790000	
	4) (KT)'//)	00800000
ISN 0031	1CC8 FORMAT(37X, 'HULL LIFT', 11X, 'WING LIFT', 7X, 'RCTGR LIFT', 8X, 'ALPHA	C0800100
	1, 16X, 'ALPHA E/L', 738X, '(PCUNDS)', 12X, '(PCUNDS)', 7X, '(POUNDS)', 10X,	00800200
	2 '(DEG)', 17X, '(DEG)'//)	00800300
ISN 0032	LC1 = 0	C0810000
ISN 0033	LC3 = 0	00820000
ISN 0034	YLS2 = (ENP - ENFCR(ICRUS))/ENP	C0830000
ISN 0035	TIN = TIN4(ICRUS)	00840000
ISN 0036	CALL ATMOS(F, TIN)	00850000
ISN 0037	15 V=VMO/SSIGMA	00860000
ISN 0038	1 C = 1.42636 * R+C * V * V	00870000
ISN 0039	LC3 = LC3 + 1	00880000
ISN 0040	CALL LIFT	C0890000
ISN 0041	CALL DRAG(ALFR)	00900000
ISN 0042	BR=XLB/W	C0900100
ISN 0043	IF(INDCYL.GT.2) GO TO 2	00910000
ISN 0045	T = T + C * CELFCR(ICRUS)	00920000
ISN 0046	IF(INCETA.EC.C) GO TO 4	C0930000
ISN 0048	TPROP = T	C0940000
ISN 0049	CALL PCWER	00950000
ISN 0050	BHPR = SHPR * BHPP * DELRTH * YLS2	C0960000
ISN 0051	GO TO 5	C0970000
ISN 0052	2 CX = CX + 2. * AMU * AMU * CELFCR(ICRUS)/(PI * DMR * DMR * ENR)	00980000
ISN 0053	CALL RCTPCW	C0990000
ISN 0054	BHPR = RHPMR/ETAT	01000000
ISN 0055	GO TO 5	01010000

7-53

ORIGINAL PAGE IS  
OF POOR QUALITY

ISN 0056	4	ETAP4 = XLINT(TEEMS,TEEAF4,V,NETAP4,M)	01020000
ISN 0057		IF (M.NE.C) WRITE(6,1C1) 1	01030000
ISN 0059		ETAP=ETAP4	01030100
ISN 0060	1C1	FCRMT(22X35HTHIS ERRCF IS IN THE V-ETAP4 TAELE/ 1 22X,7HSGTINC(,I2,')')/)	01040000
ISN 0061		BHPR = T * V / (E25.E * ETAP4 * ETAT)	01050000
ISN 0062	5	BLP = XLINT(TEH2,TECFP,F,5,M)	01060000
ISN 0063		IF (M.NE.C) WRITE(6,1C2) 1	01070000
ISN 0065	1C2	FCRMT(22X35HTHIS ERRCF IS IN THE H-PCWER TAELE/ 1 22X,7HSGTINC(,I2,')')/)	01080000
ISN 0066		BLP=FACTR(BLP,FF,TFETA,FF)	01090000
ISN 0067		BLK=BLP	01100000
ISN 0068		BHPSUP= BLP * DELRTH * BHPP	01110100
ISN 0069		BHFA = BHPSUP * YLS2	01120000
ISN 0070		DHP = ABS(1. - BHPR/EHFA)	01130000
ISN 0071		IF(DHP.LE.0.01)GC TO 6	01140000
ISN 0073		IF(LC3.GE.2) GC TC 7	01150000
ISN 0075		IF(BHFA.GT.BHPR) GC TC 8	01160000
ISN 0077		B1 = BHPR - BHFA	01170000
ISN 0078		DELV = 1C.	01180000
ISN 0079	9	V = V - DELV	01190000
ISN 0080		IF(V.GT.5.0)GC TC 1	01200000
ISN 0082		NEXT = 1	01210000
ISN 0083		WRITE(6,1CC1)	01220000
ISN 0084	10G1	FCRMT(15X,47HINSUFFICIENT PCWER AVAILABLE FOR CRUISE(CRUS1)A)	01230000
ISN 0085		GC TO 3CC	01240000
ISN 0086	7	B2 = BHPR - EHFA	01250000
ISN 0087		IF(ABS(B1/B2 - 1.).LE.C.C1) GO TO 10	01260000
ISN 0089		DELV = DELV * E2 / (E1 - B2)	01270000
ISN 0090		IF(DELV.LE.0.0) GC TO 11	01280000
ISN 0092	12	B1 = B2	01290000
ISN 0093		GC TO 9	01300000
ISN 0094	11	IF(B2.GT.C.C)GC TC 10	01310000
ISN 0096		GC TO 12	01320000
ISN 0097	10	WRITE(6,1CC2)	01330000
ISN 0098	1CC2	FCRMT(15X,41H*** INSUFFICIENT POWER FOR CRUISE(CRUS1)B)	01340000
ISN 0099		NEXT = 1	01350000
ISN 0100		GC TO 3CC	01360000
ISN 0101	8	BHFA = BHPR	01370000
ISN 0102		BHPSUP= EHFA/YLS2	01380000
ISN 0103		BLP = BHPSUP/(EHPP * DELRTH)	01390000
ISN 0104	6	SFC = XLINT(TEFCH,TEFSC,BLP,8,M)	01400000
ISN 0105		IF (M.NE.C) WRITE(6,1C3) 1	01410000
ISN 0107	103	FCRMT(22X35HTHIS ERRCF IS IN THE SFC TABLE/ 1 22X,7HSGTINC(,I2,')')/)	01420000
ISN 0108		FP = SFC * EHFA*CKFF	01430000
ISN 0109		EN = V / FF	01440000
ISN 0110		IF(INDCYL.LT.3) ALFCL=-9C.	01450000
ISN 0112		ALFD=ALFR*RIOD	01460100
ISN 0113		PEFF=BHPSUP/(BLK*BHPP*DELRTH)	01460200
ISN 0114		IF(LC1.EQ.1) GC TC 299	01460300
ISN 0116		RMAXI = RMAX(ICRLS)	01470000
			01480000

ISN 0117	IF( R .LE. (RMAXI - DELR(ICRLS))) GO TO 13	01490000
ISN 0119	DELTAR = RMAXI - R	01500000
ISN 0120	LC1 = 1	01510000
ISN 0121	GC TO 14	01520000
ISN 0122	13 DELTAR = DELR(ICRUS)	01530000
ISN 0123	14 IF(IPRINT.EC.1) WRITE(6,1003)ST,R,W,F,W,H,TMP,V,BR,PEHF,BHPR,ETAP, LEN,RN,CLW	01540000
ISN 0125	IF(IPRINT.EC.1) WRITE(6,1005)XLHL,XLW,XLR,ALFC,ALFDE	01550000
ISN 0127	1003 FORMAT(2X,F7.2,2X,F8.1,2X,F9.C,4X,F10.0,2X,F8.C,2X,F7.2,3X,F6.1,2X, 1,F6.3,2X,F6.3,2),F8.0,2X,F5.2,2X,F9.6,2X,F6.3,2X,F5.2)	01560000
ISN 0128	1005 FORMAT(34X,F10.C,11X,F10.C,7X,F10.0,11X,F5.1,19X,F5.1/)	01570000
ISN 0129	R = R + DELTAR	01570100
ISN 0130	w = w - DELTAR/EN	01580000
ISN 0131	WF = WF + DELTAR/EN	01590000
ISN 0132	ST = ST + DELTAR/V	01600000
ISN 0133	LC3=0	01610000
ISN 0134	GC TO 15	01610100
ISN 0135	300 WRITE(6,NCRLS1)	01620000
ISN 0136	299 RETURN	01630000
ISN 0137	END	01640000
		01650000

ORIGINAL PAGE IS  
OF POOR QUALITY

NAME	TAG	TYPE	ADD.	NAME	TAG	TYPE	ACC.	NAME	TAG	TYPE	ADD.	NAME	TAG	TYPE	ADD.				
H	SFA	C	R*4	000818	I	F	I*4	0003F4	M	FA	I*4	0003F8	Q	SF	C	R*4	000869		
R	SF	C	R*4	000878	I	SF	C	R*4	0008EC	V	SFA	C	R*4	000910	W	SF	C	R*4	000914
AF		C	R*4	N.R.	AR		C	R*4	N.R.	BR	SF	C	R*4	000664	BS		C	R*4	N.R.
B1	SFA	C	R*4	0003FC	B2	SFA	C	R*4	000400	CB		C	R*4	N.R.	CV		C	R*4	N.R.
CX	SF	C	R*4	0006EC	DH		C	R*4	N.R.	EN	SF	C	R*4	0006E4	FF	FA	C	R*4	0004B4
FM		C	R*4	N.R.	FP	SF	C	R*4	000718	HC		C	R*4	N.R.	HH	SFA	C	R*4	000404
PI	F	C	R*4	0008E4	RA	F	C	R*4	00087C	SA		C	R*4	N.R.	ST	SF	C	R*4	0008B0
SW		C	R*4	N.R.	TR		C	R*4	N.R.	VC		C	R*4	N.R.	VT		C	R*4	N.R.
WE		C	R*4	N.R.	WF	SF	C	R*4	000930	WD		C	R*4	N.R.	WS		C	R*4	N.R.
Ww		C	R*4	N.R.	XC		C	R*4	N.R.	AMU	F	C	R*4	00064C	BHT		C	R*4	N.R.
BLK	SF		R*4	0004C8	BLP	SFA	C	R*4	000660	BMR		C	R*4	N.R.	BVT		C	R*4	N.R.
CCP		C	R*4	N.R.	CCT		C	R*4	N.R.	CDC		C	R*4	N.R.	CDV		C	R*4	N.R.
CKF		C	R*4	N.R.	CKW		C	R*4	N.R.	CKI		C	R*4	N.R.	CLW	F	C	R*4	00068C
GRT		C	R*4	N.R.	CTP		C	R*4	N.R.	DHP	S	C	R*4	00040C	DK3		C	R*4	N.R.
DK4		C	R*4	N.R.	DMR	F	C	R*4	0009C8	ELC		C	R*4	N.R.	ELF		C	R*4	N.R.
ELN		C	R*4	N.R.	ELT		C	R*4	N.R.	ENP	F	C	R*4	000194	ENR	F	C	R*4	00011C
FEH		C	R*4	N.R.	FET		C	R*4	N.R.	FEW		C	R*4	N.R.	GLF		C	R*4	N.R.
HES		C	R*4	N.R.	HCO		C	R*4	N.R.	LCI	S	C	I*4	000410	LC3	SF	C	I*4	000414
OWE		C	R*4	N.R.	RFC	F	C	R*4	00086C	RMI		C	R*4	N.R.	RCO		C	R*4	N.R.
SA5		C	R*4	N.R.	SA6		C	R*4	N.R.	SA7		C	R*4	N.R.	SFE		C	R*4	N.R.
SFC	SF	C	R*4	00089C	SHT		C	R*4	N.R.	SKT		C	R*4	N.R.	SK1		C	R*4	N.R.
SK2		C	R*4	N.R.	SK3		C	R*4	N.R.	SK4		C	R*4	N.R.	SK5		C	R*4	N.R.
SK6		C	R*4	N.R.	SK7		C	R*4	N.R.	SK8		C	R*4	N.R.	SK9		C	R*4	N.R.
SLM		C	R*4	N.R.	STH		C	R*4	N.R.	SVT		C	R*4	N.R.	TAF		C	R*4	N.R.
TCR		C	R*4	N.R.	TCT		C	R*4	N.R.	TIN	SFA		R*4	000418	TYP	F	C	R*4	0008F4
TCC		C	R*4	N.R.	TVW		C	R*4	N.R.	ULF		C	R*4	N.R.	VHL		C	R*4	N.R.
VIN		C	R*4	N.R.	VWC	F	C	R*4	000040	WAC		C	R*4	N.R.	WCC		C	R*4	N.R.
WEP		C	R*4	N.R.	WES		C	R*4	N.R.	WFC		C	R*4	N.R.	WFE		C	R*4	N.R.
WER		C	R*4	N.R.	WFS		C	R*4	N.R.	WFW		C	R*4	N.R.	WHL		C	R*4	N.R.
WHT		C	R*4	N.R.	WLG		C	R*4	N.R.	WMC		C	R*4	N.R.	WPC		C	R*4	N.R.
WPH		C	R*4	N.R.	WRC		C	R*4	N.R.	WSC		C	R*4	N.R.	WST		C	R*4	N.R.
WTM		C	R*4	N.R.	WVA		C	R*4	N.R.	WVT		C	R*4	N.R.	XLB	F	C	R*4	0009AC
XLR	F	C	R*4	0009E8	XLW	F	C	R*4	0009BC	XMR		C	R*4	N.R.	ALFD	SF	C	R*4	00041C
ALFR	SFA	C	R*4	000648	ARHT		C	R*4	N.R.	ARVT		C	R*4	N.R.	BHPA	SFA	C	R*4	000650
BHPP	F	C	R*4	0009D4	BHPR	SFA	C	R*4	000654	CDHT		C	R*4	N.R.	CDVT		C	R*4	N.R.
CKFF	F	C	R*4	000050	CKHT		C	R*4	N.R.	CKVT		C	R*4	N.R.	CAM1		C	R*4	N.R.
DAM2		C	R*4	N.R.	CAM3		C	R*4	N.R.	DAM4		C	R*4	N.R.	CAM5		C	R*4	N.R.
DELK	F	C	R*4	0003FC	CELV	SF		R*4	000420	DRAG	SF	XF	R*4	000000	DVOL		C	R*4	N.R.
ELDN		C	R*4	N.R.	ELDT		C	R*4	N.R.	ELHT		C	R*4	N.R.	ELOA		C	R*4	N.R.
ELVT		C	R*4	N.R.	EMLF		C	R*4	N.R.	ETAP	SF	C	R*4	0006E8	ETAT	F	C	R*4	000198
FEHI		C	R*4	N.R.	FEHL		C	R*4	N.R.	FEHT		C	R*4	N.R.	FEVT		C	R*4	N.R.
FEWH		C	R*4	N.R.	FEWI		C	R*4	N.R.	GAP1		C	R*4	N.R.	GAP2		C	R*4	N.R.
GAP3		C	R*4	N.R.	GAP4		C	R*4	N.R.	GAP5		C	R*4	N.R.	GAP6		C	R*4	N.R.
GAP7		C	R*4	N.R.	GAP8		C	R*4	N.R.	LIFT	SF	XF	I*4	000000	LTHL		C	I*4	N.R.
NEXT	S		I*4	000424	PELF	SF	C	R*4	00086C	PLIN		C	R*4	N.R.	RELI		C	R*4	N.R.
RMAX	F	C	R*4	00041C	RTCC	SF		R*4	000428	SHPA		C	R*4	N.R.	SHPR	F	C	R*4	000898
SHTE		C	R*4	N.R.	SHTH		C	R*4	N.R.	SKAC		C	R*4	N.R.	SKAR		C	R*4	N.R.
SKCC		C	R*4	N.R.	SKFS		C	R*4	N.R.	SKFW		C	R*4	N.R.	SKHL		C	R*4	N.R.
SKHT		C	R*4	N.R.	SKLG		C	R*4	N.R.	SKMC		C	R*4	N.R.	SKPA		C	R*4	N.R.
SKPH		C	R*4	N.R.	SKRC		C	R*4	N.R.	SKSC		C	R*4	N.R.	SKTM		C	R*4	N.R.

7-56

SKVT	C	R*4	N.R.	SKWP	C	R*4	N.R.	SKWV	C	R*4	N.R.	SK10	C	R*4	N.R.				
SK11	C	R*4	N.R.	SK12	C	R*4	N.R.	SK13	C	R*4	N.R.	SK14	C	R*4	N.R.				
SK15	C	R*4	N.R.	SLMH	C	R*4	N.R.	STPW	C	R*4	N.R.	SVTE	C	R*4	N.R.				
SVTW	C	R*4	N.R.	SATT	C	R*4	N.R.	TBHL	C	R*4	N.R.	TBT2	FA	C	R*4	0004E8			
TBTG	C	R*4	N.R.	TCHT	C	R*4	N.R.	TCLN	C	R*4	N.R.	TCVT	C	R*4	N.R.				
TINY	C	R*4	N.R.	TIAZ	C	R*4	N.R.	TIN4	F	C	R*4	0003D4	TMAX	C	R*4	N.R.			
TOVW	C	R*4	N.R.	TWTW	C	R*4	N.R.	WBAL	C	R*4	N.R.	WENV	C	R*4	N.R.				
WFUL	C	R*4	N.R.	WGSB	C	R*4	N.R.	WPDS	C	R*4	N.R.	WPEI	C	R*4	N.R.				
WPRB	C	R*4	N.R.	WPRG	C	R*4	N.R.	WPRP	C	R*4	N.R.	WRCA	C	R*4	N.R.				
WSCA	C	R*4	N.R.	XLBH	C	R*4	N.R.	XLGD	C	R*4	N.R.	XLHL	F	C	R*4	0009B4			
YLS2	SF	C	R*4	0009CC	ALFDL	SF	C	R*4	000644	ATMIY	C	R*4	N.R.	ATMOS	SF	XF	R*4	000000	
CBARF	C	R*4	N.R.	CEARW	C	R*4	N.R.	CLDES	C	R*4	N.R.	CLEYE	C	R*4	N.R.				
CPIND	C	R*4	N.R.	CFAUC	C	R*4	N.R.	CPPAR	C	R*4	N.R.	CPPRO	C	R*4	N.R.				
CPTOT	C	R*4	N.R.	CRUS1	C	R*4	00042C	DELTA	C	R*4	N.R.	DELTH	C	R*4	N.R.				
DELWF	C	R*4	N.R.	DELWP	C	R*4	N.R.	DSWET	C	R*4	N.R.	ELDGA	C	R*4	N.R.				
ENPCR	F	C	R*4	000438	ETAP2	C	R*4	N.R.	ETAP4	SF	C	R*4	00071C	FACTR	F	XF	R*4	000000	
FETDT	C	R*4	N.R.	GMCDD	C	R*4	N.R.	HMAXD	C	R*4	N.R.	ICRUS	F	C	R*4	I*4	000430		
IDUM3	C	I*4	N.R.	NCCPP	C	I*4	N.R.	NGXPJ	C	I*4	N.R.	PFET2	C	R*4	N.R.				
POWER	SF	XF	R*4	0000C0	REALJ	C	R*4	N.R.	RHPMR	F	C	R*4	000874	RMAXI	SF	C	R*4	000434	
SIGMA	C	R*4	N.R.	SIGMR	C	R*4	N.R.	SKAMD	C	R*4	N.R.	SKBAL	C	R*4	N.R.				
SKGB1	C	R*4	N.R.	SKGB2	C	R*4	N.R.	SKPDS	C	R*4	N.R.	SKPEI	C	R*4	N.R.				
SKPES	C	R*4	N.R.	SKPRB	C	R*4	N.R.	SKRBF	C	R*4	N.R.	SKRCA	C	R*4	N.R.				
SKSCA	C	R*4	N.R.	SLMVT	C	R*4	N.R.	STMAX	C	R*4	N.R.	SWETH	C	R*4	N.R.				
SWEEXP	C	R*4	N.R.	SWWET	C	R*4	N.R.	S2RHU	C	R*4	N.R.	TBCL1	C	R*4	N.R.				
TBCRP	FA	C	R*4	0004FC	TEEMS	FA	C	R*4	000164	TBPOW	FA	C	R*4	000530	TBSFC	FA	C	R*4	000510
TCBAR	C	R*4	N.R.	TFETA	FA	C	R*4	0008EC	TPROP	S	C	R*4	0008F8	TVCMR	C	R*4	N.R.		
VBARH	C	R*4	N.R.	VBARV	C	R*4	N.R.	VDIVE	C	R*4	N.R.	VGASB	C	R*4	N.R.				
VGASR	C	R*4	N.R.	WPAYL	C	R*4	N.R.	WPSTR	C	R*4	N.R.	XLALB	C	R*4	N.R.				
XLBWD	C	R*4	N.R.	XLINT	F	XF	R*4	000000	XLRLA	C	R*4	N.R.	ALFDES	C	R*4	N.R.			
BHPSUP	SF	C	R*4	000658	CEARHT	C	R*4	N.R.	CBARVT	C	R*4	N.R.	CBYLGA	C	R*4	N.R.			
CLALPH	C	R*4	N.R.	CRSIND	C	R*4	N.R.	CTSIGH	C	R*4	N.R.	CYCPRL	C	R*4	N.R.				
DELFCR	F	C	R*4	000424	DELRTH	F	C	R*4	0006BC	DELTA	SF	C	R*4	000438	DELWFC	C	R*4	N.R.	
DELWPL	C	R*4	N.R.	DELWST	C	R*4	N.R.	DLSWSH	C	R*4	N.R.	DLTAFE	C	R*4	N.R.				
DLVLHL	C	R*4	N.R.	ERGINC	C	R*4	N.R.	DSPLMT	C	R*4	N.R.	DYLIND	C	R*4	N.R.				
ELHLJA	C	R*4	N.R.	ELVICA	C	R*4	N.R.	ETAIND	C	R*4	N.R.	ETAP4N	F	C	R*4	000160			
EXPDRG	C	R*4	N.R.	FECRAG	C	R*4	N.R.	FIXIND	C	R*4	N.R.	FWRNL#	F	XF	I*4	000000			
GAMD11	C	R*4	N.R.	FULINC	C	R*4	N.R.	IBCOM#	F	XF	I*4	000000	INDCRU	C	I*4	N.R.			
INDDRG	C	I*4	N.R.	INCDYL	C	I*4	000828	INDETA	C	I*4	00082C	INCFIX	C	I*4	N.R.				
INDHUL	C	I*4	N.R.	INCOPT	C	I*4	N.R.	INDOSW	C	I*4	N.R.	INPCW	C	I*4	N.R.				
INDPRP	C	I*4	N.R.	INCRND	C	I*4	N.R.	IPRINT	C	I*4	00084C	INCRUSI	F	C	R*4	000803			
NETAP4	SFA	C	R*4	00042C	CPTIND	C	R*4	N.R.	OSWIND	C	R*4	N.R.	PRPIND	C	R*4	N.R.			
RCMIND	C	R*4	N.R.	RPCRHO	C	R*4	N.R.	ROTPOW	SF	XF	R*4	000000	SGTIND	C	R*4	N.R.			
SKBLNT	C	R*4	N.R.	SKENV1	C	R*4	N.R.	SKENV2	C	R*4	N.R.	SKPDSZ	C	R*4	N.R.				
SKVTAR	C	R*4	N.R.	SSIGMA	F	C	R*4	0008AC	STHETA	C	R*4	N.R.	TBCDWI	C	R*4	N.R.			
TBBAP4	FA	C	R*4	000178	TFETMR	C	R*4	N.R.	TOLIND	C	R*4	N.R.	VGBQVH	C	R*4	N.R.			
WBALNT	C	R*4	N.R.	WPAYLC	C	R*4	N.R.	XTGTA2	C	R*4	N.R.	XTGTA4	C	R*4	N.R.				

\*\*\*\*\* COMMON INFORMATION \*\*\*\*\*

NAME OF COMMON BLOCK \* \* SIZE OF BLOCK 0009DC HEXADECIMAL BYTES



VAR. NAME	TYPE	REL. ADDR.	VAR. NAME	TYPE	REL. ADDR.	VAR. NAME	TYPE	REL. ADDR.	VAR. NAME	TYPE	REL. ADDR.
OPTIND	R*4	N.R.	FULIND	R*4	N.R.	DYLAND	R*4	N.R.	DRGIND	R*4	N.R.
OSWIND	R*4	N.R.	FIXIND	R*4	N.R.	ROMIND	R*4	N.R.	PRPIND	R*4	N.R.
ETAIND	R*4	N.R.	WC	R*4	N.R.	XLBWO	R*4	N.R.	XLRLA	R*4	N.R.
VGBCVH	R*4	N.R.	XLGC	R*4	N.R.	HMAXD	R*4	N.R.	RHCRHO	R*4	N.R.
VPC	R*4	000040	EMLF	R*4	N.R.	CK1	R*4	N.R.	DELWF	R*4	N.R.
CKFF	R*4	000050	VDIVE	R*4	N.R.	HOO	R*4	N.R.	ROO	R*4	N.R.
TCC	R*4	N.R.	GAF1	R*4	N.R.	SGTIND	R*4	N.R.	ELHLGA	R*4	N.R.
ELVLCA	R*4	N.R.	GAP2	R*4	N.R.	AR	R*4	N.R.	WS	R*4	N.R.
TCR	R*4	N.R.	TCT	R*4	N.R.	SLM	R*4	N.R.	ARHT	R*4	N.R.
TCFT	R*4	N.R.	VBART	R*4	N.R.	SLMH	R*4	N.R.	ARVT	R*4	N.R.
TCLT	R*4	N.R.	VBARV	R*4	N.R.	SLMVT	R*4	N.R.	ELDN	R*4	N.R.
ELCT	R*4	N.R.	ELCCA	R*4	N.R.	CLSWSH	R*4	N.R.	DSKET	R*4	N.R.
DLVFL	R*4	N.R.	DVCL	R*4	N.R.	CBYLOA	R*4	N.R.	ENR	R*4	00011C
WVA	R*4	N.R.	DAMI	R*4	N.R.	DAMZ	R*4	N.R.	BMR	R*4	N.R.
CAN3	R*4	N.R.	CLEYE	R*4	N.R.	THETMR	R*4	N.R.	XC	R*4	N.R.
XPR	R*4	N.R.	TVCMP	R*4	N.R.	VT	R*4	N.R.	CTSIGH	R*4	N.R.
TVK	R*4	N.R.	FES	R*4	N.R.	TINY	R*4	N.R.	ETAP2	R*4	N.R.
ETAP4N	R*4	000160	TBEM5	R*4	000164	TB8AP4	R*4	000178	GAP3	R*4	N.R.
CAN4	R*4	N.R.	ENF	R*4	000194	ETAT	R*4	000198	HC	R*4	N.R.
VC	R*4	N.R.	ATMIY	R*4	N.R.	CDVT	R*4	N.R.	COMT	R*4	N.R.
DAN5	R*4	N.R.	CLTAFE	R*4	N.R.	FEDRAG	R*4	N.R.	EXPDRG	R*4	N.R.
CCC	R*4	N.R.	CLALFF	R*4	N.R.	CKVT	R*4	N.R.	CKHT	R*4	N.R.
CKF	R*4	N.R.	CKW	R*4	N.R.	RELI	R*4	N.R.	TCLN	R*4	N.R.
TBCL1	R*4	N.R.	TBCDW1	R*4	N.R.	GAP4	R*4	N.R.	WFE	R*4	N.R.
WFLL	R*4	N.R.	DELWFC	R*4	N.R.	DELWP	R*4	N.R.	DELWST	R*4	N.R.
SKCC	R*4	N.R.	SKRC	R*4	N.R.	SKSC	R*4	N.R.	SKFW	R*4	N.R.
SKTM	R*4	N.R.	SKRCA	R*4	N.R.	SKSCA	R*4	N.R.	SKPC	R*4	N.R.
SKAC	R*4	N.R.	SKFL	R*4	N.R.	SKENV1	R*4	N.R.	SKENV2	R*4	N.R.
SKCE1	R*4	N.R.	SKGB2	R*4	N.R.	SKBLNT	R*4	N.R.	SKBAL	R*4	N.R.
SKLG	R*4	N.R.	SKW	R*4	N.R.	ELF	R*4	N.R.	RMI	R*4	N.R.
SKWP	R*4	N.R.	SKHT	R*4	N.R.	SKVT	R*4	N.R.	SKPRB	R*4	N.R.
SKRBF	R*4	N.R.	SKPT	R*4	N.R.	SKAMD	R*4	N.R.	SKAR	R*4	N.R.
SKPA	R*4	N.R.	SKVTAF	R*4	N.R.	SKPDS	R*4	N.R.	SKPDSZ	R*4	N.R.
SKT	R*4	N.R.	SKFS	R*4	N.R.	SKPEI	R*4	N.R.	SKPES	R*4	N.R.
SK1	R*4	N.R.	SK2	R*4	N.R.	DK3	R*4	N.R.	DK4	R*4	N.R.
SK5	R*4	N.R.	SK6	R*4	N.R.	SK7	R*4	N.R.	SK8	R*4	N.R.
SK9	R*4	N.R.	SK10	R*4	N.R.	SK11	R*4	N.R.	SK12	R*4	N.R.
SK13	R*4	N.R.	SK14	R*4	N.R.	SK15	R*4	N.R.	PLIN	R*4	N.R.
GAF5	R*4	N.R.	TCLINC	R*4	N.R.	XTGTA2	R*4	N.R.	TIN2	R*4	N.R.
THTH	R*4	N.R.	PFET2	R*4	N.R.	DFLTH	R*4	N.R.	STH	R*4	N.R.
CRSINC	R*4	N.R.	XTGTA4	R*4	N.R.	TIN4	R*4	0003D4	VIN	R*4	N.R.
DELR	R*4	0003FC	RMAX	R*4	000410	DELFCR	R*4	000424	ENPCR	R*4	000438
DELWFL	R*4	N.R.	STPW	R*4	N.R.	HFIN	R*4	N.R.	GAP6	R*4	N.R.
CYCPFL	R*4	N.R.	FF	R*4	0004B4	SK3	R*4	N.R.	SK4	R*4	N.R.
TBH1	R*4	N.R.	TBTC	R*4	N.R.	TBH2	R*4	0004E8	TBCRP	R*4	0004FC
TBSFC	R*4	000510	TBFCW	R*4	000530	GAP7	R*4	N.R.	ALFDES	R*4	N.R.
ALFCL	R*4	000644	ALFR	R*4	000648	AMU	R*4	00064C	BHPA	R*4	000650
BHFR	R*4	000654	BHPSUP	R*4	000658	BHT	R*4	N.R.	BLP	R*4	000660
BR	R*4	000664	ES	R*4	N.R.	BVT	R*4	N.R.	CBARF	R*4	N.R.
CBARFT	R*4	N.R.	CBARVT	R*4	N.R.	CBARW	R*4	N.R.	CCP	R*4	N.R.

CCCT	R*4	N.R.	CCV	R*4	N.R.	CLW	R*4	00068C	CPIND	R*4	N.R.
CPNLD	R*4	N.R.	CPPAF	R*4	N.R.	CPPRO	R*4	N.R.	CPTCT	R*4	N.R.
CRT	R*4	N.R.	CTF	R*4	N.R.	CV	R*4	N.R.	CX	R*4	0006B0
CLDES	R*4	N.R.	CE	R*4	N.R.	DELRTH	R*4	00068C	DELTA	R*4	N.R.
CF	R*4	N.R.	CSPLM1	R*4	N.R.	ELC	R*4	N.R.	ELHT	R*4	N.R.
ELN	R*4	N.R.	ELOA	R*4	N.R.	ELT	R*4	N.R.	ELVT	R*4	N.R.
EN	R*4	0006E4	ETAF	R*4	0006E8	FEH	R*4	N.R.	FEHI	R*4	N.R.
FEFL	R*4	N.R.	FEFT	R*4	N.R.	FET	R*4	N.R.	FETCT	R*4	N.R.
FEVT	R*4	N.R.	FEW	R*4	N.R.	FEWH	R*4	N.R.	FEWI	R*4	N.R.
FM	R*4	N.R.	FF	R*4	000718	ETAP4	R*4	00071C	GAMD11	R*4	N.R.
GLF	R*4	N.R.	GMCDI	R*4	N.R.	H	R*4	000818	IDUM3	I*4	N.R.
INDCRU	I*4	N.R.	INCCRG	I*4	N.R.	INDDYL	I*4	000828	INDETA	I*4	00082C
INDFIX	I*4	N.R.	INDHUL	I*4	N.R.	INDOPT	I*4	N.R.	INDOSH	I*4	N.R.
INDPCW	I*4	N.R.	INCPRF	I*4	N.R.	INDROM	I*4	N.R.	IPRINT	I*4	00084C
LTHL	I*4	N.R.	NOCPP	I*4	N.R.	NOXPJ	I*4	N.R.	QWE	R*4	N.R.
PEFF	R*4	000860	PI	R*4	000864	Q	R*4	000868	RHO	R*4	00086C
REALJ	R*4	N.R.	RHPMF	R*4	000874	R	R*4	000878	RN	R*4	00087C
SA	R*4	N.R.	SAE	R*4	N.R.	SA6	R*4	N.R.	SA7	R*4	N.R.
SFC	R*4	000850	SHPA	R*4	N.R.	SHPR	R*4	000898	SHT	R*4	N.R.
SHTE	R*4	N.R.	SHTW	R*4	N.R.	SIGMA	R*4	N.R.	SSIGMA	R*4	0008AC
ST	R*4	000880	STHETA	R*4	N.R.	STMAX	R*4	N.R.	SVT	R*4	N.R.
SVTE	R*4	N.R.	SVTW	R*4	N.R.	SW	R*4	N.R.	SWETH	R*4	N.R.
SWEXP	R*4	N.R.	SWTT	R*4	N.R.	SWWET	R*4	N.R.	SZPHO	R*4	N.R.
T	R*4	0008E0	TAF	R*4	N.R.	TCBAR	R*4	N.R.	THETA	R*4	0008EC
TMAX	R*4	N.R.	TMF	R*4	0008F4	TPROP	R*4	0008F8	TK	R*4	N.R.
ULF	R*4	N.R.	VGASE	R*4	N.R.	VGASR	R*4	N.R.	VHL	R*4	N.R.
V	R*4	000910	V	R*4	000914	WBAL	R*4	N.R.	WBALNT	R*4	N.R.
WCC	R*4	N.R.	WE	R*4	N.R.	WEP	R*4	N.R.	WES	R*4	N.R.
WF	R*4	000930	WFC	R*4	N.R.	WFR	R*4	N.R.	WFS	R*4	N.R.
WFH	R*4	N.R.	WGSE	R*4	N.R.	WHL	R*4	N.R.	WHT	R*4	N.R.
WLG	R*4	N.R.	WMC	R*4	N.R.	WPAYL	R*4	N.R.	WPC	R*4	N.R.
WPDS	R*4	N.R.	WPEI	R*4	N.R.	WPH	R*4	N.R.	WPRB	R*4	N.R.
WPPG	R*4	N.R.	WPPF	R*4	N.R.	WPSTR	R*4	N.R.	WRC	R*4	N.R.
WRCA	R*4	N.R.	WSC	R*4	N.R.	WSCA	R*4	N.R.	WST	R*4	N.R.
WTN	R*4	N.R.	WVT	R*4	N.R.	WW	R*4	N.R.	WPAYLO	R*4	N.R.
WAC	R*4	N.R.	WENV	R*4	N.R.	XLALB	R*4	N.R.	XLB	R*4	0009AC
XLBF	R*4	N.R.	XLFL	R*4	0009B4	XLR	R*4	0009B8	XLW	R*4	0009BC
YLS2	R*4	0009C0	TOVK	R*4	N.R.	DMR	R*4	0009C8	SIGMR	R*4	N.R.
AF	R*4	N.R.	BHPF	R*4	0009D4	SEE	R*4	N.R.			

7-59

ORIGINAL PAGE IS  
OF POOR QUALITY

LABEL	ADDR	LABEL	ADDR	LABEL	ADDR	LABEL	ADDR	PAGE
304	0CC666	301	CCC67C	15	0C06FA	1	00070A	009
2	CCC794	4	CCC7CA	5	0C083A	9	0008F4	
7	0CC924	12	CCC964	11	CC0970	10	000986	
8	0CC9AC	6	CCC9C2	13	CC0A84	14	000A8C	
300	0CCB9A	299	CC0EAE					

\*OPTIONS IN EFFECT\* NAME= MAIN,CPT=C2,LINECNT=54,SIZE=0000K,

\*OPTIONS IN EFFECT\* SOURCE,EBCDIC,NCLIST,ACDECK,LOAD,MAP,NOEDIT,ID,NOXREF

\*STATISTICS\* SOURCE STATEMENTS = 136 ,PROGRAM SIZE = 3032

\*STATISTICS\* NO DIAGNOSTICS GENERATED

\*\*\*\*\* END OF COMPILED \*\*\*\*\*

95K BYTES OF CORE NOT USED

COMPILER OPTICNS - NAME= MAIN,OPT=C2,LINECNT=54,SIZE=0CCCK, SOURCE,EPCCIC,NCLIST,NODECK,LCAD,MAP,ACEDIT,LD,NCXREF

ISN 0002	C	SLEPOUTINE CPUS2 (ICRUS)								00010000
		**** MEMBER NAME B81CRUS2								00020000
ISN 0003	C	PAGE 1	INPLT	LCC	CCC1	THRU	0050			00030000
		CCMMON	CPTINC	,HLLINC	,DYLIND	,CRGIND	,OSKIND			,00040000
		IFIXIND	,KDMINC	,FRFINC	,ETAIND	,KC	,XLBND			,00050000
		2XLRLA	,VGEVH	,XIGD	,HPAXD	,FFCFHO	,VMC			,00060000
		3EMLF	,CK1	,DELWF	,CKFF	,VCIVE	,FGC			,00070000
		4RCC	,TOC	,CAF1(5)	,SCTIND(12)	,ELFLOA	,ELVLOA			,00080000
		5GAF2(6)								00090000
ISN 0004	C	PAGE 2	INPLT	LCC	CC5	THRU	0100			00100000
		CCMMON	AR	,S	,TCR	,TCT	,SLM			,00110000
		1ARFT	,TCFT	,VEARH	,SLMH	,ARVT	,TCVT			,00120000
		2VBARV	,SLMVT	,ELCN	,ELDT	,ELOGA	,DLSHSH			,00130000
		3DSWET	,CLVFL	,CVCL	,CBYLOA	,ENR	,KVA			,00140000
		4CAM1	,EAY2	,EMF	,DAM3	,CLEYE	,TFETMR			,00150000
		5XC	,XMR	,TVCMR	,VT	,CTSIGH	,TVH			,00160000
		6HES	,TINY	,ETAP2	,ETAP4N	,TBEM5(5)	,TB8AP4(5)			,00170000
		7GAF3								00180000
ISN 0005	C	PAGE 3	INPUT	LCC	CICI	THRU	140			00190000
		CCMMON	CAM4	,ENF	,ETAT	,FC	,VC			,00200000
		1ATMIY	,CDVT	,CDFT	,DAM5	,CLTAFE	,FECRAG			,00210000
		2EXPDRG	,CDC	,CLALPH	,CKVT	,CKHT	,CKF			,00220000
		3CKK	,RELI	,TCLN	,TBCL1(8)	,TBCDWI(8)	,GAP4(4)			,00230000
ISN 0006	C	PAGE 4	INPLT	LCC	141	THRU	200	WEIGHT DATA		00240000
		CCMMON	WFE	,VFL	,DELWFC	,CELWP	,DELWST			,00250000
		1SKCC	,SKRC	,SKSC	,SKFW	,SKTM	,SKRCA			,00260000
		2SKSCA	,SKMC	,SKAC	,SKHL	,SKENV1	,SKENV2			,00270000
		3SKCB1	,SKCE2	,SKELNT	,SKBAL	,SKLG	,SKW			,00280000
		4ELF	,RMI	,SKRP	,SKHT	,SKVT	,SKPRB			,00290000
		5SKRBF	,SKPH	,SKMD	,SKAR	,SKPA	,SKVTAR			,00300000
		6SKPDS	,SKPCS2	,SKT	,SKFS	,SKPE1	,SKPES			,00310000
		7SK1	,SK2	,CK3	,OK4	,SK5	,SK6			,00320000
		8SK7	,SK8	,SK9	,SK10	,SK11	,SK12			,00330000
		9SK13	,SK14	,SK15	,PLIN	,GAP5(3)				00340000
ISN 0007	C	PAGE 5	INPLT	LCC	201	THRU	300			00350000
		CCMMON	TCLIN(5)	,XTCTA2(5)	,TIN2(5)	,TKTW(5)	,PFET2(5)			,00360000
		1DELTH(5)	,STH(5)	,CRSIND(5)	,XTGTA4(5)	,TIN4(5)	,VIN(5)			,00370000
		2DELR(5)	,RMAX(5)	,DELFCR(5)	,ENPCR(5)	,CELWPL(5)	,STPH(5)			,00380000
		3FFIN(5)	,CAF6(10)							00390000
ISN 0008	C	PAGE 6	INPLT	LCC	301	THRU	400			00400000
		CCMMON	CYCFLL	,FF	,SK3	,SK4	,TBH1(5)			,00410000
		1TETO(5)	,TBH2(5)	,TBCHP(5)	,TBSEFC(8)	,TBPCW(8)	,GAP7(60)			,00420000
ISN 0009	C	WORKING	CCMMON							00430000
		CCMMON	ALFDES,ALFBL,ALFF,AML,							00440000
		1	BPPA,BFFR,BFFSCL,BFT,ELP,BR,BS,BVT,							00450000
		2	CBARF,CEARFT,CEARVT,CEARH,CCP,CCT,CDV,CLW,CPIND,CPNUD,PPAR,CPPROG0460000							00460000
		3	CPTOT,CRT,CTP,CV,CX,CLDES,CE,							00470000
		4	DELRT,DELTA,DF,DSPLMT,ELC,ELHT,ELN,ELCA,ELT,ELVT,EN,ETAP,							00480000
ISN 0010	C	PAGE 7	INPLT	LCC	401	THRU	500			00490000
		CCMMON	GAMD1(3,15),CLF,CMDD1(16),H,							00500000

7-61

ORIGINAL PAGE IS OF POOR QUALITY

	7	ICUM4, INECRU, INCEAG, INCCYL, INDETA, INDFIX, INDFUL, INDOPT, INCOSW,	00510000
		8 INDPON, INDRP, INCRDM, JPRINT	00520000
ISN 0011		COMMON LTHL, ACCFF, ACXP, CKE, FEHF, PI, Q, RHC, REALJ, RFPMP, R, RA	00530000
ISN 0012		COMMON SA, SA5, SA6, SA7, SFC, SHPA, SHPR, SHT, SHTE, SHTW, SIGMA, SSIGMA, ST,	00540000
		1STHETA, STMAX, SVT, SVTE, SVTH, SW, SWETH, SWEXP, SWTT, SWST, S2RFC	00550000
ISN 0013		COMMON T, TAF, TCAF, THETA, TMAX, TMP, TPRCP, TR, ULF, VGASB, VGASR, VHL, V	00560000
ISN 0014		COMMON W, WBAL, WREALT, WCC, WE, WEP, WES, WF, WFC, WFR, WFS, WFW,	00570000
		1 WCSB, WFL, WHT, WLG, WMC, WPAYL, WPC, WPES, WPEI, WPT, WPRB, WPRG, WPRP, WPSTRO	00580000
		2, WRC, WRCA, WSC, WSCA, WST, WTP, WVT, WW, WPAYLC, WAC, WENV	00590000
ISN 0015		COMMON XLALB, XLE, XLBT, XLFL, XLR, XLW, YLS2, TCVW	00600000
ISN 0016		COMMON CMF, SICR, AF, EFFF, SEE	00600001
ISN 0017		NAMELIST /NCRUS2/ LC1, YLS2, V, T, C, CX, BHPR, BHPA, BLP,	00610000
		1 EHPSLP, FP, EN, INCETA, ETAP4, R, W, WF, ST	00620000
ISN 0018		RTCO=57.2997795	00620100
ISN 0019		H=H	00620200
ISN 0020		NETAP4 = ETAP4 + C.1	00630000
ISN 0021		IF(IPRINT.NE.1) GO TO 301	00640000
ISN 0023		WRITE(6,302)VIN(ICRUS)	00650000
ISN 0024	302	FORMAT(7X,'CRUISE AT ',F6.1,2X,'KNOTS TAS//')	00660000
ISN 0025	301	CONTINUE	00670000
ISN 0026		IF(IPRINT.EC.1) WRITE(6,1005)	00680000
ISN 0028		IF(IPRINT.EC.1) WRITE(6,1006)	00680100
ISN 0030	1005	FORMAT(2X,'TIME',7X,'RANCE',5X,'FUEL USED',5X,'WEIGHT',6X,'ALT.',600690000	
		1X,'TEMP',5X,'TAS',5X,'E.F.',4X,'PEHF',5X,'BHPR',4X,'ETAP',5X,'NMPP0070000	
		2',6X,'R.N.',4X,'CL//	00710000
		32X,'(HOURS) (N.MI) (PCLNDS) (POUNDS) (FEET) (DEG.F00720000	
		4) (KT)')//)	00730000
ISN 0031	1008	FORMAT(37X,'HULL LIFT',11X,'WING LIFT',7X,'ROTOR LIFT',8X,'ALPHA F00730100	
		1',16X,'ALPHA E/L'/38X,'(POUNCS)',12X,'(POUNDS)',7X,'(POUNDS)',10X,00730200	
		2'(DEG)',17X,'(DEG)')//)	00730300
ISN 0032		LC1 = 0	00740000
ISN 0033		YLS2 = 1. - ENFCR(ICRUS)/ENP	00750000
ISN 0034		V = VIN(ICRUS)	00760000
ISN 0035		TEMP = TIN4(ICRUS)	00770000
ISN 0036		CALL ATMCS(F, TEMP)	00780000
ISN 0037		IF(V.LT.(VMC/SSIGMA)) GO TO 1	00790000
ISN 0039		V = VMO/SSIGMA	00800000
ISN 0040	1	Q = 1.42636 * RHC * V * V	00810000
ISN 0041		CALL LIFT	00820000
ISN 0042		CALL CRAG(ALFR)	00830000
ISN 0043		BR=XLB/W	00830100
ISN 0044		IF(INDCYL.GT.2) GO TO 2	00840000
ISN 0046		T = T + Q * DELFCR(ICRUS)	00850000
ISN 0047		IF(INDETA) 3,3,4	00860000
ISN 0048	4	TPROP = T	00870000
ISN 0049		CALL PCKER	00880000
ISN 0050		B+PR=S+PK*B+PF*CELRT#YLS2	00890000
ISN 0051		GO TO 5	00900000
ISN 0052	3	ETAP4 = XLINT(TEEM,TECAF4,V,NETAP4,M)	00910000
ISN 0053		IF(M.NE.0) WRITE(6,101) INDSGT	00920000
ISN 0055		ETAP=ETAP4	00920100
ISN 0056	101	FORMAT(15X,'THIS ERROR IS IN THE V-ETAP4 TABLE SGTINC(','I2,')')00930000	

7-62

ISN 0057	BHPR = T * V / ( 325.8 * ETAP4 * ETAT )	00940000
ISN 0058	GC TO 5	00950000
ISN 0059	2 CX = CX + 2. * AMU * AML * DELFCR(ICRUS)/(PI * DMR * DMR *ENR)	00960000
ISN 0060	CALL RCTPCW	00970000
ISN 0061	BHPR = RHPMR/ETAT	00980000
ISN 0062	5 BLP = XLINT(TBH2,TECRF,H,5,M)	00990000
ISN 0063	IF(M.NE.0)WRITE(6,102)I	01000000
ISN 0065	102 FORMAT(22X,35#YFIS ERRCR IS IN THE H-POWER TABLE / 1 22X, 7#SGTIND(,12,*)'//)	01010000 01020000 01030000
ISN 0066	BLP=FACTR(BLP,FF,THETA,FF)	01030100
ISN 0067	BLK=BLP	01040000
ISN 0068	BHFSUP = ELP * CELRTH * BHPP	01050000
ISN 0069	BHPA = BHPSLP * YLS2	01060000
ISN 0070	IF(BHPR - BHPA) 6,6,7	01070000
ISN 0071	6 BHPA = BHPR	01080000
ISN 0072	BHPSUP = BHPA/YLS2	01090000
ISN 0073	BLP = BHPSLP/(BHPP * CELRTH)	01100000
ISN 0074	SFC = XLINT(TEFCW, TESFC, BLP, 8, M)	01110000
ISN 0075	IF(M.NE.0) WRITE(6,103)I	01120000
ISN 0077	103 FORMAT(22X,30#YFIS ERRCR IS IN THE SFC TABLE/ 1 22X, 7#SCTINE(,12,*)'//)	01130000 01140000
ISN 0078	F=SFC*BHPA*CKFF	01150000
ISN 0079	EN= V/F	01150100
ISN 0080	IF(INDCYL.LT.3) ALFDL=-9C.	01150200
ISN 0082	ALFD=ALFR*RTCC	01150300
ISN 0083	PEPF=BHPSLP/(BLK*BHPP*CELRTH)	01150400
ISN 0084	IF(IPRINT.EC.1)WRITE(6,10C1)ST,R,WF,W,H,TMP,V,BR,PEHF,BHPR,ETAP, 1EN,RN,CLW	01150500
ISN 0086	IF(IPRINT.EC.1)WRITE(6,10C9)XLHL,XLW,XLR,ALFC,ALFDL	01160000
ISN 0088	IF(LC1.EC.1) CC TC 30C	01170000
ISN 0090	RMAXI = RMAX(ICRUS)	01180000
ISN 0091	DELTAR= RMAXI - R	01230000
ISN 0092	10C1 FORMAT(2X,F7.2,2X,F8.1,2X,F9.0,4X,F10.0,2X,F8.0,2X,F7.2,3X,F6.1,2X 1,F6.3,2X,F6.3,2X,F8.0,2X,F5.2,2X,F9.6,2X,F6.3,2X,F5.2)	01240100 01240000
ISN 0093	10C9 FORMAT(34X,F10.C,11X,F10.C,7X,F10.0,11X,F5.1,19X,F5.1/)	01250000
ISN 0094	IF(DELTAR.GT.CELR(ICRUS)) GC TO 13	01250100
ISN 0096	IF(DELTAR.LE.CELR(ICRUS)) LC1=1	01250200
ISN 0098	IF(LC1.EQ.1) GC TC 14	01250300
ISN 0100	13 DELTAR=DELRCR(ICRUS)	01250400
ISN 0101	14 R = R + DELTAR	01260000
ISN 0102	W = W - DELTAR/EN	01270000
ISN 0103	WF = WF+ DELTAR/EN	01280000
ISN 0104	ST = ST+ DELTAR/ V	01290000
ISN 0105	GC TO 1	01300000
ISN 0106	300 RETURN	01320000
ISN 0107	7 NEXT=1	01330000
ISN 0108	WRITE(6,1006)	01340000
ISN 0109	1006 FORMAT(15X,47#INSUFFICIENT POWER AVAILABLE FOR CRUISE(CRUS2)A)	01350000
ISN 0110	CALL CRUS1 (ICRUS)	01360000
ISN 0111	RETURN	01370000
ISN 0112	END	

7-63

ORIGINAL PAGE IS  
OF POOR QUALITY

NAME	TAG	TYPE	ADD.	NAME	TAG	TYPE	ADD.	NAME	TAG	TYPE	ADD.	NAME	TAG	TYPE	ADD.				
F	SF	R**4	0003C0	H	SFA	C	R**4	000818	I	F	I**4	0003C4	M	FA	I**4	0C03C8			
Q	SF	C	R**4	000868	R	SF	C	R**4	000878	T	SF	C	R**4	0008E0	V	SFA	C	R**4	0C0910
W	SF	C	R**4	000914	AF		C	R**4	N.R.	AR		C	R**4	N.R.	BF	SF	C	R**4	000664
BS		C	R**4	N.R.	CB		C	R**4	N.R.	CV		C	R**4	N.R.	CX	SF	C	R**4	0C06B0
DH		C	R**4	N.R.	EN	SF	C	R**4	0G0bE4	FF	FA	C	R**4	0C04B4	FM		C	R**4	N.P.
FP		C	R**4	000718	HC		C	R**4	N.R.	HH	SFA		R**4	00C3CC	PI	F	C	R**4	0C0864
RA	F	C	R**4	00087C	SA		C	R**4	N.R.	ST	SF	C	R**4	0CC8B0	SW		C	R**4	N.R.
TR		C	R**4	N.R.	VC		C	R**4	N.R.	VT		C	R**4	N.R.	WE		C	R**4	N.R.
WF	SF	C	R**4	000930	WD		C	R**4	N.R.	WS		C	R**4	N.R.	Ww		C	R**4	N.R.
XC		C	R**4	N.R.	AML	F	C	R**4	00064C	BHT		C	R**4	N.R.	BLK	SF		R**4	0C03D0
BLP	SFA	C	R**4	000660	BMR		C	R**4	N.R.	BVT		C	R**4	N.R.	CCP		C	R**4	N.R.
CCT		C	R**4	N.R.	CCC		C	R**4	N.R.	CDV		C	R**4	N.R.	CKF		C	R**4	N.R.
CKW		C	R**4	N.R.	CK1		C	R**4	N.R.	CLW	F	C	R**4	00C68C	CRT		C	R**4	N.R.
CTP		C	R**4	N.R.	CK3		C	R**4	N.R.	DK4		C	R**4	N.R.	DMR	F	C	R**4	0009C8
ELC		C	R**4	N.R.	ELF		C	R**4	N.R.	ELN		C	R**4	N.R.	ELT		C	R**4	N.R.
ENP	F	C	R**4	000194	ENR	F	C	R**4	00011C	FEH		C	R**4	N.R.	FET		C	R**4	N.R.
FEW		C	R**4	N.R.	GLF		C	R**4	N.R.	HES		C	R**4	N.R.	HCO		C	R**4	N.P.
LC1	S		I**4	0003C4	GWE		C	R**4	N.R.	RHO	F	C	R**4	0CC86C	RMI		C	R**4	N.R.
RJO		C	R**4	N.R.	SA5		C	R**4	N.R.	SA6		C	R**4	N.R.	SA7		C	R**4	N.R.
SEE		C	R**4	N.R.	SFC	SF	C	R**4	0C089C	SHT		C	R**4	N.R.	SKT		C	R**4	N.R.
SK1		C	R**4	N.R.	SK2		C	R**4	N.R.	SK3		C	R**4	N.R.	SK4		C	R**4	N.R.
SK5		C	R**4	N.R.	SK6		C	R**4	N.R.	SK7		C	R**4	N.R.	SK8		C	R**4	N.R.
SK9		C	R**4	N.R.	SLM		C	R**4	N.R.	STH		C	R**4	N.R.	SVT		C	R**4	N.R.
TAF		C	R**4	N.R.	TCR		C	R**4	N.R.	TCT		C	R**4	N.R.	TMP	F	C	R**4	0C08F4
TOO		C	R**4	N.R.	TVW		C	R**4	N.R.	ULF		C	R**4	N.R.	VHL		C	R**4	N.R.
VIN	F	C	R**4	0003E8	VMC	F	C	R**4	000040	WAC		C	R**4	N.R.	WCC		C	R**4	N.R.
WEP		C	R**4	N.R.	WES		C	R**4	N.R.	WFC		C	R**4	N.R.	WFE		C	R**4	N.R.
WFR		C	R**4	N.R.	WFS		C	R**4	N.R.	WFW		C	R**4	N.R.	WHL		C	R**4	N.R.
WHT		C	R**4	N.R.	WLG		C	R**4	N.R.	WMC		C	R**4	N.R.	WPC		C	R**4	N.R.
WPH		C	R**4	N.R.	WRC		C	R**4	N.R.	WSC		C	R**4	N.R.	WST		C	R**4	N.R.
WTM		C	R**4	N.R.	WVA		C	R**4	N.R.	WVT		C	R**4	N.R.	XLB	F	C	R**4	0009AC
XLR	F	C	R**4	000988	XLW	F	C	R**4	0009BC	XMR		C	R**4	N.R.	ALFD	SF		R**4	0C03D8
ALFR	SFA	C	R**4	000648	ARHT		C	R**4	N.R.	ARVT		C	R**4	N.R.	BHPA	SF	C	R**4	0C0650
BHPP	F	C	R**4	0009C4	PRPR	SF	C	R**4	000654	CDHT		C	R**4	N.R.	CDVT		C	R**4	N.R.
CKFF	F	C	R**4	000050	CKHT		C	R**4	N.R.	CKVT		C	R**4	N.R.	CAM1		C	R**4	N.R.
DAM2		C	R**4	N.R.	DAM3		C	R**4	N.R.	DAM4		C	R**4	N.R.	CAM5		C	R**4	N.R.
DELR	F	C	R**4	0003FC	DRAG	SF	XF	R**4	000000	DVOL		C	R**4	N.R.	ELDN		C	R**4	N.R.
ELDT		C	R**4	N.R.	ELHT		C	R**4	N.R.	ELOA		C	R**4	N.R.	ELVT		C	R**4	N.R.
EMLF		C	R**4	N.R.	ETAF	SF	C	R**4	0006E8	ETAT	F	C	R**4	00C198	FEHI		C	R**4	N.R.
FEHL		C	R**4	N.R.	FEHT		C	R**4	N.R.	FEVT		C	R**4	N.R.	FEWH		C	R**4	N.R.
FEWI		C	R**4	N.R.	GAP1		C	R**4	N.R.	GAP2		C	R**4	N.R.	GAP3		C	R**4	N.P.
GAP4		C	R**4	N.R.	GAP5		C	R**4	N.R.	GAP6		C	R**4	N.R.	GAP7		C	R**4	N.R.
HFIN		C	R**4	N.R.	LIFT	SF	XF	I**4	0CC000	LTHL		C	I**4	N.R.	NEXT	S		I**4	0003DC
PEHF	SF	C	R**4	000860	FLIN		C	R**4	N.R.	PELI		C	R**4	N.R.	PMAX	F	C	R**4	0C0410
RTOD	SF		R**4	0003E0	SFPA		C	R**4	N.R.	SHPR	F	C	R**4	00C898	SHTe		C	R**4	N.R.
SHTw		C	R**4	N.R.	SKAC		C	R**4	N.R.	SKAR		C	R**4	N.R.	SKCC		C	R**4	N.R.
SKFS		C	R**4	N.R.	SKFW		C	R**4	N.R.	SKHL		C	R**4	N.R.	SKHT		C	R**4	N.R.
SKLG		C	R**4	N.R.	SKMC		C	R**4	N.R.	SKPA		C	R**4	N.R.	SKPH		C	R**4	N.R.
SKRC		C	R**4	N.R.	SKSC		C	R**4	N.R.	SKTM		C	R**4	N.R.	SKVT		C	R**4	N.R.
SKWP		C	R**4	N.R.	SKWw		C	R**4	N.R.	SK10		C	R**4	N.R.	SK11		C	R**4	N.R.

7-64

SK12	C	R*4	N.R.	SK13	C	R*4	N.R.	SK14	C	R*4	N.R.	SK15	C	R*4	N.P.			
SLMH	C	R*4	N.R.	STPW	C	R*4	N.R.	SVTE	C	R*4	N.R.	SVTW	C	R*4	N.R.			
SWTT	C	R*4	N.R.	T8H1	C	R*4	N.R.	T8H2	FA	C	R*4	0004E8	T8TO	C	R*4	N.P.		
TCHT	C	R*4	N.R.	TCLN	C	R*4	N.R.	TCVT	C	R*4	N.R.	TEMP	SFA	C	R*4	0003E4		
TINY	C	R*4	N.R.	TIN2	C	R*4	N.R.	TIN4	F	C	R*4	0003D4	TMAX	C	R*4	N.R.		
TOVA	C	R*4	N.R.	TWTh	C	R*4	N.R.	WBAL	C	R*4	N.R.	WENV	C	R*4	N.R.			
WFUL	C	R*4	N.R.	WCSB	C	R*4	N.R.	WPDS	C	R*4	N.R.	WPEI	C	R*4	N.R.			
WPRB	C	R*4	N.R.	WPRG	C	R*4	N.R.	WPRP	C	R*4	N.R.	WPCA	C	R*4	N.R.			
WSCA	C	R*4	N.R.	XLBF	C	R*4	N.R.	XLGD	C	R*4	N.R.	XLHL	F	C	R*4	0009B4		
YLS2	SF	C	R*4	0009C0	ALFDL	SF	C	R*4	000644	ATMIY	C	R*4	N.R.	ATMCS	SF	XF	R*4	000000
CBARF	C	R*4	N.R.	CEARW	C	R*4	N.R.	CLDES	C	R*4	N.R.	CLFYE	C	R*4	N.R.			
CPIND	C	R*4	N.R.	CFNUD	C	R*4	N.R.	CPPAR	C	R*4	N.R.	CPPRO	C	R*4	N.R.			
CPTGT	C	R*4	N.R.	CFLS1	SF	XF	R*4	000G00	CRUS2	C	R*4	0003E8	DELTA	C	R*4	N.R.		
DELTH	C	R*4	N.R.	DELWF	C	R*4	N.R.	DELWP	C	R*4	N.R.	DSWET	C	R*4	N.R.			
ELDDA	C	R*4	N.R.	ENPCR	F	C	R*4	000438	ETAP2	C	R*4	N.P.	ETAP4	SF	C	R*4	00071C	
FACTR	F	XF	R*4	000CC0	FETCT	C	R*4	N.R.	GMDD1	C	R*4	N.R.	HMAXD	C	R*4	N.R.		
ICRUS	SFA	I*4	0003EC	ICUM4	C	I*4	N.R.	NUCPP	C	I*4	N.R.	KCXPJ	C	I*4	N.R.			
PFET2	C	R*4	N.R.	PCWER	SF	XF	R*4	000J00	REALJ	C	R*4	N.R.	KHPVR	F	C	R*4	000874	
RMAXI	SF	R*4	0003F0	SIGMA	C	R*4	N.R.	SIGMR	C	R*4	N.R.	SKAND	C	R*4	N.R.			
SKBAL	C	R*4	N.R.	SKCBI	C	R*4	N.R.	SKGB2	C	R*4	N.R.	SKPCS	C	R*4	N.R.			
SKPEI	C	R*4	N.R.	SKPES	C	R*4	N.R.	SKPRB	C	R*4	N.R.	SKPBF	C	R*4	N.R.			
SKRCA	C	R*4	N.R.	SKSCA	C	R*4	N.R.	SLMVT	C	R*4	N.R.	STMAX	C	R*4	N.R.			
SWETH	C	R*4	N.R.	SWEXP	C	R*4	N.R.	SWWET	C	R*4	N.R.	SZFHG	C	R*4	N.R.			
TBCL1	C	R*4	N.R.	TECRP	FA	C	R*4	0004FC	TBEM5	FA	C	R*4	000164	TBPQW	FA	C	R*4	000530
TBSFC	FA	C	R*4	000510	TCEAR	C	R*4	N.R.	THETA	FA	C	R*4	0008EC	TPOP	S	C	R*4	0008F8
TVCMR	C	R*4	N.R.	VEAKH	C	R*4	N.R.	VEARV	C	R*4	N.R.	VCIIVE	C	R*4	N.R.			
VGASB	C	R*4	N.R.	VGASR	C	R*4	N.R.	WPAYL	C	R*4	N.R.	WPSTR	C	R*4	N.R.			
XLALB	C	R*4	N.R.	XLBWC	C	R*4	N.R.	XLINT	F	XF	R*4	000C00	XLRLA	C	R*4	N.R.		
ALFDES	C	R*4	N.R.	EHFSUP	SF	C	R*4	000658	CBARHT	C	R*4	N.R.	CBARVT	C	R*4	N.R.		
CBYLOA	C	R*4	N.R.	CLALPH	C	R*4	N.R.	CRSIND	C	R*4	N.R.	CTSIGH	C	R*4	N.R.			
CYCPRL	C	R*4	N.R.	DELFCR	F	C	R*4	000424	DELRTH	F	C	R*4	00063C	DELTA	SF	C	R*4	0003F4
DELWFC	C	R*4	N.R.	DELWFL	C	R*4	N.R.	DELWST	C	R*4	N.R.	DSWSH	C	R*4	N.R.			
DLTAFE	C	R*4	N.R.	ELVLHL	C	R*4	N.R.	DRGIND	C	R*4	N.R.	DSPLMT	C	R*4	N.R.			
DYLIND	C	R*4	N.R.	ELFLCA	C	R*4	N.R.	ELVLOA	C	R*4	N.R.	ETAIND	C	R*4	N.R.			
ETAP4N	F	C	R*4	000160	EXPCRG	C	R*4	N.R.	FEDRAG	C	R*4	N.R.	FIXIND	C	R*4	N.R.		
GAMD11	C	R*4	N.R.	FULIND	C	R*4	N.R.	IBCOM#	F	XF	I*4	000000	INCCRU	C	I*4	N.R.		
INDDRG	C	I*4	N.R.	INCCYL	C	I*4	000828	INDETA	C	I*4	00082C	INCFIX	C	I*4	N.R.			
INDHUL	C	I*4	N.R.	INCCPT	C	I*4	N.R.	INDUSW	C	I*4	N.R.	INDPGW	C	I*4	N.R.			
INDPPP	C	I*4	N.R.	INCRDM	C	I*4	N.R.	INDSGT	F	C	I*4	0003F8	IPRINT	C	I*4	00084C		
NCRUS2	C	I*4	0000C0	NETAP4	SFA	C	I*4	0003FC	OPTIND	C	R*4	N.R.	OSWIND	C	R*4	N.R.		
PRPIND	C	R*4	N.R.	PCIND	C	R*4	N.R.	RHGRHO	C	R*4	N.R.	RCTPQW	SF	XF	R*4	000000		
SGTIND	C	R*4	N.R.	SKELNT	C	R*4	N.R.	SKENV1	C	R*4	N.R.	SKENV2	C	R*4	N.R.			
SKPDSZ	C	R*4	N.R.	SKVTAR	C	R*4	N.R.	SSIGMA	F	C	R*4	0008AC	STHETA	C	R*4	N.R.		
TBCDWI	C	R*4	N.R.	T8EAP4	FA	C	R*4	000178	THETMR	C	R*4	N.R.	TCLIND	C	R*4	N.R.		
VGBOVH	C	R*4	N.R.	WALNT	C	R*4	N.R.	WPAYLO	C	R*4	N.R.	XTGTA2	C	R*4	N.R.			
XTGTA4	C	R*4	N.R.															

\*\*\*\*\* CCMCN INFORMATION \*\*\*\*\*

NAME OF CCMCN BLOCK \* \* SIZE OF BLOCK 0009DC HEXADECIMAL BYTES



VAR. NAME	TYPE	REL. ADDR.	VAR. NAME	TYPE	REL. ADDR.	VAR. NAME	TYPE	REL. ADDR.	VAR. NAME	TYPE	REL. ADDR.
OPTINC	R*4	N.R.	FULINC	R*4	N.R.	CYLIND	R*4	N.R.	DRGIND	R*4	N.R.
OSWINC	R*4	N.R.	FIXINC	R*4	N.R.	RDMIND	R*4	N.R.	PRPIND	R*4	N.R.
ETAIND	R*4	N.R.	WC	R*4	N.R.	XLBWO	R*4	N.R.	XLPLA	R*4	N.R.
VGBCVF	R*4	N.R.	XLCC	R*4	N.R.	HMAXD	R*4	N.R.	RHORHO	R*4	N.R.
VVC	R*4	000040	EMLF	R*4	N.R.	CK1	R*4	N.R.	DELWF	R*4	N.R.
CKFF	R*4	000050	VDIVE	R*4	N.R.	HOO	R*4	N.R.	ROO	R*4	N.R.
TCC	R*4	N.R.	GAP1	R*4	N.R.	SGTIND	R*4	N.R.	ELHLCA	R*4	N.R.
ELVLCA	R*4	N.R.	GAP2	R*4	N.R.	AR	R*4	N.R.	WS	R*4	N.R.
TCR	R*4	N.R.	TCT	R*4	N.R.	SLM	R*4	N.R.	ARHT	R*4	N.R.
TCFT	R*4	N.R.	VBARF	R*4	N.R.	SLMH	R*4	N.R.	APVT	R*4	N.R.
TCVT	R*4	N.R.	VBARV	R*4	N.R.	SLMVT	R*4	N.R.	ELDN	R*4	N.R.
ELCT	R*4	N.R.	ELCCZ	R*4	N.R.	CLSWSH	R*4	N.R.	DSWET	R*4	N.R.
DLVFL	R*4	N.R.	CVCL	R*4	N.R.	CBYLOA	R*4	N.R.	ENP	R*4	00011C
WVA	R*4	N.R.	CAM1	R*4	N.R.	CAM2	R*4	N.R.	BMR	R*4	N.R.
CAM3	R*4	N.R.	CLEYE	R*4	N.R.	THETMR	R*4	N.R.	XC	R*4	N.R.
XMR	R*4	N.R.	TVCMR	R*4	N.R.	VT	R*4	N.R.	CTSIGH	R*4	N.R.
TVK	R*4	N.R.	FES	R*4	N.R.	TINY	R*4	N.R.	ETAP2	R*4	N.R.
ETAP4N	R*4	000160	TBEMS	R*4	000164	TBBAP4	R*4	000178	GAP3	R*4	N.R.
CAM4	R*4	N.R.	ENF	R*4	000194	ETAT	R*4	000198	HC	R*4	N.R.
VC	R*4	N.R.	ATMIY	R*4	N.R.	CDVT	R*4	N.R.	CDHT	R*4	N.R.
CAM5	R*4	N.R.	CLTAFE	R*4	N.R.	FEDRAG	R*4	N.R.	EXPDRG	R*4	N.R.
CEC	R*4	N.R.	CLALPF	R*4	N.R.	CKVT	R*4	N.R.	CKHT	R*4	N.R.
CKF	R*4	N.R.	CKW	R*4	N.R.	RELI	R*4	N.R.	TCLN	R*4	N.R.
TBCL1	R*4	N.R.	TBCCY1	R*4	N.R.	GAP4	R*4	N.R.	WFE	R*4	N.R.
WFLL	R*4	N.R.	DELWFC	R*4	N.R.	DELWP	R*4	N.R.	DELWST	R*4	N.R.
SKCC	R*4	N.R.	SKRC	R*4	N.R.	SKSC	R*4	N.R.	SKFW	R*4	N.R.
SKTM	R*4	N.R.	SKRCA	R*4	N.R.	SKSCA	R*4	N.R.	SKMC	R*4	N.R.
SKAC	R*4	N.R.	SKFL	R*4	N.R.	SKENVI	R*4	N.R.	SKENV2	R*4	N.R.
SKGE1	R*4	N.R.	SKGB2	R*4	N.R.	SKBLNT	R*4	N.R.	SKBAL	R*4	N.R.
SKLG	R*4	N.R.	SKKH	R*4	N.R.	ELF	R*4	N.R.	RVI	R*4	N.R.
SKWP	R*4	N.R.	SKF1	R*4	N.R.	SKVT	R*4	N.R.	SKPRB	R*4	N.R.
SKREF	R*4	N.R.	SKP1	R*4	N.R.	SKAMD	R*4	N.R.	SKAR	R*4	N.R.
SKFA	R*4	N.R.	SKVIAF	R*4	N.R.	SKPDS	R*4	N.R.	SKPDSZ	R*4	N.R.
SKT	R*4	N.R.	SKFS	R*4	N.R.	SKPEI	R*4	N.R.	SKPES	R*4	N.R.
SK1	R*4	N.R.	SK2	R*4	N.R.	OK3	R*4	N.R.	DK4	R*4	N.R.
SK5	R*4	N.R.	SK6	R*4	N.R.	SK7	R*4	N.R.	SK8	R*4	N.R.
SK9	R*4	N.R.	SK10	R*4	N.R.	SK11	R*4	N.R.	SK12	R*4	N.R.
SK13	R*4	N.R.	SK14	R*4	N.R.	SK15	R*4	N.R.	PLIN	R*4	N.R.
GAF5	R*4	N.R.	TCLINC	R*4	N.R.	XTGTA2	R*4	N.R.	TIN2	R*4	N.R.
T+TW	P*4	N.R.	PFET2	R*4	N.R.	DELTH	R*4	N.R.	STH	R*4	N.R.
CPSIAC	R*4	N.R.	XTGTA4	R*4	N.R.	TIN4	R*4	0003D4	VIN	R*4	0003E8
DELR	R*4	0003FC	RMAX	R*4	000410	DELFCR	R*4	000424	EXPCR	R*4	000438
DELWFL	R*4	N.R.	STPW	R*4	N.R.	HFIN	R*4	N.R.	GAP6	R*4	N.R.
CYCPRL	R*4	N.R.	FF	R*4	0004B4	SK3	R*4	N.R.	SK4	R*4	N.R.
TB-1	R*4	N.R.	TBTC	R*4	N.R.	TBH2	R*4	0004E8	TBCRP	R*4	0004FC
TBSFC	R*4	000510	TBPCW	R*4	000530	GAP7	R*4	N.R.	ALFDES	R*4	N.R.
ALFCL	R*4	000644	ALFF	R*4	000648	AMU	R*4	0006+C	BHPA	R*4	000650
BHFR	R*4	000654	BHPSLF	R*4	000658	BHT	R*4	N.R.	BLP	R*4	000660
BR	R*4	000664	BS	R*4	N.R.	BVT	R*4	N.R.	CBARF	R*4	N.R.
CBARFT	R*4	N.R.	CBARVT	R*4	N.R.	CBARW	R*4	N.R.	CCP	R*4	N.R.
CCT	R*4	N.R.	CCV	R*4	N.R.	CLW	R*4	00068C	CPIND	R*4	N.R.

7-66

CPNLD	R*4	N.R.	CPFAF	R*4	N.R.	CPPRO	R*4	N.R.	CPTGT	R*4	N.R.
CFT	R*4	N.R.	CTF	R*4	N.R.	CV	R*4	N.R.	CX	R*4	0006B0
CLCES	R*4	N.R.	CE	R*4	N.R.	DELRTH	R*4	0006BC	DELTA	R*4	N.R.
CF	R*4	N.R.	CSPLMT	R*4	N.R.	ELC	R*4	N.R.	ELHT	R*4	N.R.
ELN	R*4	N.R.	ELCA	R*4	N.R.	ELT	R*4	N.R.	ELVT	R*4	N.R.
EN	R*4	0006E4	ETAP	R*4	0006E8	FEH	R*4	N.R.	FEHI	R*4	N.R.
FEHL	R*4	N.R.	FEFT	R*4	N.R.	FET	R*4	N.R.	FETCT	R*4	N.R.
FEVT	R*4	N.R.	FEV	R*4	N.R.	FEWH	R*4	N.R.	FEWI	R*4	N.P.
FM	R*4	N.R.	FF	R*4	000718	ETAP4	R*4	00071C	GAMC11	R*4	N.R.
CLF	R*4	N.R.	GMCCI	R*4	N.R.	H	R*4	000818	IDUM4	I*4	N.R.
INDCRU	I*4	N.R.	INCCRC	I*4	N.R.	INDJYL	I*4	000828	INDETA	I*4	00082C
INDFIX	I*4	N.R.	INDFUL	I*4	N.R.	INDOPT	I*4	N.R.	INDOSW	I*4	N.R.
INDPCW	I*4	N.R.	INDPRF	I*4	N.R.	INORDM	I*4	N.R.	IPRINT	I*4	00084C
LTFI	I*4	N.R.	NCCPF	I*4	N.R.	NOXPJ	I*4	N.R.	CWE	R*4	N.R.
PEFF	R*4	00086C	PI	R*4	000864	Q	R*4	000868	RHO	R*4	00086C
REALJ	R*4	N.R.	RFPMR	R*4	000874	R	R*4	000878	RN	R*4	00087C
SA	R*4	N.R.	SAS	R*4	N.R.	SAG	R*4	N.R.	SA7	R*4	N.P.
SFC	R*4	000890	SAPA	R*4	N.R.	SHPR	R*4	000898	SHT	R*4	N.R.
SFTE	R*4	N.F.	SHTP	R*4	N.R.	SIGMA	R*4	N.R.	SSIGMA	R*4	0008AC
ST	R*4	0008BC	STFETZ	R*4	N.R.	STMAX	R*4	N.R.	SVT	R*4	N.R.
SVTE	R*4	N.R.	SVTP	R*4	N.R.	SW	R*4	N.R.	SWETH	R*4	N.R.
SWEXP	R*4	N.F.	SWTT	R*4	N.R.	SWWET	R*4	N.R.	SZRHO	R*4	N.R.
T	R*4	0008EC	TAF	R*4	N.R.	TCDAR	R*4	N.R.	THETA	R*4	0008EC
TMAX	R*4	N.R.	TMP	R*4	0008F4	TPROP	R*4	0008F8	TR	R*4	N.R.
ULF	R*4	N.R.	VGASE	R*4	N.R.	VGASR	R*4	N.R.	VHL	R*4	N.R.
V	R*4	000910	V	R*4	000914	WBAL	R*4	N.R.	WBALNT	R*4	N.R.
WCC	R*4	N.R.	WE	R*4	N.R.	WEP	R*4	N.R.	WES	R*4	N.R.
WF	R*4	000930	WFC	R*4	N.R.	WFR	R*4	N.R.	WFS	R*4	N.R.
WFW	R*4	N.R.	WGSE	R*4	N.R.	WHL	R*4	N.R.	WHT	R*4	N.R.
WLG	R*4	N.R.	WMC	R*4	N.R.	WPAYL	R*4	N.R.	WPC	R*4	N.R.
WPCS	R*4	N.R.	WPEI	R*4	N.R.	WPH	R*4	N.R.	WPRB	R*4	N.R.
WFRG	R*4	N.R.	WPRF	R*4	N.R.	WPSTR	R*4	N.R.	WRC	R*4	N.R.
WRCA	R*4	N.R.	WSC	R*4	N.R.	WSCA	R*4	N.R.	WST	R*4	N.R.
WTP	R*4	N.R.	WVT	R*4	N.R.	WW	R*4	N.R.	WPAYLO	R*4	N.R.
WAC	R*4	N.R.	WENV	R*4	N.R.	XLALB	R*4	N.R.	XLB	R*4	0009AC
XLBH	R*4	N.R.	XLFL	R*4	0009B4	XLR	R*4	0009B8	XLW	R*4	0009BC
YLS2	R*4	0009C0	TCVW	R*4	N.R.	DMR	R*4	0009C8	SIGMR	R*4	N.R.
AF	R*4	N.R.	BHFF	R*4	0009D4	SEE	R*4	N.R.			

LABEL	ADDR	LABEL	ADDR	LABEL	ADDR	LABEL	ADDR	PAGE
301	0CC5DC	1	CCC666	4	CC06C6	3	0006F2	008
2	0CC756	5	CCC75E	6	CC0812	13	0009BE	
14	0CC9C6	3CC	CCCACC	7	CCOAC8			

\*OPTIONS IN EFFECT\* NAME= MAIN,CPT=02,LINECNT=54,SIZE=00CCK,

\*OPTIONS IN EFFECT\* SOURCE,EBCCIC,NCLIST,PCDECK,LOAD,MAP,NCEDIT,ID,NOXREF

\*STATISTICS\* SOURCE STATEMENTS = 111 ,PROGRAM SIZE = 2662

\*STATISTICS\* NO DIAGNOSTICS GENERATED

\*\*\*\*\* END OF COMPILE \*\*\*\*\*

99K BYTES OF CORE NOT USED

7-68

CCMPILER OPTICNS - NAME= MAIN,OPT=C2,LINECNT=54,SIZE=0000K,  
SCURCE,EBCCIC,NCLIST,NODECK,LGAC,MAP,NCEDIT,IO,NOXREF

ISN 0002	SLBRoutine CRLS3 (ICRLS3)	00010000
	C**** MEMBER NAME BEICRLS3	00020000
	C PAGE 1 INPUT LCC 001 THRU 0050	00030000
ISN 0003	CCMMON CPTINC ,FULLINC ,DYLIND ,CRGIND ,OSWIND ,00040000	
	1FI>IND ,RDMINC ,PRFIND ,ETAIND ,WO ,XLBWO ,00050000	
	2XLRLA ,VGBCVH ,>LCO ,HMAXD ,FHGRHO ,VMC ,00060000	
	3ENLF ,CK1 ,DELWF ,CKFF ,VDIVE ,HCC ,00070000	
	4ROC ,TOC ,CAF1(5) ,SGTIND(12) ,ELHLOA ,ELVLOA ,00080000	
	5GAP2(6)	00090000
	C PAGE 2 INPUT LGC 001 THRU 0100	00100000
ISN 0004	CCMMON AR ,WS ,TCR ,TCT ,SLM ,00110000	
	1ARFT ,TCFT ,VEARH ,SLMH ,ARVT ,TCVT ,00120000	
	2VBARV ,SLMVT ,ELCN ,ELDT ,ELDOA ,DLSSH ,00130000	
	3DSWET ,DLVLF ,CVCL ,CBYLOA ,ENR ,WVA ,00140000	
	4CAF1 ,CAF2 ,ENF ,DAM3 ,CLÉYE ,TFETMR ,00150000	
	5XC ,XMR ,TVCNR ,VT ,CTSIGH ,TVH ,00160000	
	6ES ,TINY ,ETAP2 ,ETAP4N ,TBEM5(5) ,TB8AP4(5) ,00170000	
	7GAP3	00180000
	C PAGE 3 INPUT LGC 0101 THRU 140	00190000
ISN 0005	CCMMON CAM4 ,ENF ,ETAT ,FC ,VC ,00200000	
	1ATMIY ,CDVT ,CDFT ,DAM5 ,CLTAFE ,FEDRAG ,00210000	
	2EXFDRG ,CCC ,CLALPH ,CKVT ,CKHT ,CKF ,00220000	
	3CKW ,RELI ,TCLA ,TBCL1(8) ,TBODWI(8) ,GAP4(4) ,00230000	
	C PAGE 4 INFLI LCC 141 THRU 200 WEIGHT DATA	00240000
ISN 0006	CCMMON WFE ,WFL ,DELWFC ,DELWST ,00250000	
	1SKCC ,SKRC ,SKSC ,SKFW ,SKTM ,SKRCA ,00260000	
	2SKSCA ,SKMC ,SKAC ,SKHL ,SKENVI ,SKENV2 ,00270000	
	3SKGB1 ,SKGB2 ,SKELNT ,SKBAL ,SKLG ,SKW ,00280000	
	4ELF ,RMI ,SKWP ,SKHT ,SKVT ,SKPRB ,00290000	
	5SKRBF ,SKPT ,SKAND ,SKAR ,SKPA ,SKVTAR ,00300000	
	6SKPDS ,SKPDSZ ,SKT ,SKFS ,SKPEI ,SKPES ,00310000	
	7SK1 ,SK2 ,CK2 ,DK4 ,SK5 ,SK6 ,00320000	
	ESK7 ,SK8 ,SK9 ,SK10 ,SK11 ,SK12 ,00330000	
	9SK13 ,SK14 ,SK15 ,PLIN ,GAP5(3) ,00340000	
	C PAGE 5 INPUT LGC 201 THRU 300	00350000
ISN 0007	CCMMON TLLIN(15) ,XTGTA2(5) ,TIN2(5) ,TWTW(5) ,PFET2(5) ,00360000	
	1DELTH(5) ,STH(5) ,CRSINC(5) ,XTGTA4(5) ,TIN4(5) ,VIN(5) ,00370000	
	2DELRI(5) ,RMAX(5) ,DELFCR(5) ,ENPCR(5) ,DELWPL(5) ,STPh(5) ,00380000	
	3FFIN(5) ,GAP6(10)	00390000
	C PAGE 6 INPUT LCC 301 THRU 400	00400000
ISN 0008	CCMMON CYCPFL ,FF ,SK3 ,SK4 ,TBH1(5) ,00410000	
	1TBH(5) ,TBH2(5) ,TBCRP(5) ,TBSFC(8) ,TBPOW(8) ,GAP7(60) ,00420000	
	C WORKING CCMMON	00430000
ISN 0009	CCMMON ALFCES,ALFCL,ALFF,AMC, 00440000	
	1 BHPA,BFFR,BFPSCP,EHT,BLP,BR,BS,BVT, 00450000	
	2 CBARF,CBARFT,CEARVT,CEARW,CCP,CCT,CDV,CLW,CPIND,CPNUD,CPPAR,CPPRQ 00460000	
	3,CPTDT,CRT,CTP,CV,CX,CLDES,CB, 00470000	
	4 DELRTH,DELTA,DF,CSPLMT, ELC,ELHT,ELN,ELCA,ELT,ELVT,EN,ETAP, 00480000	
	5 FEH,FEH1,FEHL,FEHT,FET,FETCT,FEVT,FEW,FEWH,FEWI,FM,FP,ETAP4 00490000	
ISN 0010	CCMMON GANC11(3,15),CLF,GMDD1(16),H, 00500000	

7-69

ORIGINAL PAGE IS  
OF POOR QUALITY

	7	IDUM5, INCCR, INCCRG, INCCYL, INDETA, INDFIX, INCHUL, INDOPT, INCOSW,	00510000
		E INDPW, INDRP, INCRDM, IPFINT	00520000
ISN 0011		CCMON LTHL, NCCFF, NCXPL, CKE, PEFF, PI, Q, RHC, REALJ, RHPMR, R, RN	00530000
ISN 0012		CCMON SA, SA5, SA6, SA7, SFC, S-PA, SHPF, SHT, SHTE, SHTW, SIGMA, SSIGMA, ST,	00540000
		ISTFETA, STMAX, SVT, SVTE, SVTH, SW, SWETH, SWEXP, SWIT, SWWET, SZRHC	00550000
ISN 0013		CCMON T, TAF, TCEAF, TETA, TMAX, TMP, TPROP, TR, ULF, VGASB, VGASR, VHL, V	00560000
ISN 0014		CCMON W, WBAL, WEALNT, WCC, WE, WEP, WES, WF, WFC, WFR, WFS, WFW,	00570000
		1 WGSB, WFL, WFT, WLG, WMC, WPAYL, WPC, WPCS, WPEI, WPT, WPRB, WPRG, WPRP, WPSTR	00580000
		2, WRC, WRCA, WSC, WSCA, WST, WTM, WVT, WW, WPAYLC, WAC, WENV	00590000
ISN 0015		CCMON XLALB, XLB, XLBH, XLFL, XLR, XLW, YLS2, TCVW	00600000
ISN 0016		CCMON CMP, SIGPR, AF, BFFP, SEE	00600001
ISN 0017		NAMELIST /NCRLS/ LC1, LC2, LC4, LC5, YLS2, V, T, Q, CX, BHPR,	00610000
	1	EHFA, ELF, BHPSLP, FP, EN, INDETA, ETAP4, EN2, EN1, R, W, WF, ST	00620000
ISN 0018		RTCD=57.2957795	00620100
ISN 0019		H=H	00620200
ISN 0020		NETAP4 = ETAP4N + C.1	00630000
ISN 0021		IF(IPRINT.EC.1)WRITE(6,301)	00640000
ISN 0023	301	FORMAT(7X, 'CRUISE AT SPEED FOR BEST SPECIFIC RANGE'/)	00650000
ISN 0024		IF(IPRINT.EC.1)WRITE(6,1G05)	00660000
ISN 0026		IF(IPRINT.EC.1)WRITE(6,1CC8)	00660100
ISN 0028	1CC5	FORMAT(2X, 'TIME', 7X, 'RANGE', 5X, 'FUEL USED', 5X, 'WEIGHT', 6X, 'ALT.', 600670000	
		1X, 'TEMP', 5X, 'TA', 5X, 'E.F.', 4X, 'PEHF', 5X, 'BHPR', 4X, 'ETAP', 5X, 'NMPP	00680000
		2', 6X, 'R.N.', 4X, 'CL'/'	00690000
		32X, '(HOURS) (N.MI) (PCLNDS) (PCUNDS) (FEET) (DEG.F	00700000
		4) (KT)'//)	00710000
ISN 0029	1CC8	FORMAT(37X, 'HULL LIFT', 11X, 'WING LIFT', 7X, 'RCTCR LIFT', 8X, 'ALPHA F	00710100
		1', 16X, 'ALPHA C/L', 38X, '(FCUNDS)', 12X, '(POUNDS)', 7X, '(POUNDS)', 10X,	00710200
		2'(CEG)', 17X, '(CEG)'//)	00710300
ISN 0030		LC1 = C	00720000
ISN 0031		LC2 = 0	00730000
ISN 0032		LC4 = C	00740000
ISN 0033		LC5 = C	00750000
ISN 0034		YLS2 = 1. - ENFCR(ICRLS)/ENF	00760000
ISN 0035		TIN = TJN4(ICRLS)	00770000
ISN 0036		CALL ATMCS( H , TIN)	00780000
ISN 0037		V = VMC/SSIGMA	00790000
ISN 0038		VMAX=V	00790100
ISN 0039		1 Q = 1.42636 * RFC * V * V	00800000
ISN 0040		LC2 = LC2 + 1	00810000
ISN 0041		CALL LIFT	00820000
ISN 0042		CALL DRAG(ALFR)	00830000
ISN 0043		BR=XLB/W	00830100
ISN 0044		IF(INDCYL-2) 2, 2, 3	00840000
ISN 0045	2	T = T + Q * DELFCR(ICRLS)	00850000
ISN 0046		IF(INDETA) 4, 4, 5	00860000
ISN 0047	4	ETAP4 = XLINT( TBEM5, TEBAP4, V, NETAP4, M)	00870000
ISN 0048		IF(M.NE.0)WRITE(6,101)I	00880000
ISN 0050		ETAP=ETAP4	00880100
ISN 0051	101	FORMAT(22X, 'THIS ERROR IS IN THE V-ETAP4 TABLE SGTIND(' , I2, ')')	00890000
ISN 0052		BHPR = T * V / ( 325.8 * ETAP4 * ETAT)	00900000
ISN 0053		GC TO 6	00910000
ISN 0054	5	TPROP = T	00920000

ISN 0055	CALL PCWER	00930000
ISN 0056	BHPR = SHPR * EHPP * DELRTH * YLS2	00940000
ISN 0057	GC TO 6	00950000
ISN 0058	3 CX = CX + 2.0 * ANU * AML * DELFCR(ICRUS) / (PI * DMR * DMR * ENR)	00960000
ISN 0059	CALL RCTFCW	00970000
ISN 0060	BHPR = RHPR / ETAT	00980000
ISN 0061	6 BLP = XLINT(TEH2, TBCRF, H, 5, M)	00990000
ISN 0062	IF(M.NE.0)WRITE(6,102)I	01000000
ISN 0064	102 FCRMAT(22X, 'THIS ERROR IS IN THE H-POWER TABLE SGTIND(*,I2,*)')	01010000
ISN 0065	BLF=FACTR(BLP, TT, TETA, FF)	01020000
ISN 0066	BLK=BLP	01020100
ISN 0067	BHPSUP = BLP * DELRTH * BHPP	01030000
ISN 0068	BHPA = BHPSUP * YLS2	01040000
ISN 0069	IF(BHPA - BHPR) 6, 7, 7	01050000
ISN 0070	7 BHPA = BHPR	01060000
ISN 0071	BHPSUP= BHPA / YLS2	01070000
ISN 0072	BLP = BHPSUP / (EHPP * DELRTH)	01080000
ISN 0073	SFC = XLINT(TBFCW, TESFC, BLP, 8, M)	01090000
ISN 0074	IF(M.NE.0)WRITE(6,103)I	01100000
ISN 0076	103 FCRMAT(22X, 'THIS ERROR IS IN THE SFC TABLE SGTIND(*,I2,*) BHPA.GE	01110000
	1. BHPR')	01120000
ISN 0077	F=SFC*BHPA*CKFF	01130000
ISN 0078	LC5 = 1	01140000
ISN 0079	IF(LC3 - 2) 10, 9, 9	01150000
ISN 0080	9 EN2 = V/F	01160000
ISN 0081	IF(EN2 - EN1) 11, 11, 12	01170000
ISN 0082	11 IF(LC4.EQ.1) GC TC 13	01180000
ISN 0084	16 V = V + 1.	01190000
ISN 0085	IF(V.GT.VMAX) V=VMAX	01190100
ISN 0087	IF(V.GE.VMAX) GC TC 13	01190200
ISN 0089	EN1= EN2	01200000
ISN 0090	LC4= 1	01210000
ISN 0091	14 IF(V - 5.) 15, 15, 1	01220000
ISN 0092	15 WRITE(6,104)I	01230000
ISN 0093	104 FCRMAT(22X, 'INSUFFICIENT POWER FOR CRUISE SGTIND(*,I2,*)')	01240000
ISN 0094	GC TO 302	01250000
ISN 0095	8 SFC = XLINT(TBFCW, TBSFC, BLP, 8, M)	01260000
ISN 0096	IF(M.NE.0)WRITE(6,105)I	01270000
ISN 0098	105 FCRMAT(22X, 'THIS ERROR IS IN THE SFC TABLE(BHPA.LT.BHPR)SGTIND(*,I	01280000
	12,*)')	01290000
ISN 0099	F=SFC*BHPA*CKFF	01300000
ISN 0100	IF(LC5.EQ.1) GC TC 13	01310000
ISN 0102	10 EN1 = V/F	01320000
ISN 0103	17 V = V - 10.	01330000
ISN 0104	GC TO 14	01340000
ISN 0105	12 IF(LC4.EQ.1) GC TC 16	01350000
ISN 0107	EN1 = EN2	01360000
ISN 0108	GC TO 17	01370000
ISN 0109	13 EN = EN1	01380000
ISN 0110	V=V-1.	01380001
ISN 0111	IF(INDOYL.LT.3) ALFDL=-90.	01380100
ISN 0113	ALFD=ALFR*RTGD	01380200

7-71

ISN 0114	PEHF=BHPSLP/(BLK*BT*PF*DELRT)	013803CC
ISN 0115	IF(IPRINT.EC.1)WRITE(6,1C03)ST,R,WF,W,H,TMP,V,BR,PEHF,BHPR,ETAP, 1EN,RN,CLW	013804CC 013805CC
ISN 0117	IF(IPRINT.EC.1)WRITE(6,1C09)XLHL,XLW,XLR,ALFC,ALFDL	013806CC
ISN 0119	IF(LC1.EC.1) GC TC 3CC	01390000
ISN 0121	DELTAR = FMAX(ICRUS) - R	01400000
ISN 0122	1003 FCFMAT(2X,F7.2,2X,F8.1,2X,F9.0,4X,F10.0,2X,F8.0,2X,F7.2,3X,F6.1,2X, 1,F6.3,2X,F6.3,2X,F8.C,2X,F5.2,2X,F9.6,2X,F6.3,2X,F5.2)	01450000 01460000
ISN 0123	1CC9 FCFMAT(34X,F10.C,11X,F10.C,7X,F10.C,11X,F5.1,19X,F5.1/)	01460100
ISN 0124	IF(DELTAR.GT.CELR(ICRUS)) GC TO 20	01470000
ISN 0126	IF(DELTAR.LE.CELR(ICRUS)) LC1=1	01470100
ISN 0128	IF(LC1.EC.1) GC TC 21	01470200
ISN 0130	20 DELTAR=DELR(ICRUS)	01470300
ISN 0131	21 R = R + DELTAR	01470400
ISN 0132	W = W - DELTAR/EN	01480000
ISN 0133	WF = WF + DELTAR/EN	01490000
ISN 0134	ST = ST + DELTAR/V	01500000
ISN 0135	LC3= 0	01510000
ISN 0136	LC4= 0	01520000
ISN 0137	LC5= 0	01530000
ISN 0138	GC TO 1	01540000
ISN 0139	3CC RETURN	01550000
ISN 0140	3C2 WRITE(6,ACRUS3)	01560000
ISN 0141	RETURN	01560100
ISN 0142	ENC	01570000

NAME	TAG	TYPE	ADD.	NAME	TAG	TYPE	ADD.	NAME	TAG	TYPE	ADD.	NAME	TAG	TYPE	ADD.
F SF		R*4	000410	H SFA	C	R*4	000818	I F		I*4	00C414	M FA		I*4	0C0418
C SF	C	R*4	000868	R SF	C	R*4	000878	T SF	C	R*4	0CC8E0	V SFA	C	R*4	0C0910
W SF	C	R*4	000914	AF	C	R*4	N.R.	AR	C	R*4	N.R.	BR SF	C	R*4	0C0664
BS	C	R*4	N.R.	CB	C	R*4	N.R.	CV	C	R*4	N.R.	CX SF	C	R*4	0C06B0
DH	C	R*4	N.R.	EN SF	C	R*4	0006E4	FF FA	C	R*4	0004B4	FM	C	R*4	N.R.
FP	C	R*4	000718	HC	C	R*4	N.R.	HH SFA		R*4	00C41C	PI F	C	R*4	000864
RN F	C	R*4	00087C	SA	C	R*4	N.R.	ST SF	C	R*4	00C8B0	SW	C	R*4	N.R.
TR	C	R*4	N.R.	VC	C	R*4	N.R.	VT	C	R*4	N.R.	WE	C	R*4	N.R.
WF SF	C	R*4	000930	WO	C	R*4	N.R.	WS	C	R*4	N.R.	LW	C	R*4	N.R.
XC	C	R*4	N.R.	AMU F	C	R*4	00064C	BHT	C	R*4	N.R.	BLK SF		R*4	000420
BLP SFA	C	R*4	000660	BMR	C	R*4	N.R.	BVT	C	R*4	N.R.	CCP	C	R*4	N.R.
CCT	C	R*4	N.R.	CCD	C	R*4	N.R.	CDV	C	R*4	N.R.	CKF	C	R*4	N.R.
CKK	C	R*4	N.R.	CKI	C	R*4	N.R.	CLW F	C	R*4	00C68C	CRT	C	R*4	N.R.
CTP	C	R*4	N.R.	CK3	C	R*4	N.R.	DK4	C	R*4	N.R.	DMR F	C	R*4	0C09C8
ELC	C	R*4	N.R.	ELF	C	R*4	N.R.	ELN	C	R*4	N.R.	ELT	C	R*4	N.R.
ENP F	C	R*4	000194	ENR F	C	R*4	00011C	EN1 SF		R*4	000424	EN2 SF		R*4	0C0428
FEH	C	R*4	N.R.	FET	C	R*4	N.R.	FEW	C	R*4	N.R.	GLF	C	R*4	N.R.
HES	C	R*4	N.R.	FOO	C	R*4	N.R.	LC1 S		I*4	00042C	LC3 SF		I*4	000430
LC4 S		I*4	000434	LC5 S		I*4	000438	OWE	C	R*4	N.R.	RHO F	C	R*4	0C086C
RMI	C	R*4	N.R.	RGO	C	R*4	N.R.	SA5	C	R*4	N.R.	SA6	C	R*4	N.R.
SA7	C	R*4	N.R.	SEE	C	R*4	N.R.	SFC SF	C	R*4	0CC890	SHT	C	R*4	N.R.
SKT	C	R*4	N.R.	SK1	C	R*4	N.R.	SK2	C	R*4	N.R.	SK3	C	R*4	N.R.
SK4	C	R*4	N.R.	SK5	C	R*4	N.R.	SK6	C	R*4	N.R.	SK7	C	R*4	N.R.
SK8	C	R*4	N.R.	SK9	C	R*4	N.R.	SLM	C	R*4	N.R.	STH	C	R*4	N.R.
SVT	C	R*4	N.R.	TAF	C	R*4	N.R.	TCR	C	R*4	N.R.	TCT	C	R*4	N.R.
TIN SFA		R*4	00043C	TMP F	C	R*4	0008F4	TOO	C	R*4	N.R.	TVW	C	R*4	N.R.
ULF	C	R*4	N.R.	VHL	C	R*4	N.R.	VIN	C	R*4	N.R.	VMO F	C	R*4	0C084C
WAC	C	R*4	N.R.	WCC	C	R*4	N.R.	WEP	C	R*4	N.R.	WES	C	R*4	N.R.
WFC	C	R*4	N.R.	WFE	C	R*4	N.R.	WFR	C	R*4	N.R.	WFS	C	R*4	N.R.
WFW	C	R*4	N.R.	WFL	C	R*4	N.R.	WHT	C	R*4	N.R.	WLG	C	R*4	N.R.
WMC	C	R*4	N.R.	WPC	C	R*4	N.R.	WPH	C	R*4	N.R.	WRC	C	R*4	N.R.
WSC	C	R*4	N.R.	WST	C	R*4	N.R.	WTM	C	R*4	N.R.	WVA	C	R*4	N.R.
WVT	C	R*4	N.R.	XLB F	C	R*4	0009AC	XLR F	C	R*4	0009B8	XLW F	C	R*4	0C09BC
XMR	C	R*4	N.R.	ALFD SF		R*4	000440	ALFR SFA	C	R*4	000648	ARHT	C	R*4	N.R.
ARVT	C	R*4	N.R.	BHPA SF	C	R*4	000650	BHPP F	C	R*4	0009D4	BHPR SF	C	R*4	0C0654
CDHT	C	R*4	N.R.	CCVT	C	R*4	N.R.	CKFF F	C	R*4	00C050	CKHT	C	R*4	N.R.
CKVT	C	R*4	N.R.	CAM1	C	R*4	N.R.	DAM2	C	R*4	N.R.	CAM3	C	R*4	N.R.
DAM4	C	R*4	N.R.	CAM5	C	R*4	N.R.	DELR F	C	R*4	0003FC	CRAG SF XF		R*4	000000
DVOL	C	R*4	N.R.	ELDN	C	R*4	N.R.	ELDT	C	R*4	N.R.	ELHT	C	R*4	N.R.
ELDA	C	R*4	N.R.	ELVT	C	R*4	N.R.	EMLF	C	R*4	N.R.	ETAP SF	C	R*4	0C06E8
ETAT F	C	R*4	000198	FEHI	C	R*4	N.R.	FEHL	C	R*4	N.R.	FEHT	C	R*4	N.R.
FEVT	C	R*4	N.R.	FEWH	C	R*4	N.R.	FEWI	C	R*4	N.R.	GAPI	C	R*4	N.R.
GAP2	C	R*4	N.R.	GAP3	C	R*4	N.R.	GAP4	C	R*4	N.R.	GAP5	C	R*4	N.R.
GAP6	C	R*4	N.R.	GAP7	C	R*4	N.R.	HFIN	C	R*4	N.R.	LIFT SF XF		I*4	0C0000
LTHL	C	I*4	N.R.	FEFF SF	C	R*4	0C0860	PLIN	C	R*4	N.R.	RELI	C	R*4	N.R.
RMAX F	C	R*4	000410	RTOD SF		R*4	000444	SHPA	C	R*4	N.R.	SHPR F	C	R*4	0C0898
SHTE	C	R*4	N.R.	SHTW	C	R*4	N.R.	SKAC	C	R*4	N.R.	SKAR	C	R*4	N.R.
SKCC	C	R*4	N.R.	SKFS	C	R*4	N.R.	SKFW	C	R*4	N.R.	SKHL	C	R*4	N.R.
SKHT	C	R*4	N.R.	SKLG	C	R*4	N.R.	SKMC	C	R*4	N.R.	SKPA	C	R*4	N.R.
SKPH	C	R*4	N.R.	SKRC	C	R*4	N.R.	SKSC	C	R*4	N.R.	SKTM	C	R*4	N.R.

7-73



SKVT	C	R*4	N.R.	SKWP	C	R*4	N.R.	SKWW	C	R*4	N.R.	SK10	C	R*4	N.R.				
SK11	C	R*4	N.R.	SK12	C	R*4	N.R.	SK13	C	R*4	N.R.	SK14	C	R*4	N.R.				
SK15	C	R*4	N.R.	SLMP	C	R*4	N.R.	STPW	C	R*4	N.R.	SVTE	C	R*4	N.R.				
SVTW	C	R*4	N.R.	SWTT	C	R*4	N.R.	TBHI	C	R*4	N.R.	TBHI	FA	C	R*4	0004E8			
TBTC	C	R*4	N.R.	TCHT	C	R*4	N.R.	TCLN	C	R*4	N.R.	TCVT	C	R*4	N.R.				
TINY	C	R*4	N.R.	TIN2	C	R*4	N.R.	TIN4	F	C	R*4	0003D4	TMAX	C	R*4	N.R.			
TOVW	C	R*4	N.R.	THTH	C	R*4	N.R.	VMAX	SF	C	R*4	000448	WBAL	C	R*4	N.R.			
WENV	C	R*4	N.R.	WFUL	C	R*4	N.R.	WGSB	C	R*4	N.R.	WPDS	C	R*4	N.R.				
WPEI	C	R*4	N.R.	WPRB	C	R*4	N.R.	WPRG	C	R*4	N.R.	WPRP	C	R*4	N.R.				
WPCA	C	R*4	N.R.	WSCA	C	R*4	N.R.	XLBH	C	R*4	N.R.	XLGD	C	R*4	N.R.				
XLHL	F	C	R*4	0005B4	YLS2	SF	C	R*4	0009C0	ALFDL	SF	C	R*4	00C644	ATMIY	C	R*4	N.R.	
ATMGS	SF	XF	R*4	0000C0	CBARF	C	R*4	N.R.	CBARW	C	R*4	N.R.	CLDES	C	R*4	N.R.			
CLEYE	C	R*4	N.R.	CFIND	C	R*4	N.R.	CPNUD	C	R*4	N.R.	CPPAR	C	R*4	N.R.				
CPPRC	C	R*4	N.R.	CFTCT	C	R*4	N.R.	CRUS3	C	R*4	00044C	DELTA	C	R*4	N.R.				
DELTH	C	R*4	N.R.	DELWF	C	R*4	N.R.	DELWP	C	R*4	N.R.	DSWET	C	R*4	N.R.				
ELDOA	C	R*4	N.R.	ENPCR	F	C	R*4	000438	ETAP2	C	R*4	N.R.	ETAP4	SF	C	R*4	00071C		
FACTR	F	XF	R*4	000CC0	FETCT	C	R*4	N.R.	GMDD1	C	R*4	N.R.	HMAXD	C	R*4	N.R.			
ICRUS	F	I*4	000450	ICUM5	C	I*4	N.R.	NOCPP	C	I*4	N.R.	KCXPJ	C	I*4	N.R.				
PFET2	C	R*4	N.R.	PCWER	SF	XF	R*4	000000	REALJ	C	R*4	N.R.	RHPMR	F	C	R*4	000874		
SIGMA	C	R*4	N.R.	SIGMR	C	R*4	N.R.	SKAMD	C	R*4	N.R.	SKBAL	C	R*4	N.R.				
SKGB1	C	R*4	N.R.	SKGB2	C	R*4	N.R.	SKPDS	C	R*4	N.R.	SKPEI	C	R*4	N.R.				
SKPES	C	R*4	N.R.	SKPRB	C	R*4	N.R.	SKRBF	C	R*4	N.R.	SKRCA	C	R*4	N.R.				
SKSCA	C	R*4	N.R.	SLMVT	C	R*4	N.R.	STMAX	C	R*4	N.R.	SKETH	C	R*4	N.R.				
SWEXP	C	R*4	N.R.	SWWET	C	R*4	N.R.	S2RHO	C	R*4	N.R.	TBCL1	C	R*4	N.R.				
TBCRP	FA	C	R*4	0004FC	TEEM5	FA	C	R*4	000164	TBPOW	FA	C	R*4	000530	TBSFC	FA	C	R*4	00051G
TGBAR	C	R*4	N.R.	TETA	FA	C	R*4	0008EC	TPROP	S	C	R*4	0008F8	TVCMR	C	R*4	N.R.		
VBARH	C	R*4	N.R.	VEARV	C	R*4	N.R.	VDIVE	C	R*4	N.R.	VGASB	C	R*4	N.R.				
VGASR	C	R*4	N.R.	WPAYL	C	R*4	N.R.	WPSTR	C	R*4	N.R.	XLALB	C	R*4	N.R.				
XLBWG	C	R*4	N.R.	XLINT	F	XF	R*4	000000	XLRLA	C	R*4	N.R.	ALFDES	C	R*4	N.R.			
BHPSUP	SF	C	R*4	000658	CBARFT	C	R*4	N.R.	CBARVT	C	R*4	N.R.	CBYLCA	C	R*4	N.R.			
CLALPH	C	R*4	N.R.	CRSIND	C	R*4	N.R.	CTSIGH	C	R*4	N.R.	CYCPRL	C	R*4	N.R.				
DELFCR	F	C	R*4	000424	DELRTH	F	C	R*4	00068C	DELTA	SF	C	R*4	000454	DELWFC	C	R*4	N.R.	
DELWPL	C	R*4	N.R.	DELWST	C	R*4	N.R.	DLWSH	C	R*4	N.R.	DLTAFE	C	R*4	N.R.				
DLVLHL	C	R*4	N.R.	DRGIND	C	R*4	N.R.	DSPLMT	C	R*4	N.R.	DYLIND	C	R*4	N.R.				
ELHLQA	C	R*4	N.R.	ELVLCA	C	R*4	N.R.	ETAIND	C	R*4	N.R.	ETAP4N	F	C	R*4	000160			
EXPDRG	C	R*4	N.R.	FEDRAG	C	R*4	N.R.	FIXIND	C	R*4	N.R.	FWRNL#	F	XF	I*4	000000			
GAMD11	C	R*4	N.R.	HLLIND	C	R*4	N.R.	IBCOM#	F	XF	I*4	000000	INCCRU	C	I*4	N.R.			
IADDRG	C	I*4	N.R.	INCCYL	C	I*4	000828	INDETA	C	I*4	00082C	INCFIX	C	I*4	N.R.				
IADHUL	C	I*4	N.R.	INCCPT	C	I*4	N.R.	INDOSW	C	I*4	N.R.	INDPOW	C	I*4	N.R.				
IADPRP	C	I*4	N.R.	INDROP	C	I*4	N.R.	IPRINT	C	I*4	00084C	NCRUS3	F	C	R*4	800809			
NETAP4	SFA	I*4	000458	CPTIND	C	R*4	N.R.	OSWIND	C	R*4	N.R.	PRPIND	C	R*4	N.R.				
RCMIND	C	R*4	N.R.	FFCRHO	C	R*4	N.R.	ROTPOW	SF	XF	R*4	000000	SGTIND	C	R*4	N.R.			
SKBLNT	C	R*4	N.R.	SKENV1	C	R*4	N.R.	SKENV2	C	R*4	N.R.	SKPDSZ	C	R*4	N.R.				
SKVTAR	C	R*4	N.R.	SSIGMA	F	C	R*4	0008AC	STHETA	C	R*4	N.R.	TBCDWI	C	R*4	N.R.			
TBBAP4	FA	C	R*4	000178	TETMR	C	R*4	N.R.	TOLIND	C	R*4	N.R.	VGBOVH	C	R*4	N.R.			
WBALNT	C	R*4	N.R.	WPAYLC	C	R*4	N.R.	XTGTA2	C	R*4	N.R.	XTGTA4	C	R*4	N.R.				

7-74

\*\*\*\* COMMON INFORMATION \*\*\*\*

NAME OF COMMON BLOCK \* \* SIZE OF BLOCK 0009DC HEXADECIMAL BYTES

VAR. NAME	TYPE	REL. ADDR.	VAR. NAME	TYPE	REL. ADDR.	VAR. NAME	TYPE	REL. ADDR.	VAR. NAME	TYPE	REL. ADDR.
OPTIND	R*4	N.R.	FULINC	R*4	N.R.	DYLIND	R*4	N.R.	DRGIND	R*4	N.R.
OSWIND	R*4	N.R.	FIXINC	R*4	N.R.	RDMIND	R*4	N.R.	PKPIND	R*4	N.R.
ETAIND	R*4	N.R.	WC	R*4	N.R.	XLBWO	R*4	N.R.	XLRLA	R*4	N.R.
VGBCVF	R*4	N.R.	XLCC	R*4	N.R.	HMAXD	R*4	N.R.	RHORHO	R*4	N.R.
VMC	R*4	000040	EMLF	R*4	N.R.	CK1	R*4	N.R.	DELWF	R*4	N.R.
CKFF	R*4	000050	VDIVE	R*4	N.R.	HOO	R*4	N.R.	RCO	R*4	N.R.
TCC	R*4	N.R.	GAP1	R*4	N.R.	SGTIND	R*4	N.R.	ELHLOA	R*4	N.R.
ELVLCA	R*4	N.R.	GAP2	R*4	N.R.	AR	R*4	N.R.	WS	R*4	N.R.
TCR	R*4	N.R.	TCT	R*4	N.R.	SLM	R*4	N.R.	ARHT	R*4	N.R.
TCHT	R*4	N.R.	VBARH	R*4	N.R.	SLMH	R*4	N.R.	ARVT	R*4	N.R.
TCVT	R*4	N.R.	VEARV	R*4	N.R.	SLMVT	R*4	N.R.	ELDN	R*4	N.R.
ELCT	R*4	N.R.	ELDCA	R*4	N.R.	DLWSH	R*4	N.R.	DSWET	R*4	N.R.
DLVLFL	R*4	N.R.	CVCL	R*4	N.R.	CBYLOA	R*4	N.R.	ENR	R*4	00011C
WVA	R*4	N.R.	CAM1	R*4	N.R.	DAM2	R*4	N.R.	BMR	R*4	N.R.
CAM3	R*4	N.R.	CLEYE	R*4	N.R.	THETMR	R*4	N.R.	XC	R*4	N.R.
XMR	R*4	N.R.	TVCMR	R*4	N.R.	VT	R*4	N.R.	CTSIGH	R*4	N.R.
TW	R*4	N.R.	FES	R*4	N.R.	TINY	R*4	N.R.	ETAP2	R*4	N.R.
ETAP4N	R*4	000160	TBEM5	R*4	000164	TB8AP4	R*4	000178	GAP3	R*4	N.R.
CAM4	R*4	N.R.	ENF	R*4	000194	ETAT	R*4	000198	HC	R*4	N.R.
VC	R*4	N.R.	ATMIY	R*4	N.R.	CDVT	R*4	N.R.	CDHT	R*4	N.R.
CAM5	R*4	N.R.	CLTAFE	R*4	N.R.	FEDRAG	R*4	N.R.	EXPDRG	R*4	N.R.
CCC	R*4	N.R.	CLALFF	R*4	N.R.	CKVT	R*4	N.R.	CKHT	R*4	N.R.
CKF	R*4	N.R.	CKW	R*4	N.R.	RELI	R*4	N.R.	TCLN	R*4	N.R.
TBCLI	R*4	N.R.	TBCDWI	R*4	N.R.	GAP4	R*4	N.R.	WFE	R*4	N.R.
WFLI	R*4	N.R.	DELWFC	R*4	N.R.	DELWP	R*4	N.R.	DELWST	R*4	N.R.
SKCC	R*4	N.R.	SKRC	R*4	N.R.	SKSC	R*4	N.R.	SKFW	R*4	N.R.
SKTM	R*4	N.R.	SKRCA	R*4	N.R.	SKSCA	R*4	N.R.	SKMC	R*4	N.R.
SKAC	R*4	N.R.	SKFL	R*4	N.R.	SKENV1	R*4	N.R.	SKENV2	R*4	N.R.
SKCE1	R*4	N.R.	SKGB2	R*4	N.R.	SKBLNT	R*4	N.R.	SKBAL	R*4	N.R.
SKLG	R*4	N.R.	SKW	R*4	N.R.	ELF	R*4	N.R.	RMI	R*4	N.R.
SKWP	R*4	N.R.	SKHT	R*4	N.R.	SKVT	R*4	N.R.	SKPRB	R*4	N.R.
SKREF	R*4	N.R.	SKPI	R*4	N.R.	SKAMD	R*4	N.R.	SKAR	R*4	N.R.
SKFA	R*4	N.R.	SKVIAF	R*4	N.R.	SKPDS	R*4	N.R.	SKPDSZ	R*4	N.R.
SKT	R*4	N.R.	SKFS	R*4	N.R.	SKPEI	R*4	N.R.	SKPES	R*4	N.R.
SK1	R*4	N.R.	SK2	R*4	N.R.	DK3	R*4	N.R.	DK4	R*4	N.R.
SK5	R*4	N.R.	SK6	R*4	N.R.	SK7	R*4	N.R.	SK8	R*4	N.R.
SK9	R*4	N.R.	SK10	R*4	N.R.	SK11	R*4	N.R.	SK12	R*4	N.R.
SK13	R*4	N.R.	SK14	R*4	N.R.	SK15	R*4	N.R.	PLIN	R*4	N.R.
GAP5	R*4	N.R.	TCLINC	R*4	N.R.	XTGTA2	R*4	N.R.	TIN2	R*4	N.R.
TWTW	R*4	N.R.	PFET2	R*4	N.R.	DELTH	R*4	N.R.	STH	R*4	N.R.
CRSIND	R*4	N.R.	XTGTA4	R*4	N.R.	TIN4	R*4	0003D4	VIN	R*4	N.R.
DELIR	R*4	0003FC	RYA7	R*4	000410	DELFCR	R*4	000424	ENPCR	R*4	000438
DELWFL	R*4	N.R.	STPH	R*4	N.R.	HFIN	R*4	N.R.	GAP6	R*4	N.R.
CYCPFL	R*4	N.R.	FF	R*4	0004B4	SK3	R*4	N.R.	SK4	R*4	N.R.
TBHI	R*4	N.R.	TBTC	R*4	N.R.	TBH2	R*4	0004E8	TBCRP	R*4	0004FC
TBSFC	R*4	000510	TBPC	R*4	000530	GAP7	R*4	N.R.	ALFDES	R*4	N.R.
ALFCL	R*4	000644	ALFF	R*4	000648	AMU	R*4	00064C	BHPA	R*4	000650
BHPR	R*4	000654	BHPSLF	R*4	000658	BHT	R*4	N.R.	BLP	R*4	000660
ER	R*4	000664	BS	R*4	N.R.	BVT	R*4	N.R.	CBARF	R*4	N.R.
CBARFT	R*4	N.R.	CBARVT	R*4	N.R.	CBARW	R*4	N.R.	CCP	R*4	N.R.

CCI	R*4	N.R.	CCV	R*4	N.R.	CLW	R*4	00068C	CPIND	R*4	N.R.
CPALC	R*4	N.R.	CPPAF	R*4	N.R.	CPPRO	R*4	N.R.	CPTOT	R*4	N.R.
CFT	R*4	N.R.	CTF	R*4	N.R.	CV	R*4	N.R.	CX	R*4	0006B0
CLDES	R*4	N.R.	CE	R*4	N.R.	DELRTH	R*4	0006BC	DELTA	R*4	N.R.
CH	R*4	N.R.	CSPLMT	R*4	N.R.	ELC	R*4	N.R.	ELHT	R*4	N.R.
ELN	R*4	N.R.	ELOA	R*4	N.R.	ELT	R*4	N.R.	ELVT	R*4	N.R.
EN	R*4	0006E4	ETAF	R*4	0006E8	FEH	R*4	N.R.	FEHI	R*4	N.R.
FEFL	R*4	N.R.	FEFT	R*4	N.R.	FET	R*4	N.R.	FETCT	R*4	N.R.
FEVT	R*4	N.R.	FEW	R*4	N.R.	FEWH	R*4	N.R.	FEWI	R*4	N.R.
FM	R*4	N.R.	FF	R*4	000718	ETAP4	R*4	00071C	GAMD11	R*4	N.R.
GLF	R*4	N.R.	GMCCI	R*4	N.R.	H	R*4	000818	IDUM5	I*4	N.R.
INDCFU	I*4	N.R.	INDCRG	I*4	N.R.	INDOYL	I*4	000828	INDETA	I*4	00082C
INDFIX	I*4	N.R.	INDHUL	I*4	N.R.	INDOPT	I*4	N.R.	INDCSW	I*4	N.R.
INDFCW	I*4	N.R.	INCPRP	I*4	N.R.	INDRDM	I*4	N.R.	IPRINT	I*4	00084C
LTHL	I*4	N.R.	NGCPF	I*4	N.R.	NOXPJ	I*4	N.R.	CWE	R*4	N.R.
PEFF	R*4	000860	FI	R*4	000864	Q	R*4	000868	RHO	R*4	00086C
REALJ	R*4	N.R.	RHPMR	R*4	000874	R	R*4	000878	RN	R*4	00087C
SA	R*4	N.R.	SAS	R*4	N.R.	SA6	R*4	N.R.	SA7	R*4	N.R.
SFC	R*4	000890	S+PA	R*4	N.R.	SHPR	R*4	000898	SHT	R*4	N.R.
S+TE	R*4	N.R.	SHTA	R*4	N.R.	SIGMA	R*4	N.R.	SSIGMA	R*4	0008AC
ST	R*4	0008B0	STHETA	R*4	N.R.	STMAX	R*4	N.R.	SVT	R*4	N.R.
SVTE	R*4	N.R.	SVTH	R*4	N.R.	SW	R*4	N.R.	SWETH	R*4	N.R.
SWEXP	R*4	N.R.	SWTT	R*4	N.R.	SWWET	R*4	N.R.	S2RHO	R*4	N.R.
T	R*4	0008EC	TAF	R*4	N.R.	TCBAR	R*4	N.R.	THETA	R*4	0008EC
TMAX	R*4	N.R.	TMP	R*4	0008F4	TPROP	R*4	0008F8	TR	R*4	N.R.
LLF	R*4	N.R.	VGASE	R*4	N.R.	VGASR	R*4	N.R.	VHL	R*4	N.R.
V	R*4	000910	V	R*4	000914	WBAL	R*4	N.R.	WBALNT	R*4	N.R.
WCC	R*4	N.R.	WE	R*4	N.R.	WEP	R*4	N.R.	WES	R*4	N.R.
WF	R*4	000930	WFC	R*4	N.R.	WFR	R*4	N.R.	WFS	R*4	N.R.
WFW	R*4	N.R.	WGSE	R*4	N.R.	WHL	R*4	N.R.	WFT	R*4	N.R.
WLG	R*4	N.R.	WMC	R*4	N.R.	WPAYL	R*4	N.R.	WPC	R*4	N.R.
WPCS	R*4	N.R.	WFEI	R*4	N.R.	WPH	R*4	N.R.	WPRB	R*4	N.R.
WPRG	R*4	N.R.	WFRF	R*4	N.R.	WPSTR	R*4	N.R.	WRC	R*4	N.R.
WRCA	R*4	N.R.	WSC	R*4	N.R.	WSCA	R*4	N.R.	WST	R*4	N.R.
WTM	R*4	N.R.	WVT	R*4	N.R.	WW	R*4	N.R.	WPAYLO	R*4	N.R.
WAC	R*4	N.R.	WENV	R*4	N.R.	XLALB	R*4	N.R.	XLB	R*4	0009AC
XLBH	R*4	N.R.	XLHL	R*4	0009B4	XLR	R*4	000988	XLW	R*4	0009BC
YLS2	R*4	0009C0	TGVH	R*4	N.R.	DMR	R*4	0009C8	SIGMR	R*4	N.R.
AF	R*4	N.R.	BHPF	R*4	0009D4	SEE	R*4	N.R.			

7-76

ORIGINAL PAGE IS  
OF POOR QUALITY

LABEL	ADDR	LABEL	ADDR	LABEL	ADDR	LABEL	ADDR	PAGE 009
1	0CC742	2	CCC7E6	4	CC07A4	5	000806	
3	0CC832	6	CCC87E	7	CC08F0	9	000964	
11	0CC578	16	CCC57E	14	0CC980	15	0009CC	
8	CCC9FC	10	CCCA42	17	CCCA4E	12	000A5E	
13	0CCA7C	20	CC0BCE	21	CC0BD6	300	000C16	
302	CCCC22							

\*OPTIONS IN EFFECT\* NAME= MAIN,CPT=C2,LINECNT=54,SIZE=0000K,

\*OPTIONS IN EFFECT\* SOURCE,EBCDIC,NCLIST,ACDECK,LOAD,MAP,NCEDIT,ID,NOXREF

\*STATISTICS\* SOURCE STATEMENTS = 141 ,PROGRAM SIZE = 3166

\*STATISTICS\* NO DIAGNOSTICS GENERATED

\*\*\*\*\* END OF CCMPILATION \*\*\*\*\*

95K BYTES OF CCRE NOT USED

7-77

ORIGINAL PAGE IS  
OF POOR QUALITY

COMPILER OPTIONS - NAME= MAIN,OPT=02,LINECNT=54,SIZE=0000K,  
SOURCE,EBCDIC,NULIST,NODECK,LOAD,MAP,NODEDIT,ID,NOXREF

ISN 0002	SUBROUTINE DRAG(ALFR)						00C10000	
	C****	MEMBER NAME B01DRAG					00020000	
	C	PAGE 1	INPUT	LOC 0001	THRU 0050	00030000		
ISN 0003		COMMON	OPTIND	,HULIND	,DYLIND	,DRGIND	,OSWIND	,00C40000
		1FIXIND	,RDMIND	,PRPIND	,ETAIND	,WO	,XLBWO	,00050000
		2XLRLA	,VGBOVH	,XLGD	,HMAXD	,RHORHO	,VMO	,00060000
		3EMLF	,CK1	,DELWF	,CKFF	,VDIVE	,HDO	,00070000
		4ROO	,TOO	,GAP1(5)	,SGTIND(12)	,ELHLOA	,ELVLOA	,00C80000
		5GAP2(6)						00C90000
	C	PAGE 2	INPUT	LOC 0051	THRU 0100	00100000		
ISN 0004		COMMON	AK	,WS	,TCR	,TCT	,SLM	,00110000
		1ARHT	,TCHT	,VBARH	,SLMH	,ARVT	,TCVT	,00120000
		2VBARV	,SLMVT	,ELDN	,ELDT	,ELDOA	,DLSWSH	,00130000
		3DSWET	,DLVLHL	,DVUL	,CBYLOA	,ENR	,WVA	,00140000
		4DAMI	,DAM2	,BMR	,DAM3	,CLEYE	,THETMR	,00150000
		5XC	,XMR	,TVCMR	,VT	,CTSIGH	,TVW	00160000
ISN 0005		COMMON	HES	,TINY	,ETAP2	,ETAP4N	,TBEM5(5)	,00170000
		1TB8AP4(5)	,GAP3					00180000
	C	PAGE 3	INPUT	LOC 0101	THRU 140	00190000		
ISN 0006		COMMON	DAM4	,ENP	,ETAT	,HC	,VC	,00200000
		1ATHIY	,CDVT	,CDHT	,DAM5	,DLTAFE	,FEDRAG	,00210000
		2EXPDRG	,CDC	,CLALPH	,CKVT	,CKHT	,CKF	,00220000
		3CKW	,KELI	,TCLN	,TBCLI(8)	,TBCDWI(8)	,GAP4(4)	00230000
	C	PAGE 4	INPUT	LOC 141	THRU 200	WEIGHT DATA	00240000	
ISN 0007		COMMON	WFE	,WFUL	,DELWFC	,DELWP	,DELWST	,00250000
		1SKCC	,SKRC	,SKSC	,SKFW	,SKTM	,SKKCA	,00260000
		2SKSCA	,SKMC	,SKAC	,SKHL	,SKENV1	,SKENV2	,00270000
		3SKGB1	,SKGB2	,SKHLNT	,SKBAL	,SKLG	,SKWW	,00280000
		4ELF	,RMI	,SKWP	,SKHT	,SKVT	,SKPRB	,00290000
		5SKR8F	,SKPH	,SKAMD	,SKAR	,SKPA	,SKVTAR	,00300000
		6SKPDS	,SKPDSZ	,SKT	,SKFS	,SKPEI	,SKPES	,00310000
		7SK1	,SK2	,DK3	,DK4	,SK5	,SK6	,00320000
		8SK7	,SK8	,SK9	,SK10	,SK11	,SK12	,00330000
		9SK13	,SK14	,SK15	,PLIN	,GAP5(3)		00340000
	C	PAGE 5	INPUT	LOC 201	THRU 300	00350000		
ISN 0008		COMMON	TGLIND(5)	,XTGTA2(5)	,TIN2(5)	,TWTW(5)	,PFET2(5)	,00360000
		1DELTH(5)	,STH(5)	,CRSIND(5)	,XTGTA4(5)	,TIN4(5)	,VIN(5)	,00370000
		2DELRL(5)	,RMAX(5)	,DELFCR(5)	,ENPCR(5)	,DELWPL(5)	,STPW(5)	,00380000
		3HFIN(5)	,GAP6(10)					00390000
	C	PAGE 6	INPUT	LOC 301	THRU 400	00400000		
ISN 0009		COMMON	CYCPRL	,FF	,SK3	,SK4	,TBH1(5)	,00410000
		1TBTO(5)	,TBH2(5)	,TBCRP(5)	,TBSFC(8)	,TBPDW(8)	,GAP7(60)	00420000
	C	WORKING COMMON						00430000
ISN 0010		COMMON	ALFDES,ALFDL,DUM1,AMU,					00440000
		1	BHPA,BHPR,BHPSUP,BHT,BLP,BR,BS,BVT,					00450000
		2	CBARF,CBARHT,CBARVT,CBARW,CCP,CCT,CDV,CLW,CPIND,CPNUD,CPPAR,CPPKG					00460000
		3	CPTOT,CRT,CTP,CV,CX,CLDES,CB,					00470000
		4	DELRTH,DELTA,DH,DSPLMT,	ELC,ELHT,ELN,ELOA,ELT,ELVT,EN,ETAP,				00480000
		5	FEH,FEHI,FEHL,FEHT,FET,FETOT,FEVT,FEWH,FEWI,FM,FP,ETAP4					00490000
ISN 0011		COMMON	GAMU1(3,15),GLF,GMDD1(16),H,					00500000

7-78

	7	ICRUS, INDCRU, INDDRG, INDDYL, INDETA, INDFIX, INCHUL, INDOPT, INDOSW,	00510000
	8	INDPOW, INDPKP, INDRDM, IPRINT	00520000
ISN 0012		COMMON LTHL, NCCPP, NXPJ, OWE, PEHF, PI, Q, RHO, REALJ, RHPMK, R, RN	00530000
ISN 0013		COMMON SA, SA5, SA6, SA7, SFC, SHPA, SHPR, SHT, SHTE, SHTN, SIGMA, SSIGMA, ST,	00540000
		1STHETA, STMAX, SVT, SVTE, SVTW, SW, SWETH, SWEXP, SWTT, SWWT, S2RHO	00550000
ISN 0014		COMMON T, TAF, TCBAR, THETA, TMAX, TMP, TPROP, TK, ULF, VGASB, VGASR, VHL, V	00560000
ISN 0015		COMMON W, WBAL, WBALNT, WCC, WE, WEP, WES, WF, WFC, WFK, WFS, WFW,	00570000
		1 WGSB, WHL, WHT, WLG, WMC, WPAYL, WPC, WPDS, WPEI, WPH, WPRB, WPRG, WPRP, WPSTR	00580000
		2, WRC, WRC A, WSC, WSCA, WST, WTM, hVT, WW, WPAYLO, WAC, WENV	00600000
ISN 0016		COMMON XLALB, XLB, XLBH, XLHL, XLR, XLW, YLS2, TOVW	00610000
ISN 0017		COMMON DMK, SIGMR, AF, BHPP, SEE	00610100
ISN 0018		NAMELIST /NDRAG/ FEWH, FEHI, FEWI, FEH, FET, T, AMU, CX, CDWI, Q, RHO, SA5, V	00620000
ISN 0019		NTCL=TCLN*0.01	00630000
ISN 0020		IF (INDY L.EQ.2.OR.INDY L.EQ.4) GO TO 10	00640000
ISN 0022		IF (INDHUL.GT.1) GO TO 10	00650000
ISN 0024		FEWH=0.	00660000
ISN 0025		FEHI=ELUA*DH*(CLALPH*ALFR**2+CDC*ALFR**2*ABS(ALFR))	00670000
ISN 0026		FEWI=0.	00680000
ISN 0027		GO TO 15	00690000
ISN 0028	10	IF (INDHUL.EQ.3) GO TO 17	00700000
ISN 0030		CDW I=XLINT(TBCL1, TBCDWI, CLW, NTCL, M)	00700100
ISN 0031		IF (N.NE.0) WRITE(6,1002)	00710000
ISN 0033		FEWH=SA6*CDWI*SW	00720000
ISN 0034		IF (INDHUL.EQ.1) GO TO 12	00730000
ISN 0036		FEWI=SW*(CLALPH*ALFR**2+CDC*ALFR**2*ABS(ALFR))	00740000
ISN 0037		FEHI=0.0	00750000
ISN 0038		GO TO 15	00760000
ISN 0039	12	FEHI=ELUA*DH*(CLALPH*ALFR**2+CDC*ALFR**2*ABS(ALFR))	00770000
ISN 0040		FEWI=SA7*CLW**2*SW	00780000
ISN 0041	15	FEH=SA5	00790000
ISN 0042		FET=FEH+FEWH+FEHI+FEWI	00800000
ISN 0043		Q=1.42636*RHO*V**2	00810000
ISN 0044		T=FET*Q	00820000
ISN 0045		IF (INDPRP.EQ.0) GO TO 16	00830000
ISN 0047		AMU=1.688*V/VT	00840000
ISN 0048		CX=2.*AMU**2*FET/(PI*DMR**2*ENR)	00850000
ISN 0049	1002	FORMAT(22X,34HTHIS ERROR IS IN THE CL,CDWI TABLE)	00860000
ISN 0050	16	RETURN	00880000
ISN 0051	17	FEWI=0.0	00880100
ISN 0052		FEHI=SW*(CLALPH*ALFR**2+CDC*ALFR**2*ABS(ALFR))	00880200
ISN 0053		FEWH=0.0	00880300
ISN 0054		GO TO 15	00880400
ISN 0055		END	00890000

NAME	TAG	TYPE	ADD.	NAME	TAG	TYPE	ADD.	NAME	TAG	TYPE	ADD.	NAME	TAG	TYPE	ADD.			
H	C	R#4	N.R.	M	FA	I#4	0000E8	Q	SF	C	R#4	000868	R	C	R#4	N.R.		
T	S	C	R#4	0008E0	V	F	C	R#4	000910.	W	C	R#4	N.R.	AF	C	R#4	N.R.	
AR	C	R#4	N.R.	BR	C	R#4	N.R.	BS	C	R#4	N.R.	CB	C	R#4	N.R.	N.R.		
CV	C	R#4	N.R.	CX	S	C	R#4	0006B0	DH	F	C	R#4	0006C4	EN	C	R#4	N.R.	
FF	C	R#4	N.R.	FM	C	R#4	N.R.	FP	C	R#4	N.R.	HC	C	R#4	N.R.	N.R.		
PI	F	C	R#4	000864	RN	C	R#4	N.R.	SA	C	R#4	N.R.	ST	C	R#4	N.R.		
SW	F	C	R#4	0008C8	TK	C	R#4	N.R.	VC	C	R#4	N.R.	VT	F	C	R#4	000148	
WE	C	R#4	N.R.	WF	C	R#4	N.R.	WO	C	R#4	N.R.	WS	C	R#4	N.R.	N.R.		
WW	C	R#4	N.R.	XC	C	R#4	N.R.	AMU	SF	C	R#4	00064C	BHT	C	R#4	N.R.		
BLP	C	R#4	N.R.	BMR	C	R#4	N.R.	BVT	C	R#4	N.R.	CCP	C	R#4	N.R.	N.R.		
CCT	C	R#4	N.R.	CDC	F	C	R#4	0001C0	CDV	C	R#4	N.R.	CKF	C	R#4	N.R.		
CKW	C	R#4	N.R.	CK1	C	R#4	N.R.	CLW	FA	C	R#4	00068C	CRT	C	R#4	N.R.		
CIP	C	R#4	N.R.	OK3	C	R#4	N.R.	DK4	C	R#4	N.R.	DMR	F	C	R#4	0009C8		
ELC	C	R#4	N.R.	ELF	C	R#4	N.R.	ELN	C	R#4	N.R.	ELT	C	R#4	N.R.	N.R.		
ENP	C	R#4	N.R.	ENR	F	C	R#4	00011C	FEH	SF	C	R#4	0006EC	FET	SF	C	R#4	0006FC
FEW	C	R#4	N.R.	GLF	C	R#4	N.R.	HES	C	R#4	N.R.	HOO	C	R#4	N.R.	N.R.		
QWE	C	R#4	N.R.	RHO	F	C	R#4	00086C	RMI	C	R#4	N.R.	ROO	C	R#4	N.R.		
SA5	F	C	R#4	000884	SA6	F	C	R#4	000888	SA7	F	C	R#4	00088C	SEE	C	R#4	N.R.
SEC	C	R#4	N.R.	SHT	C	R#4	N.R.	SKT	C	R#4	N.R.	SK1	C	R#4	N.R.	N.R.		
SK2	C	R#4	N.R.	SK3	C	R#4	N.R.	SK4	C	R#4	N.R.	SK5	C	R#4	N.R.	N.R.		
SK6	C	R#4	N.R.	SK7	C	R#4	N.R.	SK8	C	R#4	N.R.	SK9	C	R#4	N.R.	N.R.		
SLM	C	R#4	N.R.	SIH	C	R#4	N.R.	SVT	C	R#4	N.R.	TAF	C	R#4	N.R.	N.R.		
TCR	C	R#4	N.R.	TCT	C	R#4	N.R.	TMP	C	R#4	N.R.	TOO	C	R#4	N.R.	N.R.		
TVW	C	R#4	N.R.	ULF	C	R#4	N.R.	VHL	C	R#4	N.R.	VIN	C	R#4	N.R.	N.R.		
VMD	C	R#4	N.R.	WAC	C	R#4	N.R.	WCC	C	R#4	N.R.	WEP	C	R#4	N.R.	N.R.		
WES	C	R#4	N.R.	WFC	C	R#4	N.R.	WFE	C	R#4	N.R.	WFR	C	R#4	N.R.	N.R.		
WFS	C	R#4	N.R.	WFW	C	R#4	N.R.	WHL	C	R#4	N.R.	WHT	C	R#4	N.R.	N.R.		
WLG	C	R#4	N.R.	WMC	C	R#4	N.R.	WPC	C	R#4	N.R.	WPH	C	R#4	N.R.	N.R.		
WRC	C	R#4	N.R.	WSC	C	R#4	N.R.	WST	C	R#4	N.R.	WTM	C	R#4	N.R.	N.R.		
WVA	C	R#4	N.R.	WVT	C	R#4	N.R.	XLB	C	R#4	N.R.	XLR	C	R#4	N.R.	N.R.		
XLW	C	R#4	N.R.	XMR	C	R#4	N.R.	ALFR	FA	C	R#4	0000EC	ARHT	C	R#4	N.R.		
ARVT	C	R#4	N.R.	BHPA	C	R#4	N.R.	BHP	C	R#4	N.R.	BHPR	C	R#4	N.R.	N.R.		
CDHT	C	R#4	N.R.	CDVT	C	R#4	N.R.	CDWI	SF	C	R#4	0000F0	CKFF	C	R#4	N.R.		
CKHT	C	R#4	N.R.	CKVT	C	R#4	N.R.	DAMI	C	R#4	N.R.	DAM2	C	R#4	N.R.	N.R.		
DAM3	C	R#4	N.R.	DAM4	C	R#4	N.R.	DAMS	C	R#4	N.R.	DELR	C	R#4	N.R.	N.R.		
DRAG	C	R#4	0000F4	DUM1	C	R#4	N.R.	DVOL	C	R#4	N.R.	ELDN	C	R#4	N.R.	N.R.		
ELDT	C	R#4	N.R.	ELHT	C	R#4	N.R.	ELOA	F	C	R#4	0006D8	ELVT	C	R#4	N.R.		
EMLF	C	R#4	N.R.	ETAP	C	R#4	N.R.	ETAT	C	R#4	N.R.	FEHI	SF	C	R#4	0006F0		
FEHL	C	R#4	N.R.	FEHT	C	R#4	N.R.	FEVT	C	R#4	N.R.	FEWH	SF	C	R#4	00070C		
FEWI	SF	C	R#4	000710	GAP1	C	R#4	N.R.	GAP2	C	R#4	N.R.	GAP3	C	R#4	N.R.		
GAP4	C	R#4	N.R.	GAP5	C	R#4	N.R.	GAP6	C	R#4	N.R.	GAP7	C	R#4	N.R.	N.R.		
HFIN	C	R#4	N.R.	LTHL	C	I#4	N.R.	NTCL	SFA	C	I#4	0000F8	PEHF	C	R#4	N.R.		
PLIN	C	R#4	N.R.	RELI	C	R#4	N.R.	RMAX	C	R#4	N.R.	SHPA	C	R#4	N.R.	N.R.		
SHPR	C	R#4	N.R.	SHTI	C	R#4	N.R.	SHTW	C	R#4	N.R.	SKAC	C	R#4	N.R.	N.R.		
SKAR	C	R#4	N.R.	SKCC	C	R#4	N.R.	SKFS	C	R#4	N.R.	SKFW	C	R#4	N.R.	N.R.		
SKHL	C	R#4	N.R.	SKHT	C	R#4	N.R.	SKLG	C	R#4	N.R.	SKMC	C	R#4	N.R.	N.R.		
SKPA	C	R#4	N.R.	SKPH	C	R#4	N.R.	SKRC	C	R#4	N.R.	SKSC	C	R#4	N.R.	N.R.		
SKTM	C	R#4	N.R.	SKVT	C	R#4	N.R.	SKWP	C	R#4	N.R.	SKWW	C	R#4	N.R.	N.R.		
SK10	C	R#4	N.R.	SK11	C	R#4	N.R.	SK12	C	R#4	N.R.	SK13	C	R#4	N.R.	N.R.		
SK14	C	R#4	N.R.	SK15	C	R#4	N.R.	SLMH	C	R#4	N.R.	STPW	C	R#4	N.R.	N.R.		

7-80

SVTE	C	R*4	N.R.	SVTW	C	R*4	N.R.	SWTT	C	R*4	N.R.	TBHI	C	R*4	N.R.	
TBH2	C	R*4	N.R.	TBTO	C	R*4	N.R.	TCHT	C	R*4	N.R.	TCLN	F	C	R*4	0001DC
TCVT	C	R*4	N.R.	TINY	C	R*4	N.R.	TINZ	C	R*4	N.R.	TIN4	C	R*4	N.R.	
TMAX	C	R*4	N.R.	TUVW	C	R*4	N.R.	TWTW	C	R*4	N.R.	WBAL	C	R*4	N.R.	
WENV	C	R*4	N.R.	WFUL	C	R*4	N.R.	WGSB	C	R*4	N.R.	WPDS	C	R*4	N.R.	
WPEI	C	R*4	N.R.	WPRB	C	R*4	N.R.	WPRG	C	R*4	N.R.	WPRP	C	R*4	N.R.	
WRCA	C	R*4	N.R.	WSCA	C	R*4	N.R.	XLBH	C	R*4	N.R.	XLGD	C	R*4	N.R.	
XLHL	C	R*4	N.R.	YLS2	C	R*4	N.R.	ALFDL	C	R*4	N.R.	ATMIY	C	R*4	N.R.	
CBARF	C	R*4	N.R.	CBARW	C	R*4	N.R.	CLDES	C	R*4	N.R.	CLEYE	C	R*4	N.R.	
CPIND	C	R*4	N.R.	CPNUD	C	R*4	N.R.	CPPAR	C	R*4	N.R.	CPPRO	C	R*4	N.R.	
CPTOT	C	R*4	N.R.	DLLTA	C	R*4	N.R.	DELTH	C	R*4	N.R.	DELWF	C	R*4	N.R.	
DELAP	C	R*4	N.R.	DSWET	C	R*4	N.R.	ELDOA	C	R*4	N.R.	ENPCR	C	R*4	N.R.	
ETAP2	C	R*4	N.R.	ETAP4	C	R*4	N.R.	FETUT	C	R*4	N.R.	GMDD1	C	R*4	N.R.	
HMAXD	C	R*4	N.R.	ICRUS	C	I*4	N.R.	NDKAG	C	R*4	000000	NOCPP	C	I*4	N.R.	
NOXPJ	C	I*4	N.R.	PFET2	C	R*4	N.R.	REALJ	C	R*4	N.R.	RHPMR	C	R*4	N.R.	
SIGMA	C	R*4	N.R.	SIGMR	C	R*4	N.R.	SKAMD	C	R*4	N.R.	SKBAL	C	R*4	N.R.	
SKGB1	C	R*4	N.R.	SKGB2	C	R*4	N.R.	SKPDS	C	R*4	N.R.	SKPEI	C	R*4	N.R.	
SKPES	C	R*4	N.R.	SKPRB	C	R*4	N.R.	SKRBF	C	R*4	N.R.	SKRCA	C	R*4	N.R.	
SKSCA	C	R*4	N.R.	SLMVT	C	R*4	N.R.	STMAX	C	R*4	N.R.	SWETH	C	R*4	N.R.	
SWEXP	C	R*4	N.R.	SWWET	C	R*4	N.R.	S2KHU	C	R*4	N.R.	TBCL1	FA	C	R*4	0001E0
TBCRP	C	R*4	N.R.	TBEM5	C	R*4	N.R.	TBPOW	C	R*4	N.R.	TBSCF	C	R*4	N.R.	
TCBAR	C	R*4	N.R.	THETA	C	R*4	N.R.	TPRGP	C	R*4	N.R.	TVCMR	C	R*4	N.R.	
VBAKH	C	R*4	N.R.	VBARV	C	R*4	N.R.	VOIVE	C	R*4	N.R.	VGASB	C	R*4	N.R.	
VGASR	C	R*4	N.R.	WPAYL	C	R*4	N.R.	WPSTR	C	R*4	N.R.	XLALB	C	R*4	N.R.	
XLBWD	C	R*4	N.R.	XLINT	F	XF	R*4	000000	XLRLA	C	R*4	N.R.	ALFUE	C	R*4	N.R.
BHPSUP	C	R*4	N.R.	CBARHT	C	R*4	N.R.	CBARVT	C	R*4	N.R.	CBYLOA	C	R*4	N.R.	
CLALPH	F	C	R*4	0001C4	CRSIND	C	R*4	N.R.	CTSIGH	C	R*4	N.R.	CYCPRL	C	R*4	N.R.
DELFCR	C	R*4	N.R.	DELRTH	C	R*4	N.R.	DELWFC	C	R*4	N.R.	DELWPL	C	R*4	N.R.	
DELWST	C	R*4	N.R.	DLWSH	C	R*4	N.R.	JLTAFE	C	R*4	N.R.	DLVLHL	C	R*4	N.R.	
DRGIND	C	R*4	N.R.	DSPLMT	C	R*4	N.R.	DYLIND	C	R*4	N.R.	ELHLOA	C	R*4	N.R.	
ELVLOA	C	R*4	N.R.	ETAIND	C	R*4	N.R.	ETAP4N	C	R*4	N.R.	EXPDRG	C	R*4	N.R.	
FEDRAG	C	R*4	N.R.	FIXIND	C	R*4	N.R.	GAMD11	C	R*4	N.R.	HULIND	C	R*4	N.R.	
IBCOM#	F	XF	I*4	000000	INDCRU	C	I*4	N.R.	INDDRG	C	I*4	N.R.	INDDYL	C	I*4	000028
INDETA	C	I*4	N.R.	INDFIX	C	I*4	N.R.	INDHUL	C	I*4	000834	INDOPT	C	I*4	N.R.	
INDOSW	C	I*4	N.R.	INDPOW	C	I*4	N.R.	INDPRP	C	I*4	000844	INDRDM	C	I*4	N.R.	
IPRINT	C	I*4	N.R.	OPTIND	C	R*4	N.R.	OSWIND	C	R*4	N.R.	PRPIND	C	R*4	N.R.	
RDMIND	C	R*4	N.R.	RHORHO	C	R*4	N.R.	SGTIND	C	R*4	N.R.	SKBLNT	C	R*4	N.R.	
SKENV1	C	R*4	N.R.	SKENV2	C	R*4	N.R.	SKPDSZ	C	R*4	N.R.	SKVTAR	C	R*4	N.R.	
SSIGMA	C	R*4	N.R.	STHETA	C	R*4	N.R.	TBCDWI	FA	C	R*4	000200	TB8AP4	C	R*4	N.R.
THETM	C	R*4	N.R.	TOLIND	C	R*4	N.R.	VGBOVH	C	R*4	N.R.	WBALNT	C	R*4	N.R.	
WPAYLO	C	R*4	N.R.	XTGTA2	C	R*4	N.R.	XTGTA4	C	R*4	N.R.					

\*\*\*\*\* COMMON INFORMATION \*\*\*\*\*

NAME OF COMMON BLOCK * * SIZE OF BLOCK 0009DC HEXADECIMAL BYTES															
VAR. NAME	TYPE	REL.	ADDR.	VAR. NAME	TYPE	REL.	ADDR.	VAR. NAME	TYPE	REL.	ADDR.	VAR. NAME	TYPE	REL.	ADDR.
OPTIND	R*4	N.R.		HULIND	R*4	N.R.		DYLIND	R*4	N.R.		DRGIND	R*4	N.R.	
OSWIND	R*4	N.R.		FIXIND	R*4	N.R.		RDMIND	R*4	N.R.		PRPIND	R*4	N.R.	
ETAIND	R*4	N.R.		NO	R*4	N.R.		XLBWO	R*4	N.R.		XLRLA	R*4	N.R.	
VGBOVH	R*4	N.R.		XLGD	R*4	N.R.		HMAXD	R*4	N.R.		RHORHO	R*4	N.R.	



VMO	R*4	N.R.	EMLF	R*4	N.R.	CKI	R*4	N.R.	DELWF	R*4	N.R.
CKFF	R*4	N.R.	VDIVE	R*4	N.R.	HOO	R*4	N.R.	ROO	R*4	N.R.
TUO	R*4	N.R.	GAPI	R*4	N.R.	SGTIND	R*4	N.R.	ELHLGA	R*4	N.R.
ELVLDA	R*4	N.R.	GAP2	R*4	N.R.	AR	R*4	N.R.	WS	R*4	N.R.
TCR	R*4	N.R.	TCT	R*4	N.R.	SLM	R*4	N.R.	ARHT	R*4	N.R.
TCHT	R*4	N.R.	VBARH	R*4	N.R.	SLMH	R*4	N.R.	AKVT	R*4	N.R.
TCVT	R*4	N.R.	VBARV	R*4	N.R.	SLMVT	R*4	N.R.	ELDN	R*4	N.R.
ELDT	R*4	N.R.	ELUOA	R*4	N.R.	DLSW SH	R*4	N.R.	DSWET	R*4	N.R.
DLVLHL	R*4	N.R.	DVOL	R*4	N.R.	CBYLOA	R*4	N.R.	ENR	R*4	00011C
WVA	R*4	N.R.	DAM1	R*4	N.R.	DAM2	R*4	N.R.	BMR	R*4	N.R.
DAM3	R*4	N.R.	CLEYE	R*4	N.R.	THETMR	R*4	N.R.	XC	R*4	N.R.
XMR	R*4	N.R.	TVCMR	R*4	N.R.	VT	R*4	00014B	CTSIGH	R*4	N.R.
TVW	R*4	N.R.	HES	R*4	N.R.	TINY	R*4	N.R.	ETAP2	R*4	N.R.
ETAP4N	R*4	N.R.	TBEM5	R*4	N.R.	TBBAP4	R*4	N.R.	GAP3	R*4	N.R.
DAM4	R*4	N.R.	ENP	R*4	N.R.	ETAT	R*4	N.R.	HC	R*4	N.R.
VC	R*4	N.R.	ATMIY	R*4	N.R.	CUVT	R*4	N.R.	CDHT	R*4	N.R.
DAM5	R*4	N.R.	DLTAFE	R*4	N.R.	FEDRAC	R*4	N.R.	EXPDRG	R*4	N.R.
CHC	R*4	0001C0	CLALPH	R*4	0001C4	CKVT	R*4	N.R.	CKHT	R*4	N.R.
CKF	R*4	N.R.	CKW	R*4	N.R.	RELI	R*4	N.R.	TCLN	R*4	0001DC
TBCL1	R*4	0001E0	TBCDWI	R*4	000200	GAP4	R*4	N.R.	WFE	R*4	N.R.
WEUL	R*4	N.R.	DELWFC	R*4	N.R.	DELWP	R*4	N.R.	DELWST	R*4	N.R.
SKCC	R*4	N.R.	SKRC	R*4	N.R.	SKSC	R*4	N.R.	SKFW	R*4	N.R.
SKTM	R*4	N.R.	SKRCA	R*4	N.R.	SKSCA	R*4	N.R.	SKMC	R*4	N.R.
SKAC	R*4	N.R.	SKHL	R*4	N.R.	SKENVI	R*4	N.R.	SKENV2	R*4	N.R.
SKGB1	R*4	N.R.	SKGB2	R*4	N.R.	SKBLNT	R*4	N.R.	SKBAL	R*4	N.R.
SKLG	R*4	N.R.	SKWW	R*4	N.R.	ELF	R*4	N.R.	RMI	R*4	N.R.
SKWP	R*4	N.R.	SKHT	R*4	N.R.	SKVT	R*4	N.R.	SKPRB	R*4	N.R.
SKR9F	R*4	N.R.	SKPH	R*4	N.R.	SKAMD	R*4	N.R.	SKAR	R*4	N.R.
SKPA	R*4	N.R.	SKVTAR	R*4	N.R.	SKPUS	R*4	N.R.	SKPDSZ	R*4	N.R.
SKT	R*4	N.R.	SKFS	R*4	N.R.	SKPEI	R*4	N.R.	SKPES	R*4	N.R.
SK1	R*4	N.R.	SK2	R*4	N.R.	DK3	R*4	N.R.	DK4	R*4	N.R.
SK5	R*4	N.R.	SK6	R*4	N.R.	SK7	R*4	N.R.	SK8	R*4	N.R.
SK9	R*4	N.R.	SK10	R*4	N.R.	SK11	R*4	N.R.	SK12	R*4	N.R.
SK13	R*4	N.R.	SK14	R*4	N.R.	SK15	R*4	N.R.	PLIN	R*4	N.R.
GAP5	R*4	N.R.	TOLIND	R*4	N.R.	XTGTA2	R*4	N.R.	TIN2	R*4	N.R.
JWTA	R*4	N.R.	PFET2	R*4	N.R.	DELTH	R*4	N.R.	STH	R*4	N.R.
CRSIND	R*4	N.R.	XTGTA4	R*4	N.R.	TIN4	R*4	N.R.	VIN	R*4	N.R.
DELR	R*4	N.R.	RMAX	R*4	N.R.	DELFCR	R*4	N.R.	ENPCR	R*4	N.R.
DELWPL	R*4	N.R.	STPW	R*4	N.R.	HF IN	R*4	N.R.	GAP6	R*4	N.R.
CYCPHL	R*4	N.R.	FF	R*4	N.R.	SK3	R*4	N.R.	SK4	R*4	N.R.
TBH1	R*4	N.R.	TBTU	R*4	N.R.	TBH2	R*4	N.R.	TBCRP	R*4	N.R.
TBSEC	R*4	N.R.	TBPQW	R*4	N.R.	GAP7	R*4	N.R.	ALFDES	R*4	N.R.
ALFDL	R*4	N.R.	DUM1	R*4	N.R.	AMU	R*4	00064C	BHPA	R*4	N.R.
BHPR	R*4	N.R.	BHPSUP	R*4	N.R.	BHT	R*4	N.R.	BLP	R*4	N.R.
BH	R*4	N.R.	BS	R*4	N.R.	BVT	R*4	N.R.	CBARF	R*4	N.R.
CBARHT	R*4	N.R.	CBARVT	R*4	N.R.	CBARW	R*4	N.R.	CCP	R*4	N.R.
CCT	R*4	N.R.	CDV	R*4	N.R.	CLW	R*4	00068C	CPIND	R*4	N.R.
CPNUD	R*4	N.R.	CPPAR	R*4	N.R.	CPPRO	R*4	N.R.	CPTOT	R*4	N.R.
CRT	R*4	N.R.	CTP	R*4	N.R.	CV	R*4	N.R.	CX	R*4	0006B0
CLDES	R*4	N.R.	CB	R*4	N.R.	DELRTH	R*4	N.R.	DELTA	R*4	N.R.
DH	R*4	0006C4	DSPLMT	R*4	N.R.	ELC	R*4	N.R.	ELHT	R*4	N.R.
ELN	R*4	N.R.	ELOA	R*4	0006D8	ELT	R*4	N.R.	ELVT	R*4	N.R.

7-82

EN	R*4	N.R.	ETAP	R*4	N.R.	FEH	R*4	0006EC	FEHI	R*4	0006FO
FEHL	R*4	N.R.	FEHT	R*4	N.R.	FET	R*4	0006FC	FETUT	R*4	N.R.
FEVT	R*4	N.R.	FEW	R*4	N.R.	FEWH	R*4	00070C	FEWI	R*4	000710
FM	R*4	N.R.	FP	R*4	N.R.	ETAP4	R*4	N.R.	GAMDI	R*4	N.R.
GLF	R*4	N.R.	GMDD1	R*4	N.R.	H	R*4	N.R.	ICRUS	I*4	N.R.
INDCRU	I*4	N.R.	INDDRG	I*4	N.R.	INDDYL	I*4	000828	INDETA	I*4	N.R.
INDFIX	I*4	N.R.	INDHUL	I*4	000834	INDOPT	I*4	N.R.	INDUSW	I*4	N.R.
INDPOW	I*4	N.R.	INDPRP	I*4	000844	INDKDM	I*4	N.R.	IPRINT	I*4	N.R.
LTHL	I*4	N.R.	NOCPP	I*4	N.R.	NUXPJ	I*4	N.R.	OWE	R*4	N.R.
PEHF	R*4	N.R.	PI	R*4	000864	Q	R*4	000868	RHO	R*4	00086C
REALJ	R*4	N.R.	RHPMR	R*4	N.R.	R	R*4	N.R.	RN	R*4	N.R.
SA	R*4	N.R.	SA5	R*4	000884	SA6	R*4	000888	SA7	R*4	00088C
SFC	R*4	N.R.	SHPA	R*4	N.R.	SHPR	R*4	N.R.	SHT	R*4	N.R.
SHTE	R*4	N.R.	SHTW	R*4	N.R.	SIGMA	R*4	N.R.	SSIGMA	R*4	N.R.
ST	R*4	N.R.	STHETA	R*4	N.R.	SIMAX	R*4	N.R.	SVT	R*4	N.R.
SVTE	R*4	N.R.	SVTH	R*4	N.R.	SW	R*4	0008C8	SWETH	R*4	N.R.
SWEXP	R*4	N.R.	SWTT	R*4	N.R.	SWWET	R*4	N.R.	SZRHO	R*4	N.R.
T	R*4	0008E0	TAF	R*4	N.R.	TCBAR	R*4	N.R.	THETA	R*4	N.R.
TMAX	R*4	N.R.	TMP	R*4	N.R.	TPROP	R*4	N.R.	TR	R*4	N.R.
ULF	R*4	N.R.	VGASB	R*4	N.R.	VGASK	R*4	N.R.	VHL	R*4	N.R.
V	R*4	000910	W	R*4	N.R.	WBAL	R*4	N.R.	WBALNT	R*4	N.R.
WCC	R*4	N.R.	WE	R*4	N.R.	WEP	R*4	N.R.	WES	R*4	N.R.
WF	R*4	N.R.	WFC	R*4	N.R.	WFK	R*4	N.R.	WFS	R*4	N.R.
WFW	R*4	N.R.	WGSB	R*4	N.R.	WHL	R*4	N.R.	WHT	R*4	N.R.
WLG	R*4	N.R.	WMC	R*4	N.R.	WPAYL	R*4	N.R.	WPC	R*4	N.R.
WPDS	R*4	N.R.	WPEI	R*4	N.R.	WPH	R*4	N.R.	WPRB	R*4	N.R.
WPKG	R*4	N.R.	WPRP	R*4	N.R.	WPSTR	R*4	N.R.	WKC	R*4	N.R.
WRCA	R*4	N.R.	WSC	R*4	N.R.	WSCA	R*4	N.R.	WST	R*4	N.R.
WTM	R*4	N.R.	WVT	R*4	N.R.	WW	R*4	N.R.	WPAYLO	R*4	N.R.
WAC	R*4	N.R.	WENV	R*4	N.R.	XLALB	R*4	N.R.	XLB	R*4	N.R.
XLBH	R*4	N.R.	XLHL	R*4	N.R.	XLK	R*4	N.R.	XLW	R*4	N.R.
YLS2	R*4	N.R.	TOVW	R*4	N.R.	DMR	R*4	0009C8	SIGMR	R*4	N.R.
AF	R*4	N.R.	BHPP	R*4	N.R.	SEE	R*4	N.R.			

7-83

ORIGINAL PAGE IS  
OF POOR QUALITY

LABEL ADDR

LABEL ADDR

LABEL ADDR

LABEL ADDR

PAGE 007

10 000280  
17 0003B4

12 000302

15 000342

16 0003AC

\*OPTIONS IN EFFECT\* NAME= MAIN,OPT=02,LINECNT=54,SIZE=0000K,

\*OPTIONS IN EFFECT\* SOURCE,EBCDIC,NOLIST,NODECK,LOAD,MAP,NOEDIT,NOXREF

\*STATISTICS\* SOURCE STATEMENTS = 54 ,PROGRAM SIZE = 1054

\*STATISTICS\* NO DIAGNOSTICS GENERATED

\*\*\*\*\* END OF COMPILATION \*\*\*\*\*

107K BYTES OF CORE NOT USED

7-84

COMPILER OPTIONS = NAME= MAIN,OPT=02,LINENCT=54,SIZE=0000K,  
SOURCF,EBCDIC,NOLIST,NODECK,LOAD,MAP,NOEDIT, ID,NOXREF

ISN 0002		SUBROUTINE ENGSZ						00010000
	C***	MEMBER NAME B81ENGSZ						00020000
	C	PAGE 1	INPUT LOC 0001 THRU 0050					00030000
ISN 0003		COMMON	OPTIND ,HULIND ,DYLIND ,DRGIND ,OSWIND					00040000
		1FIXIND ,RDMIND ,PRPIND ,ETAIND ,KO						00050000
		2XLRLA ,VGBUVH ,XLGD ,HMAXD ,RHORHO ,VMO						00060000
		3EMLF ,CK1 ,DELWF ,CKFF ,VDIVE ,HOO						00070000
		4ROO ,TOO ,GAP1(5) ,SGTIND(12) ,ECLLOA ,ELVLOA						00080000
		5GAP2(6)						00090000
	C	PAGE 2	INPUT LOC 0051 THRU 0100					00100000
ISN 0004		COMMON	AR ,WS ,TCR ,TCT ,SLM					00110000
		1ARHT ,TCHT ,VBARH ,SLMH ,ARVT ,TCVT						00120000
		2VBARV ,SLMVT ,ELDN ,ELDT ,ELDOA ,DLSWSH						00130000
		3DSWET ,DLVHL ,DVOL ,CBYLOA ,ENR ,WVA						00140000
		4DAM1 ,DAM2 ,BMR ,DAM3 ,CLEYE ,THETMR						00150000
		5XC ,XMR ,TVCMR ,VT ,CTSIGH ,TVW						00160000
ISN 0005		COMMON	HES ,TINY ,ETAP2 ,ETAP4N ,TBEM5(5)					00170000
		1TB0AP4(5) ,GAP3						00180000
	C	PAGE 3	INPUT LOC 0101 THRU 140					00190000
ISN 0006		COMMON	DAM4 ,ENP ,ETAT ,HC ,VC					00200000
		1ATMIY ,CDVT ,CDHT ,DAMS ,DLTAFE ,FEDRAG						00210000
		2EXPDRG ,CDC ,CLALPH ,CKVT ,CKHT ,CKF						00220000
		3CKW ,KELI ,TCLN ,TBCLT(8) ,TBCDWT(8) ,GAP4(4)						00230000
	C	PAGE 4	INPUT LOC 141 THRU 200 WEIGHT DATA					00240000
ISN 0007		COMMON	WFE ,WFUL ,DELWFC ,DELWP ,DELWST					00250000
		1SKCC ,SKRC ,SKSC ,SKFW ,SKTM ,SKRCA						00260000
		2SKSCA ,SKMC ,SKAC ,SKHL ,SKENV1 ,SKENV2						00270000
		3SKGB1 ,SKGB2 ,SKBLNT ,SKBAL ,SKLG ,SKWW						00280000
		4ELF ,RMI ,SKAP ,SKHT ,SKVT ,SKPRB						00290000
		5SKRBF ,SKPH ,SKAMD ,SKAR ,SKPA ,SKVTAR						00300000
		6SKPDS ,SKPDSZ ,SKT ,SKFS ,SKPEI ,SKPES						00310000
		7SKI ,SK2 ,DK3 ,DK4 ,SK5 ,SK6						00320000
		8SK7 ,SK8 ,SK9 ,SK10 ,SK11 ,SK12						00330000
		9SKI3 ,SK14 ,SK15 ,PLIN ,GAP5(3)						00340000
	C	PAGE 5	INPUT LOC 201 THRU 300					00350000
ISN 0008		COMMON	TOLIND(5) ,XTGTA2(5) ,TIN2(5) ,TWTW(5) ,PFET2(5)					00360000
		1DELTH(5) ,STH(5) ,CRSIND(5) ,XTGTA4(5) ,TIN4(5) ,VIN(5)						00370000
		2DELK(5) ,RMAX(5) ,DELPCR(5) ,ENPCR(5) ,DELWPL(5) ,STPW(5)						00380000
		3HFIN(5) ,GAP6(10)						00390000
	C	PAGE 6	INPUT LOC 301 THRU 400					00400000
ISN 0009		COMMON	CYCPRL ,PF ,SK3 ,SK4 ,TBH1(5)					00410000
		1TBTU(5) ,TBH2(5) ,TBCRP(5) ,TBSFC(8) ,TBPOW(8) ,GAP7(60)						00420000
	C	WORKING COMMON						00430000
ISN 0010		COMMON	ALFDES ,ALFDE ,ALFR ,AMU					00440000
		1	BHPA ,RHPR ,BHPSUP ,BHT ,BLP ,BR ,BS ,BVT					00450000
		2	CBARF ,CBARHT ,CBARVT ,CBARW ,CCP ,CCT ,CDV ,CLW ,CPIND ,CPNUD ,CPPAR ,CPPRO					00460000
		3	CPTOT ,CRT ,CTR ,CV ,CX ,CLDES ,CB					00470000
		4	DELRTH ,DELTA ,DH ,DSPLMT , ELC ,ELHT ,ELN ,ELOA ,ELT ,ELVT ,EN ,ETAP					00480000
		5	FEH ,FEHI ,FEHL ,FEHT ,FET ,FETOT ,FEVT ,FEW ,FEWH ,FEWI ,FM ,FP ,ETAP4					00490000
ISN 0011		COMMON	GAMDI1(3,15) ,GLF ,GMDD1(16) ,H					00500000

7-85

ORIGINAL PAGE IS OF POOR QUALITY

	7	ICRUS,INDCRU,INDDRG,INDDYL,INDETA,INDFIX,INCHOL,INDOPT,INDOSW,	00510000
	8	INDPOW,INDPRP,INDRDM,IPRINT	00520000
ISN 0012		COMMON LTHL,NOCP,NUXPJ,OWE,PEHF,PI,Q,RHO,REALJ,RHPR,K,RN	00530000
ISN 0013		COMMON SA,SA5,SA6,SA7,SFC,SHPA,SHPR,SHI,SHTE,SHW,SIGMA,SSIGMA,ST,	00540000
ISN 0014		1STHETA,STMAX,SVT,SVTE,SVTW,SW,SWETH,SWEXP,SWIT,SWNET,S2RHO	00550000
ISN 0015		COMMON T,TAF,TCBAR,THETA,TMAX,TMP,TPROP,TR,ULF,VGASB,VGASR,VHL,V	00560000
		COMMON W,WBAL,WBALNT,WCC,WE,WEP,WES,WF,WFC,WFR,WFS,WFW,	00570000
	1	WGSB,WHL,WHT,WLG,WMC,WPAYL,WPC,WPDS,WPEI,WPH,WPRB,WPRG,WPRP,WPSTR	00580000
	2	WRC,WRCAL,WSC,WSCA,WST,WTM,WVT,WW,WPAYLO,WAC,WENV	00600000
ISN 0016		COMMON XLALB,XLB,XLBH,XLHL,XLR,XLW,YLESZ,UDV	00610000
ISN 0017		COMMON DMR,SIGNK,AF,BHPP,SEE	00610100
ISN 0018		NAMLIST /NENGZ/ XLR,XLH,LE1,XLH2,B1,B2,DALFR,ALFR,LE2,CLW2,	00620000
	1	CLW,BHPR,BLP,BHPPI,BRPP,I,ITER,TPROP,TPROPI	00630000
ISN 0019		IF (INDFIX.EQ.0) GO TO 22	00640000
ISN 0021		ALFR=0.0	00640100
ISN 0022		V=VC	00650000
ISN 0023		HH=HC	00660000
ISN 0024		CALL ATMOS(HC,ATMIY)	00670000
ISN 0025		Q=1.42636*RHO*V**2	00680000
ISN 0026		IF (INDHUL.GT.1) GO TO 11	00690000
ISN 0028		XLR=0.0	00700000
ISN 0029		IF (INDDYL.GT.2) GO TO 1	00710000
ISN 0031		GO TO 2	00720000
ISN 0032	1	ALFR=0.	00730000
ISN 0033		XLR=XLR/LA*XLALB*XLBWO*WO	00740000
ISN 0034		CLW=0.0	00750000
ISN 0035		IF (INDDYL.EQ.3) GO TO 2	00760000
ISN 0037		CLW=CLDES	00770000
ISN 0038	2	IF (INDDYL.EQ.1) GO TO 3	00780000
ISN 0040		CLW=CLDES	00790000
ISN 0041		ALFR=0.	00800000
ISN 0042		GO TO 8	00810000
ISN 0043	3	XLH=WO-(XLBWO*WO)	00820000
ISN 0044		IF (XLH.GT.0) GO TO 4	00830000
ISN 0046		ALFR=0.0	00840000
ISN 0047		CLW=0.0	00850000
ISN 0048		GO TO 8	00860000
ISN 0049	4	LE1=0	00870000
ISN 0050		IF (INDHUL.EQ.3) SPL=SW	00870100
ISN 0052		IF (INDHUL.EQ.1) SPL=ELCA*DH	00870200
ISN 0054		IF (XLBWO.EQ.1.0) GO TO 10	00870300
ISN 0056		ALFR=0.08727	00880000
ISN 0057	5	LE1=LE1+1	00890000
ISN 0058		XLH2=Q*SPL*(CLALPH*ALFR+CDC*ALFR*ABS(ALFR))	00900000
ISN 0059		IF (ABS((XLH-XLH2)/XLH).LT.0.01) GO TO 10	00910000
ISN 0061		IF (LE1.LT.2) GO TO 6	00920000
ISN 0063		B2=XLH2-XLH	00930000
ISN 0064		DALFR=(B2/(B1-B2))*DALFR	00940000
ISN 0065		B1=B2	00950000
ISN 0066		GO TO 7	00960000
ISN 0067	6	B1=XLH2-XLH	00970000
ISN 0068		DALFR=0.17453	00980000

7-86

ISN 0069	7 ALFR=ALFR+DALFR	00990000
ISN 0070	GU TO 5	01000000
ISN 0071	8 IF (INDDYL.GT.2) GO TO 9	01010000
ISN 0073	GO TO 10	01020000
ISN 0074	9 CTP=4.0*XLR/(RHO*VT**2*PI*DMR**2*ENR)	01030000
ISN 0075	AMU=1.688*V/VT	01040000
ISN 0076	10 GO TO 17	01050000
ISN 0077	11 IF (INDDYL.EQ.2) GO TO 12	01060000
ISN 0079	XLK=XLRLA*XLALB*XLBWO*WO	01070000
ISN 0080	XLH=WO*XLK=XLBWO*WO	01080000
ISN 0081	CLW=XLH/(Q*SW)	01090000
ISN 0082	CLDES=CLW	01090100
ISN 0083	CTP=4.0*XLR/(RHO*VT**2*PI*DMR**2*ENR)	01100000
ISN 0084	AMU=1.688*V/VT	01110000
ISN 0085	GO TO 13	01120000
ISN 0086	12 XLH=WO*(T.O=XLBWO)	01130000
ISN 0087	CLW=XLH/(Q*SW)	01140000
ISN 0088	CLDES=CLW	01140100
ISN 0089	XLK=0.0	01150000
ISN 0090	13 IF (INDHUL.EQ.3) GO TO 4	01150100
ISN 0092	IF (XLBWO.EQ.1.0) GO TO 17	01150200
ISN 0094	LE2=0	01160000
ISN 0095	ALFR=0.08727	01170000
ISN 0096	14 LE2=LE2+1	01180000
ISN 0097	CLW2=CLALPH*ALFR+COC*ALFR*ABS(ALFR)	01190000
ISN 0098	IF (ABS((CLW-CLW2)/CLW).LT.0.01) GO TO 17	01200000
ISN 0100	IF (LE2.LT.2) GO TO 15	01210000
ISN 0102	B2=CLW2-CLW	01220000
ISN 0103	DALFR=(B2/(B1-B2))*DALFR	01230000
ISN 0104	B1=B2	01240000
ISN 0105	GO TO 16	01250000
ISN 0106	15 B1=CLW2-CLW	01260000
ISN 0107	DALFR=0.17453	01270000
ISN 0108	16 ALFR=ALFR+DALFR	01280000
ISN 0109	GO TO 14	01290000
ISN 0110	17 CALL DRAG(ALFK)	01300000
ISN 0111	IF (INDHUL.GT.1) ALFDES=ALFR	01301000
ISN 0113	IF (INDDYL.GT.2) GO TO 20	01310000
ISN 0115	IF (INDETA.GT.0.) GO TO 18	01320000
ISN 0117	NETAP4 = ETAP4N + 0.1	01330000
ISN 0118	ETAP4=XLINT(TBEM, TB8AP4, V, NETAP4, M)	01340000
ISN 0119	IF (M.NE.0) WRITE(6,1001)	01350000
ISN 0121	BHPR=T*V/(325.6365*ETAP4*ETAT)	01360000
ISN 0122	GO TO 21	01370000
ISN 0123	18 BLP=XLINT(TBH2, TBCRP, HH, 5, M)	01380000
ISN 0124	IF (M.NE.0) WRITE(6,1002)	01390000
ISN 0126	BLP=FACTR(BLP, HH, THETA, FF)	01400000
ISN 0127	YLS2=1.0	01401000
ISN 0128	ITER=0	01410000
ISN 0129	ETA=0.85	01420000
ISN 0130	TPROP=T	01430000
ISN 0131	TPROPI=TPROP	01440000

7-87

ISN 0132	BHPP1=I*V/(325.6365*ETAT*DELRTH*BLP)	01450000
ISN 0133	19 ITER=ITER+1	01460000
ISN 0134	BHPP=BHPP1/ETA	01470000
ISN 0135	CALL THRUST(TPROP)	01480000
ISN 0136	IF (ABS(1.0-(TPROP/TPROP1)) .LT.005) GO TO 22	01490000
ISN 0138	ETA=ETAP	01500000
ISN 0139	IF (ITER.GT.25) WRITE(6,1003)	01510000
ISN 0141	GO TO 19	01520000
ISN 0142	20 CALL ROTPOW	01530000
ISN 0143	BHPR=RHPMR/ETAT	01540000
ISN 0144	21 BLP=XLINT(TBH2,TBCRP,HH,5,M)	01550000
ISN 0145	BLP=FACTR(BLP, FH,THETA,FF)	01560000
ISN 0146	IF(M.NE.0) WRITE(6,1002)	01570000
ISN 0148	BHPP=BHPR/(BLP*DELRTH)	01580000
ISN 0149	1001 FORMAT(22X35HTHIS ERROR IS IN THE V-ETAP4 TABLE )	01590000
ISN 0150	1002 FORMAT(22X35HTHIS ERROR IS IN THE H-POWER TABLE )	01600000
ISN 0151	1003 FORMAT(22X,' ERROR , THE NUMBER OF ITERATIONS IN THE ENGINE 1 SIZING ROUTINE EXCEEDED 25,CASE TERMINATED')	01610000 01620000
ISN 0152	22 RETURN	01630000
ISN 0153	END	01650000

NAME	TAG	TYPE	ADD.	NAME	TAG	TYPE	ADD.	NAME	TAG	TYPE	ADD.	NAME	TAG	TYPE	ADD.		
H	C	R#4	N.R.	M	FA	I#4	0001D8	Q	SF	C	R#4	000868	k	C	R#4	N.R.	
T	F	C	R#4	V	SFA	C	R#4	W	C	R#4	N.R.	AI	C	R#4	N.R.		
AR	C	R#4	N.R.	BR	C	R#4	N.R.	BS	C	R#4	N.R.	B1	SF	C	R#4	0001DC	
B2	SF	C	R#4	CB	C	R#4	N.R.	CV	C	R#4	N.R.	CX	C	R#4	N.R.		
DH	F	C	R#4	EN	C	R#4	N.R.	FF	FA	C	R#4	0004B4	FM	C	R#4	N.R.	
FP	C	R#4	N.R.	HC	SFA	C	R#4	HH	SFA	C	R#4	0001E4	PI	F	C	R#4	000864
RN	C	R#4	N.R.	SA	C	R#4	N.R.	ST	C	R#4	N.R.	SW	F	C	R#4	0003C8	
TR	C	R#4	N.R.	VC	F	C	R#4	VT	F	C	R#4	000148	WE	C	R#4	N.R.	
WF	C	R#4	N.R.	WO	F	C	R#4	WS	C	R#4	N.R.	WW	C	R#4	N.R.		
XC	C	R#4	N.R.	AMU	S	C	R#4	BHT	C	R#4	N.R.	BLP	SFA	C	R#4	000660	
BHR	C	R#4	N.R.	BVT	C	R#4	N.R.	CCP	C	R#4	N.R.	CCT	C	R#4	N.R.		
CDC	F	C	R#4	CDV	C	R#4	N.R.	CKF	C	R#4	N.R.	CKW	C	R#4	N.R.		
CK1	C	R#4	N.R.	CLW	SFA	C	R#4	CRT	C	R#4	N.R.	CTP	S	C	R#4	0006A8	
DK3	C	R#4	N.R.	DK4	C	R#4	N.R.	DMR	F	C	R#4	0009C8	ELC	C	R#4	N.R.	
ELF	C	R#4	N.R.	ELN	C	R#4	N.R.	ELT	C	R#4	N.R.	ENP	C	R#4	N.R.		
ENR	F	C	R#4	ETA	SF	C	R#4	FEH	C	R#4	N.R.	FET	C	R#4	N.R.		
FEW	C	R#4	N.R.	GLF	C	R#4	N.R.	HES	C	R#4	N.R.	HOO	C	R#4	N.R.		
LE1	SF	C	R#4	LE2	SF	C	R#4	OWE	C	R#4	N.R.	RHO	F	C	R#4	00086C	
RMI	C	R#4	N.R.	KOO	C	R#4	N.R.	SA5	C	R#4	N.R.	SAo	C	R#4	N.R.		
SA7	C	R#4	N.R.	SEE	C	R#4	N.R.	SFC	C	R#4	N.R.	SHT	C	R#4	N.R.		
SKT	C	R#4	N.R.	SK1	C	R#4	N.R.	SK2	C	R#4	N.R.	SK3	C	R#4	N.R.		
SK4	C	R#4	N.R.	SK5	C	R#4	N.R.	SK6	C	R#4	N.R.	SK7	C	R#4	N.R.		
SK8	C	R#4	N.R.	SK9	C	R#4	N.R.	SLM	C	R#4	N.R.	SPL	SF	C	R#4	0001F4	
STH	C	R#4	N.R.	SVT	C	R#4	N.R.	TAF	C	R#4	N.R.	TCR	C	R#4	N.R.		
TCT	C	R#4	N.R.	TMP	C	R#4	N.R.	TOD	C	R#4	N.R.	TVW	C	R#4	N.R.		
ULF	C	R#4	N.R.	VHL	C	R#4	N.R.	VIN	C	R#4	N.R.	VMO	C	R#4	N.R.		
WAC	C	R#4	N.R.	WCC	C	R#4	N.R.	WEP	C	R#4	N.R.	WES	C	R#4	N.R.		
WFC	C	R#4	N.R.	WFE	C	R#4	N.R.	WFR	C	R#4	N.R.	WFS	C	R#4	N.R.		
WFW	C	R#4	N.R.	WHL	C	R#4	N.R.	WHT	C	R#4	N.R.	WLG	C	R#4	N.R.		
WMC	C	R#4	N.R.	WPC	C	R#4	N.R.	WPH	C	R#4	N.R.	WRC	C	R#4	N.R.		
WSC	C	R#4	N.R.	WST	C	R#4	N.R.	WTM	C	R#4	N.R.	WVA	C	R#4	N.R.		
WVT	C	R#4	N.R.	XLB	C	R#4	N.R.	XLH	SFA	C	R#4	0001F8	XLR	SF	C	R#4	000988
XLW	C	R#4	N.R.	XMR	C	R#4	N.R.	ALFR	SFA	C	R#4	000648	ARHT	C	R#4	N.R.	
ARVT	C	R#4	N.R.	BHPA	C	R#4	N.R.	BHPP	S	C	R#4	0009D4	BHPR	SF	C	R#4	000654
CDHT	C	R#4	N.R.	CDVT	C	R#4	N.R.	CKFF	C	R#4	N.R.	CKHT	C	R#4	N.R.		
CKVT	C	R#4	N.R.	CLW2	SFA	C	R#4	DAM1	C	R#4	N.R.	DAM2	C	R#4	N.R.		
DAM3	C	R#4	N.R.	DAM4	C	R#4	N.R.	DAM5	C	R#4	N.R.	DELR	C	R#4	N.R.		
DRAG	SF	XF	R#4	DVOL	C	R#4	N.R.	ELDN	C	R#4	N.R.	ELDT	C	R#4	N.R.		
ELHT	C	R#4	N.R.	ELUA	F	C	R#4	ELVT	C	R#4	N.R.	EMLF	C	R#4	N.R.		
ETAP	F	C	R#4	ETAT	F	C	R#4	FEHI	C	R#4	N.R.	FEHL	C	R#4	N.R.		
FEHT	C	R#4	N.R.	FEVT	C	R#4	N.R.	FEWH	C	R#4	N.R.	FEWI	C	R#4	N.R.		
GAP1	C	R#4	N.R.	GAP2	C	R#4	N.R.	GAP3	C	R#4	N.R.	GAP4	C	R#4	N.R.		
GAP5	C	R#4	N.R.	GAP6	C	R#4	N.R.	GAP7	C	R#4	N.R.	HFIN	C	R#4	N.R.		
ITER	SF	C	R#4	LTHL	C	R#4	N.R.	PLHF	C	R#4	N.R.	PLIN	C	R#4	N.R.		
RELI	C	R#4	N.R.	RMAX	C	R#4	N.R.	SHPA	C	R#4	N.R.	SHPR	C	R#4	N.R.		
SHTe	C	R#4	N.R.	SHTW	C	R#4	N.R.	SKAC	C	R#4	N.R.	SKAR	C	R#4	N.R.		
SKCC	C	R#4	N.R.	SKFS	C	R#4	N.R.	SKFH	C	R#4	N.R.	SKHL	C	R#4	N.R.		
SKHT	C	R#4	N.R.	SKLG	C	R#4	N.R.	SKMC	C	R#4	N.R.	SKPA	C	R#4	N.R.		
SKPH	C	R#4	N.R.	SKRC	C	R#4	N.R.	SKSC	C	R#4	N.R.	SKTM	C	R#4	N.R.		
SKVT	C	R#4	N.R.	SKWP	C	R#4	N.R.	SKWV	C	R#4	N.R.	SK10	C	R#4	N.R.		

7-89



SK11	C	R*4	N.R.	SK12	C	R*4	N.R.	SK13	C	R*4	N.R.	SK14	C	R*4	N.R.			
SK15	C	R*4	N.R.	SLMH	C	R*4	N.R.	STPW	C	R*4	N.R.	SVTE	C	R*4	N.R.			
SVTW	C	R*4	N.R.	SWTT	C	R*4	N.R.	TBHI	C	R*4	N.R.	TB2	FA	C	R*4			
TBTU	C	R*4	N.R.	TCHT	C	R*4	N.R.	TCLN	C	R*4	N.R.	TCVT	C	R*4	N.R.			
TINY	C	R*4	N.R.	TIN2	C	R*4	N.R.	TIN4	C	R*4	N.R.	TMAX	C	R*4	N.R.			
TUVW	C	R*4	N.R.	TWTW	C	R*4	N.R.	WBAL	C	R*4	N.R.	WENV	C	R*4	N.R.			
WFUL	C	R*4	N.R.	WGSB	C	R*4	N.R.	WPDS	C	R*4	N.R.	WPEI	C	R*4	N.R.			
WPRB	C	R*4	N.R.	WPRG	C	R*4	N.R.	WPRP	C	R*4	N.R.	WRCA	C	R*4	N.R.			
WSCA	C	R*4	N.R.	XLBH	C	R*4	N.R.	XLGD	C	R*4	N.R.	XLHL	C	R*4	N.R.			
XLH2	SFA	R*4	000204	YLS2	S	C	R*4	0009C0	ALFDL	C	R*4	N.R.	ATMIY	SFA	C	R*4		
ATMUS	SF	XF	R*4	000000	BHPP1	SF	C	R*4	000208	CBARF	C	R*4	N.R.	CBARW	C	R*4		
CLOES	SF	C	R*4	0006B4	CLEYE	C	R*4	N.R.	CPIND	C	R*4	N.R.	CPNUD	C	R*4	N.R.		
CPPAR	C	R*4	N.R.	CPPRO	C	R*4	N.R.	CPTOT	C	R*4	N.R.	DALFR	SF	C	R*4			
DELTA	C	R*4	N.R.	DELTH	C	R*4	N.R.	DELWF	C	R*4	N.R.	DELWP	C	R*4	N.R.			
DSWET	C	R*4	N.R.	ELDOA	C	R*4	N.R.	ENG SZ	C	R*4	000210	EMPCR	C	R*4	N.R.			
ETAP2	C	R*4	N.R.	ETAP4	SF	C	R*4	0007IC	FACTR	F	XF	R*4	000000	FETOT	C	R*4		
GMDD1	C	R*4	N.R.	HMAXD	C	R*4	N.R.	ICKUS	C	I*4	N.R.	NDCPP	C	I*4	N.R.			
NOXPJ	C	I*4	N.R.	PFET2	C	R*4	N.R.	REALJ	C	R*4	N.R.	RHPMR	F	C	R*4			
STGMA	C	R*4	N.R.	SIGMR	C	R*4	N.R.	SKAMD	C	R*4	N.R.	SKBAL	C	R*4	N.R.			
SKGB1	C	R*4	N.R.	SKGB2	C	R*4	N.R.	SKPDS	C	R*4	N.R.	SKPEI	C	R*4	N.R.			
SKPES	C	R*4	N.R.	SKPRB	C	R*4	N.R.	SKRBF	C	R*4	N.R.	SKRCA	C	R*4	N.R.			
SKSCA	C	R*4	N.R.	SLMVT	C	R*4	N.R.	STMAX	C	R*4	N.R.	SWETH	C	R*4	N.R.			
SWEXP	C	R*4	N.R.	SWWET	C	R*4	N.R.	S2RHO	C	R*4	N.R.	TBCL1	C	R*4	N.R.			
TBCKP	FA	C	R*4	0004FC	TBEM5	FA	C	R*4	000164	TBPGW	C	R*4	N.R.	TBSFC	C	R*4		
TCBAR	C	R*4	N.R.	THETA	FA	C	R*4	0008EC	TPROP	SFA	C	R*4	0008FB	TVCMR	C	R*4		
VBARH	C	R*4	N.R.	VBARV	C	R*4	N.R.	VDIVE	C	R*4	N.R.	VGASB	C	R*4	N.R.			
VGASR	C	R*4	N.R.	WPAYL	C	R*4	N.R.	WPSTR	C	R*4	N.R.	XLALB	F	C	R*4			
XCWBO	F	C	R*4	000028	XLINT	F	XF	R*4	000000	XLRLA	F	C	R*4	00002C	ALFDES	S	C	R*4
BHP SUP	C	R*4	N.R.	CRARHT	C	R*4	N.R.	CBARVT	C	R*4	N.R.	CBYLOA	C	R*4	N.R.			
CLALPH	F	C	R*4	0001C4	CKSIND	C	R*4	N.R.	CTSIGH	C	R*4	N.R.	CYCPRL	C	R*4	N.R.		
DELFCR	C	R*4	N.R.	DELRTH	F	C	R*4	0006BC	DELWFC	C	R*4	N.R.	DELWPL	C	R*4	N.R.		
DELWST	C	R*4	N.R.	DLWSH	C	R*4	N.R.	DLTAFE	C	R*4	N.R.	DLVLHL	C	R*4	N.R.			
DKGIND	C	R*4	N.R.	DSPLMT	C	R*4	N.R.	DYLIND	C	R*4	N.R.	ELHLOA	C	R*4	N.R.			
ELVLOA	C	R*4	N.R.	ETATND	C	R*4	N.R.	ETAP4N	F	C	R*4	000160	EXPDRG	C	R*4	N.R.		
FEDRAG	C	R*4	N.R.	FIXIND	C	R*4	N.R.	GAMD11	C	R*4	N.R.	HULIND	C	R*4	N.R.			
IBCOM#	F	XF	I*4	0C0000	INDCRU	C	I*4	N.R.	INDDRG	C	I*4	N.R.	INDOYL	C	I*4	000828		
INDETA	C	I*4	00082C	INDFIX	C	I*4	000830	INDHUL	C	I*4	000834	INDOPT	C	I*4	N.R.			
INDOSW	C	I*4	N.R.	INDPOW	C	I*4	N.R.	INDPRP	C	I*4	N.R.	INDRDM	C	I*4	N.R.			
IPRINT	C	I*4	N.R.	NEGSZ			000001	NETAP4	SFA	I*4	0C0214	OPTIND	C	R*4	N.R.			
OSWIND	C	R*4	N.R.	PRPIND	C	R*4	N.R.	RDMIND	C	R*4	N.R.	RHORHC	C	R*4	N.R.			
ROTPDW	SF	XF	R*4	000000	SGTIND	C	R*4	N.R.	SKBLNT	C	R*4	N.R.	SKENV1	C	R*4	N.R.		
SKENV2	C	R*4	N.R.	SKPDSZ	C	R*4	N.R.	SKVTAR	C	R*4	N.R.	SSIGMA	C	R*4	N.R.			
STHETA	C	R*4	N.R.	TBCDWI	C	R*4	N.R.	TBBAP4	FA	C	R*4	000178	THEIMR	C	R*4	N.R.		
THRUST	SF	XF	R*4	000000	TOLIND	C	R*4	N.R.	TPROP1	S	A	R*4	000218	VGBOVH	C	R*4	N.R.	
WBALNT	C	R*4	N.R.	WPAYLO	C	R*4	N.R.	XTGTA2	C	R*4	N.R.	XTGTA4	C	R*4	N.R.			

\*\*\*\*\* COMMON INFORMATION \*\*\*\*\*

NAME OF COMMON BLOCK \* \* SIZE OF BLOCK 0009DC HEXADECIMAL BYTES

VAR. NAME	TYPE	REL.	ADDR.	VAR. NAME	TYPE	REL.	ADDR.	VAR. NAME	TYPE	REL.	ADDR.	VAR. NAME	TYPE	REL.	ADDR.
OPTIND	R**4	N.R.		HULIND	R**4	N.R.		DYLIND	R**4	N.R.		DRGIND	R**4	N.R.	
OSWIND	R**4	N.R.		FIXIND	R**4	N.R.		RDMIND	R**4	N.R.		PRPIND	R**4	N.R.	
ETAIND	R**4	N.R.		WU	R**4	000024		XLBWO	R**4	000028		XLRLA	R**4	00002C	
VGBOVH	R**4	N.R.		XLGD	R**4	N.R.		HMAXD	R**4	N.R.		RHORH	R**4	N.R.	
VMO	R**4	N.R.		ENLF	R**4	N.R.		CKI	R**4	N.R.		DELWF	R**4	N.R.	
CKFF	R**4	N.R.		VDIVE	R**4	N.R.		HOO	R**4	N.R.		ROU	R**4	N.R.	
T00	R**4	N.R.		GAP1	R**4	N.R.		SGTIND	R**4	N.R.		ELHLOA	R**4	N.R.	
ELVLUA	R**4	N.R.		GAP2	R**4	N.R.		AR	R**4	N.R.		WS	R**4	N.R.	
TCR	R**4	N.R.		TCT	R**4	N.R.		SLM	R**4	N.R.		ARHT	R**4	N.R.	
TCHT	R**4	N.R.		VBARH	R**4	N.R.		SLMH	R**4	N.R.		ARVT	R**4	N.R.	
TCVT	R**4	N.R.		VBARV	R**4	N.R.		SLMVT	R**4	N.R.		ELDN	R**4	N.R.	
ELDT	R**4	N.R.		ELDOA	R**4	N.R.		DLSWSH	R**4	N.R.		DSWET	R**4	N.R.	
DLVLHL	R**4	N.R.		DVGL	R**4	N.R.		GBYLOA	R**4	N.R.		ENR	R**4	00011C	
WVA	R**4	N.R.		DAMI	R**4	N.R.		DAM2	R**4	N.R.		BMR	R**4	N.R.	
DAM3	R**4	N.R.		CLEVE	R**4	N.R.		THETMR	R**4	N.R.		XC	R**4	N.R.	
XMR	R**4	N.R.		TVCMR	R**4	N.R.		VT	R**4	000148		CTSIGH	R**4	N.R.	
TVW	R**4	N.R.		HES	R**4	N.R.		TINY	P**4	N.R.		ETAP2	R**4	N.R.	
ETAP4N	R**4	000150		TBEM5	R**4	000164		TBAP4	R**4	000178		GAP3	R**4	N.R.	
DAM4	R**4	N.R.		ENP	R**4	N.R.		ETAT	R**4	000198		HC	R**4	00019C	
VC	R**4	0001A0		ATMIY	R**4	0001A4		CDVT	R**4	N.R.		CDHT	R**4	N.R.	
DAM5	R**4	N.R.		DLTAFE	R**4	N.R.		FEDKAG	R**4	N.R.		EXPDRG	R**4	N.R.	
CDC	R**4	0001C0		CLALPH	R**4	0001C4		CKVT	R**4	N.R.		CKHT	R**4	N.R.	
CKF	R**4	N.R.		CKW	R**4	N.R.		RELI	R**4	N.R.		TCLN	R**4	N.R.	
TBCLI	R**4	N.R.		TBCDWI	R**4	N.R.		GAP4	R**4	N.R.		WFE	R**4	N.R.	
WFUL	R**4	N.R.		DELWFC	R**4	N.R.		DELWP	R**4	N.R.		DELWST	R**4	N.R.	
SKCC	R**4	N.R.		SKRC	R**4	N.R.		SKSC	R**4	N.R.		SKFW	R**4	N.R.	
SKTM	R**4	N.R.		SKRCA	R**4	N.R.		SKSCA	R**4	N.R.		SKMC	R**4	N.R.	
SKAC	R**4	N.R.		SKHL	R**4	N.R.		SKENV1	R**4	N.R.		SKENV2	R**4	N.R.	
SKGB1	R**4	N.R.		SKGB2	R**4	N.R.		SKBLNT	R**4	N.R.		SKBAL	R**4	N.R.	
SKLG	R**4	N.R.		SKWV	R**4	N.R.		ELF	R**4	N.R.		RMI	R**4	N.R.	
SKWP	R**4	N.R.		SKHT	R**4	N.R.		SKVT	R**4	N.R.		SKPRB	R**4	N.R.	
SKRBF	R**4	N.R.		SKPH	R**4	N.R.		SKAMD	R**4	N.R.		SKAR	R**4	N.R.	
SKPA	R**4	N.R.		SKVTAR	R**4	N.R.		SKPDS	R**4	N.R.		SKPDSZ	R**4	N.R.	
SKT	R**4	N.R.		SKFS	R**4	N.R.		SKPEI	R**4	N.R.		SKPES	R**4	N.R.	
SK1	R**4	N.R.		SK2	R**4	N.R.		DK3	R**4	N.R.		DK4	R**4	N.R.	
SK5	R**4	N.R.		SK6	R**4	N.R.		SK7	R**4	N.R.		SK8	R**4	N.R.	
SK9	R**4	N.R.		SK10	R**4	N.R.		SK11	R**4	N.R.		SK12	R**4	N.R.	
SK13	R**4	N.R.		SK14	R**4	N.R.		SK15	R**4	N.R.		PLIN	R**4	N.R.	
GAPS	R**4	N.R.		TOLIND	R**4	N.R.		XTGTA2	R**4	N.R.		TIN2	R**4	N.R.	
TWTW	R**4	N.R.		PFET2	R**4	N.R.		DELTH	R**4	N.R.		STH	R**4	N.R.	
CKSIND	R**4	N.R.		XTGTA4	R**4	N.R.		TIN4	R**4	N.R.		VIN	R**4	N.R.	
DELPR	R**4	N.R.		RMAX	R**4	N.R.		DELPCR	R**4	N.R.		ENPCR	R**4	N.R.	
DELWPL	R**4	N.R.		STPW	R**4	N.R.		HFIN	R**4	N.R.		GAP6	R**4	N.R.	
CYCPKL	R**4	N.R.		FF	R**4	000484		SK3	R**4	N.R.		SK4	R**4	N.R.	
TBH1	R**4	N.R.		TBTO	R**4	N.R.		TBH2	R**4	0004E8		TBCRP	R**4	0004FC	
TBSFC	R**4	N.R.		TBPOW	R**4	N.R.		GAP7	R**4	N.R.		ALFDES	R**4	000640	
ALFDL	R**4	N.R.		ALFR	R**4	000648		AMU	R**4	00064C		BHPA	R**4	N.R.	
BHPR	R**4	000654		BHPSUP	R**4	N.R.		BHT	R**4	N.R.		BLP	R**4	000680	
BR	R**4	N.R.		BS	R**4	N.R.		BVT	R**4	N.R.		CBARF	R**4	N.R.	
CBARHT	R**4	N.R.		CBARVT	R**4	N.R.		CBARW	R**4	N.R.		CCP	R**4	N.R.	
CCT	R**4	N.R.		CDV	R**4	N.R.		CLW	R**4	00068C		CPIND	R**4	N.R.	

7-91

CPNOD	R#4	N.R.	CPPAR	R#4	N.R.	CPPRO	R#4	N.R.	CPTOT	R#4	N.R.
CRT	R#4	N.R.	CTP	R#4	0006A8	CV	R#4	N.R.	CX	R#4	N.R.
CLOES	R#4	0006B4	CB	R#4	N.R.	DELRTH	R#4	0006BC	DELTA	R#4	N.R.
DH	R#4	0006C4	DSPLMT	R#4	N.R.	ELC	R#4	N.R.	ELHT	R#4	N.R.
ELN	R#4	N.R.	ELOA	R#4	0006D8	ELT	R#4	N.R.	ELVT	R#4	N.R.
EN	R#4	N.R.	ETAP	R#4	0006E8	FEH	R#4	N.R.	FEHI	R#4	N.R.
FEHL	R#4	N.R.	FERT	R#4	N.R.	FET	R#4	N.R.	FETOT	R#4	N.R.
FEVT	R#4	N.R.	FEW	R#4	N.R.	FEWH	R#4	N.R.	FEWI	R#4	N.R.
FM	R#4	N.R.	FP	R#4	N.R.	ETAP4	R#4	00071C	GAMD11	R#4	N.R.
GLF	R#4	N.R.	GMDDI	R#4	N.R.	H	R#4	N.R.	ICRUS	I#4	N.R.
INDCRU	I#4	N.R.	INDDRG	I#4	N.R.	INDOYL	I#4	000828	INDETA	I#4	00082C
INDFIX	I#4	000830	INDHUL	I#4	000834	INDOPT	I#4	N.R.	INDOSW	I#4	N.R.
INDPOW	I#4	N.R.	INDPRP	I#4	N.R.	INDRDM	I#4	N.R.	IPRINT	I#4	N.R.
LTHL	I#4	N.R.	NOCPP	I#4	N.R.	NOXPJ	I#4	N.R.	DWE	R#4	N.R.
PEHF	R#4	N.R.	PI	R#4	000864	Q	R#4	000868	RHO	R#4	00086C
REALJ	R#4	N.R.	RHPMR	R#4	000874	R	R#4	N.R.	RN	R#4	N.R.
SA	R#4	N.R.	SA5	R#4	N.R.	SA6	R#4	N.R.	SA7	R#4	N.R.
SFC	R#4	N.R.	SHPA	R#4	N.R.	SHPR	R#4	N.R.	SHT	R#4	N.R.
SHTE	R#4	N.R.	SHTW	R#4	N.R.	SIGMA	R#4	N.R.	SSIGMA	R#4	N.R.
ST	R#4	N.R.	STHETA	R#4	N.R.	STMAX	R#4	N.R.	SVT	R#4	N.R.
SVTE	R#4	N.R.	SVTW	R#4	N.R.	SW	R#4	0008C8	SWETH	R#4	N.R.
SWEXP	R#4	N.R.	SWTT	R#4	N.R.	SWWET	R#4	N.R.	SZRHO	R#4	N.R.
T	R#4	0008E0	TAF	R#4	N.R.	TCBAR	R#4	N.R.	THETA	R#4	0008EC
TMAX	R#4	N.R.	TMP	R#4	N.R.	TPROP	R#4	0008F8	.TR	R#4	N.R.
ULF	R#4	N.R.	VGASB	R#4	N.R.	VGASK	R#4	N.R.	VHL	R#4	N.R.
V	R#4	000910	W	R#4	N.R.	WBAL	R#4	N.R.	WBALNT	R#4	N.R.
WCC	R#4	N.R.	WE	R#4	N.R.	WEP	R#4	N.R.	WES	R#4	N.R.
WF	R#4	N.R.	WFC	R#4	N.R.	WFR	R#4	N.R.	WFS	R#4	N.R.
WFW	R#4	N.R.	WGSB	R#4	N.R.	WHL	R#4	N.R.	WHT	R#4	N.R.
WLG	R#4	N.R.	WMC	R#4	N.R.	WPAYL	R#4	N.R.	WPC	R#4	N.R.
WPDS	R#4	N.R.	WPEI	R#4	N.R.	WPH	R#4	N.R.	WPRB	R#4	N.R.
WPRG	R#4	N.R.	WPRP	R#4	N.R.	WPSTR	R#4	N.R.	WRC	R#4	N.R.
WRCA	R#4	N.R.	WSC	R#4	N.R.	WSCA	R#4	N.R.	WST	R#4	N.R.
WTM	R#4	N.R.	WVT	R#4	N.R.	WW	R#4	N.R.	WPAYLU	R#4	N.R.
WAC	R#4	N.R.	WENV	R#4	N.R.	XLALB	R#4	0009A8	XLB	R#4	N.R.
XLBH	R#4	N.R.	XLHL	R#4	N.R.	XHR	R#4	0009B8	XLW	R#4	N.R.
YLS2	R#4	0009C0	YDVM	R#4	N.R.	DMK	R#4	0009C8	SIGMR	R#4	N.R.
AF	R#4	N.R.	BHPP	R#4	0009D4	SEE	R#4	N.R.			

7-92

LABEL	ADDR	LABEL	ADDR	LABEL	ADDR	LABEL	ADDR
1	00040B	2	00043C	3	000458	4	00047E
5	0004CE	6	00052A	7	00053E	8	00054E
9	00055A	10	000592	11	000596	12	000610
13	00063A	14	00065C	15	0006B4	16	0006C8
17	0006D8	18	0007A2	19	00082E	20	000888
21	0008A0	22	0008FE				

\*OPTIONS IN EFFECT\* NAME= MAIN,OPT=02,LINECNT=54,SIZE=0000K,

\*OPTIONS IN EFFECT\* SOURCE,EBCDIC,NOLIST,NUDECK,LOAD,MAP,NOEDIT,NOXREF

\*STATISTICS\* SOURCE STATEMENTS = 152 ,PROGRAM SIZE = 2338

\*STATISTICS\* NO DIAGNOSTICS GENERATED

\*\*\*\*\* END OF COMPILATION \*\*\*\*\* 95K BYTES OF CORE NOT USED

7-93

CCMPILER CPTICNS - NAME= MAIN,OPT=C2,LINECNT=54,SIZE=0000K,

SCURCE,EECDIC,NCLIST,NODECK,LOAD,MAP,NCEDIT,ID,NOXREF

ISN 0002	FUNCTION FACTR (STAR, HH, THETA, FF)	00010000
	C**** MEMBER NAME B81FACIR	00020000
ISN 0003	TFESTD=C.7519	00030000
ISN 0004	IF (HH.LE.36089.) THESIC=1.C-0.000006875*HH	00040000
ISN 0006	FACTR=STAR+FF*(THESTD-THETA)	00050000
ISN 0007	RETURN	00060000
ISN 0008	END	00070000

NAME	TAG	TYPE	ADD.	NAME	TAG	TYPE	ADD.	NAME	TAG	TYPE	ADD.	NAME	TAG	TYPE	ADD.
FF	F	R*4	000088	HM	F	R*4	00008C	STAR	F	R*4	000090	FACTR	S	R*4	000094
THETA	F	R*4	000098	1-E-STD	SF	R*4	00009C								

\*OPTIONS IN EFFECT\* NAME= MAIN,CPT=C2,LINECNT=54,SIZE=00C0K,

\*OPTIONS IN EFFECT\* SOURCE,EBCDIC,ACLIST,ACDECK,LOAD,MAP,NOEDIT,NOXREF

\*STATISTICS\* SOURCE STATEMENTS = 7 ,PROGRAM SIZE = 294

\*STATISTICS\* NO DIAGNOSTICS GENERATED

\*\*\*\*\* END OF COMPIATION \*\*\*\*\*

123K BYTES OF CORE NOT USED

ORIGINAL PAGE IS  
OF POOR QUALITY

COMPIILER OPTIONS - NAME= MAIN,OPT=02,LINECNT=54,SIZE=0'000K,  
SOURCE,EBCDIC,NOLIST,NODECK,LOAD,MAP,NOEDIT, ID,NOXREF

ISN 0002	SUBROUTINE LIFT						00C10000
	C**** MEMBER NAME B81LIFI						00020000
	C	PAGE 1	INPUT	LOC 0001 THRU 0050			00C30000
ISN 0003		COMMON	OPTIND	,HULIND	,DYLIND	,DRGIND	,OSWIND
		1FIXIND	,RDMIND	,PRPIND	,ETAIND	,KO	,XLBWD
		2XLRLA	,VGBDVH	,XLGD	,HMAXD	,RHJRHO	,VMO
		3EMLF	,CKI	,DELWF	,CKFF	,VDIVE	,HOO
		4ROO	,TOO	,GAPI(5)	,SGTIND(12)	,ELHLOA	,ELVLOA
		5GAP2(6)					00C90000
	C	PAGE 2	INPUT	LOC 0051 THRU 0100			00100000
ISN 0004		COMMON	AR	,WS	,TCR	,ICI	,SLM
		1ARHT	,TCHT	,VBARH	,SLMH	,ARVT	,TCVT
		2VBARV	,SLMVT	,ELDN	,ELDT	,ELDOA	,OLSWSH
		3DSWET	,DLVHL	,DVOE	,CBYLOA	,ENR	,WVA
		4DAMI	,DAM2	,BMR	,DAM3	,CLEYE	,THETMR
		5XC	,XMR	,TVCMR	,VT	,CTSIGH	,TVW
		6HES	,TINY	,ETAP2	,ETAP4N	,TBEM5(5)	,TB8AP4(5)
		7GAP3					00170000
	C	PAGE 3	INPUT	LOC 0101 THRU 140			00190000
ISN 0005		COMMON	DAM4	,EMP	,ETAT	,RC	,VC
		1ATMIY	,CDVT	,CDHT	,DAM5	,DLTAFE	,FEDRAG
		2EXPDRG	,CDC	,CLALPH	,CKVT	,CKHT	,CKF
		3CKW	,RELI	,TCIN	,TBCLI(8)	,TBCDWI(8)	,GAP4(4)
	C	PAGE 4	INPUT	LOC 141 THRU 200	WEIGHT DATA		00230000
ISN 0006		COMMON	WFE	,WFUL	,DELWFC	,DELWP	,DELWST
		1SKCC	,SKRC	,SKSC	,SKFW	,SKTM	,SKRCA
		2SKSCA	,SKMC	,SKAC	,SKHL	,SKENV1	,SKENV2
		3SKGB1	,SKGB2	,SKBLNT	,SKBAL	,SKLG	,SKWW
		4ELF	,RMI	,SKNP	,SKHT	,SKVT	,SKPRB
		5SKRBF	,SKPH	,SKAMU	,SKAR	,SKPA	,SKVTAR
		6SKPDS	,SKPDSZ	,SKT	,SKFS	,SKPEI	,SKPES
		7SK1	,SK2	,DK3	,DK4	,SK5	,SK6
		8SK7	,SK8	,SK9	,SK10	,SK11	,SK12
		9SK13	,SK14	,SK15	,PLIN	,GAP5(3)	00340000
	C	PAGE 5	INPUT	LOC 201 THRU 300			00350000
ISN 0007		COMMON	TOLIND(5)	,XTGTA2(5)	,TIN2(5)	,TWTW(5)	,PFET2(5)
		1DELTH(5)	,STH(5)	,CRSIND(5)	,XTGTA4(5)	,TIN4(5)	,VIN(5)
		2DELCR(5)	,RMAX(5)	,DELFCR(5)	,ENPCR(5)	,DELWPL(5)	,STPW(5)
		3HF IN(5)	,GAP6(10)				00390000
	C	PAGE 6	INPUT	LOC 301 THRU 400			00400000
ISN 0008		COMMON	CYCPRL	,FF	,SK3	,SK4	,TBHI(5)
		1TBTO(5)	,TBH2(5)	,TBCRP(5)	,TBSFC(8)	,TBPOW(8)	,GAP7(60)
	C	WORKING	COMMON				00430000
ISN 0009		COMMON	ALFDES,ALFDL,ALFR,AMU,				00440000
		1	BHPA,BHPR,BHPSUP,BHT,BLP,BR,BS,BVT,				00450000
		2	CBAKF,CBAKHT,CBARVT,CBARW,CCP,CCT,CDV,CLW,CPIND,CPNUD,CPPAR,CPPR				00460000
		3,	CPTOT,CRT,CTP,CV,CX,CLDES,CB,				00470000
		4	DELKTH,DELTA,DH,DSPLMT, ELC,ELHT,ELN,ELQA,ELT,ELVT,EN,ETAP,				00480000
		5	FEH,FEHI,FEHL,FEHT,FET,FETOT,FEVT,FEW,FEWH,FEWI,FM,FP,ETAP4				00490000
ISN 0010		COMMON	GAMD1(3,15),GLF,GMDD1(16),H,				00500000

7-96

	7	ICRUS,INDCRU,INDDKG,INDDYL,INDETA,INDFIX,INCHUL,INDOPT,INDUSW,	00510000
	8	INDPOW,INDPRP,INDKOM,I PRINT	00520000
ISN 0011		COMMON LTHL,NOCPP,NOXPJ,UWE,PEHF,PI,Q,RHO,REALJ,RHPR,k,RN	00530000
ISN 0012		COMMON SA,SA3,SA6,SA7,SFC,SHPA,SHPR,SHTE,SHTE,SHTW,SSIGMA,SSIGMA,ST,	00540000
		1STHETA,STMAX,SVT,SVTE,SVTW,SW,SWETH,SWEXP,SWIT,SWWET,S2RHU	00550000
ISN 0013		COMMON T,TAF,TCBAR,THETA,TMAX,TMP,TPROP,TR,ULF,VGASB,VGASR,VHL,V	00560000
ISN 0014		COMMON W,WBAL,WBALNT,WCC,WEP,WES,WFC,WFR,WFS,WFW,	00570000
		1 WGSB,WHL,WHT,WLG,WMC,WPAYL,WPC,WPDS,WPEI,WPH,WPRB,WPRG,WPRP,WPST	00580000
		2,WRC,WRCB,WSC,WSCA,WST,WTM,WVT,WW,WPAYLO,WAC,WENV	00590000
ISN 0015		COMMON XLALB,XLB,XLBH,XLHL,XLK,XLW, YLS2,TOVW	00600000
ISN 0016		COMMON DMR,SIGMR,AF,BHPP,SEE	00600001
ISN 0017		NAMELIST /NLIFT/ XLB,XLHL,XLR,XLW,ALFR,LAI,LBI,LDI,XLHRW,	00610000
	1	XLHRW1,XLHRW2,XLHRW3,XLHRWP,B1,B1A,B1B,B1C,B2,DALFR,RN,CL	00620000
	2W,XLHKW4,B1D		00620100
ISN 0018		CLW=0.0	00620200
ISN 0019		TOT = XTGT4(ICRUS)	00630000
ISN 0020		IF(TOT.EQ.1.0) XLB=XLBWD*WO	00630100
ISN 0022		IF(TOT.NE.1.0) XLB=(.076474*(TOT-1.)/(1.076474-XLGD)+1.)*XLBWD*WO	00640000
ISN 0024		XLHRW=W-XLB	00650000
ISN 0025		IF (INDDYL.EQ.2.OR.INDDYL.EQ.4) GO TO 30	00650001
ISN 0027		IF(XLHKW.EQ.0.) GO TO 23	00650100
ISN 0029		IF(XLHRW.LT.0.) GO TO 23	00650200
ISN 0031	30	IF (INDDYL.EQ.2.OR.INDDYL.EQ.4) GO TO 10	00660000
ISN 0033		IF (INDDYL.NE.1.) GO TO 22	00670000
ISN 0035		LDI=0	00680000
ISN 0036		ALFR=0.08727	00690000
ISN 0037	7	LDI=LDI+1	00700000
ISN 0038		XLHRW3=Q*ELOA*DH*(CLALPH*ALFR+CDC*ALFR+ABS(ALFR))	00710000
ISN 0039		IF (ABS((XLHRW-XLHRW3)/XLHRW).LT.0.01) GO TO 8	00720000
ISN 0041		IF (LDI.LT.2) GO TO 5	00730000
ISN 0043		B1A=B1	00730100
ISN 0044		B2=XLHRW3-XLHRW	00740000
ISN 0045		DALFR=(B2/(B1-B2))*DALFR	00750000
ISN 0046		B1=B2	00760000
ISN 0047		GO TO 6	00770000
ISN 0048	5	B1=XLHRW3-XLHRW	00780000
ISN 0049		DALFR=0.17453	00790000
ISN 0050	6	ALFR=ALFR+DALFR	00800000
ISN 0051		GO TO 7	00810000
ISN 0052	8	XLHL=XLHRW	00820000
ISN 0053		XLK=0.	00830000
ISN 0054		XLW=0.	00840000
ISN 0055		GO TO 21	00850000
ISN 0056	10	IF (INDHUL.GT.1) GO TO 20	00860000
ISN 0058		XLHRWP=XLHRW	00870000
ISN 0059		XLK=0.	00880000
ISN 0060		IF (INDDYL.EQ.2) GO TO 11	00890000
ISN 0062		XLHRWP=XLHRW*(1.-XLRLA)	00900000
ISN 0063		XLK=XLRLA*XLHRW	00910000
ISN 0064	11	LBI=0	00920000
ISN 0065		ALFR=0.08727	00930000
ISN 0066	12	LBI=LBI+1	00940000

ORIGINAL PAGE IS  
OF POOR QUALITY

7-97



	ISN 0067	IF(W.LT.0.0) GO TO 23	00940100
	ISN 0069	XLHRW2=Q*(ELOA*DH*(CLALPH*ALFR+CDC*ALFR*ABS(ALFR)))+SW*6.28*(ALFR+A00950000 1LFDDES))	00950001
	ISN 0070	IF (ABS((XLHRWP-XLHRW2)/XLHRWP).LT.0.01) GO TO 15	00960000
	ISN 0072	IF (LB1.LT.2) GO TO 13	00970000
	ISN 0074	B1B=B1	00970100
	ISN 0075	B2=XLHRW2-XLHRWP	00980000
	ISN 0076	DALFR=(B2/(B1-B2))*DALFR	00990000
	ISN 0077	B1=B2	01000000
	ISN 0078	GO TO 14	01010000
	ISN 0079	13 B1=XLHRW2-XLHRWP	01020000
	ISN 0080	DALFR=0.17453	01030000
	ISN 0081	14 ALFR=ALFR+DALFR	01040000
	ISN 0082	GO TO 12	01050000
	ISN 0083	15 XLHL=Q*ELOA*DH*(CLALPH*ALFR+CDC*ALFR*ABS(ALFR))	01060000
	ISN 0084	XLW=XLHRW-XLHL-XLR	01070000
	ISN 0085	CLW=XLW/(Q*SW)	01070100
	ISN 0086	GO TO 21	01080000
	ISN 0087	20 XLHRWP=XLHRW	01090000
	ISN 0088	XLHL=XLHRW	01100000
	ISN 0089	XLR=0.0	01110000
	ISN 0090	XLW=0.0	01120000
	ISN 0091	IF (INDDYL.EQ.2) GO TO 16	01130000
	ISN 0093	XLHRWP=XLHRW*(1.-XLR)	01140000
	ISN 0094	XLHL=XLHRWP	01150000
	ISN 0095	XLR=XLRLA*XLHRW	01160000
	ISN 0096	16 IF (INDHUL.EQ.3) GO TO 28	01160100
	ISN 0098	LA1 = 0	01170000
	ISN 0099	ALFR=0.08727	01180000
	ISN 0100	17 LA1=LA1+1	01190000
	ISN 0101	IF(XLHRW.EQ.0.) GO TO 23	01190100
	ISN 0103	IF(W.LT.0.0) GO TO 23	01190200
	ISN 0105	XLHRW1=Q*SW*(CLALPH*ALFR+CDC*ALFR*ABS(ALFR))	01200000
	ISN 0106	IF (ABS((XLHRWP-XLHRW1)/XLHRWP).LT.0.01) GO TO 21	01210000
	ISN 0108	IF (LA1.LT.2) GO TO 18	01220000
	ISN 0110	B1C=B1	01220100
	ISN 0111	B2=XLHRW1-XLHRWP	01230000
	ISN 0112	DALFR=(B2/(B1-B2))*DALFR	01240000
	ISN 0113	B1=B2	01250000
	ISN 0114	GO TO 19	01250000
	ISN 0115	28 LE1=0	01260100
	ISN 0116	IF(XLHRW.EQ.0.) GO TO 23	01260110
	ISN 0118	IF(W.LT.0.0) GO TO 23	01260120
	ISN 0120	ALFR=0.08727	01260200
	ISN 0121	26 LE1=LE1+1	01260300
	ISN 0122	XLHRW4=Q*SW*(CLALPH*ALFR+CDC*ALFR*ABS(ALFR))	01260400
	ISN 0123	IF (ABS((XLHRW-XLHRW4)/XLHRW).LT.0.01) GO TO 27	01260500
	ISN 0125	IF (LE1.LT.2) GO TO 24	01260600
	ISN 0127	B2=XLHRW4-XLHRW	01260700
	ISN 0128	B1D=B1	01260800
	ISN 0129	DALFR=(B2/(B1-B2))*DALFR	01260900
	ISN 0130	B1=B2	01261000

C-3

7-98

ISN 0131	GO TO 25	01261100
ISN 0132	24 B1=XLHRW4-XLHRW	01261200
ISN 0133	DALFR=0.17453	01261300
ISN 0134	25 ALFR=ALFR+DALFR	01261400
ISN 0135	GO TO 26	01261500
ISN 0136	27 GO TO 21	01261600
ISN 0137	18 B1=XLHRW1-XLHRWP	01270000
ISN 0138	DALFR=0.17453	01280000
ISN 0139	19 ALFR=ALFR+DALFR	01290000
ISN 0140	GO TO 17	01300000
ISN 0141	21 RN=XLR/XLHRW	01310000
ISN 0142	CTP=4.0*XLR/(RHO*VT**2*PI*DMR**2*ENR)	01310100
ISN 0143	CLW=XLHL/(Q*SW)	01310200
ISN 0144	IF(INDHUL.EQ.1) CLW=XLW/(Q*SW)	01310300
ISN 0146	RETURN	01330000
ISN 0147	22 XLHL=0.0	01340000
ISN 0148	XLR=XLHRW	01350000
ISN 0149	CTP=4.0*XLR/(RHO*VT**2*PI*DMR**2*ENR)	01350100
ISN 0150	XLW=0	01360000
ISN 0151	RN=XLR/XLHRW	01370000
ISN 0152	RETURN	01390000
ISN 0153	23 ALFR=0.0	01390100
ISN 0154	XLHL=0.0	01390200
ISN 0155	RN=0.	01390300
ISN 0156	XLW=0.	01390400
ISN 0157	XLR=0.	01390500
ISN 0158	RETURN	01390700
ISN 0159	END	01400000

7-99

ORIGINAL PAGE IS  
OF POOR QUALITY

NAME	TAG	TYPE	ADD.	NAME	TAG	TYPE	ADD.	NAME	TAG	TYPE	ADD.	NAME	TAG	TYPE	ADD.				
H	C	R*4	N.R.	Q	F	C	R*4	000868	R	C	R*4	N.R.	T	C	R*4	N.R.			
V	C	R*4	N.R.	W	F	C	R*4	000914	AF	C	R*4	N.R.	AK	C	R*4	N.R.			
BR	C	R*4	N.R.	BS	C	R*4	N.R.	B1	SF	C	R*4	0000BC	B2	SF	C	R*4	0000C0		
CB	C	R*4	N.R.	CV	C	R*4	N.R.	CX	C	R*4	N.R.	DH	F	C	R*4	0006C4			
EN	C	R*4	N.R.	FF	C	R*4	N.R.	FM	C	R*4	N.R.	FP	C	R*4	N.R.				
HC	C	R*4	N.R.	PI	F	C	R*4	000864	RN	S	C	R*4	00087C	SA	C	R*4	N.R.		
ST	C	R*4	N.R.	SW	F	C	R*4	0008C8	TR	C	R*4	N.R.	VC	C	R*4	N.R.			
VI	F	C	R*4	000148	WE	C	R*4	N.R.	WF	C	R*4	N.R.	WO	F	C	R*4	000024		
WS	C	R*4	N.R.	WW	C	R*4	N.R.	XC	C	R*4	N.R.	AMU	C	R*4	N.R.				
BHT	C	R*4	N.R.	BLP	C	R*4	N.R.	BMR	C	R*4	N.R.	BVT	C	R*4	N.R.				
BIA	S	C	R*4	0000C4	BIB	S	C	R*4	0000C8	BIC	S	C	R*4	0000CC	BID	S	C	R*4	0000D0
CCP	C	R*4	N.R.	CCT	C	R*4	N.R.	CDC	F	C	R*4	0001C0	CDV	C	R*4	N.R.			
CKF	C	R*4	N.R.	CKW	C	R*4	N.R.	CK1	C	R*4	N.R.	CLW	S	C	R*4	00068C			
CRT	C	R*4	N.R.	CTP	S	C	R*4	0006A8	DK3	C	R*4	N.R.	DK4	C	R*4	N.R.			
DMR	F	C	R*4	0009C8	ELC	C	R*4	N.R.	ELF	C	R*4	N.R.	ELN	C	R*4	N.R.			
ELT	C	R*4	N.R.	ENP	C	R*4	N.R.	ENR	F	C	R*4	00011C	FEH	C	R*4	N.R.			
FET	C	R*4	N.R.	FEW	C	R*4	N.R.	GLF	C	R*4	N.R.	HES	C	R*4	N.R.				
HOO	C	R*4	N.R.	LAI	SF	C	I*4	0000D4	LBI	SF	C	I*4	0000D8	LDI	SF	C	I*4	0000DC	
LE1	SF	C	I*4	0000E0	(JWE	C	R*4	N.R.	RFO	F	C	R*4	00086C	RMI	C	R*4	N.R.		
RJO	C	R*4	N.R.	SA5	C	R*4	N.R.	SA6	C	R*4	N.R.	SA7	C	R*4	N.R.				
SEE	C	R*4	N.R.	SFC	C	R*4	N.R.	SHT	C	R*4	N.R.	SKT	C	R*4	N.R.				
SK1	C	R*4	N.R.	SK2	C	R*4	N.R.	SK3	C	R*4	N.R.	SK4	C	R*4	N.R.				
SK5	C	R*4	N.R.	SK6	C	R*4	N.R.	SK7	C	R*4	N.R.	SK8	C	R*4	N.R.				
SK9	C	R*4	N.R.	SLM	C	R*4	N.R.	STH	C	R*4	N.R.	SVT	C	R*4	N.R.				
TAF	C	R*4	N.R.	TCR	C	R*4	N.R.	TCT	C	R*4	N.R.	TMP	C	R*4	N.R.				
TOU	C	R*4	N.R.	TOT	SF	C	R*4	0000E4	TVH	C	R*4	N.R.	ULF	C	R*4	N.R.			
VHL	C	R*4	N.R.	VIN	C	R*4	N.R.	VMG	C	R*4	N.R.	WAC	C	R*4	N.R.				
wCC	C	R*4	N.R.	WEP	C	R*4	N.R.	WES	C	R*4	N.R.	WFC	C	R*4	N.R.				
WFE	C	R*4	N.R.	WFR	C	R*4	N.R.	WFS	C	R*4	N.R.	WFW	C	R*4	N.R.				
WHL	C	R*4	N.R.	WHT	C	R*4	N.R.	WLG	C	R*4	N.R.	WMC	C	R*4	N.R.				
WPC	C	R*4	N.R.	WPH	C	R*4	N.R.	WRC	C	R*4	N.R.	WSC	C	R*4	N.R.				
WST	C	R*4	N.R.	WTM	C	R*4	N.R.	WVA	C	R*4	N.R.	WVT	C	R*4	N.R.				
XLB	SF	C	R*4	0009AC	XLR	SF	C	R*4	0009B8	XLW	SF	C	R*4	00098C	XMR	C	R*4	N.R.	
ALFR	SFA	C	R*4	000648	ARHT	C	R*4	N.R.	ARVT	C	R*4	N.R.	BHPA	C	R*4	N.R.			
BHPP	C	R*4	N.R.	BHPR	C	R*4	N.R.	CDFT	C	R*4	N.R.	CDVT	C	R*4	N.R.				
CKFF	C	R*4	N.R.	CKHT	C	R*4	N.R.	CKVT	C	R*4	N.R.	DAM1	C	R*4	N.R.				
DAM2	C	R*4	N.R.	DAM3	C	R*4	N.R.	DAM4	C	R*4	N.R.	DAM5	C	R*4	N.R.				
DELK	C	R*4	N.R.	DVOL	C	R*4	N.R.	ELDN	C	R*4	N.R.	ELDT	C	R*4	N.R.				
ELHT	C	R*4	N.R.	ELOA	F	C	R*4	0006D8	ELVT	C	R*4	N.R.	EMLF	C	R*4	N.R.			
ETAP	C	R*4	N.R.	ETAT	C	R*4	N.R.	FEHI	C	R*4	N.R.	FEHL	C	R*4	N.R.				
FEHT	C	R*4	N.R.	FEVT	C	R*4	N.R.	FEWH	C	R*4	N.R.	FEWI	C	R*4	N.R.				
GAP1	C	R*4	N.R.	GAP2	C	R*4	N.R.	GAP3	C	R*4	N.R.	GAP4	C	R*4	N.R.				
GAP5	C	R*4	N.R.	GAP6	C	R*4	N.R.	GAP7	C	R*4	N.R.	HF IN	C	R*4	N.R.				
LIFT	I*4	C	R*4	0000E8	LTHL	C	I*4	N.R.	PERF	C	R*4	N.R.	PLIN	C	R*4	N.R.			
RELI	C	R*4	N.R.	RMAX	C	R*4	N.R.	SHPA	C	R*4	N.R.	SHPR	C	R*4	N.R.				
SHTE	C	R*4	N.R.	SHTW	C	R*4	N.R.	SKAC	C	R*4	N.R.	SKAR	C	R*4	N.R.				
SKCC	C	R*4	N.R.	SKFS	C	R*4	N.R.	SKFW	C	R*4	N.R.	SKHL	C	R*4	N.R.				
SKHT	C	R*4	N.R.	SKLG	C	R*4	N.R.	SKMC	C	R*4	N.R.	SKPA	C	R*4	N.R.				
SKPH	C	R*4	N.R.	SKKC	C	R*4	N.R.	SKSC	C	R*4	N.R.	SKTM	C	R*4	N.R.				
SKVI	C	R*4	N.R.	SKWP	C	R*4	N.R.	SKWW	C	R*4	N.R.	SKIO	C	R*4	N.R.				

7-100

ORIGINAL PAGE IS  
OF POOR QUALITY

SK11	C	R#4	N.R.	SK12	C	R#4	N.R.	SK13	C	R#4	N.R.	SK14	C	R#4	N.R.				
SK15	C	R#4	N.R.	SLMH	C	R#4	N.R.	STPW	C	R#4	N.R.	SVTE	C	R#4	N.R.				
SVTW	C	R#4	N.R.	SWTT	C	R#4	N.R.	TBHI	C	R#4	N.R.	TBH2	C	R#4	N.R.				
TSTO	C	R#4	N.R.	TCHT	C	R#4	N.R.	TCLN	C	R#4	N.R.	TCVT	C	R#4	N.R.				
TIMY	C	R#4	N.R.	TINZ	C	R#4	N.R.	TIN4	C	R#4	N.R.	TMAX	C	R#4	N.R.				
TOVW	C	R#4	N.R.	TWTW	C	R#4	N.R.	WBAL	C	R#4	N.R.	WENV	C	R#4	N.R.				
WFUL	C	R#4	N.R.	WGSB	C	R#4	N.R.	WPDS	C	R#4	N.R.	WPEI	C	R#4	N.R.				
WPRB	C	R#4	N.R.	WPRG	C	R#4	N.R.	WPKP	C	R#4	N.R.	WRCA	C	R#4	N.R.				
WSCA	C	R#4	N.R.	XLBH	C	R#4	N.R.	XLGD	F	C	R#4	000034	XLHL	SF	C	R#4	0009B4		
YLSZ	C	R#4	N.R.	ALFDL	C	R#4	N.R.	ATMIY	C	R#4	N.R.	CBARF	C	R#4	N.R.				
CBAKW	C	R#4	N.R.	CLDES	C	R#4	N.R.	CLEYE	C	R#4	N.R.	CPIND	C	R#4	N.R.				
CPNUD	C	R#4	N.R.	CPPAR	C	R#4	N.R.	CPPRO	C	R#4	N.R.	CPTOT	C	R#4	N.R.				
DALFR	SF	C	R#4	000UEC	DELTA	C	R#4	N.R.	DELTH	C	R#4	N.R.	DELWF	C	R#4	N.R.			
DELWP	C	R#4	N.R.	DSWET	C	R#4	N.R.	ELDGA	C	R#4	N.R.	ENPCR	C	R#4	N.R.				
ETAP2	C	R#4	N.R.	ETAP4	C	R#4	N.R.	FETOT	C	R#4	N.R.	GMDD1	C	R#4	N.R.				
HMAXD	C	R#4	N.R.	ICRUS	F	C	R#4	00081C	NLFTT	C	R#4	000000	NUCPP	C	R#4	N.R.			
NOXPJ	C	I#4	N.R.	PFET2	C	R#4	N.R.	REALJ	C	R#4	N.R.	RHPMR	C	R#4	N.R.				
SIGMA	C	R#4	N.R.	SIGMR	C	R#4	N.R.	SKAMD	C	R#4	N.R.	SKBAL	C	R#4	N.R.				
SKG91	C	R#4	N.R.	SKGB2	C	R#4	N.R.	SKPUS	C	R#4	N.R.	SKPEI	C	R#4	N.R.				
SKPES	C	R#4	N.R.	SKPRB	C	R#4	N.R.	SKRBF	C	R#4	N.R.	SKRCA	C	R#4	N.R.				
SKSCA	C	R#4	N.R.	SLMVT	C	R#4	N.R.	STMAX	C	R#4	N.R.	SWETH	C	R#4	N.R.				
SWEXP	C	R#4	N.R.	SWWET	C	R#4	N.R.	SZRHO	C	R#4	N.R.	TBCLI	C	R#4	N.R.				
TBCRP	C	R#4	N.R.	TBEM5	C	R#4	N.R.	TBPOW	C	R#4	N.R.	TBSFC	C	R#4	N.R.				
TCBAR	C	R#4	N.R.	THETA	C	R#4	N.R.	TPRGP	C	R#4	N.R.	TVCMR	C	R#4	N.R.				
VBARH	C	R#4	N.R.	VBARV	C	R#4	N.R.	VDIVE	C	R#4	N.R.	VGASB	C	R#4	N.R.				
VGASR	C	R#4	N.R.	WPAYL	C	R#4	N.R.	WPSTR	C	R#4	N.R.	XLALB	C	R#4	N.R.				
XLBDW	F	C	R#4	000028	XLHRW	SFA	C	R#4	0000F0	XLRLA	F	C	R#4	00002C	ALFDES	F	C	R#4	000640
BHPSUP	C	R#4	N.R.	CBAKHT	C	R#4	N.R.	CBARVT	C	R#4	N.R.	CBYLG	C	R#4	N.R.				
CLALPH	F	C	R#4	0001C4	CKSIND	C	R#4	N.R.	CTSIGH	C	R#4	N.R.	CYCPRL	C	R#4	N.R.			
DELFCR	C	R#4	N.R.	DELKTH	C	R#4	N.R.	DELWFC	C	R#4	N.R.	DELWPL	C	R#4	N.R.				
DELWST	C	R#4	N.R.	DESWSH	C	R#4	N.R.	DLTAFE	C	R#4	N.R.	DEVLHL	C	R#4	N.R.				
DRGIND	C	R#4	N.R.	DSPLMT	C	R#4	N.R.	DYLIND	C	R#4	N.R.	ELHLOA	C	R#4	N.R.				
ELVL0A	C	R#4	N.R.	ETAIND	C	R#4	N.R.	ETAP4N	C	R#4	N.R.	EXPDRG	C	R#4	N.R.				
FEDKAG	C	R#4	N.R.	FIXIND	C	R#4	N.R.	GAMD11	C	R#4	N.R.	HULIND	C	R#4	N.R.				
INDCRU	C	I#4	N.R.	INDDRG	C	I#4	N.R.	INDDYL	C	I#4	000828	INDETA	C	I#4	N.R.				
INDFIX	C	I#4	N.R.	INDHUL	C	I#4	000834	INDOPT	C	I#4	N.R.	INDOSW	C	I#4	N.R.				
INDPOW	C	I#4	N.R.	INDPRP	C	I#4	N.R.	INDKDM	C	I#4	N.R.	IPRINT	C	I#4	N.R.				
OPTIND	C	R#4	N.R.	OSWIND	C	R#4	N.R.	PRPIND	C	R#4	N.R.	RDMIND	C	R#4	N.R.				
RHORHO	C	R#4	N.R.	SGTIND	C	R#4	N.R.	SKBLNT	C	R#4	N.R.	SKENVI	C	R#4	N.R.				
SKENVZ	C	R#4	N.R.	SKPDSZ	C	R#4	N.R.	SKVTAR	C	R#4	N.R.	SSIGMA	C	R#4	N.R.				
STHETA	C	R#4	N.R.	TBCDWI	C	R#4	N.R.	TBBA P4	C	R#4	N.R.	THETMR	C	R#4	N.R.				
TOLIND	C	R#4	N.R.	VGBOVH	C	R#4	N.R.	WBALNT	C	R#4	N.R.	WPAYLO	C	R#4	N.R.				
XLHRWP	SFA	R#4	0000F4	XLHRW1	SFA	R#4	0000F8	XLHRW2	SFA	R#4	0000FC	XLHRW3	SFA	R#4	000100				
XLHRW4	SFA	R#4	000104	XTGTAZ	C	R#4	N.R.	XTGTA4	F	C	R#4	0003C0							

\*\*\*\*\* COMMON INFORMATION \*\*\*\*\*

NAME OF COMMON BLOCK \* \* \* \* \* SIZE OF BLOCK 0009DC HEXADECIMAL BYTES

VAR. NAME	TYPE	REL. ADDR.	VAR. NAME	TYPE	REL. ADDR.	VAR. NAME	TYPE	REL. ADDR.	VAR. NAME	TYPE	REL. ADDR.
OPTIND	R#4	N.R.	HULIND	R#4	N.R.	DYLIND	R#4	N.R.	DRGIND	R#4	N.R.

OSWIND	R*4	N.R.	FIXIND	R*4	N.R.	ROMIND	R*4	N.R.	PRPIND	R*4	N.R.
ETAIND	R*4	N.R.	WO	R*4	000024	XLBWO	R*4	000028	XLRLA	R*4	00002C
VGBOVH	R*4	N.R.	XLGD	R*4	000034	HMAXD	R*4	N.R.	RHORHO	R*4	N.R.
VMO	R*4	N.R.	EMLF	R*4	N.R.	CKI	R*4	N.R.	DELWF	R*4	N.R.
CKFF	R*4	N.R.	VDIVE	R*4	N.R.	HOO	R*4	N.R.	ROO	R*4	N.R.
TGO	R*4	N.R.	GAPI	R*4	N.R.	SGTIND	R*4	N.R.	ELHLOA	R*4	N.R.
ELVLOA	R*4	N.R.	GAPZ	R*4	N.R.	AR	R*4	N.R.	WS	R*4	N.R.
TCR	R*4	N.R.	TCT	R*4	N.R.	SLM	R*4	N.R.	ARHT	R*4	N.R.
TCHT	R*4	N.R.	VBARH	R*4	N.R.	SLMH	R*4	N.R.	ARVT	R*4	N.R.
TCVT	R*4	N.R.	VBARV	R*4	N.R.	SLMVI	R*4	N.R.	ELDN	R*4	N.R.
ELDT	R*4	N.R.	ELDUA	R*4	N.R.	DLSWSH	R*4	N.R.	DSWET	R*4	N.R.
DLVLHL	R*4	N.R.	DVOL	R*4	N.R.	CBYLOA	R*4	N.R.	ENR	R*4	00011C
HVA	R*4	N.R.	DAMI	R*4	N.R.	DAMZ	R*4	N.R.	BMR	R*4	N.R.
DAM3	R*4	N.R.	CLEYE	R*4	N.R.	THETMR	R*4	N.R.	XC	R*4	N.R.
XMK	R*4	N.R.	TVCMR	R*4	N.R.	VT	R*4	000148	CTSIGH	R*4	N.R.
TVV	R*4	N.R.	HES	R*4	N.R.	TINY	R*4	N.R.	ETAP2	R*4	N.R.
ETAP4N	R*4	N.R.	TBEM5	R*4	N.R.	T88AP4	R*4	N.R.	GAP3	R*4	N.R.
DAM4	R*4	N.R.	ENP	R*4	N.R.	ETAT	R*4	N.R.	HC	R*4	N.R.
VC	R*4	N.R.	ATMIY	R*4	N.R.	CDVI	R*4	N.R.	CDHT	R*4	N.R.
DAM5	R*4	N.R.	DLTAFE	R*4	N.R.	FEDRAG	R*4	N.R.	EXPDRG	R*4	N.R.
CDC	R*4	0001C0	CLALPH	R*4	0001C4	CKVT	R*4	N.R.	CKHT	R*4	N.R.
CKF	R*4	N.R.	CKW	R*4	N.R.	RELI	R*4	N.R.	TCLN	R*4	N.R.
TBCL1	R*4	N.R.	TBCDWI	R*4	N.R.	GAP4	R*4	N.R.	WFE	R*4	N.R.
WFUL	R*4	N.R.	DELWFC	R*4	N.R.	DELWP	R*4	N.R.	DELWST	R*4	N.R.
SKCC	R*4	N.R.	SKRC	R*4	N.R.	SK5C	R*4	N.R.	SKFW	R*4	N.R.
SKTM	R*4	N.R.	SKRCA	R*4	N.R.	SKSCA	R*4	N.R.	SKMC	R*4	N.R.
SKAC	R*4	N.R.	SKHL	R*4	N.R.	SKENV1	R*4	N.R.	SKENV2	R*4	N.R.
SKGB1	R*4	N.R.	SKGB2	R*4	N.R.	SKBLNT	R*4	N.R.	SKBAL	R*4	N.R.
SKLG	R*4	N.R.	SKWN	R*4	N.R.	ELF	R*4	N.R.	RMI	R*4	N.R.
SKWP	R*4	N.R.	SKHT	R*4	N.R.	SKVT	R*4	N.R.	SKPRB	R*4	N.R.
SKRBF	R*4	N.R.	SKPH	R*4	N.R.	SKAMD	R*4	N.R.	SKAR	R*4	N.R.
SKPA	R*4	N.R.	SKVTAR	R*4	N.R.	SKPDS	R*4	N.R.	SKPDSZ	R*4	N.R.
SKT	R*4	N.R.	SKFS	R*4	N.R.	SKPEI	R*4	N.R.	SKPES	R*4	N.R.
SKI	R*4	N.R.	SKZ	R*4	N.R.	DK3	R*4	N.R.	DK4	R*4	N.R.
SK5	R*4	N.R.	SK6	R*4	N.R.	SK7	R*4	N.R.	SK8	R*4	N.R.
SK9	R*4	N.R.	SK10	R*4	N.R.	SK11	R*4	N.R.	SK12	R*4	N.R.
SK13	R*4	N.R.	SK14	R*4	N.R.	SK15	R*4	N.R.	PLIN	R*4	N.R.
GAP5	R*4	N.R.	TDLIND	R*4	N.R.	XTGTA2	R*4	N.R.	TIN2	R*4	N.R.
TWTW	R*4	N.R.	PFET2	R*4	N.R.	DELTH	R*4	N.R.	STH	R*4	N.R.
CRSIND	R*4	N.R.	XTGTA4	R*4	0003C0	TIN4	R*4	N.R.	VIN	R*4	N.R.
DELIR	R*4	N.R.	RMAX	R*4	N.R.	DELFCR	R*4	N.R.	ENPCR	R*4	N.R.
DELWPL	R*4	N.R.	STPW	R*4	N.R.	HF IN	R*4	N.R.	GAP6	R*4	N.R.
CYCPRL	R*4	N.R.	FF	R*4	N.R.	SK3	R*4	N.R.	SK4	R*4	N.R.
TBH1	R*4	N.R.	TBTO	R*4	N.R.	TBH2	R*4	N.R.	TBCRP	R*4	N.R.
TBSFC	R*4	N.R.	TBPOW	R*4	N.R.	GAP7	R*4	N.R.	ALFDES	R*4	000640
ALFDL	R*4	N.R.	ALFR	R*4	000648	AMU	R*4	N.R.	BHPA	R*4	N.R.
BHPR	R*4	N.R.	BHPSUP	R*4	N.R.	BHT	R*4	N.R.	BLP	R*4	N.R.
BR	R*4	N.R.	BS	R*4	N.R.	BVT	R*4	N.R.	CBARF	R*4	N.R.
CBARHT	R*4	N.R.	CBARVT	R*4	N.R.	CBARW	R*4	N.R.	CCP	R*4	N.R.
CCT	R*4	N.R.	CDV	R*4	N.R.	CLW	R*4	00068C	CPIND	R*4	N.R.
CPNUD	R*4	N.R.	CPPAR	R*4	N.R.	CPPRO	R*4	N.R.	CPTOT	R*4	N.R.
CRT	R*4	N.R.	CTP	R*4	0006A8	CV	R*4	N.R.	CX	R*4	N.R.

7-102

CLDES	R**	N.R.	CB	R**	N.R.	DELRTH	R**	N.R.	DELTA	R**	N.R.
DH	R**	0006C4	DSPLMT	R**	N.R.	ELC	R**	N.R.	ELHT	R**	N.R.
ELN	R**	N.R.	ELUA	R**	0006D8	ELT	R**	N.R.	ELVT	R**	N.R.
EN	R**	N.R.	ETAP	R**	N.R.	FEH	R**	N.R.	FEHI	R**	N.R.
FEHL	R**	N.R.	FEHT	R**	N.R.	FET	R**	N.R.	FETOT	R**	N.R.
FEVT	R**	N.R.	FEW	R**	N.R.	FEWH	R**	N.R.	FEWI	R**	N.R.
FM	R**	N.R.	FP	R**	N.R.	ETAP4	R**	N.R.	GAMU11	R**	N.R.
GLF	R**	N.R.	GMDD1	R**	N.R.	H	R**	N.R.	ICRUS	I**	00081C
INDCRU	I**	N.R.	INDDRG	I**	N.R.	INDDYL	I**	000828	INDETA	I**	N.R.
INDFIX	I**	N.R.	INDHUL	I**	000834	INDOPT	I**	N.R.	INDOSW	I**	N.R.
INDPGW	I**	N.R.	INDPRP	I**	N.R.	INDRDM	I**	N.R.	IPRINT	I**	N.R.
LTHL	I**	N.R.	NOCP	I**	N.R.	NOXPJ	I**	N.R.	OWE	R**	N.R.
PEHF	R**	N.R.	PI	R**	000864	Q	R**	000868	RHC	R**	00086C
REALJ	R**	N.R.	RHPMR	R**	N.R.	R	R**	N.R.	RN	R**	00087C
SA	R**	N.R.	SAS	R**	N.R.	SA6	R**	N.R.	SA7	R**	N.R.
SFC	R**	N.R.	SHPA	R**	N.R.	SHPK	R**	N.R.	SHT	R**	N.R.
SHT	R**	N.R.	SHTW	R**	N.R.	SIGMA	R**	N.R.	SSIGMA	R**	N.R.
ST	R**	N.R.	STHETA	R**	N.R.	STMAX	R**	N.R.	SVT	R**	N.R.
SVTE	R**	N.R.	SVTW	R**	N.R.	SW	R**	0008C8	SWETH	R**	N.R.
SWEXP	R**	N.R.	SWTT	R**	N.R.	SWWET	R**	N.R.	S2RHO	R**	N.R.
T	R**	N.R.	TAF	R**	N.R.	TCBAR	R**	N.R.	THETA	R**	N.R.
TMAX	R**	N.R.	TMP	R**	N.R.	TPROP	R**	N.R.	TR	R**	N.R.
ULF	R**	N.R.	VGASB	R**	N.R.	VGASR	R**	N.R.	VHL	R**	N.R.
V	R**	N.R.	W	R**	000914	WBAL	R**	N.R.	WBALNT	R**	N.R.
WCC	R**	N.R.	WE	R**	N.R.	WEP	R**	N.R.	WES	R**	N.R.
WF	R**	N.R.	WFC	R**	N.R.	WFR	R**	N.R.	WFS	R**	N.R.
WFV	R**	N.R.	WGSB	R**	N.R.	WHL	R**	N.R.	WHT	R**	N.R.
WLG	R**	N.R.	WMC	R**	N.R.	WPAYL	R**	N.R.	WPC	R**	N.R.
WPDS	R**	N.R.	WPEI	R**	N.R.	WPH	R**	N.R.	WPKB	R**	N.R.
WPRG	R**	N.R.	WPRP	R**	N.R.	WPSTR	R**	N.R.	WRC	R**	N.R.
WRCA	R**	N.R.	WSC	R**	N.R.	WSCA	R**	N.R.	WST	R**	N.R.
WTM	R**	N.R.	WVT	R**	N.R.	WW	R**	N.R.	WPAYLO	R**	N.R.
WAC	R**	N.R.	WENV	R**	N.R.	XLALB	R**	N.R.	XLB	R**	0009AC
XLBH	R**	N.R.	XLHL	R**	0009B4	XLR	R**	0009B8	XLW	R**	0009BC
YLS2	R**	N.R.	TOVW	R**	N.R.	DMR	R**	0009C8	SIGMR	R**	N.R.
AF	R**	N.R.	BHPP	R**	N.R.	SEE	R**	N.R.			

ORIGINAL PAGE IS  
OF POOR QUALITY

7-103

LABEL ADDR

LABEL ADDR

LABEL ADDR

LABEL ADDR

PAGE 009

30 000350  
8 000422  
13 00050C  
16 0005C0  
24 000608  
19 000714

7 0003A2  
10 00043A  
14 000520  
17 0005DC  
25 0006EC  
21 000724

5 0003FE  
11 000472  
15 000530  
28 00064C  
27 0006FC  
22 000786

6 000412  
12 000494  
20 000582  
26 00067C  
18 000700  
23 0007DA

\*OPTIONS IN EFFECT\* NAME= MAIN,OPT=02,LINECNT=54,SIZE=0000K,

\*OPTIONS IN EFFECT\* SOURCE,EBCDIC,NOLIST,NODECK,LOAD,MAP,NOEDIT,LD,NOXREF

\*STATISTICS\* SOURCE STATEMENTS = 158 ,PROGRAM SIZE = 2070

\*STATISTICS\* NO DIAGNOSTICS GENERATED

\*\*\*\*\* END OF COMPILATION \*\*\*\*\*

91K BYTES OF CORE NOT USED

\*STATISTICS\* NO DIAGNOSTICS THIS STEP

7-104

COMPILER OPTIONS - NAME= MAIN,OPT=02,LINECNT=54,SIZE=0000K,  
SOURCE,EBCDIC,NOLIST,NODECK,LOAD,MAP,NOEDIT,ID,NOXREF

```

ISN 0002      SUBROUTINE LOADER (X,I)                00010000
C**** MEMBER NAME B81LOADR                          00020000
ISN 0003      DIMENSION T(5), IDENT(20), X(1)        00030000
ISN 0004      DATA KLANK /4H /                      00040000
ISN 0005      917 FORMAT(/47X,13HC A S C O M P/18X,53HCOMPREHENSIVE AIRSHIP SIZING C00050000
10MPUTER PROGRAM B-81,                               00060000
2 //15X76HTHE FOLLOWING IS A CARD BY CARD R00070000
3REPRODUCTION OF THE INPUT DECK FOR THIS CASE//9X,58HLOC. CORRESPOND00080000
4DS TO LOCATION NUMBER GIVEN ON INPUT SHEET / 9X,83HNUM STANDS F00090000
5R THE NUMBER OF SEQUENTIAL INPUT VALUES STARTING WITH LOC. (MAX. =00100000
65)// 9X,53HVAL EQUALS VALUE FOR VARIABLE CORRESPONDING TO LOC./9X00110000
7,4HVAL1,9X,5HVALUE,14X,26HCCORRESPONDING TO LOC.+0001/9X,4HVAL2,9X,00120000
85HVALUE,14X,26HCCORRESPONDING TO LOC.+0002/15X,4HETC./11X,4HLOC.,700130000
9X,3HNUM,9X,3HVAL,15X,4HVAL1,14X,4HVAL2,14X,4HVAL3,14X,4HVAL4/) 00140000
ISN 0006      918 FORMAT(11X,I4,8X,I1,5X,5(G14.5,4X)) 00150000
ISN 0007      999 FORMAT(/47X,13HC A S C O M P/18X,53HCOMPREHENSIVE AIRSHIP SIZING C00160000
10MPUTER PROGRAM B-81//)
ISN 0008      C IPRTIT = 0                            00210000
IDTST(ON 360)= 1077952576 IDTST(ON 94)=-17997958192 00220000
ISN 0009      IDTST = KLANK                          00230000
ISN 0010      KADD = 0                                00240000
ISN 0011      IADD = 0                                00250000
ISN 0012      GO TO (1,11),I                          00260000
ISN 0013      1 READ(5,2)K,J,(T(L),L=1,5)             00270000
ISN 0014      2 FCRMAT(I4,I1,5E14.7)                 00280000
ISN 0015      GO TO (4,4,4,4,4,20,6,13,14),J        00290000
ISV 0016      20 IADD = IADD + 1                      00300000
ISV 0017      IF (IADD.EQ.1) KADD = 1000            00310000
ISV 0019      IF (IADD.EQ.2) KADD = 0               00320000
ISN 0021      IF (IADD.EQ.2) IADD = 0               00330000
ISN 0023      GO TO 1                                00340000
ISN 0024      4 CCNTINUE                              00350000
ISN 0025      IF(IPRTIT.NE.0) GO TO 99              00360000
ISN 0027      WRITE(6,11111)                         00370000
ISV 0028      11111 FORMAT(1H1)                     00380000
ISN 0029      WRITE(6,917)                           00390000
ISN 0030      IPRTIT= 1                              00400000
ISN 0031      99 K = K+ KADD                          00410000
ISN 0032      DO 5 L = 1,J                            00420000
ISN 0033      N = K + L - 1                          00430000
ISN 0034      5 X(N)= T(L)                            00440000
ISN 0035      WRITE (6,918) K,J,(X(IVY),IVY=K.N.)   00450000
ISN 0036      GO TO 1                                00460000
ISN 0037      6 READ(5,7)(IDENT(M),M=1,19)           00470000
ISN 0038      7 FORMAT(A4,2X,18A4)                   00480000
ISN 0039      IF(IDENT(1)-IDTST) 8,10,8             00490000
ISN 0040      8 WRITE(6,9)                           00500000
ISN 0041      9 FORMAT(5X,43H*** ERROR - NO TITLE CARD AFTER SEVEN CARD,/ 00510000
1 5X,44HCOLUMNS 1 THRU 6 ON TITLE CARD MUST BE BLANK/ 00520000
2 5X,45HOR THERE WAS A 6 IN COLUMN 5 OF AN INPUT CARD) 00530000

```

7-105

ORIGINAL PAGE IS  
OF POOR QUALITY



ISN 0042	GO TO 14	00540000
ISN 0043	10 IPAGE=0	00550000
ISN 0044	11 IPAGE=IPAGE+1	00560000
ISN 0045	WRITE(6,12) (IDENT(M),M=2,19),IPAGE	00570000
ISN 0046	IF(I.EQ.1) WRITE(6,917)	00580000
ISN 0048	12 FORMAT(1H11X18A4,6H PAGE I3//)	00600000
ISN 0049	IF(I.NE.1) GO TC113	00610000
ISN 0051	IPRIT=1	00620000
ISN 0052	GO TO 1	00630000
ISN 0053	113 WRITE(6,999)	00640000
ISN 0054	13 RETURN	00650000
ISN 0055	14 CALL EXIT	00660000
ISN 0056	RETURN	00670000
ISN 0057	END	00680000

/ LOADER /

SIZE OF PROGRAM 000796 HEXADECIMAL BYTES PAGE 003

NAME	TAG	TYPE	ADD.
I	F	I*4	000400
M	F	I*4	000410
IVY	F	I*4	000418
IDENT	SF	I*4	00044C
IBCCM#	F XF	I*4	000000

NAME	TAG	TYPE	ADD.
J	SF	I*4	000404
N	SF	I*4	000414
EXIT	SF XF	R*4	000000
IDTST	S	I*4	000424
IPRTIT	S	I*4	000430

NAME	TAG	TYPE	ADD.
K	SF	I*4	000408
T	SF	R*4	000438
IADD	SF	I*4	00041C
IPAGE	SF	I*4	000428
LOADER		I*4	000434

NAME	TAG	TYPE	ADD.
L	SF	I*4	00040C
X	SF XR	R*4	000000
KADD	SF	I*4	000420
KLANK	F	I*4	00042C

LABEL	ADDR
1	000508
5	0005F6
11	00068C

LABEL	ADDR
20	000558
6	000668
113	000728

LABEL	ADDR
4	00059C
8	00069C
13	00073C

LABEL	ADDR
99	000504
10	000684
14	000744

```

*OPTIONS IN EFFECT*      NAME= MAIN,OPT=02,LINECNT=54,SIZE=0000K,
*OPTIONS IN EFFECT*      SOURCE,EBCDIC,NOLIST,NODECK,LOAD,MAP,NOEDIT,ID,NOXREF
*STATISTICS*             SOURCE STATEMENTS =      56 ,PROGRAM SIZE =      1942
*STATISTICS* NO DIAGNOSTICS GENERATED
***** END OF COMPILATION *****

```

115K BYTES OF CORE NOT USED

7-108

CC+PILER CPTICNS - NAME= MAIN,OPT=C2,LINECNT=54,SIZE=0C00K,  
SCURCE,ECCIC,ICLIST,NOCK,LCAD,MAP,NCEDIT,ID,NOXREF

ISN 0002	C****	SUBCLTINE FCWER								00C10C00
		MEMBER NAME B81FCWER								00020C00
ISN 0003	C	PAGE 1	INPUT	LCC	CCC1	TRU	0050			00030000
		CCMMON	CPTIND	,FLIND	,DYIND	,DRGIND	,OSWIND			,00040000
		IFIXIND	,RDMINC	,FFFIND	,ETAIND	,KC	,XLEAD			,00050000
		2XLRLA	,VGEVCF	,LCC	,HMAYD	,RHRHO	,VMC			,00060000
		3EMLF	,CK1	,DELWF	,CKFF	,VCIVE	,HCC			,00070000
		4RCC	,TGC	,CAF1(5)	,SGTIND(12)	,ELHLOA	,ELVLOA			,00080000
		5GAP2(6)								00090000
ISN 0004	C	PAGE 2	INPLT	LCC	CC51	THRU	010C			0010C000
		CCMMON	AR	,KS	,TCR	,TCT	,SLM			,00110000
		1ARFT	,TCHT	,VEARH	,SLMH	,ARVT	,TCVT			,00120000
		2VEARV	,SLMT	,ELCA	,ELDT	,ELCOA	,OLSWSH			,00130000
		3DSWET	,DLVFL	,CVCL	,CBYLOA	,ENR	,AVA			,00140000
		4CAM1	,CAM2	,EMF	,CAM3	,CLEVE	,TFETMR			,00150000
		5XC	,XMR	,TVCMR	,VT	,CTSIGH	,TVW			,00160000
		6HES	,TINY	,ETAP2	,ETAP4N	,TBEM5(5)	,TRBAP4(5)			,00170000
		7GAP3								00180000
ISN 0005	C	PAGE 3	INPUT	LCC	01C1	THRU	140			00190000
		CCMMON	CAM4	,ENF	,ETAT	,FC	,VC			,0020C000
		1ATMIY	,CDVT	,CCFT	,DAM5	,CLYAFE	,FECRAG			,00210000
		2EXFDRG	,CCC	,CLALPH	,CKVT	,CKHT	,CKF			,00220000
		3CKW	,RELI	,ICLN	,TECL1(8)	,TBODWI(8)	,GAP4(4)			,00230000
		4PAGE 4	INPLT	LCC	141	THRU	20C			00240000
ISN 0006	C	CCMMON	WFE	,WFL	,DELWFC	,DELWST				,00250000
		1SKCC	,SKRC	,SKSC	,SKFW	,SKTM	,SKRCA			,00260000
		2SKSCA	,SKPC	,SKAC	,SKHL	,SKENVI	,SKENV2			,00270000
		3SKGB1	,SKGB2	,SKELNT	,SKBAL	,SKLG	,SKW			,00280000
		4ELF	,PMI	,SKWP	,SKHT	,SKVT	,SKRRB			,00290000
		5SKRBF	,SKPF	,SKAFD	,SKAR	,SKFA	,SKVYAR			,00300000
		6SKPDS	,SKPDSZ	,SKT	,SKFS	,SKPEI	,SKPES			,00310000
		7SK1	,SK2	,CKE	,DK4	,SK5	,SK6			,00320000
		8SK7	,SK8	,SK9	,SK10	,SK11	,SK12			,00330000
		9SK13	,SK14	,SK15	,PLIN	,CAP5(3)				00340000
		0SK13	,SK14	,SK15	,PLIN	,CAP5(3)				00350000
ISN 0007	C	PAGE 5	INPLT	LCC	201	THRU	30C			00360000
		CCMMON	TCLINC(5)	,XTCTA2(5)	,TIN2(5)	,TWTW(5)	,PFET2(5)			,00370000
		1DELTH(5)	,STH(5)	,CRSINC(5)	,XTGTA4(5)	,TIN4(5)	,VIN(5)			,00380000
		2DEL(5)	,RMAX(5)	,DELFCR(5)	,ENPCR(5)	,DELWPL(5)	,STPW(5)			,00390000
		3FFIN(5)	,GAP6(10)							00400000
ISN 0008	C	PAGE 6	INPLT	LCC	301	THRU	40C			00410000
		CCMMON	CYCFLL	,FF	,SK3	,SK4	,TBH1(5)			,00420000
		1TETO(5)	,TBH2(5)	,TBCFP(5)	,TBSFC(8)	,TBPOW(8)	,GAP7(60)			,00430000
		2WORKING	CCMMON							00440000
ISN 0009	C	CCMMON	ALFCS,ALFCL,ALFF,AML,							00450000
		1	BFA,EFPR,EPSCF,ERT,ELP,BR,BS,BVT,							00460000
		2	CEARF,CEART,CEART,CEAFW,CCP,CCT,CDV,CLW,CPIND,CPNUD,CPPAR,CPPRO							00470000
		3	CPTOT,CFI,CTP,CV,CX,CLDES,CE,							00480000
		4	DELRTF,DELTA,CF,CSPLM1,	ELC,ELHT,ELN,ELCA,ELT,ELVT,EN,ETAP,						00490000
		5	FEH,FEHI,FEHL,FEFT,FE1,FETCT,FEVT,FEW,FEWH,FEWI,FM,FP,ETAP4							00500000
ISN 0010		CCMMON	GAP011(3,15),CLF,CMDC1(16),H,							00510000

7-109

ORIGINAL PAGE IS  
OF POOR QUALITY

	7	ICRUS, INCRU, INCRG, INCCYL, INDETA, INDFIX, INCHLL, INDOPT, INCOSW,	00510000
	8	INDPOW, INDPRF, INCRDM, IPFIINT	00520000
ISN 0011		CCMMON LTHL, NCCPP, NCXP, CKE, PEHF, PI, Q, RHC, REALJ, RHPMR, R, RN	00530000
ISN 0012		CCMMON SA, SA5, SA6, SA7, SFC, SFA, SHPR, SHT, SHTE, SHTW, SIGMA, SSIGMA, ST,	00540000
ISN 0013		1STHETA, STMAX, SVT, SVTE, SVTH, SW, SWETH, SWEXP, SWTT, SWWET, S2RHC	00550000
ISN 0014		CCMMON T, TAF, TCEAR, THETA, TMAX, TMP, TPROF, TR, ULF, VGASB, VGASR, VHL, V	00560000
		CCMMON W, WBAL, WREALT, WCC, WE, WEP, WES, WF, WFC, WFR, WFS, WFW,	00570000
ISN 0015		1 WGSB, WFL, WHT, WLG, WMC, WPAYL, WFC, WPCS, WPEI, WPF, WPRB, WPRG, WPRP, WPSTR	00580000
ISN 0016		2, WRC, WRCA, WSC, WSCA, WST, WTM, WVT, WW, WPAYLD, WAC, WENV	00590000
ISN 0017		CCMMON XLALB, XLE, XLBH, XLFL, XLR, XLW, YLS2, TGVW	00600000
ISN 0018		CCMMON DMR, SIGPR, AF, EFFP, SEE	00600000
		DIMENSION SHP(10), ETAPP(10), TPROPP(10)	00600001
		NAMELIST /NPCWER/ REAL, ETAP, NOXPJ, NOCPP, CCP, CCT, LTHL, BLP,	00600100
ISN 0019	1	SFPR, SFA, TPRCP, IT1, P1, V	00610000
ISN 0020		NCXPJ=XPJNC+C.1	00620000
ISN 0021		NCCPP=CPFAC+0.1	00630000
ISN 0022		PI=3.14155	00640000
ISN 0023		TPRCP1=TPRCP	00650000
ISN 0024		IT1=0	00660000
ISN 0025		ETAP=0.8	00670000
ISN 0026		P1=0.0	00680000
ISN 0028	14	IF (V.E.C.C) GC TC 11	00690000
		SHPR=(1.689*V*TPRCP1)/(50.C*ETAT*ETAP*DELTA*STHETA*BHPP*	00700000
		1YLS2)	00710000
ISN 0029	15	IF (LTHL.EC.1) GC TC 23	00720000
ISN 0031		BLP=XLINT(TBH2, TBCFP, FF, S, M)	00730000
ISN 0032		BLF=FACTR(BLP, FF, THETA, FF)	00740000
ISN 0033		IF (M.NE.C) WRITE(6, 9)	00750000
ISN 0035		GC TO 16	00760000
ISN 0036	23	BLP=XLINT(TBH1, TETC, FF, S, M)	00770000
ISN 0037		BLF=FACTR(BLP, FF, THETA, FF)	00780000
ISN 0038		IF (M.NE.C) WRITE(6, 8)	00790000
ISN 0040	16	SHPA=BLP	00800000
ISN 0041		IF (SHPA.LT.SFPR) GC TC 25	00810000
ISN 0043	22	IF (IT1.GT.25) GC TO 5	00820000
ISN 0045		IT1=IT1+1	00830000
ISN 0046	13	SFPA=SFPR	00840000
ISN 0047		CALL TFRCT(TPRCP, YLS2, ETAP)	00850000
ISN 0048		IF (ABS(1.0-TPRCP/TPRCP1).GT.0.005) GO TO 27	00860000
ISN 0050		IF (ABS(1.0-P1/P).LE.C.C1) GC TO 6	00870000
ISN 0052	27	P1=P	00880000
ISN 0053		IF (IT1.GT.10) GC TC 25	00890000
ISN 0055		GC TO 14	00900000
ISN 0056	11	SFPR=TPRCP1**1.5*SQRT(4./(PI*DMR**2*ENR))/(50.C*ETAT*ETAP*	00910000
		1DELTA*STHETA*S2RHC*BHPP*YLS2)	00920000
ISN 0057		GC TO 15	00930000
ISN 0058	5	WRITE(6, 10)	00940000
ISN 0059		WRITE(6, NPCWER)	00950000
ISN 0060		GC TO 6	00960000
ISN 0061	25	IF (LTHL.EC.1) GC TC 23C	00970000
ISN 0063		BLP=XLINT(TBH2, TBCRP, FF, S, M)	00980000
ISN 0064		BLF=FACTR(BLP, FF, THETA, FF)	00990000
			01000000

7-1110

ISN 0065		IF (M.NE.C) WRITE(6,9)	01010000
ISN 0067		GC TO 231	01020000
ISN 0068	230	BLP=XLIAT(TBH1,TBTC,Hh,S,M)	01030000
ISN 0069		BLF=FACTR(BLP,Ht,THETA,FF)	01040000
ISN 0070		IF (M.NE.C) WRITE(6,8)	01050000
ISN 0072	231	SFPA=BLF	01060000
ISN 0073		SFMAX=SFPA	01070000
ISN 0074		SFFMIN=V*TPRCF1/(325.6329*ETAP*DELTA*BHPP*YLS2*STHETA)	01080000
ISN 0075		IF (V.EQ.C.0) SFFMIN=TFRCF1**1.5*SQRT(4./(PI*DMR**2*ENR))/ 1(550.*ETAP*ETAP*DELTA*STHETA*S2RHG*BHPP*YLS2)	01090000 01100000
ISN 0077		DELSHP=(SFPMAX-SFFMIN)/9.0	01110000
ISN 0078		DC 20 I=1,10	01120000
ISN 0079		XI=I	01130000
ISN 0080		SFP(I)=SFFMIN+DELSHP*(XI-1.0)	01140000
ISN 0081		SFPR=SFP(I)	01150000
ISN 0082	21	SFPA=SFPR	01160000
ISN 0083		CALL TFRCSITFFCF,YLS2,ETAP)	01170000
ISN 0084		ETAPP(I)=ETAP	01180000
ISN 0085		TPROPP(I)=TPRCF	01190000
ISN 0086		K=1	01200000
ISN 0087		IF (K.LT.3) GC TO 20	01210000
ISN 0089		IF (TPRCF1.LT.TFFCF(K)) GC TO 215	01220000
ISN 0091	20	CONTINUE	01230000
ISN 0092		SFPR=1.1*SFMA)	01240000
ISN 0093		WRITE(6,NFCWER)	01250000
ISN 0094		GC TO 6	01260000
ISN 0095	215	ETAP=TABLE(TPRCF1,TPRCFP,ETAPP,K,2,M)	01270000
ISN 0096		SFPR=TABLE(TPRCF1,TPRCFP,SFP,K,2,M)	01280000
ISN 0097	10	FORMAT(10), 'J DOES NOT CONVERGE IN TWENTY FIVE ITERATIONS - 1 SUBROUTINE POWER')	01290000 01300000
ISN 0098	9	FORMAT(22), '3HTF IS ERROR IS IN THE CRUISE POWER TABLE)	01310000
ISN 0099	8	FORMAT(22), '4HTF IS ERROR IS IN THE TAKEOFF POWER TABLE)	01320000
ISN 0100	6	RETURN	01330000
ISN 0101		END	01340000

ORIGINAL PAGE IS  
OF POOR QUALITY

NAME	TAG	TYPE	ADD.	NAME	TAG	TYPE	ADD.	NAME	TAG	TYPE	ADD.	NAME	TAG	TYPE	ADD.		
H	C	R*4	N.R.	I	SF	I*4	00020C	K	SFA	I*4	000210	M	FA	I*4	000214		
P	FA	R*4	000218	G	C	R*4	N.R.	R	C	R*4	N.R.	T	C	R*4	N.R.		
V	F	C	R*4	000910	W	C	R*4	N.R.	AF	C	R*4	N.R.	AR	C	R*4	N.R.	
BR	C	R*4	N.R.	BS	C	R*4	N.R.	CB	C	R*4	N.R.	CV	C	R*4	N.R.		
CX	C	R*4	N.R.	DH	C	R*4	N.R.	EN	C	R*4	N.R.	FF	FA	C	R*4	000434	
FM	C	R*4	N.R.	FP	C	R*4	N.R.	HC	C	R*4	N.R.	HH	FA	C	R*4	00021C	
PI	SFA	C	R*4	000864	PI	S	A	R*4	000220	RN	C	R*4	N.R.	SA	C	R*4	N.R.
ST	C	R*4	N.R.	SK	C	R*4	N.R.	TR	C	R*4	N.R.	VC	C	R*4	N.R.		
VT	C	R*4	N.R.	WE	C	R*4	N.R.	WF	C	R*4	N.R.	WO	C	R*4	N.R.		
WS	C	R*4	N.R.	WW	C	R*4	N.R.	XC	C	R*4	N.R.	XI	SF	C	R*4	000224	
AMU	C	R*4	N.R.	EHT	C	R*4	N.R.	BLP	SFA	C	R*4	000660	BMP	C	R*4	N.R.	
BVT	C	R*4	N.R.	CCP	C	R*4	00068C	CCT	C	R*4	000684	CCC	C	R*4	N.R.		
CDV	C	R*4	N.R.	CKF	C	R*4	N.R.	CKW	C	R*4	N.R.	CKI	C	R*4	N.R.		
CLW	C	R*4	N.R.	CRT	C	R*4	N.R.	CTP	C	R*4	N.R.	DK3	C	R*4	N.R.		
DK4	C	R*4	N.R.	DMR	FA	C	R*4	0009C8	ELC	C	R*4	N.R.	ELF	C	R*4	N.R.	
ELN	C	R*4	N.R.	ELT	C	R*4	N.R.	ENP	C	R*4	N.R.	ENR	FA	C	R*4	00011C	
FEH	C	R*4	N.R.	FET	C	R*4	N.R.	FEW	C	R*4	N.R.	GLF	C	R*4	N.R.		
HES	C	R*4	N.R.	HCC	C	R*4	N.R.	ITI	SF	I*4	000228	CWE	C	R*4	N.R.		
RHC	C	R*4	N.R.	RMI	C	R*4	N.R.	ROO	C	R*4	N.R.	SA5	C	R*4	N.R.		
SA6	C	R*4	N.R.	SA7	C	R*4	N.R.	SEE	C	R*4	N.R.	SFC	C	R*4	N.R.		
SHP	SFA	C	R*4	000248	SHT	C	R*4	N.R.	SKT	C	R*4	N.R.	SK1	C	R*4	N.R.	
SK2	C	R*4	N.R.	SK3	C	R*4	N.R.	SK4	C	R*4	N.R.	SK5	C	R*4	N.R.		
SK6	C	R*4	N.R.	SK7	C	R*4	N.R.	SK8	C	R*4	N.R.	SK9	C	R*4	N.R.		
SLM	C	R*4	N.R.	STH	C	R*4	N.R.	SVT	C	R*4	N.R.	TAF	C	R*4	N.R.		
TCR	C	R*4	N.R.	TCT	C	R*4	N.R.	TMP	C	R*4	N.R.	TGO	C	R*4	N.R.		
TVW	C	R*4	N.R.	ULF	C	R*4	N.R.	VHL	C	R*4	N.R.	VIN	C	R*4	N.R.		
VMC	C	R*4	N.R.	WAC	C	R*4	N.R.	WCC	C	R*4	N.R.	WEP	C	R*4	N.R.		
WES	C	R*4	N.R.	WFC	C	R*4	N.R.	WFE	C	R*4	N.R.	WFR	C	R*4	N.R.		
WFS	C	R*4	N.R.	WFW	C	R*4	N.R.	WHL	C	R*4	N.R.	WHT	C	R*4	N.R.		
WLG	C	R*4	N.R.	WMC	C	R*4	N.R.	WPC	C	R*4	N.R.	WPH	C	R*4	N.R.		
WRC	C	R*4	N.R.	WSC	C	R*4	N.R.	WST	C	R*4	N.R.	WTM	C	R*4	N.R.		
WVA	C	R*4	N.R.	WVT	C	R*4	N.R.	XLB	C	R*4	N.R.	XLR	C	R*4	N.R.		
XLW	C	R*4	N.R.	XMR	C	R*4	N.R.	ALFR	C	R*4	N.R.	ARHT	C	R*4	N.R.		
ARVT	C	R*4	N.R.	BHPA	C	R*4	N.R.	BHPP	F	C	R*4	0009D4	BHPR	C	R*4	N.R.	
CDHT	C	R*4	N.R.	CCVT	C	R*4	N.R.	CKFF	C	R*4	N.R.	CKHT	C	R*4	N.R.		
CKVT	C	R*4	N.R.	CAM1	C	R*4	N.R.	CAM2	C	R*4	N.R.	DAM3	C	R*4	N.R.		
DAM4	C	R*4	N.R.	LAM5	C	R*4	N.R.	DELR	C	R*4	N.R.	DVCL	C	R*4	N.R.		
ELDN	C	R*4	N.R.	ELDT	C	R*4	N.R.	ELHT	C	R*4	N.R.	ELCA	C	R*4	N.R.		
ELVT	C	R*4	N.R.	EMLF	C	R*4	N.R.	ETAP	SFA	C	R*4	0006E8	ETAT	F	C	R*4	000198
FEHI	C	R*4	N.R.	FEHL	C	R*4	N.R.	FEHT	C	R*4	N.R.	FEVT	C	R*4	N.R.		
FEWH	C	R*4	N.R.	FEWI	C	R*4	N.R.	GAP1	C	R*4	N.R.	GAP2	C	R*4	N.R.		
GAP3	C	R*4	N.R.	GAP4	C	R*4	N.R.	GAP5	C	R*4	N.R.	GAP6	C	R*4	N.R.		
GAP7	C	R*4	N.R.	FFIN	C	R*4	N.R.	LTHL	C	I*4	000850	PEHF	C	R*4	N.R.		
PLIN	C	R*4	N.R.	RELI	C	R*4	N.R.	RMAX	C	R*4	N.R.	SHPA	SF	C	R*4	000894	
SHPR	SF	C	R*4	000898	SFTE	C	R*4	N.R.	SIITW	C	R*4	N.R.	SKAC	C	R*4	N.R.	
SKAR	C	R*4	N.R.	SKCC	C	R*4	N.R.	SKFS	C	R*4	N.R.	SKFW	C	R*4	N.R.		
SKHL	C	R*4	N.R.	SKHT	C	R*4	N.R.	SKLG	C	R*4	N.R.	SKMC	C	R*4	N.R.		
SKPA	C	R*4	N.R.	SKPH	C	R*4	N.R.	SKRC	C	R*4	N.R.	SKSC	C	R*4	N.R.		
SKTM	C	R*4	N.R.	SKVT	C	R*4	N.R.	SKWP	C	R*4	N.R.	SKWW	C	R*4	N.R.		
SK10	C	R*4	N.R.	SK11	C	R*4	N.R.	SK12	C	R*4	N.R.	SK13	C	R*4	N.R.		

SK14	C	R*4	N.R.	SK15	C	R*4	N.R.	SLMH	C	R*4	N.R.	STPK	C	R*4	N.P.			
SVTE	C	R*4	N.R.	SVTW	C	R*4	N.R.	SWTT	C	R*4	N.R.	TBHL	FA	C	R*4	0004C0		
TB2	FA	C	R*4	0004E8	TBTC	FA	C	R*4	0004D4	TCHT	C	R*4	N.R.	TCLN	C	R*4	N.R.	
TCVT	C	R*4	N.R.	TINY	C	R*4	N.R.	TINZ	C	R*4	N.R.	TIN4	C	R*4	N.R.	N.R.		
TMAX	C	R*4	N.R.	TOVW	C	R*4	N.R.	TWTW	C	R*4	N.R.	WBAL	C	R*4	N.R.	N.R.		
WENV	C	R*4	N.R.	VFUL	C	R*4	N.R.	WGSB	C	R*4	N.R.	WPDS	C	R*4	N.R.	N.R.		
WPEI	C	R*4	N.R.	WPRB	C	R*4	N.R.	WPRG	C	R*4	N.R.	WPRP	C	R*4	N.R.	N.R.		
WRCA	C	R*4	N.R.	WSCA	C	R*4	N.R.	XLBH	C	R*4	N.R.	XLGD	C	R*4	N.R.	N.R.		
XLHL	C	R*4	N.R.	YLS2	SFA	C	R*4	0009C0	ALFDL	C	R*4	N.R.	ATMIY	C	R*4	N.R.	N.R.	
CBARF	C	R*4	N.R.	CEARW	C	R*4	N.R.	CLDES	C	R*4	N.R.	CLEYE	C	R*4	N.R.	N.R.		
CPIND	C	R*4	N.R.	CFNUC	C	R*4	N.R.	CPPAR	C	R*4	N.R.	CPPKO	F	C	R*4	00022C		
CPPRC	C	R*4	N.R.	CFTOT	C	R*4	N.R.	DELTA	F	C	R*4	0006C0	DELTH	C	R*4	N.R.	N.R.	
DELWF	C	R*4	N.R.	DELWP	C	R*4	N.R.	DSWFT	C	R*4	N.R.	ELCCA	C	R*4	N.R.	N.R.		
ENPCR	C	R*4	N.R.	ETAPF	SFA	C	R*4	00027C	ETAP2	C	R*4	N.R.	ETAP4	C	R*4	N.R.	N.R.	
FACTR	F	XF	R*4	0000C0	FETCT	C	R*4	N.R.	GMDD1	C	R*4	N.R.	HMAXD	C	R*4	N.R.	N.R.	
ICRUS	C	I*4	N.R.	NCCPP	S	C	I*4	000854	NGXPJ	S	C	I*4	000858	PFET2	C	R*4	N.R.	N.R.
POWER	C	R*4	000230	REALJ	C	R*4	000870	RHPMP	C	R*4	N.R.	SIGPA	C	R*4	N.R.	N.R.		
SIGMR	C	R*4	N.R.	SKAMD	C	R*4	N.R.	SKHAL	C	R*4	N.R.	SKGPI	C	R*4	N.P.	N.R.		
SKGB2	C	R*4	N.R.	SKPDS	C	R*4	N.R.	SKPEI	C	R*4	N.R.	SKPES	C	R*4	N.R.	N.R.		
SKPRB	C	R*4	N.R.	SKRBF	C	R*4	N.R.	SKRCA	C	R*4	N.R.	SKSCA	C	R*4	N.R.	N.R.		
SLMVT	C	R*4	N.R.	STMAX	C	R*4	N.R.	SWETH	C	R*4	N.R.	SWEXP	C	R*4	N.R.	N.R.		
SWWET	C	R*4	N.R.	SZRFC	F	C	R*4	000ADC	TABLE	F	XF	R*4	000C00	TBCL1	C	R*4	N.R.	N.R.
TBCRP	FA	C	R*4	0004FC	TEEP5	C	R*4	N.R.	TBPOW	C	R*4	N.R.	YBSFC	C	R*4	N.R.	N.R.	
TGBAR	C	R*4	N.R.	THETA	FA	C	R*4	0008EC	TPROP	SFA	C	R*4	0008F8	TVCNR	C	R*4	N.P.	N.R.
VBAPH	C	R*4	N.R.	VEARV	C	R*4	N.R.	VDIVE	C	R*4	N.R.	VGASB	C	R*4	N.P.	N.R.		
VGASR	C	R*4	N.R.	WPAYL	C	R*4	N.R.	WPSTR	C	R*4	N.R.	XLALB	C	R*4	N.R.	N.R.		
XLBWO	C	R*4	N.R.	XLINT	F	XF	R*4	000000	XLRLA	C	R*4	N.R.	XPJND	F	C	R*4	000234	N.R.
SQRT	XF	R*4	0000C0	FRXPR#	XF	R*4	000000	ALFDES	C	R*4	N.R.	BHPSUP	C	R*4	N.R.	N.R.		
CBARHT	C	R*4	N.R.	CEARVT	C	R*4	N.R.	CBYLOA	C	R*4	N.R.	CLALPH	C	R*4	N.R.	N.R.		
CRSIND	C	R*4	N.R.	CTSIGH	C	R*4	N.R.	CYCPRL	C	R*4	N.R.	DELFCR	C	R*4	N.R.	N.R.		
DELRTH	C	R*4	N.R.	DELSHP	SF	C	R*4	000238	DELJFC	C	R*4	N.R.	DELWPL	C	R*4	N.R.	N.R.	
DELWST	C	R*4	N.R.	ELSWSH	C	R*4	N.R.	ELYAFE	C	R*4	N.R.	ELVHL	C	R*4	N.R.	N.R.		
DPGIND	C	R*4	N.R.	ESPLMT	C	R*4	N.R.	DYLIND	C	R*4	N.R.	ELHLOA	C	R*4	N.R.	N.R.		
ELVLOA	C	R*4	N.R.	ETAIND	C	R*4	N.R.	ETAP4N	C	R*4	N.R.	EXPDRG	C	R*4	N.R.	N.R.		
FEDRAG	C	R*4	N.R.	FIXIND	C	R*4	N.R.	FWRNL#	F	XF	I*4	000000	GAMCII	C	R*4	N.R.	N.R.	
HULIND	C	R*4	N.R.	IBCCM#	F	XF	I*4	000000	INDCRU	C	I*4	N.R.	INDDRG	C	I*4	N.R.	N.R.	
INDDYL	C	I*4	N.R.	INCETA	C	I*4	N.R.	INDFIX	C	I*4	N.R.	INCHUL	C	I*4	N.R.	N.R.		
INDOPT	C	I*4	N.R.	INCCSW	C	I*4	N.R.	INDPOW	C	I*4	N.R.	INDPPP	C	I*4	N.P.	N.R.		
INDRDM	C	I*4	N.R.	IPRINT	C	I*4	N.R.	NPOWER	F	C	R*4	000002	OPTIND	C	R*4	N.R.	N.R.	
DSWIND	C	R*4	N.R.	PRFIND	C	R*4	N.R.	ROMIND	C	R*4	N.R.	RHCRHO	C	R*4	N.R.	N.R.		
SGTINC	C	R*4	N.R.	SHFMAX	SF	C	R*4	00023C	SHPMIN	SF	C	R*4	000240	SKBLNT	C	R*4	N.R.	N.R.
SKENV1	C	R*4	N.R.	SKENV2	C	R*4	N.R.	SKPDSZ	C	R*4	N.R.	SKVTAP	C	R*4	N.R.	N.R.		
SSIGMA	C	R*4	N.R.	THETA	F	C	R*4	0008B4	TBCDWI	C	R*4	N.R.	TB8AP4	C	R*4	N.R.	N.R.	
THETMR	C	R*4	N.R.	THRCST	SF	XF	R*4	000000	TOLIND	C	R*4	N.R.	TPRPPP	SFA	C	R*4	000298	N.R.
TPROP1	SFA	C	R*4	000244	VGEOVH	C	R*4	N.R.	WBALNT	C	R*4	N.R.	WPAYLG	C	R*4	N.R.	N.R.	
XTGTA2	C	R*4	N.R.	XTGTA4	C	R*4	N.R.											

\*\*\*\*\* COMMON INFORMATION \*\*\*\*\*

NAME OF COMMON BLOCK \* \* SIZE OF BLOCK 0009DC HEXADECIMAL BYTES



VAR. NAME	TYPE	REL. ADDR.	VAR. NAME	TYPE	REL. ADDR.	VAR. NAME	TYPE	REL. ADDR.	VAR. NAME	TYPE	REL. ADDR.
OPTIND	R*4	N.R.	FULIND	R*4	N.R.	DYLIND	R*4	N.R.	DRGIND	R*4	N.R.
OSWIND	R*4	N.R.	FIXIND	R*4	N.P.	RDMIND	R*4	N.R.	PRPIND	R*4	N.R.
ETAIND	R*4	N.R.	WC	R*4	N.R.	XLBWD	R*4	N.R.	XLRLA	R*4	N.R.
VGBCVH	R*4	N.R.	XLGF	R*4	N.R.	HMAXD	R*4	N.R.	RHCRPHO	R*4	N.R.
V*VC	R*4	N.R.	EMLF	R*4	N.R.	CK1	R*4	N.R.	DELWF	R*4	N.R.
CKFF	R*4	N.R.	VCIVE	R*4	N.R.	HOO	R*4	N.R.	RCO	R*4	N.R.
TCC	P*4	N.R.	GAF1	R*4	N.R.	SGTIND	P*4	N.R.	ELHLCA	R*4	N.R.
ELVLCA	R*4	N.R.	GAP2	R*4	N.R.	AR	R*4	N.P.	WS	R*4	N.R.
TCR	R*4	N.R.	TC1	R*4	N.R.	SLM	R*4	N.H.	APHT	R*4	N.R.
TCFT	R*4	N.R.	VEARF	R*4	N.R.	SLMH	R*4	N.R.	ARVT	R*4	N.R.
TCVT	R*4	N.R.	VEARV	R*4	N.R.	SLMVT	R*4	N.R.	ELDN	R*4	N.R.
ELCT	R*4	N.R.	ELCOA	R*4	N.R.	DLSSH	R*4	N.R.	DSWET	R*4	N.R.
DLVLF	R*4	N.R.	DVCL	R*4	N.R.	CBYLOA	R*4	N.R.	ENR	R*4	00011C
WVA	R*4	N.R.	CAM1	R*4	N.R.	CAM2	R*4	N.R.	BMR	R*4	N.R.
CAM3	R*4	N.R.	CLEYE	R*4	N.R.	THETMR	R*4	N.R.	XC	R*4	N.R.
XMR	R*4	N.R.	TVMR	R*4	N.R.	VT	R*4	N.R.	CTSIGH	R*4	N.R.
TVA	R*4	N.R.	FES	R*4	N.R.	TINY	R*4	N.R.	ETAP2	R*4	N.R.
ETAP4N	R*4	N.R.	TBEM5	R*4	N.R.	TBAP4	R*4	N.R.	GAP3	R*4	N.R.
CAM4	R*4	N.R.	ENP	R*4	N.R.	ETAT	R*4	000198	HC	R*4	N.R.
VC	R*4	N.R.	ATMIY	R*4	N.R.	CDVT	R*4	N.R.	CCHT	R*4	N.R.
DAM5	R*4	N.R.	CLTAF	R*4	N.R.	FEDRAG	R*4	N.R.	EXPDRG	R*4	N.R.
CCC	R*4	N.R.	CLALF	R*4	N.R.	CKVT	R*4	N.R.	CKHT	R*4	N.R.
CKF	R*4	N.R.	CKW	R*4	N.R.	RELI	R*4	N.R.	TCLN	R*4	N.R.
TBCL1	R*4	N.R.	TBCW1	R*4	N.R.	GAP4	R*4	N.R.	WFE	P*4	N.R.
WFL1	R*4	N.R.	DELWFC	R*4	N.R.	DELWP	R*4	N.R.	DELWST	R*4	N.R.
SKCC	R*4	N.R.	SKRC	R*4	N.R.	SKSC	R*4	N.R.	SKFW	R*4	N.R.
SKTM	R*4	N.R.	SKRC1	R*4	N.R.	SKSCA	R*4	N.R.	SKMC	R*4	N.R.
SKAC	R*4	N.R.	SKHL	R*4	N.R.	SKENV1	R*4	N.R.	SKENV2	P*4	N.R.
SKGB1	R*4	N.R.	SKGB2	R*4	N.R.	SKBLNT	R*4	N.P.	SKBAL	R*4	N.R.
SKLG	R*4	N.R.	SKW	R*4	N.R.	ELF	R*4	N.R.	RMI	P*4	N.R.
SKWP	R*4	N.R.	SKHT	R*4	N.R.	SKVT	R*4	N.R.	SKPRB	R*4	N.R.
SKRBF	R*4	N.R.	SKPT	R*4	N.R.	SKAMD	R*4	N.R.	SKAP	R*4	N.R.
SKPA	R*4	N.R.	SKVTAR	R*4	N.R.	SKPDS	R*4	N.R.	SKPCSZ	R*4	N.R.
SKT	R*4	N.R.	SKFS	R*4	N.R.	SKPEI	R*4	N.P.	SKPES	R*4	N.R.
SK1	R*4	N.R.	SK2	R*4	N.R.	JK3	P*4	N.R.	DK4	R*4	N.R.
SK5	R*4	N.R.	SK6	R*4	N.R.	SK7	R*4	N.R.	SK8	R*4	N.R.
SK9	R*4	N.R.	SK10	R*4	N.R.	SK11	R*4	N.R.	SK12	R*4	N.R.
SK13	R*4	N.R.	SK14	R*4	N.R.	SK15	R*4	N.R.	PLIN	R*4	N.R.
GAF5	R*4	N.R.	TCLINC	R*4	N.R.	XTGTA2	R*4	N.R.	TIN2	R*4	N.R.
TWTW	R*4	N.R.	PFET2	R*4	N.R.	DELTH	R*4	N.R.	STH	R*4	N.R.
CRSIND	R*4	N.R.	XTCTA4	P*4	N.R.	TIN4	R*4	N.R.	VIN	R*4	N.R.
DELW	R*4	N.R.	RMAX	R*4	N.R.	DELFCR	R*4	N.R.	ENPCR	R*4	N.R.
DELWFL	R*4	N.R.	STPW	R*4	N.R.	HFIN	R*4	N.R.	GAP6	R*4	N.R.
CYCPFL	R*4	N.R.	FF	R*4	0004B4	SK3	R*4	N.R.	SK4	R*4	N.R.
TBF1	R*4	0004C0	TBTC	R*4	0004D4	TBH2	R*4	0004E8	TBCRP	R*4	0004FC
TBSFC	R*4	N.R.	TBPCW	R*4	N.R.	GAP7	R*4	N.R.	ALFDES	R*4	N.R.
ALFCL	R*4	N.R.	ALFR	R*4	N.R.	AMU	R*4	N.R.	BHFA	R*4	N.R.
BHFR	R*4	N.R.	BHPSUF	R*4	N.R.	BHT	R*4	N.R.	BLP	R*4	000660
ER	R*4	N.R.	ES	R*4	N.R.	BVT	R*4	N.R.	CBAFF	R*4	N.R.
CBARHT	R*4	N.R.	CBARV1	R*4	N.R.	CBARW	R*4	N.R.	CCP	R*4	000680
CCT	R*4	000684	CCV	R*4	N.R.	CLW	R*4	N.R.	CPIND	R*4	N.R.

7-114

CPALC	R*4	N.R.	CPPAF	R*4	N.R.	CPPRO	R*4	N.R.	CPTCT	R*4	N.R.
CRT	R*4	N.R.	CTF	R*4	N.R.	CV	R*4	N.R.	CX	R*4	N.R.
CLDES	R*4	N.R.	CE	R*4	N.R.	DELRTH	R*4	N.R.	DELTA	R*4	0006C0
CF	R*4	N.R.	CSPLMT	R*4	N.R.	ELC	R*4	N.R.	ELHT	R*4	N.R.
ELN	R*4	N.R.	ELCA	R*4	N.R.	ELT	R*4	N.R.	ELVT	R*4	N.R.
EA	R*4	N.R.	ETAP	R*4	0006E8	FEH	R*4	N.R.	FEHI	R*4	N.R.
FEHL	R*4	N.R.	FEHT	R*4	N.R.	FET	R*4	N.R.	FETCT	R*4	N.R.
FEVT	R*4	N.R.	FEW	R*4	N.R.	FEWH	R*4	N.R.	FEWI	R*4	N.R.
FM	R*4	N.R.	FF	R*4	N.R.	ETAP4	R*4	N.R.	GAMD11	R*4	N.R.
GLF	R*4	N.R.	CMCD1	R*4	N.R.	H	R*4	N.R.	ICRUS	I*4	N.R.
INDCRU	I*4	N.R.	INCCRC	I*4	N.R.	INDDYL	I*4	N.R.	INDETA	I*4	N.R.
INCFIX	I*4	N.R.	INDHLL	I*4	N.P.	INDOPT	I*4	N.R.	INDCSW	I*4	N.R.
INDFCW	I*4	N.R.	INCPRF	I*4	N.R.	INDRDM	I*4	N.R.	IPRINT	I*4	N.R.
LTHL	I*4	000850	NCCPF	I*4	000854	NOXPJ	I*4	000858	OWE	R*4	N.R.
PEHF	R*4	N.R.	PI	R*4	000864	Q	R*4	N.R.	RHO	R*4	N.R.
REALJ	R*4	000870	RHFMR	R*4	N.F.	R	R*4	N.R.	RN	R*4	N.R.
SA	R*4	N.R.	SAE	R*4	N.R.	SA6	R*4	N.R.	SA7	R*4	N.R.
SFC	R*4	N.R.	SHPA	R*4	000894	SHPR	R*4	000898	SHT	R*4	N.P.
SFTE	R*4	N.R.	SHTK	R*4	N.R.	SIGMA	R*4	N.R.	SSIGMA	R*4	N.P.
ST	R*4	N.R.	STFETA	R*4	0008B4	STMAX	R*4	N.R.	SVT	R*4	N.R.
SVTE	R*4	N.R.	SVTK	R*4	N.R.	SW	R*4	N.R.	SWETH	R*4	N.R.
SWEXP	R*4	N.R.	SWTT	R*4	N.R.	SWWET	R*4	N.R.	S2RHO	R*4	0008DC
T	R*4	N.R.	TAF	R*4	N.R.	TCBAR	R*4	N.P.	THETA	R*4	0008EC
TMAX	R*4	N.R.	TMF	R*4	N.R.	TPROP	R*4	0008F8	TR	R*4	N.R.
LLF	R*4	N.R.	VGASE	R*4	N.R.	VGASR	R*4	N.R.	VHL	R*4	N.R.
V	R*4	000910	W	R*4	N.R.	WBAL	R*4	N.R.	WBALNT	R*4	N.R.
WCC	R*4	N.R.	WE	R*4	N.R.	WEP	R*4	N.R.	WES	R*4	N.R.
WF	R*4	N.R.	WFC	R*4	N.R.	WFR	R*4	N.R.	WFS	R*4	N.R.
WFK	R*4	N.R.	WGSE	R*4	N.R.	WHL	R*4	N.R.	WHT	R*4	N.R.
WLG	R*4	N.R.	WMC	R*4	N.R.	WPAYL	R*4	N.R.	WPC	R*4	N.R.
WPDS	R*4	N.R.	WPEI	R*4	N.R.	WPH	R*4	N.R.	WPRE	R*4	N.R.
WPRG	R*4	N.R.	WPRF	R*4	N.R.	WPSTR	R*4	N.R.	WRC	R*4	N.R.
WRCA	R*4	N.R.	WSC	R*4	N.R.	WSCA	R*4	N.R.	WST	R*4	N.R.
WTV	R*4	N.R.	WVT	R*4	N.R.	WW	R*4	N.R.	WPAYLO	R*4	N.R.
WAC	R*4	N.R.	WENV	R*4	N.R.	XLALB	R*4	N.R.	XCB	R*4	N.R.
XLBH	R*4	N.R.	XLHL	R*4	N.R.	XLR	R*4	N.R.	XLW	R*4	N.R.
YLS2	R*4	0009C0	TCVK	R*4	N.R.	DMR	R*4	0009C8	SIGMR	R*4	N.R.
AF	R*4	N.R.	BHPF	R*4	0009D4	SEE	R*4	N.R.			

7-115

LABEL	ADDR	LABEL	ADDR	LABEL	ADDR	LABEL	ADDR	PAGE	008
14	0CC4A6	15	CCG4DE	23	0C0534	16	000580		
22	0CC598	13	CC05AE NR	27	0005F6	11	000610		
5	0CC66C	25	CCC694	230	CC06EC	231	000738		
21	0CC81C NR	20	CCCE64	215	0C068C	6	0008B8		

\*OPTIONS IN EFFECT\* NAME= MAIN,GPT=C2,LINECNT=54,SIZE=00COK,

\*OPTIONS IN EFFECT\* SOURCE,EBCCIC,ACLIST,ACDECK,LOAD,MAP,NOEDIT,ID,NOXREF

\*STATISTICS\* SOURCE STATEMENTS = 100 ,PROGRAM SIZE = 2268

\*STATISTICS\* NO DIAGNOSTICS GENERATED

\*\*\*\*\* END OF COMPIATION \*\*\*\*\*

95K BYTES OF CORE NOT USED

7-116

ORIGINAL PAGE IS  
OF POOR QUALITY

COMPILEK OPTIONS - NAME= MAIN,OPT=02,LINECNT=54,SIZE=0000K,  
SOURCE,EBCDIC,NOLIST,NODECK,LOAD,MAP,NOEDIT, ID,NOXREF

```

ISN 0002      SUBROUTINE PRFRM                                00C10000
               C**** MEMBER NAME B81PRFRM                    00C20000
               C PAGE 1 INPUT LOC 0001 THRU 0050             00C30000
ISN 0003      COMMON OPTIND ,HULIND ,DYLIND ,DRGIND ,OSWIND ,00C40000
               1FIXIND ,RDMIND ,PRPIND ,ETAIND ,WO ,XLBWO ,00C50000
               2XLRLA ,VGBOVH ,XLGD ,HMAXD ,RHORHO ,VMO ,00C60000
               3EMLF ,CK1 ,DELWF ,CKFF ,VDIVE ,HGG ,00070000
               4ROO ,TOO ,GAP1(5) ,SGTIND(12) ,ELHLOA ,ELVLOA ,00C80000
               5GAP2(6)                                       00C90000
ISN 0004      C PAGE 2 INPUT LOC 0051 THRU 0100             00100000
               COMMON AR ,WS ,TCR ,TCT ,SLM ,00110000
               1ARHT ,TCHT ,VBARH ,SLMH ,ARVT ,TCVT ,00120000
               2VBARV ,SLMVT ,ELDN ,ELDT ,ELDOA ,DLWSH ,00130000
               3DSWET ,DLVLHL ,DVOL ,CBYLOA ,ENR ,WVA ,00140000
               4DAMI ,DAM2 ,BMR ,DAM3 ,CLEYE ,THETMR ,00150000
               5XC ,XMR ,TVMR ,VT ,CTSIGH ,TVW ,00160000
               6HES ,TINY ,ETAP2 ,ETAP4N ,TBEM5(5) ,TB8AP4(5) ,00170000
               7GAP3                                           00180000
ISN 0005      C PAGE 3 INPUT LOC 0101 THRU 140              00190000
               COMMON DAM4 ,ENP ,ETAT ,HC ,VC ,00200000
               1ATMIY ,CDVT ,CDHT ,DAM5 ,DLTAFE ,FEDRAG ,00210000
               2EXPDRG ,CDC ,CLALPH ,CKVT ,CKHT ,CKF ,00220000
               3CKW ,RELI ,TCLN ,TBCL1(8) ,TBCDWI(8) ,GAP4(4) ,00230000
ISN 0006      C PAGE 4 INPUT LOC 141 THRU 200 WEIGHT DATA 00240000
               COMMON WFE ,WFUL ,DELWFC ,DELWP ,DELWST ,00250000
               1SKCC ,SKRC ,SKSC ,SKFW ,SKTM ,SKRCA ,00260000
               2SKSCA ,SKMC ,SKAC ,SKHL ,SKENV1 ,SKENV2 ,00270000
               3SKGB1 ,SKGB2 ,SKBLNT ,SKBAL ,SKLG ,SKW ,00280000
               4ELF ,RMI ,SKWP ,SKHT ,SKVT ,SKPRB ,00290000
               5SKRBF ,SKPH ,SKAMD ,SKAR ,SKPA ,SKVTAR ,00300000
               6SKPDS ,SKPDSZ ,SKT ,SKFS ,SKPEI ,SKPES ,00310000
               7SK1 ,SK2 ,DK3 ,DK4 ,SK5 ,SK6 ,00320000
               8SK7 ,SK8 ,SK9 ,SK10 ,SK11 ,SK12 ,00330000
               9SK13 ,SK14 ,SK15 ,PLIN ,GAP5(3) ,00340000
ISN 0007      C PAGE 5 INPUT LOC 201 THRU 300                00350000
               COMMON TOLIND(5) ,XTGTA2(5) ,TIN2(5) ,TWTW(5) ,PFET2(5) ,00360000
               1DELTH(5) ,STH(5) ,CRSIND(5) ,XTGTA4(5) ,TIN4(5) ,VIN(5) ,00370000
               2DELR(5) ,RMAX(5) ,DELFCR(5) ,ENPCR(5) ,DELWPL(5) ,STPW(5) ,00380000
               3HFIN(5) ,GAP6(10) ,00390000
ISN 0008      C PAGE 6 INPUT LOC 301 THRU 400                00400000
               COMMON CYCPRL ,FF ,SK3 ,SK4 ,TBH1(5) ,00410000
               1TBTO(5) ,TBH2(5) ,TBCRP(5) ,TBSFC(8) ,TBPOW(8) ,GAP7(60) ,00420000
ISN 0009      C WORKING COMMON                                00430000
               COMMON ALFDES,ALFDL,ALFR,AMU,                00440000
               1 BHPA,BHPR,BHPSUP,BHT,ELP,BR,BS,BVT,        00450000
               2 CBARF,CBARHT,CBARVT,CBARW,CCP,CCT,CDV,CLW,CPIND,CPNUD,CPPAR,CPPROO00460000
               3,CPTOT,CRT,CTP,CV,CX,CLDES,CB,              00470000
               4 DELRTH,DELTA,DH,DSPLMT, ELC,ELHT,ELN,ELOA,ELT,ELVT,EN,ETAP, 00480000
               5 FEH,FEH1,FEHL,FEHT,FET,FETOT,FEVT,FEW,FEWH,FEWI,FM,FP,ETAP4 00490000
ISN 0010      COMMON GAMD11(3,15),GLF,GMDD1(16),H,          00500000

```

7-117

ORIGINAL PAGE IS  
OF POOR QUALITY

```

7 ICRUS, INDCRU, INDDRG, INDDYL, INDETA, INDFIX, INCHUL, INDCPT, INDOOSW, 00510000
8 INDPWA, INDRP, INDRDM, IPRINT 00520000
ISN 0011 COMMON LTHL, NOCPP, NOXPJ, OWE, PEHF, PI, Q, RHO, REALJ, RHPMR, R, RN 00530000
ISN 0012 COMMON SA, SA5, SA6, SA7, SFC, SHPA, SHPR, SHT, SHTE, SHTW, SIGMA, SSIGMA, ST, 00540000
1STHETA, STMAX, SVT, SVTE, SVTW, SW, SWETH, SWEXP, SWIT, SWHET, S2RH0 00550000
ISN 0013 COMMON T, TAF, TCBAR, THETA, TMAX, TMP, TPROP, TR, ULF, VGASB, VGASR, VHL, V 00560000
ISN 0014 COMMON W, WBAL, WBALNT, WCC, WE, WEP, WES, WF, WFC, WFR, WFS, WFW, 00570000
1 WGSB, WHL, WHT, WLG, WMC, WPAYL, WPC, WPDS, WPEI, WPH, WPRB, WPRG, WPRP, WPSTROC 00580000
2, WRC, WKCA, WSC, WSCA, WST, WTM, WVT, WW, WPAYLO, WAC, WENV 00590000
ISN 0015 COMMON XLALB, XLB, XLBH, XLHL, XLR, XLW, YLS2, TOVW 00600000
ISN 0016 COMMON DMR, SIGMR, AF, BHPP, SEE 00600001
ISN 0017 IF (IPRINT.EQ.1) WRITE(6,1001) 00610000
ISN 0019 1001 FORMAT(/1H1,15X,24HMISSION PERFORMANCE DATA/) 00620000
ISN 0020 W = WO 00630000
ISN 0021 WF = 0. 00640000
ISN 0022 ST = TOU 00650000
ISN 0023 R = ROO 00660000
ISN 0024 H = HOO 00670000
ISN 0025 WPAYLG = WPAYL 00680000
ISN 0026 ITOHL = 0 00690000
ISN 0027 ICRUS = 0 00700000
ISN 0028 ICHGPL = 0 00710000
ISN 0029 ITRALT = 0 00720000
ISN 0030 I = 1 00730000
ISN 0031 NEXT=0. 00730500
ISN 0032 INDCGT = SGTIND(I) + 0.1 00740000
ISN 0033 100 INDEX = INDCGT 00750000
ISN 0034 GO TO (1,2,1,4,1,1,1,8,9), INDEX 00760000
ISN 0035 IF (I.EQ.1) GO TO 20 00770000
ISN 0037 WFSR = WF 00780000
ISN 0038 WFR = CK1 * WF + DELWF 00790000
ISN 0039 WFRE = WFR - WF 00800000
ISN 0040 IF (IPRINT.EQ.1) WRITE(6,1002) WFSR, WFRE, WFR 00810000
ISN 0042 1002 FORMAT(/15X,23HMISSION FUEL REQUIRED =,F9.0 00820000
1 /15X,23HRESERVE FUEL REQUIRED =,F9.0 00830000
2 /15X,23HTOTAL FUEL REQUIRED =,F9.0) 00840000
ISN 0043 IF (IPRINT.NE.1) GO TO 300 00840100
ISN 0045 W = WO 00850000
ISN 0046 WF = 0. 00860000
ISN 0047 ST = TOU 00870000
ISN 0048 R = ROO 00880000
ISN 0049 H = HOO 00890000
ISN 0050 IF ((IPRINT.EQ.1).AND.(INDEX.EQ.0)) WRITE(6,1003) 00900000
ISN 0052 1003 FORMAT(1H1,15X,17HSECONDARY MISSION/) 00910000
ISN 0053 IF ((IPRINT.EQ.1).AND.(INDEX.EQ.100)) WRITE(6,1004) 00920000
ISN 0055 1004 FORMAT(/15X,22HEND OF SUCCESSFUL CASE) 00930000
ISN 0056 IF (INDEX.EQ.0) GO TO 201 00940000
ISN 0058 GO TO 300 00950000
ISN 0059 1 WRITE(6,1005) 00960000
ISN 0060 1005 FORMAT(/15X,80HTAXI ,CLIMB, DESCEND, LOITER, AND CHGFUEL SUBROUT 00970000
1 LINES ARE NOT AVAILABLE *****) 00980000
ISN 0061 NEXT = 1 00990000

```

ISN 0062	GO TO 200	01C00000
ISN 0063	20 WRITE(C,1006)	01010000
ISN 0064	1006 FORMAT(15X,44H***** FIRST SEGMENT IS ZERO OR 100 *****)	01C20000
ISN 0065	NEXT = 1	01C30000
ISN 0066	GO TO 200	01040000
ISN 0067	2 ITOHL = ITOHL + 1	01C50000
ISN 0068	CALL TOHL(ITOHL)	C1C60000
ISN 0069	GO TO 200	01070000
ISN 0070	4 ICRUS = ICRUS + 1	01C80000
ISN 0071	INDCKU = CRSIND(ICRUS) + 0.1	01C90000
ISN 0072	IF(INDCKU - 2)11,12,13	01100000
ISN 0073	11 CALL CRUS1(ICRUS)	C1110000
ISN 0074	GO TO 200	01120000
ISN 0075	12 CALL CRUS2(ICRUS)	01130000
ISN 0076	GO TO 200	01140000
ISN 0077	13 CALL CRUS3(ICRUS)	01150000
ISN 0078	GO TO 200	01160000
ISN 0079	8 ICHGPL = ICHGPL + 1	01170000
ISN 0080	CALL CHGPL(ICHGPL)	01180000
ISN 0081	GO TO 200	01190000
ISN 0082	9 ITRALT = ITRALT + 1	01200000
ISN 0083	CALL TRALT(ITRALT)	01210000
ISN 0084	200 IF(NEXT.NE.0)GO TO 300	C1220000
ISN 0085	201 I = I + 1	01230000
ISN 0087	INDSGT = SGTIND(I) + 0.1	01240000
ISN 0088	GO TO 100	01250000
ISN 0089	300 RETLKN	01260000
ISN 0090	END	01270000

NAME	TAG	TYPE	ADD.	NAME	TAG	TYPE	ADD.	NAME	TAG	TYPE	ADD.	NAME	TAG	TYPE	ADD.
H S	C	R#4	000B18	I	SF	I#4	000220	Q	C	R#4	N.R.	R S	C	R#4	000878
T	C	R#4	N.R.	V	C	R#4	N.R.	W S	C	R#4	0C0914	AF	C	R#4	N.R.
AR	C	R#4	N.R.	BR	C	R#4	N.R.	BS	C	R#4	N.R.	CS	C	R#4	N.R.
CV	C	R#4	N.R.	CX	C	R#4	N.R.	DH	C	R#4	N.R.	EN	C	R#4	N.R.
FF	C	R#4	N.R.	FM	C	R#4	N.R.	FP	C	R#4	N.R.	HC	C	R#4	N.R.
PI	C	R#4	N.R.	RN	C	R#4	N.R.	SA	C	R#4	N.R.	ST S	C	R#4	000880
SW	C	R#4	N.R.	TR	C	R#4	N.R.	VC	C	R#4	N.R.	VT	C	R#4	N.R.
WE	C	R#4	N.R.	WF	SF	C	000930	WD	F	C	000024	WS	C	R#4	N.R.
WW	C	R#4	N.R.	XC	C	R#4	N.R.	AMU	C	R#4	N.R.	BHT	C	R#4	N.R.
BLP	C	R#4	N.R.	BMR	C	R#4	N.R.	BVT	C	R#4	N.R.	CCP	C	R#4	N.R.
CCT	C	R#4	N.R.	CDC	C	R#4	N.R.	CDV	C	R#4	N.R.	CKF	C	R#4	N.R.
CKW	C	R#4	N.R.	CKL	F	C	000048	CLW	C	R#4	N.R.	CRT	C	R#4	N.R.
CTP	C	R#4	N.R.	DK3	C	R#4	N.R.	DK4	C	R#4	N.R.	DMR	C	R#4	N.R.
ELC	C	R#4	N.R.	ELF	C	R#4	N.R.	ELN	C	R#4	N.R.	ELT	C	R#4	N.R.
ENP	C	R#4	N.R.	ENR	C	R#4	N.R.	FEH	C	R#4	N.R.	FET	C	R#4	N.R.
FEW	C	R#4	N.R.	GLF	C	R#4	N.R.	HES	C	R#4	N.R.	HGO	F	C	000058
CHIE	C	R#4	N.R.	RHO	C	R#4	N.R.	RMI	C	R#4	N.R.	ROD	F	C	00005C
SA5	C	R#4	N.R.	SA6	C	R#4	N.R.	SA7	C	R#4	N.R.	SEE	C	R#4	N.R.
SFC	C	R#4	N.R.	SHT	C	R#4	N.R.	SKT	C	R#4	N.R.	SK1	C	R#4	N.R.
SK2	C	R#4	N.R.	SK3	C	R#4	N.R.	SK4	C	R#4	N.R.	SK5	C	R#4	N.R.
SK6	C	R#4	N.R.	SK7	C	R#4	N.R.	SK8	C	R#4	N.R.	SK9	C	R#4	N.R.
SLM	C	R#4	N.R.	STH	C	R#4	N.R.	SVT	C	R#4	N.R.	TAF	C	R#4	N.R.
TCR	C	R#4	N.R.	TCT	C	R#4	N.R.	TMP	C	R#4	N.R.	TOO	F	C	000060
TVW	C	R#4	N.R.	ULF	C	R#4	N.R.	VHL	C	R#4	N.R.	VIN	C	R#4	N.R.
VMD	C	R#4	N.R.	WAC	C	R#4	N.R.	WCC	C	R#4	N.R.	WEP	C	R#4	N.R.
WES	C	R#4	N.R.	WFC	C	R#4	N.R.	WFE	C	R#4	N.R.	WFR	SF	C	000938
WFS	C	R#4	N.R.	WFN	C	R#4	N.R.	WHL	C	R#4	N.R.	WHT	C	R#4	N.R.
WLG	C	R#4	N.R.	WMC	C	R#4	N.R.	WPC	C	R#4	N.R.	WPH	C	R#4	N.R.
WRC	C	R#4	N.R.	WSC	C	R#4	N.R.	WST	C	R#4	N.R.	WTM	C	R#4	N.R.
WVA	C	R#4	N.R.	WVT	C	R#4	N.R.	XLB	C	R#4	N.R.	XLR	C	R#4	N.R.
XLW	C	R#4	N.R.	XMR	C	R#4	N.R.	ALFR	C	R#4	N.R.	ARHT	C	R#4	N.R.
ARVT	C	R#4	N.R.	BHPA	C	R#4	N.R.	BHPP	C	R#4	N.R.	BHPR	C	R#4	N.R.
CDHT	C	R#4	N.R.	CDVT	C	R#4	N.R.	CKFF	C	R#4	N.R.	CKHT	C	R#4	N.R.
CKVT	C	R#4	N.R.	DAM1	C	R#4	N.R.	DAM2	C	R#4	N.R.	DAM3	C	R#4	N.R.
DAM4	C	R#4	N.R.	DAM5	C	R#4	N.R.	DELR	C	R#4	N.R.	DVGL	C	R#4	N.R.
ELUN	C	R#4	N.R.	ELDT	C	R#4	N.R.	ELHT	C	R#4	N.R.	ELJA	C	R#4	N.R.
ELVT	C	R#4	N.R.	EMLF	C	R#4	N.R.	ETAP	C	R#4	N.R.	ETAT	C	R#4	N.R.
FEHI	C	R#4	N.R.	FEHL	C	R#4	N.R.	FEHT	C	R#4	N.R.	FEVT	C	R#4	N.R.
FEWH	C	R#4	N.R.	FEWI	C	R#4	N.R.	GAP1	C	R#4	N.R.	GAP2	C	R#4	N.R.
GAP3	C	R#4	N.R.	GAP4	C	R#4	N.R.	GAP5	C	R#4	N.R.	GAP6	C	R#4	N.R.
GAP7	C	R#4	N.R.	HF IN	C	R#4	N.R.	LTHL	C	I#4	N.R.	NEXT	S	I#4	000224
PEHF	C	R#4	N.R.	PL IN	C	R#4	N.R.	RELI	C	R#4	N.R.	RMAX	C	R#4	N.R.
SHPA	C	R#4	N.R.	SHPR	C	R#4	N.R.	SHTP	C	R#4	N.R.	SHTX	C	R#4	N.R.
SKAC	C	R#4	N.R.	SKAR	C	R#4	N.R.	SKCC	C	R#4	N.R.	SKFS	C	R#4	N.R.
SKFW	C	R#4	N.R.	SKHL	C	R#4	N.R.	SKHT	C	R#4	N.R.	SKLG	C	R#4	N.R.
SKYC	C	R#4	N.R.	SKPA	C	R#4	N.R.	SKPH	C	R#4	N.R.	SKRC	C	R#4	N.R.
SKSC	C	R#4	N.R.	SKTM	C	R#4	N.R.	SKVT	C	R#4	N.R.	SKWP	C	R#4	N.R.
SKWW	C	R#4	N.R.	SK10	C	R#4	N.R.	SK11	C	R#4	N.R.	SK12	C	R#4	N.R.
SK13	C	R#4	N.R.	SK14	C	R#4	N.R.	SK15	C	R#4	N.R.	SLMH	C	R#4	N.R.
STPW	C	R#4	N.R.	SVTE	C	R#4	N.R.	SVTW	C	R#4	N.R.	SWTT	C	R#4	N.R.

7-120

ORIGINAL PAGE IS  
OF POOR QUALITY

7-121

TBH1	C	R#4	N.R.	TBH2	C	R#4	N.R.	TBTO	C	R#4	N.R.	TCHT	C	R#4	N.R.	
TCLN	C	R#4	N.R.	TCVT	C	R#4	N.R.	TINY	C	R#4	N.R.	TIN2	C	R#4	N.R.	
TIN4	C	R#4	N.R.	TMAX	C	R#4	N.R.	TOHL	SF	XF	R#4	CC0000	C	R#4	N.R.	
TWTW	C	R#4	N.R.	WBAL	C	R#4	N.R.	WENV	C	R#4	N.R.	TOGV	C	R#4	N.R.	
WFSR	SF	R#4	00022C	WFUL	C	R#4	N.R.	WGSB	C	R#4	N.R.	WFRF	SF	R#4	000228	
WPEI	C	R#4	N.R.	WPRB	C	R#4	N.R.	WPPG	C	R#4	N.R.	WPDS	C	R#4	N.R.	
WRCA	C	R#4	N.R.	WSCA	C	R#4	N.R.	XLBH	C	R#4	N.R.	WPRP	C	R#4	N.R.	
XLHL	C	R#4	N.R.	YLSL	C	R#4	N.R.	ALFDL	C	R#4	N.R.	XLGD	C	R#4	N.R.	
CBARF	C	R#4	N.R.	CBARW	C	R#4	N.R.	CHGPL	SF	XF	R#4	GC0000	C	R#4	N.R.	
CLEYE	C	R#4	N.R.	CPIND	C	R#4	N.R.	CPNUD	C	R#4	N.R.	CLDES	C	R#4	N.R.	
CPPRO	C	R#4	N.R.	CPTOT	C	R#4	N.R.	CRUS1	SF	XF	R#4	CC0000	C	R#4	N.R.	
CRUS3	SF	XF	R#4	000000	DELTA	C	R#4	N.R.	DELTH	C	R#4	N.R.	CRUS2	XF	R#4	000000
DELJP	C	R#4	N.R.	DSWET	C	R#4	N.R.	ELDCA	C	R#4	N.R.	DELWF	C	R#4	00004C	
ETAP2	C	R#4	N.R.	ETAP4	C	R#4	N.R.	FETOT	C	R#4	N.R.	ENPCR	C	R#4	N.R.	
HMAXU	C	R#4	N.R.	ICRUS	SFA	C	I#4	00081C	INDEX	SF	I#4	0C0230	GMD01	C	R#4	N.R.
NOCPP	C	I#4	N.R.	NUXPJ	C	I#4	N.R.	PFET2	C	R#4	N.R.	ITOHL	SFA	I#4	000234	
REALJ	C	R#4	N.R.	RHPMR	C	R#4	N.R.	SIGMA	C	R#4	N.R.	PRFRM	C	R#4	000238	
SKAMD	C	R#4	N.R.	SKBAL	C	R#4	N.R.	SKGB1	C	R#4	N.R.	SIGMR	C	R#4	N.R.	
SKPUS	C	R#4	N.R.	SKPEI	C	R#4	N.R.	SKPES	C	R#4	N.R.	SKG82	C	R#4	N.R.	
SKR9F	C	R#4	N.R.	SKRCA	C	R#4	N.R.	SKSCA	C	R#4	N.R.	SKPRB	C	R#4	N.R.	
STMAX	C	R#4	N.R.	SWETH	C	R#4	N.R.	SWEXP	C	R#4	N.R.	SLMVT	C	R#4	N.R.	
SZRHO	C	R#4	N.R.	TBCLI	C	R#4	N.R.	TBCRP	C	R#4	N.R.	SWET	C	R#4	N.R.	
TBPCW	C	R#4	N.R.	TBSFC	C	R#4	N.R.	TGBAR	C	R#4	N.R.	TBEM5	C	R#4	N.R.	
TPRUP	C	R#4	N.R.	TRALT	SF	XF	R#4	000000	TVMCK	C	R#4	N.R.	THETA	C	R#4	N.R.
VBARV	C	R#4	N.R.	VUIVE	C	R#4	N.R.	VGASB	C	R#4	N.R.	VBARH	C	R#4	N.R.	
WPAYL	F	C	R#4	000958	WPSTR	C	R#4	N.R.	XLALB	C	R#4	N.R.	VGASR	C	R#4	N.R.
XLRLA	C	R#4	N.R.	ALFDES	C	R#4	N.R.	BHPSUP	C	R#4	N.R.	XLBN0	C	R#4	N.R.	
CBARVT	C	R#4	N.R.	CBYLOA	C	R#4	N.R.	CLALPH	C	R#4	N.R.	CBARHT	C	R#4	N.R.	
CTSLGH	C	R#4	N.R.	CYCPRL	C	R#4	N.R.	DELFCR	C	R#4	N.R.	CRSIND	C	R#4	0003AC	
UELWFC	C	R#4	N.R.	DELWPL	C	R#4	N.R.	DELWST	C	R#4	N.R.	DELRTH	C	R#4	N.R.	
DLTAFE	C	R#4	N.R.	DLVLHL	C	R#4	N.R.	DRGIND	C	R#4	N.R.	DLWSH	C	R#4	N.R.	
DYLIND	C	R#4	N.R.	ELHLOA	C	R#4	N.R.	ELVLOA	C	R#4	N.R.	DSPLMT	C	R#4	N.R.	
ETAP4N	C	R#4	N.R.	EXPJRG	C	R#4	N.R.	FEDRAG	C	R#4	N.R.	ETAIND	C	R#4	N.R.	
GAMD11	C	R#4	N.R.	HULIND	C	R#4	N.R.	IBCOM#	F	XF	I#4	000000	FIXIND	C	R#4	N.R.
INDCRU	S	C	I#4	000820	INDORG	C	I#4	N.R.	INDIYL	C	I#4	N.R.	ICHGPL	SFA	I#4	00023C
INDFIX	C	I#4	N.R.	INDHUL	C	I#4	N.R.	INDOPT	C	I#4	N.R.	INDETA	C	I#4	N.R.	
INDPOW	C	I#4	N.R.	INDPRP	C	I#4	N.R.	INDKDM	C	I#4	N.R.	INDOSW	C	I#4	N.R.	
IPRINT	C	I#4	00084C	ITRALT	SFA	I#4	000244	OPTIND	C	R#4	N.R.	INCSGT	SF	I#4	000240	
PRPIND	C	R#4	N.R.	RHORDH	C	R#4	N.R.	SGTIND	F	C	R#4	N.R.	OSKIND	C	R#4	N.R.
SKBLNT	C	R#4	N.R.	SKENV1	C	R#4	N.R.	SGTIND	F	C	R#4	N.R.	SGTIND	F	C	000078
SKVTAR	C	R#4	N.R.	SSIGMA	C	R#4	N.R.	SKENV2	C	R#4	N.R.	SKPDSZ	C	R#4	N.R.	
TRBAP4	C	R#4	N.R.	THETMR	C	R#4	N.R.	STHETA	C	R#4	N.R.	TBCDWI	C	R#4	N.R.	
WBALNT	C	R#4	N.R.	WPAYLO	S	C	R#4	00099C	TOLIND	C	R#4	N.R.	VGBOVH	C	R#4	N.R.
									XTGTA2	C	R#4	N.R.	XTGTA4	C	R#4	N.R.

\*\*\*\*\* COMMON INFORMATION \*\*\*\*\*

NAME OF COMMON BLOCK *			* SIZE OF BLOCK			0009DC HEXADECIMAL BYTES					
VAR. NAME	TYPE	REL. ADDR.	VAR. NAME	TYPE	REL. ADDR.	VAR. NAME	TYPE	REL. ADDR.	VAR. NAME	TYPE	REL. ADDR.
OPTIND	R#4	N.R.	HULIND	R#4	N.R.	DYLIND	R#4	N.R.	DRGIND	R#4	N.R.



OSWIND	R*4	N.R.	FIXIND	R*4	N.R.	RCMIND	R*4	N.R.	PRPIND	R*4	N.R.
ETAIND	R*4	N.R.	WO	R*4	000024	XLBWO	R*4	N.R.	XLRLA	R*4	N.R.
VGBOVH	R*4	N.R.	XLGD	R*4	N.R.	HMAXD	R*4	N.R.	RHORHO	R*4	N.R.
VMO	R*4	N.R.	EMLF	R*4	N.R.	CKI	R*4	000048	DELWF	R*4	00004C
CKFF	R*4	N.R.	VDIVE	R*4	N.R.	HOO	R*4	000058	ROO	R*4	00005C
TDO	R*4	000060	GAP1	R*4	N.R.	SGTIND	R*4	000078	ELHLOA	R*4	N.R.
ELVLUA	R*4	N.R.	GAP2	R*4	N.R.	AR	R*4	N.R.	HS	R*4	N.R.
TGR	R*4	N.R.	TCT	R*4	N.R.	SLM	R*4	N.R.	ARHT	R*4	N.R.
TCHT	R*4	N.R.	VBARH	R*4	N.R.	SLMH	R*4	N.R.	ARVT	R*4	N.R.
TCVT	R*4	N.R.	VBARV	R*4	N.R.	SLMVT	R*4	N.R.	ELDN	R*4	N.R.
ELDT	R*4	N.R.	ELDOA	R*4	N.R.	DLSWSH	R*4	N.R.	DSWET	R*4	N.R.
DLVLHL	R*4	N.R.	DVOL	R*4	N.R.	CBYLCA	R*4	N.R.	ENR	R*4	N.R.
WVA	R*4	N.R.	DAMI	R*4	N.R.	DAM2	R*4	N.R.	BMR	R*4	N.R.
DAM3	R*4	N.R.	CLEYE	R*4	N.R.	THETMR	R*4	N.R.	XC	R*4	N.R.
XMR	R*4	N.R.	TVCMR	R*4	N.R.	VT	R*4	N.R.	CTSIGH	R*4	N.R.
TVW	R*4	N.R.	HES	R*4	N.R.	TINY	R*4	N.R.	ETAP2	R*4	N.R.
ETAP4N	R*4	N.R.	TBEM5	R*4	N.R.	TBBA P4	R*4	N.R.	GAP3	R*4	N.R.
DAM4	R*4	N.R.	ENP	R*4	N.R.	ETAT	R*4	N.R.	HC	R*4	N.R.
VC	R*4	N.R.	ATMIY	R*4	N.R.	CDVT	R*4	N.R.	GDHT	R*4	N.R.
DAM5	R*4	N.R.	DLTAFE	R*4	N.R.	FEDRAG	R*4	N.R.	EXPDRG	R*4	N.R.
CDC	R*4	N.R.	CLALPH	R*4	N.R.	CKVT	R*4	N.R.	CKHT	R*4	N.R.
CKF	R*4	N.R.	CKW	R*4	N.R.	RELI	R*4	N.R.	TCLN	R*4	N.R.
TBCL1	R*4	N.R.	TBCDWI	R*4	N.R.	GAP4	R*4	N.R.	WFE	R*4	N.R.
WFUL	R*4	N.R.	DELWFC	R*4	N.R.	DELWP	R*4	N.R.	DELWST	R*4	N.R.
SKCC	R*4	N.R.	SKRC	R*4	N.R.	SKSC	R*4	N.R.	SKFW	R*4	N.R.
SKTM	R*4	N.R.	SKRCA	R*4	N.R.	SKSCA	R*4	N.R.	SKMC	R*4	N.R.
SKAC	R*4	N.R.	SKHL	R*4	N.R.	SKENV1	R*4	N.R.	SKENV2	R*4	N.R.
SKGB1	R*4	N.R.	SKGB2	R*4	N.R.	SKBLNT	R*4	N.R.	SKBAL	R*4	N.R.
SKLG	R*4	N.R.	SKWW	R*4	N.R.	ELF	R*4	N.R.	RMI	R*4	N.R.
SKWP	R*4	N.R.	SKHT	R*4	N.R.	SKVT	R*4	N.R.	SKPRB	R*4	N.R.
SKRBF	R*4	N.R.	SKPH	R*4	N.R.	SKAMD	R*4	N.R.	SKAR	R*4	N.R.
SKPA	R*4	N.R.	SKVTAR	R*4	N.R.	SKPDS	R*4	N.R.	SKPDSZ	R*4	N.R.
SKT	R*4	N.R.	SKFS	R*4	N.R.	SKPEI	R*4	N.R.	SKPES	R*4	N.R.
SK1	R*4	N.R.	SK2	R*4	N.R.	DK3	R*4	N.R.	DK4	R*4	N.R.
SK5	R*4	N.R.	SK6	R*4	N.R.	SK7	R*4	N.R.	SK8	R*4	N.R.
SK9	R*4	N.R.	SK10	R*4	N.R.	SK11	R*4	N.R.	SK12	R*4	N.R.
SK13	R*4	N.R.	SK14	R*4	N.R.	SK15	R*4	N.R.	PLIN	R*4	N.R.
GAP5	R*4	N.R.	TOLIND	R*4	N.R.	XTGT A2	R*4	N.R.	TIN2	R*4	N.R.
TWTW	R*4	N.R.	PFET2	R*4	N.R.	DELTH	R*4	N.R.	STH	R*4	N.R.
CRSIND	R*4	0003AC	XTGTA4	R*4	N.R.	TIN4	R*4	N.R.	VIN	R*4	N.R.
DELK	R*4	N.R.	RMAX	R*4	N.R.	DELFCR	R*4	N.R.	ENPCR	R*4	N.R.
DELWPL	R*4	N.R.	STPW	R*4	N.R.	HFIN	R*4	N.R.	GAP6	R*4	N.R.
CYCPXL	R*4	N.R.	FF	R*4	N.R.	SK3	R*4	N.R.	SK4	R*4	N.R.
TBHL	R*4	N.R.	TBTO	R*4	N.R.	TBH2	R*4	N.R.	TBCRP	R*4	N.R.
TBSFC	R*4	N.R.	TBPOW	R*4	N.R.	GAP7	R*4	N.R.	ALFDES	R*4	N.R.
ALFDL	R*4	N.R.	ALFR	R*4	N.R.	AMU	R*4	N.R.	BHPA	R*4	N.R.
BHPR	R*4	N.R.	BHPSUP	R*4	N.R.	BHT	R*4	N.R.	BLP	R*4	N.R.
BR	R*4	N.R.	BS	R*4	N.R.	BVT	R*4	N.R.	CBARF	R*4	N.R.
CBARHT	R*4	N.R.	CBARVT	R*4	N.R.	CBARW	R*4	N.R.	CCP	R*4	N.R.
CCT	R*4	N.R.	CDV	R*4	N.R.	CLW	R*4	N.R.	CPIND	R*4	N.R.
CPNUD	R*4	N.R.	CPPAR	R*4	N.R.	CPPRO	R*4	N.R.	CPTOT	R*4	N.R.
CRT	R*4	N.R.	GTP	R*4	N.R.	CV	R*4	N.R.	CX	R*4	N.R.

CLDES	R*4	N.R.	CB	R*4	N.R.	DEL RTH	R*4	N.R.	DELTA	R*4	N.R.
DH	K*4	N.R.	DSPLMT	R*4	N.R.	ELC	R*4	N.R.	ELHT	R*4	N.R.
ELN	R*4	N.R.	ELOA	R*4	N.R.	ELT	R*4	N.R.	ELVT	R*4	N.R.
EN	R*4	N.R.	ETAP	R*4	N.R.	FEH	R*4	N.R.	FEHI	R*4	N.R.
FEHL	R*4	N.R.	FEHT	R*4	N.R.	FET	R*4	N.R.	FETOT	R*4	N.R.
FEVT	R*4	N.R.	FEW	R*4	N.R.	FEWH	R*4	N.R.	FEWI	R*4	N.R.
FM	R*4	N.R.	FP	R*4	N.R.	ETAP4	R*4	N.R.	GAMD11	R*4	N.R.
GLF	K*4	N.R.	GMD1	R*4	N.R.	H	R*4	000818	ICRUS	I*4	00081C
INDCRU	I*4	000820	INDDRG	I*4	N.R.	INDDYL	I*4	N.R.	INDETA	I*4	N.R.
INDFIX	I*4	N.R.	INDHUL	I*4	N.R.	INDOPT	I*4	N.R.	INDOSW	I*4	N.R.
INDPOW	I*4	N.R.	INDPRP	I*4	N.R.	INDRDM	I*4	N.R.	IPRINT	I*4	00084C
LTHL	I*4	N.R.	NOCPP	I*4	N.R.	NOXPJ	I*4	N.R.	OWE	R*4	N.R.
PEHF	R*4	N.R.	PI	R*4	N.R.	Q	R*4	N.R.	RHO	R*4	N.R.
REALJ	R*4	N.R.	RHPMR	R*4	N.R.	R	R*4	000878	RN	R*4	N.R.
SA	R*4	N.R.	SAS	R*4	N.R.	SA6	R*4	N.R.	SA7	R*4	N.R.
SFC	R*4	N.R.	SHPA	R*4	N.R.	SHPR	R*4	N.R.	SHT	R*4	N.R.
SHT	R*4	N.R.	SHTW	R*4	N.R.	SIGMA	R*4	N.R.	SSIGMA	R*4	N.R.
ST	R*4	000830	STHETA	R*4	N.R.	STMAX	R*4	N.R.	SVT	R*4	N.R.
SVTE	R*4	N.R.	SVTW	R*4	N.R.	SW	R*4	N.R.	SWETH	R*4	N.R.
SWEXP	R*4	N.R.	SWTT	R*4	N.R.	SWWET	R*4	N.R.	S2RHO	R*4	N.R.
T	K*4	N.R.	TAF	R*4	N.R.	TCBAR	R*4	N.R.	THETA	R*4	N.R.
TMAX	R*4	N.R.	TMP	R*4	N.R.	TPROP	R*4	N.R.	TR	R*4	N.R.
ULF	R*4	N.R.	VGASB	R*4	N.R.	VGA SR	R*4	N.R.	VHL	R*4	N.R.
V	K*4	N.R.	W	R*4	000914	WBAL	K*4	N.R.	WBALNT	R*4	N.R.
WCC	R*4	N.R.	WE	R*4	N.R.	WEP	R*4	N.R.	WES	R*4	N.R.
WF	R*4	000930	WFC	R*4	N.R.	WFR	R*4	000938	WFS	R*4	N.R.
WFW	R*4	N.R.	WGSB	R*4	N.R.	WHL	R*4	N.R.	WHT	R*4	N.R.
WLG	R*4	N.R.	WMC	R*4	N.R.	WPAYL	R*4	000958	WPC	R*4	N.R.
WPDS	R*4	N.R.	WPEI	R*4	N.R.	WPH	R*4	N.R.	WPRB	R*4	N.R.
WPRG	R*4	N.R.	WPRP	R*4	N.R.	WPSTR	R*4	N.R.	WRC	R*4	N.R.
WRCA	R*4	N.R.	WSC	R*4	N.R.	WSCA	R*4	N.R.	WST	R*4	N.R.
WTM	R*4	N.R.	WVT	R*4	N.R.	WV	R*4	N.R.	WPAYLO	R*4	00099C
WAC	R*4	N.R.	WENV	R*4	N.R.	XLALB	R*4	N.R.	XLB	R*4	N.R.
XLBH	R*4	N.R.	XLHL	R*4	N.R.	XLR	R*4	N.R.	XLW	R*4	N.R.
YLS2	R*4	N.R.	TDVW	R*4	N.R.	DMR	R*4	N.R.	SIGMR	R*4	N.R.
AF	R*4	N.R.	BHPP	R*4	N.R.	SEE	R*4	N.R.			

7-123

ORIGINAL PAGE IS  
OF POOR QUALITY

LABEL	ADDR	LABEL	ADDR	LABEL	ADDR	LABEL	ADDR
100	000310	1	000422	20	00043E	2	00045A
4	000476	11	0004B4	12	0004C6	13	0004D8
8	0004EA	9	000506	200	00051E	201	000524
300	00054C						

\*OPTIONS IN EFFECT\*      NAME= MAIN,OPT=02,LINECNT=54,SIZE=0000K,

\*OPTIONS IN EFFECT\*      SOURCE,EBCDIC,NOLIST,NODECK,LOAD,MAP,NOEDIT,ID,NOXREF

\*STATISTICS\*      SOURCE STATEMENTS =      89 ,PROGRAM SIZE =      1392

\*STATISTICS\* NO DIAGNOSTICS GENERATED

\*\*\*\*\* END OF COMPILATION \*\*\*\*\*

103K BYTES OF CORE NOT USED

7-124

COMPILER OPTIONS - NAME= MAIN,DPT=02,LINECNT=54,SIZE=0000K,  
SOURCE,EBCDIC,NOLIST,NODECK,LOAD,MAP,NOEDIT,LD,NOXREF

ISN 0002		SUBROUTINE ROTPOW								00010000	
	C****	MEMBER NAME B81ROTPOW								00020000	
	C	PAGE 1	INPUT	LOC	0001	THRU	0050			00030000	
ISN 0003		COMMON	OPTIND		HULIND		DYLIND		DRGIND	OSWIND	00040000
		1FIXIND	RDWIND		PRPIND		ETAIND		WO	XLBWO	00050000
		2XLKLA	VGBOVH		XLGD		HMAXD		KHORHO	VMO	00060000
		3EMLF	CKL		DELWF		CKFF		VDIVE	HUU	00070000
		4ROD	TDD		GAP1(5)		SGTIND(12)		ELHLOA	ELVLDA	00080000
		5GAP2(6)									00090000
	C	PAGE 2	INPUT	LOC	0051	THRU	0100			00100000	
ISN 0004		COMMON	AR		WS		TCR		TCT	SLM	00110000
		1ARHT	TCHT		VBARH		SLMH		ARVT	TCVT	00120000
		2VBARV	SLMVT		ELDN		ELDT		ELDOA	DLSWSH	00130000
		3DSNET	DLVLHL		DVOL		CBYLOA		ENR	NVA	00140000
		4DAM1	DAM2		BMR		DAM3		CLEYE	THETMR	00150000
		5XC	XMK		TVCMR		VT		CTSIGH	TVW	00160000
		6HES	TINY		ETAP2		ETAP4N		TBEM5(5)	TB8AP4(5)	00170000
		7GAP3									00180000
	C	PAGE 3	INPUT	LOC	0101	THRU	140			00190000	
ISN 0005		COMMON	DAM4		ENP		ETAT		HC	VC	00200000
		1ATHIY	CDVT		CDHT		DAM5		DLTAFE	FEDRAG	00210000
		2EXPDRG	CDC		CLALPH		CKVT		CKHT	CKF	00220000
		3CKW	RELI		TCLN		TBCL1(8)		TBCDWI(8)	GAP4(4)	00230000
	C	PAGE 4	INPUT	LOC	141	THRU	200			WEIGHT DATA	00240000
ISN 0006		COMMON	WFE		WFUL		DELWFC		DELWP	DELWST	00250000
		1SKCC	SKRC		SKSC		SKFW		SKTM	SKRCA	00260000
		2SKSCA	SKMC		SKAC		SKHL		SKENV1	SKENV2	00270000
		3SKGB1	SKGB2		SKBLNT		SKBAL		SKLG	SKWN	00280000
		4ELF	RMI		SKWP		SKHT		SKVT	SKPRB	00290000
		5SKRBF	SKPH		SKAMD		SKAR		SKPA	SKVTAR	00300000
		6SKPDS	SKPDSZ		SKT		SKFS		SKPEI	SKPES	00310000
		7SK1	SK2		DK3		DK4		SK5	SK6	00320000
		8SK7	SK8		SK9		SK10		SK11	SK12	00330000
		9SK13	SK14		SK15		PLIN		GAP5(3)		00340000
	C	PAGE 5	INPUT	LOC	201	THRU	300			00350000	
ISN 0007		COMMON	TQLIND(5)		XTGTA2(5)		TIN2(5)		TWTW(5)	PFET2(5)	00360000
		1DELTH(5)	STH(5)		CRSIND(5)		XTGTA4(5)		TIN4(5)	VIN(5)	00370000
		2DELR(5)	RMAX(5)		DELFGR(5)		ENPCR(5)		DELWPL(5)	STPW(5)	00380000
		3HFIN(5)	GAP6(10)								00390000
	C	PAGE 6	INPUT	LOC	301	THRU	400			00400000	
ISN 0008		COMMON	CYCPRL		FF		SK3		SK4	TBHI(5)	00410000
		1TBTO(5)	TBH2(5)		TBCRP(5)		TBSFC(8)		TBPOW(8)	GAP7(60)	00420000
	C	WORKING COMMON									00430000
ISN 0009		COMMON	ALFDES,ALFOL,ALFR,AMU,								00440000
	1	BHPA,BHPR,BHPSUP,BHT,BLP,BR,BS,BVT,									00450000
	2	CHARF,CBARHT,CBARVT,CBARW,CCP,CCT,CDV,CLW,CPIND,CPNUD,CPPAR,CPPROD									00460000
	3	CPTOT,CRT,CTP,CV,CX,CLDES,CB,									00470000
	4	DELRT,DELTA,DH,DSPLMT, ELC,ELHT,ELN,ELOA,ELT,ELVT,EN,ETAP,									00480000
	5	FEH,FEH1,FEHL,FEHT,FET,RETOT,FEVT,FEW,FEWH,FEWI,FM,FP,ETAP4									00490000
ISN 0010		COMMON	GAMD1(3,15),GLF,GMDD1(16),H,								00500000

7-125

	7	ICRUS, INDCRU, INDDRG, INDDYL, INDETA, INDFIX, INDHUL, INDOPT, INDOOSW,	00510000
	8	INDPOW, INDRPR, INDRDM, IPRINT	00520000
ISN 0011		COMMON L, IHL, NOCPP, NOXPJ, QWE, PEHF, PI, Q, RHO, REALJ, RHPMK, R, RN	00530000
ISN 0012		COMMON SA, SA5, SA6, SA7, SFC, SHPA, SHPK, SHT, SHTE, SHTA, SIGMA, SSIGMA, ST,	00540000
		1STHETA, STMAX, SVT, SVTE, SVTW, SW, SWETH, SWEXP, SWTT, SWWET, S2RHO	00550000
ISN 0013		COMMON T, TAF, TCBAR, THCTA, TMAX, TMP, TPROP, TR, ULF, VGASB, VGASR, VHL, V	00560000
ISN 0014		COMMON W, WBAL, WBALNT, WCC, WE, WEP, WES, WF, WFC, WFR, WFS, WFW,	00570000
	1	WGSB, WHL, WHT, WLG, WMC, WPAYL, WPC, WPOS, WPEI, WPH, WPRB, WPRG, WPRP, WPSTR	00580000
	2	WRC, WRCA, WSC, WSCA, WST, WTM, WVI, WW, WPAYLO, WAC, WENV	00590000
ISN 0015		COMMON XLALB, XLB, XLBH, XLHL, XLR, XLW, YLS2, TOVW	00600000
ISN 0016		COMMON DMR, SIGMR, AF, BHPP, SEE	00600001
ISN 0017		COMMON /RTPQW/ CTTBLE(1,2), THTBLE(5), DKHTB(1,2,5), AMUTB(20),	00601000
	1	CKNDTB(20), DMDBB(9), CKBLH(9), CTT(10), CKHUVT(10)	00602000
ISN 0018		NAMLIST /NRTPOW/ CTMR, CTSMR, CDB, DCDM, CDMR, EMD, FM, TOVW,	00610000
	1	CTPSMR, AMU, V, CPPRO, CPIND, CPPAR, CPNUC, DCDS, CKPER,	00620000
	2	ALFDL, RHPMK, BHPR, EPS, SVI, FFRM, CKINDM, CKHOVM, CKNUDM,	00630000
	3	DKHVM, DKHVRM, LC2, DL, INDTOL, B1, B2, DTOVW	00640000
ISN 0019		RTOD=57.2957795	00640100
ISN 0020		INDTOL=TOLIND(IHOHL)	00640200
ISN 0021		CPPRO=0.0	00650000
ISN 0022		CPIND=0.0	00660000
ISN 0023		CPPAR=0.0	00670000
ISN 0024		CPNUC=0.0	00680000
ISN 0025		CDUMR=0.0	00690000
ISN 0026		DCDS=0.0	00700000
ISN 0027		DCDM=0.0	00710000
ISN 0028		Q=1.42636*RHO*V**2	00720000
ISN 0029		LC2=0	00730000
ISN 0030		DL=TVW-1.0	00740000
ISN 0031		IF (V, EQ, Q) GO TO 10	00750000
ISN 0033		CT=4.0*XLR*TVW/(RHO*PI*DMR**2*ENR*VT**2)	00760000
ISN 0034		SVI=VT*SQRT((SQRT(AMU**4+CT**2)-AMU**2)/2.0)	00770000
ISN 0035		EPS=ATAN(2.0*SVI/(1.689*V))	00780000
ISN 0036		AMUP=SQRT((1.689*V)**2+SVI**2)/VT	00790000
ISN 0037		CTP=CTP*(1.0+DL*SIN(EPS)**2)	00800000
ISN 0038		CT=4.0*XLR*(1.0+DL*SIN(EPS)**2)/(RHO*PI*ENR*(DMR*VT)**2)	00810000
ISN 0039		GO TO 51	00820000
ISN 0040		10. IF (INDTOL.EQ.1) GO TO 50	00830000
ISN 0042		15 LC2=LC2+1	00840000
ISN 0043		50 XLA=ABS(XLR)	00850000
ISN 0044		CT=4.0*XLA*TCVW/(RHO*PI*ENR*(DMR*VT)**2)	00850100
ISN 0045		51 CTSNR=CT/SIGMR	00860000
ISN 0046		CTMR=CT	00870000
ISN 0047		CDBO=.00995	00880000
ISN 0048		CKH1=-.028	00890000
ISN 0049		CKH2=.262	00900000
ISN 0050		CKH3=.276	00910000
ISN 0051		CKH4=2.45	00920000
ISN 0052		EMDBO=.865	00930000
ISN 0053		CDB=CTSMR*(CKH2*CTSMR+CKH1)+CDBO	00940000
ISN 0054		IB=BMR-1	00950000
ISN 0055		EMDB=EMDBO+DMDBB(IB)-0.0028*THETMR-.0252	00960000

ISN 0056	EMD=EMDB-CKH4*CTSMR	00970000
ISN 0057	EMT=VT/(SA*1.688)	00980000
ISN 0058	DELTAM=EMT-EMD	00990000
ISN 0059	DCDM=CKH3*DELTAM**2	01000000
ISN 0060	IF (DELTAM.LE.0.0) DCDM=0.0	01010000
ISN 0062	IF (V.NE.0.0) GO TO 60	01020000
ISN 0064	CDO=CDB+DCDM	01030000
ISN 0065	CDMR=CDO	01040000
ISN 0066	CPPRO=CDO*SIGMR*(1.0-XC)/8.0	01050000
ISN 0067	GO TO 70	01060000
ISN 0068	60 CDBP=CDB	01070000
ISN 0069	DCDMP=DCDM	01080000
ISN 0070	CTPSMR=CTP/SIGMR	01090000
ISN 0071	CDBB=.0105	01100000
ISN 0072	CKC1=2.82	01110000
ISN 0073	CKC2=.09	01120000
ISN 0074	CKC3=1.17	01130000
ISN 0075	CKC4=.00124	01140000
ISN 0076	CKC5=.758	01150000
ISN 0077	EMDU=.743	01160000
ISN 0078	FG=(CTP/(SIGMR*((1.0-AMU)**2))*(1.0+CX/CTP))-CKC2	01170000
ISN 0079	F-FMR=FG	01180000
ISN 0080	EMD=EMDU-CKC5*CTP/SIGMR	01190000
ISN 0081	EMT90=(1.088*V+VT)/(SA*1.688)	01200000
ISN 0082	DCDS=CKC1*FG**3*(1.0-AMU)**2*COS(EPS)**2	01210000
ISN 0083	IF (DCDS.LT.0.0) DCDS=0.0	01220000
ISN 0085	DM90=EMT90-EMD	01230000
ISN 0086	IF (DM90.LE.0.0) GO TO 67	01240000
ISN 0088	DCDM=(CKC3*DM90**3+CKC4*DM90)*COS(EPS)**2+DCDMP*SIN(EPS)**2	01250000
ISN 0089	GO TO 65	01260000
ISN 0090	67 DCDM=DCDMP*SIN(EPS)**2	01270000
ISN 0091	65 CDO=CDBB*COS(EPS)**2+CDBP*SIN(EPS)**2+DCDS+DCDM	01280000
ISN 0092	CDMR=CDO	01290000
ISN 0093	CPPRO=CDO*SIGMR*(1.0+4.65*AMU**2)*(1.0-XC)/8.0	01300000
ISN 0094	CT=4.0*XLR*(1.0+DL*SIN(EPS)**2)/(RHU*PI*ENR*(DMR*VT)**2)	01310000
ISN 0095	70 CKHOVA=XLINT(CTT,CKHOVT,CT,10,M)	01320000
ISN 0096	IF (M.NE.0) WRITE(6,1003)	01330000
ISN 0098	DKHVT=XLKUP(CT,THETMR,CTTBLE,12,THBTB,5,DKHTB,12,5,IX,IY)	01340000
ISN 0099	DKHVM=DKHVT	01350000
ISN 0100	IF (IX.NE.0) WRITE(6,1004)	01360000
ISN 0102	IF (IY.NE.0) WRITE(6,1005)	01370000
ISN 0104	1003 FORMAT(10X,55HTHIS ERROR IS IN THE CT,KHOVA TABLE - SUBROUTINE ROT01380000	
	1POW)	01390000
ISN 0105	1004 FORMAT(10X,82HTHIS ERROR IS IN THE CT PART OF THE DELTA KHOVER THE01400000	
	1TA T TABLE - SUBROUTINE ROTPOW)	01410000
ISN 0106	1005 FORMAT(10X,86HTHIS ERROR IS IN THE THETA MR PART OF THE DELTA KHOV01420000	
	1ER THETA TABLE - SUBROUTINE ROTPOW)	01430000
ISN 0107	1006 FORMAT(10X,82HTHIS ERROR IS IN THE CT PART OF THE DELTA KHOVER THE01440000	
	1TA T TABLE - SUBROUTINE ROTPOW)	01450000
ISN 0108	1007 FORMAT(10X,89HTHIS ERROR IS IN THE THETA REF PART OF THE DELTA KH001460000	
	1VER THETA T TABLE - SUBROUTINE ROTPOW)	01470000
ISN 0109	THE TRF=-9.	01480000

ISN 0110	DKHVTR=XLKUP(CT,THETRF,CTTBLE,12,THTBLE,5,DKHTB,12,5,IX,IY)	01490000
ISN 0111	DKHVRM=DKHVTR	01500000
ISN 0112	IF (IX.NE.0) WRITE(6,1006)	01510000
ISN 0114	IF (IY.NE.0) WRITE(6,1007)	01520000
ISN 0116	CKHUV=CKBLH(IB)*(CKHOVA+DKHVTH-DKHVTR-1.0)+1.0	01530000
ISN 0117	CKHOVN=CKHUV	01540000
ISN 0118	IF (V.EQ.0.0) GO TO 100	01550000
ISN 0120	CKHOVP=CKHUV	01560000
ISN 0121	CKIND=1.1*CUS(EPS)**2+CKHOVP*SIN(EPS)**2	01570000
ISN 0122	CKINDM=CKIND	01580000
ISN 0123	CPIND=0.5*CKIND*CTP**2/AMUP	01590000
ISN 0124	CKPER=1.0+12.8*AMU**4	01600000
ISN 0125	CPPAR=AMU*CX*CKPER	01610000
ISN 0126	CKNUD=XLINT(AMUTB,CKNODB,AMU,20,M)	01620000
ISN 0127	CKNUDM=CKNUD	01630000
ISN 0128	IF (M.NE.0) WRITE(6,1009)	01640000
ISN 0130	1009 FORMAT(10X,52HTHIS ERROR IS IN THE MU,KNUD TABLE SUBROUTINE ROTPOW	01650000
	1)	01660000
ISN 0131	CPNUD=2.0*CTP*SIGMR*CKNUD/(BMR**2*(1.0+DL*SIN(EPS)**2))	01670000
ISN 0132	CPTOT=CPPRO+CPIND+CPPAR+CPNUD	01680000
ISN 0133	RHPMR=RHO*PI*DMR**2*ENR*VT**3*CPTOT/2200.	01690000
ISN 0134	ALFDL=-ATAN(CX*(1.0+DL*SIN(EPS)**2)/CTP)*RTOD	01700000
ISN 0135	RETURN	01710000
ISN 0136	100 CPIND=0.707*CKHUV*CT**1.5	01720000
ISN 0137	CPTOT=CPPRO+CPIND	01730000
ISN 0138	FM=0.707*CT**1.5/CPTOT	01740000
ISN 0139	RHPMK=RHO*PI*DMR**2*ENR*VT**3*CPTOT/2200.	01750000
ISN 0140	BHPR=RHPMR/ETAT	01760000
ISN 0141	IF (INDTOL.EQ.2.) GO TO 110	01770000
ISN 0143	RETURN	01780000
ISN 0144	110 IF (ABS((BHPA-BHPR)/BHPA).LT.0.01) GO TO 140	01790000
ISN 0146	IF (LC2.LT.2) GO TO 120	01800000
ISN 0148	B2=BHPR-BHPA	01810000
ISN 0149	DTQVW=B2*DTQVW/(B1-B2)	01820000
ISN 0150	B1=B2	01830000
ISN 0151	GO TO 130	01840000
ISN 0152	120 B1=BHPR-BHPA	01850000
ISN 0153	DTQVW=-0.5	01860000
ISN 0154	130 TQVW=TQVW-DTQVW	01870000
ISN 0155	GO TO 15	01880000
ISN 0156	140 RETURN	01890000
ISN 0157	END	01910000

NAME	TAG	TYPE	ADD.	NAME	TAG	TYPE	ADD.	NAME	TAG	TYPE	ADD.	NAME	TAG	TYPE	ADD.	
H	C	R*4	N.R.	M	FA	I*4	0003F0	Q	S	C	R*4	R	C	R*4	N.R.	
T	C	R*4	N.R.	V	FA	C	R*4	W		C	R*4	AF	C	R*4	N.R.	
AR	C	R*4	N.R.	BK		C	R*4	BS		C	R*4	B1	SF	C	R*4	
B2	SF	R*4	0003F8	CB		C	R*4	CT	SFA	R*4	0C03FC	CV	C	R*4	N.R.	
CX	FA	C	R*4	DH		C	R*4	CL	SFA	R*4	0C0400	EN	C	R*4	N.R.	
FF		C	R*4	FG	SF	R*4	000404	FM	S	C	R*4	000714	FP	C	R*4	N.R.
HC		C	R*4	IB	SF	I*4	000408	IX	FA	I*4	00040C	IY	FA	I*4	000410	
PI	F	C	R*4	RN		C	R*4	SA	F	C	R*4	ST	C	R*4	N.R.	
SW		C	R*4	TR		C	R*4	VC		C	R*4	VT	F	C	R*4	
WE		C	R*4	WF		C	R*4	WD		C	R*4	WS	C	R*4	N.R.	
WW		C	R*4	XC	F	C	R*4	AMU	FA	C	R*4	BHT	C	R*4	N.R.	
BLP		C	R*4	BMR	F	C	R*4	BVT		C	R*4	CCP	C	R*4	N.R.	
CCT		C	R*4	CDB	SF	R*4	000414	CDC		C	R*4	CDD	SF	R*4	000418	
CDV		C	R*4	CKF		C	R*4	CKW		C	R*4	CKL	C	R*4	N.R.	
CLW		C	R*4	CRT		C	R*4	CTP	SFA	C	R*4	CTT	FA	C	P*4	
DK3		C	R*4	DK4		C	R*4	DMR	F	C	R*4	ELC	C	R*4	N.R.	
ELF		C	R*4	ELN		C	R*4	ELT		C	R*4	EMD	SF	R*4	00041C	
EMT	SF	R*4	000420	ENP		C	R*4	ENR	F	C	R*4	EPS	SFA	R*4	000424	
FEH		C	R*4	FET		C	R*4	FEW		C	R*4	GLF	C	R*4	N.R.	
HES		C	R*4	HOO		C	R*4	LC2	SF	I*4	000428	OWE	C	R*4	N.R.	
RHO	F	C	R*4	RMI		C	R*4	ROO		C	R*4	SA5	C	R*4	N.R.	
SA6		C	R*4	SA7		C	R*4	SEE		C	R*4	SFC	C	R*4	N.R.	
SHT		C	R*4	SKT		C	R*4	SKI		C	R*4	SK2	C	R*4	N.R.	
SK3		C	R*4	SK4		C	R*4	SK5		C	R*4	SK6	C	R*4	N.R.	
SK7		C	R*4	SKB		C	R*4	SK9		C	R*4	SLM	C	R*4	N.R.	
STH		C	R*4	SVI	SFA	R*4	00042C	SVT		C	R*4	TAF	C	R*4	N.R.	
TCR		C	R*4	TCT		C	R*4	TMP		C	R*4	TOO	C	R*4	N.R.	
TVW	F	C	R*4	ULF		C	R*4	VHL		C	R*4	VIN	C	R*4	N.R.	
VMD		C	R*4	WAC		C	R*4	WCC		C	R*4	WEP	C	P*4	N.R.	
WES		C	R*4	WFC		C	R*4	WFE		C	R*4	WFR	C	R*4	N.R.	
WFS		C	R*4	WFW		C	R*4	WHL		C	R*4	WHT	C	R*4	N.R.	
WLG		C	R*4	WMC		C	R*4	WPC		C	R*4	WPH	C	R*4	N.R.	
WRC		C	R*4	WSC		C	R*4	WST		C	R*4	WTH	C	R*4	N.R.	
WVA		C	R*4	WVT		C	R*4	XLA	SF	R*4	000430	XLB	C	R*4	N.R.	
XLR	FA	C	R*4	XLW		C	R*4	XMR		C	R*4	ALFR	C	R*4	N.R.	
AMUP	SF	R*4	000434	ARHT		C	R*4	ARVT		C	R*4	BHPA	FA	C	R*4	
BHPP		C	R*4	BHPR	SFA	C	R*4	CDBB	SF	R*4	000438	COB0	SF	R*4	00043C	
CDBP	SF	R*4	000440	CDHT		C	R*4	CDVT		C	R*4	CKC1	SF	R*4	000444	
CKC2	SF	R*4	000448	CKC3	SF	R*4	00044C	CKC4	SF	R*4	0C0450	CKC5	SF	R*4	000454	
CKFF		C	R*4	CKHT		C	R*4	CKH1	SF	R*4	000458	CKH2	SF	R*4	00045C	
CKH3	SF	R*4	000460	CKH4	SF	R*4	000464	CKVT		C	R*4	CTMR	S	R*4	000468	
DAM1		C	R*4	DAM2		C	R*4	DAM3		C	R*4	DAM4	C	R*4	N.R.	
DAM5		C	R*4	DCDM	SF	R*4	00046C	DCDS	SF	R*4	000470	DELR	C	R*4	N.R.	
DM90	SF	R*4	000474	DVOL		C	R*4	ELDN		C	R*4	ELDT	C	R*4	N.R.	
ELHT		C	R*4	ELOA		C	R*4	ELVT		C	R*4	EMDB	SF	P*4	000478	
EMDO	SF	R*4	00047C	ENLF		C	R*4	ETAP		C	R*4	ETAT	F	C	R*4	
FEHI		C	R*4	FEHL		C	R*4	FEHT		C	R*4	FEVT	C	R*4	N.R.	
FEWH		C	R*4	FEWI		C	R*4	FFMR	S	R*4	000480	GAP1	C	R*4	N.R.	
GAP2		C	R*4	GAP3		C	R*4	GAP4		C	R*4	GAP5	C	R*4	N.R.	
GAP6		C	R*4	GAP7		C	R*4	HF IN		C	R*4	LTHL	C	I*4	N.R.	

7-129



PLHF	C	R*4	N.R.	PLIN	C	R*4	N.R.	RELI	C	R*4	N.R.	RMAX	C	P*4	N.R.
RTOD SF		R*4	000484	SHPA	C	R*4	N.R.	SHPR	C	R*4	N.R.	SHTE	C	R*4	N.R.
SHTW	C	R*4	N.R.	SKAC	C	R*4	N.R.	SKAR	C	R*4	N.R.	SKCC	C	P*4	N.R.
SKFS	C	R*4	N.R.	SKFW	C	R*4	N.R.	SKHL	C	R*4	N.R.	SKHT	C	R*4	N.R.
SKLG	C	R*4	N.R.	SKMC	C	R*4	N.R.	SKPA	C	R*4	N.R.	SKPH	C	R*4	N.R.
SKRC	C	R*4	N.R.	SKSC	C	R*4	N.R.	SKTM	C	R*4	N.R.	SKVT	C	R*4	N.R.
SKWP	C	R*4	N.R.	SKWW	C	R*4	N.R.	SK10	C	R*4	N.R.	SK11	C	R*4	N.R.
SK12	C	R*4	N.R.	SK13	C	R*4	N.R.	SK14	C	R*4	N.R.	SK15	C	P*4	N.R.
SLMH	C	R*4	N.R.	STPW	C	R*4	N.R.	SVTE	C	R*4	N.R.	SVTW	C	R*4	N.R.
SWTT	C	R*4	N.R.	TBHI	C	R*4	N.R.	TB2	C	R*4	N.R.	TBTU	C	R*4	N.R.
TCHT	C	R*4	N.R.	TCLN	C	R*4	N.R.	TCVT	C	R*4	N.R.	TINY	C	R*4	N.R.
TIN2	C	R*4	N.R.	TIN4	C	R*4	N.R.	TMAX	C	R*4	N.R.	TQVW SF	C	R*4	0009C4
TWTW	C	R*4	N.R.	WBAL	C	R*4	N.R.	WENV	C	R*4	N.R.	WFUL	C	R*4	N.R.
WGSB	C	R*4	N.R.	WPDS	C	R*4	N.R.	WPEI	C	R*4	N.R.	WPRB	C	R*4	N.R.
WPRG	C	R*4	N.R.	WPRP	C	R*4	N.R.	WPCA	C	R*4	N.R.	WSCA	C	R*4	N.R.
XLBH	C	R*4	N.R.	XLGD	C	R*4	N.R.	XLHL	C	R*4	N.R.	YLS2	C	R*4	N.R.
ALFUD S	C	R*4	000644	AMUTB FA	C	R*4	000134	ATMIY	C	R*4	N.R.	CBARF	C	R*4	N.R.
CBAR#	C	R*4	N.R.	CDOMR S		R*4	000488	CKBLH F	C	R*4	0001F8	CKHOV SF		R*4	00048C
CKIND SF		R*4	000490	CKNUD SF		R*4	000494	CKPEK SF		R*4	000498	CLDES	C	R*4	N.R.
CLEYE	C	R*4	N.R.	CPIND SF	C	R*4	000690	CPNUD SF	C	R*4	000694	CPPAK SF	C	R*4	000698
CPPBQ SF	C	R*4	00069C	CPIUT SF	C	R*4	0006A0	CISMR SF		R*4	00049C	UCDMP SF		R*4	0004AU
DELTA	C	R*4	N.R.	DELTH	C	R*4	N.R.	DELWF	C	R*4	N.R.	DELWP	C	R*4	N.R.
DKHTB FA	C	R*4	000444	DKHVM S		R*4	0004A4	DMDBB F	C	R*4	0001D4	DSWET	C	R*4	N.R.
DTCVW SF		R*4	0004A8	ELDOA	C	R*4	N.R.	EMDBO SF		R*4	0004AC	EMT90 SF		R*4	0004EJ
ENPCR	C	R*4	N.R.	ETAP2	C	R*4	N.R.	ETAP4	C	R*4	N.R.	FETOT	C	R*4	N.R.
GMDD1	C	R*4	N.R.	HMAX	C	R*4	N.R.	ICRUS	C	I*4	N.R.	ITOHL F		I*4	0004B4
NDCPP	C	I*4	N.R.	NOXPJ	C	I*4	N.R.	PEETZ	C	R*4	N.R.	REALJ	C	P*4	N.R.
RHPNR SF	C	R*4	000874	SIGMA	C	R*4	N.R.	SIGMR F	C	R*4	0009CC	SKAMD	C	R*4	N.R.
SKBAL	C	R*4	N.R.	SKGB1	C	R*4	N.R.	SKGB2	C	R*4	N.R.	SKPDS	C	R*4	N.R.
SKPEI	C	R*4	N.R.	SKPES	C	R*4	N.R.	SKPRB	C	R*4	N.R.	SKRBF	C	R*4	N.R.
SKRCA	C	R*4	N.R.	SKSCA	C	R*4	N.R.	SLMVT	C	R*4	N.R.	STMAX	C	R*4	N.R.
SWETH	C	R*4	N.R.	SWEXP	C	R*4	N.R.	SWWET	C	R*4	N.R.	S2RHO	C	R*4	N.R.
TBCL1	C	R*4	N.R.	TBCRP	C	R*4	N.R.	TBEM5	C	R*4	N.R.	TBPOW	C	R*4	N.R.
TBSFC	C	R*4	N.R.	TCBAR	C	R*4	N.R.	FHETA	C	R*4	N.R.	TPROP	C	R*4	N.R.
TVCMR	C	R*4	N.R.	VBARH	C	R*4	N.R.	VBARV	C	R*4	N.R.	VDIVE	C	R*4	N.R.
VGASB	C	R*4	N.R.	VGASR	C	R*4	N.R.	WPAYL	C	R*4	N.R.	WPSTR	C	R*4	N.R.
XLALB	C	R*4	N.R.	XLBDU	C	R*4	N.R.	XLINT F	XF	R*4	000000	XLKUP F	XF	R*4	000000
XLRLA	C	R*4	N.R.	FRXPR#	XF	R*4	000000	COS	XF	R*4	000000	SIN	XF	R*4	000000
ATAN	XF	R*4	000000	SJKT	XF	R*4	000000	ALFDES	C	R*4	N.R.	BHPSUP	C	R*4	N.R.
CBARHT	C	R*4	N.R.	CBARVT	C	R*4	N.R.	CBYLCA	C	R*4	N.R.	CKHOVA SF		R*4	000488
CKHOVM S		R*4	00048C	CKHOVP SF		R*4	0004C0	CKHOVT FA	C	R*4	000244	CKINDM S		R*4	0004C4
CKNDIB FA	C	R*4	000184	CKNUDM S		R*4	0004C8	CLALPH	C	R*4	N.R.	CRSIND	C	R*4	N.R.
CTPSMR S		R*4	0004CC	CTSIGH	C	R*4	N.R.	CTBLE FA	C	R*4	000000	CYCPRL	C	R*4	N.R.
DELFCR	C	R*4	N.R.	DELRTH	C	R*4	N.R.	DELTAM SF		R*4	0004D0	DELWFC	C	R*4	N.R.
DELWPL	C	R*4	N.R.	DELWST	C	R*4	N.R.	DKHYRM S		R*4	0004D4	DKHVTH SF		R*4	0004DB
DKHVTR SF		R*4	0004DC	DLWSH	C	R*4	N.R.	DLTAFE	C	R*4	N.R.	DLVLHL	C	R*4	N.R.
DRGIND	C	R*4	N.R.	DSPLMT	C	R*4	N.R.	DYLIND	C	R*4	N.R.	ELHLOA	C	R*4	N.R.
ELVIGA	C	R*4	N.R.	ETAIND	C	R*4	N.R.	ETAP4N	C	R*4	N.R.	EXPORG	C	R*4	N.R.
FEDRAG	C	R*4	N.R.	FIXIND	C	R*4	N.R.	GAMD11	C	R*4	N.R.	HULIND	C	R*4	N.R.
IBCUM# F	XF	I*4	000000	INDCRU	C	I*4	N.R.	INDORG	C	I*4	N.R.	INDOYL	C	I*4	N.R.
INDETA	C	I*4	N.R.	INDEFIX	C	I*4	N.R.	INDHUL	C	I*4	N.R.	INDOPT	C	I*4	N.R.
INDOSW	C	I*4	N.R.	INDPOW	C	I*4	N.R.	INDPRP	C	I*4	N.R.	INDRDM	C	I*4	N.R.

INDTOL S	I#4	0004E0	IPRINT	C	I#4	N.R.	NKTPOW		OCF00	OPTIND	C	R#4	N.R.				
OSWIND	C	R#4	N.R.	PRPIND	C	R#4	N.R.	RDMIND	C	R#4	N.R.	RHORHO	C	R#4	N.R.		
KUTPOW		R#4	0004E4	SGTIND	C	R#4	N.R.	SKBLNT	C	R#4	N.R.	SKENV1	C	R#4	N.R.		
SKENV2	C	R#4	N.R.	SKPDSZ	C	R#4	N.R.	SKVTAR	C	R#4	N.R.	SSIGMA	C	R#4	N.R.		
STHETA	C	R#4	N.R.	TBCDWI	C	R#4	N.R.	T88AP4	C	R#4	N.R.	THETMR	FA	C	R#4	000138	
THETRF SFA		R#4	0004E8	THBLE	FA	C	R#4	000030	TOLIND	F	C	R#4	0C0320	VGBOVH	C	R#4	N.R.
WBALNT	C	R#4	N.R.	WPAYLO	C	R#4	N.R.	XTGTA2	C	R#4	N.R.	XTGTA4	C	R#4	N.R.		

## \*\*\*\*\* COMMON INFORMATION \*\*\*\*\*

NAME OF COMMON BLOCK *		* SIZE OF BLOCK		0009DC HEXADECIMAL BYTES							
VAR. NAME	TYPE	REL. ADDR.	VAR. NAME	TYPE	REL. ADDR.	VAR. NAME	TYPE	REL. ADDR.	VAR. NAME	TYPE	REL. ADDR.
OPTIND	R#4	N.R.	HULIND	R#4	N.R.	DYLIND	R#4	N.R.	DRGIND	R#4	N.R.
OSWIND	R#4	N.R.	FIXIND	R#4	N.R.	RDMIND	R#4	N.R.	PRPIND	R#4	N.R.
ETAIND	R#4	N.R.	WO	R#4	N.R.	XLBWO	R#4	N.R.	XLKLA	R#4	N.R.
VGBOVH	R#4	N.R.	XLGD	R#4	N.R.	HMAXD	R#4	N.R.	KHORHO	R#4	N.R.
VMO	R#4	N.R.	EMLF	R#4	N.R.	CKI	R#4	N.R.	DELWF	R#4	N.R.
CKFF	R#4	N.R.	VDIVE	R#4	N.R.	HOO	R#4	N.R.	ROO	R#4	N.R.
TQO	R#4	N.R.	GAP1	R#4	N.R.	SGTIND	R#4	N.R.	ELHLOA	R#4	N.R.
ELVLOA	R#4	N.R.	GAP2	R#4	N.R.	AR	R#4	N.R.	WS	R#4	N.R.
TCH	R#4	N.R.	TCT	R#4	N.R.	SLM	R#4	N.R.	ARHT	R#4	N.R.
TCHT	R#4	N.R.	VBAKH	R#4	N.R.	SLMH	R#4	N.R.	ARVT	R#4	N.R.
TCVT	R#4	N.R.	VBARV	R#4	N.R.	SLMVT	R#4	N.R.	ELDN	R#4	N.R.
ELDT	R#4	N.R.	ELDOA	R#4	N.R.	DLSSH	R#4	N.R.	DSWET	R#4	N.R.
DLVLHL	R#4	N.R.	DVOL	R#4	N.R.	CBYLOA	R#4	N.R.	ENR	R#4	00011C
MVA	R#4	N.R.	DAM1	R#4	N.R.	DAM2	R#4	N.R.	BMK	R#4	00012C
DAM3	R#4	N.R.	CLEVE	R#4	N.R.	THETMR	R#4	000138	XC	R#4	00013C
XMR	R#4	N.R.	TVCMK	R#4	N.R.	VT	R#4	000148	CTSIGH	R#4	N.R.
TVW	R#4	000150	HES	R#4	N.R.	TINY	R#4	N.R.	ETAP2	R#4	N.R.
ETAP4N	R#4	N.R.	TBEM5	R#4	N.R.	T88AP4	R#4	N.R.	GAP3	R#4	N.R.
DAM4	R#4	N.R.	ENP	R#4	N.R.	ETAT	R#4	000198	HC	R#4	N.R.
VC	R#4	N.R.	ATMIY	R#4	N.R.	CDVT	R#4	N.R.	CDHT	R#4	N.R.
DAM5	R#4	N.R.	DLTAFE	R#4	N.R.	FEDKAG	R#4	N.R.	EXPORG	R#4	N.R.
CDC	R#4	N.R.	CLALPH	R#4	N.R.	CKVT	R#4	N.R.	CKHT	R#4	N.R.
CKF	R#4	N.R.	CKW	R#4	N.R.	RELI	R#4	N.R.	TCLN	R#4	N.R.
TBCL1	R#4	N.R.	TBCDWI	R#4	N.R.	GAP4	R#4	N.R.	WFE	R#4	N.R.
WFUL	R#4	N.R.	DELWFC	R#4	N.R.	DELWP	R#4	N.R.	DELWST	R#4	N.R.
SKCC	R#4	N.R.	SKRC	R#4	N.R.	SKSC	R#4	N.R.	SKFW	R#4	N.R.
SKTM	R#4	N.R.	SKRCA	R#4	N.R.	SKSCA	R#4	N.R.	SKMC	R#4	N.R.
SKAC	R#4	N.R.	SKHL	R#4	N.R.	SKENV1	R#4	N.R.	SKENV2	R#4	N.R.
SKGB1	R#4	N.R.	SKGB2	R#4	N.R.	SKBLNT	R#4	N.R.	SKBAL	R#4	N.R.
SKLG	R#4	N.R.	SKWW	R#4	N.R.	ELF	R#4	N.R.	RMI	R#4	N.R.
SKWP	R#4	N.R.	SKHT	R#4	N.R.	SKVT	R#4	N.R.	SKPRB	R#4	N.R.
SKRBF	R#4	N.R.	SKPH	R#4	N.R.	SKAMD	R#4	N.R.	SKAR	R#4	N.R.
SKPA	R#4	N.R.	SKVTAR	R#4	N.R.	SKPDS	R#4	N.R.	SKPDSZ	R#4	N.R.
SKT	R#4	N.R.	SKFS	R#4	N.R.	SKPEI	R#4	N.R.	SKPE5	R#4	N.R.
SK1	R#4	N.R.	SK2	R#4	N.R.	DK3	R#4	N.R.	DK4	R#4	N.R.
SK5	R#4	N.R.	SK6	R#4	N.R.	SK7	R#4	N.R.	SK8	R#4	N.R.
SK9	R#4	N.R.	SK10	R#4	N.R.	SK11	R#4	N.R.	SK12	R#4	N.R.

ORIGINAL PAGE IS  
OF POOR QUALITY

7-131

SK13	R*4	N.R.	SK14	R*4	N.R.	SK15	R*4	N.R.	PLIN	R*4	N.R.
GAP5	R*4	N.R.	TULIND	R*4	000320	XTGTA2	R*4	N.R.	TIN2	R*4	N.R.
TWTW	R*4	N.R.	PFET2	R*4	N.R.	DELTH	R*4	N.R.	STH	R*4	N.R.
CRSIND	R*4	N.R.	XTGTA4	R*4	N.R.	TIN4	R*4	N.R.	VIN	R*4	N.R.
DELK	R*4	N.R.	RMAX	R*4	N.R.	DELFCR	R*4	N.R.	ENPCR	R*4	N.R.
DELWPL	R*4	N.R.	STPW	R*4	N.R.	HFIN	R*4	N.R.	GAP6	R*4	N.R.
CYCPRL	R*4	N.R.	FF	R*4	N.R.	SK3	R*4	N.R.	SK4	R*4	N.R.
TBHI	R*4	N.R.	TBTO	R*4	N.R.	TBHZ	R*4	N.R.	TBCRP	R*4	N.R.
TBSFC	R*4	N.R.	TBPOW	R*4	N.R.	GAP7	R*4	N.R.	ALFDES	R*4	N.R.
ALFDL	R*4	000044	ALFR	R*4	N.R.	AMU	R*4	00004C	BHPA	R*4	000650
BHPR	R*4	000654	BHPSUP	R*4	N.R.	BHT	R*4	N.R.	BLP	R*4	N.R.
BR	R*4	N.R.	BS	R*4	N.R.	HVT	R*4	N.R.	CBARF	R*4	N.R.
CBARHT	R*4	N.R.	CBARVT	R*4	N.R.	CBARW	R*4	N.R.	CCP	R*4	N.R.
CCT	R*4	N.R.	CDV	R*4	N.R.	CLW	R*4	N.R.	CPIND	R*4	000690
CPNUD	R*4	000094	CPPAR	R*4	000698	CPPKQ	R*4	00069C	CPTQT	R*4	0006A0
CRT	R*4	N.R.	CTP	R*4	0006A8	CV	R*4	N.R.	CX	R*4	000580
CLDES	R*4	N.R.	CB	R*4	N.R.	DELRTH	R*4	N.R.	DELTA	R*4	N.R.
DH	R*4	N.R.	DSPLMT	R*4	N.R.	ELC	R*4	N.R.	ELHT	R*4	N.R.
ELN	R*4	N.R.	ELUA	R*4	N.R.	ELT	R*4	N.R.	ELVT	R*4	N.R.
EN	R*4	N.R.	ETAP	R*4	N.R.	FEH	R*4	N.R.	FEHI	R*4	N.R.
FEHL	R*4	N.R.	FEHT	R*4	N.R.	FET	R*4	N.R.	FEIQT	R*4	N.R.
FEVT	R*4	N.R.	FEW	R*4	N.R.	FEWH	R*4	N.R.	FEWI	R*4	N.R.
FM	R*4	000714	FP	R*4	N.R.	ETAP4	R*4	N.R.	GAMD11	R*4	N.R.
GLE	R*4	N.R.	GMDL	R*4	N.R.	H	R*4	N.R.	ICRUS	R*4	N.R.
INDCRU	I*4	N.R.	INDDKG	I*4	N.R.	INDDYL	I*4	N.R.	INDETA	I*4	N.R.
INDFIX	I*4	N.R.	INDHUL	I*4	N.R.	INDOPT	I*4	N.R.	INDOSW	I*4	N.R.
INDPOW	I*4	N.R.	INDPRP	I*4	N.R.	INDROM	I*4	N.R.	IPRINT	I*4	N.R.
LTHL	I*4	N.R.	NOCPP	I*4	N.R.	NOXPJ	I*4	N.R.	OWE	R*4	N.R.
PEHT	R*4	N.R.	PI	R*4	000864	Q	R*4	000868	RHO	R*4	00086C
REALJ	R*4	N.R.	RHPMR	R*4	000874	R	R*4	N.R.	RN	R*4	N.R.
SA	R*4	000880	SA5	R*4	N.R.	SA6	R*4	N.R.	SA7	R*4	N.R.
SFC	R*4	N.R.	SHPA	R*4	N.R.	SHPK	R*4	N.R.	SHT	R*4	N.R.
SHTF	R*4	N.R.	SHTW	R*4	N.R.	SIGMA	R*4	N.R.	SSIGMA	R*4	N.R.
ST	R*4	N.R.	STHETA	R*4	N.R.	STMAX	R*4	N.R.	SVT	R*4	N.R.
SVTE	R*4	N.R.	SVTW	R*4	N.R.	SW	R*4	N.R.	SWETH	R*4	N.R.
SWEXP	R*4	N.R.	SWTT	R*4	N.R.	SWWET	R*4	N.R.	SZRHO	R*4	N.R.
T	R*4	N.R.	TAF	R*4	N.R.	TCBAR	R*4	N.R.	THETA	R*4	N.R.
TMAX	R*4	N.R.	TMP	R*4	N.R.	TPROP	R*4	N.R.	TR	R*4	N.R.
ULF	R*4	N.R.	VGASB	R*4	N.R.	VGASR	R*4	N.R.	VHL	R*4	N.R.
V	R*4	000910	W	R*4	N.R.	WBAL	R*4	N.R.	WBALNT	R*4	N.R.
WCC	R*4	N.R.	WE	R*4	N.R.	WEP	R*4	N.R.	WES	R*4	N.R.
WE	R*4	N.R.	WEC	R*4	N.R.	WER	R*4	N.R.	WFS	R*4	N.R.
WFW	R*4	N.R.	WGSB	R*4	N.R.	WHL	R*4	N.R.	WHT	R*4	N.R.
WLG	R*4	N.R.	WMC	R*4	N.R.	WPAYL	R*4	N.R.	WPC	R*4	N.R.
WPDS	R*4	N.R.	WPEI	R*4	N.R.	WPH	R*4	N.R.	WPRB	R*4	N.R.
WPRG	R*4	N.R.	WPKP	R*4	N.R.	WPSTR	R*4	N.R.	WRC	R*4	N.R.
WRCA	R*4	N.R.	WSC	R*4	N.R.	WSCA	R*4	N.R.	WST	R*4	N.R.
WTM	R*4	N.R.	WVT	R*4	N.R.	WW	R*4	N.R.	WPAYLO	R*4	N.R.
WAC	R*4	N.R.	WENV	R*4	N.R.	XLALB	R*4	N.R.	XLB	R*4	N.R.
XLBH	R*4	N.R.	XLHL	R*4	N.R.	XLR	R*4	0009B8	XLW	R*4	N.R.
YLS2	R*4	N.R.	TQVW	R*4	0009C4	DMR	R*4	0009C8	SIGMR	R*4	0009CC
AF	R*4	N.R.	BHPP	R*4	N.R.	SEE	R*4	N.R.			

7-132

NAME OF COMMON BLOCK \* RTPQW\* SIZE OF BLOCK 00026C HEXADECIMAL BYTES

VAR. NAME	TYPE	REL. ADDR.	VAR. NAME	TYPE	REL. ADDR.	VAR. NAME	TYPE	REL. ADDR.	VAR. NAME	TYPE	REL. ADDR.
CTTBL	R*4	000000	THTBLE	R*4	000030	DKHTB	R*4	000044	AMUTB	R*4	000134
CKNDTB	R*4	000184	DMDBB	R*4	0001D4	CKBLH	R*4	0001F8	CTT	R*4	00021C
CKHOVT	R*4	000244									

ORIGINAL PAGE IS  
OF POOR QUALITY

7-133

LABEL ADDR

LABEL ADDR

LABEL ADDR

LABEL ADDR

10 000934  
60 000A46  
100 000E9C  
140 000F84

15 00093A  
67 000B78  
110 000F42

50 000944  
65 000B98  
120 000F8E

51 000978  
70 000C24  
130 000FA4

\*OPTIONS IN EFFECT\* NAME= MAIN,OPT=02,LINECNT=54,SIZE=0000K,

\*OPTIONS IN EFFECT\* SOURCE,EBCDIC,NOLIST,NUDECK,LOAD,MAP,NOEDIT,NOXREF

\*STATISTICS\* SOURCE STATEMENTS = 156 ,PROGRAM SIZE = 4056

\*STATISTICS\* NO DIAGNOSTICS GENERATED

\*\*\*\*\* END OF COMPILATION \*\*\*\*\*

87K BYTES OF CORE NOT USED

\*STATISTICS\* NO DIAGNOSTICS THIS STEP

7-134

CCNFILER CPTICNS - NAME= MAIN,OPT=C2,LINECNT=54,SIZE=0COCK,

SOURCE,EBCDIC,ACLIST,NODECK,LOAD,MAP,NCEDIT,ID,NCXREF

ISN 0002																	00010000
																	00020000
																	00030000
																	00040000
																	00050000
																	00060000
																	00070000
																	00080000
																	00090000
ISN 0003	C	MEMBER NAME BEISIZTR															00100000
		PAGE 1	INPUT	LCC	0001	THRU	0050										00020000
		CCMMON	CPTIND	,FLLIND	,DYLIND	,CRGIND	,CSWIND										00030000
		IFIXIND	,FCMIND	,FFFIND	,ETAIND	,WC	,XLBWO										00040000
		2XLRLA	,VGEVH	,XLCD	,HMAXD	,RCHRHO	,VMC										00050000
		2EMLF	,CK1	,CELWF	,CKFF	,VDIVE	,HOC										00060000
		4RCC	,TOO	,CAPI(5)	,SGTIND(12)	,ELHLOA	,ELVLOA										00070000
		5GAP2(6)															00080000
ISN 0004	C	PAGE 2	INPUT	LOC	0051	THRU	0100										00090000
		CCMMON	AR	,AS	,TCR	,TCT	,SLN										00100000
		1ARFT	,TCFT	,VEARH	,SLMH	,ARVT	,TCVT										00110000
		2VBARV	,SLMT	,ELCN	,ELDT	,ELCOA	,DLKSH										00120000
		2DSWET	,CLVFL	,EVCL	,CBYLOA	,ENR	,WVA										00130000
		4CAM1	,CAM2	,EMR	,DAM3	,CLEVE	,THETMR										00140000
		5XC	,XMR	,TVCMR	,VT	,CTSIGH	,TVK										00150000
		6HES	,TINY	,ETAP2	,ETAP4N	,TBEM5(5)	,TB8AP4(5)										00160000
		7GAP3															00170000
ISN 0005	C	PAGE 3	INPUT	LCC	0101	THRU	140										00180000
		CCMMON	CAM4	,ENF	,ETAT	,FC	,VC										00190000
		1ATMIY	,CDVT	,CCFT	,DAM5	,CLTAFE	,FECRAG										00200000
		2EXFDRG	,CDC	,CLALP	,CKVT	,CKT	,CKF										00210000
		3CKW	,RELI	,TCLN	,TBCL1(8)	,TRCDWI(8)	,GAP4(4)										00220000
ISN 0006	C	PAGE 4	INPUT	LCC	141	THRU	200	WEIGHT DATA									00230000
		CCMMON	WFE	,WFL	,DELWFC	,CELWP	,DELWST										00240000
		1SKCC	,SKRC	,SKSC	,SKFW	,SKTM	,SKRCA										00250000
		2SKSCA	,SKMC	,SKAC	,SKHL	,SKENV1	,SKENV2										00260000
		3SKCBI	,SKGE2	,SKELNT	,SKBAL	,SKLG	,SKW										00270000
		4ELF	,RMI	,SKWP	,SKHT	,SKVT	,SKPRB										00280000
		5SKRBF	,SKFF	,SKAD	,SKAR	,SKPA	,SKVTAR										00290000
		6SKPDS	,SKPCSZ	,SKT	,SKFS	,SKPEI	,SKPES										00300000
		7SK1	,SK2	,CK2	,DK4	,SK5	,SK6										00310000
		8SK7	,SK8	,SK9	,SK10	,SK11	,SK12										00320000
		9SK13	,SK14	,SK15	,PLIN	,CAP5(3)											00330000
ISN 0007	C	PAGE 5	INPUT	LOC	201	THRU	300										00340000
		CCMMON	TCLINC(5)	,XTGTA2(5)	,TIN2(5)	,TWTW(5)	,PFET2(5)										00350000
		1CELTH(5)	,STH(5)	,CRSINC(5)	,XTGTA4(5)	,TIN4(5)	,VIN(5)										00360000
		2DELH(5)	,RMAX(5)	,DELFCR(5)	,ENPCR(5)	,DELWPL(5)	,STRW(5)										00370000
		3FFIN(5)	,GAP6(10)														00380000
ISN 0008	C	PAGE 6	INPUT	LCC	301	THRU	400										00390000
		CCMMON	CYCFPL	,FF	,SK3	,SK4	,TBH1(5)										00400000
		1TBTO(5)	,TBH2(5)	,TBCRP(5)	,TBSFC(8)	,TBPOW(8)	,GAP7(60)										00410000
ISN 0009	C	WORKING COMMON															00420000
		CCMMON	ALFCS,ALFCL,ALFR,ANU,														00430000
		1	BFFA,BFFR,BHPSLP,EHT,BLP,BR,BS,BVT,														00440000
		2	CBARF,CBARFT,CEARVT,CEARW,CCP,CCT,CDV,CLW,CPIND,CPNUD,PPAR,CPPRO														00450000
		3	CPTOT,CRT,CTP,CV,CX,CLCES,CB,														00460000
		4	DELTH,DELTA,DF,DSPLY,	ELC,ELHT,ELN,ELCA,ELT,ELVT,EN,ETAP,													00470000
		5	FEH,FEHI,FEHL,FEI,FEI,FEI,FEI,FEI,FEI,FEI,FEI,FEI,FEI,FEI,FEI,FEI,FEI,														00480000
ISN 0010		CCMMON	GAP11(3,15),GLF,CPDC1(16),H,														00490000
																	00500000

	7 ICRUS, INCRU, INCRG, INCCYL, INDETA, INDFIX, INDFUL, INDOPT, INEOSW,	00510000
	E INDPW, INDRP, INCRDM, IPRINT	00520000
ISN 0011	CCMMON LTF, NCCFF, ACXP, CKE, FEHF, PI, Q, RHC, REALJ, RFPMR, R, RA	00530000
ISN 0012	CCMMON SA, SA5, SA6, SA7, SFC, SHPA, SHPR, SHT, SHTE, SHTW, SIGMA, SSIGMA, ST,	00540000
	ISTFETA, STMAX, SVT, SVTE, SVTW, Sh, SWETH, SWEXP, SWTT, SWWET, S2RHC	00550000
ISN 0013	CCMMON T, TAF, TCEAR, TETA, TMAX, TMP, TPRCP, TR, ULF, VGASB, VGASR, VHL, V	00560000
ISN 0014	CCMMON W, WBA, WBAINT, WCC, WE, WEP, WES, WF, WFC, WFR, WFS, WFW,	00570000
	WGSB, WFL, WFT, WLG, WPC, WPAYL, WPC, WPDS, WPEI, WPF, WPRB, WPRG, WPRP, WPSTR	00580000
ISN 0015	2, WRC, WRCA, WSC, WSCA, WST, WTM, WVT, WW, WPAYLC, WAC, WENV	00600000
ISN 0016	CCMMON XLALB, XLB, XLB1, XLH, XLR, XLW, YLS2, TCVW	00610000
ISN 0017	CCMMON CTR, SIGR, AF, BFP, SEE	00610100
	NAMELIST /ASIZTR/ CPTINC, HULIND, DYLIND, DRGINC, CSWIND, FIXINC,	00620000
	1 REMINC, PRFIND, EIAINC, WQ, VGASR, VGASB, VHL, XLALB, DH,	00630000
	2 ELN, ELT, ELC, ELCA, SWETH, CV, EK1, EK2, EK3, EK4, EK5, EK6,	00640000
	3 LC1, SW1, VHL1, VHL2, Sh, BS, CRT, DELSW, B1, B2, TMAX, CBARH,	00650000
	4 R-C, C, CLDES, ALFDES, TCBAR, SKTP, SWEXP, SWWET, XLRH, TAF,	00660000
	5 SIGAR, CBARHT, SVT, SHT, SVTW, SHTW, SHTE, SVTE, DSPLMT,	00670000
	6 ELVT, ELVT, BHT, BVT, CRHT, CRVT, CTHT, CTVT, CBARHT, CBARVT,	00680000
	7 SKTH, SKTV	00690000
ISN 0018	SWWET = C.C	00700000
ISN 0019	PI=3.14159	00700100
ISN 0020	VGASR=(XLE+C*WC)/(C.C76474-XLGD)	00710000
ISN 0021	VGASB=VGASR/RHCRHC	00720000
ISN 0022	VHL=VGASB/VGBCVF	00730000
ISN 0023	XLALB=(1.C/XLE+C)-1.0	00740000
ISN 0024	IF (INDHUL.EQ.2) GC TC 1	00750000
ISN 0026	IF (INDHUL.GT.2) GC TC 10	00750100
ISN 0028	CHC=(PI*(ELCA/4.-ELDN/12.-7.*ELDT/60.))*1.0+CLVHL)	00760000
ISN 0029	CH=((VHL-DVCL)/CHC)**0.333	00770000
ISN 0030	ELN=ELCA*CH	00780000
ISN 0031	ELT=ELDT*CH	00790000
ISN 0032	ELC=ELCCA*CH-ELN-ELT	00800000
ISN 0033	ELCA=ELCCA*CH	00810000
ISN 0034	SWETH=DH*(2.40*ELN+3.14*ELC+2.07*ELT+0.46*DH))*(1.0+DLSWSH)+DSWET	00820000
ISN 0035	CV=4.0*VHL/(PI*CH**2*ELCA)	00840000
ISN 0036	GC TO 6	00850000
ISN 0037	1 EK1=0.12493-C.C7917*(1.C-SLM)**1.5+0.021*(1.C-SLM)**2	00860000
ISN 0038	EK2=-0.06642+C.C293*(1.0-SLM)**3-0.01422*(1.C-SLM)**4+	00870000
	10.C03383*(1.C-SLM)**5	00880000
ISN 0039	Sh=((VHL-DVCL)*AR**C.5*(1.+SLM)**2)/(10.*PI*TCR*(EK1+EK2)*	00890000
	1(1.+DLVHL))**C.66667	00900000
ISN 0040	5 BS=SQR(SV*AR)	00910000
ISN 0041	CRT=2.*SW/(BS*(SLM+1.C))	00920000
ISN 0042	EK3=4.4075*(1.-SLM)**2-2.494*(1.-SLM)**2.5-4.1755*(1.-SLM)**	00930000
	13.5+2.4115*(1.-SLM)**4.5-C.6695*(1.-SLM)**5.5+C.3969*(1.-SLM)	00940000
	2**2+1.4765*(1.-SLM)**4+C.64975*(1.-SLM)**5-1.7434*(1.-SLM)**	00950000
	36+1.26835*(1.-SLM)**7-C.41225*(1.-SLM)**8+0.06439*(1.-SLM)**9	00960000
ISN 0043	EK4=5.49415	00970000
ISN 0044	EK5=7.4225*(1.-SLM)**2-1.4965*(1.-SLM)**2.5-2.9825*(1.-SLM)**	00980000
	13.5+1.87575*(1.-SLM)**4.5-0.5479*(1.-SLM)**5.5+0.2646*(1.-SLM)	00990000
	2**3+1.10755*(1.-SLM)**4+C.51975*(1.-SLM)**5-1.453*(1.-SLM)**6	01000000
	3+1.08715*(1.-SLM)**7-C.3607*(1.-SLM)**8+0.0572*(1.-SLM)**9	01010000

ORIGINAL PAGE IS OF POOR QUALITY

7-136

ISN 0045	EK6=1.44513	01020000
ISN 0046	SWETH=EK6*(CRT**3*TCR**2*EK3/BS+CRT*3.*BS*SLM/2.+CRT*3.*BS* 1(1.-SLM)/4.+CRT*TCR**2*(EK4-EK5)/BS)*(1.+DLSKSH)+DSWET	01030000 01040000
ISN 0047	TMAX=TCR*CPT	01050000
ISN 0048	ELCA=CRT	01060000
ISN 0049	CBARW=CRT*C.5*(1.C+SLM)	01070000
ISN 0050	DSPLMT=C.(76474*VHL	01080000
ISN 0051	IF (INDHLL.EQ.1) GC TO 7	01090000
ISN 0053	IF (INDCYL.EQ.1.CR.INDCYL.EQ.3) GO TO 7	01100000
ISN 0055	SW=(1.0-XLRLA)*XLALB*XLB+C*WC/WS	01110000
ISN 0056	IF (INDCYL.EQ.2) SW=XLALB*XLBWC*WO/WS	01120000
ISN 0058	FF=HC	01130000
ISN 0059	V=VC	01140000
ISN 0060	CALL ATMOS(FC,ATMIY)	01150000
ISN 0061	Q=1.42636*RHC*V**2	01170000
ISN 0062	CLDES=WS/C	01180000
ISN 0063	ALPDES=CLDES/6.28	01190000
ISN 0064	BS=SQRT(SW*AR)	01200000
ISN 0065	CBARW=SW/BS	01210000
ISN 0066	TCBAR=C.5*(TCR+TCT)	01220000
ISN 0067	SKTP=1.25*TCBAR**2+0.2*TCBAR+2.0	01230000
ISN 0068	BSTCT=BS+CF	01240000
ISN 0069	ARTOT=BSTCT/CEARW	01250000
ISN 0070	SWEXP=SW	01260000
ISN 0071	SWTOT=SW+CF*CEARW	01270000
ISN 0072	SWWET=SWEXP*SKTP	01280000
ISN 0073	IF (INDRDM.EQ.1) GC TO 8	01290000
ISN 0075	FF=HES	01300000
ISN 0076	CALL ATMOS(FES,TINY)	01310000
ISN 0077	XLRH=WO*(1.0-XLEWC)	01330000
ISN 0078	IF (XLBWC.EQ.1.C) XLRH=VC*(TVW-1.0)	01340000
ISN 0080	DNR=SQRT(4.C*XLRF/(PI*VA*ENR))	01350000
ISN 0081	SIGMR=4.C*XLRF*TVW/(R+C*FI*DNR**2*ENR*VT**2*CTSIGH)	01360000
ISN 0082	IF (INDPPF.EQ.1) GC TO 9	01370000
ISN 0084	SIGAR=SIGMR	01380000
ISN 0085	TAF=2450.*SIGAR	01390000
ISN 0086	AF=TAF/BMR	01400000
ISN 0087	GC TO 9	01410000
ISN 0088	8 IF (INDPRP.EQ.C) TAF=AF*EMR	01420000
ISN 0090	IF (INDPRP.EQ.C) SIGMR=TAF/2450.	01420100
ISN 0092	9 ELHT=(1.-(CBYLCA+ELHLCA))*ELCA	01430000
ISN 0093	ELVT=(1.-(CBYLCA+ELVLCA))*ELCA	01440000
ISN 0094	SHT=VBARH*VHL/ELHT	01450000
ISN 0095	SVT=VBARV*VFL/ELVT	01460000
ISN 0096	BHT=SQRT(ARHT*SHT/2.)	01470000
ISN 0097	BVT=SQRT(ARVT*SVT/2.)	01480000
ISN 0098	CRFT=2.*BFT/(ARFT*(1.0+SLM))	01490000
ISN 0099	CRVT=2.*BVT/(ARVT*(1.0+SLMVT))	01500000
ISN 0100	CTHT=SLM*CRHT	01510000
ISN 0101	CTVT=SLMVT*CRVT	01520000
ISN 0102	CBARHT=(CRHT+CTHT)/2.	01530000
ISN 0103	CBARVT=(CRVT+CTVT)/2.	01540000

7-137

ORIGINAL PAGE IS  
OF POOR QUALITY



ISN 0104	SKTH=1.25*(TC+T)**2+0.2*TC+2.0	01550000
ISN 0105	SKTV=1.25*(TCVT)**2+0.2*TCVT+2.0	01560000
ISN 0106	SFTW=SKTH*SHT	01570000
ISN 0107	SVTW=SKTV*SVT	01580000
ISN 0108	SFTE=SFTW	01590000
ISN 0109	SVTE=SVTW	01600000
ISN 0110	GC TO 12	01610100
ISN 0111	IC IF(INDHUL.GT.3) GC TO 11	01610200
ISN 0113	CRT=2.*((3.*(VFL-CVCL))/(PI**2*AR*TCR*(1.+DLVLHL)))*0.333	01610300
ISN 0114	BS = PI * AR* CRT/4.	01610400
ISN 0115	TMAX = TCR * CRT	01610500
ISN 0116	XNEE = 1. - (TMAX/BS)**2	01610600
ISN 0117	XFE=1.5708-C.44062*XNEE+C.16289*XNEE**2-0.29316*XNEE**3	01610700
ISN 0118	SWETH=PI*CRT*BS*XEE*(1.+CLSWSH)/2.+DSWET	01610800
ISN 0119	SW=PI*CRT*BS/4.	01610900
ISN 0120	ELCA=CRT	01611000
ISN 0121	CEARW = SW/BS	01611100
ISN 0122	SLN=0.0	01611110
ISN 0123	GC TO 6	01611200
ISN 0124	II CRT=2.*((3.*(VFL-CVCL))/(4.*PI*TCR*(1.+DLVLHL)))*0.333	01611300
ISN 0125	BS=CRT	01611400
ISN 0126	AR = 1.27324	01611500
ISN 0127	TMAX=TCR*CRT	01611600
ISN 0128	XECC=(1.-(TCR)**2)**0.5	01611700
ISN 0129	SWETH=(PI/2.*CRT**2+PI/4.*TMAX**2/XECC*ALOG((1.+XECC)/(1.-XECC)))*01611800	01611800
	I(1.+DLSWSH)+DSWET	01611900
ISN 0130	SW=PI/4.*CRT**2	01612000
ISN 0131	CEARW = SW/BS	01612100
ISN 0132	ELCA=CRT	01612200
ISN 0133	SLN=0.0	01612210
ISN 0134	GC TO 6	01612300
ISN 0135	12 CCATINLE	01612400
ISN 0136	CB=ELOA*CEYLOA	01612500
ISN 0137	RETURN	01620000
ISN 0138	END	01630000

NAME	TAG	TYPE	ADD.	NAME	TAG	TYPE	ADD.	NAME	TAG	TYPE	ADD.	NAME	TAG	TYPE	ADD.			
H	C	R*4	N.R.	Q	SF	C	R*4	000868	R	C	R*4	.T	C	R*4	N.R.			
V	SF	C	R*4	000910	h	C	R*4	N.R.	AF	SF	C	R*4	AR	SFA	C	R*4		
BR	C	R*4	N.R.	BS	SF	C	R*4	000668	BI	C	R*4	000248	B2	C	R*4	00024C		
CB	S	C	R*4	0006B8	CV	S	C	R*4	0006AC	CX	C	R*4	N.R.	CH	SF	C	R*4	
EN	C	R*4	N.R.	FF	C	R*4	N.R.	000250	FM	C	R*4	N.R.	FP	C	R*4	N.R.		
HC	SFA	C	R*4	00019C	HH	S	C	R*4	000250	PI	SFA	C	R*4	PN	C	R*4	N.R.	
SA	C	R*4	N.R.	ST	C	R*4	N.R.	000864	SW	SFA	C	R*4	TR	C	R*4	N.R.		
VC	F	C	R*4	0001A0	VT	F	C	R*4	000143	WE	C	R*4	N.R.	WF	C	R*4	N.R.	
WC	F	C	R*4	000024	WS	F	C	R*4	0000CC	WW	C	R*4	N.R.	XC	C	R*4	N.R.	
AMU	C	R*4	N.R.	EHT	SF	C	R*4	00065C	BLP	C	R*4	N.R.	BMR	F	C	R*4		
BVT	SF	C	R*4	00066C	CCP	C	R*4	N.R.	CCT	C	R*4	N.R.	CDC	C	R*4	N.R.		
CDV	C	R*4	N.R.	CKF	C	R*4	N.R.	0006A4	CKW	C	R*4	N.P.	CK1	C	R*4	N.R.		
CLW	C	R*4	N.R.	CRT	SF	C	R*4	0006A4	CTP	C	R*4	N.R.	DHD	SF	C	R*4		
DK3	C	R*4	N.R.	CK4	C	R*4	N.R.	000260	DMR	SF	C	R*4	0009C8	EK1	SF	C	R*4	
EK2	SF	C	R*4	00025C	EK3	SF	C	R*4	0006CC	EK4	SF	C	R*4	000264	EK5	SF	C	R*4
EK6	SF	C	R*4	00026C	ELC	SF	C	R*4	0006CC	ELF	C	R*4	N.R.	ELN	SF	C	R*4	
ELT	SF	C	R*4	0006CC	ENP	C	R*4	N.R.	ENR	FA	C	R*4	00011C	FEH	C	R*4	N.R.	
FET	C	R*4	N.R.	FEW	C	R*4	N.R.	000270	GLF	C	R*4	N.R.	HES	SFA	C	R*4		
HGC	C	R*4	N.R.	LC1	I*4	C	R*4	000270	OWE	C	R*4	N.R.	RHD	F	C	R*4		
RMI	C	R*4	N.R.	RGO	C	R*4	N.R.	N.R.	SA5	C	R*4	N.R.	SA6	C	R*4	N.R.		
SA7	C	R*4	N.R.	SEE	C	R*4	N.R.	N.R.	SFC	C	R*4	N.R.	SHT	SFA	C	R*4		
SKT	C	R*4	N.R.	SKI	C	R*4	N.R.	N.R.	SK2	C	R*4	N.R.	SK3	C	R*4	N.R.		
SK4	C	R*4	N.R.	SK5	C	R*4	N.R.	N.R.	SK6	C	R*4	N.R.	SK7	C	R*4	N.R.		
SK8	C	R*4	N.R.	SK9	C	R*4	N.R.	N.R.	SLM	SF	C	R*4	000008	STH	C	R*4	N.R.	
SVT	SFA	C	R*4	00088C	SKI	C	R*4	000274	TAF	SF	C	R*4	0008E4	TCR	F	C	R*4	
TCT	F	C	R*4	000004	TMP	C	R*4	N.R.	TOO	C	R*4	N.R.	TVW	F	C	R*4		
ULF	C	R*4	N.R.	VFL	SF	C	R*4	00090C	VIN	C	R*4	N.R.	VMQ	C	R*4	N.R.		
WAC	C	R*4	N.R.	WCC	C	R*4	N.R.	N.R.	WEP	C	R*4	N.R.	WES	C	R*4	N.R.		
WFC	C	R*4	N.R.	WFE	C	R*4	N.R.	N.R.	WFR	C	R*4	N.R.	WFS	C	R*4	N.R.		
WFW	C	R*4	N.R.	WHL	C	R*4	N.R.	N.R.	WHT	C	R*4	N.R.	WLG	C	R*4	N.R.		
WMC	C	R*4	N.R.	WFC	C	R*4	N.R.	N.R.	WPH	C	R*4	N.R.	WRC	C	R*4	N.R.		
WSC	C	R*4	N.R.	WST	C	R*4	N.R.	N.R.	WTM	C	R*4	N.R.	WVA	FA	C	R*4		
WVT	C	R*4	N.R.	XEE	SF	C	R*4	000278	XLB	C	R*4	N.R.	XLR	C	R*4	N.R.		
XLW	C	R*4	N.R.	XMR	C	R*4	N.R.	N.R.	ALFR	C	R*4	N.R.	ARHT	FA	C	R*4		
ARVT	FA	C	R*4	0000EC	EHPA	C	R*4	N.R.	BHPP	C	R*4	N.R.	BHPR	C	R*4	N.R.		
CDHT	C	R*4	N.R.	CDVT	C	R*4	N.R.	N.R.	CKFF	C	R*4	N.R.	CKHT	C	R*4	N.R.		
CKVT	C	R*4	N.R.	CRHT	SF	C	R*4	00027C	CRVT	SF	C	R*4	000280	CTHT	SF	C	R*4	
CTVT	SF	C	R*4	000288	CAM1	C	R*4	N.R.	CAM2	C	R*4	N.R.	CAM3	C	R*4	N.R.		
DAM4	C	R*4	N.R.	CAM5	C	R*4	N.R.	N.R.	DELR	C	R*4	N.R.	CVOL	F	C	R*4		
ELDN	F	C	R*4	0000FC	ELDT	F	C	R*4	000100	ELHT	SF	C	R*4	0006DC	ELDA	SF	C	R*4
ELVT	SF	C	R*4	0006E0	EMLF	C	R*4	N.R.	ETAP	C	R*4	N.R.	ETAT	C	R*4	N.R.		
FEHI	C	R*4	N.R.	FEFL	C	R*4	N.R.	N.R.	FEHT	C	R*4	N.R.	FEVT	C	R*4	N.R.		
FEWH	C	R*4	N.R.	FEWI	C	R*4	N.R.	N.R.	GAP1	C	R*4	N.R.	GAP2	C	R*4	N.R.		
GAP3	C	R*4	N.R.	GAP4	C	R*4	N.R.	N.R.	GAP5	C	R*4	N.R.	GAP6	C	R*4	N.R.		
GAP7	C	R*4	N.R.	FFIN	C	R*4	N.R.	N.R.	LTHL	C	I*4	N.R.	PEHF	C	R*4	N.R.		
PLIN	C	R*4	N.R.	RELI	C	R*4	N.R.	N.R.	RMAX	C	R*4	N.R.	SHPA	C	R*4	N.R.		
SHPR	C	R*4	N.R.	SFTE	S	C	R*4	0008A0	SHTW	SF	C	R*4	0008A4	SKAC	C	R*4	N.R.	
SKAR	C	R*4	N.R.	SKCC	C	R*4	N.R.	N.R.	SKFS	C	R*4	N.R.	SKFW	C	R*4	N.R.		
SKHL	C	R*4	N.R.	SKHT	C	R*4	N.R.	N.R.	SKLG	C	R*4	N.R.	SKMC	C	R*4	N.R.		
SKPA	C	R*4	N.R.	SKPH	C	R*4	N.R.	N.R.	SKRC	C	R*4	N.R.	SKSC	C	R*4	N.R.		

7-139

SKTH SF	R*4	00028C	SKTM	C	R*4	N.R.	SKTP SF	R*4	00C290	SKTV SF	R*4	000294					
SKVT	C	R*4	N.R.	SKWP	C	R*4	N.R.	SKWW	C	R*4	N.R.	SK10	C	R*4	N.R.		
SK11	C	R*4	N.R.	SK12	C	R*4	N.R.	SK13	C	R*4	N.R.	SK14	C	R*4	N.R.		
SK15	C	R*4	N.R.	SLMF	F	C	R*4	0000E8	STPW	C	R*4	N.R.	SVTE	S	C	R*4	0008C0
SVTW SF	C	R*4	0008C4	SWTT	C	R*4	N.R.	TBHI	C	R*4	N.R.	TBH2	C	R*4	N.R.		
TBTD	C	R*4	N.R.	TCHT	F	C	R*4	00C0EG	TCLN	C	R*4	N.R.	TCVT	F	C	R*4	00C0F0
TINY SFA	C	R*4	000158	TIN2	C	R*4	N.R.	TIN4	C	R*4	N.R.	TMAX	SF	C	R*4	00C0F0	
TOVW	C	R*4	N.R.	TWTV	C	R*4	N.R.	VHL1	C	R*4	000298	VHL2	C	R*4	00029C		
WBAL	C	R*4	N.R.	WENV	C	R*4	N.R.	WFUL	C	R*4	N.R.	WGSB	C	R*4	N.R.		
WPDS	C	R*4	N.R.	WPEI	C	R*4	N.R.	WPRB	C	R*4	N.R.	WPRG	C	R*4	N.R.		
WPRP	C	R*4	N.R.	WRCA	C	R*4	N.R.	WSCA	C	R*4	N.R.	XECC	SFA	R*4	00C0A0		
XLBH	C	R*4	N.R.	XLCD	F	C	R*4	000034	XLHL	G	R*4	N.R.	XLRH	SFA	R*4	00C0A4	
XMSE SF	C	R*4	0002A8	YLS2	C	R*4	N.R.	ALFDL	C	R*4	N.R.	ARTGT	S	C	R*4	0002AC	
ATMIY SFA	C	R*4	0001A4	ATMCS SF	XF	R*4	00C000	BSTOT SF	R*4	0002B0	CBARF	C	R*4	N.R.			
CBARW SF	C	R*4	00067C	CLDES SF	C	R*4	0006B4	CLEYE	C	R*4	N.R.	CPIND	C	R*4	N.R.		
CPNUD	C	R*4	N.R.	CPPAR	C	R*4	N.R.	CPPRO	C	R*4	N.R.	CPTCT	C	R*4	N.R.		
CELSW	C	R*4	0002B4	DELTA	C	R*4	N.R.	DELTH	C	R*4	N.R.	DELWF	C	R*4	N.R.		
DELWP	C	R*4	N.R.	DSWET	F	C	R*4	00010C	ELDOA	F	C	R*4	00C104	ENPCR	C	R*4	N.R.
ETAP2	C	R*4	N.R.	ETAP4	C	R*4	N.R.	FETOT	C	R*4	N.R.	CMDD1	C	R*4	N.R.		
HMAXD	C	R*4	N.R.	ICRLS	C	I*4	N.R.	NOCPP	C	I*4	N.R.	NCXPJ	C	I*4	N.R.		
PFET2	C	R*4	N.R.	REALJ	C	R*4	N.R.	RHPMR	C	R*4	N.R.	SIGAR	SF	R*4	00C028		
SIGMA	C	R*4	N.R.	SICMR	SF	C	R*4	0009CC	SIZTR	C	R*4	00C2BC	SKAMD	C	R*4	N.R.	
SKBAL	C	R*4	N.R.	SKGB1	C	R*4	N.R.	SKGB2	C	R*4	N.R.	SKPCS	C	R*4	N.R.		
SKPEI	C	R*4	N.R.	SKPES	C	R*4	N.R.	SKPRB	C	R*4	N.R.	SKRBF	C	R*4	N.R.		
SKRCA	C	R*4	N.R.	SKSCA	C	R*4	N.R.	SLMVT	F	C	R*4	00CCF8	STMXX	C	R*4	N.F.	
SWETH S	C	R*4	0008CC	SWEXP SF	C	R*4	0008D0	SWTOT S	C	R*4	0002C0	SWWET S	C	R*4	00C8D8		
S2RHC	C	R*4	N.R.	TBCL1	C	R*4	N.R.	TBCRP	C	R*4	N.R.	TBEM5	C	R*4	N.R.		
TBPOW	C	R*4	N.R.	TBSFC	C	R*4	N.R.	TGBAR	SF	C	R*4	00C8E8	THETA	C	R*4	N.R.	
TPROP	C	R*4	N.R.	TVCMR	C	R*4	N.R.	VBARH	F	C	R*4	000CE4	VBARV	F	C	R*4	0000F4
VDIVE	C	R*4	N.R.	VGASB SF	C	R*4	000904	VGASP SF	C	R*4	00C908	WPAYL	C	K*4	N.R.		
WPSTR	C	R*4	N.R.	XLALB SF	C	R*4	00C9A8	XLBWO	F	C	R*4	00C028	XLRLA	F	C	R*4	00002C
ALOG	XF	R*4	000000	SCRT	XF	R*4	000J00	FRXPR#	XF	R*4	00C000	ALFDES	S	C	R*4	000640	
BHPSUP	C	R*4	N.R.	CEART S	C	R*4	000674	CBARV S	C	R*4	00C678	CBYLOA	F	C	R*4	00C118	
CLALPH	C	R*4	N.R.	CRSIND	C	R*4	N.R.	CTSIGH	F	C	R*4	00C14C	CYCPRL	C	R*4	N.R.	
DELFCR	C	R*4	N.R.	EELRTH	C	R*4	N.R.	DELWFC	C	R*4	N.R.	DELWPL	C	R*4	N.R.		
DELWST	C	R*4	N.R.	ELSWSH	F	C	R*4	000108	DLTAFE	C	R*4	N.R.	DLVLHL	F	C	R*4	00C110
DRGIND	C	R*4	0000CC	ESFLMT S	C	R*4	0006C8	DYLIND	C	R*4	00C008	ELHLGA	F	C	R*4	00C0A8	
ELVLOA	F	C	R*4	0000AC	ETAIND	C	R*4	000020	ETAP4N	C	R*4	N.R.	EXPDRG	C	R*4	N.R.	
FEDRAG	C	R*4	N.R.	FIXIND	C	R*4	000014	GAMD11	C	R*4	N.R.	HULIND	C	R*4	000004		
INDCRL	C	I*4	N.R.	INCRG	C	I*4	N.R.	INDDYL	C	I*4	000828	INDETA	C	I*4	N.R.		
INDFIX	C	I*4	N.R.	INCHUL	C	I*4	000834	INDOPT	C	I*4	N.R.	INCOSW	C	I*4	N.R.		
INDPOW	C	I*4	N.R.	INCPRP	C	I*4	000844	INDRDM	C	I*4	00C848	IPRINT	C	I*4	N.R.		
NSIZTR	C	R*4	000000	CPIIND	C	R*4	000000	OSWIND	C	R*4	000010	PRPIND	C	R*4	00001C		
RCMIND	C	R*4	000018	RHCRHO	F	C	R*4	00003C	SGTIND	C	R*4	N.R.	SKBLNT	C	R*4	N.R.	
SKENV1	C	R*4	N.R.	SKENV2	C	R*4	N.R.	SKPDSZ	C	R*4	N.R.	SKVTAR	C	R*4	N.R.		
SSIGMA	C	R*4	N.R.	STHETA	C	R*4	N.R.	TBCDWI	C	R*4	N.R.	TBAP4	C	R*4	N.R.		
THETMR	C	R*4	N.R.	TCLIND	C	R*4	N.R.	VGBOVH	F	C	R*4	00C030	WBALNT	C	R*4	N.R.	
WPAYLO	C	R*4	N.R.	XTGTA2	C	R*4	N.R.	XTGTA4	C	R*4	N.R.						

7-140

NAME OF COMMON BLOCK *			* SIZE OF BLOCK			0009DC HEXADECIMAL BYTES					
VAR. NAME	TYPE	REL. ADDR.	VAR. NAME	TYPE	REL. ADDR.	VAR. NAME	TYPE	REL. ADDR.	VAR. NAME	TYPE	REL. ADDR.
OPTIND	R*4	000000	FULIND	R*4	000004	DYLIND	R*4	000008	DRGIND	R*4	00000C
OSWIND	R*4	000010	FIXIND	R*4	000014	RDMIND	R*4	000018	PRPIAD	R*4	00001C
ETAIND	R*4	000020	WC	R*4	000024	XLBWO	R*4	000028	XLRLA	R*4	00002C
VGBCVH	R*4	000030	XLGC	R*4	000034	HMAXD	R*4	N.R.	RHGRHO	R*4	00003C
V*G	R*4	N.R.	EMLF	R*4	N.R.	CKI	R*4	N.R.	DELWF	R*4	N.R.
CKFF	R*4	N.R.	VDIVE	R*4	N.R.	HOO	R*4	N.R.	RGO	R*4	N.R.
TCC	R*4	N.R.	GAP1	R*4	N.R.	SGTIND	R*4	N.R.	ELHLCA	R*4	0000A8
ELVLCB	R*4	0000AC	GAP2	R*4	N.R.	AR	R*4	0000C8	WS	R*4	0000CC
TCR	R*4	0000D0	TCT	R*4	0000D4	SLM	R*4	0000D8	ARHT	R*4	0000DC
TCHT	R*4	0000E0	VBART	R*4	0000E4	SLMH	R*4	0000EB	ARVT	R*4	0000EC
TCVT	R*4	0000F0	VBARV	R*4	0000F4	SLMVT	R*4	0000F8	ELDN	R*4	0000FC
ELCT	R*4	000100	ELCOA	R*4	000104	CLSWSH	R*4	000108	DSWET	R*4	00010C
DLVLF1	R*4	000110	DVCL	R*4	000114	CBYLOA	R*4	000118	ENR	R*4	00011C
KVA	R*4	000120	CAMI	R*4	N.R.	DAM2	R*4	N.R.	BMR	R*4	00012C
DAM3	R*4	N.R.	CLEYE	R*4	N.R.	THETMR	R*4	N.R.	XC	R*4	N.R.
XMR	R*4	N.R.	TVCMR	R*4	N.R.	VT	R*4	000148	CTSIGH	R*4	00014C
TVK	R*4	000150	FES	R*4	000154	TINY	R*4	000158	ETAP2	R*4	N.R.
ETAP4N	R*4	N.R.	TBEM5	R*4	N.R.	TB8AP4	R*4	N.R.	GAP3	R*4	N.R.
DAM4	R*4	N.R.	ENF	R*4	N.R.	ETAT	R*4	N.R.	HC	R*4	00019C
VC	R*4	0001AC	ATMIY	R*4	0001A4	CDVT	R*4	N.R.	CDHT	R*4	N.R.
DAM5	R*4	N.R.	CLTAFE	R*4	N.R.	FEDRAG	R*4	N.R.	EXPCRG	R*4	N.R.
CCC	R*4	N.R.	CLALPH	R*4	N.R.	CKVT	R*4	N.R.	CKHT	R*4	N.R.
CKF	R*4	N.R.	CKW	R*4	N.R.	RELI	R*4	N.R.	TCLN	R*4	N.R.
TBCL1	R*4	N.R.	TBCDVI	R*4	N.R.	GAP4	R*4	N.R.	WFE	R*4	N.R.
WFL1	R*4	N.R.	CELWFC	R*4	N.R.	DELWP	R*4	N.R.	DELWST	R*4	N.R.
SKCC	R*4	N.R.	SKRC	R*4	N.R.	SKSC	R*4	N.R.	SKFW	R*4	N.R.
SKTM	R*4	N.R.	SKRCA	R*4	N.R.	SKSCA	R*4	N.R.	SKMC	R*4	N.R.
SKAC	R*4	N.R.	SKFL	R*4	N.R.	SKENV1	R*4	N.R.	SKENV2	R*4	N.R.
SKGE1	R*4	N.R.	SKGB2	R*4	N.R.	SKBLNT	R*4	N.R.	SKBAL	R*4	N.R.
SKLG	R*4	N.R.	SKWH	R*4	N.R.	ELF	R*4	N.R.	RMI	R*4	N.R.
SKVP	R*4	N.R.	SKHT	R*4	N.R.	SKVT	R*4	N.R.	SKPRB	R*4	N.R.
SKREF	R*4	N.R.	SKFF	R*4	N.R.	SKAMD	R*4	N.R.	SKAR	R*4	N.R.
SKFA	R*4	N.R.	SKVTF	R*4	N.R.	SKPDS	R*4	N.R.	SKPDSZ	R*4	N.R.
SKT	R*4	N.R.	SKFS	R*4	N.R.	SKPEI	R*4	N.R.	SKPES	R*4	N.R.
SK1	R*4	N.R.	SK2	R*4	N.R.	DK3	R*4	N.R.	DK4	R*4	N.R.
SK5	R*4	N.R.	SK6	R*4	N.R.	SK7	R*4	N.R.	SK8	R*4	N.R.
SK9	R*4	N.R.	SK10	R*4	N.R.	SK11	R*4	N.R.	SK12	R*4	N.R.
SK13	R*4	N.R.	SK14	R*4	N.R.	SK15	R*4	N.R.	PLIN	R*4	N.R.
GAP5	R*4	N.R.	TCLIND	R*4	N.R.	XTGTA2	R*4	N.R.	TIN2	R*4	N.R.
TWTV	R*4	N.R.	PFET2	R*4	N.R.	DELTH	R*4	N.R.	STH	R*4	N.R.
CRSINC	R*4	N.R.	XTGTA4	R*4	N.R.	TIN4	R*4	N.R.	VIN	R*4	N.R.
DELWFL	R*4	N.R.	RMAX	R*4	N.R.	DELFCR	R*4	N.R.	ENPCR	R*4	N.R.
CYCFEL	R*4	N.R.	STPW	R*4	N.R.	HFIN	R*4	N.R.	GAP6	R*4	N.R.
TBFI	R*4	N.R.	FF	R*4	N.R.	SK3	R*4	N.R.	SK4	R*4	N.R.
TBSFC	R*4	N.R.	TBTC	R*4	N.R.	TB2	R*4	N.R.	TBCRP	R*4	N.R.
ALFCL	R*4	N.R.	TBPCW	R*4	N.R.	GAP7	R*4	N.R.	ALFCES	R*4	000640
BHFR	R*4	N.R.	ALFR	R*4	N.R.	AMU	R*4	N.R.	BHPA	R*4	N.R.
ER	R*4	N.R.	BHPSUP	R*4	N.R.	BHT	R*4	00065C	BLP	R*4	N.R.
			BS	R*4	000668	BVT	R*4	00066C	CBARF	R*4	N.R.

7-141

CEARHT	R*4	000674	CEARVT	R*4	000678	CBARW	R*4	00067C	CCP	R*4	N.R.
CCT	R*4	N.R.	CEV	R*4	N.R.	CLW	R*4	N.R.	CPIND	R*4	N.R.
CPNUC	R*4	N.R.	CPPAF	R*4	N.K.	CPPRO	R*4	N.R.	CPTOT	R*4	N.R.
CFT	R*4	0006A4	CTF	R*4	N.R.	CV	R*4	0006AC	CX	R*4	N.R.
CLCES	R*4	0006B4	CE	R*4	0006B8	DELRTH	R*4	N.R.	DELTA	R*4	N.R.
CH	R*4	0006C4	CSFLM1	R*4	0006C8	ELC	R*4	0006CC	ELHT	R*4	0006D0
ELN	R*4	0006D4	ELCA	R*4	0006D8	ELT	R*4	0006DC	ELVT	R*4	0006E0
EN	R*4	N.R.	ETAP	R*4	N.R.	FEH	R*4	N.R.	FEHI	R*4	N.R.
FEFL	R*4	N.R.	FET	R*4	N.R.	FET	R*4	N.R.	FETCT	R*4	N.R.
FEVT	R*4	N.R.	FEW	R*4	N.R.	FEWH	R*4	N.R.	FEWI	R*4	N.R.
FM	R*4	N.R.	FF	R*4	N.R.	ETAP4	R*4	N.R.	GAMD11	R*4	N.R.
GLF	R*4	N.R.	GMDC1	R*4	N.R.	H	R*4	N.R.	ICRUS	I*4	N.R.
INCCRL	I*4	N.R.	INDDRG	I*4	N.R.	INDOYL	I*4	000828	INDETA	I*4	N.R.
INDFIX	I*4	N.R.	INCHUL	I*4	000834	INDOPL	I*4	N.R.	INDOSW	I*4	N.R.
INDFCW	I*4	N.R.	INDFFF	I*4	000844	INDRDM	I*4	000848	IPRINT	I*4	N.R.
LTEL	I*4	N.R.	NOCFE	I*4	N.R.	NOXPJ	I*4	N.R.	OWE	R*4	N.R.
PEFF	R*4	N.R.	PI	R*4	000864	Q	R*4	000868	RFO	R*4	00086C
REALJ	R*4	N.R.	RHPMF	R*4	N.R.	R	R*4	N.R.	RN	R*4	N.R.
SA	R*4	N.R.	SAE	R*4	N.R.	SA6	R*4	N.R.	SA7	R*4	N.R.
SFC	R*4	N.R.	SFPA	R*4	N.R.	SHPR	R*4	N.R.	SHT	R*4	00089C
SITE	R*4	0008A0	SHTW	R*4	0008A4	SIGMA	R*4	N.R.	SSIGMA	R*4	N.R.
ST	R*4	N.R.	STHETA	R*4	N.R.	STMAX	R*4	N.R.	SVT	R*4	0008BC
SVTE	R*4	0008C0	SVTW	R*4	0008C4	SW	R*4	0008C8	ShETH	R*4	0008CC
SWEXP	R*4	0008C0	SWTT	R*4	N.R.	SWWET	R*4	0008D8	SZRHO	R*4	N.R.
T	R*4	N.R.	TAF	R*4	0008E4	TCBAR	R*4	0008E8	THETA	R*4	N.R.
TMAX	R*4	0008F0	TMP	R*4	N.R.	TPROP	R*4	N.R.	TR	R*4	N.R.
ULF	R*4	N.R.	VGASE	R*4	000904	VGASR	R*4	000908	VHL	R*4	00090C
V	R*4	000910	W	R*4	N.R.	WBAL	R*4	N.R.	WBALNT	R*4	N.R.
WCC	R*4	N.R.	WE	R*4	N.R.	WEP	R*4	N.R.	WES	R*4	N.R.
WF	R*4	N.R.	WFC	R*4	N.R.	WFR	R*4	N.R.	WFS	R*4	N.R.
WFH	R*4	N.R.	WGSE	R*4	N.R.	WHL	R*4	N.R.	WHT	R*4	N.R.
WLG	R*4	N.R.	WMC	R*4	N.R.	WPAYL	R*4	N.R.	WPC	R*4	N.R.
WFCS	R*4	N.R.	WPEI	R*4	N.R.	WPH	R*4	N.R.	WPRB	R*4	N.R.
WPRG	R*4	N.R.	WPEF	R*4	N.R.	WPSTR	R*4	N.R.	WRC	R*4	N.R.
WRCA	R*4	N.R.	WSC	R*4	N.R.	WSCA	R*4	N.R.	WST	R*4	N.R.
WTM	R*4	N.R.	WVT	R*4	N.R.	WW	R*4	N.R.	WPAYLO	R*4	N.R.
WAC	R*4	N.R.	WENV	R*4	N.R.	XLALB	R*4	0009A8	XLB	R*4	N.R.
XLEH	R*4	N.R.	XLFL	R*4	N.R.	XLR	R*4	N.R.	XLW	R*4	N.R.
YLS2	R*4	N.R.	TCVW	R*4	N.R.	DMR	R*4	0009C8	SIGMR	R*4	0009CC
AF	R*4	0009C0	BHPF	R*4	N.R.	SEE	R*4	N.R.			

LABEL	ADDR	LABEL	ADDR	LABEL	ADDR	LABEL	ADDR	PAGE	009
1	0CC8E2	5	CCC9CE NR	6	CCOC16	7	000D38		
8	CCCECE	9	CCCE34	10	000F88	11	001080		
12	OC11A6								

\*OPTIONS IN EFFECT\* NAME= MAIN,CPT=C2,LINECNT=54,SIZE=0000K,

\*OPTIONS IN EFFECT\* SOURCE,EBCCIC,NCLIST,NCDECK,LCAD,MAP,NOEDIT,NOXREF

\*STATISTICS\* SOURCE STATEMENTS = 137 ,PROGRAM SIZE = 457C

\*STATISTICS\* NO DIAGNOSTICS GENERATED

\*\*\*\*\* END OF COMPILE \*\*\*\*\*

83K BYTES OF CORE NOT USED

7-143

COMPILER CFTICNS - NAME= MAIN,OPT=C2,LINECNT=54,SIZE=CCOOK,

SCLRCE,ECCDIC,NCLIST,NODECK,LCAD,MAP,NCEDIT,ID,NCXREF

ISN 0002		FLACTION TABLE (X,XTAB,YTAB,NXPTS,NORD,IER)	00010000
	C****	MEMBER NAME B81TAELE	CC020000
	C	ACCLANG	CC030000
	C	LAGRANGIAN INTERPOLATION FUNCTION	CC040000
ISN 0003		DIMENSION XTAB(1), YTAB(1)	CC050000
ISN 0004		IF (NORD.CE.NXFIS) GC TC 20	CC060000
ISN 0006		L=MOD(NCRC,2)	CC070000
ISN 0007		IER = 0	CC080000
ISN 0008		IF (XTAB(1).GT.XTAB(2)) GC TC 19	CC090000
	C	TABLE INCREASING	CC100000
ISN 0010		NNN = NXPTS - 1	CC110000
ISN 0011		DC 18 I = 1,NNN	CC120000
ISN 0012		IF ((X.GT.XTAB(I)).AND.(X.LT.XTAB(I+1))) GO TO 17	CC130000
ISN 0014		IF (X.EQ.XTAB(I)) GC TC 16	CC140000
ISN 0016	18	CONTINUE	CC150000
	C	ARGUMENT VALUES NOT LIE IN TABLE	CC160000
	C	SET ERROR FLAG(IER) TO 3 AND RETURN THE LAST ENTRY IN THE TABLE AS	CC170000
	C	THE RESULT	CC180000
ISN 0017	21	CONTINUE	CC190000
ISN 0018		IER = 3	CC200000
ISN 0019		TABLE = YTAB(NXFIS)	CC210000
ISN 0020		IF (X.LT.XTAB(1)) TABLE = YTAB(1)	CC220000
ISN 0022		RETURN	CC230000
	C	CRCR GREATER THAN OR EQUAL TO NUMBER OF POINTS SET ERROR FLAG(IER)	CC240000
	C	TO 2 AND RETURN 0.0 AS THE RESULT	CC250000
ISN 0023	2C	IER = 2	CC260000
ISN 0024		TABLE = 0.0	CC270000
ISN 0025		RETURN	CC280000
	C	TABLE DECREASING	CC290000
ISN 0026	19	NNN = NXPTS - 1	CC300000
ISN 0027		DC 15 I = 1,NNN	CC310000
ISN 0028		IF ((X.LT.XTAB(I)).AND.(X.GT.XTAB(I+1))) GO TO 171	CC320000
ISN 0030		IF (X.EQ.XTAB(I)) GC TO 16	CC330000
ISN 0032	15	CONTINUE	CC340000
ISN 0033		GC TO 21	CC350000
	C	SET UP LIMITS ON PRODUCT	CC360000
ISN 0034	17	CONTINUE	CC370000
ISN 0035	180	J = I - NCRC/2	CC380000
ISN 0036		K = I + NCRC/2	CC390000
ISN 0037		IF (L.NE.C) K=K+1	CC400000
	C	PRODUCT FORMULA	CC410000
ISN 0039	14	TABLE = 0.0	CC420000
	C	TEST IF J AND K ARE BETWEEN 1 AND NXPTS	CC430000
ISN 0040		IF (J.LE.C) GC TC 10	CC440000
ISN 0042		IF (K.GT.NXPTS) GC TC 9	CC450000
ISN 0044	8	DC 11 I = J,K	CC460000
ISN 0045		ANLM = 1.0	CC470000
ISN 0046		ACEN = 1.0	CC480000
ISN 0047		DC 13 M = J,K	CC490000
ISN 0048		IF (M.EQ.1) GC TC 13	CC500000

ISN 0050		ANUM = ANUM * (X-XTAE(M))	00510000
ISN 0051		ADEN = ACEN * (XTAE(I)-XTAB(M))	00520000
ISN 0052	13	CONTINUE	00530000
ISN 0053	11	TABLE = ANUM * YTAB(I) / ACEN + TABLE	00540000
ISN 0054		RETURN	00550000
ISN 0055	10	J = 1	00560000
ISN 0056		K = NORD+1	00570000
ISN 0057		GC TO 8	00580000
ISN 0058	9	J = J-1	00590000
ISN 0059		K = K-1	00600000
ISN 0060		IF (K.GT.NXPYS) GC TO 5	00610000
ISN 0062		GC TO 14	00620000
ISN 0063	171	CONTINUE	00630000
ISN 0064	182	J = I - NCRD/2	00640000
ISN 0065		K = I + NCRD/2	00650000
ISN 0066		IF (L.NE.C) J = J+1	00660000
ISN 0068		GC TO 14	00670000
	C	ARGUMENT IN TABLE	00680000
ISN 0069	16	TABLE = YTAB(I)	00690000
ISN 0070		RETURN	00700000
ISN 0071		END	00710000

7-1145

ORIGINAL PAGE IS  
OF POOR QUALITY



TABLE 7 SIZE OF PROGRAM 0C046E HEXADECIMAL BYTES PAGE 003

NAME	TAG	TYPE	ADD.	NAME	TAG	TYPE	ADD.	NAME	TAG	TYPE	ADD.	NAME	TAG	TYPE	ADD.
I	SF	I*4	000C8C	J	SF	I*4	000090	K	SF	I*4	000094	L	S	I*4	000098
M	SF	I*4	000C9C	X	F	R*4	0000AC	IER	S	I*4	0000A4	NNN	SF	I*4	0000A8
ADEN	SF	R*4	0000AC	ANUM	SF	R*4	0000B0	NORD	FA	I*4	0000B4	XTAB	F XR	R*4	0000C0
YTAB	F XR	R*4	0000C0	NXPTS	F	I*4	0000B8	TABLE	SF	R*4	0000BC				

7-146

LABEL	ADDR	LABEL	ADDR	LABEL	ADDR	LABEL	ADDR
18	0CC19E	21	CC01AE	20	CC01E8	19	000200
15	0CC266	17	CCC278	18C	CCC27C NR	14	0002A4
8	0CC2BE	13	CC032E	11	000338	10	000368
9	0CC376	171	CGC38E	182	CC0392 NR	16	0003C6

\*OPTIONS IN EFFECT\* NAME= MAIN,CPT=C2,LINECNT=54,SIZE=3000K,

\*OPTIONS IN EFFECT\* SOURCE,ECCIC,NOLIST,ACDECK,LOAD,MAP,NOEDIT,IO,NOXREF

\*STATISTICS\* SCLRCR STATEMENTS = 7C ,PROGRAM SIZE = 1134

\*STATISTICS\* NO DIAGNOSTICS GENERATED

\*\*\*\*\* END OF COMPILE \*\*\*\*\* 111K BYTES OF CORE NOT USED

7-147

ORIGINAL PAGE IS  
OF POOR  
QUALITY

COMPILER OPTIONS - NAME= MAIN,OPT=02,LINECNT=54,SIZE=0000K,  
SOURCE,EBCDIC,NOLIST,NODECK,LOAD,MAP,NOEDIT,ID,NOXREF  
SUBROUTINE THRUST(TPROP)

ISN 0002	C****	MEMBER NAME	BB1THRST						00010000
	C	PAGE 1	INPUT LOC	0001 THRU	0050				00020000
ISN 0003		COMMON	OPTIND	,HULIND	,DYLIND	,DRGIND	,OSWIND		00030000
		1FIXIND	,RDMIND	,PRPIND	,ETAIND	,WD	,XL8WD		00040000
		2XLRLA	,VG8OVH	,XLGD	,HMAXD	,RHORHO	,VMO		00050000
		3EMLF	,CK1	,DELWF	,CKFF	,VDIVE	,HOO		00060000
		4ROO	,TOO	,GAP1(5)	,SGTIND(12)	,ELHLUA	,ELVLOA		00070000
		5GAP2(6)							00080000
ISN 0004	C	PAGE 2	INPUT LOC	0051 THRU	0100				00090000
		COMMON	AR	,WS	,TCR	,TCT	,SLM		00100000
		1ARHT	,TCHT	,VBARH	,SLMH	,ARVT	,TCVT		00110000
		2VBARV	,SLMVT	,ELDN	,ELDT	,ELDJA	,DLSWSH		00120000
		3DSWET	,DLVLHL	,DVOL	,CBYLOA	,ENR	,WVA		00130000
		4DAM1	,DAM2	,BMR	,DAM3	,CLEYE	,THETMR		00140000
		5XC	,XMR	,TVCMR	,VT	,CTSGH	,TVW		00150000
		6HES	,TINY	,ETAP2	,ETAP4N	,TBEM5(5)	,TB8AP4(5)		00160000
		7GAP3							00170000
ISN 0005	C	PAGE 3	INPUT LOC	0101 THRU	140				00180000
		COMMON	DAM4	,ENP	,ETAT	,HC	,VC		00190000
		1ATMIY	,CDVT	,CDHT	,DAM5	,DLTAFE	,FEDRAG		00200000
		2EXPDRG	,CDC	,CLALPH	,CKVT	,CKHT	,CKF		00210000
		3CKW	,RELI	,TCLN	,TBCL1(8)	,TBCJWI(8)	,GAP4(4)		00220000
		4PAGE 4	INPUT LOC	141 THRU	200	WEIGHT DATA			00230000
ISN 0006		COMMON	WFE	,WFUL	,DELWFC	,DELWP	,DELWST		00240000
		1SKCC	,SKRC	,SKSC	,SKFW	,SKTM	,SKRCA		00250000
		2SKSCA	,SKMC	,SKAC	,SKHL	,SKENV1	,SKENV2		00260000
		3SKGB1	,SKGB2	,SKBLNT	,SKBAL	,SKLJ	,SKW		00270000
		4ELF	,RMI	,SKWP	,SKHT	,SKVI	,SKPRB		00280000
		5SKRBF	,SKPH	,SKAMD	,SKAR	,SKPA	,SKVTAR		00290000
		6SKPDS	,SKPDSZ	,SKT	,SKFS	,SKPEI	,SKPES		00300000
		7SK1	,SK2	,DK3	,DK4	,SK5	,SK6		00310000
		8SK7	,SK8	,SK9	,SK10	,SK11	,SK12		00320000
		9SK13	,SK14	,SK15	,PLIN	,GAP5(3)			00330000
ISN 0007	C	PAGE 5	INPUT LOC	201 THRU	300				00340000
		COMMON	TOLIND(5)	,XTGTA2(5)	,TIN2(5)	,TWT4(5)	,PFET2(5)		00350000
		1DELTH(5)	,STH(5)	,CRSIND(5)	,XTGTA4(5)	,TIN4(5)	,VIN(5)		00360000
		2DELK(5)	,RMAX(5)	,DELFCR(5)	,ENPCR(5)	,DELWPL(5)	,STPW(5)		00370000
		3HFIN(5)	,GAP6(10)						00380000
ISN 0008	C	PAGE 6	INPUT LOC	301 THRU	400				00390000
		COMMON	CYCPRL	,FF	,SK3	,SK4	,TBH1(5)		00400000
		1TBTQ(5)	,TBH2(5)	,TBCRP(5)	,TBSFC(8)	,TBPJW(8)	,GAP7(60)		00410000
ISN 0009	C	WORKING	COMMON						00420000
		COMMON	ALFDES,ALFDL,ALFR,AMU,						00430000
		1	BHPA,BHPR,BHPSUP,BHT,BLP,BR,BS,BVT,						00440000
		2	CBARF,CBARHT,CBARVT,CBARW,CCP,CCT,CDV,CLW,CPINU,CPNUD,CPPAR,CPPRO						00450000
		3	CPTOT,CRI,CTP,CV,CX,CLDES,CB,						00460000
		4	DELRT,DELTA,OH,DSPLMT,	ELC,ELHT,ELN,ELOA,ELT,ELVT,EN,ETAP,					00470000
		5	FEH,FEHI,FEHL,FEHT,FET,FETOT,FEVT,FEW,FEWH,FEWI,FM,FP,ETAP4						00480000
ISN 0010		COMMON	GAMD11(3,15),GLF,GMDD1(16),H,						00490000
									00500000

7-148

```

7 ICRUS, INDCRU, INDRG, INDDYL, INDETA, INDFIX, INDHUL, INDOPT, INDOSW, 00510000
8 INDOPW, INDRP, INDRDM, IPRINT 00520000
ISN 0C11 CCOMMON LTHL, NOCPP, NOXPJ, OWE, PEHF, PI, Q, RHO, REALJ, RHPMR, R, RN 00530000
ISN 0012 CCOMMON SA, SA5, SA6, SA7, SFC, SHPA, SHPR, SHT, SHT E, SHTW, SIGMA, SSIGMA, ST, 00540000
1STHETA, STMAX, SVT, SVTE, SVTW, SW, SWETH, SWEXP, SWTT, SWWET, S2RHO 00550000
ISN 0C13 CCOMMON T, TAF, TCBAR, THETA, TMAX, TMP, DUM2, TR, ULF, VGASB, VGASR, VHL, V 00560000
ISN 0C14 CCOMMON W, WBAL, WBALNT, WCC, WE, WEP, WES, WF, WFC, WFR, WFS, WFW, 00570000
1 WGSB, WHL, WHT, WLG, WMC, WPAYL, WPC, WPDS, WPEI, WPH, WPRB, WPRG, WPRP, WPSTR 00580000
2, WRC, WRCA, WSC, WSCA, WST, WTM, WVT, WW, WPAYLO, WAC, WENV 00590000
ISN 0015 CCOMMON XLALB, XLB, XLBH, XLHL, XLR, XLW, YLS2, TOVW 00600000
ISN 0C16 COMMON DMR, SIGMR, AF, BHPP, SEE 00600001
ISN 0017 CCOMMON /ODD/ AO(3,15), A1(3,15), A2(3,15), BBO(16), BB1(16), BB2(16), 00600002
1 RJ3(10), CPOW3(10), ETAI3(10,10), RJ4(10), CPDW4(10), 00600003
2 ETAI4(10,10), AMACH(3), CLLL(15), CLGAM(16), CPOW33(20), 00600004
3 CTI3(20), CTI4(20) 00600005
ISN 0C18 NAMELIST /NTHRST/ REALJ, ETAP, NOXPJ, NOCPP, CCP, CCT, ETAI, EMH75, 00610000
1 GAMD2, TANP, PHIT, SINP, CLIK, CL1, GAMD1, DELGM1, CL2, 00620000
2 DELGM2, ITER, CL3, CTIND, V 00630000
ISN 0C19 NOXPJ=XPJAO+0.1 00640000
ISN 0020 NOCPP=CPPND+0.1 00650000
ISN 0C21 PI=3.14159 00660000
ISN 0C22 DTOR=0.01745329 00660100
ISN 0023 RTOD=57.2957795 00660200
ISN 0C24 SIGS=0.5*SIGMR 00660300
ISN 0C25 SHPA=BLP 00660400
ISN 0026 EM=V/SA 00660500
ISN 0C27 REALJ=1.689*PI*V/VT 00670000
ISN 0C28 CCP=2200.*(PI*STHETA)**3*BHPP*YLS2*SHPA*ETAT/(0.009507*VT**3 00680000
1*DMR**2*ENR) 00690000
ISN 0C29 ITER=0 00700000
ISN 0C30 7 IF (REALJ.EQ.0.0) GO TO 19 00710000
ISN 0C32 EMH75=EM*SQRT((C.75*PI/REALJ)**2+1.0) 00720000
ISN 0033 IF (EMH75.LT.0.70) EMH75=0.70 00730000
ISN 0035 GAMD2=1.0 00740000
ISN 0036 TANP=4.0*REALJ/(3.0*PI) 00750000
ISN 0037 IF (BMR.EQ.3.0) ETAI=BIV(REALJ, CCP, RJ3, CPOW3, ETAI3, 10, 10, 10, 10) 00760000
ISN 0039 IF (BMR.EQ.4.0) ETAI=BIV(REALJ, CCP, RJ4, CPOW4, ETAI4, 10, 10, 10, 10) 00770000
ISN 0C41 PHIT=ATAN(TANP/ETAI) 00780000
ISN 0C42 SINP=SIN(PHIT) 00790000
ISN 0C43 CLIK=4.0*CCP/(SIGS*SINP*(COS(PHIT)+SINP*TANP)**2*(0.75*PI)**4) 00800000
ISN 0C44 CL1=CLIK/(1.+TAN(GAMD2*DTOR)*COTAN(PHIT)) 00810000
ISN 0045 GAMD1=BIV(EMH75, CL1, AMACH, CLLL, GAMD11, 3, 15, 3, 15) 00820000
ISN 0C46 DELGM1=GAMD1-GAMD2 00830000
ISN 0047 CL2=CLIK/(1.0+TAN(GAMD1*DTOR)*COTAN(PHIT)) 00840000
ISN 0048 23 GAMD1=BIV(EMH75, CL2, AMACH, CLLL, GAMD11, 3, 15, 3, 15) 00850000
ISN 0049 GAMD2=ATAN(TAN(PHIT)*(CLIK/CL2-1.0))*RTOD 00860000
ISN 0050 DELGM2=GAMD1-GAMD2 00870000
ISN 0C51 IF (ABS(DELGM2).LE.0.02) GO TO 3 00880000
ISN 0053 ITER=ITER+1 00890000
ISN 0054 IF (ITER.GT.20) GO TO 16 00900000
ISN 0056 CL3=(CL1*DELGM2-CL2*DELGM1)/(DELGM2-DELGM1) 00910000
ISN 0057 CL1=CL2 00920000

```

7-149

ORIGINAL PAGE IS  
OF POOR QUALITY

ISN 0058	CL2=CL3	00930000
ISN 0059	DELGM1=DELGM2	00940000
ISN 0060	GO TO 23	00950000
ISN 0061	3 ETAP=TANP/TAN(GAMD1*DTOR+PHIT)	00960000
ISN 0062	CCT=ETAP*CCP/REALJ	00970000
ISN 0063	21 TPROP=0.009507*SIGMA*(DMR*VT)**2*ENR*CCT/(4.*PI)	00980000
ISN 0064	GO TO 36	01000000
ISN 0065	19 IF (BMR.EQ.3.0) CTIND=XLINT(CPOW33,CTI3,CCP,10,M)	01010000
ISN 0067	IF (BMR.EQ.4.0) CTIND=XLINT(CPOW33,CTI4,CCP,10,M)	01020000
ISN 0069	IF (M.NE.0) WRITE(6,45)	01030000
ISN 0071	45 FORMAT(9X,52HTHIS ERROR IS IN THE CT/CP TABLE - SUBROUTINE THRUST)	01040000
ISN 0072	PHIT=ATAN(CCP/(0.75*PI*CTIND))	01060000
ISN 0073	SINP=SIN(PHIT)	01070000
ISN 0074	GAMD2=1.0	01080000
ISN 0075	CLIK=4.0*CCP/((0.75*PI)**4*SIGS*SINP*COS(PHIT)**2)	01090000
ISN 0076	CL1=CLIK/(1.+TAN(GAMD2*DTOR)*COTAN(PHIT))	01100000
ISN 0077	GAMD1=TABLE(CL1,CLGAM,GMDD1,11,2,M)	01110000
ISN 0078	IF (M.NE.0) WRITE(6,47)	01120000
ISN 0080	47 FORMAT(9X,83HTHIS ERROR IS IN THE PROPELLER EQUIVALENT LIFT/DRAG P	01130000
	LOLAR TABLE - SUBROUTINE THRUST )	01140000
ISN 0081	DELGM1=GAMD1-GAMD2	01150000
ISN 0082	CL2=CLIK/(1.0+TAN(GAMD1*DTOR)*COTAN(PHIT))	01160000
ISN 0083	14 GAMD1=TABLE(CL2,CLGAM,GMDD1,11,2,M)	01170000
ISN 0084	IF (M.NE.0) WRITE(6,47)	01180000
ISN 0086	GAMD2=ATAN(TAN(PHIT)*(CLIK/CL2-1.0))*RTOD	01190000
ISN 0087	DELGM2=GAMD1-GAMD2	01200000
ISN 0088	IF (ABS(DELGM2).LE.0.02) GO TO 12	01210000
ISN 0090	ITER=ITER+1	01220000
ISN 0091	IF (ITER.GT.20) GO TO 16	01230000
ISN 0093	CL3=(CL1*DELGM2-CL2*DELGM1)/(DELGM2-DELGM1)	01240000
ISN 0094	CL1=CL2	01250000
ISN 0095	CL2=CL3	01260000
ISN 0096	DELGM1=DELGM2	01270000
ISN 0097	GO TO 14	01280000
ISN 0098	12 CCT=CCP*(COTAN(GAMD1*DTOR+PHIT)/(0.75*PI))	01290000
ISN 0099	ETAP=0.798*CCT**1.5/CCP	01300000
ISN 0100	GO TO 21	01310000
ISN 0101	16 WRITE(6,43)	01320000
ISN 0102	WRITE(6,NTHRST)	01330000
ISN 0103	43 FORMAT(10X,65HGAMMA FAILED TO CONVERGE IN TWENTY ITERATIONS - SUBR	01340000
	OUTINE THRUST/)	01350000
ISN 0104	36 RETURN	01360000
ISN 0105	END	01370000

7-151

NAME	TAG	TYPE	ADD.	NAME	TAG	TYPE	ADD.	NAME	TAG	TYPE	ADD.	NAME	TAG	TYPE	ADD.			
H	C	R*4	N.R.	M	FA	I*4	000314	Q	C	R*4	N.R.	R	C	R*4	N.R.			
T	C	R*4	N.R.	V	F	C	000910	W	C	R*4	N.R.	AF	C	R*4	N.R.			
AR	C	R*4	N.R.	AO	C	R*4	N.R.	A1	C	R*4	N.R.	A2	C	R*4	N.R.			
BR	C	R*4	N.R.	BS	C	R*4	N.R.	CB	C	R*4	N.R.	CV	C	R*4	N.R.			
CX	C	R*4	N.R.	DH	C	R*4	N.R.	EM	SF	R*4	000318	EN	C	R*4	N.R.			
FF	C	R*4	N.R.	FM	C	R*4	N.R.	FP	C	R*4	N.R.	HC	C	R*4	N.R.			
PI	SFA	C	R*4	0J0864	RN	C	R*4	N.R.	SA	F	C	R*4	000880	ST	C	R*4	N.R.	
SN	C	R*4	N.R.	TR	C	R*4	N.R.	VC	C	R*4	N.R.	VT	F	C	R*4	000148		
WE	C	R*4	N.R.	WF	C	R*4	N.R.	WO	C	R*4	N.R.	WS	C	R*4	N.R.			
WW	C	R*4	N.R.	XC	C	R*4	N.R.	AMU	C	R*4	N.R.	BBO	C	R*4	N.R.			
EB1	C	R*4	N.R.	BB2	C	R*4	N.R.	BHT	C	R*4	N.R.	BIV	F	XF	R*4	000000		
BLP	F	C	R*4	000660	BMR	C	R*4	00012C	BVT	C	R*4	N.R.	CCP	SFA	C	R*4	000680	
CCT	SF	C	R*4	0J0684	CDC	C	R*4	N.R.	CDV	C	R*4	N.R.	CKF	C	R*4	N.R.		
CKW	C	R*4	N.R.	CK1	C	R*4	N.R.	CLW	C	R*4	N.R.	CL1	SFA	C	R*4	00031C		
CL2	SFA	C	R*4	000320	CL3	SF	C	R*4	000324	CRT	C	R*4	N.R.	CTP	C	R*4	N.R.	
CK3	C	R*4	N.R.	DK4	C	R*4	N.R.	DMR	F	C	R*4	0009C8	ELC	C	R*4	N.R.		
ELF	C	R*4	N.R.	ELN	C	R*4	N.R.	ELT	C	R*4	N.R.	ENP	C	R*4	N.R.			
ENR	F	C	R*4	00011C	FEH	C	R*4	N.R.	FET	C	R*4	N.R.	FEW	C	R*4	N.R.		
GLF	C	R*4	N.R.	HES	C	R*4	N.R.	HDD	C	R*4	N.R.	OWE	C	R*4	N.R.			
RHD	C	R*4	N.R.	RJ3	FA	C	R*4	0G02DC	RJ4	FA	C	R*4	00048C	RMI	C	R*4	N.R.	
RCD	C	R*4	N.R.	SA5	C	R*4	N.R.	SA6	C	R*4	N.R.	SA7	C	R*4	N.R.			
SEE	C	R*4	N.R.	SFC	C	R*4	N.R.	SHT	C	R*4	N.R.	SKT	C	R*4	N.R.			
SK1	C	R*4	N.R.	SK2	C	R*4	N.R.	SK3	C	R*4	N.R.	SK4	C	R*4	N.R.			
SK5	C	R*4	N.R.	SK6	C	R*4	N.R.	SK7	C	R*4	N.R.	SK8	C	R*4	N.R.			
SK9	C	R*4	N.R.	SLM	C	R*4	N.R.	STH	C	R*4	N.R.	SVT	C	R*4	N.R.			
TAF	C	R*4	N.R.	TCR	C	R*4	N.R.	TCT	C	R*4	N.R.	TMP	C	R*4	N.R.			
TCO	C	R*4	N.R.	TVW	C	R*4	N.R.	ULF	C	R*4	N.R.	VHL	C	R*4	N.R.			
VIN	C	R*4	N.R.	VMO	C	R*4	N.R.	WAC	C	R*4	N.R.	WCC	C	R*4	N.R.			
WEP	C	R*4	N.R.	WES	C	R*4	N.R.	WFC	C	R*4	N.R.	WFE	C	R*4	N.R.			
WFR	C	R*4	N.R.	WFS	C	R*4	N.R.	WFW	C	R*4	N.R.	WHL	C	R*4	N.R.			
WHT	C	R*4	N.R.	WLG	C	R*4	N.R.	WMC	C	R*4	N.R.	WPC	C	R*4	N.R.			
WPH	C	R*4	N.R.	WRC	C	R*4	N.R.	WSC	C	R*4	N.R.	WST	C	R*4	N.R.			
WTM	C	R*4	N.R.	WVA	C	R*4	N.R.	WVT	C	R*4	N.R.	XLB	C	R*4	N.R.			
XLR	C	R*4	N.R.	XLW	C	R*4	N.R.	XMR	C	R*4	N.R.	ALFR	C	R*4	N.R.			
ARHT	C	R*4	N.R.	ARVT	C	R*4	N.R.	BHPA	C	R*4	N.R.	BHPP	F	C	R*4	0009D4		
BHPR	C	R*4	N.R.	CDHT	C	R*4	N.R.	CDVT	C	R*4	N.R.	CKFF	C	R*4	N.R.			
CKHT	C	R*4	N.R.	CKVT	C	R*4	N.R.	CLIK	SFA	C	R*4	000328	CLLL	FA	C	R*4	0006A8	
CTI3	FA	C	R*4	000774	CTI4	FA	C	R*4	0007C4	DAM1	C	R*4	N.R.	DAM2	C	R*4	N.R.	
DAM3	C	R*4	N.R.	DAM4	C	R*4	N.R.	DAM5	C	R*4	N.R.	DELK	C	R*4	N.R.			
DTOR	SFA	C	R*4	00032C	DUM2	C	R*4	N.R.	DVOL	C	R*4	N.R.	ELDN	C	R*4	N.R.		
ELDI	C	R*4	N.R.	ELHT	C	R*4	N.R.	ELOA	C	R*4	N.R.	ELVT	C	R*4	N.R.			
EMLF	C	R*4	N.R.	ETAI	SFA	C	R*4	000330	ETAP	SF	C	R*4	0006E8	ETAT	F	C	R*4	000198
FEHI	C	R*4	N.R.	FEHL	C	R*4	N.R.	FEHT	C	R*4	N.R.	FEVT	C	R*4	N.R.			
FFWH	C	R*4	N.R.	FEWI	C	R*4	N.R.	GAP1	C	R*4	N.R.	GAP2	C	R*4	N.R.			
GAP3	C	R*4	N.R.	GAP4	C	R*4	N.R.	GAP5	C	R*4	N.R.	GAP6	C	R*4	N.R.			
GAP7	C	R*4	N.R.	HFIN	C	R*4	N.R.	ITER	SF	C	I*4	000334	LTHL	C	I*4	N.R.		
PEHF	C	R*4	N.R.	PHIT	SFA	C	R*4	000338	PLIN	C	R*4	N.R.	RELI	C	R*4	N.R.		
RMAX	C	R*4	N.R.	RTOD	SF	C	R*4	00033C	SHPA	SF	C	R*4	000894	SHPR	C	R*4	N.R.	
SFTE	C	R*4	N.R.	SHTW	C	R*4	N.R.	SIGS	SF	C	R*4	000340	SINP	SF	C	R*4	000344	
SKAC	C	R*4	N.R.	SKAR	C	R*4	N.R.	SKCC	C	R*4	N.R.	SKFS	C	R*4	N.R.			

SKFW	C	R*4	N.R.	SKHL	C	R*4	N.R.	SKHT	C	R*4	N.R.	SKLG	C	R*4	N.R.		
SKMC	C	R*4	N.R.	SKPA	C	R*4	N.R.	SKPH	C	R*4	N.R.	SKRC	C	R*4	N.R.		
SKSC	C	R*4	N.R.	SKTM	C	R*4	N.R.	SKVT	C	R*4	N.R.	SKWP	C	R*4	N.R.		
SKWw	C	R*4	N.R.	SK10	C	R*4	N.R.	SK11	C	R*4	N.R.	SK12	C	R*4	N.R.		
SK13	C	R*4	N.R.	SK14	C	R*4	N.R.	SK15	C	R*4	N.R.	SLMH	C	R*4	N.R.		
STPW	C	R*4	N.R.	SVTE	C	R*4	N.R.	SVTV	C	R*4	N.R.	SWTT	C	R*4	N.R.		
TANP	SFA	R*4	000348	TBHI	C	R*4	N.R.	TBHZ	C	R*4	N.R.	TBTO	C	R*4	N.R.		
TCHT	C	R*4	N.R.	TCLN	C	R*4	N.R.	TCVT	C	R*4	N.R.	TINY	C	R*4	N.R.		
TIN2	C	R*4	N.R.	TIN4	C	R*4	N.R.	TMAX	C	R*4	N.R.	TOVW	C	R*4	N.R.		
TWTW	C	R*4	N.R.	WBAL	C	R*4	N.R.	WENV	C	R*4	N.R.	WFUL	C	R*4	N.R.		
WGSB	C	R*4	N.R.	WPDS	C	R*4	N.R.	WPEI	C	R*4	N.R.	WPRB	C	R*4	N.R.		
WPRG	C	R*4	N.R.	WPRP	C	R*4	N.R.	WRCA	C	R*4	N.R.	WSCA	C	R*4	N.R.		
XLBH	C	R*4	N.R.	XLGD	C	R*4	N.R.	XLHL	C	R*4	N.R.	YLS2	F	C	R*4	0009C0	
ALFDL	C	R*4	N.R.	AMACH	FA	C	R*4	00069C	ATMIY	C	R*4	N.R.	CBARF	C	R*4	N.R.	
CBARW	C	R*4	N.R.	CLDES	C	R*4	N.R.	CLEYE	C	R*4	N.R.	CLGAM	FA	C	R*4	0006E4	
CPIND	C	R*4	N.R.	CNUO	C	R*4	N.R.	CPW3	FA	C	R*4	000304	CPW4	FA	C	R*4	0004E4
CPPAR	C	R*4	N.R.	CPNU	F	R*4	00034C	CPPRO	C	R*4	N.R.	CPTOT	C	R*4	N.R.		
CTIND	SFA	R*4	000350	DELTA	C	R*4	N.R.	DELTH	C	R*4	N.R.	DELWF	C	R*4	N.R.		
DELMP	C	R*4	N.R.	DSWET	C	R*4	N.R.	ELDOA	C	R*4	N.R.	EMH75	SFA	R*4	000354		
ENPCR	C	R*4	N.R.	ETA13	FA	C	R*4	00032C	ETA14	FA	C	R*4	00050C	ETAP2	C	R*4	N.R.
ETAP4	C	R*4	N.R.	FETOT	C	R*4	N.R.	GAM01	SFA	R*4	000358	GAM02	SFA	R*4	00035C		
GMCD1	FA	C	R*4	HMAX0	C	R*4	N.R.	ICRUS	C	I*4	N.R.	NOCPP	S	C	I*4	000854	
NOXPJ	S	C	I*4	PFET2	C	R*4	N.R.	REALJ	SFA	C	R*4	000870	RHPMR	C	R*4	N.R.	
SIGMA	F	C	R*4	SIGMR	F	C	R*4	0009CC	SKAMD	C	R*4	N.R.	SKBAL	C	R*4	N.R.	
SKGB1	C	R*4	N.R.	SKGB2	C	R*4	N.R.	SKPDS	C	R*4	N.R.	SKPEI	C	R*4	N.R.		
SKPES	C	R*4	N.R.	SKPR3	C	R*4	N.R.	SKRBF	C	R*4	N.R.	SKRCA	C	R*4	N.R.		
SKSCA	C	R*4	N.R.	SLMVT	C	R*4	N.R.	STMAX	C	R*4	N.R.	SWETH	C	R*4	N.R.		
SWEXP	C	R*4	N.R.	SWWET	C	R*4	N.R.	SZRHO	C	R*4	N.R.	TABLE	F	XF	R*4	000000	
TBCL1	C	R*4	N.R.	TBCRP	C	R*4	N.R.	TBEM5	C	R*4	N.R.	TBPOW	C	R*4	N.R.		
TASFC	C	R*4	N.R.	TCBAR	C	R*4	N.R.	THETA	C	R*4	N.R.	TPROP	S	C	R*4	000360	
TVCNR	C	R*4	N.R.	VBARH	C	R*4	N.R.	VBARV	C	R*4	N.R.	VDIVE	C	R*4	N.R.		
VGASB	C	R*4	N.R.	VGASR	C	R*4	N.R.	WPAYL	C	R*4	N.R.	WPSTR	C	R*4	N.R.		
XLALB	C	R*4	N.R.	XLBWO	C	R*4	N.R.	XLINT	F	XF	R*4	000000	XLRLA	C	R*4	N.R.	
XPJNO	F	R*4	000364	FRXPR#	XF	R*4	000000	COTAN	XF	R*4	000000	TAN	XF	R*4	000000		
COS	XF	R*4	000000	SIN	XF	R*4	000000	ATAN	XF	R*4	000000	SQRT	XF	R*4	000000		
ALFGFS	C	R*4	N.R.	BHPSUP	C	R*4	N.R.	CBARHT	C	R*4	N.R.	CBARVT	C	R*4	N.R.		
CBYLCA	C	R*4	N.R.	CLALPH	C	R*4	N.R.	CPOW33	FA	C	R*4	000724	CRSIND	C	R*4	N.R.	
CTSIGH	C	R*4	N.R.	CYCPRL	C	R*4	N.R.	JELFCR	C	R*4	N.R.	DELGM1	SF	R*4	000368		
DELGM2	SFA	R*4	00036C	DELRTH	C	R*4	N.R.	JELWFC	C	R*4	N.R.	DELWPL	C	R*4	N.R.		
DELWST	C	R*4	N.R.	CLSWSH	C	R*4	N.R.	ULTAFE	C	R*4	N.R.	DLVLHL	C	R*4	N.R.		
DRGIND	C	R*4	N.R.	CSPLMT	C	R*4	N.R.	JYLIND	C	R*4	N.R.	ELHLOA	C	R*4	N.R.		
ELVLOA	C	R*4	N.R.	ETAIND	C	R*4	N.R.	ETAP4N	C	R*4	N.R.	EXPDRG	C	R*4	N.R.		
FEDRAG	C	R*4	N.R.	FIXIND	C	R*4	N.R.	FWRNL#	F	XF	I*4	000000	GAM011	FA	C	R*4	000720
HULIND	C	R*4	N.R.	IBCOM#	F	XF	I*4	000000	INDCRU	C	I*4	N.R.	INDDRG	C	I*4	N.R.	
INDBYL	C	I*4	N.R.	INDETA	C	I*4	N.R.	INDFIX	C	I*4	N.R.	INDHUL	C	I*4	N.R.		
INDCPT	C	I*4	N.R.	INDDSA	C	I*4	N.R.	INDPOW	C	I*4	N.R.	INDPRP	C	I*4	N.R.		
INORDM	C	I*4	N.R.	IPRINT	C	I*4	N.R.	INTHRST	F	C	R*4	000001	OPTIND	C	R*4	N.R.	
OSWIND	C	R*4	N.R.	PRPIND	C	R*4	N.R.	ROMIND	C	R*4	N.R.	RHORHO	C	R*4	N.R.		
SGTIND	C	R*4	N.R.	SKBLNT	C	R*4	N.R.	SKENV1	C	R*4	N.R.	SKENV2	C	R*4	N.R.		
SKPDSZ	C	R*4	N.R.	SKVTAR	C	R*4	N.R.	SSIGMA	C	R*4	N.R.	STHETA	F	C	R*4	0008B4	
TBCDWI	C	R*4	N.R.	TB8AP4	C	R*4	N.R.	THETMR	C	R*4	N.R.	THRUST	C	R*4	000370		
TOLIND	C	R*4	N.R.	VG8DVH	C	R*4	N.R.	WBALNT	C	R*4	N.R.	WPAYLO	C	R*4	N.R.		

XTGTA2 C R\*4 N.R.

XTGTA4 C R\*4 N.R.

\*\*\*\*\* COMMON INFORMATION \*\*\*\*\*

NAME OF COMMON BLOCK *			* SIZE OF BLOCK	0009DC HEXADECIMAL BYTES				
VAR. NAME	TYPE	REL. ADDR.	VAR. NAME	TYPE	REL. ADDR.	VAR. NAME	TYPE	REL. ADDR.
CPTIND	R*4	N.R.	HULIND	R*4	N.R.	DYLIND	R*4	N.R.
CSWIND	R*4	N.R.	FIXIND	R*4	N.R.	ROMIND	R*4	N.R.
ETAINO	R*4	N.R.	WO	R*4	N.R.	XLBWO	R*4	N.R.
VGBOVH	R*4	N.R.	XLGD	R*4	N.R.	HMAXD	R*4	N.R.
VMO	R*4	N.R.	EMLF	R*4	N.R.	CKI	R*4	N.R.
CKFF	R*4	N.R.	VDIVE	R*4	N.R.	HOO	R*4	N.R.
TOO	R*4	N.R.	GAP1	R*4	N.R.	SGTIND	R*4	N.R.
ELVLGA	R*4	N.R.	GAP2	R*4	N.R.	AR	R*4	N.R.
TCR	R*4	N.R.	TCT	R*4	N.R.	SLM	R*4	N.R.
TCHT	R*4	N.R.	VBARH	R*4	N.R.	SLMH	R*4	N.R.
TCVT	R*4	N.R.	VBARV	R*4	N.R.	SLMVT	R*4	N.R.
ELDT	R*4	N.R.	ELDOA	R*4	N.R.	DLSWSH	R*4	N.R.
DLVLHL	R*4	N.R.	DYCL	R*4	N.R.	CBYLOA	R*4	N.R.
WVA	R*4	N.R.	DAMI	R*4	N.R.	DAMZ	R*4	N.R.
DAM3	R*4	N.R.	CLEYE	R*4	N.R.	THETMR	R*4	N.R.
XMR	R*4	N.R.	TVCMR	R*4	N.R.	VT	R*4	000148
TVW	R*4	N.R.	HES	R*4	N.R.	TINY	R*4	N.R.
ETAP4N	R*4	N.R.	TBEM5	R*4	N.R.	TBBAP4	R*4	N.R.
DAM4	R*4	N.R.	EAP	R*4	N.R.	ETAT	R*4	000198
VC	R*4	N.R.	ATMIY	R*4	N.R.	CDVT	R*4	N.R.
DAM5	R*4	N.R.	DLTAFE	R*4	N.R.	FEOPAG	R*4	N.R.
CDC	R*4	N.R.	CLALPH	R*4	N.R.	CKVT	R*4	N.R.
CKF	R*4	N.R.	CKW	R*4	N.R.	RELI	R*4	N.R.
TBCL1	R*4	N.R.	TBCDWI	R*4	N.R.	GAP4	R*4	N.R.
WFUL	R*4	N.R.	DELWFC	R*4	N.R.	DELWP	R*4	N.R.
SKCC	R*4	N.R.	SKRC	R*4	N.R.	SKSC	R*4	N.R.
SKTM	R*4	N.R.	SKRCA	R*4	N.R.	SKSCA	R*4	N.R.
SKAC	R*4	N.R.	SKHL	R*4	N.R.	SKENV1	R*4	N.R.
SKGB1	R*4	N.R.	SKGB2	R*4	N.R.	SKBLNT	R*4	N.R.
SKLG	R*4	N.R.	SKWW	R*4	N.R.	ELF	R*4	N.R.
SKWP	R*4	N.R.	SKHT	R*4	N.R.	SKVT	R*4	N.R.
SKRBF	R*4	N.R.	SKPH	R*4	N.R.	SKAMD	R*4	N.R.
SKPA	R*4	N.R.	SKVTAR	R*4	N.R.	SKPDS	R*4	N.R.
SKT	R*4	N.R.	SKFS	R*4	N.R.	SKPEI	R*4	N.R.
SK1	R*4	N.R.	SK2	R*4	N.R.	DK3	R*4	N.R.
SK5	R*4	N.R.	SK6	R*4	N.R.	SK7	R*4	N.R.
SK9	R*4	N.R.	SK10	R*4	N.R.	SK11	R*4	N.R.
SK13	R*4	N.R.	SK14	R*4	N.R.	SK15	R*4	N.R.
GAP5	R*4	N.R.	TOLIND	R*4	N.R.	XTGTA2	R*4	N.R.
TWTW	R*4	N.R.	PFET2	R*4	N.R.	DELTH	R*4	N.R.
CRSIND	R*4	N.R.	XTGTA4	R*4	N.R.	TIN4	R*4	N.R.
DELR	R*4	N.R.	RMAX	R*4	N.R.	DELFCR	R*4	N.R.
DELWPL	R*4	N.R.	STPW	R*4	N.R.	HFIN	R*4	N.R.
CYCPRL	R*4	N.R.	FF	R*4	N.R.	SK3	R*4	N.R.
						DRGIND	R*4	N.R.
						PRPIND	R*4	N.R.
						XLRLA	R*4	N.R.
						RHORHO	R*4	N.R.
						DELWF	R*4	N.R.
						ROO	R*4	N.R.
						ELHLOA	R*4	N.R.
						WS	R*4	N.R.
						ARHT	R*4	N.R.
						ARVT	R*4	N.R.
						ELDN	R*4	N.R.
						DSWET	R*4	N.R.
						ENR	R*4	00011C
						BMR	R*4	00012C
						XC	R*4	N.R.
						CTSIGH	R*4	N.R.
						ETAP2	R*4	N.R.
						GAP3	R*4	N.R.
						HC	R*4	N.R.
						CDHT	R*4	N.R.
						EXPDRG	R*4	N.R.
						CKHT	R*4	N.R.
						TCLN	R*4	N.R.
						WFE	R*4	N.R.
						DELWST	R*4	N.R.
						SKFW	R*4	N.R.
						SKMC	R*4	N.R.
						SKENV2	R*4	N.R.
						SKBAL	R*4	N.R.
						RMI	R*4	N.R.
						SKPFS	R*4	N.R.
						SK12	R*4	N.R.
						SKPDSZ	R*4	N.R.
						SKPES	R*4	N.R.
						DK4	R*4	N.R.
						SK8	R*4	N.R.
						SK12	R*4	N.R.
						PLIN	R*4	N.R.
						TIN2	R*4	N.R.
						SIH	R*4	N.R.
						VIN	R*4	N.R.
						ENPCR	R*4	N.R.
						GAP6	R*4	N.R.
						SK4	R*4	N.R.

7-153



TBH1	R*4	N.R.	TBTO	R*4	N.R.	TBH2	R*4	N.R.	TBCRP	R*4	N.R.
TBSFC	R*4	N.R.	TBPOW	R*4	N.R.	GAP7	R*4	N.R.	ALFUES	R*4	N.R.
ALFDL	R*4	N.R.	ALFR	R*4	N.R.	AMU	R*4	N.R.	BHPA	R*4	N.R.
BHPR	R*4	N.R.	BHPSUP	R*4	N.R.	BHT	R*4	N.R.	BLP	R*4	000660
BR	R*4	N.R.	BS	R*4	N.R.	BVT	R*4	N.R.	CBARF	R*4	N.R.
CBARHT	R*4	N.R.	CBARVT	R*4	N.R.	CBARW	R*4	N.R.	CCP	R*4	000680
CCT	R*4	000684	CDV	R*4	N.R.	CLW	R*4	N.R.	CPIND	R*4	N.R.
CPNUD	R*4	N.R.	CPPAR	R*4	N.R.	CPPRO	R*4	N.R.	CPTOT	R*4	N.R.
CRT	R*4	N.R.	CTP	R*4	N.R.	CV	R*4	N.R.	CX	R*4	N.R.
CLOES	R*4	N.R.	CB	R*4	N.R.	DELRTH	R*4	N.R.	DELTA	R*4	N.R.
DH	R*4	N.R.	DSPLMT	R*4	N.R.	ELC	R*4	N.R.	ELHT	R*4	N.R.
ELN	R*4	N.R.	ELGA	R*4	N.R.	ELT	R*4	N.R.	ELVT	R*4	N.R.
EN	R*4	N.R.	ETAP	R*4	0006E8	FEH	R*4	N.R.	FEHI	R*4	N.R.
FEHL	R*4	N.R.	FEHT	R*4	N.R.	FET	R*4	N.R.	FETOT	R*4	N.R.
FEVT	R*4	N.R.	FEW	R*4	N.R.	FEWH	R*4	N.R.	FEWI	R*4	N.R.
FM	R*4	N.R.	FP	R*4	N.R.	ETAP4	R*4	N.R.	GAMD11	R*4	000720
GLF	R*4	N.R.	GMDD1	R*4	0007D8	H	R*4	N.R.	ICRUS	I*4	N.R.
INDCRU	I*4	N.R.	INDORG	I*4	N.R.	INDDYL	I*4	N.R.	INDETA	I*4	N.R.
INDFIX	I*4	N.R.	INDHUL	I*4	N.R.	INDOPT	I*4	N.R.	INDOSW	I*4	N.R.
INDPGW	I*4	N.R.	INDPRP	I*4	N.R.	INDRDM	I*4	N.R.	IPRINT	I*4	N.R.
LTHL	I*4	N.R.	NOCPP	I*4	000854	NOXPJ	I*4	000858	QWE	R*4	N.R.
PEHF	R*4	N.R.	PI	R*4	000864	Q	R*4	N.R.	RHC	R*4	N.R.
REALJ	R*4	000870	RHPMR	R*4	N.R.	R	R*4	N.R.	RN	R*4	N.R.
SA	R*4	000880	SA5	R*4	N.R.	SA6	R*4	N.R.	SA7	R*4	N.R.
SFC	R*4	N.R.	SHPA	R*4	000894	SHPR	R*4	N.R.	SHT	R*4	N.R.
SHTE	R*4	N.R.	SHTW	R*4	N.R.	SIGMA	R*4	0008A8	SSIGMA	R*4	N.R.
ST	R*4	N.R.	STHETA	R*4	0008B4	STMAX	R*4	N.R.	SVT	R*4	N.R.
SVTE	R*4	N.R.	SVTW	R*4	N.R.	SW	R*4	N.R.	SWETH	R*4	N.R.
SWEXP	R*4	N.R.	SWTT	R*4	N.R.	SWWET	R*4	N.R.	SZRHO	R*4	N.R.
T	R*4	N.R.	TAF	R*4	N.R.	TGBAR	R*4	N.R.	THETA	R*4	N.R.
TMAX	R*4	N.R.	TMP	R*4	N.R.	DUM2	R*4	N.R.	TR	R*4	N.R.
ULF	R*4	N.R.	VGASB	R*4	N.R.	VGASR	R*4	N.R.	VHL	R*4	N.R.
V	R*4	000910	W	R*4	N.R.	WBAL	R*4	N.R.	WBALNT	R*4	N.R.
WCC	R*4	N.R.	WE	R*4	N.R.	WEP	R*4	N.R.	WES	R*4	N.R.
WF	R*4	N.R.	WFC	R*4	N.R.	WFR	R*4	N.R.	WFS	R*4	N.R.
WFH	R*4	N.R.	WGSB	R*4	N.R.	WHL	R*4	N.R.	WHT	R*4	N.R.
WLG	R*4	N.R.	WMC	R*4	N.R.	WPAYL	R*4	N.R.	WPC	R*4	N.R.
WPDS	R*4	N.R.	WPEI	R*4	N.R.	WPH	R*4	N.R.	WPRB	R*4	N.R.
WPRG	R*4	N.R.	WPRP	R*4	N.R.	WPSTR	R*4	N.R.	WRC	R*4	N.R.
WRCA	R*4	N.R.	WSC	R*4	N.R.	WSCA	R*4	N.R.	WST	R*4	N.R.
WTM	R*4	N.R.	WVT	R*4	N.R.	WW	R*4	N.R.	WPAYLO	R*4	N.R.
WAC	R*4	N.R.	WENV	R*4	N.R.	XLALB	R*4	N.R.	XLB	R*4	N.R.
XLBH	R*4	N.R.	XLHL	R*4	N.R.	XLR	R*4	N.R.	XLW	R*4	N.R.
YLS2	R*4	0009C0	TOVW	R*4	N.R.	DMR	R*4	0009C8	SIGMR	R*4	0009CC
AF	R*4	N.R.	BHPP	R*4	0009D4	SEE	R*4	N.R.			

7-154

NAME OF COMMON BLOCK \* ODD\* SIZE OF BLOCK 000814 HEXADECIMAL BYTES

VAR. NAME	TYPE	REL. ADDR.	VAR. NAME	TYPE	REL. ADDR.	VAR. NAME	TYPE	REL. ADDR.	VAR. NAME	TYPE	REL. ADDR.
AO	R*4	N.R.	A1	R*4	N.R.	A2	R*4	N.R.	BBO	R*4	N.R.
BB1	R*4	N.R.	BB2	R*4	N.R.	RJ3	R*4	0002DC	CPOW3	R*4	000304

ETAI3 R\*4 00032C  
AMACH R\*4 00069C  
CTI3 R\*4 000774

RJ4 R\*4 0004BC  
CLLL R\*4 0006AB  
CTI4 R\*4 0007C4

CPOW4 R\*4 0004E4  
CLGAM R\*4 0006E4

ETAI4 R\*4 00050C  
CPOW33 R\*4 000724

LABEL ADDR

7 00063E NR  
19 000930  
36 000C40

LABEL ADDR

23 000824  
14 000AFE

LABEL ADDR

3 0008C8  
12 00088E

LABEL ADDR

21 000902  
16 000C1C

PAGE 009

\*OPTIONS IN EFFECT\* NAME= MAIN,CPT=02,LINECNT=54,SIZE=0000K,

\*OPTIONS IN EFFECT\* SOURCE,EBCDIC,NOLIST,NODECK,LOAD,MAP,NOEDIT,LD,NOXREF

\*STATISTICS\* SOURCE STATEMENTS = 104 ,PROGRAM SIZE = 3196

\*STATISTICS\* NO DIAGNOSTICS GENERATED

\*\*\*\*\* END OF COMPILATION \*\*\*\*\*

91K BYTES OF CORE NOT USED

\*STATISTICS\* NO DIAGNOSTICS THIS STEP

7-156

CCMPILER CFTICNS - NAME= MAIN,OPT=C2,LINECNT=54,SIZE=0C00K,

SOURCE,FECCIC,NCLIST,KODECK,LOAD,MAP,NCEDIT, ID,NOXREF

ISN 0002	C****	MEMBER NAME	B811CFL						00010000
									00020000
									00030000
ISN 0003	C	PAGE 1	INPLT	LCC	CCC1	THRU	005C		00040000
		CCMMON	CPTIND		FLLINC		DYLIND	CRGIND	CSWIND
		1FIXIND	RCMIND		PRFIND		ETAIND	WG	XL8WG
		2XLRLA	VGEVH		PLCC		HFXD	RHCRHO	VPC
		3EMLF	CK1		CELWF		CKFF	VCIVE	HCC
		4RCC	TCC		CAF1(5)		SGTIND(12)	ELHLOA	ELVLCA
									00080000
									00090000
ISN 0004	C	PAGE 2	INPLT	LOC	CC51	THRU	0100		00100000
		CCMMON	AR		KS		TCR	TCT	SLM
		1ARFT	TCHT		VEARH		SLMH	ARVT	TCVT
		2VEARV	SLMVT		ELCA		ELDT	ELDOA	CLSHSH
		3DSWET	CLVFL		CVCL		CBYLCA	ENR	WVA
		4CAM1	CAM2		ENF		DAM3	CLEYE	TFETMR
		5XC	XMR		TVCMR		VT	CTSIGH	TVW
		6FES	TINY		ETAP2		ETAP4N	TBEM5(5)	TB8AP4(5)
									00170000
									00180000
ISN 0005	C	PAGE 3	INPUT	LCC	C1C1	THRU	140		00190000
		CCMMON	CAM4		ENF		ETAT	FC	VC
		1ATMIY	CDVT		CCFT		DAM5	CLTAFE	FECRAG
		2EXPDRG	CEC		CLZLPF		CKVT	CKFT	CKF
		3CKW	KELI		TCLN		T6CL1(8)	TBCCWI(8)	GAP4(4)
									00210000
									00220000
									00230000
ISN 0006	C	PAGE 4	INPLT	LCC	141	THRU	200	WEIGHT DATA	00240000
		CCMMON	WFE		WFL		DELWFC	DELWP	DELWST
		1SKCC	SKRC		SKSC		SKFW	SKTM	SKRCA
		2SKSCA	SKMC		SKAC		SKHL	SKENVI	SKENV2
		3SKCB1	SKGE2		SKELNT		SKBAL	SKLG	SKW
		4ELF	RMI		SKVP		SKVT	SKPRB	SKPRB
		5SKRHF	SKPF		SKAFD		SKAR	SKPA	SKVTAR
		6SKPDS	SKPCSZ		SKT		SKFS	SKPEI	SKPES
		7SK1	SK2		DK3		DK4	SK5	SK6
		8SK7	SK8		SK9		SK10	SK11	SK12
		9SK13	SK14		SK15		PLIN	GAP5(3)	
									00330000
									00340000
ISN 0007	C	PAGE 5	INPLT	LCC	201	THRU	300		00350000
		CCMMON	TCLIN(5)		XICTA2(5)		TIN2(5)	TWYW(5)	PFET2(5)
		1DELTH(5)	STH(5)		CRSINC(5)		XTGTA4(5)	TIN4(5)	VIN(5)
		2DEL(5)	RMA(5)		DELFCR(5)		ENPCR(5)	DELWPL(5)	STPW(5)
		3FFIN(5)	GAP2(1C)						
									00370000
ISN 0008	C	PAGE 6	INPLT	LCC	301	THRU	400		00380000
		CCMMON	CYCFEL		FF		SK3	SK4	TBF1(5)
		1TBT0(5)	TBF2(5)		TBCRP(5)		TBSFC(8)	TBPCW(8)	GAP7(60)
									00420000
ISN 0009	C	WORKING	CCMMON		ALFDES,ALFCL,ALFF,AML,				00430000
		1	BFFA,BFFR,BFFSLP,EHT,ELP,ER,BS,BVT,						00440000
		2	CEARF,CEARHT,CEARVT,CEARW,CCP,CCT,CDV,CLW,CPIND,CPNUD,CPPAR,CPPRC						00450000
		3	CPTOT,CRT,CTP,CV,CX,CLDES,CE,						00460000
		4	DELRT,DELTA,CF,CSPMT,		ELC,ELHT,ELN,ELCA,ELY,ELVT,ER,ETAP,				00470000
		5	FEH,FEHI,FEHL,FEHT,FET,FETCT,FEVT,FEW,FEWH,FEWI,FM,FP,ETAP4						00480000
ISN 0010		CCMMON	GAND11(3,15),GLF,GMDC1(16),F,						00490000
									00500000

ORIGINAL PAGE IS OF POOR QUALITY

7-157

	7	ICRUS, INCRU, INCRG, INCCYL, INDETA, INDFIX, INCFL, INDOPT, INCOSW,	00510000
	8	INDPOW, INDPRP, INCRGM, IFFINT	00520000
ISN 0011		COMMON LTHL, NCCFP, NOXP, CKE, FEHF, PI, Q, RHC, REALJ, RHPMR, R, RA	00530000
ISN 0012		COMMON SA, SA5, SA6, SA7, SFC, SHPA, SHPR, SHT, SHTE, SHTW, SIGMA, SSIGMA, ST,	00540000
ISN 0013		ISTHETA, STMAX, SVT, SVTE, SVTW, SV, SWETH, SWEXP, SWTT, SWWET, SZRFC	00550000
ISN 0014		COMMON T, TAF, TCEAF, THE1A, TMAX, TMP, TPROP, TR, ULF, VGASB, VGASR, VHL, V	00560000
		COMMON W, WBAL, WEAINT, WCC, WE, WEP, WES, WF, WFC, WFR, WFS, WFW,	00570000
ISN 0015		1 WGSB, WFL, WFT, WLG, WPC, WPAYL, WPC, WPCS, WPEI, WPF, WPRB, WPRG, WPRP, WPSTROU	00580000
		2, WRC, WRCA, WSC, WSCA, WST, WTM, WVT, WW, WPAYLO, WAC, WENV	00590000
ISN 0016		COMMON XLALB, XLE, XLBH, XLFL, XLR, XLW, YLS2, TDVW	00600000
ISN 0017		COMMON CMP, SIGMR, AF, BFFF, SEE	00600001
		NAMELIST /ITCHL/ YLS2, LTHL, W, STMAX, XLBH, BLP, SFC, BHPA, TR,	00610000
	1	TFRCP, BHER, FP, TCVW, XLR, PEHF, WF, ST, LC2, TOT, BHPSUP,	00620000
	2	SHPR, E1, E2, DTCVW, BR	00630000
ISN 0018		INCTOL=TCLINC(ITCHL)	00640000
ISN 0019		100 FCFMAT(22)4CHT- IS ERRCR IS IN THE TAKEOFF POWER TABLE)	00650000
ISN 0020		103 FCFMAT(2X, F7.2, 2X, F8.1, 3X, F9.C, 3X, F10.0, 3X, F8.C, 3X, F7.2, 2X,	00660000
		1F6.1, 2X, F6.3, 2X, F6.3, 2X, F8.C, 1X, F5.2, 1X, F6.3, 2X, F7.0, 2X, F8.0)	00670000
ISN 0021		8999 FCFMAT(7X34)TAKEOFF, HCOVER, CR LANC AT PEHF = ,F5.3, 5H FOR ,	00680000
		1F6.3, 5H HFS.)	00690000
ISN 0022		9000 FCFMAT(/7X34)TAKEOFF, HCOVER, CR LAND AT T/W = ,F5.3, 5H FCR ,	00700000
		1F6.3, 5H HFS.)	00710000
ISN 0023		9001 FCFMAT(2X, 'TIME', 7X, 'RANCE', 5X, 'FUEL USED', 5X, 'WEIGHT', 6X,	00720000
		1'ALT.', 6X, 'TEMP', 5X, 'TAS', 5X, 'B.R.', 4X, 'PEHF', 5X, 'BHPR', 4X,	00730000
		2'FM', 4X, '1/W', 3X, 'THRUST', 3X, 'FUEL FLOW', 2X, 'FCURS', 5X, '(N.MI.)', 40	00740000
		2X, '(POUNDS)', 5X, '(POUNDS)', 4X, 'FEET', 5X, '(DEC.F)', 2X, '(KTS)', 40X, 'G	00750000
		4'(PUNDS)', 3X, '(LB/HR)')//)	00760000
ISN 0024		IF (IPRINT.EQ.C.) GC TC 27	00770000
ISN 0026		IF (INDTCL .EQ.1) WRITE(6,9000) TWTW(ITOHL),STH(ITCHL)	00780000
ISN 0028		IF (INCTCL .EQ.2) WRITE(6,8999) PFET2(ITCHL),STH(ITCHL)	00790000
ISN 0030		WRITE(6,9001)	00800000
ISN 0031		27 STMAX=ST+ST*(ITCHL)	00810000
ISN 0032		PI=3.14159	00820000
ISN 0033		LC2=0	00830000
ISN 0034		H=H	00840000
ISN 0035		LTHL=1	00850000
ISN 0036		V=C.	00860000
ISN 0037		AMC=0.	00870000
ISN 0038		CX=0.	00880000
ISN 0039		IF (INCTCL .EQ.1) TCVW=TWTW(ITOHL)	00890000
ISN 0041		IF (INCTOL .EQ.2) TCVW=1.0	00900000
ISN 0043		TCT=XTGTA2(ITCHL)	00910000
ISN 0044		350 CALL ATMOS(H, IIN2(ITCHL))	00920000
ISN 0045		1 IF(TOT.EQ.1.0) XLBH=XLEWC*WC	00930000
ISN 0047		IF(TOT.NE.1.0) XLBH=((C.C76474*(TOT-1.0)/(0.C76474-XLGD))+1.0)*XLB	00930100
		WC*WC	00930200
ISN 0049		XLP=W-XLBH	00940000
ISN 0050		IF(XLBWC.EQ.1.0) XLR=WC*(TVW-1.0)	00940100
ISN 0052		XLA=ABS(XLR)	00940200
ISN 0053		TR=XLA*TCVW	00950000
ISN 0054		BLP=XLIAT(TBH1, TBT, H, 5, M)	00960000
ISN 0055		BLP=FACTR(BLP, H, THETA, FF)	00970000

7-15B

ISN 0056	IF (M.NE.C) WRITE(6,100)	CC980000
ISN 0058	IF (INCTCL .EQ.2) CC TC 5	CC950000
ISN 0060	BHFSUP=ELF*BHFF*DELRT	01000000
ISN 0061	IF (INCCYL.GT.2) GC TC 2	01010000
ISN 0063	IF (INDETA.EQ.C) GC TC 3	01020000
ISN 0065	TPROP=TR	01030000
ISN 0066	CALL PCWER	01040000
ISN 0067	BHPR=SFPR*BHPP*YLS2*DELRT	01050000
ISN 0068	GC TO 4	01060000
ISN 0069	3 BHPR=(TCVW)**1.5*>LA**1.5/(275.*ETAT*ETAP2*DPR*SQRT(2.*R+C*	01070000
	1PI*ENR))	01080000
ISN 0070	GC TO 4	01090000
ISN 0071	2 CALL RCTPCW	01100000
ISN 0072	4 IF (BHPSCP.LT.EFPR) WRITE(6,102)	01110000
ISN 0074	102 FORMAT(7X,4CHCALCICN ** PEHF IS GREATER THAN 1.0 **)	01120000
ISN 0075	BLF=BHPR/(BHPP*DELRT)	01130000
ISN 0076	SFC=XLTINT(TBPCW,TESFC,ELF,8,M)	01140000
ISN 0077	IF (M.NE.C) WRITE(6,101)	01150000
ISN 0079	101 FORMAT(22X3CHTHIS ERRCF IS IN THE SFC TABLE)	01160000
ISN 0080	FP=SFC*BHPR*CKFF	01170000
ISN 0081	GC TO 6	01180000
ISN 0082	5 PEHF=PFET2(ITCHL)	01190000
ISN 0083	SFPR=BLP*PEFF	01200000
ISN 0084	BHPA=SFPR*BHPP*DELRT	01210000
ISN 0085	ELF=SHPR	01220000
ISN 0086	SFC=XLTINT(TBPCW,TESFC,ELF,8,M)	01230000
ISN 0087	IF (M.NE.C) WRITE(6,101)	01240000
ISN 0089	FP=SFC*BHPA*CKFF	01250000
ISN 0090	IF (INCCYL.GT.2) GC TO 7	01260000
ISN 0092	IF (INDETA.EQ.C) GC TO 8	01270000
ISN 0094	LC2=0	01280000
ISN 0095	TR=XLR*TCVW	01290000
ISN 0096	TPROP=TR	01300000
ISN 0097	10 LC2=LC2+1	01310000
ISN 0098	CALL PCWER	01320000
ISN 0099	BHPR=SFPR*BHPP*YLS2*DELRT	01330000
ISN 0100	IF (ABS((BHPA-EHPR)/BHFA).LT.0.01) GO TO 6	01340000
ISN 0102	IF (LC2.LT.2) GC TC 12	01350000
ISN 0104	B2=BHPR-BHPA	01360000
ISN 0105	DTCVW=B2*ETCVW/(B1-B2)	01370000
ISN 0106	B1=B2	01380000
ISN 0107	GC TO 13	01390000
ISN 0108	12 B1=BHPR-BHPA	01400000
ISN 0109	DTCVW=-C.5	01410000
ISN 0110	13 TCVW=TOVW-DTOVW	01420000
ISN 0111	GC TO 10	01430000
ISN 0112	7 CALL RCTPCW	01440000
ISN 0113	GC TO 6	01450000
ISN 0114	8 TCVW=(275.*BHFA*ETAT*E1AF2*DPR*SQRT(2.*R+C*PI*ENR)/XLA**1.5)	01460000
	1**C.6667	01470000
ISN 0115	BHPR=BHFA	01480000
ISN 0116	6 BR=XLBH/W	01490000

7-159

ORIGINAL PAGE IS  
OF POOR QUALITY

ISN 0117		TMF=THETA*518.69-455.69	01530000
ISN 0118		IF (IPRINT.EC.C) GC TC 531	01510000
ISN 0120		IF (INDTGL.EQ.1) PEHF=EHPR/BHPSUP	01520000
ISN 0122		IF (INDETA.EC.C) FN=ETA*2	01520100
ISN 0124		WRITE(6,103)ST,R,W,F,W,F,TMP,V,BR,PEHF,BHPR,FM,TOVW,XLR,FP	01530000
ISN 0125	531	DLTH=LELTH(ITCFL)	01540000
ISN 0126		IF (ST.GE.STMAX) GC TC 541	01550000
ISN 0128		IF (ST.LT.(STMAX-DLTH)) GC TC 369	01560000
ISN 0130		DLTH=STMAX-ST	01570000
ISN 0131		GC TO 369	01580000
ISN 0132	541	LTHL=0	01590000
ISN 0133		RETURN	01610000
ISN 0134	369	W=W-FP*DLTH	01620000
ISN 0135		WF=WF+FP*DLTH	01630000
ISN 0136		ST=ST+DLTH	01640000
ISN 0137		GC TO 350	01650000
ISN 0138		END	01660000

NAME	TAG	TYPE	ADD.	NAME	TAG	TYPE	ADD.	NAME	TAG	TYPE	ADD.	NAME	TAG	TYPE	ADD.				
H	F	C	R*4	000818	M	FA	I*4	000354	Q	C	R*4	N.R.	R	F	C	R*4	000878		
T		C	R*4	N.R.	V	SF	C	R*4	000910	W	SF	C	R*4	000914	AF	C	R*4	N.R.	
AR		C	R*4	N.R.	BR	SF	C	R*4	000664	BS		C	R*4	N.R.	BL	SF	C	R*4	000358
B2	SF		R*4	00035C	CB		C	R*4	N.R.	CV		C	R*4	N.R.	CX	S	C	R*4	0006B0
DH		C	P*4	N.R.	EN		C	R*4	N.R.	FF	FA	C	R*4	0004B4	FM	SF	C	R*4	000714
FP	SF	C	R*4	000718	HC		C	R*4	N.R.	HH	SFA		R*4	000360	PI	SFA	C	R*4	000864
RN		C	R*4	N.R.	SA		C	R*4	N.R.	ST	SF	C	R*4	0008B0	SK		C	R*4	N.R.
TR	SF	C	R*4	0008FC	VC		C	R*4	N.R.	VT		C	R*4	N.R.	WE		C	R*4	N.R.
WF	SF	C	R*4	000930	WU	F	C	R*4	000024	WS		C	R*4	N.R.	WK		C	R*4	N.R.
XC		C	R*4	N.R.	APL	S	C	R*4	00064C	BHT		C	R*4	N.R.	BLP	SFA	C	R*4	000660
BMR		C	R*4	N.R.	BVT		C	R*4	N.R.	CCP		C	R*4	N.R.	CCT		C	R*4	N.R.
CJC		C	R*4	N.R.	CDV		C	R*4	N.R.	CKF		C	R*4	N.R.	CKW		C	R*4	N.P.
CK1		C	R*4	N.R.	CLW		C	R*4	N.R.	CRT		C	R*4	N.R.	CTP		C	R*4	N.R.
DK3		C	R*4	N.R.	DK4		C	R*4	N.R.	DMR	F	C	R*4	0009C8	ELC		C	R*4	N.R.
ELF		C	R*4	N.R.	ELN		C	R*4	N.R.	ELY		C	R*4	N.R.	ERP		C	R*4	N.R.
ENR	FA	C	R*4	00011C	FEH		C	R*4	N.R.	FET		C	R*4	N.R.	FEW		C	R*4	N.R.
GLF		C	R*4	N.R.	FES		C	R*4	N.R.	HOO		C	R*4	N.R.	LC2	SF		I*4	000364
GWE		C	R*4	N.R.	HFC	FA	C	R*4	00086C	RMI		C	R*4	N.R.	FCC		C	R*4	N.R.
SA5		C	R*4	N.R.	SA6		C	R*4	N.R.	SA7		C	R*4	N.R.	SEE		C	R*4	N.R.
SFC	SF	C	R*4	00089C	SHT		C	R*4	N.R.	SKT		C	R*4	N.R.	SK1		C	R*4	N.R.
SK2		C	R*4	N.R.	SK3		C	R*4	N.R.	SK4		C	R*4	N.R.	SK5		C	R*4	N.R.
SK6		C	R*4	N.R.	SK7		C	R*4	N.R.	SK8		C	R*4	N.R.	SK9		C	R*4	N.R.
SLM		C	R*4	N.R.	STH	F	C	R*4	000398	SVT		C	R*4	N.P.	TAF		C	R*4	N.R.
TCR		C	R*4	N.R.	TCT		C	R*4	N.R.	TMP	SF	C	R*4	0008F4	TLL		C	R*4	N.R.
TOT	SF		R*4	000368	TVW	F	C	R*4	000150	ULF		C	R*4	N.R.	VHL		C	R*4	N.R.
VIN		C	R*4	N.R.	VMC		C	R*4	N.R.	WAC		C	R*4	N.R.	WCC		C	R*4	N.R.
WEP		C	R*4	N.R.	WES		C	R*4	N.R.	WFC		C	R*4	N.R.	WFE		C	R*4	N.R.
WFR		C	R*4	N.R.	WFS		C	R*4	N.R.	WFN		C	R*4	N.R.	WHL		C	R*4	N.R.
WHT		C	R*4	N.R.	WLG		C	R*4	N.R.	WMC		C	R*4	N.R.	WPC		C	R*4	N.R.
WPH		C	R*4	N.R.	WRC		C	R*4	N.R.	WSC		C	R*4	N.R.	WST		C	R*4	N.R.
WTM		C	R*4	N.R.	WVA		C	R*4	N.R.	WVT		C	R*4	N.R.	XLA	SF		R*4	00036C
XLB		C	R*4	N.R.	XLR	SFA	C	R*4	000988	XLW		C	R*4	N.R.	XMR		C	R*4	N.R.
ALFR		C	R*4	N.R.	ARHT		C	R*4	N.R.	ARVT		C	R*4	N.R.	BITPA	SFA	C	R*4	000650
BHPP	F	C	R*4	0009C4	BHPR	SFA	C	R*4	000654	CDHT		C	R*4	N.R.	CDVT		C	R*4	N.R.
CKFF	F	C	R*4	00005C	CKHT		C	R*4	N.R.	CKVT		C	R*4	N.R.	DAM1		C	R*4	N.R.
DAM2		C	R*4	N.R.	DAM3		C	R*4	N.R.	DAM4		C	R*4	N.R.	DAM5		C	R*4	N.R.
DELR		C	R*4	N.R.	CVCL		C	R*4	N.R.	ELDN		C	R*4	N.R.	ELDT		C	R*4	N.R.
ELHT		C	R*4	N.R.	ELDA		C	R*4	N.R.	ELVT		C	R*4	N.R.	EMLF		C	R*4	N.R.
ETAP		C	R*4	N.R.	EYAT	F	C	R*4	000198	FEHI		C	R*4	N.R.	FEHL		C	R*4	N.R.
FEHT		C	R*4	N.R.	FEVT		C	R*4	N.R.	FEWH		C	R*4	N.R.	FEWI		C	R*4	N.R.
GAP1		C	R*4	N.R.	GAP2		C	R*4	N.R.	GAP3		C	R*4	N.R.	GAP4		C	R*4	N.R.
GAP5		C	R*4	N.R.	GAP6		C	R*4	N.R.	GAP7		C	R*4	N.R.	FFIK		C	R*4	N.R.
LTHL	S	C	I*4	000850	FEHF	SF	C	R*4	000860	PLIN		C	R*4	N.R.	RELI		C	R*4	N.R.
RMAX		C	R*4	N.R.	SHPA		C	R*4	N.R.	SHPR	SF	C	R*4	000898	SHTE		C	R*4	N.R.
SHTW		C	R*4	N.R.	SKAC		C	R*4	N.R.	SKAR		C	R*4	N.R.	SKCC		C	R*4	N.R.
SKFS		C	R*4	N.R.	SKFW		C	R*4	N.R.	SKHL		C	R*4	N.R.	SKHT		C	R*4	N.R.
SKLG		C	R*4	N.R.	SKMC		C	R*4	N.R.	SKPA		C	R*4	N.R.	SKPH		C	R*4	N.R.
SKRC		C	R*4	N.R.	SKSC		C	R*4	N.R.	SKTM		C	R*4	N.R.	SKVI		C	R*4	N.R.
SKWP		C	R*4	N.R.	SKWW		C	R*4	N.R.	SK10		C	R*4	N.R.	SK11		C	R*4	N.R.
SK12		C	R*4	N.R.	SK13		C	R*4	N.R.	SK14		C	R*4	N.R.	SK15		C	R*4	N.R.



SLMH	C	R*4	N.R.	STPW	C	R*4	N.R.	SVTE	C	R*4	N.R.	SVTW	C	R*4	N.R.			
SWTT	C	R*4	N.R.	THH1	FA	C	R*4	000400	TBM2	C	R*4	N.R.	TBTD	FA	C	R*4	000404	
TCHT	C	R*4	N.R.	TCLN	C	R*4	N.R.	TCVT	C	R*4	N.R.	TINY	C	R*4	N.R.			
TIN2	SFA	C	R*4	000348	TIN4	C	R*4	N.R.	TMAX	C	R*4	N.R.	TCHL		R*4	000370		
TOVW	SF	C	R*4	000904	TWV	F	C	R*4	000350	WVAL	C	R*4	N.R.	WENV	C	R*4	N.R.	
WFUL	C	R*4	N.R.	WGSB	C	R*4	N.R.	WPOS	C	R*4	N.R.	WPEI	C	R*4	N.R.			
WPRB	C	R*4	N.R.	WPRG	C	R*4	N.R.	WPRP	C	R*4	N.R.	WPCA	C	R*4	N.R.			
WSCA	C	R*4	N.R.	XLBH	SF	C	R*4	000980	XLGD	F	C	R*4	000034	XLHL	C	R*4	N.R.	
YLS2	F	C	R*4	000900	ALFCL	C	R*4	N.R.	ATMIY	C	R*4	N.R.	ATMCS	SF	XF	R*4	000000	
CBARF	C	R*4	N.R.	CBARW	C	R*4	N.R.	CLDES	C	R*4	N.R.	CLEYE	C	R*4	N.R.			
CPINC	C	R*4	N.R.	CFNOD	C	R*4	N.R.	CPPAR	C	R*4	N.R.	CPPRO	C	R*4	N.R.			
CPTOT	C	R*4	N.R.	DELTA	C	R*4	N.R.	DELTH	F	C	R*4	000384	DELWF	C	R*4	N.R.		
DELVP	C	R*4	N.R.	ELTTH	SF		R*4	000374	DSWET	C	R*4	N.R.	DTCVW	SF		R*4	000378	
ELDOA	C	R*4	N.R.	EKPCR	C	R*4	N.R.	ETAP2	F	C	R*4	000150	ETAP4	C	R*4	N.R.		
FACTR	F	XF	R*4	000000	FETOT	C	R*4	N.R.	GMDD1	C	R*4	N.R.	HMAXD	C	R*4	N.R.		
ICRUS	C	I*4	N.R.	ITCHL	SFA		I*4	000370	NCCPP	C	I*4	N.R.	NCXPJ	C	I*4	N.R.		
NTUHL			000000	PFET2	F	C	R*4	000370	POWER	SF	XF	R*4	000000	REALJ	C	R*4	N.R.	
RHPMR	C	R*4	N.R.	SIGPA	C	R*4	N.R.	SIGMP	C	R*4	N.R.	SKAYD	C	R*4	N.R.			
SKBAL	C	R*4	N.R.	SKCB1	C	R*4	N.R.	SKGB2	C	R*4	N.R.	SKPDS	C	R*4	N.R.			
SKPEI	C	R*4	N.R.	SKPES	C	R*4	N.R.	SKPRB	C	R*4	N.R.	SKKBF	C	R*4	N.R.			
SKRCA	C	R*4	N.R.	SKSCA	C	R*4	N.R.	SLMVT	C	R*4	N.R.	STMAX	SF	C	R*4	000888		
SWETH	C	R*4	N.R.	SWEXP	C	R*4	N.R.	SWWET	C	R*4	N.R.	SZPHQ	C	R*4	N.R.			
TBCL1	C	R*4	N.R.	TECRP	C	R*4	N.R.	TBEM5	C	R*4	N.R.	TEPOW	FA	C	R*4	000530		
TBSFC	FA	C	R*4	000510	TCEAR	C	R*4	N.R.	THETA	FA	C	R*4	000800	TPFGP	S	C	R*4	0008F8
TVCMR	C	R*4	N.R.	VEARH	C	R*4	N.R.	VEARV	C	R*4	N.R.	VCIVE	C	R*4	N.R.			
VGASB	C	R*4	N.R.	VGASR	C	R*4	N.R.	WPAYL	C	R*4	N.R.	WPSTR	C	R*4	N.R.			
XLALB	C	R*4	N.R.	XLBWO	F	C	R*4	000028	XLINT	F	XF	R*4	000000	XLKLA	C	R*4	N.R.	
SQRT	XF	R*4	000000	FRXPR#	XF	R*4	000000	ALFDES	C	R*4	N.R.	BHPSUP	SF	C	R*4	000658		
CBARHT	C	R*4	N.R.	CBARVT	C	R*4	N.R.	CBYLOA	C	R*4	N.R.	CLALPH	C	R*4	N.R.			
CRSIND	C	R*4	N.R.	CTSIGH	C	R*4	N.R.	CYCPRL	C	R*4	N.R.	DELFCR	C	R*4	N.R.			
DELPTH	F	C	R*4	000680	DELWFC	C	R*4	N.R.	DELWPL	C	R*4	N.R.	DELWST	C	R*4	N.R.		
DLKSH	C	R*4	N.R.	CLTAFE	C	R*4	N.R.	DLVLHL	C	R*4	N.R.	DRGIND	C	R*4	N.R.			
DSPLMT	C	R*4	N.R.	CYLINC	C	R*4	N.R.	ELHLOA	C	R*4	N.R.	ELVLCA	C	R*4	N.R.			
ETAIND	C	R*4	N.R.	ETAP4N	C	R*4	N.R.	EXPORG	C	R*4	N.R.	FEDRAG	C	R*4	N.R.			
FIXINC	C	R*4	N.R.	GAMC11	C	R*4	N.R.	HULIND	C	R*4	N.R.	IBCOM#	F	XF	I*4	000000		
INDCRU	C	I*4	N.R.	INDCRG	C	I*4	N.R.	INDOYL	C	I*4	000328	INDETA	C	I*4	000820			
INDFIX	C	I*4	N.R.	INDFUL	C	I*4	N.R.	INDOPT	C	I*4	N.R.	INCOSW	C	I*4	N.R.			
INDPOW	C	I*4	N.R.	INDPRP	C	I*4	N.R.	INDRDM	C	I*4	N.R.	INCTCL	S		I*4	000380		
IPRINT	C	I*4	000840	CPTIND	C	R*4	N.R.	OSWIND	C	R*4	N.R.	PRPIND	C	R*4	N.R.			
REMINC	C	R*4	N.R.	FFCRHO	C	R*4	N.R.	RGTPOW	SF	XF	R*4	000000	SGTIND	C	R*4	N.R.		
SKBLNT	C	R*4	N.R.	SKENVI	C	R*4	N.R.	SKENV?	C	R*4	N.R.	SKPDSZ	C	R*4	N.R.			
SKVTAR	C	R*4	N.R.	SSIGMA	C	R*4	N.R.	STHETA	C	R*4	N.R.	TBCDWI	C	R*4	N.R.			
TBAP4	C	R*4	N.R.	THETMR	C	R*4	N.R.	TOLIND	F	C	R*4	000320	VGBOVH	C	R*4	N.R.		
WBALNT	C	R*4	N.R.	WPAYLO	C	R*4	N.R.	XTGTA2	F	C	R*4	000334	XTGTA4	C	R*4	N.R.		

\*\*\*\*\* COMMON INFORMATION \*\*\*\*\*

NAME OF COMMON BLOCK \* \* SIZE OF BLOCK 0009DC HEXADECIMAL BYTES

VAR. NAME TYPE REL. ADDR. VAR. NAME TYPE REL. ADDR. VAR. NAME TYPE REL. ADDR. VAR. NAME TYPE REL. ADDR.

7-162

OPTINC	R*4	N.R.	HULINC	R*4	N.R.	DYLIND	R*4	N.R.	DFGIND	R*4	N.R.
CSWINC	R*4	N.R.	FIXINC	R*4	N.R.	ROMIND	R*4	N.R.	PRPIND	R*4	N.R.
ETAIND	R*4	N.R.	WC	R*4	000024	XLBWD	R*4	000028	XLPLA	R*4	N.R.
VGBCVH	R*4	N.R.	XLCC	R*4	000034	HMAXD	R*4	N.R.	RHCRHO	R*4	N.R.
VVC	R*4	N.R.	ENLF	R*4	N.R.	CKI	R*4	N.R.	DELWF	R*4	N.R.
CKFF	R*4	000050	VCIVE	R*4	N.R.	HOO	R*4	N.R.	RCO	R*4	N.R.
TCC	R*4	N.R.	CAFI	R*4	N.R.	SGTIND	R*4	N.R.	ELHLCA	R*4	N.R.
ELVLCA	R*4	N.R.	CAPZ	R*4	N.R.	AR	R*4	N.R.	WS	R*4	N.R.
TCR	R*4	N.R.	TCT	R*4	N.R.	SLM	R*4	N.P.	APHT	R*4	N.R.
TCHT	R*4	N.R.	VBARI	R*4	N.R.	SLMH	R*4	N.R.	ARVT	R*4	N.R.
TCVT	R*4	N.R.	VBARV	R*4	N.R.	SLMVT	R*4	N.R.	ELDN	R*4	N.R.
ELCT	R*4	N.R.	ELCGA	R*4	N.R.	CLS4SH	R*4	N.R.	DSWET	R*4	N.R.
DLVLHL	R*4	N.R.	CVCL	R*4	N.R.	CBYLOA	R*4	N.R.	ENF	R*4	00011C
KVA	R*4	N.R.	CAMI	R*4	N.R.	CAM2	R*4	N.R.	EMK	R*4	N.R.
CAM3	R*4	N.R.	CLEYE	R*4	N.R.	THETMR	R*4	N.R.	XC	R*4	N.R.
XMR	R*4	N.R.	TVCMR	R*4	N.R.	VT	R*4	N.R.	CTSIGH	R*4	N.R.
TVW	R*4	000150	FES	R*4	N.R.	TINY	R*4	N.R.	ETAP2	R*4	00015C
ETAF4N	R*4	N.R.	TBEMS	R*4	N.R.	TB84P4	R*4	N.R.	GAP3	R*4	N.P.
CAM4	R*4	N.R.	ENF	R*4	N.R.	ETAT	R*4	000198	HC	R*4	N.R.
VC	R*4	N.R.	ATM1Y	R*4	N.R.	CDVT	R*4	N.R.	CDHT	R*4	N.R.
CAM5	R*4	N.R.	ELTAFE	R*4	N.R.	FEDPAG	R*4	N.R.	EXPDRG	R*4	N.R.
CIC	R*4	N.R.	CLALPH	R*4	N.R.	CKVT	R*4	N.R.	CKHT	R*4	N.R.
CKF	R*4	N.R.	CKW	R*4	N.R.	RELI	R*4	N.P.	TCLN	R*4	N.R.
TBCLL	R*4	N.R.	THCDWI	R*4	N.R.	GAP4	R*4	N.R.	WFE	R*4	N.R.
WFL	R*4	N.R.	DELWFC	R*4	N.R.	DELWP	R*4	N.R.	DELWST	R*4	N.R.
SKCC	R*4	N.R.	SKFC	R*4	N.R.	SKSC	R*4	N.R.	SKFW	R*4	N.R.
SKTM	R*4	N.R.	SKRCA	R*4	N.R.	SKSCA	R*4	N.R.	SKMC	R*4	N.R.
SKAC	R*4	N.R.	SKHL	R*4	N.R.	SKENV1	R*4	N.R.	SKENV2	R*4	N.R.
SKCEL	R*4	N.R.	SKGB2	R*4	N.R.	SKBLNT	R*4	N.R.	SKBAL	R*4	N.P.
SKLG	R*4	N.R.	SKW	R*4	N.R.	ELF	R*4	N.R.	RMI	R*4	N.R.
SKWP	R*4	N.R.	SKHT	R*4	N.R.	SKVT	R*4	N.R.	SKPRB	R*4	N.R.
SKREF	R*4	N.R.	SKPF	R*4	N.R.	SKAMD	R*4	N.R.	SKAR	R*4	N.P.
SKPA	R*4	N.R.	SKVTAR	R*4	N.R.	SKPDS	R*4	N.R.	SKPDSZ	R*4	N.R.
SKT	R*4	N.R.	SKFS	R*4	N.R.	SKPEI	R*4	N.R.	SKPES	R*4	N.R.
SK1	R*4	N.R.	SK2	R*4	N.R.	DK3	R*4	N.R.	DK4	R*4	N.R.
SK5	R*4	N.R.	SK6	R*4	N.R.	SK7	R*4	N.R.	SK8	R*4	N.R.
SK9	R*4	N.R.	SK10	R*4	N.R.	SK11	R*4	N.R.	SK12	R*4	N.P.
SK13	R*4	N.R.	SK14	R*4	N.R.	SK15	R*4	N.R.	PLIN	R*4	N.R.
GAF5	R*4	N.R.	TCLIND	R*4	000320	XTGTA2	R*4	000334	TIN2	R*4	000348
THW	R*4	00035C	PFET2	R*4	000370	DELTH	R*4	000384	STH	R*4	000398
CRSINC	R*4	N.R.	XTGTA4	R*4	N.R.	TIN4	R*4	N.R.	VIN	R*4	N.R.
DELR	R*4	N.R.	KMAX	R*4	N.R.	DELFCR	R*4	N.R.	ENPCP	R*4	N.R.
DELWFL	R*4	N.R.	STPH	R*4	N.R.	HFIN	R*4	N.R.	GAP0	R*4	N.R.
CYCPFL	R*4	N.R.	FF	R*4	0004B4	SK3	R*4	N.R.	SK4	R*4	N.R.
TBF1	R*4	0004C0	TBTC	R*4	0004D4	TBH2	R*4	N.R.	TBCRP	R*4	N.R.
TBSFC	R*4	000510	TBPCW	R*4	000530	GAP7	R*4	N.R.	ALFDES	R*4	N.R.
ALFCL	R*4	N.R.	ALFR	R*4	N.R.	AMU	R*4	00064C	BHPA	R*4	000650
B-PR	R*4	000654	BHPSUP	R*4	000658	BHT	R*4	N.R.	BLP	R*4	000660
ER	R*4	000664	ES	R*4	N.R.	BVT	R*4	N.R.	CHARF	R*4	N.R.
CBARFT	R*4	N.R.	CBARVT	R*4	N.R.	CBARW	R*4	N.R.	CCP	R*4	N.R.
CCT	R*4	N.R.	CDV	R*4	N.R.	CLW	R*4	N.R.	CPINC	R*4	N.R.
CPNLC	R*4	N.R.	CPPAR	R*4	N.R.	CPPRO	R*4	N.R.	CPTCT	R*4	N.R.

CRT	R*4	N.R.	CTF	R*4	N.R.	CV	R*4	N.R.	CX	R*4	000680
CLDES	R*4	N.R.	CE	R*4	N.R.	DELRTH	R*4	00069C	DELTA	R*4	N.R.
CF	R*4	N.R.	CSPLMT	R*4	N.R.	ELC	R*4	N.R.	ELHT	R*4	N.R.
ELA	R*4	N.R.	ELCA	R*4	N.R.	ELT	R*4	N.R.	ELVT	R*4	N.R.
EN	R*4	N.R.	ETAP	R*4	N.R.	FEH	R*4	N.R.	FEHI	R*4	N.R.
FEFL	R*4	N.R.	FEHT	R*4	N.R.	FET	R*4	N.R.	FETCT	R*4	N.R.
FEVT	R*4	N.R.	FEW	R*4	N.F.	FEWH	R*4	N.R.	FEWI	R*4	N.R.
FM	R*4	000714	FF	R*4	000718	ETAP4	R*4	N.R.	GAMCII	R*4	N.R.
GLF	R*4	N.R.	GMCC1	R*4	N.R.	H	R*4	000818	ICRUS	I*4	N.R.
INDCRL	I*4	N.R.	INDDRC	I*4	N.R.	INDOYL	I*4	000828	INDETA	I*4	00082C
INDFIX	I*4	N.R.	INDHUL	I*4	N.R.	INDOPT	I*4	N.R.	INDCSW	I*4	N.R.
INDFCW	I*4	N.R.	INDPRF	I*4	N.R.	INCRDM	I*4	N.R.	IPRINT	I*4	00084C
LTL	I*4	000850	NCCPF	I*4	N.R.	NCXPJ	I*4	N.R.	CKE	R*4	N.R.
PEFF	R*4	000860	PI	R*4	000864	Q	R*4	N.R.	RFU	R*4	00086C
REALJ	R*4	N.R.	RFPMR	R*4	N.R.	R	R*4	000878	RA	R*4	N.R.
SA	R*4	N.R.	SAS	R*4	N.R.	SA6	R*4	N.R.	SA7	R*4	N.R.
SFC	R*4	000890	SFPA	R*4	N.R.	SHPR	R*4	000898	SHT	R*4	N.R.
SFTE	R*4	N.R.	SHTW	R*4	N.R.	SIGMA	R*4	N.R.	SSIGMA	R*4	N.R.
ST	R*4	0008B0	STHETA	R*4	N.P.	STMAX	R*4	0008B8	SVT	R*4	N.R.
SVTE	R*4	N.R.	SVTW	R*4	N.R.	SW	R*4	N.R.	SWETH	R*4	N.R.
SWEXP	R*4	N.R.	SHTT	R*4	N.R.	SWWET	R*4	N.P.	SZRHO	R*4	N.R.
T	R*4	N.R.	TAF	R*4	N.R.	TCBAR	R*4	N.R.	THETA	R*4	0008EC
TPAX	R*4	N.R.	TMP	R*4	0008F4	TPROP	R*4	0008F8	TR	R*4	0008FC
LLF	R*4	N.R.	VGASE	R*4	N.R.	VGASR	R*4	N.R.	VHL	R*4	N.R.
V	R*4	000910	W	R*4	000914	WBAL	R*4	N.R.	WBALNT	R*4	N.R.
WCC	R*4	N.R.	WE	R*4	N.R.	WEP	R*4	N.R.	WES	R*4	N.R.
WF	R*4	000930	WFC	R*4	N.R.	WFR	R*4	N.R.	WFS	R*4	N.R.
WFH	R*4	N.R.	WGSE	R*4	N.R.	WHL	R*4	N.R.	WHT	R*4	N.R.
WLG	R*4	N.R.	WMC	R*4	N.R.	WPAYL	R*4	N.R.	WPC	R*4	N.R.
WPES	R*4	N.R.	WPEI	R*4	N.R.	WPH	R*4	N.R.	WPRB	R*4	N.R.
WFFG	R*4	N.R.	WPRF	R*4	N.P.	WPSTR	R*4	N.R.	WPC	R*4	N.R.
WRCA	R*4	N.R.	WSC	R*4	N.R.	WSCA	R*4	N.R.	WST	R*4	N.R.
WTV	R*4	N.R.	WVT	R*4	N.R.	WW	R*4	N.R.	WPAYLO	R*4	N.R.
WAC	R*4	N.R.	WENV	R*4	N.R.	XLALB	R*4	N.R.	XLB	R*4	N.R.
XLBT	R*4	0009B0	XLFL	R*4	N.R.	XLR	R*4	0009BB	XLW	R*4	N.R.
YLS2	R*4	0009C0	TCVW	R*4	0009C4	DNR	R*4	0009C8	SIGMR	R*4	N.R.
AF	R*4	N.R.	BHFF	R*4	0009D4	SEE	R*4	N.R.			

LABEL	ADDR	LABEL	ADDR	LABEL	ADDR	LABEL	ADDR
27	CCC64C	35C	CCC6BC	1	0006D6 NR	3	0007F0
2	CCC87C	4	CCC87C	5	CC08F8	1C	000984
12	CCC9DE	13	CCC9F2	7	CC0A02	8	000A12
6	CCC958	531	CC0B6E	541	000B9C	369	000BA8

\*OPTIONS IN EFFECT\* NAME= MAIN,CPT=02,LINECNT=54,SIZE=0000K,

\*OPTIONS IN EFFECT\* SOURCE,EBCDIC,NCLIST,NCDECK,LCAD,MAP,NCEDIT,IO,NOXREF

\*STATISTICS\* SCLRC STATEMENTS = 137.,PROGRAM SIZE = 3078

\*STATISTICS\* NO DIAGNOSTICS GENERATED

\*\*\*\*\* END OF COMPILATION \*\*\*\*\*

95K BYTES OF CORE NOT USED

7-165

CCMPILER CFTICNS - NAME= MAIN,CPI=C2,LINECNT=54,SIZE=0C0GK,

SCURCE,EBCDIC,NCLIST,NODECK,LCAD,MAP,NCEDIT,ID,NCXREF

ISN 0002	SLROUTINE TRALT (ITRALT)	00010000
C****	MEMBER NAME B81TRALT	00020000
C	PAGE 1 INPUT LOC CCCI THRU 0050	00030000
ISN 0003	CCMMON OPTIND ,FULINC ,DYLIND ,CRGIND ,OSWIND ,00040000	
	1FIXIND ,RDMIND ,PFFINE ,ETAIND ,WC ,XLBWD ,00050000	
	2XLRLA ,VGBCVH ,XLCD ,HMAXD ,RPCRHO ,VMC ,00060000	
	3EMPLF ,CK1 ,CELWF ,CKFF ,VDIVE ,HOC ,00070000	
	4RGO ,TOO ,GAP1(5) ,SGTIND(12) ,ELHLOA ,ELVLOA ,00080000	
C	5GAP2(6)	00090000
C	PAGE 2 INPUT LOC C(51 THRU 0100	00100000
ISN 0004	CCMMON AR ,S ,TCR ,TCT ,SLM ,00110000	
	1ARFT ,TCHT ,VEARM ,SLMH ,ARVT ,TCVT ,00120000	
	2VEARV ,SLMVT ,ELCN ,ELDT ,ELCOA ,DLWSH ,00130000	
	3DSWET ,CLVLF ,CVCL ,CBYLOA ,EAR ,WVA ,00140000	
	4CAM1 ,CAM2 ,EMR ,DAM3 ,CLEYE ,TFETMR ,00150000	
	5XC ,XMR ,TVCMR ,VT ,CTSIGH ,TVW ,00160000	
	6FES ,TINY ,ETAP2 ,ETAP4N ,TBEM5(5) ,TB8AP4(5) ,00170000	
C	7GAP3	00180000
C	PAGE 3 INPUT LOC CICI THRU 140	00190000
ISN 0005	CCMMON CAM4 ,ENF ,ETAT ,FC ,VC ,00200000	
	1ATMIY ,CDVT ,CCFT ,DAM5 ,CLTAFE ,FEDRAG ,00210000	
	2EXPDRG ,GCC ,CLALPH ,CKVT ,CKFT ,CKF ,00220000	
	3CKW ,RELI ,TCLN ,TECLI(8) ,TECCWI(8) ,GAP4(4) ,00230000	
C	PAGE 4 INFLT LOC 141 THRU 200 WEIGHT DATA	00240000
ISN 0006	CCMMON WFE ,WFL ,DELWFC ,CELWP ,DELWST ,00250000	
	1SKCC ,SKRC ,SKSC ,SKFW ,SKTM ,SKRCA ,00260000	
	2SKSCA ,SKMC ,SKAC ,SKHL ,SKENV1 ,SKENV2 ,00270000	
	3SKCB1 ,SKGB2 ,SKELNT ,SKBAL ,SKLG ,SKW ,00280000	
	4ELF ,RMI ,SKWP ,SKHT ,SKVT ,SKPRB ,00290000	
	5SKRBF ,SKPF ,SKAMP ,SKAR ,SKPA ,SKVTAR ,00300000	
	6SKFDS ,SKFCSZ ,SK1 ,SKFS ,SKPEI ,SKPES ,00310000	
	7SK1 ,SK2 ,CK3 ,DK4 ,SK5 ,SK6 ,00320000	
	8SK7 ,SK8 ,SK9 ,SK10 ,SK11 ,SK12 ,00330000	
	9SK13 ,SK14 ,SK15 ,PLIN ,EAP5(3) ,00340000	
C	PAGE 5 INPUT LOC 201 THRU 300	00350000
ISN 0007	CCMMON TOLINC(5) ,XTCTA2(5) ,TIN2(5) ,TWTW(5) ,PFET2(5) ,00360000	
	1DELTH(5) ,STH(5) ,CRSINC(5) ,XTGTA4(5) ,TIN4(5) ,VIN(5) ,00370000	
	2DELRL(5) ,RMAX(5) ,CELFCR(5) ,ENPCR(5) ,CELWPL(5) ,STFW(5) ,00380000	
	3HFIN(5) ,GAP6(10)	00390000
C	PAGE 6 INFLT LOC 301 THRU 400	00400000
ISN 0008	CCMMON CYCFFL ,FF ,SK3 ,SK4 ,TBT1(5) ,00410000	
	1TBT0(5) ,TBT2(5) ,TBCRP(5) ,TBSFC(8) ,TBPOW(8) ,GAP7(60) ,00420000	
C	WORKING CCMMON	00430000
ISN 0009	CCMMON ALFCES,ALFCL,ALFF,AML,	00440000
	1 BTPA,BPFR,BHPSLP,BHT,BLP,BP,BS,BVT,	00450000
	2 CEARF,CEART,CEARVT,CEARW,CCP,CTT,CDV,CLW,CPIND,CPNUD,CPPAR,CPPRC,00460000	
	3,CFTOT,CRT,CTP,CV,CX,CLCES,CE,	00470000
	4 DELRTH,DELTA,DF,DSPLMT, ELC,ELHT,ELN,ELCA,ELT,ELVT,EN,ETAP,	00480000
ISN 0010	5 FEH,FEH1,FEHL,FEHT,FEI,FETCT,FEVT,FEW,FEWH,FEWI,FM,FP,ETAP4	00490000
	CCMMON GAMD11(3,15),GLF,GMDC1(16),H,	00500000

7-166

ORIGINAL PAGE IS  
OF POOR QUALITY

```

7 ICRUS,INCCRU,INCCRG,INCCYL,INDETA,INDFIX,INEFUL,INDOPT,INCOsw, 00510000
8 INCPow,INCPRF,INCDRM,IPPRINT 00520000
ISN 0011 CCMON LTHL,NCCFP,NCXP,CKE,PEHF,PI,Q,RHC,REALJ,RHPR,R,RN 00530000
ISN 0012 CCMON SA,SAS,SA6,SA7,SFC,S-PA,SHPR,SHT,SHTe,SHTW,SIGMA,SSIGMA,ST, 00540000
1STHETA,SYMAX,S/T,SVTE,SVTK,Sk,SWETH,SWEXP,SWTI,SWWET,SZRHC 00550000
ISN 0013 CCMON T,TAF,TCEAF,THETA,TMAX,TMP,TPRCP,TR,ULF,VGASB,VGASR,VHL,V 00560000
ISN 0014 CCMON W,WBAL,WALNT,WCC,WK,WEP,WES,WFC,WFR,WFS,WFW, 00570000
1 WCSB,WFL,WHT,WLC,WPC,WPAYL,WPC,WPCS,WPEI,WPF,WPRB,WPRG,WPRP,WPSTR 00580000
2,WRC,WRCa,WSC,WSCA,WST,WTM,WVT,WW,WPAYLO,WAC,WENV 00590000
ISN 0015 CCMON XLALB,XLE,XLBH,XLFL,XLR,XLW,YLS2,TCVW 00600000
ISN 0016 CCMON BWR,SIGNR,ZF,BFFP,SEE 00610000
ISN 0017 HCLD = H 00620000
ISN 0018 F = HFIN(ITRALT) 00630000
ISN 0019 IF(IPRINT.NE.1)CC TC 3CC 00640000
ISN 0021 WRITE(6,1001)HCLD,H 00650000
ISN 0022 1001 FCRMAT( 7X,'TRANSFER ALTITUDE FROM ',F8.0,2X,'FEET'/18X,'TO',4X, 00660000
1FE.0,2X,'FEET'/) 00670000
ISN 0023 WRITE(6,1002) 00680000
ISN 0024 1002 FCRMAT(7X,'TIME',8X,'RANCE',6X,'FUEL USED',6X,'WEIGHT',7X,'ALT'/ 00690000
17X,'(HOURS)',5X,'(N.MI)',6X,'(POUNDS)',5X,'(PCUNDS)',6X,'(FEET)'/) 00700000
ISN 0025 WRITE(6,1003)ST,R,Wf,w,FCLD 00710000
ISN 0026 WRITE(6,1003)ST,R,Wf,w,F 00720000
ISN 0027 1003 FCRMAT(7X,F7.2,4X,F8.1,4X,F9.0,4X,F10.0,4X,F8.0) 00730000
ISN 0028 300 RETURN 00740000
ISN 0029 ENC

```

7-167

ORIGINAL PAGE IS  
OF POOR QUALITY

NAME	TAG	TYPE	ADD.	NAME	TAG	TYPE	ADD.	NAME	TAG	TYPE	ADD.	NAME	TAG	TYPE	ADD.				
H	SF	C	R*4	000818	Q	C	R*4	N.R.	R	F	C	R*4	00C878	T	C	R*4	N.R.		
V		C	R*4	N.R.	W	F	C	R*4	000914	AF	C	R*4	N.R.	AP	C	R*4	N.R.		
BR		C	R*4	N.R.	BS		C	R*4	N.R.	CB		C	R*4	N.R.	CV		C	R*4	N.R.
CX		C	R*4	N.R.	DH		C	R*4	N.R.	EN		C	R*4	N.R.	FF		C	R*4	N.R.
FM		C	R*4	N.R.	FP		C	R*4	N.R.	HC		C	R*4	N.R.	PI		C	R*4	N.R.
RN		C	R*4	N.R.	SA		C	R*4	N.R.	ST	F	C	R*4	00C890	SW		C	R*4	N.R.
TR		C	R*4	N.R.	VC		C	R*4	N.R.	VT		C	R*4	N.R.	WE		C	R*4	N.R.
WF	F	C	R*4	000930	WO		C	R*4	N.R.	WS		C	R*4	N.R.	Wk		C	R*4	N.R.
XC		C	R*4	N.R.	APL		C	R*4	N.R.	BHT		C	R*4	N.R.	BLP		C	R*4	N.R.
BMR		C	R*4	N.R.	EVT		C	R*4	N.R.	CCP		C	R*4	N.R.	CCT		C	R*4	N.R.
CDC		C	R*4	N.R.	CDV		C	R*4	N.R.	CKF		C	R*4	N.R.	CKW		C	R*4	N.R.
CK1		C	R*4	N.R.	CLW		C	R*4	N.R.	CRT		C	R*4	N.R.	CYP		C	R*4	N.R.
DK3		C	R*4	N.R.	DK4		C	R*4	N.R.	DMR		C	R*4	N.R.	ELC		C	R*4	N.R.
ELF		C	R*4	N.R.	ELN		C	R*4	N.R.	ELT		C	R*4	N.R.	ENP		C	R*4	N.R.
ENR		C	R*4	N.R.	FEH		C	R*4	N.R.	FET		C	R*4	N.R.	FEW		C	R*4	N.R.
GLF		C	R*4	N.R.	FES		C	R*4	N.P.	HOO		C	R*4	N.R.	CHW		C	R*4	N.R.
RHD		C	R*4	N.R.	RMI		C	R*4	N.R.	ROO		C	R*4	N.R.	SA5		C	R*4	N.R.
SA6		C	R*4	N.R.	SA7		C	R*4	N.R.	SEE		C	R*4	N.R.	SFC		C	R*4	N.R.
SHT		C	R*4	N.R.	SKT		C	R*4	N.R.	SK1		C	R*4	N.R.	SK2		C	R*4	N.R.
SK3		C	R*4	N.R.	SK4		C	R*4	N.R.	SK5		C	R*4	N.R.	SK6		C	R*4	N.R.
SK7		C	R*4	N.R.	SK8		C	R*4	N.R.	SK9		C	R*4	N.R.	SLM		C	R*4	N.R.
STH		C	R*4	N.R.	SVT		C	R*4	N.R.	TAF		C	R*4	N.R.	TCR		C	R*4	N.R.
TCT		C	R*4	N.R.	TMP		C	R*4	N.R.	TOO		C	R*4	N.R.	TVk		C	R*4	N.P.
ULF		C	R*4	N.R.	VHL		C	R*4	N.R.	VIN		C	R*4	N.R.	VPC		C	R*4	N.R.
WAC		C	R*4	N.R.	WCC		C	R*4	N.R.	WEP		C	R*4	N.R.	WES		C	R*4	N.R.
WFC		C	R*4	N.R.	WFE		C	R*4	N.R.	WFR		C	R*4	N.R.	WFS		C	R*4	N.R.
WFW		C	R*4	N.R.	WHL		C	R*4	N.R.	WHT		C	R*4	N.R.	WLG		C	R*4	N.R.
WMC		C	R*4	N.R.	WPC		C	R*4	N.R.	WPH		C	R*4	N.R.	WRC		C	R*4	N.R.
WSC		C	R*4	N.R.	WST		C	R*4	N.R.	WTM		C	R*4	N.R.	WVA		C	R*4	N.R.
WVT		C	R*4	N.R.	XLB		C	R*4	N.R.	XLR		C	R*4	N.R.	XLW		C	R*4	N.R.
XMR		C	R*4	N.R.	ALFR		C	R*4	N.R.	ARHT		C	R*4	N.R.	ARVT		C	R*4	N.R.
BHPA		C	R*4	N.R.	BHPP		C	R*4	N.R.	BHPR		C	R*4	N.R.	COHT		C	R*4	N.R.
CDVT		C	R*4	N.R.	CKFF		C	R*4	N.R.	CKHT		C	R*4	N.R.	CKVT		C	R*4	N.R.
DAM1		C	R*4	N.R.	DAM2		C	R*4	N.R.	DAM3		C	R*4	N.R.	DAM4		C	R*4	N.R.
DAM5		C	R*4	N.R.	DELR		C	R*4	N.R.	CVOL		C	R*4	N.R.	ELDN		C	R*4	N.R.
ELDT		C	R*4	N.R.	ELHT		C	R*4	N.R.	ELOA		C	R*4	N.R.	ELVT		C	R*4	N.R.
EMLF		C	R*4	N.R.	ETAP		C	R*4	N.R.	ETAT		C	R*4	N.R.	FEHI		C	R*4	N.R.
FEHL		C	R*4	N.R.	FEHT		C	R*4	N.R.	FEVT		C	R*4	N.R.	FEWH		C	R*4	N.R.
FEWI		C	R*4	N.R.	GAPI		C	R*4	N.R.	GAP2		C	R*4	N.P.	GAP3		C	R*4	N.R.
GAP4		C	R*4	N.R.	CAP5		C	R*4	N.R.	GAP6		C	R*4	N.R.	GAP7		C	R*4	N.P.
HFIN	F	C	R*4	000474	FCLD	SF		R*4	000148	LTHL		C	I*4	N.R.	PEHF		C	R*4	N.R.
PLIN		C	R*4	N.R.	RELI		C	R*4	N.R.	RMAX		C	R*4	N.R.	SHIPA		C	R*4	N.R.
SHPR		C	R*4	N.R.	SFTE		C	R*4	N.R.	SHTW		C	R*4	N.R.	SKAC		C	R*4	N.R.
SKAR		C	R*4	N.R.	SKCC		C	R*4	N.R.	SKFS		C	R*4	N.R.	SKFW		C	R*4	N.R.
SKHL		C	R*4	N.R.	SKHT		C	R*4	N.R.	SKLG		C	R*4	N.R.	SKMC		C	R*4	N.R.
SKPA		C	R*4	N.R.	SKPH		C	R*4	N.R.	SKRC		C	R*4	N.R.	SKSC		C	R*4	N.R.
SKTM		C	R*4	N.R.	SKVT		C	R*4	N.R.	SKWP		C	R*4	N.R.	SKWV		C	P*4	N.R.
SK10		C	R*4	N.R.	SK11		C	R*4	N.R.	SK12		C	R*4	N.R.	SK13		C	R*4	N.R.
SK14		C	R*4	N.R.	SK15		C	R*4	N.R.	SLMH		C	R*4	N.R.	STPW		C	R*4	N.R.
SVTE		C	R*4	N.R.	SVTW		C	R*4	N.R.	SWTT		C	R*4	N.R.	TBHI		C	R*4	N.R.

7-168

TBH2	C	R*4	N.R.	TBTC	C	R*4	N.R.	TCHT	C	R*4	N.R.	TCLN	C	R*4	N.R.	
TCVT	C	R*4	N.R.	TINY	C	R*4	N.R.	TINZ	C	R*4	N.R.	TIN4	C	R*4	N.R.	
TMAX	C	R*4	N.R.	TCVH	C	R*4	N.R.	TWTW	C	R*4	N.R.	WHAL	C	R*4	N.R.	
WENV	C	R*4	N.R.	WFUL	C	R*4	N.R.	WGSB	C	R*4	N.R.	WPDS	C	R*4	N.R.	
WPEI	C	R*4	N.R.	WPRB	C	R*4	N.R.	WPRG	C	R*4	N.R.	WPRP	C	R*4	N.R.	
WRCA	C	R*4	N.R.	WSCA	C	R*4	N.R.	XLBH	C	R*4	N.R.	XLGD	C	R*4	N.R.	
XLHL	C	R*4	N.R.	YLS2	C	R*4	N.R.	ALFDL	C	R*4	N.R.	ATMIY	C	R*4	N.R.	
CBARF	C	R*4	N.R.	CBARW	C	R*4	N.R.	CLDES	C	R*4	N.R.	CLEVL	C	R*4	N.R.	
CPIND	C	R*4	N.R.	CFNLD	C	R*4	N.R.	CPPAR	C	R*4	N.R.	CPPPC	C	R*4	N.R.	
CPTOT	C	R*4	N.R.	DELTA	C	R*4	N.R.	DELTH	C	R*4	N.R.	DELWF	C	R*4	N.R.	
DELWP	C	R*4	N.R.	ESWET	C	R*4	N.R.	ELDOA	C	R*4	N.R.	ENPCX	C	R*4	N.R.	
ETAP2	C	R*4	N.R.	ETAP4	C	R*4	N.R.	FETOT	C	R*4	N.R.	GMDD1	C	R*4	N.R.	
HMAXD	C	R*4	N.R.	ICRLS	C	I*4	N.R.	NOCPP	C	I*4	N.P.	NCXPJ	C	I*4	N.R.	
PFET2	C	R*4	N.R.	REALJ	C	R*4	N.R.	RHPMR	C	R*4	N.R.	SIGMA	C	R*4	N.R.	
SIGMR	C	R*4	N.R.	SKAMD	C	R*4	N.R.	SKBAL	C	R*4	N.R.	SKGB1	C	R*4	N.R.	
SKGB2	C	R*4	N.R.	SKFCS	C	P*4	N.R.	SKPEI	C	R*4	N.R.	SKPES	C	R*4	N.R.	
SKPR8	C	R*4	N.R.	SKRBF	C	R*4	N.R.	SKRCA	C	R*4	N.R.	SKSCA	C	R*4	N.R.	
SLMVT	C	R*4	N.R.	STMAX	C	P*4	N.R.	SWETH	C	R*4	N.R.	SIEXP	C	R*4	N.R.	
SWAET	C	R*4	N.R.	SZFFC	C	R*4	N.R.	TBCL1	C	R*4	N.R.	TBCAP	C	R*4	N.R.	
TBEM3	C	R*4	N.R.	TEFCW	C	R*4	N.R.	TBSFC	C	R*4	N.R.	TCBZK	C	R*4	N.R.	
THETA	C	R*4	N.R.	TFRCP	C	P*4	N.R.	TKALT	C	R*4	00G14C	TVCPR	C	R*4	N.R.	
VBARH	C	R*4	N.R.	VBARV	C	R*4	N.R.	VDIVE	C	R*4	N.R.	VGASB	C	R*4	N.R.	
VGASR	C	R*4	N.R.	WPAYL	C	R*4	N.R.	WPSTP	C	R*4	N.R.	XLALB	C	R*4	N.R.	
XLBWC	C	R*4	N.R.	XLRLA	C	R*4	N.R.	ALFDES	C	R*4	N.R.	BHPSUP	C	R*4	N.R.	
CBAXHT	C	R*4	N.R.	CEARVT	C	R*4	N.R.	CBYLOA	C	R*4	N.R.	CLALPH	C	R*4	N.R.	
CRSIND	C	R*4	N.R.	CTSIGH	C	R*4	N.R.	CYCPRL	C	R*4	N.R.	DELFCF	C	R*4	N.R.	
DELRTH	C	R*4	N.R.	DELWFC	C	R*4	N.R.	DELWPL	C	R*4	N.R.	DELWST	C	R*4	N.R.	
DLSWSH	C	R*4	N.R.	CLTAFE	C	R*4	N.R.	CLVHL	C	R*4	N.R.	ORGIND	C	P*4	N.R.	
DSPLMT	C	R*4	N.R.	DYLIND	C	R*4	N.R.	ELHLOA	C	R*4	N.R.	ELVUCA	C	P*4	N.R.	
ETAIND	C	R*4	N.R.	ETAP4A	C	R*4	N.R.	EXPJRG	C	R*4	N.R.	FEDRAG	C	R*4	N.R.	
FIXINC	C	R*4	N.R.	GAMD11	C	R*4	N.R.	HULIND	C	R*4	N.R.	IRCDM4	F	XF	I*4	000000
INDCRU	C	I*4	N.R.	INDCRG	C	I*4	N.R.	INDOYL	C	I*4	N.R.	INCETA	C	I*4	N.R.	
INDFIX	C	I*4	N.R.	INCHLL	C	I*4	N.R.	INDOPT	C	I*4	N.R.	INCCSW	C	I*4	N.R.	
INDPOW	C	I*4	N.R.	INCPFF	C	I*4	N.R.	INDROM	C	I*4	N.R.	IPRINT	C	I*4	00084C	
ITRALT	F	I*4	000150	CPTIND	C	R*4	N.R.	OSWIND	C	R*4	N.R.	PPPIND	C	R*4	N.R.	
RCMIND	C	R*4	N.R.	RHCRTG	C	R*4	N.R.	SGTIND	C	R*4	N.R.	SKBLNT	C	R*4	N.R.	
SKENV1	C	R*4	N.R.	SKENV2	C	R*4	N.R.	SKPDSZ	C	R*4	N.R.	SKVTAR	C	R*4	N.R.	
SSIGMA	C	R*4	N.R.	STFETA	C	R*4	N.R.	TBCOWI	C	R*4	N.R.	TGBAP4	C	R*4	N.R.	
THETMR	C	R*4	N.R.	TCLIND	C	R*4	N.R.	VGBOVH	C	R*4	N.R.	WBALNT	C	R*4	N.R.	
WPAYLC	C	R*4	N.R.	XTGTAZ	C	R*4	N.R.	XTGTA4	C	R*4	N.R.					

\*\*\*\*\* COMMON INFORMATION \*\*\*\*\*

NAME OF COMMON BLOCK \* SIZE OF BLOCK 0009DC HEXADECIMAL BYTES

VAR. NAME	TYPE	REL.	ACCR.	VAR. NAME	TYPE	REL.	ADDR.	VAR. NAME	TYPE	REL.	ADDR.	VAR. NAME	TYPE	REL.	ADDR.
OPTIND	R*4	N.R.		FULINC	R*4	N.R.		DYLIND	R*4	N.P.		DFGIND	R*4	N.R.	
OSWIND	R*4	N.R.		FIXINC	R*4	N.R.		RDMIND	R*4	N.R.		PPPIND	R*4	N.P.	
ETAIND	R*4	N.R.		WC	R*4	N.R.		XLBWD	R*4	N.R.		XLRLA	R*4	N.R.	
VGBCVH	R*4	N.R.		XLGC	R*4	N.R.		HMAXD	R*4	N.R.		RHORHO	R*4	N.R.	
VVC	R*4	N.R.		EMLF	R*4	N.R.		CKI	P*4	N.R.		DELWF	R*4	N.R.	

7+1691



	CKFF	R*4	N.R.	VCIVE	R*4	N.R.	HOO	R*4	N.R.	RCC	R*4	N.R.
	TCC	R*4	N.R.	CAP1	R*4	N.P.	SGTIND	R*4	N.R.	ELHLCA	R*4	N.R.
	ELVLC	R*4	N.R.	GAP2	R*4	N.R.	AR	R*4	N.R.	WS	R*4	N.R.
	TCF	R*4	N.R.	TCT	R*4	N.R.	SLM	R*4	N.P.	ARHT	R*4	N.R.
	TCHT	R*4	N.R.	VEAFF	R*4	N.R.	SLMH	R*4	N.R.	APVT	R*4	N.R.
	TCVT	R*4	N.R.	VEARV	R*4	N.R.	SLMVT	R*4	N.R.	ELCN	R*4	N.P.
	ELET	R*4	N.R.	ELCCA	R*4	N.R.	DLSWSH	R*4	N.R.	DSWET	R*4	N.R.
	DLVLF	R*4	N.R.	CVCL	R*4	N.R.	CBYLOA	R*4	N.R.	ENR	R*4	N.R.
	HVA	R*4	N.R.	CAMI	R*4	N.R.	CAM2	R*4	N.R.	PMR	R*4	N.R.
	CAN2	R*4	N.R.	CLEYE	R*4	N.R.	THETMP	R*4	N.R.	XC	R*4	N.R.
	XPR	R*4	N.R.	TVCMP	R*4	N.R.	VT	R*4	N.R.	CTSIGH	R*4	N.R.
	Tvh	R*4	N.R.	HES	R*4	N.R.	TINY	R*4	N.R.	ETAP2	R*4	N.R.
	ETAP4N	R*4	N.R.	TBEMS	R*4	N.R.	TBAP4	R*4	N.P.	GAP3	R*4	N.R.
	CAN4	R*4	N.R.	ENP	R*4	N.R.	ETAT	R*4	N.R.	HC	R*4	N.R.
	VC	R*4	N.R.	ATMIY	R*4	N.R.	COVT	R*4	N.R.	CCHT	R*4	N.R.
	CAN5	R*4	N.R.	CLTAFE	R*4	N.R.	FEDRAG	R*4	N.R.	EXPDRG	R*4	N.R.
	CCC	R*4	N.R.	CLALFF	R*4	N.R.	CKVT	R*4	N.R.	CKHT	R*4	N.R.
	CKF	R*4	N.R.	CKW	R*4	N.R.	RELI	R*4	N.R.	TCLN	R*4	N.R.
	TBCL1	R*4	N.R.	TBCDWI	R*4	N.R.	GAP4	R*4	N.R.	HFE	R*4	N.R.
	WFL	R*4	N.R.	DELWFC	R*4	N.R.	DELWP	R*4	N.R.	DELWST	R*4	N.R.
	SKCC	R*4	N.R.	SKRC	R*4	N.R.	SKSC	R*4	N.R.	SKFW	R*4	N.R.
	SKTM	R*4	N.R.	SKPCA	R*4	N.R.	SKSCA	R*4	N.R.	SKMC	R*4	N.R.
	SKAC	R*4	N.R.	SKHL	R*4	N.R.	SKENVI	R*4	N.R.	SKENV2	R*4	N.R.
	SKGE1	R*4	N.R.	SKGB2	R*4	N.R.	SKBLNT	R*4	N.R.	SKBAL	R*4	N.R.
	SKLC	R*4	N.R.	SKW	R*4	N.R.	ELF	R*4	N.R.	RPI	R*4	N.R.
	SKWF	R*4	N.R.	SKHT	R*4	N.R.	SKVT	R*4	N.R.	SKPFB	R*4	N.R.
	SKREF	R*4	N.R.	SKPT	R*4	N.R.	SKAMD	R*4	N.R.	SKAR	R*4	N.R.
	SKFA	R*4	N.R.	SKVTAR	R*4	N.R.	SKPDS	R*4	N.R.	SKPDSZ	R*4	N.R.
	SKT	R*4	N.R.	SKFE	R*4	N.R.	SKPEI	R*4	N.R.	SKPES	R*4	N.R.
	SK1	R*4	N.R.	SK2	R*4	N.R.	DK3	R*4	N.R.	CK4	R*4	N.R.
	SK5	R*4	N.R.	SK4	R*4	N.R.	SK7	R*4	N.R.	SK8	R*4	N.R.
	SK9	R*4	N.R.	SK10	R*4	N.R.	SK11	R*4	N.R.	SK12	R*4	N.R.
	SK13	R*4	N.R.	SK14	R*4	N.R.	SK15	R*4	N.R.	PLIN	R*4	N.R.
	GAF5	R*4	N.R.	TCLINE	R*4	N.R.	XTGTA2	R*4	N.R.	TIN2	R*4	N.R.
	TW	R*4	N.R.	PFET2	R*4	N.R.	DELTH	R*4	N.R.	STH	R*4	N.R.
	CRSINC	R*4	N.R.	XTGTA4	R*4	N.R.	TIN4	R*4	N.R.	VIN	R*4	N.R.
	DEL	R*4	N.R.	RMAX	R*4	N.R.	DELFCR	R*4	N.R.	ENPCR	R*4	N.R.
	DELWFL	R*4	N.R.	STPW	R*4	N.R.	HFIN	R*4	000474	GAP6	R*4	N.R.
	CYCPFL	R*4	N.R.	FF	R*4	N.R.	SK3	R*4	N.R.	SK4	R*4	N.R.
	TBT1	R*4	N.R.	TBTC	R*4	N.R.	TGH2	R*4	N.R.	TBCRP	R*4	N.R.
	TBSFC	R*4	N.R.	TBPCV	R*4	N.R.	GAP7	R*4	N.R.	ALFDES	R*4	N.R.
	ALFCL	R*4	N.R.	ALFR	R*4	N.R.	ANU	R*4	N.R.	RHFA	R*4	N.R.
	BHFR	R*4	N.R.	BHPSLP	R*4	N.R.	BHT	R*4	N.R.	BLP	R*4	N.R.
	BR	R*4	N.R.	BS	R*4	N.R.	BVT	R*4	N.R.	CBARF	R*4	N.R.
	CBARFT	R*4	N.R.	CBARVT	R*4	N.R.	CBARW	R*4	N.R.	CCP	R*4	N.R.
	CCT	R*4	N.R.	COV	R*4	N.R.	CLW	R*4	N.R.	CPIAD	R*4	N.R.
	CPNLC	R*4	N.R.	CPPAF	R*4	N.R.	CPPRO	R*4	N.R.	CPTCT	R*4	N.R.
	CFT	R*4	N.R.	CTF	R*4	N.R.	CV	R*4	N.R.	CX	R*4	N.R.
	CLCES	R*4	N.R.	CE	R*4	N.R.	DELRTH	R*4	N.R.	DELTA	R*4	N.R.
	CF	R*4	N.R.	CSPLN1	R*4	N.R.	ELC	R*4	N.R.	ELFT	R*4	N.R.
	ELN	R*4	N.R.	ELCA	R*4	N.R.	ELT	R*4	N.R.	ELVT	R*4	N.R.
	EN	R*4	N.R.	ETAF	R*4	N.R.	FEH	R*4	N.R.	FEHI	R*4	N.R.

7-170

FEHL	R*4	N.R.	FELT	R*4	N.R.	FET	R*4	N.R.	FETCT	R*4	N.P.
FEVT	R*4	N.R.	FEV	R*4	N.R.	FEWH	R*4	N.R.	FELT	R*4	N.R.
FM	R*4	N.R.	FF	R*4	N.R.	ETAP4	R*4	N.P.	GAMC11	R*4	N.R.
CLF	R*4	N.R.	GMCD1	R*4	N.R.	H	R*4	000818	ICBUS	I*4	N.R.
INDCRG	I*4	N.R.	INDCRG	I*4	N.R.	INDOYL	I*4	N.P.	INDEYA	I*4	N.R.
INDFIX	I*4	N.R.	INDHUL	I*4	N.R.	INDOPT	I*4	N.R.	INCOSW	I*4	N.R.
INDFCW	I*4	N.R.	INDPRF	I*4	N.R.	INDPDM	I*4	N.R.	IPRINT	I*4	00084C
LTFE	I*4	N.R.	KCCFF	I*4	N.R.	NOXPJ	I*4	N.K.	CWE	R*4	N.R.
PEFF	R*4	N.R.	PI	R*4	N.R.	Q	R*4	N.R.	PHO	R*4	N.R.
REALJ	R*4	N.R.	RFFM	R*4	N.R.	R	R*4	000878	RM	R*4	N.R.
SA	R*4	N.R.	SAE	R*4	N.K.	SAG	R*4	N.R.	SA7	R*4	N.R.
SFC	R*4	N.R.	SFFA	R*4	N.R.	SHPR	R*4	N.R.	SHT	R*4	N.R.
SFTE	R*4	N.R.	SFTW	R*4	N.R.	SIGMA	R*4	N.R.	SSIGMA	R*4	N.R.
ST	R*4	000860	STHETA	R*4	N.R.	STMAX	R*4	N.R.	SVT	R*4	N.R.
SVTE	R*4	N.R.	SVTW	R*4	N.R.	SW	R*4	N.R.	SWETH	R*4	N.R.
SWEXP	R*4	N.R.	SWTT	R*4	N.R.	SWWET	R*4	N.R.	SZPHO	R*4	N.R.
T	R*4	N.R.	TAF	R*4	N.R.	TCHAR	R*4	N.R.	THETA	R*4	N.R.
TMAX	R*4	N.R.	TMF	R*4	N.R.	TPROP	R*4	N.R.	TH	R*4	N.R.
LLF	R*4	N.R.	VGASE	R*4	N.R.	VGASR	R*4	N.R.	VHL	R*4	N.R.
V	R*4	N.R.	V	R*4	000914	WBAL	R*4	N.K.	WBALNT	R*4	N.R.
WCC	R*4	N.R.	WE	R*4	N.R.	WEP	R*4	N.R.	WES	R*4	N.R.
WF	R*4	000930	WFC	R*4	N.R.	WFR	R*4	N.R.	WFS	R*4	N.R.
WFR	R*4	N.R.	WCSE	R*4	N.R.	WHL	R*4	N.R.	WHT	R*4	N.R.
WLG	R*4	N.R.	WMC	R*4	N.P.	WPAYL	R*4	N.R.	WPC	R*4	N.R.
WPCS	R*4	N.R.	WPEI	R*4	N.R.	WPH	R*4	N.R.	WPRE	R*4	N.R.
WFRG	R*4	N.R.	WPRF	R*4	N.R.	WPSTR	R*4	N.R.	WKC	R*4	N.R.
WRCA	R*4	N.R.	WSC	R*4	N.R.	WSCA	R*4	N.R.	WST	R*4	N.R.
WTN	R*4	N.R.	WVT	R*4	N.R.	WW	R*4	N.R.	WPAYLO	R*4	N.R.
WAC	R*4	N.R.	WENV	R*4	N.R.	XLALB	R*4	N.R.	XLG	R*4	N.R.
XLEF	R*4	N.R.	XLHL	R*4	N.R.	XLR	R*4	N.R.	XLW	R*4	N.R.
YLS2	R*4	N.R.	TCVW	R*4	N.R.	DMR	R*4	N.R.	SIGMR	R*4	N.R.
AF	R*4	N.R.	BHPF	R*4	N.R.	SEE	R*4	N.R.			

7-171

ORIGINAL PAGE IS  
OF POOR QUALITY

LABEL ADDR

LABEL ADDR

LABEL ADDR

LABEL ADDR

PAGE 007

300 GCC23C

\*OPTIONS IN EFFECT\* NAME= MAIN,CFT=02,LINECAT=54,SIZE=0000K,

\*OPTIONS IN EFFECT\* SOURCE,EBCDIC,NCLIST,NOCHECK,LCAD,MAP,NOEDIT,NOXREF

\*STATISTICS\* SOURCE STATEMENTS = .28 ,PROGRAM SIZE = 620

\*STATISTICS\* NO DIAGNOSTICS GENERATED

\*\*\*\*\* END OF COMPILATION \*\*\*\*\*

111K BYTES OF CORE NOT USED

7-172

CCMPILER OPTICNS - NAME= MAIN,OPT=C2,LINECNT=54,SIZE=0000K,  
SOURCE,RECOIC,NCLIST,NODECK,LOAD,MAP,NCEDIT,IC,NOXREF

ISN 0002	C	CCMPILER OPTICNS - NAME= MAIN,OPT=C2,LINECNT=54,SIZE=0000K, SOURCE,RECOIC,NCLIST,NODECK,LOAD,MAP,NCEDIT,IC,NOXREF	00010000
		SUBROUTINE WGHTR	00020000
		C**** MEMBER NAME B81WGHTR	00030000
		PAGE 1 INPUT LCC 0001 THRU 0050	00040000
ISN 0003		CCMPILER OPTICNS - NAME= MAIN,OPT=C2,LINECNT=54,SIZE=0000K, SOURCE,RECOIC,NCLIST,NODECK,LOAD,MAP,NCEDIT,IC,NOXREF	00050000
		1FIXIND ,RDMIND ,PFFINC ,ETAIND ,WC ,XLBW0	00060000
		2XLRLA ,VGBCVF ,LCD ,HMAXD ,RHCRHO ,VMC	00070000
		3EMLF ,CK1 ,CELWF ,CKFF ,VCIVE ,HCC	00080000
		4RCC ,TCC ,GAF1(5) ,SGTIND(12) ,ELHLOA ,ELVLOA	00090000
		5GAP2(6)	00100000
		PAGE 2 INPUT LCC 0051 THRU 0100	00110000
ISN 0004		CCMPILER OPTICNS - NAME= MAIN,OPT=C2,LINECNT=54,SIZE=0000K, SOURCE,RECOIC,NCLIST,NODECK,LOAD,MAP,NCEDIT,IC,NOXREF	00120000
		1ARFT ,TCHT ,VEARH ,SLMH ,ARVT ,TCVT	00130000
		2VBARV ,SLAVT ,ELEN ,ELDT ,ELCOA ,DLSSH	00140000
		3DSKET ,CLVLHL ,CVCL ,CBYLOA ,ENR ,WVA	00150000
		4CAM1 ,CAM2 ,EMP ,DAM3 ,CLEYE ,TETMR	00160000
		5XC ,XMR ,TVMR ,VT ,CTSIGH ,TVW	00170000
		6FES ,TIAY ,ETAP2 ,ETAP4N ,TEEM5(5) ,TB8AP4(5)	00180000
		7GAF3	00190000
		PAGE 3 INPUT LCC 0101 THRU 140	00200000
ISN 0005		CCMPILER OPTICNS - NAME= MAIN,OPT=C2,LINECNT=54,SIZE=0000K, SOURCE,RECOIC,NCLIST,NODECK,LOAD,MAP,NCEDIT,IC,NOXREF	00210000
		1ATMIY ,CDVT ,CCHT ,DAM5 ,ELTAFE ,FEDRAG	00220000
		2EXFDRG ,CDC ,CLALPH ,CKVT ,CKFT ,CKF	00230000
		3CKW ,RELI ,TCIN ,TECL1(8) ,TBCDWI(8) ,GAP4(4)	00240000
		PAGE 4 INPUT LCC 141 THRU 200 WEIGHT DATA	00250000
ISN 0006		CCMPILER OPTICNS - NAME= MAIN,OPT=C2,LINECNT=54,SIZE=0000K, SOURCE,RECOIC,NCLIST,NODECK,LOAD,MAP,NCEDIT,IC,NOXREF	00260000
		1SKCC ,SKRC ,SKSC ,SKFW ,SKTM ,SKRCA	00270000
		2SKSCA ,SKMC ,SKAG ,SKHL ,SKENVI ,SKENV2	00280000
		3SKCB1 ,SKGE2 ,SKELNT ,SKBAL ,SKLG ,SKW	00290000
		4ELF ,RMI ,SKWP ,SKHT ,SKVT ,SKPRB	00300000
		5SKRBF ,SKPF ,SKAMD ,SKAR ,SKPA ,SKVTAR	00310000
		6SKPDS ,SKPDS2 ,SK1 ,SKFS ,SKPEI ,SKPES	00320000
		7SK1 ,SK2 ,CK3 ,DK4 ,SK5 ,SK6	00330000
		8SK7 ,SK8 ,SK9 ,SK10 ,SK11 ,SK12	00340000
		9SK13 ,SK14 ,SK15 ,PLIN ,GAP5(3)	00350000
		PAGE 5 INPUT LCC 201 THRU 300	00360000
ISN 0007		CCMPILER OPTICNS - NAME= MAIN,OPT=C2,LINECNT=54,SIZE=0000K, SOURCE,RECOIC,NCLIST,NODECK,LOAD,MAP,NCEDIT,IC,NOXREF	00370000
		1DELTH(5) ,STF(5) ,CRSIND(5) ,XTGTA4(5) ,TIN4(5) ,VIN(5)	00380000
		2DELFR(5) ,RMAX(5) ,CELECR(5) ,EMPCR(5) ,DELWPL(5) ,STPW(5)	00390000
		3PFIN(5) ,GAP6(10)	00400000
		PAGE 6 INPUT LCC 301 THRU 400	00410000
ISN 0008		CCMPILER OPTICNS - NAME= MAIN,OPT=C2,LINECNT=54,SIZE=0000K, SOURCE,RECOIC,NCLIST,NODECK,LOAD,MAP,NCEDIT,IC,NOXREF	00420000
		1TBTO(5) ,TBH2(5) ,TBCRP(5) ,TBSFC(8) ,TBPOW(8) ,GAP7(60)	00430000
		WCRKING CCMCA	00440000
ISN 0009		CCMPILER OPTICNS - NAME= MAIN,OPT=C2,LINECNT=54,SIZE=0000K, SOURCE,RECOIC,NCLIST,NODECK,LOAD,MAP,NCEDIT,IC,NOXREF	00450000
		1 BFFA,BFFR,BFFSLP,EHT,ELP,BR,BS,BVT,	00460000
		2 CEARF,CEART,CEART,CEARW,CCP,CCT,CDV,CLW,CPIND,CPNUD,PPAR,PPRO	00470000
		3,CFTOT,CRI,CTP,CV,CX,CLEES,CB,	00480000
		4 DELRTH,DELTA,DF,CSPLMT, ELC,ELHT,ELN,ELCA,ELT,ELVT,EN,ETAP,	00490000
		5 FEH,FEHI,FEHL,FEH1,FET,FETCT,FEVT,FEW,FEWH,FEWI,FM,FP,ETAP4	00500000
ISN 0010		CCMPILER OPTICNS - NAME= MAIN,OPT=C2,LINECNT=54,SIZE=0000K, SOURCE,RECOIC,NCLIST,NODECK,LOAD,MAP,NCEDIT,IC,NOXREF	00500000
		CCMPILER OPTICNS - NAME= MAIN,OPT=C2,LINECNT=54,SIZE=0000K, SOURCE,RECOIC,NCLIST,NODECK,LOAD,MAP,NCEDIT,IC,NOXREF	00500000

7-173

ORIGINAL PAGE IS  
OF POOR QUALITY

	7	ICRUS, INCRU, INCRG, INCCYL, INDETA, INDFIX, INCFLL, INDGPT, INCCSW,	00510000
	8	INDPOW, INDRP, INCRDM, IPPINT	00520000
ISN 0011		CCMMON LTHL, NCCFP, NCXP, CWE, FEHF, PI, Q, RHC, REALJ, RHPMR, R, RN	00530000
ISN 0012		CCMMON SA, SA5, SA6, SA7, SFC, SPPA, SHPP, SHT, SHTE, SHTW, SIGMA, SSIGMA, ST,	00540000
		ISTHETA, STMAX, SVT, SVTE, SVTH, SVT, SWETH, SWEXP, SWTT, SWWET, SZRFC	00550000
ISN 0013		CCMMON T, TAF, TCEAF, TTHETA, TMAX, TMP, TPROP, TR, ULF, VGASB, VGASR, VHL, V	00560000
ISN 0014		CCMMON W, WBAL, WREALNT, WCC, WE, WEP, WES, WF, WFC, WFR, WFS, WFW,	00570000
	1	WGSB, WFL, WHT, WLG, WMC, WFAYL, WPC, WPCS, WPEI, WPF, WPRB, WPRG, WPRP, WPSTR	00580000
	2	WRC, WRCA, WSC, WSCA, WST, WTM, WLT, WW, WPAYLO, WAC, WENV	00590000
ISN 0015		CCMMON XLALB, XLE, XLBH, XLFL, XLR, XLW, YLS2, TCW	00600000
ISN 0016		CCMMON CMR, SIGMR, AF, BHFP, SEE	00600001
ISN 0017		NAMELIST /NMGTR/ WE, DWE, WEP, WPEI, WPRP, WPRG, WPH, WPRB, WPCS, WFS,	00610000
	1	WPSTR, WLC, WHT, WLT, WES, WW, WST, WFL, WGSE, WBALNT, WCC, WSC,	00620000
	2	WPC, WRC, WTM, WRCA, WSCA, WFW, WMC, WBAL, WFC, WFE, WFUL,	00630000
	3	WPAYL, CLF, ULF, WAC, WENV	00640000
ISN 0018		WFH=0.0	00650000
ISN 0019		Wk=0.0	00660000
ISN 0020		GLF=0.0	00670000
ISN 0021		WX=WO*(1.C-XLBWC)	00680000
ISN 0022		WCR=WX/ENR	00690000
ISN 0023		WEP=SK3*BT*PP+SK4*ENP	00700000
ISN 0024		WPEI=SKPEI*WEP	00710000
ISN 0025		IF (SKPEI.GT.1) GC TO 1	00720000
ISN 0027		GC TO 2	00730000
ISN 0028	1	WPEI=SKPEI	00740000
ISN 0029	2	IF (INCCYL.CT.2) GO TO 3	00750000
ISN 0031		RMR=0.5*CMR	00760000
ISN 0032		SRMR=XMR*CMR/2.	00770000
ISN 0033		PR=BHPP/ENR	00780000
ISN 0034		WPPF=ENR*SKAR*(SRMR**C.25*(0.01*SKPA*PR)**0.5*(0.01*SKVTAR*	00790000
		1VT))*(SIGMR*FI*CMR**2/4C.))**C.67	00800000
ISN 0035		WFRG=0.0	00810000
ISN 0036		WPT=0.0	00820000
ISN 0037		WPRB=0.0	00830000
ISN 0038		GC TO 4	00840000
ISN 0039	3	SKC=1200.	00850000
ISN 0040		PR=BHPP/ENR	00860000
ISN 0041		RMR=0.5*DMR	00870000
ISN 0042		TMR=TVCMR*SIGMR*PI*RMR/ENR	00880000
ISN 0043		SKCRP=RMR**1.6/(SKC*TMF)	00890000
ISN 0044		SRMR=XMR*EMR	00900000
ISN 0045		IF (SKCRP.LT.1.C) SKCRP=1.C	00910000
ISN 0047		TRM1=PI*WGR*ENLF*(RMR-SRMR)*SIGMR*SKRBF*SKDRP*RMR**3	00920000
ISN 0048		WPRB=SKPRE*(1.CE-C7*TRM1)**0.438	00930000
ISN 0049		TRM2=9CC.*VT**2*WFRB*PR*SRMR**1.82*BMR**2.5*SKAMD*1.0E-11	00940000
ISN 0050		WPT=SKPH*(TRM2/(BMR*RMF*PI**2))**0.358	00950000
ISN 0051		WPRG=ENR*(SK1*WFRB+SK2*WFT)	00960000
ISN 0052		WPRP=0.0	00970000
ISN 0053	4	PX=BHPP	00980000
ISN 0054		WPCS=SKPCS*(PX*SKPCS**C.25*PI*RMR*SKT/(30.*VT))**0.67	00990000
ISN 0055		WFS=SKFS*WFR	01000000
ISN 0056		WPSTR=WPRG+CK3*WFRP+DK4*WPCS+SK5*WEP+WPEI+WFS+CELWP	01010000

7-174

ORIGINAL PAGE IS  
OF POOR QUALITY

ISN 0057	IF (INDCYL.EQ.1.CR.INDCYL.EQ.3) GO TO 5	01020000
ISN 0059	IF (INDHUL.EQ.1) XC1=PI*AF/(1.C+SQRT((PI*AR/6.28)**2+1.0))	01030000
ISN 0061	IF (INDHUL.GT.1) XE1=PI*AF/(1.C+SQRT((PI*AR/CLALPH)**2+1.0))	01030100
ISN 0063	GLF=1.0+(C.CC545*VNC/(C.C126*CBARW+0.06216*WX*ELF/(SW*XD1)))	01040000
ISN 0064	5 ULF=1.5*ELF	01050000
ISN 0065	IF (GLF.GT.ELF) ULF=1.5*GLF	01060000
ISN 0067	IF (INDHUL.EQ.1) GC TC 6	01070000
ISN 0069	BF=BS	01080000
ISN 0070	GC TO 7	01090000
ISN 0071	6 BH=DH	01100000
ISN 0072	7 WFL=SKFL*((WG/10000.))**C.7*(SWETH/1000.)*BH*ELOA**0.5*	01110000
	IALCG10(VCIVE)*LLF**0.3)**C.685	01120000
ISN 0073	IF (SKENV1.NE.C.) WFL=C.C	01130000
ISN 0075	WENV=SWETH*(SKENV1*BH+SKENV2)	01140000
ISN 0076	WGSB=SKGB1*SWETH+SKGB2*BH**2	01150000
ISN 0077	9 WEALNT=SKELAT*SWETH	01160000
ISN 0078	WEAL=SKAL*WO	01170000
ISN 0079	WLG=SKLG*WC	01180000
ISN 0080	WHT=SKHT*SH	01190000
ISN 0081	WVT=SKVT*SV	01200000
ISN 0082	WES=SKPES*WEP	01210000
ISN 0083	IF (INDCYL.EQ.1.CR.INDCYL.EQ.3) GO TO 11	01220000
ISN 0085	IF (INDHUL.GT.1) GC TC 11	01230000
ISN 0087	IF (SKWW.EQ.0.) GC TO 10	01240000
ISN 0089	WW=SKWW*(FMI*(W)*ELF/10000.)*SW/100.*ALOG10(BS/DH)*((1.C+	01250000
	ISLM)/(2.*TCR))**C.5*LLF**C.5*ALOG10(VCIVE)*ALCG10(AR))**0.585	01260000
ISN 0090	GC TO 11	01270000
ISN 0091	10 WW=SKWP*SWEXP	01280000
ISN 0092	11 WST=SK6*(WFL+WENV)+SK7*WGSB+SK8*WW+SK9*WHT+SK10*WVT+SK11*WLG+WES+	01290000
	IDELWST+WEALNT	01300000
ISN 0093	WCC=SKCC*(WC/1000.))**C.41	01310000
ISN 0094	WAC=SKAC*WC	01320000
ISN 0095	IF (INDCYL.GT.2) GC TO 12	01330000
ISN 0097	WTP=SKTP*WPRP	01340000
ISN 0098	WPCA=SKPCA*WPRP	01350000
ISN 0099	WSCA=SKSCA*(WPRP*ENR/100.))**C.84	01360000
ISN 0100	WPC=WRCA+WSCA	01370000
ISN 0101	WRC=0.	01380000
ISN 0102	WSC=0.	01390000
ISN 0103	GC TO 13	01400000
ISN 0104	12 WSC=SKSC*((WPRB+WPT)*ENR/100.))**C.84	01410000
ISN 0105	WPC=0.0	01420000
ISN 0106	WTP=0.0	01430000
ISN 0107	WPC=SKRC*WPRG	01440000
ISN 0108	IF (SKRC.GT.1.) WFC=SKRC*(PI*SIGMR*RMR**1.5/BMR*(WPRB*ENR/	01450000
	1000.))**0.5)**1.11	01460000
ISN 0110	13 IF (INDCYL.EQ.2.CR.INDCYL.EQ.4) WFW=SKFW*WO	01470000
ISN 0112	WMC=SKMC	01480000
ISN 0113	WFC=WCC+WAC+SK12*WRC+SK13*WSC+SK14*WFW+WTP+SK15*WPC+WMC+DELWFC+	01490000
	1WEAL	01500000
ISN 0114	WE=WPSTR+WST+WFC+WFE	01510000
ISN 0115	CWE=WE+WFL	01520000

ORIGINAL PAGE IS  
OF POOR QUALITY

ISN 0116  
ISN 0117  
ISN 0118

WPAYL=HO-VE-WFUL-WFR  
RETURN  
ENC

01530000  
01550000  
01560000

7-176

NAME	TAG	TYPE	ADD.	NAME	TAG	TYPE	ADD.	NAME	TAG	TYPE	ADD.	NAME	TAG	TYPE	ADD.		
H	C	R*4	N.R.	Q	C	R*4	N.R.	R	C	R*4	N.R.	AR	T	C	R*4	N.R.	
V	C	R*4	N.R.	W	C	R*4	N.R.	AF	C	R*4	N.R.	CB	FA	C	R*4	0C00C8	
BH	SF	R*4	0001E0	BR	C	R*4	N.R.	BS	FA	C	R*4	000668	EN	C	R*4	N.R.	
CV	C	R*4	N.R.	CX	C	R*4	N.R.	DH	FA	C	R*4	0006C4	HC	C	R*4	N.R.	
FF	C	R*4	N.R.	FM	C	R*4	N.R.	FP	C	R*4	N.R.	RM	C	R*4	N.R.		
PI	FA	C	000864	PR	SF	R*4	0001E4	PX	SF	R*4	0001E8	TR	C	R*4	N.R.		
SA	C	R*4	N.R.	ST	C	R*4	N.R.	SW	F	C	R*4	0008C8	WF	C	R*4	N.R.	
VC	C	R*4	N.R.	VT	F	C	000148	WE	SF	C	R*4	000924	WX	SF	R*4	0001EC	
WC	F	C	000024	WS	C	R*4	N.R.	WW	SF	C	R*4	000998	BLP	C	R*4	N.R.	
XC	C	R*4	N.R.	AMU	C	R*4	N.R.	BHT	C	R*4	N.R.	CCT	C	R*4	N.R.		
BMR	F	C	00012C	BVT	C	R*4	N.R.	CCP	C	R*4	N.R.	CKK	C	R*4	N.R.		
CJC	C	R*4	N.R.	CCV	C	R*4	N.R.	CKF	C	R*4	N.R.	CTP	C	R*4	N.R.		
CK1	C	R*4	N.R.	CLW	C	R*4	N.R.	CRT	C	R*4	N.R.	ELC	C	R*4	N.R.		
DK3	F	C	0002CC	CK4	F	C	0002E0	DMR	F	C	R*4	0009C8	ENP	F	C	R*4	0G0194
ELF	F	C	00028C	ELN	C	R*4	N.R.	ELT	C	R*4	N.R.	FEW	C	R*4	N.R.		
ENR	F	C	00011C	FEH	C	R*4	N.R.	FET	C	R*4	N.R.	QWE	S	C	R*4	00085C	
GLF	SF	C	0007D4	FES	C	R*4	N.R.	HOO	C	R*4	N.R.	RCD	C	R*4	N.R.		
RHD	C	R*4	N.R.	RMI	F	C	000290	RMR	SF	R*4	0001F0	SEE	C	R*4	N.P.		
SA5	C	R*4	N.R.	SA6	C	R*4	N.R.	SA7	C	R*4	N.R.	SKT	F	C	R*4	0002C4	
SFC	C	R*4	N.R.	SAT	F	C	00089C	SKD	SF	R*4	0001F4	SK4	F	C	R*4	0C04BC	
SK1	F	C	0002C4	SK2	F	C	0002D8	SK3	F	C	R*4	0004B8	SK8	F	C	R*4	0C02F0
SK5	F	C	0002E4	SK6	F	C	0002E8	SK7	F	C	R*4	0002EC	SVT	F	C	R*4	0C38BC
SK9	F	C	0002F4	SLM	F	C	0000D8	STH	C	R*4	N.R.	TMP	C	R*4	N.R.		
TAF	C	R*4	N.R.	TCR	F	C	0C00DC	TCT	C	R*4	N.R.	ULF	SF	C	R*4	000900	
TMR	SF	R*4	0001F8	TCC	C	R*4	N.R.	TVW	C	R*4	N.R.	WAC	SF	C	R*4	0C09A0	
VHL	C	R*4	N.R.	VIN	C	R*4	N.R.	VMO	F	C	R*4	000040	WFC	SF	C	R*4	0C0934
WCC	SF	C	00092C	WEP	SF	C	000928	WES	SF	C	R*4	00092C	WFW	SF	C	R*4	0C0940
WFE	F	C	000230	WFR	F	C	000938	WFS	SF	C	R*4	00093C	WLG	SF	C	R*4	0C0950
WGR	SF	R*4	0001FC	WHL	SF	C	000948	WHT	SF	C	R*4	00094C	WRC	SF	C	R*4	0C097C
WMC	SF	C	000954	WPC	SF	C	00095C	WPH	SF	C	R*4	000968	WVA	C	R*4	N.R.	
WSC	SF	C	000984	WST	SF	C	00098C	WTM	SF	C	R*4	000990	XLR	C	R*4	N.R.	
WVT	SF	C	000994	XCL	SF	R*4	00020C	XLB	C	R*4	N.R.	ARHT	C	R*4	N.P.		
XLW	C	R*4	N.R.	XPR	F	C	000140	ALFR	C	R*4	N.R.	BHPR	C	R*4	N.R.		
ARVT	C	R*4	N.R.	EHPA	F	C	N.R.	BHPP	F	C	R*4	0009D4	CKHT	C	R*4	N.R.	
CDHT	C	R*4	N.R.	CDVT	C	R*4	N.R.	CKFF	C	R*4	N.R.	DAM3	C	R*4	N.R.		
CKVT	C	R*4	N.R.	LAM1	C	R*4	N.R.	CAM2	C	R*4	N.R.	DVGL	C	R*4	N.R.		
DAM4	C	R*4	N.R.	LAM5	C	R*4	N.R.	DELR	C	R*4	N.R.	ELCA	F	C	R*4	0006D8	
ELDN	C	R*4	N.R.	ELDT	C	R*4	N.R.	ELHT	C	R*4	N.R.	ETAT	C	R*4	N.R.		
ELVT	C	R*4	N.R.	EMLF	F	C	000044	ETAP	C	R*4	N.R.	FEVT	C	R*4	N.R.		
FEHI	C	R*4	N.R.	FEHL	C	R*4	N.R.	FEHT	C	R*4	N.R.	GAP2	C	R*4	N.R.		
FEWH	C	R*4	N.R.	FEWI	C	R*4	N.R.	GAP1	C	R*4	N.R.	GAP6	C	R*4	N.R.		
GAP3	C	R*4	N.R.	GAP4	C	R*4	N.R.	GAP5	C	R*4	N.R.	PEHF	C	R*4	N.R.		
GAP7	C	R*4	N.R.	FIN	C	R*4	N.R.	LTHL	C	I*4	N.R.	SHPA	C	R*4	N.R.		
PLIN	C	R*4	N.R.	RELI	C	R*4	N.R.	RMAX	C	R*4	N.R.	SKAC	F	C	R*4	0C0264	
SHPR	C	R*4	N.R.	SFTE	C	R*4	N.R.	SHTW	C	R*4	N.R.	SKFL	F	C	R*4	0C0250	
SKAR	F	C	0002B0	SKCC	F	C	000244	SKFS	F	C	R*4	0002C8	SKMC	F	C	R*4	0C0260
SKHL	F	C	000268	SKCT	F	C	000298	SKLG	F	C	R*4	000284	SKSC	F	C	R*4	00024C
SKPA	F	C	0002B4	SKPH	F	C	0002A8	SKRC	F	C	R*4	000248	SKKW	F	C	R*4	0C0288
SKTM	F	C	000254	SKVT	F	C	00029C	SKWP	F	C	R*4	000294	SK13	F	C	R*4	000304
SK10	F	C	0002F8	SK11	F	C	0002FC	SK12	F	C	R*4	000300					

7-177



SK14	F	C	R*4	0003C8	SK15	F	C	R*4	00030C	SLMH	C	R*4	N.R.	SRMR	SF	C	R*4	000204	
STPW		C	R*4	N.R.	SVTE		C	R*4	N.R.	SVTW	C	R*4	N.R.	SWTT		C	R*4	N.R.	
TBH1		C	R*4	N.R.	TBH2		C	R*4	N.R.	TBTD	C	R*4	N.R.	TCHT		C	R*4	N.R.	
TCLN		C	R*4	N.R.	TCVT		C	R*4	N.R.	TINY	C	R*4	N.R.	TIN2		C	R*4	N.R.	
TIN4		C	R*4	N.R.	TMAX		C	R*4	N.R.	TOVW	C	R*4	N.R.	TRM1	SF	C	R*4	000208	
TRM2	SF		R*4	0002CC	TtTh		C	R*4	N.R.	WBAL	SF	C	R*4	000918	WENV	SF	C	R*4	0009A4
WFUL	F	C	R*4	000234	WGSB	SF	C	R*4	000944	WPDS	SF	C	R*4	000960	WPEI	SF	C	R*4	000964
WPRB	SF	C	R*4	00096C	WPRG	SF	C	R*4	000970	WPRP	SF	C	R*4	000974	WRCA	SF	C	R*4	000980
WSCA	SF	C	R*4	000988	XLBH		C	R*4	N.R.	XLGD		C	R*4	N.R.	XLHL		C	R*4	N.R.
YLS2		C	R*4	N.R.	ALFDL		C	R*4	N.R.	ATMIY		C	R*4	N.R.	CBARF		C	R*4	N.R.
CBARW	F	C	R*4	00067C	CLDES		C	R*4	N.R.	CLÉYE		C	R*4	N.R.	CPIND		C	R*4	N.R.
CPNUD		C	R*4	N.R.	CPPAR		C	R*4	N.R.	CPPRO		C	R*4	N.R.	CPTOT		C	R*4	N.R.
DELTA		C	R*4	N.R.	DELTH		C	R*4	N.R.	DELWF		C	R*4	N.R.	DELWP	F	C	R*4	00023C
DSWET		C	R*4	N.R.	ELCOA		C	R*4	N.R.	ENPCR		C	R*4	N.R.	ETAP2		C	R*4	N.R.
ETAP4		C	R*4	N.R.	FETOT		C	R*4	N.R.	GMDD1		C	R*4	N.R.	HMAYD		C	R*4	N.R.
ICRUS		C	I*4	N.R.	NCCPP		C	I*4	N.R.	NGXPJ		C	I*4	N.R.	PFET2		C	R*4	N.R.
REALJ		C	R*4	N.R.	RFMR		C	R*4	N.R.	SIGMA		C	R*4	N.R.	SIGMR	F	C	R*4	0009CC
SKAND	F	C	R*4	0002AC	SKBAL	F	C	R*4	000280	SKDRP	SF	C	R*4	000210	SKGB1	F	C	R*4	000274
SKGB2	F	C	R*4	000278	SKPDS	F	C	R*4	00028C	SKPEI	F	C	R*4	0002CC	SKPES	F	C	R*4	0002D0
SKPRB	F	C	R*4	0002A0	SKRBF	F	C	R*4	0002A4	SKRCA	F	C	R*4	000258	SKSCA	F	C	R*4	00025C
SLMVT		C	R*4	N.R.	STMAX		C	R*4	N.R.	SWETH	F	C	R*4	0008CC	SWEXP	F	C	R*4	0008D0
SWWET		C	R*4	N.R.	S2RFC		C	R*4	N.R.	TBCL1		C	R*4	N.R.	TBCRP		C	R*4	N.R.
TBEM5		C	R*4	N.R.	TBPCW		C	R*4	N.R.	TBSFC		C	R*4	N.R.	TGBAR		C	R*4	N.R.
THETA		C	R*4	N.R.	TPRCP		C	R*4	N.R.	TVCMR	F	C	R*4	000144	VBARH		C	R*4	N.R.
VBARV		C	R*4	N.R.	VCIVE	FA	C	R*4	000054	VGASB		C	R*4	N.R.	VGASR		C	R*4	N.P.
WGHTR		C	R*4	000214	WPAYL	S	C	R*4	000958	WPSTR	SF	C	R*4	000978	XLALB		C	R*4	N.R.
XLBWG	F	C	R*4	000028	XLRLA		C	R*4	N.R.	ALOGIO	XF	C	R*4	000000	SQRT	XF	C	R*4	000000
FRXPR#		XF	R*4	0000C0	ALFDES		C	R*4	N.R.	BHPSUP		C	R*4	N.R.	CBARHT		C	R*4	N.R.
CBARVT		C	R*4	N.R.	CBYLCA		C	R*4	N.R.	CLALPH	FA	C	R*4	0001C4	CRSIND		C	R*4	N.R.
CTSIGH		C	R*4	N.R.	CYCPRL		C	R*4	N.R.	DELFCR		C	R*4	N.R.	DELRTH		C	R*4	N.R.
DELWFC	F	C	R*4	000238	DELWPL		C	R*4	N.R.	DELJST	F	C	R*4	000240	DLSWSH		C	R*4	N.R.
DLTAFE		C	R*4	N.R.	ELVLHL		C	R*4	N.R.	DRGIND		C	R*4	N.R.	DSPLMT		C	R*4	N.R.
DYLIND		C	R*4	N.R.	ELFLCA		C	R*4	N.R.	ELVLOA		C	R*4	N.R.	ETAIND		C	R*4	N.R.
ETAP4N		C	R*4	N.R.	EXPERG		C	R*4	N.R.	FEDRAG		C	R*4	N.R.	FIXIND		C	R*4	N.R.
GAMD11		C	R*4	N.R.	FULIND		C	R*4	N.R.	INDCRU		C	I*4	N.R.	INCDRG		C	I*4	N.R.
IADDYL		C	I*4	000828	IACETA		C	I*4	N.R.	INDFIX		C	I*4	N.R.	INCHUL		C	I*4	000834
INDOPT		C	I*4	N.R.	INDCSW		C	I*4	N.R.	INDPOW		C	I*4	N.R.	INDPRP		C	I*4	N.R.
INDRDM		C	I*4	N.R.	IPRINT		C	I*4	N.R.	NWGHTR		C	R*4	000027	OPTIND		C	R*4	N.R.
OSWIND		C	R*4	N.R.	FRPINC		C	R*4	N.R.	RDMINO		C	R*4	N.R.	RHGRHO		C	R*4	N.R.
SGTIND		C	R*4	N.R.	SKELNT	F	C	R*4	00027C	SKENV1	F	C	R*4	00026C	SKENV2	F	C	R*4	000270
SKPDSZ	F	C	R*4	0002C0	SKVTAR	F	C	R*4	000288	SSIGMA		C	R*4	N.R.	STHETA		C	R*4	N.R.
TBCDWI		C	R*4	N.R.	TBBAP4		C	R*4	N.R.	THETMR		C	R*4	N.R.	TOLIND		C	R*4	N.R.
VGBOVH		C	R*4	N.R.	WALNT	SF	C	R*4	00091C	WPAYLO		C	R*4	N.R.	XGTGA2		C	R*4	N.R.
XGTGA4		C	R*4	N.R.															

\*\*\*\*\* COMMON INFORMATION \*\*\*\*\*

NAME OF COMMON BLOCK \* \* SIZE OF BLOCK 0009DC HEXADECIMAL BYTES

VAR. NAME	TYPE	REL. ADDR.	VAR. NAME	TYPE	REL. ADDR.	VAR. NAME	TYPE	REL. ADDR.	VAR. NAME	TYPE	REL. ADDR.
OPTINC	R*4	N.R.	FULINC	R*4	N.R.	DYLIND	R*4	N.R.	DRGIND	R*4	N.R.

GSWIND	R*4	N.R.	FIXINC	R*4	N.R.	RDMIND	R*4	N.R.	PRPIND	R*4	N.R.
ETA INC	R*4	N.R.	WC	R*4	CC0024	XLBWO	R*4	00C028	XLRLA	R*4	N.R.
VCBCVH	R*4	N.R.	XLCC	R*4	N.R.	HMAXD	R*4	N.R.	RHCRHO	R*4	N.R.
VMC	R*4	000040	EMLF	R*4	000044	CKI	R*4	N.R.	DELWF	R*4	N.R.
CKFF	R*4	N.R.	VCIVE	R*4	000054	HOO	R*4	N.R.	RCO	R*4	N.R.
TCC	R*4	N.R.	GAP1	R*4	N.R.	SGTIND	R*4	N.R.	ELHLOA	R*4	N.R.
ELVLCA	R*4	N.R.	GAP2	R*4	N.R.	AR	R*4	00C0C8	WS	R*4	N.R.
TCR	R*4	0000C0	TCT	R*4	N.R.	SLM	R*4	00C0D8	ARHT	R*4	N.R.
TCHT	R*4	N.R.	VBART	R*4	N.R.	SLMH	R*4	N.R.	ARVT	R*4	N.R.
TCVT	R*4	N.R.	VBARV	R*4	N.R.	SLMVT	R*4	N.R.	ELDN	R*4	N.R.
ELET	R*4	N.R.	ELCCA	R*4	N.R.	DLSSH	R*4	N.R.	DSWET	R*4	N.R.
DLVLF	R*4	N.R.	DVCL	R*4	N.R.	CBYLOA	R*4	N.R.	ENR	R*4	00011C
KVA	R*4	N.R.	CAM1	R*4	N.R.	DAM2	R*4	N.R.	BMF	R*4	00012C
CAM3	R*4	N.R.	CLEYE	R*4	N.R.	THETMR	R*4	N.R.	XC	R*4	N.R.
XPR	R*4	000140	TVMR	R*4	000144	VT	R*4	000148	CTSIGH	R*4	N.R.
TVH	R*4	N.R.	FES	R*4	N.R.	TINY	R*4	N.R.	ETAP2	R*4	N.R.
ETAP4K	R*4	N.R.	TBEMS	R*4	N.R.	TB8AP4	R*4	N.R.	GAP3	R*4	N.R.
CAM4	R*4	N.R.	ENF	R*4	CC0194	ETAT	R*4	N.R.	HC	R*4	N.R.
VC	R*4	N.R.	ATMIY	R*4	N.R.	CDVT	R*4	N.R.	CDHT	R*4	N.R.
CAM5	R*4	N.R.	CLTAF	R*4	N.R.	FEDRAG	R*4	N.R.	EXPORG	R*4	N.R.
CCC	R*4	N.R.	CLALP	R*4	0001C4	CKVT	R*4	N.R.	CKHT	R*4	N.R.
CKF	R*4	N.R.	CKH	R*4	N.R.	RELI	R*4	N.R.	TCLN	R*4	N.R.
TBCL1	R*4	N.R.	TBCOI	R*4	N.R.	GAP4	R*4	N.R.	WFE	R*4	000230
WFL	R*4	000234	CELWFC	R*4	000238	DELWP	R*4	00023C	DELWST	R*4	000240
SKCC	R*4	000244	SKRC	R*4	000248	SKSC	R*4	00024C	SKFW	R*4	000250
SKTN	R*4	000254	SKRCA	R*4	000258	SKSCA	R*4	00025C	SKMC	R*4	000260
SKAC	R*4	000264	SKHL	R*4	000268	SKENV1	R*4	00026C	SKENV2	R*4	000270
SKGE1	R*4	000274	SKGB2	R*4	000278	SKBLNT	R*4	00027C	SKBAL	R*4	000280
SKLG	R*4	000284	SKWH	R*4	000288	ELF	R*4	00028C	RMI	R*4	000290
SKVP	R*4	000294	SKHT	R*4	000298	SKVT	R*4	00029C	SKPRB	R*4	0002A0
SKREF	R*4	0002A4	SKPT	R*4	0002A8	SKAMD	R*4	0002AC	SKAR	R*4	0002B0
SKFA	R*4	0002B4	SKVTA	R*4	0002B8	SKPDS	R*4	0002BC	SKPDSZ	R*4	0002C0
SKT	R*4	0002C4	SKFS	R*4	0002C8	SKPEI	R*4	0002CC	SKPES	R*4	0002D0
SK1	R*4	0002C4	SK2	R*4	0002D8	DK3	R*4	0002DC	DK4	R*4	0002E0
SK5	R*4	0002E4	SK6	R*4	0002E8	SK7	R*4	0002EC	SK8	R*4	0002F0
SK9	R*4	0002F4	SK1C	R*4	0002F8	SK11	R*4	0002FC	SK12	R*4	000300
SK13	R*4	000304	SK14	R*4	000308	SK15	R*4	00030C	PLIN	R*4	N.R.
GAF5	R*4	N.R.	TCLINC	R*4	N.R.	XTGTA2	R*4	N.R.	TIN2	R*4	N.R.
THTH	R*4	N.R.	PFET2	R*4	N.R.	DELTH	R*4	N.R.	STH	R*4	N.R.
CRSINC	R*4	N.R.	XTGTA4	R*4	N.R.	TIN4	R*4	N.R.	VIN	R*4	N.R.
DELK	R*4	N.R.	RMAH	R*4	N.R.	DELFCR	R*4	N.R.	ENFCP	R*4	N.R.
DELWFL	R*4	N.R.	STPH	R*4	N.R.	HFIN	R*4	N.R.	GAP6	R*4	N.R.
CYCPFL	R*4	N.R.	FF	R*4	N.R.	SK3	R*4	000488	SK4	R*4	0004BC
TBF1	R*4	N.R.	TBTC	R*4	N.R.	TBH2	R*4	N.R.	TBCRP	R*4	N.R.
TBSFC	R*4	N.R.	TBPOH	R*4	N.R.	GAP7	R*4	N.R.	ALFDES	R*4	N.R.
ALFCL	R*4	N.R.	ALFR	R*4	N.R.	AMU	R*4	N.R.	BHFA	R*4	N.R.
BHFR	R*4	N.R.	BHPSUP	R*4	N.R.	BHT	R*4	N.R.	BLP	R*4	N.R.
ER	R*4	N.R.	BS	R*4	000663	BVT	R*4	N.R.	CBARF	R*4	N.R.
CEARFT	R*4	N.R.	CEARVT	R*4	N.R.	CBARW	R*4	00067C	CCP	R*4	N.R.
CCY	R*4	N.R.	CCV	R*4	N.R.	CLW	R*4	N.R.	CPIAD	R*4	N.R.
CPAUC	R*4	N.R.	CPPAR	R*4	N.R.	CPPRO	R*4	N.R.	CPTOT	R*4	N.R.
CRT	R*4	N.R.	CTP	R*4	N.R.	CV	R*4	N.R.	CX	R*4	N.R.

ORIGINAL PAGE IS  
OF POOR QUALITY  
7-179

CLCES	R*4	N.R.	CE	R*4	N.R.	DELRTH	R*4	N.R.	DELTA	R*4	N.R.
CF	R*4	0006C4	CSPLMT	R*4	N.R.	ELC	R*4	N.R.	ELHT	R*4	N.R.
ELN	R*4	N.R.	ELCA	R*4	0006D8	ELT	R*4	N.R.	ELVT	R*4	N.R.
EN	R*4	N.R.	ETAF	R*4	N.R.	FEH	R*4	N.R.	FEHI	R*4	N.R.
FEFL	R*4	N.R.	FET	R*4	N.R.	FET	R*4	N.R.	FETGT	R*4	N.R.
FEVT	R*4	N.R.	FEV	R*4	N.R.	FEWH	R*4	N.R.	FEWI	R*4	N.R.
FM	R*4	N.R.	FF	R*4	N.R.	ETAP4	R*4	N.R.	GAM011	R*4	N.R.
CLF	R*4	0007C4	GMCDI	R*4	N.R.	H	R*4	N.R.	ICRUS	I*4	N.R.
INDCFL	I*4	N.R.	INDDRC	I*4	N.R.	INDDYL	I*4	000828	INDETA	I*4	N.R.
INDFIX	I*4	N.R.	INDHUL	I*4	000834	INDOPT	I*4	N.R.	INDOSW	I*4	N.R.
INDPCK	I*4	N.R.	INDPRP	I*4	N.R.	INDRDM	I*4	N.R.	IPRINT	I*4	N.R.
LTFI	I*4	N.R.	NCCPF	I*4	N.R.	NOXPJ	I*4	N.R.	CWE	R*4	00085C
PEHF	R*4	N.R.	PI	R*4	000864	Q	R*4	N.R.	RHO	R*4	N.R.
REALJ	R*4	N.R.	RFPMR	R*4	N.R.	R	R*4	N.R.	RN	R*4	N.R.
SA	R*4	N.R.	SAE	R*4	N.R.	SA6	R*4	N.R.	SAT	R*4	N.R.
SFC	R*4	N.R.	SHPA	R*4	N.R.	SHPR	R*4	N.R.	SPT	R*4	00089C
SITE	R*4	N.R.	SHTA	R*4	N.R.	SIGMA	R*4	N.R.	SSIGMA	R*4	N.R.
ST	R*4	N.R.	STHETA	R*4	N.R.	STMAX	R*4	N.R.	SVT	R*4	0008BC
SVTE	R*4	N.R.	SVTb	R*4	N.R.	SW	R*4	0008C8	SWETH	R*4	0008CC
SWEXP	R*4	0008C0	SWTI	R*4	N.R.	SWWET	R*4	N.R.	S2RHO	R*4	N.R.
T	R*4	N.R.	TAF	R*4	N.R.	TCBAR	R*4	N.R.	THETA	R*4	N.R.
TMAX	R*4	N.R.	TMP	R*4	N.R.	TPROP	R*4	N.R.	TR	R*4	N.R.
LLF	R*4	0009C0	VGASE	R*4	N.R.	VGASR	R*4	N.R.	VHL	R*4	N.R.
V	R*4	N.R.	v	R*4	N.R.	WBAL	R*4	000918	WBALNT	R*4	00091C
WCC	R*4	000920	WE	R*4	000924	WEP	R*4	000928	WES	R*4	00092C
WF	R*4	N.R.	WFC	R*4	000934	WFR	R*4	000930	WFS	R*4	00093C
WFH	R*4	000940	WGSE	R*4	000944	WHL	R*4	000948	WHT	R*4	00094C
WLG	R*4	000950	WMC	R*4	000954	WPAYL	R*4	000958	WPC	R*4	00095C
WPDS	R*4	00096C	WPEI	R*4	000964	WPH	R*4	000968	WPRB	R*4	00096C
WPRG	R*4	000970	WPRF	R*4	000974	WPSTR	R*4	000978	WRC	R*4	00097C
WRCA	R*4	000980	WSC	R*4	000984	WSCA	R*4	000988	WST	R*4	00098C
WTM	R*4	000990	WVI	R*4	000994	WW	R*4	000998	WPAYLO	R*4	N.R.
WAC	R*4	0009AC	WENV	R*4	0009A4	XLALB	R*4	N.R.	XLB	R*4	N.R.
XLBF	R*4	N.R.	XLFL	R*4	N.R.	XLRL	R*4	N.R.	XLW	R*4	N.R.
YLS2	R*4	N.R.	TOVh	R*4	N.R.	DMR	R*4	0009C8	SIGMR	R*4	0009CC
AF	R*4	N.R.	BHPP	R*4	0009D4	SEE	R*4	N.R.			

7-180

LABEL	ADDR	LABEL	ADDR	LABEL	ADDR	LABEL	ADDR
1	0CC52A	2	0CC532	3	000602	4	00078A
5	0CC8F2	6	0CC528	7	0C0930	9	000A18 NR
10	0CC858	11	0CC864	12	0CCC4C	13	000D1C

\*OPTIONS IN EFFECT\* NAME= MAIN,CPT=02,LINECNT=54,SIZE=0000K,

\*OPTIONS IN EFFECT\* SOURCE,EBCDIC,NGLIST,ACDECK,LOAD,MAP,NCEDIT,IO,NOXREF

\*STATISTICS\* SOURCE STATEMENTS = 117 ,PROGRAM SIZE = 3542

\*STATISTICS\* NO DIAGNOSTICS GENERATED

\*\*\*\*\* END OF COMPIATION \*\*\*\*\*

95K BYTES OF CORE NOT USED

\*STATISTICS\* NO DIAGNOSTICS THIS STEP

7-181

ORIGINAL PAGE IS  
OF POOR QUALITY

CCMPILER OPTICNS - NAME= MAIN,CP1=C2,LINECNT=54,SIZE=0000K,  
 SOURCE,EBCDIC,NCLIST,NODECK,LGAD,MAP,ACEDIT,IG,NCXREF

ISN 0002	FUNCTION XLINT(X,YT,X,NTAB,M)	00010000
	C*** MEMBER NAME BEI XLINT	00020000
ISN 0003	DIMENSION XT( 1), YT( 1)	00030000
ISN 0004	XSAV=XT(1)	00040000
ISN 0005	N=1	00050000
ISN 0006	M=C	00060000
ISN 0007	IF(X-XT(1)) 1,2,3	00070000
ISN 0008	1 M=-1	00080000
ISN 0009	2 XLINT= YT(1)	00090000
ISN 0010	GC TO 25	00100000
ISN 0011	3 IF(X-XT(NTAB)) 4,5,6	00110000
ISN 0012	6 M=1	00120000
ISN 0013	5 N=NTAB	00130000
ISN 0014	XSAV= XT(NTAB)	00140000
ISN 0015	XLINT= YT(NTAB)	00150000
ISN 0016	GC TO 25	00160000
ISN 0017	4 IF(X-XSAV) 7,8,9	00170000
ISN 0018	8 XLINT= YT(N)	00180000
ISN 0019	GC TO 25	00190000
ISN 0020	7 I= N-1	00200000
ISN 0021	13 IF(X-XT(I)) 10,11,12	00210000
ISN 0022	11 N= I	00220000
ISN 0023	XSAV= XT(I)	00230000
ISN 0024	XLINT= YT(I)	00240000
ISN 0025	GC TO 25	00250000
ISN 0026	10 I = I-1	00260000
ISN 0027	GC TO 13	00270000
ISN 0028	9 I = N+1	00280000
ISN 0029	14 IF(X-XT(I)) 15,11,16	00290000
ISN 0030	16 I= I+1	00300000
ISN 0031	GC TO 14	00310000
ISN 0032	15 I=I-1	00320000
ISN 0033	12 N=I	00330000
ISN 0034	XSAV=XT(I)	00340000
ISN 0035	XLINT= YT(I)+(X-XT(I))*(YT(I+1)-YT(I))/(XT(I+1)-XT(I))	00350000
ISN 0036	25 IF(M) 30,31,32	00360000
ISN 0037	30 WRITE (6,30C)	00370000
ISN 0038	30C FORMAT(/9X,57F***ERROR*** THE FOLLOWING VALUES MAY NOT BE ACCURATE 1 THE INDEPENDENT VARIABLE WAS OUT OF RANGE OF/9X,81HTHE TABLE. THOSE THESE VALUES WERE CALCULATED USING THE FIRST VALUE GIVEN IN THE TABL 3E)	00380000
ISN 0039	31 CONTINUE	00420000
ISN 0040	RETURN	00430000
ISN 0041	32 WRITE (6,30C)	00440000
ISN 0042	30C1 FORMAT(/9X,57F***ERROR*** THE FOLLOWING VALUES MAY NOT BE ACCURATE 1 THE INDEPENDENT VARIABLE WAS OUT OF RANGE OF/9X,81HTHE TABLE. THOSE THESE VALUES WERE CALCULATED USING THE LAST VALUE GIVEN IN THE TABL 3E)	00450000
ISN 0043	GC TO 31	00480000
ISN 0044	END	00490000
		00500000

/ XLINT / SIZE OF PROGRAM 000474 HEXADECIMAL BYTES

NAME	TAG	TYPE	ADD.	NAME	TAG	TYPE	ADD.	NAME	TAG	TYPE	ADD.	NAME	TAG	TYPE	ADD.		
I	SF	I*4	0002C0	M	S	I*4	000204	N	SF	I*4	00C208	X	F	R*4	0C020C		
XT	F	XR	R*4	000CCC	YT	F	XR	R*4	000000	NTAB	F	I*4	000210	XSAV	S	R*4	000214
XLINT	S	R*4	000218	IECCM#	F	XF	I*4	0C000C									

7-183

ORIGINAL PAGE IS  
OF POOR QUALITY

LABEL	ADDR	LABEL	ADDR	LABEL	ADDR	LABEL	ADDR	PAGE	COB
1	0CC2C4	2	CCC28A	3	CCQ296	6	000282		
5	0CC2B6	4	CCC2C2	8	CC02D4	7	0002EC		
13	CCC304	11	CCC312	10	CCC32E	9	00033E		
14	CCC35C	16	CCC367	15	CCC37A	12	0J0384		
25	0CC388	30	CCC3CA	31	CC03E0	32	0003E8		

\*OPTIONS IN EFFECT\* NAME= MAIN,CPT=C2,LINECNT=54,SIZE=J0CCK,

\*OPTIONS IN EFFECT\* SOURCE,EBCCIC,ACLIST,NODECK,LOAD,MAP,NOEDIT,ID,NOXREF

\*STATISTICS\* SOURCE STATEMENTS = 43 ,PROGRAM SIZE = 1140

\*STATISTICS\* NO DIAGNOSTICS GENERATED

\*\*\*\*\* END OF COMPIATION \*\*\*\*\*

123K BYTES OF CORE NOT USED

COMPILER OPTIONS - NAME= MAIN,OPT=CZ,LINECNT=54,SIZE=CCCC,SCURCE,EBCCIC,ACLIST,NODECK,LOAD,MAP,ACEDIT,IO,NOXREF

ISN 0002	FUNCTION XLKUP(XARG,YARG,XTAB,NX,YTAB,NY,ZTAB,NXTAB,NYTAB,IX,IY)	00010000
	C**** MEMBER NAME B81XLKUP	00020000
ISN 0003	DIMENSION XTAE(1),YTAE(1)	00030000
ISN 0004	DIMENSION ZTAE(NXTAE,NYTAE)	00040000
	C	00050000
	C DOUBLE TABLE PARABOLIC LCLER-UP Z = FUNCT (X,Y)	00060000
	C	00070000
ISN 0005	IERRX = 0	00080000
ISN 0006	IERRY = 0	00090000
	C	00100000
	C CHECK THE RANGE OF THE VARIABLE TABLES (NO EXTRAPOLATION)	00110000
	C	00120000
ISN 0007	10 IF (XARG - XTAE(1)) 12,13,13	00130000
ISN 0008	12 X = XTAB(1)	00140000
ISN 0009	IERRX = -1	00150000
ISN 0010	CC TO 18	00160000
ISN 0011	13 CC 15 I=2,NX	00170000
ISN 0012	IF (XARG - XTAE(1)) 16,16,15	00180000
ISN 0013	15 CONTINUE	00190000
ISN 0014	X = XTAB(NX)	00200000
ISN 0015	IERRX = 1	00210000
ISN 0016	CC TO 18	00220000
ISN 0017	16 X = XARG	00230000
ISN 0018	18 IF (YARG - YTAE(1)) 20,21,21	00240000
ISN 0019	20 Y = YTAE(1)	00250000
ISN 0020	IERRY = -1	00260000
ISN 0021	CC TO 26	00270000
ISN 0022	21 CC 23 I=2,NY	00280000
ISN 0023	IF (YARG - YTAE(1)) 24,24,23	00290000
ISN 0024	23 CONTINUE	00300000
ISN 0025	Y = YTAB(NY)	00310000
ISN 0026	IERRY = 1	00320000
ISN 0027	CC TO 26	00330000
ISN 0028	24 Y = YARG	00340000
ISN 0029	26 IX = IERRX	00350000
ISN 0030	IY = IERRY	00360000
	C	00370000
ISN 0031	XLKUP = BIV(X,Y,XTAB,YTAE,ZTAB,NX,NY,NXTAB,NYTAB)	00380000
	C	00390000
	C	00400000
	C ERRCR RETURNS	00410000
	C	00420000
ISN 0032	IF (IERRX) 40,45,50	00430000
ISN 0033	40 IF (IERRY) 41,42,43	00440000
ISN 0034	41 WRITE (6,20000)	00450000
ISN 0035	WRITE (6,20010)	00460000
ISN 0036	CC TO 60	00470000
ISN 0037	42 WRITE (6,21000)	00480000
ISN 0038	WRITE (6,20020)	00490000
ISN 0039	CC TO 60	00500000

ORIGINAL PAGE IS OF POOR QUALITY

7-185



ISN 0040	43 WRITE (6,20000)	00510000
ISN 0041	WRITE (6,20030)	00520000
ISN 0042	GC TO 60	00530000
ISN 0043	45 IF (IERRY) 46,60,47	00540000
ISN 0044	46 WRITE (6,22000)	00550000
ISN 0045	WRITE (6,20040)	00560000
ISN 0046	GC TO 60	00570000
ISN 0047	47 WRITE (6,22000)	00580000
ISN 0048	WRITE (6,20050)	00590000
ISN 0049	GC TO 60	00600000
ISN 0050	50 IF (IERRY) 51,52,53	00610000
ISN 0051	51 WRITE (6,20000)	00620000
ISN 0052	WRITE (6,20060)	00630000
ISN 0053	GC TO 60	00640000
ISN 0054	52 WRITE (6,21000)	00650000
ISN 0055	WRITE (6,20070)	00660000
ISN 0056	GC TO 60	00670000
ISN 0057	53 WRITE (6,20000)	00680000
ISN 0058	WRITE (6,20080)	00690000
ISN 0059	60 RETURN	00700000
ISN 0060	20000 FORMAT( 9X117H***ERRCR THE FOLLOWING VALUES MAY NOT BE ACCURATE. BOTH INDEPENDENT VARIABLES (X AND Y) ARE OUT OF RANGE OF THE TABLE)	00710000
ISN 0061	21000 FORMAT( 9X114H***ERRCR THE FOLLOWING VALUES MAY NOT BE ACCURATE. THE FIRST INDEPENDENT VARIABLE (X) IS OUT OF RANGE OF THE TABLE)	00720000
ISN 0062	22000 FORMAT( 9X115H***ERRCR THE FOLLOWING VALUES MAY NOT BE ACCURATE. THE SECOND INDEPENDENT VARIABLE (Y) IS OUT OF RANGE OF THE TABLE)	00730000
ISN 0063	20010 FORMAT(19X69HTHE PROGRAM PICKED UP THE FIRST VALUES, X(1) AND Y(1), IN BOTH TABLES)	00740000
ISN 0064	20030 FORMAT(19X64HTHE PROGRAM PICKED UP THE FIRST VALUE, X(1), AND THE LAST VALUE, Y(N), IN THE TABLES)	00750000
ISN 0065	20060 FORMAT(19X64HTHE PROGRAM PICKED UP THE LAST VALUE, X(N), AND THE FIRST VALUE, Y(1), IN THE TABLES)	00760000
ISN 0066	20080 FORMAT(19X68HTHE PROGRAM PICKED UP THE LAST VALUES, X(N) AND Y(N), IN BOTH TABLES)	00770000
ISN 0067	20020 FORMAT(19X57HTHE PROGRAM PICKED UP THE FIRST VALUE, X(1), IN THE TABLE)	00780000
ISN 0068	20070 FORMAT(19X56HTHE PROGRAM PICKED UP THE LAST VALUE, X(N), IN THE TABLE)	00790000
ISN 0069	20040 FORMAT(19X57HTHE PROGRAM PICKED UP THE FIRST VALUE, Y(1), IN THE TABLE)	00800000
ISN 0070	20050 FORMAT(19X56HTHE PROGRAM PICKED UP THE LAST VALUE, Y(N), IN THE TABLE)	00810000
ISN 0071	END	00820000

NAME	TAG	TYPE	ADD.	NAME	TAG	TYPE	ADD.	NAME	TAG	TYPE	ADD.	NAME	TAG	TYPE	ADD.
I	SF	I*4	000454	X	SFA	R*4	000458	Y	SFA	R*4	00045C	IX	S	I*4	000460
IY	S	I*4	000464	AX	FA	I*4	000468	NY	FA	I*4	00046C	BIV	F XF	R*4	000000
XARG	F	R*4	000470	XTAB	FA XR	R*4	000000	YARG	F	R*4	000474	YTAB	FA XR	R*4	000000
ZTAB	FA XR	R*4	000000	IERRX	SF	I*4	000478	IERRY	SF	I*4	00047C	NXTAB	FA	I*4	000480
NYTAB	FA	I*4	000484	XLKUP	S	R*4	000488	IBCLM#	F XF	I*4	000000				

481-4

LABEL	ADDR	LABEL	ADDR	LABEL	ADDR	LABEL	ADDR
10	0004F4 NR	12	000506	13	000510	15	00052C
16	00053E	18	00054E	20	000558	21	000562
23	000584	24	00059A	26	0005A2	40	0005CA
41	0005D4	42	00060C	43	00062C	45	000658
46	000662	47	00069C	50	0006BC	51	0006C6
52	0006F4	53	00072C	60	000748		

\*OPTIONS IN EFFECT\* NAME= MAIN,CPT=C2,LINECNT=54,SIZE=0000K,

\*OPTIONS IN EFFECT\* SOURCE,EBCDIC,NCLIST,ACDECK,LOAD,MAP,ACEDIT,ID,NOXREF

\*STATISTICS\* SOURCE STATEMENTS = 70 ,PROGRAM SIZE = 2132

\*STATISTICS\* NO DIAGNOSTICS GENERATED

\*\*\*\*\* END OF COMPILE \*\*\*\*\* 115K BYTES OF CORE NCT USED

\*STATISTICS\* NO DIAGNOSTICS THIS STEP

7-188

## REFERENCES

1. Schoen, A. H. and Wisniewski, J. S., User's Manual for VACOMP II, THE V/STOL AIRCRAFT SIZING AND PERFORMANCE COMPUTER PROGRAM, Boeing Vertol Company, Report D8-0375; Volume VI, Rev. 2, September 1973.
2. Burgess, C. P., AIRSHIP DESIGN, The Ronald Press Company, New York, N.Y., 1927.
3. Weaver, E. R., AN AIRSHIP SLIDE RULE, NACA Report No. 160.
4. Munk, M. M., THE AERODYNAMIC FORCES ON AIRSHIP HULLS, NACA Report No. 184.
5. Upson, R. H., APPLICATION OF PRACTICAL HYDRODYNAMICS TO AIRSHIP DESIGN, NACA Report No. 405.
6. Durand, W. F., Editor-in-Chief, AERODYNAMIC THEORY, VOLUME III, Division Q and R, Aerodynamics and Performance of Airships, California Institute of Technology, 1943.
7. Flax, A. H. and Lawrence, H. R., THE AERODYNAMICS OF LOW-ASPECT RATIO WINGS AND WING-BODY COMBINATIONS, Report No. CAL-37, Cornell Aeronautical Laboratory, Inc., Buffalo, N.Y., 1951.
8. Ellison, D. E., Principal Investigator, USAF STABILITY AND CONTROL DATCOM, Flight Control Division - Air Force Flight Dynamics Laboratory, Wright-Patterson AFB, Ohio, 1960, Revised 1969.
9. Gabriel, E. A., DRAG ESTIMATION OF V/STOL AIRCRAFT, D8-2194-1, Boeing Vertol, Phila., 1969.
10. Low, E. M. II, SHORTCUT PERFORMANCE METHODOLOGY, Boeing Vertol Company, IOM 8-7444-1-119, 22 October 1969.
11. Low, E. M. II, WATFOR PROGRAMS FOR PERFORMANCE DETERMINATION, Boeing Vertol Company, IOM 8-7444-1-188, 18 August 1971.

12. Mills, S., INCORPORATION OF ROTOR-ROTOR INTERFERENCE DATA FROM UHM TESTS INTO SHORTCUT METHODOLOGY, Boeing Vertol Company, IOM 8-7444-1-173, 9 March 1971.
13. Davis, S. Jon and Wisniewski, J. S., USER'S MANUAL FOR HESCOMP, THE HELICOPTER SIZING AND PERFORMANCE COMPUTER PROGRAM, Boeing Vertol Company, Report D210-10699-2, Rev. Nov. 1974.
14. Borst, H. V., A SHORT METHOD TO PROPELLER PERFORMANCE, Curtiss-Wright Corporation, Propeller Division.