



# NEW HOLLAND

## E385C

TIER III



	E385C EL/LC	E385C ME
<b>ENGINE POWER</b>	264 hp (197 kW)	
<b>MAX. OPERATIONAL WEIGHT</b>	36,453 kg	38,292 kg
<b>BUCKET CAPACITY</b>	0.74 m <sup>3</sup> – 1.85 m <sup>3</sup>	0.74 m <sup>3</sup> – 2.7 m <sup>3</sup>



# E385C

## RAPID CYCLES AND POWER

Powerful Tier III engine.

The advanced hydraulic system maximizes performance in accordance with the job. High efficiency hydraulics and new joysticks with optional hydraulic proportional controls (HPC) result in smooth operation, exceptional control and rapid cycles.

## DEVELOPMENTS IN COMFORT AND SAFETY

The EVO cab (new Evolution cab), with the right side completely glassed and a rear view camera, provides exceptional visibility in all directions.

The cab's sound proofing and shock absorbers result in considerably lower levels of noise and vibration. The operators can work safely in the cab thanks to the ROPS protection.



## INTELLIGENT CONSUMPTION

A new generation of intelligent total control systems (ITCS™) with progressive hydraulic acceleration combines high power and speed with precise control.

## INTEGRATED RELIABILITY AND DURABILITY

The heavy service chassis is made to last. The bar, the heavy service arm and the standard arm protection stand up to the most difficult jobs. Quick maintenance with all service points accessible from the ground.

# E385C

## SPECIFICATIONS



### TIER III ENGINE

Brand and model.....HINO EB-JO8E-TM  
 Engine power (ISO 14396/ECE R120)..... 264 hp (197 kW)  
 Maximum torque..... 998 Nm (1,600 rpm)  
 Type..... electronic common rail,

direct injection, turbocompressor intercooler

Cubic capacity.....7,684 L

No. of cylinders..... 6

Internal diameter x travel..... 112 x 130 mm

#### Remote and easily replaced engine oil filter

#### Dial type electronic engine rpm control

**Automatic low gear selector** makes the engine return to a minimum rpm when all the controls are in a neutral position

**Negative external temperature ignition** as standard equipment

Standard version.....-25°/+40°

Warm climate version (AME).....-25°/+45°

(Without EGR/Without Tier certification)

Cold climate version (CIS).....-30°/+40°

(Without EGR/Without Tier certification)

*The engine complies with the 97168IEC Phase 3A (Tier3) norms as the standard version.*



### ELECTRICAL SYSTEM

Voltage/Alternator .....24 V/60 A

Ignition engine.....5 kW

Maintenance-free batteries ..... 2 x 12 V/160 Ah



### TRANSMISSION

Type.....hydrostatic, two speeds, automatic gear lowering

Displacement engine ..... axial piston type, dual cylinder

Brakes ..... automatic disc type

Final reduction ..... oil bath, planetary reduction

Ramp capacity ..... 70% (35°)

Displacement speeds..... low 0 - 3.3 km/h/high 0 - 5.6 km/h

Traction bar boost..... 321 kN



### CHASSIS

Chassis Design with an X structure

HD tread belt reinforced with a seal bushing

	E385C ME	E385C LC
Lower rollers (each side)	9	9
Upper rollers (each side)	2	2
Length of the tread on the ground (mm)	4.050	4.050
Shoes (mm)	600-700 800	600-700 800-900

Shoe type .....Shoe with three tractor type claws

No. for each side .....48

Height of the shoe claw.....30mm



### HYDRAULIC SYSTEM

Dual high-capacity pumps with electronic supply adjustment The displacement piston pumps automatically return to zero in the neutral position. Main control valve with fail proof operation and anti-slip valve.

HAOA (Hydrotronic Active Operation Aid)

ESSC (Engine Smart Start Controller)

DOC (Dipperstick Optimized Control)

CPB (Continuous Power Boost)

New generation AEP (Advanced Electronic Processor)

### Three operating modes

H Mode - Heavy excavation work

S Mode - Standard load and excavation work

E Mode - Fuel saving

### Implement modes

Hydraulic hammer (unidirectional hydraulic flow)

Nibbler (bidirectional hydraulic flow)

Implement flow and pressure setting from the cab, storage for 20 presets

### Hydraulic pump

Maximum flow at nominal engine speed.....2x294 L/min

Gear pump for the piloting circuit.....max 20 L/min

### Directional control valves

Type..... valve with 8 spools

### System pressures

Bar, arm and bucket .....34.3 MPa

with Power Boost .....37.8 MPa

Displacement .....34.3 MPa

Turn .....29 MPa

Pilot control circuit..... 5 MPa



### CAPACITIES

Engine oil..... 28.5 L

Fuel tank..... 580 L

Hydraulic system (Including 245L tank)..... 413 L

Cooling system .....28.9L



### SWAY

Swing motor .....axial piston type

Swing brake .....hydraulic brake

swing speed .....0-10 rpm



### CAB AND CONTROLS

#### Operator cab

Structure ..... Completely enclosed steel structure

EVO operator cab..... Evolution in comfort and safety.

As an option in accordance with

ROPS (ISO 12117-2) standards

Rear view camera..... optional

Monitor .....integrated multifunctional

control monitor with an

integrated rear view camera display

(if the camera option is selected)

#### Operator seat

Operator seat..... Adjustable and reclining device

#### Operation

Engine control.....Rotating - electronic accelerator type

Displacement ..... Two levers or two independent

pedals for forward and

reverse operations

Excavation and rotation..... Two hand levers for four operations

#### Noise level

Guaranteed external noise level

(EU Directive 2000/14/EC ..... LwA 105 dB(A)

Operator cab sound pressure level

(ISO 6396..... LpA 71 dB(A)

# E385C

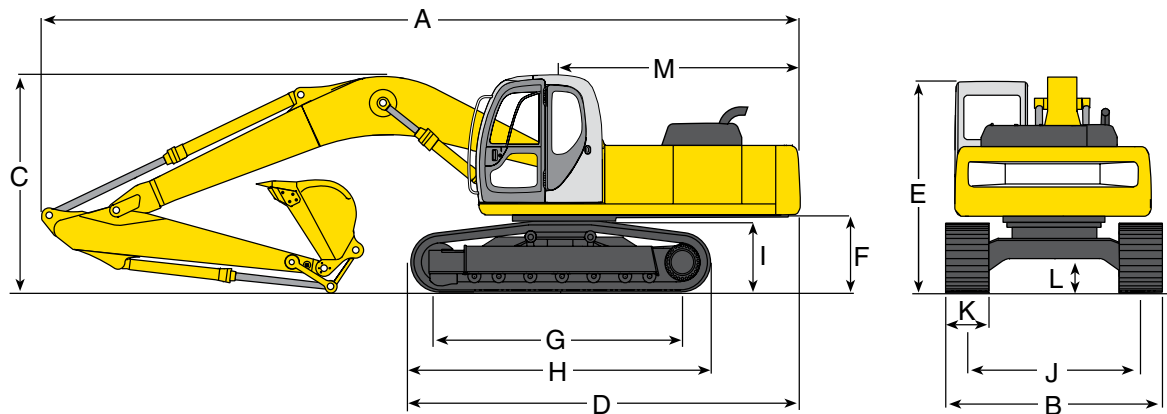

## DIMENSIONS – unit m (ft/in.)

	Mass Excavator	Standard	Optional
<b>LENGTH OF THE ARM</b>	2.20 (7'26")	3.33 (10'10")	4.15 (13'7")
<b>A.</b> Total length	10.65 (34'11.3")	11.20 (36'9")	11.23 (36'10")
<b>B.</b> Total width (with 800 mm shoes)	3.40 (11'2")	3.40 (11'2")	3.40 (11'2")
<b>C.</b> Total height (up to the upper part of the arm)	3.42 (11'2.7")	3.42 (11'3")	3.59 (11'9")
<b>D.</b> Machine base length	5.99 (19'8")	5.99 (19'8")	5.99 (19'8")
<b>E.</b> Total height (up to the upper part of the arm)	3.16 (10'4")	3.16 (10'4")	3.16 (10'4")
<b>F.</b> Rear end distance from the ground*	1.19 (3'10.8")	1.19 (3'11")	1.19 (3'11")
<b>G.</b> Center to center axle distance	4.05 (13'3")	4.05 (13'3")	4.05 (13'3")
<b>H.</b> Total tread length	4.98 (16'4")	4.98 (16'4")	4.98 (16'4")
<b>I.</b> Tread height	1.05 (3'5")	1.05 (3'5")	1.05 (3'4")
<b>J.</b> Machine gauge	2.60 (8'6")	2.60 (8'6")	2.60 (8'5")
<b>K.</b> Width of the excavator shoe	800 mm (27.5")	800 mm (31.5")	800 mm (31.5")
<b>L.</b> Rolling part distance from the ground*	500 mm (19.7")	500 mm (19.7")	500 mm (19.7")
<b>M.</b> Rear turn radius	3.50 (11'6")	3.50 (11'6")	3.50 (11'6")

\*Grouser bar height deleted.

## WEIGHTS – Bucket weight: 2,225 kg (4,905 lbs)

SHOE WIDTH	mm (in.)	800	(31.5)
Total width of the machine	mm (ft/in.)	3,400	(11'2")
Ground pressure	kgf/cm <sup>2</sup> (psi)	0.58	(8.2)
Operational weight	kg (lb)	37,260	(82,144)

SHOE WIDTH	mm (in.)	700	(27.6)	600	(23.6)
Total width of the machine	m (ft/in.)	3,300	(10'10")	3,200	(10'6")
Ground pressure	kgf/cm <sup>2</sup> (psi)	0.65	(9.2)	0.74	(10.5)
Operative weight	kg (lb)	36,840	(81,218)	36,160	(79,719)

## BUCKETS

Bucket	Capacity SAE (m3)	Width (mm)	Weight (kg)	Number of teeth
Heavy Duty	2.3	1,524	1,864	6
	2.5	1,676	2,034	6
	2.7	1,829	2,225	7

## BUCKETS - MASS EXCAVATOR

Bucket	Capacity SAE (m3)	Width (mm)	Weight (kg)	Number of teeth
Heavy Duty	2.1	1,219	2,295	4
	2.4	1,372	2,523	5
	2.7	1,524	2,750	5

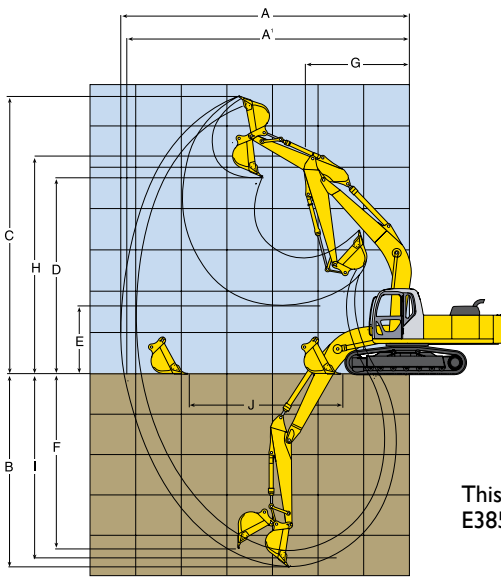

This table is a graphic representation of the work intervals for the E385C equipped with a 3.3 m arm (10'10").

## WORK INTERVALS – m (ft/in.)

ACCESSORIES	Mass Excavator Arm	Standard arm	Optional arm
	2.20 (7'26")	3.33 (10'10")	4.15 (13'7")
<b>A.</b> Maximum excavation reach	9.96 (32'8")	11.26 (36'9")	11.97 (39'4")
<b>A'.</b> Maximum excavation reach at ground level	9.74 (31'2")	11.06 (36'3")	11.79 (38'7")
<b>A.</b> Maximum excavation depth	5.25 (20'6")	7.56 (24'10")	8.41 (27'6")
<b>A.</b> Maximum excavation height	3.88 (32'5")	10.58 (34'9")	10.70 (35'1")
<b>D.</b> Maximum dumping distance	6.65 (21'1")	7.37 (24'2")	7.53 (24'7")
<b>D.</b> Minimum dumping distance	3.18 (10'5")	2.62 (8'7")	1.77 (5'8")
<b>F.</b> Maximum vertical wall excavation depth	3.00 (9'10")	6.61 (21'8")	7.15 (23'5")
<b>G.</b> Minimum frontal turn radius	1.08 (13'5")	4.37 (14'4")	4.43 (14'5")
<b>H.</b> Minimum turn radius height	-	8.64 (28'4")	8.65 (28'4")
<b>I.</b> Excavation depth for a flat foundation of 2.4m (8')	-	7.41 (24'3")	8.27 (27'1")
<b>J.</b> Horizontal excavation direction at ground level	-	5.79 (19'0")	7.21 (23'7")

## EXCAVATION FORCE (ISO 6015)

	w/ P Boost	w/o P Boost
Bucket excavation force, kgf (lbs)	24,881 (76,889)	22,638 (49,908)
*Bucket excavation force, kgf (lbs)	29,531 (65,105)	26,900 (59,304)
Arm excavation force, kgf (lbs)	18,457 (40,691)	16,825 (37,093)
*Arm excavation force, kgf (lbs)	24,575 (54,179)	22,485 (49,571)

\*Mass Excavator

## SUPPLY CAPACITIES liters (gallons)

Fuel tank	580 (153)
Hydraulic oil reservoir	280 (74)
Hydraulic system, including the oil reservoir	353 (93)
Cooling system	31 (8.2)
Engine Oil	28.5 (7.5)

## ROTATION

rotation speed	rpm	10	
Rear turn radius	m (ft/in.)	3.50	(11'6")
Turn torque	kN/m (lb/ft)	120	(88,507)

Road speed	5.6/3.3 km/h (3.5/2.1 mph)
rotation speed	10.0 rpm
Leveling capacity	35 degrees (70%)
Tow bar boost force	32,834 kgf (72,387 lb)

## SUMMARY OF SPECIFICATIONS

GENERAL		
Operational weight	kg (lb)	37,260 (82,144)
Bucket capacity	m <sup>3</sup> (yd <sup>3</sup> )	2.3 to 2.7 (3.0 to 3.6)
ENGINE		
Brand and Model	HINO	JO8E-TM
Cylinder	l (in.3)	7.684 (469)
Diameter and travel	mm (in.)	112 x 130 (4.41"x5.12")
SAE NETA Power	hp/rpm (kW/rpm)	264@2,100 (197@2,100)

HYDRAULIC SYSTEM			
Hydraulic pump	No. and type	2VP+1FG	
Nominal oil flow	L/m (gpm)	2x294	(2x77.6)
Operational pressure	Implement MPa (psi)	34.3	(4,970)
Displacement	MPa (psi)	34.3	(4,970)
Sway	MPa (psi)	29	(4,210)
Heavy lifting	MPa (psi)	37.8	(5,470)

## TRANSPORT DIMENSIONS

Height	m (ft/in.)	3.42	(11'3")
Width of the standard shoe	m (ft/in.)	3.40	(11'2")
Width	m (ft/in.)	11.20	(36'9")

# E385C

## DIMENSIONS

### Diagram of lifting capacity

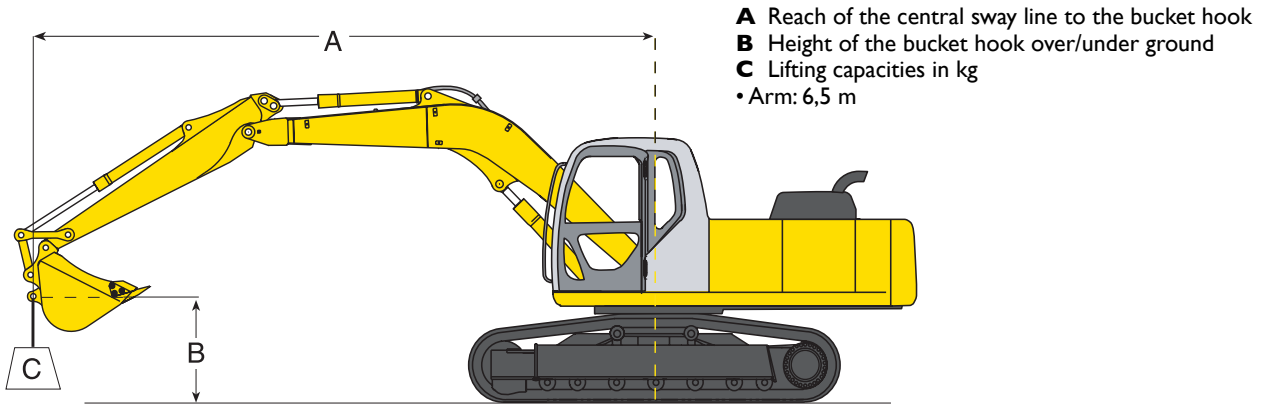















## Lifting capacity

800 mm (31.5") shoe - Based on a machine equipped with — Arm: 3,300 mm (10'10") – Bucket: HD 2.7 m<sup>3</sup> - Weight: 2,225 kg

B	A	RADIUS AT THE LIFING POINT												AT MAXIMUM REACH		
		1.5 m (5')		3.0 m (10')		4.6 m (15')		6.1 m (20')		7.6 m (25')		9.1 m (30')		RAIO		
C																RAIO
7.6 m	kg									*4,545	*4,545			*3,005	*3,005	7.97 m
6.1 m	kg									*5,485	*5,485			*2,935	*2,935	8.84 m
4.6 m	kg							*7,045	*7,045	*6,055	5,765	*4,585	3,835	*3,035	*3,035	9.39 m
3.0 m	kg			*14,915	*14,915	*11,835	*11,835	*8,505	8,215	*6,835	5,415	*5,875	3,665	*3,285	3,195	9.67 m
1.5 m	kg			*7,305	*7,305	*14,365	11,855	*9,885	7,595	*7,605	5,075	*6,265	3,485	*3,735	3,045	9.70 m
Leveled	kg			*70,715	*10,715	*15,625	11,195	*10,815	7,155	*8,165	4,815	6,135	3,340	*4,465	3,095	9.49 m
-1.5 m	kg	*10,915	*10,915	*15,705	*15,705	*15,685	10,985	*11,105	6,945	*8,345	4,675			*5,695	3,385	9.01 m
-3.0 m	kg	*15,895	*15,895	*21,535	*21,535	*14,735	11,045	*10,635	6,925	*7,885	4,675			*6,925	4,075	8.23 m
-4.6 m	kg	*21,545	*21,545	*17,825	*17,825	*12,575	11,335	*9,075	7,125					*7,235	5,595	7.03 m
-6.1 m	kg					*8,236	*8,235							*7,045	*7,045	5.14 m

## Lifting capacity

600 mm (23.6") shoe - Based on a machine equipped with — Arm: 3,300 mm (10'10") – Bucket: HD 2.7 m <sup>3</sup> - Weight: 2,225 kg																
B	A	RADIUS AT THE LIFING POINT												AT MAXIMUM REACH		
		1.5 m (5')		3.0 m (10')		4.6 m (15')		6.1 m (20')		7.6 m (25')		9.1 m (30')				
	C															RAIO
7.6 m	kg									*4,545	*4,545			*3,005	*3,005	7.97 m
6.1 m	kg									*5,485	*5,485			*2,935	*2,935	8.84 m
4.6 m	kg							*7,045	*7,045	*6,055	5,565	*4,585	3,675	*3,035	*3,035	9.39 m
3.0 m	kg			*14,915	*14,915	*11,835	*11,835	*8,505	7,955	*6,835	5,215	*5,875	3,505	*3,285	3,045	9.67 m
1.5 m	kg			*7,305	*7,305	*14,365	11,855	*9,885	7,325	*7,605	4,875	6,035	3,325	*3,735	2,895	9.70 m
Level	kg			*10,715	*10,715	*15,625	11,195	*10,815	6,895	*8,165	4,415	5,885	3,185	*4,465	2,935	9.49 m
-1.5 m	kg	*10,915	*10,915	*15,705	*15,705	*15,685	10,985	*11,105	6,675	8,045	4,475			*5,695	3,225	9.01 m
-3.0 m	kg	*15,895	*15,895	*21,535	*21,535	*14,735	11,045	*10,635	6,665	*7,885	4,475			*6,925	3,895	8.23 m
-4.6 m	kg	*21,545	*21,545	*17,825	*17,825	*12,575	11,355	*9,075	6,865					*7,235	5,375	7.03 m
-6.1 m	kg					*8,235	*8,235							*7,045	*7,045	5.14 m



Rating on the front



Rating on the side /360 degrees

### Notes:

1. Do not raise or suspend any load that exceeds these rated values for the specified load radius and height. The weight of all of the accessories should be deducted from the previously mentioned lifting capacities.
2. The lifting capacity assumes that the machine is on level, firm and uniform land. The operator should take into account the work conditions, such as fragile or irregular ground, unlevelled conditions, lateral loads, abrupt load stops, dangerous conditions, inexperienced workers, the weight of other buckets, lifting slings, accessories, etc.
3. Ratings on the bucket lifting hook.
4. The rated loads mentioned above are in accordance with the SAE Standard Hydraulic Lifting Capacity for the J 1097 Excavator. Do not exceed 87% of the hydraulic lifting capacity or 75% of the load inclination. The rated loads marked with an asterisk (\*) are more limited by the hydraulic capacity than by the load inclination.
5. The operator should have broad knowledge of the Operation and Maintenance Manuals before operating this machine. The rules for safe operation must be followed at all times.
6. The capacities apply only to the machine as it was originally manufactured and standardly equipped by CNH America LLC.

# E385C

## DIMENSIONS

### Diagram of lifting capacity

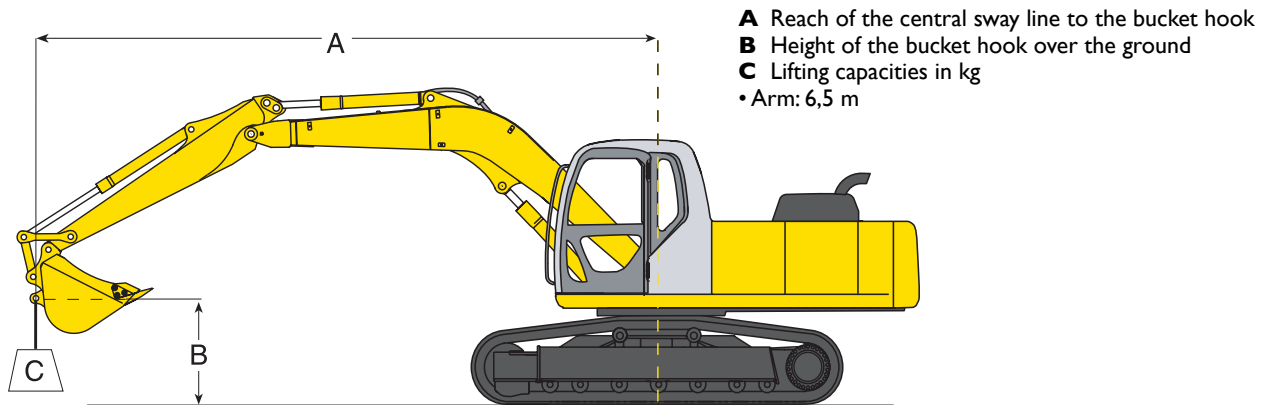













## Lifting capacity

800 mm (31.5") shoe - Based on a machine equipped with — Arm: 4,150 mm (13'7") - Bucket? HD 2.3 m<sup>3</sup> - Weight: 1,864 kg

B	A	RADIUS AT THE LIFING POINT												AT MAXIMUM REACH		
		1.5 m (5")		3.0 m (10")		4.6 m (15")		6.1 m (20")		7.6 m (25")		9.1 m (30")		RAIO		
	kg	kg	kg	kg	kg	kg	kg	kg	kg	kg	kg	kg	kg		kg	
7.6 m	kg													*2,466	*2,446	8.78 m
6.1 m	kg											*3,986	*3,986	*2,416	*2,416	9.58 m
4.6 m	kg									*5,596	*5,596	*5,196	5,196	*2,476	*2,476	10.09 m
3.0 m	kg			*16,606	*16,606	*10,246	*10,246	*7,796	*7,796	*6,446	5,896	*5,646	4,086	*2,666	*2,666	10.35 m
1.5 m	kg			*13,866	*13,866	*13,276	12,986	*9,346	8,106	*7,336	6,126	*6,146	3,856	*2,966	2,916	10.38 m
Level	kg	6,106	6,106	*12,586	*12,586	*15,186	12,026	*10,556	7,546	*8,066	5,156	6,456	3,656	*3,516	2,926	10.18 m
-1.5 m	kg	*9,896	*9,896	*15,356	*15,356	*15,886	1,586	*11,196	7,206	*8,486	4,936	6,326	3,536	*4,356	3,126	9.74 m
-3.0 m	kg	*13,816	*13,816	*19,636	*19,636	*15,546	11,496	*11,156	7,086	*8,416	4,856			*5,846	3,616	9.02 m
-4.6 m	kg	*18,186	*18,186	*20,276	*20,276	*14,116	11,666	*10,256	7,176	*7,526	4,946			*6,966	4,616	7.94 m
-6.1 m	kg			*15,896	*15,896	*11,126	*11,126	*7,836	7,516					*7,356	7,066	6.33 m



## Lifting capacity

600 mm (23.6") shoe - Based on a machine equipped with — Arm: 4,150 mm (13'7") – Bucket: HD 2.1 m <sup>3</sup> - Weight: 1,864 kg																
B	A	RADIUS AT THE LIFING POINT												AT MAXIMUM REACH		
		1.5 m (5')		3.0 m (10')		4.6 m (15')		6.1 m (20')		7.6 m (25')		9.1 m (30')		RAIO		
																
7.6 m	kg													*2,466	*2,466	3.78 m
6.1 m	kg											*3,986	*3,986	*2,416	*2,416	9.58 m
4.6 m	kg									*5,596	*5,596	*5,196	4,136	*2,476	*2,476	10.09 m
3.0 m	kg			*16,606	*16,606	*10,246	*10,246	*7,796	*7,796	*6,446	5,696	*5,646	3,926	*2,666	*2,666	10.35 m
1.5 m	kg			*13,866	*13,866	*13,276	12,596	*9,346	7,846	*7,336	5,296	*6,416	3,696	*2,966	2,766	10.38 m
Leveled	kg	*6,106	*6,106	*12,586	*12,586	*15,186	11,636	*10,556	7,276	*8,066	4,956	6,206	3,496	*3,516	2,786	10.18 m
-1.5 m	kg	*9,896	*9,896	*15,356	*15,356	*15,886	11,196	*11,196	6,946	8,316	4,736	6,066	3,376	*4,356	2,976	9.74 m
-3.0 m	kg	*13,816	*13,816	*19,636	*19,636	*15,546	11,106	11,156	6,826	8,226	4,656			*5,846	3,456	9.02 m
-4.6 m	kg	*18,096	*18,096	*20,726	*20,726	*14,116	11,276	*10,246	6,906	*7,526	4,746			*6,996	4,426	7.94 m
-6.1 m	kg			*15,896	*15,896	*11,126	*11,126	*7,836	7,246					*7,356	6,816	6.33 m



Rating on the front



Rating on the side /360 degrees

### Notes:

- Do not raise or suspend any load that exceeds these rated values for the specified load radius and height. The weight of all of the accessories should be deducted from the previously mentioned lifting capacities.
- The lifting capacity assumes that the machine is on level, firm and uniform land. The operator should take into account the work conditions, such as fragile or irregular ground, unlevelled conditions, lateral loads, abrupt load stops, dangerous conditions, inexperienced workers, the weight of other buckets, lifting slings, accessories, etc.
- Ratings on the bucket lifting hook.
- The rated loads mentioned above are in accordance with the SAE Standard Hydraulic Lifting Capacity for the J 1097 Excavator. Do not exceed 87% of the hydraulic lifting capacity or 75% of the load inclination. The rated loads marked with an asterisk (\*) are more limited by the hydraulic capacity than the load inclination.
- The operator should have broad knowledge of the Operation and Maintenance Manuals before operating this machine. The rules for safe operation should be followed at all times.
- The capacities apply only to the machine as it was originally manufactured and standardly equipped by CNH America LLC.

# E385C

## DIMENSIONS

### Diagram of lifting capacity

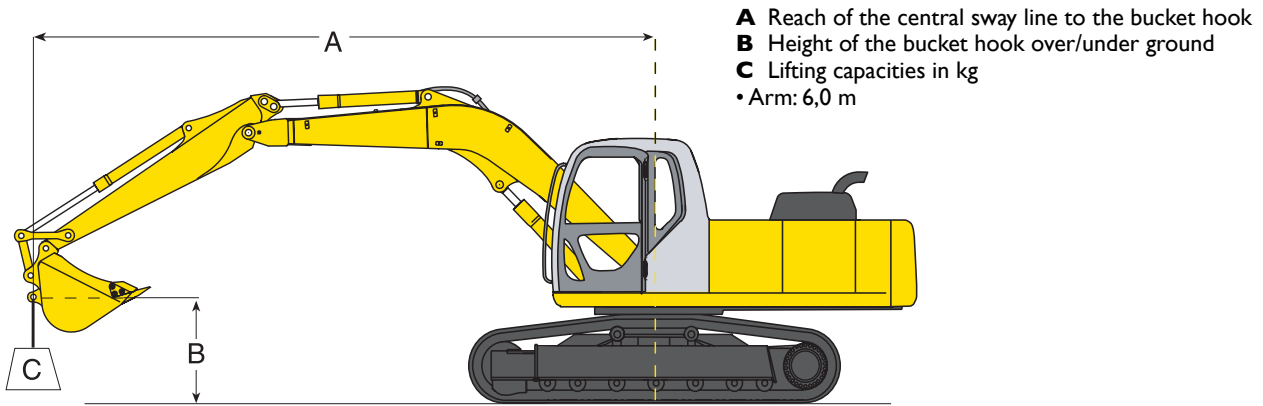













## Lifting capacity

800 mm (31.5") shoe - Based on a machine equipped with — Arm: 2,200 mm (7'26") - Bucket: HD 2.7 m<sup>3</sup> - Weight: 2,750 kg

B	A	RADIUS AT THE LIFING POINT										
		1.5 m (5')		3.0 m (10')		4.6 m (15')		6.1 m (20')		7.6 m (25')		Reach
		Upright	Horizontal	Upright	Horizontal	Upright	Horizontal	Upright	Horizontal	Upright	Horizontal	
7.6 m	kg							7,006	7,006			
6.1 m	kg							7,097	7,097			
4.6 m	kg					10,271	10,271	8,055	8,055	7,013	5,290	
3.0 m	kg					13,344	12,835	9,463	7,809	7,610	5,072	
1.5 m	kg					15,419	12,036	10,627	7,391	8,174	4,865	
Level	kg					16,028	11,704	11,230	7,135	8,426	4,730	
1.5 m	kg			17,064	17,094	15,414	11,679	11,023	7,066			
-3.0 m	kg			19,299	19,299	13,526	11,879	9,562	7,203			
-4.6 m	kg					8,792	8,792					

## Lifting capacity

600 mm (23.6") shoe - Based on a machine equipped with — Arm: 2,200 mm (7'26") – Bucket: HD 2.7 m3 - Weight: 2,750 kg												
B	A	RADIUS AT THE LIFING POINT										
		1.5 m (5')		3.0 m (10')		4.6 m (15')		6.1 m (20')		7.6 m (25')		Reach
												
7.6 m	kg							7,006	7,006			
6.1 m	kg							7,097	7,097			
4.6 m	kg					10,271	10,271	8,055	8,055	7,013	5,151	
3.0 m	kg					13,344	12,565	9,463	7,625	7,610	4,933	
1.5 m	kg					15,419	11,766	10,627	7,207	8,174	4,75	
Level	kg					16,028	11,434	11,230	6,951	8,222	4,591	
1.5 m	kg			17,064	17,094	15,414	11,409	11,023	6,882	7,917	4,593	
-3.0 m	kg			19,299	19,299	13,526	11,609	9,562	7,019			
-4.6 m	kg					8,792	8,792					



Rating on the front



Rating on the side /360 degrees

### Notes:

1. Do not raise or suspend any load that exceeds these rated values for the specified load radius and height. The weight of all of the accessories should be deducted from the previously mentioned lifting capacities.
2. The lifting capacity assumes that the machine is on level, firm and uniform land. The operator should take into account the work conditions, such as fragile or irregular ground, unlevelled conditions, lateral loads, abrupt load stops, dangerous conditions, inexperienced workers, the weight of other buckets, lifting slings, accessories, etc.
3. Ratings on the bucket lifting hook.
4. The rated loads mentioned above are in accordance with the SAE Standard Hydraulic Lifting Capacity for the J 1097 Excavator. Do not exceed 87% of the hydraulic lifting capacity or 75% or the load inclination. The rated loads marked with an asterisk (\*) are more limited by the hydraulic capacity than the load inclination.
5. The operator should have broad knowledge of the Operation and Maintenance Manuals before operating this machine. The rules for safe operation should be followed at all times.
6. The capacities apply only to the machine as it was originally manufactured and standardly equipped by CNH America LLC.

# E385C

## STANDARD EQUIPMENT

- Tier 3 Engine with 6 - 7.7 liter cylinders
- HAOA (Hydrotronic Active Operation Aid)
- CPB (Continuous Power Boost)
- Automatic low gear device
- Displacement at two speeds with an automatic gear reduction device.
- Tool box
- Lubrication of the centralized bar
- Slewing ring with a grease bath
- Rear view mirror
- Two lights on the lifting bar
- Transparent cab roof and windshield opening
- Mechanical seat suspension
- Adjustable arm supports
- New generation AEP (Advanced Electronic Processor)
- Multifunction control, mode and implements, selection, cooling temperature, fuel tank and fuel economy monitor. Menu functions for savings graphs, maintenance programs and system status. Automatic low gear mode selector.
- Air conditioning
- Radio, USB and Bluetooth with speakers
- Pressure drain valve
- Horn

## OPCIONAL EQUIPMENT

- Anti-theft device
- Gyroflex
- Additional cabin lights and rain protection
- Cab frontal protection
- Lower chassis cover
- Additional front and rear tread guide
- Object handling kit
- Customized color
- Upholstered mechanical seat
- Hammer and crusher circuit with pedal control
- HPC (Hydraulic proportional controls) for the hammer and crusher circuit
- Extra HPC (Hydraulic proportional controls) for the hammer and crusher circuit
- Single piece bar, triple articulation (two-part bar) or ME arm for Mass Excavation
- ME Arm: 2,400 mm XD
- Standard arm: 3.300 mm
- Shoes: EL/BEH: 600 - 700 - 800 mm  
LC: 600 - 700 - 800 - 900 mm

Note: the standard and optional equipment may vary by country. Consult your New Holland dealership for more details.



# FLEETFORCE™

## YOU IN CONTROL OF YOUR FLEET.



FleetForce is the New Holland telemetry system that collects information about the machine's performance and its location, made available in an easy to use format. With support from your dealership's specialist, you will have more efficiency, lower operational costs and greater profitability.

**FleetForce can be used on any New Holland machine or those from other brands, on service vehicles or any other vehicle in your fleet.**



## YOUR ON-LINE FLEET MANAGEMENT.

### MAXIMIZING THE PRODUCTIVITY OF YOUR FLEET

Provides performance and vital information about your machine. With it you can:

- Identify the machines that are not being used and those that are being used a lot.
- Compare the performance or fuel consumption tendencies throughout the workdays.
- Evaluate the notifications from the machine to optimize the use of your equipment.
- Configure the system to receive the operating records from the machine, scheduled maintenance alerts and safety alerts by e-mail.

### EFFECTIVE PLANNING

- Control of the fleet through the machine's performance trends and the operator's efficiency trends.
- Pre-programmed to monitor up to 40 parameters - some of which can be personalized -, FleetForce can be configured to supply a simpler or more complete analysis, according to your needs.

### GREATER PROFITABILITY

- Your dealer should help you increase the productivity of your fleet, analyzing the information about the machine, namely data referring to the idle time, machines that need maintenance and parts, that is, everything to maximize the efficiency of the service.

PLAN FEATURES	BASIC	ADVANCED	SATELLITE
<b>FLEET MANAGEMENT</b>			
Locate and conduct a "ping" (test) of the machines for project management.			
Report of machine hours.			
<b>PLANNED MAINTENANCE</b>			
Plan and prepare the maintenance intervals.			
<b>SAFETY</b>			
Electronic geographical fence (GeoFence): notifications about unplanned movements in real time.			
Curfew.			
<b>USAGE REPORT AND ANALYSIS</b>			
Reports about idle time, running engines, displacement time and machine use.			
<b>PERFORMANCE ANALYSIS</b>			
Load data about the engine to compare machines and operations to identify operational tendencies.			
<b>FUEL INFORMATION AND REPORTS</b>			
Data on consumption to track the use of the machine or the entire fleet.			
<b>MECHANICAL OPERATING PARAMETERS</b>			
Monitor the operational characteristics of the machine: temperature, pressure, alerts about out of bounds parameters and CAN-bus parameters for problem diagnosis and solutions.			

### SUBSCRIPTION PACKAGE

Three subscription packages are available, which depend on the level of details in the information:

- The Basic subscription uses the essential entries from the ignition key contact, movement detection and GPS tracking to guarantee an array of information and reports.
- The Advanced subscription adds personalized data controls and exclusive information not found in the other telemetry systems, through our CAN-bus data.
- The satellite connection subscription can be added to the Basic and/or Advanced subscription. Data updates for your equipment through a satellite connection can be made every 4 hours and complete reports, every 24 hours. The basic and Advanced packages offer a subscription for up to five years and a satellite connection subscription of one or two years. And you can purchase extensions for everything at your dealership through their Parts Department.

Find out more at your dealership.

[supportfleetforce@newholland.com](mailto:supportfleetforce@newholland.com)

[www.newholland.com](http://www.newholland.com)



## NEW HOLLAND AFTER-SALES AUTHORIZED NETWORK. HIGH PERFORMANCE AND PRODUCTIVITY GUARANTY.

The New Holland Authorized Network offers specialized services by professionals who are rigorously trained by the factory and genuine parts with a guarantee of quality and origin, in addition to full support in the purchase of your equipment and ease in financing.

The New Holland After-Sales service is at your service to guide you and present the best options for contracting authorized services and acquiring parts. With it, you guarantee high performance and the best performance from your machine, with complete safety and better cost-benefit.

To have full access to the productivity and high technology that only New Holland offers, contact a New Holland After-Sales service provider from the Authorized Network.



AT YOUR DEALERSHIP:

The dimensions, weights and capacities shown in this booklet, as well as any conversion used, are always approximate and are subject to variations that are considered normal within the manufacturing tolerances. It is New Holland's policy to continually strive to improve its products, and the company reserves the right to change the specifications and materials, or to introduce improvements at any time, without prior notice or obligation of any kind. The illustrations do not necessarily show the product in its standard conditions.

NC-E45C-I01 - 12/2015

COMUNICAÇÕES AMÉRICA LATINA ©

**Factory:**

Contagem - Minas Gerais - Brazil  
Av. General David Sarnoff, 2.237  
Inconfidentes - ZIP 32210-900  
Phone: 31 2104-3111

**Sales Office:**

Nova Lima - Minas Gerais - Brazil  
Rua Senador Milton Campos, 175 / 4th floor  
Vila da Serra - ZIP 34000-000  
Telephones: (31) 2123-4902 / (31) 2123-4904



[www.newholland.com.br](http://www.newholland.com.br)

