

DESIGN AND PERFORMANCE OF SHATTERED PELLETT INJECTION SYSTEMS FOR JET AND KSTAR DISRUPTION MITIGATION RESEARCH IN SUPPORT OF ITER

L.R. BAYLOR¹, S.J. MEITNER¹, T.E. GEBHART¹, J.B.O. CAUGHMAN¹, D. SHIRAKI¹, J.R. WILSON², D. CRAVEN², M. FORTUNE², S. SILBURN², A. MUIR³, A. T. PEACOCK³, S.H. PARK⁴, K.P. KIM⁴, J. H. KIM⁴, K.S. LEE⁴, G. ELLWOOD⁵, S. JACHMICH⁵, U. KRUEZI⁵, M. LEHNEN⁵, and JET CONTRIBUTORS*

¹Oak Ridge National Laboratory, Oak Ridge, TN, USA

²Culham Centre for Fusion Energy, Abingdon, UK

³JET Exploitation Unit, Culham Science Centre, Abingdon, UK

⁴Korea Institute of Fusion Energy, Daejeon 34133, Republic of Korea

⁵ITER Organization, route de Vinon sur Verdon, 13067 St Paul Lez Durance, France

E-mail: BaylorLR@ornl.gov

Abstract

Shattered pellet injection (SPI) systems that form cryogenic pellets in a pipe-gun for injection of material to mitigate disruptions have been fabricated and installed for use in thermal mitigation and runaway electron dissipation experiments on JET and KSTAR. These systems are to support disruption mitigation research for ITER and are based on an ORNL 3-barrel design for flexibility in pellet size selection and variable pellet composition studies. The SPI systems for JET and KSTAR have a common feature of the barrels being collimated into a single injection line that enters the vacuum vessel. The pellets are shattered in bent stainless steel tubes that are mounted inside the vacuum vessel of the tokamak, vertically on JET and horizontally on KSTAR. The JET installation has the unique feature of vertical SPI mounting and injection with the shatter plume aimed toward the inner wall to intercept known runaway electron (RE) beam locations generated from argon gas injection induced disruptions. The KSTAR SPI installation has two identical SPIs that are mounted on the midplane 180 degrees apart with identical injection lines and shatter tubes aimed at the plasma magnetic axis. Installation and operation of these SPI systems has provided useful lessons learned in the implementation of this SPI technology and valuable experience in optimizing the formation and firing of the pellets to optimize the physics performance.

1. INTRODUCTION

The disruption mitigation system for ITER is being designed based on the shattered pellet injection technology [1] and experiments are being carried out on many tokamaks to understand the mitigation physics and to optimize the technology. To support ITER in this effort, SPI systems have now been deployed on JET and KSTAR for thermal and current quench mitigation studies and for suppression and dissipation research on runaway electrons. These systems have a common feature of 3 different size pellets that are formed in-situ and with the barrels collimated into a single injection line that enters the vacuum vessel [2]. The pellets are fired by high pressure gas or a gas operated mechanical punch and are shattered in stainless steel tubes with a final 20-degree bend that are mounted inside the vacuum vessel of the tokamak, vertically on JET and horizontally on KSTAR. The three barrels can be fired independently and simultaneously if desired. Since they share a common coldzone they must all be fired at the same temperature.

The fragmentation shatter tubes for the SPIs have been characterized in the laboratory before deployment [3] and verified to achieve the directivity and spread desired for the specific device. The pellet mass and speed leaving the barrels are measured with a microwave cavity diagnostic before shattering, and this data coupled with fast camera views of the SPI fragments entering the plasma and plasma diagnostic data on radiation and density enable detailed studies of the disruption mitigation effectiveness [4,5]. In this paper we describe the unique features of the designs for both systems and how they were installed and operational experience. Performance of the systems are described, and the shattered fragmentation of the pellets observed in the plasma are compared with the laboratory fragmentation studies.

2. DESIGN OF SHATTERED PELLETT INJECTORS

Both SPI systems on JET and KSTAR are 3-barrel SPIs based on the design that was previously installed on DIII-D [2] that was based on a multi-barrel design originally conceived for ITER to have multiple injectors occupy as little space as possible in the port cells. These designs use angled barrel geometry such that they point to a common injection line and use a collector funnel to force the pellet into a trajectory to enter a single shared injection line. The funnel has a 2-degree conical half angle, and the barrels enter the funnel at 2 degrees

giving a 2-degree impact angle on the collector funnel exit for pellets that exit the barrel with no dispersion. This design was chosen to keep the pellets from having a normal impact velocity in excess of 20 m/s [2].

The JET SPI design had a size constraint to fit in between a diagnostic shield block and the limb structure on top of the machine. The design also had to comply with an all-metal seal configuration to meet the requirements for a possible trace tritium exposure that could be possible in the JET DT environment. This required the use of metal seals on the guard vacuum chamber instead of o-ring seals and the barrel seals at the exit of the guard vacuum had to be changed to a conflat connection that required the use of bellows to make the system possible to assemble and disassemble. This led to the utilization of a DN160 conflat cross for the guard vacuum chamber, which made it difficult to fit the internals in the chamber and have room to install instrumentation and multi-layer insulation. The cryostat for the barrels in this design shown in Fig. 1 is cooled with cold helium gas. The two largest JET SPI barrels can optionally be operated with a gas operated mechanical punch [1] for release of pure neon and argon pellets.

The KSTAR SPI design is very similar to the 3-barrel DIII-D SPI2 [2] and JET SPIs except that it uses a Gifford-McMahon (GM) cryocooler to cool the cryostat instead of LHe used at DIII-D or cold helium gas as at JET. It uses a DN200 conflat cross as the guard vacuum chamber which gives more room for the internals as shown in Fig.1. The cryocooler used is a Sumitomo RDK-415D that provides approximately 10 W of cooling at 8 K, the nominal operating temperature for forming pellets. The KSTAR SPI uses o-ring seals on the barrels and cryocooler connection. The cryostat is bolted to the cryocooler cold head mounted on the top of the chamber and does not use a thermal shield around the cryostat as the radiation heat load is estimated to be less than 2 W and compared to the conduction heat load from the breech and barrel is not that significant. The minimum temperature achieved with the cryocooler in this configuration is about 8 K.

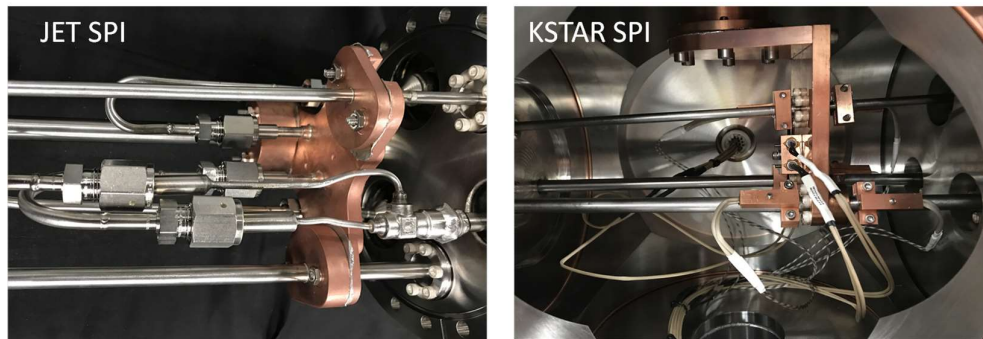

FIG. 1. JET SPI internal configuration on the left and KSTAR SPI on the right. Key differences are the helium cooling for the JET design and a cryocooler connection on top for the KSTAR design.

The barrel sizes and coldzone barrel interface define the size of pellets that are formed. Table 1 shows the initial sizes used on both SPI systems for experiments and how much material of deuterium or neon a full-size pellet contains. Mixtures of these gases are possible, and argon has also been used in the JET SPI for runaway electron dissipation studies.

TABLE 1 PELLET CYLINDRICAL SIZES AND QUANTITIES OF D₂ AND NEON FULL SIZE PELLETS IN NUMBER OF ATOMS AND BAR-L GAS EQUIVALENT.

| Device | Diameter (mm) | Len/Diam | Natoms (bar-L) D ₂ | Natoms (bar-L) Ne |
|--------|---------------|----------|-------------------------------|-------------------|
| JET | 4.5 | 1.4 | 6.3E+21 (0.10) | 4.5E+21 (0.14) |
| | 8.1 | 1.6 | 4E+22 (0.71) | 2.9E+22 (1.01) |
| | 12.5 | 1.5 | 1.4E+23 (2.15) | 1E+23 (3.78) |
| KSTAR | 4.5 | 1.5 | 6.5E+21 (0.11) | 4.6E+21 (0.16) |
| | 7 | 1.5 | 2.4E+22 (0.44) | 1.7E+22 (0.63) |
| | 8.5 | 1.5 | 4.4E+22 (0.81) | 3.1E+22 (1.15) |

For all the ORNL SPI systems put in service thus far, temperature control is achieved by using Lakeshore temperature sensors, Cernox (JET) or silicon diodes (KSTAR and DIII-D), and resistive heaters mounted on the cryostat and on the barrels. The measured temperature is monitored by a programmable logic controller that uses a proportional integral derivative (PID) algorithm to control the power to the heaters for maintaining a constant temperature. During pellet formation the temperature is allowed to go as low as possible with the cooling used. When preparing the pellet to fire, the temperature is typically raised to 12.5 K where reliable pellet release from the high-pressure gas is achieved with a 2 ms long propellant valve opening. Operating propellant gas pressures are in to 50-60 bar range. The pressure does not have a strong impact on the pellet velocity as the minimum pressure needed to break the pellet away at 12.5 K is already high enough to achieve nearly the highest possible speeds. No attempt was made to achieve lower pellet speeds with gas only that are possible with careful tuning of the propellant valve parameters as was done on the DIII-D SPI2 to minimize gas from entering the plasma.

A microwave cavity diagnostic [6] as shown in Fig. 2 is built into the injection lines on both the JET and KSTAR SPI systems. It is also used as an injection line gap for trapping propellant gas on both systems. It has a 10 cm gap with a slight funnel on the downstream side to capture pellets that may have up to 2° of dispersion when existing the upstream guide tube. Perforated screens are welded into the cavity conflat cross to screen in the microwaves in the resonant part of the cavity while allowing gas to flow into the downstream pumping chambers. A dedicated shielded electronics box is used to hold the microwave source, detector, and amplifier to condition the signal for recording by a digitizer. The signal from this diagnostic provides a relative mass measurement and indication whether the pellet is intact when leaving the injector. This is used to determine the pellet speed by computing the time of flight it takes for to the pellet to enter the plasma after passing through the cavity.



FIG. 2. The microwave cavity implemented for both JET and KSTAR SPI system with perforated screens to enable efficient pumping while screening out the microwaves.

3. INSTALLATION AND OPERATION

The JET SPI is mounted vertically from the top of the machine and fits between a diagnostic shield block and iron limb as shown in Fig. 3. The cryogenic system, vacuum ballast tank, gas manifold and electrical junction box are mounted on top of the limb [7]. The cold helium gas cooling for the SPI is provided by forcing gas through a liquid helium filled dewar to cool the gas to ~5 K. The helium exhaust is returned to the JET cryoplant for reuse in making liquid helium.

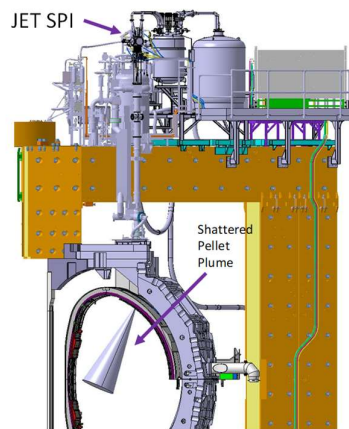

FIG. 3. JET SPI installation on Octant 1 showing vertical installation with pumping and cryogenic system infrastructure on top of JET.

The JET SPI has a reentrant shatter tube design that fits inside a 40 mm guiding tube in the port that is 1.6 meters long. Consequently the shatter tube had to be designed to provide the final shattering bend in a very constrained geometry. The resulting design is shown Fig. 4 that has a modest 'S' bend before the final ~20-degree bend at the exit of the tube. The tube exit is also flattened in order to fit within the 40 mm reentrant port guide. A 2-degree taper funnel that is 15 cm long is at the entrance of the shatter tube to capture pellets with up to 2° dispersion after jumping the torus interface valve (TIV) gap and guides them into the 21 mm inner diameter of the shatter tube. This final bend is directed toward the inner wall as shown in Fig. 3. Tests of this design were made in the ORNL pellet lab [3] and found to produce a shattered spray within a 15-degree half angle cone that is shown in the CAD model of the installation in Fig. 3.

Both of these SPI systems have multiple gaps in the injection line between the SPI and torus in order to pump away the propellant gas before it can reach the plasma in front of the pellet. Since the gas sound speed exceeds that of the pellets it is possible for the gas to reach the plasma before the pellet. This was observed to occur on

the DIII-D SPI2 system [8] from fast camera video of the shattered material entering the plasma. The thermal collapse of the plasma was found to begin when this gas reached the plasma and resulted in less effective radiation levels and density assimilation from the subsequent pellet fragments entering the plasma after a partial plasma thermal collapse had already occurred.

The JET SPI injection line and pumping system has three gaps for removing the propellant gas. The first stage gap just at the barrel exit is 6 cm with another larger second stage 9.5 cm gap just downstream through the microwave cavity. Then finally there is 10.5 cm third stage gap just before the torus interface valve. The first stage has a 59 L volume and high conductance pipe work to a 1000 L buffer tank. The second stage has 36 L of volume also connection to the main buffer tank. The third stage has 90 L of volume that is pumped by a turbopump. The total injection line length is ~ 6 m and has an inner diameter of 19 mm.

The JET SPI pumping system [7] was tested by shooting gas only shots into the torus. The resulting torus pressure increase from the gas flowing into the torus from a 2 ms valve pulse was measured while the torus pumps were closed off, thus an accurate inventory of gas introduced into the torus was obtained. For the largest barrel, 12.5 mm, 2.3 mbar-L was measured to enter the JET torus and the amount of gas leaving the propellant valve was measured to be 600 mbar-L, thus the percentage of the fired propellant gas that entered the torus was less than 0.4%. The other smaller barrels showed even lower amounts of gas entering the torus. With a pellet in the barrel, more of the gas pushing the pellet will be directed sideways in the injection line gaps and thus lower amounts of gas are expected to enter the torus in actual pellet injections.

The JET SPI non-argon pellets are formed at ~ 6 K cryostat temperature and are warmed up by heaters to fire at 12.5 K after being held at that temperature for typically 60 sec before firing. An automation pellet formation routine was generated in the PLC logic to simplify operation and maintain consistency. No operational differences were found between automatically formed pellet and those formed by manually controlling the gas flow. Warmup of the barrel coldzones is routinely done after firing a pellet to remove any remaining solid in the barrel. This is achieved on JET by stopping the cold helium flow and using the cartridge heaters on the cryostat of the injector under PLC control. The cryostat rapidly warms to ~ 30 K in less than 1 minute. Cooling back down after the warmup to be able to form another pellet takes less than 5 minutes. Operation with argon pellets uses much less helium flow to achieve the formation temperatures of ~ 50 K and firing temperatures of 68 K. Depending on the size of the pellet the cycle time is typically between 30 and 40 minutes. Pellets held cold for less than 5 minutes after formation were more likely to fracture leaving the barrel. Pellets not fired immediately were held for a maximum of 3 hrs [9].

The KSTAR SPI installation described in Ref. [10] and shown in Fig. 5 has two identical SPIs that are mounted on the midplane with identical shatter tubes inside the vessel aimed to the plasma magnetic axis after traversing a 20-degree shatter tube. Unlike the JET SPI that uses cold helium gas, these SPIs are cooled with a cryocooler that provides enough cooling to achieve 8 K pellet formation temperatures. Cooldown takes under 2 hours to be at pellet formation conditions, and it takes 5-15 minutes for the formation depending on the pellet size. The pumping system and infrastructure were all provided by KFE [10] and became operational in Nov. 2019.

The KSTAR SPIs were installed at midplane ports O and G that are 180 degrees apart from each other. Since both ports are in use by diagnostic and heating systems, the SPIs had to be installed over 10 m away from the ports with the guide tubes routed underneath these existing systems. The injection lines as well as the SPIs are identical on both KSTAR systems.

The KSTAR system injection line uses the same basic design as the DIII-D SPI2 with different pumps and connecting piping. The KSTAR injection line consists of two 10 cm pumping gaps for preventing the propellant gas from reaching the plasma in front of the pellets. Both of these gaps have a 28 L high conductance volume connected to the DN100 conflat cubes where the gaps are located. The injection line diameters are 12 mm up to

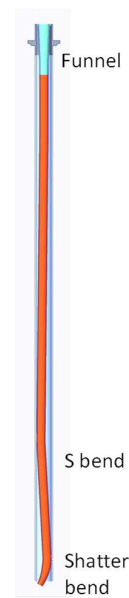

FIG. 4 JET SPI shatter tube with entrance funnel at the top and S bend and final sharp bend at the exit at the bottom.

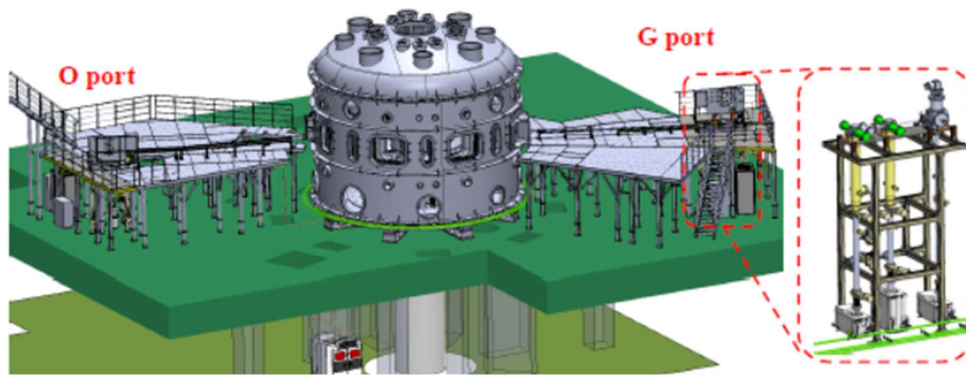

FIG. 5. KSTAR Dual SPI installation on O and G midplane ports that are on opposite sides of the machine.

27.5 mm for the final long line that connects to a torus interface gate valve before reaching the shatter tube that is inside the vacuum vessel. The pumping system that connects to the injection line was designed and installed by KFE using dry screw pumps and turbo pumps. The overall injection line is 10.4 m from the microwave cavity to the end of the shatter tube.

The shatter tube used on both SPIs shown in Fig. 5 is a 20-degree bent tube with a 32 mm inner diameter and does not require a funnel at the entrance since the diameter is larger than before the torus interface gate valve jump. This is quite similar to the DIII-D SPI shatter tube with a longer straight section after the bend in order to avoid fragments hitting the in vessel passive stabilizer. The shatter tubes fit inside the vessel and were fabricated into two pieces, a straight section that is installed from the outside port flange and the bent section installed from inside the vessel. The two sections are connected with a conflat flange interface welded to both sections. The KSTAR shatter tubes are aimed above the lower passive stabilizer toward the plasma axis [10]. The injection line and shatter tubes were all designed and supplied by ORNL with the installation performed by KFE.

The injection line and pumping system performance at removing the gas was tested after the installation. One of the 8.5 mm barrels on an SPI was fired without a pellet and the torus pressure was measured to reach 1×10^{-3} mbar indicating the about 3 mbar-L of gas reached the torus. For the valve settings used we estimate 600 mbar-L of gas was delivered based on the JET SPI valve measurements. This indicates that only 0.6% of the gas reached the torus. The pumps were active during this test and so the amount of gas is going in the torus is slightly higher than this estimate. However, when a pellet is fired it blocks most of the gas from reaching the final guide tube and therefore, we expect even lower amounts of gas reaching the plasma than measured here.

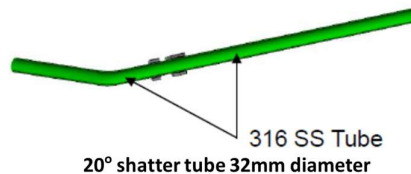

FIG. 5 KSTAR Dual SPI installation on O and G midplane ports that are on opposite sides of the machine. The pumping stand is mounted under the injector platform.

Cooldown time for the KSTAR SPIs using the cryocoolers typically takes less than 1.5 hours. Once they reach below 50 K the temperature rapidly decreases to the minimum value of ~ 8 K. Warmup of the cryostat and barrel coldzones is routinely done after firing a pellet to remove any remaining solid in the barrel. This is achieved by using the two cartridge heaters providing up to 40 W on the cryostat of the injector under PLC control and it rapidly warms to ~ 30 K in less than 1 minute. Cooling back down from the warmup to be able to form another pellet takes less than 5 minutes. Oscillations of the cryostat temperature due to the coldhead operation are found to be ± 0.4 K. This level of oscillation does not adversely impact the SPI pellet formation or firing performance at all. The cryocooler is far enough away from the KSTAR machine (> 10 m) that the magnetic field or radiation does not affect the cryocooler cold head operation.

The SPIs on both JET and KSTAR utilize custom fast acting solenoid valves developed at ORNL [11] for pellet applications. These valves open in less than 1 ms when actuated by a 180V FET switched power supply that provides a 30 A current pulse to the solenoid coil. The valves have an internal plenum volume of 5 cm^3 and an

external 75 cm³ close coupled volume to provide enough gas to accelerate the pellet and to close the valve when the current pulse ends. In all of the SPI experiments thus far the SPI propellant valves on both devices were operated with a 2 ms long current pulse with propellant gas pressures of 50-58 bar D₂ on JET and 50 bar He on KSTAR. The amount of gas released by the valves under these conditions is approximately 700 mbar-L. In both cases the vacuum systems were designed to easily handle this amount of gas and were effective at preventing it from reaching the plasma in front of the pellet, despite the much higher sound speed of the gas compared to the pellet speeds. No attempts have been made thus far in experiments in either JET or KSTAR to reduce the pellet speeds by reducing the amount of gas used to release the pellet. Slower pellet speeds are less likely to break on impact with the collector funnel and will result in larger fragment sizes and less gas formation in the shatter tube [12] and thus is a control knob for future exploration.

4. SPI PERFORMANCE AND RESULTS

The SPI systems on JET and KSTAR have both been used as have the previously installed systems on DIII-D to study the physics of the plasma shutdown and are not used as true disruption mitigation systems. JET does have a disruption mitigation system that is based on massive gas injection using large disruption mitigate valves (DMVs) with different gas mixtures [12]. These DMVs were disabled for the disruptions that were triggered by the injection of the SPI pellets. In most cases the shutdown experiments utilizing the SPI were performed with healthy steady state plasma conditions to have identical comparison conditions. In some cases, the plasmas were purposely forced into a locked mode state just before the SPI injection time to better simulate a real disrupting plasma that needs to be mitigated [4]. On JET vertical displacement events (VDEs) were triggered in some cases to demonstrate the utility of SPI in mitigating disruptions resulting from a VDE [4].

4.1 JET

The JET SPI has been used to inject 286 pellets from the various barrels with mostly mixtures of D₂ and neon and about 6% with pure argon. A subset of these has been analyzed for speeds from the time of flight between the microwave cavity and fast camera videos of fragments entering the plasma and is plotted in Fig. 7 as a function of the microwave cavity signal magnitude. In general, the heavier large pellets are slower as expected and those fired without the use of a punch are significantly faster than similar mass punched pellets. The data in Fig. 7 is not corrected for the amount of impurity in the pellet and thus this is not a direct measure of pellet mass. For similar size pellets the variability in amplitude is largely a function of the amount of neon. More neon also makes the pellets heavier and thus slower. The punched pellets are always slow as very little gas is used to accelerate the pellet once it is released by the punch. The punches were designed to release pure neon and argon pellets, which are not releasable by the available gas pressure alone. The punches produce a sharp impact on the pellet that frequently results in broken pellets, especially if the pellet contains some percentage of deuterium.

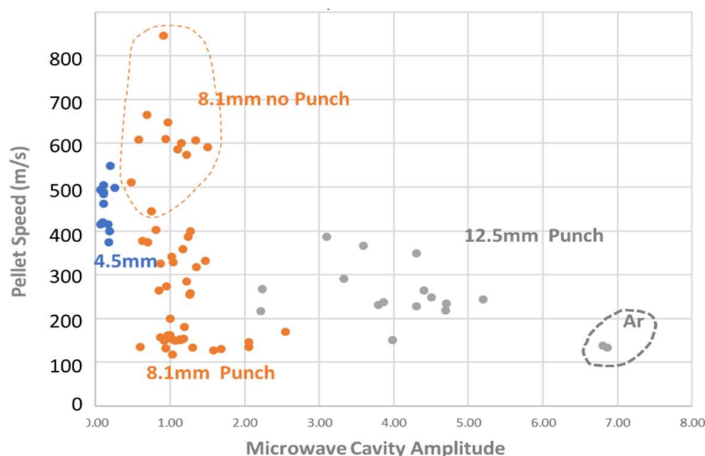

Fig. 7. JET SPI pellet speeds for 4.5 mm (blue), 8.1 mm (orange), and 12.5 mm (gray) as a function of the microwave cavity signal amplitude. Argon pellets are on the far right, all others are a mixture of D₂ and neon.

The JET installation shown in Fig. 1 has the unique feature of a vertical shatter tube with the shatter plume aimed toward the inner wall to intercept known runaway electron (RE) beam locations generated from argon gas injection induced disruptions. Observations of the shattered pellet plume in plasmas on JET shown in Fig. 8 verify that the trajectory is as designed with a bias toward the left side of the anticipated 15-degree half angle shatter cone overlaid in the image. Experiments with the SPI in plasma did not show significant amounts of propellant gas entering before the pellet fragments from the fast camera videos of the injection process.

4.2 KSTAR

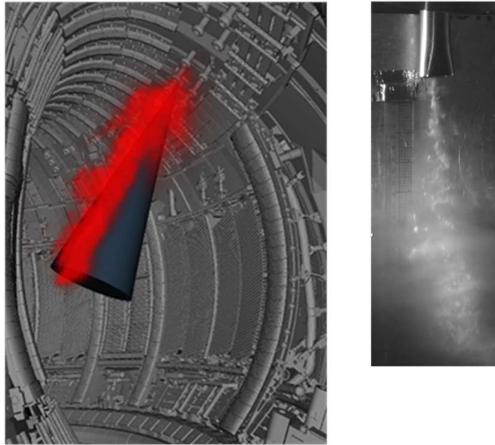

FIG. 8. a.) Time integrated fast camera image of neon fragments entering the plasma showing the plume and expected 15° dispersion cone. b.) Fast camera image of fragments leaving the JET shatter tube prototype in laboratory tests. [3].

The KSTAR SPI diagnostics include fast camera views of both injection ports [5]. The fast camera videos of pellets entering the plasma do not indicate ionization light from helium propellant gas entering in front of the pellet fragments as is expected from the small amount of gas seen entering the torus without a pellet. A number of the SPI injection videos were examined with the view shown in Fig. 11. The duration of fragments seen entering the plasma from both ports was < 1 ms, which is consistent with lab fragment analysis taking into account the velocity spread of 100 m/s observed in the laboratory shattering video analysis [13]. The fragments also clearly come into the plasma above the passive stabilizer 50 cm from the end of the shatter tube as designed.

SUMMARY

Both SPI systems have been used successfully to support the understanding of SPI plasma shutdown and the ITER disruption mitigation system design. The propellant gas removal is quite good in both systems, removing more than 99.5% of the gas, and none has been observed entering the plasma. Observations of the shattered pellet plume in plasmas on JET verify that the trajectory is as designed and has been successful at intercepting RE beams. The KSTAR shatter plumes have been observed also to follow the expected trajectory and have durations in the plasma that agree with laboratory measurements of the fragmentation.

One of the key reasons for the KSTAR dual SPI installation is to investigate the performance of simultaneous injection of SPI pellets from ports on opposite sides of the machine. Initial dual SPI results show strong radiation and assimilation at the time of injection with good pellet arrival synchronization [5]. The identical SPI systems make this research possible as the systems have shown good synchronization as shown in Fig. 9 where 7 mm D_2 pellets fired from both SPIs arrive at their respective microwave cavities only 0.13 ms apart. Initial thermal mitigation experiments with neon- D_2 mixtures have been performed with single and dual SPIs. These results show improved assimilation of the pellet material into the plasma with well synchronized pellets [5].

The typical pellet speeds achieved for a subset of the pellet fired thus far are shown in Fig. 10. All of these are without a punch and were using a 2ms valve pulse with the pellets fired at 11 K. The successful good pellet percentage for the 120 7 mm pellets fired in the 2020 campaign was 93 %,

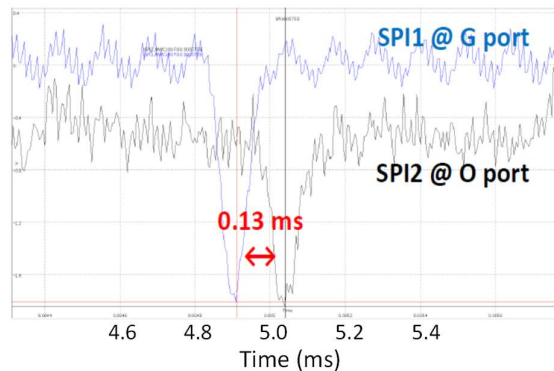

Fig. 9. a.) Two SPI injectors with identical guide and shatter tube geometries installed on the KSTAR G and O port flanges. b.) The microwave cavity signals for 7 mm D_2 pellets fired simultaneously from both O and G ports showing 0.13 ms synchronization at the cavity location. [3]

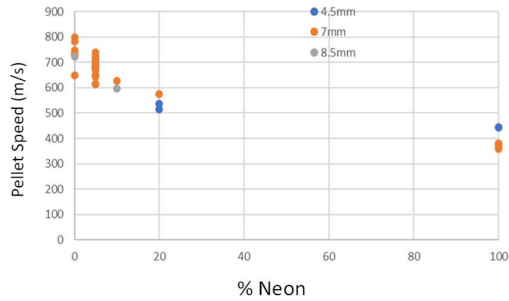

Fig. 10. Pellet speed measured in experiments on KSTAR as a function of the molar fraction of neon in the pellet.



Fig. 11. Example of Oport fast camera view of the SPI fragment interaction with the plasma. The arrow shows the shattered pellet trajectory with the inner wall on the left.

Broken pellets are less effective at mitigation; however, they can be avoided with designs that do not utilize a funnel and with optimization of the formation and firing conditions. Synchronization with identical systems can be sub millisecond as demonstrated at KSTAR. Operational experience and physics results from both systems has been very useful in development of the DMS SPI based system on ITER and scaling to performance expected in the much larger and more energetic tokamak plasmas.

ACKNOWLEDGEMENTS

This work was supported by the US DOE under contracts DE-AC05-00OR22725 and DE-FC02-04ER54698 and by the ITER Organization through contracts TA C18TD38FU, IO/CT/43-1830, 1909, 1918, and 2034 and carried out within the framework of the EUROfusion Consortium, receiving funding from the Euratom research and training programme 2014-2018 and 2019-2020 under grant agreement No 633053. The JET SPI project is a collaborative effort of EURATOM, the ITER Organization, and the US Department of Energy. The KSTAR SPI project is carried out in collaboration with the ITER DMS Task Force. The views and opinions expressed herein do not necessarily reflect those of the European Commission or the ITER Organization. Also supported by Korean Ministry of Science and ICT under the KSTAR project.

*See the author list of 'Overview of JET results for optimising ITER operation' by J. Mailloux et al to be published in Nuclear Fusion Special issue: Overview and Summary Papers from the 28th Fusion Energy Conference (Nice, France, 10-15 May 2021)

REFERENCES

- [1] BAYLOR, L. R. et al., Shattered pellet injection technology design and characterization for disruption mitigation experiments, Nucl. Fusion 68 (2019) 211.
- [2] MEITNER, S.J., et al., Design and commissioning of a three-barrel shattered pellet injector for DIII-D disruption mitigation studies, Fus. Sci. and Technol. 72 (3), (2017) 318-323
- [3] GEBHART, T.E., BAYLOR, L. R., MEITNER, S.J., Shatter Thresholds and Fragment Size Distributions of Deuterium–Neon Mixture Cryogenic Pellets for Tokamak Thermal Mitigation, Fusion Sci. Technol. 76 (7), 831-835 (2019)
- [4] JACHMICH, S. et al., IAEA FEC 2021, this conference
- [5] KIM, J., et al., IAEA FEC 2021, this conference
- [6] GOUGE, M.J., MILORA, S.L. COMBS, S.K., A combined microwave cavity and photographic diagnostic for high speed projectiles, Rev. Sci. Instrum., 61 (8), (1990).
- [7] WILSON, J., et al., The Shattered Pellet Injector system implemented at JET, SOFT 2020 poster presentation.
- [8] SHIRAKI, D. personal communication
- [9] PEACOCK, A. et al., Operational Experience with the Shattered Pellet Injector at JET, SOFT 2020 poster presentation.
- [10] PARK, S.H. et al., Deployment of Multiple Shattered Pellet Injection System in KSTAR, ISFNT 2019, Fus. Eng. Des. 154 (2020) 111535.
- [11] MILORA, S.L., COMBS, S.K., FOUST, C.R., Fast-opening Magnetic Valve for high-pressure gas injection and applications to hydrogen pellet fueling systems, Rev. Sci. Instrum., 57 (9), 2356, (1986).
- [12] KRUEZI, U. et al., A new Disruption Mitigation System for deuterium–tritium operation at JET, Fusion Engineering and Design 96-97 (2015) 286-289.
- [13] GEBHART, T.E., BAYLOR, L. R., MEITNER, S.J, Experimental Pellet Shatter Thresholds and Analysis of Shatter Tube Ejecta for Disruption Mitigation Cryogenic Pellets, IEEE Transactions on Plasma Science 48 (6), 1598-1605 (2020)