

# 80 U.S.

THE TRS-80 USERS JOURNAL

Vol. V. No. 12

\$3 per copy

December, 1982

**Disks & DOSs**  
**High-Powered**  
**Options for**  
**Your**  
**Computer**





# M I C R O T E R M

More and more hardware and communications services are allowing speeds up to 1200 baud. Soon, some may be going faster than that. Today's terminal software simply can't keep up. But now there is an alternative. Micro-Systems Software introduces MicroTerm, the high speed terminal.

Model III MicroTerm will communicate, without insertion of null characters, at 4800 baud. Guaranteed. No cop-outs, no question. MicroTerm is so fast that you can exit from the terminal to the main menu, adjust video width, open the buffer, turn on the printer, or any one of dozens of other functions, and return to the terminal mode **without missing a thing!**

MicroTerm continues to input from the RS232, even while at the main menu. This is the only terminal capable of such an astounding feat. MicroTerm offers you most of the features that "Brand X" smart terminals have, plus it gives you: • Ultra high baud rate operation (up to 9600 in certain cases). • Input while at menu. • Easy to use translation tables. • Easy to use phone number listings. • Maximum auto dial support — most major brands. • Direct file transfer companion program included at no extra cost (compatible with DFT). • DOS commands from menu without exiting program. • Over 34K of capture buffer (in a 48K TRS-80). • Can be set to automatically dial telephone and transmit buffer at preset time without any operator intervention.

And many, many more great features, MicroTerm is so fast you must see it to believe it. The various menus are displayed so fast, they seem to jump out at you. Status of various functions can be displayed and altered in split seconds.

For the computerist who wants the ultimate, state-of-the-art terminal software, there is no other choice.

MicroTerm retails for \$79.95, but registered DOSPLUS owners can purchase it for only \$59.95. \$20.00 off the retail price! MicroTerm comes complete with the terminal program, the direct file transfer program, some standard translation tables, and documentation.

Don't delay, order yours today! Specify when ordering: Model I or III and whether you want it on 40 or 80 track media. Requires a 16K TRS-80 with one disk drive. We recommend 48K for serious communications work. MicroTerm will be available beginning June 30, 1982.



**MICRO-SYSTEMS  
SOFTWARE, INC.**

4301-18 Oak Circle  
Boca Raton, FL 33431  
Telephone: (305) 983-3390  
800-327-8724



## We're Expanding Your TRS-80\* Model III With Reliable Hard-Line Thinking

Let's cut through all the "compu-babble" about hard-disk systems with some hard-line thinking.

You want a hard-disk system for your TRS-80\* Model III for some fairly basic reasons:

- More storage capacity than your present system
- Faster retrieval and storage of information
- Accurate processing with reliable hardware and software

PERCOM DATA was pioneering critical, reliable data separation functions for micro systems long before many of today's companies even began. PERCOM DATA's solid industry reputation is your promise of hard-disk performance, from a drive with specifications equal to or superior to your own system.

PERCOM DATA 5¼ inch PHD's™ are your easy, hard-line answer. These units are available in 5, 10, 15 and 30 megabyte models. The First Drive unit has a micro-processor-based drive controller, permitting you to add up to 3 more hard-disk PHD's. And PHD series prices begin at under \$2500.

So, if you're ready to expand your TRS-80 Model III, do it with PERCOM DATA's PHD. Our hard-line thinking of more than half a decade means you get a reliable, high-quality PERCOM DATA peripheral, backed by the PERCOM DATA Performance Promise.

Take a hard-line of your own today! Call one of our Sales Consultants for more information and specifications or for the name of your close-by PERCOM DATA Dealer.

PERCOM DATA's Hard-Line Hotline is 1-800-527-1222

**PERCOM DATA**  
CORPORATION

### Expanding Your Peripheral Vision

**DRIVES • NETWORKS • SOFTWARE**

11220 Pagemill Road Dallas, Texas 75243 (214) 340-7081

1-800-527-1222

# 3

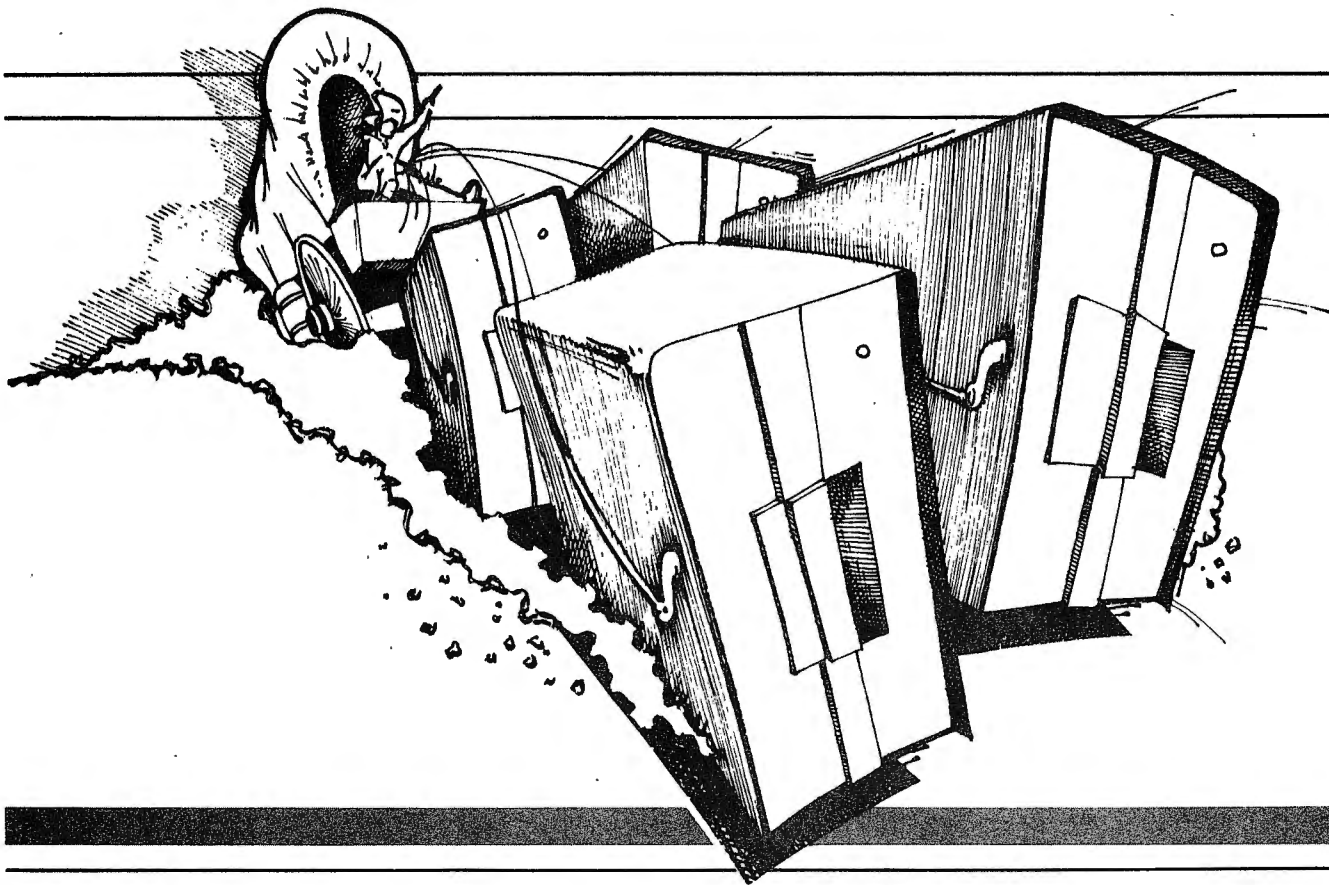

## MACHINE LANGUAGE DISK I/O & OTHER MYSTERIES, TO HARNESS THE POWER OF DISK DRIVES.

**The best and most complete book on TRS-80 Model I and Model III disk I/O available.**

"Machine-Language Disk I/O & other mysteries" by Michael Wagner. Volume 5 of the popular "... and other mysteries" series published by IJG.

More than 190 pages of information and discoveries on the subject of disk I/O for the beginner and expert alike, using Z-80 Assembly Language to directly control the TRS-80 Model I and Model III disk drives and interrupt systems. With this book anyone can become a disk I/O "expert", and make more efficient use of disk space, or to write his or her own "full blown" disk operating system!

**For the beginner and old pro'.**

Machine-Language Disk I/O & Other Mysteries is packed with source code and flow chart illustrations for every function and operation described. And the source code for two complete disk I/O driver routines, one for the Model I and one for the Model III, are also included for "instant" access to your floppy drive systems.

Plus, the source code for a small disk operation system (S/OS) is included as a bonus. This S/OS contains all of the routines described in the book and shows how all of the disk I/O and interrupt functions should be incorporated into a working system.

**On machine language disk I/O.**

Machine-Language Disk I/O & Other Mysteries explains what the floppy drive system is all about, what Tracks and Sector are,

the Western Digital Floppy Disk Controller 1771 and 1793 chips, read/write access, reading a selected drives' status, how to test and make sure a disk is in a drive or if a drive is on the system (on-line), the Head Restore command, the Head Step and Seek commands, the "Force-Interrupt of function" command, the Read Address command, the Read Track command, the Write Track (FORMAT) command, the Read Sector command, the Write

Sector command, Post Non-Maskable-Interrupt Processing for the model III, and much more.

**On TRSDOS file I/O**

and most TRSDOS-like operating systems, Machine-Language Disk I/O & Other Mysteries explains; what a disk file really is, what records are and how they're stored on the disk, creating a file, performing Direct Record I/O, performing Single Byte I/O, closing & killing files; error processing and TRSDOS error codes with their meanings, and much more.

Plus many other handy programs, routines, and revelations are included. Such as a TRSDOS error message displayer, a disk formatter program, a program to calculate a password for a given encode, a object file load-format displayer, a file oriented full screen file editor, and a FULL BLOWN smart terminal program.

Machine-Language Disk I/O & Other Mysteries is a must for all programmers at just \$29.95. Available at computer stores, selected B. Dalton Booksellers and independent book dealers. If your dealer is out of stock, order direct. Include \$4.00 for shipping and handling. Foreign residents add \$11.00 plus purchase price, in U.S. funds.



1953 West  
11th Street  
Upland, CA  
91786 (714)  
946-5805

© 1982 80-Northwest Publishing, Inc. All rights reserved. Reproduction for other than personal, non-commercial purposes, or further distribution in any other form, is prohibited. No patent liability is assumed with respect to the use of the information contained herein. While every precaution has been taken in the preparation of this publication, the publisher assumes no responsibility for errors or omissions. Neither is any liability assumed for damages resulting from the use of any information contained herein. Please address correspondence to: **80-U.S. Journal, 3838 South Warner Street, Tacoma, Washington 98409, telephone (206) 475-2219.**

**Advertisers:** 80-U.S. Journal will accept relevant commercial advertising which pertains to, or is for use on, the Tandy Corporation microcomputers. Write for a current rate schedule.

**Authors:** We constantly seek material from contributors. Send your material (double spaced, upper/lower case, please) and allow approximately 4 to 6 weeks for review. Programs must be supplied in machine readable form on diskette or tape, clearly marked as to model and operating system. Text files may be on diskette. Media will be returned if return postage is provided. Cartoons and photographs are welcome. Generous compensation will be made for non-trivial works which are accepted for publication. 80-U.S. Journal pays upon acceptance rather than on publication.

**SUBSCRIPTION PRICE:** U.S.: \$16 for one year, \$31 for two years and \$45 for three years. **Canada and Mexico:** \$25 per year, no two or three year subscriptions are offered. **All other:** \$30 per year via surface mail, \$72 per year via airmail. Two and three year subscriptions are not offered.

**ISSN Publication #0199-1035. The 80-U.S. Journal is published monthly by 80-Northwest Publishing, Inc., 3838 S. Warner St., Tacoma WA 98409-4698. Printed in the United States of America.**

**POSTMASTER:** Please send change of address form 3579 to 80-U.S. Journal, 5615 West Cermak Road, Cicero, Illinois 60650. **Second Class postage PAID at Tacoma, WA and at Aberdeen, SD.**

**80-U.S.**  
THE TRS-80 USERS JOURNAL

Vol. V No. 12 \$3 per copy December 1982

**Disks & DOSs**  
**High-Powered**  
**Options for**  
**Your**  
**Computer**

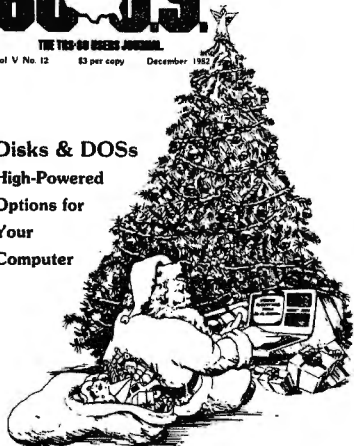

Our cover was designed by Don Snowden of Gig Harbor, WA. He also provided the excellent drawings throughout the magazine.

4 80-U.S. Journal

**80-U.S.**

**THE TRS-80 USERS JOURNAL**

TRS-80 is a trademark of the Tandy Corp.

Vol. 5, Number 12 — December, 1982

**ARTICLES**

**LDOS**

**18**

**Don Scarberry**

Why bother with another DOS? A discussion of the advantages of using a programmer's operating system.

**Radio Shack hard disk system Model II**

**24**

**T. R. Dettmann**

A report from users who have installed this system.

**Grab TRSDOS by the horns**

**28**

**Model I, PMC-80, LNW80 Michael D. Andreas, Charles P. Knight**

A utility that allows you to run a data disk in drive zero and avoid the expense of a second drive.

**EASYLINK**

**37**

**For all models**

**Cameron C. Brown**

Now you can connect to Western Union through your TRS-80.

**Hard disk for the Model III**

**40**

**Model III**

**Harry Avant**

An evaluation of MTI's hard disk and CP/M operating system.

**Christmas card**

**45**

**Models I/III, PMC-80, LNW80**

**Santa Claus**

**MULTIDOS**

**46**

**Models I/III, PMC-80, LNW80**

**Terry Kepner**

An evaluation of an extremely versatile operating system.

**USRful patch**

**48**

**Models I/III, PMC-80, LNW80, no disks**

**Charles C. Edwards**

A routine that gives you unlimited USR calls.

**Driver education** 50  
 Models I/III, PMC-80, LNW80  
 A tutorial on how to use device control blocks and create your own driver routines.  
 Bob Bowker

**Pocket adventure** 54  
 Pocket computer  
 A spoof of adventure games — but it really works.  
 Robert D. Miller

**DOSPLUS 3.4 and 3.4D** 57  
 Models I/III, PMC-80, LNW80  
 An operating system that makes density or disk size compatibility easy.  
 Captain Paul M. Hine

**Color Computer sorting** 63  
 Color Computer  
 A routine for obtaining quick results. Provided in BASIC and machine language.  
 Mark E. Goodwin

**Basically BASIC** 68  
 For all models  
 String functions and what they can do.  
 James A. Conrad

**BASIC bits** 73  
 Models I/III, PMC-80, LNW80  
 Tips on packing strings more efficiently.  
 Thomas L. Quindry

**Files and foibles** 76  
 Models I, II, III, PMC-80, LNW80  
 How to sort large sequential files that exceed your computer's memory.  
 T. R. Dettmann

**Data Ace** 87  
 Model II  
 A review of a powerful relational database manager.  
 T. R. Dettmann

**Exploring VisiCalc** 92  
 Models I, II, III, PMC-80, LNW80  
 Processing text and creating forms.  
 Timothy K. Bowman

**Screen dump utility** 106  
 Models I/III PMC-80, LNW80  
 A tiny word processor that provides an exact copy of the screen contents.  
 Alfred L. Brophy III

**Let's have a party** 108  
 For all models  
 Four computerized children's party games.  
 Alan Mandell

## REVIEWS

**Speak** 96  
 Reviewed by Tim Knight

**Crayon** 97  
 Reviewed by Tim Knight

**Beta-80** 99  
 Reviewed by Mark Schimelman

**6809 Assembly Language Programming** 100  
 Reviewed by T. R. Dettmann

**Outhouse** 101  
 Reviewed by Matt Friedenberg

**Black Sanctum** 102  
 Reviewed by Roy Seney

**Electric Webster** 102  
 Reviewed by Jim Klaproth

**Dunzhin** 104  
 Reviewed by Mark E. Renne

## DEPARTMENTS

**Editorial** 6  
 By Lawrence I. Charters

**Letters to the Editor** 8

**Directions** 10  
 By Mike Schmidt

**Notes, etc.** 14

**Tandy topics** 70  
 By Ed Juge

**@ News** 84  
 By Spencer Hall

**New Products** 90

**Captain 80** 94  
 By Bob Liddil

**Advertiser Index** 118

**Bulletin Board** 118

Publisher/Editor-in-Chief

I. Mike Schmidt

Editor

Cameron C. Brown

Associate Editors

Terry R. Dettmann  
Spencer Hall  
Jim Klapproth

Contributing Editor

Robert W. Liddil

Advertising Sales

Donald Scarberry

Promotion/Circulation

Robert P. Perez

Production

Catherine D. Doud  
Sherry A. Miksell

Editorial Secretary

Eva R. Jones

Accounting

Helen Dalton

## RENEWING?

Check your label to be sure it's correct. For uninterrupted service include your label with your order.

## MOVING?

Please enclose your label or write your name and address as it appears on your label.

Name \_\_\_\_\_

Address \_\_\_\_\_

City/State \_\_\_\_\_

Write in new address:

Name \_\_\_\_\_

Address \_\_\_\_\_

City/State \_\_\_\_\_

## 80-U.S. Journal

Subscription Department  
5615 West Cermak Road  
Cicero, IL 60650

# Editorial

**By Lawrence I. Charters**

I used to think of Radio Shack as nothing more than a somewhat dingy little chain store that gave away free batteries. It seemed that all they sold were CB radios and Made In Hong Kong battery-operated plastic toys that broke after you got them home. In retrospect, it is hard to say if this image ever was true — I never bought a CB or plastic toy — but one thing is certain: Radio Shack is not a dingy little chain store. It is a corporate colossus.

Tandy Corporation (Radio Shack) is now the 20th largest computer firm in the United States, and the top microcomputer company. According to *Computer Decisions* (June 1982), Tandy's computer revenue for 1981 totalled \$460 million, and its revenue growth rate ranked fourth in the computer field. Compared to IBM's \$25 billion in computer revenues, Tandy's performance seems modest, but, compared to IBM, no one is very impressive. More recent figures (*Computer Decision's* ranking was based on Tandy revenues ending June 30, 1981) suggest Radio Shack has climbed even higher. Other microcomputer firms in the top 100 included Apple (23rd), Commodore (49th), Warner (Atari; 71st) and Zenith (89th).

Since your average Radio Shack computer is not very expensive, this performance is remarkable. Another industry magazine, *ICP Software Business Review* (Autumn 1982), reports that Radio Shack is just as potent as a software firm. With revenues of \$38 million in 1981, Tandy was the top microcomputer software supplier in the United States, and ranked 54th when compared with all software firms. The only other microcomputer software companies to hit the top 100 were Vector Graphic (75th), Apple (77th), Commodore (92nd) and Microsoft (93rd).

There are several conclusions you can draw from these figures, but probably the most important one is

this: Radio Shack is not a joke. The microcomputer community long made fun of the "Trash-80," and suggested that Tandy get out of electronics and go back to selling leather goods. Computer magazines and newspapers used to pay so little attention to the TRS-80 that a whole new publishing industry grew up to support it. Independent retailers, often refused to carry any hardware or software for Radio Shack machines. After a time they forgot why they didn't carry such goods, and were able to delude themselves into believing nothing was available. If you go into such a store today and ask for TRS-80 merchandise, you will often be met with a sad look and a suggestion that you junk your machine and buy a *real* computer.

Computer snobbery is nothing new, nor is the sales tactic of selling one item by slandering another. What is odd is the lack of loyalty by Radio Shack computer owners and the TRS-80 press. You will rarely find an Apple owner who will admit to any problems with Apple equipment, and Apple magazines are either enthusiastic promoters of Apple, Inc., or carefully neutral. In contrast, one large TRS-80 magazine has made something of a career of criticizing Radio Shack in general and TRS-80s in particular, and TRS-80 owners have never shown any hesitancy when it comes to gripes. There is nothing wrong with healthy criticism, but is this healthy?

One commonly heard complaint is Radio Shack's lack of software support. Looking through their latest computer catalog (which, by the way, is free — some companies make you buy their catalog), it is hard to take this charge seriously. Even the newest member of the Radio Shack stable, the Model 16, has more manufacturer supported software than most microcomputer firms offer for their entire line. Radio Shack's customer service lines, and its company sponsored newsletter,



# PMC SOFTWARE

Proven Software Solutions  
for the TRS-80, PMC-80 & 81 User  
At VERY Special Prices

## GAMES

Title	List	Our Price	Title	List	Our Price	Title	List	Our Price
<b>Advanced Operating Systems</b>						<b>Big 5</b>		
+ VOYAGE OF THE VALKYRIE			SCOTT ADAMS' ADV. #1, #2 & #3			ATTACK FORCE		
D 32K I & III	39.95	32.00	D 32K I & III	39.95	31.00	D 32K I & III	19.95	15.00
T 16K I & III	29.95	24.00	SCOTT ADAMS' ADV. #4, #5 & #6			T 16K I & III	15.95	12.00
<b>Adventure International</b>			D 32K I & III	39.95	31.00	<b>COSMIC FIGHTER</b>		
ARMOR PATROL			SCOTT ADAMS' ADV. #7, #8 & #9			D 32K I & III	19.95	15.00
D 32K I & III	24.95	19.00	SCOTT ADAMS' ADV. #10, #11 & #12			T 16K I & III	15.95	12.00
T 16K I & III	19.95	15.00	D 32K I & III	39.95	31.00	<b>DEFENSE COMMAND</b>		
<b>COMBAT</b>			SEA DRAGON			D 32K I & III	19.95	15.00
D 32K I & III	20.95	16.00	D 32K I & III	24.95	19.00	T 16K I & III	15.95	12.00
T 16K I & III	19.95	15.00	T 16K I & III	19.95	15.00	<b>GALAXY INVASION</b>		
<b>CONQUEST OF CHESTERWOOD</b>			SHOWDOWN			D 32K I & III	19.95	15.00
D 32K I & III	20.95	16.00	D 32K I & III	20.95	16.00	T 16K I & III	15.95	12.00
T 16K I & III	19.95	15.00	T 16K I & III	14.95	12.00	<b>METEOR MISSION</b>		
<b>+ DEMON VENTURE #1</b>			+ SILVER FLASH-PINBALL 1			D 32K I & III	19.95	15.00
REIGN OF THE RED DRAGON			D 32K I & III	19.95	15.00	T 16K I & III	15.95	12.00
D 32K I & III	19.95	19.00	T 16K I & III	14.95	12.00	<b>ROBOT ATTACK</b>		
ELIMINATOR			SKY WARRIOR			D 32K I & III	19.95	15.00
D 32K I & III	24.95	19.00	D 32K I & III	20.95	16.00	T 16K I & III	15.95	12.00
T 16K I & III	19.95	15.00	SPACE INTRUDERS			<b>+ STELLAR ESCORT</b>		
<b>GALACTIC EMPIRE</b>			D 32K I & III	20.95	16.00	D 32K I & III	19.95	15.00
T 16K I & III	14.95	12.00	T 16K I & III	19.95	15.00	T 16K I & III	15.95	12.00
<b>GALACTIC REVOLUTION</b>			STAR FIGHTER			<b>SUPER NOVA</b>		
T 16K I & III	14.95	12.00	D 32K I & III	29.95	23.00	D 32K I & III	19.95	15.00
<b>GALACTIC TRADER</b>			T 16K I & III	24.95	19.00	T 16K I & III	15.95	12.00
T 16K I & III	14.95	12.00	STAR TREK 3.5			<b>Cornsoft</b>		
<b>+ GALACTIC TRILOGY</b>			D 32K I & III	19.95	15.00	+ BOUNCEOIDS		
D 32K I & III	39.95	30.00	T 16K I & III	14.95	11.00	D 32K I & III	19.95	15.00
<b>LUNAR LANDER</b>			TREASURE QUEST			T 16K I & III	15.95	12.00
D 32K I & III	20.95	16.00	D 32K I & III	19.95	15.00	<b>Med Systems</b>		
T 16K I & III	14.95	11.00	T 16K I & III	14.95	11.00	ASYLUM		
<b>MACES &amp; MAGIC #1-BARLOG</b>			<b>Automated Simulations (EPYX)</b>			D 32K I & III	22.95	18.00
D 32K I	29.95	23.00	CRUSH, CRUMBLE & CHOMP			T 16K I & III	19.95	15.00
<b>MACES &amp; MAGIC #2-</b>			D 32K I & III	29.95	23.00	<b>+ ASYLUM II</b>		
<b>STONE OF SISYPHUS</b>			T 16K I & III	29.95	23.00	D 32K I & III	22.95	18.00
D 32K I & III	29.95	23.00	DUNJONQUEST-			T 16K I & III	19.95	15.00
<b>MACES &amp; MAGIC #3-</b>			HELLFIRE WARRIOR			<b>DEATHMAZE 5000</b>		
<b>MORTON'S FORK</b>			D 32K I & III	39.95	30.00	D 32K I & III	17.95	14.00
D 32K I	29.95	23.00	T 16K I & III	39.95	30.00	T 16K I & III	14.95	11.00
<b>MISSILE ATTACK</b>			DUNJONQUEST-			<b>LABYRINTH</b>		
D 32K I & III	20.95	16.00	KEYS OF ACHERON			D 32K I & III	17.95	14.00
T 16K I & III	14.95	11.00	D 32K I & III	19.95	15.00	T 16K I & III	14.95	11.00
<b>OTHER VENTURE #2-</b>			T 16K I & III	19.95	15.00	<b>WARRIOR OF RAS-</b>		
<b>CROWLEY MANOR</b>			DUNJONQUEST-			D 48K I & III	29.95	23.00
D 32K I & III	20.95	16.00	SORCERER OF SIVA			T 48K I & III	29.95	23.00
T 16K I & III	19.95	15.00	D 32K I & III	29.95	23.00	<b>WARRIORS OF RAS-</b>		
<b>OTHER VENTURE #3-</b>			DUNJONQUEST-			D 48K I & III	29.95	23.00
<b>ESCAPE FROM TRAAM</b>			TEMPLE OF APSHAI			T 48K I & III	29.95	23.00
D 32K I & III	20.95	16.00	D 32K I & III	39.95	30.00	<b>THE WYLDE</b>		
T 16K I & III	19.95	15.00	T 16K I & III	39.95	30.00	D 48K I & III	29.95	23.00
<b>OTHER VENTURE #4-</b>			DUNJONQUEST-			T 48K I & III	29.95	23.00
<b>EARTHQUAKE SF 1906</b>			UPPER REACHES OF APSHAI			<b>Melbourne House Software</b>		
D 32K I & III	20.95	16.00	D 32K I & III	19.95	15.00	<b>PENETRATOR</b>		
T 16K I & III	19.95	15.00	T 16K I & III	19.95	15.00	D 32K I & III	24.95	20.00
<b>OTHER VENTURE #5-</b>			+ RICOCHET			T 16K I & III	24.95	20.00
<b>+ DEATH PLANET</b>			D 32K I & III	19.95	15.00			
D 32K I & III	19.95	15.00	T 16K I & III	19.95	15.00			
<b>PLANETOIDS</b>								
D 32K I & III	20.95	16.00						
T 16K I & III	19.95	15.00						

## Now Twice As Many Programs!

EDUCATION	WORD PROCESSING	OPERATING SYS.
Advanced Operating Systems	Aspen Software	Micro Systems Software
MOSTLY BASIC	GRAMMATIK	DOS PLUS V3.3S
EDUCATIONAL PKG 7 PRG.	D 32K I	D 32K I
T 16K I & III	PROOF EDIT	100.00
24.95	D 32K I	80.00
<b>UTILITIES</b>		
MOSTLY BASIC	PROOFREADER	Adventure International
SCIENTIFIC PKG 7 PRG.	D 32K I	+ DIRECTORY INFO MGT II (DIM II)
T 16K I & III	SOFT-SCREEN	D 32K I & III
24.95	D 48K I	24.95
<b>Howe Software</b>		
TIME DUNGEON-	SOFT-TEXT	MONS
AMERICAN HISTORY	D 48K I	T 16K I
T 16K I & III	69.00	39.95
24.95	69.00	31.00
<b>Michael Shrayer Software</b>		
TIME DUNGEON-	ELECTRIC PENCIL	MON4
WORLD HISTORY	T 16K I	D 32K I
T 16K I & III	100.00	49.95
24.95	24.00	39.00
<b>INFO. PROCESSING</b>		
Automated Simulations (EPYX)	Adventure International	STERM
JABBERTALKY	+ MAXI TRAS	T 16K I
D 32K I & III	D 48K I & III	69.95
29.95	99.95	55.00
T 16K I & III	MAXI MANAGER	SYSTEM DIAGNOSTIC
29.95	79.00	D 32K I & III
<b>BUSINESS</b>		
Small Business Systems Group	D 48K I & III	99.95
ACCOUNTS PAYABLE	+ MAXI MANAGER UTILITY PACK #1	79.00
D 48K I & III	D 48K I & III	39.00
195.00	49.95	1.00
ACCOUNTS RECEIVABLE	+ MAXI STAT	1.00
D 48K I & III	D 48K I & III	1.00
195.00	199.95	1.00
GENERAL LEDGER	+ COMPUTER FILING SYSTEM (CFS)	Adventure International
D 48K I & III	D 32K I & III	HINT SHEET for single
195.00	69.00	Adventure #1 thru #12
INVENTORY CONTROL	Dan Haney Associates	1.00
D 48K I & III	ELECTRIC SPREADSHEET	Software Affair
PAYROLL	D 32K I & III	ORCHESTRA-85
D 48K I & III	T 16K I & III	T 16K I
195.00	34.95	D 16K I
	30.00	99.95
		95.00

+ NEW # 5

# PMC SOFTWARE

475 Ellis St., Mt. View, CA 94043

Orders: (415) 968-1604

Terms: FOR FAST DELIVERY, send certified checks, money orders, VISA or MasterCard number and expiration date. Personal checks require 3 weeks U.S.A. sales only. PRICES INCLUDE UPS continental delivery (do not use P.O. Box) CALIFORNIA customers add 6 1/2% tax. Prices subject to change.

TRS-80 Microcomputer News (free for a year with every computer purchased), are unique — no other microcomputer firm offers such services.

Radio Shack does have an annoying habit of ignoring the outside world (a typical problem in the computer field), but even this is changing. Their newsletter has recently referred to 80-U.S. articles, explained how to connect various gadgets to TRS-80s, and even detailed how different versions of CP/M might work on the Model II. The NIH (Not Invented Here) syndrome is still stronger than most of us might like, but it is not as severe or as important as some contend.

Radio Shack's repair policies — particularly concerning modified machines — have received the most interesting complaints. Almost all computer firms will repair their own machines — provided those machines show no sign of modification or tampering. Considering the complexity of computer machinery, repair technicians are understandably reluctant to risk their equipment — and lives — poking around with some unidentified and undocumented modification. If a computer has been modified you are usually invited to look elsewhere for help. (Some companies will even seize your computer — permanently — claiming such tampering is equivalent to theft of proprietary material.) Such repair policies are not limited to the computer field, either; try taking a Ford in for repair to a Ford dealer — after you have installed a Chrysler engine. All things considered, Radio Shack's policies are both flexible and reasonable.

Radio Shack has grown from an uncertain, pioneering microcomputer infant into a solid, adult giant. With over a million Radio Shack computers of various types installed worldwide, it is time for the TRS-80 community of owners and users to make a similar transition. Show some loyalty, camaraderie and understanding. Add some well-considered praise as well as constructive criticism. It's more fun, and more productive, than ignorant, lonely, peevish grousing. ■

# Letters to the editor

\* I was very pleased to find an article, by Kenneth Smith, in the September issue of your magazine on using the high-resolution graphics available in my Epson MX-100 printer.

My MX-100 is attached to a Model II. That made using the programs, as published, impossible.

Just type the following from TRSDOS READY:

```
DEBUG ON <ENTER>
```

```
DEBUG <ENTER>
```

```
M
```

```
F000
```

```
<F1> (the 'F1' key)
```

```
DB E0 B7 20 FB 7E D3 E1 C9 (spaces added for clarity)
```

```
<F2> (the 'F2' key)
```

```
S
```

```
DUMP PRINTCHR (START=F000 END=F008  
RORT=R) <ENTER>
```

```
DEBUG OFF <ENTER>
```

Then make these changes to Mr. Smith's programs:

```
DELETE 280-300
```

```
ADD:
```

```
50 CLEAR 100,&HEFFF 'protect memory
```

```
60 SYSTEM"PRINTCHR" 'loads the routine
```

```
70.DEFUSR>&HF000 'set the entry point
```

```
280 A=USR(A(I)) 'call the routine
```

**Lowell Johnson**  
Thief River Falls, MN

*Thanks for the conversion. —Ed.*

Through an article in your magazine, and due to a very positive letter from one of your subscribers, I ordered GEAP (Graphics Editor And Programmer) program from Mr. Joe Fettig of J.F. Consulting, Palm Desert, CA.

The service was fast and I received the GEAP program within a short time. Due to some incompatibility problems with the diskette format I had to return the program. Mr. Fettig sent me the previous GEAP cassette version while he was working on how to get me the latest (and improved) diskette version.

The cassette version of GEAP impressed me and I was, as you can imagine, eagerly looking forward to receiving the GEAP disk version. I have this version working on my Model III and there is good reason to be impressed.

8 80-U.S. Journal

But, the service of Mr. Fettig has impressed me even more... you will not experience better service anywhere.

I've subscribed to *80-U.S. Journal* for a year now and my verdict of the magazine is: High-standard articles. Continuously improving and loaded with useful material for us TRS-80 owners. The tutorials almost couldn't be better. My wish for the future: more business application programs and not too much space devoted to reviews of games.

**Arnt Kr. Sviland**  
Stavanger, Norway

*Excellent service is worthy of note, thanks for letting us know. —Ed.*

Let me thank *80-U.S.* for reviewing our program SUPER UTILITY PLUS. Mr. Klaproth did a very fair review and we have no problems with his reporting of our features. We appreciate it when others realize the full power of this utility. SU+ is a very comprehensive product, and he highlighted it nicely.

The "source" of the program mentioned in the review was incorrectly listed as Soft Sector Marketing. That may be where Mr. Klaproth purchased his copy, but the real source is PowerSOFT — a division of Breeze/QSD, Inc., 11500 Stemmons Expressway, Suite 125, Dallas, TX 75229.

Soft Sector Marketing is one of our dealers (and a very fine one), but is not the original source.

Let me also add one other minor correction. The price listed in the review was \$49.95. That was a "summer special" that SSM was selling. The retail price of SU+ is \$74.95, and that now includes two diskettes in the package, the MASTER, and a BACKUP copy. A revised manual completes the package. We started including the BACKUP copy as of 9/1/82.

**Dennis A. Brent, President**  
Breeze/QSD, Inc.  
Dallas, TX

*Our apologies for any inconvenience we may have caused. At \$74.95 it is still a bargain. —Ed.*

I recently purchased your *The Captain 80 Book of BASIC Adventures* and I am quite pleased with it. However, I do have one question that you might be able to help me with.

The process of program entry is quite tiring and prone to error on my Osborne I computer. Do you know anyone who might have the programs available in Osborne I disk format?

**Terry A. Ward**  
Cedar Falls, IA

*Perhaps a reader can help. We have no Osborne's at 80-U.S., just good ole Tandy's. —Ed.*

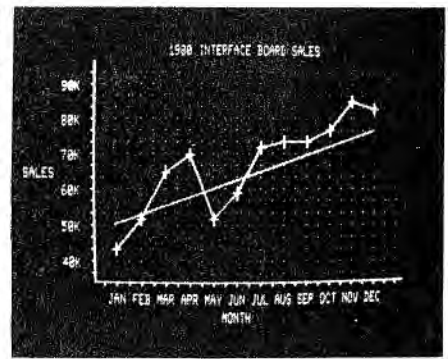
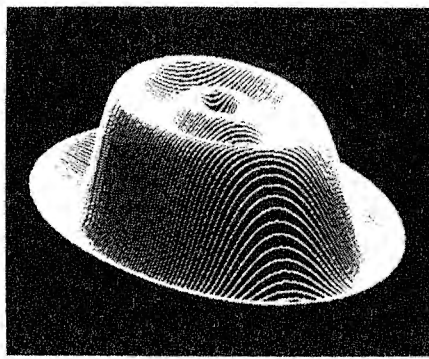
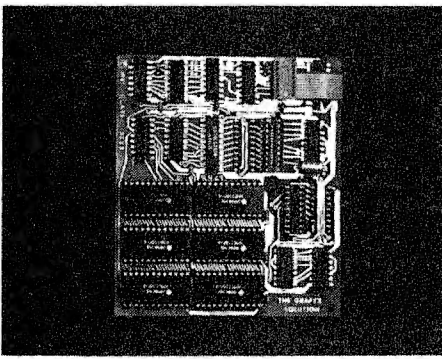

Mod III

## GRAFYX SOLUTION™

\$299.95 # 6

- 512 × 192 Dot Graphics increases resolution 16X (better than Apple)
- Extensive Business, Personal, Educational, and Scientific applications
- 14 BASIC commands set and reset Points, Lines, Circles, Boxes, etc.
- Allows Display and Printout of detailed Line, Bar, and Pie graphs
- 80 Character/line display compatible with BASIC programs and DOS
- Price includes 98K bits memory, 30 programs, 52 page manual
- Plug-in, clip-on board eliminates soldering for easy installation

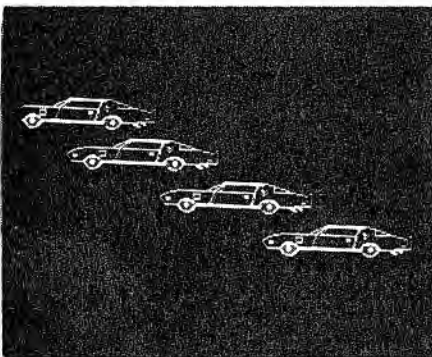

**REBATE**

**\$40**

**REBATE**

VALID 11-1 TO 12-31-82

After purchasing Grafyx Soln. or 80-Grafix, return this coupon with registration form to receive rebate

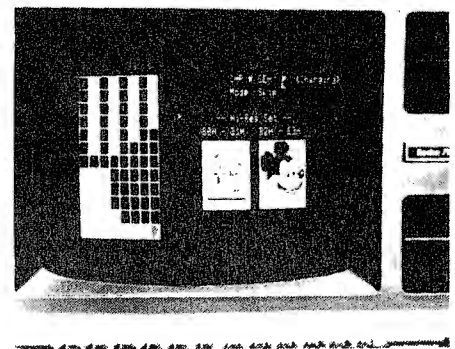

Mod I, III

## 80-GRAFIX™

\$169.95 # 7

- Create and Save 128 programmable hi-resolution characters/shapes
- Characters are generated within an 8 × 12 matrix (Mod I: 6 × 12)
- Great for creating game figures, symbols, and alternate character sets
- Excellent software support (20 programs) & extensive documentation
- Module easily installs within the computer with no soldering

Manual only \$15  
Products guaranteed  
Dealers welcome

**MICRO-LABS, INC.** 214-235-0915  
902 Pinecrest, Richardson, Texas 75080

FREE shipping  
Prepaid or COD  
Tx. res add 5%

# Directions

By I. Mike Schmidt, Publisher

Long-time readers may remember when the publisher had a page or so in which to ramble on about everything and anything. Now that we have editors to write editorials, I find myself without a platform, so we created "Directions." There may be times when this page sounds editorial in nature or, it may sound like industry news. Who knows — I may even wax philosophical at times when the spirit strikes. One thing I will not do is pontificate — only pontiffs are allowed to do that, and I don't even qualify as a minor saint — much less a pope!

## What's New at 80-U.S. Journal

The big news at *80-U.S. Journal* is that, starting in January, we will be printed entirely on slick, publication enamel paper. Since we are virtually the only TRS-80-exclusive publication left which actually supports the TRS-80 line of computers, we think it's time to enhance our image. It is also the next logical move for our publication to take, especially since our newsstand distribution has increased drastically. (Did you know that we are now available in most B. Dalton stores?)

The slick format will give us more flexibility in the placement of four-color advertising and editorial material. It's part of the growing up process. Some time during 1983, we will probably be perfect bound, which will give further flexibility and the ability to bind in special sections.

Of course, it costs more to do these things, but we take pride in the fact that issue number one had a cover price of \$3, and a subscription price of \$16, and those figures have not changed in four years! I am sure that everyone expected a price increase in January, 1982, when we went to monthly publication, but we held the price then, and will hold it now. The economic situation we live in demands that we hold it. By the way, our 1983 advertising rates will be released shortly, but you may as well look at last year's card, because the

rates remain unchanged. We are committed to making it, in spite of the times, but not at your expense!

All of this is due to your tremendous support. It is numbers that count, and as the numbers go up, the price per each copy goes down, and we intend to pass that right back to those of you who made it possible. Thank you.

## Mequon Meeting

A two-day conference was held on September 23 and 24, 1982, near Milwaukee, Wisconsin. It was hosted by Logical Systems, Inc., and was attended by about a dozen industry leaders. Most of the attendees have been engaged in TRS-80 hardware and software support almost since the TRS-80 became a reality back in '77 and '78.

The conference was a chance to get together and examine the present state of the industry and its future. The mixture of ideas and methods which resulted was astounding. I found the conference exciting and all participants believed firmly in the continued well-being of the Radio Shack computer.

Several of the companies showed off new products and handed out samples. Hard disks, new operating systems and the Model 16 were discussed at length. The consensus of the attendees was that, in spite of current economic conditions, the micro industry will continue its healthy growth.

The meeting concluded with a farewell banquet and a thoroughly fine time was had by all. We extend our thanks to Bill Schroeder, of Logical Systems, Inc., for being such a gracious host.

Those in attendance were Roger Billings of LOBO Drives International, John Lancione of Aerocomp, John Harding of Molimerx, Ltd., Dennis Brent and Kim Watt of Breeze/QSD, Inc., Earle Robinson of SoftERware, Roy Soltoff of MISOSYS, Bob Snapp of Snapp-

ware, Inc., Renato Reyes of Powersoft, Kirk Hobart of LOBO Drives, Harvard Pennington of IJG and Cam Brown and myself.

## Raburn Leaves Microsoft

Vern Raburn, who was vice president of Microsoft Consumer Products Division, has left for personal reasons. Vern, who was with Microsoft since July, 1979, was the first person to open a Byte Shop and helped organize the Byte Shop chain in California prior to coming to Microsoft.

## New BASF Service Center

In Seattle, a company which sold BASF disk drives recently went out of business and about 3000 BASF drives were sold at ridiculously low prices. Data Tech/Reliance, Inc., a local company which does drive repair, was being called upon to put many of these drives into working order. Unable to find parts for the drives, Jan Nelson, of Data Tech/Reliance, bought the entire repair stock as well as the rights to distribute and deal for BASF. He is now the only service center for BASF in the United States. If you bought one of the drives and have a problem, Jan's number is (206) 941-3296.

## It Works!

Cam Brown, our editor, recently was asked to help out a local school in selecting some computers for their classrooms. They chose the TRS-80 Color Computer and asked Cam to help them get into operation. As it turns out, the instructors (who had no previous computer experience), followed the "Getting Started" manuals supplied with the computers, and have them running without help. Aside from that, they are enjoying their new computers. Things are definitely looking up when hardware, software and documentation work so well.

Enjoy the upcoming holidays, and remember that good days are made, not had. ■

# HEXMAN D.M.S.

## DISK MANAGEMENT SYSTEM

Computerized file storage and retrieval for your whole disk library.

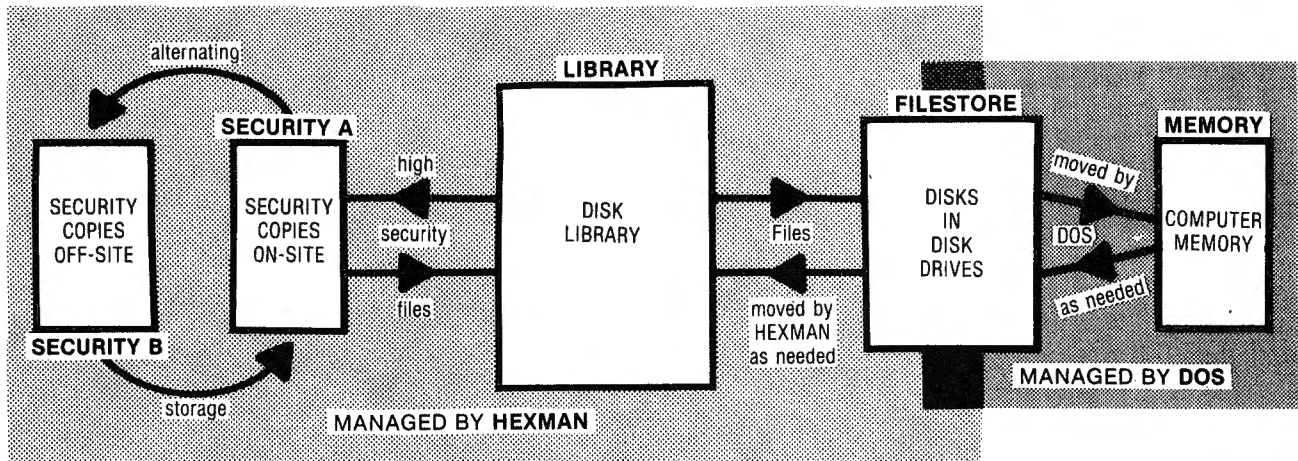

Your Disk Operating System makes a fine job of managing the files that are in your disk drives. No need to worry about where your old files are kept or where to store new files,

your DOS takes care of it. Now HEXMAN takes over where your DOS leaves off, and extends worry free file storage and retrieval to your whole disk library.

### Storage Management

Only a small portion of your disks can be in your disk drives at any one time. These disks form the "Filestore" to which your computer has immediate access, and the remaining disks form your disk "Library". Ideally the "Filestore" should contain the most active files, while inactive files are kept on "Library" disks stored near the computer.

HEXMAN comes as close to this ideal as it can by monitoring file activity and keeping the most frequently used files in the Filestore. If previously inactive files are needed, they are moved in from the Library. If the Filestore becomes full, the least active files are moved out to the Library. The net result is the files you are most likely to use are ready and waiting.

HEXMAN also performs other storage management chores such as daily backups of modified files, on-site and off-site storage of security copies, and file growth monitoring.

### File Retrieval

HEXMAN manages up to 8000 files (2000 originals with up to 4 copies of each). If remembering that many eight letter file names gives you a headache — don't worry. HEXMAN gives you two easy ways to find the files you need. With HEXMAN you find files by function e.g. "Get all the files I need for the end of month Sales Reports" or by description e.g. "Find the letter I sent to Radio Shack about my disk drives". HEXMAN finds your files in seconds. Once you have found them you may Review them, Load them or Delete them as needed.

### Requirements

Model III — 48K, 2 drives.

Model I — 48K, 2 drives. Double Density adaptor. Lower case modification.

LDOS operating System. If you do not have LDOS, please add \$35 for a copy of the small-LDOS operating system.

**\$169**  
US

Introductory offer:  
**\$20 off.**  
Valid until Jan. 31/83



90-day trial - just \$20.

We are sure HEXMAN will become a "must have" program for all serious TRS-80 users. But check it out for yourself. Purchase HEXMAN now and try it out. If you feel you can live without it (unlikely!), return it for a prompt refund less a \$20 evaluation charge.

Offer valid for direct sales only - dealer terms may vary.



**WARNING —**  
**TIMELOCKED SOFTWARE**

This product is timelocked. Unregistered copies will expire at a future date. Registered owners will receive an extension patch when needed.

A NOTE ON CANADIAN MAIL — please allow 5 to 10 days in each direction for mail delivery. For faster service leave your orders or enquiries on our 24-hour answering machine.

**HEXAGON**  
**SYSTEMS**

P.O. Box 397, Station A  
Vancouver, B.C. Canada V6C 2N2  
Telephone (604) 682-7646  
Electronic Mail-Micronet 70235,1376

# TAKE A GIANT STEP BEYOND DOS

## with the HEXMAN Disk Management System

Imagine loading a file whose name you don't know from a disk you can't specify. Imagine creating a file without having to find a disk to store it on. Imagine your computer automatically making those backup copies you know you should have but never get around to. Imagine taking a giant step forward — to the HEXMAN Disk Management System.

The HEXMAN system introduces a new approach to disk management. HEXMAN uses the computer's ability to manipulate large quantities of information to monitor the location and status of all your computer files. All of your files are treated as if they were stored in one huge storage space, called the "Library". Only a portion of this storage space is immediately accessible to your computer, and this portion is called the "Filestore"

### Filestore and Library

The "Filestore" is kept on disks permanently in the disk drives. Your computer has immediate access to these files. The "Library" is kept on disks stored close to your computer. Rather than swap disks in and out of the disk drives as has been done previously, HEXMAN swaps files on and off the diskettes. HEXMAN monitors file activity to ensure that the files in the Filestore are the ones with the highest usage, and are thus the ones most likely to be needed. When you have a large number of files per disk, this method is much more efficient than swapping a whole disk full of files at a time. Remember that while you are swapping in 30 files to get the one file you need, you are also swapping out 25 files, one of which you may need again later. Just check the files in your disk drives now. How many of those files have you used today? With HEXMAN the files you would see on your drives would be the ones you use the most.

For an example of HEXMAN in action, suppose we wish to review a letter we wrote some months ago, type up some new letters using Scripsit, and continue writing an article we have been working on for some time. We request HEXMAN to load Scripsit, the article, and the old letter into the Filestore. HEXMAN finds that Scripsit and the article are in the Filestore as they have been used recently. The letter is in the Library however, and HEXMAN tells us which Library disk to load while the needed file is moved into Filestore.



### Backing Up

HEXMAN does more than ensure that the right files are in the right place. It also takes over the tiresome job of making file backups a needed, and retrieving them when we have a problem. After we finish work, the next time HEXMAN analyzes the filestore it will note that some new files have been created. These new files, our freshly written letters, will be added to the Library. The article that has been changed will be updated in the Library by the daily backup routines. Scripsit and the old letter have not been changed, so no backup is made. Over a period of time the letters will be removed from the Filestore, to make room for more active files. If we continue to work on our article it will remain in the Filestore, and be backed-up each day as it changes.

Some files are more important than others, and for these files you may specify that an extra copy called the "Security File" is to be made. You may even have two Security files. "A" and "B", one of which is kept in a safe place such as a bank vault. Security File A is updated while B is in the bank vault, then A is moved to the bank vault while B is updated. Doing this at regular intervals ensures that vital files are saved even in the event of a fire or other disaster. This level of security is not likely to appeal to the average home computerist, but if you are using your computer for vital business files you should consider it

### Finding your files

HEXMAN can track up to 2000 original files with up to 4 copies of each, for a total of 8000 files. Making up and remembering 8 letter filenames

becomes quite impractical when dealing with hundreds or thousands of files. In the HEXMAN system you retrieve files by designating the function you wish to perform, or by describing a particular file that you wish to find.

In most practical computer applications, more than a single file is needed. For example, an accounting system may use several programs linked by menus, and a number of data and transaction files. For word processing you need not only a word processor program, but also some document files to work on, and maybe a Spelling Checker and its associated dictionary files. For this reason, HEXMAN is designed to work with groups of files, rather than a single file at a time. The group of files HEXMAN is currently working with is called the "Active List". This "Active List" may be as large as your whole library or as small as a single file (Sorry to keep introducing buzz words, but there are a number of novel ideas in HEXMAN and we have to call them something!).

Suppose we wish to do an end of the month sales analysis. We ask HEXMAN to find all the files for the function "Monthly Sales". The monthly sales analysis requires a data file plus four print programs. HEXMAN therefore makes up an Active List consisting of 5 files. Now we ask HEXMAN to load the Active List into the Filestore. HEXMAN will match the Active List to its list of files in the Filestore. It will report which files are already in the Filestore, then move any missing files in from the Library disks

### Searching by description

The Active List is also used when searching for a file by description. In the HEXMAN system, files are cataloged when they are created, under a variety of headings called "Categories". Categories are defined by the user, and you may have over 500 of them. To make this number of Categories manageable, they are divided into 24 groups called pages, with 24 categories to a page. Pages are labeled "A" thru "X", and categories within a page are "a" thru "x".

We track down an unknown file by describing the Categories it may or may not belong to. While searching for the file, a page full of Categories for us to choose from is shown in the upper half of the screen. An example of the search display is shown in Figure 1. To switch to a different page, we simply

press the appropriate upper case letter. Once we are on the correct page, we select the category we want by pressing a lower case letter. The category selected is highlighted, and we press the enter key to confirm our choice

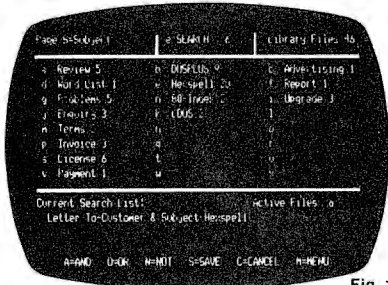

Fig. 1

Suppose we are looking for a letter we sent to Radio Shack about our disk drives. When we cataloged our letters, we filed them under several categories. On page D we specified the date of creation, on page S the subject of the letter, on N the name of the person or company it went to. To find our letter we turn to page N and specify that the name of the recipient must begin with "R", then on page S we specify that the subject is "Disks" HEXMAN replies that there are 3 letters that fit in both categories This is a small enough number to call in the Review program

The Review program gives us a screen full of information on each file in the Active List (See Figure 2). This includes Storage and Activity information, and a file description HEXMAN allows up to three lines of description for each file, enough to clearly identify the exact letter we want We "deactivate" the remaining files on the Active List, and ask HEXMAN to load in the chosen file

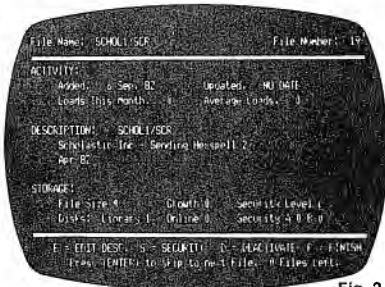

Fig. 2

### The Electronic Filing cabinet

We hope the above description will give you some idea of the power of the HEXMAN system. The effectiveness of HEXMAN depends on the number of diskettes you have in your library, how much disk storage you have (your Filestore) and your pattern of file usage. If you have a standard Model III with two 40-track disk drives, a large mailing list that takes up an entire disk would not be a suitable file to include in your HEXMAN library. On the other hand, if you have a large file of

correspondence, HEXMAN can make an effective electronic filing cabinet out of such a system

Suppose you can get eighty or a hundred letters on a diskette. Twenty or twenty-five diskettes can hold 2000 letters HEXMAN can ensure that the hundred most frequently accessed letters are on the computer, and can retrieve any of the other 2000 letters from the disk library using its advanced search functions. Buying twenty diskettes is probably cheaper than a filing cabinet to hold 2000 pieces of paper, and a lot smaller too. With HEXMAN the electronic filing cabinet becomes a practical reality.

### Hard Disk

So far we have been discussing HEXMAN in the context of a floppy disk system. We believe however that most serious TRS-80 users will move to hard disks in the next few years. HEXMAN has been designed with this move in mind.

On a hard disk system it is likely that most of your files will be in the Filestore, i.e. the hard disk. The Library becomes less an overflow for the Filestore, and more a backup for the Filestore. HEXMAN's automatic daily backup routines ensure that all your file backups are never more than a day out of date, yet only the few files that have changed are backed up each day. No need to worry about where a backup will be stored, HEXMAN takes care of it. If a file needs recovery, HEXMAN quickly selects the correct Library disk. If your hard disk crashes completely, no need to reload all the files. HEXMAN will detect that the filestore is empty and begin reloading files from the Library as they are needed. And when it comes to finding the file you want, HEXMAN's search routines are ready and waiting.

### Try it — you'll like it

We aren't claiming that HEXMAN is perfect for everyone. We have all seen programs that work well for someone else, but don't work out for us. The only way to see if HEXMAN is the program you need is to use it. We are making a unprecedented 90-day trial offer to give you the chance to do just that. When you purchase HEXMAN you have up to 90 days to use the program as much as you wish. If you return the program within 90 days of shipping we will promptly refund your money, less a \$20 charge. The charge covers the cost of the manual and diskettes, which we don't expect to be in a resaleable condition after 90 days of use! We should point out here that HEXMAN is a TIMELOCKED program, in case someone should think of returning the program and keeping a copy. At a certain date in the future the program will cease to function correctly. Long

before this happens registered owners will receive an upgrade patch to the timelock, but anyone with an unregistered copy could run into trouble.

HEXMAN works closely with the Disk Operating System. Because of this, we are releasing HEXMAN under just one operating system, LDOS. LDOS has the selection of features most useful to HEXMAN, and we believe Radio Shack's recent decision to sell LDOS will make it the most widely available of the advanced TRS-80 Operating Systems. If you do not have LDOS we have arranged with Logical Systems Inc. to distribute smal-LDOS, a mini version of LDOS, with the HEXMAN system. If you need it, smal-LDOS must be ordered at the same time as your HEXMAN system, and costs an additional \$35. Please note if you have a Model I that you need a double-density adapter to run HEXMAN, without it you are unlikely to have enough disk storage.

### Updates, and HEXMAN +

While we won't guarantee HEXMAN to be perfect, we do intend to support our product HEXMAN is a complex system, dealing with the real world. The real world is a dynamic place, always producing novel situations and unexpected events. To meet this challenge, we expect HEXMAN to grow and change over time, and will be offering occasional updates at a nominal cost. Because this growth is likely to be greatest early in the life of the program, we will guarantee at least one FREE upgrade to purchasers of Version 1

During the development of HEXMAN we tried out many nice features that didn't make it into the standard package. Only features that are essential to an effective system have been included. Too many fancy features, no matter how nice, confuse the novice user and in the end are counter productive. Once we develop a base of experienced HEXMAN users we will be releasing an extension package called "HEXMAN +". This package, for which there will be an additional charge, will add many powerful features to the standard HEXMAN package. When you are ready to trade the simplicity and ease of use of the standard system for the power and flexibility of an advanced system, HEXMAN + will be there.

### Finally

Order HEXMAN today, direct from Hexagon Systems or from your nearest Hexagon Systems dealer. And take a giant step forward into computerized disk file management.



# Notes, etc.

There has been talk in other journals that Radio Shack service is not as good as it should be. Our experience has been to the contrary. A letter was sent to us from a reader regarding the problem with a single drive copy from single density to double density when the Model I double density disk kit had been installed.

Within eleven days, we had a response from Tandy that the problem was valid and that a new diskette is in production and should be available by the time you read this. The Model I double density disk kit will now be sold with version 2.8, which corrects the single drive copy problem. Owners of version 2.7 can return their diskette for the new release under Radio Shack's standard exchange procedures. I call that quick, excellent response. Who said they don't care?

## Things we would like to see

Every month we are sent a number of articles and programs for possible publication. I would like to give you some hints if you are considering sending material to us. First, keep it brief. A twenty-seven-page submission on using NEWDOS/80 igel files may be important, but it takes up too much editorial space. Short and useful utilities, patches and subroutines are always popular. Second, try not to be too dependent on a specific operating system or peripheral. The wider the audience, the greater your chances of being accepted.

How about an article on simulations, art, music, health? A tutorial on using DEBUG, Model II graphics, a complete Color Computer function grapher, networking within an office environment, etc., would be useful.

As Mike points out in his Directions column, we will be printing on publication enamel in January. Besides giving four-color

capability to our advertisers, it also gives editorial the same ability. So, for our writers out there, feel free to submit color photos or slides with your articles. We would love to run them.

Mr. William H. Moore of Milwaukee, Wisconsin, wrote to see if any of our readers are aware of the TRS-80 being used in any political campaigns. He points out that the politician's need for word processing, fund raising, voter analysis and voter targeting, are perfect for a computer. If any of you have such information, forward an article or report to *80-U.S. Journal*. It strikes us as a subject worth reading about. We can see it now... "TRS-80 leads way to White House."

## Simple Joe—September, 1982

Mr. Dan Sitch of Pittsburg, New Hampshire, dropped us a note that converts the Simple Joe program by Mr. Ron Goodman to work on the Model III. Only three lines have to be changed. The last part of line 110 should read: IF A=109 THEN M=1 ELSE M=0. Change the beginning of line 130 to read: IF A=109, and the beginning of line 140 to read: IF A=237. When you run the program, the numbers that Mr. Goodman refers to in paragraph four will show up as 104 and 232. A good mix of these numbers will have Joe working just fine on the Model III.

## Corrections

We were getting the impression that you had stopped typing in the programs, and then some letters started arriving. For the article "Restore your data pointer" by Thomas L. Quindry, October 1982, there is a slight error in a remark on line 2 of Listing 1. The variable Z2 should equal INT(Z3/256) not the 246, as was stated.

In the article "High-resolution graphics" by Kenneth R. Smith, September 1982, a small correction

needs to be made for it to work correctly on the Model I. It turns out that Mr. Smith's method for checking printer ready status would only work on the Model III. By changing line 280 to: 280 IF (PEEK(14312) AND 240) <> 48 THEN 280, it should work on both models.

We got a number of letters regarding the program "PRINT to LPRINT," October 1982, by Roy B. Harrill. Mr. Harrill's program is a little too efficient. It will imbed a PRINT or LPRINT code within a line number or BASIC pointer when it does the conversion. We missed this only because we worked the program on a short sample listing and our line numbers did not (luckily?) coincide with codes that were being converted.

Mr. Wilfred O. Duran of Valencia, Venezuela, sent in an easy patch for the program. His letter said: ... In a normal BASIC program, a byte with a zero cannot appear inside a line. It is used as an end-of-line marker and it may also appear in the four bytes preceeding each line. The easiest way to change the routine by Mr. Harrill is to get rid of the unwanted tokens by changing line 5020 to be: 5020 FOR X=B+4 TO E. This will avoid the first four bytes, and then add a line 5025 that will avoid all other unwanted tokens. Insert line 5025 to be: 5025 IF PEEK(X) = 0 THEN X=X+5.

## December Puzzler

Before going into this month's puzzler, here is our winner to Puzzler #1, October 1982. Mr. Ron Goodman of North Hollywood, CA, submitted this following code:

```
5 'OCTOBER PUZZLER ANSWER
6 'BY RON GOODMAN
10 DEFINT A-Z
20 FOR X=1 TO 7
30 AS(X)=MID$( "HALLOWEN",X
,1)
```



```

40 NEXT X
50 FOR X=1 TO 9
60 PRINT A$(A(X));
70 NEXT X
80 PRINT,
90 X=1
100 A(X)=A(X)+1
110 IF A(X)=8 THEN A(X)=1:
X=X+1 ELSE 50
120 IF X=10 THEN END ELSE
100
    
```

According to Mr. Goodman, it works on a base 7 concept. The digits are stored in A(1) thru A(9) and line 10 sets up the characters 'HALOWEN' in the array A\$. The letters L and E don't need to be doubled because all combinations will still result.

The answer does give some extra results, such as HHH, but all possible combinations are given. From the submissions, his was the briefest, most organized in output, and closest to what we were looking for. Congratulations.

**Puzzler #3**

This time, we are looking for the etymology of the word "debug." Who said it first, and in what context? Send your answer to Puzzler, 80-U.S. Journal, 3838 South Warner Street, Tacoma, WA 98409. Winners receive \$10, notoriety, and a free tour of our facilities (you pay transportation).

**In This Issue**

Disks and DOSs is the theme this month, and we have a number of reports for you. Don Scarberry leads off with a discussion of why even bother with another DOS. Contrary to what he says, he is an LDOS lover. Terry Kepner tells us about MULTIDOS, while Cpt. Paul Hine takes a look at DOSPLUS. We have two investigations of hard disk systems, with Terry Dettmann giving a user's view of the Radio Shack Hard Disk for the Model II, and Harry Avant looks at MTY's offering for the Model III.

I had an opportunity to look at

Easylink and thought you might like to know about this new offering, plus this editor wanted to brush up on his reporting skills. If you are a single disk drive owner, be sure to look at the article by Charles Knight and Michael Andreas. It may save you from having to get another drive. Charles Edwards gives Level II users something that even disk owners can't have — unlimited USR calls. Bob Bowker presents an article on drivers that is truly informative. For Color Computerists, we have an excellent sort utility, in BASIC and machine language. Don't forget to use Alan Mandell's party programs. They are for all models and should amuse the kids.

No matter what machine you own, be sure to check out Basically BASIC, BASIC bits, Files and foibles and our other departments. For fun, don't miss Captain 80 or our gift to you entitled Christmas card.

Enjoy your holidays and may your new year be grand. ■



J. F. CONSULTING

# GEAP DOT WRITER

Another GEAP expansion module for Epson Graftrax Owners  
AND NOW — TRUE PROPORTIONAL PRINT ON YOUR EPSON!



RPM PROGRAMMER

**FEATURES:** GEAP CHARACTER FONTS • Create High Res Drawings without TRS-80 modifications or programming knowledge • Create or modify fonts • Print time options such as magnify, dot, spacing control, reverse and more • Library function allows saving to disk, printing or re-editing • proportional spacing and letters

**SAMPLE CHARACTER FONTS**

ABCD abcd
ABCD abcd
MONOCUBES

ABCD abcd
SMALL ENHANCED

ABCDE ABCD abcd MICROPRINT
GEAP

**ADDITIONAL FONT**

ABCDEFGHIJK

Computer Style ABCD abcd fg hijklmnopqrst

Mesquite x2 ABCD abcd
Mesquite x0

! "\$%&'

**SAMPLES - High Res and Modified Characters**

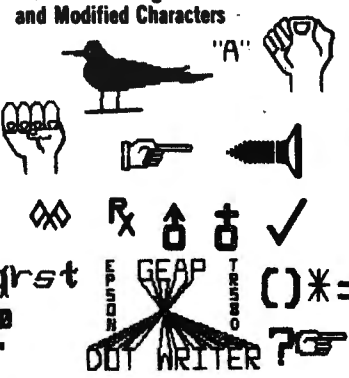

**GEAP** - The **ULTIMATE** in TRS-80 Graphics. GEAP 2.1 has instant graphic letters. Create your own screen graphics easily by: Magnifying, Reversing, Multiplying, Rotating, Merging and much more. Then let GEAP CREATE a BASIC program to recreate your graphic masterpiece! Numerous EXPANSION modules give GEAP limitless power EPSON/OKIDATA/ Radio Shack LPVI printer block graphics, Radio Shack LPV graphics ready soon! QUICKCURSOR with 2. speed controllable cursors, instant line, rectangle and circle. NEWSRIPT interactive expansion module. Much more! There is **NO** other graphic utility on the market that is as **POWERFUL, VERSATILE** and **EASY TO USE** as GEAP 2.1 **\$49.95**

**DOT WRITER** - The **UNDISPUTED** leader in **HIGH RESOLUTION** graphics. Numerous Special Hi-Res Type Fonts for your Epson MX 80/100. Many more fonts being readied now or **CREATE YOUR OWN** type fonts or HI-RES graphics. No hardware or modifications needed! **AND NOW, TRUE PROPORTIONAL PRINT** using your Epson Printer. **AND**, proportional print works with almost all of our **SPECIAL** type fonts! **DOT WRITER + GEAP 2.1**, turns your TRS-80 and EPSON into a Hi-Res Graphic TYPESETTER! Requires 48K, Disk and Epson MX 80/100 with Graftrax 80/100/PLUS. GRAFTRAX available for easy home installation. **GEAP 2.1 + DOT WRITER** **\$99.95**  
**DOT WRITER 1.5 only (Includes 11 fonts)** **\$69.95**  
**EXTRA** Fonts Available - \$30 for disk of 7-10 fonts  
 We also carry NEWSRIPT 7.0, The best TRS-80 Word Processor. \$124.95; FASTER, BASIC code optimizer \$25.95 and RPM, Disk Speed monitoring program \$24.95.

**JF Consulting**

**West Coast**  
74355 Buttonwood  
Palm Desert, Ca. 92260  
MOD 1/111 (714) 340-5471

**East Coast**  
221 Hirschfield Dr.  
Williamsville, NY 14221  
(716) 634-3026

**YOU CAN'T BEAT GEAP!**

MC/VISA

# 8



# Fun For The Holidays With

## DEMISE

By Case from Acorn

Shoot down the enemy ships which are coming—and firing—at you. After obliterating them all, you must carefully navigate a tunnel before you are in the clear. You can move your ship left, right, up, down and diagonally; your weapons include a laser cannon and “smart bombs” that render *all* ships on the screen impotent. You start with 5 ships and get another ship and “smart bomb” for each 10,000 points. 3 levels of play; great sound effects.

16K Tape or Disk, \$19.95

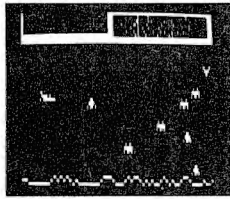

## SPACE ROCKS

By Steven Kearns from Acorn

Gigantic antimatter rocks appear on the Tactical Display Screen of your spacecraft. You blast away with lasers and they just explode into smaller chunks. To score in this fast arcade game *with sound*, you must destroy the rocks. To stay in the game at all, you must avoid them!

16K Tape or Disk, \$19.95

## KING OF THE JUNGLE

By Vandewalle from Acorn

An unusual combination of fast pinball action plus the challenges and dangers of an arcade game. Keep the ball in play, scoring points as it caroms from obstacle to obstacle, while wandering through the jungle searching for the hidden crown. And try to avoid the deadly Cobra. Lots of action, sound and fun! Choice of 3 screens. Can be used with Trisstick joystick.

16K Tape or Disk, \$19.95

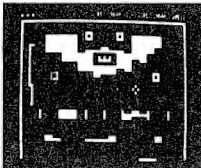

## EVADE

By Knight from Acorn

You're in charge of the USS Krestan, an interstellar tri-ship. If you defeat the enemy aliens you encounter, you get a chance to earn extra points by successfully docking with a larger ship. *Then* come the evil Malicians and dangerous meteor showers. Never a dull moment with this one!

16K Tape or Disk, \$19.95

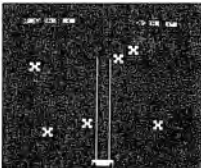

## ENEMY EVASION

By Raul Rivera from Acorn

An original fast-paced arcade style game requiring quick mental and physical reflexes. You must control your Rover to avoid oncoming Rovellan Ramcraft. You gain points for each successful pass through the “death lanes”, but the Ramcraft speed increases as you play. If you reach the double bonus mode, watch out for the land pellets they drop! Joystick compatible.

32K Disk, \$19.95

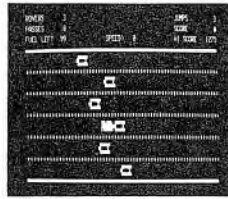

## ASTROBALL

By John Allen from Acorn

Once you load ASTROBALL into your TRS-80, the arrow keys become flipper buttons, the screen becomes the play board, and you become the “Pinball Wizard!” A flying saucer, spaceships, meteors, and black holes add to the fun as your ball realistically zings around the board. Five skill levels.

16K Tape or Disk, \$19.95

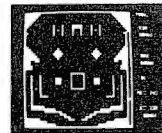

Also available:

**PINBALL:** The all-time favorite!

16K Tape, \$14.95

16K Disk, \$20.95

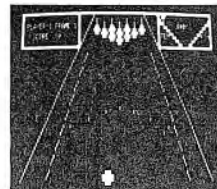

## TENPINS

By John Allen from Acorn

TENPINS brings you all the thrills of championship bowling. Up to 4 players participate, and the program automatically senses the skill of each. Beginners can position the ball and “roll” it, while more skilled players can vary the force, roll a curve and cause the ball to spin as it heads for the pins. PLUS 3-D graphics and sound effects—realistic and challenging!

16K Tape, \$14.95

32K Disk, \$20.95

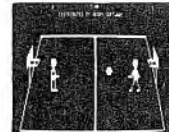

Also available:

**BASKETBALL:** You'll have to be fast!

16K Tape, \$14.95

32K Disk, \$20.95

## CATERPILLAR

From Soft Sector Marketing

This is the fast-action arcade game you've been waiting to play at home! You must hit mushrooms and caterpillars—segment by segment—moths and tumble bugs. The challenges: they are all moving; when hit they split into additional segments or metamorphose into different shapes; when you destroy a caterpillar, the new one that replaces it is a segment *longer* than the original!

16K Tape, \$15.95

32K Disk, \$19.95



## OUTHOUSE

From Soft Sector

Isn't there *anywhere* that's safe these days? Now they're invading the OUTHOUSE, trying to steal the paper supply. But watch out... when the paper is gone, *so are you!!!* If that's not enough, they're firing at you from the sky! With sound; disk version “talks”. Joystick compatible.

16K Tape, \$15.95

32K Disk, \$19.95



## SKY SWEEP

By Mark Barlow from Soft Sector

You are flying above an ever-changing terrain, with only your skill, speed, and maybe a little luck to help you avoid the missiles and gunfire coming at you. If you succeed, you must enter an ominous cave where *more danger* awaits you. Not for the timid.

16K Tape, \$15.95

32K Disk, \$19.95

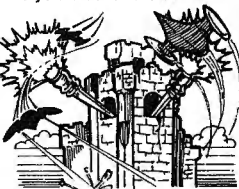

## FORTRESS

By Larry Ashmun from Soft Sector

You are in charge of a massive fortress. Your main priority is to defend it against alien attackers. With your protection and firepower, fending off the first attackers is like swatting flies—*but just wait!*

16K Tape, \$15.95

32K Disk, \$19.95

Coming Soon:

**CHICKEN:** Fast action; lots of squawking!

16K Tape, \$29.95

Over 1500 Programs for TRS-80,

ATARI 400/800, APPLE & IBM.

For Information Call  
202-363-9797

Visit our other stores:  
829 Bethel Rd., Columbus OH  
Seven Corners Center, Falls Church, VA  
W. Bell Plaza, 6600 Security Blvd., Baltimore MD



To Order Call Toll-Free  
800-424-2738



MAIL ORDERS: Send check or M.O. for total purchase price, plus \$2.00 postage & handling. D.C., MD. & VA: add sales tax. Charge cards: include all embossed information on the card.

4200 Wisconsin Avenue, NW, Dept. 8-212 Box 9609 Washington, D.C. 20016

# Our Sensational Software



## ARMORED PATROL



By Westmoreland & Gilman from Adventure  
As commander of a lumbering T-36 tank you have the firepower to destroy the enemy—if you can find them. They may be hiding behind the houses scattered about, the bleak terrain and your only view is thru the drivers port (your screen). Impressive animation in this arcade

16K Tape, \$19.95      32K Disk, \$24.95

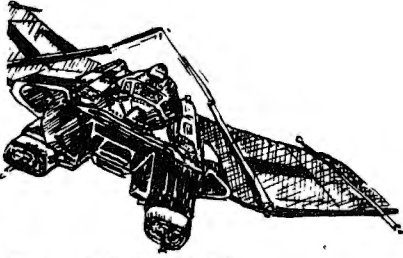

## STARFIGHTER

By Sparky Starks from Adventure Int.  
As mercenary and galactic police officer, you must maintain the condition and control of all parts of your spacecraft. You sit at the controls while peering out of the digital spaceview port. Suddenly something appears on your screen: Is it a Starpirate or a friendly merchant ship? You can't tell yet, and at this speed you may have only a fraction of a second to make an attack/no attack decision.

16K Tape, \$24.95      32K Disk, \$29.95

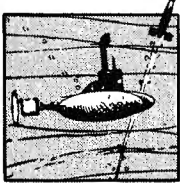

## SEA DRAGON

By Westmoreland & Gilman from Adventure  
Underwater adventure is yours as you command a nuclear sub armed with deadly missiles and torpedoes. Guide it carefully through sea mines and underwater mountains; watch out for depth charges being fired by overhead ships... and don't run out of air! Scrolling sea bottom for added excitement.

Joystick compatible.  
16K Tape, \$19.95  
32K Disk, \$24.95

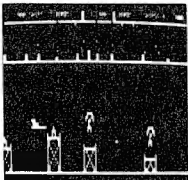

## ELIMINATOR

By Westmoreland & Gilman from A.I.  
You'll need all your keyboard manipulative skills to keep up with the action in this arcade game. You travel across the planet's low-altitude airspace in an effort to prevent the marauding enemy from capturing your energizer cells. All manner of alien craft await your arrival with destructive forces. For 1 or 2 players, with sound.

16K Tape, \$19.95      32K Disk, \$24.95

## STRIKE FORCE



From Melbourne House  
You are the warrior-savior of cities under relentless alien attack. You're armed with rapid-fire missiles, radar and incendiary star-shells; but you'll need your fastest thinking and instantaneous response to protect yourself and your people. Great real-time graphics!

16K Tape, \$15.95      32K Disk, \$19.95

## PENETRATOR



From Melbourne House  
Armed with missiles and bombs, you must fly your fighter to the enemy's cache of neutron bombs and destroy them. Your mission is in four stages, involving rugged terrain, caverns and manmade obstacles—not to mention enemy radar, missiles and paratroopers. This new departure in arcade gaming allows you to set up your own terrain and enemy emplacements, then save them for future use. Make your mission as hard or easy as you like. Joystick compatible.

16K Tape or 32K Disk, \$24.95



## PANIK

By Demas from Fantastic  
An arcade style game of a fascinating future world with high-res graphics and voice. Filled with action and excitement; in machine language.

16K Tape, \$19.95      32K Disk, \$24.95



## VENTURE

By Phillip Case from Horizons  
Set off on a journey into the stronghold of an ancient wizard. Danger is everywhere, and the penalty for a mistake may be complete destruction! The ultimate challenge lies in the forbidden Riddle Room—are you ready for the VENTURE? With sound effects; joystick compatible.

16K Tape, \$14.95      16K Disk, \$19.95

## DEFENSE COMMAND



By Hogue & Konyu from Big Five  
You are the lone defender of 10 Krotnium fuel cells essential for the survival of the planet. Aliens swoop down from above to steal the fuel; it's your job to destroy them. You can still save the cells after a raid, but you must shoot the alien and simultaneously move under the cell to catch it. If things look bad you can set off one of your 4 antimatter bombs and destroy all enemies on the screen! Arcade fun with action and sound. Joystick compatible.

16K Tape, \$15.95      32K Disk, \$19.95  
Now Thru Dec. 10: Tape \$14.36; Disk \$17.96



## STELLAR ESCORT

By Jeff Zinn from Big Five  
This new arcade game from Big Five continues their tradition of bringing you the most exciting action in innovative space games. Your fighting spacecraft must run the gauntlet of the attacking alien's weaponry in order to accomplish your defense mission. You'll use all your skill and dexterity just to survive! Joystick compatible.

16K Tape, \$15.95      32K Disk, \$19.95  
Now Thru Dec. 10: Tape \$14.36; Disk \$17.96

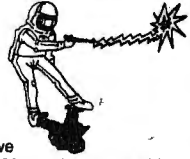

## ROBOT ATTACK

By Hogue & Konyu from Big-Five  
One of the top names in TRS-80 arcade games adds a new dimension: voice sound effects! It's you against the robots in this fast-moving shoot-em-up. Electrified Mazes and the "Flagship" complicate things as you stalk the evil androids.

The innovations built into ROBOT ATTACK take your TRS-80 near the limits of its capabilities. You MUST see and hear it! Joystick compatible.  
16K Tape, \$15.95      32K Disk, \$19.95  
Now Thru Dec. 10: Tape \$14.36; Disk \$17.96

## Four From Big-Five

By Hogue & Konyu  
COSMIC FIGHTER  
GALAXY INVASION  
METEOR MISSION 2  
ATTACK FORCE!

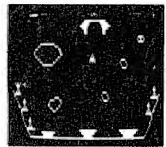

Each:  
16K Tape, \$15.95      32K Disk, \$19.95  
Now Thru Dec. 10: Tape \$14.36; Disk \$17.96

THE PROGRAM STORE • Dept. 8-212 • Box 9609 • 4200 Wisconsin Avenue, NW • Washington, D.C. 20016

Item	Tape/Disk/Book	Price	Postage \$2.00	Name _____
_____	_____	_____	Total _____	Address _____
_____	_____	_____	_____	City _____ State _____ Zip _____
_____	_____	_____	_____	Card# _____ Exp _____

# LDOS

## Why bother with another DOS?

Don Scarberry

When a customer goes to a Radio Shack computer center to purchase a microcomputer he is immediately confronted with the problem of selecting one which contains features suitable for his needs. Due to the multitude of options, the customer soon discovers that he must rely heavily on his own instinct. Shopping for a microcomputer is very much like shopping for an automobile. There is a basic, no frills, unit available which sells for a very modest price and contains very limited computing capability. By adding this or that peripheral, a customer can usually obtain a system which will perform as intended — for a price of course.

Because of the large storage capacity and rapid access speed, one of the most needed or desired options is a disk drive (or two). A disk system offers greater speed, reliability, flexibility, substantially more storage capacity than cassette systems and is absolutely necessary for any serious business or educational applications. Usually, purchase of a disk drive option will include a Disk Operating System (DOS). A Radio Shack disk-based system will include an operating system called TRSDOS (pronounced TrissDos), an acronym for Tandy Radio Shack Disk Operating System.

A disk operating system can be viewed as a traffic cop which controls the flow of data between the computer and the disk drives. The computer must be able to manipulate data flow in an organized and useful manner and TRSDOS is provided in order to take care of all the necessary chores. The

computer must be able to tell the disk drives where to store your files and, once stored, where to go to retrieve them. Without an operating system to control the complex activity that takes place between the computer and disk drives, a crash will be inevitable. It is comforting to know that all the complex control functions, provided by the operating system, are virtually invisible to you, thus freeing you for more productive endeavors.

TRSDOS, with all its power and complexity, is what I call a minimal operating system. It gets the job

done but without any frills, bells or whistles. There are many other DOSs available which are more complex and provide much more flexibility than TRSDOS. There is NEWDOS/80, DOSPLUS, MULTIDOS, LDOS and MEGADOS<sup>®</sup> (where have I heard of MEGADOS?) to name a few. All (except MEGADOS<sup>®</sup>) are excellent operating systems in their own right and much more powerful than TRSDOS — but then, they were designed to be. These operating systems will provide the user with much more computing power with



# M-ZAL™

## Release Two Is Here!

Our Users asked for it, and we made the best TRS-80 disk assembler even better! Now M-ZAL has:

- Recursive MACROS with full symbolic parameter substitution
- Conditional assembly with unlimited nesting
- Text Editor warm-start/recovery option
- Support for all popular source file formats
- Load Module inspect/superzap using LINKER

and the features that made it famous:

- True multi-pass assembly
- Full Screen Option Menus
- ENTRY/EXTERN symbols, relocation, and object module linking
- 8 character labels with sorted symbol table
- Built-in symbol table cross-reference
- Nested \*INCLUDES (source file chaining/nesting)
- Lower case support (Model 3 only)
- Over 175 pages of documentation including Z-80 Technical Manual
- Full Screen Text Editing and much, much more!

M-ZAL provides a modular, structured development environment that makes programming your TRS-80 a truly enjoyable experience. Order yours today. (Requires 32k, 2 disk system)

#1050-10	Mod 1	\$149.00
#1250-10	Mod 3	\$149.00

### CAU Development Software— The Professionals Choice:

Full Screen Text Editor for BASIC: we were the first to give the TRS-80 this indispensable ability! A must for every BASIC programmer:

#1210-20	Mod 1 & 3	\$29.95
----------	-----------	---------

T-ZAL: custom designed for the Model 3, this tape based assembler has many of M-ZAL's most desired features.

#1250-20	Mod 3 only	\$49.95
----------	------------	---------

XBUG: for machine language analysis and debugging—this tiny (2.5k) but powerful program lets you do it all!

#1020-10	Mod 1	\$19.95
#1220-10	Mod 3	\$19.95

FILEXFER: transfer any disk file between two TRS-80s. Use direct cable link or RS modems. Mod 1 and Mod 3 can be mixed. RS-232 and disk reqd.

#1040-10	Mod 1 and 3	\$49.95
----------	-------------	---------

*"We've been using M-ZAL heavily for over two months now, and it's been worth its weight in gold."*

—Chuck Tester  
PROSOFT

*"...well written software that is long overdue."*

—Bruce Douglass  
80 Microcomputing  
BASIC Editor Review

*"During the first 3 days of use, M-ZAL saved more money in programmers time than we had paid for the product."*

—William Denman  
Author of Asylum  
MED SYSTEMS

*"The editor has at least doubled my productive capacity...Having spent a good deal of money on so called 'utilities' that don't work, it's a delight to find one that not only lives up to its claims but surpasses the advertising."*

—BASIC Editor user

Our choice for the best TRS-80 DOS:

DOSPLUS 3.4	Mod 1	\$149.00
DOSPLUS 3.4	Mod 3	\$149.00

Call or write for more information.

All products require level II.

Mail orders specify catalog #.

Send check, money order, or MC/VISA numbers and expiration date to:

**Computer Applications Unlimited**  
P.O. Box 214, Dept. ABO Rye, New York 10580  
(914) 937 6286

N.Y./ State residents add applicable sales tax.  
Outside USA and Canada add \$10.00 shipping.  
Dealer Inquiries Invited.



**CAU COMPUTER APPLICATIONS UNLIMITED™**  
a div. of CAU, Inc.

TRS-80 is a TM of Tandy Corp. M-ZAL is a TM of CAU, Inc.  
Z-80 is a TM of Zilog, Inc.

the TRS-80 than is provided by TRSDOS. This is perhaps the reason Radio Shack has decided to offer another, non-Radio Shack, operating system for the TRS-80 Models I and III. They must have realized that there is need for a more powerful disk operating system than the stock version of TRSDOS. Indeed, there is. That is the very reason, other operating systems have been so successful. They fill a very real need.

The Models I and III will still come equipped with TRSDOS as standard equipment. The optional operating system chosen by Radio Shack is LDOS. By optional, I mean that you'll have to pay extra to enjoy the benefits offered by this operating system. The question that will arise immediately in a customer's mind is whether or not LDOS is for him. The answer to that is quite simple if he knows the difference between TRSDOS and LDOS and understands what his needs are. Generally, a customer will have a pretty good idea of what he wants a computer to accomplish for him. He can also experience, first hand, what TRSDOS will or will not do — the operating system comes with the computer. But, how can he justify purchasing a different operating system like LDOS if he doesn't know how it differs from TRSDOS? To cope with this problem I'll single out some of the special features of LDOS and explain how they differ from TRSDOS.

LDOS is considered to be a device-independent system. Each device the system uses has its own control area of memory. This is true for hardware devices actually connected to the system or phantom devices created by the user. Device independence makes it possible to route devices from one to another or to disk files. You may re-direct the input/output of data between the system, its devices, and the disk drives in almost any way imaginable.

Assume you wish hardcopy of a file but someone has borrowed the printer. Further imagine that someone else needs to use the computer that currently contains the file you need printed. What do you do? With LDOS you can simply

tell the computer to treat a disk drive as the printer and print the file. Later, when the printer is available, you can come back and tell the disk to print the file to the printer. It's true that this can be done with TRSDOS and a Model III, but LDOS will let you do it on a Model I also. To further illustrate the power of LDOS let's use another example.

TRSDOS for the Model III contains a FORMS command which enables you to establish the number of columns of print on a line printer before wrap-around occurs. This is a flawed command that Radio Shack claims will go uncorrected. Seems that in order to get a forty-column print-out, you must set the FORMS command to two less characters than what you will need — in this case thirty-eight. This function actually works correctly with LDOS and there is some additional flexibility not found with TRSDOS. Suppose you wish to list a BASIC program, formatted to forty columns, and have each successive line, after the line number, indented. With LDOS you can indent any number of characters you desire. If all this seems too trivial then let's take a few more complex functions and illustrate the differences between TRSDOS and LDOS.

Assume you just saw an extremely hot price on some eight-inch floppy disk drives. The price is so unbelievably low that you can't pass it up. If you stay with TRSDOS you'll have to kiss this deal good-bye. LDOS will allow you to use the eight-inch floppies on your Model I or III with ease. And LDOS will allow you to keep your 5¼-inch floppies on-line simultaneously. That's right! You will be able to intermix 5¼-inch floppies and eight-inch floppies on the same computer. You can use single density single-sided, double density double-sided, 35, 40 or 80-track drives if desired. You can use disk drive configurations I didn't even mention. Here's the sweet meat. Recently those five and ten-megabyte hard disk drives have dropped in price quite dramatically. So what, you say? Your TRSDOS holding you back? With LDOS there's no problem. Buy the hard disk and hook it up. LDOS will

provide you with a seemingly bottomless well for storage of your files. I have even seen hard disks being sold which come equipped with LDOS. Must tell you something, right? Now, that's flexibility!

Virtually every command or function that TRSDOS offers, is found in LDOS. LDOS, however, offers many more. This equates directly to more computing power and flexibility. Practically all the commands contained in TRSDOS are expanded substantially by LDOS. LDOS provides for system growth where TRSDOS does not! Your TRS-80 will not become obsolete as quickly as it would if you confined yourself to TRSDOS. In fact, TRSDOS is dwarfed by all the capabilities of LDOS. You could strip away roughly half of the capabilities of LDOS and still have a system as powerful as TRSDOS in its present state.

Next time you are in a Radio Shack store and see LDOS sitting on the shelf pick up the manual and browse through it. I think you will agree that it is probably the most comprehensive piece of documentation on the market today. If, after looking over the manual, you are still undecided whether LDOS is for you then consider this: if you wish to exploit the power of your TRS-80 to its fullest and allow for future expansion, it's for you. LDOS is a disk-owner's dream come true.

Let me assure you that this is not a biased, paid-for evaluation of LDOS. Radio Shack has realized the need to offer a more sophisticated operating system and their choice was LDOS. I have been using this system for nearly two years and I find the options in a sophisticated operating system well worth the extra money.

There are many other DOSs out there that TRS-80 owners are perfectly satisfied with, and justifiably so. I have used just about every one of them and find they all are excellent in many respects. But for now, my own pride of possession speaks when I say:

I'm not a DOS lover,  
or a DOS lover's son.  
But I'll use LDOS  
'til a better DOS comes. ■

# LDOS

## MICRO REVIEW

Volume 1 No. 1



SPECIAL EDITION



December 1, 1982



LDOS can't really turn your TRS-80 gold, but you'll think you've made the LDOS strike of the decade when you turn your micro on to LDOS. You'll find a bonanza of features like full keyboard type-ahead; a true background spooler; file backup by date, class, and between different drive types; hard disk support; data transportability between Model I and III; and a complete communications utility including disk file send and receive. Support for Radio Shack's Doubler and selected others is also provided. With our Job Control Language, you get true "hands off" running of your application programs — give a single command and then walk away. The 400 page manual includes examples of all commands and utilities. The Operator's Guide gives you step by step instructions on how to use LDOS with your applications. Stop running with only "half" a computer! Let LDOS provide the missing features to speed up and simplify your TRS-80 computer system! Visit a dealer or contact LSI for more information on the most popular sophisticated operating system for your TRS-80.

LDOS is available worldwide through thousands of dealers for just \$129.

## The BASIC Answer

The BASIC Answer is a BASIC text processing utility. It is designed to allow the BASIC programmer to build code in a structured manner. "Source" code is written with a word processor or text editor which allows the user to exploit the powerful editing and movement features characteristic to those types of editors. Source code can even be created by your own BASIC interpreter. The BASIC Answer is then used to process these files into normal interpretive BASIC code.

### Free Yourself from Line Numbers

The BASIC Answer allows substitution of labels for line numbers! This means that your BASIC code now can read like a novel. Instead of the typically un-descriptive "GOSUB 1000", a label such as "GOSUB @Search.Name" is used. Imagine yourself reading code filled with such descriptive branches and understanding it at a glance, even years later. This feature even allows totally relocatable BASIC routines without the renumbering problems.

TRS-80 is a trademark of Tandy Corporation. LDOS is available for the TRS-80 Model-I and Model-III. Prices and specifications subject to change without notice. LDOS and The BASIC ANSWER are products of Logical Systems, Inc.

```
ORLPI:=2TOHA!PRINT#32,"primes found
FHA!/LP:=INT(HA!/LP!)THENGOTO48"CH
EXTLPI:=IFVAL(FAS)=LO!THENFAS=" Pr
RI(CO%)-LO! on this scan"USING"###,
RS(CO%)-FAS LEN(FAS)-1)FORLO!-ST:IT
O%:=CO%-PS%*PS%+1ELSEFAS=LEFTS(FAS,
ORLPI:=#OTO!PRINT#0,"factoring "US
RINT#64*LP!+192,PR!(LO%),PRS(LO%):
O%:=LO%-INPUT"ORIGIN OF SCAN":INS#0
FLO%:=1IFVAL(INS)~2THENING"###,##
EXTLPI ST:=INT(VAL(INS))##;PS%:R
O%:=CO%-INPUT" END OF SCAN":INS#0
FCO%:=1EN!-INT(VAL(INS))IMPR!(10),
FHA!/LP:=INT(HA!/LP!)THENGOTO48"CH
EXTLPI:=IFVAL(FAS)=LO!THENFAS=" Pr
RI(CO%)-LO! on this scan"USING"###,
RS(CO%)-FAS LEN(FAS)-1)FORLO!-ST:IT
O%:=CO%-PS%*PS%+1ELSEFAS=LEFTS(FAS,
ORLPI:=#OTO!PRINT#0,"factoring "US
RINT#64*LP!+192,PR!(LO%),PRS(LO%):
O%:=LO%-INPUT"ORIGIN OF SCAN":INS#0
FLO%:=1IFVAL(INS)~2THENING"###,##
EXTLPI ST:=INT(VAL(INS))##;PS%:R
O%:=CO%-INPUT" END OF SCAN":INS#0
ORLPI:=2TOHA!PRINT#32,"primes found
FHA!/LP:=INT(HA!/LP!)THENGOTO48"CH
```

### A New Concept in Variable Usage

The BASIC Answer allows variable names to be as long as 14 characters and ALL 14 are significant. Imagine reading:

```
"IF ACCNT.OVERDUE #>
0 THEN GOSUB
@PRINT.DUN"
rather than
"IFAO#>0THEN
GOSUB52130"
```

Which would you rather read? It also introduces to BASIC the concept of Global and Local variables. This feature circumvents the tedious problem of variable tracking because a Local variable is only viable in its own subroutine!

NOW AVAILABLE  
LDOS 5.1 Quick  
Reference Card  
\$5.95.

### End the Multiple Machine Hassle

The BASIC Answer introduces the concept of "Conditional Translation." This feature allows the programmer to place different "machine dependent" code simultaneously into the same Source Code.

The BASIC Answer can be "switched" when processing to ignore the unwanted or include extra code! No more multiple master programs to confuse maintenance. All the masters could now be rolled into the same program. Modify the one master and you've modified them all. Process the same code with different switches set, and get two or more versions from the same source.

The BASIC Answer combines the self-documenting power of COBOL with the relative ease of BASIC together with the power of a word processor.

The BASIC Answer is available for just \$69.00.

**LOGICAL  
SYSTEMS  
INC.**

11520 N. Port Washington Rd.  
Mequon, WI 53092  
(414) 241-3066

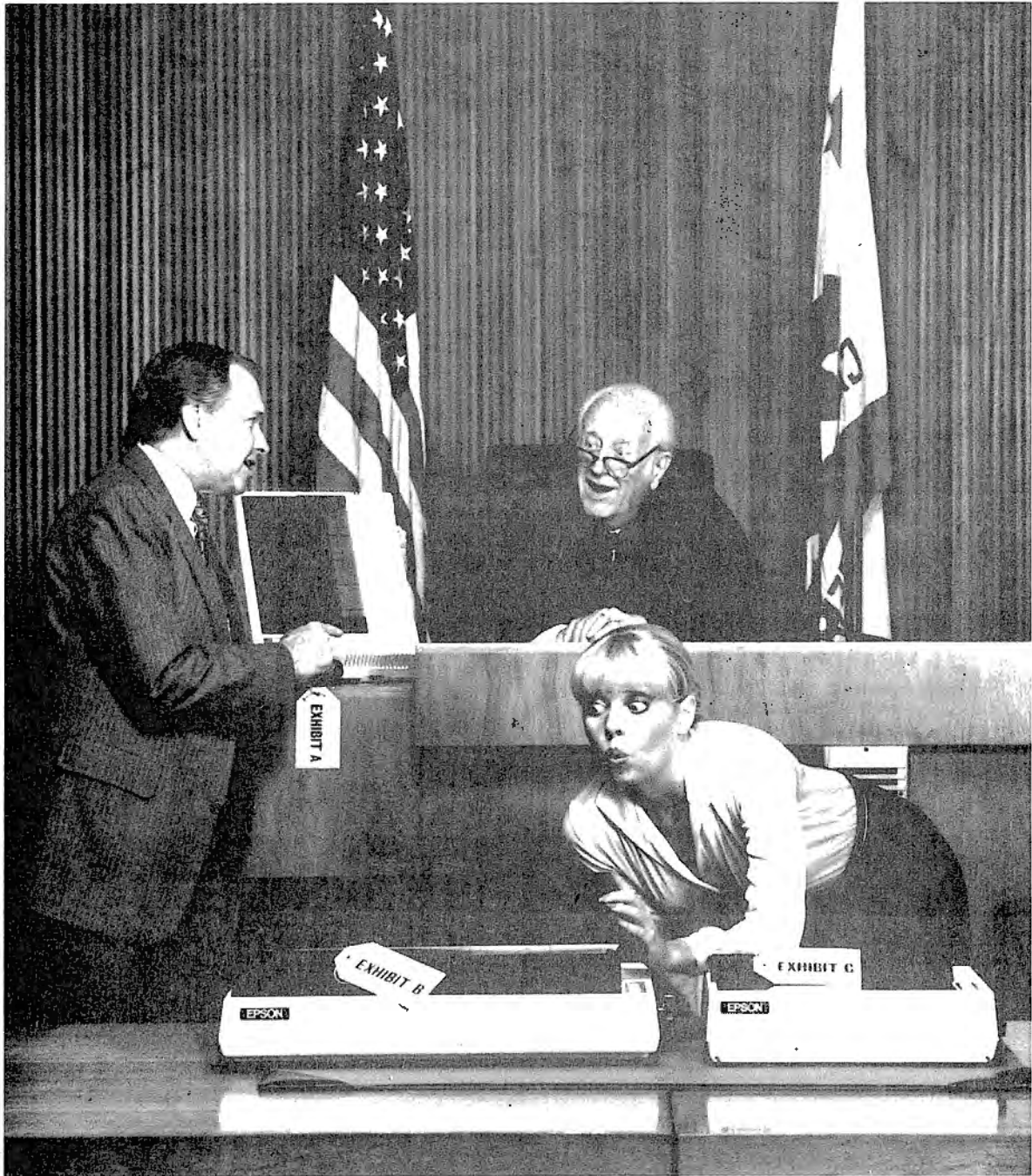

The facts.  
And nothing but the facts.

Epson.



Our MX Series printers are the best-selling dot matrix printers in the entire world. This is why.

**Fact One: We've got your type.**

Epson invented correspondence quality printing. And we still do it better than anybody.

But more importantly, we do *more* of it than anybody. On every Epson MX printer, you get a choice of *sixty-six* different type styles, including italics, a handy subscript and superscript for scientific notation and small print, enough international symbols to print most Western languages, and one-pass underscore. All in a tack-sharp, easy-to-read 9x9 matrix with full descenders.

If print quality is important to you, your next printer is an Epson.

**Fact Two: Ultra-high resolution graphics.**

There simply is no higher resolution graphics than GRAFTRAX-PLUS. And it comes standard on every MX.

You get bit image graphics free of wander, walk and jitter; graphics with blacker blacks and better definition because you can precisely place a dot at any of 25,920 positions inside a square inch (that's 120 DPI h x 216 DPI v); graphics that make our printers rival plotters.

If graphics is what you want, your next printer is an Epson.

**Fact Three: Feature shock.**

The Epson MX Series is packed with the features printer fanatics want most. A bidirectional print head with logical seeking of the shortest line. Programmable tab, form length and right margin. Top of forms recognition. Skip over perf. Software printer reset. True

backspace. Self test. The world's only disposable print head. And more. Lots more. On our MX-100 and MX-80 F/T, you even get both friction *and* tractor paper feed.

If you want performance, your next printer is an Epson.

**Fact Four: Incredible reliability.**

Epson MX Series printers are the most reliable printers ever made. And the reason is precision.

Take a look inside one and you'll understand. Notice the simplicity, the fit, the finish. That's why Epson has an out-of-box reliability rate others can only envy: 98%. And why our mean cycles between failures (MCBF) is over five million lines.

The whole package is neatly wrapped in a rugged plastic injection-molded case designed to look good — and stay looking good.

If you want a printer that works, and keeps on working, your next printer is an Epson.

**Fact Five: World's best seller. Period.**

Within months after we introduced the Epson MX-80, it was the best selling dot matrix printer in the world. It still is. Not because of anything *we* said, but because tens of thousands of computer enthusiasts went out and did some serious comparison shopping. *They* decided it was the best printer for the money they could buy. And who are we to argue?

If you want the world's best seller, your next printer is an Epson.

**Fact Six: Quality doesn't cost more.**

Don't take our word for it. Check it out. Look at what they give you. Then look at what we give you. Then look at the price.

There is only one logical choice. Epson. And that's the truth.

*"In my judgment,  
this is the  
best printer  
you can buy."*



Your next printer.

**EPSON**  
EPSON AMERICA, INC.  
COMPUTER PRODUCTS DIVISION

3415 Kashiwa Street  
Torrance, California 90505  
(213) 539-9140

---

# Radio Shack hard disk system

## *A user's report*

T. R. Dettmann, Associate editor

The Radio Shack Hard Disk System (RSHDS) is Radio Shack's entry into the hard disk market. With hard disk systems rapidly becoming more affordable, it was inevitable that the Radio Shack line should expand to include hard disk capability. This article discusses how the RSHDS works in an actual, working environment, with real day-to-day problems to solve.

This review is based on experience gained in helping several people install hard disk systems for their businesses. It is a description of how well the RSHDS worked in their situations. Each of the installations was a Model II-based system, officially installed by a Radio Shack Computer Center.

### The Hard Disk

The hard disk itself is an 8.4-megabyte, two-disk, four-platter, eight-inch hard disk system, mounted in a sealed environment. For those who like numbers, the specifications for the system are: Rotation speed, 3125 rpm; latency, 9.6 ms; track access time, 19 ms (track to track); data transfer rate, 4.34 Mb/sec.

Backup is accomplished by the Hard Disk Operating System to eight-inch floppy disks, using a special utility called save. A restore utility is provided to regenerate the hard disk files from the backup copies.

Experienced Model II owners will

find it easy to use, since it appears to the system as disk four. It is normally set up so that the system will start up with the hard disk in operation, taking the place of the drive zero diskette. In this way, your normal use of the diskette system is to transfer programs and do backups.

Once started, the hard disk operating system acts enough like TRSDOS 2.0 to be familiar to anyone who has operated a Model II. The hard disk system is actually TRSDOS 4 (.0 or .1, depending on which release you have).

All of the standard file handling commands are included with the system, as are some new commands. FLOPPY (on/off) turns floppy drives on or off. DRIVE controls drives on or offline (4.1 system). FCOPY is used to up- or download from floppy disks. I haven't personally verified that all commands work, but all that I've tried worked correctly.

One of the problems with TRSDOS 4 is incompatibility with TRSDOS 2.0. You can't just put a TRSDOS 2.0 disk in drive zero and have the hard disk operating system read it. Why, you ask? Well, TRSDOS 4.0 formats its disks differently so that they hold more information. That's great, but why can't the TRSDOS designers get the trick of recognizing a disk in some way (say a standard single density track zero) and make the transition auto-

matic? CP/M systems do it.

To correct the problem, FCOPY is provided. On the 4.0 system, it serves for uploading and downloading of files or whole disks. On the 4.1 system, you get some additional features, such as the ability to get directory listings of floppy disks.

As I noted above, there are two releases of the operating system software. One of the installations, working with a hard disk as of this writing, is still on TRSDOS 4.0. It works fine, but doesn't have some of the things TRSDOS 4.1 has, such as the drive command and the extended FCOPY.

In operation, I've helped to install several databases now using the RSHDS. The advantage of the hard disk is its speed compared to floppy disks. On one database, an increase of five to six times in search speed was noted in going from floppy disk to hard disk.

The RSHDS system is not without its difficulties, though. The FREE command is much harder to understand. It no longer has a picture of the disk layout, but is just a set of numbers. DIR takes a long time since it goes through quite a few files.

My biggest objection to the system is the fact that it allows no internal directory structure within the hard disk system. With as much space as there is, on a single hard disk, placing all of the files in a single directory can sometimes make it im-

possibly large — far too large for most people to really handle effectively.

When we reviewed the CORVUS hard disk, the Model I NEWDOS system for the CORVUS provided a multiple directory structure, allowing the user to effectively attach parts of the disk as logical disks. The CORDOS system provided this same ability on the Model II.

This capability isn't just nice. For some people, it could be essential. One of the installations I've worked on has the complete COBOL accounting system from Radio Shack. Anyone who has seen these packages knows how many files there are in one of the packages — quite a few. Directories go a long time.

There are other problems as well. One of the companies installed the Radio Shack payroll system on the hard disk. After being told it was compatible, they found (or rather, I did) that the payroll program had written over the list command with a BASIC program also called LIST. The hard disk system stores its commands as separate programs. At least, in this case, it could be changed.

One of the companies has had a number of problems with data files being scrambled. So far, no cause has been found and Radio Shack is working on it. I can't say that the problem has anything to do with the hard disk, but to paraphrase an old say: "ya better keep yer backups dry."

So, who is the system really good for? The best applications I've seen on the RSHDS system are those where a few very large files are kept. One of the systems is maintaining a 5000-item Profile database with all of the files on the hard disk. It really works well.

My impression of the RSHDS system is primarily favorable. I would go out and buy one for myself, having seen it in operation. I've heard of some repair problems, but nothing I can verify. Based upon what is admittedly not a rigorous test, I wouldn't hesitate, at this point, to recommend a Radio Shack hard disk. ■

# THE COMPUTING TEACHER

The Journal of  
The International Council for  
Computers in Education

Vol. 10 No. 2 THE COMPUTING TEACHER Oct. 1982

## Features

- |    |  |
|----|--|
| 4  | <b>Big Things Come in Small Packages</b><br><i>Camille A. Allen and Robert T. Rude</i>                                 |
| 5  | <b>Success</b><br><i>Dale Thurston</i>   |
| 9  | <b>University of Oklahoma Hosts Programming Contests</b>   |
| 14 | <b>"Messing About": Six Easy Steps for Getting Started with Computers</b><br><i>Ann White Lewis</i>                    |
| 18 | <b>Trick Play: Picking NFL Winners at Random</b><br><i>Ron Dirkse</i>  |
| 20 | <b>Jefferson High School's Computer Program: A Curriculum Development Model for the Future</b><br><i>Mary Bothwell</i> |
| 26 | <b>How Does a Speak &amp; Spell Talk?</b><br><i>Barbara Thompson</i>   |
| 27 | <b>Substrings</b><br><i>Craig Moore</i>  |
| 30 | <b>An Argument for Including String Variables in Early Programming Activities</b><br><i>M. J. Winter</i>               |
| 31 | <b>Index for the PET</b><br><i>Raymond E. Merritt</i>  |
| 34 | <b>Preparing Slide Presentations on Computers</b><br><i>John K. Elberfeld</i>  |
| 38 | <b>The First and Perhaps Last Annual TCT Official Contest</b>  |
| 43 | <b>The Holistic Approach to Introducing Computer Systems</b><br><i>Harold W. Lawson, Jr.</i>                           |
| 50 | <b>Microcomputer Remedial Instruction</b><br><i>Rita Gierzanick, Charles Lanza, Richard D. Nolan</i>                   |
| 54 | <b>Minnesota Statewide Computing Contests for Students &amp; Teachers</b><br><i>Tom Boe</i>                            |
| 59 | <b>Reflections of a High School Teacher to "Computer Power"</b><br><i>William E. Baird</i>                             |

## Departments

- |    |   |    |                                 |
|----|---|----|---------------------------------|
| 3  | Editor's Message                                    | 41 | Computing Problems              |
| 4  | Letters to the Editor                               | 64 | Book Reviews                    |
| 6  | What's New  | 70 | ICCE Organization Members       |
| 7  | Computer Literacy Film Reviews                      | 71 | Classified Ads                  |
| 11 | Computers in Science Education                      | 72 | Organization Membership in ICCE |
| 28 | Computers in the Teaching of English: Bits n Pieces | 72 | Index to Advertisers            |

The *Computing Teacher* is a journal for educators who are making instructional use of computers or who are concerned with how computers are affecting the content and process of education. Each issue contains information of use to the beginner and to the experienced user of computers. Topics covered include teaching using computers, teaching about computers at all grade levels, use of computers as an aid to problem solving in all disciplines and teacher education.

The *Computing Teacher* is a publication of the International Council for Computers in Education, a non-profit corporation. ICCE has members from every state in the United States and every Canadian province, as well as from many different countries. ICCE is dedicated to helping teachers cope with computers in education and to improving education at all levels.

### Subscription Rates

U.S.	Non-U.S. (Surface Mail*)
\$16.50 ( 9 issues)	\$20.00 (U.S. Funds)
\$31.50 (18 issues)	\$38.00 (U.S. Funds)
\$44.00 (27 issues)	\$54.00 (U.S. Funds)

The *Computing Teacher*  
University of Oregon  
Eugene, Oregon 97403

# 13

Save \$2.50 handling charge by including payment with your order.

# Announcing ACCESS UNLIMITED'S



**FREE! DOSPLUS 3.4\*\*  
disk operating system  
with any Percom or  
Access Unlimited Drive  
for the Model III\***

## SAVE \$50.00 on fully-tested PERCOM Disk Drive for Model III\* Reg. \$499.00. Now \$449.00

Percom's internally-mounted drives, with their widely-acclaimed disk controllers, are completely pre-tested with a 48 hour Burn-in. So, you know it works right when you get it. Choose single or double-density storage capacity.

A First-Drive System includes the four-drive disk controller, your choice of one or two drives, power supplies, cables and a fully-illustrated, easy-to-understand owner's manual.

## Top-of-the-line Access Unlimited addons for the Model III\* Disk Drive only \$334.00 Single, and \$628.00 Double.

Access Unlimited's drives for the Model III\* bring you all the outstanding features of the Percom Drive, plus the superb, deluxe quality of the Access Unlimited workmanship that goes into the precision-made equipment which bears our name.

## Make sure it's done right. Let us install your First-Drive System.

Purchase your Model III\* Drives from us and for \$39.95 plus shipping, you can have our experienced professionals perform a 48-hour burn-in of your Model III\* computer, install the drive system, and check out your expanded system to make sure everything works correctly. Call for pricing of complete Model III\* system with 2 to 4 Access Unlimited or Percom drives.

## Get the best! Our own fully-tested drives for as low as \$275.00

Every Access Unlimited Floppy and Flippy Disk Drive is electrically and mechanically tested, then burned-in for 48 hours under operating conditions. The signed test list in your shipping carton is proof of that.

Our floppy disk drives offer you either single or double density. With double-density, it stores up to 364 Kbytes, depending on the format. And you can use both sides of the diskette on our flippy drives.

**SATISFACTION GUARANTEED!** If you're not completely satisfied with your Access Unlimited Disk Drive, return it within 15 days for a full refund. All our drives have a comprehensive 90-day limited warranty.

For a limited time only, you can get top-quality name-brand disk drives at rock-bottom prices.

— Sale ends Feb. 28, 1983 —

(But some prices will be good after Sale ends. Please call 1-800-527-3475 for pricing.)

## Save \$\$ on our most popular items!

Percom Data Separator (reg. \$29.95)	now \$23.95
Screens for Models I*, II*, III Green, Lt. Blue, Dark blue, and Amber. Bronze for color video (reg. \$24.95)	now \$14.95
Head Cleaning Kit (reg. \$29.95)	now \$19.95
Drive Numbering Tabs, pkg. 0-3 (reg. \$4.50)	now \$3.95
Flip-N-File 5 1/4" (reg. \$39.95)	now \$24.95
Flip-N-File 8" (reg. \$54.95)	now \$39.95

## AFD 100-40-track single-density drives \$275.00

JUST PURCHASED! Overstock of Japanese-manufactured absolutely top quality CP/M<sup>x</sup> based business computers. From 160 KB to 40 + MB.

We have just added approximately \$100,000.00 worth of brand new business and game software.

Call or write for our new FREE catalog.



## Electric Crayon™ Close-out — only 80 left. When these are sold, there will be no more! reg. \$289.00 now \$149.95

Use the electric crayon with your own monitor or color TV set. Use it with your Model I or III TRS-80™ and a color monitor or color TV set for a very low cost, high quality color computer. (Hook up instructions furnished.)

## XTRA Special — Soft sector diskettes — Carload purchase — As low as \$19.90 for box of 10



SSDD, with hub, 5 1/4"	\$19.90 box of 10
SSDD, with hub, 5 1/4"	22.80 box of 10
DSSD, with hub, 5 1/4"	29.90 box of 10
DSDD, with hub, 5 1/4"	33.50 box of 10
SSSD, 8"	22.75 box of 10
SSSD, 8", high performance	22.90 box of 10
DSDD 8"	31.95 box of 10

One year limited warranty against manufacturing defects



# Grab TRSDOS by the horns

## Run a data disk in drive zero

Model I, PMC-80, LNW80

Michael D. Andreas and Charles P. Knight, Arlington, TX

TRSDOS and other compatible operating systems consist of huge amounts of code. Hence, they require a large part of the disk in drive zero. To avoid having all of the system in memory at the same time, as is done on the Apple, TRSDOS loads in portions of its code from disk as it needs it. This is why the operating system on the TRS-80 is so much more powerful than that of the Apple — it saves memory space and allows a much more sophisticated operating system to be written, but it does so at the expense of disk space. It also requires that the disk in drive zero contain these overlays at all times, if maximum use is to be made of the system. These portions of code are called “system overlays” and load into the same memory space, but at different times. The memory area used by these overlays is usually 4E00H to 51FFH.

With memory prices dropping, everyone should have 48K of memory. Yet, many applications have been written that only require 32K of memory or less. If you can tie your shoes without help, you can install memory into the TRS-80 expansion interface. So, what are you waiting for?

We propose to put this extra memory to good use by placing system overlay files into the upper 16K of memory. This will speed operations and reduce wear and tear on the disk and drive. You may have noticed that when a new file is being written on a drive other than the system drive, occasional accesses are still done to the system disk. That is because different overlay



files are being loaded.

TRSDOS has five overlays, SYS1/SYS through SYS5/SYS, which use this area, and an additional overlay, SYS6, which uses memory at 5200H. SYS0/SYS is not an overlay — it is the resident system. It is loaded into the area between 4000H and 4E00H by BOOT/SYS each time you boot and is not accessed on the disk again until you reboot.

It is the goal of the boot operation to get SYS0 into memory. Once SYS0 is there, it does not need to be on any disk in the system. It must be present on the disk used for booting, or you'll be greeted with that annoying “NO SYSTEM” message. BOOT/SYS must remain on the disk in order for the system to find the directory track should the system lose it.

SYS1 is loaded on entering DOS

and on returning to DOS READY from any of the other system overlays, or from BASIC, or any other command file. It contains code necessary to accept user input and call the correct overlay from among the other system files. It is also responsible for displaying the DOS READY prompt.

SYS2 and SYS3 are used in opening and closing files. Each time a request is made of the operating system that involves opening or closing a file, or saving or loading a BASIC or machine language program, these two files are called, one at a time, to provide the code to do this. Even a BASIC program is a file, and before that file can be loaded, it must be opened. After loading, it must be properly closed.

Since these files must be read in from disk each time they are used, a great savings in time can be

# BOOST THE POWER AND PERFORMANCE OF YOUR TRS-80™ WITH WILEY'S FRIENDLY PAPERBACK GUIDES

## THE TRS-80™ MODEL III USER'S GUIDE

Tony Bove & LeRoy Finkel

Get to know the myriad of applications, options, and accessories available for the TRS-80™ Model III—with the help of this clear, nontechnical guide. It explains everything you need to know to use your micro effectively—from handling its disk operating system to coming to grips with the incredible array of software on the market.

(1-86242-8) November 1982  
approx. 256 pp. \$12.95

## THE GENIE IN THE COMPUTER

Easy BASIC Through Graphics  
TRS-80™ Edition

Rachel Kohl, Laura Karp, & Ethan Signer

Learn how to program the fun and easy way—by interacting with the "genie", a microcomputer graphic. A tiny core program on the very first page of the book shows you how to bring the genie to life—a simple face on the monitor screen of your TRS-80™. As you master each new programming concept, you can make the genie move, smile, talk, tell stories, and even star in a movie. Ideal for young people and for adults with "technophobia."

(1-87049-8) October 1982  
approx. 320 pp. \$12.95

## FAST BASIC

Beyond TRS-80™ BASIC

George Gratzner with Thomas Gratzner

Now you can combine TRS-80™ BASIC with assembly language to dramatically increase the execution speed of your programs from 4 to as much as 1,000 times. This practical guide teaches you 20 Assembly Language Instructions and the names of 60 ROM routines, then shows you how to apply these concepts to your knowledge of BASIC. Also includes valuable information on the operating principles of the TRS-80™.

(1-09849-3) 1982 278 pp. \$14.95

*Convenience software (contains all the teaching and utility programs listed in FAST BASIC)*

Model I Disk: (1-87484-1) 5¼" disk; 32K of memory  
\$19.95

Model III Disk: (1-86838-8) 5¼" disk; 32K of memory  
\$19.95

Cassette for Model I or Model III: (1-87421-3) 16K of memory  
\$19.95

## SUBROUTINE SANDWICH

John P. Grillo & J. D. Robertson

Here, in one easy-to-use manual, are 36 BASIC subroutines—powerful modules that you can combine and build onto to write structured programs that are clearer, easier to modify, and require less composition and debugging time than traditional programs. Geared for use with the TRS-80™ Model I or Model III, the book is carefully structured, with each subroutine a separate four-page unit. You'll find crystal-clear explanations of how each subroutine works, possible applications, suggestions for modifying it, and a program that incorporates it, complete with sample output. Five mother programs demonstrate the real-world applications of this practical programming technique.

(1-86920-1) January 1983  
approx. 224 pp. \$12.95

For 36 additional subroutines in the same user-friendly format, turn to

## MORE SUBROUTINE SANDWICH

John P. Grillo & J. D. Robertson

(1-86921-X) January 1983  
approx. 224 pp. \$12.95

## SUCCESSFUL SOFTWARE FOR SMALL COMPUTERS

Graham Beech

This easy-to-use manual shows you how to write dependable, efficient, even elegant programs that work the first time—even if you're just a novice programmer. First you'll master the principles of successful software design with the aid of a PDL (program description language). Then you'll learn how to create reliable, structured programs that are easily—almost automatically convertible to Microsoft BASIC. Applications range from data structures, files, and sorting to simulations, mathematical equations and computations, and more.

(1-87458-2) November 1982  
approx. 192 pp. \$12.95

Wiley publishes more than a dozen popular, paperback guides to help you get the most use and enjoyment from your TRS-80™. Look for them all at your favorite bookshop or computer store.



**JOHN WILEY & SONS, Inc.**  
605 Third Avenue,  
New York, N.Y. 10158

In Canada: 22 Worcester Road, Rexdale, Ontario M9W 1L1

# OMNITERM

## The ULTIMATE TRS-80 Terminal Package

### What is OMNITERM?

OMNITERM is a professional communications package for the TRS-80 that allows you to easily communicate and transfer files or programs with almost any other computer. We've never found a computer that OMNITERM can't work with. It's a complete package because it includes not only the terminal program itself, but also conversion utilities, a text editor, special configuration files, serious documentation and serious support.

### Why do I need it?

You need OMNITERM if you need to communicate efficiently with many different computers, or if you want to customize your TRS-80 for use with one particular computer. You need OMNITERM to SOLVE your communications problems once and for all.

### What do I get?

The OMNITERM package includes the OMNITERM terminal program, four conversion utilities, a text editor, and setting files for use with popular computers such as CompuServe, the Source, and Dow Jones — just as samples of what you can do for the computer you want to work with. The package includes six programs, seven data files, and real documentation: a 76-page manual that has been called "the best in the industry." And OMNITERM comes with real user support. We can be reached via CompuServe, Source, phone, or mail to promptly answer your questions about using OMNITERM.

### What do I need to use OMNITERM?

A Model I or Model III TRS-80, at least 32K of memory, one disk, and the RS-232 interface, or Microconnection modem. OMNITERM works with all ROMs and DOSes, and will work with your special keyboard drivers.

### What will it do?

OMNITERM allows you to translate any character going to any device: printer, screen, disk, keyboard, or communications line, giving you complete control and allowing you to redefine the character sets of all devices. It will let you transfer data, and run your printer while connected for a record of everything that happens. OMNITERM can reformat your screen so that 80, 32, or 40 column lines are easy to read and look neat on your TRS-80 screen. It even lets you get on remote computers with just one keystroke! The program lets you send special characters, echo characters, count UART errors, configure your UART, send True Breaks and use lower case. It accepts VIDEOTEX codes, giving you full cursor control. It will even let you review text that has scrolled off the screen! Best of all, OMNITERM will save a special file with all your changes so you can quickly use OMNITERM for any one of many different computers by loading the proper file. It's easy to use since it's menu driven, and gives you a full status display so you can examine and change everything.

"OMNITERM has my vote as the top TRS-80 terminal program available today" KiloBaud Microcomputing, June 1981, pages 16-19.

OMNITERM is \$95 (plus shipping if COD) Call for 24 hour shipment. Manual alone \$15, applied toward complete package. Visa, M/C, and COD accepted. MA residents add 5% tax. Dealer inquiries invited.

Also available OMNITERM for the TRS-80 Model II and IBM personal computer. Contact Lindbergh Systems for details.

**Lindbergh Systems**

41 Fairhill Road, Holden, MA 01520  
(617) 852-0233 # 16

Source: TCAR16 - CompuServe: 70310.267 TRS-80 is a <sup>TM</sup> of Tandy Corp.

## Grab TRSDOS

realized, in a program which repeatedly opens and closes files, by having these two modules already resident in memory. Instead of reading the disk, a simple block move is done to relocate the code to the proper place in RAM. It is possible to speed things up by as much as one thousand percent this way, but it will cost you some of your high memory.

SYS4 displays DOS error messages. Actually, SYS4 isn't really an executable code. It's just a table of error messages that is accessed by SYS0 each time an error has occurred. The entire file is read into the overlay area and the proper error message is displayed. If you never make errors (you are perfect, aren't you?), then SYS4 is never used.

SYS5 is the system debugger. If you never program in machine language, then you don't need this overlay and can gain an extra gran of disk space by killing it. Many new TRS-80 users have been surprised to see the screen fill with baffling numbers when the computer should have been doing something else. This is the debug screen. To a programmer, it is very useful, but to a non-programmer, it can be quite a surprise. This program requires it to be on the disk and it will be placed in high memory with the rest of the system overlays. A flag is maintained, in the system communications area, to tell the system whether debug is active or not. If debug is active and the break key is pressed, or a /CMD file is executed, it is loaded from disk and executed. SYS1 is reloaded whenever debug is exited via the normal G402D command.

SYS6/SYS occupies an area above 5200H and is used to execute DOS library functions. Any time you enter a command which is in the TRSDOS command library, code in SYS6 is executed to perform the function requested. To get a look at the commands that use the SYS6 overlay, type "LIB" in response to DOS READY. The command "LIB", itself, is also executed by this overlay.

Since a directory access is required to load the overlays, the

files are physically located next to the directory track on the disk to minimize access time. You can see that, by placing them in unused memory, even more time would be saved by not having to access the disk at all.

DOS loads the system files, as needed, by an unusual (but logical) process. When you call a vector (documented in the DOS manual) that is in one of the overlays, the A register is loaded with a value that corresponds to the desired function. The lower four bits specify the desired overlay file. The most significant bit must be set to signify that this is a call for an overlay, and the remaining three bits specify the subfunction in the overlay.

Next, an RST 28H instruction is executed. This is the same as CALL 28H, except it is only a one-byte instruction whereas, a call would be a three-byte instruction. The ROM code at 28H vectors to 400CH, which vectors to the system overlay loader. This routine kills the return address, so that control will pass back to the program which called the documented vector. Then, it ensures that bit 7, in the A register, is set. Next, it looks at the lower four bits and compares that value with a variable that specifies which overlay is already in memory. If it's already there, control is passed directly to it, otherwise it is loaded first.

The value of the lower four bits is the directory entry code (DEC) and corresponds to the location of the entry for the /SYS file in the directory. This explains why you can't directly copy a /SYS file to a disk that doesn't already have it in the directory. If you try, the directory entry will be randomly placed in the directory and will most likely be put in a different directory slot. The system overlay loader would go crazy trying to find it.

Our program, which we call MEMSYS/CMD, copies each SYS file into memory, then modifies the system overlay loader to look first in memory for the file before going to disk. Files are stored in memory (in the load module format) as on disk, which means that any patches you have applied will be loaded



automatically with the /SYS file.

Type in the accompanying program under EDTASM. If you desire a different set of files in memory, delete the code that points to the filename, calls the loader and checks for an error. The last error check done must be the same as the one after the code that loads SYS6.

We also strongly recommend that you make a special disk to transfer your object code to while testing the program. Since we're playing around with the system, a simple typographical error could cause portions of the disk to be overwritten with garbage. This happened during the development of this program, exercising our vocabulary considerably! Previous tangles with machine language program bugs have taught us to be careful.

One note about the password, "LOY4". This seems to be a master password that allows access to any protected file under TRSDOS 2.3. Now that you know this password, you can enjoy looking at files Tandy thought you shouldn't see.

This program is compatible with any application that recognizes and respects the top of memory value which DOS stores at 4049 and 404AH (also referred to as HIGH\$). BASIC uses this value as the default answer to the "MEMORY SIZE?" initialization question. (NEWDOS 2.1 BASIC does not honor HIGH\$.) All of the TRSDOS 2.3 overlays will fit into less than 11K of memory, so any BASIC program that works in a 32K machine will certainly work with MEMSYS active in a 48K machine.

With MEMSYS active, you should notice a vast improvement in operating speed involving opens, closes and file writes, which extend the length of the file. Saving a file from BASIC will only access the drive that the file is being saved to. Typing CMD"S" will reenter DOS without reading SYS1/SYS from the disk. Entering debug is done without starting the disk. Exiting debug via G402D does not activate them either. The clock will lose less time because fewer sectors are being read from disk.

Perhaps the largest advantage of

MEMSYS is the ability to use a data disk in drive zero. This amounts to an extra eleven granules of storage space. Simply boot up with a system disk, activate MEMSYS, load BASIC and your program, and swap in a data disk. Of course, you will have to reinsert the system disk if you want to reboot. This will be a definite advantage for short programs that handle a large amount of data. Two-drive owners will find that they can copy files from one data disk to another without copying them to a system disk first.

The program listing shown is for

TRSDOS. Modifications for NEWDOS 2.1, and another for DBLDOS, are shown as additional lines of code to be added after the TRSDOS code has been entered. Use the same line numbers we have, and you can add the code for the operating system of your choice later with minimum difficulty. Where a line number exists that is not in the TRSDOS version, add that line. Where a line number is the same as in the TRSDOS version, substitute that line for the one in the TRSDOS version.

When MEMSYS is first executed, it must create an area in memory to

Listing 1

```

00100 ;*****
00110 ;**** MEMSYS 1.0 *****
00120 ;**** FOR TRSDOS 2.3 *****
00130 ;**** COPYRIGHT 1981 *****
00140 ;**** BY MICHAEL D. ANDREAS *****
00145 ;**** AND CHARLES P. KNIGHT *****
00150 ;*****
00160 ; MEMSYS WILL PLACE SYSTEM OVERLAYS
00170 ; SYS1/SYS THRU SYS6/SYS INTO THE UPPER
00180 ; MEMORY OF A 48K MACHINE AND THEN MODIFY
00190 ; THE SYSTEM OVERLAY LOADER TO LOAD OVERLAYS
00200 ; AS NEEDED FROM MEMORY INSTEAD OF WEARING
00210 ; OUT THE DISK AND DRIVE. (IT'S A LOT
00220 ; FASTER TOO!!!!)
00230
5200 00240 ORG 5200H
5200 110072 00250 INITSY LD DE,SGNMSG
5203 CD6053 00260 CALL DISPLA
5206 2180FF 00262 LD HL,SYLVAR
5209 0680 00264 LD E,128
520B 3600 00266 L3 LD (HL),0
520D 23 00268 INC HL
520E 10FB 00269 DJNZ L3
5210 11BD52 00270 LD DE,SY1 ;POINT TO FILENAME
5213 CDED52 00280 CALL TUKSYS ;PUT IT IN MEMORY
5216 2028 00290 JR NZ,ERREXT
5218 11AD52 00300 LD DE,SY2 ;SAME-O SAME-O
521B CDED52 00310 CALL TUKSYS
521E 2020 00320 JR NZ,ERREXT
5220 119D52 00330 LD DE,SY3
5223 CDED52 00340 CALL TUKSYS
5226 2018 00350 JR NZ,ERREXT
5228 118D52 00360 LD DE,SY4
522B CDED52 00370 CALL TUKSYS
522E 2010 00380 JR NZ,ERREXT
5230 117D52 00390 LD DE,SY5
5233 CDED52 00400 CALL TUKSYS
5236 2008 00410 JR NZ,ERREXT
5238 116D52 00420 LD DE,SY6
523B CDED52 00430 CALL TUKSYS
523E 2803 00440 JR Z,NEREXT
5240 C30944 00450 ERREXT JP 4409H
00460 ;THE NEXT SECTION OF CODE WILL BE EXECUTED
00470 ;ONCE THE ENTIRE SYSTEM HAS BEEN SUCCESSFULLY
00480 ;PLACED IN MEMORY. IT WILL MODIFY THE SYSTEM
00490 ;OVERLAY LOADER TO LOOK INTO RAM FOR THE DESIRED
00500 ;SYSTEM. THE ORIGINAL CODE IS MOVED INTO HIGH
00510 ;RAM FOR USE IF THE REQUIRED SYS OVERLAY IS
00520 ;NOT IN MEMORY (IT WILL LOOK ON THE DISK).
5243 215DFF 00530 NEREXT LD HL,PATCH ;POINT TO NEW CODE.
5246 11CE4B 00540 LD DE,OLDSYS ;POINT TO WHERE ORIGINAL CODE GOES
5249 061D 00550 LD B,PEND-PATCH+1 ;NUMBER OF BYTES TO MOVE
524B 4E 00560 SWAP LD C,(HL)
524C 1A 00570 LD A,(DE)
524D 77 00580 LD (HL),A
524E 79 00590 LD A,C
524F 12 00600 LD (DE),A

```

# Grab TRSDOS

be used as a mini-directory which MEMSYS will use to find the overlay when it is placed in memory. It proceeds to load each system overlay, in turn into memory, by pointing to a file control block (FCB), then calling the subroutine TUKSYS, which reads the file in and places it in high memory. If all designated system overlays are successfully loaded, it modifies the system loader and the top of available memory pointer, and returns to DOS. If it encounters an error at any point, it will abort and not modify the system.

The subroutine TUKSYS (which loads the /SYS file specified by the DE register pair) displays the filename, for the user's edification, then finds the mini-directory location specified by the byte pair following the terminating 00 byte after the filename in the FCB. In the NEWDOS 2.1 version, this must be two bytes of zeroes, for /SYS files with numbers less than ten, to keep the offset consistent. Throughout the loading of the /SYS file, the IX register pair will point to the beginning of the DOS FCB, and the IY register pair will point to the mini-directory entry. The /SYS file is opened, and the DEC is read from the eighth byte of the DOS FCB. This DEC is placed in the mini-directory entry for use when loading system overlays from high memory. Next, the ending record number (ERN) is obtained from the thirteenth byte of the FCB and placed in the second byte of the mini-directory. We can take this shortcut because /SYS files are never longer than 256 sectors long, so only one byte will be needed to store the ERN.

The value at memory location HLDARE specifies the top of available memory and the beginning of the memory location of this /SYS file. This value is placed in the mini-directory and will be used by the modified system overlay loader to find the file. The FCB is positioned to the first sector which is read into memory. A period is displayed if it is successfully read. If the last sector has not yet been read, the routine loops back for the next sector. When the last sector has been read, it returns to the routine which

```

5250 23      00610      INC      HL
5251 13      00620      INC      DE
5252 10F7    00630      DJNZ     SWAP
5254 3EC9    00640      LD       A,0C9H      ;CODE FOR 'RET'
5256 77      00650      LD       (HL),A      ;PUT ON END OF OLDSYS
5257 2160FF  00660      LD       HL,PATCH+3  ;ONE OF THE ORGSYS
525A 36C0    00670      LD       (HL),0C0H   ;INSTRUCTIONS HAS TO BE
525C 23      00680      INC      HL          ;MODIFIED
525D 3600    00690      LD       (HL),0      ;CODE FOR 'NOP'
525F 23      00700      INC      HL
5260 3600    00710      LD       (HL),0
5262 2A7EFF  00720      LD       HL,(HLDARE) ;PROTECT MEMORY
5265 2B      00730      DEC      HL
5266 224940  00740      LD       (4049H),HL  ;FROM SYSTEM.
5269 AF      00750      XOR      A
526A C32D40  00760      JP       402DH      ;BACK TO DOS.
00770      ;THE NEXT SECTION OF CODE DESCRIBES THE FILES TO
00780      ;BE PLACED IN MEMORY AND WHERE A MINI MEMSYS
00790      ;DIRECTORY ENTRY WILL BE PLACED.
00800
526D 53      00810      SYS6    DEFM   'SYS6/SYS.L0Y4' ;FILENAME
527A 00      00820      DEFB   0        ;TERMINATOR BYTE FOR PRINTOUT
527B 94FF    00830      DEFW   0FF94H   ;MEMSYS DIR ADDRESS
527D 53      00840      SYS5    DEFM   'SYS5/SYS.L0Y4'
528A 00      00850      DEFB   0
528B 90FF    00860      DEFW   0FF90H
528D 53      00870      SYS4    DEFM   'SYS4/SYS.L0Y4'
529A 00      00880      DEFB   0
529B 8CFF    00890      DEFW   0FF8CH
529D 53      00900      SYS3    DEFM   'SYS3/SYS.L0Y4'
52AA 00      00910      DEFB   0
52AB 88FF    00920      DEFW   0FF88H
52AD 53      00930      SYS2    DEFM   'SYS2/SYS.L0Y4'
52BA 00      00940      DEFB   0
52BB 84FF    00950      DEFW   0FF84H
52BD 53      00960      SYS1    DEFM   'SYS1/SYS.L0Y4'
52CA 00      00970      DEFB   0
52CB 80FF    00980      DEFW   0FF80H
00990      DEFS   32
01000
01010      ;THE NEXT SECTION OF CODE TAKES THE FILE POINTED TO
01020      ;BY THE DE REGISTER AND PLACES IT IN MEMORY.
01030
52ED D5      01040      TUKSYS  PUSH   DE
52EE DDE1    01050      POP     IX
52F0 D5      01060      PUSH   DE
52F1 114772  01070      LD      DE,LINE1
52F4 CD6053  01080      CALL   DISPLA
52F7 D1      01090      POP     DE          ;RESTORE FILENAME
52F8 CD6053  01100      CALL   DISPLA
52FB 210E00  01110      LD      HL,OFFSET   ;FIND DIR POS
52FE 19      01120      ADD     HL,DE
52FF 7E      01130      LD      A,(HL)
5300 23      01140      INC     HL
5301 66      01150      LD      H,(HL)
5302 6F      01160      LD      L,A
5303 E5      01170      PUSH   HL          ;HL POINTS TO DIR POS
5304 FDE1    01180      POP     IY
5306 210070  01190      LD      HL,BUFFER
5309 0600    01200      LD      B,0
530B CD2444  01210      CALL   OPENEX     ;SEE TRSDOS MANUAL PG. 6-9
530E C0      01220      RET
530F DD7E07  01230      LD      A,(IX+7)   ;IF ERROR
5312 FD7700  01240      LD      (IY+0),A  ;GET DEC
5315 DD7E0C  01250      LD      A,(IX+12) ;LOAD MINIDIR WITH DEC
5318 FD7701  01260      LD      (IY+1),A  ;GET ERN
531B 2A7EFF  01270      LD      HL,(HLDARE);PUT IN MINIDIR
531E FD7502  01280      LD      (IY+2),L  ;BEGINNING OF STORAGE POINTER.
5321 FD7403  01290      LD      (IY+3),H  ;INTO MINIDIR.
5324 010000  01300      LD      BC,0      ;POINT TO FIRST RECORD
5327 CD4244  01310      NXTREC CALL   POSN     ;GET RECORD FROM DISK,
532A C0      01320      RET      NZ       ;IF ERROR
532B CD3644  01330      CALL   READ
532E C0      01340      RET      NZ
532F D5      01350      PUSH   DE
5330 FDE5    01360      PUSH   IY
5332 3E2E    01370      LD      A,'.'      ;DISPLAY FOR EACH SECTOR
5334 CD3300  01380      CALL   33H
5337 FDE1    01390      POP     IY
5339 D1      01400      POP     DE
533A E5      01410      PUSH   HL
533B D5      01420      PUSH   DE
533C C5      01430      PUSH   BC
533D 21FF70  01440      LD      HL,BUFFER+255 ;POINT TO END OF DISK BUFFER.
5340 ED5B7EFF 01450      LD      DE,(HLDARE) ;POINT TO BEGINNING OF FREE STORAGE
5344 010001  01460      LD      BC,256     ;NO. OF BYTES IN A RECORD.
5347 EDB8    01470      LDDR
5349 ED537EFF 01480      LD      (HLDARE),DE ;TRANSFER IT

```

specifies the /SYS files to be loaded.

When a new system overlay is requested by the system, the modified system overlay loader calls TSYS. TSYS hunts through the mini-directory and looks for an entry that has the correct DEC. If that is not found, it executes the code which reads the /SYS file from disk. If found, HLDARE is modified to point to the first sector of the file in memory. The resident system has a routine which reads in a machine language object file, places it in the proper memory locations, and finds the execution address. The portion of the code which reads the next sector is modified to get it from memory via TREAD, by changing the code specified by VECTOR to point to TREAD instead of the disk read routine in the resident system. TSYS calls the machine language file loader, which reads in the file. Once accomplished, control is returned to the system overlay loader, which executes the code.

TREAD simply transfers the /SYS sector pointed to by HLDARE, to the system buffer, the location of which varies between operating systems. Then, it adjusts the HLDARE pointer to the next sector and returns to the calling routine.

After you have MEMSYS up and running on your favorite operating system, try putting a data disk in drive one, a data disk in drive zero, and copying files, one at a time, between disks. Who says you need three drives? Sure it's nice to have that many drives, but we don't all need this much storage. If you're running NEWDOS, there will still be a short delay before any CMD function is executed. NEWDOS still must move BASIC and its pointers up against the bottom of the MEMSYS system before it can execute the DOS command. Try running some of the Radio Shack accounting software and see how much faster it runs. We haven't done any benchmark tests, but we noticed that disk accesses seem to be almost instantaneous. In many cases where disk accesses were formerly required, they now operate without any delay. A new freedom from the confines of DOS are now available to you.

```

534D C1      01490      POP      BC
534E D1      01500      POP      DE
534F E1      01510      POP      HL
5350 03      01520      INC      BC          ;COUNT UP TO NEXT RECORD
5351 79      01530      LD       A,C        ;MAKE SURE WE'RE NOT
5352 FD8E01  01540      CP       (IX+1)     ;READING PAST END
5355 20D0    01550      JR      NZ,NXTREC   ;NOT THERE YET, SO READ ANOTHER.
5357 D5      01570      PUSH    DE
5358 115472  01580      LD      DE,LINE2
535B CD6053  01590      CALL   DISPLA
535E D1      01600      POP     DE
535F C9      01610      RET     ;GOBACK AND READ ANOTHER FILE
          01620
          01630 ;THE NEXT SECTION OF CODE WILL DISPLAY THE STRING
          01640 ;POINTED TO BY REGISTER DE AND TERMINATED BY
          01650 ;A ZERO BYTE.
          01660
5360 D5      01670 DISPLA  PUSH  DE
5361 1A      01680 L2     LD    A,(DE)
5362 B7      01690      OR     A          ;IS IT A ZERO?
5363 280C    01700      JR     Z,ENDMSG   ;IF SO THEN QUIT WRITING.
5365 D5      01710      PUSH  DE
5366 FDE5    01720      PUSH  IY
5368 CD3300  01730      CALL  33H
536B FDE1    01740      POP   IY
536D D1      01750      POP   DE
536E 13      01760      INC   DE          ;POINT TO NEXT BYTE.
536F 18F0    01770      JR    L2          ;PRINT IT.
5371 D1      01780 ENDMG   POP   DE
5372 C9      01790      RET
          01800
          01810 ;THE NEXT SECTION OF CODE IS THAT WHICH "OPENS" THE
          01820 ;SYSTEM ENTRY IN THE MINI DIRECTORY.
          01830
          01840
FF00      01840      ORG   0FF00H
FF00 DDE5    01850 TSYS   PUSH  IX
FF02 E5      01860      PUSH  HL
FF03 D5      01870      PUSH  DE
FF04 C5      01880      PUSH  BC
FF05 2A964C  01882      LD    HL,(VECTOR)
FF08 227CFE  01884      LD    (STRVEC),HL
FF0B 2142FF  01890      LD    HL,TREAD    ;MODIFY ORG SYS OBJECT
FF0E 22964C  01900      LD    (VECTOR),HL ;FILE LOADER TO GET SECTORS FROM MEMO
FF11 78      01910      LD    A,B          ;B HAS DEC
FF12 2180FF  01920      LD    HL,SY1VAR   ;HUNT THRU MINIDIR ENTRIES FOR FILE
FF15 110400  01930      LD    DE,4
FF18 0620    01940      LD    B,32
FF1A BE      01950 L1     CP    (HL)
FF1B 2805    01960      JR    Z,TOPEX     ;LOOK THRU ALL OF THEM.
FF1D 19      01970      ADD   HL,DE       ;NOT FOUND, SO WE'LL GET IT FROM DISK
FF1E 10FA    01980      DJNZ  L1
FF20 1830    01990      JR    RDISK
FF22 EB      02000 TOPEN  EX   DE,HL
FF23 D5      02010      PUSH  DE
FF24 DDE1    02020      POP   IX
FF26 DD6E02  02030      LD    L,(IX+2)    ;FIND FILE IN MEMORY
FF29 DD6603  02040      LD    H,(IX+3)
FF2C 227EFF  02050      LD    (HLDARE),HL
FF2F CD394C  02060      CALL  4C39H      ;CALL ORG SYS OBJECT FILE LOADER
FF32 22FC4B  02070      LD    (4BFCH),HL ;EXECUTION ADDRESS.
FF35 2A7CFE  02080      LD    (STRVEC),HL ;RESTORE DISK VECTOR TO LOADER.
FF38 22964C  02090      LD    (VECTOR),HL
FF3B AF      02100      XOR   A
FF3C C1      02110      POP   BC
FF3D D1      02120      POP   DE
FF3E E1      02130      POP   HL
FF3F DDE1    02140      POP   IX
FF41 C9      02150      RET
          02160
          02170 ;THE NEXT SECTION OF CODE IS CALLED BY THE ORIGINAL
          02180 ;SYSTEM'S OBJECT FILE LOADER WHEN IT NEEDS THE NEXT
          02190 ;SECTOR OF THE OVERLAY.
          02200
FF42 2A7EFF  02210 TREAD  LD    HL,(HLDARE)
FF45 11FF4D  02220      LD    DE,4DFEH
FF48 010001  02230      LD    BC,256
FF4B EDBB    02240      LDDR
FF4D 227EFF  02250      LD    (HLDARE),HL
FF50 AF      02260      XOR   A          ;SET NO ERROR
FF51 C9      02270      RET
          02280
          02290 ;THE NEXT SECTION OF CODE IS EXECUTED IF THE
          02300 ;OVERLAY HAS NOT BEEN PLACED IN MEMORY.
          02310
FF52 2A7CFE  02320 RDISK  LD    HL,(STRVEC)
FF55 22964C  02330      LD    (VECTOR),HL
FF58 C1      02340      POP   BC
FF59 D1      02350      POP   DE

```



TRS-80  
MODEL I

DISK  
INTERFACING  
GUIDE

\$5.95

POSTPAID  
FIRST CLASS

(United States Only)

\$7.95 Foreign Airmail  
(U.S. Funds)

Send to:  
80-N.W. Books  
3838 South Warner St.  
Tacoma, WA 98409  
(206) 475-2219

Dealer Inquiries Invited

TRS 80 is a registered trademark of Tandy Corporation

Send \_\_\_\_\_ Copies of the Guide

Check Enclosed \_\_\_\_\_

Visa or MasterCard \_\_\_\_\_

# \_\_\_\_\_

Exp. Date \_\_\_\_\_

Signature \_\_\_\_\_

Name \_\_\_\_\_

Address \_\_\_\_\_

City \_\_\_\_\_

State \_\_\_\_\_ Zip \_\_\_\_\_

A Division of 80-Northwest Publishing, Inc.

**80-NW**  
**Books**

Grab TRSDOS

```

FF5A E1      02360      POP      HL
FF5B DDEL    02370      POP      LX
              02380
              02390 ;THE NEXT SECTION OF CODE IS THAT WHICH MODIFIES THE
              02400 ;SYSTEM OVERLAY LOADER
              02410

4BCE        02420      OLDSYS  EQU      4BCEH
FF5D FDES   02430      PATCH  PUSH    IY
FF5F CD00FF 02440      CALL    TSYS
FF62 FDEL   02450      POP     IY
FF64 C20944 02460      JP      NZ,4409H
FF67 00     02470      NOP
FF68 00     02480      NOP
FF69 00     02490      NOP
FF6A 00     02500      NOP
FF6B 00     02510      NOP
FF6C 00     02520      NOP
FF6D 00     02530      NOP
FF6E 00     02540      NOP
FF6F 00     02550      NOP
FF70 00     02560      NOP
FF71 00     02570      NOP
FF72 00     02580      NOP
FF73 00     02590      NOP
FF74 00     02600      NOP
FF75 00     02610      NOP
FF76 00     02620      NOP
FF77 00     02630      NOP
FF78 00     02640      NOP
FF79 00     02650      PEND   NOP
FF7C        02660      ORG
FF7C 0000   02665      STRVEC DEFM   TSYS+7CH
FF7E FF7E   02670      HLDARE DEFM   TSYS-1
0080        02680      SYLVAR DEFS   128 ;MINIDIR AREA
4424        02690      OPENEX EQU    4424H
4442        02700      POSN   EQU    4442H
4436        02710      READ  EQU    4436H
4428        02720      CLOSE EQU    4428H
4409        02730      DERREX EQU    4409H
7000        02740      BUFFER EQU    7000H
7200        02750      ORG
7200 1C     02760      SGNMSG DEFB   28 ;HOME CURSOR
7201 1F     02770      DEFB   31 ;CLS
7202 4D     02780      DEFM   'MEMSYS FOR TRSDOS 2.3 VER 1.0'
7220 0D     02790      DEFB   0DH
7221 43     02800      DEFM   'COPYRIGHT 1981 BY MICHAEL D. ANDREAS'
7245 0D     02810      DEFB   0DH
7246 00     02820      DEFB   0
7247 52     02830      LINE1 DEFM   'READING —
7253 00     02840      DEFB   0
7254 20     02850      LINE2 DEFM   ' — NOW IN MEMORY'
7265 0D     02860      DEFB   0DH
7266 00     02870      DEFB   0
000E        02880      OFFSET EQU    14
4C96        02885      VECTOR EQU    4C96H
5200        02890      END     INITSY

000000 TOTAL ERRORS
27897 'TEXT' AREA BYTES LEFT

```

Listing 3

NEWDOS 2.1 PATCHES-- ALL THE DBLDOS  
PATCHES EXCEPT LINES 432-806  
CHANGE 'DEFB' TO 'DEFM' IN LINES  
820,850,880,910,940,970.

ADD THESE LINES

```

431 JR      NZ,ERREXT
432 LD      DE,SYS11
433 CALL   TUKSYS
434 JR      NZ,ERREXT
435 LDa    DE,SYS12
436 CALL   TUKSYS
437 JR      NZ,ERREXT
438 LD      DE,SYS13
439 CALL   TUKSYS

```

```

801 SYS13 DEFM 'SYS13/SYS.L0Y4'
802 DEFB 0
803 DEFW 0FFA0H
804 SYS12 DEFM 'SYS12/SYS.L0Y4'
805 DEFB 0
806 DEFW 0FF9CH
807 SYS11 DEFM 'SYS11/SYS.L0Y4'
808 DEFB 0
809 DEFW 0FF98H
2780 DEFM 'MEMSYS FOR NEWDOS 2.1V1.0'
2880 OFFSET EQU 15

```

Listing 2

```

432 JR      NZ,ERREXT
434 LD      DE,SYS7
436 CALL   TUKSYS
802 SYS7  DEFM 'SYS7/SYS.L0Y4'
804 DEFB 0
806 DEFW 0FF98H
1255 INC    A
1840 ORG   0FEFAH
2202 TREAD PUSH  HL
2204 PUSH  DE
2206 PUSH  BC
2210 LD      HL,(HLDARE)
2220 LD      DE,42FFH
2252 POP   BC
2254 POP   DE
2256 POP   HL
2660 ORG   TSYS+82H
2780 DEFM 'MEMSYS FOR DOUBLEDOS
4,23 VER 1.0
2885 VECTOR EQU 4C90H

```

# LOBO DROPS PRICES

Bigger volume and lower production costs now make Lobo high performance disk systems and accessories even more affordable.

Whether your TRS-80 is a Model I, II, or III, you've probably wished for more disk capacity. Now Lobo gives you that—and much more—at low, manufacturer-direct prices. With uncompromising quality, and the protection of Lobo's unique 1-year warranty.

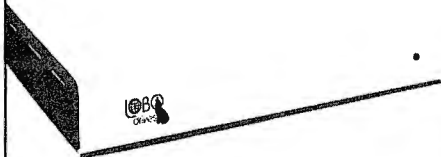

### Special for Model I owners: the LX-80 Expansion Interface

Radio Shack may have forgotten you, but Lobo hasn't! Our LX-80 expansion interface (plus LDOS operating system) gives your Model I more features and more expandability than a Model II or III. The sturdy steel enclosure fits under your monitor and adds

- 32k additional RAM
- Interfaces for standard Radio Shack minifloppy drives and Lobo high-performance disk systems
- Centronics-type printer port plus screen printer port
- Two RS-232C serial ports (optional)
- Plus a real-time clock, sockets for custom ROM, and a heavy-duty power supply for your keyboard unit

Discover the real power and potential of your Model I, with the bargain-priced Lobo LX-80!

<b>LX-80 with LDOS operating system (required)</b>	<b>\$510.00</b>
<b>LX-80 without LDOS (for current LDOS users)</b>	<b>\$460.00</b>
<b>Dual RS-232C serial port option</b>	<b>\$100.00</b>

### LDOS: the ultimate TRSDOS-compatible operating system

One of the few software products ever to receive a perfect box score from *Infoworld* magazine. The reviewer said: "LDOS 5.1 is awesome! ... It performs nearly perfectly ... a straightforward and simple system to use ... the best manual for software I've ever seen or reviewed, bar none ... This DOS takes the TRS-80 from the hobby category and endows it with features that many a so-called business system does not have ... LDOS offers unparalleled versatility and function."\*

LDOS includes a powerful extended disk BASIC, smart terminal emulator, and many other useful utilities that make it worth far more than its low price. It runs on any Model I or Model III with at least one disk drive.

**LDOS operating system (specify Model I or Model III) \$129.00**

\*© 1982 by Popular Computing/Inc. a subsidiary of CW Communications/Inc. Excerpted from INFOWORLD.

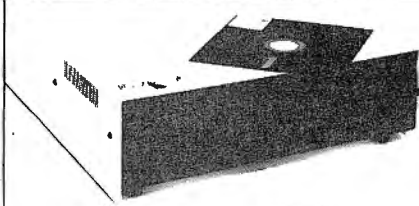

### Add-on 8" floppies for Model II

Why pay Radio Shack prices to expand your Model II's disk capacity? The Lobo 8202C2 adds two 8" double-density floppy drives, for a total of 1.1 megabytes of additional storage. Installation and operation are identical, and you get the added benefit of Lobo's 1-year parts and labor warranty.

**8202C2 dual-drive 8" floppy system for Model II \$1269.00**

### Add-on minifloppy drives for Model I

Completely compatible with all Model I hardware and software, but with an extra 5 tracks for data storage. Requires a Model I with either the Radio Shack expansion interface or the Lobo LX-80 (see left).

**4401C Add-on 5 1/4" drive for Model I \$305.00**

### High-capacity minifloppy for LX-80

An economical way to get a big storage boost for your LX-80-equipped Model I. The double-sided, 96 track/inch drive stores 720 kB, and eliminates most tedious disk swapping.

**Model 4801C high-capacity 5 1/4" drive for LX-80 \$465.00**

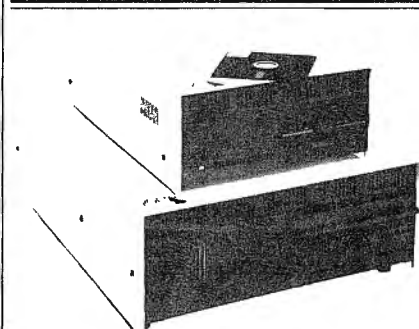

### Winchester disk systems for Model I and Model III

The ultimate mass storage devices! Enormous capacity and impressive speed give your system a dramatic performance boost. Add the impressive file-handling capabilities of LDOS (included), and you can outperform systems costing far more. **IMPORTANT:** Many Winchester disks now being sold have no provision for file backup. Lobo systems include a built-in high-density floppy drive that can store the entire contents of the hard disk on just 6 or 7 floppies. This backup drive is also usable for additional on-line storage of programs and data.

# 17

### 8" floppy systems for Model I and Model III

These rugged dual-drive systems attach to any Model I with LX-80 expansion interface, or any Model III, and add the mass storage you need for the big jobs. Double density recording stores 535kB on one side of the disk. Using the LDOS operating system (required) you get full compatibility with standard TRSDOS plus greatly increased capabilities.

**8202C3 two single-sided drives (1.1 MB total) for Model III \$1625.00**

**8202CX same as above, for Model I with LX-80 (sold separately) \$1249.00**

**5202C3 two double-sided drives (2.2 MB total) for Model III \$1925.00**

**5202CX same as above, for Model I with LX-80 (sold separately) \$1549.00**

### 5 1/4" Winchester System

Compact and exceptionally reliable, with 4.8 megabytes of high-speed Winchester storage plus a 720 kilobyte floppy drive. The value leader in mass storage.

**950T for Model III or Model I with LX-80 (sold separately) \$2675.00**

### 8" Winchester System

Over 9 million bytes of storage accessible in milliseconds: 8.2 MB on an 8" Winchester drive and another 1.1 MB on the backup floppy drive. Unsurpassed for maintaining very large data bases.

**1850T for Model III or Model I with LX-80 (sold separately) \$3459.00**

### Ordering Information

All prices include shipping and handling. California residents add 6% sales tax. Credit card orders shipped within 24 hours. Personal checks require 2-3 weeks for clearance before shipment. Please allow up to 6 weeks for delivery.

### The Lobo Warranty

All Lobo hardware products carry a limited 1-year parts and labor warranty. Call or write for complete warranty statement.

TRS-80 and TRSDOS are trademarks of Tandy Corporation © 1982 Lobo Drives International

### TOLL-FREE ORDER NUMBERS:

U.S. (except California);

**800-235-1245**



In California: **800-322-6103** or

**800-322-6104** Hours 7AM-5PM Pacific Time

Write for free catalog:



**Lobo Drives International**

Dept. US10  
358 S. Fairview Ave.  
Goleta, CA 93117

Prices subject to change without notice.

Special: SAVE \$15  
NEWSSCRIPT + Mailing Labels  
\$139.95

# "IF YOUR PRINTER

— NEWSSCRIPT COMPATIBLE PRINTERS —

Anadex 9500 (Parallel/Serial) • Anadex 9501 (Parallel/Serial) • Anadex DP-9000 (Parallel/Serial) • Anadex DP-9001 (Parallel/Serial) • Atari 825 (F  
Atari 825 (Serial) • C Itoh 8300P (Parallel) • C Itoh 8300P (Serial) • C Itoh Printmaster F10 (Parallel) • C Itoh Printmaster F10 (Serial) • C Itoh  
8510 (Parallel) • C Itoh Prowriter 8510 (Serial) • C Itoh Prowriter II 8550 (Parallel) • C Itoh Prowriter II 8550 (Serial) • C Itoh Starwriter FP 1500  
• C Itoh Starwriter FP 1500 (Serial) • C Itoh Starwriter F10 (Parallel) • C Itoh Starwriter F10 (Serial) • C Itoh II 8510 (Parallel) • C Itoh II 8510A  
Centronics 737 (Parallel) • Centronics 737 (Serial) • Centronics 739 (Parallel) • Centronics 739 (Serial) • Decwriter • Diablo 1610 • Diablo 1620 • D  
Diablo 1650 • Diablo 630 • Epson MX-70 (Parallel) • Epson MX-70 (Serial) • Epson MX-80 (Parallel) • Epson MX-80 with Graftrax 80 • Epson MX-80  
FT (Parallel) • Epson MX-80 with FT (Serial) • Epson MX-80 with Graftrax 80 and FT (Serial) • Epson MX-80 with Graftrax Plus (Parallel) • Epson MX-80  
80 and FT (Parallel) • Epson MX-80 with Graftrax Plus and FT (Parallel) • Epson MX-80 with Graftrax Plus and FT (Serial) • Epson MX-100 with Graftrax  
Epson MX-80 with Graftrax (Serial) • Epson MX-100 with Graftrax Plus (Parallel) • Kogyosha (All typewriters) • NEC 8023A (Parallel)  
MX-100 with Graftrax (Serial) • IDS Paper Tiger 460 • Kogyosha (All typewriters) • NEC Spinwriter 5525 • NEC Spinwriter 5530 • NEC  
IDS Paper Tiger 440 • IDS Paper Tiger 5520 • NEC Spinwriter 5520 • NEC Spinwriter 5525 • NEC Spinwriter 5530 • Quime Sprint 5 • Quime S  
• NEC Spinwriter 5515 • NEC Spinwriter 5520 • NEC 3525 • NEC 3530 • Olivetti 121 • Quime Sprint 5 • Quime S  
NEC 3510 • NEC 3515 • NEC 3520 • NEC 3525 • NEC 3530 • Olivetti 121 • Quime Sprint 5 • Quime S  
Line Printer I • Radio Shack Line Printer II • Radio Shack Line Printer IV • Radio Shack Line Printer V • Rad  
VII • Smith Corona TP1 (Parallel) • Smith Corona TP1 (Serial) • Teletype 33/35 • Teletype 43 • TI 725

# IS ON THIS LIST, NEWSSCRIPT SHOULD BE ON YOUR COMPUTER."

**NEWSSCRIPT'S exclusive print processor gives you total printer control.**

NEWSSCRIPT's exclusive print processor takes over where formatting leaves off with over 200 print processing and support features. NEWSSCRIPT takes you beyond text formatting — beyond just printing text on paper. With NEWSSCRIPT's Print processor you take full advantage of your printer's hardware and software features, creating an unsurpassed printed image. Text editing (the part you see), is only part of the job, printing is the other part — the part others will see.

**NEWSSCRIPT controls over 80 popular printers.**

You don't even have to know how your printer works — only what it can do. NEWSSCRIPT will do the rest with such major features as underlining, right justified proportional printing, top and bottom titles, top/bottom left-right-center page numbering, chaining and embedded printing of any length file with disk spanning, fully formatted merging of form letters with selective editing, boldface, sub/super scripts, character substitution/translation, table of contents, indexing,

hanging indents, paragraph numbering, line numbering, double width characters, italics, hard and soft hyphens, in-memory spooling, and many other features.\*

**NEWSSCRIPT'S text editor has sophistication to match its print processing.**

Buffered key entry rates to 450 characters per second — you never drop characters. Windowing to 240 characters, block move and copy within and between files, definable auto save, "HELP" and "WHOOPS" commands, repeat and query last command, search and replace within column and line limits as well as globally, and an automatic interface to the ELECTRIC WEBSTER spelling checker (sold separately).

NEWSSCRIPT'S 277 page manual contains an introductory tutorial with explanations of the beginner's most common needs, a "How to Section" to help when you're stuck, a fully alphabetized description of the commands with literally hundreds of examples, a topical index with over 1,300 entries, and a handy quick-reference card (naturally!).

Start getting the printed results only NEWSSCRIPT can give you for \$124.95. Requires TRS-80 Model I or III with 48K and 1 disk (minimum — 2 recommended)

# NewsScript

is available at computer stores, selected B. Dalton Book Sellers, and selected independent book dealers. If your dealer is out of stock order direct. Include \$3.00 (domestic), \$6.00 (Canada) for shipping and handling. Foreign residents add \$15.00 plus purchase price, in U.S. funds.

**TO ORDER, CALL NOW, TOLL-FREE:**  
(800) 824-7888, Operator 422  
Calif: (800) 852-7777, Oper. 422  
Alaska/Hawaii: (800) 824-7919  
For technical information call:  
(213) 764-3131, or write us.

**PROSOFT**  
Dept. C, Box 560, No. Hollywood, CA 91603

NEWSSCRIPT companion programs (sold separately): MAILING LABELS \$29.95, DAISY WHEEL PROPORTIONAL \$49.95 (not required for Daisy Wheel II), PENCIL & SCRIPSIT FILE CONVERSION \$24.95, ELECTRIC WEBSTER (spelling checker and automatic correction) \$149.50, GEAP (TRS-80 graphics — requires Epson MX-80) \$49.95, DOTWRITER (Hi-res graphics — requires Epson MX-80/100 with Graftrax) \$69.95, GEAP/DOTWRITER combination (requires Epson MX-80/100 with Graftrax) \$99.95

Dealers: NEWSSCRIPT is distributed by IJG, Inc. (714) 946-5805  
\*Some features work only if your printer has the mechanical capability.  
NEWSSCRIPT trademark TTS Corporation PROSOFT registered U.S. Pat Office TRS-80 registered trademark TANDY Corp

# 18

# EasyLink

## Western Union on your TRS-80

For all models

EasyLink is a new, exciting telecommunications network that Western Union has opened up for the computer owner.

No longer are users restricted to a closed network such as CompuServe or The Source. You now have complete message sending and retrieval to others who are on or off the system.

Anyone who owns a computer, modem, and terminal software can use the system. Western Union is offering a communications service that consists of two major parts, EasyLink and the ACCESS system.

EasyLink began just last spring and now has over 5000 terminals connected. They expect to grow to over 10000 by 1983. Projections show that there are over three million communication terminals in the United States, and Western Union hopes to get at least ten percent of that market.

Through EasyLink, you have a complete store and forward message-switching service. All you need is an ASCII terminal that operates at 300 or 1200 baud. Messages may be addressed to Telex I and II terminals, any other compatible terminal, auto-answer terminals, or (and here is the real advantage) to a mailbox facility or any Western Union InfoMaster service.

For the business with branch outlets, a message can be sent directly through EasyLink to all offices. For those outlets without terminals, messages can be forwarded to the nearest postal outlet for delivery as a Mailgram. If you have an unknown number of customers who wish to contact you, messages can be sent to your

EasyLink mailbox and you can retrieve them as you wish.

### Subscriber Options

EasyLink offers a variety of message types. You can direct messages to another EasyLink subscriber, to a Telex I subscriber in the United States, to a Telex II user in the United States, or to a TWX user in Canada. For subscribers with international needs, you can send via International Telex (ITX) or Cablegram (INT). For sending messages to users who don't have terminals, or those who are not EasyLink subscribers, Western Union has the answer. Messages can be specified to be telegrams (PMS) or Mailgrams (ZIP) which are delivered by the postal service.

Message traffic can be outgoing or incoming. By far the largest use is for outgoing traffic. To access incoming messages, you would need to have an auto-answer modem or call-up messages that are stored in your mailbox.

### How Is It Done?

EasyLink is quite simple to use. Each subscriber is assigned an identification code and password. These are verified by the EasyLink computer prior to accepting your message. All you need to do is power-up your computer and modem, run your terminal program, and call EasyLink. Type the code for your terminal type, I.D. code, name and password. If all is well, you get the response PTS for Proceed to Select.

Identify where and how you wish the message to be sent, and EasyLink responds with the letters GA, for Go Ahead. Then go back to the terminal program, load the ASCII text into your computer's

Cameron C. Brown, Editor

memory (RAM buffer), and send it. Text can be sent directly from keyboard input, but the primary use is to dump prewritten messages.

For TRS-80 owners, text is sent at 300 to 1200-baud (your modem determines this value), in ASCII, with even parity, one stop bit, and either half or full duplex. When receiving incoming text, you can specify that you have an 80- or 132-character printer.

Ease of operation has been a goal in the development of this system. Subscribers can predetermine a set of addresses (up to 99) and dump a message to all of them at once. Operator codes are straightforward and use easy-to-remember mnemonics. The subscriber's manual is concise and clear, but it assumes that you understand your own computer, modem and terminal operation.

### What Are the Fees?

The cost savings can be tremendous. If your business Telex cost is now \$500 per month, EasyLink could possibly lower that by fifty percent. There is a \$25 registration fee. Auto-answer terminal connection is \$15 per month or, with a mailbox to receive messages, it is a total of \$25 per month. The cost per message is based upon connect time and baud rate. At 1200-baud, it is only \$.40 per minute, or \$.20 per minute for 300-baud. Current TLX charges are \$.3745 per sixty characters. For some remote users, the cost of a Telex line is prohibitive. EasyLink may be the answer.

For businesses that require it, message costs can be billed to separate departments or indivi-

duals. This should help to simplify a number of accounting headaches. Nationwide, over thirty businesses are now using the TRS-80 Model II or III in conjunction with EasyLink.

**The ACCESS Connection**

For \$10 per month, you can join the ACCESS system. It gives you a priority mailing system that reaches worldwide. Through ACCESS, you can direct messages for one-day delivery as Mailgrams, two-day delivery via the U.S. Postal Service's electronically computer-originated message system (E-COM), or go for three-day plus delivery via a Computer Letter. With a Computer Letter, you can forward messages as well as enclose brochures and inserts. For international same-day delivery, there is the International Cablegram that goes to 150 countries. A new option is the International Priority Letter, which gives two-day delivery to Europe and the

United Kingdom. You do not have to join EasyLink to take advantage of the ACCESS system.

**Security**

Western Union offers no scrambling or message decoding. All transmissions are in plain text and go through regular communication networks, such as phone, microwave, satellite, etc. If you desire to keep your business information extremely confidential, and have needs beyond the normal password and identification procedures, the encoding and decoding of data is up to you. Western Union sends the ASCII file, it can be as scrambled as you wish to make it.

**New Options and the Future**

User requests have led to some additions and changes in the service. Single messages are restricted to 15000 characters and this was too restrictive for some subscribers.

Now, up to 50000 characters can be sent in a batch mode. If it happens that your branch office is closed when the message is sent, it can now be automatically rerouted to a second number or mailbox. It's nice to see a company that is still developing a system quick to meet user needs.

Western Union's goal is to allow any hardware device to speak to any other piece of hardware. It may not be too long before we see modems attached to all of the IBM Selectric typewriters in the world. It's clear that once a keystroke is captured, Western Union wants to deliver it.

*Ed. Note— This article is based upon interviews with Mr. David W. Hurley, Senior Communications Representative for Western Union. For further information, you may contact him, or Ed Links, at 655 South Orcas, Seattle, WA 98108, (206) 764-4578.*

**Extended BASIC**

**TRS-80 Color Computer**

**The Champagne of Software  
For a Beer Budget!**

**Over 75 quality programs a year  
for under 75¢ each!**

Ah, **CHROMASETTE** Magazine, the toast of the holiday season . . . and any season! A subscription to **CHROMASETTE** Magazine consists of 6 to 8 premium programs ON CASSETTE, delivered by First Class Mail to you and your computer every month! Tutorials, utilities, games, and practical programs to usher in a great new computing year!

So, celebrate and get a subscription to **CHROMASETTE** Magazine! Or just take a little sip and try a back issue.

**The Bottom Line:**

1 year (12 issues)	\$45 00	Calif residents add 6% to single copies
6 months (6 issues)	\$25 00	North America — First Class postage included
Single Copies	\$ 5 00	Overseas — add \$10 to subscriptions and \$1 to single copies Sent AO rate

**The Fine Print:**

All issues from July 1981 available — ask for list. Programs are for the Extended BASIC model and occasionally for disks.

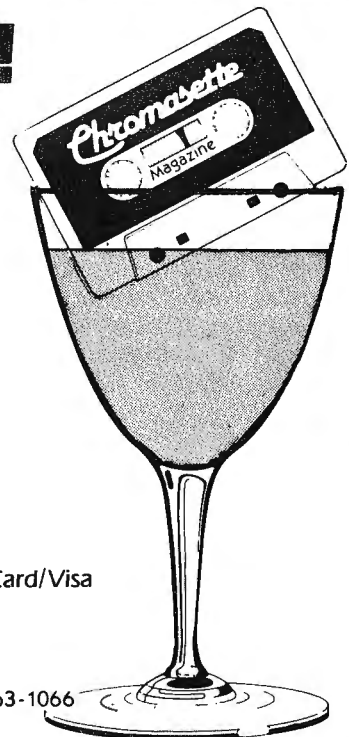

MasterCard/Visa

**Chromasette Magazine** P.O. Box 1087 Santa Barbara, CA 93102 (805) 963-1066



TRS-80  
Model I

And In This Corner,  
Another Champion.....

TRS-80  
Model III

# CLOAD'S DISK VERSION!

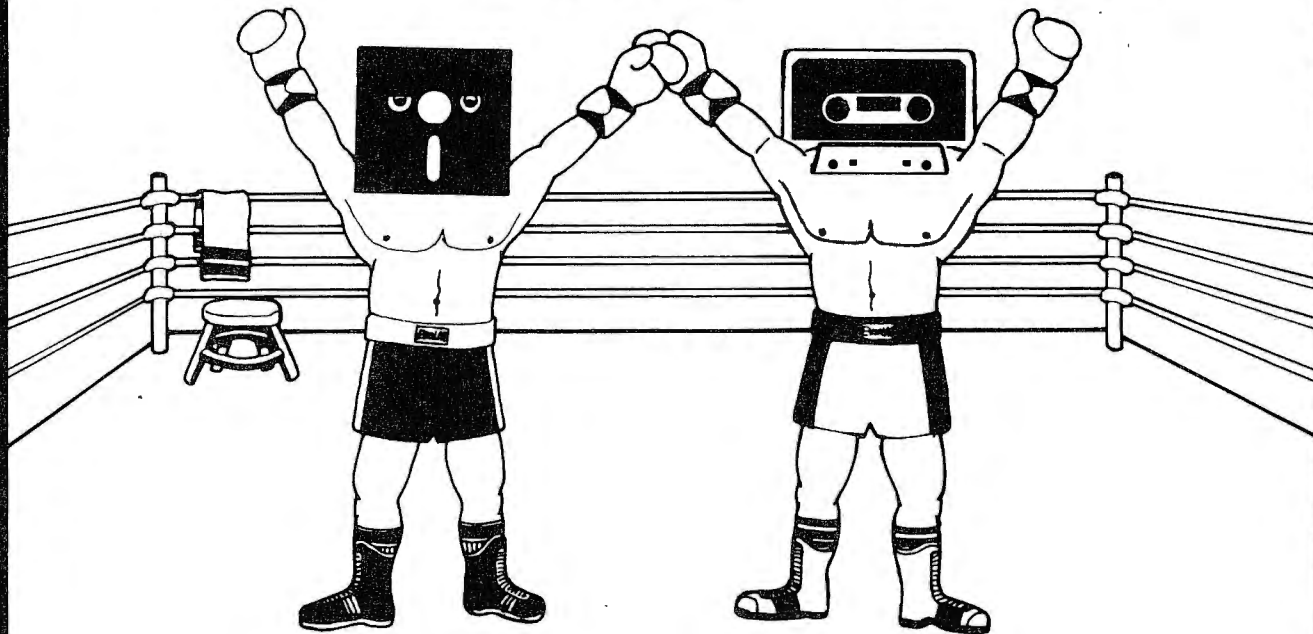

Get 12 tapes OR disks a year containing over 75 quality programs — without knocking out your budget!

We finally gave in . . . After over FOUR years of publishing some of the best (aren't we pompous), useful and fun programs on tape, we are now offering **CLOAD Magazine on disk**, too!

A subscription to **CLOAD Magazine** (tape or disk) consists of 6 to 8 ready-to-load programs delivered by First Class Mail every month. What a winner!

Fight high software prices — Get a subscription to **CLOAD Magazine**. Or just throw a single punch and try a back issue . . .

**The Bottom Line:**

	<b>Tape</b>	<b>Disk</b>
1 year (12 issues)	\$50.00	\$95.00
6 months (6 issues)	\$30.00	\$55.00
Single Copies		
Back Issues	\$ 6.00	\$11.00
Good Games #1	\$12.00	\$23.00
Adventures #1	\$13.00	\$24.00

California residents add 6% to single copies  
North America — First Class postage included  
Overseas — add \$10 to subscriptions and \$1 to single copies Sent AO rate

**The Fine Print:**

All issues from Oct 78 available on tape Issues from Oct 82 available on disk, also Ask for list (24 Level I issues also available)



(805) 962-6271

P.O. Box 1448  
Santa Barbara, CA  
93102

MasterCard/Visa

# Hard disk for Model III

## Going full-blown with MTI's CP/M

Model III, PMC-80, LNW80

Harry Avant, La Crescenta, CA

The MTI C/140 is described by Microcomputer Technology, Incorporated as "... an exciting new personal and small business computer that is both CP/M and TRSDOS compatible." Features include CP/M 2.2 compatibility, 80 x 24 display, four-megahertz speed up, and full compatibility with TRSDOS software. A built-in diagnostic and monitor are also included. A well documented BASIC program is included with the computer that gives detailed instructions for using 80 x 24 with DOSPLUS.

MTI supplied a system for purposes of evaluation, equipped with two forty-track drives (Tandon), a CP/M board, an 80 x 24 display board, an external 7.5-megabyte hard disk (Tandon), DOSPLUS 3.3 and 4.0, CP/M 2.209, WordStar 3.0, and manuals.

List price for all of the above based on the MTI catalog is:

Model III plus C/140	\$2959
Winchester/E 7.5	2999
DOSPLUS 4.0	299
CP/M hard disk	
Enhancement	149
CP/M 2.2	no charge
DOSPLUS 3.3	no charge
WordStar 3.0	495
Total System Cost	\$6901

### CP/M Compatibility

The thing that sets the C/140 apart from a Model III is the addition of a board that will allow the computer to run under CP/M and an 80 x 24 video display. CP/M is a disk operating system developed by Digital Research Corporation that dates back to 1973. Originally

the operating system was developed for 8080 microcomputer systems. During the past several years CP/M has undergone several revisions and enhancements, and today it is considered to be the "standard" operating system for 8080, 8085 and Z80 based systems.

### CP/M and 80 Column Board

Included with the two boards are very good instructions for installing them. The only thing to watch out for is during removal of the Model III's top cover. Make sure that you have plenty of room on the left side and remember that the video wires are very short.

MTI refers to the CP/M board as the Compactor I. This board plugs into the Z80 socket on the Model III's main board. When installed it allows the computer to either run standard TRSDOS type software or CP/M. In the case of the CP/M the Compactor reconfigures memory by removing the Read Only Memory (ROM) from the addressing of the Z80. Next the top 48K of Random Access Memory (RAM) at addresses 4000-FFFF hex are relocated to 0000-BFFF hex. This provides 49151 bytes of RAM for the basic CP/M system to use. Next the video display RAM and keyboard tables are moved from 3800-3FFF hex to F800-FFFF hex. Then the Compactor ROM is loaded into locations C000-CFFF hex. Locations D000-F7FF hex are not used. It is too bad they aren't, as the extra 10239 bytes would be very useful with WordStar.

When the Compactor has finished the above, which takes about two seconds, a sign-on message appears,

which indicates the CP/M software was implemented by Hurricane Labs.

The sign-on asks you to either insert a CP/M or TRS disk or press one of the following keys:

D for system diagnostics  
M for monitor  
Break to enter TRS non-disk BASIC.

The diagnostics are a nice feature incorporated into the Compactor. Ten different commands are available.

1. An automatic test mode which performs a memory test, video test, checksum test, and a display of characters test. I ran this test for twenty-four hours non-stop and no errors were indicated.

2. A test of the Compactor read only memory by use of checksums.

3. A drive select, used in conjunction with tests for drive speed.

4. Keyboard test to verify that all keys are sending correct values.

5. Display the floppy disk controllers registers. This also includes a test of the floppy disk controller.

6. A random memory test for the system memory.

7. A moving display of the character set across the video.

8. Test of video memory.

9. Drive speed test. When used with number three (above) allows you to verify that the drives are running at correct speed. This is a real nice feature and it sure beats paying \$25 for one of the drive speed test software packages.

10. Video character set display,

shows all of the characters available.

If "M" is entered in response to the sign-on message the monitor mode is entered. "L" is a command in the monitor that gives a six-line by thirty-two-character hex display of memory contents. For example, if CE25L is entered while in monitor mode, the hex display and result ASCII code for the start of the sign-on message will be shown on the screen. A "/" command shows the memory contents of the location specified, i.e., 10/ will display the contents of memory location 10 decimal.

CP/M implementation on the MTI C/140 is excellent, except for the limited memory. (After this review was completed MTI announced a new memory board that has a full 64K of RAM.) All of the standard CP/M utilities are supplied. In addition, version 2.209 has some unique files.

First is 80.COM which is used to switch-in the 80 x 24 display. In order to get back to a 64 x 16 display 64.COM is used. CONFIG.COM is a

menu-driven program to modify the drive configuration, i.e., number of tracks, step rate and number of sides. It also will configure the RS-232 port. HFORMAT.COM and HCONFIG.COM are used to format the hard disk and establish the track count, number of surfaces and other parameters needed for setting up the hard disk.

CP/M requires the use of some keys that are not found on a standard Model III keyboard, such as an escape key, control key, brackets and backslash. Under CP/M the keyboard is remapped to generate these keys. For example, the break key becomes escape, downarrow serves as a control key and shift break becomes a backslash. These changes are documented in the Compactor operating instructions.

Information about the floppies derived from STAT DSK: indicates the following: Each drive has 1520 x 128 bytes or a total of 194560 bytes available to the user. In addition there are two tracks reserved for system use. The minimum block size

is two kilobytes. This means that the smallest allocation of space on the floppy is 2048 bytes.

CP/M programs are noted for using a lot of disk space, but with the MTI configuration this should not present any problem. The version of WordStar supplied with this machine had on one disk: a 64 x 16 version, an 80 x 24 version, the install program, WordStar example program, and still had 30 kilobytes of free space.

### DOSPLUS Hard Disk Operating System

As noted above, a 7.5-megabyte hard disk was supplied as part of the system. As I had requested, this was an external disk, although several different hard disks can be supplied in place of the upper floppy drive.

I first checked out the hard disk using DOSPLUS 4.0. When formatted, the hard disk indicates 7280K bytes of free space. A 5¼-inch floppy formatted under the same DOS indicates 180K free bytes. At first blush, it would appear that the hard disk will hold 7280/180 or the

**MISOSYS**  
P.O. Box 4848  
Alexandria, VA 22303-0848  
703-960-2998

It's TIME  
to SEE  
the  
LIGHT

# 21

equivalent of 40.44 floppy disks! However, there is a "gotcha" in all of this. The hard disk has 910 grans of free space. If bytes are divided by number of grans, we see that each gran is eight kilobytes long. This means that the minimum allocation on the hard disk will be 8192 bytes. A program such as Scrispit, which is about 10.5K bytes long, will occupy 16K bytes of space on the hard disk. This is not a problem with the hard disk but is a problem with the DOSPLUS 4.0 operating system. As noted in the DOSPLUS manual, a five-megabyte disk will have each gran just over 5K bytes long.

Although a great deal of information can be stored on the hard disk, gran size is something that disk manufacturers and disk operating system writers usually don't discuss in their sales literature. When considering purchase of a hard disk, the buyer should look into this to determine if he is really getting the usable space he thinks he is. Another factor is cost per megabyte. The five-megabyte disk by MTI has a list price of \$2499 or \$499 per megabyte. The 7.5-megabyte disk sells for \$2999 list or \$399.86 per megabyte. A ten-megabyte hard disk sold by MTI has a list of \$3499 or \$349.90 per megabyte.

Something that cannot be equated to cost is the incredible speed of a hard disk. A twenty-four-kilobyte program loads instantly. There is no delay. One can really get spoiled with this speed.

A very nice feature of DOSPLUS 4.0 is the ability to place the entire operating system on the hard disk. When this is done, the floppy disk in drive zero is used to boot the computer only. After booting, all commands that normally would be handled by the disk operating system on drive zero are now performed by the system on the hard disk. The difference in speed of the system when it is accessed from the hard disk is awesome.

A problem with DOSPLUS 4.0 is the lack of a wild card for directory or catalog functions. With 200 to 300 programs on a hard disk, locating the name of a particular one from the directory is nearly impossible. (MTI has recently announced a newer version of DOSPLUS (4.0A1)

which does have a wild card feature and a command called ACAT, which gives an alphabetical listing.)

### CP/M Hard Disk Operating System

The HCONFIG program provided with the evaluation machine was evidently preset for a five-megabyte hard disk. At any rate, when I ran it, no prompts appeared and control was returned in a second or two. I formatted the hard disk using HFORMAT.COM, which resulted in an indication that the disk had been formatted so that 4864K of space was available. I do not know if HCONFIG was supposed to ask for hard disk parameters or not.

If this had been a five-megabyte hard disk, the following parameters would apply. The directory would hold 512 entries and minimum disk allocation space would be 8K bytes, the same as for DOSPLUS. In the case of CP/M, this rather large size would not present the same problem as under DOSPLUS, due to the large size of most CP/M application files. For example, WordStar is about 16K bytes long and requires two overlay files, one of 28K, the other of 34K bytes.

It is a joy using WordStar with the C/140 and a hard disk. Due to the limited memory in the C/140, using WordStar with floppy disks is not very effective. A disk I/O will occur after every few lines of text, either during text entry or scrolling. When WordStar is used with the hard disk, there is *no* apparent disk I/O! It happens so fast that it is impossible to tell when a disk access has been done.

### Video Problems

The computer supplied for evaluation suffered from two problems associated with the video display. First, the display was just not sharp, compared to my Model III. Horizontal components of the characters exhibited noticeable blooming and the single-dot components were very fuzzy. Attempting to use the 80 x 24 column display was very hard on the eyes. Similar models in the MTI showroom did not exhibit this problem, so I guess the focus had not been properly set prior to shipment. The second problem was the

noticeable video movement that occurred during floppy disk activity. Either the power supply was marginal in capacity or inadequate filtering had been used. A computer with this much potential deserves a better video. After this article was prepared, MTI announced that a P31 green phosphor tube could be installed for an additional charge.

### Heat Buildup

Something that always concerns me with the addition of internal accessories is a build up of heat due to the extra load. When I first brought the C/140 in for evaluation, I set it up next to a stock Model III equipped with two drives. I inserted matched thermometers into the number one drive of each machine and turned them both on. After a little over an hour, the stock Model III indicated 38 degrees C, and the C/140 was 40 degrees C. Evidently, MTI has done a very good job handling extra heat generated by the two additional boards.

The MTI C/140 is a powerful computer, or perhaps it should be called a powerful pair of computers. It is really two computers in one. CP/M has been implemented quite well in this machine. There is one rather strong drawback. There is just not enough memory (45K) to run many CP/M programs. MTI should have an additional memory board for the C/140 by the time this article is published.

Another thing that is really needed with the C/140 is a terminal program used with the RS-232 port to allow transfer of programs from another computer. The disk format used by the C/140 is not CP/M standard and there is no assurance that all of the software a buyer might want is available in this format. In fairness to MTI, it should be noted that there is *no* standard disk format for the 5¼-inch floppy disk.

DOSPLUS 3.3 is supplied with the C/140 at no charge. I would think that DOSPLUS 3.4 would be a better choice. It has several useful features not included in 3.3. I tried DOSPLUS 3.3 and 3.4, TRSDOS 1.3, NEWDOS/80 and LDOS with the MTI C/140, and all worked fine. However, using the hard disk does require DOSPLUS 4.0 or a driver for

NEWDOS or LDOS.

A very useful addition to the software packaged with the C/140 would be an alteration of DOSPLUS and CP/M to allow them to share a hard disk. For example, DOSPLUS could, perhaps, format one-half of the disk and CP/M the other half. Another useful software package would be a utility that allowed the transfer of TRSDOS files to CP/M and vice versa. Omikron has a very nice utility supplied with their CP/M board to convert TRSDOS files, and Misosys supplies a very versatile utility for converting a CP/M file over to LDOS. Due to different CP/M formats involved, neither of these programs will work with the MTI version of CP/M.

During the testing of the C/140, I plugged it into a wall outlet that is unusable with my own computers because of voltage fluctuations. I did not experience any low voltage problems with the computer or the hard disk. The only time I turned the power off on either device for the first couple of weeks was when it was necessary to move them to

different parts of the room. Turning the hard disk on or off while the computer was running, and turning the computer off while the hard disk was on, did not have any effect. I went to a fair amount of trouble trying to get one or the other to malfunction but without success. I never did have any rebooting or random resets with the C/140 during the month I had it for evaluation. The C/140 and its hard disk are rock solid.

The only real problem I had with the C/140 during evaluation was trying to figure out some way to convince MTI that I should be allowed to keep the hard disk for a couple of years for an extended test. By now, you should be aware that I have flipped over the 7.5-megabyte and the disk I/O speed.

Looking back at the list price of the C/140, in the configuration I tested, raises the question, "Is it worth it?" It is true that \$6901 is a lot of money, but the C/140 and 7.5-megabyte hard disk make for a lot of computing power. A stock Model III with 48K of memory and two disk

drives sells for about \$2200. A bottom-end CP/M system with two drives would cost at least \$3000. Current prices for a 7.5-megabyte hard disk may be as low as \$2600. A two-computer setup similar to the CP/M would sell for about \$7800 plus software — at least \$900 more than the MTI.

*Ed. note: Mr. Avant's article was sent to MTI for comment. Here is their response.*

Dear Mr. Avant:

I appreciate the opportunity to review your evaluation of the system we lent you. I would like to take advantage of this opportunity to address several points in your article. I shall attempt to itemize these by area within your article for reference purposes.

**Overview**

Our instructions give details for using the 80 x 24 board with DOSPLUS only, not with a TRSDOS-type operating system. It is important that the user understand that this board will only operate with CP/M automatically,



# TRS-80<sup>®</sup>

## DISCOUNT

<p><b>TRS-80 MODEL II</b>   <b>TRS-80 MODEL 16</b></p> <p>64-K \$3279   128-K \$4925</p> <p>26-4002   26-6002</p> <p>8.4 MEGABYTE HARD DISKS (PRIMARY UNIT) \$4000.</p>	 <p><b>TRS-80 MODEL III</b></p> <p>48-K \$2049   16-K \$819</p> <p>26-1066   26-1062</p> <p>WITH 2 DISK RS-232<sup>2</sup> TAPE VERSION</p> <p>(ALL RADIO SHACK EQUIPMENT)</p>	<p><b>TRS-80 COLOR</b></p> <p>4-K \$309   26-3001</p> <p>16-K \$455   32-K \$525</p> <p>26-3002   26-3003</p>
---	---	---

WE ALSO CARRY EPSON AND OKIDATA PRINTERS, XEROX 820 AND ALTOS COMPUTERS. NO OUT-OF-STATE TAXES.

Sold with the manufacturer's limited warranty. Copies of such warranty may be obtained for review from Perry Oil and Gas Co.

COLOR DISK DRIVES

0- \$475 | 1-2-3- \$315

— T.M. TANDY CORP

DEALERS' INQUIRIES INVITED.

WE ACCEPT CERTIFIED CHECKS, CASHIERS CHECKS AND MONEY ORDERS.

## PERRY OIL & GAS INCORPORATED

Dept. No. C-3 137 NORTH MAIN ST. PERRY, MICHIGAN 48872

PHONE (517) 625-4161, MICH.

# 22 FOR OUR PRICES, PLEASE CALL TOLL FREE **1-800-248-3823**

or DOSPLUS if addressed. We do not support *any* other operating system. The system supplied contained DOSPLUS 3.4 and DOSPLUS 4.0A. These distinctions are important, as we will see later in the area of examining the operating system itself.

**CP/M and 80-Col. Board**

The version you would see on the screen at bootup is 2.2, if you insert a CP/M diskette. The version 1.0 visible on the screen refers to the compactor. Perhaps clearer documentation is needed.

**DOSPLUS Hard Disk Operating System**

The version of this system you had was 4.0A. Since the time of this evaluation, a new version has come out known as 4.0A1. This version allows one to partition the disks into pseudo drives. This is a fine feature in several respects. It allows you to backup one-half of the disk to the other half. Secondly (we have not thoroughly tested this), it appears that we can, by partitioning, run both CP/M and DOSPLUS on the same disk. An additional feature is the ACAT command, which gives you an alphabetical listing of the directory (very useful when you have one hundred or more entries). The ACAT command also allows you to use wild cards in sorting.

As far as the allocation of grans and the size of the bytes per gran,

although I do not pretend to be a programmer, I do know that when all else fails... read the instructions. They do contain the necessary elements to change the CONFIG to allocate different bytes per gran and different grans per track. I do know that you cannot allocate a specific number of bytes, but you can limit the problem that you are addressing.

**Video Problems**

The video monitor is a standard Radio Shack monitor and they do have variations inherent in design and manufacture. As I demonstrated to you when you returned the machine, there is a focus control on the video board that simply requires turning a trim pot to sharpen the screen. The 80 x 24 board has no effect on the video, other than a general shrinking of the horizontal format size in order to allow for the number of lines (twenty-four) involved. We do realize that a problem exists with the large power supply we use in this machine, but corrections are on the way. Our engineering department has determined the difficulty and has worked with the manufacturer to correct this problem. Future versions should not show the movement that you refer to.

We do have available catalog #1316 green CRT and catalog #1315 white cabinet as extra cost options for anyone who wishes to dress up his machine.

All of our dealers are required to purchase a service kit. Two of the items in this kit are the CP/M transfer diskettes (Model II and Model III) and the CP/M transfer cable to link the two machines together.

In regard to standard format, the new CX machine, containing 64K RAM, etc., which we just introduced at Comdex Spring, contains the following formats for drive one, all of which are operator selectable: Xerox, Osborn, Cromemco, Omikron, Lifeboat and Eagle.

We are developing other standard formats at present and will also have these available to run on the 48K version. DOSPLUS 3.3 is provided because we have a license agreement to use it and for the average end-user it is a better DOS. We do have an optional upgrade to 3.4 if desired.

I hope that these comments have corrected some of the shortcomings you may have felt were existent in our machine. MTI is proud of its products and values its good name. We will do what is necessary to make our many customers happy. Thank you for the time and effort you put in on this article.

Sincerely,  
Paul S. Gans

Director of Marketing, Microcomputer Technology, Inc., 3304 W. MacArthur, Santa Ana, CA 92704, (714) 979-9923, TWX 910-595-1902  
MTISNA ■

**TRS-80 Models I & III**

**Business:**

**DANCE** .....\$100.00

Build a computer business out of your own home! This program matches people attending a local school or social dance based upon statistical analysis of their answers to a questionnaire. Prints tickets to the dance with matches printed on them. Recover the price of the program in just one dance!

**CHECK** .....\$75.00

Keeps track of your disbursements. Stores a Check Number, Date, Payee, Amount, and Code Number for up to 2600 checks.

**Utilities:**

**SUPERDRAW** .....\$30.00

Helps design your applications' Graphics & Text Screens. Allows cursor-controlled graphics/text design including automatic commands for drawing lines, boxes (with or without Fill), circles, and ellipses (X-Semimajor, or Y-Semimajor). Includes reflection on X or Y axis and overlay. Saves Screens as Data Files or BASIC Data Statements to be merged later.

**MDZAP** .....\$20.00

Multi-Density ZAP. Corrects disk errors on either Single or Double Density disks. Includes HEX or ASCII Modification, selectable step rate for mixed-drive systems, re-format Sector Not Found Errors without losing valuable data. Model I only.





## Christmas Card

```

10 CLS
20 FOR X=0 TO 127
30 SET(X, 0):SET (X,47)
40 NEXT
50 FOR Y=1 TO 46
60 SET(0, Y):SET (127,Y)
70 NEXT
80 FOR X=108 TO 124
90 SET(X, 2):SET (X,11)
100 NEXT
110 FOR Y=3 TO 10
120 SET(108, Y): SET (109,Y)
130 SET(123, Y): SET (124,Y)
140 NEXT
150 FOR X=109 TO 124 STEP 3
160 SET(X-1, 12)
170 NEXT
180 FOR Y=3 TO 11 STEP 2
190 SET(107, Y):SET(125,Y-1)
200 NEXT
210 PRINT @ 122,"15";
220 POKE 15484, 67
230 POKE 15479, 168
240 POKE 15480, 172
250 POKE 15481, 180
260 PRINT @ 184, CHR$(174)CHR$(187)CHR$(
187)CHR$(189);
270 FOR X=113 TO 118
280 SET(X, 9)
290 NEXT
300 FOR X=115 TO 117
310 SET(X, 10)
320 NEXT
330 PRINT @ 68,"THE REINDEER" @ 132,"% 8
0-US JOURNAL";@ 198,"TACOMA, WA";
340 PRINT @ 700,"AIR MAIL";
350 FOR X=24 TO 39
360 SET(X, 39)
370 NEXT
380 FOR X=78 TO 85
390 SET(X, 3)
400 NEXT
410 SET(86, 4): SET (87,4)
420 SET(88, 5): SET (88,6)
430 SET(87, 7)
440 FOR X=86 TO 78 STEP -1
450 SET(X, 8)
460 NEXT
470 SET(77, 7): SET(76,7)
480 SET(76, 6):SET(76,5)
490 SET(77, 4)

```

```

500 FOR X=90 TO 104
510 SET(X, 4): SET(X,7)
520 NEXT
530 PRINT @ 612,"TO:" @ 678,"Y O U";@ 33
7,"H A N D L E W I T H C A R E";@ 401,
"C H R I S T M A S C A R D E N C L O S
E D";:PRINT@862,"PRESS <ENTER> TO OPEN"
;
540 IF INKEY$ ="" THEN 540
550 CLS
560 F=-1
570 L=7
580 PRINT"FROM BOB, CAM, CATHY, DON, EVA
, KRISTI,"
590 PRINT"MIKE, SHERRY, JIM, SPENCER, TE
RRY"
600 READ A
610 IF A=-2 THEN L=L+1: X=18: GOTO 600
620 IF A=-1 THEN 700
630 IF F=-1 THEN X=X+A ELSE FOR X1=X
TO X+A-1: SET(X1, L): NEXT: X=X+A
640 F=-F
650 GOTO 600
660 DATA-2, 23, 1,-2, 22, 2, 1, 1, 10, 1
,-2, 22, 3, 8, 1, 1, 2,-2, 23, 2, 8, 3,-
2, 23, 1, 9, 2, 2, 1,-2, 23, 1, 1, 1, 6,
2, 1, 2,-2, 22, 1, 1, 1, 6, 2,-2, 25, 1
, 1, 2, 1, 2,-2, 22, 13,-2, 23, 11, 50,
1,-2, 26, 5, 22, 2, 28, 2,-2, 26, 5, 21,
2, 27, 5,-2, 27, 3
665 DATA 21,3,28,4,-2,28,3,13,4,2,2,28,8
670 DATA-2, 28, 4, 3, 16, 30, 6,-2, 5, 1
, 22, 24, 26, 8,-2, 4, 4, 19, 24, 3, 2,
21, 12,-2
680 DATA 3, 4, 20, 30, 22, 8,-2, 4, 6, 1
6, 19, 2, 5, 5, 2, 16, 13,-2, 2, 7, 15,
13, 10, 9, 3, 2, 17, 8,-2, 0, 12, 9, 3,
3, 6, 15, 2, 6, 2, 16, 15,-2, 3, 5, 12,
1, 5, 5, 27, 1, 22, 2,-2, 1, 10, 9, 1, 3
, 3, 32, 1, 21, 2,-2, 0, 12, 7, 2, 2, 2,
34, 2, 20, 2, 2, 5
690 DATA 6, 11,-2, 5, 2, 13, 5,-2, 5, 2,
5, 8,-2, 4, 8,-2, 0, 4,-1
700 PRINT @ 913,"M E R R Y C H R I S T
M A S"
710 X=45:Y=17
720 FORB=1TO100:FORC=1TO30:RESET(X,Y):RE
SET(X+2,Y):NEXTC:SET(X,Y):SET(X+2,Y):FOR
D=1TO30:NEXTD:NEXTB
730 GOTO 720

```

---

# MULTIDOS

## An extremely versatile operating system

Model I/III, PMC-80, LNWS80

Terry Kepner, Peterborough, NH

Cosmopolitan Electronics Corporation (P.O. Box 234, Plymouth, MI 48170 (313) 397-3126) has recently released MULTIDOS for the Model I and III, retailing for only \$99.95.

MULTIDOS is unique in that it can read and write all density disks, with only one exception. That is, if you have a double-density board, such as Percom's, you can read or write files in double-density mode and make backups of them, no matter whose double-density DOS you originally used. This is also true of single-density disks. The exception is that NEWDOS/80 disks can only be read, and NEWDOS/80, version 1.0, can be backed up only if the directory is exactly two granules in length. NEWDOS/80 version 2.0, for the Model III, cannot be backed up. If you want to use double-density disks on drive zero, you should order MULTIDOS on a double-density disk. MULTIDOS can read, write, or copy to and from, several Model III DOS diskettes (unfortunately, there is a problem in writing to NEWDOS/80 or TRSDOS).

You can control the number of tracks being used on the disk. For example, if your drives are 80-tracks, just backup the MULTIDOS disk from a 35-track drive to an 80-track drive. Voila, you have an 80-track DOS.

Outside of these unusual capabilities, MULTIDOS is quite similar to TRSDOS. Most of the library commands are similar to TRSDOS, but there are some new ones. You can perform a software computer reset, disable the BREAK

key, create and substitute a disk file for keyboard input (commonly called a DO file), set to zero all RAM locations from location 5200H to top of memory, or from 4000H to top of memory. You can customize the power-up stepping speed and density default values for the disk drives, set printer parameters (line width, lines per page, lines printed per page, and line spacing), set default conditions of the keyboard (lowercase and graphics drivers, repeating keyboard, CLEAR key disable, blinking cursor), and the character used for the cursor can be altered. You may link the printer to the video display, or vice versa (anything sent to one goes to both), redirect printer output to the video or vice versa, and reserve high memory in DOS for programs and/or data. (*Whew!*)

MULTIDOS's system utilities include the standard three (backup, copy and format), adapted to multiple track and single or double density operation, plus these other utilities:

1) Radio Shack's tape-based editor/assembler, as adapted by Apparat for disk I/O, and further adapted by CEC to MULTIDOS, adds (among other things) commands to view the directory and to copy or kill files. Because CEC didn't write this utility, documentation is supplied only for the commands that were added.

2) A graphics utility which uses the keyboard to generate graphics characters with single keystrokes.

3) A utility to locate one- or two-byte machine language codes in

memory.

4) A print-spooler which lets the computer operate at full speed without waiting for the printer to finish printing each line of data.

5) A "master" disk file manipulator, that copies files in batches, performs batch file purges, prints the disk directory (just the right size to tape to the diskette's envelope), and executes a program. Protection attributes in the directory are ignored, so you can use VFU to copy *any* file, which provides a handy method of customizing your DOS.

There are actually two versions of BASIC on the MULTIDOS diskette. The first is SUPERBASIC, which gives you "single keystroke commands" and "single letter commands" (a total of fourteen commands).

In addition, via the command CMD" ", you have access to more functions. Obtain automatic program space and linefeed elimination, (if they are not in quoted text), data statements, or REM statements. Redisplay the last disk I/O error code message. Zero arrays or delete them. Duplicate lines and move them. Open an additional disk file buffer from BASIC. You have a built-in machine language sort and a listing of all the scalar variables used by your program. There is the ability to transfer the resident disk BASIC program down to Level II BASIC, execute or edit it, and return to disk BASIC with the program and variables intact. This feature will be indispensable for people who



develop software for Level II machines. You can execute any MULTIDOS function from SUPER-BASIC, including SUPERBASIC, again.

You also get global ASCII character search through your program. Global mass editing of your program gives you these abilities: search and replace, merging of adjacent lines, splitting one line into two lines, and converting a CHR\$(y) into a graphics string. You can obtain cross-references of variables, reserved words (BASIC), and integers to the line numbers that they are on. Program renumbering and emergency recovery of programs accidentally deleted with the NEW command are possible. You can load and execute a program without clearing out the previous program's variable values. This lets you chain programs, one after the other, into the computer without having to reenter information.

The other BASIC, called BBASIC, supports all of the features of SUPERBASIC, plus powerful TRACE features. You can single step each instruction, single step each BASIC line, single step with times wait, trace to video, trace to the printer, and review the values of selected variables on demand. These features can be turned on and off from within your programs.

The eighty-five-page manual is not for the beginner. It is thorough, but assumes that the reader is familiar with operating systems and their commands.

MULTIDOS supports data files with logical record lengths other than 1 and 256. This eliminates the need for subrecords, or wasted disk space.

MULTIDOS is a powerful system for developing BASIC programs. To my knowledge, no other DOS supplies a BASIC with so many helpful features for the programmer. ■

*MULTIDOS has just been released in an upgraded version that now includes utilities such as Easy Zap, TAPE/CMD for conversion of machine language to disk, and DDT/CMD for disk drive timing. — Ed.*

# 70 INCOME TAX PROGRAMS

(For Filing by April 15, 1983)

## For TRS-80\* Models I and III

### FEATURES:—

1. Menu Driven.
2. 70+ Tax Programs.
3. Basic; Unlocked; Listable.
4. Name/SS No./FS carried over.
5. Inputs can be checked.
6. Inputs can be changed.
7. I.R.S. approved REVPROC format.
8. Prints entire Form/Schedule.
9. Calculates Taxes, etc.
10. On std. 35-track, Mod. I format disk.
11. CONVERT for Model III.
12. Use GREENBAR in triplicate — don't change paper all season!
13. Our 4th Year in Tax Programs.
14. We back up our Programs!

Helpful programs to calculate and print the many Tax Forms and Schedules. Ideal for the Tax Preparer, C.P.A. and Individual. For just \$24.75 per disk, post-paid (approx. 60 grams per format disk).

Programs are designed for easy-use, with check-points to correct parts as needed. Results on screen for checking before printing.

In all, there are more than 70 individual Tax Programs. These include Form 1040, 1040A, 1040EZ, 1120, 1120S, 1041 and 1065. Also Schedules A, B, C, D, E, F, G, R, RP and SE. And, Forms 1116, 2106, 2119, 2210, 2440, 3468, 3903, 4255, 4562, 4797, 4835, 4972, 5695, 6251 and 6252.

And, we have a disk we call "THE TAX PREPARER'S HELPER" which has programs for INCOME STATEMENTS, RENTAL STATEMENTS, SUPPORTING STATEMENTS, IRA, ACRS, 1040/ES, ADD W-2's and PRINT W-2's.

TRY ONE DISK AND SEE FOR YOURSELF. ONLY \$24.75 POSTPAID.

First disk is TR#1, and includes Form 1040 and Schedules A, B, C, D and G. \$24.75 POSTPAID.

### Write:—

## GOOTH TAX PROGRAMS

931 So. Bemiston • St. Louis, Mo. 63105



\*T.M.Reg. by Tandy Corp. Ft. Worth, Tx.

# NEW TRS-80\* PROGRAM LET'S YOU CHART STOCKS LIKE A WALL STREET PRO.

The Wall Street TAP is a powerful, professional stock market trading tool. It employs the same charting methods used by successful market experts to buy, sell and hold stocks.

Now, you can make these time-sensitive decisions yourself and make more money on the market.

Point and figure, moving average and on balance volume charts are at your fingertips to spot trends and compare the performance of two stocks instantly.

Easy to use, the Wall Street TAP is self-documented, user friendly, self-prompting with virtual error-free entry and batch updating. You need a TRS-80 Model I or III 48K and 1 disk drive.

\*TRS-80 is a trademark of Tandy Corp

# WALL STREET TAP\*

\* Technical Analysis Package.

# 24

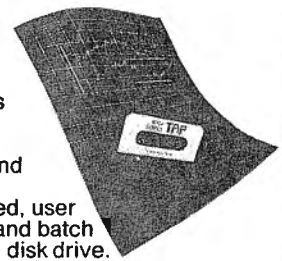

### Chart Stocks, Commodities & Currencies 3 Ways.

FOR MORE PROFIT & BIGGER GAINS  
ORDER YOUR WALL STREET TAP TODAY!

Yes. I want to start charting stocks on my TRS-80 today. Please send my Wall Street TAP tape immediately. US \$199.95 is enclosed. I understand postage, handling, documentation, sample printouts, help desk support.

Send documentation only. US \$29.95 plus \$2 postage and handling. (\$29.95 refundable if you purchase package later.)

Name \_\_\_\_\_  
Address \_\_\_\_\_  
City \_\_\_\_\_ State/Zip \_\_\_\_\_  
Payment \$ \_\_\_\_\_  Check  Money Order  Visa  MasterCard U 2  
Card No. \_\_\_\_\_  
Expiry \_\_\_\_\_ Signature \_\_\_\_\_

Fill-In & Mail Coupon To: Think Software Inc.,  
572 - 810 W. Broadway, Vancouver, B.C. Canada  
V5Z 4C9 Or Phone For Faster Delivery. Card users  
only, call 24 hours (604) 261-7261. Dealer  
Inquiries Welcome

# USRful patch

## *Have unlimited USR calls*

Model I/III, PMC-80, LNW80, no disks

Charles C. Edwards, Jacksonville, FL

Faster than a speeding GOSUB, more powerful than a Shell sort, able to leap through K of RAM in a single JP. Is it BASIC? Is it TRSDOS? No, it's assembly language. However, those of us who have tried to merge machine code with our BASIC programs have had to face the annoyance of having only one USR call available in Level II BASIC. Have you long envied those disk owners with their ten USR calls? Well, this article will describe an extremely small (twelve bytes) enhancement to Level II which will provide an unlimited number of USR calls. As a bonus, you will no longer have to POKE the address of your subroutine into memory before calling it.

First, let's examine how disk systems manage to implement their ten USR calls, and we will see how we can use the same method to our advantage. When the Level II interpreter encounters the token "USR," it branches to ROM address 27FEH to begin processing the statement. Once there, the first thing it does is call address 41A9H. Under Level II, this location contains a RET instruction, so we simply return to the caller and continue processing. Most DOSs alter this into a jump instruction, which transfers control to a piece of code in the DOS, which implements the multiple USR calls.

For this reason, 41A9H is called a "DOS." That is just a fancy way of saying that this is a point at which ROM processing can be intercepted in order to change the normal flow of logic. Well, if a DOS can intercept the interpreter at this point, so can we! Listing 1 is the complete patch which will implement infinite USR calls.

Listing 1

```
41A9      JP      USR      ;BRANCH TO THE PATCH
          USR      CALL 1E5BH ;GET THE ADDRESS, IF
                                ANY
          DEC     HL      ;BACK UP POINTER
          LD      A,D     ;SEE IF ADDRESS IS ZERO
          OR      E
          RET     Z       ;USR CALL WITH NO
                                ADDRESS
          LD      (408EH),DE ;STORE THE ADDRESS
          RET
```

You will notice that, with the exception of address 41A9, I have not provided any addresses with the listing. I did this to emphasize the fact that this code is completely relocatable. You can put it at the top of memory, or after any other routines (printer driver, etc.)

which you normally load. After loading this, you can invoke a machine language subroutine by entering, in BASIC: X=USRn(Y), where n is the address (in decimal) of the routine. For example, a common BASIC subroutine suspends processing until a key is depressed.

Listing 2 shows two methods of doing this. The first example is the typical BASIC coding. The second uses a ROM routine at decimal 73 (hex 49) to wait for a key to be hit. Of course, we don't know which key was pressed, as we do with INKEY\$. For the purposes of the example, we are assuming that we don't care.

Listing 2

```
1  REM THIS IS HOW WE WOULD NORMALLY
   DELAY IN BASIC

10  PRINT "HIT ANY KEY TO CONTINUE":GOSUB
   200

200 I$=INKEY$:IF I$="" THEN 200 ELSE RETURN

1  REM THIS IS HOW TO DO IT USING A ROM
   ROUTINE

10  PRINT "HIT ANY KEY TO CONTINUE"
   :X=USR73(Y)
```

Let's look at Listing 1 in detail. After intercepting the interpreter at the beginning of USR processing, the HL register points at the byte OC1H, which is the internal representation of the token "USR" in Level II. We call the ROM routine at 1E5BH, which will convert the ASCII number following the USR command into the binary equivalent and return the result in the DE register. If the number is omitted, the DE register will contain zero. A side effect of this routine is that HL will now point to the character following the address, which should be the "(" So, the next thing we must do is back up HL to the preceding character.

We must check if the result in DE is zero. If so, we will return to USR processing and resume the normal program flow. Otherwise, we load 408EH with the address specified and return to the ROM routine. 408EH is the location where the address of the USR routine is normally POKEd. This will cause us to branch to that

## USRful patch

location.

The beauty of this routine is that it retains the ability to pass a parameter to the subroutine. Other published methods to implement multiple USR calls usually use the parameter to pass the address of the routine to be called, whereas, my method is much easier to implement. I am surprised that it is not standard practice in most DOSs. For those of you without assembler, Listing 3 is a short BASIC program which will POKE this routine into memory for you. Simply change the value of "I" in line 10 to point to the address at which you want the code to begin.

### Listing 3

```
10 I=65524:I1%=I/256:I2%=I-I1%*256
20 POKE 16809,195:POKE 16810,I2%:POKE 16811,I1%
30 FOR J=I TO I+11:READ X:POKE J+65536*(J>327
67),X:NEXT
40 DATA 205,91,30,43,122,179,200,237,83,142,64,201
```

The next time your friend with his fancy-schmancy disk drive brags about all of the great features his DOS gives him, you can knock his socks off with more USR calls than he can shake a diskette at! ■

## STOP PLAYING GAMES

■ Calculate odds on HORSE RACES with ANY COMPUTER using BASIC.  
 ■ SCIENTIFICALLY DERIVED SYSTEM really works. TV Station WKLY of Louisville, Kentucky used this system to predict the odds of the 1980 Kentucky Derby See the Wall Street Journal (June 6, 1980) article on Horse-Handicapping This system was written and used by computer experts and is now being made available to home computer owners This method is based on storing data from a large number of races on a high speed, large scale computer 23 factors taken from the "Daily Racing Form" were then analyzed by the computer to see how they influenced race results From these 23 factors, ten were found to be the most vital in determining winners NUMERICAL PROBABILITIES of each of these 10 factors were then computed and this forms the basis of this REVOLUTIONARY NEW PROGRAM  
 ■ SIMPLE TO USE Obtain "Daily Racing Form" the day before the races and answer the 10 questions about each horse. Run the program and your computer will print out the odds for all horses in each race COMPUTER POWER gives you the advantage!  
 ■ YOU GET 1) Cassette  
 2) Listing of BASIC program for use with any computer  
 3) Instructions on how to get the needed data from the "Daily Racing Form"  
 4) Tips on using the odds generated by the program  
 5) Sample form to simplify entering data for each race

PET/CBM  
 APPLE  
 TRS-80 (Model I & III)  
 COLOR-80  
 VIC-20



MAIL COUPON OR CALL TODAY

**3G COMPANY, INC. DEPT. 80 (503) 357-9889**  
**RT. 3, BOX 28A, GASTON, OR 97119**

Yes, I want to use my computer for FUN and PROFIT. Please send me \_\_\_\_\_ programs at \$24.95 each.

I need a  TRS-80  Color-80  Apple  PET/CBM  VIC-20 Cassette

Enclosed is  check or money order  Master Charge  Visa

Card No. \_\_\_\_\_ Exp date \_\_\_\_\_

NAME \_\_\_\_\_

ADDRESS \_\_\_\_\_

CITY \_\_\_\_\_ STATE \_\_\_\_\_ ZIP \_\_\_\_\_

**START USING YOUR COMPUTER FOR FUN and PROFIT! # 25**

# The B.T. Enterprises COMPUTER CONNECTION New Toll Free Order Number

## Upgrade Kit

Putting Disk drives into your TRS-80 Model III will turn it into the powerful computer it was designed to be. The B.T. Enterprises DISK DRIVE INSTALLATION KIT is easy to do and represents a substantial savings over the cost if done by Radio Shack.

The kit was designed to be installed by a non-technical person, and takes an average of 45 to 75 minutes to complete. The only tools necessary are a phillips and flat head screw driver and a pair of diagonal cutters. No cutting of traces or soldering is necessary. The full instruction procedure was the topic of a feature in 80 US Magazine in the May, 1982 issue, and was given high marks for ease of installation.

### KIT CONSISTS OF:

- FDC III B\* Micromainframe Controller Board assembled & tested
- Switching power supply
- Disk drive mounting brackets
- All cables and hardware
- Instructions with diagrams
- Drives are optional

\*FDC III C Board optional at additional cost supports 8 inch external drives and extended density 5-1/4 inch drives (dual headed and 80 track)

203103	Disk Upgrade Kit B Version w/hardware	\$279.95
203104	Disk Upgrade Kit C Version w/hardware	\$309.95
203113	Disk Upgrade B. Version w/2 40tk & 32K	\$799.95
203114	Disk Upgrade C Version w/2 40tk & 32K	\$829.95
203115	Disk Upgrade C Version w/2 40tk DH & 32K	\$1029.95
203118	Disk Upgrade C. Version w/2 80tk & 32K	\$1029.95
203117	Disk Upgrade C Version w/2 80tk DH & 32K	\$1229.95
203003	FDC III B Controller Board Only	\$139.95
203004	FDC III C Controller Board only	\$169.95
200500	Switching Power Supply (3 voltages)	\$99.95
203010	Controller Assembly Kit	\$75.00
203510	Controller Assy kit w/power Supply	\$174.95
	DH — Dual Headed	

Add \$2.00 Shipping and Handling  
Dealer Inquires Welcome  
Prices Subject to Change



Welcome  
N.Y.S. Residents Add Tax

# 26



B.T. Enterprises  
Dept. 8L  
10B Carlough Rd.  
Bohemia, N.Y. 11716  
800 645 1165 (orders only)  
N.Y.S. Residents Call  
516 567 8155  
516 588 5836 (modem)

B.T. Enterprises is a division of Bi-Tech Enterprises Inc.

TRS-80 is a trademark of the Tandy Corp.

# Driver education

## Using device control blocks and drivers

Model I/III, PMC-80, LNW80

Bob Bowker, Los Angeles, CA

With the availability of several new DOSs on the market for the TRS-80 Models I and III, the subject of "compatibility" has become an important one: Will my TRSDOS programs run with LDOS, NEWDOS/80 or one of the others?

In the case of most application programs — accounting, database management, etc., whether BASIC or machine language — the answer is *yes*, as the new DOSs have, in general, tried to be upward compatible with TRSDOS.

"Upward compatible" is one of those buzzwords which too often get in the way; it simply means that TRSDOS programs should run on the new DOS, but programs written with the new DOS won't necessarily run on TRSDOS. None of this means that the DOSs are compatible with each other — for example, there's no guarantee that a BASIC program written on NEWDOS/80 will run on LDOS, or vice versa.

The fact that many programs will run with few changes (if any) on another DOS is due in no small part to the willingness of the new system authors to respect Randy Cook's format in the communications region. Starting with TRSDOS 1.0 on the Model I, the RAM from 4000H to 4200H was set aside for pointers, vectors and storage areas, which have been largely maintained in the versions of TRSDOS released since, and in the new DOSs.

The first twenty-one bytes from 4000H to 4014H are vectors for seven RST instructions. For example, when the Z80 encounters an RST 28H, control is transferred first to 0028H in the ROM, where a JUMP 400CH vectors the program into the DOS communications area. There, another JUMP will vector the

program to the DOS code which will execute the RST 40H commands. In the absence of a DOS, there will be a RET instruction at 400CH, sending control back to the ROM to handle things.

The next twenty-four bytes, from 4015H to 402CH, make up the DEVICE CONTROL BLOCKS — in effect, they contain all the information anyone needs to know about the keyboard, display and printer. Each of these devices is assigned an eight-byte block of RAM in which to store various codes, addresses and parameters. All of the DCBs are constructed as follows:

Rel Byte
0 — Device Type
1 — LSB of Driver Address
2 — MSB of Driver Address
3 — Device Parameter Storage byte 1
4 — Device Parameter Storage byte 2
5 — Device Parameter Storage byte 3
6 — Device Name byte #1
7 — Device Name byte #2

This format is followed in TRSDOS 1.0 through 2.3B, NEWDOS+, NEWDOS/80, LDOS, DOSPLUS, and so on: they make a very necessary contribution to compatibility.

The three DCBs for the keyboard, display and printer are maintained in the communications region at these addresses:

Keyboard DCB	... 4015H-401CH
Display DCB	..... 401DH-4024H
Printer DCB	..... 4025H-402CH

### Device Type

The first byte of every DCB is a flag which defines the directions of communication which that device supports. Only three of the eight bits available in this one byte are used consistently by all DOSs: if bit two is set, the device is capable of handling requests containing control codes; if bit one is set, the computer can get information *from* the device; and if bit zero is set, the computer can send data *to* the device.

This is really not as complex as it sounds. For example, the keyboard: the computer can get data *from* it — that happens every time you hit a key — but the computer can't send either control codes or data *to* the keyboard, since that would be fruitless. Thus, the device type for the keyboard is 0000 0001, or 01H.

Similarly, the display can handle control code requests (set bit two), the computer can send data *to* it (set bit one), and can receive data back *from* it (set bit zero). Thus, its type code is 0000 0111, or 07H. A line printer's type code is 06H, since it's capable of two-way communications with the computer but can't handle control code requests.

The rest of the bits in this device type flag are used for other parameters by LDOS, for instance, but there's no standard for them among all systems. Of all the systems on the market today, LDOS seems to be the most advanced; it carries the DCB concept to extremes, assigning one each to any number of devices, all of which are user-definable. In LDOS, we're finally seeing Randy Cook's ideas working properly, and well.

### Driver Address

Relative bytes one and two of

every DCB contain the address of the device's driver, in standard Z80 reverse notation. A driver is really nothing more than the subroutine which controls that device. A driver for each of the three devices is provided in ROM:

Keyboard Driver .... 03E3H-0457H  
 Display Driver ..... 0458H-058CH  
 Printer Driver ..... 058DH-05D8H

Each of the devices is handled by using its driver subroutine. For instance, to send a byte to the printer, load it in the C register and CALL 058DH.

This is the opening we need to customize the TRS-80 — write your own driver, or portions of one, and stuff *that* address in the DCB of the appropriate device. When an operation uses that device, your routine will be in control. This way, you can change all zeroes going to the printer into slash/zeroes, or add a linefeed to every carriage return, or activate the lowercase characters in

the Model I, or convert your "QWERTY" keyboard into a "DVORAK" keyboard, and so on — the possibilities are endless.

Let's take one example, converting all zeroes headed for the printer into slash/zeroes. This one is simple — you don't have to write a complete driver, just intercept all printer commands to check for a zero. Should the character about to be printed not be a zero, send the program on its way to the existing driver and hardly a step has been missed. If it is a zero, however, we'll go to work ourselves. The code in Listing 1 will do just that.

Step 1: The contents of the C register are transferred to the A register to be compared with 30H (hex for 0); if it's anything else, the Z flag will not be set, and a JUMP will take place to the LPRDVR: carry on, folks. However, if it is a zero, the Z flag will be set, and the JP will not take place.

Step 2: Print the zero, but don't give up control yet: make sure the LPRDVR returns things to us and

not to the caller. We can do that by CALLING the LPRDVR ourselves.

Step 3: Once the zero is on paper, we have to move the print head back one space, to "overstrike" the slash. If we were to try to use LPRDVR to do this, we'd be in trouble: the ROM printer routine ignores such control codes by masking them out (remember the printer device type — 06H means no control code requests can be handled). So we'll have to bypass LPRDVR and do the backspace ourselves, by loading the 08H directly into the printer's memory mapped location.

Step 4: All that's left is to print the slash itself, which we load in the C register. Since we're finished now, we'll let LPRDVR take it away this time — we JUMP to it, and when in turn it's done, control will be passed back to the original program.

We now have a "trap," but we need to set it in place, and activate it. Since the system already has a LPRDVR, and not necessarily ROM's driver, we'll need to incorporate the existing address in

# DISCOUNT COMPUTERS

100% RS COMPONENTS, NO FOREIGN DRIVES OR MEMORY — FULL WARRANTY

16K COLOR COMPUTER.....	427.00	DMP-500 PRINTER .....	1398.00
32K COLOR COMPUTER.....	497.00	DMP-100 PRINTER .....	299.00
16K MODEL III .....	815.00	DMP-200 PRINTER .....	599.00
48K MODEL III, 1 DR. ....	1549.00	DWP-410 DAISY.....	1195.00
48K MODEL III, 2 DR. RS232...	1795.00	DAISY WHEEL II .....	1599.00
64K MODEL II, 1 DR.....	2499.00	1 DR. EXPANSION MODEL II ....	919.00
128K MODEL 16, 1 DR.....	3898.00	8.4 MEG HD. DISK MODEL II/16.	3599.00
128K MODEL 16, 2 DR.....	4510.00	ALL RS SOFTWARE.....	20% OFF

# 27

CASHIERS CHECK OR MONEY ORDER MUST ACCOMPANY ALL ORDERS.

## (817) 825-4027

NOCONA ELECTRONICS • Box 593 • Nocona, TX 76255

our program. Also, to be really professional about this, we should relocate our subroutine into high memory, and protect it.

The first thing INIT does is get the current LPRDVR address, and load it into our code at the three spots we use it. Next, the address of the first available location in upper memory is loaded into DE (the DEstination). HL is loaded with the address of the last byte in our code, and BC (the ByteCount) is loaded with the length of our code. The command LDDR moves those bytes, one at a time, in reverse order.

The next task is to "protect" our code. The LDDR instruction leaves DE pointing to the location just ahead of our code, so storing that address in 4049H, the high memory pointer, will do the trick. Bump DE to point to the first actual byte of our code, store it in the printer's DCB, and we're done.

### Parameter Storage

The three bytes in the middle of each DCB are available to the driver

to store various parameters, values, counters, etc. In the case of the printer DCB, for instance, parameter byte one contains the number of lines per page, and byte two has the current line number.

In passing: this explains why in many cases the printer, under TRSDOS, will "creep" down the page, starting each page one line lower than the previous page: TRSDOS initializes the printer DCB byte #3 to sixty-seven lines per page, when eleven-inch paper allows only sixty-six lines. There's a practical application: write a program to stuff a 42H there, and you'll get rid of the creep!

In the case of the display DCB, the current screen address of the cursor is stored (in reverse notation) in relative bytes three and four, and the cursor character is stored in byte

five.

### Device Name

The final two bytes of each DCB contain a mnemonic for the device name: KI for keyboard (Keyboard Input), DO for the display (Display Output) and PR for the printer (Print).

This concept is carried several steps further by LDOS, which allows for several DCBs beyond the standard three. In the case of the extra DCBs, the device can be named anything you want: CL for Comm Line, SP for Serial Printer or LP for Light Pencil. In operation, these DCBs can handle any device you assign to it — even fictitious or non-existent devices.

### Filters, etc.

To be precise, the program in

### Listing 1

	00100	DRIVER	LD	A,C	;get character into A register
	00110		CP	30H	;is it a zero?

## CONVERT YOUR SERIAL PRINTER TO PARALLEL

The UPI serial printer interfaces allow an ASCII serial printer to be connected to the parallel printer port on TRS-80 Models I, II and III.

Software compatibility problems are totally eliminated because the TRS-80 "Thinks" that a parallel printer has been attached. No machine language driver needs to be loaded into high memory. VISACALC, SCRIPSIT, BASIC, FORTRAN, etc. all work as if a parallel printer was in use.

The UPI interfaces are completely self contained and ready to use. A 34 conductor cable and connector plugs onto the parallel printer port of the Model I expansion interface or onto the parallel printer port on the back of Models II and III. A DB25 socket mates with the cable from your serial printer. The UPI interfaces convert the parallel output of the TRS-80 printer port into serial data in both the RS232-C and 20 MA. loop formats.



**BINARY DEVICES**  
Formerly SPEEDWAY ELECTRONICS  
11560 TIMBERLAKE LANE  
NOBLESVILLE, IN 46060  
(317) 842-5020

TRS 80 is a trademark of Tandy

VISA MasterCard

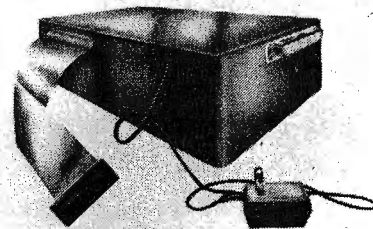

Switch selectable options include:

- Linefeed after Carriage Return
- Handshake polarity (RS232-C)
- Nulls after Carriage Return
- 7 or 8 Data Bits per word
- 1 or 2 Stop Bits per word
- Parity or no parity
- ODD or EVEN parity

### NEW VARIABLE BAUD RATE MODELS

Switch selectable from 110-9600 BAUD

UPI-3VB for models I or III	\$149.95
UPI-2VB for model II	\$149.95
UPI-3VB-6 for model I or III with 6 ft. cable	\$159.95
UPI-2VB-6 for model II with 6 ft. cable	\$159.95

Shipping and handling on U.S. orders. \$4.00  
90 day warranty on all interfaces, ten day return privilege.

# 28

Listing 1 should not be called a driver, but a *filter*: it's a subroutine which filters input to or from a device before the driver gets its hands on it. A routine which converts the "QWERTY" keyboard to "DVORAK" is a driver, while the code to add a LF to all CRs is a filter.

Using a filter, it is possible to assign special meanings to certain combinations of keys on the keyboard: that's how the JKL screen-print option was first instituted, and NEWDOS makes entry into MINI-DOS. It's not too difficult, for instance, to use the 4, 5 and 6 keys, when pressed simultaneously, to enter a subroutine which sends special codes to your printer (change type size, skip a line, start underlining, etc.) — just trap the keyboard driver, checking for a 70H in the A register.

One final idea: you could write a filter for the keyboard driver which would send all bytes to the printer first, then to the keyboard. Instant typewriter!

00120	SPOT1	JP	NZ,LPRDVR	; pass if not . . .
00130	SPOT2	CALL	LPRDVR	;print the zero
00140		LD	A,08H	;08H is a "backspace"
00150		LD	(37E8H),A	; and stuff it
00160		LD	A,2FH	;2FH is a "slash"
00170		LD	C,A	;get it into the C register
00180	SPOT3	JP	LPRDVR	; and go back to work.

Listing 2 — INIT to Driver

00190	INIT	LD	HL,(4026H)	;get current LPRDVR
00200		LD	(SPOT1+1),HL	; and stuff that address
00210		LD	(SPOT2+1),HL	; into the 3 places we
00220		LD	(SPOT3+1),HL	; need it ourselves
00230		LD	HL,INIT-1	;point to end-of-code
00240		LD	DE,(4049H)	;point to top-of-memory
00250		LD	BC,INIT-DRIVER	;load up length of DRIVER
00260		LDDR		; and move the code
00270		LD	(4049H),DE	;store new top-of-memory
00280		INC	DE	;point to DRIVER
00290		LD	(4026H),DE	; and store that address
00300		JP	402DH	;all done.
00310		END	INIT ■	

INTERPRO CORPORATION

presents

KEY COMMANDER

by JAKE COMMANDER

For the TRS-80 Model I/III, 16-48K, Disk or Tape

Add more programming power to your keyboard than you've ever imagined. . .

\* SELF RELOCATING, SELF MODIFYING, and SELF PROTECTING to fit Model I, Model III, any memory size, cassette basic, or disk basic with any major DOS.

\* DRAW GRAPHIC PICTURES on the screen with single keystrokes, then save them in BASIC PRINT STATEMENT program lines.

or

\* ASSIGN THE PICTURE TO A KEY so that, for example, (capital D) prints the picture of a dog!



\* ON SCREEN EDITING of ANY length lines. Merge or separate program lines. You can even EDIT LINE NUMBERS!

\* ASSIGN KEYS with any commands or graphics. Save your assignments to disk or tape. Unlimited assignments.

\* USE IN DOS or while running other programs, to make them faster and easier to use.

— DEALERS INVITED —

order from:

INTERPRO CORP. • P.O. Box 4211 • 562 Corning Rd. • Manchester, N.H. 03108, U.S.A. • (603-669-0477)

DISK \$34.95 CASSETTE \$29.95



---

# Pocket adventure

## *A real-time spoof*

Pocket Computer

Robert D. Miller, Hopewell, VA

"You are in an empty room that will blow up in five minutes unless you can get out!! A window faces east. Open doors face west and north."

Sound familiar? If you've ever played one of the dozens of adventure games on a computer, large or small, then you know that these words announce the challenge of yet another adventure. What's so great about another adventure? Well, this one just happens to be written for the TRS-80 Pocket Computer (PC-1)! So now all of you Pocket Computer owners can get out and rub shoulders with the micro, mini and mainframe computer adventurers!

Actually, with the memory limitations of the PC-1, it is unlikely that a serious challenge for adventurers could be written. This program, which occupies every single byte of program memory, is actually a good natured tongue-in-cheek poke at the adventure programs written for larger computers. Although there is a surprise or two in store for the game player, the primary intent is just to have a little fun. With all due respect (and apologies, as necessary) to Crowther, Woods and Adams, whose ideas I have built upon, I present for your consideration and enjoyment a "Pocket Adventure!"

Key in the program exactly as listed. When you are through, press MEM to ensure that there are zero steps and zero memories remaining. Put the PC-1 in RUN mode and RUN the program. As is traditional with most adventure type programs, only limited instructions are provided. They are as follows:

1. Use only one word to describe the direction you wish to go.
2. You may use the whole word or just the first letter.
3. Quarter points of the compass (NE, NW, SE, SW) are ineffective.
4. There *is* a solution.

The program is written in such a fashion that if you successfully complete the adventure or fail to escape the

room before time expires, you can restart the game by pressing ENTER.

This program utilizes some of the advanced features of the Pocket Computer. Line 10, for example, loads the program's "vocabulary" in variables A\$ through L\$, yet these same values are accessed using a subscript technique in lines 80 and 90. As most PC-1 owners realize, two variable access techniques can be used interchangeably. In other words, A\$(1) refers to the same memory location as A\$, A\$(2) is B\$, A\$(3) is C\$, etc. In line 10, I chose to assign the values using A\$ through L\$ because each assignment takes three less characters of program memory than if subscripts were used. Lines 80 and 90, on the other hand, use subscripts so that a loop procedure can access the vocabulary values.

Also in line 10, the variable N is used to store the number of "minutes" (chances) remaining. M\$ is used to store the letter "S," which is used to make the word "minute" plural in lines 60 and 600 when there is more than one minute remaining. As soon as the minutes (N) reduce to 1, the value of M\$ is made null (line 35).

Another advanced feature of the PC-1 is the ability to GOTO a line number contained in a variable. Lines 80 and 90 use this technique to send the program to a calculated location depending upon a proper match with an entry in the vocabulary list. Line 110 is used if the user enters a word that does not match any in the list.

Lines 200 through 710 contain the various routines used when there is a match between the user's response and an entry in the vocabulary list. All but one of the routines represent incorrect solutions and send the user back to line 30 for another try. The correct solution stops the program with the word "congratulations!!!!" Pressing ENTER at this point will restart the program.

Lines 900 and 910 are used when the "minutes" remaining reduce to zero (see line 30). The last thing displayed in this case are the words "the end." Again,



pressing ENTER at this point will restart the program.

Line 950 is a subroutine called from two locations in the program (lines 450 and 900). Its function is to take a word and have it move across the display in a "Times Square" fashion.

I realize that by entering a program of this type from a listing, one misses a lot of the impact they would normally have had from running the program without having seen it before. Even so, if you enter the program as written, without analyzing its content, I think you will find there are still a few surprises in store. Since the PC-1 is so portable, you can demonstrate the program to others quite easily and have fun observing their reactions. So, enter the program, enjoy it and remember that you've only got five minutes!

**Program Listing for  
Pocket Adventure**

```
10 :N=6:A$="EAST":B$="E":C$="WEST":D$="
W":E$="NORTH":F$="N":G$="SOUTH":H$="S"
20 :I$="UP":J$="U":K$="DOWN":L$="D":M$=
H$
30 :N=N-1:IFN=0THEN900
35 :IFN=1LET M$=""
40 :IF N<5PAUSE "TRY AGAIN!!"
50 :PAUSE"YOU ARE IN AN EMPTY ROOM":PAU
```

**First came MICROPROOF™:**

*"There is simply no finer program available..."  
(Creative Computing, March 1982)*

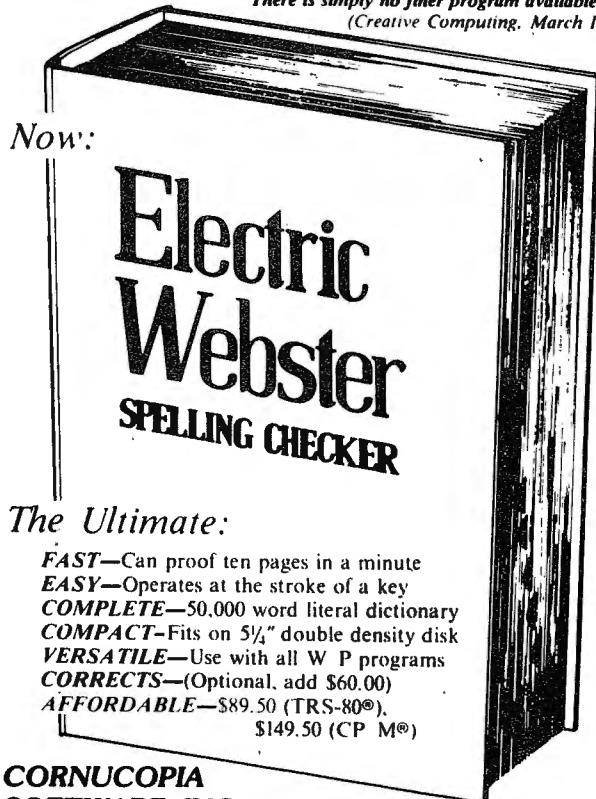

**CORNUCOPIA  
SOFTWARE, INC.**

1625 Beverly Place  
Berkeley, CA 94707

# 30

Contact your local dealer, or order direct — (415) 524-8098

INNOVATION -- QUALITY  
SUPPORT

PIONEER SOFTWARE  
1746 NORTH WEST 55TH. AVE. #204  
LAUDERHILL, FLORIDA 33313  
PHONE 1-(305)-739-2071

**PIONEER**

**SCRIPTR**

SCRIPTR MAKES SCRIPTS A COMPLETE W-P SYSTEM  
BUY BOTH (SCRIPTR + CRAYON) THIS MONTH + GET \$10 OFF

NEW! GRAPHTRAX! ITALICS-UNDERLINE-DOUBLE-EMP+JUSTIFY TEXT.  
NEW! DIAL-A-PRINT - GET LETTER QUALITY BY REPRINTING LINES  
1). ENTER/EXIT SCRIPTS AT WILL WITHOUT LOSING TEXT BUF.  
2). OUTPUT ANY CODE(S) (0-255), DIRECT FROM THE TEXT.  
3). SIMPLE LETTER COMMANDS CONTROL EVERY. MX-80 + 100  
PROGRAMMABLE FEATURE INCL. VAR LINESPACING AND FORMS.  
4). WRITE FORM LETTERS AND INPUT DATA INTO REPORT FORMS.  
5). DISPLAY ONLY MODE HELPS SHOW WHERE PAGES START/END.  
6). EDIT MODE FOR ERRORS, CHANGES, GRAPHICS OR PAUSING.  
7). SELECTED PAGES PRINTED DIRECT/CORRECT HEADERS, PAGE#S  
8). PRINT OUT FULL SCREEN PICTURE FILES MADE BY CRAYON!  
9). 7 SAMPLE TEACHING PROGRAMS TAKE YOU STEP BY STEP.  
10). 66 PAGE MANUAL, BOUND, INDEXED, COMPLETELY REVISED.  
11). CUSTOM VERSIONS AVAILABLE FOR THE FOLLOWING PRINTERS;  
NEW! MICROLINE-80 + B2A, PROWRITER + LP IV. + VIII + F-10  
NEW! DAISY WHEEL 2 VER. ALLOWS SUB/SUPER SCRIPTING 10", 12"  
NEW! + PROPORTIONAL-UNDERLINING-1+1/2 LEGAL LINE SPACING  
NEW! EMPHASIZED, DIAL-A-PRINT, PROGRAMMABLE OVERSTRIKE MODE.

MX 80/100 VER. WORKS WITH/WITHOUT GRAPHTRAX 80 OR PLUS  
DISK SCRIPTR MOD 1/3 = \$40.00 MOD I+III. VERSIONS BOTH  
WORK WITH MODEL I. SCRIPTSIT/LC NO PATCHING REQUIRED.  
CASSETTE SCRIPTR MOD 1/3 = \$40.00 WORKS WITH REG. SCRIPTS.  
1.0 FOR MOD 1/3 REQ. 32K + LC/MOD SCRIPTR IS A 5.5K PROG.  
SEND FOR OUR FREE BROCHURE THAT DEMONSTRATES ALL FEATURES  
SCRIPTR IS WELL DOCUMENTED AND BUG FREE! CUSTOMER SUPPORT  
SATURDAYS + EVENINGS FOR YOUR CONVENIENCE, FREE BROCHURE!

PLEASE INCLUDE THIS INFORMATION WHEN ORDERING  
NAME \_\_\_\_\_ MODEL 1 OR 3 \_\_\_\_\_ CASSETTE/DISK \_\_\_\_\_  
ADDRESS \_\_\_\_\_ TYPE PRINTER \_\_\_\_\_ SCRIPTSIT VER # \_\_\_\_\_  
CITY/STATE/ZIP/PHONE \_\_\_\_\_ MEMORY SIZE \_\_\_\_\_ PAYMENT METHOD \_\_\_\_\_  
CHECKS - MONEY ORDERS - COD'S ACCEPTED

**CRAYON**

CRAYON IS A GRAPHICS DESIGN UTILITY THAT NO TRS-80  
OWNER SHOULD BE WITHOUT. CRAYON DOES IT ALL!!

YOU'VE SEEN THE ADS FOR OTHER DRAWING PROGRAMS. SOME  
CHARGE AS MUCH AS \$150.00 FOR THE ABILITY TO ADD GRAPHICS  
TO YOUR PRINTOUTS. CRAYON ISN'T A CONVERTED TEXT PROCESSOR  
CRAYON WAS DESIGNED FROM THE GROUND UP TO GIVE YOU THE  
VERY FINEST GRAPHIC'S EDITOR POSSIBLE. COMPLEX GRAPHICS  
REQUIRE ROUTINES TO MOVE AND MANIPULATE GRAPHICS THAT NO  
TEXT PROCESSOR CONTAINS. ALSO CRAYON PRODUCES SUPER HIGH  
SPEED GRAPHICS THAT YOU CAN ACCESS FROM YOUR ASSEMBLY AND  
BASIC PROGRAMS. ALSO WITH A BLOCK GRAPHICS PRINTER AND  
SCRIPTR YOU CAN PRINT OUT YOUR CRAYON FILES FROM SCRIPTSIT.  
BEFORE YOU WASTE YOUR MONEY ON HALF A PROGRAM CHECK OUT  
CRAYON'S MANY FEATURES. CRAYON DOES IT ALL!!!

- 1). TYPESET LOGO'S - LETTERHEADS - ENVELOPES - BUSINESS  
CARDS AND OTHER OFFICE FORMS. THIS AD WAS TYPESET  
FROM AN MX-80 PRINTOUT THEN SHRUNK. COST = \$4.50  
IF AD WAS TYPESET AT A PRINTSHOP THE COST = \$200 +
- 2). CREATE AND RUN REAL CARTOONS WITH CRAYON AND THEN  
RUN YOUR CARTOONS FROM BASIC AT ASSEMBLY LANGUAGE  
SPEEDS. SPEEDS OF 35 FRAMES/SECOND POSSIBLE. USE IT  
TO DESIGN DISPLAYS FOR USE IN BASIC & ASSEMBLY PROG'S
- 3). MANAGE DISKETTE DIRECTORIES, PRINT THEM, SEARCH THEM,  
COMMENT THEM. MOD 3 DIR. WORKS ON A TRSDOS SYS. ONLY.
- 4). DRAW ANYTHING YOU DESIRE ONTO THE SCREEN AND PRINT IT  
OUT OR SAVE IT TO DISK/TAPE - UP TO 30 SCREENS/FILE.
- 5). SCREEN FILES MAKE CRAYON A FAST EASY WAY TO KEEP AN  
ELECTRONIC NOTEBOOK. FAST+EASY INFORMATION RETRIEVAL.
- 6). PERFORM ALL VIDEO WORKSHEET FUNCTIONS RIGHT ON SCREEN

- 1). USER FRIENDLY / 42 PAGE DOC'S, OFFSET PRINTED, INDEXED
- 2). NINE CHARACTER USER DEFINED CURSOR. ----->
- 3). 16 LETTER COMMANDS FOR GRAPHICS ENTRY.
- 4). COPY CHARACTERS IN ANY DIRECTION FAST.
- 5). UPPER/LOWER CASE SUPPORT WITHOUT DRIVERS.
- 6). DO ALL OF THE FOLLOWING ON VARIABLE LENGTH LINES->  
COPY-FILL-DELETE-EXCHANGE-MOVE-PULL-UC/LC-INVERT  
GRAPHICS-PRINT-JUSTIFY TEXT-BUFFER/RESTORE TO SCREEN.  
UTILITIES INCLUDE-> MASK - AUTOMATIC PRINT# NUMBERS  
CURSOR LOCATION AND VALUE-3 SELECTIVE CLS'S-PATTERN-  
EXTRA BUFFERS-COMBINE SCREENS -HEXDUMP-SEARCHES. MORE
- 7). FULL DISK / CASS I/O DIR-WRITE-LOAD-APPEND-COPY-KILL  
SCREENPRINT- OUTPUTS CODES TO DRIVE ANY PARALLEL PRINTER  
PROFESSIONALLY WRITTEN & SUPPORTED-NO PROGRAMMING REQUIRED  
OVER 90 COMMANDS -> FAST / EASY / FUN <- ALL MACHINE LANG.  
CASS MOD 1+3=\$35.00 / DISK MOD 1 OR 3=\$45.00 10K PROGRAM  
WORKS IN 16k. OR MORE AND ADJUSTS TO MEMORY SIZE CHANGES.  
ESPECIALLY FOR MX-80, MICROLINE80 AND OTHER BLOCK GRAPHIC  
PRINTERS. PRINTER NOT REQ. FOR FILE HANDLING + CARTOONS.  
LIBERAL DEALER TERMS AVAILABLE - INQUIRIES INVITED



---

# DOSPLUS 3.4 and 3.4D

*An operating system that makes compatibility easy*

Model I/III

Captain Paul M. Hine, San Diego, CA

The TRS-80 Model I owner can easily lay claim to a wider choice of operating systems and hardware configurations than for any computer system since the IBM System 360. The choices vary from the simple (TRSDOS 2.3 and OS-80) to the very complete (NEWDOS/80 version 2.0 from the folks at Apparat). In between have been the excellent products from LOBO and Microsystems Software, as well as NEWDOS-PLUS.

In their current offering, Microsystems Software has made worthwhile revisions to DOSPLUS 3.3, with enhancements to both the DOS and BASIC language portions of the package. The most marked change has been in documentation, which is now competitive with that offered by the finest software houses in the microcomputer support business. The least apparent change is one of adaptability to other systems designed to support hard disk systems on the TRS-80. Compatibility to eight inch floppy drives is also included if the system is configured with an appropriate drive controller.

I reviewed this new operating system using a Model I TRS-80 with an LNW expansion board, LNDOUBLER (to attain double density operation), and three disk drives. Drive zero was a 40-track (MPI B51), and both of the other drives were 80-track units (also MPI). Although DOSPLUS supports lower case modifications and automatically senses this installation, I didn't have one installed. A speedup installation can also be installed and the DOS will manage it to avoid I/O incompatibility.

All three drives were operated at six millisecond track stepping, and the 80-track drives were operated both as 80-track units and, with novel "track skipping", as 40-track drives.

Three distinct grades of floppys were used and the results were locked out during formatting. On premium floppys, no granule lock-outs occurred, proving that for 80-track, double density operation, you get pretty much what you pay for. During 75 hours of operation, three CRC errors happened, and all of these were on the economy floppys. This was cured by using the verify mode of DOSPLUS, which fought through the lower grade floppys without further lost data.

Earlier versions of DOSPLUS gained a reputation for reliability, ease of use and poor documentation. The whole documentation issue can be put to bed right away. The user's manual provided with DOSPLUS 3.4/4.0 is handsome, well written, well organized and *readable!* Some reference to Radio Shack's TRSDOS manual may be advisable, so don't throw that away if you purchase DOSPLUS. The assembly language buffs will be delighted with documentation for many calls to DOSPLUS routines. Some of these are understandable and handy for us BASIC language types to modify our little machine language modules and monitors. The printer driver is flexible enough to handle just about any ASCII serial or parallel printer, and even does the graphics conversions for EPSON owners. This DOS can do nearly anything

the others can, including:

1) Formatting from 20 to 96 cylinders (new word for track) on any drive in either single or double density.

2) Double stepping an 80-track drive to produce or read a 35- or 40-track floppy (you can change it back and forth by command from a BASIC program if you need to change disks).

3) Using any drive as either a double density or single density drive without making any changes in "system" or configuration files. Just put the disk in the drive and DOSPLUS selects the appropriate controller chip to run the show. Files from single density TRSDOS formatted disks can be "copied" directly to double density disks and vice versa!

Format is one of the long suits offered by DOSPLUS. During the format of cylinders (called that for compatibility of terminology with the dual-headed and hard disk crowd), the head is stepped toward the center as in TRSDOS and NEWDOS/80. When the innermost track is reached, the verification is done from inside-out. Aside from being quicker than TRSDOS or NEWDOS, this technique looks for excessive radial error due to hysteresis in the drive's stepper. (Hysteresis is the slop in a leadscrew or band positioner. *That is bad news*, particularly on 80-track drives.)

If the format operation verifies, and the system is operated in the Verify mode (read and verify after each write), you can be assured of good data reliability. Where

DOSPLUS 3.3 displays the sector being verified, 3.4 displays the process by cylinder and granule. This formatter is improved over 3.3, as it locks out individual granules with flaws instead of locking out a whole track. This can save some previously wasted space on floppies which have several bad spots and multiple track lockouts.

The Format utility (as well as Backup, Copy and Diskzap) is menu driven and straightforward in operation. For the students of Mr. H. C. Pennington, there are two (count 'em—two) ZAP-type utilities. Both are written in machine language and are fast. One, Diskzap, is a very complete track- and sector-oriented display/modify utility, which also includes formatting, copy, verify and print functions (it looks as if it were designed with Harv's book open to a "how to" page).

The other zapper is called Diskdump. While being track and sector oriented, it is entered by using the file specification. This initial time (and patience) saver is only a small taste of what is to follow, because changes can be entered in *either* Hex or ASCII. (It is a quick and painless way to change a couple of bytes in any file or machine language utility without writing a program, or doing a reassembly and dump, to complete the job).

As in DOSPLUS 3.3, the DIR command provides a complete directory sector breakdown including all file attributes. The MAP command is unchanged, still showing the track and sector assignments for each file (the sharp-eyed will note sufficient leading zeroes on track and sector attributes to accommodate the larger hard disks). The FREE command still provides a graphic display of all tracks and granules on the disk. DOSPLUS 3.4 adds a new command—"CAT" (or catalog). This provides a display like DIR in TRSDOS or NEWDOS.

The Model I display cursor is a square block, similar to that used on the Model III. A boot option permits accessing the Level II I/O drivers and the conventional cursor is displayed to remind you that these are in use. The keyboard is

debounced when the block cursor is displayed and the repeating key is featured on the entire keyboard.

The FORCE command from 3.3 is continued so that I/O can be redirected. Version 3.4 also features a new command—JOIN, so that output can be paralleled to two devices simultaneously (display and printer, and in Model III, display and RS-232). The previously supported AUTO, DO and BUILD commands are continued to provide for automatic execution of commands or programs at boot-up time. The only missing command is CLEARFILE, which used to erase file data while leaving the directory entry intact.

All practical commands and utilities are available from BASIC. Rather than having a reduced set of DOS commands during BASIC operation, Microsystems chose to load a larger BASIC for program development and then use most of the DOS for support. Programs can be called for execution under a smaller BASIC called TBASIC. This language module supports all of the microsystems extensions to BASIC, but has no access to the DOS commands (except for those which are supported by BASIC reserved words—TIME\$, etc.). The extensions to BASIC include a single step trace, global editing of text files (SR command), and a memory dump of variables (M command), which, if used with an ONERROR statement, can parallel the finest mainframe debugging systems.

Two extensions which are new to 3.4 include a sort utility for BASIC arrays (O command) and a new reserved word—INPUT@, which eases screen formatting during data entry routines. INPUT@ sets, and clearly indicates, input field length. Interestingly, it can provide elementary input editing to restrict alphabetic characters from numeric fields! Unfortunately, the "O" command, as well as "M" and "SR", aren't available from TBASIC.

The only mild irritation, to date, is the requirement to enter BASIC and execute a CMD"T" to disable interrupts. While the need is seldom, I've added two commands (EI/CMD and DI/CMD) to avoid the problem.

In all other respects, I found DOSPLUS 3.4D to be smooth, fast, powerful, and operator-oriented. Nothing showed up to cast a shadow on the DOSPLUS reputation for rock steady reliability. All of the NEWDOS/80 options aren't included, but the automated features of this DOS do away with the need for many of the NEWDOS switches and SYSGEN-type options. Microsystems does not include an Editor/Assembler or Disassembler with this package. Instead, a separate machine language support package is offered as a distinct product.

DOSPLUS showed strong upward compatibility with all forms of programs and data from TRSDOS 2.3. It operated satisfactorily on single density files and programs from NEWDOS/80 version 2.0 with the exception of marked-item formats. Both NEWDOS/80 and TRSDOS 2.3 had trouble reading DOSPLUS disks, due, most probably, to the extended protocols in granule allocation table codes.

Microsystems Software is offering a newsletter to users and promises both zaps and updates at reasonable prices. Patches are reportedly available for a wide variety of programs including the Microsoft BASIC Compiler. SCRIPSIT patches are available, along with patches to some other commercially available patches for special printer support. The availability of these patches makes DOSPLUS a very attractive upgrade for the established TRSDOS or OS-80 user. For the TRS-80 user upgrading to double density, or one who finds that he or she has a mixed bag of disk drives, DOSPLUS 3.4D is the easy answer. For the user with both Model I and Model III machines, the DOSPLUS system offers a high degree of compatibility. ■

*DOSPLUS 3.4 or 3.4D are available from Microsystems Software, Inc., 4301-18 Oak Circle, Boca Raton, FL 33431, (305) 983-3390. The operating system is also available for Model I or PMC in single density, as well as for the Model III. All versions are the same price, \$149.95.*



**NEW**  
FROM THE MAKERS OF  
**SCARFMAN**  
for TRS-80® Models I & III

# Bounceoids

**WHOMMP!**

**Includes exclusive challenge mode.**

Bounceoids come crashing down from space—and rebound across the screen. Blast them or they will smash you. You have a shield but its lifespan is limited so use it sparingly.

The commotion will attract alien natives with poison darts, off-world snakes and shaking bugs. Be on your guard. The longer you survive the harder it is to simply exist. Bounceoids start dropping from the sky in tiny clusters or with constantly changing outer dimensions.

Reach the exclusive challenge level and face the flying space flock in a tense challenge of strategy, coordination and targeting skills. Joystick compatible.

\$15.95 tape, \$19.95 disc plus \$1.50 shipping and handling charges. MasterCard & Visa orders accepted. Available at your software dealer.

**The Cornsoft Group**

6008 N. Keystone Ave., Indianapolis, IN 46220 • (317) 257-3227

# All TRS-80<sup>®</sup> Color

## Take Your Pick

Get Our Standard Color BASIC  
Language with 16K Memory, Plus  
An Entertaining Tutorial Manual

Now Only

Reg.  
399.95

**299<sup>95</sup>**

Less TV and  
Program Pak

Cat. No. 26-3004



### A Smart Investment

Each of Radio Shack's popular TRS-80 Color Computer models is now on sale. You can get a complete, versatile system for as low as \$299.95. It's the affordable way for the entire family to start computing! Or if you require a system for advanced applications—like high-resolution color graphics—choose one of our "professional" models for as low as \$399.95.

### Easy to Use

Plug in an instant-loading Program Pak™ cartridge and you can play exciting games, keep a personal budget, solve problems, analyze investments, write letters and themes, set up a household inventory, and much more. A TRS-80 Color Computer is educational, too. The kids can learn to type, sharpen math skills, become an artist, compose music, even improve reading.

### Write Your Own Programs

Our easy-to-use Color BASIC is ideal for home or school applications. You can create graphics with up to eight colors, and incorporate music and sound effects into your programs, too. Our entertaining tutorial manual shows you how! You get a 32 × 16 screen format, data and string handling, dimensioned arrays, math functions, 9-digit numeric accuracy and more. Save your work with an optional cassette recorder.



### More Versatility

Add a pair of joysticks (26-3008, \$24.95) and get faster, more realistic game action! Use joystick instructions in your own programs, too.

# Computers Cut \$100 and Save Big!

Select 16K or 32K Memory  
With Our Extended Color BASIC  
Language and Two Tutorial Manuals

Low As

**399<sup>95</sup>**  
Less  
TV



## A Programmer's Dream

If you want to create high-resolution color graphics, then select a sale-priced TRS-80 Color Computer with Extended BASIC. Using one-line commands, you can easily produce incredible drawings, charts, even animation. Get 16K memory for \$399.95 (26-3002, reg. \$499.95) or 32K memory for \$549.95 (26-3003, reg. \$649.95). We even include two tutorial manuals.



## Amazing Printouts

Add our new CGP-115 Color Graphics Printer (26-1192, \$249.95) for beautiful diagrams and upper and lower case text in four colors!

## Sophisticated

Extended BASIC offers the programmer a 256 x 192 screen resolution, editing, tracing, error messages, user-definable keys, PEEK, POKE and more.

## Expandable

Add disk drives, a printer, graphics tablet, digitizer, modem and other peripherals to meet future needs.

## The Perfect Gift to Give . . . or Get!

Get your TRS-80 Color Computer at a Radio Shack Computer Center, store or participating dealer today.

**Radio Shack**<sup>®</sup>  
The biggest name in little computers<sup>™</sup>

A DIVISION OF TANDY CORPORATION

Retail prices may vary at individual stores and dealers.

# DON'T GET LOCKED IN

Pascal  
Basic  
Cobol  
Forth  
Pilot  
Fortran  
Spread Sheet  
Inventory  
Logo  
"C"

Data Base Management  
Word Processor  
Communication Utility  
Accounts Receivable  
Accounts Payable  
Engineering Utility

General Ledger  
Mailing List  
Macro Assembler  
Education

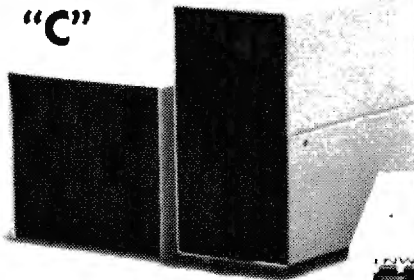
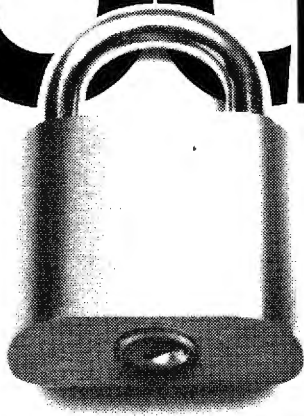

**TRSDOS\***

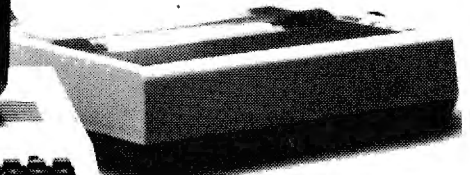

**CP/M\*\***

Open your doors to a world of SOFTWARE with LNW computers. You'll get **MORE PERFORMANCE<sup>1</sup>** than with the IBM PC<sup>2</sup>, the Apple II<sup>3</sup>, TRS80 MODEL II or TRS80 MODEL III<sup>4</sup> along with software support of TRSDOS or CP/M, the TWO MOST WIDELY USED OPERATING SYSTEMS. This means you, the user, can select from the largest base of business or personal software.

**Standard Features:** A serial RS232 communication port, parallel printer port, Hi-Resolution (480x192) B/W and COLOR graphics, an 80 character-per-line screen display along with Quad-density interface for 5" or 8" floppy disk storage offering immediate access to 3.5 million characters, or optional Hard disk

interface to 5 or 10 million characters.

**Standard Software:** LNWBASIC and DOS PLUS operating system packages, commanding all the above features, are included.

The LNW computer will be the key to your success with the starting price at **\$1695.00**, along with a full 6 month warranty.

**Dealers:** You too can open the door to a successful product. Call for our special dealer programs: (714) 544-5745.

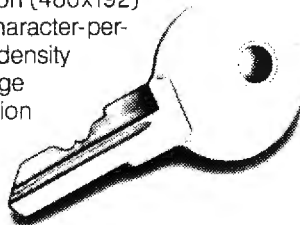

**LNW Computers**  
2620 Walnut Avenue  
Tustin, California 92680  
(714) 544-5744

\*TRSDOS is a trademark of Tandy Corp.

\*\*CP/M is a trademark of Digital Research Corp

1. Performance is based on bench mark test in the JAN 1982 issue of BYTE magazine, pg. 54, with LNW80 II as the comparison.

2. IBM PC is a trademark of IBM CORP

3. APPLE II is a trademark of APPLE COMPUTERS

4. TRS80 is a trademark of Tandy Corp.



# Color Computer sorting

## A routine for quick results

Color Computer

Mark D. Goodwin, Orland, ME

Sooner or later you'll probably write a program which requires sorted data. Sorting the elements of an array can be very time consuming, if the sort is done by a BASIC subroutine. A BASIC sort is adequate, when the array is small. But if you should have to sort a large array, say 1000 elements, you could be twiddling your thumbs for quite some time.

Enter machine language. A machine language sort can sort an array in a fraction of the time a BASIC sort routine requires. Listing 1 contains a general purpose sort routine. It can sort both string and numeric data. The size of the array is limited only by the memory size of your computer. A partial sort can also be accomplished.

In order to understand the sort routine, you must first know its requirements. The routine requires a string array, which will be sorted, and a numeric array, which is used for an index. On entry to the routine you must POKE the following values into memory: 3FF1 — VARPTR of the 1st element in the string array. 3FF3 — VARPTR of the 1st element in the numeric array. 3FEF — number of elements to be sorted, minus one.

With the above information, let's tackle the program. In order to speed up program execution, I chose to utilize the 6809's direct page-addressing mode. This of course rules out relocatability, but this isn't a very serious limitation. The program is written for a 16K machine, but can be used on a 32K machine with the following changes:

```
0002      ORG $7FFF-$9C
0003      SETDP $7F
0004 START LDA #$7F
```

The program should contain sufficient comments to understand how it works. The program can be assembled easily with an editor assembler. First enter the program line by line. Be sure to make the appropriate changes if you want to utilize the full memory of a 32K computer. Once the program has been entered, double check the program for errors. Now save a few

copies of the object code on cassette. Follow this by saving a few copies of the source code in case any typos were missed. Remember, an ounce of prevention is worth a pound of cure.

If you don't have an editor assembler, enter the program in Listing 2. This is a BASIC version, which POKES the sort routine into memory. To use the program with a 32K machine, change line 90 to:

```
90 DATA 134, 127, 30, 139, 151, 255,
15, 252
```

For a 32K computer the memory addresses in Listing 2 will have to be changed. Simply change the 3Fs to

### Listing 1

```
0001 0600      NAM SORT
0002 0600      ORG $3FFF-$9C
0003 3F63      SETDP $3F
0004 3F63 863F  START LDA #$3F      NEW DP VALUE
0005 3F65 1E8B  EXG A,DP      A = OLD DP = NEW
0006 3F67 97FF  STA <OLD      SAVE OLD DP
0007 3F69 0FFC  ST1  CLR <NUM      CLEAR SORT FLAG
0008 3F6B DCEF  LDD <V1      D=#ELEMENTS-1
0009 3F6D DDF5  STD <LEN      LOAD VARIABLE
0010 3F6F DCF1  LDD <V2      D=VARPTR(A*(1))
0011 3F71 DDF7  STD <STP      LOAD VARIABLE
0012 3F73 DCF3  LDD <V3      D=VARPTR(A(1))
0013 3F75 DDF9  STD <INT      LOAD VARIABLE
0014 3F77 9EF7  ST2  LDX <STP      X=STRING POINTER
0015 3F79 A684  LDA ,X      A=LEN(STRING1)
0016 3F7B 97FD  STA <LEN1     SAVE IT
0017 3F7D EC02  LDD 2,X      D=STRING1 POS
0018 3F7F 1F02  TFR D,Y      PUT IT IN Y
0019 3F81 A605  LDA 5,X      A=LEN(STRING2)
0020 3F83 97FE  STA <LEN2     SAVE IT
0021 3F85 EC07  LDD 7,X      D=STRING2 POS
0022 3F87 1F01  TFR D,X      PUT IT X
0023 3F89 1E12  EXG X,Y      EXCHANGE X AND Y
0024 3F8B 96FE  LDA <LEN2     A=LEN(STRING2)
0025 3F8D 2706  BEQ ST5      IF A=0 JUMP
0026 3F8F 96FD  LDA <LEN1     A=LEN(STRING1)
0027 3F91 271C  BEQ NOSWAP   IF A=0 JUMP
0028 3F93 2006  BRA ST3      JUMP
0029 3F95 96FD  ST5  LDA <LEN1  A=LEN(STRING1)
0030 3F97 2716  BEQ NOSWAP   IFA=0 JUMP
```

## CC sorting

7Fs. For example:

```
30 CLEAR200,&H7F62
```

Before loading the machine language version, enter CLEAR200, &H3F62 or CLEAR200,&H7F62; depending on the memory size of your computer. This is necessary to reserve the memory for the sort program. In line 30 the BASIC version reserves memory for you.

Listing 3 demonstrates the use of the sort routine. It only sorts an array of ten elements, but should help in understanding how the routine is used. The program uses the TIMER function to time the sort. I won't tell how long the sort takes because I prefer to surprise you.

You may have wondered why the sort routine uses a numeric array at all. This array can be quite useful as an index. If you want to sort a disk mail list file by zip codes; simply set the string array to the zip codes, sort the data and save the index on the disk. Now the mail list can be accessed by using the index. This eliminates the need of rewriting the entire mail list file after the sort. If an index isn't needed, use a dummy numeric array for the sort routine. A numeric array can be sorted by loading its values into a string array with the STR\$ command. Then sort the string array and transfer the data back with the VAL command.

I hope you find this sort routine useful. There are many uses for sorted data and having the ability to sort data quickly can greatly enhance any program.

*Ed. note: The author is making these programs available on cassette (\$9.95) or disk (\$11.95) plus \$2 shipping and handling. Contact: Mr. Goodwin at Star Route 790, Box 103, Orland, ME 04472.*

0031	3F99	2008		BRA	SWAP	JUMP	
0032	3F9B	A680	ST3	LDA	,X+	PUT CHAR IN A	
0033	3F9D	A1A0		CMPA	,Y+	COMPARE STRINGS	
0034	3F9F	272D		BEQ	ST4	IF = JUMP	
0035	3FA1	250C		BCS	NOSWAP	IF > JUMP	
0036	3FA3	9EF7	SWAP	LDX	<STP	X=STRING POINTER	
0037	3FA5	8D37		BSR	MOVE	SWITCH STRINGS	
0038	3FA7	9EF9		LDX	<INT	X=INDEX POINTER	
0039	3FA9	8D33		BSR	MOVE	SWITCH INDEX	
0040	3FAB	8601		LDA	#1	A=1	
0041	3FAD	97FC		STA	<NUM	SET SORT FLAG	
0042	3FAF	CC0005	NOSWAP	LDD	#5	D=5	
0043	3FB2	D3F7		ADDD	<STP	+ STRING POINT	
0044	3FB4	DDF7		STD	<STP	SAVE IT	
0045	3FB6	CC0005		LDD	#5	D=5	
0046	3FB9	D3F9		ADDD	<INT	+ INDEX POINT	
0047	3FBB	DDF9		STD	<INT	SAVE IT	
0048	3FBD	9EF5		LDX	<LEN	X=#ELEMENTS	
0049	3FBF	301F		LEAX	-1,X	DECREMENT IT	
0050	3FC1	9FF5		STX	<LEN	SAVE IT	
0051	3FC3	26B2		BNE	ST2	IF X<>0 JUMP	
0052	3FC5	96FC		LDA	<NUM	A=SORT FLAG	
0053	3FC7	26A0		BNE	ST1	IF A<>0 JUMP	
0054	3FC9	96FF		LDA	<OLD	A=OLD DP	
0055	3FCB	1F8B		TFR	A,DP	SET DP	
0056	3FCD	39		RTS		RETURN TO BASIC	
0057	3FCE	0AFE	ST4	DEC	<LEN2	DEC STRING2 LEN	
0058	3FD0	2706		BEQ	SWS	IF =0 JUMP	
0059	3FD2	0AFD		DEC	<LEN1	DEC STRING1 LEN	
0060	3FD4	27D9		BEQ	NOSWAP	IF =0 JUMP	
0061	3FD6	20C3		BRA	ST3	JUMP	
0062	3FDB	0AFD	SW5	DEC	<LEN1	DEC STRING1 LEN	
0063	3FDA	27D3		BEQ	NOSWAP	IF =0 JUMP	
0064	3FDC	20C5		BRA	SWAP	JUMP	
0065	3FDE	C605	MOVE	LDB	#5	B=COUNT	
0066	3FE0	D7FB		STB	<CNT	SAVE IT	
0067	3FE2	A605	MO1	LDA	5,X	SWITCH	
0068	3FE4	E684		LDB	,X	LOCATIONS	
0069	3FE6	E705		STB	5,X	POINTED	
0070	3FEB	A780		STA	,X+	TO BY X	
0071	3FEA	0AFB		DEC	<CNT	DECREMENT COUNT	
0072	3FEC	26F4		BNE	MO1	IF CNT<>0 JUMP	
0073	3FEE	39		RTS		RETURN	
0074	3FEF	0000	V1	FDB	0		
0075	3FF1	0000	V2	FDB	0		
0076	3FF3	0000	V3	FDB	0		
0077	3FF5	0000	LEN	FDB	0		
0078	3FF7	0000	STP	FDB	0		
0079	3FF9	0000	INT	FDB	0		
0080	3FFB	00	CNT	FCB	0		
0081	3FFC	00	NUM	FCB	0		
0082	3FFD	00	LEN1	FCB	0		
0083	3FFE	00	LEN2	FCB	0		
0084	3FFF	00	OLD	FCB	0		
0085	4000			END	START		
CNT	3FFB	INT	3FF9	LEN	3FF5	LEN1	3FFD
LEN2	3FFE	MO1	3FE2	MOVE	3FDE	NOSWAP	3FAF
NUM	3FFC	OLD	3FFF	ST1	3F69	ST2	3F77
ST3	3F9B	ST4	3FCE	ST5	3F95	START	3F63
STP	3FF7	SW5	3FDB	SWAP	3FA3	V1	3FEF
V2	3FF1	V3	3FF3				

### Listing 2

```
10 REM CLEAR STRING SPACE
20 REM & SET MEMORY SIZE
30 CLEAR200,&H3F62
40 REM POKE SORT ROUTINE
50 FORI=&H3F63 TO&H3FFF
60 READJ
70 POKEI,J
64 80-U.S. Journal
```

```
80 NEXTI
90 DATA134,63,30,139,151,255,15,252
100 DATA220,239,221,245,220,241,221,247
110 DATA220,243,221,249,158,247,166,132
120 DATA151,253,236,2,31,2,166,5
130 DATA151,254,236,7,31,1,30,18
140 DATA150,254,39,6,150,253,39,28
```

# DOSPLUS 4.0, the perfect score. The DOSPLUS 4.0 hard drive system is here!

A hard drive without the dynamic new DOSPLUS 4.0 is like an eggshell without the egg. The new DOSPLUS 4.0 is the leading edge—the latest in the line of advanced disk operating systems from MICRO-SYSTEMS SOFTWARE, INC. It's the only current operating system written from the ground up for hard disk operation. Not just a driver but a fully developed system. What that means to you is more bang for your buck! Finally an unlimited TRS-80 for small business. For only \$1899 you get the DOSPLUS "PLUS."

#### THE DOSPLUS 4.0 FEATURES

- Single volume addressing/Double sided floppies seen as one drive—one file can expand to limit of the hard drive
- Hard Disk—disk editing utilities
- Incredible I/O speed
- Runs any combination of densities or tracks
- Also operates 8" drives with special hardware—comes with expanded users guide and complete DOS technical section on I/O calls and DCB organization
- Ability to use hard drive as the "system" drive.

#### "PLUS" MANY OF THE SENSATIONAL NEW DOSPLUS 3.4 FEATURES

- BASIC array sort—multi key, multi array
- Tape/Disk—Disk/Tape utility (with relocater)
- Input (controlled screen input)
- Random access and ASCII modification on Diskdump
- BASIC checks for active "DO"
- Backup and Format from a "DO" file
- Much improved Backup (More reliable)

**\$1899** TAKE YOUR MICRO TO THE MAX. ORDER NOW!

COMPLETE WITH 5 MEG SYSTEM.

- I/O package much faster (disk access time reduced)
- Repeat last DOS command with ''' [ENTER]
- Short directory (filename and extension) available
- Short directory of Model III TRSDOS disks
- Single file convert from Model III TRSDOS
- COMPLETE device routing supported (DOS and BASIC)
- Ability to save BASIC programs directly to another machines' memory (if equipped with DOSPLUS 3.4)

NOTE: The final versions of 3.4 and 4.0 will have almost identical features and documentation.

#### THE COMPLETE SYSTEM

- Smooth, silent, swift
- Error-free disk I/O
- \*Add on up to 4, 10 meg units for a total of 40 megabytes!
- Plugs on the 50 pin data bus.—no loss of floppy drives
- Completely self-contained—just plug it in and go
- \*10 meg units available Soon.

NOTE: Specify 40 or 80 track when ordering DOS diskette. After initial bootup, user can create any DOS desired.

The first in the industry backed by a lifetime warranty\*\*

\*\*Lifetime warranty on original media

**DOSPLUS**

DOSPLUS first in quality!  
First in the industry!

**MICRO-SYSTEMS  
SOFTWARE, INC.**

4301-18 Oak Circle  
Boca Raton, FL 33431  
Telephone: (305) 983-3390  
(800) 327-8724



**BUY DIRECT**  
**AT DISCOUNT PRICES**  
 It's simple . . . .

**TRS-80**  
**COMPUTERS**

**NEW!** Radio Shack TRS-80 Hard Drives Model I & III. . . from **\$2087**

TRS-80 Color Computer



BUY DIRECT

PRICED FROM

**\$289**

TRS-80 Model II Computer



BUY DIRECT

PRICED FROM

**\$2899**

TRS-80 Model III Computer



BUY DIRECT

PRICED FROM

**\$599**

TRS-80 Model 16 Computer



BUY DIRECT

PRICED FROM

**\$4098**

Smith Corona TP-1 Daisy Wheel Printer

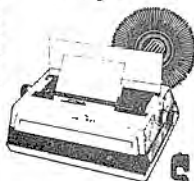

BUY DIRECT

PRICED FROM

**\$579**

**FRANKLIN ACE 1000**

**ATARI**

**Commodore**

CALL FOR PRICES

ALL TRS-80'S ARE PURE RADIO SHACK EQUIPMENT

**1-800-841-0860**

Write for our Consumer Discount Price List

**Micro Management Systems, Inc.**

PARCEL DIVISION - DEPT NO. 5  
 2803 THOMASVILLE ROAD EAST  
 CAIRO, GEORGIA 31728  
 912-377-7120

# 37

**CC sorting**

- 150 DATA32,6,150,253,39,22,32,8
- 160 DATA166,128,161,160,39,45,37,12
- 170 DATA158,247,141,55,158,249,141,51
- 180 DATA134,1,151,252,204,0,5,211
- 190 DATA247,221,247,204,0,5,211,249
- 200 DATA221,249,158,245,48,31,159,245
- 210 DATA38,178,150,252,38,160,150,255
- 220 DATA31,139,57,10,254,39,6,10
- 230 DATA253,39,217,32,195,10,253,39
- 240 DATA211,32,197,198,5,215,251,166
- 250 DATA5,230,132,231,5,167,128,10
- 260 DATA251,38,244,57,0,0,0,0
- 270 DATA0,0,0,0,0,0,0,0,0,0,0

Listing 3

- 10 REM CLEAR STRING SPACE,
- 20 REM SET MEMORY SIZE,
- 30 REM SET USR0, &
- 40 REM DIM VARIABLES
- 50 CLEAR300,&H3F62
- 60 DEFUSR0=&H3F63
- 70 DIMI(10),IS(10)
- 80 REM INITIALIZE VARIABLES
- 90 FORI=1TO10
- 100 I(I)=I
- 110 READI\$(I)
- 120 NEXTI
- 130 REM POKE POINTERS
- 140 I=VARPTR(I\$(1))
- 150 POKE&H3FF1,INT(I/256)
- 160 POKE&H3FF2,I-INT(I/256)\*256
- 170 I=VARPTR(I(1))
- 180 POKE&H3FF3,INT(I/256)
- 190 POKE&H3FF4,I-INT(I/256)\*256
- 200 REM POKE LENGTH
- 210 I=9
- 220 POKE&H3FEF,INT(I/256)
- 230 POKE&H3FF0,I-INT(I/256)\*256
- 240 REM SET TIMER
- 250 T=TIMER/60
- 260 REM CALL SORT ROUTINE
- 270 I=USR0(0)
- 280 T=TIMER/60
- 290 REM PRINT RESULTS
- 300 CLS
- 310 PRINT"SORT TIME:"T"SECONDS
- 320 PRINT:PRINT"ORIGINAL","SORTED"
- 330 FORI=1TO10
- 340 FORJ=1TO10
- 350 IFI(J)=I THENPRINTI\$(J),:GOTO370
- 360 NEXTJ
- 370 PRINTI\$(I)
- 380 NEXTI
- 390 DATAMARK, DENISE, RYAN, CANDY, GLENN, ROS  
 EMARY, DAVID, GLORIA, LOWELL, BARBARA ■

# Apparat, Inc.

4401 So. Tamarac Parkway, Denver, CO 80237 (303) 741-1778

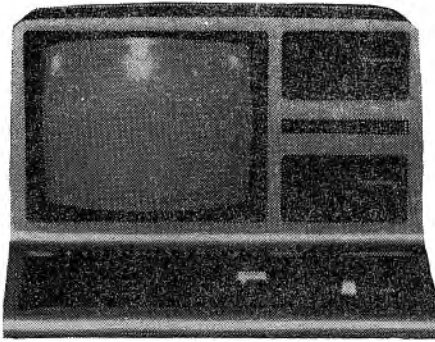

## MODEL III PRICE LIST

(All 48K with Tandon drives & the Apparat Disk Controller)

2 single sided 40 track drives .....	<b>\$1895.00</b>
2 dual sided 40 track drives .....	<b>2145.00</b>
2 dual sided 80 track drives .....	<b>2395.00</b>
with RS-232 C add.....	<b>115.00</b>

Price includes NEWDOS/80 & TRSDOS

NOTE: These Model III computers contain Apparat installed disk drives and memory. They are warranted by Apparat, Inc. for 120 days.

## OKIDATA ML 84 The best. For less.

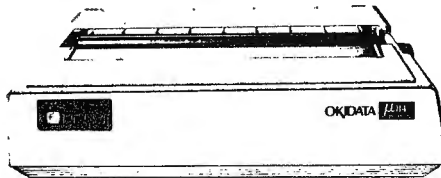

The printer with correspondence quality and data processing throughput! The 200 cps bidirectional ML 84 is the multi-mode printer you can afford. Okigraph™ dot-addressable graphics are standard. Six program-selectable character sizes with true descenders, enhanced and emphasized print. The ML 84 proves top of the line doesn't have to mean top dollar. **\$1125.00**

## SPOOL/64

**Saving time, increasing productivity  
and lowering costs.**

SPOOL/64, a 64K byte hardware print spooler, keeps your computer processing while your printer is printing. No more valuable time lost by waiting for a print run to finish.

This unit plugs directly into your personal computer and printer with one easy connection. It can then transfer up to 3,000 characters per second. The data is stored in the spooler's memory and sent to the printer at a rate the printer can accept. **\$319.00**

## TANDON DISK DRIVES

Complete with power supply, chassis & configured for TRS-80® Model I or III

- Single sided 40 track ..... **\$285.00**
  - Dual 40 or Single 80 track... **\$415.00**
  - Dual sided 80 track..... **\$515.00**
  - **Special** - 2 Dual sided 80's.. **\$999.00**
- (Adds almost 1.5 megabytes of storage to a double density model I or model III)

## NEWDOS 80

Version 2.0

The most sophisticated DOS ever produced for the TRS-80® Models I and III. It provides the user with "MAINFRAME" power on a "MICRO".

Some Features available are:

- Jobstream Control Language
- Mod I/Mod III Diskette interchangeability
- Double Density Support on Model I
- Pagenation of BASIC listings on the screen
- Basic program single stepping
- Dynamic variable manipulation
- Multiple array sorts with BASIC CMD "O"
- Complete technical support provided

All this plus much more for only

**\$149.00**

## NEWTERM /80, MODEL III \$49.95

- Runs under popular operating systems
- Interrupt driven to 19,200 baud
- Translation table
- Automatic sign-on
- Status line

## CHEXTEXT®, \$59.95

"Surefire Spelling Checker"

See Desktop Computing Sept. '82 issue, p. 52-53 for review. . . "Chertext, a program that avoids the limitation brought about by hashing/since it retains the integrity of the words . . . The dictionary, or any part of it, may be displayed on the screen."

## FLEXTEXT/PLUS, \$34.95

For the Mod I & II for all EPSON printers with GRAFTRAX/PLUS

**CREATIVE CUISINE, \$29.95**  
Electronic Cookbook

## MEAL MASTER, \$24.95

Meal planning & grocery shopping aid

## UNITERM/80, \$89.00

Universal terminal program that takes advantage of the extended NEWDOS/80 commands

**MICRO CLINIC, Mod I \$24.95, Mod III \$29.95**  
The ultimate in memory & disk diagnostics

## APPARAT'S PROM BLASTER

An eprom programmer for most 25 X X and 27 X X chips. TRS-80

**MOD I & III.....\$119.00**

**Cable .....17.95**

**Bus Extender.....69.95**

## MODEL I DOUBLE DENSITY PACKAGE

Converts a standard TRS-80 Model I to Double Density

Apparat Doubler & NEWDOS/80 V 2.0.

\$278.00 value for only **\$219.00**

Doubler alone **\$129.00**

**InfoWorld**  
Software Report Card

**NEWDOS/80**  
**Version 2.0**

	Poor	Fair	Good	Excellent
Performance	<input type="checkbox"/>	<input type="checkbox"/>	<input checked="" type="checkbox"/>	<input checked="" type="checkbox"/>
Documentation	<input type="checkbox"/>	<input type="checkbox"/>	<input checked="" type="checkbox"/>	<input checked="" type="checkbox"/>
Ease of Use	<input type="checkbox"/>	<input checked="" type="checkbox"/>	<input type="checkbox"/>	<input type="checkbox"/>
Error Handling	<input type="checkbox"/>	<input type="checkbox"/>	<input checked="" type="checkbox"/>	<input checked="" type="checkbox"/>

# 38

Scripsit® & TRS-80® are registered trademarks of Tandy Corporation Freight F.O.B. Denver, call for shipping charges. Foreign Orders shipped Air Freight

# Basically BASIC

## String functions and what they can do

For all models

James A. Conrad, Seattle, WA

Most novice, and many not-so-novice programmers don't understand much about string functions. Functions seemed relatively unimportant when they started learning BASIC — something to “get to later.” Well, “later” is now. String functions are easy to understand.

Many programmers tend to confuse *functions* and *statements*. A *statement* is an instruction to the computer, telling it to do something. It contains (or is) a verb such as PRINT or GOTO. Most *functions* calculate or convert. They're like self-contained subroutines; LOG(x), for example, computes the natural logarithm of x.

The major BASIC functions perform arithmetic or string operations. String functions analyze and manipulate strings. They're indispensable in input checking and output formatting routines.

### A Few Words About Functions

A function has two parts — a *title* and an *argument*. The *title* describes, in BASIC, what the function does, e.g., LENgth, VALue. The argument is the input to the function. The function takes this input and *returns* a *result*. The parentheses following the title contain the argument. They are pronounced *of* — the function LEN(A\$), for example, is pronounced “length of A string.”

You can do almost anything with a function that you can with a variable. You can print it. You can add or subtract it (if it's numeric). You can even put it in the argument of another function — this is called “nesting” — e.g., LEN(MID\$(A\$,3)). (When you nest functions be sure that you've put in a right parenthesis for every left one.) About the only thing you can't do with a function that you can with a variable is assign a value to it with

an assignment statement.

### The String Functions

Here's a summary of string functions, what they do, and a program line that prints an example. The symbols used in the arguments are:

\$: String being analyzed.

sub\$: Substring.

len: Length of substring to be returned (0 - 255).

pos: Position in string.

x: Any numeric expression or number the computer can handle.

chr: Character (in quotes) or ASCII, control or graphics code.

asc: ASCII, control or graphics code (0 - 255).

Any of these (except *chr*) can be a constant, variable or formula.

We'll use line 10 to make a 9-character string, A\$, to play with:

```
10 A$ = "123456789"
```

LEFT\$(\$,len)

Returns the left *len* characters of string \$.

```
20 PRINT "THE FIRST 4 CHARACTERS OF A$ ARE:  
"; LEFT$(A$,4)
```

It prints 1234.

RIGHT\$(\$,len)

Returns the right *len* characters of string \$.

```
30 PRINT "THE LAST 3 CHARACTERS OF A$ ARE:  
"; RIGHT$(A$,3)
```

This prints 789.

**MIDSTRING(\$,pos,len)**

Returns a substring of string \$, beginning with character number pos and having a length of len characters.

```
40 PRINT "CHARACTERS 2, 3, AND 4 OF A$ ARE:";
MID$(A$,2,3)
```

This time, 234 is printed.

**MIDSTRING(\$,pos) (len omitted)**

Returns the entire substring right of position pos.

```
50 PRINT "RIGHT SIDE OF A$ FROM 5 ON IS:";
MID$(A$,5)
```

Now it prints 56789.

**LEN(\$)**

Returns the number of characters in string \$.

```
60 PRINT "NUMBER OF CHARACTERS IN A$ IS:";
LEN(A$)
```

This shows 9.

**VAL(\$)**

Returns the numeric value of string \$.

```
70 PRINT "THE VALUE OF A$ IS:"; VAL(A$)
```

We get 123456789. (Note that the first position is a space.)

**STR\$(x)**

Converts a number or numeric expression (x) to a string.

```
80 LET A = 333
90 PRINT "THE STRING OF A IS:"; STR$(A)
```

This prints 333. (The first position is a space and the length of the string is 4 characters.)

**STRING\$(len, chr)**

For this the Color Computer requires Extended BASIC. Returns a string of character chr which is len characters long.

```
100 PRINT STRING$(20, "=")
```

Prints a double line 20 characters long:

```
=====
```

```
110 PRINT STRING$(20, 61) : REM 61 is ASCII code
for "="
```

Prints the same double line.

**INSTR(pos, \$, sub\$)**

This command is on Disk Models I and III or the Extended Color Computer. Searches string \$ beginning at position pos for substring sub\$. Returns position number if found, 0 if not found. If pos is omitted, search begins at first character (pos. 1).

```
120 PRINT "POSITION OF 56 IN A$ IS:"; INSTR(1,
A$, "56")
```

This prints 5 — the substring 56 begins at the 5th position in A\$.

**ASC(\$)**

Returns ASCII code number of the first character of string \$.

```
130 PRINT "A$ BEGINS WITH ASCII CHARACTER
# "; ASC(A$)
```

Prints 49 — the ASCII code for 1. Printing ASC("1") will also return 49.

**CHR\$(asc)**

Returns the character, in a one-character string, for ASCII, control or graphics code asc.

```
140 PRINT "THE CHARACTER FOR ASCII CODE 49
IS:" : CHR$(49)
```

This prints 1.

**Workhorses**

The LEFT\$, RIGHT\$ and MID\$ functions are the workhorses of string manipulation. And they're easy to understand. Run this quick FOR...NEXT loop for a display of their operation:

```
10 B$ = "ABCD"
20 FOR X=1 TO 4
30 PRINT LEFT$(B$, X)
40 NEXT X
```

Printing this, we see that as X increases, the printed string changes:

When X is	The screen shows
1	A
2	AB
3	ABC
4	ABCD

Now change line 30 to: 30 PRINT RIGHT\$(B\$, X). We get:

When X is	The screen shows
1	D
2	CD
3	BCD
4	ABCD

Try another change: 30 PRINT MID\$(B\$, X, 2). Now:

When X is	The screen shows
1	AB
2	BC
3	CD
4	D

We've briefly examined the string functions and what they do. Next time we'll use them to manipulate strings.

One of my many idiosyncrasies (some people call them symptoms of my insanity) is having a lot of fun playing with strings and string functions. They're easy to learn. The more you experiment with them, the more innovative you'll make your programs. That's BASIC. ■

# Tandy topics

Ed Juge, Director, Computer Merchandising  
1500 One Tandy Center, Fort Worth, TX 76102

Summer is really over in Texas. This morning, it was 55 degrees. A couple of times each week, we're seeing a hot air balloon drifting across the morning sky. Seems to be the same one each time. I think I need a job like his! I can't help wondering where he finds a chase crew to pick him up when he lands. Oh, well . . .

Since you're reading this in December, I thought I'd "tie up" the year by telling you a little bit about our internal structure, and the folks who have worked all year to bring you TRS-80 products. For those of you who have asked, here's a thumbnail sketch.

The Fort Worth staff people responsible for the TRS-80 product line are broken into three main groups: computer merchandising, hardware engineering, and software development (the latter two being part of our research and development department). Of course, in the support area, we have computer customer services, technical support, and national parts. Many others are involved, so I've named those you're likely to hear a little more of.

We've told you that we buy a lot of software from outside sources. Even so, we have a large software team of

analysts, programmers, testers and writers. There are project managers, who supervise development teams specializing in specific types of software. They also work with outside software vendors on the forty to fifty percent of our software which comes from third parties. There are two major divisions in the group, for systems and applications software. All software goes through extensive testing, and manuals written outside are edited by our internal staff.

Our hardware engineering staff includes groups who specialize in specific areas of hardware. They have their own group of writers for hardware manuals.

Computer merchandising includes our computer buyers (a more common industry title is product managers), software product planners, newsletter staff, the group who writes our computer center training material, and our new third-party software vendor support function. Product planning, direction, promotion and advertising are the primary department functions. Merchandising also includes a sizable software Q/A group.

Customer services is the group you're most likely to come in contact

with. We've recently put about 150 customer service representatives in selected computer centers, to serve you faster and better on a local basis. There is still a very large group here in Fort Worth to answer your (and our field folks') questions and problems. They also keep our stores updated on patches and fixes to all software items. They answer a tremendous number of phone calls, and do an outstanding job! No, they won't always have an instant answer for a just-reported problem, nor can they help you with "custom" programming or hardware questions: "How do I hook a brand xyz printer to my TRS-80?" We just can't know all of the combinations, and this is a type of information we aren't staffed to supply.

In Fort Worth, there are five computer factories, including one exclusively for software. We also have one warehouse here devoted exclusively to computer products. Our computer operation is supported by many other departments, including national quality assurance, advertising, data processing, personnel, and others.

Although in many ways we're highly self-sufficient, make no mistake that we recognize and appreciate all of the non-Radio Shack vendors who support our



# ACCEL3/4

NEW

## \$99.95

+ \$1.50 Shipping, CA add 6%  
specify Mod I or III

### Space Frontier

ACCEL3 compiles *big* programs, 30K +. This is by design; subset compilation and use of ROM routines keeps code growth low (and ensures the highest compatibility with the BASIC source program). Also, the NOEXPR option can limit compilation to the program flow operations (GOTO, GOSUB, RETURN, FOR-NEXT, IF, ON) over part of your program, or in toto. 5.5K, all DOS.

# EDIT

## Full-Screen Editor for TRS-80 Basic, Mod I/III

You need better-than-wordprocessor control when you write and edit BASIC programs. That's why EDIT has lots of better-than-wordprocessor features.

- Full-floating cursor with autorepeat (including function keys).
- Navigation by cursor-controlled scrolling, by line number or by program content.
- Overtyping, Delete or Insert characters of text (including line numbers).
- Join or Split lines. Copy, Delete, Insert, Move, Position or Replicate lines.
- Copy, Delete, Move, Position or Replicate blocks of lines.
- Find and/or Replace occurrences of strings.
- Over 30 commands and functions, supports lower-case.
- 3.3K, relocatable (all DOS), also includes TRSDOS, LDOS overlay version.

You owe it to your programming.

## \$40

+ \$2 Shipping, CA add 6%  
specify Mod I or III

NEW

ACCEL4, overlay version of ACCEL3, works with TRSDOS, LDOS *only*, no user memory requirements. Anyone for 40K + compilations?

You owe it to your programs.



### ALGORIX

(415) 387-3131

Box 11721 San Francisco CA 94101

NEW

# ENB

Southern Software's NEW relational database manager. Integrated data dictionary, recursive command structure, more.

## \$140

# 39

Developed in England by Southern Software.

TRS-80, TRSDOS, tm Radio Shack. LDOS, tm Logical Systems.

products. We can't do it all, and we couldn't make the TRS-80 nearly as useful to as many people without those fine folks!

**New, Fast-Order System**

I'd like to tell you about a change we're making, to serve you better than before with products. As any of you know, who have ever been involved in inventory control, a retail business can't stock items which move slowly, and stay in business very long. Every so often, you have to review your sales, and see what is and isn't moving, and drop slow-moving items. Yet, as a computer user, you know you'd always like to see us with even more products to choose from.

Well, we recently reviewed our computer line, and found some likely candidates for discontinuance, yet we know that many of them are darned near indispensable to those of you who do need them. So, we came up with a plan.

We took a number of "slow, but

necessary" items and created a new "fast-order system". We won't carry those items in our stores (any stores) any longer. But your local store can take a deposit and order them for you through their daily computer tie-in with Fort Worth. *Your order will be shipped the following day!* Frankly, these items move slowly enough that most stores wouldn't have stocked them anyway, so a special order would have been necessary. Normal warehouse shipments to stores are done on a cyclical basis, so the new system could literally save weeks, if your order reached our warehouse out of cycle.

Will you notice the lack of those items in the stores? Doubtful! They total less than one percent of our sales. Now, the other good news is that this system will allow us to make available some new items which we couldn't have considered in the past because we knew they would be slow sellers. Fast orders started October 1, and we think

they're going to improve our ability to supply your needs.

**The New Year**

I really wish I could tell you about some of the things we have planned for 1983, but it's a little premature. In lieu of that, how about a prediction? 1983 will be one of the most exciting years we've had for TRS-80s!

I had a visit from Mike Schmidt and Cam Brown yesterday, and they're planning some changes in *80-U.S. Journal* for '83, too — very positive changes. If you have a friend who is a TRS-80 owner and isn't getting *80-U.S.*, tell him (or her) to write to Mike and ask for a free sample copy. Tell Mike it's the free sample he promised Ed Juge he'd supply.

Now that I've done my bit to increase Mike's expenses, I'll get out of here by just wishing everyone a very, very happy holiday season and prosperous new year. See you in 1983. ■

**MOD I/III SPEED MOD**

The only resource you can't replace is TIME. PLUG IN A SPRINTER (by Holmes Engineering) and

**TRIPLE THE SPEED of your TRS-80 MODEL 1 OR MODEL 3.**

**YES! A NEW Z-80B MICROPROCESSOR IS INCLUDED!**

**YES! Special circuitry handles your slower memory chips.**

**YES! Automatic switch down to "normal" for disk I/O.**

**YES! IT IS ABSOLUTELY FANTASTIC and only 99.50 COMPLETE!!**

Only the cream of the crop -- for you, from HACKS.

SCRIPUS v3.0 (by ROSTEK) is the software "patch" for SCRIPSIT (c) that lets you output control codes to CHANGE TYPE STYLES, UNDERLINE, etc. from within your text files. Written especially for the MX-80 but works fine with most any printer that accepts control codes. Makes your printer do all the tricks it was designed for. +DIR, KILL, MERGE, and MORE, WHILE IN SCRIPSIT (c).  
How many times have you wished? Here 'tuz ON DISK 39.95

Need a SUPERFINE lowercase CHARACTER GENERATOR for your MOD 1? KSG Technology builds 'em, and we've got one just for you. Beautiful lowercase -FULL DECENDERS - All of the graphics, of course. INCLUDES the SPECIAL GRAPHICS for CHR\$ (0) thru CHR\$ (31) omitted in the later Radio Shack lower case chips. Ask for the CGA-2. You'll love it! Only 29.95

Did you ever bomb a disk? SUPER UTILITY (by Kim Watt) WILL AUTOMATICALLY RECOVER BOOT SECTIONS, GAT TABLES, READ AND COPY PROTECTED MEDIA, TRANSFER FROM ONE DOS to ANOTHER, SINGLE OR DOUBLE DENSITY, and on, and on, and on . . . You just wouldn't believe . . . Includes a hundred and some odd vital functions. The BEST (no doubt!) and very, very highly recommended for ANYONE that uses a TRS-80 MOD 1 or MOD 3 with any kind of DISK and any kind of DOS. You just got to use it to realize what you've got here! The name "SUPER UTILITY" is a gross under-statement. One use can easily pay for the program. 48K required. Specify 35tk, 40tk or 80 tk media for your Mod 1 or Mod 3. Absolutely professional! You need this! Don't get caught without it. 74.95

# 40

ALL HARDWARE **Model I Lowercase**  
TRS-80 is a Trademark of Tandy Corp

**DUALCASE**

UPPER/lowercase, full time from power-up; NO software; Standard typewriter keyboard operation (shift to UPPER-CASE); Control characters can be displayed; 128 Total character set plus full graphics.

**ELECTRONIC SHIFT-LOCK**

No extra keys or switches. Simply tap either shift key, UPPER-CASE lock, normal shift unlocks.

**DE-B-B-BOUNCE** At no extra cost

(At your option)

**BLOCK CURSOR** If you like (No chg) SWITCHABLE from key board

"THE PATCH" is compatible with any word processor, any DOS and also other languages which use ROM sub-routines Assembled and tested..\$127.00

"THE PATCH" unit plugs into the ROM sockets (does not replace existing ROM). Lowercase does require installation of the extra video ROM (supplied with "THE PATCH").

Detailed instructions guide even the most inexperienced owner to complete installation in about 30 minutes.

**WHEN ORDERING SPECIFY:** "Mem Size"  "Memory Size"  And your choice of any/all options.

To order, send payment plus \$2.00 shipping and handling. Texas residents add 5% sales tax/

**WHEN ORDERING SPECIFY:**

"Mem Size"  "Memory Size"  Any your choice of any/all options

To order, send payment plus \$2.00 shipping and handling. Texas residents add 5% sales tax.



"THE PATCH" is covered with a one year limited warranty on materials and workmanship. (Does void Radio Shack's 90 day warranty.)

**HACKS**

P.O. BOX 12963  
Houston, Texas 77017

National Distributors

"THE PATCH" is a trademark of CECDAT, INC.

713-455-3276

---

# BASIC bits

## Packing strings efficiently

Model I/III, PMC-80, LNW80

Thomas L. Quindry, Burke, VA

Last month the simplest form of string packing for BASIC programs was illustrated. To recount, the string variables, A\$ and B\$, were packed with graphic values read from data statements and concatenated using the form,  $A\$ = A\$ + \text{CHR}\$(A)$ , where A is the latest value read from the data statements given.

While this method works, it is probably one of the most archaic ways of packing a string. If much string packing takes place, noticeable time will be lost due to the constant redefining of the string A\$ for each successive concatenation of values. As you will remember, the garbage collection routine is the culprit.

There are much easier ways to pack strings. They avoid the garbage collection routine of your computer because the computer has nothing to sort. Many people don't realize that if a string function is defined within a BASIC program, it will not be sorted when the computer goes into its string function garbage collection routine. Let's say our BASIC program defines A\$ to be the word STRING. It can be defined either in a data statement such as DATA STRING, which is later read and interpreted to a string variable (READ A\$), or in the form  $A\$ = \text{"STRING"}$ .

In the above example as long as A\$ is not redefined to another value, the VARPTR for A\$ will help us find the word STRING, which appears in your BASIC program. You don't have to CLEAR string space when defining strings of this type either. Since the operating BASIC program is a permanent fixture in RAM, there is no need to reserve extra space for these string functions, which are currently a part of the program. They already have a place in memory which will not be redefined. BASIC program statements are not redefined while running them.

Well, almost not redefined! The all-powerful POKE function, used with the just as powerful VARPTR function, can redefine strings in your BASIC program without affecting operation (when used carefully). Since repetition is one of the best ways to prove a point, consider last month's program called Animate. That example illustrated the packing of graphic characters in

a string to display men jumping on the video screen. Instead of doing what we did last month, another way to define the strings, A\$ and B\$, is given in Listing 1.

I have rewritten Animate so that it performs the same as last month, but does so in a slightly more efficient manner. Notice that the CLEAR 93 command given last month is omitted. Replacing it are dummy string values of thirty-one characters each for A\$ and B\$. The graphic character values and control codes are still given in data statements, but the CHR\$ function is no longer used. Instead of defining the strings as we did last month, the strings are already defined. Each string is defined as a word of thirty-one bytes. These words are dummy words.

Using this method of string packing, we must reserve space for the final graphic character. Since each graphic character of the jumping man will have thirty-one characters as it did last month, we have to reserve thirty-one spaces. Instead of spacing over thirty-one times between the quote marks, the easiest way to do this is to count with numbers. We could count 12345678901234... or, as I like to do, leave a space in place of each of the zeroes (123456789 1234...). The spaces are easier to see and help in the counting.

Now comes the VARPTR function. The VARPTR function helps to locate the position of variables. With string variables such as A\$,  $\text{VARPTR}(A\$)$  will point to an address which tells the length of the string. That address is followed by two bytes which give the address of the string in memory, whether it be in your BASIC program or reserved string space saved by the CLEAR function. Addresses are saved in the form: Least Significant Byte (LSB) first, then Most Significant Byte (MSB). We use the value  $(\text{VARPTR}(A\$)+1 + (\text{VARPTR}(A\$)+2)*256)$  to calculate the address of our string variable.

Now that we know where the string is, we can use the POKE function to substitute values from our data statements into the reserved area. This is done in lines 80 through 110 and 290 to the end of the program. Just run the program once and the string areas will be redefined.

The beauty of this method of string packing is that once we have run our program, we have redefined our program to include the final graphic strings, A\$ and B\$. We have no use now for the routine and the data statements used in redefining it. We can delete the line numbers stated in the previous paragraph and do anything we want to the remaining part of the program. We can CSAVE it, CLOAD it, SAVE or LOAD it to disk. We can even add BASIC program statements before or after the program lines containing the redefined strings, or merge it with another program.

If you have keyed in the program from Listing 1 and run it once, you will notice something out of the ordinary when you list the program. Those with a Model I will see a series of BASIC words and spaces, within the quote marks of lines 40 and 50, which define A\$ and B\$. Each string takes four lines to be defined. If you command your computer to PRINT A\$,B\$, you will see the two positions of the graphic character (the man) we have defined.

This discrepancy is because of the way the Model I BASIC interpreter works. With both the Model I and III, each BASIC word is tokenized. These tokenized words share the same ASCII character as the graphic blocks. When listing a program line, the Model I tokenizes each word to be displayed, including those graphic characters which have been packed into a string function. The Model III is a little smarter. It only

tokenizes those ASCII characters which fall within the command line of the BASIC statement. On the Model III, you will see the graphic characters when you list lines 40 and 50.

Delete the lines, mentioned before, that are no longer needed. When you run the program, you will notice that there is no longer a pause before the men appear on the screen and start jumping.

Next month, I'll finish up string packing with some hard, fast rules for packing machine code. Also, I'll tell you about one other machine code packing technique and give you an example.

*Question:* Can I reset the memory size on my computer without turning it off?

*Answer:* Assuming that you don't want to save a BASIC program in residence, enter the SYSTEM command and respond to the \*- with "/0." This reinitializes the computer as if you had just turned it on. Then, you can enter the memory size. I have used another way which is convenient if you want to save your BASIC program in memory. POKE the new memory size you wish to save, minus two bytes, into locations 16561 and 16562. This requires a knowledge of hexadecimal addressing and is similar to what we have been doing with LSB and MSB bytes for the VARPTR function in the example of Animate.

Remember to send your questions and tips to me, care of 80-U.S. Journal, 3838 South Warner Street, Tacoma,

## Marymac INDUSTRIES, INC.

In Texas, Orders,  
Questions & Answers  
1-713-392-0747

22511 Katy Freeway  
Katy (Houston), Texas 77450

To Order  
1-800-231-3680  
800-231-3681

### SAVE BIG DOLLARS ON ALL TRS-80® HARDWARE & SOFTWARE

TRS-80® by Radio Shack. Brand new in cartons delivered. Save state sales tax. Texas residents, add only 5% sales tax. Open Mon-Sat. 9-6. We pay freight and insurance. Come by and see us. Call us for a reference in or near your city. Ref: Farmers State Bank, Brookshire, Texas.

#### WE OFFER ON REQUEST

Federal Express (overnight delivery)

Houston Intercontinental Airport  
Delivery, Same Day Service

U.P.S. BLUE—Every Day

References from people who have  
bought computers from us probably  
in your city. We have thousands  
of satisfied customers. WE WILL  
NOT BE UNDERSOLD!

**ED McMANUS**

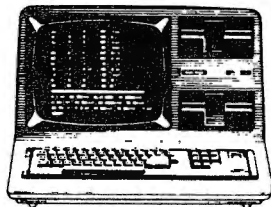

In stock TRS-80 Model  
II and III

No Tax on Out of Texas Shipments!

**Save  
10% 15%  
OR MORE**

Reserve your Model 16 Today!

TELEX: 77-4132 (FLEXS HOU)

#### WE ALWAYS OFFER

NO extra charge for Master Card or Visa

We use Direct Freight lines. No long waits

We always pay the freight and insurance

Toll free order number

Our capability to go to the giant TRS-80®  
Computer warehouse 5 hours away, in  
Ft. Worth, Texas, to keep you in stock.

® TRS-80 is a Registered Trademark of Tandy Corp.

**JOE McMANUS**

# 41



WA 98409. Send a self-addressed stamped envelope and I'll try to give you a personal handwritten reply as long as the answer is not too long and involved.

**Program Listing for  
BASIC Bits**

```

1 'BASIC BITS #3 LISTING NO. 1
10 'ANIMATE - BY THOMAS L. QUINDRY
20 'AN EXAMPLE OF AN EFFICIENT STRING PA
CKING
30 'TECHNIQUE FOR ANIMATED GRAPHIC STRIN
G CHARACTERS
40 A$="123456789 123456789 123456789 1"
50 B$="123456789 123456789 123456789 1"
60 CLS
70 PRINT@256,"THIS IS AN ANIMATION OF ME
N JUMPING"
80 X = VARPTR(A$)
90 GOSUB 370
100 X = VARPTR(B$)
110 GOSUB 370
120 PRINT@ 450,A$;
130 PRINT@ 455,A$;
140 PRINT@ 460,A$;
150 PRINT@ 465,B$;
160 PRINT@ 470,A$;
    
```

```

170 PRINT@ 475,A$;
180 FOR N=1 TO 100
190 NEXT
200 PRINT@ 450,B$;
210 PRINT@ 455,B$;
220 PRINT@ 460,B$;
230 PRINT@ 465,A$;
240 PRINT@ 470,B$;
250 PRINT@ 475,B$;
260 FOR N=1 TO 100
270 NEXT
280 GOTO 120
290 DATA 128,176,144,128,26,24,24,24,24
300 DATA 180,187,177,148,26,24,24,24,24
310 DATA 128,159,149,128,26,24,24,24,24
320 DATA 130,129,131,128
330 DATA 128,175,133,128,26,24,24,24,24
340 DATA 135,191,151,133,26,24,24,24,24
350 DATA 128,149,149,128,26,24,24,24,24
360 DATA 128,128,128,128
370 X = PEEK(X+1) + 256*PEEK(X+2)
380 FOR N=X TO X+30
390 READ A
400 POKE N,A
410 NEXT
420 RETURN ■
    
```

**WHY \$ IN DISK... WE'VE PUT SENSE IN CASSETTE**  
**RELIABLE LOW-COST HIGH-SPEED TAPING**

**NO-FUSS HIGH SPEED SOFTWARE**

**KWICOS (Mod 1, 4k to 48k) \$26**  
KWIK Cassette Operating System for Mod 1. The easy-to-use Level II enhancement for reliable fast taping (select 1000-3000 baud). Features: save, load, verify, search, chain-load, catalog, and test-read of both BASIC and machine-code programs... plus: long pgm names, passwords, debounce, slow 'list', self 'backup', and more.

**KOS3 (Mod 3, 16k to 48k) \$26**  
The KWIK Cassette Operating System for Model 3. All 'KWICOS' features at 2200 baud, plus KWIK set of: clock display, Time, Date, Cassette high/low, I/O routing, etc.

**KWIKIT (specify Model) \$12**  
Mini-system for BASIC programs only. EasyLoad 1000 baud for Mod 1, 2200 baud for Mod 3. Many 'KWICOS' features.

**KWINK (Model 1, 4k-48k) \$15**  
Makes stand-alone fast-loading (2x-6x) copies of any standard 500 baud "SYSTEM" program. (At 6x, 3 minute program loads in 44 sec!)

**KLOAD (Model 1) \$15**  
Similar to 'KWINK', but for BASIC pgms only. (Specify 16-32-48k)

**KLOAN (Mod 3, 16k-48k) \$12**  
Makes 500 or 1500 baud copy of any other standard 'system' pgm.

**KWIK Software**

Box 328  
Bolivar, MO 65613 # 42  
Phone (417) 326-7154



Call either number 'til 10 pm most any day for info or order. U.S. orders postpaid, add \$3 for COD or overseas Missouri residents add sales tax

**NO-FUSS ANY-SPEED HARDWARE**

The amazing LemonAid Loader takes the 'finickies' out of Model I loads, but even more amazing... make KWIK copies of your Model I programs and load them flawlessly at 6x speed! Instant installation... simply plug between your cable and recorder. No internal batteries or external power needed.

New Model LLQ-2 Deluxe loader has volume controlled jack for tape listening without plug-pulling, using external speaker/earphone. Ideal for Model I, compatible with Model III. ppd \$21.99.

New Model LQ-2 loader. Built-in low level audio monitor with fixed volume. Model I, Mod III compatible. \$18.99

Model LL-1. Great little economy loader for the Model I. \$14.99

Model LSS. Solid state SOFTROL (1) eliminates switch-hits. (2) Push button and slide switch control of CTR motor makes tape positioning a snap without plug pulling. (3) Cushioned motor-off delay pulls end of programs past CTR pinch rollers...no pinch-hits, plus (4) automatically gaps between saved programs. For all standard-plug recorders and computers. \$18.99

**NEW C-LEGS**  
A NEW ANGLE ON TAPING!

CASSETTE EJECTS INTO YOUR HAND  
PUTS COUNTER IN FULL VIEW  
TAKES LESS TABLE SPACE

PLATED SPRING STEEL  
EASY SLIP-ON INSTALLATION  
ADJUSTABLE RECORDER ANGLE  
VINYL TIPS

**CTR80/80A**  
\$2.99 with order from either company, Otherwise \$4.99 ppd

LEMONAID LOADER

SOFTROL

**LEMONS TECH**

325 N. Hwy 65  
P.O. Drawer 429  
Buffalo, MO 65622  
(417) 345 7643

# 42



# Files and foibles

## Sorting large sequential files

Models I/II/III, PMC-80, LNWS80

T. R. Dettmann, Associate editor

This series has been primarily concerned with random access files and techniques. But people with sequential file systems have real concerns as well. The current problem is one that faces many people with mailing lists or other data bases that are maintained as sequential files: How do we sort when there are too many items to sort in memory?

For example, several years ago, a friend was maintaining a 25000-name database on a TRS-80 Model I with five-inch disks! Imagine the problem of combining those files into a mailing list sorted by zip code.

Most people have taken to structuring their data into separate files, each of which can be sorted. However, this means that sorting can't be done on very large combined files in ways other than the original structuring.

How about having a file the size of a single disk and then sorting it? It can be done, if you have disk space for temporary files, by using a "sort/merge" technique. The same technique can also be used (by leaving out the sort) to merge a set of files.

The basic idea of the sort/merge operation is to take small steps and accomplish it little by little. For very large files, you may have to let it run for awhile, but you could restructure a whole database with this technique.

To see how a sort/merge works, let's look at it as a series of simple steps:

1. Open the input file.
2. Split the input file into smaller files by reading as many items as possible, sorting them and writing the sorted items out to one of the smaller files.
3. Merge the files by opening some of the smaller files, reading the first item from each, then writing the smallest to the output file. Read another item from the file where the smallest item was.

The basic operation sounds very easy. For the most part it is, but there are some interesting complexities that one has to deal with to make it work right.

To see how to do a real sort/merge operation, let's look at the sample program. In lines 10-150, we initialize the program. The important part of this is in lines 110-130. In line 110, we set up a set of parameters for the program which make it quite flexible. The first, NL is the number

of lines to read into memory for sorting. The sample program limits it to ten for the demonstration, but you would normally set it to 400-600, depending on your program.

Parameter NFL is the number of files that will be declared in entering BASIC. I used four so that I could merge three files into one. You could use up to sixteen if you wanted.

Parameter NX is the maximum number of temporary files to generate. Since a list of these files is kept in memory (not absolutely necessary), this will serve as the dimension of the array which remembers their names.

Line 120 sets up the line array (LN\$), the temporary filename list (FF\$), and the merge file list (FC\$). The root of the temporary filename is set to TEMP and the number of the current temporary file is set to zero.

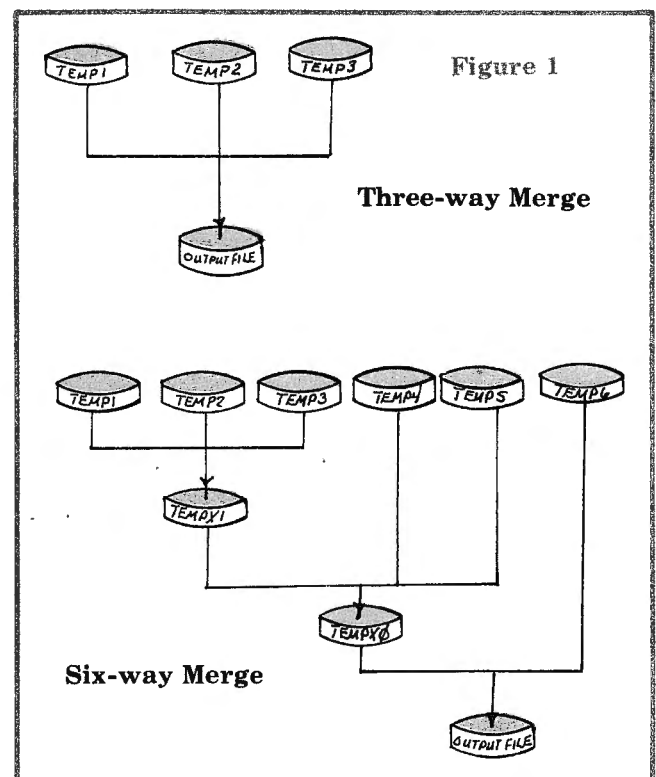

# QUALITY SOFTWARE FOR TRS-80 COLOR AND OSI ADVENTURES AND QUEST ALSO FOR SINCLAIR AND VIC-20



## ADVENTURES!!!

For TRS-80 COLOR and OSI. These Adventures are written in BASIC, are full featured, fast action, full plotted adventures that take 30-50 hours to play. (Adventures are inter-active fantasies. It's like reading a book except that you are the main character as you give the computer commands like "Look in the Coffin" and "Light the torch.")

Adventures require 16k on TRS80, TRS80 color, and Sinclair. They require 8k on OSI and 13k on Vic-20. Derelict takes 12k on OSI. \$14.95 each.

## ESCAPE FROM MARS

(by Rodger Olsen)

This ADVENTURE takes place on the RED PLANET. You'll have to explore a Martian city and deal with possibly hostile aliens to survive this one. A good first adventure.

## PYRAMID (by Rodger Olsen)

This is our most challenging ADVENTURE. It is a treasure hunt in a pyramid full of problems. Exciting and tough!

## TREK ADVENTURE (by Bob Retelle)

This one takes place aboard a familiar starship. The crew has left for good reasons — but they forgot to take you, and now you are in deep trouble.

## HAUNTED HOUSE (by Bob Anderson)

It's a real adventure—with ghosts and ghouls and goblins and treasures and problems — but it is for kids. Designed for the 8 to 12 year old population and those who haven't tried Adventure before and want to start out real easy.

## DERELICT

(by Rodger Olsen & Bob Anderson)

New winner in the toughest adventure from Aardvark sweepstakes. This one takes place on an alien ship that has been deserted for a thousand years — and is still dangerous!



**VENTURER!**—A fast action all machine code Arcade game that feels like an adventure. Go berserk as you sneak past the DREADED HALL MONSTERS to gather treasure in room after room, killing the NASTIES as you go. Great color, high res graphics, sound and Joystick game for the TRS-80 Color or OSI machines. (black and white and silent on OSI.) Tape only. \$19.95.

## BASIC THAT ZOOMS!!!

### AT LAST AN AFFORDABLE COMPILER FOR OSI AND TRS-80 COLOR MACHINES!!!

The compiler allows you to write your programs in easy BASIC and then automatically generates a machine code equivalent that runs 50 to 150 times faster.

It does have some limitations. It takes at least 8K of RAM to run the compiler and it does only support a subset of BASIC—about 20 commands including FOR, NEXT, END, GOSUB, GOTO, IF, THEN, RETURN, END, PRINT, STOP, USR (X), PEEK, POKE, \*, /, +, -, >, <, =, VARIABLE NAMES A-Z, SUBSCRIPTED VARIABLES, and INTEGER NUMBERS FORM 0-64K.

TINY COMPILER is written in BASIC. It generates native, relocatable 6502 or 6809 code. It comes with a 20 page manual and can be modified or augmented by the user. \$24.95 on tape or disk for OSI or TRS-80 Color.

## LABYRINTH — 16K EXTENDED COLOR BASIC

— With amazing 3D graphics, you fight your way through a maze facing real time monsters. The graphics are real enough to cause claustrophobia. The most realistic game that I have ever seen on either system. \$14.95. (8K on OSI)

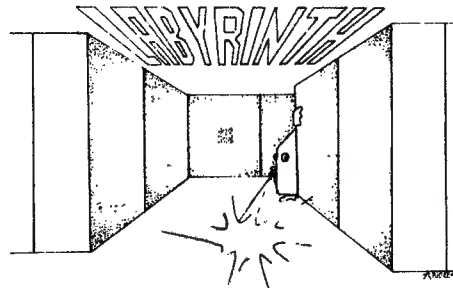

## QUEST — A NEW IDEA IN ADVENTURE GAMES!

Different from all the others. Quest is played on a computer generated map of Alesia. Your job is to gather men and supplies by combat, bargaining, exploration of ruins and temples and outright banditry. When your force is strong enough, you attack the Citadel of Moorlock in a life or death battle to the finish. Playable in 2 to 5 hours, this one is different every time. 16k TRS-80, TRS-80 Color, and Sinclair. 13K VIC-20. \$14.95 each.

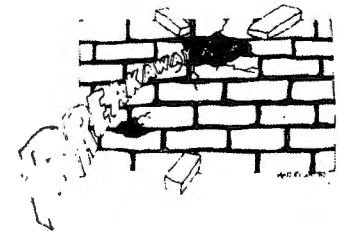

## NEW!!

**BREAKAWAY — ALL MACHINE CODE —** Every computer has some form of BREAKAWAY available. Ours is fast, smooth, has 15 levels of difficulty — and is a bargain!! 16k TRS-80 Color only \$9.95.

## PROGRAMMERS!

**SEE YOUR PROGRAM IN THIS SPACE!!** Aardvark traditionally pays the highest commissions in the industry and gives programs the widest possible coverage. Quality is the keyword. If your program is good and you want it presented by the best, send it to Aardvark.

Please specify system on all orders

ALSO FROM AARDVARK — This is only a partial list of what we carry. We have a lot of other games (particularly for the TRS-80 Color and OSI), business programs, blank tapes and disks and hardware. Send \$1.00 for our complete catalog.

## AARDVARK - 80

2352 S. Commerce, Walled Lake, MI 48088

(313) 669-3110

Phone Orders Accepted 8:00 a.m. to 4:00 p.m. EST. Mon.-Fri.



TRS-80 COLOR

SINCLAIR

OSI

VIC-20



# ACE Computer Rentals



*\*With Discount Purchase Options\**

★ COMPUTERS

Apple, Franklin, TRS-80 Model I/II/III, PMC, NEC, Heath, Others pending

★ SOFTWARE

Legal-professional, Utility, Personal, Business, Educational, Recreational

★ FIRMWARE

ROM Chips, Memory Cards, 80-column Cards, Communications Interface

★ HARDWARE

Disk Drives, Hard Disks, Printers, Modems, Monitors (B&W/Color), Others

★ PUBLICATIONS

Data Base Manuals, Hobby-Projects, Systems, Languages, Electronics Reference Manuals

*Send For Free Gift  
and Complete Details*

## Ace Computer Rentals

2104 Triplett Street, P.O. Box

Owensboro, KY 42301

WATCH FOR 800 NUMBER COMING! # 44

## Files and foibles

After getting the names of the desired input and output files, lines 250-300 break up the input file into a series of temporary smaller files. Each of these has NL or fewer lines, all in sorted order. Subroutine 1000 first reads in NL or fewer lines. Then, subroutine 2000 sorts them (you could replace this with a call to a fast machine language sort if you like). Finally, subroutine 3000 writes the sorted lines to a temporary file.

Once the input file is completely broken up, it is necessary to recombine the sorted files into a single file with a merge operation. Lines 310-460 are the merge operation.

Subroutine 4000 chooses an output filename for each merge and selects which files to merge. If we have enough file buffers available to merge all of the output files, we just merge directly to the final output file.

Whenever there aren't enough buffers available, we have to go first to an intermediate file (TEMPX0 or TEMPX1). Why two files? If we have to use an intermediate file, it will be merged in the next step. If there are still too many files, we need another intermediate file for the following step. Look at the figure for merges of four or more files to see what happens.

Once the files are selected for the merge and the output filename is assigned, the files are opened and the first line is read from all the input files in lines 320-380. With a line entered from each file, we look to see which line is smallest (or has the smallest key field, or whatever) using subroutine 5000. When the smallest line is selected, subroutine 5000 also reads in a new line from the input file that the smallest line came from. That line is written to the output file in line 410. If there was no line (we're at the EOF on all input files), we check subroutine 6000 to see if we're all done.

This procedure would be like taking a set of cards, breaking it down into smaller stacks, sorting each stack and combining them by taking the smallest visible card from each stack and placing it on the final stack. It can run automatically (which is nice) but requires a large amount of disk space (for temporary files). If it's all you've got though, it's better than nothing.

This same idea could be used to take a group of input files, sort them and during the merge operation have the results written to a series of output files of a standard size, or with a standard grouping. Can you make it do that? Try it and see.

### Program Listing for Files and foibles

```

95 REM          CLEAR SOME STRING SPACE
AND DEFINE ALL VARIABLES
96 REM          TO BE INTEGERS FOR PROCE
SSING
100 CLEAR10000:DEFINTA-Z
105 REM        THESE PARAMETERS CONTROL
THE SIZE OF THE SORT/MERGE
106 REM        OPERATION: NL = MAX NUMB
ER OF LINES IN MEMORY
107 REM        NFL = MAXIMUM NU

```



**ONLY \$69.95**

## The Magnificent WORD PROCESSING SYSTEM

For the TRS-80 Model I and III

- Written in fast Z80 machine language.
- Single key control of all editing functions for ease of use.
- Dynamic display of word count, line count, and free memory count.
- Superscripts, subscripts, underlined, bolded, expanded and condensed type styles - combine and intermix within a line.
- Automatically justifies and word-wraps on the screen as you type.
- Search, Replace, and Global Search and Replace.
- Odd and even page user-definable headers, footers, and page number lines.
- User-definable linespacing, sheet size, top, left, and bottom margins.
- Move blocks of text from disk, to disk, and within the text.
- Examine disk directory on any disk and kill files while editing.
- Full screen editing of EDTASM and BASIC text files.
- Automatic renumbering for EDTASM and BASIC files.
- Print contents of screen function.
- Print previewing formats text, inserts headers, numbers pages, etc on the screen without printing it on paper.
- Page by page pausing capability for sheet fed printers.
- Supports both parallel and serial printers.
- Printer control code access.
- Supports proportional space justifying on Centronics 737, 738, Line Printer IV, Daisy Wheel II, Diablo, Qume, Starwriter, Spinwriter, C. Itoh Prowriter, NEC PC-8023A-C, TEC 8500R.
- Also supports special functions of Microline, MX-80, MX-100, and Graftrax Plus.
- Any character or symbol your printer can print is accessible with the Special Character feature.
- Works with NEWDOS, NEWDOS80, TRSDOS, LDOS, and DOSPLUS - Single or Double Density.

**GUARANTEE**

Many word processing systems claim theirs are the best, but few would dare to guarantee them. Not us! We are confident that ZORLOF is the most useful word processing system on the market for under \$200.00. If you don't agree, return it within 30 days for a full refund.

**CALL (305) 259-9397** # 45

Small text at bottom: Add \$2.00 shipping & handling. Florida residents add 5% sales tax. Checks require 3 weeks to clear banks.

ANITEK SOFTWARE PRODUCTS □ P.O. BOX 1136 □ MELBOURNE, FL 32955 □ (305)259-9397



## Files and foibles

```

NUMBER OF FILE BUFFERS AVAILABLE
108 REM          NX = MAXIMUM NUMBER OF TEMPORARY FILES TO USE
110 NL=10:NFL=4:NX=10
115 REM          LN$( ) IS THE LINE BUFFER ARRAY
116 REM          FF$( ) IS THE TEMPORARY FILENAME LIST
117 REM          FC$( ) IS THE SET OF FILES TO USE FOR MERGE
120 DIM LN$(NL),FF$(NX),FC$(NFL)
125 REM          FT$ IS THE TEMPORARY FILENAME ROOT
126 REM          FT IS THE NUMBER OF THE CURRENT TEMPORARY FILE
130 FT$="TEMP":FT=0
135 REM          FNCTR$ PRINTS X$ CENTERED ON AN 80 CHARACTER LINE
136 REM          FNHDR$ PRINTS A 3 LINE SCREEN HEADER
140 DEFFNCTR$(X$)=STRING$( (80-LEN(X$))/2," ")+X$
150 DEFFNHDR$(X$)=STRING$(80,"-")+FNCTR$(X$)+CHR$(13)+STRING$(80,"-")
200 REM - - - - - SORT/MERGE DEMO: MAIN PROGRAM - - - - -
210 CLS:PRINTFNHDR$( "SORT/MERGE" ):PRINT:PRINT
215 REM          GET THE INPUT AND OUTPUT FILENAMES
216 REM          THESE COULD BE THE SAME
220 LINEINPUT"INPUT FILE ==>>>" ;FI$
230 LINEINPUT"OUTPUT FILE ==>>>" ;FO$
240 PRINT:PRINT
245 REM          GET THE INPUT FILE
250 OPEN"I",1,FI$
255 REM          READ IN PART OF THE INPUT FILE
260 GOSUB1000
265 REM          SORT IT
270 GOSUB2000
275 REM          WRITE IT TO A TEMPORARY OUTPUT FILE
280 GOSUB3000
285 REM          IF ALL THE DATA FROM THE INPUT FILE HASN'T BEEN READ
286 REM          THEN GO GET SOME MORE
290 IF FLG<>1 THEN 260
295 REM          CLOSE ALL FILES
300 CLOSE
305 REM          START THE MERGE OPERATION
306 REM          FIRST GET THE INPUT & OUTPUT FILE ASSIGNMENTS
310 GOSUB4000
315 REM          OPEN THE FILES - 1 FOR OUTPUT

```

TRS-80\* Model III

Hardware & Software at discount prices.

# COMPUTER HOUSE

ACORN SOFTWARE	Sug. List.	Our Price
Astro Ball (T or D)	19.95	15.95
Everest Explorer (T or D)	19.95	15.95
Invaders From Space (T)	14.95	11.95
Lost Colony (T or D)	19.95	15.95
Money Manager (D)	39.95	31.95
Space Rocks (T or D)	19.95	15.95
Superscript (D)	50.00	40.00
ADVENTURE INTERNATIONAL		
Adventures 1 thru 12 (T) each	19.95	15.95
Escape From Traum (T)	19.95	15.95
Maxi Manager (D)	99.95	79.95
Star Fighter (T)	24.95	19.95
Star Trek 3.5 (T)	14.95	11.95
Stone of Sisyphus (D)	29.95	23.95
The Curse of Crowley Manor (T)	19.95	15.95
AUTOMATED SIMULATIONS		
Crush, Crumble & Chomp (T or D)	29.95	23.95
Date Stones of Ryn (T or D)	19.95	15.95
Rescue At Rigel (T or D)	29.95	23.95
Star Warrior (T or D)	39.95	31.95
Tuesday Morning Quarterback (D)	29.95	23.95
BIG FIVE SOFTWARE		
Attack Force (T)	15.95	12.75
Galaxy Invasion (T)	15.95	12.75
Meteor Mission 2 (T)	15.95	12.75
Robot Attack (T)	15.95	12.75
Super Nova (T)	15.95	12.75
BRODERBUND SOFTWARE		
Galactic Empire (T)	14.95	11.95
Galactic Revolution (T)	14.95	11.95
Galactic Trader (T)	14.95	11.95
Galactic Trilogy (D)	39.95	31.95
Tawala's Last Redoubt (T)	19.95	15.95
THE CORNSOFT GROUP		
Scarfman (C)	15.95	12.75
DATASOFT		
Arcade - 80 (T)	19.95	15.95
HAYDEN SOFTWARE		
Sargon II (D)	34.95	27.95
MED SYSTEMS		
Asylum (T)	14.95	11.95
Asylum (D)	19.95	15.95
Deathmaze 5000 (T)	14.95	11.95
Labyrinth (T)	14.95	11.95
MICROSOFT		
Adventure (D)	29.95	23.95
Olympic Decathlon (T)	24.95	19.95
RADIO SHACK		
26-2204 Compiler Basic (D)	149.00	119.20
26-1552 General Ledger (D)	99.95	79.95
26-1553 Inventory Control I (D)	99.95	79.95
26-2014 Model III Disk Course (D)	29.95	23.95
26-1596 Model III Visicalc (D)	199.00	155.00
26-1556 Payroll (D)	199.95	155.95
26-1592 Profile III Plus (D)	199.00	155.00
26-1590 Super Scripsit (D)	199.00	155.00
STRATEGIC SIMULATIONS		
Tigers In The Snow (T)	24.95	19.95
SYNTONIC SOFTWARE		
Interlude (T)	18.95	15.15

(T) = Cassette Tape (D) = Disk

REPRESENTING OVER 20+ COMPANIES WITH 300+ PROGRAMS AND HARDWARE.

WRITE FOR FREE MODEL II, III OR COLOR COMPUTER CATALOGS TO:

## Computer House

P.O. Box 538, Mammoth Lakes, CA 93546

(714) 934-6538

Terms: FOR FAST DELIVERY, send certified checks, money orders or Visa or MasterCard number and expiration date. Personal checks require 3 weeks to clear. ADD \$1.50 for postage. Orders over \$100 we pay shipping. All foreign orders add \$10. CALIFORNIA residents add 6% tax. Prices subject to change.

# 46

\* TRS-80 is a trademark of Tandy Corp.

# FREE business software directory

- Radio Shack's Model I, II, III.
- Heath's MBASIC and HDOS
- CPM: Xerox, Alto...
- IBM Personal Computer

"IDM2 is GREAT!" - publisher of 80-US

"(GL) superior to either the Osborne (SBSG & Taranto) or Radio Shack... MAIL-X has a greater capacity... more flexible than (R.S.)"

- columnist of 80-microcomputing

"imperceptively fast...(DBMS) is a good and reliable workhorse" - publisher of Interface Age

Data base manager, integrated accounting package (AR, AP, GL & Payroll), inventory, word processing, and mailing list. Compare and be selective!

# 47



Micro Architect, Inc.  
96 Dothan St., Arlington, MA 02174

## Files and foibles

```

316 REM                                     2-NZ FO
R INPUT
320 OPEN"O",1,FC$(1)
330 PRINTFNCTR$( "OUTPUT FILE: "+FC$(1))
340 FOR I=2 TO NZ
350     OPEN"I",I,FC$(I)
360     PRINTFNCTR$( "INPUT FILE: "+FC$(I))
365 REM                                     GET THE FIRST LINE FROM
EACH FILE
370     LINEINPUT#I,LN$(I)
380 NEXTI
385 REM                                     CHOOSE THE SMALLEST LINE
390 GOSUB5000
395 REM                                     IF THERE IS NO SMALLEST
LINE THEN WE'RE DONE WITH THIS
396 REM                                     PASS THROUGH THE FILES
400 IF LN$="" THEN 430
405 REM                                     PUT THE SMALLEST LINE TO
THE OUTPUT FILE
410 PRINT#1,LN$:K=K+1:PRINTUSING"####
>";K;:PRINTLN$
420 GOTO390
430 CLOSE
435 REM                                     CHECK TO SEE IF WE'RE AL
L DONE
440 GOSUB6000
445 REM                                     IF WE'RE NOT DONE, THEN
GO GET THE REST
450 IF EF=1 THEN 310
460 END
999 END
1000 REM ----- READ FROM INPUT
FILE -----
1005 REM                                     FLG IS A FLAG TO
MARK THE END OF THE INPUT FILE
1010 FLG=0
1020 PRINTFNCTR$( "READING FROM: "+FI$)
1025 REM                                     READ IN UP TO NL
LINES
1030 FORI=1TONL
1040     IF EOF(1) THEN FLG=1:GOTO1070
1050     LINEINPUT#1,LN$(I):PRINTUSING
"####>";I;:PRINTLN$(I)
1060 NEXTI
1065 REM                                     NM IS THE NUMBER
OF LINES ACTUALLY READ IN
1070 NM=I-1:RETURN
2000 REM ----- SORT DATA IN ME
MORY -----
2005 REM                                     SHELL SORT
2006 REM                                     SET THE INITIAL
GAP
2010 GAP=NM
2015 REM                                     IF THE GAP GETS
DOWN TO 1 THEN WE'RE DONE
2020 IF GAP<=1 THEN RETURN
2025 REM                                     LOOK AT 1/2 THE

```

## A Pot Of Gold For YOUR Color Computer

"I buy practically every computer magazine there is, but the RAINBOW is the only one I read cover-to-cover as soon as it comes in the mail" - A subscriber

The RAINBOW gets that sort of response for more reasons than one but the primary one is simply it is the premier magazine for TRS-80 Color Computer users. And, because it devotes every page of each monthly issue exclusively to the Color Computer, it is the single best source of information for everything you want to know.

Tired of trying to convert other computer programs to your Color Computer? No worries. Each program in the RAINBOW is written exclusively for your computer — and many take advantage of all the excellent graphics commands unavailable on other machines! The nation's leading software authors have contributed every month.

The RAINBOW's Hints, Tips and Pipeline feature give you the best up-to-the-minute information available on the Color Computer. If you are looking for ways to do screen prints, alphabetize disk directories, save machine language programs or print Videotex input on your printer, the RAINBOW has programs for you! And, if you want to know when some promised software will really be available for purchase, you'll get that answered, too.

Our tutorials have been praised for the clear, concise way they explain — in detail — various functions of the Color Computer. And the RAINBOW's reviews are an excellent and honest buyer's guide to software and other purchases.

Whether your Color Computer is 4K, 16K or 32K. Whether you have Color Basic or Extended. Whether you're into assembly language (or want to get into it) or not. Printers, Disks, Rom packs. The RAINBOW surveys the whole world of the Color Computer each month and provides what one reader called, "A pot of gold full of fabulous information."

Because it is journalistically-oriented, the RAINBOW gives fast turnaround to meet its monthly deadline. So, you can expect fresh news when it is news and the latest information available.

If all this sounds like a lot for \$16 per year, it may be. But we'll make one more promise: if, after you see your first issue, you don't agree that the RAINBOW is the premier monthly magazine for Color Computer users, we'll happily, cheerfully and immediately refund your money.

Trademark of Tandy Corp.



the RAINBOW  
5803 Timber Ridge Drive P.O. Box 209 (502) 228-4482  
Prospect, KY 40059

Consent: YES! Sign me up right away for a one year (12 issues) subscription to the RAINBOW. My payment is enclosed.

Name \_\_\_\_\_

Address \_\_\_\_\_

City \_\_\_\_\_ State \_\_\_\_\_ Zip \_\_\_\_\_

Payment Enclosed  Charge my VISA #  Charge my MasterCard #

Signature \_\_\_\_\_ Card Exp. Date \_\_\_\_\_ Interbank # \_\_\_\_\_ # 48

Subscription to the RAINBOW is \$16 per year in the U.S. Canadian and Mexican rates are \$27 per year. Single copies to other countries are \$21. An add'l \$5.00 shipping charge applies to the colored cover. Please allow 4-6 weeks for delivery.



## Files and foibles

```

PREVIOUS GAP
2030 GAP=INT(GAP/2)
2035 REM SET THE SWAP FLAG TO NO SWAPS
2040 FG=0
2050 FORI=1TONM-GAP
2060 IF LN$(I)>LN$(I+GAP) THEN GOSUB2100:FG=1
2070 NEXTI
2080 IF FG=1 THEN 2040 ELSE 2020
2100 REM ----- SWAP LINES -----
-----
2105 REM MOD I/III OWNERS
REPLACE THIS WITH A SWAPPING
2106 REM PROCEDURE SUCH AS:
2107 REM T$=LN$(I):LN$(I)
=LN$(I+GAP):LN$(I+GAP)=T$
2110 SWAP LN$(I),LN$(I+GAP):RETURN
3000 REM ----- WRITE DATA TO TEMPORARY OUTPUT FILE -----
3005 REM FT IS THE CURRENT TEMPORARY FILE NUMBER
3006 REM MAKE NF$, THE CURRENT TEMPORARY FILE NAME & SAVE IT
3007 REM IF WE'VE USED NX FILES, THEN CUT OFF THE INPUT
3010 FT=FT+1:NF$=FT$+MID$(STR$(FT),2):FF$(FT)=NF$:IF FT>=NX THEN FLG=1
3015 REM WRITE THE LINES TO THE TEMPORARY FILE
3020 OPEN"O",2,NF$
3030 PRINTFNCTR$( "TEMPORARY FILE: "+NF$)
3040 FORI=1TONM:PRINT#2,LN$(I):PRINTUSING"####>";I,:PRINTLN$(I):NEXTI
3050 CLOSE2
3060 RETURN
4000 REM ----- PICK OUTPUT FILE & INPUT OFFSET -----
4005 REM F1 IS THE FIRST FILE TO READ
4006 REM F2 IS THE LAST FILE TO READ
4007 REM FF IS THE NUMBER OF THE INTERMEDIATE MERGE FILE
4008 REM MOD I/III CAN WRITE THIS AS FF=FF-INT(FF/2)*2
4010 F1=F2+1:F2=F2+NFL-1:FF=(FF+1)MOD2
4015 REM MAKE THE INTERMEDIATE MERGE FILE NAME
4020 FF$=FT$+"X"+MID$(STR$(FF),2)
4025 REM TWO CASES:
4026 REM FC$(1)="
" => FIRST TIME THROUGH
4027 REM FC$(2)<<
"" => ALREADY BEEN THROUGH
4030 IF FC$(1)="" THEN 4060

```

# NO BREAKS

**SLAVE DRIVER® KEEPS YOUR PRINTER WORKING WHILE YOU AND YOUR COMPUTER DO MORE IMPORTANT JOBS...**

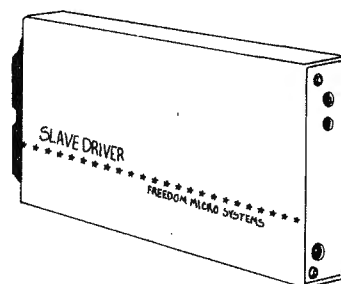

Computers are fast...printers are slow. That's a problem more people are realizing every day as they wait for the slow printer to finish before they can use the fast computer again. Technology has come to the rescue by designing an electronic device that takes the output of the fast computer fast and feeds it to the slow printer slowly, as the printer needs it. It's called a printer buffer.

**SLAVE DRIVER®** is an inexpensive, universal printer buffer. It can be used with all popular micro-computers that have a centronics parallel port to the printer.

**SLAVE DRIVER®** receives information from the computer at up to 4000 characters per second and holds it until your printer can handle it. Your **SLAVE DRIVER®** is controlled by a custom LSI and uses standard centronics signals.

### 60 SECOND INSTALLATION

**SLAVE DRIVER®** is designed to be plugged directly into the input port of the Epson and other similar printers. It is powered by the printer or an AC adapter. Other centronics compatible printers can be attached. Installation can be completed in less than 60 seconds. Just plug it in.

**SLAVE DRIVER®** takes up little space; about the size of a paper back book. Such a little fellow for such a big job!

### EASY USE AND FLEXIBILITY

**SLAVE DRIVER®** is completely transparent to the user, no machine language programming to learn, no control codes to send, no programs to change. The buffer-full light and the reset switch give full flexibility of operation. List your program to **SLAVE DRIVER®**, return to programming while the listing prints. Dump a line of data to **SLAVE DRIVER®** and compute the next record while the data prints. Send complete reports to **SLAVE DRIVER®**, make disc back-ups, even turn off the computer and go home. **SLAVE DRIVER®** oversees the printer until all the work is done.

### JUDGE FOR YOURSELF

Each **SLAVE DRIVER®** comes complete with interface cable, power supply, instruction manual, 30-day money-back guarantee and limited one year warranty. To order send your check or money order to the address below: \$189.95 for the expandable 8K model (holds approximately a 4-page letter); \$289.95 for the 64K model (holds a 32-page double-spaced report). Please include \$3.50 for shipping. Visa and MasterCard users may phone 703/228-5800 to hasten your order. (VA residents please add 4% sales tax)

IN STOCK AND AVAILABLE NOW

**FREEDOM MICRO-SYSTEMS**

Star Route ★ Wytheville, VA 24382

703/228-5800



# 49

```

4035 REM           WE HAVE TO MERGE
THE LAST INTERMEDIATE FILE &
4036 REM           1 LESS TEMPORARY
FILE
4040 FC$(2)=FC$(1):F2=F2-1:J=2
4050 GOTO4070
4060 J=1
4065 REM           CHECK FOR LAST F
ILE
4070 IF F2>FT THEN F2=FT
4075 REM           IF THIS IS THE L
AST PASS, THEN WRITE TO
4076 REM           THE DESIRED OUTP
UT FILE, OTHERWISE WE'LL USE AN
4077 REM           INTERMEDIATE
4080 IF F2=FT THEN FC$(1)=FO$ ELSE FC$(1
)=FF$
4085 REM           GET THE TEMPORAR
Y FILENAMES
4090 FORI=F1TOF2:J=J+1
4100 FC$(J)=FF$(I)
4110 NEXTI
4115 REM           NZ IS THE NUMBER
OF FILES THIS GO AROUND

4116 REM           K IS NUMBERING F
OR THE PRINTOUT
4120 NZ=J:K=0
4130 RETURN
5000 REM - - - - - SELECT SMALLEST
INPUT LINE - - - - -
5010 FOR I=2 TO NZ:IF LN$(I)<>"" THEN 50
50
5020 NEXTI
5030 LN$=""
5040 RETURN
5050 FC=I:LN$=LN$(I):J=I+1
5060 IF J>=NZ THEN 5100
5070 FORI=JTONZ:IF LN$(I)="" THEN 5090
5080 IF LN$>LN$(I) THEN LN$=LN$(I):FC
=I
5090 NEXTI
5100 IF NOT EOF(FC) THEN LINEINPUT#FC,LN
$(FC) ELSE LN$(FC)=""
5110 RETURN
6000 REM - - - - - CHECK FOR END O
F PROCESSING - - - - -
6010 IF FC$(1)<>FO$ THEN EF=1 ELSE EF=0
6020 RETURN ■
    
```

**New Software Tools for Your TRS-80**  
**Make Your Micro Even More Useful!**

>>>**REBACKUP**<<< Don't lose your important programs. Remove backup protection from Scripsit, VisiCalc, and others. Model I/III, 1 drive, 32K and up.

>>>**PAGER**<<< Document your programs better. Produces paged, formatted program listings, with byte and line count. Model I/III, 1 drive, 32K and up.

>>>**MATRICES**<<< Add important capability. Provides matrix manipulation utilities. Model I/III, BASIC, 16K and up.

>>>**UNLIST**<<< Protect your program secrets. Makes all or selected lines hard to list. Model I/III, 1 drive, 32K and up.

>>>**PHONENRD**<<< Use easily remembered phone words. Print all letter combinations for phone numbers. Model I/III, BASIC, 16K and up.

>>>**PACK**<<< Make your programs smaller and faster. Selective removal of some or all remarks, spaces, or both. Model I/III, 1 drive, 32K and up.

>>>**HIDE**<<< Frustrate software pirates. Inserts misleading errors in BASIC program listings to hide secrets. Program runs as usual. Model I/III, 1 drive, 32K and up.

>>>**COMPARE**<<< Update programs faster, easier. Compares 2 BASIC program versions to show changes and differences. Model I/III, 1 drive, 32K and up.

>>>**PRIMEINT**<<< Improve your financial analysis. Shows prime interest time series for over 30 years of monthly data. Tables and graphs. Updating data available. Add your own subroutines. Model I/III, 1 drive, 48K.

>>>Time series programs also available for S&P 500, Japan, West Germany, France, United Kingdom, Italy, and Canada <<<

Cost per program is \$24.95 postpaid. Software provided on cassette, with operating manual. Written in BASIC for easy expansion. Instructions built into program. Guaranteed to load and run. Can be provided on DOS disk if you supply

ORDER FROM # 50

**DATA ASSOCIATES**  
**Box 882-T, Framingham, Mass. 01701**  
 TRS-80 and Scripsit are trademarks of Tandy Corp.  
 VisiCalc is a trademark of VisiCorp.

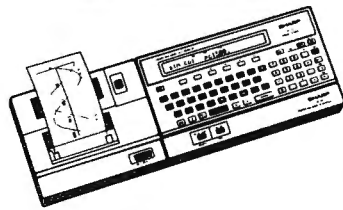

**SHARP'S NEW**  
**PC1500 / CE-150**

A POCKET Computer with PERSONAL Computer Capabilities. CE-150 Printer/Cass. Interface. Add 4 color printing and plotting and controls to cassette deck for program and data storage.

	List	Costs
PC1500	\$300.00	\$234.95
CE-150	\$250.00	\$214.95
(Printer/Lass. Int.)		
4 K Ram Module	\$ 75.00	\$ 59.95
8 K Ram Module	\$150.00	\$119.95
Pens (4 - all black or 4 colors)	\$ 3.95	\$ 3.45
Paper (1 case) (100 rolls)	\$ 39.95	\$ 37.95

Minimal order for free shipping is \$50.00

# 51

Missouri Residents Add 4 1/2% Sales Tax



**SUPERIOR SOFTWARE INC.**  
 P.O. BOX 11676  
 KANSAS CITY, MO 64138

**SHARP**

P. O. Box 11676, Kansas City, MO 64138

**The Lawyer's Microcomputer™**

**A Newsletter for Lawyers Using the TRS-80\***

**Seminar**  
**St. Thomas, U.S., Virgin Islands**  
**January 3 - 10, 1983**  
**For Lawyers using Radio Shack Computers**  
*for details*  
**Call Toll-Free:**  
**800-821-6129**

**A New Monthly Newsletter For Lawyers**

**Send \$28 For A One Year Subscription**  
**The Lawyer's Microcomputer™**  
 P.O. Box 1046B  
 Lexington, SC 29072

\*TM Tandy Corp # 52

# MULTIDOS

- IS THE DOS WITH THE MOST EFFICIENT DISK BASIC INTERPRETER.
- IS THE DOS WITH THE ORIGINAL AND STILL THE BEST SINGLE STEP BASIC.
- IS THE MOST COMPATIBLE OPERATING SYSTEM ON THE MARKET.
- IS EASY TO LEARN — EASY TO USE!

---

## MULTIDOS does the following AUTOMATICALLY!

- ADJUSTS** for CPU speeds of 1.77 thru 5.32 MHz without the need for slowdown during disk I/O.
- DISABLES INTERRUPTS** when CLOAD, CSAVE, or SYSTEM is entered from the command mode (Model I).
- EXECUTES** the most commonly used Library command, DIR, with one keystroke.
- PREVENTS** system hanging, even without a diskette in drive ZERO.
- READS** single density, double density, Model I and Model III diskettes.
- STEPS** machine language programs for debugging (controlled execute).
- TOTALS** free diskette space on all mounted diskettes.
- SENSES** type of double density hardware (RS or others).

*"Nobody Does It Better"*



— MAIL ORDERS —

### Cosmopolitan Electronics Corporation

P.O. BOX 89 • PLYMOUTH, MICHIGAN 48170

\*\*\*\*\*

— TECHNICAL INFORMATION —

### Cosmopolitan Electronics Corporation

C/O VERNON HESTER  
42403 Old Bridge Road • Canton, MI 48188 • (313) 397-3126

# 53

**\$99<sup>95</sup>**

**\$3.00 For  
Shipping & Handling**

Michigan Residents  
Add 4% Sales Tax

C.O.D. Orders Add \$1.50

Personal Checks Take  
2 Weeks To Clear

**VISA & MasterCard  
WELCOMED**

Foreign Orders Add \$10.00  
For Shipping & Handling

★ For Model I Orders Only ★  
Please specify Single, Double  
or P Density.

# @ News

## Wafer management

For ESF owners

Spencer Hall, Associate editor

There's a stereotype, in American folklore of the astute small town businessman who operates from a roll-top desk piled high with papers. Within seconds, he can lay his hands on any document he needs. I don't believe it! Do you? At any rate, serious users of the Stringy Floppy know that this approach to wafer storage is disastrous.

This month, we'll talk a bit about identifying wafers, recording their contents, storing and retrieving them—in short, wafer management. We'll address our remarks to Joe Rolltop, who has one hundred fifty wafers, give or take a few, stashed in envelopes, unmarked wafer organizers, wafer boxes, and one empty coffee can. Some of them (not all) have their contents scrawled on the labels.

First, Joe, you need "What's On It" (Exatron program 142, \$9.95). Boot it up, and you can see exactly what any wafer contains. File numbers are shown. BASIC programs, machine language programs, and data files are each identified by type. The length is given and the first few characters of each are displayed. It's a good idea to rewrite all BASIC programs to put the name in a REMark on the first line so this program will display it. Using "What's On It" is, of course, no substitute for good organization, but it does help bring order out of chaos.

As Joe "reads" his wafers with this program, he should mark them temporarily, pending a permanent label. Sanford's "Vis-a-vis" marking pen makes beautiful black

lines on glass, cellophane, etc. Use it for temporary I.D. on the old-style plastic labels. Newer labels are paper and can't take temporary marking. Get some plastic laminating sheets, such as Dennison's PRES-a-ply Clear Seal. Cut pieces in wafer label size, attach them, and voila, your paper label has turned to plastic. "Scratch" wafers, whose contents change frequently, need this type of identification.

Joe can make permanent labels, if he has a line printer, by using the X-Label program (80-U.S. Journal, July, 1982), or Bill Burnham's Super Label Maker (Exatron 182, \$9.95). If you don't have a printer, get a box of Avery 3/4" by 1" labels (stock S-1216) and a fine point pen such as Sanford's Espresso. (No, I don't own stock in Sanford!)

Now that you have all of your wafers labeled, Joe, where are you going to keep them? That coffee can has got to go! The answer depends on the nature of each program. It helps to classify programs (and wafers) as follows:

Masters— the copies you paid good money for and never touch unless there's a disaster. These need your safest, but not necessarily handiest, storage device.

Major backups— which are treated exactly the same as masters.

Often used— which may include utilities, if you're into programming; favorite games, if they're your bag; and certainly, those applications you can't do without, such as budget analyzers, check registers, data managers, etc.

Other programs— miscellaneous games, programs copied from magazines, code fragments you've written — all of the things you don't use every day but want to keep.

Data files— generated by a text editor, database manager, or special application package, such as an accounting system.

"Masters" and "major backups" are relatively small groups, while "data files" may become large over a period of time. For both of these, Joe can get himself a box of Oxford Pendaflex file guides (stock PN225). These are heavy cardboard panels with tabs from A to Z. He also needs a supply of single-pocket vinyl business card holders, available from several manufacturers.

Staple these, eight to a panel, in two rows of four, on the dividers. You can keep these panels in a letter-size file cabinet, or in a portable file box. If you keep them in Pendaflex hanging files, you can include a log of wafer contents for each panel. Keep the log on a heavy grade of ledger paper to stand repeated handling. Paste your own identification labels over the letter tabs, or use the letters as prefixes in a wafer numbering system.

If Joe has a radial arm saw (or knows someone who does) he could make himself a tray for "often used" wafers. Use a scrap of 2" by 10" lumber, cut across the grain to a width of 2 3/4", which is slightly larger than the width of a wafer. With a dado head set for a one-quarter inch slot, make uniformly spaced cuts (about one-quarter inch apart) across this piece, at an angle of about sixty degrees from horizon-

tal. Cut to a depth of one-half inch from the opposite side. Cutting with the grain avoids the problem of cross-grain in the ridges between slots, which causes them to crumble as they are cut. Close the sides by nailing on side panels. I used scrap pieces of 1½" decorative trim which were just right, if a bit ornate.

Joe could also order the Wafer Wheel from Exatron, which we mentioned in July. Either device sits handily at the left of your keyboard with its contents instantly available.

For what will ultimately be the largest part of any wafer collection, the category I called "other programs", ring binders are the most elegant. They don't have to be expensive. They won't get heavy use. Three-hole punch 8½" x 11" card stock, or hack up file folders. Tape vinyl business card pockets to these pages, two rows of three each, with the panel in the normal (vertical) position. An index on ledger paper can be placed in each

volume.

Of course, there are endless other ways to store wafers, many of them better, I'm sure, than those I've described. An element of personal preference goes into the choice. If you have a unique storage system, let's hear about it. The rest of us will be interested.

### "No Win" Department

A few months ago, I wrote about the EOT/BOT beeper which could be installed in your Stringy. I mistakenly said Exatron would retrofit it. The following month, I apologized for the error and described how even a beginner could install it. There was a major error in my instruction! With this track record, I'm afraid to even attempt a correction, but here it is, in case anyone still cares! The condenser is actually near IC 6 (it's identified on page F-2 of the manual as C21). It is mounted above, or sometimes below, the board. The trace, at the end of which the red beeper lead is to be

soldered, actually extends out from under IC 5, and not IC 11. I've answered several inquiries already and still have more to go.

### Scriptit Note

Several people have written about Scriptit for ESF. Here are some summary notes. You can put your tape version on wafer by using the ESF Monitor (Exatron 192, \$9.95 — most valuable of all ESF software). This needs a twenty-foot wafer because it's just a wee bit too long for ten feet. This version loads rapidly, but saves and loads text only via tape. Get the ESF patch from Exatron (133, \$9.95), load your tape version, then load the patch.

The patch overlays the tape version, converting it to accept commands to save by file number, load by file number, certify (@NEW) by file number and even choose the drive. Standard ESF responses, e.g., error messages, bytes certified, etc., appear in the special command line as needed. Saves are continuous and

Subscribe to CCN

## Color Computer NEWS



Are you tired of searching the latest magazine for articles about your new Color Computer? When was the last time you saw a great sounding program listing only to discover that it's for the Model I and it's too complex to translate? Do you feel that you are all alone in a sea of Z-80's? On finding on ad for a Color Computer program

did you mail your hard earned cash only to receive a turkey because the magazine the ad appeared in doesn't review Color Computer Software? If you have any of these symptoms you're suffering from Color Computer Blues!

**But take heart there is a cure!  
It's COLOR COMPUTER NEWS.**

The monthly magazine for Color Computer owners and only Color Computer owners. CCN contains the full range of essential elements for relief of CC Blues. Ingredients include: comments to the ROMS, games, program listings, product reviews, and general interest articles on such goodies as games, personal finances, a Kid's page and other subjects.

The price for 12 monthly treatments is only \$21.00 and is available from:



Mail Today!

### REMarkable Software

P.O. Box 1192  
Muskegon, MI 49443

# 54

NAME \_\_\_\_\_

ADDRESS \_\_\_\_\_

CITY \_\_\_\_\_ State \_\_\_\_\_ Zip \_\_\_\_\_

Allow 8-10 weeks for 1st issue.

80 US

are verified. The patched (revised) version can be backed up ad infinitum and you never need the tape version, or the patch you bought (darn it) again.

There's also a program called Crossword, which converts Scripsit tape files to ESF files. At this writing, I don't know what it costs, or anything else about it. If you're interested, call the hot line.

Mr. Paul Secord of Houston, Texas, reports several interesting things about Scripsit, to wit:

"If you're like me, you have entered substantial text into memory and then, instead of entering S F1 for save, you (inadvertently) enter L F1 for load. Your text disappears from the screen and the Scripsit buffer appears empty. But, it isn't! Use any monitor available to print the text, which begins at (RAM) address 6ED1H. In that way, at least you don't have to recompose your deathless prose.

"Or, once again, you have substantial text entered, but you forgot

to set your printer to the kind of typeface that you want. If you reset, give your printer the appropriate BASIC command, and return to Scripsit via 4300H, you will wipe out your text. But there is another reentry which will save your text and let you continue from where you left off. After reset, and after giving your printer the appropriate commands, do the following: 1) Type SYSTEM, 2) press ENTER, 3) type /21510, 4) press ENTER, 5) press CLEAR, and you will be back in Scripsit, with text preserved.

"Finally . . . I become impatient with the slow cursor movement during . . . editing. You can set the speed of the cursor . . . with a simple POKE command. The byte at 20785 controls cursor speed, both vertically and horizontally. The default value is decimal 13. This can be done by resetting to BASIC after loading Scripsit and POKEing (a smaller number into address 20785). Then, do SYSTEM and /21490 to return to initialized Scripsit. I prefer an

accelerated speed achieved by the command POKE 20875,4. Apparently, this value, with some kinds of touch, may cause key repeats, so if 20875,4 is too fast, try some value between four and thirteen. It will really speed up your editing!"

Your @NEWS editor has a big problem with all of this. When I reset out of Scripsit, my operating system is a mess, and I can't do anything, let alone what Mr. Secord suggests. I can change cursor speed by holding shift when I load Scripsit from wafer, thus defeating the autostart. Now, I execute the POKE 20875,6 and do a SYSTEM /17152 to get into Scripsit. As for the rest, it sounds great, so I've printed it here. If anyone knows how to take advantage of it, please write to me at 80-U.S. Journal!

**Christmas In November**

In case your January issue doesn't arrive before the holidays, have a very Merry Christmas and, in all ways, a Happy 1983. ■

**NEW** for the Color Computer TRS-80  
**COCOCASSETTE SUBSCRIPTION SOFTWARE**  
\*TRS-80 IS A TRADEMARK OF TANDY COMPANY



ENJOY A MONTHLY COLLECTION OF 8-10 PROGRAMS!  
 Including games, education, home finance and more; on cassette for as low as **\$5.00** a month! Add some action and imagination to your Color Computer. . . Best of all, we do the work!

**PRICES**  
 1 YR (12 ISSUES) . . . \$55.00  
 6 MO (6 ISSUES) . . . \$30.00  
 SINGLE COPIES . . . \$ 6.00

—MICHIGAN RESIDENTS: ADD 4% TO ORDER  
 —OVERSEAS: ADD \$10.00 TO SUBSCRIPTION AND \$1.00 TO SINGLE COPIES

616 396-7577



PROGRAMS ARE FOR EXTENDED BASIC MODEL ONLY ISSUES ARE SENT FIRST CLASS.

SUBSCRIPTION SOFTWARE



SEND CHECK OR MONEY ORDER TO:  
 # 55



T & D SOFTWARE P.O. BOX 256-C • HOLLAND, MICH 49423

**PRIZE WINNING CHESS**  
 — The Finest Available —  
 See 80 U.S. Journal, June '82

**SFINKS 3.0** Prize winner in Paris, plays ruthless chess! Problem set-up, infinite levels of play, 32 book openings, audio alert, printer output, thinks even while you're thinking!  
**32K Tape or Disk Only \$39.95**

**SFINKS CHESS TUTOR** Step-by-step programmed learning for the newcomer, includes 3-level chess game, problem set-up, printer output, audio alert, and book openings.  
**32K Disk Only Only \$19.95**

**SFINKS 1.81** Plays prize-winning chess, pre-chess and transcendental chess, nine levels, problem set-up, audio alert, move suggestion and takeback.  
**32K Tape or Disk Only \$24.95**

Please specify tape or disk and Model I or III. Include \$2.00 shipping and handling.

**William Fink (904) 377-4847**  
 1105 North Main, Suite 24-B  
 Gainesville, FL 32601

# 56





---

# Data Ace

## *A powerful database manager for the Model II*

Model II

T. R. Dettmann, Associate editor

Anyone working with business software is associated with database management. After all, what is a general ledger, if not a database? The same goes for inventory, accounts receivable, accounts payable and so forth.

Data Ace is a standalone database management system which provides the user with a simple, flexible, yet incredibly powerful, relational database management system. Using simple commands such as LIST, ADD, CHANGE and DELETE, you can do a major part of the normal data management tasks necessary in most systems.

If you wanted to list an account number 156, you would simply say: LIST ACCOUNT 156, if you had previously defined the account relation. In order to list all accounts in the account relation, you make the request plural: LIST ACCOUNTS. The whole system is this easy to use.

If that were all the system provided, it just wouldn't be enough. You should also be able to search through the database and look at records selected according to specified criteria. What if you wanted a list of all accounts that have balances over \$1000 and are greater than ninety days overdue? Could your accounts receivable provide such a list? Probably not.

Data Ace makes questions like that easy to answer, even if you didn't think of them when you

started. What's even better is that you can automate such requests as new commands in the system.

Flexible report processing is a much harder requirement to meet. If you buy an accounting program off the shelf, you're stuck with its reporting formats unless you change them yourself. With Data Ace, it's so simple to define a new report format, you just define special reports as needed.

Let's assume you have a customer file which records all orders for each customer. As a salesman, you might want to make a report which lists all customers who have large amounts of credit available and a history of buying but who haven't bought recently. The Data Ace manual shows you how to make such a report.

Do you want totals? Data Ace can handle them. Special heading on your reports? Data Ace has that too! I was most impressed with its ability to combine relations.

Let's say that we define an inventory relation (think of it as an inventory file if you wish). If we want to scan an order-entry relation for information and at the same time pull out amplifying information from the inventory, Data Ace can do that with the JOIN command. During a join operation, two normally distinct relations are treated as one. Try that with Profile or Profile Plus!

So even with all that, you still

want to make more of it. Well, that is possible too. Data Ace has a built-in fully-structured programming language modeled on Forth. Using volume two of their manual, you get a beginner's introduction that gives you enough practice in their Data Manipulation Language (DML) to be able to add your own customizing to the system.

DML is a derivative of polyForth and was developed by Computer Software Design, Inc. to provide the programming ability they needed. It comes as part of the Data Ace system. You don't have to know, or love, Forth to like DML (but it does help). Learning DML makes it possible for you to tailor a system the way you want it.

The system comes with three disks. The first disk is the Data Ace system disk. This is *not* a TRSDOS system. In fact, it is a complete system all by itself. The Data Ace system disk goes in Drive 0 when you boot-up and it starts up in the Data Ace system, ready for use. No Disk Operating System to worry about, just Data Ace.

The second disk is a demonstration data disk. The whole manual for Data Ace is keyed to playing games with the demonstration disk. Relations have been defined, data entered, and enough special work has been done so that you can play with all of the capabilities of Data Ace just on the demo disk.

The manual takes you through a series of examples and tells you what to try and what you should get. This makes the manual easy to follow. Less advanced users can stop with the simple data manipulation and definition facilities. More advanced programmers can learn to do anything they want.

It sounds like this package is too good to be true. Well, it almost is. It is remarkably flexible. It is amazing that it's here on so small a computer as the Model II. I have seen data management systems with this much power on large computers, but never on anything as small as a Model II. It gives you large machine power on a small machine.

I have had about two months to play with the system and try my hand at building databases and tearing them down. I have had numerous successes, primarily due to the ease with which I could follow the manual. By playing with their data disk, trying their examples, and working through their problems, I was able to get to the

point where I could create useful databases in only a few hours. I can safely say that I wouldn't hesitate to use this for a complete accounting system wherever it fit the task.

### Backup

There is a normal backup procedure clearly explained in the manual for the data disks. But there is no way to do it for the master disk. That seems a little excessive to me. One problem and sorry, no system! It is especially bad if you have a great deal of custom programming on that disk. What do you do? The Data Ace people will replace your system, but they can't replace your customizing.

Data Ace also suffers from its own isolation. Since it is a standalone system, it can't read TRSDOS disks without special programming. You couldn't use it to share information with existing systems. Not unless you wanted to write your own disk access routines.

By isolating itself so much, Data Ace must function for now as a

standalone system. That's not bad, it's not good, it's just the way it is. For many applications, that's just what's called for; for others, it isn't enough.

At \$850 for the Model II version, Data Ace is not the kind of thing you just pick up for fun. That kind of price is only justified by serious use. You have just got to generate some income from such a purchase.

Its advantages make Data Ace a major package to consider for the development of new software. The disadvantages of Data Ace are outweighed by the advantages. I certainly recommend Data Ace to anyone looking for the most powerful database management ability possible. ■

---

*Ed. note: Data Ace is available from Computer Software Design, Inc., 1911 Wright Circle, Anaheim, CA 92806, (714) 634-9012. The company reports that a Model III, hard disk version will be available in the near future for \$375.*

---

## JFD-III Floppy Disc Controller Kit NOW ONLY \$349<sup>00</sup>

Thousands of our controllers have been installed and the user satisfaction has been tremendous. Those who have compared the rest say that ours is the best.

Kit includes controller board, mounting brackets, cables, power supply for 2 internal drives, and illustrated instructions. This controller has been tested for compatibility with most major operating systems including TRSDOS, LDOS, NEWDOS/80, DOSPLUS, and MULTIDOS. The controller supports any mix of 5¼" drives including single or double density, single or double sided, 35, 44, 77 or 80 track drives.

## JHD-III Winchesters for TRS 80 Model III

5 Mbyte formatted — \$1,895  
10 Mbyte formatted — \$2,195

These drives plug into the 50 pin I/O expansion port. System includes host adaptor, cables, fan cooled cabinet. Controller features 11 bit error detection and correction, automatic track remapping and variable sector interleaving. LDOS driver included with system. LDOS Operating System \$89.00.

**TERMS:** Cashier's Check or COD. Personal Checks take 3-4 weeks to clear.

To order call (505) 265-5072  
or send order to:

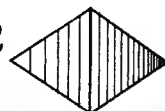

J&M Systems, Ltd.

137 Utah N.E.,  
Albuquerque, NM 87108

TRADEMARK CREDITS:

TRSDOS is a Trademark of Tandy Corporation.  
LDOS is a Trademark of Logical Systems, Inc.

NEWDOS is a Trademark of Apparat, Inc.  
DOSPLUS is a Trademark of Micro-Systems Software, Inc.  
MULTIDOS is a Trademark of Cosmopolitan Electronics Corporation.

# 57

Dealer inquiries invited.

Call for the name of dealer nearest you.

All photos are actual TRS-80 screens.



### SCARFMAN

This incredibly popular game craze now runs on your TRS-80! It's eat or be eaten. You run Scarfman around the maze, gobbling up everything in your path. Try to eat it all before nasty monsters devour you. Excellent high speed machine language action game from the Corsoft Group. With sound. Price: A



### ARMORED PATROL

A realistic tank battle simulation. Your view is a 3-D perspective of an alien landscape. Maneuver your T-36 tank to locate and destroy enemy tanks and robots that lay hidden ready to assault you. Clever graphics create the illusion of movement and dimension. From Adventure International. With sound. Price: B



### REAR GUARD

Deadly waves of enemy Cyborg craft attack your fleet from the rear. You are the Mothership's sole defender. You have unlimited firepower but the Cyborgs are swift, nimble attackers. Your abilities are tested hard in this game of lightning fast action and lively sound from Adventure International. Price: B



### STRIKE FORCE

As the primary defender of a world of cities under deadly alien attack, your weaponry is the latest: rapid fire missiles, long range radar, and incendiary star shells. Your force field can absorb only a limited number of impacts. A complex game of strategy, skill and reflexes from Melbourne House. Price: A



### PANIK

Trapped at an enemy building site, your fate seems certain. Your laser is empty, and evil Martians are closing in. You'll have to climb ladders and think one step ahead of the various monsters. A challenging game for agile minds. From Fantastic Software with voice. (Disk has larger vocabulary). Price: B

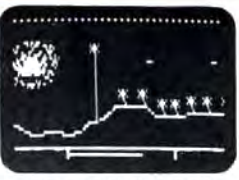

### SEA DRAGON

Your submarine, the U.S.S. Sea Dragon, penetrates a mined enemy channel. Armed with missiles and torpedoes, you engage the enemy while navigating unknown waters. Succeed or come to a salty end in this game. 29 screens of horizontally scrolling sea-scape and sound from Adventure International. Price: B

# SAVE

# 10, 15, 20%



### BOUNCEBOIDS

Huge boulders careen off the walls. You're in the middle in danger of being flattened. Keep your wits about you as you blast these "bounceboids" from the screen. Large ones break into many small ones. Clear a screen, and enter a fast-paced challenge stage with a chance for big bonus points from the Corsoft Group. Price: A



### CATERPILLAR

An arcade favorite! Stop these multi-sectioned crawlers before they creep down through the mushrooms. Zap one and it splits into two smaller bugs, each with its own sense of direction. There are moths and tumble bugs too. It all adds up to lots of fun for kids and adults alike. From Soft Sector Marketing. With sound. Price: A



### DEFENSE COMMAND

The invaders are back! Alone, you defend the all important nuclear fuel canisters from the repeated attacks of thieving aliens, repeatedly. An alien passes your guard, snatches a canister and flies straight off! Quick! You have one last chance to blast him from the sky! With sound and voice. Price: A



### CRAZY PAINTER

You have to paint the floor white. We give you the paint and brush. Sounds easy? Hah! You'll be confounded by stray dogs, snakes, sloshing buckets of turpentine, even a ravenous "paint eater." A crazy, imaginative new game with ten selectable levels of skill for new or seasoned game players. Lots of laughs. Price: A



### SUPER NOVA

Asteroids loat ominously around the screen. You must destroy the asteroids before they destroy you! (Big asteroids break into little ones.) Your ship will respond to thrust, rotate, hyperspace and fire. Watch out for that saucer with the laser! As reviewed in May 1981 Byte Magazine. Price: A

**THE ALPHA JOYSTICK**

**ONLY \$39.95**

© 1982 AIC ALPHA Products

*"If you purchase Alpha's Joystick you get the exquisite pleasure of enjoying (action games) to the limit of arcade-style realism."*

-80 Microcomputing 80 Reviews, Jan '82

**FEEL THE POWER...**

- Features the famous Atari Joystick
- Works with all Model I or III systems
- Compatible with any other accessories
- Saves your keyboard from abuse
- Experiment in BASIC (Use A=IMP/D)
- Complete, ready to plug in and use
- Model I: plugs into KB or E/I
- Model III: plugs into 50 pin I/O bus

Price includes Joystick + Alpha Interface  
+ Instructions + Demo Program listing  
Please specify Model I or III

**14 DAY MONEY BACK GUARANTEE**

**THE BEST FOR LESS**

As you can see, all the best games from the top producers are joystick compatible. These games are fun without the joystick but we hope that you are one of the many thousands who enjoy the advantage of real joystick action.

Now you can deduct up to 20% on the price of games; buy any 2 games deduct 10%, buy any 3 games deduct 15%, buy any 4 games deduct 20% from game prices.

**TOP TEN**

1. SCARFMAN *All time favorite*
2. ARMORED PATROL *Super 3D graphics*
3. PENETRATOR *Rave reviews*
4. STELLAR ESCORT *Fast and Challenging*
5. CRAZY PAINTER *Unique game concept*
6. PANIK *Remarkable Voices*
7. DEFENSE COMMAND *Tough struggle*
8. CATERPILLAR *Good rendition*
9. ROBOT ATTACK *With voice*
10. SEA DRAGON *Amazing "Seascape"*

**STELLAR ESCORT**

The latest super action game from Big Five. As the Federation's top space fighter you've been chosen to escort what is possibly the most important shipment in Federation history. The enemy will send many squadrons of their best fighters to intercept! With sound. Disk version has voices. Price: A

**ROBOT ATTACK**

Talks without a voice synthesizer. Through the cassette port. With just a hand laser in a remote space station, you encounter armed robots. Some march towards you, more wait around corners. Careful, the walls are electrified. Zap as many robots as you dare before escaping to a new section. More robots await you. Price: A

**LUNAR LANDER**

As a vast panoramic moonscape scrolls by, select one of many landing sights. The more perilous the spot, the more points scored -- if you land safely. You control LEM main engines and side thrusters. One of the best uses of TRS-80 graphics we have ever seen. From Adventure International. With sound. Price: A



### METEOR MISSION II

As you look down on your view, astronauts cry out for rescue. You must maneuver through the asteroids and meteors. (Can you get back to the space station?) Fire lasers to destroy the asteroids, but watch out, there could be an alien Flagship lurking. Includes sound effects! Price: A



### OUTHOUSE

You are the mighty protector of this small but important wooden structure. For reasons unknown, a madman gang of miscreants wish to vandalize, loot and otherwise despoil the little, half moon house. Your patrol craft has lasers and smart bombs to deal with this terror. From SSM with sound. Price: A



### GALAXY INVASION

The sound of the klaxon is calling you! Invaders have been spotted warping toward Earth. You shift right and left as you fire your lasers. A low break formation and fly straight at you! You place your finger on the fire button knowing that this shot must connect! With sound effects! Price: A



### LASER DEFENSE

In this game of ICBM's, high-energy lasers and particle beams, you control the U.S. strategic defense satellite system. From your viewpoint high above the globe, you intercept Soviet nuclear missiles in flight and attempt to destroy their scattered missile silos. With sound from MED Systems. Price: B



### CHICKEN

Will the chicken cross the road? That's up to you. Can you guide these helpless little chicks across the perilous "to lane" super highway to safety? Or will you bump, hitting the backstop with a storm of chicken feathers? A humorous yet challenging game of nerves from SSM with sound. Price: A



### PENETRATOR

Soar swiftly over jagged landscape, swooping high and low to avoid obstacles and enemy missile attacks. With miles of wild terrain and tunnels to penetrate, you're well armed with bombs and multiple forward missile capability. From Melbourne House. Features sound, trainer mode and customizing program. Price: C

**Toll Free Order Line**  
**800-221-0916**  
Orders Only, NY & Info call (212) 296-5916. Hours: 9-5 E.S.T.

**TAPE: For Model I + III, 16K Level II**  
**DISK: For Model I + III, 32K, 1 Disk**  
All games are joystick compatible or may be played using the arrow keys.

**GAME PRICES**

A: TAPE: \$15.95 + DISK: \$19.95  
B: TAPE: \$19.95 + DISK: \$24.95  
C: TAPE: \$24.95 + DISK: \$24.95

ALPHA Products

# 58

79-04 Jamaica Ave., Woodhaven, NY 11421

ADD \$2.00 PER ORDER FOR SHIPPING AND HANDLING  
WE ACCEPT VISA, MASTERCARD, CHECKS, M.O.  
C.O.D. ADD \$3.00 EXTRA  
NY RESIDENTS ADD SALES TAX  
OVERSEAS: FPO, APO ADD 10%  
DEALER DISCOUNTS AVAILABLE

All photos are actual TRS-80 screens.

December, 1982 \$9

# New products

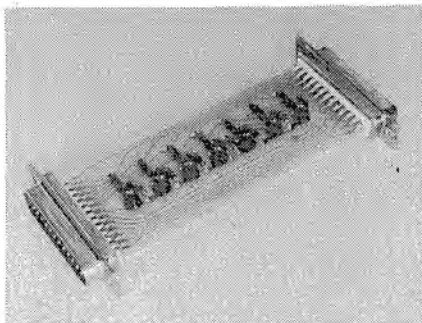

## RS232 Tester

B & B Electronics offers an RS232 Tester which monitors and displays the status of the seven most important RS232 lines. LEDs clearly display the status of Transmit Data, Receive Data, Request To Send, Clear To Send, Data Set Ready, Carrier Detect and Data Terminal Ready. The unit has one male and one female 25-pin connector for easy (no adaptor required) insertion into any RS232 interface. The tester requires no power, and is designed to be left in the line permanently. It does not affect data-transfer ability.

Available directly from the manufacturer, B & B Electronics, Box 475, Mendota, IL 61342 or Phone: (815) 539-5827, at \$39.95 postpaid.

#200

## New 3" Micro-Floppydisk Drive and Cartridge

Just introduced by Amdek Corporation, the Micro-Floppydisk offers one-megabyte capacity and is plug compatible with standard five-inch floppydisk drives. The new drive has a built-in power supply and accommodates two three-inch Micro-Floppydisk cartridges.

Only .179" x 3.15" x 3.94," the new Micro-Floppydisk cartridge features a flip-type, hinged head cover that protects the three-inch disk from dust, scratches or fingerprints.

Single-side recording capacity is 125K bytes or 250K bytes for both sides with double density (500K byte) capability. A "write protect" mechanism is available to assure "read only" status.

Micro-Floppydisk cartridges are low-priced and the new drive unit is only \$899.

For further information, write or phone: Amdek Corporation, Marketing Dept., 2201 Lively Blvd., Elk Grove Village, IL 60007, (312) 364-1180. Tlx 25-4786.

#201

## COPY-TAPE

COPY-TAPE is a utility program used to duplicate BASIC or system

tapes. Make back-up copies of your software on both the TRS-80 Model I and Model III. On the Model III, COPY-TAPE converts 500 to 1500-baud and vice versa. It is menu-driven and extremely easy to use. Options include load original tape, record new tape, verify tape and advance tape. COPY-TAPE presents the ASCII code of the program on the screen during loading and recording. Available for the TRS-80 computers Model I Level II and Model III, requires 16K minimum. The guaranteed cassette tape sells for \$11.95 and is available from Modtec, Software Division, 4144 N. Via Villas, Tucson, AZ 85719.

#202

## COLOR-FORTH

COLOR-FORTH for the TRS-80 Color Computer (6809) is now available. Prices are \$58.95 for the RAM version and \$123 for the ROM plus RAM version. Included with the ROM are instructions for installing it in the disk controller, or it will work in a ROM cartridge.

COLOR-FORTH works with both disk and tape. The ROM version will work with 4K of RAM. The RAM-based version requires 16K.

COLOR-FORTH comes with a powerful Semigraphic-8 editor and a set of utilities. It has a unique trace feature, and handles interrupts cleanly in high-level Forth. COLOR-FORTH maintains the CPU carry

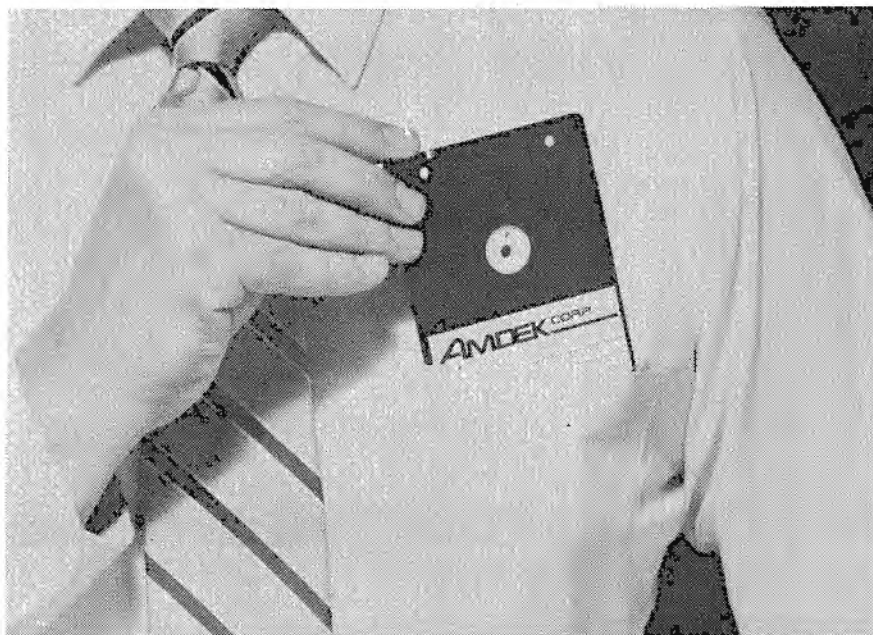

flag, for easy implementation of extended math, and has words for bit manipulation, graphics, sound, task multiplexing, fast math, auto-repeat keys, control keys, disk and tape control and linkage to BASIC routines.

COLOR-FORTH was written largely in assembly language, and it takes advantage of the unique features of the Color Computer. COLOR-FORTH does not affect normal operation of the Color Computer.

For more information contact: Hoyt Stearns Electronics, 4131 E. Cannon Dr., Phoenix, AZ 85028, (602) 996-1717.

**#203**

---

**Low priced  
212A-compatible modem  
from Radio Shack**

Radio Shack now offers a high-speed direct-connect modem that operates at either 0-300 or 1200 baud. The new TRS-80 DC-1200 High Speed Direct Connect Modem (76-1005) is available for \$699; an optional add-on auto-dialer accessory module (76-1009) is also available for \$149.95.

With high speed operation, time charges (and in some cases, affiliated long distance charges) may be greatly reduced.

The DC-1200 Modem can operate asynchronously at 0-300 baud (Bell 103/113 compatible). Both full- and half-duplex operation are supported at both speeds. The unit features manual originate (plus auto-dialer option available), automatic answer operation, and is self-adjusting to the incoming baud rate. A self-test mode has also been incorporated, as well as eight LED status indicator lights. Connection to TRS-80 computers is made to its DB25 connector with standard RS232C cables.

For further information contact your local Radio Shack Computer Center.

**#204**

---

**COLORTEXT**

MICRO SCHOOL PROGRAMS announces COLORTEXT, for use on TRS-80, 32K Color Computers, with one disk drive. COLORTEXT is an easy-to-use, high-resolution text driver which displays a variety of

character fonts and graphics on the screen simultaneously, including the use of all features of Extended BASIC. It permits the intermixing of upper-lowercase text and graphics in various sizes and colors.

Other features include non-destructive overwrite for animation, variable screen scrolling speed, a BREAK key lock-up option, and ADDCHR — a program for creating and editing all characters, (including graphics, alphanumeric, etc.). ADDCHR can be used to create character sets of up to 200 characters. The defined character sets may be for foreign languages such as Greek, Hebrew, Russian, or various other print types. Special characters may also be defined and displayed within standard print statements.

The TRS-80 Model III graphics character set is included in COLORTEXT. This permits the user to enter and use programs written for Models I and III very quickly, using the same graphics character set numbers used in the other programs. This character set may be changed by the user if desired.

COLORTEXT comes on disk with a fifty-plus-page manual priced at \$79.80. For further information contact: BERTAMAX, Inc., 101 Nickerson, Suite 202, Seattle, WA 98109, (206) 282-6249.

**#205**

**Double Density Adapter**

The Holmes DX-1D Double Density Adapter adds double density and eight-inch drive capacity to the TRS-80 Model I for only \$129.50. Double density, eight-inch drives for the Model I require faster system speed and it can be achieved using the Holmes Sprinter II.

Designed for use in the TRS-80 Model I, the DX-1D can be used with the Radio Shack Expansion Interface, Holmes DX-1S single density disk controller, and other single density Model I compatible disk controllers.

Complete with a "state-of-the-art" LSI Data Separator, this new product offers greater disk storage, fewer read errors, and greater long-term performance than other controllers.

This product with the Holmes Expansion Mainframe and DX-1S Single Density disk controller provides a complete double density disk controller for \$319.

The Double Density Adapter is available through Holmes Engineering, Inc. or any of its authorized dealers. For more information call or write: Holmes Engineering, Inc., Dept. #20, 3555 South 3200 West, Salt Lake City, Utah 84119. (801) 967-2324.

**#206**

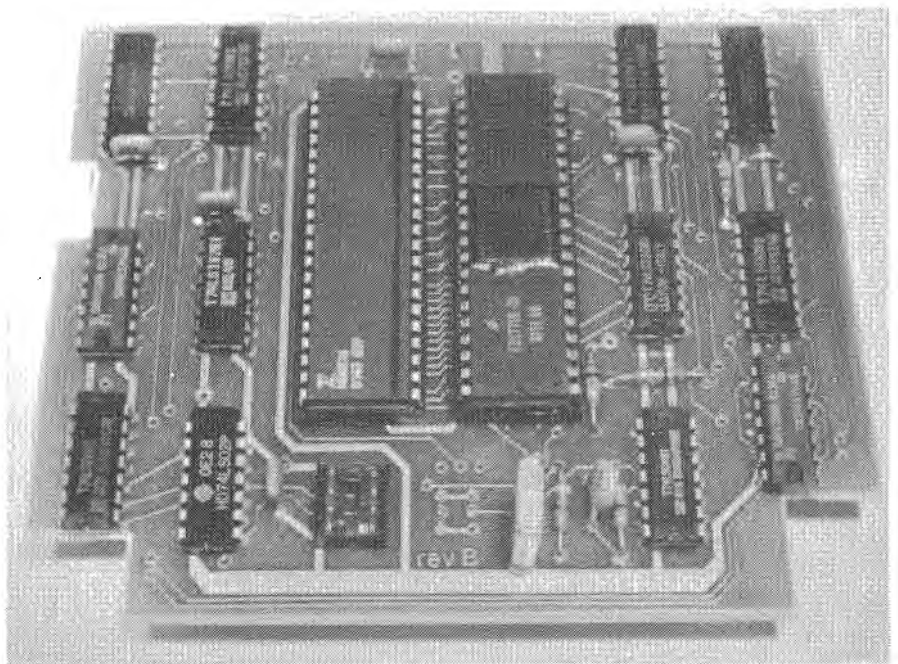

---

# Exploring VisiCalc

Models I/II/III/16, PMC-80, LNW80

Tim Bowman, Spokane, WA

The VisiCalc program is best known for its ability to perform calculations and allow the user to consider questions like, "What if..." This month, let's use VisiCalc to do some things that you may not have considered using it for: text processing and forms creation.

## Text Processing

Believe it or not, VisiCalc can be used as a very adequate text processor and it is very easy to use. All that you need to do after loading the program is to set the column width equal to fifty-five by typing /GC55 ENTER. Then, begin typing. It is important to remember that the regular VisiCalc commands govern the input of text material. For example, if you wish to begin a sentence with a non-alphabetic character, you must type a quote sign (shifted 2) before typing the text material. It is also important to note that while typing in text on the edit line, you can type many more characters on the edit line than will actually print on the screen or a lineprinter.

The power of VisiCalc comes into play when you want to enter additional lines of text in the middle of existing text. This is done by typing /IR and typing the text to be inserted. Similarly, you can delete lines of text by typing /DR. For those of you with the older version of VisiCalc, you do not have a line edit

capability, so if you wish to edit a line, you must type the whole line over again.

In order to properly position the output on a lineprinter, so that it does not print the left margin on the left edge of the paper, you will have to either shift the paper in the printer to the left, or start typing the text after ten or twelve presses of the spacebar.

In any event, VisiCalc can serve as an emergency word processor, or, for the budget-conscious person, an inexpensive text processor.

## Forms Creation

In my occupation, I have discovered that we use a number of forms and that VisiCalc can be used to easily create forms. The reason VisiCalc can create forms so easily is due to its replicate command. Before you try what I suggest next, I would encourage you to refresh your memory and review your VisiCalc documentation of the replicate command.

If you wish to save any text that you created using the preceding tip, now is the time to save it. Type in /CY and /GC5 to set the column width at five spaces. We'll create a simple form to keep track of time by job. Type in the information shown in Figure 1. Be sure to provide the spaces after any quotes in order to get the proper character alignment.

After Figure 1 has been typed in,

the real power of the replicate feature can now be used. With the cursor at position B6, type /R.K6 DOWNARROW ENTER B18 ENTER. After the enter key is pressed, you should see the screen fill the cell positions with the replicated material. I've found that it is faster than any word processor at duplicating repetitive material, such as lines or boxes, or any other characters. The reader who is familiar with the replicate command will also see other uses of that command while typing in the detail in Figures 1 and 2.

To finish out the form, type in the additional information as shown in Figure 2, with your cursor beginning at position C19.

After you have typed in Figure 2, your final product should look like Figure 3. I have found that I like more space between the empty lines, so I use the insert command (/I) before any line that I wish to have more space. The example in Figure 3 is relatively simple, but by using a little imagination, I am confident that you can create useful forms for your own use.

---

*Ed. note: Correspondence for Mr. Bowman should be addressed to Mr. Tim Bowman, c/o 80-U.S. Journal, 3838 S. Warner St., Tacoma, WA 98409. Be sure to include a SASE if you desire written response.*

---





# Captain 80

*The adventures of a software secret agent*

© 1982, Bob Liddil, Contributing editor

Here's the Software Secret Agent, off on another deadly mission into the hinterlands of TRS-80 software-dom. My top-secret equipment includes some of the old standards: a combination belt buckle telephone/modem and laser blaster in case of aliens, a ballpoint pen watch/micro-cassette recorder and standard top-secret, all-purpose, milk of human kindness gumdrop popper.

This mission was commissioned by none other than the CIA, (better known as Citizens against Interaction in Arcadia), committee on plots to reinstate adventure as the number one genre in microcomputer gamedom. The nature of the assignment was so secret that the guy who briefed me wasn't allowed to listen.

It was simple. All I had to do was investigate rumors that Scott Adams, who had launched a fully-computerized submarine, had been kidnapped by Blowhard, notorious international criminal, oil baron, shipping tycoon and litterbug.

It was true. Investigation revealed Adventure International's new Sea Dragon. The latest twitch by arcade geniuses Wayne Westmoreland and Terry Gilman created a great sigh of

acceptance from video game aficionados. I must confess that I am among those who embraced this game enthusiastically.

Sea Dragon succeeds where Sky Warrior failed, as far as combining elements of different popular arcade games into a coherent, new activity. By going underwater with their scenario, the dynamic duo of diverse compuanimation freed this offering of all but the most oblique similarities, to Defender and other coin-op twitches.

Here's how Sea Dragon works. The submarine is launched from shallow water into a sea of floating mines which (most inconveniently) float up to blow her to smithereens. Ah, but she is not without defenses. The forward tubes spit out an endless stream of deadly torpedos which are quite capable of destroying these mines. Chained, or unchained, they are worth points to the player.

As the cleverly-executed sea floor scrolls under her keel, Sea Dragon makes the briny deep safer for mankind. If this were all there were to the game, the terrific twosome would have scored a fair hit with me. But, not content to simply be good,

they added other elements.

First of all, air is not unlimited, so frequent surfacing is required. Also, the aforementioned scrolling seabed, which makes up the one-way course Sea Dragon must follow, is fraught with caves containing killer stalagmites which fall, and can do in undersea travelers. And, what submarine game would be worth its salt without battleships to blow up?

There are EATS (Enemy Attack Stations), which fire at random as you pass. Not an altogether safe way to travel, Sea Dragon, if you ask me. There is also a reactor (possibly owned by Blowhard, remember him?), that spews radioactive chunks and is protected by a large neutronium shield fabricated by a work force recruited from pro-nuclear plaque carriers at airports in seventy cities.

Sea Dragon's ability to blow things up extends to both the horizontal and vertical plane, and allows a lot of room for growth in skill level. Resident arcade munchkins have to be dragged away from the computer that contains this program. It is a winner, a challenge, an amusement, an achievement and a fair buy for the money, all rolled up into one neatly-



illustrated package, onto which the Adventure International nameless artist lovingly airbrushed a fine poster-quality submarine scene fit for hanging on a computer room wall.

All this was useful information as I set out to rescue Scott from the clutches of the guest Evil Villain of the Month—namely Blowhard. I would use my patented electromagnetic, microprocessor-equipped, infrared adventure grandmaster detector, and a cleverly-designed Bad Guy Buster, guaranteed to foil any evil plot.

When I arrived at Blowhard's mansion, I noticed that the lights were dimming. Was I too late? I raced through the corridors to Blowhard's laboratory. The fiend! He was torturing the Phooba of

Puzzles by making him read old two-color documentation covers from Mad Hatter, Ramware and The Programmer's Guild.

I aimed my Bad Guy Buster squarely at the skulking torturer and fired, but the rays bounced off and melted my gun. Then, he ordered me to drop the BGB, or he'd turn up the power and torture poor Scott to death. I hesitated. He reached for a copy of Ting-Tong. I knew I was beaten. I capitulated. I dropped the BGB and surrendered.

"Ah, ha! I've *beaten you, Captain.*" Blowhard cried triumphantly. As he opened his mouth and let out a squeal of pure joy, I let him have both barrels of my milk of human kindness gumdrop popper.

"Oh, no!" he yelped.

"Oh, yes, Blowhard!" says I. "From now on, you will have to be kind to everyone you meet. No nasty letters, no dastardly deeds, no littering. The milk of human kindness gumdrops have no antidote."

He left the lab a confirmed do-gooder, and the last I saw of him, he was heading for the coast in his Jaguar, ready to perform massive good deeds in the Orient. Another threat to humanity foiled.

I turned Scott over to the crew of the Sea Dragon for the long voyage back to Orlando. "Who *was* that caped crusader?" I heard him mutter, obviously still dazed from re-reading the instructions to Journey to the Center of the Earth.

I chuckled to myself. A good day's work, well done, thought I . . . and wait until the CIA gets my bill. ■



# Reviews

## Speak

Model I/III  
48K with disk  
Model I version

Order direct from author:

Mr. Bill Neville, III  
P.O. Box 2581

Houston, TX 77001

\$39.95

Model III version:

The Alternate Source

704 No. Pennsylvania Ave.

Lansing, MI 48906

(800) 248-0284

\$39.95

Speak is a program which will "add lips to your TRS-80" computer. I have always wanted to have a program which could produce voices on my computer, but I have never been able to find such a program, until now.

The program itself will work only

on disk systems, and recording can only be accomplished using a Model III computer. Model I users can record voices if they bypass the Radio Shack tape recorder modification — this process is described in the Speak documentation. There are several programs on the disk, including Record, which allows me to talk to the computer to record my voice, Pack which lets me pack my voice into BASIC programs, and several demonstration game programs such as talking Hangman. Note that any voice can be recorded, since Speak can recognize and record any word.

### How it works

After typing in Record from my DOS READY prompt, I may record in either the word or phrase mode. The word mode is used most often,

since it is the only type that can be packed into my own programs. The only difference between these two modes is that in word mode, each word is packed into a string. Phrases are packed continuously into memory. Words in phrase mode are, in effect, "strung together" so that a sentence is stored, rather than a word. Usually, about eight words can be packed into any one phrase.

Recording is very simple since all I have to do is talk into the small microphone on my tape recorder. The computer will acknowledge each time a word is spoken by saying "word 1 recorded," "word 2 recorded" and so on. The buffer will be full after about eight or ten words. At this point, I save my words onto disk in a data file.

After saving I can pack my words into BASIC programs by using the

DISK DRIVE WOES?  
PRINTER INTERACTION?  
MEMORY LOSS?  
ERRATIC OPERATION?

## Don't Blame The Software!



Power Line Spikes, Surges & Hash could be the culprit! Floppies, printers, memory & processor often interact! Our patented ISOLATORS eliminate equipment interaction AND curb damaging Power Line Spikes, Surges and Hash. MONEY BACK GUARANTEE!

- ISOLATOR (ISO-1) 3 filter isolated 3-prong sockets; Integral Surge/Spike Suppression; 1875 W Maximum load, 1 KW load any socket ..... \$69.95
- ISOLATOR (ISO-2) 2 filter isolated 3-prong socket banks; (6 sockets total); Integral Spike/Surge Suppression; 1875 W Max load, 1 KW either bank ..... \$69.95
- SUPER ISOLATOR (ISO-3) similar to ISO-1 except double Isolation & Suppression ..... \$104.95
- SUPER ISOLATOR (ISO-11) similar to ISO-2 except double Isolation & Suppression ..... \$104.95
- MAGNUM ISOLATOR (ISO-17) 4 Quad Isolated sockets; For ULTRA-SENSITIVE Systems ..... \$181.95
- CIRCUIT BREAKER, any model (Add-CB) ..... Add \$9.00
- REMOTE SWITCH, any model (Add-RS) ..... Add \$16.00

AT YOUR DEALERS

MasterCard, Visa, American Express  
ORDER TOLL FREE 1-800-225-4876  
(except AK, HI, PR & Canada)

# 61

**Electronic Specialists, Inc.**

171 South Main Street, Box 389 Natick, Mass. 01760  
(617) 655-1532

COLOR COMPUTER SOFTWARE

## BASIC AID

HELP FOR THE BASIC PROGRAMMER

At last, the development tools you need! All available instantly at power-up

**MERGE COMMAND:** Insert programs stored on cassette into your Basic program. You can even assign new line numbers to the file you read in. Create your own tape library!

**MOVE COMMAND:** Lets you renumber any part of your Basic program. GOTO's GOSUB's etc automatically changed.

**AUTOMATIC LINE NUMBERING:** You'll love this! Never type in another line number

**PLUS 45 common Basic commands** available as single key Control characters. Or change ANY OR ALL keys to your own specifications! Comes with convenient easy to remove, plastic keyboard overlay. All of this in a convenient ROM cartridge that uses almost none of your valuable memory ..... CARTRIDGE \$34.95

### COLORCOM/E SMART TERMINAL PROGRAM

We didn't wait for the competition to catch up with us! We've added even more features to COLORCOM/E, our superb Smart Terminal program

- Complete upload & download support
- On line cassette reads & writes
- Automatic capture of files
- Pre-enter data before calling
- Send all 127 ASCII characters
- Word mode eliminates split words
- Off line AND on line scrolling
- Selectable RS232 parameters

We've got the best cassette and upload/download support available. And you can conveniently print any portion of the received buffer you want. NOW ON DISK! Reads and writes files from disk. Same great features plus more ..... DISK OR CARTRIDGE \$49.95

### EDITOR ASSEMBLER DEBUGGER \$695

**CCEAD:** This 8K Basic Program supports cassette files, has full cursor control line insertion/deletion, and much more. Two pass assembler supports full 6809 instruction set & addressing modes, lists to screen or printer. Debugger allows memory examine/modify, program execution. If not delighted return within 2 weeks for a full refund. You get fully commented Basic source & complete instructions. Requires Ext. Basic & 16K ..... CASSETTE \$69.95

**STRIPPER:** Three valuable commands: (1) Delete Remarks, (2) Pack Lines, (3) Delete Spaces. Fully automatic, is not fooled by GOTO's GOSUB's etc. Your programs will run faster and take up much less memory ..... CASSETTE \$79.95

**CUSTOM CARTRIDGES:** Put YOUR Basic program into a convenient ROM Cartridge Runs instantly at power-up. Use for Ad displays, schools, etc. Call or write for info

Send check, money order, or Visa/MC Number, include \$1 for postage and handling, Visa/MC. Phone for fast service

**Eigen Systems**

P.O. Box 10234  
Austin, Texas 78766  
(512) 837-4665

# 62

Pack/Bas program. I can listen to each word and then decide if I want it packed or not. I am amazed at the clarity of the voices, they sound almost exactly as if I were talking. Once all the strings are packed into BASIC (an amount limited only by your memory — usually about fifteen words), the process of putting voices into my program is finished.

**Using the words**

Although only disk systems can use Speak, the voices may be reproduced on any TRS-80 Model I or Model III. Due to the limited number of words that can be packed into one program, games will probably make the best use of speak for saying things like "game over" and "you're dead." However, other applications can be practical. On a disk system many files can be saved and accessed quickly for teaching the alphabet and numbers or any other thing which is re-enforced by using real voices. Hundreds of words can be saved to disk ready to be used

later.

Although the voice sounds very much like my own, the speed may be changed so that I can sound like Mickey Mouse or a very old man. Every word is produced through the cassette AUX plug connected to an amplifier.

Speak is an excellent program with many applications. I have never seen a program of this type before, and I believe that programmers would find this especially helpful. Speak's clarity is excellent, and I highly recommend it to anyone wanting a way to put voices in their programs.

Tim Knight

**Crayon  
Model I/III,  
PMC-80, LNW80  
Pioneer Software  
1746 NW 55th Ave. #204  
Lauderhill, FL 33313  
\$35 tape  
\$45 disk  
Pioneer Software, the maker of the**

excellent "Scriptr" program, has come out with another impressive program. It is a program for the TRS-80 Model I/III owners with either disk or cassette and it is appropriately named Crayon.

It is named Crayon because it literally turns your screen and keyboard into just that. With the Crayon program, it is possible to draw and modify graphics on your TRS-80 screen. But that is only the tip of the iceberg, as far as Crayon's power goes.

In brief, here are some of the fine features of this program that took one and a half years to write. Crayon will allow you to typeset logos. For instance, if you are part of a company, say, "Acme Green Beans," you can use a simple command to get "Acme Green Beans" printed in bold graphics letters on your paper. Doing this is much less expensive than having the same job done at a printing shop. You don't even have to be part of a company — maybe you'd like your

STATEMENT OF OWNERSHIP, MANAGEMENT AND CIRCULATION (Required by 39 U.S.C. 3685)		
1. TITLE OF PUBLICATION 80-U.S. Journal	2. PUBLICATION NO. 0 1 9 8 1 0 3 5	3. DATE OF FILING 1 Oct 82
4. FREQUENCY OF ISSUE Monthly	5. NO. OF ISSUES PUBLISHED ANNUALLY 12	6. ANNUAL SUBSCRIPTION PRICE \$16.00
7. COMPLETE MAILING ADDRESS OF KNOWN OFFICE OF PUBLICATION (Street, City, County, State and ZIP Code) (Not printers)		
3838 South Warner St., Tacoma, Washington 98409		
8. COMPLETE MAILING ADDRESS OF THE HEADQUARTERS OR GENERAL BUSINESS OFFICES OF THE PUBLISHERS (Not printers)		
3838 South Warner St., Tacoma, Washington 98409		
9. FULL NAMES AND COMPLETE MAILING ADDRESS OF PUBLISHER, EDITOR, AND MANAGING EDITOR (Full name MUST NOT be blank)		
PUBLISHER (Name and Complete Mailing Address) Irvin Mike Schmidt 3838 South Warner St., Tacoma, Washington 98409		
EDITOR (Name and Complete Mailing Address) Cameron C Brown 3838 South Warner St., Tacoma, Washington 98409		
MANAGING EDITOR (Name and Complete Mailing Address) ---		
10. OWNER (If owned by a corporation, its name and address must be stated and also immediately thereunder the names and addresses of stockholders owning or holding 1 percent or more of total amount of stock. If not owned by a corporation, the names and addresses of the individual owners must be given. If owned by a partnership or other unincorporated firm, its name and address, as well as that of each individual must be given. If the publication is published by a nonprofit organization, its name and address must be stated. If item must be completed)		
FULL NAME COMPLETE MAILING ADDRESS		
Irvin M Schmidt Pres/Treas 7574 68th Ave W, Tacoma WA 98467		
Kristine E Schmidt, Vice Pres 3611 S 10th St Tacoma, WA 98405		
Helene Schmidt, Sec 7574 68th Ave W, Tacoma WA 98467		
11. KNOWN BONDHOLDERS, MORTGAGEES AND OTHER SECURITY HOLDERS OWNING OR HOLDING 1 PERCENT OR MORE OF TOTAL AMOUNT OF BONDS, MORTGAGES OR OTHER SECURITIES (If there are none, so state)		
NONE		
12. FOR COMPLETION BY NONPROFIT ORGANIZATIONS AUTHORIZED TO MAIL AT SPECIAL RATES (Section 4113, DMM only) (The purpose, function, and nonprofit status of this organization and the exempt status for Federal income tax purposes (Check one))		
<input type="checkbox"/> HAS NOT CHANGED DURING PRECEDING 12 MONTHS <input type="checkbox"/> HAS CHANGED DURING PRECEDING 12 MONTHS (If changed, publisher must submit explanation of change with this statement.)		
13. EXTENT AND NATURE OF CIRCULATION	AVERAGE NO COPIES EACH ISSUE DURING PRECEDING 12 MONTHS	ACTUAL NO COPIES OF SINGLE ISSUE PUBLISHED NEAREST TO FILING DATE
A. TOTAL NO COPIES (Net Press Run)	24125	31000
B. PAID CIRCULATION 1. SALES THROUGH DEALERS AND CARRIERS, STREET VENDORS AND COUNTER SALES 2. MAIL SUBSCRIPTION	7698 12933	13668 14132
C. TOTAL PAID CIRCULATION (Sum of B1 and B2)	20631	27800
D. FREE DISTRIBUTION BY MAIL, CARRIER OR OTHER MEANS, SAMPLES, COMPLIMENTARY AND OTHER FREE COPIES	1180	1425
E. TOTAL DISTRIBUTION (Sum of C and D)	21811	29225
F. COPIES NOT DISTRIBUTED 1. OFFICE USE, LEFT-OVER UNACCOUNTED SPOILED 2. RETURN FROM NEWS AGENTS	2309 405	1775 0
G. TOTAL (Sum of E, F1 and F2 - should equal net press run in 13)	24125	31000
14. I certify that the statements made by me above are correct and complete		
SIGNATURE AND TITLE OF PUBLISHER, BUSINESS MANAGER OR OWNER <i>[Signature]</i>		



**FILE TRAN**

**SALE TRS-80® / MOD I SALE**

**OMIKRON SYSTEMS**

**COUGARS**, get **FILETRAning** from TRS DOS to CP/M® and from CP/M® to TRS DOS.

You've got both operating systems, USE 'EM-MIX 'EM.

Don't be **Inhibited** any longer ... **FILETRAN it!**

And remember ... **FILETRAN** is more than just a **FILETRANsfer** program ... disk dump, memory dump, MBASIC conversion aids and more .... **HIGH SPEED** disk to disk **FILETRANSFER** - no MODEMS required.

Osborne I Users, call for special introductory offer.  
Martin Data Systems Users, call for special introductory offer.  
Mod. III Users, call for special introductory offer.

**FILETRANit!**

**ORDER LINE**  
1-800-547-5995, ext. 8080  
1-800-452-8847, ext. 8080  
(Oregon)

**TECHNICAL HOTLINE**  
(303) 945-8166

**WAS \$149.00**  
**NOW \$ 49.00** (2-way)

---

**SAVINGS = \$100.00**

Sale ends January 31, 1983

Add \$3.00 Shipping, USA  
\$10 Shipping Outside USA  
COD. Add \$1.50  
COLORADO RESIDENTS:  
Add 3% Sales Tax

**BUSINESS MICRO PRODUCTS**

311 1/2 8th - Suite 400  
Glenwood Springs, Colorado 81601

TRS-80® Trademark of Tandy Corporation.  
CP/M® Trademark of Digital Research.

VISA  # 63

name printed in huge letters on your paper! Crayon allows you to create and run real-time cartoons. These are not shoddy, flicker-filled creations, either. Crayon has the power to run the cartoons you make at thirty-five screens (or frames, if you wish) every second!

In addition, this program will maintain a full disk directory for you, along with commenting and searches for your directory.

One of Crayon's main functions allows you to draw anything on the screen you would like, and then save it to either tape or disk.

Also available with Crayon is the ability to keep an appointment schedule. Using the thirty-frame storage area, you may keep a full month's appointments on your system! I think this is an especially creative idea of Pioneer.

Crayon allows you to do virtually anything you would do with a video worksheet, but much more efficiently and effectively.

You use the screen as a drawing board, then send that drawing to

your printer, tape or disk file. This is much easier to do than drawing out your picture on a graphics worksheet, then trying to transfer your picture from paper to computer.

Of course, using a cursor to form these pictures might get a little difficult, since the cursor is the same as the graphics. Pioneer has planned ahead for that. Crayon has a nine-character cursor that surrounds the character but never covers it and is always clearly visible in any display. Along with that, there are sixteen different commands for efficient graphics entry, for things like title pages and bar graphs.

Crayon can work in conjunction with another fine program from Pioneer Software called Scriptr. Using the two together, you can load in a picture from Crayon, temporarily halt the printing of Scripsit, then send the picture directly to your printer!

The thirty-screen buffer is another handy item to have, especially considering the imaginative

possibilities. Lists and records can be kept within the thirty-screen buffer, which may also be used to print mailing labels! Crayon certainly is a number of great individual programs rolled up into one package.

Using Crayon as a text or graphics processor is well supported by many sub-commands. These are all covered in the easy to understand forty-page documentation. These commands include functions for deleting, inserting, exchanging and inverting graphics. One might think that with all of those graphics within a print-out, that print justification (the alignment along the side of the paper) would be lost. Not so! Crayon makes sure that no matter how many graphics you create, the print-out will remain justified.

Crayon is a professionally done program. It has fine documentation, excellent versatility and great features. If you work with graphics, either on the video screen or paper, I recommend that you buy Crayon. It

**"NEW! Plug-in products add Speed, 80-Column Video, Memory and other quality features to your TRS-80"**

Model I/III  
"80 Character Video"



80 x 24

"Model III Speed-up" \$99.50



"Memory mapped" (allows peek & poke) — NO SOFTWARE DRIVERS. COMPATIBLE W/TRS-DOS® & others.

Model I VX-1	\$179.00
Model III VX-3	\$199.00

*Introductory pricing good thru 12/31/82*

**holmes engineering inc.**  
3555 South 3200 West  
Salt Lake City, Utah 84119  
(801) 967-2324



# 64

One year warranty on all products. Add Shipping/Handling - Mainframe \$9.00 U.S., \$15.00 Canada, Overseas \$30.00. All other products \$5.00 U.S. & Canada, all others, add 15%. Prices subject to change without notice. Dealer inquiries invited. For information send Self-Addressed Stamped Envelope. Reader Service takes 8 weeks.

From Computer Plus to YOU ...

## PLUS after PLUS after PLUS



Model 16 128K  
1 Drive \$4199  
2 Drive \$4799



Color Computer 16K \$249  
w/16K Ext. Basic \$335  
w/32K Ext. Basic \$449



Model III 16K \$799  
Model III  
2 Disk & RS232 c \$1899



Okidata 80 \$325  
Okidata 82A \$425  
Okidata 84 \$1029



Color Computer Disk Drive  
Drive 0 \$470 Drive 1 \$315



Smith Corona TPI  
Daisy Wheel \$599

**BUY DIRECT** Here are just a few of our fine offers ... call TOLL FREE for full information.

<p><b>COMPUTERS</b></p> <p>Model II 64K \$2999 Model III 4K LEV I 599 Model III 16K 799 Model III 32K 850.50 *MODEL III 32K 831.50 Model III 48K 914 *MODEL III 48K 864 Model III 48K 864 2 Disk &amp; RS232 c 1899 Color Computer 16K 249 Color Computer 16K w/extended basic 335 Color Computer 32K w/extended basic 469 Color Computer 32K-64K w/extended basic 510 Pocket Computer 2 230 Model 16 1DR 128K 4199 Model 16 2DR 128K 4799 DI-1 Data Terminal 599 PI-210 Portable Terminal 779</p>	<p><b>MODEMS</b></p> <p>Lynx Direct Connect MII/III 235 Hayas Smart Modem II 235 R S Acoustic Coupler AC-3 134 R S Modem I D C 130 R S Modem II D C 210</p> <p><b>PRINTERS</b></p> <p>Daisy Wheel II 1715 DWP-410 1335 Smith Corona TPI Daisy Wheel 599 Epson MX80 599 Epson MX80 FT 549 Epson MX100 735 CGP-115 199 DMP-100 315 DMP-200 599 DMP-400 1029 DMP-500 1569 Microline 80 325 Microline 82A 425 Microline 83A 679 Microline 84 Parallel 1029 P. C. Plotter Printer 199</p>	<p><b>DISK DRIVES</b></p> <p>R S Model III 1ST-Drive 679 Tandon 40 Track MI 289 Color Computer Drive 1 315 Color Computer Drive 0 470 Primary Hard Disk Mill 3999 Primary Hard Disk Mill 1999</p> <p><b>ETC.</b></p> <p>CCR-81 recorder 52 C C Joysticks 22 16K RAM N E C 200 N S chips 25 64K Ram Chips 75 Color Computer Files D O S 99 Brand Name Software + Send for listing R S Software 10% off list</p> <p>*Computer Plus New Equipment with NEC RAM installed 180 Day Computer Plus Warranty Color Computer 64K requires Disk 0 and Files D O S</p>
--	--	---

# 65

We have the lowest possible Fully Warranted Prices AND a full complement of Radio Shack Software.

# 65

**computer plus**

TOLL FREE 1-800-343-8124

P.O. Box 926  
480 King Street  
Littleton, MA 01450  
617-486-3193

Write for your free catalog

Prices subject to change without notice. Not responsible for typographical errors. TRS-80 is a registered trademark of Tandy Corp.

is very reasonably priced, and certainly well worth it. In my experience with Pioneer Software, they are courteous and willing to answer any questions you might have about their software. These things — good software, good documentation and good software support — are what make purchasing and using software enjoyable. Crayon is a superb program. If you think you might need anything like it, buy it.

Tim Knight

**BETA-80  
Model I  
MECA**

56677 Sunset Avenue  
Yucca Valley, CA 92284  
(714) 365-7686

\$699 single density  
\$849 double density

One of the most persistent, and potentially expensive, problems

microcomputer users run into is how the heck he or she is going to store programs and data. The ubiquitous tape recorder is slow, error prone, generally cumbersome to operate, has limited storage and retrieval capabilities, and is quite inexpensive. One the other hand, floppy disk systems are very fast, much less error prone, computer operated, have excellent storage and retrieval qualities (90K to multi-megabytes), and are very expensive!

These alternatives are also true for TRS-80 owners. To make the leap from cassette to disk involves the purchase of an interface (\$299 without memory), one or more disk drives (\$495 from Radio Shack, as low as \$300 from some sources) and disks (about \$5-8 per disk usually). That's over \$800 for 90-120K bytes of storage! When my time of truth arrived, I was bound and determined to find effective mass storage at low cost.

I pored over computer journals and searched computer stores for months before I learned about a small company in California called MECA. They had just begun production of a digital cassette storage device called the BETA-80 which was designed to interface directly with the TRS-80 Level II. The promotion literature promised 512K bytes of formatted storage on two tracks per drive (256K per track in 1000, 256-byte blocks) and up to four drives on-line at once. Each track could hold up to sixty-four file names, which could be used to access any combination of BASIC, machine language program or data. The BETA-80 has its own microprocessor and runs asynchronously. This means that it runs independently of the main computer and communicates with it in much the same way that a terminal might, a very nice feature. Access time to any point on any track is thirty-six

AUTOMATED ELECTRONIC MAIL PICK-UP & DELIVERY

# electronic mail

**A PERFECT TRIO** - The Hayes Stack Smartmodem, ACEMAIL, and the TRS-80. Now you can access other computers and information systems nationwide over the telephone!

The unique Automated Computer Electronic MAIL package allows you to send and receive ASCII files from your **COMPLETELY UNATTENDED TRS-80!** The new, highly sophisticated version 1.4 works in conjunction with the popular Hayes Stack Smartmodem featuring auto-answer/auto-dial, RS232C compatibility, 0-300 baud, 7 LED indicators, an audio monitor, over 30 commands, and is programmable in any language. ACEMAIL operates with NEWDOS/80 or DOSPLUS and is supplied on 'tiny' DOSPLUS - ready to run!

HAYES STACK SMARTMODEM - \$239  
ACEMAIL SOFTWARE 1.4 - \$79



**NEW! 4 TIMES FASTER!!!  
SMARTMODEM 1200 - \$649**

ACEMAIL 1200 - \$119

**ACE COMPUTER PRODUCTS  
OF FLORIDA, INC.**

# 66

1640 N.W. 3rd St. Deerfield Beach, FL 33441  
Data (305) 427-6300/Voice (305) 427-1257

MC/VISA accepted FL res add sales tax Freight incl (UPS ground-Cont USA)

**1-800-327-2283**

## Convert Your TRS-80\* into a World Class Computer

**THAT REDUCES EYE FATIGUE  
AND DOESN'T FLICKER**

— with LSI's new *Soft-View*™ Replacement CRT —

The black & white "TV Screen" CRT (picture tube) which came with your TRS-80\* is an inexpensive rapid "P4" Phosphor CRT intended for TV use. The display is actually strobing 60 times a second. No amount of "green plastic" will stop this strobing or eliminate the eye fatigue it causes. But a new *Soft-View* CRT display tube with a slower decaying, colored Phosphor will.

- Available in slow-decay green (similar to new IBM\* and APPLE III\* monitors) or medium decay "European Orange" (easy on the eyes, elegantly beautiful, and the standard for CRT displays in Europe).
- Leaded glass stops X-ray emission.
- Optional Anti-Glare Frosted Glass available to reduce eye strain from glare.
- Easy installation — tubes come with pre-mounted hardware.
- 30-Day Money-Back Guarantee, 1 Year Warranty.
- Ideal for Word-Processing & Programming, fast enough for Games & Graphics.
- Finest quality double-dark glass and phosphor fields make the letters seem to be coming out of black space.

LSI SYSTEMS *Soft-View*™ CRT's:

- #GN42 Green Phosphor \$79.95
  - #GN42G Green Phosphor with anti-glare \$89.95
  - #OR34 Orange Phosphor \$89.95
  - #OR34G Orange Phosphor with anti-glare \$99.95
- ADD \$7 FOR PACKAGING AND UPS SHIPPING.



Langley-St.Clair To Order Call:

**Instrumentation 1-800-221-7070**  
Systems, Inc. Or ask your Local Dealer.

132 West 24th Street, New York, N.Y. 10011 212-989-6876

\*IBM\*, APPLE\* and TRS-80\* are trademarks of IBM, APPLE Computer & TANDY Corp.

# 67

seconds maximum and usually much less. This combined with the fact that the computer does the searching for files by name or location (provided in the directory) made this very attractive in a cassette-based system. Then came the clincher; no interface is necessary and \$699 for the first drive! Drive two costs \$499. (Ed. note: A new double density version is available for \$849 for drive 1 and \$649 for a second drive — capable of over one megabyte of storage.)

This sounded like the answer to my prayers. The operating system allowed all cassette commands to be programmed into BASIC programs as well as by machine language and direct BASIC commands. I sent off my money and waited for it to arrive by UPS. I scanned the manual for any obvious no-nos and plugged the unit into my keyboard. The machine is self-booting just like disk and worked perfectly the first time! The instruction manual, when you get around to reading it, is complete with very good hardware and

software sections. There are numerous examples to try and directions for approved modifications to suit special needs. This is one company that is not afraid to have their equipment looked at and altered. They have sent me annotated source listings for the O.S. and complete schematics. They even have an open royalty proposition for modifications and programs sent for appraisal.

Within a few hours, I had loaded all my programs from the ridiculous pile of tapes on my desk onto two tapes (one working, one backup) with two-thirds of both tapes still empty.

I have owned my BETA-80 for well over a year now, with no more than a handful of lost bytes, usually my fault. In that time, I have acquired a second drive and modified my tape version of Scipsit to run on the BETA-80. This is available to owners of Scipsit for \$20 plus shipping (\$25 for a version that allows selection of typing mode for printers such as the MX-80). MECA

also makes available to registered owners of G2L3 Level III BASIC (Ed. note: from Microsoft, Inc. Bellevue, WA), a self-booting version that gives BETA-80 owners all the power of Disk BASIC at half the cost. Incidentally, I never bothered to get an expansion interface.

Mark A. Schimelman

**6809 Assembly Language Programming**  
**Lance Leventhal**  
**Osborne/McGraw-Hill**  
**\$16.99**

When the Motorola 6809 chip was first introduced, I was chomping at the bit to find out more about it. I questioned engineers about it and was impressed by what I heard. When I heard the Color Computer was going to use it, it became imperative for me to learn more.

I collected all the technical information I could, but nothing I collected came close to comparing with the completeness and usefulness of Leventhal's 6809

**BUY! SELL! TRADE!**  
 COMPUTER & HAM EQUIPMENT  
**COMPUTER®**  
**TRADER**  
**PERMANENT**  
**SUBSCRIPTION**  
**\$10.00**  
 Low Ad Rates — Mailed Monthly  
**COMPUTER TRADER®**  
 Chet Lambert, W4WDR  
 1704 Sam Drive • Birmingham, AL 35235  
 (205) 854-0271  
 # 68  
 Please include your Name, Address, Call Sign or Phone Number

**5-1/4 DISKBOX**  
 BARGAIN DISK STORAGE  
 Why pay \$29 to store only 50 minidisks?  
**DISKBOX HOLDS 100 MINIDISKS FOR HALF THAT PRICE.**

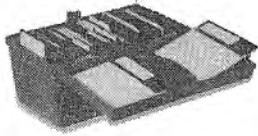

FREE - 10 tabbed index cards.  
 Follower bars hold disks in position.  
 Handle and latch provide portability.  
 Use cover as safe disk holding area.  
 High impact plastic protects disks.  
 Color - Chocolate.

**ONLY - \$14.90**

=====

**ATTENTION ALL DISK DRIVERS**  
 TIRED OF LISTENING TO THE DRIVE MOTOR FIGHTING TO SHOW THE HEAD FROM TRACK TO TRACK ??  
 END THE STRUGGLE WITH A DAB OF **DRIVE-LIFE.**

EASY TO APPLY.  
 REDUCE FRICTION.  
 ELIMINATE NOISE.  
 OWN THE QUIETEST  
 DRIVES IN TOWN.

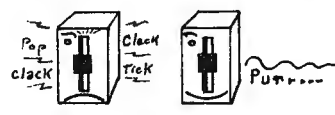

**RELIEF FOR MODEL I OWNERS**  
 STOP using abrasive erasers..... STOP eraser mess.  
 DRIVE-LIFE quickly wipes away card-edge corrosion.  
 Retards electrolysis. Decreases maintenance.

**DRIVE-LIFE.....Only \$5**  
 SAVE! - Order both DISKBOX and DRIVE-LIFE **\$18.50**

=====

LOOK=> **TABBED MINIDISK INDEX CARDS.** Pkg of 10 - \$2

THE JESSUP COMPANY Dept. NU  
 P.O. BOX 33485  
 SEATTLE, WA. 98133  
 (206) 365 5511

Check or M.O. please.  
 Moneyback Guarantee.  
 Shipped U.P.S.-p.p.

WA.res.add tax.  
 # 69

**Assembly Language Programming.**

It's a hefty book, filled with a large amount of information about the 6809 and various peripheral chips that the programmer has to know about. There's also a large amount of information on general assembly language programming which is useful even to the professional programmer. If you already have some of the Osborne/McGraw-Hill books on various microprocessors, you're already familiar with some of the information.

I've been using the book as a general reference for programming the 6809 and I've never had a real problem with it. It did take me awhile to figure out some of the intricacies of the processor such as the post byte, when to expect it and when not. Here, I got more from the programmer's card for the 6809 than from Leventhal's book.

I can't claim comprehensive application of everything in the 528 pages, but of those instructions I have used, it hasn't lead me wrong.

T.R. Dettmann

**Outhouse**

By J. Weaver, Jr.

Soft Sector Marketing

6250 Middlebelt

Garden City, MI 48135

Model I/III, \$15.95 cassette

\$19.95 disk

An arcade game about an outhouse? You've gotta be kidding!

Nope — this is Outhouse, Soft Sector M's hilarious new entry into the "original arcade game" category of TRS-80 software.

Actually, the game itself is not hilarious — just the concept of protecting an outhouse and its contents from thieves and aliens bent on destroying your ship and the outhouse below. The outhouse begins with 200 feet of paper. The enemy attacks you in waves, and after each wave that you survive, you are awarded bonus points based on how many feet of paper remain. After every fourth wave, you are also rewarded with a fifty foot roll of paper, although your total cannot exceed 250 feet.

By now, you are surely wondering what types of villainous vandals are attacking the outhouse, and what you, as a concerned citizen, can do to save the paper and the outhouse from certain destruction. First of all, there are seven different types of enemy creatures. Fireballs and rotors will try to destroy you by colliding with you. Anglers and crunchers will try to obliterate the outhouse by crashing into it. Zappers will try to destroy you by firing a laser at you. Thieves will run toward the outhouse and run out of it with the loose end of the paper, unrolling it until they leave the screen. Squatters will run toward the outhouse, enter it, use up about five feet of paper and leave.

In order to protect yourself and the outhouse from these vicious varmints, you ship is armed with a laser which never runs out, and three smart bombs, which destroy all aliens on the screen.

The game starts out fairly slow, but gets progressively faster and harder. After about wave eleven, it gets so fast that it is almost physically impossible to destroy everything without using a smart bomb. I honestly cannot remember the last computer game that I have played that was so fast moving. It really tests your skill and coordination.

So, what we have here is a game that is fast and funny. But is it a good game? I have played a few fast-action games that just did not appeal to me. Fortunately, Outhouse is not one of these. There are enough different types of aliens to give the game variety and hold your interest. There is enough variance in speed to provide a seemingly endless challenge.

The controls for Outhouse are rather difficult to master. They are similar to those of Big Five's Robot Attack, and consist of using the arrow keys for movement, any number key for a smart bomb, and the space bar and arrows for firing. The way the firing works is that you simultaneously press the space bar and the direction that you want your laser to go. It is not that hard once

## SAVE MONEY ON YOUR TRS-80<sup>®</sup> COMPUTERS

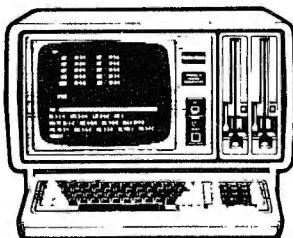

TRS-80<sup>®</sup> Model 16

### Jimscot Inc.

1023 N. Kansas — Box 607

Liberal, Ks. 67901

TRS-80 is the registered trademark of Tandy Corporation

### 1-800-835-9056

Kansas Residents — 316-624-1919 (collect)

✓ CHECK WITH US AND SAVE

- ✓ Visa or Mastercard
- ✓ Bank Cashier's Checks
- ✓ Bank Money Orders
- ✓ Bank Wire Transfers

- ✓ We now carry telephones and telephone answering systems!

\* Free Price List

# 60

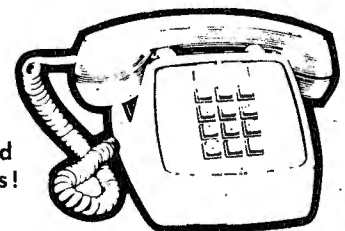

# ARRANGER

100% Machine Language Disk Index Program for the TRS-80 Model I&III.

Automatically recognizes ALL major DOS's!

The Arranger is a master index system that automatically records the names of your programs, what disks those programs are on and type of DOS. Features include —

- Automatic single and double density recognition.
- Accepts LDOS, DOS+, TRSDOS, DBLDOS, NEWDOS/80, MULTIDOS...
- Works interchangeably with Model III, I double density.
- Capacity of 200 disks, 44 filenames/disk
- Quickly locates any amount of free granules
- Finds a program in less than 30 seconds!
- Alphabetizes 1500 filenames in 40 secs.!
- Option to sort by any extension (/BAS, /CMD, /???)
- Easily updates diskettes previously added with only 2 keystrokes.
- Backup function built in.
- Uses 1 to 4 drives, 35, 40 or 80 tracks.
- Radio Shack doubler compatible

Requires 32k

1 disk minimum

**JUST ..... \$29.95**

**FREE SHIPPING**

Specify: TRS-80 Model number

(If you've added double density, to your Model I, please indicate)

**TRIPLE-D SOFTWARE**

P.O. Box 642

Layton, Utah 84041

(801) 546-2833

# 70

VISA OR  
MASTERCARD

## Reviews

you get used to it, but it can take a while to get used to it. Outhouse is joystick compatible, although you must go back to the keyboard to press a number for a smart bomb.

The sound and graphics are good (although there is no crescent moon on the outhouse). The disk version has a very high quality voice and saves the eight highest scores to disk.

Outhouse — it is fun, fast and funny. It is, perhaps, Soft Sector Marketing's best game yet. After a day, you will like it. After a week, you will love it. Call SSM sick. Call them disgusting. Call them today and order Outhouse.

**Matt Friedenber**

challenges the player by putting him or her in a complex situation and saying, "Now what are you going to do!?" This is fine until one finally decides to do something, — no list of the available commands is included. It's save game feature allows you to save the game's present condition out to tape (takes about five seconds) and then continue from that point sometime later.

Black Sanctum combines complex situations, fast machine language, and a helpful save game feature to make one of the most fun times one can have on the TRS-80 Color Computer.

**Roy Seney**

**Black Sanctum**

**Color Computer**

**16K cassette**

**Mark Data Product**

**23802 Barquilla**

**Mission Viejo, CA 92691**

**(714) 768-1551**

**\$19.95**

**Electric Webster**

**Cornucopia Software, Inc.**

**P.O. Box 5028**

**Walnut Creek, CA 94596**

**Model I/III — \$89.50**

**Model II — \$149.50**

**Options:**

**Correction Feature — \$60**

If you think that creating a text adventure for the TRS-80 Color Computer is a waste of the many graphic features available then you've made a very grave mistake. Black Sanctum has none of that, but what it lacks in graphics is made up for in complexity and difficulty.

Black Sanctum is the thinking man's adventure. It has even stumped this author as of this writing (maybe I'll complete it by publication time). When I first heard about Black Sanctum I thought, "What a welcome relief a nice quiet adventure would be from battling space rocks and U.F.O.s." I should have known that anything Mark Data Products creates could not be taken lightly. Black Sanctum is definitely not for the novice at adventuring. Black Sanctum is puzzling, perplexing, problematic, delicate, ticklish and trying — but, most of all, Black Sanctum is fun.

Without trying to spoil the thrill of discovery, the idea behind Black Sanctum is to destroy the Evil Presence of an ancient, but not yet abandoned, monastery. Black Sanctum is *not* patterned after the popular Dungeon and Dragon type games. There is no fighting or combat in it. Black Sanctum

Electric Webster is a second generation spelling checker, sometimes called Son of Microproof. Although patterned after Microproof, Electric Webster is superior in several areas. There are several possible configurations of the program; however, all testing was conducted on a 48K Model I with two 40-track, single density disk drives using the optional correcting feature integrated into the word processor, Newsprint. It was also tested using an integrated copy for Lazy Writer. Electric Webster can also be incorporated into Electric Pencil version 2.0, Scripsit, and Superscript. It can be used manually from DOS when using the older Electric Pencil, Copyart, Pensadyne and all other word processors. The integration feature is handy because the user never has to leave the word processor to invoke the spelling checker. The corrected text is automatically renamed and Electric Webster returns you to your word processor.

The standard Electric Webster operates by comparing the words in the working document against the words contained in its 50000 word dictionary. All words that are contained in the dictionary are

**TRS-80\***  
Models  
I & III



**Discount  
Prices!**

*Great Gift Ideas for Christmas!*

	Your Cost
	Tape / Disk
<b>For Little Kids (Ages 4 - 10)</b>	
Little Red Riding Hood (Adv. Int.)	11.90/ -
Old McDonald's Farm (Adv. Int.)	11.90/ -
Twas the Night Before Xmas (Adv. Int.)	11.90/ -
The Playful Professor (Med. Sys.)	11.90/14.30
<b>For Big Kids</b>	
The Eliminator (Adv. Int.)	15.90/19.90
Reign...Red Dragon (Adv. Int.)	- / 19.90
Star Fighter (Adv. Int.)	19.90/23.90
Crush, Crumble & Chomp (Auto. Sim.)	23.90/23.90
Defense Command (Big Five)	12.70/15.90
Robot Attack (Big Five)	12.70/15.90
Pe :ik (Fantastic)	15.90/19.90
The Institute (Med. Sys.)	15.90/18.30
Laser Defense (Med. Sys.)	11.90/14.30
Strike Force (Melbourne)	13.55/16.95
<b>For the Office</b>	
Personal Check Mgr. (Adv. Int.)	- / 19.90
Mail List (Precision Proto.)	- / 71.90
Electric Webster (Prosoft)	- /119.60
Newsprint 7.0 (Prosoft)	- / 99.90
Newsprint 7.0 & Labels (Prosoft)	- /111.90

*Check reader service for our catalog.*

**RIMES COMPUTER PRODUCTS**

262 Tracey, Dept. 12B  
Grand Island, N.Y. 14072  
(716) 773-2519

Add \$1.50 for U.S. shipping. Add \$1.50 for COD  
Add \$4.50 for Canada or Mexico

For fastest service send M.O. or cert. check,  
Mastercard/Visa also accepted

Allow 2 weeks for personal checks. # 71

New York Residents add sales tax.

\*TRS-80 is a trademark of Tandy Corp



listed out on the screen or optionally, on a printer. This list of words becomes a list of "potential errors." I say potential, because a word will appear in the list if it is spelled correctly but not contained in the dictionary. Proper names, plural forms of nouns, and many technical buzzwords are not included in the original dictionary. You then take the list of potential errors and correct the document using the global search and replace features of your word processor. This method is probably sufficient for those who do not have a large amount of material to proof; but, if you do a lot of writing, the optional correction feature would be a wise investment.

Using the optional correction feature is very handy and simple. After the list of potential errors appears, the user hits the ENTER key and is presented with the first word that was identified as an error. The user has six options at this point, each one requiring only one keystroke. The first option is simply to leave the correctly spelled word "as is" without adding to the dictionary. If the word is correctly spelled and will be commonly used in the future, you may decide to add the word to the expansion dictionary. This allows the user to tailor the dictionary to specific needs. If you know the correct spelling, correct it by simply typing in the word and hitting ENTER (option three). The fourth option is to simply exit the correcting feature once all of the necessary corrections were completed.

Options five and six require a bit more explanation and are features that make Electric Webster unique. You may be unsure of the correct spelling and can choose to display the dictionary. After hitting the proper key, you are presented with a list of words in the dictionary, with words above and below where the word in question would appear. Electric Webster actually shows you where that word would appear in relation to several words on either side of it. You can then scroll forward or backward through the dictionary in order to find the correct spelling. This feature is extremely useful if the misspelled word is very close to the correct spelling. Most of the time, the word will appear in the

close proximity on the displayed dictionary. If the correct word is found, another feature allows you to scroll the dictionary until the proper word appears on the bottom line and by hitting a key, will automatically replace the misspelled word.

Another handy feature covers when you know the word is misspelled, and are unsure of the correct spelling. Type the proposed new spelling, preceded by an "@"." If it is already in the dictionary, it will automatically replace the misspelled word. If it is not correct, Electric Webster will take you to the part of its dictionary where the new spelling would have appeared.

The last option is to ask to see the word displayed in context. Here you have the opportunity to see where the word appears in relation to a small portion of the text. However, the only options available while in this mode are to leave the word "as is," type in the correct spelling, or leave it "as is" and skip all subsequent context displays of that particular word.

After all of the words are proofed, the dictionary is automatically expanded and then the corrected text is either written over the original text or a backup copy is made. The entire process is transparent to the user and if disk swapping is necessary, the program prompts you on which disk to insert. On a two-drive, single density computer, four disks are involved: Your normal word processor, the Electric Webster system disk, the dictionary disk and your text disk. On a double density system, disks three and four can be combined. Single-drive owners can also use Electric Webster by swapping disks more often.

The most outstanding feature is its speed. It took a total of seventy-four seconds to produce the list of potential errors for a 2000-word text. Another impressive feature is the compactness of the dictionary. The 50000-word dictionary fits into only 104K of disk space. Electric Webster is truly a state-of-the-art product that performs flawlessly and effortlessly. If you need a spelling checker and have not purchased one as yet, Electric Webster is certainly an outstanding choice.

Jim Klaproth



If you use a Word Processor, you need

## GRAMMATIK™

### Beyond Spelling Checking

Grammatik can find over 15 different kinds of common errors missed by simple spelling checkers alone, including punctuation and capitalization errors, overworked and wordy phrases, and many others. Use Grammatik with Aspen Software's spelling checker Proofreader, featuring the Random House Dictionary®, or with your current spelling checker for a complete document proofreading system.

#### Read what the experts say:

"The perfect complement to a spelling checker."

Alan Miller, Interface Age, 5/82

"A surprisingly fast and easy tool for analyzing writing style and punctuation."

Bob Loudon, InfoWorld, 12/81

"Anyone involved with word processing in any way is encouraged to get this excellent program."

A.A. Wicks, Computronics, 6/82

"A dynamic tool for comprehensive editing beyond spelling corrections."

Dona Z. Meilach, Interface Age, 5/82

"A worthy and useful addition to your word processing software."

Stephen Kimmel, Creative Computing, 6/82

Works with CP/M®, IBM-PC®, TRS-80®

**Grammatik \$75.00**  
**Proofreader \$50.00**

Order directly from Aspen Software, or see your local dealer. Specify your computer system configuration when ordering! Visa, Mastercard accepted.

Random House is a registered trademark of Random House, Inc. Other registered trademarks: CP/M: Digital Research -- TRS-80: Tandy Corp. -- IBM: IBM -- Proofreader, Grammatik: Aspen Software Co.

**Aspen Software Co.**

P.O. Box 339-E Tijeras, NM 87059  
(505) 281-1634



## KOUPON KEEPER

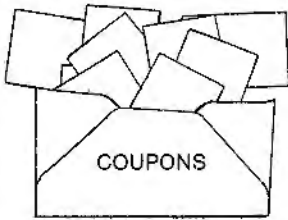

Which do you prefer? No system for filing and retrieving coupons? Or a quick, easy to use index program that lets you review your coupons in 5 different ways? The choice is yours. For the TRS-80 1 & 3, LVL 2, just \$9.75 postpaid.

### KENSOFT

2102 - 50th Street  
Kenosha, WI 53140

# 72

**LARGECAPACITYSYSTEMSLAR**  
**SMALL & (REQ. 32K 2 DISKS)**  
**LARGE CAPACITY**  
**ACCOUNTS RECEIVABLE**  
**FOR MODEL I/III**  
**5000+CUSTOMERS**  
**15000+ TRANSACTIONS**  
BALANCE FORWARD 99 TRANS CODES  
30-60-90-120 AGED STATEMENTS SHOW  
DATE/INV#/DESCRIP/AMT (WITH AGEING)  
SELECTIVE FINANCE CHARGES & RATES  
RATES, FAST ENTRY, POSTING W/AUDIT  
REPORT SUB-ACCTS % OF CREDIT LIMIT,  
DATE OF LAST PAYMENT SALES ANALYSIS  
SPECIAL 90 DAY ACCOUNTS LABELS

**\$ 99.95**  
TEST SET \$50.00 MAUAL ONLY \$30.00

**HOLMAN D-P SERVICE**  
2059 WEST LINCOLN 3.00 S&H  
OROVILLE, CA 95965 VISA OR MC  
916-533-5992 COD\*  
\*COD (CASH, CERTIFIED, OK, MONEY ORDER)

**LARGECAPACITYSYSTEMSLAR**  
**EMSLARGECAPACITYSYSTEM**

# 73

## GIANT Introductory Offer!

### NEW FLIGHT SIMULATION GAME WITH ADF NAVIGATION!

Mission-bomb and strafe. Take off, navigate by ADF/DME to target and back and land on runway. You might have a dogfight, stall, run out of fuel, overshoot landing...lots can happen! Instrument panel, air strip, fighters, etc.  
...all in graphics.

#### SUPER BONUS!

7 personal programs including  
Income Tax, Mail List, etc..  
**OVER \$100 VALUE!**

All for **\$29.95** Disk only.  
Requires 32K-TRS 80 M I/III™  
**BAP\$ Software** Tandy Corp.

8011 San Felipe Houston, TX 77057

# 74

## Reviews

**Dunzhin**  
**Model I/III**  
**48K tape or disk**  
**Med Systems Software**  
**P.O. Box 3558**  
**Chapel Hill, NC27514**  
**(800) 334-5470**  
**\$29.95 + \$2 s/h**

Dunzhin is part one of a trilogy of fantasy role-playing adventure games. (Ed. note: *KAIV* and *The WYLDE* are the other two.) Your goal is fame, fortune and retrieval of a precious object buried deep in the Dunzhin. Machine language programming makes this role-playing adventure fast and furious.

You begin as a level one warrior armed with a magic wand, minimum armor, sword and treasure pouch to fill with goodies. Starting at the first level of the Dunzhin, you work your way down to the last level where the mysterious gift is kept. The Dunzhin varies from four to seven levels and contains fifteen rooms on each level. The rooms are arranged randomly in each adventure so there is no way to determine a pattern. Three of the rooms in the Dunzhin contain poisonous gas, three others teleport you to various places in the maze, and three more are regeneration rooms that heal you if you run into some trouble. There are also rooms scattered about to repair armor, weapons and recharge your wand.

Probably the most exciting feature of Dunzhin is its mapping

feature. As you progress the various levels, a map is automatically drawn. This map is never erased. Even if you got to a different level, when you return the map will still be there. The rooms are shown on the map with the letters A through O. You enter the room by placing your warrior directly on the letter. Be careful, Med Systems has thrown in some traps to add to the fun.

Movement is accomplished with a number for steps, and a letter for direction. For example, W9 would move your warrior nine steps to the West. If you have not been through this part of the maze you have no way of knowing where the walls are. Of course, you don't want to go too slow, monsters have a way of popping up.

Monsters have three levels of difficulty and you might be confronted by one or five. Different parts of the body are easier to hit on different monsters. There is also a wandering thief who occasionally takes your treasure pouch. Occasionally, there is a fog which totally obscures the Dunzhin.

In all fantasy games battles are always the best part and that's also true in Dunzhin. When you encounter a monster, or many monsters, you can try to hide or run or fight. Hiding and running are randomly "rolled" or decided. If you're a Storm Bull and decide to fight, you choose a location — head, chest, leg, etc. — and start swinging. Again it's chance and skill that determines if you slay the enemy. Should you be lucky enough to fend off the enemy, you may move up the warrior scale. With each rank comes better armor, greater attack skill, and of course, tougher monsters.

Either Dunzhins or characters may be saved at anytime. A character can gain experience and then be saved to play in a different Dunzhin or the entire Dunzhin can be saved. You may save up to five of each. Saves are done at high speed and do not disrupt the play of the game.

The game is a must for fantasy role-playing adventurers. If you RuneQuest or Dungeons and Dragons, you should enjoy Dunzhin. It's fast, exciting and features most of the ideas of role-playing games.

Mark E. Renne

**FANTASY**

Castle of Doom \$14.95 each House of Shades

Fantasy programs require 32K RAM, Model I/III, Level 2 Basic.  
Send orders or \$1 deductible for our catalogue to.

**Software Magic**  
P.O. Box 2184, Bramalea, Ont.,  
Canada L6T 3S4

# 75

# How to hunt for hidden treasure with your TRS-80.

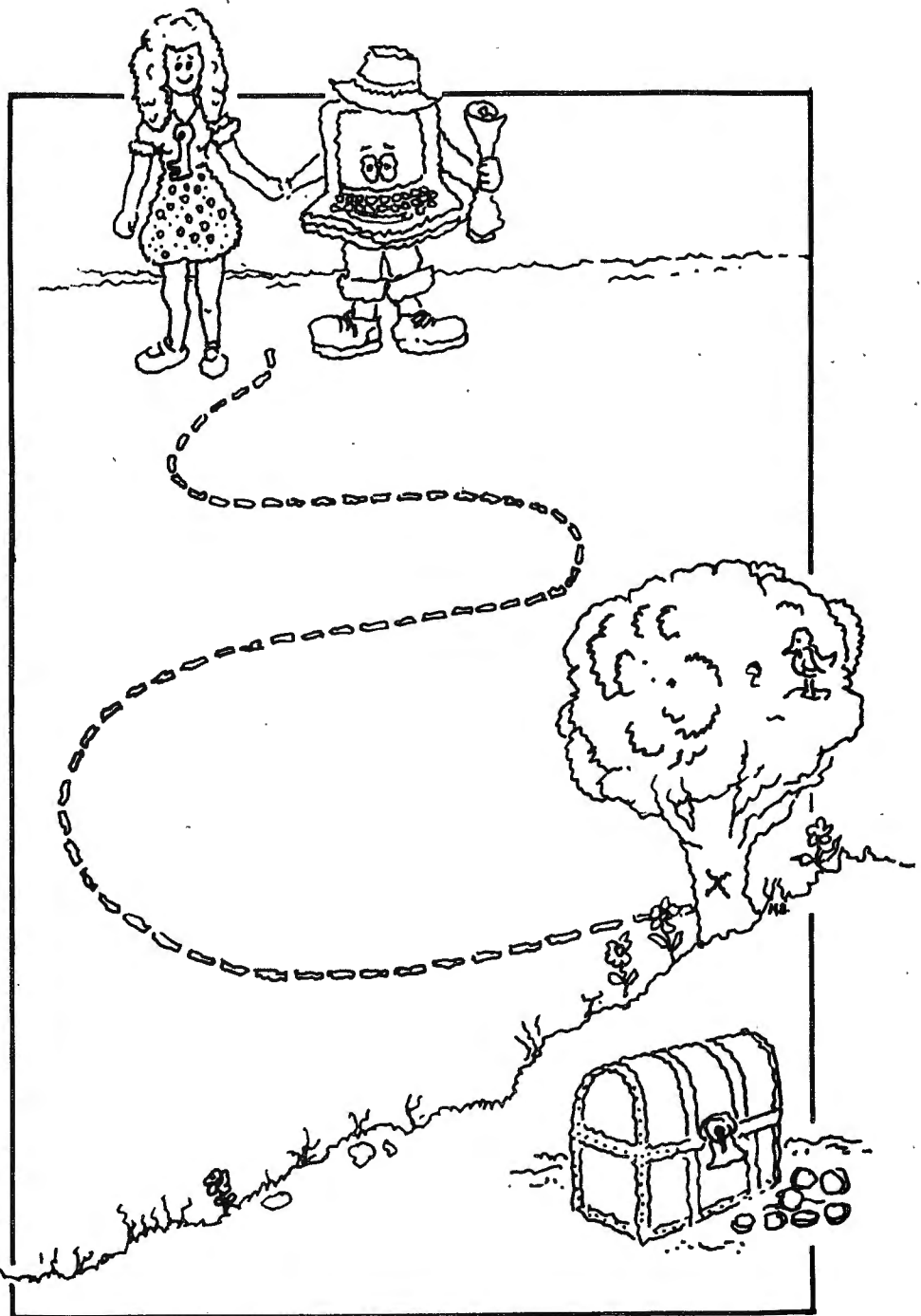

## Captain 80 Book of BASIC Adventures.

Thar's GOLD in them thar plots! Eighteen tantalizing, challenging fantasy adventures in which YOU play the role of adventurer and hero! Finding treasures and achieving goals while trying to avoid deadfalls and other insidious obstacles are just a few of the things you'll experience in the *Captain 80 Book of BASIC Adventures*.

This 252-page book contains eighteen exciting adventures edited by Bob Liddil of The Programmer's

Guild. Seven chapters tell you the what, when, where, why and how of adventures, including how to play, write and sell your own programs. Although written for the TRS-80 Models I and III, these adventure programs will easily adapt to most computers using Microsoft® BASIC.

The highlight of this book is the Adventure Generator. This program requires disk BASIC and will actually write another BASIC program around your imaginative instructions!

Please send \_\_\_\_\_ copies of the ADVENTURE BOOK for only \$19.95 each, plus \$2.05 shipping and handling. Check, M.O., VISA/MC# enclosed. C.O.D. orders accepted.

Name \_\_\_\_\_

Address \_\_\_\_\_

City \_\_\_\_\_ State \_\_\_\_\_ Zip \_\_\_\_\_

VISA MC \_\_\_\_\_ Exp Date \_\_\_\_\_

Signature \_\_\_\_\_

SEND TO:  
80-NW Books  
3838 So. Warner St., Dept. C, Tacoma, WA 98409  
DEALER INQUIRIES INVITED

# Screen dump utility

## A tiny word processor

Model I/III, PMC-80, LNW80

Alfred L. Brophy, III, West Chester, PA

A number of programs have been published that dump the contents of the TRS-80 screen to a printer. Some of them delete spaces, and others store the text to be printed in a buffer before printing it. Although these features can have some advantages, I wanted a screen-dump utility that dumps directly from the screen to the printer and provides an exact copy of the screen contents without changing the text in any way. I was also dissatisfied with the inefficiency of the programs that store every line in a string before printing it. I would rather have the text printed immediately, thus avoiding the use of any extra variables.

I decided to write my own screen-dump routine and, wanting to make it really concise, set out to write a one-line program. Here is the program:

```
20 FOR A=15360 TO 16320 STEP 64:FOR B=A TO A+63: LPRINT CHR$(PEEK(B)); :NEXT B:LPRINT: NEXT A
```

The program works by PEEKing into screen memory, and then LPRINTing the CHR\$ value of the memory location just PEEKed. After printing 64 characters, the printer advances a line and begins printing again. In this way the screen is dumped to the printer exactly as it appears.

If you are dealing with graphics, you might like to maintain about the same height-to-width ratio on the printer as on the video screen. To accomplish this, change the screen dump routine to:

```
20 FOR A=15360 TO 16320 STEP 64: FOR B=A TO A+63: LPRINT CHR$(PEEK(B)); :NEXT B:LPRINT:LPRINT: NEXT A
```

This adds an extra linefeed between each line so the printout will be double spaced. The printout of a full screen will now be 6.4" wide by 5.3" high, about the same height-to-width ratio as the screen. This assumes that your printer is set to print ten characters per inch.

This routine has a number of uses. It can be called as a subroutine in programs that require minimal printer output. It can easily be expanded into the following word processor:

```
10 A$=INKEY$:IF A$=CHR$(13) THEN PRINT CHR$(15);: GOTO 20 ELSE PRINT CHR$(14);A$;:
```

106 80-U.S. Journal

GOTO 10

20 (same as line 20 above)

The word processor works by using INKEY\$ to get keyboard input. It checks to see if ENTER, CHR\$(13), has been pressed. If ENTER has been pressed, the program turns off the cursor, CHR\$(15), in order to omit the cursor from the printout. It then proceeds to the screen-dump routine at line 20. If, on the other hand, ENTER has not been pressed, the cursor is turned on, CHR\$(14), and the INKEY\$ character is displayed. The GOTO statement at the end of line 10 repeats this process.

Now RUN the program. Type anything you want, up to one full screen. You can use the arrow keys to position the cursor to the spot where you want to type. See Table 1 for a description of the uses of the arrow keys and other control keys in this program. If you make a mistake, use the arrow keys to position the cursor over the character you mistyped, and type over it. When you want to dump the contents of the screen to the printer, press ENTER, which transfers control to the screen-dump routine. If you have a lowercase modification installed in your computer be sure to use your lowercase driver with this program, otherwise the PEEK values will not be correct.

Table 1

Tiny Word Processor Commands

Command	Use
Backarrow	Backspaces cursor and erases character.
Shift backarrow	Backspaces cursor; does not affect any character.
Forwardarrow	Has no function.
Shift forwardarrow	Advances cursor one position;
Uparrow	Prints up arrow.
Shift uparrow	Upward linefeed; does not affect any character.
Downarrow	Places cursor at start of next line and erases that line.
Shift downarrow	Has no function.
CLEAR	Clears screen from cursor's position to end of screen.
ENTER	Dumps screen to printer. ■

# CompuKids<sup>TM</sup>

## Magazine and Club

(Special school rates available)

### MEMBERSHIPS INCLUDE:

**1 year magazine subscription**  
**Contests with GREAT prizes**  
**Free Computer Advice**  
**Program Exchange**  
**Educational Programs**  
**....and lots more....**

- One year subscription *plus* one year membership in CompuKids Club — \$24.00 (Canada — \$31.00)
- One year subscription only — \$16.00 (Canada — \$20.00)
- Six month trial subscription — \$9.00 (Canada — \$11.00)
- Payment enclosed (check or money order)
- Please bill me later (a \$1.00 billing fee will be added)

Name \_\_\_\_\_

Age \_\_\_\_\_

Address \_\_\_\_\_

City \_\_\_\_\_ State \_\_\_\_\_

Zip Code \_\_\_\_\_ Phone \_\_\_\_\_

Signature (if billing) \_\_\_\_\_

**Mail check or money order  
today to:**

CompuKids Magazine  
P.O. Box 874  
Sedalia, Mo. 65301

**Or Call TOLL FREE:  
1-800-822-KIDS**

# 122

---

# Let's have a party

*For children of all ages*

For all models

Alan Mandell, Portsmouth, VA

So, you are going to host a birthday party for your child. Do you anticipate, with trepidation, several hours of high noise levels and chaotic destruction of your furniture? Perhaps there is a way for your child to have a successful party and for you to retain your sanity while protecting your property.

This article offers some ideas and programs for a different type of preteen party. By mixing computer-centered activities with other birthday festivities, you may be able to survive an indoor celebration with this age group.

The listings provide some program outlines which are built around children's party games. They provide opportunity for interaction with the computer. The listings are outlines of possible procedures. You will want to use them as models, and insert your own "forfeits" and "treasure hunt" clues. You can also add animation and sound to the programs, if you desire.

Listing 1 provides a program for Forfeits. Lines 1000-1010 grab the attention of the party goers. The OUT 255,4 and OUT 255,0 make it possible for taped music to be played while the graphics are displayed. You will have to change the length of the time loop T to fit the amount of music you wish to play. After the players enter their names (lines 20-25), the computer randomly picks a name and a forfeit to be performed.

Lines 100 and 110 are sample forfeits; you may want to change them after consultation with the party person about the nature of the intended guests. In any event, you should add more forfeits at lines 120 to 190.

The subroutine in lines 200 - 215 erases each player's name after it has been called for a forfeit. If you want to play the game again, the names of the players will have to be reentered. Incidentally, this game (appropriately modified) might add life to some of the parties you host for your own friends.

Listing 2 provides an outline of a "Treasure Hunt" game involving teams of guests. This can be another time consuming game if you have 10 clues that lead to 10 secret words. You enter the clues in lines 30, 35, 40, etc., and the checks for the correct secret words in line 100 to 900. Use the pattern of GOTOs shown in the model for the ones that you add. Be sure to have a prize for winning team. Between you and your spouse, you should be able to develop some tricky and clever clues and

secret words.

Listing 3 will randomly assign players to a team. This could be added to Listing 2 as a subroutine to pick the team members and perhaps protect everybody's feelings.

If the crowd isn't too large, you can load up some individual games and let each guest try to score the highest number of points. A possible disadvantage of computer games played by one person at a time is that the rest of the guests are not involved, except as spectators, and may invent things to do on their own.

Listing 4 offers a short program which will solve the problem of "who gets the first turn" in the individual games.

Don't overlook the fine opportunity for exercising your genius to create a computer birthday card (with several pages) which can be run at cake cutting time, perhaps accompanied by a taped version of the Happy Birthday song.

## Some General Suggestions

For certain age groups, insist that you have lent all your space invasion type games to a friend or the party may be a failure in the opinion of your child. "All the boys wanted to do was zap aliens."

Keep the computer keyboard away from the food and drink area. Melted ice cream will really give you a key-bounce problem that even KBFIX can't fix. Make sure your programs have long delay loops for reading directions, or use INKEY\$. Not everyone reads and comprehends at the same rate.

Mix up a computer activity with other non-computer activities to give yourself time to load the next program, while the crowd is busy elsewhere.

Plan to give prizes to the winners. This may add motivation to participate among the guests who would rather wrestle near your china cabinet.

Know the nature and interests of your child and the expected guests. If your child doesn't seem too enthused about computer games at the party, don't push it. After all, it's his, or her, birthday.

I hope that the programs and suggestions will make the party a success, both for the parents and the children. In any event, my best wishes for the party person: Happy Birthday.

# How to Buy or Sell Computer Equipment and Software

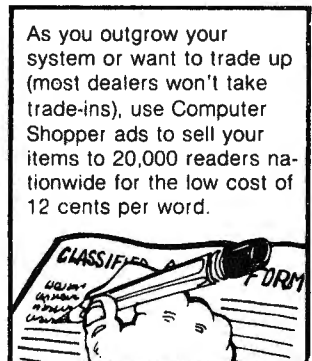
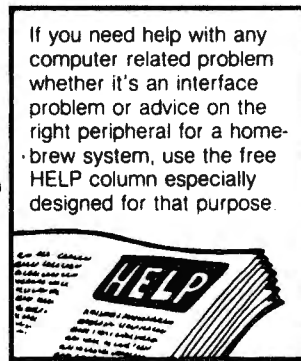
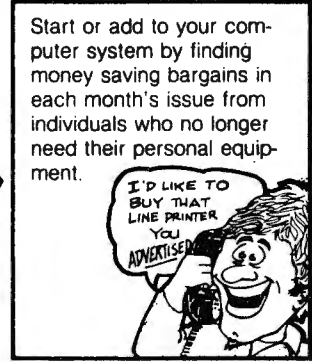
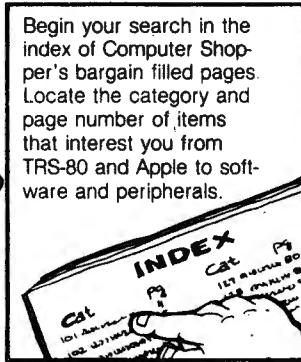

Computer Shopper is THE nationwide magazine for buying, selling and trading Micro and Mini-computer equipment and software. Each issue has over 60 pages full of bargains of new and used equipment.

You can save hundreds of dollars by getting the equipment you need from the hundreds of classified ads individuals place in Computer Shopper every month.

Now is the time for you to join over 20,000 other computer users who save time and money with a subscription to Computer Shopper.

Subscribe today and get your first issue and a classified ad absolutely FREE. Type or print your ad on a plain piece of paper and send it along with your subscription.

Just fill in the coupon or MasterCard or VISA holders can phone **TOLL FREE 1-800-327-9920** and start making your computer dollar go further today.

Cut out and mail to: **COMPUTER SHOPPER**  
P.O. Box F115 • Titusville, FL 32780

Yes, I'll try Computer Shopper, I understand that if I'm not satisfied with my first issue I can receive a full refund and keep the first issue free.

1 year \$10.00 (\$30.00 in Canada)

I have enclosed my free classified ad.

I want to use my free ad later, send me a coupon.

NAME: \_\_\_\_\_

ADDRESS: \_\_\_\_\_

CITY: \_\_\_\_\_

STATE: \_\_\_\_\_ ZIP: \_\_\_\_\_

# 123

 **COMPUTER SHOPPER**  
P.O. Box F115 • Titusville, FL 32780  
Telephone: 305-269-3211

December, 1982 109

*Ed. note: Model II owners are not to attempt the OUT procedure that is remarked in Listing 1. Model I/III owners may use the audio feature by changing line 1110 to:*

```
1110 FOR T=1 TO 50:PRINT#-1,A:OUT255,4:NEXT:
CLS:OUT255,4:RETURN
```

*You can change the amount of time the recorder remains on by changing T to be higher or lower than 50. Experimentation is encouraged.*

### Program Listing 1

```
1 'LISTING 1 FOR FORFEITS GAME
5 CLS:RANDOM:GOSUB1000
10 PRINT"HI GANG. I'LL HELP YOU DECIDE
WHO IS GOING TO DO WHAT FORFEIT."
15 PRINT:PRINT"LET'S SEE WHO WILL BE FI
RST":PRINT
20 INPUT"ENTER THE NUMBER OF PEOPLE PLA
YING";N:DIMP$(N)
25 FOR I=1TON:INPUT"ENTER NAME OF PLAY
ER ";P$(I):NEXTI
30 GOSUB200
35 PRINT"YOUR FORFEIT IS - ":GOSUB500:P
RINT
40 Y=RND(10):ON Y GOTO 100,110,120,130,
140,150,160,170,180,190
50 PRINT@832,"WHEN YOU ARE READY FOR ME
TO CHOOSE THE NEXT PERSON, PRESS ANY
KEY"
55 KY$=INKEY$:IFKY$="" GOTO 55 ELSE CLS
:GOTO30
100 PRINT"YOU MUST IMITATE A MONKEY WIT
H FLEAS":GOSUB500:GOTO50
110 PRINT"YOU MUST KISS EVERY PERSON OF
THE OPPOSITE SEX":GOSUB500:GOTO50
111 ' YOU MUST ENTER FORFEITS FOR LINES
120,130,... 190 USING THE FORMAT IN LI
NES 100 AND 110
200 X=RND(N):CLS
205 IFP$(X)=" "GOTO200
210 PRINT@256,"OK ";P$(X);" IT'S YOUR T
URN . . ."
215 P$(X)=" ":RETURN
500 FORT=1TO8000:NEXT:RETURN
1000 PRINTCHR$(23):PRINT"* * * ARE YOU
READY FOR * * *":PRINT:PRINT
1005 PRINT:PRINT"! ! ! F O R F E I T S
! ! !"
1110 FOR T = 1TO1000:NEXT:CLS:RETURN
1111 ' YOU CAN ADD SOUND FROM YOUR TAPE
RECORDER IF YOU DESIRE BY USING 'OUT 2
55,1' AND OUT 255,0 AROUND LINE 1110 AN
D INCREASING THE TIME DELAY TO FIT YOUR
MUSIC'S LENGTH
```

### Program Listing 2

```
3 ! LISTING 2 - TREASURE HUNT GAME
5 CLS:CLEAR100
10 PRINTCHR$(23):PRINTTAB(8)"IT'S TIME
FOR":PRINT
11 PRINTTAB(15)"A":PRINT
12 PRINTTAB(8)"TREASURE HUNT"
13 FORT=1TO2000:NEXT:CLS
15 PRINT"IN A MINUTE I WILL GIVE YOU TH
E FIRST CLUE TO START THE TREASURE HUNT
.":PRINT
16 PRINT"WHEN YOU FIGURE OUT THE FIRST
CLUE GO TO THAT PLACE AND YOU WILL FIND
SECRET-WORD #1.":PRINT
17 PRINT"LEAVE THE SECRET WORD THERE AN
D COME BACK TO ME.":PRINT
18 PRINT"I WILL TELL YOU TO ENTER THE S
ECRET WORD TO FIND THE NEXT CLUE.":PRIN
T
19 PRINT"THE TEAM THAT FINDS ALL THE SE
CRET WORDS FIRST, WINS THE PRIZE.":PRIN
T
20 PRINT"WHEN YOU ALL UNDERSTAND THE RU
LES OF THE HUNT, PRESS ANY KEY."
25 KY$=INKEY$:IFKY$="" GOTO 25 ELSE 30
30 CLS:PRINT"CLUE #1 - A PLACE WHERE FO
OD IS KEPT"
31 ' MAKE THIS CLUE GENERAL ENOUGH SO T
HAT THE TEAMS HAVE SEVERAL DIFFERENT PL
ACES THAT MIGHT FIT THE CLUE
32 GOSUB500:GOTO95
35 CLS:PRINT"HERE IS CLUE #2 -"
36 GOSUB500:GOTO95
40 CLS:PRINT"HERE IS CLUE #3 - "
90 CLS:PRINT"HERE IS CLUE #9 -"
92 GOSUB500:GOTO95
95 GOTO1000
100 CLS:INPUT"TYPE IN AND ENTER SECRET
WORD #1";W1$
105 IF W1$="BREADBOX" GOTO 115 ELSE 110
110 PRINT:PRINT"SORRY, THAT'S THE WRONG
SECRET WORD":GOSUB500:GOTO30
115 PRINT:PRINT"YOU'RE ON YOUR WAY. HER
E IS CLUE #2":GOSUB500:GOTO35
200 CLS:INPUT"TYPE IN AND ENTER SECRET
WORD #2";W2$
205 IF W2$ = "WHATEVER" GOTO215 ELSE 21
0
210 PRINT:PRINT"SORRY THAT'S THE WRONG
SECRET WORD":GOSUB500:GOTO35
215 PRINT:PRINT"YOU'RE GETTING HOT. HER
E IS CLUE #3":GOSUB500:GOTO40
500 FORT=1TO2500:NEXT:RETURN
1000 CLS:INPUT"WHICH NUMBER SECRET WORD
DO YOU WISH TO ENTER";N
1005 ON N GOTO 100,200,300
```



THE PROGRAMMER'S GUILD PRESENTS  
**PAC  DROIDS™**

BY

CHARLES FORSYTHE

THE ULTIMATE IN PAC-ACTION

ONLY \$19.95

UPTO 4 PLAYERS!!

Unlike any other "PAC" game you've ever seen!!

Hot Machine Language Multi-Color  
Hi-Res Graphics For All 16K TRS 80  
Color Computers

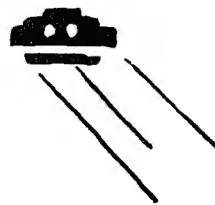

MORE SOUND - MORE ACTION -  
MORE FEATURES THAN ANY  
"PAC" GAME IN EXISTENCE!!

Try "PAC-DROIDS"™ for the Outer Limit in pure,  
explosive arcade action!!

SEND \$19.95 CHECK / MONEY ORDER OR VISA / MC #  
TO

THE PROGRAMMER'S GUILD  
PO BOX 66  
PETERBOROUGH NH 03458  
OR CALL 603-924-6065 FOR C.O.D.

AND GET "FREE" SHIPPING ANYWHERE ON THE PLANET  
EARTH OR HER COLONIES

1006 ' YOU WOULD NEED AN ADDITIONAL 'GO  
TO' LINE FOR EACH SECRET WORD

**Program Listing 3**

```

3 ' LISTING 3 - PROGRAM FOR PICKING TEA
MS
5 CLS: CLEAR100
7 PRINT "I'M GOING TO HELP YOU CHOOSE TH
E TEAMS FOR THE NEXT GAME": PRINT
8 PRINT "PRESS ANY KEY WHEN YOU WANT ME
TO START"
9 KY$=INKEY$: IFKY$="" GOTO 9 ELSE CLS:G
OTO10
10 INPUT "HOW MANY PEOPLE ARE PLAYING"; P
: DIM P$(P)
11 INPUT "HOW MANY TEAMS DO YOU WANT"; T:
M=P/T
15 CLS: PRINT "ENTER PLAYERS NAMES, ONE A
T A TIME"
20 FOR I=1 TO P: INPUT ""; P$(I): NEXT
25 CLS: FOR K=1 TO T: PRINT "OK, TEAM # "; K; "
WILL BE:"
30 FOR J=1 TO M
31 X=RND(P)
32 IF P$(X)=" " GOTO 31
    
```

```

35 PRINT P$(X); "-"; : P$(X)=" "
45 NEXT J: PRINT
50 FORT=1 TO 500: NEXT T
55 NEXT K
    
```

**Program Listing 4**

```

1 ' LISTING 4 A PROGRAM TO DECIDE WHO GO
ES FIRST
5 CLS: PRINT "HI GANG, I'LL HELP YOU DECI
DE WHO WILL WORK WITH ME FIRST"
10 PRINT: INPUT "WHAT IS THE SIZE OF THE
GROUP"; N: DIM C$(N)
15 FOR I=1 TO N: INPUT "ENTER THE NAMES OF
THE PEOPLE, ONE AT A TIME"; C$(I): NEXT I
20 X=RND(N): I=X
25 CLS: PRINT @256, "AND THE WINNER IS ..
.";
28 IF C$(I)=" " GOTO 20
30 FOR T=1 TO 1000: NEXT: PRINT C$(I): C$(I)=
" "
35 FOR T=1 TO 1000: NEXT: CLS: GOTO 40
40 PRINT "WHEN YOU WANT ME TO TELL YOU W
HO WILL BE NEXT, PRESS ANY KEY"
45 KY$=INKEY$: IFKY$="" GOTO 45 ELSE 20
    
```

# 80-U.S.

## BACK ISSUES

**May/June 1979**

String packing techniques  
Determine functions of the brain  
How to win Nim-type games

**Jul/Aug 1979**

Create fast graphics  
Renew lost programs  
No-hardware lowercase mod.

**Nov/Dec 1979**

Function grapher/root finder  
Home heat loss program  
Restoring killed disk files

**May/June 1980**

Telecommunications with the TRS-80  
BASIC game program technique  
Produce sound with BASIC programs

**Nov/Dec 1980**

Simple payroll program  
Digital plotter interface  
Produce keyboard typeahead

**May/June 1981**

Line packing techniques  
How to use "PRINT USING"  
Animation and the TRS-80

**Jul/Aug 1981**

Descending lower case for Model I  
Student timetable program  
Easy tape loading for Model I

**Sep/Oct 1981**

Keyword search database program

Compute a retail installment contract  
The vertical mill: a 3-D plotter?

**Nov/Dec 1981**

Comparison shopper program  
Real time clock construction  
Pocket Computer biorhythms program

**Jan 1982**

Microcomputers in business

**Feb 1982**

Micros and word processing

**Mar 1982**

Microcomputers and medicine merge

**Apr 1982**

Microcomputers and investments

**May 1982**

Space: An infinite frontier

**Jun 1982**

Games issue

**Jul 1982**

The TRS-80 in law offices

**Aug 1982**

Microcomputers in education

**Sep 1982**

Graphing and graphics

**Oct 1982**

Microcomputing tips and tricks

**Nov 1982**

Telecommunicate with your computer

**Please send the following back issues postpaid:**

- |  |                                       |                                   |
|--|---------------------------------------|-----------------------------------|
| <input type="checkbox"/> May/June 1979 | <input type="checkbox"/> Sep/Oct 1981 | <input type="checkbox"/> Jun 1982 |
| <input type="checkbox"/> Jul/Aug 1979  | <input type="checkbox"/> Nov/Dec 1981 | <input type="checkbox"/> Jul 1982 |
| <input type="checkbox"/> Nov/Dec 1979  | <input type="checkbox"/> Jan 1982     | <input type="checkbox"/> Aug 1982 |
| <input type="checkbox"/> May/June 1980 | <input type="checkbox"/> Feb 1982     | <input type="checkbox"/> Sep 1982 |
| <input type="checkbox"/> Nov/Dec 1980  | <input type="checkbox"/> Mar 1982     | <input type="checkbox"/> Oct 1982 |
| <input type="checkbox"/> May/June 1981 | <input type="checkbox"/> Apr 1982     | <input type="checkbox"/> Nov 1982 |
| <input type="checkbox"/> Jul/Aug 1981  | <input type="checkbox"/> May 1982     |                                   |

Name \_\_\_\_\_

Address \_\_\_\_\_

City \_\_\_\_\_ State \_\_\_\_\_ Zip \_\_\_\_\_

Visa/MasterCard # \_\_\_\_\_ Exp. Date \_\_\_\_\_

Please remit \$4.00 for each back issue ordered.

**80-U.S. Back Issues**

3838 South Warner St., Tacoma, WA 98409, (206) 475-2219

## MICRO MOONLIGHTER NEWSLETTER

The ONLY publication devoted exclusively to helping you create, build, and maintain a home-based business using your micro-system. **SUBSCRIBE NOW** to what may be the most important publication in YOUR FUTURE!

1 Year (12 issues) only \$25 U.S., \$29 Canada, \$35 World Wide

J. Norman Goode, Publisher  
**Micro Moonlighter  
Newsletter**

2115-J Bernard Avenue  
Nashville, TN 37212

Visa and Mastercard welcome. Send account number and expiration date.

# 77

## PRESSURE-SENSITIVE

# LABELS

FOR ALL PRINTERS  
INCLUDING



CALL OR WRITE  
FOR FREE CATALOG.  
(IF YOU HAVE A FIXED-PIN PRINTER,  
PLEASE LET US KNOW)

COMPUTER LABEL CO.

10619 BURBANK BLVD.  
NO. HOLLYWOOD, CA 91601  
(213) 762-2090

PHONE OR MAIL ORDERS ONLY.  
NO SALES AT OFFICE ADDRESS.

# 78

## Eight good reasons for using a Mod III:

1. Minibiz<sup>™</sup> General Ledger Accounting System
2. Accounts Receivable
3. Accounts Payable
4. Full-Service Payroll
5. Order Entry & Invoicing  
-with Inventory Interface  
-with Accts. Rec. Interface
6. Fixed Assets Accounting
7. Job Cost Accounting
8. Cost Estimating Systems  
-for Manufacturing  
-for Food Service

At selected Dealers or  
from the publisher

**Neperthe Programs**

44 Third Ave., Ste. F  
Chula Vista, CA 92010

714-425-5501

## VIZ.A.CON

A CONSOLIDATION SYSTEM  
for VISICALC users

New product adds 3-dimensional  
capability to any VISICALC model

Now with the help of VIZ.A.CON you can combine multiple "pages" of data from a model for hierarchical consolidations (eg. Dept., Div., Co.) or for summations over periods of time (eg. Week, Month, Quarter, Year-to-date).

Typical uses are to combine weekly sales reports or departmental budget data. You can create a complete network of consolidation processes and modify it any time (eg. for Merger & Acquisition analysis).

Special formulas (eg. ratios, percentages) can be recalculated after any consolidation. VISICALC precision is maintained for all data. You can customize titles, row and column headings, footnotes, etc. for each report.

VIZ.A.CON creates data files usable with VISICALC. After VISICALC "what if" games, use VIZ.A.CON to find out what happened.

Model I/III \$89.95      Model II \$119.95  
TOLL FREE 24-HR. SERVICE 800-547-5995 (Ext. 170)  
— Visa/Master Card —

Or mail Check to:  
A B A C U S ASSOCIATES  
Suite #240, Dept 101  
6565 W. Loop South, Bellaire, TX 77401



"Creating Simple Solutions to Complex Problems"

# 79

## Micro-Grip<sup>™</sup>

FRICION FEED FOR YOUR EPSON  
**MX-70<sup>™</sup> or MX-80<sup>™</sup>**

\*MX-70 and MX-80 are Trademarks of EPSON.

- Converts your printer for friction feed of SINGLE SHEETS or ROJ PAPER.
- SIMPLE Installation (all you need is a screwdriver, no soldering)
- Tractor feed remains undisturbed.
- Only \$39.95 (add \$1.90 for postage)



SATISFACTION GUARANTEED OR YOUR MONEY BACK  
MIL HO-GRIP Ltc  
Box 427  
VISA & Master Card Accept Northern AFB CA 944

(714) 864-6643

# 80

## EPRINT

The Model III ROM has a built-in screen print routine which replaces graphics with periods. With EPRINT and an MX-80, MX-80 FT, or MX-100 you can dump the screen, including Block Graphics! (Except for new Graftrax-Plus) Also EPRINT allows direct control of all print modes from the keyboard. Automatic relocating Z80 code works with 16-48K, disk or cassette. EPRINT will also work on newer Model I's.

EPRINT \$17.95

## COMMERCIAL BIORHYTHMS

This program prints a full year Biorhythm chart on any printer. Documentation includes examples of ways to sell these charts. Let your computer help pay for its self. Whether for fun or profit, this is the ultimate Biorhythm program For Model I or III, Lvl II. On cassette.

COMMERCIAL BIORHYTHMS \$14.95

California residents add 6.5% sales tax.

RAY KLOTZ & ASSOC.

P.O. Box 85513  
Los Angeles CA 90072  
(213) 918-0275

# 81

## New Arcade Games For Color Computer

Two exciting arcade-style games from Disk 'n Data:

**TUNNEL MAKER** — Dig your way to freedom while pitting your skills against those of the evil tunnel monsters. Use your laser to zap falling boulders — but watch out for shriggers! ..... \$11.95

**WUMPUS** — Destroy the dreaded Wumpus, lurking in the maze of caves. Tight passageways abound, but your arrows will help ward off evil. Keep an eye out for bottomless pits! ..... \$14.95

Both games require 16K Ext. BASIC and joysticks. Please add \$2 for shipping. Order direct from:

**DISK 'N DATA**



5450 Rugby Street  
Burnaby, B.C., Canada V5E 2N1

# 82

MAGAZINE SAMPLES  
FREE listing of over 150  
magazines offering a  
sample copy - 50¢ per  
sample. Send stamped  
self-addressed #10  
envelope to:

**PUBLISHERS  
EXCHANGE**

P.O. Box 220, Dept. 278A  
Dunellen, NJ 08812

## TRS-80 Color Computer

**STARS** Educational & entertaining. Constellations, planets, etc. \$14.95

**DATAFILE** Multi-purpose data storage system. Best on the market. Free file included. Specify 16K or 32K. \$19.95

**SPIDER ATTACK** Shoot-em action! Extended basic with ML sub-routines. \$14.95

**MILLBORN** Popular French card game. Can you drive 700 miles and beat CoCo? \$14.95

**COLORSHOW** Music, color & your computer. Turn on the stereo and watch the show. \$14.95

**DISKPRO** No more crashed disks. Creates back-ups of your disk directory and allocation tables. On disk for \$29.95

All programs for Extended Basic TRS-80 Color Computer on cassette tapes or disks, \$5.00 extra • Add \$1.00 postage.

**ILUME DESIGN**

Dept. S 4653 Jeanne Mance St.  
Montreal, Quebec Canada H2V 4J5

# 83

## Architectural Engineering Library

50 programs in a total of 10 categories including:

Heat Loss: SLR  
Timber Beams,  
Steel Beams,  
Wood Trusses (4 types),  
Concrete Beams, Walls,  
Slabs and Footings

TOTAL COST: \$225 (U S)  
Individual Categories: \$35  
Disk, ESF or Cassette

### ERIC CLOUGH

Box 52, Winlaw, B.C.  
Canada VOG 2J0

or

DHU-GLAS — Box 1664  
Sausalito, CA 94966

# 84

## Dental Computer Newsletter

E. J. Neiburger, D.D.S., Editor  
1000 North Avenue  
Waukegan, IL 60085

The D.C.N. is an international group of dentists, physicians and office management people who have interests in office computers. Though the emphasis is on micro-computers, many members use minis. We cater to all makes and brand names.

Annual membership dues \$15.00. Membership runs from January to January. If you join mid-year, we will supply you with the year's back issues.

# 85

## TRS-80 MODEL I T.M.\* GOLDPLUG - 80

Eliminate disk re-boots and data loss due to poor contact problems at card edge connectors. The GOLD PLUG - 80 solders to the board card edge. Use your existing cables.

CPU/keyboard to expansion interface . . . . \$18.95  
Expansion interface to disk, printer, RS232, screen printer (specify) . . . . \$9.95 ea  
Full set, six connectors. . . \$54.95



EAP COMPANY  
P.O. Box 14, Keller, TX 76248  
(817) 498-4242

\*TRS-80 is a trademark of Tandy Corp.

# 86

## COLOR COMPUTER COLORFORTH

FORTH is a high level computer language like BASIC or PASCAL. COLORFORTH, a version of figFORTH, is available NOW for the TRS-80C computer. COLORFORTH execution time is as much as 10 times faster than BASIC. COLORFORTH requires a minimum of 16K ram, but does not require either Extended Basic or disk system. When you purchase COLORFORTH, you receive both cassette and disk versions, the standard figEDITOR, and an extensive instruction manual. ALL FOR ONLY..... \$49.95



Armadillo Int'l Software  
P.O. BOX 7661 PH. (512)459-7325  
AUSTIN, TEXAS 78712

# 87

## LNW80 COMPUTERS

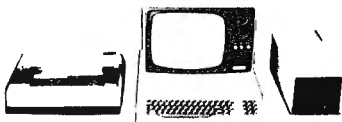

IN STOCK NOW!! CALL FOR SPECIAL PRICES ON LNW80s, NEC PRINTERS, RGB COLOR MONITORS, AND TANDON DISK SYSTEMS.

\*\*\*\* NEW LNW SOFTWARE! \*\*\*\*

### EXCELLONIX

7180 WOODROW WILSON DR  
LOS ANGELES, CA 90068

(213) 650-5754 - (714) 973-1939

# 88

## MODEL I/III SOFTWARE BY: Rip

\*\*\* RIPCHECK \*\*\* ..... \$59.95  
SUPER FAST MENU DRIVEN PAYABLES SYSTEM (4) USER DEFINED ACCOUNTS - REVIEWS - (156) VENDOR NAMES/ADDRESSES - LPRINT CHECKS/REG. - (4) SEARCHES WITH TOTALS

\*\*\* RIPBONDS \*\*\* ..... \$89.95  
A COMPUTERIZED PORTFOLIO FOR THE BOND INVESTOR - YTM - CURRENT ACCRUED INT. OUTSTANDING CURRENT/SOLD BOND REPORTS

\*\*\* PAYROLL5 \*\*\* ..... \$79.95  
CONVERT RADIO SHACK'S® DISK PAYROLL TO OPERATE 5 SEPARATE DIVISIONS/DEPTS. WITH INDIVIDUAL & CONSOLIDATED RECAPS - SEND ORIGINAL PROGRAM DISKETTES -

\*\*\* SHUTTLE COMMAND \*\*\* ..... \$19.95  
TRANSPORT YOUR GRP FUEL CELLS THROUGH BI-DIRECTIONAL METEOR SHOWER - MACHINE LANGUAGE ARCADE TYPE GAME - AUTOMATIC HIGH SCORE SAVE - ONLY ORDER IF YOU'RE READY FOR "THE ULTIMATE CHALLENGE".....

- - SEND CHECK OR MONEY ORDER - -

GLENN/CLIFF ASSOCIATES  
8301 EAST MONTEBELLO  
SCOTTSDALE, ARIZONA 85253

# 90

Easy File: Database, Mail List, ect . \$15.00\*  
Easy File: Disk, 32K Min., Model I/III . \$15.00  
Stock Quest: 39-week Data File . . . \$11.00  
Household Inventory: Database Program . . . . . \$7.00\*  
Zaars Citadel: RND Situation Game . . \$5.00  
Miners: Hammurabi Type Game . . . \$4.00  
Stock Game: Easy Type Stock Market Game . . . . . \$5.00

## DATA MANIA, INC.

51625 Chestnut Road  
Granger, IN 46530

Add \$2.00 P/H  
\* 16K or 32K, Specify  
For 16K TRS-80\* Color and Model I/III Tape Only. Specify

# 91

IEEE-488 TO TRS-80\* INTERFACE  
Everything needed to add powerful BASIC GPIB-488 controller capability to TRS-80 Model 1 or 3, Level 2 or DOS with a minimum of 16K.

488-80B  
For Model 1  
Operation



488-80C  
For Model 3  
Operation

Model 488-80B or 488-80C Price: \$375.  
+ shipping, insurance & tax

WHEN ORDERING SPECIFY DISK OR TAPE

SCIENTIFIC ENGINEERING LABORATORIES  
11 Neil Drive • Old Bethpage, NY 11804  
Telephone: (516) 694-3370

\*Trademark of Tandy Corp.  
There is no affiliation between Scientific Engineering Laboratories and Tandy Corp. or Radio Shack.

# 92

**TRS-80 MODEL 16 AND  
68000 SYSTEMS**

**DATABASE AND FILE  
SOFTWARE**

Relational Database System  
Easy To Use - Powerful  
**INTRODUCTORY OFFER \$595**

Menus & English Subset  
Query Language  
68000 Code Efficiency

Separate File & Sort Packages  
Features Never Seen Before.  
Send For Catalog.

DATA MANAGEMENT SYSTEMS  
211 N. EL CAMINO REAL, 101C  
ENCINITAS, CA 92024  
or Phone: (714) 942-0744  
TRS-80 is a trademark of Tandy Corp.

# 93

**SMITH-CORONA TP-1  
DAISY WHEEL PRINTER**



- Serial RS232 / Parallel Centronics
- Ask about our discount catalog

**\$575**

**MICRO TECHNOLOGY**  
7817 Ivanhoe Ave., San Diego, CA 92037  
**(714) 457-2149**

# 94

**Save Grief & Aggravation**

—Know Before You Buy—  
READ

**"Consumer Protection for  
the Microcomputer Owner"**

COVERS:

1. Preliminary Considerations before Buying
2. Legal Differences between Mail Order and Local Store
3. Pitfalls and Protection of Paying by Cash, Check, Credit Card, etc.
4. What a Warranty Really Is
5. How to Complain Effectively
6. How to Legally Reject and Revoke Acceptance of Goods
7. Miscellaneous Hints and Suggestions

**ONLY \$15 Post Paid (COD \$3 Extra)**

Send Check or Money Order to

**L. J. KUTTEN, ATTORNEY**  
201 South Central  
P.O. Box 16185

St. Louis (Clayton), MO 63105  
**314-721-6644**

Mo. Residents add 4.625% sales tax  
Compuserve ID #70855,376 Source ID# TCK092

# 95

**COCO SOFTWARE**

**COCO MAIL LIST:**

Up to 600 names per disk. ML sorts of any field. Plus many more features!

**COLOR LEDGER:**

A double entry general ledger, which will easily meet the needs of any small business.

**COLOR CALC:**

Now CoCo can assist you in spreadsheet preparation.

All of the above require:  
32K RAM, Disk, and a Printer

**PRICES:**

\$50.00 each, any 2 for \$85.00,

or all 3 for only \$105.00

**ORDER FROM:**

MOFS Inc.  
S.R. 79, Box 103  
Orland, ME 04472

# 96

**PROFILE USERS**

PROAID Gives Dramatic Time Savings!!

- \* add records in sequence without sorting
- \* remove deleted records without sorting
- \* display, edit and delete records randomly
- \* no need to reformat existing files

PROGRAM & DOCUMENTATION \$50

30 Day Guarantee

1 Year Maintenance

Write: Clay Watts  
68C N. Loop  
Cedar Hill, TX 75104

PROFILE IS A TRADEMARK OF TANDY CORP

# 97

Most Disk-Directories show only the filespecs plus some hard-to-understand superfluous information. Our

**DISK-MENU &  
DIRECTORY**

DISPLAYS DETAILED DESCRIPTION OF EACH PROGRAM ON A DISKETTE,

filespec and date of creation.  
SELECT & RUN PROGRAMS INSTANTLY.

(For Model I/III, all systems)

**\$29<sup>95</sup> + 1<sup>50</sup>** shipping & handling

**TAPE-TRONICS**

346 NO. WESTERN AVE.  
LOS ANGELES, CALIF. 90004



Toucan  
Presents:

A new generation of adventures — with graphics!!!

**Subterranean Encounter** — A fantastic medieval adventure which will take you from above ground with its castles, wizards, moats, and alligators to the subterranean depths whose evil and danger knows no bounds. A new plateau in adventuring — from Toucan Software, who else?? (TRS-80\* Model I or III (Please specify), 32K, 1 Disk Drive). Just \$29.95 at fine software stores everywhere or directly from us.

**TOUCAN SOFTWARE**  
4024 Canonero Court  
Fair Oaks, CA 95628  
(916) 966-4241

\*TRS-80 is a registered trademark of Radio Shack, a division of Tandy Corporation.

# 98

**DISKETTES  
CASSETTES**

Error-Free 5¼-inch Diskettes (MD-5) single-sided, soft sector, single or double density, reinforced hub.

Item	Qty 10	Qty 50
MD-5	\$25.00	\$110.00
C-10	\$ 7.50	\$ 32.50
C-20	9.00	39.00
C-60	11.50	50.00
C-90	15.00	70.00

UPS SHIPPING INCLUDED  
in Continental USA  
CA Customers add taxes

**MICROSETTE**

475 Ellis St., Mt. View,  
CA 94043 (415) 968-1604

# 99



**BARCLAY WHYTE  
ASSOCIATES.**  
THE BEAR WITH THE SOFTWARE. TM  
WordProc I/III.  
VER 2.0-BASIC-MACHINE LANGUAGE  
WORD PROCESSOR.

**MAILING LIST.**  
VER 2.1 - DISK BASIC.  
FILESTRUCTURE REQUIRES  
NEWDOS VERSION 2.0-SPECIFY MAIL  
VERS 2.0 IF DOS NOT AVAILABLE  
**PRETTY LIST.**  
FORMATS BASIC PROGRAM LISTINGS  
DOCUMENTATION INCLUDES COMPLETE  
PROGRAM LISTINGS

48K MOD I/III DISK-EASILY  
MODIFIED TO RUN IN 32KILOBYTES  
\$14.95 EACH. WITH DISK.  
\$10.95 EACH. DOCUMENTATION ONLY  
BARCLAY WHYTE ASSOCIATES DEPT D  
549 WEST COLUMBIA STREET.  
P.O. BOX 948, NEW WESTMINSTER.  
B.C. CANADA. V3L 5C3.  
ADD \$1.00 FOR POSTAGE ABOU53  
B.C. RESIDENTS ADD TAX AT 6%  
TRS-80 TM OF TANDY CORPORATION.  
NEWDOS TM OF APPARAT INC.

# 100

## TRS-80 MODEL I/III PROGRAMS

for Cassette and Disc

EDUCATIONAL  
BUSINESS  
HOME MANAGER  
UTILITIES

INQUIRIES WELCOMED

J/C ENTERPRISES  
BOX 441186  
MIAMI, FL 33144

'trademark Tandy Corp.

# 101

## WHO NEEDS DISKS FOR RELIABLE, HIGH QUALITY WORD PROCESSING?

MOST HOME USERS DON'T!

For long texts or short what you need is TXMODE

TXMODE is a new, sophisticated machine language program that extends ROM edit capability to text material and adjusts line lengths for any desired output format. No limit on manuscript size--has been used to revise a 300-page novel. Commands added to BASIC direct mode, plus many prompts, make proofreading, tape operations and page formatting easy. Works with any printer; special options with Epson MX80.

Models I and III, 16K up \$29.95 + \$2 P&H. FREE BROCHURE.

TOPS Programming Enterprises  
QUALITY TAPE OPERATING SYSTEMS  
AND COMPATIBLE SOFTWARE FOR HOME USE  
8990 S.W. Camille Terrace  
Portland, Oregon 97223

# 102

## PROGRAMMING EASE WITH TRS-80 III AND EP-10

The new Model EP-10 can program 2716/2732 eeproms also Signetics 82S123 & 82S129 bipolar proms. EP-10 comes with easy to use menu driven software. Connects to existing 50 Pin connector! Software supplied on cassette or 5 1/4" disk.

EP-10	279.95
Shipping, Ins., Handling	5.00
<b>Total</b>	<b>284.95</b>

Riverlake Systems, Inc.

P.O. Box 1927  
Roswell, Ga. 30077  
404-475-0028

Send for brochure.

# 103

## CANADIANS A-K SOFTWARE DISCOUNT PRICES

**STAR WARRIOR:** 2 scenarios; 5 levels of skill; 19 command options; 6 different sounds. Emphasis is on fast action and challenge.

\*Cassette level 11, 16K or Disk TRSDOS 32K. Guaranteed by A-K and Automated Simulations.

\$44 Canadian plus \$1.50 postage and handling. B.C. Residents add 6% sales tax.

### A-K SOFTWARE

480 Balsam Ave., Pentlcton, B.C. V2A 6J7

Cassette  Disk  
 Payment enclosed or charge my  VISA  M.C.

Name (PRINT) \_\_\_\_\_

Address \_\_\_\_\_

City \_\_\_\_\_ Prov. \_\_\_\_\_ PC \_\_\_\_\_

Acct. # \_\_\_\_\_ Exp. Date \_\_\_\_\_

Signature \_\_\_\_\_

\* TRSDOS -- Trademark of Tandy Corp.

# 104

## Professional REAL ESTATE SOFTWARE

for APPLE, TRS-80 & CPM SYSTEMS

- **PROPERTY MANAGEMENT SYSTEM: \$450**  
Tenant History      Operating Stmt.  
Late Rent Report    Building Reports  
Vacancy Report      Utilities Report  
Income Report        Tax Expense Report  
Auto Late Charge    Prints Checks  
Returned Checks     Prints Receipts
- **PROPERTY LISTINGS/COMPARABLES: \$325**  
SCREEN BY →      Max/Min Price  
22 Items/Listing    Max Price/Income  
1000 Listing/Disk    Max Price/Sq Foot  
Listing Memo Field    Min Cashflow
- **REAL ESTATE ANALYSIS MODULES: \$50/Module**  
Home Purchase      Tax Deferred Exchange  
Income Prop Analysis    APR Loan Analysis  
Property Sales        Loan Amortization  
Construction Cost/Profit    Depreciation/ACRS Analysis  
Loan Sales/Purchase    Loan Wrap Analysis
- **WORD PROCESSOR - WORD STAR: \$295**



All Computer Stores Everywhere  
or Order COD Direct  
Cal Residents add 8 1/2% Sales Tax  
(213) 372-9419

Suite E, 1116-Bth Street, Manhattan Beach, CA 90266

# 105

## ☆☆ SUPER™ ☆☆ ISA's DATABASE

The only DBMS with all these features:

- ★ PROVEN in one year of test marketing
- ★ TOUGH, reliable file structure
- ★ MENU driven for simplicity and easy use
- ★ ARITHMETIC with stored calculations
- ★ FAST set-up and report formatting
- ★ CLEAR user-oriented documentation
- ★ PRINTS totals & subtotals - mail labels
- ★ REFORMATS and merges data files
- ★ MULTI-DISK files: Up to 128K records
- ★ SORTS full disks on up to 40 fields
- ★ PRODUCTION input of repetitive data
- ★ COUPLES to word processor & statistics
- ★ POSTS transactions to master file
- ★ SEARCH by strings, ranges, comparisons
- ★ DATA COMPRESSION: Over twice as many labels as the other system

For TRS-80\* Models I, II, & III - 250.00

CDC  
13715 Vanowen Street  
Van Nuys, CA 91405  
(213) 873-6621

\*T.M. Tandy Corp

# 106

## Pascal-80 Phelps Gates

This friendly, easy to use version of Standard Pascal, as reviewed in the December 1981 Byte, is now even better! New version works on TRS-80 Model I and Model III, under TRS-DOS, NewDOS, NewDOS 80, DOSPlus, LDOS, and DoubleDOS. An author package allows you to create your own /CMD files without any royalty payments! Upper and lower case is fully supported. You can protect memory and call machine language programs. New extensions include SET, RESET, POINT, RND, and the UCSD Include procedure. Utilities are provided to convert to and from ASCII files. Pascal 80 now comes in a binder with an 80 page manual by George Blank.

With monitor, editor, and compiler in memory at the same time, no other Pascal is easier to learn! One college found that it could teach half again as many students on the same number of computers after switching from UCSD Pascal to Pascal 80.

Full 14 digit accuracy on all math functions, including log and trig functions, makes this a serious Pascal. Disk file handling is supported, with a mail list program included as a demonstration.

Upgrades are available for those who bought Ramware Pascal 80. Call or write for information.

Send \$101 (includes shipping) to: New Classic Software  
239 Fox Hill Road, B  
Denville, NJ 07834

Credit card orders: (201) 625-8838

(PASCAL-80 does not implement variant records, pointer and window variables, or functions and procedures used as parameters.)

# 107

## TRS-80 DISK and TAPE USERS!!!

Protect your investment in disks and tapes! END loading problems. One TOOL does it ALL!

### Tape Reproduction System

Tape or Disk Utility for Model I or III

- Read TAPE and/or DISK
- Write TAPE and/or DISK
- Verify TAPE written will load
- ANY TRS-80 protocol TAPE
- Identifies BASIC, SYSTEM, EDTASM
- Change program name as desired
- Select tape speed H/L (Mod III)
- Select tape port 0/1 (Mod I)
- OFFSET load addresses
- UNOFFSET load addresses if offset
- Displays operational STATUS plus
  - Diskette directory (0-3)
  - Load Map (start-end addresses)
  - NAME, LENGTH, FORMAT of data
  - START, END, EXECUTE addresses
- Automatic protocol conversion
- SINGLE disk drive copy (Mod I)
- Archives on TAPE for DISK or TAPE
- Run TAPE programs from DISK
- 14 Menu-driven features in all!
- DISK features require TRSDUM

TRSDUM-16K tape systems . . . . . ONLY \$16.95  
TRSDUM-1 drive TRSDOS systems . . . . . ONLY \$17.95

Specify Model I or III - add \$1.00 postage and handling  
Send check, money order or SASe to:

CRB Microtools  
"Software #10015 for the 80's"  
14835 N. First Avenue  
Phoenix, AZ 85023

TRSDUM-16K tape systems . . . . . ONLY \$16.95  
TRSDUM-1 drive TRSDOS systems . . . . . ONLY \$17.95  
Specify Model I or III - add \$1.00 postage and handling  
Send check, money order or SASe to:

CRB Microtools  
"Software #10015 for the 80's"  
14835 N. First Avenue  
Phoenix, AZ 85023

TRSDUM-16K tape systems . . . . . ONLY \$16.95  
TRSDUM-1 drive TRSDOS systems . . . . . ONLY \$17.95  
Specify Model I or III - add \$1.00 postage and handling  
Send check, money order or SASe to:

CRB Microtools  
"Software #10015 for the 80's"  
14835 N. First Avenue  
Phoenix, AZ 85023

TRSDUM-16K tape systems . . . . . ONLY \$16.95  
TRSDUM-1 drive TRSDOS systems . . . . . ONLY \$17.95  
Specify Model I or III - add \$1.00 postage and handling  
Send check, money order or SASe to:

CRB Microtools  
"Software #10015 for the 80's"  
14835 N. First Avenue  
Phoenix, AZ 85023

TRSDUM-16K tape systems . . . . . ONLY \$16.95  
TRSDUM-1 drive TRSDOS systems . . . . . ONLY \$17.95  
Specify Model I or III - add \$1.00 postage and handling  
Send check, money order or SASe to:

CRB Microtools  
"Software #10015 for the 80's"  
14835 N. First Avenue  
Phoenix, AZ 85023

TRSDUM-16K tape systems . . . . . ONLY \$16.95  
TRSDUM-1 drive TRSDOS systems . . . . . ONLY \$17.95  
Specify Model I or III - add \$1.00 postage and handling  
Send check, money order or SASe to:

CRB Microtools  
"Software #10015 for the 80's"  
14835 N. First Avenue  
Phoenix, AZ 85023

TRSDUM-16K tape systems . . . . . ONLY \$16.95  
TRSDUM-1 drive TRSDOS systems . . . . . ONLY \$17.95  
Specify Model I or III - add \$1.00 postage and handling  
Send check, money order or SASe to:

CRB Microtools  
"Software #10015 for the 80's"  
14835 N. First Avenue  
Phoenix, AZ 85023

TRSDUM-16K tape systems . . . . . ONLY \$16.95  
TRSDUM-1 drive TRSDOS systems . . . . . ONLY \$17.95  
Specify Model I or III - add \$1.00 postage and handling  
Send check, money order or SASe to:

# 108

## EPSON\* LOVERS

Save money by reloading your own MX-80\* cartridges. Low prices on ribbon inserts. You'll like my service and detailed instruction sheet.

More savings available by using the MARK I or MARK II reinkers. You can reink your own cartridges with less than a dime's worth of special ink.

Join the COLOR bandwagon with my new list of color inks, color and uninked ribbons, plus other goodies.

Save BIG BUCKS by using the less than \$4.00 single sheet feeding device.

All sorts of new ideas in the works. Write today for free information.

**PETE SKEBERDIS**  
P.O. Box 27  
Fremont, Michigan 49412

\*EPSON & MX-80 trademarks of EPSON America, Inc.

# 109

### \*\*\* FAST \*\*\*

- \* In-Memory Data Base program for Mod I, III, 48K disk
- \* Sophisticated 3 Machine-Language Subroutines:
  1. Sort 1 to 5 Major Fields, carry all Minor Fields.
  2. Instring Search on 1 to 2 Fields with as few as 1 character up to an entire Field.
  3. Instant Deletion of Record. No waiting on record move-up.
- \* Any number of Fields & up to 255 characters per Field. Limited only by available memory.
- \* Easy Print-out Formatting. Great for Data Storage AND Mailing Lists.
- \* Only **\$29.95 + \$2 P&H** On Formatted S.D. 35-Trk. Disk. Check or M.O.

**W.H. Sumrall**

Rt. 1, Box 142 AB1  
Sherman, TX 75090  
(214) 532-6565

# 110

## SECUR-IT

Stringy File



Secur-It Stringy File storage containers offer safe, no-spill portability and secure, orderly storage for your wafers. High-impact plastic construction. 20 wafer capacity. Black only. \$14.95 ea.

Model I/III Software

- Label Maker, \$12.95 • Page Maker (disk only), \$19.95 • Home Inventory, \$39.95 • Document Maker, \$39.95 •

- Send For Free Catalog
- For Fastest Service Send Money Order Or Certified Check • Add \$2.00 Shipping Charge Per Order • Calif. Residents Add 6 1/2% Sales Tax • All Merchandise Shipped From Stock •

**REM Industries, Inc.**

9420 "B" Lurline Ave., Chatsworth, Ca. 91311  
(213) 341-3719

# 111

## NUMBER CRUNCHER

A complete STATISTICAL PACKAGE. Includes a menu-driven database manager with the following: Multiple Regression, Interactive Stepwise Regression, One-way Anova with post hoc comparisons, Two-way Anova with interaction and unequal cell frequencies, Analysis of Covariance, Repeated Measure Anova, Contingency Tables, Cross Tabulation, t-tests, Principle Component (factor) Analysis, Nonparametrics, Probability Distribution Calculator, Correlation Analysis, Histograms, Scatter Plots, Forecasting Programs and Univariate Statistics.

The program includes over 25 variable transformations, including a recording facility.

Send **\$99.95** plus \$3 shipping.

**Dr. Jerry L. Hintze**

865 East 400 North  
Kaysville, Utah 84037  
801-546-0445

# 112

Do you have a few holes  
in your collection of  
**80-U.S. Journals?**

We might be able to  
fill them!

Contact:

**80-U.S.  
Back Issues**

3838 South Warner  
Tacoma, WA 98409  
(206) 475-2219

# 115

## LARGECAPACITYSYSTEMSLAR

**MI M3**

**GENERAL LEDGER**

**400+ACCOUNTS**

**5000+TRANSACTIONS/MONTH**

**NO OTHER SYSTEM OFFERS....**

- +REPORT FLEXIBILITY/CAPACITY
- +DEPARTMENT P & L (UP TO 5)
- +UNLIMITED ACCOUNT CATEGORIES
- +STATEMENT OF CHANGES (ASSETS)
- +PERCENT P & L comparison
- 100% sales MTD vs YTD
- or net sales QTD VS YTD
- or total Exp MTD VS QTD
- +WITH TDOS (A MINI DOSPLUS)

**149.95**

reg 32K 2 drives

manual \$30.00 test set \$50.00

HOLMAN D-P SERVICE  
2059 W LINCOLN  
OROVILLE, CA 95965 VISA/MC 300 S&H  
(916) 533-5992 COD

# 113

Get  
**FREE**  
Programs  
for the  
**Color Computer**

Join the  
**East Texas  
Color Computer  
Club**

2101 East Main St.  
Henderson, TX 75652

# 114

## WILDCAT

**REMARKABLE DISK  
DIRECTORY CATALOG SYSTEM**  
For TRS 80 Model I & III

- Unique abstract feature permits positive file identification. Catalog includes human readable remarks from machine code files. Contains ID, name, date, free space, filespec and remark.
- Read any size directory from any size disk of any density with any number of tracks and any number of sides.
- Machine language sort by any field. Multi-format print in any sorted order. Single sheet or continuous forms. Save to disk option. Very fast machine code. Self-prompting. User friendly. Complete easy to understand documentation.

Please Specify MODEL and DOS When Ordering.  
Requires 2 Drives and 48K RAM

Satisfaction Guaranteed - Ten day return privilege

**Introductory Price Until January '83**  
**39.95** (plus 2<sup>00</sup> shipping and handling)

Check - Visa - Mastercard

Don Fielding • 2207 N W 61st Place • Margate, FL 33063  
(305) 972-6744



# 115



## BASF



the LEADER  
of the pack . . .

Write for free catalog with more than 400 fantastic values for all your word and data processing needs. Outside USA, enclose \$1.00.

**ABM PRODUCTS**

8868 CLAIREMONT MESA BLVD.  
SAN DIEGO, CALIFORNIA 92123

Toll Free 800-854-1555 Orders Only  
For information or California Orders  
(714) 266-3537

# 116

## ribbons

For Radio Shack Printers

new

- Ribbons For:**
- Daisywheel II
  - Line Printer II, III, V
  - and Others

recycle

- Your Used Ribbons.**
- Service available for most printer ribbon types.

Buy directly from a major  
manufacturer and save!  
**FREE CATALOGUE!**

Aspen Ribbons, Inc. 1700 N. 55th St.  
Boulder, CO 80301 (303) 444-4054  
Toll Free 1-800-525-0646

# 117

RSN	Advertiser	Page	RSN	Advertiser	Page
104	A-K Software	116	101	J/C Enterprises	116
43	Aardvark-80	77	8	J. F. Consulting	15
79	Abacus Associates	113	69	Jessup Company, The	100
116	ABM Products	117	60	Jimsco, Inc.	101
14	Access Unlimited	26, 27	72	Kensoft	104
44	Ace Computer Rentals	78	81	Klotz, Ray & Assoc.	113
66	Ace Computer Prod. of Florida, Inc.	99	95	Kutten, L. J., Attorney	115
39	Algorix	71	42	KWIK Software	75
58	Alpha Products	89	67	Langley-St. Clair Systems, Inc.	99
45	Anitek Software Products	78	52	Lawyer's Microcomputer, The	82
38	Apparat, Inc.	67	121	Leading Edge, The	Back Cover
87	Armadillo International	114	42	Lemons Tech Services	75
117	Aspen Ribbons, Inc.	117	16	Lindbergh Systems	30
★	Aspen Software Co.	101	35	LNW Research Corp.	62
26	B. T. Enterprises	49	17	Lobo Drives	35
74	BAP\$ Software	104	1	Logical Systems, Inc.	Inside Front Cover
100	Barclay Whyte Associates	115	11	Logical Systems, Inc.	21
28	Binary Devices	52	41	Marymac Industries, Inc.	74
119	Business Division, The		96	MDFS, Inc.	115
	A Div. of Scott Adams, Inc.	120	47	Micro Architect	80
63	Business Micro Products	97	6, 7	Micro Labs, Inc.	9
19	Chromasette Magazine	38	37	Micro Management Systems	66
20	CLOAD Magazine, Inc.	39	77	Micro Moonlighter Newsletter	113
84	Clough, Eric	114	94	Micro Technology	115
89	Comnet Software Assoc., Inc.	114	80	Micro-Grip, Ltd.	113
122	CompuKids	107	2	Micro-Systems Software, Inc.	1
10	Computer Applications Unltd.	19	36	Micro-Systems Software, Inc.	65
46	Computer House	79	99	Microsette	115
78	Computer Label Company	113	59	Miller Microcomputer Services	93
65	Computer Plus	98	21	MISOSYS	41
123	Computer Shopper	109	32	MISOSYS	56
68	Computer Trader	100	★	Nepenthe Programs	113
13	Computing Teacher, The	25	107	New Classic Software	116
33	Cornsoft Group, The	59	27	Nocona Electronics	51
30	Cornucopia Software, Inc.	55	23	One Stop Software	44
53	Cosmopolitan Electronics Corp.	83	3	Percom Data Company, Inc.	2
108	CRB Microtools	116	22	Perry Oil & Gas, Inc.	43
106	CDC	116	31	Pioneer Software	55
50	Data Associates	82	5	PMC Software	7
93	Data Management Systems	115	9	Program Store, The	16, 17
91	Data Mania, Inc.	114	76	Programmer's Guild, The	111
85	Dental Computer Newsletter	114	18	Prosoft	36
82	Disk 'n Data	113	★	Publisher's Exchange	113
86	EAP Company	114	34	Radio Shack	60, 61
114	East Texas Color Computer Club	116	120	Radio Shack	Inside Back Cover
62	Eigen Systems	96	48	Rainbow, The	80
★	80-N.W. Books	34, 105	105	Realty Software Company	116
★	80-U.S. Journal	112, 117	111	REM Industries, Inc.	117
61	Electronic Specialists, Inc.	96	54	REMarkable Software	85
12	Epson America, Inc.	22, 23	71	Rimes Computer Products	102
88	Excellonix	114	103	Riverlake Systems, Inc.	116
115	Fielding, Don	117	92	Scientific Engineering Labs.	114
56	Fink, William	86	109	Skeberdis, Pete	116
49	Freedom Micro Systems, Inc.	81	118	Soft Sector Marketing, Inc.	119
90	Glen/Cliff Associates	114	75	Software Magic	104
★	Gooth Software	47	110	Sumrall, W. H.	117
40	Hacks	72	51	Superior Software, Inc.	82
★	Hexagon Systems	11, 12, 13	55	T & D Software	86
112	Hintze, Jerry, Dr.	117	★	TAPE-TRONICS	115
73	Holman D-P Service	104	24	Think Software	47
113	Holman D-P Service	117	25	3G Company, Inc.	49
64	Holmes Engineering, Inc.	98	102	TOPS Programming Enterprises	116
4	IJG	3	98	Toucan Software	115
83	Ilume Design	113	70	Triple D	102
29	Interpro Corporation	53	97	Watts, Clay, Inc.	115
57	J & M Systems, Ltd.	88	15	Wiley, John & Sons, Inc.	29
			★	Contact these advertisers directly.	

This bulletin board space is available free to individuals with single or unusual items for sale or trade, and for other announcements of interest to the general readership of this magazine. *80-U.S. Journal* reserves the right to reject any commercial advertising in this section and suggests using our display advertising for that purpose.

These notices are free of charge and will be printed one time only on a space available basis. Notices will be accepted from individuals or bona fide computer user clubs only. All announcements must be typed, contain 75 words or less and include complete name and address.

The LNW USER Group is a group of LNW80 owners with the desire to share their experiences and programs with others. The group publishes a bi-monthly newsletter of hi-res and color programs and hardware hints. Dues are \$12 per year. Contact the LNW USER, 4345 Manchester, Grand Island, NE 68801.

**Call for papers:** A new quarterly, *The Journal of Computers Reading & Language Arts (CRLA)*, is ready to receive papers. The journal supports the rapidly growing interest in computers and their relationship to reading, language arts and related issues. The theme will be pragmatic in perspective. It will emphasize papers which have clear classroom/teaching implications. The journal will be interdisciplinary and directed toward reading-language arts teachers, educational specialists, classroom teachers, and others. Send papers or requests for information to Gerald H. Block, CRLA, P.O. Box 13039, Oakland, CA 94661.

**FOR SALE** — TRS-80 software on original disk or cassette with original documentation. Astrology, \$15, Eliza, \$8; Profile, \$35; Airaid, \$7; VisiCalc, \$50; Scripsit, \$50. *TRS-80 Disk and Other Mysteries Book*, \$13. Also, 20 issues of *CLOAD* and dozens of *Softside*, *80-U S Journal*, etc., for sale or trade. Melvin L. Mauck, 16 Edmondson Avenue, Lexington, VA 24450. (703) 463-4389.

**FOR SALE:** Percom Data Separators (2) \$20 each Cashier's Check or postal money order. Construction Engineering, Inc., 125 Irving Street, P.O. Box 2154, Framingham, MA

**COLOR COMPUTER DISK INTERFACE** for the Exatron "thing." Includes Color Disk 1.0 ROM \$80 plus postage. Earnie Kahn, 8222 Kingsbrook No. 560, Houston, TX 77024, (713) 467-9734.

**FOR SALE:** Radio Shack Line Printer V. Excellent condition. Sold for \$1850 new, will sell for \$1500 or best offer. 160 cps with 15" platten and adjustable tractor. 7 x 9 matrix with five type styles. Upper/lowercase with true descenders. Bold face and underline. Radio Shack's BEST printer for heavy business use. Will consider Epson MX-80 or equivalent for partial payment.

**For Sale:** Percom (MPI) 40-track, drive 1 for Model III. Working perfectly — \$190. R/S Line Printer 2, 100 cps — \$400 or best offer. BASF 40-track refurb — \$155 bare. New 5 1/4" case and power supply — \$50. Color Computer drive 0 new! — \$400. Steve Kolokowsky, 8 Wilson Court, Spring Valley, NY 10977. (914) 362-0713 after 7 p.m. EST.

**HAVE an interesting way to make money with your microcomputer?** I'm writing a book on it and would like to hear your suggestions! Please contact Tim Knight, 10 Fieldbrook Place, Moraga, CA 94556, (415) 376-8471.

## Merry Christmas



# OUTHOUSE

Is There Nothing Sacred?



**DISK  
VERSION  
TALKS**

**JOYSTICK  
Compatible\***

Don't Miss This Outstanding  
Original Arcade Game!

**SSM SOFT SECTOR MARKETING,  
INCORPORATED**  
6250 Middlebelt • Garden City, MI 48135 •

Written by Factory Programming - ©1982  
Prices per Game: TRS-80 16K Level II Mod I/Mod III Cassette ..... \$15.95  
TRS-80 32K Level II Mod I/Mod III Diskette ..... \$19.95

10% discount for 2 items, 15% for 3 or more. Please add \$2.50 per order  
for postage & handling. Michigan residents add 4% sales tax.  
Outside USA (except Canada) please add \$10.00 per  
order for postage & handling.

800-521-6504/(313)425-4020

Talking and sound effects are play-  
able through the cassette AUX plug.  
High scores are automatically saved  
after each game on disk versions.  
\*Compatible with Trisstick.  
Call or write for our complete catalog.



The Quality Continues . . .

# PLEASE ANSWER THESE 5 QUESTIONS

- |   | YES                      | NO                       |
|---|--------------------------|--------------------------|
| 1. Do you have information that must be kept organized and accessible? .....  | <input type="checkbox"/> | <input type="checkbox"/> |
| 2. Do you ever need to perform statistical analyses? .....  | <input type="checkbox"/> | <input type="checkbox"/> |
| 3. Would you like to have a tool that will allow you greater flexibility in managing your own or your company's money? .....  | <input type="checkbox"/> | <input type="checkbox"/> |
| 4. Could you use a mail list program that will be easy to use, maintain an unlimited number of names, allow you great sorting flexibility, and even interact with a word processor? ..... | <input type="checkbox"/> | <input type="checkbox"/> |
| 5. Do you own or have access to a TRS-80 microcomputer? .....   | <input type="checkbox"/> | <input type="checkbox"/> |

If you answered "yes" to any of these questions, we can be of assistance to you. Our Maxi Series of applications programs are designed to give you maximum versatility with a minimum of hassle. These programs were created for business use, but you'll find yourself using them for personal applications as well.

**Thorough support** — Of course, each program comes with in-depth, user-oriented documentation, and is menu-driven to make it easy to use. When necessary, the Maxi programs are compatible with each other, and, whenever pertinent, are interactive with the major word processing and spreadsheet programs published by other manufacturers. Also, we maintain a telephone support line to provide you with any assistance you might require.

## Maxi Manager by Dale Kubler

Maxi Manager is a remarkable data base manager. Its fast machine language sort complements its large data storage capacity. The sophistication of its data entry, management, and printing capabilities makes Maxi Manager a versatile tool for many applications.

The program now includes Maxi Utility, which allows you to rescue files on diskettes that have been damaged by excessive wear or misuse and lets you expand, add, or delete fields from an existing data base. Let the unmatched capabilities of Maxi Manager handle your data management!

Model I & Model III. Minimum 1 disk drive required 012-0196 \$149.99

## Maxi Cras by Dale Kubler

(Check Register Accounting System)

Maxi Cras is a system that will computerize check writing, recording and analysis for business and personal finance. The system features 223 income and expense accounts, each of which will handle an unlimited number of transactions. Extensive register and report printing capabilities make Maxi CRAS an indispensable tool for managing money effectively.

Model I & Model III. Minimum 2 drives required 012-0145 \$99.95

## Maxi Mail by Dale Kubler

Maxi Mail is a powerful mail list management system that:

1. Is easy to use.
2. Has virtually unlimited storage capacity.
3. Interfaces with the major word processors to generate form letters and other text.
4. Prints mailing labels up to four-across in any format desired.
5. Has virtually unlimited coding capabilities with thirteen fields of information for each record.

Maxi Mail is the most sophisticated user-oriented mail list program available.

RS-80 Model III only. 2 disk drives required 012-0148 \$99.95

## Maxi Stat by David Watonick

Maxi Stat is the most useful statistical analysis package on the market today. It was developed to allow maximum flexibility in designing customized analysis. Maxi Stat handles the three main components of statistical analysis:

1. Complete menu-driven codebook creation and editing.
2. Menu-assisted data entry.
3. User-created control files to describe the statistical analyses to be performed and printed out on the variables of your choice.

Model I & Model III. Minimum 2 drives required 012-0153 \$199.95



A Division of Scott Adams, Inc.

# 119

Send \$1.00 for our 16 page booklet "Getting The Most From Your Micro" All 16 pages are packed with in-depth explanations and printout samples from the Maxi Series of applications programs.

**THE BUSINESS DIVISION**  
 BOX 3435  
 LONGWOOD, FL 32750  
 (305) 830-8194



# Gifts to Please the Man Who Has Everything—Including a TRS-80®



**A Program Pak™ File Box.** Keep your Color Computer Program Paks or boxed cassettes right at your fingertips. Holds 16. #26-1314, \$34.95

**B Screen Cleaner.** Includes pre-wet wipes and cleaning cloth. #26-1318, \$6.95

**C Anti-Static Spray.** Use on carpet, screen, equipment to protect data. #26-515, \$5.95

**D TRS-80 Color Computer Graphics Tablet.** Instant graphics at the touch of a pen! Use pen for drawing or stylus for tracing—the “X-Pad” reads the design into your Color Computer at 100 points per second. Controller plugs into ROM slot. Accesses Extended BASIC graphics commands. #26-1196, \$349.95



**E Anti-Glare Screen.** Nylon mesh reduces glare and improves contrast. Protects your eyes from fatigue. Installs easily on Model I, II, III, 16. #26-511, \$16.95



**F SW-301 Auto Control Power Strip.** Automatically turns on up to 5 peripherals when you power on your Model II, III or 16. Two-stage transient protection. U.L. listed. #26-1429, \$69.95

**G SW-302 Parallel Printer Switch.** Dual parallel ports let you connect two printers to a single computer, or two computers to one printer. U.L. listed AC power module. #26-1498, \$119.95

**Complete Your Shopping Today!** Choose from many other accessories at the Radio Shack Computer Center, store or participating dealer near you.

## Radio Shack®

The biggest name in little computers™

A DIVISION OF TANDY CORPORATION

Retail prices may vary at individual stores and dealers.

# REMEMBER:



## MORE THAN JUST ANOTHER PRETTY FACE.

Says who? Says ANSI.

Specifically, subcommittee X3B8 of the American National Standards Institute (ANSI) says so. The fact is all Elephant™ floppies meet or exceed the specs required to meet or exceed all their standards.

But just who is "subcommittee X3B8" to issue such pronouncements?

They're a group of people representing a large, well-balanced cross section of disciplines—from academia, government agencies, and the computer industry. People from places like IBM, Hewlett-Packard, 3M, Lawrence Livermore Labs, The U.S. Department of Defense, Honeywell and The Association of Computer Programmers and Analysts. In short, it's a bunch of high-caliber nitpickers whose mission, it seems, in order to make better disks for consumers, is also to

make life miserable for everyone in the disk-making business.

How? By gathering together periodically (often, one suspects, under the full moon) to concoct more and more rules to increase the quality of flexible disks. Their most recent rule book runs over 20 single-spaced pages—listing, and insisting upon—hundreds upon hundreds of standards a disk must meet in order to be blessed by ANSI. (And thereby be taken seriously by people who take disks seriously.)

In fact, if you'd like a copy of this formidable document, for free, just let us know and we'll send you one. Because once you know what it takes to make an Elephant for ANSI . . .

We think you'll want us to make some Elephants for you.

## ELEPHANT.™ HEAVY DUTY DISKS.

For a free poster-size portrait of our powerful pachyderm, please write us.

Distributed Exclusively by Leading Edge Products, Inc., 225 Turnpike Street, Canton, Massachusetts 02021  
Call: toll-free 1-800-343-6833; or in Massachusetts call collect (617) 828-8150. Telex 951-624.