



# **PRECISION INSTALLATION PRODUCTS**



**2020  
CATALOG**



# CATALOG CONTENTS



PRECISION  
INSTALLATION  
PRODUCTS

## WATER TREATMENT

- 01 PUMPS & ACCESSORIES - AQUATEC & NUERT
- 02 WATER FILTER HOUSINGS, BRACKETS, & WRENCHES
- 03 R.O. COMPONENT PARTS
- 04 WATER FILTERS
- 05 R.O. MEMBRANES & VESSELS
- 06 TUBING - R.O. - DRAINLINE - COPPER
- 07 PEX TUBING
- 08 LEGRIS LIQUIFIT CONNECT FITTINGS
- 09 HYDRONIX HYDROFIT QUICK CONNECT FITTINGS
- 10 PARKER FAST 'N' TITE, PAR-BARB, & NYLON FITTINGS
- 11 STAINLESS STEEL FITTINGS, CHECK VALVES, & TOOLS
- 12 SEATECH QUICK CONNECT FITTINGS
- 13 FAUCETS & ACCESSORIES
- 14 RELTON CUTTERS
- 15 ULTRA-VIOLET (UV) LIGHTS
- 16 PRO PRODUCTS
- 17 R.O. & FILTRATION SYSTEMS
- 18 WATER FILTER & WATER SOFTENER PARTS - AQUATROL
- 19 MISC ACCESSORIES

## PLUMBING SUPPLIES

- 20 CTS CPVC FITTINGS
- 21 PEX BARB FITTINGS
- 22 BLACK MALLEABLE IRON PIPE FITTINGS & NIPPLES
- 23 GALVANIZED MALLEABLE IRON PIPE FITTINGS & NIPPLES
- 24 BRASS PIPE FITTINGS & NIPPLES
- 25 BRASS COMPRESSION FITTINGS
- 26 BRASS FLARE FITTINGS & HOSE BARBS
- 27 COPPER FITTINGS
- 28 ANGLE STOPS / SUPPLY STOPS
- 28 SADDLE VALVES, NEEDLE VALVES & MAX ADAPTERS
- 30 WATER HEATER CONNECTORS & COMPONENT PARTS
- 31 WATER VALVES, HOSE BIBBS & REGULATORS
- 32 CLAMPS - METAL HOSE - POLY PIPE - OETIKER

## ELECTRICAL

- 33 ELECTRICAL COMPONENTS
- 34 ELECTRICAL CORDS

## GAS - APPLIANCE - WATER

- 35 AIR GAPS
- 36 DRAIN HOSE
- 37 FILL HOSES
- 38 HOSE CONNECTORS, WASHERS, SCREENS, & ACCESSORIES
- 39 WATER / ICEMAKER CONNECTORS
- 40 GAS VALVES, CONNECTORS, & FITTINGS
- 41 APPLIANCE INSTALLATION KITS
- 42 VENTING & DUCTING

## MISCELLANEOUS SUPPLIES

- 43 LUBRICANTS, SOLVENTS, & GLUE
- 44 TAPES & PIPE COMPOUNDS
- 45 FURNITURE PADS & WEBBING
- 46 TIE STRAPS / BIN BOXES
- 47 YEATS DOLLIES
- 48 CLEARANCE



**PRECISION  
INSTALLATION  
PRODUCTS**

# HOW TO PLACE AN ORDER

## ORDERS MAY BE PLACED BY ANY OF THE FOLLOWING METHODS:

**PHONE:** Call us toll free at 800-747-1244 or direct at 949-583-1244. Please have your part numbers and company information or customer ID ready when calling to place an order.

**FAX:** For your convenience, you can also fax your order toll free at 866-420-8802 or direct at 949-583-1548. Please include your company information or customer ID on your order.

**EMAIL:** Orders via email are greatly accepted. Please place them through [info@precisioninstallationproducts.net](mailto:info@precisioninstallationproducts.net) or contact our office for a specific customer representative.

**WEBSITE:** [www.precisioninstallationproducts.net](http://www.precisioninstallationproducts.net)

*We have a large inventory ready for immediate delivery. If the product is not in stock, we will gladly process a back order and ship as soon as it becomes available.*

Orders for in-stock items placed before 3:00 P.M. PST will ship the same business day, and orders placed after 3:00 P.M. PST will ship the following business day.

## TYPICAL TRANSIT TIMES:

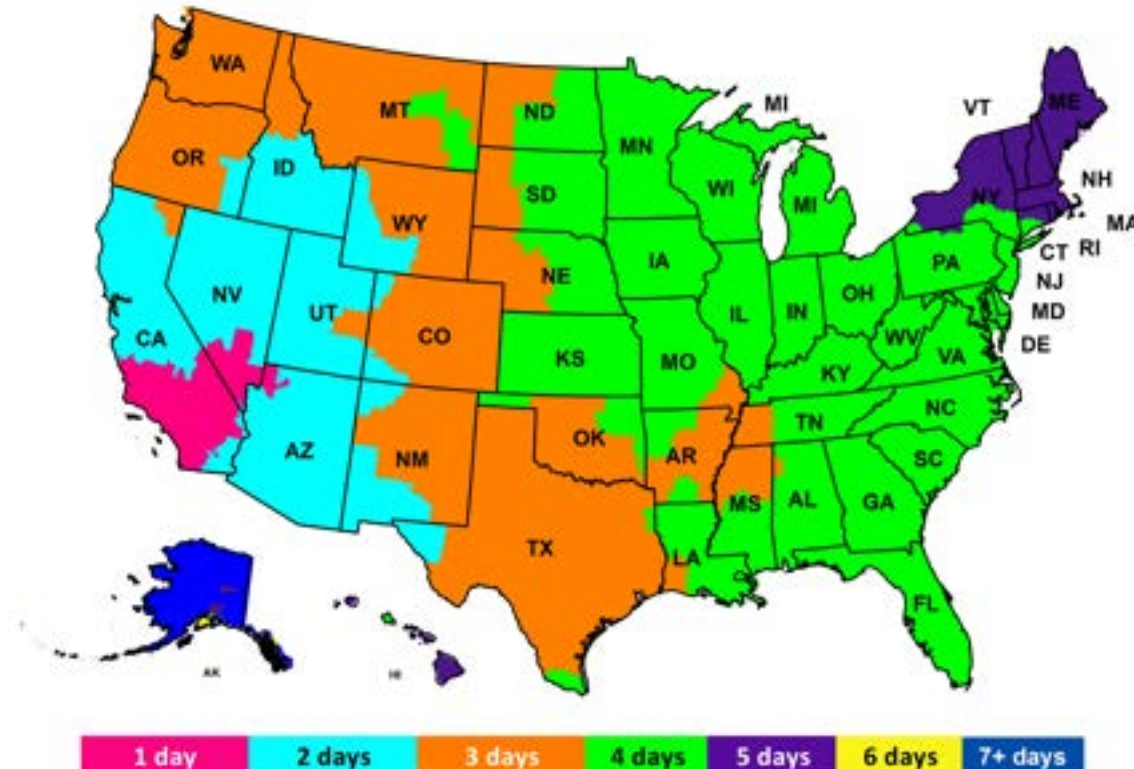

# PRODUCT RETURN POLICY



PRECISION  
INSTALLATION  
PRODUCTS

- To obtain an RGA (Returned Goods Authorization) number, call your Precision Installation Products, Inc. representative.
- The RGA number must appear on all packages.
- All returned items must be new and unused.
- Assembled items or kits consisting of multiple parts must be returned complete with all components present; otherwise, credit will not be issued.
- All goods must be returned freight prepaid within 7 days of shipment. Freight will not be credited.
- Returned goods must be properly packaged before shipment and arrive in good condition to be considered for a credit.
- Claims for error in quantity or condition must be made within 3 (THREE) days after receipt of the material. Precision Installation Products, Inc. will not be held responsible for any claimed shortages not reported within this period.
- Claims for damages incurred in transit from the freight forwarder must be filed immediately and directly with the freight forwarding company. Please notify us if a claim has been made, so we can keep this for our records. Precision Installation Products, Inc. will offer as much assistance as possible. Damaged product will be picked up by the freight company once the claim has been issued.
- Return of any goods within the warranty period must be authorized by Precision Installation Products, Inc., and have an RGA number. Buyer pays all freight charges for returned goods.
- Returned goods must be properly packaged before shipment to allow a complete warranty inspection.
- A restocking charge of 30-50 percent can be added on all goods returned for reasons other than defective merchandise.



**PRECISION  
INSTALLATION  
PRODUCTS**

# TERMS & CONDITIONS

- Open account will be extended only to those with good credit rating. All invoices are net 30 days. If credit has not been established with us, please authorize payment by credit card, or UPS/C.O.D. shipment.
- All California customers are required to furnish us with a current sales tax exemption card. If such certificate is not in our possession, we are legally bound to charge the applicable sales tax.
- No merchandise will be shipped to customers who have unpaid invoices older than 60 days from the invoice date. A late charge of 1 ½ percent monthly will be added to all past due accounts.
- All prices are FOB Foothill Ranch, California. Only domestic packaging is included. Special packaging or crating is not included in the prices.
- Most products carry a one-year material and workmanship guarantee. Ask for our detailed guarantee information.
- Precision Installation Products, Inc. expressly disclaims the liability for consequential damages resulting from the failure of its products to perform as specified.
- Freight claims must be made directly to the carrier. Precision Installation Products Inc. will offer as much assistance as possible.
- Claims for error in quantity or condition must be made within 3 (THREE) days after receipt of the material. Precision Installation Products Inc. will not be held responsible for any claimed shortages not reported within the period.
- All prices are quoted in US Dollars. Prices subject to change without notice.

# WATER TREATMENT

Pumps & Accessories - Aquatec & Nuert

Aquatec Pumps - Permeate Pumps



PRECISION  
INSTALLATION  
PRODUCTS

## PAM1000 PERMEATE PUMP / PAM500 PERMEATE PUMP



### BENEFITS TO YOUR SYSTEM

- No loss of recovery during filling cycle
- Requires no electricity
- Pump powered by energy from brine normally lost to the drain
- Better water quality out of the System
- New applications w/ > 1000 l/day can use the double Permeate Pump Technology
- Faster production against tank pressure
- Can replace industrial systems used in commercial applications
- Saves up to 85% of the Water that normally goes down the drain
- Allows smaller capacity membranes
- Saves up to 85% of your Pre-filter and Booster pump life
- Prevents "membrane TDS creep"
- Allows up to line pressure in your tank
- Allows you to use smaller system components



With its revolutionary design, the PAM1000/PAM500 Permeate Pump from Aquatec performs like no other pump. Designed to use the energy of the brine water of your RO system to pump the permeate into your pressure tank. It does not require any electricity for that. It just uses hydraulic energy that normally goes to the drain unused. This process effectively reduces the membrane back pressure to less than 5 psi, and allows the membrane to take full advantage of the available feed pressure, greatly increasing efficiency and dramatically reducing the waste water.

The Permeate Pump's advanced technology isolates your tank from the membrane and lets your membrane perform like in an atmospheric tank system. It is capable of bringing the product water holding tank up to line pressure and shutting the system down when the tank reaches full capacity. This function results in higher delivery pressure, more available water, superior water quality and extended filter and membrane life.

The Permeate Pump is effective with RO membranes rated up to 120 GPD and when combined with the 8800 series booster pump, your system will rival the production capacity of most 200 GPD commercial RO systems with a fraction of the noise level and significantly lower cost.

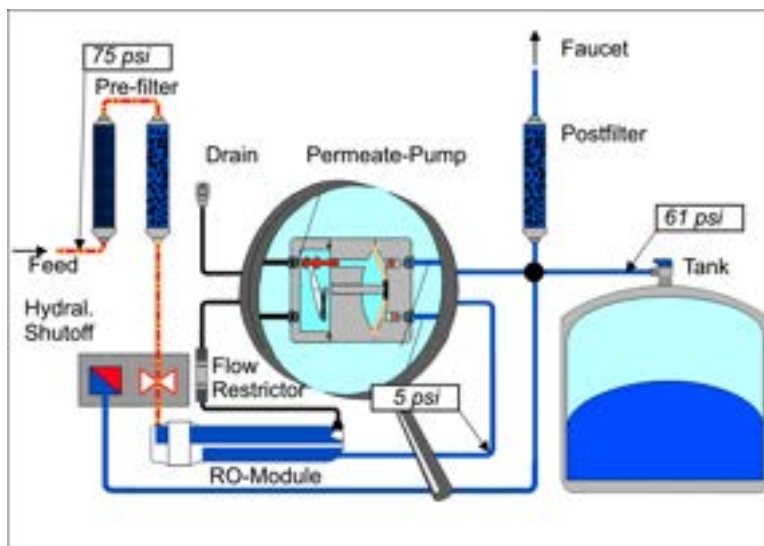



PRECISION  
INSTALLATION  
PRODUCTS



aquatec

# WATER TREATMENT

Pumps & Accessories - Aquatec & Nuert

Aquatec Pumps - Permeate Pumps

## PERMEATE PUMP



<u>PART NUMBER</u>	<u>ITEM DESCRIPTION</u>
PAM1000	AQUATEC PERMEATE PUMP W/ 1/4"JG INSERTS - FOR USE W/ 100 GPD MEMBRANES
PAM500	AQUATEC PERMEATE PUMP W/ 1/4"JG INSERTS - FOR USE W/ 50 GPD MEMBRANES

## PERMEATE PUMP MOUNTING CLIP & SCREWS



<u>PART NUMBER</u>	<u>ITEM DESCRIPTION</u>
PAMC	AQUATEC PERMEATE PUMP MOUNTING CLIP - SURFACE MOUNT
PAMC SCREWS	AQUATEC PERMEATE PUMP SCREWS - # 10-3/4" PH SM SS

## AQUATEC SS MANDRIL SPRING



<u>PART NUMBER</u>	<u>ITEM DESCRIPTION</u>
10-274	AQUATEC SS MANDRIL SPRING FOR PAM500
13-038	AQUATEC SS MANDRIL SPRING FOR PAM1000



# WATER TREATMENT

## Pumps & Accessories - Aquatec & Nuert

### Aquatec Pumps - Permeate Pumps



PRECISION  
INSTALLATION  
PRODUCTS

## TECHNICAL SPECIFICATIONS - PAM1000 PERMEATE PUMP

- PART NUMBER: ERP 1000
- PUMP DESIGN: "Positive displacement, reciprocating, single action diaphragm, hydraulically driven
- WEIGHT: 1 lb.
- WETTED MATERIALS - PERMEATE SIDE: NSF listed and FDA approved thermoplastic, EPDM
- NON-WETTED MATERIAL: Stainless Steel, Polypropylene
- FITTINGS: 1/4" Quick Connect push-in
- MOUNTING: Always mount pump with outlet ports up. Mounting clip (PAMC) with (2) #10 S.S. screws available.

FIGURE 1. PERMEATE PUMP DIMENSIONS

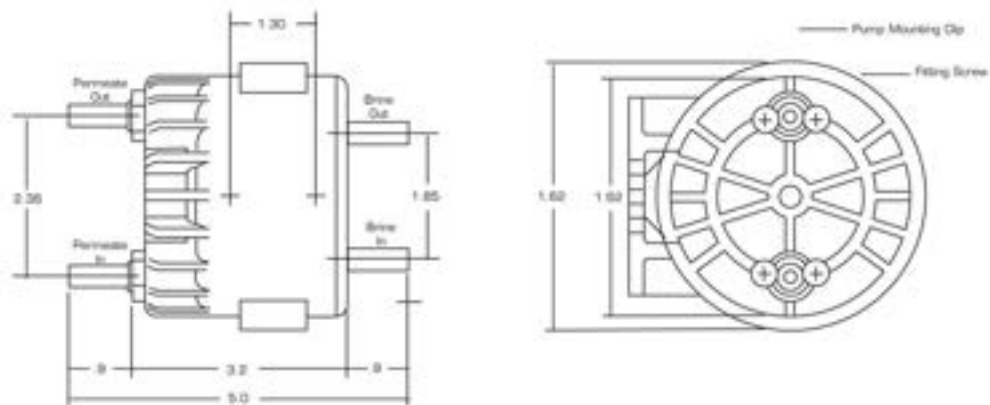

## PAM1000 PERFORMANCE CURVE

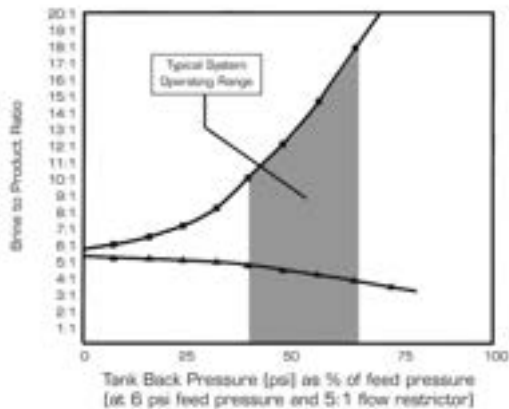



**PRECISION  
INSTALLATION  
PRODUCTS**



# WATER TREATMENT

## Pumps & Accessories - Aquatec & Nuert

### Aquatec Pumps - Permeate Pumps

#### PERFORMANCE - FILL RATE @ 60 PSI FEED

<u>PRODUCT</u>		<u>TIME TO FILL</u>	
Qty (ml)	Tank psi	With Perm. Pump	W/O Pump
4989 ml	60 psi	1hr. 13min.	
4232 ml	40 psi		1hr. 42min.
300 ml	60 psi	7min.	
1047 ml	60 psi	22.5min.	
1800 ml	40 psi		1.1hrs.

Data shown in graph above shows strong advantage of Permeate Pump in tank pressure achieved, time to completely fill the tank, and total amount of water: Permeate Pump allows 50% greater tank pressure (60 psi vs 40 psi), 18% more water (4989 ml vs 4232 ml), in 28% less time (1:13 min vs 1:42 min).

The last three lines in the chart show a significant benefit for the Permeate Pump in withdrawal of small amounts of water. A glass full (10.6 oz) takes 7 minutes to refill with a permeate system. Six cups (36.9 oz), enough for a pot of coffee is replenished in 22.5 minutes with the Permeate Pump. 1800 ml (or 63.5 oz) must be withdrawn from a conventional system to allow the hydraulic shut off valve to reopen allowing the system to refill. It takes 62 min. to replenish 1800 ml, a 176% increase in time to refill.

#### PERFORMANCE - FILL RATE @ 30 PSI FEED

<u>PRODUCT</u>		<u>TIME TO FILL</u>	
Qty (ml)	Tank psi	With Perm. Pump	W/O Pump
2947 ml	24 psi	2hr. 10 min.	
2636 ml	22 psi		4hr. 41min.
300 ml	24 psi	15min.	
1047 ml	24 psi	35min.	
**	22 psi		4.20hrs.

Data shown in graph above shows strong advantage of Permeate Pump for low feed water pressures. Per-meate Pump allows slightly more tank pressure (24 psi vs 22 psi), 12% more water (2947 ml vs 2636 ml), in less than half the time (2:10 min vs 4:41 min). The last three lines in the chart shows a huge benefit for the Permeate Pump in withdrawal of small amounts of water. A glass full (10.6 oz) takes 15 minutes to refill with the Permeate system. Six cups (36.9 oz), enough for a pot of coffee is replenished in 35 minutes with the Permeate Pump.

No Data was taken to determine quantity that must be withdrawn from a conventional system to allow the hydraulic shut off valve to reopen allowing the system to refill, although it was observed that the product tank pressure fell 11 psi before refill commenced. It then took 4 hours 20 min. to completely refill the tank, or 800% increase in time to refill.

# WATER TREATMENT

Pumps & Accessories - Aquatec & Nuert

Aquatec Pumps - Permeate Pumps



PRECISION  
INSTALLATION  
PRODUCTS

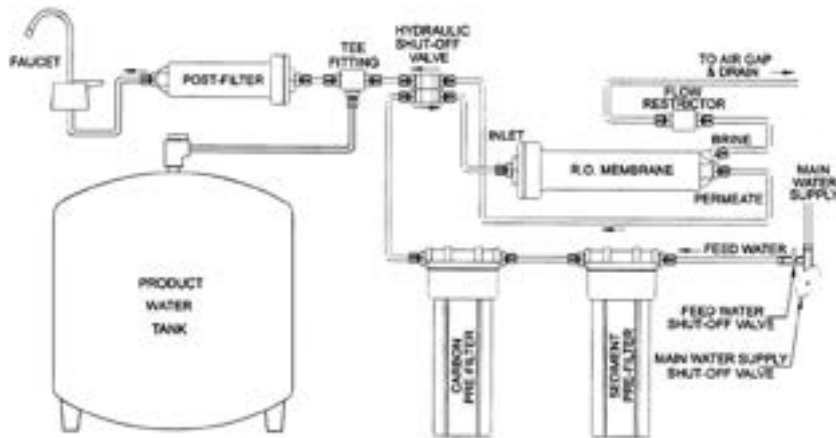

Figure 1. Typical R.O. System before installation of Permeate Pump.

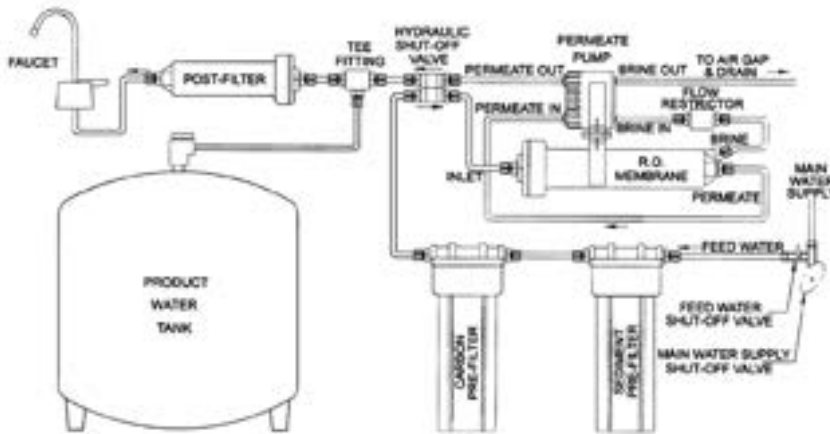

Figure 2. Typical R.O. System after installation of Permeate Pump with hydraulic shut-off valve that uses 1/8" Female pipe thread connections - Part# PAMASV

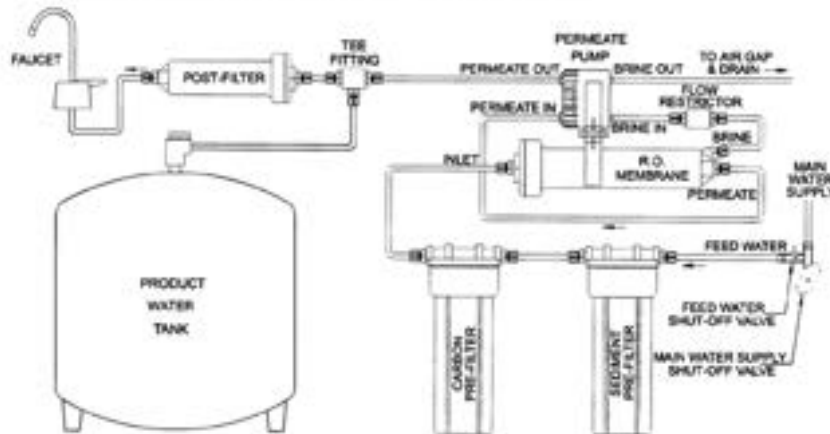

Figure 3. Typical R.O. System after installation of Permeate Pump without hydraulic shut-off valve.



# WATER TREATMENT

## Pumps & Accessories - Aquatec & Nuert

### Aquatec Pumps - Permeate Pumps

## INSTALLATION OF PERMEATE PUMP MANIFOLD RO SYSTEM USNG 1/4" TUBING

1. The Permeate Pump is equipped with 1/4" John Guest push-to-connect fittings. To install, position the pump as shown, cut the tubing, and push in to the appropriate ports per the following directions.
2. The tubing leading to the faucet must be cut, and terminated using an End Stop. The internal polishing filter is now by-passed.
3. Cut the tubing leading to the tank and re-route from the manifold to the permeate in port of the pump. The other end should be inserted into the permeate out port, connecting the tank with the pump. The outlet ports of the Permeate Pump should always be above the inlet ports in order to allow entrapped air to escape.
4. Cut the tubing between the pump and tank so that a 1/4" Union Tee can be added. The middle branch will attach to the previously cut faucet tubing, or new tubing can be added.
5. Add a polishing filter as shown by cutting the tubing between the tee and the faucet, and insert into the filter's 1/4" push-to-connect fittings.
6. Finally, cut the tubing leading to the drain and re-route from the manifold to the brine in port. Attach the drain tubing to the brine out port.

### B.O.M.:

1 each Permeate Pump	P/N PAM1000 OR PAM500
1 each Permeate Mounting Clip	P/N PAMC
1 each 1/4" End Stop	P/N LEG46-4
1 each 1/4" Union Tee	P/N LEG02-4
1 each Polishing Filter	P/N P2333-4JG

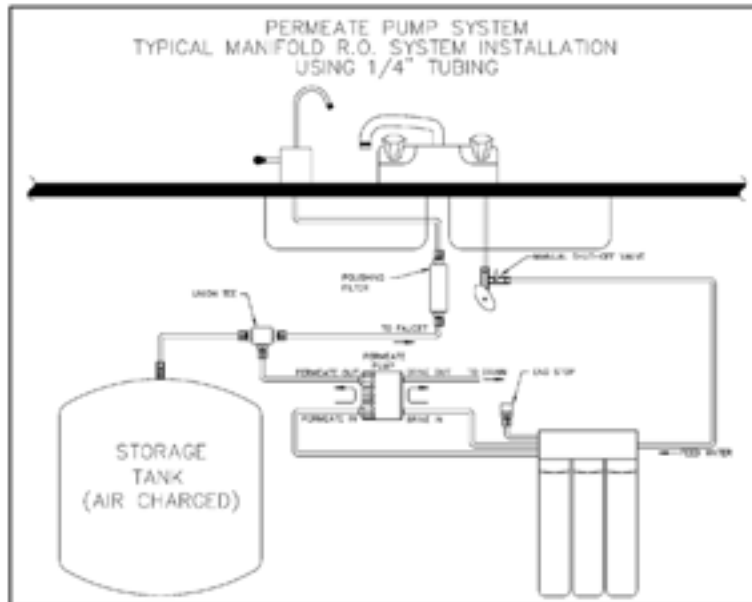

# WATER TREATMENT

## Pumps & Accessories - Aquatec & Nuert

Aquatec Pumps - Permeate Pumps



PRECISION  
INSTALLATION  
PRODUCTS

### INSTALLATION OF PERMEATE PUMP MANIFOLD RO SYSTEM USING 3/8" TUBING

1. The Permeate Pump is equipped with 1/4" push-to-connect fittings. The pump can be used in R.O. systems with 3/8" tubing by installing a short piece of 1/4" tubing into each port, and attaching a 3/8" x 1/4" Reducer Union to each of the 4 pieces of tubing.
2. The tubing leading to the faucet must be cut and terminated using an End Stop. The internal polishing filter is now by-passed.
3. Cut the 3/8" tubing leading to the tank and re-route from the manifold to the permeate in port of the pump. The other end should be inserted into the permeate out port, connecting the tank with the pump. The outlet ports of the Permeate Pump should always be above the inlet ports in order to allow entrapped air to escape.
4. Cut the tubing between the pump and tank so that a Union Tee can be added. The middle branch will attach to the previously cut faucet tubing, or new tubing can be added.
5. Add a polishing filter to the system as shown by cutting the tubing between the tee and the faucet, and insert into the filter's 3/8" push-to-connect fittings.
6. Finally, cut the 3/8" tubing leading to the drain and re-route from the manifold to the brine in port. Attach the drain tubing to the brine out port.

#### B.O.M.:

1 each Permeate Pump	P/N PAM1000 OR PAM500
1 each Permeate Mounting Clip	P/N PAMC
4 each Reducer Union	P/N LEG20-6-4
4 each 1/4" tubing, 1 1/2" long	
1 each End Stop	P/N LEG46-6
1 each Union Tee	P/N LEGSV6-6LG
1 each Polishing Filter	P/N P2333-6JG

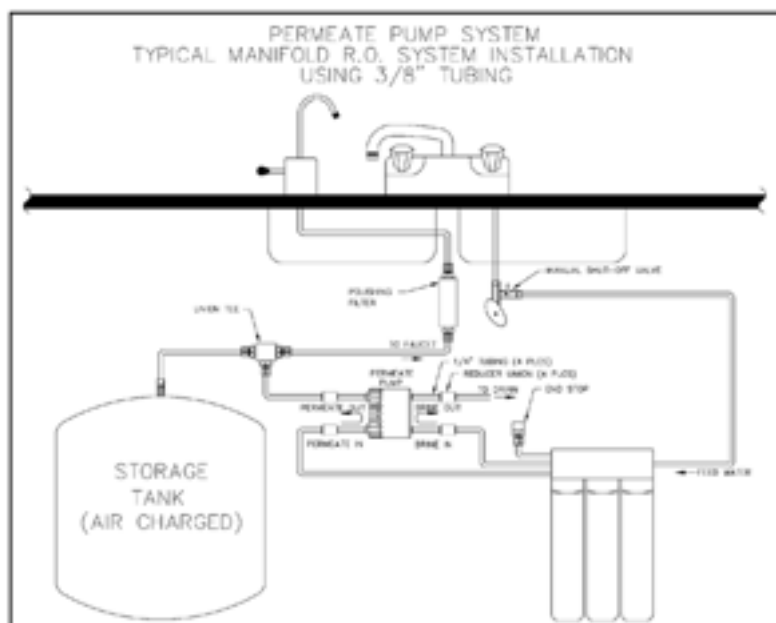



**PRECISION  
INSTALLATION  
PRODUCTS**



**aquatec**

# WATER TREATMENT

Pumps & Accessories - Aquatec & Nuert

## Aquatec Pumps - Low Flow Booster Pumps

### BOOSTER PUMPS

#### PAB6800 SERIES LOW FLOW BOOSTER PUMP

##### DISTINGUISHING FEATURES:

- Toughest, most durable pump on the market
- Adjustable max. outlet psi.(regardless of feed pressure)
- Expels trapped air (no more air locks)
- Can be mounted with pump head up or horizontal
- More flow at extremely low inlet pressures
- New motor venting system to remove moisture
- EMI/RFI electronic noise suppression
- 100% final performance tested
- Available in 12VDC and 24VDC



**PAB6840-2J03-B221**

The 6800 Series is intended for use with RO membranes rated up to 50 GPD. Close tolerances within the pump head and motor, give a lower amp draw; lower operating temperatures; smoother running; longer life; lower maintenance; and greater efficiencies.

It incorporates powder coated die cast alloy and a unique label sealing process to reduce exposure to moisture which is the major cause of motor failure. The pump is available with optional EMI/RFI electronic noise suppression to reduce TV reception interference. The PAB6800 Series is capable of operating in a warm, humid hostile environment where other pumps have been known to fail. It is the strongest, most durable pump available on the market today.

Standard flex mounting bracket is shown above. Optional steel or "H-shaped" universal brackets are also available.

# WATER TREATMENT

## Pumps & Accessories - Aquatec & Nuert

### Aquatec Pumps - Low Flow Booster Pumps



## PAB6800 SERIES LOW FLOW BOOSTER PUMP

### KEY OPERATIONAL BENEFITS

- Boosts pressure 40 to 120 psi (adjustable)
- Fixed pressures to 160 psi
- Up to 30,000+ operating hours
- Whisper quiet -- less than 45 DBA
- Can run dry without damage
- Self-priming -- 60" lift
- low voltage (12-24V) for maximum safety
- Corrosion resistant exterior
- Continuous or intermittent operation
- Available in 12VDC and 24VDC

### TECHNICAL SPECIFICATIONS

**OPERATION:** The 6800 is designed to operate with a PAW tank shut-off switch for hydro-pneumatic storage systems. The PAW, when used with a typical undercounter R.O. system, can be augmented with an ESO, Electronic Shut-off Valve. It is also compatible with most hydraulic shut-off valves. For counter-top systems, Aquatec's TIC, Tank level Controllers, shut off feed water and the pump when the product water storage tank is full.

**MOUNTING PIATES:** The "S" Shaped Flex Bracket base plate is standard. The "Universal" base plate and "Steel" base plate are also available.

**POWER:** Pumps operate with low energy (only 14 watts), low voltage (12-24 volt) motors, powered with compatible transformers with world wide primary voltages available (100 VAC, 120 VAC, 230 VAC). Transformers are optional and must be ordered in addition to the pump.

**FITTINGS:** Built-in 1/4" Quick Connect half cartridge fittings eliminate need for external fittings as standard. It is also available with 3/8" built in Quick Connect half cartridges.

**INSTALLATION:** The location and positioning of the pump may affect its performance. Always consult the factory for recommendations that will optimize your system, if you have any concerns or questions.

Schematic of PAB6800 Series with a Flex Bracket

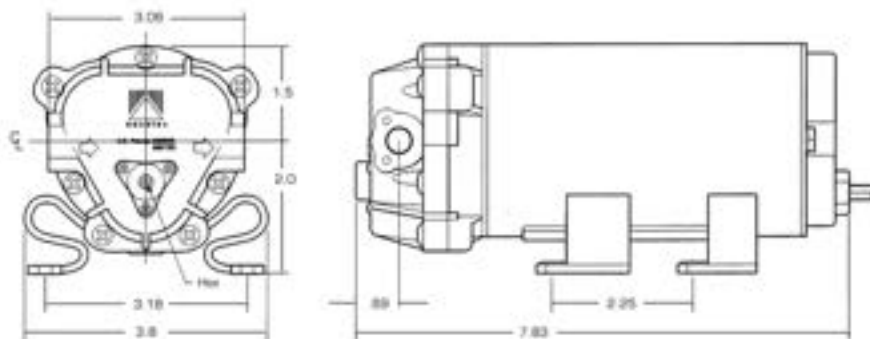



PRECISION  
INSTALLATION  
PRODUCTS



# WATER TREATMENT

## Pumps & Accessories - Aquatec & Nuert

### Aquatec Pumps - Low Flow Booster Pumps

## AQUATEC BOOSTER PUMPS - LOW FLOW (1/4" JG PORTS)



<u>PART NUMBER</u>	<u>ITEM DESCRIPTION</u>
PAB6840-2D12-E204	AQUATEC LF BOOSTER PUMP - 24VDC - 50 PSI BYPASS - 1/4"JG - STEEL - W/ EMI/RFI
PAB6840-2H03-B221	AQUATEC LF BOOSTER PUMP - 24VAC - 90 PSI BYPASS - 1/4"JG - FLEX
PAB6840-2J03-B203	AQUATEC LF BOOSTER PUMP - 24 VDC - 110 PSI BYPASS - 1/4" JG PORTS - UNIVERSAL BRACKET
PAB6840-2J03-B221	AQUATEC LF BOOSTER PUMP - 24VAC - 110PSI BYPASS - 1/4"JG - FLEX
PAB6840-2J03-B223	AQUATEC LF BOOSTER PUMP - 24VAC - 110PSI BYPASS - 1/4"JG - UNIVERSAL
PAB6840-2J03-B224	AQUATEC LF BOOSTER PUMP - 24VAC - 110PSI BYPASS - 1/4"JG - STEEL
PAB6840-2J03-V201	AQUATEC LF BOOSTER PUMP - 24VDC - 110 PSI BYPASS - 1/4"JG PORTS - FLEX BRACKET - LEAD WIRES W/ E...
PAB6840-2J03-V221	AQUATEC LF BOOSTER PUMP - 24VAC - 110PSI BYPASS - 1/4"JG - FLEX - W/ CONNECTORS - EMI/RFI
PAB6840-2J03-V223	AQUATEC LF BOOSTER PUMP - 24VAC - 110PSI BYPASS - 1/4"JG - UNIVERSAL - W/ CONNECTORS - EMI/RFI

<u>PART NUMBER</u>	<u>ITEM DESCRIPTION</u>
PAB6841-2G01-B204	AQUATEC LF BOOSTER PUMP - 24VDC - 80PSI BYPASS - 1/4"JG - STEEL BRKT
PAB6841-2G01-B224	AQUATEC LF BOOSTER PUMP - 24VAC - 80PSI BYPASS - 1/4"JG - STEEL BRKT
PAB6841-2H03-B221	AQUATEC LF BOOSTER PUMP - 24VAC - 90 PSI BYPASS - 1/4"JG - FLEX
PAB6841-2J03-B221	AQUATEC LF BOOSTER PUMP - 24VAC - 110PSI BYPASS - 1/4"JG - FLEX
PAB6841-2J03-B331	AQUATEC LF BOOSTER PUMP - 12VDC - 110PSI BYPASS - 1/4"JG - FLEX
PAB6841-2J03-B334	AQUATEC LF BOOSTER PUMP - 12VDC - 110PSI BYPASS - 1/4"JG - METAL
PAB6841-2J03-V201	AQUATEC LF BOOSTER PUMP - 24VDC - 110 PSI BYPASS - 1/4"JG - FLEX - LEAD WIRES W/ EMI/RFI
PAB6841-2J03-V221	AQUATEC LF BOOSTER PUMP - 24VAC - 110PSI BYPASS - 1/4"JG - FLEX - W/ CONNECTORS - EMI/RFI
PAB6841-2J63-B221	AQUATEC LF BOOSTER PUMP - 24VAC - 110PSI BYPASS - 1/4"JG - FLEX - VITON VALVES & O-RINGS
PAB6841-2P01-B331	AQUATEC LF MISTING PUMP - 12VDC - 160PSI BYPASS - 1/4"JG - FLEX
PAB6841-2P03-B221	AQUATEC LF BOOSTER PUMP - 24VAC - 160PSI BYPASS - 1/4"JG - FLEX
PAB6841-2P77-B330	AQUATEC LF MISTING PUMP - 12VDC - VITON SEALS & DIAPHRAGM - 160 PSI BYPASS - 1/4" JG - NO BRACKET
PAB6841-2P77-B334	AQUATEC LF MISTING PUMP - 12VDC - VITON - 160PSI BYPASS - 1/4"JG - METAL



# WATER TREATMENT

Pumps & Accessories - Aquatec & Nuert

Aquatec Pumps - Low Flow Booster Pumps



## AQUATEC BOOSTER PUMPS - LOW FLOW (3/8" JG PORTS)



<u>PART NUMBER</u>	<u>ITEM DESCRIPTION</u>
PAB6850-2DF2-S204	AQUATEC LF BOOSTER PUMP - 24VDC- 50PSI BYPASS - 3/8"JG - STEEL - W/ EMI/RFI - 120°ROTATION - THE..
PAB6850-2J03-B221	AQUATEC LF BOOSTER PUMP - 24VAC - 110PSI BYPASS - 3/8"JG - FLEX
PAB6850-2J03-V201	AQUATEC LF BOOSTER PUMP - 24VDC - 110 BYPASS - 3/8"JG - FLEX - LEAD WIRES W/ EMI/RFI

<u>PART NUMBER</u>	<u>ITEM DESCRIPTION</u>
PAB6851-2J03-B221	AQUATEC LF BOOSTER PUMP - 24VAC - 110 PSI BYPASS - 3/8" JG - FLEX BRACKET
PAB6851-2J03-B331	AQUATEC LF BOOSTER PUMP - 12VDC - 110PSI BYPASS - 3/8"JG - 2-1/2°CAM - FLEX
PAB6851-2P01-B221	AQUATEC LF BOOSTER PUMP - 24VAC - 160PSI BYPASS - 3/8"JG - FLEX
PAB6851-2P01-B224	AQUATEC LF BOOSTER PUMP - 24VAC - 160PSI BYPASS - 3/8" JG - STEEL
PAB6851-2P01-B331	AQUATEC LF BOOSTER PUMP - 12VDC - 160PSI BYPASS - 3/8"JG - FLEX

## REPAIR PARTS FOR PAB6800 SERIES

<u>PART NUMBER</u>	<u>ITEM DESCRIPTION</u>
PAB-SCREWS	AQUATEC SCREWS FOR BASE PLATE ON CDP6800 PUMP
PAB53-015-00	AQUATEC DIAPHRAGM KIT (LOWER HOUSING ASSEMBLY) ONLY FOR 6840/8840 & 6850/8850 BOOSTER PUMPS (FOR...
PAB53-082	AQUATEC DIAPHRAGM KIT (LOWER HOUSING ASSEMBLY) ONLY FOR 6841/8841 & 6851/8851 BOOSTER PUMPS (FOR...
PAB6840-2J03	AQUATEC 6840-2J03 COMPLETE PUMP HEAD ASSEMBLY ONLY
PAB6841-2J03	AQUATEC 6841-2J03 COMPLETE PUMP HEAD ONLY
PAB6850-2J03	AQUATEC 6850 COMPLETE PUMP HEAD ASSEMBLY ONLY
PAB6851-2P01	AQUATEC 6851-2P01 COMPLETE PUMP HEAD ASSEMBLY ONLY
PAB6871-2B01	AQUATEC 6871-2B01 COMPLETE PUMP HEAD ONLY
PAB6840-2J03-V223	AQUATEC LF BOOSTER PUMP - 24VAC - 110PSI BYPASS - 1/4"JG - UNIVERSAL - W/ CONNECTORS - EMI/RFI



# WATER TREATMENT

## Pumps & Accessories - Aquatec & Nuert

### Aquatec Pumps - Low Flow Booster Pumps

## OPERATIONAL & INSTALLATION GUIDELINES

### PAB6800 SERIES BOOSTER PUMP

Please read these Operational and Installation Guidelines before installing the PAB6800 Series Booster Pump. If additional help is needed, please consult the Factory.

#### CAUTIONS:

- The pump is equipped with either a fixed or adjustable bypass valve which controls the maximum operating pressure.
- Never operate the pump in harsh environment or hazardous atmosphere, since motor brush and switch may cause electrical arcing.
- Pumphead materials are designed for use with water only. Do not use with petroleum products.
- As long as there is feed water pressure, the pump will not stop forward flow of water even if the motor is turned off. Be sure the system has positive means of shutting off water supply.
- Always consider electrical shock hazard when working with and handling electrical equipment. If uncertain, consult an Electrician. Electrical wiring should only be done by a qualified Electrician per local and State Electric Codes.

#### MOUNTING:

- The pump should be mounted in a dry place and away from any source of heat. If an enclosure is used, special provisions for cooling the motor may be necessary. Certain models may be ordered with a thermal protected motor.
- Do not subject the Pump to extreme high or low (freezing) temperatures while in operation. (Operating ambient temperatures range is 32°F to 115°F)
- The pump may be mounted in any position. If "ceiling mounted", with the pump down, air entrapment may reduce the operational performance by up to 15%. Consult Aquatec for ceiling mount solutions.

#### PLUMBING:

- We recommend use of flexible tubing with proper pressure rating.
- Pump will prime only if all pressure is relieved from the outlet port.
- It is recommended that an in-line sediment filter be installed at the inlet side to keep foreign debris out of the system. This does not include a dual purpose filter (sediment/carbon).
- Avoid any sharp bends which may crimp tubing and restrict flow. Use 90° elbow fittings if necessary.
- The pump should always be mounted prior to the carbon pre-filter to prevent carbon particles from entering the pump chambers and possibly causing clogging. This includes any dual purpose (sediment/carbon) filter.

#### ELECTRICAL:

- The PAB6800 series pumps are designed for continuous duty. If used for intermittent duty cycle, make sure that "off" periods are greater than 60 seconds. Consult the Factory for particular data and design criteria.
- If a power supply used with the system is not furnished by Aquatec, it will need to be reviewed for correct application and approval by Aquatec.

# WATER TREATMENT

Pumps & Accessories - Aquatec & Nuert

Aquatec Pumps - Low Flow Booster Pumps



## INSTALLATION PROCEEDURE

### PAB6800 SERIES BOOSTER PUMPS

The basic PAB6800 pump consists of a pump and transformer unit. Systems may be supplied with other options: e.g. PAW system pressurized shut-off switch, LPS low feed-water shut-off switch, TLC tank level controller or PAF membrane auto-flush valve or PFR membrane auto-flush flow restrictor valve. Pumps are completely assembled, tested and ready for immediate connection to your R.O. system.

Read the operational and installation guidelines carefully before starting to install the pump.

Consult the Factory if there is any question.

1. Determine the optimum location for your pump before proceeding.

note: locate the pump after the sediment pre-filter and before the carbon pre-filter (If part of R.O. system).

2. Turn off water.

3. Cut the 1/4" or 3/8" O.D. flexible tubing in sufficient length to avoid any stress on the tubing where it connects to the pump or the fitting on any accessory.

4. Insert tubing into pump ports. Be sure tubing is inserted past the resistance point until it bottoms out against the port stop.

5. The "CDP" pump is now ready for operation. Open feed-water valve to allow water to flow through the R.O. system (Open flow-restrictor by-pass valve if part of R.O. system).

6. If the power source is a transformer, plug the appropriate Aquatec supplied/approved transformer into the receptacle and connect the pump to the transformer. If the power source is not a transformer, connect the pump to the appropriate power source. Allow water to circulate, purging any entrapped air. For pumps equipped with our "AFT" auto-flush, the flow restrictor by-pass will open and close automatically when the transformer is plugged in.

7. The pump will now start building pressure. Operating pressure will vary with membrane flow rate, flow restrictor flow rate, feed-water pressure and line voltage. Check for fitting leaks.

**NOTE:** If the flow restrictor is too small (We recommend 300MI/MIN. for standard CDP 6800 series pumps and 500MI/MIN. for CDP 8800 series pumps), or if the R.O. systems is clogged, an internal pump by-pass mechanism limits the output pressure.

#### SERVICING:

Every Year: Check system against operating standards.

Every 2-3 Years: Replace diaphragm and check against operating standards.



# WATER TREATMENT

## Pumps & Accessories - Aquatec & Nuert

Aquatec Pumps - Low Flow Booster Pumps

## AQUATEC WARRANTY INFORMATION

**Aquatec Water Systems, Inc.** ("Aquatec") warrants its products to be free from defects in material and workmanship under the following terms:

**All Aquatec products with the exception of series 68XX, ERP 1000 and Aquajet model pumps:** The warranty will last for a period of thirteen months from the date of shipping from an Aquatec warehouse. Warranty period for 68XX and ERP 1000 is twenty-five months from the date of shipment from Aquatec. Aquatec warrants its Model Aquajet RV Pumps (Part Numbers 55-AQUAJET-ARV and 55-AQUAJET-AES) for a period of 2 years from the date of shipment from Aquatec. Aquatec's obligation under this warranty shall be limited to replacing or repairing at Aquatec's discretion, any such product or part which must be returned to Aquatec's factory with a Return Material Authorization Number (RMA No.), transportation charges approved by Aquatec or prepaid, and which upon examination, is found to Aquatec's satisfaction to have been defective under the terms of this warranty. No credit will be allowed against future purchases for items returned as defective under the terms of Aquatec's warranty.

**This warranty does not extend to any products, which have been altered or modified outside the Aquatec factory, nor does it apply to units that are returned in an unassembled condition.** Furthermore, the warranty does not extend to pumps that are identified by a 9XXX model number, indicating non-compliance with Aquatec's Engineering Standards. This includes, but is not limited to, pumps ordered without an integral control mechanism. The warranty guarantees that products will perform to Aquatec's flow and pressure specifications throughout the life of the warranty. The warranty does not cover wear, appearance, misapplication or external water damage. If the returned product is found not to be defective under the conditions of this warranty, a charge will be made for repair or replacement.

**Brush wear may be limited to 1000 hours or less.**

**This is a Limited Warranty. It covers the product only and the extent of the coverage is limited to the cost of the product. As the manufacturer has no control over shipping, handling and installation, the warranty cannot cover water damage, or any other damage, caused by a leak or other malfunction.**

This warranty is in lieu of all other warranties, expressed or implied, and no person is authorized to give any other warranty or assume obligation or liability in Aquatec's behalf. Aquatec shall not be liable for any indirect, incidental or consequential damages of any kind incurred by the reason of the use or sale of any defective product and part.

# WATER TREATMENT

Pumps & Accessories - Aquatec & Nuert

## Aquatec Pumps - High Flow Booster Pumps



## BOOSTER PUMPS

### PAB8800 SERIES HIGH FLOW BOOSTER PUMP

#### DISTINGUISHING FEATURES:

- Toughest, most durable pump on the market
- Adjustable max. outlet psi.(regardless of feed pressure)
- Expels trapped air (no more air locks)
- Can be mounted with pump head up or horizontal
- More flow at extremely low inlet pressures
- New motor venting system to remove moisture
- EMI/RFI electronic noise suppression
- 100% final performance tested
- Available in 12VDC and 24VDC



PAB8851-2J03-B423

The 8800 Series is intended for membranes rated up to 120 GPD. Close tolerances within the pump head and motor, result in lower amp draw; lower operating temperatures; smoother running; longer life; lower maintenance; and greater efficiencies.

The pump incorporates powder coated die cast alloys and a unique label sealing process to reduce exposure to moisture which is the major cause of motor failure. The pump is available with optional EMI/RFI electronic noise suppression to reduce TV reception interference. It is capable of operating in a warm, humid, hostile environment where other pumps have been known to fail. It is the toughest, most durable pump available on the market today.

The standard flex mounting bracket is a "S-shaped" plastic bracket. The universal bracket (as shown above) and steel bracket are also available.



# WATER TREATMENT Pumps & Accessories - Aquatec & Nuert

## Aquatec Pumps - High Flow Booster Pumps

### PAB8800 SERIES HIGH FLOW BOOSTER PUMP

#### KEY OPERATIONAL BENEFITS:

- Boosts pressure 40 to 120 psi (adjustable)
- Used with membranes 50 to 120 GPD
- 15,000+ operating hours (estimated)
- Quiet -- less than 52 DBA
- Can run dry without damage
- Self-priming -- 60" lift
- Low voltage [12-24V] for maximum safety
- Corrosion resistant exterior
- Available in 12VDC and 24VDC

#### TECHNICAL SPECIFICATIONS

**OPERATION:** The PAB8800 is designed to operate with a PAW tank shut-off switch for hydro-pneumatic storage systems. The PAW, when used with a typical under counter R.O. system, can be augmented with an PSO, Electronic Shut-off Valve. It is also compatible with most hydraulic shut-off valves. For counter-top systems, Aquatec's TIC, Tank level Controllers, shut off feed water and the pump when the product water storage tank is full. The PFR, Auto Flush Valve, is highly recommended for higher production membranes to ensure membrane efficiency.

**MOUNTING PLATES:** The flex base plate is standard. The "Universal" base plate and "steel" base plates are also available.

**POWER:** Pumps operate with safe, low energy (only 24 watts), low voltage (12-24 volt) motors, powered with compatible transformers with world wide primary voltages available (100 VAC, 120 VAC, 230 VAC). Transformers are optional and must be ordered in addition to the pump.

**FITTINGS:** Built-in 3/8" Quick Connect half cartridge fittings eliminate need for external fittings as standard. It is also available with 1/4" built-in Quick Connect half cartridges.

**INSTALLATION:** The location and positioning of the pump may affect its performance. Always consult the factory for recommendations that will optimize your system, if you have any concerns or questions.

Schematic of PAB8851 Series with steel mounting bracket

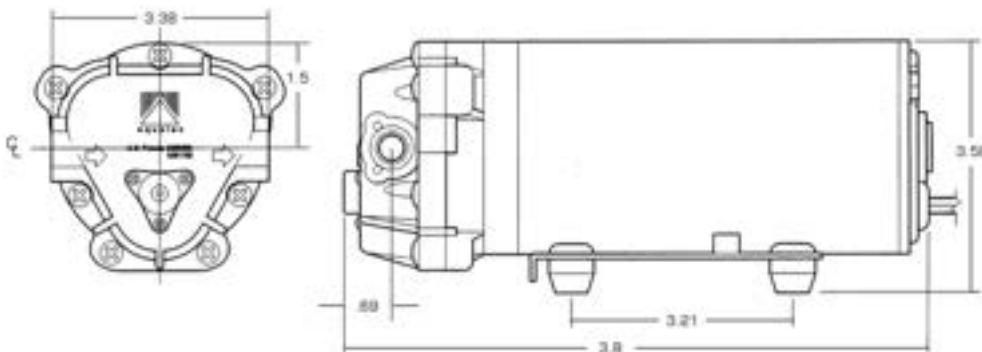

# WATER TREATMENT

## Pumps & Accessories - Aquatec & Nuert

Aquatec Pumps - High Flow Booster Pumps



**PRECISION  
INSTALLATION  
PRODUCTS**

## BOOSTER PUMPS - HIGH FLOW (1/4" JG PORTS)



<u>PART NUMBER</u>	<u>ITEM DESCRIPTION</u>
PAB8840-2J03-B424	AQUATEC HF BOOSTER PUMP - 24VAC - 110PSI BYPASS - 1.90LPM - 1/4"JG - STEEL BRACKET
PAB8841-2HO1-T421	AQUATEC HF BOOSTER PUMP - 90PSI BYPASS - THERMAL MOTOR - 1/4"JG - FLEX
PAB8841-2J03-B421	AQUATEC HF BOOSTER PUMP - 24VAC - 110PSI BYPASS - 2.10LPM - 1/4"JG - FLEX
PAB8841-2J03-B423	AQUATEC HF BOOSTER PUMP - 24VAC - 110PSI BYPASS - 2.10LPM - 1/4"JG - UNIVERSAL
PAB8841-2J03-B424	AQUATEC HF BOOSTER PUMP - 24VAC - 110PSI BYPASS - 2.10LPM - 1/4"JG - STEEL
PAB8841-2J03-B541	AQUATEC HF BOOSTER PUMP - 12VDC - 110PSI BYPASS - 1/4"JG - FLEX
PAB8841-2J03-B544	AQUATEC HF BOOSTER PUMP - 12VDC - 110PSI BYPASS - 1/4"JG - STEEL
PAB8841-2P02-T421	AQUATEC HF BOOSTER PUMP-24VAC-160 PSI BYPASS-1/4" JG-THERMAL MOTOR-FLEX BRKT
PAB8842-2D01-V594	AQUATEC HF BOOSTER PUMP-24VDC-50 PSI BYPASS-1/4' JG-W/ LEAD WIRES ONLY-EMI/RFI-STEEL BRACKET
PAB8842-2E01-V594	AQUATEC HF BOOSTER PUMP - 24VDC - 60 PSI BYPASS - 1/4"JG - W/ LEAD WIRES ONLY - EMI/RFI - STEEL
PAB8842-2E12-V544	AQUATEC HF BOOSTER PUMP - 12VDC - 60 PSI BYPASS - 1.4LPM - 1/4"JG - W/ LEAD WIRES ONLY - EMI/RFI...
PAB8842-2F12-V594	AQUATEC HF BOOSTER PUMP-24VDC-70PSI BYPASS-1/4" JG-W/LEAD WIRES ONLY-EMI/RFI
PAB8842-2G02-T424	AQUATEC HF BOOSTER PUMP - 24VAC - 2.6 LPM - 80PSI BYPASS - 1/4"JG - THERMAL MOTOR - METAL BRACKET
PAB8842-2J03-B423	AQUATEC HF BOOSTER PUMP - 24VAC - 110PSI BYPASS - 1/4"JG - UNIVERSAL BRKT
PAB8842-2J03-B424	AQUATEC HF BOOSTER PUMP - 24VAC - 110PSI BYPASS - 1/4"JG - STEEL
PAB8842-2J03-B544	AQUATEC HF BOOSTER PUMP - 12VDC - 110PSI BYPASS - 1/4"JG - STEEL
PAB8842-2J03-V594	AQUATEC HF BOOSTER PUMP-24VDC-110 PSI BYPASS-1/4' JG-W/ LEAD WIRES ONLY-EMI/RFI-STEEL BRACKET
PAB8842-2M03-V594	AQUATEC HF BOOSTER PUMP - 24VDC - 140PSI BYPASS - 1/4"JG - W/ LEAD WIRES ONLY - EMI/RFI - STEEL
PAB8842-2P01-B594	AQUATEC HF BOOSTER PUMP- 24VDC - 160 PSI BYPASS - 2.35 LPM-STEEL BRKT
PAB8842-2P02-T421	AQUATEC HF BOOSTER PUMP - 24VAC-2.6 LPM-160 PSI BYPASS- 1/4"JG -THERMAL MOTOR-FLEX BRACKET



**PRECISION  
INSTALLATION  
PRODUCTS**



# WATER TREATMENT

## Pumps & Accessories - Aquatec & Nuert

### Aquatec Pumps - High Flow Booster Pumps

## BOOSTER PUMPS - HIGH FLOW (3/8" JG PORTS)



<u>PART NUMBER</u>	<u>ITEM DESCRIPTION</u>
PDP5853-2LM2-B534	AQUATEC HF BOOSTER PUMP-24VAC-130PSI BYPASS-1.2GPM-3/8" JG* * *AKA PART # 5858-2LM2-B534
PAB8850-2E03-B424	AQUATEC HF BOOSTER PUMP - 60PSI BYPASS - 3/8"JG - 2°CAM - STEEL
PAB8850-2H03-B424	AQUATEC HF BOOSTER PUMP-90PSI-BYPASS-1.9LPM-24VAC-3/8" JG
PAB8850-2J03-B421	AQUATEC HF BOOSTER PUMP - 24 VAC - 110 PSI BYPASS - 3/8" JG - FLEX BRACKET
PAB8850-2P02-T424	AQUATEC HF BOOSTER PUMP - 1.9 LPM - 24VAC - 160PSI BYPASS - 3/8"JG - THERMAL MOTOR - 2°CAM - STEEL
PAB8850-2P02-T541	AQUATEC HF BOOSTER PUMP - 12VDC - 160PSI BYPASS - 3/8"JG - THERMAL MOTOR - FLEX
PAB8850-2P02-T544	AQUATEC HF BOOSTER PUMP - 12VDC - 160PSI BYPASS - 3/8"JG - THERMAL MOTOR - STEEL

<u>PART NUMBER</u>	<u>ITEM DESCRIPTION</u>
PAB8851-2F03-V594	AQUATEC HF BOOSTER PUMP - 24VDC - 70PSI BYPASS - 1.93LPM - 3/8"JG - W/ LEAD WIRES ONLY - EMI/RFI...
PAB8851-2G03-B593	AQUATEC HF BOOSTER PUMP - 24VDC - 80 PSI BYPASS - 1.93LPM - 3/8"JG - UNIVERSAL
PAB8851-2J03-B323	AQUATEC HF BOOSTER PUMP-24VAC-110PSI BYPASS-3/8JG-UNIVERSAL BRKT
PAB8851-2J03-B421	AQUATEC HF BOOSTER PUMP - 24VAC - 110PSI BYPASS - 3/8"JG - FLEX
PAB8851-2J03-B423	AQUATEC HF BOOSTER PUMP - 24VAC - 110PSI BYPASS - 3/8"JG - UNIVERSAL
PAB8851-2J03-B424	AQUATEC HF BOOSTER PUMP - 24VAC - 110PSI BYPASS - 3/8"JG - STEEL
PAB8851-2J03-V323	AQUATEC HF BOOSTER PUMP - 24VAC - 110PSI BYPASS - 3/8"JG - W/ CONNECTORS - EMI/RFI - UNIVERSAL
PAB8851-2J03-V594	AQUATEC HF BOOSTER PUMP - 24VDC - 110PSI BYPASS - 1.93LPM - 3/8"JG - W/ LEAD WIRES ONLY - EMI/RF...
PAB8851-2J12-V421	AQUATEC HF BOOSTER - 24VAC - 110PSI BYPASS - 3/8"JG - W/ CONNECTORS - EMI/RFI - FLEX
PAB8851-2J12-V423	AQUATEC HF BOOSTER - 24VAC - 110PSI BYPASS - 3/8"JG - W/ CONNECTORS - EMI/RFI - UNIVERSAL
PAB8851-2P02-T424	AQUATEC HF BOOSTER PUMP - 2.10 LPM - 24VAC - 160PSI BYPASS - 3/8"JG - THERMAL MOTOR - STEEL
PAB6841-2P77-B330	AQUATEC LF MISTING PUMP - 12VDC - VITON SEALS & DIAPHRAGM - 160 PSI BYPASS - 1/4" JG - NO BRACKET
PAB6841-2P77-B334	AQUATEC LF MISTING PUMP - 12VDC - VITON - 160PSI BYPASS - 1/4"JG - METAL



# WATER TREATMENT

## Pumps & Accessories - Aquatec & Nuert

Aquatec Pumps - High Flow Booster Pumps



## BOOSTER PUMPS - HIGH FLOW (3/8" JG PORTS)



<u>PART NUMBER</u>	<u>ITEM DESCRIPTION</u>
PAB8852-2D01-V594	AQUATEC - 24VDC - 50PSI BYPASS - 3/8"JG - 2.35LPM - W/ LEAD WIRES ONLY - EMI/RFI...
PAB8852-2E01-V594	AQUATEC - 24VDC - 60PSI BYPASS - 3/8"JG - 2.35LPM - W/ LEAD WIRES ONLY - EMI/RFI...
PAB8852-2E12-B424	AQUATEC - 24VAC - 60PSI BYPASS - 3/8"JG - STEEL
PAB8852-2F03-V594	AQUATEC - 24VDC - 70PSI BYPASS - 3/8"JG - 2.35LPM - W/ LEAD WIRES ONLY - EMI/RFI...
PAB8852-2G03-B593	AQUATEC - 24VDC - 80 PSI BYPASS - 2.35LPM - 3/8"JG - UNIVERSAL
PAB8852-2H03-B424	AQUATEC - 24VAC - 90PSI BYPASS - 3/8"JG - STEEL
PAB8852-2H03-V594	AQUATEC - 24VDC - 90PSI BYPASS - 3/8"JG - W/ LEAD WIRES ONLY - EMI/RFI - STEEL
PAB8852-2I77-B424	AQUATEC - 24VAC - 100PSI BYPASS - 3/8"JG - VITON SEALS - STEEL
PAB8852-2J01-B594	AQUATEC - 24VDC - 110PSI BYPASS - 3/8"JG - W/ LEAD WIRES ONLY - STEEL
PAB8852-2J03-B421	AQUATEC - 24VAC - 110PSI BYPASS - 3/8"JG - 3°CAM - FLEX
PAB8852-2J03-B423	AQUATEC - 24VAC - 110PSI BYPASS - 3/8"JG - 3°CAM - UNIVERSAL
PAB8852-2J03-B424	AQUATEC - 24VAC - 110PSI BYPASS - 3/8"JG - 3°CAM - STEEL
PAB8852-2J03-B544	AQUATEC HF BOOSTER PUMP-12VDC -110PSI BYPASS-1.4 LPM -3/8JG
PAB8852-2J03-V423	AQUATEC - 24VAC - 110PSI BYPASS - 3/8"JG - 3°CAM - W/ CONNECTORS - EMI/RFI - UNI...
PAB8852-2J03-V424	AQUATEC - 24VAC - 110PSI BYPASS - 3/8"JG - 3°CAM - W/ CONNECTORS - EMI/RFI - STEEL
PAB8852-2J03-V594	AQUATEC - 24VDC - 110PSI BYPASS - 3/8"JG - W/ LEAD WIRES ONLY - EMI/RFI/CE - STEEL
PAB8852-2J77-B423	AQUATEC - 24VAC - 110PSI BYPASS - 3/8"JG - VITON SEALS - UNIVERSAL
PAB8852-2L03-T421	AQUATEC - 24VAC -130PSI BYPASS - 3/8 JG - THERMAL MOTOR - FLEX BRACKET
PAB8852-2P02-T421	AQUATEC - 2.6 LPM - 24VAC - 160PSI BYPASS - 3/8"JG - THERMAL MOTOR - FLEX
PAB8852-2P02-T423	AQUATEC -160PSI-BYPASS-24VAC-2.6LPM-THERMAL MOTOR-UNIV BRKT-3/8 JG
PAB8852-2P02-T424	AQUATEC - 2.6 LPM - 24VAC - 160PSI BYPASS - 3/8"JG - THERMAL MOTOR - STEEL
PAB8852-2P02-T541	AQUATEC - 12VDC - 160PSI BYPASS - 3/8"JG - THERMAL MOTOR - FLEX
PAB8852-8D77-V594	AQUATEC - 24VDC -50PSI BYPASS - 3/8"JG - VITON SEALS - W/ LEAD WIRES ONLY - EMI/...
PAB8852-8F77-V594	AQUATEC - 24VDC - 70PSI BYPASS - 3/8"JG - VITON SEALS - W/ LEAD WIRES ONLY - EMI...
PAB8852-8FE1-V594	AQUATEC - 24VDC - 70PSI BYPASS - 3/8"JG - W/ PE SHIELD - W/ LEAD WIRES ONLY - EM...



PRECISION  
INSTALLATION  
PRODUCTS



# WATER TREATMENT

Pumps & Accessories - Aquatec & Nuert

## Aquatec Pumps - High Flow Booster Pumps

### BOOSTER PUMPS - HIGH FLOW (3/8" FPT PORTS)



<u>PART NUMBER</u>	<u>ITEM DESCRIPTION</u>
PAB8881-2J03-B594	AQUATEC HF BOOSTER PUMP-24VDC-110PSI BYPASS-3/8"FPT PORTS-NO CORD-LEAD WIRES ONLY
PAB8882-2H12-V594	AQUATEC HF BOOSTER PUMP - 24VDC - 90PSI BYPS - 3/8"FPT - THERMAL PROTECTED - W/ LEAD WIRES ONLY ...

### REPAIR PARTS FOR PAB8800 SERIES

<u>PART NUMBER</u>	<u>ITEM DESCRIPTION</u>
PAB53-015-00	AQUATEC DIAPHRAGM KIT (LOWER HOUSING ASSEMBLY) ONLY FOR 6840/8840 & 6850/8850 BOOSTER PUMPS (FOR...
PAB53-082	AQUATEC DIAPHRAGM KIT (LOWER HOUSING ASSEMBLY) ONLY FOR 6841/8841 & 6851/8851 BOOSTER PUMPS (FOR...
PAB8840-2J03	AQUATEC 8840-2J03 COMPLETE PUMP HEAD ASSEMBLY ONLY
PAB8841-2J03	AQUATEC 8841-2J03 COMPLETE PUMP HEAD ASSEMBLY ONLY
PAB8850-2J03-B421-VHA	AQUATEC VALVE HOUSING ASSEMBLY FOR 8850-2J03-B421
PAB8851-2G03	AQUATEC 8851-2G03 COMPLETE PUMP HEAD ASSEMBLY
PAB8851-2J03	AQUATEC 8851-2J03 COMPLETE PUMP HEAD ASSEMBLY ONLY
PAB8852-2J03	AQUATEC 8852-2J03 COMPLETE PUMP HEAD ASSEMBLY
PAB8852-2J03-B421-LHA	LOWER HOUSING ASSEMBLY ONLY FOR MODEL # 8852-2J03-B421
PAB8852-2J03-V594-HEAD	AQUATEC 8852-2J03-594 COMPLETE PUMP HEAD ASSEMBLY
PAB8852-2P02-HEAD	AQUATEC 8852-2P02 COMPLETE PUMP HEAD ASSEMBLY
PAB8852-8F77-V594-HEAD	AQUATEC 8852-8F77-V594 COMPLETE PUMP HEAD ASSEMBLY ONLY
PAB8852-8FE1-V594-HEAD	AQUATEC 8852-8FE1-V594 COMPLETE PUMP HEAD ASSEMBLY ONLY

# WATER TREATMENT

## Pumps & Accessories - Aquatec & Nuert

Aquatec Pumps - High Flow Booster Pumps



PRECISION  
INSTALLATION  
PRODUCTS

## OPERATIONAL & INSTALLATION GUIDELINES

### PAB8800 SERIES BOOSTER PUMP

Please read these Operational and Installation Guidelines before installing the PAB8800 Series Booster Pump. If additional help is needed, please consult the Factory.

#### CAUTIONS:

1. The pump is equipped with either a fixed or adjustable bypass valve which controls the maximum operating pressure. In addition, never subject the pump to pressures above 125 PSI (8.5 bars).
2. Never operate the pump in harsh environment or hazardous atmosphere, since motor brush and switch may cause electrical arcing.
3. Pumphead materials are designed for use with water only. Do not use with petroleum products.
4. As long as there is feed water pressure, the pump will not stop forward flow of water even if the motor is turned off. Be sure the system has positive means of shutting off water supply.
5. Always consider electrical shock hazard when working with and handling electrical equipment. If uncertain, consult an Electrician. Electrical wiring should only be done by a qualified Electrician per local and State Electric Codes.

#### MOUNTING:

- A. The pump should be mounted in a dry place and away from any source of heat. If an enclosure is used, special provisions for cooling the motor may be necessary. Certain models may be ordered with a thermal protected motor.
- B. Do not subject the Pump to extreme high or low (freezing) temperatures while in operation. (Operating ambient temperatures range is 32°F to 115°F)
- C. The pump may be mounted in any position. If "ceiling mounted", however, with the pump head upside down, air entrapment may reduce the operational performance by up to 15%. Consult Aquatec for ceiling mount solutions.

#### PLUMBING:

- A. We recommend use of flexible tubing with proper pressure rating.
- B. Pump will prime only if all pressure is relieved from the outlet port.
- C. It is recommended that an in-line sediment filter (150 micron or 100 mesh) be installed at the inlet side to keep foreign debris out of the system. Please consult your Aquatec catalog for an in-line filter.
- D. Avoid any sharp bends which may crimp tubing and restrict flow. Use 90° elbow fittings if necessary. Aquatec provides pumps with different kinds of fittings. Please consult the Factory for your needs.
- E. The pump should always be mounted prior to the carbon pre-filter to prevent carbon particles from entering the pump chambers and possibly causing clogging.

#### ELECTRICAL:

- A. The PAB8800 series pumps are designed for continuous duty. If used for intermittent duty cycle, make sure that "off" periods are great than 60 seconds. Consult the Factory for particular data and design criteria.
- B. If a power supply used with the system and the supply is not furnished by Aquatec, it will need to be reviewed for correct application and approval by Aquatec.



# WATER TREATMENT

Pumps & Accessories - Aquatec & Nuert

## Aquatec Pumps - High Flow Booster Pumps

## INSTALLATION PROCEEDURE

### 8800 SERIES BOOSTER PUMPS

The basic 8800 pump consists of a pump and transformer unit. Systems may be supplied with other options: e.g. **PSW** system pressurized shut-off switch, **LPS** low feed-water shut-off switch, **TLC** tank level controller or **PAF** membrane auto-flush valve or **PFR** membrane auto-flush flow restrictor valve. Pumps are completely assembled, tested and ready for immediate connection to your R.O. system.

**Read the operational and installation guidelines carefully before starting to install the pump. Consult the Factory if there is any question.**

1. Determine the optimum location for your pump before proceeding.

**note:** locate the pump after the sediment pre-filter and before the carbon pre-filter (If part of R.O. system).

2. Turn off water.

3. Cut the 1/4" or 3/8" O.D. flexible tubing in sufficient length to avoid any stress on the tubing where it connects to the pump or the fitting on any accessory.

4. Insert tubing into pump ports. If fittings are John Guest type, be sure tubing is inserted past the resistance point until it bottoms out against the port stop. If the compression fittings with threaded nuts are used, insert tubing until it bottoms out in the port and hand tighten the compression nut until the connection is tight. Then tighten the nut 1/2 turn clockwise or follow the wrench tightening instructions provided by fitting manufacturer.

5. The "CDP" pump is now ready for operation. Open feed-water valve to allow water to flow through the R.O. system (Open flow-restrictor by-pass valve if part of R.O. system).

6. If the power source is a transformer, plug the appropriate Aquatec supplied/approved transformer into the receptacle and connect the pump to the transformer. If the power source is not a transformer, connect the pump to the appropriate power source. Allow water to circulate, purging any entrapped air. For pumps equipped with our "AFT" auto-flush, the flow restrictor by-pass will open and close automatically when the transformer is plugged in.

7. The pump will now start building pressure. Operating pressure will vary with membrane flow rate, flow restrictor flow rate, feed-water pressure and line voltage. Check for fitting leaks.

**note:** If the flow restrictor is too small (We recommend 300MI/min. for standard CDP 6800 series pumps and 500MI/min. for CDP 8800 series pumps), or if the R.O. systems is clogged, an internal pump by-pass mechanism limits the output pressure.

8. If compression fittings with threaded nuts are used, observe any leaks after pump has run for approximately 15 minutes. Further tighten compression nuts approximately 1/8 to 1/4 of a turn on all fittings in the system. Wait 15 minutes and repeat the leak check.

**NOTE:** Further adjustments should not be necessary although it may take several days of operation before all air has been purged and the system is stabilized.

#### SERVICING:

**Every Year:** Check system against operating standards. **Every 2-3 Years:** Replace diaphragm and check against operating standards.

# WATER TREATMENT

Pumps & Accessories - Aquatec & Nuert

Aquatec Pumps - High Flow Booster Pumps



## WARRANTY INFORMATION

### AQUATEC WARRANTY

**Aquatec Water Systems, Inc.** ("Aquatec") warrants its products to be free from defects in material and workmanship under the following terms:

**All Aquatec products with the exception of series 68XX, ERP 1000 and Aquajet model pumps:** The warranty will last for a period of thirteen months from the date of shipping from an Aquatec warehouse. Warranty period for 68XX and ERP 1000 is twenty-five months from the date of shipment from Aquatec. Aquatec warrants its Model Aquajet RV Pumps (Part Numbers 55-AQUAJET-ARV and 55-AQUAJET-AES) for a period of 2 years from the date of shipment from Aquatec. Aquatec's obligation under this warranty shall be limited to replacing or repairing at Aquatec's discretion, any such product or part which must be returned to Aquatec's factory with a Return Material Authorization Number (RMA No.), transportation charges approved by Aquatec or prepaid, and which upon examination, is found to Aquatec's satisfaction to have been defective under the terms of this warranty. No credit will be allowed against future purchases for items returned as defective under the terms of Aquatec's warranty.

**This warranty does not extend to any products, which have been altered or modified outside the Aquatec factory, nor does it apply to units that are returned in an unassembled condition.** Furthermore, the warranty does not extend to pumps that are identified by a 9XXX model number, indicating non-compliance with Aquatec's Engineering Standards. This includes, but is not limited to, pumps ordered without an integral control mechanism. The warranty guarantees that products will perform to Aquatec's flow and pressure specifications throughout the life of the warranty. The warranty does not cover wear, appearance, misapplication or external water damage. If the returned product is found not to be defective under the conditions of this warranty, a charge will be made for repair or replacement.

**Brush wear may be limited to 1000 hours or less.**

**This is a Limited Warranty. It covers the product only and the extent of the coverage is limited to the cost of the product. As the manufacturer has no control over shipping, handling and installation, the warranty cannot cover water damage, or any other damage, caused by a leak or other malfunction.**

This warranty is in lieu of all other warranties, expressed or implied, and no person is authorized to give any other warranty or assume obligation or liability in Aquatec's behalf. Aquatec shall not be liable for any indirect, incidental or consequential damages of any kind incurred by the reason of the use or sale of any defective product and part.



PRECISION  
INSTALLATION  
PRODUCTS



aquatec

# WATER TREATMENT

Pumps & Accessories - Aquatec & Nuert

Aquatec Pumps - Booster Pumps

## APPLICATION GUIDE - 1

### TYPICAL UNDER-COUNTER R.O. SYSTEM WITH HYDRO-PNEUMATIC STORAGE TANK

The following schematic diagram shows a combination of Aquatec's products and accessories designed to enhance the performance of a typical under-counter R.O. system using a hydro-pneumatic storage tank. Any or all products and accessories shown below can be integrated into your system. It is important that the proper size transformer and wiring harness arrangement is specified to match the combination of components required.

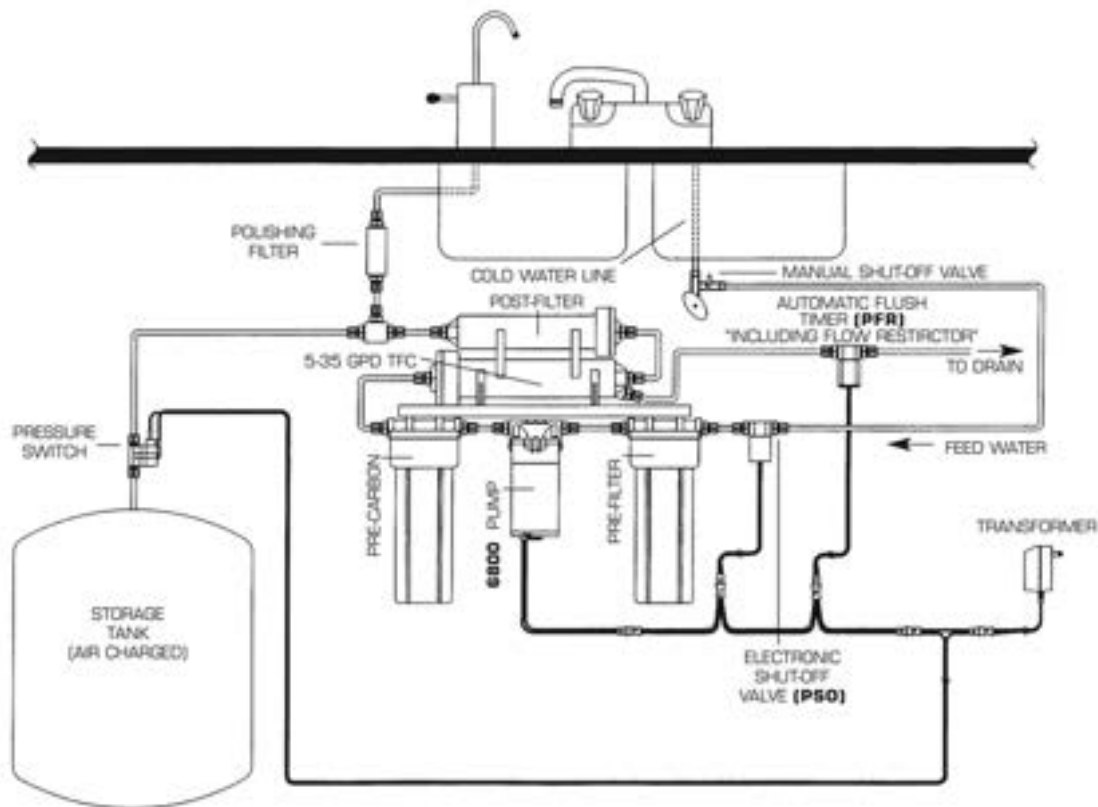

Figure 1. Aquatec Water Systems - CDP Series - Typical Under counter Installation - Air Charged Storage Tank.

# WATER TREATMENT

Pumps & Accessories - Aquatec & Nuert

Aquatec Pumps - Booster Pumps



## APPLICATION GUIDE - 2

### TYPICAL UNDER-COUNTER R.O. SYSTEM WITH HYDRO-PNEUMATIC STORAGE TANK

The following schematic diagram shows a combination of Aquatec's products and accessories designed to enhance the performance of a typical under-counter R.O. system using a hydro-pneumatic storage tank. Any or all products and accessories shown below can be integrated into your system. It is important that the proper size transformer and wiring harness arrangement is specified to match the combination of components required.

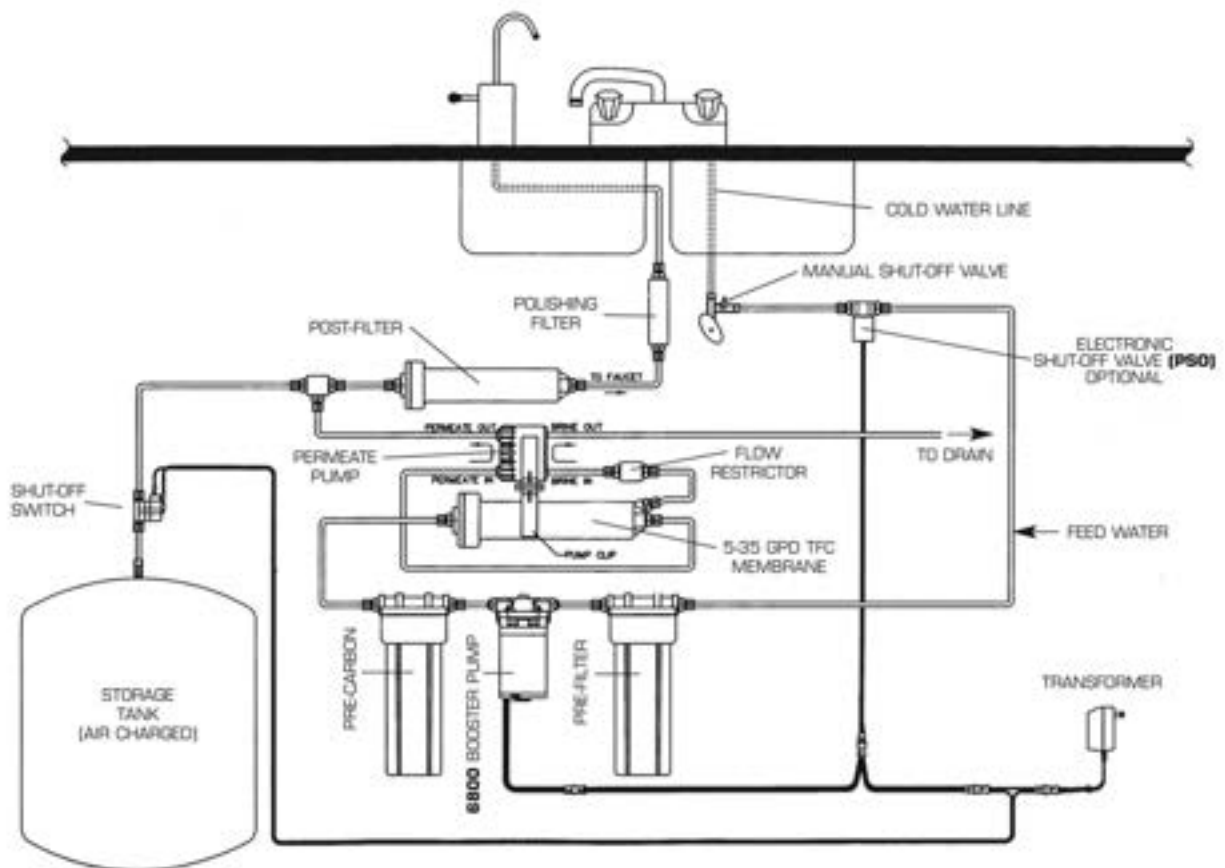

**Figure 2.** Aquatec Water Systems - Permeate Pump & Booster Pump  
- Typical Under counter Installation - Air Charged Storage Tank.



PRECISION  
INSTALLATION  
PRODUCTS



# WATER TREATMENT

Pumps & Accessories - Aquatec & Nuert

Aquatec Pumps - Demand Delivery Pumps

## DEMAND DELIVERY PUMPS - TRANSFER PUMPS

### 550 SERIES SUPER FLOW PUMP

#### DISTINGUISHING FEATURES:

- 5 chamber construction
- Pressure switch and transducer options
- Closed impervious diaphragm
- Independent symmetrical valves
- Highest structural integrity
- Engineered composite plastics
- Corrosion resistant metal
- Ten point clamping
- Multiple porting options
- DC and AC motors



The 550 series is Aquatec's latest introduction in Diaphragm Pump Technology. Designed to meet a wide variety of fluid transfer applications, the 550 series is a classic example of Aquatec's commitment in offering silent solutions to pump applications. When compared to competitive Diaphragm pumps, the 550 series offers dramatically lower noise and hydraulic pulsations in its performance. As a wash down pump, the 550 series offers much higher pressures than competitive models making clean up faster and easier.

Some typical uses include: RV and marine water systems, filtration system pressurization, beverage booster systems, portable wash down systems, agricultural spraying systems, coffee and food service.

Flow rates are available from 1.75 to 6.0 GPM and pressures to 100 PSI. It has a variety of control features optionally available including an optional electronic control system which allows the pump to meet a wide range of flow rate requirements automatically. Consult the factory to meet your application requirements.

**NOTE: THESE PUMPS REQUIRE FITTINGS SHOWN ON PAGE # 01-60 & 61**



# WATER TREATMENT

## Pumps & Accessories - Aquatec & Nuert

### Aquatec Pumps - Demand Delivery Pumps



PRECISION  
INSTALLATION  
PRODUCTS

## 550 SERIES SUPER FLOW PUMP

### DISTINGUISHING FEATURES:

- Unparalleled performance
- 1.75 to 6 GPM (20lpm) flow
- Up to 100 psi (7 bars) pressure
- 7 year design life
- Highly efficient
- Minimal pulsations
- Whisper quiet at lower flows
- Self priming
- Can run dry without damage
- Chemically resistant versions

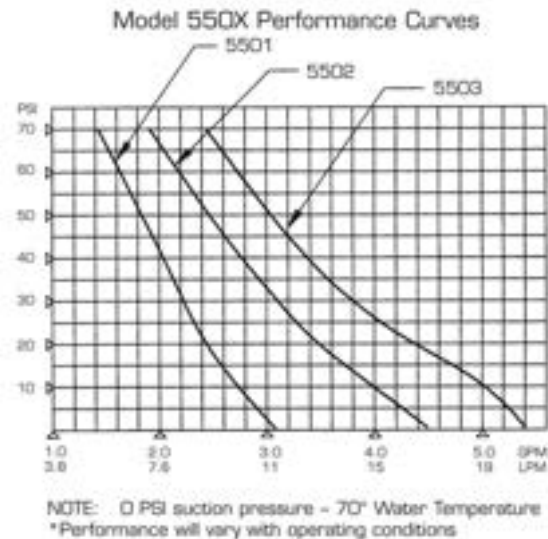

**OPERATION:** The 550 pump can draw water from a holding tank and pressurize it, or boost the pressure from a low pressure source. It is designed to operate intermittently, but most versions can run continuously for several hour intervals. It can be operated in demand mode controlled by an integral pressure switch, or in delivery mode controlled by an external power switching device.

**POWER:** The power demand varies depending on flow and pressure from 50W to 200W.

Motors are available in various configurations from 12 VDC to 230 VAC. Transformers or DC power supplies are optional and must be ordered separately if applicable. Standard terminations are 12" long 16 AWG lead wires with a stripped end, connectors or cords with plugs.

**MOUNTING:** A standard steel mounting base with four hollow rubber grommets is included (6 - Steel, high profile, wide 1.95, 2.35, 3.15-2.5x4.25). A custom base plate may be ordered. Specifications are:

(8 - Steel, high profile, narrow 1.95, 2.35, 3.15-2.25 & 2.90).

(4 - Steel, low profile, narrow 1.95, 2.35-2.25x3.18). The pump may be mounted in any position.

**FITTINGS:** The standard pumphead has a .750" port opening that accepts "quick-connect" beverage style O-ringed barb fittings, or Quick Connect fittings that can be used with 3/8", 1/2", 5/8" or 3/4" tubing. The pump can also be ordered with a 1/2" NPT female port. Always consult the factory for recommendations that will optimize your system.

**NOTE: THESE PUMPS REQUIRE FITTINGS SHOWN ON PAGE # 01-60 & 61**



PRECISION  
INSTALLATION  
PRODUCTS



# WATER TREATMENT

Pumps & Accessories - Aquatec & Nuert

Aquatec Pumps - Demand Delivery Pumps

## DEMAND DELIVERY PUMPS - 5500 SERIES (3/4" QUAD PORTS)



<u>PART NUMBER</u>	<u>ITEM DESCRIPTION</u>
PDP5500-1E11-B576	AQUATEC - 115V - 1.75GPM - 60PSI - W/ QD PORTS - NO CORD
PDP5500-1E12-J576	AQUATEC - 115V - 1.75GPM - 60PSI - W/ QD PORTS - CORD
PDP5500-1F12-B596	AQUATEC - 24VDC - 70PSI - QD PORTS - NO CORD
PDP5500-1F12-B706	AQUATEC - 230V - 3.0GPM - 70PSI - QD PORTS - NO CORD
PDP5500-1F12-J526	AQUATEC - 115V - 70PSI - 2.85GPM - QD PORTS - CORD - EVERPURE
PDP5500-1F12-J586	AQUATEC - 115V - 2.35GPM - 70PSI - QD PORTS - CORD
PDP5500-1F12-J706	AQUATEC - 230V - 3.0GPM - 70PSI - QD PORTS - CORD/NO PLUG
PDP5500-1G01-B666	AQUATEC - 12VDC - 2.5 GPM - 80PSI - QD PORTS - STEEL
PDP5500-2B02-N586	AQUATEC - 115V - 40PSI BYPASS - 2.35GPM - QD PORTS - CORD
PDP5500-2E12-B576	AQUATEC - 115V - 60PSI BYPASS - QD PORTS - NO CORD
PDP5500-2F03-B426	AQUATEC - 24VAC - 70PSI BYPASS - 1.7 GPM - QD PORTS - NO CORD
PDP5500-2F12-N576	AQUATEC - 115V - 70PSI - 1.76 GPM - BYPASS - QD PORTS - CORD
PDP5500-2HM1-J526	AQUATEC - 115V-90 PSI BYPASS-2.85 GPM-QD PORTS-CORD

<u>PART NUMBER</u>	<u>ITEM DESCRIPTION</u>
PDP5501-1E12-B526	AQUATEC - 115V - 60PSI - 3.6GPM - QD PORTS - NO CORD
PDP5501-1E12-J576	AQUATEC - 115V - 60PSI - 2.25GPM - QD PORTS - CORD
PDP5501-1F87-O668	AQUATEC - 12VDC/1600RPM - 2.9 GPM - 70PSI - NYLON HOUSING - GEOLAST DIAPHRAGM - VITON ...
PDP5501-1FF2-J586	AQUATEC - 115V - 70PSI - 2.80GPM - QD PORTS - CORD - PE SHIELD
PDP5501-2D01-B706	AQUATEC - 230VAC - 50PSI BYPASS - 3.50GPM - QD PORTS - NO CORD
PDP5501-2D01-N526	AQUATEC - 3.6 GPM - 115VAC - 50PSI BYPASS - QD PORTS - CORD
PDP5501-2D01-V578	AQUATEC - 115V - 50PSI BYPASS - 2.25GPM - QD PORTS - W/ LEAD WIRES ONLY - EMI/RFI
PDP5501-2D12-N576	AQUATEC - 115V - 50PSI BYPASS - 1.75GPM - QD PORTS - CORD
PDP5501-2D12-N586	AQUATEC - 115V - 50PSI BYPASS - 2.78GPM - QD PORTS - CORD
PDP5501-2E12-B526	AQUATEC - 115VAC-60 PSI BYPASS-3.60 GPM- QD PORTS-NO CORD
PDP5501-2FB1-B596	AQUATEC - 24VDC - 70PSI BYPASS - 2.0GPM - QD PORTS - EPDM- NO CORD
PDP5501-2FE1-B596	AQUATEC - 24VDC - 70PSI BYPASS - 2.0GPM - QD PORTS - BUNA - NO CORD
PDP5500-2HM1-J526	AQUATEC - 115V-90 PSI BYPASS-2.85 GPM-QD PORTS-CORD

**NOTE: THESE PUMPS REQUIRE FITTINGS SHOWN ON PAGE # 01-60 & 61**

# WATER TREATMENT

Pumps & Accessories - Aquatec & Nuert

Aquatec Pumps - Demand Delivery Pumps



PRECISION  
INSTALLATION  
PRODUCTS

## DEMAND DELIVERY PUMPS - 5500 SERIES (3/4" QUAD PORTS)



<u>PART NUMBER</u>	<u>ITEM DESCRIPTION</u>
PDP5502-1E01-B666	AQUATEC - 12VDC - 3.4 GPM - 60PSI - NYLON PH W/ QD PORTS - STEEL
PDP5502-1E12-J526UR	AQUATEC - 115V - 60PSI - 4.3GPM - QD PORTS - UR - CORD
PDP5502-1E15-B666	AQUATEC - 12VDC - 3.4 GPM - 60PSI - QD PORTS - STEEL
PDP5502-1H12-B726	AQUATEC - 24VDC - 90PSI - 3.25GPM - QUAD PORTS - NO CORD
PDP5502-2D12-B738	AQUATEC - 24VDC - 60PSI BYPASS - 3.25GPM - QUAD PORTS - NO CORD-STEEL(HIGH PROFILE, NAR...
PDP5502-2E12-B666	AQUATEC - 12VDC - BYPASS 60PSI - 3.4 GPM - QUAD PORTS - STEEL BRACKET
PDP5502-2E12-B726	AQUATEC - 24VDC - 60PSI BYPASS - 3.25GPM - QUAD PORTS - NO CORD
PDP5502-2GC1-B526	AQUATEC - 115V - 80PSI BYPASS - QD PORTS - VITON ORING - NO CORD
PDP5502-2GC1-B706	AQUATEC - 230V - 80PSI BYPASS - 4.25GPM - QD PORTS - VITON ORING - NO CORD

**NOTE: THESE PUMPS REQUIRE FITTINGS SHOWN ON PAGE # 01-60 & 61**



PRECISION  
INSTALLATION  
PRODUCTS



# WATER TREATMENT

Pumps & Accessories - Aquatec & Nuert

Aquatec Pumps - Demand Delivery Pumps

## DEMAND DELIVERY PUMPS - 5500 SERIES (3/4" QUAD PORTS)



<u>PART NUMBER</u>	<u>ITEM DESCRIPTION</u>
PDP5503-1B01-B706	AQUATEC - 230V - 40PSI - QD PORTS - BB MOTOR - NO CORD
PDP5503-1D12-B636	AQUATEC - 12VDC - 50PSI - 5.30GPM - QD PORTS - NO CORD
PDP5503-1D12-B736	AQUATEC - 24VDC/2200RPM - 50PSI - 5.15GPM - QD PORTS - WIDE STEEL BRKT
PDP5503-1D12-D736	AQUATEC - 24VDC/2200RPM - PUMP HEAD ROTATED 180° (RIGHT TO LEFT FLOW) - 50PSI - 5.15GPM...
PDP5503-1E02-J526	AQUATEC - 115V - 60PSI - 4.90GPM - QD PORTS - NYLON PUMPHEAD - CORD
PDP5503-1E02-J586	AQUATEC - 115V - 60PSI - 3.50GPM - QD PORTS - NYLON PUMP HEAD - CORD
PDP5503-1E02-J606	AQUATEC - 60PSI - 115V - 6.00GPM - QD PORTS - NYLON PUMPHEAD - CORD
PDP5503-1E12-J526	AQUATEC - 115V - 60PSI - 4.90GPM - QD PORTS - CORD
PDP5503-1F01-V706	AQUATEC - 230V - 4.50GPM - 70PSI - NYLON HOUSING - 3/4" QD PORTS - CORD W/ EMI/RFI
PDP5503-1FE1-B706	AQUATEC - 230V - 70PSI - 4.50GPM - ENHANCED MOTOR - QD PORTS - NO CORD
PDP5503-1FE1-J526	AQUATEC - 115V - 70PSI - 4.90GPM - ENHANCED MOTOR - QD PORTS - CORD
PDP5503-1H77-B726	AQUATEC - 24VDC - 90 PSI SWITCH - 3.5GPM - VITON SEALS & DIAPHRAGM - QUAD PORTS - NO CORD
PDP5503-2D12-N524	AQUATEC - 115 VOLT - 50 PSI BYPASS - 4.9 GPM - QD PORTS - CORD
PDP5503-2D12-N586	AQUATEC - 115V - 50PSI BYPASS - 3.50GPM - QD PORTS - CORD
PDP5503-2D77-N586	AQUATEC - 115VAC - 50PSI BYPASS - 3.50GPM - VITON SEALS - QD PORTS - CORD
PDP5503-2E6E-L586	AQUATEC - 115V (MOTOR SEALED) - 60PSI BYPS - NYLON HEAD / VITON VALVES & ORINGS / SANTO...
PDP5503-2G12-N606	AQUATEC - 115V - 80PSI BYPASS - 6.0GPM - QD PORTS - CORD W/NO SWITCH WIRES

<u>PART NUMBER</u>	<u>ITEM DESCRIPTION</u>
PDP5508-1GP1-B588	AQUATEC - 115VAC - 80PSI - 3.5GPM - QD PORTS - NO CORD - POLYPROP HEAD - PE SHIELD - CO...

**NOTE: THESE PUMPS REQUIRE FITTINGS SHOWN ON PAGE # 01-60 & 61**

# WATER TREATMENT

Pumps & Accessories - Aquatec & Nuert

Aquatec Pumps - Demand Delivery Pumps



PRECISION  
INSTALLATION  
PRODUCTS

## DEMAND DELIVERY PUMPS - 5500 SERIES (1/2" FPT PORTS)



<u>PART NUMBER</u>	<u>ITEM DESCRIPTION</u>
PDP5510-1B12-B526	AQUATEC - 115V-40 PSI- 2.85 GPM- 1/2" FPT PORTS- NO CORD
PDP5510-1D02-B636	AQUATEC - 12VDC - 50PSI - 2.75 GPM - NYLON PUMP HEAD - NO CORD
PDP5510-1D12-0586UR	AQUATEC - 115V - 50PSI - 2.35 GPM - 1/2"FPT - UL APPROVED - NO CORD
PDP5510-1D12-B586	AQUATEC - 115V - 50PSI - 2.35GPM - 1/2"FPT - NO CORD
PDP5510-1E01-B586	AQUATEC - 115V - 60PSI - 2.35GPM - 1/2"FPT - NYLON PUMP HEAD - NO CORD
PDP5510-1E12-B636	AQUATEC - 12VDC - 60PSI - 2.75GPM - 1/2"FPT - NO CORD
PDP5510-1E12-B716	AQUATEC - 230V - 2.45GPM - 60PSI - 1/2"FPT - NO CORD
PDP5510-1E12-J526	AQUATEC - 115V - 60PSI - 2.85GPM - 1/2"FPT - WITH CORD
PDP5510-1E12-J576	AQUATEC - 115V - 60PSI - 1.75GPM - 1/2"FPT - CORD
PDP5510-1F12-B636	AQUATEC - 12VDC - 70PSI - 2.75GPM - 1/2"FPT - NO CORD
PDP5510-2E12-B726	AQUATEC - 24VDC-60 PSI BYPASS-2.25 GPM-1/2" FPT PORTS-NO CORD
PDP5510-2F12-V726	AQUATEC - 24VDC - 70 PSI BYPASS - 2.25 GPM - 1/2" FPT PORTS - W/ LEAD WIRES ONLY - EMI/RFI
PDP5510-2I02-B586	AQUATEC - 115V - 100PSI BYPASS - 2.35 GPM - 1/2"FPT - NO CORD
PDP5510-2K12-V596	AQUATEC - 24VDC-120 PSI BYSPASS-1/2" FPT-W/LEAD WIRES ONLY- EMI/RF1
PDP5503-2D77-N586	AQUATEC - 115VAC - 50PSI BYPASS - 3.50GPM - VITON SEALS - QD PORTS - CORD
PDP5503-2E6E-L586	AQUATEC - 115V (MOTOR SEALED) - 60PSI BYPS - NYLON HEAD / VITON VALVES & ORINGS / SANTO...
PDP5503-2G12-N606	AQUATEC - 115V - 80PSI BYPASS - 6.0GPM - QD PORTS - CORD W/NO SWITCH WIRES



PRECISION  
INSTALLATION  
PRODUCTS



# WATER TREATMENT

Pumps & Accessories - Aquatec & Nuert

Aquatec Pumps - Demand Delivery Pumps

## DEMAND DELIVERY PUMPS - 5500 SERIES (1/2" FPT PORTS)



<u>PART NUMBER</u>	<u>ITEM DESCRIPTION</u>
PDP5511-1D77-M638	AQUATEC - 12VDC - 50PSI - 3.35GPM - 1/2"FPT - VITON VALVES - COATED MOTOR - AGRICULTURE
PDP5511-1E01-B526	AQUATEC - 115V - 60PSI - 3.60GPM - 1/2"FPT - NO CORD
PDP5511-1E12-B596	AQUATEC - 24VDC - 60 PSI - 2.0 GPM - 1/2" FPT PORTS - NO CORD
PDP5511-1E12-B636	AQUATEC - 12VDC - 60PSI - 3.35GPM - 1/2"FPT - NO CORD
PDP5511-1E12-J526	AQUATEC - 115V - 60PSI - 3.60GPM - 1/2"FPT - WITH CORD
PDP5511-1E12-J576	AQUATEC - 115V - 60PSI - 2.25GPM - 1/2"FPT - CORD
PDP5511-1E12-J586	AQUATEC - 115V - 60PSI - 2.78GPM - 1/2"FPT - CORD
PDP5511-1E12-V726	AQUATEC - 24VDC - 2.7GPM - 60PSI - 1/2"FPT - W/ LEAD WIRES ONLY - EMI/RFI
PDP5511-1F01-B596	AQUATEC - 24VDC - 70PSI - 2.0 GPM - 1/2"FPT PORTS - NO CORD
PDP5511-1F01-V726	AQUATEC - 24VDC - 2.7GPM - 70PSI - 1/2"FPT - W/ LEAD WIRES ONLY - EMI/RFI
PDP5511-1F12-B638	AQUATEC - 12VDC - 70PSI - 3.35 GPM - 1/2"FPT - NO CORD
PDP5511-1I77-J586	AQUATEC - 115VAC - 100PSI - 2.30GPM - VITON SEALS - CORD
PDP5500-2HM1-J526	AQUATEC - 115V-90 PSI BYPASS-2.85 GPM-QD PORTS-CORD

# WATER TREATMENT

Pumps & Accessories - Aquatec & Nuert

Aquatec Pumps - Demand Delivery Pumps



## DEMAND DELIVERY PUMPS - 5500 SERIES (1/2" FPT PORTS)



<u>PART NUMBER</u>	<u>ITEM DESCRIPTION</u>
PDP5512-1B12-B736	AQUATEC - 24VDC - 2200 RPM - 40 PSI SWITCH - 4.5 GPM - 1/2" FPT - WIDE STEEL BRACKET
PDP5512-1D12-0586UR	AQUATEC - 115V - 3.2GPM - 50PSI - 1/2" FPT - UR
PDP5512-1E02-B636	AQUATEC - 12VDC - 60PSI - 4.25GPM - 1/2" FPT - NO CORD
PDP5512-1E12-B586	AQUATEC - 115V - 3.2GPM - 60PSI - 1/2" FPT - NO CORD
PDP5512-1E12-B636	AQUATEC - 12VDC - 60PSI - 4.25GPM - 1/2" FPT - NO CORD
PDP5512-1E12-B666	AQUATEC - 12VDC - 3.4 GPM - 60PSI - 1/2" FPT PORTS - NO CORD/PLUG
PDP5512-1E12-B726	AQUATEC - 24VDC - 60PSI - 3.25GPM - NO CORD
PDP5512-1E12-B736	AQUATEC - 24VDC/2200RPM - 60PSI - 4.5GPM - 1/2" FPT - WIDE STEEL BRKT
PDP5512-1E12-J586	AQUATEC - 115V - 60PSI - 3.20GPM - 1/2" FPT - CORD
PDP5512-1E12-J716	AQUATEC - 230V - 3.25GPM - 60PSI - 1/2" FPT PORTS - CORD W/ SCHUKO PLUG
PDP5512-1E77-M668	AQUATEC - 12VDC - 3.40GPM - 1/2" FPT - VITON SEALS - COATED MOTOR
PDP5512-1F01-B636	AQUATEC - 12VDC - 70PSI - 4.25GPM - 1/2" FPT PORTS - NO CORD/ PLUG - NYLON PH
PDP5512-1F01-J706	AQUATEC - 230V - 70PSI - 4.25 GPM - 1/2" FPT PORTS - CORD W/ SCHUKO PLUG - NYLON PH
PDP5512-1F02-J526	AQUATEC - 115V - 70PSI - 4.30GPM - 1/2" FPT - CORD
PDP5512-2B77-B726	AQUATEC - 24VDC - 40PSI BYPASS - 3.25GPM - VITON SEALS - NO CORD
PDP5512-2E12-B736	AQUATEC - 24VDC/2200RPM - 60PSI BYPASS - 4.5GPM - 1/2" FPT - WIDE STEEL BRKT
PDP5512-2H12-B586	AQUATEC - 115V - 90PSI BYPASS - 3.2GPM - 1/2" FPT - NO CORD



PRECISION  
INSTALLATION  
PRODUCTS



# WATER TREATMENT

Pumps & Accessories - Aquatec & Nuert

Aquatec Pumps - Demand Delivery Pumps

## DEMAND DELIVERY PUMPS - 5500 SERIES (1/2" FPT PORTS)



<u>PART NUMBER</u>	<u>ITEM DESCRIPTION</u>
PDP5513-1B12-B726	AQUATEC - 24VDC - 40PSI - 3.50GPM - NO CORD
PDP5513-1C02-J586	AQUATEC - 115V - 45PSI - 3.50GPM - 1/2"FPT - CORD
PDP5513-1E01-B526	AQUATEC - 115 V - 60 PSI - 4.9 GPM - 1/2" FPT PORTS - NO CORD
PDP5513-1E01-J706	AQUATEC - 230V - 60PSI - 4.50GPM - NYLON HOUSING - 1/2"FPT - CORD W/ PLUG
PDP5513-1E02-J606	AQUATEC - 115V - 60PSI - 6.00GPM - NYLON HOUSING - 1/2"FPT - CORD W/ PLUG
PDP5513-1E12-B526	AQUATEC - 115V - 60PSI - 4.90GPM - 1/2"FPT - NO CORD
PDP5513-1E12-B606	AQUATEC - 115V - 60PSI - 6.00GPM - 1/2" FPT - NO CORD
PDP5513-1E12-B636	AQUATEC - 12VDC - 60PSI - 5.30GPM - 1/2"FPT - NO CORD
PDP5513-1E12-B706	AQUATEC - 230V - 60PSI - 4.50GPM - 1/2"FPT - NO CORD
PDP5513-1E12-B736	AQUATEC - 24VDC/2200RPM - 60PSI - 5.15GPM - 1/2"FPT - WIDE STEEL BRKT
PDP5513-1E12-J526	AQUATEC - 115V - 60PSI - 4.90GPM - 1/2"FPT - CORD
PDP5513-1E12-J586	AQUATEC - 115V - 60PSI - 3.50GPM - 1/2"FPT - CORD
PDP5513-1E12-J606	AQUATEC - 60PSI - 115V - 6.00GPM - 1/2"FPT - CORD
PDP5513-1E12-U526	AQUATEC - 115V - 60PSI - 4.90GPM - 1/2"FPT - CORD-SWITCH WIRES WITH 180* FRONT END BELL...
PDP5513-1E12-V706	AQUATEC - 230V - 4.50GPM - 60PSI - 1/2" FPT - CORD W/ EMI/RFI
PDP5513-1E12-V726	AQUATEC - 24VDC - 3.50GPM - 60PSI - 1/2"FPT - W/ LEAD WIRES ONLY - EMI/RFI
PDP5513-1E61-V726	AQUATEC - 24VDC - 60PSI - 3.50GPM - 1/2"FPT - VITON VALVES/ORINGS - W/ LEAD WIRES ONLY ...
PDP5513-1E77-M638	AQUATEC - 12VDC - 60 PSI - 1/2"FPT - 5.3 GPM - VITON VALVES - COATED MOTOR
PDP5513-1E89-M638	AQUATEC - 12VDC - 60PSI - VITON VALVE - GEOLAST DIAPHRAGM - 5.3GPM - 1/2FPT-COATED MOTOR
PDP5513-1EN1-O636	AQUATEC - 12VDC - 60PSI - 1/2"FPT - NOT ROTATED
PDP5513-1F12-B636	AQUATEC - 12VDC - 70PSI - 5.30GPM - 1/2"FPT - NO CORD
PDP5513-1F77-M638	AQUATEC - 12VDC - 70PSI - 1/2"FPT - VITON VALVES - COATED MOTOR - AGRICULTURE
PDP5513-2D12-N524	AQUATEC - 115V - 50PSI BYPASS - 4.90GPM - 1/2"FPT - CORD
PDP5513-2E12-B636	AQUATEC - 12VDC - 60PSI BYPASS - 5.30GPM - 1/2"FPT - NO CORD
PDP5513-2F12-N528	AQUATEC - 115V - 70PSI BYPASS - 4.90GPM - CORD



# WATER TREATMENT

Pumps & Accessories - Aquatec & Nuert  
Aquatec Pumps - Demand Delivery Pumps



## DEMAND DELIVERY PUMPS - 5500 SERIES (1/2" FPT PORTS)



<u>PART NUMBER</u>	<u>ITEM DESCRIPTION</u>
PDP5516-1EN2-V726	AQUATEC - 24VDC - 2.7GPM-60PSI - PE SHIELD - COATED WOBBLER - 1/2" FPT PORTS - W/ LEAD WIRES...

<u>PART NUMBER</u>	<u>ITEM DESCRIPTION</u>
PDP5518-1FN2-J526	AQUATEC - 115V - 4.9GPM - 70PSI - PE SHIELD - COATED WOBBLER - 1/2" FPT PORTS - W/ CORD - ST...



PRECISION  
INSTALLATION  
PRODUCTS



aquatec

# WATER TREATMENT

Pumps & Accessories - Aquatec & Nuert

Aquatec Pumps - Demand Delivery Pumps

## REPAIR PARTS FOR 5500 SERIES DEMAND DELIVERY PUMPS



<u>PART NUMBER</u>	<u>ITEM DESCRIPTION</u>
PDP5500-2D12	AQUATEC 5500-2D12 COMPLETE PUMP HEAD ASSEMBLY ONLY
PDP5500-2E12	AQUATEC 5500-2E12 COMPLETE PUMP HEAD ASSEMBLY ONLY
PDP5501-2E12	AQUATEC 5501-2E12 COMPLETE PUMP HEAD ASSEMBLY
PDP5501-2E12-B526-HEAD	AQUATEC 5501-2E12-B526 COMPLETE PUMP HEAD ASSEMBLY ONLY
PDP5501-2FB1-B596-LHA	AQUATEC LOWER HOUSING ASSEMBLY FOR 5501-2FB1-B596
PDP5502-1E12	AQUATEC 5502-1E12 COMPLETE PUMP HEAD ASSEMBLY ONLY
PDP5502-2D12	AQUATEC 5502-2D12 COMPLETE PUMP HEAD ASSEMBLY ONLY
PDP5502-2E12-B726-HEAD	AQUATEC 5502-2E12-B726 COMPLETE PUMP HEAD ASSEMBLY ONLY
PDP5503-1E02-J586-VHA	AQUATEC VALVE HOUSING ASSEMBLY FOR 5503-1E02-J586
PDP5510-1E12-12VDC	AQUATEC 5510-1E12 COMPLETE PUMP HEAD ASSEMBLY - FOR 12VDC PUMPS
PDP5510-2E12-B726-HEAD	AQUATEC 5510-2E12-B726 COMPLETE PUMP HEAD ASSEMBLY ONLY
PDP5511-1E12	AQUATEC 5511-1E12 COMPLETE PUMP HEAD ASSEMBLY
PDP5512-1E02	AQUATEC 5512-1E01 COMPLETE PUMP HEAD ASSEMBLY
PDP5512-1E12	AQUATEC 5512-1E12 COMPLETE PUMP HEAD ASSEMBLY
PDP5512-2B77	AQUATEC 5512-2B77 PUMP HEAD ASSEMBLY ONLY - W/ VITON SEALS
PDP5512-2B77-B726-LHA	AQUATEC LOWER HOUSING ASSEMBLY FOR 5512-2B77-B726
PDP5513-1E12-115V(J1)	AQUATEC 5513-1E12 PUMP HEAD ASSEMBLY ONLY - FOR 115V PUMPS W/ MATE N' LOCK CONNECTOR
PDP5513-1E12-115V(-JO)	AQUATEC 5513-1E12 PUMP HEAD ASSEMBLY ONLY - FOR 115V PUMPS W/ RED SPADE CONNECTORS
PDP5513-1E12-12VDC	AQUATEC 5513-1E12 PUMP HEAD ASSEMBLY ONLY - FOR 12VDC PUMPS
PDP5513-1E77	AQUATEC 5513-1E77 PUMP HEAD ASSEMBLY ONLY - W/ VITON SEALS
PDP5513-1F77	AQUATEC 5513-1F77 PUMP HEAD ASSEMBLY ONLY - W/ VITON SEALS
PDP5513-2F12	AQUATEC 5513-2F12 COMPLETE PUMP HEAD ASSEMBLY ONLY

# WATER TREATMENT

Pumps & Accessories - Aquatec & Nuert

Aquatec Pumps - Demand Delivery Pumps



PRECISION  
INSTALLATION  
PRODUCTS

## REPAIR PARTS FOR 5500 SERIES DEMAND DELIVERY PUMPS



<u>PART NUMBER</u>	<u>ITEM DESCRIPTION</u>
PDP5518-1FN2-J526-EBK	AQUATEC BRUSH KIT FOR 5518-1FN2-J526 MODEL ONLY
PSW-580B	AQUATEC PRESSURE SWITCH - FOR 550 SERIES, 115V, NO CORD - (1) 6" BLACK LEAD W/ RED SPADE CONNECT...
PSW-580B-J1	AQUATEC PRESSURE SWITCH - FOR 550 SERIES, 115V, CORDED - (2) 6" BLACK LEADS TO MATE N' LOCK CONN...
PSW-580B-J0	AQUATEC PRESSURE SWITCH - FOR 550 SERIES, 115V, CORDED - (2) 6" BLACK LEADS W/ RED SPADE CONNECTORS
PSW-580R	AQUATEC PRESSURE SWITCH - FOR 550 SERIES, 12VDC OR 24VDC - (1) 6" RED LEAD W/ RED SPADE CONNECTO...



PRECISION  
INSTALLATION  
PRODUCTS



# WATER TREATMENT

Pumps & Accessories - Aquatec & Nuert

Aquatec Pumps - Demand Delivery Pumps

## TRANSFER PUMPS PDP5800 & PDP7800

### DELIVERY DEMAND PUMPS

#### DISTINGUISHING FEATURES:

- 3 chamber construction
- Closed impervious diaphragm
- Asymmetrical manifold
- Integral switch or bypass
- Highest structural integrity
- Seven point clamping
- Engineered composite plastics
- Corrosion resistant metal
- Multiple porting options
- DC and AC motors



PDP5852-1E12-B574

The 5800/7800 Series utilizes Aquatec's patented multi-chamber configuration. Its applications range from delivering purified water from atmospheric storage tanks on demand to meeting the requirements of high pressure spraying and misting systems. Some typical uses include: coffee maker, refrigerator ice maker, post mix dispenser, filter systems, misting systems.

The 5800/7800 is controlled by an optional built-in pressure sensing demand switch. When a faucet or valve is open downstream of the pump, the line pressure drops and the pump automatically starts, conversely, when the valve closes, the line pressure will increase, turning the pump off automatically.

In comparison tests, the 5800/7800 series of pumps from Aquatec prove to be more efficient, quieter and more reliable than competitive models. This series is available in Flows from .5 GPM to 1.90 GPM and Pressures up to 160 PSI.

The standard 5850 version comes with 3/8" JG built-in fittings on the inlet and outlet port.

The standard 7860 version comes with 5/8" quick disconnect on the inlet and outlet port.

# WATER TREATMENT

Pumps & Accessories - Aquatec & Nuert

Aquatec Pumps - Demand Delivery Pumps



## TRANSFER PUMPS PDP5800 & PDP7800

### KEY OPERATIONAL BENEFITS:

- .25 to 1.7 GPM (5 lpm) flow
- Up to 160 psi (10 bars) pressure
- Adjustable switch and bypass settings
- Chemically resistant versions
- Minimal pulsations
- Whisper quiet at lower flows
- Self priming
- Can run dry without damage
- Auto purging
- 7 year design life
- Highly efficient

### TECHNICAL SPECIFICATIONS:

**OPERATION:** The 5800/7800 pumps can draw water from a holding tank and pressurize it, or boost the pressure from a low pressure source. They are designed to operate intermittently, but most versions can run continuously for several hour intervals. The pumps can be operated in demand mode controlled by an integral pressure switch, or in delivery mode controlled by an external power switching device. An integral bypass may be used to limit pressure. **POWER:** The power demand varies depending on flow and pressure from 25W to 100W. Motors are available in various configurations from 12VDC to 230 VAC. Transformers or DC power supplies are optional and must be ordered separately if applicable. Standard connections are 12" long 16 AWG lead wires with a stripped end, connectors or cords with plugs.

**MOUNTING:** A standard steel mounting base with four hollow rubber grommets is included: [4 - Steel, low profile, narrow 1.95, 2.35-2.25x3.18].

A custom base plate may be ordered. Specifications are: [6 - Steel, high profile, wide 1.95, 2.35, 3.15-2.5x4.25].

[8 - Steel, high profile, narrow 1.95, 2.35, 3.15-2.25 & 2.90].

A flex [1] or universal [3] bracket may be used with a 24VAC motor.

**FITTINGS:** The 5850 pump is offered with an integral John Guest style-Quick Connect push-in fitting for 3/8" OD semi-rigid tubing. The 7860 pump is offered with an Quick Disconnect (QD) 5/8" ports that accept 7800 series pump fittings.

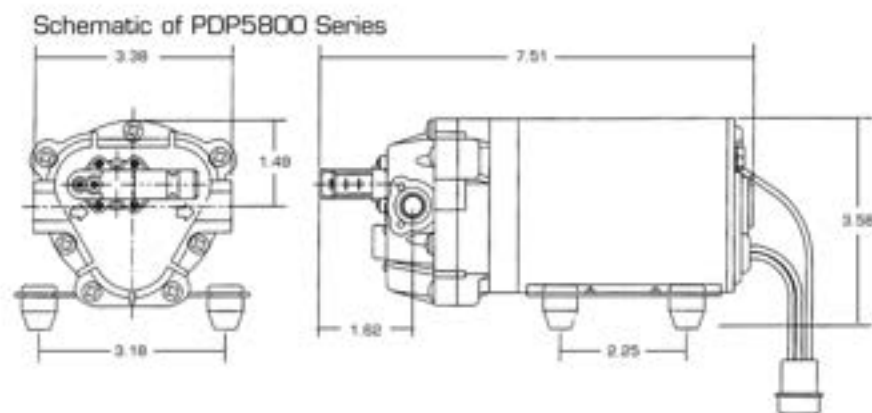



PRECISION  
INSTALLATION  
PRODUCTS



# WATER TREATMENT

Pumps & Accessories - Aquatec & Nuert

Aquatec Pumps - Demand Delivery Pumps

## DEMAND DELIVERY PUMPS - 5800 SERIES (1/4" JG PORTS)



<u>PART NUMBER</u>	<u>ITEM DESCRIPTION</u>
PDP5840-2P02-V544	AQUATEC - 12VDC - 160 PSI BYPASS - EMI/RFI PROTECTION - 1/4" JG - NO CORD
PDP5841-2FM1-V594	AQUATEC - 24VDC - 0.50GPM - 70PSI BYPASS - COATED WOBBLER - 1/4"JG - NO CORD W/ EMI/RFI..
PDP5842-2F01-B724	AQUATEC - 0.9 GPM - 70 PSI BYPASS-24VDC-1/4" JG-STEEL BRACKET-LASERS/PRINTERS
PDP5842-2F02-B594	AQUATEC - 24VDC - 70PSI BYPASS - 0.62GPM - 1/4JG - NO CORD
PDP5842-2H01-N581-UR	AQUATEC - 115 V - 1.2GPM - 90PSI BYPASS - 1/4" JG - WITH CORD AND UL - FLEX BRACKET
PDP5842-2I01-N584	AQUATEC - 115V - 100PSI BYPASS - 1.10GPM - 1/4"JG - CORD
PDP5843-2K01-B664	AQUATEC - 12VDC - 120PSI BYPASS - 1.2 GPM - 1/4" JG -NYLON/EPDM/SANTOPRENE - STEEL
PDP5843-2K12-V724	AQUATEC - 24VDC-120 PSI BYPASS-1 GPM-1/4" JG-W/LEAD WIRES ONLY-EMI/RFI
PDP5843-2S0D-B744	AQUATEC - 200 PSI BYPASS-1/4JG-12VDC-REINFORCED DIAPHRAGM-METHANOL INJECT USE
PDP5843-8D02-B754	AQUATEC - 12VDC - 50PSI BYPASS - 0.35GPM - 1/4"JG - NO CORD - PRINTERS/LASERS
PDP5843-8D02-B544	AQUATEC - 12VDC - 50PSI BYPASS - 1/4"JG - NO CORD - MED BRKT..
PDP5844-2E01-V591	AQUATEC - 24VDC - 0.50GPM - 60PSI BYPASS - 1/4"JG - NO CORD W/ EMI/RFI - FLEX
PDP5844-8E01-B594	AQUATEC - 24VDC - 60PSI BYPASS - 1.0GPM - 1/4" JG - NO CORD
PDP5844-8F01-B594	AQUATEC - 24VDC - 70PSI BYPASS - 0.95GPM - 1/4" JG - NO CORD
PDP5846-2NM2-V274	AQUATEC - 2.5 DEG CAM - 150 BYPS - NESBPE - 1/4"JG - LEAD WIRES W/ EMI/RFI ONLY
PDP5512-2B77-B726-LHA	AQUATEC LOWER HOUSING ASSEMBLY FOR 5512-2B77-B726
PDP5513-1E12-115V(J1)	AQUATEC 5513-1E12 PUMP HEAD ASSEMBLY ONLY - FOR 115V PUMPS W/ MATE N' LOCK CONNECTOR
PDP5513-1E12-115V(JO)	AQUATEC 5513-1E12 PUMP HEAD ASSEMBLY ONLY - FOR 115V PUMPS W/ RED SPADE CONNECTORS
PDP5513-1E12-12VDC	AQUATEC 5513-1E12 PUMP HEAD ASSEMBLY ONLY - FOR 12VDC PUMPS
PDP5513-1E77	AQUATEC 5513-1E77 PUMP HEAD ASSEMBLY ONLY - W/ VITON SEALS
PDP5513-1F77	AQUATEC 5513-1F77 PUMP HEAD ASSEMBLY ONLY - W/ VITON SEALS
PDP5513-2F12	AQUATEC 5513-2F12 COMPLETE PUMP HEAD ASSEMBLY ONLY

# WATER TREATMENT

Pumps & Accessories - Aquatec & Nuert

Aquatec Pumps - Demand Delivery Pumps



PRECISION  
INSTALLATION  
PRODUCTS

## DEMAND DELIVERY PUMPS - 5800 SERIES (3/8" JG PORTS)



<u>PART NUMBER</u>	<u>ITEM DESCRIPTION</u>
PDP5850-1F12-B423	AQUATEC - 24VAC - 70PSI - 0.55GPM - 3/8"JG - UNIVERSAL BRKT-NO CORD
PDP5850-2D01-V714	AQUATEC - 230V - 50PSI BYPASS - .75 GPM - 3/8"JG - EMI/RFI NOISE SUPPRESSION - NO CORD
PDP5850-2D12-V204	AQUATEC - 24VDC - 50PSI BYPASS - 3/8"JG - W/ LEAD WIRES ONLY - EMI/RFI
PDP5850-2E02-N574	AQUATEC - 60PSI BYPASS - 0.40GPM - 3/8"JG - CORD
PDP5850-2I12-B584	AQUATEC - 115V-100PSI - BYPASS - .8 GPM - 3/8" JG - STEEL BRKT
PDP5850-2K02-N574	AQUATEC - 115V - 120PSI BYPASS - 0.50GPM - 3/8"JG - CORD
PDP5850-2L01-B724	AQUATEC - 24VDC - 130PSI BYPASS - 3/8" JG PORTS - .6 GPM - STEEL BRACKET
PDP5850-2L02-N574	AQUATEC - .5GPM-130PSI BYPASS-3/8"JG-115V-CORD
PDP5850-2P01-V704	AQUATEC - 230V - .5GPM - 160PSI BYPASS - 3/8" JG PORTS - LEAD WIRES - EMI/RFI
PDP5850-2P02-N574	AQUATEC - 115V - 160PSI BYPASS - 0.50GPM - 3/8"JG - CORD
PDP5850-7A12-V204	AQUATEC - 24VDC - 35PSI - 3/8"JG - W/ LEAD WIRES ONLY - EMI/RFI
PDP5850-7D12-B704	AQUATEC - 230V - 50PSI - 1.0GPM - 3/8"JG - NO CORD
PDP5850-7E01-B664	AQUATEC - 12VDC - 60PSI - 0.75GPM - 3/8"JG - NO CORD
PDP5850-7E12-B714	AQUATEC - 230V - 60PSI - 0.82GPM - 3/8"JG - NO CORD
PDP5850-7E12-J574	AQUATEC - 60PSI - 0.64 GPM - 3/8"JG - CORD
PDP5850-7E71-B424	AQUATEC - 60PSI-24VAC-.5GPM-VITON..3/8JG



PRECISION  
INSTALLATION  
PRODUCTS



# WATER TREATMENT

Pumps & Accessories - Aquatec & Nuert

Aquatec Pumps - Demand Delivery Pumps

## DEMAND DELIVERY PUMPS - 5800 SERIES (3/8" JG PORTS)



<u>PART NUMBER</u>	<u>ITEM DESCRIPTION</u>
PDP5851-1B03-B543	AQUATEC - 12VDC - 40PSI - 0.32GPM - 3/8"JG - NO CORD
PDP5851-1F12-B423	AQUATEC - 24VAC - 70PSI - 0.63GPM - 3/8"JG - UNIVERSAL BRKT-NO CORD
PDP5851-1H02-J574	AQUATEC - 115V - 90PSI - 0.64GPM - 3/8"JG - STEEL - CORD
PDP5851-1I02-V421	AQUATEC - 24VAC - 100PSI - 0.55GPM - FLEX - 3/8"JG - W/ CONNECTORS - EMI/RFI
PDP5851-1I03-B574	AQUATEC - 115V - 0.70GPM - 100 PSI - 3/8" JG - STEEL - NO CORD
PDP5851-2A12-B594	AQUATEC - 24VDC - 35PSI BYPASS - .51GPM - 3/8"JG - STEEL BRACKET
PDP5851-2A12-V204	AQUATEC - 24VDC - 35PSI BYPASS - 3/8"JG - W/ LEAD WIRES ONLY - EMI/RFI
PDP5851-2F12-B984	AQUATEC - 12VDC/ 1750RPM - 0.8GPM - 70PSI BYPASS - 3/8"JG - STEEL - NO CORD
PDP5851-2L02-B424	AQUATEC - 24VAC - 130PSI BYPASS - 0.55GPM - STEEL - NO SWITCH
PDP5851-7E12-B574	AQUATEC - 115VAC - 60PSI - 0.70GPM - 3/8"JG - NO CORD
PDP5851-7E12-B594	AQUATEC - 24VDC - 60PSI - 0.55 GPM - 3/8"JG - NO CORD - STEEL
PDP5851-7E12-J574	AQUATEC - 115 VAC - 60 PSI - 0.70 GPM - 3/8"JG - CORD
PDP5851-7E12-J584	AQUATEC - 115 VAC - 60 PSI - 0.99 GPM - 3/8" JG - CORD
PDP5851-7E12-J714	AQUATEC - 230VAC - 60PSI - 0.93GPM - 3/8"JG - W/ CORD & SCHUKO PLUG - EMI/RFI



# WATER TREATMENT

## Pumps & Accessories - Aquatec & Nuert

Aquatec Pumps - Demand Delivery Pumps



**PRECISION  
INSTALLATION  
PRODUCTS**

## DEMAND DELIVERY PUMPS - 5800 SERIES (3/8" JG PORTS)



<u>PART NUMBER</u>	<u>ITEM DESCRIPTION</u>
PDP5852-1E02-J574	AQUATEC - 60PSI - 0.83GPM - 115V - 3/8"JG - CORD
PDP5852-1E12-B574	AQUATEC - 115V-60PSI-.83 GPM-3/8"QC PORTS - NO CORD
PDP5852-1E12-J574	AQUATEC - 115V-60PSI-0.83 GPM-3/8"QC PORTS - CORD
PDP5852-1F12-B423	AQUATEC - 24VAC - 70PSI - 0.80GPM - 3/8"JG - UNIVERSAL BRKT-NO CORD
PDP5852-1FH2-B534	AQUATEC - 24VAC - 0.8 GPM - 70PSI - 3/8"JG - EPDM - STARBUCKS
PDP5852-2A12-B594	AQUATEC - 24VDC - 35 PSI BYPASS - 0.62 GPM - 3/8" JG - NO CORD - STEEL BRACKET
PDP5852-2A12-B724	AQUATEC - 24VDC - 35 PSI BYPASS - .92GPM - 3/8" JG PORTS - STEEL BRACKET - NO CORD
PDP5852-2E02-N574	AQUATEC - 115V - 60PSI BYPASS - 0.70GPM - 3/8"JG - CORD
PDP5852-2F01-B724	AQUATEC - 0.9 GPM - 70PSI BYPASS - 24VDC - 3/8" JG - STEEL BRKT - PRINTERS/LASERS
PDP5852-2F02-B594	AQUATEC - .62GPM - 70PSI -BYPASS - 24VDC - 3/8JG - NO CORD - PRINTERS - LASERS
PDP5852-2G12-B421	AQUATEC - 24VAC - 80PSI BYPASS - 0.69GPM - 3/8"JG - FLEX BRKT - W/ CONNECTOR ONLY
PDP5852-2H02-N574	AQUATEC - 115V - .83 GPM - 90 PSI BYPASS - 3/8 JG - CORD
PDP5852-2JB3-S798	AQUATEC - 24VDC - 0.8 GPM - 110PSI BYPASS - DIAPHRAGM SPT
PDP5852-2K77-N584	AQUATEC - 120PSI BYPASS - 1.22GPM - VITON SEALS - 3/8"JG - CORD
PDP5852-2L12-V574	AQUATEC - 115 VOLT- 0.83GPM - 130 PSI BYPASS - 3/8"JG - EMI/RFI NOISE SUPPRESSION - W/ L...
PDP5852-7B12-J584	AQUATEC - 40PSI - 1.22GPM - 3/8"JG - CORD
PDP5852-7D12-B574	AQUATEC - 50PSI - 0.90GPM - 3/8"JG - NO CORD
PDP5852-7D12-B594	AQUATEC - 24VDC - 50PSI - 0.62 GPM - 3/8"JG - NO CORD - STEEL BRACKET
PDP5852-7D12-J574	AQUATEC - 50 PSI - .90 GPM - 3/8" JG - 115 VOLT WITH CORD
PDP5852-7E02-J524	AQUATEC - 60PSI - 1.55GPM - 3/8"JG - CORD
PDP5852-7E12-B584	AQUATEC - 60PSI - 1.22GPM - 3/8"JG - 115V - NO CORD
PDP5852-7E12-B664	AQUATEC D/D PUMP-12VDC-0.9 GPM - 60 PSI SWITCH-3/8" JG - NO CORD
PDP5852-7E12-B718	AQUATEC - 230V - 60PSI - 1.17GPM - 3/8"JG - NO CORD
PDP5852-7E12-J574	AQUATEC - 60PSI - 0.90GPM - 3/8"JG - 115V - CORD
PDP5852-7E12-J584	AQUATEC - 60PSI - 1.22GPM - 3/8"JG - 115V - CORD
PDP5852-7E12-J584-UR	AQUATEC - 60PSI - 1.22GPM - 3/8"JG - CORD - UL APPROVED
PDP5852-7F01-B544	AQUATEC - 12VDC - 0.4-.5GPM - 3/8"JG - NO CORD
PDP5852-7F02-B524	AQUATEC - 70PSI - 1.66GPM - 3/8"JG - NO CORD
PDP5852-7F12-B584	AQUATEC - 110V - 70PSI - 1.22 GPM - 3/8"JG - NO CORD
PDP5852-8I12-V574	AQUATEC - 115V - 0.83GPM - 100PSI BYPASS - 3/8"JG - W/ LEAD WIRES ONLY - EMI/RFI



PRECISION  
INSTALLATION  
PRODUCTS



# WATER TREATMENT

Pumps & Accessories - Aquatec & Nuert

Aquatec Pumps - Demand Delivery Pumps

## DEMAND DELIVERY PUMPS - 5800 SERIES (3/8" JG PORTS)



<u>PART NUMBER</u>	<u>ITEM DESCRIPTION</u>
PDP5853-1E12-B424	AQUATEC - 24VAC - 60PSI - 0.90GPM - 3/8"JG - NO CORD
PDP5853-1E12-J524	AQUATEC - 115V - 60PSI - 1.70GPM - CORD - 3/8"JG PORTS
PDP5853-1E12-J574	AQUATEC - 115V - 60PSI - 0.98GPM - 3/8"JG - CORD
PDP5853-1E12-U524	AQUATEC - 115V - 60PSI - 1.70GPM - CORD - SWITCH WIRES WITH 180* FRONT END BELL ROTATION...
PDP5853-1H01-J606	AQUATEC - 115V - 90PSI - 1.75GPM - 3/8"JG - CORD
PDP5853-1I02-J584	AQUATEC - 115V - 100PSI - 1.18GPM - 3/8"JG - CORD
PDP5853-1I12-B524	AQUATEC - 115V - 100PSI - 1.70GPM - NO CORD - 3/8"JG PORTS
PDP5853-1I77-J584	AQUATEC - 115V - 100PSI - 1.4GPM - VITON SEALS & HEAD - 3/8"JG - W/ CORD
PDP5853-2D12-V204	AQUATEC - 24VDC - 50PSI BYPASS - 0.40GPM - 3/8"JG - W/ LEAD WIRES ONLY - EMI/RFI
PDP5853-2E12-N524	AQUATEC - 115V - 60PSI BYPASS - 1.50GPM - 3/8"JG
PDP5853-2G01-B724	AQUATEC - 24VDC - 1 GPM - 80PSI BYPASS - 3/8" JG - STEEL BRKT - PRINTERS/LASERS
PDP5853-2H02-N524	AQUATEC - 115V - 90PSI BYPASS - 1.50GPM - 3/8"JG - CORD
PDP5853-2H02-P704	AQUATEC - 230V - 90PSI BYPASS - 1.30GPM - 3/8"JG - CORD W/ SCHUKO 2 PRONG PLUG - W/ EMI...
PDP5853-2I03-B574	AQUATEC - 115V - 100PSI BYPASS - 0.9 GPM - 3/8"JG - NO CORD - PRINTERS/LASERS
PDP5853-2I03-B584	AQUATEC - 115V - 100PSI BYPASS - 1.18 GPM - 3/8"JG - NO CORD
PDP5853-2J12-V664	AQUATEC - 12VDC - 1.5 GPM - 110 PSI BYPASS - 3/8" JG - W/ LEAD WIRES ONLY - EMI/RFI
PDP5853-2K02-N524	AQUATEC - 115 VOLT - 120 PSI BYPASS - 1.50 GPM - 3/8" JG W/ CORD
PDP5853-2K02-P704	AQUATEC - 230 VOLT - 120 PSI BYPASS - 1.30 GPM - 3/8" JG - CORD W/ SCHUKO 2 PRONG PLUG ...
PDP5853-2K12-0521-UR	AQUATEC - 115V - 120PSI BYPASS - UR RATED
PDP5853-2P67-B664	AQUATEC - VITON VALVES - 160PSI BYPASS - 12VDC - 3/8 JG - STEEL BRKT
PDP5853-2S67-B664	AQUATEC - 200PSI BYPASS - 12VDC - 3/8 JG - STEEL BRKT - 1.2 GPM
PDP5853-2SM1-N574	AQUATEC - HF MISTING PUMP - 200 PSI BYPASS - 0.9 GPM - ENHANCED DISPHRAGM - 115V WITH CORD - 3/8" JG
PDP5853-7E12-B421	AQUATEC - 24VAC - .9GPM - 60PSI - 3/8"JG - FLEX - NO CORD
PDP5853-7E12-B424	AQUATEC - 24VAC - 60PSI - .90 GPM - 3/8"JG - METAL - NO CORD
PDP5853-7E12-B724	AQUATEC - 60PSI - 1.1GPM - 24VDC - 3/8JG - NO CORD, WIRES ONLY - PRINTERS/LASERS
PDP5853-7E12-J524	AQUATEC - 115V - 60PSI - 1.70GPM - 3/8"JG - CORD
PDP5853-7E12-J574	AQUATEC - 115V - 60PSI - 0.98GPM - 3/8"JG - CORD
PDP5853-7E12-J584	AQUATEC - 115V - 60PSI - 1.40GPM - 3/8"JG - CORD

# WATER TREATMENT

Pumps & Accessories - Aquatec & Nuert

Aquatec Pumps - Demand Delivery Pumps



PRECISION  
INSTALLATION  
PRODUCTS

## DEMAND DELIVERY PUMPS - 5800 SERIES (3/8" JG PORTS)



<u>PART NUMBER</u>	<u>ITEM DESCRIPTION</u>
PDP5853-7F12-B584	AQUATEC - 110V - 70PSI - 1.40GPM - 3/8"JG - NO CORD
PDP5853-8B12-B588	AQUATEC - 115V - 40PSI BYPASS (100PSI FULL BYPASS VALVE LIMIT W/ LARGE HOLE VALVE HOUSI...
PDP5853-8D02-B754	AQUATEC - 12VDC - 50PSI BYPASS - 0.35GPM - 3/8"JG - NO CORD - PRINTERS/LASERS
PDP5853-8D12-B588	AQUATEC - 115V - 50PSI BYPASS (100PSI FULL BYPASS VALVE LIMIT W/ LARGE HOLE VALVE HOUSI...
PDP5853-8V12-B588	AQUATEC - 115V - 65PSI BYPASS (100PSI FULL BYPASS VALVE LIMIT W/ LARGE HOLE VALVE HOUSI...
PDP5853-8V12-B718	AQUATEC - 230V - 65PSI BYPASS (100PSI FULL BYPASS VALVE LIMIT W/ LARGE HOLE VALVE HOUSI...
PDP5853-8V12-B738	AQUATEC - 24VDC/2200RPM - 65PSI BYPASS (100PSI FULL BYPASS VALVE LIMIT W/ LARGE HOLE VA...
PDP5851-2F12-B984	AQUATEC - 12VDC/1750RPM - 0.8GPM - 70PSI BYPASS - 3/8"JG - STEEL - NO CORD
PDP5851-2L02-B424	AQUATEC - 24VAC - 130PSI BYPASS - 0.55GPM - STEEL - NO SWITCH
PDP5851-7E12-B574	AQUATEC - 115VAC - 60PSI - 0.70GPM - 3/8"JG - NO CORD
PDP5851-7E12-B594	AQUATEC - 24VDC - 60PSI - 0.55 GPM - 3/8"JG - NO CORD - STEEL
PDP5851-7E12-J574	AQUATEC - 115 VAC - 60 PSI - 0.70 GPM - 3/8"JG - CORD
PDP5851-7E12-J584	AQUATEC - 115 VAC - 60 PSI - 0.99 GPM - 3/8" JG - CORD
PDP5851-7E12-J714	AQUATEC - 230VAC - 60PSI - 0.93GPM - 3/8"JG - W/ CORD & SCHUKO PLUG - EMI/RFI



PRECISION  
INSTALLATION  
PRODUCTS



# WATER TREATMENT

Pumps & Accessories - Aquatec & Nuert

Aquatec Pumps - Demand Delivery Pumps

## DEMAND DELIVERY PUMPS - 5800 SERIES (3/8" JG PORTS)



<u>PART NUMBER</u>	<u>ITEM DESCRIPTION</u>
PDP5854-2F01-B724	AQUATEC - 0.9 GPM-70 PSI BYPASS-24VDC-STEEL BRACKET-LASERS/PRINTERS
PDP5854-2L01-B724	AQUATEC - 0.9 GPM-130 PSI BYPASS-24VDC-STEEL BRACKET
PDP5854-2P01-0584-UR	AQUATEC - 115V - 160PSI BYPASS - 1.2GPM-3/8"JG - UL APPROVED
PDP5854-2P01-B714	AQUATEC - 230V - 160 PSI BYPASS - 3/8" JG PORTS - 1.2 GPM - NO CORD
PDP5854-2P01-F584	AQUATEC - 115V - 160PSI BYPASS - 3/8"JG - 1.9GPM - NO CORD (LEAD WIRE ON UL RECOGNIZED ...
PDP5854-2P02-N584	AQUATEC - 115V - 160PSI BYPASS - 1.2GPM-3/8"JG - CORD
PDP5854-2P02-N714	AQUATEC - 230V - 160PSI BYPASS - 1.2GPM -3/8"JG - CORD W/ SCHUKO PLUG
PDP5854-2P61-N584	AQUATEC - 115V - 160PSI BYPS - 1.9GPM - VITON VALVES, ORINGS & SANTO DIAPHRAGM - 3/8"JG...
PDP5854-7B12-B424	AQUATEC - 24VAC - 40PSI - 0.95GPM - 3/8"JG - METAL - NO CORD
PDP5854-7C12-V724	AQUATEC - 45PSI - 1.5GPM -24VDC - 3/8JG - NO CORD, WIRES ONLY W/ EMI/RFI PROTECTION
PDP5854-7E01-B424	AQUATEC - 24VAC - 60PSI - 0.95GPM - 3/8"JG - STEEL BRKT - NO CORD
PDP5854-7E12-J574	AQUATEC - 115V - 60PSI - 1.10GPM - 3/8"JG - CORD
PDP5854-7E12-J714	AQUATEC - 230VAC - 60PSI - 1.40GPM - 3/8"JG - W/ CORD - EMI/RFI
PDP5854-7F12-B574	AQUATEC - 115V-70PSI-1.1 GPM-LEAD WIRES-3/8 JG
PDP5854-7F12-B594	AQUATEC - 24VDC - 70PSI - 0.95GPM - 3/8"JG - NO CORD
PDP5854-7F12-B664	AQUATEC - 1.5GPM - 70PSI - 12VDC - 3/8"JG - NO CORD
PDP5854-7F12-J584	AQUATEC - 1.5GPM - 70PSI - 115V - 3/8"JG - CORD
PDP5854-8E71-B584	AQUATEC - 115V - 60PSI BYPASS - 3/8"JG - VITON - NO CORD

# WATER TREATMENT

Pumps & Accessories - Aquatec & Nuert

Aquatec Pumps - Demand Delivery Pumps



PRECISION  
INSTALLATION  
PRODUCTS

## REPAIR PARTS FOR 5800 DEMAND DELIVERY PUMPS

<u>PART NUMBER</u>	<u>ITEM DESCRIPTION</u>
PDP5842-2F02	AQUATEC PUMP HEAD PDP5842-2F02
PDP5843-8D01	AQUATEC 5843-8D01 COMPLETE PUMP HEAD
PDP5843-8D02-B754-LHA	AQUATEC LOWER HOUSING ASSEMBLY FOR 5843-8D02-B754
PDP5843-8D02-B754-UHA	AQUATEC UPPER HOUSING ASSEMBLY FOR 5843-8D02-B754
PDP5843-8D02-B754-VHA	AQUATEC VALVE HOUSING ASSEMBLY FOR 5843-8D02-B754
PDP5850-2I12-B584-HEAD	AQUATEC 5850-2I12-B584 COMPLETE PUMP HEAD ASSEMBLY ONLY
PDP5850-2L01-B724-HEAD	AQUATEC 5850-2L01-B724 COMPLETE PUMP HEAD ASSEMBLY ONLY
PDP5850-2P02-N574-HEAD	AQUATEC 5850-2P02-N574 PUMP HEAD ASSEMBLY ONLY
PDP5850-7E12-J574-HEAD	AQUATEC 5850-7E12-J574 PUMP HEAD ASSEMBLY ONLY
PDP5851-2A12	AQUATEC 5851-2A12 COMPLETE PUMP HEAD ASSEMBLY ONLY
PDP5851-2L01	AQUATEC 5851-2I01 COMPLETE PUMP HEAD ASSEMBLY ONLY
PDP5851-7E12	AQUATEC 5851-7E12 PUMP HEAD ASSEMBLY ONLY
PDP5851-7E12-SWITCH	AQUATEC 5850-5851-5852-7E12 PRESSURE SWITCH ONLY
PDP5852-7E12	AQUATEC 5852-7E12 COMPLETE PUMP HEAD ASSEMBLY ONLY
PDP5852-7E12-SWITCH	AQUATEC PDP5852-7E12 PRESSURE SWITCH ONLY
PDP5852-7F12	AQUATEC 5852-7F12 COMPLETE PUMP HEAD ASSY
PDP5853-2D12-V204-HEAD	AQUATEC 5853-2D12-V204 COMPLETE PUMP HEAD ASSEMBLY ONLY
PDP5853-2LM2	AQUATEC 5853-2LM2 COMPLETE PUMP HEAD ASSEMBLY ONLY
PDP5853-2S67	AQUATEC 5853-2S67 PUMP HEAD COMPLETE ASSEMBLY
PDP5853-5U67	AQUATEC 5853-5U67 PUMP HEAD COMPLETE ASSEMBLY
PDP5853-5U67-V574	AQUATEC D/D PUMP - 1.15V - DEMAND @ 55PSI & BYPASS @ 100PSI - 1GPM - EMI/RFI - VITON VALVES/ORING...
PDP5853-5U67-V574-LHA	AQUATEC LOWER HOUSING ASSEMBLY FOR 5853-5U67-V574
PDP5853-5U67-V574-VHA	AQUATEC VITON VALVE HOUSING ASSEMBLY FOR 5853-5U67-V574
PDP5853-7C12-V724	AQUATEC D/D PUMP - 45PSI - 1.1GPM -24VDC - 3/8JG - NO CORD, WIRES ONLY W/ EMI/RFI PROTECTION
PDP5853-7E12	AQUATEC 5853-7E12 COMPLETE PUMP HEAD ONLY-SWITCH INCLUDED
PDP5853-7E12-B724-LHA	AQUATEC LOWER HOUSING ASSEMBLY FOR 5853-7E12-B724
PDP5853-7E12-SWITCH	AQUATEC PRESSURE SWITCH FOR PDP5853-7E12- PUMP
PDP5853-8V12	AQUATEC 5853-8V12 COMPLETE PUMP HEAD ASSEMBLY
PDP5854-2P02	AQUATEC 5854-2P02 PUMP HEAD ASSEMBLY ONLY
PDP5854-2P61-N584-PHK	AQUATEC COMPLETE PUMP HEAD KIT W/ VITON VALVES, ORINGS & SANTOPRENE DIAPHRAMS FOR 5854-2P61-N584
PDP5854-2P61-N584-VHA	AQUATEC VALVE HOUSING ASSY W/ VITON VALVES & ORINGS FOR 5854-2P61-N584



PRECISION  
INSTALLATION  
PRODUCTS



# WATER TREATMENT

Pumps & Accessories - Aquatec & Nuert

Aquatec Pumps - Demand Delivery Pumps

## DEMAND DELIVERY PUMPS - 5800 SERIES (3/8" FPT PORTS)



<u>PART NUMBER</u>	<u>ITEM DESCRIPTION</u>
PDP5880-8E89-N584	AQUATEC - 115V - 60PSI BYPASS - 0.5GPM - VITON/GEOLAST - 3/8" FPT - STEEL BRACKET
PDP5880-8F01-B744	AQUATEC - 12VDC - 0.77 GPM - 70PSI (100PSI FULL BYPS VALVE LIMIT W/ LARGE HOLE VALVE HOLE

<u>PART NUMBER</u>	<u>ITEM DESCRIPTION</u>
PDP5881-1J03-B574	AQUATEC - 115V - 0.7 GPM - 110 PSI - 3/8" FPT PORTS - STEEL BRACKET - NO CORD
PDP5881-2E01-B744	AQUATEC - 12VDC-60 PSI BYPASS - .9 GPM - 3/8 FPT - NO CORD - STEEL BRACKET
PDP5881-2E01-B794	AQUATEC - 24VDC - 60PSI BYPASS - 0.8 GPM - 3/8" FPT - NO CORD - STEEL BRACKET

<u>PART NUMBER</u>	<u>ITEM DESCRIPTION</u>
PDP5882-2HM2-V594	AQUATEC - 24VDC - 0.60GPM - 90PSI BYPASS - COATED WOBBLER - 3/8" FPT - 12" LEAD WIRES- ...

<u>PART NUMBER</u>	<u>ITEM DESCRIPTION</u>
PDP5883-2D12-B664	AQUATEC D/D PUMP- 1.5 GPM- 3/8" FPT - 12VDC - BYPASS 50PSI - STEEL BRKT
PDP5883-2F12-B736	AQUATEC - 24VDC/2200RPM - 70PSI BYPS - 1.6GPM - 3/8"FPT PORTS - STEEL BRACKET
PDP5883-2G01-B574	AQUATEC - 115V - 80PSI BYPASS - 0.50GPM - 3/8"NPT - NO CORD
PDP5883-2S02-B594	AQUATEC - 24VDC - 200PSI BYPS - 0.71GPM - 3/8"FPT - NO CORD - STEEL BRACKET
PDP5883-2S60-B604	AQUATEC - 115V - 200PSI BYPASS - 1.75GPM - VITON VALVES & ORINGS - 3/8"FPT - NO CORD
PDP5883-2SB1-B524	AQUATEC - 1.5GPM - 115V - 200PSI BYPASS - 3/8"NPT - STEEL BRKT - NO CORD
PDP5883-7E67-B638	AQUATEC - 12VDC - 1.2 GPM - NYLON HEAD & VITON VALVES - 60PSI - 3/8 NPT - STEEL BRACKET

# WATER TREATMENT

Pumps & Accessories - Aquatec & Nuert

Aquatec Pumps - Demand Delivery Pumps



## DEMAND DELIVERY PUMPS - 5800 SERIES (3/8" FPT PORTS)



<u>PART NUMBER</u>	<u>ITEM DESCRIPTION</u>
PDP5884-1I01-B664	AQUATEC - 12VDC - 1.4GPM - 100 PSI - 3/8" FPT - NO CORD - STEEL
PDP5884-2F12-N584	AQUATEC - 1.5GPM - 70PSI - BYPASS - 115V - 3/8" FPT - CORD
PDP5881-2E01-B794	AQUATEC - 24VDC - 60PSI BYPASS - 0.8 GPM - 3/8" FPT - NO CORD - STEEL

<u>PART NUMBER</u>	<u>ITEM DESCRIPTION</u>
PDP5887-2PM2-B574	AQUATEC - 115V - COATED WOBBLER - 160PSI BYPS - 0.70GPM - 3/8" FPT - NO CORD

<u>PART NUMBER</u>	<u>ITEM DESCRIPTION</u>
PDP5888-2SMD-B724	AQUATEC - METHONAL INJECTION - 200 PSI BYPASS-24VDC-3/8 FPT- STEEL BRACKET

<u>PART NUMBER</u>	<u>ITEM DESCRIPTION</u>
PDP5889-2P12-V704	AQUATEC - 230V - 160PSI BYPASS - 3/8" FPT PORTS - 1.35 GPM - NO CORD

<u>PART NUMBER</u>	<u>ITEM DESCRIPTION</u>
PDP58-FLC-220-12	AQUATEC - 12VDC - 3/8" FPT - 220 PSI BYPS - NYLON/VITON/SANTO - SEALED MOTOR - STEEL BRACKET

## REPAIR PARTS FOR 5800 DEMAND DELIVERY PUMPS

<u>PART NUMBER</u>	<u>ITEM DESCRIPTION</u>
PDP5883-7E67	AQUATEC 5883-7E67 PUMP HEAD COMPLETE ASSEMBLY



PRECISION  
INSTALLATION  
PRODUCTS



# WATER TREATMENT

Pumps & Accessories - Aquatec & Nuert

Aquatec Pumps - Demand Delivery Pumps

## DEMAND DELIVERY PUMPS - 7800 SERIES (5/8" QUAD PORTS)



<u>PART NUMBER</u>	<u>ITEM DESCRIPTION</u>
PDP7864-1J77-B726	AQUATEC D/D PUMP - 24VDC - VITON VALVES - 1.25 GPM - 110 PSI - 5/8" QD PORTS - STEEL - W/LEAD WI.RE
PDP7864-7E01-B664	AQUATEC D/D PUMP - 12VDC - NYLON/EPDM VALVES - 60PSI - 1.5 GPM - 5/8" QD PORTS - STEEL BRKT
PDP7864-7F01-B574	AQUATEC D/D PUMP - 115V - 1.10GPM - 70PSI - 5/8" QD PORTS - STEEL-NO CORD
PDP7864-NIB2-H524UL	AQUATEC D/D PUMP - 115VAC - 1.7GPM - 100PSI - NYLON/ EPDM/ SANTO - 5/8"QD PORTS - PE SHEILD W/ CORD
PDP7864-NIB2-H704	AQUATEC D/D PUMP - 230VAC - 1.7GPM - 100PSI - NYLON/ EPDM/ SANTO - 5/8"QD PORTS - PE SHEILD W/ CORD

## REPAIR PARTS FOR 7800 DEMAND DELIVERY PUMPS

<u>PART NUMBER</u>	<u>ITEM DESCRIPTION</u>
PDP7864-NIB2	AQUATEC 7864-NIB2-H524-UL COMPLETE PUMP HEAD ASSEMBLY ONLY



# WATER TREATMENT

Pumps & Accessories - Aquatec & Nuert

Aquatec Pumps - Demand Delivery Pumps



PRECISION  
INSTALLATION  
PRODUCTS

## DEMAND DELIVERY PUMPS - FATBOY

The FatBoy™. Pumps up the volume with 7 GPM.

Demanding industrial pump environments require precise engineering and quality components—the FatBoy™ was designed with both. To maximize the potential of all five diaphragm chambers, matching it with a high torque, completely sealed motor. For it's size, it is one of the most powerful and productive diaphragm pumps you can buy, pumping up to 7.0 gallons per minute. If your specifications call for low noise, smooth operation, continuous operation and high capacity, the FatBoy™ will meet the challenge.

### Typical Applications

- De-icing
- Bulk Transfer
- Starter Fertilizer
- Roof Cleaning
- Heavy Duty Spraying
- High Pressure Cleaning
- Agricultural Spraying



### Pump Specifications

- **Type:** 5 chamber positive displacement diaphragm pump, self priming, capable of being run dry, demand or bypass mode
- **Liquid Temperature:** 140°F (60°C) Max.
- **Priming Capabilities:** 14 feet (4 m)
- **Max Pressure:** 150 PSI (10 bar)
- **Inlet/Outlet Ports:** Fatboy 5538: 1/2" FNPT Fatboy 5518: Remco Quick Attach
- **Weight:** 10 lbs (4.5 kg)

### Motor Specifications

- **Type:** 12 VDC permanent magnet, totally enclosed, non-ventilated
- **Leads:** 14 AWG, 12" long
- **Temperature Limits:** Motor is not equipped with thermal protection. For user safety, optimal performance, and maximum motor life, the motor surface temperature should not exceed 180°F (82°C)

### Heat Rise Fatboy

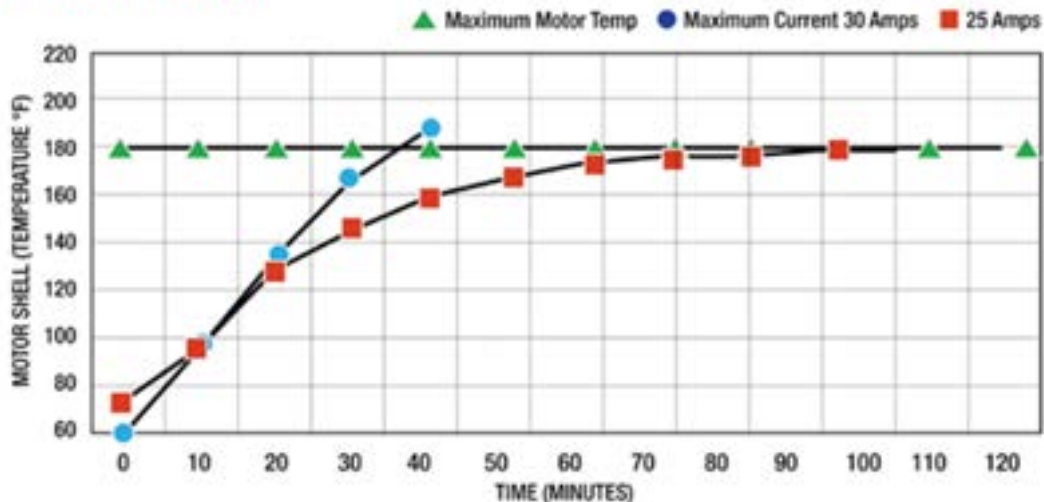



PRECISION  
INSTALLATION  
PRODUCTS



aquatec

# WATER TREATMENT

Pumps & Accessories - Aquatec & Nuert  
Aquatec Pumps - Demand Delivery Pumps

## DEMAND DELIVERY PUMPS - FATBOY

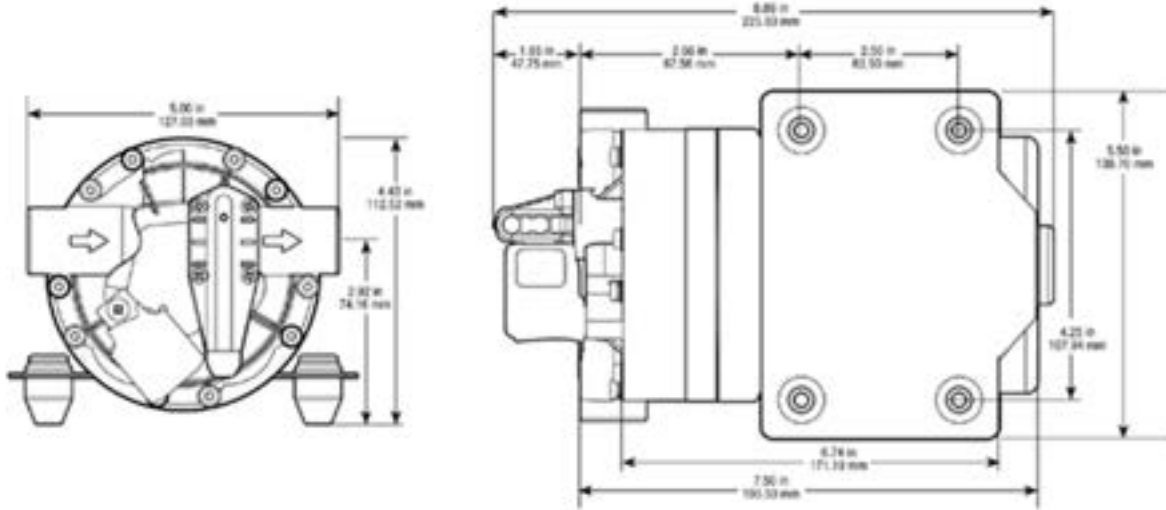

### Materials of Construction

- Pump Housing: Nylon
- Valves: Viton
- Diaphragm: Santoprene
- Fasteners: Stainless steel
- Motor Shell: Coated Steel

### Product Highlights

- Made in USA
- Sealed motor
- Heavier wire for low amp draw
- Constant flow working pressures

### Performance Fatboy

PSI	GPM	Amps
10	7.00	11.00
20	6.81	12.00
30	6.45	12.00
40	5.96	13.00
50	5.50	15.00
60	4.98	17.00
70	4.41	19.00
80	3.96	21.00
90	3.52	23.00
100	2.55	25.00



# WATER TREATMENT

Pumps & Accessories - Aquatec & Nuert  
Aquatec Pumps - Demand Delivery Pumps



## DEMAND DELIVERY PUMPS - "FATBOY" 4" MOTOR PUMPS



<u>PART NUMBER</u>	<u>ITEM DESCRIPTION</u>
PDP5513-2LM3-B946	AQUATEC D/D FATBOY PUMP - 12VDC - 6GPM - 130PSI BYPASS - 4" MOTOR - 1/2"FPT

<u>PART NUMBER</u>	<u>ITEM DESCRIPTION</u>
PDP5514-2EM3-B946	AQUATEC FATBOY - 7GPM - 12VDC - 60PSI BYPASS - 1/2"FPT

<u>PART NUMBER</u>	<u>ITEM DESCRIPTION</u>
PDP55-SWZ60735	AQUATEC SWEEPER PUMP W/ 4" MOTOR - 12VDC - 3.4GPM - 120 BYPS - 30 AMPS

## REPAIR PARTS FOR DEMAND DELIVERY PUMPS - FATBOY

<u>PART NUMBER</u>	<u>ITEM DESCRIPTION</u>
PDP55-SWZHEAD	AQUATEC SWEEPER PUMP HEAD ONLY-NO MOTOR



PRECISION  
INSTALLATION  
PRODUCTS



# WATER TREATMENT

Pumps & Accessories - Aquatec & Nuert

## Aquatec Pumps - Variable Speed Pumps

## VARIABLE SPEED PUMPS

*Patent-pending "smart pump" technology providing constant pressure at variable flow rates.*

### 550 SERIES VARIABLE SPEED PUMP

#### DISTINGUISHING FEATURES:

- Constant pressure across multiple outlets
- No accumulator tanks required
- Reduced system bacteria
- Reduced space requirements
- No pressure switches required
- Less system service required
- Plug-and-play performance
- Optional logic interface available
- QD ports



Most automatic demand pumps are designed for a limited flow range. When variable flows are required (i.e. multiple fixtures drawing fluid from a single source), such pumps require a supplementary accumulator tank, and even then, often experience pressure fluctuations of at least 20 psi.

The Aquajet Variable Speed series integrates a state-of-the-art digital controller with our proven 5-valve specialty diaphragm pumps. The result is a patent-pending, intelligent pump series which can maintain constant pressures (within 2 psi) for variable flow rates throughout their operating ranges. Utilizing an integrated pressure transducer, these Aquajet pumps monitor any pressure changes and adjust their operating speeds accordingly. Bulky accumulator tanks and unreliable pressure switches are no longer required.

5-valve variable speed pump. Used in applications that require more flow. Comes with a built-in power cord for ease of installation.

**NOTE: THESE PUMPS REQUIRE FITTINGS SHOWN ON PAGE # 01-60 & 61**

# WATER TREATMENT

## Pumps & Accessories - Aquatec & Nuert

Aquatec Pumps - Variable Speed Pumps



PRECISION  
INSTALLATION  
PRODUCTS

## VARIABLE SPEED PUMPS

*Patent-pending "smart pump" technology providing constant pressure at variable flow rates.*

### 5800 SERIES VARIABLE SPEED PUMP

#### DISTINGUISHING FEATURES:

- Constant pressure across multiple outlets
- No accumulator tanks required
- Reduced system bacteria
- Reduced space requirements
- No pressure switches required
- Less system service required
- Plug-and-play performance
- Optional logic interface available
- 3/8" John Guest Quick Connect Fittings



Most automatic demand pumps are designed for a limited flow range. When variable flows are required (i.e. multiple fixtures drawing fluid from a single source), such pumps require a supplementary accumulator tank, and even then, often experience pressure fluctuations of at least 20 psi.

The Aquatec Variable Speed series integrates a state-of-the-art digital controller with our proven 3-valve specialty diaphragm pumps. The result is a patent-pending, intelligent pump series which can maintain constant pressures (within 2 psi) for variable flow rates throughout their operating ranges. Utilizing an integrated pressure transducer, these Aquatec pumps monitor any pressure changes and adjust their operating speeds accordingly. Bulky accumulator tanks and unreliable pressure switches are no longer required.

3-valve variable speed pump. Used in applications that require less flow. Comes with a built-in power cord for ease of installation, and John Guest 3/8" built-in cartridges.



PRECISION  
INSTALLATION  
PRODUCTS



# WATER TREATMENT

Pumps & Accessories - Aquatec & Nuert

Aquatec Pumps - Variable Speed Pumps

## VARIABLE SPEED PUMPS - AQUAJET (3/4" QUAD PORTS)



<u>PART NUMBER</u>	<u>ITEM DESCRIPTION</u>
PVP55-AQUAJET-AES	AQUAJET VARIABLE SPEED PUMP - 12VDC - 3.40GPM - QUAD PORT (PACKED W/ TWO QTS-556 1/2" MPT PUMP F..

NOTE: THESE PUMPS COME PACKED WITH 2 QTS-556 FITTINGS (1/2" MPT)

## REPAIR PARTS FOR VARIABLE SPEED PUMPS - AQUAJET

<u>PART NUMBER</u>	<u>ITEM DESCRIPTION</u>
PVP55-ARV	AQUATEC COMPLETE HEAD FOR 55-AQUAJET-ARV
25-174	AQUATEC HOSE KIT WITH FITTING FOR 550 RV PUMP

## VARIABLE SPEED PUMPS - 5500 SERIES (3/4" QUAD PORTS)



<u>PART NUMBER</u>	<u>ITEM DESCRIPTION</u>
PVP5501-1EN2-V77DUL	AQUATEC VARIABLE SPEED PUMP - 60PSI - 0.3-3.8GPM - 3 MINUTE TIMEOUT - 115 VOLT W/ CORD - ENHANCE...
PVP5501-1EN2-V89D	AQUATEC VARIABLE SPEED PUMP - 230VAC - 60PSI - 0.0-3.80GPM - THERMAL PROTECTED - EMI/RFI - QD PORT
PVP5501-1VN2-V77DUL	AQUAJET VARIABLE SPEED PUMP - 65PSI - 0.4-4.0 GPM - 3 MINUTE TIME OUT - 115 VOLT W/ CORD - ENHAN...
PVP5502-1DN2-V77DUL	AQUATEC VARIABLE SPEED PUMP - 50PSI - 0.25-4.30GPM - 3 MINUTE TIME OUT - 115 VOLT W/ CORD - ENHA...

NOTE: THESE PUMPS REQUIRE FITTINGS SHOWN ON PAGE #01-60 & 61

## VARIABLE SPEED PUMPS - 5800 SERIES (3/8" JG PORTS)

<u>PART NUMBER</u>	<u>ITEM DESCRIPTION</u>
PVP5853-GB12-V81D	AQUATEC VARIABLE SPEED PUMP - 40PSI - 0.0-1.30GPM - 3 MINUTE TIME OUT - 115 VOLT W/ CORD - 3/8"J...
PVP5853-GB12-V88D	AQUATEC VARIABLE SPEED PUMP - 230 VOLT - 40PSI - 0.5-1.40GPM - 3/8JG
PVP5853-GE12-V81D	AQUATEC VARIABLE SPEED PUMP - 60PSI - 0.0-1.36GPM - 3 MINUTE TIME OUT - 115VAC W/ CORD - 3/8"JG ...
PVP5853-GE12-V88D	AQUATEC VARIABLE SPEED PUMP - 230 VOLT - 60PSI - 0.5-1.40GPM - 3/8JG

# WATER TREATMENT

## Pumps & Accessories - Aquatec & Nuert



PRECISION  
INSTALLATION  
PRODUCTS

Aquatec Pumps - Demand Delivery & Variable Speed Pumps

## INSTALLATION PROCEDURE - 5800/550 BOOSTER PUMPS

The basic 5800/550 pump is controlled by a built-in pressure sensing demand switch. When a faucet or valve is opened down stream of the pump, line pressure drops thus starting the pump automatically. Conversely, when the valve shuts, the line pressure increases turning the pump off automatically. The pressure switch actuates in response to the pump outlet pressure at a predetermined and preset pressure. The pump label indicates the predetermined OFF pressures. Typically, the OFF pressure is accurately set at the FACTORY and the ON pressure is within an allowable range below that value. In response to the characteristics of the system in which the pump is installed, such as the flexibility and length of the tubing, and the faucet or valves and the duration that they are open, these pressure settings may vary. Therefore, changes in pressure settings is expected with use over time.

**Read the operational and instruction guides carefully before starting to install the pump. Consult the Factory if there is any question.**

1. Determine the optimum location for your pump before proceeding.
2. Turn off water.
3. Cut the flexible tubing in sufficient length to avoid any stress on the tubing where it connects to the pump or the fitting on any accessory.
4. Insert tubing into pump ports. Be sure tubing is inserted past the resistance point until it bottoms out against the port stop.
5. The 5800/550 pump is now ready for operation. Open the inlet water valve to allow water to flow to the pump.
6. If the power source is a transformer, plug the appropriate Aquatec supplied or approved transformer into the receptacle and connect the pump to the transformer. If the power source is not a transformer, connect the pump to the appropriate power source. Open the discharge or dispensing valve. Allow water to circulate, purging any entrapped air.
7. The pump will now start building pressure. Operating pressure will vary with membrane flow rate, flow restrictor flow rate, feed-water pressure and line voltage. Check for fitting leaks.
8. **ADJUSTING THE PRESSURE SWITCH.** Should the pressure switch OFF setting vary with use and time to an unsuitable value, it may be adjusted for optimum performance. Turn the set screw clockwise to increase the OFF pressure setting and counter clockwise to decrease. The screw should not be adjusted more than one turn without consulting the Factory. Excessive adjustment of the pressure switch could cause low system pressure, and rapid ON/OFF cycling, reducing pump and motor life. Damage may occur if recommended maximum pressures are exceeded. **the Warranty does not cover improper adjustment of the pressure switch.**
9. Rapid On/Off Cycling must be limited to no more than 6 times per minute, even if the pump is operating in the Continuous Duty zone. Start up current each time the pump is turned on will always exceed the normal running current, and could cause the motor to heat beyond the recommended maximum temperature.

### SERVICING:

**Every Year:** Check system against operating standards.

**Every 2-3 Years:** Replace diaphragm and check against operating standards.



PRECISION  
INSTALLATION  
PRODUCTS



aquatec

# WATER TREATMENT

## Pumps & Accessories - Aquatec & Nuert

Aquatec Pumps - Demand Delivery & Variable Speed Pumps

## OPERATION & INSTALLATION - 5800/550 BOOSTER PUMPS

Please read these Operational and Installation Guidelines before installing the 5800/550 Delivery/Demand Pump. If additional help is needed, please consult the Factory.

### CAUTIONS:

1. The pump is equipped with a pressure sensing demand switch which controls the maximum safe operating pressure.
2. Never operate the pump in harsh environment or hazardous atmosphere, since motor brush and switch may cause electrical arcing.
3. Pumphead materials are designed for use with water only. Do not use with petroleum products.
4. As long as there is inlet water pressure, the pump will not stop forward flow of water even if the motor is turned off. Be sure the system has positive means of shutting off water supply.
5. Always consider electrical shock hazard when working with and handling electrical equipment. If uncertain, consult an Electrician. Electrical wiring should only be done by a qualified Electrician per local and State Electric Codes.

### MOUNTING:

- A. The pump should be mounted in a dry place and away from any source of heat. If an enclosure is used, special provisions for cooling the motor may be necessary. Certain models may be ordered with a thermal protected motor.
- B. Do not subject the Pump to extreme high or low (freezing) temperatures while in operation. (Operating ambient temperatures range is 32°F to 115°F)
- C. The pump may be mounted horizontally with the outlet port on the right when viewed from the pump end or vertically with the pump above the motor.
- D. Do not mount the pump with the head down, as air can become trapped causing the pump to malfunction.

### PLUMBING:

- A. We recommend use of flexible tubing with proper pressure rating.
- B. Pump will prime only if all pressure is relieved from the outlet port.
- C. It is recommended that an in-line sediment filter be installed at the inlet side to keep foreign debris out of the system.
- D. Avoid any sharp bends which may crimp tubing and restrict flow. Use 90° elbow fittings if necessary.
- E. The pump should always be mounted prior to the carbon pre-filter to prevent carbon particles from entering the pump chambers and possibly causing clogging.

### ELECTRICAL:

- A. The 5800/550 series pumps are designed for intermittent duty, but may run continuously if the motor temperature does not exceed the recommended limit. Please consult the appropriate Data Sheet for continuous running parameters, noting the effect of rapid On/Off Cycling.
- B. If a power supply is used with the system and the supply is not furnished by Aquatec, it will need to be reviewed for correct application and approval by Aquatec.



# WATER TREATMENT

## Pumps & Accessories - Aquatec & Nuert

Aquatec Pumps - Demand Delivery & Variable Speed Pumps



## AQUATEC WARRANTY

**Aquatec Water Systems, Inc.** ("Aquatec") warrants its products to be free from defects in material and workmanship under the following terms:

**All Aquatec products with the exception of series 68XX, ERP 1000 and Aquajet model pumps:** The warranty will last for a period of thirteen months from the date of shipping from an Aquatec warehouse. Warranty period for 68XX and ERP 1000 is twenty-five months from the date of shipment from Aquatec. Aquatec warrants its Model Aquajet RV Pumps (Part Numbers 55-AQUAJET-ARV and 55-AQUAJET-AES) for a period of 2 years from the date of shipment from Aquatec. Aquatec's obligation under this warranty shall be limited to replacing or repairing at Aquatec's discretion, any such product or part which must be returned to Aquatec's factory with a Return Material Authorization Number (RMA No.), transportation charges approved by Aquatec or prepaid, and which upon examination, is found to Aquatec's satisfaction to have been defective under the terms of this warranty. No credit will be allowed against future purchases for items returned as defective under the terms of Aquatec's warranty.

**This warranty does not extend to any products, which have been altered or modified outside the Aquatec factory, nor does it apply to units that are returned in an unassembled condition.** Furthermore, the warranty does not extend to pumps that are identified by a 9XXX model number, indicating non-compliance with Aquatec's Engineering Standards. This includes, but is not limited to, pumps ordered without an integral control mechanism. The warranty guarantees that products will perform to Aquatec's flow and pressure specifications throughout the life of the warranty. The warranty does not cover wear, appearance, misapplication or external water damage. If the returned product is found not to be defective under the conditions of this warranty, a charge will be made for repair or replacement.

**Brush wear may be limited to 1000 hours or less.**

**This is a Limited Warranty. It covers the product only and the extent of the coverage is limited to the cost of the product. As the manufacturer has no control over shipping, handling and installation, the warranty cannot cover water damage, or any other damage, caused by a leak or other malfunction.**

This warranty is in lieu of all other warranties, expressed or implied, and no person is authorized to give any other warranty or assume obligation or liability in Aquatec's behalf. Aquatec shall not be liable for any indirect, incidental or consequential damages of any kind incurred by the reason of the use or sale of any defective product and part.

### AQUATEC FITTINGS USED WITH 5500, 5501, 5502 & 5503 SERIES PUMPS

Used with any 550 Aquatec pump with a Quick Disconnect (QD) 3/4" port. All fittings are manufactured with a Buna N O-Ring. To specify Viton O-Ring, please add the letter "V" to the end of the part number.

## BARB ELBOW CONNECTOR



<u>PART NUMBER</u>	<u>ITEM DESCRIPTION</u>
QBE553	AQUATEC PUMP FITTING - 3/8" BARB ELBOW CONNECTOR USED W/ 550 VARIABLE PUMP
QBE554	AQUATEC PUMP FITTING - 1/2" BARB ELBOW CONNECTOR USED W/ 550 VARIABLE PUMP
QBE555	AQUATEC PUMP FITTING - 5/8" BARB ELBOW CONNECTOR USED W/ 550 VARIABLE PUMP
QBE556	AQUATEC PUMP FITTING - 3/4" BARB ELBOW CONNECTOR USED W/ 550 VARIABLE PUMP

## BARB STRAIGHT CONNECTOR



<u>PART NUMBER</u>	<u>ITEM DESCRIPTION</u>
QBS553	AQUATEC PUMP FITTING - 3/8" BARB STRAIGHT CONNECTOR USED W/ 550 VARIABLE PUMP
QBS554	AQUATEC PUMP FITTING - 1/2" BARB STRAIGHT CONNECTOR USED W/ 550 VARIABLE PUMP
QBS555	AQUATEC PUMP FITTING - 5/8" BARB STRAIGHT CONNECTOR USED W/ 550 VARIABLE PUMP
QBS556	AQUATEC PUMP FITTING - 3/4" BARB STRAIGHT CONNECTOR USED W/ 550 VARIABLE PUMP

**NOTE: FOR FLOWS LESS THAN 1.5 LPM**

## JG STRAIGHT CONNECTOR



<u>PART NUMBER</u>	<u>ITEM DESCRIPTION</u>
QJG-058	AQUATEC PUMP FITTING - 3/8" JG STRAIGHT FITTING USED W/ 550 VARIABLE PUMP
QJG-061	AQUATEC PUMP FITTING - 1/2" JG STRAIGHT FITTING USED W/ 550 VARIABLE PUMP

**NOTE: FOR FLOWS LESS THAN 1.5 LPM**

# WATER TREATMENT

## Pumps & Accessories - Aquatec & Nuert

Aquatec Pumps - Fittings



PRECISION  
INSTALLATION  
PRODUCTS

### AQUATEC FITTINGS USED WITH 5500, 5501, 5502 & 5503 SERIES PUMPS

Used with any 550 Aquatec pump with a Quick Disconnect (QD) 3/4" port. All fittings are manufactured with a Buna N O-Ring. To specify Viton O-Ring, please add the letter "V" to the end of the part number.

## MALE STRAIGHT CONNECTOR



<u>PART NUMBER</u>	<u>ITEM DESCRIPTION</u>
QTS556	AQUATEC PUMP FITTING - 1/2" MPT STRAIGHT FITTING USED W/ 550 VARIABLE PUMP

## JG ELBOW CONNECTOR

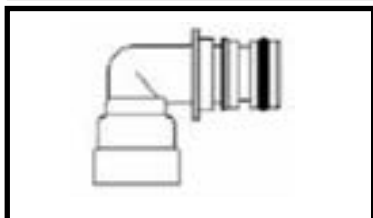

<u>PART NUMBER</u>	<u>ITEM DESCRIPTION</u>
QJGE-553	AQUATEC PUMP FITTING - 3/8" JG ELBOW FITTING USED W/ 550 VARIABLE PUMP
QJGE-554	AQUATEC PUMP FITTING - 1/2" JG ELBOW FITTING USED W/ 550 VARIABLE PUMP

NOTE: FOR FLOWS LESS THAN 1.5 LPM

## BARB ELBOW CONNECTOR



<u>PART NUMBER</u>	<u>ITEM DESCRIPTION</u>
QBS784*	AQUATEC PUMP FITTING - 1/2" BARB STRAIGHT CONNECTOR USED W/ 7800 VARIABLE PUMP

## BARB STRAIGHT CONNECTOR



<u>PART NUMBER</u>	<u>ITEM DESCRIPTION</u>
QBS783	AQUATEC PUMP FITTING - 3/8" BARB STRAIGHT CONNECTOR USED W/ 7800 VARIABLE PUMP (EACH)
QBS783-V*	AQUATEC PUMP FITTING - 3/8" BARB STRAIGHT CONNECTOR W/ VITON ORINGS USED W/ 7800 VARIABLE PUMP
QBS784*	AQUATEC PUMP FITTING - 1/2" BARB STRAIGHT CONNECTOR USED W/ 7800 VARIABLE PUMP



PRECISION  
INSTALLATION  
PRODUCTS



# WATER TREATMENT

Pumps & Accessories - Aquatec & Nuert

## Pressure Chart

### PRESSURE DROP VS. FLOW-RATE FOR PLASTIC TUBING AND HOSE

The following information is the calculated pressure drop for plastic hose and tubing as flow rate increases. This information is based on 60 degree F water. Lower temperatures will increase the pressure drop. In addition, fittings, bends and loops in the hose will further increase the pressure drop.

FLOW-RATE GPM	1/4" I.D.	3/8" I.D.	1/2" I.D.
0.25	<1	<.25	<.2
0.5	<1	<.25	<.2
0.75	<1	<.25	<.2
1.00	3.6	0.6	<.2
1.50	7.7	1.3	<.2
2.00	12.5	2.4	0.46
3.00	24.8 (NR)	4.8	0.99
4.00	NR	7.4	1.71
5.00	NR	11.6	2.6
6.00	NR	16.7 (NR)	3.7

\*\*\* PRESSURE DROP - PSI PER 10 FEET \*\*\*\*\*

- NR - HOSE SIZE GENERALLY NOT RECOMMENDED FOR THIS FLOW-RATE.

This table is designed to serve as a guide in hose selection bases on the length of hose required and the maximum potential flow-rate. Some hose barb type fittings affect the pressure drop as much as 6 feet of additional hose.

# WATER TREATMENT

Pumps & Accessories - Aquatec & Nuert

Aquatec - Transformers



## AQUATEC TRANSFORMERS

Designed to provide the necessary power to the Aquatec product line, based on your specific application. Nominal primary voltages and frequencies, along with system feed, back pressures, and accessories will influence the transformer selection.

## 24VAC TRANSFORMERS - .8 AMP



<u>PART NUMBER</u>	<u>ITEM DESCRIPTION</u>
PAT115	AQUATEC .8 AMP TRANSFORMER - 115 VOLT - USED W/ 6800
PAT130	AQUATEC .8 AMP TRANSFORMER - 100 VOLT - 50/60 HZ
PAT140	AQUATEC .8 AMP TRANSFORMER - 230 VOLT - 50/60 HZ

## 24VAC TRANSFORMERS - 2 AMP



<u>PART NUMBER</u>	<u>ITEM DESCRIPTION</u>
PAT200	AQUATEC 2 AMP TRANSFORMER - 100 VOLT - 24 VAC
PAT215	AQUATEC 2 AMP TRANSFORMER - 115 VOLT - 24 VAC
PAT315	AQUATEC 2 AMP TRANSFORMER - 230 VOLT - 24 VAC



PRECISION  
INSTALLATION  
PRODUCTS



# WATER TREATMENT

## Pumps & Accessories - Aquatec & Nuert

### Aquatec - Tank Switches

#### AQUATEC TANK PRESSURE SWITCHES

Aquatec's tank pressure switch is available to turn off the booster pump when the tank is full.

**It should be mounted in-line, as close to the tank as possible. It is reading tank pressure, not line pressure!**

## 2 PRONG "NORMALLY CLOSED"



<u>PART NUMBER</u>	<u>ITEM DESCRIPTION</u>
PAW220	AQUATEC PRESSURE SWITCH WITH 1/4" JG INSERTS-0/20 SET - USED WITH A NORMALLY CLOSED CIRCUIT
PAW235	AQUATEC PRESSURE SWITCH W/ 1/4"JG INSERTS - 15/35 SET - USED WITH NORMALLY CLOSED CIRCUIT
PAW240	AQUATEC PRESSURE SWITCH W/ 1/4"JG INSERTS - 20/40 SET - USED WITH NORMALLY CLOSED CIRCUIT
PAW260	AQUATEC PRESSURE SWITCH W/ 1/4"JG INSERTS - 40/60 SET - USED WITH NORMALLY CLOSED CIRCUIT
PAW280	AQUATEC PRESSURE SWITCH W/ 1/4"JG INSERTS - 60/80 SET - USED WITH NORMALLY CLOSED CIRCUIT
PAW2100	AQUATEC PRESSURE SWITCH W/ 1/4"JG INSERTS - 80/100 SET - USED WITH NORMALLY CLOSED CIRCUIT
PAW335	AQUATEC PRESSURE SWITCH W/ 3/8" JG INSERTS-15/35 SET - USED WITH A NORMALLY CLOSED CIRCUIT
PAW340	AQUATEC PRESSURE SWITCH W/ 3/8"JG INSERTS – 20/40 SET - USED WITH A NORMALLY CLOSED CIRCUIT
PAW360	AQUATEC PRESSURE SWITCH W/ 3/8"JG INSERTS - 40/60 SET - USED WITH A NORMALLY CLOSED CIRCUIT
PAW380	AQUATEC PRESSURE SWITCH W/ 3/8"JG INSERTS - 60/80 SET - USED WITH A NORMALLY CLOSED CIRCUIT
PAW3100	AQUATEC PRESSURE SWITCH W/ 3/8"JG INSERTS - 80/100 SET - USED WITH A NORMALLY CLOSED CIRCUIT

# WATER TREATMENT

Pumps & Accessories - Aquatec & Nuert

## Aquatec - Tank Switches



### AQUATEC TANK PRESSURE SWITCHES

Aquatec's tank pressure switch is available to turn off the booster pump when the tank is full.

**It should be mounted in-line, as close to the tank as possible. It is reading tank pressure, not line pressure!**

## 3 PRONG - "NORMALLY CLOSED / NORMALLY OPEN"



<u>PART NUMBER</u>	<u>ITEM DESCRIPTION</u>
PAW220-HNW	AQUATEC PRESSURE SWITCH WITH 1/4" JG INSERTS - 0/20 SET - 3 PRONG - USED WITH A NORMALLY OPEN CI...
PAW240-HNW	AQUATEC PRESSURE SWITCH W/ 1/4"JG INSERTS - 20/40 SET - 3 PRONG - USED WITH A NORMALLY OPEN CIRCUIT
PAW2100-HNW	AQUATEC PRESSURE SWITCH W/ 1/4"JG INSERTS - 80/100 SET - 3 PRONG - USED WITH A NORMALLY OPEN CIR...
PAW320-HNW	AQUATEC PRESSURE SWITCH W/ 3/8"JG INSERTS - 0/20 SET - 3 PRONG
PAW340-HNW	AQUATEC PRESSURE SWITCH W/ 3/8"JG INSERTS - 20/40 SET - 3 PRONG
PAW360-HNW	AQUATEC PRESSURE SWITCH W/ 3/8"JG INSERTS - 40/60 SET - 3 PRONG
PAW3100-HNW	AQUATEC PRESSURE SWITCH W/ 3/8"JG INSERTS - 80/100 SET - 3 PRONG



PRECISION  
INSTALLATION  
PRODUCTS



# WATER TREATMENT

Pumps & Accessories - Aquatec & Nuert

## Aquatec - Wiring Harnesses

### WIRING HARNESS



<u>PART NUMBER</u>	<u>ITEM DESCRIPTION</u>
21-035-05	AQUATEC 12" EXTENSION HARNESS
21-035-02	AQUATEC 24" SINGLE EXTENSION HARNESS
21-127-1	AQUATEC DOUBLE WIRING HARNESS
21-028-1	AQUATEC DOUBLE WIRING HARNESS - 10" FOR SWITCH/LP PUMP/LPS-340G
21-308-10	AQUATEC DOUBLE WIRING HARNESS - 11" FOR HIGH FLOW SOLENOID VALVE (26-187)
21-161	AQUATEC TRIPLE WIRING HARNESS - 3 FEMALE & 1 MALE CONNECTORS
21-224	AQUATEC 4-WAY JUNCTION HARNESS FOR 1 TRANSFORMER
PAW340	AQUATEC PRESSURE SWITCH W/ 3/8"JG INSERTS – 20/40 SET - USED WITH A NORMALLY CLOSED CIRCUIT
PAW360	AQUATEC PRESSURE SWITCH W/ 3/8"JG INSERTS - 40/60 SET - USED WITH A NORMALLY CLOSED CIRCUIT
PAW380	AQUATEC PRESSURE SWITCH W/ 3/8"JG INSERTS - 60/80 SET - USED WITH A NORMALLY CLOSED CIRCUIT
PAW3100	AQUATEC PRESSURE SWITCH W/ 3/8"JG INSERTS – 80/100 SET - USED WITH A NORMALLY CLOSED CIRCUIT



# WATER TREATMENT

Pumps & Accessories - Aquatec & Nuert

Aquatec - Brackets & Heat Shield



## BRACKETS



**PART NUMBER**

25-150

**ITEM DESCRIPTION**

AQUATEC BLACK STEEL BRACKET: 2.5" X 4.25"



**PART NUMBER**

25-166

**ITEM DESCRIPTION**

AQUATEC BLACK CUSTOM STEEL BRACKET: 2.25" X 3.18"



**PART NUMBER**

25-033

**ITEM DESCRIPTION**

AQUATEC COMPLETE UNIVERSAL PLASTIC BRACKET W/ (4) FEET, (4) SPACERS & (2) SCREWS



**PART NUMBER**

51-109

**ITEM DESCRIPTION**

AQUATEC FLEX BRACKET FOR 6800/8800 PUMPS

## HEAT SHIELD



**PART NUMBER**

50-075

**ITEM DESCRIPTION**

AQUATEC HEAT SINK SHIELD FOR MOTORS. USED IN CONTINUOUS DUTY APPLICATIONS, ALLOWING 15% MORE RUN TIME BEFORE THERMAL OVERLOAD



PRECISION  
INSTALLATION  
PRODUCTS



# WATER TREATMENT

Pumps & Accessories - Aquatec & Nuert

## Aquatec - Small Parts Replacements

### RUBBER FEET FOR BRACKETS



<u>PART NUMBER</u>	<u>ITEM DESCRIPTION</u>
10-024	AQUATEC SMALL BLACK RUBBER FEET FOR STEEL BRACKET
52-016	AQUATEC RUBBER GROMMET/FEET USED W/ UNIVERSAL PLASTIC BRACKET

### STEM



<u>PART NUMBER</u>	<u>ITEM DESCRIPTION</u>
51-078	AQUATEC SPACER/STEM USED W/ UNIVERSAL PLASTIC BRACKET

### RETAINER CLIP



<u>PART NUMBER</u>	<u>ITEM DESCRIPTION</u>
51-251	AQUATEC RETAINER CLIP FOR 550 QUICK DISCONNECT PUMPS

### SCREWS



<u>PART NUMBER</u>	<u>ITEM DESCRIPTION</u>
11-123	AQUATEC SCREWS USED W/ UNIVERSAL PLASTIC BRACKET ONLY (PACK OF 2)
PAB-SCREWS	AQUATEC SCREWS FOR BASE PLATE ON CDP6800 PUMP

### BOTTLE CAPS



<u>PART NUMBER</u>	<u>ITEM DESCRIPTION</u>
PBC25-154	AQUATEC 5 GALLON BOTTLE WATER CAP

### INLET SCREENS



<u>PART NUMBER</u>	<u>ITEM DESCRIPTION</u>
S10-269	AQUATEC 1/2" MESH SCREEN

# WATER TREATMENT

Pumps & Accessories - Aquatec & Nuert

Aquatec - LPS Installation



PRECISION  
INSTALLATION  
PRODUCTS

## AQUATEC BOOSTER PUMP SYSTEM

TYPICAL UNDERCOUNTER INSTALLATION PSW, ESO AND LPS SHOWN

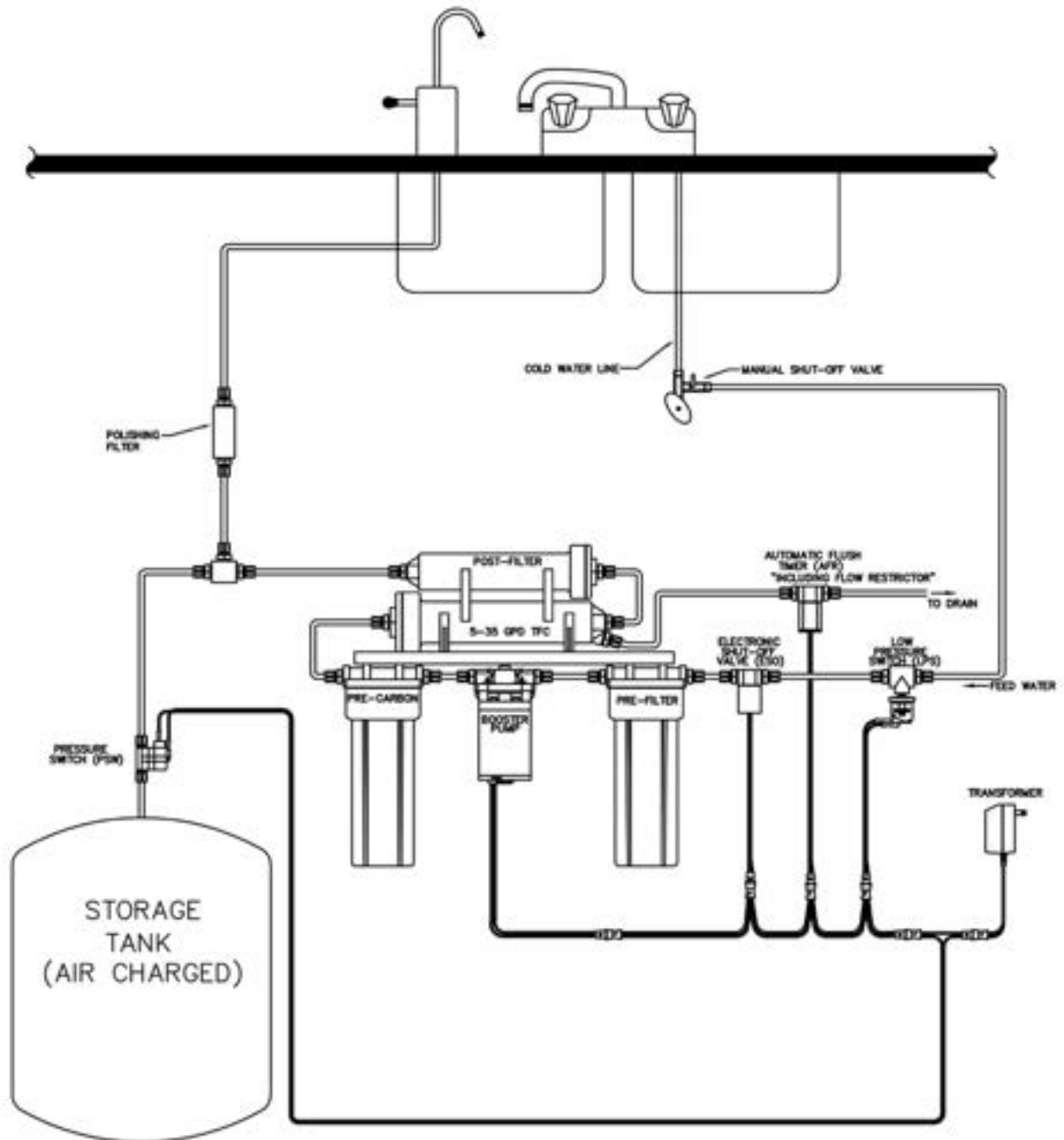

### LOW PRESSURE SWITCH



PART NUMBER	ITEM DESCRIPTION
LOW PRESSURE SWITCH	AQUATEC SMALL BLACK RUBBER FEET FOR STEEL BRACKET

The LPS Low Pressure Switch electrically shuts off the booster pump if the feed water is interrupted. The LPS is designed to be mounted on the inlet side of the pump. Although the pump will not be damaged if operated without feed-water, pumping air into the membrane for extended periods can damage the module. We strongly recommend this device for applications where feed-water shut-off or interruption can occur. The LPS includes a wiring harness (21-028-1) that interconnects a pump and transformer.

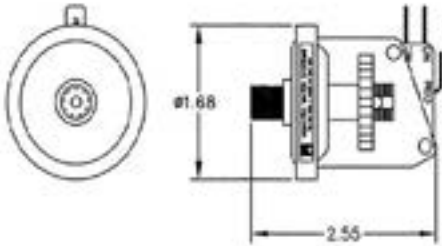

**SPECIFICATIONS:**

**A. GENERAL:**

1. MATERIAL: ALL WETTED PARTS TO BE FDA APPROVED OR NSF LISTED.
2. PRESSURE CONNECTION: 1/8" NPT.

**B. ELECTRICAL:**

1. SWITCH: CHERRY E34 OR EQUIV., 125 - 250 VAC, 15A MAX. SPDT
2. TERMINALS: 3/16" MALE QUICK CONNECT
3. AGENCY LISTINGS: UL APPROVED
4. SWITCH LIFE: 100,000 CYCLES MINIMUM

**C. HYDRAULIC:**

1. SUSTAINED OPERATING PRESSURE: 50 PSI MAX.
2. BURST PRESSURE: 200 PSI
3. PRESSURE SETTING RANGE:
  - c.) SWITCH CLOSED 5 PSI OR MORE
  - b.) SWITCH OPEN: 1 PSI TO 5 PSI, FACTORY PRESET AT 2.3±.2 PSI

CAD# LPS540 PRODUCT CODE LPP 341-21LPP 341-2	MATERIAL PART APPROVALS DATE DESIGNED CHECKED	<b>AQUATEC WATER SYSTEMS INC.</b> 17422 Pulman St., Irvine, Ca. 92614  <b>LOW PRESSURE SWITCH</b>
--	--	--

# WATER TREATMENT

## Pumps & Accessories - Aquatec & Nuert

Aquatec - Tank Level Controller PLC902



## AQUATEC COMPONENT PARTS - TANK LEVEL CONTROLLER

### PLC902 TANK LEVEL CONTROL SWITCH VALVE

#### DISTINGUISHING FEATURES:

- Conserves water
- Separately adjustable on and off levels
- Positive level control and water shut-off
- Conserves energy
- Extends system component life
- Hermetically sealed circuitry for long life



Aquatec's PIC902 Tank Level Control "switch/valve" combination senses the water level through (3) sensors installed through the wall of a non-metallic holding tank. A stainless steel sensor positioned at the pre-determined "fill-level" turns the pump off and closes the integral valve, thereby shutting off the feed-water. As product water is used and falls below the "refill level" the lower sensor automatically restarts the pump and reopens the integral feed-water valve. The valve is powered by Aquatec's exclusive patented energy saving 24 volt coil, strong enough to open against 100 psi. It is intended for high flow applications up to 2500 MI/MIN. The unique circuit allows the 24 volt valve coil to operate without heat build up and AC coil noise. The control circuitry is integrated into the valve and is hermetically sealed for maximum reliability under severe operating conditions.

In a booster pump application, the TLC valve is mounted in-line on the feed water line in front of the inlet to the pump. It's powered by a 24 VAC transformer. The TIC prevents making more water than necessary to fill the unit, thus conserving water and extending the life of the system components.

#### TECHNICAL SPECIFICATIONS:

**WETTED MATERIAL OF CONSTRUCTION:** Polypropylene, EPDM, 300 and 400 Series Stainless Steel

**POWER REQUIREMENTS:** 24 VAC, 50/60 Hz, 130 mA;

**SWITCHED OUTPUT POWER:** 24 VAC, 1 amp.

**INLET PRESSURE/ORIFICE:** 100 psi max./ .093" diameter orifice

**FITTINGS:** 1/4" Quick Connect push in fittings

**SENSORS/SENSITIVITY:** Stainless Steel; up to 250 kilo-ohms for water greater than 3 ppm TDS



PRECISION  
INSTALLATION  
PRODUCTS



aquatec

# WATER TREATMENT

Pumps & Accessories - Aquatec & Nuert

## Aquatec - Tank Level Controller PLC902

### TANK LEVEL CONTROLLER PLC902 TANK LEVEL CONTROL SWITCH VALVE

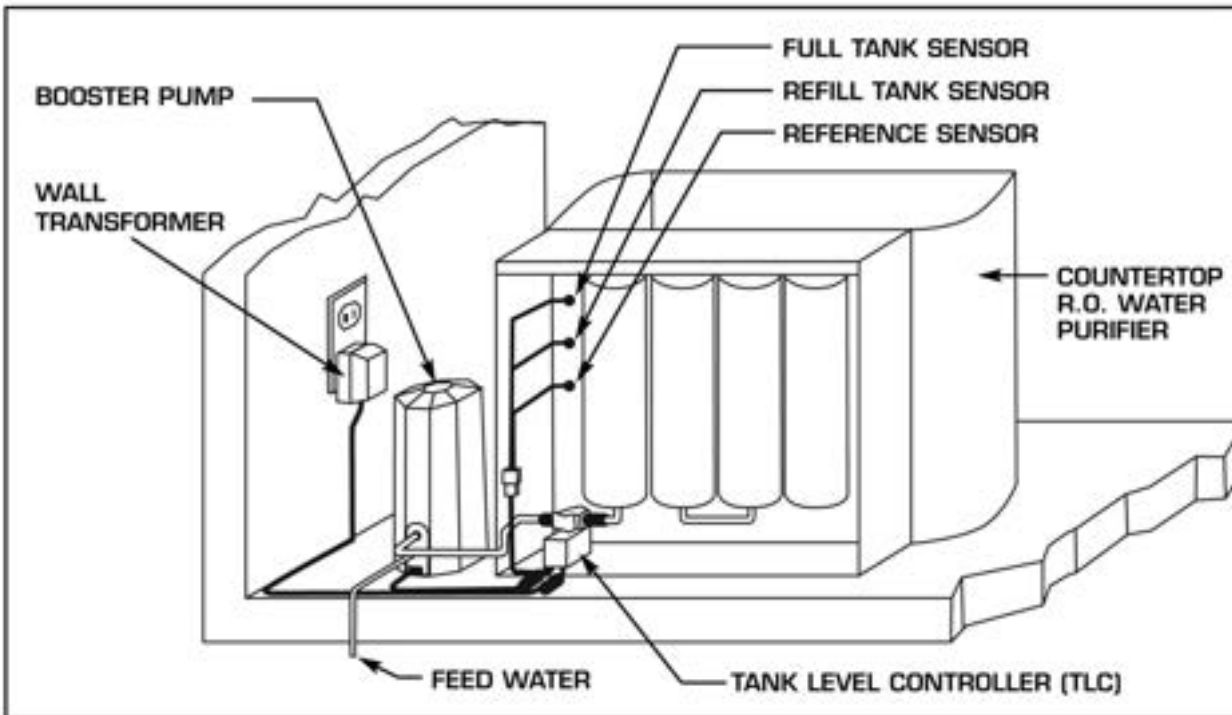
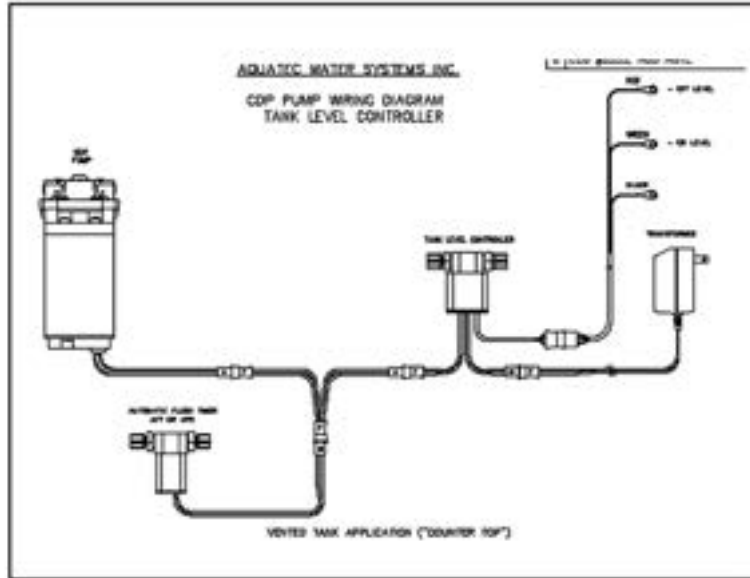
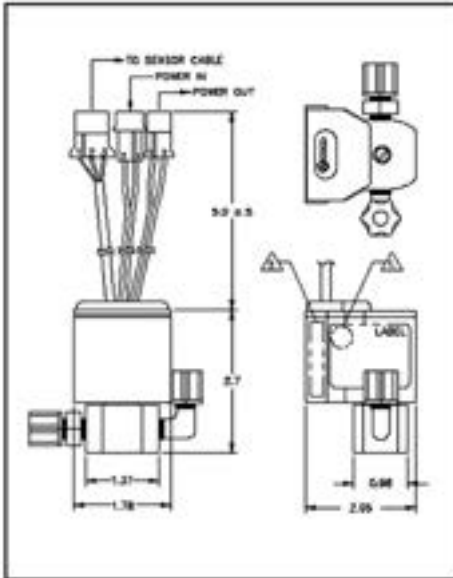

# WATER TREATMENT

Pumps & Accessories - Aquatec & Nuert

Aquatec - Leak Detector Sensor Valve PDU900



## LEAK DETECTOR VALVE



<u>PART NUMBER</u>	<u>ITEM DESCRIPTION</u>
PDU900	AQUATEC UNIVERSAL LEAK DETECTOR SENSOR VALVE - 1/4" JG - 24VAC - COMES W/ WIRE HARNESS

### DISTINGUISHING FEATURES:

- Protection from leaks
- Integrated sensing circuit
- Hermetically sealed for reliability
- 1 year warranty
- Optional latched or unlatched for output

Aquatec's PDU900 leak Detector/Valve has been engineered to prevent serious water damage. Its detection circuit senses moisture or leaks and instantly closes the integral valve. Several sensor probes can be connected to the same shut-off valve to provide maximum valve shut off speed and a wider protection area. The PDU900 is perfect for any system including Reverse Osmosis systems, water coolers, ice makers, post-mix dispensers, coffee makers, or juice dispensers. This product will act like a automatic shutoff (PSO) - a separate one will not be needed.

### TECHNICAL SPECIFICATIONS:

**WETTED MATERIAL OF CONSTRUCTION:** Polypropylene, EPDM, 300 and 400 Series Stainless Steel

**POWER REQUIREMENTS:** 24 VAC, 50/60 Hz, 130 mA; Switched Output Power: 24 VAC, 1 amp.; IDS 700: 24 VAC 50/60 Hz, 30 mA

**INLET PRESSURE/ORIFICE:** IDS 800: 100 psi max./ .093" orifice 1/4"

**FITTINGS:** John Guest fittings

**PROBE SENSITIVITY:** 250 kilo-ohm-Stainless Steel Valve Position: Closed Water Temperature: 180° F maximum



PRECISION  
INSTALLATION  
PRODUCTS



aquatec

# WATER TREATMENT

Pumps & Accessories - Aquatec & Nuert

## Aquatec - Electronic Shut Off Valve PSO-100DC

### ELECTRONIC SHUT OFF VALVE



**PART NUMBER**

PSO-100DC

**ITEM DESCRIPTION**

AQUATEC ELECTRONIC AUTOMATIC HIGH PRESSURE SHUT-OFF VALVE - 24 VAC OR VDC - 1/4"JG - COMES W/ WIRE HARNESS

**DISTINGUISHING FEATURES:**

- Conserves both water and energy
- Provides positive water shut-off
- Low power, cool running
- Hermetically sealed circuitry
- Compact design, plastic valve body

The ESO 460-DC1 utilizes our patented, energy saving 24V coil, which operates without heat buildup or AC coil noise. All integrated control circuitry is hermetically sealed for extended life and maximum reliability under severe operating conditions. The ESO 460-DC1 can be powered by either AC or DC voltage.

**TECHNICAL SPECIFICATIONS:**

**POWER REQUIREMENTS:** ESO 460-DC1 24 VAC or VDC, 120 mA

**INIET PRESSURE/ORIFICE:** ESO DC - Maximum 100 psi, .093" diameter orifice

**STANDARD FITTINGS:** John Guest 1/4" built-in ports

**ELECTRICAL CONNECTION:** AMP Mate-N-lok



# WATER TREATMENT

Pumps & Accessories - Aquatec & Nuert

Aquatec - High Flow ESO 26-187



PRECISION  
INSTALLATION  
PRODUCTS

## HIGH FLOW ELECTRONIC SHUT OFF VALVE



<u>PART NUMBER</u>	<u>ITEM DESCRIPTION</u>
26-187	AQUATEC PSO 600 HI-FLO SOLENOID VALVE - 3/8" MBSP - WIRING HARNESS SOLD SEPARATELY (21-308-10)
21-308-10	AQUATEC DOUBLE WIRING HARNESS - 11" FOR HIGH FLOW SOLENOID VALVE (26-187)

**NOTE: THIS PART COMES WITH 3/8" BRITISH STANDARD PORT THREADS. PLEASE ORDER FITTINGS BELOW TO MAKE YOUR CONNECTION.**

<u>PART NUMBER</u>	<u>ITEM DESCRIPTION</u>
BWT-FITTING-1/4"	BWT 3/8" EURO THREAD X 1/4" QC FOR HEAD
BWT-FITTING-3/8"	BWT 3/8" EURO THREAD X 3/8" QC FOR HEAD

### DISTINGUISHING FEATURES:

- Higher flow capability - up to 3 GPM
- Perfect for larger systems (100-600 GPD)
- Compact size - less than 3"
- Energy efficient
- Normally closed, positive shut-off
- Plastic corrosion resistant valve body
- Works with most Aquatec switches (PFT, PIC, etc.)

The PSO600 is a compact, industrial grade valve designed to handle flows up to 3 GPM (11 lpm). It is intended for flow ranges between .5 - 3 GPM. It is a fast acting, normally closed solenoid valve with a .315" orifice opening that positively shuts off feedwater. It has a 3/8" male NPT port opening, and can be used with any of Aquatec's transformers

### TECHNICAL SPECIFICATIONS:

**WETTED MATERIAL OF CONSTRUCTION:** Polypropylene, EPDM, 300 and 400 Series Stainless Steel

**POWER REQUIREMENTS:** 24 VAC, 50/60 Hz, 150 mA

**INLET PRESSURE/OFFICE:** 100 PSI MAX. WITH .025" DIA. ORIFICE

**PORT SIZE:** 3/8" MAIE BSPT

**ELECTRICAL CONNECTION:** AMP Mate-N-lok



PRECISION  
INSTALLATION  
PRODUCTS



# WATER TREATMENT

## Pumps & Accessories - Aquatec & Nuert

### Aquatec - Auto Flush Timer Valve 21-127-1

## AUTO FLUSH TIMER VALVE



<u>PART NUMBER</u>	<u>ITEM DESCRIPTION</u>
PFR603	AQUATEC 300 ML/MIN FLUSH TIMER WITH FLOW RESTRICTOR - 1/4" JG W/ WIRE HARNESS INCLUDED (21-127-1)
PFR604	AQUATEC 400 ML/MIN FLUSH TIMER WITH FLOW RESTRICTOR - 1/4" JG W/ WIRE HARNESS INCLUDED (21-127-1)
PFR605	AQUATEC 500 ML/MIN FLUSH TIMER WITH FLOW RESTRICTOR - 1/4" JG W/ WIRE HARNESS INCLUDED (21-127-1)
PFT510	AQUATEC 600 ML/MIN FLUSH TIMER W/O FLOW RESTRICTOR - 1/4" JG W/ WIRE HARNESS INCLUDED (21-127-1)
PFR606	AQUATEC 600 ML/MIN FLUSH TIMER WITH FLOW RESTRICTOR - 1/4" JG W/ WIRE HARNESS INCLUDED (21-127-1)
PFR607	AQUATEC 700 ML/MIN FLUSH TIMER WITH FLOW RESTRICTOR - 1/4" JG W/ WIRE HARNESS INCLUDED (21-127-1)
PFR608	AQUATEC 800 ML/MIN FLUSH TIMER WITH FLOW RESTRICTOR - 1/4" JG W/ WIRE HARNESS INCLUDED (21-127-1)

### DISTINGUISHING FEATURES:

- Reduces "brine to product" ratio
- Hermetically protected electronics for long life
- Improves system "TDS" rejection rate
- Extended membrane life

An Auto-Flush Timer Valve will assist the RO membrane to perform with maximum efficiency for longer time periods. Most designers recommend that an RO system be flushed on a regular basis. In addition, designers can reduce the "brine to product" ratio, especially in low "TDS" applications, while maintaining or improving system "TDS" rejection rate and extending membrane sediment and carbon filter life.

Upon system start-up and every hour thereafter, the 24VAC normally closed solenoid valve automatically "power-flushes" the membrane at full pump flow, or full line pressure in unboosted systems, for 18 seconds every hour. Turbulent water action scrubs organic and inorganic contaminant's from the membrane surface, extending membrane life and efficiency. The "power flush" system only occurs only while the system is in the water making mode. The flush cycle is reset automatically when the RO system repeats the "water making" mode after the "full tank shut-down" mode. Water which has been standing idle in the membrane module for extended period is plurged to the drain. The PFR requires its own transformer or can be powered by the pump transformer.

The valve has a built in, self cleaning, flow restrictor which allows controlled flow to drain when the valve is in the de-activated (closed) state.

### TECHNICAL SPECIFICATIONS:

**WETTED MATERIAL OF CONSTRUCTION:** Polypropylene, EPDM, 300 & 400 Stainless Steel Transformer

**POWER REQUIREMENTS:** 24 VAC, 50/60 Hz, 220mA during flush, 40 mA during aquiescent (off) period.

**OFFICE PRESSURE:** .093" diameter/100 PSI max.; 300 to 700 ml/min flow restrictor orifices. 1/4"

**FITTINGS:** Straight John Guest fittings for inlet and outlet ports.

**VALVE MOUNTING:** Valve mounting position is after the outlet of the booster pump but in front of the RO membrane.

# WATER TREATMENT

Pumps & Accessories - Aquatec & Nuert

## Aquatec - Pump Strainers



PRECISION  
INSTALLATION  
PRODUCTS

## AQUATEC STRAINERS

### DISTINGUISHING FEATURES:

- Grilamid TR55 Nylon clear bowl which is FDA approved (TR55 can handle all grades of water, pesticides, brake fluid, transmission oil, gear oil, power steering fluid, chlorine, petroleum based chemicals and oils and many more.)
- Temperature resistant to 200 degrees F
- Pressure resistant to 200 psi (on the inlet side, pressures rarely reach over 100 psi)
- UV crack resistant and stress crack resistant.

We recommend the use of strainers whenever there is the possibility of introducing debris into our pumps, as they will become clogged and/or will suffer a reduction in performance. The "long bowl" 1/2" port models are rated to 5 GPM and the "short bowl" 3/8" port models are rated to 2 GPM. Our stainless steel screen is 50 mesh, so it will keep out any debris that can get clogged in our pumps.



#### PART NUMBER

25-181

#### ITEM DESCRIPTION

AQUATEC STRAINER-40 MESH SS SCREEN-BUNA O-RING-3/4 QD-FOR USE W/ 550 PUMPS



#### PART NUMBER

25-183

#### ITEM DESCRIPTION

AQUATEC STRAINER-50 MESH SS SCREEN-SHORT BOWL-VITON GASKET-3/8 FPT-UP TO 2 GPM



#### PART NUMBER

25-184

#### ITEM DESCRIPTION

AQUATEC STRAINER-50 MESH SS SCREEN-SHORT BOWL-VITON GASKET-3/8 HOSE BARB-UP TO 2 GPM



#### PART NUMBER

25-185

#### ITEM DESCRIPTION

AQUATEC STRAINER-50 MESH SS SCREEN-LONG BOWL-VITON GASKET-1/2 FPT-UP TO 5 GPM



#### PART NUMBER

25-186

#### ITEM DESCRIPTION

AQUATEC STRAINER-50 MESH SS SCREEN-LONG BOWL-VITON GASKET-1/2 HOSE BARB- UP TO 5 GPM



**PRECISION  
INSTALLATION  
PRODUCTS**

**NU.ER.T.**  
rotary vane pumps  
Volumetric rotary vane pump producer

# WATER TREATMENT

## Pumps & Accessories - Aquatec & Nuert

### Nuert - Rotary Vane Pumps

## NU.ER.T. ROTARY VANE PUMPS

NUERT volumetric rotary vane pumps are self-priming, high-performance (pressure up to 18 bar) and with flow rates up from 50 to 1,080 l/hr at 1450 rpm. All models are available in a lead-free brass or stainless steel body and are classified according to their size and flow rate.

#### FIELDS OF APPLICATION:

- Car Wash
- Beverage Pumps
- Espresso Coffee Machines
- Reverse Osmosis Systems
- Water Purification & Ultrapurifying Systems
- Water Carbonation
- Chemical Transfer Pump
- Cooling Circuits for Labs
- Steam Cleaning Machines
- Cooling Circuits for Medical Lasers
- Solar Pumps

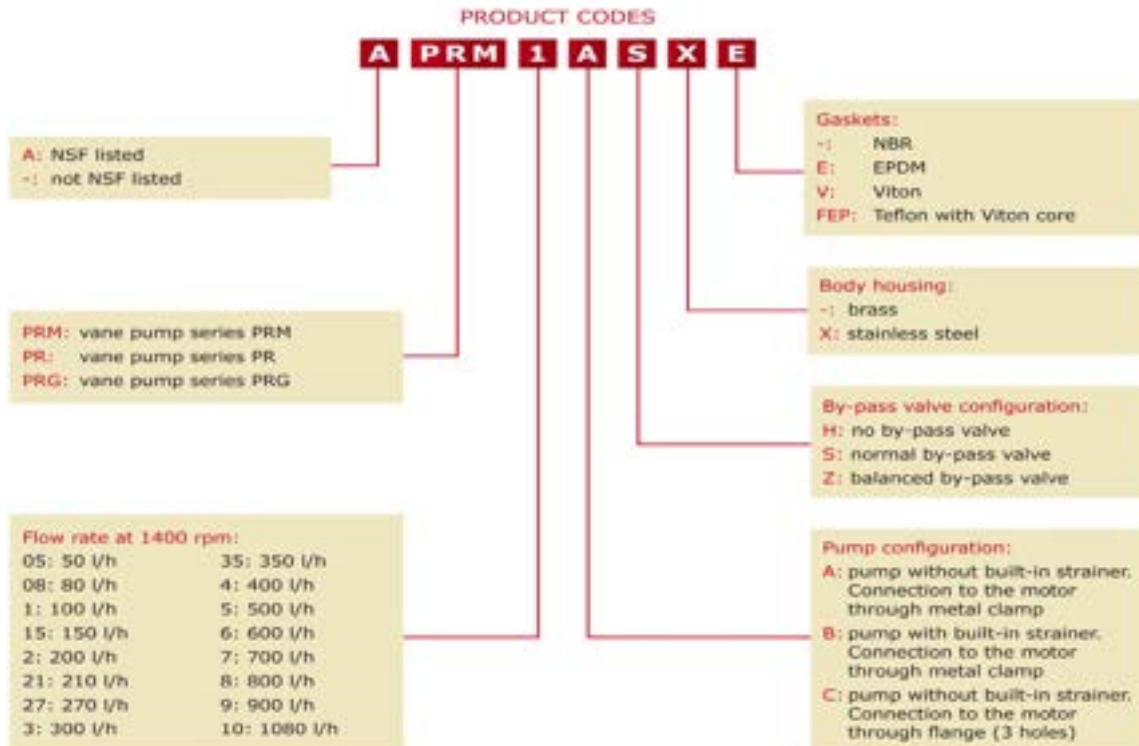

# WATER TREATMENT

Pumps & Accessories - Aquatec & Nuert

## Nuert - Rotary Vane Pumps

**NU.E.R.T.**  
rotary vane pumps  
Nuert's rotary vane pump production



**PRECISION  
INSTALLATION  
PRODUCTS**

## MINI PUMPS - PRM SERIES - LEAD FREE BRASS BODY

They are compact pumps, silent and highly reliable. Due to their limited overall dimensions they are perfect to be installed on small size machines. NSF Approved.



**PART NUMBER**

XAPRM05AZ-LF

**ITEM DESCRIPTION**

NUERT ROTARY VANE PUMP - LF BRASS BODY - BALANCED BYPASS - CLAMP MOUNTING - 3/8" PORTS - 15GPH @ 1450RPM



**PART NUMBER**

XAPRM15FZ-LF

**ITEM DESCRIPTION**

NUERT ROTARY VANE PUMP - LF BRASS BODY - BALANCED BYPASS - FLANGE MOUNTING (2 HOLES, FAEMA STYLE) - 3/8"FPT - 60GPH @ 1450RPM - NSF - USED W/ FAEMA ESPRESSO MACHINES



PRECISION  
INSTALLATION  
PRODUCTS

**NU.ERT.**  
rotary vane pumps  
Volume's rotary vane pump producer

# WATER TREATMENT

Pumps & Accessories - Aquatec & Nuert

## Nuert - Rotary Vane Pumps

### MINI PUMPS PRM SERIES

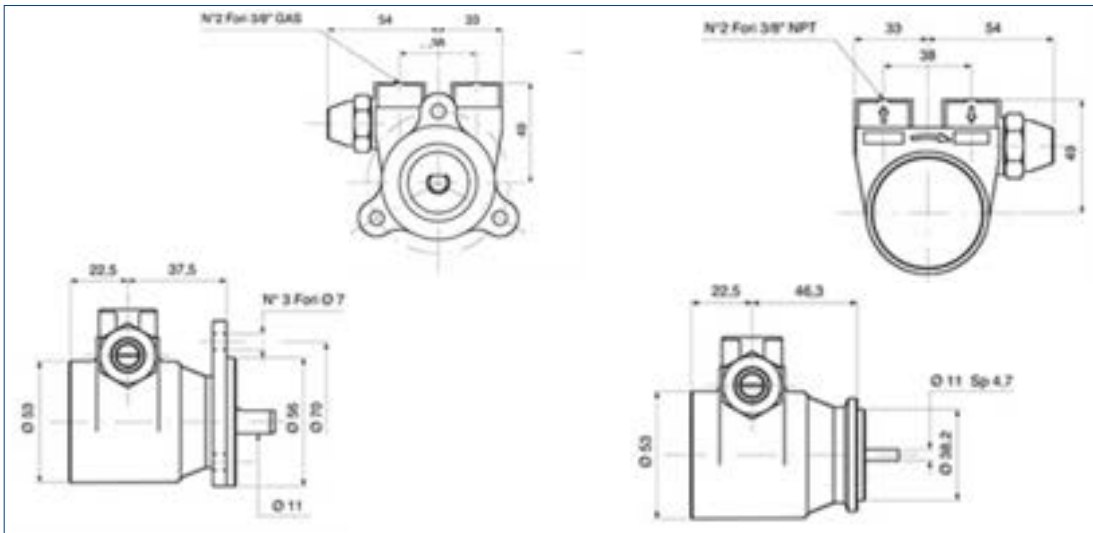
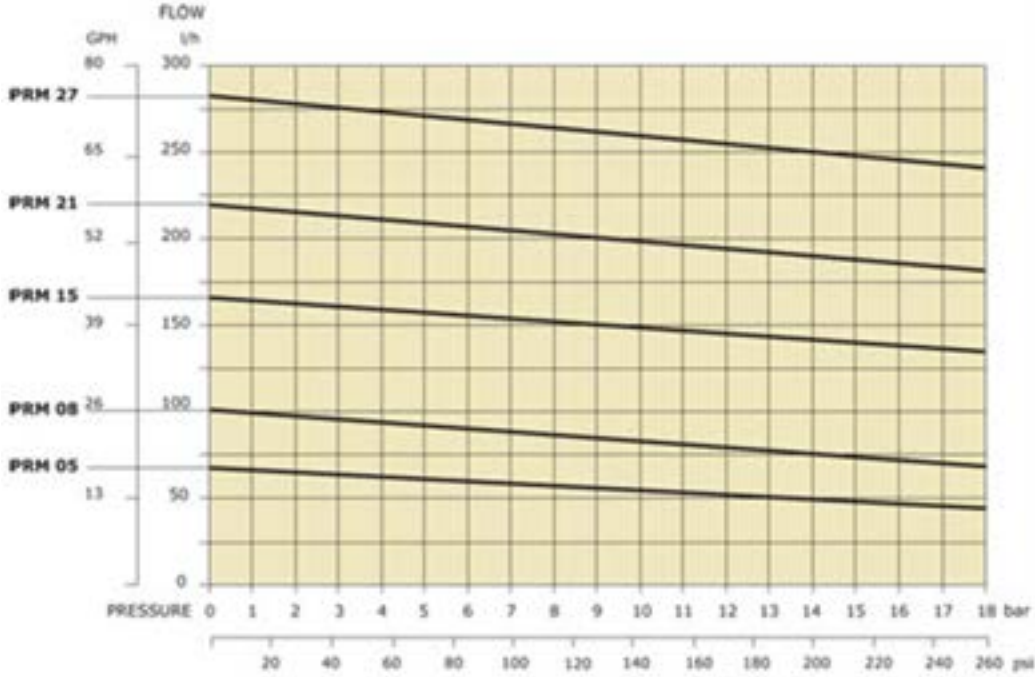

PRM series	flow rate (L/h) at 1400 rpm				flow rate (GPH) at 1750 rpm			
	0 bar	5 bar	9 bar	14 bar	0 psi	75 psi	130 psi	200 psi
PRM 05	75	62	56	43	24	20	18	14
PRM 08	105	94	85	75	34	31	28	24
PRM 15	160	150	140	135	52	49	46	44
PRM 21	220	208	195	182	72	68	63	59
PRM 27	280	268	255	245	91	87	83	80

# WATER TREATMENT

Pumps & Accessories - Aquatec & Nuert

Nuert - Rotary Vane Pumps

**NU.E.R.T.**  
rotary vane pumps  
Nuert's rotary vane pump production



PRECISION  
INSTALLATION  
PRODUCTS

## SHORT PUMPS - PRM SERIES - LEAD FREE BRASS BODY



**PART NUMBER**

XAPRS10AZLF

**ITEM DESCRIPTION**

NUERT ROTARY VANE PUMP - LF BRASS BODY - BALANCED BYPASS - CLAMP MOUNTING - 3/8" PORTS - 30 GPH @ 1725RPM - NSF

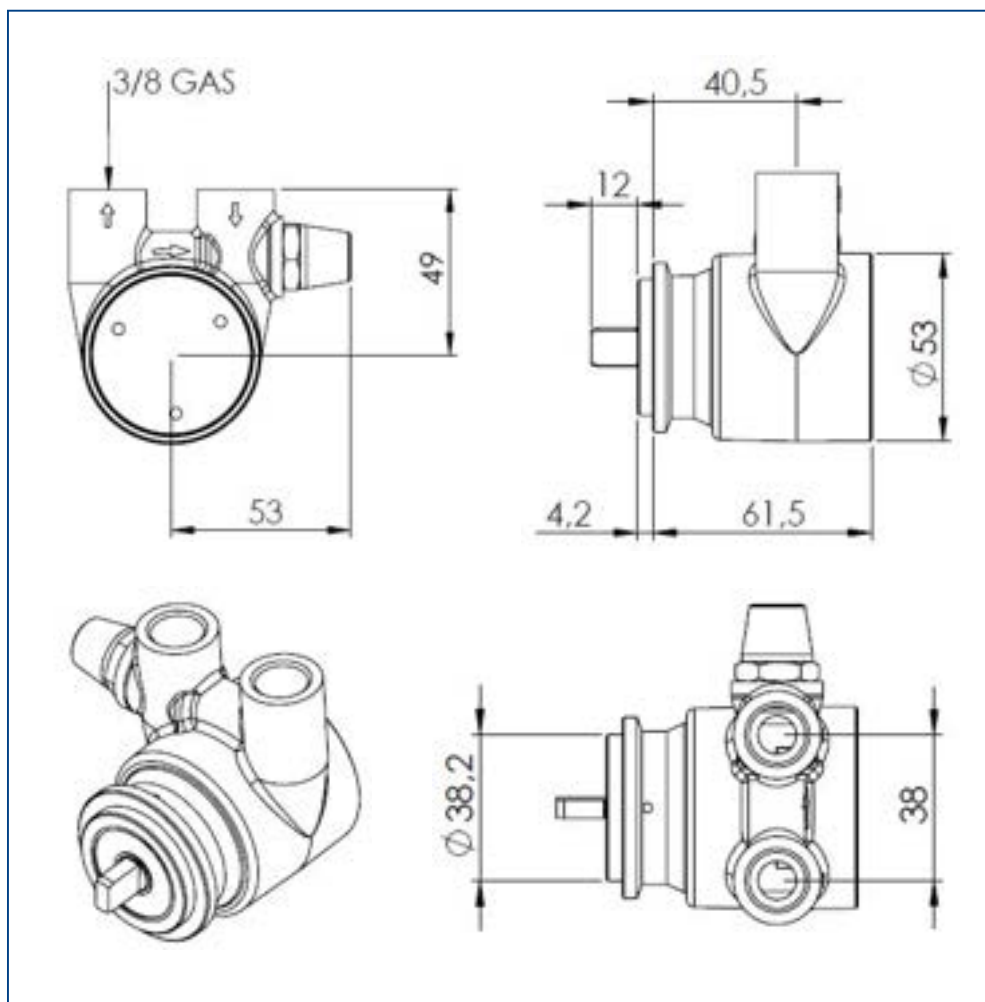



**PRECISION  
INSTALLATION  
PRODUCTS**

**NU.ER.T.**  
rotary vane pumps  
Wauwatec rotary vane pump producer

# WATER TREATMENT

## Pumps & Accessories - Aquatec & Nuert

### Nuert - Rotary Vane Pumps

## STANDARD PUMPS - PR SERIES

The balance between their high performance and limited size makes them the most widely used model in the market. They are silent and highly reliable pumps appreciated also for the possibility of customization.

## NU.ER.T. PR SERIES - LEAD FREE BRASS BODY



<u>PART NUMBER</u>	<u>ITEM DESCRIPTION</u>
XAPR1AS-LF	NORMAL BYPS - CLAMP MOUNT - 3/8"FPT - 35GPH @ 1450RPM
XAPR1BZLF	BAL BYPS - STRAINER - CLAMP MOUNT - 3/8"FPT - 35GPH @ 1450RPM NO BYPS - CLAMP MOUNT - 3/8"FPT - 60GPH @ 1450RPM
XAPR2AH-LF	BAL BYPS - STRAINER - CLAMP MOUNT - 3/8"FPT - 65GPH @ 1450RPM NO BYPS - CLAMP MOUNT - 3/8"FPT - 100GPH @ 1450RPM
XAPR2BZLF	NORMAL BYPS - CLAMP MOUNT - 3/8"FPT - 90GPH @ 1450RPM BAL BYPS - CLAMP MOUNT - 3/8"FPT - 90GPH @ 1450RPM
XAPR3AH-LF	NORMAL BYPS - STRAINER - CLAMP MOUNT - 3/8"FPT - 90GPH @ 1450RPM
XAPR3AS-LF	BAL BYPS - STRAINER - CLAMP MOUNT - 3/8"FPT - 90GPH @ 1450RPM
XAPR3AZLF	NORMAL BYPS - STRAINER - CLAMP MOUNT - 3/8"FPT - 130GPH @ 1725 RPM
XAPR3BS-LF	BAL BYPS - STRAINER - CLAMP MOUNT - 3/8"FPT - 130GPH @ 1450RPM
XAPR3BZLF	NORMAL BYPS - CLAMP MOUNT - 3/8"FPT - 130GPH @ 1450RPM
XAPR4BS-LF	NORMAL BYPS - STRAINER - CLAMP MOUNT - 3/8"FPT - 130GPH @ 1725 RPM
XAPR4BZLF	BAL BYPS - STRAINER - CLAMP MOUNT - 3/8"FPT - 130GPH @ 1450RPM
XAPR4AS-LF	NORMAL BYPS - CLAMP MOUNT - 3/8"FPT - 130GPH @ 1450RPM

## NU.ER.T. PR SERIES - STAINLESS STEEL BODY



<u>PART NUMBER</u>	<u>ITEM DESCRIPTION</u>
XAPR1ASX	NORMAL BYPS - CLAMP MOUNT - 3/8"FPT - 35GPH @ 1450RPM
XAPR2AHX	NO BYPS - CLAMP MOUNT - 3/8"FPT - 60GPH @ 1450RPM
XAPR2ASX	NORMAL BYPS - CLAMP MOUNT - 3/8"FPT - 65GPH @ 1450RPM
XAPR3ASX	NORMAL BYPS - CLAMP MOUNT - 3/8"FPT - 90GPH @ 1450RPM
XAPR3AHX	NO BYPS - CLAMP MOUNT - 3/8"FPT - 90GPH @ 1450RPM
XAPR4ASX	NORMAL BYPS - CLAMP MOUNT - 3/8"FPT - 130GPH @ 1450RPM



# WATER TREATMENT

## Pumps & Accessories - Aquatec & Nuert

### Nuert - Rotary Vane Pumps

**NU.E.R.T.**  
rotary vane pumps  
Volume's rotary vane pump production



**PRECISION  
INSTALLATION  
PRODUCTS**

## STANDARD PUMPS - PR SERIES

PR Series	FLOW RATE (L/h) a 1400 RPM			
	0 bar	5 bar	9 bar	14 bar
PR 06	90	78	63	55
PR 1	125	115	110	85
PR 15	175	160	150	135
PR 2	230	220	205	185
PR 3	320	310	295	280
PR 35	370	355	340	330
PR 4	420	405	390	380
PR 5	500	490	475	458

Indicative flow rates referred to:  
pump without by-pass valve,  
speed 1400 rpm, water at 20°C (68°F)

FLOW RATE (GPH) a 1750 rpm				
0 psi	75 psi	130 psi	200 psi	
29	25	21	18	
41	37	36	28	
57	52	49	44	
75	72	67	60	
104	101	96	91	
120	116	111	107	
137	132	127	124	
163	159	155	149	

Indicative flow rates referred to:  
pump without by-pass valve,  
speed 1750 rpm, water at 20°C (68°F)



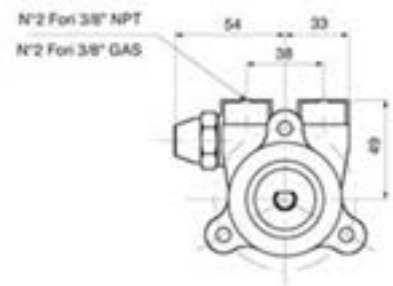
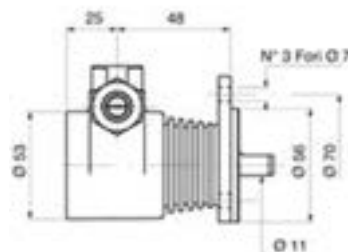
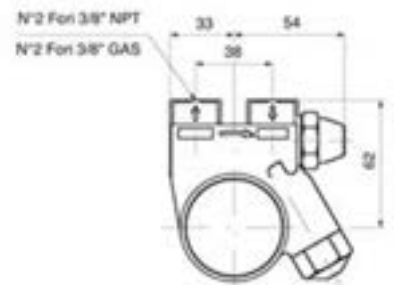
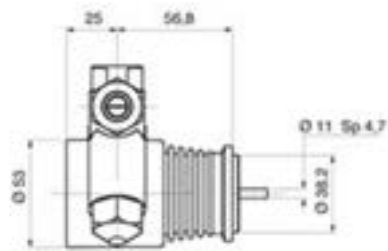
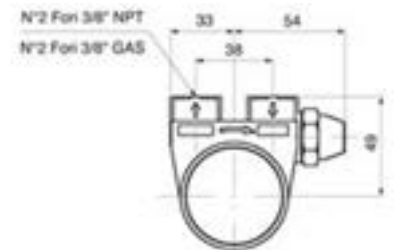
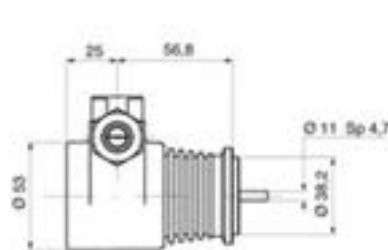
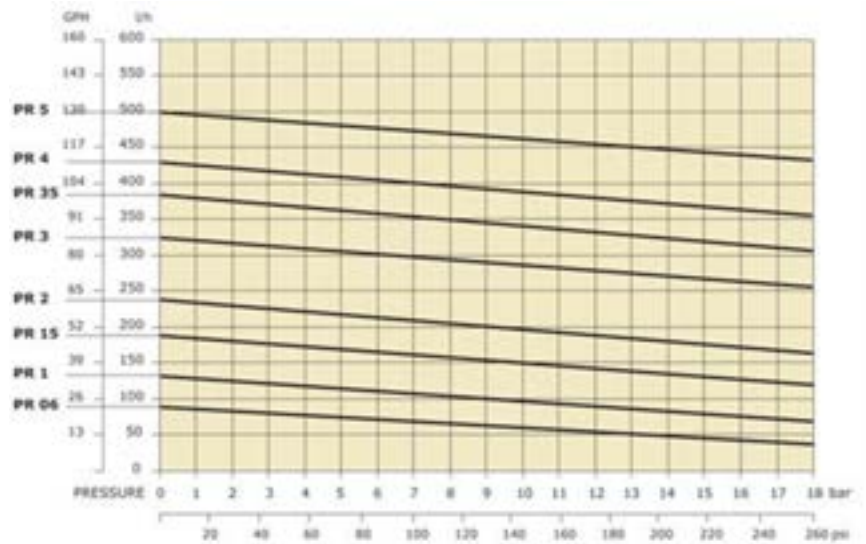

PRECISION  
INSTALLATION  
PRODUCTS

**NU.ER.T.**  
rotary vane pumps  
Waukena's rotary vane pump producer

# WATER TREATMENT

## Pumps & Accessories - Aquatec & Nuert

### Nuert - Rotary Vane Pumps

## MAXI PUMPS - PRG SERIES

Used mainly at industrial level, these pumps boast flow rates and head pressures typical of bigger and more expensive models. The size of inlet and outlet threaded ports is 1/2". NSF Approved.

## NU.ER.T. PR SERIES - LEAD FREE BRASS BODY



<u>PART NUMBER</u>	<u>ITEM DESCRIPTION</u>
XAPRG5AH-LF	NO BYPS - CLAMP MOUNT - 1/2"FPT - 140GPH @ 1450RPM
XAPRG5AS-LF	NORMAL BYPS - CLAMP MOUNT - 1/2"FPT - 140GPH @ 1450RPM
XAPRG6AH-LF	NO BYPS - CLAMP MOUNT - 1/2"FPT - 190GPH @ 1450RPM
XAPRG6AS-LF	NORMAL BYPS - CLAMP MOUNT - 1/2"FPT - 190GPH @ 1450RPM
XAPRG7AH-LF	NO BYPS - CLAMP MOUNT - 1/2"FPT - 215GPH @ 1450RPM
XAPRG7AS-LF	NORMAL BYPS - CLAMP MOUNT - 1/2"FPT - 215GPH @ 1450RPM
XAPRG8AH-LF	NO BYPS - CLAMP MOUNT - 1/2"FPT - 240GPH @ 1450RPM
XAPRG8AS-LF	NORMAL BYPS - CLAMP MOUNT - 1/2"FPT - 240GPH @ 1450RPM
XAPRG9AS-LF	NORMAL BYPS - CLAMP MOUNT - 1/2"FPT - 270GPH @ 1450RPM
XAPRG10AH-LF	NO BYPS - CLAMP MOUNT - 1/2"FPT - 330GPH @ 1450RPM
XAPRG10AS-LF	NORMAL BYPS - CLAMP MOUNT - 1/2"FPT - 350GPH @ 1450RPM



## NU.ER.T. PR SERIES - STAINLESS STEEL BODY



<u>PART NUMBER</u>	<u>ITEM DESCRIPTION</u>
XAPRG5AHX	NO BYPS - CLAMP MOUNT - 1/2"FPT - 140GPH @ 1450RPM
XAPRG6AHX	NO BYPS - CLAMP MOUNT - 1/2"FPT - 190GPH @ 1450RPM
XAPRG6ASX	NORMAL BYPS - CLAMP MOUNT - 1/2"FPT - 180GPH @ 1450RPM
XAPRG7AHX	NO BYPS - CLAMP MOUNT - 1/2"FPT - 215GPH @ 1450RPM
XAPRG8AHX	NO BYPS - CLAMP MOUNT - 1/2"FPT - 240GPH @ 1450RPM
XAPRG8ASX	NORMAL BYPS - CLAMP MOUNT - 1/2"FPT - 240GPH @ 1450RPM
XAPRG10AHX	NO BYPS - CLAMP MOUNT - 1/2"FPT - 330GPH @ 1450RPM
XAPRG10ASX	NORMAL BYPS - CLAMP MOUNT - 1/2"FPT - 350GPH @ 1450RPM
XAPRG10CHX	NO BYPS - FLANGE MOUNT - 1/2"FPT - 330GPH @ 1450RPM

# WATER TREATMENT

Pumps & Accessories - Aquatec & Nuert

## Nuert - Rotary Vane Pumps

**NU.E.R.T.**  
rotary vane pumps  
Volume's rotary vane pump producer



**PRECISION  
INSTALLATION  
PRODUCTS**

### MAXI PUMPS - PRG SERIES

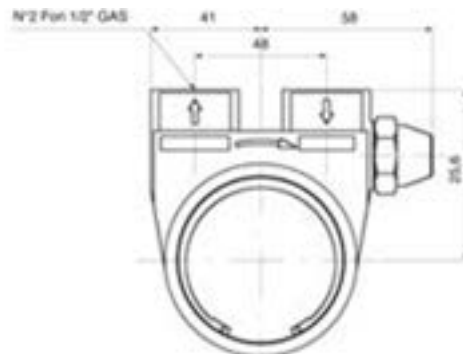
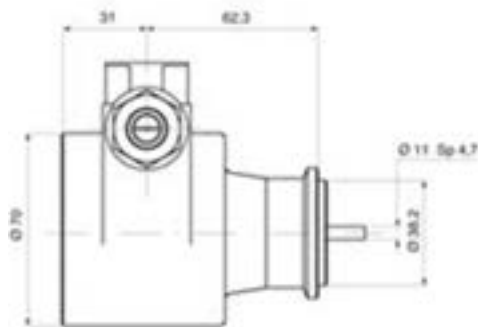
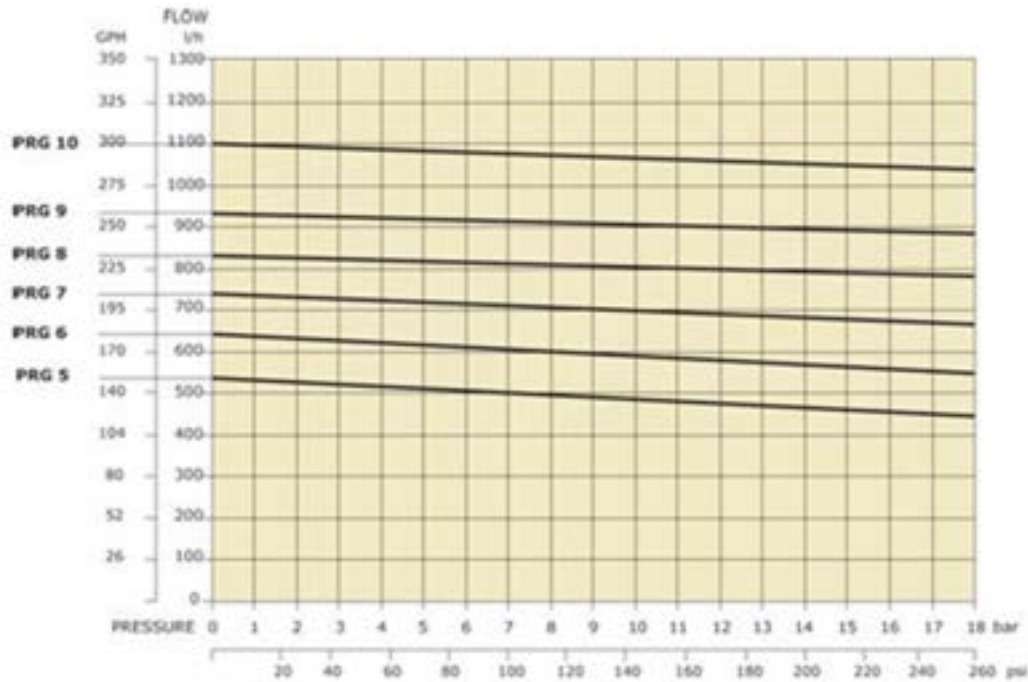

PRG series	FLOW RATE (L/h) at 1400 rpm				FLOW RATE (GPH) at 1750 rpm			
	0 bar	5 bar	9 bar	14 bar	0 psi	75 psi	130 psi	200 psi
PRG 5	535	510	490	475	174	166	159	155
PRG 6	640	620	590	575	208	202	192	187
PRG 7	730	715	690	675	238	233	225	220
PRG 8	830	815	800	780	270	265	260	254
PRG 9	930	920	905	880	303	299	295	286
PRG 10	1100	1080	1070	1030	358	352	348	335

Indicative flow rates referred to:  
pump without by-pass valve,  
speed 1400 rpm, water at 20°C (68°F)

Indicative flow rates referred to:  
pump without by-pass valve,  
speed 1750 rpm, water at 20°C (68°F)



PRECISION  
INSTALLATION  
PRODUCTS

**NU.E.R.T.**  
rotary vane pumps  
Nuert's rotary vane pump producer

# WATER TREATMENT

Pumps & Accessories - Aquatec & Nuert

## Nuert - Rotary Vane Pumps

### NU.E.R.T. PUMP ENGINES/MOTORS



NUERT pumps can be easily activated by special 48YZ engines with direct connection especially created for this type of pump or engines with standard IE C B14 flange with dimensions of 56, 63, 71 and 80 through suitable couplings and adaptors.

<u>PART NUMBER</u>	<u>ITEM DESCRIPTION</u>
XM02395	1/4 HP - 180W - 115/230V
XM02396	1/3 HP - 270W - 115/230V

### AXEON MARATHON CARBONATOR MOTORS



NUERT pumps can be easily activated by special 48YZ engines with direct connection especially created for this type of pump or engines with standard IE C B14 flange with dimensions of 56, 63, 71 and 80 through suitable couplings and adaptors.

<u>PART NUMBER</u>	<u>ITEM DESCRIPTION</u>
XRVM-1/2HP	1/2 HP - 110/220V - 50/60HZ - PUMPS UP TO 180 GPH
XRVM-3/4HP	3/4 HP - 110/220V - 50/60HZ - PUMPS UP TO 210 GPH

# WATER TREATMENT

Pumps & Accessories - Aquatec & Nuert

Nuert - Rotary Vane Pumps

**NU.E.R.T.**  
rotary vane pumps  
NUERT'S rotary vane pump production



PRECISION  
INSTALLATION  
PRODUCTS

## ROTARY VANE PUMP - ACCESSORIES



**PART NUMBER**

XAPRG-SSNIPPLE

**ITEM DESCRIPTION**

NUERT 1/2" NPT SS NIPPLE FOR USE W/ 1/2" PORT SS BODY SERIES PUMPS



**PART NUMBER**

XAPR2178

**ITEM DESCRIPTION**

NUERT BLACK PLASTIC NYLON COUPLING - USE ON SHAFT BETWEEN PUMP & MOTOR



**PART NUMBER**

XAPR2149

**ITEM DESCRIPTION**

NUERT BRASS COUPLING FOR FEMALE ROTOR - USE ON SHAFT BETWEEN PUMP & MOTOR

### GUIDELINES FOR CORRECT USE OF NU.ER.T. PUMPS

1. Do not let the pump run dry.
2. ALWAYS use a filter on the inlet line (100 micron at least).
3. Always use a softener in the inlet line to avoid limestone accumulation inside the pump.
4. During assembly of nipples on the pump, do not allow dope you are using (glue, teflon, or other) to fall into the pump, because it might cause the damaging of carbon components and, as a consequence, pump blocking.
5. Make sure that alignment between pump axis and motor axis is perfect. For this purpose, check that there are no dents or deformations on the contact surface between motor and pump. V-band clamp must be closed moderately, because an excessive closing might cause misalignment between pump and motor.
6. Make sure that liquid used is not a chemical weapon for brass (OT-58 or CZ-129), stainless steel (AISI 303) or NBR gaskets. Verify that liquid does not have debris content. Avoid that liquid temperature exceeds 50°C (for higher temperatures, ask for viton gaskets).
7. If it is a long time that your pump does not work, maybe limestone and other minerals might block it up. Before using it again, we suggest to disassemble it from the motor, fill it up with clean water and vinegar (or other type of anti-limestone not granular) and execute some manual rotations till pump turns without difficulty.
8. Avoid to close the motor and the pump inside machines without appropriate ventilation or air intake. In any case, pump temperature must not exceed 50°C.
9. Owing to materials dimensional shrinkage, due to low temperatures, pump might block. For this reason avoid to make it work at temperatures lower than 8°C. If you place it in cold rooms, before making it work, make sure it turns freely.
10. Before assembly of the pump, avoid categorically that abrasive substances or debris (even if of very small dimensions) go into the pump.
11. In the case of, for assembly reasons, you must block pump using a vice, do it following the scheme:



**NO !**



**NO !**

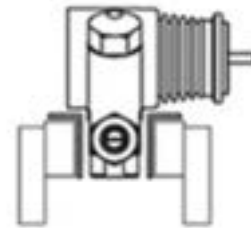

**YES**

# WATER TREATMENT

## Pumps & Accessories - Aquatec & Nuert

### Nuert - Rotary Vane Pumps

**NU.ER.T.**  
rotary vane pumps  
Volume 10: rotary vane pump production



**PRECISION  
INSTALLATION  
PRODUCTS**

## GUIDELINES FOR CORRECT USE OF NU.ER.T. PUMPS

### PUMP DOES NOT REACH NOMINAL FLOW RATE OR AN ADEQUATE PRESSURE

- If equipment is provided with filter at pump inlet, make sure that it is not clogged or inadequate.
- Make sure that pump end plate has not been slack.
- Make sure that bypass valve and its seat are undamaged and clean.
- Check that inlet and outlet nipples are not clogged.
- Make sure that piston of bypass nut is not blocked.
- If, after all these operations, pump does not work yet, get in touch with our company or a service center.

### PUMP IS NOISY OR MANOMETER VIBRATES

- Verify that water reaching pump is sufficient. Exclude any throat or obstacle.
- Verify that bypass nut is not slack and that its gasket is not damaged.
- Verify integrity and cleanness of O-RING assembled on bypass piston.
- For models with filter, check that PR 2042 nut is well tight and that its O-RING (PR 2073) is undamaged.
- Make sure that inlet filter is not clogged.
- Check that pump does not suck up air. For this purpose, make sure that inlet pipes and nipples are undamaged and well tight.
- Verify that V-band clamp is not slack or too closed. Line up again pump and block it properly.
- Check coupling between motor and pump. There must be no dents on the contact surface. If there should be, eliminate them.
- Verify concentricity between motor axis and fixing seat of the pump.
- If you made use of potential abrasive liquids or with suspended solids, get in touch with our company or with a service center.
- If you pour off carbonated liquids, this might cause noise.

### PUMP IS LEAKING

- If it leaks from peephole, replace pump and get in touch with our company or a service center.
- If it leaks from bypass nut, make sure that it is well tight. If necessary replace gasket (PR 2072).
- If it leaks from pressure adjustment screw, disassemble nut and replace piston O-RING, lubricate it with vaseline oil.
- Pump model with filter: if it leaks from PR 2042 nut, make sure it is well tight and, if necessary, disassemble it and replace its O-RING (PR 2073).

### PUMP JAMS OR TURNS IN AN IRREGULAR WAY

- Make sure that motor axis and pump axis are perfectly aligned.
- Suppose there is limestone inside the pump, disassemble pump from the motor and wash it internally using an anti-limestone, then execute some manual rotations till it turns without difficulty, then assemble it again.
- Owing to materials dimensional shrinkage, due to low temperatures, pump might block. For this reason avoid to make it work at temperatures lower than 8°C. If you place it in cold rooms, before making it work, make sure it turns freely.

### MOTOR IS STALLING OR WORKS IN AN IRREGULAR WAY

- Verify that the voltage of the motor is correct and that it is not defective.
- If the pump is blocked or it does not turn freely, maybe there is too much limestone or pump and motor are misaligned. In the first case, remove pump from motor and eliminate limestone with an additive. In the second case, replace motor with another one having an axis with a radial run-out and perpendicularity error of 0.1 mm maximum compared to fixing seat of the pump.

### WARNING!

Before you try to work on the pump or the systems, turn the motor off and disconnect the power to the motor



PRECISION  
INSTALLATION  
PRODUCTS



# WATER TREATMENT

Pumps & Accessories - Aquatec & Nuert

**END OF SECTION**

**THIS PAGE IS LEFT  
INTENTIONALLY BLANK.**



# WATER TREATMENT

## Water Filter Housings, Brackets & Wrenches

### 5" & 10" Slimline Housings W/ Flat Lids



PRECISION  
INSTALLATION  
PRODUCTS

#### HYDRONIX HF2 SERIES SLIM FLAT CAP FILTER HOUSINGS

Are NSF/ANSI Standard 42 certified for material and structural integrity requirements only.

#### HYDRONIX HF2 SERIES SLIM FLAT CAP FILTER HOUSINGS

Are available in a variety of colors and are made to house 2.5" diameter cartridges. Most 9 7/8", 10", and 20" cartridges fit easily and caps are available in 1/4", 3/8" and 1/2" female NPT ports.

#### HYDRONIX HF2 SERIES SLIM FLAT CAP FILTER HOUSINGS

Are ideal for typical applications as pre and post-filtration for RO systems, under sink filters, counter top systems, ice machines, food service and other applications.

- Multiple housing sizes to accept 4 7/8", 9 7/8" and 20" length cartridges

- 1/4", 3/8" and 1/2" female NPT ports standard

- Opaque housings are NSF Listed\*

#### Materials of Construction

<i>Opaque Housing:</i>	Polypropylene
<i>Clear Housing:</i>	San
<i>Cap:</i>	Polypropylene
<i>O-Ring:</i>	Buna-N

#### Applications

- Reverse Osmosis
- Residential Plumbing
- Photography
- Beverage
- Ice maker
- Misting Units

#### Temperature Rating

Maximum Temperature: 125°F (51.7°C)  
Maximum Pressure: 75 PSI (5.17 bar)





PRECISION  
INSTALLATION  
PRODUCTS

# WATER TREATMENT

## Water Filter Housings, Brackets & Wrenches

5" & 10" Slimline Housings W/ Flat Lids

### 2.5" X 5" WHITE HOUSING / WHITE FLAT LID - HF2 - NSF



**PART NUMBER**

PF10-WH

**ITEM DESCRIPTION**

HYDRONIX 2.5" X 5" (HF2) WHITE SLIM HOUSING WHITE FLAT CAP - 1/4" PORTS - NSF (EACH) CASE-15

Tested and certified by NSF International to ANSI/NSF Standard 42 for material requirements only.



### 2.5" X 10" BLUE HOUSING/BLACK FLAT LID - HF2 - NSF



**PART NUMBER**

PF20-BLK

**ITEM DESCRIPTION**

HYDRONIX 2.5" X 10" (HF2) BLUE SLIM HOUSING BLACK FLAT CAP - 1/4" PORTS - NSF (EACH)

PF206-BLK

HYDRONIX 2.5" X 10" (HF2) BLUE SLIM HOUSING BLACK FLAT CAP - 3/8" PORTS - NSF (EACH)

PF208-BLK

HYDRONIX 2.5" X 10" (HF2) BLUE SLIM HOUSING BLACK FLAT CAP - 1/2" PORTS - NSF (EACH)

Tested and certified by NSF International to ANSI/NSF Standard 42 for material requirements only.



### 2.5" X 10" WHITE HOUSING / WHITE FLAT LID - HF2 - NSF



**PART NUMBER**

PF20-WH

**ITEM DESCRIPTION**

HYDRONIX 2.5" X 10" (HF2) WHITE SLIM HOUSING WHITE FLAT CAP - 1/4" PORTS - NSF (EACH)

PF206-WH

HYDRONIX 2.5" X 10" (HF2) WHITE SLIM HOUSING WHITE FLAT CAP - 3/8" PORTS - NSF (EACH)

PF208-WH

HYDRONIX 2.5" X 10" (HF2) WHITE SLIM HOUSING WHITE FLAT CAP - 1/2" PORTS - NSF (EACH)

Tested and certified by NSF International to ANSI/NSF Standard 42 for material requirements only.



# WATER TREATMENT

## Water Filter Housings, Brackets & Wrenches

### 10" Slimline Clear Housings



PRECISION  
INSTALLATION  
PRODUCTS

## 2.5" X 10" CLEAR HOUSING / BLACK FLAT LID - HF2 - NSF



<u>PART NUMBER</u>	<u>ITEM DESCRIPTION</u>
PCF20-BLK	HYDRONIX 2.5" X 10" (HF2) CLEAR SLIM HOUSING BLACK FLAT CAP - 1/4" PORTS - NSF (EACH)
PCF206-BLK	HYDRONIX 2.5" X 10" (HF2) CLEAR SLIM HOUSING BLACK FLAT CAP - 3/8" PORTS - NSF (EACH)
PCF208-BLK	HYDRONIX 2.5" X 10" (HF2) CLEAR SLIM HOUSING BLACK FLAT CAP - 1/2" PORTS - NSF (EACH)



## 2.5" X 10" CLEAR HOUSINGS / WHITE FLAT LID - HF2 - NSF



<u>PART NUMBER</u>	<u>ITEM DESCRIPTION</u>
PCF20-WH	HYDRONIX 2.5" X 10" (HF2) CLEAR SLIM HOUSING WHITE FLAT CAP - 1/4" PORTS - NSF (EACH)
PCF206-WH	HYDRONIX 2.5" X 10" (HF2) CLEAR SLIM HOUSING WHITE FLAT CAP - 3/8" PORTS - NSF (EACH)
PCF208-WH	HYDRONIX 2.5" X 10" (HF2) CLEAR SLIM HOUSING WHITE FLAT CAP - 1/2" PORTS - NSF (EACH)



## O-RINGS FOR SLIMLINE HOUSINGS

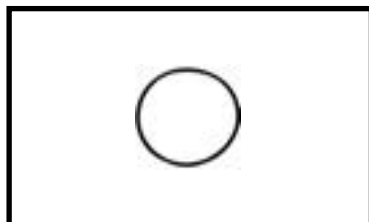

<u>PART NUMBER</u>	<u>ITEM DESCRIPTION</u>
P20-OR	HYDRONIX (HF2 / HF3) O-RING REPLACEMENT - FITS SLIM HOUSINGS (EACH)
P20/40-OR-AMETEK	SLIMLINE AMETEK O-RING FOR 10" & 20" HOUSINGS



PRECISION  
INSTALLATION  
PRODUCTS

# WATER TREATMENT

## Water Filter Housings, Brackets & Wrenches

5" & 10" Slimline Housings W/ Ribbed Lids

### HYDRONIX HF3 SERIES SLIM RIB CAP FILTER HOUSINGS

Are available in a variety of colors and are made to house 2.5" diameter cartridges. Most 9 7/8" and 10" cartridges fit easily and caps are available in 1/4", 3/8", 1/2" and 3/4" female NPT ports.

### HYDRONIX HF3 SERIES SLIM RIB CAP FILTER HOUSINGS

Are ideal for typical applications as pre and post-filtration for RO systems, under sink filters, countertop systems, ice machines, food service and other applications.

### HYDRONIX HF3 SERIES SLIM RIB CAP FILTER HOUSINGS

Have pressure relief (PR) buttons available for 1/2" and 1/4" port housings.

### Applications

- Reverse Osmosis
- Residential Plumbing
- Photography
- Beverage
- Ice maker
- Misting Units

• Manufactured of reinforced Polypropylene

• Multiple housing colors and port sizes

### Materials of Construction

Opaque Housing:	Polypropylene
Clear Housing:	San
Cap:	Polypropylene
O-Ring:	EPDM
Maximum Temperature:	125°F (51.7°C)
Maximum Pressure:	75 PSI (5.17 bar)



# WATER TREATMENT

## Water Filter Housings, Brackets & Wrenches

10" Slimline Housings W/ Ribbed Lids



PRECISION  
INSTALLATION  
PRODUCTS

### 2.5" X 10" WHITE HOUSING/WHITE RIB LID - HF3



<u>PART NUMBER</u>	<u>ITEM DESCRIPTION</u>
PR20-WH	HYDRONIX 2.5" X 10" (HF3) WHITE SLIM HOUSING WHITE RIB CAP - 1/4" PORTS W/O PR (EACH)
PR206-WH	HYDRONIX 2.5" X 10" (HF3) WHITE SLIM HOUSING WHITE RIB CAP - 3/8" PORTS W/O PR (EACH)
PR208-WH-08PR	HYDRONIX 2.5" X 10" (HF3) WHITE SLIM HOUSING WHITE RIB CAP - 1/2" PORTS W/ PR (EACH)
PR212-WH	HYDRONIX 2.5" X 10" (HF3) WHITE SLIM HOUSING WHITE RIB CAP - 3/4" PORTS W/O PR (EACH)

### 2.5" X 10" BLUE HOUSING / BLACK RIB LID - HF3



<u>PART NUMBER</u>	<u>ITEM DESCRIPTION</u>
PR212-BLK	HYDRONIX 2.5" X 10" (HF3) BLUE SLIM HOUSING BLACK RIB CAP - 3/4" PORTS W/O PR (EACH)
PR212-BLK-PR	HYDRONIX 2.5" X 10" (HF3) BLUE SLIM HOUSING BLACK RIB CAP - 3/4" PORTS W/ PR (EACH)

### 2.5" X 10" CLEAR HOUSING / WHITE RIB LID - HF3



<u>PART NUMBER</u>	<u>ITEM DESCRIPTION</u>
PCR212-WH	HYDRONIX 2.5" X 10" (HF3) CLEAR SLIM HOUSING WHITE RIB CAP - 3/4" PORTS W/O PR (EACH)
PCR212-WH-PR	HYDRONIX 2.5" X 10" (HF3) CLEAR SLIM HOUSING WHITE RIB CAP - 3/4" PORTS W/ PR (EACH)

### 2.5" X 10" CLEAR HOUSING / BLACK RIB LID - HF3



<u>PART NUMBER</u>	<u>ITEM DESCRIPTION</u>
PCR212-BLK-PR	HYDRONIX 2.5" X 10" (HF3) CLEAR SLIM HOUSING BLACK RIB CAP - 3/4" PORTS W/ PR (EACH)



PRECISION  
INSTALLATION  
PRODUCTS

# WATER TREATMENT

## Water Filter Housings, Brackets & Wrenches

### 10" & 20" BB Housings

#### HYDRONIX HF45 SERIES COMMERCIAL FILTER HOUSINGS

Are high durability commercial filter housings for 10" and 20" length cartridges. HF45 Series housings have excellent chemical resistance and are ideal for many high flow residential, commercial and light industrial applications.

#### HYDRONIX HF45 SERIES COMMERCIAL FILTER HOUSINGS

Accept 4 1/2" diameter cartridges and feature larger ports to allow for a greater flow of liquid to pass through the housing. They are ideal for your larger capacity filtration needs and are made from durable Polypropylene.

- Ideal for high flow applications
- Made with durable Polypropylene
- Available with pressure relief valves



Tested and certified by NSF International to ANSI/NSF Standard 42 for material requirements only.



#### Applications

- Whole house filtration
- Wineries
- Reverse osmosis
- Drip irrigation
- Residential plumbing
- Plating
- Photography
- Milling Machines
- Commercial pre-filtration
- Green Houses
- Beverage
- Analytical
- Ice maker
- Food Processing
- Misting units

#### Temperature Rating *Opaque Housing*

Maximum Temperature: 100° (37.7°C)  
Maximum Pressure: 90 PSI (6.21 bar)

#### Materials of Construction

Opaque Housing: Polypropylene  
Clear Housing: Polycarbonate  
Cap: Polypropylene  
O-Ring: Buna-N  
Button Assembly: Stainless Steel, EPDM and Polypropylene

# WATER TREATMENT

## Water Filter Housings, Brackets & Wrenches

10" BB Housings



PRECISION  
INSTALLATION  
PRODUCTS

### 4.5 X 10" BLUE HOUSING / BLACK LID - HF45 - NSF

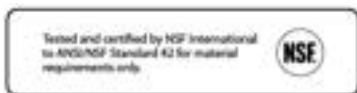

<u>PART NUMBER</u>	<u>ITEM DESCRIPTION</u>
P30-12	HYDRONIX 4.5" X 10" (HF45) BLUE HOUSING BLACK CAP - 3/4" PORTS W/O PR - NSF (EACH)
P30-12PR	HYDRONIX 4.5" X 10" (HF45) BLUE HOUSING BLACK CAP - 3/4" PORTS W/ PR - NSF (EACH)
P30-16	HYDRONIX 4.5" X 10" (HF45) BLUE HOUSING BLACK CAP - 1" PORTS W/O PR - NSF (EACH)
P30-16PR	HYDRONIX 4.5" X 10" (HF45) BLUE HOUSING BLACK CAP - 1" PORTS W/ PR - NSF (EACH)
P30-20	HYDRONIX 4.5" X 10" (HF45) BLUE HOUSING BLACK CAP - 1-1/2" PORTS W/O PR - NSF (EACH)
P30-20PR	HYDRONIX 4.5" X 10" (HF45) BLUE HOUSING BLACK CAP - 1-1/2" PORTS W/ PR - NSF (EACH)

### 4.5" 10" CLEAR HOUSING / BLACK RIB LID - HF45 - NSF

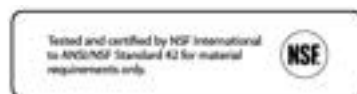

<u>PART NUMBER</u>	<u>ITEM DESCRIPTION</u>
PC30-BLK-16PR	HYDRONIX 4.5" X 10" (HF45) CLEAR HOUSING BLACK CAP - 1" PORTS W/ PR - NSF (EACH)

### REPLACEMENT PARTS



<u>PART NUMBER</u>	<u>ITEM DESCRIPTION</u>
P50/30-PR	HYDRONIX PR BUTTON KIT - FITS (HF45) 4.5" HOUSINGS ** USE WILL VOID WARRANTY **
P30-OR-20R	10" BB IMPORT DOUBLE O-RING HOUSING O-RING ONLY



PRECISION  
INSTALLATION  
PRODUCTS

# WATER TREATMENT

## Water Filter Housings, Brackets & Wrenches

### 20" BB Housings

## 4.5" X 20" BLUE HOUSING / BLACK LID - HF45 - NSF



<u>PART NUMBER</u>	<u>ITEM DESCRIPTION</u>
P50-12	HYDRONIX 4.5" X 20" (HF45) BLUE HOUSING BLACK CAP - 3/4" PORTS W/O PR - NSF (EACH)
P50-12PR	HYDRONIX 4.5" X 20" (HF45) BLUE HOUSING BLACK CAP - 3/4" PORTS W/ PR - NSF (EACH) (CS/4)
P50-16	HYDRONIX 4.5" X 20" (HF45) BLUE HOUSING BLACK CAP - 1" PORTS W/O PR - NSF (EACH)
P50-16PR	HYDRONIX 4.5" X 20" (HF45) BLUE HOUSING BLACK CAP - 1" PORTS W/ PR - NSF (EACH)
P50-20	HYDRONIX 4.5" X 20" (HF45) BLUE HOUSING BLACK CAP - 1-1/2" PORTS W/O PR - NSF (EACH)
P50-20PR	HYDRONIX 4.5" X 20" (HF45) BLUE HOUSING BLACK CAP - 1-1/2" PORTS W/ PR - NSF (EACH)

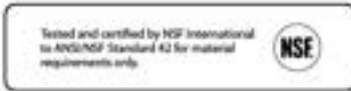

## 4.5" X 20" CLEAR HOUSING / BLACK LID - HF45 - NSF



<u>PART NUMBER</u>	<u>ITEM DESCRIPTION</u>
PC50-BLK-16PR	HYDRONIX 4.5" X 20" (HF45) CLEAR HOUSING BLACK CAP - 1" PORTS W/ PR - NSF (EACH)

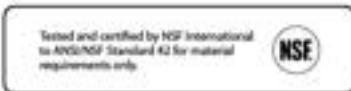

## O-RING REPLACEMENTS



<u>PART NUMBER</u>	<u>ITEM DESCRIPTION</u>
P50/30-OR	HYDRONIX (HF45) O-RING REPLACEMENT - FITS 4.5" HOUSINGS (EACH)
P50/30-OR-AMETEK	BB AMETEK HOUSING O-RING ONLY FOR 10" & 20" HOUSINGS



# WATER TREATMENT

## Water Filter Housings, Brackets & Wrenches

### Hydronix 10" & 20" Commercial Housings



PRECISION  
INSTALLATION  
PRODUCTS

#### HYDRONIX HF5 SERIES COMMERCIAL FILTER HOUSINGS

Are high durability commercial filter housings for 10" and 20" length cartridges. HF5 Series housings have excellent chemical resistance and are ideal for many residential, commercial and light industrial applications.

#### HYDRONIX HF5 SERIES COMMERCIAL FILTER HOUSINGS

Are NSF tested and certified to NSF/ANSI Standard 42\* for material and structural integrity.

Great for a wide range of applications

NSF standard 42 listed

Available with pressure relief valves (PR)



#### Applications

- Reverse osmosis
- Residential plumbing
- Photography
- Commercial pre-filtration
- Beverage
- Ice makers
- Misting units
- Food processing
- Analytical
- Wineries

#### Materials of Construction

Filter Media:	Polypropylene
Cap:	Polypropylene
Button Assembly:	Stainless steel, EPDM and Polypropylene
O-Ring:	Buna-N
Maximum Temp:	125°F (51.7°C)
Maximum Pressure:	100 PSI (6.89 bar)

Tested and certified by NSF International to ANSI/NSF Standard 42 for material requirements only.





PRECISION  
INSTALLATION  
PRODUCTS

# WATER TREATMENT

## Water Filter Housings, Brackets & Wrenches

### 10" & 20" Commercial Housings

## 2.5" X 10" BLUE HOUSING / BLACK RIB LID - HF5 - NSF



PART NUMBER	ITEM DESCRIPTION
PR202-BLK-12	HYDRONIX 2.5" X 10" (HF5) BLUE COMMERCIAL HOUSING BLACK RIB LID - 3/4" PORTS W/O PR - NSF (EACH)
PR202-BLK-12PR	HYDRONIX 2.5" X 10" (HF5) BLUE COMMERCIAL HOUSING BLACK RIB LID - 3/4" PORTS W/ PR - NSF (EACH)

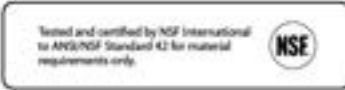

## 2.5" X 10" CLEAR HOUSING / BLACK RIB LID - HF5 - NSF



PART NUMBER	ITEM DESCRIPTION
PCR202-BLK-12PR	HYDRONIX 2.5" X 10" (HF5) CLEAR SLIM HOUSING BLACK FLAT CAP - 3/4" PORTS W/ PR (EACH)

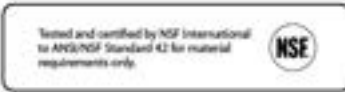

## 2.5" X 20" BLUE HOUSING / BLACK RIB LID - HF5 - NSF



PART NUMBER	ITEM DESCRIPTION
PR402-BLK-12	HYDRONIX 2.5" X 20" (HF5) BLUE COMMERCIAL HOUSING BLACK RIB LID - 3/4" PORTS W/O PR - NSF (EACH)
PR402-BLK-12PR	HYDRONIX 2.5" X 20" (HF5) BLUE COMMERCIAL HOUSING BLACK RIB LID - 3/4" PORTS W/ PR - NSF (EACH)

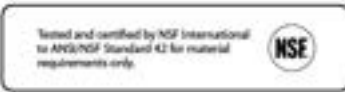

## 2.5" X 20" CLEAR HOUSING / BLACK RIB LID - HF5 - NSF



PART NUMBER	ITEM DESCRIPTION
PCR402-BLK-12PR	HYDRONIX 2.5" X 20" (HF5) CLEAR COMMERCIAL HOUSING BLACK RIB LID - 3/4" PORTS W/ PR - NSF (EACH)

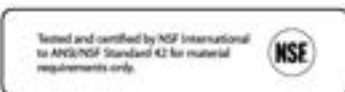

# WATER TREATMENT

Water Filter Housings, Brackets & Wrenches

## 20" Commercial Housings



PRECISION  
INSTALLATION  
PRODUCTS

### 2.5" X 20" WHITE HOUSING / WHITE LID - 890



<u>PART NUMBER</u>	<u>ITEM DESCRIPTION</u>
P40-WH-12	PURE T WHITE HOUSING 2.5" X 20" W/ ..WHITE LID 3/4" PORTS
P40-WH-12PR	PURE T WHITE HOUSING 2.5" X 20" WITH WHITE 3/4" PORTS W/ PRESSURE RELIEF

### 2.5" X 20" CLEAR HOUSING / BLACK LID - 910



<u>PART NUMBER</u>	<u>ITEM DESCRIPTION</u>
PCR406-BLK-20R	PURE T CLEAR COMMERCIAL HOUSING 2.5" X 20" W/ BLACK LID W/ 3/8" PORTS & PR - DOUBLE O-RING

### O-RING REPLACEMENTS

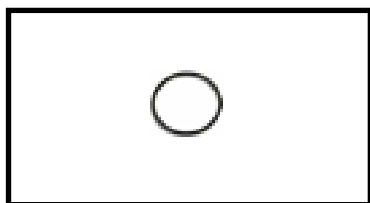

<u>PART NUMBER</u>	<u>ITEM DESCRIPTION</u>
P20/40-OR-AMETEK	SLIMLINE AMETEK O-RING FOR 10" & 20" HOUSINGS
P40-OR	HYDRONIX (HF5) O-RING REPLACEMENT - FITS 10"/20" COMMERCIAL HOUSINGS (EACH)



PRECISION  
INSTALLATION  
PRODUCTS

# WATER TREATMENT

## Water Filter Housings, Brackets & Wrenches

### Brackets

## SINGLE HOUSING MOUNTING BRACKET - FOR HF2/HF3



<u>PART NUMBER</u>	<u>ITEM DESCRIPTION</u>
PD1	HYDRONIX SINGLE MOUNTING BRACKET - ANODIZED STEEL - FOR USE W/ HF2/HF3 (NEEDS 4 SCREWS)
PD1-PB	SINGLE HOUSING MOUNTING BRACKET - BLACK PLASTIC - FOR USE W/ HF2/HF3 (NEEDS 4 SCREWS)
PD1-PW	SINGLE HOUSING MOUNTING BRACKET - WHITE PLASTIC - FOR USE W/ HF2/HF3 (NEEDS 4 SCREWS)
PD1-WH	HYDRONIX SINGLE MOUNTING BRACKET - WHITE STEEL - FOR USE W/ HF2/HF3 (NEEDS 4 SCREWS)

## DOUBLE HOUSING MOUNTING BRACKET - FOR HF2/HF3



<u>PART NUMBER</u>	<u>ITEM DESCRIPTION</u>
PD2	HYDRONIX DOUBLE MOUNTING BRACKET - WHITE STEEL - BEND UP FRONT - FOR USE W/ HF2/HF3 (NEEDS 8 SCREWS)
PD2-DOWN	HYDRONIX DOUBLE MOUNTING BRACKET - WHITE STEEL - BEND DOWN FRONT - FOR USE W/ HF2/HF3 (NEEDS 8 SCREWS)
PD2-PB	DOUBLE HOUSING MOUNTING BRACKET - BLACK PLASTIC - FOR USE W/ HF2/HF3 (NEEDS 8 SCREWS)
PD2-PW	DOUBLE HOUSING MOUNTING BRACKET - WHITE PLASTIC (NEEDS 8 SCREWS)

## TRIPLE HOUSING MOUNTING BRACKET - FOR HF2/HF3



<u>PART NUMBER</u>	<u>ITEM DESCRIPTION</u>
PD3	HYDRONIX TRIPLE HOUSING MOUNTING BRACKET - WHITE METAL - BEND UP - FOR USE W/ HF2/HF3 (NEEDS 12 SCREWS)
PD3-DOWN	HYDRONIX TRIPLE HOUSING MOUNTING BRACKET - WHITE METAL - BEND DOWN - FOR USE W/ HF2/HF3 (NEEDS 12 SCREWS)
PD3-PB	TRIPLE HOUSING MOUNTING BRACKET - BLACK PLASTIC - FOR USE W/ HF2/HF3 (NEEDS 12 SCREWS)
PD3-PUMP	HYDRONIX TRIPLE MOUNTING BRACKET - WHITE STEEL - PUMP MOUNT - FOR USE W/ HF2/HF3 (NEEDS 12 SCREWS)
PD3-PW	TRIPLE HOUSING MOUNTING BRACKET-WHITE PLASTIC - FOR USE W/ HF2/HF3 (NEEDS 12 SCREWS)

# WATER TREATMENT

## Water Filter Housings, Brackets & Wrenches

### Brackets



PRECISION  
INSTALLATION  
PRODUCTS

## COMMERICAL HOUSING MOUNTING BRACKET - FOR HF5



<u>PART NUMBER</u>	<u>ITEM DESCRIPTION</u>
PD20-WH	HYDRONIX 10"/20" SINGLE BRACKET - WHITE METAL - FITS (HF5) COMMERCIAL RIB HOUSINGS (NEEDS 4 PD20-WH-SCREWS)
PD20-WH-2	HYDRONIX DOUBLE 10"/20" BRACKET - WHITE STEEL - FITS (HF5) COMMERCIAL RIB HOUSINGS (NEEDS 8 D20-WH-SCREWS)
PD20-WH-3	HYDRONIX TRIPLE 10"/20" BRACKET - WHITE STEEL - FITS (HF5) COMMERCIAL RIB HOUSINGS (NEEDS 12 PD20-WH-SCREWS)

## BB HOUSING MOUNTING BRACKETS - FOR HF45

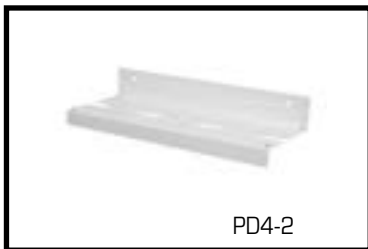

<u>PART NUMBER</u>	<u>ITEM DESCRIPTION</u>
PD4	HYDRONIX SINGLE BB MOUNTING BRACKET - WHITE METAL - FOR USE W/ HF45 (NEEDS 4 PD4 SCREWS)
PD4-2	HYDRONIX DOUBLE MOUNTING BRACKET - WHITE METAL - FOR USE W/ HF45 (NEEDS 8 PD4 SCREWS)
PD4-3	HYDRONIX TRIPLE BB MOUNTING BRACKET - WHITE METAL - FOR USE W/ HF45 (NEEDS 12 PD4 SCREWS)

## BB MOUNT BRACKET STAND (ASSEMBLED) - FOR HF45



<u>PART NUMBER</u>	<u>ITEM DESCRIPTION</u>
PD4-210-STAND	HYDRONIX DOUBLE BB STAND - WHITE METAL - FOR USE W/ 10" HF45 - COMPLETELY ASSEMBLED (NEEDS 8 PD4 SCREWS)
PD4-310-STAND	HYDRONIX TRIPLE BB STAND - WHITE METAL - FOR USE W/ 10" HF45 - COMPLETELY ASSEMBLED (NEEDS 12 PD4 SCREWS)
PD4-2-STAND	HYDRONIX DOUBLE BB STAND - WHITE METAL - FOR USE W/ 20" HF45 (NEEDS 8 PD4 SCREWS)
PD4-3-STAND	HYDRONIX TRIPLE BB STAND - WHITE METAL - FOR USE W/ 20" HF45 (NEEDS 12 PD4 SCREWS)

## ZINC SCREWS - FOR MOUNTING BRACKETS



<u>PART NUMBER</u>	<u>ITEM DESCRIPTION</u>
SCREWS	D 10 X 3/4" PP - "A" - SMS ZINC - USED WITH BRACKETS AND CLIPS
PD4 SCREW	5/16" X 1 1/2" HEX HEAD LAG ZINC SCREW FOR BB
PD4 WASHER	5/16" STEEL WASHER TO USE WITH PD4 BRACKET
PD20-WH-SCREWS	# 14 PHILLIP PAN STEEL ZINC 1 1/4" SCREWS



PRECISION  
INSTALLATION  
PRODUCTS

# WATER TREATMENT

## Water Filter Housings, Brackets & Wrenches

### Housing Wrenches

## HYDRONIX & PT FILTER WRENCHES



PSWF

<u>PART NUMBER</u>	<u>ITEM DESCRIPTION</u>
PSWF	HYDRONIX WHITE FULL CIRCLE FILTER WRENCH - FITS SLIM (HF2 / HF3) HOUSINGS (EACH)
PSWC	HYDRONIX WHITE FULL CIRCLE FILTER WRENCH - FITS COMMERCIAL (HF5 & 890) HOUSINGS (EACH)
PSWB-BB	HYDRONIX WHITE FULL CIRCLE FILTER WRENCH - FITS 4.5" (HF45) HOUSINGS

## AMETEK/PENTAIR FILTER WRENCHES



PSWF-6

<u>PART NUMBER</u>	<u>ITEM DESCRIPTION</u>
PSWF-B	AMETEK/PENTAIR FULL WRENCH FOR 10" BB HOUSING - BLACK
PSWF-G	AMETEK/PENTAIR FULL WRENCH FOR 20" BB HOUSING - GRAY

## HYDROTECH FILTER WRENCH



<u>PART NUMBER</u>	<u>ITEM DESCRIPTION</u>
PSW-HYDROTECH	HYDROTECH WHITE FULL CIRCLE FILTER WRENCH - FITS 1240 SERIES HOUSINGS (EACH)

# WATER TREATMENT

R.O. Component Parts

Clips



PRECISION  
INSTALLATION  
PRODUCTS

## SINGLE PLASTIC CLIPS FOR INLINE FILTERS W/ HOLES FOR TUBING



<u>PART NUMBER</u>	<u>ITEM DESCRIPTION</u>
PFO-1WH	WHITE 2" PLASTIC INLINE FILTER MOUNT CLIP - WITH HOLES
PFO-1BLK	BLACK 2" PLASTIC INLINE FILTER MOUNT CLIP - WITH HOLES
PFO-2	WHITE SINGLE CLIP FOR 2 1/2" FILTER OR MEMBRANE
PFO-2BLK	BLACK SINGLE CLIP FOR 2 1/2" FILTER OR MEMBRANE
PFO-7	WHITE SINGLE CLIP FOR 3" MEMBRANE

## DOUBLE PLASTIC CLIPS FOR INLINE FILTERS



<u>PART NUMBER</u>	<u>ITEM DESCRIPTION</u>
PFO-3	WHITE DOUBLE CLIP FOR 2 1/2" MEMBRANE X INLINE 2"
PFO-5	WHITE DOUBLE CLIP FOR MEMBRANE 2 1/2" X MEMBRANE 2 1/2"



PRECISION  
INSTALLATION  
PRODUCTS

# WATER TREATMENT

R.O. Component Parts

Drain Saddles

## METAL DRAIN SADDLE CLAMP - MALE COMPRESSION - ADJ.



<u>PART NUMBER</u>	<u>ITEM DESCRIPTION</u>
PFO33	STEEL SADDLE DRAIN CLAMP W/ BRASS 3/8" COMP X 2.0" OD
PFO43	STEEL SADDLE DRAIN CLAMP W/ BRASS 1/4" COMP X 2.0" OD

## PLASTIC DRAIN SADDLE CLAMP - MALE COMPRESSION



<u>PART NUMBER</u>	<u>ITEM DESCRIPTION</u>
PFO33P	PLASTIC SADDLE DRAIN CLAMP W/ 3/8" MALE COMP
PFO43P	PLASTIC SADDLE DRAIN CLAMP W/ 1/4" MALE COMP

## PLASTIC DRAIN SADDLE CLAMP - FPT



<u>PART NUMBER</u>	<u>ITEM DESCRIPTION</u>
PFO53P	PLASTIC SADDLE DRAIN CLAMP W/ 1/4"FPT
PFO83P	PLASTIC SADDLE DRAIN CLAMP W/ 3/8"FPT



# WATER TREATMENT

R.O. Component Parts

Drain Saddles



PRECISION  
INSTALLATION  
PRODUCTS

## PLASTIC DRAIN SADDLE CLAMP - QC



<u>PART NUMBER</u>	<u>ITEM DESCRIPTION</u>
PF063P	PLASTIC SADDLE DRAIN CLAMP W/ 3/8"JG
PF073P	PLASTIC SADDLE DRAIN CLAMP W/ 1/4"JG

## RO DRAINLINE ADAPTER



<u>PART NUMBER</u>	<u>ITEM DESCRIPTION</u>
AG109-002	RO DRAIN LINE ADAPTER - DLA-9 W/ 3/8" QC (RO DRAIN FOR SINGLE SINK W/ DISPOSAL)
AG112-002	RO DRAIN LINE ADAPTER - DLA-12 W/ 3/8" QC (RO DRAIN FOR DUAL SINK OR NO DISPOSAL)
AG116-002	RO UNIVERSAL DRAIN LINE ADAPTER - DLA-D W/ 3/8" QC (RO DRAIN ON ALL DISPOSALS WITH OR WITHOUT DISHWASHER)



**PRECISION  
INSTALLATION  
PRODUCTS**

# WATER TREATMENT

R.O. Component Parts

Shut Off Valves

## AUTOMATIC SHUT-OFF VALVE



<u>PART NUMBER</u>	<u>ITEM DESCRIPTION</u>
PASV-4LQ-WH	HYDRONIX NSF WHITE AUTO SHUTOFF W/ 1/4" QUICK CONNECT
PASV-S1-4QC	U-TURN AUTO SHUT-OFF VALVE "STYLE 1" W/ 1/4" QC

**Product Specifications**

Operating Pressure: 30-100 PSI

Operating Temperature: 120°F (50°C)

*\*At 60 PSI feed water pressure, RO System will turn off at 40 PSI. (Accuracy +/- 20%)*

## SMC 689 SERIES T-LINK FEED ADAPTER



<u>PART NUMBER</u>	<u>ITEM DESCRIPTION</u>
A689-4JG	SMC T-LINK FEED ADAPTER - 1/2" FPT X 1/2" MPT W/ 1/4" JG OUT-LET-NSF
A689-6JG	SMC T-LINK ADAPTER - 1/2" FPT X 1/2" MPT W/ 3/8" JG OUTLET- NSF

**FEATURES**

- MAXIMUM OPERATING PRESSURE: 125 PSI
- MAXIMUM OPERATING TEMPERATURE: 140 F
- BALL THROUGH HOLE DIAMETER: .437
- NSF 42 CERTIFIED

# WATER TREATMENT

## R.O. Component Parts

### Flow Restrictors



PRECISION  
INSTALLATION  
PRODUCTS

## CAPILLARY FLOW RESTRICTORS



PART NUMBER	ITEM DESCRIPTION
PFRCT-12	12 GPD CAPILLARY FLOW RESTRICTOR - RED - 125 ML/MN
PFRCT-18	18 GPD CAPILLARY FLOW RESTRICTOR - BROWN - 189 ML/MN
PFRCT-25	25 GPD CAPILLARY FLOW RESTRICTOR - BLACK - 263 ML/MN
PFRCT-35	35 GPD CAPILLARY FLOW RESTRICTOR - YELLOW - 368 ML/MN
PFRCT-50	50 GPD CAPILLARY FLOW RESTRICTOR - GREEN - 525 ML/MN
PFRCT-60	60 GPD CAPILLARY FLOW RESTRICTOR - DARK BLUE - 580 ML/MN
PFRCT-75	75 GPD CAPILLARY FLOW RESTRICTOR - BLUE - 735 ML/MN
PFRCT-100	100 GPD CAPILLARY FLOW RESTRICTOR - WHITE - 1052 ML/MN
PFRCT-150	150 GPD CAPILLARY FLOW RESTRICTOR - GREY - 1577 ML/MN

### Features

- Dairin Material For Increased Strength
- Compatible with Quick-Connect and Compression Fittings
- Save On Shipping, Storage and Fittings
- Unique Design Prevents Clogging
- Easy Installation
- Fits All Standard Size 1/4" Tubing

Part # 200985 AXEON 25 GPD Black 263 ml/gmin Capillary Flow Restrictor

Part # 200989 AXEON 35 GPD Yellow 368 ml/gmin Capillary Flow Restrictor

Part # 200990 AXEON 50 GPD Green 525 ml/gmin Capillary Flow Restrictor

Part # 200991 AXEON 75 GPD Blue 735 ml/gmin Capillary Flow Restrictor

Part # 200992 AXEON 100 GPD White 1052 ml/gmin Capillary Flow Restrictor

Part # 200993 AXEON 150 GPD Gray 1577 ml/gmin Capillary Flow Restrictor

4:1 Waste to Product Ratio				
AXEON Capillary Flow Restrictor Part Number	Color Code	Tubing Inner Diameter	Size	Membrane Size
200985	Red	.023"	105 ml/gmin	10 GPD
200986	Red	.023"	125 ml/gmin	12 GPD
200987	Brown	.023"	189 ml/gmin	18 GPD
200988	Black	.029"	263 ml/gmin	25 GPD
200989	Yellow	.029"	368 ml/gmin	35 GPD
200990	Green	.036"	525 ml/gmin	50 GPD
200991	Blue	.036"	735 ml/gmin	75 GPD
200992	White	.042"	1052 ml/gmin	100 GPD
200993	Grey	1/4"	1577 ml/gmin	150 GPD

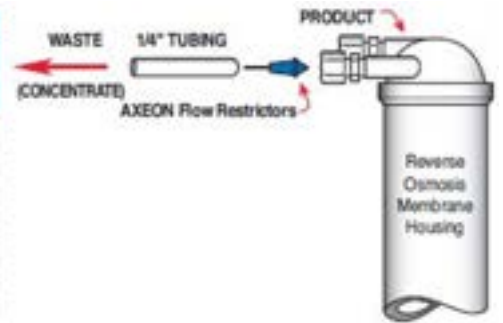



PRECISION  
INSTALLATION  
PRODUCTS

# WATER TREATMENT

R.O. Component Parts

Flow Restrictors

## INLINE FLOW RESTRICTORS



<u>PART NUMBER</u>	<u>ITEM DESCRIPTION</u>
PFR-150QC	PT 150 ML/MN INLINE FLOW RESTRICTOR WITH 1/4" QC ENDS
PFR-300QC	HYDRONIX 300 ML/MN INLINE FLOW RESTRICTOR WITH 1/4" QC ENDS - 24 GPD
PFR-420QC	HYDRONIX 420 ML/MN INLINE FLOW RESTRICTOR WITH 1/4" QC ENDS - 36 GPD
PFR-550QC	HYDRONIX 550 ML/MN INLINE FLOW RESTRICTOR W/ 1/4" QC ENDS - 50 GPD
PFR-1000F	HYDRONIX 1000 ML/MN INLINE FLOW RESTRICTOR WITH 1/4" FPT ENDS
PFR-1000QC	PT 1000 ML/MN INLINE FLOW RESTRICTOR WITH 1/4" QC ENDS
PFR-A-3000F	HYDRONIX 3000 ML/MN ADJUSTABLE INLINE FLOW RESTRICTOR WITH 1/4" FPT ENDS
PFRCT-100	100 GPD CAPILLARY FLOW RESTRICTOR - WHITE - 1052 ML/MN
PFRCT-150	150 GPD CAPILLARY FLOW RESTRICTOR - GREY - 1577 ML/MN

# WATER TREATMENT

R.O. Component Parts

Diverter Valves



PRECISION  
INSTALLATION  
PRODUCTS

## CHROME FAUCET DIVERTER VALVE



<u>PART NUMBER</u>	<u>ITEM DESCRIPTION</u>
ICDV-1/4C	HYDRONIX CHROME FAUCET DIVERTER VALVE WITH 1/4" COMP
ICDV-3/8C	HYDRONIX CHROME FAUCET DIVERTER VALVE WITH 3/8" COMP

## CHROME MALE ADAPTER FOR DIVERTER VALVE



<u>PART NUMBER</u>	<u>ITEM DESCRIPTION</u>
ICDV-MXM	HYDRONIX CHROME 13/16" MALE X MALE ADAPTER FOR DIVERTER VALVE



PRECISION  
INSTALLATION  
PRODUCTS

# WATER TREATMENT

R.O. Component Parts

PAE Tanks

## PAE TANK - 1 YEAR WARRANTY

MAXIMUM TEMPERATURE: 40 DEGREES C / 104 DEGREES F

MAXIMUM WORKING PRESSURE: 100 psi

The volume above is total capacity - not the water storage volumue



Certified to  
ANSI/ NSF 58

Patented stain ess stee  
water connection

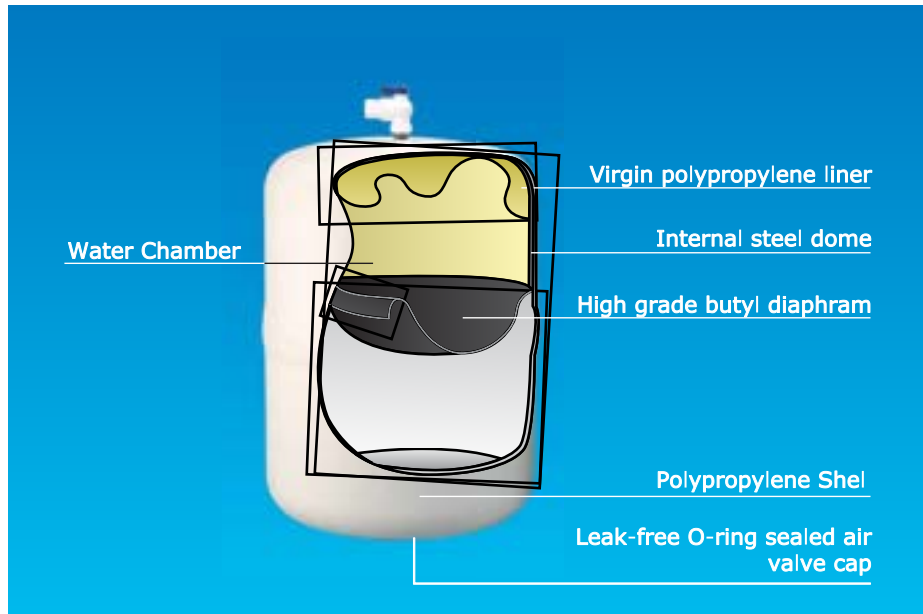

MODEL NO.	Dimensions						Volume	
	HEIGHT (A)		DIAMENTER (B)		BASE (C)		liter	gal
	cm	inch	cm	inch	cm	inch		
PRO-2W	31.7	12.7	20.3	8.1			8	2
PRO-3W	36.6	14.6	24.4	9.8			12	3.2
PRO-4W	36.8	14.7	27.9	11.2			18	4.4
PRO-6W	39	15.6	29	11.6			21	5.5
PRO-14W	62.6	25	38.9	15.5	10.4	4.2	60	14
PRO-20W-12	79	31.6	38.9	15.5	10.4	4.2	80	20
PRO-28W-16	80.4	31.6	43	16.9	12.9	5	100	28
PRO-40W-16								

# WATER TREATMENT

R.O. Component Parts

PAE Tanks



PRECISION  
INSTALLATION  
PRODUCTS

## .5 GAL TANK - 5.1" DIAMETER X 8.5" HEIGHT



<u>PART NUMBER</u>	<u>ITEM DESCRIPTION</u>
PRO-0.5W	AQUATROL 0.5 GAL WHITE METAL HOLDING TANK - 1/4" NIPPLE - NSF

## 2 GAL TANK - 8" DIAMETER X 11.4" HEIGHT

<u>PART NUMBER</u>	<u>ITEM DESCRIPTION</u>
PRO-2W	AQUATROL 2 / 1.2 GAL WHITE METAL HOLDING TANK - 1/4" NIPPLE - NSF

## 3 GAL TANK - 9.1" DIAMETER X 15.4" HEIGHT

<u>PART NUMBER</u>	<u>ITEM DESCRIPTION</u>
PRO-3W	AQUATROL 3 / 2.2 GAL WHITE METAL HOLDING TANK - 1/4" NIPPLE - NSF

## 4 GAL TANK - 11" DIAMETER X 15.4" HEIGHT

<u>PART NUMBER</u>	<u>ITEM DESCRIPTION</u>
PRO-4W	AQUATROL 4 / 3.2 GAL WHITE METAL HOLDING TANK - 1/4" NIPPLE - NSF
PRO-4B	AQUATROL 4 / 3.2 GAL BLUE METAL HOLDING TANK - 1/4" NIPPLE - NSF
PRO-4BLK	AQUATROL 4 / 3.2 GAL BLACK METAL HOLDING TANK - 1/4" NIPPLE - NSF

## 6 GAL TANK - 11.6" DIAMETER X 15.7" HEIGHT

<u>PART NUMBER</u>	<u>ITEM DESCRIPTION</u>
PRO-6W	AQUATROL 6 / 5.2 GAL WHITE METAL HOLDING TANK - 1/4" NIPPLE - NSF



PRECISION  
INSTALLATION  
PRODUCTS

# WATER TREATMENT

R.O. Component Parts

PAE Tanks

## 10 GAL TANK - 11.6" DIAMETER X 22.4" HEIGHT



<u>PART NUMBER</u>	<u>ITEM DESCRIPTION</u>
PRO-10W	AQUATROL 10 / 9.2 GAL WHITE METAL HOLDING TANK - 1/4" NIPPLE - NSF

## 14 GAL TANK - 15" DIAMETER X 23.6" HEIGHT

<u>PART NUMBER</u>	<u>ITEM DESCRIPTION</u>
PRO-14W	AQUATROL 14 / 10.7 GAL WHITE METAL HOLDING TANK - 1/4" NIPPLE - NSF
PRO-14B	AQUATROL 14 / 10.7 GAL BLUE METAL HOLDING TANK - 1/4" NIPPLE - NSF
PRO-14W-12	AQUATROL 14 / 10.7 GAL WHITE METAL HOLDING TANK - 3/4" NIPPLE - NSF
PRO-14B-12	AQUATROL 14 / 10.7 GAL BLUE METAL HOLDING TANK - 3/4" NIPPLE - NSF

## 20 GAL TANK - 30.7" DIAMETER X 31.9" HEIGHT

<u>PART NUMBER</u>	<u>ITEM DESCRIPTION</u>
PRO-20B-12	AQUATROL 20 / 14.9 GAL BLUE METAL HOLDING TANK - 3/4" NIPPLE - NSF
PRO-20W-12	AQUATROL 20 / 14.9 GAL WHITE METAL HOLDING TANK - 3/4" NIPPLE - NSF

## 28 GAL TANK - 38.5" DIAMETER X 39.2" HEIGHT

<u>PART NUMBER</u>	<u>ITEM DESCRIPTION</u>
PRO-28W-16	AQUATROL 28 / 17 GAL WHITE METAL HOLDING TANK - 1" FPT 90 - NSF



# WATER TREATMENT

R.O. Component Parts

PAE Tanks



PRECISION  
INSTALLATION  
PRODUCTS

## 44 GAL TANK - 36" DIAMETER X 35.7" HEIGHT



<u>PART NUMBER</u>	<u>ITEM DESCRIPTION</u>
PRO-40W-16	AQUATROL 44/30 GAL WHITE METAL HOLDING TANK - 1" NIPPLE - NSF
PRO-44W-18	AQUATROL 44 GAL WHITE METAL HOLDING TANK - 1 1/4" NIPPLE

## PARTS



<u>PART NUMBER</u>	<u>ITEM DESCRIPTION</u>
PRO-STAND	PRO-3W & PRO-4W TANK STAND ONLY - BLACK PLASTIC



PRECISION  
INSTALLATION  
PRODUCTS

# WATER TREATMENT

R.O. Component Parts

## ARO Hydroneumatic Pressurized Tanks

### PRESSURIZED FIBERGLASS STORAGE TANKS



These tanks are high-performance, high-value vessels for residential and light commercial reverse osmosis applications.

Specifically designed for reverse osmosis systems, these small vessels offer big advantages over competitive tanks via 100% seamless, composite construction, and the ability to discharge in any position.

### VERTICAL MODELS

<u>PART NUMBER</u>	<u>ITEM DESCRIPTION</u>
AQT-ARO-5814V-B10	AQUATROL HYDROPNEUMATIC VERTICAL PRESSURIZED TANK - 14GAL/11.3GAL-15"X23.6" WITH 1" NPT
AQT-ARO-8020V-B10	AQUATROL HYDROPNEUMATIC VERTICAL PRESSURIZED TANK - 20GAL/13GAL-15"X30.7" WITH 1" NPT
AQT-ARO-10025V-B10	AQUATROL HYDROPNEUMATIC VERTICAL PRESSURIZED TANK - 28GAL/15GAL-15"X39.2" WITH 1" NPT
AQT-ARO-12032V-B10	AQUATROL HYDROPNEUMATIC VERTICAL PRESSURIZED TANK - 32GAL/16GAL-15"X44" WITH 1" NPT
AQT-ARO-13034V-B114	AQUATROL HYDROPNEUMATIC VERTICAL PRESSURIZED TANK - 34GAL/22.5GAL-22"X29.5" WITH 1-1/4" NPT
AQT-ARO-16044V-B114	AQUATROL HYDROPNEUMATIC VERTICAL PRESSURIZED TANK - 44GAL/30GAL-22"X36" WITH 1-1/4" NPT
AQT-ARO-23562V-B114	AQUATROL HYDROPNEUMATIC VERTICAL PRESSURIZED TANK - 62GAL/35.2GAL-22"X45.7" WITH 1-1/4" NPT
AQT-ARO-30582V-B114	AQUATROL HYDROPNEUMATIC VERTICAL PRESSURIZED TANK - 82GAL/44GAL-22"X57.1" WITH 1-1/4" NPT
AQT-ARO-450120V-B114	AQUATROL HYDROPNEUMATIC VERTICAL PRESSURIZED TANK - 120 GAL / 95.1 GAL - 25.6" X 55.2" W/ 1 1/4 NPT

# WATER TREATMENT

R.O. Component Parts

ARO Hydroneumatic Pressurized Tanks



PRECISION  
INSTALLATION  
PRODUCTS

## HORIZONTAL MODELS

---

<u>PART NUMBER</u>	<u>ITEM DESCRIPTION</u>
AQT-ARO-1845H-B10	AQUATROL HYDROPNEUMATIC HORIZONTAL PRESSURIZED TANK - 4.5 GAL / 2.5 GAL - 11" X 12" W / 1" NPT
AQT-ARO-246H-B10	AQUATROL HYDROPNEUMATIC HORIZONTAL PRESSURIZED TANK - 6 GAL / 3 GAL - 11.6" X 12.6" W / 1" NPT
AQT-ARO-3810H-B10	AQUATROL HYDROPNEUMATIC HORIZONTAL PRESSURIZED TANK - 10 GAL / 5.2 GAL - 11.6" X 12.6" W / 1" NPT
AQT-ARO-5814H-B10	AQUATROL HYDROPNEUMATIC HORIZONTAL PRESSURIZED TANK - 14 GAL / 11.3 GAL - 15" X 17" W / 1" NPT
AQT-ARO-8020H-B10	AQUATROL HYDROPNEUMATIC HORIZONTAL PRESSURIZED TANK - 20 GAL / 13 GAL - 15" X 17" W / 1" NPT

## INLINE MODELS

---

<u>PART NUMBER</u>	<u>ITEM DESCRIPTION</u>
AQT-ARO-305I-B10	AQUATROL HYDROPNEUMATIC INLINE PRESSURIZED TANK - 0.5 GAL / .25 GAL - 5.1" X 8.5" W / 1" NPT
AQT-ARO-82I-B10	AQUATROL HYDROPNEUMATIC INLINE PRESSURIZED TANK - 2 GAL / 0.9 GAL - 8" X 11.4" W / 1" NPT
AQT-ARO-1232I-B10	AQUATROL HYDROPNEUMATIC INLINE PRESSURIZED TANK - 3.3 GAL / 1.6 GAL - 9.1" X 15.4" W / 1" NPT
AQT-ARO-1845I-B10	AQUATROL HYDROPNEUMATIC INLINE PRESSURIZED TANK - 4.5 GAL / 2.5 GAL - 11" X 15.4" W / 1" NPT
AQT-ARO-246I-B10	AQUATROL HYDROPNEUMATIC INLINE PRESSURIZED TANK - 6 GAL / 3 GAL - 11.6" X 16.3" W / 1" NPT
AQT-ARO-3810I-B10	AQUATROL HYDROPNEUMATIC INLINE PRESSURIZED TANK - 10 GAL / 5.2 GAL - 11.6" X 21.7" W / 1" NPT



PRECISION  
INSTALLATION  
PRODUCTS

# WATER TREATMENT

R.O. Component Parts

Accumulator Tanks

## 3/8" FPT END PORTS

---

<u>PART NUMBER</u>	<u>ITEM DESCRIPTION</u>
ACT-820-6FPT	AQUATEC ACCUMULATOR TANK - PULSATION DAMPENER WITH 3/8" FEMALE PIPE THREAD PORTS - NSF APPROVED

## 3/8" JG END PORTS

---

<u>PART NUMBER</u>	<u>ITEM DESCRIPTION</u>
ACT-820-6JG	AQUATEC ACCUMULATOR TANK-PULSATION DAMPENER WITH 3/8" QUICK CONNECT JG PORTS - NSF APPROVED

# WATER TREATMENT

## R.O. Component Parts

### Leak Protectors



PRECISION  
INSTALLATION  
PRODUCTS

Protects against potential leaks due to high water pressure, installation mishaps or customer issues.

This Leak Detector detects leaks and shuts off water flow to your water drinking system should a leak occur. This water leak protection system is designed to help eliminate the possibility of damage to your property. When a leak occurs, an absorbent applicator tablet expands to close the valve and shut the incoming water supply off.

#### LEAK DETECTOR SPECIFICATIONS:

- Detects potential leaks
- Features shut-off valve
- Maximum ambient humidity: 70%
- Maximum operating pressure: 100 PSI

## LEAK DETECTOR CONTROL VALVES



<u>PART NUMBER</u>	<u>ITEM DESCRIPTION</u>
XLP-3/8QC	WATTS LEAK PROTECTOR - AUTO..SHUTOFF VALVE - 3/8"QC
XLK-14	HYDRONIX FLOWLOK - (1) LEAK CONTROL VALVE W/ 1/4"QC & (1) COMPRESSED PAD
XLK-PAD	HYDRONIX FLOWLOK - LEAK CONTROL VALVE REPLACEMENT COMPRESSED PAD
XLK-TRAY	HYDRONIX FLOWLOK - LEAK SAFETY TRAY - FOR USE WITH HF2 SERIES HOUSING SYSTEMS
XLK-TRAY-QC	HYDRONIX FLOWLOK - LEAK SAFETY TRAY - FOR USE WITH TWIST-LOC SYSTEMS
XLK-KIT	HYDRONIX FLOWLOK SAFETY KIT - (1) LEAK CONTROL VALVE W/ 1/4"QC, (1) TRAY & (2) COMPRESSED PADS



PRECISION  
INSTALLATION  
PRODUCTS



**END OF SECTION**

**THIS PAGE IS LEFT  
INTENTIONALLY BLANK.**

# WATER TREATMENT

## Water Filters

### Hydronix Sediment Filters



PRECISION  
INSTALLATION  
PRODUCTS

#### HYDRONIX SDC SERIES 2.5" DIAMETER CARTRIDGES

The Hydronix Series 2.5" diameter SDC cartridge's coreless design is an economical solution to pre-filtration for many applications. They are used widely as pre-filtration for RO systems and post-filtration for GAC filters. They are also used in applications such as ice machines, film processing, beverage, coffee, analytical, wineries, and many others.

#### HYDRONIX SDC SERIES 4.5" DIAMETER CARTRIDGES

Our 4.5" diameter SDC Series Cartridges have true multi-stage depth filtration integrated into their design. Utilizing four separate layers of micron filtration, outside-in flow allows the outer layer to trap the larger sized particles, resulting in a much lower pressure drop compared to conventional filters. Trapping various sized particles layer-by-layer, our SDC Series Cartridges provide a much higher dirt holding capacity than standard spun Polypropylene and string wound cartridges.

- Manufactured from 100% pure Polypropylene
- Graded density for higher dirt holding capacity



#### PRODUCT APPLICATIONS

- Electroplating, etching, and image developing processes in PCB Industry
- Filtration for electroplating industry
- Pre-filter for DI and RO water filtration systems
- Pre-filtration for low viscosity chemicals
- Pre-filtration for manufacturing and water recycling
- Certified NSF Standard 42/FDA approved material

#### Operating Data

Max. operating temperature: 145°F (63°C)  
Max. pressure drop: 69°F (20°C) 46.4 psi (3.2 kg/cm<sup>2</sup>)  
Recommended replaceable pressure drop: 21.75 PSI (1.5 kg/cm<sup>2</sup>)  
Temperature range: 40°F to 145°F (4.4°C to 62.8°C)  
Maximum flow: 2-8 GPM (Depending on micron rating)

#### Materials of Construction

Filter Media: Polypropylene  
Temperature Range: 40°F to 145°F (4.4°C to 62.8°C)

Tested and certified by NSF International to ANSI/NSF Standard 42 for material requirements only.



#### SERIES SPECIFICATIONS

Nominal Micron Ratings: 1, 5, 10, 20, 50 and 75  
Materials of Construction: 100% Polypropylene  
Available Lengths: 4-7/8", 9-7/8", 20", 30" and 40"  
Inside Diameter: 1.1"  
Outside Diameter: 2.5" and 4.5"



PRECISION  
INSTALLATION  
PRODUCTS

# WATER TREATMENT

Water Filters

## Hydronix Sediment Filters

### HYDRONIX SEDIMENT FILTERS



<u>PART NUMBER</u>	<u>ITEM DESCRIPTION</u>
PP1X	HYDRONIX 10" X 2.5" SEDIMENT FILTER - 1 MICRON - NSF (CASE IS 40)
PP5X	HYDRONIX 10" X 2.5" SEDIMENT FILTER - 5 MICRON - NSF (CASE IS 40)
PP10X	HYDRONIX 10" X 2.5" SEDIMENT FILTER - 10 MICRON - NSF (CASE IS 40)
PP20X	HYDRONIX 10" X 2.5" SEDIMENT FILTER - 20 MICRON - NSF (CASE IS 40)
PP50X	HYDRONIX 10" X 2.5" SEDIMENT FILTER - 50 MICRON - NSF (CASE IS 40)

<u>PART NUMBER</u>	<u>ITEM DESCRIPTION</u>
PP201X	HYDRONIX 20" X 2.5" SEDIMENT FILTER - 1 MICRON - NSF (CASE IS 20)
PP205X	HYDRONIX 20" X 2.5" SEDIMENT FILTER - 5 MICRON - NSF (CASE IS 20)
PP210X	HYDRONIX 20" X 2.5" SEDIMENT FILTER - 10 MICRON - NSF (CASE IS 20)
PP220X	HYDRONIX 20" X 2.5" SEDIMENT FILTER - 20 MICRON - NSF (CASE IS 20)
PP250X	HYDRONIX 20" X 2.5" SEDIMENT FILTER - 50 MICRON - NSF (CASE IS 20)

<u>PART NUMBER</u>	<u>ITEM DESCRIPTION</u>
PP405X	HYDRONIX 40" X 2.5" SEDIMENT FILTER - 5 MICRON NSF (CASE IS 20)

<u>PART NUMBER</u>	<u>ITEM DESCRIPTION</u>
PP301X	HYDRONIX 10" X 4.5" MULTI-DEPTH SEDIMENT FILTER - 25 TO 1 MICRON - NSF (CASE IS 12)
PP305X	HYDRONIX 10" X 4.5" MULTI-DEPTH SEDIMENT FILTER - 50 TO 5 MICRON - NSF - (CASE IS 12)
PP310X	HYDRONIX 10" X 4.5" MULTI-DEPTH SEDIMENT FILTER - 75 TO 10 MICRON (CASE IS 12)
PP320X	HYDRONIX 10" X 4.5" MULTI-DEPTH SEDIMENT FILTER - 100 TO 20 MICRON - NSF (CASE IS 12)
PP350X	HYDRONIX 10" X 4.5" MULTI-DEPTH SEDIMENT FILTER - 100 TO 50 MICRON (CASE IS 12)

<u>PART NUMBER</u>	<u>ITEM DESCRIPTION</u>
PP501X	HYDRONIX 20" X 4.5" MULTI-DEPTH SEDIMENT FILTER - 25 TO 1 MICRON - NSF (CASE IS 6)
PP505X	HYDRONIX 20" X 4.5" MULTI-DEPTH SEDIMENT FILTER - 50 TO 5 MICRON - NSF (CASE IS 6)
PP510X	HYDRONIX 20" X 4.5" MULTI-DEPTH SEDIMENT FILTER - 75 TO 10 MICRON (CASE IS 6)
PP520X	HYDRONIX 20" X 4.5" MULTI-DEPTH SEDIMENT FILTER - 100 TO 20 MICRON - NSF - (CASE IS 6)
PP550X	HYDRONIX 20" X 4.5" MULTI-DEPTH SEDIMENT FILTER - 100 TO 50 MICRON (CASE IS 6)



# WATER TREATMENT

## Water Filters

### Hydronix Sediment Bonded Depth Filters



PRECISION  
INSTALLATION  
PRODUCTS

#### HYDRONIX SBC SERIES BONDED DEPTH CARTRIDGES

Are specially designed thermally bonded Polypropylene filters that provide superior filtration performance. SBC Bonded Depth Cartridges utilize a durable Polypropylene center core for increased strength and structural integrity.

#### HYDRONIX SBC SERIES BONDED DEPTH CARTRIDGES

Have fine grooves on the outside of the filter for increased surface area and will not impart color, taste and odor on the liquid being filtered. SBC cartridges produce consistent flow rates and have no fiber release, making them ideal for food and beverage applications.

Thermally bonded Polypropylene

Superior filtration performance

Polypropylene center core for added strength

Tested and certified by NSF International  
to ANSI/NSF Standard 42 for material  
requirements only.



#### Operating Data

Maximum Differential Pressure	Recommended Change Out Differential Pressure
15 psid at 175°F (1.0 bar at 80°C)	35 psi (2.4 bar)
25 psid at 140°F (1.7 bar at 60°C)	
60 psid at 68°F (4.13 bar at 20°C)	

#### Materials of Construction

Filter Media:	Polypropylene
Temperature Range:	40°F to 175°F (4.4°C to 79.4°C)

#### PRODUCT APPLICATIONS

- Electric components
- Plating
- Parts washing
- Pulp and paper
- Ink
- Bottled water
- Soft drinks
- Juice
- Oil and gas
- Pre-RO
- Rinse water

## HYDRONIX SEDIMENT BONDED DEPTH FILTERS



#### PART NUMBER

#### ITEM DESCRIPTION

PX101	HYDRONIX 2 1/2 X 10" SEDIMENT BONDED DEPTH FILTER - 1 MICRON
PX105	HYDRONIX 2 1/2 X 10" SEDIMENT BONDED DEPTH FILTER - 5 MICRON

#### PART NUMBER

#### ITEM DESCRIPTION

PX201	HYDRONIX 2 1/2 X 20" SEDIMENT BONDED DEPTH FILTER - 1 MICRON
PX205	HYDRONIX 2 1/2 X 20" SEDIMENT BONDED DEPTH FILTER - 5 MICRON



**PRECISION  
INSTALLATION  
PRODUCTS**

# WATER TREATMENT

Water Filters

## Hydronix Sediment Grooved Filters

### HYDRONIX SGC SERIES SEDIMENT GROOVED CARTRIDGES

are a reliable and economical solution for pre filtration in many applications. Typically utilized for pre filtration in Reverse Osmosis systems and post filtration in GAC filters, Hydronix SGC Cartridges with their grooved design offer a larger filtration area for longer life and larger filtration capacity.

#### PRODUCT APPLICATIONS

- Food and beverage processing
- Pre-filtration for manufacturing and water recycling
- Pre-filter for DI and RO water filtration systems
- Certified NSF Standard 42/FDA approved material

- 100% Pure Polypropylene
- Grooved for larger filtration area

#### Materials of Construction

Filter Media: Polypropylene  
 Temperature Range: 40°F to 145°F (4.4°C to 62.8°C)

#### Operating Data

Max. operating temperature: 145°F (63°C)  
 Max. pressure drop: 69°F (20°C) 46.4 psi (3.2 kg/cm<sup>2</sup>)  
 Recommended replaceable pressure drop: 21.75 PSI (1.5 kg/cm<sup>2</sup>)  
 Temperature range: 40°F to 145°F (4.4°C to 62.8°C)  
 Maximum flow: 2-8 GPM (Depending on micron rating)



Tested and certified by NSF International to ANSI/NSF Standard 42 for material requirements only.



## HYDRONIX SEDIMENT GROOVED FILTERS

<u>PART NUMBER</u>	<u>ITEM DESCRIPTION</u>
PPG-1005	HYDRONIX 10" X 2.5" POLY-SPUN SEDIMENT FILTER W/ GROOVES - 5 MICRON
PPG-1020	HYDRONIX 10" X 2.5" POLY-SPUN SEDIMENT FILTER W/ GROOVES - 20 MICRON

# WATER TREATMENT

## Water Filters

### Hydronix Polyester Pleated Sediment Filters



PRECISION  
INSTALLATION  
PRODUCTS

#### HYDRONIX SPC SERIES POLYESTER PLEATED CARTRIDGES

Are manufactured from durable polyester to provide you with a superior pleated cartridge that is washable, reusable and durable. Hydronix SPC Series Pleated Cartridges are bacteria and chemical resistant and provide great dirt holding capacity to extend the time between cartridge changes.

#### HYDRONIX SPC SERIES POLYESTER PLEATED CARTRIDGES

Can be used in residential, commercial and industrial applications. The Polyester media is pleated around a Polypropylene core for added strength and the ends are immersed in a thermosetting Vinyl Plastisol which fuses the three components together forming a unified end cap and gasket.

#### HYDRONIX SPC SERIES POLYESTER PLEATED CARTRIDGES

Are of a consistent and uniform quality and are unsurpassed in performance and value.

Manufactured from durable Polyester

Washable and reusable

Bacteria and chemical resistant

#### SPC Series Flow Rates

Microns	2.5" x 10"	2.5" x 20"	4.5" x 10"	4.5" x 20"
1	4	8	15	25
5	7	14	15	25
10	7	14	15	25
20	8	16	15	25
30	8	16	15	25
50	10	20	15	25

*Flow Rates in GPMs*

#### Materials of Construction

Filter Media: Non-woven Polyester  
End Caps: Vinyl Plastisol  
Core: Polypropylene  
Temperature Range: 40°F to 125°F (4.4°C to 51.7°C)





**PRECISION  
INSTALLATION  
PRODUCTS**

# WATER TREATMENT

Water Filters

## Hydronix Polyester Pleated Sediment Filters

### HYDRONIX POLYESTER PLEATED SEDIMENT FILTERS



<u>PART NUMBER</u>	<u>ITEM DESCRIPTION</u>
PL101	HYDRONIX 2.5" X 10" PLEATED POLYESTER SEDIMENT FILTER - 1 MICRON (MUST PURCHASE IN CASE QTY'S)
PL105	HYDRONIX 2.5" X 10" PLEATED POLYESTER SEDIMENT FILTER - 5 MICRON (MUST PURCHASE IN CASE QTY'S)
PL110	HYDRONIX 2.5" X 10" PLEATED POLYESTER SEDIMENT FILTER - 10 MICRON (MUST PURCHASE IN CASE QTY'S)
PL120	HYDRONIX 2.5" X 10" PLEATED POLYESTER SEDIMENT FILTER - 20 MICRON (MUST PURCHASE IN CASE QTY'S)
PL130	HYDRONIX 2.5" X 10" PLEATED POLYESTER SEDIMENT FILTER - 30 MICRON (MUST PURCHASE IN CASE QTY'S)
PL150	HYDRONIX 2.5" X 10" PLEATED POLYESTER SEDIMENT FILTER - 50 MICRON (MUST PURCHASE IN CASE QTY'S)

<u>PART NUMBER</u>	<u>ITEM DESCRIPTION</u>
PL201	HYDRONIX 2.5" X 20" PLEATED POLYESTER SEDIMENT FILTER - 1 MICRON (MUST PURCHASE IN CASE QTY'S)
PL205	HYDRONIX 2.5" X 20" PLEATED POLYESTER SEDIMENT FILTER - 5 MICRON (MUST PURCHASE IN CASE QTY'S)
PL210	HYDRONIX 2.5" X 20" PLEATED POLYESTER SEDIMENT FILTER - 10 MICRON (MUST PURCHASE IN CASE QTY'S)
PL220	HYDRONIX 2.5" X 20" PLEATED POLYESTER SEDIMENT FILTER - 20 MICRON (MUST PURCHASE IN CASE QTY'S)
PL230	HYDRONIX 2.5" X 20" PLEATED POLYESTER SEDIMENT FILTER - 30 MICRON (MUST PURCHASE IN CASE QTY'S)
PL250	HYDRONIX 2.5" X 20" PLEATED POLYESTER SEDIMENT FILTER - 50 MICRON (MUST PURCHASE IN CASE QTY'S)

# WATER TREATMENT

## Water Filters

### Hydronix Sediment Filters



PRECISION  
INSTALLATION  
PRODUCTS

## HYDRONIX POLYESTER PLEATED SEDIMENT FILTERS



<u>PART NUMBER</u>	<u>ITEM DESCRIPTION</u>
PL301	HYDRONIX 4.5" X 10" PLEATED POLYESTER SEDIMENT FILTER - 1 MICRON (MUST PURCHASE IN CASE QTY'S)
PL305	HYDRONIX 4.5" X 10" PLEATED POLYESTER SEDIMENT FILTER - 5 MICRON (MUST PURCHASE IN CASE QTY'S)
PL310	HYDRONIX 4.5" X 10" PLEATED POLYESTER SEDIMENT FILTER - 10 MICRON (MUST PURCHASE IN CASE QTY'S)
PL320	HYDRONIX 4.5" X 10" PLEATED POLYESTER SEDIMENT FILTER - 20 MICRON (MUST PURCHASE IN CASE QTY'S)
PL330	HYDRONIX 4.5" X 10" PLEATED POLYESTER SEDIMENT FILTER - 30 MICRON (MUST PURCHASE IN CASE QTY'S)
PL350	HYDRONIX 4.5" X 10" PLEATED POLYESTER SEDIMENT FILTER - 50 MICRON (MUST PURCHASE IN CASE QTY'S)

<u>PART NUMBER</u>	<u>ITEM DESCRIPTION</u>
PL501	HYDRONIX 4.5" X 20" PLEATED POLYESTER SEDIMENT FILTER - 1 MICRON (MUST PURCHASE IN CASE QTY'S)
PL505	HYDRONIX 4.5" X 20" PLEATED POLYESTER SEDIMENT FILTER - 5 MICRON (MUST PURCHASE IN CASE QTY'S)
PL510	HYDRONIX 4.5" X 20" PLEATED POLYESTER SEDIMENT FILTER - 10 MICRON (MUST PURCHASE IN CASE QTY'S)
PL520	HYDRONIX 4.5" X 20" PLEATED POLYESTER SEDIMENT FILTER - 20 MICRON (MUST PURCHASE IN CASE QTY'S)
PL530	HYDRONIX 4.5" X 20" PLEATED POLYESTER SEDIMENT FILTER - 30 MICRON (MUST PURCHASE IN CASE QTY'S)
PL550	HYDRONIX 4.5" X 20" PLEATED POLYESTER SEDIMENT FILTER - 50 MICRON (MUST PURCHASE IN CASE QTY'S)



**PRECISION  
INSTALLATION  
PRODUCTS**

# WATER TREATMENT

## Water Filters

### Hydronix Absolute Rated Pleated Filters

#### HYDRONIX AR SERIES ABSOLUTE RATED PLEATED FILTERS

Are Beta 5,000 Absolute rated filters. Made from 100% pure Polypropylene, Hydronix AR Series Filters comply with USP XXIII and FDA CFR Title 21 for food and beverage applications.



#### HYDRONIX AR SERIES ABSOLUTE RATED PLEATED FILTERS

Offer a longer service life and contain no binders, adhesives or surfactants for wide compatibility of fluids. They combine exceptional solids holding capacity with precise micron ratings. Layered double sheets of media provide absolute particle retention and long service life.

- Double layer structure, absolute rated
- Thermal bonded end caps and connectors free of any binders
- USP XXIII and FDA CFR Title 21
- End connections fit most standard housings

#### Model # Guide

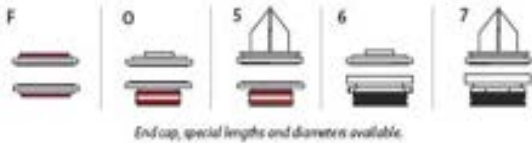

#### Maximum Pressure Drop

68°F at 70 PSI	20°C at 4.9 kg/cm <sup>2</sup>
140°F at 40 PSI	60°C at 2.8 kg/cm <sup>2</sup>
203°F at 20 PSI	95°C at 1.4 kg/cm <sup>2</sup>

#### Operating Data

Recommended Replaceable Pressure Drop: 35.6 PSI (2.5 kg/cm<sup>2</sup>)  
 Max. Operating Temperature: 203°F (95°C)

#### Materials of Construction

Filter Media:	Polypropylene
Support:	Polypropylene
Core:	Polypropylene
End Cap:	Polypropylene
O-Ring:	EPDM, Buna-N, Silicone, Viton, Viton encapsulated PFA

## HYDRONIX ABSOLUTE RATED PLEATED FILTERS



PART NUMBER	ITEM DESCRIPTION
PR102A-DOE	.2 ABSOLUTE 10 X 2.5 HP FILTER - DOUBLE OPEN END (DOE)
PR102A-FLAT	.2 ABSOLUTE 10 X 2.5 HP FILTER - TOP DOUBLE SILICONE ORING
PR102B-DOE	.2 ABSOLUTE 10 X 2.5 HP FILTER - DOUBLE OPEN END (DOE)
PR202A-DOE	.2 ABSOLUTE 20 X 2.5 HP FILTER - DOUBLE OPEN END (DOE)
PR202A-FLAT	.2 ABSOLUTE 20 X 2.5 HP FILTER - TOP DOUBLE SILICONE ORING
PR202B-DOE	.2 ABSOLUTE 20 X 2.5 HP FILTER - DOUBLE OPEN END (DOE)
PR202B-FIN	.2 ABSOLUTE 20 X 2.5 HP FILTER - FIN TOP W/ SILICONE ORING
PR202B-FLAT	.2 ABSOLUTE 20 X 2.5 HP FILTER - TOP DOUBLE SILICONE ORING
PR102B-DOE	.2 ABSOLUTE 10 X 2.5 HP FILTER - DOUBLE OPEN END (DOE)

# WATER TREATMENT

## Water Filters

### Hydronix String Wound Sediment Filters



PRECISION  
INSTALLATION  
PRODUCTS

#### HYDRONIX SWC SERIES STRING WOUND CARTRIDGES

A cost effective solution for the reduction of sand, silt, rust, dirt and scale particles. Made from 100% Polypropylene cord, SWC Series String Wound Cartridges can withstand temperatures of up to 165°F (73.9°C).

#### HYDRONIX SWC SERIES STRING WOUND CARTRIDGES

Are suitable for a variety of applications including residential and commercial applications using both municipal and well water. Different wound patterns for different micron ratings ensure that you are getting the right product for the right application.

- Manufactured from 100% Polypropylene Cord
- High dirt holding capacity
- Reduces sand, silt, rust and scale particles

#### Materials of Construction

---

Filter Media: Polypropylene Fiber Cord  
Core: Polypropylene  
Temperature Range: 40°F to 165°F (4.4°C to 73.9°C)





PRECISION  
INSTALLATION  
PRODUCTS

# WATER TREATMENT

## Water Filters

### Hydronix String Wound Sediment Filters

## HYDRONIX STRING WOUND SEDIMENT FILTERS



<u>PART NUMBER</u>	<u>ITEM DESCRIPTION</u>
PS101/2	HYDRONIX 10" X 2.5" STRING WOUND SEDIMENT FILTER - 1/2 MICRON (CASE IS 40)
PS101	HYDRONIX 10" X 2.5" STRING WOUND SEDIMENT FILTER - 1 MICRON
PS105	HYDRONIX 10" X 2.5" STRING WOUND SEDIMENT FILTER - 5 MICRON
PS110	HYDRONIX 10" X 2.5" STRING WOUND SEDIMENT FILTER - 10 MICRON
PS120	HYDRONIX 10" X 2.5" STRING WOUND SEDIMENT FILTER - 20 MICRON
PS130	HYDRONIX 10" X 2.5" STRING WOUND SEDIMENT FILTER - 30 MICRON - CS/40
PS150	HYDRONIX 10" X 2.5" STRING WOUND SEDIMENT FILTER - 50 MICRON
PS100	HYDRONIX 10" X 2.5" STRING WOUND SEDIMENT FILTER - 100 MICRON

<u>PART NUMBER</u>	<u>ITEM DESCRIPTION</u>
PS201/2	HYDRONIX 20" X 2.5" STRING WOUND SEDIMENT FILTER - 1/2 MICRON (CASE IS 20)
PS201	HYDRONIX 20" X 2.5" STRING WOUND SEDIMENT FILTER - 1 MICRON
PS205	HYDRONIX 20" X 2.5" STRING WOUND SEDIMENT FILTER - 5 MICRON
PS210	HYDRONIX 20" X 2.5" STRING WOUND SEDIMENT FILTER - 10 MICRON
PS220	HYDRONIX 20" X 2.5" STRING WOUND SEDIMENT FILTER - 20 MICRON
PS230	HYDRONIX 20" X 2.5" STRING WOUND SEDIMENT FILTER - 30 MICRON
PS250	HYDRONIX 20" X 2.5" STRING WOUND SEDIMENT FILTER - 50 MICRON
PS200	HYDRONIX 20" X 2.5" STRING WOUND SEDIMENT FILTER - 100 MICRON

<u>PART NUMBER</u>	<u>ITEM DESCRIPTION</u>
PS1350	HYDRONIX 30" X 2.5" STRING WOUND SEDIMENT FILTER - 50 MICRON* * *DISCONTINUED



# WATER TREATMENT

## Water Filters

### Hydronix String Wound Sediment Filters



PRECISION  
INSTALLATION  
PRODUCTS

## HYDRONIX STRING WOUND SEDIMENT FILTERS



<u>PART NUMBER</u>	<u>ITEM DESCRIPTION</u>
PS501/2	HYDRONIX 20" X 4.5" STRING WOUND SEDIMENT FILTER - 1/2 MICRON (CASE IS 6)
PS501	HYDRONIX 20" X 4.5" STRING WOUND SEDIMENT FILTER - 1 MICRON
PS505	HYDRONIX 20" X 4.5" STRING WOUND SEDIMENT FILTER - 5 MICRON (CASE 6)
PS510	HYDRONIX 20" X 4.5" STRING WOUND SEDIMENT FILTER - 10 MICRON
PS520	HYDRONIX 20" X 4.5" STRING WOUND SEDIMENT FILTER - 20 MICRON
PS530	HYDRONIX 20" X 4.5" STRING WOUND SEDIMENT FILTER - 30 MICRON
PS550	HYDRONIX 20" X 4.5" STRING WOUND SEDIMENT FILTER - 50 MICRON (CASE 6)
PS500	HYDRONIX 20" X 4.5" STRING WOUND SEDIMENT FILTER - 100 MICRON

<u>PART NUMBER</u>	<u>ITEM DESCRIPTION</u>
PS301/2	HYDRONIX 10" X 4.5" STRING WOUND SEDIMENT FILTER - 1/2 MICRON (CASE IS 12)
PS301	HYDRONIX 10" X 4.5" STRING WOUND SEDIMENT FILTER - 1 MICRON
PS305	HYDRONIX 10" X 4.5" STRING WOUND SEDIMENT FILTER - 5 MICRON (CASE 12)
PS310	HYDRONIX 10" X 4.5" STRING WOUND SEDIMENT FILTER - 10 MICRON
PS320	HYDRONIX 10" X 4.5" STRING WOUND SEDIMENT FILTER - 20 MICRON - CS/12
PS330	HYDRONIX 10" X 4.5" STRING WOUND SEDIMENT FILTER - 30 MICRON
PS350	HYDRONIX 10" X 4.5" STRING WOUND SEDIMENT FILTER - 50 MICRON
PS300	HYDRONIX 10" X 4.5" STRING WOUND SEDIMENT FILTER - 100 MICRON



**PRECISION  
INSTALLATION  
PRODUCTS**

# WATER TREATMENT

Water Filters

## Hydronix Carbon Blocks

### HYDRONIX CB SERIES CARBON BLOCK FILTERS

Are manufactured with high purity coconut shell activated carbon and are available in a wide range of lengths, diameters, and micron ratings. Hydronix blocks provide an exceptional cost-to-performance value. With high chlorine reduction, great dirt-holding capacity, and greatly reduced carbon fines, you will soon make the CB series your carbon block of choice.

### HYDRONIX CB SERIES CARBON BLOCK FILTERS

Are ideal for point-of-use (POU) and reverse osmosis applications. These cartridges can be used in a wide range of applications such as residential, food service, commercial, and industrial. The CB Series carbon blocks are great for displacing traditional GAC (Granular Activated Carbon) and PAC (Powder Activated Carbon) filters in applications where high chlorine reduction is needed.

Reduce taste, odor, chlorine and certain VOCs from drinking water\*

Great chlorine removal capacity competitive with the finest carbon blocks\*

Nominal 0.5, 1, 5 and 10 micron available

Tested and certified by NSF International to ANSI/NSF Standard 42 for material requirements only.



#### Materials of Construction

Carbon:	Coconut shell	Netting:	Polypropylene
End caps:	Polypropylene	Gaskets:	Neoprene
Outer wrap:	Polypropylene	Temp. Rating:	40°F to 180°F
Inner wrap:	Polypropylene		

NOTE: Performance capacity depends on system design, flow rate and certain other application conditions. CB series cartridges will contain a very small amount of carbon fines (very fine black powder). After installation, follow the instructions for flushing the cartridge to remove all traces of the fines before using the water. You should run (flush) the tap at least 20 seconds prior to using water for drinking or cooking purposes. This is particularly important if the tap has not been used daily.

NOTE: Micron ratings based on 85% or greater removal of given particle size.

#### Temperature Rating

40°F to 180°F (4.4°C to 82.2°C)  
Maximum Operating Pressure: 250 PSI  
Maximum Differential Pressure: 100 PSD  
Collapse Pressure: 200 PSD

## HYDRONIX CARBON FILTERS



PART NUMBER	ITEM DESCRIPTION
PCB250-1/2M	HYDRONIX 10" X 2.5" 1/2 MICRON CARBON BLOCK - NSF - CASE PACK 20
PCB250-1M	HYDRONIX 10" X 2.5" 1 MICRON CARBON BLOCK - NSF - CASE PACK 20
PCB250-5M	HYDRONIX 10" X 2.5" 5 MICRON CARBON BLOCK - NSF - CASE PACK 20
PCB250-10M	HYDRONIX 10" X 2.5" 10 MICRON CARBON BLOCK - NSF - CASE PACK 20
PCB201/2X	HYDRONIX 20" X 2.5" 1/2 MICRON CARBON BLOCK - NSF - CASE PACK 20
PCB201X	HYDRONIX 20" X 2.5" 1 MICRON CARBON BLOCK - NSF - CASE PACK 20
PCB205X	HYDRONIX 20" X 2.5" 5 MICRON CARBON BLOCK - NSF - CASE PACK 20
PCB200X	HYDRONIX 20" X 2.5" 10 MICRON CARBON BLOCK - NSF - CASE PACK 20
PCB301/2X	HYDRONIX 10" X 4.5" 1/2 MICRON CARBON BLOCK - NSF - CASE PACK 12
PCB301X	HYDRONIX 4.5" X 10" 1 MICRON CARBON BLOCK - NSF - CASE PACK 9
PCB305X	HYDRONIX 4.5" X 10" 5 MICRON CARBON BLOCK - NSF - CASE PACK 9
PCB300X	HYDRONIX 4.5" X 10" COCONUT 10 MICRON BLOCK - NSF - CASE PACK 9
PCB501/2X	HYDRONIX 20" X 4.5" 1/2 MICRON CARBON BLOCK - NSF - CASE PACK 6
PCB501X	HYDRONIX 20" X 4 /12" 1 MICRON CARBON BLOCK - NSF - CASE PACK 6
PCB505X	HYDRONIX 20" X 4 1/2" 5 MICRON BB CARBON BLOCK - NSF - CASE PACK 6
PCB500X	HYDRONIX 4.5" X 20" 10 MICRON BB CARBON BLOCK - NSF - CASE PACK 6

# WATER TREATMENT

## Water Filters

### Radial Flow Carbon Blocks



PRECISION  
INSTALLATION  
PRODUCTS

## HYDRONIX RADIAL FLOW CARBON FILTERS - 25 MICRON



Hydronix Radial Flow Carbon Filters provide a unique design combining all the benefits of a granular activated carbon (GAC) filter and that of a sediment filter. This combination produces higher flow rates and low pressure drop while providing you with effective taste and odor reduction. These carbon filters have a radial flow design that is ideal for higher point of entry (POE) applications. They provide less carbon fine release and are available in different sizes.

#### COMPARABLE TO:

AMETEK/PENTEK #RFC20-BB, 144247-51 & WRC25HD20

<u>PART NUMBER</u>	<u>ITEM DESCRIPTION</u>
PRF-2510	HYDRONIX 2.5" X 10" RADIAL FLOW-25 MICRON WRAP WITH COCONUT SHELL GAC INNER CORE (CASE IS 25)
PRF-2520	HYDRONIX 2.5" X 20" RADIAL FLOW-25 MICRON WRAP WITH COCONUT SHELL GAC INNER CORE (CASE IS 12)
PRF-4510	HYDRONIX 4.5" X 10" RADIAL FLOW-25 MICRON WRAP WITH COCONUT SHELL GAC INNER CORE (CASE IS 12)
PRF-4520	HYDRONIX 4.5" X 20" RADIAL FLOW-25 MICRON WRAP WITH COCONUT SHELL GAC INNER CORE (CASE IS 6)



**PRECISION  
INSTALLATION  
PRODUCTS**

# WATER TREATMENT

Water Filters

Inline Filters

## INLINE SEDIMENT FILTERS - 5 MICRON



<u>PART NUMBER</u>	<u>ITEM DESCRIPTION</u>
PCL10-F5X	HYDRONIX 10" X 2" INLINE SEDIMENT FILTER - 5 MICRON - 1/4" FPT
PCL10X-F5-4QC	PURE T 2" X 10" INLINE SEDIMENT FILTER - 5 MICRON - 1/4" QC
PCL12-F5X	HYDRONIX 2.5" X 12" INLINE SEDIMENT FILTER - 5 MICRON - 1/4" FPT
PCL12-F5X-4QC	HYDRONIX 2.5" X 12" INLINE SEDIMENT FILTER - 5 MICRON - 1/4" QC

## INLINE COCO SHELL GAC FILTERS



<u>PART NUMBER</u>	<u>ITEM DESCRIPTION</u>
PCL6X-4FPT	PURE T 2" X 6" COCO SHELL INLINE GAC - NSF - 1/4" FPT - CASE PACK 40
PCL6X-40	HYDRONIX 6" X 2" INLINE COCONUT SHELL GAC FILTER - 1000 GAL - 1/4" FPT PORTS - CASE PACK 50
PCL6X-4QC	PURE T 2" X 6" COCO SHELL INLINE GAC - NSF - 1/4" QC - CASE PACK 40
PCL6X-40-4QC	HYDRONIX 6" X 2" INLINE COCONUT SHELL GAC FILTER - 1000 GAL - 1/4" QC PORTS - CASE PACK 50
PCL6X-40-4QC-NL	HYDRONIX 6" X 2" INLINE COCONUT SHELL GAC FILTER - 1000 GAL - 1/4" QC PORTS - NO LABEL - CASE 50
PCL6X-6QC	PURE T 6" X 2" INLINE COCONUT SHELL GAC FILTER-NSF-3/8" QUICK CONNECT PORTS - CASE PACK 40
PCL6X-6QC-NL	PURE T 6" X 2" INLINE COCONUT SHELL GAC FILTER-NSF-3/8" QUICK CONNECT PORTS-NO LABEL - CASE PACK 40
PCL6X-40-6QC	HYDRONIX 6" X 2" INLINE COCONUT SHELL GAC FILTER - 3/8" QUICK CONNECT PORTS - CASE PACK 50
PCL6X-40-6QC-NL	HYDRONIX 6" X 2" INLINE COCONUT SHELL GAC FILTER - 3/8" QUICK CONNECT PORTS - NO LABEL - CASE 50
PCL10X-40	HYDRONIX 10" X 2" INLINE COCONUT SHELL GAC - 2000 GAL - 1/4" FPT PORTS - CASE 25
PCL10X-4QC	PURE T 2" X 10" COCO SHELL INLINE GAC - NSF - 1/4" QC
PCL10X-P-4FPT	PURE T 2" X 10" INLINE SCALE REMOVAL - GAC & PHOSPHATE - 1/4" FPT
PCL10X-P-4QC	PURE T 2" X 10" INLINE SCALE REMOVAL - GAC & PHOSPHATE - 1/4" QC
PCL10X-40-4QC	HYDRONIX 10" X 2" INLINE COCONUT SHELL GAC - 2000 GAL - 1/4" QUICK CONNECT PORTS - CASE 25
PCL10X-6FPT	PURE T 2" X 10" COCO SHELL INLINE GAC - NSF - 3/8" FPT
PCL10X-6QC	PURE T 2" X 10" COCO SHELL INLINE GAC - NSF - 3/8" QC
PCL12X-40	HYDRONIX 12" X 2 1/2" INLINE COCO SHELL GAC - 3500 GAL - 1/4" FPT
PCL12X-40-4QC	HYDRONIX 12" X 2 1/2" INLINE COCO SHELL GAC - 3500 GAL - 1/4" QC

# WATER TREATMENT

## Water Filters

### Inline Filters



PRECISION  
INSTALLATION  
PRODUCTS

## INLINE ALKALINE FILTERS



PALK-10-4QC

INLINE ALKALINE FILTERS - CAN INCREASE pH TO 8.5-10

Increases alkalinity and negative ORP (Oxidation Reduction Potential). Adds beneficial minerals back into water.

<u>PART NUMBER</u>	<u>ITEM DESCRIPTION</u>
PALK-10	NUWATER 2" X 10" INLINE ALKALINE FILTER - 1/4" FPT PORTS (CASE IS 25)
PALK-10-4QC	NUWATER 2" X 10" INLINE ALKALINE FILTER-1/4" QC PORTS (CASE IS 25)
PALK-10-6QC	NUWATER 2" X 10" INLINE ALKALINE FILTER - 3/8" QC PORTS (CASE IS 25)
PALK-12X-4FPT	HYDRONIX 2.5" X 12" INLINE ALKALINE FILTER-1/4" FPT PORTS NSF & FDA LISTED

## INLINE CALCITE / COROSEX FILTERS



<u>PART NUMBER</u>	<u>ITEM DESCRIPTION</u>
PCL10CAL/COR-4QC	NUWATER 2" X 10" INLINE CALCITE/COROSEX 50/50 FILTER CARTRIDGE - 1/4"QC - CLEAR SHELL
PCL10CAL/COR-6QC	NUWATER 2" X 10" INLINE CALCITE/COROSEX 50/50 FILTER CARTRIDGE - 3/8"QC - CLEAR SHELL

## INLINE NITRATE REMOVAL FILTERS



<u>PART NUMBER</u>	<u>ITEM DESCRIPTION</u>
PCL10NIT-4JG	NUWATER 2" X 10" INLINE NITRATE REMOVAL CARTRIDGE-1/4" JG-WHITE SHELL
PCL10NIT-6JG	NUWATER 2" X 10" INLINE NITRATE REMOVAL CARTRIDGE-3/8"-JG-WHITE SHELL



**PRECISION  
INSTALLATION  
PRODUCTS**

# WATER TREATMENT

Water Filters

Empty Cartridges

## EMPTY CARTRIDGES W/ FELT PADS

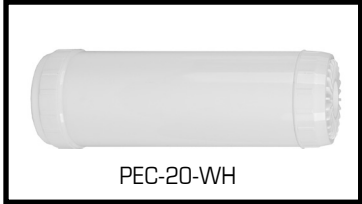

<u>PART NUMBER</u>	<u>ITEM DESCRIPTION</u>
PEC-2505-WH	HYDRONIX 2 1/2" X 5" WHITE EMPTY CARTRIDGE - 20 MICRON PAD (MUST PURCHASE IN CS. QTY 25)
PEC-20-CL	HYDRONIX 2 1/2" X 10" CLEAR EMPTY CARTRIDGE - 20 MICRON PAD
PEC-20-WH	HYDRONIX 2 1/2" X 10" WHITE EMPTY CARTRIDGE - 20 MICRON PAD
PEC-30-CL	HYDRONIX 4 1/2" X 10" CLEAR EMPTY CARTRIDGE - 20 MICRON PAD
PEC-30-WH	HYDRONIX 4 1/2" X 10" WHITE EMPTY CARTRIDGE - 20 MICRON PAD
PEC-40-WH	HYDRONIX 2 1/2" X 20" WHITE EMPTY CARTRIDGE - 20 MICRON PAD
PEC-50-CL	HYDRONIX 4 1/2" X 20" CLEAR EMPTY CARTRIDGE - 20 MICRON PAD
PEC-50-WH	HYDRONIX 4 1/2" X 20" WHITE EMPTY CARTRIDGE - 20 MICRON PAD
PEC-2.5-PADX	HYDRONIX 2.5" EMPTY CARTRIDGE FELT PAD REPLACEMENT
PEC-2.5PAD KIT	HYDRONIX 2.5" EMPTY CARTRIDGE STAR GRID FELT PAD & WASHER - COMPLETE SET
PEC-4.5-PADX	HYDRONIX 4.5" EMPTY CARTRIDGE FELT PAD REPLACEMENT
PEC-PAD-2.5	OMNIPURE 2.875" EMPTY CARTRIDGE FELT PAD REPLACEMENT
PECI-10X-CL-40	HYDRONIX 2" X 10" CLEAR EMPTY INLINE CARTRIDGE - 1/4" FPT ENDS
PECI-10X-WH-40	HYDRONIX 2" X 10" WHITE EMPTY INLINE CARTRIDGE - 1/4" FPT ENDS
PECI-12-CL-6FPT	PT 2.5" X 12" CLEAR EMPTY REFILLABLE INLINE CARTRIDGE - 3/8" FPT ENDS
PECI-12WH-4F	PG 2.5" X 12" WHITE EMPTY REFILLABLE INLINE CARTRIDGE - 1/4" FPT ENDS

# WATER TREATMENT

## Water Filters

### Replacement Cartridges



PRECISION  
INSTALLATION  
PRODUCTS

## GRANULAR ACTIVATED CARBON CARTIDGES (COCO SHELL GAC)



<u>PART NUMBER</u>	<u>ITEM DESCRIPTION</u>
POCB28	OMNIPURE 2 1/2" X 10" GAC T-28 COCO SHELL CARBON CARTRIDGE
POCB28-1M	OMNIPURE 2 1/2" X 10" GAC T-28 COCO SHELL CARBON CARTRIDGE W/ 1 MICRON PAD
POCB28X	HYDRONIX 2 1/2" X 10" GAC REPLACEMENT CARTRIDGE, 25/CASE
POCB28X-WRAP	HYDRONIX 2 1/2" X 10" GRANULAR ACTIVATED CARBON REPLACEMENT CARTRIDGE WITH SEDIMENT OUTER WRAP
POCB33	OMNIPURE 2 1/2" X 10" GAC T-33 COCO SHELL CARBON CARTRIDGE
POCB40	OMNIPURE 2 1/2" X 10" GAC T-40 COCO SHELL CARBON CARTRIDGE
POCB20X	HYDRONIX 2 1/2" X 20" GAC REPLACEMENT CARTRIDGE - NSF
POCB33-20	OMNIPURE 20" GAC T-33 COCO SHELL CARBON CARTRIDGE *OVERSTOCK SPECIAL*
POCB33-20-25MIC	OMNIPURE 20" GAC T-33 COCO SHELL CARBON CARTRIDGE W/ 25 MICRON PAD *OVERSTOCK SPECIAL*
POCB33-20X	PURE T 20" X 2.5" GAC CARTRIDGE (CASE IS 12) *BLOWOUT SPECIAL*
POCB50X	HYDRONIX 4 1/2" X 20" BB GAC REPLACEMENT CARTRIDGE CASE/6
POCB30X	HYDRONIX 4 1/2" X 10" BB GAC REPLACEMENT CARTRIDGE (CASE 12)

## CALCITE CARTRIDGES



<u>PART NUMBER</u>	<u>ITEM DESCRIPTION</u>
POCB-CAL	OMNIPURE 2 1/2" X 10" ALL CALCITE REPLACEMENT CARTRIDGE
POCB-CAL-COR	NUWATER 2 1/2" X 10" CLEAR CARTRIDGE - 50% CALCITE & 50% COROSEX
POCB-CAL-GAC	SYSTEMATIX 2.5" X 10" CARTRIDGE - 50% CALCITE & 50% GAC
POCB20-CAL-GAC	SYSTEMATIX 2.5" X 20" CARTRIDGE - 50% CALCITE & 50% GAC
POCB30-CAL	NUWATER 4.5" X 10" BB CALCITE FILTER CARTRIDGE
POCB30-CAL-GAC	SYSTEMATIX 4.5" X 10" BB CARTRIDGE - 50% CALCITE & 50% GAC
POCB50-CAL	NUWATER 4.5" X 20" BB CALCITE FILTER CARTRIDGE
POCB50-CAL-COR	NUWATER 4.5" X 20" BB CARTRIDGE - 50% CALCITE & 50% COROSEX



PRECISION  
INSTALLATION  
PRODUCTS

# WATER TREATMENT

Water Filters

## Replacement Cartridges

### PHOSPHATE CARTRIDGES



<u>PART NUMBER</u>	<u>ITEM DESCRIPTION</u>
PPOCBS-4	OMNIPURE 2 1/2" X 10" CARBON W/ 4 OZ PHOSPHATE REPLACEMENT CARTRIDGE
PPOCBS-8	OMNIPURE 2 1/2" X 10" CARBON W/ 8 OZ PHOSPHATE REPLACEMENT CARTRIDGE
POS10-32	SYSTEMATIX 2 1/2" x 10" 100% PHOSPHATE (32 OZ) W/ HI-FLO FILTER
POS10-48	NUWATER 2 1/2" x 10" 100% PHOSPHATE (48 OZ) CARTRIDGE
POB934	OMNIPURE 2 1/2" X 10" 100% PHOSPHATE CARTRIDGE - 56 OZ
POCB200G	OMNIPURE 2 1/2" X 20" CARBON W/ PHOSPHATE REPLACEMENT CARTRIDGE - 80Z
POS10BB-64	SYSTEMATIX 4 1/2" X 10" BB 100%PHOSPHATE (64 OZ) FILTER
POS20-64	SYSTEMATIX 2 1/2" X 20" 100% PHOSPHATE (64 OZ) WITH HIGH FLOW FILTER
POS20BB-128	SYSTEMATIX 4 1/2" X 20" GLOSSY PHOSPHATE/ ANTISCALE & CORROSION - 8LBS CARTRIDGE

### SOFTENING RESIN CARTRIDGES

<u>PART NUMBER</u>	<u>ITEM DESCRIPTION</u>
POCB-R23	OMNIPURE 2 1/2" X 10" 2/3 C100E RESIN & 1/3 GAC REPLACEMENT CARTRIDGE
POCB-RES	OMNIPURE 2 1/2" X 10" CATION RESIN REPLACEMENT CARTRIDGE
POCB-RES-10BB	SYSTEMATIX 4 1/2" X 10" BB CATION RESIN CARTRIDGE
POCB-RES-20BB	SYSTEMATIX 4 1/2" X 20" BB CATION RESIN CARTRIDGE
POCB-20-RES	OMNIPURE 2 1/2" X 20" 100% CATION RESIN REPLACEMENT CARTRIDGE
POCB-RES-GAC	OMNIPURE 2 1/2" X 10" REPLACEMENT CARTRIDGE - 2/3 CATION RESIN - 1/3 GAC

### D.I. RESIN CARTRIDGES

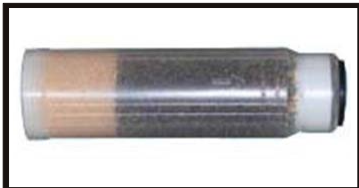

<u>PART NUMBER</u>	<u>ITEM DESCRIPTION</u>
POCB-DICC	OMNIPURE 2 1/2" X 10" DI (MIXED BED RESIN) REPLACEMENT CARTRIDGE
POCB-T55	OMNIPURE 2 1/2" X 20" DI (MIXED BED RESIN) REPLACEMENT CARTRIDGE
POCB-T55-20	OMNIPURE 2 1/2" X 10" CARTRIDGE - 70% DI - 30% GAC
POCB-T55-70	NUWATER 2 1/2" X 10" DI MIXED BED COLOR CHANGING RESIN
POCB30-T55	PG 4 1/2" X 10" BIG BLUE DI MIXED BED RESIN CARTRIDGE
POCB50-T55	PG 4 1/2" X 20" BIG BLUE DI MIXED BED RESIN CARTRIDGE



# WATER TREATMENT

## Water Filters

### Replacement Cartridges



PRECISION  
INSTALLATION  
PRODUCTS

## NITRATE CARTRIDGES

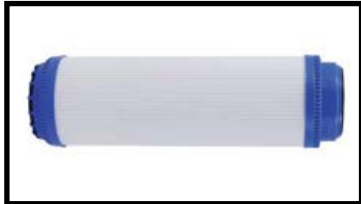

Constructed totally of FDA grade anion exchange resin (brine regenerable). It will remove virtually all nitrates, nitrites and sulphates from tap water.

<u>PART NUMBER</u>	<u>ITEM DESCRIPTION</u>
POCB-NRC	SYSTEMATIX 2 1/2" X 10" NITRATE/SULPHATE CARTRIDGE - 7500PPM
POCB-NRC+	SYSTEMATIX 2 1/2" X 10" NITRATE/SULPHATE CARTRIDGE - 5000PPM
POCB50-NRC	SYSTEMATIX 4.5" X 20" BB NITRATE REMOVAL CARTRIDGE

## FLUORIDE REDUCTION CARTRIDGES - ACTIVATED ALUMINA

Using an Aluminum Oxide media it effectively reduces over 90% of fluoride from typical municipal water. Capable of capturing arsenic or lead; Requirements vary.

<u>PART NUMBER</u>	<u>ITEM DESCRIPTION</u>
POCB50-AAL	NUWATER 4 1/2" X 20" ACTIVATED ALUMINA FLUORIDE REDUCTION CARTRIDGE
POCB20-AAL	NUWATER 2 1/2" X 20" ACTIVATED ALUMINA FLUORIDE REDUCTION CARTRIDGE
POCB-AAL	NUWATER 2 1/2" X 10" ACTIVATED ALUMINA FLUORIDE REDUCTION CARTRIDGE

## SILVER CARBON CARTRIDGES

Silver Impregnated Carbon is proven to stop the growth of ash/dust fed bacteria.

<u>PART NUMBER</u>	<u>ITEM DESCRIPTION</u>
POCB50-AAL	NUWATER 4 1/2" X 20" ACTIVATED ALUMINA FLUORIDE REDUCTION CARTRIDGE
POCB20-AAL	NUWATER 2 1/2" X 20" ACTIVATED ALUMINA FLUORIDE REDUCTION CARTRIDGE
POCB-AAL	NUWATER 2 1/2" X 10" ACTIVATED ALUMINA FLUORIDE REDUCTION CARTRIDGE



PRECISION  
INSTALLATION  
PRODUCTS

# WATER TREATMENT

Water Filters

## Replacement Cartridges

### ALKALINE CARTRIDGES

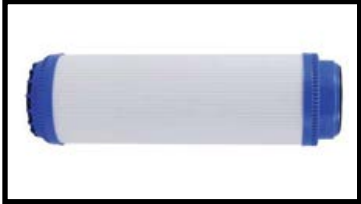

Alkaline ceramic balls made of high grade clay and tourmaline; to adjust raise the water's pH (increasing pH level up to 8.5-9.5). Supplies minerals such as Ca, K, Na, Mg.

<u>PART NUMBER</u>	<u>ITEM DESCRIPTION</u>
POCB-ALK	NUWATER 2 1/2" X 10" ALKALINE CARTRIDGE (CASE IS 20)
POCB20X-ALK	HYDRONIX 2 1/2" X 20" BIO CERAMIC ALKALINE CARTRIDGE
POCB50X-ALK	HYDRONIX 4 1/2" X 20" BIO CERAMIC ALKALINE CARTRIDGE
POCB28X-ALK	HYDRONIX 2 1/2" X 10" BIO CERAMIC ALKALINE CARTRIDGE
POCB30X-ALK	HYDRONIX 4 1/2" X 10" BIO CERAMIC ALKALINE CARTRIDGE

### ARSENIC REMOVAL CARTRIDGES

Arsenic removal cartridges use a hybrid anion ion exchange resin infused with iron oxide for efficient, selective removal of arsenic. It also captures and removes nitrate, uranium, chromate and other objectionable anions. Certified to NSF/ANSI 61 Standard.

<u>PART NUMBER</u>	<u>ITEM DESCRIPTION</u>
POCB-ASC	NUWATER 2 1/2" X 10" ARSENIC REDUCTION CARTRIDGE
POCB30-ASC	SYSTEMATIX 4.5" X 10" BIG BLUE ARSENIC REDUCTION CARTRIDGE (CASE 4)
POCB50-ASC	SYSTEMATIX 4.5" X 20" BIG BLUE ARSENIC REDUCTION CARTRIDGE.. (CASE 4)

### KDF55 W/ LAYERED GAC CARTRIDGES

Applications: Chlorine, Heavy Metal Removal and Bacteria.

<u>PART NUMBER</u>	<u>ITEM DESCRIPTION</u>
POCB-KDF-1/2	HYDRONIX 2 1/2" X 10" GAC CARTRIDGE W/ 1/2 LBS KDF55 MEDIA
POCB20-KDF-1.5	SYSTEMATIX 2 1/2" X 20" LAYERED GAC CARTRIDGE W/ 1-1/2 LBS KDF55 MEDIA
POCB30-KDF-1.5	SYSTEMATIX 4.5" X 10" BIG BLUE LAYERED GAC CARTRIDGE W/ 1-1/2 LBS KDF55 MEDIA
POCB50-XF	HYDRONIX 4 1/2" X 20" BB GAC CARTRIDGE W/ 2 LBS KDF55 MEDIA

# WATER TREATMENT

## Water Filters

### Replacement Cartridges



PRECISION  
INSTALLATION  
PRODUCTS

## KDF85 W/ LAYERED GAC CARTRIDGES

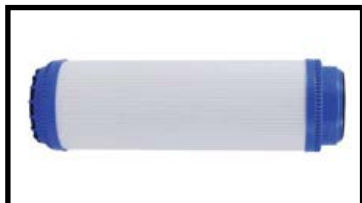

Applications: Chloramine Reduction, Chlorine, Heavy Metal Removal and Bacteria.

<u>PART NUMBER</u>	<u>ITEM DESCRIPTION</u>
POCB-KDF85-.25	SYSTEMATIX 2 1/2" X 10" LAYERED GAC CARTRIDGE WITH .25LBS KDF 85 MEDIA
POCB-KDF85-.50	SYSTEMATIX 2 1/2" X 10" LAYERED GAC CARTRIDGE W/ .5LBS KDF 85 MEDIA
POCB-KDF85-1.0	SYSTEMATIX 2 1/2" X 10" LAYERED GAC CARTRIDGE WITH 1 LBS KDF 85 MEDIA
POCB-KDF85-1.5	SYSTEMATIX 2 1/2" X 10" LAYERED GAC CARTRIDGE WITH 1.5 LBS KDF 85 MEDIA
POCB-KDF85-2.5	SYSTEMATIX 2 1/2" X 10" LAYERED GAC CARTRIDGE WITH 2.5 LBS KDF 85 MEDIA
POCB-KDF85-4.0	SYSTEMATIX 2 1/2" X 10" LAYERED GAC CARTRIDGE WITH 4 LBS KDF 85 MEDIA
POCB-KDF85-ALL	SYSTEMATIX 2 1/2" X 10" ALL KDF 85 CARTRIDGE (5 LBS)
POCB20-KDF85-1.5	SYSTEMATIX 2 1/2" X 20" LAYERED GAC CARTRIDGE W/ 1-1/2 LBS KDF85 MEDIA
POCB30-KDF85-2.0	SYSTEMATIX 4.5" X 10" LAYERED GAC CARTRIDGE WITH 2.0 LBS KDF 85 MEDIA
POCB50-KDF85-4.0	SYSTEMATIX 4.5" X 20" BIG BLUE LAYERED GAC & 4.0 LBS OF KDF85 CARTRIDGE



PRECISION  
INSTALLATION  
PRODUCTS

# WATER TREATMENT

Water Filters

Inline Filters

## KDF85 W/ LAYERED CATALYTIC CARBON CARTRIDGES

Applications: Chloramine Removal, Chlorine, Heavy Metal Removal and Bacteria.

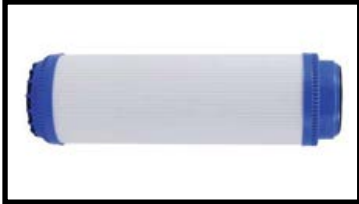

<u>PART NUMBER</u>	<u>ITEM DESCRIPTION</u>
POCB-CAT-KDF85-.25	SYSTEMATIX 2 1/2" X 10" LAYERED CATALYTIC CARBON WITH .25 LBS KDF 85
POCB-CAT-KDF85-.50	SYSTEMATIX 2 1/2" X 10" LAYERED CATALYTIC CARBON WITH .50 LBS KDF 85
POCB-CAT-KDF85-1.0	SYSTEMATIX 2 1/2" X 10" LAYERED CATALYTIC CARBON WITH 1 LBS KDF 85
POCB-CAT-KDF85-1.5	SYSTEMATIX 2 1/2" X 10" LAYERED CATALYTIC CARBON WITH 1.5 LBS KDF 85
POCB-CAT-KDF85-2.0	SYSTEMATIX 2 1/2" X 10" LAYERED CATALYTIC CARBON WITH 2.0 LBS KDF 85
POCB-CAT-KDF85-2.5	SYSTEMATIX 2 1/2" X 10" LAYERED CATALYTIC CARBON WITH 2.5 LBS KDF 85
POCB20-CAT-KDF85-1.5	SYSTEMATIX 2 1/2" X 20" LAYERED CATALYTIC CARBON WITH 1.5 LBS KDF 85
POCB30-CAT-KDF85-1.0	SYSTEMATIX 4.5" X 10" BB LAYERED CATALYTIC CARBON WITH 1 LB KDF 85- CASE OF 4
POCB50-CAT-KDF85-2.5	SYSTEMATIX 4.5" X 20" BB LAYERED CATALYTIC CARBON WITH 2.5 LBS OF KDF85
POCB50-CAT-KDF85-3.0	SYSTEMATIX 4.5" X 20" BB LAYERED CATALYTIC CARBON WITH 3.0 LBS OF KDF85

# WATER TREATMENT

## Water Filters

### Omnipure Carbon Block



PRECISION  
INSTALLATION  
PRODUCTS

## OMNIPURE CARBON BLOCK SERIES



Manufactured entirely from FDA approved materials, the OmnipureBlock™ is suitable for residential point-of-use water filtration, as well as, commercial and food service applications. The OmnipureBlock is manufactured from high purity activated carbon and is designed to fit most standard household and commercial housings. NSF approved and USA made.

<u>PART NUMBER</u>	<u>ITEM DESCRIPTION</u>
PCB975-1/2M	OMNIPURE CARBON BLOCK - 9 3/4" X 2 1/2" FILTER - 1/2 MICRON - NSF
PCB975-1/2M-FR	OMNIPURE CARBON BLOCK - 9 3/4" X 2 1/2" FILTER - 1/2 MICRON - W/ FLOW RESTRICTOR CAPS - NSF
PCB975-1M	OMNIPURE CARBON BLOCK - 9 3/4" X 2 1/2" FILTER - 1 MICRON - NSF
PCB975-1ML	OMNIPURE CARBON BLOCK - 9 3/4" X 2 1/2" FILTER - 1 MICRON - LEAD REDUCTION - NSF
PCB975G-1M	OMNIPURE CARBON BLOCK - 9 3/4" X 2 1/2" FILTER - 1 MICRON - PHOSPHATE - NSF
PCB975-5M	OMNIPURE CARBON BLOCK - 9 3/4" X 2 1/2" FILTER - 5 MICRON - NSF (CASE IS 20)
PCB975G-5M	OMNIPURE CARBON BLOCK - 9 3/4" X 2 1/2" FILTER - 5 MICRON - PHOSPHATE - NSF
PCB975-10M	OMNIPURE CARBON BLOCK - 9 3/4" X 2 1/2" FILTER - 10 MICRON - NSF (CASE IS 20)
PCB200-1/2M	OMNIPURE 20" CARBON BLOCK FILTER - 1/2 MICRON - DOMESTIC *OVERSTOCK SPECIAL *
PCB200G-1/2M	OMNIPURE 20" CARBON BLOCK FILTER W/ PHOSPHATE - 1/2 MICRON - DOMESTIC
PCB200G-1M	OMNIPURE 20" CARBON BLOCK FILTER W/ PHOSPHATE - DOMESTIC *OVERSTOCK SPECIAL *
PCB200-1M	OMNIPURE 20" CARBON BLOCK FILTER - 1 MICRON - DOMESTIC *OVERSTOCK SPECIAL *
PCB200-5M	OMNIPURE 20" CARBON BLOCK FILTER - 5 MICRON - DOMESTIC
PCB200G-5M	OMNIPURE 20" CARBON BLOCK FILTER W/ PHOSPHATE - 5 MICRON
PCB200	OMNIPURE 20" CARBON BLOCK FILTER - 10 MICRON - DOMESTIC
PCB200G-10M	OMNIPURE 20" X 2 1/2" CARBON BLOCK - 10 MICRON-PHOSPHATE



**PRECISION  
INSTALLATION  
PRODUCTS**

# WATER TREATMENT

## Water Filters

### Omnipure CL-Series Filters

#### CL SERIES

#### Specification table for the CL-Series Inline Filters and the OC-Series of Carbon Cartridges

Every Omnipure filter undergoes rigorous testing and independent verification for performance. Each filter is rated at .5 gpm with a maximum pressure of 125 psi and a maximum temperature of 100° F. Every cartridge is rated at 1.0 gpm.

Description application	model number	Filter Length	Volume Cubic Inch	Service Life Gal. or 1 year	Degree of nominal Filtration	Connection Size
Taste and odor reduction down to 10 microns. Granular Activated Carbon.	PCL6	6"	8.3	1000	10 microns	3/8"
	PCL10	10"	16.6	1500	10 microns	3/8"
Dirt, sand and sediment removal. Polypropylene filtration.	PCL6-F5	6"	NA	NA	5 microns	1/4"
	PCL-F5	10"	NA	NA	5 microns	1/4"
Taste and odor reduction. Specifically designed for R.O. or distillation units. Granular activated Carbon.	PCL6RO-BL	6"	8.3	1000	5 microns	1/4"
	PCL10RO	10"	16.6	1500	5 microns	1/8", 1/4", 3/8"
	PCL10RO-T/33	10"	16.6	1500	5 microns	1/4"
Taste and odor reduction. Equipment scaling protection.	PCL6G	6"	8.3	750 gal. or 6 months	10 microns	1/4"
	PCL10G	10"	16.6	1250 gal. or 6 months	10 microns	1/4", 3/8"
Replacement cartridges for standard housings. Taste and odor reduction. GAC.	POCB28	10"	56	5000	10 microns	NA
	POCB33	10"	56	5000	10 microns	NA
	POCB40	10"	56	5000	10 microns	NA

Omnipure products have been tested and listed under Standard 42 for taste, odor and chlorine reduction; or particulate reduction; or have been materials certified All filters should be installed on cold water lines only.

Note: Activated carbon filters are not intended to be used where the water is microbiologically unsafe or with water of unknown quality without adequate disinfection before or after the unit.

# WATER TREATMENT

## Water Filters

### Omnipure CL-Series Filters



PRECISION  
INSTALLATION  
PRODUCTS

## TASTE AND ODOR REMOVAL - CL SERIES



Designed to remove impurities that can cause unwanted taste and odor in water, the CL Series utilizes Granular Activated Coco-Shell Carbon for the removal of Chlorine and other contaminants down to 10 Micron. These filters are ideal for point of use applications.

<u>PART NUMBER</u>	<u>ITEM DESCRIPTION</u>
PCL10-6	OMNIPURE 10" TASTE/ODOR INLINE FILTER W/ 3/8" FPT TAP

## HARD WATER PROTECTION - SCL SERIES

The SCL Series combines granular activated carbon with polyphosphate resulting in the removal of contaminants that can cause taste and odor in water as well as reduce or eliminate Lime Scale that is associated with "Hard Water." This Series is ideal for the protection of equipment.

<u>PART NUMBER</u>	<u>ITEM DESCRIPTION</u>
PCL6G	OMNIPURE 6" GAC W/LIME SCALE INHIBITOR INLINE FILTER - 1/4" FPT
PCL10G-4J	OMNIPURE 10" X 2" GAC/LIME SCALE INHIBITOR INLINE FILTER W/ 1/4" JG
PCL10G-6J	OMNIPURE 10" X 2" GAC/LIME SCALE INHIBITOR INLINE FILTER W/ 3/8" JG
PCL12G-25	OMNIPURE 12" X 2 1/2" SCALE/CARBON INLINE FILTER W/ 1/4" FPT



PRECISION  
INSTALLATION  
PRODUCTS

# WATER TREATMENT

## Water Filters

### Omnipure CL-Series Filters

## R.O. SYSTEM CARBON FILTERS - CL "RO" SERIES



Specifically designed to handle the Ultra-Pure water produced by reverse osmosis and distillation systems. Granular Activated Coco-Shell Carbon is used primarily as a Pre-Filter and in slower flow conditions, such as between a membrane and storage tank, and as a Post-Filter. Filtration is effective down to 5 Micron.

<u>PART NUMBER</u>	<u>ITEM DESCRIPTION</u>
PCL6RO-BL	OMNIPURE 6" RO BLACK INLINE FILTER - 1/4" FPT TAP
PCL10RO-2	OMNIPURE 10" RO INLINE FILTER W/ 1/8" TAP
PCL10RO-4ST	OMNIPURE 10" RO INLINE FILTER W/ 1/4" STEMS
PCL10RO-6J	OMNIPURE 10" RO INLINE FILTER W/ 3/8" PUSH LOCK ENDS
PCL10RO-T/40	OMNIPURE 2" X 10" RO INLINE CARBON BLOCK T/40 FILTER - 1/4" FPT PORTS

## SEDIMENT FILTERS - CL "F5" SERIES

Developed to remove dirt, sand and sediment that can cause damage to downline equipment. These filters utilize a Multi-Layer Depth Filtration construction that results in the removal of sediment down to 25 or 5 Microns.

<u>PART NUMBER</u>	<u>ITEM DESCRIPTION</u>
PCL6-F5	OMNIPURE 6" IN-LINE PREFILTER - 5 MICRON
PCLF5	OMNIPURE 10" IN-LINE SEDIMENT FILTER - 5 MICRON WITH 1/4" FPT

## SCALE INHIBITOR FILTERS - CL "SL" SERIES

These filters are designed with 100% Polyphosphate to stop scale and rust formation. This holds contaminants in suspension, which prevents reaction in your pipes and/or equipment.

<u>PART NUMBER</u>	<u>ITEM DESCRIPTION</u>
PSL6	OMNIPURE 2" X 6" ALL PHOSPHATE INLINE FILTER - 1/4" FPT TAP
PSL6-6	OMNIPURE 2" X 6" ALL PHOSPHATE INLINE FILTER - 3/8" FPT TAP
PSL10	OMNIPURE 2" X 10" ALL PHOSPHATE INLINE FILTER - 1/4" FPT TAP
PSL10-6	OMNIPURE 2" X 10" ALL PHOSPHATE INLINE FILTER - 3/8" FPT TAP



# WATER TREATMENT

## Water Filters

### Omnipure CL-Series Filters



PRECISION  
INSTALLATION  
PRODUCTS

## KDF MEDIA FILTERS - CL "KDF MEDIA" SERIES



Specifically designed to handle special water conditions, and the impurities found in it. 1/2" CarBO<sub>n</sub> & 1/2" KDF. A long-lasting, patented medium for Dechlorination and removal of other problem contaminants: Can last for 3 years. KDF is a unique media which can be backwashed much more effectively than activated carbon.

<u>PART NUMBER</u>	<u>ITEM DESCRIPTION</u>
PXF10	OMNIPURE 2" X 10" INLINE FILTER W/ 50% KDF55 & 50% GAC W/ 1/4"FPT
PXF10-4JG	OMNIPURE 2" X 10" INLINE FILTER W/ 50% KDF55 & 50% GAC W/ 1/4"JG
PXF10-6	OMNIPURE 2" X 10" INLINE FILTER W/ 50% KDF55 & 50% GAC W/ 3/8"FPT
P25XF10	OMNIPURE 2 X 10 100% KDF55 INLINE FILTER W/ 1/4" FPT

## SPECIAL MEDIA FILTERS - CL SERIES

These filters are designed with Speical media to resolve extraordinary filter problems.

<u>PART NUMBER</u>	<u>ITEM DESCRIPTION</u>
PCL10AAL-4JG	NUWATER 2" X 10" INLINE ACTIVATED ALUMINA FLUORIDE REDUCTION CARTRIDGE-1/4" JG - WHITE SHELL
PCL10AAL-6JG	NUWATER 2" X 10" INLINE ACTIVATED ALUMINA FLUORIDE REDUCTION CARTRIDGE - 3/8" JG - WHITE SHELL
PCL10LD	OMNIPURE 10" TASTE/ ODOR/ LEAD/ CHLORINE REDUCTION INLINE FILTER - 1/4" FPT



**PRECISION  
INSTALLATION  
PRODUCTS**

# WATER TREATMENT

Water Filters

## Omnipure K-Series Filters

### THE K-SERIES FROM OMNIPURE

K-Series lengths are 6", 8", 10", 12", available in 2" and 2-1/2" diameters. Volumes reach 35 cu.in. and service life maximums of 2500 gallons. Quick-Connect fittings are available in 1/4" and 3/8". Female Pipe Thread are offered in 1/8", 1/4" and 3/8". All standard media and custom fills are available.

- Ice makers
- Beverage equipment
- In conjunction with purification system
- Under the counter
- R.O. Systems
- Drinking Fountains

## R.O. SYSTEM CARBON FILTERS - CL "RO" SERIES



Developed to remove dirt, sand and sediment that can cause damage to downline equipment. These filters utilize a Multi-Layer Depth Filtration construction that results in the removal of sediment down to 5 Micron.

<u>PART NUMBER</u>	<u>ITEM DESCRIPTION</u>
P2305-4JG	OMNIPURE 2" x 6" 5 MICRON INLINE SEDIMENT FILTER W/ 1/4"JG ENDS
P2505-4JG	OMNIPURE 2" X 10" 5-MICRON SEDIMENT FILTER W/ 1/4 JG
P2505-6	OMNIPURE 2" X 10" 5-MICRON SEDIMENT FILTER W/ 3/8 FPT
P2505-6JG	OMNIPURE 2" X 10" 5-MICRON SEDIMENT FILTER W/ 3/8 JG
P5305	OMNIPURE 2 1/2 X 6 SEDIMENT 5-MICRON FILTER - 1/4" FPT
P5305-6	OMNIPURE 2 1/2 X 6 SEDIMENT 5-MICRON FILTER - 3/8" FPT
P5505	OMNIPURE 2 1/2 X 10 SEDIMENT 5-MICRON FILTER
P5505-4JG	OMNIPURE 2 1/2 x 10 5 MICRON SEDIMENT W/1/4 " JG
P5505-6	OMNIPURE 2 1/2 X 10 SEDIMENT 5-MICRON FILTER W 3/8" FPT
P5605	OMNIPURE 2 1/2 X 12 INLINE FILTER-5 MICRON SEDIMENT-1/4 FPT
P5605-4JG	OMNIPURE 2 1/2 X 12 INLINE FILTER - 5 MICRON SEDIMENT - 1/4JG

## TASTE AND ODOR REMOVAL GAC - FILTERS K-SERIES

Designed to reduce impurities that can cause unwanted taste and odor in water, the filter utilizes T-28 Coco Shell Granular Activated Carbon for the reduction of chlorine and other contaminants down to 5 Microns. These filters are ideal for point of use applications.

<u>PART NUMBER</u>	<u>ITEM DESCRIPTION</u>
P2328-4JG	OMNIPURE 2" x 6" GAC T-28 COCO SHELL CARBON INLINE FILTER W/ 1/4"JG *OVERSTOCK SPECIAL*
P2328-6JG	OMNIPURE 2" x 6" GAC T-28 COCO SHELL CARBON INLINE FILTER W/ 3/8"JG ENDS
P5428-4JG	OMNIPURE 2 1/2" X 8" LENGTH RO PREFILTER-T/28 CARBON W/1/4" JG *OVERSTOCK SPECIAL*
P5528-4JG	OMNIPURE 2 1/2" X 10" GAC COCO SHELL CARBON INLINE W/ 1/4" JG
P5528-6	OMNIPURE 2 1/2"X 10" POST RO CARBON - T/28 FILTER W/ 3/8" FPT
P5628-6	OMNIPURE 2 1/2 X 12 INLINE FILTER - T/28 CARBON - 3/8 FPT
P5605-4JG	OMNIPURE 2 1/2 X 12 INLINE FILTER - 5 MICRON SEDIMENT - 1/4JG

# WATER TREATMENT

## Water Filters

### Omnipure K-Series Filters



PRECISION  
INSTALLATION  
PRODUCTS

## R.O. SYSTEMS GAC FILTERS K SERIES



Specifically designed to handle the Ultra-Pure water produced by Reverse Osmosis and Distillation Systems. T-33 Coco Shell Granular Activated Carbon is used for slower flow conditions, such as between a membrane and storage tank, and as a Post-Filter.

<u>PART NUMBER</u>	<u>ITEM DESCRIPTION</u>
P2333	OMNIPURE 2" X 6" GAC T-33 COCO SHELL INLINE FILTER W/ 1/4" FPT ENDS
P2333-4JG	OMNIPURE 2" X 6" GAC T-33 COCO SHELL GAC INLINE FILTER W/ 1/4" JG ENDS
P2333-6JG	OMNIPURE 2" X 6" GAC T-33 COCO SHELL GAC INLINE FILTER W/ 3/8" JG ENDS
P2533-4JG	OMNIPURE 2" X 10" RO INLINE CARBON-T/33 FILTER W/ 1/4 JOHN GUEST ENDS
P2533-6JG	OMNIPURE 2" X 10" RO INLINE CARBON-T/33 FILTER W/ 3/8 JG ENDS
P5433-4JG	OMNIPURE 2 1/2" X 8" LENGTH RO POLISHING-T/33 CARBON W/ 1/4" JG *OVERSTOCK SPECIAL*
P5433-6JG	OMNIPURE 2 1/2" X 8" LENGTH RO POLISHING FILTER-T/33 CARBON W/3/8" JG *OVERSTOCK SPECIAL*
P5533	OMNIPURE 2 1/2" X 10" POST RO CARBON - T/33 FILTER W/ 1/4" FPT
P5533-4JG	OMNIPURE 2 1/2" X 10" COCO SHELL GAC INLINE W/ 1/4 JG
P5633	OMNIPURE 2 1/2 X 12 T/33 GAC INLINE FILTER - COCO SHELL CARBON - 1/4 FPT
P5633-4JG	OMNIPURE 2 1/2 X 12 T/33 GAC INLINE FILTER - COCO SHELL CARBON - 1/4 QC ENDS

## HARD WATER PROTECTION - K SERIES

Combined Coco Shell Granular Activated Carbon with Polyphosphate results in the reduction of contaminants that can cause taste and odor in water, as well as reduce or eliminate lime scale that is associated with "Hard Water."

<u>PART NUMBER</u>	<u>ITEM DESCRIPTION</u>
P2386-4JG	OMNIPURE 2" X 6" GAC/POLY PHOSPHATE FILTER W/ 1/4" JG
P2386-6JG	OMNIPURE 2" X 6" GAC/POLY PHOSPHATE FILTER W/ 3/8" JG *OVERSTOCK SPECIAL*
P2586-6	OMNIPURE 2 X 10 CARBON W/ POLYPHOSPHATE INLINE FILTER W/ 3/8" FPT
P5686-4JG	OMNIPURE 2-1/2" X 12" CARBON W/ POLYPHOSPHATE INLINE FILTER W/ 1/4" JG
P5686-6JG	OMNIPURE 2-1/2" X 12" CARBON W/ POLYPHOSPHATE INLINE FILTER W/ 3/8" JG



PRECISION  
INSTALLATION  
PRODUCTS

# WATER TREATMENT

Water Filters

## Omnipure K-Series Filters

### SPECIAL MEDIA FILTERS - K SERIES



Specially designed to treat abnormal water conditions.

<u>PART NUMBER</u>	<u>ITEM DESCRIPTION</u>
P2330-4JG	OMNIPURE 2" X 6" SILVER (X262) POST CARBON INLINE FILTER W/ 1/4"JG ENDS
P2350-6JG	OMNIPURE 2" X 6" 1/3 CALCITE - 2/3 GAC INLINE FILTER W/ 3/8"JG ENDS
P2355	OMNIPURE 2" X 6" DI RESIN INLINE FILTER W/ 1/4"FPT ENDS
P2355-4JG	OMNIPURE 2" X 6" DI RESIN INLINE FILTER W/ 1/4"JG ENDS
P2355-6	OMNIPURE 2" X 6" DI RESIN INLINE FILTER W/ 3/8"FPT ENDS
P2355-6JG	OMNIPURE 2" X 6" DI RESIN INLINE FILTER W/ 3/8"JG ENDS
P2370-4JG	OMNIPURE 2" X 6" 50% SILVER & 50% KDF55 POLISHING INLINE FILTER W/ 1/4"JG *OVERSTOCK SPECIAL *
P2521	OMNIPURE 2" X 10" INLINE CARBON BLOCK -10MICRON W/ 1/4" FEMALE PIPE THREADS
P2521-4JG	OMNIPURE 2" X 10" INLINE CARBON BLOCK -10 MICRON W/ 1/4" JOHN GUEST
P2521-6JG	OMNIPURE 2" X 10" INLINE CARBON BLOCK -10 MICRON W/ 3/8" JG
P2533	OMNIPURE 2" X 10" T/33 GAC INLINE CARBON FILTER - COCO SHELL CARBON - 1/4" FPT
P2533-6	OMNIPURE 2" X 10" RO INLINE CARBON T/33 FILTER - 3/8 FPT
P2548	OMNIPURE 2" X 10" ALL CALCITE INLINE FILTER W/ 1/4" FPT
P2548-4JG	OMNIPURE 2" X 10" ALL CALCITE INLINE FILTER W/ 1/4" JOHN GUEST
P2548-6JG	OMNIPURE 2" X 10" ALL CALCITE INLINE FILTER W/ 3/8" JOHN GUEST
P2549	OMNIPURE 2" X 10" INLINE REMINERALIZATION CARTRIDGE - 1/3 CALCITE+1/3 MAGNESIUM+1/3 GAC W/ 1/4"FPT
P2549-4JG	OMNIPURE 2" X 10" INLINE REMINERALIZATION CARTRIDGE - 1/3 CALCITE+1/3 MAGNESIUM+1/3 GAC W/ 1/4"JG
P2549-6JG	OMNIPURE 2" X 10" INLINE REMINERALIZATION CARTRIDGE - 1/3 CALCITE+1/3 MAGNESIUM+1/3 GAC W/ 3/8"JG
P2551	OMNIPURE 2" X 10" INLINE FILTER - 50% CALCITE / 50% GAC W/ 1/4" FPT ENDS
P2551-4JG	OMNIPURE 2" X 10" INLINE FILTER - 50% CALCITE / 50% GAC W/ 1/4"JG ENDS
P2551-6JG	OMNIPURE 2" X 10" INLINE FILTER - 50% CALCITE / 50% GAC W/ 3/8"JG ENDS
P2554	OMNIPURE 2" X 10" 100% CATION SOFTENING RESIN (C249) INLINE FILTER - 1/4"FPT
P2555	OMNIPURE 2 X 10 INLINE 100% DI RESIN FILTER W/ 1/4" FPT ENDS
P2555-4JG	OMNIPURE 2 X 10 INLINE 100% DI RESIN FILTER W/ 1/4" JG ENDS
P2555-6JG	OMNIPURE 2" X 10" 100% D.I. RESIN INLINE FILTER W/ 3/8" JG ENDS

# WATER TREATMENT

## Water Filters

### Omnipure K-Series Filters



PRECISION  
INSTALLATION  
PRODUCTS

## SPECIAL MEDIA FILTERS - K SERIES



Specially designed to treat abnormal water conditions.

<u>PART NUMBER</u>	<u>ITEM DESCRIPTION</u>
P2556	OMNIPURE 2" X 10" 2/3 RESIN (C100E) & 1/3 GAC INLINE FILTER - 1/4" FPT
P2556-6JG	OMNIPURE 2" X 10" INLINE FILTER - 2/3 C249 RESIN + 1/3 GAC W/ 3/8" JG
P5430-4JG	OMNIPURE 2 1/2" X 8" LENGTH SILVER POST CARBON W/ 1/4 JG
P5467-4JG	OMNIPURE 2 1/2 x 8 KDF55/GAC POST CARBON W/ 1/4" JG
P5470-4JG	OMNIPURE 2 1/2 x 8 POLISH 50% SILVER-50% KDF55 W/ 1/4" JG *OVERSTOCK SPECIAL*
P5515-4	OMNIPURE 2 1/2 X 10 CARBON BLOCK-1M CYST/LEAD RED W/ 1/4" FPT
P5515-4JG	OMNIPURE 2 1/2 X 10 CARBON BLOCK-1M CYST/LEAD RED W/ 1/4" JG *OVERSTOCK SPECIAL*
P5520-4JG	OMNIPURE 2 1/2" X 10" INLINE CARBON BLOCK - 1 MICRON WITH 3% KDF W/ 1/4" JG ENDS
P5530	OMNIPURE 2 1/2" X 10" SILVER IMPREG CARBON - 1/4" FPT *OVERSTOCK SPECIAL*
P5540-6	OMNIPURE 2 1/2" X 10" GAC T/40 COCO SHELL CARBON W/ 3/8" FPT ENDS
P5555	OMNIPURE 2 1/2" X 10" INLINE FILTER-100% MIXED BED DI RESIN-1/4" FEMALE PIPE THREAD PORTS
P5567-1M-4JG	OMNIPURE 2 1/2 X 10 GAC W/ 1/2LB KDF55 INLINE FILTER W/ 1 MICRON PAD - 1/4" JG ENDS
P5615-4JG	OMNIPURE 2 1/2 X 12 CARBON BLOCK-1M CYST/LEAD RED W/ 1/4" JG
P5615-6JG	OMNIPURE 2 1/2 X 12 CARBON BLOCK-1M CYST/LEAD RED W/ 3/8" JG
P5625	OMNIPURE 2 1/2 X 12 INLINE FILTER - 1/2 SEDIMENT & 1/2 GAC - 1/4" FPT *OVERSTOCK SPECIAL*
P5654	OMNIPURE 2 1/2" X 12" 100% RESIN INLINE FILTER - 1/4" FPT
P5586	OMNIPURE 2 1/2 X 10 CARBON W/ POLYPHOSPHATE-1/4" FEMALE PIPE THREAD PORTS
P5655	OMNIPURE 2 1/2" X 12" INLINE FILTER - 100% MIXED BED DI RESIN - 1/4" FPT PORTS
P5655-6	OMNIPURE 2 1/2" X 12" INLINE FILTER-100% MIXED BED DI RESIN-3/8" FPT PORTS



**PRECISION  
INSTALLATION  
PRODUCTS**

# WATER TREATMENT

Water Filters

## Omnipure E-Series Filters

### OMNIPURE E-SERIES REPLACEMENT FILTERS

The Omnipure cap is reinforced to ensure structural integrity under extreme pressure variances and features a dual o-ring system that provides an even, consistent seal while preventing seepage or weeping.

## TASTE & ODOR REDUCTION - GAC 20 X 50 MESH NON-RINSED



Designed to reduce impurities that can cause unwanted taste and odor in water; for the reduction of chlorine and other contaminants down to 10 Microns.

<u>PART NUMBER</u>	<u>ITEM DESCRIPTION</u>
PE-6	OMNIPURE 6" - 1250 GALLONS GAC T-28 COCO SHELL CARBON CARTRIDGE FOR EVERPURE *OVERSTOCK SPECIAL *
PE-12	OMNIPURE 12" - 2500 GAL - GAC T/28 COCO SHELL CARBON CARTRIDGE FOR EVERPURE

## LEAD, CYST, TASTE & ODOR REDUCTION CARBON BLOCK TREATED WITH LEAD SPECIFIC MEDIA

Fine grain activated carbon in block form treated with lead specific media. Ideal for polishing potable water while reducing undesirable contaminants such as lead and cysts down to 1 Micron.

<u>PART NUMBER</u>	<u>ITEM DESCRIPTION</u>
PE-6CB-1M	OMNIPURE 6" - 727 GALLON 1 MICRON CARBON BLOCK FILTER FOR EVERPURE *OVERSTOCK SPECIAL *
PE-10CB-5M-P	OMNIPURE 10" - 2500 GAL - 5 MICRON CARBON BLOCK W/SCALE INHIBITOR FOR EVERPURE
PE-10CB-1ML	OMNIPURE 10" - 1200 GAL 1M CARBON BLOCK - LEAD REDUCING REPLACEMENT FOR EVERPURE *OVERSTOCK SPEC...
PE-12CB-1M	OMNIPURE 12" - 3000 GALLON 1M CARBON BLOCK REPLACEMENT FOR EVERPURE
PE-12CB-1M-P	OMNIPURE 12" - 3000 GAL - 1 MICRON CARBON BLOCK W/SCALE INHIBITOR FOR EVERPURE
PE-12CB-1ML	OMNIPURE 12" - 1500 GAL 1 MIC CARBON BLOCK W/ LEAD -CYST FOR EVERPURE
PE-14CB-1M	OMNIPURE 14" - 3500 GALLON 1M CARBON BLOCK FOR EVERPURE
PE-14CB-1M-P	OMNIPURE 14" - 3500 GAL-1 MICRON CARBON BLOCK W/SCALE INHIBITOR FOR EVERPURE

# WATER TREATMENT

## Water Filters

### Omnipure E-Series Filters



PRECISION  
INSTALLATION  
PRODUCTS

## HARD WATER PROTECTION - GAC & POLYPHOSPHATE FOR SCALE INHIBITOR AND TASTE & ODOR REDUCTION



Combined activated carbon with polyphosphate results in the reduction of contaminants that can cause taste and odor in water as well as reduce or eliminate lime scale that is associated with "Hard Water." This media combination is ideal for the protection of equipment.

<u>PART NUMBER</u>	<u>ITEM DESCRIPTION</u>
PE-6P	OMNIPURE 6" - 1000 GAL GAC CARBON W/ PHOSPHATE FOR EVERPURE
PE-12P	OMNIPURE 12" - 2000 GAL CARBON W/ PHOSPHATE REPLACEMENT FOR EVERPURE
PE-14P	OMNIPURE 14" - 2500 GALLON GAC CARBON W/ PHOSPHATE FOR EVERPURE

## TASTE AND ODOR REDUCTION - 10 MICRON CARBON BLOCK W/ SCREEN & SMALL BAYONETTE END

<u>PART NUMBER</u>	<u>ITEM DESCRIPTION</u>
PESB-14CB-P-SCREENS	OMNIPURE 14" 10 MICRON CARBON BLOCK W/ PHOSPHATE & SCREENS-SMALL BAYONETTE - EVERPURE REPLACEMENT...
PESB-14CB-SCREENS	OMNIPURE 14" 10 MICRON CARBON BLOCK W/ SCREENS - SMALL BAYONETTE - EVERPURE REPLACEMENT - 3,500 ...

## WATER SOFTENING - 700 GRAIN WATER SOFTENING RESIN

Primarily used for espresso machines to protect equipment.

<u>PART NUMBER</u>	<u>ITEM DESCRIPTION</u>
PE-12RES	OMNIPURE 12" 100% SOFTENING RESIN REPLACEMENT FOR EVERPURE
PE-14DI	OMNIPURE 14" DI RESIN CARTRIDGE FOR EVERPURE
PE-12P-100%	OMNIPURE 12" 100% PHOSPHATE FILTER CARTRIDGE FOR EVERPURE

## BRACKETS & HEADS - E - SERIES & ELF SERIES

<u>PART NUMBER</u>	<u>ITEM DESCRIPTION</u>
PE/ELF-HEAD	OMNIPURE ELF & E SERIES HEAD - NON-VALVED W/ 3/8" FPT PORTS
PE/ELF-HEAD-QC	OMNIPURE ELF & E SERIES HEAD - NON-VALVED W/ 3/8" QC PORTS
PELF-BRACKET-STEEL	OMNIPURE ELF STEEL BRACKET W/ SCREWS - FOR ELF VALVE HEADS ONLY
PELF-BRACKET	OMNIPURE G, ELF & E OMNIPURE SERIES PLASTIC BRACKET W/ SCREWS



**PRECISION  
INSTALLATION  
PRODUCTS**

# WATER TREATMENT

Water Filters

## Omnipure Q-Series Filters

### CONVENIENT, HIGH-PERFORMANCE FILTERS FOR POINT-OF-USE APPLICATIONS.

The Q-series is primarily designed to be fast and easy to use. The two-piece construction, as shown, includes a permanently mounted head and a replaceable body that contains the media. When the time comes to replace the media, the body is easily detached from the head without the use of tools, in a matter of seconds. The new body is just as easily attached and the unit is ready for a service life of up to six months.

## NON-VALVED HEADS FOR Q-SERIES



Available in both 1/4" and 3/8" versions.

<u>PART NUMBER</u>	<u>ITEM DESCRIPTION</u>
PQNVH-4	OMNIPURE Q-SERIES 1/4" FPT NON-VALVED HEAD
PQNVH-4JG	OMNIPURE Q-SERIES 1/4" JG NON-VALVED HEAD
PQNVH-6	OMNIPURE Q-SERIES 3/8" FPT NON-VALVED HEAD

## VALVED HEADS FOR Q-SERIES

Available in both 1/4" and 3/8" versions.

<u>PART NUMBER</u>	<u>ITEM DESCRIPTION</u>
PQVH-4	OMNIPURE Q-SERIES 1/4" FPT VALVED HEAD
PQVH-4JG	OMNIPURE Q-SERIES 1/4" JG VALVED HEAD
PQVH-6	OMNIPURE Q-SERIES 3/8" FPT VALVED HEAD

## BRACKETS & O-RINGS FOR Q-SERIES

<u>PART NUMBER</u>	<u>ITEM DESCRIPTION</u>
PQ-HO11	OMNIPURE SMALL O-RING FOR Q-SERIES VALVED & NON-VALVED HEADS
PQ-HO18	OMNIPURE LARGE O-RING FOR Q-SERIES VALVED & NON-VALVED HEADS
PELF-BRACKET	OMNIPURE Q, ELF & E OMNIPURE SERIES PLASTIC BRACKET W/ SCREWS



# WATER TREATMENT

## Water Filters

### Omnipure Q-Series Filters



PRECISION  
INSTALLATION  
PRODUCTS

## TASTE AND ODOR REMOVAL - Q-SERIES



Designed to reduce impurities that can cause unwanted taste and odor in water, the filter utilizes T-28 activated coco-shell carbon for the reduction of chlorine and other contaminants down to 10 micron. These filters are ideal for point of use applications.

<u>PART NUMBER</u>	<u>FILTER LENGTH</u>	<u>VOLUME (CI)</u>	<u>SERVICE LIFE (US Gal)</u>
PQ5528	10"	28.6	2000
PQ5628	12"	35.5	2500

## R.O. SYSTEM CARBON FILTERS - Q-SERIES

Specifically designed to handle the ultra-pure water produced by Reverse Osmosis and Distillation systems. T-33 activated coco-shell carbon is used for slower flow conditions, such as between a membrane and storage tank, and as a post-filter. Filtration is effective down to 5 micron.

<u>PART NUMBER</u>	<u>FILTER LENGTH</u>	<u>VOLUME (CI)</u>	<u>SERVICE LIFE (US Gal)</u>
PQ5533	10"	28.6	2000
PQ5633	12"	35.5	2500

## R.O. SYSTEM CARBON FILTERS - COCONUT SHELL - Q-SERIES

<u>PART NUMBER</u>	<u>FILTER LENGTH</u>	<u>VOLUME (CI)</u>	<u>SERVICE LIFE (US Gal)</u>
PQ5640	12"	N/A	2500

## SEDIMENT FILTERS (5 MICRON) - Q-SERIES

Developed to remove dirt, sand and sediment that can cause damage to downline equipment. These filters utilize a multi-layer depth filtration construction that results in the removal of sediment down to 25 micron or 1 micron, depending on the need.

<u>PART NUMBER</u>	<u>FILTER LENGTH</u>	<u>VOLUME (CI)</u>	<u>SERVICE LIFE (US Gal)</u>
PQ5505	10"	28.6	N/A
PQ5605	12"	35.5	N/A
PQ5705	14"	42.4	N/A



PRECISION  
INSTALLATION  
PRODUCTS

# WATER TREATMENT

## Water Filters

### Omnipure Q-Series Filters

## SEDIMENT FILTERS (1 MICRON) - Q-SERIES



<u>PART NUMBER</u>	<u>FILTER LENGTH</u>	<u>VOLUME (G)</u>	<u>SERVICE LIFE (US Gal)</u>
PQ5701	14"	N/A	N/A

## HARD WATER PROTECTION - Q-SERIES

Combined activated carbon with polyphosphate results in the reduction of contaminants that can cause taste and odor in water, as well as reduce or eliminate lime scale that is associated with "hard water." This media combination is ideal for the protection of equipment.

<u>PART NUMBER</u>	<u>FILTER LENGTH</u>	<u>VOLUME (G)</u>	<u>SERVICE LIFE (US Gal)</u>
PQ5486	8"	21.6	1250
PQ5586	10"	28.6	1500
PQ5686	12"	35.5	2000

## REMINERALIZATION FILTERS - Q-SERIES

<u>PART NUMBER</u>	<u>ITEM DESCRIPTION</u>
PQ5651	OMNIPURE Q-SERIES 12" GAC & REMINERALIZATION FILTER
PQ5751	OMNIPURE Q-SERIES 14" GAC & REMINERALIZATION FILTER
PQ5748	OMNIPURE Q-SERIES 14" REMINERALIZATION & PH CORRECTION FILTER
PQ5648	OMNIPURE Q-SERIES 12" REMINERALIZATION & PH CORRECTION FILTER

# WATER TREATMENT

## Water Filters

### Omnipure Q-Series Filters



PRECISION  
INSTALLATION  
PRODUCTS

## CARBON BLOCK - Q-SERIES



Made of FDA compliant material and high purity acid washed carbon for high quality filtration with slower flow conditions. Added special media.

<u>PART NUMBER</u>	<u>ITEM DESCRIPTION</u>
PQ5515	OMNIPURE Q-SERIES 10" 1 MICRON CARBON BLOCK - LEAD & CYST REMOVAL
PQ5620	OMNIPURE Q-SERIES 12" 1-MICRON CARBON BLOCK FILTER
PQ5620-P	OMNIPURE Q-SERIES 12" 1-MICRON CARBON BLOCK WITH PHOSPHATE
PQ5621	OMNIPURE Q-SERIES 12" 10 MICRON CARBON BLOCK FILTER
PQ5715	OMNIPURE Q-SERIES 14" CARON BLOCK FILTER
PQ5715-P	OMNIPURE Q-SERIES 14" 1 MICRON CARBON BLOCK - W/ LEAD REMOVAL & PHOSPHATE SCALE INHIBITOR
PQ5721	OMNIPURE Q-SERIES 14" 10 MICRON CARBON BLOCK FILTER
PQ5615	OMNIPURE Q-SERIES 12" CARBON BLOCK FILTER
PQ5615-P	OMNIPURE Q-SERIES 12" CARBON BLOCK FILTER W/ PHOSPHATE

## MEMBRANE - Q-SERIES

The Omnipure Q5672 Q-Series Membrane with optional check valve and flow restrictor will fit Omnipure Twist Tap filter heads.

<u>PART NUMBER</u>	<u>FILTER LENGTH</u>	<u>FLOW RATE</u>	<u>SERVICE LIFE</u>
PQ5672-MEM35	12"	35 GPD	2 YEARS
PQ5672-MEM50	12"	50 GPD	2 YEARS
PQ5672-MEM80	12"	80 GPD	2 YEARS
PQ5672S-MEM50	12"	80 GPD	2 YEARS



PRECISION  
INSTALLATION  
PRODUCTS

# WATER TREATMENT

## Water Filters

### Omnipure Q-Series Filters

## CATION RESIN Q-SERIES



Also known as the QWS or Water Softening Cartridge (LXC-BSF Resin), is a cation exchange softening cartridge which reduced hardness and scale deposits.

<u>PART NUMBER</u>	<u>FILTER LENGTH</u>	<u>FLOW RATE</u>	<u>SERVICE LIFE</u>
PQ5654	12"	0.50 GPM	710 GRAINS OR 6 MONTHS
PQ5754	14"	0.50 GPM	900 GRAINS OR 6 MONTHS

## CATION RESIN Q-SERIES

<u>PART NUMBER</u>	<u>FILTER LENGTH</u>	<u>FLOW RATE</u>	<u>SERVICE LIFE</u>
PQ5758	14"	0.50 GPM	910 GRAINS OR 6 MONTHS

## MIXBED DI RESIN Q-SERIES

Made of FDA compliant resin, the Deionization Water Filter reduces salt and TDS from your water.

<u>PART NUMBER</u>	<u>FILTER LENGTH</u>	<u>FLOW RATE</u>	<u>SERVICE LIFE</u>
PQ5655	12"	0.50 GPM	270 GRAINS OR 6 MONTHS
PQ5755	14"	0.50 GPM	320 GRAINS OR 6 MONTHS

## KDF55 Q-SERIES

The KDF55/T-33 GAC replacement filter cartridge offers chlorine, taste, and odor reduction in your drinking water.

<u>PART NUMBER</u>	<u>FILTER LENGTH</u>	<u>FLOW RATE</u>	<u>SERVICE LIFE</u>
PQ5767	14"	0.50 GPM	3000 GALLONS OR 1 YEAR

## KDF85 Q-SERIES

The KDF85/T-33 GAC replacement filter cartridge offers everything the KDF55 does plus removal of iron and hydrogen sulfides (rotten egg smell). This combination of KDF85/T-33 GAC will remove chloramines from your water.

<u>PART NUMBER</u>	<u>FILTER LENGTH</u>	<u>FLOW RATE</u>	<u>SERVICE LIFE</u>
PQ5750	14"	0.50 GPM	3000 GALLONS OR 1 YEAR

# WATER TREATMENT

## Water Filters

### Omnipure ELF-Series Filters



PRECISION  
INSTALLATION  
PRODUCTS



#### ELF FILTER BODIES

Omnipure Filter Company has an extra-large format series of filters designed for the commercial food service industries.

In contrast to what the name implies, the new Extra-Large Format or ELF-Series' capacity of up to 25,000 gallons and hefty flow rate of up to 2.0 gal/min make it ideal for food service and commercial beverage operations. Engineered in a two-piece configuration, the ELF features a permanent head and a bayonet style replaceable polypropylene body. The virgin, high-impact polypropylene body is especially ideal for use in applications where sanitary conditions are required as polypropylene has been approved by the FDA.

## SEDIMENT 5 MICRON FILTERS ELF SERIES

<u>PART NUMBER</u>	<u>ITEM DESCRIPTION</u>
PELF-10SED-5M	OMNIPURE ELF 10" 5 MICRON SEDIMENT CARTRIDGE
PELF-15SED-5M	OMNIPURE ELF 15" 5 MICRON SEDIMENT CARTRIDGE

## GAC CARBON FILTERS ELF SERIES

<u>PART NUMBER</u>	<u>ITEM DESCRIPTION</u>
PELF-10GAC-T/40	OMNIPURE ELF 10" GAC T-40 CARTRIDGE - COCO SHELL CARBON - 5,000 GALLONS
PELF-15GAC-T/40	OMNIPURE ELF 15" GAC T-40 CARTRIDGE COCO SHELL CARBON - 7,500 GALLONS

## CARBON BLOCK FILTERS ELF SERIES

<u>PART NUMBER</u>	<u>ITEM DESCRIPTION</u>
PELF-10CB	OMNIPURE ELF 10" 10 MICRON CARBON BLOCK CARTRIDGE - 10,000 GALLONS
PELF-15CB	OMNIPURE ELF 15" 10 MICRON CARBON BLOCK CARTRIDGE - 15,000 GALLONS
PELF-15CB-1M	OMNIPURE ELF 15" 1 MICRON CARBON BLOCK CARTRIDGE - 20,000 GALLONS
PELF-15CB-5M	OMNIPURE ELF 15" 5 MICRON CARBON BLOCK CARTRIDGE - 15,000 GALLONS
PELF-15CB-SCREENS	OMNIPURE ELF 15" 10 MICRON CARBON BLOCK CARTRIDGE W/ SCREENS - 15,000 GALLONS



PRECISION  
INSTALLATION  
PRODUCTS

# WATER TREATMENT

Water Filters

Omnipure ELF-Series Filters

## ENCAPSULATED MEMBRANES ELF SERIES



<u>PART NUMBER</u>	<u>ITEM DESCRIPTION</u>
PELF-10MEM-250	OMNIPURE ELF 10" 180-250 GPD MEMBRANE CARTRIDGE
PELF-15MEM-500	OMNIPURE ELF 15" 250-500 GPD MEMBRANE CARTRIDGE -3.5" x 15"
PELF-10MEM-250W/CV	OMNIPURE ELF 10" 180-250 GPD MEMBRANE CARTRIDGE W/ CHECK VALVE
PELF-15MEM-500W/CV	OMNIPURE ELF 15" 250-500 GPD MEMBRANE CARTRIDGE - 3.5" X 15" W/ CHECK VALVE

## CARBON BLOCK FILTER W/ LEAD & PHOSPHATE WITH SMALL BAYONETTE END

<u>PART NUMBER</u>	<u>ITEM DESCRIPTION</u>
PELFSB-10CB-1MLP	OMNIPURE ELF 10" 1 MICRON CARBON BLOCK CARTRIDGE W/ LEAD & PHOSPHATE - SMALL BAYONETTE - 2,500 GALLON

# WATER TREATMENT

## Water Filters

### Omnipure ELF-Series Filters



PRECISION  
INSTALLATION  
PRODUCTS

## SPECIAL MEDIA FILTERS ELF SERIES



<u>PART NUMBER</u>	<u>ITEM DESCRIPTION</u>
PELF-10CAL	OMNIPURE ELF 10" CALCITE (1/3) AND CARBON (2/3) CARTRIDGE
PELF-10CB-1ML-KDF	OMNIPURE ELF 10" 1 MICRON CARBON BLOCK CARTRIDGE W/ LEAD & KDF55 - 2,500 GALLONS
PELF-10CB-1MP	OMNIPURE ELF 10" 1 MICRON CARBON BLOCK CARTRIDGE W/ PHOSPHATE - 15,000 GALLON
PELF-10CB-5MP	OMNIPURE ELF 10" 5 MICRON CARBON BLOCK CARTRIDGE W/ PHOSPHATE - 10,000 GALLON
PELF-10CB-P	OMNIPURE ELF 10" 10 MICRON CARBON BLOCK CARTRIDGE W/ PHOSPHATE - 10,000 GALLONS
PELF-10CAL/COR	OMNIPURE ELF 10" CALCITE (1/2) AND COROSEX DK7 (1/2) CARTRIDGE-12/CS
PELF-10CB-1ML-AM	OMNIPURE ELF 10" 1 MICRON CARBON BLOCK CARTRIDGE W/ LEAD REDUCTION & AGION - 2,500 GALLONS
PELF-10RES-UXC8SF	OMNIPURE ELF 10" ALL SOFTENING RESIN (UXC-8SF) CARTRIDGE - 1,150 GRAINS
PELF-15CAL	OMNIPURE ELF 15" CALCITE (1/3) AND CARBON (2/3) CARTRIDGE
PELF-15CB-1ML	OMNIPURE ELF 15" 1 MICRON CARBON BLOCK CARTRIDGE W/ LEAD REDUCTION - 3,000 GALLONS
PELF-15CB-1/2MP	OMNIPURE ELF 15" 1/2 MICRON CARBON BLOCK CARTRIDGE W/ PHOSPHATE - 20,000 GALLONS
PELF-15CB-1MP	OMNIPURE ELF 15" 1 MICRON CARBON BLOCK CARTRIDGE W/ PHOSPHATE - 20,000 GALLONS
PELF-15CB-1MP-AM	OMNIPURE ELF 15" 1 MICRON CARBON BLOCK CARTRIDGE W/ PHOSPHATE & AGION(ANTIBACTERIAL) - 20,000 GALLONS
PELF-15CB-5MP	OMNIPURE ELF 15" 5 MICRON CARBON BLOCK CARTRIDGE W/ PHOSPHATE - 15,000 GALLONS
PELF-15CB-P	OMNIPURE ELF 15" 10 MICRON CARBON BLOCK CARTRIDGE W/ PHOSPHATE - 15,000 GALLONS
PELF-15CB-P-SCREENS	OMNIPURE ELF 15" 10 MICRON CARBON BLOCK W/ PHOSPHATE CARTRIDGE W/ SCREENS - 15,000 GALLONS
PELF-15CB-PWRAP	OMNIPURE ELF 15" 10 MICRON CARBON BLOCK CARTRIDGE W/ 80Z PHOSPHATE WRAPPED - 15-20,000 GALLONS
PELF-15CB1MLP-KDF-WRAP	OMNIPURE ELF 15" 1 MICRON CARBON BLOCK - LEAD/PHOSPHATE/ KDF WRAPPED CARTRIDGE- 20,000 GALLONS.
PELF-15RES-UXC8SF	OMNIPURE ELF 15" ALL SOFTENING RESIN (UXC-8SF) CARTRIDGE - 2,000 GRAINS



PRECISION  
INSTALLATION  
PRODUCTS

# WATER TREATMENT

Water Filters

Omnipure ELF-Series Filters

## CUNO COMPATIBLE FILTERS - ELF-SERIES



<u>PART NUMBER</u>	<u>ITEM DESCRIPTION</u>
PCELF-13CB-1ML-PKDF	OMNIPURE CUNO ELF 13" 1M CARBON BLOCK CARTRIDGE W/ LEAD REDUCTION & PHOSPHATE & KDF55 - 2,500 GALLONS
PCELF-13CB-1MP	OMNIPURE CUNO ELF 13" 1 MICRON CARBON BLOCK CARTRIDGE W/ PHOSPHATE - 15,000 GALLONS
PCELF-13CB-5M	OMNIPURE CUNO ELF 13" 5 MICRON CARBON BLOCK CARTRIDGE - 10,000 GALLONS
PCELF-15CB-5M	OMNIPURE CUNO ELF 15" 5 MICRON CARBON BLOCK CARTRIDGE - 15,000 GALLONS

## BRACKETS & HEADS - E AND/OR ELF & Q SERIES

<u>PART NUMBER</u>	<u>ITEM DESCRIPTION</u>
PELF-BRACKET	OMNIPURE Q, ELF & E OMNIPURE SERIES PLASTIC BRACKET W/ SCREWS
PE/ELF-HEAD	OMNIPURE ELF & E SERIES HEAD - NON-VALVED W/ 3/8" FPT PORTS
PE/ELF-HEAD-QC	OMNIPURE ELF & E SERIES HEAD - NON-VALVED W/ 3/8" QC PORTS
PELF-BRACKET-STEEL	OMNIPURE ELF STEEL BRACKET W/ SCREWS - FOR ELF VALVE HEADS ONLY



# WATER TREATMENT

Water Filters

Hydronix Culligan Compatible Sediment Filters



PRECISION  
INSTALLATION  
PRODUCTS



## HYDROGUARD HDG-SED-AC5 FILTERS

Provide excellent dirt holding capacity through their integrated depth filtration design.

## HYDROGUARD HDG-SED-ACS

Are manufactured with 100% high purity, surfactant free and binder free polypropylene.

- Spun bonded Polypropylene
- Dirt, rust and sediment reduction
- 5 micron sediment filtration

Temperature rating: 48°F - 145°F

Micron rating: 5μ nominal

## HYDRONIX CULLIGAN COMPATIBLE SEDIMENT FILTERS

<u>PART NUMBER</u>	<u>ITEM DESCRIPTION</u>
PP5-CULLIGAN-5MX	HYDRONIX CULLIGAN COMPATIBLE 5 MICRON SEDIMENT FILTER - AC30 - LC50 - H82 - H83 - CASE PACK 36
	*GRAPHICS ON HYDROGUARD FILTERS*



PRECISION  
INSTALLATION  
PRODUCTS

# WATER TREATMENT

## Water Filters

Omnipure Culligan / Hydrotech Compatible Sediment Filters

### OMNIPURE CULLIGAN COMPATIBLE SEDIMENT FILTER



<u>PART NUMBER</u>	<u>ITEM DESCRIPTION</u>
PP5-CULLIGAN-5M	OMNIPURE CULLIGAN COMPATIBLE 5 MICRON SEDIMENT FILTER - AC30 - LC50 - H82 - H83 - CASE PACK 36
*SPECS AND TABLE WITH INFO ON FILTER*	

**Performance Certified to ANSI/NSF<sup>1</sup> Standard 42**

Particulate Reduction						
Parameter	USEPA MCL	Influent Challenge	Effluent Average	Effluent Maximum	Percent Reduction Average	Percent Reduction Minimum
Particulate Reduction <sup>2</sup>	-	2,086,110	25,525	72,800	98.8	96.5

<sup>1</sup>Tested using initial flow rate = 1.28 gpm; pressure = 60 psig; pH = 7.5 ± 0.5; temp. = 20 ± 2.5 °C

<sup>2</sup>Measurement in Particles/mL

**Operating Specifications**

Service Flow Rate: 0.75 GPM (2.8 LPM)

Maximum Pressure: 125 PSIG

Temperature: 35-100 °F (2-38 °C)

### OMNIPURE HYDROTECH COMPATIBLE SEDIMENT FILTER



<u>PART NUMBER</u>	<u>ITEM DESCRIPTION</u>
PP5-HYDROTECH-5M	OMNIPURE HYDROTECH COMPATIBLE 5 MICRON SEDIMENT FILTER - CASE PACK 36

**Performance Certified to ANSI/NSF<sup>1</sup> Standard 42**

Particulate Reduction						
Parameter	USEPA MCL	Influent Challenge	Effluent Average	Effluent Maximum	Percent Reduction Average	Percent Reduction Minimum
Particulate Reduction <sup>2</sup>	-	2,086,110	25,525	72,800	98.8	96.5

<sup>1</sup>Tested using initial flow rate = 1.28 gpm; pressure = 60 psig; pH = 7.5 ± 0.5; temp. = 20 ± 2.5 °C

<sup>2</sup>Measurement in Particles/mL

**Operating Specifications**

Service Flow Rate: 0.75 GPM (2.8 LPM)

Maximum Pressure: 125 PSIG

Temperature: 35-100 °F (2-38 °C)

# WATER TREATMENT

Water Filters



PRECISION  
INSTALLATION  
PRODUCTS

Hydronix Culligan / Hydrotech Compatible Carbon Block



## HYDROGUARD HDG-CB-AC10 FILTERS

Are manufactured with high purity coconut shell carbon and offer an excellent cost to performance value.

## HYDROGUARD HDG-CB-AC10 FILTERS

Offer high chlorine reduction and are ideal pre and post filters.

- Reduces taste, odor, and chlorine
- High chlorine reduction
- 10 micron nominal filtration

Temperature rating: 40°F - 180°F

Micron rating: 10μ nominal

Chlorine reduction: 3000 GAL @ .5 GPM

## HYDRONIX CULLIGAN COMPATIBLE CARBON BLOCK

### PART NUMBER

PCB-CULLIGAN-10MX

### ITEM DESCRIPTION

HYDRONIX CULLIGAN COMPATIBLE 10 MICRON CARBON BLOCK - USED WITH AC30/LC50/H82/H83 - CASE PACK 36

\*GRAPHICS ON HYDROGUARD FILTERS\*



PRECISION  
INSTALLATION  
PRODUCTS

# WATER TREATMENT

## Water Filters

### Omnipure Culligan Compatible Carbon Block Filters

## OMNIPURE CULLIGAN COMPATIBLE CARBON BLOCK



**PART NUMBER**

PCB-CULLIGAN-1M

**ITEM DESCRIPTION**

OMNIPURE CULLIGAN COMPATIBLE 1 MICRON CARBON BLOCK - AC30/  
LC50/H82/H83 - CASE PACK 36

Performance Certified to ANSI/NSF<sup>1</sup> Standard 42

Performance Data Table						
Parameter	US EPA MCL	Influent Challenge	Effluent Average	Effluent Maximum	Percent Reduction Average	Percent Reduction Minimum
Chlorine	-	2.22 ppm	<0.1	<0.1	>99	90
Cyst, Cryptosporidium, Giardia	99.95% Reduction	104,457 Particles	< 1	<1	99.99%	-

### Operating Specifications

- Capacity: 3,000 Gallons
- Flow Rate: 0.50 GPM (1.9 LPM)
- Maximum Pressure: 125 PSIG
- Temperature: 35-100° F (2-38° C)

## OMNIPURE CULLIGAN COMPATIBLE CARBON BLOCK



**PART NUMBER**

PCB-CULLIGAN-10M

**ITEM DESCRIPTION**

OMNIPURE CULLIGAN COMPATIBLE 10 MICRON CARBON BLOCK - AC30/  
LC50/H82/H83 - CASE PACK 36

Performance Certified to ANSI/NSF<sup>1</sup> Standard 42

Performance Data Table						
Parameter	US EPA MCL	Influent Challenge	Effluent Average	Effluent Maximum	Percent Reduction Average	Percent Reduction Minimum
Chlorine	-	2.22 ppm	<0.1	<0.1	>99	90

### Operating Specifications

- Capacity: 2,500 Gallons Chlorine Removal
- Flow Rate: 0.50 GPM (1.9 LPM)
- Maximum Pressure: 125 PSIG
- Temperature: 35-100° F (2-38° C)

# WATER TREATMENT

## Water Filters

### Omnipure Hydrotech Compatible Carbon Block Filters



PRECISION  
INSTALLATION  
PRODUCTS

## OMNIPURE HYDROTECH COMPATIBLE CARBON BLOCK



### PART NUMBER

### ITEM DESCRIPTION

PCB-HYDROTECH-1M

OMNIPURE HYDROTECH COMPATIBLE 1 MICRON CARBON BLOCK - CASE  
PACK 36

Performance Certified to ANSI/NSF<sup>1</sup> Standard 42

Performance Data Table						
Parameter	US EPA MCL	Influent Challenge	Effluent Average	Effluent Maximum	Percent Reduction Average	Percent Reduction Minimum
Chlorine	-	2.22 ppm	<0.1	<0.1	>99	90
Cyst, Cryptosporidium, Giardia	99.95% Reduction	104,457 Particles	< 1	<1	99.99%	-

### Operating Specifications

Capacity: 3,000 Gallons

Flow Rate: 0.50 GPM (1.9 LPM)

Maximum Pressure: 125 PSIG

Temperature: 35-100° F (2-38° C)

## OMNIPURE HYDROTECH COMPATIBLE CARBON BLOCK



### PART NUMBER

### ITEM DESCRIPTION

PCB-HYDROTECH-10M

OMNIPURE HYDROTECH COMPATIBLE 10 MICRON CARBON BLOCK -  
CASE PACK 36

Performance Certified to ANSI/NSF<sup>1</sup> Standard 42

Performance Data Table						
Parameter	US EPA MCL	Influent Challenge	Effluent Average	Effluent Maximum	Percent Reduction Average	Percent Reduction Minimum
Chlorine	-	2.22 ppm	<0.1	<0.1	>99	90

### Operating Specifications

Capacity: 2,500 Gallons

Flow Rate: 0.50 GPM (1.9 LPM)

Maximum Pressure: 125 PSIG

Temperature: 35-100° F (2-38° C)



PRECISION  
INSTALLATION  
PRODUCTS

# WATER TREATMENT

Water Filters

Omnipure Hydrotech Compatible Carbon Block Filters

## HYDROTECH REPLACEMENT ACCESSORIES

---

PART NUMBER

ITEM DESCRIPTION

P-HYDROTECH-ORINGS

OMNIPURE PP5 & PCB HYDROTECH O-RINGS FOR OMNIPURE FILTERS

# WATER TREATMENT

## Water Filters

### Aqua Pure (P117) Compatible Filters



PRECISION  
INSTALLATION  
PRODUCTS

Are ideal for whole house Pre-Filtration for the reduction of taste, odor, and chlorine. It's rigid construction eliminates sediment unloading and yeild a low pressure drop.

These filters are manufactured with FDA CFR-21 compliant materials and provide a flow rate of up to 3 gallons per minute for point-of-entry applications.

**Temperature rating:** 48°F - 120°F

**Flow rate:** 3 GPM

- REDUCES TASTE, ODOR, AND CHLORINE.
- DIRT, RUST, AND SEDIMENT REDUCTION.
- 5 MICRON SEDIMENT FILTRATION.

## HYDRONIX HYDRO GUARD AQUA-PURE (P117) COMPATIBLE FILTER



<u>PART NUMBER</u>	<u>ITEM DESCRIPTION</u>
PHG-P117	HYDRONIX HYDRO GUARD "AQUA PURE" P117 GAC FILTER W/ 5 MICRON PADS (SIZE 2.5" X 10" - FLOW RATE 3GPM)

**COMPATIBLE TO:**

3M PURIFICATION #AP117 AQUA-PURE #AP117

COSTGUARD #EV9108-11 & #CGT-10

EVERPURE #EV9108-11, GCT-10, DEV9108-11 &

DEV9108-44 FOOD SERVICE #EX9108-11 & GCT-10

PURE MARK #PFS17

SHURFLO #SF31-TO & GCT-10

WHIRLPOOL #WHCF-GAC



**PRECISION  
INSTALLATION  
PRODUCTS**

# WATER TREATMENT

## Water Filters

### Mult-Pure Aquaversa Compatible Filters

#### HYDRONIX HYDRO GUARD MULTI-PURE AQUAVERSA COMPATIBLE FILTER

The Hydronix HDG-CB6-14 is a coconut shell carbon block filter that is compatible with several Multi-pure Aquaversa water filtration systems.

- COCON SHELL CARBON BLOCK MEDIA.
- REDUCES TASTE, ODOR, AND CHLORINE.
- 0.5 MICRON SEDIMENT FILTRATION.
- CAPACITY OF 750 GALLONS OR 12 MONTHS.

## HYDRONIX HYDRO GUARD MULTI-PURE AQUAVERSA COMPATIBLE FILTER



<u>PART NUMBER</u>	<u>ITEM DESCRIPTION</u>
PCB-MP-CB6	MULTI-PURE COMPATIBLE 6.5" X 4" CARBON BLOCK FILTER - 1/2 MICRON

#### COMPATIBLE TO THE FOLLOWING MULTIPURE SYSTEMS:

- MP750SB
- MP750SI
- MP750SC
- MP1200EL
- MPCT
- MPSSCT
- MPC500B
- MPC500C
- MPC900
- MP750SSCT
- MPC500I

#### COMPATIBLE TO THE FOLLOWING MULTIPURE SKU NUMBERS:

- CB6
- CB6D



# WATER TREATMENT

## Water Filters

### Amway Compatible Filters



PRECISION  
INSTALLATION  
PRODUCTS

#### HYDRONIX HYDRO GUARD AMWAY COMPATIBLE FILTER

The Hydronix HDG-CB8-38 is a coconut shell carbon block filter that is compatible with several Amway water filtration systems.

- COCON SHELL CARBON BLOCK MEDIA.
- REDUCES TASTE, ODOR, AND CHLORINE.
- 0.5 MICRON SEDIMENT FILTRATION.
- CAPACITY OF 750 GALLONS OR 12 MONTHS.

#### HYDRONIX HYDRO GUARD AMWAY COMPATIBLE FILTER



**PART NUMBER**

PCB-AM-CB7

**ITEM DESCRIPTION**

AMWAY COMPATIBLE CARBON BLOCK FILTER - 1/2 MICRON - 7" TALL X  
4" WIDE - 3/8" TOP CENTER THREAD

**COMPATIBLE TO THE FOLLOWING ESPRING WATER TREATMENT SYSTEMS:**

GEN IV  
WATER TREATMENT SYSTEM  
ESPRING WATER PURIFIER 10-0186

**COMPATIBLE TO THE FOLLOWING AMWAY SKU NUMBERS:**

AMWAY WTS GEN IV WATER TREATMENT SYSTEM REPLACEMENT FILTER  
E0085 REPLACEMENT FILTER  
E-85 REPLACEMENT FILTER



**PRECISION  
INSTALLATION  
PRODUCTS**

# WATER TREATMENT

## Water Filters

### Nu-Calgon Micro-Plus Compatible Filters

#### NU-CALGON MICRO-PLUS COMPATIBLE FILTERS

The Nu-Calgon Micro Plus compatible filters are a series of filters made for ice makers, coffee urns and brewers, beverage machines and other water-using equipment such as humidifiers and steamers. The Micro-Plus compatible filters are available in a variety of size capacities, from the 6" inline, which can be used on equipment using up to 12.5 gallons of water per day, to the 12" inline for treating up to 100 gallons of water per day. Nu-Calgon Micro-Plus compatible filters are designed and manufactured to eliminate or reduce water-related issues such as lime scale build up, sediment, and tastes or odors.

- Eliminate Lime Scale Formation
- Remove Silt, Sediment & Other Suspended Matter
- Complete Treatment for Up to Six Months
- Remove Chlorine & Other Objectionable Tastes/Odors

#### HOW DOES MICRO-PLUS® WORK?



## NU-CALGON MICRO-PLUS COMPATIBLE FILTERS



PART NUMBER	ITEM DESCRIPTION
P2386-4JG-SCREENS	OMNIPURE NU-CALGON MICRO-PLUS COMPATIBLE 2 X 6 CARBON W/ POLYPHOSPHATE W/ SCREEN - 1/4"JG PORTS
P2386-SCREENS	OMNIPURE NU-CALGON MICRO-PLUS COMPATIBLE 2 X 6 CARBON W/ POLYPHOSPHATE W/ SCREEN - 1/4"FPT PORTS
P5686-SCREENS	OMNIPURE NU-CALGON MICRO-PLUS COMPATIBLE 2 1/2 X 12 CARBON W/ POLYPHOSPHATE W/ SCREEN - 1/4"FPT PORTS
P2586-4JG-SCREENS	OMNIPURE NU-CALGON MICRO-PLUS COMPATIBLE 2 X 10 CARBON W/ POLYPHOSPHATE W/ SCREEN - 1/4"JG PORTS
P2586-SCREENS	OMNIPURE NU-CALGON MICRO-PLUS COMPATIBLE 2 X 10 CARBON W/ POLYPHOSPHATE W/ SCREEN - 1/4"FPT PORTS
P5686-4JG-SCREENS	OMNIPURE NU-CALGON MICRO-PLUS COMPATIBLE 2 1/2 X 12 CARBON W/ POLYPHOSPHATE W/ SCREEN - 1/4"JG PORTS
P5586-4JG-SCREENS	OMNIPURE NU-CALGON MICRO-PLUS COMPATIBLE 2 1/2 X 10 CARBON W/ POLYPHOSPHATE W/ SCREEN - 1/4"JG PORTS
P5586-SCREENS	OMNIPURE NU-CALGON MICRO-PLUS COMPATIBLE 2 1/2 X 10 CARBON W/ POLYPHOSPHATE W/ SCREEN - 1/4"FPT PORTS

# WATER TREATMENT

## Water Filters

### Water Factory Cuno SQC Compatibles



PRECISION  
INSTALLATION  
PRODUCTS

## WATER FACTORY CUNO SQC COMPATIBLES



<u>PART NUMBER</u>	<u>ITEM DESCRIPTION</u>
PC5605-WF	OMNIPURE WATER FACTORY CUNO SQC COMPATIBLE - 5 MICRON SEDIMENT FILTER
PC5615-WF	OMNIPURE WATER FACTORY CUNO SQC COMPATIBLE - 1 MICRON LEAD, CYST, TASTE, ODOR & CHLORINE REDUCTI...
PC5615-AM-WF	OMNIPURE WATER FACTORY CUNO SQC COMPATIBLE - 1 MICRON LEAD, CYST, TASTE, & ANTI-MICROBIAL FILTER
PC5621-WF	OMNIPURE WATER FACTORY CUNO SQC COMPATIBLE - 10 MICRON CARBON BLOCK
PC5640-WF	OMNIPURE WATER FACTORY CUNO SQC COMPATIBLE - GRANULAR ACTIVATED CARBON FILTER
PC5651-WF	OMNIPURE WATER FACTORY CUNO SQC COMPATIBLE - 1/2 SEDIMENT + 1/2 GAC FILTER
PC5672-WF	OMNIPURE WATER FACTORY CUNO SQC COMPATIBLE - 35 GPD TFC MEMBRANE W/ FR & CV





**PRECISION  
INSTALLATION  
PRODUCTS**

# WATER TREATMENT

Water Filters

BWT Cartridges

## BWT BESTMAX CARTRIDGES

This Innovative and Leading Edge Technology provides the perfect protection against scale deposits, sediment and chlorine. Tailor-made specifically for coffee machines/brewers, vending machines, beverage dispensers, combi steamers/ovens and ice cube machines. In the foodservice sector, water should always be optimized with the bestmax filter system; protecting equipment, eliminating downtimes and expensive service calls. Your water is then always free of particles, tastes great and has no odor, making it the ideal ingredient for foods and drinks.

Always 100 % of the water gets filtered, independent of bypass-setting, no waste water as like with a reverse osmosis system. Does not address TDS (total dissolved solids) instead provides a perfect balanced water due to application related bypass setting and removal of calcium (Ca<sup>2+</sup>) and Magnesium (Mg<sup>2+</sup>) vs Na<sup>+</sup> and H<sup>+</sup> by special BWT weak ion exchange resin, to ensure perfect lime scale build-up prevention.



## BENEFITS:

- Universal Filter Head  
(Fits All Bestmax Cartridge Sizes)
- High-Capacity Carbonate Hardness Removal
- Quick & Easy Filter Cartridge Change (Like Changing a Light Bulb)
- Cost-Effective, Practical & Efficient
- Very Compact Filter System
- No Regeneration w/ Salt Necessary
- 3 Times Higher Capacity (In Comparable Same Size Filter Tank)
- Extended Filter Life
- Ready to Use Single Cartridge
- Can be Installed Vertical or Horizontal

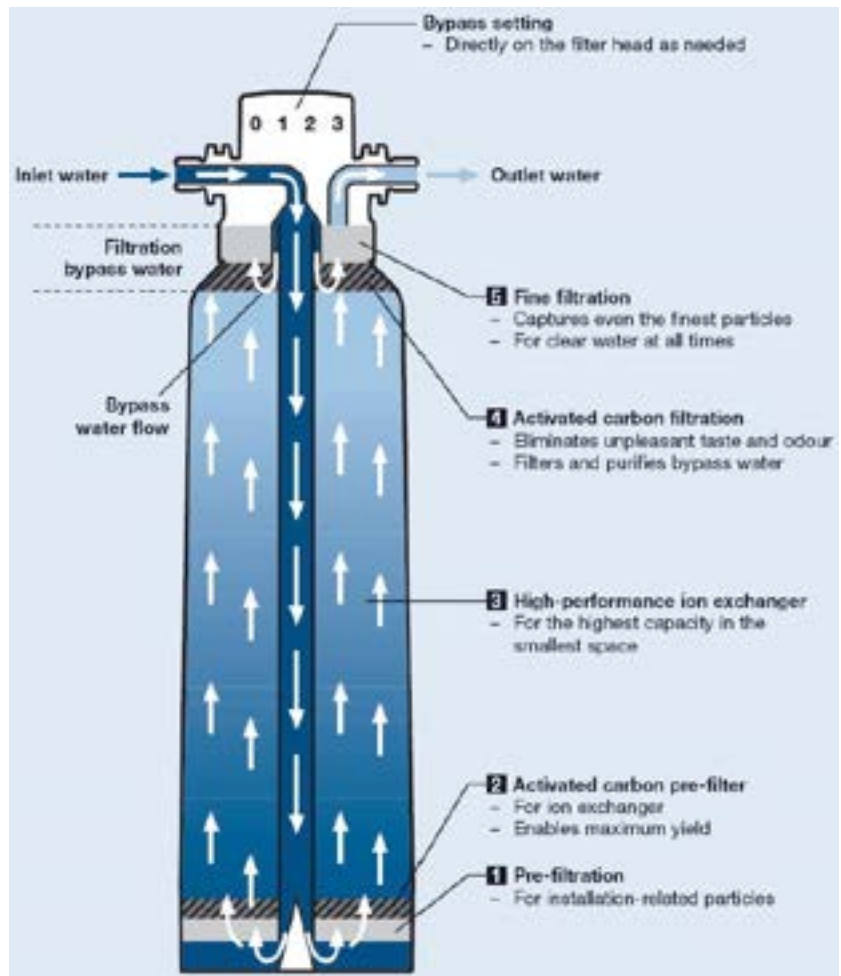

# WATER TREATMENT

Water Filters

BWT Cartridges



PRECISION  
INSTALLATION  
PRODUCTS

## BESTMAX CARTRIDGES - NSF



<u>PART NUMBER</u>	<u>ITEM DESCRIPTION</u>
BWT-MAX-SMALL	BWT BESTMAX SMALL NSF CARTRIDGE
BWT-MAX-SML/MED	BWT BESTMAX SMALL/MEDIUM NSF CARTRIDGE
BWT-MAX-MEDIUM	BWT BESTMAX MEDIUM NSF CARTRIDGE
BWT-MAX-LARGE	BWT BESTMAX LARGE NSF CARTRIDGE
BWT-MAX-XLARGE	BWT BESTMAX X-LARGE NSF CARTRIDGE
BWT-MAX-2XLARGE	BWT BESTMAX XX-LARGE NSF CARTRIDGE

## BESTMAX PREMIUM CARTRIDGES



<u>PART NUMBER</u>	<u>ITEM DESCRIPTION</u>
BWT-MAXPREM-SMALL	BWT BESTMAX SMALL PREMIUM CARTRIDGE
BWT-MAXPREM-SML/ MED	BWT BESTMAX SMALL/MEDIUM PREMIUM CARTRIDGE
BWT-MAXPREM-MED	BWT BESTMAX MEDIUM PREMIUM CARTRIDGE
BWT-MAXPREM-XLARGE	BWT BESTMAX X-LARGE PREMIUM CARTRIDGE
BWT-MAXPREM- 2XLARGE	BWT BESTMAX XX-LARGE PREMIUM CARTRIDGE
BWT-MAX-2XLARGE	BWT BESTMAX XX-LARGE NSF CARTRIDGE

## BESTTASTE CARTRIDGES - NSF



The Improver - Filter your system using a Besttaste along with the Bestmax to remove flavour-affecting elements from untreated water (e.g. chlorine). It is a highly effective food-safe active carbon (GAC) cartridge, where it safely removes suspended solids and particles from 5 µm. This guarantees an optimal taste for all hot and cold drinks. Besttaste can also provide improved water quality in areas with low carbonate hardness (scale content).

<u>PART NUMBER</u>	<u>ITEM DESCRIPTION</u>
BWT-TASTE-XSMALL	BWT BESTTASTE X-SMALL NSF CARTRIDGE
BWT-TASTE-SMALL	BWT BESTTASTE SMALL NSF CARTRIDGE



PRECISION  
INSTALLATION  
PRODUCTS

# WATER TREATMENT

Water Filters

BWT Cartridges

## BESTFLUSH & AQUAMETER



The Bestflush and Aquameter, when integrated into a space-saving combi-device. The Bestflush is a 3-way valve for effective bleeding and the Aquameter is a measuring unit for reliable assessment of residual capacity displayed in the LCD display.

<u>PART NUMBER</u>	<u>ITEM DESCRIPTION</u>
BWT-FLUSH	BWT BESTFLUSH W/ GASKET - FOR BESTMAX FILTER HEAD
BWT-METER	BWT AQUAMETER SENSOR W/ LCD EXTERNAL DISPLAY - 3/8" NUT X 3/8" THREAD

## FILTER HEAD & FITTINGS - EURO THREADS



<u>PART NUMBER</u>	<u>ITEM DESCRIPTION</u>
BWT-HEAD	BWT BESTMAX SINGLE NSF FILTER HEAD W/ EURO THREAD PORTS - COMES W/ MOUNTING BRACKET
BWT-FITTING-1/4"	BWT 3/8" EURO THREAD X 1/4" QC FOR HEAD
BWT-FITTING-3/8"	BWT 3/8" EURO THREAD X 3/8" QC FOR HEAD
BWT-FILTER HEAD FLEX	BWT-BESTHEAD FLEX - WITH DVGW MODEL-TESTED BACKFLOW PREVENTER & AUTO SHUT-OFF VALVE & 3/8" BSP MOUNTING BRACKET

## CARBONATE HARDNESS TEST



<u>PART NUMBER</u>	<u>ITEM DESCRIPTION</u>
BWT-CARBOTEST	BWT CARBONATE HARDNESS TEST KIT

# WATER TREATMENT

R.O. Membranes & Vessels

Domestic/Residential Membranes & Vessels



PRECISION  
INSTALLATION  
PRODUCTS

## 1.8" X 12" DRY TFC MEMBRANES - NSF DOMESTIC (USA MADE)



<u>PART NUMBER</u>	<u>ITEM DESCRIPTION</u>
PW112-25	AXEON 1.5" X 12" - 25 GPD DRY TFC MEMBRANE
PW112-35	AXEON 1.8" X 12" - 35 GPD DRY TFC MEMBRANE
PW112-50	AXEON 1.8" X 12" - 50 GPD DRY TFC MEMBRANE
PW112-50X	HYDRON TFC 1.8" X 12" - RESIDENTIAL MEMBRANE - 50GPD - NSF
PW112-75	AXEON 1.8" X 12" - 75 GPD DRY TFC MEMBRANE
PW112-75X	HYDRON TFC 1.8" X 12" - RESIDENTIAL MEMBRANE - 75GPD - NSF
PW112-100	AXEON 2.0" X 12" - 100 GPD DRY TF MEMBRANE
PW112-100X	HYDRON TFC 1.8" X 12" RESIDENTIAL MEMBRANE - 100GPD - NSF

## 1.8" X 12" DRY TFC MEMBRANES - NSF IMPORT



<u>PART NUMBER</u>	<u>ITEM DESCRIPTION</u>
PW112-25AX	AXEON 1.8" X 12" - 25 GPD DRY TFC MEMBRANE - IMPORT
PW112-35AX	AXEON 1.8" X 12" - 35 GPD DRY TFC MEMBRANE - IMPORT
PW112-50AX	AXEON 1.8" X 12" - 50 GPD DRY TFC MEMBRANE - IMPORT
PW112-75AX	AXEON 1.8" X 12" - 75 GPD DRY TFC MEMBRANE - IMPORT
PW112-100AX	AXEON 1.8" X 12" - 100 GPD DRY TFC MEMBRANE - IMPORT
PW112-150AX	AXEON 1.8" X 12" - 150 GPD DRY TFC MEMBRANE - IMPORT

## 2" X 12" DRY TFC MEMBRANES - NSF DOMESTIC (USA MADE)



<u>PART NUMBER</u>	<u>ITEM DESCRIPTION</u>
PW112-150	AXEON 2.0" X 12" - 150 GPD DRY TF MEMBRANE (25/CS)
PW112-200	AXEON 2.0" X 12" - 200 GPD DRY TF MEMBRANE

## 3" X 12" DRY TFC MEMBRANES - NSF



<u>PART NUMBER</u>	<u>ITEM DESCRIPTION</u>
PW03-12	AXEON 3" X 12" - 500 GPD DRY TFC MEMBRANE -SPECIAL ORDER ONLY
PW03-12X	HYDRON 3" X 12" - 300 GPD DRY TFC MEMBRANE



PRECISION  
INSTALLATION  
PRODUCTS

# WATER TREATMENT

R.O. Membranes & Vessels

Domestic/Residential Membranes & Vessels

## 2" X 12" DRY TFC MEMBRANES - NSF DOMESTIC (USA MADE)



**PART NUMBER**

**ITEM DESCRIPTION**

PW112-150	AXEON 2.0" X 12" - 150 GPD DRY TF MEMBRANE (25/CS)
PW112-200	AXEON 2.0" X 12" - 200 GPD DRY TF MEMBRANE

**Product Features**

- FDA approved material
- 90° angle outlet
- 1/8" NPT thread ports

## RO MEMBRANE HOUSING PARTS / ACCESSORIES



**PART NUMBER**

**ITEM DESCRIPTION**

PM10-GASKET	HYDRONIX GASKET FOR CAP OF PM10X HYDRONIX MEMBRANE VESSEL
PM10-OR	HYDRONIX MEMBRANE O-RING FOR HYDRONIX PM10X VESSEL
PSWM	HYDRONIX WHITE FULL CIRCLE FILTER WRENCH - FITS MEMBRANE (MHO3) HOUSINGS (EACH)



# WATER TREATMENT

R.O. Membranes & Vessels

2.5" Commercial Membranes



PRECISION  
INSTALLATION  
PRODUCTS

## 2.5" X 14" DRY TFC AXEON MEMBRANE - NSF



<u>PART NUMBER</u>	<u>ITEM DESCRIPTION</u>
PW2514-HF1	AXEON 2.5" X 14" - TFC LOW ENERGY DRY MEMBRANE - 225GPD @ 150PSI
PW2514-HF4	AXEON 2.5" X 14" - TFC EXTRA LOW ENERGY DRY MEMBRANE - 225GPD @ 100PSI
PW2514-HF5	AXEON 2.5" X 14" - TFC ULTRA LOW ENERGY DRY MEMBRANE - 225GPD @ 80PSI
PW2514-HR3	AXEON 2.5" X 14" - TFC HIGH REJECTION DRY MEMBRANE - 150GPD @ 225PSI
PW2514-NF3	AXEON 2.5" X 14" - TFC NANOFILTRATION DRY MEMBRANE - 200 GPD @ 70 PSI
PW2514-NF4	AXEON 2.5" X 14" - TFC NANOFILTRATION DRY MEMBRANE - 200GPD @ 70PSI

## 2.5" X 21" DRY TFC AXEON MEMBRANE - NSF



<u>PART NUMBER</u>	<u>ITEM DESCRIPTION</u>
PW2521-HF1	AXEON 2.5" X 21" - TFC LOW ENERGY DRY MEMBRANE - 400GPD @ 150PSI
PW2521-HF4	AXEON 2.5" X 21" - TFC EXTRA LOW ENERGY DRY MEMBRANE - 400GPD @ 100PSI
PW2521-HF5	AXEON 2.5" X 21" - TFC ULTRA LOW ENERGY DRY MEMBRANE - 400GPD @ 80PSI
PW2521-HR3	AXEON 2.5" X 21" - TFC HIGH REJECTION DRY MEMBRANE - 250GPD @ 225PSI
PW2521-NF3	AXEON 2.5" X 21" - TFC NANOFILTRATION DRY MEMBRANE - 350 GPD @ 70 PSI
PW2521-NF4	AXEON 2.5" X 21" - TFC NANOFILTRATION DRY MEMBRANE - 250GPD @ 70PSI

## 2.5" X 21" DRY TFC HYDRON MEMBRANE - NSF



<u>PART NUMBER</u>	<u>ITEM DESCRIPTION</u>
PW2521	HYDRON TFC MEMBRANE - 2.5" X 21" - 300 GPD @ 150 PSI

# WATER TREATMENT

R.O. Membranes & Vessels

## 2.5" Commercial Membranes

### 2.5" X 25" DRY TFC AXEON MEMBRANE - NSF



<u>PART NUMBER</u>	<u>ITEM DESCRIPTION</u>
PW2525-HR3	AXEON 2.5" X 25" - TFC HIGH REJECTION DRY MEMBRANE - STARBUCKS

### 2.5" X 40" DRY TFC HYDRON MEMBRANE - NSF



<u>PART NUMBER</u>	<u>ITEM DESCRIPTION</u>
PW2540	HYDRON TFC MEMBRANE - 2.5" X 40" - 750 GPD @ 150 PSI

### 2.5" X 40" DRY TFC AXEON MEMBRANE - NSF



<u>PART NUMBER</u>	<u>ITEM DESCRIPTION</u>
PW2540-HF1	AXEON 2.5" X 40" - TFC LOW ENERGY DRY MEMBRANE - 1,000GPD @ 150PSI
PW2540-HF4	AXEON 2.5" X 40" - TFC EXTRA LOW ENERGY DRY MEMBRANE - 1,000GPD @ 100PSI
PW2540-HF5	AXEON 2.5" X 40" - TFC ULTRA LOW ENERGY DRY MEMBRANE - 850GPD @ 80PSI
PW2540-HR3	AXEON 2.5" X 40" - TFC HIGH REJECTION DRY MEMBRANE - 650 GPD @ 225PSI
PW2540-NF3	AXEON 2.5" X 40" - TFC NANOFILTRATION DRY MEMBRANE - 850 GPD @ 70 PSI
PW2540-NF4	AXEON 2.5" X 40" - TFC NANOFILTRATION DRY MEMBRANE - 680GPD @ 70PSI

### 2.5" AXEON MEMBRANE REPLACEMENT PARTS



<u>PART NUMBER</u>	<u>ITEM DESCRIPTION</u>
PW25-BRINESEAL	AXEON REPLACEMENT BLACK CHEVRON BRINE SEAL FOR 2.5" MEMBRANE

# WATER TREATMENT

R.O. Membranes & Vessels

4" Commercial Membranes



PRECISION  
INSTALLATION  
PRODUCTS

## 4" X 14" DRY TFC AXEON MEMBRANE - NSF



<u>PART NUMBER</u>	<u>ITEM DESCRIPTION</u>
PW4014-HF1	AXEON 4" X 14" - TFC LOW ENERGY DRY MEMBRANE - 600GPD @ 150PSI
PW4014-HF4	AXEON 4" X 14" - TFC EXTRA LOW ENERGY DRY MEMBRANE - 600GPD @ 100PSI
PW4014-HF5	AXEON 4" X 14" - TFC ULTRA LOW ENERGY DRY MEMBRANE - 600GPD @ 80PSI
PW4014-HR3	AXEON 4" X 14" - TFC HIGH REJECTION DRY MEMBRANE - 400GPD @ 225PSI
PW4014-NF3	AXEON 4" X 14" - TFC NANOFILTRATION DRY MEMBRANE - 400 GPD @ 70 PSI
PW4014-NF4	AXEON 4" X 14" - TFC NANOFILTRATION DRY MEMBRANE - 400GPD @ 70PSI

## 4" X 21" DRY TFC AXEON MEMBRANE - NSF



<u>PART NUMBER</u>	<u>ITEM DESCRIPTION</u>
PW4021-HF1	AXEON 4" X 21" - TFC LOW ENERGY DRY MEMBRANE - 1,000GPD @ 150PSI
PW4021-HF4	AXEON 4" X 21" - TFC EXTRA LOW ENERGY DRY MEMBRANE - 1,000GPD @ 100PSI
PW4021-HF5	AXEON 4" X 21" - TFC ULTRA LOW ENERGY DRY MEMBRANE - 1,000GPD @ 80PSI
PW4021-HR3	AXEON 4" X 21" - TFC HIGH REJECTION DRY MEMBRANE - 900GPD @ 225PSI
PW4021-NF3	AXEON 4" X 21" - TFC NANOFILTRATION DRY MEMBRANE - 1,000 GPD @ 70 PSI
PW4021-NF4	AXEON 4" X 21" - TFC NANOFILTRATION DRY MEMBRANE - 950GPD @ 70PSI

## 4" X 21" DRY TFC HYDRON MEMBRANE - NSF

<u>PART NUMBER</u>	<u>ITEM DESCRIPTION</u>
PW4021	HYDRON TFC MEMBRANE - 4" X 21" - 1000 GPD @ 150 PSI

# WATER TREATMENT

R.O. Membranes & Vessels

4" Commercial Membranes

## 4" X 40" DRY TFC AXEON MEMBRANE - NSF



<u>PART NUMBER</u>	<u>ITEM DESCRIPTION</u>
PW4040-HF1	AXEON 4" X 40" - TFC LOW ENERGY DRY MEMBRANE - 2,500GPD @ 150PSI
PW4040-HF4	AXEON 4" X 40" - TFC EXTRA LOW ENERGY DRY MEMBRANE - 2,500GPD @ 100PSI
PW4040-HF5	AXEON 4" X 40" - TFC ULTRA LOW ENERGY DRY MEMBRANE - 2,500GPD @ 80PSI
PW4040-HR3	AXEON 4" X 40" - TFC HIGH REJECTION DRY MEMBRANE - 2,500GPD @ 225PSI
PW4040-NF3	AXEON 4" X 40" - TFC NANOFILTRATION DRY MEMBRANE - 2,500 GPD @ 70 PSI
PW4040-NF4	AXEON 4" X 40" - TFC NANOFILTRATION DRY MEMBRANE - 2,000GPD @ 70PSI

## 4" X 40" DRY TFC LOW ENERGY HYDRON MEMBRANE - NSF



<u>PART NUMBER</u>	<u>ITEM DESCRIPTION</u>
PW4040-LE	HYDRON TFC LOW ENERGY MEMBRANE - 4' X 40" - 2400 GPD @ 100 PSI

## DRY TFC AXEON MEMBRANE - FOR BRACKISH WATER



<u>PART NUMBER</u>	<u>ITEM DESCRIPTION</u>
PW4040-BW	HYDRON TFC MEMBRANE - 4" X 40" - 2400 GPD @ 150 PSI - HANDLES BRACKISH WATER - 98% REJECTION

# WATER TREATMENT

R.O. Membranes & Vessels

Commercial PVC Vessels



PRECISION  
INSTALLATION  
PRODUCTS

## PVC MEMBRANE VESSELS - CHAMP



<u>PART NUMBER</u>	<u>ITEM DESCRIPTION</u>
PX2514-3/8	AXEON 2.5" X 14" CHAMP PVC MEMBRANE VESSEL - 3/8" PERMEATE X 3/8" CONCENTRATE FNPT
PX2521-3/8	AXEON 2.5" X 21" CHAMP PVC MEMBRANE VESSEL - 3/8" PERMEATE X 3/8" CONCENTRATE FNPT
PX2540-3/8	AXEON 2.5" X 40" CHAMP PVC MEMBRANE VESSEL - 3/8" PERMEATE X 3/8" CONCENTRATE FNPT
PX4014-1/2	AXEON 4" X 14" CHAMP PVC MEMBRANE VESSEL - 1/2" PERMEATE X 1/2" CONCENTRATE FNPT
PX4021-1/2	AXEON 4" X 21" CHAMP PVC MEMBRANE VESSEL - 1/2" PERMEATE X 1/2" CONCENTRATE FNPT



PRECISION  
INSTALLATION  
PRODUCTS

# WATER TREATMENT

R.O. Membranes & Vessels

Commercial SS Vessels

## SS MEMBRANE VESSELS



<u>PART NUMBER</u>	<u>ITEM DESCRIPTION</u>
PV2514-3/8	AXEON 2.5" X 14" SS MEMBRANE VESSEL W/ INSTALL KIT-3/8" PERMEATE X 3/8" CONCENTRATE FNPT
PV2521-3/8	AXEON 2.5" X 21" SS MEMBRANE VESSEL W/ INSTALL KIT - 3/8" PERMEATE X 3/8" CONCENTRATE FNPT
PV2521-300	HYDRONIX 304 GRADE STAINLESS STEEL 2.5" X 21" VESSEL-300 PSI-3/8" FEED-1/4"PERMEATE
PV2540-3/8	AXEON 2.5" X 40" SS MEMBRANE VESSEL W/ INSTALL KIT - 3/8" PERMEATE X 3/8" CONCENTRATE FNPT
PV2540-300	HYDRONIX 304 GRADE STAINLESS STEEL 2.5" X 40" VESSEL-300 PSI-3/8" FEED-1/4" PERMEATE
PV4021-1/2	AXEON 4" X 21" SS MEMBRANE VESSEL W/ INSTALL KIT-1/2" PERMEATE X 1/2" CONCENTRATE FNPT
PV4021-300	HYDRONIX 304 GRADE STAINLESS STEEL 4" X 21" VESSEL-300 PSI-1/2" FEED-1/2" PERMEATE..
PV4040-1/2	AXEON 4" X 40" SS MEMBRANE VESSEL W/ INSTALL KIT - 1/2" PERMEATE X 1/2" CONCENTRATE FNPT
PV4040-1/2-300	HYDRONIX 304 GRADE STAINLESS STEEL 4" X 40" VESSEL-300 PSI-1/2" FEED-1/2" PERMEATE
PV4040-3/4-300	HYDRONIX 304 GRADE STAINLESS STEEL 4" X 40" VESSEL-300 PSI-3/4" FEED-1/2" PERMEATE

## SS MEMBRANE VESSEL REPLACEMENT PARTS



<u>PART NUMBER</u>	<u>ITEM DESCRIPTION</u>
PV-ORINGX	HYDRON PERMEATE ORING FOR 2.5" & 4" SPV SERIES END CAP
PV25-CAPORINGX	HYDRON CAP ORING FOR 2.5" RO VESSEL
PV25-CLAMP	AXEON 304 SS CLAMP FOR ENDCAP OF 2.5" SS VESSEL W/ FASTNERS
PV25-CLAMPX	HYDRON CLAMP SET FOR ENDCAP OF 2.5" RO VESSEL
PV25-ENDCAPX	HYDRON BLACK END CAP FOR 2.5" RO VESSEL - NO ORING INCLUDED
PV40-CLAMP	AXEON 304 SS CLAMP FOR ENDCAP OF 4" SS VESSEL W/ FASTNERS

# WATER TREATMENT

R.O. Membranes & Vessels

Specialty Membranes



PRECISION  
INSTALLATION  
PRODUCTS

## CULLIGAN MEMBRANES - COMPATIBLES (FITS AC30 MODELS)



<u>PART NUMBER</u>	<u>ITEM DESCRIPTION</u>
PW-CULL-36X	HYDRONIX TFC DRY CULLIGAN COMPATIBLE 36 GPD MEMBRANE FOR AC30
PW-CULL-50X	HYDRONIX TFC DRY CULLIGAN COMPATIBLE 50 GPD MEMBRANE FOR AC30
PW-CULLIGAN-36	APPLIED MEMBRANE DRY TFC CULLIGAN COMPATIBLE 36GPD MEMBRANE - FITS AC30 MODEL - 1.8" X 12" - CAS...
PW-CULLIGAN-50	APPLIED MEMBRANE DRY TFC CULLIGAN COMPATIBLE 50GPD MEMBRANE - FITS AC30 MODEL - 1.8" X 12" - CAS...

## INLINE MEMBRANES



<u>PART NUMBER</u>	<u>ITEM DESCRIPTION</u>
P5572-MEM100	OMNIPURE 2 1/2" X 10" INLINE 100 GPD TFC MEMBRANE CARTRIDGE W/ CHECK VALVE - (2) 1/4" JG - IN & [...]

## ELF MEMBRANES



<u>PART NUMBER</u>	<u>ITEM DESCRIPTION</u>
PELF-10MEM-250	OMNIPURE ELF 10" 180-250 GPD MEMBRANE CARTRIDGE
PELF-15MEM-500	OMNIPURE ELF 15" 250-500 GPD MEMBRANE CARTRIDGE -3.5" x 15"

## Q-SERIES MEMBRANE (W/ FLOW RESTRICTOR & CHECK VALVE)



<u>PART NUMBER</u>	<u>ITEM DESCRIPTION</u>
PQ5672-MEM35	OMNIPURE Q-SERIES 12" 35 GPD TFC MEMBRANE CARTRIDGE W/ FLOW RESTRICTOR & CHECK VALVE
PQ5672-MEM50	OMNIPURE Q-SERIES 12" 50 GPD TFC MEMBRANE CARTRIDGE W/ FLOW RESTRICTOR & CHECK VALVE
PQ5672-MEM80	OMNIPURE Q-SERIES 12" 80 GPD TFC MEMBRANE CARTRIDGE W/ FLOW RESTRICTOR & CHECK VALVE



PRECISION  
INSTALLATION  
PRODUCTS

# WATER TREATMENT

R.O. Membranes & Vessels

Specialty Membranes

## 4" X 40" ESPA HIGH PURITY MEMBRANES



<u>PART NUMBER</u>	<u>ITEM DESCRIPTION</u>
PW-ESPA2-LD-4040	HYDRANAUTICS 4" X 40" HIGH PURITY MEMBRANE-2,000 GPD @ 150 PSI-99.6% SALT REJECTION - LOW FOULING



# WATER TREATMENT

Tubing - R.O. - Drainline - Copper

Parker Polyethylene Tubing



PRECISION  
INSTALLATION  
PRODUCTS

## PARKER POLYETHYLENE TUBING - NSF



<u>PART NUMBER</u>	<u>ITEM DESCRIPTION</u>
LEG4-500N	PARKER 1/4" OD X 500 FEET NATURAL POLYETHYLENE TUBING
LEG4-500BLK	PARKER 1/4" OD X 500 FEET BLACK POLYETHYLENE TUBING
LEG4-500BU	PARKER 1/4" OD X 500' BLUE POLY TUBE-NSF
LEG4-500R	PARKER 1/4" OD X 500' RED POLY TUBE-NSF
LEG4-500WH	PARKER 1/4" OD X 500 FEET WHITE POLYETHYLENE TUBING
LEG4-500Y	PARKER 1/4" OD X 500' YELLOW POLY TUBE-NSF
LEG5-100BLK	PARKER 5/16" OD X 100 FEET BLACK POLYETHYLENE TUBING
LEG5-500BLK	PARKER 5/16" OD X 500 FEET BLACK POLYETHYLENE TUBING
LEG5-500N	PARKER 5/16" OD X 500 FEET NATURAL POLYETHYLENE TUBING
LEG6-500BLK	PARKER 3/8" OD X 500 FEET BLACK POLYETHYLENE TUBING
LEG6-500BU	PARKER 3/8" OD X 500' BLUE POLY TUBE-NSF
LEG6-500N	PARKER 3/8" OD X 500' NATURAL POLY TUBE - NSF
LEG6-500R	PARKER 3/8" OD X 500 FEET RED POLYETHYLENE TUBING
LEG6-500WH	PARKER 3/8" OD X 500 FEET WHITE POLYETHYLENE TUBING
LEG8-100N	PARKER 1/2" OD X 100 FEET NATURAL POLYETHYLENE TUBING - NSF
LEG8-250BLK	PARKER 1/2" OD X 250 FEET BLACK POLYETHYLENE TUBING - NSF
LEG8-250N	PARKER 1/2" OD X 250 FEET POLYETHYLENE TUBING-NON-STOCKING ITEM AT PARKER-4 WEEK LEADTIME
LEG8-500BLK	PARKER 1/2" OD X 500 FEET BLACK POLYETHYLENE TUBING - NSF
LEG8-500N	PARKER 1/2" OD X 500 FEET NATURAL POLYETHYLENE TUBING - NSF

### Features

- Made from 100% virgin resin material
- Chemically resistant and flexible.
- High molecular weight resin provides increased dimensional stability, uniformity and long-term strength.
- Economical system solution

### Certifications

- FDA compliant for food contact
- ASTM D-1693 (10% IGEPAL) for stress crack resistance
- NSF - 51
- NSF - 61

PART NUMBER	PART NUMBER	TUBE O.D.		TUBE I.D.		AVERAGE WALL THICKNESS		WORKING PRESSURE AT 73°F / 23°C		MINIMUM BURST AT 73°F / 23°C		MINIMUM BEND RADIUS	
		INCH	MM	INCH	MM	INCH	MM	PSI	BAR	PSI	BAR	INCH	MM
LEG4-500N	LEG4-500BLK	1/4	6.4	.170	4.3	.040	1.0	120	8.3	480	33.1	1.00	25.4
LEG5-500N	LEG5-500BLK	5/16	7.9	.187	4.8	.062	1.6	145	10.0	580	40.0	1.13	28.7
LEG6-500N	LEG6-500BLK	3/8	9.5	.250	6.4	.062	1.6	125	8.6	500	34.5	1.25	31.8
LEG8-250N	LEG8-250BLK	1/2	12.7	.375	9.5	.062	1.6	90	6.2	360	24.8	2.50	63.5



**PRECISION  
INSTALLATION  
PRODUCTS**

# WATER TREATMENT

Tubing – R.O. – Drainline – Copper

## Hydronix Polyethylene Tubing

### PARKER POLYETHYLENE TUBING - NSF



<u>PART NUMBER</u>	<u>ITEM DESCRIPTION</u>
KHD-4-500B	HYDRONIX 1/4"OD X 500' BLACK POLYETHYLENE TUBING - NSF
KHD-4-500BU	HYDRONIX 1/4"OD X 500' BLUE POLYETHYLENE TUBING - NSF
KHD-4-500G	HYDRONIX 1/4"OD X 500' GREEN POLYETHYLENE TUBING - NSF
KHD-4-500N	HYDRONIX 1/4"OD X 500' NATURAL POLYETHYLENE TUBING - NSF
KHD-4-500OR	HYDRONIX 1/4" OD X 500' ORANGE POLYETHYLENE TUBING - NSF
KHD-4-500R	HYDRONIX 1/4"OD X 500' RED POLYETHYLENE TUBING - NSF
KHD-4-500W	HYDRONIX 1/4"OD X 500' WHITE POLYETHYLENE TUBING - NSF
KHD-4-500Y	HYDRONIX 1/4"OD X 500' YELLOW POLYETHYLENE TUBING - NSF
KHD-6-500B	HYDRONIX 3/8"OD X 500' BLACK POLYETHYLENE TUBING - NSF
KHD-6-500BU	HYDRONIX 3/8"OD X 500' BLUE POLYETHYLENE TUBING - NSF
KHD-6-500N	HYDRONIX 3/8"OD X 500' NATURAL POLYETHYLENE TUBING - NSF
KHD-6-500R	HYDRONIX 3/8"OD X 500' RED POLYETHYLENE TUBING-NSF
KHD-6-500W	HYDRONIX 3/8"OD X 500' WHITE POLYETHYLENE TUBING - NSF
KHD-8-250B	HYDRONIX 1/2"OD X 250' BLACK POLYETHYLENE TUBING - NSF
KHD-8-250BU	HYDRONIX 1/2"OD X 250' BLUE POLYETHYLENE TUBING - NSF
KHD-8-250N	HYDRONIX 1/2"OD X 250' NATURAL POLYETHYLENE TUBING - NSF
KHD-8-250W	HYDRONIX 1/2"OD X 250' WHITE POLYETHYLENE TUBING - NSF

Outside Diameter	Inside Diameter
1/4"	0.160"
3/8"	0.250"
1/2"	0.37"

Tubing Working Pressure & Temperature Range	
1/4" & 3/8"	- 230 PSI @ 70°F (15 BAR @ 20°C)
Max	120 PSI @ 150°F (8 BAR @ 65°C)
1/2"	- 150 PSI @ 70°F (10 BAR @ 20°C)
Max	90 PSI @ 150°F (6 BAR @ 65°C)

NSF LISTED FDA  
APPROVED BPA  
FREE

OD (Inch)		Wall Thickness (Inch)		Max. Ovality (Inch)	Min. Bend Radius @ +20°C (mm)	Max. Working Pressure (bar)		
D	Tolerance	e	Tolerance			-15°C to +20°C	+40°C	+65°C
1/4"	± 0.0004	0.047	± 0.0004	± 0.008	1"	16	12	10
3/8"	± 0.0004	0.063	± 0.0004	± 0.009	1.25"	13	12	7
1/2"	± 0.0004	0.063	± 0.0004	± 0.01	2.5"	11	9	7

### HYDRONIX TUBING CUTTER / COLLET REMOVAL TOOL



<u>PART NUMBER</u>	<u>ITEM DESCRIPTION</u>
HDF-TC-RT	HYDRONIX BLUE TUBING CUTTER W/ BUILT-IN COLLET REMOVAL TOOL

# WATER TREATMENT

Tubing – R.O. – Drainline – Copper

Pure T Polyethylene Tubing



PRECISION  
INSTALLATION  
PRODUCTS

## PURE T POLYETHYLENE TUBING - NSF



<u>PART NUMBER</u>	<u>ITEM DESCRIPTION</u>
KTU4-1000B	PURE T 1/4"OD X 1000' BLACK POLYETHYLENE TUBING - NSF
KTU4-1000BU	PURE T 1/4"OD X 1000' BLUE POLYETHYLENE TUBING - NSF
KTU4-1000R	PURE T 1/4"OD X 1000' RED POLYETHYLENE TUBING - NSF
KTU4-1000W	PURE T 1/4"OD X 1000' WHITE POLYETHYLENE TUBING - NSF
KTU6-500B	PURE T 3/8"OD X 500' BLACK POLYETHYLENE TUBING - NSF
KTU6-500BU	PURE T 3/8"OD X 500' BLUE POLYETHYLENE TUBING - NSF
KTU6-500W	PURE T 3/8"OD X 500' WHITE POLYETHYLENE TUBING - NSF
KTU8-165B	PURE T 1/2"OD X 165' BLACK POLYETHYLENE TUBING - NSF
KTU8-165BU	PURE T 1/2"OD X 165' BLUE POLYETHYLENE TUBING - NSF
KTU8-165W	PURE T 1/2"OD X 165' WHITE POLYETHYLENE TUBING - NSF

Specification	
Material	Polyethylene
Max. Working Pressure	120 psi @ 70F 60 psi @ 150F
Max. Temp.	45°C/113°F
	NSF 42 / 58 / 61

- Keep away from FIRE. DO NOT use in high temperature areas.  
(Max. temperature: 45°C/113°F)
- DO NOT bend the tubing at a 90 degree angle.
- Inspect the tubing appearance before using it. Make sure there are NO foreign objects, scratches, or uneven surfaces, etc.
- To avoid leaks, cut off used portion before reusing it.
- To avoid leaks due to the material's physical properties and temperature expansion, please DO NOT use the tubing under HOT and COLD conditions at the same time.
- Please DO NOT expose to or use the tubing under direct sunlight.

## SOUIX CHIEF DRAIN LINE TUBING

<u>PART NUMBER</u>	<u>ITEM DESCRIPTION</u>
KH10-100BR	5/8 OD X 1/2 ID X 100' BLACK POLY VINYL DRAIN LINE TUBING ON REEL
KH14-100R	7/8 OD X 5/8 ID X 100' CLEAR POLY/VINYL DRAIN LINE TUBING REEL

## PURE T TUBING CUTTER / COLLET REMOVAL TOOL



<u>PART NUMBER</u>	<u>ITEM DESCRIPTION</u>
LQTC	PURE T YELLOW TUBING CUTTERS



PRECISION  
INSTALLATION  
PRODUCTS

# WATER TREATMENT

Tubing – R.O. – Drainline – Copper

Parker High Pressure Polypropylene Tubing

## PARKER POLYPROPYLENE TUBING - HIGH PRESSURE



<u>PART NUMBER</u>	<u>ITEM DESCRIPTION</u>
KP4-500W	PARKER HIGH PRESSURE POLYPROPYLENE WHITE TUBING-1/4" OD X 3/16" ID X 500 FEET X 300 PSI
KP6-500W	PARKER HIGH PRESSURE POLYPROPYLENE WHITE TUBING-3/8" OD X 1/4" ID X 500 FEET X 300 PSI
KP8-250W	PARKER HIGH PRESSURE POLYPROPYLENE WHITE TUBING - 1/2" OD X 3/8" ID X 250 FEET X 225 PSI

**Features:**

- ACID AND CHEMICALLY RESISTANT
- MAY BE USED IN HIGHER TEMPERATURES & WORKING PRESSURES THAN POLYETHYLENE TUBING
- EXCELLENT COMPATIBILITY WITH HIGH TEMPERATURE WATER
- LOW WATER ABSORPTION (LESS THAN 0.01%)
- GOOD COMPATIBILITY WITH VEGETABLE OILS
- EXCELLENT RESISTANCE TO ENVIRONMENTAL STRESS CRACKING

Polypropylene tubing exhibits excellent chemical resistance to chlorinated water.

Part Number	Color	Nom. Tube O. D. in.	Nom. Tube I. D. in.	Avg. Wall Thick. in.	Reel Length ft.	Working Pressure at 73°F psi	Min. Burst Pressure at 73°F psi	Min. Bend Radius in.
#								
KP4-500W KP4-500B	White Black	1/4	.170	.040	500	300	1200	1
KP6-500W KP6-500B	White Black	3/8	.250	.062	500	300	1200	1-1/4
KP8-250W KP8-250B	White Black	1/2	.375	.062	250	225	900	2-1/2

# WATER TREATMENT

Tubing - R.O. - Drainline - Copper

PVC Vinyl Drain Tubing



PRECISION  
INSTALLATION  
PRODUCTS

## PVC ADAPTER FOR USE W/ DRAIN LINE TUBING



**PART NUMBER**

**ITEM DESCRIPTION**

A4180

PVC SCHEDULE 80 - 1/2" BARB X 1/2" MPT ADAPTER



**PRECISION  
INSTALLATION  
PRODUCTS**

# WATER TREATMENT

Tubing - R.O. - Drainline - Copper

## Copper Tubing

### COPPER TUBING - REFRIGERATION GRADE (.30 WALL)



<u>PART NUMBER</u>	<u>ITEM DESCRIPTION</u>
KR2	1/8 X 50' REFRIGERATOR COPPER
KR3	3/16 X 50' REFRIGERATOR COPPER
KR4	1/4 X 50' REFRIGERATOR COPPER
KR5	5/16 X 50' REFRIGERATOR COPPER
KR6	3/8 X 50' REFRIGERATOR COPPER
KR8	1/2 X 50' REFRIGERATOR COPPER
KR10	5/8 X 50' REFRIGERATOR COPPER
KR12	3/4 X 50' REFRIGERATOR COPPER
KR14	7/8 X 50' REFRIGERATOR COPPER

### COPPER TUBING - UTILITY GRADE (.20 WALL)



<u>PART NUMBER</u>	<u>ITEM DESCRIPTION</u>
KU4-15	1/4 X 15' UTILITY COPPER-.020 WALL THICKNESS
KU4-25	1/4 X 25' UTILITY COPPER-.020 WALL THICKNESS
KU4-50	1/4 X 50' UTILITY COPPER-.020 WALL THICKNESS

# WATER TREATMENT

Pex Tubing

Pex Bulk Line



PRECISION  
INSTALLATION  
PRODUCTS

## PEX BULK LINE



### PART NUMBER

### ITEM DESCRIPTION

KLP4-100	1/4" OD X 100' PEX BULK LINE - GRAY COLOR
KLP6-100	3/8" OD X 100' PEX BULK LINE - GRAY COLOR
KLP8-100	1/2" OD X 100' PEX BULK LINE - GRAY COLOR



### **Why Use PEX?**

It has no taste or odor associated with copper or other types of tubing. It's highly flexible & heat resistant providing for quick and economical installations. It's NSF (Standard 14 & 61), CSA and IAPMO approved. It's corrosion resistant and will not pit corrode or scale. It is resistant to household cleaners, chloramines & chloride. PEX has been used for over 25 years in plumbing systems with superior results!

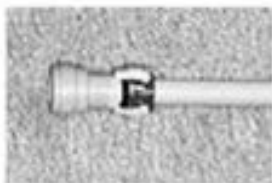

It's compatible with all  
Liquatec & Legris quick  
connect fittings!

### **Want Awesome Performance?**

It is one of the few products that we've found that is virtually rodent resistant! Require high performance? Check these impressive specs: 160 PSI @ 73 degrees Fahrenheit  
100 PSI @ 160 degrees Fahrenheit  
80 PSI @ 200 degrees Fahrenheit

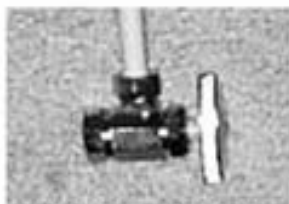

Replace the brass sleeve  
with a plastic (Delrin)  
sleeve when using PEX  
with compression fittings!

### **How Do You Use PEX?**

It can be used anywhere you would install copper or poly tubing: refrigerator icemaker lines, dishwashers, reverse osmosis systems, under-the-counter filters, vending machines, coffeemakers, ice machines and water coolers. Installations are a snap because this tubing is compatible with Legris, Liquatec, JACO, John Guest and all compression fittings! Cut it with a plastic tube cutter (like our #LQTC) to give it a clean edge. If you're using compression fittings, just replace the brass sleeve with a plastic (Delrin) sleeve - **no tubing inserts are required!**





**PRECISION  
INSTALLATION  
PRODUCTS**

# WATER TREATMENT

Pex Tubing

Pex Icemaker Line

## PEX ICEMAKER LINES - WITH 1/4" COMP NUTS - GREY

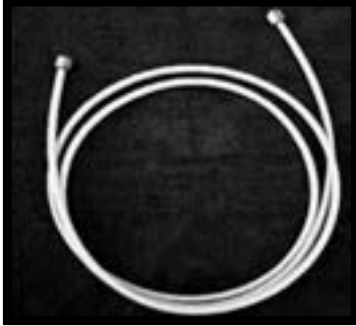

<u>PART NUMBER</u>	<u>ITEM DESCRIPTION</u>
LP44-96	96" PEX ICEMAKER LINE W/ 1/4" COMP NUTS
LP44-120	120" PEX ICEMAKER LINE W/ 1/4" COMP NUTS

### Merflex® Pex OT refrigerator Water supply line Hook-Up

Our patented Merflex PEX OT Refrigerator Water Supply Line Hook-Up is designed to be economical and easier to use than conventional copper tubing. In fact, Merflex PEX OT is the only plastic tubing that a major appliance manufacturer has tested and approved for refrigerator connections to a residential potable water supply.

#### Features:

- Patented one-piece formed or molded ends with captive brass nuts provide a reliable, leak-free connection
- Faster and easier than expensive copper installations
- Excellent burst strength for long-term performance
- Kink and creep resistant
- Resists environmental stress cracks and degradation
- Corrosion resistant
- Approved for chlorine and chloramine water applications
- Superior odor and taste compared to copper and other plastics
  - PEX OT for optimal odor and taste characteristics

#### Complies With:

- ANSI/NSF Standard 61
- ASME Standard: Flexible Water Connectors - A112.18.6
- U. P. Code
- Listing requirements of NSF and CSA

### Installation Instructions

- Riser plain end should be clean-cut, squared and bottomed-out in supply stop to insure a proper seal.
- All fittings and end connections should be free of pipe dope, compounds or sealant.
- Metal nuts on the faucet or toilet connection should be hand-tightened and then tightened 1 additional turn with wrench. DO NOT OVER-TIGHTEN.
- Plastic nuts should be firmly hand-tightened and if required, tightened an additional quarter (1/4) to one half (1/2) turn. DO NOT OVER-TIGHTEN.
- Use supplied plastic compression ring only. To install at the supply stop, hand-tighten compression nut, then add additional 2 to 3 complete turns with wrench. NOTE: When properly tightened, the compression sleeve should compress the plastic tubing sufficiently to not allow slippage or removal by hand.
- Merflex PEX tubing should not be bent to a radius smaller than 3" for 1/4"CTS X 3/8"OD lines and 4" for 3/8"CTS X 1/2"OD lines. Bending the tubing to a radius smaller than recommended can lead to failure.

Manufacturer assumes no responsibility for failure due to improper installation.



# WATER TREATMENT

Pex Tubing

Pex Universal Dishwasher Line



PRECISION  
INSTALLATION  
PRODUCTS

## PEX UNIVERSAL DISHWASHER LINES - WITH 3/8 - 1/2 NUTS - GREY



<u>PART NUMBER</u>	<u>ITEM DESCRIPTION</u>
LP86-60	60" PEX UNIV DISHWASHER LINE W/ 3/8 - 1/2" NUTS
LP86-72	72" PEX UNIV DISHWASHER LINE W/ 3/8 - 1/2" NUTS
LP86-96	96" PEX UNIV DISHWASHER LINE W/ 3/8 - 1/2" NUTS

### Pex Universal Dishwasher Hose

Mercury Plastics' PEX Universal Dishwasher Hose is preferred by many major appliance manufacturers for its ease of use and superior odor and taste properties. Designed to connect multiple configurations, PEX Universal Dishwasher Hose eliminates the need for adaptors. In addition, because it is manufactured using our electron beam cross-linking process, this product offers proven durability.

- Quick and easy installation
- One piece design means no leaks
- Resists kinks
- Won't pit, corrode or scale
- Superior strength and long life
- Resistant to chlorine, chloramines and typical household chemicals
- PEX is an NSF approved material for residential plumbing systems
- Complies with ASME Standard: Flexible Water Connectors - A112.18.6
- Meets P171 for chlorine

The PEX Universal Dishwasher Line comes with the three most common supply line connections built in. 3/8", 1/2" compression & 1/2" NPT.

### Installation Instructions

- Shut off water supply.
  - Determine the nut size required to make the connection to the stop valve.
  - If you will be using the "compression" or "NPT", cut the PEX tubing just before the overmolded end and the corresponding nut, using a sharp PEX approved cutter. Otherwise, leave the existing hardware intact.
  - Connect the elbow to the dishwasher inlet using Teflon® tape. Important note: Do not use Teflon tape on any other connections.
  - Connect one end of tubing to elbow (no tape).
  - Connect other end to water supply (no tape).
- If water supply is 3/8" compression, connect other end of tubing directly to this valve outlet.
- If water supply is "compression", insert flat washer into pipe thread adapter & thread onto valve outlet before connecting tubing.
- If water supply is "NPT", insert cone washer into pipe thread adapter and thread onto valve outlet before connecting tubing.
- Hand tighten all connections, then one additional turn with a wrench. Do not over tighten.
- Slowly turn on water supply and check for leaks. If leak appears, carefully tighten further by hand.

Manufacturer assumes no responsibility for failure due to improper installation.



PRECISION  
INSTALLATION  
PRODUCTS



**END OF SECTION**

**THIS PAGE IS LEFT  
INTENTIONALLY BLANK.**

# WATER TREATMENT

## Legris "Liquifit" Quick Connect Fittings

LIQUIfit™



PRECISION  
INSTALLATION  
PRODUCTS

### The Advantages of the Liquifit Range

#### Advantages of the LIQUIfit™ Range



#### • Optimal Sealing

- Quality control and date coding
- Automatic sealing: the D seal within the fitting provides a positive seal on the O.D. of the tube, in both static and dynamic positions, due to an optimized design of the fitting cavity.

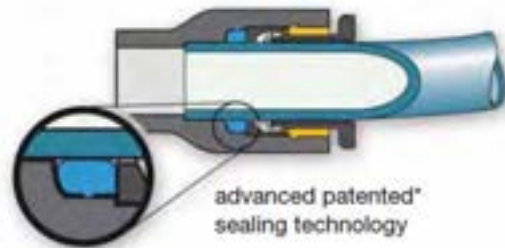

#### • High Performance Materials

- Suitable for: water, beverages, CO<sub>2</sub>...
- High chemical resistance (chlorine, cleaning agents, UV)...
- Approved quality for contact with food : FDA, NSF 61, 51, ACS, WRAS inch
- Mechanical resistance over time

#### • Renewable Bio-Based Material

- The LIQUIfit™ body is manufactured from a unique bio-based high performance polymer produced from renewable plants, to expand the use of non-fossil-based resources.
- CO<sub>2</sub> emissions are divided by 5 compared to classic polymer fittings.



PTFE immediate seal of threads

- All LIQUIfit™ threaded fittings have pre-applied PTFE thread sealant to save time during assembly, but may be ordered without thread pre-coating.

Part numbers : 63XX = with pre-coating  
65XX = without pre-coating

LIQUIfit™ white and grey fittings comply with the following standards:

The Parker Legris production process includes individual testing and unit quality control and dating for all LIQUIfit™ instant fittings, in order to guarantee their quality and traceability.



### Advantages of the LIQUIfit™ Range

- **Advanced Design (Registered Design\*)**

- The most compact profile on the market
- Ergonomic and aesthetic design
- Ergonomic release button
- Easy-to-clean surfaces



- **Innovative Technology**

- Instant connection/disconnection
- The much-reduced movement of the LIQUIfit™ gripping system prevents any pumping effect.
- No tube insert or locking clip required at any working temperature (with Parker Legris Advanced PE Tubing)
- Advanced gripping design patented\*\* allows a tight bend radius without leaks
- Can be used with prepared metallic tubing (please consult Parker Legris' technical department for the groove dimensions)



Simply push the tubing until it can go no further. Gripping and sealing are accomplished instantaneously.

First depress the manual release button, then pull the tubing out of the fitting.

**Convenient compact full flow profile:** as gripping and sealing within the fitting is achieved using the outside of the tube, there is no flow restriction. The smallest orifice inside the fitting is equal to or larger than the internal diameter of the tube.

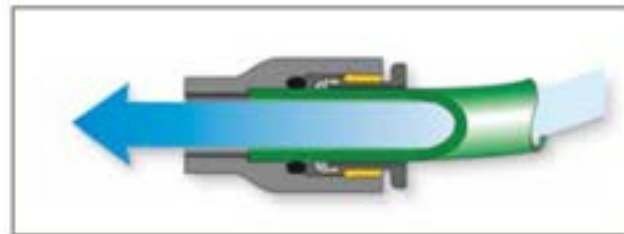

Internal hex to allow easy mounting in a restricted amount of space



# WATER TREATMENT

Legris "Liquifit" Quick Connect Fittings

LIQUIFIT™



PRECISION  
INSTALLATION  
PRODUCTS

## MALE CONNECTOR - TUBE X MPT



<u>PART NUMBER</u>	<u>ITEM DESCRIPTION</u>
LEGO1-4-2	LEGRIS MALE CONNECTOR - 1/4" TUBE X 1/8" MALE PIPE THREAD (MUST PURCHASE IN 10'S)
LEGO1-4-4	LEGRIS MALE CONNECTOR - 1/4" TUBE X 1/4" MALE PIPE THREAD (MUST PURCHASE IN 10'S)
LEGO1-4-6	LEGRIS MALE CONNECTOR - 1/4" TUBE X 3/8" MALE PIPE THREAD (MUST PURCHASE IN 10'S)
LEGO1-6-2	LEGRIS MALE CONNECTOR - 3/8" TUBE X 1/8" MALE PIPE THREAD (MUST PURCHASE IN 10'S)
LEGO1-6-4	LEGRIS MALE CONNECTOR - 3/8" TUBE X 1/4" MALE PIPE THREAD (MUST PURCHASE IN 10'S)
LEGO1-6-6	LEGRIS MALE CONNECTOR - 3/8" TUBE X 3/8" MALE PIPE THREAD (MUST PURCHASE IN 10'S)
LEGO1-6-8	LEGRIS MALE CONNECTOR - 3/8" TUBE X 1/2" MALE PIPE THREAD (MUST PURCHASE IN 10'S)
LEGO1-8-6	LEGRIS MALE CONNECTOR - 1/2" TUBE X 3/8" MALE PIPE THREAD (MUST PURCHASE IN 10'S)
LEGO1-8-8	LEGRIS MALE CONNECTOR - 1/2" TUBE X 1/2" MALE PIPE THREAD (MUST PURCHASE IN 5'S)

## UNION TEE - TUBE X TUBE X TUBE



<u>PART NUMBER</u>	<u>ITEM DESCRIPTION</u>
LEGO2-4	LEGRIS UNION TEE - 1/4" TUBE X 1/4" TUBE X 1/4" TUBE (MUST PURCHASE IN 10'S)
LEGO2-5	LEGRIS UNION TEE - 5/16" TUBE X 5/16" TUBE X 5/16" TUBE (MUST PURCHASE IN 10'S)
LEGO2-6	LEGRIS UNION TEE - 3/8" TUBE X 3/8" TUBE X 3/8" TUBE (MUST PURCHASE IN 10'S)
LEGO2-8	LEGRIS UNION TEE - 1/2" TUBE X 1/2" TUBE X 1/2" TUBE (MUST PURCHASE IN 5'S)



PRECISION  
INSTALLATION  
PRODUCTS

LIQUIfit™

# WATER TREATMENT

## Legris "Liquifit" Quick Connect Fittings

### UNION ELBOW - TUBE X TUBE



<u>PART NUMBER</u>	<u>ITEM DESCRIPTION</u>
LEG03-4	LEGRIS UNION ELBOW - 1/4" TUBE X 1/4" TUBE (MUST PURCHASE IN 10'S)
LEG03-5	LEGRIS UNION ELBOW - 5/16" TUBE X 5/16" TUBE (MUST PURCHASE IN 10'S)
LEG03-6	LEGRIS UNION ELBOW - 3/8" TUBE X 3/8" TUBE (MUST PURCHASE IN 10'S)
LEG03-8	LEGRIS UNION ELBOW - 1/2" TUBE X 1/2" TUBE (MUST PURCHASE IN 5'S)

### UNION CONNECTOR - TUBE X TUBE



<u>PART NUMBER</u>	<u>ITEM DESCRIPTION</u>
LEG04-4	LEGRIS UNION CONNECTOR - 1/4" TUBE X 1/4" TUBE (MUST PURCHASE IN 10'S)
LEG04-5	LEGRIS UNION CONNECTOR - 5/16" TUBE X 5/16" TUBE (MUST PURCHASE IN 10'S)
LEG04-6	LEGRIS UNION CONNECTOR - 3/8" TUBE X 3/8" TUBE (MUST PURCHASE IN 10'S)
LEG04-8	LEGRIS UNION CONNECTOR - 1/2" TUBE X 1/2" TUBE (MUST PURCHASE IN 5'S)

### STEM ADAPTER - STEM X MPT



<u>PART NUMBER</u>	<u>ITEM DESCRIPTION</u>
LEG05-4-2	LEGRIS STEM ADAPTER - 1/4" STEM X 1/8" MALE PIPE THREAD (MUST PURCHASE IN 10'S)
LEG05-4-4	LEGRIS STEM ADAPTER - 1/4" STEM X 1/4" MALE PIPE THREAD (MUST PURCHASE IN 10'S)
LEG05-4-6	LEGRIS STEM ADAPTER - 1/4" STEM X 3/8" MALE PIPE THREAD (MUST PURCHASE IN 10'S)
LEG05-6-4	LEGRIS STEM ADAPTER - 3/8" STEM X 1/4" MALE PIPE THREAD (MUST PURCHASE IN 10'S)
LEG05-6-6	LEGRIS STEM ADAPTER - 3/8" STEM X 3/8" MALE PIPE THREAD (MUST PURCHASE IN 10'S)
LEG05-8-6	LEGRIS STEM ADAPTER - 1/2" STEM X 3/8" MALE PIPE THREAD (MUST PURCHASE IN 5'S)
LEG05-8-8	LEGRIS STEM ADAPTER - 1/2" STEM X 1/2" MALE PIPE THREAD (MUST PURCHASE IN 5'S)

# WATER TREATMENT

Legris "Liquifit" Quick Connect Fittings

LIQUIFIT™



PRECISION  
INSTALLATION  
PRODUCTS

## STEM REDUCER - STEM X TUBE



<u>PART NUMBER</u>	<u>ITEM DESCRIPTION</u>
LEG06-5-4	LEGRIS STEM ADAPTER - 5/16" STEM X 1/4" TUBE (MUST PURCHASE IN 10'S)
LEG06-6-4	LEGRIS STEM ADAPTER - 3/8" STEM X 1/4" TUBE (MUST PURCHASE IN 10'S)
LEG06-8-6	LEGRIS STEM ADAPTER - 1/2" STEM X 3/8" TUBE (MUST PURCHASE IN 5'S)

## PLUG IN TEE - TUBE X TUBE X STEM



<u>PART NUMBER</u>	<u>ITEM DESCRIPTION</u>
LEG07-4	LEGRIS PLUG IN TEE - 1/4" TUBE X 1/4" TUBE X 1/4" STEM (MUST PURCHASE IN 10'S)
LEG07-6	LEGRIS PLUG IN TEE - 3/8" TUBE X 3/8" TUBE X 3/8" STEM (MUST PURCHASE IN 10'S)
LEG07-8	LEGRIS PLUG IN TEE - 1/2" TUBE X 1/2" TUBE X 1/2" STEM (MUST PURCHASE IN 5'S)

## PLUG



<u>PART NUMBER</u>	<u>ITEM DESCRIPTION</u>
LEG08-4	LEGRIS PLUG - 1/4" SIZE FOR TUBE ID (MUST PURCHASE IN 10'S)
LEG08-6	LEGRIS PLUG - 3/8" SIZE FOR TUBE ID (MUST PURCHASE IN 10'S)
LEG08-8	LEGRIS PLUG - 1/2" SIZE FOR TUBE ID (MUST PURCHASE IN 5'S)



PRECISION  
INSTALLATION  
PRODUCTS

LIQUIfit™

# WATER TREATMENT

## Legris "Liquifit" Quick Connect Fittings

### SWIVEL ELBOW - TUBE X MPT



<u>PART NUMBER</u>	<u>ITEM DESCRIPTION</u>
LEG09-4-2	LEGRIS SWIVEL ELBOW - 1/4" TUBE X 1/8" MALE PIPE THREAD (MUST PURCHASE IN 10'S)
LEG09-4-4	LEGRIS SWIVEL ELBOW - 1/4" TUBE X 1/4" MALE PIPE THREAD (MUST PURCHASE IN 10'S)
LEG09-4-6	LEGRIS SWIVEL ELBOW - 1/4" TUBE X 3/8" MALE PIPE THREAD (MUST PURCHASE IN 10'S)
LEG09-6-4	LEGRIS SWIVEL ELBOW - 3/8" TUBE X 1/4" MALE PIPE THREAD (MUST PURCHASE IN 10'S)
LEG09-6-6	LEGRIS SWIVEL ELBOW - 3/8" TUBE X 3/8" MALE PIPE THREAD (MUST PURCHASE IN 10'S)
LEG09-8-6	LEGRIS SWIVEL ELBOW - 1/2" TUBE X 3/8" MALE PIPE THREAD (MUST PURCHASE IN 4'S)
LEG09-8-8	LEGRIS SWIVEL ELBOW - 1/2" TUBE X 1/2" MALE PIPE THREAD (MUST PURCHASE IN 4'S)

### SWIVEL BRANCH TEE - TUBE X TUBE X MPT



<u>PART NUMBER</u>	<u>ITEM DESCRIPTION</u>
LEG10-4-2	LEGRIS SWIVEL BRANCH TEE - 1/4" TUBE X 1/4" TUBE X 1/8" MALE PIPE THREAD (MUST PURCHASE IN 10'S)
LEG10-4-4	LEGRIS SWIVEL BRANCH TEE - 1/4" TUBE X 1/4" TUBE X 1/4" MALE PIPE THREAD (MUST PURCHASE IN 10'S)
LEG10-4-6	LEGRIS SWIVEL BRANCH TEE - 1/4" TUBE X 1/4" TUBE X 3/8" MALE PIPE THREAD (MUST PURCHASE IN 10'S)
LEG10-6-6	LEGRIS SWIVEL BRANCH TEE - 3/8" TUBE X 3/8" TUBE X 3/8" MALE PIPE THREAD (MUST PURCHASE IN 10'S)
LEG10-8-6	LEGRIS SWIVEL BRANCH TEE - 1/2" TUBE X 1/2" TUBE X 3/8" MALE PIPE THREAD (MUST PURCHASE IN 4'S)
LEG10-8-8	LEGRIS SWIVEL BRANCH TEE - 1/2" TUBE X 1/2" TUBE X 1/2" MALE PIPE THREAD (MUST PURCHASE IN 4'S)
LEG09-8-8	LEGRIS SWIVEL ELBOW - 1/2" TUBE X 1/2" MALE PIPE THREAD (MUST PURCHASE IN 4'S)



# WATER TREATMENT

Legris "Liquifit" Quick Connect Fittings

LIQUIFIT™



PRECISION  
INSTALLATION  
PRODUCTS

## MALE RUN TEE - TUBE X MPT X TUBE



<u>PART NUMBER</u>	<u>ITEM DESCRIPTION</u>
LEG11-4-2	LEGRIS SWIVEL MALE RUN TEE - 1/4" TUBE X 1/8" MALE PIPE THREAD X 1/4" TUBE (MUST PURCHASE IN 10'S)
LEG11-4-4	LEGRIS SWIVEL MALE RUN TEE - 1/4" TUBE X 1/4" MALE PIPE THREAD X 1/4" TUBE (MUST PURCHASE IN 10'S)
LEG11-4-6	LEGRIS SWIVEL MALE RUN TEE - 1/4" TUBE X 3/8" MALE PIPE THREAD X 1/4" TUBE (MUST PURCHASE IN 10'S)
LEG11-6-4	LEGRIS SWIVEL MALE RUN TEE - 3/8" TUBE X 1/4" MALE PIPE THREAD X 3/8" TUBE (MUST PURCHASE IN 10'S)
LEG11-6-6	LEGRIS SWIVEL MALE RUN TEE - 3/8" TUBE X 3/8" MALE PIPE THREAD X 3/8" TUBE (MUST PURCHASE IN 10'S)
LEG11-8-6	LEGRIS SWIVEL MALE RUN TEE - 1/2" TUBE X 3/8" MALE PIPE THREAD X 1/2" TUBE (MUST PURCHASE IN 4'S)
LEG11-8-8	LEGRIS SWIVEL MALE RUN TEE - 1/2" TUBE X 1/2" MALE PIPE THREAD X 1/2" TUBE (MUST PURCHASE IN 4'S)

## BULKHEAD UNION - TUBE X TUBE



<u>PART NUMBER</u>	<u>ITEM DESCRIPTION</u>
LEG12-4	LEGRIS BULKHEAD UNION - 1/4" TUBE X 1/4" TUBE (MUST PURCHASE IN 10'S)
LEG12-6	LEGRIS BULKHEAD UNION - 3/8" TUBE X 3/8" TUBE (MUST PURCHASE IN 10'S)
LEG12-8	LEGRIS BULKHEAD UNION - 1/2" TUBE X 1/2" TUBE (MUST PURCHASE IN 5'S)

## REDUCING ELBOW - TUBE X TUBE



<u>PART NUMBER</u>	<u>ITEM DESCRIPTION</u>
LEG14-5-4	LEGRIS REDUCING ELBOW - 5/16" TUBE X 1/4" TUBE (MUST PURCHASE IN 10'S)
LEG14-6-4	LEGRIS REDUCING ELBOW - 3/8" TUBE X 1/4" TUBE (MUST PURCHASE IN 10'S)
LEG14-6-5	LEGRIS REDUCING ELBOW - 3/8" TUBE X 5/16" TUBE (MUST PURCHASE IN 10'S)
LEG14-8-6	LEGRIS REDUCING ELBOW - 1/2" TUBE X 3/8" TUBE (MUST PURCHASE IN 5'S)



PRECISION  
INSTALLATION  
PRODUCTS

LIQUIFIT™

# WATER TREATMENT

## Legris "Liquifit" Quick Connect Fittings

### REDUCING UNION CONNECTOR - TUBE X TUBE



<u>PART NUMBER</u>	<u>ITEM DESCRIPTION</u>
LEG20-5-4	LEGRIS REDUCING UNION - 5/16" TUBE X 1/4" TUBE (MUST PURCHASE IN 10'S)
LEG20-6-4	LEGRIS REDUCING UNION - 3/8" TUBE X 1/4" TUBE (MUST PURCHASE IN 10'S)
LEG20-6-5	LEGRIS REDUCING UNION - 3/8" TUBE X 5/16" TUBE (MUST PURCHASE IN 10'S)
LEG20-8-6	LEGRIS REDUCING UNION - 1/2" TUBE X 3/8" TUBE (MUST PURCHASE IN 5'S)

### PLUG IN RUN TEE - TUBE X STEM X TUBE



<u>PART NUMBER</u>	<u>ITEM DESCRIPTION</u>
LEG21-4-4	LEGRIS PLUG IN RUN TEE - 1/4" TUBE X 1/4" STEM X 1/4" TUBE (MUST PURCHASE IN 10'S)
LEG21-6-6	LEGRIS PLUG IN RUN TEE - 3/8" TUBE X 3/8" STEM X 3/8" TUBE (MUST PURCHASE IN 10'S)
LEG21-8-8	LEGRIS PLUG IN RUN TEE - 1/2" TUBE X 1/2" STEM X 1/2" TUBE (MUST PURCHASE IN 5'S)

### PLUG IN ELBOW



<u>PART NUMBER</u>	<u>ITEM DESCRIPTION</u>
LEG22-4	LEGRIS PLUG IN ELBOW - 1/4" STEM X 1/4" TUBE (MUST PURCHASE IN 10'S)
LEG22-4-6	LEGRIS PLUG IN ELBOW - 1/4" STEM X 3/8" TUBE (MUST PURCHASE IN 10'S)
LEG22-6	LEGRIS PLUG IN ELBOW - 3/8" STEM X 3/8" TUBE (MUST PURCHASE IN 10'S)
LEG22-6-4	LEGRIS PLUG IN ELBOW - 3/8" STEM X 1/4" TUBE (MUST PURCHASE IN 10'S)
LEG22-8	LEGRIS PLUG IN ELBOW - 1/2" STEM X 1/2" TUBE (MUST PURCHASE IN 5'S)

# WATER TREATMENT

Legris "Liquifit" Quick Connect Fittings

LIQUIFIT™



PRECISION  
INSTALLATION  
PRODUCTS

## 2-WAY DIVIDER - TUBE X (2) TUBE



<u>PART NUMBER</u>	<u>ITEM DESCRIPTION</u>
LEG23-4	LEGRIS 2-WAY DIVIDER - 1/4" TUBE X 1/4" TUBE X 1/4" TUBE (MUST PURCHASE IN 10'S)
LEG23-6	LEGRIS 2-WAY DIVIDER - 3/8" TUBE X 3/8" TUBE X 3/8" TUBE (MUST PURCHASE IN 10'S)
LEG23-8	LEGRIS 2-WAY DIVIDER - 1/2" TUBE X 1/2" TUBE X 1/2" TUBE (MUST PURCHASE IN 5'S)

## TUBE TO HOSE STEM - STEM X HOSE BARB



<u>PART NUMBER</u>	<u>ITEM DESCRIPTION</u>
LEG25-4-4	LEGRIS TUBE TO HOSE STEM - 1/4" O.D. STEM X 1/4" I.D. HOSE BARB (MUST PURCHASE IN 10'S)
LEG25-6-4	LEGRIS TUBE TO HOSE STEM - 3/8" O.D. STEM X 1/4" I.D. HOSE BARB (MUST PURCHASE IN 10'S)
LEG25-6-5	LEGRIS TUBE TO HOSE STEM - 3/8" O.D. STEM X 5/16" I.D. HOSE BARB (MUST PURCHASE IN 10'S)
LEG25-6-6	LEGRIS TUBE TO HOSE STEM - 3/8" O.D. STEM X 3/8" I.D. HOSE BARB (MUST PURCHASE IN 10'S)
LEG25-8-6	LEGRIS TUBE TO HOSE STEM - 1/2" O.D. STEM X 3/8" I.D. HOSE BARB (MUST PURCHASE IN 5'S)



PRECISION  
INSTALLATION  
PRODUCTS

LIQUIfit™

# WATER TREATMENT

Legris "Liquifit" Quick Connect Fittings

## REDUCING TEE - TUBE X TUBE X TUBE



<u>PART NUMBER</u>	<u>ITEM DESCRIPTION</u>
LEG30-6-4	LEGRIS REDUCING TEE - 3/8" TUBE X 3/8" TUBE X 1/4" TUBE (MUST PURCHASE IN 10'S)
LEG30-8-6	LEGRIS REDUCING TEE - 1/2" TUBE X 1/2" TUBE X 3/8" TUBE (MUST PURCHASE IN 5'S)

## FAUCET CONNECTOR - TUBE X 7/16-24 UNS (1/4" FEMALE COMP)



<u>PART NUMBER</u>	<u>ITEM DESCRIPTION</u>
LEG32-4	LEGRIS FAUCET CONNECTOR - 1/4" TUBE X 7/16-24UNS (1/4" FEMALE COMPRESSION) (MUST PURCHASE IN 10'S)
LEG32-6	LEGRIS FAUCET CONNECTOR - 3/8" TUBE X 7/16-24UNS (1/4" FEMALE COMPRESSION) (MUST PURCHASE IN 10'S)

## FEMALE CONNECTOR - TUBE X FPT



<u>PART NUMBER</u>	<u>ITEM DESCRIPTION</u>
LEG45-4-4	LEGRIS FEMALE CONNECTER - 1/4" TUBE X 1/4" FEMALE PIPE THREAD (MUST PURCHASE IN 10'S)
LEG45-6-4	LEGRIS FEMALE CONNECTER - 3/8" TUBE X 1/4" FEMALE PIPE THREAD (MUST PURCHASE IN 10'S)
LEG45-6-6	LEGRIS FEMALE CONNECTER - 3/8" TUBE X 3/8" FEMALE PIPE THREAD (MUST PURCHASE IN 10'S)
LEGBSP-45-6-6	LEGRIS BSP FEMALE CONNECTOR - 3/8" TUBE X 3/8" FEMALE BSP THREAD

# WATER TREATMENT

Legris "Liquifit" Quick Connect Fittings

LIQUIFIT™



PRECISION  
INSTALLATION  
PRODUCTS

## END STOP - TUBE



<u>PART NUMBER</u>	<u>ITEM DESCRIPTION</u>
LEG46-4	LEGRIS END STOP - 1/4" TUBE (MUST PURCHASE IN 10'S)
LEG46-6	LEGRIS END STOP - 3/8" TUBE (MUST PURCHASE IN 10'S)

## FIXED ELBOW - TUBE X MPT



<u>PART NUMBER</u>	<u>ITEM DESCRIPTION</u>
LEG48-4-2	LEGRIS FIXED ELBOW - 1/4" TUBE X 1/8" MALE PIPE THREAD ELBOW (MUST PURCHASE IN 10'S)
LEG48-4-4	LEGRIS FIXED ELBOW - 1/4" TUBE X 1/4" MALE PIPE THREAD ELBOW (MUST PURCHASE IN 10'S)
LEG48-4-6	LEGRIS FIXED ELBOW - 1/4" TUBE X 3/8" MALE PIPE THREAD ELBOW (MUST PURCHASE IN 10'S)
LEG48-6-4	LEGRIS FIXED ELBOW - 3/8" TUBE X 1/4" MALE PIPE THREAD ELBOW (MUST PURCHASE IN 10'S)
LEG48-6-6	LEGRIS FIXED ELBOW - 3/8" TUBE X 3/8" MALE PIPE THREAD ELBOW (MUST PURCHASE IN 10'S)



PRECISION  
INSTALLATION  
PRODUCTS

LIQUIFIT™

# WATER TREATMENT

Legris "Liquifit" Quick Connect Fittings

Legris / Parker Brass & Check Valves

## LF BRASS FEMALE FLARE CONNECTOR - FEMALE FLARE X TUBE



<u>PART NUMBER</u>	<u>ITEM DESCRIPTION</u>
LEGBF4-4	LEGRIS NO LEAD BRASS 1/4" FEMALE FLARE X 1/4" TUBE
LEGBF6-6	LEGRIS NO LEAD BRASS 3/8" FEMALE FLARE X 3/8" TUBE

## LF BRASS FEMALE GARDEN HOSE SWIVEL CONNECTOR - FGH X TUBE



<u>PART NUMBER</u>	<u>ITEM DESCRIPTION</u>
LEGBH12-4	LEGRIS NO LEAD BRASS 3/4" FEMALE HOSE THREAD X 1/4" TUBE
LEGBH12-6	LEGRIS NO LEAD BRASS 3/4" FEMALE HOSE THREAD X 3/8" TUBE

## PARKER INLINE CHECK VALVE - TUBE X TUBE



<u>PART NUMBER</u>	<u>ITEM DESCRIPTION</u>
LEG138-4	PARKER INLINE SINGLE CHECK VALVE - 1/4" TUBE X 1/4" TUBE
LEG138-5	PARKER INLINE SINGLE CHECK VALVE - 5/16" TUBE X 5/16" TUBE
LEG138-6	PARKER INLINE SINGLE CHECK VALVE - 3/8" TUBE X 3/8" TUBE
LEG138-8	PARKER INLINE SINGLE CHECK VALVE - 1/2" TUBE X 1/2" TUBE

**Materials of Construction**

Body: Acetal

O-ring: EPDM

Metal Grip Edge: 300 Stainless

**Working Pressure**

Up to 150 PSI depending on tubing

**Temperature Range**

+34°F (1° C) to +150°F (65°C)

**Cracking Pressure**

1/3 PSI

# WATER TREATMENT

## Legris "Liquifit" Quick Connect Fittings

Legris / Parker Valves

LIQUIFIT™



PRECISION  
INSTALLATION  
PRODUCTS

### PARKER BALL VALVE FEATURES:

- Glass-reinforced polypropylene body
- Working Pressure: 150 PSI @ 730 PSI
- Temp Range: 0°F TO 255°F

## PARKER INLINE BALL VALVE - TUBE X TUBE



<u>PART NUMBER</u>	<u>ITEM DESCRIPTION</u>
LEGSV4-4LG	LEGRIS INLINE BALL VALVE - 1/4" TUBE X 1/4" TUBE (MUST PURCHASE IN 10'S)
LEGSV4-4LG-BULK	LEGRIS INLINE BALL VALVE - 1/4" TUBE X 1/4" TUBE - BULK ONLY, NOT BAGGED OR BOXED (MUST PURCHASE IN 10'S)
LEGSV4-6LG	LEGRIS INLINE BALL VALVE - 1/4" TUBE X 3/8" TUBE (MUST PURCHASE IN 10'S)
LEGSV6-6LG	LEGRIS INLINE BALL VALVE - 3/8" TUBE X 3/8" TUBE (MUST PURCHASE IN 10'S)

## PARKER INLINE BALL VALVE - TUBE X MPT



<u>PART NUMBER</u>	<u>ITEM DESCRIPTION</u>
LEGSV-4LG-4M	LEGRIS INLINE BALL VALVE - 1/4" TUBE X 1/4" MPT (MUST PURCHASE IN 10'S)
LEGSV-4LG-6M	LEGRIS INLINE BALL VALVE - 1/4" TUBE X 3/8" MPT (MUST PURCHASE IN 10'S)
LEGSV-6LG-4M	LEGRIS INLINE BALL VALVE - 3/8" TUBE X 1/4" MPT (MUST PURCHASE IN 10'S)
LEGSV-6LG-6M	LEGRIS INLINE BALL VALVE - 3/8" TUBE X 3/8" MPT (MUST PURCHASE IN 10'S)

## PARKER INLINE BALL VALVE - TUBE X FPT



<u>PART NUMBER</u>	<u>ITEM DESCRIPTION</u>
LEGSV-6LG-4F	LEGRIS INLINE BALL VALVE - 3/8" TUBE X 1/4" FPT (MUST PURCHASE IN 10'S)
LEGSV-6LG-6F	LEGRIS INLINE BALL VALVE - 3/8" TUBE X 3/8" FPT (MUST PURCHASE IN 10'S)



**PRECISION  
INSTALLATION  
PRODUCTS**

**LIQUIfit™**

# WATER TREATMENT

## Legris "Liquifit" Quick Connect Fittings

**Legris / Parker Valves**

### PARKER BALL VALVE FEATURES:

- Glass-reinforced polypropylene body
- Working Pressure: 150 PSI @ 730 PSI
- Temp Range: 0°F TO 255°F

## PARKER TANK VALVE (ANGLE) - TUBE X FPT



<u>PART NUMBER</u>	<u>ITEM DESCRIPTION</u>
LEGABV-4LG-4F	LEGRIS TANK VALVE - 1/4" TUBE X 1/4" FPT (MUST PURCHASE IN 10'S)
LEGABV-6LG-4F	LEGRIS TANK VALVE - 3/8" TUBE X 1/4" FPT (MUST PURCHASE IN 10'S)
LEGABV-6LG-6F	LEGRIS TANK VALVE - 3/8" TUBE X 3/8" FPT (MUST PURCHASE IN 10'S)

## PARKER TANK VALVE (ANGLE) TUBE X MPT



<u>PART NUMBER</u>	<u>ITEM DESCRIPTION</u>
LEGABV-6LG-6M	LEGRIS ANGLE VALVE-3/8" TUBE X 3/8" MPT (MUST PURCHASE IN 10'S)



# WATER TREATMENT

## Legris "Liquifit" Quick Connect Fittings

Legris / Parker Valves

LIQUIFIT™



PRECISION  
INSTALLATION  
PRODUCTS

### PARKER FEED ADAPTER FEATURES:

Parker's new Angle Stop Valve (VAS) design allows quick additions of connections for a filtration, reverse osmosis, coffee, or ice making unit between your existing water supply valve and supply line. By combining Parker's advanced LIQUIFIT™ connection technology with proven TrueSeal™ ball valve construction, our VAS is designed for superior performance and reliability. The banjo bolt, made from a tough polyetherimide plastic, minimizes the potential for cross-threading while meeting low load regulations.

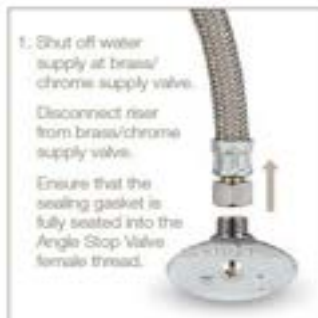

• Full flow design reduces pressure drop across the valve

• Removable clip for changing the handle orientation

• Full flow design reduces pressure drop across the valve

• Removable clip for changing the handle orientation

## FEED ADAPTER - TUBE X MALE COMP X FEMALE COMP



### PART NUMBER

### ITEM DESCRIPTION

LEGFA-664	LEGRIS FEED ADAPTER - 3/8"MC X 3/8"FC X 1/4"QC
LEGFA-666	LEGRIS FEED ADAPTER - 3/8"MC X 3/8"FC X 3/8"QC
LEGFA-884	LEGRIS FEED ADAPTER - 3/8"MC + ADAPTER X 1/2"FC X 1/4"QC
LEGFA-886	LEGRIS FEED ADAPTER - 3/8"MC + ADAPTER X 1/2"FC X 3/8"QC

## LEGRIS SERVICE KIT



### PART NUMBER

### ITEM DESCRIPTION

LEGRIS SERVICE KIT  
LEGRIS PARKER INSTALL/SERVICE KIT INCLUDES (ASSORTMENT OF STYLES & SIZES):

Kit Includes The Following Items:

5 - LEG01-4-4	5 - LEG03-4	5 - LEG22-4	3 - LEGSV4-4LG
5 - LEG01-6-4	5 - LEG03-6	5 - LEG22-6	2 - LEGFA-664
5 - LEG01-6-6	5 - LEG04-4	5 - LEG32-4	1 - LEGFA-884
5 - LEG02-4	5 - LEG04-6	5 - LEG32-6	
5 - LEG02-6	5 - LEG06-6-4	5 - LEG48-4-2	
1 - TUBING CUTTER	5 - LEG20-6-4	5 - LEG48-6-6	



PRECISION  
INSTALLATION  
PRODUCTS

LIQUIfit™

# WATER TREATMENT

## Legris "Liquifit" Quick Connect Fittings

### Chemical Compatibility Chart

	Very Acceptable ●	Acceptable ○	Slightly Unacceptable △	Unacceptable ✕
Acetic acid (10%, 68°F)	●			
Acetic acid (100%, 68°F)	✕			
Acetic acid (50%, 68°F)	✕			
Acetic acid (50%, 158°F)	✕			
Acetone	○			
Acetone (73°F)	●			
Acetone (185°F)	△			
Air	●			
Aliphatic alcohol	●			
Alum				
Aluminium chloride				
Aluminium sulfate	●			
Ammonia	●			
Ammonium chloride	●			
Ammonium hydroxide				
Ammonium nitric	●			
Ammonium phosphate	●			
Ammonium sulphate				
Animal oil (lard oil)	●			
Anionic surfactants				
Antifreeze (73°F)	●			
Antifreeze (185°F)				
Automotive undercoat (73°F)				
Automotive undercoat (122°F)				
Barium chloride				
Barium hydroxide				
Beer	●			
Benzene (benzol)	○			
Borax (sodium tetraborate)				
Boric acid	●			
Brine				
Bromine liquid				
Bunker oil				
Butane	●			
Butyl alcohol (butanol)				
Calcium chloride	●			
Calcium hydroxide	●			
Calcium hypochloride				
Carbon tetrachloride			△	
Carbonate drinks (Coca Cola)				
Castor oil				
Cautic soda (10%, 68°F)	●			
Cautic soda (50%, 73°F)	●			
Cautic soda (50%, 185°F)			△	
Benzalkonium chloride				
Chromic acid (10%, 158°F)				✕
Chromic acid (2%, 122°F)				
Chromic acid (2%, 158°F)				
Chromic acid (25%, 158°F)				✕
Citric acid				
CO <sub>2</sub>				
Cyanide				
Cresol				
Detergents, alkaline				
Detergents, synthetic				
Dextrin (starch gum)				
Dextrose (glucose, grape sugar)				
Dioxane		○		
Ethyl acetate (73°F)	●			
Ethyl acetate (185°F)	○			
Ethyl alcohol (ethanol)	●			
Ethyl alcohol (ethanol) (73°F)	●			
Ethyl alcohol (ethanol) (185°F)			△	
Ethylene glycol				
Fatty ammonium acetates	●			
Fluorine				
Formic acid (25%, 68°F)	○			
Fruit juices				
Fuel oil				
Gasoline	●			
Glucose	●			
Glycerin	●			
Grease	●			
Hydrochloric acid (10%, 68°F)				
Hydrochloric acid (20%, 68°F)		○		
Hydrochloric acid (20%, 176°F)				✕
Hydrochloric acid (38%, 68°F)				✕
Hydrogen	●			
Hydrogen peroxide				
Hydrogen sulfide	●			
Hydrogenated castor oil	●			
Inert gases	●			
Isopropyl alcohol (73°F)	●			
Isopropyl alcohol (185°F)				
Kerosene	●			
Ketones	●			
Lactic acid				
Lauryl dimethylamine oxide				
Liquefied petroleum gas (LPG)	●			
Lye solution				
Magnesium chloride				
Magnesium hydroxide				
Mercury	●			
Methacrylate sealant (73°F)				
Methane	●			
Methyl alcohol (73°F)	●			
Methyl alcohol (185°F)	○			
Methyl alcohol (methanol)	●			
Milk	●			
Mineral oil	●			
Motor oil (DW-40) (73°F)	●			
N <sub>2</sub>	○			
Naptha	●			
Natural gas	●			
Nickel salts				
Nitrogen	●			
Non ionic surfactants	●			
Oil essentials				
Olive oil	●			
Oxygen	●			
Ozone		○		
Peracetic acid				
Petroleum	●			
Phosphates	●			
Phosphoric acid (80%, 73°F)		○		
Potassium hydroxide				
Potassium hydroxide (50%, 73°F)	●			
Potassium hydroxide (50%, 185°F)	○			
Potassium sulfate	●			
Propane	●			
Propylene glycol		○		
Sea water	●			
Silicates	●			
Silicates potassium	●			
Silicone greases	●			
Silicone oil	●			
Soda ash (sodium carbonate)	○			
Sodium cyanide				
Sodium hydroxide	●			
Sodium phosphate	●			
Sodium silicate	●			
Soybean oil	●			
Steam (302°F)				
Sulfur		○		
Sulfuric acid (10%, 68°F)	●			
Sulfuric acid (10%, 158°F)				✕
Sulfuric acid (30%, 68°F)		○		
Sulfuric acid (30%, 158°F)				✕
Sulfuric acid (98%, 68°F)				✕
Sulfurous acid gas		○		
Toluene		○		
Transmission fluid (73°F)				
Transmission fluid (185°F)				
Vegetal oil	●			
Water (212°F)		○		
Water (75°F)	●			
Water demineralized	●			
Water with chlorine (250 mg/l)				
Water with chlorine (5 mg/l)	●			

# WATER TREATMENT

Hydrofit "Hydroit" Quick Connect Fittings



PRECISION  
INSTALLATION  
PRODUCTS

## MALE CONNECTOR - TUBE X MPT



<u>PART NUMBER</u>	<u>ITEM DESCRIPTION</u>
HDF-01-4-2	HYDRONIX 1/4" TUBE X 1/8" MPT CONNECTOR (MUST PURCHASE IN 10'S)
HDF-01-4-4	HYDRONIX 1/4" TUBE X 1/4" MPT CONNECTOR (MUST PURCHASE IN 10'S)
HDF-01-4-6	HYDRONIX 1/4" TUBE X 3/8" MPT CONNECTOR (MUST PURCHASE IN 10'S)
HDF-01-6-4	HYDRONIX 3/8" TUBE X 1/4" MPT CONNECTOR (MUST PURCHASE IN 10'S)
HDF-01-6-6	HYDRONIX 3/8" TUBE X 3/8" MPT CONNECTOR (MUST PURCHASE IN 10'S)
HDF-01-6-8	HYDRONIX 3/8" TUBE X 1/2" MPT CONNECTOR (MUST PURCHASE IN 10'S)
HDF-01-8-6	HYDRONIX 1/2" TUBE X 3/8" MPT CONNECTOR (MUST PURCHASE IN 10'S)
HDF-01-8-8	HYDRONIX 1/2" TUBE X 1/2" MPT CONNECTOR (MUST PURCHASE IN 10'S)

## UNION TEE - TUBE X TUBE X TUBE



<u>PART NUMBER</u>	<u>ITEM DESCRIPTION</u>
HDF-02-4	HYDRONIX 1/4" TUBE UNION TEE (MUST PURCHASE IN 10'S)
HDF-02-6	HYDRONIX 3/8" TUBE UNION TEE (MUST PURCHASE IN 10'S)

## UNION ELBOW - TUBE X TUBE



<u>PART NUMBER</u>	<u>ITEM DESCRIPTION</u>
HDF-03-4	HYDRONIX 1/4" TUBE X 1/4" TUBE UNION ELBOW (MUST PURCHASE IN 10'S)
HDF-03-6	HYDRONIX 3/8" TUBE X 3/8" TUBE UNION ELBOW (MUST PURCHASE IN 10'S)

## UNION CONNECTOR - TUBE X TUBE



<u>PART NUMBER</u>	<u>ITEM DESCRIPTION</u>
HDF-04-4	HYDRONIX 1/4" TUBE X 1/4" TUBE UNION CONNECTOR (MUST PURCHASE IN 10'S)
HDF-04-6	HYDRONIX 3/8" TUBE X 3/8" TUBE UNION CONNECTOR (MUST PURCHASE IN 10'S)

## UNION CONNECTOR - STEM X MPT



<u>PART NUMBER</u>	<u>ITEM DESCRIPTION</u>
HDF-05-6-4	HYDRONIX 3/8" STEM X 1/4" MPT STEM ADAPTER (MUST PURCHASE IN 10'S)
HDF-05-6-6	HYDRONIX 3/8" STEM X 3/8" MPT STEM ADAPTER (MUST PURCHASE IN 10'S)

## STEM REDUCER - STEM X TUBE

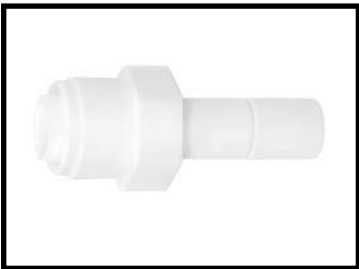

<u>PART NUMBER</u>	<u>ITEM DESCRIPTION</u>
HDF-06-6-4	HYDRONIX 3/8" STEM X 1/4" TUBE STEM REDUCER (MUST PURCHASE IN 10'S)

## MALE RUN TEE - TUBE X X TUBE X MPT



<u>PART NUMBER</u>	<u>ITEM DESCRIPTION</u>
HDF-10-4-4	HYDRONIX 1/4" TUBE X 1/4" TUBE X 1/4" MPT MALE RUN TEE (MUST PURCHASE IN 10'S)

# WATER TREATMENT

Hydrofit "Hydroit" Quick Connect Fittings



## STEM RUN TEE - TUBE X TUBE X STEM



<u>PART NUMBER</u>	<u>ITEM DESCRIPTION</u>
HDF-11-4-4	HYDRONIX 1/4" TUBE X 1/4" TUBE X 1/4" STEM RUN TEE (MUST PURCHASE IN 10'S)

## BULKHEAD UNION - TUBE X TUBE



<u>PART NUMBER</u>	<u>ITEM DESCRIPTION</u>
HDF-12-4	HYDRONIX 1/4" TUBE X 1/4" TUBE BULKHEAD UNION (MUST PURCHASE IN 10'S)
HDF-12-6	HYDRONIX 3/8" TUBE X 3/8" TUBE BULKHEAD UNION (MUST PURCHASE IN 10'S)
HDF-12-6-4	HYDRONIX 3/8" TUBE X 1/4" TUBE REDUCING BULKHEAD UNION (MUST PURCHASE IN 10'S)

## LOCKING CLIPS

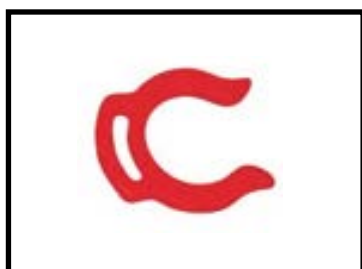

<u>PART NUMBER</u>	<u>ITEM DESCRIPTION</u>
HDF-18-4	HYDRONIX 1/4" RED LOCKING CLIP (MUST PURCHASE IN 100'S)
HDF-18-6	HYDRONIX 3/8" LOCKING CLIP (MUST PURCHASE IN 100'S)

## REDUCING UNION CONNECTOR - TUBE X TUBE



<u>PART NUMBER</u>	<u>ITEM DESCRIPTION</u>
HDF-20-6-4	HYDRONIX 3/8" TUBE X 1/4" TUBE REDUCING UNION (MUST PURCHASE IN 10'S)

## REDUCING UNION ELBOW - TUBE X TUBE



<u>PART NUMBER</u>	<u>ITEM DESCRIPTION</u>
HDF-21-6-4	HYDRONIX 3/8" TUBE X 1/4" TUBE REDUCING UNION ELBOW (MUST PURCHASE IN 10'S)

## PLUG IN ELBOW - STEM X TUBE



<u>PART NUMBER</u>	<u>ITEM DESCRIPTION</u>
HDF-22-4	HYDRONIX 1/4" STEM X 1/4" TUBE PLUG-IN ELBOW (MUST PURCHASE IN 10'S)
HDF-22-4-6	HYDRONIX 1/4" STEM X 3/8" TUBE PLUG-IN ELBOW (MUST PURCHASE IN 10'S)
HDF-22-6	HYDRONIX 3/8" STEM X 3/8" TUBE PLUG-IN ELBOW (MUST PURCHASE IN 10'S)
HDF-22-6-4	HYDRONIX 3/8" STEM X 1/4" TUBE PLUG-IN ELBOW (MUST PURCHASE IN 10'S)

## 2- WAY DIVIDER - TUBE X (2) TUBE



<u>PART NUMBER</u>	<u>ITEM DESCRIPTION</u>
HDF-23-4	HYDRONIX (1) 1/4" TUBE X (2) 1/4" TUBE 2-WAY DIVIDER (MUST PURCHASE IN 10'S)
HDF-23-6	HYDRONIX (1) 3/8" TUBE X (2) 3/8" TUBE 2-WAY DIVIDER (MUST PURCHASE IN 10'S)

# WATER TREATMENT

Hydrofit "Hydroit" Quick Connect Fittings



PRECISION  
INSTALLATION  
PRODUCTS

## REDUCING TEE - TUBE X TUBE X TUBE



<u>PART NUMBER</u>	<u>ITEM DESCRIPTION</u>
HDF-30-446	HYDRONIX 1/4" TUBE X 1/4" TUBE X 3/8" TUBE TEE (MUST PURCHASE IN 10'S)
HDF-30-664	HYDRONIX 3/8" TUBE X 3/8" TUBE X 1/4" TUBE TEE (MUST PURCHASE IN 10'S)

## FAUCET CONNECTOR - TUBE X 7/16-24 UNS (1/4" FEMALE COMP)



<u>PART NUMBER</u>	<u>ITEM DESCRIPTION</u>
HDF-32-4	HYDRONIX 1/4" TUBE X 7/16-24UNS (1/4" FEMALE COMPRESSION) FAUCET FITTING (MUST PURCHASE IN 10'S)
HDF-32-6	HYDRONIX 3/8" TUBE X 7/16-24UNS (1/4" FEMALE COMPRESSION) FAUCET FITTING (MUST PURCHASE IN 10'S)

## FEMALE CONNECTOR - TUBE X FPT



<u>PART NUMBER</u>	<u>ITEM DESCRIPTION</u>
HDF-45-4-4	HYDRONIX 1/4" TUBE X 1/4" FPT CONNECTOR (MUST PURCHASE IN 10'S)

## FIXED ELBOW - TUBE X MPT



<u>PART NUMBER</u>	<u>ITEM DESCRIPTION</u>
HDF-48-4-2	HYDRONIX 1/4" TUBE X 1/8" MPT ELBOW (MUST PURCHASE IN 10'S)
HDF-48-4-4	HYDRONIX 1/4" TUBE X 1/4" MPT ELBOW (MUST PURCHASE IN 10'S)
HDF-48-4-6	HYDRONIX 1/4" TUBE X 3/8" MPT ELBOW (MUST PURCHASE IN 10'S)
HDF-48-6-4	HYDRONIX 3/8" TUBE X 1/4" MPT ELBOW (MUST PURCHASE IN 10'S)
HDF-48-6-6	HYDRONIX 3/8" TUBE X 3/8" MPT ELBOW (MUST PURCHASE IN 10'S)
HDF-48-6-8	HYDRONIX 3/8" TUBE X 1/2" MPT ELBOW (MUST PURCHASE IN 10'S)
HDF-48-8-8	HYDRONIX 1/2" TUBE X 1/2" MPT ELBOW (MUST PURCHASE IN 10'S)

## LF BRASS FEMALE FLARE CONNECTOR - TUBE X FEMALE FLARE



<u>PART NUMBER</u>	<u>ITEM DESCRIPTION</u>
HDFB-25-4-4	HYDRONIX LF BRASS 1/4" TUBE X 1/4" FEMALE FLARE (MUST PURCHASE IN 10'S)
HDFB-25-6-4	HYDRONIX LF BRASS 3/8" TUBE X 1/4" FEMALE FLARE (MUST PURCHASE IN 10'S)
HDFB-25-6-6	HYDRONIX LF BRASS 3/8" TUBE X 3/8" FEMALE FLARE (MUST PURCHASE IN 10'S)

## LF BRASS FEMALE GARDEN HOSE CONNECTOR - TUBE X FGH



<u>PART NUMBER</u>	<u>ITEM DESCRIPTION</u>
HDFB-28-4	HYDRONIX LF BRASS 1/4" TUBE X 3/4" FEMALE GARDEN HOSE CONNECTOR (MUST PURCHASE IN 10'S)

## INLINE CHECK VALVE



<u>PART NUMBER</u>	<u>ITEM DESCRIPTION</u>
HDF-138-4	HYDRONIX 1/4" TUBE X 1/4" TUBE INLINE CHECK VALVE (MUST PURCHASE IN 10'S)
HDF-138-6	HYDRONIX 3/8" TUBE X 3/8" TUBE INLINE CHECK VALVE (MUST PURCHASE IN 10'S)



# WATER TREATMENT

Hydrofit "Hydroit" Quick Connect Fittings



PRECISION  
INSTALLATION  
PRODUCTS

## ANGLE CHECK VALVE - TUBE X TUBE



<u>PART NUMBER</u>	<u>ITEM DESCRIPTION</u>
JVL40-4-2	HYDRONIX CHECK VALVE-1/4" TUBE X 1/8" MPT ELBOW

## INLINE BALL VALVE - TUBE X TUBE



<u>PART NUMBER</u>	<u>ITEM DESCRIPTION</u>
HSBV-4QC	HYDRONIX 1/4" TUBE X 1/4" TUBE INLINE BALL VALVE (MUST PURCHASE IN 10'S)
HSBV-6QC	HYDRONIX 3/8" TUBE X 3/8" TUBE INLINE BALL VALVE (MUST PURCHASE IN 10'S)

## INLINE BALL VALVE - TUBE X MPT



<u>PART NUMBER</u>	<u>ITEM DESCRIPTION</u>
HSBV-4QC-4M	HYDRONIX 1/4" TUBE X 1/4" MPT INLINE BALL VALVE (MUST PURCHASE IN 10'S)
HSBV-6QC-6M	HYDRONIX 3/8" TUBE X 3/8" MPT INLINE BALL VALVE (MUST PURCHASE IN 10'S)

## ANGLE TANK VALVE - TUBE X FPT



<u>PART NUMBER</u>	<u>ITEM DESCRIPTION</u>
HABV-4QC-4F	HYDRONIX 1/4" TUBE X 1/4" FPT ANGLE BALL TANK VALVE (EACH)
HABV-6QC-4F	HYDRONIX 3/8" TUBE X 1/4" FPT ANGLE BALL TANK VALVE (EACH)

## ORINGS



<u>PART NUMBER</u>	<u>ITEM DESCRIPTION</u>
HDF-4ORING	HYDRONIX 1/4" ORING FOR QUICK CONNECT FITTINGS (MUST PURCHASE IN 100'S)
HDF-6ORING	HYDRONIX 3/8" ORING FOR QUICK CONNECT FITTINGS (MUST PURCHASE IN 100'S)

## WATER FEED ADAPTERS - FPT X MPT X TUBE



<u>PART NUMBER</u>	<u>ITEM DESCRIPTION</u>
HDF-WFV-884	HYDRONIX PLASTIC WATER FEED VALVE-1/2" FPT X 1/2" MPT X 1/4" QC OUTLET***NEW***
HDF-WFV-886	HYDRONIX PLASTIC WATER FEED VALVE-1/2" FPT X 1/2" MPT X 3/8" QC OUTLET***NEW***

## TUBING CUTTER W/ COLLET REMOVAL TOOL



<u>PART NUMBER</u>	<u>ITEM DESCRIPTION</u>
HDF-TC-RT	HYDRONIX BLUE TUBING CUTTER W/ BUILT-IN COLLET REMOVAL TOOL

# WATER TREATMENT

## Hydrofit "Hydroit" Quick Connect Fittings



PRECISION  
INSTALLATION  
PRODUCTS

### HYDROFIT™ - QUALITY AND INNOVATION

HYDROFIT™ - Quick Connect Fittings offer you a quality engineered product designed to give you a reliable connector for a reliable connection. HYDROFIT™ - Quick Connect Fittings have been designed to provide you with all the typical benefits and ease of use of a quick connect fitting while providing you with an user friendly ergonomically pleasing design.

HYDROFIT's innovative design is not only an aesthetically appealing improvement to conventional quick connect fittings, our improved valve handle design allow for ease of use for installers, maintenance personnel and end users everywhere. The HYDROFIT™ exclusive HYDRO FIN DESIGN valve handles accommodate for an easier grip, less strain and smoother ball rotation for truly quick and easy operation.



HYDROFIT™ - Quick Connect Fittings have been tested by NSF International under NSF/ANSI Standard 61 and comply with FDA requirements for all materials in contact with food and drinking water. HYDROFIT™ - Quick Connect Fittings have been Independently Tested to NSF/ANSI 58 Standards for Burst pressure, Static pressure and Cyclic pressure testing (see chart) and undergo rigorous quality assurance testing for quality performance time and time again.

#### Materials of Construction

HYDROFIT™ - Quick Connect Fittings are made of the following components:

Body FDA POM (Polyacetal, Polyoxymethylene)

O-Ring Nitrile (NBR)

Collet Polyoxymethylene & SS Teeth

#### Fittings Working Pressure & Temperature Range

Max	150 PSI (10 BAR) @ 70°F (20°C)
Max	60 PSI (4 BAR) @ 140°F (60°C)
Min	33°F (1°C)

#### Tubing Working Pressure & Temperature Range

1/4" & 3/8"	- 230 PSI @ 70°F (15 BAR @ 20°C)
Max	120 PSI @ 150°F (8 BAR @ 65°C)
1/2"	- 150 PSI @ 70°F (10 BAR @ 20°C)
Max	90 PSI @ 150°F (6 BAR @ 65°C)



Certified to NSF/ANSI standard 61

**BPA FREE**



All materials in contact with food and drinking water are in compliance with the United States Food and Drug Administration



USDA NSF H1

The grease used in Hydrofit Quick Connect fittings conforms to USDA NSF H1 recommendations

#### Potable Water Applications

HYDROFIT™ Tubing is suitable for potable water applications with a maximum chlorine content of 4ppm (parts per million). Water heated above 70°F (20°C) and/or pressure above the rated maximum pressures will significantly reduce the service life. Avoid direct exposure to sunlight. Direct exposure to sunlight will also reduce its service life and may

lead to failure. It is commonly known and good practice to inspect tubing and fittings regularly. Should there be evidence of damage, color change, cracking or hardening, fittings and tubing should be replaced immediately. All fitting and tubing should not be used near heat emitting appliances. Note: Hot and Cold water plumbing systems MUST comply with local plumbing code for pipe and fittings. Frequent visual inspections are advisable. Frequency should be predicated on the severity of the application, risk of failure or when failure could result in unacceptable downtime, damage or injury risk. Keep away from contact with ANY chemicals or aggressive liquids.

#### FOOD QUALITY

HYDROFIT™ - Quick Connect Fittings are suitable for food and water use. They are manufactured using FDA approved materials and are certified by NSF to NSF/ANSI standards 61.

#### MAXIMUM TORQUE VALUES

Thread	Max. Torque
1/4"	1.0 ft/lb (1.5 Nm)
3/8"	2.2 ft/lb (3.0 Nm)
1/2"	2.2 ft/lb (3.0 Nm)

#### CHEMICAL COMPATIBILITY

HYDROFIT™ - Quick Connect Fittings can be used on liquids other than potable water. We recommend that you consult with our Chemical Compatibility Chart to determine if they can be utilized under your specifications. You may also contact us to further verify compatibility.

Certified to NSF /ANSI Standard 61



Independently tested to NSF /ANSI Standard 58 Testing Criteria



- Static - 3x Rated Pressure or 300 PSI minimum
- Burst - 4x Rated Pressure or 400 PSI minimum
- Cyclic - 100,000 cycles at 150 PSI



**END OF SECTION**

**THIS PAGE IS LEFT  
INTENTIONALLY BLANK.**

# WATER TREATMENT

Parker Fast N' tite, Par-Barb & Nylon Fittings

Parker Fast N' Tite Fittings



PRECISION  
INSTALLATION  
PRODUCTS

## NUT & SPACER



<u>PART NUMBER</u>	<u>ITEM DESCRIPTION</u>
NP4N	PARKER FNT BLACK POLY 1/4 NUT ONLY
NP4S	PARKER FNT BLACK POLY 1/4 SPACERS - SOLD AS EACH

## ORING



<u>PART NUMBER</u>	<u>ITEM DESCRIPTION</u>
N4OR	PARKER FNT BLACK 1/4" O-RING
N6OR	PARKER FNT BLACK 3/8" O-RING
N8OR	PARKER FNT BLACK 1/2" O-RING

## TUBE SUPPORTS



<u>PART NUMBER</u>	<u>ITEM DESCRIPTION</u>
N4TS3	PARKER WHITE NYLON 1/4 TUBE SUPPORTS
NP4TS3	PARKER BLACK POLY 1/4 TUBE SUPPORTS
N5TS3	PARKER WHITE NYLON 5/16 TUBE SUPPORTS
N6TS4	PARKER WHITE NYLON 3/8 TUBE SUPPORTS
NP6TS4	PARKER BLACK POLY 3/8 TUBE SUPPORTS

## GRAB RING



<u>PART NUMBER</u>	<u>ITEM DESCRIPTION</u>
N4GRP	PARKER FNT WHITE PLASTIC 1/4" GRAB RING
N5GRP	PARKER FNT PLASTIC 5/16 GRAB RING
N6GRP	PARKER FNT WHITE PLASTIC 3/8" GRAB RING



PRECISION  
INSTALLATION  
PRODUCTS

# WATER TREATMENT

Parker Fast N' tite, Par-Barb & Nylon Fittings

## Parker Fast N' Tite Fittings

### ELBOW UNION - FNT X FNT



<u>PART NUMBER</u>	<u>ITEM DESCRIPTION</u>
NP4EU4	PARKER FNT BLACK POLY 1/4 FNT X 1/4 FNT UNION ELBOW
NP6EU4	PARKER FNT BLACK POLY 3/8 FNT X 1/4 FNT UNION ELBOW
NP6EU6	PARKER FNT BLACK POLY 3/8 FNT X 3/8 FNT UNION ELBOW
NP8EU6	PARKER FNT BLACK POLY 1/2 FNT X 3/8 FNT UNION ELBOW
NP8EU8	PARKER FNT BLACK POLY 1/2 FNT X 1/2 FNT UNION ELBOW

### FEMALE ELBOW - FNT X FNT



<u>PART NUMBER</u>	<u>ITEM DESCRIPTION</u>
NP4FE4	PARKER FNT BLACK POLY 1/4 FNT X 1/4 FPT FEMALE ELBOW
NP6FE4	PARKER FNT BLACK POLY 3/8 FNT X 1/4 FPT FEMALE ELBOW
NP6FE6	PARKER FNT BLACK POLY 3/8 FNT X 3/8 FPT FEMALE ELBOW
NP8FE6	PARKER FNT BLACK POLY 1/2 FNT X 3/8 FPT FEMALE ELBOW
NP8FE8	PARKER FNT BLACK POLY 1/2 FNT X 1/2 FPT FEMALE ELBOW

### MALE ELBOW - FNT X MPT



<u>PART NUMBER</u>	<u>ITEM DESCRIPTION</u>
NP4ME2	PARKER FNT BLACK POLY 1/4 FNT X 1/8 MPT MALE ELBOW
NP4ME4	PARKER FNT BLACK POLY 1/4 FNT X 1/4 MPT MALE ELBOW
NP4ME6	PARKER FNT BLACK POLY 1/4 FNT X 3/8 MPT MALE ELBOW
NP6ME4	PARKER FNT BLACK POLY 3/8 FNT X 1/4 MPT MALE ELBOW
NP6ME6	PARKER FNT BLACK POLY 3/8 FNT X 3/8 MPT MALE ELBOW
NP6ME8	PARKER FNT BLACK POLY 3/8 FNT X 1/2 MPT MALE ELBOW
NP8ME4	PARKER FNT BLACK POLY 1/2 FNT X 1/4 MPT MALE ELBOW
NP8ME6	PARKER FNT BLACK POLY 1/2 FNT X 3/8 MPT MALE ELBOW
N8ME6	PARKER FNT WHITE NYLON 1/2 FNT X 3/8 MPT ELBOW
N8ME8	PARKER FNT WHITE NYLON 1/2 FNT X 1/2 MPT ELBOW
NP8ME4	PARKER FNT BLACK POLY 1/2 FNT X 1/4 MPT MALE ELBOW
NP8ME6	PARKER FNT BLACK POLY 1/2 FNT X 3/8 MPT MALE ELBOW
NP8MEB8	PARKER PAR-BARB BLACK POLY 1/2 BARB X 1/2 MPT ELBOW
N10ME8	PARKER PAR-BARB WHITE NYLON 5/8 BARB X 1/2 MPT ELBOW
NP10ME8	PARKER FNT BLACK POLY 5/8 FNT X 1/2 MPT MALE ELBOW

# WATER TREATMENT

Parker Fast N' tite, Par-Barb & Nylon Fittings

Parker Fast N' Tite Fittings



PRECISION  
INSTALLATION  
PRODUCTS

## UNION CONNECTOR - FNT X FNT



<u>PART NUMBER</u>	<u>ITEM DESCRIPTION</u>
NP4UC4	PARKER FNT BLACK POLY 1/4 FNT X 1/4 FNT UNION CONNECTOR
NP5UC4	PARKER FNT BLACK POLY 5/16 FNT X 1/4 FNT UNION CONNECTOR
NP6UC4	PARKER FNT BLACK POLY 3/8 FNT X 1/4 FNT UNION CONNECTOR
N6UC5	PARKER FNT WHITE NYLON 3/8 FNT X 5/16 FNT UNION CONNECTOR
NP6UC6	PARKER FNT BLACK POLY 3/8 FNT X 3/8 FNT UNION CONNECTOR
NP8UC6	PARKER FNT BLACK POLY 1/2 FNT X 3/8 FNT UNION CONNECTOR
NP8UC8	PARKER FNT BLACK POLY 1/2 FNT X 1/2 FNT UNION CONNECTOR

## MALE BRANCH TEE - FNT X FNT X MPT



<u>PART NUMBER</u>	<u>ITEM DESCRIPTION</u>
NP4MT4	PARKER FNT BLACK POLY 1/4 FNT X 1/4 FNT X 1/4 MPT MALE BRANCH TEE
NP6MT4	PARKER FNT BLACK POLY 3/8 FNT X 3/8" FNT X 1/4 MPT MALE BRANCH TEE

## TEE UNION - FNT X FNT X FNT



<u>PART NUMBER</u>	<u>ITEM DESCRIPTION</u>
NP4TU4	PARKER FNT BLACK POLY 1/4 FNT UNION TEE
NP6TU6	PARKER FNT BLACK POLY 3/8 FNT UNION TEE
NP8TU6	PARKER FNT BLACK POLY 1/2 FNT X 1/2 FNT X 3/8 FNT UNION TEE



PRECISION  
INSTALLATION  
PRODUCTS

# WATER TREATMENT

Parker Fast N' tite, Par-Barb & Nylon Fittings

## Parker Fast N' Tite Fittings

### MALE CONNECTOR - FNT X MPT



<u>PART NUMBER</u>	<u>ITEM DESCRIPTION</u>
N6MC4	PARKER FNT BLACK POLY 3/8 FNT X 1/4 MPT MALE CONNECTOR
NP4MC2	PARKER FNT BLACK POLY 1/4 FNT X 1/8 MPT MALE CONNECTOR
NP4MC4	PARKER FNT BLACK POLY 1/4 FNT X 1/4 MPT MALE CONNECTOR
NP5MC4	PARKER FNT BLACK POLY 5/16 FNT X 1/4 MPT MALE CONNECTOR
NP6MC12	PARKER FNT BLACK POLY 3/8 FNT X 3/4 MPT MALE CONNECTOR
NP6MC6	PARKER FNT BLACK POLY 3/8 FNT X 3/8 MPT MALE CONNECTOR
NP6MC8	PARKER FNT BLACK POLY 3/8 FNT X 1/2 MPT MALE CONNECTOR
NP8MC4	PARKER FNT BLACK POLY 1/2 FNT X 1/4 MPT MALE CONNECTOR
NP8MC6	PARKER FNT BLACK POLY 1/2 FNT X 3/8 MPT MALE CONNECTOR
NP8MC8	PARKER FNT BLACK POLY 1/2 FNT X 1/2 MPT MALE CONNECTOR
NP8MCB12	PARKER PAR-BARB BLACK POLY 1/2 BARB X 3/4 MPT CONNECTOR
NP10MC8	PARKER FNT BLACK POLY 5/8 FNT X 1/2 MPT MALE CONNECTOR

### FEMALE CONNECTOR - FNT X FPT



<u>PART NUMBER</u>	<u>ITEM DESCRIPTION</u>
NP4FC4	PARKER FNT BLACK POLY 1/4 FNT X 1/4 FPT FEMALE CONNECTOR
NP6FC4	PARKER FNT BLACK POLY 3/8 FNT X 1/4 FPT FEMALE ADAPTER
NP6FC6	PARKER FNT BLACK POLY 3/8 FNT X 3/8 FPT FEMALE CONNECTOR
N6FC8	PARKER FNT WHITE NYLON 3/8 FNT X 1/2 FPT CONNECTOR
NP6FC8	PARKER FNT BLACK POLY 3/8 FNT X 1/2 FPT FEMALE ADAPTER
NP8FC8	PARKER FNT BLACK POLY 1/2 FNT X 1/2 FPT FEMALE CONNECTOR
NP10FC8	PARKER FNT BLACK POLY 5/8 FNT X 1/2 FPT FEMALE CONNECTOR



# WATER TREATMENT

Parker Fast N' tite, Par-Barb & Nylon Fittings

Parker Barb Fittings



PRECISION  
INSTALLATION  
PRODUCTS

## HEX NIPPLE - MPT X MPT



<u>PART NUMBER</u>	<u>ITEM DESCRIPTION</u>
N4HP2	PARKER WHITE NYLON 1/4 X 1/8 HEX NIPPLE
N4HP4	PARKER WHITE NYLON 1/4 X 1/4 HEX NIPPLE
N6HP4	PARKER PAR-BARB WHITE NYLON 3/8 X 1/4 HEX NIPPLE
N6HP6	PARKER PAR-BARB WHITE NYLON 3/8 X 3/8 HEX NIPPLE
NP6HP6	PARKER PAR-BARB BLACK POLY 3/8 X 3/8 HEX NIPPLE
N8HP8	PARKER PAR-BARB WHITE NYLON 1/2 X 1/2 HEX NIPPLE
N12HP12	PARKER WHITE NYLON 3/4 HEX NIPPLE
N16HP16	PARKER WHITE NYLON 1" HEX NIPPLE

## HEX PLUG - MPT



<u>PART NUMBER</u>	<u>ITEM DESCRIPTION</u>
NP4HPL	PARKER PAR-BARB BLACK POLY 1/4 HEX PLUG
NP6HPL	PARKER PAR-BARB BLACK POLY 3/8 HEX PLUG
NP8HPL	PARKER PAR-BARB BLACK POLY 1/2 HEX PLUG

## REDUCING HEX BUSHING - FPT

<u>PART NUMBER</u>	<u>ITEM DESCRIPTION</u>
N12MB8	PARKER WHITE NYLON 3/4" MPT X 1/2" FPT REDUCING HEX BUSHING

## HEX NIPPLE - MPT X MPT



<u>PART NUMBER</u>	<u>ITEM DESCRIPTION</u>
N4MCB4	PARKER PAR-BARB WHITE NYLON 1/4 MPT X 1/4 BARB CONNECTOR
N6MCB4	PARKER PAR-BARB WHITE NYLON 3/8 BARB X 1/4 MPT CONNECTOR
N6MCB6	PARKER PAR-BARB WHITE NYLON 3/8 BARB X 3/8 MPT CONNECTOR
N6MCB8	PARKER PAR-BARB WHITE NYLON 3/8 BARB X 1/2 MPT CONNECTOR
N8MCB4	PARKER PAR-BARB WHITE NYLON 1/2 BARB X 1/4 MPT CONNECTOR
N8MCB6	PARKER PAR-BARB WHITE NYLON 1/2 BARB X 3/8 MPT CONNECTOR
N8MCB8	PARKER PAR-BARB WHITE NYLON 1/2 BARB X 1/2 MPT CONNECTOR
N8MCB12	PARKER PAR-BARB WHITE NYLON 1/2 BARB X 3/4 MPT CONNECTOR
N10MCB8	PARKER PAR-BARB WHITE NYLON 5/8 BARB X 1/2 MPT CONNECTOR
N10MCB12	PARKER PAR-BARB WHITE NYLON 5/8 BARB X 3/4 MPT CONNECTOR
N12MCB12	PARKER PAR-BARB WHITE NYLON 3/4 BARB X 3/4 MPT CONNECTOR



PRECISION  
INSTALLATION  
PRODUCTS

# WATER TREATMENT

Parker Fast N' tite, Par-Barb & Nylon Fittings

## Parker Barb Fittings

### UNION - BARB X BARB



<u>PART NUMBER</u>	<u>ITEM DESCRIPTION</u>
N4UCB4	PARKER PAR-BARB WHITE NYLON 1/4 BARB X 1/4 BARB UNION CONNECTOR
NP4UCB4	PARKER PAR-BARB BLACK POLY 1/4 BARB X 1/4 BARB UNION CONNECTOR
N6UCB4	PARKER PAR-BARB WHITE NYLON 3/8 BARB X 1/4 BARB UNION CONNECTOR
N6UCB6	PARKER PAR-BARB WHITE NYLON 3/8 BARB X 3/8 BARB UNION CONNECTOR
N8UCB4	PARKER PAR-BARB WHITE NYLON 1/2 BARB X 1/4 BARB UNION CONNECTOR
N8UCB6	PARKER PAR-BARB WHITE NYLON 1/2 BARB X 3/8 BARB UNION CONNECTOR
N8UCB8	PARKER PAR-BARB WHITE NYLON 1/2 BARB X 1/2 BARB UNION CONNECTOR
N10UCB6	PARKER PAR-BARB WHITE NYLON 5/8 BARB X 3/8 BARB UNION CONNECTOR

### ELBOW - BARB X BARB



<u>PART NUMBER</u>	<u>ITEM DESCRIPTION</u>
N4EUB4	PARKER PAR-BARB WHITE NYLON 1/4 BARB X 1/4 BARB UNION ELBOW
N6EUB6	PARKER PAR-BARB WHITE NYLON 3/8 BARB X 3/8 BARB UNION ELBOW
N8EUB4	PARKER PAR-BARB WHITE NYLON 1/2 BARB X 1/4 BARB UNION ELBOW
N8EUB8	PARKER PAR-BARB WHITE NYLON 1/2 BARB X 1/2 BARB UNION ELBOW

# WATER TREATMENT

Parker Fast N' tite, Par-Barb & Nylon Fittings

## Parker Barb Fittings



PRECISION  
INSTALLATION  
PRODUCTS

### MALE ELBOW - BARB X MPT



<u>PART NUMBER</u>	<u>ITEM DESCRIPTION</u>
NP4MEB4	PARKER PAR-BARB BLACK POLY 1/4 BARB X 1/4 MPT ELBOW
N4MEB8	PARKER PAR-BARB WHITE NYLON 1/4 BARB X 1/2 MPT ELBOW
N6MEB4	PARKER PAR-BARB WHITE NYLON 3/8 BARB X 1/4 MPT ELBOW
N6MEB6	PARKER PAR-BARB WHITE NYLON 3/8 BARB X 3/8 MPT ELBOW
N6MEB8	PARKER PAR-BARB WHITE NYLON 3/8 BARB X 1/2 MPT ELBOW
N8MEB4	PARKER PAR-BARB WHITE NYLON 1/2 BARB X 1/4 MPT ELBOW
N8MEB6	PARKER PAR-BARB WHITE NYLON 1/2 BARB X 3/8 MPT ELBOW
N8MEB8	PARKER PAR-BARB WHITE NYLON 1/2 BARB X 1/2 MPT ELBOW

### TEE - BARB X BARB X BARB



<u>PART NUMBER</u>	<u>ITEM DESCRIPTION</u>
N6TUB6	PARKER PAR-BARB WHITE NYLON 3/8 BARBED UNION TEE
NP6TUB6	PARKER PAR-BARB BLACK POLY 3/8 BARBED UNION TEE
N8TUB8	PARKER PAR-BARB WHITE NYLON 1/2 BARB UNION TEE



PRECISION  
INSTALLATION  
PRODUCTS

# WATER TREATMENT

Parker Fast N' tite, Par-Barb & Nylon Fittings

## Parker Bass Fittings

### QUICK CONNECT COUPLINGS



<u>PART NUMBER</u>	<u>ITEM DESCRIPTION</u>
N2-60	PARKER 1/4 BRASS QUICK CONNECT COUPLER
N3-60	PARKER 3/8 BRASS QUICK CONNECT COUPLER
N4-60	PARKER 1/2 BRASS QUICK CONNECT COUPLER
N6-60	PARKER 3/4 BRASS QUICK CONNECT COUPLER

### QUICK CONNECT NIPPLE



<u>PART NUMBER</u>	<u>ITEM DESCRIPTION</u>
N2-61	PARKER 1/4 BRASS QUICK CONNECT NIPPLE
N3-61	PARKER 3/8 BRASS QUICK CONNECT NIPPLE
N4-61	PARKER 1/2 BRASS QUICK CONNECT NIPPLE
N6-61	PARKER 3/4 BRASS QUICK CONNECT NIPPLE

# WATER TREATMENT

Stainless Steel Fittings, Check Valves, & Tools

## Stainless Steel Fittings



PRECISION  
INSTALLATION  
PRODUCTS

### SWIVEL NUTS - FEMALE FLARE



<u>PART NUMBER</u>	<u>ITEM DESCRIPTION</u>
S101	1/4 STAINLESS STEEL SWIVEL NUT-NICKEL PLATE
S301	3/8 STAINLESS STEEL SWIVEL HEX NUT - NICKEL PLATE

### SWIVEL ELBOWS - BARB X FEMALE FLARE



<u>PART NUMBER</u>	<u>ITEM DESCRIPTION</u>
S30-44	1/4" BARB X 1/4" FEM FLARE SS SWIVEL ELBOW

### HOSE BARB STEMS - BARB



<u>PART NUMBER</u>	<u>ITEM DESCRIPTION</u>
S305	3/8 STAINLESS STEEL BARB FOR 3/8 NUT

### HOSE BARB SPLICERS - BARB X BARB



<u>PART NUMBER</u>	<u>ITEM DESCRIPTION</u>
S404	1/4 X 1/4 SS BARB HOSE SPLICER
S40-46	1/4 X 3/8 SS BARB HOSE SPLICER
S406	3/8 STAINLESS STEEL BARB HOSE SPLICER



PRECISION  
INSTALLATION  
PRODUCTS

# WATER TREATMENT

Stainless Steel Fittings, Check Valves, & Tools

## Stainless Steel Fittings

### REDUCING BELL HOUSING - FPT X FPT - #304 / CLASS 150



<u>PART NUMBER</u>	<u>ITEM DESCRIPTION</u>
SBH-16-12	# 304 STAINLESS STEEL 1" X 3/4" REDUCING BELL HOUSING-CLASS 150
SBH-18-12	# 304 STAINLESS STEEL 1 1/4" X 3/4" REDUCING BELL HOUSING-CLASS 150
SBH-18-16	# 304 STAINLESS STEEL 1 1/4" X 1" REDUCING BELL HOUSING-CLASS 150..

### NIPPLES - MPT X MPT



<u>PART NUMBER</u>	<u>ITEM DESCRIPTION</u>
SN12-2	3/4" X 2" STAINLESS STEEL (304) NIPPLE
SN16-2	1" X 2" STAINLESS STEEL (304) NIPPLE
SN18-2	1 1/4" X 2" STAINLESS STEEL (304) NIPPLE
SN18-25	1 1/4" X 2 1/2" STAINLESS STEEL (304) NIPPLE

### DOUBLE CHECK VALVE



<u>PART NUMBER</u>	<u>ITEM DESCRIPTION</u>
S470-4	1/4" FLARE STAINLESS STEEL DOUBLE CHECK VALVE
S470-6	3/8" FLARE STAINLESS STEEL DOUBLE CHECK VALVE
S470-6COMP	3/8" COMP X 3/8" COMP STAINLESS STEEL VENTED DOUBLE CHECK VALVE
S470-6COMP-2	3/8" COMP X 3/8" COMP STAINLESS STEEL VENTED DOUBLE CHECK VALVE W/ 1/8" HOSE BARB FOR EXTERNAL V...
S470-6V	3/8" FLARE STAINLESS STEEL DOUBLE CHECK VALVE

For prevention of back flow of gas (CO<sub>2</sub>) into water supply lines in carbonated water systems. Venting device with integral double check valve.

# WATER TREATMENT

Stainless Steel Fittings, Check Valves, & Tools

## Stainless Steel Fittings



PRECISION  
INSTALLATION  
PRODUCTS

## CRIMP FERRULES (100 PK)



<u>PART NUMBER</u>	<u>ITEM DESCRIPTION</u>
S6204	3/8" STAINLESS STEEL CRIMP FERRULE
S6295	1/4" STAINLESS STEEL CRIMP FERRULE

## CRIMP TOOLS



<u>PART NUMBER</u>	<u>ITEM DESCRIPTION</u>
S6547	2-HOLE CRIMP TOOL



PRECISION  
INSTALLATION  
PRODUCTS



**END OF SECTION**

**THIS PAGE IS LEFT  
INTENTIONALLY BLANK.**



# WATER TREATMENT

## SeaTech Quick Connect Fittings

Series 35 - Used with PEX, CPVC, and Copper



**PRECISION  
INSTALLATION  
PRODUCTS**

### Seatech Series 35 Fittings

35 Series products are manufactured in polysulfone and certified to NSF-61, NSF-14, CSA B137.5, ASTM F877, IGC 188-04c and recognized by the Uniform Plumbing Code.

Rated:

180°F @ 100psi (82°C @ 6.8 bar)

75°F @ 250psi (24°C @ 17.25 bar)

## MALE CONNECTOR - CTS X MPT



<u>PART NUMBER</u>	<u>ITEM DESCRIPTION</u>
TS3501-0806	SEATECH 3/8" CTS X 3/8" NPT MALE CONNECTOR (BOX IS 150)
TS3501-0808	SEATECH 3/8" CTS X 1/2" NPT MALE CONNECTOR (BOX IS 120)
TS3501-1006	SEATECH 1/2" CTS X 3/8" NPT MALE CONNECTOR (BOX IS 150)
TS3501-1008	SEATECH 1/2" CTS X 1/2" NPT MALE CONNECTOR (BOX IS 130)
TS3501-1012	SEATECH 1/2" CTS X 3/4" NPT MALE CONNECTOR (BOX IS 100)
TS3501-1014	SEATECH 1/2" CTS X 3/4" MIGHT MALE CONNECTOR (BOX IS 100)
TS3501-1412	SEATECH 3/4" CTS X 3/4" NPT MALE CONNECTOR (BOX IS 40)
TS3501-1816	SEATECH 1" CTS X 1" NPT MALE CONNECTOR (BOX IS 20)

## FEMALE CONNECTOR - CTS X FPT



<u>PART NUMBER</u>	<u>ITEM DESCRIPTION</u>
TS3510-0808	SEATECH 3/8" CTS X 1/2" NPT FEMALE CONNECTOR (BOX IS 120)
TS3510-0814	SEATECH 3/8" CTS X 3/4" FEMALE GHT CONNECTOR (BOX IS 80)
TS3510-1008	SEATECH 1/2" CTS X 1/2" NPT FEMALE CONNECTOR (BOX IS 100)
TS3510-1012	SEATECH 1/2" CTS X 3/4" NPT FEMALE CONNECTOR (BOX IS 80)
TS3510-1014	SEATECH 1/2" CTS X 3/4" FGHT FEMALE CONNECTOR (BOX IS 80)
TS3510-1412	SEATECH 3/4" CTS X 3/4" NPT FEMALE CONNECTOR (BOX IS 60)
TS3510-1416	SEATECH 3/4" CTS X 1" NPT FEMALE CONNECTOR (BOX IS 30)
TS3510-1816	SEATECH 1" CTS X 1" NPT FEMALE CONNECTOR (BOX IS 35)

## STACKABLE UNION - STEM X HOSE BARB



<u>PART NUMBER</u>	<u>ITEM DESCRIPTION</u>
TS3511-1008	SEATECH 1/2" CTS X 1/2" STACKABLE HOSE BARB UNION (BOX IS 200)

### STACKABLE ELBOW - STEM X HOSE BARB



<u>PART NUMBER</u>	<u>ITEM DESCRIPTION</u>
TS3512-1008	SEATECH 1/2" CTS STACKABLE HOSE BARB ELBOW (BOX IS 200)

### HOSE BARB FITTING - CTS X HOSE BARB



<u>PART NUMBER</u>	<u>ITEM DESCRIPTION</u>
TS3513-1008	SEATECH 1/2" CTS X 1/2" HOSE BARB FITTING (BOX IS 130)
TS3513-1412	SEATECH 3/4" CTS X 3/4" HOSE BARB FITTING (BOX IS 70)
TS3513-1816	SEATECH 1" CTS X 1" HOSE BARB FITTING (BOX IS 30)

### REDUCING STEM ADAPTER - STEM X CTS



<u>PART NUMBER</u>	<u>ITEM DESCRIPTION</u>
TS3514-1008	SEATECH 1/2" CTS STEM X 3/8" CTS REDUCING ADAPTER (BOX IS 100)
TS3514-1410	SEATECH 3/4" CTS STEM X 1/2" CTS REDUCING ADAPTER (BOX IS 100)
TS3514-1810	SEATECH 1" CTS STEM X 1/2" CTS REDUCING ADAPTER (BOX IS 70)
TS3514-1814	SEATECH 1" CTS STEM X 3/4" CTS REDUCING ADAPTER (BOX IS 50)

### UNION CONNECTOR - CTS X CTS



<u>PART NUMBER</u>	<u>ITEM DESCRIPTION</u>
TS3515-08	SEATECH 3/8" CTS UNION CONNECTOR (BOX IS 100)
TS3515-10	SEATECH 1/2" CTS UNION CONNECTOR (BOX IS 90)
TS3515-14	SEATECH 3/4" CTS UNION CONNECTOR (BOX IS 40)
TS3515-18	SEATECH 1" CTS UNION CONNECTOR (BOX IS 20)

# WATER TREATMENT

SeaTech Quick Connect Fittings

Series 35 - Used with PEX, CPVC, and Copper



PRECISION  
INSTALLATION  
PRODUCTS

## REDUCING UNION CONNECTOR - CTS X CTS



<u>PART NUMBER</u>	<u>ITEM DESCRIPTION</u>
TS3515R-1004	SEATECH 1/2" CTS X 1/4" OD REDUCING UNION CONNECTOR (BOX IS 90)
TS3515R-1008	SEATECH 1/2" CTS X 3/8" CTS REDUCING UNION CONNECTOR (BOX IS 90)
TS3515R-1410	SEATECH 3/4" CTS X 1/2" CTS REDUCING UNION CONNECTOR (BOX IS 40)
TS3515R-1814	SEATECH 1" CTS X 3/4" CTS REDUCING UNION CONNECTOR (BOX IS 25)

## UNION ELBOW - CTS X CTS



<u>PART NUMBER</u>	<u>ITEM DESCRIPTION</u>
TS3517-08	SEATECH 3/8" CTS UNION ELBOW (BOX IS 100)
TS3517-10	SEATECH 1/2" CTS UNION ELBOW (BOX IS 80)
TS3517-14	SEATECH 3/4" CTS UNION ELBOW (BOX IS 30)
TS3517-18	SEATECH 1" CTS UNION ELBOW (BOX IS 20)

## STACKABLE "STREET" ELBOW - CTS X STEM



<u>PART NUMBER</u>	<u>ITEM DESCRIPTION</u>
TS3518-08	SEATECH 3/8" CTS STACKABLE "STREET" STEM ELBOW (BOX IS 120)
TS3518-10	SEATECH 1/2" CTS STACKABLE "STREET" STEM ELBOW (BOX IS 100)
TS3518-14	SEATECH 3/4" CTS STACKABLE "STREET" STEM ELBOW (BOX IS 50)
TS3518-18	SEATECH 1" CTS STACKABLE "STREET" STEM ELBOW (BOX IS 25)

## MALE ELBOW - CTS X MALE



<u>PART NUMBER</u>	<u>ITEM DESCRIPTION</u>
TS3519-1006	SEATECH 1/2" CTS X 3/8" NPT MALE ELBOW (BOX IS 100)
TS3519-1008	SEATECH 1/2" CTS X 1/2" NPT MALE ELBOW (BOX IS 100)
TS3519-1816	SEATECH 1" CTS X 1" NPT MALE ELBOW (BOX IS 25)
TS3518-18	SEATECH 1" CTS STACKABLE "STREET" STEM ELBOW (BOX IS 25)

### FEMALE SWIVEL ELBOW - CTS X FPT SWIVEL



<u>PART NUMBER</u>	<u>ITEM DESCRIPTION</u>
TS3520-0808	SEATECH 3/8" CTS X 1/2" NPS FEMALE SWIVEL ELBOW (BOX IS 24)
TS3520-1008	SEATECH 1/2" CTS X 1/2" NPS FEMALE SWIVEL ELBOW (BOX IS 80)
TS3520-1012	SEATECH 1/2" CTS X 3/4" NPS FEMALE SWIVEL ELBOW (BOX IS 60)
TS3520-1014	SEATECH 1/2" CTS X 3/4" FGHT FEMALE SWIVEL ELBOW (BOX IS 70)

### UNION TEE - CTS X CTS X CTS



<u>PART NUMBER</u>	<u>ITEM DESCRIPTION</u>
TS3523-08	SEATECH 3/8" CTS UNION TEE (BOX IS 80)
TS3523-10	SEATECH 1/2" CTS UNION TEE (BOX IS 50)
TS3523-14	SEATECH 3/4" CTS UNION TEE (BOX IS 20)
TS3523-18	SEATECH 1" CTS UNION TEE (BOX IS 15)

### REDUCING BRANCH TEE - CTS X CTS X CTS



<u>PART NUMBER</u>	<u>ITEM DESCRIPTION</u>
TS3524R-1004	SEATECH 1/2" CTS X 1/4" OD REDUCING BRANCH TEE (BOX IS 50)
TS3524R-1410	SEATECH 3/4" CTS X 1/2" CTS REDUCING BRANCH TEE (BOX IS 25)
TS3524R-1814	SEATECH 1" CTS X 3/4" CTS REDUCING BRANCH TEE (BOX IS 25)

### REDUCING RUN TEE - CTS X CTS X CTS



<u>PART NUMBER</u>	<u>ITEM DESCRIPTION</u>
TS3526-1410	SEATECH 3/4" CTS X 1/2" CTS X 1/2" CTS RED RUN TEE (BOX IS 30)

# WATER TREATMENT

SeaTech Quick Connect Fittings

Series 35 - Used with PEX, CPVC, and Copper



PRECISION  
INSTALLATION  
PRODUCTS

## MALE STEM - STEM X MPT



<u>PART NUMBER</u>	<u>ITEM DESCRIPTION</u>
TS3527-1008	SEATECH 1/2" CTS PLASTIC STEM X 1/2" MPT (BOX IS 200)

## FEMALE STEM - STEM X FPT



<u>PART NUMBER</u>	<u>ITEM DESCRIPTION</u>
TS3528-1008	SEATECH 1/2" CTS PLASTIC STEM X 1/2" FPT (BOX IS 150)

## MALE PIPE THREAD TEE - CTS X CTS X MPT



<u>PART NUMBER</u>	<u>ITEM DESCRIPTION</u>
TS3530-1008	SEATECH 1/2" CTS X 1/2" CTS X 1/2" MPT TEE (BOX IS 60)

## STACKABLE TEE - CTS X STEM X CTS



<u>PART NUMBER</u>	<u>ITEM DESCRIPTION</u>
TS3533-08	SEATECH 3/8" CTS STACKABLE TEE (BOX IS 80)
TS3533-10	SEATECH 1/2" CTS STACKABLE TEE (BOX IS 50)
TS3533-14	SEATECH 3/4" CTS STACKABLE TEE (BOX IS 20)
TS3533-18	SEATECH 1" CTS STACKABLE TEE (BOX IS 15)

## REDUCING STACKABLE TEE - CTS X STEM X CTS



<u>PART NUMBER</u>	<u>ITEM DESCRIPTION</u>
TS3533R-1004	SEATECH 1/2" CTS X 1/4" OD REDUCING BRANCH STEM TEE (STACKABLE TEE) (BOX IS 50)
TS3533R-1410	SEATECH 3/4" CTS X 1/2" CTS REDUCING BRANCH STEM TEE (STACKABLE TEE) (BOX IS 20)

## STACKABLE BRANCH TEE - CTS X CTS X STEM



<u>PART NUMBER</u>	<u>ITEM DESCRIPTION</u>
TS3534-10	SEATECH 1/2" CTS X 1/2" CTS X 1/2" CTS STEM STACKABLE BRANCH TEE (BOX IS 50)

## 3 WAY SELECTOR VALVE - CTS X CTS X CTS



<u>PART NUMBER</u>	<u>ITEM DESCRIPTION</u>
TS3538-10	SEATECH 1/2" CTS 3-WAY SELECTOR VALVE (BOX IS 20)

## INLINE SHUT OFF VALVE - CTS X CTS



<u>PART NUMBER</u>	<u>ITEM DESCRIPTION</u>
TS3539-08	SEATECH 3/8" CTS INLINE SHUT-OFF VALVE (BOX IS 40)
TS3539-10	SEATECH 1/2" CTS INLINE SHUT-OFF VALVE (BOX IS 40)
TS3539-14	SEATECH 3/4" CTS INLINE SHUT-OFF VALVE (BOX IS 10)
TS3539-18	SEATECH 1" CTS INLINE SHUT-OFF VALVE (BOX IS 8)

# WATER TREATMENT

SeaTech Quick Connect Fittings

Series 35 - Used with PEX, CPVC, and Copper



PRECISION  
INSTALLATION  
PRODUCTS

## REDUCING INLINE SHUT OFF VALVE - CTS X TUBE



**PART NUMBER**

TS3539R-1004

**ITEM DESCRIPTION**

SEATECH 1/2" CTS X 1/4" OD REDUCING INLINE VALVE (BOX IS 40)

## UNION CHECK VALVE - CTS X CTS



**PART NUMBER**

TS3540-10

**ITEM DESCRIPTION**

SEATECH 1/2" CTS UNION CHECK VALVE (BOX IS 50)

## STACKABLE VALVE - CTS X STEM



**PART NUMBER**

TS3543-10

**ITEM DESCRIPTION**

SEATECH 1/2" CTS STACKABLE VALVE (BOX IS 40)

## REDUCING STACKABLE VALVE - STEM X TUBE



**PART NUMBER**

TS3543R-1004

**ITEM DESCRIPTION**

SEATECH 1/2" CTS X 1/4" OD REDUCING STACKABLE VALVE (BOX IS 40)

### END STOP - CTS



<u>PART NUMBER</u>	<u>ITEM DESCRIPTION</u>
TS3545-08	SEATECH 3/8" CTS END STOP (BOX IS 100)
TS3545-10	SEATECH 1/2" CTS END STOP (BOX IS 100)
TS3545-14	SEATECH 3/4" CTS END STOP (BOX IS 90)
TS3545-18	SEATECH 1" CTS END STOP (BOX IS 50)

### END PLUG - CTS



<u>PART NUMBER</u>	<u>ITEM DESCRIPTION</u>
TS3546-18	SEATECH 1" CTS END PLUG (BOX IS 100)

### COLLET CLIP - CTS



<u>PART NUMBER</u>	<u>ITEM DESCRIPTION</u>
TS3547-08	SEATECH 3/8" CTS COLLET CLIP (BOX IS 2500)
TS3547-10	SEATECH 1/2" CTS COLLET CLIP (BOX IS 2500)
TS3547-14	SEATECH 3/4" CTS COLLET CLIP (BOX IS 2000)
TS3547-18	SEATECH 1" CTS COLLET CLIP (BOX IS 1500)



# WATER TREATMENT

SeaTech Quick Connect Fittings

Series 35 - Used with PEX, CPVC, and Copper



PRECISION  
INSTALLATION  
PRODUCTS

## VALVED TEE - CTS X CTS X CTS



<u>PART NUMBER</u>	<u>ITEM DESCRIPTION</u>
TS3550-1004	SEATECH 1/2" CTS X 1/2" CTS X 1/4" OD VALVED TEE (BOX IS 40)
TS3550-1008	SEATECH 1/2" CTS X 1/2" CTS X 3/8" CTS VALVED TEE (BOX IS 30)
TS3550-1404	SEATECH 3/4" CTS X 3/4" CTS X 1/4" OD VALVED TEE (BOX IS 30)

## VALVED TEE - MPT X FPT X CTS



<u>PART NUMBER</u>	<u>ITEM DESCRIPTION</u>
TS3551-0808	SEATECH 1/2" MPT X 1/2" FPT X 3/8" CTS VALVED TEE (BOX IS 30)

## REDUCING INLINE VALVE - CTS X CTS



<u>PART NUMBER</u>	<u>ITEM DESCRIPTION</u>
TS3555-1006	SEATECH 1/2" CTS X 1/4" CTS INLINE REDUCING VALVE (BOX IS 60)
TS3555-1008	SEATECH 1/2" CTS X 3/8" CTS INLINE REDUCING VALVE (BOX IS 40)

## REDUCING ANGLE VALVE - CTS X CTS



<u>PART NUMBER</u>	<u>ITEM DESCRIPTION</u>
TS3556-1006	SEATECH 1/2" CTS X 1/4" CTS ANGLE REDUCING VALVE (BOX IS 60)
TS3556-1008	SEATECH 1/2" CTS X 3/8" CTS ANGLE REDUCING VALVE (BOX IS 40)

## TUBE SUPPORT LINER - CTS



<u>PART NUMBER</u>	<u>ITEM DESCRIPTION</u>
TS3560-08	SEATECH 3/8" CTS PLASTIC TUBE SUPPORT LINER (BOX IS 2500)
TS3560-10	SEATECH 1/2" CTS PLASTIC TUBE SUPPORT LINER (BOX IS 750)
TS3560-14	SEATECH 3/4" CTS PLASTIC TUBE SUPPORT LINER (BOX IS 500)
TS3560-18	SEATECH 1" CTS PLASTIC TUBE SUPPORT LINER (BOX IS 250)

## ADAPTER STOP VALVE - MALE COMP X FEMALE COMP X TUBE



<u>PART NUMBER</u>	<u>ITEM DESCRIPTION</u>
TS3561-0604-LF	SEATECH VALVE ADAPTER - 3/8" MALE CONN X 3/8" FEMALE CONN X 1/4"OD - LEAD FREE (BOX IS 50)
TS3561-0606	SEATECH VALVE ADAPTER - 3/8" MALE CONN X 3/8" FEMALE CONN X 3/8"OD (BOX IS 50)

## STRAIGHT PUMP FITTING - CTS TO AQUATEC PUMP



<u>PART NUMBER</u>	<u>ITEM DESCRIPTION</u>
TS3575-10	SEATECH 1/2" CTS UNION PUMP FITTING (BOX IS 120)

# WATER TREATMENT

SeaTech Quick Connect Fittings

Series 35 - Used with PEX, CPVC, and Copper



PRECISION  
INSTALLATION  
PRODUCTS

## ELBOW PUMP FITTING - CTS TO AQUATEC PUMP



<u>PART NUMBER</u>	<u>ITEM DESCRIPTION</u>
TS3576-10	SEATECH 1/2" CTS ELBOW PUMP FITTING (BOX IS 100)

## O-RING ASSEMBLY - CTS



<u>PART NUMBER</u>	<u>ITEM DESCRIPTION</u>
TS35159-08	SEATECH 3/8" CTS O-RING ASSEMBLY (BOX IS 500)
TS35159-10	SEATECH 1/2" CTS O-RING ASSEMBLY (BOX IS 500)
TS35159-14	SEATECH 3/4" CTS O-RING ASSEMBLY (BOX IS 250)
TS35159-18	SEATECH 1" CTS O-RING ASSEMBLY (BOX IS 100)

## SINGLE UNION BODY - CTS X CTS BODY & CTS PORT



<u>PART NUMBER</u>	<u>ITEM DESCRIPTION</u>
TS3589-1810	SEATECH 1" CTS BODY X 1/2" CTS PORT SINGLE BODY UNION (BOX IS 12)

## TUBING CUTTER



<u>PART NUMBER</u>	<u>ITEM DESCRIPTION</u>
TS1158-1522	SEATECH PEX TUBING CUTTER (BOX IS 20)



**PRECISION  
INSTALLATION  
PRODUCTS**



# WATER TREATMENT

## SeaTech Quick Connect Fittings

Series 35 - Used with PEX, CPVC, and Copper

### Material Specifications

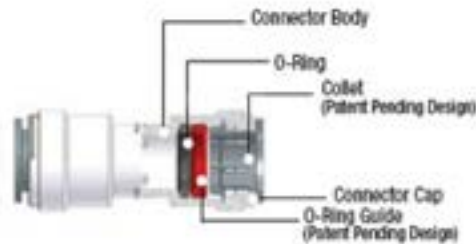

SERIES	MATERIAL	COLOR	O-RING
10 Series	High Performance Thermal Plastic	Off White	EPDM
24 Series	Thermal Plastic	Bright White	EPDM
35 Series	High Performance Thermal Plastic	Off White	EPDM
45 Series	Brass	Brass	EPDM
Metric Series	Thermal Plastic	Black	EPDM

### Product Features



#### O-Ring Guide is the Key

All Sea Tech connectors incorporate an exclusive O-Ring Guide for improved reliability. This unique feature insures zero-leak connections by:

- Protecting the O-Ring from damage during connection
- Increasing the connector's side load capacity
- Correctly aligning the tubing with the O-Ring every time
- Prevents the O-Ring from becoming dislodged

\*Patent Pending Collet Design & O-Ring Guide

### Performance Ratings

10 Series	60psi @ 140°F 4 Bar @ 60°C	150psi @ 70°F 10 Bar @ 20°C
24 Series	100psi @ 140°F 6.8 bar @ 60°C	250psi @ 75°F 17.25 bar @ 24°C
35 Series	100psi @ 180°F 6.8 bar @ 82°C	250psi @ 75°F 17.25 bar @ 24°C
45 Series	200psi @ 180°F 14 bar @ 82°C	250psi @ 75°F 17 bar @ 24°C
Metric Series	100psi @ 140°F 6.8 bar @ 60°C	250psi @ 75°F 17.25 bar @ 24°C

**FDA** FDA approval: Sea Tech fittings are produced from FDA approved materials.

**CSA** CSA B117.3 Certifications: Sea Tech 20 Series and 40 Series products are tested, certified, and approved to Canadian standard CSA B117.3.

**NSF** ANSI/NSF-61 Certifications: Sea Tech 10 Series, 24 Series, 35 Series, 45 Series and Metric Series products are tested, certified, and approved for contact with drinking water.

**ASTM** ASTM F1177 Certifications: Sea Tech 20 Series and 40 Series products are tested, certified, and approved to ASTM F1177 performance standards.

**NSF** ANSI/NSF-14 Certifications: Sea Tech 20 Series and 40 Series products are tested, certified, and approved to NSF-14 standards.

**IPC** NSF-14 Code Certifications: Sea Tech 20 Series and 40 Series products are tested, certified, and approved to meet the requirements of the Uniform Plumbing Code.

### Connect to Multiple Materials!

The Sea Tech fittings incorporate Stainless Steel Gripping Teeth in the Collets. These corrosion resistant teeth allow Sea Tech connectors to interconnect with multiple materials without the need for special tools or tube inserts.



- Copper
- CPVC
- LDPE, MDPE, & HDPE PEX Tubings
- Polybutylene
- Non-Oxygen Barrier PEX
- Potable Monowall PEX

### Thread Torque Values

1/2 in.	3/4 in.
Min. 17.7 in-lbs	Min. 22.7 in-lbs
Max. 26.5 in-lbs	Max. 31 in-lbs

# WATER TREATMENT

## Faucets & Accessories

### Pure T Long Reach Faucets



PRECISION  
INSTALLATION  
PRODUCTS

## PURE T LONG REACH FAUCETS



- 2 year warranty - fully guaranteed
- NSF & UPC certified
- Lead free
- IAPMO approved

<u>PART NUMBER</u>	<u>ITEM DESCRIPTION</u>
PFOT-3/14WLR	PURE T LR CHROME FAUCET - NSF - LEAD FREE - IAPMO
PFOT-3/14WLR-AG	PURE T LR CHROME AG FAUCET - NSF - LEAD FREE - IAPMO
PFOT-3/14WLR-AL-AG	PURE T LR ALMOND AG FAUCET-NSF/LEAD FREE/IAPMO
PFOT-3/14WLR-BLK	PURE T LR BLACK FAUCET - NSF - LEAD FREE - IAPMO
PFOT-3/14WLR-BLK-AG	PURE T LR BLACK AG FAUCET - NSF - LEAD FREE - IAPMO
PFOT-3/14WLR-BN	PURE T LR BRUSHED NICKEL FAUCET - NSF - LEAD FREE - IAPMO
PFOT-3/14WLR-BN-AG	PURE T LR BRUSHED NICKEL AG FAUCET - NSF - LEAD FREE - IAPMO
PFOT-3/14WLR-ORB	PURE T LR OIL RUBBED FAUCET - NSF - LEAD FREE - IAPMO
PFOT-3/14WLR-ORB-AG	PURE T LR OIL RUBBED AG FAUCET - NSF - LEAD FREE - IAPMO
PFOT-3/14WLR-SS	PURE T LR STAINLESS STEEL FAUCET - NSF - LEAD FREE - IAPMO
PFOT-3/14WLR-SS-AG	PURE T LR STAINLESS STEEL AG FAUCET - NSF - LEAD FREE - IAPMO
PFOT-3/14WLR-WH-AG	PURE T LR WHITE AG FAUCET - NSF - LEAD FREE - IAPMO

## PURE T COLOR CHART



<u>PART NUMBER</u>	<u>ITEM DESCRIPTION</u>
PFOT-3/14WLR-COLOR	PURE T COLOR CHART FOR LR FAUCETS

## PURE T REPAIR KIT



<u>PART NUMBER</u>	<u>ITEM DESCRIPTION</u>
PFO14	PURE T FAUCET REPAIR KIT FOR PURETEK ONLY



PRECISION  
INSTALLATION  
PRODUCTS

# WATER TREATMENT

Faucets & Accessories

## Hydronix Ceramic Disc Faucets

### 1/4 TURN CERAMIC DISC FAUCETS - LEAD FREE / NSF LISTED



<u>PART NUMBER</u>	<u>ITEM DESCRIPTION</u>
PFOT-CER25-AB	HYDRONIX ANTIQUE BRASS LEAD FREE CERAMIC DISC FAUCET - NSF - 3" SHANK
PFOT-CER25-AW	HYDRONIX ANTIQUE WINE LEAD FREE CERAMIC DISC FAUCET - NSF - 3" SHANK
PFOT-CER25-BN	HYDRONIX BRUSHED NICKEL LEAD FREE CERAMIC DISC FAUCET - NSF - 3" SHANK
PFOT-CER25-BN-AG	HYDRONIX BRUSHED NICKEL AIRGAP LEAD FREE CERAMIC DISC FAUCET - NSF - 3" SHANK
PFOT-CER25-CP	HYDRONIX CHROME LEAD FREE CERAMIC DISC FAUCET - NSF - 3" SHANK
PFOT-CER25-CP-AG	HYDRONIX CHROME AIRGAP LEAD FREE CERAMIC DISC FAUCET - NSF - 3" SHANK
PFOT-CER25-ORB	HYDRONIX OIL RUBBED BRONZE LEAD FREE CERAMIC DISC FAUCET - NSF - 3" SHANK
XAPRG10ASX	NORMAL BYPS - CLAMP MOUNT - 1/2"FPT - 350GPH @ 1450RPM
XAPRG10CHX	NO BYPS - FLANGE MOUNT - 1/2"FPT - 330GPH @ 1450RPM

### 1/4 TURN CERAMIC DISC COKE BOTTLE FAUCETS - LEAD FREE / NSF LISTED



<u>PART NUMBER</u>	<u>ITEM DESCRIPTION</u>
PFOT-CER32-ANTB	HYDRONIX ANTIQUE BRONZE LEAD FREE CERAMIC DISC "COKE STYLE" FAUCET - NSF-3" SHANK
PFOT-CER32-ANTB-AG	HYDRONIX ANTIQUE BRONZE AIRGAP LEAD FREE CERAMIC DISC "COKE STYLE" FAUCET-NSF-3" SHANK
PFOT-CER32-BN	HYDRONIX BRUSHED NICKEL LEAD FREE CERAMIC DISC "COKE STYLE" FAUCET - NSF - 3" SHANK
PFOT-CER32-BN-AG	HYDRONIX BRUSHED NICKEL AIRGAP LEAD FREE CERAMIC DISC NSF "COKE BOTTLE" FAUCET-NSF-3" SHANK
PFOT-CER32-CP	HYDRONIX CHROME LEAD FREE CERAMIC DISC "COKE STYLE" FAUCET - NSF - 3" SHANK
PFOT-CER32-CP-AG	HYDRONIX CHROME AIRGAP LEAD FREE CERAMIC DISC "COKE STYLE" FAUCET - NSF - 3" SHANK
PFOT-CER32-ORB	HYDRONIX OIL RUBBED BRONZE LEAD FREE CERAMIC DISC "COKE BOT-TLE" FAUCET-NSF-3" SHANK
PFOT-CER32-ORB-AG	HYDRONIX OIL RUBBED BRONZE AIRGAP LEAD FREE CERAMIC DISC "COKE BOTTLE" FAUCET-NSF-3" SHANK
XAPRG10CHX	NO BYPS - FLANGE MOUNT - 1/2"FPT - 330GPH @ 1450RPM

# WATER TREATMENT

Faucets & Accessories

Tomlinson Designer Faucets

tomlinson®



PRECISION  
INSTALLATION  
PRODUCTS

## DESIGNER RO FAUCET SERIES

Made of high quality lead-free brass, our designer kitchen faucet is a real standout – and a great opportunity for you to set yourself apart. This reverse osmosis faucet features a smooth operating ceramic disk element, lever style handle, high reach neck design of 12", protective spout tip to prevent after drip, and a patented modular air gap. The Designer Reverse Osmosis faucet retrofits most brands and is shipped complete with preinstalled tubing for quick connections. Choose from 9 designer finishes to compliment virtually any décor! All reverse osmosis faucets are NSF listed to ANSI NSF Std. 61. Two year warranty.



### Features:

- Retrofits most brands
- Smooth operating ceramic disk element
- Lever style handle
- High reach neck design of 12" (305 mm)
- Neck swivels 360°
- Protective spout tip prevents after drip
- Patented modular air gap (U.S. patent #7,011,106)
- Base diameter is 2-1/4" (57 mm)
- Two year warranty
- Spout reach is approximately 5" (127 mm)
- Pressure rating: 125 PSI/8.6 BAR
- Flow rate: 1.0 gpm/3.785 lpm at 35 PSI/2.32 BAR
- Temperature rating: 40°F/4°C to 150°F/66°C
- 1/4" OD x 30" tubing pre-installed
- Includes installation hardware and instructions

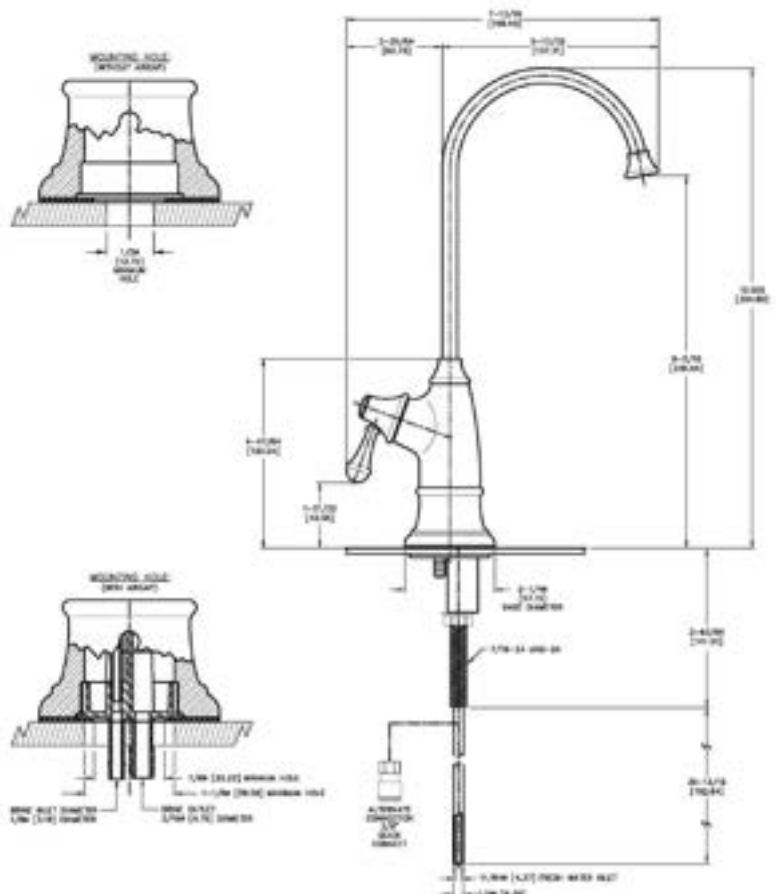

## TOMLINSON DESIGNER "COLD ONLY" FAUCETS



<u>PART NUMBER</u>	<u>ITEM DESCRIPTION</u>
PFOT-DES-ANTB	TOMLINSON ANTIQUE OIL-RUBBED BRONZE DESIGNER AG FAUCET - "COLD ONLY" - NSF
PFOT-DES-BLK	TOMLINSON BLACK DESIGNER AG FAUCET - "COLD ONLY" - NSF
PFOT-DES-BRN	TOMLINSON BRILLIANT NICKEL DESIGNER AG FAUCET - "COLD ONLY" - NSF
PFOT-DES-BS	TOMLINSON BISCUIT DESIGNER AG FAUCET - "COLD ONLY" - NSF
PFOT-DES-CH	TOMLINSON POLISHED CHROME DESIGNER AG FAUCET - "COLD ONLY" - NSF
PFOT-DES-FBLK	TOMLINSON FLAT BLACK DESIGNER AG FAUCET - "COLD ONLY" - NSF
PFOT-DES-PB	TOMLINSON POLISHED BRASS DESIGNER AG FAUCET - "COLD ONLY" - NSF
PFOT-DES-PN	TOMLINSON POLISHED NICKEL DESIGNER AG FAUCET - "COLD ONLY" - NSF
PFOT-DES-SN	TOMLINSON SATIN NICKEL DESIGNER AG FAUCET - "COLD ONLY" - NSF
PFOT-DES-SS	TOMLINSON BRUSHED STAINLESS DESIGNER AG FAUCET - "COLD ONLY" - NSF
PFOT-DES-VB	TOMLINSON VENETIAN BRONZE DESIGNER AG FAUCET - "COLD ONLY" - NSF
PFOT-DES-WH	TOMLINSON WHITE DESIGNER AG FAUCET - "COLD ONLY" - NSF

## TOMLINSON FAUCET DISPLAYS



<u>PART NUMBER</u>	<u>ITEM DESCRIPTION</u>
PFOT-DES/CONT-BASE	TOMLINSON MARBLE GRANITE DISPLAY BASE FOR TOMLISON FAUCETS - HOLDS 4 FAUCETS
PFOT-DES-DISPLAY	TOMLINSON DESIGNER FAUCET DISPLAY WITH COLOR KIT ON MARBLE/GRANITE BASE
PFOT-DES/CONT-CHART	TOMLINSON COLOR SAMPLES FOR DESIGNER/CONTEMPORARY LINES
PFOT-CONT-DISPLAY	TOMLINSON CONTEMPORARY FAUCET DISPLAY WITH COLOR KIT ON MARBLE/GRANITE BASE

## AIRGAPS



<u>PART NUMBER</u>	<u>ITEM DESCRIPTION</u>
PFOT-1419655	TOMLINSON DESIGNER AIRGAP ASSEMBLY
PFOT-1922731	TOMLINSON TUBING - 804-3HC 3/8 X 1/2 X 36"



# WATER TREATMENT

Faucets & Accessories

tomlinson



PRECISION  
INSTALLATION  
PRODUCTS

Tomlinson Contemporary Faucets - Cold Only

## CONTEMPORARY "COLD ONLY" AIRGAP FAUCETS - LEAD FREE



PART NUMBER	ITEM DESCRIPTION
PFOT-CONT-ANTB	TOMLINSON ANTIQUE OIL-RUBBED BRONZE CONTEMPORARY AG FAUCET - "COLD ONLY" - NSF
PFOT-CONT-BLK	TOMLINSON BLACK CONTEMPORARY AG FAUCET - "COLD ONLY" - NSF
PFOT-CONT-FBLK	TOMLINSON FLAT BLACK CONTEMPORARY AG FAUCET - "COLD ONLY" - NSF
PFOT-CONT-BRN	TOMLINSON BRILLIANT NICKEL CONTEMPORARY AG FAUCET - "COLD ONLY" - NSF
PFOT-CONT-BS	TOMLINSON BISCUIT CONTEMPORARY AG FAUCET - "COLD ONLY" - NSF
PFOT-CONT-CH	TOMLINSON CHROME CONTEMPORARY AG FAUCET - "COLD ONLY" - NSF
PFOT-CONT-PB	TOMLINSON POLISHED BRASS CONTEMPORARY AG FAUCET - "COLD ONLY" - NSF
PFOT-CONT-PN	TOMLINSON POLISHED NICKEL CONTEMPORARY AG FAUCET - "COLD ONLY" - NSF
PFOT-CONT-SN	TOMLINSON SATIN NICKEL CONTEMPORARY AG FAUCET - "COLD ONLY" - NSF
PFOT-CONT-SS	TOMLINSON BRUSHED STAINLESS CONTEMPORARY AG FAUCET - "COLD ONLY" - NSF
PFOT-CONT-VB	TOMLINSON VENETIAN BRONZE CONTEMPORARY AG FAUCET - "COLD ONLY" - NSF
PFOT-CONT-WH	TOMLINSON WHITE CONTEMPORARY AG FAUCET - "COLD ONLY" - NSF

## CONTEMPORARY RO FAUCET SERIES

Tomlinson's Contemporary Reverse Osmosis Faucets add high style to the high-end kitchen. Nine fabulous finishes give dealers and distributors lots of ways to up-sell customers. Plus, the lead-free brass construction of these reverse osmosis faucets is quality all the way. This contemporary kitchen faucet features a smooth operating ceramic disk element, lever style handle, high reach neck design of 12", protective spout tip to prevent after drip, and a patented modular air gap. The Contemporary Reverse Osmosis faucet retrofits most brands and is shipped complete with preinstalled tubing for quick connections. Any of the available designer finishes can compliment virtually any décor! All reverse osmosis faucets are NSF listed to ANSI NSF Std. 61. Two year warranty.

### Features:

- Retrofits most brands
- Smooth operating ceramic disk element
- Lever style handle
- High reach neck design of 12" (305 mm)
- Neck swivels 360°
- Protective spout tip prevents after drip
- Patented modular air gap (U.S. patent #7,011,106)
- Base diameter is 2-1/4" (57 mm)
- Two year warranty
- Spout reach is approximately 5" (127 mm)
- Pressure rating: 125 PSI/8.6 BAR
- Flow rate: 1.0 gpm/3.785 lpm at 35 PSI/2.32 BAR
- Temperature rating: 40°F/4°C to 150°F/66°C
- 1/4" OD x 30" tubing pre-installed
- Includes installation hardware and instructions

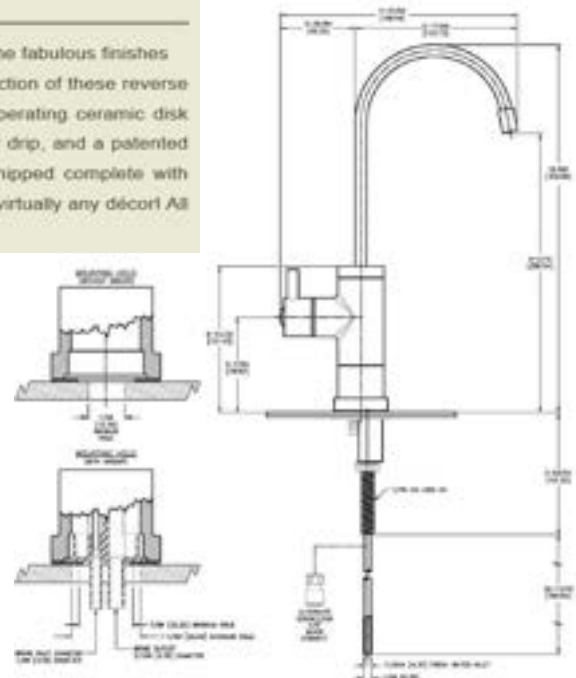

## ULTRA CONTEMPORARY "COLD ONLY" AIRGAP FAUCETS - LEAD FREE / NSF



<u>PART NUMBER</u>	<u>ITEM DESCRIPTION</u>
PFOT-ULTCON-ANTB	TOMLINSON ANTIQUE OIL-RUBBED BRONZE ULTRA CONTEMPORARY AG FAUCET - "COLD ONLY" - NSF
PFOT-ULTCON-CH	TOMLINSON CHROME ULTRA CONTEMPORARY AG FAUCET - "COLD ONLY" - NSF
PFOT-ULTCON-PN	TOMLINSON POLISHED NICKEL ULTRA CONTEMPORARY AG FAUCET - "COLD ONLY" - NSF
PFOT-ULTCON-SN	TOMLINSON SATIN NICKEL ULTRA CONTEMPORARY AG FAUCET - "COLD ONLY" - NSF
PFOT-ULTCON-SS	TOMLINSON BRUSHED STAINLESS ULTRA CONTEMPORARY AG FAUCET - "COLD ONLY" - NSF
PFOT-ULTCON-VB	TOMLINSON VENETIAN BRONZE ULTRA CONTEMPORARY AG FAUCET - "COLD ONLY" - NSF

## VINTAGE "COLD ONLY" AIRGAP FAUCETS - LEAD FREE/NSF



<u>PART NUMBER</u>	<u>ITEM DESCRIPTION</u>
PFOT-VINTAGE-ANTB	TOMLINSON ANTIQUE OIL-RUBBED BRONZE VINTAGE AG FAUCET - "COLD ONLY" - NSF
PFOT-VINTAGE-CH	TOMLINSON CHROME VINTAGE AG FAUCET - "COLD ONLY" - NSF
PFOT-VINTAGE-PN	TOMLINSON POLISHED NICKEL VINTAGE AG FAUCET - "COLD ONLY" - NSF
PFOT-VINTAGE-SN	TOMLINSON SATIN NICKEL VINTAGE AG FAUCET - "COLD ONLY" - NSF
PFOT-VINTAGE-SS	TOMLINSON BRUSHED STAINLESS VINTAGE AG FAUCET - "COLD ONLY" - NSF
PFOT-VINTAGE-VB	TOMLINSON VENETIAN BRONZE VINTAGE AG FAUCET - "COLD ONLY" - NSF

# WATER TREATMENT

Faucets & Accessories

Tomlinson Hot & Cold Faucets

tomlinson



PRECISION  
INSTALLATION  
PRODUCTS

## DESIGNER "HOT & COLD" FAUCETS - LEAD FREE



PART NUMBER	ITEM DESCRIPTION
PFOT-DESHC-ANTB	TOMLINSON ANTIQUE OIL-RUBBED BRONZE DESIGNER "HOT & COLD" FAUCET - NSF
PFOT-DESHC-CH	TOMLINSON CHROME DESIGNER "HOT & COLD" FAUCET - NSF
PFOT-DESHC-SN	TOMLINSON SATIN NICKEL DESIGNER "HOT & COLD" FAUCET - NSF
PFOT-DESHC-SS	TOMLINSON BRUSHED STAINLESS DESIGNER "HOT & COLD" FAUCET - NSF

PLEASE NOTE THAT THESE PRODUCTS DO NOT WORK WITH INSINKERATOR TANKS.

### HOT AND COLD FAUCETS

Tomlinson now offers Hot and Cold Water Faucets designed to work with instant hot water dispensers. These faucets can also be adapted for use with RO systems. Available in both Designer and Contemporary styles, these beautifully crafted hot and cold faucets give you the flexibility you need for today's upscale kitchens and entertainment areas. These hot and cold faucets feature a smooth operating ceramic disk element, lever style handle, high reach neck design of 12" and a protective spout tip to prevent after-drip. For additional safety, this faucet also has self-closing "hot" handles. Hot and cold faucets are shipped complete with preinstalled tubing for quick connections. Faucet is NSF listed to ANSI Std. 61.

#### Features:

- Smooth operating ceramic disk element
- Lever style handle
- High reach neck design of 12" (305 mm)
- Neck swivels 360°
- Protective spout tip prevents after drip
- Two-year warranty
- Spout reach is approximately 5" (127 mm)
- Pressure rating: 125 PSI/8.6 BAR
- Flow rate: varies depending on instant hot water dispenser
- Temperature rating: 40°F/4°C to 190°F/88°C
- 1/4" OD x 30" tubing pre-installed
- Includes installation hardware and instructions

#### Compatible with the following hot water dispensers:

- Waste King® (Anaheim Mfg.)
- Everpure® Everhot EV931840
- HT200 Franke® Little Butler Heating Tank
- Everpure® Commercial Grade Instant Hot CGHE1
- Little Gourmet®
- KitchenAid® (Whirlpool®)
- Mountain Plumbing MT641
- Quick & Hot® Waterstone #5000 Hot Tank
- Solaria™ Instant Hot Water Dispenser EV9318-40

*\*Not compatible with InSinkErator® products.*

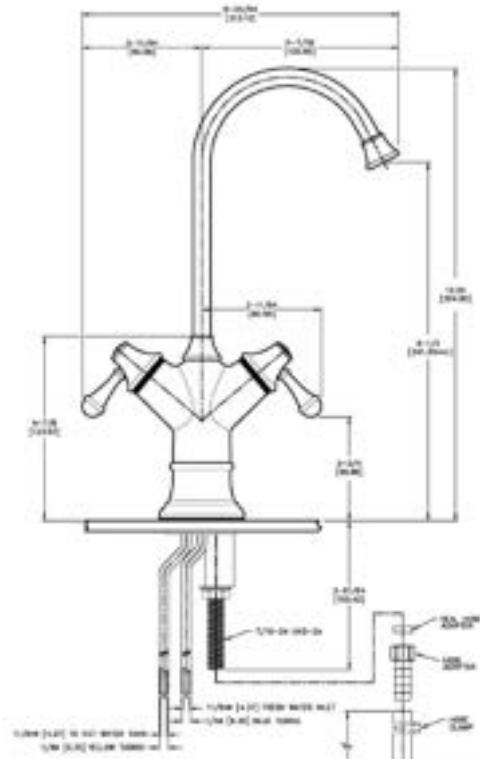

## CONTEMPORARY "HOT & COLD" FAUCETS - LEAD FREE



<u>PART NUMBER</u>	<u>ITEM DESCRIPTION</u>
PFOT-CONHC-ANTB	TOMLINSON ANTIQUE OIL-RUBBED BRONZE CONTEMPORARY "HOT & COLD" FAUCET - NSF
PFOT-CONHC-CH	TOMLINSON CHROME CONTEMPORARY "HOT & COLD" FAUCET - NSF
PFOT-CONHC-SN	TOMLINSON SATIN NICKEL CONTEMPORARY "HOT & COLD" FAUCET - NSF
PFOT-CONHC-SS	TOMLINSON BRUSHED STAINLESS CONTEMPORARY "HOT & COLD" FAUCET - NSF

PLEASE NOTE THAT THESE PRODUCTS DO NOT WORK WITH INSINKERATOR TANKS.

### HOT AND COLD FAUCETS

Tomlinson now offers Hot and Cold Water Faucets designed to work with instant hot water dispensers. These faucets can also be adapted for use with RO systems. Available in both Designer and Contemporary styles, these beautifully crafted hot and cold faucets give you the flexibility you need for today's upscale kitchens and entertainment areas. These hot and cold faucets feature a smooth operating ceramic disk element, lever style handle, high reach neck design of 12" and a protective spout tip to prevent after-drip. For additional safety, this faucet also has self-closing "hot" handles. Hot and cold faucets are shipped complete with preinstalled tubing for quick connections. Faucet is NSF listed to ANSI Std. 61.

#### Features:

- Smooth operating ceramic disk element
- Lever style handle
- High reach neck design of 12" (305 mm)
- Neck swivels 360°
- Protective spout tip prevents after drip
- Two-year warranty
- Spout reach is approximately 5" (127 mm)
- Pressure rating: 125 PSI/8.6 BAR
- Flow rate: varies depending on instant hot water dispenser
- Temperature rating: 40°F/4°C to 190°F/88°C
- 1/4" OD x 30" tubing pre-installed
- Includes installation hardware and instructions

#### Compatible with the following hot water dispensers:

- Waste King® (Anaheim Mfg.)
- Everpure® Everhot EV931840
- HT200 Franke® Little Butler Heating Tank
- Everpure® Commercial Grade Instant Hot CGHE1
- Little Gourmet®
- KitchenAid® (Whirlpool®)
- Mountain Plumbing MT641
- Quick & Hot® Waterstone #5000 Hot Tank
- Solaria™ Instant Hot Water Dispenser EV9318-40

\*Not compatible with InSinkErator® products.

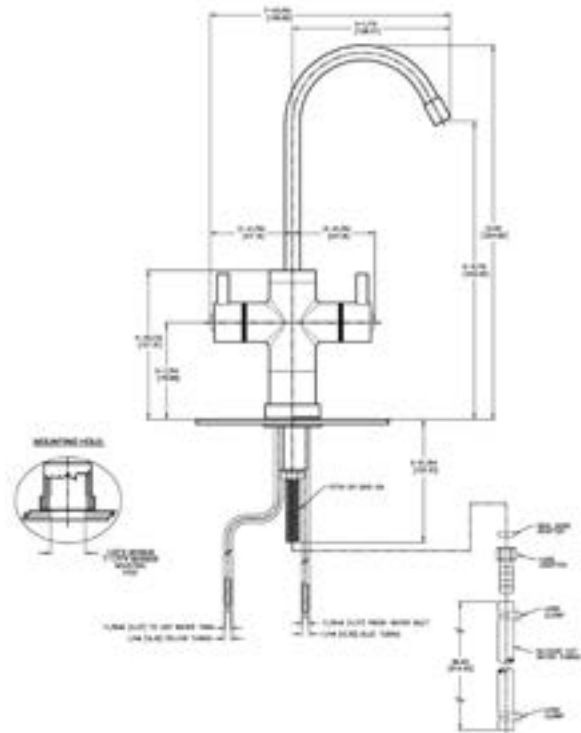

# WATER TREATMENT

Faucets & Accessories

Tomlinson Hot Only Faucets

tomlinson®



PRECISION  
INSTALLATION  
PRODUCTS

## DESIGNER "HOT ONLY" FAUCETS - LEAD FREE



PART NUMBER	ITEM DESCRIPTION
PFOT-DESH-ANTB	TOMLINSON ANTIQUE OIL-RUBBED BRONZE DESIGNER "HOT ONLY" FAUCET - NSF
PFOT-DESH-CH	TOMLINSON POLISHED CHROME DESIGNER "HOT ONLY" FAUCET - NSF
PFOT-DESH-SN	TOMLINSON SATIN NICKEL DESIGNER "HOT ONLY" FAUCET - NSF
PFOT-DESH-SS	TOMLINSON BRUSHED STAINLESS DESIGNER "HOT ONLY" FAUCET - NSF

### HOT ONLY FAUCETS

Tomlinson now offers a Hot Water Dispenser Faucet specifically designed to work with instant hot water dispensers. Available in both Designer and Contemporary styles, these beautifully crafted hot water faucets give you the flexibility you need for today's upscale kitchens and entertainment areas. These hot water faucets feature a smooth operating ceramic disk element, lever style handle, high reach neck design of 12", protective spout tip to prevent after-drip and self-closing "hot" handles for additional safety. This hot water dispenser faucet is shipped complete with preinstalled tubing for quick connections. Faucets are NSF listed to ANSI Std. 61.

#### Features:

- Smooth operating ceramic disk element
- Lever style handle
- High reach neck design of 12" (305 mm)
- Neck swivels 360°
- Protective spout tip prevents after drip
- Two-year warranty
- Spout reach is approximately 5" (127 mm)
- Pressure rating: 125 PSI/8.6 BAR
- Flow rate: varies depending on instant hot water dispenser
- Temperature rating: 40°F/4°C to 190°F/88°C
- 1/4" OD x 30" tubing pre-installed
- Includes installation hardware and instructions

#### Compatible with the following hot water dispensers:

- Waste King® (Anaheim Mfg.)
  - Everpure® Everhot EV931840
  - HT200 Franke® Little Butler Heating Tank
  - Everpure® Commercial Grade Instant Hot CGHE1
  - Little Gourmet®
  - KitchenAid® (Whirlpool®)
  - Mountain Plumbing MT641
  - Quick & Hot® Waterstone #5000 Hot Tank
  - Solaria™ Instant Hot Water Dispenser EV9318-40
- Not compatible with InSinkErator® products.*

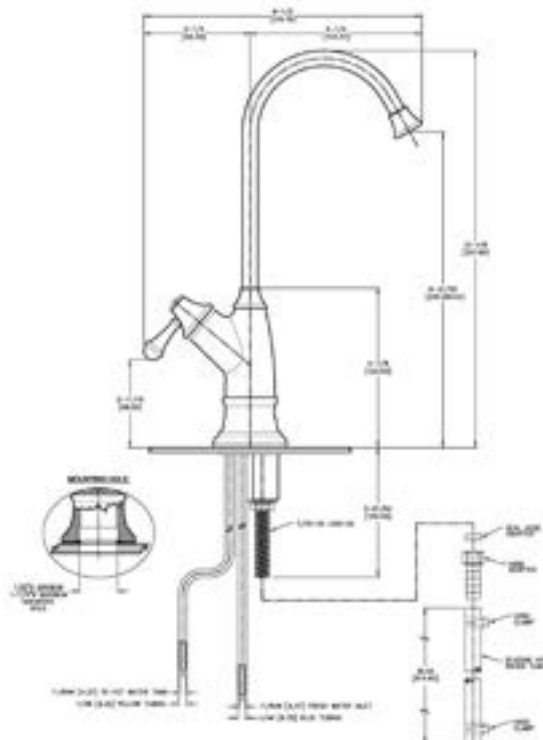

## CONTEMPORARY "HOT ONLY" FAUCETS - LEAD FREE



PART NUMBER	ITEM DESCRIPTION
PFOT-CONH-ANTB	TOMLINSON ANTIQUE OIL-RUBBED BRONZE CONTEMPORARY "HOT ONLY" FAUCET - NSF
PFOT-CONH-CH	TOMLINSON POLISHED CHROME CONTEMPORARY "HOT ONLY" FAUCET - NSF
PFOT-CONH-SN	TOMLINSON SATIN NICKEL CONTEMPORARY "HOT ONLY" FAUCET - NSF
PFOT-CONH-SS	TOMLINSON BRUSHED STAINLESS CONTEMPORARY "HOT ONLY" FAUCET - NSF

### HOT ONLY FAUCETS

Tomlinson now offers a Hot Water Dispenser Faucet specifically designed to work with instant hot water dispensers. Available in both Designer and Contemporary styles, these beautifully crafted hot water faucets give you the flexibility you need for today's upscale kitchens and entertainment areas. These hot water faucets feature a smooth operating ceramic disk element, lever style handle, high reach neck design of 12", protective spout tip to prevent after-drip and self-closing "hot" handles for additional safety. This hot water dispenser faucet is shipped complete with preinstalled tubing for quick connections. Faucets are NSF listed to ANSI Std. 61.

#### Features:

- Smooth operating ceramic disk element
- Lever style handle
- High reach neck design of 12" (305 mm)
- Neck swivels 360°
- Protective spout tip prevents after drip
- Two-year warranty
- Spout reach is approximately 5" (127 mm)
- Pressure rating: 125 PSI/8.6 BAR
- Flow rate: varies depending on instant hot water dispenser
- Temperature rating: 40°F/4°C to 190°F/88°C
- 1/4" OD x 30" tubing pre-installed
- Includes installation hardware and instructions

#### Compatible with the following hot water dispensers:

- Waste King® (Anaheim Mfg.)
  - Everpure® Everhot EV931840
  - HT200 Franke® Little Butler Heating Tank
  - Everpure® Commercial Grade Instant Hot CGHE1
  - Little Gourmet®
  - KitchenAid® (Whirlpool®)
  - Mountain Plumbing MT641
  - Quick & Hot® Waterstone #5000 Hot Tank
  - Solaria™ Instant Hot Water Dispenser EV9318-40
- \*Not compatible with InSinkErator® products.*

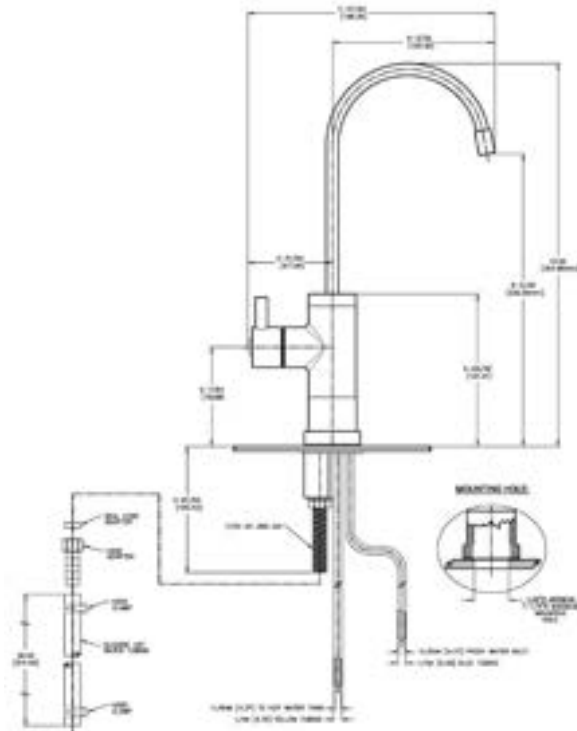

# WATER TREATMENT

Faucets & Accessories

Faucet Parts & Accessories



PRECISION  
INSTALLATION  
PRODUCTS

## FAUCET HOLE COVERS



<u>PART NUMBER</u>	<u>ITEM DESCRIPTION</u>
PFO44	2" OVERSIZED HOLE COVER - DOUBLE PLATE
PFO45	SINK HOLE COVER - 1 3/4" DIA. - SINGLE PLATE

## FAUCET WRENCH



<u>PART NUMBER</u>	<u>ITEM DESCRIPTION</u>
PFOT-WRENCH	BLACK METAL 12" FAUCET WRENCH

## SPIGOT



<u>PART NUMBER</u>	<u>ITEM DESCRIPTION</u>
PHFSA	TOMLINSON BLACK SPIGOT W/ 3/4" NUTS/THREADS/WASHER
PFOT-1025387	TOMLINSON SPIGOT - CHROME PLATED ABS BODY W/ 3/4"-16 UNF THREADS - STANDARD BLACK HANDLE-NUT SOL...



PRECISION  
INSTALLATION  
PRODUCTS



**END OF SECTION**

**THIS PAGE IS LEFT  
INTENTIONALLY BLANK.**



# WATER TREATMENT

Relton Cutters & Finish Saws

Saw Kits & Bits



PRECISION  
INSTALLATION  
PRODUCTS

## 3 PIECE RELTON FINISH PORCELAIN KIT



<u>PART NUMBER</u>	<u>ITEM DESCRIPTION</u>
PFO24	RELTON 3 PIECE 7/8" FINISH PORCELAIN KIT
PFO65	RELTON 3 PIECE 1" FINISH PORCELAIN KIT
PFO87	RELTON 3 PIECE 1-1/4" FINISH PORCELAIN KIT

## FINISH SAW - HEAD ONLY



<u>PART NUMBER</u>	<u>ITEM DESCRIPTION</u>
PFO24-HO	RELTON 7/8" FINISH SAW - HEAD ONLY
PFO87-HO	RELTON 1-1/4" FINISH SAW - HEAD ONLY

## FINISH SAW - SHANK ONLY



<u>PART NUMBER</u>	<u>ITEM DESCRIPTION</u>
PFO87-SO	RELTON 1-1/4" FINISH SAW - SHANK ONLY

## FINISH HOLE SAW - COMPLETE



<u>PART NUMBER</u>	<u>ITEM DESCRIPTION</u>
PFO914	RELTON 7/8" FINISH HOLE SAW COMPLETE
PFO916	RELTON 1" FINISH HOLE SAW COMPLETE
PFO920	RELTON 1-1/4" FINISH HOLE SAW COMPLETE
PFO925	RELTON 1-1/4" THIN GAUGE SS HOLE SAW COMPLETE
PFO926	RELTON 1-3/8" THIN GAUGE SS HOLE SAW COMPLETE
PFO928	RELTON 1-3/4" FINISH HOLE SAW COMPLETE



PRECISION  
INSTALLATION  
PRODUCTS

# WATER TREATMENT

Relton Cutters & Finish Saws

Saw Kits & Bits

## FINISH SAW GUIDE

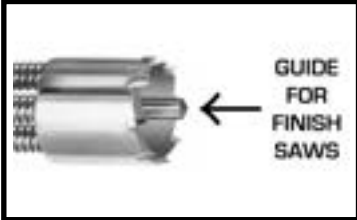

<u>PART NUMBER</u>	<u>ITEM DESCRIPTION</u>
PFOG	RELTON GUIDE FOR FINISH SAWS

## THIN GAUGE FINISH SAW - COMPLETE



<u>PART NUMBER</u>	<u>ITEM DESCRIPTION</u>
PFO925	RELTON 1-1/4" THIN GAUGE SS HOLE SAW COMPLETE
PFO926	RELTON 1-3/8" THIN GAUGE SS HOLE SAW COMPLETE

## 3 PIECE METAL HOLE SAW KIT



<u>PART NUMBER</u>	<u>ITEM DESCRIPTION</u>
PFO89	RELTON 1-3/8" METAL HOLE SAW COMPLETE KIT

## GRANITE / MARBLE HOLE SAW - COMPLETE



<u>PART NUMBER</u>	<u>ITEM DESCRIPTION</u>
PFO200	RELTON 1-1/4" GRANITE & MARBLE HOLE SAW COMPLETE

# WATER TREATMENT

Relton Cutters & Finish Saws

Saw Kits & Bits



PRECISION  
INSTALLATION  
PRODUCTS

## DRILL BITS

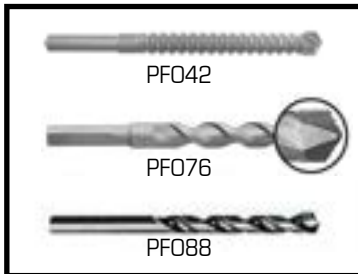

<u>PART NUMBER</u>	<u>ITEM DESCRIPTION</u>
PF042	RELTON 7/16" DIA. CARBIDE DRILL BIT (1/4" SHANK)
PF076	RELTON 7/16" DIA. GRANITE DRILL BIT FOR RELTON CUTTER
PF078	RELTON 7/8" DIA. GRANITE DRILL BIT FOR RELTON CUTTER
PF086	RELTON 1/4" THIN GAUGE PILOT - DRILL BIT
PF088	RELTON CARBIDE TIPPED PILOT DRILL 1/4"



PRECISION  
INSTALLATION  
PRODUCTS



**END OF SECTION**

**THIS PAGE IS LEFT  
INTENTIONALLY BLANK.**

# WATER TREATMENT

## Ultra-Violet (UV) Lights



PRECISION  
INSTALLATION  
PRODUCTS

### Polaris Ultraviolet System:

- Utilize natural quartz sleeves to protect the lamps and allow the maximum amount of UV rays to penetrate and disinfect the water.
- Systems inactivate micro-organisms within seconds with no harmful chemicals or byproducts.
- Provide a compact design and economical ultraviolet water treatment for low flow and medium flow applications such as; Light Commercial RO Systems, water vending machines, food industry, laboratory, medical facility water, pharmaceutical, cosmetic processes, final electronic component rinsing, recirculation loops and more.
- Produce little change in water temperature even after prolonged periods of no water flow, making it ideal for many application requirements.

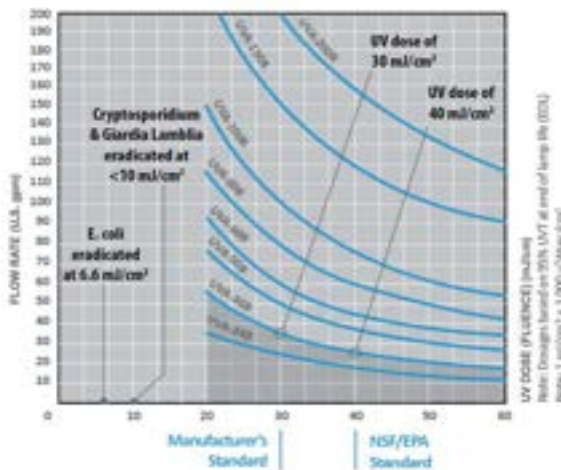
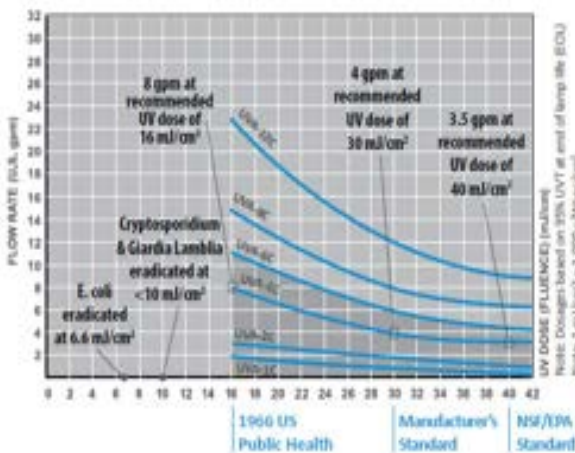



**PRECISION  
INSTALLATION  
PRODUCTS**

# WATER TREATMENT

## Ultra-Violet (UV) Lights

### Polaris Ultra-Violet Sterilization Systems

GPM	Rated Life (hours)	Lamp Watts	Voltage @ 50/60HZ	Visual Warning	Audible Warning	Number of Lamps	Port Size Inlet/Outlet	Water Chamber	Length	Width	Maximum Pressure	Working Temp.	Wavelength	Microjoules	
1	9,000	10W	110V/220V	LED	BUZZER	1	1/4" MNPT	STAINLESS 304	10.47"	2"	125 PSI	35°F- 104°F	254 nm	30 mJ/cm <sup>2</sup>	
2	9,000	14W	110V/220V	LED	BUZZER	1	1/4" MNPT	STAINLESS 304	13.74"	2.5"	125 PSI	35°F- 104°F	254 nm	30 mJ/cm <sup>2</sup>	
4	9,000	17W	110V/220V	LED	BUZZER	1	1/2" MNPT	STAINLESS 304	15.50"	2.5"	125 PSI	35°F- 104°F	254 nm	30 mJ/cm <sup>2</sup>	
6	9,000	24W	110V/220V	LED	INDICATOR W/ ALARM	1	1/2" MNPT	STAINLESS 304	20.23"	2.5"	125 PSI	35°F- 104°F	254 nm	30 mJ/cm <sup>2</sup>	
8	9,000	32W	110V/220V	LED	INDICATOR W/ALARM	1	3/4" MNPT	STAINLESS 304	27.87"	2.5"	125 PSI	35°F- 104°F	254 nm	30 mJ/cm <sup>2</sup>	
12	9,000	39W	110V/220V	LED	INDICATOR W/ ALARM	1	3/4" MNPT	STAINLESS 304	36.81"	2.5"	125 PSI	35°F- 104°F	254 nm	30 mJ/cm <sup>2</sup>	
24	9,000	39W	110V/220V	LED	INDICATOR W/ALARM	2	1" MNPT	STAINLESS 304	✓	36.93"	3.5"	125 PSI	35°F- 104°F	254 nm	30 mJ/cm <sup>2</sup>
36	9,000	39W	110V/220V	LED	INDICATOR W/ ALARM	3	1.5"	STAINLESS 304	✓	36.93"	5.5"	125 PSI	35°F- 104°F	254 nm	30 mJ/cm <sup>2</sup>
50	9,000	39W	110V/220V	LED	INDICATOR W/ALARM	4	1.5"	STAINLESS 304	✓	36.93"	5.5"	125 PSI	35°F- 104°F	254 nm	30 mJ/cm <sup>2</sup>

NOTE: Flanges available upon request.

NOTE: Flanges available upon request.

Parts & Accessories								
Part Number	Lamp	Quartz Sleeve	Electronic Ballast	Additional Accessories Specific to Your UV System				
UVA1C	QL10PP	QS10	BEB-1024	UV-NUT-1	•	•	UV-SEAL	UV-PLUG
UVA2C	QL14PP	QS14	BEB-1024	UV-NUT-1	•	•	UV-SEAL	UV-PLUG
UVA4C	QL17PP	QS17	BEB-1024	UV-NUT-1	•	•	UV-SEAL	UV-PLUG
UVA6C	QL24PP	QS24	BEB-2438	UV-NUT-1/ UV-NUT-2	•	•	UV-SEAL	UV-PLUG
UVA8C	QL32PP	QS32	BEB-2438	UV-NUT-1/ UV-NUT-2	UV-32 SPRING	•	UV-SEAL	UV-PLUG
UVA12C	QL39PP	QS39	BEB-2438	UV-NUT-1/ UV-NUT-2	UV-39 SPRING	•	UV-SEAL	UV-PLUG
UVA24B	QL39PP	QS39	BEB-2438	UV-NUT-1/ UV-NUT-2	UV-39 SPRING	UV-TIMER	UV-SEAL	UV-PLUG
UVA36B	QL39PP	QS39	BEB-2438	UV-NUT-1/ UV-NUT-2	UV-39 SPRING	UV-TIMER	UV-SEAL	UV-PLUG
UVA50B	QL39PP	QS39	BEB-2438	UV-NUT-1/ UV-NUT-2	UV-39 SPRING	UV-TIMER	UV-SEAL	UV-PLUG

# WATER TREATMENT

## Ultra-Violet (UV) Lights



PRECISION  
INSTALLATION  
PRODUCTS

### UV LIGHT



<u>PART NUMBER</u>	<u>ITEM DESCRIPTION</u>
UV-610	OMNI PACIFIC 6-VOLT UV LIGHT-1 GPM

### UV GERMICIDAL LAMPS

<u>PART NUMBER</u>	<u>ITEM DESCRIPTION</u>
UV-GL10SE4P	POLARIS UV 10 WATT GERMICIDAL LAMP FOR UV-1C SYSTEMS
UV-GL14SE4P	POLARIS UV 14 WATT GERMICIDAL LAMP FOR UV-2C SYSTEMS
UV-GL17SE4P	POLARIS UV 17 WATT GERMICIDAL LAMP FOR UV-4C SYSTEMS
UV-GL24PP	POLARIS UV 24 WATT GERMICIDAL LAMP FOR UV-6C SYSTEMS
UVA-GL10PP	POLARIS 10 WATT UV GERMICIDAL LAMP FOR 1 GPM SYSTEMS
UVA-GL14PP	POLARIS 14 WATT UV GERMICIDAL LAMP FOR 2 GPM SYSTEMS
UVA-GL17PP	POLARIS 17 WATT UV GERMICIDAL LAMP FOR 4 GPM SYSTEMS
UVA-GL24PP	POLARIS 24 WATT UV GERMICIDAL LAMP FOR 6 GPM SYSTEMS
UVA-GL32PP	POLARIS 32 WATT UV GERMICIDAL LAMP FOR 8 GPM SYSTEMS
UVA-GL39PP	POLARIS 39 WATT UV GERMICIDAL LAMP FOR 12-80 GPM SYSTEMS



**END OF SECTION**

**THIS PAGE IS LEFT  
INTENTIONALLY BLANK.**



# WATER TREATMENT

Pro Products

Sanitize Systems & Resin Care



PRECISION  
INSTALLATION  
PRODUCTS

## RO SANI-SYSTEM - SANITIZER - NSF



<u>PART NUMBER</u>	<u>ITEM DESCRIPTION</u>
UPRO-SS96RO	SANI-SYSTEM RO - UNIT SANITIZER - NSF EPA - 0.25 FL OZ - CASE 96

## WATER SOFTENER SANI-SYSTEM - SANITIZER - NSF



<u>PART NUMBER</u>	<u>ITEM DESCRIPTION</u>
UPRO-SS96WS	SANI-SYSTEM WATER SOFTENER - SANITIZER - NSF EPA - 0.5 FL OZ - CASE 96

## UV LIGHT TRANSFORMER



<u>PART NUMBER</u>	<u>ITEM DESCRIPTION</u>
UPRO-265062-SS	SANI - INLINE FILTER CARTRIDGE
UPRO-SM100S	SOFTENER MATE - ALL PURPOSE WATER SOFTENER CLEANER - 4 OZ

## UV QUARTZ SLEEVE



<u>PART NUMBER</u>	<u>ITEM DESCRIPTION</u>
UV-QS14	POLARIS UV QUARTZ SLEEVE FOR 14 WATT UV LAMP FOR UVA-2C SYSTEMS
UV-QS24	POLARIS UV QUARTZ SLEEVE FOR 24 WATT UV LAMP FOR UV-6C SYSTEMS



PRECISION  
INSTALLATION  
PRODUCTS

# WATER TREATMENT

Pro Products

Sanitize Systems & Resin Care

## WATER SOFTENER - CLEAN & SANITIZE



<u>PART NUMBER</u>	<u>ITEM DESCRIPTION</u>
UPRO-SSCSDISPLAY	WATER SOFTENER CLEAN & SANITIZE KIT: CONTAINS (1) 0.5 OZ SANI-SYSTEM & (1) 4 OZ RES CARE

## PRO EASY FEEDER STARTER KIT



<u>PART NUMBER</u>	<u>ITEM DESCRIPTION</u>
UPRO-RK11K	PRO EASY FEEDER STARTER KIT: CONTAINS (1) RES CARE - 64 OZ & (1) 1 OZ/DAY FEEDER

## RES CARE



<u>PART NUMBER</u>	<u>ITEM DESCRIPTION</u>
UPRO-RK32N	RES CARE - 32 OZ - CASE 12
UPRO-RK50N	RES CARE - 4 OZ.
UPRO-RK64N	RES CARE - 64 OZ

# WATER TREATMENT

Pro Products

Sanitize Systems & Resin Care



PRECISION  
INSTALLATION  
PRODUCTS

## RUST OUT



<u>PART NUMBER</u>	<u>ITEM DESCRIPTION</u>
UPRO-RO100S	RUST OUT (WATER SOFTENER CLEANER / IRON REMOVER) - 4 OZ PKG. - CASE 100
UPRO-RO12N	RUST OUT (WATER SOFTENER CLEANER / IRON REMOVER) - 22 OZ. - CASE 12
UPRO-RO50N	RUST OUT (WATER SOFTENER CLEANER / IRON REMOVER) - 50 LB. BUCKET
UPRO-RO65N	RUST OUT (WATER SOFTENER CLEANER / IRON REMOVER) - 76 OZ. - CASE 6

## SOFTENER MATE



<u>PART NUMBER</u>	<u>ITEM DESCRIPTION</u>
UPRO-SM12N	SOFTENER MATE - ALL PURPOSE WATER SOFTENER CLEANER - 1 LB 8 OZ. - CASE 12

## NUTRA SUL

<u>PART NUMBER</u>	<u>ITEM DESCRIPTION</u>
UPRO-NS22N	NEUTRA SUL - 2.5 GAL - CASE 2 - POWERFUL OXIDENT WHEN TREATING IRON OR MANGANESE & HYDROGEN SULFIDE
UPRO-NS41N	NEUTRA SUL - 1 GALLON - CASE 4 - POWERFUL OXIDENT WHEN TREATING IRON OR MANGANESE & HYDROGEN SUL...

## POT PERM

<u>PART NUMBER</u>	<u>ITEM DESCRIPTION</u>
UPRO-PP28N	POT PERM - 28 OZ - CASE 6 - GREEN SAND FILTER REGENERANT



PRECISION  
INSTALLATION  
PRODUCTS

# WATER TREATMENT

Pro Products

Testing Kits & Solutions

## BASIC FIELD TEST KITS



**PART NUMBER**

**ITEM DESCRIPTION**

UPRO-2403

"BASIC" HARDNESS FIELD TEST KIT

## STANDARD FIELD ANALYSIS KIT



**PART NUMBER**

**ITEM DESCRIPTION**

UPRO-2401

"STANDARD" HARDNESS FIELD TEST KIT (IRON, HARDNESS, pH)

## DELUXE FIELD ANALYSIS KIT



**PART NUMBER**

**ITEM DESCRIPTION**

UPRO-2404

"DELUXE" HARDNESS FIELD TEST KIT (IRON, HARDNESS, pH, CHLORINE, TDS METER)

## REFILL SOLUTIONS FOR FIELD KITS



**PART NUMBER**

**ITEM DESCRIPTION**

UPRO-2003

HARDNESS #1 - REFILL SOLTION - 16 OZ.

UPRO-2006

HARDNESS #2 - REFILL SOLTION - 16 OZ.

UPRO-2009

HARDNESS #3 - REFILL SOLTION - 16 OZ.

# WATER TREATMENT

R.O. & Filtration Systems

Hydronix R.O. Systems



PRECISION  
INSTALLATION  
PRODUCTS

## 3 STAGE REVERSE OSMOSIS SYSTEMS



<u>PART NUMBER</u>	<u>ITEM DESCRIPTION</u>
PERO-3100-WOTF	HYDRONIX 3 STAGE 100 GPD R.O. SYSTEM - NO TANK, FAUCET OR INSTALLATION KIT

## 4 STAGE REVERSE OSMOSIS SYSTEMS



<u>PART NUMBER</u>	<u>ITEM DESCRIPTION</u>
PERO-450-WOT	HYDRONIX 4 STAGE 50GPD R.O. SYSTEM WITH TITEGRIP - NO TANK
PERO-450-TWIST	HYDRONIX 4STAGE 50GPD TWIST RO SYSTEM W/ TANK, CERAMIC DISC CHROME FAUCET, SHOK BLOK, LEAK DETECTION

## 5 STAGE REVERSE OSMOSIS SYSTEMS



<u>PART NUMBER</u>	<u>ITEM DESCRIPTION</u>
PERO-550-WOT	HYDRONIX 5 STAGE 50 GPD R.O. SYSTEM WITH TITEGRIP - NO TANK - W/ TUBING (1/4" IN & 1/4" OUT)
PERO-575-WOT	HYDRONIX 5 STAGE 75 GPD R.O. SYSTEM WITH TITEGRIP-NO TANK



PRECISION  
INSTALLATION  
PRODUCTS

# WATER TREATMENT

R.O. & Filtration Systems

Hydronix R.O. Systems

## REPLACEMENT FOR TWIST SERIES

<u>PART NUMBER</u>	<u>ITEM DESCRIPTION</u>
PERO-TWIST-MEM50	HYDRONIX 4STAGE TWIST RO SYSTEM REPLACEMENT 50GPD MEMBRANE CARTRIDGE
PERO-TWIST-POST	HYDRONIX 4STAGE TWIST RO SYSTEM REPLACEMENT POST CARBON CARTRIDGE
PERO-TWIST-SED	HYDRONIX 4STAGE TWIST RO SYSTEM REPLACEMENT 5 MICRON SEDIMENT CARTRIDGE

## REPLACEMENT CARTRIDGES FOR EVERPURE SYSTEM

<u>PART NUMBER</u>	<u>ITEM DESCRIPTION</u>
QCS15-CB-KD-LR	3.25" X 14" - EVERPURE REPLACEMENT (4H, 4H-L) QUICK CHANGE CARTRIDGE - INTRODUCTORY SPECIAL
QCS20-CB-HF	3.25" X 20.40" EVERPURE REPLACEMENT (MC²) QUICK CHANGE CARTRIDGE - INTRODUCTORY SPECIAL
QCS20-CB-PH	3.25" X 20.40" - EVERPURE REPLACEMENT (i2000², i4000²) QUICK CHANGE CARTRIDGE - INTRODUCTORY SPE...

# WATER TREATMENT

R.O. & Filtration Systems

Hydronix R.O. Systems



PRECISION  
INSTALLATION  
PRODUCTS

- QUICK CONNECT TITEGRIP™ FITTINGS
- ASSEMBLED WITH NSF COMPONENTS : FILTER HOUSING, MEMBRANE HOUSING, CARTRIDGES, FAUCET, FITTINGS & TUBING
- AVAILABLE WITH OPTIONAL BOOSTER OR PERMEATE PUMP
- 100% WET TESTED
- FILTER WRENCH & COMPLETE INSTALLATION KIT INCLUDED
- TFC MEMBRANE ELEMENT
- HIGH QUALITY PRE AND POST FILTERS
- 4 & 5 STAGE MODELS AVAILABLE



DAILY PRODUCTION RATES:	50 GPD
TANK CAPACITY:	4 GALLONS (3.2 NET)
RECOVERY RATE:	1:4 PRODUCT WASTE
APPROX. SYSTEM WEIGHT:	27 LBS
APPROX SYTEM DIMENSIONS:	17X18X19 IN
SHIPPING BOX:	18X19X20 IN



NOMINAL SALT REJECTION:	98%
OPERATING PRESSURE:	40 - 80 PSI
OPERATING TEMPERATURE:	40 - 100°F
WATER HARDNESS:	<120 PPM (7 GPG)
PH RANGE:	3 - 11
TDS:	<1000 PPM
PRESSURE REGULATOR RECOMMENDED	

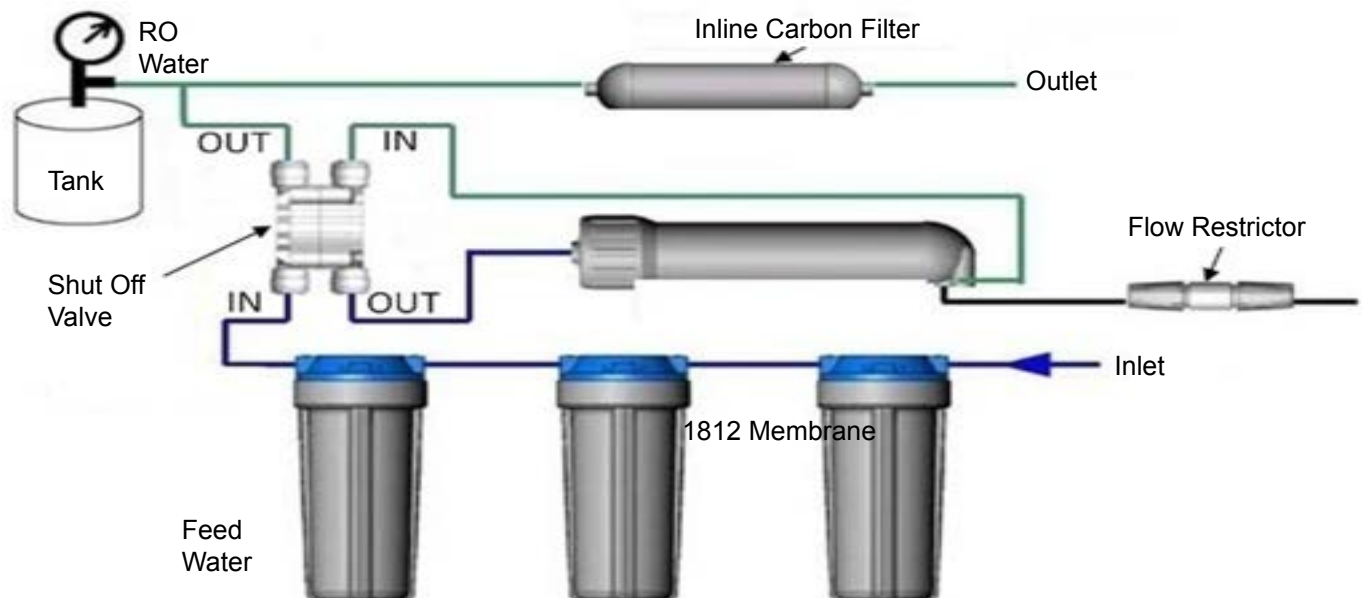



PRECISION  
INSTALLATION  
PRODUCTS

# WATER TREATMENT

R.O. & Filtration Systems

Hydronix R.O. Systems

## 4 STAGE REVERSE OSMOSIS SYSTEMS



<u>PART NUMBER</u>	<u>ITEM DESCRIPTION</u>
PERO-4200-WOTF	HYDRONIX 4 STAGE 200 GPD WHITE 20" R.O. SYSTEM & STAND W/ WRENCH & GARDEN HOSE ADAPTER (NO TANK OR FAUCET)

Comes with stand, pump, and pressure gauge. Does not include storage tank or faucet.

## 5 STAGE REVERSE OSMOSIS SYSTEMS WITH QUICK CHANGE CARTRIDGES



<u>PART NUMBER</u>	<u>ITEM DESCRIPTION</u>
PERO-550-EZ	PT 5 STAGE 50GPD QUICK CHANGE COMPLETE R.O. SYSTEM W/ STORAGE TANK, FAUCET AND INSTALL KIT
PERO-575-EZ	PT 5 STAGE 75GPD QUICK CHANGE COMPLETE R.O. SYSTEM W/ STORAGE TANK, FAUCET AND INSTALL KIT
PERO-5100-EZ	PT 5 STAGE 100GPD QUICK CHANGE COMPLETE R.O. SYSTEM W/ STORAGE TANK, FAUCET AND INSTALL KIT

Comes with stand, pump, and pressure gauge. Does not include storage tank or faucet.

## REPLACEMENT FILTERS FOR EZ SERIES

<u>PART NUMBER</u>	<u>ITEM DESCRIPTION</u>
PERO-EZ-CB	PT 5 STAGE QUICK CHANGE R.O. SYSTEM REPLACEMENT 5 MICRON CARBON BLOCK CARTRIDGE - NAVY BLUE
PERO-EZ-GAC	PT 5 STAGE QUICK CHANGE R.O. SYSTEM REPLACEMENT GAC CAR- TRIDGE - LIGHT BLUE
PERO-EZ-SEDIMENT	PT 5 STAGE QUICK CHANGE R.O. SYSTEM REPLACEMENT 5 MICRON SEDIMENT CARTRIDGE - GREY



# WATER TREATMENT

R.O. & Filtration Systems

Hydronix R.O. Systems



PRECISION  
INSTALLATION  
PRODUCTS

## 5 STAGE REVERSE OSMOSIS SYSTEMS



**PART NUMBER**

PERO-550-WM5

**ITEM DESCRIPTION**

WATERMAKER 5 STAGE 50 GPD R.O. SYSTEM COMPLETE WITH TANK -  
FAUCET SOLD SEPARATELY \*SPECIAL \*

## REPLACEMENT FILTER FOR WATERMAKER FIVE



**PART NUMBER**

PERO-550-VESSEL

**ITEM DESCRIPTION**

WATERMAKER 5 STAGE 50 GPD R.O. SYSTEM COMPLETE REPLACEMENT  
VESSEL



PRECISION  
INSTALLATION  
PRODUCTS

# WATER TREATMENT

R.O. & Filtration Systems

Hydronix R.O. Systems

## WaterMaker FIVE

The WaterMaker Five reverse osmosis system produces high quality drinking water quickly and easily. The system features hygienically sealed filter cartridges and color-coded fittings for fast installation and easy service. Compared to traditional RO systems, the unique WaterMaker Five delivers 30% more flow from the faucet and the 50 gpd membrane quickly refills the storage tank.

- ▶ The Green-by-Design® WaterMaker Five uses a new membrane configuration to reduce water waste by 50%.
- ▶ Unique five-stage design utilizes water pressure more effectively resulting in 30% higher flow from the faucet.
- ▶ 50 gpd membrane refills the storage tank quickly, giving you more water when you need it.
- ▶ Tested and certified by NSF International, Standard 58, for the reduction of Total Dissolved Solids (TDS), Lead, Fluoride, Arsenic V, and Cysts.
- ▶ Certified as a carbon neutral product through independent, third party assessment.
- ▶ Top quality coconut carbon post-filtration provides final polishing for the freshest taste.
- ▶ Easy to install with pre-connected, color coded tubing and hygienically sealed filter cartridges.
- ▶ Easy to maintain. Replace the filter cartridges without tools.
- ▶ Manufactured in the USA.



SINGLE CARTRIDGE	Stage 1	Prefilter	20 micron
	Stage 2	Prefilter	GAC
	Stage 3	RO Membrane	50 gpd
	Stage 4	Postfilter	GAC
	Stage 5	Post-tank filter	Inline GAC
System Dimensions		15.5" H x 9.75" W x 13.5" D	

### CONTAMINANT REDUCTION

Total dissolved solids	96.5%
Arsenic V	97.8%
Cysts	>99.99%
Fluoride	96.3%
Lead	98.0%

Please see the WM-5 Performance Data Sheet for more information on these claims.

### FEED WATER REQUIREMENTS

Total Dissolved Solids (TDS)	<2,000 mg/L (ppm)
Feed Temperature	40° F-100° F
Feed Pressure	40-80 psi
Turbidity	<1 NTU
Silt Density Index	<5
pH	4-8
Chlorine	<1.0 mg/L (ppm)

Feed water must be potable. Must be free of potential membrane foulants such as Iron, Hydrogen Sulfide and Manganese.

# WATER TREATMENT

R.O. & Filtration Systems

Hydronix R.O. Systems



PRECISION  
INSTALLATION  
PRODUCTS

## REVERSE OSMOSIS DRINKING WATER SYSTEM TYPICAL CONTAMINANT REMOVAL

Contaminant	% Reduction	Contaminant	% Reduction
Algae	99.9%	Mercury	93-98%
Aluminum	96-99%	Mold	99.9%
Amoebic Cysts	>99%	Nickel	93-98%
Arsenic	93-98%	Nitrate	85-90%
Asbestos	>99%	Phosphate	93-98%
Atrazine	95%	Potassium	94-97%
Bacteria	>99%	Protozoa	>99%
Barium	93-98%	Radioactivity	93-98%
Calcium	93-98%	Sediment	>99%
Chloride	95-98%	Selenium	94-96%
Chlorine	99.5%	Silicate	85-90%
Chromate	90-95%	Silver	93-98%
Copper	93-98%	Sodium	90-95%
Cryptosporidium Cysts	99.9%	Strontium	96-98%
Cyanide	90-95%	Sulfate	93-98%
Fluoride	95-98%	Thiosulfate	96-99%
Giardia Lamblia Cysts	99.9%	Trihalomethene (THM)	98%
Lead	93-98%	Total Volatile Organics	95%
Manganese	93-98%	Zinc	93-98%
Magnesium	93-98%	2,4-D	95%

• **Safer Drinking Water:** Consumers want safe, healthy, good-tasting water. RO purified water meets the requirements of the Safe Drinking Water Act and EPA standards for drinking water.

• **Good Taste:** RO removes excess minerals, odor, color, and other organic compounds that contribute to bad taste.

• **Health:** RO membranes provide a barrier to bacteria and virus resulting in healthier water for drinking and cooking.



**PRECISION  
INSTALLATION  
PRODUCTS**

# WATER TREATMENT

R.O. & Filtration Systems

## Benefits of R.O. Systems

*This information is extracted from the Water Quality Association WQA.*

Contaminants	Reduces /Rejects	Contaminants	Reduces /Rejects
Sodium	Yes	Chromium-6	Yes
Calcium	Yes	Chromium-3	Yes
Magnesium	Yes	Sodium	Yes
Potassium	Yes	Lead	Yes
Iron 2	Yes	Chloride	Yes
Manganese 2	Yes	Bicarbonate	Yes
Aluminum	Yes	Nitrate3	Yes
Copper	Yes	Fluoride	Yes
Nickel	Yes	Phosphate	Yes
Zinc	Yes	Chromate	Yes
Strontium	Yes	Cyanide	Yes
Cadmium	Yes	Sulfate	Yes
Silver	Yes	Arsenic + 3	Yes
Mercury	Yes	Arsenic + 5	Yes
Barium	Yes	Selenium	Yes
Radioactivity	Yes	Asbestos	Yes
Bacteria	Yes	Sediment	Yes
Protozoa	Yes	Turbidity	Yes
Amoebic	Yes	Giardia	Yes
Cysts	Yes		
Organic Contaminants Organic molecules with a molecular weight < 300	Yes	Organic molecules with a molecular weight < 3005	Yes

Reverse osmosis (RO) is used to purify tap water for drinking water in homes. In addition to removing excess or harmful minerals, reverse osmosis removes odor, color, chemicals, and other organic compounds and contaminants, which contribute to bad taste or health concerns.

# WATER TREATMENT

## Water Filter & Water Softener Parts - Aquatrol

### Parts - Aquatrol Pressure Tanks



**PRECISION  
INSTALLATION  
PRODUCTS**

Aquatrol Pressure Tanks offer a reliable and cost-effective alternative for all of your light residential to heavy-duty commercial applications. Aquatrol tanks are available in a variety of sizes ranging from 0713 to 6096 and all tanks up to 16" are NSF/ANSI Standard 44 certified.

Aquatrol proudly offers a 10 year warranty on tanks from 6" -- 13" (5 year warranty on all tanks from 14" - 16").

Aquatrol Pressure Tanks provide outstanding performance and durability characteristics while giving you exceptional cost saving benefits. With Aquatrol there really is no need to go with a higher priced alternative.



- ✓ **COST EFFECTIVE RELIABILITY**
- ✓ **EASY HANDLING AND INSTALLATION**
- ✓ **STANDARD AND TRIPOD BASE**
- ✓ **NSF/ANSI STANDARD 44 CERTIFIED**
- ✓ **OUTSTANDING PERFORMANCE AND DURABILITY**



This product has been tested and certified by NSF International against NSF/ANSI Standard 44 for material and structural requirements only.

COMPONENT

#### OPERATING PARAMETERS

- Maximum Operating Pressure: 150 PSI (10 Bar)
- Maximum Operating Temperature: 104°F (40°C)

#### DESIGN PARAMETERS

- Cycle Test
- Safety Factor

#### SAFETY FACTORS

- 100,000 Cycle Test without leaks
- Safety Factor 4:1 (Minimum burst at 600 psi)

#### SPECIFICATIONS

- Max. Pressure: 10.5 Bar (150 PSIG)
- Max. Temperature: 49°C (120°F)
- Min. Temperature: 1°C (34°F)
- Max. Vacuums: 140 mmHg (5.5" Hg)

**DO NOT EXCEED SPECIFICATIONS**

#### HANDLING INSTRUCTIONS

THIS VESSEL IS ONLY APPROVED FOR WATER PRESSURE USE. ALL OTHER USES OR SOLUTIONS TO BE USED MUST BE APPROVED BY MANUFACTURER.

Do not use for Pneumatic or Hydro-Pneumatic application. VESSEL MUST NOT BE EXPOSED TO TEMPERATURE BELOW -20°C (-20°F)





#### CONNECTIONS

- 2.5", 4", 6" Connections
- Top, Top and Bottom
- Threaded and Flange

#### MATERIALS OF CONSTRUCTION

- Polyethylene inner shell: 7" - 36"
- FRP: 40" - 60"

#### WARRANTY

- 10 Year Warranty for 6" - 13" vessels
- 5 Year Warranty for 14" - 16" vessels



PRECISION  
INSTALLATION  
PRODUCTS

# WATER TREATMENT

Water Filter & Water Softner Parts - AquatrolAquatrol

## Parts - Aquatrol Pressure Tanks

### 2.5" TOP - PRESSURE TANKS



<u>PART NUMBER</u>	<u>ITEM DESCRIPTION</u>
AQT-AT-0713BL-25T	AQUATROL PRESSURE TANK - 7" X 13" PG, 2.5" TOP, STANDARD, BLUE TANK, 1.8 GAL
AQT-AT-0713BK-25T	AQUATROL PRESSURE TANK - 7" X 13" PG, 2.5" TOP, STANDARD, BLACK TANK, 1.8 GAL
AQT-AT-0735BL-25T	AQUATROL PRESSURE TANK - 7" X 35" PG, 2.5" TOP, STANDARD, BLUE TANK, 5.2 GAL
AQT-AT-0817BL-25T	AQUATROL PRESSURE TANK - 8" X 17" PG, 2.5" TOP, STANDARD, BLUE TANK, 3.1 GAL
AQT-AT-0820BL-25T	AQUATROL PRESSURE TANK - 8" X 20" PG, 2.5" TOP, STANDARD, BLUE TANK, 3.5 GAL
AQT-AT-0835BL-25T	AQUATROL PRESSURE TANK - 8" X 35" PG, 2.5" TOP, STANDARD, BLUE TANK, 6.6 GAL
AQT-AT-0844BK-25T	AQUATROL PRESSURE TANK - 8" X 44" PG, 2.5" TOP, STANDARD, BLACK TANK, 8.7 GAL
AQT-AT-0844BL-25T	AQUATROL PRESSURE TANK - 8" X 44" PG, 2.5" TOP, STANDARD, BLUE TANK, 8.7 GAL
AQT-AT-0935BL-25T	AQUATROL PRESSURE TANK - 9" X 35" PG, 2.5" TOP, STANDARD, BLUE TANK, 8.3 GAL
AQT-AT-0948BK-25T	AQUATROL PRESSURE TANK - 9" X 48" PG, 2.5" TOP, STANDARD, BLACK TANK, 12.7 GAL
AQT-AT-0948BL-25T	AQUATROL PRESSURE TANK - 9" X 48" PG, 2.5" TOP, STANDARD, BLUE TANK, 12.7 GAL
AQT-AT-1035BL-25T	AQUATROL PRESSURE TANK - 10" X 35" PG, 2.5" TOP, STANDARD, BLUE TANK, 10.2 GAL
AQT-AT-1044BL-25T	AQUATROL PRESSURE TANK - 10" X 44" PG, 2.5" TOP, STANDARD, BLUE TANK, 13.1 GAL
AQT-AT-1054BK-25T	AQUATROL PRESSURE TANK - 10" X 54" PG, 2.5" TOP, STANDARD, BLACK TANK, 16.4 GAL
AQT-AT-1054BL-25T	AQUATROL PRESSURE TANK - 10" X 54" PG, 2.5" TOP, STANDARD, BLUE TANK, 16.4 GAL
AQT-AT-1248BL-25T	AQUATROL PRESSURE TANK - 12" X 48" PG, 2.5" TOP, STANDARD, BLUE TANK, 20.96 GAL
AQT-AT-1252BL-25T	AQUATROL PRESSURE TANK - 12" X 52" PG, 2.5" TOP, STANDARD, BLUE TANK, 22.2 GAL
AQT-AT-1265BL-25T	AQUATROL PRESSURE TANK - 12" X 65" PG, 2.5" TOP, STANDARD, BLUE TANK, 22.2 GAL
AQT-AT-1354BL-25T	AQUATROL PRESSURE TANK - 13" X 54" PG, 2.5" TOP, STANDARD, BLUE TANK, 27.5 GAL
AQT-AT-1465BL-25T	AQUATROL PRESSURE TANK - 14" X 65" PG, 2.5" TOP, STANDARD, BLUE TANK, 40.6 GAL
AQT-AT-1665BL-25T	AQUATROL PRESSURE TANK - 16" X 65" PG, 2.5" TOP, STANDARD, BLUE TANK, 49 GAL

# WATER TREATMENT

## Water Filter & Water Softener Parts - Aquatrol



PRECISION  
INSTALLATION  
PRODUCTS

### Parts - Aquatrol Pressure Tanks

## 4" TOP - PRESSURE TANKS



<u>PART NUMBER</u>	<u>ITEM DESCRIPTION</u>
AQT-AT-1465BL-4T	AQUATROL PRESSURE TANK - 14" X 65" PG, 4" TOP, STANDARD, BLUE TANK, 40.6 GAL
AQT-AT-1665NA-4T4B	AQUATROL PRESSURE TANK - 16" X 65" PG, 4" TOP, 4" BOTTOM, TRIPOD, NATURAL TANK, 49 GAL
AQT-AT-1665BL-4T	AQUATROL PRESSURE TANK - 16" X 65" PG, 4" TOP, STANDARD, BLUE TANK, 49 GAL
AQT-AT-1865NA-4T4B	AQUATROL PRESSURE TANK - 18" X 65" PG, 4" TOP, 4" BOTTOM, TRIPOD, NATURAL TANK, 66.7 GAL
AQT-AT-1865NA-4T	AQUATROL PRESSURE TANK - 18" X 65" PG, 4" TOP, TRIPOD, NATURAL TANK, 66.7 GAL
AQT-AT-2072NA-4T4B	AQUATROL PRESSURE TANK - 20" X 72" PG, 4" TOP, 4" BOTTOM, TRIPOD, NATURAL TANK, 89 GAL
AQT-AT-2162NA-4T4B	AQUATROL PRESSURE TANK - 21" X 62" PG, 4" TOP, 4" BOTTOM, TRIPOD, NATURAL TANK, 88 GAL
AQT-AT-2162NA-4T	AQUATROL PRESSURE TANK - 21" X 62" PG, 4" TOP, TRIPOD, NATURAL TANK, 88 GAL
AQT-AT-2472NA-4T4B	AQUATROL PRESSURE TANK - 24" X 72" PG, 4" TOP, 4" BOTTOM, TRIPOD, NATURAL TANK, 126.8 GAL
AQT-AT-2472NA-4T	AQUATROL PRESSURE TANK - 24" X 72" PG, 4" TOP, TRIPOD, NATURAL TANK, 126.8 GAL
AQT-AT-3072NA-4T4B	AQUATROL PRESSURE TANK - 30" X 72" PG, 4" TOP, 4" BOTTOM, TRIPOD, NATURAL TANK, 195.5 GAL
AQT-AT-3072NA-4T	AQUATROL PRESSURE TANK - 30" X 72" PG, 4" TOP, TRIPOD, NATURAL TANK, 195.5 GAL
AQT-AT-3672NA-4T4B	AQUATROL PRESSURE TANK - 36" X 72" PG, 4" TOP, 4" BOTTOM, TRIPOD, NATURAL TANK, 283 GAL
AQT-AT-3672NA-4T	AQUATROL PRESSURE TANK - 36" X 72" PG, 4" TOP, TRIPOD, NATURAL TANK, 283 GAL

## 6" TOP / 6" BOTTOM- PRESSURE TANKS



<u>PART NUMBER</u>	<u>ITEM DESCRIPTION</u>
AQT-AT-3672NA-6T6B	AQUATROL PRESSURE TANK - 36" X 72" PG, 6" TOP, 6" BOTTOM, TRIPOD, NATURAL TANK, 283 GAL
AQT-AT-4072NA-6T6B	AQUATROL PRESSURE TANK - 40" X 72" PG, 6" TOP, 6" BOTTOM, FLANGE, NATURAL TANK, 338.7 GAL
AQT-AT-4872NA-6T6B	AQUATROL PRESSURE TANK - 48" X 72" PG, 6" TOP, 6" BOTTOM, FLANGE, NATURAL TANK, 477.7 GAL



PRECISION  
INSTALLATION  
PRODUCTS

# WATER TREATMENT

## Water Filter & Water Softner Parts - Aquatrol

### Control Valves



#### ✓ PERFORMANCE

#### ✓ QUALITY

#### ✓ RELIABILITY

##### PERFORMANCE

Aquatrol valves have been designed to provide customers worldwide a breadth of product options to satisfy a wide range of application needs. Aquatrol constantly strives to produce products that offer exceptional performance that meet and exceed industry expectations time and time again.

##### QUALITY

Aquatrol valves are manufactured in a state of the art ISO9000 certified facility. They undergo strict Quality Control standards and have to comply with a broad scope of testing parameters. Strict Quality Control coupled with a market commitment to offer quality products, which increase your bottom line, are a major driving force in the success of Aquatrol, its distributors and its customers.

##### RELIABILITY

Aquatrol recognizes that in order to grow and expand our global distribution force, our products have to offer not just performance and quality, they have to offer reliability. We strive to deliver a product which you can confidently utilize knowing you have the peace of mind of the Aquatrol name behind it.



# WATER TREATMENT

## Water Filter & Water Softner Parts - Aquatrol

### AQT-56 Timer-Meter / Control Valves



PRECISION  
INSTALLATION  
PRODUCTS

Aquatrol AQT-56 Timer/Meter Control Valves offer a rigid valve body made from Noryl material for a superior quality and durability. The AQT-56 Control Valves are low power consumption and have a precision piston-seal-spacer assembly. With a wide range of piston selectors as well as a full series of DLFC/BLFC injector modules the AQT-56 n be customized to meet many requirements.



#### Features:

- Durable Noryl Plastic Body Design
- Residential/Light Commercial Applications
- Non-Corrosive
- 3/4"-1" Control Valve
- Time Clock: 7 and 12 Days

\*Now offered in Digital verion.

Models:	
AQT-56ST:	Mechanical Softener Timer Control Valve
AQT-56SM:	Mechanical Softener Meter Control Valve
AQT-56FT:	Mechanical Filter Timer Control Valve

Meter:
Accuracy Range: 0.25 - 15 gpm (0.95 - 57 lpm) ± 5%
Capacity Range: Standard: 125 - 2100 gal (0.5m <sup>3</sup> - 8m <sup>3</sup> ) Extended: 625 - 10800 gal (2.4m <sup>3</sup> - 40m <sup>3</sup> )

Flow Rate @ 50 psi (3.5 bar) Valve Alone:	
Continuous 15 psi (1 bar) Drop:	20 gpm (76 lpm)
Peak 25 psi (1.7 bar) Drop:	26 gpm (98 lpm)
Max Backwash 25 psi (1.7bar) Drop:	7 gpm (26 lpm)
CV 1 psi (0.07 bar) Drop:	5.0

Valve Specifications:	
Inlet/Outlet:	1" or 3/4"
Mounting Base:	2-1/2" 8 NPSM
Distributor Pilot:	1.05" OD
Drain Line:	1/2"
Brine Line:	3/8"
Height:	7" (178 mm)
Weight (Valve Gross):	Timer 5.1 lb (2.3 kg) Meter 5.5 lb (2.5 kg)

Flow Rate @ 50 psi (3.5bar) Filter/Softener 15 psi (1bar) Drop:		
7x35	0.5 cf (14 l) Resin	8.0 gpm (30.3 lpm)
8x44	0.75 cf (21 l) Carbon/Resin	9.6 gpm (36.5 lpm)
9x48	1.0 cf (29 l) Carbon/Resin	11.5 gpm (43.5 lpm)
10x54	1.5 cf (43 l) Carbon/Resin	11.8 gpm (44.5 lpm)
12x48	2.0 cf (57 l) Resin	12.8 gpm (48.5 lpm)
13x54	2.5 cf (71 l) Resin	13.5 gpm (51.1 lpm)
14x65	3.0 cf (85 l) Resin	14.5 gpm (54.8 lpm)

Additional Information:	
Electrical Rating:	220V, 110V, 24V - 50Hz, 60Hz
Max. VA	3 VA
Water Pressure:	Hydrostatic: 300 psi (20 bar) Working: 20 - 120 psi (1.4 bar - 8 bar)
Temperature:	34 - 110° F (1 - 43° C)

Regeneration/Backwash:	
Downflow/Upflow:	Downflow
Cycles:	4 - 7
Adjust able Cycles:	Brine Fill
Time Available:	180 Minutes





**PRECISION  
INSTALLATION  
PRODUCTS**

# WATER TREATMENT

## Water Filter & Water Softner Parts - Aquatrol

### AQT-275 Timer-Meter / Control Valves

Aquatrol 275 Timer/Meter Mechanical Valves offer a flanged body design for convenient maintenance and are made of solid lead-free brass for superior strength and durability. The AT-275 also offers a NHWB piston and is 5 cycle adjustable.



#### Features:

- Lead Free Brass Body
- Adjustable 5 Cycle Control
- Residential/Light Commercial Applications
- Backwash Capacity for Tanks Up to 21"
- 1" Control Valve
- Time Clock: 7 And 12 Days (Manual or Meter)
- Meter: Delayed or Immediate Regeneration

#### **Models:**

AQT-275ST	Softener Timer
AQT-275SM	Softener Meter
AQT-275ST-NX	Electronic Softener Timer
AQT-275SM-NX	Electronic Softener Meter
AQT-275FT	Filter Timer
AQT-275FM	Filter Meter
AQT-275FT-NX	Electronic Filter Timer
AQT-275FM-NX	Electronic Filter Meter

#### **Flow Rate 50 psi (3.5 bar) Valve Alone:**

Continuous 15 psi (1 bar) Drop:	26 gpm (98 lpm)
Peak 25 psi (1.7 bar) Drop:	33 gpm (125 lpm)
Max Backwash 25 psi (1.7 bar) Drop:	25 gpm (95 lpm)
CV 1 psi (0.07 bar) Drop:	6.8

#### **Regeneration/Backwash:**

Downflow/Upflow:	Downflow or Upflow
Cycles:	5
Adjustable Cycles:	Mechanical, All
Time Available:	164 Minutes

#### **Meter:**

Accuracy:	0.7 - 40 gpm (2.7 - 151 lpm) ± 5%
Capacity	Standard: 310 - 5,270 gal (1.2 - 20m <sup>3</sup> )
Range:	Extended: 1,550 - 26,350 gal (6 - 100m <sup>3</sup> )

#### **Valve Specifications:**

Inlet/Outlet:	1" NPT
Mounting Base:	2-1/2" - 8 NPSM
Distributor Pilot:	1.05" OD
Drain Line:	3/4"
Brine Line:	3/8" or 1/2"
Height:	7" (198 mm)
Weight (Valve Gross):	Timer 13.2 lb (6 kg) Meter 17.2 lb (7.8 kg)

#### **Additional Information:**

Electrical Rating:	220V, 110V, 24V - 50Hz, 60Hz
Max. VA	74 VA
Water Pressure:	Hydrostatic: 300 psi (20 bar) Working: 20 - 120 psi (1.4 bar - 8 bar)
Temperature:	34 - 110° F (1 - 43° C)



# WATER TREATMENT

## Water Filter & Water Softner Parts - Aquatrol

### AQT-285 Timer-Meter / Control Valves



PRECISION  
INSTALLATION  
PRODUCTS

Aquatrol 285 Timer/Meter Mechanical Valves offer a flanged body design for convenience maintenance and are made of solid lead-free brass for superior strength and durability. The AQT-285 also offers a NHVB piston option and has a time-tested piston, seal, and spacer design.



#### Features:

- Lead Free Brass Body
- Adjustable 5 Cycle Control
- 1.5" Control Valve
- Backwash Capacity for Tanks Up to 24"
- Continuous Flow Rate of 51 GPM with Backwash of 49 GPM
- Time Clock: 7 And 12 Days (Manual or Meter)
- Meter: Delayed or Immediate Regeneration

Models:	
AQT-285ST:	Softener Timer
AQT-285SM:	Softener Meter
AQT-285ST-NX	Electronic Softener Timer
AQT-285SM-NX	Electronic Softener Meter
AQT-285FT:	Filter Timer
AQT-285FM:	Filter Meter
AQT-285FT-NX:	Electronic Filter Timer
AQT-285FM-NX:	Electronic Filter Meter

Flow Rate 50 psi (3.5 bar) Valve Alone:	
Continuous 15 psi (1 bar) Drop:	51 gpm (193 lpm)
Peak 25 psi (1.7 bar) Drop:	66 gpm (250 lpm)
Max Backwash 25 psi (1.7 bar) Drop:	49 gpm (185 lpm)
CV 1 psi (0.07 bar) Drop:	13.2

Regeneration/Backwash:	
Downflow/Upflow:	Downflow
Cycles:	5
Adjustable Cycles:	Mechanical, All
Time Available:	164 Minutes

Meter:	
Accuracy Range:	1.5 - 75 gpm (5.7 - 284 lpm) ± 5%
Capacity Range:	Standard: 625 - 10,125 gal (2.5 - 40m <sup>3</sup> ) Extended: 3,125 - 53,125 gal (12-200m <sup>3</sup> )

Valve Specification:	
Inlet/Outlet:	1-1/2" NPT
Mounting Base:	4" - 8 UN
Distributor Pilot:	1.96" OD
Drain Line:	1"
Brine Line:	3/8" or 1/2"
Height:	7-1/2" (190 mm)
Weight (Valve Gross):	Timer 22 lb (10 kg) Meter 27.6 lb (12.5 kg)

Additional Information:	
Electrical Rating:	220V, 110V, 24V - 50Hz, 60Hz
Max. VA	74 VA
Water Pressure:	Hydrostatic: 300 psi (20 bar) Working: 20 - 120 psi (1.4 bar - 8 bar)
Temperature:	34 - 110° F (1 - 43° C)





**PRECISION  
INSTALLATION  
PRODUCTS**

# WATER TREATMENT

## Water Filter & Water Softener Parts - AQT-290 Timer-Meter / Control Valves

Aquatrol 290 Timer/Meter Mechanical Valves are made of solid lead-free brass for superior strength and durability. The AQT-290 also offers a NHWB piston option. The AQT-290 incorporates 2 hydraulically balanced pistons, seal, and spacers. It can be used with single or multiple tank systems and it also offers continuous flow rate of 106 GPM.



### Features:

- Lead Free Brass Body
- Adjustable 5 Cycle Control
- 2" Control Valve
- Backwash Capacity for Tanks Up to 21" Diameter
- Continuous Flow Rate of 106 GPM

### Models:

AQT-290ST:	Softener Timer
AQT-290SM:	Softener Meter
AQT-290ST-NX:	Electronic Softener Timer
AQT-290SM-NX:	Electronic Softener Meter
AQT-290FT:	Filter Timer
AQT-290FM:	Filter Meter
AQT-290FT-NX:	Electronic Filter Timer
AQT-290FM-NX:	Electronic Filter Meter

### Flow Rate 50 psi (3.5 bar) Valve Alone:

Continuous 15 psi (1 bar) Drop:	160 gpm (401 lpm)
Peak 25 psi (1.7 bar) Drop:	140 gpm (530 lpm)
Max Backwash 25 psi (1.7 bar) Drop:	25 gpm (95 lpm)
CV 1 psi (0.07 bar) Drop:	27.5

### Regeneration/Backwash:

Downflow/Upflow:	Downflow or Upflow
Cycles:	5
Adjustable Cycles:	Mechanical, All
Time Available:	164 Minutes

### Meter:

Accuracy:	3 - 150 gpm (11.5 - 568 lpm) ± 5%
Capacity	Standard: 1,250 - 21,250 gal (4.8 - 40m <sup>3</sup> )
Range:	Extended: 6,250 - 106,250 gal (24 - 400m <sup>3</sup> )

### Valve Specifications:

Inlet/Outlet:	2" NPT
Mounting Base:	4" 8 UN
Distributor Pilot:	1.96" OD
Drain Line:	3/4"
Brine Line:	3/8" or 1/2"
Height:	11.5" (290 mm)
Weight (Valve Gross):	Timer 35.3 lb (16 kg) Meter 41.9 lb (19 kg)

### Additional Information:

Electrical Rating:	220V, 110V, 24V - 50Hz, 60Hz
Max. VA	143 VA
Water Pressure:	Hydrostatic: 300 psi (20 bar) Working: 20 - 120 psi (1.4 bar - 8 bar)
Temperature:	34 - 110° F (1 - 43° C)



**RoHS  
COMPLIANT**

# WATER TREATMENT

## Water Filter & Water Softner Parts - Aquatrol

### AQT-315 Timer-Meter / Control Valves



PRECISION  
INSTALLATION  
PRODUCTS

Aquatrol 315 Timer/Meter Mechanical Valves are made of solid lead-free brass for superior strength and durability. The AQT-315 also offers a NHWB piston option and has a time-tested piston, seal, and spacer design. It also offers a fully adjustable 5 cycle controller that allows you to control the upflow backwash, downflow bringing and slow rinse, rapid rinse, timed brine refill and downflow. The AQT-315 is ideal for filter applications.



#### Features:

- Lead Free Brass Body
- Adjustable 5 Cycle Control
- 2" Control Valve
- Backwash Capacity for Tanks Up to 24" Diameter

Models:	
AQT-315ST:	Softener Timer
AQT-315SM:	Softener Meter
AQT-315ST-NX:	Electronic Softener Timer
AQT-315SM-NX:	Electronic Softener Meter
AQT-315FT:	Filter Timer
AQT-315FM:	Filter Meter
AQT-315FT-NX:	Electronic Filter Timer
AQT-315FM-NX:	Electronic Filter Meter

Flow Rate 50 psi (3.5 bar) Valve Alone:	
Continuous 15 psi (1 bar) Drop:	95 gpm (360 lpm)
Peak 25 psi (1.7 bar) Drop:	124 gpm (470 lpm)
Max Backwash 25 psi (1.7 bar) Drop:	105 gpm (398 lpm)
CV 1 psi (0.07 bar) Drop:	24.8

Regeneration/Backwash:	
Downflow/Upflow:	Downflow or Upflow
Cycles:	5
Adjustable Cycles:	Mechanical, All
Time Available:	164 Minutes

Meter:	
Accuracy:	3 - 150 gpm (11.5 - 568 lpm) ± 5%
Capacity	Standard: 1,250 - 21,250 gal (4.8 - 40m <sup>3</sup> )
Range:	Extended: 6,250 - 106,250 gal (24 - 400m <sup>3</sup> )

Valve Specifications:	
Inlet/Outlet:	2" NPT
Mounting Base:	4" 8 UN
Distributor Pilot:	2.49" OD
Drain Line:	2"
Brine Line:	1"
Height:	10" (254 mm)
Weight (Valve Gross):	Timer 41.9 lb (19 kg) Meter 48.5 lb (22 kg)

Additional Information:	
Electrical Rating:	220V, 110V, 24V - 50Hz, 60Hz
Max. VA	85 VA
Water Pressure:	Hydrostatic: 300 psi (20 bar) Working: 20 - 120 psi (1.4 - 8 bar)
Temperature:	34 - 110° F (1 - 43° C)





**PRECISION  
INSTALLATION  
PRODUCTS**

# WATER TREATMENT

## Water Filter & Water Softner Parts - Aquatrol

### AQT-390 Timer-Meter / Control Valves

Aquatrol 390 Timer/Meter Mechanical Valves are made of solid lead-free brass for superior strength and durability. The AQT-390 also offers a NHWB piston option and has a time-tested piston, seal, and spacer design. The AQT-390 also offers a fully adjustable 5 cycle controller that allows you to control the upflow backwash, downflow bringing and slow rinse, rapid rinse, timed brine refill and downflow service



#### Features:

- Lead Free Brass Body
- Adjustable 5 Cycle Control
- 3" Control Valve
- Ideal for Most Filter Applications Up to 42" Diameter

#### Models:

AQT-390ST:	Softener Timer
AQT-390SM:	Softener Meter
AQT-390ST-NX:	Electronic Softener Timer
AQT-390SM-NX:	Electronic Softener Meter
AQT-390FT:	Filter Timer
AQT-390FM:	Filter Meter
AQT-390FT-NX:	Electronic Filter Timer
AQT-390FM-NX:	Electronic Filter Meter

#### Flow Rate 50 psi (3.5 bar) Valve Alone:

Continuous 15 psi (1 bar) Drop:	250 gpm (950 lpm)
Peak 25 psi (1.7 bar) Drop:	325 gpm (1,230 lpm)
Max Backwash 25 psi (1.7 bar) Drop:	100 gpm (380 lpm)
CV 1 psi (0.07 bar) Drop:	65.0

#### Regeneration/Backwash:

Downflow/Upflow:	Downflow or Upflow
Cycles:	5
Adjustable Cycles:	Mechanical, All
Time Available:	164 Minutes

#### Meter:

Accuracy:	7 - 300 gpm (26.5 - 1,135 lpm) ± 5%
Capacity	Standard: 3,750 - 63,750 gal (14 - 204m <sup>3</sup> )
Range:	Extended: 18,750 - 318,250 gal (70 - 1200m <sup>3</sup> )

#### Valve Specifications:

Inlet/Outlet:	3" BSPT
Mounting Base:	6" -8 Threaded or Flanged
Distributor Pilot:	3.5" OD
Drain Line:	2"
Brine Line:	1"
Height:	15.3" (390 mm)
Weight (Valve Gross):	Timer 94.7 lb (43 kg) Meter 121.3 lb (55 kg)

#### Additional Information:

Electrical Rating:	220V, 110V, 24V - 50Hz, 60Hz
Max. VA	171 VA
Water Pressure:	Hydrostatic: 300 psi (20 bar) Working: 20 - 120 psi (1.4 - 8 bar)
Temperature:	34 - 110° F (1 - 43° C)



**RoHS  
COMPLIANT**

# WATER TREATMENT

Water Filter & Water Softner Parts - Aquatrol

## Softening Systems



PRECISION  
INSTALLATION  
PRODUCTS

## AQUATROL SOFTENING SYSTEMS

---

<u>PART NUMBER</u>	<u>ITEM DESCRIPTION</u>
AQT-SS-56SESM-1	AQUATROL SOFTENING SYSTEM, ELECTRONIC METER, 3/4", 948, 32000 GRAIN
AQT-SS-56SESM-1.5	AQUATROL SOFTENING SYSTEM, ELECTRONIC METER, 3/4", 1054, 48000 GRAIN
AQT-SS-56SESM-2	AQUATROL SOFTENING SYSTEM, ELECTRONIC METER, 3/4", 1354, 64000 GRAIN



**PRECISION  
INSTALLATION  
PRODUCTS**

# WATER TREATMENT

## Water Filter & Water Softener Parts - Aquatrol

### Manual Filter & Softener Valves

Aquatrol AQT Manual Filter Valves offer a simple to use manually controlled valve for easy operation. Used with activated carbon filtration and other water treatment applications. These Manual Filter Valves are available in 2.5" and 4" base and provide an easy to use lever operation for moving from Service to Rinse and back to Wash positions.



#### **AQT-MFV-1 Specifications:**

Temp Range: 41° F (5° C) – 113° F (45° C)  
 Maximum Temperature: 122F  
 Pressure Range: 21 psi - 87 psi  
 Control Type: Manual  
 Electricity: None Required  
 Base: 2.5"  
 Inlet: 1"  
 Outlet: 1"  
 Drain: 1"  
 Riser Pipe: 1.05" OD  
 Water Capacity Service: 16.5 gpm @ 21.8 psi  
 Water Capacity Back Wash: 17 gpm @ 21.8 psi

#### **Material of Construction:**

Body: Noryl  
 Handle: Metal  
 Internal Disc: Ceramic



#### **AQT-MFV-2 Specifications:**

Temp Range: 41° F (5° C) – 113° F (45° C)  
 Maximum Temperature: 122F  
 Pressure Range: 21 psi - 87 psi  
 Control Type: Manual  
 Electricity: None Required  
 Base: 4"  
 Inlet: 2"  
 Outlet: 2"  
 Drain: 1.5"  
 Riser Pipe: 1.96" OD  
 Water Capacity Service: 46.3 gpm @ 21.8 psi  
 Water Capacity Back Wash: 41.85 gpm @ 21.8 psi

#### **Material of Construction:**

Body: Noryl  
 Handle: Plastic  
 Internal Disc: Ceramic

## AQUATROL AQT-MFV

<u>PART NUMBER</u>	<u>ITEM DESCRIPTION</u>
AQT-MFV-1	AQUATROL MANUAL FILTER VALVE W/ 2.5" BASE & 1" IN/OUT - LEVER TURNS FROM SERVICE, TO RINSE, TO BACK WASH
AQT-MFV-2	AQUATROL MANUAL FILTER VALVE W/ 4" BASE & 2" IN/OUT - LEVER TURNS FROM SERVICE, TO RINSE, TO BACK WASH



# WATER TREATMENT

## Water Filter & Water Softner Parts - Aquatrol

### Manual Filter & Softener Valves



PRECISION  
INSTALLATION  
PRODUCTS

Aquatrol AQT Manual Filter Valves offer a simple to use manually controlled valve for easy operation. Used with activated carbon filtration and other water treatment applications. These Manual Filter Valves are available in 2.5" and 4" base and provide an easy to use lever operation for moving from Service to Rinse and back to Wash positions.



#### AQT-MSV-1 Specifications:

Temp Range: 41° F (5° C) – 113F (45° C)  
 Maximum Temperature: 122F  
 Pressure Range: 21.8 psi - 87 psi  
 Control Type: Manual  
 Electricity: None Required  
 Base: 2.5"  
 Inlet: 1"  
 Outlet: 1"  
 Drain: 1"  
 Riser Pipe: 1.05" OD  
 Water Capacity Service: 17.02 gpm @ 21.8 psi  
 Water Capacity Back Wash: 6.7 gpm @ 21.8 psi

#### Material of Construction:

Body: Noryl  
 Handle: Metal  
 Internal Disc: Ceramic



#### AQT-MSV-2 Specifications:

Temp Range: 41° F (5° C) – 113° F (45° C)  
 Maximum Temperature: 122F  
 Pressure Range: 21 psi - 87 psi  
 Control Type: Manual  
 Electricity: None Required  
 Base: 4"  
 Inlet: 2"  
 Outlet: 2"  
 Drain: 1.5"  
 Riser Pipe: 1.96" OD  
 Water Capacity Service: 36.4 gpm @ 21.8 psi  
 Water Capacity Back Wash: 25.1 gpm @ 21.8 psi

#### Material of Construction:

Body: Noryl  
 Handle: Plastic  
 Internal Disc: Ceramic

## AQUATROL AQT-MSV

<u>PART NUMBER</u>	<u>ITEM DESCRIPTION</u>
AQT-MSV-1	AQUATROL MANUAL SOFTENER VALVE W/ 2.5" BASE & 1" IN/OUT
AQT-MSV-2	AQUATROL MANUAL SOFTENER VALVE W/ 4" BASE & 2" IN/OUT
AQT-MSV-34	AQUATROL MANUAL SOFTENER VALVE WITH 4" BASE AND 3/4" IN/OUT



**PRECISION  
INSTALLATION  
PRODUCTS**

# WATER TREATMENT

## Water Filter & Water Softner Parts - Aquatrol

### Residential Distributors - Basket - Top & Bottom

#### Aquatrol Basket Top Distributors - Residential

Top Distributor Basket for 0713-1354 Tanks. For 1.05" and 13/16" riser pipes. Available in Lock Control Valve Engagement or Solvent Weld Control Valve Engagement. Made out of high impact FDA approved ABS plastic. The fixed slot is .01-.03. The molded basket distributors are designed for general domestic water softener use for 7" to 10" diameter tanks without a gravel support bed, or 12" to 13" diameter tanks with a gravel support bed.



#### **AQT-TD-1203**

FOR 1.05" RISER PIPE. LOCK CONTROL VALVE ENGAGEMENT.



#### **AQT-TD-1206**

FOR 1.05" RISER PIPE. SOLVENT WELD CONTROL VALVE ENGAGEMENT.



#### **AQT-TD-1207**

FOR 13/16" RISER PIPE. SOLVENT WELD CONTROL VALVE ENGAGEMENT.

#### Aquatrol Basket Bottom Distributors - Residential

Bottom Distributor Basket for 0713-1354 Tanks. For 13/16" or 1.05" riser pipe. Solvent weld control valve engagement. Made out of high impact FDA approved ABS plastic. The fixed slot is .01-.03. The molded basket distributors are designed for general domestic water softener use for 7" to 10" diameter tanks without a gravel support bed, or 12" to 13" diameter tanks with a gravel support bed.



#### **AQT-BD-1212-04**

FOR 1.05" RISER PIPE.



#### **AQT-BD-1213-04**

FOR 1.05" RISER PIPE.

# WATER TREATMENT

## Water Filter & Water Softner Parts - Aquatrol

Commercial Distributors - Basket - Top & Bottom



PRECISION  
INSTALLATION  
PRODUCTS

### Aquatrol Stack Top Distributors - Commercial

Top Stack Distributor for top mounted valves. The stack diffusers are designed to diffuse or break up the inlet water flow when the top stack distributor is not used. Available with Screw or Threaded Valve Connections. Installation is accomplished by simply pinning, threading or screwing in the top stack distributor and diffuser or snapping the top baffle diffuser directly inside the control valve. 3.5" stack diameter X 5.5" stack height for 1.5" riser pipe.



**AQT-TD-1199**  
SCREW INSTALLATION



**AQT-TD-MV2**  
THREADED CONNECTION.



### Aquatrol Stack Bottom Distributors - Commercial

Bottom Stack Distributor for top mounted valves. For 1.05" riser pipe opening. There is no stack distributor assembly required. To install, solvent weld the riser pipe directly into the distributor and extend the distributor to the bottom of the mineral tank. 3.5" stack diameter for tanks with 4" top openings.



**AQT-BD-1196-07**  
3" STACK HEIGHT.



**AQT-BD-1197-07**  
6" STACK HEIGHT.





**PRECISION  
INSTALLATION  
PRODUCTS**

# WATER TREATMENT

**Water Filter & Water Softner Parts - Aquatrol**

**Commercial Distributors - Stack - Top Or Bottom**

## Aquatrol Stack Top or Bottom Distributors - Commercial

The stack distributor assemblies are designed to be used interchangeably as either top or bottom distributors. The distributor assemblies consist of a segmented stack distributor, 4"-8UN adapter, and a 2" CPVC or 3" FNPT straight connector. The segmented distributor has the ability to open up when backwashed, removing any possible fines that might accumulate on the distributor. The top and bottom assemblies are designed for use with 14" - 36" and 40" - 48" diameter fiberglass mineral tanks.



**TANK  
DIAMETER**  
14"-36"

### AQT-TBD-7155H

4"-8UN ADAPTER, 2" CPVC SOLVENT STRAIGHT CONNECTOR.

FOR USE WITH 14"-36" DIAMETER FIBERGLASS MINERAL TANKS.



**TANK  
DIAMETER**  
40"-48"

### AQT-TBD-B5679

6" FLANGE X 3" FNPT ADAPTER.

FOR USE WITH 40"-48" DIAMETER FIBERGLASS MINERAL TANKS.

## STACK BOTTOM DISTRIBUTORS

### PART NUMBER

AQT-TB-65

### ITEM DESCRIPTION

AQUATROL BASKET BOTTOM DISTRIBUTOR FOR 7"-13" TANKS, PRE-GLUED 63" RISER TUBE, CUT-TO-SIZE

# WATER TREATMENT

## Water Filter & Water Softner Parts - Aquatrol

Commercial Distributors - Hubs & Laterals



PRECISION  
INSTALLATION  
PRODUCTS

### Aquatrol HUB Distributor, 6 Quick Lock Laterals, 1.5" Solvent Riser

Aquatrol Top Mount Hub and Lateral Distributor Systems are designed primarily for use with top mount water softeners or filter valves. The series consists of an ABS hub and 6-PVC slotted laterals with 3/4" quick lock adapters.



#### AQT-HL-B5665

FOR USE WITH 14"-16" DIAMETER  
FIBERGLASS MINERAL TANKS  
WITH 4" TOP OPENINGS.



#### AQT-HL-B5666

FOR USE WITH 18"-21" DIAMETER  
FIBERGLASS MINERAL TANKS  
WITH 4" TOP OPENINGS.



#### AQT-HL-B5667

FOR USE WITH 24" DIAMETER  
FIBERGLASS MINERAL TANKS  
WITH 4" TOP OPENINGS.



#### AQT-HL-B10848

FOR USE WITH 30" DIAMETER  
FIBERGLASS MINERAL TANKS  
WITH 4" TOP OPENINGS.



#### AQT-HL-B10849

FOR USE WITH 36" DIAMETER  
FIBERGLASS MINERAL TANKS  
WITH 4" TOP OPENINGS.



**PRECISION  
INSTALLATION  
PRODUCTS**

# WATER TREATMENT

## Water Filter & Water Softner Parts - Aquatrol

**Commercial Distributors - Hubs & Laterals**

### Aquatrol HUB Distributor, 6 Quick Lock Laterals, 2" Straight Connector, Solvent

Aquatrol Bottom Mount Hub and Lateral Distributor Systems are designed specifically to fit into a 4" bottom mineral tank opening eliminating the need for a 6" bottom hole where a greater possibility of leaks exist. The series consists of an ABS hub, 6-PVC slotted laterals with 3/4" quick lock adapters, 4"-BUN tank adapter and 2" CPVC straight connector.



#### **AQT-HL-7160**

FOR USE WITH 16" DIAMETER FIBERGLASS MINERAL TANKS.



#### **AQT-HL-B5669**

FOR USE WITH 18"-21" DIAMETER FIBERGLASS MINERAL TANKS.



#### **AQT-HL-7161**

FOR USE WITH 24" DIAMETER FIBERGLASS MINERAL TANKS.



#### **AQT-HL-7162**

FOR USE WITH 30" DIAMETER FIBERGLASS MINERAL TANKS.



#### **AQT-HL-7163**

FOR USE WITH 36" DIAMETER FIBERGLASS MINERAL TANKS.

# WATER TREATMENT

## Water Filter & Water Softner Parts - Aquatrol

Commercial Distributors - Basket - Top & Bottom



PRECISION  
INSTALLATION  
PRODUCTS

### Aquatrol HUB Distributor, 8 Quick Lock Laterals, 6" Flange, 3" FNPT

Aquatrol Bottom Mount Hub and Laterals have 8 quick lock polypropylene laterals with .008 slot and polypropylene hub. (6" Flange x 3" FNPT x 3" FNPT Adapter Included). For 6" flange connection.



#### AQT-HL-B5683

FOR USE WITH 30" DIAMETER  
FIBERGLASS MINERAL TANKS.



#### AQT-HL-B5684

FOR USE WITH 36" DIAMETER  
FIBERGLASS MINERAL TANKS.



#### AQT-HL-B5685

FOR USE WITH 42" DIAMETER  
FIBERGLASS MINERAL TANKS.



#### AQT-HL-B5686

FOR USE WITH 48" DIAMETER  
FIBERGLASS MINERAL TANKS.



#### AQT-HL-D63FB

FOR USE WITH 60" DIAMETER  
FIBERGLASS MINERAL TANKS.



**PRECISION  
INSTALLATION  
PRODUCTS**

# WATER TREATMENT

## Water Filter & Water Softner Parts - Aquatrol

### Commercial Distributors - Hubs & Laterals

#### Aquatrol HUB Distributor, 16 Quick Lock Laterals, 6" Flange, 3" FNPT

Aquatrol Bottom Mount Hub and Laterals have 16 quick lock polypropylene laterals with .008 slot and polypropylene hub. (6" Flange x 3" FNPT x 3" FNPT Adapter Included). For 6" flange connection.



**AQT-HL-B11665HF**  
FOR USE WITH 48" DIAMETER  
FIBERGLASS MINERAL TANKS.



**AQT-HL-B14248HF**  
FOR USE WITH 60" DIAMETER  
FIBERGLASS MINERAL TANKS.



# WATER TREATMENT

## Water Filter & Water Softner Parts - Aquatrol

### Tank Heads - In / Out



PRECISION  
INSTALLATION  
PRODUCTS

#### Aquatrol Tank Heads

The AQT Tank Heads are durable, rugged plastic injection molded In/Out heads designed for simple applications such as carbon filters for sediment, taste and odor reduction or ph neutralization systems. Inlet and outlet are 1" or 2" female NPT for easy straight line installation where higher flow rates are required. These economical heads will fit onto standard 2 1/2" or 4" tank openings.



**AQT-TH1-25**  
1" FNPT IN/OUT  
2 1/2" TOP TANK OPENING



**AQT-TH2-4**  
2" FNPT IN/OUT  
4" TOP TANK OPENING



PRECISION  
INSTALLATION  
PRODUCTS

# WATER TREATMENT

## Water Filter & Water Softner Parts - Aquatrol

### Accessories

#### THREADED CLOSURES



**AQT-TC4**

*Threaded Closure 4"*



**AQT-TC6F**

*Flange Closure 6"*

#### TANK ADAPTORS



**AQT-FA-6F4T**

*Flange Adaptor - 6" Flange  
Exterior, 4" Interior Thread*



**AQT-FA-6F3T**

*Flange Adaptor - 6" Flange  
Exterior, 3" Interior Thread*



**AQT-TA-6F4**

*Reducer 6" Flange - 4"  
Threaded*



**AQT-TA-425**

*Reducer 4" - 2.5"  
Threaded*

#### VACUUM BREAKERS



**AQT-VB-1**

*Vacuum Breaker,  
125PSI, 120DEG F, 1.5" MNPT*



**AQT-VB-2**

*Vacuum Breaker,  
150PSI, 150DEG F, 1.0" FNPT*

# WATER TREATMENT

## Water Filter & Water Softner Parts - Aquatrol

### Resin



PRECISION  
INSTALLATION  
PRODUCTS

#### Cation Resin

Aquatrol CAT100E cation resin provides a high purity, premium cation resin designed for the treatment of foods, beverages, potable waters, and water used in the processing of food. Aquatrol CAT100E resin is a high grade resin which complies with the U.S. Food & Drug Administration (USFDA) CFR 21, Title 173.25 for use in the treatment of foods for human consumption. NSF Standard 44 Certified. Aquatrol CAT100E cation resin has excellent hydraulic characteristics for optimal flow rate and backwash flow rates. Its high capacity and porosity characteristic provide exceptional kinetic behavior along with good physical, chemical and thermal stability.



#### Chemical and Thermal Stability

Aquatrol CAT100E is insoluble in dilute or moderately concentrated acids, alkalis, and in all common solvents. Thermally stable to higher than 248°F (120°C) in alkali's such as, sodium or alkaline earth like calcium and magnesium salt forms.

#### Applications

This product is mainly used for softening hard water and preparing pure and high purity water. In addition, it is used in separation and purification of trace elements as well as hydro-metallurgy and pharmaceutical industry.

Typical Physical & Chemical Characteristics	
Polymer Matrix Structure	Crosslinked Polystyrene Divinylbenzene
Physical Form and Appearance	Brownish Yellow - Brown, Amber
Whole Bead Count	95% min.
Functional Groups	R-SO <sub>3</sub>
Ionic Form, as shipped	Na <sup>+</sup>
Screen Size Range - US Standard Screen	16 - 50 mesh, wet
Particle Size Range	+1.2 mm <5%, -0.3 mm <1%
Moisture Retention, Na <sup>+</sup> form	46 - 50%
Swelling Na <sup>+</sup> → H <sup>+</sup>	8 - 10%
Specific Gravity, Moist Na <sup>+</sup> Form	1.27
Total Exchange Capacity, Na <sup>+</sup> Form	
Wet, volumetric	1.9 eq/l min.
Dry, weight	4.5 eq/kg min.
Operating Temperature, Na <sup>+</sup> Form	248°F (120°C)
pH Range Stability, Na <sup>+</sup> Form	0 - 14
pH Range Operating, Na <sup>+</sup> Form	6 - 10



This product has been tested and certified by NSF International against NSF-ANSI Standard 44 for material requirements only.

COMPONENT



**PRECISION  
INSTALLATION  
PRODUCTS**

# WATER TREATMENT

## Water Filter & Water Softener Parts - Aquatrol

### Carbon

#### Carbon

Aquatrol coconut shell granular activated carbon is a high quality coconut shell activated carbon for the removal of dissolved organic contaminants from water, wastewater and process liquids. The list of contaminants include taste and odor compounds, organic color, total organic carbon (TOC) and industrial chemicals such as chlorinated solvents (PCE, TCE). Aquatrol GAC is produced under controlled conditions through high temperature steam activation. Its pore structure enables it to be used for adsorption of both high and low molecule weight impurities from water and diverse liquids. Aquatrol GAC is especially effective for adsorbing trace organic compounds such as vinyl chloride, MTBE, methylene chloride and trihalomethanes/disinfection by-products. Aquatrol GAC is certified to NSF/ANSI 61 standard and complies with the requirements for activated carbon as defined by the Food Chemicals Codex (FCC) (8th Edition) published by the U.S. Pharmacopeia.

#### Features

- Coconut shell carbon
- High mechanical strength
- Low ash



#### Benefits

- Strong adsorbing pore structure optimal for the treatment of chlorine and other organics.
- Hardness and abrasion resistance required for thermal reactivation and minimizing fines when operations backwashing is required.
- Provides a wide range of contaminant removal capabilities.

Specifications	GCS-830
Iodine Number, mg/g	1000 (min)
Ash, wt%	5.0 (max)
Moisture (As Packaged), wt%	5 (max)
Density (Apparent), g/cc	0.44 (min)
Hardness Number	95 (min)
8 US Mesh [2.4 mm], wt%	5 (max)
< 30 US Mesh [0.595 mm] (PAN), wt%	4 (max)

Specifications	GCS-1240
Iodine Number, mg/g	1000 (min)
Ash, wt%	4.0 (max)
Moisture (As Packaged), wt%	5 (max)
Density (Apparent), g/cc	0.48 (min)
Hardness Number	95 (min)
12 US Mesh [1.70 mm], wt%	5 (max)
< 40 US Mesh [0.425 mm] (PAN), wt%	4 (max)



This product has been tested and certified by NSF International against NSF/ANSI Standard 61 for material requirements only.

COMPONENT

# WATER TREATMENT

## Water Filter & Water Softner Parts - Aquatrol

### Brine Tanks



PRECISION  
INSTALLATION  
PRODUCTS

#### AQUATROL BT SERIES BRINE TANKS

Aquatrol BT Series Brine Tanks are durable tanks made to provide you with years of service. With their ¼" thick tank wall Aquatrol BT Series Brine Tanks will not bulge or crack easily and offer true heavy duty performance.

Aquatrol BT Series Brine tanks are molded from durable polyethylene and are chemical resistant. All tanks come with a heavy duty salt plate, brine well, cap and come standard with safety float and air check valve.

Aquatrol BT Series Brine Tanks can be used in residential, commercial and industrial applications making them an attractive product of choice for industry professionals everywhere.

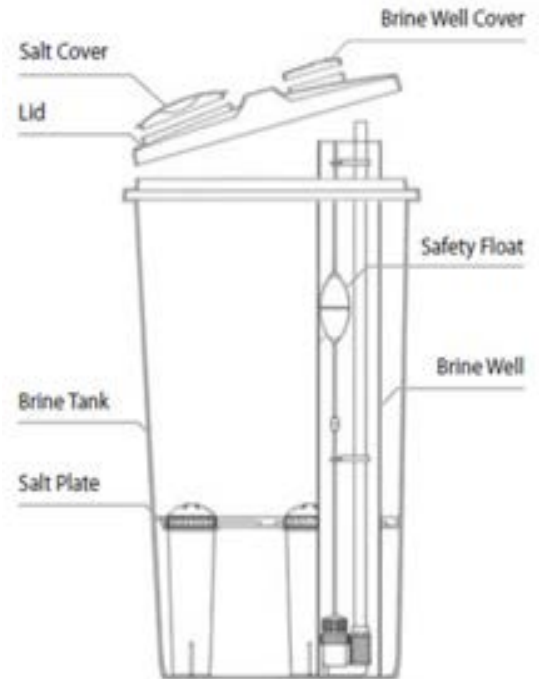

AQT-BT-1840-145



AQT-BT-2450-350

Part Number	Tank Size		Diameter		Tank Volume		Salt Storage		Brine Capacity (Salt)			
	In	cm	In	cm	gal	L	lbs	kg	MIN (lbs)	MAX (lbs)	MIN (kg)	MAX (kg)
AQT-BT-1840-145	20.3	51.6	37.4	95	38.3	145	245	111	15.4	24.7	7	11.22
AQT-BT-2450-350	29.1	73.91	50.2	127.50	92.5	350	592	268	37.6	59.8	17.0	27.1
AQT-BT-3050-500	33.1	84.07	52.6	133.60	132.0	500	842	382	52.7	81.4	23.9	36.9
AQT-BT-3948-1000	42.5	107.95	57.5	146.05	264.2	1000	1,679	762	100.9	148.3	45.8	67.3
AQT-BT-4260-1500	48.8	123.95	62.0	157.48	396.3	1500	2,496	1,132	141.8	204.3	64.3	92.7
AQT-BT-5060-2000	53.5	135.89	66.4	168.66	528.3	2000	3,345	1,517	176.9	252.1	80.2	114.4

\* Model BT-2450-350 and larger.



PRECISION  
INSTALLATION  
PRODUCTS



**END OF SECTION**

**THIS PAGE IS LEFT  
INTENTIONALLY BLANK.**

# WATER TREATMENT

Misc. Accessories

Pressure Gauges



PRECISION  
INSTALLATION  
PRODUCTS

## BOSHART PRESSURE GAUGE - 1.5" FACE - CENTER BACK MOUNT - NOT FILLED - LEAD FREE



<u>PART NUMBER</u>	<u>ITEM DESCRIPTION</u>
PGNF-15100B-LF	BOSHART 1.5" 0-100PSI NO FILL CENTER BACK MOUNT STEEL PRESSURE GAUGE - LEAD FREE 1/8" MPT
PGNF-15160B-LF	BOSHART 1.5" 0-160PSI NO FILL CENTER BACK MOUNT STEEL PRESSURE GAUGE - LEAD FREE 1/8" MPT

## BOSHART PRESSURE GAUGE - 2.0" FACE - CENTER BACK MOUNT - NOT FILLED - LEAD FREE



<u>PART NUMBER</u>	<u>ITEM DESCRIPTION</u>
PG-20100B-LF	BOSHART 2" 0-100PSI GLYCERINE FILLED CENTER BACK MOUNT STEEL PRESSURE GAUGE - LEAD FREE 1/4" MPT

## BOSHART PRESSURE GAUGE - 2.5" FACE - CENTER BACK MOUNT - NOT FILLED - LEAD FREE



<u>PART NUMBER</u>	<u>ITEM DESCRIPTION</u>
PG-25100B-LF	BOSHART 2.5" 0-100PSI GLYCERINE FILLED CENTER BACK MOUNT 304SS PRESSURE GAUGE - LEAD FREE 1/4" MPT
PG-25160B-LF	BOSHART 2.5" 0-160PSI GLYCERINE FILLED CENTER BACK MOUNT 304SS PRESSURE GAUGE - LEAD FREE 1/4" MPT
PG-25160L-LF	BOSHART 2.5" 0-160PSI GLYCERINE FILLED LOWER MOUNT 304SS PRESSURE GAUGE - LEAD FREE 1/4" MPT
PG-25200B-LF	BOSHART 2.5" 0-200PSI GLYCERINE FILLED CENTER BACK MOUNT 304SS PRESSURE GAUGE - LEAD FREE 1/4" MPT
PG-25300B-LF	BOSHART 2.5" 0-300PSI GLYCERINE FILLED CENTER BACK MOUNT 304SS PRESSURE GAUGE - LEAD FREE 1/4" MPT

# WATER TREATMENT

Misc. Accessories

Pressure Gauges

## BOSHART MOUNTING FLANGE - FOR BACK MOUNT GAUGES



<u>PART NUMBER</u>	<u>ITEM DESCRIPTION</u>
PG25CBM-UC	BOSHART U-CLAMP PANEL MOUNT FLANGE FOR 2.5" DIAL PRESSURE GAUGE

## BOSHART PRESSURE GAUGE - 2.5" FACE - 3/4" FEMALE HOSE CONNECTION



<u>PART NUMBER</u>	<u>ITEM DESCRIPTION</u>
PG-25300HC-MP	BOSHART 2.5" 0-300PSI WATER TEST GAUGE WITH MAX PRESSURE INDICATOR- 3/4" FGH SWIVEL CONN

Hose Connection Gauges are used to test water supply pressure within a distribution system. Its red indicator hand holds the highest reading registered for detection of thermal expansion pressure surges.

## BOSHART PRESSURE GAUGE - 2" FACE - LOWER MOUNT - NOT FILLED



<u>PART NUMBER</u>	<u>ITEM DESCRIPTION</u>
PGNF-20160L-LF	BOSHART 2" 0-160 PSI - NO FILL - LOWER MOUNT STEEL CASE PRESSURE GAUGE - 1/4" MPT - LEAD FREE



# WATER TREATMENT

Misc. Accessories

Pressure Gauges



PRECISION  
INSTALLATION  
PRODUCTS

## BOSHART PRESSURE GAUGE - 2" FACE - LOWER MOUNT - GLYCERINE FILLED - LEAD FREE



<u>PART NUMBER</u>	<u>ITEM DESCRIPTION</u>
PG-20160LLF	BOSHART 2" 0-160 PSI GLYCERINE FILLED - LOWER MOUNT STEEL CASE PRESSURE GAUGE - 1/4" MPT - LEAD FREE

## BOSHART PRESSURE GAUGE - 2.5" FACE - LOWER MOUNT - GLYCERINE FILLED - LEAD FREE



<u>PART NUMBER</u>	<u>ITEM DESCRIPTION</u>
PG-25060LLF	BOSHART 2.5" 0-60PSI GLYCERINE FILLED LOWER MOUNT 304SS PRESSURE GAUGE - LEAD FREE 1/4" MPT
PG-25100LLF	BOSHART 2.5" 0-100PSI GLYCERINE FILLED LOWER MOUNT 304SS PRESSURE GAUGE - LEAD FREE 1/4" MPT
PG-25200LLF	BOSHART 2.5" 0-200PSI GLYCERINE FILLED LOWER MOUNT 304SS PRESSURE GAUGE - LEAD FREE 1/4" MPT
PG-25300LLF	BOSHART 2.5" 0-300PSI GLYCERINE FILLED LOWER MOUNT 304SS PRESSURE GAUGE - LEAD FREE 1/4" MPT

## HYDRONIX PRESSURE GAUGE - 2.5" FACE - BACK MOUNT



<u>PART NUMBER</u>	<u>ITEM DESCRIPTION</u>
PG-25160B-X	HYDRONIX 2.5" 0-160PSI LIQUID FILLED CENTER BACK MOUNT - 1/4" MPT
PG-25300B-X	HYDRONIX 2.5" 0-300PSI LIQUID FILLED CENTER BACK MOUNT PRESSURE GAUGE - 1/4" MPT

## LIQUATEC MOUNTING FLANGE - FOR BACK MOUNT GAUGES



<u>PART NUMBER</u>	<u>ITEM DESCRIPTION</u>
PG-25CBM-CLAMP	LIQUATEC U-CLAMP PANEL MOUNT FLANGE FOR 2.5" DIAL PRESSURE GAUGE



**PRECISION  
INSTALLATION  
PRODUCTS**

# WATER TREATMENT

Misc. Accessories

## Shower Filters & Extensions

### HYDRONIX SHOWER FILTER

The Hydro Guard Aqualux Dechlorinating Shower Filter doesn't stop at basic chlorine reduction. Through its 4 stage filtration process utilizing Coconut Shell Carbon, KDF55 Chlorine Scavenging media, BioCeramic pH Balancing spheres and Sediment filtration to give you an invigorating shower experience.

#### PRODUCT BENEFITS

- ✓ Soft, smooth skin
- ✓ Healthy, silky, beautiful hair
- ✓ Reduces itchy skin or scalp
- ✓ Helps extend hair color
- ✓ Reduces Comb-Ability
- ✓ Reduces Frizz
- ✓ Adjusts pH of water
- ✓ Reduces Chlorine absorption from skin
- ✓ Reduces Chlorine inhalation

#### PRODUCT SPECIFICATIONS

Filter Capacity:	15,000 Gallon		57,000 Liter
Maximum Flow:	1.3-2.6 gpm		5-10 lpm
Water Pressure:	20-80 psi		1.38-5.51 Bar
Water Temperature:	41-100 °F		5-38 °C
Expected Life:	4-6 months		



#### STAGE 1.

Bioceramic pH Balancing Media

#### STAGE 2.

25 Micron Sediment Filtration

#### STAGE 3.

Coconut Shell Carbon

#### STAGE 4.

KDF Chlorine Scavenging Media

## HYDRONIX SHOWER FILTERS - HEADS



#### PART NUMBER

PRSF-AH-CHX

#### ITEM DESCRIPTION

HYDRONIX HIGH-OUTPUT CHROME SHOWER FILTER HOUSING, FILTER & ADJUSTABLE SHOWER HEAD

PRSF-AH-WHX

HYDRONIX HIGH-OUTPUT WHITE SHOWER FILTER HOUSING, FILTER & ADJUSTABLE SHOWER HEAD

## HYDRONIX SHOWER FILTERS - HOUSING



#### PART NUMBER

PRSF-CHX

#### ITEM DESCRIPTION

HYDRONIX HIGH-OUTPUT CHROME SHOWER FILTER HOUSING W/ FILTER

PRSF-WHX

HYDRONIX HIGH-OUTPUT WHITE SHOWER FILTER HOUSING W/ FILTER

# WATER TREATMENT

Misc. Accessories

Shower Filters & Extensions



PRECISION  
INSTALLATION  
PRODUCTS

## HYDRONIX SHOWER FILTERS - CARTRIDGES



<u>PART NUMBER</u>	<u>ITEM DESCRIPTION</u>
PRCX	HYDRONIX REPLACEMENT CARTRIDGE FOR HYDRONIX SHOWER FILTER

## SPRITE REPLACABLE SHOWER FILTER



<u>PART NUMBER</u>	<u>ITEM DESCRIPTION</u>
PRC	SPRITE REPLACEMENT CARTRIDGE FOR SHOWER FILTER
PRC-ORING	SPRITE O-RINGS REPLACEMENT FOR SHOWER FILTER CARTRIDGE
PRCX-ORINGX	HYDRONIX REPLACEMENT ORING FOR HYDRONIX SHOWER FILTER CARTRIDGE

Patented new technology shower filter removes harmful chlorine, dirt and odors for a cleaner, fresher shower. KDF and Chlorgon. KDF is a patented specialty medium used in most shower filters and in other water filtration venues. Chlorgon is a patented special filter medium unique to Sprite products. CHLORGON is the only non-carbon shower filter media that removes total chlorine, and it's pH balanced! Designed to be used with 3.0 GPM shower head.

## SHOWER HEAD "S" SHAPED CHROME EXTENSION



<u>PART NUMBER</u>	<u>ITEM DESCRIPTION</u>
P524	8" CHROME "S" SHAPED SHOWER HEAD EXTENSION
P525	11" CHROME "S" SHAPED SHOWER HEAD EXTENSION

Heavy duty brass, polished chrome, replaces standard 1/2" gooseneck. Recommended use with the replaceable shower filter above. Helps eliminate the inconvenience of bending over in the shower. Made in USA

# WATER TREATMENT

Misc. Accessories

Testers/Meters/Sensors

## TDS POCKET TESTER



**PART NUMBER**

PFO-TDS

**ITEM DESCRIPTION**

HM DIGITAL TDS POCKET TESTER FOR 0-9999 PPM

Digital TDS Handheld Meter. Measurement from 0-999 ppm, the resolution is in increments of 1ppm. From 1000 to 9990 ppm, the resolution is in increments of 10ppm, indicated by a blinking 'x10' image. Factory Calibrated; Can be recalibrated with mini-screwdriver. Auto-Off Function, Data-Hold Function. Includes: Cap, Batteries, and Ez-Chart with values on back.

## TDS/TEMP POCKET TESTER W/ CARRYING CASE



**PART NUMBER**

PFO-TDS-3

**ITEM DESCRIPTION**

HM DIGITAL HANDHELD TDS METER W/ CARRYING CASE - RANGE:  
0-9990 PPM (MUST ORDER IN QTY OF 10)

Digital TDS Handheld Meter. Measurement from 0-999 ppm, the resolution is in increments of 1ppm. From 1000 to 9990 ppm, the resolution is in increments of 10ppm, indicated by a blinking 'x10' image. Factory Calibrated; Can be recalibrated with mini-screwdriver. Auto-Off Function, Data-Hold Function. Includes: carrying case with belt clip.

# WATER TREATMENT

Misc. Accessories

Testers/Meters/Sensors



PRECISION  
INSTALLATION  
PRODUCTS

## TDS/TEMP POCKET TESTER



**PART NUMBER**

PFO-AP-1

**ITEM DESCRIPTION**

HM DIGITAL AQUAPRO TDS/TEMP POCKET TESTER FOR 0-5000 PPM & 32-176 °F

Digital TDS Handheld Meter. Measurement from 0-5000 ppm (mg/L), EC to TDS conversion. Water resistant, push button digital calibration, simultaneous TDS and Temperature reading, large ready to use screen, and magnetic body - perfect for the fridge.

## EC/TDS/TEMP COMBO TESTER



**PART NUMBER**

PFO-COM-100

**ITEM DESCRIPTION**

HM DIGITAL HANDHELD "LAB GRADE" WATERPROOF EC/TDS/TEMP COMBO METER

Measures electrical conductivity (EC), total dissolved solids (TDS), salinity and temperature. Automatic Temperature Compensation (ATC) using three temperature coefficients. Digital Calibration (push button). Auto-off function, data-hold function and low-battery indicator. Simultaneous temperature reading. Factory Calibrated: Includes cap, 2 batteries and lanyard.

# WATER TREATMENT

Misc. Accessories

Testers/Meters/Sensors

## INLINE DUAL EC MONTIOR



<u>PART NUMBER</u>	<u>ITEM DESCRIPTION</u>
PFO-DM-2EC-3/8	HM DIGITAL INLINE DUAL EC (ELECTRICAL CONDUCTIVITY) MONITOR W/ 3/8" QC ENDS. DISPLAYS THE EC
PFO-DM2-14	HM DIGITAL INLINE DUAL TDS MONITOR W/ 1/4" QC ENDS. DISPLAYS THE TDS IN (FEED WATER) & OUT

The DM-2EC is a commercial grade monitor measuring ELECTRICAL CONDUCTIVITY feed (input) water vs. product (output) water of a water filtration system at any time. With its shielded cables and diagnostic messaging this robust device is ideal for Reverse Osmosis (RO) and Deionized water (DI) filtration systems.

## PH POCKET TESTER



<u>PART NUMBER</u>	<u>ITEM DESCRIPTION</u>
PFO-PH-200	HM DIGITAL HANDHELD "LAB GRADE" WATERPROOF PH & TEMP METER. PH RANGE 0-14. TEMP RANGE 32*-130* F
PFO-PH-80	HM DIGITAL HANDHELD "STANDARD" WATER RESISTANT PH & TEMP METER. PH RANGE 0-14.

Digital pH & Temp Handheld Meter. Simultaneous temperature display. Digital Auto-Calibration. Auto Temperature Compensation (ATC). Auto-Off Function, Data-Hold Function and Low-Battery Indicator. Factory Calibrated to pH 7.0; Can be Re-Calibrated. Includes: Cap, Batteries, and pH 7.0 Buffer.

## LEAKBLOCK SENSOR



<u>PART NUMBER</u>	<u>ITEM DESCRIPTION</u>
PFO-LBS-10	HM DIGITAL LEAKBLOCK SENSOR, LATCHING SOLENOID VALVE, UP TO 5 GPM FLOW, 1/2" MBSP (OD) / 3/8" QC

The LBS-10 LeakBlock Sensor is perfect for traditional applications: RO Systems, inlets of a Filter System, and individual Filters. The robust commercial design of our latching valve, enables the LBS-10 LeakBlock Sensor to be used for numerous applications to avoid flooding and unnecessary leaks.

# WATER TREATMENT

Misc. Accessories

Testers/Meters/Sensors



PRECISION  
INSTALLATION  
PRODUCTS

## COFFEE REFRACTOMETER



<u>PART NUMBER</u>	<u>ITEM DESCRIPTION</u>
PFO-RCM-1000BT	COFFEE REFRACTOMETER - HANDHELD BRIX - TDS - TEMP - EXTRACTION LCD METER

The Smart Digital Refractometer with Bluetooth technology. Measure, Check, record, and send your Coffee data via your smartphone. Take Measurement in Brix, TDS, Temp sugar percentage in Brix(%) unit. Automatic Temperature Compensation (ATC). Water resistance washable with flowing water. Store up 20 measurement data at once. Auto-off function, Auto brightness adjusting LCD Display, Easy to read everything anywhere. One press Zero Calibration. Removable protective cover included.

## BEER REFRACTOMETER

<u>PART NUMBER</u>	<u>ITEM DESCRIPTION</u>
PFO-BTR-1000	BEER REFRACTOMETER FOR BRIX - TEMP - PLATO

## WINE REFRACTOMETER

<u>PART NUMBER</u>	<u>ITEM DESCRIPTION</u>
PFO-RWM-1000	WINE REFRACTOMETER FOR BRIX - TEMP - KMW - BE - BABO - OE - TAVP%

## THERMOMETER

<u>PART NUMBER</u>	<u>ITEM DESCRIPTION</u>
PFO-TM1	HM DIGITAL THERMOMETER

## DUAL SIDE METER

<u>PART NUMBER</u>	<u>ITEM DESCRIPTION</u>
PFO-COM-360	HM DIGITAL WATER PROOF DUAL SIDE METER - EC/TDS/TEMP AND PH/TEMP WITH AUTO SCREEN ROTATION

## PFO-COM-80

<u>PART NUMBER</u>	<u>ITEM DESCRIPTION</u>
PFO-COM-80	HM DIGITAL HANDHELD "STANDARD" WATER PROOF EC/TDS/TEMP COMBO METER



**PRECISION  
INSTALLATION  
PRODUCTS**

# WATER TREATMENT

Misc. Accessories

## Hydronix Flow Meters

### HYDRONIX PFM/AFM/IFM SERIES FLOW METERS

Have easy to read scales that are silk screened onto the acrylic bodies and are extremely accurate. With the attractive design and durable construction the acrylic bodies are practically unbreakable. You will soon make these your flow meters of choice.

#### Specifications

Max. Pressure: 120 PSI (827 KPA)  
Max. Temp: 120°F (49°C)  
Accuracy: +/- 5%

#### Materials of Construction

Body: Acrylic, Plastic  
O-Rings: EPDM  
Connections: Polypropylene  
Guide: 304 Stainless Steel  
Float: 304 Stainless Steel



### HYDRONIX PFM/AFM/IFM SERIES FLOW METERS

<u>PART NUMBER</u>	<u>ITEM DESCRIPTION</u>
PMF-0202	HYDRONIX PANEL MOUNT FLOWMETER - 0.2-2GPM - 3/8"MPT
PMF-0505	HYDRONIX PANEL MOUNT FLOWMETER - 0.5-5GPM - 1/2"MPT
PMF-2016	HYDRONIX PANEL MOUNT FLOWMETER - 2-16GPM - 1"MPT
PMF-5035	HYDRONIX PANEL MOUNT FLOWMETER - 5-35GPM - 1"MPT

### ADJUSTABLE PANEL MOUNT FLOW METERS

<u>PART NUMBER</u>	<u>ITEM DESCRIPTION</u>
PMF-0101A	HYDRONIX PANEL MOUNT FLOWMETER - 0.1-1GPM - 1/4"MPT - ADJUSTABLE
PMF-0202A	HYDRONIX PANEL MOUNT FLOWMETER - 0.2-2GPM - 3/8"MPT - ADJUSTABLE
PMF-0505A	HYDRONIX PANEL MOUNT FLOWMETER - 0.5-5GPM - 1/2"MPT - ADJUSTABLE

### HYDRONIX INLINE FLOW METERS

<u>PART NUMBER</u>	<u>ITEM DESCRIPTION</u>
PMFI-022	HYDRONIX INLINE FLOWMETER - 0.2 TO 2.0GPM - 1/2"FPT
PMFI-055	HYDRONIX INLINE FLOWMETER - 0.5 TO 5.0GPM - 1/2"FPT
PMFI-110	HYDRONIX INLINE FLOWMETER - 1 TO 10GPM - 3/4"FPT
PMFI-530	HYDRONIX INLINE FLOW METER - 5 TO 30 GPM - 1" FNPT



# WATER TREATMENT

CTS CPVC & PVC Fittings

CTS CPVC Fittings



PRECISION  
INSTALLATION  
PRODUCTS

## TEES - SLIP X SLIP X SLIP



<u>PART NUMBER</u>	<u>ITEM DESCRIPTION</u>
ALAS-4101-005	LASCO CTS CPVC TEE - 1/2" SLIP X 1/2" SLIP X 1/2" SLIP (MUST PURCHASE IN BAG OF 50)
ALAS-4101-007	LASCO CTS CPVC TEE - 3/4" SLIP X 3/4" SLIP X 3/4" SLIP (MUST PURCHASE IN BAG OF 50)
ALAS-4101-010	LASCO CTS CPVC TEE - 1" SLIP X 1" SLIP X 1" SLIP (MUST PURCHASE IN BAG OF 10)

## 90 DEGREE ELBOWS - SLIP X SLIP



<u>PART NUMBER</u>	<u>ITEM DESCRIPTION</u>
ALAS-4106-005	LASCO CTS CPVC 90* ELBOW - 1/2" SLIP X 1/2" SLIP (MUST PURCHASE IN BAG OF 50)
ALAS-4106-007	LASCO CTS CPVC 90* ELBOW - 3/4" SLIP X 3/4" SLIP (MUST PURCHASE IN BAG OF 50)
ALAS-4106-010	LASCO CTS CPVC 90* ELBOW - 1" SLIP X 1" SLIP (MUST PURCHASE IN BAG OF 10)

## 90 DEGREE STREET ELBOWS - SPIGOT X SLIP



<u>PART NUMBER</u>	<u>ITEM DESCRIPTION</u>
ALAS-4109-005	LASCO CTS CPVC 90* STREET ELBOW - 1/2" SPIGOT X 1/2" SLIP (MUST PURCHASE IN BAG OF 50)
ALAS-4109-007	LASCO CTS CPVC 90* STREET ELBOW - 3/4" SPIGOT X 3/4" SLIP (MUST PURCHASE IN BAG OF 50)
ALAS-4109-010	LASCO CTS CPVC 90* STREET ELBOW - 1" SPIGOT X 1" SLIP (MUST PURCHASE IN BAG OF 10)

## 45 DEGREE ELBOWS - SLIP X SLIP



<u>PART NUMBER</u>	<u>ITEM DESCRIPTION</u>
ALAS-4117-007	LASCO CTS CPVC 45* ELBOW - 3/4" SLIP X 3/4" SLIP (MUST PURCHASE IN BAG OF 50)
ALAS-4117-010	LASCO CTS CPVC 45* ELBOW - 1" SLIP X 1" SLIP (MUST PURCHASE IN BAG OF 10)



PRECISION  
INSTALLATION  
PRODUCTS

# WATER TREATMENT

## CTS CPVC & PVC Fittings

### CTS CPVC Fittings

## 45 DEGREE STREET ELBOWS



<u>PART NUMBER</u>	<u>ITEM DESCRIPTION</u>
ALAS-4127-007	LASCO CTS CPVC 45* STREET ELBOW - 3/4" SPIGOT X 3/4" SLIP (MUST PURCHASE IN BAG OF 50)
ALAS-4127-010	LASCO CTS CPVC 45* STREET ELBOW - 1" SPIGOT X 1" SLIP (MUST PURCHASE IN BAG OF 10)

## COUPLINGS - SLIP X SLIP



<u>PART NUMBER</u>	<u>ITEM DESCRIPTION</u>
ALAS-4129-005	LASCO CTS CPVC COUPLING - 1/2" SLIP X 1/2" SLIP (MUST PURCHASE IN BAG OF 50)
ALAS-4129-007	LASCO CTS CPVC COUPLING - 3/4" SLIP X 3/4" SLIP (MUST PURCHASE IN BAG OF 50)
ALAS-4129-010	LASCO CTS CPVC COUPLING - 1" SLIP X 1" SLIP (MUST PURCHASE IN BAG OF 10)
ALAS-4129-101	LASCO CTS CPVC REDUCING COUPLING - 3/4" SLIP X 1/2" SLIP (MUST PURCHASE IN BAG OF 50)
ALAS-4129-131	LASCO CTS CPVC REDUCING COUPLING - 1" SLIP X 3/4" SLIP (MUST PURCHASE IN BAG OF 10)

## FEMALE (STAINLESS STEEL) ADAPTERS - SLIP X SS FPT



<u>PART NUMBER</u>	<u>ITEM DESCRIPTION</u>
ALAS-4135-005SS	LASCO CTS-CPVC THREADED FEMALE ADAPTER - STAINLESS STEEL - 1/2" FPT X 1/2" SLIP (EACH)
ALAS-4135-007SS	LASCO CTS CPVC THREADED FEMALE ADAPTER - STAINLESS STEEL - 3/4" FPT X 3/4" SLIP (EACH)
ALAS-4135-010SS	LASCO CTS CPVC THREADED FEMALE ADAPTER - STAINLESS STEEL - 1" FPT X 1" SLIP (MUST PURCHASE IN BAG OF 10)

## MALE ADAPTERS -SLIP X MPT



<u>PART NUMBER</u>	<u>ITEM DESCRIPTION</u>
ALAS-4136-005	LASCO CTS CPVC MALE ADAPTER - 1/2" SLIP X 1/2" MPT (MUST PURCHASE IN BAG OF 50)
ALAS-4136-007	LASCO CTS CPVC MALE ADAPTER - 3/4" SLIP X 3/4" MPT (MUST PURCHASE IN BAG OF 50)
ALAS-4136-010	LASCO CTS CPVC MALE ADAPTER - 1" SLIP X 1" MPT (MUST PURCHASE IN BAG OF 10)

# WATER TREATMENT

CTS CPVC & PVC Fittings

CTS CPVC Fittings



PRECISION  
INSTALLATION  
PRODUCTS

## REDUCER BUSHINGS - SLIP X SPIGOT



<u>PART NUMBER</u>	<u>ITEM DESCRIPTION</u>
ALAS-4137-101	LASCO CTS CPVC REDUCER BUSHING - 3/4" SLIP X 1/2" SPIGOT (MUST PURCHASE IN BAG OF 50)
ALAS-4137-131	LASCO CTS CPVC REDUCER BUSHING - 1" SLIP X 3/4" SPIGOT (MUST PURCHASE IN BAG OF 10)

## TRANSITION BUSHINGS - IPS X SLIP



<u>PART NUMBER</u>	<u>ITEM DESCRIPTION</u>
ALAS-4140-007	LASCO CPVC 3/4" IPS X 3/4" CTS TRANSITION BUSHING (MUST PURCHASE IN BAG OF 10)
ALAS-4140-010	LASCO CPVC 1" IPS X 1" CTS TRANSITION BUSHING (MUST PURCHASE IN BAG OF 10)

## TRANSITION COUPLINGS - IPS X SLIP



<u>PART NUMBER</u>	<u>ITEM DESCRIPTION</u>
ALAS-4141-010	LASCO CPVC 1" IPS X 1" CTS TRANSITION COUPLING (MUST PURCHASE IN BAG OF 10)

## CAPS - SLIP



<u>PART NUMBER</u>	<u>ITEM DESCRIPTION</u>
ALAS-4147-005	LASCO CTS CPVC CAP - 1/2" SLIP (MUST PURCHASE IN BAG OF 50)
ALAS-4147-007	LASCO CTS CPVC CAP - 3/4" SLIP (MUST PURCHASE IN BAG OF 50)
ALAS-4147-010	LASCO CTS CPVC CAP - 1" SLIP (MUST PURCHASE IN BAG OF 10)



PRECISION  
INSTALLATION  
PRODUCTS

# WATER TREATMENT

## CTS CPVC & PVC Fittings

CTS CPVC Fittings

### BALL VALVES - SLIP X SLIP



<u>PART NUMBER</u>	<u>ITEM DESCRIPTION</u>
ALAS-V07491CE	LASCO CTS CPVC BALL VALVE - 1/2" SLIP X 1/2" SLIP - EACH
ALAS-V08491CE	LASCO CTS CPVC BALL VALVE - 3/4" SLIP X 3/4" SLIP - EACH
ALAS-V10491CE	LASCO CTS CPVC BALL VALVE - 1" SLIP X 1" SLIP - EACH

# WATER TREATMENT

## CTS CPVC & PVC Fittings

Schedule 40 & 80 PVC Fittings



PRECISION  
INSTALLATION  
PRODUCTS

### UNION - SLIP X SLIP



<u>PART NUMBER</u>	<u>ITEM DESCRIPTION</u>
ALAS-457-010	LASCO PVC SCHEDULE 40 UNION - 1" SLIP X 1" SLIP - NSF 61 (MUST PURCHASE IN BAG OF 10)
ALAS-897-010	LASCO PVC SCHEDULE 80 UNION - 1" SLIP X 1" SLIP (MUST PURCHASE IN BAG OF 10)

### NIPPLE - MPT X MPT



<u>PART NUMBER</u>	<u>ITEM DESCRIPTION</u>
ALAS-205-015	LASCO PVC SCHEDULE 80 NIPPLE - 1/2" X 1 1/2" (MUST PURCHASE IN CASE OF 50)
ALAS-207-015	LASCO PVC SCHEDULE 80 NIPPLE - 3/4" X 1 1/2" (MUST PURCHASE IN CASE OF 50)
ALAS-212-040	LASCO PVC SCHEDULE 80 NIPPLE - 1-1/4" X 4" (MUST PURCHASE IN CASE OF 25)

### 90 DEGREE ELBOW - FPT X FPT



<u>PART NUMBER</u>	<u>ITEM DESCRIPTION</u>
ALAS-808-007	LASCO PVC SCHEDULE 80 - 90* ELBOW - 3/4" FPT X 3/4" FPT (MUST PURCHASE IN BAG OF 25)

### TEE - FPT X FPT X FPT



<u>PART NUMBER</u>	<u>ITEM DESCRIPTION</u>
ALAS-805-005	LASCO PVC SCHEDULE 80 - TEE - 1/2" FPT X 1/2" FPT X 1/2" FPT (MUST PURCHASE IN BAG OF 25)



PRECISION  
INSTALLATION  
PRODUCTS

# WATER TREATMENT

CTS CPVC & PVC Fittings

Schedule 40 & 80 PVC Fittings

## BUSHING - MPT X FPT



**PART NUMBER**

ALAS-839-072

**ITEM DESCRIPTION**

LASCO PVC SCHEDULE 80 - REDUCER BUSHING (FLUSH) - 1/2" MPT X 1/4" FPT (MUST PURCHASE IN BAG OF 25)

## BALL VALVE - FPT X FPT



**PART NUMBER**

ALAS-V07791N

**ITEM DESCRIPTION**

LASCO PVC SCHEDULE 80 BALL VALVE - 1/2" FPT X 1/2" FPT - EACH

## CHECK VALVE - FPT X FPT



**PART NUMBER**

ALAS-V07221T

**ITEM DESCRIPTION**

LASCO PVC SPRING CHECK VALVE - 1/2" FPT X 1/2" FPT - EACH

# PLUMBING SUPPLIES

## PEX Barb Fittings

### Black Plastic Barb Fittings



PRECISION  
INSTALLATION  
PRODUCTS

## MALE ADAPTERS - BARB X MPT



<u>PART NUMBER</u>	<u>ITEM DESCRIPTION</u>
JPX-01-08-08	BLACK PLASTIC PEX MALE ADAPTER - 1/2" PEX BARB X 1/2" MPT (MUST PURCHASE IN BAG'S OF 50)
JPX-01-08-12	BLACK PLASTIC PEX MALE ADAPTER - 1/2" PEX BARB X 3/4" MPT (MUST PURCHASE IN BAG'S OF 50)
JPX-01-12-12	BLACK PLASTIC PEX MALE ADAPTER - 3/4" PEX BARB X 3/4" MPT (MUST PURCHASE IN BAG'S OF 25)
JPX-01-16-16	BLACK PLASTIC PEX MALE ADAPTER - 1" PEX BARB X 1" MPT (MUST PURCHASE IN BAG'S OF 10)

## TEES- BARB X BARB X BARB



<u>PART NUMBER</u>	<u>ITEM DESCRIPTION</u>
JPX-02-08	BLACK PLASTIC PEX TEE - 1/2" PEX BARB X 1/2" PEX BARB X 1/2" PEX BARB (MUST PURCHASE IN BAG'S OF 50)
JPX-02-12	BLACK PLASTIC PEX TEE - 3/4" PEX BARB X 3/4" PEX BARB X 3/4" PEX BARB (MUST PURCHASE IN BAG'S OF 25)
JPX-02-16	BLACK PLASTIC PEX TEE - 1" PEX BARB X 1" PEX BARB X 1" PEX BARB (MUST PURCHASE IN BAG'S OF 10)

## ELBOWS - BARB X BARB



<u>PART NUMBER</u>	<u>ITEM DESCRIPTION</u>
JPX-03-08	BLACK PLASTIC PEX ELBOW - 1/2" PEX BARB X 1/2" PEX BARB (MUST PURCHASE IN BAG'S OF 50)
JPX-03-12	BLACK PLASTIC PEX ELBOW - 3/4" PEX BARB X 3/4" PEX BARB (MUST PURCHASE IN BAG'S OF 25)
JPX-03-16	BLACK PLASTIC PEX ELBOW - 1" PEX BARB X 1" PEX BARB (MUST PURCHASE IN BAG'S OF 10)

## COUPLINGS - BARB X BARB



<u>PART NUMBER</u>	<u>ITEM DESCRIPTION</u>
JPX-04-08	BLACK PLASTIC PEX COUPLING - 1/2" PEX BARB X 1/2" PEX BARB (MUST PURCHASE IN BAG'S OF 50)
JPX-04-12	BLACK PLASTIC PEX COUPLING - 3/4" PEX BARB X 3/4" PEX BARB (MUST PURCHASE IN BAG'S OF 50)
JPX-04-16	BLACK PLASTIC PEX COUPLING - 1" PEX BARB X 1" PEX BARB (MUST PURCHASE IN BAG'S OF 25)



PRECISION  
INSTALLATION  
PRODUCTS

# PLUMBING SUPPLIES

PEX Barb Fittings

Black PEX Fittings

## REDUCING COUPLINGS - BARB X BARB



<u>PART NUMBER</u>	<u>ITEM DESCRIPTION</u>
JPX-20-12-08	BLACK PLASTIC PEX REDUCING COUPLING - 3/4" PEX BARB X 1/2" PEX BARB (MUST PURCHASE IN BAG'S OF 50)
JPX-20-16-12	BLACK PLASTIC PEX REDUCING COUPLING - 1" PEX BARB X 3/4" PEX BARB (MUST PURCHASE IN BAG'S OF 25)

## REDUCING TEES - BARB X BARB X BARB



<u>PART NUMBER</u>	<u>ITEM DESCRIPTION</u>
JPX-30-12-12-08	BLACK PLASTIC PEX BRANCH TEE - 3/4" PEX BARB X 3/4" PEX BARB X 1/2" PEX BARB (MUST PURCHASE IN BAG'S OF 25)
JPX-30-16-16-08	BLACK PLASTIC PEX BRANCH TEE - 1" PEX BARB X 1" PEX BARB X 1/2" PEX BARB (MUST PURCHASE IN BAG'S OF 25)
JPX-30-16-16-12	BLACK PLASTIC PEX BRANCH TEE - 1" PEX BARB X 1" PEX BARB X 3/4" PEX BARB (MUST PURCHASE IN BAG'S OF 10)

## FEMALE SWIVEL ADAPTERS - BARB X FPT



<u>PART NUMBER</u>	<u>ITEM DESCRIPTION</u>
JPX-45-12-12	BLACK PLASTIC PEX FEMALE ADAPTER (SWIVEL) - 3/4" PEX BARB X 3/4" FPT (MUST PURCHASE IN BAG'S OF 25)
JPX-47-12-12	BLACK PLASTIC PEX FEMALE ELBOW (SWIVEL) - 3/4" PEX BARB X 3/4" FPT (MUST PURCHASE IN BAG'S OF 100)

## MALE ELBOWS - BARB X MPT



<u>PART NUMBER</u>	<u>ITEM DESCRIPTION</u>
JPX-48-08-08	BLACK PLASTIC PEX MALE ELBOW - 1/2" PEX BARB X 1/2" MPT (MUST PURCHASE IN BAG'S OF 50)
JPX-48-12-12	BLACK PLASTIC PEX MALE ELBOW - 3/4" PEX BARB X 3/4" MPT (MUST PURCHASE IN BAG'S OF 25)



# PLUMBING SUPPLIES

PEX Barb Fittings

Crimp Rings



PRECISION  
INSTALLATION  
PRODUCTS

## CRIMP RINGS



<u>PART NUMBER</u>	<u>ITEM DESCRIPTION</u>
JX-18-12B	PEX CRIMP RING - 3/4" BLACK - EACH PIECE (MUST PURCHASE IN BAG'S OF 50)
JX-18-12C	PEX CRIMP RING - 3/4" COPPER - EACH PIECE (MUST PURCHASE IN BAG'S OF 100)
JX-18-16B	PEX CRIMP RING - 1" BLACK - EACH PIECE (MUST PURCHASE IN BAG'S OF 100)
JX-18-16C	PEX CRIMP RING - 1" COPPER - EACH PIECE (MUST PURCHASE IN BAG'S OF 100)



PRECISION  
INSTALLATION  
PRODUCTS

# PLUMBING SUPPLIES

PEX Barb Fittings

Lead Free Brass PEX Fittings

## LF BRASS MALE ADAPTERS - BARB X MPT



**PART NUMBER**

JBX-01-12-LF

JBX-01-16-LF

**ITEM DESCRIPTION**

LF BRASS PEX MALE ADAPTER - 3/4" PEX BARB X 3/4" MPT (EACH)

LF BRASS PEX MALE ADAPTER - 1" PEX BARB X 1" MPT (EACH)

## LF BRASS MALE ADAPTERS - BARB X MALE SWEAT



**PART NUMBER**

JBX-01S-12-LF

JBX-01S-16-LF

**ITEM DESCRIPTION**

LF BRASS PEX MALE SWEAT ADAPTER - 3/4" PEX BARB X 3/4" MALE SWEAT (EACH)

LF BRASS PEX MALE SWEAT ADAPTER - 1" PEX BARB X 1" MALE SWEAT (EACH)

## LF BRASS FEMALE ADAPTERS - BARB X FPT



**PART NUMBER**

JBX-45-12-12-LF

JBX-45-16-16-LF

**ITEM DESCRIPTION**

LF BRASS PEX FEMALE ADAPTER - 3/4" PEX BARB X 3/4" FPT (EACH)

LF BRASS PEX FEMALE ADAPTER - 1" PEX BARB X 1" FPT (EACH)

# PLUMBING SUPPLIES

PEX Barb Fittings

Lead Free Brass PEX Fittings



PRECISION  
INSTALLATION  
PRODUCTS

## LF BRASS FEMALE ADAPTERS - BARB X FEMALE SWEAT



**PART NUMBER**

JBX-45S-12-12-LF

**ITEM DESCRIPTION**

LF BRASS PEX FEMALE SWEAT ADAPTER - 3/4" PEX BARB X 3/4" FEMALE SWEAT (EACH)

JBX-45S-16-16-LF

LF BRASS PEX FEMALE SWEAT ADAPTER - 1" PEX BARB X 1" FEMALE SWEAT (EACH)

## LF BRASS FEMALE ADAPTERS - BARB X FEMALE SWEAT



**PART NUMBER**

JBX-45S-12-12-LF

**ITEM DESCRIPTION**

LF BRASS PEX FEMALE SWEAT ADAPTER - 3/4" PEX BARB X 3/4" FEMALE SWEAT (EACH)

JBX-45S-16-16-LF

LF BRASS PEX FEMALE SWEAT ADAPTER - 1" PEX BARB X 1" FEMALE SWEAT (EACH)



PRECISION  
INSTALLATION  
PRODUCTS



**END OF SECTION**

**THIS PAGE IS LEFT  
INTENTIONALLY BLANK.**

# PLUMBING SUPPLIES

Black Malleable Iron Pipe

Fittings & Nipples



PRECISION  
INSTALLATION  
PRODUCTS

## CAPS - FPT



<u>PART NUMBER</u>	<u>ITEM DESCRIPTION</u>
BCP12	3/4" FPT BLACK CAP
BCP140	1-1/4" FPT BLACK CAP
BCP8	1/2" FPT BLACK CAP

## CROSS - FPT X FPT X FPT X FPT



<u>PART NUMBER</u>	<u>ITEM DESCRIPTION</u>
BCR8	1/2" FPT BLACK CROSS

## FLOOR FLANGE - FPT



<u>PART NUMBER</u>	<u>ITEM DESCRIPTION</u>
BFF8	1/2" FPT BLACK FLOOR FLANGE

## HEX BUSHINGS - MPT X FPT



<u>PART NUMBER</u>	<u>ITEM DESCRIPTION</u>
BHB12-8	3/4" MPT X 1/2" FPT BLACK HEX BUSHING
BHB8-6	1/2" MPT X 3/8" FPT BLACK HEX BUSHING



PRECISION  
INSTALLATION  
PRODUCTS

# PLUMBING SUPPLIES

Black Malleable Iron Pipe

Fittings & Nipples

## PLUGS / SQUARE HEAD - MPT



<u>PART NUMBER</u>	<u>ITEM DESCRIPTION</u>
BP12	3/4" BLACK MALLEABLE SQUARE HEAD SOLID PIPE PLUG
BP2	1/8" BLACK MALLEABLE SQUARE HEAD SOLID PIPE PLUG
BP8	1/2" BLACK MALLEABLE SQUARE HEAD SOLID PIPE PLUG

## COUPLINGS - FPT X FPT



<u>PART NUMBER</u>	<u>ITEM DESCRIPTION</u>
BC100	1" FPT BLACK COUPLING
BC12	3/4" FPT BLACK COUPLING
BC6	3/8" FPT BLACK COUPLING
BC8	1/2" FPT BLACK COUPLING

## REDUCING COUPLINGS - FPT X FPT



<u>PART NUMBER</u>	<u>ITEM DESCRIPTION</u>
BRC12-8	3/4" X 1/2" FPT BLACK MALLEABLE REDUCING COUPLING
BRC8-4	1/2" X 1/4" FPT BLACK MALLEABLE REDUCING COUPLING
BRC8-6	1/2" X 3/8" FPT BLACK MALLEABLE REDUCING COUPLING
BRC103	1" X 3/4" FPT BLACK MALLEABLE REDUCING COUPLING

## 90 DEGREE ELBOWS - FPT X FPT



<u>PART NUMBER</u>	<u>ITEM DESCRIPTION</u>
BL100-90	1" FPT BLACK 90° ELBOW
BL12-90	3/4" FPT BLACK 90° ELBOW
BL4-90	1/4" FPT BLACK 90° ELBOW
BL6-90	3/8" FPT BLACK 90° ELBOW
BL8-90	1/2" FPT BLACK 90° ELBOW

# PLUMBING SUPPLIES

Black Malleable Iron Pipe

Fittings & Nipples



PRECISION  
INSTALLATION  
PRODUCTS

## REDUCING ELBOWS - FPT X FPT



<u>PART NUMBER</u>	<u>ITEM DESCRIPTION</u>
BRL12-6	3/4" X 3/8" FPT BLACK REDUCING ELBOW-90 DEGREE
BRL12-8	3/4" X 1/2" FPT BLACK REDUCING ELBOW-90 DEGREE
BRL8-4	1/2" X 1/4" FPT BLACK REDUCING ELBOW-90 DEGREE
BRL8-6	1/2" X 3/8" FPT BLACK REDUCING ELBOW-90 DEGREE

## 90 DEGREE STREET ELBOW MPT X FPT



<u>PART NUMBER</u>	<u>ITEM DESCRIPTION</u>
BSL12-90	3/4" BLACK MALLEABLE STREET ELBOW-90 DEGREE
BSL4-90	1/4" BLACK MALLEABLE STREET ELBOW-90 DEGREE
BSL6-90	3/8" BLACK MALLEABLE STREET ELBOW-90 DEGREE
BSL8-90	1/2" BLACK MALLEABLE STREET ELBOW-90 DEGREE

## 45 DEGREE ELBOWS - FPT X FPT



<u>PART NUMBER</u>	<u>ITEM DESCRIPTION</u>
BL6-45	3/8" FPT BLACK 45° ELBOW
BL8-45	1/2" FPT BLACK 45° ELBOW

## 45 DEGREE STREET ELBOW - MPT X FPT



<u>PART NUMBER</u>	<u>ITEM DESCRIPTION</u>
BSL8-45	1/2" BLACK MALLEABLE STREET ELBOW-45 DEGREE



PRECISION  
INSTALLATION  
PRODUCTS

# PLUMBING SUPPLIES

Black Malleable Iron Pipe

Fittings & Nipples

## TEES - FPT X FPT X FPT



<u>PART NUMBER</u>	<u>ITEM DESCRIPTION</u>
BT100	1" FPT BLACK MALLEABLE TEE
BT12	3/4" FPT BLACK MALLEABLE TEE
BT6	3/8" FPT BLACK MALLEABLE TEE
BT8	1/2" FPT BLACK MALLEABLE TEE

## REDUCING TEE - FPT X FPT X FPT



<u>PART NUMBER</u>	<u>ITEM DESCRIPTION</u>
BRT12-8	3/4" X 3/4" X 1/2" FPT BLACK MALLEABLE REDUCING TEE
BRT8-6	1/2" X 1/2" X 3/8" FPT BLACK MALLEABLE REDUCING TEE

## UNIONS / BRASS TO IRON SEAT - FPT X FPT



<u>PART NUMBER</u>	<u>ITEM DESCRIPTION</u>
BU12	3/4" BLACK UNION
BU8	1/2" BLACK UNION



# PLUMBING SUPPLIES

Black Malleable Iron Pipe

Fittings & Nipples



PRECISION  
INSTALLATION  
PRODUCTS

## 1/8" NIPPLES - MPT X MPT



<u>PART NUMBER</u>	<u>ITEM DESCRIPTION</u>
BN2	1/8" X CLOSE BLACK NIPPLE-LENGTH 3/4" LONG
BN2-3	1/8" X 3" BLACK NIPPLE

## 1/4" NIPPLES - MPT X MPT

<u>PART NUMBER</u>	<u>ITEM DESCRIPTION</u>
BN4	1/4" X CLOSE BLACK NIPPLE-LENGTH 7/8" LONG
BN4-15	1/4" X 1-1/2" BLACK NIPPLE
BN4-2	1/4" X 2" BLACK NIPPLE
BN4-25	1/4" X 2-1/2" BLACK NIPPLE
BN4-3	1/4" X 3" BLACK NIPPLE
BN4-35	1/4" X 3-1/2" BLACK NIPPLE
BN4-4	1/4" X 4" BLACK NIPPLE

## 3/8" NIPPLES - MPT X MPT

<u>PART NUMBER</u>	<u>ITEM DESCRIPTION</u>
BN6	3/8" X CLOSE BLACK NIPPLE-LENGTH 1" LONG
BN6-10	3/8" X 10" BLACK NIPPLE
BN6-15	3/8" X 1-1/2" BLACK NIPPLE
BN6-2	3/8" X 2" BLACK NIPPLE
BN6-25	3/8" X 2-1/2" BLACK NIPPLE
BN6-3	3/8" X 3" BLACK NIPPLE
BN6-4	3/8" X 4" BLACK NIPPLE
BN6-6	3/8" X 6" BLACK NIPPLE



PRECISION  
INSTALLATION  
PRODUCTS

# PLUMBING SUPPLIES

Black Malleable Iron Pipe

Fittings & Nipples

## 1/2" NIPPLES - MPT X MPT



<u>PART NUMBER</u>	<u>ITEM DESCRIPTION</u>
BN8	1/2" X CLOSE BLACK NIPPLE-LENGTH 1-1/8" LONG
BN8-10	1/2" X 10" BLACK NIPPLE
BN8-12	1/2" X 12" BLACK NIPPLE
BN8-15	1/2" X 1-1/2" BLACK NIPPLE
BN8-18	1/2" X 18" BLACK NIPPLE
BN8-2	1/2" X 2" BLACK NIPPLE
BN8-24	1/2" X 24" BLACK NIPPLE
BN8-25	1/2" X 2-1/2" BLACK NIPPLE
BN8-3	1/2" X 3" BLACK NIPPLE
BN8-30	1/2" X 30" BLACK NIPPLE
BN8-35	1/2" X 3-1/2" BLACK NIPPLE
BN8-36	1/2" X 36" BLACK NIPPLE
BN8-4	1/2" X 4" BLACK NIPPLE
BN8-45	1/2" X 4-1/2" BLACK NIPPLE
BN8-48	1/2" X 48" BLACK NIPPLE
BN8-5	1/2" X 5" BLACK NIPPLE
BN8-55	1/2" X 5-1/2" BLACK NIPPLE
BN8-6	1/2" X 6" BLACK NIPPLE
BN8-7	1/2" X 7" BLACK NIPPLE
BN8-72	1/2" X 72" BLACK NIPPLE
BN8-8	1/2" X 8" BLACK NIPPLE
BN8-9	1/2" X 9" BLACK NIPPLE

# PLUMBING SUPPLIES

Black Malleable Iron Pipe

Fittings & Nipples



PRECISION  
INSTALLATION  
PRODUCTS

## 3/4" NIPPLES - MPT X MPT



<u>PART NUMBER</u>	<u>ITEM DESCRIPTION</u>
BN12	3/4" X CLOSE BLACK NIPPLE-LENGTH 1-3/8" LONG
BN12-10	3/4" X 10" BLACK NIPPLE
BN12-12	3/4" X 12" BLACK NIPPLE
BN12-15	3/4" X 1-1/2" BLACK NIPPLE
BN12-18	3/4" X 18" BLACK NIPPLE
BN12-2	3/4" X 2" BLACK NIPPLE
BN12-24	3/4" X 24" BLACK NIPPLE
BN12-25	3/4" X 2-1/2" BLACK NIPPLE
BN12-3	3/4" X 3" BLACK NIPPLE
BN12-30	3/4" X 30" BLACK NIPPLE
BN12-35	3/4" X 3-1/2" BLACK NIPPLE
BN12-36	3/4" X 36" BLACK NIPPLE
BN12-4	3/4" X 4" BLACK NIPPLE
BN12-45	3/4" X 4-1/2" BLACK NIPPLE
BN12-5	3/4" X 5" BLACK NIPPLE
BN12-55	3/4" X 5-1/2" BLACK NIPPLE
BN12-6	3/4" X 6" BLACK NIPPLE
BN12-7	3/4" X 7" BLACK NIPPLE
BN12-8	3/4" X 8" BLACK NIPPLE
BN12-9	3/4" X 9" BLACK NIPPLE
BN8-8	1/2" X 8" BLACK NIPPLE
BN8-9	1/2" X 9" BLACK NIPPLE



PRECISION  
INSTALLATION  
PRODUCTS

# PLUMBING SUPPLIES

Black Malleable Iron Pipe

Fittings & Nipples

## 1" NIPPLES - MPT X MPT



PART NUMBER

ITEM DESCRIPTION

BN100

1" X CLOSE BLACK NIPPLE-LENGTH 1-1/2" LONG

## 1-1/2" NIPPLES - MPT X MPT

PART NUMBER

ITEM DESCRIPTION

BN172

1-1/2" X CLOSE BLACK NIPPLE-LENGTH 1-3/4" LONG

## NIPPLE TRAYS - CLOSE THRU 6"



PART NUMBER

ITEM DESCRIPTION

BNT12

3/4" BLACK NIPPLE TRAY - CLOSE THRU 6"

BNT8

1/2" BLACK NIPPLE TRAY - CLOSE THRU 6"

# PLUMBING SUPPLIES

Galvanized Malleable Iron Pipe

Fittings & Nipples



PRECISION  
INSTALLATION  
PRODUCTS

## CAPS - FPT



<u>PART NUMBER</u>	<u>ITEM DESCRIPTION</u>
GC8	1/2" GALVANIZED COUPLING
GCP12	3/4" GALVANIZED CAP
GCP6	3/8 GALVANIZED CAP

## HEX BUSHINGS - MPT X FPT



<u>PART NUMBER</u>	<u>ITEM DESCRIPTION</u>
GHB12-6	3/4 X 3/8 GALVANIZED HEX BUSHING
GHB12-8	3/4 X 1/2 GALVANIZED HEX BUSHING
GHB6-2	3/8 X 1/8 GALVANIZED HEX BUSHING
GHB6-4	3/8 X 1/4 GALVANIZED HEX BUSHING
GHB8-2	1/2 X 1/8 GALVANIZED HEX BUSHING
GHB8-4	1/2 X 1/4 GALVANIZED HEX BUSHING
GHB8-6	1/2 X 3/8 GALVANIZED HEX BUSHING

## COUPLINGS - FPT X FPT



<u>PART NUMBER</u>	<u>ITEM DESCRIPTION</u>
GC12	3/4 GALVANIZED COUPLING
GC6	3/8" GALVANIZED COUPLING

## REDUCING COUPLING - FPT X FPT



<u>PART NUMBER</u>	<u>ITEM DESCRIPTION</u>
GRC12-6	3/4 X 3/8 GALVANIZED REDUCING COUPLING
GRC12-8	3/4 X 1/2 GALVANIZED REDUCING COUPLING
GRC8-6	1/2 X 3/8 GALVANIZED REDUCING COUPLING



PRECISION  
INSTALLATION  
PRODUCTS

# PLUMBING SUPPLIES

Galvanized Malleable Iron Pipe

Fittings & Nipples

## PLUGS/ SQUARE HEAD - MPT



<u>PART NUMBER</u>	<u>ITEM DESCRIPTION</u>
GP12	3/4 GALVANIZED PLUG-SQUARE HEAD
GP2	1/8 GALVANIZED PLUG-SQUARE HEAD
GP4	1/4 GALVANIZED PLUG-SQUARE HEAD
GP6	3/8 GALVANIZED PLUG-SQUARE HEAD
GP8	1/2 GALVANIZED PLUG-SQUARE HEAD

## 90 DEGREE ELBOWS - FPT X FPT



<u>PART NUMBER</u>	<u>ITEM DESCRIPTION</u>
GL6-90	3/8 GALVANIZED 90 DEGREE ELBOW
GL8-90	1/2 GALVANIZED 90 DEGREE ELBOW
GL12-90	3/4 GALVANIZED 90 DEGREE ELBOW

## REDUCING ELBOW - FPT X FPT



<u>PART NUMBER</u>	<u>ITEM DESCRIPTION</u>
GRL8-6	1/2 X 3/8 GALVANIZED 90 DEGREE REDUCING ELBOW
GRL12-6	3/4 X 3/8 GALVANIZED 90 DEGREE REDUCING ELBOW
GRL12-8	3/4 X 1/2 GALVANIZED 90 DEGREE REDUCING ELBOW

## 90 DEGREE STREET ELBOW - MPT X FPT



<u>PART NUMBER</u>	<u>ITEM DESCRIPTION</u>
GSL6-90	3/8 GALVANIZED 90 DEGREE STREET ELBOW
GSL8-90	1/2 GALVANIZED 90 DEGREE STREET ELBOW
GSL12-90	3/4 GALVANIZED 90 DEGREE STREET ELBOW

# PLUMBING SUPPLIES

Galvanized Malleable Iron Pipe

Fittings & Nipples



PRECISION  
INSTALLATION  
PRODUCTS

## 45 DEGREE ELBOWS - FPT X FPT



<u>PART NUMBER</u>	<u>ITEM DESCRIPTION</u>
GL6-45	3/8 GALVANIZED 45 DEGREE ELBOW
GL8-45	1/2 GALVANIZED 45 DEGREE ELBOW
GL12-45	3/4 GALVANIZED 45 DEGREE ELBOW

## 45 DEGREE STREET ELBOW - MPT X FPT



<u>PART NUMBER</u>	<u>ITEM DESCRIPTION</u>
GSL8-45	1/2 GALVANIZED 45 DEGREE STREET ELBOW
GSL12-45	3/4 GALVANIZED 45 DEGREE STREET ELBOW

## TEES - FPT X FPT X FPT



<u>PART NUMBER</u>	<u>ITEM DESCRIPTION</u>
GT12	3/4 GALVANIZED TEE
GT6	3/8 GALVANIZED TEE
GT8	1/2 GALVANIZED TEE

## TEES - FPT X FPT X FPT



<u>PART NUMBER</u>	<u>ITEM DESCRIPTION</u>
GRT12-4	3/4 X 3/4 X 1/4 GALVANIZED REDUCING TEE
GRT12-8	3/4 X 3/4 X 1/2 GALVANIZED REDUCING TEE
GRT8-6	1/2 X 1/2 X 3/8 GALVANIZED REDUCING TEE



PRECISION  
INSTALLATION  
PRODUCTS

# PLUMBING SUPPLIES

Galvanized Malleable Iron Pipe

Fittings & Nipples

## UNION / BRASS TO IRON SEAT - FPT X FPT



<u>PART NUMBER</u>	<u>ITEM DESCRIPTION</u>
GU12	3/4 GALVANIZED UNION-BRASS TO IRON SEAT
GU6	3/8 GALVANIZED UNION-BRASS TO IRON SEAT
GU8	1/2 GALVANIZED UNION-BRASS TO IRON SEAT

## 1/8" NIPPLES - MPT X MPT



<u>PART NUMBER</u>	<u>ITEM DESCRIPTION</u>
GN2	1/8 X CLOSE GALVANIZED NIPPLE

## 1/4" NIPPLES - MPT X MPT

<u>PART NUMBER</u>	<u>ITEM DESCRIPTION</u>
GN4	1/4 X CLOSE GALVANIZED NIPPLE
GN4-15	1/4 X 1 1/2 GALVANIZED NIPPLE
GN4-2	1/4 X 2 GALVANIZED NIPPLE
GN4-3	1/4 X 3 GALVANIZED NIPPLE
GN4-4	1/4 X 4 GALVANIZED NIPPLE
GN4-45	1/4 X 4 1/2 GALVANIZED NIPPLE
GN4-5	1/4 X 5 GALVANIZED NIPPLE
GN4-6	1/4 X 6 GALVANIZED NIPPLE



# PLUMBING SUPPLIES

Galvanized Malleable Iron Pipe

Fittings & Nipples



PRECISION  
INSTALLATION  
PRODUCTS

## 3/8" NIPPLES - MPT X MPT



<u>PART NUMBER</u>	<u>ITEM DESCRIPTION</u>
GN6	3/8 X CLOSE GALVANIZED NIPPLE
GN6-10	3/8 X 10 GALVANIZED NIPPLE
GN6-15	3/8 X 1 1/2 GALVANIZED NIPPLE
GN6-2	3/8 X 2 GALVANIZED NIPPLE
GN6-25	3/8 X 2 1/2 GALVANIZED NIPPLE
GN6-3	3/8 X 3 GALVANIZED NIPPLE
GN6-4	3/8 X 4 GALVANIZED NIPPLE
GN6-55	3/8 X 5 1/2 GALVANIZED NIPPLE
GN6-6	3/8 X 6 GALVANIZED NIPPLE

## 1/2" NIPPLES - MPT X MPT

<u>PART NUMBER</u>	<u>ITEM DESCRIPTION</u>
GN8	1/2 X CLOSE GALVANIZED NIPPLE
GN8-10	1/2 X 10 GALVANIZED NIPPLE
GN8-12	1/2 X 12 GALVANIZED NIPPLE
GN8-15	1/2 X 1 1/2 GALVANIZED NIPPLE
GN8-18	1/2 X 18 GALVANIZED NIPPLE
GN8-2	1/2 X 2 GALVANIZED NIPPLE
GN8-24	1/2 X 24 GALVANIZED NIPPLE
GN8-25	1/2 X 2 1/2 GALVANIZED NIPPLE
GN8-3	1/2 X 3 GALVANIZED NIPPLE
GN8-35	1/2 X 3 1/2 GALVANIZED NIPPLE
GN8-36	1/2 X 36 GALVANIZED NIPPLE
GN8-4	1/2 X 4 GALVANIZED NIPPLE
GN8-45	1/2 X 4 1/2 GALVANIZED NIPPLE
GN8-48	1/2 X 48 GALVANIZED NIPPLE
GN8-5	1/2 X 5 GALVANIZED NIPPLE
GN8-55	1/2 X 5 1/2 GALVANIZED NIPPLE
GN8-6	1/2 X 6 GALVANIZED NIPPLE
GN8-60	1/2 X 60 GALVANIZED NIPPLE
GN8-7	1/2 X 7 GALVANIZED NIPPLE
GN8-72	GALVANIZED NIPPLE - 1/2" X 72"
GN8-8	1/2 X 8 GALVANIZED NIPPLE
GN8-9	1/2 X 9 GALVANIZED NIPPLE



PRECISION  
INSTALLATION  
PRODUCTS

# PLUMBING SUPPLIES

Galvanized Malleable Iron Pipe

Fittings & Nipples

## 3/4" NIPPLES - MPT X MPT



<u>PART NUMBER</u>	<u>ITEM DESCRIPTION</u>
GN12	3/4 X CLOSE GALVANIZED NIPPLE
GN12-10	3/4 X 10 GALVANIZED NIPPLE
GN12-12	3/4 X 12 GALVANIZED NIPPLE
GN12-15	3/4 X 1 1/2 GALVANIZED NIPPLE
GN12-18	3/4 X 18 GALVANIZED NIPPLE
GN12-2	3/4 X 2 GALVANIZED NIPPLE
GN12-24	3/4 X 24 GALVANIZED NIPPLE
GN12-25	3/4 X 2 1/2 GALVANIZED NIPPLE
GN12-3	3/4 X 3 GALVANIZED NIPPLE
GN12-35	3/4 X 3 1/2 GALVANIZED NIPPLE
GN12-4	3/4 X 4 GALVANIZED NIPPLE
GN12-45	3/4 X 4 1/2 GALVANIZED NIPPLE
GN12-5	3/4 X 5 GALVANIZED NIPPLE
GN12-55	3/4 X 5 1/2 GALVANIZED NIPPLE
GN12-6	3/4 X 6 GALVANIZED NIPPLE
GN12-7	3/4 X 7 GALVANIZED NIPPLE
GN12-8	3/4 X 8 GALVANIZED NIPPLE

## 1" NIPPLES - MPT X MPT



<u>PART NUMBER</u>	<u>ITEM DESCRIPTION</u>
GN100	1 X CLOSE GALVANIZED NIPPLE

## NIPPLE TRAYS - CLOSE THRU 6"



<u>PART NUMBER</u>	<u>ITEM DESCRIPTION</u>
GNT12	3/4" GALVANIZED NIPPLE TRAY - CLOSE THRU 6"
GNT8	1/2" GALVANIZED NIPPLE TRAY - CLOSE THRU 6"

# PLUMBING SUPPLIES

Brass Pipe Fittings & Nipples

Brass Pipe



PRECISION  
INSTALLATION  
PRODUCTS

## 90 DEGREE ELBOW - FPT X FPT



<u>PART NUMBER</u>	<u>ITEM DESCRIPTION</u>
R100-12	3/4" FPT X 3/4" FPT BRASS 90 DEGREE ELBOW
R100-4	1/4" FPT X 1/4" FPT BRASS 90 DEGREE ELBOW
R100-4-LF	1/4" FPT X 1/4" FPT BRASS 90 DEGREE ELBOW - LEAD FREE
R100-6	3/8" FPT X 3/8" FPT BRASS 90 DEGREE ELBOW
R100-6-LF	3/8" FPT X 3/8" FPT BRASS 90 DEGREE ELBOW - LEAD FREE
R100-8-LF	1/2" FPT X 1/2" FPT BRASS 90 DEGREE ELBOW - LEAD FREE

## 90 DEGREE ELBOW - MPT X MPT



<u>PART NUMBER</u>	<u>ITEM DESCRIPTION</u>
R118-4	1/4" MPT X 1/4" MPT BRASS 90 DEGREE ELBOW
R118-6	3/8" MPT X 3/8" MPT BRASS 90 DEGREE ELBOW
R118-8	1/2" MPT X 1/2" MPT BRASS 90 DEGREE ELBOW

## 90 DEGREE STREET ELBOW - FPT X MPT



<u>PART NUMBER</u>	<u>ITEM DESCRIPTION</u>
R116-12	3/4" FPT X 3/4" MPT BRASS STREET ELBOW
R116-12-LF	3/4" FPT X 3/4" MPT BRASS STREET ELBOW - LEAD FREE
R116-4	1/4" FPT X 1/4" MPT BRASS STREET ELBOW
R116-4-LF	1/4" FPT X 1/4" MPT BRASS STREET ELBOW - LEAD FREE
R116-6	3/8" FPT X 3/8" MPT BRASS STREET ELBOW
R116-6-LF	3/8" FPT X 3/8" MPT BRASS STREET ELBOW - LEAD FREE
R116-8-LF	1/2" FPT X 1/2" MPT BRASS STREET ELBOW - LEAD FREE

## 45 DEGREE ELBOW - MPT X FPT



<u>PART NUMBER</u>	<u>ITEM DESCRIPTION</u>
R124-4	1/4" - 45 DEGREE BRASS STREET ELBOW



PRECISION  
INSTALLATION  
PRODUCTS

# PLUMBING SUPPLIES

Brass Pipe Fittings & Nipples

Brass Pipe

## TEE - FPT X FPT X FPT



<u>PART NUMBER</u>	<u>ITEM DESCRIPTION</u>
R101-2	1/8" FPT X 1/8" FPT X 1/8" FPT BRASS TEE
R101-4	1/4" FPT X 1/4" FPT X 1/4" FPT BRASS TEE
R101-4-LF	1/4" FPT X 1/4" FPT X 1/4" FPT BRASS TEE - LEAD FREE
R101-6-LF	3/8" FPT X 3/8" FPT X 3/8" FPT BRASS TEE - LEAD FREE
R101-8-LF	1/2" FPT X 1/2" FPT X 1/2" FPT BRASS TEE - LEAD FREE
R100-8-LF	1/2" FPT X 1/2" FPT BRASS 90 DEGREE ELBOW - LEAD FREE

## STREET TEE - FPT X MPT X FPT



<u>PART NUMBER</u>	<u>ITEM DESCRIPTION</u>
R127S-4	1/4" FPT X 1/4" MPT X 1/4" FPT BRASS STREET TEE

## COUPLING - FPT X FPT



<u>PART NUMBER</u>	<u>ITEM DESCRIPTION</u>
R103-12	3/4" FPT X 3/4" FPT BRASS COUPLING
R103-2	1/8" FPT X 1/8" FPT BRASS COUPLING
R103-4	1/4" FPT X 1/4" FPT BRASS COUPLING
R103-4-LF	1/4" FPT X 1/4" FPT BRASS COUPLING - LEAD FREE
R103-6	3/8" FPT X 3/8" FPT BRASS COUPLING
R103-6-LF	3/8" FPT X 3/8" FPT BRASS COUPLING - LEAD FREE
R103-8	1/2" FPT X 1/2" FPT BRASS COUPLING
R103-8-LF	1/2" FPT X 1/2" FPT BRASS COUPLING - LEAD FREE

## REDUCING COUPLING - FPT X FPT



<u>PART NUMBER</u>	<u>ITEM DESCRIPTION</u>
R119-4-2	1/4" FPT X 1/8" FPT BRASS REDUCING COUPLING
R119-6-4	3/8" FPT X 1/4" FPT BRASS REDUCING COUPLING
R119-8-6	1/2" FPT X 3/8" FPT BRASS REDUCING COUPLING

# PLUMBING SUPPLIES

Brass Pipe Fittings & Nipples

Brass Pipe



PRECISION  
INSTALLATION  
PRODUCTS

## ADAPTER - FPT X MPT



<u>PART NUMBER</u>	<u>ITEM DESCRIPTION</u>
R120-12-8	3/4" FPT X 1/2" MPT BRASS PIPE ADAPTER
R120-2-2	1/8" FPT X 1/8" MPT BRASS PIPE ADAPTER
R120-4-2	1/4" FPT X 1/8" MPT BRASS PIPE ADAPTER
R120-4-2-LF	1/4" FPT X 1/8" MPT BRASS PIPE ADAPTER - LEAD FREE
R120-4-4	1/4" FPT X 1/4" MPT BRASS PIPE ADAPTER
R120-6-4	3/8" FPT X 1/4" MPT BRASS PIPE ADAPTER
R120-8-4	1/2" FPT X 1/4" MPT BRASS PIPE ADAPTER
R120-8-6	1/2" FPT X 3/8" MPT BRASS PIPE ADAPTER
R120-8-8	1/2" FPT X 1/2" MPT BRASS PIPE ADAPTER

## CROSS - FPT X FPT X FPT X FPT



<u>PART NUMBER</u>	<u>ITEM DESCRIPTION</u>
R102-2	1/8" FPT BRASS CROSS
R102-4-LF	1/4" FPT BRASS CROSS - LEAD FREE
R102-6-LF	3/8" FPT BRASS CROSS - LEAD FREE

## CAPS - FPT



<u>PART NUMBER</u>	<u>ITEM DESCRIPTION</u>
R108-12	3/4" FEMALE PIPE THREAD BRASS CAP
R108-16	1" FEMALE PIPE THREAD BRASS CAP
R108-2	1/8" FEMALE PIPE THREAD BRASS CAP
R108-4	1/4" FEMALE PIPE THREAD BRASS CAP
R108-6	3/8" FEMALE PIPE THREAD BRASS CAP
R108-8	1/2" FEMALE PIPE THREAD BRASS CAP

## LOCK NUT PART



<u>PART NUMBER</u>	<u>ITEM DESCRIPTION</u>
R111-6	3/8" BRASS PIPE LOCK NUT
R111-8	1/2" BRASS PIPE LOCKNUT



PRECISION  
INSTALLATION  
PRODUCTS

# PLUMBING SUPPLIES

Brass Pipe Fittings & Nipples

Brass Pipe

## FLUSH BUSHING - FPT X MPT



<u>PART NUMBER</u>	<u>ITEM DESCRIPTION</u>
R110-12-8	3/4" MPT X 1/2" FPT BRASS FLUSH BUSHING
R110-6-4	3/8" MPT X 1/4" FPT BRASS FLUSH BUSHING
R110-8-6	1/2" MPT X 3/8" FPT BRASS FLUSH BUSHING

## HEX BUSHING - MPT X FPT



<u>PART NUMBER</u>	<u>ITEM DESCRIPTION</u>
R209-12-4-LF	3/4" MPT X 1/4" FPT BRASS HEX BUSHING - LEAD FREE
R209-12-6	3/4" MPT X 3/8" FPT BRASS HEX BUSHING
R209-12-6-LF	3/4" MPT X 3/8" FPT BRASS HEX BUSHING - LEAD FREE
R209-12-8-LF	3/4" MPT X 1/2" FPT BRASS HEX BUSHING - LEAD FREE
R209-4-2	1/4" MPT X 1/8" FPT BRASS HEX BUSHING
R209-4-2-LF	1/4" MPT X 1/8" FPT BRASS HEX BUSHING - LEAD FREE
R209-6-2	3/8" MPT X 1/8" FPT BRASS HEX BUSHING
R209-6-4-LF	3/8" MPT X 1/4" FPT BRASS HEX BUSHING - LEAD FREE
R209-8-2	1/2" MPT X 1/8" FPT BRASS HEX BUSHING
R209-8-4	1/2" MPT X 1/4" FPT BRASS HEX BUSHING
R209-8-4-LF	1/2" MPT X 1/4" FPT BRASS HEX BUSHING - LEAD FREE
R209-8-6-LF	1/2" MPT X 3/8" FPT BRASS HEX BUSHING - LEAD FREE

## SQUARE HEAD PLUG - CORED - MPT



<u>PART NUMBER</u>	<u>ITEM DESCRIPTION</u>
R109-12	3/4" MALE PIPE SQUARE HEAD BRASS PLUG
R109-4-LF	1/4" MALE PIPE SQUARE HEAD BRASS PLUG - LEAD FREE
R109-6	3/8" MALE PIPE SQUARE HEAD BRASS PLUG
R109-8	1/2" MALE PIPE SQUARE HEAD BRASS PLUG

# PLUMBING SUPPLIES

Brass Pipe Fittings & Nipples

Brass Pipe



PRECISION  
INSTALLATION  
PRODUCTS

## SQUARE HEAD PLUG - SOLID - MPT



<u>PART NUMBER</u>	<u>ITEM DESCRIPTION</u>
R109S-12	3/4" SOLID BRASS PLUG - SQUARE HEAD
R109S-2	1/8" SOLID BRASS PLUG - SQUARE HEAD
R109S-4	1/4" SOLID BRASS PLUG - SQUARE HEAD
R109S-6	3/8" SOLID BRASS PLUG - SQUARE HEAD
R109S-8	1/2" SOLID BRASS PLUG - SQUARE HEAD
R109S-8-LF	1/2" SOLID BRASS PLUG - SQUARE HEAD - LEAD FREE

## HEXHEAD PLUG - CORED - MPT



<u>PART NUMBER</u>	<u>ITEM DESCRIPTION</u>
R121-12	3/4" MPT BRASS HEX HEAD PLUG - CORED
R121-2	1/8" MPT BRASS HEX HEAD PLUG - CORED
R121-2-LF	1/8" MPT BRASS HEX HEAD PLUG - CORED - LEAD FREE
R121-4	1/4" MPT BRASS HEX HEAD PLUG - CORED
R121-6	3/8" MPT BRASS HEX HEAD PLUG - CORED
R121-8	1/2" MPT BRASS HEX HEAD PLUG - CORED

## HEX NIPPLES - MPT X MPT



<u>PART NUMBER</u>	<u>ITEM DESCRIPTION</u>
R106-2	1/8" MPT X 1/8" MPT BRASS HEX NIPPLE
R106-4	1/4" MPT X 1/4" MPT BRASS HEX NIPPLE (1.09 LONG)
R106-4-LF	1/4" MPT X 1/4" MPT BRASS HEX NIPPLE (1.09 LONG) - LEAD FREE
R106-6	3/8" MPT X 3/8" MPT BRASS HEX NIPPLE
R106-6-LF	3/8" MPT X 3/8" MPT BRASS HEX NIPPLE - LEAD FREE
R106-8-LF	1/2" MPT X 1/2" MPT BRASS HEX NIPPLE - LEAD FREE

## REDUCING HEX NIPPLES - MPT X MPT



<u>PART NUMBER</u>	<u>ITEM DESCRIPTION</u>
R106R12-8	3/4" X 1/2" BRASS HEX REDUCING NIPPLE
R106R12-8-LF	3/4" X 1/2" BRASS HEX REDUCING NIPPLE - LEAD FREE
R106R4-2	1/4" X 1/8" BRASS HEX REDUCING NIPPLE
R106R6-4	3/8" X 1/4" BRASS HEX REDUCING NIPPLE
R106R8-4	1/2" X 1/4" BRASS HEX REDUCING NIPPLE
R106R8-6	1/2" X 3/8" BRASS HEX REDUCING NIPPLE



PRECISION  
INSTALLATION  
PRODUCTS

# PLUMBING SUPPLIES

Brass Pipe Fittings & Nipples

Cast Brass / Bronze

## HEX BUSHING - MPT X FPT



<u>PART NUMBER</u>	<u>ITEM DESCRIPTION</u>
RC144-12-4	3/4" X 1/4" CAST BRASS HEX BUSHING
RC144-12-6	3/4" X 3/8" CAST BRASS HEX BUSHING
RC144-12-8-LF	3/4" X 1/2" CAST BRASS HEX BUSHING - LEAD FREE
RC144-16-12-LF	1" X 3/4" CAST BRASS HEX BUSHING - LEAD FREE
RC144-16-4	1" X 1/4" CAST BRASS HEX BUSHING
RC144-16-8	1" X 1/2" CAST BRASS HEX BUSHING
RC144-16-8-LF	1" X 1/2" CAST BRASS HEX BUSHING - LEAD FREE
RC144-20-12-LF	1 1/4" X 3/4" CAST BRASS HEX BUSHING - LEAD FREE
RC144-20-16	1 1/4" X 1" CAST BRASS HEX BUSHING
RC144-20-8-LF	1 1/4" X 1/2" CAST BRASS HEX BUSHING - LEAD FREE
RC144-26-16-LF	2" X 1" CAST BRASS HEX BUSHING - LEAD FREE
RC144-4-2	1/4" X 1/8" CAST BRASS HEX BUSHING
RC144-6-2	3/8" X 1/8" CAST BRASS HEX BUSHING
RC144-6-2-LF	3/8" X 1/8" CAST BRASS HEX BUSHING - LEAD FREE
RC144-6-4	3/8" X 1/4" CAST BRASS HEX BUSHING
RC144-8-2	1/2" X 1/8" CAST BRASS HEX BUSHING
RC144-8-4-LF	1/2" X 1/4" CAST BRASS HEX BUSHING - LEAD FREE
RC144-8-6	1/2" X 3/8" CAST BRASS HEX BUSHING
RC144-8-6-LF	1/2" X 3/8" CAST BRASS HEX BUSHING - LEAD FREE

## CAP - FPT



<u>PART NUMBER</u>	<u>ITEM DESCRIPTION</u>
RC145-12-LF	3/4" FPT CAST BRONZE CAP - LEAD FREE
RC145-16-LF	1" FPT CAST BRONZE CAP - LEAD FREE
RC145-2	1/8" FPT CAST BRONZE CAP
RC145-20-LF	1 1/4" FPT CAST BRONZE CAP - LEAD FREE
RC145-26-LF	2" FPT CAST BRONZE CAP - LEAD FREE
RC145-8-LF	1/2" FPT CAST BRONZE CAP - LEAD FREE



# PLUMBING SUPPLIES

Brass Pipe Fittings & Nipples

Cast Brass / Bronze



PRECISION  
INSTALLATION  
PRODUCTS

## COUPLINGS - FPT X FPT



<u>PART NUMBER</u>	<u>ITEM DESCRIPTION</u>
RC165-12	3/4" FPT CAST BRASS COUPLING
RC165-12-LF	3/4" FPT CAST BRASS COUPLING - LEAD FREE
RC165-16	1" FPT CAST BRASS COUPLING
RC165-16-LF	1" FPT CAST BRASS COUPLING - LEAD FREE
RC165-20-LF	1 1/4" FPT CAST BRASS COUPLING - LEAD FREE
RC165-8-LF	1/2" FPT CAST BRASS COUPLING - LEAD FREE

## REDUCING COUPLINGS - FPT X FPT

<u>PART NUMBER</u>	<u>ITEM DESCRIPTION</u>
RC165-12-4-LF	3/4" FPT X 1/4" FPT CAST BRASS REDUCING COUPLING - LEAD FREE
RC165-12-6-LF	3/4" FPT X 3/8" FPT CAST BRASS REDUCING COUPLING - LEAD FREE
RC165-12-8-LF	3/4" FPT X 1/2" FPT CAST BRASS REDUCING COUPLING - LEAD FREE
RC165-16-12-LF	1" FPT X 3/4" FPT CAST BRASS REDUCING COUPLING - LEAD FREE
RC165-16-8-LF	1" FPT X 1/2" FPT CAST BRASS REDUCING COUPLING - LEAD FREE
RC165-20-12	1 1/4" FPT X 3/4" FPT CAST BRASS REDUCING COUPLING
RC165-20-16	1 1/4" FPT X 1" FPT CAST BRASS REDUCING COUPLING
RC165-20-8-LF	1 1/4" FPT X 1/2" FPT CAST BRASS REDUCING COUPLING - LEAD FREE
RC165-26-22-LF	2" FPT X 1 1/2" FPT CAST BRASS REDUCING COUPLING - LEAD FREE
RC165-6-4	3/8" FPT X 1/4" FPT CAST BRASS REDUCING COUPLING
RC165-8-4	1/2" FPT X 1/4" FPT CAST BRASS REDUCING COUPLING
RC165-8-4-LF	1/2" FPT X 1/4" FPT CAST BRASS REDUCING COUPLING - LEAD FREE
RC165-8-6	1/2" FPT X 3/8" FPT CAST BRASS REDUCING COUPLING

## 90 DEGREE ELBOW - FPT X FPT



<u>PART NUMBER</u>	<u>ITEM DESCRIPTION</u>
RC235-12-LF	3/4" FPT CAST BRASS 90 DEGREE ELBOW-FPT X FPT - LEAD FREE
RC235-16	1" FPT CAST BRASS 90 DEGREE ELBOW-FPT X FPT
RC235-16-LF	1" FPT CAST BRASS 90 DEGREE ELBOW-FPT X FPT - LEAD FREE
RC235-20-LF	1 1/4" CAST BRASS FPT 90 DEGREE ELBOW - FPT X FPT - LEAD FREE
RC235-26-LF	2" CAST BRASS FPT 90 DEGREE ELBOW - FPT X FPT - LEAD FREE
RC235-4	1/4" FPT CAST BRASS 90 DEGREE ELBOW - FPT X FPT
RC235-6	3/8" FPT CAST BRASS 90 DEGREE ELBOW - FPT X FPT
RC235-8	1/2" FPT CAST BRASS 90 DEGREE ELBOW-FPT X FPT
RC235-8-LF	1/2" FPT CAST BRASS 90 DEGREE ELBOW-FPT X FPT - LEAD FREE



PRECISION  
INSTALLATION  
PRODUCTS

# PLUMBING SUPPLIES

Brass Pipe Fittings & Nipples

Cast Brass / Bronze

## 45 DEGREE ELBOW - FPT X FPT



<u>PART NUMBER</u>	<u>ITEM DESCRIPTION</u>
RC236-12	3/4" CAST BRASS 45 DEGREE ELBOW - FPT X FPT
RC236-16-LF	1" CAST BRASS 45 DEGREE ELBOW - FPT X FPT - LEAD FREE
RC236-20-LF	1 1/4" CAST BRASS 45 DEGREE ELBOW - FPT X FPT - LEAD FREE
RC236-4-LF	1/4" CAST BRASS 45 DEGREE ELBOW - FPT X FPT - LEAD FREE
RC236-6-LF	3/8" CAST BRASS 45 DEGREE ELBOW - FPT X FPT - LEAD FREE
RC236-8	1/2" CAST BRASS 45 DEGREE ELBOW - FPT X FPT

## 90 DEGREE STREET ELBOW - MPT X FPT



<u>PART NUMBER</u>	<u>ITEM DESCRIPTION</u>
RC254-12-LF	3/4" CAST BRASS 90 DEGREE STREET ELBOW - LEAD FREE
RC254-16	1" CAST BRASS 90 DEGREE STREET ELBOW
RC254-16-LF	1" CAST BRASS 90 DEGREE STREET ELBOW - LEAD FREE
RC254-2	1/8" CAST BRASS 90 DEGREE STREET ELBOW
RC254-4	1/4" CAST BRASS 90 DEGREE STREET ELBOW
RC254-6-LF	3/8" CAST BRASS 90 DEGREE STREET ELBOW - LEAD FREE
RC254-8-LF	1/2" CAST BRASS 90 DEGREE STREET ELBOW - LEAD FREE

## 45 DEGREE STREET ELBOW - MPT X FPT



<u>PART NUMBER</u>	<u>ITEM DESCRIPTION</u>
RC255-12	3/4" CAST BRASS 45 DEGREE STREET ELBOW
RC255-8	1/2" CAST BRASS 45 DEGREE STREET ELBOW

# PLUMBING SUPPLIES

Brass Pipe Fittings & Nipples

Cast Brass / Bronze



PRECISION  
INSTALLATION  
PRODUCTS

## TEE - FPT X FPT X FPT



<u>PART NUMBER</u>	<u>ITEM DESCRIPTION</u>
RC460-12-LF	3/4" FPT CAST BRASS TEE - LEAD FREE
RC460-16	1" FPT CAST BRASS TEE
RC460-16-LF	1" FPT CAST BRASS TEE - LEAD FREE
RC460-20-LF	1 1/4" FPT CAST BRASS TEE - LEAD FREE
RC460-26-LF	2" FPT CAST BRASS TEE - LEAD FREE
RC460-4	1/4" FPT CAST BRASS TEE
RC460-6-LF	3/8" FPT CAST BRASS TEE - LEAD FREE
RC460-8-LF	1/2" FPT CAST BRASS TEE - LEAD FREE

## REDUCING TEE - FPT X FPT X FPT



<u>PART NUMBER</u>	<u>ITEM DESCRIPTION</u>
RC460R12-8-LF	3/4" X 3/4" X 1/2" CAST BRASS REDUCING TEE - LEAD FREE
RC460R6-4	3/8" X 3/8" X 1/4" FEMALE CAST BRASS REDUCING TEE

## SQUARE HEAD PLUG - CORED - MPT



<u>PART NUMBER</u>	<u>ITEM DESCRIPTION</u>
RC520-12	3/4" CAST BRASS CORED SQUARE PLUG
RC520-12-LF	3/4" CAST BRASS CORED SQUARE PLUG - LEAD FREE
RC520-16-LF	1" CAST BRASS CORED SQUARE PLUG - LEAD FREE
RC520-20-LF	1 1/4" CAST BRASS CORED SQUARE PLUG - LEAD FREE
RC520-26-LF	2" CAST BRASS CORED SQUARE PLUG - LEAD FREE
RC520-8	1/2" CAST BRASS CORED SQUARE PLUG
RC520-8-LF	1/2" CAST BRASS CORED SQUARE PLUG - LEAD FREE
RC460-8-LF	1/2" FPT CAST BRASS TEE - LEAD FREE



PRECISION  
INSTALLATION  
PRODUCTS

# PLUMBING SUPPLIES

Brass Pipe Fittings & Nipples

Cast Brass / Bronze

## CROSS - FPT X FPT X FPT X FPT



<u>PART NUMBER</u>	<u>ITEM DESCRIPTION</u>
RC625-8-LF	1/2" FPT CAST BRASS CROSS - LEAD FREE

## THREADED UNION - FPT X FPT



<u>PART NUMBER</u>	<u>ITEM DESCRIPTION</u>
RC657-12-LF	3/4" FPT CAST BRASS THREADED UNION - LEAD FREE
RC657-16-LF	1" FPT CAST BRASS THREADED UNION - LEAD FREE
RC657-20-LF	1 1/4" FPT CAST BRASS THREADED UNION - LEAD FREE
RC657-22-LF	1 1/2" FPT CAST BRASS THREADED UNION - LEAD FREE
RC657-26-LF	2" FPT CAST BRASS THREADED UNION - LEAD FREE
RC657-4-LF	1/4" FPT CAST BRASS THREADED UNION - LEAD FREE
RC657-6	3/8" FPT CAST BRASS THREADED UNION
RC657-8-LF	1/2" FPT CAST BRASS THREADED UNION - LEAD FREE

# PLUMBING SUPPLIES

Brass Pipe Fittings & Nipples

Brass Nipples



PRECISION  
INSTALLATION  
PRODUCTS

## 1/8" NIPPLES - LEAD FREE - MPT X MPT



<u>PART NUMBER</u>	<u>ITEM DESCRIPTION</u>
RN2	1/8" X CLOSE RED BRASS NIPPLE - LEAD FREE

## 1/4" NIPPLES - LEAD FREE - MPT X MPT

<u>PART NUMBER</u>	<u>ITEM DESCRIPTION</u>
RN4	1/4" X CLOSE RED BRASS NIPPLE - LEAD FREE
RN4-15	1/4" X 1 1/2" RED BRASS NIPPLE - LEAD FREE
RN4-2	1/4" X 2" RED BRASS NIPPLE - LEAD FREE
RN4-25	1/4" X 2 1/2" RED BRASS NIPPLE - LEAD FREE
RN4-3	1/4" X 3" RED BRASS NIPPLE - LEAD FREE
RN4-4	1/4" X 4" RED BRASS NIPPLE - LEAD FREE
RN4-6	1/4" X 6" RED BRASS NIPPLE - LEAD FREE

## 3/8" NIPPLES - LEAD FREE - MPT X MPT

<u>PART NUMBER</u>	<u>ITEM DESCRIPTION</u>
RN6	3/8" X CLOSE RED BRASS NIPPLE - LEAD FREE
RN6-10	3/8" X 10" RED BRASS NIPPLE - LEAD FREE
RN6-12	3/8" X 12" RED BRASS NIPPLE - LEAD FREE
RN6-15	3/8" X 1 1/2" RED BRASS NIPPLE - LEAD FREE
RN6-2	3/8" X 2" RED BRASS NIPPLE - LEAD FREE
RN6-25	3/8" X 2 1/2" RED BRASS NIPPLE - LEAD FREE
RN6-3	3/8" X 3" RED BRASS NIPPLE - LEAD FREE
RN6-4	3/8" X 4" RED BRASS NIPPLE - LEAD FREE
RN6-6	3/8" X 6" RED BRASS NIPPLE - LEAD FREE



PRECISION  
INSTALLATION  
PRODUCTS

# PLUMBING SUPPLIES

Brass Pipe Fittings & Nipples

## Brass Nipples

### 1/2" NIPPLES - LEAD FREE - MPT X MPT



<u>PART NUMBER</u>	<u>ITEM DESCRIPTION</u>
RN8	1/2" X CLOSE RED BRASS NIPPLE - LEAD FREE
RN8-10	1/2" X 10" RED BRASS NIPPLE - LEAD FREE
RN8-12	1/2" X 12" RED BRASS NIPPLE - LEAD FREE
RN8-15	1/2" X 1 1/2" RED BRASS NIPPLE - LEAD FREE
RN8-2	1/2" X 2" RED BRASS NIPPLE - LEAD FREE
RN8-25	1/2" X 2 1/2" RED BRASS NIPPLE - LEAD FREE
RN8-3	1/2" X 3" RED BRASS NIPPLE - LEAD FREE
RN8-35	1/2" X 3 1/2" RED BRASS NIPPLE - LEAD FREE
RN8-4	1/2" X 4" RED BRASS NIPPLE - LEAD FREE
RN8-45	1/2" X 4 1/2" RED BRASS NIPPLE - LEAD FREE
RN8-5	1/2" X 5" RED BRASS NIPPLE - LEAD FREE
RN8-55	1/2" X 5 1/2" RED BRASS NIPPLE - LEAD FREE
RN8-6	1/2" X 6" RED BRASS NIPPLE - LEAD FREE
RN8-7	1/2" X 7" RED BRASS NIPPLE - LEAD FREE
RN8-8	1/2" X 8" RED BRASS NIPPLE - LEAD FREE
RN8-9	1/2" X 9" RED BRASS NIPPLE - LEAD FREE

### 3/4" NIPPLES - LEAD FREE - MPT X MPT

<u>PART NUMBER</u>	<u>ITEM DESCRIPTION</u>
RN12	3/4" X CLOSE RED BRASS NIPPLE - LEAD FREE
RN12-10	3/4" X 10" RED BRASS NIPPLE - LEAD FREE
RN12-12	3/4" X 12" RED BRASS NIPPLE - LEAD FREE
RN12-15	3/4" X 1 1/2" RED BRASS NIPPLE - LEAD FREE
RN12-2	3/4" X 2" RED BRASS NIPPLE - LEAD FREE
RN12-24	3/4" X 24" RED BRASS NIPPLE - LEAD FREE
RN12-25	3/4" X 2 1/2" RED BRASS NIPPLE - LEAD FREE
RN12-3	3/4" X 3" RED BRASS NIPPLE - LEAD FREE
RN12-35	3/4" X 3 1/2" RED BRASS NIPPLE - LEAD FREE
RN12-36	3/4" X 36" RED BRASS NIPPLE - LEAD FREE
RN12-4	3/4" X 4" RED BRASS NIPPLE - LEAD FREE
RN12-45	3/4" X 4 1/2" RED BRASS NIPPLE - LEAD FREE
RN12-5	3/4" X 5" RED BRASS NIPPLE - LEAD FREE
RN12-55	3/4" X 5 1/2" RED BRASS NIPPLE - LEAD FREE
RN12-6	3/4" X 6" RED BRASS NIPPLE - LEAD FREE
RN12-7	3/4" X 7" RED BRASS NIPPLE - LEAD FREE
RN12-8	3/4" X 8" RED BRASS NIPPLE - LEAD FREE
RN12-9	3/4" X 9" RED BRASS NIPPLE - LEAD FREE

# PLUMBING SUPPLIES

Brass Pipe Fittings & Nipples

Brass Nipples



PRECISION  
INSTALLATION  
PRODUCTS

## 1" NIPPLES - LEAD FREE - MPT X MPT



<u>PART NUMBER</u>	<u>ITEM DESCRIPTION</u>
RN100	1" X CLOSE RED BRASS NIPPLE - LEAD FREE
RN101	1" X 2" RED BRASS NIPPLE - LEAD FREE
RN102	1" X 2 1/2" RED BRASS NIPPLE - LEAD FREE
RN103	1" X 3" RED BRASS NIPPLE - LEAD FREE
RN104	1" X 3 1/2" RED BRASS NIPPLE - LEAD FREE
RN105	1" X 4" RED BRASS NIPPLE - LEAD FREE
RN106	1" X 4 1/2" RED BRASS NIPPLE - LEAD FREE
RN107	1" X 5" RED BRASS NIPPLE - LEAD FREE
RN108	1" X 5 1/2" RED BRASS NIPPLE - LEAD FREE
RN109	1" X 6" RED BRASS NIPPLE - LEAD FREE

## 1-1/4" NIPPLES - LEAD FREE - MPT X MPT

<u>PART NUMBER</u>	<u>ITEM DESCRIPTION</u>
RN14-25	1 1/4" X 2 1/2" RED BRASS NIPPLE - LEAD FREE

## 1-1/2" NIPPLES - LEAD FREE - MPT X MPT

<u>PART NUMBER</u>	<u>ITEM DESCRIPTION</u>
RN180	1 1/2" X CLOSE RED BRASS NIPPLE - LEAD FREE
RN181	1 1/2" X 2" RED BRASS NIPPLE - LEAD FREE
RN182	1 1/2" X 2 1/2" RED BRASS NIPPLE - LEAD FREE
RN183	1 1/2" X 3" RED BRASS NIPPLE - LEAD FREE
RN184	1 1/2" X 4" RED BRASS NIPPLE - LEAD FREE

## 2" NIPPLES - LEAD FREE - MPT X MPT

<u>PART NUMBER</u>	<u>ITEM DESCRIPTION</u>
RN200	2" X CLOSE RED BRASS NIPPLE - LEAD FREE
RN202	2" X 2 1/2" RED BRASS NIPPLE - LEAD FREE
RN203	2" X 3" RED BRASS NIPPLE - LEAD FREE
RN204	2" X 3 1/2" RED BRASS NIPPLE - LEAD FREE



PRECISION  
INSTALLATION  
PRODUCTS



**END OF SECTION**

**THIS PAGE IS LEFT  
INTENTIONALLY BLANK.**



# PLUMBING SUPPLIES

## Brass Compression Fittings



PRECISION  
INSTALLATION  
PRODUCTS

### CAPS - COMP



<u>PART NUMBER</u>	<u>ITEM DESCRIPTION</u>
C5-4-LF	1/4" BRASS COMPRESSION CAP - LEAD FREE
C5-6-LF	3/8" BRASS COMPRESSION CAP - LEAD FREE
C5-8	1/2" BRASS COMPRESSION CAP
C5-8-LF	1/2" BRASS COMPRESSION CAP - LEAD FREE
C5-10	5/8" BRASS COMPRESSION CAP
C5-10-LF	5/8" BRASS COMPRESSION CAP - LEAD FREE

### BRASS SLEEVES (100 PACK)



<u>PART NUMBER</u>	<u>ITEM DESCRIPTION</u>
C60-02	1/8" BRASS COMPRESSION SLEEVE (PER 100)
C60-03	3/16" BRASS COMPRESSION SLEEVE (PER 100)
C60-04	1/4" BRASS COMPRESSION SLEEVE (PER 100)
C60-05	5/16" BRASS COMPRESSION SLEEVE (PER 100)
C60-06	3/8" BRASS COMPRESSION SLEEVE (PER 100)
C60-07	7/16" BRASS COMPRESSION SLEEVE (PER 100)
C60-08	1/2" BRASS COMPRESSION SLEEVE (PER 100)
C60-10	5/8" BRASS COMPRESSION SLEEVE (PER 100)
C60-12	3/4" BRASS COMPRESSION SLEEVE (PER 100)
C60-14	7/8" BRASS COMPRESSION SLEEVE (PER 100)

### PLASTIC DELRIN SLEEVES



<u>PART NUMBER</u>	<u>ITEM DESCRIPTION</u>
C60PT4	1/4" PLASTIC DELRIN SLEEVE (PER 100)
C60PT5	5/16" PLASTIC DELRIN SLEEVE (PER 100)
C60PT6	3/8" PLASTIC DELRIN SLEEVE (PER 100)
C60PT8	1/2" PLASTIC DELRIN SLEEVE (EACH)
C60PT10	5/8" PLASTIC DELRIN SLEEVES (EACH)



PRECISION  
INSTALLATION  
PRODUCTS

# PLUMBING SUPPLIES

## Brass Compression Fittings

### NUTS - COMP



<u>PART NUMBER</u>	<u>ITEM DESCRIPTION</u>
C61-02	1/8" BRASS COMPRESSION NUT
C61-03	3/16" BRASS COMPRESSION NUT
C61-04	1/4" BRASS COMPRESSION NUT
C61-05	5/16" BRASS COMPRESSION NUT
C61-06	3/8" BRASS COMPRESSION NUT
C61-07	7/16" BRASS COMPRESSION NUT
C61-08	1/2" BRASS COMPRESSION NUT
C61-10	5/8" BRASS COMPRESSION NUT
C61-12	3/4" BRASS COMPRESSION NUT
C61-14	7/8" BRASS COMPRESSION NUT

### UNIONS - COMP X COMP



<u>PART NUMBER</u>	<u>ITEM DESCRIPTION</u>
C62-02	1/8" COMPRESSION UNION
C62-03	3/16" COMPRESSION UNION
C62-04-LF	1/4" COMPRESSION UNION - LEAD FREE
C62-05-LF	5/16" COMPRESSION UNION - LEAD FREE
C62-06-LF	3/8" COMPRESSION UNION - LEAD FREE
C62-07	7/16" COMPRESSION UNION
C62-08	1/2" COMPRESSION UNION
C62-08-LF	1/2" COMPRESSION UNION - LEAD FREE
C62-10-LF	5/8" COMPRESSION UNION - LEAD FREE
C62-14	7/8" COMPRESSION UNION
C62-14-LF	7/8" COMPRESSION UNION - LEAD FREE

# PLUMBING SUPPLIES

Brass Compression Fittings



PRECISION  
INSTALLATION  
PRODUCTS

## REDUCING UNIONS - COMP X COMP



<u>PART NUMBER</u>	<u>ITEM DESCRIPTION</u>
C62R4-2	1/4" X 1/8" COMPRESSION REDUCING UNION
C62R4-3	1/4" X 3/16" COMPRESSION REDUCING UNION
C62R5-4	5/16" X 1/4" COMPRESSION REDUCING UNION
C62R6-4-LF	3/8" X 1/4" COMPRESSION REDUCING UNION - LEAD FREE
C62R6-5	3/8" X 5/16" COMPRESSION REDUCING UNION
C62R8-6-LF	1/2" X 3/8" COMPRESSION REDUCING UNION - LEAD FREE
C62R10-6	5/8" X 3/8" COMPRESSION REDUCING UNION
C62R10-6-LF	5/8" X 3/8" COMPRESSION REDUCING UNION - LEAD FREE
C62R10-8	5/8" X 1/2" COMPRESSION REDUCING UNION
C62R10-8-LF	5/8" X 1/2" COMPRESSION REDUCING UNION - LEAD FREE
C62-14-LF	7/8" COMPRESSION UNION - LEAD FREE

## BRASS INSERTS - LEADS FREE (100 PACK)



<u>PART NUMBER</u>	<u>ITEM DESCRIPTION</u>
C63PT4-LF	1/4" BRASS TUBE INSERTS - LEAD FREE (PER 100)
C63PT5-LF	5/16" BRASS TUBE INSERTS - LEAD FREE (PER 100)
C63PT6-LF	3/8" BRASS TUBE INSERTS - LEAD FREE (PER 100)
C63PT8-LF	1/2" BRASS TUBE INSERTS - LEAD FREE (PER 100)
C63PT10-LF	5/8" BRASS TUBE INSERTS - LEAD FREE (PER 100)

## PLASTIC TUBE INSERTS



<u>PART NUMBER</u>	<u>ITEM DESCRIPTION</u>
JIN-4	1/4" PLASTIC INSERT FOR TUBING-WHITE NYLON
JIN-6	3/8" PLASTIC INSERT FOR TUBING-WHITE NYLON
JIN-8	1/2" PLASTIC INSERT FOR TUBING-WHITE NYLON



PRECISION  
INSTALLATION  
PRODUCTS

# PLUMBING SUPPLIES

## Brass Compression Fittings

### TEES - COMP X COMP X COMP



<u>PART NUMBER</u>	<u>ITEM DESCRIPTION</u>
C64-2	1/8" BRASS COMPRESSION TEE
C64-3	3/16" BRASS COMPRESSION TEE
C64-4-LF	1/4" BRASS COMPRESSION TEE - LEAD FREE
C64-5	5/16" BRASS COMPRESSION TEE
C64-6-LF	3/8" BRASS COMPRESSION TEE - LEAD FREE
C64-8	1/2" BRASS COMPRESSION TEE
C64-8-LF	1/2" BRASS COMPRESSION TEE - LEAD FREE
C64-10	5/8" BRASS COMPRESSION TEE
C64-10-LF	5/8" BRASS COMPRESSION TEE - LEAD FREE
C64-14	7/8" BRASS COMPRESSION TEE

### REDUCING TEES - COMP X COMP X COMP



<u>PART NUMBER</u>	<u>ITEM DESCRIPTION</u>
C64R4-46	1/4" X 1/4" X 3/8" BRASS COMPRESSION REDUCING TEE
C64R6-44	3/8" X 1/4" X 1/4" BRASS COMPRESSION REDUCING TEE
C64R6-64-LF	3/8" X 3/8" X 1/4" BRASS COMPRESSION REDUCING TEE - LEAD FREE

### ELBOWS - COMP X COMP



<u>PART NUMBER</u>	<u>ITEM DESCRIPTION</u>
C65-4-LF	1/4" COMPRESSION ELBOW - LEAD FREE
C65-6	3/8" COMPRESSION ELBOW
C65-6-LF	3/8" COMPRESSION ELBOW - LEAD FREE
C65-8	1/2" COMPRESSION ELBOW
C65-8-LF	1/2" COMPRESSION ELBOW - LEAD FREE
C65-10-LF	5/8" COMPRESSION ELBOW - LEAD FREE
C65-12-LF	3/4" COMPRESSION ELBOW - LEAD FREE

# PLUMBING SUPPLIES

Brass Compression Fittings



PRECISION  
INSTALLATION  
PRODUCTS

## REDUCING ELBOWS - COMP X COMP



<u>PART NUMBER</u>	<u>ITEM DESCRIPTION</u>
C65R10-6-LF	5/8" COMPRESSION X 3/8" COMPRESSION REDUCING ELBOW - LEAD FREE
C65R10-8	5/8" COMPRESSION X 1/2" COMPRESSION REDUCING ELBOW
C65R6-4	3/8" COMPRESSION X 1/4" COMPRESSION REDUCING ELBOW



PRECISION  
INSTALLATION  
PRODUCTS

# PLUMBING SUPPLIES

## Brass Compression Fittings

### FEMALE ADAPTERS - COMP X FPT



<u>PART NUMBER</u>	<u>ITEM DESCRIPTION</u>
C66-2-2	1/8" COMPRESSION X 1/8" FPT UNION
C66-3-2	3/16" COMPRESSION X 1/8" FPT UNION
C66-3-4	3/16" COMPRESSION X 1/4" FPT UNION
C66-4-2	1/4" COMPRESSION X 1/8" FPT UNION
C66-4-2-LF	1/4" COMPRESSION X 1/8" FPT UNION - LEAD FREE
C66-4-4-LF	1/4" COMPRESSION X 1/4" FPT UNION - LEAD FREE
C66-4-6	1/4" COMPRESSION X 3/8" FPT UNION
C66-4-6-LF	1/4" COMPRESSION X 3/8" FPT UNION - LEAD FREE
C66-4-8	1/4" COMPRESSION X 1/2" FPT UNION
C66-4-8-LF	1/4" COMPRESSION X 1/2" FPT UNION - LEAD FREE
C66-5-2	5/16" COMPRESSION X 1/8" FPT UNION
C66-6-2	3/8 COMPRESSION X 1/8 FEMALE PIPE UNION
C66-6-2-LF	3/8 COMPRESSION X 1/8 FEMALE PIPE UNION - LEAD FREE
C66-6-4	3/8 COMPRESSION X 1/4 FEMALE PIPE UNION
C66-6-4-LF	3/8 COMPRESSION X 1/4 FEMALE PIPE UNION - LEAD FREE
C66-6-6-LF	3/8 COMPRESSION X 3/8 FEMALE PIPE UNION - LEAD FREE
C66-6-8	3/8 COMPRESSION X 1/2 FEMALE PIPE UNION
C66-6-8-LF	3/8 COMPRESSION X 1/2 FEMALE PIPE UNION - LEAD FREE
C66-8-12	1/2 COMPRESSION X 3/4 FEMALE PIPE UNION
C66-8-6	1/2 COMPRESSION X 3/8 FEMALE PIPE UNION
C66-8-6-LF	1/2 COMPRESSION X 3/8 FEMALE PIPE UNION - LEAD FREE
C66-8-8-LF	1/2 COMPRESSION X 1/2 FEMALE PIPE UNION - LEAD FREE
C66-10-12	5/8" COMPRESSION X 3/4" FPT UNION
C66-10-12-LF	5/8" COMPRESSION X 3/4" FPT UNION - LEAD FREE
C66-10-6-CO	5/8" COMPRESSION X 3/8" FPT UNION **CLOSEOUT**
C66-10-8	5/8" COMPRESSION X 1/2" FPT UNION
C66-10-8-LF	5/8" COMPRESSION X 1/2" FPT UNION - LEAD FREE
C66-14-12	7/8" COMPRESSION X 3/4" FPT UNION
C66-14-12-LF	7/8" COMPRESSION X 3/4" FPT UNION - LEAD FREE

# PLUMBING SUPPLIES

## Brass Compression Fittings



PRECISION  
INSTALLATION  
PRODUCTS

### MALE ADAPTERS - COMP X MPT



<u>PART NUMBER</u>	<u>ITEM DESCRIPTION</u>
C68-2-2	1/8 COMPRESSION X 1/8 MALE PIPE THREAD UNION
C68-3-2	3/16 COMPRESSION X 1/8 MALE PIPE THREAD UNION
C68-3-4	3/16 COMPRESSION X 1/4 MALE PIPE THREAD UNION
C68-4-2	1/4 COMPRESSION X 1/8 MALE PIPE THREAD UNION
C68-4-2-LF	1/4 COMPRESSION X 1/8 MALE PIPE THREAD UNION - LEAD FREE
C68-4-4-LF	1/4 COMPRESSION X 1/4 MALE PIPE THREAD UNION - LEAD FREE
C68-4-6-LF	1/4" COMPRESSION X 3/8" MALE PIPE THREAD BRASS UNION - LEAD FREE
C68-4-8-LF	1/4 COMPRESSION X 1/2 MALE PIPE THREAD UNION - LEAD FREE
C68-5-4	5/16 COMPRESSION X 1/4 MALE PIPE THREAD UNION
C68-5-4-LF	5/16 COMPRESSION X 1/4 MALE PIPE THREAD UNION -LEAD FREE
C68-6-12-LF	3/8 COMPRESSION X 3/4 MALE PIPE THREAD UNION - LEAD FREE
C68-6-2	3/8 COMPRESSION X 1/8 MALE PIPE THREAD UNION
C68-6-2-LF	3/8 COMPRESSION X 1/8 MALE PIPE THREAD UNION - LEAD FREE
C68-6-4-LF	3/8" COMPRESSION X 1/4" MALE PIPE THREAD BRASS UNION - LEAD FREE
C68-6-6-LF	3/8 COMPRESSION X 3/8 MALE PIPE THREAD UNION - LEAD FREE
C68-6-8-LF	3/8 COMPRESSION X 1/2 MALE PIPE THREAD UNION - LEAD FREE
C68-7-4	7/16 COMPRESSION X 1/4 MALE PIPE THREAD UNION
C68-7-6	7/16 COMPRESSION X 3/8 MALE PIPE THREAD UNION
C68-8-12-LF	1/2 COMPRESSION X 3/4 MALE PIPE THREAD UNION - LEAD FREE
C68-8-4	1/2 COMPRESSION X 1/4 MALE PIPE THREAD UNION
C68-8-4-LF	1/2 COMPRESSION X 1/4 MALE PIPE THREAD UNION - LEAD FREE
C68-8-6	1/2 COMPRESSION X 3/8 MALE PIPE THREAD UNION
C68-8-6-LF	1/2 COMPRESSION X 3/8 MALE PIPE THREAD UNION - LEAD FREE
C68-8-8	1/2 COMPRESSION X 1/2 MALE PIPE THREAD UNION
C68-8-8-LF	1/2 COMPRESSION X 1/2 MALE PIPE THREAD UNION - LEAD FREE
C68-10-12	5/8 COMPRESSION X 3/4 MALE PIPE THREAD UNION
C68-10-12-LF	5/8 COMPRESSION X 3/4 MALE PIPE THREAD UNION - LEAD FREE
C68-10-6	5/8 COMPRESSION X 3/8 MALE PIPE THREAD UNION
C68-10-6-LF	5/8 COMPRESSION X 3/8 MALE PIPE THREAD UNION - LEAD FREE
C68-10-8	5/8 COMPRESSION X 1/2 MALE PIPE THREAD UNION
C68-10-8-LF	5/8 COMPRESSION X 1/2 MALE PIPE THREAD UNION - LEAD FREE
C68-14-12-LF	7/8 COMPRESSION X 3/4 MALE PIPE THREAD UNION - LEAD FREE
C68-14-8	7/8 COMPRESSION X 1/2 MALE PIPE THREAD UNION



PRECISION  
INSTALLATION  
PRODUCTS

# PLUMBING SUPPLIES

## Brass Compression Fittings

### MALE ELBOWS - COMP X MPT



<u>PART NUMBER</u>	<u>ITEM DESCRIPTION</u>
C69-4-2-LF	1/4 COMPRESSION X 1/8 MALE PIPE THREAD ELBOW - LEAD FREE
C69-4-4-LF	1/4 COMPRESSION X 1/4 MALE PIPE THREAD ELBOW - LEAD FREE
C69-4-6-LF	1/4 COMPRESSION X 3/8 MALE PIPE THREAD ELBOW - LEAD FREE
C69-4-8	1/4 COMPRESSION X 1/2 MALE PIPE THREAD ELBOW
C69-5-4	5/16 COMPRESSION X 1/4 MALE PIPE THREAD ELBOW
C69-5-6	5/16 COMPRESSION X 3/8 MALE PIPE THREAD ELBOW
C69-6-2	3/8 COMPRESSION X 1/8 MALE PIPE THREAD ELBOW
C69-6-2-LF	3/8 COMPRESSION X 1/8 MALE PIPE THREAD ELBOW - LEAD FREE
C69-6-4-LF	3/8" COMPRESSION X 1/4" MALE PIPE THREAD BRASS ELBOW - LEAD FREE
C69-6-6	3/8 COMPRESSION X 3/8 MALE PIPE THREAD ELBOW
C69-6-6-LF	3/8 COMPRESSION X 3/8 MALE PIPE THREAD ELBOW - LEAD FREE
C69-6-6 BODY	3/8 COMPRESSION X 3/8 MALE PIPE THREAD ELBOW--BODY ONLY
C69-6-8	3/8 COMPRESSION X 1/2 MALE PIPE THREAD ELBOW
C69-6-8-LF	3/8 COMPRESSION X 1/2 MALE PIPE THREAD ELBOW - LEAD FREE
C69-7-4	7/16 COMPRESSION X 1/4 MALE PIPE THREAD ELBOW
C69-7-6	7/16 COMPRESSION X 3/8 MALE PIPE THREAD ELBOW
C69-8-12	1/2 COMPRESSION X 3/4 MALE PIPE THREAD ELBOW
C69-8-4	1/2 COMPRESSION X 1/4 MALE PIPE THREAD ELBOW
C69-8-6	1/2 COMPRESSION X 3/8 MALE PIPE THREAD ELBOW
C69-8-6-LF	1/2 COMPRESSION X 3/8 MALE PIPE THREAD ELBOW - LEAD FREE
C69-8-8	1/2 COMPRESSION X 1/2 MALE PIPE THREAD ELBOW
C69-8-8-LF	1/2 COMPRESSION X 1/2 MALE PIPE THREAD ELBOW - LEAD FREE
C69-10-12	5/8 COMPRESSION X 3/4 MALE PIPE THREAD ELBOW
C69-10-12-LF	5/8 COMPRESSION X 3/4 MALE PIPE THREAD ELBOW - LEAD FREE
C69-10-6	5/8 COMPRESSION X 3/8 MALE PIPE THREAD ELBOW
C69-10-6-LF	5/8 COMPRESSION X 3/8 MALE PIPE THREAD ELBOW - LEAD FREE
C69-10-8	5/8 COMPRESSION X 1/2 MALE PIPE THREAD ELBOW
C69-10-8-LF	5/8 COMPRESSION X 1/2 MALE PIPE THREAD ELBOW - LEAD FREE
C69-14-12	7/8 COMPRESSION X 3/4 MALE PIPE THREAD ELBOW



# PLUMBING SUPPLIES

Brass Compression Fittings



PRECISION  
INSTALLATION  
PRODUCTS

## FEMALE ELBOWS - COMP X COMP



<u>PART NUMBER</u>	<u>ITEM DESCRIPTION</u>
C70-4-2-LF	1/4 COMPRESSION X 1/8 FEMALE PIPE THREAD ELBOW - LEAD FREE
C70-4-4-LF	1/4 COMPRESSION X 1/4 FEMALE PIPE THREAD ELBOW - LEAD FREE
C70-6-2	3/8 COMPRESSION X 1/8 FEMALE PIPE THREAD ELBOW
C70-6-2-LF	3/8 COMPRESSION X 1/8 FEMALE PIPE THREAD ELBOW - LEAD FREE
C70-6-4-LF	3/8 COMPRESSION X 1/4 FEMALE PIPE THREAD ELBOW - LEAD FREE
C70-6-6	3/8 COMPRESSION X 3/8 FEMALE PIPE THREAD ELBOW
C70-6-6-LF	3/8 COMPRESSION X 3/8 FEMALE PIPE THREAD ELBOW - LEAD FREE
C70-6-8	3/8 COMPRESSION X 1/2 FEMALE PIPE THREAD ELBOW
C70-6-8-LF	3/8 COMPRESSION X 1/2 FEMALE PIPE THREAD ELBOW - LEAD FREE
C70-8-6	1/2 COMPRESSION X 3/8 FEMALE PIPE THREAD ELBOW
C70-8-8	1/2 COMPRESSION X 1/2 FEMALE PIPE THREAD ELBOW
C70-10-8	5/8 COMPRESSION X 1/2 FEMALE PIPE THREAD ELBOW
C70-10-8-LF	5/8 COMPRESSION X 1/2 FEMALE PIPE THREAD ELBOW - LEAD FREE

## MALE RUN TEES - COMP X MPT X COMP



<u>PART NUMBER</u>	<u>ITEM DESCRIPTION</u>
C71-4-2	1/4 COMPRESSION X 1/8 MALE PIPE X 1/4 COMP RUN TEE
C71-4-4-LF	1/4 COMP X 1/4 MALE PIPE X 1/4 COMP RUN TEE - LEAD FREE
C71-6-4	3/8 COMP X 1/4 MALE PIPE X 3/8 COMP RUN TEE

## MALE BRANCH TEE - COMP X COMP X MPT



<u>PART NUMBER</u>	<u>ITEM DESCRIPTION</u>
C72-4-2	1/4 COMP X 1/4 COMP X 1/8 MALE PIPE BRANCH TEE
C72-4-2-LF	1/4 COMP X 1/4 COMP X 1/8 MALE PIPE BRANCH TEE - LEAD FREE
C72-4-4-LF	1/4 COMP X 1/4 COMP X 1/4 MALE PIPE BRANCH TEE - LEAD FREE
C72-6-4	3/8 COMP X 3/8 COMP X 1/4 MALE PIPE BRANCH TEE
C72-8-4	1/2 COMP X 1/2 COMP X 1/4 MALE PIPE BRANCH TEE
C72-8-6	1/2 COMP X 1/2 COMP X 3/8 MALE PIPE BRANCH TEE
C72-8-8	1/2 COMP X 1/2 COMP X 1/2 MALE PIPE BRANCH TEE
C72-8-8-LF	1/2 COMP X 1/2 COMP X 1/2 MALE PIPE BRANCH TEE - LEAD FREE
C72-10-8	5/8 COMP X 5/8 COMP X 1/2 MALE PIPE BRANCH TEE



PRECISION  
INSTALLATION  
PRODUCTS

# PLUMBING SUPPLIES

Brass Compression Fittings

## NYLON COMPRESSION BALLS



<u>PART NUMBER</u>	<u>ITEM DESCRIPTION</u>
N9613-4	1/4" NYLON COMPRESSION BALLS (PK100)
N9613-6	3/8" NYLON COMPRESSION BALLS (PK50)
N9623-8	1/2" NYLON COMPRESSION BALLS (PK10)

## BRASS SLIP JOINT ADAPTER WITH 1/8" TAP



<u>PART NUMBER</u>	<u>ITEM DESCRIPTION</u>
C308	3/4" BRASS HOSE THREAD ADAPTER W/ 1/8" TAP
C309-08-LF	1/2" IPS BRASS ADAPTER W/ 1/8" TAP - LEAD FREE
C309-12-LF	3/4" IPS BRASS ADAPTER W/ 1/8" TAP - LEAD FREE

## CHROME SLIP JOINT ADAPTER & WASHERS



<u>PART NUMBER</u>	<u>ITEM DESCRIPTION</u>
IC309S	1/2" IPS CHROME SLIP JOINT ADAPTER W/ 1/8" TAP & WASHER
IC309S-4	1/2" IPS CHROME SLIP JOINT ADAPTER W/ 1/4" TAP & WASHER

## SLIP JOINT WASHER



<u>PART NUMBER</u>	<u>ITEM DESCRIPTION</u>
C309SW	1/2" IPS SLIP JOINT WASHER

# PLUMBING SUPPLIES

Brass Compression Fittings



PRECISION  
INSTALLATION  
PRODUCTS

## FEMALE HOSE ADAPTER WITH 1/8" TAP



<u>PART NUMBER</u>	<u>ITEM DESCRIPTION</u>
C310-08	1/2" HOSE ADAPTER WITH 1/8" TAP
C310-12-LF	3/4" HOSE ADAPTER WITH 1/8" TAP - LEAD FREE

## HOSE ADAPTERS - FGH X COMP



<u>PART NUMBER</u>	<u>ITEM DESCRIPTION</u>
C310-62-LF	3/4" FEMALE HOSE CAP X 1/4" COMPRESSION STRAIGHT FITTING - LEAD FREE
C310-66-LF	3/4" FEMALE HOSE CAP X 3/8" COMPRESSION STRAIGHT FITTING - LEAD FREE

## ICEMAKER FITTINGS - COMP X FEM FLARE

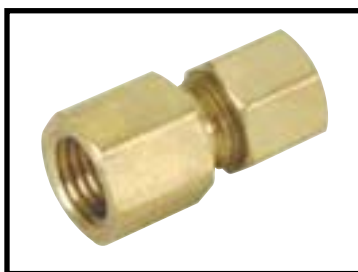

<u>PART NUMBER</u>	<u>ITEM DESCRIPTION</u>
CF4-6-LF	BRASS 1/4" FEMALE FLARE X 3/8" MALE COMPRESSION FITTING - LEAD FREE
CF4-LF	BRASS 1/4" MALE COMPRESSION X 1/4" FEMALE FLARE - LEAD FREE



PRECISION  
INSTALLATION  
PRODUCTS



**END OF SECTION**

**THIS PAGE IS LEFT  
INTENTIONALLY BLANK.**

# PLUMBING SUPPLIES

Brass Flare Fittings & Hose Barbs

Hose Barbs



PRECISION  
INSTALLATION  
PRODUCTS

## MALE HOSE ADAPTER - BARB X MPT



<u>PART NUMBER</u>	<u>ITEM DESCRIPTION</u>
F29-2-2	1/8" HOSE BARB X 1/8" MALE PIPE THREAD
F29-3-2	3/16" HOSE BARB X 1/8" MALE PIPE THREAD
F29-4-2	1/4" HOSE BARB X 1/8" MALE PIPE THREAD
F29-4-2-LF	1/4" HOSE BARB X 1/8" MALE PIPE THREAD - LEAD FREE
F29-4-4-LF	1/4" HOSE BARB X 1/4" MALE PIPE THREAD - LEAD FREE
F29-4-6-LF	1/4" HOSE BARB X 3/8" MALE PIPE THREAD - LEAD FREE
F29-4-8-LF	1/4" HOSE BARB X 1/2" MALE PIPE THREAD - LEAD FREE
F29-5-4	5/16" HOSE BARB X 1/4" MALE PIPE THREAD
F29-5-4-LF	5/16" HOSE BARB X 1/4" MALE PIPE THREAD - LEAD FREE
F29-5-6	5/16" HOSE BARB X 3/8" MALE PIPE THREAD
F29-5-6-LF	5/16" HOSE BARB X 3/8" MALE PIPE THREAD - LEAD FREE
F29-6-12	3/8" HOSE BARB X 3/4" MALE PIPE THREAD
F29-6-12-LF	3/8" HOSE BARB X 3/4" MALE PIPE THREAD - LEAD FREE
F29-6-2	3/8" HOSE BARB X 1/8" MALE PIPE THREAD
F29-6-2-LF	3/8" HOSE BARB X 1/8" MALE PIPE THREAD - LEAD FREE
F29-6-4	3/8" HOSE BARB X 1/4" MALE PIPE THREAD
F29-6-4-LF	3/8" HOSE BARB X 1/4" MALE PIPE THREAD - LEAD FREE
F29-6-6-LF	3/8" HOSE BARB X 3/8" MALE PIPE THREAD - LEAD FREE
F29-6-8	3/8" HOSE BARB X 1/2" MALE PIPE THREAD
F29-6-8-LF	3/8" HOSE BARB X 1/2" MALE PIPE THREAD - LEAD FREE
F29-8-12	1/2" HOSE BARB X 3/4" MALE PIPE THREAD
F29-8-12-LF	1/2" HOSE BARB X 3/4" MALE PIPE THREAD - LEAD FREE
F29-8-4	1/2" HOSE BARB X 1/4" MALE PIPE THREAD
F29-8-4-LF	1/2" HOSE BARB X 1/4" MALE PIPE THREAD - LEAD FREE
F29-8-6	1/2" HOSE BARB X 3/8" MALE PIPE THREAD
F29-8-6-LF	1/2" HOSE BARB X 3/8" MALE PIPE THREAD - LEAD FREE
F29-8-8	1/2" HOSE BARB X 1/2" MALE PIPE THREAD
F29-8-8-LF	1/2" HOSE BARB X 1/2" MALE PIPE THREAD - LEAD FREE
F29-10-12	5/8" HOSE BARB X 3/4" MALE PIPE THREAD
F29-10-6	5/8" HOSE BARB X 3/8" MALE PIPE THREAD
F29-10-6-LF	5/8" HOSE BARB X 3/8" MALE PIPE THREAD - LEAD FREE
F29-10-8-LF	5/8" HOSE BARB X 1/2" MALE PIPE THREAD - LEAD FREE
F29-12-12-LF	3/4" HOSE BARB X 3/4" MALE PIPE THREAD - LEAD FREE
F29-12-6	3/4" HOSE BARB X 3/8" MALE PIPE THREAD
F29-12-6-LF	3/4" HOSE BARB X 3/8" MALE PIPE THREAD - LEAD FREE
F29-12-8-LF	3/4" HOSE BARB X 1/2" MALE PIPE THREAD - LEAD FREE
F29-16-16-LF	1" HOSE BARB X 1" MALE PIPE THREAD - LEAD FREE



PRECISION  
INSTALLATION  
PRODUCTS

# PLUMBING SUPPLIES

Brass Flare Fittings & Hose Barbs

Hose Barbs

## MALE HOSE ADAPTER - BALL SEAT X MPT



<u>PART NUMBER</u>	<u>ITEM DESCRIPTION</u>
F292-6-6	3/8" BALL SEAT X 3/8" MALE PIPE THREAD

## MALE 90 DEGREE HOSE ELBOWS - BARB X MPT



<u>PART NUMBER</u>	<u>ITEM DESCRIPTION</u>
F29E10-6	5/8" BARB X 3/8" MPT 90° ELBOW
F29E10-8-LF	5/8" BARB X 1/2 MALE PIPE THREAD 90 DEGREE ELBOW - LEAD FREE
F29E12-8	3/4 BARB X 1/2 MALE PIPE THREAD 90 DEGREE ELBOW
F29E4-2	1/4 BARB X 1/8 MALE PIPE THREAD 90 DEGREE ELBOW
F29E4-2-LF	1/4 BARB X 1/8 MALE PIPE THREAD 90 DEGREE ELBOW - LEAD FREE
F29E4-4-LF	1/4 BARB X 1/4 MALE PIPE THREAD 90 DEGREE ELBOW - LEAD FREE
F29E4-6-LF	1/4 BARB X 3/8 MALE PIPE THREAD 90 DEGREE ELBOW - LEAD FREE
F29E6-4	3/8 BARB X 1/4 MALE PIPE THREAD 90 DEGREE ELBOW
F29E6-4-LF	3/8 BARB X 1/4 MALE PIPE THREAD 90 DEGREE ELBOW - LEAD FREE
F29E6-6	3/8 BARB X 3/8 MALE PIPE THREAD 90 DEGREE ELBOW
F29E6-6-LF	3/8 BARB X 3/8 MALE PIPE THREAD 90 DEGREE ELBOW - LEAD FREE
F29E6-8	3/8 BARB X 1/2 MALE PIPE THREAD 90 DEGREE ELBOW
F29E8-4	1/2 BARB X 1/4 MALE PIPE THREAD 90 DEGREE ELBOW
F29E8-6	1/2 BARB X 3/8 MALE PIPE THREAD 90 DEGREE ELBOW
F29E8-6-LF	1/2 BARB X 3/8 MALE PIPE THREAD 90 DEGREE ELBOW - LEAD FREE
F29E8-8	1/2 BARB X 1/2 MALE PIPE THREAD 90 DEGREE ELBOW
F29E8-8-LF	1/2 BARB X 1/2 MALE PIPE THREAD 90 DEGREE ELBOW - LEAD FREE

# PLUMBING SUPPLIES

Brass Flare Fittings & Hose Barbs

Hose Barbs



PRECISION  
INSTALLATION  
PRODUCTS

## FEMALE HOSE ADAPTER - BARB X FPT



<u>PART NUMBER</u>	<u>ITEM DESCRIPTION</u>
F29F-2-2	1/8" HOSE BARB X 1/8" FEMALE PIPE THREAD
F29F-4-2	1/4" HOSE BARB X 1/8" FEMALE PIPE THREAD
F29F-4-4	1/4" HOSE BARB X 1/4" FEMALE PIPE THREAD
F29F-4-4-LF	1/4" HOSE BARB X 1/4" FEMALE PIPE THREAD - LEAD FREE
F29F-4-6	1/4" HOSE BARB X 3/8" FEMALE PIPE THREAD
F29F-6-4	3/8" HOSE BARB X 1/4" FEMALE PIPE THREAD
F29F-6-6	3/8" HOSE BARB X 3/8" FEMALE PIPE THREAD
F29F-6-8	3/8" HOSE BARB X 1/2" FEMALE PIPE THREAD
F29F-8-4-LF	1/2" HOSE BARB X 1/4" FEMALE PIPE THREAD - LEAD FREE
F29F-8-6	1/2" HOSE BARB X 3/8" FEMALE PIPE THREAD
F29F-8-6-LF	1/2" HOSE BARB X 3/8" FEMALE PIPE THREAD - LEAD FREE
F29F-8-8	1/2" HOSE BARB X 1/2" FEMALE PIPE THREAD

## FHG HOSE ADAPTER - BARB X FGH (SWIVEL)



<u>PART NUMBER</u>	<u>ITEM DESCRIPTION</u>
F29FGH-8-12	1/2" HOSE BARB X 3/4" FEMALE SWIVEL HOSE
F29FGH-8-12-LF	1/2" HOSE BARB X 3/4" FEMALE SWIVEL HOSE - LEAD FREE

## MGH ADAPTER - BARB X MGH (SWIVEL)



<u>PART NUMBER</u>	<u>ITEM DESCRIPTION</u>
F29FGH-8-12	1/2" HOSE BARB X 3/4" FEMALE SWIVEL HOSE
F29FGH-8-12-LF	1/2" HOSE BARB X 3/4" FEMALE SWIVEL HOSE - LEAD FREE



PRECISION  
INSTALLATION  
PRODUCTS

# PLUMBING SUPPLIES

Brass Flare Fittings & Hose Barbs

Hose Barbs

## FEMALE FLARE HOSE ADAPTER - BARB X FEM FLARE (SWIVEL)



<u>PART NUMBER</u>	<u>ITEM DESCRIPTION</u>
F29SAE-4-4-LF	1/4" HOSE BARB X 1/4" FEMALE FLARE SWIVEL - LEAD FREE
F29SAE-4-6-LF	1/4" HOSE BARB X 3/8" FEMALE FLARE SWIVEL - LEAD FREE
F29SAE-6-6-LF	3/8" HOSE BARB X 3/8" FEMALE FLARE SWIVEL - LEAD FREE

## HOSE SPLICER - BARB X BARB



<u>PART NUMBER</u>	<u>ITEM DESCRIPTION</u>
F29SP-4	1/4" BRASS HOSE BARB SPLICER
F29SP-4-LF	1/4" BRASS HOSE BARB SPLICER - LEAD FREE
F29SP-6	3/8" BRASS HOSE BARB SPLICER
F29SP-6-LF	3/8" BRASS HOSE BARB SPLICER - LEAD FREE
F29SP-8	1/2" BRASS HOSE BARB SPLICER
F29SP-8-LF	1/2" BRASS HOSE BARB SPLICER - LEAD FREE
F29SP-10-LF	5/8" BRASS HOSE BARB SPLICER - LEAD FREE

## HOSE CONNECTOR - BARB X TUBE



<u>PART NUMBER</u>	<u>ITEM DESCRIPTION</u>
F29ST-4	1/4" BRASS HOSE BARB X 1/4" TUBE
F29ST-6	3/8" BRASS HOSE BARB X 3/8" TUBE

## HOSE TEES - BARB X BARB X BARB



<u>PART NUMBER</u>	<u>ITEM DESCRIPTION</u>
F29T-4-LF	1/4" BRASS HOSE BARB TEE - LEAD FREE
F29T-6	3/8" BRASS HOSE BARB TEE
F29T-6-LF	3/8" BRASS HOSE BARB TEE - LEAD FREE



# PLUMBING SUPPLIES

Brass Flare Fittings & Hose Barbs

Flare Fittings



PRECISION  
INSTALLATION  
PRODUCTS

## FLARE NUT - SHORT



<u>PART NUMBER</u>	<u>ITEM DESCRIPTION</u>
F41S-3	3/16" BRASS SHORT FLARE NUT
F41S-4	1/4" BRASS SHORT FLARE NUT
F41S-5	5/16" BRASS SHORT FLARE NUT
F41S-6	3/8" BRASS SHORT FLARE NUT
F41S-8	1/2" BRASS SHORT FLARE NUT
F41S-10	5/8" BRASS SHORT FLARE NUT

## UNIONS - FLARE X FLARE



<u>PART NUMBER</u>	<u>ITEM DESCRIPTION</u>
F42-4	1/4" BRASS FLARE UNION
F42-4-LF	1/4" BRASS FLARE UNION - LEAD FREE
F42-6-LF	3/8" BRASS FLARE UNION - LEAD FREE
F42-8-LF	1/2" BRASS FLARE UNION - LEAD FREE
F42-10	5/8" BRASS FLARE UNION

## REDUCING UNIONS - FLARE X FLARE



<u>PART NUMBER</u>	<u>ITEM DESCRIPTION</u>
F42R6-4-LF	3/8" X 1/4" BRASS REDUCING FLARE UNION - LEAD FREE
F42R8-6-LF	1/2" X 3/8" BRASS REDUCING FLARE UNION - LEAD FREE
F42R10-6	5/8" X 3/8" BRASS REDUCING FLARE UNION
F42R10-8	5/8" X 1/2" BRASS REDUCING FLARE UNION



PRECISION  
INSTALLATION  
PRODUCTS

# PLUMBING SUPPLIES

Brass Flare Fittings & Hose Barbs

Flare Fittings

## PLUGS - FLARE



<u>PART NUMBER</u>	<u>ITEM DESCRIPTION</u>
F439-4	1/4" BRASS FLARE PLUG
F439-6	3/8" BRASS FLARE PLUG
F439-8	1/2" BRASS FLARE PLUG
F439-10	5/8" BRASS FLARE PLUG

## TEES - FLARE X FLARE X FLARE



<u>PART NUMBER</u>	<u>ITEM DESCRIPTION</u>
F44-4-LF	1/4" BRASS FLARE TEE - LEAD FREE
F44-6	3/8" BRASS FLARE TEE
F44-8	1/2" BRASS FLARE TEE
F44-10	5/8" BRASS FLARE TEE

## REDUCING TEES - FLARE X FLARE X FLARE



<u>PART NUMBER</u>	<u>ITEM DESCRIPTION</u>
F44R44-6	1/4" X 1/4" X 3/8" BRASS REDUCING FLARE TEE
F44R46-4	1/4" X 3/8" X 1/4" BRASS REDUCING FLARE TEE
F44R64-6	3/8" X 1/4" X 3/8" BRASS REDUCING FLARE TEE
F44R66-4	3/8" X 3/8" X 1/4" BRASS REDUCING FLARE TEE
F44R66-8	3/8" X 3/8" X 1/2" BRASS REDUCING FLARE TEE
F44R86-6	1/2" X 3/8" X 3/8" BRASS REDUCING FLARE TEE
F44R88-6	1/2" X 1/2" X 3/8" BRASS REDUCING FLARE TEE

# PLUMBING SUPPLIES

Brass Flare Fittings & Hose Barbs



PRECISION  
INSTALLATION  
PRODUCTS

## Flare Fittings

### MALE BRANCH TEES - FLARE X FLARE X MPT



<u>PART NUMBER</u>	<u>ITEM DESCRIPTION</u>
F45-4-4	1/4" FLARE X 1/4" FLARE X 1/4" MALE PIPE THREAD TEE
F45-4-4-LF	1/4" FLARE X 1/4" FLARE X 1/4" MALE PIPE THREAD TEE - LEAD FREE
F45-4-6-LF	1/4" FLARE X 1/4" FLARE X 3/8" MALE PIPE THREAD TEE - LEAD FREE
F45-6-4	3/8" FLARE X 3/8" FLARE X 1/4" MALE PIPE THREAD TEE
F45-6-4-LF	3/8" FLARE X 3/8" FLARE X 1/4" MALE PIPE THREAD TEE - LEAD FREE
F45-6-6	3/8" FLARE X 3/8" FLARE X 3/8" MALE PIPE THREAD TEE
F45-6-8	3/8" FLARE X 3/8" FLARE X 1/2" MALE PIPE THREAD TEE

### FEMALE ADAPTERS - FLARE X FPT



<u>PART NUMBER</u>	<u>ITEM DESCRIPTION</u>
F46-4-2	1/4" FLARE X 1/8" FEMALE PIPE THREAD BRASS UNION
F46-4-2-LF	1/4" FLARE X 1/8" FEMALE PIPE THREAD BRASS UNION - LEAD FREE
F46-4-4	1/4" FLARE X 1/4" FEMALE PIPE THREAD BRASS UNION
F46-4-6	1/4" FLARE X 3/8" FEMALE PIPE THREAD BRASS UNION
F46-4-8	1/4" FLARE X 1/2" FEMALE PIPE THREAD BRASS UNION
F46-6-12	3/8" FLARE X 3/4" FEMALE PIPE THREAD BRASS UNION
F46-6-2	3/8" FLARE X 1/8" FEMALE PIPE THREAD BRASS UNION
F46-6-4	3/8" FLARE X 1/4" FEMALE PIPE THREAD BRASS UNION
F46-6-6	3/8" FLARE X 3/8" FEMALE PIPE THREAD BRASS UNION
F46-6-6-LF	3/8" FLARE X 3/8" FEMALE PIPE THREAD BRASS UNION - LEAD FREE
F46-6-8-LF	3/8" FLARE X 1/2" FEMALE PIPE THREAD BRASS UNION - LEAD FREE
F46-8-12	1/2" FLARE X 3/4" FEMALE PIPE THREAD BRASS UNION
F46-8-6	1/2" FLARE X 3/8" FEMALE PIPE THREAD BRASS UNION
F46-8-8	1/2" FLARE X 1/2" FEMALE PIPE THREAD BRASS UNION
F46-10-12	5/8" FLARE X 3/4" FEMALE PIPE THREAD BRASS UNION
F46-10-8	5/8" FLARE X 1/2" FEMALE PIPE THREAD BRASS UNION



PRECISION  
INSTALLATION  
PRODUCTS

# PLUMBING SUPPLIES

Brass Flare Fittings & Hose Barbs

Flare Fittings

## MALE ADAPTERS - FLARE X MPT



<u>PART NUMBER</u>	<u>ITEM DESCRIPTION</u>
F48-3-2	3/16" FLARE X 1/8" MALE PIPE THREAD UNION
F48-4-2	1/4" FLARE X 1/8" MALE PIPE THREAD UNION
F48-4-2-LF	1/4" FLARE X 1/8" MALE PIPE THREAD UNION - LEAD FREE
F48-4-4-LF	1/4" FLARE X 1/4" MALE PIPE THREAD UNION - LEAD FREE
F48-4-6-LF	1/4" FLARE X 3/8" MALE PIPE THREAD BRASS UNION - LEAD FREE
F48-4-8	1/4" FLARE X 1/2" MALE PIPE THREAD UNION
F48-4-8-LF	1/4" FLARE X 1/2" MALE PIPE THREAD UNION - LEAD FREE
F48-6-12	3/8" FLARE X 3/4" MALE PIPE THREAD UNION
F48-6-2	3/8" FLARE X 1/8" MALE PIPE THREAD UNION
F48-6-4	3/8" FLARE X 1/4" MALE PIPE THREAD UNION
F48-6-4-LF	3/8" FLARE X 1/4" MALE PIPE THREAD UNION - LEAD FREE
F48-6-6-LF	3/8" FLARE X 3/8" MALE PIPE THREAD UNION - LEAD FREE
F48-6-8-LF	3/8" FLARE X 1/2" MALE PIPE THREAD UNION - LEAD FREE
F48-8-12	1/2" FLARE X 3/4" MALE PIPE THREAD UNION
F48-8-4	1/2" FLARE X 1/4" MPT BRASS UNION
F48-8-6	1/2" FLARE X 3/8" MALE PIPE THREAD UNION
F48-8-6-LF	1/2" FLARE X 3/8" MALE PIPE THREAD UNION - LEAD FREE
F48-8-8-LF	1/2" FLARE X 1/2" MALE PIPE THREAD UNION - LEAD FREE
F48-10-12	5/8" FLARE X 3/4" MALE PIPE THREAD UNION
F48-10-6	5/8" FLARE X 3/8" MALE PIPE THREAD UNION
F48-10-8	5/8" FLARE X 1/2" MALE PIPE THREAD UNION
F48-12-8	3/4" FLARE X 1/2" MALE PIPE THREAD UNION

# PLUMBING SUPPLIES

Brass Flare Fittings & Hose Barbs



PRECISION  
INSTALLATION  
PRODUCTS

## Flare Fittings

### MALE 90 DEGREE ELBOWS - FLARE X MPT



<u>PART NUMBER</u>	<u>ITEM DESCRIPTION</u>
F49-3-2	3/16" FLARE X 1/8" MALE PIPE THREAD 90 DEGREE ELBOW
F49-4-2-LF	1/4" FLARE X 1/8" MALE PIPE THREAD 90 DEGREE ELBOW - LEAD FREE
F49-4-4-LF	1/4" FLARE X 1/4" MALE PIPE THREAD 90 DEGREE ELBOW - LEAD FREE
F49-4-6-LF	1/4" FLARE X 3/8" MALE PIPE THREAD 90 DEGREE ELBOW - LEAD FREE
F49-4-8	1/4" FLARE X 1/2" MALE PIPE THREAD 90 DEGREE ELBOW
F49-6-12	3/8" FLARE X 3/4" MALE PIPE THREAD 90 DEGREE ELBOW
F49-6-2	3/8" FLARE X 1/8" MALE PIPE THREAD 90 DEGREE ELBOW
F49-6-4	3/8" FLARE X 1/4" MALE PIPE THREAD 90 DEGREE ELBOW
F49-6-6-LF	3/8" FLARE X 3/8" MALE PIPE THREAD 90 DEGREE ELBOW - LEAD FREE
F49-6-8	3/8" FLARE X 1/2" MALE PIPE THREAD 90 DEGREE ELBOW
F49-6-8-LF	3/8" FLARE X 1/2" MALE PIPE THREAD 90 DEGREE ELBOW - LEAD FREE
F49-8-12	1/2" FLARE X 3/4" MALE PIPE THREAD 90 DEGREE ELBOW
F49-8-4	1/2" FLARE X 1/4" MALE PIPE THREAD 90 DEGREE ELBOW
F49-8-6	1/2" FLARE X 3/8" MALE PIPE THREAD 90 DEGREE ELBOW
F49-8-8	1/2" FLARE X 1/2" MALE PIPE THREAD 90 DEGREE ELBOW
F49-10-12	5/8" FLARE X 3/4" MALE PIPE THREAD 90 DEGREE ELBOW
F49-10-8	5/8" FLARE X 1/2" MALE PIPE THREAD 90 DEGREE ELBOW

### FEMALE 90 DEGREE ELBOWS - FLARE X MPT



<u>PART NUMBER</u>	<u>ITEM DESCRIPTION</u>
F50-4-4	1/4" FLARE X 1/4" FEMALE PIPE THREAD 90 DEGREE ELBOW
F50-6-4-LF	3/8" FLARE X 1/4" FEMALE PIPE THREAD 90 DEGREE ELBOW - LEAD FREE
F50-6-6-LF	3/8" FLARE X 3/8" FEMALE PIPE THREAD 90 DEGREE ELBOW - LEAD FREE
F50-6-8-LF	3/8" FLARE X 1/2" FEMALE PIPE THREAD 90 DEGREE ELBOW - LEAD FREE
F50-8-12	1/2" FLARE X 3/4" FEMALE PIPE THREAD 90 DEGREE ELBOW
F50-8-6	1/2" FLARE X 3/8" FEMALE PIPE THREAD 90 DEGREE ELBOW
F50-8-6-LF	1/2" FLARE X 3/8" FEMALE PIPE THREAD 90 DEGREE ELBOW - LEAD FREE
F50-8-8-LF	1/2" FLARE X 1/2" FEMALE PIPE THREAD 90 DEGREE ELBOW - LEAD FREE
F50-10-8	5/8" FLARE X 1/2" FEMALE PIPE THREAD 90 DEGREE ELBOW
F50-10-12	5/8" FLARE X 3/4" FEMALE PIPE THREAD 90 DEGREE ELBOW



PRECISION  
INSTALLATION  
PRODUCTS

# PLUMBING SUPPLIES

Brass Flare Fittings & Hose Barbs

Flare Fittings

## FEMALE BRANCH TEES - FLARE X FLARE X FPT



<u>PART NUMBER</u>	<u>ITEM DESCRIPTION</u>
F508-66	3/8" FLARE X 3/8" FLARE X 3/8" FEMALE PIPE THREAD TEE
F508-86	1/2" FLARE X 1/2" FLARE X 3/8" FEMALE PIPE THREAD TEE

## 90 DEGREE ELBOWS - FLARE X FLARE



<u>PART NUMBER</u>	<u>ITEM DESCRIPTION</u>
F55-4	1/4" BRASS FLARE ELBOW-90 DEGREE
F55-6	3/8" BRASS FLARE ELBOW-90 DEGREE
F55-8	1/2" BRASS FLARE ELBOW-90 DEGREE

## FEMALE FLARE X MALE FLARE



<u>PART NUMBER</u>	<u>ITEM DESCRIPTION</u>
F61-4-6	1/4" FEMALE FLARE X 3/8" MALE FLARE BRASS FITTING
F61-6-4	3/8" FEMALE FLARE X 1/4" MALE FLARE BRASS FITTING
F61-6-8	3/8" FEMALE FLARE X 1/2" MALE FLARE BRASS FITTING
F61-8-6	1/2" FEMALE FLARE X 3/8" MALE FLARE BRASS FITTING
F61-10-8	5/8" FEMALE FLARE X 1/2" MALE FLARE BRASS FITTING

# PLUMBING SUPPLIES

Brass Flare Fittings & Hose Barbs

Flare Fittings



PRECISION  
INSTALLATION  
PRODUCTS

## COMPRESSION X FEMALE FINE FLARE



<u>PART NUMBER</u>	<u>ITEM DESCRIPTION</u>
F6280T6-6	3/8" COMP X 3/8" FEMALE FLARE FINE THREAD ADAPTER

## FORGED NUT - SHORT - FLARE



<u>PART NUMBER</u>	<u>ITEM DESCRIPTION</u>
F64S-12	3/4" SHORT FLARE FORGED NUT
F64S-4	1/4" SHORT FLARE FORGED NUT
F64S-6	3/8" SHORT FLARE FORGED NUT
F64S-8	1/2" SHORT FLARE FORGED NUT
F64S-10	5/8" SHORT FLARE FORGED NUT

## FORGED REDUCING NUT - SHORT - FLARE



<u>PART NUMBER</u>	<u>ITEM DESCRIPTION</u>
F66S-6-4	3/8" X 1/4" SHORT FLARE FORGED REDUCING NUT
F66S-8-6	1/2" X 3/8" SHORT FLARE FORGED REDUCING NUT

## FEMALE SWIVEL UNIONS - FEM FLARE X FEM FLARE



<u>PART NUMBER</u>	<u>ITEM DESCRIPTION</u>
F700-4	1/4" FEMALE FLARE SWIVEL UNION
F700-6	3/8" FEMALE FLARE SWIVEL UNION
F700-8	1/2" FEMALE FLARE SWIVEL UNION
F700-10	5/8" FEMALE FLARE SWIVEL UNION



PRECISION  
INSTALLATION  
PRODUCTS

# PLUMBING SUPPLIES

Brass Flare Fittings & Hose Barbs

Flare Fittings

## REDUCING FEMALE SWIVEL UNIONS - FEM FLARE X FEM FLARE



PART NUMBER

ITEM DESCRIPTION

F700R6-4

3/8" X 1/4" FEMALE FLARE REDUCING SWIVEL UNION

F700R8-6

1/2" X 3/8" FEMALE FLARE REDUCING SWIVEL UNION

## FEMALE 90 DEGREE SWIVEL ELBOWS - FLARE X FEM FLARE



PART NUMBER

ITEM DESCRIPTION

F800-4

1/4" FLARE SWIVEL ELBOW

F800-6

3/8" FLARE SWIVEL ELBOW

## FLARE X FGH - NON SWIVEL



PART NUMBER

ITEM DESCRIPTION

F98GH

3/8" FLARE X 3/4" FEMALE HOSE



# PLUMBING SUPPLIES

Brass Flare Fittings & Hose Barbs

Flare Fittings



PRECISION  
INSTALLATION  
PRODUCTS

## CAP/NUT - FLARE



<u>PART NUMBER</u>	<u>ITEM DESCRIPTION</u>
FN5-12	3/4" FLARE CAP NUT
FN5-14	5/16" - 16 THREAD FLARE CAP NUT (FITS DORMONT VALVES 91-3032, 91-3042 & 93-3042)
FN5-4	1/4" FLARE CAP NUT
FN5-4-LF	1/4" FLARE CAP NUT - LEAD FREE
FN5-6	3/8" FLARE CAP NUT
FN5-8-LF	1/2" FLARE CAP NUT - LEAD FREE
FN5-10	5/8" FLARE CAP NUT

## COPPER BONNET - FLARE



<u>PART NUMBER</u>	<u>ITEM DESCRIPTION</u>
FB1-4	1/4" FLARE BONNET

## COPPER GASKET - FLARE



<u>PART NUMBER</u>	<u>ITEM DESCRIPTION</u>
FB2-4	1/4" COPPER FLARE GASKET
FB2-6	3/8" COPPER FLARE GASKET
FB2-8	1/2" COPPER FLARE GASKET
FB2-10	5/8" COPPER FLARE GASKET



PRECISION  
INSTALLATION  
PRODUCTS



**END OF SECTION**

**THIS PAGE IS LEFT  
INTENTIONALLY BLANK.**

# PLUMBING SUPPLIES

## Copper Fittings



PRECISION  
INSTALLATION  
PRODUCTS

### ROLLED STOP COUPLINGS - COPPER X COPPER



<u>PART NUMBER</u>	<u>ITEM DESCRIPTION</u>
RB1009	1/4" COPPER X 1/4" COPPER ROLLED STOP COUPLING (BAG IS 25)
RB1022	1/2" COPPER X 1/2" COPPER ROLLED STOP COUPLING (BAG IS 25)
RB1034	3/4" COPPER X 3/4" COPPER ROLLED STOP COUPLING (BAG IS 25)
RB1047	1" COPPER X 1" COPPER ROLLED STOP COUPLING (BAG IS 10)
RB1055	1 1/4" COPPER X 1 1/4" COPPER ROLLED STOP COUPLING (BAG IS 5)
RB1060	1 1/2" COPPER X 1 1/2" COPPER ROLLED STOP COUPLING (BAG IS 5)
RB1062	2" COPPER X 2" COPPER ROLLED STOP COUPLING (EACH)

### REDUCING COUPLINGS - COPPER X COPPER



<u>PART NUMBER</u>	<u>ITEM DESCRIPTION</u>
RB1036	3/4" COPPER X 1/2" COPPER REDUCING COUPLING (BAG IS 25)
RB1049	1" COPPER X 3/4" COPPER REDUCING COUPLING (BAG IS 10)
RB1051	1" COPPER X 1/2" COPPER REDUCING COUPLING (BAG IS 10)
RB1056	1 1/4" COPPER X 1" COPPER REDUCING COUPLING (BAG IS 5)
RB1057	1 1/2" COPPER X 1/2" COPPER REDUCING COUPLING (BAG IS 5)
RB1064	1 1/2" COPPER X 1 1/4" COPPER REDUCED COUPLING (EACH)
RB1059	2" COPPER X 1 1/4" COPPER REDUCING COUPLING (EACH)

### NO STOP COUPLINGS - COPPER X COPPER



<u>PART NUMBER</u>	<u>ITEM DESCRIPTION</u>
RB1901	1/4" COPPER X 1/4" COPPER NO STOP COUPLING (BAG IS 25)
RB1903	1/2" COPPER X 1/2" COPPER NO STOP COUPLING (BAG IS 25)
RB1905	3/4" COPPER X 3/4" COPPER NO STOP COUPLING (BAG IS 25)
RB1906	1 COPPER X 1 COPPER NO STOP COUPLING (BAG IS 10)
RB1907	1 1/4" COPPER X 1 1/4" COPPER NO STOP COUPLING (BAG IS 5)
RB1908	1 1/2" COPPER X 1 1/2" COPPER NO STOP COUPLING (BAG IS 5)
RB1909	2" COPPER X 2" COPPER NO STOP COUPLING (EACH)



PRECISION  
INSTALLATION  
PRODUCTS

# PLUMBING SUPPLIES

## Copper Fittings

### MALE ADAPTERS - COPPER X MPT



<u>PART NUMBER</u>	<u>ITEM DESCRIPTION</u>
RB1115	1/4" COPPER X 1/4" MPT ADAPTER (BAG IS 25)
RB1131	1/2" COPPER X 1/2" MPT ADAPTER (BAG IS 25)
RB1146	3/4" COPPER X 3/4" MPT ADAPTER (BAG IS 25)
RB1163	1" COPPER X 1" MPT ADAPTER (BAG IS 10)
RB1170	1 1/4" COPPER X 1 1/4" MPT ADAPTER (BAG IS 5)
RB1179	1 1/2" COPPER X 1 1/2" MPT ADAPTER (BAG IS 5)
RB1180	2" COPPER X 2" MPT ADAPTER (EACH)

### MALE FITTINGS - FITTING X MPT



<u>PART NUMBER</u>	<u>ITEM DESCRIPTION</u>
RB1431	1/2" FITTING X 1/2" MPT ADAPTER (BAG IS 25)
RB1446	3/4" FITTING X 3/4" MPT ADAPTER (BAG IS 25)
RB1463	1" FITTING X 1" MPT ADAPTER (BAG IS 10)
RB1465	1 1/4" FITTING X 1 1/4" MPT ADAPTER (EACH)
RB1469	1 1/2" FITTING X 1 1/2" MPT ADAPTER (EACH)
RB1475	2" FITTING X 2" MPT ADAPTER (EACH)

### MALE REDUCING FITTINGS - FITTING X MPT

<u>PART NUMBER</u>	<u>ITEM DESCRIPTION</u>
RB1435	1/2" FITTING X 3/4" MPT REDUCING ADAPTER (BAG IS 25)

# PLUMBING SUPPLIES

## Copper Fittings



PRECISION  
INSTALLATION  
PRODUCTS

### REDUCING MALE ADAPTERS - COPPER X MPT



<u>PART NUMBER</u>	<u>ITEM DESCRIPTION</u>
RB1129	1/2" COPPER X 1" MPT REDUCING ADAPTER (BAG IS 10)
RB1130	1/2" COPPER X 3/4" MPT REDUCING ADAPTER (BAG IS 25)
RB1145	3/4" COPPER X 1" MPT REDUCING ADAPTER (BAG IS 10)
RB1147	3/4" COPPER X 1/2" MPT REDUCING ADAPTER (BAG IS 25)
RB1164	1" COPPER X 3/4" MPT REDUCING ADAPTER (BAG IS 10)
RB1165	1" COPPER X 1/2" MPT REDUCING ADAPTER (BAG IS 10)
RB1166	1" COPPER X 1 1/4" MPT REDUCING ADAPTER (BAG IS 5)
RB1168	1" COPPER X 1 1/2" MPT REDUCING ADAPTER (BAG IS 5)
RB1181	1 1/2" COPPER X 2" MPT REDUCING ADAPTER (BAG IS 5)

### FEMALE ADAPTERS - COPPER X FPT



<u>PART NUMBER</u>	<u>ITEM DESCRIPTION</u>
RB1205	1/8" COPPER X 3/8" FPT REDUCING ADAPTER
RB1230	1/2" COPPER X 3/4" FPT REDUCING ADAPTER (BAG IS 25)
RB1231	1/2" COPPER X 1/2" FPT ADAPTER (BAG IS 25)
RB1232	1/2" COPPER X 1" FPT REDUCING ADAPTER (BAG IS 10)
RB1245	3/4" COPPER X 1" FPT REDUCING ADAPTER (BAG IS 10)
RB1246	3/4" COPPER X 3/4" FPT ADAPTER (BAG IS 25)
RB1247	3/4" COPPER X 1/2" FPT REDUCING ADAPTER (BAG IS 25)
RB1248	1" COPPER X 1/2" FPT REDUCING ADAPTER (BAG IS 10)
RB1263	1" COPPER X 1" FPT ADAPTER (BAG IS 10)
RB1264	1" COPPER X 3/4" FPT REDUCING ADAPTER (BAG IS 10)
RB1265	1 1/4" COPPER X 1 1/4" FPT ADAPTER (BAG IS 5)
RB1279	1 1/2" COPPER X 1 1/2" FPT ADAPTER (BAG IS 5)
RB1280	2" COPPER X 2" FPT ADAPTER (EACH)



PRECISION  
INSTALLATION  
PRODUCTS

# PLUMBING SUPPLIES

## Copper Fittings

### FEMALE FITTINGS - FITTING X FPT



<u>PART NUMBER</u>	<u>ITEM DESCRIPTION</u>
RB1531	1/2" FITTING X 1/2" FPT ADAPTER (BAG IS 25)
RB1546	3/4" FITTING X 3/4" FPT ADAPTER (BAG IS 25)
RB1549	1" FITTING X 1" FPT ADAPTER (BAG IS 10)
RB1555	1 1/4" FITTING X 1 1/4" FPT ADAPTER (EACH)

### REDUCERS - FITTING X COPPER



<u>PART NUMBER</u>	<u>ITEM DESCRIPTION</u>
RB1807	3/4" FITTING X 1/2" WROT COPPER REDUCER (BAG IS 25)
RB1812	1" FITTING X 1/2" WROT COPPER REDUCER (BAG IS 10)
RB1859	1" FITTING X 3/4" WROT COPPER REDUCER (BAG IS 10)
RB1862	1 1/4" FITTING X 3/4" COPPER REDUCER (BAG IS 5)
RB1864	1 1/4" FITTING X 1" COPPER REDUCER (EACH)
RB1869	1 1/2" FITTING X 3/4" COPPER REDUCER (BAG IS 5)
RB1870	1 1/2" FITTING X 1" COPPER REDUCER (BAG IS 5)
RB1872	1 1/2" FITTING X 1 1/4" COPPER REDUCER (EACH)
RB1876	2 1/2" FITTING X 2" COPPER REDUCER (EACH)

### FLUSH BUSHINGS - FITTING X COPPER



<u>PART NUMBER</u>	<u>ITEM DESCRIPTION</u>
RB1726	3/4" FITTING X 1/2" COPPER FLUSH BUSHING (BAG IS 25)
RB1737	1" FITTING X 3/4" COPPER FLUSH BUSHING (BAG IS 10)
RB1744	1 1/4" FITTING X 1" COPPER FLUSH BUSHING (EACH)
RB1745	1 1/2" FITTING X 1 1/4" COPPER FLUSH BUSHING (BAG IS 5)
RB1747	2" FITTING X 1 1/2" COPPER FLUSH BUSHING (EACH)

# PLUMBING SUPPLIES

## Copper Fittings



PRECISION  
INSTALLATION  
PRODUCTS

### 90 DEGREE ELBOWS - COPPER X COPPER



<u>PART NUMBER</u>	<u>ITEM DESCRIPTION</u>
RB1622	1/2" COPPER X 1/2" COPPER 90 DEGREE ELBOW (BAG IS 25)
RB1634	3/4" COPPER X 3/4" COPPER 90 DEGREE ELBOW (BAG IS 25)
RB1647	1" COPPER X 1" COPPER 90 DEGREE ELBOW (BAG IS 10)
RB2084	1 1/4" COPPER X 1 1/4" COPPER 90 DEGREE ELBOW (EACH)
RB2085	1 1/2" COPPER X 1 1/2" COPPER 90 DEGREE ELBOW (BAG IS 5)
RB2086	2" COPPER X 2" COPPER 90 DEGREE ELBOW (EACH)
RB2088	2 1/2" COPPER X 2 1/2" COPPER 90 DEGREE ELBOW (EACH)

### 90 DEGREE STREET ELBOWS - FITTING X COPPER



<u>PART NUMBER</u>	<u>ITEM DESCRIPTION</u>
RB1652	1/2" FITTING X 1/2" COPPER 90 DEGREE STREET ELBOW (BAG IS 25)
RB1654	3/4" FITTING X 3/4" COPPER 90 DEGREE STREET ELBOW (BAG IS 25)
RB2344	1" FITTING X 1" COPPER 90 DEGREE STREET ELBOW (BAG IS 10)
RB2384	1 1/4" FITTING X 1 1/4" COPPER 90 DEGREE STREET ELBOW (EACH)
RB2386	1 1/2" FITTING X 1 1/2" COPPER 90 DEGREE STREET ELBOW (BAG IS 5)
RB2388	2" FITTING X 2" COPPER 90 DEGREE STREET ELBOW (EACH)

### REDUCING 90 DEGREE ELBOWS - COPPER X COPPER



<u>PART NUMBER</u>	<u>ITEM DESCRIPTION</u>
RB2036	3/4" COPPER X 1/2" COPPER REDUCING 90 DEGREE ELBOW (BAG IS 25)
RB2039	1" COPPER X 1/2" COPPER REDUCING 90 DEGREE ELBOW (BAG IS 10)
RB2049	1" COPPER X 3/4" COPPER REDUCING 90 DEGREE ELBOW (BAG IS 10)
RB2056	1 1/4" COPPER X 1" COPPER REDUCING 90 DEGREE ELBOW (BAG IS 5)
RB2059	1 1/2" COPPER X 1 1/4" COPPER REDUCING 90 DEGREE ELBOW (BAG IS 5)
RB2065	2 COPPER X 1 1/2" COPPER REDUCING 90 DEGREE ELBOW (EACH)



PRECISION  
INSTALLATION  
PRODUCTS

# PLUMBING SUPPLIES

## Copper Fittings

### 90 DEGREE CLOSE ROUGH ELBOWS - FITTING X FITTING



<u>PART NUMBER</u>	<u>ITEM DESCRIPTION</u>
RB2626	1/2" FITTING X 1/2" FITTING 90 DEGREE CLOSE ROUGH ELBOW
RB2634	3/4" FITTING X 3/4" FITTING 90 DEGREE CLOSE ROUGH ELBOW (BAG IS 25)

### 45 DEGREE ELBOWS - COPPER X COPPER



<u>PART NUMBER</u>	<u>ITEM DESCRIPTION</u>
RB3026	1/2" COPPER X 1/2" COPPER 45 DEGREE ELBOW (BAG IS 25)
RB3034	3/4" COPPER X 3/4" COPPER 45 DEGREE ELBOW (BAG IS 25)
RB3044	1" COPPER X 1" COPPER 45 DEGREE ELBOW (BAG IS 10)
RB3050	1-1/4" COPPER X 1-1/4" COPPER 45 DEGREE ELBOW (BAG IS 5)
RB3070	1-1/2" COPPER X 1-1/2" COPPER 45 DEGREE ELBOW (BAG IS 5)
RB3090	2" COPPER X 2" COPPER 45 DEGREE ELBOW (EACH)

### 45 DEGREE STREET ELBOWS - FITTING X COPPER



<u>PART NUMBER</u>	<u>ITEM DESCRIPTION</u>
RB3326	1/2" FITTING X 1/2" COPPER 45 DEGREE STREET ELBOW (BAG IS 25)
RB3334	3/4" FITTING X 3/4" COPPER 45 DEGREE STREET ELBOW (BAG IS 25)
RB3344	1" FITTING X 1" COPPER 45 DEGREE STREET ELBOW (BAG IS 10)
RB3350	1 1/4" FITTING X 1 1/4" COPPER 45 DEGREE STREET ELBOW (BAG IS 5)
RB3351	1-1/2" FITTING X 1-1/2" COPPER 45 DEGREE STREET ELBOW (BAG IS 5)
RB3352	2" FITTING X 2" COPPER 45 DEGREE STREET ELBOW (EACH)



# PLUMBING SUPPLIES

## Copper Fittings



PRECISION  
INSTALLATION  
PRODUCTS

### TEES - COPPER X COPPER X COPPER

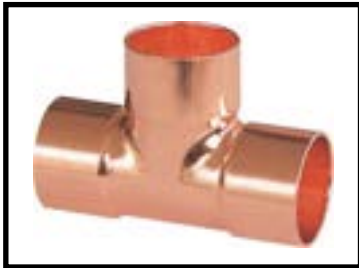

<u>PART NUMBER</u>	<u>ITEM DESCRIPTION</u>
RB4000	1/4" COPPER X 1/4" COPPER X 1/4" COPPER TEE (BAG IS 25)
RB4006	1/2" COPPER X 1/2" COPPER X 1/2" COPPER TEE (BAG IS 50)
RB4031	3/4" COPPER X 3/4" COPPER X 3/4" COPPER TEE (BAG IS 10)
RB4068	1 1/4" COPPER X 1 1/4" COPPER X 1 1/4" COPPER TEE (BAG IS 5)
RB4070	1 1/2" COPPER X 1 1/2" COPPER X 1 1/2" COPPER TEE (BAG IS 5)
RB4072	2" COPPER X 2" COPPER X 2" COPPER TEE (EACH)
RB4048	1" COPPER X 1" COPPER X 1" COPPER TEE (BAG IS 10)

### REDUCING TEES - COPPER X COPPER X COPPER



<u>PART NUMBER</u>	<u>ITEM DESCRIPTION</u>
RB4033	3/4" COPPER X 3/4" COPPER X 1/2" COPPER TEE (BAG IS 10)
RB4041	3/4" COPPER X 1/2" COPPER X 3/4" COPPER TEE (BAG IS 10)
RB4043	3/4" COPPER X 1/2" COPPER X 1/2" COPPER TEE (BAG IS 10)
RB4047	1/2" COPPER X 1/2" COPPER X 3/4" COPPER TEE (BAG IS 10)
RB4049	1" COPPER X 1" COPPER X 3/4" COPPER TEE (BAG IS 10)
RB4050	3/4" COPPER X 3/4" COPPER X 1" COPPER TEE (BAG IS 10)
RB4055	1" COPPER X 3/4" COPPER X 1" COPPER TEE (BAG IS 10)
RB4056	1" COPPER X 3/4" COPPER X 3/4" COPPER TEE (BAG IS 10)
RB4060	1" COPPER X 1" COPPER X 1/2" COPPER TEE (BAG IS 10)
RB4061	1" COPPER X 1/2" COPPER X 1" COPPER TEE (BAG IS 10)
RB4066	1 1/4" COPPER X 1 1/4" COPPER X 3/4" COPPER TEE (EACH)
RB4067	1 1/4" COPPER X 3/4" COPPER X 1 1/4" COPPER TEE (BAG IS 5)
RB4071	2" COPPER X 3/4" COPPER X 2" COPPER TEE (EACH)
RB4083	1 1/4" COPPER X 1/2" COPPER X 1 1/4" COPPER TEE (EACH)
RB4099	1 1/2" COPPER X 3/4" COPPER X 1 1/2" COPPER TEE (EACH)



PRECISION  
INSTALLATION  
PRODUCTS

# PLUMBING SUPPLIES

## Copper Fittings

### TUBE STRAPS - 2 HOLE - NOM COPPER



<u>PART NUMBER</u>	<u>ITEM DESCRIPTION</u>
RB1366	3/8" NOM COPPER TUBE STRAP - 2 HOLE (BAG IS 25)
RB1367	1/2" NOM COPPER TUBE STRAP - 2 HOLE (BAG IS 25)
RB1368	5/8" NOM COPPER TUBE STRAP - 2 HOLE (BAG IS 25)
RB1369	3/4" NOM COPPER TUBE STRAP - 2 HOLE (BAG IS 25)
RB1370	1" NOM COPPER TUBE STRAP - 2 HOLE (BAG IS 10)
RB1371	1 1/4" NOM COPPER TUBE STRAP - 2 HOLE (BAG IS 5)
RB1372	1 1/2" NOM COPPER TUBE STRAP - 2 HOLE (BAG IS 5)
RB1373	2" NOM COPPER TUBE STRAP - 2 HOLE (BAG IS 5)

### DIELECTRIC UNIONS - FPT X SOLDER



<u>PART NUMBER</u>	<u>ITEM DESCRIPTION</u>
GFX08	1/2" FIP X SOLDER DIELECTRIC UNION
GFX08-LF	1/2" FIP X SOLDER DIELECTRIC UNION - LEAD FREE
GFX12-LF	3/4" FIP X SOLDER DIELECTRIC UNION-LEAD FREE
GFX16-LF	1" FIP X SOLDER DIELECTRIC UNION - LEAD FREE
GFX20-LF	1 1/4" FIP X SOLDER DIELECTRIC UNION - LEAD FREE
GFX22-LF	1 1/2" FIP X SOLDER DIELECTRIC UNION - LEAD FREE

### CAST UNIONS - COPPER X COPPER



<u>PART NUMBER</u>	<u>ITEM DESCRIPTION</u>
RB8003	1/2" COPPER X COPPER CAST UNION (BAG IS 25)
RB8004	3/4" COPPER X COPPER CAST UNION (BAG IS 25)
RB8005	1" COPPER X COPPER CAST UNION (BAG IS 10)

# PLUMBING SUPPLIES

## Copper Fittings



PRECISION  
INSTALLATION  
PRODUCTS

### CAPS - COPPER



<u>PART NUMBER</u>	<u>ITEM DESCRIPTION</u>
RB7007	1/2" COPPER CAP (BAG IS 25)
RB7009	3/4" COPPER CAP (BAG IS 25)
RB7011	1" COPPER CAP (BAG IS 10)
RB7012	1 1/4" COPPER CAP (BAG IS 5)
RB7014	1 1/2" COPPER CAP (BAG IS 5)
RB7016	2" COPPER CAP (EACH)
RB7020	2 1/2" COPPER CAP (EACH)

### HANGER STRAPS



<u>PART NUMBER</u>	<u>ITEM DESCRIPTION</u>
RB2574	COPPER HANGER STRAP - 3/4" X 25 FOOT COIL (EACH)
TP28	30 GAUGE HANGER STRAPS-3/4" X 10 FOOT COILS

### FITTING BRUSHES - CARBON CRIMPED STEEL



<u>PART NUMBER</u>	<u>ITEM DESCRIPTION</u>
RBFT-4	1/4" CARBON CRIMPED STEEL BRISTLE FITTING BRUSH W/ EASY GRIP HANDLE
RBFT-6	3/8" CARBON CRIMPED STEEL BRISTLE FITTING BRUSH W/ EASY GRIP HANDLE
RBFT-8	1/2" CARBON CRIMPED STEEL BRISTLE FITTING BRUSH W/ EASY GRIP HANDLE
RBFT-10	5/8" CARBON CRIMPED STEEL BRISTLE FITTING BRUSH W/ EASY GRIP HANDLE
RBFT-12	3/4" CARBON CRIMPED STEEL BRISTLE FITTING BRUSH W/ EASY GRIP HANDLE
RBFT-14	7/8" CARBON CRIMPED STEEL BRISTLE FITTING BRUSH W/ EASY GRIP HANDLE
RBFT-16	1" CARBON CRIMPED STEEL BRISTLE FITTING BRUSH W/ EASY GRIP HANDLE
RBFT-20	1-1/4" CARBON CRIMPED STEEL BRISTLE FITTING BRUSH W/ EASY GRIP HANDLE
RBFT-22	1-1/2" CARBON CRIMPED STEEL BRISTLE FITTING BRUSH W/ EASY GRIP HANDLE



PRECISION  
INSTALLATION  
PRODUCTS

A graphic of a blue water splash with bubbles, centered at the top of the page.

# PLUMBING SUPPLIES

Copper Fittings

**END OF SECTION**

**THIS PAGE IS LEFT  
INTENTIONALLY BLANK.**

# PLUMBING SUPPLIES

Angle Stops / Supply Stops



PRECISION  
INSTALLATION  
PRODUCTS

## QUARTER TURN CHROME STOPS



<u>PART NUMBER</u>	<u>ITEM DESCRIPTION</u>
LKT-CI4	CHARMAN QUARTER TURN CHROME ANGLE STOP-1/2 FPT X 1/4 COMP
LKT-CI6-6	CHARMAN QUARTER TURN CHROME DUAL STOP-1/2" FPT X 3/8 X 3/8
LKT-CI6-LF	CHARMAN QUARTER TURN CHROME ANGLE STOP - 1/2 FPT X 3/8 COMP - LEAD FREE
LKT-CI8	CHARMAN QUARTER TURN CHROME ANGLE STOP-1/2 FPT X 1/2 COMP
LKT-CN4-LF	CHARMAN QUARTER TURN CHROME ANGLE STOP - 1/2" COMP X 1/4" COMP - LEAD FREE
LKT-CN6-LF	CHARMAN QUARTER TURN CHROME ANGLE STOP-1/2" COMP X 3/8" COMP-LEAD FREE
LKT-CN6-S-LF	CHARMAN QUARTER TURN CHROME STRAIGHT STOP-1/2" COMP X 3/8" COMP-LEAD FREE
LKT-CN664-LF	CHARMAN QTR TURN CHROME DUAL STOP-1/2" COMP INLET X 3/8" COMP X 1/4" COMP OUTLETS - LEAD FREE
LKT-CN666-LF	CHARMAN QTR TURN CHROME DUAL STOP - 1/2" COMP INLET X 3/8" COMP X 3/8" COMP OUTLETS - LEAD FREE
LKT-CN8	CHARMAN QUARTER TURN CHROME ANGLE STOP-1/2 COMP X 1/2" COMP
LKT-PF8-6-LF	CHARMAN QUARTER TURN CHROME STRAIGHT STOP -1/2" PEX X 3/8" COMP-LEAD FREE
LKT-PF8-6L-LF	CHARMAN QUARTER TURN CHROME ANGLE STOP -1/2" PEX X 3/8" COMP-LEAD FREE

## DOUBLE SHUT OFF ANGLE STOPS



<u>PART NUMBER</u>	<u>ITEM DESCRIPTION</u>
LD466-LF	SIoux CHIEF ANGLE DUAL STOP - 3/8" OD X 3/8" OD X 1/2" NOM INLET(5/8"OD) - LEAD FREE

NOTE: 1/2" COMPRESSION = 5/8" NOM COMPRESSION



PRECISION  
INSTALLATION  
PRODUCTS

# PLUMBING SUPPLIES

Angle Stops / Supply Stops

## INLINE ANGLE STOP SHUT OFF VALVE



PART NUMBER

ISA6-4

ITEM DESCRIPTION

CHROME ANGLE STOP ADAPTER-3/8" M X 3/8" F X 1/4" COMPRESSION  
(TO BE USED WITH ISA8 ONLY)

## CHROME ADAPTER



PART NUMBER

ISA8

ITEM DESCRIPTION

1/2" CHROME ADAPTER FOR USE WITH ISA6-4

# PLUMBING SUPPLIES

Saddle Valves, Needle Valves, & Max Adapters



PRECISION  
INSTALLATION  
PRODUCTS

## BRASS SADDLE TEES - 1/2" FPT OUT



<u>PART NUMBER</u>	<u>ITEM DESCRIPTION</u>
R1120	2" X 1/2" BRASS SADDLE TEE
R1121	1 1/2" X 1/2" BRASS SADDLE TEE
R1141-LF	1 1/4" X 1/2" BRASS SADDLE TEE - LEAD FREE
R1150-LF	1" X 1/2" BRASS SADDLE TEE - LEAD FREE
R1155-LF	3/4" X 1/2" BRASS SADDLE TEE - LEAD FREE

## SADDLE VALVES - SELF PIERCING - FITS 3/8" TO 1-3/8" OD TUBING



<u>PART NUMBER</u>	<u>ITEM DESCRIPTION</u>
CGSV2	SUPCO SELF-PIERCING SADDLE VALVE - FITS 3/8" - 1-3/8" O.D. TUBING W/ 1/4" COMP OUTLET (SUPCO)
CGSV2-LF	SUPCO SELF-PIERCING SADDLE VALVE - LEAD FREE - FITS 3/8" - 1-3/8" O.D. TUBING W/ 1/4" COMP OUTLET (SUPCO)
CGSV2X-LF	SELF-PIERCING SADDLE VALVE - LEAD FREE - FITS 3/8" - 1-3/8" O.D. TUBING W/ 1/4" COMP OUTLET (IMPORT)

## SADDLE VALVES - SELF PIERCING "C" CLAMP STYLE



<u>PART NUMBER</u>	<u>ITEM DESCRIPTION</u>
CSV-11	SELF PIERCING 'C' CLAMP FOR 3/8" TUBING
CSV-6-LF	SELF PIERCING 'C' CLAMP FOR 1/4" TUBING - LEAD FREE



PRECISION  
INSTALLATION  
PRODUCTS

# PLUMBING SUPPLIES

Saddle Valves, Needle Valves, & Max Adapters

## NEEDLE VALVES - STRAIGHT - FPT X FPT



<u>PART NUMBER</u>	<u>ITEM DESCRIPTION</u>
INV271-4-LF	BRASS 1/4" FPT X 1/4" FPT NEEDLE VALVE - LEAD FREE

## NEEDLE VALVES - STRAIGHT - FPT X MPT



<u>PART NUMBER</u>	<u>ITEM DESCRIPTION</u>
INV272-4-LF	BRASS 1/4" FPT X 1/4" MPT NEEDLE VALVE - LEAD FREE

## INLINE NEEDLE VALVES - FLARE X FLARE



<u>PART NUMBER</u>	<u>ITEM DESCRIPTION</u>
F715-4-LF	1/4" BRASS FLARE INLINE VALVE W/ PIN HANDLE - LEAD FREE
F715-6-LF	3/8" BRASS FLARE INLINE VALVE W/ PIN HANDLE - LEAD FREE



# PLUMBING SUPPLIES

Saddle Valves, Needle Valves, & Max Adapters



PRECISION  
INSTALLATION  
PRODUCTS

## INLINE NEEDLE VALVES - COMP X COMP



<u>PART NUMBER</u>	<u>ITEM DESCRIPTION</u>
C783-4P-LF	1/4" COMPRESSION INLINE VALVE W/ PIN HANDLE - LEAD FREE
C783-6-LF	3/8" COMPRESSION INLINE VALVE - LEAD FREE

## INLINE NEEDLE VALVES - COMP X MPT



<u>PART NUMBER</u>	<u>ITEM DESCRIPTION</u>
C744-4-4-LF	1/4" COMP X 1/4" MIP NEEDLE VALVE - LEAD FREE
C744-6-4-LF	3/8" COMP X 1/4" MIP NEEDLE VALVE - LEAD FREE

## ANGLE NEEDLE VALVES - COMP X MPT



<u>PART NUMBER</u>	<u>ITEM DESCRIPTION</u>
C745-4-2-LF	1/4" COMP X 1/8" MIP ANGLE NEEDLE VALVE - LEAD FREE
C745-4-4	1/4" COMP X 1/4" MIP ANGLE NEEDLE VALVE
C745-4-4-LF	1/4" COMP X 1/4" MIP ANGLE NEEDLE VALVE - LEAD FREE
C745-6-4-LF	3/8" COMP X 1/4" MIP ANGLE NEEDLE VALVE - LEAD FREE



PRECISION  
INSTALLATION  
PRODUCTS

# PLUMBING SUPPLIES

## Saddle Valves, Needle Valves, & Max Adapters

### MAX ADAPTERS - SUPPLY STOP TEES



<u>PART NUMBER</u>	<u>ITEM DESCRIPTION</u>
L65-2000-LF	3/8" FEMALE COMP X 3/8" MALE COMP X 1/4" MALE COMP MAX ADAPTER - LEAD FREE
L65-2001-LF	3/8" FEMALE COMP X 3/8" MALE COMP X 3/8" MALE COMP MAX ADAPTER - LEAD FREE
L65-2002-LF	1/2" FEMALE COMP X 1/2" MALE COMP X 1/4" MALE COMP MAX ADAPTER - LEAD FREE
L65-2003	1/2" FEMALE COMP X 1/2" MALE COMP X 3/8" MALE COMP MAX ADPT
L65-2003-LF	1/2" FEMALE COMP X 1/2" MALE COMP X 3/8" MALE COMP MAX ADAPTER - LEAD FREE
L65-3000-LF	3/8" FEMALE COMP X 3/8" MALE COMP X 1/4" FEMALE PIPE THREAD MAX ADAPTER - LEAD FREE
L65-4000-LF	1/2" NPS X 1/2" NPS X 1/4" MALE COMP MAX ADAPTER - LEAD FREE
L65-4001-LF	1/2" NPS X 1/2" NPS X 3/8" MALE COMP MAX ADAPTER - LEAD FREE

### SUPPLY STOP EXTENDER TEE

- NO NEED TO INSTALL A NEW WATER LINE.
- NO NEED TO REPLACE A GOOD 2-WAY STOP WITH A 3-WAY STOP.
- NO NEED TO SHUT OFF THE WATER SUPPLY TO AN ENTIRE HOUSE.

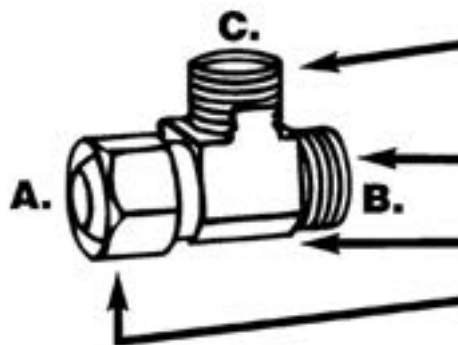

COMES WITH EITHER 1/4" MALE COMPRESSION OR 3/8" MALE COMPRESSION CONNECTION FOR NEW WATER LINE.

3/8" MALE COMPRESSION CONNECTION TO RECONNECT RISER TO FAUCET.

HEAVY BRASS CONNECTION.

3/8" FEMALE COMPRESSION SWIVEL NUT CONNECTS DIRECTLY TO SHUT OFF VALVE.

# PLUMBING SUPPLIES

## Water Heater Connectors & Component Parts



PRECISION  
INSTALLATION  
PRODUCTS

### RUBBER WASHERS FOR WATERFLEX



<u>PART NUMBER</u>	<u>ITEM DESCRIPTION</u>
WFW	WATER FLEX 3/4" WASHERS
WFW-16	1" RUBBER WATERFLEX WASHERS FOR WATERFLEX
WFW-20	1-1/4" RUBBER WATERFLEX WASHERS FOR WATERFLEX
WFW-22	1-1/2" RUBBER WATERFLEX WASHERS FOR WATERFLEX

### CORRUGATED STAINLESS STEEL WATERFLEX - FPT X FPT



<u>PART NUMBER</u>	<u>ITEM DESCRIPTION</u>
WSC3412	CORRUGATED SS WATER HTR/SFTNR CONN-3/4" FPT X 3/4" FPT X 12" LONG
WSC3415	CORRUGATED SS WATER HTR/SFTNR CONN-3/4" FPT X 3/4" FPT X 15" LONG
WSC3418	CORRUGATED SS WATER HTR/SFTNR CONN-3/4" FPT X 3/4" FPT X 18" LONG
WSC3424	CORRUGATED SS WATER HTR/SFTNR CONN-3/4" FPT X 3/4" FPT X 24" LONG
WSC3436	CORRUGATED SS WATER HTR/SFTNR CONN - 3/4" FPT X 3/4" FPT X 36" LONG
WSC112	CORRUGATED SS WATERFLEX - 1"FPT X 1"FPT X 12"LONG
WSC112114-18	CORRUGATED SS WATERFLEX - 1-1/2"FPT X 1-1/4"FPT X 18"LONG
WSC112114-24	CORRUGATED SS WATERFLEX - 1-1/2"FPT X 1-1/4"FPT X 24"LONG
WSC11218	CORRUGATED SS WATERFLEX - 1-1/2"FPT X 1-1/2"FPT X 18"LONG
WSC11224	CORRUGATED SS WATERFLEX - 1-1/2"FPT X 1-1/2"FPT X 24"LONG
WSC1141-18	CORRUGATED SS WATERFLEX - 1-1/4"FPT X 1"FPT X 18"LONG
WSC1141-24	CORRUGATED SS WATERFLEX - 1-1/4"FPT X 1"FPT X 24"LONG
WSC11418	CORRUGATED SS WATERFLEX - 1-1/4"FPT X 1-1/4"FPT X 18"LONG
WSC11424	CORRUGATED SS WATERFLEX - 1-1/4"FPT X 1-1/4"FPT X 24"LONG
WSC11434-18	CORRUGATED SS WATERFLEX - 1-1/4"FPT X 3/4"FPT X 18"LONG
WSC11434-24	CORRUGATED SS WATERFLEX - 1-1/4"FPT X 3/4"FPT X 24"LONG
WSC118	CORRUGATED SS WATER HTR/SFTNR CONN-1" FPT X 1" FPT X 18" LONG-1" OD
WSC124	CORRUGATED SS WATER HTR/SFTNR CONN-1" FPT X 1" FPT X 24" LONG-1" OD
WSC13418	CORRUGATED SS WATER HTR/SFTNR CONN-1" FPT X 3/4" FPT X 18" LONG
WSC13424	CORRUGATED SS WATER HTR/SFTNR CONN-1" FPT X 3/4" FPT X 24" LONG
WSC218	CORRUGATED SS WATERFLEX - 2"FPT X 2"FPT X 18" LONG
WSC224	CORRUGATED SS WATERFLEX - 2"FPT X 2"FPT X 24" LONG



PRECISION  
INSTALLATION  
PRODUCTS

# PLUMBING SUPPLIES

## Water Heater Connectors & Component Parts

### CORRUGATED STAINLESS STEEL WATERFLEX - FPT X SWEAT



<u>PART NUMBER</u>	<u>ITEM DESCRIPTION</u>
WSCT3418	CORRUGATED SS WATER HTR/SFTNR CONN-3/4" FPT X 3/4" SWEAT X 18" LONG
WSCT3424	CORRUGATED SS WATER HTR/SFTNR CONN-3/4" FPT X 3/4" SWEAT X 24" LONG

### BRAIDED STAINLESS STEEL WATERFLEX - FPT X FPT



<u>PART NUMBER</u>	<u>ITEM DESCRIPTION</u>
LAB7812	3/4" X 3/4" X 12"
LAB7815	3/4" X 3/4" X 15"

# PLUMBING SUPPLIES

## Water Heater Connectors & Component Parts



PRECISION  
INSTALLATION  
PRODUCTS

### SAFETY GAS AUTOMATIC SHUT-OFF VALVE

The IWLL210-5-LF automatic gas shutoff valves are positive-acting energy shutoff for the emergency temperature protection of gas water heaters. They are self-contained devices independent of all other operating controls. They provide protection against overheating water in the domestic hot water supply heating systems by automatically shutting off the gas supply to the heater in the event that the water temperature reaches 210°F (99°C).

The IWLL210-5-LF must be manually reset in order to resume heater service. This feature serves as a warning of malfunctioning of the normal operating controls. Manual resetting is easily done and does not require dismantling or replacing of any part of the valve. See "Reset Button" feature. The IWLL210-5-LF features Lead Free\* construction to comply with Lead Free\* installation requirements.

This gas shutoff differs from other contemporary design in that engineers have embodied the time tested auto-thermatic thermal actuator principle along with a snap-acting trip latch which closes the valve at a definite controlled temperature.

The IWLL210-5-LF features an extended shank for use with the new generation of water heaters containing extra thick insulation.

### WATTS SAFETY GAS AUTOMATIC SHUT-OFF VALVE - LEAD FREE

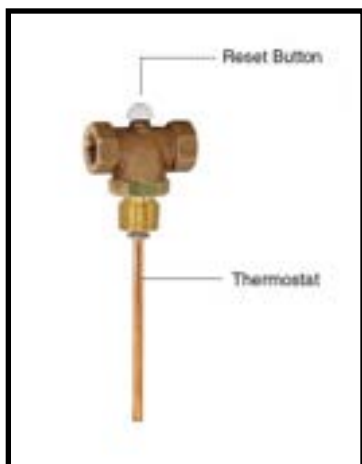

<u>PART NUMBER</u>	<u>ITEM DESCRIPTION</u>
IWLL210-5-LF	WATTS WATER HEATER SAFETY VALVE FOR 2 1/2" INSULATION - LEAD FREE



**PRECISION  
INSTALLATION  
PRODUCTS**

# PLUMBING SUPPLIES

## Water Heater Connectors & Component Parts

### POPPET PRESSURE RELIEF VALVES

The IWLF3L series are used for protection against excessive pressure on domestic storage tanks or tankless water heaters. This series has no temperature relieving element.

Pressure range is 75-150psi (5.2-10.3 bar). The IWLF3L come in standard settings of 75, 100, 125 and 150psi (5.2, 6.9, 8.6 and 10.3 bar).

These Pressure Relief Valves are popularly used in conjunction with the IWLL210-5-LF gas shutoff valve on gas water heaters to shut off gas to heater if water heater temperature exceeds 210°F (99°C).

The IWLF3L series features Lead Free\* construction to comply with Lead Free\* installation requirements.

### POPPET TYPE PRESSURE RELIEF VALVE - 3/4" - LEAD FREE



<u>PART NUMBER</u>	<u>ITEM DESCRIPTION</u>
IWLF3L-075-12	WATTS "POPPET" TYPE PRESSURE RELIEF VALVE - 3/4" - 75 PSI - LEAD FREE

# PLUMBING SUPPLIES

## Water Heater Connectors & Component Parts



PRECISION  
INSTALLATION  
PRODUCTS

### WATTS PRESSURE & TEMPERATURE RELIEF VALVE

A.S.M.E Rated\*, CSA Listed. Self-closing T&P Relief Valves for Water Heaters up to 105,000 BTU/Hr.

The combined 2 in 1 T&P relief valve provides the least expensive and proven means for protection against both excessive temperature and pressure emergency conditions.

Provides fully automatic temperature and pressure relief protection for hot water storage tanks and heaters up to 105,000 BTU/HR. The IPT is furnished with test lever and extension thermostat for installation in the hot water outlet line or directly in the tank tapping.

Temperature sensing element must be immersed in the water within the top 6" (152mm) of the tank.  
Male inlet and female outlet.

Temperature relief 210°F (99°C). Standard settings 75, 100, 125, 150psi (5.3, 7.0, 8.8, 10.6 bar).

### WATTS PRESSURE & TEMPERATURE RELIEF VALVE



<u>PART NUMBER</u>	<u>ITEM DESCRIPTION</u>
IPT	WATTS PRESSURE & TEMPERATURE GAUGE W/ 4" TAILPIECE



PRECISION  
INSTALLATION  
PRODUCTS

# PLUMBING SUPPLIES

## Water Heater Connectors & Component Parts

Part#	Volume Gallon	A Height	B Diameter
PRO-2.1-EXP	2	11"	8"
PRO-4.2-EXP	4.5	14"	11"

### TECHNICAL INFORMATION

Factory Pre- Charge	35 PSI
System Connection	304 Stainless Steel
Max working Pressure	150 PSI
Max Operating Temp	200° F
Connection size	3/4 Male Pipe Thread

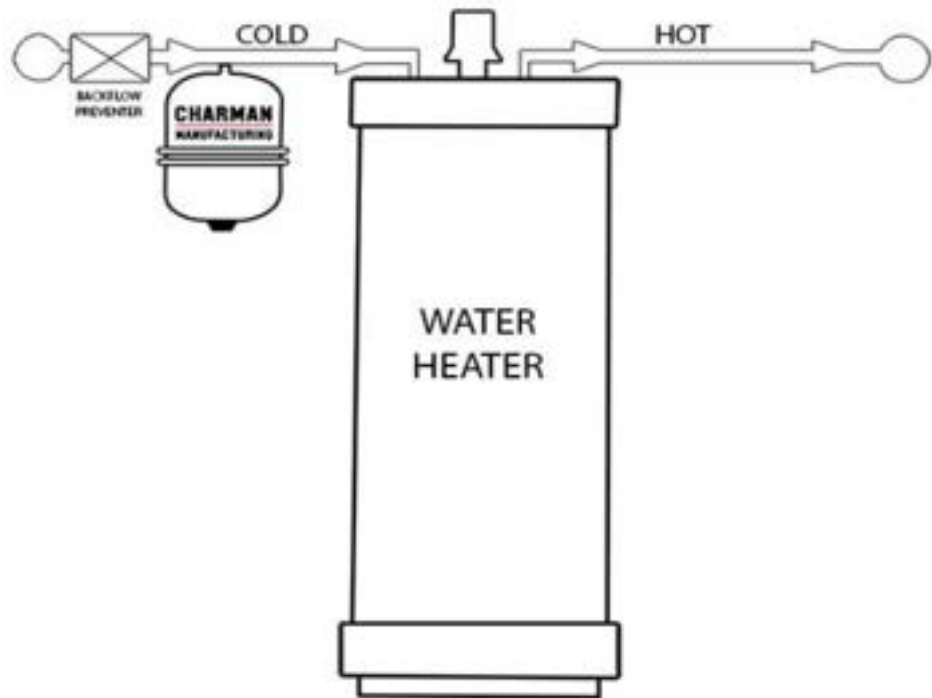
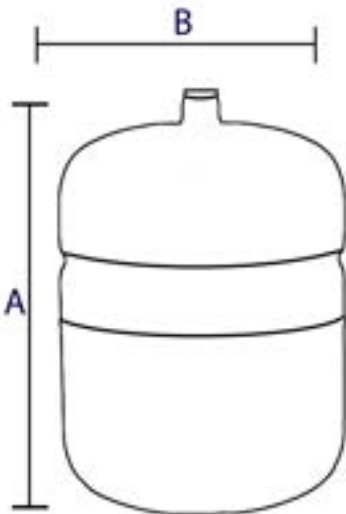

### Materials

Diaphragm: Butyl rubber  
Inlet Connection: Stainless Steel  
Shell: Steel

### Thermal Expansion

- Accepts expanded water as system temperature rises and returns hot water to system when demand occurs.
- Requires by most building codes where backflow preventors are specified

### What is an Expansion Tank?

When water is heated it expands. Reacting to physical Law, water expands in volume as its temperature rises. In a 40 gallon water heater, water being heated to its thermostat setting will end up expanding to about 40.53 gallons when the desired temperature is reached. The extra volume created by this expansion has got to go somewhere. Expansion tanks are designed to absorb the increase volume of water created when the hot water storage tank is heated and keeps the system pressure below the relief setting of the T&P relief valve.

It is a pre-pressurized steel tank with an expansion membrane that prevents contact of the water with the air in the tank. This prevents loss of air to the water and insures long and trouble free life for the system. These tanks can be used with most standard hot water heaters and storage tanks.



# PLUMBING SUPPLIES

Water Valves, Hose Bibbs, & Regulators



PRECISION  
INSTALLATION  
PRODUCTS

## CHROME ANGLE BALL VALVES - COMPRESSION



<u>PART NUMBER</u>	<u>ITEM DESCRIPTION</u>
IBVA4-4	1/4" COMP X 1/4" FPT 90* CHROME ANGLE BALL VALVE FOR TANKS

## CHROME INLINE BALL VALVES - THREADED



<u>PART NUMBER</u>	<u>ITEM DESCRIPTION</u>
IBV4-4	1/4 FEMALE PIPE X 1/4 FEMALE PIPE STRAIGHT CHROME BALL VALVE

## BRASS INLINE BALL VALVES - THREADED



<u>PART NUMBER</u>	<u>ITEM DESCRIPTION</u>
IS253-4-2	1/4 FPT X 1/8 MPT INLINE BALL VALVE

## BRASS INLINE BALL VALVES - HOSE BARB



<u>PART NUMBER</u>	<u>ITEM DESCRIPTION</u>
A027-4B	SMC INLINE BRASS BALL VALVE - 1/4" BARB X 1/4" BARB



PRECISION  
INSTALLATION  
PRODUCTS

# PLUMBING SUPPLIES

Water Valves, Hose Bibbs, & Regulators

## LF BRASS FULL PORT BALL VALVES - FPT X FPT



<u>PART NUMBER</u>	<u>ITEM DESCRIPTION</u>
IR5044-04-LF	LEAD FREE BRASS 1/4" FPT X 1/4" FPT FULL PORT BALL VALVE
IR5044-06-LF	LEAD FREE BRASS 3/8" FPT X 3/8" FPT FULL PORT BALL VALVE
IR5044-08-LF	LEAD FREE BRASS 1/2" FPT X 1/2" FPT FULL PORT BALL VALVE
IR5044-12-LF	LEAD FREE BRASS 3/4" FPT X 3/4" FPT FULL PORT BALL VALVE
IR5044-16-LF	LEAD FREE BRASS 1" FPT X 1" FPT FULL PORT BALL VALVE
IR5044-20-LF	LEAD FREE BRASS 1 1/4" FPT X 1 1/4" FPT FULL PORT BALL VALVE
IR5044-200-LF	LEAD FREE BRASS 2" FPT X 2" FPT FULL PORT BALL VALVE
IR5044-22-LF	LEAD FREE BRASS 1 1/2" FPT X 1 1/2" FPT FULL PORT BALL VALVE

## BRASS STANDARD PORT BALL VALVES - MPT X FPT



<u>PART NUMBER</u>	<u>ITEM DESCRIPTION</u>
IR5049-08-LF	LEAD FREE BRASS 1/2" C X 1/2" C FULL PORT BALL VALVE
IR5049-12-LF	LEAD FREE BRASS 3/4" C X 3/4" C FULL PORT BALL VALVE
IR5049-16-LF	LEAD FREE BRASS 1" C X 1" C FULL PORT BALL VALVE
IR5049-20-LF	LEAD FREE BRASS 1 1/4" C X 1 1/4" C FULL PORT BALL VALVE
IR5049-200-LF	LEAD FREE BRASS 2" C X 2" C FULL PORT BALL VALVE
IR5049-22-LF	LEAD FREE BRASS 1 1/2" C X 1 1/2" C FULL PORT BALL VALVE

# PLUMBING SUPPLIES

Water Valves, Hose Bibbs, & Regulators



PRECISION  
INSTALLATION  
PRODUCTS

## BRASS GATE VALVES - FPT X FPT



<u>PART NUMBER</u>	<u>ITEM DESCRIPTION</u>
IRGV12	BRASS 3/4" FPT X 3/4" FPT GATE VALVE
IRGV16	BRASS 1" FPT X 1" FPT GATE VALVE

## BRASS GATE VALVES - SWEAT X SWEAT



<u>PART NUMBER</u>	<u>ITEM DESCRIPTION</u>
IRGV12S	BRASS 3/4" COMP X 3/4" COMP GATE VALVE-SWEAT X SWEAT
IRGV16S	BRASS 1" COMP X 1" COMP GATE VALVE-SWEAT X SWEAT



PRECISION  
INSTALLATION  
PRODUCTS

# PLUMBING SUPPLIES

Water Valves, Hose Bibbs, & Regulators

## ANTI-SIPHON VALVES - LEAD FREE ROUGH BRASS



<u>PART NUMBER</u>	<u>ITEM DESCRIPTION</u>
IW-ASV-08-LF	WATTS 1/2" ROUGH BRASS ANTI-SIPHON VALVE - LEAD FREE

## BRASS INLINE SPRING CHECK VALVES - FPT X FPT



<u>PART NUMBER</u>	<u>ITEM DESCRIPTION</u>
IWBSPV12-LF	LEAD FREE BRASS 3/4" FPT SPRING LOADED INLINE CHECK VALVE - 200 WOG

## BRASS SWING CHECK VALVES - FPT X FPT



<u>PART NUMBER</u>	<u>ITEM DESCRIPTION</u>
IWBSCV08-LF	BRASS 1/2" FEMALE PIPE THREAD SWING CHECK VALVE - LEAD FREE
IWBVC12-LF	LEAD FREE BRASS 3/4" FEMALE PIPE THREAD SWING CHECK VALVE

# PLUMBING SUPPLIES

Water Valves, Hose Bibbs, & Regulators



PRECISION  
INSTALLATION  
PRODUCTS

## HOSE BIBBS - MPT X MGH - LEAD FREE - ROUGH BRASS



<u>PART NUMBER</u>	<u>ITEM DESCRIPTION</u>
IA251-LF	ARROWHEAD NO-KINK HOSEBIBB-1/2 MIP X 3/4 HOSE - LEAD FREE
IA351-LF	ARROWHEAD NO-KINK HOSEBIBB-3/4 MIP X 3/4 HOSE - LEAD FREE

## HOSE BIBBS - FPT X MGH - LEAD FREE



<u>PART NUMBER</u>	<u>ITEM DESCRIPTION</u>
IA253-LF	ARROWHEAD NO-KINK HOSEBIBB-1/2 FIP X 3/4 HOSE - LEAD FREE
IA353-LF	ARROWHEAD NO-KINK HOSEBIBB-3/4 FIP X 3/4 HOSE - LEAD FREE

## HOSE BIBBS - SWEAT X MGH - LEAD FREE



<u>PART NUMBER</u>	<u>ITEM DESCRIPTION</u>
IA252CC-LF	ARROWHEAD NO-KINK HOSEBIBB-1/2 NOM COPPER X 3/4 HOSE - LEAD FREE

## HOSE BIBBS - COMP X MGH - LEAD FREE



<u>PART NUMBER</u>	<u>ITEM DESCRIPTION</u>
IA252CC-LF	ARROWHEAD NO-KINK HOSEBIBB-1/2 NOM COPPER X 3/4 HOSE - LEAD FREE



PRECISION  
INSTALLATION  
PRODUCTS

# PLUMBING SUPPLIES

Water Valves, Hose Bibbs, & Regulators

## VACUUM BREAKERS - ADD-ON W/ BREAKAWAY SET SCREW



<u>PART NUMBER</u>	<u>ITEM DESCRIPTION</u>
IA58ABP	ARROWHEAD VACUUM BREAKER 5/8-HOSE THREAD CONNECTION

## PLASTIC HOSE BIBBS - CELCON



<u>PART NUMBER</u>	<u>ITEM DESCRIPTION</u>
A208-48	1/2" MPT X 3/4" GARDEN HOSE CELCON HOSE BIBB
A208-49	3/4" MPT X 3/4" GARDEN HOSE CELCON HOSE BIBB

## DOUBLE UNION PRESSURE REGULATOR - FPT X FPT - WATTS



<u>PART NUMBER</u>	<u>ITEM DESCRIPTION</u>
IPR608-LF	WATTS 1/2" PIPE THREAD DOUBLE UNION PRESSURE REGULATOR - LEAD FREE*SPECIAL*
IPR615C-LF	WATTS 1" SWEAT DOUBLE UNION PRESSURE REGULATOR - LEAD FREE*SPECIAL*

# PLUMBING SUPPLIES

Water Valves, Hose Bibbs, & Regulators



PRECISION  
INSTALLATION  
PRODUCTS

## DOUBLE UNION PRESSURE REGULATOR - FPT X FPT - WILKINS



**PART NUMBER**

**ITEM DESCRIPTION**

IPR612-NR3-LF

WILKINS 3/4"IPS DOUBLE UNION PRESSURE REGULATOR-LEAD FREE

## LF BRASS PRESSURE REGULATORS - ADJUSTABLE



**PART NUMBER**

**ITEM DESCRIPTION**

I26A-LF

WATTS LEAD FREE 2-WAY ADJUSTABLE PRESSURE REGULATOR - 10 TO 125 PSI - 3/8"

IW263A-LF

WATTS 3-WAY ADJUSTABLE WATER REGULATOR - 10 TO 125 PSI - 3/8" - LEAD FREE

## PLASTIC PRESSURE REGULATORS - ADJUSTABLE



**PART NUMBER**

**ITEM DESCRIPTION**

IW60-125

WATTS PLASTIC 1/4" FPT P.O.U. ADJUSTABLE PRESSURE REGULATOR-0-125PSI

IW60-25

WATTS PLASTIC 1/4" FPT P.O.U. ADJUSTABLE PRESSURE REGULATOR-0-25PSI

IW60-60

WATTS PLASTIC 1/4" FPT P.O.U. ADJUSTABLE PRESSURE REGULATOR-0-60PSI



PRECISION  
INSTALLATION  
PRODUCTS

# PLUMBING SUPPLIES

Water Valves, Hose Bibbs, & Regulators

## DIVERTAFLO - CULLIGAN SERIES - SWEAT X FPT



<u>PART NUMBER</u>	<u>ITEM DESCRIPTION</u>
IW4033-STEM	WATTS DIVERTAFLO - CULLIGAN STYLE -..REPLACEMENT STEM ONLY

- HOUSE PORTS 1.875" ON CENTER
- EQUIPMENT PORTS 3" ON CENTER

## DIVERTAFLO - FLECK 2500 SERIES



<u>PART NUMBER</u>	<u>ITEM DESCRIPTION</u>
IW31766-STEM	WATTS DIVERTAFLO - REPLACEMENT STEM ONLY - IN ALL DIVERTAFLO VALVES

## PLASTIC WYE-PATTERN STRAINERS



<u>PART NUMBER</u>	<u>ITEM DESCRIPTION</u>
IW-YS-6	WATTS 3/8" PIPE THREAD BLACK POLYPROP Y STRAINER

- 100 MESH SCREEN NSF APPROVED ACETAI PLASTIC

## HYDRONIX "SHOCK BLOK" PRESSURE REGULATORS

<u>PART NUMBER</u>	<u>ITEM DESCRIPTION</u>
IWSB-40	1/4" QC ENDS 0-40 PSI
IWSB-60	1/4" QC ENDS 0-60 PSI
IWSB-70	1/4" QC ENDS 0-70 PSI
IWSB-125	1/4" QC ENDS 0-125 PSI
IWSB-60-3/8"	3/8" QC ENDS 0-60 PSI
IWSB-70-3/8"	3/8" QC ENDS 0-70 PSI



# PLUMBING SUPPLIES

## Water Valves, Hose Bibbs, & Regulators



PRECISION  
INSTALLATION  
PRODUCTS

### SHOK BLOK™ FILTER PROTECTION VALVES

Are you best choice for limiting water pressure to your water filtration device. SHOK BLOK™ Filter Protection Valves are designed for high pressure installations to protect reverse osmosis systems, water filters, ice makers, coffee machines, chillers, hot tanks and water coolers.

### SHOK BLOK™ FILTER PROTECTION VALVES

Protect water filtration devices by limiting water pressure and reducing water hammer. Four models to choose from to best suit your applications.

- Kills water hammer
- Limits water pressure
- Available in 40, 60, 70 and 125 PSI limits

#### Product Specifications

Flow: 4 Gal/min (15L/min) at 100 PSI  
 Max. Pressure: 300 PSI  
 Max. Temperature: 104°F (40°C)

#### ASV SERIES SPECIFICATIONS

Model	PSI Specification	Inlet Pressure (PSI)	Outlet Pressure (PSI)
SB-FPV-40	40	100	40
	40	150	44
	40	200	50
SB-FPV-60	60	100	60
	60	150	64
	60	200	70
SB-FPV-70	70	100	68
	70	150	72
	70	200	74
SB-FPV-125	125	150	130
	125	250	135
	125	300	140

For SB-FPV-40, 60, and 70: Testing Standard Pressure = 100 PSI (Tolerance ± 0.05)  
 For SB-FPV-125: Testing Standard Pressure = 150 PSI (Tolerance ± 0.05)





PRECISION  
INSTALLATION  
PRODUCTS



**END OF SECTION**

**THIS PAGE IS LEFT  
INTENTIONALLY BLANK.**

# PLUMBING SUPPLIES

Clamps - Metal Hose - Poly Pipe - Oetiker



PRECISION  
INSTALLATION  
PRODUCTS

## STAINLESS STEEL WORM DRIVE CLAMP



<u>PART NUMBER</u>	<u>ITEM DESCRIPTION</u>
WCS06	#6 ALL STAINLESS WORM DRIVE CLAMP—SIZE 3/8" - 7/8"
WCS08	#8 ALL STAINLESS WORM DRIVE CLAMP—SIZE 7/16" - 1"
WCS10	#10 ALL STAINLESS WORM DRIVE CLAMP—SIZE 1/2" - 1 1/16"
WCS104	#104 ALL STAINLESS WORM DRIVE CLAMP—SIZE 5" - 7"
WCS116	#116 ALL STAINLESS WORM DRIVE CLAMP—SIZE 5 3/4" - 7 3/4"
WCS12	#12 ALL STAINLESS WORM DRIVE CLAMP—SIZE 1/2" - 1 1/4"
WCS128	#128 ALL STAINLESS WORM DRIVE CLAMP—SIZE 6 1/2" - 8 1/2"
WCS152	#152 ALL STAINLESS WORM DRIVE CLAMP—SIZE 8" - 10"
WCS16	#16 ALL STAINLESS WORM DRIVE CLAMP—SIZE 1 1/16" - 1 1/2"
WCS188	#188 ALL STAINLESS WORM DRIVE CLAMP—SIZE 10 1/2" - 12 1/4"
WCS20	#20 ALL STAINLESS WORM DRIVE CLAMP—SIZE 3/4" - 1 3/4"
WCS224	#224 ALL STAINLESS WORM DRIVE CLAMP—SIZE 12 1/2" - 14 1/2"
WCS24	#24 ALL STAINLESS WORM DRIVE CLAMP—SIZE 1" - 2"
WCS248	#248 ALL STAINLESS WORM DRIVE CLAMP—SIZE 14" - 16"
WCS28	#28 ALL STAINLESS WORM DRIVE CLAMP—SIZE 1 1/4" - 2 1/4"
WCS36	#36 ALL STAINLESS WORM DRIVE CLAMP—SIZE 1 3/4" - 2 3/4"
WCS40	#40 ALL STAINLESS WORM DRIVE CLAMP—SIZE 2" - 3"
WCS44	#44 ALL STAINLESS WORM DRIVE CLAMP—SIZE 2 1/4" - 3 1/4"
WCS48	#48 ALL STAINLESS WORM DRIVE CLAMP—SIZE 2 1/2" - 3 1/2"
WCS64	#64 ALL STAINLESS WORM DRIVE CLAMP—SIZE 2 1/2" - 4 1/2"
WCS72	#72 ALL STAINLESS WORM DRIVE CLAMP—SIZE 3" - 5"
WCS80	#80 ALL STAINLESS WORM DRIVE CLAMP—SIZE 3 1/2" - 5 1/2"
WCS88	#88 ALL STAINLESS WORM DRIVE CLAMP—SIZE 4" - 6"
WCS96	#96 ALL STAINLESS WORM DRIVE CLAMP—SIZE 4 1/2" - 6 1/2"

## MINI STAINLESS STEEL WORM DRIVE CLAMPS



<u>PART NUMBER</u>	<u>ITEM DESCRIPTION</u>
WCSM4	#4 MINI ALL STAINLESS WORM DRIVE CLAMP—SIZE 1/4" - 5/8"
WCSM6	#6 MINI ALL STAINLESS WORM DRIVE CLAMP—SIZE 5/16" - 7/8"

CLAMPS ON THIS PAGE HAVE 100% STAINLESS STEEL BAND AND 100% STAINLESS STEEL SCREW.

[ALL CLAMPS ON THIS PAGE MUST BE PURCHASED IN 10'S]



PRECISION  
INSTALLATION  
PRODUCTS

# PLUMBING SUPPLIES

Clamps - Metal Hose - Poly Pipe - Oetiker

## 3-HOLE PLASTIC SURFACE MOUNT CLAMPS



<u>PART NUMBER</u>	<u>ITEM DESCRIPTION</u>
WPC230	1/2" PLASTIC SURFACE MOUNT PIPE CLAMPS (MUST BUY IN BAG QTY OF 100)
WPC231	3/4" PLASTIC SURFACE MOUNT PIPE CLAMPS (MUST BUY IN BAG QTY OF 100)

## SNAP OVER CLAMPS

<u>PART NUMBER</u>	<u>ITEM DESCRIPTION</u>
WPC31	1" SNAP-OVER POLY PIPE CLAMP FOR COPPER, CPVC OR POLYBUTE ISOLATING IT FROM THE MOUNTING SURFACE
WPC32	1 1/4" SNAP-OVER POLY PIPE CLAMP FOR COPPER, CPVC OR POLYBUTE ISOLATING IT FROM THE MOUNTING SUR...
WPC61	3/4" SNAP-OVER POLY PIPE CLAMP FOR COPPER, CPVC OR POLYBUTE ISOLATING IT FROM THE MOUNTING SURFACE

## QUICK LATCH PLASTIC PIPE HANGER - UV RATED (BAG OF 100)



<u>PART NUMBER</u>	<u>ITEM DESCRIPTION</u>
WPC172	1/2" QUICK LATCH PIPE HANGER - PLASTIC - UV RATED (MUST BUY IN BAG QTY OF 100)
WPC175	1-1/4" QUICK LATCH PIPE HANGER - PLASTIC - UV RATED (MUST BUY IN BAG QTY OF 100)

# PLUMBING SUPPLIES

Clamps - Metal Hose - Poly Pipe - Oetiker



PRECISION  
INSTALLATION  
PRODUCTS

## NYLON CABLE CLAMPS



<u>PART NUMBER</u>	<u>ITEM DESCRIPTION</u>
E1202	1/4" NYLON CABLE CLAMPS
E1204	3/8" NYLON CABLE CLAMPS
E1205	1/2" NYLON CABLE CLAMPS

## CABLE CLIPS W/ NAIL - FOR USE WITH 1/4" CABLE (100 PACK)



<u>PART NUMBER</u>	<u>ITEM DESCRIPTION</u>
EB62	WHITE CABLE CLIP W/ NAIL FOR 1/4" (100PK)
EB63	BLACK CABLE CLIP W/ NAIL FOR 1/4" (100PK)

## PLASTIC SUSPENSION CLAMPS W/EARS



<u>PART NUMBER</u>	<u>ITEM DESCRIPTION</u>
E1270	1/2" PLASTIC SUSPENSION CLAMP W/ EARS
E1271	3/4" PLASTIC SUSPENSION CLAMP W/ EARS



PRECISION  
INSTALLATION  
PRODUCTS

# PLUMBING SUPPLIES

Clamps - Metal Hose - Poly Pipe - Oetiker

## OETIKER CLAMPS - STAINLESS STEEL



<u>PART NUMBER</u>	<u>ITEM DESCRIPTION</u>
S10-5	1/4" OETIKER CLAMP MIN/MAX .346-.413
S11-3	1/4" OETIKER CLAMP MIN/MAX .378-.445
S12-3	1/4" OETIKER CLAMP MIN/MAX .385-.484
S12-8	1/4" OETIKER CLAMP MIN/MAX .406-.504
S13-3	1/4" OETIKER CLAMP MIN/MAX .425-.524
S14-0	3/8" OETIKER CLAMP MIN/MAX .453-.551
S14-5	3/8" OETIKER CLAMP MIN/MAX .472-.571
S15-7	3/8" OETIKER DEGREASED STEPLES CLAMP MIN/MAX .520-.618
S16-2	3/8" OETIKER CLAMP MIN/MAX .539-.638
S17-0	3/8" OETIKER CLAMP MIN/MAX .571-.669
S18-5	1/2" OETIKER CLAMP MIN/MAX .602-.728
S19-8	1/2" OETIKER CLAMP MIN/MAX .654-.780
S21-0	3/4" OETIKER CLAMP MIN/MAX .701-.827
S22-6	5/8" OETIKER CLAMP
S23-0	1" OETIKER CLAMP MIN/MAX 1.000-1.126

## OETIKER CLAMP TOOL



<u>PART NUMBER</u>	<u>ITEM DESCRIPTION</u>
S1000-396	OETIKER CLAMP TOOL - SINGLE ACTION PINCER
S2000-386	OETIKER CLAMP TOOL - COMPOUND ACTION PINCER
S2000-387	OETIKER CLAMP TOOL - COMPOUND ACTION PINCER W/ SIDE JAW

## 3-2 WIRE GROUND ADAPTER



<u>PART NUMBER</u>	<u>ITEM DESCRIPTION</u>
E419	3-2 WIRE GROUND ADAPTER

## TRIPLE TAP



<u>PART NUMBER</u>	<u>ITEM DESCRIPTION</u>
E17402	TRIPLE TAP

## ROUGH DUTY MALE GROUNDING PLUG



<u>PART NUMBER</u>	<u>ITEM DESCRIPTION</u>
E612235	20 AMP-250 VOLT MALE GROUNDING PLUG

## VINYL LAMP CORD



<u>PART NUMBER</u>	<u>ITEM DESCRIPTION</u>
EW649405	18/2 GAUGE, SPT- 1 - 250' SPOOL WHITE VINYL WIRE



PRECISION  
INSTALLATION  
PRODUCTS

# ELECTRICAL

Electrical Components

## THERMOSTAT WIRE - VINYL JACKET



<u>PART NUMBER</u>	<u>ITEM DESCRIPTION</u>
EW648824	20 GAUGE-3 CONDUCTOR-500' THERMOSTAT WIRE

## SURFACE MOUNT RANGE RECEPTACLE - 50 AMP - BROWN

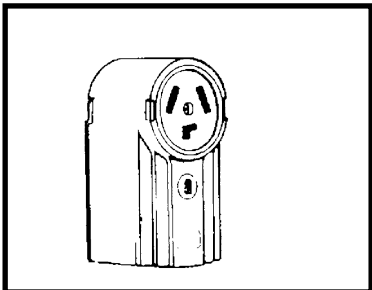

<u>PART NUMBER</u>	<u>ITEM DESCRIPTION</u>
E3650	3-WIRE SURFACE MOUNT 50 AMP RANGE RECEPTACLE
E650574	4-WIRE SURFACE MOUNT 50 AMP RANGE RECEPTACLE

## SURFACE MOUNT DRYER RECEPTACLE - 30 AMP - BROWN

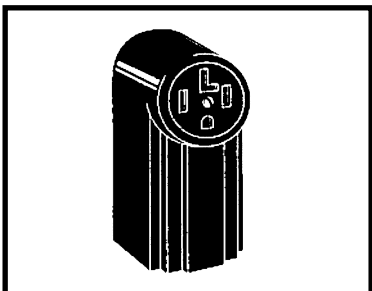

<u>PART NUMBER</u>	<u>ITEM DESCRIPTION</u>
E3630	3-WIRE SURFACE MOUNT 30 AMP DRYER RECEPTACLE
E650567	4-WIRE SURFACE MOUNT 30 AMP DRYER RECEPTACLE



## FLUSH MOUNT RANGE RECEPTACLE - 50 AMP - BROWN



<u>PART NUMBER</u>	<u>ITEM DESCRIPTION</u>
E650525	3-WIRE FLUSH MOUNT 50 AMP RANGE RECEPTACLE
E650658	4-WIRE FLUSH MOUNT 50 AMP RANGE RECEPTACLE

## FLUSH MOUNT DRYER RECEPTACLE - 30 AMP - BROWN



<u>PART NUMBER</u>	<u>ITEM DESCRIPTION</u>
E650504	3-WIRE FLUSH MOUNT 30 AMP DRYER RECEPTACLE
E650657	4-WIRE FLUSH MOUNT 30 AMP DRYER RECEPTACLE



PRECISION  
INSTALLATION  
PRODUCTS

# ELECTRICAL

Electrical Components

## DUPLEX RECEPTACLE - 125V- 3-WIRE



<u>PART NUMBER</u>	<u>ITEM DESCRIPTION</u>
E1517	DUPLEX RECEPTACLE - IVORY
E1517W	DUPLEX RECEPTACLE - WHITE
E611145	20 AMP GROUNDED DUPLEX RECEPTACLE-IVORY
E611145W	20 AMP GROUNDED DUPLEX RECEPTACLE-WHITE

## GROUNDING OUTLET - HEAVY DUTY - 3-WIRE - 20 AMP



<u>PART NUMBER</u>	<u>ITEM DESCRIPTION</u>
E1876	250 VOLT SINGLE GROUND RECEPTACLE - IVORY
E1877	125 VOLT SINGLE GROUND RECEPTACLE - IVORY

MADE IN THE USA

## METAL HANDY UTILITY BOX



<u>PART NUMBER</u>	<u>ITEM DESCRIPTION</u>
E103	ELECTRICAL HANDY BOX 2" X 4"

MADE IN THE USA

## 4" METAL SQUARE UTILITY BOX



<u>PART NUMBER</u>	<u>ITEM DESCRIPTION</u>
E4SW-8-12	4" SQUARE BOX WITH 1/2 & 3/4 KNOCKOUT

MADE IN THE USA

## METAL SQUARE BOX BLANK COVERS



<u>PART NUMBER</u>	<u>ITEM DESCRIPTION</u>
E400K	4" SQUARE METAL PLATE
E400KO	4" SQUARE METAL PLATE W/ KNOCKOUT

MADE IN THE USA



PRECISION  
INSTALLATION  
PRODUCTS

# ELECTRICAL

Electrical Components

## METAL HANDY BOX COVERS - GALVANIZED W/MOUNT SCREWS



<u>PART NUMBER</u>	<u>ITEM DESCRIPTION</u>
E100DR	METAL DUPLEX COVER
E101DR	METAL UTILITY COVER
E102KO	SOLID METAL DUPLEX BOX COVER W/KNOCKOUT

## DRYER/RANGE COVER PLATE



<u>PART NUMBER</u>	<u>ITEM DESCRIPTION</u>
E650539	CHROME RANGE/DRYER WALL PLATE

# ELECTRICAL

Electrical Components



PRECISION  
INSTALLATION  
PRODUCTS

## DUPLEX RECEPTACLE WALL PLATE - 2 3/4" X 4 1/2" - SMOOTH



<u>PART NUMBER</u>	<u>ITEM DESCRIPTION</u>
E2811	IVORY DUPLEX RECEPTACLE COVER
E2811W	WHITE DUPLEX RECEPTACLE COVER

## SINGLE RECEPTACLE WALL PLATE - 2 3/4" X 4 1/2" - SMOOTH



<u>PART NUMBER</u>	<u>ITEM DESCRIPTION</u>
E2131	SINGLE ROUND RECEPTACLE PLATE - IVORY



PRECISION  
INSTALLATION  
PRODUCTS

# ELECTRICAL

Electrical Components

## METAL CABLE BOX CONNECTORS



<u>PART NUMBER</u>	<u>ITEM DESCRIPTION</u>
ERC	3/8-1/2" METAL ROMEX CONNECTOR - BOX 100
ERC-12	3/4" METAL ROMEX BOX CONNECTOR-BOX QUANTITY 25

## PLASTIC CABLE BOX CONNECTORS



<u>PART NUMBER</u>	<u>ITEM DESCRIPTION</u>
ERW100	1/2" PLASTIC ROMEX CONNECTOR-U.L. APPROVED
ERW100-34	3/4" PLASTIC ROMEX CONNECTOR-U.L. APPROVED

## METAL ROMEX BOX CONNECTORS



<u>PART NUMBER</u>	<u>ITEM DESCRIPTION</u>
ERS6	3/8" METAL SCREW IN ROMEX CONNECTOR
ERS8	1/2" METAL SCREW IN ROMEX CONNECTOR
ERS12	3/4" METAL SCREW IN ROMEX CONNECTOR

## 90 DEGREE METAL ROMEX BOX CONNECTORS



<u>PART NUMBER</u>	<u>ITEM DESCRIPTION</u>
ERCL6	3/8" ELBOW METAL ROMEX CONNECTOR
ERCL8	1/2" ELBOW METAL ROMEX CONNECTOR - BOX 25
ERCL12	3/4" ELBOW METAL ROMEX CONNECTOR



PRECISION  
INSTALLATION  
PRODUCTS

# ELECTRICAL

## Electrical Components

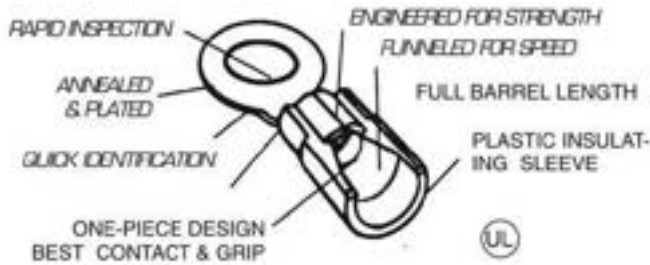

### FEMALE QUICK DISCONNECT

Part No.	Wire Size	Dia. Tab	Pk. Qty.
Red <b>E630519</b>	22-18	0.25	100
Blue <b>E630526</b>	16-14	0.25	100
Yellow <b>E630533</b>	12-10	0.25	100

### SOLDERLESS CRIMP TERMINALS

- First choice of the professionals
- Funnel-entry feature eliminates wire strand "hang-up" and increases crimping speed with reliability
- Continuous duty temperature range of -40°F to 194°F [-40° to 90°C]



### MALE QUICK DISCONNECT

Blue <b>E630540</b>	16-14	0.25	100
------------------------	-------	------	-----



### RING TONGUE

Part No.	Wire Size	Dia. Tab	Pk. Qty.
Blue <b>E630428</b>	16-14	10	100
Yellow <b>E630449</b>	12-10	1/4	50



### WIRE CONNECTOR - Wing type

- UL Listed for pressure type connectors for 600V max. building wire, 1000V max. on signs and fixtures
- 105°C [122°F] max. temperature rating



### SPADE TONGUE

Red <b>E630470</b>	22-18	8-10	100
Blue <b>E630484</b>	16-14	10	100
Yellow <b>E630491</b>	12-10	10	50

Part No.	Copper Wire Range		Pk. Qty.
	Min.	Max.	
Yellow <b>E630309</b>	2#18	3#12 Box	100
Red <b>E630316</b>	2#16	5#12 Box	100
Blue <b>E630337</b>	3#12	1#6 w/2#8 Box	50
Grey <b>E630339</b>	Extra-Large		50



### BUTT SPLICE

Red <b>E630498</b>	22-18	-	100
Blue <b>E630505</b>	16-14	-	50
Yellow <b>E630512</b>	12-10	-	50



### FULL INSULATED NYLON

Female - Blue <b>E630547</b>	16-14	0.25	50
---------------------------------	-------	------	----



### INSULATED STAPLES

sharp pointed, rust proof processed, stiff wire. Will not bend easily, White. Size: 9/16" x 11/4"  
For use with #10, 12 or 14 non-metallic cable

Part No.	Carton	Pk. Qty.
<b>E264</b>	1000	40







# ELECTRICAL

## Electrical Components



PRECISION  
INSTALLATION  
PRODUCTS

Color	Shown Actual Size	Item No.	Trade Equiv	Wire Combination Range	300 Volt Pressure-Type Splicing Connector	600 Volt Pressure-Type Splicing Connector	Copper to Aluminum	Aluminum to Aluminum	Copper to Aluminum (Dry Locations only)
Blue		EWN 22		Joins No. 22 thru 14 AWG Min. 3 No. 20 Max. 3 No. 16	<b>X</b>	<b>X</b>	<b>X</b>		
Orange		EWN 33	Size 73B	Joins No. 18 thru 14 AWG Min. 2 No. 18 Max. 3 No. 14	<b>X</b>	<b>X</b>	<b>X</b>		
Yellow		EWN 44	Size 74B	Joins No. 18 thru 10 AWG Min. 1 No. 14 & 2 No. 18 Max. 1 No. 10 & 2 No. 14	<b>X</b>	<b>X</b>	<b>X</b>	<b>X</b>	<b>X</b>
Red		EWN 66	Size 76B	Joins No. 18 thru 8 AWG Min. 2 No. 16 & 2 No. 18 Max. 2 No. 8	<b>X</b>	<b>X</b>	<b>X</b>	<b>X</b>	<b>X</b>



PRECISION  
INSTALLATION  
PRODUCTS



**END OF SECTION**

**THIS PAGE IS LEFT  
INTENTIONALLY BLANK.**

# ELECTRICAL

## Electrical Cords



PRECISION  
INSTALLATION  
PRODUCTS

### EXTENSION CORDS - 14/3-124V 15AMP - ANGLE CORD



<u>PART NUMBER</u>	<u>ITEM DESCRIPTION</u>
EAC03	3 FOOT EXTENSION CORD W/ ANGLE PLUG-14 GAUGE-3 WIRE-125 VOLT-15 AMP
EAC06	6 FOOT EXTENSION CORD W/ ANGLE PLUG-14 GAUGE-3 WIRE-125 VOLT-15 AMP-UL LISTED
EAC09	9 FOOT EXTENSION CORD W/ ANGLE PLUG-14 GAUGE-3 WIRE-125 VOLT-15 AMP
EAC12	12 FOOT EXTENSION CORD W/ ANGLE PLUG-14 GAUGE-3 WIRE-125 VOLT-15 AMP

**UL LISTED**

### ELECTRICAL DRYER CORDS - 30 AMP - 3-WIRE



<u>PART NUMBER</u>	<u>ITEM DESCRIPTION</u>
ED4L	4' 3-WIRE ELECTRIC DRYER CORD-30 AMP-CLOSED TERMINAL ENDS
ED5L	5' 3-WIRE ELECTRIC DRYER CORD-30 AMP-CLOSED TERMINAL ENDS
ED6L	6' 3-WIRE ELECTRIC DRYER CORD-30 AMP-CLOSED TERMINAL ENDS

**UL LISTED**

### ELECTRIC DRYER CORDS - 30 AMP - 4 WIRE



<u>PART NUMBER</u>	<u>ITEM DESCRIPTION</u>
EDM4L	4' 4-WIRE ELECTRIC DRYER CORD-30 AMP-CLOSED TERMINAL ENDS
EDM5L	5' 4-WIRE ELECTRIC DRYER CORD-30 AMP-CLOSED TERMINAL ENDS
EDM6L	6' 4-WIRE ELECTRIC DRYER CORD-30 AMP-CLOSED TERMINAL ENDS
EDM10L	10' 4-WIRE ELECTRIC DRYER CORD-30 AMP-CLOSED TERMINAL ENDS

**UL LISTED**



PRECISION  
INSTALLATION  
PRODUCTS

# ELECTRICAL

## Electrical Cords

### ELECTRIC RANGE CORDS - 40 AMP - 3-WIRE



<u>PART NUMBER</u>	<u>ITEM DESCRIPTION</u>
ER4LX	4' 3-WIRE ELECTRIC RANGE CORD-40 AMP-CLOSED TERMINAL ENDS
ER5E	5' 3-WIRE ELECTRIC RANGE CORD-40 AMP-CLOSED TERMINAL ENDS
ER6E	6' 3-WIRE ELECTRIC RANGE CORD-40 AMP-CLOSED TERMINAL ENDS

**UL LISTED**

### ELECTRIC RANGE CORDS - 50 AMP - 3-WIRE



<u>PART NUMBER</u>	<u>ITEM DESCRIPTION</u>
ER4	4' 3-WIRE ELECTRIC RANGE CORD-50 AMP-CLOSED TERMINAL ENDS
ER5	5' 3-WIRE ELECTRIC RANGE CORD-50 AMP-CLOSED TERMINAL ENDS
ER6	6' 3-WIRE ELECTRIC RANGE CORD-50 AMP-CLOSED TERMINAL ENDS
ER10	10' 3-WIRE ELECTRIC RANGE CORD-50 AMP-CLOSED TERMINAL ENDS

**UL LISTED**

# ELECTRICAL

## Electrical Cords



PRECISION  
INSTALLATION  
PRODUCTS

### ELECTRIC RANGE CORDS - 40 AMP - 4-WIRE



<u>PART NUMBER</u>	<u>ITEM DESCRIPTION</u>
ERM4L	4' 4-WIRE ELECTRIC RANGE CORD-50 AMP-CLOSED TERMINAL ENDS
ERM5X	5' 4-WIRE ELECTRIC RANGE CORD-40 AMP-CLOSED TERMINAL ENDS
ERM6X	6' 4-WIRE ELECTRIC RANGE CORD-40 AMP-CLOSED TERMINAL ENDS

**UL LISTED**

### ELECTRIC RANGE CORDS - 50 AMP - 4-WIRE



<u>PART NUMBER</u>	<u>ITEM DESCRIPTION</u>
ERM5	5' 4-WIRE ELECTRIC RANGE CORD-50 AMP-CLOSED TERMINAL ENDS
ERM6	6' 4-WIRE ELECTRIC RANGE CORD-50 AMP-CLOSED TERMINAL ENDS
ERM10	10' 4-WIRE ELECTRIC RANGE CORD-50 AMP-CLOSED TERMINAL ENDS

**UL LISTED**



PRECISION  
INSTALLATION  
PRODUCTS

# ELECTRICAL

## Electrical Cords

### POWER SUPPLY CORDS - 16/3 - 125V - ANGLE PLUG



<u>PART NUMBER</u>	<u>ITEM DESCRIPTION</u>
EPT3A-JP	3' 125 VOLT-10 AMP- 16/3 APPLIANCE POWER CORD WITH ANGLE PLUG
EPT6A-JP	6' 125 VOLT-13 AMP-16/3 GAUGE-APPLIANCE POWER CORD WITH ANGLE PLUG
EPT8A-JP	8' 125 VOLT-13 AMP-16/3 GAUGE-APPLIANCE POWER CORD W/ ANGLE PLUG

**UL LISTED**

### POWER SUPPLY CORDS - 16/3 - 125V - STRAIGHT PLUG

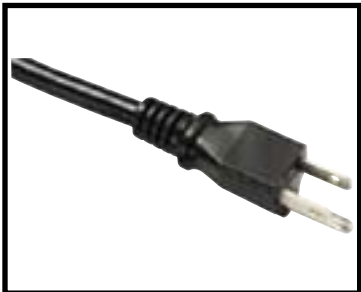

<u>PART NUMBER</u>	<u>ITEM DESCRIPTION</u>
EPT3S-JP	3' 125 VOLT-13 AMP-16/3 GAUGE-APPLIANCE POWER CORD WITH STRAIGHT PLUG
EPT6S-JP	6' VOLT-13 AMP-16/3 GAUGE-APPLIANCE POWER CORD WITH STRAIGHT PLUG
EPT8S-LUM	8' 16 GAUGE 3-WIRE 13-AMP POWER SUPPLY CORD - STRAIGHT PLUG

**UL LISTED**

### POWER SUPPLY CORDS - 14/3 - 15 AMP - ANGLE PLUG



<u>PART NUMBER</u>	<u>ITEM DESCRIPTION</u>
EPT6A-14/3	6' APPLIANCE POWER CORD - 14/3 GAUGE - 15AMP - ANGLE PLUG
EPT8A-14/3	8' APPLIANCE POWER CORD - 14/3 GAUGE - 15 AMP - ANGLE PLUG

**UL LISTED**

# GAS - APPLIANCE - WATER

## Airgaps



PRECISION  
INSTALLATION  
PRODUCTS

## DISHWASHER AIRGAP - IMPORT



<u>PART NUMBER</u>	<u>ITEM DESCRIPTION</u>
AG5P	ECONOMY DW AIRGAP W/ POLYPROPYLENE BODY AND CHROME PLATED PLASTIC CAP

## REPLACEMENT AIRGAP COVER - UPC, IPC, NSF



<u>PART NUMBER</u>	<u>ITEM DESCRIPTION</u>
AGAP-COVER-ORB	AIRGAP COVER - OIL RUBBED BRONZE
AGAP-COVER-SS	AIRGAP COVER - BRUSHED STAINLESS

## DISHWASHER & RO AMERIGAP™



<u>PART NUMBER</u>	<u>ITEM DESCRIPTION</u>
AT52-RO	AMERIGAP 3-PORTED AIRGAP W/ 1/4" JG DRAIN - CODE APPROVED

### Description

One inlet port accepts standard dishwasher hose (5/8" I.D.). Other small flow inlet port comes with quick connect type fitting that accepts 1/4" O.D. poly tubing from an undersink RO unit. Eliminates the need for an RO air gap faucet and also the illegal metal screw drive clamp. UPC®, IPC and NSF.



PRECISION  
INSTALLATION  
PRODUCTS

# GAS - APPLIANCE - WATER Airgaps

## DRAIN BOA™



**PART NUMBER**

AT52-RO

**ITEM DESCRIPTION**

AMERIGAP 3-PORTED AIRGAP W/ 1/4" JG DRAIN - CODE APPROVED

**Description**

Inlet port directly accepts 3/8" and 1/2" O.D. poly tubing. Dual plumbing code listed sink tailpiece fitting. Comes with 2 plastic clamps and a stainless steel screw drive clamp as shown. Comes with a metal worm clamp for securing tubing to small port. UPC® and NSF.

## DISHWASHER AIRGAP - EASTMAN



**PART NUMBER**

DAGE-EA

**ITEM DESCRIPTION**

EASTMAN PLASTIC AIR GAP - BOX - METAL CHROME CAP

**Description**

Blue body with brushed nickel cap. For Dishwasher & Disposer installation. UPC®.

## EASTMAN / EZ-FLO REPLACEMENT AIRGAP PARTS ONLY



**PART NUMBER**

AGOCCP

**ITEM DESCRIPTION**

EZ-FLO/EASTMAN CHROME PLATED AIR GAP OUTER CAP

AGOCBN

EZ-FLO/EASTMAN BRUSHED NICKEL AIR GAP OUTER CAP

AGPIC

EZ-FLO/EASTMAN PLASTIC INNER CAP FOR AIRGAP

AGPSW

EZ-FLO/EASTMAN PLASTIC SPACER WASHER FOR AIRGAP

AGRW

EZ-FLO/EASTMAN RUBBER WASHER FOR AIRGAP



# GAS - APPLIANCE - WATER

## Airgaps



PRECISION  
INSTALLATION  
PRODUCTS

### GAP-A-RO: 31-S (KIT S-A)



<u>PART NUMBER</u>	<u>ITEM DESCRIPTION</u>
AGAP-31S-A	AIRGAP GAP-A-RO 3/8" INLET X 3/8" OUTLET AIRGAP (CASE 50)

#### Description

Easy connection to inlet and outlet ports. Comes with 3/8" inlet and outlet ports. Unit designs lab tested at over 1/2 G.P.M. [2 Liter/minute] or more, depending on style of unit. Suggested usage approximately 1 to 16 oz/min. [30 to 500 ml/min]. Vertical wall mounting bracket and screws included. UPC®, IPC and NSF.

### GAP-A-RO: 31-S (KIT S-B)



<u>PART NUMBER</u>	<u>ITEM DESCRIPTION</u>
AGAP-31S-B	AIRGAP GAP-A-RO 1/4" INLET X 3/8" OUTLET AIRGAP

#### Description

Easy connection to inlet and outlet ports. Comes with 1/4" inlet and 3/8" outlet ports. Unit designs lab tested at over 1/2 G.P.M. [2 L/min] or more, depending on style of unit. Suggested usage approximately 1 to 16 oz/min [30 to 500 ml/min]. Vertical wall mounting bracket and screws included. UPC®, IPC and NSF.

### GAP-A-RO: 31-S (KIT S-C)



<u>PART NUMBER</u>	<u>ITEM DESCRIPTION</u>
AGAP-31S-C	AIRGAP GAP-A-RO INLINE AIRGAP WALL MOUNT

#### Description

Easy connection to inlet and outlet ports. Provides compact air gap unit and convenient mounting arrangement for RO type water coolers. Unit designs lab tested at over 1/2 G.P.M. [2 L/min] or more, depending on style of unit. Suggested usage approximately 1 to 16 oz/min [30 to 500 ml/min]. Vertical wall mounting bracket and screws included. UPC®, IPC and NSF.

### GAP-A-RO:31-S KIT(S-D)



<u>PART NUMBER</u>	<u>ITEM DESCRIPTION</u>
AGAP-31S-D	AIRGAP GAP-A-RO SINK MOUNT 1/4" INLET X 3/8" OUT

#### Description

Easy connection to inlet and outlet ports. Provides a convenient alternative to include a code listed air gap unit in the indirect drain piping; if a dispensing faucet is not needed or is to be remotely located or if installer prefers not to use an air gap style dispensing faucet. Unit designs lab tested at over 1/2 G.P.M. [2 L/min] or more, depending on style of unit. Suggested usage approximately 1 to 16 oz/min. [30 to 500 ml/min]. Mounts on top of sink. UPC®, IPC and NSF.



PRECISION  
INSTALLATION  
PRODUCTS

# GAS - APPLIANCE - WATER

## Airgaps

### GAP-IT: 61-D (KIT HF1)



**PART NUMBER**

AT52-RO

**ITEM DESCRIPTION**

AMERIGAP 3-PORTED AIRGAP W/ 1/4" JG DRAIN - CODE APPROVED

**Description**

Designed to fit into recessed washing machine outlet boxes w/ 2" standpipes. Fits onto top of exposed 2" standpipes. Units feature a flow straightener to quiet and smooth out turbulent flow and splatter shields to eliminate any water droplets that may splatter out of either air gap opening. Units designed to allow space for washer drain hook or soft rubber washer hose to share standpipe with Gap-It. Multiple air gap openings exceed the code mandated minimum of at least one (1)" vertical opening. Comes with mounting base for 2" pipe. UPC®, IPC and NSF.

### GAP-IT: 61-S (KIT HF2)



**PART NUMBER**

AGAP-612

**ITEM DESCRIPTION**

AIRGAP GAP-IT INLINE HIGH FLOW AIRGAP FOR 1-1/2" PIPE

**Description**

Designed to fit into recessed washing machine outlet boxes w/ 1 1/2" standpipes. Units feature a flow straightener to quiet and smooth out turbulent flow and splatter shields to eliminate any water droplets that may splatter out of either air gap opening. Units designed to allow space for washer drain hook or soft rubber washer hose to share standpipe with Gap-It. Multiple air gap openings exceed the code mandated minimum of at least one (1)" vertical opening. Comes with vertical wall mounting bracket and screws. UPC®, IPC and NSF.

### MR.DRAIN



**PART NUMBER**

AMD-10A

**ITEM DESCRIPTION**

AIRGAP MISTER DRAIN AIRGAP USED WITH STANDPIPE

**Description**

Fits 1 1/2" or 2" standpipes. Unit housing length approx. 5 1/2" (13.97 cm). Recommended usage 1 to 7 gal/min (3.7 to 26.5 L/min). Tested at 15 gal/min (56.8 L/min). Allows soft rubber washer hose or washer metal drain hook to share standpipe with other Air Gap units. Inlet port fits 1/2" SCH 40 PVC slip fittings or special couplings. Provides more than twice the code-required minimum air gap opening. Can be mounted at 3 different levels. UPC®, IPC and NSF.

# GAS - APPLIANCE - WATER

## Airgaps



PRECISION  
INSTALLATION  
PRODUCTS

## GAP-CAP



### PART NUMBER

AGAP-CAP

### ITEM DESCRIPTION

AIRGAP GAP-CAP-MODEL 8500- MOUNTS ON 1-1/2" - 2" PIPE (METAL OR PLASTIC)

### Description

Ideal space-saving air gap. Twin inlet port: Larger port is 1/2" slip that also directly accommodates 5/8" O.D. poly tubing. Smaller RO port directly accepts 3/8" O.D. poly tubing. Includes inlet elbow with flow straightener 5 to 7 gal/min. Fits 1 1/2" & 2" standpipes. UPC®, IPC and NSF.

## DUAL BARB ELBOW



### PART NUMBER

AG170-008

### ITEM DESCRIPTION

AIRGAP DUAL BARB ELBOW - FITS 1/2" & 5/8" ID POLY TUBE - FITS THE AMD-10A & AGAP-CAP

### Description

Fits Mr. Drain and Gap-Cap™ units.

## GAP-A-DRAIN UNIVERSAL AIRGAP



### PART NUMBER

AG180-002

### ITEM DESCRIPTION

AIRGAP GAP-A-DRAIN UNIVERSAL AIRGAP - FLOOR DRAINS, 2" AND 1-1/2" STAND PIPES

### Description

Fits 1 1/2" stand pipe with reducer or 2" standpipes. Accommodates discharge rates of up to 35 gal/min. Design lab tested at 15 gal/min. Fits up to three 3/4" PVC or copper drain pipes and two Mr. Drains. Provides required airgap to comply with ASME standard. Easily attaches to floor drains using metal hook (included) Can be mounted on floor drain, 2", and 1 1/2" stand pipes. UPC®, IPC and NSF.



PRECISION  
INSTALLATION  
PRODUCTS

# GAS - APPLIANCE - WATER

## Airgaps

### GAP-A-FLO



**PART NUMBER**

**ITEM DESCRIPTION**

AGAF-211

AIRGAP GAP-A-FLO INLINE AIRGAP WITH MALE & FEMALE THREADS

**Description**

Unit approximately 8" long. Provides an in-line air gap, usually installed in the last 5 ft (1.5 meters) of the indirect drain piping and must be in the down leg of the drain line piping. Unit can be tilted at any angle (down as low as 45° angle) when installing if needed, (window opening on top side). Molded clamp groove plus included "Jiffy Clip" enable easy vertical wall mounting. Unique design incorporates a rotatable splash guard/splatter shield, to eliminate splatter of water droplets out of either air gap opening. Multiple air gap openings far exceed the code mandated minimum of (1)" vertical. All noted threads are American NPT threads. Unit design lab tested at 15 gal/min (56.8 L/min). Recommended usage up to 7 gal/min (26.5 L/min). UPC®, IPC and NSF.

### HYDROTECH AIRGAP



**PART NUMBER**

**ITEM DESCRIPTION**

AG3001

HYDROTECH WALL MOUNTED AIRGAP

# GAS - APPLIANCE - WATER

Drain Hose



PRECISION  
INSTALLATION  
PRODUCTS

## DISHWASHER REINFORCED BULK DRAIN HOSE - BLACK RUBBER



**PART NUMBER**

**ITEM DESCRIPTION**

DW5

5/8 X 50 FT DRAIN HOSE FOR DISHWASHERS

DW7

7/8 X 50 FT DRAIN HOSE FOR DISHWASHERS

## PVC ADAPTER - USE W/ DRAIN LINE FOR WATER SOFTENERS



**PART NUMBER**

**ITEM DESCRIPTION**

A4180

PVC SCHEDULE 80 - 1/2" BARB X 1/2" MPT ADAPTER



PRECISION  
INSTALLATION  
PRODUCTS



**END OF SECTION**

**THIS PAGE IS LEFT  
INTENTIONALLY BLANK.**

# GAS - APPLIANCE - WATER

## Fill Hoses

High Pressure Black Rubber Fill Hoses



PRECISION  
INSTALLATION  
PRODUCTS

## 3/8" ID RUBB FILL HOSES



Hose Connection Gauges are used to test water supply pressure within a distribution system. Its red indicator hand holds the highest reading registered for detection of thermal expansion pressure surges.

### 4 FOOT - HOSE INLET 3/4" FGH

<u>PART NUMBER</u>	<u>ITEM DESCRIPTION</u>
H4FF	4' BLACK RUBBER HIGH PRESSURE INLET HOSE-3/4 FGH X 3/4 FGH
H4FL	4' BLACK RUBBER HIGH PRESSURE INLET HOSE-3/4 FGH X 3/4 FGH ELBOW

### 5 FOOT - HOSE INLET 3/4" FGH

<u>PART NUMBER</u>	<u>ITEM DESCRIPTION</u>
H5FF	5' BLACK RUBBER HIGH PRESSURE INLET HOSE-3/4 FGH X 3/4 FGH
H5FL	5' BLACK RUBBER HIGH PRESSURE INLET HOSE-3/4 FGH X 3/4 FGH ELBOW

### 6 FOOT - HOSE INLET 3/4" FGH

<u>PART NUMBER</u>	<u>ITEM DESCRIPTION</u>
H6FF	6' BLACK RUBBER HIGH PRESSURE INLET HOSE-3/4 FGH X 3/4 FGH
H6FL	6' BLACK RUBBER HIGH PRESSURE INLET HOSE-3/4 FGH X 3/4 FGH ELBOW

### 8 FOOT - HOSE INLET 3/4" FGH

<u>PART NUMBER</u>	<u>ITEM DESCRIPTION</u>
H8FF	8' BLACK RUBBER HIGH PRESSURE INLET HOSE-3/4 FGH X 3/4 FGH
H8FL	8' BLACK RUBBER HIGH PRESSURE INLET HOSE-3/4 FGH X 3/4 FGH ELBOW

### 10 FOOT - HOSE INLET 3/4" FGH

<u>PART NUMBER</u>	<u>ITEM DESCRIPTION</u>
H10FF	10' BLACK RUBBER HIGH PRESSURE INLET HOSE-3/4 FGH X 3/4 FGH



PRECISION  
INSTALLATION  
PRODUCTS

# GAS - APPLIANCE - WATER Fill Hoses

High Pressure Black Rubber Fill Hoses

## MIXER HOSE - "Y" HIGH PRESSURE BLACK RUBBER 3/8" ID



Blends hot and hold water; ferrules crimp fitted to maintain high pressure.

<u>PART NUMBER</u>	<u>ITEM DESCRIPTION</u>
H820	"Y" HIGH PRESSURE MIXER HOSE-3/4 FGH X 3/4 MPT X 3/4 FGH

## BRAIDED STAINLESS STEEL FILL HOSES



- GREAT FOR THOSE CONCERNED WITH RUBBER HOSE BURSTING
- PRESSURE RATING TO 180 PSI

<u>PART NUMBER</u>	<u>ITEM DESCRIPTION</u>
HB4FF	4' BRAIDED SS FILL HOSE - 3/4" FGH X 3/4" FGH - 3/8" ID FLOW THROUGH
HB5FF	5' BRAIDED 3/8" ID SS FILL HOSE - 3/4"FGH X 3/4"FGH - 3/8" ID FLOW THROUGH
HB6FF	6' BRAIDED SS FILL HOSE - 3/4" FGH X 3/4" FGH - 3/8" ID FLOW THROUGH
HB8FF	8' BRAIDED SS FILL HOSE - 3/4" FGH X 3/4" FGH - 3/8" ID FLOW THROUGH
HB10FF	10' BRAIDED SS FILL HOSE - 3/4" FGH X 3/4" FGH
HB12MF	12" BRAIDED SS FILL HOSE - 3/4" MGH X 3/4" FGH - 3/8" ID FLOW THROUGH



# GAS - APPLIANCE - WATER

Hose Connectors

Hose Washers, Screens, & Accessories



PRECISION  
INSTALLATION  
PRODUCTS

## WATER VALVE REPAIR KIT



<u>PART NUMBER</u>	<u>ITEM DESCRIPTION</u>
W7438K	SINGLE WATER VALVE REPAIR KIT
W7438K2	DUAL WATER VALVE REPAIR KIT

## NO-HUB FLEX COUPLINGS



<u>PART NUMBER</u>	<u>ITEM DESCRIPTION</u>
DS150	BLACK RUBBER NO HUB CONNECTOR - 1 1/2" X 1 1/2"
DS2150	2" X 1-1/2" NO HUB CONNECTOR
DS220	BLACK RUBBER NO HUB CONNECTOR - 2" X 2"

## CAPS - 3/4" FGH



<u>PART NUMBER</u>	<u>ITEM DESCRIPTION</u>
HC	3/4" FEMALE GARDEN HOSE BRASS CAP
HCP	3/4" PLASTIC HOSE CAP



PRECISION  
INSTALLATION  
PRODUCTS

# GAS - APPLIANCE - WATER Hose Connectors

Hose Washers, Screens, & Accessories

## “Y” FITTING - BRASS



<u>PART NUMBER</u>	<u>ITEM DESCRIPTION</u>
HBY	3/4" BRASS HOSE Y

## MGH X MGH



<u>PART NUMBER</u>	<u>ITEM DESCRIPTION</u>
HMC-LF	3/4" X 3/4" BRASS MALE GARDEN HOSE COUPLING - LEAD FREE
HMC-P	3/4" X 3/4" PLASTIC MALE GARDEN HOSE COUPLING-BLACK

## MGH X MPT - BRASS

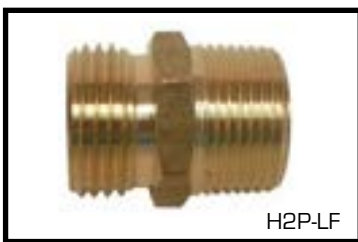

<u>PART NUMBER</u>	<u>ITEM DESCRIPTION</u>
H2P-8-LF	3/4" MALE GARDEN HOSE X 3/4" MPT (TAPPED 1/2" FPT) - LEAD FREE
H2P-8M	3/4" MALE GARDEN HOSE X 1/2" MALE PIPE THREAD
H2P-LF	3/4" MALE GARDEN HOSE X 3/4" MPT - LEAD FREE

## MGH X FPT - BRASS



<u>PART NUMBER</u>	<u>ITEM DESCRIPTION</u>
H2FP	3/4" MALE GARDEN HOSE X 3/4" FEMALE PIPE THREAD

# GAS - APPLIANCE - WATER

## Hose Connectors

Hose Washers, Screens, & Accessories



PRECISION  
INSTALLATION  
PRODUCTS

### FGH X FGH - BRASS



**PART NUMBER**

**ITEM DESCRIPTION**

HFC

3/4" FEMALE GARDEN HOSE X 3/4" FEMALE GARDEN HOSE COUPLING

HFC5

3/4" FEMALE GARDEN HOSE X 3/4" FEMALE GARDEN HOSE SWIVEL UNION

### FGH TO FPT - BRASS



**PART NUMBER**

**ITEM DESCRIPTION**

H5AS

3/4" FEMALE GARDEN HOSE X 3/4" FEMALE PIPE SWIVEL

H5A-8

3/4" FEMALE GARDEN HOSE X 1/2" FEMALE PIPE THREAD

H5AS-8

3/4" FEMALE GARDEN HOSE X 1/2" FEMALE PIPE SWIVEL

### FGH TO HOSE BARB - BRASS



**PART NUMBER**

**ITEM DESCRIPTION**

HB29-6

3/4" FEMALE HOSE X 3/8" HOSE BARB SWIVEL



PRECISION  
INSTALLATION  
PRODUCTS

# GAS - APPLIANCE - WATER Hose Connectors

Hose Washers, Screens, & Accessories

## BRASS FGH X MPT CONNECTORS



**PART NUMBER**

**ITEM DESCRIPTION**

H5AM-LF

3/4" FEMALE GARDEN HOSE X 3/4" MALE PIPE THREAD-LEAD FREE

## WHIRLPOOL DISHWASHER FITTING ELBOW - SWIVEL FGH X COMP



**USED WITH:**

AMANA®, MAYTAG®, KITCHEN AID®, JENN-AIR®, MAGIC CHEF®, ESTATE®, INGLIS®, ROPER®,  
IKEA®, CROSLEY®, KENMORE® & KENMORE ELITE®

**PART NUMBER**

**ITEM DESCRIPTION**

H5AS-C69

WHIRLPOOL DISHWASHER FITTING - 3/4" HOSE THREAD X 3/8" COMP  
ELBOW-SWIVEL

H5AS-C69-B0

WHIRLPOOL DISHWASHER ELBOW - BODY ONLY - 3/4" GH X 3/8"COMP

## GOOSENECK FOR DRAIN HOSE



**PART NUMBER**

**ITEM DESCRIPTION**

HAGN

3/4" ALUMINUM GOOSENECK FOR DRAIN HOSE/STAND PIPE

HAGN-16

1" ALUMINUM GOOSENECK FOR DRAIN HOSE/STAND PIPE-HIGH FLOW

# GAS - APPLIANCE - WATER

Hose Connectors

Hose Washers, Screens, & Accessories



PRECISION  
INSTALLATION  
PRODUCTS

## BLACK NEOPRENE 3/4" HOSE WASHER (PK100)



<u>PART NUMBER</u>	<u>ITEM DESCRIPTION</u>
HW	BLACK NEOPRENE 3/4" HOSE WASHER (PK100)

## SHUR-FLO 30 MESH HOSE SCREEN W/ RUBBER WASHER



<u>PART NUMBER</u>	<u>ITEM DESCRIPTION</u>
HSWR-30	30 MESH HOSE SCREENS W/ WASHER - COURSE MESH (PK100)

HOSE SCREEN WASHERS - PREVENTS CLOGGED VALVES ON NOZZLES. IDEAL FOR AUTOMATIC WASHERS, POWER SPRAYERS, GARDEN HOSES AND SPRINKLERS

## HOSE SCREEN FOR WATER VALVE

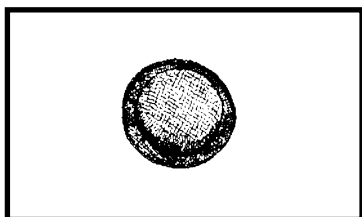

<u>PART NUMBER</u>	<u>ITEM DESCRIPTION</u>
HSW	COARSE HOSE SCREENS ONLY (PK 100)

## DISPOSER / DISHWASHER DRAIN ADAPTER



<u>PART NUMBER</u>	<u>ITEM DESCRIPTION</u>
DDCK	BLACK RUBBER GARBAGE DISPOSAL DRAIN CONNECTOR W/ 4 SCREW CLAMPS



PRECISION  
INSTALLATION  
PRODUCTS

# GAS - APPLIANCE - WATER Hose Connectors

Hose Washers, Screens, & Accessories

## STRAIGHT PLASTIC HOSE MENDER

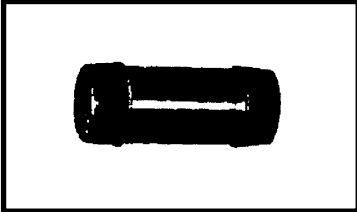

<u>PART NUMBER</u>	<u>ITEM DESCRIPTION</u>
HMPS	HIGH IMPACT PLASTIC HOSE MENDER STRAIGHT FITS 15/16" & 1" ID HOSE

## 90 DEGREE ELBOW PLASTIC HOSE MENDER

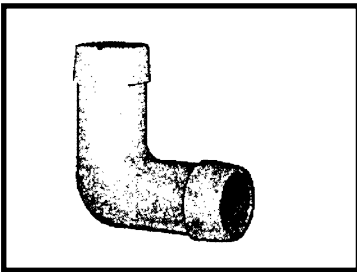

<u>PART NUMBER</u>	<u>ITEM DESCRIPTION</u>
HMPL	HIGH IMPACT PLASTIC 90 ELBOWHOSE MENDER STRAIGHT FITS 15/16" & 1" ID HOSE

## HOSE SIPHON BREAK

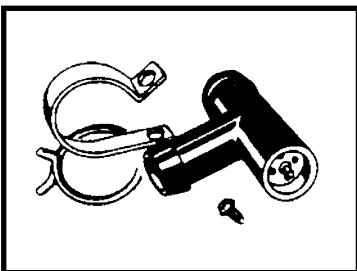

<u>PART NUMBER</u>	<u>ITEM DESCRIPTION</u>
HSB	HOSE SIPHON BRAKE

# GAS - APPLIANCE - WATER

PEX

Icemaker Connectors



PRECISION  
INSTALLATION  
PRODUCTS

## PEX ICEMAKER LINES W/ 1/4" COMP NUTS



<u>PART NUMBER</u>	<u>ITEM DESCRIPTION</u>
LP44-120	120" PEX ICEMAKER LINE W/ 1/4" COMP NUTS
LP44-96	96" PEX ICEMAKER LINE W/ 1/4" COMP NUTS

## MERFLEX® PEX OT REFRIGERATOR WATER SUPPLY LINE HOOK-UP

OUR PATENTED MERFLEX PEX OT REFRIGERATOR WATER SUPPLY LINE HOOK-UP IS DESIGNED TO BE ECONOMICAL AND EASIER TO USE THAN CONVENTIONAL COPPER TUBING. IN FACT, MERFLEX PEX OT IS THE ONLY PLASTIC TUBING THAT A MAJOR APPLIANCE MANUFACTURER HAS TESTED AND APPROVED FOR REFRIGERATOR CONNECTIONS TO A RESIDENTIAL POTABLE WATER SUPPLY.

- PATENTED ONE-PIECE FORMED OR MOLDED ENDS WITH CAPTIVE BRASS NUTS PROVIDE A RELIABLE, LEAK-FREE CONNECTION
- FASTER AND EASIER THAN EXPENSIVE COPPER INSTALLATIONS
- EXCELLENT BURST STRENGTH FOR LONG-TERM PERFORMANCE
- KINK AND CREEP RESISTANT
- RESISTS ENVIRONMENTAL STRESS CRACKS AND DEGRADATION
- CORROSION RESISTANT
- APPROVED FOR CHLORINE AND CHLORAMINE WATER APPLICATIONS
- SUPERIOR ODOR AND TASTE COMPARED TO COPPER AND OTHER PLASTICS
- PEX OT FOR OPTIMAL ODOR AND TASTE CHARACTERISTICS

COMPLIES WITH:

- ANSI/NSF STANDARD 61: DRINKING WATER SYSTEM COMPONENTS - HEALTH EFFECTS
- ASME STANDARD: FLEXIBLE WATER CONNECTORS - A112.18.6
- U.P. CODE
- LISTING REQUIREMENTS OF NSF AND CSA

MANUFACTURER ASSUMES NO RESPONSIBILITY FOR FAILURE DUE TO IMPROPER INSTALLATION.



PRECISION  
INSTALLATION  
PRODUCTS

# GAS - APPLIANCE - WATER PEX

## IceMaker Connectors

### INSTALLATION INSTRUCTIONS FOR MERFLEX® PEX RISERS AND WATER SUPPLY LINES

- RISER PLAIN END SHOULD BE CLEAN-CUT, SQUARED AND BOTTOMED-OUT IN SUPPLY STOP TO INSURE A PROPER SEAL.
- ALL FITTINGS AND END CONNECTIONS SHOULD BE FREE OF PIPE DOPE, COMPOUNDS OR SEALANT.
- METAL NUTS ON THE FAUCET OR TOILET CONNECTION SHOULD BE HAND-TIGHTENED AND THEN TIGHTENED 1 ADDITIONAL TURN WITH WRENCH. DO NOT OVER-TIGHTEN.
- PLASTIC NUTS SHOULD BE FIRMLY HAND-TIGHTENED AND IF REQUIRED, TIGHTENED AN ADDITIONAL QUARTER (1/4) TO ONE HALF (1/2) TURN. DO NOT OVER-TIGHTEN.
- USE SUPPLIED PLASTIC COMPRESSION RING ONLY. TO INSTALL AT THE SUPPLY STOP, HAND-TIGHTEN COMPRESSION NUT, THEN ADD ADDITIONAL 2 TO 3 COMPLETE TURNS WITH WRENCH. NOTE: WHEN PROPERLY TIGHTENED, THE COMPRESSION SLEEVE SHOULD COMPRESS THE PLASTIC TUBING SUFFICIENTLY TO NOT ALLOW SLIPPAGE OR REMOVAL BY HAND.
- MERFLEX PEX TUBING SHOULD NOT BE BENT TO A RADIUS SMALLER THAN 3" FOR 1/4"CTS X 3/8"OD LINES AND 4" FOR 3/8"CTS X 1/2"OD LINES. BENDING THE TUBING TO A RADIUS SMALLER THAN RECOMMENDED CAN LEAD TO FAILURE.

MANUFACTURER ASSUMES NO RESPONSIBILITY FOR FAILURE DUE TO IMPROPER INSTALLATION.



# GAS - APPLIANCE - WATER

PEX

Dishwasher Connectors



PRECISION  
INSTALLATION  
PRODUCTS

## PEX ICEMAKER LINES W/ 1/4" COMP NUTS



<u>PART NUMBER</u>	<u>ITEM DESCRIPTION</u>
LP86-60	60" PEX UNIV DISHWASHER LINE W/ 3/8 - 1/2" NUTS
LP86-72	72" PEX UNIV DISHWASHER LINE W/ 3/8 - 1/2" NUTS
LP86-96	96" PEX UNIV DISHWASHER LINE W/ 3/8 - 1/2" NUTS

## PEX UNIVERSAL DISHWASHER HOSE

MERCURY PLASTICS' PEX UNIVERSAL DISHWASHER HOSE IS PREFERRED BY MANY MAJOR APPLIANCE MANUFACTURERS FOR ITS EASE OF USE AND SUPERIOR ODOR AND TASTE PROPERTIES. DESIGNED TO CONNECT MULTIPLE CONFIGURATIONS, PEX UNIVERSAL DISHWASHER HOSE ELIMINATES THE NEED FOR ADAPTORS. IN ADDITION, BECAUSE IT IS MANUFACTURED USING OUR ELECTRON BEAM CROSS-LINKING PROCESS, THIS PRODUCT OFFERS PROVEN DURABILITY.

- QUICK AND EASY INSTALLATION
- ONE PIECE DESIGN MEANS NO LEAKS
- RESISTS KINKS
- WON'T PIT, CORRODE OR SCALE
- SUPERIOR STRENGTH AND LONG LIFE
- RESISTANT TO CHLORINE, CHLORAMINES AND TYPICAL HOUSEHOLD CHEMICALS
- PEX IS AN NSF APPROVED MATERIAL FOR RESIDENTIAL PLUMBING SYSTEMS
- COMPLIES WITH ASME STANDARD: FLEXIBLE WATER CONNECTORS - A112.18.6
- MEETS P171 FOR CHLORINE

PEX UNIVERSAL DISHWASHER HOSE COME WITH THE THREE MOST COMMON SUPPLY LINE CONNECTIONS BUILT IN - 3/8", 1/2" COMPRESSION AND 1/2" NPT.

MANUFACTURER ASSUMES NO RESPONSIBILITY FOR FAILURE DUE TO IMPROPER INSTALLATION.



PRECISION  
INSTALLATION  
PRODUCTS

# GAS - APPLIANCE - WATER PEX

## Dishwasher Connectors

### INSTALLATION INSTRUCTIONS FOR PEX UNIVERSAL DISHWASHER HOSE

- SHUT OFF WATER SUPPLY.
- DETERMINE THE NUT SIZE REQUIRED TO MAKE THE CONNECTION TO THE STOP VALVE.
- IF YOU WILL BE USING THE "COMPRESSION" OR "NPT", CUT THE PEX TUBING JUST BEFORE THE OVERMOLDED END AND THE CORRESPONDING NUT, USING A SHARP PEX APPROVED CUTTER. OTHERWISE, LEAVE THE EXISTING HARDWARE INTACT.
- CONNECT THE ELBOW TO THE DISHWASHER INLET USING TEFLON® TAPE. IMPORTANT NOTE: DO NOT USE TEFLON TAPE ON ANY OTHER CONNECTIONS.
- CONNECT ONE END OF TUBING TO ELBOW (NO TAPE).
- CONNECT OTHER END TO WATER SUPPLY (NO TAPE).
- IF WATER SUPPLY IS 3/8" COMPRESSION, CONNECT OTHER END OF TUBING DIRECTLY TO THIS VALVE OUTLET.
- IF WATER SUPPLY IS "COMPRESSION", INSERT FLAT WASHER INTO PIPE THREAD ADAPTER AND THREAD ONTO VALVE OUTLET BEFORE CONNECTING TUBING.
- IF WATER SUPPLY IS "NPT", INSERT CONE WASHER INTO PIPE THREAD ADAPTER AND THREAD ONTO VALVE OUTLET BEFORE CONNECTING TUBING.
- HAND TIGHTEN ALL CONNECTIONS, THEN ONE ADDITIONAL TURN WITH A WRENCH. DO NOT OVER TIGHTEN.
- SLOWLY TURN ON WATER SUPPLY AND CHECK FOR LEAKS. IF LEAK APPEARS, CAREFULLY TIGHTEN FURTHER BY HAND.

MANUFACTURER ASSUMES NO RESPONSIBILITY FOR FAILURE DUE TO IMPROPER INSTALLATION.

# GAS - APPLIANCE - WATER

Braided Stainless Steel Connectors

Lavatory/Sink SS Braided Lines



PRECISION  
INSTALLATION  
PRODUCTS

## 3/8" COMP X 1/2" FIP



<u>PART NUMBER</u>	<u>ITEM DESCRIPTION</u>
LAB2312	3/8" COMP X 1/2" FEMALE PIPE THREAD-12" BRAIDED STEELINE
LAB2316	3/8" COMP X 1/2" FEMALE PIPE THREAD-16" BRAIDED STEELINE
LAB2320	3/8" COMP X 1/2" FEMALE PIPE THREAD-20" BRAIDED STEELINE
LAB2324	3/8" COMP X 1/2" FEMALE PIPE THREAD-24" BRAIDED STEELINE
LAB2330	3/8" COMP X 1/2" FEMALE PIPE THREAD-30" BRAIDED STEELINE

## 1/2" FIP X 1/2" FIP



<u>PART NUMBER</u>	<u>ITEM DESCRIPTION</u>
LAB2112	1/2" FEMALE PIPE THREAD X 1/2" FEMALE PIPE THREAD-12" BRAIDED STEELINE
LAB2116	1/2" FEMALE PIPE THREAD X 1/2" FEMALE PIPE THREAD-16" BRAIDED STEELINE
LAB2120	1/2" FEMALE PIPE THREAD X 1/2" FEMALE PIPE THREAD-20" BRAIDED STEELINE
LAB2124	1/2" FEMALE PIPE THREAD X 1/2" FEMALE PIPE THREAD-24" BRAIDED STEELINE
LAB2130	1/2" FEMALE PIPE THREAD X 1/2" FEMALE PIPE THREAD-30" BRAIDED STEELINE
LAB2136	1/2" FEMALE PIPE THREAD X 1/2" FEMALE PIPE THREAD-36" BRAIDED STEELINE
LAB2148	1/2" FEMALE PIPE THREAD X 1/2" FEMALE PIPE THREAD-48" BRAIDED STEELINE
LAB2160	1/2" FEMALE PIPE THREAD X 1/2" FEMALE PIPE THREAD-60" BRAIDED STEELINE



PRECISION  
INSTALLATION  
PRODUCTS

# GAS - APPLIANCE - WATER

## Braided Stainless Steel Connectors

Icemaker Dishwasher/Sink SS Braided Lines

### ICEMAKER - 1/4" COMP X 1/4" COMP



<u>PART NUMBER</u>	<u>ITEM DESCRIPTION</u>
LAB1912	1/4" COMP X 1/4" COMP - 12" BRAIDED STAINLESS STEEL ICEMAKER LINE
LAB1924	1/4" COMP X 1/4" COMP - 24" BRAIDED STAINLESS STEEL ICEMAKER LINE
LAB1936	1/4" COMP X 1/4" COMP - 36" BRAIDED STAINLESS STEEL ICEMAKER LINE
LAB1948	1/4" COMP X 1/4" COMP - 48" BRAIDED STAINLESS STEEL ICEMAKER LINE
LAB1960	1/4" COMP X 1/4" COMP - 60" BRAIDED STAINLESS STEEL ICEMAKER LINE
LAB1972	1/4" COMP X 1/4" COMP - 72" BRAIDED STAINLESS STEEL ICEMAKER LINE
LAB1984	1/4" COMP X 1/4" COMP - 84" BRAIDED STAINLESS STEEL ICEMAKER LINE *SPECIAL*
LAB1996	1/4" COMP X 1/4" COMP - 96" BRAIDED STAINLESS STEEL ICEMAKER LINE
LAB19120	1/4" COMP X 1/4" COMP - 120" BRAIDED STAINLESS STEEL ICEMAKER LINE
LAB19180	1/4" COMP X 1/4" COMP - 180" BRAIDED STAINLESS STEEL ICEMAKER LINE
LAB19240	1/4" COMP X 1/4" COMP-240" BRAIDED STAINLESS STEEL ICEMAKER LINE

### DISHWASHER - 3/8" COMP X 3/8" COMP



<u>PART NUMBER</u>	<u>ITEM DESCRIPTION</u>
LAB2409	3/8 COMPRESSION X 3/8 COMPRESSION-9" BRAIDED STEELINE
LAB2412	3/8 COMPRESSION X 3/8 COMPRESSION-12" BRAIDED STEELINE
LAB2416	3/8 COMPRESSION X 3/8 COMPRESSION-16" BRAIDED STEELINE
LAB2420	3/8 COMPRESSION X 3/8 COMPRESSION-20" BRAIDED STEELINE
LAB2424	3/8 COMPRESSION X 3/8 COMPRESSION-24" BRAIDED STEELINE
LAB2430	3/8 COMPRESSION X 3/8 COMPRESSION-30" BRAIDED STEELINE
LAB2436	3/8 COMPRESSION X 3/8 COMPRESSION-36" BRAIDED STEELINE
LAB2448	3/8 COMPRESSION X 3/8 COMPRESSION-48" BRAIDED STEELINE
LAB2460	3/8 COMPRESSION X 3/8 COMPRESSION-60" BRAIDED STEELINE
LAB2472	3/8 COMPRESSION X 3/8 COMPRESSION-72" BRAIDED STEEL
LAB2484	3/8 COMPRESSION X 3/8 COMPRESSION-84" BRAIDED STEELINE
LAB2496	3/8 COMPRESSION X 3/8 COMPRESSION-96" BRAIDED STEELINE
LAB24120	3/8 COMPRESSION X 3/8 COMPRESSION-120" BRAIDED STEELINE

# GAS - APPLIANCE - WATER

Braided Stainless Steel Connectors

Lavatory/Sink SS Braided Lines



PRECISION  
INSTALLATION  
PRODUCTS

## 3/8" COMP X 3/4" FGHT FIXED ELBOW



<u>PART NUMBER</u>	<u>ITEM DESCRIPTION</u>
LAB2972-12	3/8" COMP X 3/4" FGH FUSED ELBOW - 72" BRAIDED STEEL LINE DISH-WASHER HOSE



PRECISION  
INSTALLATION  
PRODUCTS

# GAS - APPLIANCE - WATER

Braided Stainless Steel Connectors

Miscellaneous SS Braided Lines

## CLOSET - 3/8" COMP X 7/8" BALLCOCK NUT (PLASTIC)



<u>PART NUMBER</u>	<u>ITEM DESCRIPTION</u>
LAB3416	7/8 PLASTIC BALLCOCK X 3/8 COMPRESSION-16" BRAIDED STEELINE
LAB3420	7/8 PLASTIC BALLCOCK X 3/8 COMPRESSION-20" BRAIDED STEELINE

## STEAM DRYER - 3/4" MGH X 3/4" FGH



<u>PART NUMBER</u>	<u>ITEM DESCRIPTION</u>
LAB3112	3/4 MGH X 3/4 FGH - 12" BRAIDED STEELINE

# GAS - APPLIANCE - WATER

Gas Valves, Connectors, & Fittings

Gas Valves



PRECISION  
INSTALLATION  
PRODUCTS

## STANDARD PORT - LEVER HANDLE - FPT X FPT



### PART NUMBER

### ITEM DESCRIPTION

IR500L-06	IMPORT QTR TURN LEVER HANDLE GAS VALVE - 3/8" FPT X 3/8" FPT
IR500L-08	IMPORT QTR TURN LEVER HANDLE GAS VALVE - 1/2" FPT X 1/2" FPT
IR500L-12	IMPORT QTR TURN LEVER HANDLE GAS VALVE - 3/4" FPT X 3/4" FPT

## ARROWHEAD LOG LIGHTER - 1/2" FPT X 1/2" FPT



- ROUGH BRASS BODY
- 2 1/4" ADJUSTABLE CHROME FLANGE AND LOOSE KEY

### PART NUMBER

### ITEM DESCRIPTION

IA258	LOG LIGHTER VALVE-1/2 FIP STRAIGHT-CHROME FLANGE & KEY
-------	--



### PART NUMBER

### ITEM DESCRIPTION

IA259	LOG LIGHTER VALVE-1/2 FIP ANGLE-CHROME FLANGE & KEY
-------	---

## LOG LIGHTER KEYS



### PART NUMBER

### ITEM DESCRIPTION

IA51	ARROWHEAD LOG LIGHTER KEY ONLY - STANDARD
IA52	ARROWHEAD LOG LIGHTER KEY ONLY - 9" LONG



PRECISION  
INSTALLATION  
PRODUCTS

# GAS - APPLIANCE - WATER

Gas Valves, Connectors, & Fittings

## Stainless Steel Gas Connectors

### 3/8" OD (1/4" NOM ID) - NUT X NUT



<u>PART NUMBER</u>	<u>ITEM DESCRIPTION</u>
SD312	3/8" X 12" SS IMPORTED GAS FLEX-STEEL FLARE NUT X STEEL FLARE NUT
SD318	3/8" X 18" SS IMPORTED GAS FLEX-STEEL FLARE NUT X STEEL FLARE NUT
SD324	3/8" X 24" SS IMPORTED GAS FLEX-STEEL FLARE NUT X STEEL FLARE NUT
SD330	3/8" X 30" SS IMPORTED GAS FLEX-STEEL FLARE NUT X STEEL FLARE NUT
SD336	3/8" X 36" SS IMPORTED GAS FLEX-STEEL FLARE NUT X STEEL FLARE NUT
SD348	3/8" X 48" SS IMPORTED GAS FLEX-STEEL FLARE NUT X STEEL FLARE NUT
SD360	3/8" X 60" SS IMPORTED GAS FLEX-STEEL FLARE NUT X STEEL FLARE NUT
SD372	3/8" X 72" SS IMPORTED GAS FLEX-STEEL FLARE NUT X STEEL FLARE NUT

### 1/2" OD (3/8" NOM ID) - NUT X NUT



<u>PART NUMBER</u>	<u>ITEM DESCRIPTION</u>
SD412	1/2" X 12" SS IMPORTED GAS FLEX-STEEL FLARE NUT X STEEL FLARE NUT
SD418	1/2" X 18" SS IMPORTED GAS FLEX-STEEL FLARE NUT X STEEL FLARE NUT
SD424	1/2" X 24" SS IMPORTED GAS FLEX-STEEL FLARE NUT X STEEL FLARE NUT
SD430	1/2" X 30" SS IMPORTED GAS FLEX-STEEL FLARE NUT X STEEL FLARE NUT
SD436	1/2" X 36" SS IMPORTED GAS FLEX-STEEL FLARE NUT X STEEL FLARE NUT
SD448	1/2" X 48" SS IMPORTED GAS FLEX-STEEL FLARE NUT X STEEL FLARE NUT
SD460	1/2" X 60" SS IMPORTED GAS FLEX-STEEL FLARE NUT X STEEL FLARE NUT
SD472	1/2" X 72" SS IMPORTED GAS FLEX-STEEL FLARE NUT X STEEL FLARE NUT

### 7/8" OD (1/2" NOM ID) - NUT X NUT



<u>PART NUMBER</u>	<u>ITEM DESCRIPTION</u>
SD712	7/8" X 12" SS IMPORT GAS FLEX-NUT X NUT
SD718	7/8" X 18" SS IMPORT GAS FLEX-NUT X NUT
SD724	7/8" X 24" SS IMPORT GAS FLEX-NUT X NUT
SD730	7/8" X 30" SS IMPORT GAS FLEX-NUT X NUT
SD736	7/8" X 36" SS IMPORT GAS FLEX-NUT X NUT
SD748	7/8" X 48" SS IMPORT GAS FLEX-NUT X NUT
SD760	7/8" X 60" SS IMPORT GAS FLEX-NUT X NUT
SD772	7/8" X 72" SS IMPORT GAS FLEX-NUT X NUT



# GAS - APPLIANCE - WATER

Gas Valves, Connectors, & Fittings

High BTU / Coated SS Gas Lines



PRECISION  
INSTALLATION  
PRODUCTS

## 3/8" OD (1/4" NOM ID) - NUT X NUT



<u>PART NUMBER</u>	<u>ITEM DESCRIPTION</u>
SS4141-60	1" OD X 60" SS GAS CONN - 3/4"MPT X 3/4"MPT
SS4142-18	1" OD X 18" SS GAS CONN - 3/4"MPT X 3/4"FPT
SS4142-24	1" OD X 24" SS GAS CONN - 3/4"MPT X 3/4"FPT
SS4142-30	1" OD X 30" SS GAS CONN - 3/4"MPT X 3/4"FPT
SS4142-36	1" OD X 36" SS GAS CONN - 3/4"MPT X 3/4" FPT
SS4142-48	1" OD X 48" SS GAS CONN - 3/4"MPT X 3/4"FPT
SS4142-60	1" OD X 60" SS GAS CONN - 3/4"MPT X 3/4"FPT
SS4142-72	1" OD X 72" SS GAS CONN - 3/4"MPT X 3/4"FPT

## BLACK COATED SS GAS LINES - TRANQUILE WHISPER CONNECTORS



ELIMINATE WHISTLING NOISE AT HIGHER BTU GAS FLOWS AND THERE IS NO FLOW DECREASE COMPARED TO STANDARD FLEXIBLE GAS CONNECTORS. HIGH-TEMP BLACK COATING.

<u>PART NUMBER</u>	<u>ITEM DESCRIPTION</u>
SB312	3/8" X 10" BLACK POLY TRANQUIL GAS FLEX - NUT X NUT
SB318	3/8" X 16" BLACK POLY TRANQUIL GAS FLEX - NUT X NUT
SB324	3/8" X 22" BLACK POLY TRANQUIL GAS FLEX - NUT X NUT
SB330	3/8" X 28" BLACK POLY TRANQUIL GAS FLEX - NUT X NUT
SB336	3/8" X 34" BLACK POLY TRANQUIL GAS FLEX - NUT X NUT
SB348	3/8" X 46" BLACK POLY TRANQUIL GAS FLEX - NUT X NUT
SB412	1/2" X 10" BLACK POLY TRANQUIL GAS FLEX - NUT X NUT
SB418	1/2" X 16" BLACK POLY TRANQUIL GAS FLEX - NUT X NUT
SB424	1/2" X 22" BLACK POLY TRANQUIL GAS FLEX - NUT X NUT
SB430	1/2" X 28" BLACK POLY TRANQUIL GAS FLEX - NUT X NUT
SB436	1/2" X 34" BLACK POLY TRANQUIL GAS FLEX - NUT X NUT
SB448	1/2" X 46" BLACK POLY TRANQUIL GAS FLEX - NUT X NUT



PRECISION  
INSTALLATION  
PRODUCTS

# GAS - APPLIANCE - WATER

Gas Valves, Connectors, & Fittings

High BTU / Coated SS Gas Lines

## YELLOW POLYMER COATED SS GAS LINES



PROVIDE PROTECTION AGAINST ACCIDENTAL CONTACT WITH COMMON HOUSEHOLD CLEANING PRODUCTS, AMMONIA, CHLORINE, SOLDER FLUX, AND MURIATIC ACIDS. ALSO PROTECTING AGAINST UV RAYS AND SALT SPRAY.

<u>PART NUMBER</u>	<u>ITEM DESCRIPTION</u>
SC360-13	3/8" X 60" YELLOW COATED GAS FLEX - 1/2" MIP X 1/2" MIP
SC372-13	3/8" X 72" YELLOW COATED GAS FLEX-1/2" MIP X 1/2" MIP
SC472-06	1/2" X 72" YELLOW COATED GAS FLEX-1/2 MIP X 1/2 MIP
SC748-12	7/8" X 48" YELLOW COATED GAS FLEX-3/4 MIP X 3/4 MIP
SC760-01	7/8" X 60" YELLOW COATED GAS FLEX-1/2 MIP X NUT
SC772-01	7/8" X 72" YELLOW COATED GAS FLEX-1/2 MIP X NUT

# GAS - APPLIANCE - WATER

Gas Valves, Connectors, & Fittings

Gas Fittings



PRECISION  
INSTALLATION  
PRODUCTS

## STRAIGHT GAS VALVE - FLARE X FPT



<u>PART NUMBER</u>	<u>ITEM DESCRIPTION</u>
3SV	3/8" FLARE X 1/2" FPT STRAIGHT SHUT OFF GAS VALVE - BOX QUANTITY 12
4SV	1/2" FLARE X 1/2" FPT STRAIGHT GAS SHUT OFF VALVE - BOX QUANTITY 10
4SV-12	1/2" FLARE X 3/4" FPT STRAIGHT GAS SHUT OFF VALVE
7SV	7/8"(5/8"OD) FLARE X 3/4" FPT STRAIGHT GAS SHUT OFF VALVE
7SV-8	7/8"(5/8"OD) FLARE X 1/2" FPT STRAIGHT GAS SHUT OFF VALVE

## ANGLE GAS VALVE - FLARE X FPT



<u>PART NUMBER</u>	<u>ITEM DESCRIPTION</u>
3AV	3/8" FLARE X 1/2" FPT GAS ANGLE SHUT OFF VALVE - BOX QUANTITY 12
4AV	1/2" FLARE X 1/2" FPT ANGLE GAS SHUT OFF VALVE - BOX QUANTITY 10
7AV	7/8" (5/8") FLARE X 3/4" FPT ANGLE GAS SHUT OFF VALVE



PRECISION  
INSTALLATION  
PRODUCTS

# GAS - APPLIANCE - WATER

Gas Valves, Connectors, & Fittings

## Gas Fittings

### FLARE X FPT



<u>PART NUMBER</u>	<u>ITEM DESCRIPTION</u>
3F6	3/8" FLARE X 3/8" FPT STEEL GAS LINE FITTING
3F8	3/8" FLARE X 1/2" FPT STEEL GAS LINE FITTING
4F6	1/2" FLARE X 3/8" FPT STEEL GAS LINE FITTING
4F8	1/2" FLARE X 1/2" FPT STEEL GAS LINE FITTING
7F12	7/8" (5/8") FLARE X 3/4" FPT STEEL GAS LINE FITTING
7F8	7/8" (5/8") FLARE X 1/2" FPT STEEL GAS LINE FITTING

### FLARE X MPT



<u>PART NUMBER</u>	<u>ITEM DESCRIPTION</u>
3M6	3/8" FLARE X 3/8" MPT STEEL GAS LINE FITTING
3M8	3/8" FLARE X 1/2" MPT STEEL GAS LINE FITTING
4M12	1/2" FLARE X 3/4" MPT STEEL GAS LINE FITTING
4M6	1/2" FLARE X 3/8" MPT STEEL GAS LINE FITTING
4M8	1/2" FLARE X 1/2" MPT STEEL GAS LINE FITTING
7M12	7/8" (5/8") FLARE X 3/4" MPT STEEL GAS LINE FITTING
7M8	7/8" (5/8") FLARE X 1/2" MPT STEEL GAS LINE FITTING

### FLARE X FLARE



<u>PART NUMBER</u>	<u>ITEM DESCRIPTION</u>
7RA	7/8" FLARE X 5/8" FLARE - RANGE FITTING FOR OLD 5/8" LINE

# GAS - APPLIANCE - WATER

Appliance Installation Kits



PRECISION  
INSTALLATION  
PRODUCTS

## STEAM DRYER VENT KIT



**PART NUMBER**

Z20B

**ITEM DESCRIPTION**

UNIVERSAL STEAM DRYER INSTALL KIT - BAGGED INCLUDES:

- 1 - 6' SS BRAIDED LINE W/ FGH X FGH 90° ELBOW
- 1 - CHROME Y
- 1' SS BRAIDED LINE FGH X MGH

## GAS DRYER VENT KIT

**PART NUMBER**

Z21-5PB+ KIT

**ITEM DESCRIPTION**

4' GAS DRYER INSTALLATION KIT W/ 5-PLY DUCTING W/ EXTRA FITTING

- BAGGED INCLUDES:

- 1 - 3/8" X 48" SS IMPT GAS FLEX - 1/2" MPT X 3/8" FPT (SD348)
- 1 - 3/8" FLARE X 1/2" MPT STEEL GAS LINE FITTING (3M8)
- 1 - 3/8" FLARE X 3/8" FPT STEEL GAS LINE FITTING (3F6)
- 1 - 4" X 5' ALUMINUM DUCTING 5-PLY (VFA405-D5P)
- 2 - 4" SPRING TENSION CLAMPS (VC4T)

## GAS DRYER VENT KIT

**PART NUMBER**

Z23B KIT

**ITEM DESCRIPTION**

5' GAS DRYER INSTALLATION KIT W/ ELBOWS - BAGGED

INCLUDES:

- 1 - 3/8" X 48" SS IMPT GAS FLEX - 1/2" MPT (SD348)
- 1 - 3/8" FLARE X 1/2" MPT STEEL GAS LINE FITTING (3M8)
- 1 - 4" X 8' ALUMINUM SEMI-RIGID DUCT QUICK FIT KIT W/ 2 ELBOWS, 8' DUCTING & WALL PLATE (VK4004)

A graphic of a blue water splash with bubbles and ripples, centered at the top of the page.

# **GAS - APPLIANCE - WATER**

Appliance Installation Kits

**END OF SECTION**

**THIS PAGE IS LEFT  
INTENTIONALLY BLANK.**

# GAS - APPLIANCE - WATER

## Venting & Ducting



### SHEET METAL SCREWS - SELF-TAP COMBO PAN HEAD



<u>PART NUMBER</u>	<u>ITEM DESCRIPTION</u>
MSMS-06	#6 X 1-1/4 SELF TAP COMBO (PHILLIPS/SLOTTED) PAN HEAD SHEET METAL SCREWS (P/100)

### PLASTIC ANCHORS



<u>PART NUMBER</u>	<u>ITEM DESCRIPTION</u>
MSA-06	#6-8 PLASTIC ANCHOR (P/100)
MSA-06-RIBBED	#6-8 PLASTIC ANCHOR - RIBBED SHANK (P/100)

### “TRANSITION” STRAIGHT BOOT - 30 GAUGE



<u>PART NUMBER</u>	<u>ITEM DESCRIPTION</u>
VB5	5" X 3 1/4" X 10" TRANSITION STRAIGHT BOOT
VB6	6" X 3 1/4" X 10" TRANSITION STRAIGHT BOOT-30 GAUGE
VB6-SE	6" X 3 1/4" X 10" TRANSITION STRAIGHT FAN BOOT WITH STRAIGHT ENDS - 30 GAUGE
VB7	7" X 3 1/4" X 10" TRANSITION STRAIGHT BOOT-30 GAUGE
VB7-SE	7" X 3 1/4" X 10" TRANSITION STRAIGHT FAN BOOT WITH STRAIGHT ENDS - 30 GAUGE
VB8	8" X 3 1/4" X 10" TRANSITION STRAIGHT BOOT-30 GAUGE

### “TRANSITION” CONE BOOT



<u>PART NUMBER</u>	<u>ITEM DESCRIPTION</u>
VBC6	6" X 3 1/4" X 10" CONE STYLE BOOT - 30 GAUGE
VBC7	7" X 3 1/4" X 10" CONE STYLE BOOT - 30 GAUGE



PRECISION  
INSTALLATION  
PRODUCTS

# GAS - APPLIANCE - WATER

Venting & Ducting

## 90 DEGREE STACKHEAD BOOT - 30 GAUGE



<u>PART NUMBER</u>	<u>ITEM DESCRIPTION</u>
VB6-90	6" X 3 1/4" X 10" 90 DEGREE STACKHEAD BOOT

## WORM DRIVE VENT CLAMPS - SCREW STYLE



<u>PART NUMBER</u>	<u>ITEM DESCRIPTION</u>
VC4S	4" VENT SCREW CLAMP

## SPRING VENT CLAMPS - TENSION STYLE



<u>PART NUMBER</u>	<u>ITEM DESCRIPTION</u>
VC4T	4" SPRING CLAMP

## ALUMINUM VENT KIT - FOR 4" DRYER



<u>PART NUMBER</u>	<u>ITEM DESCRIPTION</u>
VDKA5	4" X 5' ALUMINUM DUCT & 2 SPRING CLAMPS - BAGGED
VDKA8	8' ALUMINUM DUCT & 2 SPRING CLAMPS - BAGGED



# GAS - APPLIANCE - WATER

Venting & Ducting



PRECISION  
INSTALLATION  
PRODUCTS

## 3-PLY ALUMINUM DUCTING

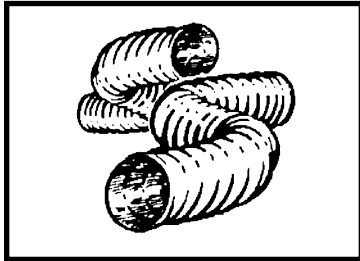

<u>PART NUMBER</u>	<u>ITEM DESCRIPTION</u>
VFA405	4" X 5' ALUMINUM DUCTING 2 PLY
VFA408	4" X 8' ALUMINUM DUCTING 2 PLY
VFA425	4" X 25' ALUMINUM DUCT - 3 PLY
VFA450	4" X 50' ALUMINUM DUCT - 3 PLY

## 5-PLY ALUMINUM DUCTING



<u>PART NUMBER</u>	<u>ITEM DESCRIPTION</u>
VFA405-D5P	4" X 5' ALUMINUM DUCTING 5 PLY
VFA408-D5P	4" X 8' ALUMINUM DUCTING - 5 PLY
VFA408-D5P-UL	4" X 8' ALUMINUM DUCTING - 5 PLY-UL APPROVED
VFA425-D5P	4" X 25' ALUMINUM DUCT - 5 PLY
VFA450-D5P	4" X 50' ALUMINUM DUCT - 5 PLY
VFA450-D5P-UL	4" X 50' ALUMINUM DUCT - 5 PLY - UL APPROVED
VFA725-D5P	7" X 25 FOOT ALUMINUM DUCTING - 5 PLY
VFA825-D5P-UL	8" X 25' FOIL LAMINATE DUCTING- 5PLY -UL RATED

## SEMI-RIGID COMPRESSED ALUMINUM DUCTING



<u>PART NUMBER</u>	<u>ITEM DESCRIPTION</u>
VFAD3	3" X 8 FOOT ALUMINUM DUCT - SEMI RIGID - COMPRESSED
VFAD4	4" X 8 FOOT ALUMINUM DUCT - SEMI RIGID - COMPRESSED
VFAD4-UL	4" X 8 FOOT ALUMINUM DUCT - SEMI RIGID - COMPRESSED - UL
VFAD5	5" X 8 FOOT ALUMINUM DUCT - SEMI RIGID - COMPRESSED
VFAD6	6" X 8 FOOT ALUMINUM DUCT - SEMI RIGID - COMPRESSED
VFAD7	7" X 8 FOOT ALUMINUM DUCT - SEMI RIGID - COMPRESSED
VFAD8	8" X 8 FOOT ALUMINUM DUCT - SEMI RIGID - COMPRESSED

## VENT BUCKET W/ ALUMINUM DUCT & 2 CLAMPS



<u>PART NUMBER</u>	<u>ITEM DESCRIPTION</u>
VFG1A	4" ROUND VENT BUCKET W/ 4" X 5' DUCTING & CLAMPS

## VENT HOOD - FLUSH MOUNT - GALVANIZED



<u>PART NUMBER</u>	<u>ITEM DESCRIPTION</u>
VH4G	4" GALVANIZED METAL VENT HOOD WITH FLANGE-FLUSH MOUNT-30 GAUGE
VH5G	5" GALVANIZED METAL VENT HOOD-FLUSH MOUNT-30 GAUGE
VH6G	6" GALVANIZED METAL VENT HOOD-FLUSH MOUNT-30 GAUGE
VH7G	7" GALVANIZED METAL VENT HOOD-FLUSH MOUNT-30 GAUGE
VH8G	8" GALVANIZED METAL VENT HOOD WITH FLANGE-FLUSH MOUNT-26 GAUGE
VH10G	10" GALVANIZED METAL VENT HOOD-FLUSH MOUNT-26 GAUGE

## DRYER VENT - PLASTIC LOUVERED



<u>PART NUMBER</u>	<u>ITEM DESCRIPTION</u>
VHL4	4" PLASTIC LOUVERED VENT HOOD - WHITE- WITH TAILPIECE
VHL4-BR	4" PLASTIC LOUVERED VENT HOOD - BROWN - WITH TAILPIECE
VHL5	5" WHITE PLASTIC LOUVERED VENT HOOD - HOOD ONLY
VHL6	6" WHITE PLASTIC LOUVERED VENT HOOD - HOOD ONLY
VHL7	7" WHITE PLASTIC LOUVERED VENT HOOD - HOOD ONLY
VHL8	8" WHITE PLASTIC LOUVERED VENT HOOD - HOOD ONLY

# GAS - APPLIANCE - WATER

Venting & Ducting



PRECISION  
INSTALLATION  
PRODUCTS

## DRYER VENT HOOD - ALUMINUM WIDE MOUTH



<u>PART NUMBER</u>	<u>ITEM DESCRIPTION</u>
--------------------	-------------------------

VHM4	4" ALUMINUM VENT HOOD WITH TAILPIECE
------	--------------------------------------

## DRYER VENT - PLASTIC HOOD - WIDE MOUTH



<u>PART NUMBER</u>	<u>ITEM DESCRIPTION</u>
--------------------	-------------------------

VHP4	4" WHITE PLASTIC VENT HOOD/WIDE MOUTH WITH TAILPIECE
VHP4-BR	4" BROWN PLASTIC VENT HOOD/WIDE MOUTH WITH TAILPIECE

## 90 DEGREE VENT ELBOW - 4 SECTION ADJUSTABLE



<u>PART NUMBER</u>	<u>ITEM DESCRIPTION</u>
VL3	3" 4-SECTION ADJUSTABLE VENT ELBOW- 90 DEGREE - 30 GAUGE
VL4	4" 4-SECTION ADJUSTABLE VENT ELBOW- 90 DEGREE - 30 GAUGE
VL5	5" 4-SECTION ADJUSTABLE VENT ELBOW- 90 DEGREE - 30 GAUGE
VL6	6" 4-SECTION ADJUSTABLE VENT ELBOW- 90 DEGREE - 30 GAUGE
VL7	7" 4-SECTION ADJUSTABLE VENT ELBOW- 90 DEGREE - 30 GAUGE
VL8	8" 4-SECTION ADJUSTABLE VENT ELBOW- 90 DEGREE - 30 GAUGE
VL10	10" 4-SECTION ADJUSTABLE VENT ELBOW-90 DEGREE - 30 GAUGE
VL12	12" 4-SECTION ADJUSTABLE VENT ELBOW-90 DEGREE - 28 GAUGE

## 90 DEGREE VENT ELBOW - CLOSED END



<u>PART NUMBER</u>	<u>ITEM DESCRIPTION</u>
VL4-CE	4" 90 DEGREE CLOSE ELBOW

## RECTANGULAR 90 DEGREE VENT ELBOW



<u>PART NUMBER</u>	<u>ITEM DESCRIPTION</u>
VL90	3 1/4" X 10" RECTANGULAR 90 DEGREE VENT ELBOW - 30 GAUGE

# GAS - APPLIANCE - WATER

Venting & Ducting



PRECISION  
INSTALLATION  
PRODUCTS

## VENT BUCKET W/ ALUMINUM DUCT & 2 CLAMPS



<u>PART NUMBER</u>	<u>ITEM DESCRIPTION</u>
VLTBHA	RECTANGULAR VENT BUCKET W/ALUM DUCTING & CLAMPS

## PANCAKE TAPER VENT - 30 GAUGE



<u>PART NUMBER</u>	<u>ITEM DESCRIPTION</u>
VPT4-3	4" X 3" VENT PANCAKE TAPER - 30 GAUGE
VPT5-4	5" X 4" VENT PANCAKE TAPER/COOKIE CUTTER REDUCER- 30 GAUGE
VPT6-4	6" X 4" VENT PANCAKE TAPER/COOKIE CUTTER REDUCER - 30 GAUGE
VPT6-5	6" X 5" VENT PANCAKE TAPER - 30 GAUGE
VPT7-5	7" X 5" VENT PANCAKE TAPER - 30 GAUGE
VPT7-6	7" X 6" VENT PANCAKE TAPER/COOKIE CUTTER REDUCER - 30 GAUGE
VPT8-4	8" X 4" VENT PANCAKE TAPER - 30 GAUGE
VPT8-6	8" X 6" VENT PANCAKE TAPER - 30 GAUGE
VPT8-7	8" X 7" VENT PANCAKE TAPER/COOKIE CUTTER REDUCER- 30 GAUGE
VPT10-7	10" X 7" VENT PANCAKE TAPER - 30 GAUGE

## ROUND END CAP



<u>PART NUMBER</u>	<u>ITEM DESCRIPTION</u>
V4RAC	4" ROUND GALVANIZED END CAP W/O CRIMPING - 26 GAUGE



PRECISION  
INSTALLATION  
PRODUCTS

# GAS - APPLIANCE - WATER

## Venting & Ducting

### PANTS WYE VENT - 30 GAUGE



<u>PART NUMBER</u>	<u>ITEM DESCRIPTION</u>
VPY6-4-4	6" X 4" X 4" PANTS WYE VENT - 45/45 DEGREE-30 GAUGE
VPY8-6-6	8" X 6" X 6" PANTS WYE VENT- 45/45 DEGREE-30 GAUGE

### VENT REDUCER - SHORT TAPER 9" HIGH



<u>PART NUMBER</u>	<u>ITEM DESCRIPTION</u>
VR6-4	6" TO 4" VENT REDUCER-SHORT TAPER 9" HIGH
VR6-5	6" TO 5" VENT REDUCER-SHORT TAPER 9" HIGH-30 GAUGE
VR7-5	7" TO 5" VENT REDUCER-SHORT TAPER 9" HIGH
VR7-6	7" TO 6" VENT REDUCER-SHORT TAPER 9" HIGH-30 GAUGE
VR8-6	8" TO 6" VENT REDUCER-SHORT TAPER 9" HIGH *OVERSTOCK SPECIAL *
VR8-7	8" TO 7" VENT REDUCER-SHORT TAPER 9" HIGH
VR10-7	10" TO 7" VENT REDUCER-SHORT TAPER 9" HIGH-30 GAUGE
VR10-8	10" TO 8" VENT REDUCER-SHORT TAPER 9" HIGH - 30 GAUGE

### RECTANGULAR KNOCK-DOWN RISER VENT PIPE

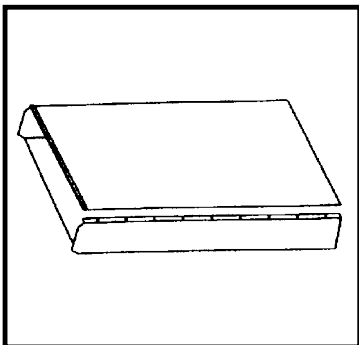

<u>PART NUMBER</u>	<u>ITEM DESCRIPTION</u>
VRP310-36	3 1/4 X 10 X 36 RECTANGULAR KD RISER VENT PIPE-30 GAUGE

# GAS - APPLIANCE - WATER

## Venting & Ducting



PRECISION  
INSTALLATION  
PRODUCTS

### SNAPLOCK VENT PIPE - 30 GAUGE



<u>PART NUMBER</u>	<u>ITEM DESCRIPTION</u>
VSL3	3" DIAMETER X 36" LONG SNAPLOCK VENT PIPE - 30 GAUGE
VSL4	4" DIAMETER X 36" LONG SNAPLOCK VENT PIPE - 30 GAUGE
VSL4-12	4" DIAMETER X 12" LONG SNAPLOCK VENT PIPE - 30 GAUGE
VSL460	4" DIAMETER X 60" LONG SNAPLOCK VENT PIPE - 30 GAUGE
VSL5	5" DIAMETER X 36" LONG SNAPLOCK VENT PIPE - 30 GAUGE
VSL6	6" DIAMETER X 36" LONG SNAPLOCK VENT PIPE - 30 GAUGE
VSL660	6" DIAMETER X 60" LONG SNAPLOCK VENT PIPE - 30 GAUGE
VSL7	7" DIAMETER X 36" LONG SNAPLOCK VENT PIPE - 30 GAUGE
VSL760	7" DIAMETER X 60" LONG SNAPLOCK VENT PIPE - 30 GAUGE
VSL8	8" DIAMETER X 36" LONG SNAPLOCK VENT PIPE - 30 GAUGE
VSL860	8" DIAMETER X 60" LONG SNAPLOCK VENT PIPE - 30 GAUGE
VSL10	10" DIAMETER X 36" LONG SNAPLOCK VENT PIPE - 30 GAUGE
VSL1060	10" DIAMETER X 60" LONG SNAPLOCK VENT PIPE - 30 GAUGE
VSL12	12" DIAMETER X 36" LONG SNAPLOCK VENT PIPE - 28 GAUGE

### SNAPLOCK VENT PIPE - 30 GAUGE



<u>PART NUMBER</u>	<u>ITEM DESCRIPTION</u>
VT18-4-4	8" PANCAKE REDUCER-30 GAUGE-WITH 2-4" COLLARS
VT18-4-4-4	10" PANCAKE REDUCER-30 GAUGE-WITH 3-4" COLLARS

### TELESCOPIC VENT

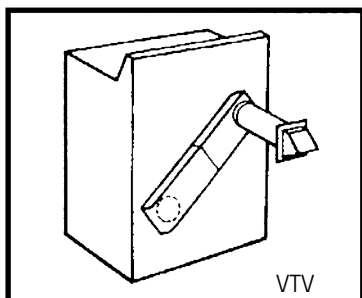

<u>PART NUMBER</u>	<u>ITEM DESCRIPTION</u>
VTV	48" TELESCOPIC VENT WITH SIDE OUTLET
VTVE	48" TELESCOPIC VENT WITH END OUTLET



**END OF SECTION**

**THIS PAGE IS LEFT  
INTENTIONALLY BLANK.**



# MISCELLANEOUS SUPPLIES

Lubricants, Solvents, & Glue



PRECISION  
INSTALLATION  
PRODUCTS

## WD40 SPRAY

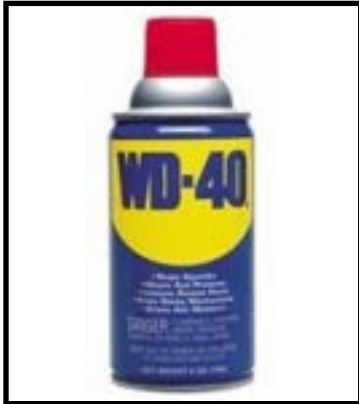

<u>PART NUMBER</u>	<u>ITEM DESCRIPTION</u>
WD40	WD40 - 11 OUNCE CAN
WD40-CA	WD40-11 OUNCE CAN-CALIFORNIA APPROVED

## SILICONE LUBRICANT - DOW #111



<u>PART NUMBER</u>	<u>ITEM DESCRIPTION</u>
M220	SILICONE LUBRICANT #111-5.3 OZ TUBE
M220-PP	SILICONE LUBRICANT # 111-PILLOW PACK-1 GRAM

## ZOOM SPOUT OILER



A high quality all purpose lubricating oil. It has a flexible spout that expands and retracts, to adjust to any length in between. The Zoom Spout Oiler can withstand high temperatures without breaking down.

<u>PART NUMBER</u>	<u>ITEM DESCRIPTION</u>
MZSO	ZOOM SPOUT OILER - 4 OZ. SQUIRT BOTTLE W/ FLEXIBLE SPOUT



PRECISION  
INSTALLATION  
PRODUCTS

# MISCELLANEOUS SUPPLIES

Lubricants, Solvents, & Glue

## ABS CEMENT - BLACK



<u>PART NUMBER</u>	<u>ITEM DESCRIPTION</u>
ABS/CMT	1/4 PT ABS BLACK CEMENT

## PURPLE PRIMER - FOR PVC/CPVC



<u>PART NUMBER</u>	<u>ITEM DESCRIPTION</u>
MCPRIME	OATEY PURPLE PRIMER FOR PVC/CPVC - PINT SIZE -

## PVC CEMENT - BLUE MEDIUM ALL TEMP 1-STEP



<u>PART NUMBER</u>	<u>ITEM DESCRIPTION</u>
MRHB-4	4 OZ (1/4 PINT) ONE STEP BLUE PVC CEMENT
MRHB-8	8 OZ (1/2 PINT) ONE STEP BLUE PVC CEMENT

## CPVC CEMENT - FLOWGUARD GOLD



<u>PART NUMBER</u>	<u>ITEM DESCRIPTION</u>
MCPVC-GOLD-16	CPVC CEMENT - FLOWGUARD GOLD - PINT (16OZ)

# MISCELLANEOUS SUPPLIES

Tapes & Pipe Compound

Teflon Tape



PRECISION  
INSTALLATION  
PRODUCTS

## TEFLON TAPE - STANDARD WHITE - 0.4 DENSITY



<u>PART NUMBER</u>	<u>ITEM DESCRIPTION</u>
TT1	1/2" X 100" TEFLON TAPE-0.4 DENSITY
TT2	1/2" X 260" TEFLON TAPE-0.4 DENSITY
TT5	1/2" X 520" TEFLON TAPE-0.4 DENSITY
TT5-14	1/4" X 520" TEFLON TAPE-0.4 DENSITY
TT5-34	3/4" X 520" TEFLON TAPE-0.4 DENSITY
TT5-1"	1" X 520" TEFLON TAPE - 0.4 DENSITY

## TEFLON TAPE - UL YELLOW GAS LINE - 1.2 DENSITY



Certified by Underwriters Laboratory (UL) USA for usage in threaded assemblies handling Gasoline, Petroleum Oils, Propane, Butane, Naptha, Benzene, Kerosene, Natural Gas for pressures <100 PSIG.

<u>PART NUMBER</u>	<u>ITEM DESCRIPTION</u>
TT2-GAS	1/2" X 260" YELLOW GAS TEFLON TAPE-1.2 DENSITY

## TEFLON TAPE - UL YELLOW GAS LINE - 1.2 DENSITY



Designed for sealing threaded joints in general water systems and water heating systems. It is certified by DIN-DVGW\* for usage in Hot Water up to 125°C and <= 7 bar.

<u>PART NUMBER</u>	<u>ITEM DESCRIPTION</u>
TT2-PLUMBER	1/2" X 260" PINK PLUMBERS TEFLON TAPE-1.2 DENSITY



PRECISION  
INSTALLATION  
PRODUCTS

# MISCELLANEOUS SUPPLIES

Tapes & Pipe Compound

Tapes

## CLEAR TAPE - CARTON SEALING



<u>PART NUMBER</u>	<u>ITEM DESCRIPTION</u>
TC	QSPAC CARTON SEALING TAPE - 48MM X 100M (ROLL)

## DUCT TAPE



<u>PART NUMBER</u>	<u>ITEM DESCRIPTION</u>
TD	2" X 50 YDS DUCT TAPE-ECONOMY GRADE-3M BRAND
TD-P	2" X 60 YDS 11MIL DUCT TAPE - NASHUA PREMIUM GRADE

## ELECTRICAL TAPE - UL APPROVED



<u>PART NUMBER</u>	<u>ITEM DESCRIPTION</u>
TE	3/4" X 60 FT X 7MIL ELECTRICAL VINYL TAPE - UL APPROVED

# MISCELLANEOUS SUPPLIES

Tapes & Pipe Compound

Tapes



PRECISION  
INSTALLATION  
PRODUCTS

## FILAMENT (STRAPPING) TAPE



<u>PART NUMBER</u>	<u>ITEM DESCRIPTION</u>
--------------------	-------------------------

TF	QSPAC FILAMENT TAPE - 18MM X 55M (ROLL)
----	---

## ALUMINUM FOIL TAPE



<u>PART NUMBER</u>	<u>ITEM DESCRIPTION</u>
--------------------	-------------------------

TA	2" X 50 YARDS 2 MIL HVAC ALUMINUM FOIL TAPE
TA-3	3" X 50 YARDS 2 MIL ALUMINUM FOIL TAPE



PRECISION  
INSTALLATION  
PRODUCTS

# MISCELLANEOUS SUPPLIES

## Tapes & Pipe Compound

### LEAD-FREE SOLDER

---



Flows like 50/50 wire and outperforms 95/5 wire. Meets ASTM B-32 and ANSI/NSF61 requirements.

<u>PART NUMBER</u>	<u>ITEM DESCRIPTION</u>
MLF-1LB	LEAD FREE SOLDER-1 LB ROLL-ANSI/NSF61-UPC

### SOLDER FLUX - BRUSH IN CAP

---



<u>PART NUMBER</u>	<u>ITEM DESCRIPTION</u>
MSFP	SOLDER FLUX PASTE - 4 OZ.

# MISCELLANEOUS SUPPLIES

Tapes & Pipe Compound

Pastes & Compounds



PRECISION  
INSTALLATION  
PRODUCTS

## SLIC-TITE PASTE W/ TEFLON BRUSH-IN CAP



Premium thread sealant paste that has been used for decades to seal water, air, steam, natural gas, and more. Easy to clean up and works in extremely high pressure systems; it comes with approvals such as NSF, UPC, UL, etc, to ensure industry standards are met.

<u>PART NUMBER</u>	<u>ITEM DESCRIPTION</u>
MTP42	OATEY 1/4 PINT BLUE THREAD SEALANT W/ TEFLON-BRUSH IN CAP
MTP82	1/2 PINT BLUE THREAD SEALANT W/ TEFLON-BRUSH IN CAP

## PIPE JOINT COMPOUND - BRUSH-IN CAP



<u>PART NUMBER</u>	<u>ITEM DESCRIPTION</u>
MPJC	PIPE JOINT COMPOUND - 8 OZ - BRUSH IN CAP

## PIPE STICK - PIPE JOINT COMPOUND STICK



<u>PART NUMBER</u>	<u>ITEM DESCRIPTION</u>
MPTS	PIPE SEAL STICK 1.25 OZ (12 PER BOX)..PRICED AND SOLD AS EACH - PER STICK

## PUMBERS PUTTY



<u>PART NUMBER</u>	<u>ITEM DESCRIPTION</u>
MPTS	PIPE SEAL STICK 1.25 OZ (12 PER BOX)..PRICED AND SOLD AS EACH - PER STICK



PRECISION  
INSTALLATION  
PRODUCTS



**END OF SECTION**

**THIS PAGE IS LEFT  
INTENTIONALLY BLANK.**



# MISCELLANEOUS SUPPLIES

Furniture Pads & Webbing

Furniture Pads



PRECISION  
INSTALLATION  
PRODUCTS

## FURNITURE PADS - 72" X 80"



**PART NUMBER**

**ITEM DESCRIPTION**

MFP

FURNITURE PAD - MED GRADE - BLUE/BLUE



**PART NUMBER**

**ITEM DESCRIPTION**

MFP-PLUS

FURNITURE PAD - MED GRADE PLUS - BLUE/BLACK



**PART NUMBER**

**ITEM DESCRIPTION**

MFP-UPGRADE

FURNITURE PAD - MEDI GRADE UPGRADE PLUS - BLUE/YELLOW



**PART NUMBER**

**ITEM DESCRIPTION**

MFP-PRE

FURNITURE PAD - PREMIUM GRADE PLUSH -BLUE/RED



PRECISION  
INSTALLATION  
PRODUCTS

# MISCELLANEOUS SUPPLIES

Furniture Pads & Webbing

Webbing / Tie Towns

## COTTON TIE DOWNS



<u>PART NUMBER</u>	<u>ITEM DESCRIPTION</u>
MCT	COTTON TIE DOWN 2" X 100'

## NYLON TIE DOWNS



<u>PART NUMBER</u>	<u>ITEM DESCRIPTION</u>
MNT	150' X 1" NYLON TIE STRAP

# MISCELLANEOUS SUPPLIES

Tie Straps / Bin Boxes

Tie Straps



PRECISION  
INSTALLATION  
PRODUCTS

## NYLON TIE STRAPS



<u>PART NUMBER</u>	<u>ITEM DESCRIPTION</u>
T1231	4" NYLON CABLE TIE (100 PACK)
T1232	4" NYLON CABLE TIE (1000 PACK)
T1239	7 1/2" NYLON CABLE TIES (20 PACK)
T1234	12" NYLON CABLE TIES (100 PACK)
T1236	14" NYLON CABLE TIE (10 PACK)
T1238	14" NYLON CABLE TIE (500 PACK)

## NYLON TIE STRAPS - HEAVY DUTY W/ SCREW MOUNT



<u>PART NUMBER</u>	<u>ITEM DESCRIPTION</u>
T1243	7 1/2" HEAVY NYLON TIE W/SCREW MOUNT (PK 100)
T1244	8" HEAVY NYLON TIE W/SCREW MOUNT (PK 100)
T1245	14" HEAVY NYLON TIE W/ SCREW MOUNT (PK100)



PRECISION  
INSTALLATION  
PRODUCTS

# MISCELLANEOUS SUPPLIES

Tie Straps / Bin Boxes

Bin Boxes

## CORRUGATED BIN BOXES

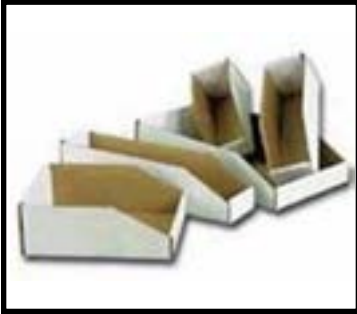

<u>PART NUMBER</u>	<u>ITEM DESCRIPTION</u>
PT4	4" W X 12" D X 4" H - CORRUGATED BIN BOX
PT6	6" W X 12" D X 4 1/2" H - CORRUGATED BIN BOX
PT8	8" W X 12" D X 4" H - CORRUGATED BIN BOX
PT10	10" W X 12" D X 4" H - CORRUGATED BIN BOX
PT12	12" W X 12" D X 4" H - CORRUGATED BIN BOX
PT16	16" W X 12" D X 4" H - CORRUGATED BIN BOX

# MISCELLANEOUS SUPPLIES

Yeats

Dollies



PRECISION  
INSTALLATION  
PRODUCTS

## DOLLY - MODEL #5



"Shorty Model" - Height 47" - Single Strap - Weight 32.5 Lbs  
Designed for moving TV's, Room Air Conditioners and Dishwashers.

<u>PART NUMBER</u>	<u>ITEM DESCRIPTION</u>
YM5	Y5 YEATS DOLLY W/ FELT PADDING - "SHORTY" - 47" HIGH, SINGLE STRAP, WEIGHT 32.5 LBS
YM5-P	Y5 YEATS DOLLY W/ PLASTIC PADDING - "SHORTY" - 47" HIGH, SINGLE STRAP, WEIGHT 32.5 LBS

## DOLLY - MODEL #7



"Standard Model" - Height 59" - Single Strap - Weight 37 Lbs  
Single strap and ratchet holds down your load making it easy to move all types of appliances, including Water Heaters.

<u>PART NUMBER</u>	<u>ITEM DESCRIPTION</u>
YM7	Y7 YEATS DOLLY W/ FELT PADDING - "STANDARD" - 59" HIGH, SINGLE STRAP, WEIGHT 37.5 LBS



PRECISION  
INSTALLATION  
PRODUCTS

# MISCELLANEOUS SUPPLIES

Yeats

Dollies

## DOLLY - MODEL #9



Height 71" - Double Strap - Weight 50.5 Lbs

The largest model of Yeats dollies. Equipped with 4 wheels for rolling heavy loads and 2 straps to secure it firmly. Perfect for large or over-sized appliances.

<u>PART NUMBER</u>	<u>ITEM DESCRIPTION</u>
YM9	Y9 YEATS DOLLY W/ FELT PADDING - 71" HIGH, DOUBLE STRAP, WEIGHT 50 LBS..

## DOLLY - MODEL #14



Height 59" - Double Strap - Weight 40.5 Lbs

Designes for both short and tall appliances. This 2-Strap model holds any appliance firmly in place. Features 2 Ratchets and 2 Straps with 4 Operating Positions.

<u>PART NUMBER</u>	<u>ITEM DESCRIPTION</u>
YM14	Y14 YEATS DOLLY W/ FELT PADDING - 59" HIGH, DOUBLE STRAP, WEIGHT 40.5 LBS..

# MISCELLANEOUS SUPPLIES

Yeats

Dollies



PRECISION  
INSTALLATION  
PRODUCTS

## DOLLY - MODEL #16

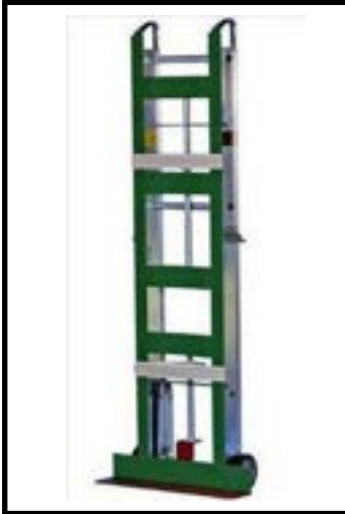

Height 65" - Double Strap - Weight 44.5 Lbs  
Designed for Large Freezers, Refrigerators and Commercial Boxes. When you need something larger than the Standard, but smaller than the #9, This Is It!

<u>PART NUMBER</u>	<u>ITEM DESCRIPTION</u>
YM16	Y16 YEATS DOLLY W/ FELT PADDING - 65" HIGH, DOUBLE STRAP, WEIGHT 44 LBS.

## DOLLY - MODEL #18



Height 79" - Width 24" at Nose Plate - Weight 48 Lbs  
Designed for the Tallest of Appliances, when combined with the Yeats Two Man Handle (Part# Y44) and the Big Wheel Attachment (Part# Y100), no job is too big.

<u>PART NUMBER</u>	<u>ITEM DESCRIPTION</u>
YM18	Y18 YEATS DOLLY W/ FELT PADDING - 79" HIGH, WIDTH 24" AT NOSE PLATE, WEIGHT 48 LBS



PRECISION  
INSTALLATION  
PRODUCTS

# MISCELLANEOUS SUPPLIES

Yeats

Accessories

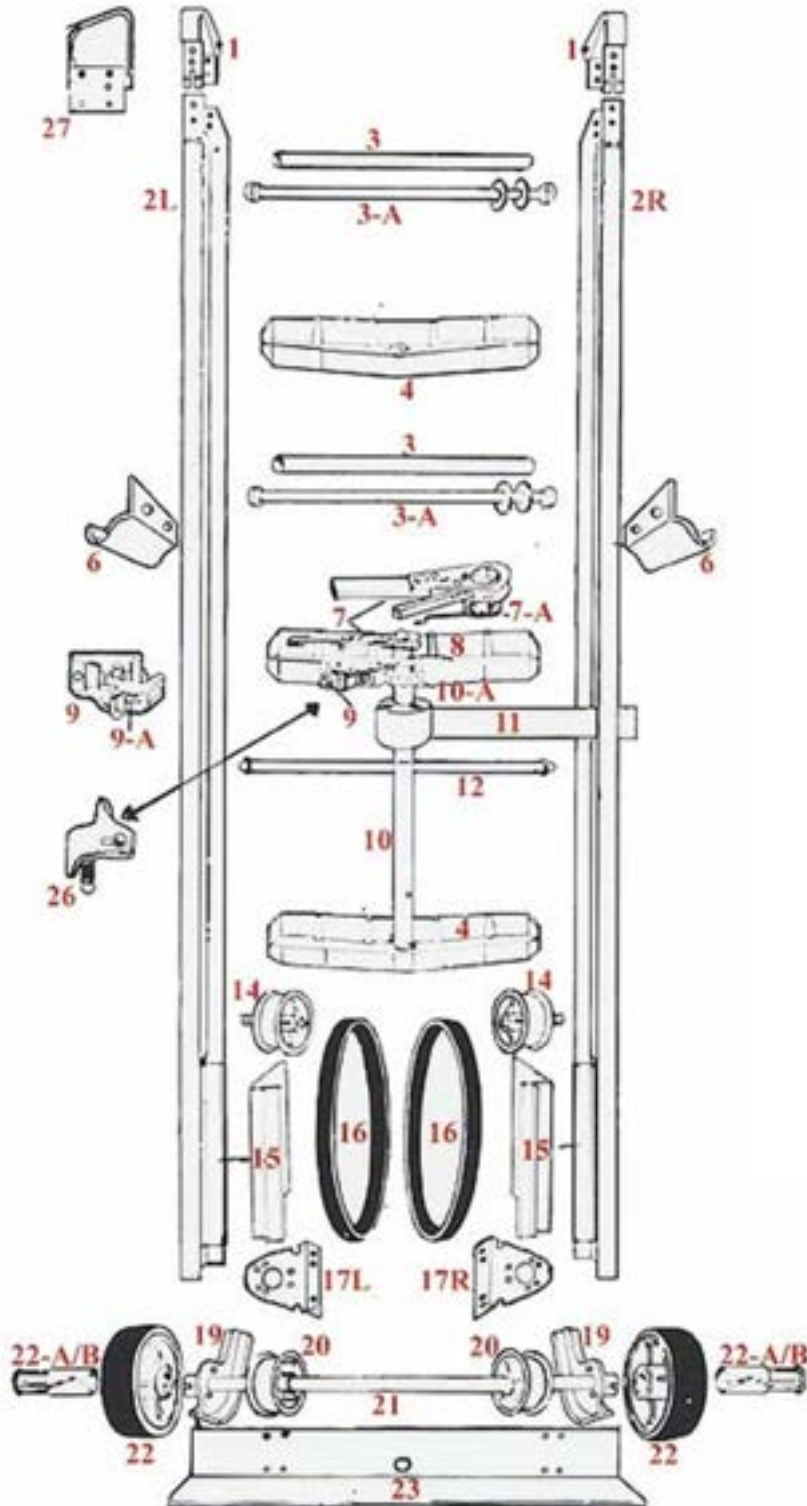



# MISCELLANEOUS SUPPLIES

Yeats

Accessories



PRECISION  
INSTALLATION  
PRODUCTS

## TOP HANDLES



<u>PART NUMBER</u>	<u>ITEM DESCRIPTION</u>
Y1	YEATS TOP HANDLE
Y27	YEATS REPLACEMENT TOP HANDLE

## SIDE RAIL - COMPLETE SET



<u>PART NUMBER</u>	<u>ITEM DESCRIPTION</u>
Y2-5-L	YEATS SIDE RAIL - COMPLETE (MODEL 5 - LEFT)
Y2-5-R	YEATS SIDE RAIL - COMPLETE (MODEL 5 - RIGHT)
Y2-7-L	YEATS SIDE RAIL - COMPLETE (MODEL 7 - LEFT)
Y2-7-R	YEATS SIDE RAIL - COMPLETE (MODEL 7 - RIGHT)
Y2-9-L	YEATS SIDE RAIL - COMPLETE (MODEL 9 - LEFT)
Y2-9-R	YEATS SIDE RAIL - COMPLETE (MODEL 9 - RIGHT)
Y2-14-L	YEATS SIDE RAIL - COMPLETE (MODEL 14 - LEFT)
Y2-14-R	YEATS SIDE RAIL - COMPLETE (MODEL 14 - RIGHT)
Y2-16-L	YEATS SIDE RAIL - COMPLETE (MODEL 16 - LEFT)
Y2-16-R	YEATS SIDE RAIL - COMPLETE (MODEL 16 - RIGHT)
Y2-18-L	YEATS SIDE RAIL - COMPLETE (MODEL 18 - LEFT)
Y2-18-R	YEATS SIDE RAIL - COMPLETE (MODEL 18 - RIGHT)

## SPACE BAR & PARTS



<u>PART NUMBER</u>	<u>ITEM DESCRIPTION</u>
Y3	YEATS SPACER
Y3P	YEATS SPACER - PADDED
Y3A	YEATS SPACER BAR BOLT



PRECISION  
INSTALLATION  
PRODUCTS

# MISCELLANEOUS SUPPLIES

Yeats

Accessories

## CROSS MEMBER



<u>PART NUMBER</u>	<u>ITEM DESCRIPTION</u>
Y4	YEATS TOP CROSS MEMBER - PLAIN W/O THUMB LATCH
Y8	YEATS MIDDLE CROSS MEMBER W/ THUMB LATCH

## RIVETS



<u>PART NUMBER</u>	<u>ITEM DESCRIPTION</u>
Y5	YEATS RIVETS (EACH - SPECIFY)

## SIDE HANDLE



<u>PART NUMBER</u>	<u>ITEM DESCRIPTION</u>
Y6	YEATS SIDE HANDLE

## RATCHET HANDLE



<u>PART NUMBER</u>	<u>ITEM DESCRIPTION</u>
Y7	YEATS RATCHET HANDLE - COMPLETE W/ SPRING, BOLT & WASHER
Y7A	YEATS RATCHET RETURN SPRING

# MISCELLANEOUS SUPPLIES

Yeats

Accessories



PRECISION  
INSTALLATION  
PRODUCTS

## THUMB LATCH



<u>PART NUMBER</u>	<u>ITEM DESCRIPTION</u>
Y9	YEATS THUMB LATCH W/ BRACKET & SPRING
Y9A	YEATS THUMB LATCH SPRING
Y26	YEATS THUMB LATCH TRIGGER & SPRING

## SHAFT & HOLDING GEAR - VERTICAL



<u>PART NUMBER</u>	<u>ITEM DESCRIPTION</u>
Y10-5	YEATS VERTICAL-SHAFT & HOLDING GEAR (MODEL 5)
Y10-7	YEATS VERTICAL-SHAFT & HOLDING GEAR (MODEL 7)
Y10-9-L	YEATS VERTICAL-SHAFT & HOLDING GEAR (MODEL 9 - LOWER)
Y10-9-U	YEATS VERTICAL-SHAFT & HOLDING GEAR (MODEL 9 - UPPER)
Y10-14-L	YEATS VERTICAL-SHAFT & HOLDING GEAR (MODEL 14 - LOWER)
Y10-14-U	YEATS VERTICAL-SHAFT & HOLDING GEAR (MODEL 14 - UPPER)
Y10-16-L	YEATS VERTICAL-SHAFT & HOLDING GEAR (MODEL 16 - LOWER)
Y10-16-U	YEATS VERTICAL-SHAFT & HOLDING GEAR (MODEL 16 - UPPER)
Y10-18-L	YEATS VERTICAL-SHAFT & HOLDING GEAR (MODEL 18 - LOWER)
Y10-18-U	YEATS VERTICAL-SHAFT & HOLDING GEAR (MODEL 18 - UPPER)
Y10A	YEATS HOLDING GEAR WITH PIN



PRECISION  
INSTALLATION  
PRODUCTS

# MISCELLANEOUS SUPPLIES

Yeats

Accessories

## WEB STRAP



<u>PART NUMBER</u>	<u>ITEM DESCRIPTION</u>
Y11	YEATS DOLLY STRAP - WEB STRAP

## WEB STRAP SUPPORT ROD



<u>PART NUMBER</u>	<u>ITEM DESCRIPTION</u>
Y12	YEATS WEB-STRAP SUPPORT ROD

## TOP PULLEY

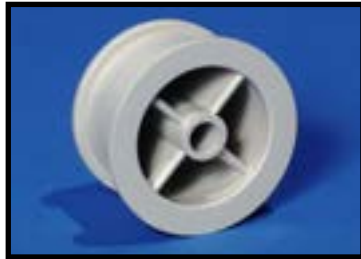

<u>PART NUMBER</u>	<u>ITEM DESCRIPTION</u>
Y14	YEATS TOP PULLEY

## SLIDE



<u>PART NUMBER</u>	<u>ITEM DESCRIPTION</u>
Y15	YEATS GLIDE BELT SLIDE

# MISCELLANEOUS SUPPLIES

Yeats

Accessories



PRECISION  
INSTALLATION  
PRODUCTS

## RATCHET HANDLE



<u>PART NUMBER</u>	<u>ITEM DESCRIPTION</u>
Y16	YEATS GLIDE BELT - GREY IN COLOR - NO MARKINGS

## AXLE BRACKET



<u>PART NUMBER</u>	<u>ITEM DESCRIPTION</u>
Y17	YEATS AXLE BRACKET

## NOSE PLATE (LIP) EXTENSION



<u>PART NUMBER</u>	<u>ITEM DESCRIPTION</u>
Y18	YEATS NOSE PLATE (LIP) EXTENSION - 24"W x 8"D

## SIDE RAIL BASE



<u>PART NUMBER</u>	<u>ITEM DESCRIPTION</u>
Y19-L	YEATS SIDE RAIL BASE (LEFT SIDE RAIL)
Y19-R	YEATS SIDE RAIL BASE (RIGHT SIDE RAIL)



PRECISION  
INSTALLATION  
PRODUCTS

# MISCELLANEOUS SUPPLIES

Yeats

Accessories

## LOWER PULLEY

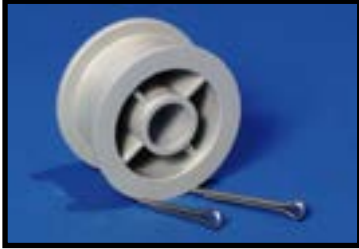

<u>PART NUMBER</u>	<u>ITEM DESCRIPTION</u>
Y20	YEATS LOWER PULLEY WITH PINS

## AXLE



<u>PART NUMBER</u>	<u>ITEM DESCRIPTION</u>
Y21	YEATS AXLE WITH PINS

## WHEEL



<u>PART NUMBER</u>	<u>ITEM DESCRIPTION</u>
Y22	YEATS WHEEL COMPLETE W/ BEARING
Y22A	YEATS WHEEL BEARING & SLEEVE

## NOSE PLATE - STUD BOLT & FELT ATTACHED



<u>PART NUMBER</u>	<u>ITEM DESCRIPTION</u>
Y23-5	YEATS NOSE PLATE - STUD BOLT & FELT ATTACHED (MODEL 5)
Y23-7	YEATS NOSE PLATE - STUD BOLT & FELT ATTACHED (MODEL 7)
Y23-9	YEATS NOSE PLATE - STUD BOLT & FELT ATTACHED (MODEL 9)
Y23-14	YEATS NOSE PLATE - STUD BOLT & FELT ATTACHED (MODEL 14)
Y23-16	YEATS NOSE PLATE - STUD BOLT & FELT ATTACHED (MODEL 16)
Y23-18	YEATS NOSE PLATE - STUD BOLT & FELT ATTACHED (MODEL 18)

# MISCELLANEOUS SUPPLIES

Yeats

Accessories



PRECISION  
INSTALLATION  
PRODUCTS

## FELT PAD SETS - COMPLETE WITH CEMENT



<u>PART NUMBER</u>	<u>ITEM DESCRIPTION</u>
Y24A-5	YEATS FELT PAD SET - COMPLETE W/ CEMENT (MODEL 5)
Y24A-7	YEATS FELT PAD SET - COMPLETE W/ CEMENT (MODEL 7)
Y24A-9	YEATS FELT PAD SET - COMPLETE W/ CEMENT (MODEL 9)
Y24A-14	YEATS FELT PAD SET - COMPLETE W/ CEMENT (MODEL 14)
Y24A-16	YEATS FELT PAD SET - COMPLETE W/ CEMENT (MODEL 16)
Y24A-18	YEATS FELT PAD SET - COMPLETE W/ CEMENT (MODEL 18)

## LOWER FELT PAD



<u>PART NUMBER</u>	<u>ITEM DESCRIPTION</u>
Y24B	YEATS LOWER FELT PAD - FOR NOSE PLATE

## UPPER FELT PAD FOR SIDE RAIL



<u>PART NUMBER</u>	<u>ITEM DESCRIPTION</u>
Y24C-5	YEATS UPRIGHT FELT PAD (MODEL 5)
Y24C-7	YEATS UPRIGHT FELT PAD (MODEL 7)
Y24C-9	YEATS UPRIGHT FELT PAD (MODEL 9)
Y24C-14	YEATS UPRIGHT FELT PAD (MODEL 14)
Y24C-16	YEATS UPRIGHT FELT PAD (MODEL 16)
Y24C-18	YEATS UPRIGHT FELT PAD (MODEL 18)

## CENTER FELT PAD



<u>PART NUMBER</u>	<u>ITEM DESCRIPTION</u>
Y24D	YEATS CENTER FELT PAD

## FELT PAD CEMENT

<u>PART NUMBER</u>	<u>ITEM DESCRIPTION</u>
Y24E	YEATS ADHESIVE FOR FELT PADS

## PLASTIC PAD SET - COMPLETE WITH CEMENT



<u>PART NUMBER</u>	<u>ITEM DESCRIPTION</u>
Y25-5	YEATS PLASTIC PAD SET COMPLETE W/ CEMENT (MODEL 5)
Y25-7	YEATS PLASTIC PAD SET COMPLETE W/ CEMENT (MODEL 7)
Y25-9	YEATS PLASTIC PAD SET COMPLETE W/ CEMENT (MODEL 9)
Y25-14	YEATS PLASTIC PAD SET COMPLETE W/ CEMENT (MODEL 14)
Y25-16	YEATS PLASTIC PAD SET COMPLETE W/ CEMENT (MODEL 16)
Y25-18	YEATS PLASTIC PAD SET COMPLETE W/ CEMENT (MODEL 18)

## UPRIGHT PLASTIC PAD - FOR SIDE RAIL

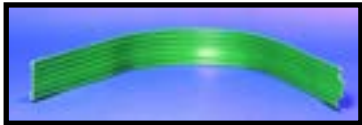

<u>PART NUMBER</u>	<u>ITEM DESCRIPTION</u>
Y25C-5-L	YEATS UPRIGHT PLASTIC PAD (MODEL 5 - LEFT SIDE RAIL)
Y25C-5-R	YEATS UPRIGHT PLASTIC PAD (MODEL 5 - RIGHT SIDE RAIL)
Y25C-7-L	YEATS UPRIGHT PLASTIC PAD (MODEL 7 - LEFT SIDE RAIL)
Y25C-7-R	YEATS UPRIGHT PLASTIC PAD (MODEL 7 - RIGHT SIDE RAIL)
Y25C-9-L	YEATS UPRIGHT PLASTIC PAD (MODEL 9 - LEFT SIDE RAIL)
Y25C-9-R	YEATS UPRIGHT PLASTIC PAD (MODEL 9 - RIGHT SIDE RAIL)
Y25C-14-L	YEATS UPRIGHT PLASTIC PAD (MODEL 14 - LEFT SIDE RAIL)
Y25C-14-R	YEATS UPRIGHT PLASTIC PAD (MODEL 14 - RIGHT SIDE RAIL)
Y25C-16-L	YEATS UPRIGHT PLASTIC PAD (MODEL 16 - LEFT SIDE RAIL)
Y25C-16-R	YEATS UPRIGHT PLASTIC PAD (MODEL 16 - RIGHT SIDE RAIL)
Y25C-18-L	YEATS UPRIGHT PLASTIC PAD (MODEL 18 - LEFT SIDE RAIL)
Y25C-18-R	YEATS UPRIGHT PLASTIC PAD (MODEL 18 - RIGHT SIDE RAIL)

## HANDLE GUARD BUMPER SET



<u>PART NUMBER</u>	<u>ITEM DESCRIPTION</u>
Y28	YEATS HANDLE GUARD (SET OF 2)



# MISCELLANEOUS SUPPLIES

Yeats

Accessories



PRECISION  
INSTALLATION  
PRODUCTS

## NOSE PLATE STUD SET



<u>PART NUMBER</u>	<u>ITEM DESCRIPTION</u>
Y29	YEATS NOSE PLATE STUD SET (INCLUDES 8 BOLTS & 8 LOCK NUTS)

## NOSE PLATE EXPANDER

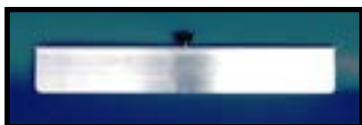

<u>PART NUMBER</u>	<u>ITEM DESCRIPTION</u>
Y30	YEATS NOSE PLATE WIDTH EXPANDER 26" WIDE - ALUMINUM

## BIG WHEEL



<u>PART NUMBER</u>	<u>ITEM DESCRIPTION</u>
Y33A	YEATS BIG WHEEL - PNEUMATIC TIRE - WHEEL & TIRE
Y33B	YEATS BRACKETS FOR BIG WHEEL ATTACHMENT
Y33C	YEATS AXLES FOR BIG WHEEL ATTACHMENT
Y33D	YEATS BIG WHEEL - TURN-BUCKLE
Y33E	YEATS BIG WHEEL - SOLID - WHEEL & TIRE - HARD RUBBER MATERIAL
Y33F	YEATS BIG WHEEL ATTACHMENT - SOLID TIRE

## BIG WHEEL ATTACHMENT



<u>PART NUMBER</u>	<u>ITEM DESCRIPTION</u>
Y100	YEATS BIG WHEEL ATTACHMENT - PNEUMATIC



PRECISION  
INSTALLATION  
PRODUCTS

# MISCELLANEOUS SUPPLIES

Yeats

Accessories

## TWO MAN HANDLE



<u>PART NUMBER</u>	<u>ITEM DESCRIPTION</u>
Y44	YEATS TWO MAN HANDLE

ATTACHMENT PROVIDES MULTIPLE MOVERS WITH EXCELLENT SIDE X SIDE LIFTING AND MANEUVERABILITY. MOVE HEAVY OR BULKY ITEMS ON STAIRS AND THROUGH DOORWAYS WITH EASE. CUSHIONED BRACKETS ALLOW DOLLY TO BE LAID HORIZONTALLY WITHOUT DAMAGE TO FLOORING.

# MISCELLANEOUS SUPPLIES

Clearance

Pumps & Parts



PRECISION  
INSTALLATION  
PRODUCTS

## AUTO FLUSH TIMER VAVLES W/ FLOW RESTRICTOR



<u>PART NUMBER</u>	<u>PRICE</u>	<u>ITEM DESCRIPTION</u>
PFR603-CO	\$11.00	AQUATEC 300 ML/MN FLUSH TIMER WITH FLOW RESTRICTOR - 1/4" JACO FITTING *CLOSEOUT*
PFR605-CO	\$11.00	AQUATEC 500 ML/MN FLUSH TIMER WITH FLOW RESTRICTOR - 1/4" JACO FITTINGS AND WIRE HARNESS *CLOSEOUT*

## AQUATEC SMALL REPLACEMENT PARTS



<u>PART NUMBER</u>	<u>PRICE</u>	<u>ITEM DESCRIPTION</u>
PSF374-CO	\$6.00	AQUATEC PREFILTER 100 MESH SCREEN FOR PUMPS - 1/4" QC ELBOW X 1/4" STEM *CLOSEOUT*

\*NOTE: SUBJECT TO AVAILABILITY.



PRECISION  
INSTALLATION  
PRODUCTS

# MISCELLANEOUS SUPPLIES

Clearance

PVC Fittings

## PVC INLINE BALL VALVE - BARB X BARB



<u>PART NUMBER</u>	<u>PRICE</u>	<u>ITEM DESCRIPTION</u>
A226-8B-CO	\$1.68	PVC INLINE BALL VALVE - 1/2" BARB X 1/2" BARB*CLOSEOUT*

\*NOTE: SUBJECT TO AVAILABILITY.

# MISCELLANEOUS SUPPLIES

Clearance

Stainless Steele Fittings



PRECISION  
INSTALLATION  
PRODUCTS

## SS ELBOWS - BARB X BARB



<u>PART NUMBER</u>	<u>PRICE</u>	<u>ITEM DESCRIPTION</u>
S29-44-CO	\$0.31	1/4 X 1/4 STAINLESS STEEL BARB HOSE ELBOW **CLOSEOUT**
S29-66-CO	\$0.47	3/8 X 3/8 STAINLESS STEEL BARB HOSE ELBOW **CLOSEOUT**
S29-88-CO	\$1.14	1/2" STAINLESS STEEL HOSE BARB 90* ELBOW **CLOSEOUT**

## SS SWIVEL ELBOWS - BARB X BARB X FEMALE FLARE



<u>PART NUMBER</u>	<u>PRICE</u>	<u>ITEM DESCRIPTION</u>
S30-46-CO	\$1.38	1/4" BARB X 3/8" FEM FLARE SS SWIVEL ELBOW **CLOSEOUT**

## SS BARB STEMS



<u>PART NUMBER</u>	<u>PRICE</u>	<u>ITEM DESCRIPTION</u>
S104-CO	\$0.23	1/4 STAINLESS STEEL BARB HOSE STEM FOR 1/4 NUT **CLOSEOUT**
S304-CO	\$0.39	1/4 SS BARB HOSE STEM X 3/8 FEM FLARE - 3/8 NUT **CLOSEOUT**

## SS BARB SPLICERS



<u>PART NUMBER</u>	<u>PRICE</u>	<u>ITEM DESCRIPTION</u>
S408-CO	\$0.56	1/2 STAINLESS STEEL BARB HOSE SPLICER **CLOSEOUT**

\*NOTE: SUBJECT TO AVAILABILITY.



PRECISION  
INSTALLATION  
PRODUCTS

# MISCELLANEOUS SUPPLIES

Clearance

## Stainless Steele Fittings

### SS BARB PLUG



<u>PART NUMBER</u>	<u>PRICE</u>	<u>ITEM DESCRIPTION</u>
S21-4-CO	\$0.21	1/4 STAINLESS STEEL BARB PLUG **CLOSEOUT**
S21-6-CO	\$0.34	3/8 STAINLESS STEEL BARB PLUG **CLOSEOUT**
S21-8-CO	\$0.62	1/2 STAINLESS STEEL BARB PLUG **CLOSEOUT**

### SS REDUCING BARB TEE



<u>PART NUMBER</u>	<u>PRICE</u>	<u>ITEM DESCRIPTION</u>
S60-4-6-CO	\$1.26	1/4 X 1/4 X 3/8 SS BARBED HOSE RED TEE **CLOSEOUT**
S60-6-4-CO	\$0.73	3/8 X 3/8 X 1/4 SS BARBED HOSE RED TEE **CLOSEOUT**
S60-6-8-CO	\$1.47	1/2 X 3/8 X 3/8 SS BARBED HOSE RED TEE **CLOSEOUT**
S60-8-6-CO	\$1.50	1/2 X 1/2 X 3/8 SS BARBED HOSE RED TEE **CLOSEOUT**

### SS BARB TEE



<u>PART NUMBER</u>	<u>PRICE</u>	<u>ITEM DESCRIPTION</u>
S601-CO	\$0.71	1/4 STAINLESS STEEL BARB HOSE TEE **CLOSEOUT**
S605-CO	\$1.66	1/2 STAINLESS STEEL BARB HOSE TEE **CLOSEOUT**

### SS BARB CROSS



<u>PART NUMBER</u>	<u>PRICE</u>	<u>ITEM DESCRIPTION</u>
S707-4-CO	\$0.79	1/4 STAINLESS STEEL BARB HOSE CROSS **CLOSEOUT**
S707-6-CO	\$0.93	3/8 STAINLESS STEEL BARB HOSE CROSS **CLOSEOUT**

\*NOTE: SUBJECT TO AVAILABILITY.

# MISCELLANEOUS SUPPLIES

Clearance

Stainless Steel Fittings



PRECISION  
INSTALLATION  
PRODUCTS

## SS BARB WYE TEE

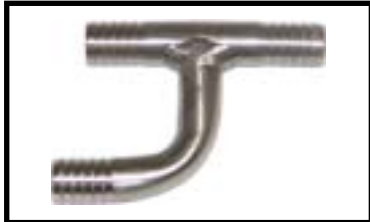

<u>PART NUMBER</u>	<u>PRICE</u>	<u>ITEM DESCRIPTION</u>
S90-6-CO	\$0.29	3/8 SS HOSE BARB WYE TEE **CLOSEOUT**

## SS ADAPTER - MALE FLARE X MALE FLARE



<u>PART NUMBER</u>	<u>PRICE</u>	<u>ITEM DESCRIPTION</u>
S49-4-4-CO	\$0.62	1/4 MALE FLARE X 1/4 MALE FLARE SS **CLOSEOUT**
S49-6-6-CO	\$1.31	3/8 MALE FLARE X 3/8 MALE FLARE SS **CLOSEOUT**

\*NOTE: SUBJECT TO AVAILABILITY.



PRECISION  
INSTALLATION  
PRODUCTS

# MISCELLANEOUS SUPPLIES

Clearance

Electrical

## EXTENSION CORDS W/ ANGLE PLUG - UL LISTED



<u>PART NUMBER</u>	<u>PRICE</u>	<u>ITEM DESCRIPTION</u>
EAC15-CO	\$4.50	15 FOOT EXTENSION CORD W/ ANGLE PLUG-14 GAUGE-3 WIRE-125 VOLT-15 AMP **CLOSEOUT**

## HIGH HEAT PORCELAIN WIRE CONNECTOR



<u>PART NUMBER</u>	<u>PRICE</u>	<u>ITEM DESCRIPTION</u>
E2071-CO	\$1.99	X-LARGE HIGH HEAT PORCELAIN WIRE CONNECTOR (PK15) **CLOSEOUT**

## ELECTRICAL SQUARE BOX



<u>PART NUMBER</u>	<u>PRICE</u>	<u>ITEM DESCRIPTION</u>
E4SW-12-CO	\$0.28	4" SQUARE BOX WITH 3/4" KNOCKOUT **CLOSEOUT**

\* NOTE: SUBJECT TO AVAILABILITY.



# MISCELLANEOUS SUPPLIES

Clearance

Kitchen Faucets & Accessories



PRECISION  
INSTALLATION  
PRODUCTS

## BRASS FAUCET ADAPTER



<u>PART NUMBER</u>	<u>PRICE</u>	<u>ITEM DESCRIPTION</u>
PFO18-CO	\$0.69	BRASS FAUCET ADAPTER - 1/2"COMP X 7/16-24UNS*CLOSEOUT*

## TWISTLOC LF FEED ADAPTERS



<u>PART NUMBER</u>	<u>PRICE</u>	<u>ITEM DESCRIPTION</u>
TLC88-6-BOGO	\$4.68	TWISTLOC LEAD FREE FEED ADAPTER - 1/2"MC X 1/2"FC X 3/8" OD**BOGO**

\*NOTE: SUBJECT TO AVAILABILITY.



PRECISION  
INSTALLATION  
PRODUCTS

# MISCELLANEOUS SUPPLIES

Clearance

Misc. Parts

## LOW VOC CLEAR MEDIUM BODY PVC CEMENT



<u>PART NUMBER</u>	<u>PRICE</u>	<u>ITEM DESCRIPTION</u>
MP9110-CO	\$2.85	CHRISTY'S LOW VOC CLEAR MED BODY PVC CEMENT **CLOSEOUT**

## RED HOT BLUE GLUE PVC CEMENT



<u>PART NUMBER</u>	<u>PRICE</u>	<u>ITEM DESCRIPTION</u>
MRHB-16-CO	\$6.53	16 OZ "RED HOT BLUE GLUE" PVC CEMENT **CLOSEOUT**

## PLASTO JOINT STICK COMPOUND



<u>PART NUMBER</u>	<u>PRICE</u>	<u>ITEM DESCRIPTION</u>
MPJS-CO	\$0.38	1-1/4 OZ. PLASTO JOINT STICK COMPOUND *CLOSEOUT*

\* NOTE: SUBJECT TO AVAILABILITY.

# MISCELLANEOUS SUPPLIES

Clearance

Toilet & Shower Parts



PRECISION  
INSTALLATION  
PRODUCTS

## ANTI-SIPHON BALLCOCK



<u>PART NUMBER</u>	<u>PRICE</u>	<u>ITEM DESCRIPTION</u>
PAS1010-CO	\$1.83	PASCO 10" ANTI-SIPHON BALLCOCK *CLOSEOUT*

## REPLACEMENT SHOWER FILTER



<u>PART NUMBER</u>	<u>PRICE</u>	<u>ITEM DESCRIPTION</u>
PRSF-AH-CO	\$21.93	SPRITE SHOWER FILTER W/ ADJUSTABLE SHOWER HEAD *CLOSEOUT*



**PRECISION  
INSTALLATION  
PRODUCTS**

# MISCELLANEOUS SUPPLIES

Clearance

R.O. & Filtration

## QUICK CHANGE RO SYSTEM

The PERO-Q550-BL-1/4 is a State-of-the-Art Under Sink RO System Designed by Engineers with the Most Modern Materials and Technologies to Produce a Truly Affordable and Reliable Water Treatment Device. The Semi-Manifold Assembly was Designed to Save your Labor Costs and to Lessen the Possibility of Leaks in the field.

The PERO-Q550-BL-1/4 R.O. System Comes with a Sediment Filter, GAC Filter, Carbon Block, a 50 GPD Membrane and Inline GAC Filter. This System is Competitively Priced with Conventional Under-Sink RO Systems.

### FEATURES:

- Compact Design to Save Space
- Quick and Easy Installation
- Inexpensive and Proprietary Quick Change Filters
- System Comes with 3.2 Gallon Tank
- System Comes with Chrome Plated Faucet
- Installation Hardware Supplied

## 5-STAGE 50GPD QUICK CHANGE RO SYSTEM



<u>PART NUMBER</u>	<u>PRICE</u>	<u>ITEM DESCRIPTION</u>
PERO-Q550-BL-1/4-CO	\$110.00	PRO-Q SERIES BLACK 5 STAGE 50 GPD 1/4" QC R.O. SYSTEM **CLOSEOUT**

## REPLACEMENT FILTERS FOR PERO-Q550-BL-1/4

<u>PART NUMBER</u>	<u>ITEM DESCRIPTION</u>
PERO-Q550-SF	PRO-Q SERIES 5 MICRON BLACK SEDIMENT FILTER - STAGE #1 *SPECIAL*
PERO-Q550-GAC	PRO-Q SERIES BLACK GRANULAR ACTIVATED CARBON FILTER - STAGE #2 *SPECIAL*
PERO-Q550-CB	PRO-Q SERIES BLACK CARBON BLOCK - STAGE #3 *SPECIAL*
PERO-Q550-MEM	PRO-Q SERIES 50 GPD TFC BLACK MEMBRANE - STAGE #4 *SPECIAL*

\* NOTE: SUBJECT TO AVAILABILITY.

# MISCELLANEOUS SUPPLIES

Clearance

R.O. Components & Parts



PRECISION  
INSTALLATION  
PRODUCTS

## INLINE FLOW RESTRICTORS



<u>PART NUMBER</u>	<u>PRICE</u>	<u>ITEM DESCRIPTION</u>
PFR-700F-CO	\$0.82	700 ML/MN FLOW RESTRICTOR WITH 1/4" FPT ENDS*CLOSEOUT*
PFR-1200F-CO	\$0.82	1,200 ML/MN FLOW RESTRICTOR WITH 1/4" FPT ENDS*CLOSEOUT*
PFR-1200JG-CO	\$1.38	1,200 ML/MN FLOW RESTRICTOR WITH 1/4" JG ENDS*CLOSEOUT*

## SINGLE 2" INLINE FILTER MOUNT CLIP



<u>PART NUMBER</u>	<u>PRICE</u>	<u>ITEM DESCRIPTION</u>
PFO-1BLK-W/O-CO	\$0.05	PAYNE BLACK 2" PLASTIC INLINE FILTER MOUNT CLIP - NO HOLES*CLOSEOUT*

## PANEL MOUNT FLOW METERS



<u>PART NUMBER</u>	<u>PRICE</u>	<u>ITEM DESCRIPTION</u>
PMF-4024-CO	\$12.95	LIGUATEC PANEL MOUNT FLOWMETER - 4-24GPM - 1"MPT*CLOSEOUT*
PMF-6020A-CO	\$12.95	LIGUATEC PANEL MOUNT FLOWMETER - 6-20GPM - 1"MPT ADJUSTABLE*CLOSEOUT*

\*NOTE: SUBJECT TO AVAILABILITY.



PRECISION  
INSTALLATION  
PRODUCTS

# MISCELLANEOUS SUPPLIES

Clearance

Membranes / Vessels

## AXEON CTA MEMBRANES



<u>PART NUMBER</u>	<u>PRICE</u>	<u>ITEM DESCRIPTION</u>
PWC-16-CO	\$16.96	AXEON 1.8" X 12"- 16 GPD CTA MEMBRANE*CLOSEOUT*
PWC-20-CO	\$17.18	AXEON 1.8" X 12" - 20 GPD CTA MEMBRANE*CLOSEOUT*

\*NOTE: SUBJECT TO AVAILABILITY.

# MISCELLANEOUS SUPPLIES

Clearance

Brass Fittings & Nipples



PRECISION  
INSTALLATION  
PRODUCTS

## CARBON STEEL FITTING BRUSH W/ WIRE HANDLE

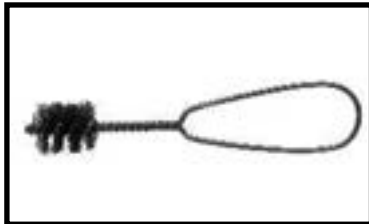

<u>PART NUMBER</u>	<u>PRICE</u>	<u>ITEM DESCRIPTION</u>
RB703-2-CO	\$0.88	1/2" CARBON STEEL FITTING BRUSH W/ WIRE LOOP HANDLE (BOX IS 12) **CLOSEOUT**

## BRASS ADAPTER - COMPRESSION X FPT



<u>PART NUMBER</u>	<u>PRICE</u>	<u>ITEM DESCRIPTION</u>
C66-10-6-CO	\$3.55	5/8" COMPRESSION X 3/8" FPT UNION **CLOSEOUT**

## FLARE POLY WASHER FOR BRASS COMP UNIONS



<u>PART NUMBER</u>	<u>PRICE</u>	<u>ITEM DESCRIPTION</u>
HFV-8-CO	\$0.02	1/2" FLARE POLY WASHER FOR CU6-6-8 **CLOSEOUT**

\*NOTE: SUBJECT TO AVAILABILITY.



PRECISION  
INSTALLATION  
PRODUCTS

# MISCELLANEOUS SUPPLIES

Clearance

Venting

## VENT OFFSET ELBOW



<u>PART NUMBER</u>	<u>PRICE</u>	<u>ITEM DESCRIPTION</u>
V109-CO	\$1.03	BUILDER'S BEST 4" WALL OFFSET ELBOW*CLOSEOUT*

## VENT CAP



<u>PART NUMBER</u>	<u>PRICE</u>	<u>ITEM DESCRIPTION</u>
V3RAC-CO	\$1.35	3" ROUND ALUMINUM VENT CAPS*CLOSEOUT*

## PLASTIC WALL CAP W/ SPRING DAMPER



<u>PART NUMBER</u>	<u>PRICE</u>	<u>ITEM DESCRIPTION</u>
VC350-CO	\$3.01	5" PLASTIC WALL CAP W/ SPRING DAMPER*CLOSEOUT*
VC351-CO	\$3.30	6" PLASTIC WALL CAP W/ SPRING DAMPER*CLOSEOUT*

## SPIRAL VENT COUPLING -SPIRAL



<u>PART NUMBER</u>	<u>PRICE</u>	<u>ITEM DESCRIPTION</u>
VCP7-CO	\$1.11	7" DIAM X 6" HIGH SPIRAL VENT COUPLING*CLOSEOUT*

\*NOTE: SUBJECT TO AVAILABILITY.



# MISCELLANEOUS SUPPLIES

Clearance

Venting



PRECISION  
INSTALLATION  
PRODUCTS

## GALVANIZED VENT HOODS

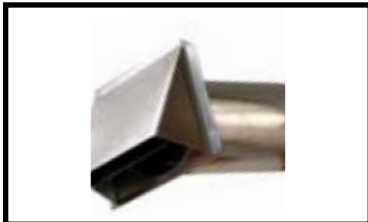

<u>PART NUMBER</u>	<u>PRICE</u>	<u>ITEM DESCRIPTION</u>
VH4G-WO-CO	\$1.03	4" GALV HOOD-FLUSH MOUNT W/O FLAPPER*CLOSEOUT*
VH4G-STG-CO	\$2.88	4" GALV VENT HOOD - 1" STUCCO STOP - 28 GAUGE*CLOSEOUT*
VH7G-STG-CO	\$4.25	7" GALV VENT HOOD-STUCCO STOP 28 GAUGE*CLOSEOUT*

## VENT EXTERIOR WALL CAP

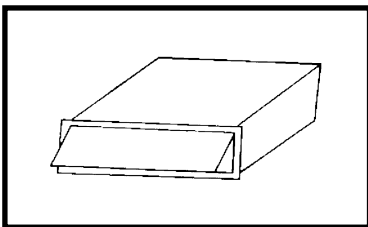

<u>PART NUMBER</u>	<u>PRICE</u>	<u>ITEM DESCRIPTION</u>
V310WC-CO	\$14.51	3 1/4" X 10" EXTERIOR WALL CAP-GALVANIZED SHEET METAL **CLOSEOUT**

## VENT REVERSE WYE TEE



<u>PART NUMBER</u>	<u>PRICE</u>	<u>ITEM DESCRIPTION</u>
VRT8-4-CO	\$1.72	8 X 8 X 4 REVERSE VENT TEE Y-30 G*CLOSEOUT*
VRT8-44-CO	\$4.15	8 X 8 X 4 X 4 REVERSE DUAL TEE Y-30 G*CLOSEOUT*

\*NOTE: SUBJECT TO AVAILABILITY.



PRECISION  
INSTALLATION  
PRODUCTS

# MISCELLANEOUS SUPPLIES

Clearance

## CONDUCTOR PIPE

---

<u>PART NUMBER</u>	<u>PRICE</u>	<u>ITEM DESCRIPTION</u>
VP310-CO		3" X 10 FOOT CONDUCTOR PIPE-28 GAUGE *CLOSEOUT*
VP810-CO		8" X 10 FOOT CONDUCTOR PIPE-28 GAUGE *CLOSEOUT*

## PANCAKE TAPER

---

<u>PART NUMBER</u>	<u>PRICE</u>	<u>ITEM DESCRIPTION</u>
VPT8-5-CO		8" X 5" VENT PANCAKE TAPER - 30 GAUGE *CLOSEOUT*

## EZ-FLO/EASTMAN AIR GAP REPLACEMENT PARTS

---

<u>PART NUMBER</u>	<u>PRICE</u>	<u>ITEM DESCRIPTION</u>
AGPE-CO		EZ-FLO/EASTMAN PLASTIC EXTENSION FOR AIRGAP **CLOSEOUT**
AGPLN-CO		EZ-FLO/EASTMAN PLASTIC LOCK NUT FOR AIRGAP **CLOSEOUT**

\* NOTE: SUBJECT TO AVAILABILITY.

# MISCELLANEOUS SUPPLIES

Clearance

Filters & Cartridges



PRECISION  
INSTALLATION  
PRODUCTS

## BONDED POLY-SPUN SEDIMENT FILTERS (SOLD IN 20E)

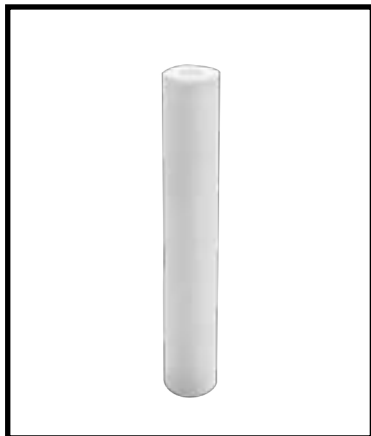

<u>PART NUMBER</u>	<u>PRICE</u>	<u>ITEM DESCRIPTION</u>
PX201-CO	\$0.49	LIQUATEC 20" X 2.5" NSF POLY SPUN FILTER - 1 MICRON (MUST PURCHASE IN CASE QTY'S)*CLOSEOUT*
PX250-CO	\$0.49	LIQUATEC 20" X 2.5" NSF POLY SPUN FILTER - 50 MICRON (MUST PURCHASE IN CASE QTY'S)*CLOSEOUT*
PX275-CO	\$0.49	LIQUATEC 20" X 2.5" NSF POLY SPUN FILTER - 75 MICRON (MUST PURCHASE IN CASE QTY'S)*CLOSEOUT*

## CARBON BLOCK



<u>PART NUMBER</u>	<u>PRICE</u>	<u>ITEM DESCRIPTION</u>
PCB05-5M-CO	\$0.50	LIQUATEC 2.5" X 5" COCO SHELL CARBON BLOCK - 5 MICRON - NSF*CLOSEOUT*

\*NOTE: SUBJECT TO AVAILABILITY.



**PRECISION  
INSTALLATION  
PRODUCTS**

# MISCELLANEOUS SUPPLIES

Clearance

## Omnipure Q-Series Water Filters

### TASTE AND ODOR REMOVAL Q-SERIES



Designed to reduce impurities that can cause unwanted taste and odor in water, the filter utilizes water-rinsed T-28 activated coco-shell carbon for the reduction of chlorine and other contaminants down to 10 micron. These filters are ideal for point of use applications.

<u>PART NUMBER</u>	<u>PRICE</u>	<u>ITEM DESCRIPTION</u>
PQ5328-CO	\$4.68	OMNIPURE Q-SERIES 6" GAC T-28 COCO SHELL CARBON CARTRIDGE***CLOSEOUT***
PQ5428-CO	\$5.40	OMNIPURE Q-SERIES 8" GAC T-28 COCO SHELL CARBON CARTRIDGE***CLOSEOUT***

### R.O. SYSTEMS CARBON FILTERS - Q-SERIES

Acid-rinsed T-33 activated coco-shell carbon is used for slower flow conditions, such as between a membrane and storage tank, and as a post-filter. Filtration is effective down to 5 micron. These filters are ideal for R.O. System use applications.

<u>PART NUMBER</u>	<u>PRICE</u>	<u>ITEM DESCRIPTION</u>
PQ5333-CO	\$4.86	OMNIPURE Q-SERIES 6" GAC T-33 COCO SHELL CARBON CARTRIDGE***CLOSEOUT***
PQ5433-CO	\$5.40	OMNIPURE Q-SERIES 8" GAC T-33 COCO SHELL CARBON CARTRIDGE***CLOSEOUT***

### CARBON BLOCK - Q-SERIES

Made of FDA compliant material and high purity acid washed carbon for high quality filtration with slower flow conditions.

<u>PART NUMBER</u>	<u>PRICE</u>	<u>ITEM DESCRIPTION</u>
PQ5321-CO	\$5.86	OMNIPURE Q-SERIES 6" 10 MICRON CARBON BLOCK**CLOSEOUT**
PQ5415-CO	\$7.89	OMNIPURE Q-SERIES 8" 1 MICRON CARBON BLOCK W/ LEAD & CYST REMOVAL***CLOSEOUT***
PQ5420-CO	\$7.74	OMNIPURE Q-SERIES 8" 1 MICRON CARBON BLOCK***CLOSEOUT***

\*NOTE: SUBJECT TO AVAILABILITY.















## **PRECISION INSTALLATION PRODUCTS, INC**

20135 Ellipse  
Foothill Ranch, CA 92610  
Phone: 949-583-1244  
Fax: 949-583-1548  
Web: [www.precisioninstallationproducts.net](http://www.precisioninstallationproducts.net)