

DRAFT

**American's With Disabilities Act (ADA)
Self-Evaluation and Transition Plan**



Everett, WA

April 2021

**Prepared by Transportation Solutions, Inc
and design2 LAST, Inc.**



The Americans with Disabilities Act Notice:

In accordance with the requirements of Title II of the Americans with Disabilities Act of 1990 ("ADA"), the Port of Everett will not discriminate against qualified individuals with disabilities on the basis of disability in its services, programs, or activities.

Alternative Formats:

Materials can be requested in alternative formats by contacting the Port's Office Manager, Emily Hammer at:

Phone: (425) 388-0625
WA Relay Service/TTY: 7-1-1
E-mail: emilyh@portofeverett.com
Mail: P.O. Box 538, Everett, WA 98206

ADA/504 Coordinator:

The ADA/504 Coordinator is responsible for responding to grievances, complaints and other alleged ADA discrimination concerns. For questions related to these concerns or about the content of this report, please contact Port Planner and ADA Coordinator Laura Gurley at:

Phone: (425) 388-0720
WA Relay Service/TTY: 7-1-1
E-mail: laurag@portofeverett.com
Mail: P.O. Box 538, Everett, WA 98206

Acknowledgements

The Port of Everett wishes to thank the organizations and individuals who contributed to this project. This was truly a collaborative venture that could not have happened without the input, creativity, and participation of many people. Thank you all.

Port of Everett Commission

David Simpson – District 1
Tom Stiger – District 2
Glen Bachman – District 3
Lisa Lefeber – CEO/Executive Director

Port of Everett Project Team

Laura Gurley, ADA/504 Coordinator and Planner
Catherine Soper, Public Affairs Manager
Kate Anderson, Communications Specialist

Consultant Team



Transportation Solutions, Inc.
Victor Salemann, Principal
Kirk Harris, Project Manager
Jennifer Salemann, Planner



design2 LAST, Inc.
Lauri Strauss, President and CEO

Table of Contents

A. Introduction & Legal Requirements	9
A.1 Legal Precedent.....	9
A.2 Scope of ADA Transition Plan	10
A.3 Organization of Document.....	11
B. Self-Evaluation and Compliance Activities to Date.....	12
B.1 Transportation Network	12
B.2 Recreational Facilities	26
B.3 Administrative Policies & Procedures.....	36
C. Public Outreach.....	38
C.1 Public Outreach Strategy	38
C.2 Public Engagement Findings	40
C.3. Recommendations	47
D. Barrier Prioritization & Removal Schedule Recommendations	48
D.1 Generic Prioritization Criteria	48
D.2 Transportation Network	49
D.3 Recreational Facilities	51
D.4 Administrative Policies & Procedures.....	53
E. Future Actions to Maintain and Achieve Compliance	56
E.1 Future Actions Needed.....	56
E.2 Annual Report of Barriers Removed	56
E.3 Five-Year ADA Transition Plan Update Schedule	56
F. Accessibility Regulations, Standards & Guidelines Resources.....	57
F.1 General Resources.....	57
F.2 Barrier-Specific Resources.....	57

List of Tables

Table 1. Transportation Network Facilities Assessed for ADA Compliance in January 2021 12

Table 2. Curb Ramp Inventory Data Fields and Attributes Collected January 2021..... 14

Table 3. Curb Ramp Grading System (VDOT) Amended for Port of Everett..... 15

Table 4. Curb Ramp Condition and Compliance Inventory 16

Table 5. Sidewalk Barrier Inventory Data Fields and Attributes Collected January 2021 19

Table 6. Sidewalk Barrier Inventory (Non-Compliant Features)..... 20

Table 7. DSI Inventory Data Fields and Attributes Collected January 2021 22

Table 8. DSI Condition and Compliance Inventory 23

Table 9. Recreational Facilities Assessed for ADA Compliance in January 2021 26

Table 10. Recreational Facilities by Overall ADA Barrier Priority Level..... 28

Table 11. Survey Responses by Platform..... 40

Table 12. ArcGIS Survey123® Ranked Results for Most Wanted Barrier Types for Removal..... 42

Table 13. ArcGIS Survey123® Ranked Results for Most Wanted Barrier Removal Locations 42

Table 14. SurveyMonkey® Ranked Results for Most Wanted Barrier Types for Removal 45

Table 15. SurveyMonkey® Ranked Results for Most Wanted Barrier Removal Locations..... 45

Table 16. Combined Ranked Score for Most Wanted Barrier Type for Removal..... 46

Table 17. Combined Ranked Score for Top Priority Location for Removal 46

List of Figures

Figure 1. Transportation Network Facilities Assessed for ADA Compliance - Phase I.....	13
Figure 2. Curb Ramp ADA Compliance Status Map (North/Central) - January 2021	17
Figure 3. Curb Ramp ADA Compliance Status Map (South) - January 2021.....	18
Figure 4. Sidewalk ADA Barriers Map - January 2021.....	21
Figure 5. Driveway/Sidewalk Interface (DSI) Map - January 2021	24
Figure 6. Recreational Facilities to Be Assessed for ADA Compliance - Phase I.....	27
Figure 7. South Marina Marking Lot Sections.....	29
Figure 8. Marina Waterfront Trail System Map (North).....	32
Figure 9. Marina Waterfront Trail System Map (South/Central)	33
Figure 10. ArcGIS Survey123® Results for Most Wanted Barrier Types for Removal by Score....	41
Figure 11. ArcGIS Survey123® Results for Most Wanted Barrier Removal Locations by Score ...	41
Figure 12. SurveyMonkey® Results for Most Wanted Barrier Types for Removal by Score	44
Figure 13. SurveyMonkey® Results for Most Wanted Barrier Removal Locations by Score.....	44
Figure 14. Port of Everett Recreational Facility ADA Barrier Prioritization Matrix	52

List of Appendices

Appendix A - Federal Code and Washington State Requirements Documentation

Appendix B - Transportation Network ADA Inventory Documentation

Appendix C - Recreational Facilities ADA Assessments

Appendix D - Public Outreach Documentation

Appendix E - Updated Administrative Policies and Procedures Documentation

List of Abbreviations

ABA - Architectural Barriers Act

ADA - American with Disabilities Act

ADA/504 - Americans With Disabilities Act/Section 504 of the Rehabilitation Act of 1973

APS - Accessible Pedestrian System

CFR - Code of Federal Regulations (United States)

COVID-19 - Coronavirus Disease of 2019

DOJ - Department of Justice (United States)

DSI - Driveway/Sidewalk Interface

DWS - Detectable Warning System

GIS - Geographic Information System

LAG - Local Agency Guidelines (published by Washington State Department of Transportation)

NCHRP - National Cooperative Highways Research Program

POE - Port of Everett

POE_ID - Identification Number for Inventoried Transportation Network Facilities

PROWAG - Public Right of Way Accessibility Guidelines

SR - State Route

USDOT - United States Department of Transportation

WSDOT - Washington State Department of Transportation

VDOT - Virginia Department of Transportation

A. Introduction & Legal Requirements

The Port of Everett is committed to removing barriers to accessibility in its facilities, services, programs, and activities. To achieve this end, the Port has completed an Americans with Disabilities Act (ADA) Self-Evaluation and Transition Plan.

This introduction summarizes the legal precedent for and the required components of an ADA Self-Evaluation and Transition Plan. It also provides an overview of the scope and organization of the Port's ADA Self-Evaluation and Transition Plan with respect to these requirements.

A.1 Legal Precedent

The following federal laws and local Washington State guidelines informed the content and scope of this ADA Self-Evaluation and Transition Plan. See also Washington State Department of Transportation (WSDOT) Local Agency Guidelines Chapter 29 (June 2020).

A.1.1 Section 504 of the Rehabilitation Act (1973)

Section 504 of the Rehabilitation Act of 1973 states that no person with a disability shall be excluded from participation in, denied the benefits of, or be subjected to discrimination under any program or activity that receives Federal funding. This includes both transportation and non-transportation funding.

Section 504 extends to the entire operations of a recipient or subrecipient, regardless of the specific funding source of a particular operation. Section 504 Regulations (49 CFR Part 27.5) define a recipient as any public entity that receives Federal financial assistance from the United States Department of Transportation (USDOT) or its operating administrations either directly or through another recipient. An example of a recipient is WSDOT. An example of a subrecipient is a local agency receiving USDOT funds through WSDOT, for projects/programs/activities administered by the local agency.

A.1.2 American with Disabilities Act

The *Americans with Disabilities Act* of 1990 is a civil rights statute that prohibits discrimination against people who have disabilities. There are five separate Titles, or sections, of the Act that cover different aspects of potential discrimination. These include:

- Title I – Employment
- Title II – Public Services and Transportation
- Title III – Public Accommodations
- Title IV – Telecommunications, and
- Title V – Miscellaneous

Title II of the Act specifically addresses the subject of making public services and public transportation accessible to those with disabilities. Designing and constructing facilities for public use that are not accessible by people with disabilities constitutes discrimination.

The ADA is mirrored after Section 504 but extends the reach of Federal accessibility laws to include those agencies that are not recipients or subrecipients of Federal funding. Title II (28 CFR Part 35) of the ADA specifically pertains to state and local governments, which includes Port Districts.

The ADA applies to all facilities, including both facilities built before and after 1990. State and local government and public entities or agencies are required to perform self-evaluations of their current facilities relative to the accessibility requirements of the current ADA accessibility standards. The requirements of the ADA apply to all public entities or agencies, no matter the size. The transition plan formal procedures as outlined in 28 C.F.R. section 35.150 only governs those public entities with more than 50 employees.

A.2 Scope of ADA Transition Plan

The Federal requirements for preparing and implementing an ADA Transition Plan are outlined in specific code sections. Certain code sections also identify accessibility requirements for existing facilities, new construction and alterations of existing facilities. In addition, WSDOT provides local agency guidelines on ADA Transition Plan content. These codes and guidelines utilized in preparing the Port's ADA Self-Evaluation and Transition Plan as well as the steps undertaken to engage the public in the process are included for reference in **Appendix A**.

The Port is undertaking this Plan in phases. The initial scope of the Port's ADA Self-Evaluation and Transition Plan includes areas within the Port's destination waterfront from 10th to 18th Streets, west of West Marine View Drive. Other facilities and infrastructure will be evaluated and added to the Plan in subsequent years.

A.2.1 Federal ADA Transition Plan Requirements

Under Title II of the ADA, Section 28 CFR Part 35.150 (d) - Transition Plan outlines four requirements of an ADA Transition Plan. For full code text, see **Appendix A**.

- Identify physical obstacles in the public entity's facilities that limit the accessibility of its programs or activities to individuals with disabilities;
- Describe in detail the methods that will be used to make the facilities accessible;
- Specify the schedule for taking the steps necessary to achieve compliance with this section and, if the time period of the transition plan is longer than one (1) year, identify steps that will be taken during each year of the transition period; and
- Indicate the official responsible for implementation of the plan.

A.2.2 Federal Accessibility Requirements for Existing Facilities

Section 28 § 35.150 of Title II of the ADA identifies the accessibility requirements for existing facilities. For full code text, see **Appendix A**.

A.2.3 Federal Accessibility Requirements for New Construction or Alterations

Section 28 § 35.151 of Title II of the ADA identifies the accessibility requirements for new construction or alterations to existing facilities. For full code text, see **Appendix A**.

A.2.4 Washington State Department of Transportation (WSDOT) Local Agency Guidelines

WSDOT's Local Agency Guidelines (LAG) Chapter 29 includes additional ADA Transition Plan items per Section 504 listed below. For full local agency guidelines text, see **Appendix A**.

- Designate an ADA/504 Coordinator
- Adopt and publish Complaint/Grievance procedure
- Adopt an Accessible Pedestrian System (APS) Policy

A.3 Organization of Document

The National Cooperative Highway Research Program (NCHRP) No. 20-7 (232) ADA Transition Plans: *A Guide to Best Practices* (May 2009) report demonstrates how the federal ADA Transition Plan requirements give agencies flexibility on how to format their Transition Plans.

The Port of Everett is preparing its ADA Self-Evaluation and Transition Plan in phases across multiple budget years. This first phase of the Transition Plan addresses these components:

- Self-Evaluation and Compliance Activities to Date
- Barrier Prioritization & Removal Schedule Recommendations

The document addresses each of these barrier types:

- Transportation Network
- Recreational Facilities
- Administrative Policies and Procedures

The remaining sections address:

- Public Outreach
- Future Actions to Maintain and Achieve Compliance
- Accessibility Guidelines, Standards, and Resources
- Appendices

Cost estimating and barrier removal implementation scheduling are not addressed in Phase I. They will be addressed in a future update to the Plan.

B. Self-Evaluation and Compliance Activities to Date

This chapter describes the Port’s efforts to self-assess select transportation and recreational facilities for ADA barriers per the Phase I scope of the Port’s ADA Self-Evaluation and Transition Plan. An audit of select administrative policies and procedures also occurred. Recent efforts to remove barriers and/or increase accessibility across the Port’s facilities and services are also identified. In general, facilities constructed five (5) years or more ago demonstrate more barriers than those constructed more recently. Several barriers are related to ongoing settlement or upheaval and are not a function of inadequate design. Large parking lots at the Port also lack continuous accessible routes across them.

B.1 Transportation Network

In early 2021, Transportation Solutions, Inc., conducted a Geographic Information System (GIS)-based ADA assessment inventory of the Port of Everett’s curb ramps, sidewalk barriers, and driveway/sidewalk interface locations. The self-evaluation findings provided here address the transportation network facilities identified in **Table 1** and **Figure 1** below. For Transportation Network ADA Inventory Documentation, see **Appendix B**.

Table 1. Transportation Network Facilities Assessed for ADA Compliance in January 2021

Transportation Network Facility Location and Description	Map Marking
10 th Street	Yellow Line
Craftsman Way	
11 th Street	
Port Gardner Way/13 th Street	
18 th Street to South Marina Parking Lot Driveway	
South Marina Parking Lot and Sidewalks	Green Line

Figure 1. Transportation Network Facilities Assessed for ADA Compliance - Phase I



FIGURE KEY:

Green outline: Parking infrastructure

Yellow outline: Transportation infrastructure

Blue outline: New construction, not assessed

B.1.1 Curb Ramps

A GIS inventory assessment of Port curb ramps within the transportation corridors identified in yellow in **Figure 1** was conducted in January 2021. Curb ramps within the new-construction area identified in blue were not included in Phase I (a windshield review of curb ramps within this area appear to be compliant). Curb ramps along SR 529 on the eastern side of the Port are not under Port jurisdiction and were not included. The inventory includes the following data fields and attributes collected for evaluation. The inventory was focused on field conditions; date of construction is not included in this inventory. See **Table 2**.

Table 2. Curb Ramp Inventory Data Fields and Attributes Collected January 2021

No	Field	Attribute
1	Condition	Fair or Better
		Poor
		Very Poor
		Missing (Needed but does not Exist)
2	Width (unobstructed and excluding flares)	48" or greater
		36" to > 48"
		Less than 36"
3	DWS (Detectable Warning Surface)	Compliant (Truncated Domes with contrasting color)
		Old Standard (Diamond/Exposed Aggregate)
		No DWS (Non-Compliant)
4	Ramp Type	Perpendicular (triangular wings)
		Parallel
		Combination
		Single-Direction Parallel
		Diagonally-Oriented Parallel
		Blended Transition
5	Running slope	Up to or equal to 8.3%
		More than 8.3%
6	Cross slope	Up to or equal to 2%
		More than 2%
7	Landing	4 x 4 feet or greater
		Less than 4 x 4 feet
8	Photos	Attached as .jpg
9	Notes	
10	Grade	A
		B
		C
		D
		N/A

The "Grade" field was assigned after reviewing the other collected field data and was based on a system developed by the Virginia Department of Transportation (VDOT), which has been amended for the Port of Everett as shown in the curb ramp assessment table provided in **Table 3**. This assigned curb ramp grade was based on the lowest graded attribute (i.e. if a ramp were 48" or greater in width but had no detectable warning surface, it would receive a "C" grade because the lack of DWS makes it non-compliant). To be assigned a particular grade, the ramp had to meet each of the criteria list in **Table 3**. Some ramps identified as "N/A" are provided with photos to show why a curb ramp is NOT needed at the location.

Table 3. Curb Ramp Grading System (VDOT) Amended for Port of Everett

Grade	Material Condition	Ramp Width	DWS (Detectable Warning Surface)	Slopes (Cross and Running)
A GREEN	<u>Fair or Better Condition</u> Limited or tight cracking, faulting (<1/4"), isolated spalling	48" or greater	Truncated Dome	Cross Slope ≤ 2% and Running Slope ≤ 8.3%
B YELLOW	<u>Poor Condition</u> Moderate cracking, faulting (1/4"-3/4"), moderate spalling	36" to < 48"	Exposed Aggregate Surface or Diamond Shape Stamp	Either Cross Slope > 2% or Running Slope > 8.3%
C ORANGE	<u>Very Poor Condition</u> Severe cracking, faulting (>3/4"), extensive spalling	Less than 36"	No Detectable Warning Surface	Both Cross Slope > 2% and Running Slope > 8.3%
D RED	A curb ramp is needed but does not exist at the location to access an existing sidewalk where it crosses a curb.			
N/A GREY	A curb ramp is NOT needed at the location (typically because either a sidewalk does not exist or there is no curb at this location. See notes in inventory for further explanation).			

In general and as shown in **Figures 2-3**, fair or better condition ramps tended to be found nearest the Central Marina docks and Waterfront Place facilities. This is consistent with the Port’s recent and current construction activities. Poor or very poor ramps predominated in the northern Port area along 11th Street and Craftsman Way and in the southern Port area and parking lot adjacent to 18th Street. The Port’s curb ramp inventory according to the “Grade” field is shown in **Table 4**.

The “Compliance” category shown in **Table 4** has been added to show that only curb ramps with a grade of “A” met the technical requirements for compliance. A curb ramp need only fail one technical compliance requirement to be considered non-compliant; the Grade can therefore serve as a way to prioritize which non-compliant curb ramps will be addressed before others.

Note on “Type” attribute: In some older locations, pavement overlays are often constructed to intersect at grade with sidewalks so the pavement/sidewalk interface is flush (i.e. Blended Transition). While these roadway/sidewalk interfaces may not present a barrier to mobility if in good condition, they are considered non-compliant due to lack of a detectable warning surface that indicates a street crossing to pedestrians, particularly those who are blind or who have poor vision.

Table 4. Curb Ramp Condition and Compliance Inventory

Grade	Description	Compliance	Number	Percentage (Grade)	Percentage (Compliance)
A	Fair or Better	Compliant	40	30%	30%
B	Poor	Non-Compliant	11	8%	70%
C	Very Poor		71	54%	
D	Missing		1	1%	
NA	Not Needed	N/A	9	7%	Not included
Total	-	-	132	100%	100%

In summary, approximately 30% of the Port’s curb ramp inventory is compliant and 70% is non-compliant. For maps of the Port’s curb ramp compliance inventory by grade, see **Figures 2-3**. Note: Map label numbers represent the individual curb ramp identification number (POE_ID field) provided in the inventory data spreadsheets in **Appendix B**.

Figure 3. Curb Ramp ADA Compliance Status Map (South) - January 2021

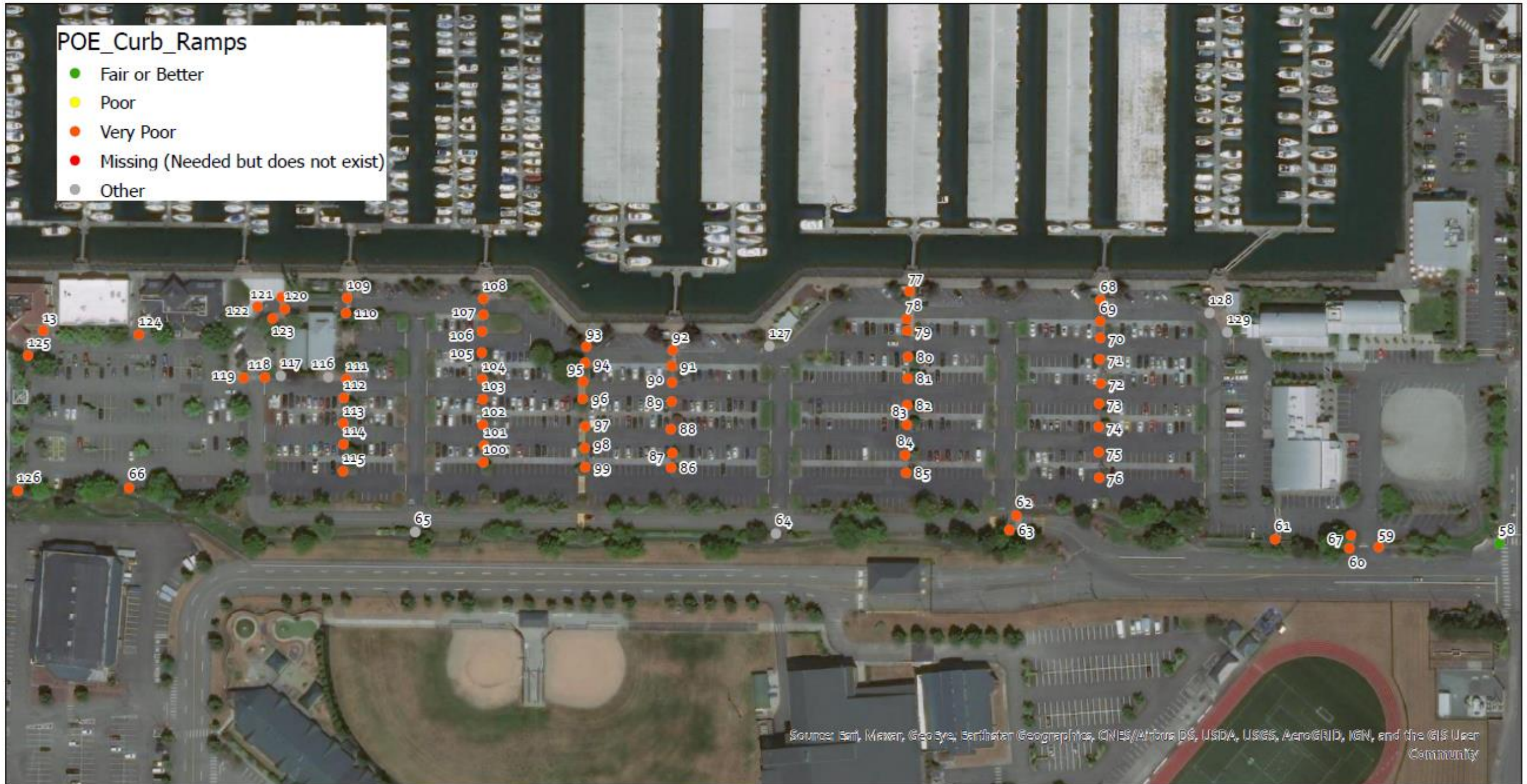

B.1.2 Sidewalks

Data was collected for existing sidewalk ADA barriers in the Port’s sidewalk network within the areas identified in yellow in **Figure 1**. The data points collected represent barriers, not a full inventory of the presence or lack of sidewalks. Note: Absence of sidewalks is not in and of itself an ADA barrier. However, safety is a legitimate concern for roadways without dedicated pedestrian facilities or with narrow/absent shoulders.

The identified ADA sidewalk barriers are often related to sidewalk upheaval, cracks, fixed objects blocking the path of travel and overgrown vegetation. Note: Snow/ice and water from flooding should be mentioned as they can also present temporary barriers. For the data collected at sidewalk barrier locations, see **Tables 5** and **6**.

Table 5. Sidewalk Barrier Inventory Data Fields and Attributes Collected January 2021

No	Field	Attribute
1	Condition	Fair or Better
		Poor
		Very Poor
		Missing (Needed but does not Exist)
2	Width	60" or greater
		48" to > 60"
		36" to > 48"
		Less than 36"
3	Cross Slope	Up to or equal to 2%
		More than 2%
4	Running Slope	Up to or equal to 5%
		5% to equal to 8.3%
		More than 8.3%
5	Obstacle	Utility Pole/Box
		Sign
		Upheaval or Cracks
		Vegetation
		Other
6	Notes	
7	Photos	Attached as .jpg

Table 6. Sidewalk Barrier Inventory (Non-Compliant Features)

Obstacle	Number	Percentage (Obstacle)
Upheaval/Cracks	9	52%
Utility Pole/Box	1	6%
Vegetation	3	17%
Sign	1	6%
Other	3	17%
Total	17	100%

In summary, the most common sidewalk barrier is upheaval or cracks. For a map of the Port’s sidewalk barrier inventory by obstacle type see **Figure 4**. Note: Map label numbers represent the individual sidewalk barrier identification number (POE_ID field) provided in the inventory data spreadsheets in **Appendix B**.

Figure 4. Sidewalk ADA Barriers Map - January 2021



B.1.3 Driveway Sidewalk Interface (DSI)

Data inventory was collected for existing driveway sidewalk interfaces (DSI) in the Port’s transportation network within the areas identified in yellow in **Figure 1**. The data points collected represent an inventory including compliant and non-complaint features.

The DSI location west of Bayside Marine has utility covers and sidewalk settlement that create tripping hazards. The DSI location at the east end of 13th Street has steep cross slopes for the sidewalk route. The DSI location south of West Marine on 18th Street has fixed object barriers in the path of travel and steep cross and running slopes. DSI locations along 10th street and in the vicinity of Waterfront Place are compliant.

For the data collected at sidewalk barrier locations, see **Tables 7-8**.

Table 7. DSI Inventory Data Fields and Attributes Collected January 2021

No	Field	Attribute
1	Condition	Fair or Better
		Poor
		Very Poor
		Missing (Needed but does not Exist)
2	Width	48" or greater
		36" to > 48"
		Less than 36"
3	Cross Slope	Up to or equal to 2%
		More than 2%
4	Running Slope	Up to or equal to 5%
		5% to equal to 8.3%
		More than 8.3%
5	Driveway (Dwy) Type	Option A - Set Back
		Option B - Integrated
		Option C - Diagonal Set Back
		Option D - Parallel
6	Notes	
7	Photos	Attached as .jpg

Table 8. DSI Condition and Compliance Inventory

Condition	Compliance	Number	Percentage (Condition)	Percentage (Compliance)
Fair or Better	Compliant	8	73%	73%
Poor	Non-Compliant	1	9%	27%
Very Poor		2	18%	
Missing		0	0%	
Total	-	11	100%	100%

In summary, 73% of DSI locations are compliant and 27% are non-compliant. For a map of the Port’s DSI Condition and Compliance inventory by obstacle type see **Figure 5**. Note: Map label numbers represent the individual DSI location identification number (POE_ID field) provided in the inventory data spreadsheets in **Appendix B**.

B.1.4 Accessible Parking

In August 2020, consultant firm Walker Parking conducted a study of the Port's accessible parking stalls to identify ADA non-compliance features of stall design. The Port's ADA Self-Evaluation and Transition Plan consultant team reviewed the Walker Parking study and found that it provides accurate recommendations for removing accessibility barriers and achieving compliance for individual accessible parking spaces through design corrections. It does not include documentation that the parking meets the ratios for accessible parking compared to other parking within individual facilities as prescribed in the 2010 ADA Standards or 2011 PROWAG guidelines.

The [2010 ADA Standards](#) require a minimum number of accessible parking spaces, including van-accessible spaces, based upon a ratio of available parking spaces at individual agency-owned facilities. See Table 208.2 of the 2010 ADA Standards and the [ADA National Network Fact Sheet on Accessible Parking](#) for a summary. The [2011 PROWAG Guidelines](#) include additional guidance for accessible on-street parking spaces based upon a ratio of available marked or metered parking spaces on block perimeters. See Table R214 of 2011 PROWAG for details. Note: While recommended as best practices, the 2011 PROWAG is currently not enforceable.

The recreational facility evaluations that were conducted by design2 LAST checked that parking facilities meet the ratios prescribed in the 2010 ADA Standards; they did not address on-street accessible parking ratios prescribed in the 2011 PROWAG.

B.1.5 Accessible Pedestrian Signals

The Port does not currently own nor maintain any signalized intersections and is establishing an APS policy through the process of adoption of this Transition Plan. The future signalized intersections along SR 529 adjacent to the Port will be owned and maintained by City of Everett or WSDOT. See **Appendix E**.

B.1.6 Recent Compliance Activities

The Port has completed the following actions to increase accessibility and remove barriers within the Port's public right-of-way:

- The Port has constructed ADA compliant ramp upgrades through recent capital improvement projects.
- The Port requires all new ramps to be ADA compliant to WSDOT Design Manual standards.

B.2 Recreational Facilities

In early 2021, architectural firm design2 LAST, Inc., conducted ADA assessments of select recreational facilities at the Port of Everett. The self-evaluation findings provided here address the facilities identified in **Table 9** and **Figure 6** below.

Table 9. Recreational Facilities Assessed for ADA Compliance in January 2021

Recreational Facility Location and Description	Map Marking
South Marina Parking Lot and Sidewalks	Solid Green Outline
Waterfront Center Parking Lots and Access	
Jetty Landing (10 th Street) Boat Launch	Red Oval Area 1
Jetty Landing Park and Jetty Island Ferry Dock	
South Guest Dock 2 (Accessible Dock)	Red Oval Area 2
Marina, Waterfront Trail System	Pink Dashed Line
Boxcar Park: Parking Lot and Access, and Kite Shelters (excludes temporary restroom trailer)	Red Oval Area 3

Figure 6. Recreational Facilities to Be Assessed for ADA Compliance - Phase I



FIGURE KEY:

- Pink dash: Waterfront Trail System
- Green outline: Parking infrastructure
- Yellow outline: Transportation infrastructure
- Area 1: Jetty Landing Park and Boat Launch
- Area 2: South Guest Dock 2 (Accessible Dock)
- Area 3: Boxcar Park
- Blue outline: New construction, not assessed

B.2.1 Compliance Requirements Defined

The recreational facility assessments are based on both ADA Title II and Title III regulations, the 2010 Department of Justice (DOJ) ADA Standards, and the 2014 Architectural Barriers Act (ABA) Accessibility Standards for Outdoor Developed Areas. Links to these are provided below:

- [ADA Title II Regulations \(28 CFR Part 35\)](#)
- [ADA Title III Regulations \(28 CFR Part 36\)](#)
- [2010 Department of Justice \(DOJ\) ADA Standards](#)
- [ABA Accessibility Standards](#)
- [2014 ABA Accessibility Standards for Outdoor Developed Areas](#)

B.2.2 Assessment Format Notes

Each evaluation checklist contains an overall plan of the Port showing where the evaluated area is located and enlarged plans of each evaluated area. If site feature names or numbers are not indicated on those plans, fictional site feature names and numbers were given to spaces to correlate them to the evaluation checklists. These are intended to be used for the purpose of locating which features pertain to which portion of the checklist and may or may not represent the actual site feature numbers and names at the facility. For the Recreational Facilities ADA Assessment documentation and instructions for how to read the assessment checklist spreadsheets, see **Appendix C**.

B.2.3 Recreational Facility Narrative Summaries

This section includes narrative summaries of each recreational facility and its ADA-compliance condition, general recommendations for barrier removal, and a proposed overall facility priority rating of low, medium or high provided by design2 LAST, Inc. See **Table 10** for an overview of the facility priority levels. Note: Prior to evaluation, each facility was given a preliminary Inspection Priority (1a, 1b or 2a) by Port staff that represents the priority order in which inspections should be performed based predominantly on level of use by the public. These are provided as a comparison to the facility Repair Priority level provided by the architect who conducted the on-site evaluations which is based more on the severity of the issue to be resolved or combined with the level of use by the public.

Table 10. Recreational Facilities by Overall ADA Barrier Priority Level

Facility Location and Description	Inspection Priority	Repair Priority
South Marina Parking Lot and Sidewalks	(1a)	High
Waterfront Center Parking Lots and Access	(1a)	High
Jetty Landing (10 th Street) Boat Launch	(1a)	High
Jetty Landing Park and Jetty Island Ferry Dock	(1a)	High
South Guest Dock 2 (Accessible Dock)	(1b)	Medium
Marina Waterfront Trail System	(1b)	High
Boxcar Park: Parking Lot and Access, and Kite Shelters (excludes temporary restroom trailer)	(2a)	Medium

Reference maps are provided for each facility in the respective assessment checklist in **Appendix C**. For select facilities, reference maps are reproduced below.

South Marina Parking Lot and Sidewalks - HIGH (1a)

For the purposes of this evaluation and due to its size, the South Marina Parking Lot has been split into 4 sections: West (SM-1), West-Center (SM-2), East-Center, (SM-3) and East (SM-4). The areas associated with this evaluation are highlighted in green on the plan sheets in **Appendix C**. See **Figure 7**. Notes: Three (3) sets of accessible parking spaces and 1 related curb ramp were measured for this evaluation, and are identified on the plans and on the spreadsheets as SM PKG (#). Some of the accessible parking spaces and their curb ramps associated with the Marina Waterfront Trail System are included in that evaluation file. Those are identified as PKG (#).

Figure 7. South Marina Marking Lot Sections



The South Marina Parking Lot contains approximately 1037 parking spaces, with 31 spaces signed as accessible. Each lot identifies the correct ratio of accessible spaces to total number of parking spaces. However, within the accessible spaces, there are not enough van accessible spaces. Not all identified spaces (shown on the evaluation plan sheets) have compliant identification markings. Curb cuts from the accessible spaces near the center of the lots need to be reconstructed as they are not accessible in their current configuration.

The West lot (SM-1) is adjacent to several buildings (including Anthony's Homeport) and has several accessible spaces dispersed throughout the lot. This is compliant with locating the accessible spaces closest to the building entries.

The West-Center lot (SM-2) also has one building in the NE corner that features marina restrooms, showers, laundry and a leased space. For the purposes of this evaluation, the spaces around that building are not included, as they will be evaluated with that building in a future evaluation phase.

The East-Center lot (SM-3) has the most parking spaces, with the fewest number of marked accessible spaces. One additional space should be added to make this lot compliant.

Only the north end of the East lot (SM-4) is included in this evaluation. The spaces surrounding the buildings in this area will be evaluated with the buildings in a future evaluation phase. The East lot is closest to the Port's ADA accessible dock (South Guest Dock 2). The accessible spaces are not, however, the closet spaces to the dock's gangway. These should be relocated.

In general, all the accessible parking spaces in the south lot need to be re-stripped and marked with compliant signage. Some will also need to be re-paved for compliant slopes (<2% in all directions). Van accessible spaces need to be added to achieve compliant numbers.

Waterfront Center Parking Lots and Access - HIGH (1a)

Waterfront Center is located near the center of the marina facilities, with direct access to the Marina Waterfront Trail System. The parking lot and access to the building was reviewed for this evaluation. The building will be evaluated in a future evaluation phase.

There are three (3) marked accessible parking spaces on the west side of the building; two (2) near the building entry, and one (1) on the west side closer to the trail. The lack of van accessible spaces is the biggest issue in this location. Accessible parking spaces should be reconfigured to include a minimum of one (1) compliant van accessible space.

Jetty Landing (10th Street) Boat Launch - HIGH (1a)

The northern most portion of the Marina facilities contains the large public boat launch docks. There are 279 boat trailer parking spaces and eight (8) appear to be accessible spaces, although they are not identified with compliant signage.

There are 13 lanes, numbered from south to north, with the northernmost, Lane 13, being identified as accessible. With the large wood docks located on the north side of this lane, the pier width is compliant. There is no identified direct accessible route from the accessible parking to the piers. This should be added and identified. An accessible load/unload area east of Lane 13 is denoted with striping, however clear signage should be installed.

The comfort station (restroom) adjacent to the south end of this area within Jetty Landing Park is slated to be replaced in 2021 and the new building will be evaluated in a future evaluation phase.

Jetty Landing Park and Jetty Island Ferry Dock - HIGH (1a)

The Jetty Landing Park and Jetty Island Ferry Dock (also known as North Guest Dock 8) are located just south of the Jetty Landing (10th Street) Boat Launch. There is a small, adjacent parking lot containing accessible spaces nearest the ferry dock access. This evaluation covers the parking lot, the route from the parking lot to the ferry dock, the gangway and the ferry dock. As noted earlier, the comfort station on the north edge of the parking lot is slated to be replaced in 2021 and the new building will be evaluated in a future evaluation phase.

The signs at the accessible spaces need to be raised. A minimum of one (1) van accessible space should be provided.

There is no identified direct accessible route from the single accessible parking stall east of the comfort station to the comfort station, Marina Waterfront Trail System or the boat launch. This should be added and identified.

The one major issue to be addressed is at the fishing pier. There are no accessible fishing spaces provided on the pier, and the ramp between the trail and the pier is too steep. The rails of the fishing pier need to be removed and rebuilt to comply.

Some changes to the ramp at the gangway of the ferry dock need to be made for full compliance to that loading area.

The concrete pads within and around the picnic (kite) shelters appear new and are compliant, although they do not connect to an accessible route in the related parking lots.

South Guest Dock 2 (Accessible Dock) - MEDIUM (1b)

The South Guest Dock 2 is located in the South Marina along the Marina Waterfront Trail System. The access consists of five sloped gangways leading down to the float. The landings between the gangways are all compliant, as are the gangways.

The curbs on the float were found to be non-compliant. This means none of the launch points are accessible. The grip strut grating also has openings greater than 1/2" in the direction of travel, although the width of the openings are perpendicular to the direction of travel.

Replacing the curbs is a simple and inexpensive correction to bring this facility into compliance.

Marina Waterfront Trail System - HIGH (1b)

Due to the linear nature of this facility and its extensive length, this evaluation section is presented differently than the typical evaluations.

The Port's entire Marina Waterfront Trail System is approximately 3.5 miles long. As part of the first phase of this Plan, all 3.5 miles of Trail was evaluated. To make this checklist easier to follow, the trail is divided into seven areas, numbered from north to south. To facilitate easier identification, some of these areas are further divided up into sections such as east or west. For example, Area 6 is divided up into four sections: northwest, northeast, southwest and southeast. For a map of the seven areas and their subdivided sections, see **Figures 8-9** and individual evaluation in **Appendix C**.

Each area contains some Priority 1 and Priority 2 items. Under the ADA Title III regulations, certain aspects of accessibility for public accommodations are assigned a priority level. See section D.3.1 for explanation of these priority levels. Parking (PKG) and Curb Ramps (CR) are Priority 1 items, all others (such as the route, benches, picnic tables, etc.) are Priority 2 (access to services). The plans for each of the areas identify the items found in each with notes and may have an abbreviation and a number. Similar type items may have the same number (i.e. Bench 3 is the same in each condition where it occurs) unless different dimensions were found.

Figure 8. Marina Waterfront Trail System Map (North)

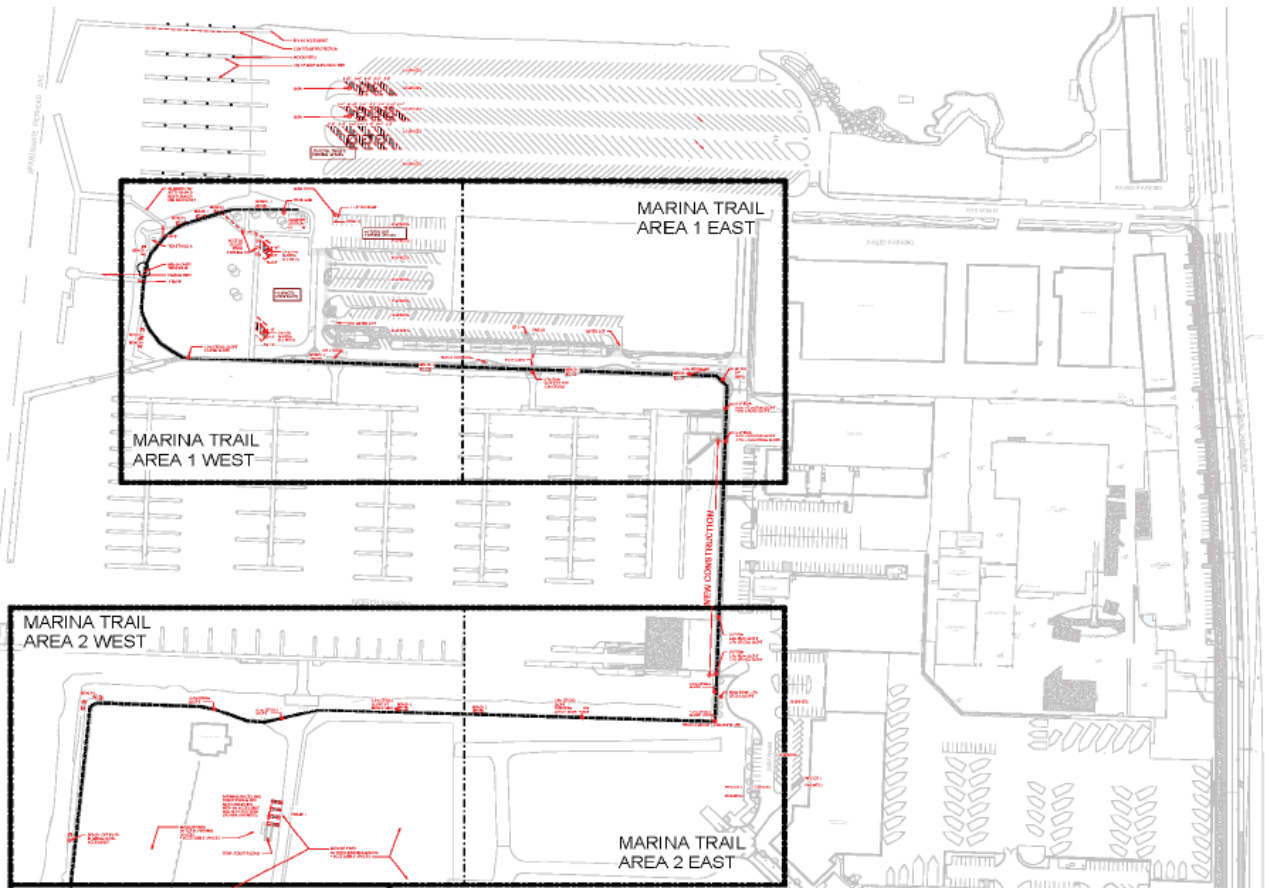
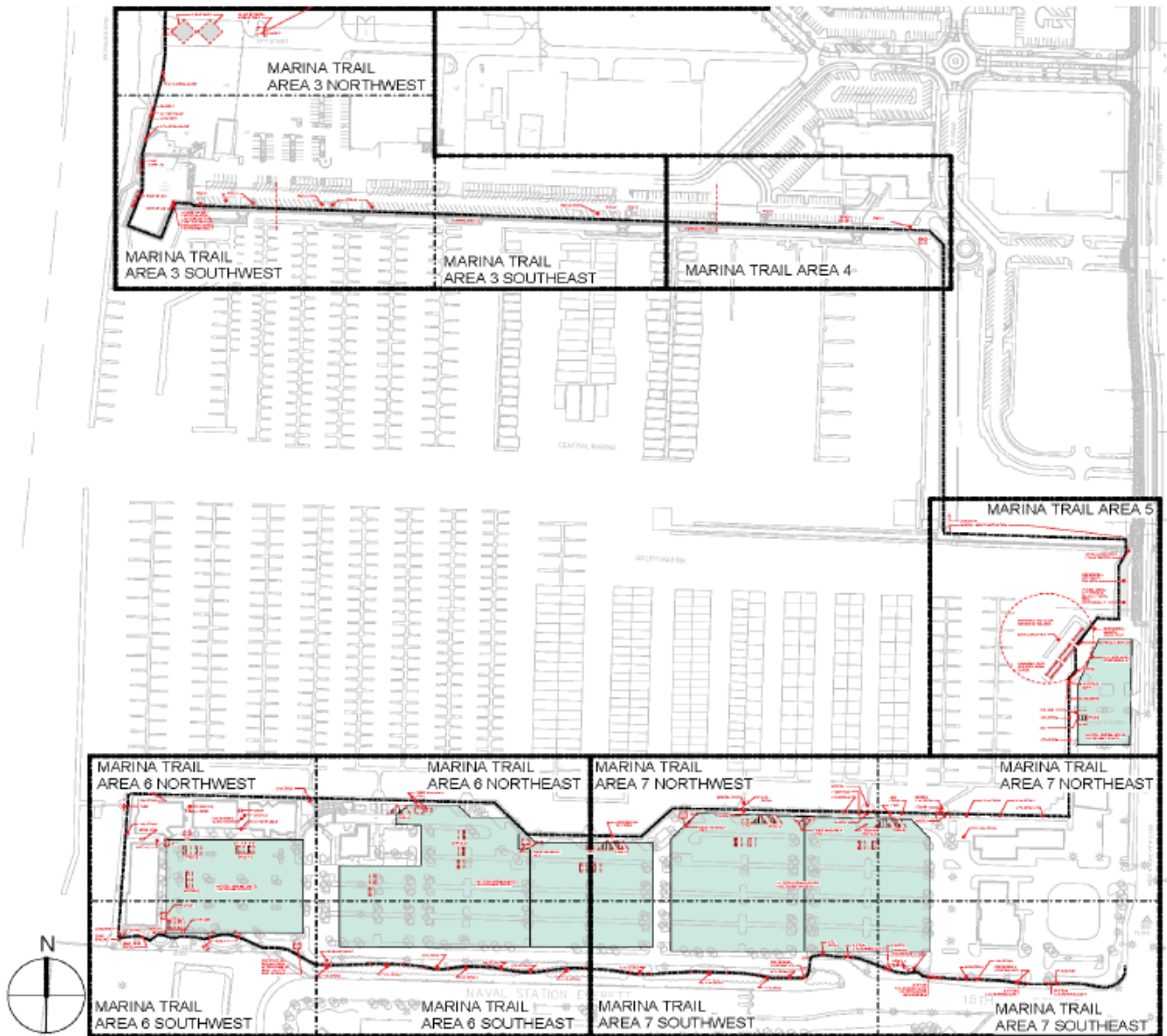

Figure 9. Marina Waterfront Trail System Map (South/Central)



The majority of the trail has compliant slopes for accessibility. Some exceptions that should be addressed follow.

1. The self-assessment inventory plans identify many locations where non-compliant running and cross slopes were measured.
2. Benches Type 1 at the northern end of the trail are typically placed in the grass off the path without an adjacent wheelchair space.
3. The asphalt trail at the south side of the North Marina (Area 2) has a higher amount of non-compliant cross slopes.
4. All three ramps leading around the former Yacht Club building (currently vacated and slated for future redevelopment) located at the Northwest corner of the Central Marina (Area 3) need to be reconstructed to bring them into compliance.
5. The trail is mostly new construction at Area 4 and is compliant.
6. In Area 5, between the new Seiner Wharf and the accessible South Guest Dock 2, there is large section of wharf where the boards are very weathered and worn. There are non-compliant gaps, protruding nails, and vertical bumps greater than 1" high. These boards should be replaced or refinished.
7. The trail along the north side of the South Marina (the north sections of Areas 6 and 7) is concrete and has mostly compliant slopes. There are non-compliant gaps and bumps in locations where the trail joins the entry to the marina access gates. Typically, this is where flat concrete meets pavers and the pavers meet boards. The map indicates the locations where these were found.
8. The four (4) picnic tables provided along the trail at Areas 6 and 7 do not have a wheelchair compliant space. At least two of the four (4) tables should be replaced.
9. In Area 6, at the western end where there are four buildings surrounding a parking lot, the "alleys" created between the buildings have non-compliant slopes to go from the parking lot to the trail. At a minimum, a 36" wide level concrete path should be added to navigate these areas from the parking lot.
10. The curb ramps from the parking lot to the sidewalk near the buildings in Area 6 also need to be demolished and rebuilt with compliant slopes.
11. The curvy, asphalt portion of the trail at the far south end of the marina (the south sections of Areas 6 and 7), adjacent to the Navy facility, has many sections with non-compliant cross slopes. These slope back and forth from north to south and back again along the entire pathway. The plan shows some of the non-compliant areas. Typically, the steepest slope in a section was indicated on the plan.
12. The drinking fountain near Bench 9 should be replaced with a compliant outdoor HiLo® fountain.

13. The approximately 20 foot section of trail leading east from the drinking fountain should be replaced with a concrete ramp that includes handrails due to the steep slope.
14. In Area 7, where the trail crosses the driveway to the buildings at the SE corner of the marina complex, the running slopes are very steep. These sections of trail should either be outfitted with handrails or rebuilt to compliant slopes (<5% running and <2% cross).

Boxcar Park: Parking Lot and Access, and Kite Shelters - MEDIUM (2a)

Boxcar Park is a large, flat primarily grassy area, with two (2) adjacent picnic “kite” shelter facilities on the south end, and a large gravel parking area to the east. A portion of the parking area has been paved and three (3) accessible parking spaces added adjacent to the temporary, portable comfort station building. There is no accessible walking path connecting these parking spaces to the picnic facilities or to the Marina Waterfront Trail System.

While the parking spaces were reviewed, the temporary portable comfort station and the ramp up to the entry door was not reviewed as part of this evaluation due to their temporary nature. The parking spaces are mostly compliant, with minor slope corrections needed. A minimum of one (1) van accessible space should also be added.

The two (2) picnic shelters have compliant slopes, but no compliant picnic table. Accessible compliant picnic tables designed for wheelchair forward approach should be added to each shelter.

There is a parking space near the picnic shelters that is painted with the international accessibility symbol but is not fully compliant. Adding a painted access aisle, compliant signage, and an identified accessible route, would bring this into compliance and provide access to the picnic shelters.

B.2.4 Implications for Walker Parking Study

The 2020 Walker Study identifies ADA non-compliant features of stall design and is useful for addressing design barriers. Additionally, the individual facility evaluations provided in this ADA Transition Plan also evaluated parking stall access aisle slopes and cross slopes, as well as whether the ratios for accessible parking compared to other parking within individual facilities meet the 2010 ADA Standards. Implementation of the actions identified in the Walker Parking study will address many of the items identified in this Transition Plan.

B.2.5 Recent Compliance Activities

The Port has completed the following actions to increase accessibility and remove barriers within the Port’s recreational facilities identified within the Phase 1 scope of the Port’s Self-Evaluation and Transition Plan through recent redevelopment projects that include new and upgraded recreational facilities:

- Seiner Wharf was reconstructed in 2018 to include new surface boards that are compliant.
- Pacific Rim Plaza near the new apartments and hotel in Fisherman’s Harbor includes accessible benches, accessible frontage improvements and accessible parking.
- Accessible routes within and around the Kite Shelters (Picnic Units in evaluation checklist) at Jetty Landing Park and Boxcar Park have been added.

B.3 Administrative Policies & Procedures

In December 2020, Transportation Solutions, Inc., conducted an inventory of existing ADA-related administrative policies and procedures identified in the WSDOT LAG Manual Chapter 29 Checklist (see **Appendix A**).

B.3.1 ADA/504 Coordinator

At the time of self-evaluation, the Port did not have an employee specified as the ADA/504 Coordinator. The Port has designated an ADA/504 Coordinator as part of this ADA Self-Evaluation and Transition Plan.

B.3.2 Official Responsible to Implement the ADA Transition Plan

At the time of self-evaluation, the Port did not have an employee specified as the official responsible for the ADA Self-Evaluation and Transition Plan. The Port has designated an official responsible to implement this Plan as part of this ADA Self-Evaluation and Transition Plan.

B.3.3 Public Notice of ADA Provisions

The notice requirement applies to all state and local governments covered by Title II, even localities fewer than 50 employees. The target audience for public notice includes anyone who may potentially interact with the agency and must be accessible to all. An effective notice states the basis of what the ADA requires of the public agency in clear, concise language and should include the name and contact information of the ADA Coordinator. It addresses the public agency’s commitment to non-discrimination on the basis of disability and addresses the agency’s associated policies regarding employment, effective communication, modifications to policies and procedures, provision of auxiliary aids, scope of the ADA, complaints, and provision of aid/services at no additional cost. The U.S. Department of Justice’s ADA Best Practices Tool Kit for Local and State Governments provides a [template ADA Notice](#) for use by public agencies.

At the time of self-evaluation, the Port did not have a Public Notice under the ADA Provisions posted on its website. The Port will publicly post a Port Public Notice of ADA Provisions as part of this ADA Self-Evaluation and Transition Plan.

B.3.4 ADA Grievance Procedure/ADA Discrimination Complaint Record

In the last five years, the Port has received and responded to five reports of incidents involving ADA barriers; two of which where the person involved contacted the Port directly. In all cases, the Port observed there was a problem and fixed the issue. The Port has not received formal complaints related to ADA barriers within the last five (5) years.

At the time of self-evaluation, the Port did not have a formal ADA Grievance Procedure posted on its website. The Port will publicly post an ADA Grievance Procedure and establish an ADA Complaint Record as part of this ADA Transition Plan.

B.3.5 Accessible Pedestrian Signal (APS) Policy

At the time of self-evaluation, the Port did not have an Accessible Pedestrian Signal (APS) Policy because the Port does not currently own or maintain any signalized intersections. The future signalized intersections along SR 529 adjacent to the Port are owned and maintained by City of Everett or WSDOT. The Port is establishing an APS Policy through the process of adoption of this ADA Self-Evaluation and Transition Plan.

C. Public Outreach

C.1 Public Outreach Strategy

The Port's public outreach strategy to inform interested members of the public of the undertaking of this Plan and to invite participation in the process, included digital and print mediums and stakeholder engagement with members of the local ADA community and general public. The Port's website hosted the project information webpage, links to the online surveys, and registration and access information for a virtual public workshop to seek feedback. The Port's communication staff issued a press release as well as published articles and ads to promote the project and feedback process. Other communication efforts were made via the Port's social media platforms and Port staff conducted direct engagement to existing contacts within the ADA community and various stakeholder groups who make use of Port facilities and programs. For documentation of public engagement, see **Appendix D**.

C.1.1 Project Webpage

The project webpage content was launched in January 2021. The project webpage included:

- Project description
- Schedule
- Public Involvement section:
 - Links to online surveys:
 - Map-enabled ArcGIS Survey123® version
 - Screen-reader friendly Survey Monkey® version
 - Virtual public workshop meeting information
- Port staff contacts and other ADA resources
- Documents section for posting the draft version for public comment
- Recent and annual accomplishments section for further tracking of ADA Transition Plan implementation progress

The ADA Transition Plan Project webpage is available at:

www.portofeverett.com/adatransitionplan

C.1.2 Print and Other Web-Based Publications/Outreach

The following print and web-based publications and outreach efforts promoted the project, online surveys, and virtual workshop in February 2021.

- Port Side (mailed to approx. 52,000 households in the Port District, and shared digitally)
- Included in a section of the Port Report full page print ad of the Herald Business Journal in February 2021
- Posted on social media (3 posts with 3 shares)

- Sent emails to key communicator lists (engaged community members), Marina slipholders, business tenants, port staff
- Created a webpage, posted a news item on our webpage
- Commission Meetings
- Port of Everett Website Calendar

C.1.3 Direct Engagement with Local ADA Community Organizations

In February 2021, Port staff contacted the following organizations via direct e-mail to seek out interest in the online survey and virtual public workshop.

- Snohomish County Council of the Blind
- ARC of Snohomish County
- Northwest ADA Center
- Everett Station District Alliance
- Volunteers Of America
- Hopeworks Senior Services of Snohomish County
- Port Commission

C.1.4 Online Surveys

In consultation with Port staff, a 5-minute survey was created on two (2) digital platforms. The screen-reader friendly Survey Monkey® version was built to accommodate persons with visual disabilities. The map-enabled ArcGIS Survey123® survey gave respondents the option to mark barrier locations on a map. Links to the online survey options were activated from January 22 through February 22, 2021.

C.1.5 Virtual Public Workshop and Presentation

A virtual public workshop and presentation was hosted by the Port on the Zoom® platform on February 18, 2021, from 5:00-6:00pm. Workshop materials were provided in accessible formats with alternative text prior to the event. The presentation explained the reasons for and required content of an ADA Transition Plan and the Port's phased approach to self-evaluation and barrier removal implementation. An open comment opportunity followed the presentation.

C.2 Public Engagement Findings

The virtual platform of online surveys and a virtual public workshop provided the public with an accessible and safe participation method in the midst of the COVID-19 pandemic. Online survey participation yielded an equal number of participants as the virtual public workshop. The public workshop provided a conversational space to further discuss topics and establish relationships with interested citizens with ADA expertise and personal experience. The survey findings are helpful in guiding Port staff in the selection and prioritization of barrier removal. For documentation, see **Appendix D**.

C.2.1 Online Survey Responses

The online SurveyMonkey® and ArcGIS Survey123® surveys yielded a combined total of four (4) responses. See **Table 11**.

Table 11. Survey Responses by Platform

Survey Platform	Number of Responses
ArcGIS Survey123®	3 (only 2 provided rankings)
SurveyMonkey®	1
Total	4

ArcGIS Survey123® Findings

Three respondents provided feedback on ArcGIS Survey123®. For documentation, see **Figures 10-11** and **Tables 12-13**. Survey respondents also offered comments not related to ADA concerns. Such non-ADA related comments are not included in this report.

One (1) respondent requested long term ADA parking for a person with a disability who is a part time Hat Island resident. The respondent also shared that “ADA parking without fees must be provided for disabled Hat Island residents.”

Another respondent marked the 10th Street Boat Launch area, commenting “There needs to be an easier, dedicated location for people with kayaks, canoes, etc. to put in. It should be designed with people with disabilities in-mind, recognizing that most would have assistance in putting in. The distance from a parked car to the input point should be reduced (so watercraft doesn't have to be carried as far), and there should be a boat ramp reserved exclusively for kayaks/canoes. In addition, lighting could be improved throughout the Port's lands.” It should be noted that at this time, the Port does not have any designated launch areas for kayaks, canoes, etc. The person had heard of fixed-route transit issues including the long walk from the bus stop on West Marine View Drive. This person does not have physical disabilities but advocates for ADA accessibility for the Snohomish County Transportation Coalition. The respondent listed various ADA organizations that could be brought on-site for walking and rolling audits: Arc of Snohomish County, Homage Senior Services, Everett Senior Center, Disability Rights Washington, and Lighthouse for the Blind.

Figure 10. ArcGIS Survey123® Results for Most Wanted Barrier Types for Removal by Score

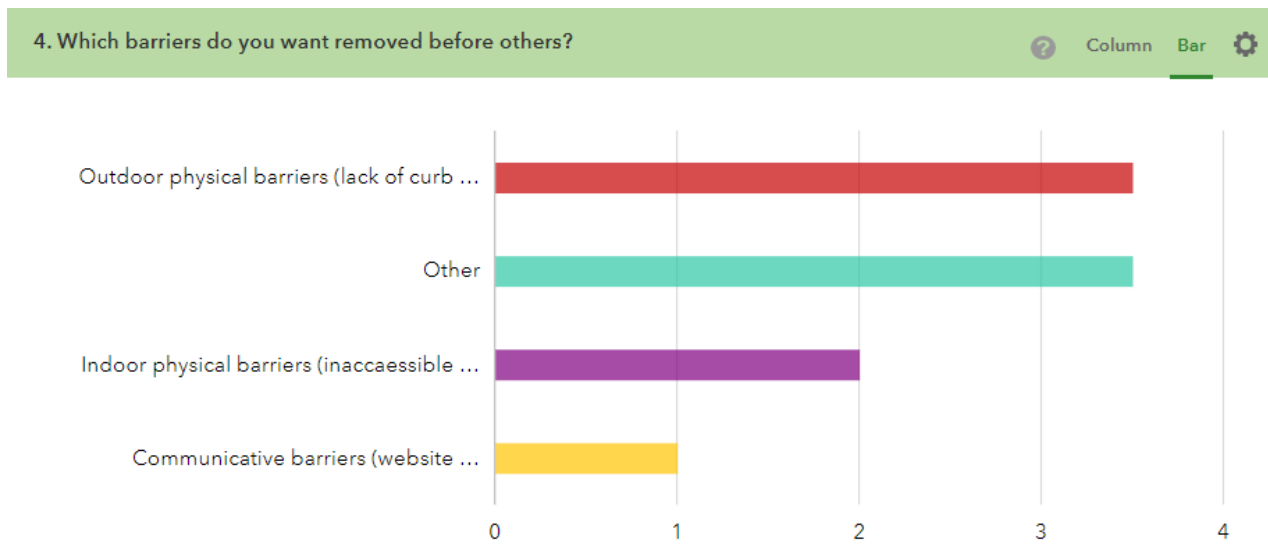

Figure 11. ArcGIS Survey123® Results for Most Wanted Barrier Removal Locations by Score

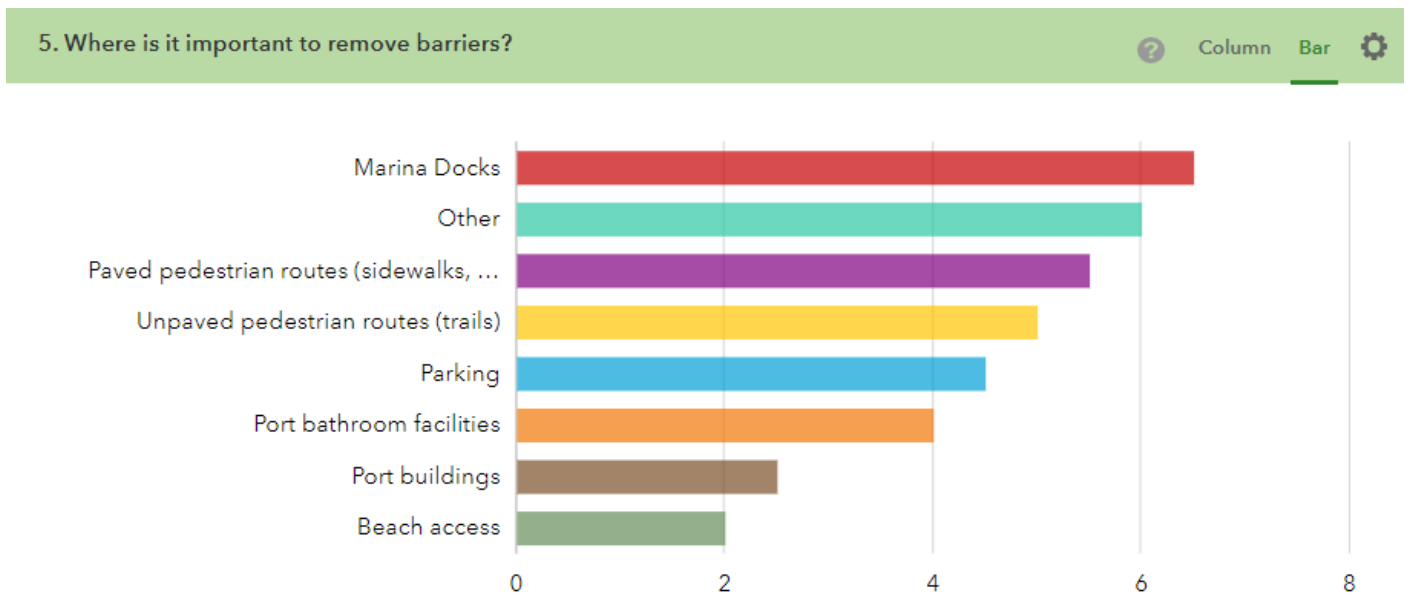

Table 12. ArcGIS Survey123® Ranked Results for Most Wanted Barrier Types for Removal

Answer Options	1		2		3		4		Total*	Score
Outdoor physical barriers	50%	1	50%	1	0%	0	0%	0	2	3.5
Other	50%	1	50%	1	0%	0	0%	0	2	3.5
Indoor physical barriers	0%	0	0%	0	100%	2	0%	0	2	2.0
Communicative barriers	0%	0	0%	0	0%	0	100%	2	2	1.5

*Answered: 2. Skipped: 1.

Table 13. ArcGIS Survey123® Ranked Results for Most Wanted Barrier Removal Locations

Answer Options	1		2		3		4		5		6		7		8		Total**	Score
Marina Docks	50%	1	0%	0	0%	0	50%	1	0%	0	0%	0	0%	0	0%	0	2	6.5
Other	0%	0	0%	0	100%	2	0%	0	0%	0	0%	0	0%	0	0%	0	2	6.0
Paved pedestrian routes	0%	0	50%	1	0%	0	0%	0	50%	1	0%	0	0%	0	0%	0	2	5.5
Unpaved pedestrian routes	0%	0	50%	1	0%	0	0%	0	0%	0	50%	1	0%	0	0%	0	2	5.0
Parking	50%	1	0%	0	0%	0	0%	0	0%	0	0%	0	0%	0	50%	1	2	4.5
Port bathroom facilities	0%	0	0%	0	0%	0	50%	1	0%	0	50%	1	0%	0	0%	0	2	4.0
Port buildings	0%	0	0%	0	0%	0	0%	0	50%	1	0%	0	0%	0	50%	1	2	2.5
Beach Access	0%	0	0%	0	0%	0	0%	0	0%	0	0%	0	100%	2	0%	0	2	2.0

**Answered: 2. Skipped: 1.

Survey Monkey® Narrative Findings

One (1) person submitted a survey on the Survey Monkey platform. For documentation, see **Figures 12-13, and Tables 14-15.**

The respondent reported “jetty access for people with mobility disabilities” as an accessibility barrier and that “there is no way for someone who uses mobility aids (e.g. wheelchair, scooter, walker) to visit the Jetty.” This person also participated in the Virtual Workshop. It should be noted that at this time, the Port does not provide any transportation to or from Jetty Island which is accessible only by watercraft. However, the City of Everett does run a summertime program called Jetty Island Days, which includes a foot ferry.

Figure 12. SurveyMonkey® Results for Most Wanted Barrier Types for Removal by Score

Q2: Which barriers do you want removed before others? Please rank the following barriers in order of importance for barrier removal (1 = most important). Answered : 1; Skipped: 0.

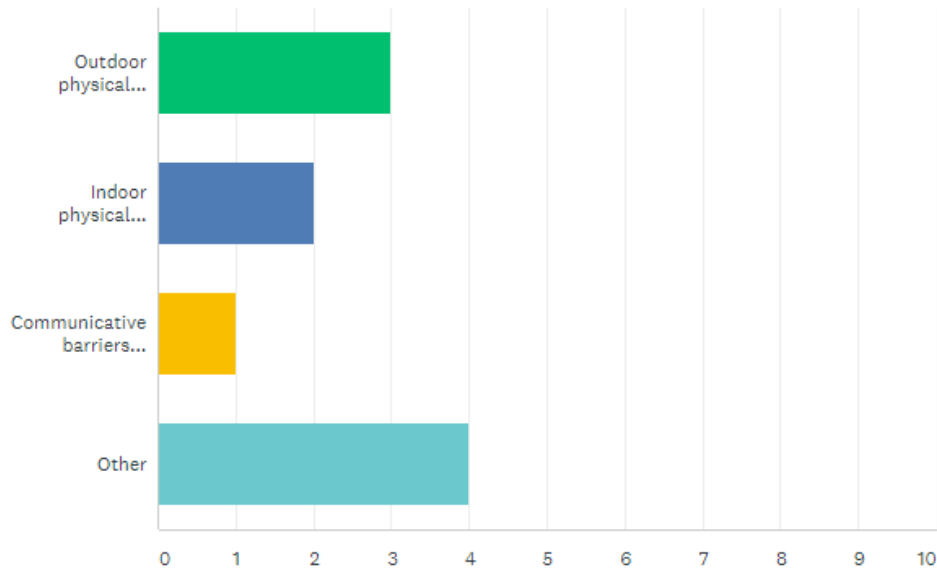

Figure 13. SurveyMonkey® Results for Most Wanted Barrier Removal Locations by Score

Q3: Where is it important to remove barriers? Please rank the following locations in order of importance for barrier removal (1 = most important). Answered : 1; Skipped: 0.

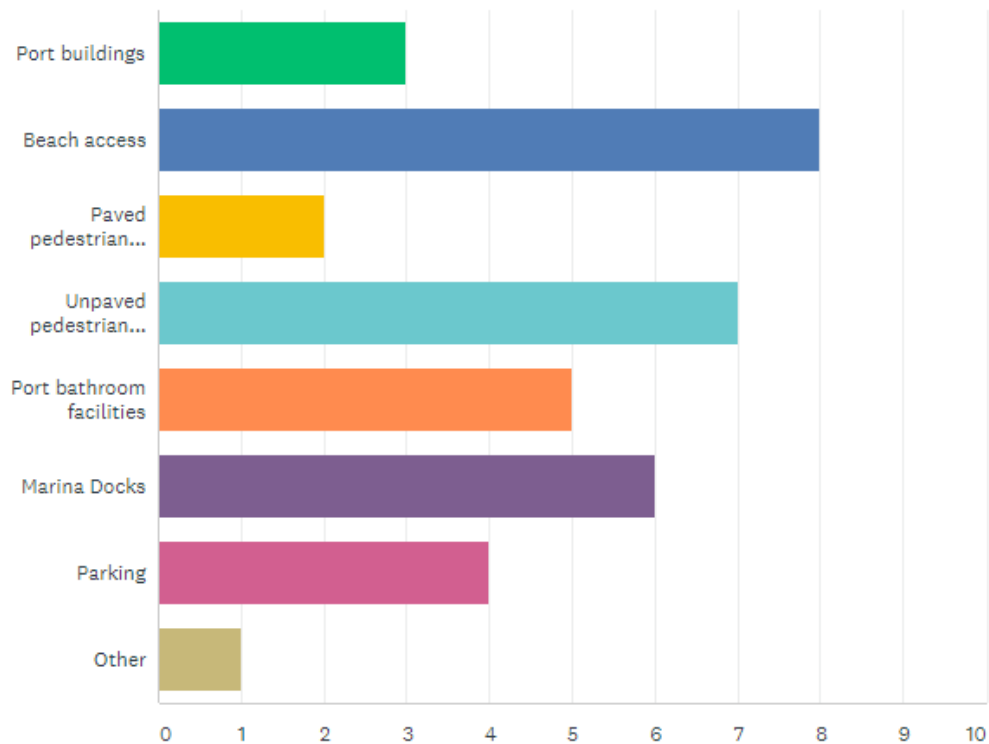

Table 14. SurveyMonkey® Ranked Results for Most Wanted Barrier Types for Removal

Answer Options	1		2		3		4		Total	Score
Other	100%	1	0%	0	0%	0	0%	0	1	4.0
Outdoor physical barriers	0%	0	100%	1	0%	0	0%	0	1	3.0
Indoor physical barriers	0%	0	0%	0	100%	1	0%	0	1	2.0
Communicative barriers	0%	0	0%	0	0%	0	100%	1	1	1.0

Table 15. SurveyMonkey® Ranked Results for Most Wanted Barrier Removal Locations

Answer Options	1		2		3		4		5		6		7		8		Total	Score
Beach Access	100%	1	0%	0	0%	0	0%	0	0%	0	0%	0	0%	0	0%	0	1	8.0
Unpaved pedestrian routes	0%	0	100%	1	0%	0	0%	0	0%	0	0%	0	0%	0	0%	0	1	7.0
Marina Docks	0%	0	0%	0	100%	1	0%	0	0%	0	0%	0	0%	0	0%	0	1	6.0
Port bathroom facilities	0%	0	0%	0	0%	0	100%	1	0%	0	0%	0	0%	0	0%	0	1	5.0
Parking	0%	0	0%	0	0%	0	0%	0	100%	1	0%	0	0%	0	0%	0	1	4.0
Port buildings	0%	0	0%	0	0%	0	0%	0	0%	0	100%	1	0%	0	0%	0	1	3.0
Paved pedestrian routes	0%	0	0%	0	0%	0	0%	0	0%	0	0%	0	100%	1	0%	0	1	2.0
Other	0%	0	0%	0	0%	0	0%	0	0%	0	0%	0	0%	0	100%	1	1	1.0

Ranking Observations Across Both Surveys

Three survey respondents completed the ranking questions. Outdoor physical barriers ranked higher for both survey cohorts for the most wanted barrier type for removal (see **Table 16**). Marina Docks ranked highest as a top priority location for barrier removal (see **Table 17**).

Table 16. Combined Ranked Score for Most Wanted Barrier Type for Removal

Answer Options	1		2		3		4		Total	Score
Other	67%	2	33%	1	0%	0	0%	0	3	3.67
Outdoor physical barriers	33%	1	67%	2	0%	0	0%	0	3	3.33
Indoor physical barriers	0%	0	0%	0	100%	3	0%	0	3	2.00
Communicative barriers	0%	0	0%	0	0%	0	100%	3	3	1.00

Table 17. Combined Ranked Score for Top Priority Location for Removal

Answer Options	1		2		3		4		5		6		7		8		Total	Score
Marina Docks	33%	1	0%	0	33%	1	33%	1	0%	0	0%	0	0%	0	0%	0	3	6.33
Unpaved pedestrian routes	0%	0	67%	2	0%	0	0%	0	0%	0	33%	1	0%	0	0%	0	3	5.66
Port bathroom facilities	0%	0	0%	0	0%	0	67%	2	0%	0	33%	1	0%	0	0%	0	3	4.33
Parking	33%	1	0%	0	0%	0	0%	0	33%	1	0%	0	0%	0	33%	1	3	4.33
Paved pedestrian routes	0%	0	33%	1	0%	0	0%	0	33%	1	0%	0	33%	1	0%	0	3	4.33
Other	0%	0	0%	0	67%	2	0%	0	0%	0	0%	0	0%	0	33%	1	3	4.33
Beach Access	33%	1	0%	0	0%	0	0%	0	0%	0	0%	0	67%	2	0%	0	3	4.00
Port buildings	0%	0	0%	0	0%	0	0%	0	33%	1	33%	1	0%	0	33%	1	3	3.00

C.2.2 Virtual Public Workshop Findings

Virtual Public Workshop feedback regarding barriers was provided by four (4) members of the public. One (1) participant was an interested City of Everett resident who uses a motorized scooter. Another participant was affiliated with the Northwest ADA Network. A third participant was affiliated with the Arc of Snohomish County and serves on local community transportation committees and boards. A fourth participant was a City of Everett Public Works Department employee working on the City of Everett ADA Transition Plan. The remaining participants consisted of the ADA Transition Plan project team: three (3) Port staff and two (2) Transportation Solutions, Inc. consultant team members. For minutes, see **Appendix D**. Workshop participants identified the following key themes:

- Accessible Parking: Suggested Port provide accessible parking beyond minimums and routes from parking to facilities.
- Visual Communication: Desire for an accessibility map of Port facilities and accessible wayfinding throughout the Port's facilities.
- Jetty Island Access: Desire for ADA access to, from and on Jetty Island.
- Explore Inter-Organizational Programming Opportunities: Port partnering with Imagine Children's, Arc in the Park, Holiday on the Bay, potential Arc sponsored movie nights.
- Inter-Organizational Opportunity for Information Sharing: share relevant information garnered through concurrent City of Everett and Port ADA Transition Plan processes.

C.2.3 Draft ADA Transition Plan Public Comments

(insert # of comments received into final plan) public comments were received on the Draft ADA Transition Plan from the public comment period of May 12 through May 26, 2021. For more detailed information, see **Appendix D**.

C.3. Recommendations

It is recommended that the Port:

- Consider developing an accessibility map for existing facilities (in-house) as proactive step towards addressing communicative barriers.
- Consider prioritizing the high-ranking barrier type of outdoor physical barriers for removal before other types.
- Consider reaching out to survey respondents to better understand perceived marina dock barriers, then evaluating prioritization of marina dock barriers before other barrier locations.
- Consider establishing a dedicated annual budget reserve that may fund addressing barriers identified by the public. Such a fund will help the Port mitigate risk for potential grievances as well as respond to requests by persons with disabilities in the local community who are most affected by barriers to accessibility.

- Utilize the Port of Everett ADA Transition Plan project webpage as a tool for future public outreach efforts related to ADA Transition Plan barrier removal progress updates.

D. Barrier Prioritization & Removal Schedule Recommendations

This Plan utilizes both generic and barrier-specific prioritization criteria. The first section describes the generic prioritization criteria applicable to all barrier types. The subsequent sections focus on prioritization criteria unique to individual barrier types with a recommended schedule for removal of barriers.

D.1 Generic Prioritization Criteria

It is recommended the Port consider this generic schema as the guiding prioritization policy for all barrier types:

D.1.1 Higher Priority

- Barriers to accessibility identified in filed grievances/complaints (see Note below).
- Barriers to accessibility identified through public engagement efforts.
- Barriers to accessibility correlated to planned capital improvement project improvements or department upgrades.

D.2 Lower Priority

- Barriers for services not frequently used by the public.
- Barriers to accessibility in buildings or facilities slated for demolition or pending renovation.
- Barriers to accessibility where alternative locations or communication formats make programs, services, or activities accessible (i.e. situations wherein accommodations can be made to provide alternative equal access).

Note: It is assumed that formally filed grievances/complaints about barriers to accessibility be considered high priority for a response and resolution in accordance with the Port's adopted ADA Grievance Procedure and any other established relevant policies.

ADA Transition Plan best practices recommend that Plans be guided by the principle that the barriers identified or experienced by people within the ADA community are of higher priority for removal than other barriers. Public outreach efforts were therefore a critical component of the prioritization process. The criteria also take into consideration concurrent Port projects and planning efforts to maximize the efficiency of accessibility barrier removal.

D.2 Transportation Network

D.2.1 Curb Ramps

It is recommended the Port:

- Consider the role of public feedback to identify high priority curb ramp barriers, including addressing ADA barriers identified by public grievances as a higher priority than other barriers.
- Prioritize missing curb ramps before other curb ramp barriers.
- Identify curb ramp barriers that are likely to be removed through scheduled planned capital improvement projects.
- Prioritize curb ramps nearest to accessible parking stalls.
- Prioritize curb ramps that provide connections to other accessible facilities.
- Consider establishing a policy regarding installation of detectable warning surfaces at blended transition locations.
- Upon completion of current construction activities, complete a follow-up inventory of the curb ramps in the blue corridors of **Figure 1** as part of a future Phase of the Port's ADA Self-Evaluation and Transition Plan.

Of note to the Port:

- Maintenance of curb ramps along SR 529 within the City of Everett's right-of-way are the responsibility of the City of Everett or WSDOT. See WSDOT's City Streets as Part of State Highways Guidelines (April 2013).
- For more information on blended transitions, see Section R305.2.3 of the 2011 PROWAG.

D.2.2 Sidewalk Barriers

It is recommended that the Port:

- Consider public feedback to guide further identification and prioritization of sidewalk ADA barriers, including those identified through complaints or public grievances.
- Establish monthly or seasonal maintenance activities to address overgrown vegetation blocking ground and airspace within pedestrian paths of travel.
- Relocate the ADA parking stall sign on 11th Street to not block pedestrian access route
- Ensure construction fencing does not encroach into pedestrian path of travel.

D.2.3 Driveway/Sidewalk Interface

It is recommended that the Port:

- Consider the role of public feedback to identify high priority DSI barriers, including addressing those barriers identified by public grievances.
- Consider as high priority for removal within short (2-6 year) period:
 - Bayside Marine - utilities and sidewalk settlement
 - 18th Street south of West Marine - Joint DSI/curb ramp barriers
- Consider as medium priority:
 - 13th Street driveway (unless slated for redevelopment)
- Identify DSI barriers that are likely to be removed through scheduled planned capital improvement projects.
- Upon completion of current construction activities, complete a follow-up inventory of the DSI locations in the blue corridors of **Figure 1** as part of a future Phase of the Port's ADA Self-Evaluation and Transition Plan.

D.2.4 Accessible Pedestrian Signals

The Port established an APS policy through the process of adoption of this Transition Plan. See APS Policy in **Appendix E**.

D.2.5 Accessible Parking

It is recommended that the Port:

- Carry out the Walker Parking Study recommendations as well as supplemental recommendations provided by design2 LAST's recreational facilities evaluations.
- At a future Phase update to the Port's ADA Self-Evaluation and Transition Plan, consider creating a GIS inventory of the Port's parking and accessible parking, including on-street marked or metered parking stalls in accordance with 2010 ADA Standards and 2011 PROWAG Guidelines.

D.3 Recreational Facilities

D.3.1 Recreational Facility Prioritization Matrix

A **Recreational Facility Prioritization Matrix** was developed to give the Port a flexible tool for prioritizing barrier removal projects. The matrix allows for three schemes of prioritization: federal guidelines, project team-developed public use/risk level, and a rating for the number/complexity of ADA barrier issues. Note: Cost estimates are not included in Phase I, but this matrix can be adjusted to replace the ratings with cost estimates. See **Figure 14**.

On the x-axis, the criteria are categorized by the four (4) priorities listed in the Department of Justice ADA Title III regulations (28 CFR Part 36.304) and additional recreational features per the new sections added to Appendix A of Chapter 10 of the 2010 ADA standards.

Specific types of barriers are grouped under four (4) overarching priorities:

- **Priority 1** - Accessible approach and entrance (typically from the identified accessible parking spaces to the accessible activity, facility, field, shelter, etc.)
- **Priority 2** - Access to goods and services (play components, public and team seating, route between features, picnic table, fire grills, utility hook-ups, etc.)
- **Priority 3** - Access to public toilet rooms (multi stall and/or unisex toilets)
- **Priority 4** - Access to other items (amenities) such as water fountains and public telephones.

Further, the matrix includes a rating for each priority subgroup identifying the number or complexity of ADA barrier issues at that facility:

- “Not Applicable” means the subgroup feature does not exist at the facility.
- “No issues” means the feature exists at the facility but does not present an ADA barrier.
- “A few issues” means the feature has ADA barriers to be addressed.
- “Many issues” means the feature has a greater number or more complex ADA barriers to be addressed.

On the y-axis, recreational facilities are ranked in order of a “Public Use/Risk Level” subjectively determined by the consultant’s architect and refined through discussion with Port staff. This rank is based on a composite evaluation. First, the architect considered the frequency of use or likelihood of facility use by members of the ADA community (high = many users to low = fewer users). The architect also subjectively evaluated how compliant the facility is overall to determine a risk level (high = more deficiencies to low = fewer deficiencies).

At a meeting held February 18th, 2021, the architect presented the preliminary ADA evaluation findings and a suggested facility public use/risk level rank for each of the Port’s eight (8) assessed facilities. These initial high, medium and low rankings were discussed and refined with input from Port staff. The final facility level rankings are shown in **Figure 14**.

Figure 14. Port of Everett Recreational Facility ADA Barrier Prioritization Matrix

Risk Level - Frequency of Use and Likelihood of ADA User Type	Parks and Trails Facility	Priority 1 - Approach and Entrance (Exterior to Facility)				Priority 2 - Access (to/from Facilities and Constructed Features)							Priority 3 - Toilet Rooms, Comfort Stations (Future)		Priority 4 - Other Amenities & Emergency Services	
		Parking and Curb ramps	Route from Parking to Facilities	Exterior Ramps	Exterior Steps (Future)	Routes to Piers, Boat Launches, other	Trails	Bench Seating	Picnic Facilities, Tables, Trash bins	Boating Facilities	Fishing Piers and Platforms	Viewing Platforms	Single User Toilet Rooms	Multi-User Toilet Rooms	Drinking fountains	Fire Alarms (Future)
High	Marina Waterfront Trail System Area 1	○	◐	n/a		n/a	○	◐	n/a	○	○	n/a			n/a	
High	Marina Waterfront Trail System Area 2	n/a	n/a	n/a		n/a	◐	◐	n/a	n/a	n/a	n/a			n/a	
High	Marina Waterfront Trail System Area 3	●	◐	●		○	◐	◐	◐	○	n/a	◐			n/a	
High	Marina Waterfront Trail System Area 4	◐	○	n/a		n/a	○	○	○	n/a	n/a	◐			n/a	
High	Marina Waterfront Trail System Area 5	◐	○	n/a		◐	●	○	n/a	n/a	n/a	n/a			n/a	
High	Marina Waterfront Trail System Area 6	◐	◐	n/a		◐	●	◐	◐	n/a	n/a	n/a			n/a	
High	Marina Waterfront Trail System Area 7	◐	◐	n/a		◐	●	◐	◐	n/a	n/a	n/a			◐	
High	Jetty Landing (10th Street) Boat Launch	●	◐	n/a		●	○	n/a	n/a	●	n/a	n/a			n/a	
High	Jetty Landing Park and Jetty Island Ferry Dock	◐	◐	n/a		◐	○	◐	◐	◐	●	n/a			n/a	
Medium	South Marina Parking Lot and Sidewalks	●	●	n/a		n/a	n/a	n/a	n/a	n/a	n/a	n/a			n/a	
Low	Waterfront Center Ext Access	◐	○	n/a		n/a	n/a	n/a	n/a	n/a	n/a	n/a			n/a	
Low	Boxcar Park	◐	◐	n/a		n/a	◐	◐	◐	n/a	n/a	n/a			n/a	
Low	South Guest Dock 2 (Accessible Dock)	◐	◐	○		○	n/a	n/a	n/a	◐	n/a	n/a			n/a	
Total by Priority Subgroup		\$0.00	\$0.00	\$0.00	\$0.00	\$0.00		\$0.00	\$0.00	\$0.00	\$0.00	\$0.00	\$0.00	\$0.00	\$0.00	\$0.00
Total by Priority					\$0.00							\$0.00	\$0.00	\$0.00	\$0.00	\$0.00
Issues Ratings		Not Applicable n/a		No Issues ○		A Few Issues ◐		Many Issues ●								

D.3.2 Recommendations

It is recommended that the Port:

- Consider the role of public feedback in the final facility-level prioritization rankings.
- Utilize the flexibility of the Recreational Facility ADA Prioritization Matrix and individual facility assessments to:
 - Identify barriers that can be removed through in-house maintenance activities and across multiple facilities
 - Schedule barrier removal at a future phase of the Port's ADA Self-Evaluation and Transition Plan

D.4 Administrative Policies & Procedures

The following personnel, policy and procedural updates have been established as of the adoption of this ADA Transition Plan. For documentation, see **Appendix E**.

D.4.1 ADA/504 Coordinator

The Port intends to have one (1) employee serve as the ADA/504 Coordinator responsible for responding to grievances, complaints and other alleged ADA discrimination concerns. Another administrative employee will serve as the person responsible for providing auxiliary aids and responding to requests for accommodation.

For questions related to grievances, complaints and other alleged ADA discrimination concerns, or about the content of this report, please contact the Port's ADA/504 Coordinator, Laura Gurley at:

Phone: (425) 388-0720

WA Relay Service/TTY: 7-1-1

E-mail: laurag@portofeverett.com

Mail: P.O. Box 538, Everett, WA 98206

To request an alternative format or accommodation, please contact administrative employee, Emily Hammer at:

Phone: (425) 388-0625

WA Relay Service/TTY: 7-1-1

E-mail: emilyh@portofeverett.com

Mail: P.O. Box 538, Everett, WA 98206

It is recommended that the Port:

- Notify all Port staff of the roles and responsibilities of the ADA/504 Coordinator and employee responsible for providing auxiliary aids and responding to requests for accommodation.
- Consider having the ADA/504 Coordinator and supporting employee complete the ADA National Network's [ADA Title II Tutorial](#).

D.4.2 Official Responsible to Implement the ADA Transition Plan

The Port has identified Laura Gurley as the official responsible to implement the ADA Transition Plan. Laura will work in cooperation with other relevant Port staff.

It is recommended that the Port:

- Notify all Port staff of the role and responsibilities of the official responsible for ADA Transition Plan implementation.

D.4.3 Public Notice of ADA Provisions

The Port has posted the Public Notice of ADA Provisions as recommended by the Department of Justice to the Port's website **available at:**

It is recommended that the Port:

- Train department staff on the significance of the Public Notice Under the ADA as a policy and procedure reference document. Helpful guidance is available from the DOJ's [ADA Best Practices Tool Kit for State and Local Governments](#) website.
- Coordinate with all departments to make them aware of the Public Notice Under the ADA, how to access it, and how to provide it in alternative formats.

D.4.4 ADA Grievance Procedure/ADA Discrimination Complaint Record

The Port has updated its ADA Grievance Procedure as recommended by the Department of Justice and posted it to the Port's website

It is recommended the Port:

- Train department staff on the significance of the ADA Grievance Procedure. Helpful guidance is available from the DOJ's [ADA Best Practices Tool Kit for State and Local Governments](#) website.
- Coordinate with all departments to make them aware of the Port's ADA Grievance Procedure, how to access it, and how to provide it in alternative formats.
- Consider using the ADA Grievance Forms and Record Template provided in **Appendix E** to track ADA grievances.

D.4.5 Accessible Pedestrian Signal (APS) Policy

The Port will establish an APS policy through the process of adoption of this Transition Plan. See **Appendix E** and APS Policy on the Port's website available at:

https://cms9.revize.com/revize/everett/Document%20Center/Your%20Port/Document%20Center/Planning/Port%20Plans/2021-05-12_Final%20Draft%20ADA%20Trans%20Plan-CONSOLIDATED.pdf

D.4.6 Additional Programmatic Barrier Self-Evaluation and Prioritization

An agency should have staff who are knowledgeable about ADA compliance requirements and have appropriate tools to serve members of the public who have disabilities. An internal self-assessment can help identify gaps in knowledge regarding ADA compliance requirements, educate public-facing staff about the variety of potential barriers people with disabilities could face, and inform staff of a variety of potential solutions to remove barriers to accessibility.

It is recommended that the Port:

- Conduct an internal ADA self-assessment of Port staff/department representatives who interact with the public to determine level of knowledge regarding ADA compliance. An example questionnaire is provided in **Appendix E**. Provide additional training if necessary.

E. Future Actions to Maintain and Achieve Compliance

E.1 Future Actions Needed

The Port is pursuing a phased approach to its ADA Self-Evaluation and Transition Plan. This first phase focused on self-evaluation, barrier prioritization, and initial barrier removal scheduling for transportation network and recreational facilities frequently visited by the public surrounding the Port of Everett Marina facilities and destination waterfront between 10th and 18th Streets and West Marine View Drive. The Port of Everett owns other recreational and building facilities that were not part of the first phase of self-evaluation and will be evaluated for ADA barriers at a future update to the Plan. These facilities include but are not limited to:

- Port-owned buildings with publicly accessible areas
- Port of Everett Seaport and satellite shipping facility Mount Baker Terminal
- Pigeon Creek public access trail and viewpoint
- Union Slough Saltmarsh Restoration Site public access
- Jetty Island
- Port of Everett-owned Mukilteo Public Access Dock/Fishing Pier

The Port of Everett also provides programs, services and activities at its facilities. The Port addressed the policy and procedure requirements identified in Section D.3 as part of this initial phase. The Port will conduct an internal self-assessment and barrier prioritization for programmatic barriers at a future update to the Plan. Cost estimates for barrier removal and a refined schedule for barrier removal will be included in a future update to the Plan.

E.2 Annual Report of Barriers Removed

To ensure implementation of this ADA Transition Plan, it is recommended that the Port incorporate an annual review/update process to track ADA self-evaluation and barrier removal progress across all of its transportation network, recreational, and building facilities as well as its programs, services, and activities. It is recommended that the official responsible for implementation of the ADA Transition Plan coordinate this effort in cooperation with relevant Port staff from other departments who are involved with projects that remove ADA barriers.

E.3 Five-Year ADA Transition Plan Update Schedule

This Plan is intended to be reviewed and updated at five year intervals. As the Plan is updated, an updated barrier removal schedule will be identified. With each five-year Plan update, an official public comment period is recommended to continue public engagement. The inventories and cost estimates will be re-analyzed at each five-year Plan update to determine patterns of need as it relates to the complete facility inventory and barrier removal prioritization rankings.

F. Accessibility Regulations, Standards & Guidelines Resources

This ADA Transition Plan is based on the most recent federal and state ADA regulations, standards, and guidelines. The resources are divided into general and barrier specific groups with links to websites. For the WSDOT Local Agency Guidelines Chapter 29 ADA Title II Checklist of requirements for ADA transition plans, see **Appendix A**.

F.1 General Resources

Federal ADA Regulations

- [ADA Title II Regulations \(28 CFR Part 35\)](#)
- [ADA Title III Regulations \(28 CFR Part 36\)](#)

U.S. Access Board Standards

- [U.S. Access Board DOJ ADA Accessibility Standards \(2010\)](#)

U.S. Department of Justice Guidelines

- [U.S. DOJ ADA Best Practices Tool Kit for State and Local Governments](#)

WSDOT Local Agency Guidelines

- [Local Agency Guidelines: Chapter 29 Section 504 of the Americans with Disabilities Act](#)

F.2 Barrier-Specific Resources

Transportation Network:

- [ADA Title II Technical Assistance Manual](#)
- [U.S. DOJ ADA Best Practices Tool Kit for State and Local Governments](#)
- [WSDOT Field Guide for Accessible Pedestrian Facilities \(2012\)](#)

Recreational Facilities

- [ABA \(Architectural Barriers Act\) Chapters 2 and 10 Amendments \(2013\)](#)
- [ADA Title III Technical Assistance Manual](#)
- [US Access Board Federal Outdoor Developed Areas Accessibility Standards \(May 2014\)](#)

Programmatic (Services, Programs and Activities):

- [National ADA Network Title II Tutorial](#)
- [U.S. DOJ ADA Best Practices Tool Kit for State and Local Governments](#)



Appendix A

Federal and Washington State Requirements Documentation

Section 28 CFR § 35.150 - Existing Facilities
(includes § 35.150 (d) - Transition Plan)

Section 28 CFR § 35.151 - New Construction or Alterations

Washington State Department of Transportation (WSDOT)
Local Agency Guidelines (LAG), Chapter 29 - Section 504 and the
Americans with Disabilities Act



Section 28 CFR § 35.150 - Existing Facilities (includes § 35.150 (d) - Transition Plan)

28 CFR § 35.150 - Existing facilities.

§ 35.150 Existing facilities.

(a) **General.** A [public entity](#) shall operate each service, program, or activity so that the service, program, or activity, when viewed in its entirety, is readily accessible to and usable by individuals with disabilities. This paragraph does not -

(1) Necessarily require a [public entity](#) to make each of its existing facilities accessible to and usable by individuals with disabilities;

(2) Require a [public entity](#) to take any action that would threaten or destroy the historic significance of an historic property; or

(3) Require a [public entity](#) to take any action that it can demonstrate would result in a fundamental alteration in the nature of a service, program, or activity or in undue financial and administrative burdens. In those circumstances where personnel of the [public entity](#) believe that the proposed action would fundamentally alter the service, program, or activity or would result in undue financial and administrative burdens, a [public entity](#) has the burden of proving that compliance with [§ 35.150\(a\)](#) of this part would result in such alteration or burdens. The decision that compliance would result in such alteration or burdens must be made by the head of a [public entity](#) or his or her designee after considering all resources available for use in the funding and operation of the service, program, or activity, and must be accompanied by a written statement of the reasons for reaching that conclusion. If an action would result in such an alteration or such burdens, a [public entity](#) shall take any other action that would not result in such an alteration or such burdens but would nevertheless ensure that individuals with disabilities receive the benefits or services provided by the [public entity](#).

(b) *Methods* -

(1) **General.** A [public entity](#) may comply with the requirements of this section through such means as redesign or acquisition of equipment, reassignment of services to accessible buildings, assignment of aides to beneficiaries, home visits, delivery of services at alternate accessible sites, alteration of existing facilities and construction of new facilities, use of accessible rolling stock or other conveyances, or any other methods that result in making its services, programs, or activities readily accessible to and usable by individuals with disabilities. A [public entity](#) is not required to make structural changes in existing facilities where other methods are effective in achieving compliance with this section. A [public entity](#), in making alterations to existing buildings, shall meet the accessibility requirements of [§ 35.151](#). In choosing among available methods for meeting the requirements of this section, a [public entity](#) shall give priority to those methods that offer services, programs, and activities to qualified individuals with disabilities in the most integrated setting appropriate.

(2)

(i) **Safe harbor.** Elements that have not been altered in existing facilities on or after March 15, 2012 and that comply with the corresponding technical and scoping specifications for

those elements in either the 1991 Standards or in the Uniform Federal Accessibility Standards (UFAS), Appendix A to [41 CFR part 101-19.6](#) (July 1, 2002 ed.), [49 FR 31528](#), app. A (Aug. 7, 1984) are not required to be modified in order to comply with the requirements set forth in the 2010 Standards.

(ii) The safe harbor provided in [§ 35.150\(b\)\(2\)\(i\)](#) does not apply to those elements in existing facilities that are subject to supplemental requirements (*i.e.*, elements for which there are neither technical nor scoping specifications in the 1991 Standards). Elements in the 2010 Standards not eligible for the element-by-element safe harbor are identified as follows -

(A) Residential facilities dwelling units, sections 233 and 809.

(B) Amusement rides, sections 234 and 1002; 206.2.9; 216.12.

(C) Recreational boating facilities, sections 235 and 1003; 206.2.10.

(D) Exercise machines and equipment, sections 236 and 1004; 206.2.13.

(E) Fishing piers and platforms, sections 237 and 1005; 206.2.14.

(F) Golf facilities, sections 238 and 1006; 206.2.15.

(G) Miniature golf facilities, sections 239 and 1007; 206.2.16.

(H) Play areas, sections 240 and 1008; 206.2.17.

(I) Saunas and steam rooms, sections 241 and 612.

(J) Swimming pools, wading pools, and spas, sections 242 and 1009.

(K) Shooting facilities with firing positions, sections 243 and 1010.

(L) Miscellaneous.

(1) Team or player seating, section 221.2.1.4.

(2) Accessible route to bowling lanes, section 206.2.11.

(3) Accessible route in court sports facilities, section 206.2.12.

(3) Historic preservation programs. In meeting the requirements of [§ 35.150\(a\)](#) in [historic preservation programs](#), a [public entity](#) shall give priority to methods that provide physical access to individuals with disabilities. In cases where a physical alteration to an historic property is not required because of paragraph (a)(2) or (a)(3) of this section, alternative methods of achieving program accessibility include -

(i) Using audio-visual materials and devices to depict those portions of an historic property that cannot otherwise be made accessible;

(ii) Assigning persons to guide individuals with handicaps into or through portions of [historic properties](#) that cannot otherwise be made accessible; or

(iii) Adopting other innovative methods.

(4) *Swimming pools, wading pools, and spas.* The requirements set forth in sections 242 and 1009 of the 2010 Standards shall not apply until January 31, 2013, if a [public entity](#) chooses to make structural changes to existing swimming pools, wading pools, or spas built before March 15, 2012, for the sole purpose of complying with the program accessibility requirements set forth in this section.

(c) *Time period for compliance.* Where structural changes in facilities are undertaken to comply with the obligations established under this section, such changes shall be made within three years of January 26, 1992, but in any event as expeditiously as possible.

(d) *Transition plan.*

(1) In the event that structural changes to facilities will be undertaken to achieve program accessibility, a [public entity](#) that employs 50 or more persons shall develop, within six months of January 26, 1992, a transition plan setting forth the steps necessary to complete such changes. A [public entity](#) shall provide an opportunity to interested persons, including individuals with disabilities or organizations representing individuals with disabilities, to participate in the development of the transition plan by submitting comments. A copy of the transition plan shall be made available for public inspection.

(2) If a [public entity](#) has responsibility or authority over streets, roads, or walkways, its transition plan shall include a schedule for providing curb ramps or other sloped areas where pedestrian walks cross curbs, giving priority to walkways serving entities covered by the [Act](#), including [State](#) and local government offices and facilities, transportation, places of public accommodation, and employers, followed by walkways serving other areas.

(3) The plan shall, at a minimum -

(i) Identify physical obstacles in the [public entity](#)'s facilities that limit the accessibility of its programs or activities to individuals with disabilities;

(ii) Describe in detail the methods that will be used to make the facilities accessible;

(iii) Specify the schedule for taking the steps necessary to achieve compliance with this section and, if the time period of the transition plan is longer than one year, identify steps that will be taken during each year of the transition period; and

(iv) Indicate the official responsible for implementation of the plan.

(4) If a [public entity](#) has already complied with the transition plan requirement of a Federal agency regulation implementing section 504 of the [Rehabilitation Act of 1973](#), then the requirements of this paragraph (d) shall apply only to those policies and practices that were not included in the previous transition plan.

(Approved by the Office of Management and Budget under control number 1190-0004)

[[56 FR 35716](#), July 26, 1991, as amended by Order No. 1694-93, [58 FR 17521](#), Apr. 5, 1993; AG Order No. 3180-2010, [75 FR 56180](#), Sept. 15, 2010; AG Order 3332-2012, [77 FR 30179](#), May 21, 2012]



Section 28 CFR § 35.151 - New Construction or Alterations

28 CFR § 35.151 - New construction and alterations.

§ 35.151 New construction and alterations.

(a) *Design and construction.*

(1) Each [facility](#) or part of a [facility](#) constructed by, on behalf of, or for the use of a [public entity](#) shall be designed and constructed in such manner that the [facility](#) or part of the [facility](#) is readily accessible to and usable by individuals with disabilities, if the construction was commenced after January 26, 1992.

(2) *Exception for structural impracticability.*

(i) Full compliance with the requirements of this section is not required where a [public entity](#) can demonstrate that it is structurally impracticable to meet the requirements. Full compliance will be considered structurally impracticable only in those rare circumstances when the unique characteristics of terrain prevent the incorporation of accessibility features.

(ii) If full compliance with this section would be structurally impracticable, compliance with this section is required to the extent that it is not structurally impracticable. In that case, any portion of the [facility](#) that can be made accessible shall be made accessible to the extent that it is not structurally impracticable.

(iii) If providing accessibility in conformance with this section to individuals with certain disabilities (*e.g.*, those who use wheelchairs) would be structurally impracticable, accessibility shall nonetheless be ensured to persons with other types of disabilities, (*e.g.*, those who use crutches or who have sight, hearing, or mental impairments) in accordance with this section.

(b) *Alterations.*

(1) Each [facility](#) or part of a [facility](#) altered by, on behalf of, or for the use of a [public entity](#) in a manner that affects or could affect the usability of the [facility](#) or part of the [facility](#) shall, to the maximum extent feasible, be altered in such manner that the altered portion of the [facility](#) is readily accessible to and usable by individuals with disabilities, if the alteration was commenced after January 26, 1992.

(2) The path of travel requirements of [§ 35.151\(b\)\(4\)](#) shall apply only to alterations undertaken solely for purposes other than to meet the program accessibility requirements of [§ 35.150](#).

(3)

(i) Alterations to [historic properties](#) shall comply, to the maximum extent feasible, with the provisions applicable to [historic properties](#) in the design standards specified in [§ 35.151\(c\)](#).

(ii) If it is not feasible to provide physical access to an historic property in a manner that will not threaten or destroy the historic significance of the building or [facility](#), alternative methods of access shall be provided pursuant to the requirements of [§ 35.150](#).

(4) Path of travel. An alteration that affects or could affect the usability of or access to an area of a [facility](#) that contains a primary function shall be made so as to ensure that, to the maximum extent feasible, the path of travel to the altered area and the restrooms, telephones, and drinking fountains serving the altered area are readily accessible to and usable by individuals with disabilities, including individuals who use wheelchairs, unless the cost and scope of such alterations is disproportionate to the cost of the overall alteration.

(i) Primary function. A “primary function” is a [major](#) activity for which the [facility](#) is intended. Areas that contain a primary function include, but are not limited to, the dining area of a cafeteria, the meeting rooms in a conference center, as well as offices and other work areas in which the activities of the [public entity](#) using the [facility](#) are carried out.

(A) Mechanical rooms, boiler rooms, supply storage rooms, employee lounges or locker rooms, janitorial closets, entrances, and corridors are not areas containing a primary function. Restrooms are not areas containing a primary function unless the provision of restrooms is a primary purpose of the area, *e.g.*, in highway rest stops.

(B) For the purposes of this section, alterations to windows, hardware, controls, electrical outlets, and signage shall not be deemed to be alterations that affect the usability of or access to an area containing a primary function.

(ii) A “path of travel” includes a continuous, unobstructed way of pedestrian passage by means of which the altered area may be approached, entered, and exited, and which connects the altered area with an exterior approach (including sidewalks, streets, and parking areas), an entrance to the [facility](#), and other parts of the [facility](#).

(A) An accessible path of travel may consist of walks and sidewalks, curb ramps and other interior or exterior pedestrian ramps; clear floor paths through lobbies, corridors, rooms, and other improved areas; parking access aisles; elevators and lifts; or a combination of these elements.

(B) For the purposes of this section, the term “path of travel” also includes the restrooms, telephones, and drinking fountains serving the altered area.

(C) Safe harbor. If a [public entity](#) has constructed or altered required elements of a path of travel in accordance with the specifications in either the 1991 Standards or the Uniform Federal Accessibility Standards before March 15, 2012, the [public entity](#) is not required to retrofit such elements to reflect incremental changes in the 2010 Standards solely because of an alteration to a primary function area served by that path of travel.

(iii) Disproportionality.

(A) Alterations made to provide an accessible path of travel to the altered area will be deemed disproportionate to the overall alteration when the cost exceeds 20% of the cost of the alteration to the primary function area.

(B) Costs that may be counted as expenditures required to provide an accessible path of travel may include:

(1) Costs associated with providing an accessible entrance and an accessible route to the altered area, for example, the cost of widening doorways or installing ramps;

(2) Costs associated with making restrooms accessible, such as installing grab bars, enlarging toilet stalls, insulating pipes, or installing accessible faucet controls;

(3) Costs associated with providing accessible telephones, such as relocating the telephone to an accessible height, installing amplification devices, or installing a text telephone (TTY); and

(4) Costs associated with relocating an inaccessible drinking fountain.

(iv) *Duty to provide accessible features in the event of disproportionality.*

(A) When the cost of alterations necessary to make the path of travel to the altered area fully accessible is disproportionate to the cost of the overall alteration, the path of travel shall be made accessible to the extent that it can be made accessible without incurring disproportionate costs.

(B) In choosing which accessible elements to provide, priority should be given to those elements that will provide the greatest access, in the following order -

(1) An accessible entrance;

(2) An accessible route to the altered area;

(3) At least one accessible restroom for each sex or a single unisex restroom;

(4) Accessible telephones;

(5) Accessible drinking fountains; and

(6) When possible, additional accessible elements such as parking, storage, and alarms.

(v) *Series of smaller alterations.*

(A) The obligation to provide an accessible path of travel may not be evaded by performing a series of small alterations to the area served by a single path of travel if those alterations could have been performed as a single undertaking.

(B)(1) If an area containing a primary function has been altered without providing an accessible path of travel to that area, and subsequent alterations of that area, or a different area on the same path of travel, are undertaken within three years of the original alteration, the total cost of alterations to the primary function areas on that path of travel during the preceding three year period shall be considered in determining whether the cost of making that path of travel accessible is disproportionate.

(2) Only alterations undertaken on or after March 15, 2011 shall be considered in determining if the cost of providing an accessible path of travel is disproportionate to the overall cost of the alterations.

(c) Accessibility standards and compliance date.

(1) If physical construction or alterations commence after July 26, 1992, but prior to September 15, 2010, then new construction and alterations subject to this section must comply with either UFAS or the 1991 Standards except that the elevator exemption contained at [section 4.1.3\(5\)](#) and [section 4.1.6\(1\)\(k\)](#) of the 1991 Standards shall not apply. Departures from particular requirements of either standard by the use of other methods shall be permitted when it is clearly evident that equivalent access to the [facility](#) or part of the [facility](#) is thereby provided.

(2) If physical construction or alterations commence on or after September 15, 2010 and before March 15, 2012, then new construction and alterations subject to this section may comply with one of the following: The 2010 Standards, UFAS, or the 1991 Standards except that the elevator exemption contained at [section 4.1.3\(5\)](#) and [section 4.1.6\(1\)\(k\)](#) of the 1991 Standards shall not apply. Departures from particular requirements of either standard by the use of other methods shall be permitted when it is clearly evident that equivalent access to the [facility](#) or part of the [facility](#) is thereby provided.

(3) If physical construction or alterations commence on or after March 15, 2012, then new construction and alterations subject to this section shall comply with the 2010 Standards.

(4) For the purposes of this section, ceremonial groundbreaking or razing of structures prior to site preparation do not commence physical construction or alterations.

(5) Noncomplying new construction and alterations.

(i) Newly constructed or altered facilities or elements covered by [§§ 35.151\(a\)](#) or (b) that were constructed or altered before March 15, 2012, and that do not comply with the 1991 Standards or with UFAS shall before March 15, 2012, be made accessible in accordance with either the 1991 Standards, UFAS, or the 2010 Standards.

(ii) Newly constructed or altered facilities or elements covered by [§§ 35.151\(a\)](#) or (b) that were constructed or altered before March 15, 2012 and that do not comply with the 1991 Standards or with UFAS shall, on or after March 15, 2012, be made accessible in accordance with the 2010 Standards.

APPENDIX TO [§ 35.151\(C\)](#)

Compliance dates for new construction and alterations	Applicable standards
Before September 15, 2010	1991 Standards or UFAS.
On or after September 15, 2010 and before March 15, 2012	1991 Standards, UFAS, or 2010 Standards.
On or after March 15, 2012	2010 Standards.

(d) Scope of coverage. The 1991 Standards and the 2010 Standards apply to fixed or built-in elements of buildings, structures, site improvements, and pedestrian routes or vehicular ways located on a site. Unless specifically [stated](#) otherwise, the advisory notes, appendix notes, and figures contained in the 1991 Standards and the 2010 Standards explain or illustrate the requirements of the rule; they do not establish enforceable requirements.

(e) Social service center establishments. Group homes, halfway houses, shelters, or similar social service center establishments that provide either temporary sleeping accommodations or residential dwelling units that are subject to this section shall comply with the provisions of the 2010 Standards applicable to residential facilities, including, but not limited to, the provisions in sections 233 and 809.

(1) In sleeping rooms with more than 25 beds covered by this section, a minimum of 5% of the beds shall have clear floor space complying with [section 806.2.3](#) of the 2010 Standards.

(2) Facilities with more than 50 beds covered by this section that provide common use bathing facilities shall provide at least one roll-in shower with a seat that complies with the relevant provisions of section 608 of the 2010 Standards. Transfer-type showers are not permitted in lieu of a roll-in shower with a seat, and the exceptions in [sections 608.3](#) and [608.4](#) for residential dwelling units are not permitted. When separate shower facilities are provided for men and for women, at least one roll-in shower shall be provided for each group.

(f) Housing at a place of education. [Housing at a place of education](#) that is subject to this section shall comply with the provisions of the 2010 Standards applicable to transient lodging, including, but not limited to, the requirements for transient lodging guest rooms in sections 224 and 806 subject to the following exceptions. For the purposes of the application of this section, the term “sleeping room” is intended to be used interchangeably with the term “guest room” as it is used in the transient lodging standards.

(1) Kitchens within housing units containing accessible sleeping rooms with mobility features (including suites and clustered sleeping rooms) or on floors containing accessible sleeping rooms with mobility features shall provide turning spaces that comply with [section 809.2.2](#) of the 2010 Standards and kitchen work surfaces that comply with [section 804.3](#) of the 2010 Standards.

(2) Multi-bedroom housing units containing accessible sleeping rooms with mobility features shall have an accessible route throughout the unit in accordance with [section 809.2](#) of the 2010 Standards.

(3) Apartments or townhouse facilities that are provided by or on behalf of a place of education, which are leased on a year-round basis exclusively to graduate students or faculty, and do not contain any public use or common use areas available for educational programming, are not subject to the transient lodging standards and shall comply with the requirements for residential facilities in sections 233 and 809 of the 2010 Standards.

(g) Assembly areas. Assembly areas subject to this section shall comply with the provisions of the 2010 Standards applicable to assembly areas, including, but not limited to, sections 221 and 802. In addition, assembly areas shall ensure that -

(1) In stadiums, arenas, and grandstands, [wheelchair](#) spaces and companion seats are dispersed to all levels that include seating served by an accessible route;

(2) Assembly areas that are required to horizontally disperse [wheelchair](#) spaces and companion seats by [section 221.2.3.1](#) of the 2010 Standards and have seating encircling, in whole or in part, a field of play or performance area shall disperse [wheelchair](#) spaces and companion seats around that field of play or performance area;

(3) [Wheelchair](#) spaces and companion seats are not located on (or obstructed by) temporary platforms or other movable structures, except that when an entire seating section is placed on temporary platforms or other movable structures in an area where fixed seating is not provided, in order to increase seating for an event, [wheelchair](#) spaces and companion seats may be placed in that section. When [wheelchair](#) spaces and companion seats are not required to accommodate persons eligible for those spaces and seats, individual, removable seats may be placed in those spaces and seats;

(4) Stadium-style movie theaters shall locate [wheelchair](#) spaces and companion seats on a riser or cross-aisle in the stadium section that satisfies at least one of the following criteria -

(i) It is located within the rear 60% of the seats provided in an auditorium; or

(ii) It is located within the area of an auditorium in which the vertical viewing angles (as measured to the top of the screen) are from the 40th to the 100th percentile of vertical viewing angles for all seats as ranked from the seats in the first row (1st percentile) to seats in the back row (100th percentile).

(h) Medical care facilities. Medical care facilities that are subject to this section shall comply with the provisions of the 2010 Standards applicable to medical care facilities, including, but not limited to, sections 223 and 805. In addition, medical care facilities that do not specialize in the treatment of conditions that affect mobility shall disperse the accessible patient bedrooms required by [section 223.2.1](#) of the 2010 Standards in a manner that is proportionate by type of medical specialty.

(i) Curb ramps.

(1) Newly constructed or altered streets, roads, and highways must contain curb ramps or other sloped areas at any intersection having curbs or other barriers to entry from a street level pedestrian walkway.

(2) Newly constructed or altered street level pedestrian walkways must contain curb ramps or other sloped areas at intersections to streets, roads, or highways.

(j) Facilities with residential dwelling units for sale to individual owners.

(1) Residential dwelling units designed and constructed or altered by public entities that will be offered for sale to individuals shall comply with the requirements for residential facilities in the 2010 Standards, including sections 233 and 809.

(2) The requirements of paragraph (1) also apply to housing programs that are operated by public entities where design and construction of particular residential dwelling units take place only after a specific buyer has been identified. In such programs, the covered entity must provide the units that comply with the requirements for accessible features to those pre-identified buyers with disabilities who have requested such a unit.

(k) Detention and correctional facilities.

(1) New construction of jails, prisons, and other detention and correctional facilities shall comply with the 2010 Standards except that public entities shall provide accessible mobility features complying with [section 807.2](#) of the 2010 Standards for a minimum of 3%, but no fewer than one, of the total number of cells in a [facility](#). Cells with mobility features shall be provided in each classification level.

(2) **Alterations to detention and correctional facilities.** Alterations to jails, prisons, and other detention and correctional facilities shall comply with the 2010 Standards except that public entities shall provide accessible mobility features complying with [section 807.2](#) of the 2010 Standards for a minimum of 3%, but no fewer than one, of the total number of cells being altered until at least 3%, but no fewer than one, of the total number of cells in a [facility](#) shall provide mobility features complying with [section 807.2](#). Altered cells with mobility features shall be provided in each classification level. However, when alterations are made to specific cells, detention and correctional [facility](#) operators may satisfy their obligation to provide the required number of cells with mobility features by providing the required mobility features in substitute cells (cells other than those where alterations are originally planned), provided that each substitute cell -

(i) Is located within the same prison site;

(ii) Is integrated with other cells to the maximum extent feasible;

(iii) Has, at a minimum, equal physical access as the altered cells to areas used by inmates or detainees for visitation, dining, recreation, educational programs, medical services, work programs, religious services, and participation in other programs that the [facility](#) offers to inmates or detainees; and

(iv) If it is technically infeasible to locate a substitute cell within the same prison site, a substitute cell must be provided at another prison site within the corrections system.

(3) With respect to medical and long-term care facilities in jails, prisons, and other detention and correctional facilities, public entities shall apply the 2010 Standards technical and scoping requirements for those facilities irrespective of whether those facilities are licensed.

[[56 FR 35716](#), July 26, 1991, as amended by Order No. 1694-93, [58 FR 17521](#), Apr. 5, 1993; AG Order No. 3180-2010, [75 FR 56180](#), Sept. 15, 2010; [76 FR 13285](#), Mar. 11, 2011]



Washington State Department of Transportation (WSDOT)
Local Agency Guidelines (LAG), Chapter 29 - Section 504 and the
Americans with Disabilities Act

29.1 General Discussion

This chapter summarizes the regulations and implementing requirements local agencies shall follow regarding services, programs, and activities in or that affect the public right of way.

Section 504 of the *Rehabilitation Act of 1973 (Section 504)* states that no person with a disability shall be excluded from participation in, denied the benefits of, or be subjected to discrimination under any program or activity that receives Federal funding. This includes both transportation and non-transportation funding. Transportation funding includes funding from the United States Department of Transportation (USDOT) or the operating administrations under it (Federal Highway Administration, Federal Transit Administration, Federal Railroad Administration, Federal Aviation Administration, Research and Special Programs Administration, National Highway Traffic Safety Administration, or the U.S. Coast Guard).

Section 504 extends to the entire operations of a recipient or subrecipient, regardless of the specific funding source of a particular operation. Section 504 Regulations ([49 CFR Part 27.5](#)) define a recipient as any public entity that receives Federal financial assistance from the USDOT or its operating administrations either directly or through another recipient. An example of a recipient is WSDOT an example of a subrecipient is a local agency receiving USDOT funds through WSDOT, for projects/programs/activities administered by the local agency.

All public entities shall follow *the Americans with Disabilities Act of 1990 (ADA)*, regardless of funding sources. The ADA is mirrored after Section 504 but extends the reach of Federal accessibility laws to include those agencies that are not recipients or subrecipients of Federal funding. Title II ([28 CFR Part 35](#)) of the ADA specifically pertains to state and local governments.

The respective Federal funding agency (FHWA) and WSDOT will ensure that local agencies comply with Section 504 and the ADA. For more information about Section 504 and the ADA, please see WSDOT Equal Opportunity ADA website: www.wsdot.wa.gov/EqualOpportunity/ADA.htm

Local agency public works staff should also refer to Chapter 42 of the Local Agency Guidelines (LAG) for technical information specific to public right-of-way facilities.

29.2 Assurances

Each local agency that receives Federal funding from the USDOT or its operating administrations (such as FHWA) shall submit a written assurance that all of its services, programs, and activities will be conducted in compliance with Section 504 and the ADA. The assurance shall be signed by the Agency Executive, and submitted to each agency (such as WSDOT) administering funds for the USDOT or an operating administration.

Federal aid projects administered through WSDOT require a Local Agency Agreement between the local agency and WSDOT. That agreement may serve as the local agency's assurance of compliance with Section 504 and the ADA as long as it is signed by the Agency Executive and states the following:

In accordance with Section 504 and the ADA, the Agency shall not discriminate on the basis of disability in any of its programs, services, or activities.

29.3 Administrative Requirements

The following list and [Appendix 29.11](#) summarize some of the key requirements of Section 504 and the ADA. Note that when a requirement cites a number of employees, that number is the number of paid permanent, temporary, and contract employees regardless of whether the employees are full or part time.

- Each agency, regardless of the number of employees and funding sources, shall ensure that its services, programs, and activities are accessible to persons with disabilities. Some things this includes are:
 - Transportation and community evacuation elements of emergency management programs/plans
 - Communications. Communications with persons with disabilities shall be as effective as communications with other persons. This applies to all forms of communications, including information posted on an agency's website (ref. Section 508 of the Rehabilitation Act and the ADA), emergency services communications, pedestrian signal systems, etc.
 - Maintenance of programs and facilities. This includes maintaining accessibility of pedestrian facilities that may be impacted by overgrown vegetation, snow/ice, severe heaving/cracking of surfaces, construction work zones, etc. Pedestrian signals/pushbuttons must also be accessible and maintained in working order.
 - New construction and altered facilities.
- Each agency regardless of the number of employees shall designate at least one person as its ADA/504 Coordinator. The individual designated as the ADA/504 Coordinator is responsible for coordinating ADA/Section 504 compliance throughout the agency. The agency shall provide the name, office address, and telephone number of the ADA/504 Coordinator both internally and externally. This information is required to be posted in areas likely to be viewed by employees and the general public (such as the agency's Web page, etc.).
- Each agency regardless of the number of employees shall adopt and publish grievance/complaint procedures. These procedures shall be posted internally and externally and be made available in alternative formats that address the needs of persons with mobility, visual, and hearing disabilities. This information is required to be posted in areas likely to be viewed by employees and the general public (such as the agency's Web page).

- Each agency, regardless of the number of employees, shall provide public notice of its ADA provisions. This notice shall contain a brief description about how the agency will address ADA accessibility in its employment, communications, policies, and resolution of complaints. This notice shall be placed in locations and/or facilities that are accessible internally and externally and be available in alternative formats that address the needs of persons with mobility, visual, and hearing disabilities. Information placed on the agency's Web page counts as posting externally.
- Each agency, regardless of the number of employees, shall conduct a self-evaluation of its policies, programs, services, and activities to determine whether Section 504/ADA accessibility requirements are being met. This includes all public right-of-way facilities. See [Appendix 29.11](#). Each agency shall provide an opportunity for interested parties (i.e., persons with disabilities/advocacy groups) to participate in the process.
- Each agency with 50 or more employees shall develop a transition plan (See Section 29.4) when structural modifications, identified through a self-evaluation process, are necessary to achieve program accessibility under the ADA. While Section 504 regulations contain similar requirements, there is no employee threshold and the regulation is not as descriptive as the ADA regulations. Therefore, each agency with fewer than 50 employees that is a recipient or subrecipient of Federal financial assistance shall develop a program access plan. See [Section 29.4](#) for the requirements of these plans.

An agency's self-evaluation and transition plan must cover all of the agency's programs (including facilities), services, and activities. The information contained in this chapter is intended to provide local agency transportation departments (i.e., public works) with guidance/expectations for addressing ADA accessibility requirements associated with public right-of-way facilities.

29.4 Transition Plan, Program Access Plan, and Accessible Pedestrian Signal and Pushbutton Policy

Each agency shall provide an opportunity for interested parties (i.e., persons with disabilities/advocacy groups) to participate in the process to develop a transition plan or program access plan.

FHWA considers transition plans and program access plans to be living documents. The applicable plan should be used in conjunction with the planning and prioritizing of projects, and for monitoring progress on completing modifications. If the time period of the plan is longer than one year, the plan shall identify steps that will be taken during each year of the transition period. FHWA also recommends that the plan be updated annually until all planned modifications have been completed.

Transition Plan

As stated in [Section 29.3](#) of this chapter, agencies with 50 or more employees (ADA), regardless of funding source, shall develop a transition plan when structural modifications are necessary to achieve ADA compliance. Based on the agency's self-evaluation, at a minimum the plan shall:

- Identify the physical obstacles in the public entity's facilities that limit the accessibility of its programs or activities to individuals with disabilities, including those within the public right of way.

- Describe in detail the methods that will be used to make the facilities accessible.
- Specify the schedule for each facility and/or obstacle to be retrofitted. FHWA recommends that an agency include the estimated cost of each modification as part of the schedule, to assist in the budget and/or Transportation Improvement Program (TIP) preparation.
- Identify the official responsible for implementation of the plan. This is typically the agency's Executive, or the agency's designated ADA/504 Coordinator who has the authority to act on behalf of the agency's Executive.

Program Access Plan

As stated in [Section 29.3](#), agencies with fewer than 50 employees and a recipient of Federal financial assistance are required to develop a program access plan. Similar to a transition plan, agencies shall:

- Identify the physical obstacles in the public entity's facilities that limit the accessibility of its programs or activities to individuals with disabilities, including those within the public right of way.
- Describe in detail the methods/actions needed to make the facilities accessible.
- Specify a schedule (milestones) of when the agency plans to make the necessary modifications.

Accessible Pedestrian Signal and Pushbutton (APS) Policy

Based on input from the U.S. Department of Justice (DOJ), it is FHWA's policy to require recipients and subrecipients (of FHWA funding) to establish a "reasonable and consistent" policy for installing accessible pedestrian signals and pushbuttons (APS) on all alteration and new construction projects, consistent with the requirements of Title II of the ADA ([28 CFR Part 35.151](#)) and Section 504 regulations ([49 CFR Part 27.7\(c\)](#)). This policy should be part of a transition plan, program access plan, or a stand-alone document if a transition plan or program access plan has not yet been completed. FHWA and WSDOT will work with local agencies to ensure that all new and altered pedestrian signal and pushbutton installations are usable by persons with visual disabilities.

29.5 Requirements for New Construction and Alterations in the Public Right of Way

Title II of the ADA requires that new and altered facilities be designed and constructed to be readily accessible to and usable by persons with disabilities.

New Construction

New construction projects address the construction of a new roadway, interchange, or other transportation facility where none existed before. New construction is expected to meet the highest level of ADA accessibility unless it is structurally impracticable to achieve full compliance. Full compliance will be considered structurally impracticable only when, in rare circumstances, the unique characteristics of terrain prevent full compliance.

Alterations

The vast majority of construction projects undertaken by local agency public works/ transportation departments are classified as alterations. An alteration is a change that affects or could affect the usability of a facility or part of a facility. Alterations include reconstruction, major rehabilitation, widening, resurfacing (e.g., asphalt overlays and mill and fill), signal installation and upgrades, and projects of similar scale and effect. Alterations to existing facilities shall meet new construction standards unless it is technically infeasible to do so. If full ADA compliance cannot be achieved in an alteration, the agency shall alter the facility to provide the maximum degree of accessibility possible. The feasibility meant by this standard is physical possibility only. Neither cost nor schedule are factors in determining whether the ADA standards can be met, nor are they factors in determining the feasibility of complying with the standard.

An alteration project shall be planned, designed, and constructed so that the required accessibility improvements occur at the same time as the alteration. If a project involves resurfacing the street, connections between the sidewalk and street crossings (i.e., curb ramps) are considered to be within the scope of the alteration project. Any accessibility issues shall be addressed in conjunction with the resurfacing project, either prior to or at the same time as the resurfacing project. For the requirements for curb ramps during resurfacing projects, see USDOJ-USDOT's Joint Technical Assistance document, dated July 8, 2013 and the Supplement to this document, dated December 1, 2015; and a FHWA recorded webinar from FHWA, dated March 1, 2016.

Safe Harbor for Alterations

Both the Section 504 and ADA requirements contain a "safe harbor" provision. However, there is a difference in the timeline associated with the Section 504 safe harbor provision and the ADA safe harbor provision.

If an agency receives Federal financial assistance from USDOT – either directly or through another USDOT recipient (such as WSDOT), the agency is subject to the 2004 ADA Accessibility Guidelines (2004 ADAAG).

This became effective in 2006 when the USDOT adopted the 2004 ADA Accessibility Guideline (2004 ADAAG) into its Section 504 regulations. This document is known as the 2004 ADA Standards. The 2004 Standards have a "safe harbor" provision for curb ramps. The provision is that if a curb ramp was constructed or altered prior to November 29, 2006, and complies with either the 1991 ADA Standards for Accessible Design (1991 ADA Accessibility Guidelines) or the Uniform Federal Accessibility Standards (UFAS), it does not need to be modified as part of a roadway resurfacing project. If this is not the case, or if the curb ramp is in disrepair then the curb ramp and its detectable warnings (truncated domes) must shall be brought into compliance with the 2004 Standards) at the time of an alternation. As mentioned above in Section 29.1, if an agency receives Federal financial assistance from USDOT – either directly or through another DOT recipient (such as WSDOT), then the agency is subject to the 2004 ADAAG as part of the USDOT Section 504 regulations.

For those agencies who are not a recipient or subrecipient of Federal financial assistance from USDOT, the safe harbor provision in the 2010 ADA Standards for Accessible Design (2010 Standards) applies. Under the 2010 Standards' safe harbor provision, if curb ramps were built or altered (in existing facilities) prior to March 15, 2012 and if they

comply with the 1991 Standards or the UFAS, they do not need to be modified as part of a resurfacing project.

However, if an existing curb ramp does not comply with either the 1991 Standards or the UFAS (including if the curb ramp is in a state of disrepair), then the Safe Harbor provision does not apply and the curb ramp would need to be brought into compliance with the 2010 Standards at the time of roadway alteration.

When curb ramps or abutting sidewalks abutting ramps are altered, they shall be reconstructed to meet the 2010 Standards. For additional curb ramp design guidance, see LAG manual Chapter 42.

Documentation for Structural Impracticability and Maximum Extent Feasible

While ADA/Section 504 regulations do not require documentation of the application of structural impracticability nor maximum extent feasible, both FHWA and the U.S. Access Board recommend that these instances be documented so the agency can support its decisions if challenged at a later date. The documentation of these instances should reveal the standard of care that guided engineering judgments. While careful documentation will not protect an agency against complaint, evidence of the considerations that led to the specific project solution may be persuasive in discussions with stakeholders or in court.

As described in the [Design Manual](#) M 22-01, WSDOT has a documentation procedure for applications of maximum extent feasible in alteration projects on state routes. If a local agency applies maximum extent feasible to a pedestrian facility located on a state route, it is WSDOT's expectation that the agency follow the WSDOT documentation procedure described in the [Design Manual](#) M 22-01. The completed documentation should be contained in local agency project files to document the agencies design efforts in complying with the ADA/Section 504 requirements.

If a local agency finds the need to apply maximum extent feasible to a pedestrian facility that is not located on a state route, the WSDOT documentation procedure does not need to be followed. However, it is highly recommended that the agency develop its own documentation protocol for such situations that is consistent with the FHWA and U.S. Access Board recommendations.

29.6 Monitoring and Enforcement

Responsibility for monitoring and enforcement of Section 504 rests with the Federal funding agency (such as FHWA). While USDOJ has the ultimate enforcement authority for ADA compliance, USDOJ has delegated monitoring and enforcement responsibility to several Federal executive agencies including the USDOT and its operating administrations (such as FHWA).

FHWA requires WSDOT to monitor and enforce the compliance with both Section 504 and the ADA of any entity receiving disbursement of either state or Federal funding through WSDOT. FHWA monitors WSDOT and local agency compliance through various means such as process and program reviews, construction inspections, PS&E reviews, and complaint investigations. If noncompliance is found, and the noncompliance is not corrected to FHWA's satisfaction, FHWA may terminate existing Federal funding or refuse to grant future funding.

29.7 Laws

- 29 USC 794 - Section 504 of the Rehabilitation Act of 1973 (as amended by the Civil Rights Restoration Act of 1987)
- 42 USC 12111 - Americans with Disabilities Act (Title II)

29.8 Regulations

- [28 CFR Part 35](#) (Title II) “Nondiscrimination on the Basis of Disability in State and Local Government Services”
- [49 CFR Part 27](#) (Section 504) “Nondiscrimination on the Basis of Disability in Programs or Activities Receiving Federal Financial Assistance”
- [49 CFR Part 37](#) “Transportation Services for Individuals with Disabilities (ADA)”
- [49 CFR Part 38](#) “Americans with Disabilities Act (ADA) Accessibility Specifications for Transportation Vehicles”

29.9 Resources

- Chapters [1510](#) and [1515](#) of the *Design Manual* M 22-01
- [Chapter 42](#) of this manual

29.10 Appendices

- [29.11](#) ADA Title II and Section 504 Regulatory References

Appendix 29.11 ADA Title II and Section 504 Regulatory References

ADA Title II and Rehabilitation Act Section 504 Regulatory References	Requirements for agencies with less than 50 employees	Requirements for agencies with 50 or more employees
Programs, Services, and Activities: Ensure that programs, services, and activities are accessible to persons with disabilities. (28 CFR Part 35.150(a) and (c))	✓	✓
ADA/504 Coordinator: Designate at least one responsible employee (ADA/504 Coordinator) and make the name and contact information available internally and externally. (28 CFR Part 35.107(a) and 49 CFR Part 27.13(a))	✓	✓
Complaint/Grievance Procedures: Adopt and publish complaint/grievance procedures. (28 CFR Part 35.107(b) and 49 CFR Part 27.13(b))	✓	✓
Notice of ADA Provisions: Provide a public notice of how the agency will address ADA accessibility in its employment, communications, policies, and resolution of complaints. (28 CFR 35.106)	✓	✓
Self-evaluation²: Evaluate all services, policies, and practices for barriers that restrict / limit persons with disabilities from access to services, programs, and activities. (28 CFR Part 35.105(a) and 49 CFR Part 27.11(c)(2)(i) and (v))	✓	✓
Self-evaluation²: Maintain the completed self-evaluation on file and make it available for public inspection for at least three years following its completion. (28 CFR Part 35.105(c) and 49 CFR Part 27.11(c)(3)(ii):	✓	✓
Transition Plan²/Program Access Plan: Develop a transition plan or program access plan that outlines the structural modifications that must be made to those services, programs, and activities that are not accessible. (28 CFR Part 35.150(d) and 49 CFR Part 27.11(c)(2)(ii))	✓ program access plan	✓ transition plan (post it on the agency's website)
Accessible Pedestrian Signal and Pushbutton (APS) Policy²: Develop a "reasonable and consistent" policy for installing accessible pedestrian signals and pushbuttons when a transition plan has not yet been completed. (28 CFR Part 35.130 and 35.160a(1) and 49 CFR Part 27.7(c))	✓	✓

Notes:

¹Employees include paid permanent, temporary, and contract employees regardless of whether the employees are full or part time.

²Complete self-evaluations, and develop transition plans, program access plan and APS policies by engaging persons with disabilities and/or their advocates (28 CFR Parts 35.105 and 35.150 and 49 CFR Part 27.11(c)(2)).



Appendix B

Transportation Network ADA Inventory Documentation

List of Abbreviations - Transportation Network

Curb Ramp Inventory Map

Curb Ramp Inventory Spreadsheet

Sidewalk Barrier Inventory Map

Sidewalk Barrier Inventory Spreadsheet

Driveway/Sidewalk Interface (DSI) Inventory Map

Driveway/Sidewalk Interface (DSI) Inventory Spreadsheet



List of Abbreviations - Transportation Network

ADAAG – Americans with Disabilities Act Accessibility Guidelines (2004/2010; enforceable)

DOJ – Department of Justice

DOT – Department of Transportation

DSI – Driveway/Sidewalk Interface (Tech Memo abbr.)

DWS – Detectable Warning Surface

PROWAG – Public Right of Way Accessibility Guidelines (2011; not enforceable)

Sidewalks_Point – locations of sidewalk barriers

SWDWInterface – Sidewalk/Driveway Interface (used in Spreadsheets)

VDOT – Virginia Department of Transportation

WSDOT – Washington Department of Transportation

Port of Everett - ADA Transition Plan
April 2021



Curb Ramp Inventory Map

Curb Ramp ADA Compliance Status Map (North/Central)

POE_Curb_Ramps

- Fair or Better
- Poor
- Very Poor
- Missing (Needed but does not exist)
- Other

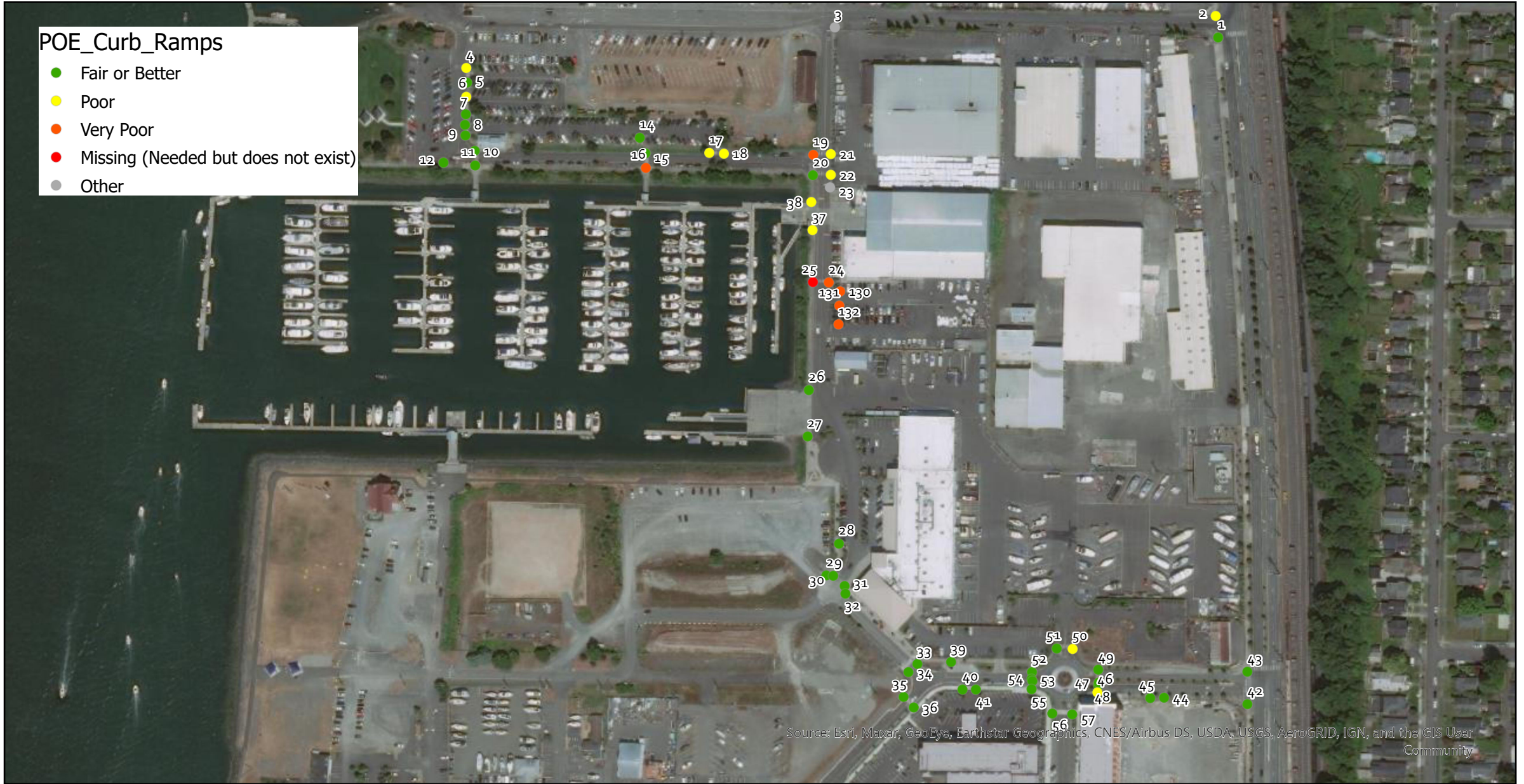

Curb Ramp ADA Compliance Status Map (South)

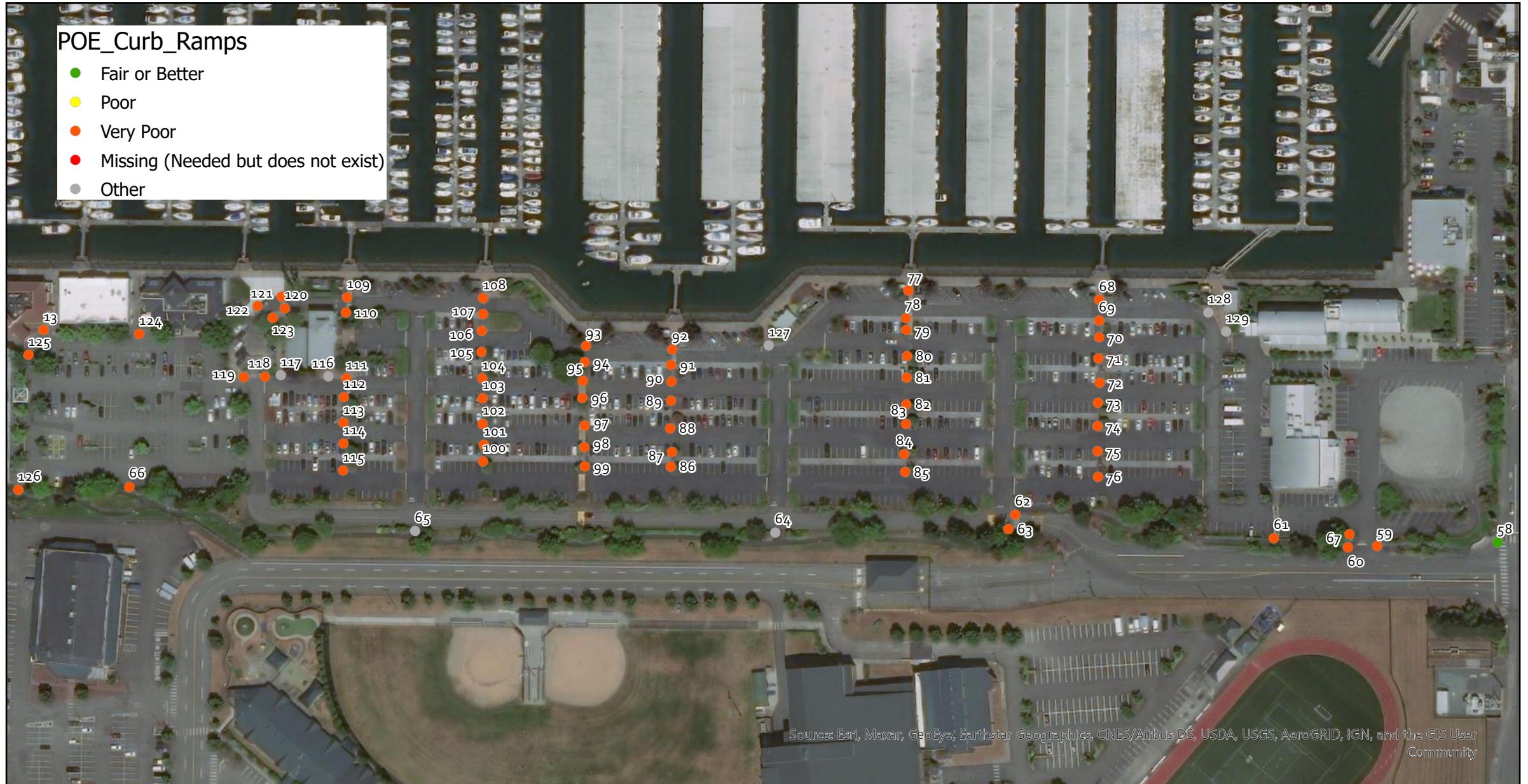



Curb Ramp Inventory Spreadsheet

Port of Everett
Curb Ramp ADA Inventory Data (January 2021)

POE_ID	OBJECTID	GlobalID	CreationDate	Creator	EditDate	Editor	Condition	Ramp Width	DWS	Grade	Ramp Type	Running slope	Cross slope	Landing	Notes	X	Y
1	2	1a193675-3020-436c-905c-a6237908afb	1/7/2021 22:23	jennifers127	1/25/2021 22:09	jennifers127	Fair or Better	48" or greater	Compliant (Truncated Domes w/ contrast color)	A	Perpendicular (triangular wings)	Up to or equal to 8.3%	Up to or equal to 2%	4 x 4 feet or greater		-122.2143024	48.00417755
2	3	52c0b7e8-e19a-4c7c-937f-7de7ba51e08	1/7/2021 22:27	jennifers127	2/1/2021 3:11	jennifers127	Fair or Better	48" or greater	Compliant (Truncated Domes w/ contrast color)	B	Parallel	Up to or equal to 8.3%	More than 2%	Less than 4 x 4 feet		-122.2143244	48.00430762
3	5	076ec07c-6bb7-466e-bd39-59aa902904cb	1/7/2021 22:37	jennifers127	1/31/2021 22:12	jennifers127				NA					Not required because no PAR exists to the West. It may be desirable to create a PAR to the West to access boat launch area SR 529.	-122.2177987	48.0042395
4	6	4b8f81da-336f-44c0-8772-c16d27ac106b	1/7/2021 22:47	jennifers127	2/1/2021 3:31	jennifers127	Poor	36" to > 48"	Compliant (Truncated Domes w/ contrast color)	B	Perpendicular (triangular wings)	More than 8.3%	Up to or equal to 2%	Less than 4 x 4 feet		-122.2211658	48.00399162
5	7	6bd30d2f-260a-43e1-a548-6cd2df95a193	1/7/2021 22:50	jennifers127	2/1/2021 3:31	jennifers127	Fair or Better	36" to > 48"	Compliant (Truncated Domes w/ contrast color)	A	Perpendicular (triangular wings)	Up to or equal to 8.3%	Up to or equal to 2%	4 x 4 feet or greater		-122.221158	48.00390151
6	8	dced1d47-3543-435e-a5fb-b2dd147456d7	1/7/2021 22:51	jennifers127	2/1/2021 3:30	jennifers127	Poor	36" to > 48"	Compliant (Truncated Domes w/ contrast color)	B	Perpendicular (triangular wings)	Up to or equal to 8.3%	More than 2%	4 x 4 feet or greater		-122.2211651	48.00381401
7	9	9a82e0a9-f39f-4459-b2af-6095f5bf23ef	1/7/2021 22:53	jennifers127	2/1/2021 3:30	jennifers127	Fair or Better	36" to > 48"	Compliant (Truncated Domes w/ contrast color)	A	Perpendicular (triangular wings)	Up to or equal to 8.3%	Up to or equal to 2%	4 x 4 feet or greater		-122.2211669	48.00370902
8	10	15f8624b-b3a5-42d5-b310-94cd9f9399f1	1/7/2021 22:55	jennifers127	2/1/2021 3:30	jennifers127	Fair or Better	36" to > 48"	Compliant (Truncated Domes w/ contrast color)	A	Perpendicular (triangular wings)	More than 8.3%	Up to or equal to 2%	4 x 4 feet or greater		-122.2211748	48.00364276
9	11	d0de8ac4-0c8b-4db7-b33b-28d42f1f08dfa	1/7/2021 22:57	jennifers127	2/1/2021 3:30	jennifers127	Fair or Better	36" to > 48"	Compliant (Truncated Domes w/ contrast color)	A	Perpendicular (triangular wings)	Up to or equal to 8.3%	Up to or equal to 2%	4 x 4 feet or greater		-122.2211712	48.00357833
10	12	6ed7e598-dfa2-4c4b-b418-df0826950591	1/7/2021 22:59	jennifers127	2/1/2021 3:28	jennifers127	Fair or Better	36" to > 48"	Compliant (Truncated Domes w/ contrast color)	A	Perpendicular (triangular wings)	Up to or equal to 8.3%	Up to or equal to 2%	4 x 4 feet or greater		-122.2210855	48.0034838
11	13	f6e209e7-c344-4337-bb5d-05781dabcf6b	1/7/2021 23:00	jennifers127	2/1/2021 3:27	jennifers127	Fair or Better	48" or greater	Compliant (Truncated Domes w/ contrast color)	A	Single Direction Parallel	Up to or equal to 8.3%	Up to or equal to 2%	4 x 4 feet or greater		-122.2210846	48.00339533
12	14	987f810-990e-4faa-8d58-1bcd8dbbada7a	1/7/2021 23:02	jennifers127	2/1/2021 3:28	jennifers127	Fair or Better	48" or greater	Compliant (Truncated Domes w/ contrast color)	A	Single Direction Parallel	Up to or equal to 8.3%	Up to or equal to 2%	4 x 4 feet or greater		-122.221374	48.00341377
13	15	cc31cff-zc99-469c-8e47-63bcdabdcd168	1/7/2021 23:08	jennifers127	2/1/2021 3:26	jennifers127	Fair or Better	48" or greater	Compliant (Truncated Domes w/ contrast color)	A	Single Direction Parallel	Up to or equal to 8.3%	Up to or equal to 2%	4 x 4 feet or greater		-122.2195806	48.0035654
14	16	cc31cff-zc99-469c-8e47-63bcdabdcd168	1/7/2021 23:08	jennifers127	2/1/2021 3:26	jennifers127	Fair or Better	48" or greater	Compliant (Truncated Domes w/ contrast color)	A	Single Direction Parallel	Up to or equal to 8.3%	Up to or equal to 2%	4 x 4 feet or greater		-122.2195303	48.00346883
15	17	6f18c82a-f16-4f03-9213-48dc82f09bfc	1/7/2021 23:10	jennifers127	2/1/2021 3:27	jennifers127	Fair or Better	48" or greater	Compliant (Truncated Domes w/ contrast color)	A	Blended Transition	Up to or equal to 8.3%	Up to or equal to 2%	4 x 4 feet or greater		-122.2195253	48.00337933
16	18	c9dd3707-2c98-4c1e-8ba2-16c7884ba6f7	1/7/2021 23:11	jennifers127	2/1/2021 3:27	jennifers127	Very Poor	48" or greater	No DWS (Non-Compliant)	D	Blended Transition	Up to or equal to 8.3%	Up to or equal to 2%	4 x 4 feet or greater		-122.2195253	48.00337933
17	19	cd48a255-520b-4179-9f25-9cd2528281a0	1/7/2021 23:13	jennifers127	2/1/2021 3:26	jennifers127	Poor	Less than 36"	Compliant (Truncated Domes w/ contrast color)	B	Perpendicular (triangular wings)	More than 8.3%	Up to or equal to 2%	4 x 4 feet or greater		-122.218945	48.00347255
18	20	badbbd47-0122-4ffb-98c9-c56a97881616	1/7/2021 23:15	jennifers127	2/1/2021 3:26	jennifers127	Poor	36" to > 48"	Compliant (Truncated Domes w/ contrast color)	B	Perpendicular (triangular wings)	More than 8.3%	Up to or equal to 2%	4 x 4 feet or greater		-122.2188143	48.0034676
19	21	b6434b7e-0f03-437f-acda-c0d9a80abb43	1/7/2021 23:17	jennifers127	2/1/2021 3:17	jennifers127	Very Poor	Less than 36"	Compliant (Truncated Domes w/ contrast color)	C	Perpendicular (triangular wings)	More than 8.3%	Up to or equal to 2%	4 x 4 feet or greater		-122.2179965	48.00346109
20	22	851e4e33-4170-4116-8808-2d2ba42c90a2	1/7/2021 23:25	jennifers127	2/1/2021 3:28	jennifers127	Fair or Better	36" to > 48"	Compliant (Truncated Domes w/ contrast color)	A	Perpendicular (triangular wings)	Up to or equal to 8.3%	Up to or equal to 2%	4 x 4 feet or greater		-122.217999	48.00335447
21	23	53dadad8-b0f7-4626-9334-b6da1780f427	1/7/2021 23:32	jennifers127	2/1/2021 3:16	jennifers127	Poor	48" or greater	Compliant (Truncated Domes w/ contrast color)	B	Parallel	Up to or equal to 8.3%	More than 2%	Less than 4 x 4 feet		-122.2178387	48.00346483
22	24	ec4bc4cb-2f48-4376-b991-24d34029fbd7	1/7/2021 23:33	jennifers127	2/1/2021 3:16	jennifers127	Poor	48" or greater	Compliant (Truncated Domes w/ contrast color)	B	Parallel	Up to or equal to 8.3%	Up to or equal to 2%	Less than 4 x 4 feet		-122.2178367	48.00333933
23	25	37d48aa1-e1ff-4de5-b109-05e72653549	1/7/2021 23:34	jennifers127	1/31/2021 22:15	jennifers127				NA	Unknown				Not required because there is no PAR to south. Consider closing sidewalk south of curb ramp.	-122.2178432	48.00326217
24	26	25020d6a-d889-4189-86b0e-494aad77aa5b	1/7/2021 23:51	jennifers127	2/1/2021 3:07	jennifers127	Very Poor	36" to > 48"	No DWS (Non-Compliant)	C	Blended Transition					-122.2178551	48.00268035
25	27	969a6f4f-fd90-406e-b32e-2c4b89203a8a	1/7/2021 23:52	jennifers127	2/4/2021 16:59	jennifers127	Missing			D						-122.21218	48.00268291
26	28	8cc982b6-1348-4e99-92df-5da8db4ad0c0	1/7/2021 23:53	jennifers127	2/1/2021 3:04	jennifers127	Fair or Better	48" or greater	Compliant (Truncated Domes w/ contrast color)	A	Single Direction Parallel	Up to or equal to 8.3%	Up to or equal to 2%	4 x 4 feet or greater		-122.2180384	48.00202349
27	29	ecca7e53-517c-40d9-a409-16e02460a7e	1/7/2021 23:55	jennifers127	2/1/2021 3:04	jennifers127	Fair or Better	48" or greater	Compliant (Truncated Domes w/ contrast color)	A	Single Direction Parallel	Up to or equal to 8.3%	Up to or equal to 2%	4 x 4 feet or greater		-122.2180491	48.00174059
28	30	798f88aa-ccb-4106-a0c4-6d871468af07	1/7/2021 23:57	jennifers127	2/1/2021 3:03	jennifers127	Fair or Better	48" or greater	Compliant (Truncated Domes w/ contrast color)	A	Perpendicular (triangular wings)	Up to or equal to 8.3%	Up to or equal to 2%	4 x 4 feet or greater		-122.2177635	48.00108422
29	31	50fcd63-41da-44b1-98f8-8926a18071ac	1/7/2021 23:59	jennifers127	2/1/2021 3:02	jennifers127	Fair or Better	48" or greater	Compliant (Truncated Domes w/ contrast color)	A	Perpendicular (triangular wings)	Up to or equal to 8.3%	Up to or equal to 2%	4 x 4 feet or greater		-122.2178771	48.00089022
30	32	ce64f29e-e674-455c-8b53-507ac7f5a10c	1/8/2021 0:00	jennifers127	2/1/2021 3:02	jennifers127	Fair or Better	48" or greater	Compliant (Truncated Domes w/ contrast color)	A	Perpendicular (triangular wings)	Up to or equal to 8.3%	Up to or equal to 2%	4 x 4 feet or greater		-122.217814	48.00088749
31	33	abb8a020-3151-417f-9a9e-a526c02a31e0	1/8/2021 0:01	jennifers127	2/1/2021 3:02	jennifers127	Fair or Better	48" or greater	Compliant (Truncated Domes w/ contrast color)	A	Perpendicular (triangular wings)	Up to or equal to 8.3%	More than 2%	4 x 4 feet or greater		-122.21771	48.00082638
32	34	264a3765-26b8-45dc-89e1-34d86d74da87	1/8/2021 0:03	jennifers127	2/1/2021 3:02	jennifers127	Fair or Better	48" or greater	Compliant (Truncated Domes w/ contrast color)	A	Perpendicular (triangular wings)	Up to or equal to 8.3%	Up to or equal to 2%	4 x 4 feet or greater		-122.2177042	48.00077899
33	35	c02c7b74-5f6f-4328-aaf2-9f50480f5d7	1/8/2021 0:06	jennifers127	2/1/2021 3:01	jennifers127	Fair or Better	48" or greater	Compliant (Truncated Domes w/ contrast color)	A	Single Direction Parallel	Up to or equal to 8.3%	Up to or equal to 2%	4 x 4 feet or greater		-122.2170476	48.00035033
34	36	2a30b5fd-6ba3-4dfb-a578-7bd1dc6e5eeb	1/8/2021 0:07	jennifers127	2/1/2021 3:01	jennifers127	Fair or Better	48" or greater	Compliant (Truncated Domes w/ contrast color)	A	Single Direction Parallel	Up to or equal to 8.3%	Up to or equal to 2%	4 x 4 feet or greater		-122.2171284	48.00030058
35	37	e947a815-039b-4aad-91b7-34e35c990c3b	1/8/2021 0:08	jennifers127	2/1/2021 2:59	jennifers127	Fair or Better	48" or greater	Compliant (Truncated Domes w/ contrast color)	A	Single Direction Parallel	Up to or equal to 8.3%	Up to or equal to 2%	4 x 4 feet or greater		-122.217175	48.00014919
36	38	47b9040f-2592-4257-a622-8a439b363b74	1/8/2021 0:09	jennifers127	2/1/2021 2:59	jennifers127	Fair or Better	48" or greater	Compliant (Truncated Domes w/ contrast color)	A	Single Direction Parallel	Up to or equal to 8.3%	Up to or equal to 2%	4 x 4 feet or greater		-122.2170801	48.00008489
37	39	480f9426-6d82-4174-a73b-8765dca87f	1/8/2021 0:16	jennifers127	2/1/2021 3:24	jennifers127	Poor	48" or greater	Compliant (Truncated Domes w/ contrast color)	B	Unknown	More than 8.3%	Up to or equal to 2%	4 x 4 feet or greater		-122.2180056	48.00300187
38	40	dcea522b-ee96-4678-ae11-8240b7c762f	1/8/2021 0:17	jennifers127	2/1/2021 3:25	jennifers127	Poor	48" or greater	Compliant (Truncated Domes w/ contrast color)	B	Unknown	Up to or equal to 8.3%	More than 2%	4 x 4 feet or greater		-122.2180154	48.00317129
39	41	9f36fca-d288-4cde-a084-ab854eb35b5b	1/8/2021 0:31	jennifers127	2/1/2021 3:00	jennifers127	Fair or Better	48" or greater	Compliant (Truncated Domes w/ contrast color)	A	Perpendicular (triangular wings)	Up to or equal to 8.3%	Up to or equal to 2%	4 x 4 feet or greater		-122.21674	48.00036205
40	42	b8130071-caba-4af4-a1fa-f42c52319453	1/8/2021 0:32	jennifers127	2/1/2021 2:58	jennifers127	Fair or Better	48" or greater	Compliant (Truncated Domes w/ contrast color)	A	Single Direction Parallel	Up to or equal to 8.3%	Up to or equal to 2%	4 x 4 feet or greater		-122.2166356	48.00019364
41	43	04623239-5baa-48cd-b850-465906b0497a	1/8/2021 0:33	jennifers127	2/1/2021 2:58	jennifers127	Fair or Better	48" or greater	Compliant (Truncated Domes w/ contrast color)	A	Single Direction Parallel	Up to or equal to 8.3%	Up to or equal to 2%	4 x 4 feet or greater		-122.2165132	48.00019317
42	44	8a581f78-8a81-4415-bd64-5266fa787a14	1/8/2021 0:37	jennifers127	2/1/2021 2:31	jennifers127	Fair or Better	48" or greater	Compliant (Truncated Domes w/ contrast color)	A	Perpendicular (triangular wings)	More than 8.3%	Up to or equal to 2%	4 x 4 feet or greater		-122.2160321	48.00010407
43	45	16281144-a140-4a3e-976c-fea8bed33f1d	1/8/2021 0:38	jennifers127	2/1/2021 2:31	jennifers127	Fair or Better	48" or greater	Compliant (Truncated Domes w/ contrast color)	A	Perpendicular (triangular wings)	Up to or equal to 8.3%	Up to or equal to 2%	4 x 4 feet or greater		-122.2140345	48.00030313
44	46	5a64fab8-f24c-436d-bb85-cac6d48b1233	1/8/2021 0:39	jennifers127	2/1/2021 2:32	jennifers127	Fair or Better	48" or greater	Compliant (Truncated Domes w/ contrast color)	A	Single Direction Parallel	Up to or equal to 8.3%	Up to or equal to 2%	4 x 4 feet or greater		-122.2147969	48.00014462
45	47	3e75c139-4dcd-46d4-96e7-faec7f1ea431	1/8/2021 0:40	jennifers127	2/1/2021 2:32	jennifers127	Fair or Better	48" or greater	Compliant (Truncated Domes w/ contrast color)	A	Single Direction Parallel	Up to or equal to 8.3%	Up to or equal to 2%	4 x 4 feet or greater		-122.2149199	48.00014175
46	48	a3a52020-38f7-44c5-9173-dc58964fc398	1/8/2021 0:42	jennifers127	2/1/2021 2:54	jennifers127	Poor	48" or greater	Compliant (Truncated Domes w/ contrast color)	B	Parallel	More than 8.3%	Up to or equal to 2%	4 x 4 feet or greater		-122.2154049	48.00017581
47	49	84cc897a-0cd7-4946-b804-80ae103ec5f5	1/8/2021 0:42	jennifers127	2/1/2021 2:54	jennifers127	Fair or Better	48" or greater	Compliant (Truncated Domes w/ contrast color)	A	Blended Transition					-122.2153961	48.00022015
48	50	64fd2189-fdae-4e0d-9ee2-b681adab89d4	1/8/2021 0:43	jennifers127	2/1/2021 2:52	jennifers127	Fair or Better	48" or greater	Compliant (Truncated Domes w/ contrast color)	A	Blended Transition					-122.2153944	48.00023465
49	51	f5108b5-5597-4c73-b074-cfe808d3d1e	1/8/2021 0:44	jennifers127	2/1/2021 2:52	jennifers127	Fair or Better	48" or greater	Compliant (Truncated Domes w/ contrast color)	A	Single Direction Parallel						



Sidewalk Barrier Inventory Map

Sidewalk Barrier Inventory Map

Sidewalks_Point

- Upheaval or Cracks
- Utility Pole/Box
- Vegetation
- Other
- Sign



Source: Esri, Maxar, GeoEye, Earthstar Geographics, CNES/Airbus DS, USDA, USGS, AeroGRID, IGN, and the GIS User Community



Sidewalk Barrier Inventory Spreadsheet

Port of Everett Sidewalk Barrier ADA Inventory (January 2021)

POE_ID	OBJECTID	GlobalID	CreationDate	Creator	EditDate	Editor	Condition	Width	Cross Slope	Running Slope	Obstacle	Notes	x	y
1	1	1830fc91-d95a-4c4a-9739-022deaabe550	1/10/2021 21:23	jennifers127	2/1/2021 3:45	jennifers127	Poor	48" or greater			Upheaval or Cracks	Multiple cracks and upheaval.	-122.2166827	47.99443681
2	2	48cbbe91-b425-4212-9f0e-cd8323291fc2	1/10/2021 21:25	jennifers127	1/25/2021 21:53	jennifers127	Poor				Other	Brick surface may be problematic. No upheaval.	-122.216281	47.99438034
3	3	4d3bdca0-449a-41f3-8c75-93daa03c87d1	1/10/2021 21:30	jennifers127	2/1/2021 3:45	jennifers127	Poor	48" or greater			Upheaval or Cracks	Roots, lip between brick and asphalt may be problematic.	-122.2160378	47.99435214
4	4	158b3d57-bb38-4a24-9d8d-8134a5c0dba2	1/10/2021 21:34	jennifers127	1/25/2021 21:53	jennifers127	Poor	48" or greater		Up to or equal to 5%	Upheaval or Cracks	Interacts with steep slopes area to bollarded curb at south West Marine parking lot entrance.	-122.214901	47.99434375
5	10	9ebe690c-8800-4041-b53c-4eefe315ca6d	1/10/2021 22:30	jennifers127	2/5/2021 21:39	jennifers127	Poor	Less than 36"	Up to or equal to 2%		Utility Pole/Box	May be NA	-122.2178558	48.00334812
6	11	3c17f0f2-3729-48a2-8c40-f19dd97cd750	1/10/2021 22:43	jennifers127	2/5/2021 21:39	jennifers127	Poor	48" or greater			Vegetation	Above ground blocking path of travel	-122.2184027	48.00347576
7	12	ffc9388a-f4fe-4d87-9394-c4dc0feb3166	1/10/2021 22:45	jennifers127	2/5/2021 21:39	jennifers127		Less than 36"			Sign	ADA sign creates less than 36" to pass	-122.2195594	48.00353317
8	13	769eb5a7-48df-4ee4-959c-136fa9ebfb4a	1/22/2021 17:55	jennifers127	2/5/2021 21:39	jennifers127	Poor	48" or greater			Other	Faded paint. Temporary hose blocking path of travel	-122.217739	48.00259983
9	14	8c1ef1cc-9e41-4c8a-92d1-9dc61d38058e	1/22/2021 19:15	jennifers127	2/5/2021 21:39	jennifers127					Upheaval or Cracks	Tripping hazard	-122.221387	47.99507433
10	15	4667279a-ad88-4a6d-9da4-92ed7105a83a	1/22/2021 19:18	jennifers127	2/5/2021 21:39	jennifers127				More than 8.3%	Other		-122.2216508	47.99520383
11	16	008c3877-d6f0-4a62-8cfe-62c013bc620c	1/22/2021 19:20	jennifers127	2/5/2021 21:39	jennifers127	Poor				Upheaval or Cracks	Tripping hazard	-122.2220355	47.99518467
12	17	bce28d67-2ebb-448d-976a-7ae74240201a	1/22/2021 19:21	jennifers127	2/5/2021 21:39	jennifers127	Very Poor				Upheaval or Cracks	Tripping hazard	-122.2220712	47.99515267
13	18	4888fa02-37de-41f8-826f-0c8f801a139a	1/22/2021 19:22	jennifers127	2/5/2021 21:39	jennifers127	Poor				Upheaval or Cracks		-122.2222995	47.995161
14	19	b9f46d43-79a8-4cd7-9cd8-4a5c14e14017	1/22/2021 19:44	jennifers127	2/5/2021 21:39	jennifers127					Upheaval or Cracks		-122.2229182	47.99499356
15	20	770cf5b7-80ff-47d9-b8d7-00fb99d4f3e4	1/22/2021 20:06	jennifers127	2/5/2021 21:39	jennifers127	Poor				Vegetation		-122.2183331	47.99511707
16	21	3aacbeca-d1b2-4418-87a7-3680887a0daa	1/22/2021 20:06	jennifers127	2/5/2021 21:39	jennifers127	Poor				Vegetation		-122.2181735	47.99521748
17	22	38d42a38-a7c3-4260-b833-5994f29c96ca	1/22/2021 20:10	jennifers127	2/5/2021 21:39	jennifers127	Poor				Upheaval or Cracks	Settled panel	-122.2156997	47.99520458



Driveway/Sidewalk Interface (DSI) Inventory Map

Driveway/Sidewalk Interface (DSI) Inventory Map

POE_SWDWInterface

- Fair or Better
- Poor
- Very Poor
- Missing (Needed but does not exist)
- Other



Source: Esri, Maxar, GeoEye, Earthstar Geographics, CNES/Airbus DS, USDA, USGS, AeroGRID, IGN, and the GIS User Community



Driveway/Sidewalk Interface (DSI) Inventory Spreadsheet

Port of Everett Driveway/Sidewalk Interface (DSI) ADA Inventory (January 2021)

POE_ID	OBJECTID	GlobalID	CreationDate	Creator	EditDate	Editor	Condition	Width	Cross Slope	Running Slope	Notes	Dwy Type	x	y
1	3	1cf025ce-471b-4851-9780-5093838d8555	1/10/2021 22:06	jennifers127	2/5/2021 21:38	jennifers127	Fair or Better	48" or greater	Up to or equal to 2%	Up to or equal to 8.3%		Option A	-122.216281	48.00029389
2	4	54b219a9-51aa-4725-91ca-75004ae81c4c	1/10/2021 22:10	jennifers127	2/5/2021 21:38	jennifers127	Poor	36" to > 48"	More than 2%	Up to or equal to 8.3%	PAR is in sloped driveway but driveway does not access a property as of Jan 2021.	Option B	-122.2143866	48.00029329
3	5	6e544335-1cc9-495d-b9a8-29effbb43cda	1/10/2021 22:19	jennifers127	2/5/2021 21:38	jennifers127	Fair or Better	48" or greater	Up to or equal to 2%	Up to or equal to 8.3%		Option D	-122.2146992	48.00012954
4	6	48f1b853-0524-4e75-b51a-c0afd76b4563	1/10/2021 22:22	jennifers127	2/5/2021 21:38	jennifers127	Fair or Better	48" or greater	Up to or equal to 2%	Up to or equal to 8.3%	See adjacent curb ramps	Option D	-122.2165814	48.00022344
5	7	78c30716-b7b7-47bd-ad3b-3655f1a1305c	1/10/2021 22:26	jennifers127	2/5/2021 21:38	jennifers127	Fair or Better	48" or greater	Up to or equal to 2%	Up to or equal to 8.3%	DWS may be unnecessary	Option D	-122.2180387	48.00189672
6	8	c7b76da5-6720-41ed-aa7f-76af780e26c7	1/10/2021 22:28	jennifers127	2/5/2021 21:38	jennifers127	Very Poor	48" or greater	More than 8.3%	More than 8.3%	Utilities and sidewalk settling causes tripping hazard.	Option D	-122.2180248	48.00308359
7	9	f5d1045f-c0b8-4ed5-94a4-90c204abbd97	1/10/2021 22:33	jennifers127	2/5/2021 21:38	jennifers127	Fair or Better	48" or greater	Up to or equal to 2%	Up to or equal to 8.3%		Option B	-122.2175516	48.0042604
8	10	6095846c-da91-4698-a7df-7bd840f14c08	1/10/2021 22:35	jennifers127	2/5/2021 21:38	jennifers127	Fair or Better	36" to > 48"	Up to or equal to 2%	Up to or equal to 8.3%		Option B	-122.2158153	48.00422019
9	11	5efaff39-9547-42d2-87a0-a3ebddeb30f6	1/10/2021 22:36	jennifers127	2/5/2021 21:38	jennifers127	Fair or Better	48" or greater	Up to or equal to 2%	Up to or equal to 8.3%		Option B	-122.2151999	48.00420958
10	12	b0132290-d2f0-43b3-9677-b2fb78042077	1/10/2021 22:38	jennifers127	2/5/2021 21:38	jennifers127	Fair or Better	48" or greater	Up to or equal to 2%	Up to or equal to 8.3%		Option B	-122.2148818	48.00420698
11	15	50f02bb7-5b1d-4ce1-891b-6729c12c3254	1/15/2021 0:41	jennifers127	2/5/2021 21:38	jennifers127	Very Poor	Less than 36"	More than 2%	More than 8.3%	Poles block path of travel	Option A	-122.2148267	47.99430124



Appendix C

Recreational Facilities ADA Assessments

How to Read Assessment Spreadsheets

List of Abbreviations - Recreational Facilities

1. Marina Waterfront Trail System
2. Jetty Landing (10th Street) Boat Launch
3. Jetty Landing Park and Jetty Island Ferry Dock
4. Waterfront Center Exterior Access
5. Boxcar Park
6. South Guest Dock 2 (Accessible Dock)
7. South Marina Parking Lot



How to Read the Assessment Spreadsheets

1. The 1st column is the identity mark, typically the priority number (1, 2, 3, or 4) followed by an identifying number. These may or may not be in order depending on whether non relevant rows have been hidden.
2. The 2nd column describes the compliance issue in the form of a question. The compliant measurement or count is identified in the question. If the response to the question is 'yes' the issue is compliant.
3. The 3rd and 4th columns are the 'yes' and 'no' responses, and measurements taken in the field. If the issue is compliant and the 'yes' box is checked, there may or may not be a measurement included. If the 'no' box is checked, the issue is non-compliant, and a measurement or count will indicate how the issue is noncompliant.
4. The 5th column may contain a pictogram or drawing of the issue being evaluated. This may also include a sketch of what the evaluator found in the field as it related to the condition being evaluated.
5. The 6th column may contain a photo of the field condition. Only a select number of conditions are photographed to keep the digital file size manageable.
6. The last column may contain a list of suggested corrections. These are helpful to the cost estimating team but may not reflect all of the work required to move or replace an item to bring it into compliance. There may be some economy of scale when multiple non-compliance issues can be completed with one action. There may also be several ways to make corrective changes. How changes and corrections are made will depend on several things, most importantly the existing conditions. These typically are addressed as part of a design process.
7. Some cells are highlighted yellow. The yellow highlighted cells are identifying non-compliance issues. The yellow is used simply to make the non-compliant issues easier to find among the large number of pages.
8. If no boxes are checked, or it is labeled as "N/A" (not applicable), that particular issue does not apply to the instance being evaluated.



List of Abbreviations - Recreational Facilities

CB - Catch Basin

CR - Curb Ramp

DF - Drinking Fountain

P1 - Priority 1

P2 - Priority 2

P3 - Priority 3

P4 - Priority 4

PKG - Parking

PKG BP1 - Parking Boxcar Park 1

PKG BP2 - Parking Boxcar Park 2

PKG WFC1 - Parking Waterfront Center 1

PKG WFC2 - Parking Waterfront Center 2

SM CR - South Marina Curb Ramp

SM-1 - South Marina Parking Area 1

SM-2 - South Marina Parking Area 2

SM-3 - South Marina Parking Area 3

SM-4 - South Marina Parking Area 4

SM PKG - South Marina Parking Stalls

TB - Table and Bench

T&R - Trash and Recycling

WFC - Waterfront Center



1. Marina Waterfront Trail System

DATE OF EVALUATION

1/22/2021

Figure 6. Recreational Facilities to Be Assessed for ADA Compliance - Phase I



ADA Evaluation

FOR

Marina Waterfront Trail System

Port of Everett

ADA Transition Plan



Based on the 2010 ADA Standards for Accessible Design

Completed by:

design2 LAST, inc

534 Main St, Suite 101
Edmonds, WA 98020

Notes Regarding ADA Evaluation for this facility

Each file contains an aerial view of the site as shown on Google. If plans for the facilities were available, they are included. If room names or numbers are not indicated on those plans, fictional room names and numbers were given to spaces to correlate them to the enclosed checklists. These are intended to be used for the purpose of locating which rooms pertain to which portion of the checklist, and may or may not represent the actual room numbers and names at the facility.

How to read these checklists:

1. The 1st column is the identity mark, typically the priority number (1, 2, 3, or 4) followed by an identifying number. These may or may not be in order depending on whether non relevant rows have been hidden.
2. The 2nd column describes the compliance issue in the form of a question. The compliant measurement or count is identified in the question. If the response to the question is 'yes' the issue is compliant.
3. The 3rd and 4th columns are the 'yes' and 'no' responses, and measurements taken in the field. If the issue is compliant and the 'yes' box is checked, there may or may not be a measurement included. If the 'no' box is checked, the issue is non-compliant, and a measurement or count will indicate how the issue is noncompliant.

ADA Checklist for Existing Facilities

The Americans with Disabilities Act (ADA) requires state and local governments, businesses and non-profit organizations to provide goods, services and programs to people with disabilities on an equal basis with the rest of the public.

Some people think that only new construction and alterations need to be accessible and that older facilities are "grandfathered," but that's not true. Because the ADA is a civil rights law and not a building code, older facilities are often required to be accessible to ensure that people with disabilities have an equal opportunity to participate.

The ADA has different requirements for state and local governments and for places of public accommodation (businesses and non-profit organizations that serve the public).

Requirements for State and Local Governments

State and local governments must ensure that services, programs and activities, when viewed in their entirety, are accessible to people with disabilities. This is part of public entities' program accessibility obligations. Alterations to older buildings may be needed to ensure program accessibility. Generally this is a greater obligation than "readily achievable barrier removal" the standard that applies to public accommodations. State and local governments are not required to take any action that would result in undue financial and administrative burdens.

State and local governments' ADA obligations for program accessibility are in the Department of Justice's ADA Title II regulations 28 CFR Part 35.150.

Requirements for Places of Public Accommodation

Businesses and non-profit organizations that serve the public must remove architectural barriers when it is "readily achievable" to do so; in other words, when barrier removal is "easily accomplishable and able to be carried out without much difficulty or expense."

The decision of what is readily achievable is made considering the size, type, and overall finances of the public accommodation and the nature and cost of the access improvements needed. Barrier removal that is difficult now may be readily achievable in the future as finances change.

4. The 5th column may contain a pictogram or drawing of the issue being evaluated. This may also contain a sketch of what the evaluator found in the field as it related to the condition being evaluated.
5. The 6th column may contain a photo of the field condition. Only a select number of conditions are photographed to keep the file size manageable.
6. The last column may contains a list of suggested corrections. These are helpful to the cost estimating team but may not reflect the amount of work required to move or replace an item to bring it into compliance. There may be some economy when multiple non-compliance issues can be completed with one action. There may also be several ways to make corrective changes. How changes and corrections are made will depend on several things, most importantly the existing conditions. These typically are addressed in a design process.
7. Some cells are highlighted yellow. The highlighted cells are identifying non-compliance issues. The yellow is used simply to make the non-compliant issues easier to find among the large number of pages.
8. If no boxes are checked, or there is a slash thru the compliance issue, that particular issue does not apply to the instance being evaluated.

Public accommodations' ADA obligations for barrier removal are in the Department of Justice's ADA Title III regulations 28 CFR Part 36.304.

Priorities for Accessibility

The checklist follows the four priorities that are listed in the Department of Justice ADA Title III regulations. These priorities are equally applicable to state and local government facilities.

Priority 1 - Accessible approach and entrance

Priority 2 - Access to goods and services

Priority 3 - Access to public toilet rooms

Priority 4 - Access to other items such as water fountains and public telephones

2010 ADA Standards for Accessible Design

The checklist is based on the 2010 ADA Standards for Accessible Design (2010 Standards). The checklist may not include all sections of the 2010 Standards. Consult the 2010 Standards for situations not covered in the checklist. Full compliance with the 2010 Standards is required only for new construction and alterations.

Safe Harbor – Construction Prior to March 15, 2012

Elements in facilities built or altered before March 15, 2012 that comply with the 1991 ADA Standards for Accessible Design (1991 Standards) are not required to be modified to specifications in the 2010 Standards. For example, the 1991 Standards allow 54 inches maximum for a side reach range to a control such as the operating part of a paper towel dispenser. The 2010 Standards lower that side reach range to 48 inches maximum. If a paper towel dispenser was installed prior to March 15, 2012 with the highest operating part at 54 inches, the paper towel dispenser does not need to be lowered to 48".

What this Checklist is Not

The ADA Title II and III regulations require more than program accessibility and barrier removal. The regulations include requirements for nondiscriminatory policies and practices and for the provision of auxiliary aids and services, such as sign language interpreters for people who are deaf and material in Braille for people who are blind. This checklist does not cover those requirements.

Since this checklist does not include all of the 2010 Standards it is not intended to determine compliance for new construction or facilities being altered.

Resources**U.S. Department of Justice ADA Information**

800-514-0301 voice: 800-514-0383 TTY
www.ada.gov

ADA National Network

800-949-4232 voice/TTY connects to
your regional ADA Center:
www.adata.org

U.S. Access Board

800- 872-2253 voice: 800-993-2822 TTY
www.access-board.gov

[ADA Title III Regulations 28 CFR Part 36
www.ada.gov/regs2010/titleIII_2010/titleII_2010_regulations.htm](http://www.ada.gov/regs2010/titleIII_2010/titleII_2010_regulations.htm)

[2010 ADA Standards for Accessible
Design
www.ada.gov/2010ADASTandards_index.htm](http://www.ada.gov/2010ADASTandards_index.htm)

[1991 ADA Standards for Accessible
Design
www.ada.gov/stdspdf.htm](http://www.ada.gov/stdspdf.htm)

Acknowledgements

The Institute for Human Centered Design and the New England ADA Center created the ADA Checklists. Originals can be accessed at www.adachecklist.org.

What are Public Accommodations?

Under the ADA public accommodations are private entities that own, lease, lease to or operate a place of public accommodation. This means that both a landlord who leases space in a building to a tenant and the tenant who operates a place of public accommodation have responsibilities to remove barriers.

A place of public accommodation is a facility whose operations affect commerce and fall within at least one of the following 12 categories:

- 1) Places of lodging (e.g., inns, hotels, motels, except for owner-occupied establishments renting fewer than six rooms)
- 2) Establishments serving food or drink (e.g. , restaurants and bars)
- 3) Places of exhibition or entertainment (e.g. , motion picture houses, theaters, concert halls, stadiums)
- 4) Places of public gathering (e.g. , auditoriums, convention centers, lecture halls)
- 5) Sales or rental establishments (e.g. , bakeries, grocery stores, hardware stores, shopping centers)
- 6) Service establishments (e.g. , laundromats, dry-cleaners, banks, barber shops, beauty shops, travel services, shoe repair services, funeral parlors, gas stations, offices of accountants or lawyers, pharmacies, insurance offices, professional offices of health care providers, hospitals)
- 7) Public transportation terminals, depots, or stations (not including facilities relating to air transportation)
- 8) Places of public display or collection (e.g. , museums, libraries, galleries)
- 9) Places of recreation (e.g. , parks, zoos, amusement parks)
- 10) Places of education (e.g. , nursery schools, elementary, secondary, undergraduate, or postgraduate private schools)
- 11) Social service center establishments (e.g. , day care centers, senior citizen centers, homeless shelters, food banks, adoption agencies)
- 12) Places of exercise or recreation (e.g. , gymnasiums, health spas, bowling alleys, golf courses).

Many of the illustrations are from the U.S. Department of Justice and the U.S. Access Board or are based on illustrations produced by the U.S. Access Board and the

New sections added to Appendix A to Chapter 10

F201.4 Requirements Apply to Facilities Constructed or Altered by or on Behalf of Federal Agencies.

The requirements in F216.13, F244 through F248, and 1011 through 1019 shall apply only to facilities constructed or altered by federal agencies or by non-federal entities on federal land on behalf of federal agencies pursuant to a concession contract, partnership agreement, or similar arrangement.

F201.4.1 Documentation and Notification When Exceptions Used for Trails and Beach Access

Routes. Federal agencies shall document the basis for not fully complying with a specific provision in 1017 or 1018 on a portion of a trail or beach access route based on Exception 1 in 1017 or Exception 1 in 1018, and shall maintain the documentation with the records for the trail or beach project. Federal agencies shall notify the Access Board if an entire trail is exempted from complying with 1017 based on Exception 2 in 1017.1, and if a beach access route is not provided based on Exception 2 in 1018.1.6)

F202.3 Alterations. * * * * *

EXCEPTIONS: * * * * *

4. Where elements or spaces are altered in camping facilities, picnic facilities, viewing areas, or trailheads and the circulation path to the altered element or space is not altered, the circulation path shall not be required to comply with 1016.

F202.4 Alterations Affecting Primary Function Areas. * * * * *

EXCEPTIONS: * * * * *

2. Camping facilities, picnic facilities, viewing areas, trailheads, trails, and beach access routes shall not be required to comply with F202.4.

F206.1 General. * * * * *

EXCEPTIONS: 1. Accessible routes shall not be required where outdoor recreation access routes are provided at camping facilities in accordance with F244.5, picnic facilities in accordance with F245.4, viewing areas in accordance with F246.3, or trailheads in accordance with F247.3.2.

2. Accessible routes shall not be required where camping facilities, picnic facilities, viewing areas, or outdoor constructed features are provided on trails.

3. Accessible routes shall not be required where beach access routes are provided in accordance with F248.

F212.3 Sinks. * * * * *

EXCEPTIONS: * * * * *

2. In camping facilities and picnic facilities, sinks shall not be required to comply with F212.3 where a cooktop or conventional range is not provided.

F213.1 General. * * * * *

EXCEPTION: Pit toilets provided on trails and in camping facilities shall not be required to comply with F213

F216.13 Trailhead Signs. Where new trail information signs are provided at trailheads on newly constructed or altered

SUMMARY

Marina Waterfront Trail System

Due to the linear nature of this facility and its extensive length, this evaluation section is presented differently than the typical evaluations.

The Port's entire Marina Waterfront Trail System is approximately four (3.5) miles long. As part of the first phase of this Plan, all 3.5 miles of Trail was evaluated. To make this checklist easier to follow, the trail is divided into seven areas, numbered from north to south. To facilitate easier identification, some of these areas are further divided up into sections such as east or west. For example, Area 6 is divided up into four sections: northwest, northeast, southwest and southeast. For a map of the seven areas and their subdivided sections, see **Figures 8-9** and individual evaluation in **Appendix C**.

Each area contains some Priority 1 and Priority 2 items. Under the ADA Title III regulations, certain aspects of accessibility for public accommodations are assigned a priority level. See section D.3.1 for explanation of these priority levels. Parking (PKG) and Curb Ramps (CR) are Priority 1 items, all others (such as the route, benches, picnic tables, etc.) are Priority 2 (access to services). The plans for each of the areas identify the items found in each with notes and may have an abbreviation and a number. Similar type items may have the same number (i.e. Bench 3 is the same in each condition where it occurs) unless different dimensions were found.

The majority of the trail has compliant slopes for accessibility. Some exceptions that should be addressed follow.

1. The self-assessment inventory plans identify many locations where non-compliant running and cross slopes were measured.
2. Benches Type 1 at the northern end of the trail are typically placed in the grass off the path without an adjacent wheelchair space.
3. The asphalt trail at the south side of the North Marina (Area 2) has a higher amount of non-compliant cross slopes.
4. All three ramps leading around the former Yacht Club building (currently vacated and slated for future redevelopment) located in the Northwest corner of the Central Marina (Area 3) need to be reconstructed to bring them into compliance.
5. The trail is mostly new construction at Area 4 and is compliant.
6. In Area 5, between the new Seiner Wharf and the accessible South Guest Dock 2, there is large section of pier where the boards are very weathered and worn. There are non-compliant gaps, protruding nails, and vertical bumps greater than 1" high. These boards should be replaced or refinished.
7. The trail along the north side of the South Marina (the north sections of Areas 6 and 7) is concrete and has mostly compliant slopes. There are non-compliant gaps and bumps in locations where the trail joins the entry to the marina access gates. Typically, this is where flat concrete meets pavers and the pavers meet boards. The map indicates the locations where these were found.
8. The four (4) picnic tables provided along the trail at Areas 6 and 7 do not have a wheelchair compliant space. At least two of the four (4) tables should be replaced.
9. In Area 6, at the western end where there are four buildings surrounding a parking lot, the "alleys" created between the buildings have non-compliant slopes to go from the parking lot to the trail. At a minimum, a 36" wide level concrete path should be added to navigate these areas from the parking lot.
10. The curb ramps from the parking lot to the sidewalk near the building in Area 6 also need to be demolished and rebuilt with compliant slopes.
11. The curvy, asphalt portion of the trail at the far south end of the marina (the south sections of Areas 6 and 7) has many sections with non-compliant cross slopes. These slope back and forth from north to south and back again along the entire pathway. The plan shows some of the non-compliant areas. Typically, the steepest slope in a section was indicated on the plan.
12. The drinking fountain near Bench 9 should be replaced with a compliant outdoor HiLo® fountain.
13. The approximately 20 foot section of trail leading east from the drinking fountain should be replaced with a concrete ramp that includes handrails due to the steep slope.
14. In Area 7, where the trail crosses the driveway to the buildings at the SE corner of the marina, the running slopes are very steep. These sections of trail should either be outfitted with handrails or rebuilt to compliant slopes (<5% running and <2% cross).

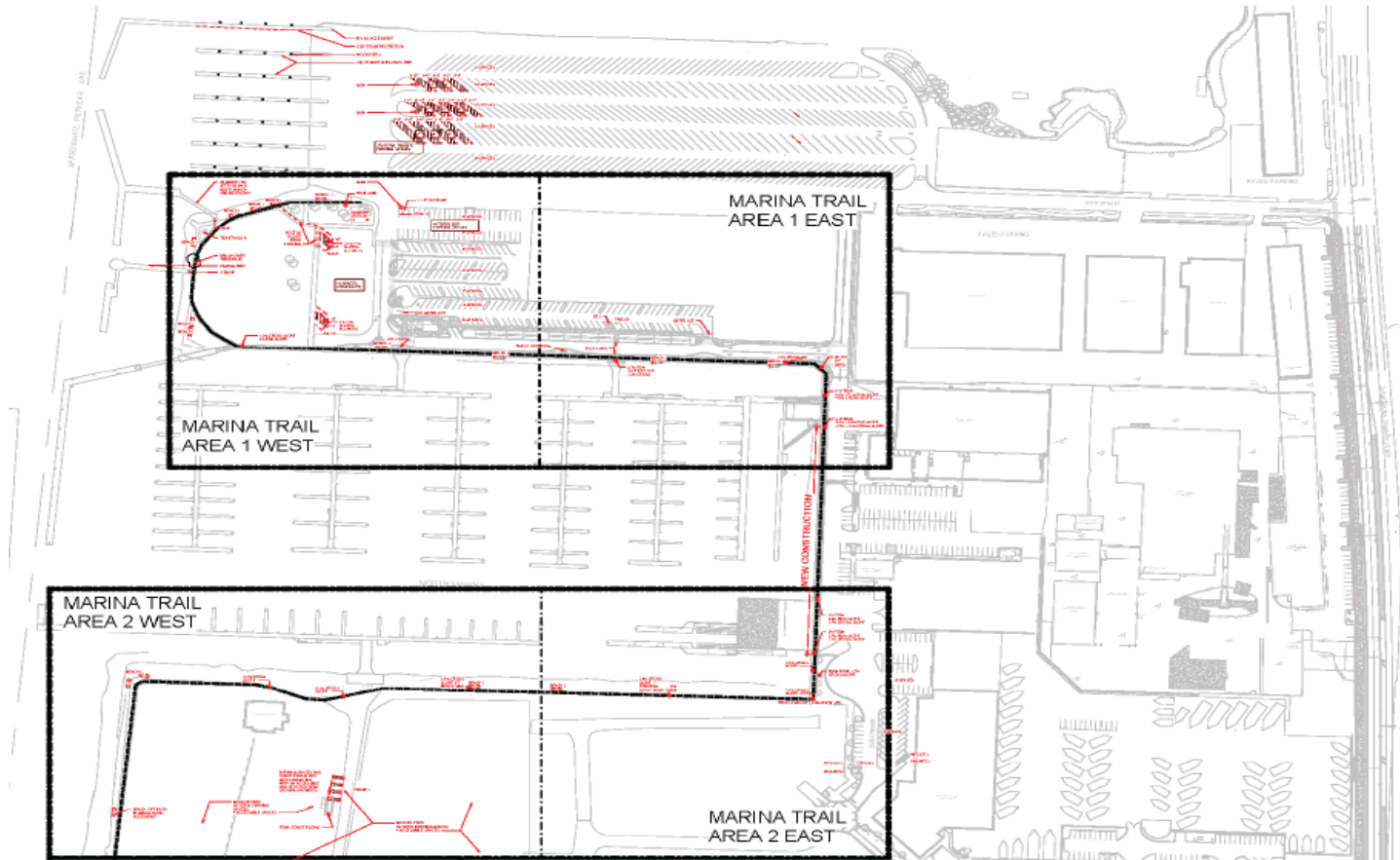

MARINA WATERFRONT TRAIL SYSTEM - NORTH (DASHED LINE)

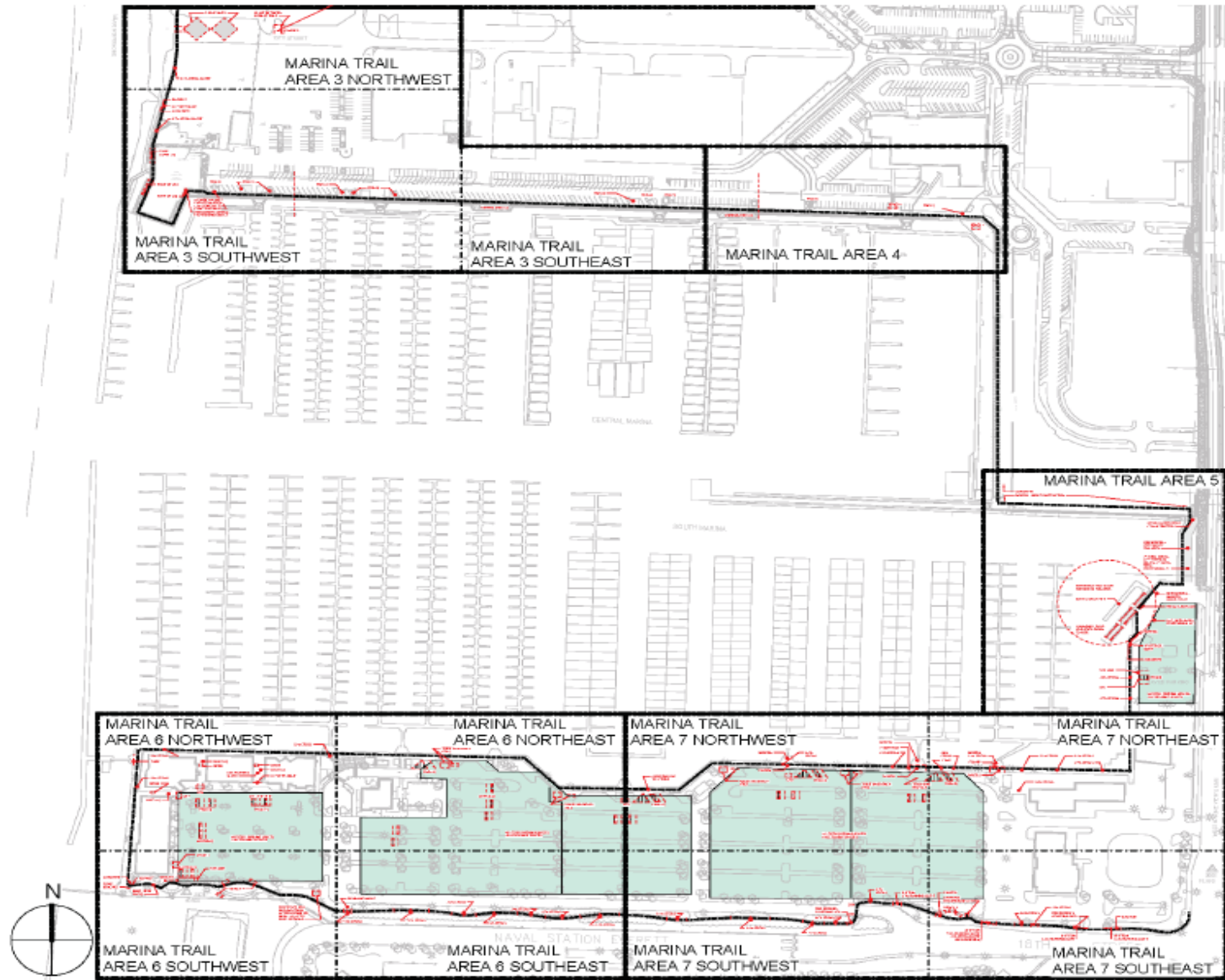

MARINA WATERFRONT TRAIL SYSTEM - SOUTH/CENTRAL (DASHED LINE)

ADA Checklist for Existing

Priority 1 - Approach & Entrance

Based on the 2010 ADA Standards for Accessible Design



Project: ADA Transition Plan

Building: Marina Waterfront Trail System

Location: Everett, WA

Date: 1/22/2021

Surveyors: Lauri Strauss, AIA, LEED AP BD&C
President, CEO, design2 LAST, inc

Contact Information: o. 425-673-7269 c. 907-317-5040

543 Main St, Suite 101, Edmonds, WA 98020

An accessible route from site arrival points and an accessible entrance should be provided for everyone.

Priority 1 - Approach & Entrance					Comments	Possible Solutions
1.001	Is there at least one route from site arrival points (parking, passenger loading zones, public sidewalks and public transportation stops) that does not require the use of stairs? [See 2010 ADA Standards for Accessible Design – 206.2.1]	<input checked="" type="checkbox"/> YES If yes, location of route:	<input type="checkbox"/> NO		Photo:	<ul style="list-style-type: none"> • Add a ramp • Regrade to 1:20 maximum slope • Add a lift if site constraints prevent other solutions

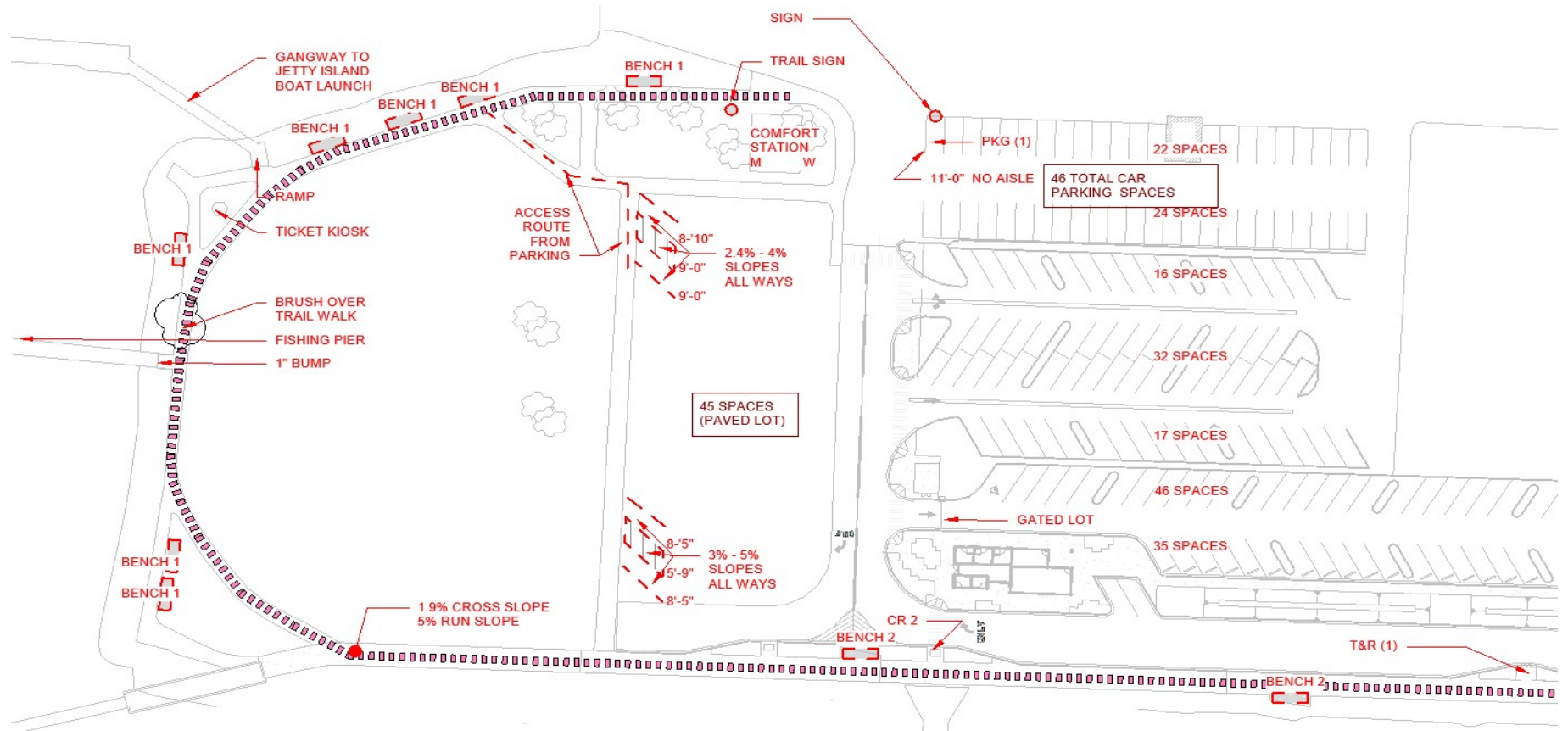

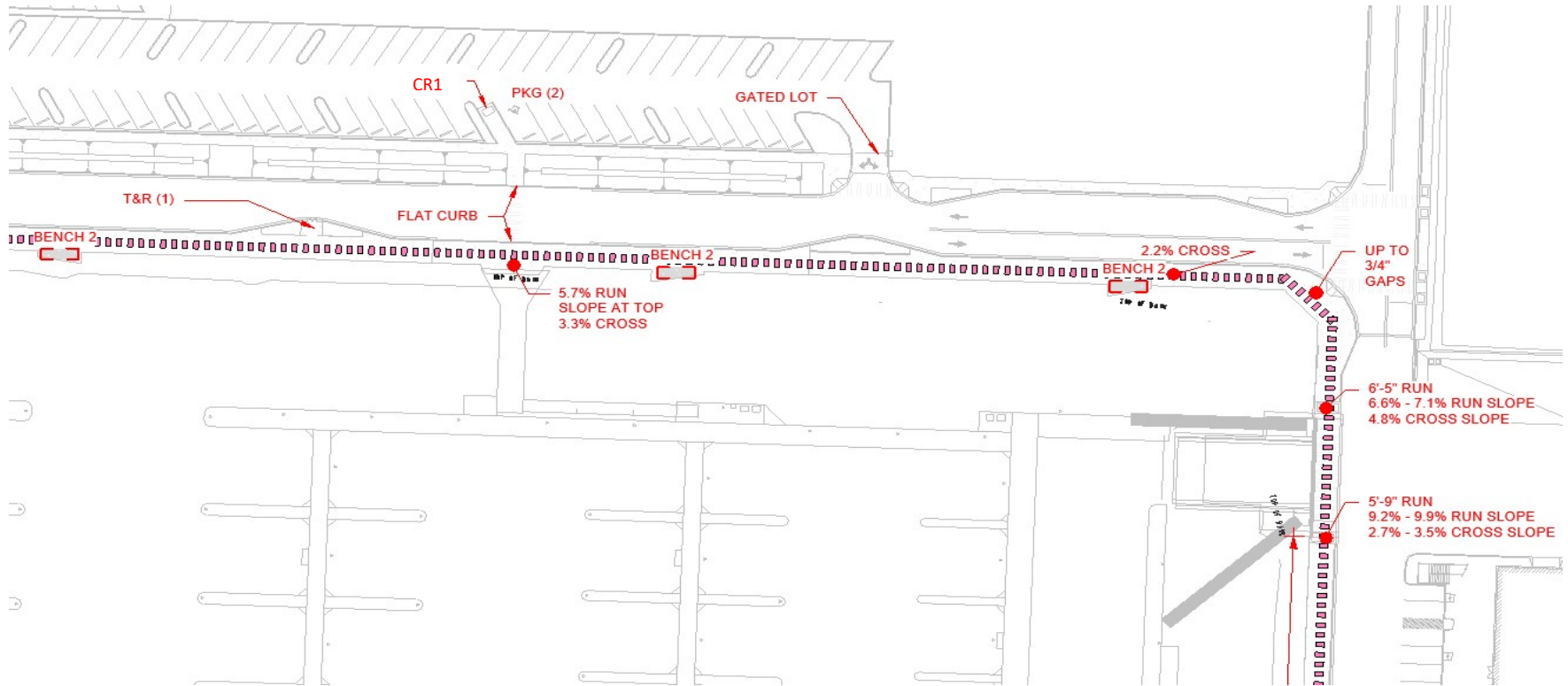

AREA 1 WEST - MARINA WATERFRONT TRAIL (PINK DASHED LINE)



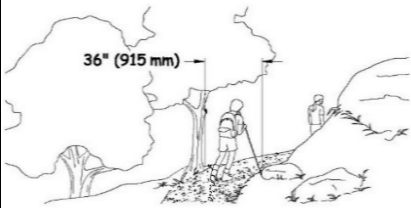

AREA 1 EAST - MARINA WATERFRONT TRAIL (PINK DASHED LINE)

Trail [1017] (pedestrian route developed primarily for outdoor recreational purposes) (A pedestrian route developed primarily to connect elements, spaces, or facilities within a site is not a trail)					
2.220	Trails shall comply with 1017 [F247]			EXCEPTIONS: 1. When an entity determines that a condition in 1019 does not permit full compliance with a specific provision in 1017 on a portion of a trail, the portion of the trail shall comply with the provision to the extent practicable. 2. After applying Exception 1, when an entity determines that it is impracticable for the entire trail to comply with 1017, the trail shall not be required to comply with 1017.	
2.221	If the trail is designed for hikers or pedestrians, does the trail directly connect to a trailhead or another accessible trail?	<input checked="" type="checkbox"/> YES	<input type="checkbox"/> NO		• Modify route • Provide new route Photo #:
2.223	Is the surface of trails, passing spaces, and resting intervals stable, firm and slip-resistant? [40.2, 302.1]	<input checked="" type="checkbox"/> YES Material: ASPHALT CONC BOARDS	<input type="checkbox"/> NO	A firm trail surface resists deformation by indentations. A stable trail surface is not permanently affected by expected weather conditions and can sustain normal wear and tear from the expected uses between planned maintenance.	• Replace Surface • Recover Surface Photo #:
2.224	Is the clear tread width of trails 36 inches (915 mm) minimum? [1017.3]	<input checked="" type="checkbox"/> YES Measurement:	<input type="checkbox"/> NO		• Modify route • Provide new route Photo #:

Trailhead (outdoor space that serves as the access point to a trail - not the junction of trails and/or roads)						
2.241	If Outdoor Constructed Features are provided within the trailhead, are at least 20 percent, but not less than one, of each type of outdoor constructed feature compliant with 1011? (reference Outdoor Constructed Features table)	<input checked="" type="checkbox"/> YES Number: 1 EA T&R	<input type="checkbox"/> NO	OUTDOOR CONSTRUCTED FEATURES: Picnic Tables Trash and Recycling Benches Viewing Scopes		<ul style="list-style-type: none"> • Add outdoor constructed features
2.244	Do trail information signs at trailheads include the following: 1. Length of the trail or trail segment?	<input type="checkbox"/> YES	<input checked="" type="checkbox"/> NO NO TRAIL INFO			<ul style="list-style-type: none"> • Add information to sign • Provide new sign
	2. Surface type?	<input type="checkbox"/> YES	<input checked="" type="checkbox"/> NO			
	3. Typical and minimum tread width?	<input type="checkbox"/> YES	<input checked="" type="checkbox"/> NO			
	4. Typical and maximum running slope?	<input type="checkbox"/> YES	<input checked="" type="checkbox"/> NO			
	5. Typical and maximum cross slope?	<input type="checkbox"/> YES	<input checked="" type="checkbox"/> NO		Photo #:	

Outdoor Recreation Access Routes [1016]

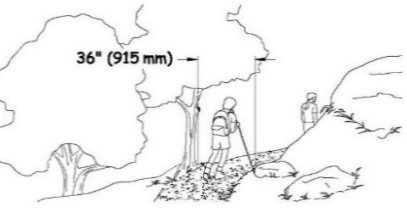
(A pedestrian route developed primarily to connect elements, spaces, or facilities within a site is not a trail)

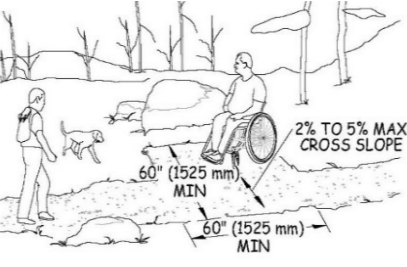
<p>2.200</p>	<p>Outdoor Recreation Access Routes shall comply with 1016 [F247]</p>			<p>EXCEPTIONS: 1. In alterations to existing camping facilities, picnic facilities, and trailheads, when an entity determines that a condition in 1019 does not permit full compliance with a specific provision in 1016 on a portion of an outdoor recreation access route, the portion of the outdoor recreation access route shall comply with the provision to the extent practicable.</p> <p>2. At viewing areas, when an entity determines that a condition in 1019 does not permit full compliance on a portion of an outdoor recreation access route with a specific provision in 1016, the portion of the outdoor recreation access route shall comply with the provision to the extent practicable.</p> <p>3. Where outdoor recreation access routes are provided within vehicular ways, outdoor recreation access routes shall not be required to comply with 1016.4, 1016.7, and 1016.8.</p>		
<p>2.201</p>	<p>Is the surface of outdoor recreation access routes, passing spaces, and resting intervals stable, firm and slip-resistant? [40.2, 302.1]</p>	<p><input checked="" type="checkbox"/> YES Material: ASPHALT</p>	<p><input type="checkbox"/> NO</p>	<p>A firm trail surface resists deformation by indentations. A stable trail surface is not permanently affected by expected weather conditions and can sustain normal wear and tear from the expected uses between planned maintenance.</p>	<p>Photo #:</p>	<ul style="list-style-type: none"> • Modify surface • Replace Surface
<p>2.202</p>	<p>Is the clear width of the outdoor recreation access route 36 inches (915 mm) minimum? [1016.3]</p>	<p><input checked="" type="checkbox"/> YES Measurement: ~7'-0"</p>	<p><input type="checkbox"/> NO</p>			<ul style="list-style-type: none"> • Modify route • Provide new route
<p>2.203</p>	<p>If the outdoor recreation access route width is less than 60 inches (1525 mm) are passing spaces provided at intervals of 200 feet (61 m) maximum? (Passing spaces and resting intervals shall be permitted to overlap.)</p>	<p><input checked="" type="checkbox"/> YES Measurement:</p>	<p><input type="checkbox"/> NO</p>		<p>Photo #:</p>	<ul style="list-style-type: none"> • Modify route • Provide passing spaces

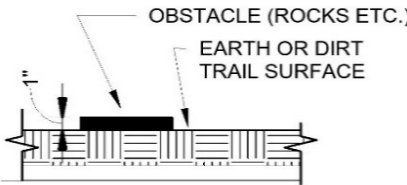
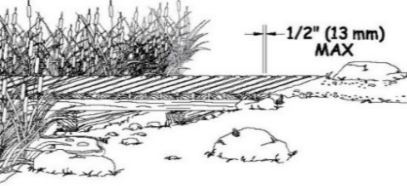
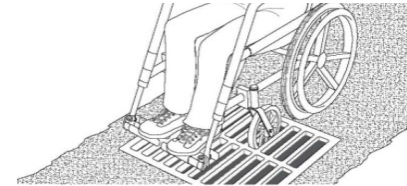

	<p>Is the passing space 60 inches (1525 mm) minimum by 60 inches (1525 mm) minimum; [1017.4.1] or</p>	<input checked="" type="checkbox"/> YES Measurement:	<input type="checkbox"/> NO		<p>Photo #:</p>	<ul style="list-style-type: none"> • Modify route • Provide passing spaces
<p>2.204</p>	<p>Does the intersection of two outdoor recreation access routes provide a T-shaped space complying with 304.3.2 where the base and the arms of the T-shaped space extend 48 inches (1220 mm) minimum beyond the intersection? And,</p>	<input checked="" type="checkbox"/> YES Measurement:	<input type="checkbox"/> NO		<p>Photo #:</p>	<ul style="list-style-type: none"> • Modify route • Provide passing spaces • Regrade
	<p>Is the vertical alignment at the intersection of the outdoor recreation access routes that form the T-shaped space nominally planar? (virtually flat)</p>	<input checked="" type="checkbox"/> YES Measurement:	<input type="checkbox"/> NO		<p>Photo #:</p>	
<p>2.200</p>	<p>If the outdoor recreation access routes surface is asphalt, concrete or boards, and there are obstacles on route, passing spaces, and resting intervals, are they less than 1/2 inch (13 mm) in height measured vertically to the highest point? [1016.5]</p>	<input checked="" type="checkbox"/> YES Measurement:	<input type="checkbox"/> NO		<p>Photo #:</p>	<ul style="list-style-type: none"> • Modify route • Regrade

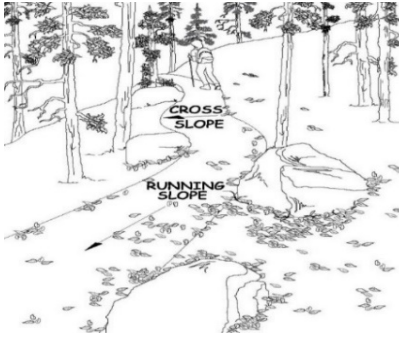
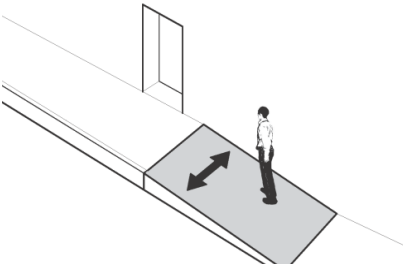

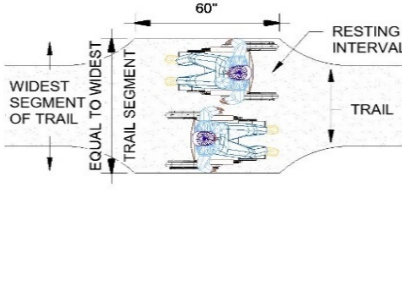
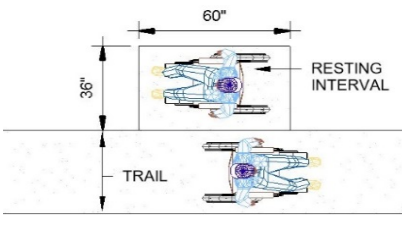
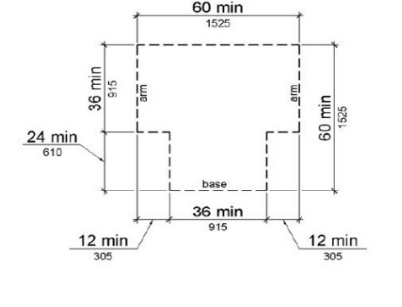
<p>2.206</p>	<p>If the outdoor recreation access routes surface is not asphalt, concrete or boards, and there are tread obstacles on outdoor recreation access routes passing spaces, and resting intervals, are they less than 1 inch (25 mm) in height measured vertically to the highest point? [1016.5]</p>	<p><input type="checkbox"/> YES <input type="checkbox"/> NO Measurement: N/A</p>	<p><input type="checkbox"/> YES <input type="checkbox"/> NO Measurement:</p>		<p>Photo #:</p>	<ul style="list-style-type: none"> • Modify route • Regrade
<p>2.207</p>	<p>Are openings in the surface of outdoor recreation access routes passing spaces, and resting intervals small enough to not allow the passage of a sphere more than 1/2 inch (13 mm) in diameter? [1016.6]</p>	<p><input checked="" type="checkbox"/> YES <input type="checkbox"/> NO Measurement:</p>	<p><input type="checkbox"/> YES <input type="checkbox"/> NO Measurement:</p>		<p>Photo #:</p>	<ul style="list-style-type: none"> • Modify route • Replace grates or boards
<p>2.208</p>	<p>If there are elongated openings, are they placed so that the long dimension is perpendicular, or as close to perpendicular as possible, to the dominant direction of travel? [1016.6]</p>	<p><input type="checkbox"/> YES <input type="checkbox"/> NO Measurement: N/A</p>	<p><input type="checkbox"/> YES <input type="checkbox"/> NO Measurement:</p>		<p>Photo #:</p>	<ul style="list-style-type: none"> • Modify route • Replace grates or boards

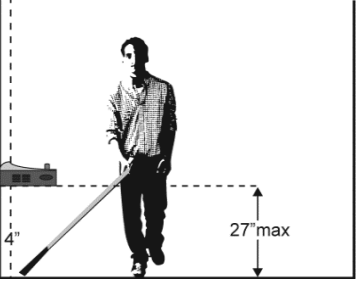
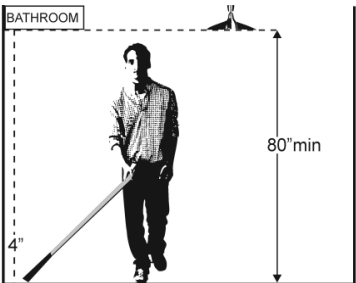

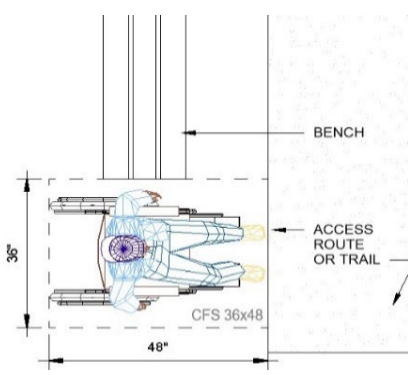
<p>2.209</p>	<p>Is the running slope of all segments of the outdoor recreation access routes less than 1:10 (10%). [1016.7.1]</p>	<p><input checked="" type="checkbox"/> YES Measurement: <5%</p>	<p><input type="checkbox"/> NO</p>		<p>Photo #:</p>	<ul style="list-style-type: none"> • Regrade 											
<p>2.210</p>	<p>If the running slope of a segment of a outdoor recreation access route is steeper than 1:20 (5%), is the maximum length of the segment in accordance with Table 1016.7.1, and,</p>	<p><input type="checkbox"/> YES Measurement: N/A</p> <p>Length:</p>	<p><input type="checkbox"/> NO</p>	<table border="1"> <thead> <tr> <th colspan="2">Running Slope of Outdoor Recreation Access Route Segment</th> <th rowspan="2">Maximum Length of Segment</th> </tr> <tr> <th>Steeper than</th> <th>But not Steeper than</th> </tr> </thead> <tbody> <tr> <td>1:20 (5%)</td> <td>1:12 (8.33%)</td> <td>50 feet (15 m)</td> </tr> <tr> <td>1:12 (8.33%)</td> <td>1:10 (10%)</td> <td>30 feet (9 m)</td> </tr> </tbody> </table>	Running Slope of Outdoor Recreation Access Route Segment		Maximum Length of Segment	Steeper than	But not Steeper than	1:20 (5%)	1:12 (8.33%)	50 feet (15 m)	1:12 (8.33%)	1:10 (10%)	30 feet (9 m)	<p>Photo #:</p>	<ul style="list-style-type: none"> • Regrade
Running Slope of Outdoor Recreation Access Route Segment		Maximum Length of Segment															
Steeper than	But not Steeper than																
1:20 (5%)	1:12 (8.33%)	50 feet (15 m)															
1:12 (8.33%)	1:10 (10%)	30 feet (9 m)															
<p>2.211</p>	<p>Is there a resting interval provided at the top and bottom of each segment?</p>	<p><input type="checkbox"/> YES Top: <input type="checkbox"/> YES N/A</p>	<p><input type="checkbox"/> NO <input type="checkbox"/> NO</p>		<p>Photo #:</p>	<ul style="list-style-type: none"> • Modify route • Regrade 											
<p>2.212</p>	<p>Is the cross slope no steeper than 1:48? [1016.7.2] Where the surface is other than concrete, asphalt, or boards, cross slopes not steeper than 1:20 shall be permitted when necessary for drainage.</p>	<p><input type="checkbox"/> YES Measurement: N/A</p> <p>Material:</p>	<p><input type="checkbox"/> NO</p>		<p>Photo #:</p>	<ul style="list-style-type: none"> • Regrade 											
<p>2.213</p>	<p>Is the resting interval length at least 60 inches (1525 mm) long? [1017.8.1]</p>	<p><input checked="" type="checkbox"/> YES Measurement:</p> <p>Material:</p>	<p><input type="checkbox"/> NO</p>		<p>Photo #:</p>	<ul style="list-style-type: none"> • Modify route • Regrade 											

<p>2.214</p>	<p>If the resting intervals are provided within the outdoor recreation access route, is it at least as wide as the widest segment of the outdoor recreation access route leading to the resting interval? [1016.8.2]</p>	<p><input type="checkbox"/> YES Measurement: N/A</p>	<p><input type="checkbox"/> NO</p>		<p>Photo #:</p>	<ul style="list-style-type: none"> • Modify route • Regrade
<p>2.215</p>	<p>If resting intervals are provided adjacent to the trail tread, is the resting interval clear width at least 36 inches (915 mm)? [1016.8.2]</p>	<p><input checked="" type="checkbox"/> YES Measurement:</p>	<p><input type="checkbox"/> NO</p>		<p>Photo #:</p>	<ul style="list-style-type: none"> • Modify route • Regrade
<p>2.216</p>	<p>Are the resting interval slopes no steeper than 1:48 in any direction? Where the surface is other than concrete, asphalt, or boards, cross slopes not steeper than 1:20 shall be permitted when necessary for drainage.</p>	<p><input checked="" type="checkbox"/> YES Measurement:</p>	<p><input type="checkbox"/> NO</p>			<ul style="list-style-type: none"> • Modify route • Regrade
<p>2.217</p>	<p>Where resting intervals are provided adjacent to an outdoor recreation access route, is there a T-shaped turning space within a 60 inch (1525 mm) square minimum with arms and base 36 inches (915 mm) wide minimum?</p>	<p><input type="checkbox"/> YES Measurement: N/A</p>	<p><input type="checkbox"/> NO</p>			<ul style="list-style-type: none"> • Modify route • Provide turning space

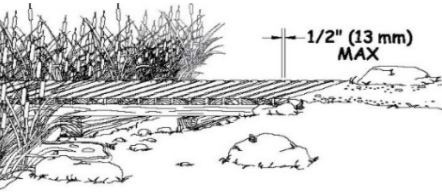
<p>2.218</p>	<p>Is the vertical alignment between the outdoor recreation access route, turning space, and resting interval nominally planar? (virtually flat)</p>	<p><input checked="" type="checkbox"/> YES Measurement:</p>	<p><input type="checkbox"/> NO</p>			<ul style="list-style-type: none"> • Modify route • Regrade
<p>2.219</p>	<p>Do all objects on outdoor recreation access routes, passing spaces, and resting intervals, e.g. signs, etc., protrude no more than 4 inches into the path? (does not apply to natural features, such as tree branches, rock formations) Or</p>	<p><input checked="" type="checkbox"/> YES Measurement:</p>	<p><input type="checkbox"/> NO</p>		<p>Photo #:</p>	<ul style="list-style-type: none"> • Remove object • Add tactile warning such as permanent planter or partial walls
	<p>If an object protrudes more than 4 inches, is the bottom leading edge at 27 inches or lower above the floor? [307.2] Or</p>	<p><input type="checkbox"/> YES Measurement: N/A</p>	<p><input type="checkbox"/> NO</p>		<p>Photo #:</p>	<ul style="list-style-type: none"> • Remove object • Add tactile warning such as permanent planter or partial walls
	<p>Is the bottom leading edge at 80 inches or higher above the floor? [307.4]</p>	<p><input type="checkbox"/> YES Measurement: N/A</p>	<p><input type="checkbox"/> NO</p>		<p>Photo #:</p>	<ul style="list-style-type: none"> • Remove object • Add tactile warning such as permanent planter or partial walls

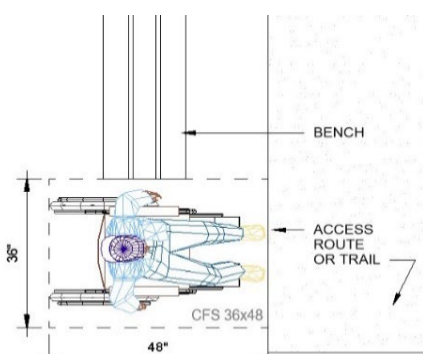

Benches					
2.470	Where benches are provided, is there clear ground space 36 inches (915 mm) by 48 inches (1220 mm) positioned near the bench with one side of the space adjoining an outdoor recreation access route or trail, as applicable? [1011.2.1]	<input type="checkbox"/> YES <input checked="" type="checkbox"/> NO Measure ment:		 Photo #:	<ul style="list-style-type: none"> • Modify space • Provide new unit(s)
2.471	Is the clear ground space located such that it does not overlap the outdoor recreation access route or trail, or another clear ground space?	<input type="checkbox"/> YES <input checked="" type="checkbox"/> NO		Photo #:	<ul style="list-style-type: none"> • Enlarge space • Provide new space
2.472	Is the surface of the clear ground space firm and stable? [1011.2.2]	<input type="checkbox"/> YES <input checked="" type="checkbox"/> NO Material GRASS		Photo #:	<ul style="list-style-type: none"> • Modify surface • Replace Surface
2.473	Is the slope of the clear ground space surface no steeper than 1:48 in any direction? [1011.2.3] or	<input type="checkbox"/> YES <input type="checkbox"/> NO Measure ment: N/A		Photo #:	<ul style="list-style-type: none"> • Level the area
	If the surface is other than asphalt, concrete, or boards, is the slope no steeper than 1:20 if necessary for drainage?	<input checked="" type="checkbox"/> YES <input type="checkbox"/> NO Measure ment:		Photo #:	<ul style="list-style-type: none"> • Level the area

<p>2.474</p>	<p>If openings (grates) are present in the clear ground space surface, are they sized so they do not allow the passage of a sphere more than 1/2 inch (13 mm) in diameter? And</p>	<p><input type="checkbox"/> YES <input type="checkbox"/> NO Measurement: N/A NOT IN THE PATH OF TRAVEL</p>		<p>Photo #:</p>	<ul style="list-style-type: none"> • Modify route • Replace grates or boards
	<p>Are elongated openings placed so that the long dimension is perpendicular, or as close to perpendicular as possible, to the dominant direction of travel?</p>	<p><input checked="" type="checkbox"/> YES <input type="checkbox"/> NO</p>		<p>Photo #:</p>	<ul style="list-style-type: none"> • Modify route • Replace grates or boards

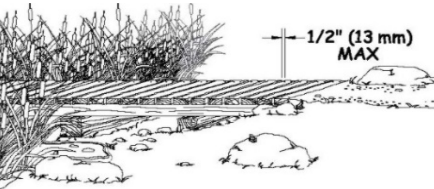
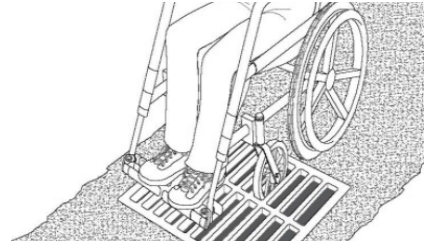
Benches					
2.470	Where benches are provided, is there clear ground space 36 inches (915 mm) by 48 inches (1220 mm) positioned near the bench with one side of the space adjoining an outdoor recreation access route or trail, as applicable? [1011.2.1]	<input checked="" type="checkbox"/> YES <input type="checkbox"/> NO Measure ment:		 <p>Photo #:</p>	<ul style="list-style-type: none"> • Modify space • Provide new unit(s)
2.471	Is the clear ground space located such that it does not overlap the outdoor recreation access route or trail, or another clear ground space?	<input checked="" type="checkbox"/> YES <input type="checkbox"/> NO		<p>Photo #:</p>	<ul style="list-style-type: none"> • Enlarge space • Provide new space
2.472	Is the surface of the clear ground space firm and stable? [1011.2.2]	<input checked="" type="checkbox"/> YES <input type="checkbox"/> NO Material CONC.		<p>Photo #:</p>	<ul style="list-style-type: none"> • Modify surface • Replace Surface
2.473	Is the slope of the clear ground space surface no steeper than 1:48 in any direction? [1011.2.3] or	<input checked="" type="checkbox"/> YES <input type="checkbox"/> NO Measure ment: <1.9%		<p>Photo #:</p>	<ul style="list-style-type: none"> • Level the area
	If the surface is other than asphalt, concrete, or boards, is the slope no steeper than 1:20 if necessary for drainage?	<input type="checkbox"/> YES <input type="checkbox"/> NO Measure ment: N/A		<p>Photo #:</p>	<ul style="list-style-type: none"> • Level the area

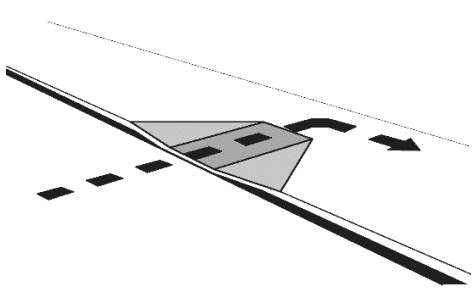
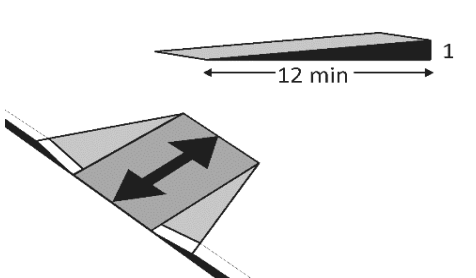
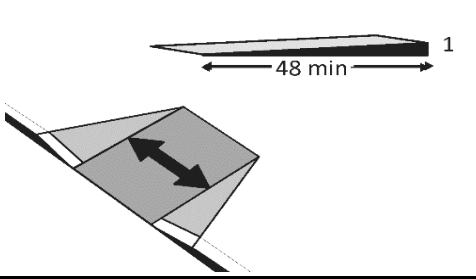
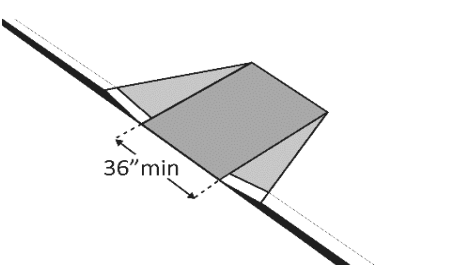
<p>2.474</p>	<p>If openings (grates) are present in the clear ground space surface, are they sized so they do not allow the passage of a sphere more than 1/2 inch (13 mm) in diameter? And</p>	<p><input type="checkbox"/> YES <input type="checkbox"/> NO Measure ment: N/A</p>		<p>Photo #:</p>	<ul style="list-style-type: none"> • Modify route • Replace grates or boards
	<p>Are elongated openings placed so that the long dimension is perpendicular, or as close to perpendicular as possible, to the dominant direction of travel?</p>	<p><input type="checkbox"/> YES <input type="checkbox"/> NO N/A</p>		<p>Photo #:</p>	<ul style="list-style-type: none"> • Modify route • Replace grates or boards

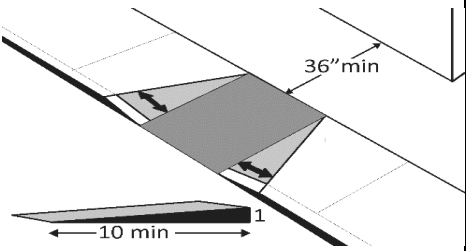
Curb Ramps				
1.111	If the accessible route crosses a curb, is there a curb ramp? [402.2]	<input checked="" type="checkbox"/> YES <input type="checkbox"/> NO	 <p>THIS CURB RAMP LEADS DIRECTLY INTO A TRAFFIC PATH AND THEREFORE SHOULD INCLUDE A TACTILE WARNING PAD AT THE BOTTOM OF THE SLOPE.</p>	<ul style="list-style-type: none"> • Install curb ramp
1.112	Is the running slope of the curb ramp no steeper than 1:12, i.e. for every inch of height change there are at least 12 inches of curb ramp run? [406.1, 405.2]	<input checked="" type="checkbox"/> YES <input type="checkbox"/> NO Measure ment: 5'-0" L	 <p>1 12 min</p>	<ul style="list-style-type: none"> • Regrade curb ramp <p>Photo #:</p>
1.113	Is the cross slope of the curb ramp, excluding flares, no steeper than 1:48? [406.1, 405.3]	<input checked="" type="checkbox"/> YES <input type="checkbox"/> NO Measure ment:	 <p>1 48 min</p>	<ul style="list-style-type: none"> • Regrade curb ramp <p>Photo #:</p>
1.114	Is the curb ramp, excluding flares, at least 36 inches wide? [406.1, 405.5]	<input checked="" type="checkbox"/> YES <input type="checkbox"/> NO Measure ment: 48"	 <p>36" min</p>	<ul style="list-style-type: none"> • Widen curb ramp <p>Photo #:</p>

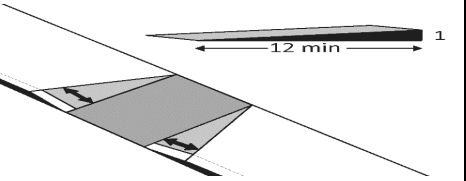
<p>1.115</p>	<p>At the top of the curb ramp is there a level landing (slope no steeper than 1:48 in all directions) that is at least 36 inches long and at least as wide as the curb ramp? [406.4]</p>	<p><input checked="" type="checkbox"/> YES <input type="checkbox"/> NO</p> <p>Measure ment:</p>			<ul style="list-style-type: none"> • Reconfigure • Add ramp flares
<p>1.116</p>	<p>If there are curb ramp flares, are the slopes of the flares no steeper than 1:10, i.e. for every inch of height change there are at least 10 inches of flare run? [406.3]</p>	<p><input type="checkbox"/> YES <input type="checkbox"/> NO</p> <p>Measure ment:</p> <p>N/A</p>			
<p>1.116</p>	<p>If the landing at the top is less than 36 inches long, are there curb ramp flares?</p>	<p><input type="checkbox"/> YES <input type="checkbox"/> NO</p> <p>Measure ment:</p> <p>N/A</p>			<ul style="list-style-type: none"> • Add ramp flares • Regrade flares
	<p>Are the slopes of the flares no greater than 1:12, i.e. for every inch of height change there are at least 12 inches of flare run? [406.4]</p>	<p><input type="checkbox"/> YES <input type="checkbox"/> NO</p> <p>Measure ment:</p> <p>N/A</p>			

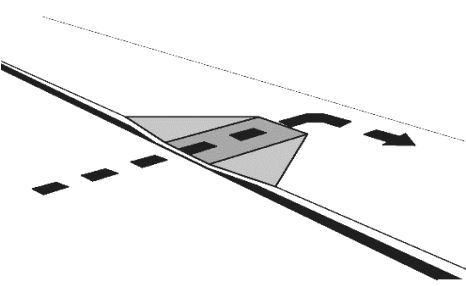
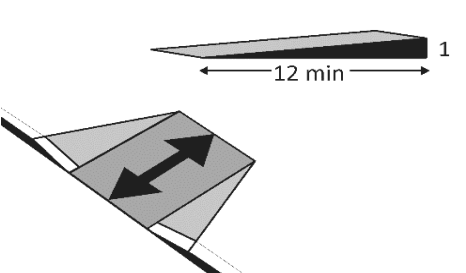
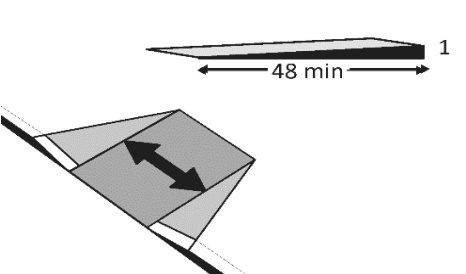
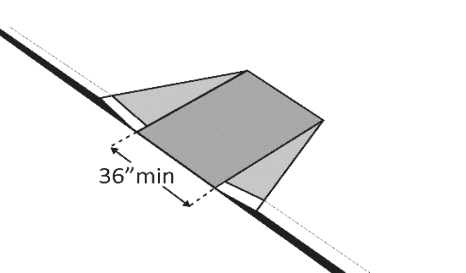
Curb Ramps					
1.111	If the accessible route crosses a curb, is there a curb ramp? [402.2]	<input checked="" type="checkbox"/> YES <input type="checkbox"/> NO		<p style="color: red;">THIS CURB RAMP LEADS DIRECTLY INTO A TRAFFIC PATH AND THEREFORE SHOULD INCLUDE A TACTILE WARNING PAD AT THE BOTTOM OF THE SLOPE.</p>	<ul style="list-style-type: none"> • Install curb ramp
1.112	Is the running slope of the curb ramp no steeper than 1:12, i.e. for every inch of height change there are at least 12 inches of curb ramp run? [406.1, 405.2]	<input checked="" type="checkbox"/> YES <input type="checkbox"/> NO Measure ment: 5.6%		<p>Photo #:</p>	<ul style="list-style-type: none"> • Regrade curb ramp
.113	Is the cross slope of the curb ramp, excluding flares, no steeper than 1:48? [406.1, 405.3]	<input checked="" type="checkbox"/> YES <input type="checkbox"/> NO Measure ment: 1.2%		<p>Photo #:</p>	<ul style="list-style-type: none"> • Regrade curb ramp
1.114	Is the curb ramp, excluding flares, at least 36 inches wide? [406.1, 405.5]	<input checked="" type="checkbox"/> YES <input type="checkbox"/> NO Measure ment: 94"		<p>Photo #:</p>	<ul style="list-style-type: none"> • Widen curb ramp

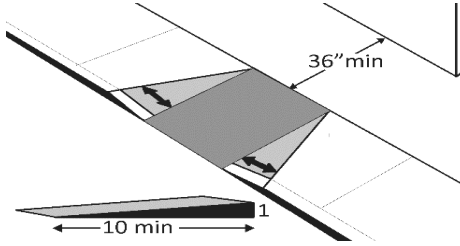
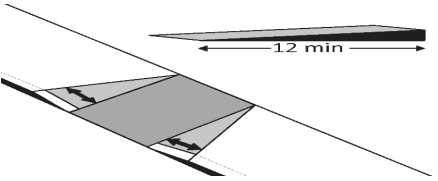

<p>1.115</p>	<p>At the top of the curb ramp is there a level landing (slope no steeper than 1:48 in all directions) that is at least 36 inches long and at least as wide as the curb ramp? [406.4]</p>	<p><input checked="" type="checkbox"/> YES <input type="checkbox"/> NO Measure ment:</p>			<ul style="list-style-type: none"> • Reconfigure • Add ramp flares
	<p>If there are curb ramp flares, are the slopes of the flares no steeper than 1:10, i.e. for every inch of height change there are at least 10 inches of flare run? [406.3]</p>	<p><input type="checkbox"/> YES <input type="checkbox"/> NO Measure ment: N/A</p>			<ul style="list-style-type: none"> • Add ramp flares • Regrade flares
<p>1.116</p>	<p>If the landing at the top is less than 36 inches long, are there curb ramp flares?</p>	<p><input type="checkbox"/> YES <input type="checkbox"/> NO Measure ment: N/A</p>			
	<p>Are the slopes of the flares no greater than 1:12, i.e. for every inch of height change there are at least 12 inches of flare run? [406.4]</p>	<p><input type="checkbox"/> YES <input type="checkbox"/> NO Measure ment: N/A</p>			

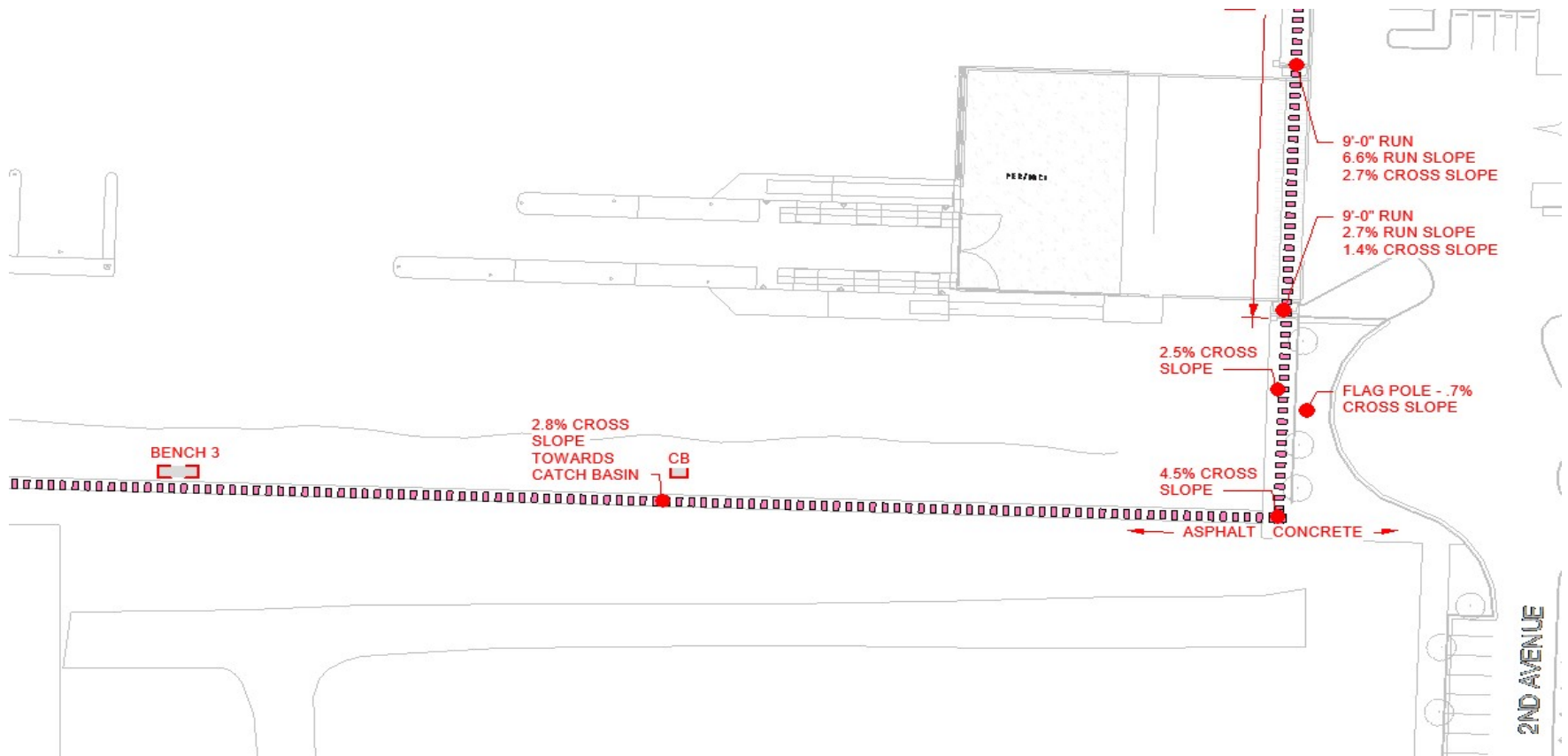
Trash and recycling			
<p>2.480</p>	<p>Is there a clear ground space 36 inches (915 mm) by 48 inches (1220 mm) positioned for forward approach to the receptacle opening; or 30 inches (760 mm) by 60 inches (1525 mm) positioned for a parallel approach to the receptacle opening? [1011.2.1]</p>	<p><input checked="" type="checkbox"/> YES <input type="checkbox"/> NO Measurement:</p>	<div data-bbox="1360 191 1724 431" data-label="Image"> </div> <div data-bbox="1360 436 1724 626" data-label="Text"> <p>Photo #:</p> </div> <div data-bbox="1730 191 2034 227" data-label="List-Group"> <ul style="list-style-type: none"> • Add or Relocate bins </div>



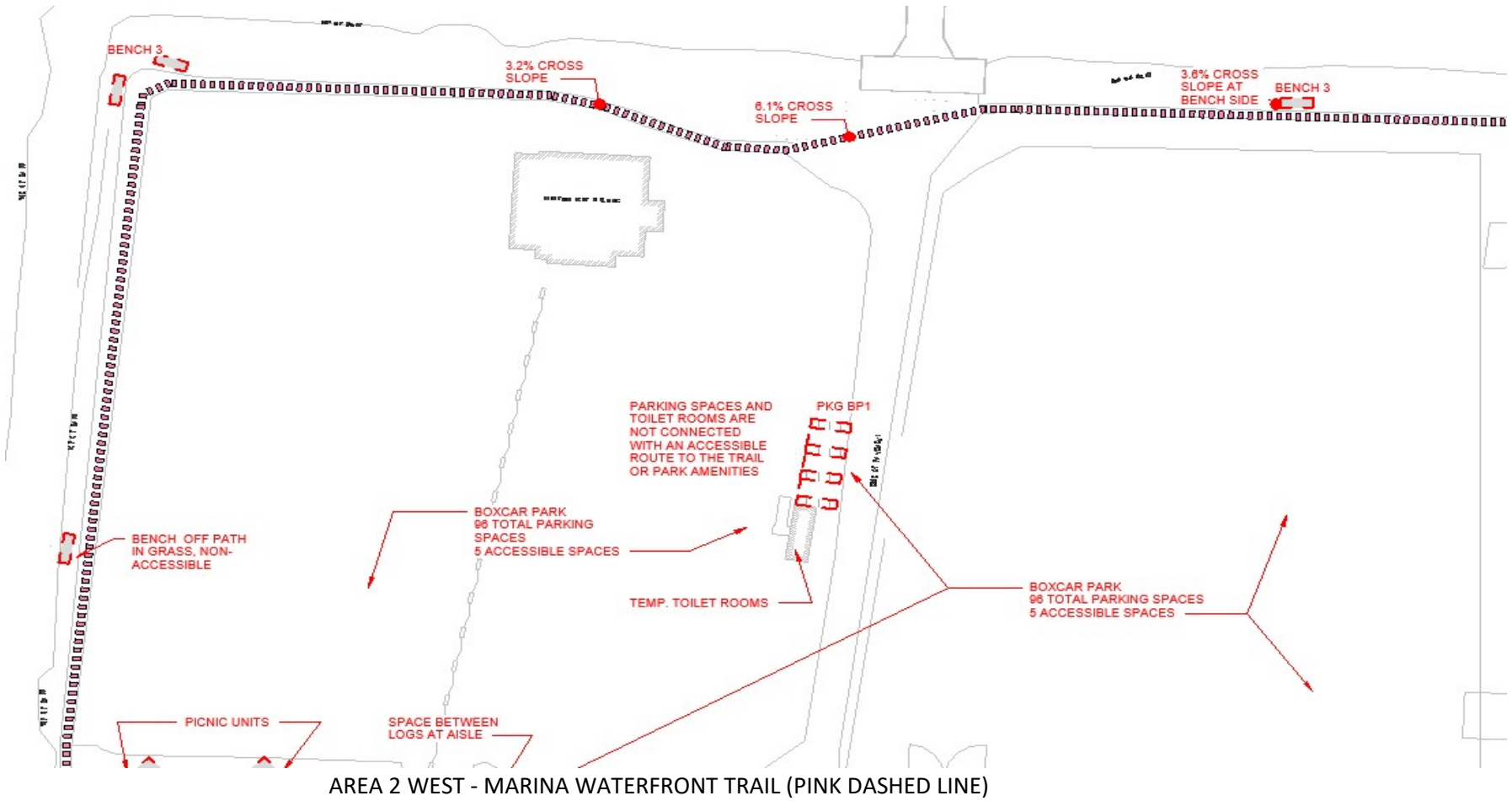

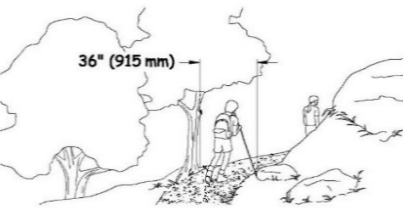

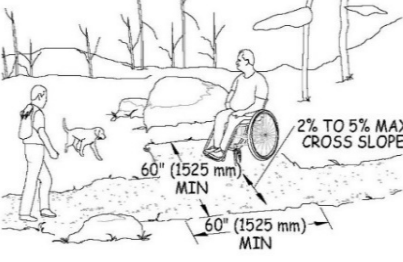
AREA 2 EAST - MARINA WATERFRONT TRAIL (PINK DASHED LINE)



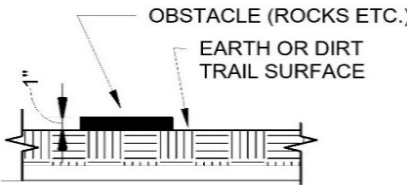
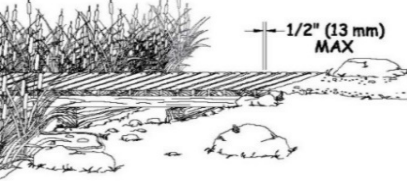
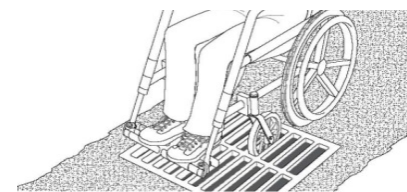

Outdoor Recreation Access Routes [1016] (A pedestrian route developed primarily to connect elements, spaces, or facilities within a site is not a trail)					
2.200	Outdoor Recreation Access Routes shall comply with 1016 [F247]			EXCEPTIONS: 1. In alterations to existing camping facilities, picnic facilities, and trailheads, when an entity determines that a condition in 1019 does not permit full compliance with a specific provision in 1016 on a portion of an outdoor recreation access route, the portion of the outdoor recreation access route shall comply with the provision to the extent practicable. 2. At viewing areas, when an entity determines that a condition in 1019 does not permit full compliance on a portion of an outdoor recreation access route with a specific provision in 1016, the portion of the outdoor recreation access route shall comply with the provision to the extent practicable. 3. Where outdoor recreation access routes are provided within vehicular ways, outdoor recreation access routes shall not be required to comply with 1016.4, 1016.7, and 1016.8.	
2.201	Is the surface of outdoor recreation access routes, passing spaces, and resting intervals stable, firm and slip-resistant? [40.2, 302.1]	<input checked="" type="checkbox"/> YES Material: CONC ASPHALT	<input type="checkbox"/> NO	A firm trail surface resists deformation by indentations. A stable trail surface is not permanently affected by expected weather conditions and can sustain normal wear and tear from the expected uses between planned maintenance.	 <ul style="list-style-type: none"> • Modify surface • Replace Surface
2.202	Is the clear width of the outdoor recreation access route 36 inches (915 mm) minimum? [1016.3]	<input checked="" type="checkbox"/> YES Measurement: 66"	<input type="checkbox"/> NO		 <ul style="list-style-type: none"> • Modify route • Provide new route
2.203	If the outdoor recreation access route width is less than 60 inches (1525 mm) are passing spaces provided at intervals of 200 feet (61 m) maximum? (Passing spaces and resting intervals shall be permitted to overlap.)	<input type="checkbox"/> YES Measurement: N/A	<input type="checkbox"/> NO		Photo #: <ul style="list-style-type: none"> • Modify route • Provide passing spaces

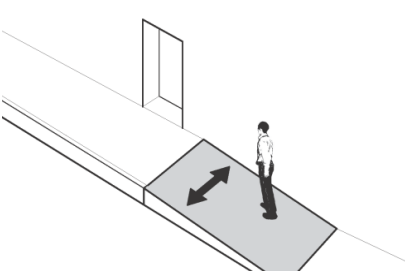

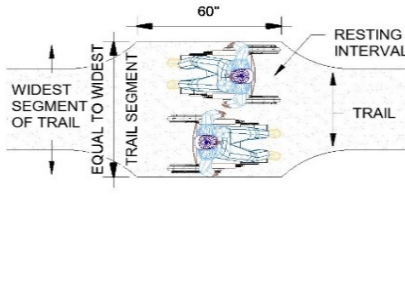
	<p>Is the passing space 60 inches (1525 mm) minimum by 60 inches (1525 mm) minimum; [1017.4.1] or</p>	<input checked="" type="checkbox"/> YES Measurement:	<input type="checkbox"/> NO		<p>Photo #:</p>	<ul style="list-style-type: none"> • Modify route • Provide passing spaces
<p>2.204</p>	<p>Does the intersection of two outdoor recreation access routes provide a T-shaped space complying with 304.3.2 where the base and the arms of the T-shaped space extend 48 inches (1220 mm) minimum beyond the intersection? And,</p>	<input checked="" type="checkbox"/> YES Measurement:	<input type="checkbox"/> NO		<p>Photo #:</p>	<ul style="list-style-type: none"> • Modify route • Provide passing spaces • Regrade
	<p>Is the vertical alignment at the intersection of the outdoor recreation access routes that form the T-shaped space nominally planar? (virtually flat)</p>	<input checked="" type="checkbox"/> YES Measurement:	<input type="checkbox"/> NO		<p>Photo #:</p>	
<p>2.200</p>	<p>If the outdoor recreation access routes surface is asphalt, concrete or boards, and there are obstacles on route, passing spaces, and resting intervals, are they less than 1/2 inch (13 mm) in height measured vertically to the highest point? [1016.5]</p>	<input checked="" type="checkbox"/> YES Measurement:	<input type="checkbox"/> NO		<p>Photo #:</p>	<ul style="list-style-type: none"> • Modify route • Regrade

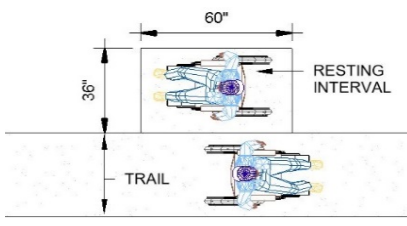
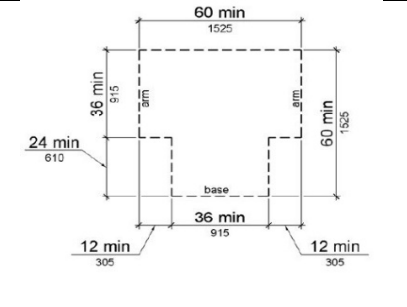
<p>2.206</p>	<p>If the outdoor recreation access routes surface is not asphalt, concrete or boards, and there are tread obstacles on outdoor recreation access routes passing spaces, and resting intervals, are they less than 1 inch (25 mm) in height measured vertically to the highest point? [1016.5]</p>	<p><input type="checkbox"/> YES Measurement: N/A</p>	<p><input type="checkbox"/> NO</p>		<p>Photo #:</p>	<ul style="list-style-type: none"> • Modify route • Regrade
<p>2.207</p>	<p>Are openings in the surface of outdoor recreation access routes passing spaces, and resting intervals small enough to not allow the passage of a sphere more than 1/2 inch (13 mm) in diameter? [1016.6]</p>	<p><input type="checkbox"/> YES Measurement: N/A</p>	<p><input type="checkbox"/> NO</p>		<p>Photo #:</p>	<ul style="list-style-type: none"> • Modify route • Replace grates or boards
<p>2.208</p>	<p>If there are elongated openings, are they placed so that the long dimension is perpendicular, or as close to perpendicular as possible, to the dominant direction of travel? [1016.6]</p>	<p><input type="checkbox"/> YES Measurement: N/A</p>	<p><input type="checkbox"/> NO</p>		<p>Photo #:</p>	<ul style="list-style-type: none"> • Modify route • Replace grates or boards
<p>2.209</p>	<p>Is the running slope of all segments of the outdoor recreation access routes less than 1:10 (10%). [1016.7.1]</p>	<p><input type="checkbox"/> YES Measurement: N/A</p>	<p><input type="checkbox"/> NO</p>		<p>Photo #:</p>	<ul style="list-style-type: none"> • Regrade

<p>2.210</p>	<p>If the running slope of a segment of a outdoor recreation access route is steeper than 1:20 (5%), is the maximum length of the segment in accordance with Table 1016.7.1, and,</p>	<p><input type="checkbox"/> YES Measure Length: N/A</p>	<p><input type="checkbox"/> NO ment:</p>	<table border="1"> <thead> <tr> <th colspan="2">Running Slope of Outdoor Recreation Access Route Segment</th> <th rowspan="2">Maximum Length of Segment</th> </tr> <tr> <th>Steeper than</th> <th>But not Steeper than</th> </tr> </thead> <tbody> <tr> <td>1:20 (5%)</td> <td>1:12 (8.33%)</td> <td>50 feet (15 m)</td> </tr> <tr> <td>1:12 (8.33%)</td> <td>1:10 (10%)</td> <td>30 feet (9 m)</td> </tr> </tbody> </table>	Running Slope of Outdoor Recreation Access Route Segment		Maximum Length of Segment	Steeper than	But not Steeper than	1:20 (5%)	1:12 (8.33%)	50 feet (15 m)	1:12 (8.33%)	1:10 (10%)	30 feet (9 m)	<p>Photo #:</p>	<ul style="list-style-type: none"> • Regrade
Running Slope of Outdoor Recreation Access Route Segment		Maximum Length of Segment															
Steeper than	But not Steeper than																
1:20 (5%)	1:12 (8.33%)	50 feet (15 m)															
1:12 (8.33%)	1:10 (10%)	30 feet (9 m)															
<p>2.211</p>	<p>Is there a resting interval provided at the top and bottom of each segment?</p>	<p><input type="checkbox"/> YES Top: N/A</p>	<p><input type="checkbox"/> NO ment:</p>		<p>Photo #:</p>	<ul style="list-style-type: none"> • Modify route • Regrade 											
<p>2.212</p>	<p>Is the cross slope no steeper than 1:48? [1016.7.2] Where the surface is other than concrete, asphalt, or boards, cross slopes not steeper than 1:20 shall be permitted when necessary for drainage.</p>	<p><input type="checkbox"/> YES Measure N/A</p>	<p><input type="checkbox"/> NO ment: Material:</p>		<p>Photo #:</p>	<ul style="list-style-type: none"> • Regrade 											
<p>2.213</p>	<p>Is the resting interval length at least 60 inches (1525 mm) long? [1017.8.1]</p>	<p><input type="checkbox"/> YES Measure N/A</p>	<p><input type="checkbox"/> NO ment: Material:</p>		<p>Photo #:</p>	<ul style="list-style-type: none"> • Modify route • Regrade 											
<p>2.214</p>	<p>If the resting intervals are provided within the outdoor recreation access route, is it at least as wide as the widest segment of the outdoor recreation access route leading to the resting interval? [1016.8.2]</p>	<p><input type="checkbox"/> YES Measure N/A</p>	<p><input type="checkbox"/> NO ment:</p>		<p>Photo #:</p>	<ul style="list-style-type: none"> • Modify route • Regrade 											

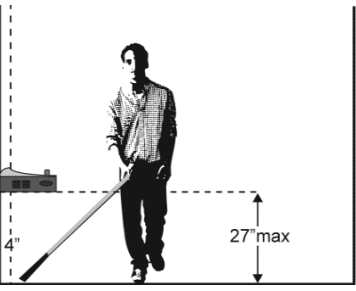
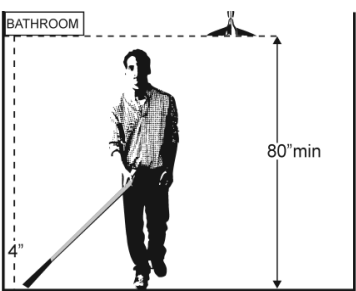
<p>2.215</p>	<p>If resting intervals are provided adjacent to the trail tread, is the resting interval clear width at least 36 inches (915 mm)? [1016.8.2]</p>	<p><input type="checkbox"/> YES Measurement: N/A</p>	<p><input type="checkbox"/> NO</p>		<p>Photo #:</p>	<ul style="list-style-type: none"> • Modify route • Regrade
<p>2.216</p>	<p>Are the resting interval slopes no steeper than 1:48 in any direction? Where the surface is other than concrete, asphalt, or boards, cross slopes not steeper than 1:20 shall be permitted when necessary for drainage.</p>	<p><input type="checkbox"/> YES Measurement: N/A</p>	<p><input type="checkbox"/> NO</p>			<ul style="list-style-type: none"> • Modify route • Regrade
<p>2.217</p>	<p>Where resting intervals are provided adjacent to an outdoor recreation access route, is there a T-shaped turning space within a 60 inch (1525 mm) square minimum with arms and base 36 inches (915 mm) wide minimum?</p>	<p><input type="checkbox"/> YES Measurement: N/A</p>	<p><input type="checkbox"/> NO</p>			<ul style="list-style-type: none"> • Modify route • Provide turning space
<p>2.218</p>	<p>Is the vertical alignment between the outdoor recreation access route, turning space, and resting interval nominally planar? (virtually flat)</p>	<p><input type="checkbox"/> YES Measurement: N/A</p>	<p><input type="checkbox"/> NO</p>			<ul style="list-style-type: none"> • Modify route • Regrade

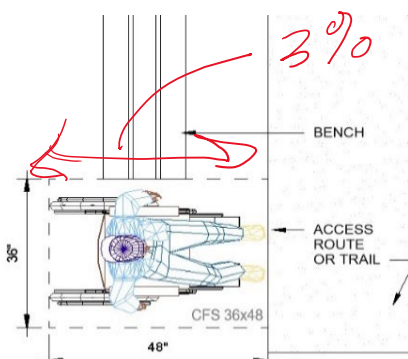
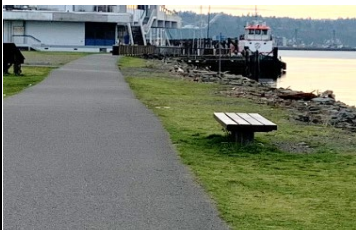
<p>2.219</p>	<p>Do all objects on outdoor recreation access routes, passing spaces, and resting intervals, e.g. signs, etc., protrude no more than 4 inches into the path? (does not apply to natural features, such as tree branches, rock formations) Or</p>	<p><input checked="" type="checkbox"/> YES Measurement:</p>	<p><input type="checkbox"/> NO</p>		<p>Photo #:</p>	<ul style="list-style-type: none"> • Remove object • Add tactile warning such as permanent planter or partial walls
	<p>If an object protrudes more than 4 inches, is the bottom leading edge at 27 inches or lower above the floor? [307.2] Or</p>	<p><input type="checkbox"/> YES Measurement: N/A</p>	<p><input type="checkbox"/> NO</p>		<p>Photo #:</p>	<ul style="list-style-type: none"> • Remove object • Add tactile warning such as permanent planter or partial walls
	<p>Is the bottom leading edge at 80 inches or higher above the floor? [307.4]</p>	<p><input type="checkbox"/> YES Measurement: N/A</p>	<p><input type="checkbox"/> NO</p>		<p>Photo #:</p>	<ul style="list-style-type: none"> • Remove object • Add tactile warning such as permanent planter or partial walls

Benches					
2.470	Where benches are provided, is there clear ground space 36 inches (915 mm) by 48 inches (1220 mm) positioned near the bench with one side of the space adjoining an outdoor recreation access route or trail, as applicable? [1011.2.1]	<input checked="" type="checkbox"/> YES <input type="checkbox"/> NO Measure ment:			<ul style="list-style-type: none"> • Modify space • Provide new unit(s)
2.471	Is the clear ground space located such that it does not overlap the outdoor recreation access route or trail, or another clear ground space?	<input checked="" type="checkbox"/> YES <input type="checkbox"/> NO		Photo #:	<ul style="list-style-type: none"> • Enlarge space • Provide new space
2.472	Is the surface of the clear ground space firm and stable? [1011.2.2]	<input checked="" type="checkbox"/> YES <input type="checkbox"/> NO Material ASPHALT		Photo #:	<ul style="list-style-type: none"> • Modify surface • Replace Surface
2.473	Is the slope of the clear ground space surface no steeper than 1:48 in any direction? [1011.2.3] or	<input type="checkbox"/> YES <input checked="" type="checkbox"/> NO Measure ment: 3.0%		Photo #:	<ul style="list-style-type: none"> • Level the area
	If the surface is other than asphalt, concrete, or boards, is the slope no steeper than 1:20 if necessary for drainage?	<input type="checkbox"/> YES <input type="checkbox"/> NO Measure ment: N/A		Photo #:	<ul style="list-style-type: none"> • Level the area

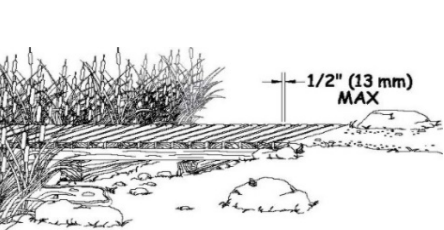
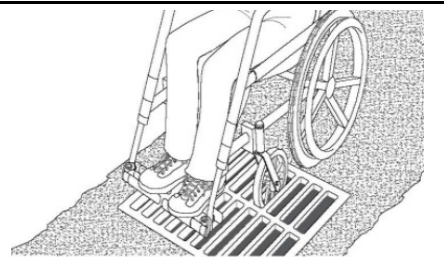
<p>2.474</p>	<p>If openings (grates) are present in the clear ground space surface, are they sized so they do not allow the passage of a sphere more than 1/2 inch (13 mm) in diameter? And</p>	<p><input type="checkbox"/> YES <input type="checkbox"/> NO Measurement: N/A</p>	 <p>A technical drawing of a grate with a grid of rectangular openings. A dimension line above the grid indicates a maximum opening size of 1/2" (13 mm) MAX.</p>	<p>Photo #:</p>	<ul style="list-style-type: none"> • Modify route • Replace grates or boards
	<p>Are elongated openings placed so that the long dimension is perpendicular, or as close to perpendicular as possible, to the dominant direction of travel?</p>	<p><input type="checkbox"/> YES <input type="checkbox"/> NO N/A</p>	 <p>A technical drawing showing a person's legs in a wheelchair positioned over a grate. The grate has elongated rectangular openings. The long dimension of the openings is perpendicular to the direction of travel.</p>	<p>Photo #:</p>	<ul style="list-style-type: none"> • Modify route • Replace grates or boards

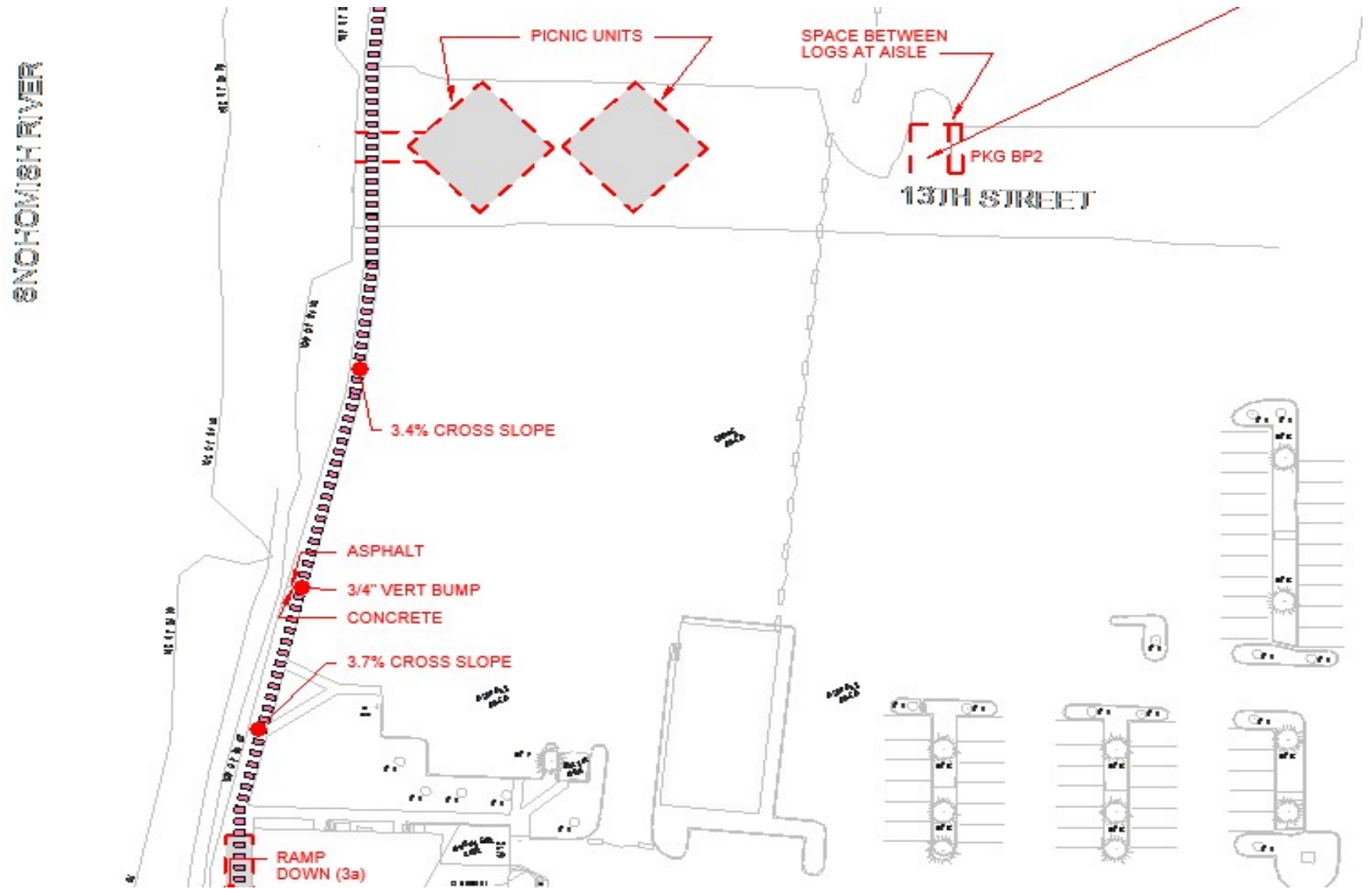

AREA 3 NORTHWEST - MARINA WATERFRONT TRAIL (PINK DASHED LINE)

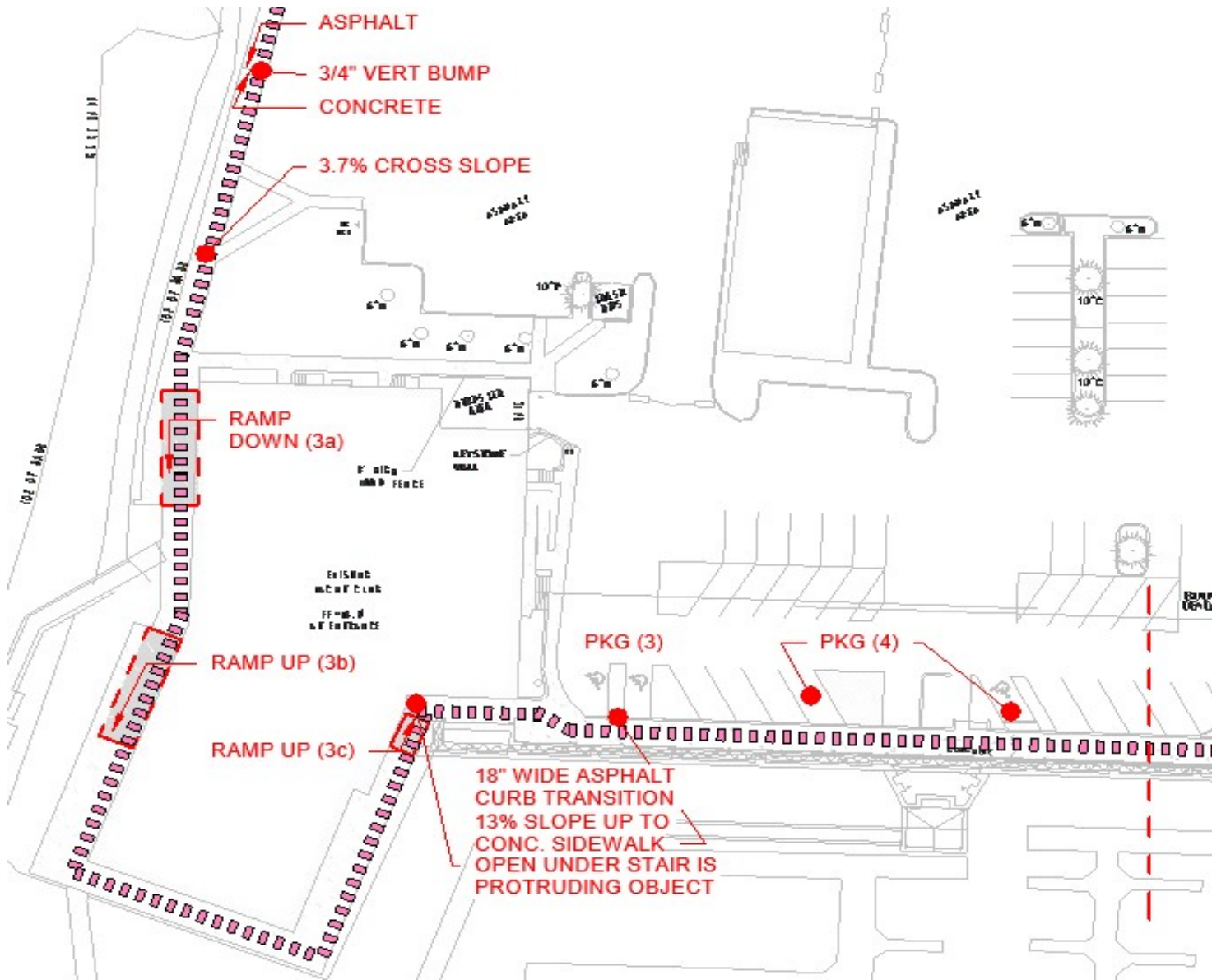

AREA 3 SOUTHWEST - MARINA WATERFRONT TRAIL (PINK DASHED LINE)

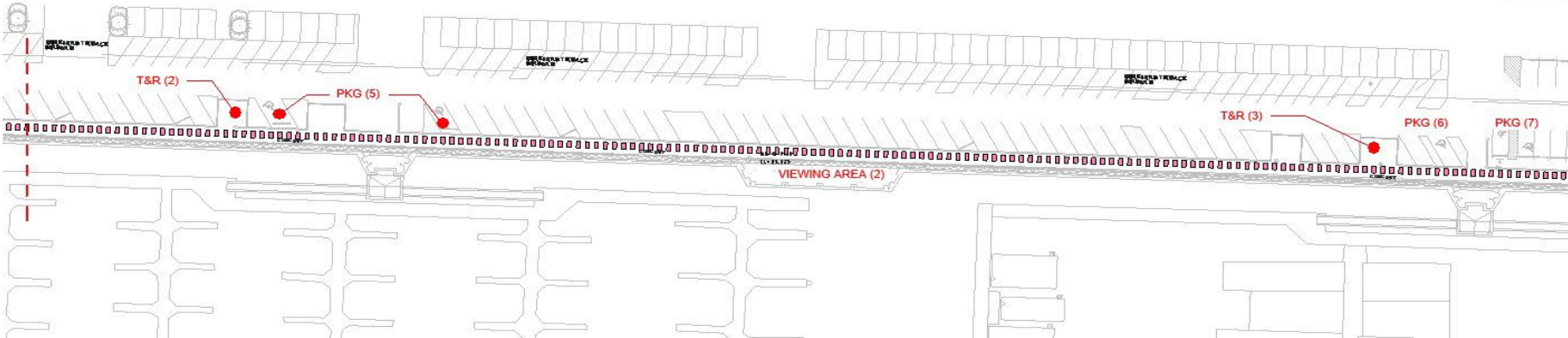

AREA 3 SOUTHEAST - MARINA WATERFRONT TRAIL (PINK DASHED LINE)

Outdoor Recreation Access Routes [1016]

(A pedestrian route developed primarily to connect elements, spaces, or facilities within a site is not a trail)

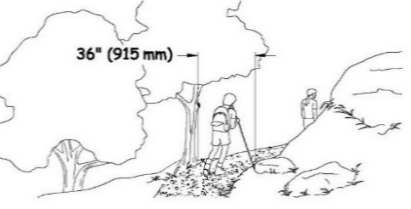
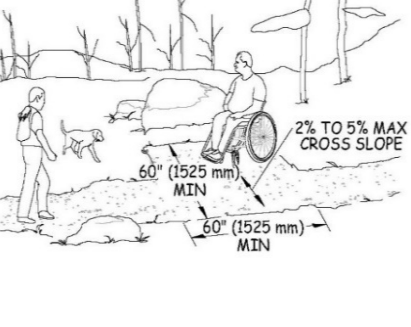
<p>2.200</p>	<p>Outdoor Recreation Access Routes shall comply with 1016 [F247]</p>			<p>EXCEPTIONS: 1. In alterations to existing camping facilities, picnic facilities, and trailheads, when an entity determines that a condition in 1019 does not permit full compliance with a specific provision in 1016 on a portion of an outdoor recreation access route, the portion of the outdoor recreation access route shall comply with the provision to the extent practicable.</p> <p>2. At viewing areas, when an entity determines that a condition in 1019 does not permit full compliance on a portion of an outdoor recreation access route with a specific provision in 1016, the portion of the outdoor recreation access route shall comply with the provision to the extent practicable.</p> <p>3. Where outdoor recreation access routes are provided within vehicular ways, outdoor recreation access routes shall not be required to comply with 1016.4, 1016.7, and 1016.8.</p>		
<p>2.201</p>	<p>Is the surface of outdoor recreation access routes, passing spaces, and resting intervals stable, firm and slip-resistant? [40.2, 302.1]</p>	<p><input checked="" type="checkbox"/> YES Material:</p>	<p><input type="checkbox"/> NO</p>	<p>A firm trail surface resists deformation by indentations. A stable trail surface is not permanently affected by expected weather conditions and can sustain normal wear and tear from the expected uses between planned maintenance.</p>	<p>Photo #:</p>	<ul style="list-style-type: none"> • Modify surface • Replace Surface
<p>2.202</p>	<p>Is the clear width of the outdoor recreation access route 36 inches (915 mm) minimum? [1016.3]</p>	<p><input checked="" type="checkbox"/> YES Measure</p>	<p><input type="checkbox"/> NO ment:</p>		<p>Photo #:</p>	<ul style="list-style-type: none"> • Modify route • Provide new route
<p>2.203</p>	<p>If the outdoor recreation access route width is less than 60 inches (1525 mm) are passing spaces provided at intervals of 200 feet (61 m) maximum? (Passing spaces and resting intervals shall be permitted to overlap.) [1017.4]</p>	<p><input checked="" type="checkbox"/> YES Measure</p>	<p><input type="checkbox"/> NO ment:</p>		<p>Photo #:</p>	<ul style="list-style-type: none"> • Modify route • Provide passing spaces

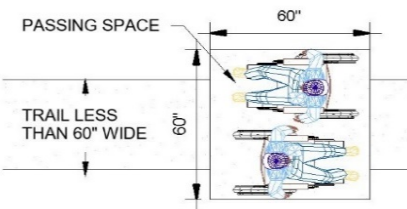
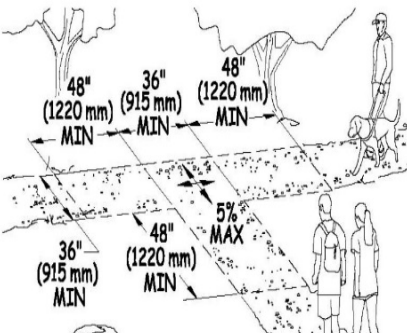
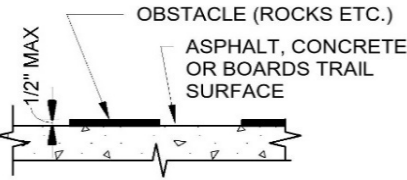

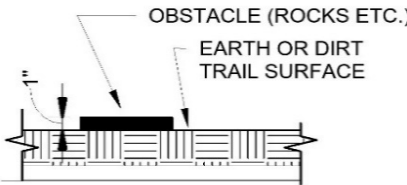
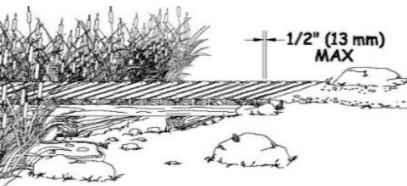
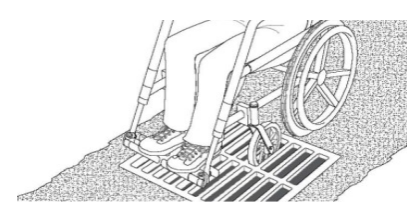

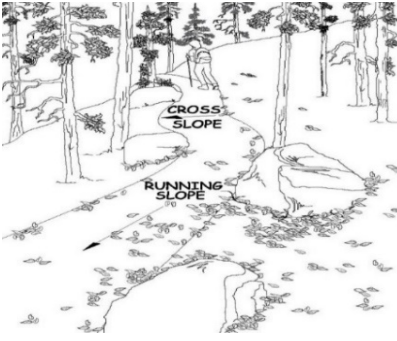
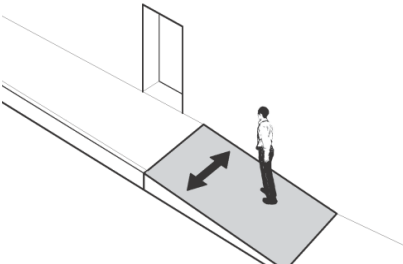
	<p>Is the passing space 60 inches (1525 mm) minimum by 60 inches (1525 mm) minimum; [1017.4.1] or</p>	<p><input checked="" type="checkbox"/> YES Measurement:</p>	<p><input type="checkbox"/> NO</p>		<p>Photo #:</p>	<ul style="list-style-type: none"> • Modify route • Provide passing spaces
<p>2.204</p>	<p>Does the intersection of two outdoor recreation access routes provide a T-shaped space complying with 304.3.2 where the base and the arms of the T-shaped space extend 48 inches (1220 mm) minimum beyond the intersection? And,</p>	<p><input checked="" type="checkbox"/> YES Measurement:</p>	<p><input type="checkbox"/> NO</p>		<p>Photo #:</p>	<ul style="list-style-type: none"> • Modify route • Provide passing spaces • Regrade
	<p>Is the vertical alignment at the intersection of the outdoor recreation access routes that form the T-shaped space nominally planar? (virtually flat)</p>	<p><input checked="" type="checkbox"/> YES Measurement:</p>	<p><input type="checkbox"/> NO</p>		<p>Photo #:</p>	
<p>2.200</p>	<p>If the outdoor recreation access routes surface is asphalt, concrete or boards, and there are obstacles on route, passing spaces, and resting intervals, are they less than 1/2 inch (13 mm) in height measured vertically to the highest point? [1016.5]</p>	<p><input type="checkbox"/> YES Measurement:</p>	<p><input checked="" type="checkbox"/> NO 3/4" - 1"</p>		<p>Photo #:</p>	<ul style="list-style-type: none"> • Modify route • Regrade

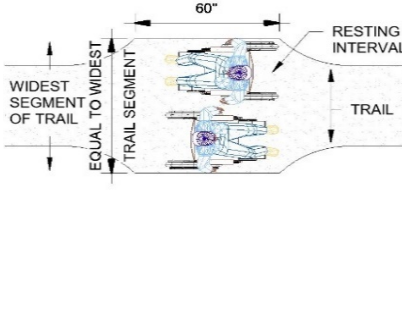
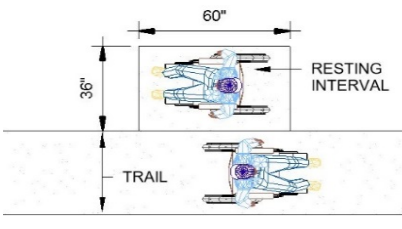
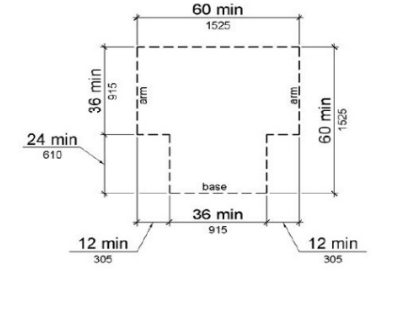

<p>2.206</p>	<p>If the outdoor recreation access routes surface is not asphalt, concrete or boards, and there are tread obstacles on outdoor recreation access routes passing spaces, and resting intervals, are they less than 1 inch (25 mm) in height measured vertically to the highest point? [1016.5]</p>	<p><input type="checkbox"/> YES Measurement: N/A</p>	<p><input type="checkbox"/> NO</p>		<p>Photo #:</p>	<ul style="list-style-type: none"> • Modify route • Regrade
<p>2.207</p>	<p>Are openings in the surface of outdoor recreation access routes passing spaces, and resting intervals small enough to not allow the passage of a sphere more than 1/2 inch (13 mm) in diameter? [1016.6]</p>	<p><input type="checkbox"/> YES Measurement: N/A</p>	<p><input type="checkbox"/> NO</p>		<p>Photo #:</p>	<ul style="list-style-type: none"> • Modify route • Replace grates or boards
<p>2.208</p>	<p>If there are elongated openings, are they placed so that the long dimension is perpendicular, or as close to perpendicular as possible, to the dominant direction of travel? [1016.6]</p>	<p><input type="checkbox"/> YES N/A</p>	<p><input type="checkbox"/> NO</p>		<p>Photo #:</p>	<ul style="list-style-type: none"> • Modify route • Replace grates or boards

<p>2.209</p>	<p>Is the running slope of all segments of the outdoor recreation access routes less than 1:10 (10%). [1016.7.1]</p>	<p><input type="checkbox"/> YES Measure N/A</p>	<p><input type="checkbox"/> NO ment:</p>		<p>Photo #:</p>	<ul style="list-style-type: none"> • Regrade 											
<p>2.210</p>	<p>If the running slope of a segment of a outdoor recreation access route is steeper than 1:20 (5%), is the maximum length of the segment in accordance with Table 1016.7.1, and,</p>	<p><input type="checkbox"/> YES Measure N/A</p>	<p><input type="checkbox"/> NO ment:</p>	<table border="1"> <thead> <tr> <th colspan="2">Running Slope of Outdoor Recreation Access Route Segment</th> <th rowspan="2">Maximum Length of Segment</th> </tr> <tr> <th>Steeper than</th> <th>But not Steeper than</th> </tr> </thead> <tbody> <tr> <td>1:20 (5%)</td> <td>1:12 (8.33%)</td> <td>50 feet (15 m)</td> </tr> <tr> <td>1:12 (8.33%)</td> <td>1:10 (10%)</td> <td>30 feet (9 m)</td> </tr> </tbody> </table>	Running Slope of Outdoor Recreation Access Route Segment		Maximum Length of Segment	Steeper than	But not Steeper than	1:20 (5%)	1:12 (8.33%)	50 feet (15 m)	1:12 (8.33%)	1:10 (10%)	30 feet (9 m)	<p>Photo #:</p>	<ul style="list-style-type: none"> • Regrade
Running Slope of Outdoor Recreation Access Route Segment		Maximum Length of Segment															
Steeper than	But not Steeper than																
1:20 (5%)	1:12 (8.33%)	50 feet (15 m)															
1:12 (8.33%)	1:10 (10%)	30 feet (9 m)															
<p>2.211</p>	<p>Is there a resting interval provided at the top and bottom of each segment?</p>	<p><input type="checkbox"/> YES Top: <input type="checkbox"/> YES N/A</p>	<p><input type="checkbox"/> NO <input type="checkbox"/> NO</p>		<p>Photo #:</p>	<ul style="list-style-type: none"> • Modify route • Regrade 											
<p>2.212</p>	<p>Is the cross slope no steeper than 1:48? [1016.7.2] Where the surface is other than concrete, asphalt, or boards, cross slopes not steeper than 1:20 shall be permitted when necessary for drainage.</p>	<p><input type="checkbox"/> YES Measure N/A</p>	<p><input type="checkbox"/> NO ment:</p>		<p>Photo #:</p>	<ul style="list-style-type: none"> • Regrade 											
<p>2.213</p>	<p>Is the resting interval length at least 60 inches (1525 mm) long? [1017.8.1]</p>	<p><input type="checkbox"/> YES Measure N/A</p>	<p><input type="checkbox"/> NO ment:</p>		<p>Photo #:</p>	<ul style="list-style-type: none"> • Modify route • Regrade 											

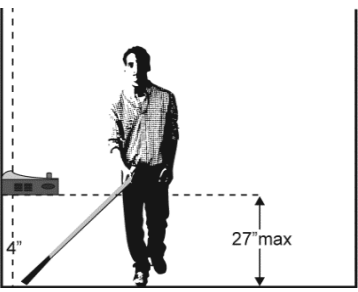
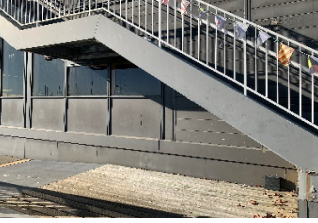
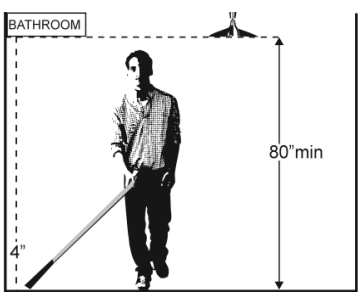
<p>2.214</p>	<p>If the resting intervals are provided within the outdoor recreation access route, is it at least as wide as the widest segment of the outdoor recreation access route leading to the resting interval? [1016.8.2]</p>	<p><input type="checkbox"/> YES Measure N/A</p>	<p><input type="checkbox"/> NO ment:</p>		<p>Photo #:</p>	<ul style="list-style-type: none"> • Modify route • Regrade
<p>2.215</p>	<p>If resting intervals are provided adjacent to the trail tread, is the resting interval clear width at least 36 inches (915 mm)? [1016.8.2]</p>	<p><input type="checkbox"/> YES Measure N/A</p>	<p><input type="checkbox"/> NO ment:</p>		<p>Photo #:</p>	<ul style="list-style-type: none"> • Modify route • Regrade
<p>2.216</p>	<p>Are the resting interval slopes no steeper than 1:48 in any direction? Where the surface is other than concrete, asphalt, or boards, cross slopes not steeper than 1:20 shall be permitted when necessary for drainage.</p>	<p><input type="checkbox"/> YES Measure N/A</p>	<p><input type="checkbox"/> NO ment:</p>			<ul style="list-style-type: none"> • Modify route • Regrade
<p>2.217</p>	<p>Where resting intervals are provided adjacent to an outdoor recreation access route, is there a T-shaped turning space within a 60 inch (1525 mm) square minimum with arms and base 36 inches (915 mm) wide minimum?</p>	<p><input type="checkbox"/> YES Measure N/A</p>	<p><input type="checkbox"/> NO ment:</p>			<ul style="list-style-type: none"> • Modify route • Provide turning space

<p>2.218</p>	<p>Is the vertical alignment between the outdoor recreation access route, turning space, and resting interval nominally planar? (virtually flat)</p>	<p><input checked="" type="checkbox"/> YES Measurement:</p>	<p><input type="checkbox"/> NO</p>			<ul style="list-style-type: none"> • Modify route • Regrade
---------------------	--	--	------------------------------------	--	--	---

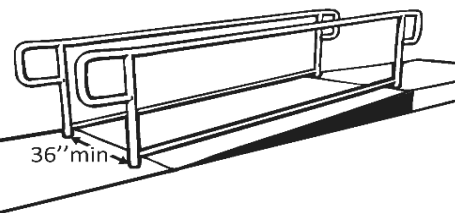
<p>2.219</p>	<p>Do all objects on outdoor recreation access routes, passing spaces, and resting intervals, e.g. signs, etc., protrude no more than 4 inches into the path? (does not apply to natural features, such as tree branches, rock formations) Or</p>	<p><input type="checkbox"/> YES Measure</p>	<p><input checked="" type="checkbox"/> NO ment: STAIR @ EAST END OF YACHT CLUB</p>		 <p>Photo #:</p>	<ul style="list-style-type: none"> • Remove object • Add tactile warning such as permanent planter or partial walls
	<p>If an object protrudes more than 4 inches, is the bottom leading edge at 27 inches or lower above the floor? [307.2] Or</p>	<p><input type="checkbox"/> YES Measure</p>	<p><input checked="" type="checkbox"/> NO ment: 29" AT LOW POINT</p>		 <p>Photo #:</p>	<ul style="list-style-type: none"> • Remove object • Add tactile warning such as permanent planter or partial walls
	<p>Is the bottom leading edge at 80 inches or higher above the floor? [307.4]</p>	<p><input type="checkbox"/> YES Measure</p>	<p><input checked="" type="checkbox"/> NO ment: 29" AT LOW POINT</p>		 <p>Photo #:</p>	<ul style="list-style-type: none"> • Remove object • Add tactile warning such as permanent planter or partial walls

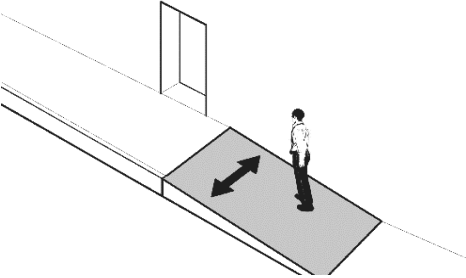
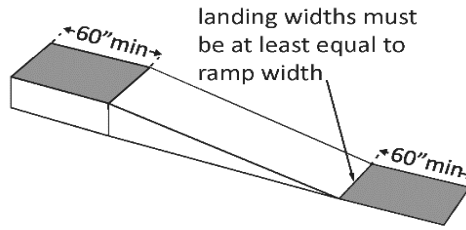
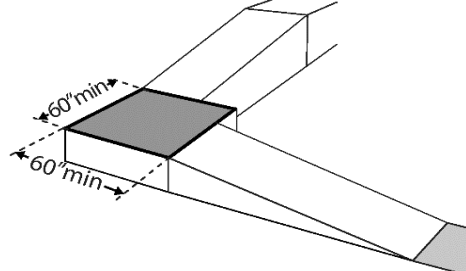
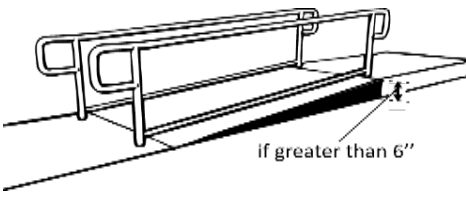

Ramps (Exterior)					
1.130	Return to a wall, guard, or landing surface? [505.10.1] Note: If a 12 inch extension would be a hazard (in circulation path) it is not required.	<input checked="" type="checkbox"/> YES <input type="checkbox"/> NO Measurement: 36"		Photo #: 	<ul style="list-style-type: none"> • Alter ramp
1.131	Is the surface stable, firm and slip resistant? [405.4]	<input checked="" type="checkbox"/> YES <input type="checkbox"/> NO Material CONC		Photo #: 	<ul style="list-style-type: none"> • Resurface ramp
1.132	For each section of the ramp, is the running slope no greater than 1:12, i.e. for every inch of height change there are at least 12 inches of ramp run? [405.2] AND	<input type="checkbox"/> YES <input checked="" type="checkbox"/> NO Measurement: UP TO 10% NEAR TOP		Photo #: 	<ul style="list-style-type: none"> • Relocate ramp • Lengthen ramp to decrease slope
	No greater than 30" rise? [405.6] Note: Rises no greater than 3 inches with a slope no steeper than 1:8 and rises no greater than 6 inches with a slope no steeper than 1:10 are permitted when such slopes are necessary due to space limitations.	<input type="checkbox"/> YES <input checked="" type="checkbox"/> NO Measurement: 34 1/2"		Photo #: 	Photo #:

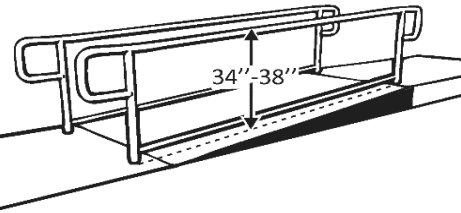
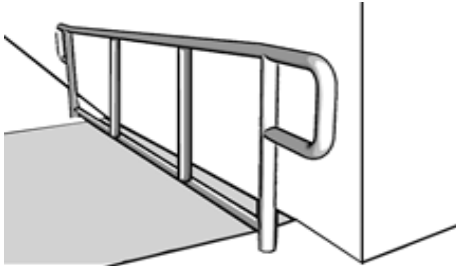
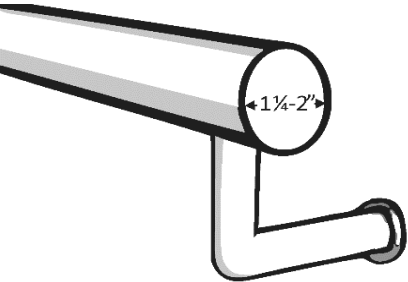
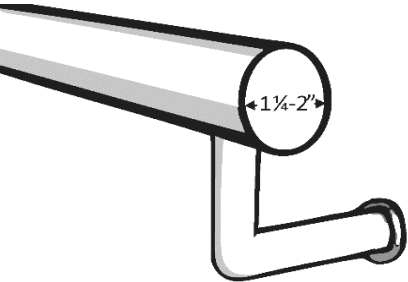
<p>1.133</p>	<p>Is the cross slope no steeper than 1:48? [403.3]</p>	<p><input checked="" type="checkbox"/> YES <input type="checkbox"/> NO</p> <p>Measure ment:</p>		<p>Photo #:</p>	<ul style="list-style-type: none"> • Regrade to 1:48 max.
<p>1.134</p>	<p>Is there a level landing that is at least 60 inches long and at least as wide as the ramp: At the top of the ramp?</p>	<p><input checked="" type="checkbox"/> YES <input type="checkbox"/> NO</p> <p>Measure ment:</p>		<p>Photo #:</p>	<ul style="list-style-type: none"> • Alter ramp • Relocate ramp
	<p>At the bottom of the ramp? [405.7.2, 405.7.3]</p>	<p><input checked="" type="checkbox"/> YES <input type="checkbox"/> NO</p> <p>Measure ment:</p>			
<p>1.135</p>	<p>Is there a level landing where the ramp changes direction that is at least 60 x 60 inches? [405.7.4]</p>	<p><input type="checkbox"/> YES <input type="checkbox"/> NO</p> <p>Measure ment:</p> <p>N/A</p>		<p>Photo #:</p>	<ul style="list-style-type: none"> • Alter ramp • Increase landing size
<p>1.136</p>	<p>If the ramp has a rise higher than 6 inches, are there handrails on both sides? [405.8]</p> <p>Note: Curb ramps are not required to have handrails.</p>	<p><input type="checkbox"/> YES <input checked="" type="checkbox"/> NO</p> <p>Measure ment:</p>		<p>Photo #:</p>	<ul style="list-style-type: none"> • Add handrails

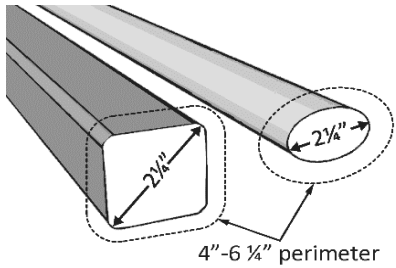
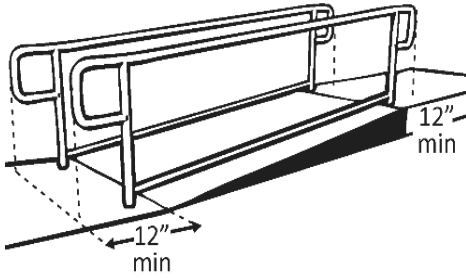
<p>1.137</p>	<p>Is the top of the handrail gripping surface no less than 34 inches and no greater than 38 inches above the ramp surface? [505.4]</p>	<p><input type="checkbox"/> YES</p>	<p><input checked="" type="checkbox"/> NO</p>		<p>Photo #:</p>	<ul style="list-style-type: none"> • Reconfigure or replace handrails • Adjust handrail height
<p>1.138</p>	<p>Is the handrail gripping surface continuous and not obstructed along the top or sides? [505.3]</p>	<p><input type="checkbox"/> YES</p>	<p><input checked="" type="checkbox"/> NO</p>		<p>Photo #:</p>	<ul style="list-style-type: none"> • Reconfigure or replace handrails
<p>1.139</p>	<p>If there are obstructions, is the bottom of the gripping surface obstructed no greater than 20%? [505.6]</p>	<p><input type="checkbox"/> YES</p>	<p><input checked="" type="checkbox"/> NO</p>		<p>Photo #:</p>	<ul style="list-style-type: none"> • Replace handrails
<p>1.139</p>	<p>If the handrail gripping surface is circular, is it no less than 1 1/4 inches and no greater than 2 inches in diameter? [505.7.1]</p>	<p><input type="checkbox"/> YES</p>	<p><input checked="" type="checkbox"/> NO</p>		<p>Photo #:</p>	<ul style="list-style-type: none"> • Replace handrails

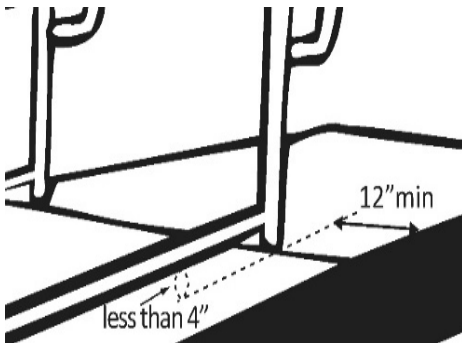
<p>1.140</p>	<p>If the handrail gripping surface is non-circular: Is the perimeter no less than 4 inches and no greater than 6¼ inches?</p>	<p><input type="checkbox"/> YES <input type="checkbox"/> NO Measure ment: N/A</p>		<p>Photo #:</p>	<ul style="list-style-type: none"> • Replace handrails
<p>Is the cross section no greater than 2¼ inches? [505.7.2]</p>	<p><input type="checkbox"/> YES <input type="checkbox"/> NO Measure ment: N/A</p>				
<p>1.141</p>	<p>Does the handrail: Extend at least 12 inches horizontally beyond the top of the ramp?</p>	<p><input type="checkbox"/> YES <input checked="" type="checkbox"/> NO Measure ment:</p>		<p>Photo #:</p>	<ul style="list-style-type: none"> • Alter handrails • Replace Handrails
<p>and Bottom of the ramp?</p>	<p><input type="checkbox"/> YES <input checked="" type="checkbox"/> NO Measure ment:</p>				
<p>Return to a wall, guard, or landing surface? [505.10.1] Note: If a 12 inch extension would be a hazard (in circulation path) it is not required.</p>	<p><input type="checkbox"/> YES <input checked="" type="checkbox"/> NO Measure ment:</p>				

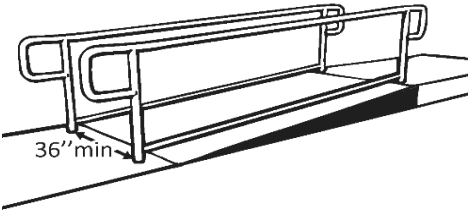
<p>1.142</p>	<p>To prevent wheelchair casters and crutch tips from falling off:</p> <p>Does the surface of the ramp extend at least 12 inches beyond the inside face of the handrail?</p>	<p><input type="checkbox"/> YES <input type="checkbox"/> NO</p> <p>Measure ment: N/A</p>		<p>Photo #:</p>	<ul style="list-style-type: none"> • Add curb • Add barrier • Extend ramp width
	<p>Or</p> <p>Is there a curb or barrier that prevents the passage of a 4-inch diameter sphere? [405.9.1, 405.9.2]</p>	<p><input checked="" type="checkbox"/> YES <input type="checkbox"/> NO</p> <p>Measure ment: SOLID WALL</p>			

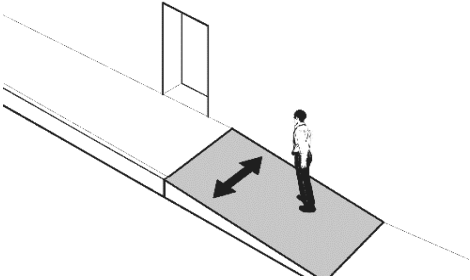
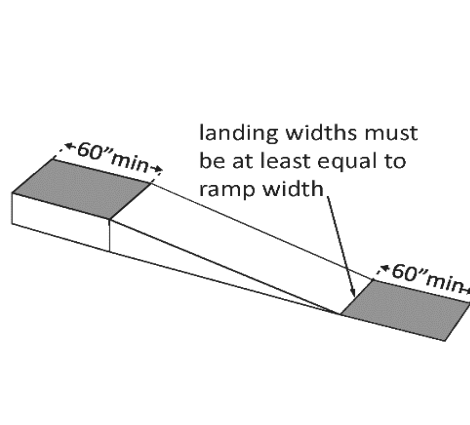
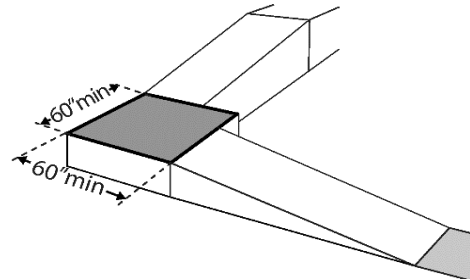

Ramps (Exterior)					
1.130	<p>If there is a ramp is it at least 36 inches wide? [405.5]</p> <p>Note: If there are handrails, measure between the handrails.</p>	<p><input checked="" type="checkbox"/> YES <input type="checkbox"/> NO</p> <p>Measure ment:</p>		<p>Photo #:</p>	<ul style="list-style-type: none"> • Alter ramp
1.131	<p>Is the surface stable, firm and slip resistant? [405.4]</p>	<p><input checked="" type="checkbox"/> YES <input type="checkbox"/> NO</p> <p>Material CONC</p>		<p>Photo #:</p>	<ul style="list-style-type: none"> • Resurface ramp
1.132	<p>For each section of the ramp, is the running slope no greater than 1:12, i.e. for every inch of height change there are at least 12 inches of ramp run? [405.2]</p> <p>AND</p>	<p><input type="checkbox"/> YES <input checked="" type="checkbox"/> NO</p> <p>Measure ment: 8.5% NEAR TOP</p>		 <p>Photo #:</p>	<ul style="list-style-type: none"> • Relocate ramp • Lengthen ramp to decrease slope
	<p>No greater than 30" rise? [405.6]</p> <p>Note: Rises no greater than 3 inches with a slope no steeper than 1:8 and rises no greater than 6 inches with a slope no steeper than 1:10 are permitted when such slopes are necessary due to space limitations.</p>	<p><input checked="" type="checkbox"/> YES <input type="checkbox"/> NO</p> <p>Measure ment: 26"</p>		<p>Photo #:</p>	<p>Photo #:</p>

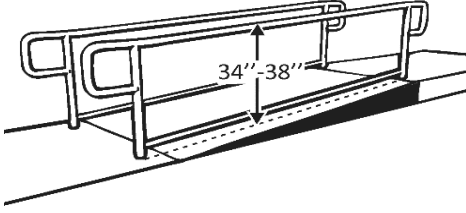
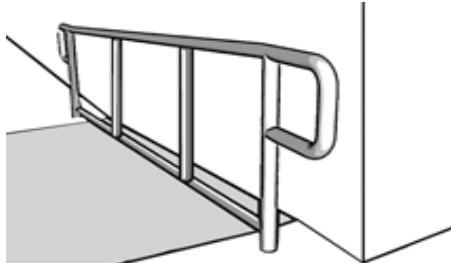
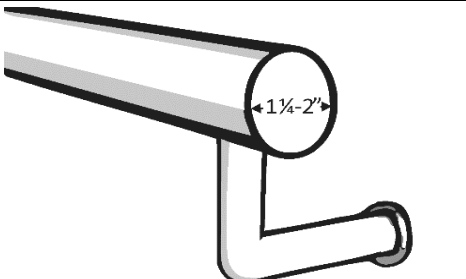
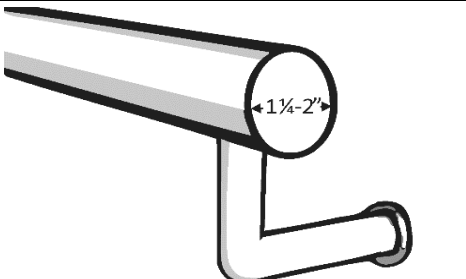
<p>1.133</p>	<p>Is the cross slope no steeper than 1:48? [403.3]</p>	<p><input checked="" type="checkbox"/> YES <input type="checkbox"/> NO Measure ment:</p>		<p>Photo #:</p>	<ul style="list-style-type: none"> • Regrade to 1:48 max.
<p>1.134</p>	<p>Is there a level landing that is at least 60 inches long and at least as wide as the ramp: At the top of the ramp?</p>	<p><input checked="" type="checkbox"/> YES <input type="checkbox"/> NO Measure ment:</p>		<p>Photo #:</p>	<ul style="list-style-type: none"> • Alter ramp • Relocate ramp
<p>1.135</p>	<p>At the bottom of the ramp? [405.7.2, 405.7.3]</p>	<p><input checked="" type="checkbox"/> YES <input type="checkbox"/> NO Measure ment:</p>		<p>Photo #:</p>	<ul style="list-style-type: none"> • Alter ramp • Increase landing size
<p>1.136</p>	<p>Is there a level landing where the ramp changes direction that is at least 60 x 60 inches? [405.7.4]</p>	<p><input type="checkbox"/> YES <input type="checkbox"/> NO Measure ment: N/A</p>		<p>Photo #:</p>	<ul style="list-style-type: none"> • Alter ramp • Increase landing size
<p>1.136</p>	<p>If the ramp has a rise higher than 6 inches, are there handrails on both sides? [405.8]</p> <p>Note: Curb ramps are not required to have handrails.</p>	<p><input checked="" type="checkbox"/> YES <input type="checkbox"/> NO Measure ment:</p>		<p>Photo #:</p>	<ul style="list-style-type: none"> • Add handrails

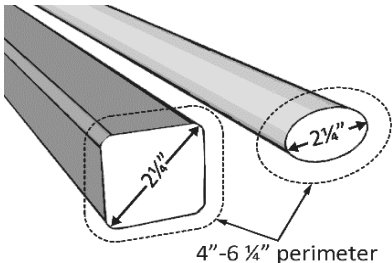
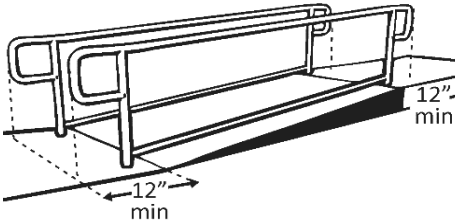
<p>1.137</p>	<p>Is the top of the handrail gripping surface no less than 34 inches and no greater than 38 inches above the ramp surface? [505.4]</p>	<p><input checked="" type="checkbox"/> YES <input type="checkbox"/> NO Measure ment: 37 1/2"</p>		<p>Photo #:</p>	<ul style="list-style-type: none"> • Reconfigure or replace handrails • Adjust handrail height
<p>1.138</p>	<p>Is the handrail gripping surface continuous and not obstructed along the top or sides? [505.3]</p>	<p><input checked="" type="checkbox"/> YES <input type="checkbox"/> NO</p>		<p>Photo #:</p>	<ul style="list-style-type: none"> • Reconfigure or replace handrails
<p>1.139</p>	<p>If there are obstructions, is the bottom of the gripping surface obstructed no greater than 20%? [505.6]</p>	<p><input type="checkbox"/> YES <input type="checkbox"/> NO Measure ment: N/A</p>		<p>Photo #:</p>	<ul style="list-style-type: none"> • Replace handrails
<p>1.139</p>	<p>If the handrail gripping surface is circular, is it no less than 1 1/4 inches and no greater than 2 inches in diameter? [505.7.1]</p>	<p><input checked="" type="checkbox"/> YES <input type="checkbox"/> NO Measure ment:</p>		<p>Photo #:</p>	<ul style="list-style-type: none"> • Replace handrails

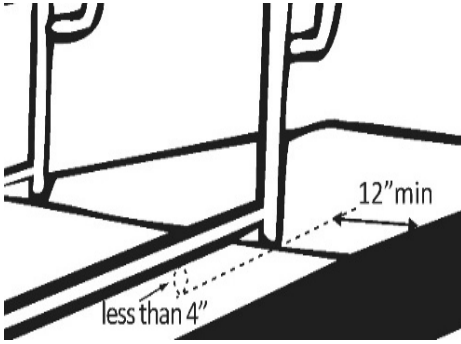
<p>1.140</p>	<p>If the handrail gripping surface is non-circular:</p> <p>Is the perimeter no less than 4 inches and no greater than 6¼ inches?</p>	<p><input type="checkbox"/> YES <input type="checkbox"/> NO</p> <p>Measure ment: N/A</p>		<p>Photo #:</p>	<ul style="list-style-type: none"> • Replace handrails
	<p>Is the cross section no greater than 2¼ inches? [505.7.2]</p>	<p><input type="checkbox"/> YES <input type="checkbox"/> NO</p> <p>Measure ment: N/A</p>			
<p>1.141</p>	<p>Does the handrail:</p> <p>Extend at least 12 inches horizontally beyond the top of the ramp?</p>	<p><input type="checkbox"/> YES <input checked="" type="checkbox"/> NO</p> <p>Measure ment:</p>		<p>Photo #:</p>	<ul style="list-style-type: none"> • Alter handrails • Replace Handrails
	<p>and</p> <p>Bottom of the ramp?</p>	<p><input checked="" type="checkbox"/> YES <input type="checkbox"/> NO</p> <p>Measure ment:</p>			
<p>Return to a wall, guard, or landing surface? [505.10.1]</p> <p>Note: If a 12 inch extension would be a hazard (in circulation path) it is not required.</p>	<p><input checked="" type="checkbox"/> YES <input type="checkbox"/> NO</p> <p>Measure ment:</p>				

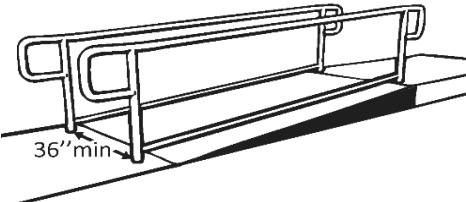
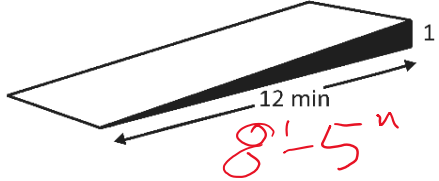
<p>1.142</p>	<p>To prevent wheelchair casters and crutch tips from falling off:</p> <p>Does the surface of the ramp extend at least 12 inches beyond the inside face of the handrail?</p>	<p><input type="checkbox"/> YES <input type="checkbox"/> NO</p> <p>Measure ment: N/A</p>		<p>Photo #:</p>	<ul style="list-style-type: none"> • Add curb • Add barrier • Extend ramp width
<p>Or</p> <p>Is there a curb or barrier that prevents the passage of a 4-inch diameter sphere? [405.9.1, 405.9.2]</p>	<p><input checked="" type="checkbox"/> YES <input type="checkbox"/> NO</p> <p>Measure ment: 3 1/2"</p>				

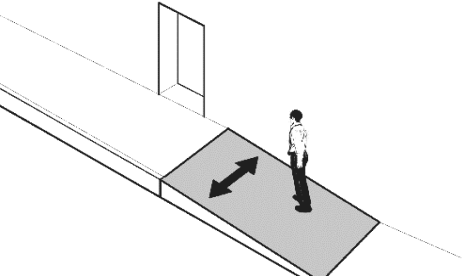
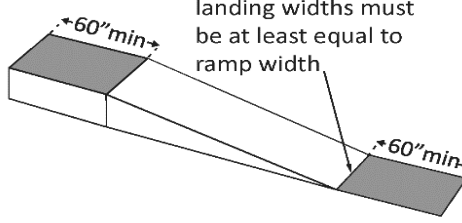
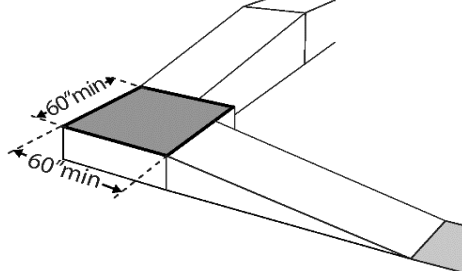
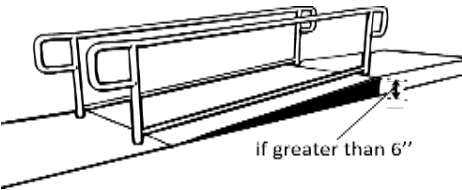

Ramps (Exterior)					
1.130	<p>If there is a ramp is it at least 36 inches wide? [405.5]</p> <p>Note: If there are handrails, measure between the handrails.</p>	<p><input checked="" type="checkbox"/> YES <input type="checkbox"/> NO</p> <p>Measure ment: 8'-0"</p>		<p>Photo #:</p>	<ul style="list-style-type: none"> • Alter ramp
1.131	<p>Is the surface stable, firm and slip resistant? [405.4]</p>	<p><input checked="" type="checkbox"/> YES <input type="checkbox"/> NO</p> <p>Material PLYWD</p>		<p>Photo #:</p>	<ul style="list-style-type: none"> • Resurface ramp
1.132	<p>For each section of the ramp, is the running slope no greater than 1:12, i.e. for every inch of height change there are at least 12 inches of ramp run? [405.2]</p>	<p><input type="checkbox"/> YES <input checked="" type="checkbox"/> NO</p> <p>Measure ment: UP TO 9.4% NEAR TOP</p>			<ul style="list-style-type: none"> • Relocate ramp • Lengthen ramp to decrease slope
1.132	<p>AND</p> <p>No greater than 30" rise? [405.6]</p> <p>Note: Rises no greater than 3 inches with a slope no steeper than 1:8 and rises no greater than 6 inches with a slope no steeper than 1:10 are permitted when such slopes are necessary due to space limitations.</p>	<p><input checked="" type="checkbox"/> YES <input type="checkbox"/> NO</p> <p>Measure ment: 9 1/2"</p>		<p>Photo #:</p>	<p>Photo #:</p>

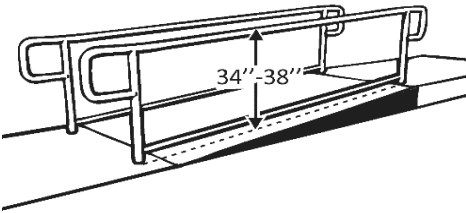
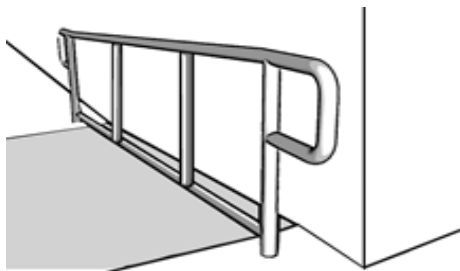
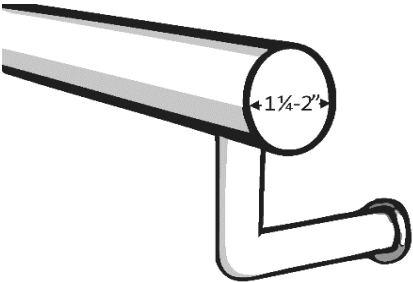
<p>1.133</p>	<p>Is the cross slope no steeper than 1:48? [403.3]</p>	<p><input checked="" type="checkbox"/> YES <input type="checkbox"/> NO</p> <p>Measure ment:</p>		<p>Photo #:</p>	<ul style="list-style-type: none"> • Regrade to 1:48 max.
<p>1.134</p>	<p>Is there a level landing that is at least 60 inches long and at least as wide as the ramp: At the top of the ramp?</p>	<p><input checked="" type="checkbox"/> YES <input type="checkbox"/> NO</p> <p>Measure ment:</p>		<p>Photo #:</p>	<ul style="list-style-type: none"> • Alter ramp • Relocate ramp
	<p>At the bottom of the ramp? [405.7.2, 405.7.3]</p>	<p><input checked="" type="checkbox"/> YES <input type="checkbox"/> NO</p> <p>Measure ment:</p>			
<p>1.135</p>	<p>Is there a level landing where the ramp changes direction that is at least 60 x 60 inches? [405.7.4]</p>	<p><input type="checkbox"/> YES <input type="checkbox"/> NO</p> <p>Measure ment: N/A</p>		<p>Photo #:</p>	<ul style="list-style-type: none"> • Alter ramp • Increase landing size
<p>1.136</p>	<p>If the ramp has a rise higher than 6 inches, are there handrails on both sides? [405.8]</p> <p>Note: Curb ramps are not required to have handrails.</p>	<p><input type="checkbox"/> YES <input checked="" type="checkbox"/> NO</p> <p>Measure ment:</p>		<p>Photo #:</p>	<ul style="list-style-type: none"> • Add handrails

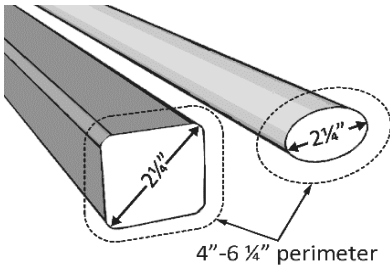
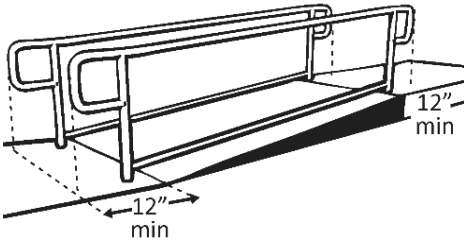
<p>1.137</p>	<p>Is the top of the handrail gripping surface no less than 34 inches and no greater than 38 inches above the ramp surface? [505.4]</p>	<p><input type="checkbox"/> YES <input checked="" type="checkbox"/> NO</p>	<p>Measurement:</p>		<p>Photo #:</p>	<ul style="list-style-type: none"> • Reconfigure or replace handrails • Adjust handrail height
<p>1.138</p>	<p>Is the handrail gripping surface continuous and not obstructed along the top or sides? [505.3]</p>	<p><input type="checkbox"/> YES <input checked="" type="checkbox"/> NO</p>	<p>Measurement:</p>		<p>Photo #:</p>	<ul style="list-style-type: none"> • Reconfigure or replace handrails
<p>1.139</p>	<p>If there are obstructions, is the bottom of the gripping surface obstructed no greater than 20%? [505.6]</p>	<p><input type="checkbox"/> YES <input checked="" type="checkbox"/> NO</p>	<p>Measurement:</p>		<p>Photo #:</p>	<ul style="list-style-type: none"> • Replace handrails

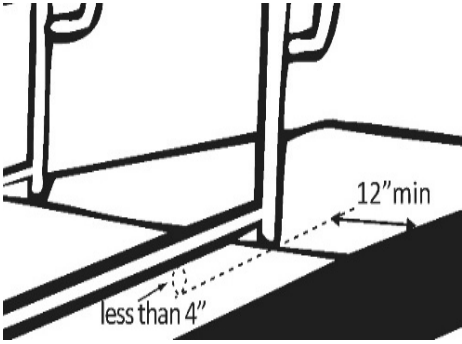
<p>1.140</p>	<p>If the handrail gripping surface is non-circular:</p> <p>Is the perimeter no less than 4 inches and no greater than 6¼ inches?</p>	<p><input type="checkbox"/> YES <input type="checkbox"/> NO</p> <p>Measure ment: N/A</p>		<p>Photo #:</p>	<ul style="list-style-type: none"> • Replace handrails
	<p>Is the cross section no greater than 2¼ inches? [505.7.2]</p>	<p><input type="checkbox"/> YES <input type="checkbox"/> NO</p> <p>Measure ment: N/A</p>			
<p>1.141</p>	<p>Does the handrail:</p> <p>Extend at least 12 inches horizontally beyond the top of the ramp?</p>	<p><input type="checkbox"/> YES <input checked="" type="checkbox"/> NO</p> <p>Measure ment:</p>		<p>Photo #:</p>	<ul style="list-style-type: none"> • Alter handrails • Replace Handrails
	<p>and</p> <p>Bottom of the ramp?</p>	<p><input type="checkbox"/> YES <input checked="" type="checkbox"/> NO</p> <p>Measure ment:</p>			
<p>Return to a wall, guard, or landing surface? [505.10.1]</p> <p>Note: If a 12 inch extension would be a hazard (in circulation path) it is not required.</p>	<p><input type="checkbox"/> YES <input checked="" type="checkbox"/> NO</p> <p>Measure ment:</p>				

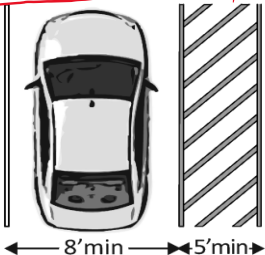
<p>1.142</p>	<p>To prevent wheelchair casters and crutch tips from falling off:</p> <p>Does the surface of the ramp extend at least 12 inches beyond the inside face of the handrail?</p>	<p><input type="checkbox"/> YES <input type="checkbox"/> NO</p> <p>Measure ment: N/A</p>		<p>Photo #:</p>	<ul style="list-style-type: none"> • Add curb • Add barrier • Extend ramp width
<p>Or</p> <p>Is there a curb or barrier that prevents the passage of a 4-inch diameter sphere? [405.9.1, 405.9.2]</p>	<p><input checked="" type="checkbox"/> YES <input type="checkbox"/> NO</p> <p>Measure ment: SOLID WALL</p>				

Parking Accessible parking spaces should be identified by size, access aisle and signage.																			
1.100	If parking is provided for the public, are an adequate number of accessible spaces provided? (208.2)	<input checked="" type="checkbox"/> YES <input type="checkbox"/> NO Total #: 18 Acsbl #: 2	<table border="1"> <thead> <tr> <th>Total Spaces</th> <th>Accessible Spaces</th> </tr> </thead> <tbody> <tr> <td>1 - 25</td> <td>1</td> </tr> <tr> <td>26 - 50</td> <td>2</td> </tr> <tr> <td>51 - 75</td> <td>3</td> </tr> <tr> <td>76 - 100</td> <td>4</td> </tr> <tr> <td>1200</td> <td>22</td> </tr> <tr> <td colspan="2">100+ see 2010 Standards 208.2</td> </tr> </tbody> </table>	Total Spaces	Accessible Spaces	1 - 25	1	26 - 50	2	51 - 75	3	76 - 100	4	1200	22	100+ see 2010 Standards 208.2		 <p>Photo:</p>	<ul style="list-style-type: none"> • Reconfigure by repainting lines
Total Spaces	Accessible Spaces																		
1 - 25	1																		
26 - 50	2																		
51 - 75	3																		
76 - 100	4																		
1200	22																		
100+ see 2010 Standards 208.2																			
1.101	Of the accessible spaces, is at least one a van accessible space?* [208.2.4]	<input type="checkbox"/> YES <input checked="" type="checkbox"/> NO	*For every 6 or fraction of 6 parking spaces required by the table above, at least 1 should be a van accessible space.	<p style="color: red; font-size: 2em; text-align: center;">SLOPED CURB</p> <p>Photo:</p>	<ul style="list-style-type: none"> • If constructed before 3/15/2012, parking is compliant if at least 1 in every 8 accessible spaces is van accessible • Reconfigure by repainting lines 														
1.102	Are accessible spaces at least 8 feet wide with an access aisle at least 5 feet wide? [502.2, 502.3] Note: Two spaces may share an access aisle. Check state/local requirements; some specify that each space have its own aisle.	<input checked="" type="checkbox"/> YES <input type="checkbox"/> NO Measure ment:		 <p>Photo:</p>	<ul style="list-style-type: none"> • Reconfigure by repainting lines 														

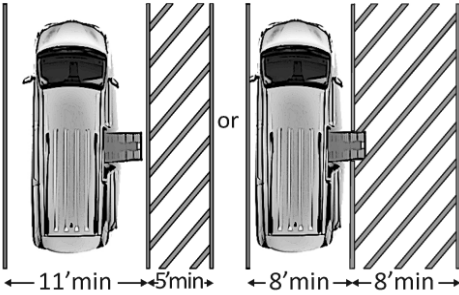
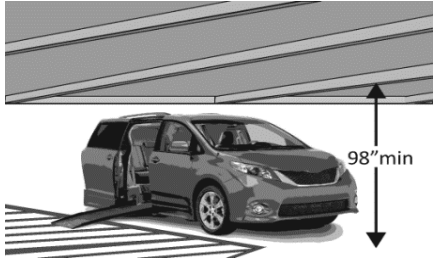
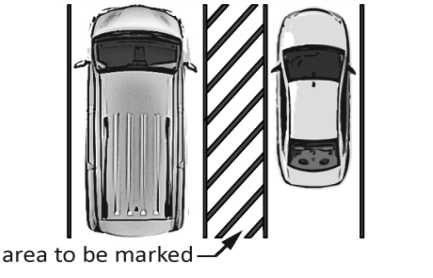

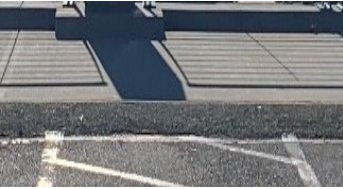
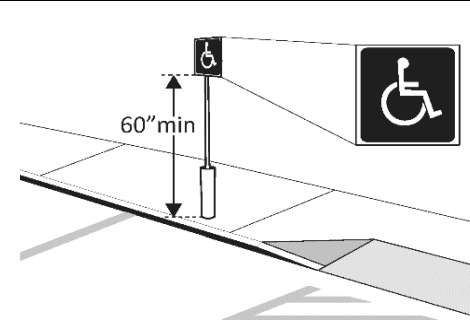
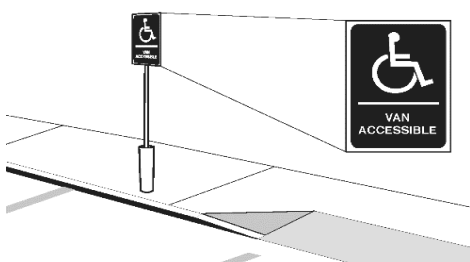
<p>1.103</p>	<p>Is the van accessible space: At least 11 feet wide with an access aisle at least 5 feet wide? Or At least 8 feet wide with an access aisle at least 8 feet wide? [502.2]</p>	<p><input type="checkbox"/> YES <input checked="" type="checkbox"/> NO Measurement:</p>		<p>Photo:</p>	<ul style="list-style-type: none"> • Reconfigure by repainting lines
<p>1.104</p>	<p>Is at least 98 inches of vertical clearance provided for the van accessible space? [502.5]</p>	<p><input checked="" type="checkbox"/> YES <input type="checkbox"/> NO Measurement:</p>		<p>Photo:</p>	<ul style="list-style-type: none"> • Reconfigure to provide van-accessible space(s)
<p>1.105</p>	<p>Are the access aisles marked so as to discourage parking in them? [502.3.3] Note: The marking method and color may be addressed by state/local requirements.</p>	<p><input checked="" type="checkbox"/> YES <input type="checkbox"/> NO Measurement:</p>		<p>Photo:</p>	<ul style="list-style-type: none"> • Mark access aisles
<p>1.106</p>	<p>Is the slope of the accessible parking spaces and access aisles no steeper than 1:48 in all directions? [502.4]</p>	<p><input checked="" type="checkbox"/> YES <input type="checkbox"/> NO Measurement</p>		<p>Photo:</p>	<ul style="list-style-type: none"> • Regrade surface

<p>1.107</p>	<p>Do the access aisles adjoin an accessible route? [502.3]</p>	<p><input type="checkbox"/> YES <input checked="" type="checkbox"/> NO 3.6% 24" WIDEx 6" HIGH SLOPED CURB</p>		 <p>Photo:</p>	<ul style="list-style-type: none"> • Create accessible route • Relocate accessible space
<p>1.108</p>	<p>Are accessible spaces identified with a sign that includes the International Symbol of Accessibility? Is the bottom of the sign at least 60 inches above the ground? [502.6] Note: The International Symbol of Accessibility is not required on the ground.</p>	<p><input checked="" type="checkbox"/> YES <input type="checkbox"/> NO <input type="checkbox"/> YES <input checked="" type="checkbox"/> NO 31"</p>		<p>Photo:</p> <p>Photo:</p>	<ul style="list-style-type: none"> • Install signs
<p>1.109</p>	<p>Are there signs reading "van accessible" at van accessible spaces? [502.6]</p>	<p><input type="checkbox"/> YES <input checked="" type="checkbox"/> NO 27"</p>		<p>Photo:</p>	<ul style="list-style-type: none"> • Install signs

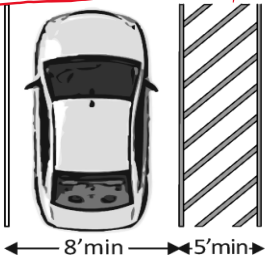
<p>1.110</p>	<p>Of the total parking spaces, are the accessible spaces located on the closest accessible route to the accessible entrance(s)? [208.3.1] Note: If parking serves multiple entrances, accessible parking should be dispersed.</p>	<p><input checked="" type="checkbox"/> YES <input type="checkbox"/> NO</p> <p>TO BLDG AND TRAIL</p>		<p>Photo:</p>	<ul style="list-style-type: none"> • Reconfigure spaces
---------------------	---	---	--	---------------	--

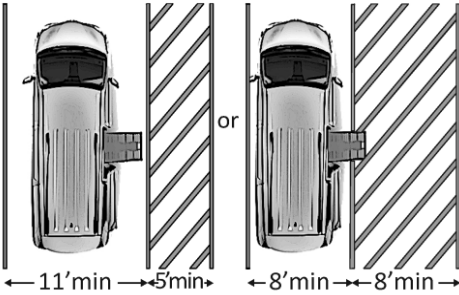
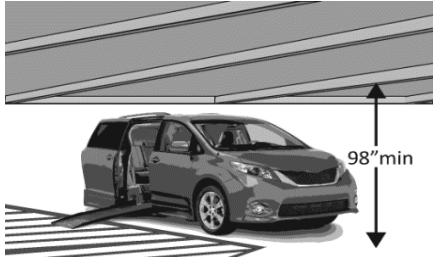
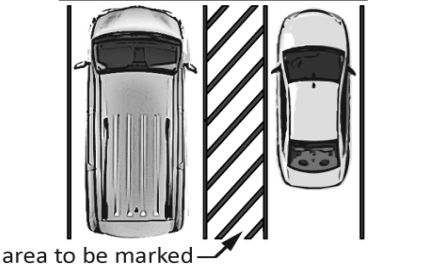
Parking Accessible parking spaces should be identified by size, access aisle and signage.																			
1.100	If parking is provided for the public, are an adequate number of accessible spaces provided? (208.2)	<input checked="" type="checkbox"/> YES <input type="checkbox"/> NO Total #: 18 Acsbl #: 2	<table border="1"> <thead> <tr> <th>Total Spaces</th> <th>Accessible Spaces</th> </tr> </thead> <tbody> <tr> <td>1 - 25</td> <td>1</td> </tr> <tr> <td>26 - 50</td> <td>2</td> </tr> <tr> <td>51 - 75</td> <td>3</td> </tr> <tr> <td>76 - 100</td> <td>4</td> </tr> <tr> <td>1200</td> <td>22</td> </tr> <tr> <td colspan="2">100+ see 2010 Standards 208.2</td> </tr> </tbody> </table>	Total Spaces	Accessible Spaces	1 - 25	1	26 - 50	2	51 - 75	3	76 - 100	4	1200	22	100+ see 2010 Standards 208.2		 <p>Photo:</p>	<ul style="list-style-type: none"> • Reconfigure by repainting lines
Total Spaces	Accessible Spaces																		
1 - 25	1																		
26 - 50	2																		
51 - 75	3																		
76 - 100	4																		
1200	22																		
100+ see 2010 Standards 208.2																			
1.101	Of the accessible spaces, is at least one a van accessible space?* [208.2.4]	<input type="checkbox"/> YES <input checked="" type="checkbox"/> NO	*For every 6 or fraction of 6 parking spaces required by the table above, at least 1 should be a van accessible space.	<p style="color: red; font-size: 2em; text-align: center;">SLOPED CURB</p> <p>Photo:</p>	<ul style="list-style-type: none"> • If constructed before 3/15/2012, parking is compliant if at least 1 in every 8 accessible spaces is van accessible • Reconfigure by repainting lines 														
1.102	Are accessible spaces at least 8 feet wide with an access aisle at least 5 feet wide? [502.2, 502.3] Note: Two spaces may share an access aisle. Check state/local requirements; some specify that each space have its own aisle.	<input checked="" type="checkbox"/> YES <input type="checkbox"/> NO Measure ment:		<p>Photo:</p>	<ul style="list-style-type: none"> • Reconfigure by repainting lines 														

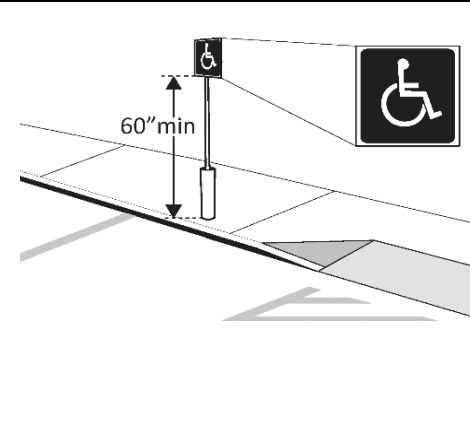
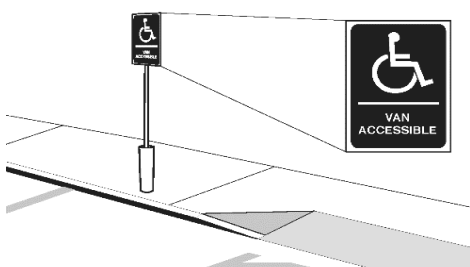

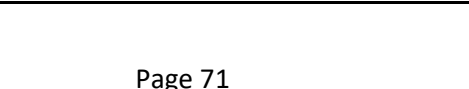
<p>1.103</p>	<p>Is the van accessible space: At least 11 feet wide with an access aisle at least 5 feet wide? Or At least 8 feet wide with an access aisle at least 8 feet wide? [502.2]</p>	<p><input type="checkbox"/> YES <input checked="" type="checkbox"/> NO Measurement:</p>		<p>Photo:</p>	<ul style="list-style-type: none"> • Reconfigure by repainting lines
<p>1.104</p>	<p>Is at least 98 inches of vertical clearance provided for the van accessible space? [502.5]</p>	<p><input checked="" type="checkbox"/> YES <input type="checkbox"/> NO Measurement:</p>		<p>Photo:</p>	<ul style="list-style-type: none"> • Reconfigure to provide van-accessible space(s)
<p>1.105</p>	<p>Are the access aisles marked so as to discourage parking in them? [502.3.3] Note: The marking method and color may be addressed by state/local requirements.</p>	<p><input checked="" type="checkbox"/> YES <input type="checkbox"/> NO Measurement:</p>		<p>Photo:</p>	<ul style="list-style-type: none"> • Mark access aisles
<p>1.106</p>	<p>Is the slope of the accessible parking spaces and access aisles no steeper than 1:48 in all directions? [502.4]</p>	<p><input checked="" type="checkbox"/> YES <input type="checkbox"/> NO Measurement: <2% FIX BUMP @ ELECT MANHL COVER</p>		<p>Photo:</p>	<ul style="list-style-type: none"> • Regrade surface

<p>1.107</p>	<p>Do the access aisles adjoin an accessible route? [502.3]</p>	<p><input type="checkbox"/> YES <input checked="" type="checkbox"/> NO 24" WIDEx 6" HIGH SLOPED CURB</p>		<p>Photo:</p>	<ul style="list-style-type: none"> • Create accessible route • Relocate accessible space
<p>1.108</p>	<p>Are accessible spaces identified with a sign that includes the International Symbol of Accessibility?</p>	<p><input checked="" type="checkbox"/> YES <input type="checkbox"/> NO</p>		<p>Photo:</p>	<ul style="list-style-type: none"> • Install signs
<p>1.109</p>	<p>Is the bottom of the sign at least 60 inches above the ground? [502.6] Note: The International Symbol of Accessibility is not required on the ground.</p>	<p><input type="checkbox"/> YES <input checked="" type="checkbox"/> NO 33"</p>		<p>Photo:</p>	<ul style="list-style-type: none"> • Install signs
<p>1.110</p>	<p>Are there signs reading "van accessible" at van accessible spaces? [502.6]</p>	<p><input type="checkbox"/> YES <input checked="" type="checkbox"/> NO</p>		<p>Photo:</p>	<ul style="list-style-type: none"> • Reconfigure spaces
<p>1.110</p>	<p>Of the total parking spaces, are the accessible spaces located on the closest accessible route to the accessible entrance(s)? [208.3.1] Note: If parking serves multiple entrances, accessible parking should be dispersed.</p>	<p><input checked="" type="checkbox"/> YES <input type="checkbox"/> NO TO TRAIL</p>		<p>Photo:</p>	<ul style="list-style-type: none"> • Reconfigure spaces

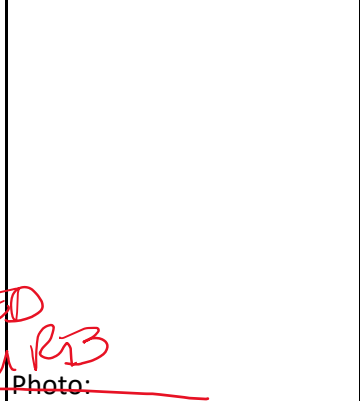
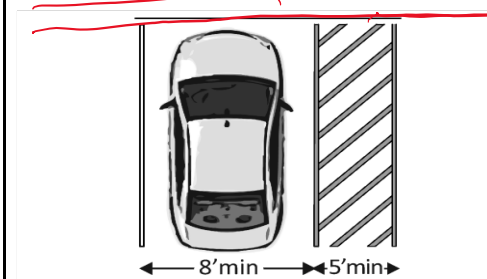
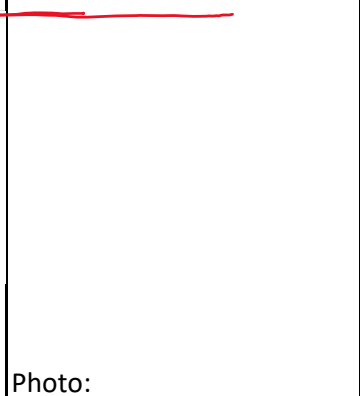
Trash and recycling			
2.480	Is there a clear ground space 36 inches (915 mm) by 48 inches (1220 mm) positioned for forward approach to the receptacle opening; or 30 inches (760 mm) by 60 inches (1525 mm) positioned for a parallel approach to the receptacle opening? [1011.2.1]	<input type="checkbox"/> YES <input checked="" type="checkbox"/> NO Measurement:	<div data-bbox="1339 191 1696 435" data-label="Image"> </div> <div data-bbox="1339 435 1696 626" data-label="Text"> Photo #: </div> <div data-bbox="1696 191 2007 626" data-label="List-Group"> <ul style="list-style-type: none"> • Add or Relocate bins </div>

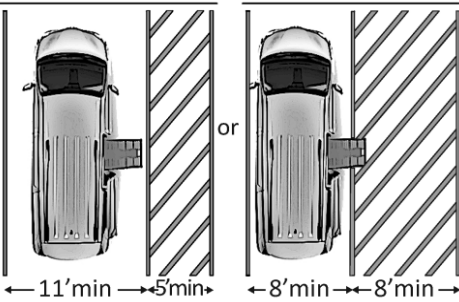
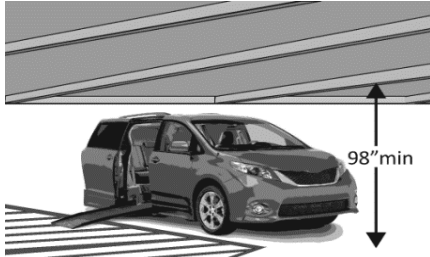
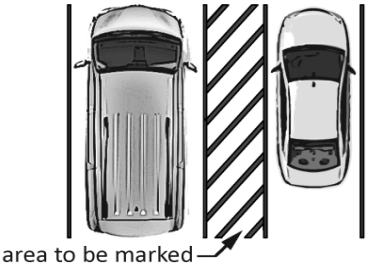
Parking Accessible parking spaces should be identified by size, access aisle and signage.																				
1.100	If parking is provided for the public, are an adequate number of accessible spaces provided? (208.2)	<input type="checkbox"/> YES	<input checked="" type="checkbox"/> NO	<table border="1"> <thead> <tr> <th>Total Spaces</th> <th>Accessible Spaces</th> </tr> </thead> <tbody> <tr> <td>1 - 25</td> <td>1</td> </tr> <tr> <td>26 - 50</td> <td>2</td> </tr> <tr> <td>51 - 75</td> <td>3</td> </tr> <tr> <td>76 - 100</td> <td>4</td> </tr> <tr> <td>1200</td> <td>22</td> </tr> <tr> <td colspan="2">100+ see 2010 Standards 208.2</td> </tr> </tbody> </table>	Total Spaces	Accessible Spaces	1 - 25	1	26 - 50	2	51 - 75	3	76 - 100	4	1200	22	100+ see 2010 Standards 208.2			<ul style="list-style-type: none"> Reconfigure by repainting lines
Total Spaces	Accessible Spaces																			
1 - 25	1																			
26 - 50	2																			
51 - 75	3																			
76 - 100	4																			
1200	22																			
100+ see 2010 Standards 208.2																				
1.101	Of the accessible spaces, is at least one a van accessible space? [208.2.4]	<input type="checkbox"/> YES	<input checked="" type="checkbox"/> NO	*For every 6 or fraction of 6 parking spaces required by the table above, at least 1 should be a van accessible space.	 <p style="color: red; font-style: italic;">SLOPED CURB</p>	<ul style="list-style-type: none"> If constructed before 3/15/2012, parking is compliant if at least 1 in every 8 accessible spaces is van accessible Reconfigure by repainting lines 														
1.102	Are accessible spaces at least 8 feet wide with an access aisle at least 5 feet wide? [502.2, 502.3] Note: Two spaces may share an access aisle. Check state/local requirements; some specify that each space have its own aisle.	<input checked="" type="checkbox"/> YES	<input type="checkbox"/> NO			<ul style="list-style-type: none"> Reconfigure by repainting lines 														

<p>1.103</p>	<p>Is the van accessible space: At least 11 feet wide with an access aisle at least 5 feet wide? Or At least 8 feet wide with an access aisle at least 8 feet wide? [502.2]</p>	<p><input type="checkbox"/> YES <input checked="" type="checkbox"/> NO Measurement:</p>		<p>Photo:</p>	<ul style="list-style-type: none"> • Reconfigure by repainting lines
<p>1.104</p>	<p>Is at least 98 inches of vertical clearance provided for the van accessible space? [502.5]</p>	<p><input checked="" type="checkbox"/> YES <input type="checkbox"/> NO Measurement:</p>		<p>Photo:</p>	<ul style="list-style-type: none"> • Reconfigure to provide van-accessible space(s)
<p>1.105</p>	<p>Are the access aisles marked so as to discourage parking in them? [502.3.3] Note: The marking method and color may be addressed by state/local requirements.</p>	<p><input checked="" type="checkbox"/> YES <input type="checkbox"/> NO Measurement:</p>		<p>Photo:</p>	<ul style="list-style-type: none"> • Mark access aisles
<p>1.106</p>	<p>Is the slope of the accessible parking spaces and access aisles no steeper than 1:48 in all directions? [502.4]</p>	<p><input checked="" type="checkbox"/> YES <input type="checkbox"/> NO Measurement: <2%</p>		<p>Photo:</p>	<ul style="list-style-type: none"> • Regrade surface

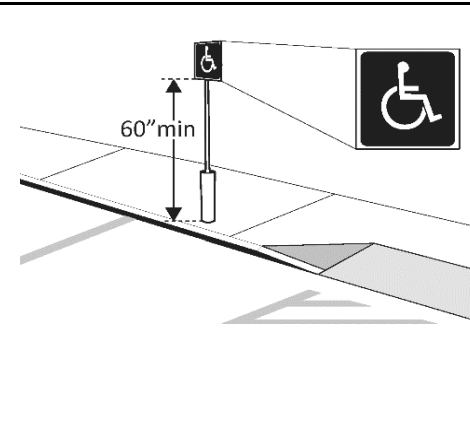
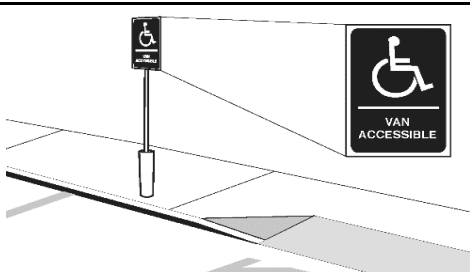
<p>1.107</p>	<p>Do the access aisles adjoin an accessible route? [502.3]</p>	<p><input type="checkbox"/> YES</p>	<p><input checked="" type="checkbox"/> NO 24" WIDEx 6" HIGH SLOPED CURB</p>			<ul style="list-style-type: none"> • Create accessible route • Relocate accessible space
<p>1.108</p>	<p>Are accessible spaces identified with a sign that includes the International Symbol of Accessibility?</p>	<p><input type="checkbox"/> YES</p>	<p><input checked="" type="checkbox"/> NO</p>		<p>Photo:</p>	<ul style="list-style-type: none"> • Install signs
	<p>Is the bottom of the sign at least 60 inches above the ground? [502.6] Note: The International Symbol of Accessibility is not required on the ground.</p>	<p><input type="checkbox"/> YES</p>	<p><input checked="" type="checkbox"/> NO</p>		<p>Photo:</p>	
<p>1.109</p>	<p>Are there signs reading "van accessible" at van accessible spaces? [502.6]</p>	<p><input type="checkbox"/> YES</p>	<p><input checked="" type="checkbox"/> NO</p>		<p>Photo:</p>	<ul style="list-style-type: none"> • Install signs

<p>1.110</p>	<p>Of the total parking spaces, are the accessible spaces located on the closest accessible route to the accessible entrance(s)? [208.3.1] Note: If parking serves multiple entrances, accessible parking should be dispersed.</p>	<p><input checked="" type="checkbox"/> YES <input type="checkbox"/> NO TO TRAIL</p>		<p>Photo:</p>	<ul style="list-style-type: none"> • Reconfigure spaces
---------------------	---	--	--	---------------	--

Viewing Areas [1015] (an outdoor space developed for viewing landscapes, wildlife, or other points of interest)				
2.150	Where provided within viewing areas, are at least 20 percent, but not less than one, of each type of outdoor constructed feature accessible? [246.3]	<input type="checkbox"/> YES <input type="checkbox"/> NO Total #: 0 Acsbl#: N/A	OUTDOOR CONSTRUCTED FEATURES: Picnic Tables Trash and Recycling Benches Viewing Scopes	 <ul style="list-style-type: none"> • Modify unit(s) • Provide new unit(s)
2.151	Is there at least one outdoor recreation access route connecting accessible parking spaces or other arrival points serving the viewing area with accessible elements, spaces, and facilities provided within the viewing area?	<input checked="" type="checkbox"/> YES <input type="checkbox"/> NO TRAIL		<ul style="list-style-type: none"> • Modify route • Provide new route <p>Photo #:</p>
2.152	Is there a clear ground space at each distinct viewing location?	<input checked="" type="checkbox"/> YES <input type="checkbox"/> NO Measure ment:		<p>Photo #:</p> <ul style="list-style-type: none"> • Modify space • Add Space

<p>2.153</p>	<p>Is the clear ground space 36 inches (915 mm) minimum by 48 inches (1220 mm) minimum and positioned for either a forward or parallel approach to the viewing location?</p>	<p><input checked="" type="checkbox"/> YES <input type="checkbox"/> NO Measurement:</p>		<p>Photo #:</p>	<ul style="list-style-type: none"> • Enlarge space • Provide new space
	<p>Does one full unobstructed side of the clear ground space adjoin or overlap an outdoor recreation access route or trail, as applicable, or another clear ground space? [1015.2]</p>	<p><input checked="" type="checkbox"/> YES <input type="checkbox"/> NO</p>		<p>Photo #:</p>	<ul style="list-style-type: none"> • Enlarge space • Provide new space
<p>2.154</p>	<p>Does each distinct viewing location provide a viewing space adjacent to the clear ground space through which the point of interest is viewable that is 32 inches (815 mm) maximum and 51 inches (1295 mm) minimum high above the ground and extends the full width of the clear ground space? [1015.3]</p>	<p><input type="checkbox"/> YES <input checked="" type="checkbox"/> NO Measurement: RAIL AROUND AREA IS 48" HIGH</p>		<p>Photo #:</p>	<ul style="list-style-type: none"> • Modify space • Add Space

2.155	Is the surface of the clear ground space firm and stable? [1015.5]	<input checked="" type="checkbox"/> YES <input type="checkbox"/> NO Material CONC		Photo #:	<ul style="list-style-type: none"> • Modify surface • Replace Surface
2.156	Is there a clear space within the viewing area for a person in a wheelchair to turn around, i.e. a circle at least 60 inches in diameter or a T-shaped space within a 60-inch square? [1015.4]	<input checked="" type="checkbox"/> YES <input type="checkbox"/> NO Measure ment:		Photo #:	<ul style="list-style-type: none"> • Modify space • Add Space
2.157	Is the slope of the surface of the clear ground space and turning space no more than 1:48 in any direction? [1015.6] or	<input checked="" type="checkbox"/> YES <input type="checkbox"/> NO Measure ment:		Photo #:	<ul style="list-style-type: none"> • Regrade
2.158	If the surface is other than asphalt, concrete, or boards, are the slopes no more than 1:20 as necessary for drainage? [1015.6]	<input type="checkbox"/> YES <input type="checkbox"/> NO Measure ment: N/A		Photo #:	<ul style="list-style-type: none"> • Regrade

Parking Spaces					
2.166	If parking spaces for vehicles, other than recreational vehicles, are provided, are they 16 feet (4880 mm) wide minimum? [1012.3] Or	<input type="checkbox"/> YES <input type="checkbox"/> NO Measure ment: NO ACCESSB L SPACE NEAR VIEW AREA		Photo #:	<ul style="list-style-type: none"> • Enlarge space • Provide new space
	If two adjacent parking spaces are provided for vehicles other than recreational vehicles, is one parking space 8 feet (2440 mm) wide minimum? [1012.3]	<input type="checkbox"/> YES <input type="checkbox"/> NO Measure ment: N/A		Photo #:	<ul style="list-style-type: none"> • Enlarge space • Provide new space
2.167	Is the parking surface firm and stable? [1012.4]	<input type="checkbox"/> YES <input type="checkbox"/> NO Measure ment: N/A		Photo #:	<ul style="list-style-type: none"> • Modify surface • Replace Surface
2.168	Is the slope of the surface of parking spaces and pull-up spaces less than 1:48 in any direction? [1012.5] or	<input type="checkbox"/> YES <input type="checkbox"/> NO Measure ment: N/A		Photo #:	<ul style="list-style-type: none"> • Regrade
	Where the surface is other than asphalt, concrete, or boards, are the slopes less than 1:20 for drainage?	<input type="checkbox"/> YES <input type="checkbox"/> NO Measure ment: N/A		Photo #:	<ul style="list-style-type: none"> • Regrade

Trash and recycling			
2.480	Is there a clear ground space 36 inches (915 mm) by 48 inches (1220 mm) positioned for forward approach to the receptacle opening; or 30 inches (760 mm) by 60 inches (1525 mm) positioned for a parallel approach to the receptacle opening? [1011.2.1]	<input type="checkbox"/> YES <input checked="" type="checkbox"/> NO Measurement:	<div data-bbox="1339 191 1696 431" data-label="Image"> </div> <div data-bbox="1339 431 1696 626" data-label="Text"> <p>Photo #:</p> </div> <div data-bbox="1696 191 2009 626" data-label="List-Group"> <ul style="list-style-type: none"> • Add or Relocate bins </div>

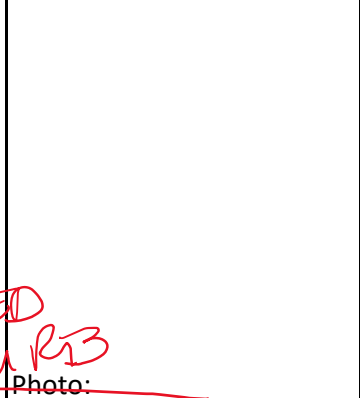
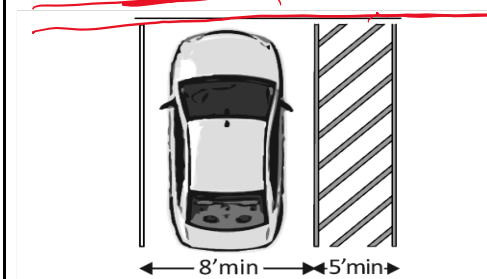

Parking Accessible parking spaces should be identified by size, access aisle and signage.																				
1.100	If parking is provided for the public, are an adequate number of accessible spaces provided? (208.2)	<input type="checkbox"/> YES	<input checked="" type="checkbox"/> NO	<table border="1"> <thead> <tr> <th>Total Spaces</th> <th>Accessible Spaces</th> </tr> </thead> <tbody> <tr> <td>1 - 25</td> <td>1</td> </tr> <tr> <td>26 - 50</td> <td>2</td> </tr> <tr> <td>51 - 75</td> <td>3</td> </tr> <tr> <td>76 - 100</td> <td>4</td> </tr> <tr> <td>1200</td> <td>22</td> </tr> <tr> <td colspan="2">100+ see 2010 Standards 208.2</td> </tr> </tbody> </table>	Total Spaces	Accessible Spaces	1 - 25	1	26 - 50	2	51 - 75	3	76 - 100	4	1200	22	100+ see 2010 Standards 208.2			<ul style="list-style-type: none"> Reconfigure by repainting lines
Total Spaces	Accessible Spaces																			
1 - 25	1																			
26 - 50	2																			
51 - 75	3																			
76 - 100	4																			
1200	22																			
100+ see 2010 Standards 208.2																				
1.101	Of the accessible spaces, is at least one a van accessible space? [208.2.4]	<input type="checkbox"/> YES	<input checked="" type="checkbox"/> NO	*For every 6 or fraction of 6 parking spaces required by the table above, at least 1 should be a van accessible space.	 <p><i>Photo:</i></p>	<ul style="list-style-type: none"> If constructed before 3/15/2012, parking is compliant if at least 1 in every 8 accessible spaces is van accessible Reconfigure by repainting lines 														
1.102	Are accessible spaces at least 8 feet wide with an access aisle at least 5 feet wide? [502.2, 502.3] Note: Two spaces may share an access aisle. Check state/local requirements; some specify that each space have its own aisle.	<input checked="" type="checkbox"/> YES	<input type="checkbox"/> NO		<p><i>Photo:</i></p>	<ul style="list-style-type: none"> Reconfigure by repainting lines 														

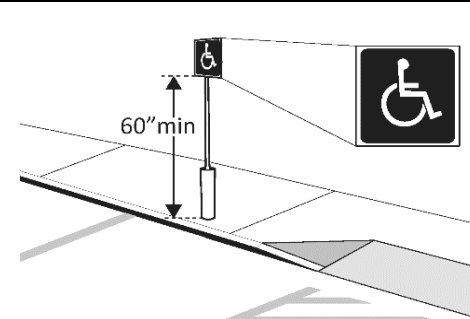
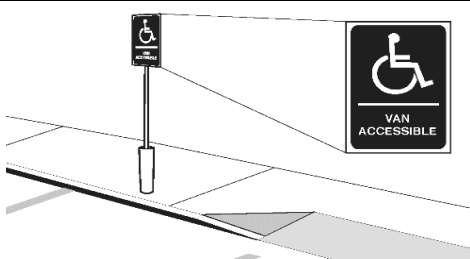

<p>1.103</p>	<p>Is the van accessible space: At least 11 feet wide with an access aisle at least 5 feet wide? Or At least 8 feet wide with an access aisle at least 8 feet wide? [502.2]</p>	<p><input type="checkbox"/> YES <input checked="" type="checkbox"/> NO Measurement:</p>	<p>← 11' min → 5' min ← or → 8' min → 8' min →</p>	<p>Photo:</p>	<ul style="list-style-type: none"> • Reconfigure by repainting lines
<p>1.104</p>	<p>Is at least 98 inches of vertical clearance provided for the van accessible space? [502.5]</p>	<p><input checked="" type="checkbox"/> YES <input type="checkbox"/> NO Measurement:</p>	<p>98" min</p>	<p>Photo:</p>	<ul style="list-style-type: none"> • Reconfigure to provide van-accessible space(s)
<p>1.105</p>	<p>Are the access aisles marked so as to discourage parking in them? [502.3.3] Note: The marking method and color may be addressed by state/local requirements.</p>	<p><input checked="" type="checkbox"/> YES <input type="checkbox"/> NO Measurement:</p>	<p>area to be marked</p>	<p>Photo:</p>	<ul style="list-style-type: none"> • Mark access aisles
<p>1.106</p>	<p>Is the slope of the accessible parking spaces and access aisles no steeper than 1:48 in all directions? [502.4]</p>	<p><input type="checkbox"/> YES <input checked="" type="checkbox"/> NO Measurement: 3.2% WAVY</p>		<p>Photo:</p>	<ul style="list-style-type: none"> • Regrade surface

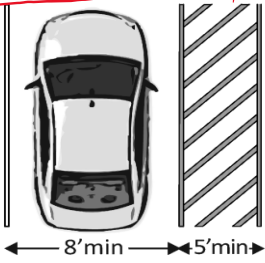
<p>1.107</p>	<p>Do the access aisles adjoin an accessible route? [502.3]</p>	<p><input type="checkbox"/> YES <input checked="" type="checkbox"/> NO 24" WIDEX 6" HIGH SLOPED CURB 1 1/2" BUMP AT CURB</p>		<p>Photo:</p>	<ul style="list-style-type: none"> • Create accessible route • Relocate accessible space
<p>1.108</p>	<p>Are accessible spaces identified with a sign that includes the International Symbol of Accessibility? Is the bottom of the sign at least 60 inches above the ground? [502.6] Note: The International Symbol of Accessibility is not required on the ground.</p>	<p><input checked="" type="checkbox"/> YES <input type="checkbox"/> NO <input type="checkbox"/> YES <input checked="" type="checkbox"/> NO 29"</p>		<p>Photo:</p>	<ul style="list-style-type: none"> • Install signs
<p>1.109</p>	<p>Are there signs reading "van accessible" at van accessible spaces? [502.6]</p>	<p><input type="checkbox"/> YES <input checked="" type="checkbox"/> NO</p>		<p>Photo:</p>	<ul style="list-style-type: none"> • Install signs

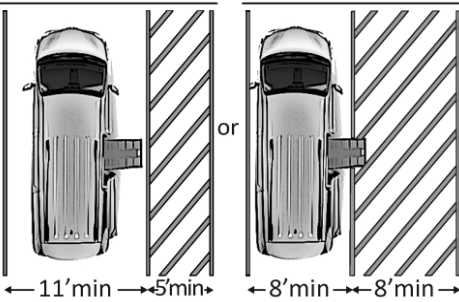
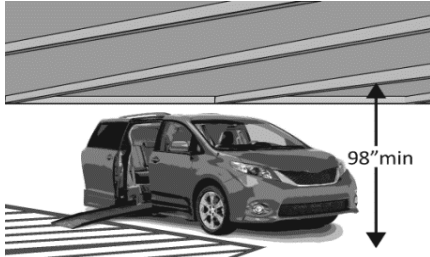
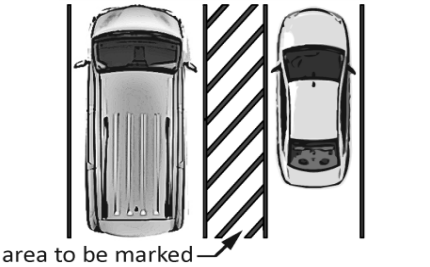
<p>1.110</p>	<p>Of the total parking spaces, are the accessible spaces located on the closest accessible route to the accessible entrance(s)? [208.3.1] Note: If parking serves multiple entrances, accessible parking should be dispersed.</p>	<p><input checked="" type="checkbox"/> YES <input type="checkbox"/> NO</p> <p>TO TRAIL</p>		<p>Photo:</p>	<ul style="list-style-type: none"> • Reconfigure spaces
---------------------	---	--	--	---------------	--

Parking Accessible parking spaces should be identified by size, access aisle and signage.																			
1.100	If parking is provided for the public, are an adequate number of accessible spaces provided? (208.2)	<input checked="" type="checkbox"/> YES <input type="checkbox"/> NO Total #: 38 Acsbl #: 2	<table border="1"> <thead> <tr> <th>Total Spaces</th> <th>Accessible Spaces</th> </tr> </thead> <tbody> <tr> <td>1 - 25</td> <td>1</td> </tr> <tr> <td>26 - 50</td> <td>2</td> </tr> <tr> <td>51 - 75</td> <td>3</td> </tr> <tr> <td>76 - 100</td> <td>4</td> </tr> <tr> <td>1200</td> <td>22</td> </tr> <tr> <td colspan="2">100+ see 2010 Standards 208.2</td> </tr> </tbody> </table>	Total Spaces	Accessible Spaces	1 - 25	1	26 - 50	2	51 - 75	3	76 - 100	4	1200	22	100+ see 2010 Standards 208.2		 <p>Photo:</p>	<ul style="list-style-type: none"> • Reconfigure by repainting lines
Total Spaces	Accessible Spaces																		
1 - 25	1																		
26 - 50	2																		
51 - 75	3																		
76 - 100	4																		
1200	22																		
100+ see 2010 Standards 208.2																			
1.101	Of the accessible spaces, is at least one a van accessible space?* [208.2.4]	<input type="checkbox"/> YES <input checked="" type="checkbox"/> NO	<p>*For every 6 or fraction of 6 parking spaces required by the table above, at least 1 should be a van accessible space.</p> <p>1</p> <p><i>SLOPED CURB</i></p>	<p>Photo:</p>	<ul style="list-style-type: none"> • If constructed before 3/15/2012, parking is compliant if at least 1 in every 8 accessible spaces is van accessible • Reconfigure by repainting lines 														
1.102	Are accessible spaces at least 8 feet wide with an access aisle at least 5 feet wide? [502.2, 502.3] Note: Two spaces may share an access aisle. Check state/local requirements; some specify that each space have its own aisle.	<input checked="" type="checkbox"/> YES <input type="checkbox"/> NO Measure ment: 8'-8" S 5'-0" A		<p>Photo:</p>	<ul style="list-style-type: none"> • Reconfigure by repainting lines 														

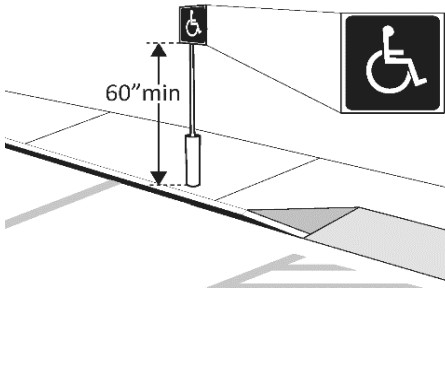
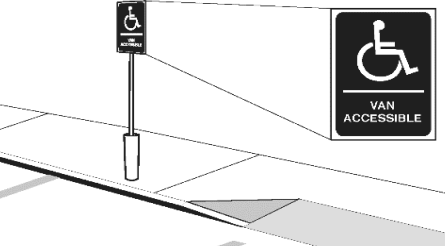
<p>1.103</p>	<p>Is the van accessible space: At least 11 feet wide with an access aisle at least 5 feet wide? Or At least 8 feet wide with an access aisle at least 8 feet wide? [502.2]</p>	<p><input type="checkbox"/> YES <input checked="" type="checkbox"/> NO Measurement:</p>		<p>Photo:</p>	<ul style="list-style-type: none"> • Reconfigure by repainting lines
<p>1.104</p>	<p>Is at least 98 inches of vertical clearance provided for the van accessible space? [502.5]</p>	<p><input checked="" type="checkbox"/> YES <input type="checkbox"/> NO Measurement:</p>		<p>Photo:</p>	<ul style="list-style-type: none"> • Reconfigure to provide van-accessible space(s)
<p>1.105</p>	<p>Are the access aisles marked so as to discourage parking in them? [502.3.3] Note: The marking method and color may be addressed by state/local requirements.</p>	<p><input checked="" type="checkbox"/> YES <input type="checkbox"/> NO Measurement:</p>		<p>Photo:</p>	<ul style="list-style-type: none"> • Mark access aisles
<p>1.106</p>	<p>Is the slope of the accessible parking spaces and access aisles no steeper than 1:48 in all directions? [502.4]</p>	<p><input checked="" type="checkbox"/> YES <input type="checkbox"/> NO Measurement: <2%</p>		<p>Photo:</p>	<ul style="list-style-type: none"> • Regrade surface

<p>1.107</p>	<p>Do the access aisles adjoin an accessible route? [502.3]</p>	<p><input type="checkbox"/> YES <input checked="" type="checkbox"/> NO 24" WIDEx 6" HIGH SLOPED CURB</p>		<p>Photo:</p>	<ul style="list-style-type: none"> • Create accessible route • Relocate accessible space
<p>1.108</p>	<p>Are accessible spaces identified with a sign that includes the International Symbol of Accessibility? Is the bottom of the sign at least 60 inches above the ground? [502.6] Note: The International Symbol of Accessibility is not required on the ground.</p>	<p><input checked="" type="checkbox"/> YES <input type="checkbox"/> NO <input type="checkbox"/> YES <input checked="" type="checkbox"/> NO 18"</p>		<p>Photo:</p>	<ul style="list-style-type: none"> • Install signs
<p>1.109</p>	<p>Are there signs reading "van accessible" at van accessible spaces? [502.6]</p>	<p><input type="checkbox"/> YES <input checked="" type="checkbox"/> NO</p>		<p>Photo:</p>	<ul style="list-style-type: none"> • Install signs
<p>1.110</p>	<p>Of the total parking spaces, are the accessible spaces located on the closest accessible route to the accessible entrance(s)? [208.3.1] Note: If parking serves multiple entrances, accessible parking should be dispersed.</p>	<p><input checked="" type="checkbox"/> YES <input type="checkbox"/> NO TO TRAIL</p>		<p>Photo:</p>	<ul style="list-style-type: none"> • Reconfigure spaces

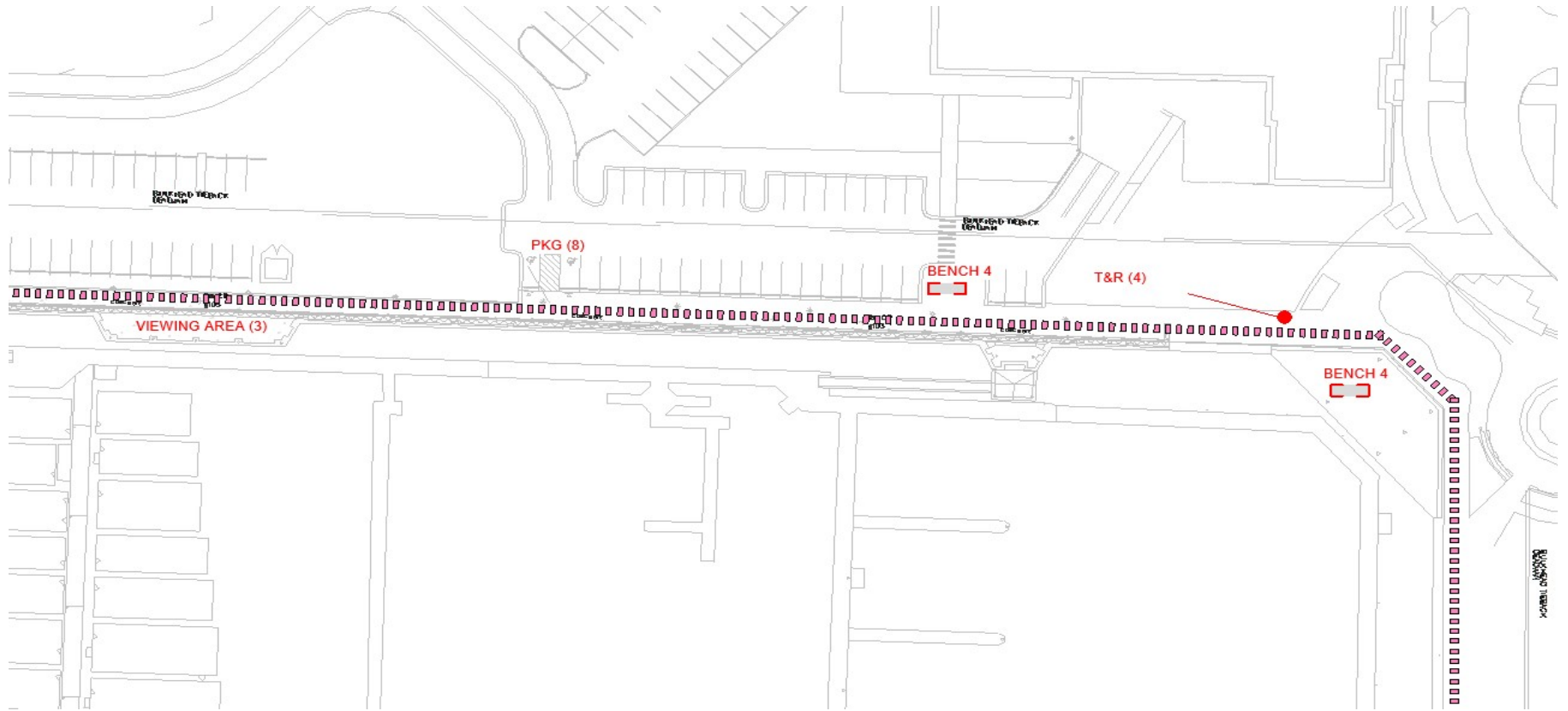

AREA 4 - MARINA WATERFRONT TRAIL (PINK DASHED LINE)

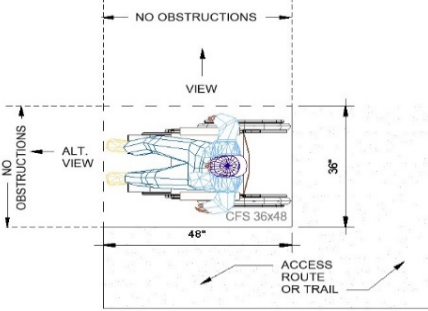
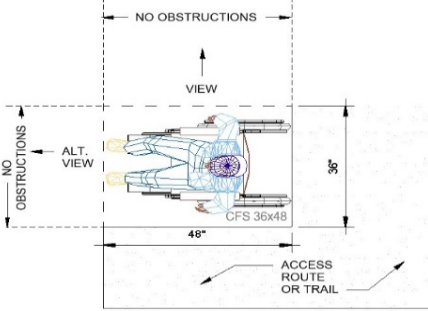
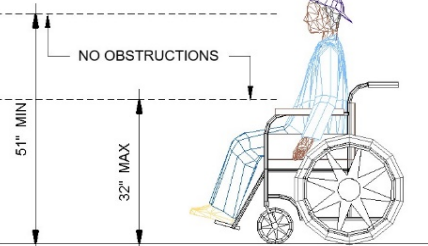

Viewing Areas [1015] (an outdoor space developed for viewing landscapes, wildlife, or other points of interest)			
<p>2.150</p>	<p>Where provided within viewing areas, are at least 20 percent, but not less than one, of each type of outdoor constructed feature accessible? [246.3]</p>	<p><input type="checkbox"/> YES <input type="checkbox"/> NO</p> <p>Total #: 0</p> <p>Acsbl#: N/A</p>	<p>OUTDOOR CONSTRUCTED FEATURES:</p> <p>Picnic Tables Trash and Recycling Benches Viewing Scopes</p>  <p>Photo #:</p>
<p>2.151</p>	<p>Is there at least one outdoor recreation access route connecting accessible parking spaces or other arrival points serving the viewing area with accessible elements, spaces, and facilities provided within the viewing area?</p>	<p><input checked="" type="checkbox"/> YES <input type="checkbox"/> NO</p>	<p>Photo #:</p>
<p>2.152</p>	<p>Is there a clear ground space at each distinct viewing location?</p>	<p><input checked="" type="checkbox"/> YES <input type="checkbox"/> NO</p> <p>Measurement:</p>	<p>Photo #:</p>

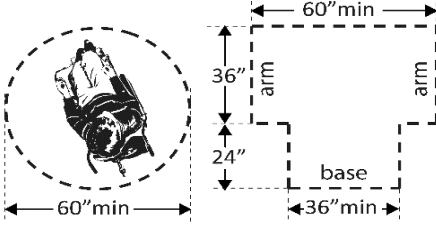
<p>2.153</p>	<p>Is the clear ground space 36 inches (915 mm) minimum by 48 inches (1220 mm) minimum and positioned for either a forward or parallel approach to the viewing location?</p>	<p><input checked="" type="checkbox"/> YES <input type="checkbox"/> NO Measure ment:</p>		<p>Photo #:</p>	<ul style="list-style-type: none"> • Enlarge space • Provide new space
	<p>Does one full unobstructed side of the clear ground space adjoin or overlap an outdoor recreation access route or trail, as applicable, or another clear ground space? [1015.2]</p>	<p><input checked="" type="checkbox"/> YES <input type="checkbox"/> NO</p>		<p>Photo #:</p>	<ul style="list-style-type: none"> • Enlarge space • Provide new space
<p>2.154</p>	<p>Does each distinct viewing location provide a viewing space adjacent to the clear ground space through which the point of interest is viewable that is 32 inches (815 mm) maximum and 51 inches (1295 mm) minimum high above the ground and extends the full width of the clear ground space? [1015.3]</p>	<p><input type="checkbox"/> YES <input checked="" type="checkbox"/> NO Measure ment: RAIL AROUND AREA IS 48" HIGH</p>		<p>Photo #:</p>	<ul style="list-style-type: none"> • Modify space • Add Space

2.155	Is the surface of the clear ground space firm and stable? [1015.5]	<input checked="" type="checkbox"/> YES <input type="checkbox"/> NO Material CONC		Photo #:	<ul style="list-style-type: none"> • Modify surface • Replace Surface
2.156	Is there a clear space within the viewing area for a person in a wheelchair to turn around, i.e. a circle at least 60 inches in diameter or a T-shaped space within a 60-inch square? [1015.4]	<input checked="" type="checkbox"/> YES <input type="checkbox"/> NO Measure ment:		Photo #:	<ul style="list-style-type: none"> • Modify space • Add Space
2.157	Is the slope of the surface of the clear ground space and turning space no more than 1:48 in any direction? [1015.6] or	<input checked="" type="checkbox"/> YES <input type="checkbox"/> NO Measure ment:		Photo #:	<ul style="list-style-type: none"> • Regrade
2.158	If the surface is other than asphalt, concrete, or boards, are the slopes no more than 1:20 as necessary for drainage? [1015.6]	<input type="checkbox"/> YES <input type="checkbox"/> NO Measure ment: N/A		Photo #:	<ul style="list-style-type: none"> • Regrade

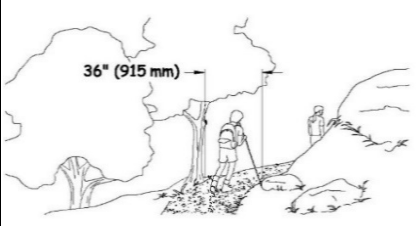
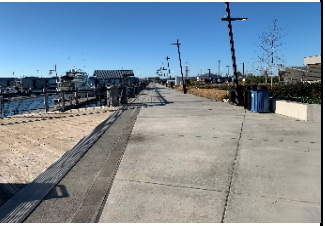
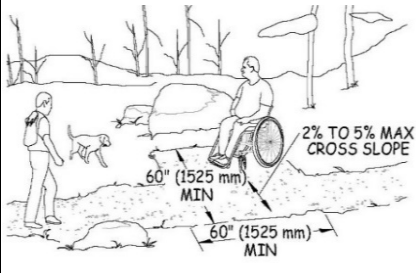
Parking Spaces					
2.166	If parking spaces for vehicles, other than recreational vehicles, are provided, are they 16 feet (4880 mm) wide minimum? [1012.3] Or	<input type="checkbox"/> YES <input type="checkbox"/> NO Measure ment: N/A		Photo #:	<ul style="list-style-type: none"> • Enlarge space • Provide new space
	If two adjacent parking spaces are provided for vehicles other than recreational vehicles, is one parking space 8 feet (2440 mm) wide minimum? [1012.3]	<input type="checkbox"/> YES <input type="checkbox"/> NO Measure ment: N/A		Photo #:	<ul style="list-style-type: none"> • Enlarge space • Provide new space
2.167	Is the parking surface firm and stable? [1012.4]	<input type="checkbox"/> YES <input type="checkbox"/> NO Measure ment: N/A		Photo #:	<ul style="list-style-type: none"> • Modify surface • Replace Surface
2.168	Is the slope of the surface of parking spaces and pull-up spaces less than 1:48 in any direction? [1012.5] or	<input type="checkbox"/> YES <input type="checkbox"/> NO Measure ment: N/A		Photo #:	<ul style="list-style-type: none"> • Regrade
	Where the surface is other than asphalt, concrete, or boards, are the slopes less than 1:20 for drainage?	<input type="checkbox"/> YES <input type="checkbox"/> NO Measure ment: N/A		Photo #:	<ul style="list-style-type: none"> • Regrade

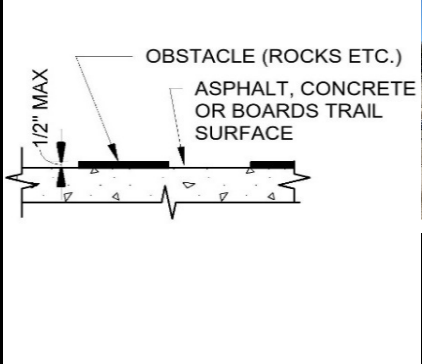

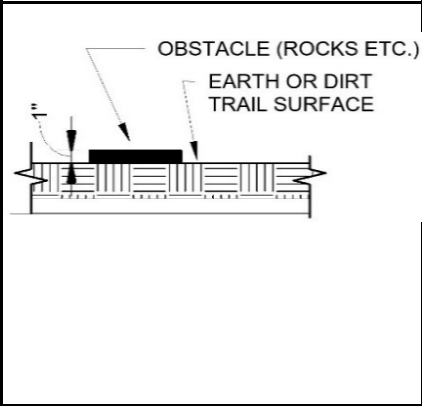
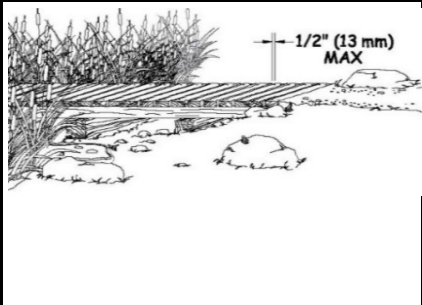
Outdoor Recreation Access Routes [1016] (A pedestrian route developed primarily to connect elements, spaces, or facilities within a site is not a trail)					
2.200	Outdoor Recreation Access Routes shall comply with 1016 [F247]			EXCEPTIONS: 1. In alterations to existing camping facilities, picnic facilities, and trailheads, when an entity determines that a condition in 1019 does not permit full compliance with a specific provision in 1016 on a portion of an outdoor recreation access route, the portion of the outdoor recreation access route shall comply with the provision to the extent practicable. 2. At viewing areas, when an entity determines that a condition in 1019 does not permit full compliance on a portion of an outdoor recreation access route with a specific provision in 1016, the portion of the outdoor recreation access route shall comply with the provision to the extent practicable. 3. Where outdoor recreation access routes are provided within vehicular ways, outdoor recreation access routes shall not be required to comply with 1016.4, 1016.7, and 1016.8.	
2.201	Is the surface of outdoor recreation access routes, passing spaces, and resting intervals stable, firm and slip-resistant? [40.2, 302.1]	<input checked="" type="checkbox"/> YES Material: CONC BOARDS	<input type="checkbox"/> NO	A firm trail surface resists deformation by indentations. A stable trail surface is not permanently affected by expected weather conditions and can sustain normal wear and tear from the expected uses between planned maintenance.	 <ul style="list-style-type: none"> • Modify surface • Replace Surface
2.202	Is the clear width of the outdoor recreation access route 36 inches (915 mm) minimum? [1016.3]	<input checked="" type="checkbox"/> YES Measurement:	<input type="checkbox"/> NO		 <ul style="list-style-type: none"> • Modify route • Provide new route
2.203	If the outdoor recreation access route width is less than 60 inches (1525 mm) are passing spaces provided at intervals of 200 feet (61 m) maximum? (Passing spaces and resting intervals shall be permitted to overlap.)	<input type="checkbox"/> YES Measurement: N/A	<input type="checkbox"/> NO		<ul style="list-style-type: none"> • Modify route • Provide passing spaces <p>Photo #:</p>

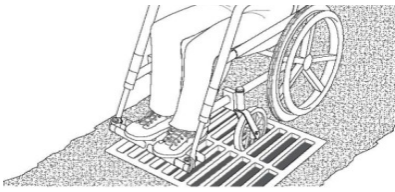
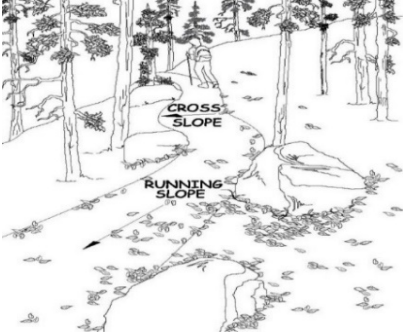

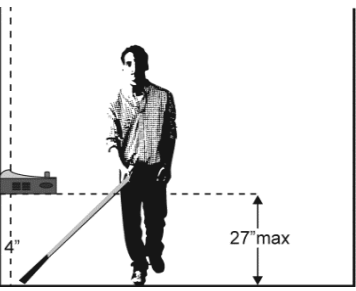
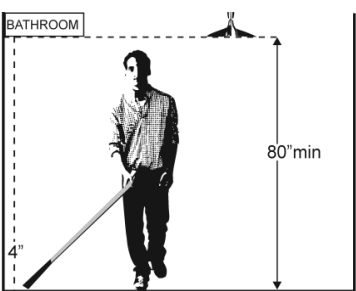
<p>2.200</p>	<p>If the outdoor recreation access routes surface is asphalt, concrete or boards, and there are obstacles on route, passing spaces, and resting intervals, are they less than 1/2 inch (13 mm) in height measured vertically to the highest point? [1016.5]</p>	<p><input checked="" type="checkbox"/> YES Measurement:</p>	<p><input type="checkbox"/> NO</p>		 <p>Photo #:</p>	<ul style="list-style-type: none"> • Modify route • Regrade
<p>2.206</p>	<p>If the outdoor recreation access routes surface is not asphalt, concrete or boards, and there are tread obstacles on outdoor recreation access routes passing spaces, and resting intervals, are they less than 1 inch (25 mm) in height measured vertically to the highest point? [1016.5]</p>	<p><input type="checkbox"/> YES Measurement: N/A</p>	<p><input type="checkbox"/> NO</p>		<p>Photo #:</p>	<ul style="list-style-type: none"> • Modify route • Regrade
<p>2.207</p>	<p>Are openings in the surface of outdoor recreation access routes passing spaces, and resting intervals small enough to not allow the passage of a sphere more than 1/2 inch (13 mm) in diameter? [1016.6]</p>	<p><input type="checkbox"/> YES Measurement: N/A</p>	<p><input type="checkbox"/> NO</p>		<p>Photo #:</p>	<ul style="list-style-type: none"> • Modify route • Replace grates or boards

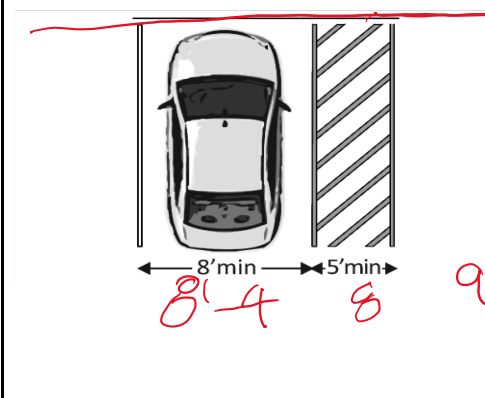
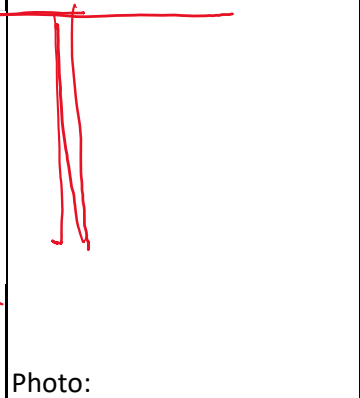

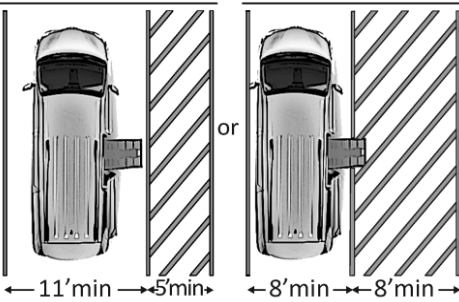
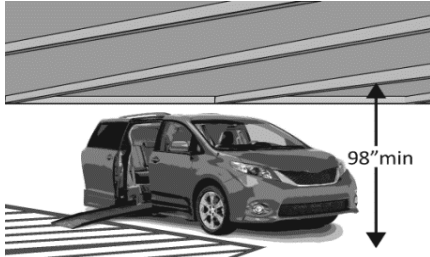
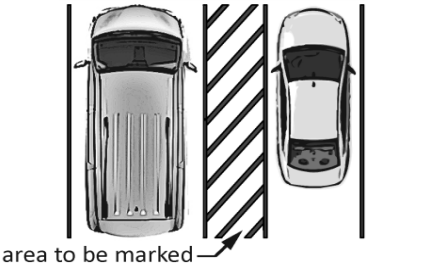

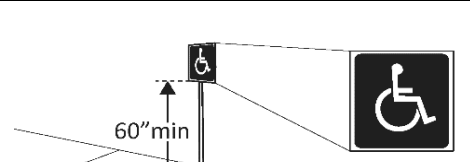
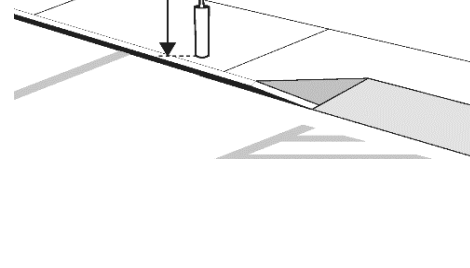
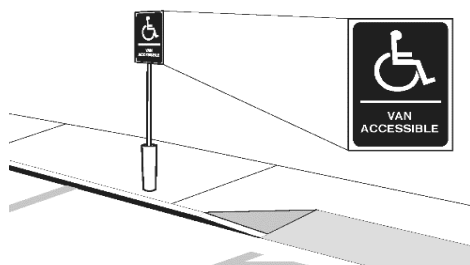

<p>2.208</p>	<p>If there are elongated openings, are they placed so that the long dimension is perpendicular, or as close to perpendicular as possible, to the dominant direction of travel? [1016.6]</p>	<p><input type="checkbox"/> YES N/A</p>	<p><input type="checkbox"/> NO</p>		<p>Photo #:</p>	<ul style="list-style-type: none"> • Modify route • Replace grates or boards
<p>2.209</p>	<p>Is the running slope of all segments of the outdoor recreation access routes less than 1:10 (10%). [1016.7.1]</p>	<p><input type="checkbox"/> YES Measurement: N/A</p>	<p><input type="checkbox"/> NO</p>		<p>Photo #:</p>	<ul style="list-style-type: none"> • Regrade

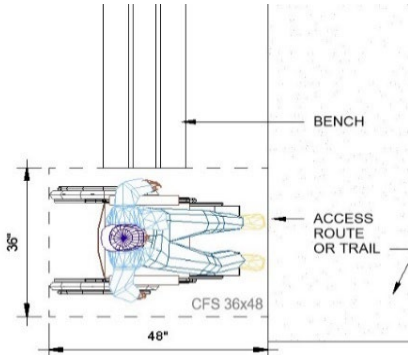

<p>2.219</p>	<p>Do all objects on outdoor recreation access routes, passing spaces, and resting intervals, e.g. signs, etc., protrude no more than 4 inches into the path? (does not apply to natural features, such as tree branches, rock formations) Or</p>	<p><input checked="" type="checkbox"/> YES Measurement:</p>	<p><input type="checkbox"/> NO</p>		<p>Photo #:</p>	<ul style="list-style-type: none"> • Remove object • Add tactile warning such as permanent planter or partial walls
	<p>If an object protrudes more than 4 inches, is the bottom leading edge at 27 inches or lower above the floor? [307.2] Or</p>	<p><input type="checkbox"/> YES Measurement: N/A</p>	<p><input type="checkbox"/> NO</p>		<p>Photo #:</p>	<ul style="list-style-type: none"> • Remove object • Add tactile warning such as permanent planter or partial walls
	<p>Is the bottom leading edge at 80 inches or higher above the floor? [307.4]</p>	<p><input checked="" type="checkbox"/> YES Measurement:</p>	<p><input type="checkbox"/> NO</p>		<p>Photo #:</p>	<ul style="list-style-type: none"> • Remove object • Add tactile warning such as permanent planter or partial walls

Parking Accessible parking spaces should be identified by size, access aisle and signage.																			
1.100	If parking is provided for the public, are an adequate number of accessible spaces provided? (208.2)	<input checked="" type="checkbox"/> YES <input type="checkbox"/> NO Total #: 38 Acsbl #: 2	<table border="1"> <thead> <tr> <th>Total Spaces</th> <th>Accessible Spaces</th> </tr> </thead> <tbody> <tr> <td>1 - 25</td> <td>1</td> </tr> <tr> <td>26 - 50</td> <td>2</td> </tr> <tr> <td>51 - 75</td> <td>3</td> </tr> <tr> <td>76 - 100</td> <td>4</td> </tr> <tr> <td>1200</td> <td>22</td> </tr> <tr> <td colspan="2">100+ see 2010 Standards 208.2</td> </tr> </tbody> </table>	Total Spaces	Accessible Spaces	1 - 25	1	26 - 50	2	51 - 75	3	76 - 100	4	1200	22	100+ see 2010 Standards 208.2		 <p>Photo:</p>	<ul style="list-style-type: none"> Reconfigure by repainting lines
Total Spaces	Accessible Spaces																		
1 - 25	1																		
26 - 50	2																		
51 - 75	3																		
76 - 100	4																		
1200	22																		
100+ see 2010 Standards 208.2																			
1.101	Of the accessible spaces, is at least one a van accessible space? [208.2.4]	<input type="checkbox"/> YES <input checked="" type="checkbox"/> NO	*For every 6 or fraction of 6 parking spaces required by the table above, at least 1 should be a van accessible space.	<p>Photo:</p>	<ul style="list-style-type: none"> If constructed before 3/15/2012, parking is compliant if at least 1 in every 8 accessible spaces is van accessible Reconfigure by repainting lines 														
1.102	Are accessible spaces at least 8 feet wide with an access aisle at least 5 feet wide? [502.2, 502.3] Note: Two spaces may share an access aisle. Check state/local requirements; some specify that each space have its own aisle.	<input checked="" type="checkbox"/> YES <input type="checkbox"/> NO Measure ment: 9'-0" S 9'-0" A 8'-4" S	 <p style="text-align: center;">TRAIL</p>	 <p>Photo:</p>	<ul style="list-style-type: none"> Reconfigure by repainting lines 														

<p>1.103</p>	<p>Is the van accessible space: At least 11 feet wide with an access aisle at least 5 feet wide? Or At least 8 feet wide with an access aisle at least 8 feet wide? [502.2]</p>	<p><input type="checkbox"/> YES <input checked="" type="checkbox"/> NO Measurement:</p>		<p>Photo:</p>	<ul style="list-style-type: none"> • Reconfigure by repainting lines
<p>1.104</p>	<p>Is at least 98 inches of vertical clearance provided for the van accessible space? [502.5]</p>	<p><input checked="" type="checkbox"/> YES <input type="checkbox"/> NO Measurement:</p>		<p>Photo:</p>	<ul style="list-style-type: none"> • Reconfigure to provide van-accessible space(s)
<p>1.105</p>	<p>Are the access aisles marked so as to discourage parking in them? [502.3.3] Note: The marking method and color may be addressed by state/local requirements.</p>	<p><input checked="" type="checkbox"/> YES <input type="checkbox"/> NO Measurement:</p>		<p>Photo:</p>	<ul style="list-style-type: none"> • Mark access aisles
<p>1.106</p>	<p>Is the slope of the accessible parking spaces and access aisles no steeper than 1:48 in all directions? [502.4]</p>	<p><input checked="" type="checkbox"/> YES <input type="checkbox"/> NO Measurement: <2%</p>		<p>Photo:</p>	<ul style="list-style-type: none"> • Regrade surface

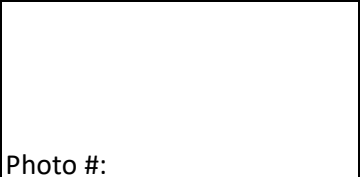
<p>1.107</p>	<p>Do the access aisles adjoin an accessible route? [502.3]</p>	<p><input checked="" type="checkbox"/> YES <input type="checkbox"/> NO TRAIL</p>		<p>Photo:</p>	<ul style="list-style-type: none"> • Create accessible route • Relocate accessible space
<p>1.108</p>	<p>Are accessible spaces identified with a sign that includes the International Symbol of Accessibility?</p>	<p><input checked="" type="checkbox"/> YES <input type="checkbox"/> NO</p>		<p>Photo:</p>	<ul style="list-style-type: none"> • Install signs
	<p>Is the bottom of the sign at least 60 inches above the ground? [502.6] Note: The International Symbol of Accessibility is not required on the ground.</p>	<p><input type="checkbox"/> YES <input checked="" type="checkbox"/> NO 19"</p>		<p>Photo:</p>	
<p>1.109</p>	<p>Are there signs reading “van accessible” at van accessible spaces? [502.6]</p>	<p><input type="checkbox"/> YES <input checked="" type="checkbox"/> NO</p>		<p>Photo:</p>	<ul style="list-style-type: none"> • Install signs
<p>1.110</p>	<p>Of the total parking spaces, are the accessible spaces located on the closest accessible route to the accessible entrance(s)? [208.3.1] Note: If parking serves multiple entrances, accessible parking should be dispersed.</p>	<p><input checked="" type="checkbox"/> YES <input type="checkbox"/> NO TO TRAIL</p>		<p>Photo:</p>	<ul style="list-style-type: none"> • Reconfigure spaces

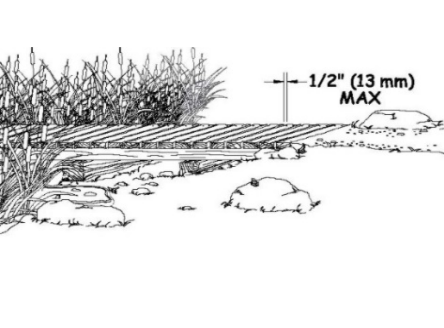
Benches					
2.470	Where benches are provided, is there clear ground space 36 inches (915 mm) by 48 inches (1220 mm) positioned near the bench with one side of the space adjoining an outdoor recreation access route or trail, as applicable? [1011.2.1]	<input checked="" type="checkbox"/> YES <input type="checkbox"/> NO Measure ment:			<ul style="list-style-type: none"> • Modify space • Provide new unit(s)
2.471	Is the clear ground space located such that it does not overlap the outdoor recreation access route or trail, or another clear ground space?	<input checked="" type="checkbox"/> YES <input type="checkbox"/> NO			<ul style="list-style-type: none"> • Enlarge space • Provide new space
2.472	Is the surface of the clear ground space firm and stable? [1011.2.2]	<input checked="" type="checkbox"/> YES <input type="checkbox"/> NO Material CONC			<ul style="list-style-type: none"> • Modify surface • Replace Surface
2.473	Is the slope of the clear ground space surface no steeper than 1:48 in any direction? [1011.2.3] or	<input checked="" type="checkbox"/> YES <input type="checkbox"/> NO Measure ment:			<ul style="list-style-type: none"> • Level the area
	If the surface is other than asphalt, concrete, or boards, is the slope no steeper than 1:20 if necessary for drainage?	<input type="checkbox"/> YES <input type="checkbox"/> NO Measure ment: N/A			<ul style="list-style-type: none"> • Level the area

<p>2.474</p>	<p>If openings (grates) are present in the clear ground space surface, are they sized so they do not allow the passage of a sphere more than 1/2 inch (13 mm) in diameter? And</p>	<p><input type="checkbox"/> YES <input type="checkbox"/> NO Measure ment: N/A</p>		<p>Photo #:</p>	<ul style="list-style-type: none"> • Modify route • Replace grates or boards
	<p>Are elongated openings placed so that the long dimension is perpendicular, or as close to perpendicular as possible, to the dominant direction of travel?</p>	<p><input type="checkbox"/> YES <input type="checkbox"/> NO N/A</p>		<p>Photo #:</p>	<ul style="list-style-type: none"> • Modify route • Replace grates or boards

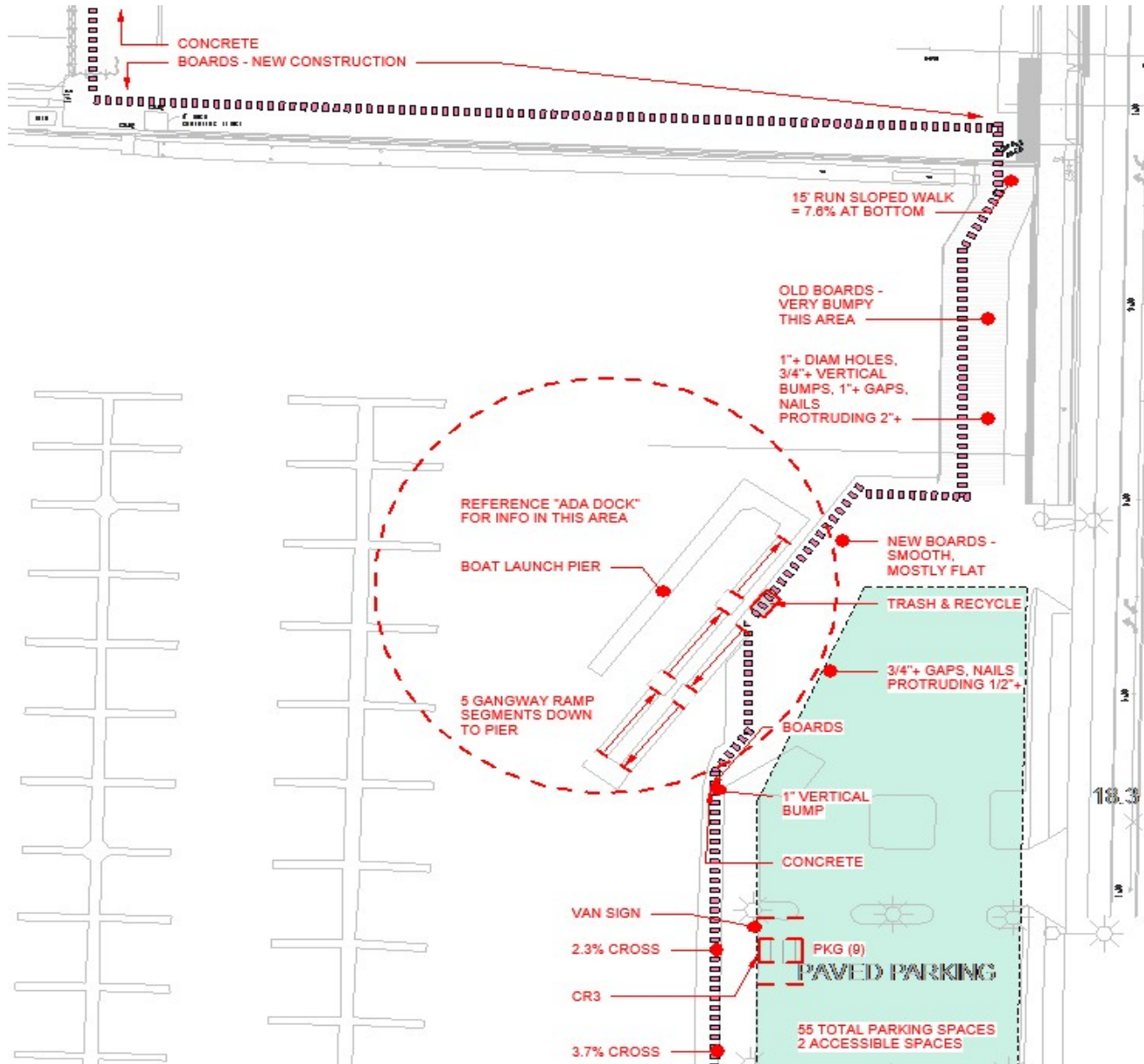

Trash and recycling			
2.480	Is there a clear ground space 36 inches (915 mm) by 48 inches (1220 mm) positioned for forward approach to the receptacle opening; or 30 inches (760 mm) by 60 inches (1525 mm) positioned for a parallel approach to the receptacle opening? [1011.2.1]	<input checked="" type="checkbox"/> YES <input type="checkbox"/> NO Measure ment:	<div style="text-align: center;">  </div> <p>Photo #:</p>
			<ul style="list-style-type: none"> • Add or Relocate bins



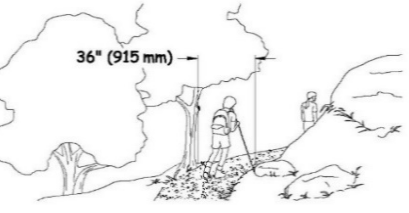
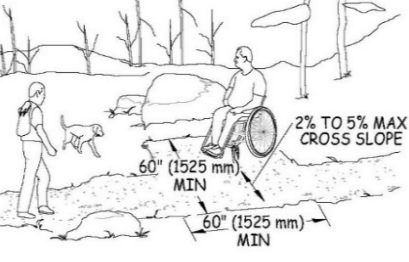

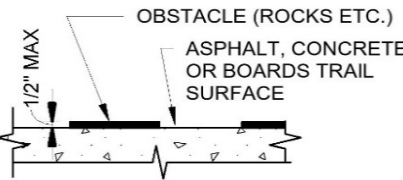

AREA 5 - MARINA WATERFRONT TRAIL (PINK DASHED LINE)

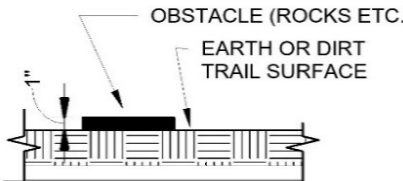
Outdoor Recreation Access Routes [1016]				
(A pedestrian route developed primarily to connect elements, spaces, or facilities within a site is not a trail)				
2.200	Outdoor Recreation Access Routes shall comply with 1016 [F247]			<p>EXCEPTIONS: 1. In alterations to existing camping facilities, picnic facilities, and trailheads, when an entity determines that a condition in 1019 does not permit full compliance with a specific provision in 1016 on a portion of an outdoor recreation access route, the portion of the outdoor recreation access route shall comply with the provision to the extent practicable.</p> <p>2. At viewing areas, when an entity determines that a condition in 1019 does not permit full compliance on a portion of an outdoor recreation access route with a specific provision in 1016, the portion of the outdoor recreation access route shall comply with the provision to the extent practicable.</p> <p>3. Where outdoor recreation access routes are provided within vehicular ways, outdoor recreation access routes shall not be required to comply with 1016.4, 1016.7, and 1016.8.</p>
2.201	Is the surface of outdoor recreation access routes, passing spaces, and resting intervals stable, firm and slip-resistant? [40.2, 302.1]	<input checked="" type="checkbox"/> YES Material:	<input type="checkbox"/> NO	<p>A firm trail surface resists deformation by indentations. A stable trail surface is not permanently affected by expected weather conditions and can sustain normal wear and tear from the expected uses between planned maintenance.</p>  <ul style="list-style-type: none"> • Modify surface • Replace Surface
2.202	Is the clear width of the outdoor recreation access route 36 inches (915 mm) minimum? [1016.3]	<input checked="" type="checkbox"/> YES Measurement:	<input type="checkbox"/> NO	 <p>Photo #:</p> <ul style="list-style-type: none"> • Modify route • Provide new route
2.203	If the outdoor recreation access route width is less than 60 inches (1525 mm) are passing spaces provided at intervals of 200 feet (61 m) maximum? (Passing spaces and resting intervals shall be permitted to overlap.)	<input checked="" type="checkbox"/> YES Measurement:	<input type="checkbox"/> NO	 <p>Photo #:</p> <ul style="list-style-type: none"> • Modify route • Provide passing spaces

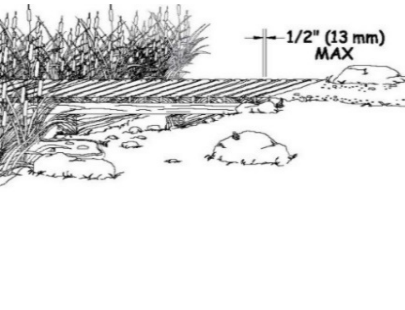
	<p>Is the passing space 60 inches (1525 mm) minimum by 60 inches (1525 mm) minimum; [1017.4.1] or</p>	<input checked="" type="checkbox"/> YES Measurement:	<input type="checkbox"/> NO		<p>Photo #:</p>	<ul style="list-style-type: none"> • Modify route • Provide passing spaces
<p>2.204</p>	<p>Does the intersection of two outdoor recreation access routes provide a T-shaped space complying with 304.3.2 where the base and the arms of the T-shaped space extend 48 inches (1220 mm) minimum beyond the intersection? And,</p>	<input checked="" type="checkbox"/> YES Measurement:	<input type="checkbox"/> NO		<p>Photo #:</p>	<ul style="list-style-type: none"> • Modify route • Provide passing spaces • Regrade
	<p>Is the vertical alignment at the intersection of the outdoor recreation access routes that form the T-shaped space nominally planar? (virtually flat)</p>	<input checked="" type="checkbox"/> YES Measurement:	<input type="checkbox"/> NO	<p>Photo #:</p>	<p>Photo #:</p>	

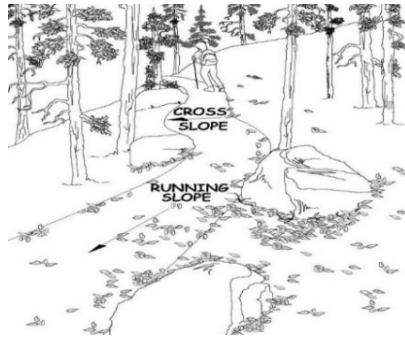

<p>2.200</p>	<p>If the outdoor recreation access routes surface is asphalt, concrete or boards, and there are obstacles on route, passing spaces, and resting intervals, are they less than 1/2 inch (13 mm) in height measured vertically to the highest point? [1016.5]</p>	<p><input type="checkbox"/> YES Measurement:</p>	<p><input checked="" type="checkbox"/> NO BOARDS FOR PART</p>	 <p>OBSTACLE (ROCKS ETC.) 1/2" MAX ASPHALT, CONCRETE OR BOARDS TRAIL SURFACE</p>	 <p>Photo #:</p>	<ul style="list-style-type: none"> • Modify route • Regrade
<p>2.206</p>	<p>If the outdoor recreation access routes surface is not asphalt, concrete or boards, and there are tread obstacles on outdoor recreation access routes passing spaces, and resting intervals, are they less than 1 inch (25 mm) in height measured vertically to the highest point? [1016.5]</p>	<p><input type="checkbox"/> YES Measurement: N/A</p>	<p><input type="checkbox"/> NO</p>	 <p>OBSTACLE (ROCKS ETC.) 1" MAX EARTH OR DIRT TRAIL SURFACE</p>	<p>Photo #:</p>	<ul style="list-style-type: none"> • Modify route • Regrade

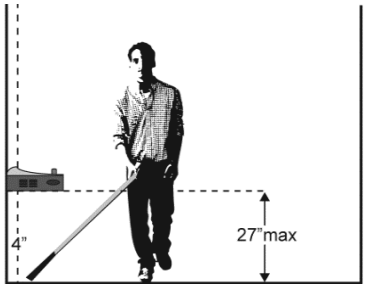
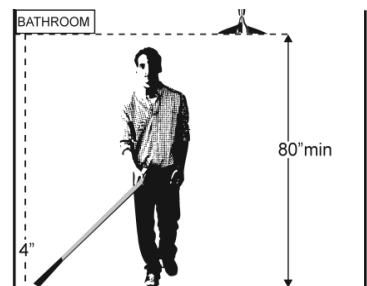
<p>2.207</p>	<p>Are openings in the surface of outdoor recreation access routes passing spaces, and resting intervals small enough to not allow the passage of a sphere more than 1/2 inch (13 mm) in diameter? [1016.6]</p>	<p><input type="checkbox"/> YES Measurement: N/A</p>	<p><input type="checkbox"/> NO</p>		<p>Photo #:</p>	<ul style="list-style-type: none"> • Modify route • Replace grates or boards
<p>2.208</p>	<p>If there are elongated openings, are they placed so that the long dimension is perpendicular, or as close to perpendicular as possible, to the dominant direction of travel? [1016.6]</p>	<p><input type="checkbox"/> YES N/A</p>	<p><input type="checkbox"/> NO</p>		<p>Photo #:</p>	<ul style="list-style-type: none"> • Modify route • Replace grates or boards
<p>2.209</p>	<p>Is the running slope of all segments of the outdoor recreation access routes less than 1:10 (10%). [1016.7.1]</p>	<p><input checked="" type="checkbox"/> YES Measurement:</p>	<p><input type="checkbox"/> NO</p>		 <p>Photo #:</p>	<ul style="list-style-type: none"> • Regrade
<p>2.219</p>	<p>Do all objects on outdoor recreation access routes, passing spaces, and resting intervals, e.g. signs, etc., protrude no more than 4 inches into the path? (does not apply to natural features, such as tree branches, rock formations) Or</p>	<p><input type="checkbox"/> YES Measurement: N/A</p>	<p><input type="checkbox"/> NO</p>		<p>Photo #:</p>	<ul style="list-style-type: none"> • Remove object • Add tactile warning such as permanent planter or partial walls

<p>If an object protrudes more than 4 inches, is the bottom leading edge at 27 inches or lower above the floor? [307.2]</p> <p>Or</p>	<p><input type="checkbox"/> YES Measurement: N/A</p>	<p><input type="checkbox"/> NO</p>		<p>Photo #:</p>	<ul style="list-style-type: none"> • Remove object • Add tactile warning such as permanent planter or partial walls
<p>Is the bottom leading edge at 80 inches or higher above the floor? [307.4]</p>	<p><input type="checkbox"/> YES Measurement: N/A</p>	<p><input type="checkbox"/> NO</p>		<p>Photo #:</p>	<ul style="list-style-type: none"> • Remove object • Add tactile warning such as permanent planter or partial walls

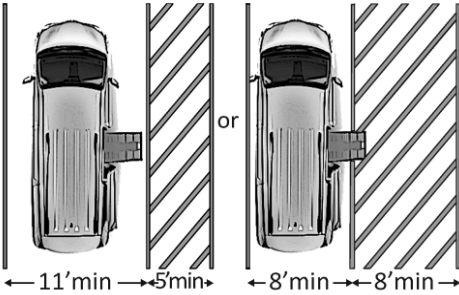
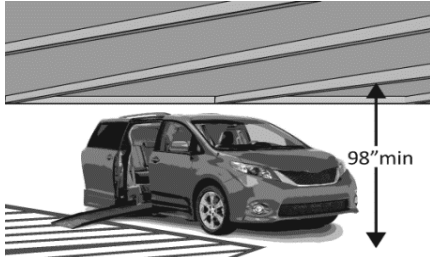
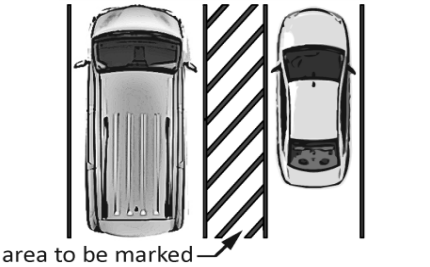
Parking Accessible parking spaces should be identified by size, access aisle and signage.																				
1.100	If parking is provided for the public, are an adequate number of accessible spaces provided? (208.2)	<input type="checkbox"/> YES <input checked="" type="checkbox"/> NO Total #: 55 Acsbl #: 2	<input checked="" type="checkbox"/> NO	<table border="1"> <thead> <tr> <th>Total Spaces</th> <th>Accessible Spaces</th> </tr> </thead> <tbody> <tr> <td>1 - 25</td> <td>1</td> </tr> <tr> <td>26 - 50</td> <td>2</td> </tr> <tr> <td>51 - 75</td> <td>3</td> </tr> <tr> <td>76 - 100</td> <td>4</td> </tr> <tr> <td>1200</td> <td>22</td> </tr> <tr> <td colspan="2">100+ see 2010 Standards 208.2</td> </tr> </tbody> </table>	Total Spaces	Accessible Spaces	1 - 25	1	26 - 50	2	51 - 75	3	76 - 100	4	1200	22	100+ see 2010 Standards 208.2		Photo:	<ul style="list-style-type: none"> Reconfigure by repainting lines
Total Spaces	Accessible Spaces																			
1 - 25	1																			
26 - 50	2																			
51 - 75	3																			
76 - 100	4																			
1200	22																			
100+ see 2010 Standards 208.2																				
1.101	Of the accessible spaces, is at least one a van accessible space? [208.2.4]	<input checked="" type="checkbox"/> YES <input type="checkbox"/> NO	*For every 6 or fraction of 6 parking spaces required by the table above, at least 1 should be a van accessible space.	Photo:	<ul style="list-style-type: none"> If constructed before 3/15/2012, parking is compliant if at least 1 in every 8 accessible spaces is van accessible Reconfigure by repainting lines 															
1.102	Are accessible spaces at least 8 feet wide with an access aisle at least 5 feet wide? [502.2, 502.3] Note: Two spaces may share an access aisle. Check state/local requirements; some specify that each space have its own aisle.	<input checked="" type="checkbox"/> YES <input type="checkbox"/> NO Measure ment: 9'-0" S 12'-10" A 8'-4" S		Photo:	<ul style="list-style-type: none"> Reconfigure by repainting lines 															

<p>1.103</p>	<p>Is the van accessible space: At least 11 feet wide with an access aisle at least 5 feet wide? Or</p>	<p><input type="checkbox"/> YES <input type="checkbox"/> NO Measure ment: N/A</p>		<p>Photo:</p>	<ul style="list-style-type: none"> • Reconfigure by repainting lines
	<p>At least 8 feet wide with an access aisle at least 8 feet wide? [502.2]</p>	<p><input checked="" type="checkbox"/> YES <input type="checkbox"/> NO Measure ment:</p>		<p>Photo:</p>	
<p>1.104</p>	<p>Is at least 98 inches of vertical clearance provided for the van accessible space? [502.5]</p>	<p><input checked="" type="checkbox"/> YES <input type="checkbox"/> NO Measure ment:</p>		<p>Photo:</p>	<ul style="list-style-type: none"> • Reconfigure to provide van-accessible space(s)
<p>1.105</p>	<p>Are the access aisles marked so as to discourage parking in them? [502.3.3] Note: The marking method and color may be addressed by state/local requirements.</p>	<p><input checked="" type="checkbox"/> YES <input type="checkbox"/> NO Measure ment:</p>		<p>Photo:</p>	<ul style="list-style-type: none"> • Mark access aisles
<p>1.106</p>	<p>Is the slope of the accessible parking spaces and access aisles no steeper than 1:48 in all directions? [502.4]</p>	<p><input type="checkbox"/> YES <input checked="" type="checkbox"/> NO Measure ment: UP TO 2.5%</p>		<p>Photo:</p>	<ul style="list-style-type: none"> • Regrade surface

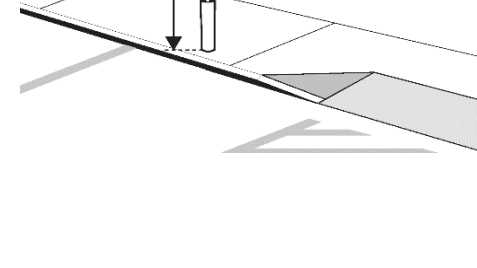
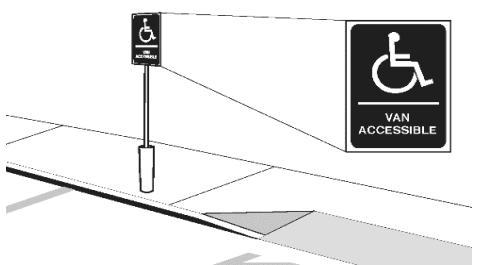
1.107	Do the access aisles adjoin an accessible route? [502.3]	<input checked="" type="checkbox"/> YES <input type="checkbox"/> NO		Photo:	<ul style="list-style-type: none"> • Create accessible route • Relocate accessible space
1.108	Are accessible spaces identified with a sign that includes the International Symbol of Accessibility?	<input checked="" type="checkbox"/> YES <input type="checkbox"/> NO		Photo:	<ul style="list-style-type: none"> • Install signs
	Is the bottom of the sign at least 60 inches above the ground? [502.6] Note: The International Symbol of Accessibility is not required on the ground.	<input type="checkbox"/> YES <input checked="" type="checkbox"/> NO 31 1/2" 22 1/2" @ VAN SIGN		Photo:	
1.109	Are there signs reading "van accessible" at van accessible spaces? [502.6]	<input checked="" type="checkbox"/> YES <input type="checkbox"/> NO		Photo:	<ul style="list-style-type: none"> • Install signs
1.110	Of the total parking spaces, are the accessible spaces located on the closest accessible route to the accessible entrance(s)? [208.3.1] Note: If parking serves multiple entrances, accessible parking should be dispersed.	<input checked="" type="checkbox"/> YES <input type="checkbox"/> NO TO TRAIL		Photo:	<ul style="list-style-type: none"> • Reconfigure spaces

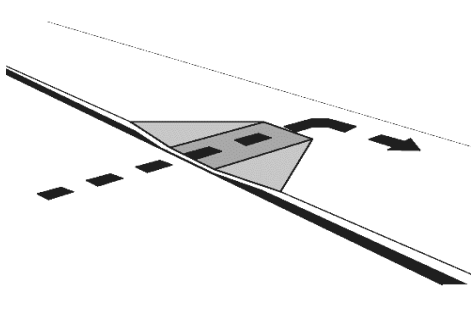
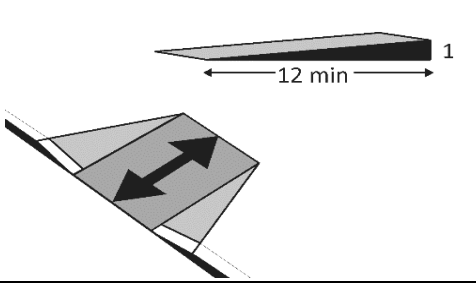
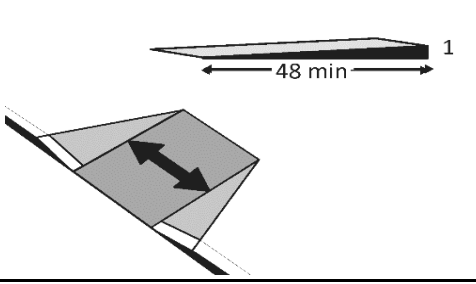
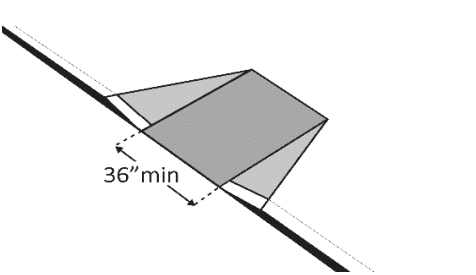
Curb Ramps					
1.111	If the accessible route crosses a curb, is there a curb ramp? [402.2]	<input checked="" type="checkbox"/> YES <input type="checkbox"/> NO		Photo #: 	<ul style="list-style-type: none"> • Install curb ramp
1.112	Is the running slope of the curb ramp no steeper than 1:12, i.e. for every inch of height change there are at least 12 inches of curb ramp run? [406.1, 405.2]	<input checked="" type="checkbox"/> YES <input type="checkbox"/> NO Measure ment: 5'-0" L 6.5%		Photo #: 	<ul style="list-style-type: none"> • Regrade curb ramp
1.113	Is the cross slope of the curb ramp, excluding flares, no steeper than 1:48? [406.1, 405.3]	<input checked="" type="checkbox"/> YES <input type="checkbox"/> NO Measure ment:		Photo #: 	<ul style="list-style-type: none"> • Regrade curb ramp
1.114	Is the curb ramp, excluding flares, at least 36 inches wide? [406.1, 405.5]	<input checked="" type="checkbox"/> YES <input type="checkbox"/> NO Measure ment: 36"		Photo #: 	<ul style="list-style-type: none"> • Widen curb ramp

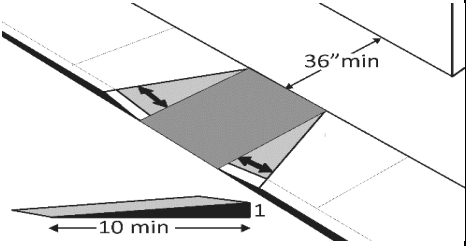
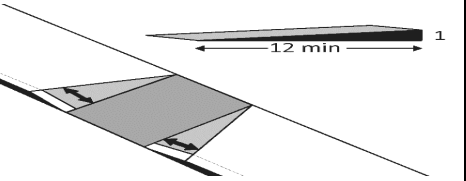
<p>1.115</p>	<p>At the top of the curb ramp is there a level landing (slope no steeper than 1:48 in all directions) that is at least 36 inches long and at least as wide as the curb ramp? [406.4]</p>	<p><input checked="" type="checkbox"/> YES <input type="checkbox"/> NO Measure ment:</p>			<ul style="list-style-type: none"> • Reconfigure • Add ramp flares
	<p>If there are curb ramp flares, are the slopes of the flares no steeper than 1:10, i.e. for every inch of height change there are at least 10 inches of flare run? [406.3]</p>	<p><input checked="" type="checkbox"/> YES <input type="checkbox"/> NO Measure ment:</p>			
<p>1.116</p>	<p>If the landing at the top is less than 36 inches long, are there curb ramp flares?</p>	<p><input checked="" type="checkbox"/> YES <input type="checkbox"/> NO Measure ment:</p>			<ul style="list-style-type: none"> • Add ramp flares • Regrade flares
	<p>Are the slopes of the flares no greater than 1:12, i.e. for every inch of height change there are at least 12 inches of flare run? [406.4]</p>	<p><input checked="" type="checkbox"/> YES <input type="checkbox"/> NO Measure ment:</p>			

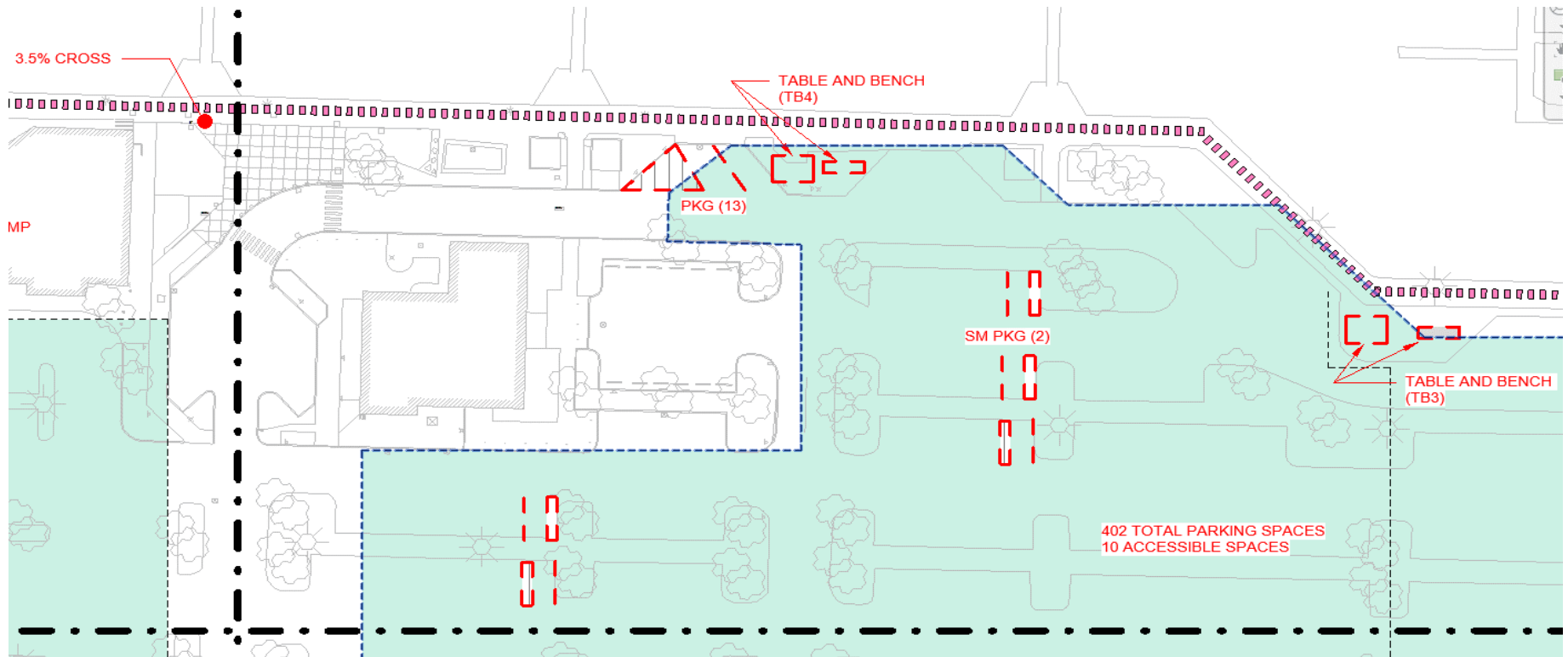

AREA 6 NORTHEAST - MARINA WATERFRONT TRAIL (PINK DASHED LINE)

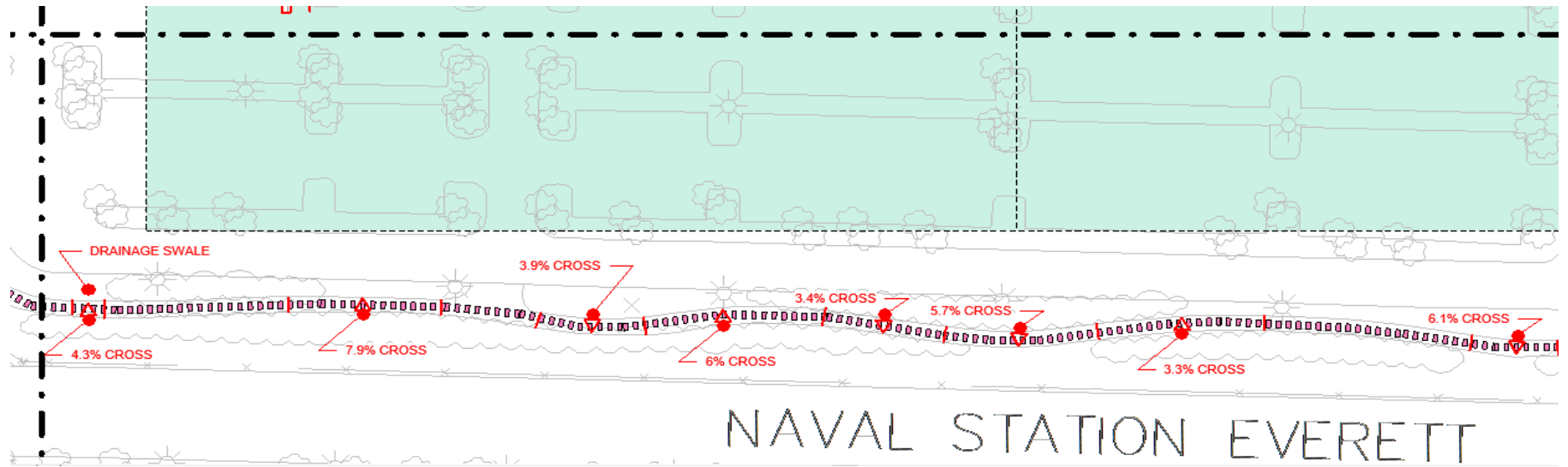

AREA 6 SOUTHEAST - MARINA WATERFRONT TRAIL (PINK DASHED LINE)

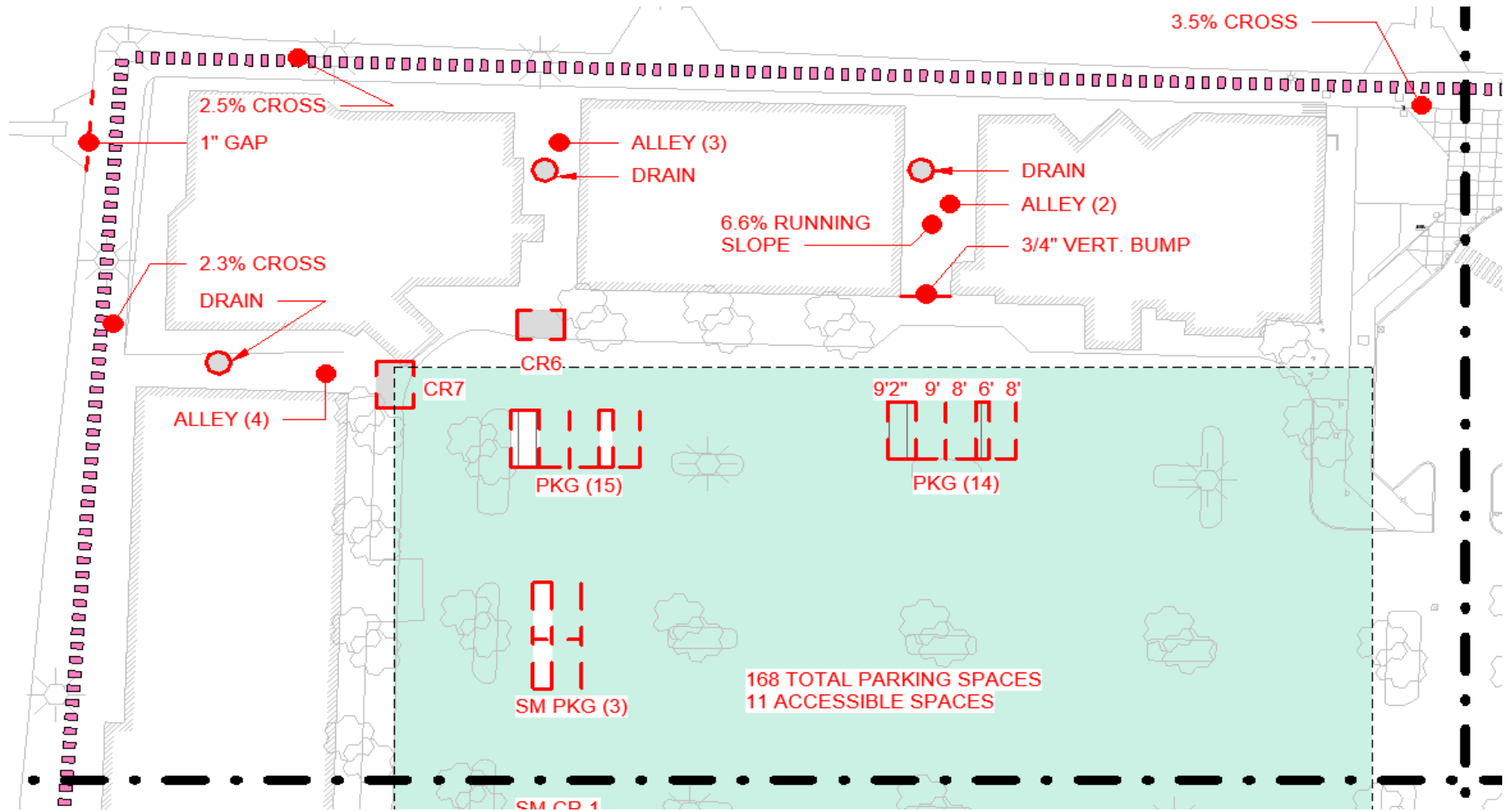

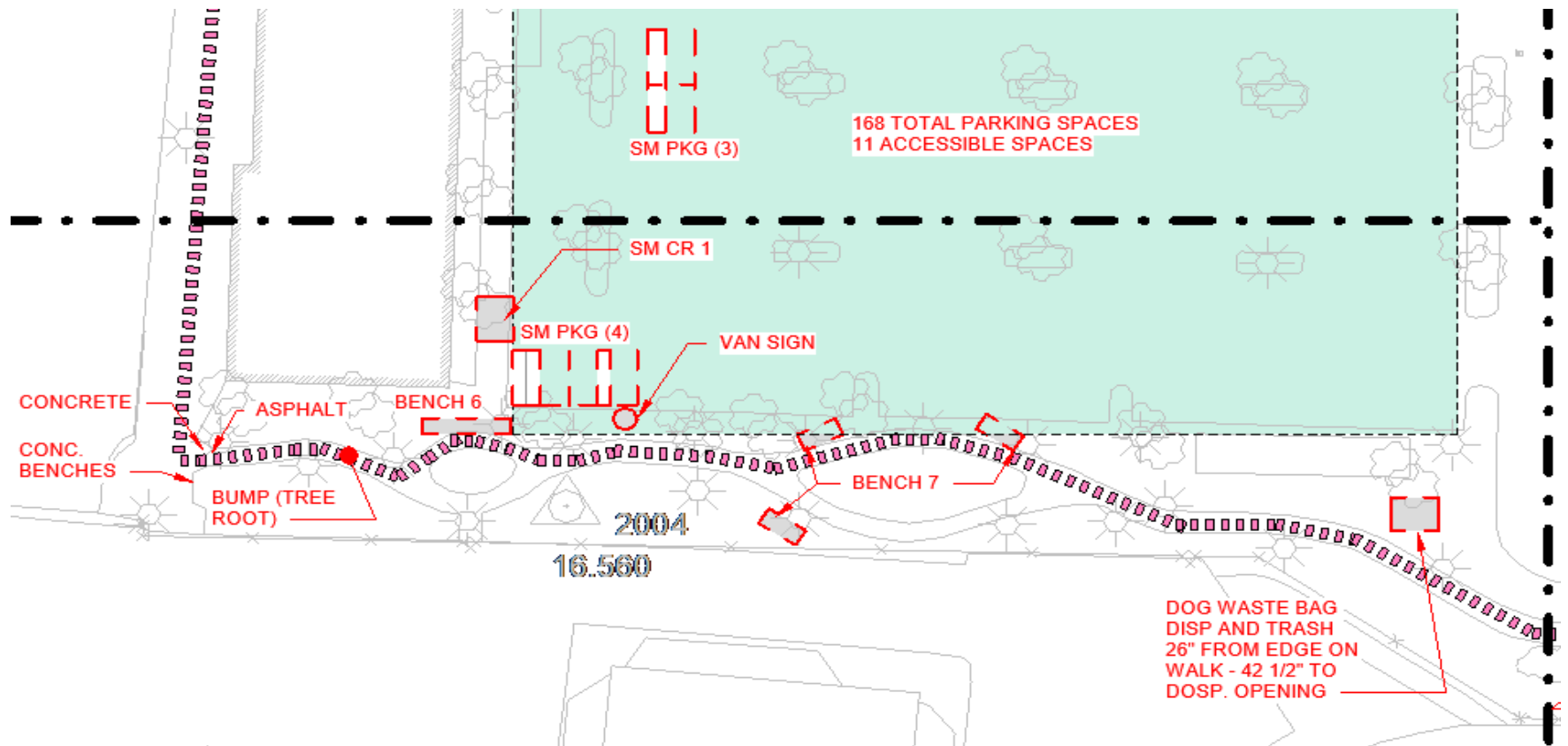

AREA 6 NORTHWEST - MARINA WATERFRONT TRAIL (PINK DASHED LINE)



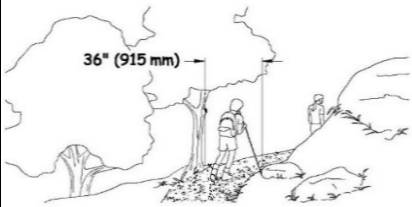
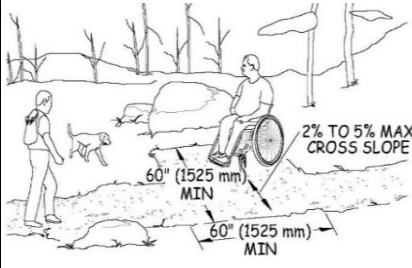

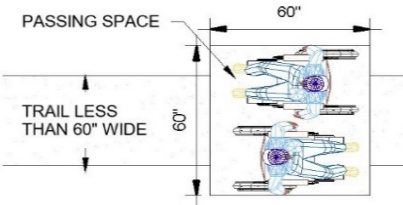
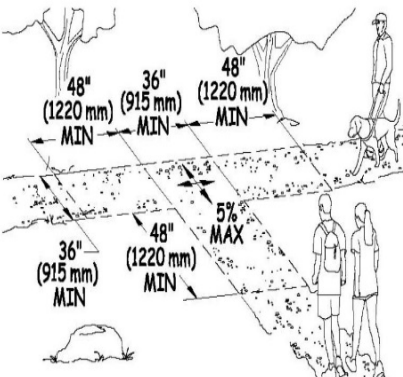

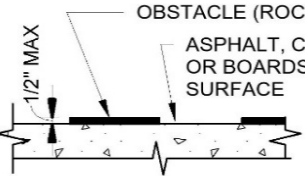
AREA 6 SOUTHWEST - MARINA WATERFRONT TRAIL (PINK DASHED LINE)

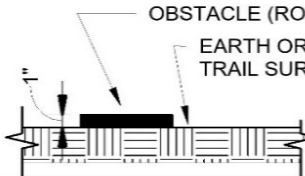

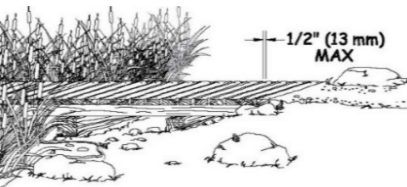
Outdoor Recreation Access Routes [1016] (A pedestrian route developed primarily to connect elements, spaces, or facilities within a site is not a trail)					
2.200	Outdoor Recreation Access Routes shall comply with 1016 [F247]			EXCEPTIONS: 1. In alterations to existing camping facilities, picnic facilities, and trailheads, when an entity determines that a condition in 1019 does not permit full compliance with a specific provision in 1016 on a portion of an outdoor recreation access route, the portion of the outdoor recreation access route shall comply with the provision to the extent practicable. 2. At viewing areas, when an entity determines that a condition in 1019 does not permit full compliance on a portion of an outdoor recreation access route with a specific provision in 1016, the portion of the outdoor recreation access route shall comply with the provision to the extent practicable. 3. Where outdoor recreation access routes are provided within vehicular ways, outdoor recreation access routes shall not be required to comply with 1016.4, 1016.7, and 1016.8.	
2.201	Is the surface of outdoor recreation access routes, passing spaces, and resting intervals stable, firm and slip-resistant? [40.2, 302.1]	<input checked="" type="checkbox"/> YES Material: CONC PAVERS BOARDS	<input type="checkbox"/> NO	A firm trail surface resists deformation by indentations. A stable trail surface is not permanently affected by expected weather conditions and can sustain normal wear and tear from the expected uses between planned maintenance.	 <ul style="list-style-type: none"> • Modify surface • Replace Surface
2.202	Is the clear width of the outdoor recreation access route 36 inches (915 mm) minimum? [1016.3]	<input checked="" type="checkbox"/> YES Measurement: 10'-0"	<input type="checkbox"/> NO		Photo #: <ul style="list-style-type: none"> • Modify route • Provide new route
2.203	If the outdoor recreation access route width is less than 60 inches (1525 mm) are passing spaces provided at intervals of 200 feet (61 m) maximum? (Passing spaces and resting intervals shall be permitted to overlap.)	<input type="checkbox"/> YES Measurement: N/A	<input type="checkbox"/> NO		Photo #: <ul style="list-style-type: none"> • Modify route • Provide passing spaces

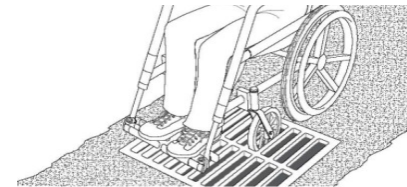
	<p>Is the passing space 60 inches (1525 mm) minimum by 60 inches (1525 mm) minimum; [1017.4.1] or</p>	<p><input type="checkbox"/> YES Measurement: N/A</p>	<p><input type="checkbox"/> NO</p>		<p>Photo #:</p>	<ul style="list-style-type: none"> • Modify route • Provide passing spaces
<p>2.204</p>	<p>Does the intersection of two outdoor recreation access routes provide a T-shaped space complying with 304.3.2 where the base and the arms of the T-shaped space extend 48 inches (1220 mm) minimum beyond the intersection? And,</p>	<p><input checked="" type="checkbox"/> YES Measurement:</p>	<p><input type="checkbox"/> NO</p>		<p>Photo #:</p>	<ul style="list-style-type: none"> • Modify route • Provide passing spaces • Regrade
	<p>Is the vertical alignment at the intersection of the outdoor recreation access routes that form the T-shaped space nominally planar? (virtually</p>	<p><input checked="" type="checkbox"/> YES Measurement:</p>	<p><input type="checkbox"/> NO</p>	<p>Photo #:</p>	<p>Photo #:</p>	

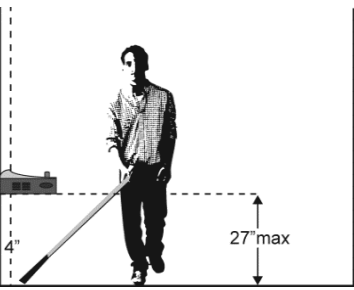
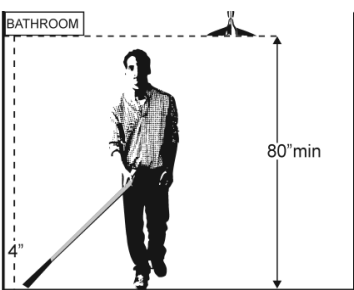

<p>2.200</p>	<p>If the outdoor recreation access routes surface is asphalt, concrete or boards, and there are obstacles on route, passing spaces, and resting intervals, are they less than 1/2 inch (13 mm) in height measured vertically to the highest point? [1016.5]</p>	<p><input type="checkbox"/> YES Measurement:</p>	<p><input checked="" type="checkbox"/> NO UP TO 1"</p>		 <p>Photo #:</p>	<ul style="list-style-type: none"> • Modify route • Regrade
<p>2.206</p>	<p>If the outdoor recreation access routes surface is not asphalt, concrete or boards, and there are tread obstacles on outdoor recreation access routes passing spaces, and resting intervals, are they less than 1 inch (25 mm) in height measured vertically to the highest point? [1016.5]</p>	<p><input type="checkbox"/> YES Measurement: N/A</p>	<p><input type="checkbox"/> NO</p>		<p>Photo #:</p>	<ul style="list-style-type: none"> • Modify route • Regrade

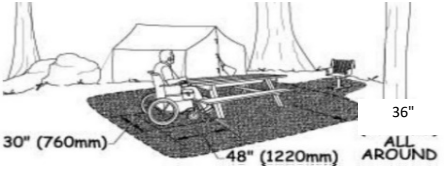
<p>2.207</p>	<p>Are openings in the surface of outdoor recreation access routes passing spaces, and resting intervals small enough to not allow the passage of a sphere more than 1/2 inch (13 mm) in diameter? [1016.6]</p>	<p><input type="checkbox"/> YES Measurement:</p>	<p><input checked="" type="checkbox"/> NO UP TO 1" IN PLACES</p>		 <p>Photo #:</p>	<ul style="list-style-type: none"> • Modify route • Replace grates or boards
<p>2.208</p>	<p>If there are elongated openings, are they placed so that the long dimension is perpendicular, or as close to perpendicular as possible, to the dominant direction of travel? [1016.6]</p>	<p><input type="checkbox"/> YES N/A</p>	<p><input type="checkbox"/> NO</p>		<p>Photo #:</p>	<ul style="list-style-type: none"> • Modify route • Replace grates or boards
<p>2.209</p>	<p>Is the running slope of all segments of the outdoor recreation access routes less than 1:10 (10%). [1016.7.1]</p>	<p><input checked="" type="checkbox"/> YES Measurement:</p>	<p><input type="checkbox"/> NO</p>		<p>Photo #:</p>	<ul style="list-style-type: none"> • Regrade

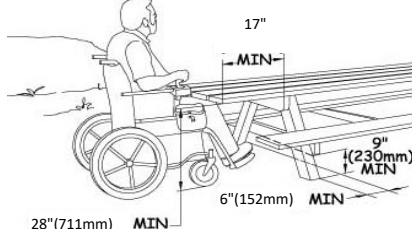
<p>2.219</p>	<p>Do all objects on outdoor recreation access routes, passing spaces, and resting intervals, e.g. signs, etc., protrude no more than 4 inches into the path? (does not apply to natural features, such as tree branches, rock formations) Or</p>	<p><input type="checkbox"/> YES Measurement: N/A</p>	<p><input type="checkbox"/> NO</p>		<p>Photo #:</p>	<ul style="list-style-type: none"> • Remove object • Add tactile warning such as permanent planter or partial walls
	<p>If an object protrudes more than 4 inches, is the bottom leading edge at 27 inches or lower above the floor? [307.2] Or</p>	<p><input type="checkbox"/> YES Measurement: N/A</p>	<p><input type="checkbox"/> NO</p>		<p>Photo #:</p>	<ul style="list-style-type: none"> • Remove object • Add tactile warning such as permanent planter or partial walls
	<p>Is the bottom leading edge at 80 inches or higher above the floor? [307.4]</p>	<p><input type="checkbox"/> YES Measurement: N/A</p>	<p><input type="checkbox"/> NO</p>		<p>Photo #:</p>	<ul style="list-style-type: none"> • Remove object • Add tactile warning such as permanent planter or partial walls

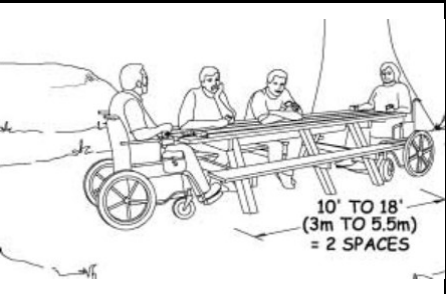
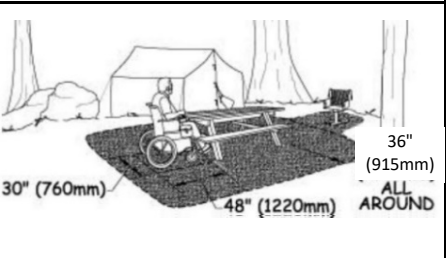
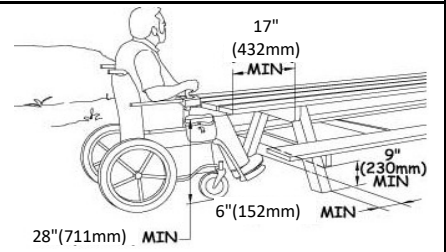

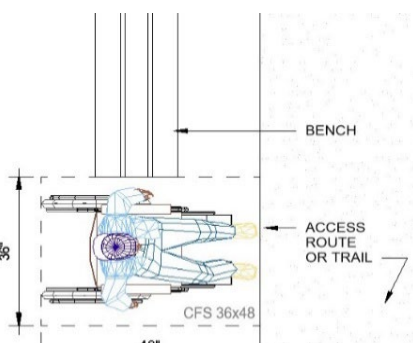
Picnic Tables [1011.4]					
2.420	Is there 36 inches (915 mm) minimum on all usable sides of the table measured from the back edge of the benches? [1011.2.1]	<input checked="" type="checkbox"/> YES <input type="checkbox"/> NO Measure ment:			<ul style="list-style-type: none"> • Replace table • Provide new table
2.421	Is the surface of the clear ground space firm and stable? [1011.2.2]	<input checked="" type="checkbox"/> YES <input type="checkbox"/> NO Material PAVERS		Photo:	<ul style="list-style-type: none"> • Replace surface
2.422	Is the slope of the clear ground space surface no steeper than 1:48 in any direction? [1011.2.3] or	<input checked="" type="checkbox"/> YES <input type="checkbox"/> NO Measure ment:		Photo:	<ul style="list-style-type: none"> • Level the area
	If the surface is other than asphalt, concrete, or boards, is the slope no steeper than 1:20 if necessary for drainage?	<input type="checkbox"/> YES <input type="checkbox"/> NO Measure ment: N/A		Photo:	<ul style="list-style-type: none"> • Level the area
2.424	Are the tops of picnic tables 28 inches (710 mm) minimum and 34 inches (865 mm) maximum above the finish floor or ground? [1011.4.1]	<input checked="" type="checkbox"/> YES <input type="checkbox"/> NO Measure ment: 30"		Photo:	<ul style="list-style-type: none"> • Replace table • Provide new table

<p>2.425</p>	<p>For each 24 linear feet (7320 mm) of usable picnic table surface perimeter, is there at least one wheelchair space? [1011.4.2] (Note: Tables over 9' long need two WC spaces)</p>	<p><input checked="" type="checkbox"/> YES <input type="checkbox"/> NO Measurement:</p>		<p>Photo:</p>	<ul style="list-style-type: none"> • Replace table • Provide new table
<p>2.426</p>	<p>Is the wheelchair space 30 inches (760mm) minimum by 48 inches (1220 mm) minimum and positioned for a forward approach to the table? [1011.4.2]</p>	<p><input type="checkbox"/> YES <input checked="" type="checkbox"/> NO Measurement: 26 1/4" BTWN CONC LEGS</p>		<p>Photo:</p>	<ul style="list-style-type: none"> • Replace table • Provide new table
<p>and</p>	<p>provide knee and toe clearance complying with 306 under the table? [1011.4.2]</p>	<p><input type="checkbox"/> YES <input checked="" type="checkbox"/> NO Measurement: 27 3/4" UNDER 7 1/2" DP</p>		<p>Photo:</p>	<ul style="list-style-type: none"> • Replace table • Provide new table

Benches					
2.470	Where benches are provided, is there clear ground space 36 inches (915 mm) by 48 inches (1220 mm) positioned near the bench with one side of the space adjoining an outdoor recreation access route or trail, as applicable? [1011.2.1]	<input type="checkbox"/> YES <input checked="" type="checkbox"/> NO Measure ment:	 <p>The diagram illustrates a bench with a clear ground space (CFS) of 36 inches by 48 inches. An access route or trail is shown adjacent to the CFS. Labels include 'BENCH', 'ACCESS ROUTE OR TRAIL', and 'CFS 36x48'.</p>	<p>Photo #:</p>	<ul style="list-style-type: none"> • Modify space • Provide new unit(s)
2.471	Is the clear ground space located such that it does not overlap the outdoor recreation access route or trail, or another clear ground space?	<input type="checkbox"/> YES <input checked="" type="checkbox"/> NO	 <p>The illustration shows a person in a wheelchair sitting on a bench next to another person. A child is sitting on the ground nearby. This illustrates the requirement for clear ground space around the bench.</p>	<p>Photo #:</p>	<ul style="list-style-type: none"> • Enlarge space • Provide new space
2.472	Is the surface of the clear ground space firm and stable? [1011.2.2]	<input type="checkbox"/> YES <input type="checkbox"/> NO N/A		<p>Photo #:</p>	<ul style="list-style-type: none"> • Modify surface • Replace Surface
2.473	Is the slope of the clear ground space surface no steeper than 1:48 in any direction? [1011.2.3] or	<input type="checkbox"/> YES <input type="checkbox"/> NO Measure ment: N/A		<p>Photo #:</p>	<ul style="list-style-type: none"> • Level the area
	If the surface is other than asphalt, concrete, or boards, is the slope no steeper than 1:20 if necessary for drainage?	<input type="checkbox"/> YES <input type="checkbox"/> NO Measure ment: N/A		<p>Photo #:</p>	<ul style="list-style-type: none"> • Level the area

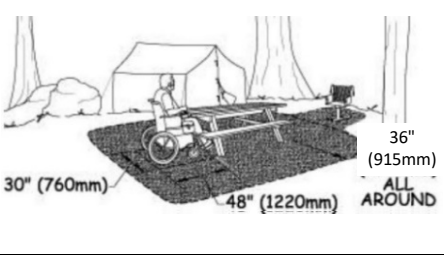
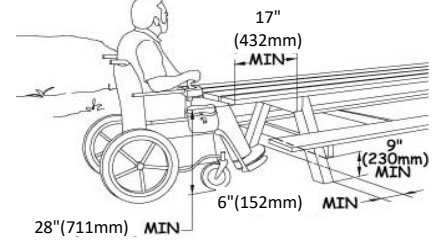

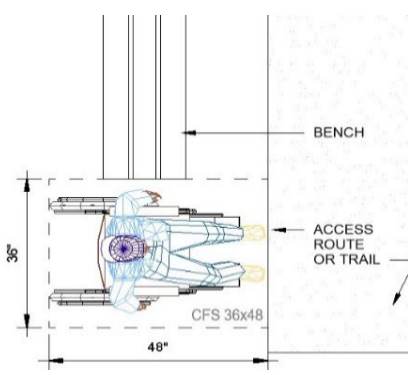

Picnic Tables [1011.4]				
2.420	Is there 36 inches (915 mm) minimum on all usable sides of the table measured from the back edge of the benches? [1011.2.1]	<input checked="" type="checkbox"/> YES <input type="checkbox"/> NO Measure ment:		Photo: <ul style="list-style-type: none"> • Replace table • Provide new table
2.421	Is the surface of the clear ground space firm and stable? [1011.2.2]	<input checked="" type="checkbox"/> YES <input type="checkbox"/> NO Material PAVERS		Photo: <ul style="list-style-type: none"> • Replace surface
2.422	Is the slope of the clear ground space surface no steeper than 1:48 in any direction? [1011.2.3] or	<input checked="" type="checkbox"/> YES <input type="checkbox"/> NO Measure ment:		Photo: <ul style="list-style-type: none"> • Level the area
	If the surface is other than asphalt, concrete, or boards, is the slope no steeper than 1:20 if necessary for drainage?	<input type="checkbox"/> YES <input type="checkbox"/> NO Measure ment: N/A		Photo: <ul style="list-style-type: none"> • Level the area
2.424	Are the tops of picnic tables 28 inches (710 mm) minimum and 34 inches (865 mm) maximum above the finish floor or ground? [1011.4.1]	<input checked="" type="checkbox"/> YES <input type="checkbox"/> NO Measure ment: 30"		Photo: <ul style="list-style-type: none"> • Replace table • Provide new table
2.425	For each 24 linear feet (7320 mm) of usable picnic table surface perimeter, is there at least one wheelchair space? [1011.4.2] (Note: Tables over 9' long need two WC spaces)	<input checked="" type="checkbox"/> YES <input type="checkbox"/> NO Measure ment:		Photo: <ul style="list-style-type: none"> • Replace table • Provide new table

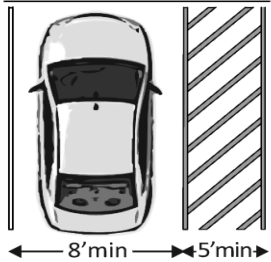
<p>2.426</p>	<p>Is the wheelchair space 30 inches (760mm) minimum by 48 inches (1220 mm) minimum and positioned for a forward approach to the table? [1011.4.2]</p>	<p><input type="checkbox"/> YES <input checked="" type="checkbox"/> NO Measurement: 26 1/4" BTWN CONC LEGS</p>		<p>Photo:</p>	<ul style="list-style-type: none"> • Replace table • Provide new table
	<p>and provide knee and toe clearance complying with 306 under the table? [1011.4.2]</p>	<p><input type="checkbox"/> YES <input checked="" type="checkbox"/> NO Measurement: 27 3/4" UNDER 7 1/2" DP</p>		<p>Photo:</p>	<ul style="list-style-type: none"> • Replace table • Provide new table

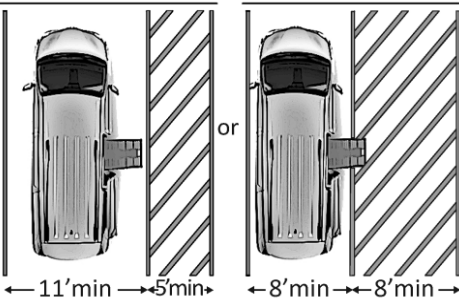
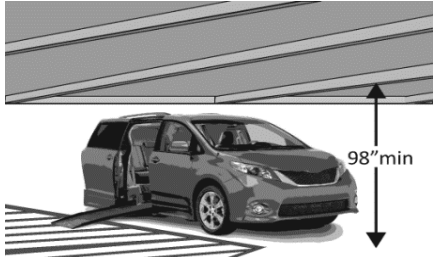
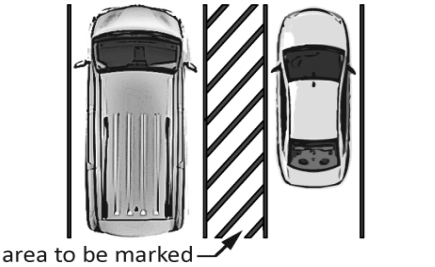
Benches				
2.470	Where benches are provided, is there clear ground space 36 inches (915 mm) by 48 inches (1220 mm) positioned near the bench with one side of the space adjoining an outdoor recreation access route or trail, as applicable? [1011.2.1]	<input type="checkbox"/> YES <input checked="" type="checkbox"/> NO Measure ment:	 <p>The diagram illustrates a bench with a clear ground space (CFS) of 36 inches by 48 inches positioned next to an access route or trail. The bench is labeled 'BENCH' and the clear space is labeled 'CFS 36x48'. The access route or trail is labeled 'ACCESS ROUTE OR TRAIL'.</p>	<p>Photo #:</p> <ul style="list-style-type: none"> • Modify space • Provide new unit(s)
2.471	Is the clear ground space located such that it does not overlap the outdoor recreation access route or trail, or another clear ground space?	<input type="checkbox"/> YES <input checked="" type="checkbox"/> NO	 <p>The illustration shows a person in a wheelchair sitting on a bench. A child is sitting on the ground nearby. The clear ground space is shown to be separate from the access route or trail.</p>	<p>Photo #:</p> <ul style="list-style-type: none"> • Enlarge space • Provide new space
2.472	Is the surface of the clear ground space firm and stable? [1011.2.2]	<input type="checkbox"/> YES <input type="checkbox"/> NO N/A		<p>Photo #:</p> <ul style="list-style-type: none"> • Modify surface • Replace Surface
2.473	Is the slope of the clear ground space surface no steeper than 1:48 in any direction? [1011.2.3] or	<input type="checkbox"/> YES <input type="checkbox"/> NO Measure ment: N/A		<p>Photo #:</p> <ul style="list-style-type: none"> • Level the area
	If the surface is other than asphalt, concrete, or boards, is the slope no steeper than 1:20 if necessary for drainage?	<input type="checkbox"/> YES <input type="checkbox"/> NO Measure ment: N/A		<p>Photo #:</p> <ul style="list-style-type: none"> • Level the area

Parking Accessible parking spaces should be identified by size, access aisle and signage.																			
1.100	If parking is provided for the public, are an adequate number of accessible spaces provided? (208.2)	<input checked="" type="checkbox"/> YES <input type="checkbox"/> NO Total #: 148 Acsbl #: 2 @ PKG13 (6 THIS AREA)	<table border="1"> <thead> <tr> <th>Total Spaces</th> <th>Accessible Spaces</th> </tr> </thead> <tbody> <tr> <td>1 - 25</td> <td>1</td> </tr> <tr> <td>26 - 50</td> <td>2</td> </tr> <tr> <td>51 - 75</td> <td>3</td> </tr> <tr> <td>76 - 100</td> <td>4</td> </tr> <tr> <td>101 to 150</td> <td>5</td> </tr> <tr> <td colspan="2">100+ see 2010 Standards 208.2</td> </tr> </tbody> </table>	Total Spaces	Accessible Spaces	1 - 25	1	26 - 50	2	51 - 75	3	76 - 100	4	101 to 150	5	100+ see 2010 Standards 208.2		 <p>Photo:</p>	<ul style="list-style-type: none"> • Reconfigure by repainting lines
Total Spaces	Accessible Spaces																		
1 - 25	1																		
26 - 50	2																		
51 - 75	3																		
76 - 100	4																		
101 to 150	5																		
100+ see 2010 Standards 208.2																			
1.101	Of the accessible spaces, is at least one a van accessible space?* [208.2.4]	<input type="checkbox"/> YES <input checked="" type="checkbox"/> NO	*For every 6 or fraction of 6 parking spaces required by the table above, at least 1 should be a van accessible space.	<p>Photo:</p>	<ul style="list-style-type: none"> • If constructed before 3/15/2012, parking is compliant if at least 1 in every 8 accessible spaces is van accessible • Reconfigure by repainting lines 														
1.102	Are accessible spaces at least 8 feet wide with an access aisle at least 5 feet wide? [502.2, 502.3] Note: Two spaces may share an access aisle. Check state/local requirements; some specify that each space have its own aisle.	<input checked="" type="checkbox"/> YES <input type="checkbox"/> NO Measure ment:		<p>Photo:</p>	<ul style="list-style-type: none"> • Reconfigure by repainting lines 														

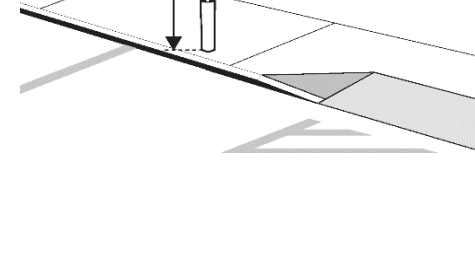
<p>1.103</p>	<p>Is the van accessible space: At least 11 feet wide with an access aisle at least 5 feet wide? Or At least 8 feet wide with an access aisle at least 8 feet wide? [502.2]</p>	<p><input type="checkbox"/> YES <input checked="" type="checkbox"/> NO Measurement:</p>		<p>Photo:</p>	<ul style="list-style-type: none"> • Reconfigure by repainting lines
<p>1.104</p>	<p>Is at least 98 inches of vertical clearance provided for the van accessible space? [502.5]</p>	<p><input checked="" type="checkbox"/> YES <input type="checkbox"/> NO Measurement:</p>		<p>Photo:</p>	<ul style="list-style-type: none"> • Reconfigure to provide van-accessible space(s)
<p>1.105</p>	<p>Are the access aisles marked so as to discourage parking in them? [502.3.3] Note: The marking method and color may be addressed by state/local requirements.</p>	<p><input checked="" type="checkbox"/> YES <input type="checkbox"/> NO Measurement:</p>		<p>Photo:</p>	<ul style="list-style-type: none"> • Mark access aisles
<p>1.106</p>	<p>Is the slope of the accessible parking spaces and access aisles no steeper than 1:48 in all directions? [502.4]</p>	<p><input type="checkbox"/> YES <input checked="" type="checkbox"/> NO Measurement: UP TO 2.4%</p>		<p>Photo:</p>	<ul style="list-style-type: none"> • Regrade surface

1.107	Do the access aisles adjoin an accessible route? [502.3]	<input checked="" type="checkbox"/> YES <input type="checkbox"/> NO		Photo:	<ul style="list-style-type: none"> • Create accessible route • Relocate accessible space
1.108	Are accessible spaces identified with a sign that includes the International Symbol of Accessibility?	<input type="checkbox"/> YES <input checked="" type="checkbox"/> NO		Photo:	<ul style="list-style-type: none"> • Install signs
	Is the bottom of the sign at least 60 inches above the ground? [502.6] Note: The International Symbol of Accessibility is not required on the ground.	<input type="checkbox"/> YES <input checked="" type="checkbox"/> NO		Photo:	
1.109	Are there signs reading “van accessible” at van accessible spaces? [502.6]	<input type="checkbox"/> YES <input checked="" type="checkbox"/> NO		Photo:	<ul style="list-style-type: none"> • Install signs
1.110	Of the total parking spaces, are the accessible spaces located on the closest accessible route to the accessible entrance(s)? [208.3.1] Note: If parking serves multiple entrances, accessible parking should be dispersed.	<input checked="" type="checkbox"/> YES <input type="checkbox"/> NO TO TRAIL		Photo:	<ul style="list-style-type: none"> • Reconfigure spaces

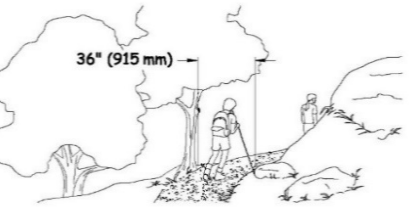
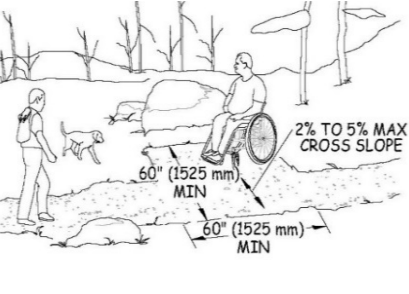
Outdoor Recreation Access Routes [1016] (A pedestrian route developed primarily to connect elements, spaces, or facilities within a site is not a trail)				
2.200	Outdoor Recreation Access Routes shall comply with 1016 [F247]			EXCEPTIONS: 1. In alterations to existing camping facilities, picnic facilities, and trailheads, when an entity determines that a condition in 1019 does not permit full compliance with a specific provision in 1016 on a portion of an outdoor recreation access route, the portion of the outdoor recreation access route shall comply with the provision to the extent practicable. 2. At viewing areas, when an entity determines that a condition in 1019 does not permit full compliance on a portion of an outdoor recreation access route with a specific provision in 1016, the portion of the outdoor recreation access route shall comply with the provision to the extent practicable. 3. Where outdoor recreation access routes are provided within vehicular ways, outdoor recreation access routes shall not be required to comply with 1016.4, 1016.7, and 1016.8.
2.201	Is the surface of outdoor recreation access routes, passing spaces, and resting intervals stable, firm and slip-resistant? [40.2, 302.1]	<input checked="" type="checkbox"/> YES Material: PAVERS	<input type="checkbox"/> NO	A firm trail surface resists deformation by indentations. A stable trail surface is not permanently affected by expected weather conditions and can sustain normal wear and tear from the expected uses between planned maintenance.  <ul style="list-style-type: none"> • Modify surface • Replace Surface Photo #:
2.202	Is the clear width of the outdoor recreation access route 36 inches (915 mm) minimum? [1016.3]	<input checked="" type="checkbox"/> YES Measurement: 10'-0"	<input type="checkbox"/> NO	 <ul style="list-style-type: none"> • Modify route • Provide new route Photo #:
2.203	If the outdoor recreation access route width is less than 60 inches (1525 mm) are passing spaces provided at intervals of 200 feet (61 m) maximum? (Passing spaces and resting intervals shall be permitted to overlap.) [1017.4]	<input type="checkbox"/> YES Measurement: N/A	<input type="checkbox"/> NO	 <ul style="list-style-type: none"> • Modify route • Provide passing spaces Photo #:

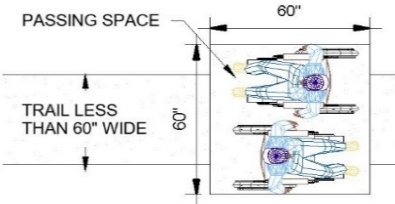
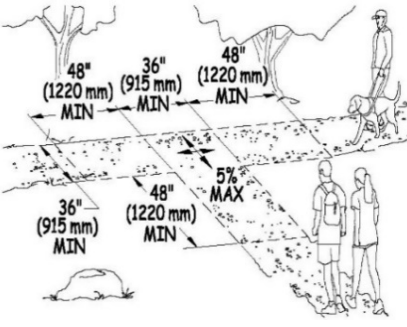
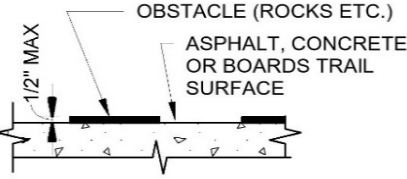
	<p>Is the passing space 60 inches (1525 mm) minimum by 60 inches (1525 mm) minimum; [1017.4.1] or</p>	<p><input type="checkbox"/> YES Measure N/A</p>	<p><input type="checkbox"/> NO ment:</p>		<p>Photo #:</p>	<ul style="list-style-type: none"> • Modify route • Provide passing spaces
<p>2.204</p>	<p>Does the intersection of two outdoor recreation access routes provide a T-shaped space complying with 304.3.2 where the base and the arms of the T-shaped space extend 48 inches (1220 mm) minimum beyond the intersection? And,</p>	<p><input checked="" type="checkbox"/> YES Measure</p>	<p><input type="checkbox"/> NO ment:</p>		<p>Photo #:</p>	<ul style="list-style-type: none"> • Modify route • Provide passing spaces • Regrade
	<p>Is the vertical alignment at the intersection of the outdoor recreation access routes that form the T-shaped space nominally planar? (virtually</p>	<p><input checked="" type="checkbox"/> YES Measure</p>	<p><input type="checkbox"/> NO ment:</p>		<p>Photo #:</p>	
<p>2.200</p>	<p>If the outdoor recreation access routes surface is asphalt, concrete or boards, and there are obstacles on route, passing spaces, and resting intervals, are they less than 1/2 inch (13 mm) in height measured vertically to the highest point? [1016.5]</p>	<p><input type="checkbox"/> YES Measure</p>	<p><input checked="" type="checkbox"/> NO ment: 1" IN SOME AREAS</p>		<p>Photo #:</p>	<ul style="list-style-type: none"> • Modify route • Regrade

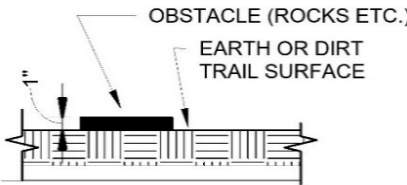
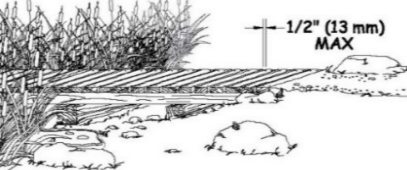
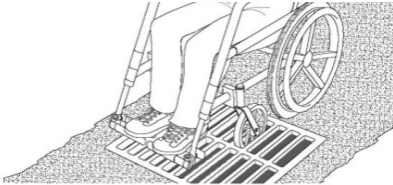

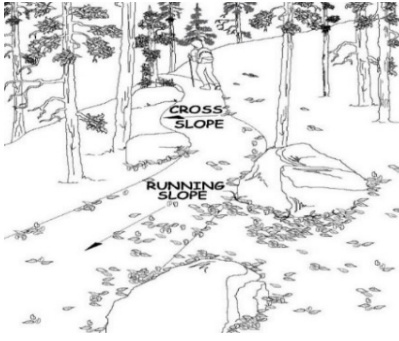
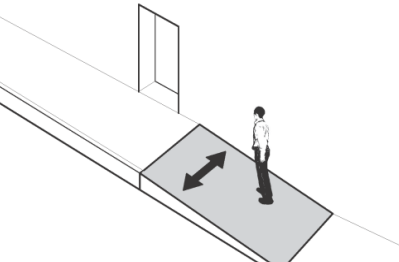
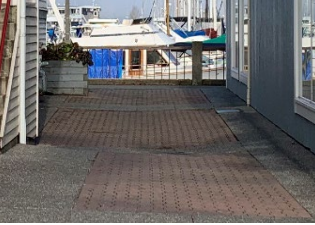
<p>2.206</p>	<p>If the outdoor recreation access routes surface is not asphalt, concrete or boards, and there are tread obstacles on outdoor recreation access routes passing spaces, and resting intervals, are they less than 1 inch (25 mm) in height measured vertically to the highest point? [1016.5]</p>	<p><input type="checkbox"/> YES Measurement: N/A</p>	<p><input type="checkbox"/> NO</p>		<p>Photo #:</p>	<ul style="list-style-type: none"> • Modify route • Regrade
<p>2.207</p>	<p>Are openings in the surface of outdoor recreation access routes passing spaces, and resting intervals small enough to not allow the passage of a sphere more than 1/2 inch (13 mm) in diameter? [1016.6]</p>	<p><input type="checkbox"/> YES Measurement: N/A</p>	<p><input type="checkbox"/> NO</p>		<p>Photo #:</p>	<ul style="list-style-type: none"> • Modify route • Replace grates or boards
<p>2.208</p>	<p>If there are elongated openings, are they placed so that the long dimension is perpendicular, or as close to perpendicular as possible, to the dominant direction of travel? [1016.6]</p>	<p><input type="checkbox"/> YES</p>	<p><input checked="" type="checkbox"/> NO DIAGNL</p>		<p>Photo #:</p>	<ul style="list-style-type: none"> • Modify route • Replace grates or boards

<p>2.209</p>	<p>Is the running slope of any segment of the outdoor recreation access routes steeper than 1:10 (10%). [1016.7.1]</p>	<p><input checked="" type="checkbox"/> YES Measurement:</p>	<p><input type="checkbox"/> NO</p>		<p>Photo #:</p>	<ul style="list-style-type: none"> • Regrade 											
<p>2.210</p>	<p>If the running slope of a segment of a outdoor recreation access route is steeper than 1:20 (5%), is the maximum length of the segment in accordance with Table 1016.7.1, and,</p>	<p><input type="checkbox"/> YES Measurement:</p> <p>Length: ~60'</p>	<p><input checked="" type="checkbox"/> NO</p>	<table border="1"> <thead> <tr> <th colspan="2">Running Slope of Outdoor Recreation Access Route Segment</th> <th rowspan="2">Maximum Length of Segment</th> </tr> <tr> <th>Steeper than</th> <th>But not Steeper than</th> </tr> </thead> <tbody> <tr> <td>1:20 (5%)</td> <td>1:12 (8.33%)</td> <td>50 feet (15 m)</td> </tr> <tr> <td>1:12 (8.33%)</td> <td>1:10 (10%)</td> <td>30 feet (9 m)</td> </tr> </tbody> </table>	Running Slope of Outdoor Recreation Access Route Segment		Maximum Length of Segment	Steeper than	But not Steeper than	1:20 (5%)	1:12 (8.33%)	50 feet (15 m)	1:12 (8.33%)	1:10 (10%)	30 feet (9 m)	<p>Photo #:</p>	<ul style="list-style-type: none"> • Regrade
Running Slope of Outdoor Recreation Access Route Segment		Maximum Length of Segment															
Steeper than	But not Steeper than																
1:20 (5%)	1:12 (8.33%)	50 feet (15 m)															
1:12 (8.33%)	1:10 (10%)	30 feet (9 m)															
<p>2.211</p>	<p>Is there a resting interval provided at the top and bottom of each segment?</p>	<p><input checked="" type="checkbox"/> YES Top:</p> <p><input checked="" type="checkbox"/> YES Bottom:</p>	<p><input type="checkbox"/> NO</p> <p><input type="checkbox"/> NO</p>		<p>Photo #:</p>	<ul style="list-style-type: none"> • Modify route • Regrade 											
<p>2.212</p>	<p>Is the cross slope no steeper than 1:48? [1016.7.2] Where the surface is other than concrete, asphalt, or boards, cross slopes not steeper than 1:20 shall be permitted when necessary for drainage.</p>	<p><input type="checkbox"/> YES Measurement:</p> <p>Material: 9%</p>	<p><input checked="" type="checkbox"/> NO</p>		 <p>Photo #:</p>	<ul style="list-style-type: none"> • Regrade 											
<p>2.213</p>	<p>Is the resting interval length at least 60 inches (1525 mm) long? [1017.8.1]</p>	<p><input checked="" type="checkbox"/> YES Measurement:</p> <p>Material:</p>	<p><input type="checkbox"/> NO</p>		<p>Photo #:</p>	<ul style="list-style-type: none"> • Modify route • Regrade 											

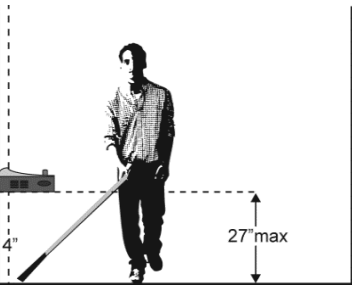
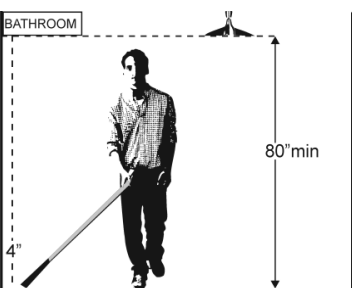
<p>2.218</p>	<p>Is the vertical alignment between the outdoor recreation access route, turning space, and resting interval nominally planar? <i>(virtually flat)</i></p>	<p><input checked="" type="checkbox"/> YES Measurement:</p>	<p><input type="checkbox"/> NO</p>			<ul style="list-style-type: none"> • Modify route • Regrade
---------------------	---	--	------------------------------------	--	--	---

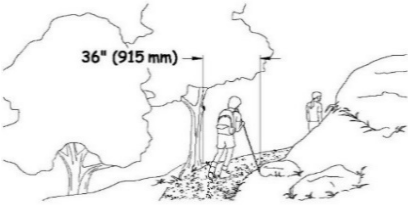
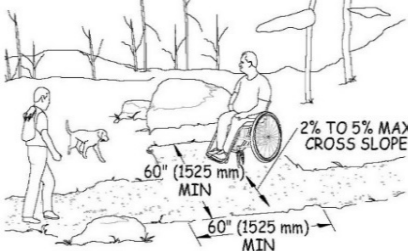
<p>2.219</p>	<p>Do all objects on outdoor recreation access routes, passing spaces, and resting intervals, e.g. signs, etc., protrude no more than 4 inches into the path? (does not apply to natural features, such as tree branches, rock formations) Or</p>	<p><input type="checkbox"/> YES Measurement: N/A</p>	<p><input type="checkbox"/> NO</p>		<p>Photo #:</p>	<ul style="list-style-type: none"> • Remove object • Add tactile warning such as permanent planter or partial walls
	<p>If an object protrudes more than 4 inches, is the bottom leading edge at 27 inches or lower above the floor? [307.2] Or</p>	<p><input type="checkbox"/> YES Measurement: N/A</p>	<p><input type="checkbox"/> NO</p>		<p>Photo #:</p>	<ul style="list-style-type: none"> • Remove object • Add tactile warning such as permanent planter or partial walls
	<p>Is the bottom leading edge at 80 inches or higher above the floor? [307.4]</p>	<p><input type="checkbox"/> YES Measurement: N/A</p>	<p><input type="checkbox"/> NO</p>		<p>Photo #:</p>	<ul style="list-style-type: none"> • Remove object • Add tactile warning such as permanent planter or partial walls

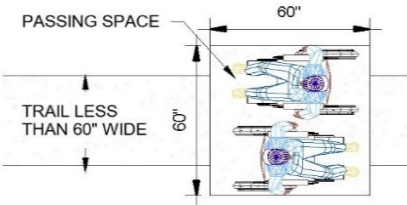
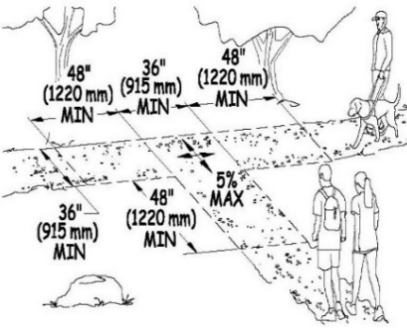
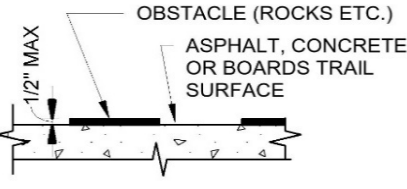
Outdoor Recreation Access Routes [1016] (A pedestrian route developed primarily to connect elements, spaces, or facilities within a site is not a trail)					
2.200	Outdoor Recreation Access Routes shall comply with 1016 [F247]			<p>EXCEPTIONS: 1. In alterations to existing camping facilities, picnic facilities, and trailheads, when an entity determines that a condition in 1019 does not permit full compliance with a specific provision in 1016 on a portion of an outdoor recreation access route, the portion of the outdoor recreation access route shall comply with the provision to the extent practicable.</p> <p>2. At viewing areas, when an entity determines that a condition in 1019 does not permit full compliance on a portion of an outdoor recreation access route with a specific provision in 1016, the portion of the outdoor recreation access route shall comply with the provision to the extent practicable.</p> <p>3. Where outdoor recreation access routes are provided within vehicular ways, outdoor recreation access routes shall not be required to comply with 1016.4, 1016.7, and 1016.8.</p>	
2.201	Is the surface of outdoor recreation access routes, passing spaces, and resting intervals stable, firm and slip-resistant? [40.2, 302.1]	<input checked="" type="checkbox"/> YES Material: PAVERS	<input type="checkbox"/> NO	<p>A firm trail surface resists deformation by indentations. A stable trail surface is not permanently affected by expected weather conditions and can sustain normal wear and tear from the expected uses between planned maintenance.</p>	 <p>Photo #:</p> <ul style="list-style-type: none"> • Modify surface • Replace Surface
2.202	Is the clear width of the outdoor recreation access route 36 inches (915 mm) minimum? [1016.3]	<input checked="" type="checkbox"/> YES Measurement: 10'-0"	<input type="checkbox"/> NO	 <p>Photo #:</p> <ul style="list-style-type: none"> • Modify route • Provide new route 	
2.203	If the outdoor recreation access route width is less than 60 inches (1525 mm) are passing spaces provided at intervals of 200 feet (61 m) maximum? (Passing spaces and resting intervals shall be permitted to overlap.)	<input type="checkbox"/> YES Measurement: N/A	<input type="checkbox"/> NO	 <p>Photo #:</p> <ul style="list-style-type: none"> • Modify route • Provide passing spaces 	

	<p>Is the passing space 60 inches (1525 mm) minimum by 60 inches (1525 mm) minimum; [1017.4.1] or</p>	<p><input type="checkbox"/> YES Measurement: N/A</p>	<p><input type="checkbox"/> NO Measurement:</p>		<p>Photo #:</p>	<ul style="list-style-type: none"> • Modify route • Provide passing spaces
<p>2.204</p>	<p>Does the intersection of two outdoor recreation access routes provide a T-shaped space complying with 304.3.2 where the base and the arms of the T-shaped space extend 48 inches (1220 mm) minimum beyond the intersection? And,</p>	<p><input checked="" type="checkbox"/> YES Measurement:</p>	<p><input type="checkbox"/> NO Measurement:</p>		<p>Photo #:</p>	<ul style="list-style-type: none"> • Modify route • Provide passing spaces • Regrade
	<p>Is the vertical alignment at the intersection of the outdoor recreation access routes that form the T-shaped space nominally planar? (virtually flat)</p>	<p><input type="checkbox"/> YES Measurement:</p>	<p><input checked="" type="checkbox"/> NO Measurement: 5.1% FROM CURB RAMP</p>		<p>Photo #:</p>	
<p>2.200</p>	<p>If the outdoor recreation access routes surface is asphalt, concrete or boards, and there are obstacles on route, passing spaces, and resting intervals, are they less than 1/2 inch (13 mm) in height measured vertically to the highest point? [1016.5]</p>	<p><input type="checkbox"/> YES Measurement:</p>	<p><input checked="" type="checkbox"/> NO Measurement: UP TO 1"</p>		 <p>Photo #:</p>	<ul style="list-style-type: none"> • Modify route • Regrade

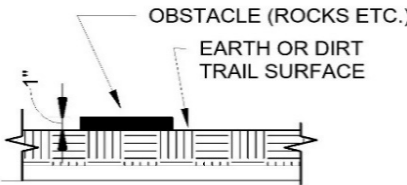
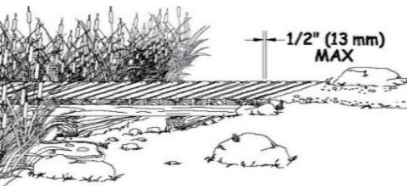
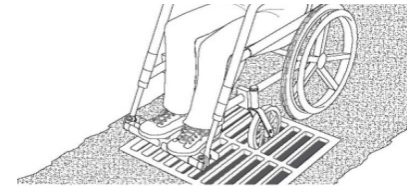

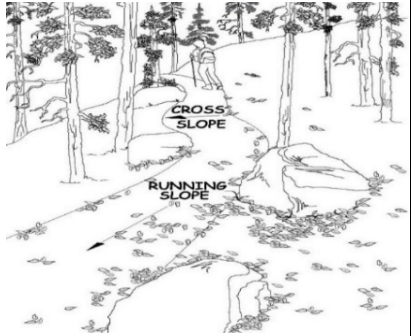
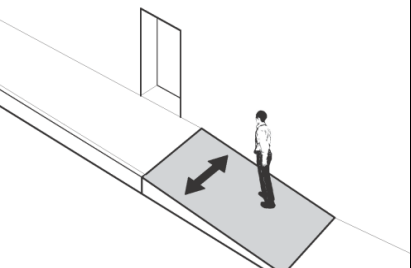
<p>2.206</p>	<p>If the outdoor recreation access routes surface is not asphalt, concrete or boards, and there are tread obstacles on outdoor recreation access routes passing spaces, and resting intervals, are they less than 1 inch (25 mm) in height measured vertically to the highest point? [1016.5]</p>	<p><input type="checkbox"/> YES Measure N/A</p>	<p><input type="checkbox"/> NO ment:</p>		<p>Photo #:</p>	<ul style="list-style-type: none"> • Modify route • Regrade
<p>2.207</p>	<p>Are openings in the surface of outdoor recreation access routes passing spaces, and resting intervals small enough to not allow the passage of a sphere more than 1/2 inch (13 mm) in diameter? [1016.6]</p>	<p><input type="checkbox"/> YES Measure N/A</p>	<p><input type="checkbox"/> NO ment:</p>		<p>Photo #:</p>	<ul style="list-style-type: none"> • Modify route • Replace grates or boards
<p>2.208</p>	<p>If there are elongated openings, are they placed so that the long dimension is perpendicular, or as close to perpendicular as possible, to the dominant direction of travel? [1016.6]</p>	<p><input type="checkbox"/> YES</p>	<p><input checked="" type="checkbox"/> NO DIAGNL</p>		<p>Photo #:</p>	<ul style="list-style-type: none"> • Modify route • Replace grates or boards

<p>2.209 Is the running slope of any segment of the outdoor recreation access routes steeper than 1:10 (10%). [1016.7.1]</p>	<p><input checked="" type="checkbox"/> YES <input type="checkbox"/> NO Measurement:</p>		<p>Photo #:</p>	<ul style="list-style-type: none"> • Regrade 											
<p>2.210 If the running slope of a segment of a outdoor recreation access route is steeper than 1:20 (5%), is the maximum length of the segment in accordance with Table 1016.7.1, and,</p>	<p><input type="checkbox"/> YES <input checked="" type="checkbox"/> NO Measurement:</p> <p>Length: ~60'</p>	<table border="1"> <thead> <tr> <th colspan="2">Running Slope of Outdoor Recreation Access Route Segment</th> <th rowspan="2">Maximum Length of Segment</th> </tr> <tr> <th>Steeper than</th> <th>But not Steeper than</th> </tr> </thead> <tbody> <tr> <td>1:20 (5%)</td> <td>1:12 (8.33%)</td> <td>50 feet (15 m)</td> </tr> <tr> <td>1:12 (8.33%)</td> <td>1:10 (10%)</td> <td>30 feet (9 m)</td> </tr> </tbody> </table>	Running Slope of Outdoor Recreation Access Route Segment		Maximum Length of Segment	Steeper than	But not Steeper than	1:20 (5%)	1:12 (8.33%)	50 feet (15 m)	1:12 (8.33%)	1:10 (10%)	30 feet (9 m)	<p>Photo #:</p>	<ul style="list-style-type: none"> • Regrade
Running Slope of Outdoor Recreation Access Route Segment		Maximum Length of Segment													
Steeper than	But not Steeper than														
1:20 (5%)	1:12 (8.33%)	50 feet (15 m)													
1:12 (8.33%)	1:10 (10%)	30 feet (9 m)													
<p>2.211 Is there a resting interval provided at the top and bottom of each segment?</p>	<p><input checked="" type="checkbox"/> YES <input type="checkbox"/> NO Top:</p> <p><input checked="" type="checkbox"/> YES <input type="checkbox"/> NO Bottom:</p>		<p>Photo #:</p>	<ul style="list-style-type: none"> • Modify route • Regrade 											
<p>2.212 Is the cross slope no steeper than 1:48? [1016.7.2] Where the surface is other than concrete, asphalt, or boards, cross slopes not steeper than 1:20 shall be permitted when necessary for drainage.</p>	<p><input type="checkbox"/> YES <input checked="" type="checkbox"/> NO Measurement:</p> <p>Material: 16.1%</p>		<p>Photo #:</p>	<ul style="list-style-type: none"> • Regrade 											
<p>2.213 Is the resting interval length at least 60 inches (1525 mm) long? [1017.8.1]</p>	<p><input checked="" type="checkbox"/> YES <input type="checkbox"/> NO Measurement:</p> <p>Material:</p>		<p>Photo #:</p>	<ul style="list-style-type: none"> • Modify route • Regrade 											

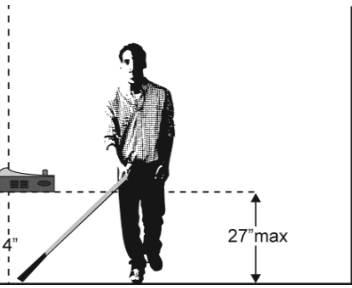
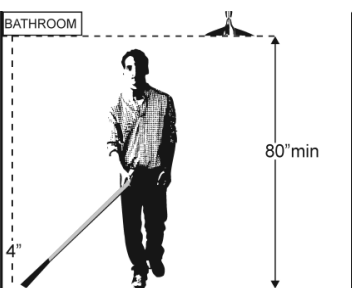
<p>2.218</p>	<p>Is the vertical alignment between the outdoor recreation access route, turning space, and resting interval nominally planar? (virtually flat)</p>	<p><input checked="" type="checkbox"/> YES</p>	<p><input type="checkbox"/> NO</p>	<p>Measurement:</p>		<ul style="list-style-type: none"> • Modify route • Regrade
---------------------	--	--	------------------------------------	----------------------------	--	---

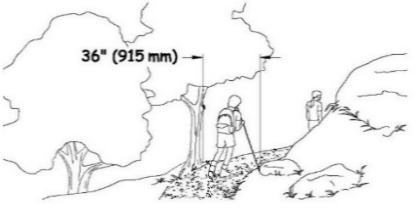
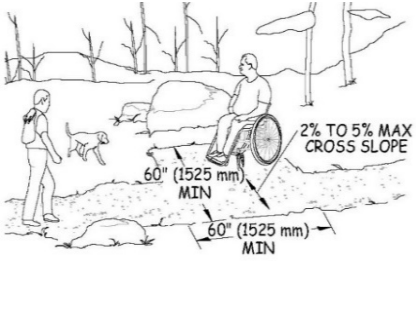
<p>2.219</p>	<p>Do all objects on outdoor recreation access routes, passing spaces, and resting intervals, e.g. signs, etc., protrude no more than 4 inches into the path? (does not apply to natural features, such as tree branches, rock formations) Or</p>	<p><input type="checkbox"/> YES Measurement: N/A</p>	<p><input type="checkbox"/> NO</p>		<p>Photo #:</p>	<ul style="list-style-type: none"> • Remove object • Add tactile warning such as permanent planter or partial walls
	<p>If an object protrudes more than 4 inches, is the bottom leading edge at 27 inches or lower above the floor? [307.2] Or</p>	<p><input type="checkbox"/> YES Measurement: N/A</p>	<p><input type="checkbox"/> NO</p>		<p>Photo #:</p>	<ul style="list-style-type: none"> • Remove object • Add tactile warning such as permanent planter or partial walls
	<p>Is the bottom leading edge at 80 inches or higher above the floor? [307.4]</p>	<p><input type="checkbox"/> YES Measurement: N/A</p>	<p><input type="checkbox"/> NO</p>		<p>Photo #:</p>	<ul style="list-style-type: none"> • Remove object • Add tactile warning such as permanent planter or partial walls

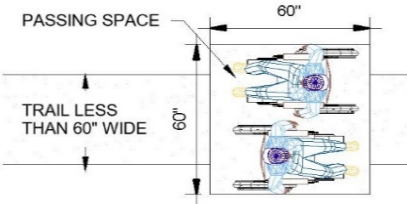
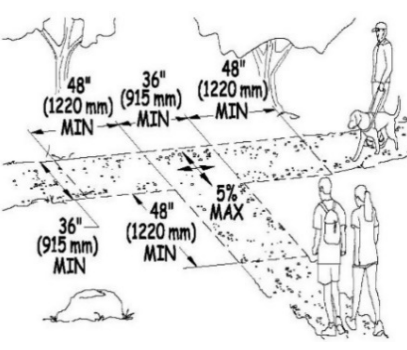
Outdoor Recreation Access Routes [1016] (A pedestrian route developed primarily to connect elements, spaces, or facilities within a site is not a trail)					
2.200	Outdoor Recreation Access Routes shall comply with 1016 [F247]			EXCEPTIONS: 1. In alterations to existing camping facilities, picnic facilities, and trailheads, when an entity determines that a condition in 1019 does not permit full compliance with a specific provision in 1016 on a portion of an outdoor recreation access route, the portion of the outdoor recreation access route shall comply with the provision to the extent practicable. 2. At viewing areas, when an entity determines that a condition in 1019 does not permit full compliance on a portion of an outdoor recreation access route with a specific provision in 1016, the portion of the outdoor recreation access route shall comply with the provision to the extent practicable. 3. Where outdoor recreation access routes are provided within vehicular ways, outdoor recreation access routes shall not be required to comply with 1016.4, 1016.7, and 1016.8.	
2.201	Is the surface of outdoor recreation access routes, passing spaces, and resting intervals stable, firm and slip-resistant? [40.2, 302.1]	<input checked="" type="checkbox"/> YES Material: PAVERS	<input type="checkbox"/> NO	A firm trail surface resists deformation by indentations. A stable trail surface is not permanently affected by expected weather conditions and can sustain normal wear and tear from the expected uses between planned maintenance.	 <ul style="list-style-type: none"> • Modify surface • Replace Surface Photo #:
2.202	Is the clear width of the outdoor recreation access route 36 inches (915 mm) minimum? [1016.3]	<input checked="" type="checkbox"/> YES Measure 10'-0"	<input type="checkbox"/> NO ment:		<ul style="list-style-type: none"> • Modify route • Provide new route Photo #:
2.203	If the outdoor recreation access route width is less than 60 inches (1525 mm) are passing spaces provided at intervals of 200 feet (61 m) maximum? (Passing spaces and resting intervals shall be permitted to overlap.) [1017.4]	<input type="checkbox"/> YES Measure N/A	<input type="checkbox"/> NO ment:		<ul style="list-style-type: none"> • Modify route • Provide passing spaces Photo #:

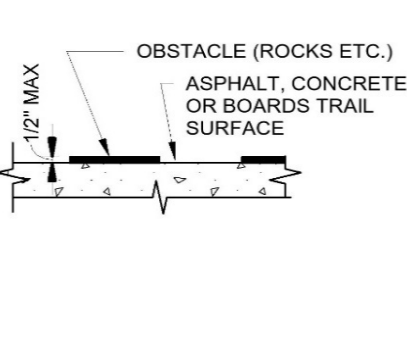
	<p>Is the passing space 60 inches (1525 mm) minimum by 60 inches (1525 mm) minimum; [1017.4.1] or</p>	<p><input type="checkbox"/> YES Measurement: N/A</p>	<p><input type="checkbox"/> NO Measurement:</p>		<p>Photo #:</p>	<ul style="list-style-type: none"> • Modify route • Provide passing spaces
<p>2.204</p>	<p>Does the intersection of two outdoor recreation access routes provide a T-shaped space complying with 304.3.2 where the base and the arms of the T-shaped space extend 48 inches (1220 mm) minimum beyond the intersection? And,</p>	<p><input checked="" type="checkbox"/> YES Measurement:</p>	<p><input type="checkbox"/> NO Measurement:</p>		<p>Photo #:</p>	<ul style="list-style-type: none"> • Modify route • Provide passing spaces • Regrade
	<p>Is the vertical alignment at the intersection of the outdoor recreation access routes that form the T-shaped space nominally planar? (virtually</p>	<p><input type="checkbox"/> YES Measurement:</p>	<p><input checked="" type="checkbox"/> NO Measurement: 6%</p>		<p>Photo #:</p>	<ul style="list-style-type: none"> • Modify route • Regrade
<p>2.200</p>	<p>If the outdoor recreation access routes surface is asphalt, concrete or boards, and there are obstacles on route, passing spaces, and resting intervals, are they less than 1/2 inch (13 mm) in height measured vertically to the highest point? [1016.5]</p>	<p><input type="checkbox"/> YES Measurement:</p>	<p><input checked="" type="checkbox"/> NO Measurement: UP TO 1"</p>		<p>Photo #:</p>	<ul style="list-style-type: none"> • Modify route • Regrade

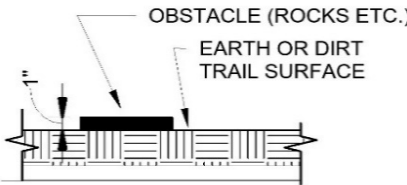
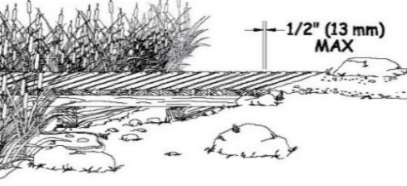
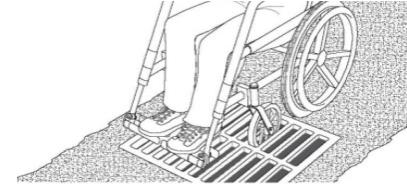
<p>2.206</p>	<p>If the outdoor recreation access routes surface is not asphalt, concrete or boards, and there are tread obstacles on outdoor recreation access routes passing spaces, and resting intervals, are they less than 1 inch (25 mm) in height measured vertically to the highest point? [1016.5]</p>	<p><input type="checkbox"/> YES Measurement: N/A</p>	<p><input type="checkbox"/> NO</p>		<p>Photo #:</p>	<ul style="list-style-type: none"> • Modify route • Regrade
<p>2.207</p>	<p>Are openings in the surface of outdoor recreation access routes passing spaces, and resting intervals small enough to not allow the passage of a sphere more than 1/2 inch (13 mm) in diameter? [1016.6]</p>	<p><input type="checkbox"/> YES Measurement: N/A</p>	<p><input type="checkbox"/> NO</p>		<p>Photo #:</p>	<ul style="list-style-type: none"> • Modify route • Replace grates or boards
<p>2.208</p>	<p>If there are elongated openings, are they placed so that the long dimension is perpendicular, or as close to perpendicular as possible, to the dominant direction of travel? [1016.6]</p>	<p><input type="checkbox"/> YES</p>	<p><input checked="" type="checkbox"/> NO DIAGNL</p>		<p>Photo #:</p>	<ul style="list-style-type: none"> • Modify route • Replace grates or boards

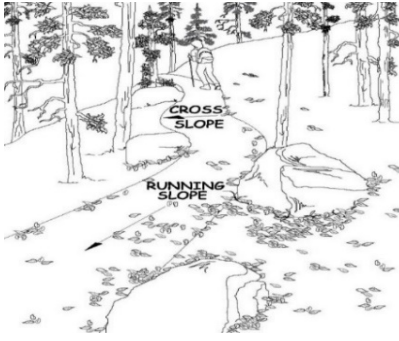
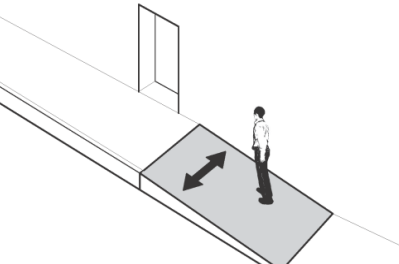
<p>2.209</p>	<p>Is the running slope of any segment of the outdoor recreation access routes steeper than 1:10 (10%). [1016.7.1]</p>	<p><input checked="" type="checkbox"/> YES Measure ment: 3%</p>	<p><input type="checkbox"/> NO</p>		<p>Photo #:</p>	<ul style="list-style-type: none"> • Regrade 											
<p>2.210</p>	<p>If the running slope of a segment of a outdoor recreation access route is steeper than 1:20 (5%), is the maximum length of the segment in accordance with Table 1016.7.1, and,</p>	<p><input type="checkbox"/> YES Measure ment: Length: ~70'</p>	<p><input checked="" type="checkbox"/> NO</p>	<table border="1"> <thead> <tr> <th colspan="2">Running Slope of Outdoor Recreation Access Route Segment</th> <th rowspan="2">Maximum Length of Segment</th> </tr> <tr> <th>Steeper than</th> <th>But not Steeper than</th> </tr> </thead> <tbody> <tr> <td>1:20 (5%)</td> <td>1:12 (8.33%)</td> <td>50 feet (15 m)</td> </tr> <tr> <td>1:12 (8.33%)</td> <td>1:10 (10%)</td> <td>30 feet (9 m)</td> </tr> </tbody> </table>	Running Slope of Outdoor Recreation Access Route Segment		Maximum Length of Segment	Steeper than	But not Steeper than	1:20 (5%)	1:12 (8.33%)	50 feet (15 m)	1:12 (8.33%)	1:10 (10%)	30 feet (9 m)	<p>Photo #:</p>	<ul style="list-style-type: none"> • Regrade
Running Slope of Outdoor Recreation Access Route Segment		Maximum Length of Segment															
Steeper than	But not Steeper than																
1:20 (5%)	1:12 (8.33%)	50 feet (15 m)															
1:12 (8.33%)	1:10 (10%)	30 feet (9 m)															
<p>2.211</p>	<p>Is there a resting interval provided at the top and bottom of each segment?</p>	<p><input checked="" type="checkbox"/> YES Top: <input checked="" type="checkbox"/> YES Bottom:</p>	<p><input type="checkbox"/> NO <input type="checkbox"/> NO</p>		<p>Photo #:</p>	<ul style="list-style-type: none"> • Modify route • Regrade 											
<p>2.212</p>	<p>Is the cross slope no steeper than 1:48? [1016.7.2] Where the surface is other than concrete, asphalt, or boards, cross slopes not steeper than 1:20 shall be permitted when necessary for drainage.</p>	<p><input type="checkbox"/> YES Measure ment: Material: 6.3%</p>	<p><input checked="" type="checkbox"/> NO</p>		<p>Photo #:</p>	<ul style="list-style-type: none"> • Regrade 											
<p>2.213</p>	<p>Is the resting interval length at least 60 inches (1525 mm) long? [1017.8.1]</p>	<p><input checked="" type="checkbox"/> YES Measure ment: Material:</p>	<p><input type="checkbox"/> NO</p>		<p>Photo #:</p>	<ul style="list-style-type: none"> • Modify route • Regrade 											

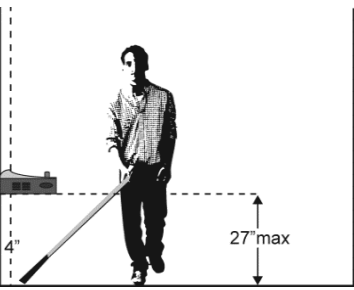
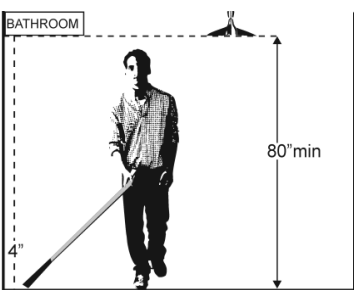

<p>2.218</p>	<p>Is the vertical alignment between the outdoor recreation access route, turning space, and resting interval nominally planar? (virtually flat)</p>	<p><input checked="" type="checkbox"/> YES</p>	<p><input type="checkbox"/> NO</p>	<p>Measurement:</p>		<ul style="list-style-type: none"> • Modify route • Regrade
---------------------	--	--	------------------------------------	----------------------------	--	---

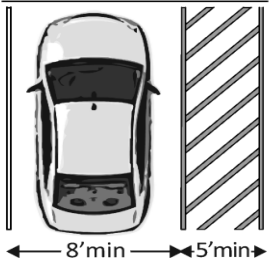
<p>2.219</p>	<p>Do all objects on outdoor recreation access routes, passing spaces, and resting intervals, e.g. signs, etc., protrude no more than 4 inches into the path? (does not apply to natural features, such as tree branches, rock formations) Or</p>	<p><input type="checkbox"/> YES Measurement: N/A</p>	<p><input type="checkbox"/> NO</p>		<p>Photo #:</p>	<ul style="list-style-type: none"> • Remove object • Add tactile warning such as permanent planter or partial walls
	<p>If an object protrudes more than 4 inches, is the bottom leading edge at 27 inches or lower above the floor? [307.2] Or</p>	<p><input type="checkbox"/> YES Measurement: N/A</p>	<p><input type="checkbox"/> NO</p>		<p>Photo #:</p>	<ul style="list-style-type: none"> • Remove object • Add tactile warning such as permanent planter or partial walls
	<p>Is the bottom leading edge at 80 inches or higher above the floor? [307.4]</p>	<p><input type="checkbox"/> YES Measurement: N/A</p>	<p><input type="checkbox"/> NO</p>		<p>Photo #:</p>	<ul style="list-style-type: none"> • Remove object • Add tactile warning such as permanent planter or partial walls

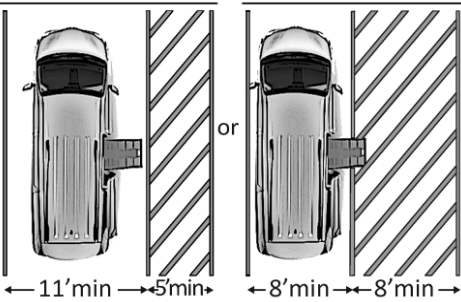
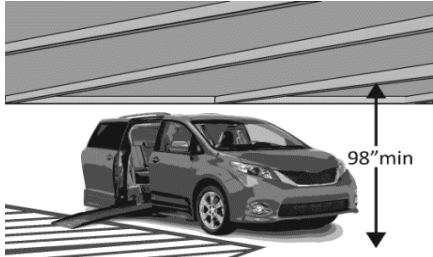
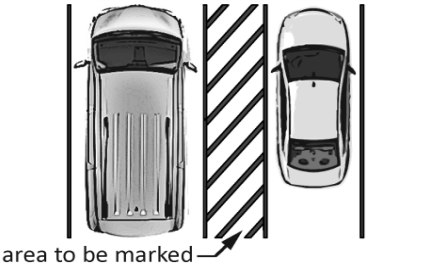

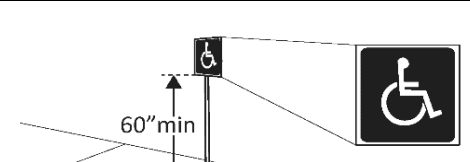
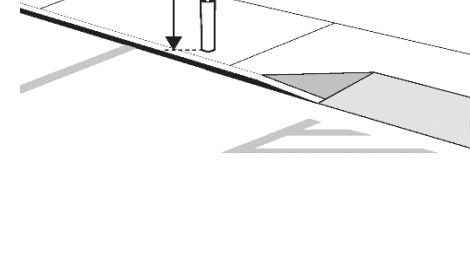
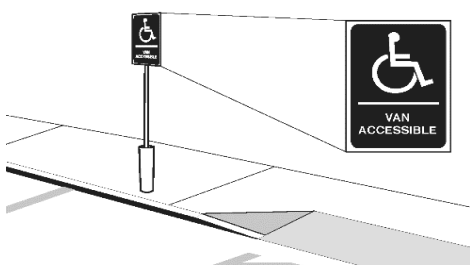

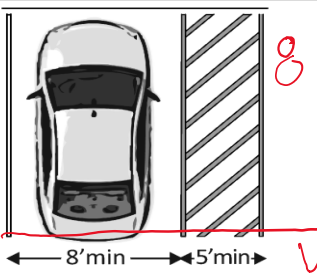
Parking Accessible parking spaces should be identified by size, access aisle and signage.																			
1.100	If parking is provided for the public, are an adequate number of accessible spaces provided? (208.2)	<input checked="" type="checkbox"/> YES <input type="checkbox"/> NO Total #: 168 Acsbl #: 3@PK G 14 (11 TOTAL)	<table border="1"> <thead> <tr> <th>Total Spaces</th> <th>Accessible Spaces</th> </tr> </thead> <tbody> <tr> <td>1 - 25</td> <td>1</td> </tr> <tr> <td>26 - 50</td> <td>2</td> </tr> <tr> <td>51 - 75</td> <td>3</td> </tr> <tr> <td>76 - 100</td> <td>4</td> </tr> <tr> <td>151 to 200</td> <td>6</td> </tr> <tr> <td>100+ see 2010 Standards 208.2</td> <td></td> </tr> </tbody> </table>	Total Spaces	Accessible Spaces	1 - 25	1	26 - 50	2	51 - 75	3	76 - 100	4	151 to 200	6	100+ see 2010 Standards 208.2		Photo:	<ul style="list-style-type: none"> Reconfigure by repainting lines
Total Spaces	Accessible Spaces																		
1 - 25	1																		
26 - 50	2																		
51 - 75	3																		
76 - 100	4																		
151 to 200	6																		
100+ see 2010 Standards 208.2																			
1.101	Of the accessible spaces, is at least one a van accessible space? [208.2.4]	<input type="checkbox"/> YES <input checked="" type="checkbox"/> NO	*For every 6 or fraction of 6 parking spaces required by the table above, at least 1 should be a van accessible space.	Photo:	<ul style="list-style-type: none"> If constructed before 3/15/2012, parking is compliant if at least 1 in every 8 accessible spaces is van accessible Reconfigure by repainting lines 														
1.102	Are accessible spaces at least 8 feet wide with an access aisle at least 5 feet wide? [502.2, 502.3] Note: Two spaces may share an access aisle. Check state/local requirements; some specify that each space have its own aisle.	<input checked="" type="checkbox"/> YES <input type="checkbox"/> NO Measure ment: 8'-0" S 6'-0" A 8'-0" S 9'-0" S		Photo:	<ul style="list-style-type: none"> Reconfigure by repainting lines 														

<p>1.103</p>	<p>Is the van accessible space: At least 11 feet wide with an access aisle at least 5 feet wide? Or</p>	<p><input type="checkbox"/> YES <input checked="" type="checkbox"/> NO Measurement:</p>		<p>Photo:</p>	<ul style="list-style-type: none"> • Reconfigure by repainting lines
<p></p>	<p>At least 8 feet wide with an access aisle at least 8 feet wide? [502.2]</p>	<p><input type="checkbox"/> YES <input checked="" type="checkbox"/> NO Measurement:</p>		<p>Photo:</p>	<p></p>
<p>1.104</p>	<p>Is at least 98 inches of vertical clearance provided for the van accessible space? [502.5]</p>	<p><input checked="" type="checkbox"/> YES <input type="checkbox"/> NO Measurement:</p>		<p>Photo:</p>	<ul style="list-style-type: none"> • Reconfigure to provide van-accessible space(s)
<p>1.105</p>	<p>Are the access aisles marked so as to discourage parking in them? [502.3.3] Note: The marking method and color may be addressed by state/local requirements.</p>	<p><input checked="" type="checkbox"/> YES <input type="checkbox"/> NO Measurement: FADED</p>		<p>Photo:</p>	<ul style="list-style-type: none"> • Mark access aisles
<p>1.106</p>	<p>Is the slope of the accessible parking spaces and access aisles no steeper than 1:48 in all directions? [502.4]</p>	<p><input type="checkbox"/> YES <input checked="" type="checkbox"/> NO Measurement: UP TO 5%</p>	<p></p>	<p>Photo:</p>	<ul style="list-style-type: none"> • Regrade surface

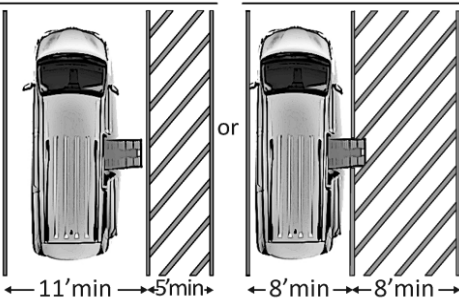
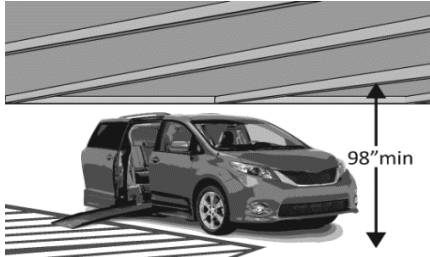
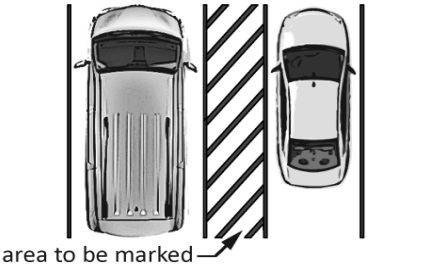
1.107	Do the access aisles adjoin an accessible route? [502.3]	<input checked="" type="checkbox"/> YES <input type="checkbox"/> NO		Photo:	<ul style="list-style-type: none"> • Create accessible route • Relocate accessible space
1.108	Are accessible spaces identified with a sign that includes the International Symbol of Accessibility?	<input checked="" type="checkbox"/> YES <input type="checkbox"/> NO		Photo:	<ul style="list-style-type: none"> • Install signs
	Is the bottom of the sign at least 60 inches above the ground? [502.6] Note: The International Symbol of Accessibility is not required on the ground.	<input type="checkbox"/> YES <input checked="" type="checkbox"/> NO 29 1/2"		Photo:	
1.109	Are there signs reading "van accessible" at van accessible spaces? [502.6]	<input type="checkbox"/> YES <input checked="" type="checkbox"/> NO		Photo:	<ul style="list-style-type: none"> • Install signs
1.110	Of the total parking spaces, are the accessible spaces located on the closest accessible route to the accessible entrance(s)? [208.3.1] Note: If parking serves multiple entrances, accessible parking should be dispersed.	<input checked="" type="checkbox"/> YES <input type="checkbox"/> NO TO TRAIL		Photo:	<ul style="list-style-type: none"> • Reconfigure spaces

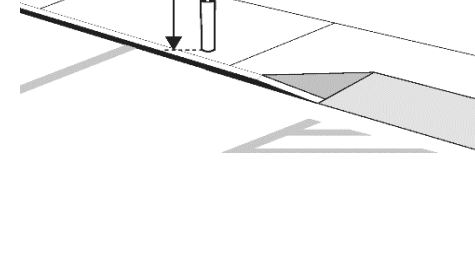

Parking Accessible parking spaces should be identified by size, access aisle and signage.																			
1.100	If parking is provided for the public, are an adequate number of accessible spaces provided? (208.2)	<input checked="" type="checkbox"/> YES <input type="checkbox"/> NO Total #: 168 Acsbl #: 3@PK G 15 (11 TOTAL)	<table border="1"> <thead> <tr> <th>Total Spaces</th> <th>Accessible Spaces</th> </tr> </thead> <tbody> <tr> <td>1 - 25</td> <td>1</td> </tr> <tr> <td>26 - 50</td> <td>2</td> </tr> <tr> <td>51 - 75</td> <td>3</td> </tr> <tr> <td>76 - 100</td> <td>4</td> </tr> <tr> <td>151 to 200</td> <td>6</td> </tr> <tr> <td colspan="2">100+ see 2010 Standards 208.2</td> </tr> </tbody> </table>	Total Spaces	Accessible Spaces	1 - 25	1	26 - 50	2	51 - 75	3	76 - 100	4	151 to 200	6	100+ see 2010 Standards 208.2		 <p>Photo:</p>	<ul style="list-style-type: none"> Reconfigure by repainting lines
Total Spaces	Accessible Spaces																		
1 - 25	1																		
26 - 50	2																		
51 - 75	3																		
76 - 100	4																		
151 to 200	6																		
100+ see 2010 Standards 208.2																			
1.101	Of the accessible spaces, is at least one a van accessible space? [208.2.4]	<input checked="" type="checkbox"/> YES <input type="checkbox"/> NO	*For every 6 or fraction of 6 parking spaces required by the table above, at least 1 should be a van accessible space.	<p>Photo:</p>	<ul style="list-style-type: none"> If constructed before 3/15/2012, parking is compliant if at least 1 in every 8 accessible spaces is van accessible Reconfigure by repainting lines 														
1.102	Are accessible spaces at least 8 feet wide with an access aisle at least 5 feet wide? [502.2, 502.3] Note: Two spaces may share an access aisle. Check state/local requirements; some specify that each space have its own aisle.	<input checked="" type="checkbox"/> YES <input type="checkbox"/> NO Measure ment: 8'-2" S 4'-6" A 8'-5" S 4'-10" A 8'-0" S		 <p>Photo:</p>	<ul style="list-style-type: none"> Reconfigure by repainting lines 														

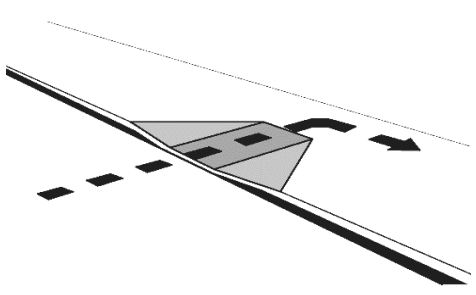
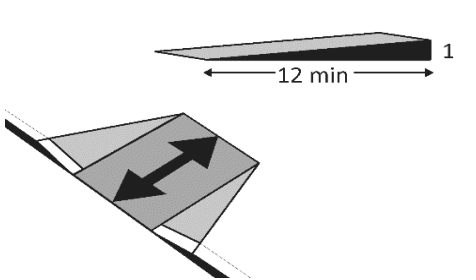
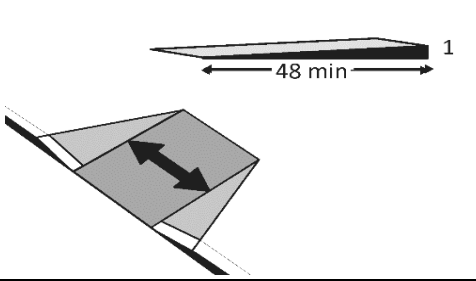
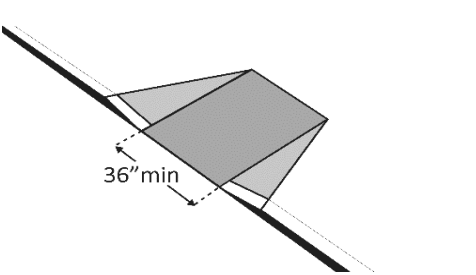

<p>1.103</p>	<p>Is the van accessible space: At least 11 feet wide with an access aisle at least 5 feet wide? Or At least 8 feet wide with an access aisle at least 8 feet wide? [502.2]</p>	<p><input type="checkbox"/> YES <input checked="" type="checkbox"/> NO Measurement:</p>		<p>Photo:</p>	<ul style="list-style-type: none"> • Reconfigure by repainting lines
<p>1.104</p>	<p>Is at least 98 inches of vertical clearance provided for the van accessible space? [502.5]</p>	<p><input checked="" type="checkbox"/> YES <input type="checkbox"/> NO Measurement:</p>		<p>Photo:</p>	<ul style="list-style-type: none"> • Reconfigure to provide van-accessible space(s)
<p>1.105</p>	<p>Are the access aisles marked so as to discourage parking in them? [502.3.3] Note: The marking method and color may be addressed by state/local requirements.</p>	<p><input checked="" type="checkbox"/> YES <input type="checkbox"/> NO Measurement: FADED</p>		<p>Photo:</p>	<ul style="list-style-type: none"> • Mark access aisles
<p>1.106</p>	<p>Is the slope of the accessible parking spaces and access aisles no steeper than 1:48 in all directions? [502.4]</p>	<p><input type="checkbox"/> YES <input checked="" type="checkbox"/> NO Measurement: UP TO 4.2%</p>		<p>Photo:</p>	<ul style="list-style-type: none"> • Regrade surface

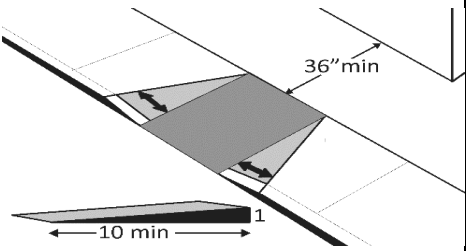
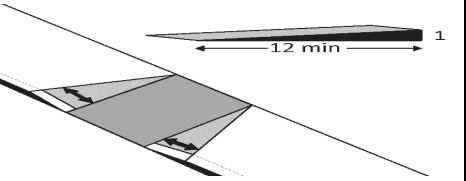
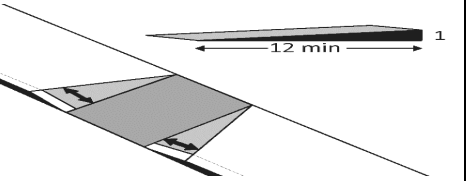

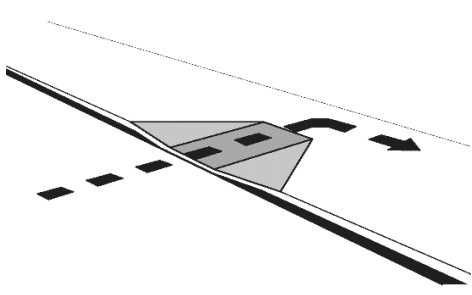
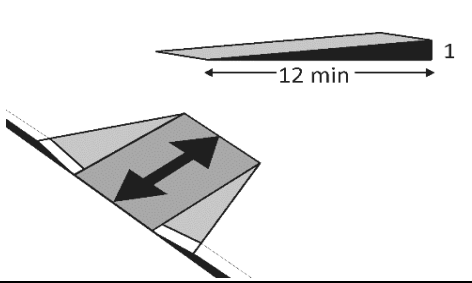
1.107	Do the access aisles adjoin an accessible route? [502.3]	<input checked="" type="checkbox"/> YES <input type="checkbox"/> NO TRAIL		Photo:	<ul style="list-style-type: none"> • Create accessible route • Relocate accessible space
1.108	Are accessible spaces identified with a sign that includes the International Symbol of Accessibility?	<input checked="" type="checkbox"/> YES <input type="checkbox"/> NO		Photo:	<ul style="list-style-type: none"> • Install signs
	Is the bottom of the sign at least 60 inches above the ground? [502.6] Note: The International Symbol of Accessibility is not required on the ground.	<input type="checkbox"/> YES <input checked="" type="checkbox"/> NO 29 1/2"		Photo:	
1.109	Are there signs reading "van accessible" at van accessible spaces? [502.6]	<input checked="" type="checkbox"/> YES <input type="checkbox"/> NO 30"		Photo:	<ul style="list-style-type: none"> • Install signs
1.110	Of the total parking spaces, are the accessible spaces located on the closest accessible route to the accessible entrance(s)? [208.3.1] Note: If parking serves multiple entrances, accessible parking should be dispersed.	<input checked="" type="checkbox"/> YES <input type="checkbox"/> NO TRAIL		Photo:	<ul style="list-style-type: none"> • Reconfigure spaces

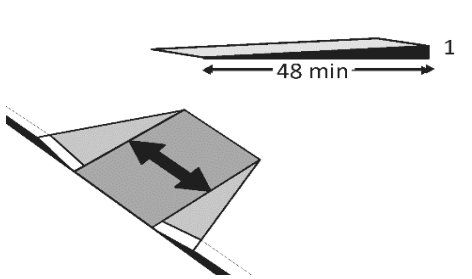
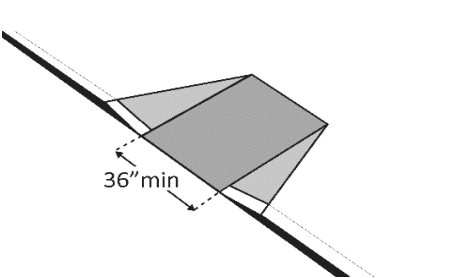

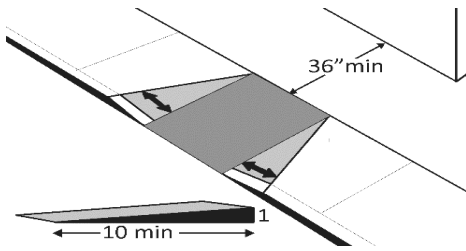
Curb Ramps					
1.111	If the accessible route crosses a curb, is there a curb ramp? [402.2]	<input checked="" type="checkbox"/> YES <input type="checkbox"/> NO		<p style="color: red;">THIS CURB RAMP LEADS DIRECTLY INTO A TRAFFIC PATH AND THEREFORE SHOULD INCLUDE A TACTILE WARNING PAD AT THE BOTTOM OF THE SLOPE.</p>	<ul style="list-style-type: none"> • Install curb ramp
1.112	Is the running slope of the curb ramp no steeper than 1:12, i.e. for every inch of height change there are at least 12 inches of curb ramp run? [406.1, 405.2]	<input checked="" type="checkbox"/> YES <input type="checkbox"/> NO Measure ment: 4.1%		<p>Photo #:</p>	<ul style="list-style-type: none"> • Regrade curb ramp
.113	Is the cross slope of the curb ramp, excluding flares, no steeper than 1:48? [406.1, 405.3]	<input type="checkbox"/> YES <input checked="" type="checkbox"/> NO Measure ment: 6.9%		<p>Photo #:</p>	<ul style="list-style-type: none"> • Regrade curb ramp
1.114	Is the curb ramp, excluding flares, at least 36 inches wide? [406.1, 405.5]	<input checked="" type="checkbox"/> YES <input type="checkbox"/> NO Measure ment: 36"		<p>Photo #:</p>	<ul style="list-style-type: none"> • Widen curb ramp

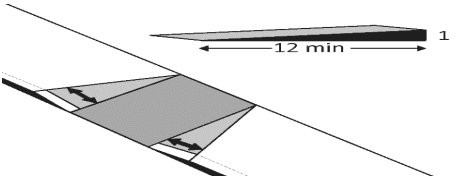
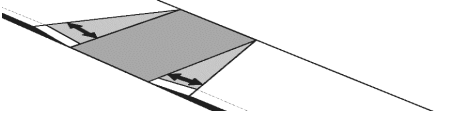

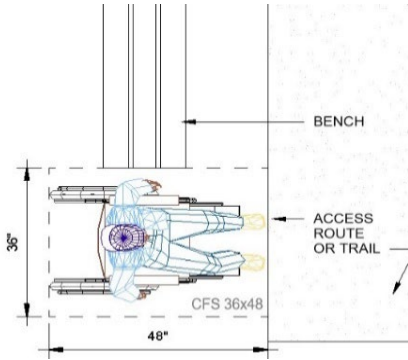
<p>1.115</p>	<p>At the top of the curb ramp is there a level landing (slope no steeper than 1:48 in all directions) that is at least 36 inches long and at least as wide as the curb ramp? [406.4]</p>	<p><input type="checkbox"/> YES <input checked="" type="checkbox"/> NO</p> <p>Measurement: 5.5%</p>		<p>Photo #:</p>	<ul style="list-style-type: none"> • Reconfigure • Add ramp flares
<p>1.116</p>	<p>If the landing at the top is less than 36 inches long, are there curb ramp flares? [406.3]</p>	<p><input type="checkbox"/> YES <input type="checkbox"/> NO</p> <p>Measurement: N/A</p>		<p>Photo #:</p>	<ul style="list-style-type: none"> • Add ramp flares • Regrade flares
<p>1.116</p>	<p>If the landing at the top is less than 36 inches long, are there curb ramp flares? [406.4]</p>	<p><input type="checkbox"/> YES <input type="checkbox"/> NO</p> <p>Measurement: N/A</p>		<p>Photo #:</p>	<ul style="list-style-type: none"> • Add ramp flares • Regrade flares

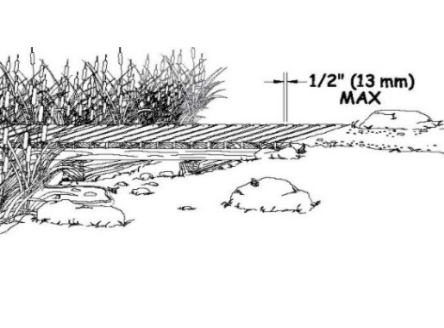

Curb Ramps					
1.111	If the accessible route crosses a curb, is there a curb ramp? [402.2]	<input checked="" type="checkbox"/> YES <input type="checkbox"/> NO		<p>THIS CURB RAMP LEADS DIRECTLY INTO A TRAFFIC PATH AND THEREFORE SHOULD INCLUDE A TACTILE WARNING PAD AT THE BOTTOM OF THE SLOPE.</p>	<ul style="list-style-type: none"> • Install curb ramp
1.112	Is the running slope of the curb ramp no steeper than 1:12, i.e. for every inch of height change there are at least 12 inches of curb ramp run? [406.1, 405.2]	<input type="checkbox"/> YES <input checked="" type="checkbox"/> NO Measure ment: 9.4%			<ul style="list-style-type: none"> • Regrade curb ramp
.113	Is the cross slope of the curb ramp, excluding flares, no steeper than 1:48? [406.1, 405.3]	<input checked="" type="checkbox"/> YES <input type="checkbox"/> NO Measure ment:		<p>Photo #:</p>	<ul style="list-style-type: none"> • Regrade curb ramp
1.114	Is the curb ramp, excluding flares, at least 36 inches wide? [406.1, 405.5]	<input checked="" type="checkbox"/> YES <input type="checkbox"/> NO Measure ment:		<p>Photo #:</p>	<ul style="list-style-type: none"> • Widen curb ramp

<p>1.115</p>	<p>At the top of the curb ramp is there a level landing (slope no steeper than 1:48 in all directions) that is at least 36 inches long and at least as wide as the curb ramp? [406.4]</p>	<p><input type="checkbox"/> YES <input checked="" type="checkbox"/> NO Measurement: UP TO 4%</p>		<p>Photo:</p>	<ul style="list-style-type: none"> • Reconfigure • Add ramp flares
<p>1.116</p>	<p>If there are curb ramp flares, are the slopes of the flares no steeper than 1:10, i.e. for every inch of height change there are at least 10 inches of flare run? [406.3]</p>	<p><input type="checkbox"/> YES <input checked="" type="checkbox"/> NO Measurement:</p>		<p>Photo:</p>	<ul style="list-style-type: none"> • Add ramp flares • Regrade flares
<p>1.116</p>	<p>If the landing at the top is less than 36 inches long, are there curb ramp flares? [406.4]</p>	<p><input type="checkbox"/> YES <input type="checkbox"/> NO Measurement: N/A</p>		<p>Photo:</p>	<ul style="list-style-type: none"> • Add ramp flares • Regrade flares
<p>1.116</p>	<p>Are the slopes of the flares no greater than 1:12, i.e. for every inch of height change there are at least 12 inches of flare run? [406.4]</p>	<p><input type="checkbox"/> YES <input type="checkbox"/> NO Measurement: N/A</p>		<p>Photo:</p>	<ul style="list-style-type: none"> • Add ramp flares • Regrade flares

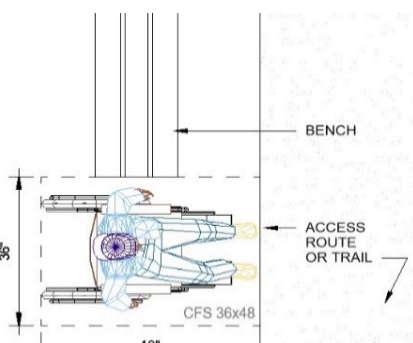
Benches					
2.470	Where benches are provided, is there clear ground space 36 inches (915 mm) by 48 inches (1220 mm) positioned near the bench with one side of the space adjoining an outdoor recreation access route or trail, as applicable? [1011.2.1]	<input type="checkbox"/> YES <input checked="" type="checkbox"/> NO Measure ment:		 <p>Photo #:</p>	<ul style="list-style-type: none"> • Modify space • Provide new unit(s)
2.471	Is the clear ground space located such that it does not overlap the outdoor recreation access route or trail, or another clear ground space?	<input type="checkbox"/> YES <input checked="" type="checkbox"/> NO		<p>Photo #:</p>	<ul style="list-style-type: none"> • Enlarge space • Provide new space
2.472	Is the surface of the clear ground space firm and stable? [1011.2.2]	<input checked="" type="checkbox"/> YES <input type="checkbox"/> NO Material ASPHALT		<p>Photo #:</p>	<ul style="list-style-type: none"> • Modify surface • Replace Surface
2.473	Is the slope of the clear ground space surface no steeper than 1:48 in any direction? [1011.2.3] or	<input checked="" type="checkbox"/> YES <input type="checkbox"/> NO Measure ment: <2% WALK		<p>Photo #:</p>	<ul style="list-style-type: none"> • Level the area
	If the surface is other than asphalt, concrete, or boards, is the slope no steeper than 1:20 if necessary for drainage?	<input type="checkbox"/> YES <input type="checkbox"/> NO Measure ment: N/A		<p>Photo #:</p>	<ul style="list-style-type: none"> • Level the area

<p>2.474</p>	<p>If openings (grates) are present in the clear ground space surface, are they sized so they do not allow the passage of a sphere more than 1/2 inch (13 mm) in diameter? And</p>	<p><input type="checkbox"/> YES <input type="checkbox"/> NO Measure ment: N/A</p>	 <p>A technical drawing of a grate with a grid pattern. A dimension line above the grid indicates a maximum opening size of 1/2" (13 mm) MAX.</p>	<p>Photo #:</p>	<ul style="list-style-type: none"> • Modify route • Replace grates or boards
	<p>Are elongated openings placed so that the long dimension is perpendicular, or as close to perpendicular as possible, to the dominant direction of travel?</p>	<p><input type="checkbox"/> YES <input type="checkbox"/> NO N/A</p>	 <p>A technical drawing showing a person's legs in a wheelchair positioned over a grate. The grate has elongated rectangular openings. The long dimension of the openings is perpendicular to the direction of travel.</p>	<p>Photo #:</p>	<ul style="list-style-type: none"> • Modify route • Replace grates or boards

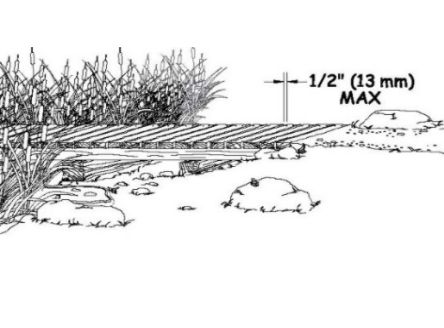
Benches					
2.470	Where benches are provided, is there clear ground space 36 inches (915 mm) by 48 inches (1220 mm) positioned near the bench with one side of the space adjoining an outdoor recreation access route or trail, as applicable? [1011.2.1]	<input type="checkbox"/> YES <input checked="" type="checkbox"/> NO Measure ment:			<ul style="list-style-type: none"> • Modify space • Provide new unit(s)
2.471	Is the clear ground space located such that it does not overlap the outdoor recreation access route or trail, or another clear ground space?	<input type="checkbox"/> YES <input checked="" type="checkbox"/> NO		Photo #:	<ul style="list-style-type: none"> • Enlarge space • Provide new space
2.472	Is the surface of the clear ground space firm and stable? [1011.2.2]	<input type="checkbox"/> YES <input type="checkbox"/> NO N/A		Photo #:	<ul style="list-style-type: none"> • Modify surface • Replace Surface
2.473	Is the slope of the clear ground space surface no steeper than 1:48 in any direction? [1011.2.3] or	<input type="checkbox"/> YES <input type="checkbox"/> NO Measure ment: N/A		Photo #:	<ul style="list-style-type: none"> • Level the area
	If the surface is other than asphalt, concrete, or boards, is the slope no steeper than 1:20 if necessary for drainage?	<input type="checkbox"/> YES <input type="checkbox"/> NO Measure ment: N/A		Photo #:	<ul style="list-style-type: none"> • Level the area

<p>2.474</p>	<p>If openings (grates) are present in the clear ground space surface, are they sized so they do not allow the passage of a sphere more than 1/2 inch (13 mm) in diameter? And</p>	<p><input type="checkbox"/> YES <input type="checkbox"/> NO Measurement: N/A</p>	 <p>A technical drawing of a grate with a grid of rectangular openings. A dimension line above the grid indicates a maximum opening size of 1/2" (13 mm) MAX.</p>	<p>Photo #:</p>	<ul style="list-style-type: none"> • Modify route • Replace grates or boards
	<p>Are elongated openings placed so that the long dimension is perpendicular, or as close to perpendicular as possible, to the dominant direction of travel?</p>	<p><input type="checkbox"/> YES <input type="checkbox"/> NO N/A</p>	 <p>A technical drawing showing a person's legs and feet in a wheelchair positioned on a grate. The grate has elongated rectangular openings oriented perpendicular to the direction of travel.</p>	<p>Photo #:</p>	<ul style="list-style-type: none"> • Modify route • Replace grates or boards

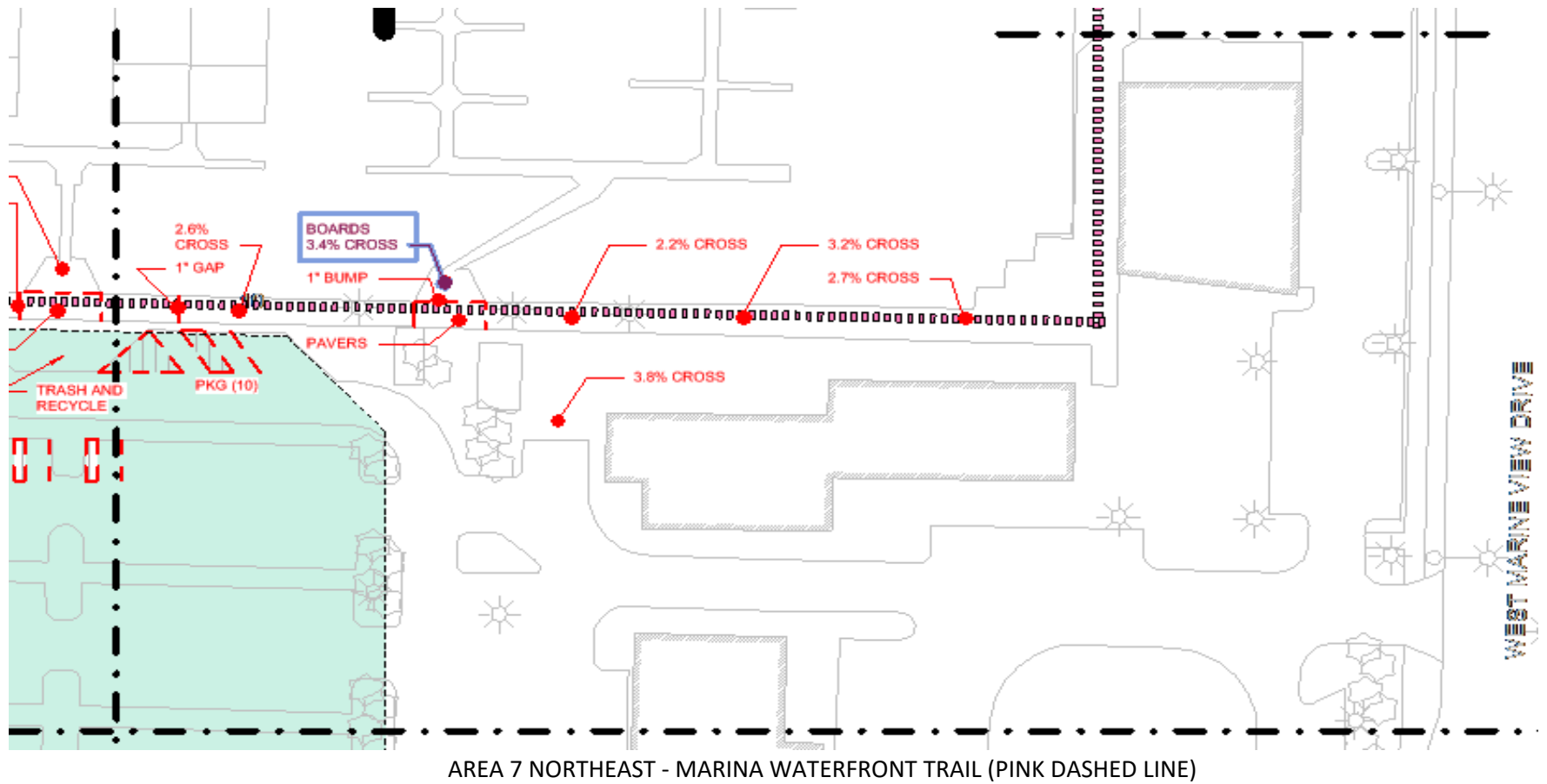

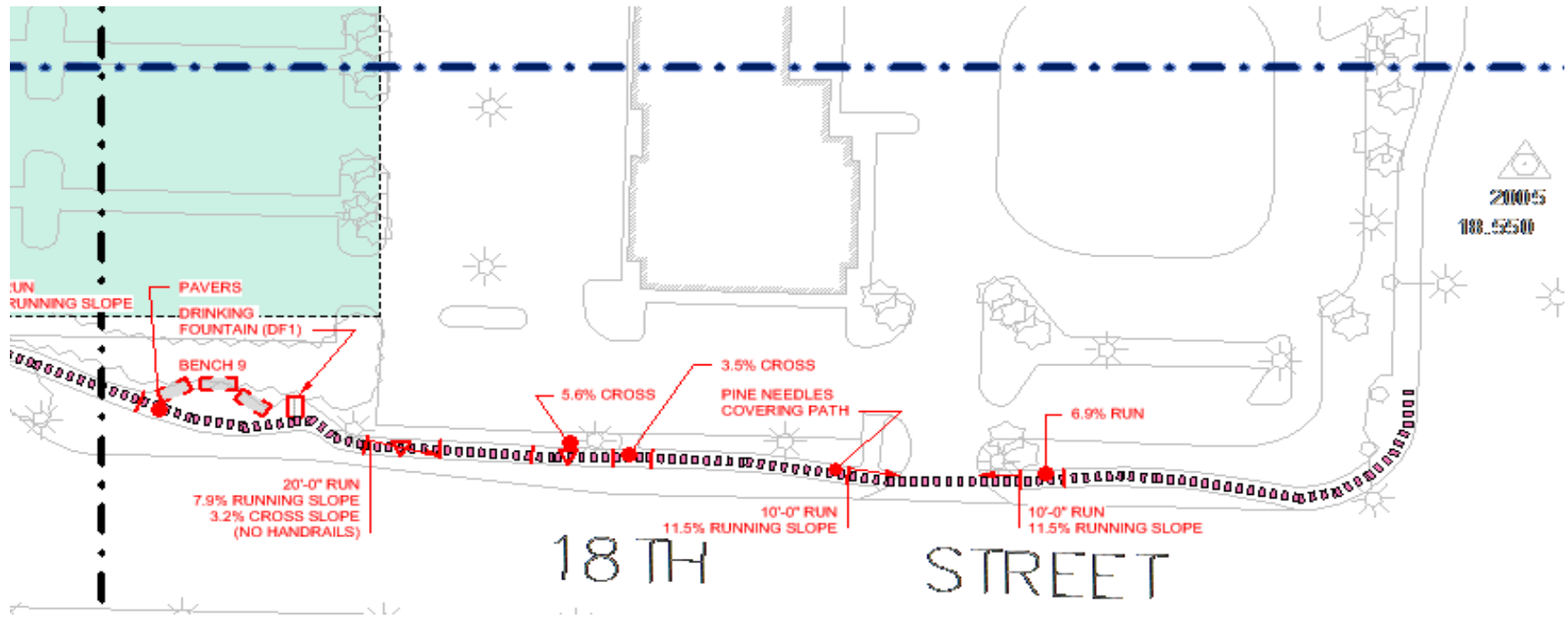



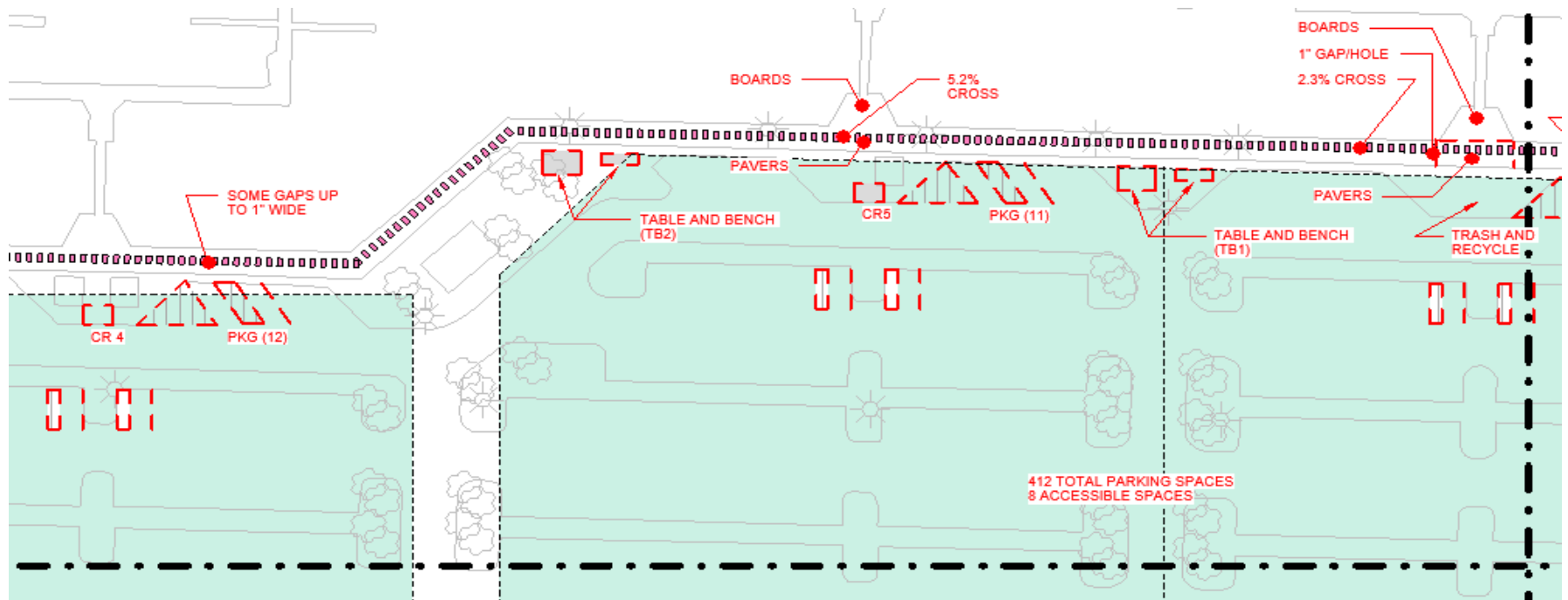

AREA 7 SOUTHEAST - MARINA WATERFRONT TRAIL (PINK DASHED LINE)

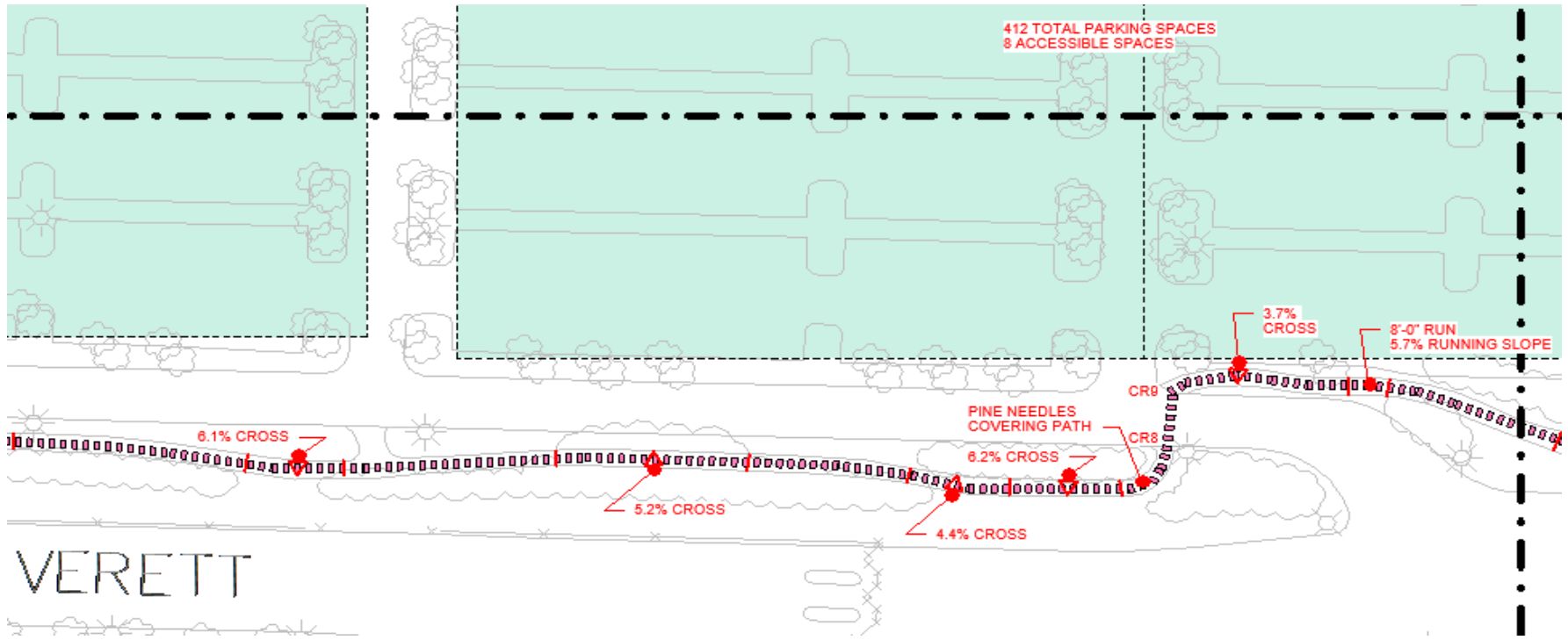



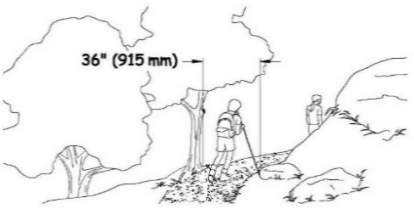

AREA 7 NORTHWEST - MARINA WATERFRONT TRAIL (PINK DASHED LINE)

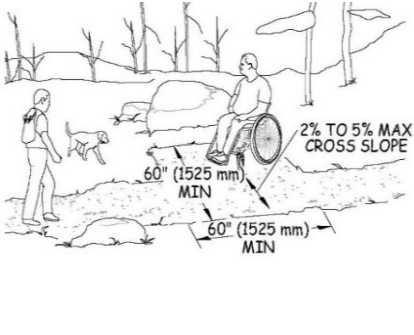

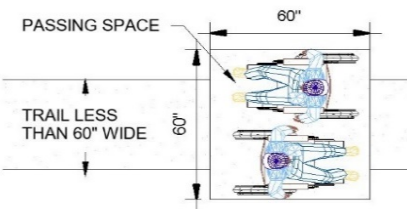
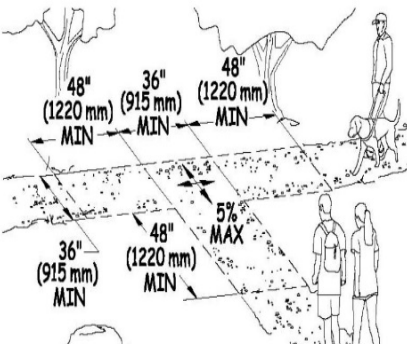
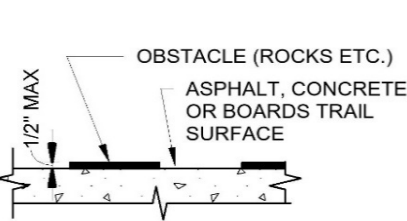
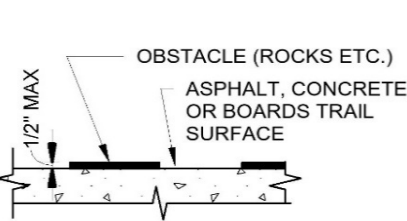

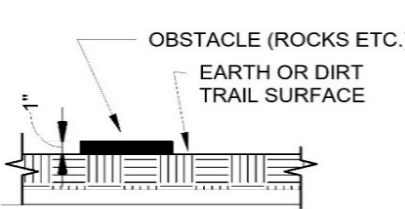
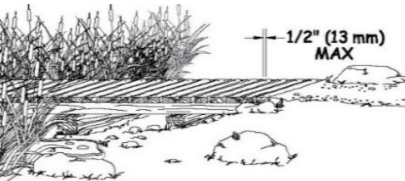

AREA 7 SOUTHWEST - MARINA WATERFRONT TRAIL (PINK DASHED LINE)

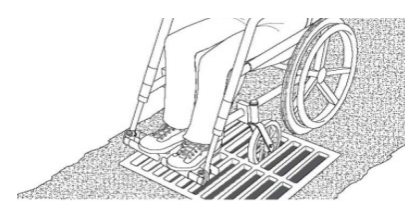
Outdoor Recreation Access Routes [1016] (A pedestrian route developed primarily to connect elements, spaces, or facilities within a site is not a trail)					
2.200	Outdoor Recreation Access Routes shall comply with 1016 [F247]			EXCEPTIONS: 1. In alterations to existing camping facilities, picnic facilities, and trailheads, when an entity determines that a condition in 1019 does not permit full compliance with a specific provision in 1016 on a portion of an outdoor recreation access route, the portion of the outdoor recreation access route shall comply with the provision to the extent practicable. 2. At viewing areas, when an entity determines that a condition in 1019 does not permit full compliance on a portion of an outdoor recreation access route with a specific provision in 1016, the portion of the outdoor recreation access route shall comply with the provision to the extent practicable. 3. Where outdoor recreation access routes are provided within vehicular ways, outdoor recreation access routes shall not be required to comply with 1016.4, 1016.7, and 1016.8.	
2.201	Is the surface of outdoor recreation access routes, passing spaces, and resting intervals stable, firm and slip-resistant? [40.2, 302.1]	<input checked="" type="checkbox"/> YES Material: CONC PAVERS BOARDS	<input type="checkbox"/> NO	A firm trail surface resists deformation by indentations. A stable trail surface is not permanently affected by expected weather conditions and can sustain normal wear and tear from the expected uses between planned maintenance.	 <ul style="list-style-type: none"> • Modify surface • Replace Surface Photo #:
2.202	Is the clear width of the outdoor recreation access route 36 inches (915 mm) minimum? [1016.3]	<input checked="" type="checkbox"/> YES Measure	<input type="checkbox"/> NO ment:		 <ul style="list-style-type: none"> • Modify route • Provide new route Photo #:
2.203	If the outdoor recreation access route width is less than 60 inches (1525 mm) are passing spaces provided at intervals of 200 feet (61 m) maximum? (Passing spaces and resting intervals shall be permitted to overlap.) [1017.4]	<input type="checkbox"/> YES Measure N/A	<input type="checkbox"/> NO ment:		<ul style="list-style-type: none"> • Modify route • Provide passing spaces Photo #:

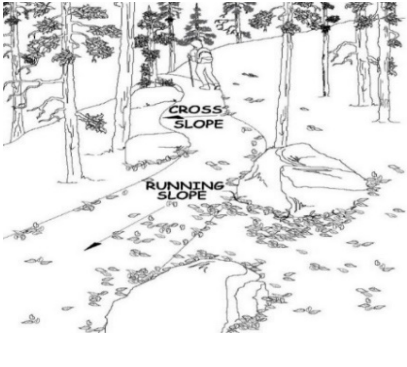
	<p>Is the passing space 60 inches (1525 mm) minimum by 60 inches (1525 mm) minimum; [1017.4.1] or</p>	<p><input type="checkbox"/> YES Measure N/A</p>	<p><input type="checkbox"/> NO ment:</p>		<p>Photo #:</p>	<ul style="list-style-type: none"> • Modify route • Provide passing spaces
<p>2.204</p>	<p>Does the intersection of two outdoor recreation access routes provide a T-shaped space complying with 304.3.2 where the base and the arms of the T-shaped space extend 48 inches (1220 mm) minimum beyond the intersection? And,</p>	<p><input checked="" type="checkbox"/> YES Measure</p>	<p><input type="checkbox"/> NO ment:</p>		<p>Photo #:</p>	<ul style="list-style-type: none"> • Modify route • Provide passing spaces • Regrade
	<p>Is the vertical alignment at the intersection of the outdoor recreation access routes that form the T-shaped space nominally planar? (virtually flat)</p>	<p><input checked="" type="checkbox"/> YES Measure</p>	<p><input type="checkbox"/> NO ment:</p>		<p>Photo #:</p>	<ul style="list-style-type: none"> • Modify route • Regrade
<p>2.200</p>	<p>If the outdoor recreation access routes surface is asphalt, concrete or boards, and there are obstacles on route, passing spaces, and resting intervals, are they less than 1/2 inch (13 mm) in height measured vertically to the highest point? [1016.5]</p>	<p><input type="checkbox"/> YES Measure</p>	<p><input checked="" type="checkbox"/> NO ment: UP TO 1" WHERE ASPHLT MEETS PAVERS</p>		 <p>Photo #:</p>	<ul style="list-style-type: none"> • Modify route • Regrade

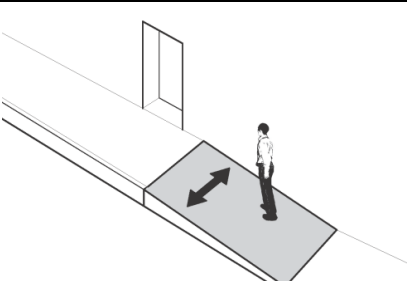
<p>2.206</p>	<p>If the outdoor recreation access routes surface is not asphalt, concrete or boards, and there are tread obstacles on outdoor recreation access routes passing spaces, and resting intervals, are they less than 1 inch (25 mm) in height measured vertically to the highest point? [1016.5]</p>	<p><input type="checkbox"/> YES Measurement: N/A</p>	<p><input type="checkbox"/> NO</p>		<p>Photo #:</p>	<ul style="list-style-type: none"> • Modify route • Regrade
<p>2.207</p>	<p>Are openings in the surface of outdoor recreation access routes passing spaces, and resting intervals small enough to not allow the passage of a sphere more than 1/2 inch (13 mm) in diameter? [1016.6]</p>	<p><input type="checkbox"/> YES Measurement:</p>	<p><input checked="" type="checkbox"/> NO UP TO 1" AT EA PIER ENTRY</p>		 <p>Photo #:</p>	<ul style="list-style-type: none"> • Modify route • Replace grates or boards
<p>2.208</p>	<p>If there are elongated openings, are they placed so that the long dimension is perpendicular, or as close to perpendicular as possible, to the dominant direction of travel? [1016.6]</p>	<p><input type="checkbox"/> YES N/A</p>	<p><input type="checkbox"/> NO</p>		<p>Photo #:</p>	<ul style="list-style-type: none"> • Modify route • Replace grates or boards

<p>2.209</p>	<p>Is the running slope of all segments of the outdoor recreation access routes less than 1:10 (10%). [1016.7.1]</p>	<p><input type="checkbox"/> YES Measurement:</p>	<p><input checked="" type="checkbox"/> NO SEE AREA 7 SE MARNA LOOP TRAIL PLANS FOR LOC.</p>		 <p>Photo #:</p>	<p>• Regrade</p>
<p>2.212</p>	<p>Is the cross slope no steeper than 1:48? [1016.7.2] Where the surface is other than concrete, asphalt, or boards, cross slopes not steeper than 1:20 shall be permitted when necessary for drainage.</p>	<p><input type="checkbox"/> YES Measurement:</p> <p>Material:</p>	<p><input checked="" type="checkbox"/> NO SEE PLANS ASPHALT</p>		<p>Photo #:</p>	<p>• Regrade</p>

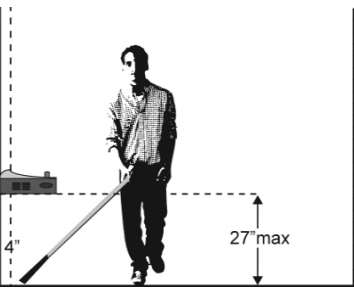
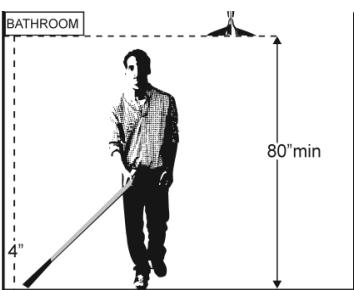
<p>2.219</p>	<p>Do all objects on outdoor recreation access routes, passing spaces, and resting intervals, e.g. signs, etc., protrude no more than 4 inches into the path? (does not apply to natural features, such as tree branches, rock formations) Or</p>	<p><input type="checkbox"/> YES Measurement: N/A</p>	<p><input type="checkbox"/> NO</p>		<p>Photo #:</p>	<ul style="list-style-type: none"> • Remove object • Add tactile warning such as permanent planter or partial walls
	<p>If an object protrudes more than 4 inches, is the bottom leading edge at 27 inches or lower above the floor? [307.2] Or</p>	<p><input type="checkbox"/> YES Measurement: N/A</p>	<p><input type="checkbox"/> NO</p>		<p>Photo #:</p>	<ul style="list-style-type: none"> • Remove object • Add tactile warning such as permanent planter or partial walls
	<p>Is the bottom leading edge at 80 inches or higher above the floor? [307.4]</p>	<p><input type="checkbox"/> YES Measurement: N/A</p>	<p><input type="checkbox"/> NO</p>		<p>Photo #:</p>	<ul style="list-style-type: none"> • Remove object • Add tactile warning such as permanent planter or partial walls

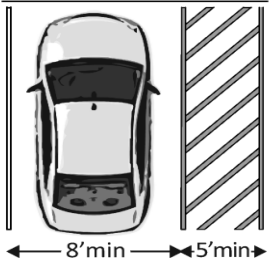

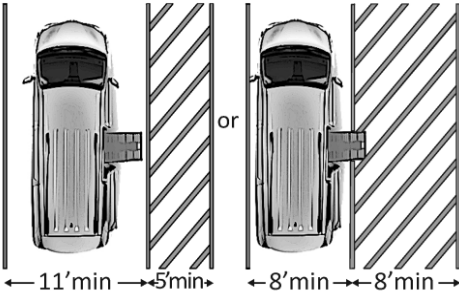
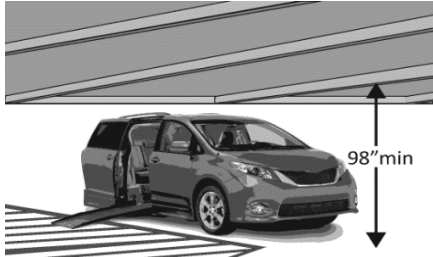
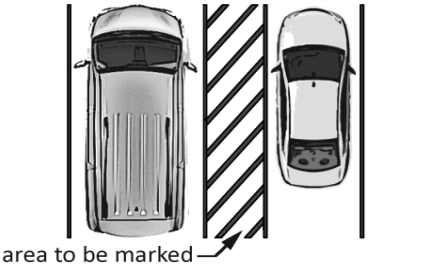
Parking Accessible parking spaces should be identified by size, access aisle and signage.																				
1.100	If parking is provided for the public, are an adequate number of accessible spaces provided? (208.2)	<input type="checkbox"/> YES	<input checked="" type="checkbox"/> NO	<table border="1"> <thead> <tr> <th>Total Spaces</th> <th>Accessible Spaces</th> </tr> </thead> <tbody> <tr> <td>1 - 25</td> <td>1</td> </tr> <tr> <td>26 - 50</td> <td>2</td> </tr> <tr> <td>51 - 75</td> <td>3</td> </tr> <tr> <td>76 - 100</td> <td>4</td> </tr> <tr> <td>151 to 200</td> <td>6</td> </tr> <tr> <td>100+ see 2010 Standards 208.2</td> <td></td> </tr> </tbody> </table>	Total Spaces	Accessible Spaces	1 - 25	1	26 - 50	2	51 - 75	3	76 - 100	4	151 to 200	6	100+ see 2010 Standards 208.2		 <p>Photo #:</p>	<ul style="list-style-type: none"> • Reconfigure by repainting lines
Total Spaces	Accessible Spaces																			
1 - 25	1																			
26 - 50	2																			
51 - 75	3																			
76 - 100	4																			
151 to 200	6																			
100+ see 2010 Standards 208.2																				
1.101	Of the accessible spaces, is at least one a van accessible space?*[208.2.4]	<input type="checkbox"/> YES	<input checked="" type="checkbox"/> NO	*For every 6 or fraction of 6 parking spaces required by the table above, at least 1 should be a van accessible space.	<p>Photo #:</p>	<ul style="list-style-type: none"> • If constructed before 3/15/2012, parking is compliant if at least 1 in every 8 accessible spaces is van accessible • Reconfigure by repainting lines 														
1.102	Are accessible spaces at least 8 feet wide with an access aisle at least 5 feet wide? [502.2, 502.3] Note: Two spaces may share an access aisle. Check state/local requirements; some specify that each space have its own aisle.	<input type="checkbox"/> YES	<input checked="" type="checkbox"/> NO		<p>Photo #:</p>	<ul style="list-style-type: none"> • Reconfigure by repainting lines 														

<p>1.103</p>	<p>Is the van accessible space: At least 11 feet wide with an access aisle at least 5 feet wide? Or At least 8 feet wide with an access aisle at least 8 feet wide? [502.2]</p>	<p><input type="checkbox"/> YES <input checked="" type="checkbox"/> NO Measurement:</p>		<p>Photo #:</p>	<ul style="list-style-type: none"> • Reconfigure by repainting lines
<p>1.104</p>	<p>Is at least 98 inches of vertical clearance provided for the van accessible space? [502.5]</p>	<p><input checked="" type="checkbox"/> YES <input type="checkbox"/> NO Measurement:</p>		<p>Photo #:</p>	<ul style="list-style-type: none"> • Reconfigure to provide van-accessible space(s)
<p>1.105</p>	<p>Are the access aisles marked so as to discourage parking in them? [502.3.3] Note: The marking method and color may be addressed by state/local requirements.</p>	<p><input checked="" type="checkbox"/> YES <input type="checkbox"/> NO Measurement:</p>		<p>Photo #:</p>	<ul style="list-style-type: none"> • Mark access aisles
<p>1.106</p>	<p>Is the slope of the accessible parking spaces and access aisles no steeper than 1:48 in all directions? [502.4]</p>	<p><input checked="" type="checkbox"/> YES <input type="checkbox"/> NO Measurement: <2%</p>		<p>Photo #:</p>	<ul style="list-style-type: none"> • Regrade surface

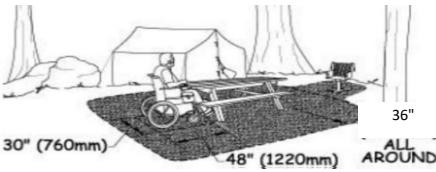
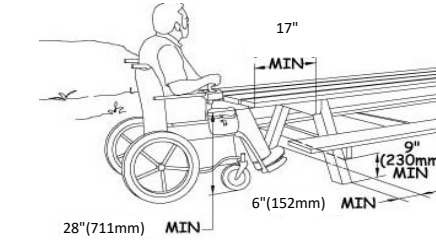
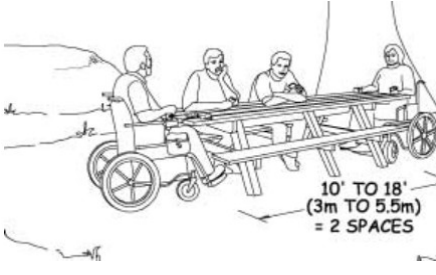
1.107	Do the access aisles adjoin an accessible route? [502.3]	<input checked="" type="checkbox"/> YES <input type="checkbox"/> NO		Photo #:	<ul style="list-style-type: none"> • Create accessible route • Relocate accessible space
1.108	Are accessible spaces identified with a sign that includes the International Symbol of Accessibility?	<input type="checkbox"/> YES <input checked="" type="checkbox"/> NO		Photo #:	<ul style="list-style-type: none"> • Install signs
	Is the bottom of the sign at least 60 inches above the ground? [502.6] Note: The International Symbol of Accessibility is not required on the ground.	<input type="checkbox"/> YES <input checked="" type="checkbox"/> NO		Photo #:	
1.109	Are there signs reading “van accessible” at van accessible spaces? [502.6]	<input type="checkbox"/> YES <input checked="" type="checkbox"/> NO		Photo #:	<ul style="list-style-type: none"> • Install signs
1.110	Of the total parking spaces, are the accessible spaces located on the closest accessible route to the accessible entrance(s)? [208.3.1] Note: If parking serves multiple entrances, accessible parking should be dispersed.	<input checked="" type="checkbox"/> YES <input type="checkbox"/> NO TO TRAIL		Photo #:	<ul style="list-style-type: none"> • Reconfigure spaces

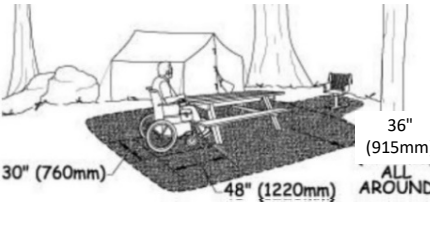
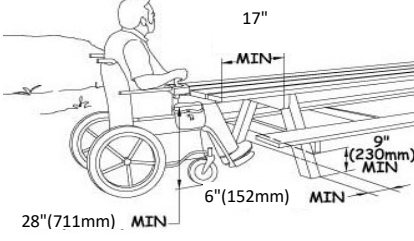
Picnic Tables [1011.4]				
2.420	Is there 36 inches (915 mm) minimum on all usable sides of the table measured from the back edge of the benches? [1011.2.1]	<input checked="" type="checkbox"/> YES <input type="checkbox"/> NO Measure ment:		<p>Photo:</p> <ul style="list-style-type: none"> • Replace table • Provide new table
2.421	Is the surface of the clear ground space firm and stable? [1011.2.2]	<input checked="" type="checkbox"/> YES <input type="checkbox"/> NO Material PAVERS		<p>Photo:</p> <ul style="list-style-type: none"> • Replace surface
2.422	Is the slope of the clear ground space surface no steeper than 1:48 in any direction? [1011.2.3] or	<input checked="" type="checkbox"/> YES <input type="checkbox"/> NO Measure ment:		<p>Photo:</p> <ul style="list-style-type: none"> • Level the area
	If the surface is other than asphalt, concrete, or boards, is the slope no steeper than 1:20 if necessary for drainage?	<input type="checkbox"/> YES <input type="checkbox"/> NO Measure ment: N/A		<p>Photo:</p> <ul style="list-style-type: none"> • Level the area
2.424	Are the tops of picnic tables 28 inches (710 mm) minimum and 34 inches (865 mm) maximum above the finish floor or ground? [1011.4.1]	<input checked="" type="checkbox"/> YES <input type="checkbox"/> NO Measure ment: 30"		<p>Photo:</p> <ul style="list-style-type: none"> • Replace table • Provide new table
2.425	For each 24 linear feet (7320 mm) of usable picnic table surface perimeter, is there at least one wheelchair space? [1011.4.2] (Note: Tables over 9' long need two WC spaces)	<input checked="" type="checkbox"/> YES <input type="checkbox"/> NO Measure ment:		<p>Photo:</p> <ul style="list-style-type: none"> • Replace table • Provide new table

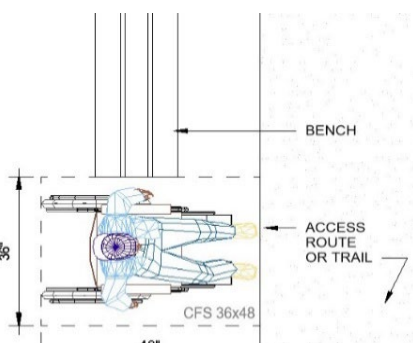
<p>2.426</p>	<p>Is the wheelchair space 30 inches (760mm) minimum by 48 inches (1220 mm) minimum and positioned for a forward approach to the table? [1011.4.2]</p>	<p><input type="checkbox"/> YES <input checked="" type="checkbox"/> NO Measurement: 26 1/4" BTWN CONC LEGS</p>		<p>Photo:</p>	<ul style="list-style-type: none"> • Replace table • Provide new table
	<p>and provide knee and toe clearance complying with 306 under the table? [1011.4.2]</p>	<p><input type="checkbox"/> YES <input checked="" type="checkbox"/> NO Measurement: 27 3/4" UNDER 7 1/2" DP</p>		<p>Photo:</p>	<ul style="list-style-type: none"> • Replace table • Provide new table

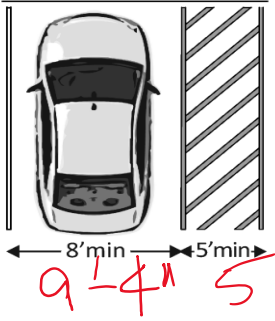

Benches					
2.470	Where benches are provided, is there clear ground space 36 inches (915 mm) by 48 inches (1220 mm) positioned near the bench with one side of the space adjoining an outdoor recreation access route or trail, as applicable? [1011.2.1]	<input type="checkbox"/> YES <input checked="" type="checkbox"/> NO Measurement:		Photo #:	<ul style="list-style-type: none"> • Modify space • Provide new unit(s)
2.471	Is the clear ground space located such that it does not overlap the outdoor recreation access route or trail, or another clear ground space?	<input type="checkbox"/> YES <input checked="" type="checkbox"/> NO		Photo #:	<ul style="list-style-type: none"> • Enlarge space • Provide new space
2.472	Is the surface of the clear ground space firm and stable? [1011.2.2]	<input type="checkbox"/> YES <input type="checkbox"/> NO N/A		Photo #:	<ul style="list-style-type: none"> • Modify surface • Replace Surface
2.473	Is the slope of the clear ground space surface no steeper than 1:48 in any direction? [1011.2.3] or	<input type="checkbox"/> YES <input type="checkbox"/> NO Measurement: N/A		Photo #:	<ul style="list-style-type: none"> • Level the area
	If the surface is other than asphalt, concrete, or boards, is the slope no steeper than 1:20 if necessary for drainage?	<input type="checkbox"/> YES <input type="checkbox"/> NO Measurement: N/A		Photo #:	<ul style="list-style-type: none"> • Level the area

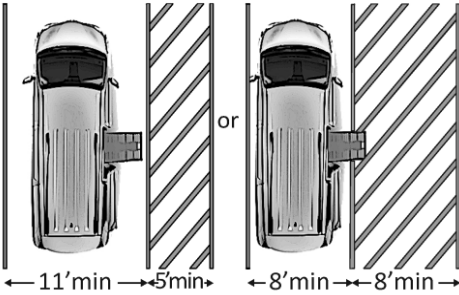
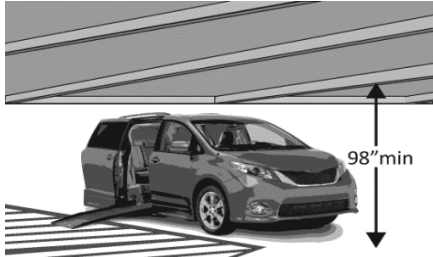
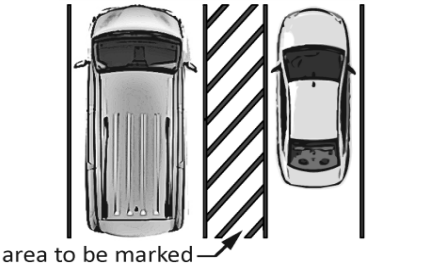
Parking Accessible parking spaces should be identified by size, access aisle and signage.																				
1.100	If parking is provided for the public, are an adequate number of accessible spaces provided? (208.2)	<input type="checkbox"/> YES	<input checked="" type="checkbox"/> NO	<table border="1"> <thead> <tr> <th>Total Spaces</th> <th>Accessible Spaces</th> </tr> </thead> <tbody> <tr> <td>1 - 25</td> <td>1</td> </tr> <tr> <td>26 - 50</td> <td>2</td> </tr> <tr> <td>51 - 75</td> <td>3</td> </tr> <tr> <td>76 - 100</td> <td>4</td> </tr> <tr> <td>201 to 300</td> <td>7</td> </tr> <tr> <td>100+ see 2010 Standards 208.2</td> <td></td> </tr> </tbody> </table>	Total Spaces	Accessible Spaces	1 - 25	1	26 - 50	2	51 - 75	3	76 - 100	4	201 to 300	7	100+ see 2010 Standards 208.2		Photo #:	<ul style="list-style-type: none"> Reconfigure by repainting lines
Total Spaces	Accessible Spaces																			
1 - 25	1																			
26 - 50	2																			
51 - 75	3																			
76 - 100	4																			
201 to 300	7																			
100+ see 2010 Standards 208.2																				
1.101	Of the accessible spaces, is at least one a van accessible space? [208.2.4]	<input type="checkbox"/> YES	<input checked="" type="checkbox"/> NO	*For every 6 or fraction of 6 parking spaces required by the table above, at least 1 should be a van accessible space.	Photo #:	<ul style="list-style-type: none"> If constructed before 3/15/2012, parking is compliant if at least 1 in every 8 accessible spaces is van accessible Reconfigure by repainting lines 														
1.102	Are accessible spaces at least 8 feet wide with an access aisle at least 5 feet wide? [502.2, 502.3] Note: Two spaces may share an access aisle. Check state/local requirements; some specify that each space have its own aisle.	<input checked="" type="checkbox"/> YES	<input type="checkbox"/> NO		Photo #:	<ul style="list-style-type: none"> Reconfigure by repainting lines 														

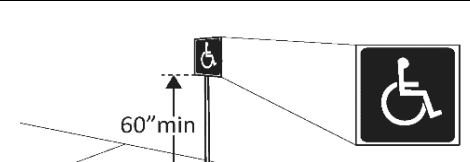
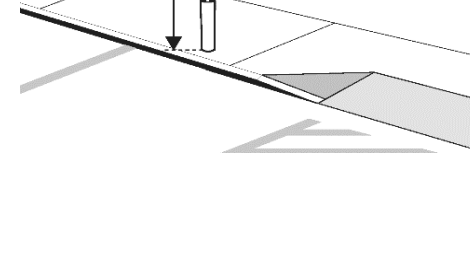
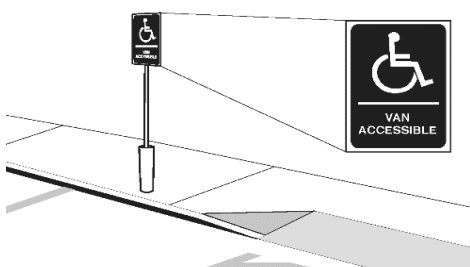
<p>1.103</p>	<p>Is the van accessible space: At least 11 feet wide with an access aisle at least 5 feet wide? Or At least 8 feet wide with an access aisle at least 8 feet wide? [502.2]</p>	<p><input type="checkbox"/> YES <input checked="" type="checkbox"/> NO Measurement:</p>		<p>Photo #:</p>	<ul style="list-style-type: none"> • Reconfigure by repainting lines
<p>1.104</p>	<p>Is at least 98 inches of vertical clearance provided for the van accessible space? [502.5]</p>	<p><input checked="" type="checkbox"/> YES <input type="checkbox"/> NO Measurement:</p>		<p>Photo #:</p>	<ul style="list-style-type: none"> • Reconfigure to provide van-accessible space(s)
<p>1.105</p>	<p>Are the access aisles marked so as to discourage parking in them? [502.3.3] Note: The marking method and color may be addressed by state/local requirements.</p>	<p><input checked="" type="checkbox"/> YES <input type="checkbox"/> NO Measurement:</p>		<p>Photo #:</p>	<ul style="list-style-type: none"> • Mark access aisles
<p>1.106</p>	<p>Is the slope of the accessible parking spaces and access aisles no steeper than 1:48 in all directions? [502.4]</p>	<p><input checked="" type="checkbox"/> YES <input type="checkbox"/> NO Measurement:</p>		<p>Photo #:</p>	<ul style="list-style-type: none"> • Regrade surface

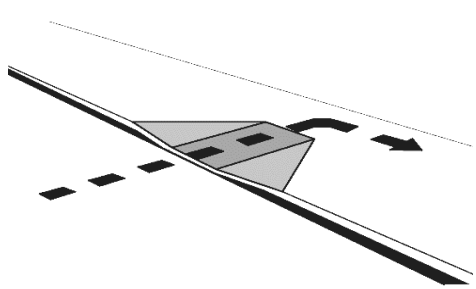
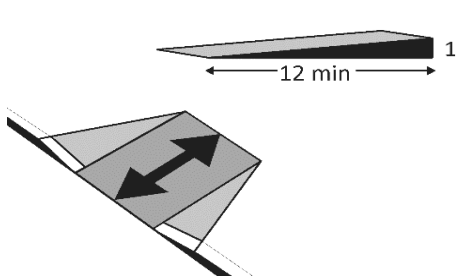
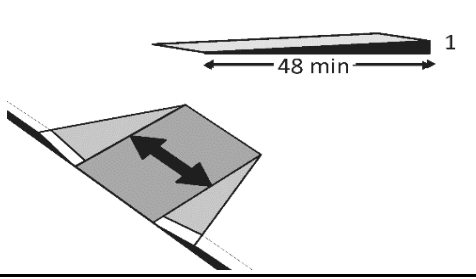
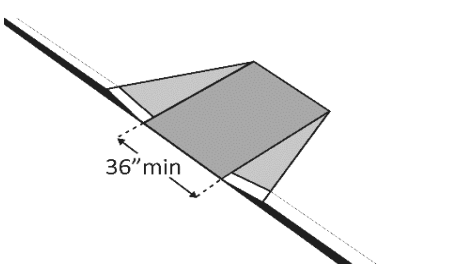
1.107	Do the access aisles adjoin an accessible route? [502.3]	<input checked="" type="checkbox"/> YES <input type="checkbox"/> NO		Photo #:	<ul style="list-style-type: none"> • Create accessible route • Relocate accessible space
1.108	Are accessible spaces identified with a sign that includes the International Symbol of Accessibility?	<input type="checkbox"/> YES <input checked="" type="checkbox"/> NO ONLY ONE SPACE		Photo #:	<ul style="list-style-type: none"> • Install signs
	Is the bottom of the sign at least 60 inches above the ground? [502.6] Note: The International Symbol of Accessibility is not required on the ground.	<input type="checkbox"/> YES <input checked="" type="checkbox"/> NO 32"		Photo #:	
1.109	Are there signs reading "van accessible" at van accessible spaces? [502.6]	<input type="checkbox"/> YES <input checked="" type="checkbox"/> NO		Photo #:	<ul style="list-style-type: none"> • Install signs
1.110	Of the total parking spaces, are the accessible spaces located on the closest accessible route to the accessible entrance(s)? [208.3.1] Note: If parking serves multiple entrances, accessible parking should be dispersed.	<input checked="" type="checkbox"/> YES <input type="checkbox"/> NO TO TRAIL		Photo #:	<ul style="list-style-type: none"> • Reconfigure spaces

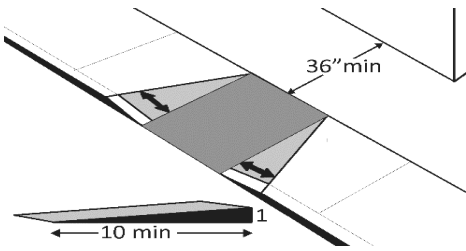

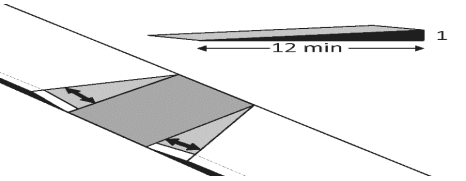
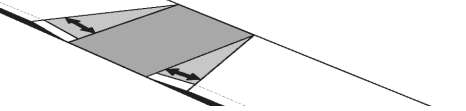
Curb Ramps					
1.111	If the accessible route crosses a curb, is there a curb ramp? [402.2]	<input checked="" type="checkbox"/> YES <input type="checkbox"/> NO	 <p>THIS CURB RAMP LEADS DIRECTLY INTO A TRAFFIC PATH AND THEREFORE SHOULD INCLUDE A TACTILE WARNING PAD AT THE BOTTOM OF THE SLOPE.</p>	<p>Photo #:</p>	<ul style="list-style-type: none"> • Install curb ramp
1.112	Is the running slope of the curb ramp no steeper than 1:12, i.e. for every inch of height change there are at least 12 inches of curb ramp run? [406.1, 405.2]	<input checked="" type="checkbox"/> YES <input type="checkbox"/> NO Measure ment: 2.6%		<p>Photo #:</p>	<ul style="list-style-type: none"> • Regrade curb ramp
.113	Is the cross slope of the curb ramp, excluding flares, no steeper than 1:48? [406.1, 405.3]	<input checked="" type="checkbox"/> YES <input type="checkbox"/> NO Measure ment:		<p>Photo #:</p>	<ul style="list-style-type: none"> • Regrade curb ramp
1.114	Is the curb ramp, excluding flares, at least 36 inches wide? [406.1, 405.5]	<input checked="" type="checkbox"/> YES <input type="checkbox"/> NO Measure ment:		<p>Photo #:</p>	<ul style="list-style-type: none"> • Widen curb ramp

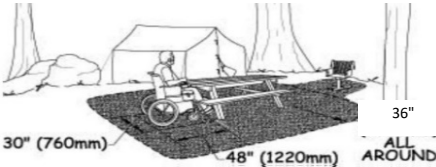

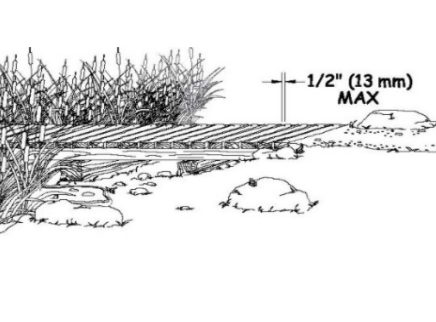
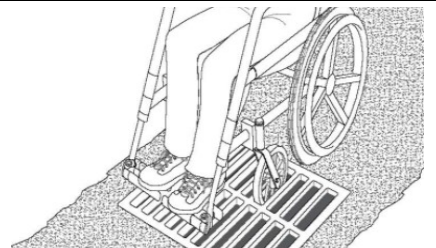
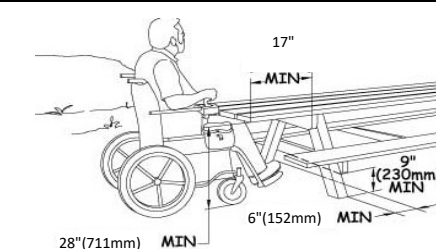
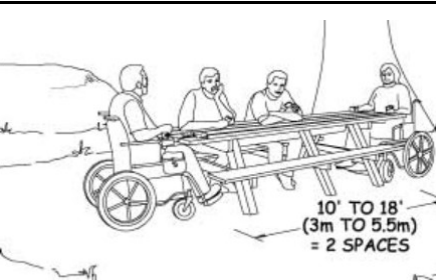
<p>1.115</p>	<p>At the top of the curb ramp is there a level landing (slope no steeper than 1:48 in all directions) that is at least 36 inches long and at least as wide as the curb ramp? [406.4]</p>	<p><input checked="" type="checkbox"/> YES <input type="checkbox"/> NO</p> <p>Measure ment:</p>		<p>Photo #:</p>	<ul style="list-style-type: none"> • Reconfigure • Add ramp flares
<p>1.116</p>	<p>If there are curb ramp flares, are the slopes of the flares no steeper than 1:10, i.e. for every inch of height change there are at least 10 inches of flare run? [406.3]</p>	<p><input type="checkbox"/> YES <input type="checkbox"/> NO</p> <p>Measure ment:</p> <p>N/A</p>		<p>Photo #:</p>	<ul style="list-style-type: none"> • Add ramp flares • Regrade flares
<p>1.116</p>	<p>If the landing at the top is less than 36 inches long, are there curb ramp flares? [406.3]</p>	<p><input type="checkbox"/> YES <input type="checkbox"/> NO</p> <p>Measure ment:</p> <p>N/A</p>		<p>Photo #:</p>	<ul style="list-style-type: none"> • Add ramp flares • Regrade flares
<p>1.116</p>	<p>Are the slopes of the flares no greater than 1:12, i.e. for every inch of height change there are at least 12 inches of flare run? [406.4]</p>	<p><input type="checkbox"/> YES <input type="checkbox"/> NO</p> <p>Measure ment:</p> <p>N/A</p>		<p>Photo #:</p>	<ul style="list-style-type: none"> • Add ramp flares • Regrade flares

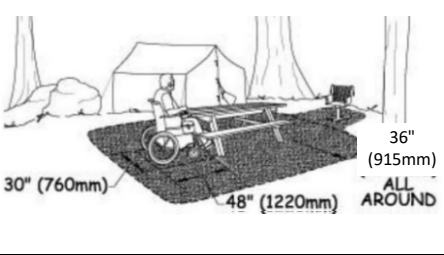
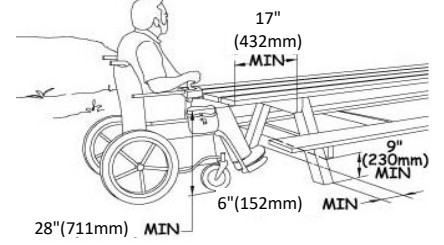
Picnic Tables [1011.4]				
2.420	Is there 36 inches (915 mm) minimum on all usable sides of the table measured from the back edge of the benches? [1011.2.1]	<input checked="" type="checkbox"/> YES <input type="checkbox"/> NO Measure ment:		<p>Photo:</p> <ul style="list-style-type: none"> • Replace table • Provide new table
2.421	Is the surface of the clear ground space firm and stable? [1011.2.2]	<input checked="" type="checkbox"/> YES <input type="checkbox"/> NO Material PAVERS		<p>Photo:</p> <ul style="list-style-type: none"> • Replace surface
2.422	Is the slope of the clear ground space surface no steeper than 1:48 in any direction? [1011.2.3] or	<input checked="" type="checkbox"/> YES <input type="checkbox"/> NO Measure ment:		<p>Photo:</p> <ul style="list-style-type: none"> • Level the area
	If the surface is other than asphalt, concrete, or boards, is the slope no steeper than 1:20 if necessary for drainage?	<input type="checkbox"/> YES <input type="checkbox"/> NO Measure ment: N/A		<p>Photo:</p> <ul style="list-style-type: none"> • Level the area

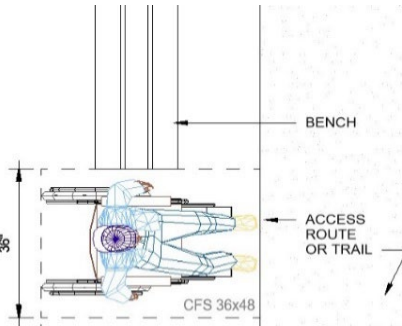
<p>2.423</p>	<p>If openings (grates) are present in the clear ground space surface, are they sized so they do not allow the passage of a sphere more than 1/2 inch (13 mm) in diameter? And</p>	<p><input type="checkbox"/> YES <input type="checkbox"/> NO Measure ment: N/A</p>		<p>Photo:</p>	<ul style="list-style-type: none"> • Modify surface • Replace Boards
	<p>Are elongated openings placed so that the long dimension is perpendicular, or as close to perpendicular as possible, to the dominant direction of travel?</p>	<p><input type="checkbox"/> YES <input type="checkbox"/> NO N/A</p>		<p>Photo:</p>	<ul style="list-style-type: none"> • Replace Grate
<p>2.424</p>	<p>Are the tops of picnic tables 28 inches (710 mm) minimum and 34 inches (865 mm) maximum above the finish floor or ground? [1011.4.1]</p>	<p><input checked="" type="checkbox"/> YES <input type="checkbox"/> NO Measure ment: 30"</p>		<p>Photo:</p>	<ul style="list-style-type: none"> • Replace table • Provide new table
<p>2.425</p>	<p>For each 24 linear feet (7320 mm) of usable picnic table surface perimeter, is there at least one wheelchair space? [1011.4.2] (Note: Tables over 9' long need two WC spaces)</p>	<p><input checked="" type="checkbox"/> YES <input type="checkbox"/> NO Measure ment:</p>		<p>Photo:</p>	<ul style="list-style-type: none"> • Replace table • Provide new table

<p>2.426</p>	<p>Is the wheelchair space 30 inches (760mm) minimum by 48 inches (1220 mm) minimum and positioned for a forward approach to the table? [1011.4.2]</p>	<p><input type="checkbox"/> YES <input checked="" type="checkbox"/> NO Measurement: 26 1/4" BTWN CONC LEGS</p>		<p>Photo:</p>	<ul style="list-style-type: none"> • Replace table • Provide new table
	<p>and provide knee and toe clearance complying with 306 under the table? [1011.4.2]</p>	<p><input type="checkbox"/> YES <input checked="" type="checkbox"/> NO Measurement: 27 3/4" UNDER 7 1/2" DP</p>		<p>Photo:</p>	<ul style="list-style-type: none"> • Replace table • Provide new table

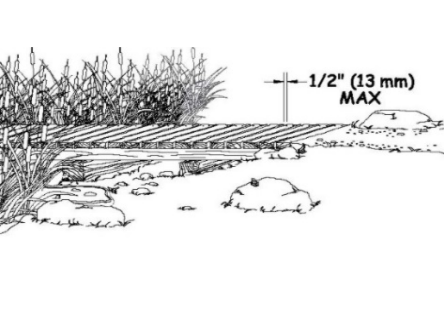
Benches					
2.470	Where benches are provided, is there clear ground space 36 inches (915 mm) by 48 inches (1220 mm) positioned near the bench with one side of the space adjoining an outdoor recreation access route or trail, as applicable? [1011.2.1]	<input checked="" type="checkbox"/> YES <input type="checkbox"/> NO Measure ment:	 <p>The diagram illustrates a bench with a 36-inch wide and 48-inch deep clear ground space (CFS) positioned next to an access route or trail. The CFS is shaded in blue and labeled 'CFS 36x48'. The bench is labeled 'BENCH' and the access route is labeled 'ACCESS ROUTE OR TRAIL'.</p>	<p>Photo #:</p>	<ul style="list-style-type: none"> • Modify space • Provide new unit(s)
2.471	Is the clear ground space located such that it does not overlap the outdoor recreation access route or trail, or another clear ground space?	<input checked="" type="checkbox"/> YES <input type="checkbox"/> NO	 <p>The illustration shows a person in a wheelchair sitting on a bench. A child is sitting on the ground nearby. The scene is outdoors with some rocks and a path.</p>	<p>Photo #:</p>	<ul style="list-style-type: none"> • Enlarge space • Provide new space
2.472	Is the surface of the clear ground space firm and stable? [1011.2.2]	<input checked="" type="checkbox"/> YES <input type="checkbox"/> NO Material PAVERS		<p>Photo #:</p>	<ul style="list-style-type: none"> • Modify surface • Replace Surface
2.473	Is the slope of the clear ground space surface no steeper than 1:48 in any direction? [1011.2.3] or	<input checked="" type="checkbox"/> YES <input type="checkbox"/> NO Measure ment:		<p>Photo #:</p>	<ul style="list-style-type: none"> • Level the area
	If the surface is other than asphalt, concrete, or boards, is the slope no steeper than 1:20 if necessary for drainage?	<input type="checkbox"/> YES <input type="checkbox"/> NO Measure ment: N/A		<p>Photo #:</p>	<ul style="list-style-type: none"> • Level the area

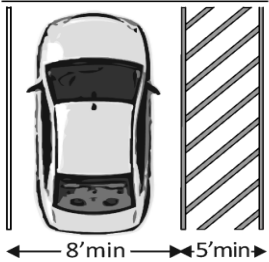

<p>2.474</p>	<p>If openings (grates) are present in the clear ground space surface, are they sized so they do not allow the passage of a sphere more than 1/2 inch (13 mm) in diameter? And</p>	<p><input type="checkbox"/> YES <input type="checkbox"/> NO Measure ment: N/A</p>		<p>Photo #:</p>	<ul style="list-style-type: none"> • Modify route • Replace grates or boards
	<p>Are elongated openings placed so that the long dimension is perpendicular, or as close to perpendicular as possible, to the dominant direction of travel?</p>	<p><input type="checkbox"/> YES <input type="checkbox"/> NO N/A</p>		<p>Photo #:</p>	<ul style="list-style-type: none"> • Modify route • Replace grates or boards

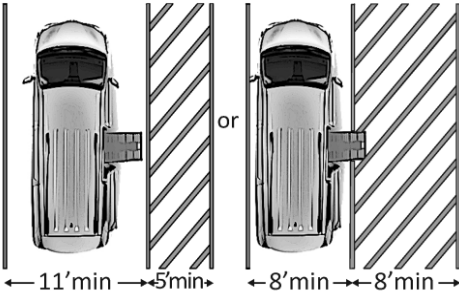
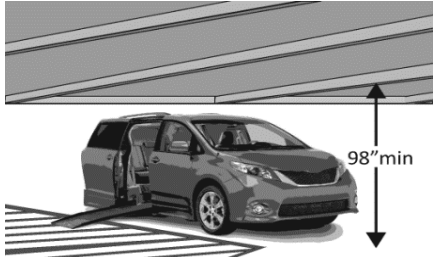
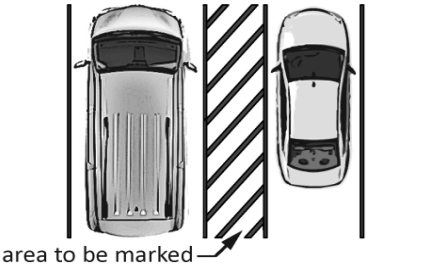

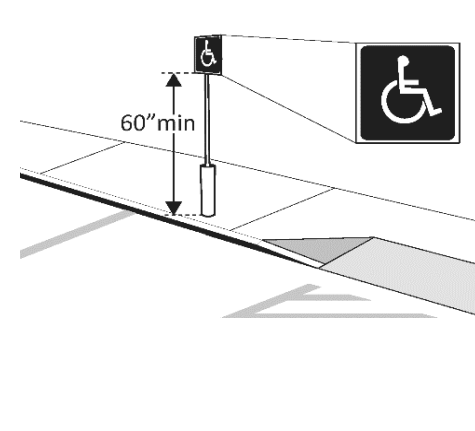
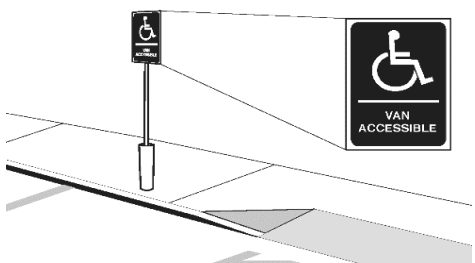
Parking Accessible parking spaces should be identified by size, access aisle and signage.																			
1.100	If parking is provided for the public, are an adequate number of accessible spaces provided? (208.2)	<input type="checkbox"/> YES	<input checked="" type="checkbox"/> NO Total #: 166 Acsbl #: 2 @ PKG 12 (5 TOT)	<table border="1"> <thead> <tr> <th>Total Spaces</th> <th>Accessible Spaces</th> </tr> </thead> <tbody> <tr> <td>1 - 25</td> <td>1</td> </tr> <tr> <td>26 - 50</td> <td>2</td> </tr> <tr> <td>51 - 75</td> <td>3</td> </tr> <tr> <td>76 - 100</td> <td>4</td> </tr> <tr> <td>151 to 200</td> <td>6</td> </tr> <tr> <td colspan="2">100+ see 2010 Standards 208.2</td> </tr> </tbody> </table>	Total Spaces	Accessible Spaces	1 - 25	1	26 - 50	2	51 - 75	3	76 - 100	4	151 to 200	6	100+ see 2010 Standards 208.2		Photo #: • Reconfigure by repainting lines
Total Spaces	Accessible Spaces																		
1 - 25	1																		
26 - 50	2																		
51 - 75	3																		
76 - 100	4																		
151 to 200	6																		
100+ see 2010 Standards 208.2																			
1.101	Of the accessible spaces, is at least one a van accessible space?*[208.2.4]	<input type="checkbox"/> YES	<input checked="" type="checkbox"/> NO	*For every 6 or fraction of 6 parking spaces required by the table above, at least 1 should be a van accessible space.	Photo #: • If constructed before 3/15/2012, parking is compliant if at least 1 in every 8 accessible spaces is van accessible • Reconfigure by repainting lines														
1.102	Are accessible spaces at least 8 feet wide with an access aisle at least 5 feet wide? [502.2, 502.3] Note: Two spaces may share an access aisle. Check state/local requirements; some specify that each space have its own aisle.	<input type="checkbox"/> YES	<input checked="" type="checkbox"/> NO Measurement: 9'-5" S 4'-9" A 8'-0" S		Photo #: • Reconfigure by repainting lines														

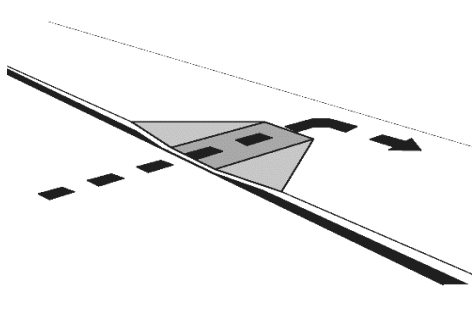
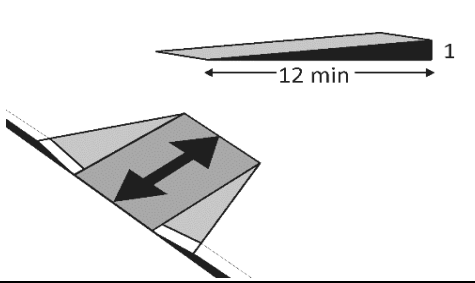
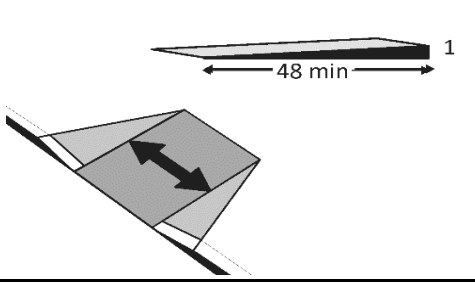
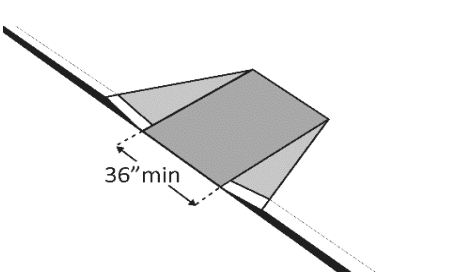

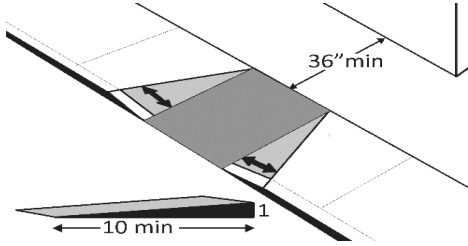
<p>1.103</p>	<p>Is the van accessible space: At least 11 feet wide with an access aisle at least 5 feet wide? Or At least 8 feet wide with an access aisle at least 8 feet wide? [502.2]</p>	<p><input type="checkbox"/> YES <input checked="" type="checkbox"/> NO Measurement:</p>		<p>Photo #:</p>	<ul style="list-style-type: none"> • Reconfigure by repainting lines
<p>1.104</p>	<p>Is at least 98 inches of vertical clearance provided for the van accessible space? [502.5]</p>	<p><input checked="" type="checkbox"/> YES <input type="checkbox"/> NO Measurement:</p>		<p>Photo #:</p>	<ul style="list-style-type: none"> • Reconfigure to provide van-accessible space(s)
<p>1.105</p>	<p>Are the access aisles marked so as to discourage parking in them? [502.3.3] Note: The marking method and color may be addressed by state/local requirements.</p>	<p><input checked="" type="checkbox"/> YES <input type="checkbox"/> NO Measurement:</p>		<p>Photo #:</p>	<ul style="list-style-type: none"> • Mark access aisles
<p>1.106</p>	<p>Is the slope of the accessible parking spaces and access aisles no steeper than 1:48 in all directions? [502.4]</p>	<p><input checked="" type="checkbox"/> YES <input type="checkbox"/> NO Measurement: <2%</p>		<p>Photo #:</p>	<ul style="list-style-type: none"> • Regrade surface

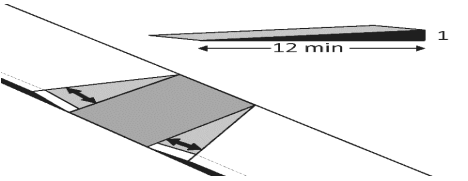
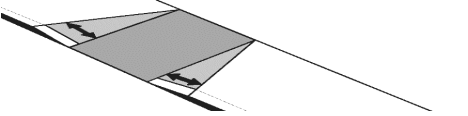

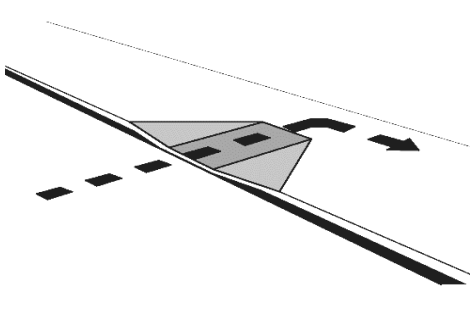
1.107	Do the access aisles adjoin an accessible route? [502.3]	<input checked="" type="checkbox"/> YES <input type="checkbox"/> NO		Photo #:	<ul style="list-style-type: none"> • Create accessible route • Relocate accessible space
1.108	Are accessible spaces identified with a sign that includes the International Symbol of Accessibility? Is the bottom of the sign at least 60 inches above the ground? [502.6] Note: The International Symbol of Accessibility is not required on the ground.	<input checked="" type="checkbox"/> YES <input type="checkbox"/> NO <input type="checkbox"/> YES <input checked="" type="checkbox"/> NO 39 1/2" 30 3/4"		Photo #:	<ul style="list-style-type: none"> • Install signs
1.109	Are there signs reading "van accessible" at van accessible spaces? [502.6]	<input type="checkbox"/> YES <input checked="" type="checkbox"/> NO		Photo #:	<ul style="list-style-type: none"> • Install signs
1.110	Of the total parking spaces, are the accessible spaces located on the closest accessible route to the accessible entrance(s)? [208.3.1] Note: If parking serves multiple entrances, accessible parking should be dispersed.	<input checked="" type="checkbox"/> YES <input type="checkbox"/> NO TO TRAIL		Photo #:	<ul style="list-style-type: none"> • Reconfigure spaces

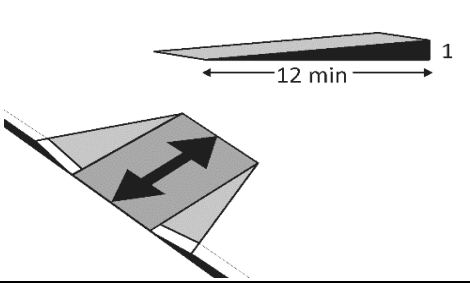
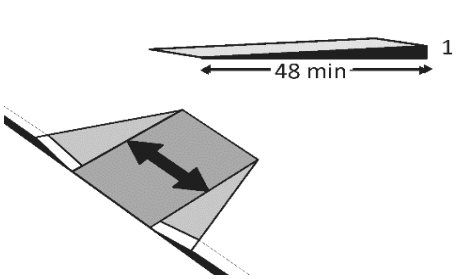
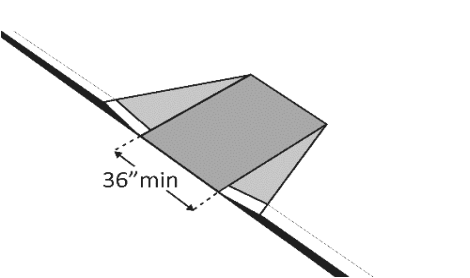

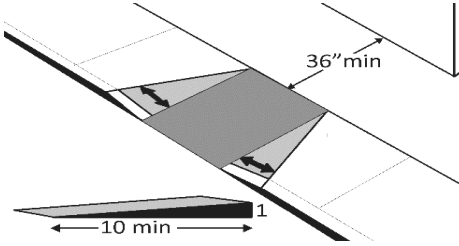
Curb Ramps					
1.111	If the accessible route crosses a curb, is there a curb ramp? [402.2]	<input checked="" type="checkbox"/> YES <input type="checkbox"/> NO		<p style="color: red;">THIS CURB RAMP LEADS DIRECTLY INTO A TRAFFIC PATH AND THEREFORE SHOULD INCLUDE A TACTILE WARNING PAD AT THE BOTTOM OF THE SLOPE.</p> Photo #:	<ul style="list-style-type: none"> • Install curb ramp
1.112	Is the running slope of the curb ramp no steeper than 1:12, i.e. for every inch of height change there are at least 12 inches of curb ramp run? [406.1, 405.2]	<input checked="" type="checkbox"/> YES <input type="checkbox"/> NO Measure ment: 2.7%		Photo #:	<ul style="list-style-type: none"> • Regrade curb ramp
.113	Is the cross slope of the curb ramp, excluding flares, no steeper than 1:48? [406.1, 405.3]	<input checked="" type="checkbox"/> YES <input type="checkbox"/> NO Measure ment:		Photo #:	<ul style="list-style-type: none"> • Regrade curb ramp
1.114	Is the curb ramp, excluding flares, at least 36 inches wide? [406.1, 405.5]	<input checked="" type="checkbox"/> YES <input type="checkbox"/> NO Measure ment:		Photo #:	<ul style="list-style-type: none"> • Widen curb ramp

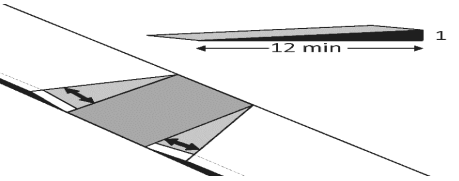
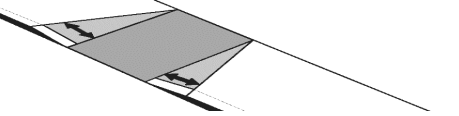

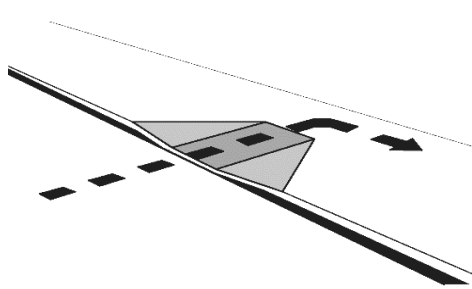
<p>1.115</p>	<p>At the top of the curb ramp is there a level landing (slope no steeper than 1:48 in all directions) that is at least 36 inches long and at least as wide as the curb ramp? [406.4]</p>	<p><input checked="" type="checkbox"/> YES <input type="checkbox"/> NO</p> <p>Measure ment:</p>		<p>Photo #:</p>	<ul style="list-style-type: none"> • Reconfigure • Add ramp flares
<p>1.116</p>	<p>If there are curb ramp flares, are the slopes of the flares no steeper than 1:10, i.e. for every inch of height change there are at least 10 inches of flare run? [406.3]</p>	<p><input type="checkbox"/> YES <input type="checkbox"/> NO</p> <p>Measure ment:</p> <p>N/A</p>		<p>Photo #:</p>	<ul style="list-style-type: none"> • Add ramp flares • Regrade flares
<p>1.116</p>	<p>If the landing at the top is less than 36 inches long, are there curb ramp flares?</p>	<p><input type="checkbox"/> YES <input type="checkbox"/> NO</p> <p>Measure ment:</p> <p>N/A</p>		<p>Photo #:</p>	<ul style="list-style-type: none"> • Add ramp flares • Regrade flares
<p>1.116</p>	<p>Are the slopes of the flares no greater than 1:12, i.e. for every inch of height change there are at least 12 inches of flare run? [406.4]</p>	<p><input type="checkbox"/> YES <input type="checkbox"/> NO</p> <p>Measure ment:</p> <p>N/A</p>		<p>Photo #:</p>	<ul style="list-style-type: none"> • Add ramp flares • Regrade flares

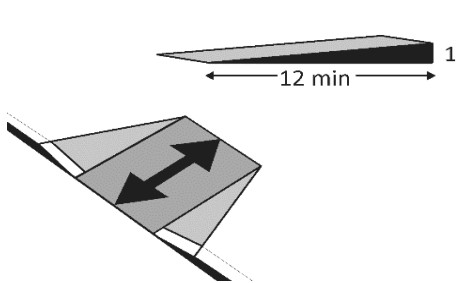
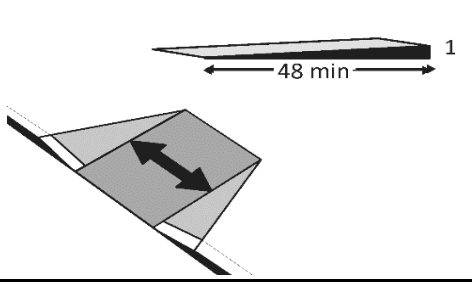
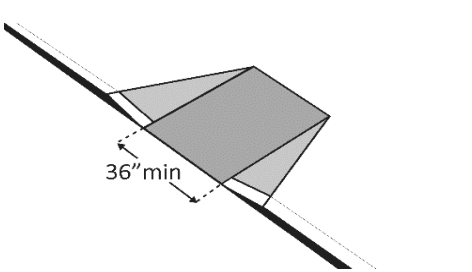
Curb Ramps					
1.111	If the accessible route crosses a curb, is there a curb ramp? [402.2]	<input checked="" type="checkbox"/> YES <input type="checkbox"/> NO			<ul style="list-style-type: none"> • Install curb ramp
1.112	Is the running slope of the curb ramp no steeper than 1:12, i.e. for every inch of height change there are at least 12 inches of curb ramp run? [406.1, 405.2]	<input type="checkbox"/> YES <input checked="" type="checkbox"/> NO Measure ment: 8.9%		<p style="color: red;">THIS CURB RAMP LEADS DIRECTLY INTO A TRAFFIC PATH AND THEREFORE SHOULD INCLUDE A TACTILE WARNING PAD AT THE BOTTOM OF THE SLOPE.</p>	<ul style="list-style-type: none"> • Regrade curb ramp
.113	Is the cross slope of the curb ramp, excluding flares, no steeper than 1:48? [406.1, 405.3]	<input checked="" type="checkbox"/> YES <input type="checkbox"/> NO Measure ment:		<p>Photo #:</p>	<ul style="list-style-type: none"> • Regrade curb ramp
1.114	Is the curb ramp, excluding flares, at least 36 inches wide? [406.1, 405.5]	<input checked="" type="checkbox"/> YES <input type="checkbox"/> NO Measure ment: 60"		<p>Photo #:</p>	<ul style="list-style-type: none"> • Widen curb ramp

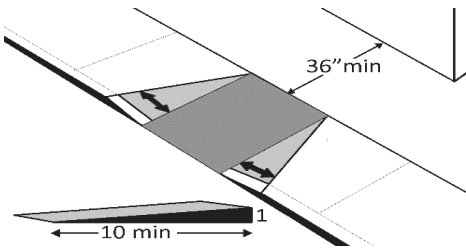

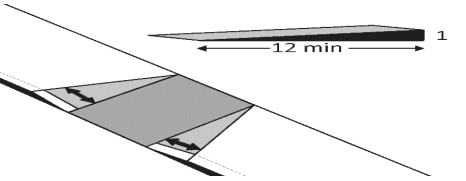
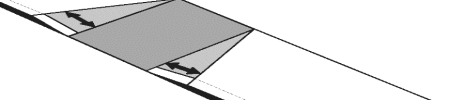
<p>1.115</p>	<p>At the top of the curb ramp is there a level landing (slope no steeper than 1:48 in all directions) that is at least 36 inches long and at least as wide as the curb ramp? [406.4]</p>	<p><input type="checkbox"/> YES <input checked="" type="checkbox"/> NO</p> <p>Measure ment: 3.2%</p>		<p>Photo #:</p>	<ul style="list-style-type: none"> • Reconfigure • Add ramp flares
<p>1.116</p>	<p>If there are curb ramp flares, are the slopes of the flares no steeper than 1:10, i.e. for every inch of height change there are at least 10 inches of flare run? [406.3]</p>	<p><input type="checkbox"/> YES <input type="checkbox"/> NO</p> <p>Measure ment: N/A</p>		<p>Photo #:</p>	<ul style="list-style-type: none"> • Add ramp flares • Regrade flares
<p>1.116</p>	<p>If the landing at the top is less than 36 inches long, are there curb ramp flares? [406.4]</p>	<p><input type="checkbox"/> YES <input type="checkbox"/> NO</p> <p>Measure ment: N/A</p>		<p>Photo #:</p>	<ul style="list-style-type: none"> • Add ramp flares • Regrade flares
<p>1.116</p>	<p>Are the slopes of the flares no greater than 1:12, i.e. for every inch of height change there are at least 12 inches of flare run? [406.4]</p>	<p><input type="checkbox"/> YES <input type="checkbox"/> NO</p> <p>Measure ment: N/A</p>		<p>Photo #:</p>	<ul style="list-style-type: none"> • Add ramp flares • Regrade flares

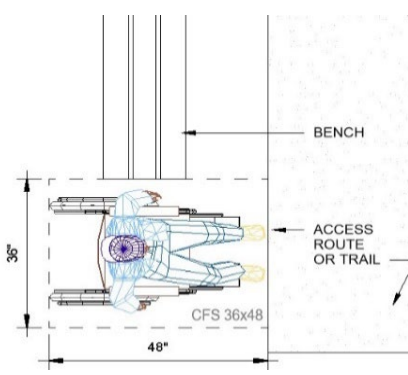

Curb Ramps					
1.111	If the accessible route crosses a curb, is there a curb ramp? [402.2]	<input checked="" type="checkbox"/> YES <input type="checkbox"/> NO			<ul style="list-style-type: none"> • Install curb ramp
1.112	Is the running slope of the curb ramp no steeper than 1:12, i.e. for every inch of height change there are at least 12 inches of curb ramp run? [406.1, 405.2]	<input checked="" type="checkbox"/> YES <input type="checkbox"/> NO Measure ment: 5.3%		<p>THIS CURB RAMP LEADS DIRECTLY INTO A TRAFFIC PATH AND THEREFORE SHOULD INCLUDE A TACTILE WARNING PAD AT THE BOTTOM OF THE SLOPE.</p>	<ul style="list-style-type: none"> • Regrade curb ramp
.113	Is the cross slope of the curb ramp, excluding flares, no steeper than 1:48? [406.1, 405.3]	<input type="checkbox"/> YES <input checked="" type="checkbox"/> NO Measure ment: 3.0%		<p>Photo #:</p>	<ul style="list-style-type: none"> • Regrade curb ramp
1.114	Is the curb ramp, excluding flares, at least 36 inches wide? [406.1, 405.5]	<input checked="" type="checkbox"/> YES <input type="checkbox"/> NO Measure ment: 60"		<p>Photo #:</p>	<ul style="list-style-type: none"> • Widen curb ramp

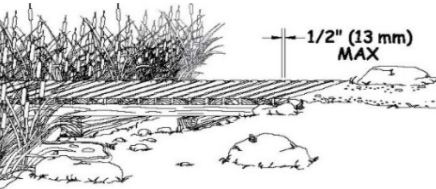
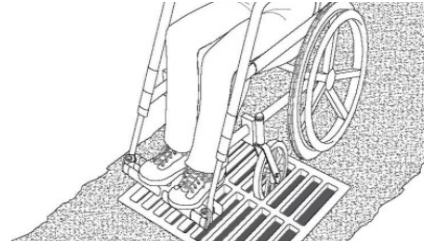
<p>1.115</p>	<p>At the top of the curb ramp is there a level landing (slope no steeper than 1:48 in all directions) that is at least 36 inches long and at least as wide as the curb ramp? [406.4]</p>	<p><input type="checkbox"/> YES <input checked="" type="checkbox"/> NO</p> <p>Measure ment: 3.2%</p>		<p>Photo #:</p>	<ul style="list-style-type: none"> • Reconfigure • Add ramp flares
<p>1.116</p>	<p>If there are curb ramp flares, are the slopes of the flares no steeper than 1:10, i.e. for every inch of height change there are at least 10 inches of flare run? [406.3]</p>	<p><input type="checkbox"/> YES <input type="checkbox"/> NO</p> <p>Measure ment: N/A</p>		<p>Photo #:</p>	<ul style="list-style-type: none"> • Add ramp flares • Regrade flares
<p>1.116</p>	<p>If the landing at the top is less than 36 inches long, are there curb ramp flares? [406.4]</p>	<p><input type="checkbox"/> YES <input type="checkbox"/> NO</p> <p>Measure ment: N/A</p>		<p>Photo #:</p>	<ul style="list-style-type: none"> • Add ramp flares • Regrade flares
<p>1.116</p>	<p>Are the slopes of the flares no greater than 1:12, i.e. for every inch of height change there are at least 12 inches of flare run? [406.4]</p>	<p><input type="checkbox"/> YES <input type="checkbox"/> NO</p> <p>Measure ment: N/A</p>		<p>Photo #:</p>	<ul style="list-style-type: none"> • Add ramp flares • Regrade flares

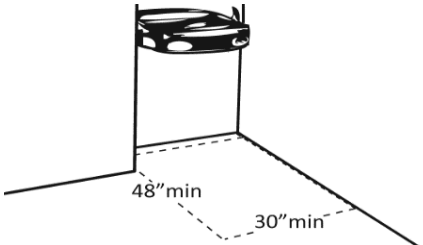
Benches					
2.470	Where benches are provided, is there clear ground space 36 inches (915 mm) by 48 inches (1220 mm) positioned near the bench with one side of the space adjoining an outdoor recreation access route or trail, as applicable? [1011.2.1]	<input checked="" type="checkbox"/> YES <input type="checkbox"/> NO Measure ment:			<ul style="list-style-type: none"> • Modify space • Provide new unit(s)
2.471	Is the clear ground space located such that it does not overlap the outdoor recreation access route or trail, or another clear ground space?	<input checked="" type="checkbox"/> YES <input type="checkbox"/> NO		Photo #:	<ul style="list-style-type: none"> • Enlarge space • Provide new space
2.472	Is the surface of the clear ground space firm and stable? [1011.2.2]	<input checked="" type="checkbox"/> YES <input type="checkbox"/> NO Material PAVERS		Photo #:	<ul style="list-style-type: none"> • Modify surface • Replace Surface
2.473	Is the slope of the clear ground space surface no steeper than 1:48 in any direction? [1011.2.3] or	<input checked="" type="checkbox"/> YES <input type="checkbox"/> NO Measure ment: 2.0%		Photo #:	<ul style="list-style-type: none"> • Level the area
	If the surface is other than asphalt, concrete, or boards, is the slope no steeper than 1:20 if necessary for drainage?	<input type="checkbox"/> YES <input type="checkbox"/> NO Measure ment: N/A		Photo #:	<ul style="list-style-type: none"> • Level the area

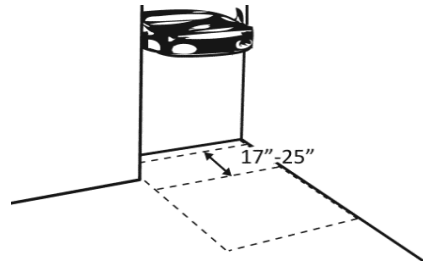
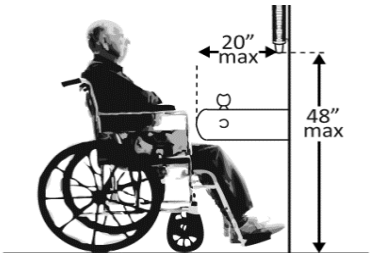
<p>2.474</p>	<p>If openings (grates) are present in the clear ground space surface, are they sized so they do not allow the passage of a sphere more than 1/2 inch (13 mm) in diameter? And</p>	<p><input type="checkbox"/> YES <input type="checkbox"/> NO Measurement: N/A</p>		<p>Photo #:</p>	<ul style="list-style-type: none"> • Modify route • Replace grates or boards
	<p>Are elongated openings placed so that the long dimension is perpendicular, or as close to perpendicular as possible, to the dominant direction of travel?</p>	<p><input type="checkbox"/> YES <input type="checkbox"/> NO N/A</p>		<p>Photo #:</p>	<ul style="list-style-type: none"> • Modify route • Replace grates or boards

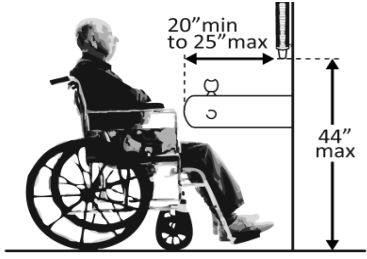
Priority 4 - Additional Access		Comments	Possible Solutions	
Drinking Fountains				
<p>4.100 Does at least one drinking fountain have a clear floor space at least 30 inches wide x at least 48 inches long centered in front of it for a forward approach?*</p> <p>[See 2010 ADA Standards for Accessible Design – 602.2]</p>	<p><input checked="" type="checkbox"/> YES <input type="checkbox"/> NO Measure ment:</p>		 <p>Photo #:</p>	<ul style="list-style-type: none"> Alter space Relocate drinking fountain Install a drinking fountain in another location <p>*If installed before 3/15/2012, a parallel approach is permitted and the clear floor space is not required to be centered</p>
<p>4.101 If there is a forward approach, do no less than 17 inches and no greater than 25 inches of the clear floor space extend under the drinking fountain?</p> <p>[306.2.2, 306.2.3]</p> <p>Note: If the drinking fountain is primarily for children’s use and the spout is no more than 30 inches above the floor and no more than 3 ½ inches from the edge of the unit, a parallel approach is permitted.</p>	<p><input checked="" type="checkbox"/> YES <input type="checkbox"/> NO Measure ment: 20 1/2"</p>		<p>Photo #:</p>	<ul style="list-style-type: none"> Alter space Replace drinking fountain
<p>4.102 If the drinking fountain is no deeper than 20 inches, are the operable parts no higher than 48 inches above the floor?</p> <p>[308.2.2]</p>	<p><input type="checkbox"/> YES <input type="checkbox"/> NO Measure ment: N/A</p>		<p>Photo #:</p>	<ul style="list-style-type: none"> Adjust drinking fountain Replace drinking fountain

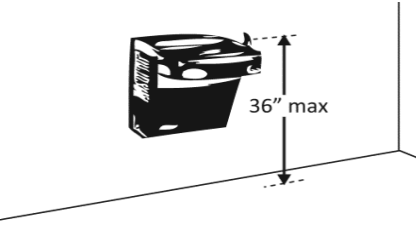
<p>4.103</p>	<p>If the drinking fountain is no less than 20 inches and no greater than 25 inches deep, are the operable parts no higher than 44 inches above the floor? [308.2.2]</p>	<p><input checked="" type="checkbox"/> YES <input type="checkbox"/> NO Measure ment: 32"</p>		<p>Photo #:</p>	<ul style="list-style-type: none"> • Adjust drinking fountain • Replace drinking fountain
<p>4.104</p>	<p>Can the control be operated with one hand and without tight grasping, pinching or twisting of the wrist?</p>	<p><input checked="" type="checkbox"/> YES <input type="checkbox"/> NO</p>		<p>Photo #:</p>	<ul style="list-style-type: none"> • Change control • Adjust control
<p>Is the force required to activate the control no more than 5 pounds? [309.4]</p>	<p><input checked="" type="checkbox"/> YES <input type="checkbox"/> NO Measure ment:</p>				
<p>Is the height of the water flow 4" minimum to allow a cup to bbe filled? [602.6]</p>	<p><input type="checkbox"/> YES <input type="checkbox"/> NO Measure ment: UNKNOW N H2O IS OFF</p>				
<p>4.105</p>	<p>Is the spout outlet no higher than 36 inches above the floor? [602.4]</p>	<p><input type="checkbox"/> YES <input checked="" type="checkbox"/> NO Measure ment: 38"</p>		<p>Photo #:</p>	<ul style="list-style-type: none"> • Adjust drinking fountain • Replace drinking fountain

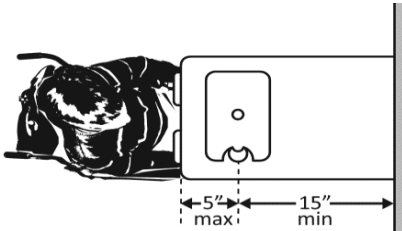
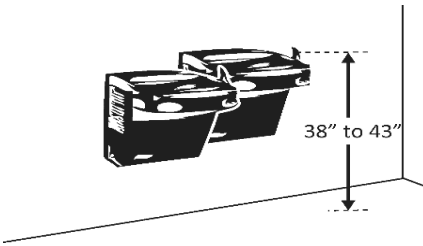
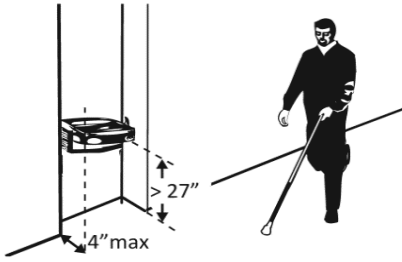
<p>4.106</p>	<p>Is the spout: At least 15 inches from the rear of the drinking fountain?</p>	<p><input checked="" type="checkbox"/> YES <input type="checkbox"/> NO Measure ment:</p>		<p>Photo #:</p>	<ul style="list-style-type: none"> • Adjust spout • Replace drinking fountain
	<p>No more than 5 inches from the front of the drinking fountain? [602.5]</p>	<p><input checked="" type="checkbox"/> YES <input type="checkbox"/> NO Measure ment:</p>			
<p>4.107</p>	<p>If there is more than one drinking fountain, is there at least one for standing persons? [211.2]</p>	<p><input type="checkbox"/> YES <input type="checkbox"/> NO N/A</p>		<p>Photo #:</p>	<ul style="list-style-type: none"> • Adjust drinking fountain • Install new drinking fountain for standing height
	<p>Is the spout outlet no lower than 38 inches and no higher than 43 inches above the floor? [602.7]</p>	<p><input type="checkbox"/> YES <input type="checkbox"/> NO Measure ment: N/A</p>			
<p>4.108</p>	<p>If the leading (bottom) edge of the fountain is higher than 27 inches above the floor, does the front of the fountain protrude no more than 4 inches into the circulation path? [307.2]</p>	<p><input checked="" type="checkbox"/> YES <input type="checkbox"/> NO Measure ment: 30" NOT ON PATH</p>		<p>Photo #:</p>	<ul style="list-style-type: none"> • Adjust drinking fountain • Replace drinking fountain • Add tactile warning such as permanent planter or partial walls

Port of Everett - ADA Transition Plan
April 2021



2. Jetty Landing (10th Street) Boat Launch

Prepared by
Transportation Solutions, Inc.
design2Last, Inc.

DATE OF EVALUATION

1/20/2021

Figure 6. Recreational Facilities to Be Assessed for ADA Compliance - Phase I



ADA Evaluation

FOR Jetty Landing (10th St) Boat Launch

Port of Everett

ADA Transition Plan



Based on the 2010 ADA Standards for Accessible Design

Completed by:

design2 LAST, inc
534 Main St, Suite 101
Edmonds, WA 98020

Notes Regarding ADA Evaluation for this facility

Each file contains an aerial view of the site as shown on Google. If plans for the facilities were available, they are included. If room names or numbers are not indicated on those plans, fictional room names and numbers were given to spaces to correlate them to the enclosed checklists. These are intended to be used for the purpose of locating which rooms pertain to which portion of the checklist, and may or may not represent the actual room numbers and names at the facility.

How to read these checklists:

1. The 1st column is the identity mark, typically the priority number (1, 2, 3, or 4) followed by an identifying number. These may or may not be in order depending on whether non relevant rows have been hidden.
2. The 2nd column describes the compliance issue in the form of a question. The compliant measurement or count is identified in the question. If the response to the question is 'yes' the issue is compliant.
3. The 3rd and 4th columns are the 'yes' and 'no' responses, and measurements taken in the field. If the issue is compliant and the 'yes' box is checked, there may or may not be a measurement included. If the 'no' box is checked, the issue is non-compliant, and a measurement or count will indicate how the issue is noncompliant.

ADA Checklist for Existing Facilities

The Americans with Disabilities Act (ADA) requires state and local governments, businesses and non-profit organizations to provide goods, services and programs to people with disabilities on an equal basis with the rest of the public.

Some people think that only new construction and alterations need to be accessible and that older facilities are "grandfathered," but that's not true. Because the ADA is a civil rights law and not a building code, older facilities are often required to be accessible to ensure that people with disabilities have an equal opportunity to participate.

The ADA has different requirements for state and local governments and for places of public accommodation (businesses and non-profit organizations that serve the public).

Requirements for State and Local Governments

State and local governments must ensure that services, programs and activities, when viewed in their entirety, are accessible to people with disabilities. This is part of public entities' program accessibility obligations. Alterations to older buildings may be needed to ensure program accessibility. Generally this is a greater obligation than "readily achievable barrier removal" the standard that applies to public accommodations. State and local governments are not required to take any action that would result in undue financial and administrative burdens.

State and local governments' ADA obligations for program accessibility are in the Department of Justice's ADA Title II regulations 28 CFR Part 35.150.

Requirements for Places of Public Accommodation

Businesses and non-profit organizations that serve the public must remove architectural barriers when it is "readily achievable" to do so; in other words, when barrier removal is "easily accomplishable and able to be carried out without much difficulty or expense."

The decision of what is readily achievable is made considering the size, type, and overall finances of the public accommodation and the nature and cost of the access improvements needed. Barrier removal that is difficult now may be readily achievable in the future as finances change.

4. The 5th column may contain a pictogram or drawing of the issue being evaluated. This may also contain a sketch of what the evaluator found in the field as it related to the condition being evaluated.
5. The 6th column may contain a photo of the field condition. Only a select number of conditions are photographed to keep the file size manageable.
6. The last column may contains a list of suggested corrections. These are helpful to the cost estimating team but may not reflect the amount of work required to move or replace an item to bring it into compliance. There may be some economy when multiple non-compliance issues can be completed with one action. There may also be several ways to make corrective changes. How changes and corrections are made will depend on several things, most importantly the existing conditions. These typically are addressed in a design process.
7. Some cells are highlighted yellow. The highlighted cells are identifying non-compliance issues. The yellow is used simply to make the non-compliant issues easier to find among the large number of pages.
8. If no boxes are checked, or there is a slash thru the compliance issue, that particular issue does not apply to the instance being evaluated.

Public accommodations' ADA obligations for barrier removal are in the Department of Justice's ADA Title III regulations 28 CFR Part 36.304.

Priorities for Accessibility

The checklist follows the four priorities that are listed in the Department of Justice ADA Title III regulations. These priorities are equally applicable to state and local government facilities.

Priority 1 - Accessible approach and entrance

Priority 2 - Access to goods and services

Priority 3 - Access to public toilet rooms

Priority 4 - Access to other items such as water fountains and public telephones

2010 ADA Standards for Accessible Design

The checklist is based on the 2010 ADA Standards for Accessible Design (2010 Standards). The checklist may not include all sections of the 2010 Standards. Consult the 2010 Standards for situations not covered in the checklist. Full compliance with the 2010 Standards is required only for new construction and alterations.

Safe Harbor – Construction Prior to March 15, 2012

Elements in facilities built or altered before March 15, 2012 that comply with the 1991 ADA Standards for Accessible Design (1991 Standards) are not required to be modified to specifications in the 2010 Standards. For example, the 1991 Standards allow 54 inches maximum for a side reach range to a control such as the operating part of a paper towel dispenser. The 2010 Standards lower that side reach range to 48 inches maximum. If a paper towel dispenser was installed prior to March 15, 2012 with the highest operating part at 54 inches, the paper towel dispenser does not need to be lowered to 48".

What this Checklist is Not

The ADA Title II and III regulations require more than program accessibility and barrier removal. The regulations include requirements for nondiscriminatory policies and practices and for the provision of auxiliary aids and services, such as sign language interpreters for people who are deaf and material in Braille for people who are blind. This checklist does not cover those requirements.

Since this checklist does not include all of the 2010 Standards it is not intended to determine compliance for new construction or facilities being altered.

Resources**U.S. Department of Justice ADA Information**

800-514-0301 voice: 800-514-0383 TTY
www.ada.gov

ADA National Network

800-949-4232 voice/TTY connects to
your regional ADA Center:
www.adata.org

U.S. Access Board

800- 872-2253 voice: 800-993-2822 TTY
www.access-board.gov

[ADA Title III Regulations 28 CFR Part 36
www.ada.gov/regs2010/titleIII_2010/titleII_2010_regulations.htm](http://www.ada.gov/regs2010/titleIII_2010/titleII_2010_regulations.htm)

[2010 ADA Standards for Accessible
Design
www.ada.gov/2010ADASTandards_index.htm](http://www.ada.gov/2010ADASTandards_index.htm)

[1991 ADA Standards for Accessible
Design
www.ada.gov/stdspdf.htm](http://www.ada.gov/stdspdf.htm)

Acknowledgements

The Institute for Human Centered Design and the New England ADA Center created the ADA Checklists. Originals can be accessed at www.adachecklist.org.

What are Public Accommodations?

Under the ADA public accommodations are private entities that own, lease, lease to or operate a place of public accommodation. This means that both a landlord who leases space in a building to a tenant and the tenant who operates a place of public accommodation have responsibilities to remove barriers.

A place of public accommodation is a facility whose operations affect commerce and fall within at least one of the following 12 categories:

- 1) Places of lodging (e.g., inns, hotels, motels, except for owner-occupied establishments renting fewer than six rooms)
- 2) Establishments serving food or drink (e.g. , restaurants and bars)
- 3) Places of exhibition or entertainment (e.g. , motion picture houses, theaters, concert halls, stadiums)
- 4) Places of public gathering (e.g. , auditoriums, convention centers, lecture halls)
- 5) Sales or rental establishments (e.g. , bakeries, grocery stores, hardware stores, shopping centers)
- 6) Service establishments (e.g. , laundromats, dry-cleaners, banks, barber shops, beauty shops, travel services, shoe repair services, funeral parlors, gas stations, offices of accountants or lawyers, pharmacies, insurance offices, professional offices of health care providers, hospitals)
- 7) Public transportation terminals, depots, or stations (not including facilities relating to air transportation)
- 8) Places of public display or collection (e.g. , museums, libraries, galleries)
- 9) Places of recreation (e.g. , parks, zoos, amusement parks)
- 10) Places of education (e.g. , nursery schools, elementary, secondary, undergraduate, or postgraduate private schools)
- 11) Social service center establishments (e.g. , day care centers, senior citizen centers, homeless shelters, food banks, adoption agencies)
- 12) Places of exercise or recreation (e.g. , gymnasiums, health spas, bowling alleys, golf courses).

Many of the illustrations are from the U.S. Department of Justice and the U.S. Access Board or are based on illustrations produced by the U.S. Access Board and the U.S. Department of Justice.

New sections added to Appendix A to Chapter 10

F201.4 Requirements Apply to Facilities Constructed or Altered by or on Behalf of Federal Agencies.

The requirements in F216.13, F244 through F248, and 1011 through 1019 shall apply only to facilities constructed or altered by federal agencies or by non-federal entities on federal land on behalf of federal agencies pursuant to a concession contract, partnership agreement, or similar arrangement.

F201.4.1 Documentation and Notification When Exceptions Used for Trails and Beach Access

Routes. Federal agencies shall document the basis for not fully complying with a specific provision in 1017 or 1018 on a portion of a trail or beach access route based on Exception 1 in 1017 or Exception 1 in 1018, and shall maintain the documentation with the records for the trail or beach project. Federal agencies shall notify the Access Board if an entire trail is exempted from complying with 1017 based on Exception 2 in 1017.1, and if a beach access route is not provided based on Exception 2 in 1018.1.6)

F202.3 Alterations. * * * * *

EXCEPTIONS: * * * * *

4. Where elements or spaces are altered in camping facilities, picnic facilities, viewing areas, or trailheads and the circulation path to the altered element or space is not altered, the circulation path shall not be required to comply with 1016.

F202.4 Alterations Affecting Primary Function Areas. * * * * *

EXCEPTIONS: * * * * *

2. Camping facilities, picnic facilities, viewing areas, trailheads, trails, and beach access routes shall not be required to comply with F202.4.

F206.1 General. * * * * *

EXCEPTIONS: 1. Accessible routes shall not be required where outdoor recreation access routes are provided at camping facilities in accordance with F244.5, picnic facilities in accordance with F245.4, viewing areas in accordance with F246.3, or trailheads in accordance with F247.3.2.

2. Accessible routes shall not be required where camping facilities, picnic facilities, viewing areas, or outdoor constructed features are provided on trails.

3. Accessible routes shall not be required where beach access routes are provided in accordance with F248.

F212.3 Sinks. * * * * *

EXCEPTIONS: * * * * *

2. In camping facilities and picnic facilities, sinks shall not be required to comply with F212.3 where a cooktop or conventional range is not provided.

F213.1 General. * * * * *

EXCEPTION: Pit toilets provided on trails and in camping facilities shall not be required to comply with F213

F216.13 Trailhead Signs. Where new trail information signs are provided at trailheads on newly constructed or altered

SUMMARY

Jetty Landing (10th St) Boat Launch

The northern most portion of the Marina facilities contains the large public boat launch docks. There are 279 boat trailer parking spaces and eight (8) appear to be accessible spaces, although they are not identified with compliant signage.

There are 13 lanes, numbered from south to north, with the northernmost, Lane 13, being identified as accessible. With the large wood docks located on the north side of this lane, the pier width is compliant. There is no identified direct accessible route from the accessible parking to the piers. This should be added and identified. An accessible load/unload area east of Lane 13 is denoted with striping, however clear signage should be installed.

The comfort station (restroom) adjacent to the south end of this area within Jetty Landing Park is slated to be replaced in 2021 and the new building will be evaluated in a future evaluation phase.

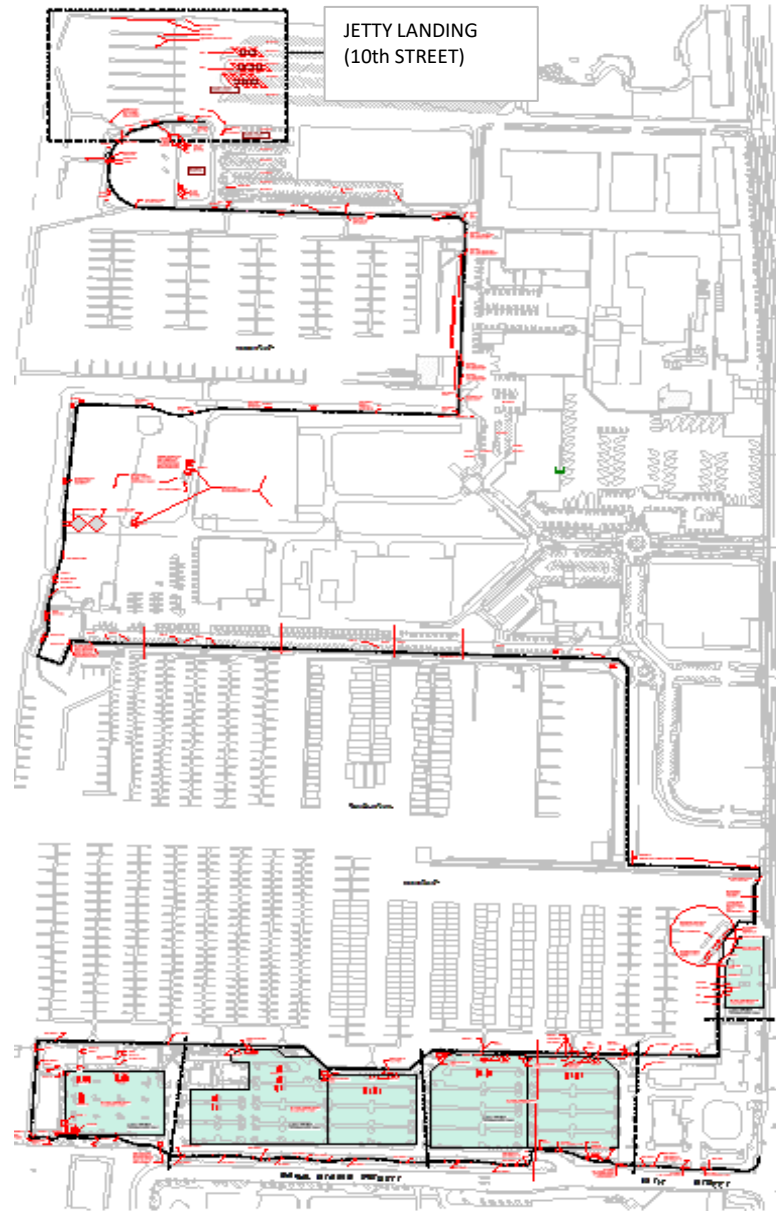

JETTY LANDING (10th STREET)
BOAT LAUNCH AND PARKING -
OVERALL PORT PLAN

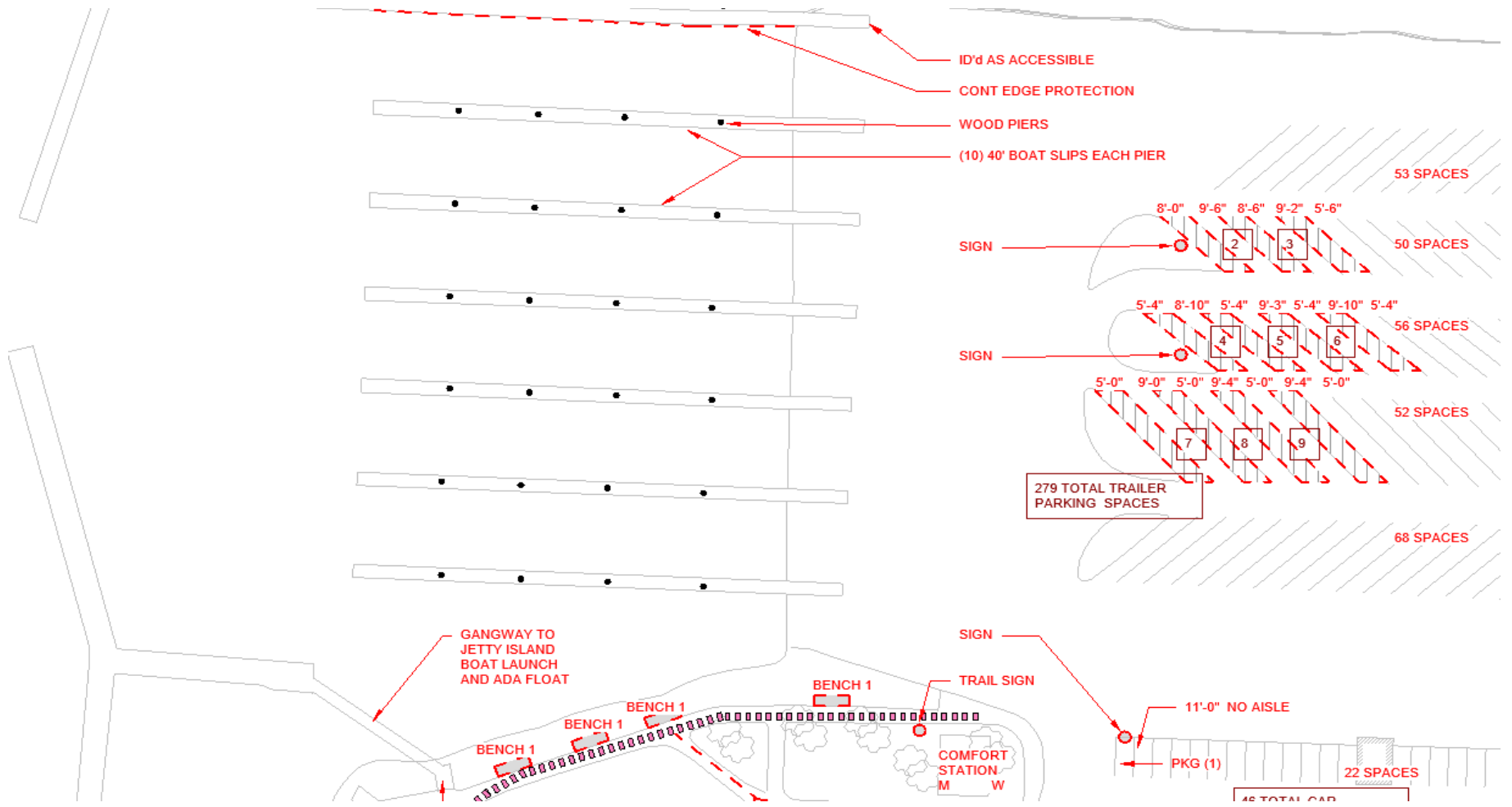

JETTY LANDING (10th STREET) BOAT LAUNCH AND PARKING

ADA Checklist for Existing

Priority 1 - Approach & Entrance

Based on the 2010 ADA Standards for Accessible Design



Project: ADA Transition Plan

Building: Jetty Landing (10th St) Boat Launch

Location: Everett, WA

Date: 1/20/2021



Surveyors: Lauri Strauss, AIA, LEED AP BD&C
President, CEO, design2 LAST, inc

Contact Information: o. 425-673-7269 c. 907-317-5040



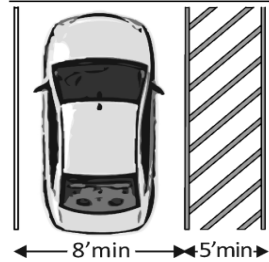

543 Main St, Suite 101, Edmonds, WA 98020

An accessible route from site arrival points and an accessible entrance should be provided for everyone.

Priority 1 - Approach & Entrance					Comments	Possible Solutions
1.001	Is there at least one route from site arrival points (parking, passenger loading zones, public sidewalks and public transportation stops) that does not require the use of stairs? [See 2010 ADA Standards for Accessible Design – 206.2.1]	<input type="checkbox"/> YES <input checked="" type="checkbox"/> NO If yes, location of route:	NO ROUTE FROM PARKIN G LOT TO PIER		Photo:	<ul style="list-style-type: none"> • Add a ramp • Regrade to 1:20 maximum slope • Add a lift if site constraints prevent other solutions



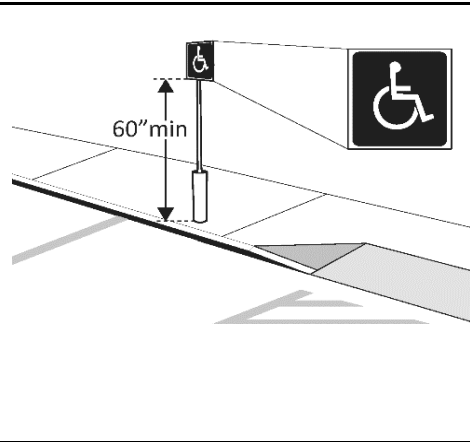
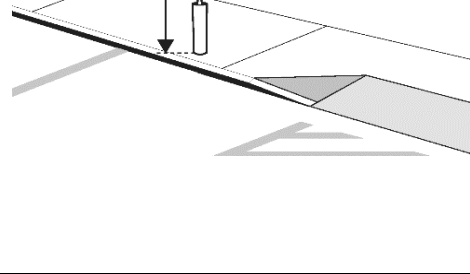

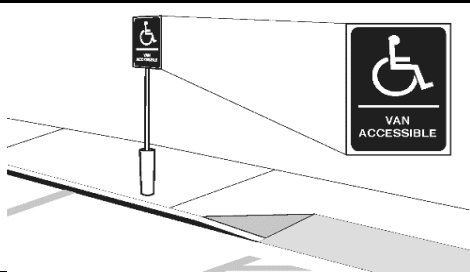
Parking Accessible parking spaces should be identified by size, access aisle and signage.																	
1.100	If parking is provided for the public, are an adequate number of accessible spaces provided? (208.2)	<input checked="" type="checkbox"/> YES <input type="checkbox"/> NO Total #: 279 Acsbl #: 9	<table border="1"> <thead> <tr> <th>Total Spaces</th> <th>Accessible Spaces</th> </tr> </thead> <tbody> <tr> <td>1 - 25</td> <td>1</td> </tr> <tr> <td>26 - 50</td> <td>2</td> </tr> <tr> <td>51 - 75</td> <td>3</td> </tr> <tr> <td>76 - 100</td> <td>4</td> </tr> <tr> <td>201 to 300</td> <td>7</td> </tr> <tr> <td colspan="2">100+ see 2010 Standards 208.2</td> </tr> </tbody> </table>	Total Spaces	Accessible Spaces	1 - 25	1	26 - 50	2	51 - 75	3	76 - 100	4	201 to 300	7	100+ see 2010 Standards 208.2	
Total Spaces	Accessible Spaces																
1 - 25	1																
26 - 50	2																
51 - 75	3																
76 - 100	4																
201 to 300	7																
100+ see 2010 Standards 208.2																	
1.101	Of the accessible spaces, is at least one a van accessible space?* [208.2.4]	<input type="checkbox"/> YES <input checked="" type="checkbox"/> NO	*For every 6 or fraction of 6 parking spaces required by the table above, at least 1 should be a van accessible space.														
1.102	Are accessible spaces at least 8 feet wide with an access aisle at least 5 feet wide? [502.2, 502.3] Note: Two spaces may share an access aisle. Check state/local requirements; some specify that each space have its own aisle.	<input checked="" type="checkbox"/> YES <input type="checkbox"/> NO Measure ment: SEE PLANS FOR SPACE & AISLE MEASUREMENTS															
		 <p>Photo:</p>	<ul style="list-style-type: none"> • Reconfigure by repainting lines 														
		<p>Photo:</p>	<ul style="list-style-type: none"> • If constructed before 3/15/2012, parking is compliant if at least 1 in every 8 accessible spaces is van accessible • Reconfigure by repainting lines 														
		 <p>Photo:</p>	<ul style="list-style-type: none"> • Reconfigure by repainting lines 														

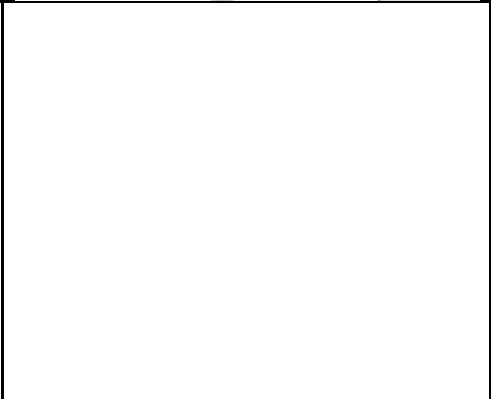

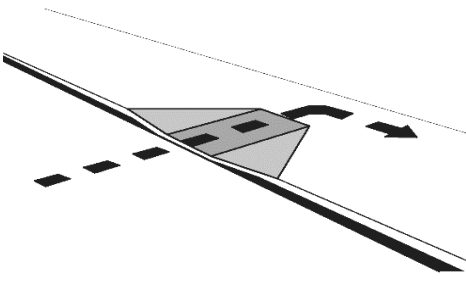

<p>1.103</p>	<p>Is the van accessible space: At least 11 feet wide with an access aisle at least 5 feet wide? Or At least 8 feet wide with an access aisle at least 8 feet wide? [502.2]</p>	<p><input type="checkbox"/> YES <input checked="" type="checkbox"/> NO Measurement: NONE ID'D</p>		<p>Photo:</p>	<ul style="list-style-type: none"> • Reconfigure by repainting lines
<p>1.104</p>	<p>Is at least 98 inches of vertical clearance provided for the van accessible space? [502.5]</p>	<p><input checked="" type="checkbox"/> YES <input type="checkbox"/> NO Measurement:</p>		<p>Photo:</p>	<ul style="list-style-type: none"> • Reconfigure to provide van-accessible space(s)
<p>1.105</p>	<p>Are the access aisles marked so as to discourage parking in them? [502.3.3] Note: The marking method and color may be addressed by state/local requirements.</p>	<p><input checked="" type="checkbox"/> YES <input type="checkbox"/> NO Measurement:</p>		<p>Photo:</p>	<ul style="list-style-type: none"> • Mark access aisles
<p>1.106</p>	<p>Is the slope of the accessible parking spaces and access aisles no steeper than 1:48 in all directions? [502.4]</p>	<p><input checked="" type="checkbox"/> YES <input type="checkbox"/> NO Measurement:</p>		<p>Photo:</p>	<ul style="list-style-type: none"> • Regrade surface

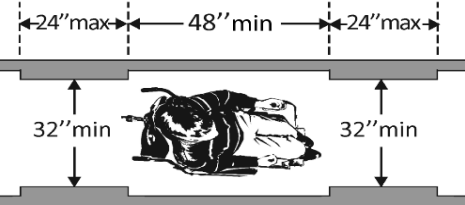
<p>1.107</p>	<p>Do the access aisles adjoin an accessible route? [502.3]</p>	<p><input type="checkbox"/> YES</p>	<p><input checked="" type="checkbox"/> NO</p>			<ul style="list-style-type: none"> • Create accessible route • Relocate accessible space
<p>1.108</p>	<p>Are accessible spaces identified with a sign that includes the International Symbol of Accessibility?</p>	<p><input type="checkbox"/> YES</p>	<p><input checked="" type="checkbox"/> NO (2) SIGNS AT 8 PCS</p>		<p>Photo:</p>	<ul style="list-style-type: none"> • Install signs
	<p>Is the bottom of the sign at least 60 inches above the ground? [502.6] Note: The International Symbol of Accessibility is not required on the ground.</p>	<p><input type="checkbox"/> YES</p>	<p><input checked="" type="checkbox"/> NO 42"@# 4 41"@# 2 48"@# 1</p>		<p>Photo:</p> 	
<p>1.109</p>	<p>Are there signs reading "van accessible" at van accessible spaces? [502.6]</p>	<p><input type="checkbox"/> YES</p>	<p><input checked="" type="checkbox"/> NO</p>		<p>Photo:</p>	<ul style="list-style-type: none"> • Install signs

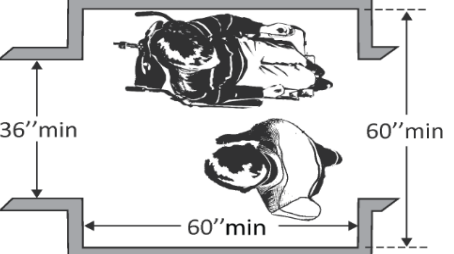
<p>1.110</p>	<p>Of the total parking spaces, are the accessible spaces located on the closest accessible route to the accessible entrance(s)? [208.3.1] Note: If parking serves multiple entrances, accessible parking should be dispersed.</p>	<p><input checked="" type="checkbox"/> YES <input type="checkbox"/> NO</p>		<p>Photo:</p>	<ul style="list-style-type: none"> • Reconfigure spaces
---------------------	---	---	--	---------------	--

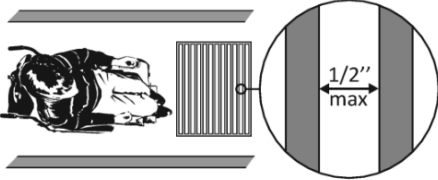
Curb Ramps - NONE PROVIDED					
1.111	If the accessible route crosses a curb, is there a curb ramp? [402.2]	<input type="checkbox"/> YES <input type="checkbox"/> NO N/A		<p>Photo #:</p>	<ul style="list-style-type: none"> • Install curb ramp

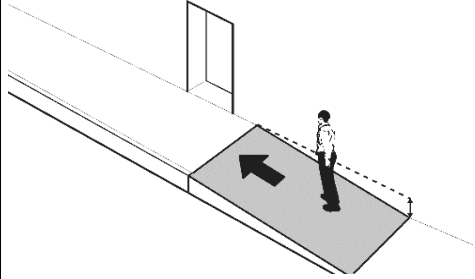
Accessible Route to Recreational Boating Facilities - PIERS 1-12					
1.120	Is the route stable, firm and slip-resistant? [302.1]	<input checked="" type="checkbox"/> YES <input type="checkbox"/> NO Measure ment: ASPHALT & CONC		Photo #:	<ul style="list-style-type: none"> • Repair uneven paving • Fill small bumps and breaks with patches • Replace gravel with asphalt or other surface
1.121	Is the route at least 36 inches wide? [403.5.1]	<input checked="" type="checkbox"/> YES <input type="checkbox"/> NO Measure ment: 72"		 Photo #:	<ul style="list-style-type: none"> • Change or move landscaping, furnishings or other items • Widen route
	Note: The accessible route can narrow to 32 inches min. for a max. of 24 inches. These narrower portions of the route must be at least 48 inches from each other.	<input type="checkbox"/> YES <input checked="" type="checkbox"/> NO Measure ment: 27"		 Photo #:	<ul style="list-style-type: none"> • Change or move obstacles or other items • Widen route
1.122	If the route is greater than 200 feet in length and less than 60 inches wide, is there a passing space no less than 60 x 60 inches? [403.5.3]	<input checked="" type="checkbox"/> YES <input type="checkbox"/> NO Measure ment:		Photo #:	<ul style="list-style-type: none"> • Widen route for passing space

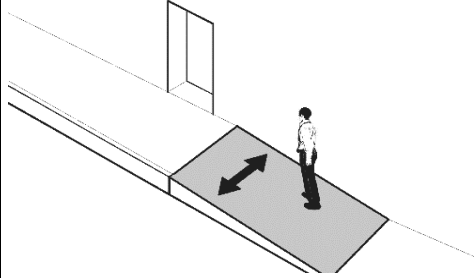
<p>1.123</p>	<p>If there are grates or openings on the route, are the openings no larger than ½ inches?</p>	<p><input type="checkbox"/> YES <input checked="" type="checkbox"/> NO Measure ment: 1" @ JOINTS</p>			<ul style="list-style-type: none"> • Replace or move grate
	<p>Is the long dimension perpendicular to the dominant direction of travel? [302.3]</p>	<p><input checked="" type="checkbox"/> YES <input type="checkbox"/> NO Measure ment:</p>			
<p>1.124</p>	<p>Is the running slope no steeper than 1:20, i.e. for every inch of height change there are at least 20 inches of route run? [403.3]</p> <p>Note: If the running slope is steeper than 1:20, treat as a ramp and add features such as edge protection and</p>	<p><input checked="" type="checkbox"/> YES <input type="checkbox"/> NO Measure ment:</p>		 <p>Photo #:</p>	<ul style="list-style-type: none"> • Regrade to 1:20 max. • Rebuild to 1:20 max.
<p>1.125</p>	<p>Is the cross slope no steeper than 1:48? [403.3]</p>	<p><input checked="" type="checkbox"/> YES <input type="checkbox"/> NO Measure ment:</p>		<p>Photo #:</p>	<ul style="list-style-type: none"> • Regrade to 1:48 max.

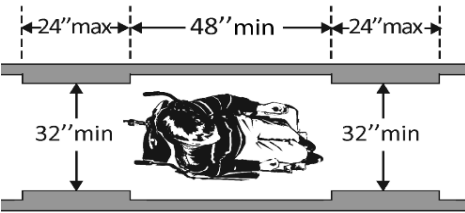
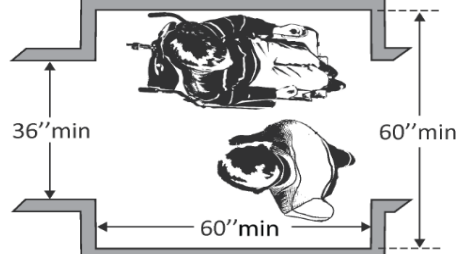
Accessible Route to Recreational Boating Facilities						
1.120	Is the route stable, firm and slip-resistant? [302.1]	<input checked="" type="checkbox"/> YES <input type="checkbox"/> NO	Material ASPHALT CONC		Photo #: 	<ul style="list-style-type: none"> • Repair uneven paving • Fill small bumps and breaks with patches • Replace gravel with asphalt or other surface
1.121	Is the route at least 36 inches wide? [403.5.1]	<input checked="" type="checkbox"/> YES <input type="checkbox"/> NO	Measure ment: 68"		Photo #: 	<ul style="list-style-type: none"> • Change or move landscaping, furnishings or other items • Widen route
	Note: The accessible route can narrow to 32 inches min. for a max. of 24 inches. These narrower portions of the route must be at least 48 inches from each other.	<input checked="" type="checkbox"/> YES <input type="checkbox"/> NO	Measure ment:		Photo #: 	<ul style="list-style-type: none"> • Change or move obstacles or other items • Widen route
1.122	If the route is greater than 200 feet in length and less than 60 inches wide, is there a passing space no less than 60 x 60 inches? [403.5.3]	<input checked="" type="checkbox"/> YES <input type="checkbox"/> NO	Measure ment:		Photo #: 	<ul style="list-style-type: none"> • Widen route for passing space

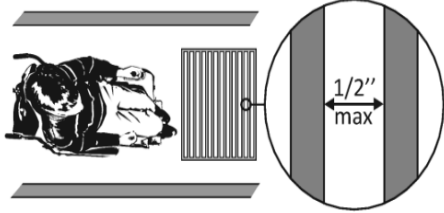
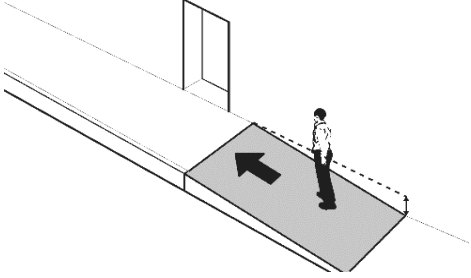
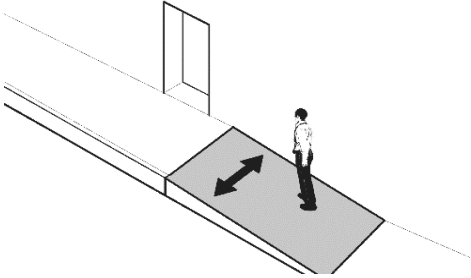
<p>1.123</p>	<p>If there are grates or openings on the route, are the openings no larger than 1/2 inches?</p>	<p><input type="checkbox"/> YES <input checked="" type="checkbox"/> NO</p> <p>Measure ment: 1" AT JOINTS</p>		<p>Photo #:</p>	<ul style="list-style-type: none"> • Replace or move grate
	<p>Is the long dimension perpendicular to the dominant direction of travel? [302.3]</p>	<p><input checked="" type="checkbox"/> YES <input type="checkbox"/> NO</p> <p>Measure ment:</p>		<p>Photo #:</p>	
<p>1.124</p>	<p>Is the running slope no steeper than 1:20, i.e. for every inch of height change there are at least 20 inches of route run? [403.3]</p> <p>Note: If the running slope is steeper than 1:20, treat as a ramp and add features such as edge protection and handrails.</p>	<p><input checked="" type="checkbox"/> YES <input type="checkbox"/> NO</p> <p>Measure ment:</p>		<p>Photo #:</p>	<ul style="list-style-type: none"> • Regrade to 1:20 max.
<p>1.125</p>	<p>Is the cross slope no steeper than 1:48? [403.3]</p>	<p><input checked="" type="checkbox"/> YES <input type="checkbox"/> NO</p> <p>Measure ment:</p>		<p>Photo #:</p>	<ul style="list-style-type: none"> • Regrade to 1:48 max.

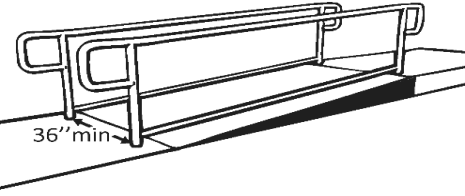
Ramps and Gangways					
<p>1.130</p>	<p>If there is a ramp is it at least 36 inches wide? [405.5]</p> <p>Note: If there are handrails, measure between the handrails.</p>	<p><input checked="" type="checkbox"/> YES <input type="checkbox"/> NO</p> <p>Measure ment:</p>		<p>Photo #:</p>	<ul style="list-style-type: none"> • Alter ramp
<p>1.131</p>	<p>Is the surface stable, firm and slip resistant? [405.4]</p>	<p><input checked="" type="checkbox"/> YES <input type="checkbox"/> NO</p> <p>Material</p> <p>BOARDS</p> <p>@</p> <p>GNGWY</p> <p>CONC @</p> <p>RAMP</p>		<p>Photo #:</p>	<ul style="list-style-type: none"> • Resurface ramp

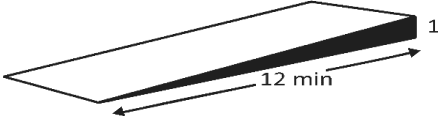
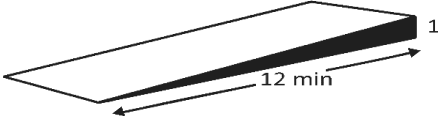
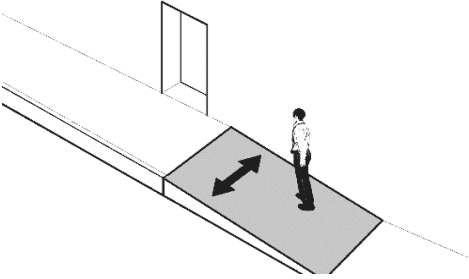
<p>1.132</p>	<p>For each section of the ramp or Gangway, is the running slope no greater than 1:12, i.e. for every inch of height change there are at least 12 inches of ramp run? [405.2] AND</p>	<p><input checked="" type="checkbox"/> YES <input type="checkbox"/> NO Measure ment:</p>		<p>Photo #:</p>	<ul style="list-style-type: none"> • Relocate ramp • Lengthen ramp to decrease slope <p>NOTE: Where the total length of a gangway or series of gangways serving as part of a required accessible route is 80 feet (24 m) minimum, gangways shall not be required to comply with 405.2.</p>
	<p>(Except for Gangways) No greater than 30" rise? [405.6] Note: Rises no greater than 3 inches with a slope no steeper than 1:8 and rises no greater than 6 inches with a slope no steeper than 1:10 are permitted when such slopes are necessary due to space limitations.</p>	<p><input checked="" type="checkbox"/> YES <input type="checkbox"/> NO Measure ment:</p>		<p>Photo #:</p>	<p>Where facilities contain fewer than 25 boat slips and the total length of the gangway or series of gangways serving as part of a required accessible route is 30 feet (9145 mm) minimum, gangways shall not be required to comply with 405.2.</p>
<p>1.133</p>	<p>Is the cross slope no steeper than 1:48? [405.3]</p>	<p><input type="checkbox"/> YES <input checked="" type="checkbox"/> NO Measure ment: 2.7% @ PIER</p>		<p>Photo #:</p>	<ul style="list-style-type: none"> • Modify to 1:48 max. <p>NOTE: The cross slope specified in 403.3 and 405.3 for gangways, transition plates, and floating piers that are part of accessible routes shall be measured in the static position</p>

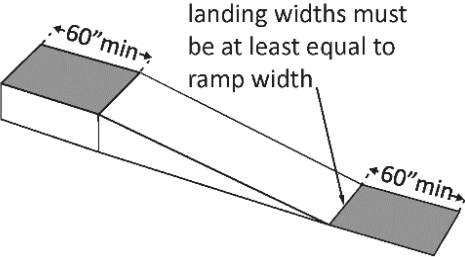
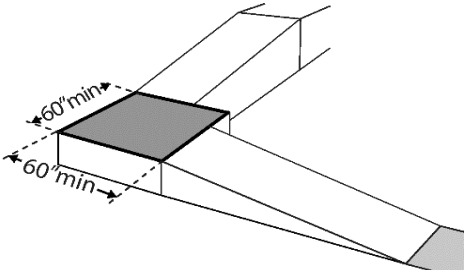
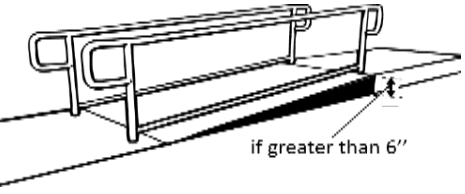
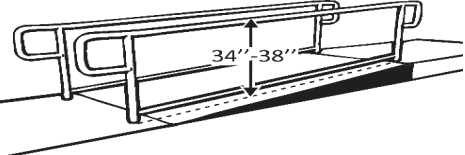
<p>1.134</p>	<p>Is there a level landing that is at least 60 inches long and at least as wide as the ramp:</p> <p>At the top of the ramp?</p> <p>At the bottom of the ramp? [405.7.2, 405.7.3]</p>	<p><input checked="" type="checkbox"/> YES <input type="checkbox"/> NO</p> <p>Measure ment:</p> <p><input checked="" type="checkbox"/> YES <input type="checkbox"/> NO</p> <p>Measure ment:</p>		<p>Photo #:</p>	<ul style="list-style-type: none"> • Alter ramp • Relocate ramp <p>NOTE: Where gangways connect to transition plates, landings specified by 405.7 shall not be required.</p>
<p>1.135</p>	<p>Is there a level landing where the ramp changes direction that is at least 60 x 60 inches? [405.7.4]</p>	<p><input type="checkbox"/> YES <input type="checkbox"/> NO</p> <p>Measure ment:</p> <p>N/A</p>		<p>Photo #:</p>	<ul style="list-style-type: none"> • Alter ramp • Increase landing size
<p>1.136</p>	<p>If the ramp has a rise higher than 6 inches, are there handrails on both sides? [405.8]</p> <p>Note: Curb ramps are not required to have handrails.</p>	<p><input type="checkbox"/> YES <input checked="" type="checkbox"/> NO</p> <p>Measure ment:</p>		<p>Photo #:</p>	<ul style="list-style-type: none"> • Add handrails
<p>1.137</p>	<p>Is the top of the handrail gripping surface no less than 34 inches and no greater than 38 inches above the ramp surface? [505.4]</p>	<p><input type="checkbox"/> YES <input checked="" type="checkbox"/> NO</p> <p>Measure ment:</p>		<p>Photo #:</p>	<ul style="list-style-type: none"> • Reconfigure or replace handrails • Adjust handrail height

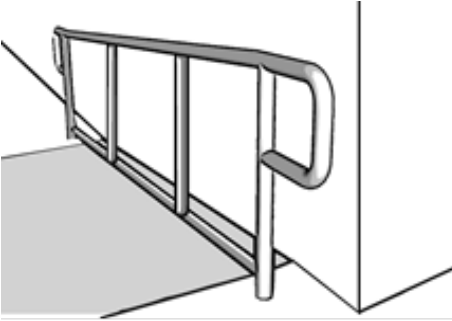
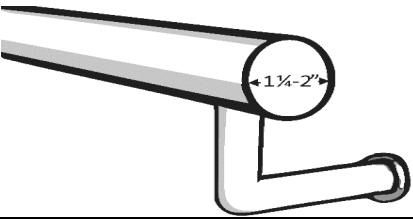
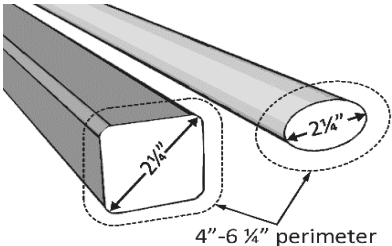
<p>1.138</p>	<p>Is the handrail gripping surface continuous and not obstructed along the top or sides? [505.3]</p>	<p><input type="checkbox"/> YES <input checked="" type="checkbox"/> NO</p>		<p>Photo #:</p>	<ul style="list-style-type: none"> • Reconfigure or replace handrails
	<p>If there are obstructions, is the bottom of the gripping surface obstructed no greater than 20%? [505.6]</p>	<p><input type="checkbox"/> YES <input checked="" type="checkbox"/> NO Measurement:</p>			
<p>1.139</p>	<p>If the handrail gripping surface is circular, is it no less than 1 ¼ inches and no greater than 2 inches in diameter? [505.7.1]</p>	<p><input type="checkbox"/> YES <input checked="" type="checkbox"/> NO Measurement:</p>		<p>Photo #:</p>	<ul style="list-style-type: none"> • Replace handrails
<p>1.140</p>	<p>If the handrail gripping surface is non-circular: Is the perimeter no less than 4 inches and no greater than 6 ¼ inches?</p>	<p><input type="checkbox"/> YES <input checked="" type="checkbox"/> NO Measurement:</p>		<p>Photo #:</p>	<ul style="list-style-type: none"> • Replace handrails
	<p>Is the cross section no greater than 2 ¼ inches? [505.7.2]</p>	<p><input type="checkbox"/> YES <input checked="" type="checkbox"/> NO Measurement:</p>			

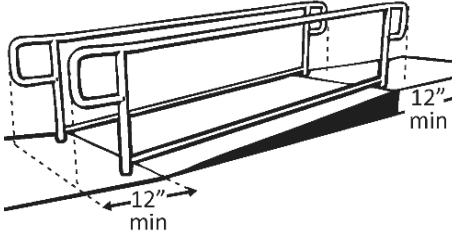
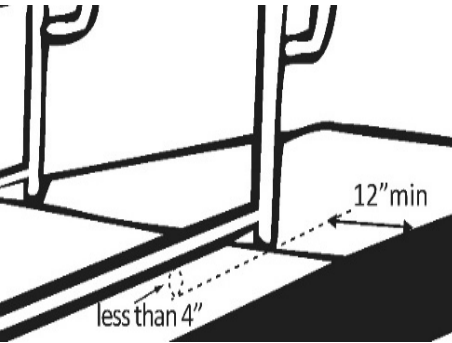
<p>1.141</p>	<p>Does the handrail: Extend at least 12 inches horizontally beyond the top of the ramp?</p>	<p><input type="checkbox"/> YES <input checked="" type="checkbox"/> NO Measure ment:</p>		<p>Photo #:</p>	<ul style="list-style-type: none"> • Alter handrails • Replace Handrails <p>NOTE: Where gangways and transition plates connect and are required to have handrails, handrail extensions shall not be required. Where handrail extensions are provided on gangways or transition plates, the handrail extensions shall not be required to be parallel with the ground or floor surface.</p>
<p>and Bottom of the ramp?</p>	<p><input type="checkbox"/> YES <input checked="" type="checkbox"/> NO Measure ment:</p>				
<p>Return to a wall, guard, or landing surface? [505.10.1]</p> <p>Note: If a 12 inch extension would be a hazard (in circulation path) it is not required.</p>	<p><input type="checkbox"/> YES <input checked="" type="checkbox"/> NO Measure ment:</p>				
<p>1.142</p>	<p>To prevent wheelchair casters and crutch tips from falling off: Does the surface of the ramp extend at least 12 inches beyond the inside face of the handrail?</p>	<p><input type="checkbox"/> YES <input checked="" type="checkbox"/> NO Measure ment:</p>		<p>Photo #:</p>	<ul style="list-style-type: none"> • Add curb • Add barrier • Extend ramp width
<p>Or Is there a curb or barrier that prevents the passage of a 4-inch diameter sphere? [405.9.1, 405.9.2]</p>	<p><input type="checkbox"/> YES <input checked="" type="checkbox"/> NO Measure ment:</p>				

ADA Checklist for Existing

Priority 2 - Access to Goods & Services

Based on the 2010 ADA Standards for Accessible Design

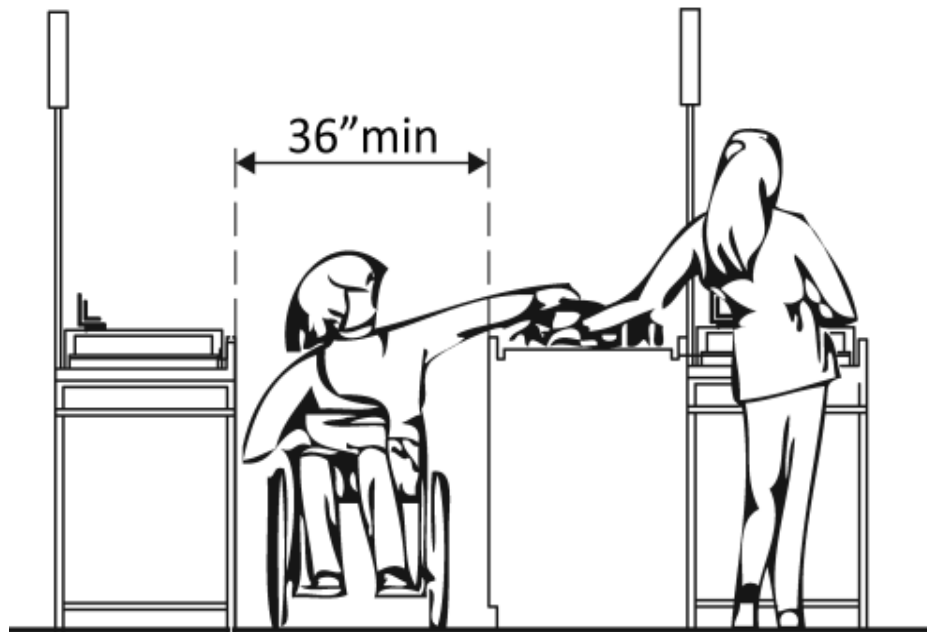

Project: ADA Transition Plan

Building: Jetty Landing (10th St) Boat Launch

Location: Everett, WA



Date: 1/20/2021

Surveyors: Lauri Strauss, AIA, LEED AP BD&C
President, CEO, design2 LAST, inc

Contact Information: o. 425-673-7269 c. 907-317-5040



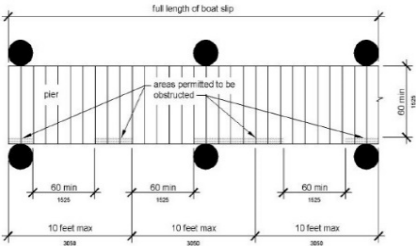
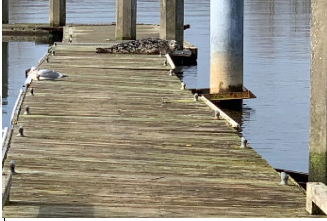
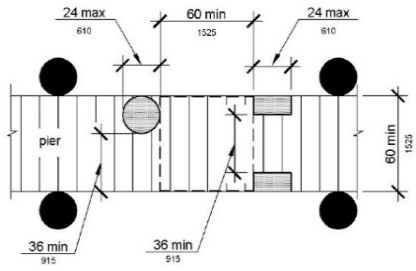
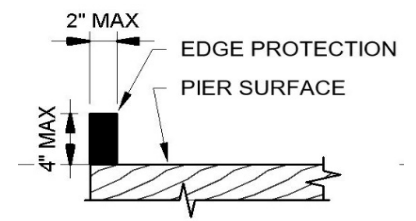

543 Main St, Suite 101, Edmonds, WA 98020

The layout of the building should allow people with disabilities to obtain goods and services and to participate in activities without assistance.

Recreational Boating Facilities																																	
<p>2.300</p>	<p>Is there an adequate number of accessible Boat Slips provided? (235.2) NOTE: Where the number of boat slips is not identified, each 40 feet (12m) of boat slip edge provided along the perimeter of the pier shall be counted as one boat slip</p>	<p><input checked="" type="checkbox"/> YES <input type="checkbox"/> NO Number (11*6) TOTAL: 66 ACCBL: 4</p>	<table border="1"> <thead> <tr> <th>Total Number of Boat Slips Provided in Facility</th> <th>Minimum Number of Required Accessible Boat Slips</th> </tr> </thead> <tbody> <tr><td>1 to 25</td><td>1</td></tr> <tr><td>26 to 50</td><td>2</td></tr> <tr><td>51 to 100</td><td>3</td></tr> <tr><td>101 to 150</td><td>4</td></tr> <tr><td>151 to 300</td><td>5</td></tr> <tr><td>301 to 400</td><td>6</td></tr> <tr><td>401 to 500</td><td>7</td></tr> <tr><td>501 to 600</td><td>8</td></tr> <tr><td>601 to 700</td><td>9</td></tr> <tr><td>701 to 800</td><td>10</td></tr> <tr><td>801 to 900</td><td>11</td></tr> <tr><td>901 to 1000</td><td>12</td></tr> <tr><td>1001 and over</td><td>12, plus 1 for every 100, or fraction thereof, over 1000</td></tr> </tbody> </table>	Total Number of Boat Slips Provided in Facility	Minimum Number of Required Accessible Boat Slips	1 to 25	1	26 to 50	2	51 to 100	3	101 to 150	4	151 to 300	5	301 to 400	6	401 to 500	7	501 to 600	8	601 to 700	9	701 to 800	10	801 to 900	11	901 to 1000	12	1001 and over	12, plus 1 for every 100, or fraction thereof, over 1000	 <p>Photo #:</p>	<ul style="list-style-type: none"> • Add more slips • Modify existing slips
Total Number of Boat Slips Provided in Facility	Minimum Number of Required Accessible Boat Slips																																
1 to 25	1																																
26 to 50	2																																
51 to 100	3																																
101 to 150	4																																
151 to 300	5																																
301 to 400	6																																
401 to 500	7																																
501 to 600	8																																
601 to 700	9																																
701 to 800	10																																
801 to 900	11																																
901 to 1000	12																																
1001 and over	12, plus 1 for every 100, or fraction thereof, over 1000																																
<p>2.301</p>	<p>Are the accessible Boat Slips dispersed throughout the various types of boat slips provided?</p>	<p><input checked="" type="checkbox"/> YES <input type="checkbox"/> NO</p>	<p>Types Include: single berths and double berths shallow water or deep water, transient or longer-term lease, covered or uncovered; and whether slips are equipped with features such as telephone, water, electricity or cable connections.</p>	 <p>Photo #:</p>	<ul style="list-style-type: none"> • Add more slips • Modify existing slips 																												
<p>2.302</p>	<p>Are at least 5 percent, but no fewer than one, of the boarding piers accessible?</p>	<p><input checked="" type="checkbox"/> YES <input type="checkbox"/> NO Number TOTAL: 13 LANES 1 ADA ACCBL: MARKED</p>		<p>Photo #:</p>	<ul style="list-style-type: none"> • Modify pier • Provide new pier 																												

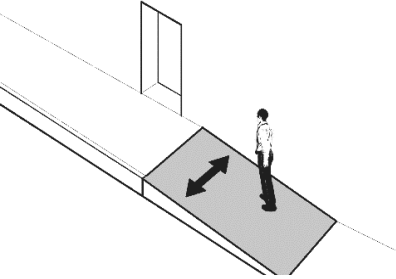
Boat Slips					
2.303	Does each Boat slip provide no less than 60" wide clear pier space?	<input checked="" type="checkbox"/> YES <input type="checkbox"/> NO Measure ment:			<ul style="list-style-type: none"> • Add more slips • Modify existing slips
	and Is the Pier Space at least as long as the boat slips?	<input checked="" type="checkbox"/> YES <input type="checkbox"/> NO Measure ment:			
2.304	Does each 10 feet (3050 mm) maximum of linear pier edge serving boat slips contain at least one continuous clear opening 60 inches (1525 mm) wide minimum?	<input checked="" type="checkbox"/> YES <input type="checkbox"/> NO Measure ment:			<ul style="list-style-type: none"> • Modify pier • Provide new pier
2.305	If the clear pier space is no less than 36 inches (915 mm) wide minimum, for a length of 24 inches (610 mm) maximum, are the 36" wide segments separated by segments that are 60 inches (1525 mm) wide minimum and 60 inches (1525 mm) long minimum?	<input checked="" type="checkbox"/> YES <input type="checkbox"/> NO Measure ment:			<ul style="list-style-type: none"> • Modify pier • Remove obstacles • Provide new pier
2.306	If edge protection is provided at the clear openings, is it no more than 4 inches (100 mm) high maximum and 2 inches (51 mm) wide maximum?	<input checked="" type="checkbox"/> YES <input type="checkbox"/> NO Measure ment:			<ul style="list-style-type: none"> • Modify edge • Remove edge protection

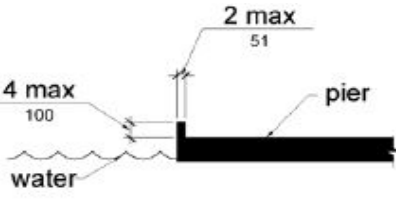
Boarding Piers						
2.307	Does each Boarding Pier provide no less than 60" wide clear pier space?	<input checked="" type="checkbox"/> YES <input type="checkbox"/> NO Measure ment:			Photo:	<ul style="list-style-type: none"> • Add more slips • Modify existing slips
	and Is the Boarding Pier Space at least as long as the boat slips?	<input checked="" type="checkbox"/> YES <input type="checkbox"/> NO Measure ment:				
2.308	Does each 10 feet (3050 mm) maximum of linear boarding pier edge contain at least one continuous clear opening 60 inches (1525 mm) wide minimum?	<input checked="" type="checkbox"/> YES <input type="checkbox"/> NO Measure ment:			Photo #:	<ul style="list-style-type: none"> • Modify pier • Provide new pier
2.309	If the clear pier space is no less than 36 inches (915 mm) wide minimum, for a length of 24 inches (610 mm) maximum, are the 36" wide segments separated by segments that are 60 inches (1525 mm) wide minimum and 60 inches (1525 mm) long minimum?	<input type="checkbox"/> YES <input type="checkbox"/> NO Measure ment: N/A			Photo #:	<ul style="list-style-type: none"> • Modify pier • Remove obstacles • Provide new pier

<p>2.310</p>	<p>Is the cross slope of the floating pier no steeper than 1:48 (measured in the static position)? [403.3]</p>	<p><input type="checkbox"/> YES <input checked="" type="checkbox"/> NO</p> <p>Measurement:</p>		 <p>Photo #:</p>	<ul style="list-style-type: none"> • Replace/repair dock floats to correct slope to 1:48 max. in static position
<p>2.311</p>	<p>If edge protection is provided at the clear openings, is it no more than 4 inches (100 mm) high maximum and 2 inches (51 mm) wide maximum?</p>	<p><input checked="" type="checkbox"/> YES <input type="checkbox"/> NO</p> <p>Measurement:</p>		 <p>Photo #:</p>	<ul style="list-style-type: none"> • Modify edge • Remove edge protection



3. Jetty Landing Park and Jetty Island Ferry Dock

DATE OF EVALUATION

1/20/2021

Figure 6. Recreational Facilities to Be Assessed for ADA Compliance - Phase I



ADA Evaluation

FOR

Jetty Landing Park & Jetty Island Ferry Dock

Port of Everett

ADA Transition Plan



Based on the 2010 ADA Standards for Accessible Design

Completed by:

design2 LAST, inc

534 Main St, Suite 101
Edmonds, WA 98020

Notes Regarding ADA Evaluation for this facility

Each file contains an aerial view of the site as shown on Google. If plans for the facilities were available, they are included. If room names or numbers are not indicated on those plans, fictional room names and numbers were given to spaces to correlate them to the enclosed checklists. These are intended to be used for the purpose of locating which rooms pertain to which portion of the checklist, and may or may not represent the actual room numbers and names at the facility.

How to read these checklists:

1. The 1st column is the identity mark, typically the priority number (1, 2, 3, or 4) followed by an identifying number. These may or may not be in order depending on whether non relevant rows have been hidden.
2. The 2nd column describes the compliance issue in the form of a question. The compliant measurement or count is identified in the question. If the response to the question is 'yes' the issue is compliant.
3. The 3rd and 4th columns are the 'yes' and 'no' responses, and measurements taken in the field. If the issue is compliant and the 'yes' box is checked, there may or may not be a measurement included. If the 'no' box is checked, the issue is non-compliant, and a measurement or count will indicate how the issue is noncompliant.

ADA Checklist for Existing Facilities

The Americans with Disabilities Act (ADA) requires state and local governments, businesses and non-profit organizations to provide goods, services and programs to people with disabilities on an equal basis with the rest of the public.

Some people think that only new construction and alterations need to be accessible and that older facilities are "grandfathered," but that's not true. Because the ADA is a civil rights law and not a building code, older facilities are often required to be accessible to ensure that people with disabilities have an equal opportunity to participate.

The ADA has different requirements for state and local governments and for places of public accommodation (businesses and non-profit organizations that serve the public).

Requirements for State and Local Governments

State and local governments must ensure that services, programs and activities, when viewed in their entirety, are accessible to people with disabilities. This is part of public entities' program accessibility obligations. Alterations to older buildings may be needed to ensure program accessibility. Generally this is a greater obligation than "readily achievable barrier removal" the standard that applies to public accommodations. State and local governments are not required to take any action that would result in undue financial and administrative burdens.

State and local governments' ADA obligations for program accessibility are in the Department of Justice's ADA Title II regulations 28 CFR Part 35.150.

Requirements for Places of Public Accommodation

Businesses and non-profit organizations that serve the public must remove architectural barriers when it is "readily achievable" to do so; in other words, when barrier removal is "easily accomplishable and able to be carried out without much difficulty or expense."

The decision of what is readily achievable is made considering the size, type, and overall finances of the public accommodation and the nature and cost of the access improvements needed. Barrier removal that is difficult now may be readily achievable in the future as finances change.

4. The 5th column may contain a pictogram or drawing of the issue being evaluated. This may also contain a sketch of what the evaluator found in the field as it related to the condition being evaluated.

5. The 6th column may contain a photo of the field condition. Only a select number of conditions are photographed to keep the file size manageable.

6. The last column may contains a list of suggested corrections. These are helpful to the cost estimating team but may not reflect the amount of work required to move or replace an item to bring it into compliance. There may be some economy when multiple non-compliance issues can be completed with one action. There may also be several ways to make corrective changes. How changes and corrections are made will depend on several things, most importantly the existing conditions. These typically are addressed in a design process.

7. Some cells are highlighted yellow. The highlighted cells are identifying non-compliance issues. The yellow is used simply to make the non-compliant issues easier to find among the large number of pages.

8. If no boxes are checked, or there is a slash thru the compliance issue, that particular issue does not apply to the instance being evaluated.

Public accommodations' ADA obligations for barrier removal are in the Department of Justice's ADA Title III regulations 28 CFR Part 36.304.

Priorities for Accessibility

The checklist follows the four priorities that are listed in the Department of Justice ADA Title III regulations. These priorities are equally applicable to state and local government facilities.

Priority 1 - Accessible approach and entrance

Priority 2 - Access to goods and services

Priority 3 - Access to public toilet rooms

Priority 4 - Access to other items such as water fountains and public telephones

2010 ADA Standards for Accessible Design

The checklist is based on the 2010 ADA Standards for Accessible Design (2010 Standards). The checklist may not include all sections of the 2010 Standards. Consult the 2010 Standards for situations not covered in the checklist. Full compliance with the 2010 Standards is required only for new construction and alterations.

Safe Harbor – Construction Prior to March 15, 2012

Elements in facilities built or altered before March 15, 2012 that comply with the 1991 ADA Standards for Accessible Design (1991 Standards) are not required to be modified to specifications in the 2010 Standards. For example, the 1991 Standards allow 54 inches maximum for a side reach range to a control such as the operating part of a paper towel dispenser. The 2010 Standards lower that side reach range to 48 inches maximum. If a paper towel dispenser was installed prior to March 15, 2012 with the highest operating part at 54 inches, the paper towel dispenser does not need to be lowered to 48".

What this Checklist is Not

The ADA Title II and III regulations require more than program accessibility and barrier removal. The regulations include requirements for nondiscriminatory policies and practices and for the provision of auxiliary aids and services, such as sign language interpreters for people who are deaf and material in Braille for people who are blind. This checklist does not cover those requirements.

Since this checklist does not include all of the 2010 Standards it is not intended to determine compliance for new construction or facilities being altered.

Resources**U.S. Department of Justice ADA Information**

800-514-0301 voice: 800-514-0383 TTY
www.ada.gov

ADA National Network

800-949-4232 voice/TTY connects to
your regional ADA Center:
www.adata.org

U.S. Access Board

800- 872-2253 voice: 800-993-2822 TTY
www.access-board.gov

[ADA Title III Regulations 28 CFR Part 36
www.ada.gov/regs2010/titleIII_2010/titleII_2010_regulations.htm](http://www.ada.gov/regs2010/titleIII_2010/titleII_2010_regulations.htm)

[2010 ADA Standards for Accessible
Design
www.ada.gov/2010ADASTandards_index.htm](http://www.ada.gov/2010ADASTandards_index.htm)

[1991 ADA Standards for Accessible
Design
www.ada.gov/stdspdf.htm](http://www.ada.gov/stdspdf.htm)

Acknowledgements

The Institute for Human Centered Design and the New England ADA Center created the ADA Checklists. Originals can be accessed at www.adachecklist.org.

What are Public Accommodations?

Under the ADA public accommodations are private entities that own, lease, lease to or operate a place of public accommodation. This means that both a landlord who leases space in a building to a tenant and the tenant who operates a place of public accommodation have responsibilities to remove barriers.

A place of public accommodation is a facility whose operations affect commerce and fall within at least one of the following 12 categories:

- 1) Places of lodging (e.g., inns, hotels, motels, except for owner-occupied establishments renting fewer than six rooms)
- 2) Establishments serving food or drink (e.g., restaurants and bars)
- 3) Places of exhibition or entertainment (e.g., motion picture houses, theaters, concert halls, stadiums)
- 4) Places of public gathering (e.g., auditoriums, convention centers, lecture halls)
- 5) Sales or rental establishments (e.g., bakeries, grocery stores, hardware stores, shopping centers)
- 6) Service establishments (e.g., laundromats, dry-cleaners, banks, barber shops, beauty shops, travel services, shoe repair services, funeral parlors, gas stations, offices of accountants or lawyers, pharmacies, insurance offices, professional offices of health care providers, hospitals)
- 7) Public transportation terminals, depots, or stations (not including facilities relating to air transportation)
- 8) Places of public display or collection (e.g., museums, libraries, galleries)
- 9) Places of recreation (e.g., parks, zoos, amusement parks)
- 10) Places of education (e.g., nursery schools, elementary, secondary, undergraduate, or postgraduate private schools)
- 11) Social service center establishments (e.g., day care centers, senior citizen centers, homeless shelters, food banks, adoption agencies)
- 12) Places of exercise or recreation (e.g., gymnasiums, health spas, bowling alleys, golf courses).

Many of the illustrations are from the U.S. Department of Justice and the U.S. Access Board or are based on illustrations produced by the U.S. Access Board and the U.S. Department of Justice.

New sections added to Appendix A to Chapter 10

F201.4 Requirements Apply to Facilities Constructed or Altered by or on Behalf of Federal Agencies.

The requirements in F216.13, F244 through F248, and 1011 through 1019 shall apply only to facilities constructed or altered by federal agencies or by non-federal entities on federal land on behalf of federal agencies pursuant to a concession contract, partnership agreement, or similar arrangement.

F201.4.1 Documentation and Notification When Exceptions Used for Trails and Beach Access Routes.

Federal agencies shall document the basis for not fully complying with a specific provision in 1017 or 1018 on a portion of a trail or beach access route based on Exception 1 in 1017 or Exception 1 in 1018, and shall maintain the documentation with the records for the trail or beach project. Federal agencies shall notify the Access Board if an entire trail is exempted from complying with 1017 based on Exception 2 in 1017.1, and if a beach access route is not provided based on Exception 2 in 1018.1.6)

F202.3 Alterations. * * * * *

EXCEPTIONS: * * * * *

4. Where elements or spaces are altered in camping facilities, picnic facilities, viewing areas, or trailheads and the circulation path to the altered element or space is not altered, the circulation path shall not be required to comply with 1016.

F202.4 Alterations Affecting Primary Function Areas. * * * * *

EXCEPTIONS: * * * * *

2. Camping facilities, picnic facilities, viewing areas, trailheads, trails, and beach access routes shall not be required to comply with F202.4.

F206.1 General. * * * * *

EXCEPTIONS: 1. Accessible routes shall not be required where outdoor recreation access routes are provided at camping facilities in accordance with F244.5, picnic facilities in accordance with F245.4, viewing areas in accordance with F246.3, or trailheads in accordance with F247.3.2.

2. Accessible routes shall not be required where camping facilities, picnic facilities, viewing areas, or outdoor constructed features are provided on trails.

3. Accessible routes shall not be required where beach access routes are provided in accordance with F248.

F212.3 Sinks. * * * * *

EXCEPTIONS: * * * * *

2. In camping facilities and picnic facilities, sinks shall not be required to comply with F212.3 where a cooktop or conventional range is not provided.

F213.1 General. * * * * *

EXCEPTION: Pit toilets provided on trails and in camping facilities shall not be required to comply with F213

F216.13 Trailhead Signs. Where new trail information signs are provided at trailheads on newly constructed or altered

SUMMARY

Jetty Landing Park & Jetty Island Ferry Dock

The Jetty Landing Park and Jetty Island Ferry Dock (also known as North Guest Dock 8) are located just south of the Jetty Landing (10th Street) Boat Launch. There is a small, adjacent parking lot containing accessible spaces nearest the ferry dock access. This evaluation covers the parking lot, the route from the parking lot to the ferry dock, the gangway and the ferry dock. As noted earlier, the comfort station on the north edge of the parking lot is slated to be replaced in 2021 and the new building will be evaluated in a future evaluation phase.

The signs at the accessible spaces need to be raised. A minimum of one (1) van accessible space should be provided.

There is no identified direct accessible route from the single accessible parking stall east of the comfort station to the comfort station, Marina Waterfront Trail System or the boat launch. This should be added and identified.

The one major issue to be addressed is at the fishing pier. There are no accessible fishing spaces provided on the pier, and the ramp between the trail and the pier is too steep. The rails of the fishing pier need to be removed and rebuilt to comply. Some changes to the ramp at the gangway of the ferry dock need to be made for full compliance to that loading area.

The concrete pads within and around the picnic (kite) shelters appear new and are compliant, although they do not connect to an accessible route in the related parking lots.

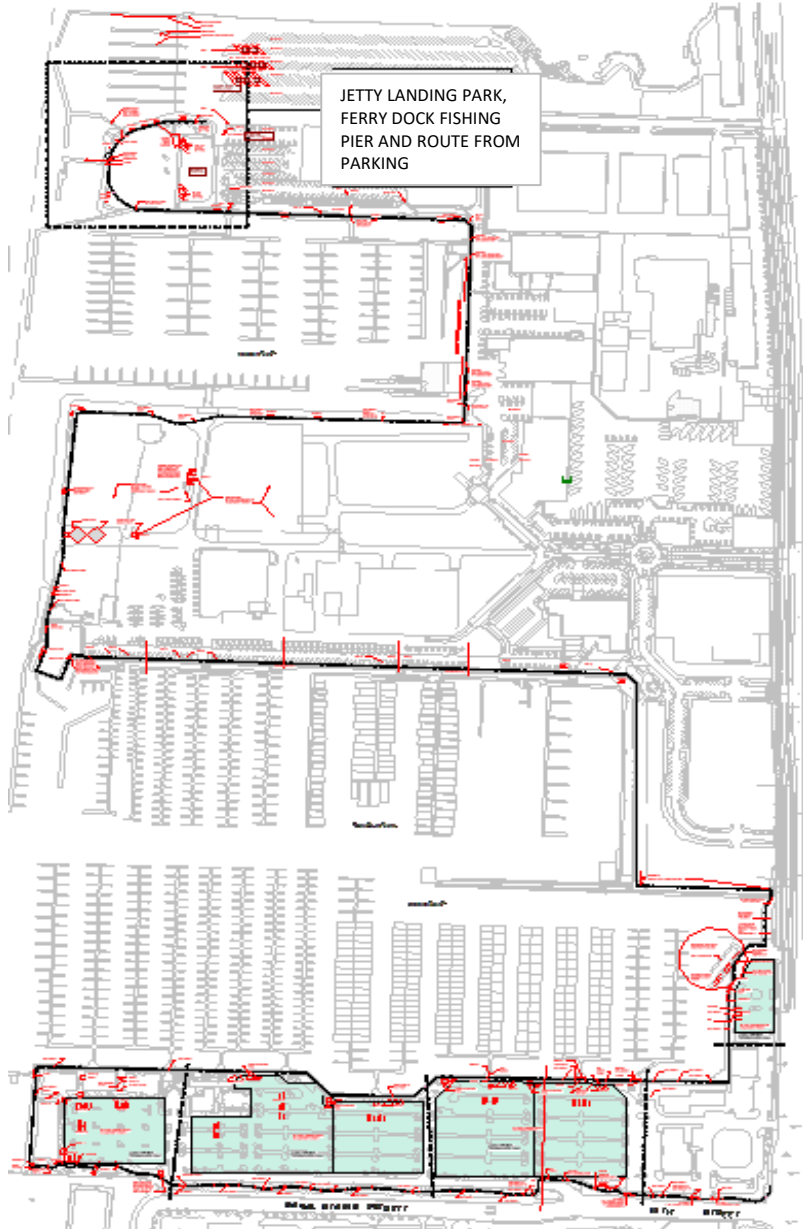

JETTY LANDING PARK, FERRY DOCK FISHING PIER AND ROUTE FROM PARKING

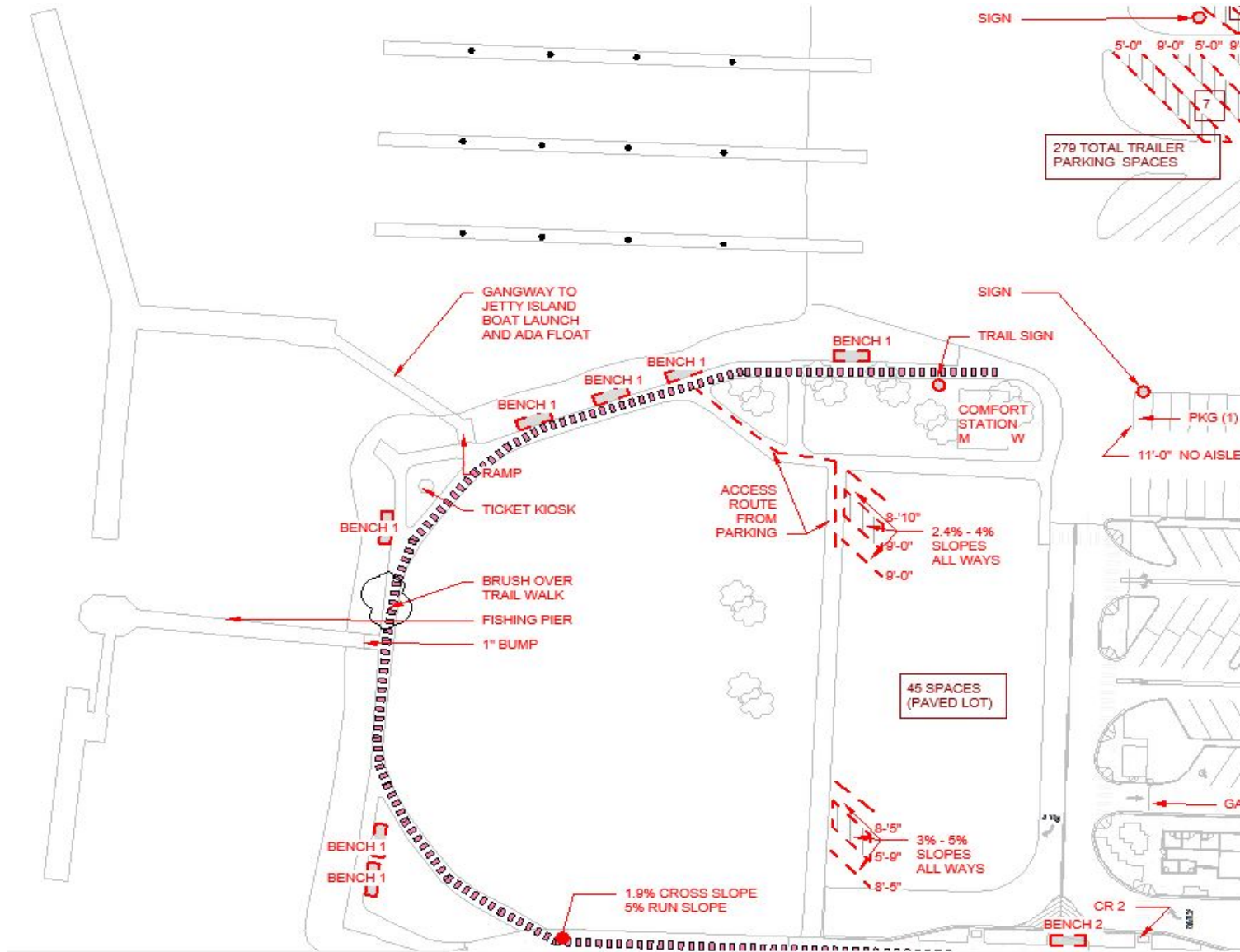

JETTY LANDING PARK, FERRY DOCK, FISHING PIER, AND ACCESS FROM PARKING

ADA Checklist for Existing

Priority 1 - Approach & Entrance

Based on the 2010 ADA Standards for Accessible Design



Project: ADA Transition Plan

Building: Jetty Landing Park & Jetty Island Ferry Dock

Location: Everett, WA

Date: 1/20/2021



Surveyors: Lauri Strauss, AIA, LEED AP BD&C
President, CEO, design2 LAST, inc

Contact Information: o. 425-673-7269 c. 907-317-5040

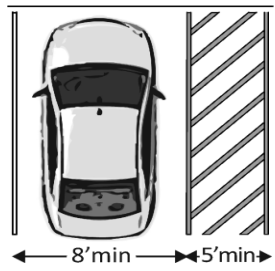

543 Main St, Suite 101, Edmonds, WA 98020

An accessible route from site arrival points and an accessible entrance should be provided for everyone.

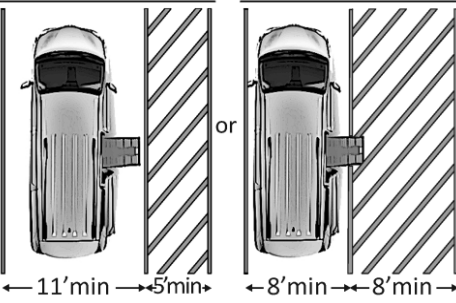
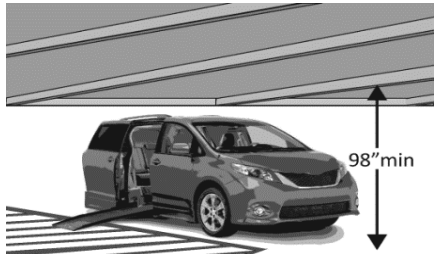
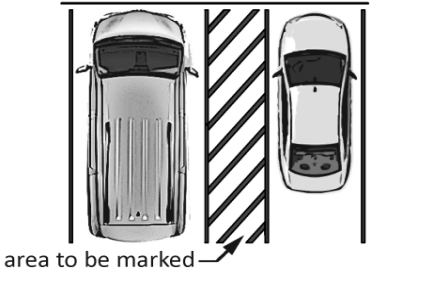

Priority 1 - Approach & Entrance					Comments	Possible Solutions
1.001	Is there at least one route from site arrival points (parking, passenger loading zones, public sidewalks and public transportation stops) that does not require the use of stairs? [See 2010 ADA Standards for Accessible Design – 206.2.1]	<input checked="" type="checkbox"/> YES If yes, location of route:	<input type="checkbox"/> NO		Photo:	<ul style="list-style-type: none"> • Add a ramp • Regrade to 1:20 maximum slope • Add a lift if site constraints prevent other solutions

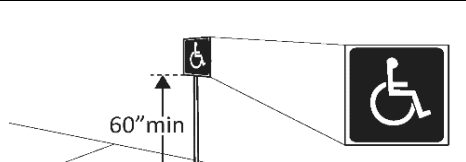
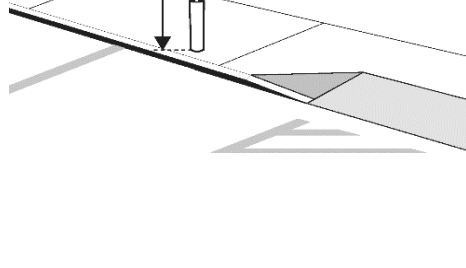
Parking Accessible parking spaces should be identified by size, access aisle and signage.																				
1.100	If parking is provided for the public, are an adequate number of accessible spaces provided? (208.2)	<input type="checkbox"/> YES	<input checked="" type="checkbox"/> NO	<table border="1"> <thead> <tr> <th>Total Spaces</th> <th>Accessible Spaces</th> </tr> </thead> <tbody> <tr> <td>1 - 25</td> <td>1</td> </tr> <tr> <td>26 - 50</td> <td>2</td> </tr> <tr> <td>51 - 75</td> <td>3</td> </tr> <tr> <td>76 - 100</td> <td>4</td> </tr> <tr> <td>1200</td> <td>22</td> </tr> <tr> <td colspan="2">100+ see 2010 Standards 208.2</td> </tr> </tbody> </table>	Total Spaces	Accessible Spaces	1 - 25	1	26 - 50	2	51 - 75	3	76 - 100	4	1200	22	100+ see 2010 Standards 208.2		Photo:	<ul style="list-style-type: none"> Reconfigure by repainting lines
Total Spaces	Accessible Spaces																			
1 - 25	1																			
26 - 50	2																			
51 - 75	3																			
76 - 100	4																			
1200	22																			
100+ see 2010 Standards 208.2																				
1.101	Of the accessible spaces, is at least one a van accessible space? * [208.2.4]	<input type="checkbox"/> YES	<input checked="" type="checkbox"/> NO	*For every 6 or fraction of 6 parking spaces required by the table above, at least 1 should be a van accessible space.	Photo:	<ul style="list-style-type: none"> If constructed before 3/15/2012, parking is compliant if at least 1 in every 8 accessible spaces is van accessible Reconfigure by repainting lines 														
1.102	Are accessible spaces at least 8 feet wide with an access aisle at least 5 feet wide? [502.2, 502.3] Note: Two spaces may share an access aisle. Check state/local requirements; some specify that each space have its own aisle.	<input checked="" type="checkbox"/> YES	<input type="checkbox"/> NO	<p>Measurement:</p> <p>9'-0" S</p> <p>6'-0" A</p> <p>AISLE IS NOT STRIPED</p> 	 <p>Photo:</p>	<ul style="list-style-type: none"> Reconfigure by repainting lines 														



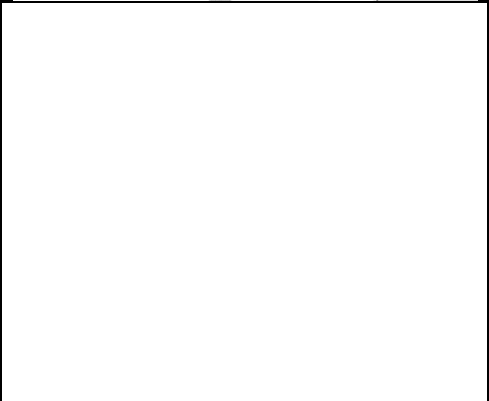

<p>1.103</p>	<p>Is the van accessible space: At least 11 feet wide with an access aisle at least 5 feet wide? Or</p>	<p><input type="checkbox"/> YES <input checked="" type="checkbox"/> NO Measure</p>		<p>Photo:</p>	<ul style="list-style-type: none"> • Reconfigure by repainting lines
	<p>At least 8 feet wide with an access aisle at least 8 feet wide? [502.2]</p>	<p><input type="checkbox"/> YES <input checked="" type="checkbox"/> NO Measure</p>		<p>Photo:</p>	
<p>1.104</p>	<p>Is at least 98 inches of vertical clearance provided for the van accessible space? [502.5]</p>	<p><input checked="" type="checkbox"/> YES <input type="checkbox"/> NO Measure ment:</p>		<p>Photo:</p>	<ul style="list-style-type: none"> • Reconfigure to provide van-accessible space(s)
<p>1.105</p>	<p>Are the access aisles marked so as to discourage parking in them? [502.3.3] Note: The marking method and color may be addressed by state/local requirements.</p>	<p><input type="checkbox"/> YES <input checked="" type="checkbox"/> NO Measure ment:</p>		<p>Photo:</p>	<ul style="list-style-type: none"> • Mark access aisles
<p>1.106</p>	<p>Is the slope of the accessible parking spaces and access aisles no steeper than 1:48 in all directions? [502.4]</p>	<p><input checked="" type="checkbox"/> YES <input type="checkbox"/> NO Measure ment:</p>		<p>Photo:</p>	<ul style="list-style-type: none"> • Regrade surface

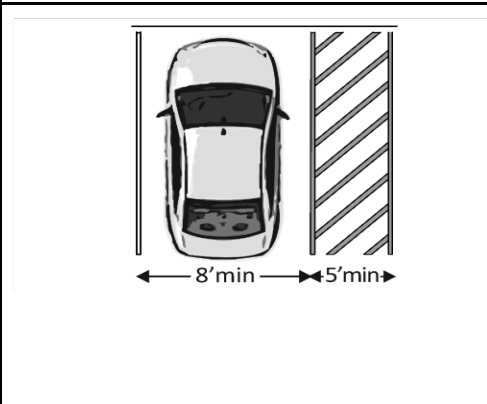

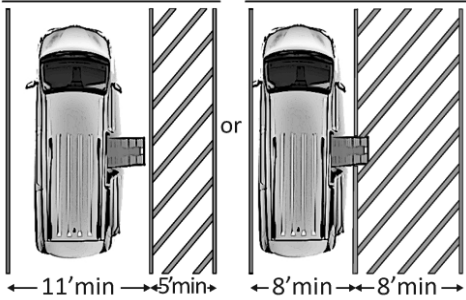
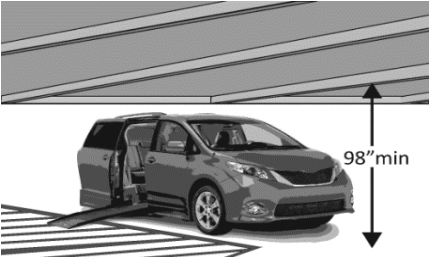
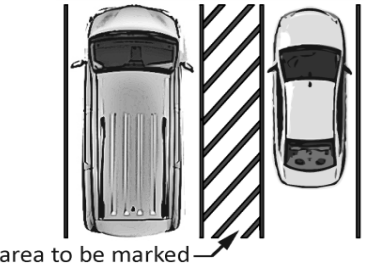
<p>1.107</p>	<p>Do the access aisles adjoin an accessible route? [502.3]</p>	<p><input type="checkbox"/> YES</p>	<p><input checked="" type="checkbox"/> NO</p>		<p>Photo:</p>	<ul style="list-style-type: none"> • Create accessible route • Relocate accessible space
<p>1.108</p>	<p>Are accessible spaces identified with a sign that includes the International Symbol of Accessibility?</p>	<p><input checked="" type="checkbox"/> YES</p>	<p><input type="checkbox"/> NO</p>		<p>Photo:</p>	<ul style="list-style-type: none"> • Install signs
	<p>Is the bottom of the sign at least 60 inches above the ground? [502.6] Note: The International Symbol of Accessibility is not required on the ground.</p>	<p><input type="checkbox"/> YES</p>	<p><input checked="" type="checkbox"/> NO 31"</p>		<p>Photo:</p>	
<p>1.109</p>	<p>Are there signs reading “van accessible” at van accessible spaces? [502.6]</p>	<p><input type="checkbox"/> YES</p>	<p><input checked="" type="checkbox"/> NO</p>		<p>Photo:</p>	<ul style="list-style-type: none"> • Install signs

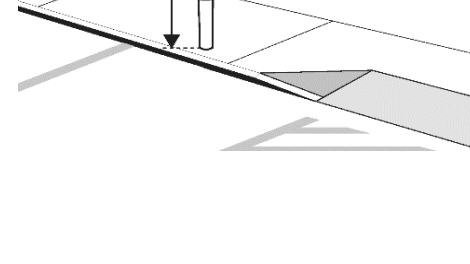
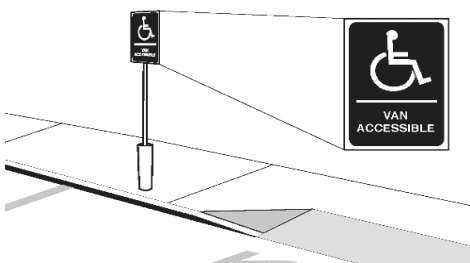

<p>1.110</p>	<p>Of the total parking spaces, are the accessible spaces located on the closest accessible route to the accessible entrance(s)? [208.3.1] Note: If parking serves multiple entrances, accessible parking should be dispersed.</p>	<p><input checked="" type="checkbox"/> YES <input type="checkbox"/> NO</p>		<p>Photo:</p>	<ul style="list-style-type: none"> • Reconfigure spaces
---------------------	--	---	--	---------------	--

Parking Accessible parking spaces should be identified by size, access aisle and signage.																			
1.100	If parking is provided for the public, are an adequate number of accessible spaces provided? (208.2)	<input checked="" type="checkbox"/> YES <input type="checkbox"/> NO Total #: 45 Acsbl #: 4 (2 EA. END)	<table border="1"> <thead> <tr> <th>Total Spaces</th> <th>Accessible Spaces</th> </tr> </thead> <tbody> <tr> <td>1 - 25</td> <td>1</td> </tr> <tr> <td>26 - 50</td> <td>2</td> </tr> <tr> <td>51 - 75</td> <td>3</td> </tr> <tr> <td>76 - 100</td> <td>4</td> </tr> <tr> <td>1200</td> <td>22</td> </tr> <tr> <td colspan="2">100+ see 2010 Standards 208.2</td> </tr> </tbody> </table>	Total Spaces	Accessible Spaces	1 - 25	1	26 - 50	2	51 - 75	3	76 - 100	4	1200	22	100+ see 2010 Standards 208.2		 <p>Photo #: NORTH END</p>	<ul style="list-style-type: none"> • Reconfigure by repainting lines
Total Spaces	Accessible Spaces																		
1 - 25	1																		
26 - 50	2																		
51 - 75	3																		
76 - 100	4																		
1200	22																		
100+ see 2010 Standards 208.2																			
1.101	Of the accessible spaces, is at least one a van accessible space? [208.2.4]	<input type="checkbox"/> YES <input checked="" type="checkbox"/> NO	*For every 6 or fraction of 6 parking spaces required by the table above, at least 1 should be a van accessible space.	 <p>Photo #: SOUTH END</p>	<ul style="list-style-type: none"> • If constructed before 3/15/2012, parking is compliant if at least 1 in every 8 accessible spaces is van accessible • Reconfigure by repainting lines 														
1.102	Are accessible spaces at least 8 feet wide with an access aisle at least 5 feet wide? [502.2, 502.3] Note: Two spaces may share an access aisle. Check state/local requirements; some specify that each space have its own aisle.	<input checked="" type="checkbox"/> YES <input type="checkbox"/> NO Measure ment:		<p>Photo #:</p>	<ul style="list-style-type: none"> • Reconfigure by repainting lines 														

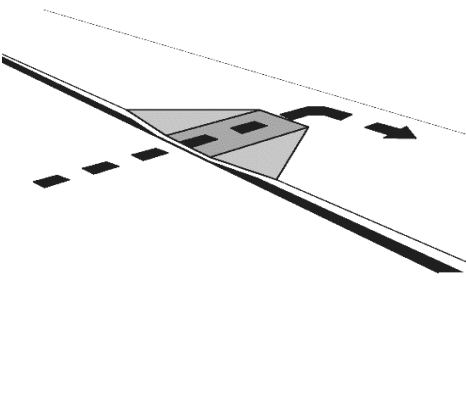
<p>1.103</p>	<p>Is the van accessible space: At least 11 feet wide with an access aisle at least 5 feet wide? Or At least 8 feet wide with an access aisle at least 8 feet wide? [502.2]</p>	<p><input type="checkbox"/> YES <input checked="" type="checkbox"/> NO Measure</p>		<p>Photo #: Photo #:</p>	<ul style="list-style-type: none"> • Reconfigure by repainting lines
<p>1.104</p>	<p>Is at least 98 inches of vertical clearance provided for the van accessible space? [502.5]</p>	<p><input checked="" type="checkbox"/> YES <input type="checkbox"/> NO Measure ment:</p>		<p>Photo #:</p>	<ul style="list-style-type: none"> • Reconfigure to provide van-accessible space(s)
<p>1.105</p>	<p>Are the access aisles marked so as to discourage parking in them? [502.3.3] Note: The marking method and color may be addressed by state/local requirements.</p>	<p><input checked="" type="checkbox"/> YES <input type="checkbox"/> NO Measure ment:</p>		<p>Photo #:</p>	<ul style="list-style-type: none"> • Mark access aisles
<p>1.106</p>	<p>Is the slope of the accessible parking spaces and access aisles no steeper than 1:48 in all directions? [502.4]</p>	<p><input checked="" type="checkbox"/> YES <input type="checkbox"/> NO Measure ment:</p>		<p>Photo #:</p>	<ul style="list-style-type: none"> • Regrade surface

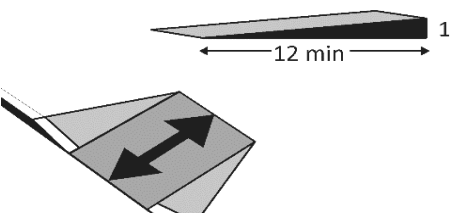
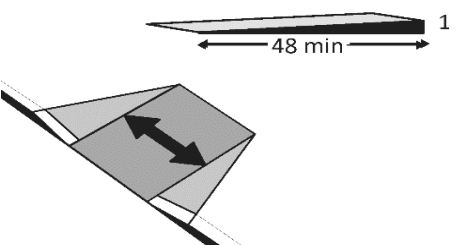
<p>1.107</p>	<p>Do the access aisles adjoin an accessible route? [502.3]</p>	<p><input type="checkbox"/> YES</p>	<p><input checked="" type="checkbox"/> NO @ S END</p>			<ul style="list-style-type: none"> • Create accessible route • Relocate accessible space
<p>1.108</p>	<p>Are accessible spaces identified with a sign that includes the International Symbol of Accessibility?</p>	<p><input checked="" type="checkbox"/> YES</p>	<p><input type="checkbox"/> NO</p>		<p>Photo #:</p>	<ul style="list-style-type: none"> • Install signs
<p>1.108</p>	<p>Is the bottom of the sign at least 60 inches above the ground? [502.6] Note: The International Symbol of Accessibility is not required on the ground.</p>	<p><input type="checkbox"/> YES</p>	<p><input checked="" type="checkbox"/> NO 54" ALL (4)</p>		<p>Photo #:</p>	<ul style="list-style-type: none"> • Install signs
<p>1.109</p>	<p>Are there signs reading "van accessible" at van accessible spaces? [502.6]</p>	<p><input type="checkbox"/> YES</p>	<p><input checked="" type="checkbox"/> NO</p>		<p>Photo #:</p>	<ul style="list-style-type: none"> • Install signs
<p>1.110</p>	<p>Of the total parking spaces, are the accessible spaces located on the closest accessible route to the accessible entrance(s)? [208.3.1] Note: If parking serves multiple entrances, accessible parking should be dispersed.</p>	<p><input checked="" type="checkbox"/> YES</p>	<p><input type="checkbox"/> NO</p>		<p>Photo #:</p>	<ul style="list-style-type: none"> • Reconfigure spaces

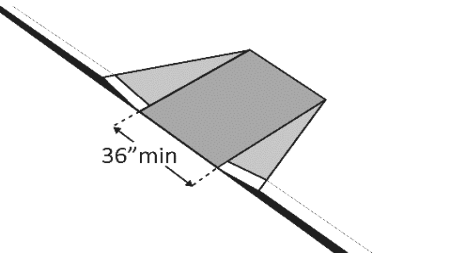
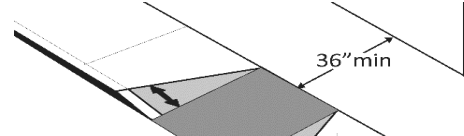
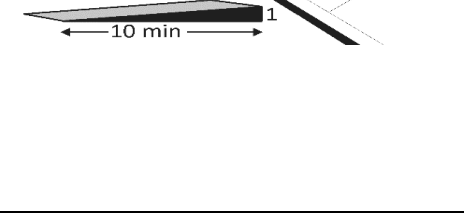

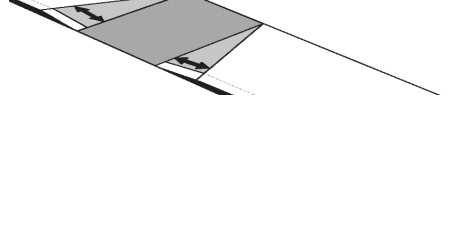
Curb Ramps					
1.111	If the accessible route crosses a curb, is there a curb ramp? [402.2]	<input type="checkbox"/> YES <input checked="" type="checkbox"/> NO	<p style="color: red; text-align: center;">OPENING IN CURB - @ N. END ONLY - NOT SLOPED NOT WIDE ENOUGH</p> 	 <p>Photo #:</p>	<ul style="list-style-type: none"> • Install curb ramp
1.112	Is the running slope of the curb ramp no steeper than 1:12, i.e. for every inch of height change there are at least 12 inches of curb ramp run? [406.1, 405.2]	<input checked="" type="checkbox"/> YES <input type="checkbox"/> NO Measure ment:		<p>Photo #:</p>	<ul style="list-style-type: none"> • Regrade curb ramp
1.113	Is the cross slope of the curb ramp, excluding flares, no steeper than 1:48? [406.1, 405.3]	<input checked="" type="checkbox"/> YES <input type="checkbox"/> NO Measure		<p>Photo #:</p>	<ul style="list-style-type: none"> • Regrade curb ramp

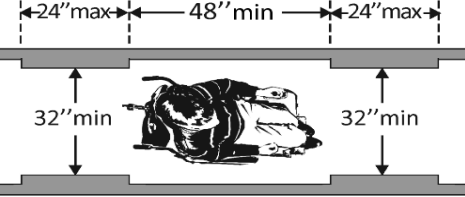
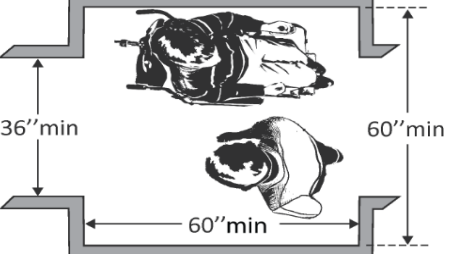
<p>1.114</p>	<p>Is the curb ramp, excluding flares, at least 36 inches wide? [406.1, 405.5]</p>	<p><input checked="" type="checkbox"/> YES <input type="checkbox"/> NO Measure</p>			<ul style="list-style-type: none"> • Widen curb ramp
<p>1.115</p>	<p>At the top of the curb ramp is there a level landing (slope no steeper than 1:48 in all directions) that is at least 36 inches long and at least as wide as the curb ramp? [406.4]</p>	<p><input checked="" type="checkbox"/> YES <input type="checkbox"/> NO Measure</p>			<ul style="list-style-type: none"> • Reconfigure • Add ramp flares
	<p>If there are curb ramp flares, are the slopes of the flares no steeper than 1:10, i.e. for every inch of height change there are at least 10 inches of flare run? [406.3]</p>	<p><input type="checkbox"/> YES <input type="checkbox"/> NO Measure N/A</p>			
<p>1.116</p>	<p>If the landing at the top is less than 36 inches long, are there curb ramp flares?</p>	<p><input type="checkbox"/> YES <input type="checkbox"/> NO Measure N/A</p>			<ul style="list-style-type: none"> • Add ramp flares • Regrade flares
	<p>Are the slopes of the flares no greater than 1:12, i.e. for every inch of height change there are at least 12 inches of flare run? [406.4]</p>	<p><input type="checkbox"/> YES <input type="checkbox"/> NO Measure ment: N/A</p>			

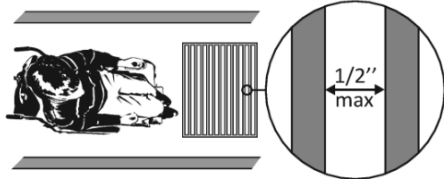
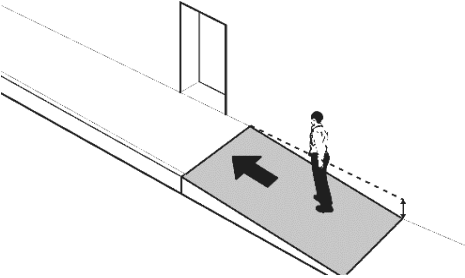
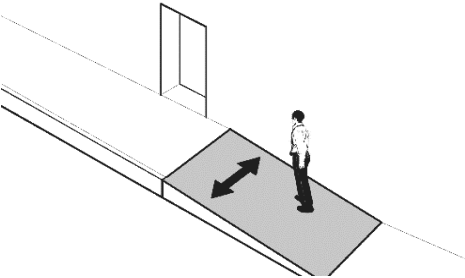
Exterior Accessible Route FROM PARKING LOT TO TRAIL					
1.120	Is the route stable, firm and slip-resistant? [302.1]	<input checked="" type="checkbox"/> YES <input type="checkbox"/> NO Material ASPHALT			<ul style="list-style-type: none"> • Repair uneven paving • Fill small bumps and breaks with patches • Replace gravel with asphalt or other surface
1.121	Is the route at least 36 inches wide? [403.5.1]	<input checked="" type="checkbox"/> YES <input type="checkbox"/> NO Measure ment:			<ul style="list-style-type: none"> • Change or move landscaping, furnishings or other items • Widen route
	Note: The accessible route can narrow to 32 inches min. for a max. of 24 inches. These narrower portions of the route must be at least 48 inches from each other.	<input type="checkbox"/> YES <input type="checkbox"/> NO Measure N/A			
1.122	If the route is greater than 200 feet in length and less than 60 inches wide, is there a passing space no less than 60 x 60 inches? [403.5.3]	<input type="checkbox"/> YES <input type="checkbox"/> NO Measure N/A			<ul style="list-style-type: none"> • Widen route for passing space

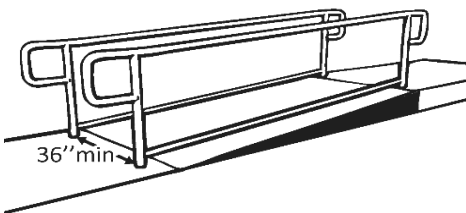
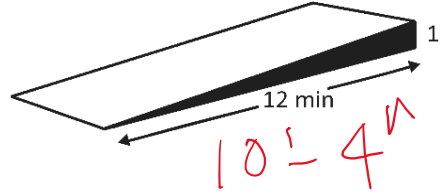
<p>1.123</p>	<p>If there are grates or openings on the route, are the openings no larger than 1/2 inches?</p>	<p><input type="checkbox"/> YES <input type="checkbox"/> NO Measure N/A</p>			<ul style="list-style-type: none"> • Replace or move grate
<p>1.124</p>	<p>Is the long dimension perpendicular to the dominant direction of travel? [302.3]</p> <p>Note: If the running slope is steeper than 1:20, treat as a ramp and add features such as edge protection and handrails.</p>	<p><input type="checkbox"/> YES <input type="checkbox"/> NO Measure ment:</p>			<ul style="list-style-type: none"> • Regrade to 1:20 max.
<p>1.125</p>	<p>Is the cross slope no steeper than 1:48? [403.3]</p>	<p><input checked="" type="checkbox"/> YES <input type="checkbox"/> NO Measure</p>		<p>Photo #:</p>	<ul style="list-style-type: none"> • Regrade to 1:48 max.
<p>1.126</p>	<p>Is the main entrance accessible?</p>	<p><input checked="" type="checkbox"/> YES <input type="checkbox"/> NO</p>			<ul style="list-style-type: none"> • Redesign to make it accessible

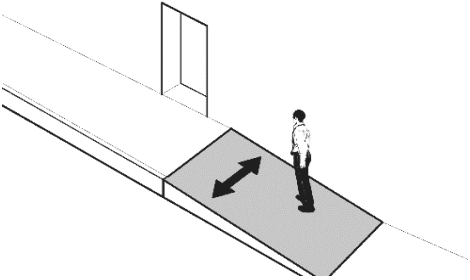
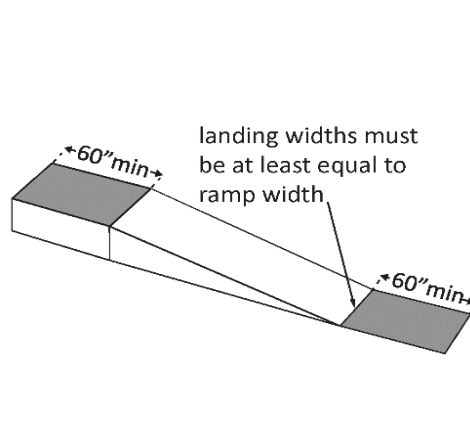
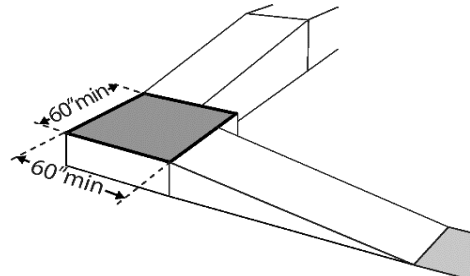
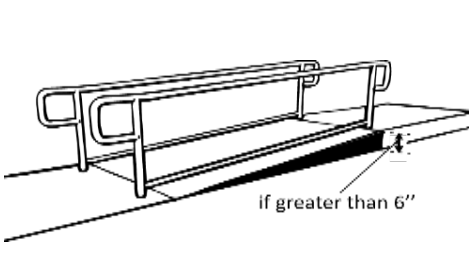
Ramps (Exterior) LEADING TO GANGWAY TO JETTY ISLAND FERRY LAUNCH PIER					
1.130	<p>If there is a ramp is it at least 36 inches wide? [405.5]</p> <p>Note: If there are handrails, measure between the handrails.</p>	<p><input checked="" type="checkbox"/> YES <input type="checkbox"/> NO</p> <p>Measure ment:</p>		<p>Photo #:</p>	<ul style="list-style-type: none"> • Alter ramp
1.131	<p>Is the surface stable, firm and slip resistant? [405.4]</p>	<p><input checked="" type="checkbox"/> YES <input type="checkbox"/> NO</p> <p>Material CONC</p>		<p>Photo #:</p>	<ul style="list-style-type: none"> • Resurface ramp
1.132	<p>For each section of the ramp, is the running slope no greater than 1:12, i.e. for every inch of height change there are at least 12 inches of ramp run? [405.2]</p> <p>AND</p>	<p><input checked="" type="checkbox"/> YES <input type="checkbox"/> NO</p> <p>Measure 6.9%</p>		<p>Photo #:</p>	<ul style="list-style-type: none"> • Relocate ramp • Lengthen ramp to decrease slope
	<p>No greater than 30" rise? [405.6]</p> <p>Note: Rises no greater than 3 inches with a slope no steeper than 1:8 and rises no greater than 6 inches with a slope no steeper than 1:10 are permitted when such slopes are necessary due to space limitations.</p>	<p><input checked="" type="checkbox"/> YES <input type="checkbox"/> NO</p> <p>Measure</p>		<p>Photo #:</p>	

<p>1.133</p>	<p>Is the cross slope no steeper than 1:48? [403.3]</p>	<p><input checked="" type="checkbox"/> YES <input type="checkbox"/> NO</p> <p>Measure <2%</p>			<ul style="list-style-type: none"> • Regrade to 1:48 max.
<p>1.134</p>	<p>Is there a level landing that is at least 60 inches long and at least as wide as the ramp: At the top of the ramp?</p>	<p><input type="checkbox"/> YES <input checked="" type="checkbox"/> NO</p> <p>Measure</p>		<p>Photo #:</p>	<ul style="list-style-type: none"> • Alter ramp • Relocate ramp
<p>1.135</p>	<p>At the bottom of the ramp? [405.7.2, 405.7.3]</p>	<p><input checked="" type="checkbox"/> YES <input type="checkbox"/> NO</p> <p>Measure</p>		<p>Photo #:</p>	<ul style="list-style-type: none"> • Alter ramp • Increase landing size
<p>1.136</p>	<p>Is there a level landing where the ramp changes direction that is at least 60 x 60 inches? [405.7.4]</p>	<p><input type="checkbox"/> YES <input type="checkbox"/> NO</p> <p>Measure N/A</p>		<p>Photo #:</p>	<ul style="list-style-type: none"> • Add handrails
<p>1.136</p>	<p>If the ramp has a rise higher than 6 inches, are there handrails on both sides? [405.8]</p> <p>Note: Curb ramps are not required to have handrails.</p>	<p><input checked="" type="checkbox"/> YES <input type="checkbox"/> NO</p> <p>Measure ment: GANG-WAY</p>		<p>Photo #:</p>	<ul style="list-style-type: none"> • Add handrails

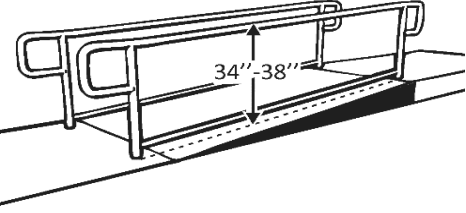
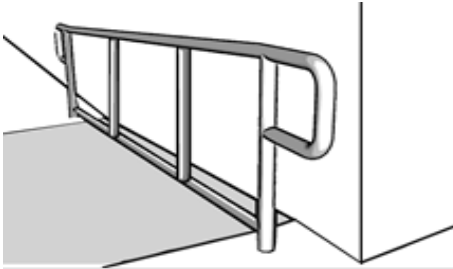
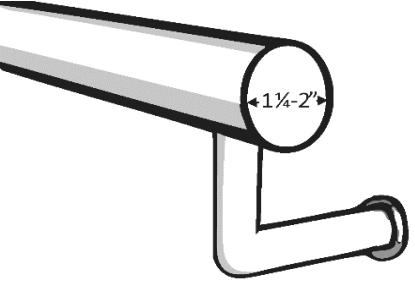
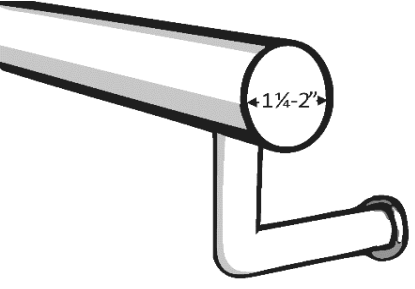

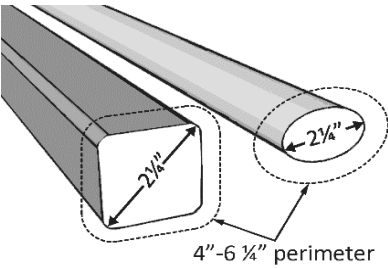
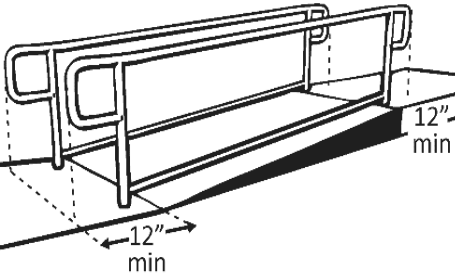
<p>1.137</p>	<p>Is the top of the handrail gripping surface no less than 34 inches and no greater than 38 inches above the ramp surface? [505.4]</p>	<p><input checked="" type="checkbox"/> YES <input type="checkbox"/> NO</p> <p>Measure 36"</p>		<p>Photo #:</p>	<ul style="list-style-type: none"> • Reconfigure or replace handrails • Adjust handrail height
<p>1.138</p>	<p>Is the handrail gripping surface continuous and not obstructed along the top or sides? [505.3]</p>	<p><input checked="" type="checkbox"/> YES <input type="checkbox"/> NO</p>		<p>Photo #:</p>	<ul style="list-style-type: none"> • Reconfigure or replace handrails
<p>1.139</p>	<p>If there are obstructions, is the bottom of the gripping surface obstructed no greater than 20%? [505.6]</p>	<p><input type="checkbox"/> YES <input type="checkbox"/> NO</p> <p>Measure ment: N/A</p>		<p>Photo #:</p>	<ul style="list-style-type: none"> • Replace handrails
<p>1.139</p>	<p>If the handrail gripping surface is circular, is it no less than 1 ¼ inches and no greater than 2 inches in diameter? [505.7.1]</p>	<p><input checked="" type="checkbox"/> YES <input type="checkbox"/> NO</p> <p>Measure ment:</p>		<p>Photo #:</p>	<ul style="list-style-type: none"> • Replace handrails

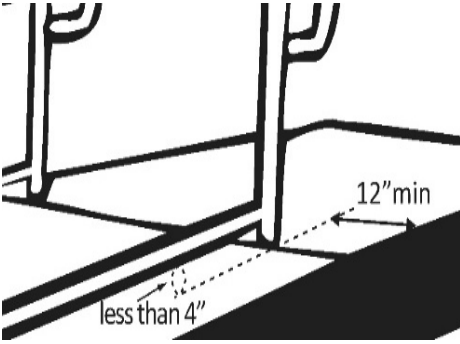
<p>1.140</p>	<p>If the handrail gripping surface is non-circular: Is the perimeter no less than 4 inches and no greater than 6¼ inches?</p>	<p><input type="checkbox"/> YES <input type="checkbox"/> NO Measure ment: N/A</p>		<p>Photo #:</p>	<ul style="list-style-type: none"> • Replace handrails
	<p>Is the cross section no greater than 2¼ inches? [505.7.2]</p>	<p><input type="checkbox"/> YES <input type="checkbox"/> NO Measure ment: N/A</p>			
<p>1.141</p>	<p>Does the handrail: Extend at least 12 inches horizontally beyond the top of the ramp?</p>	<p><input type="checkbox"/> YES <input checked="" type="checkbox"/> NO Measure ment:</p>		<p>Photo #:</p>	<ul style="list-style-type: none"> • Alter handrails • Replace Handrails
	<p>and Bottom of the ramp?</p>	<p><input checked="" type="checkbox"/> YES <input type="checkbox"/> NO Measure ment:</p>			
	<p>Return to a wall, guard, or landing surface? [505.10.1] Note: If a 12 inch extension would be a hazard (in circulation path) it is not required.</p>	<p><input checked="" type="checkbox"/> YES <input type="checkbox"/> NO Measure ment:</p>			

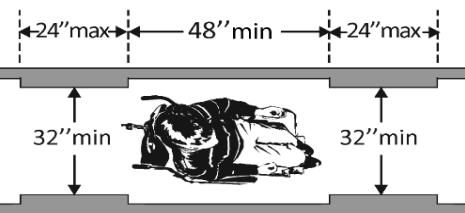
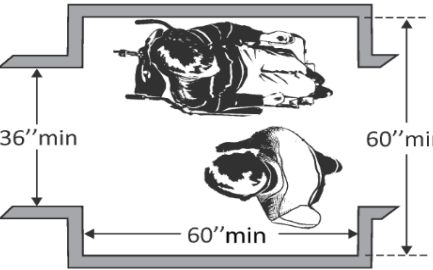
<p>1.142</p>	<p>To prevent wheelchair casters and crutch tips from falling off:</p> <p>Does the surface of the ramp extend at least 12 inches beyond the inside face of the handrail?</p>	<p><input type="checkbox"/> YES <input checked="" type="checkbox"/> NO</p> <p>Measurement:</p>		<p>Photo #:</p>	<ul style="list-style-type: none"> • Add curb • Add barrier • Extend ramp width
<p>Or</p> <p>Is there a curb or barrier that prevents the passage of a 4-inch diameter sphere? [405.9.1, 405.9.2]</p>	<p><input type="checkbox"/> YES <input checked="" type="checkbox"/> NO</p> <p>Measurement:</p>				

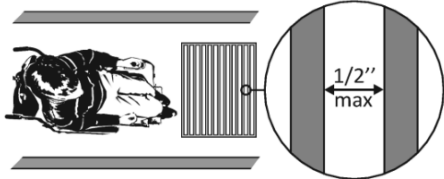
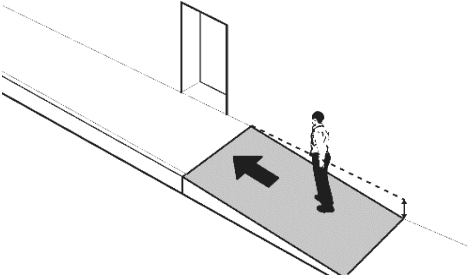
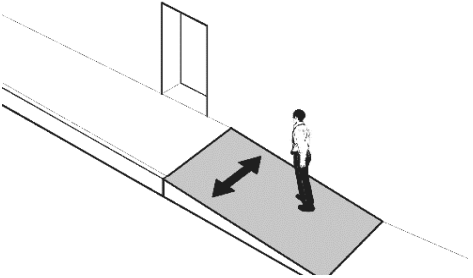
Accessible Route to Recreational Boating Facilities					
1.120	Is the route stable, firm and slip-resistant? [302.1]	<input checked="" type="checkbox"/> YES <input type="checkbox"/> NO Measure ment:		Photo #:	<ul style="list-style-type: none"> • Repair uneven paving • Fill small bumps and breaks with patches • Replace gravel with asphalt or other surface
1.121	Is the route at least 36 inches wide? [403.5.1]	<input checked="" type="checkbox"/> YES <input type="checkbox"/> NO Measure ment:		Photo #:	<ul style="list-style-type: none"> • Change or move landscaping, furnishings or other items • Widen route
	Note: The accessible route can narrow to 32 inches min. for a max. of 24 inches. These narrower portions of the route must be at least 48 inches from each other.	<input type="checkbox"/> YES <input type="checkbox"/> NO Measure N/A			<ul style="list-style-type: none"> • Change or move obstacles or other items • Widen route
1.122	If the route is greater than 200 feet in length and less than 60 inches wide, is there a passing space no less than 60 x 60 inches? [403.5.3]	<input checked="" type="checkbox"/> YES <input type="checkbox"/> NO Measure			<ul style="list-style-type: none"> • Widen route for passing space

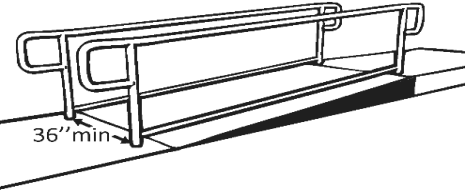
<p>1.123</p>	<p>If there are grates or openings on the route, are the openings no larger than 1/2 inches?</p>	<p><input checked="" type="checkbox"/> YES <input type="checkbox"/> NO</p> <p>Measure</p>		<p>Photo #:</p>	<ul style="list-style-type: none"> • Replace or move grate
	<p>Is the long dimension perpendicular to the dominant direction of travel? [302.3]</p>	<p><input checked="" type="checkbox"/> YES <input type="checkbox"/> NO</p> <p>Measure</p>			
<p>1.124</p>	<p>Is the running slope no steeper than 1:20, i.e. for every inch of height change there are at least 20 inches of route run? [403.3]</p> <p>Note: If the running slope is steeper than 1:20, treat as a ramp and add features such as edge protection and</p>	<p><input checked="" type="checkbox"/> YES <input type="checkbox"/> NO</p> <p>Measure</p>		<p>Photo #:</p>	<ul style="list-style-type: none"> • Regrade to 1:20 max.
<p>1.125</p>	<p>Is the cross slope no steeper than 1:48? [403.3]</p>	<p><input checked="" type="checkbox"/> YES <input type="checkbox"/> NO</p> <p>Measure</p>		<p>Photo #:</p>	<ul style="list-style-type: none"> • Regrade to 1:48 max.

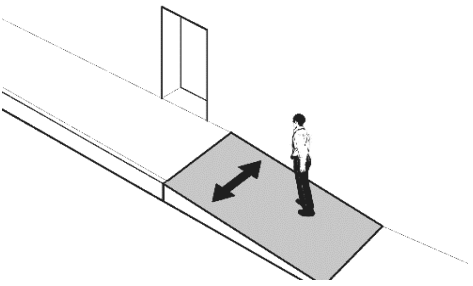
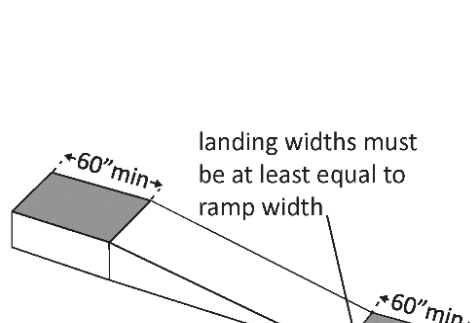
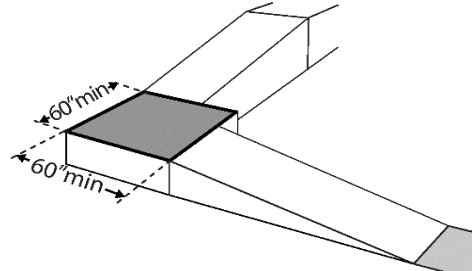

Ramps and Gangways					
1.130	<p>If there is a ramp is it at least 36 inches wide? [405.5]</p> <p>Note: If there are handrails, measure between the handrails.</p>	<p><input checked="" type="checkbox"/> YES <input type="checkbox"/> NO</p> <p>Measure ment:</p>		<p>Photo #:</p>	<ul style="list-style-type: none"> • Alter ramp
1.131	<p>Is the surface stable, firm and slip resistant? [405.4]</p>	<p><input checked="" type="checkbox"/> YES <input type="checkbox"/> NO</p> <p>Material</p>		<p>Photo #:</p>	<ul style="list-style-type: none"> • Resurface ramp
1.132	<p>For each section of the ramp or Gangway, is the running slope no greater than 1:12, i.e. for every inch of height change there are at least 12 inches of ramp run? [405.2] AND</p>	<p><input checked="" type="checkbox"/> YES <input type="checkbox"/> NO</p> <p>Measure ment:</p>		<p>Photo #:</p>	<ul style="list-style-type: none"> • Relocate ramp • Lengthen ramp to decrease slope <p>NOTE: Where the total length of a gangway or series of gangways serving as part of a required accessible route is 80 feet (24 m) minimum, gangways shall not be required to comply with 405.2.</p>
	<p>(Except for Gangways) No greater than 30" rise? [405.6]</p> <p>Note: Rises no greater than 3 inches with a slope no steeper than 1:8 and rises no greater than 6 inches with a slope no steeper than 1:10 are permitted when such slopes are necessary due to space limitations.</p>	<p><input checked="" type="checkbox"/> YES <input type="checkbox"/> NO</p> <p>Measure ment:</p>		<p>Photo #:</p>	<p>Where facilities contain fewer than 25 boat slips and the total length of the gangway or series of gangways serving as part of a required accessible</p>

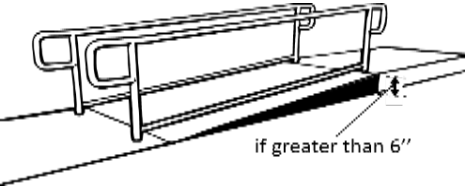
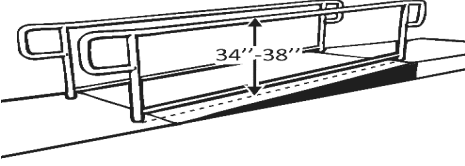
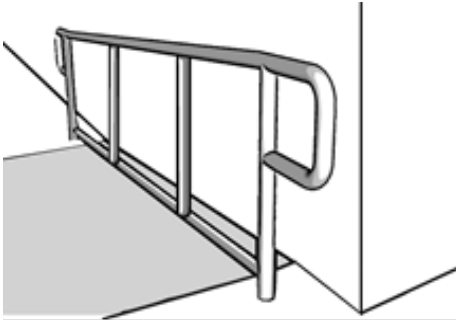
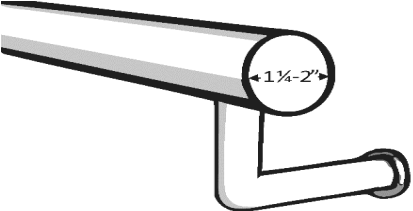
<p>1.133</p>	<p>Is the cross slope no steeper than 1:48? [405.3]</p>	<p><input checked="" type="checkbox"/> YES <input type="checkbox"/> NO Measure ment:</p>		<p>Photo #:</p>	<ul style="list-style-type: none"> • Modify to 1:48 max. <p>NOTE: The cross slope specified in 403.3 and 405.3 for gangways, transition plates, and floating piers that are part of accessible routes shall be measured in the static</p>
<p>1.134</p>	<p>Is there a level landing that is at least 60 inches long and at least as wide as the ramp: At the top of the ramp?</p>	<p><input type="checkbox"/> YES <input checked="" type="checkbox"/> NO Measure ment: RAMP</p>		<p>Photo #:</p>	<ul style="list-style-type: none"> • Alter ramp • Relocate ramp <p>NOTE: Where gangways connect to transition plates, landings specified by 405.7 shall not be required.</p>
	<p>At the bottom of the ramp? [405.7.2, 405.7.3]</p>	<p><input checked="" type="checkbox"/> YES <input type="checkbox"/> NO Measure ment:</p>		<p>Photo #:</p>	
<p>1.135</p>	<p>Is there a level landing where the ramp changes direction that is at least 60 x 60 inches? [405.7.4]</p>	<p><input checked="" type="checkbox"/> YES <input type="checkbox"/> NO Measure ment:</p>		<p>Photo #:</p>	<ul style="list-style-type: none"> • Alter ramp • Increase landing size

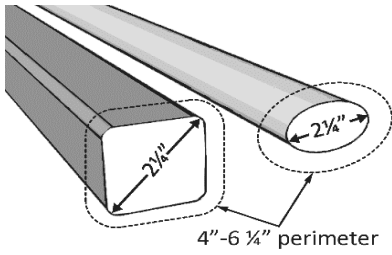
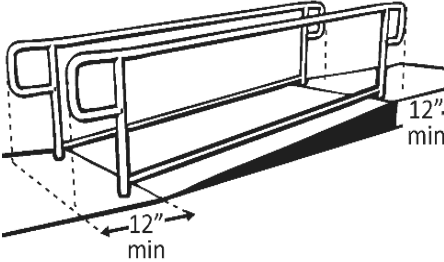
<p>1.136</p>	<p>If the ramp has a rise higher than 6 inches, are there handrails on both sides? [405.8]</p> <p>Note: Curb ramps are not required to have handrails.</p>	<p><input checked="" type="checkbox"/> YES <input type="checkbox"/> NO</p> <p>Measure ment:</p>		<p>Photo #:</p>	<ul style="list-style-type: none"> • Add handrails
<p>1.137</p>	<p>Is the top of the handrail gripping surface no less than 34 inches and no greater than 38 inches above the ramp surface? [505.4]</p>	<p><input checked="" type="checkbox"/> YES <input type="checkbox"/> NO</p> <p>Measure ment:</p>		<p>Photo #:</p>	<ul style="list-style-type: none"> • Reconfigure or replace handrails • Adjust handrail height
<p>1.138</p>	<p>Is the handrail gripping surface continuous and not obstructed along the top or sides? [505.3]</p>	<p><input checked="" type="checkbox"/> YES <input type="checkbox"/> NO</p>		<p>Photo #:</p>	<ul style="list-style-type: none"> • Reconfigure or replace handrails
	<p>If there are obstructions, is the bottom of the gripping surface obstructed no greater than 20%? [505.6]</p>	<p><input type="checkbox"/> YES <input type="checkbox"/> NO</p> <p>Measure ment:</p> <p>N/A</p>			
<p>1.139</p>	<p>If the handrail gripping surface is circular, is it no less than 1 ¼ inches and no greater than 2 inches in diameter? [505.7.1]</p>	<p><input checked="" type="checkbox"/> YES <input type="checkbox"/> NO</p> <p>Measure ment:</p>		<p>Photo #:</p>	<ul style="list-style-type: none"> • Replace handrails

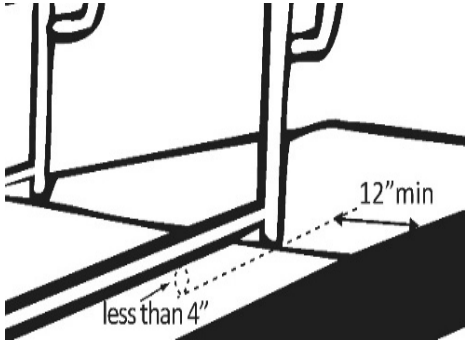
<p>1.140</p>	<p>If the handrail gripping surface is non-circular:</p> <p>Is the perimeter no less than 4 inches and no greater than 6¼ inches?</p> <p>Is the cross section no greater than 2¼ inches? [505.7.2]</p>	<p><input type="checkbox"/> YES <input type="checkbox"/> NO</p> <p>Measure ment: N/A</p> <p><input type="checkbox"/> YES <input type="checkbox"/> NO</p> <p>Measure ment: N/A</p>		<p>Photo #:</p>	<ul style="list-style-type: none"> • Replace handrails
<p>1.141</p>	<p>Does the handrail:</p> <p>Extend at least 12 inches horizontally beyond the top of the ramp?</p> <p>and Bottom of the ramp?</p> <p>Return to a wall, guard, or landing surface? [505.10.1]</p> <p>Note: If a 12 inch extension would be a hazard (in circulation path) it is not required.</p>	<p><input checked="" type="checkbox"/> YES <input type="checkbox"/> NO</p> <p>Measure ment:</p> <p><input checked="" type="checkbox"/> YES <input type="checkbox"/> NO</p> <p>Measure ment:</p>		<p>Photo #:</p>	<ul style="list-style-type: none"> • Alter handrails • Replace Handrails <p>NOTE: Where gangways and transition plates connect and are required to have handrails, handrail extensions shall not be required. Where handrail extensions are provided on gangways or transition plates, the handrail extensions shall not be required to be parallel with the ground</p>

<p>1.142</p>	<p>To prevent wheelchair casters and crutch tips from falling off:</p> <p>Does the surface of the ramp extend at least 12 inches beyond the inside face of the handrail?</p>	<p><input type="checkbox"/> YES <input checked="" type="checkbox"/> NO</p> <p>Measurement:</p>		<p>Photo #:</p>	<ul style="list-style-type: none"> • Add curb • Add barrier • Extend ramp width
<p>Or</p> <p>Is there a curb or barrier that prevents the passage of a 4-inch diameter sphere? [405.9.1, 405.9.2]</p>	<p><input checked="" type="checkbox"/> YES <input type="checkbox"/> NO</p> <p>Measurement:</p> <p>3 1/2"</p>				

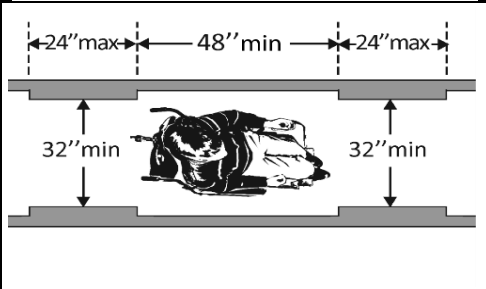
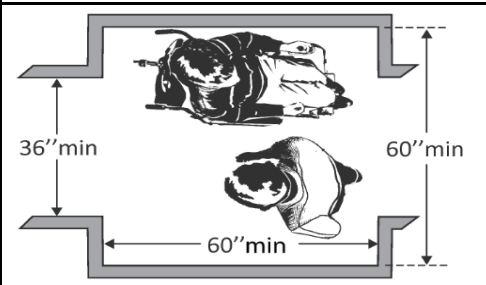
Accessible Route to Fishing Piers				
1.120	Is the route stable, firm and slip-resistant? [302.1]	<input checked="" type="checkbox"/> YES <input type="checkbox"/> NO Material BOARDS		 <ul style="list-style-type: none"> • Repair uneven paving • Fill small bumps and breaks with patches • Replace gravel with asphalt or other surface
1.121	Is the route at least 36 inches wide? [403.5.1]	<input checked="" type="checkbox"/> YES <input type="checkbox"/> NO Measure ment:		Photo #: <ul style="list-style-type: none"> • Change or move landscaping, furnishings or other items • Widen route
	Note: The accessible route can narrow to 32 inches min. for a max. of 24 inches. These narrower portions of the route must be at least 48 inches from each other.	<input type="checkbox"/> YES <input type="checkbox"/> NO Measure N/A		<ul style="list-style-type: none"> • Change or move obstacles or other items • Widen route
1.122	If the route is greater than 200 feet in length and less than 60 inches wide, is there a passing space no less than 60 x 60 inches? [403.5.3]	<input type="checkbox"/> YES <input type="checkbox"/> NO Measure N/A		<ul style="list-style-type: none"> • Widen route for passing space

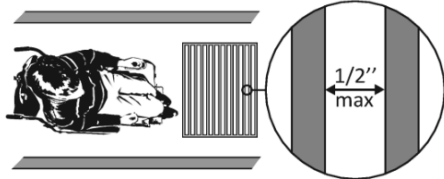
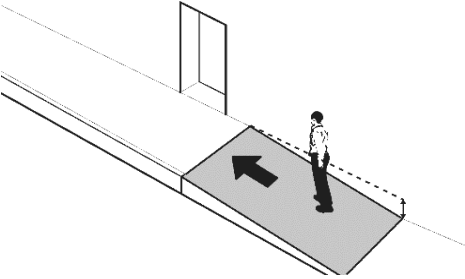
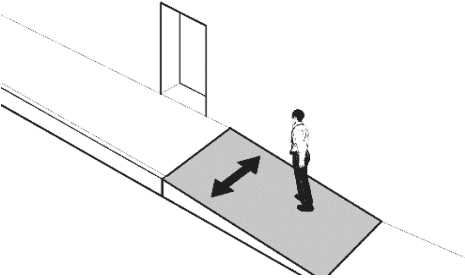
<p>1.123</p>	<p>If there are grates or openings on the route, are the openings no larger than ½ inches?</p>	<p><input type="checkbox"/> YES <input type="checkbox"/> NO Measure N/A</p>		<p>Photo #:</p>	<ul style="list-style-type: none"> • Replace or move grate
<p>1.124</p>	<p>Is the long dimension perpendicular to the dominant direction of travel? [302.3]</p> <p>Note: If the running slope is steeper than 1:20, treat as a ramp and add features such as edge protection and</p>	<p><input type="checkbox"/> YES <input checked="" type="checkbox"/> NO Measurement: 7.3% FROM TRAIL TO PIER</p>		<p>Photo #:</p>	<ul style="list-style-type: none"> • Regrade to 1:20 max.
<p>1.125</p>	<p>Is the cross slope no steeper than 1:48? [403.3]</p>	<p><input checked="" type="checkbox"/> YES <input type="checkbox"/> NO Measure</p>		<p>Photo #:</p>	<ul style="list-style-type: none"> • Regrade to 1:48 max.

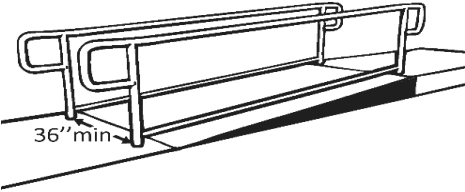
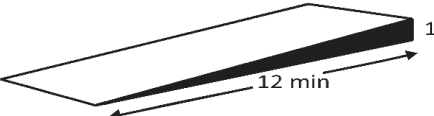
Ramps and Gangways					
1.130	<p>If there is a ramp is it at least 36 inches wide? [405.5]</p> <p>Note: If there are handrails, measure between the handrails.</p>	<p><input checked="" type="checkbox"/> YES <input type="checkbox"/> NO</p> <p>Measure ment:</p>		<p>Photo #:</p>	<ul style="list-style-type: none"> • Alter ramp
1.131	<p>Is the surface stable, firm and slip resistant? [405.4]</p>	<p><input checked="" type="checkbox"/> YES <input type="checkbox"/> NO</p> <p>Material METAL W/ NON SLIP</p>		<p>Photo #:</p>	<ul style="list-style-type: none"> • Resurface ramp
1.132	<p>For each section of the ramp or Gangway, is the running slope no greater than 1:12, i.e. for every inch of height change there are at least 12 inches of ramp run? [405.2] AND</p>	<p><input checked="" type="checkbox"/> YES <input type="checkbox"/> NO</p> <p>Measure ment: 8.3%</p>		<p>Photo #:</p>	<ul style="list-style-type: none"> • Relocate ramp • Lengthen ramp to decrease slope <p>NOTE: Where the total length of the gangway or series of gangways serving as part of a required accessible route is 30 feet (9145 mm) minimum, gangways shall not be required to comply with 405.2.</p>
	<p>(Except for Gangways) No greater than 30" rise? [405.6]</p> <p>Note: Rises no greater than 3 inches with a slope no steeper than 1:8 and rises no greater than 6 inches with a slope no steeper than 1:10 are permitted when such slopes are necessary due to space limitations.</p>	<p><input checked="" type="checkbox"/> YES <input type="checkbox"/> NO</p> <p>Measure ment: GANG-WAY</p>	<p>20'-0" LONG</p>	<p>Photo #:</p>	

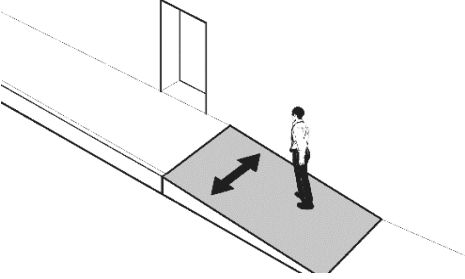
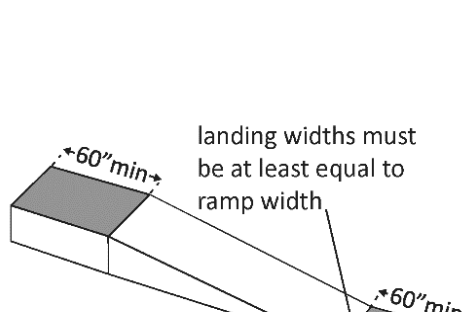
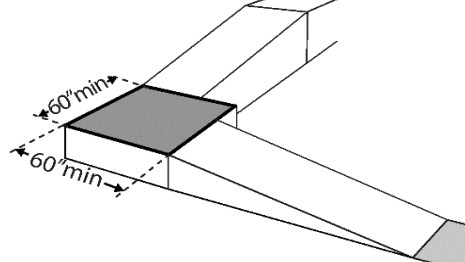
<p>1.133</p>	<p>Is the cross slope no steeper than 1:48? [405.3]</p>	<p><input checked="" type="checkbox"/> YES <input type="checkbox"/> NO Measure ment:</p>		<p>Photo #:</p>	<ul style="list-style-type: none"> • Modify to 1:48 max. <p>NOTE: The cross slope specified in 403.3 and 405.3 for gangways, transition plates, and floating piers that are part of accessible routes shall be measured in the static</p>
<p>1.134</p>	<p>Is there a level landing that is at least 60 inches long and at least as wide as the ramp: At the top of the ramp?</p>	<p><input checked="" type="checkbox"/> YES <input type="checkbox"/> NO Measure ment:</p>		<p>Photo #:</p>	<ul style="list-style-type: none"> • Alter ramp • Relocate ramp <p>NOTE: Where gangways connect to transition plates, landings specified by 405.7 shall not be required.</p>
	<p>At the bottom of the ramp? [405.7.2, 405.7.3]</p>	<p><input checked="" type="checkbox"/> YES <input type="checkbox"/> NO Measure ment:</p>		<p>Photo #:</p>	
<p>1.135</p>	<p>Is there a level landing where the ramp changes direction that is at least 60 x 60 inches? [405.7.4]</p>	<p><input type="checkbox"/> YES <input type="checkbox"/> NO Measure ment: N/A</p>		<p>Photo #:</p>	<ul style="list-style-type: none"> • Alter ramp • Increase landing size

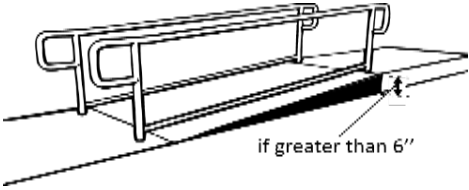
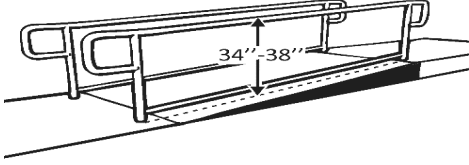
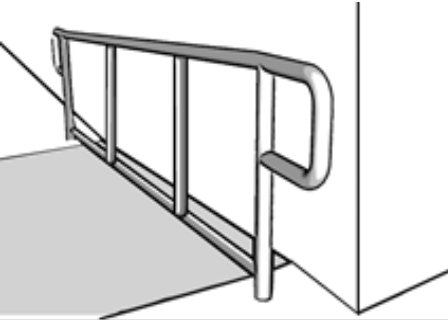
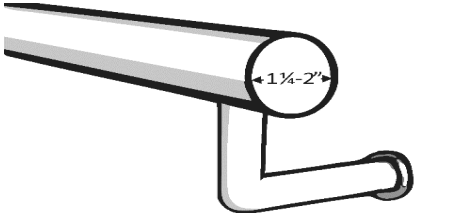
<p>1.136</p>	<p>If the ramp has a rise higher than 6 inches, are there handrails on both sides? [405.8]</p> <p>Note: Curb ramps are not required to have handrails.</p>	<p><input type="checkbox"/> YES <input checked="" type="checkbox"/> NO</p> <p>Measurement:</p>		<p>Photo #:</p>	<ul style="list-style-type: none"> • Add handrails
<p>1.137</p>	<p>Is the top of the handrail gripping surface no less than 34 inches and no greater than 38 inches above the ramp surface? [505.4]</p>	<p><input type="checkbox"/> YES <input checked="" type="checkbox"/> NO</p> <p>Measurement:</p>		<p>Photo #:</p>	<ul style="list-style-type: none"> • Reconfigure or replace handrails • Adjust handrail height
<p>1.138</p>	<p>Is the handrail gripping surface continuous and not obstructed along the top or sides? [505.3]</p>	<p><input type="checkbox"/> YES <input checked="" type="checkbox"/> NO</p> <p>Measurement:</p>		<p>Photo #:</p>	<ul style="list-style-type: none"> • Reconfigure or replace handrails
<p>1.139</p>	<p>If there are obstructions, is the bottom of the gripping surface obstructed no greater than 20%? [505.6]</p>	<p><input type="checkbox"/> YES <input checked="" type="checkbox"/> NO</p> <p>Measurement:</p>		<p>Photo #:</p>	<ul style="list-style-type: none"> • Replace handrails

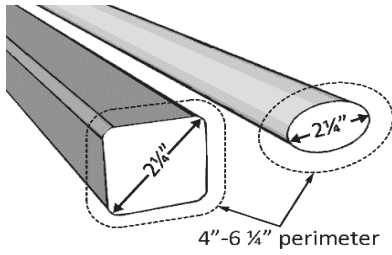
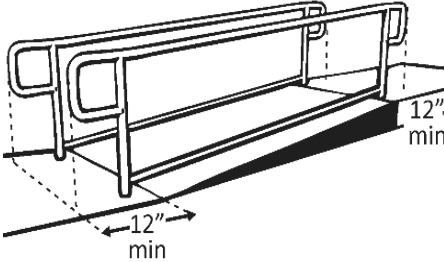
<p>1.140</p>	<p>If the handrail gripping surface is non-circular: Is the perimeter no less than 4 inches and no greater than 6¼ inches? Is the cross section no greater than 2¼ inches? [505.7.2]</p>	<p><input type="checkbox"/> YES <input checked="" type="checkbox"/> NO Measure ment:</p>		<p>Photo #:</p>	<ul style="list-style-type: none"> • Replace handrails
<p>1.141</p>	<p>Does the handrail: Extend at least 12 inches horizontally beyond the top of the ramp? and Bottom of the ramp? Return to a wall, guard, or landing surface? [505.10.1] Note: If a 12 inch extension would be a hazard (in circulation path) it is not required.</p>	<p><input type="checkbox"/> YES <input checked="" type="checkbox"/> NO Measure ment:</p>		<p>Photo #:</p>	<ul style="list-style-type: none"> • Alter handrails • Replace Handrails <p>NOTE: Where gangways and transition plates connect and are required to have handrails, handrail extensions shall not be required. Where handrail extensions are provided on gangways or transition plates, the handrail extensions shall not be required to be parallel with the ground</p>

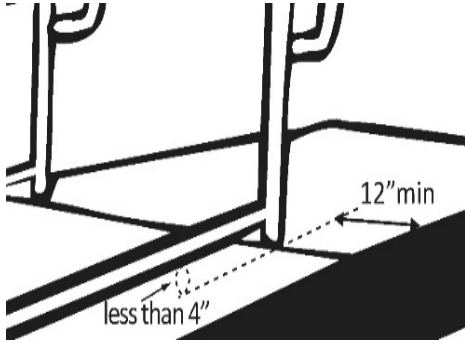
<p>1.142</p>	<p>To prevent wheelchair casters and crutch tips from falling off:</p> <p>Does the surface of the ramp extend at least 12 inches beyond the inside face of the handrail?</p>	<p><input type="checkbox"/> YES <input checked="" type="checkbox"/> NO</p> <p>Measurement:</p>		<p>Photo #:</p>	<ul style="list-style-type: none"> • Add curb • Add barrier • Extend ramp width
<p>Or</p> <p>Is there a curb or barrier that prevents the passage of a 4-inch diameter sphere? [405.9.1, 405.9.2]</p>	<p><input checked="" type="checkbox"/> YES <input type="checkbox"/> NO</p> <p>Measurement:</p> <p>3"</p>				

ADA Checklist for Existing

Priority 2 - Access to Goods & Services

Based on the 2010 ADA Standards for Accessible Design

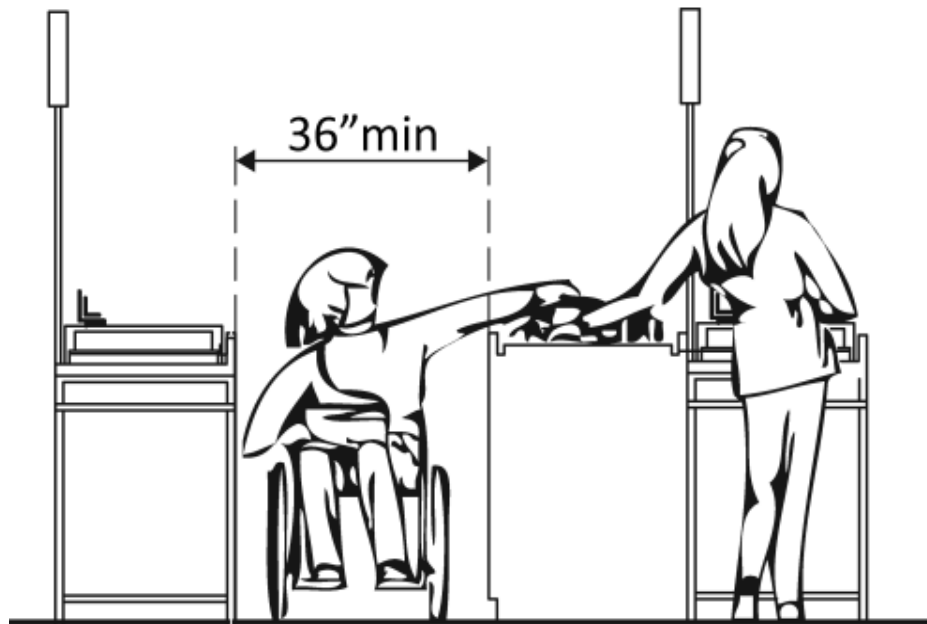

Project: ADA Transition Plan

Building: Jetty Landing Park & Jetty Island Ferry Dock

Location: Everett, WA

Date: 1/20/2021



Surveyors: Lauri Strauss, AIA, LEED AP BD&C
President, CEO, design2 LAST, inc



Contact Information: o. 425-673-7269 c. 907-317-5040

543 Main St, Suite 101, Edmonds, WA 98020

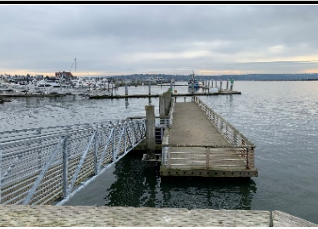
The layout of the building should allow people with disabilities to obtain goods and services and to participate in activities without assistance.

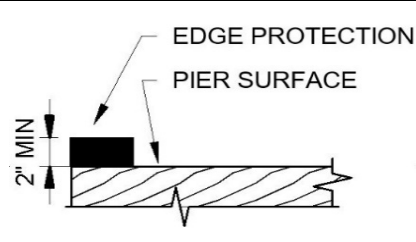

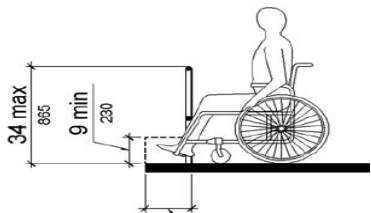
Recreational Boating Facilities																																	
<p>2.300</p>	<p>Is there an adequate number of accessible Boat Slips provided? (235.2) NOTE: Where the number of boat slips is not identified, each 40 feet (12m) of boat slip edge provided along the perimeter of the pier shall be counted as one boat slip</p>	<p><input type="checkbox"/> YES <input type="checkbox"/> NO Number TOTAL: N/A THIS IS USED ACCBL: ONLY FOR THE PILOTED JETTY ISLAND FERRY</p>	<table border="1"> <thead> <tr> <th>Total Number of Boat Slips Provided in Facility</th> <th>Minimum Number of Required Accessible Boat Slips</th> </tr> </thead> <tbody> <tr><td>1 to 25</td><td>1</td></tr> <tr><td>26 to 50</td><td>2</td></tr> <tr><td>51 to 100</td><td>3</td></tr> <tr><td>101 to 150</td><td>4</td></tr> <tr><td>151 to 300</td><td>5</td></tr> <tr><td>301 to 400</td><td>6</td></tr> <tr><td>401 to 500</td><td>7</td></tr> <tr><td>501 to 600</td><td>8</td></tr> <tr><td>601 to 700</td><td>9</td></tr> <tr><td>701 to 800</td><td>10</td></tr> <tr><td>801 to 900</td><td>11</td></tr> <tr><td>901 to 1000</td><td>12</td></tr> <tr><td>1001 and over</td><td>12, plus 1 for every 100, or fraction thereof, over 1000</td></tr> </tbody> </table>	Total Number of Boat Slips Provided in Facility	Minimum Number of Required Accessible Boat Slips	1 to 25	1	26 to 50	2	51 to 100	3	101 to 150	4	151 to 300	5	301 to 400	6	401 to 500	7	501 to 600	8	601 to 700	9	701 to 800	10	801 to 900	11	901 to 1000	12	1001 and over	12, plus 1 for every 100, or fraction thereof, over 1000	<p>Photo #:</p>	<ul style="list-style-type: none"> • Add more slips • Modify existing slips
Total Number of Boat Slips Provided in Facility	Minimum Number of Required Accessible Boat Slips																																
1 to 25	1																																
26 to 50	2																																
51 to 100	3																																
101 to 150	4																																
151 to 300	5																																
301 to 400	6																																
401 to 500	7																																
501 to 600	8																																
601 to 700	9																																
701 to 800	10																																
801 to 900	11																																
901 to 1000	12																																
1001 and over	12, plus 1 for every 100, or fraction thereof, over 1000																																
<p>2.301</p>	<p>Are the accessible Boat Slips dispersed throughout the various types of boat slips provided?</p>	<p><input type="checkbox"/> YES <input type="checkbox"/> NO N/A</p>	<p>Types Include: single berths and double berths shallow water or deep water, transient or longer-term lease, covered or uncovered; and whether slips are equipped with features such as telephone, water, electricity or cable connections.</p>	<p>Photo #:</p>	<ul style="list-style-type: none"> • Add more slips • Modify existing slips 																												
<p>2.302</p>	<p>Are at least 5 percent, but no fewer than one, of the boarding piers accessible?</p>	<p><input checked="" type="checkbox"/> YES <input type="checkbox"/> NO Number TOTAL: 14 (=27/2) ACCBL: 1</p>		<p>Photo #:</p>	<ul style="list-style-type: none"> • Modify pier • Provide new pier 																												

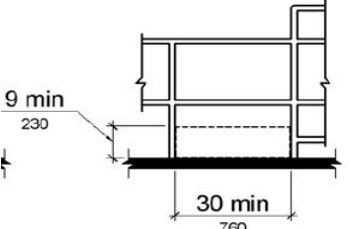
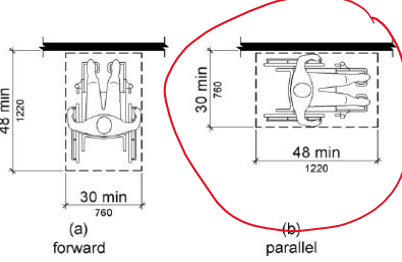
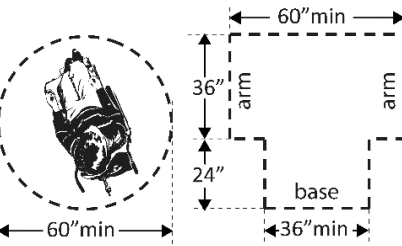

Recreational Fishing Piers					
2.300	Where rails are provided for fishing opportunities, are at least 25 percent of the railings, guards, or handrails no more than 34 inches (865 mm) above the ground or deck surface?	<input type="checkbox"/> YES <input checked="" type="checkbox"/> NO Number CONT TOTAL: RAIL 41 1/2" ACCBL: 0		 Photo #:	<ul style="list-style-type: none"> • Add rails • Modify rails
2.301	Are the rails providing fishing opportunities dispersed throughout the fishing pier or platform?	<input type="checkbox"/> YES <input checked="" type="checkbox"/> NO CONT		 Photo #:	<ul style="list-style-type: none"> • Add rails • Modify rails
2.302	Are curbs or barriers that extend 2 inches (51 mm) minimum above the surface of the fishing pier or platform provided?	<input checked="" type="checkbox"/> YES <input type="checkbox"/> NO Measure ment: 3"	 <p>EDGE PROTECTION PIER SURFACE 2" MIN</p>	Photo #:	<ul style="list-style-type: none"> • Modify edge • Add edge protection

<p>2.303</p>	<p>Does the ground or deck surface extend 12 inches (305 mm) minimum beyond the inside face of the railing? AND</p>	<p><input type="checkbox"/> YES <input checked="" type="checkbox"/> NO Measurement:</p>			<ul style="list-style-type: none"> • Add rails • Modify rails
	<p>Is there toe clearance provided that is 30 inches (760 mm) wide minimum and 9 inches (230 mm) minimum above the ground or deck surface beyond the railing?</p>	<p><input type="checkbox"/> YES <input checked="" type="checkbox"/> NO Measurement:</p>		<p>Photo #:</p>	
<p>2.304</p>	<p>At each location where there are railings, guards, or handrails is a clear floor or ground space provided? Where there are no railings, guards, or handrails, at least one clear floor or ground space complying with 305 shall be provided on the fishing pier or platform.</p>	<p><input checked="" type="checkbox"/> YES <input type="checkbox"/> NO</p>		<p>Photo #:</p>	<ul style="list-style-type: none"> • Reconfigure space
<p>2.305</p>	<p>Is there at least one turning space provided on fishing piers and platforms?</p>	<p><input checked="" type="checkbox"/> YES <input type="checkbox"/> NO</p>		<p>Photo #:</p>	<ul style="list-style-type: none"> • Reconfigure space

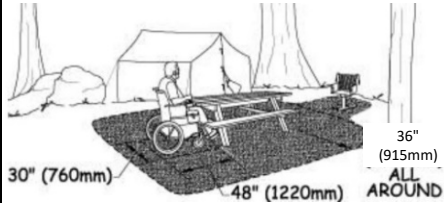
Priority 2 Access to Picnic Units [F245] (contains outdoor constructed features)						
2.400	Where picnic facilities contain two or fewer picnic units , does each picnic unit provide mobility features complying with F245.2.?	<input type="checkbox"/> YES <input checked="" type="checkbox"/> NO	Total #: 2 (3 TBL EA) Acsbl#: 0		 Photo #:	<ul style="list-style-type: none"> Modify unit(s) Provide new unit(s)
2.401	Where picnic facilities contain more than two picnic units , do at least 20 percent, but not less than two, of the picnic units provide mobility features complying with F245.2.?	<input type="checkbox"/> YES <input type="checkbox"/> NO	Total #: 0 Acsbl#: N/A		Photo #:	<ul style="list-style-type: none"> Modify unit(s) Provide new unit(s)
2.402	Are the accessible picnic units dispersed throughout the picnic facility providing a variety of choices?	<input type="checkbox"/> YES <input checked="" type="checkbox"/> NO			Photo #:	<ul style="list-style-type: none"> Modify unit(s) Provide new unit(s)
2.403	Where provided, is at least one of each type of outdoor constructed feature compliant with 1011?	<input type="checkbox"/> YES <input type="checkbox"/> NO	Total #: Acsbl#:	OUTDOOR CONSTRUCTED FEATURES: Picnic Tables Fire Rings or Grills Trash and Recycling Water Hydrants Benches Viewing Scopes	Photo #:	<ul style="list-style-type: none"> Modify unit(s) Provide new unit(s)

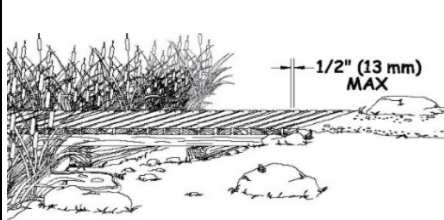
<p>2.404</p>	<p>OR- Where more than one of the same type of outdoor constructed feature is provided, are at least two of the same type of outdoor constructed features compliant with 1011.</p>	<p><input type="checkbox"/> YES <input checked="" type="checkbox"/> NO</p> <p>Total #:</p> <p>Acsbl#:</p>		<p>OUTDOOR CONSTRUCTED FEATURES: Picnic Tables Fire Rings or Grills Trash and Recycling Water Hydrants Benches Viewing Scopes Outdoor Rinsing Shower</p>	<p>Photo #:</p>	<ul style="list-style-type: none"> • Modify unit(s) • Provide new unit(s)
<p>2.405</p>	<p>Where provided in common use and public use areas that serve picnic units with mobility features, are at least 20 percent, but not less than one, of each type of outdoor constructed feature provided at each location compliant with 1011.2.</p>	<p><input type="checkbox"/> YES <input checked="" type="checkbox"/> NO</p> <p>Total #:</p> <p>Acsbl#:</p>			<p>Photo #:</p>	<ul style="list-style-type: none"> • Modify unit(s) • Provide new unit(s)
<p>Trash and recycling</p>						
<p>2.410</p>	<p>Is there a clear ground space 36 inches (915 mm) by 48 inches (1220 mm) positioned for forward approach to the receptacle opening; or 30 inches (760 mm) by 60 inches (1525 mm) positioned for a parallel approach to the receptacle opening? [1011.2.1]</p>	<p><input checked="" type="checkbox"/> YES <input type="checkbox"/> NO</p> <p>Measurement:</p>		 <p>Photo #:</p>	<ul style="list-style-type: none"> • Add or Relocate bins 	

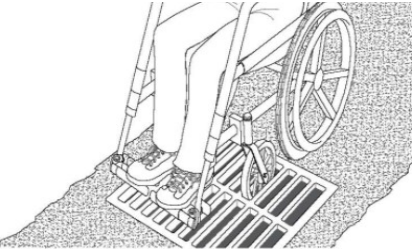
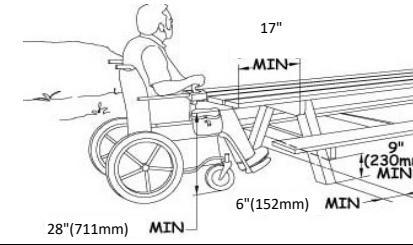
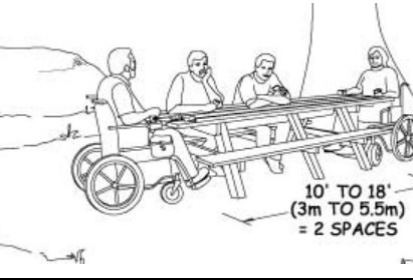
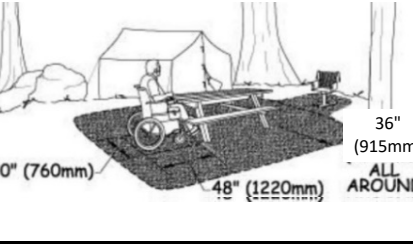
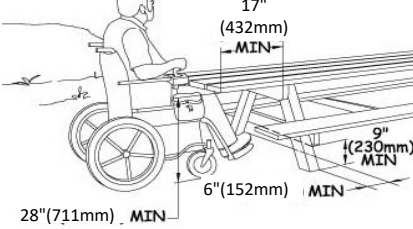
Picnic Tables [1011.4]					
2.420	Is there 36 inches (915 mm) minimum on all usable sides of the table measured from the back edge of the benches? [1011.2.1]	<input checked="" type="checkbox"/> YES <input type="checkbox"/> NO Measure ment: 48"		 <p>Photo:</p>	<ul style="list-style-type: none"> • Replace table • Provide new table
2.421	Is the surface of the clear ground space firm and stable? [1011.2.2]	<input checked="" type="checkbox"/> YES <input type="checkbox"/> NO Material CONC		<p>Photo:</p>	<ul style="list-style-type: none"> • Replace surface
2.422	Is the slope of the clear ground space surface no steeper than 1:48 in any direction? [1011.2.3] or	<input checked="" type="checkbox"/> YES <input type="checkbox"/> NO Measure ment:		<p>Photo:</p>	<ul style="list-style-type: none"> • Level the area
	If the surface is other than asphalt, concrete, or boards, is the slope no steeper than 1:20 if necessary for drainage?	<input type="checkbox"/> YES <input type="checkbox"/> NO Measure ment: N/A		<p>Photo:</p>	<ul style="list-style-type: none"> • Level the area
2.423	If openings (grates) are present in the clear ground space surface, are they sized so they do not allow the passage of a sphere more than 1/2 inch (13 mm) in diameter? And	<input type="checkbox"/> YES <input type="checkbox"/> NO Measure ment: N/A		<p>Photo:</p>	<ul style="list-style-type: none"> • Modify surface • Replace Boards

	<p>Are elongated openings placed so that the long dimension is perpendicular, or as close to perpendicular as possible, to the dominant direction of travel?</p>	<p><input type="checkbox"/> YES <input type="checkbox"/> NO</p> <p>N/A</p>		<p>Photo:</p>	<ul style="list-style-type: none"> • Replace Grate
<p>2.424</p>	<p>Are the tops of picnic tables 28 inches (710 mm) minimum and 34 inches (865 mm) maximum above the finish floor or ground? [1011.4.1]</p>	<p><input checked="" type="checkbox"/> YES <input type="checkbox"/> NO</p> <p>Measure ment:</p> <p>31"</p>		<p>Photo:</p>	<ul style="list-style-type: none"> • Replace table • Provide new table
<p>2.425</p>	<p>For each 24 linear feet (7320 mm) of usable picnic table surface perimeter, is there at least one wheelchair space? [1011.4.2] (Note: Tables over 9' long need two WC spaces)</p>	<p><input type="checkbox"/> YES <input checked="" type="checkbox"/> NO</p> <p>Measure ment:</p>		<p>Photo:</p>	<ul style="list-style-type: none"> • Replace table • Provide new table
<p>2.426</p>	<p>Is the wheelchair space 30 inches (760mm) minimum by 48 inches (1220 mm) minimum and positioned for a forward approach to the table? [1011.4.2]</p>	<p><input type="checkbox"/> YES <input checked="" type="checkbox"/> NO</p> <p>Measure ment:</p>		<p>Photo:</p>	<ul style="list-style-type: none"> • Replace table • Provide new table
	<p>and provide knee and toe clearance complying with 306 under the table? [1011.4.2]</p>	<p><input type="checkbox"/> YES <input checked="" type="checkbox"/> NO</p> <p>Measure ment:</p>			<ul style="list-style-type: none"> • Replace table • Provide new table



4. Waterfront Center Exterior Access

DATE OF EVALUATION

1/20/2021

Figure 6. Recreational Facilities to Be Assessed for ADA Compliance - Phase I



ADA Evaluation

FOR

Waterfront Center Parking and Access

Port of Everett

ADA Transition Plan



Based on the 2010 ADA Standards for Accessible Design

Completed by:

design2 LAST, inc
534 Main St, Suite 101
Edmonds, WA 98020

Notes Regarding ADA Evaluation for this facility

Each file contains an aerial view of the site as shown on Google. If plans for the facilities were available, they are included. If room names or numbers are not indicated on those plans, fictional room names and numbers were given to spaces to correlate them to the enclosed checklists. These are intended to be used for the purpose of locating which rooms pertain to which portion of the checklist, and may or may not represent the actual room numbers and names at the facility.

How to read these checklists:

1. The 1st column is the identity mark, typically the priority number (1, 2, 3, or 4) followed by an identifying number. These may or may not be in order depending on whether non relevant rows have been hidden.
2. The 2nd column describes the compliance issue in the form of a question. The compliant measurement or count is identified in the question. If the response to the question is 'yes' the issue is compliant.
3. The 3rd and 4th columns are the 'yes' and 'no' responses, and measurements taken in the field. If the issue is compliant and the 'yes' box is checked, there may or may not be a measurement included. If the 'no' box is checked, the issue is non-compliant, and a measurement or count will indicate how the issue is noncompliant.

ADA Checklist for Existing Facilities

The Americans with Disabilities Act (ADA) requires state and local governments, businesses and non-profit organizations to provide goods, services and programs to people with disabilities on an equal basis with the rest of the public.

Some people think that only new construction and alterations need to be accessible and that older facilities are "grandfathered," but that's not true. Because the ADA is a civil rights law and not a building code, older facilities are often required to be accessible to ensure that people with disabilities have an equal opportunity to participate.

The ADA has different requirements for state and local governments and for places of public accommodation (businesses and non-profit organizations that serve the public).

Requirements for State and Local Governments

State and local governments must ensure that services, programs and activities, when viewed in their entirety, are accessible to people with disabilities. This is part of public entities' program accessibility obligations. Alterations to older buildings may be needed to ensure program accessibility. Generally this is a greater obligation than "readily achievable barrier removal" the standard that applies to public accommodations. State and local governments are not required to take any action that would result in undue financial and administrative burdens.

State and local governments' ADA obligations for program accessibility are in the Department of Justice's ADA Title II regulations 28 CFR Part 35.150.

Requirements for Places of Public Accommodation

Businesses and non-profit organizations that serve the public must remove architectural barriers when it is "readily achievable" to do so; in other words, when barrier removal is "easily accomplishable and able to be carried out without much difficulty or expense."

The decision of what is readily achievable is made considering the size, type, and overall finances of the public accommodation and the nature and cost of the access improvements needed. Barrier removal that is difficult now may be readily achievable in the future as finances change.

4. The 5th column may contain a pictogram or drawing of the issue being evaluated. This may also contain a sketch of what the evaluator found in the field as it related to the condition being evaluated.
5. The 6th column may contain a photo of the field condition. Only a select number of conditions are photographed to keep the file size manageable.
6. The last column may contains a list of suggested corrections. These are helpful to the cost estimating team but may not reflect the amount of work required to move or replace an item to bring it into compliance. There may be some economy when multiple non-compliance issues can be completed with one action. There may also be several ways to make corrective changes. How changes and corrections are made will depend on several things, most importantly the existing conditions. These typically are addressed in a design process.
7. Some cells are highlighted yellow. The highlighted cells are identifying non-compliance issues. The yellow is used simply to make the non-compliant issues easier to find among the large number of pages.
8. If no boxes are checked, or there is a slash thru the compliance issue, that particular issue does not apply to the instance being evaluated.

Public accommodations' ADA obligations for barrier removal are in the Department of Justice's ADA Title III regulations 28 CFR Part 36.304.

Priorities for Accessibility

The checklist follows the four priorities that are listed in the Department of Justice ADA Title III regulations. These priorities are equally applicable to state and local government facilities.

Priority 1 - Accessible approach and entrance

Priority 2 - Access to goods and services

Priority 3 - Access to public toilet rooms

Priority 4 - Access to other items such as water fountains and public telephones

2010 ADA Standards for Accessible Design

The checklist is based on the 2010 ADA Standards for Accessible Design (2010 Standards). The checklist may not include all sections of the 2010 Standards. Consult the 2010 Standards for situations not covered in the checklist. Full compliance with the 2010 Standards is required only for new construction and alterations.

Safe Harbor – Construction Prior to March 15, 2012

Elements in facilities built or altered before March 15, 2012 that comply with the 1991 ADA Standards for Accessible Design (1991 Standards) are not required to be modified to specifications in the 2010 Standards. For example, the 1991 Standards allow 54 inches maximum for a side reach range to a control such as the operating part of a paper towel dispenser. The 2010 Standards lower that side reach range to 48 inches maximum. If a paper towel dispenser was installed prior to March 15, 2012 with the highest operating part at 54 inches, the paper towel dispenser does not need to be lowered to 48".

What this Checklist is Not

The ADA Title II and III regulations require more than program accessibility and barrier removal. The regulations include requirements for nondiscriminatory policies and practices and for the provision of auxiliary aids and services, such as sign language interpreters for people who are deaf and material in Braille for people who are blind. This checklist does not cover those requirements.

Since this checklist does not include all of the 2010 Standards it is not intended to determine compliance for new construction or facilities being altered.

Resources**U.S. Department of Justice ADA Information**

800-514-0301 voice: 800-514-0383 TTY
www.ada.gov

ADA National Network

800-949-4232 voice/TTY connects to
your regional ADA Center:
www.adata.org

U.S. Access Board

800- 872-2253 voice: 800-993-2822 TTY
www.access-board.gov

[ADA Title III Regulations 28 CFR Part 36
www.ada.gov/regs2010/titleIII_2010/titleII_2010_regulations.htm](http://www.ada.gov/regs2010/titleIII_2010/titleII_2010_regulations.htm)

[2010 ADA Standards for Accessible
Design
www.ada.gov/2010ADASTandards_index.htm](http://www.ada.gov/2010ADASTandards_index.htm)

[1991 ADA Standards for Accessible
Design
www.ada.gov/stdspdf.htm](http://www.ada.gov/stdspdf.htm)

Acknowledgements

The Institute for Human Centered Design and the New England ADA Center created the ADA Checklists. Originals can be accessed at www.adachecklist.org.

What are Public Accommodations?

Under the ADA public accommodations are private entities that own, lease, lease to or operate a place of public accommodation. This means that both a landlord who leases space in a building to a tenant and the tenant who operates a place of public accommodation have responsibilities to remove barriers.

A place of public accommodation is a facility whose operations affect commerce and fall within at least one of the following 12 categories:

- 1) Places of lodging (e.g., inns, hotels, motels, except for owner-occupied establishments renting fewer than six rooms)
- 2) Establishments serving food or drink (e.g., restaurants and bars)
- 3) Places of exhibition or entertainment (e.g., motion picture houses, theaters, concert halls, stadiums)
- 4) Places of public gathering (e.g., auditoriums, convention centers, lecture halls)
- 5) Sales or rental establishments (e.g., bakeries, grocery stores, hardware stores, shopping centers)
- 6) Service establishments (e.g., laundromats, dry-cleaners, banks, barber shops, beauty shops, travel services, shoe repair services, funeral parlors, gas stations, offices of accountants or lawyers, pharmacies, insurance offices, professional offices of health care providers, hospitals)
- 7) Public transportation terminals, depots, or stations (not including facilities relating to air transportation)
- 8) Places of public display or collection (e.g., museums, libraries, galleries)
- 9) Places of recreation (e.g., parks, zoos, amusement parks)
- 10) Places of education (e.g., nursery schools, elementary, secondary, undergraduate, or postgraduate private schools)
- 11) Social service center establishments (e.g., day care centers, senior citizen centers, homeless shelters, food banks, adoption agencies)
- 12) Places of exercise or recreation (e.g., gymnasiums, health spas, bowling alleys, golf courses).

Many of the illustrations are from the U.S. Department of Justice and the U.S. Access Board or are based on illustrations produced by the U.S. Access Board and the U.S. Department of Justice.

New sections added to Appendix A to Chapter 10

F201.4 Requirements Apply to Facilities Constructed or Altered by or on Behalf of Federal Agencies.

The requirements in F216.13, F244 through F248, and 1011 through 1019 shall apply only to facilities constructed or altered by federal agencies or by non-federal entities on federal land on behalf of federal agencies pursuant to a concession contract, partnership agreement, or similar arrangement.

F201.4.1 Documentation and Notification When Exceptions Used for Trails and Beach Access

Routes. Federal agencies shall document the basis for not fully complying with a specific provision in 1017 or 1018 on a portion of a trail or beach access route based on Exception 1 in 1017 or Exception 1 in 1018, and shall maintain the documentation with the records for the trail or beach project. Federal agencies shall notify the Access Board if an entire trail is exempted from complying with 1017 based on Exception 2 in 1017.1, and if a beach access route is not provided based on Exception 2 in 1018.1.6)

F202.3 Alterations. * * * * *

EXCEPTIONS: * * * * *

4. Where elements or spaces are altered in camping facilities, picnic facilities, viewing areas, or trailheads and the circulation path to the altered element or space is not altered, the circulation path shall not be required to comply with 1016.

F202.4 Alterations Affecting Primary Function Areas. * * * * *

EXCEPTIONS: * * * * *

2. Camping facilities, picnic facilities, viewing areas, trailheads, trails, and beach access routes shall not be required to comply with F202.4.

F206.1 General. * * * * *

EXCEPTIONS: 1. Accessible routes shall not be required where outdoor recreation access routes are provided at camping facilities in accordance with F244.5, picnic facilities in accordance with F245.4, viewing areas in accordance with F246.3, or trailheads in accordance with F247.3.2.

2. Accessible routes shall not be required where camping facilities, picnic facilities, viewing areas, or outdoor constructed features are provided on trails.

3. Accessible routes shall not be required where beach access routes are provided in accordance with F248.

F212.3 Sinks. * * * * *

EXCEPTIONS: * * * * *

2. In camping facilities and picnic facilities, sinks shall not be required to comply with F212.3 where a cooktop or conventional range is not provided.

F213.1 General. * * * * *

EXCEPTION: Pit toilets provided on trails and in camping facilities shall not be required to comply with F213

F216.13 Trailhead Signs. Where new trail information signs are provided at trailheads on newly constructed or altered

SUMMARY

Waterfront Center Parking and Access

Waterfront Center is located near the center of the marina facilities, with direct access to the Marina Waterfront Trail System. The parking lot and access to the building was reviewed for this evaluation. The building will be evaluated in a future evaluation phase.

There are three (3) marked accessible parking spaces on the west side of the building; two (2) near the building entry, and one (1) on the west side closer to the trail. The lack of van accessible spaces is the biggest issue in this location. Accessible parking spaces should be reconfigured to include a minimum of one (1) compliant van accessible space.

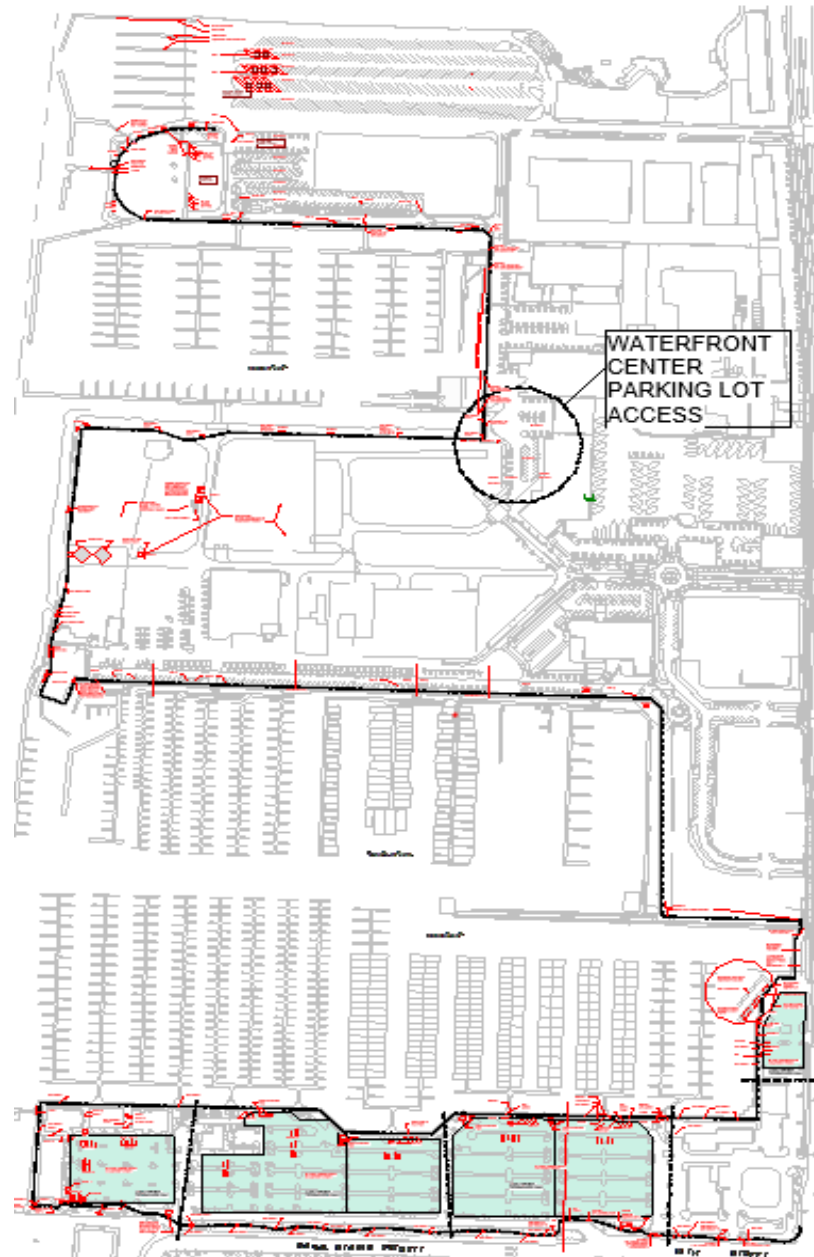

WATERFRONT CENTER PARKING
LOT ACCESS -
OVERALL PORT PLAN

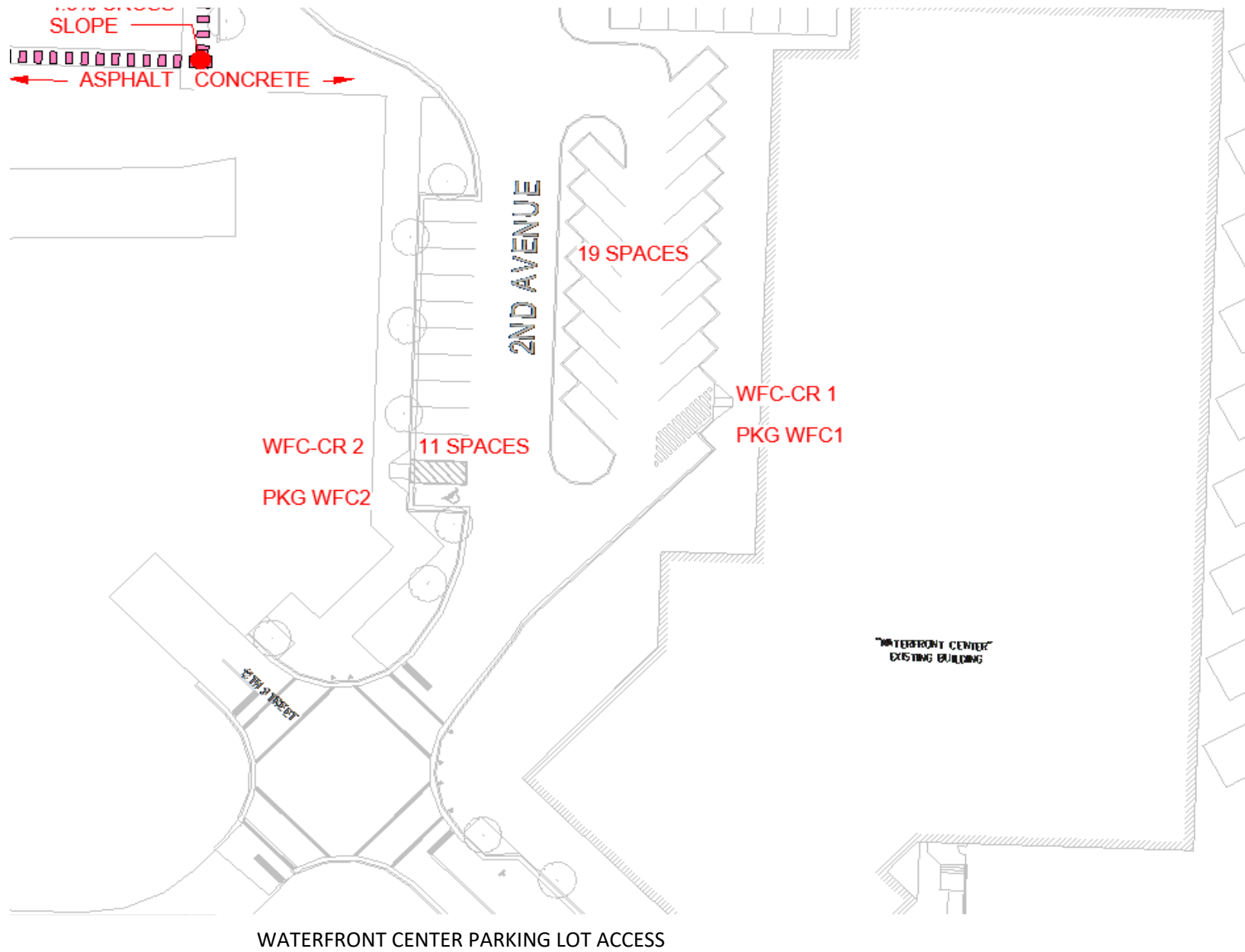

ADA Checklist for Existing

Priority 1 - Approach & Entrance

Based on the 2010 ADA Standards for Accessible Design



Project: ADA Transition Plan

Building: Waterfront Center Parking and Access

Location: Everett, WA

Date: 1/20/2021

Surveyors: Lauri Strauss, AIA, LEED AP BD&C
President, CEO, design2 LAST, inc

Contact Information: o. 425-673-7269 c. 907-317-5040



543 Main St, Suite 101, Edmonds, WA 98020

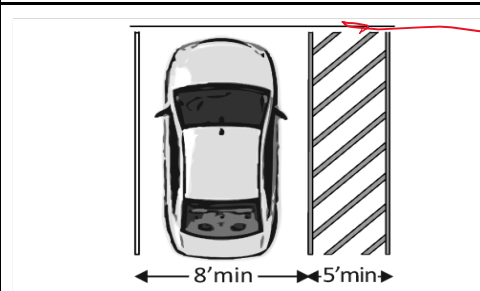

An accessible route from site arrival points and an accessible entrance should be provided for everyone.

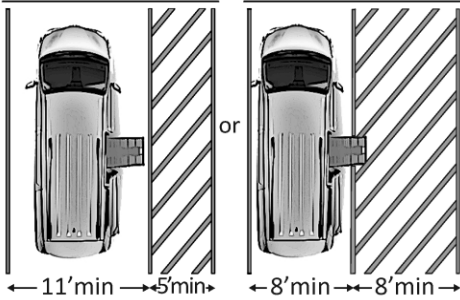
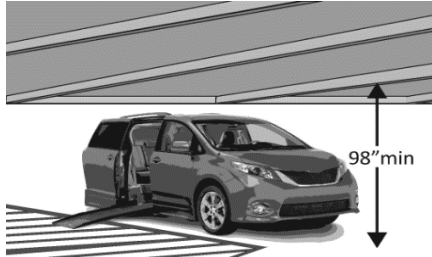
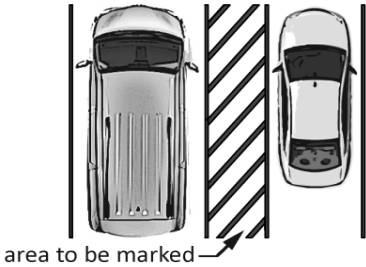
Priority 1 - Approach & Entrance					Comments	Possible Solutions
1.001	Is there at least one route from site arrival points (parking, passenger loading zones, public sidewalks and public transportation stops) that does not require the use of stairs? [See 2010 ADA Standards for Accessible Design – 206.2.1]	<input checked="" type="checkbox"/> YES If yes, location of route:	<input type="checkbox"/> NO		Photo:	<ul style="list-style-type: none"> • Add a ramp • Regrade to 1:20 maximum slope • Add a lift if site constraints prevent other solutions

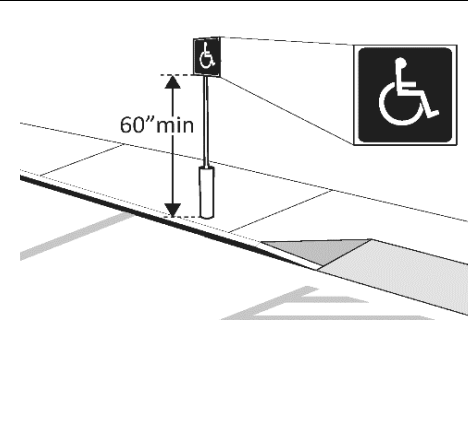
Parking Accessible parking spaces should be identified by size, access aisle and signage.																	
1.100	If parking is provided for the public, are an adequate number of accessible spaces provided? (208.2)	<input checked="" type="checkbox"/> YES <input type="checkbox"/> NO Total #: 19 Acsbl #: 2	<table border="1"> <thead> <tr> <th>Total Spaces</th> <th>Accessible Spaces</th> </tr> </thead> <tbody> <tr> <td>1 - 25</td> <td>1</td> </tr> <tr> <td>26 - 50</td> <td>2</td> </tr> <tr> <td>51 - 75</td> <td>3</td> </tr> <tr> <td>76 - 100</td> <td>4</td> </tr> <tr> <td>1200</td> <td>22</td> </tr> <tr> <td colspan="2">100+ see 2010 Standards 208.2</td> </tr> </tbody> </table>	Total Spaces	Accessible Spaces	1 - 25	1	26 - 50	2	51 - 75	3	76 - 100	4	1200	22	100+ see 2010 Standards 208.2	
Total Spaces	Accessible Spaces																
1 - 25	1																
26 - 50	2																
51 - 75	3																
76 - 100	4																
1200	22																
100+ see 2010 Standards 208.2																	
 <p>Photo:</p>	<ul style="list-style-type: none"> • Reconfigure by repainting lines 																
1.101	Of the accessible spaces, is at least one a van accessible space? [208.2.4]	<input type="checkbox"/> YES <input checked="" type="checkbox"/> NO	*For every 6 or fraction of 6 parking spaces required by the table above, at least 1 should be a van accessible space.														
<p>Photo:</p>	<ul style="list-style-type: none"> • If constructed before 3/15/2012, parking is compliant if at least 1 in every 8 accessible spaces is van accessible • Reconfigure by repainting lines 																
1.102	Are accessible spaces at least 8 feet wide with an access aisle at least 5 feet wide? [502.2, 502.3] Note: Two spaces may share an access aisle. Check state/local requirements; some specify that each space have its own aisle.	<input checked="" type="checkbox"/> YES <input type="checkbox"/> NO Measure ment: 9'-0" S 8'-0" A															
<p>Photo:</p>	<ul style="list-style-type: none"> • Reconfigure by repainting lines 																

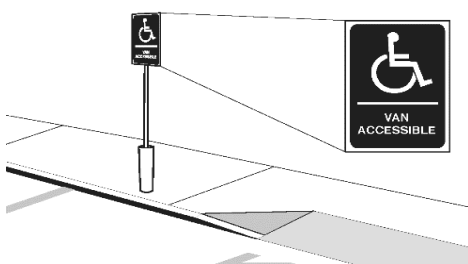
<p>1.103</p>	<p>Is the van accessible space: At least 11 feet wide with an access aisle at least 5 feet wide? Or At least 8 feet wide with an access aisle at least 8 feet wide? [502.2]</p>	<p><input type="checkbox"/> YES <input checked="" type="checkbox"/> NO Measurement:</p>		<p>Photo:</p>	<ul style="list-style-type: none"> • Reconfigure by repainting lines
<p>1.104</p>	<p>Is at least 98 inches of vertical clearance provided for the van accessible space? [502.5]</p>	<p><input checked="" type="checkbox"/> YES <input type="checkbox"/> NO Measurement:</p>		<p>Photo:</p>	<ul style="list-style-type: none"> • Reconfigure to provide van-accessible space(s)
<p>1.105</p>	<p>Are the access aisles marked so as to discourage parking in them? [502.3.3] Note: The marking method and color may be addressed by state/local requirements.</p>	<p><input checked="" type="checkbox"/> YES <input type="checkbox"/> NO Measurement:</p>		<p>Photo:</p>	<ul style="list-style-type: none"> • Mark access aisles
<p>1.106</p>	<p>Is the slope of the accessible parking spaces and access aisles no steeper than 1:48 in all directions? [502.4]</p>	<p><input type="checkbox"/> YES <input checked="" type="checkbox"/> NO Measurement: 1.2% - 4.2%</p>		<p>Photo:</p>	<ul style="list-style-type: none"> • Regrade surface

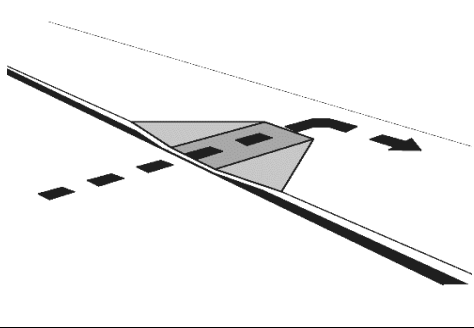

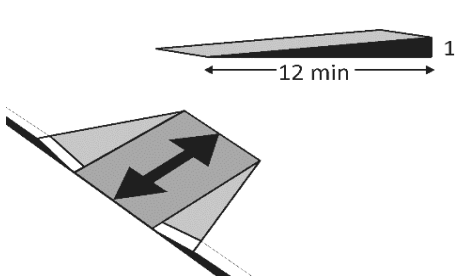
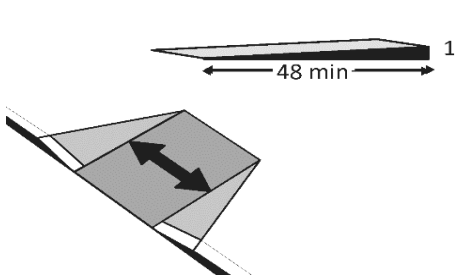
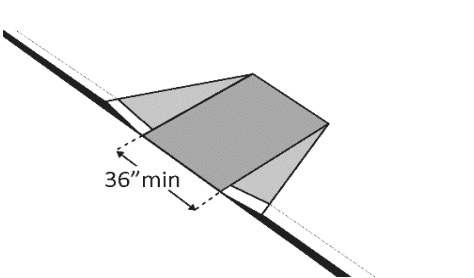
1.107	Do the access aisles adjoin an accessible route? [502.3]	<input checked="" type="checkbox"/> YES <input type="checkbox"/> NO		Photo:	<ul style="list-style-type: none"> • Create accessible route • Relocate accessible space
1.108	Are accessible spaces identified with a sign that includes the International Symbol of Accessibility? Is the bottom of the sign at least 60 inches above the ground? [502.6] Note: The International Symbol of Accessibility is not required on the ground.	<input checked="" type="checkbox"/> YES <input type="checkbox"/> NO <input type="checkbox"/> YES <input checked="" type="checkbox"/> NO 59 1/2"		 Photo:	<ul style="list-style-type: none"> • Install signs
1.109	Are there signs reading “van accessible” at van accessible spaces? [502.6]	<input type="checkbox"/> YES <input checked="" type="checkbox"/> NO		Photo:	<ul style="list-style-type: none"> • Install signs
1.110	Of the total parking spaces, are the accessible spaces located on the closest accessible route to the accessible entrance(s)? [208.3.1] Note: If parking serves multiple entrances, accessible parking should be dispersed.	<input checked="" type="checkbox"/> YES <input type="checkbox"/> NO		Photo:	<ul style="list-style-type: none"> • Reconfigure spaces

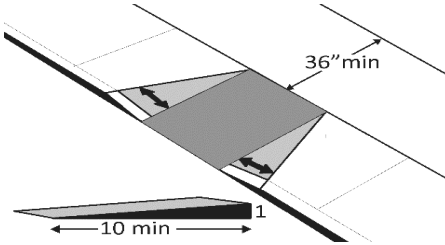
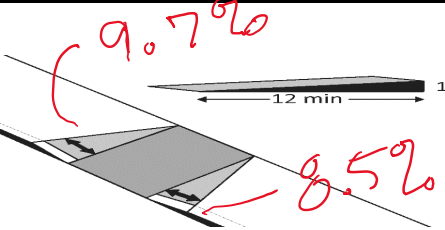

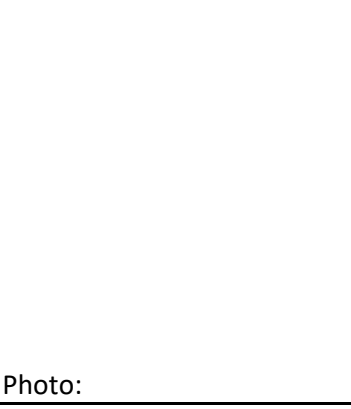
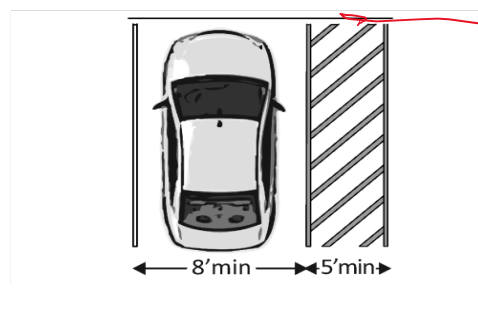
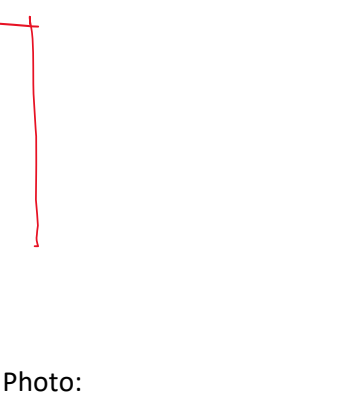
Curb Ramps					
1.111	If the accessible route crosses a curb, is there a curb ramp? [402.2]	<input checked="" type="checkbox"/> YES <input type="checkbox"/> NO			<ul style="list-style-type: none"> • Install curb ramp
1.112	Is the running slope of the curb ramp no steeper than 1:12, i.e. for every inch of height change there are at least 12 inches of curb ramp run? [406.1, 405.2]	<input type="checkbox"/> YES <input checked="" type="checkbox"/> NO Measure ment: 11.8%		<p>Photo #:</p>	<ul style="list-style-type: none"> • Regrade curb ramp
.113	Is the cross slope of the curb ramp, excluding flares, no steeper than 1:48? [406.1, 405.3]	<input checked="" type="checkbox"/> YES <input type="checkbox"/> NO Measure ment: <2%		<p>Photo #:</p>	<ul style="list-style-type: none"> • Regrade curb ramp
1.114	Is the curb ramp, excluding flares, at least 36 inches wide? [406.1, 405.5]	<input checked="" type="checkbox"/> YES <input type="checkbox"/> NO Measure ment: 48"		<p>Photo #:</p>	<ul style="list-style-type: none"> • Widen curb ramp

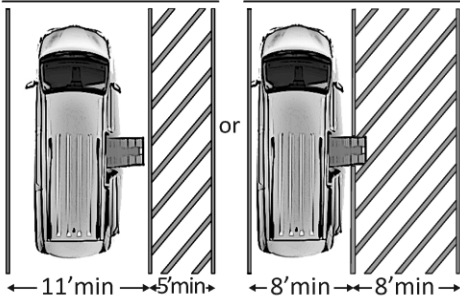
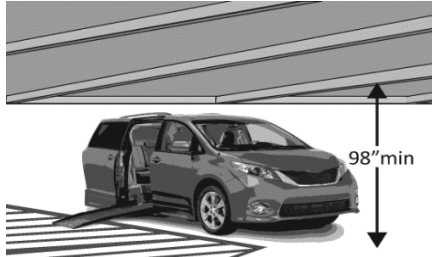
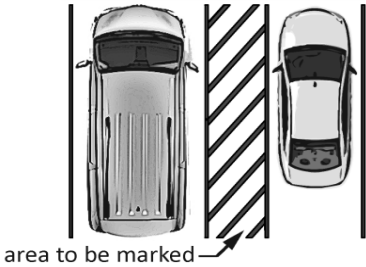
<p>1.115</p>	<p>At the top of the curb ramp is there a level landing (slope no steeper than 1:48 in all directions) that is at least 36 inches long and at least as wide as the curb ramp? [406.4]</p>	<p><input checked="" type="checkbox"/> YES <input type="checkbox"/> NO</p> <p>Measure ment:</p>			<ul style="list-style-type: none"> • Reconfigure • Add ramp flares
<p>1.116</p>	<p>If there are curb ramp flares, are the slopes of the flares no steeper than 1:10, i.e. for every inch of height change there are at least 10 inches of flare run? [406.3]</p>	<p><input checked="" type="checkbox"/> YES <input type="checkbox"/> NO</p> <p>Measure ment:</p> <p>9.7%</p> <p>8.5%</p>			
<p>1.116</p>	<p>If the landing at the top is less than 36 inches long, are there curb ramp flares?</p>	<p><input checked="" type="checkbox"/> YES <input type="checkbox"/> NO</p> <p>Measure ment:</p>			<ul style="list-style-type: none"> • Add ramp flares • Regrade flares
<p>1.116</p>	<p>Are the slopes of the flares no greater than 1:12, i.e. for every inch of height change there are at least 12 inches of flare run? [406.4]</p>	<p><input type="checkbox"/> YES <input type="checkbox"/> NO</p> <p>Measure ment:</p> <p>N/A</p>			

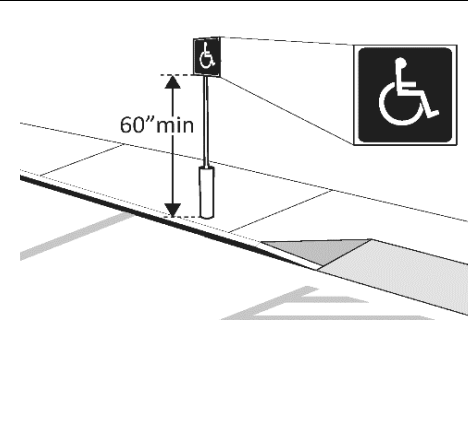
Parking Accessible parking spaces should be identified by size, access aisle and signage.																	
1.100	If parking is provided for the public, are an adequate number of accessible spaces provided? (208.2)	<input checked="" type="checkbox"/> YES <input type="checkbox"/> NO Total #: 11 Acsbl #: 1	<table border="1"> <thead> <tr> <th>Total Spaces</th> <th>Accessible Spaces</th> </tr> </thead> <tbody> <tr> <td>1 - 25</td> <td>1</td> </tr> <tr> <td>26 - 50</td> <td>2</td> </tr> <tr> <td>51 - 75</td> <td>3</td> </tr> <tr> <td>76 - 100</td> <td>4</td> </tr> <tr> <td>1200</td> <td>22</td> </tr> <tr> <td colspan="2">100+ see 2010 Standards 208.2</td> </tr> </tbody> </table>	Total Spaces	Accessible Spaces	1 - 25	1	26 - 50	2	51 - 75	3	76 - 100	4	1200	22	100+ see 2010 Standards 208.2	
Total Spaces	Accessible Spaces																
1 - 25	1																
26 - 50	2																
51 - 75	3																
76 - 100	4																
1200	22																
100+ see 2010 Standards 208.2																	
	<ul style="list-style-type: none"> Reconfigure by repainting lines 		Photo:														
1.101	Of the accessible spaces, is at least one a van accessible space? [208.2.4]	<input type="checkbox"/> YES <input checked="" type="checkbox"/> NO	*For every 6 or fraction of 6 parking spaces required by the table above, at least 1 should be a van accessible space.														
	<ul style="list-style-type: none"> If constructed before 3/15/2012, parking is compliant if at least 1 in every 8 accessible spaces is van accessible Reconfigure by repainting lines 		Photo:														
1.102	Are accessible spaces at least 8 feet wide with an access aisle at least 5 feet wide? [502.2, 502.3] Note: Two spaces may share an access aisle. Check state/local requirements; some specify that each space have its own aisle.	<input checked="" type="checkbox"/> YES <input type="checkbox"/> NO Measure ment: 8'-6" S 8'-0" A															
	<ul style="list-style-type: none"> Reconfigure by repainting lines 		Photo:														

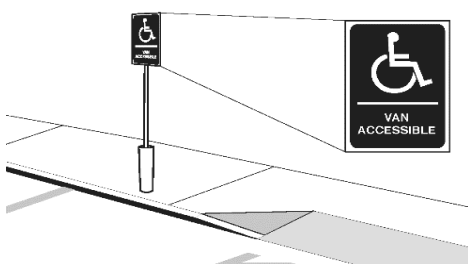
<p>1.103</p>	<p>Is the van accessible space: At least 11 feet wide with an access aisle at least 5 feet wide? Or At least 8 feet wide with an access aisle at least 8 feet wide? [502.2]</p>	<p><input type="checkbox"/> YES <input checked="" type="checkbox"/> NO Measure ment:</p>		<p>Photo:</p>	<ul style="list-style-type: none"> • Reconfigure by repainting lines
<p>1.104</p>	<p>Is at least 98 inches of vertical clearance provided for the van accessible space? [502.5]</p>	<p><input checked="" type="checkbox"/> YES <input type="checkbox"/> NO Measure ment:</p>		<p>Photo:</p>	<ul style="list-style-type: none"> • Reconfigure to provide van-accessible space(s)
<p>1.105</p>	<p>Are the access aisles marked so as to discourage parking in them? [502.3.3] Note: The marking method and color may be addressed by state/local requirements.</p>	<p><input checked="" type="checkbox"/> YES <input type="checkbox"/> NO Measure ment:</p>		<p>Photo:</p>	<ul style="list-style-type: none"> • Mark access aisles
<p>1.106</p>	<p>Is the slope of the accessible parking spaces and access aisles no steeper than 1:48 in all directions? [502.4]</p>	<p><input type="checkbox"/> YES <input checked="" type="checkbox"/> NO Measure ment: 2.2% - 2.6%</p>		<p>Photo:</p>	<ul style="list-style-type: none"> • Regrade surface

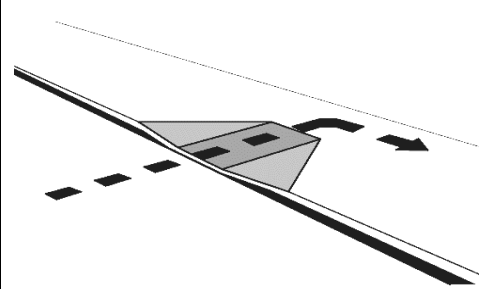
1.107	Do the access aisles adjoin an accessible route? [502.3]	<input checked="" type="checkbox"/> YES <input type="checkbox"/> NO TRAIL		Photo:	<ul style="list-style-type: none"> • Create accessible route • Relocate accessible space
1.108	Are accessible spaces identified with a sign that includes the International Symbol of Accessibility? Is the bottom of the sign at least 60 inches above the ground? [502.6] Note: The International Symbol of Accessibility is not required on the ground.	<input checked="" type="checkbox"/> YES <input type="checkbox"/> NO <input type="checkbox"/> YES <input checked="" type="checkbox"/> NO 36"			<ul style="list-style-type: none"> • Install signs
1.109	Are there signs reading “van accessible” at van accessible spaces? [502.6]	<input type="checkbox"/> YES <input checked="" type="checkbox"/> NO		Photo:	<ul style="list-style-type: none"> • Install signs
1.110	Of the total parking spaces, are the accessible spaces located on the closest accessible route to the accessible entrance(s)? [208.3.1] Note: If parking serves multiple entrances, accessible parking should be dispersed.	<input checked="" type="checkbox"/> YES <input type="checkbox"/> NO		Photo:	<ul style="list-style-type: none"> • Reconfigure spaces

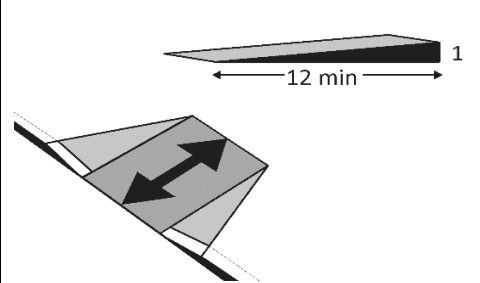
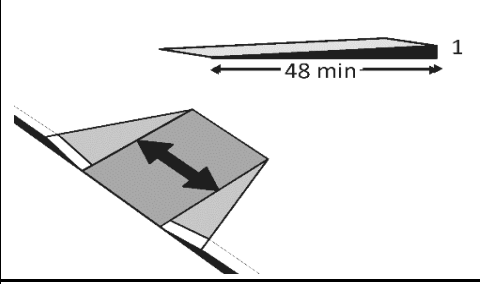
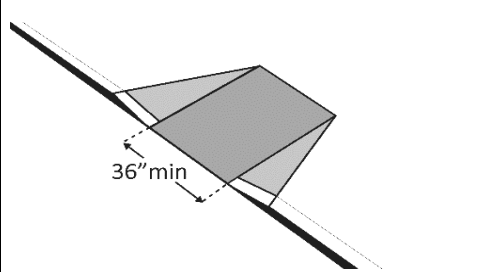
Curb Ramps				
1.111	If the accessible route crosses a curb, is there a curb ramp? [402.2]	<input checked="" type="checkbox"/> YES <input type="checkbox"/> NO		 <ul style="list-style-type: none"> • Install curb ramp
		Photo #:		
1.112	Is the running slope of the curb ramp no steeper than 1:12, i.e. for every inch of height change there are at least 12 inches of curb ramp run? [406.1, 405.2]	<input checked="" type="checkbox"/> YES <input type="checkbox"/> NO Measure ment: 8.2%		<ul style="list-style-type: none"> • Regrade curb ramp
		Photo #:		
.113	Is the cross slope of the curb ramp, excluding flares, no steeper than 1:48? [406.1, 405.3]	<input checked="" type="checkbox"/> YES <input type="checkbox"/> NO Measure ment: <2%		<ul style="list-style-type: none"> • Regrade curb ramp
		Photo #:		
1.114	Is the curb ramp, excluding flares, at least 36 inches wide? [406.1, 405.5]	<input checked="" type="checkbox"/> YES <input type="checkbox"/> NO Measure ment: 48"		<ul style="list-style-type: none"> • Widen curb ramp
		Photo #:		

<p>1.115</p>	<p>At the top of the curb ramp is there a level landing (slope no steeper than 1:48 in all directions) that is at least 36 inches long and at least as wide as the curb ramp? [406.4]</p>	<p><input checked="" type="checkbox"/> YES <input type="checkbox"/> NO</p> <p>Measure ment:</p>		<p>Photo:</p>	<ul style="list-style-type: none"> • Reconfigure • Add ramp flares
<p>1.116</p>	<p>If there are curb ramp flares, are the slopes of the flares no steeper than 1:10, i.e. for every inch of height change there are at least 10 inches of flare run? [406.3]</p>	<p><input checked="" type="checkbox"/> YES <input type="checkbox"/> NO</p> <p>Measure ment:</p> <p>9.8%</p> <p>9.6%</p>			
	<p>If the landing at the top is less than 36 inches long, are there curb ramp flares?</p>	<p><input checked="" type="checkbox"/> YES <input type="checkbox"/> NO</p> <p>Measure ment:</p>			
	<p>Are the slopes of the flares no greater than 1:12, i.e. for every inch of height change there are at least 12 inches of flare run? [406.4]</p>	<p><input type="checkbox"/> YES <input type="checkbox"/> NO</p> <p>Measure ment:</p> <p>N/A</p>			

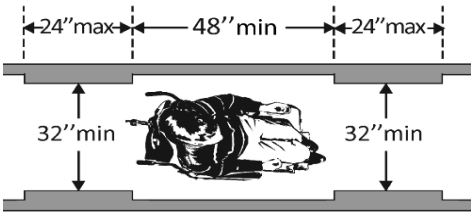
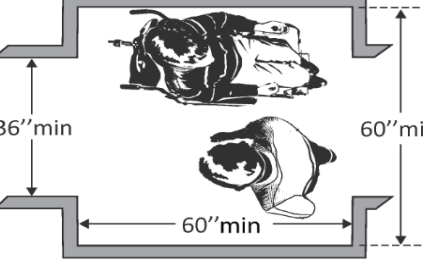
Exterior Accessible Route					
1.120	Is the route stable, firm and slip-resistant? [302.1]	<input checked="" type="checkbox"/> YES <input type="checkbox"/> NO Measure ment:		Photo:	<ul style="list-style-type: none"> • Repair uneven paving • Fill small bumps and breaks with patches • Replace gravel with asphalt or other surface
1.121	Is the route at least 36 inches wide? [403.5.1]	<input checked="" type="checkbox"/> YES <input type="checkbox"/> NO Measure ment:		Photo:	<ul style="list-style-type: none"> • Change or move landscaping, furnishings or other items • Widen route
	Note: The accessible route can narrow to 32 inches min. for a max. of 24 inches. These narrower portions of the route must be at least 48 inches from each other.	<input type="checkbox"/> YES <input type="checkbox"/> NO Measure ment: N/A		Photo:	
1.122	If the route is greater than 200 feet in length and less than 60 inches wide, is there a passing space no less than 60 x 60 inches? [403.5.3]	<input checked="" type="checkbox"/> YES <input type="checkbox"/> NO Measure ment:		Photo:	<ul style="list-style-type: none"> • Widen route for passing space

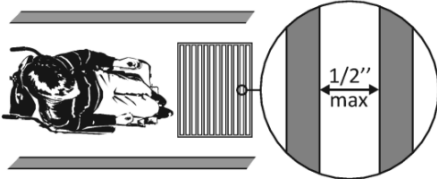
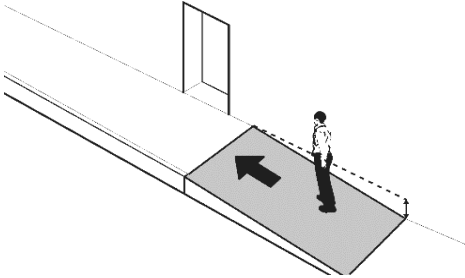
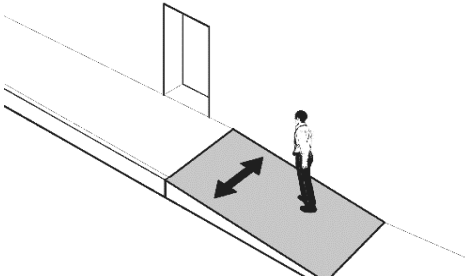
<p>1.123</p>	<p>If there are grates or openings on the route, are the openings no larger than ½ inches?</p>	<p><input type="checkbox"/> YES <input type="checkbox"/> NO Measure ment: N/A</p>		<p>Photo:</p>	<ul style="list-style-type: none"> • Replace or move grate
<p>1.124</p>	<p>Is the long dimension perpendicular to the dominant direction of travel? [302.3]</p> <p>Note: If the running slope is steeper than 1:20, treat as a ramp and add features such as edge protection and handrails.</p>	<p><input type="checkbox"/> YES <input type="checkbox"/> NO Measure ment:</p>		<p>Photo:</p>	<ul style="list-style-type: none"> • Regrade to 1:20 max.
<p>1.125</p>	<p>Is the cross slope no steeper than 1:48? [403.3]</p>	<p><input checked="" type="checkbox"/> YES <input type="checkbox"/> NO Measure ment:</p>		<p>Photo:</p>	<ul style="list-style-type: none"> • Regrade to 1:48 max.
<p>1.126</p>	<p>Is the main entrance accessible?</p>	<p><input checked="" type="checkbox"/> YES <input type="checkbox"/> NO</p>		<p>Photo:</p>	<ul style="list-style-type: none"> • Redesign to make it accessible



5. Boxcar Park

DATE OF EVALUATION

1/20/2021

Figure 6. Recreational Facilities to Be Assessed for ADA Compliance - Phase I



ADA Evaluation

FOR
Boxcar Park

Port of Everett

ADA Transition Plan



Based on the 2010 ADA Standards for Accessible Design

Completed by:

design2 LAST, inc
534 Main St, Suite 101
Edmonds, WA 98020

Notes Regarding ADA Evaluation for this facility

Each file contains an aerial view of the site as shown on Google. If plans for the facilities were available, they are included. If room names or numbers are not indicated on those plans, fictional room names and numbers were given to spaces to correlate them to the enclosed checklists. These are intended to be used for the purpose of locating which rooms pertain to which portion of the checklist, and may or may not represent the actual room numbers and names at the facility.

How to read these checklists:

1. The 1st column is the identity mark, typically the priority number (1, 2, 3, or 4) followed by an identifying number. These may or may not be in order depending on whether non relevant rows have been hidden.
2. The 2nd column describes the compliance issue in the form of a question. The compliant measurement or count is identified in the question. If the response to the question is 'yes' the issue is compliant.
3. The 3rd and 4th columns are the 'yes' and 'no' responses, and measurements taken in the field. If the issue is compliant and the 'yes' box is checked, there may or may not be a measurement included. If the 'no' box is checked, the issue is non-compliant, and a measurement or count will indicate how the issue is noncompliant.

ADA Checklist for Existing Facilities

The Americans with Disabilities Act (ADA) requires state and local governments, businesses and non-profit organizations to provide goods, services and programs to people with disabilities on an equal basis with the rest of the public.

Some people think that only new construction and alterations need to be accessible and that older facilities are "grandfathered," but that's not true. Because the ADA is a civil rights law and not a building code, older facilities are often required to be accessible to ensure that people with disabilities have an equal opportunity to participate.

The ADA has different requirements for state and local governments and for places of public accommodation (businesses and non-profit organizations that serve the public).

Requirements for State and Local Governments

State and local governments must ensure that services, programs and activities, when viewed in their entirety, are accessible to people with disabilities. This is part of public entities' program accessibility obligations. Alterations to older buildings may be needed to ensure program accessibility. Generally this is a greater obligation than "readily achievable barrier removal" the standard that applies to public accommodations. State and local governments are not required to take any action that would result in undue financial and administrative burdens.

State and local governments' ADA obligations for program accessibility are in the Department of Justice's ADA Title II regulations 28 CFR Part 35.150.

Requirements for Places of Public Accommodation

Businesses and non-profit organizations that serve the public must remove architectural barriers when it is "readily achievable" to do so; in other words, when barrier removal is "easily accomplishable and able to be carried out without much difficulty or expense."

The decision of what is readily achievable is made considering the size, type, and overall finances of the public accommodation and the nature and cost of the access improvements needed. Barrier removal that is difficult now may be readily achievable in the future as finances change.

4. The 5th column may contain a pictogram or drawing of the issue being evaluated. This may also contain a sketch of what the evaluator found in the field as it related to the condition being evaluated.
5. The 6th column may contain a photo of the field condition. Only a select number of conditions are photographed to keep the file size manageable.
6. The last column may contains a list of suggested corrections. These are helpful to the cost estimating team but may not reflect the amount of work required to move or replace an item to bring it into compliance. There may be some economy when multiple non-compliance issues can be completed with one action. There may also be several ways to make corrective changes. How changes and corrections are made will depend on several things, most importantly the existing conditions. These typically are addressed in a design process.
7. Some cells are highlighted yellow. The highlighted cells are identifying non-compliance issues. The yellow is used simply to make the non-compliant issues easier to find among the large number of pages.
8. If no boxes are checked , or there is a slash thru the compliance issue, that particular issue does not apply to the instance being evaluated.

Public accommodations' ADA obligations for barrier removal are in the Department of Justice's ADA Title III regulations 28 CFR Part 36.304.

Priorities for Accessibility

The checklist follows the four priorities that are listed in the Department of Justice ADA Title III regulations. These priorities are equally applicable to state and local government facilities.

Priority 1 - Accessible approach and entrance

Priority 2 - Access to goods and services

Priority 3 - Access to public toilet rooms

Priority 4 - Access to other items such as water fountains and public telephones

2010 ADA Standards for Accessible Design

The checklist is based on the 2010 ADA Standards for Accessible Design (2010 Standards). The checklist may not include all sections of the 2010 Standards. Consult the 2010 Standards for situations not covered in the checklist. Full compliance with the 2010 Standards is required only for new construction and alterations.

Safe Harbor – Construction Prior to March 15, 2012

Elements in facilities built or altered before March 15, 2012 that comply with the 1991 ADA Standards for Accessible Design (1991 Standards) are not required to be modified to specifications in the 2010 Standards. For example, the 1991 Standards allow 54 inches maximum for a side reach range to a control such as the operating part of a paper towel dispenser. The 2010 Standards lower that side reach range to 48 inches maximum. If a paper towel dispenser was installed prior to March 15, 2012 with the highest operating part at 54 inches, the paper towel dispenser does not need to be lowered to 48".

What this Checklist is Not

The ADA Title II and III regulations require more than program accessibility and barrier removal. The regulations include requirements for nondiscriminatory policies and practices and for the provision of auxiliary aids and services, such as sign language interpreters for people who are deaf and material in Braille for people who are blind. This checklist does not cover those requirements.

Since this checklist does not include all of the 2010 Standards it is not intended to determine compliance for new construction or facilities being altered.

Resources**U.S. Department of Justice ADA Information**

800-514-0301 voice: 800-514-0383 TTY
www.ada.gov

ADA National Network

800-949-4232 voice/TTY connects to
your regional ADA Center:
www.adata.org

U.S. Access Board

800- 872-2253 voice: 800-993-2822 TTY
www.access-board.gov

[ADA Title III Regulations 28 CFR Part 36
www.ada.gov/regs2010/titleIII_2010/titleII_2010_regulations.htm](http://www.ada.gov/regs2010/titleIII_2010/titleII_2010_regulations.htm)

[2010 ADA Standards for Accessible Design
www.ada.gov/2010ADASTandards_index.htm](http://www.ada.gov/2010ADASTandards_index.htm)

[1991 ADA Standards for Accessible Design
www.ada.gov/stdspdf.htm](http://www.ada.gov/stdspdf.htm)

Acknowledgements

The Institute for Human Centered Design and the New England ADA Center created the ADA Checklists. Originals can be accessed at www.adachecklist.org.

What are Public Accommodations?

Under the ADA public accommodations are private entities that own, lease, lease to or operate a place of public accommodation. This means that both a landlord who leases space in a building to a tenant and the tenant who operates a place of public accommodation have responsibilities to remove barriers.

A place of public accommodation is a facility whose operations affect commerce and fall within at least one of the following 12 categories:

- 1) Places of lodging (e.g., inns, hotels, motels, except for owner-occupied establishments renting fewer than six rooms)
- 2) Establishments serving food or drink (e.g. , restaurants and bars)
- 3) Places of exhibition or entertainment (e.g. , motion picture houses, theaters, concert halls, stadiums)
- 4) Places of public gathering (e.g. , auditoriums, convention centers, lecture halls)
- 5) Sales or rental establishments (e.g. , bakeries, grocery stores, hardware stores, shopping centers)
- 6) Service establishments (e.g. , laundromats, dry-cleaners, banks, barber shops, beauty shops, travel services, shoe repair services, funeral parlors, gas stations, offices of accountants or lawyers, pharmacies, insurance offices, professional offices of health care providers, hospitals)
- 7) Public transportation terminals, depots, or stations (not including facilities relating to air transportation)
- 8) Places of public display or collection (e.g. , museums, libraries, galleries)
- 9) Places of recreation (e.g. , parks, zoos, amusement parks)
- 10) Places of education (e.g. , nursery schools, elementary, secondary, undergraduate, or postgraduate private schools)
- 11) Social service center establishments (e.g. , day care centers, senior citizen centers, homeless shelters, food banks, adoption agencies)
- 12) Places of exercise or recreation (e.g. , gymnasiums, health spas, bowling alleys, golf courses).

Many of the illustrations are from the U.S. Department of Justice and the U.S. Access Board or are based on illustrations produced by the U.S. Access Board and the U.S. Department of Justice.

New sections added to Appendix A to Chapter 10

F201.4 Requirements Apply to Facilities Constructed or Altered by or on Behalf of Federal Agencies.

The requirements in F216.13, F244 through F248, and 1011 through 1019 shall apply only to facilities constructed or altered by federal agencies or by non-federal entities on federal land on behalf of federal agencies pursuant to a concession contract, partnership agreement, or similar arrangement.

F201.4.1 Documentation and Notification When Exceptions Used for Trails and Beach Access

Routes. Federal agencies shall document the basis for not fully complying with a specific provision in 1017 or 1018 on a portion of a trail or beach access route based on Exception 1 in 1017 or Exception 1 in 1018, and shall maintain the documentation with the records for the trail or beach project. Federal agencies shall notify the Access Board if an entire trail is exempted from complying with 1017 based on Exception 2 in 1017.1, and if a beach access route is not provided based on Exception 2 in 1018.1.6)

F202.3 Alterations. * * * * *

EXCEPTIONS: * * * * *

4. Where elements or spaces are altered in camping facilities, picnic facilities, viewing areas, or trailheads and the circulation path to the altered element or space is not altered, the circulation path shall not be required to comply with 1016.

F202.4 Alterations Affecting Primary Function Areas. * * * * *

EXCEPTIONS: * * * * *

2. Camping facilities, picnic facilities, viewing areas, trailheads, trails, and beach access routes shall not be required to comply with F202.4.

F206.1 General. * * * * *

EXCEPTIONS: 1. Accessible routes shall not be required where outdoor recreation access routes are provided at camping facilities in accordance with F244.5, picnic facilities in accordance with F245.4, viewing areas in accordance with F246.3, or trailheads in accordance with F247.3.2.

2. Accessible routes shall not be required where camping facilities, picnic facilities, viewing areas, or outdoor constructed features are provided on trails.

3. Accessible routes shall not be required where beach access routes are provided in accordance with F248.

F212.3 Sinks. * * * * *

EXCEPTIONS: * * * * *

2. In camping facilities and picnic facilities, sinks shall not be required to comply with F212.3 where a cooktop or conventional range is not provided.

F213.1 General. * * * * *

EXCEPTION: Pit toilets provided on trails and in camping facilities shall not be required to comply with F213

F216.13 Trailhead Signs. Where new trail information signs are provided at trailheads on newly constructed or altered

SUMMARY

Boxcar Park

Boxcar Park is a large, flat primarily grassy area, with two (2) adjacent picnic “kite” shelter facilities on the south end, and a large gravel parking area to the east. A portion of the parking area has been paved and three (3) accessible parking spaces added adjacent to the temporary, portable comfort station building. There is no accessible walking path connecting these parking spaces to the picnic facilities or to the Marina Waterfront Trail System.

While the parking spaces were reviewed, the temporary portable comfort station and the ramp up to the entry door was not reviewed as part of this evaluation due to their temporary nature. The parking spaces are mostly compliant, with minor slope corrections needed. A minimum of one (1) van accessible space should also be added.

The two (2) picnic shelters have compliant slopes, but no compliant picnic table. Accessible compliant picnic tables designed for wheelchair forward approach should be added to each shelter.

There is a parking space near the picnic shelters that is painted with the international accessibility symbol but is not fully compliant. Adding a painted access aisle, compliant signage, and an identified accessible route, would bring this into compliance and provide access to the picnic shelters.

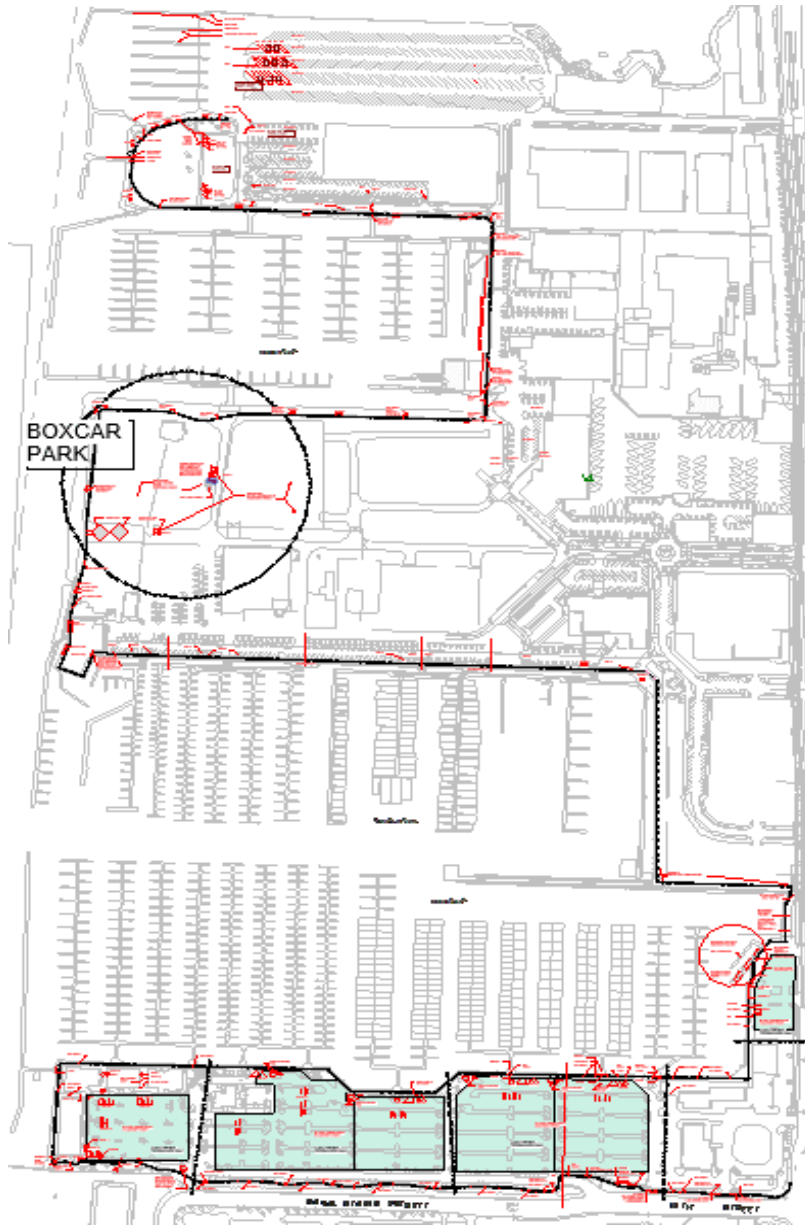

BOXCAR PARK
OVERALL PORT PLAN

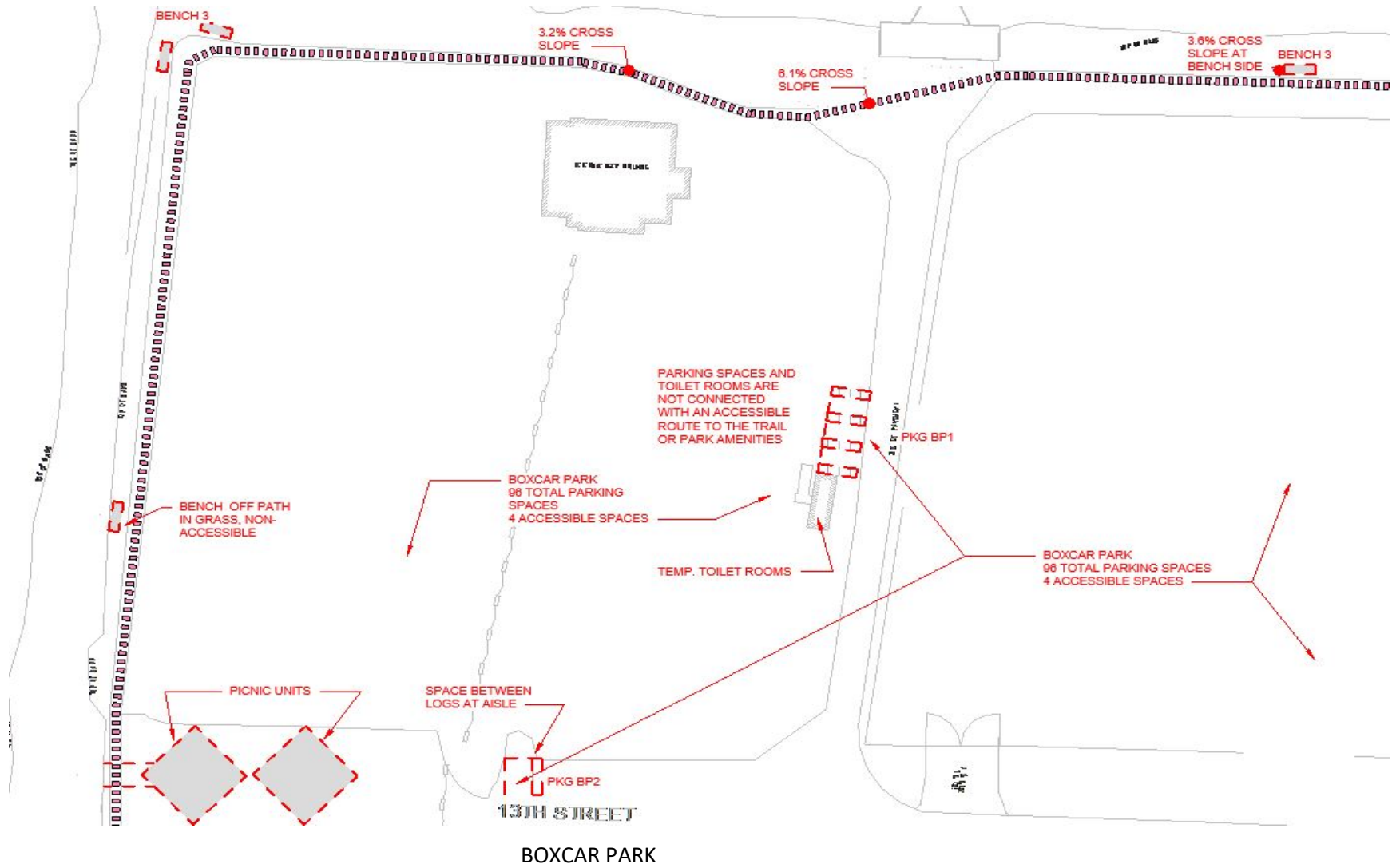

ADA Checklist for Existing

Priority 1 - Approach & Entrance

Based on the 2010 ADA Standards for Accessible Design



Project: ADA Transition Plan

Building: Boxcar Park

Location: Everett, WA

Date: 1/20/2021

Surveyors: Lauri Strauss, AIA, LEED AP BD&C
President, CEO, design2 LAST, inc



Contact Information: o. 425-673-7269 c. 907-317-5040

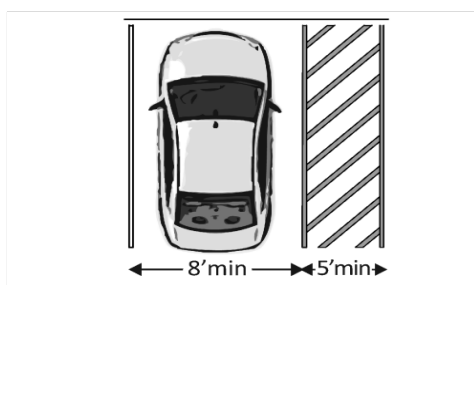

543 Main St, Suite 101, Edmonds, WA 98020

An accessible route from site arrival points and an accessible entrance should be provided for everyone.

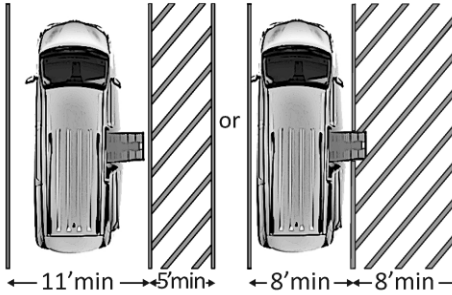
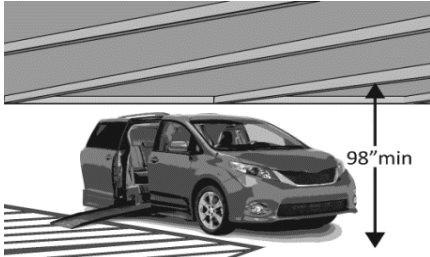
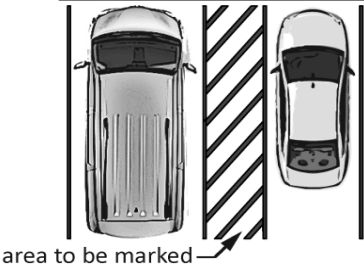
Priority 1 - Approach & Entrance					Comments	Possible Solutions
1.001	Is there at least one route from site arrival points (parking, passenger loading zones, public sidewalks and public transportation stops) that does not require the use of stairs? [See 2010 ADA Standards for Accessible Design – 206.2.1]	<input type="checkbox"/> YES If yes, location of route:	<input checked="" type="checkbox"/> NO NO ACCESSIBLE ROUTE TO TOILET ROOMS AND PICNIC UNITS		Photo:	<ul style="list-style-type: none"> • Add a ramp • Regrade to 1:20 maximum slope • Add a lift if site constraints prevent other solutions

Parking Accessible parking spaces should be identified by size, access aisle and signage.																	
1.100	If parking is provided for the public, are an adequate number of accessible spaces provided? (208.2)	<input checked="" type="checkbox"/> YES <input type="checkbox"/> NO Total #: 96 Acsbl #: 3 THIS LOC - 4 TOTAL	<table border="1"> <thead> <tr> <th>Total Spaces</th> <th>Accessible Spaces</th> </tr> </thead> <tbody> <tr> <td>1 - 25</td> <td>1</td> </tr> <tr> <td>26 - 50</td> <td>2</td> </tr> <tr> <td>51 - 75</td> <td>3</td> </tr> <tr> <td>76 - 100</td> <td>4</td> </tr> <tr> <td>1200</td> <td>22</td> </tr> <tr> <td colspan="2">100+ see 2010 Standards 208.2</td> </tr> </tbody> </table>	Total Spaces	Accessible Spaces	1 - 25	1	26 - 50	2	51 - 75	3	76 - 100	4	1200	22	100+ see 2010 Standards 208.2	
Total Spaces	Accessible Spaces																
1 - 25	1																
26 - 50	2																
51 - 75	3																
76 - 100	4																
1200	22																
100+ see 2010 Standards 208.2																	
 <p>Photo:</p>	<ul style="list-style-type: none"> • Reconfigure by repainting lines 																
1.101	Of the accessible spaces, is at least one a van accessible space? [208.2.4]	<input type="checkbox"/> YES <input checked="" type="checkbox"/> NO	*For every 6 or fraction of 6 parking spaces required by the table above, at least 1 should be a van accessible space.														
<p>Photo:</p>	<ul style="list-style-type: none"> • If constructed before 3/15/2012, parking is compliant if at least 1 in every 8 accessible spaces is van accessible • Reconfigure by repainting lines 																
1.102	Are accessible spaces at least 8 feet wide with an access aisle at least 5 feet wide? [502.2, 502.3] Note: Two spaces may share an access aisle. Check state/local requirements; some specify that each space have its own aisle.	<input checked="" type="checkbox"/> YES <input type="checkbox"/> NO Measure ment: 10'-0" S 5'-0" A (ALL)															
<p>Photo:</p>	<ul style="list-style-type: none"> • Reconfigure by repainting lines 																

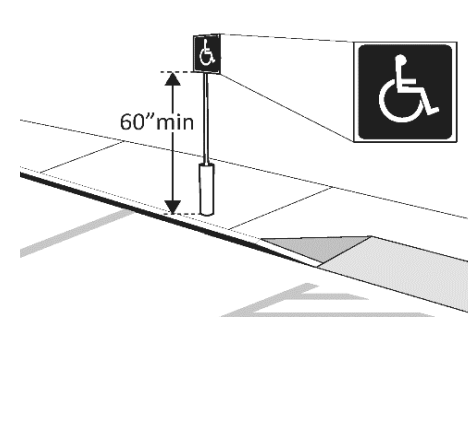
<p>1.103</p>	<p>Is the van accessible space: At least 11 feet wide with an access aisle at least 5 feet wide? Or</p>	<p><input type="checkbox"/> YES <input checked="" type="checkbox"/> NO ment:</p>		<p>Photo:</p>	<ul style="list-style-type: none"> • Reconfigure by repainting lines
	<p>At least 8 feet wide with an access aisle at least 8 feet wide? [502.2]</p>	<p><input type="checkbox"/> YES <input checked="" type="checkbox"/> NO Measure ment:</p>		<p>Photo:</p>	
<p>1.104</p>	<p>Is at least 98 inches of vertical clearance provided for the van accessible space? [502.5]</p>	<p><input checked="" type="checkbox"/> YES <input type="checkbox"/> NO Measure ment:</p>		<p>Photo:</p>	<ul style="list-style-type: none"> • Reconfigure to provide van-accessible space(s)
<p>1.105</p>	<p>Are the access aisles marked so as to discourage parking in them? [502.3.3] Note: The marking method and color may be addressed by state/local requirements.</p>	<p><input checked="" type="checkbox"/> YES <input type="checkbox"/> NO Measure ment:</p>		<p>Photo:</p>	<ul style="list-style-type: none"> • Mark access aisles
<p>1.106</p>	<p>Is the slope of the accessible parking spaces and access aisles no steeper than 1:48 in all directions? [502.4]</p>	<p><input type="checkbox"/> YES <input checked="" type="checkbox"/> NO Measure ment: 2.6% @ N.STLL (DRAIN)</p>			<ul style="list-style-type: none"> • Regrade surface

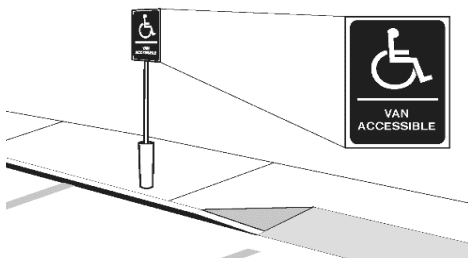
1.107	Do the access aisles adjoin an accessible route? [502.3]	<input checked="" type="checkbox"/> YES <input type="checkbox"/> NO TO TOILET ROOMS ONLY		Photo:	<ul style="list-style-type: none"> • Create accessible route • Relocate accessible space
1.108	Are accessible spaces identified with a sign that includes the International Symbol of Accessibility? Is the bottom of the sign at least 60 inches above the ground? [502.6] Note: The International Symbol of Accessibility is not required on the ground.	<input checked="" type="checkbox"/> YES <input type="checkbox"/> NO <input type="checkbox"/> YES <input checked="" type="checkbox"/> NO 52"			<ul style="list-style-type: none"> • Install signs
1.109	Are there signs reading “van accessible” at van accessible spaces? [502.6]	<input type="checkbox"/> YES <input checked="" type="checkbox"/> NO		Photo:	<ul style="list-style-type: none"> • Install signs
1.110	Of the total parking spaces, are the accessible spaces located on the closest accessible route to the accessible entrance(s)? [208.3.1] Note: If parking serves multiple entrances, accessible parking should be dispersed.	<input checked="" type="checkbox"/> YES <input type="checkbox"/> NO		Photo:	<ul style="list-style-type: none"> • Reconfigure spaces

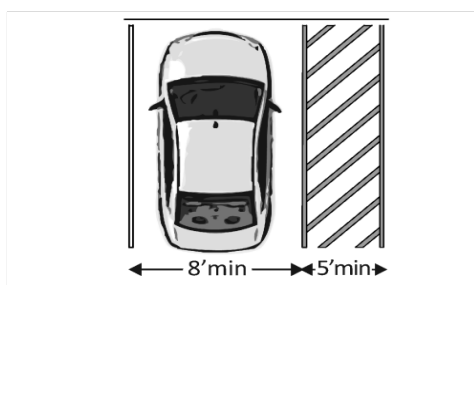
Parking Accessible parking spaces should be identified by size, access aisle and signage.																			
1.100	If parking is provided for the public, are an adequate number of accessible spaces provided? (208.2)	<input checked="" type="checkbox"/> YES <input type="checkbox"/> NO Total #: 96 Acsbl #: 1 THIS LOC - 4 TOTAL	<table border="1"> <thead> <tr> <th>Total Spaces</th> <th>Accessible Spaces</th> </tr> </thead> <tbody> <tr> <td>1 - 25</td> <td>1</td> </tr> <tr> <td>26 - 50</td> <td>2</td> </tr> <tr> <td>51 - 75</td> <td>3</td> </tr> <tr> <td>76 - 100</td> <td>4</td> </tr> <tr> <td>1200</td> <td>22</td> </tr> <tr> <td colspan="2">100+ see 2010 Standards 208.2</td> </tr> </tbody> </table>	Total Spaces	Accessible Spaces	1 - 25	1	26 - 50	2	51 - 75	3	76 - 100	4	1200	22	100+ see 2010 Standards 208.2		 <p>Photo:</p>	<ul style="list-style-type: none"> Reconfigure by repainting lines
Total Spaces	Accessible Spaces																		
1 - 25	1																		
26 - 50	2																		
51 - 75	3																		
76 - 100	4																		
1200	22																		
100+ see 2010 Standards 208.2																			
1.101	Of the accessible spaces, is at least one a van accessible space? [208.2.4]	<input type="checkbox"/> YES <input checked="" type="checkbox"/> NO	*For every 6 or fraction of 6 parking spaces required by the table above, at least 1 should be a van accessible space.	<p>Photo:</p>	<ul style="list-style-type: none"> If constructed before 3/15/2012, parking is compliant if at least 1 in every 8 accessible spaces is van accessible Reconfigure by repainting lines 														
1.102	Are accessible spaces at least 8 feet wide with an access aisle at least 5 feet wide? [502.2, 502.3] Note: Two spaces may share an access aisle. Check state/local requirements; some specify that each space have its own aisle.	<input checked="" type="checkbox"/> YES <input type="checkbox"/> NO Measure ment: 10'-0" S 5'-0" A (ALL)		<p>Photo:</p>	<ul style="list-style-type: none"> Reconfigure by repainting lines 														

<p>1.103</p>	<p>Is the van accessible space: At least 11 feet wide with an access aisle at least 5 feet wide? Or At least 8 feet wide with an access aisle at least 8 feet wide? [502.2]</p>	<p><input type="checkbox"/> YES <input checked="" type="checkbox"/> NO Measurement:</p>		<p>Photo:</p>	<ul style="list-style-type: none"> • Reconfigure by repainting lines
<p>1.104</p>	<p>Is at least 98 inches of vertical clearance provided for the van accessible space? [502.5]</p>	<p><input checked="" type="checkbox"/> YES <input type="checkbox"/> NO Measurement:</p>		<p>Photo:</p>	<ul style="list-style-type: none"> • Reconfigure to provide van-accessible space(s)
<p>1.105</p>	<p>Are the access aisles marked so as to discourage parking in them? [502.3.3] Note: The marking method and color may be addressed by state/local requirements.</p>	<p><input checked="" type="checkbox"/> YES <input type="checkbox"/> NO Measurement: COVERED WITH GRAVEL</p>			<ul style="list-style-type: none"> • Mark access aisles
<p>1.106</p>	<p>Is the slope of the accessible parking spaces and access aisles no steeper than 1:48 in all directions? [502.4]</p>	<p><input checked="" type="checkbox"/> YES <input type="checkbox"/> NO Measurement:</p>		<p>Photo:</p>	<ul style="list-style-type: none"> • Regrade surface

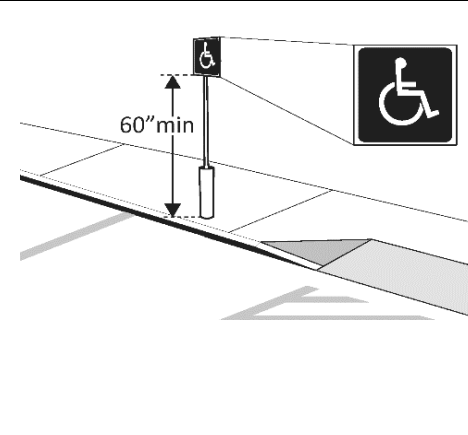
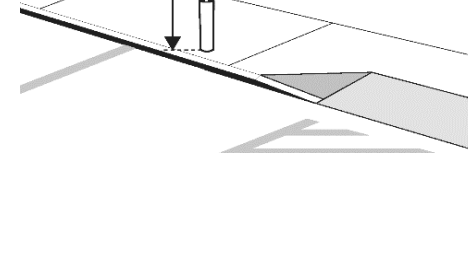
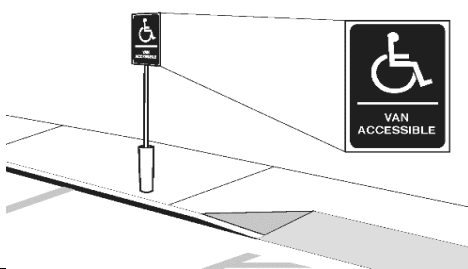
1.107	Do the access aisles adjoin an accessible route? [502.3]	<input checked="" type="checkbox"/> YES <input type="checkbox"/> NO		Photo:	<ul style="list-style-type: none"> • Create accessible route • Relocate accessible space
1.108	Are accessible spaces identified with a sign that includes the International Symbol of Accessibility?	<input type="checkbox"/> YES <input checked="" type="checkbox"/> NO		Photo:	<ul style="list-style-type: none"> • Install signs
	Is the bottom of the sign at least 60 inches above the ground? [502.6] Note: The International Symbol of Accessibility is not required on the ground.	<input type="checkbox"/> YES <input checked="" type="checkbox"/> NO		Photo:	
1.109	Are there signs reading “van accessible” at van accessible spaces? [502.6]	<input type="checkbox"/> YES <input checked="" type="checkbox"/> NO		Photo:	<ul style="list-style-type: none"> • Install signs
1.110	Of the total parking spaces, are the accessible spaces located on the closest accessible route to the accessible entrance(s)? [208.3.1] Note: If parking serves multiple entrances, accessible parking should be dispersed.	<input checked="" type="checkbox"/> YES <input type="checkbox"/> NO		Photo:	<ul style="list-style-type: none"> • Reconfigure spaces

ADA Checklist for Existing

Priority 2 - Access to Goods & Services

Based on the 2010 ADA Standards for Accessible Design

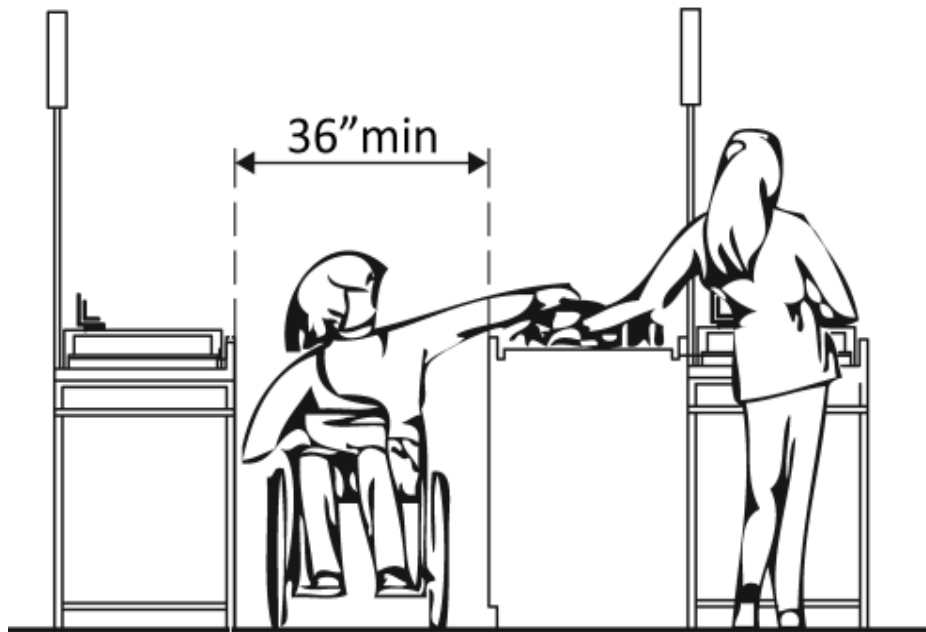

Project: ADA Transition Plan

Building: Boxcar Park

Location: Everett, WA

Date: 1/20/2021

Surveyors: Lauri Strauss, AIA, LEED AP BD&C
President, CEO, design2 LAST, inc

Contact Information: o. 425-673-7269 c. 907-317-5040

543 Main St, Suite 101, Edmonds, WA 98020

The layout of the building should allow people with disabilities to obtain goods and services and to participate in activities without assistance.

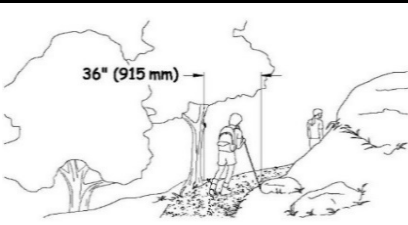
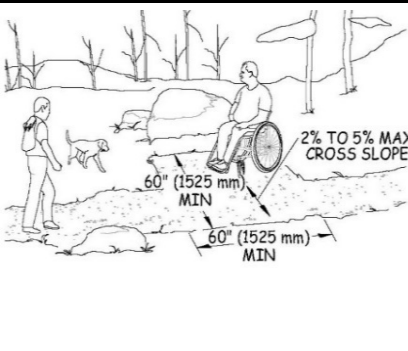
Outdoor Recreation Access Routes [1016] (A pedestrian route developed primarily to connect elements, spaces, or facilities within a site is not a trail)					
2.200	Outdoor Recreation Access Routes shall comply with 1016 [F247]			EXCEPTIONS: 1. In alterations to existing camping facilities, picnic facilities, and trailheads, when an entity determines that a condition in 1019 does not permit full compliance with a specific provision in 1016 on a portion of an outdoor recreation access route, the portion of the outdoor recreation access route shall comply with the provision to the extent practicable. 2. At viewing areas, when an entity determines that a condition in 1019 does not permit full compliance on a portion of an outdoor recreation access route with a specific provision in 1016, the portion of the outdoor recreation access route shall comply with the provision to the extent practicable. 3. Where outdoor recreation access routes are provided within vehicular ways, outdoor recreation access routes shall not be required to comply with 1016.4, 1016.7, and 1016.8.	
2.201	Is the surface of outdoor recreation access routes, passing spaces, and resting intervals stable, firm and slip-resistant? [40.2, 302.1]	<input checked="" type="checkbox"/> YES Material: ASPHALT	<input type="checkbox"/> NO	A firm trail surface resists deformation by indentations. A stable trail surface is not permanently affected by expected weather conditions and can sustain normal wear and tear from the expected uses between planned maintenance.	 Photo #: <ul style="list-style-type: none"> • Modify surface • Replace Surface
2.202	Is the clear width of the outdoor recreation access route 36 inches (915 mm) minimum? [1016.3]	<input checked="" type="checkbox"/> YES Measurement:	<input type="checkbox"/> NO		Photo #: <ul style="list-style-type: none"> • Modify route • Provide new route
2.203	If the outdoor recreation access route width is less than 60 inches (1525 mm) are passing spaces provided at intervals of 200 feet (61 m) maximum? (Passing spaces and resting intervals shall be permitted to overlap.) [1017.4]	<input type="checkbox"/> YES Measurement: N/A	<input type="checkbox"/> NO		Photo #: <ul style="list-style-type: none"> • Modify route • Provide passing spaces

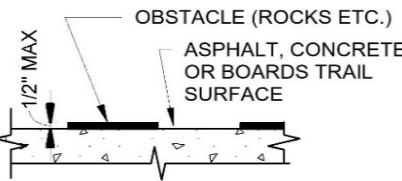
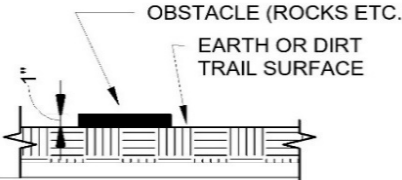
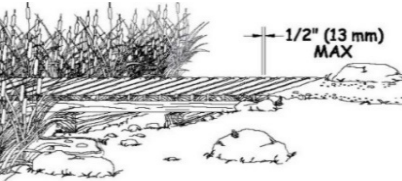
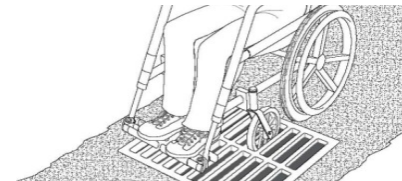
<p>2.200</p>	<p>If the outdoor recreation access routes surface is asphalt, concrete or boards, and there are obstacles on route, passing spaces, and resting intervals, are they less than 1/2 inch (13 mm) in height measured vertically to the highest point? [1016.5]</p>	<p><input checked="" type="checkbox"/> YES Measurement:</p>	<p><input type="checkbox"/> NO</p>		<p>Photo #:</p>	<ul style="list-style-type: none"> • Modify route • Regrade
<p>2.206</p>	<p>If the outdoor recreation access routes surface is not asphalt, concrete or boards, and there are tread obstacles on outdoor recreation access routes passing spaces, and resting intervals, are they less than 1 inch (25 mm) in height measured vertically to the highest point? [1016.5]</p>	<p><input type="checkbox"/> YES Measurement: N/A</p>	<p><input type="checkbox"/> NO</p>		<p>Photo #:</p>	<ul style="list-style-type: none"> • Modify route • Regrade
<p>2.207</p>	<p>Are openings in the surface of outdoor recreation access routes passing spaces, and resting intervals small enough to not allow the passage of a sphere more than 1/2 inch (13 mm) in diameter? [1016.6]</p>	<p><input type="checkbox"/> YES Measurement: N/A</p>	<p><input type="checkbox"/> NO</p>		<p>Photo #:</p>	<ul style="list-style-type: none"> • Modify route • Replace grates or boards
<p>2.208</p>	<p>If there are elongated openings, are they placed so that the long dimension is perpendicular, or as close to perpendicular as possible, to the dominant direction of travel? [1016.6]</p>	<p><input type="checkbox"/> YES Measurement: N/A</p>	<p><input type="checkbox"/> NO</p>		<p>Photo #:</p>	<ul style="list-style-type: none"> • Modify route • Replace grates or boards

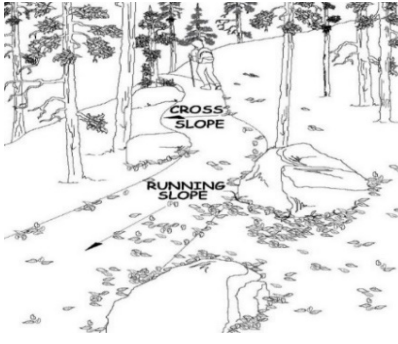
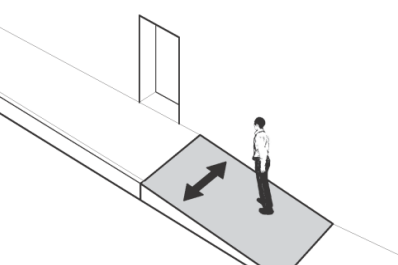

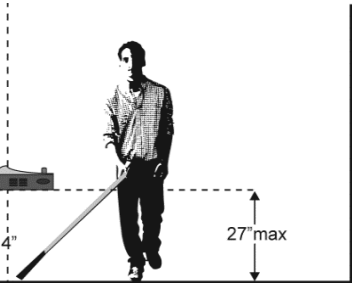
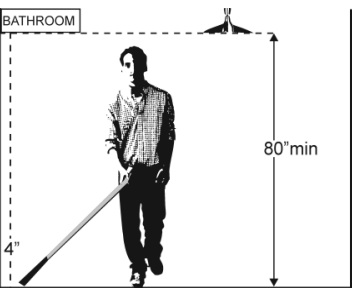
<p>2.209</p>	<p>Is the running slope of any segment of the outdoor recreation access routes steeper than 1:10 (10%). [1016.7.1]</p>	<p><input checked="" type="checkbox"/> YES <input type="checkbox"/> NO Measurement: .3%</p>	<p><input type="checkbox"/> NO</p>		<p>Photo #:</p>	<ul style="list-style-type: none"> • Regrade
<p>2.212</p>	<p>Is the cross slope no steeper than 1:48? [1016.7.2] Where the surface is other than concrete, asphalt, or boards, cross slopes not steeper than 1:20 shall be permitted when necessary for drainage.</p>	<p><input checked="" type="checkbox"/> YES <input type="checkbox"/> NO Measurement: .3% Material: CONC</p>	<p><input type="checkbox"/> NO</p>		<p>Photo #:</p>	<ul style="list-style-type: none"> • Regrade



<p>2.219</p>	<p>Do all objects on outdoor recreation access routes, passing spaces, and resting intervals, e.g. signs, etc., protrude no more than 4 inches into the path? (does not apply to natural features, such as tree branches, rock formations) Or</p>	<p><input checked="" type="checkbox"/> YES Measurement:</p>	<p><input type="checkbox"/> NO</p>		<p>Photo #:</p>	<ul style="list-style-type: none"> • Remove object • Add tactile warning such as permanent planter or partial walls
	<p>If an object protrudes more than 4 inches, is the bottom leading edge at 27 inches or lower above the floor? [307.2] Or</p>	<p><input checked="" type="checkbox"/> YES Measurement:</p>	<p><input type="checkbox"/> NO</p>		<p>Photo #:</p>	<ul style="list-style-type: none"> • Remove object • Add tactile warning such as permanent planter or partial walls
	<p>Is the bottom leading edge at 80 inches or higher above the floor? [307.4]</p>	<p><input checked="" type="checkbox"/> YES Measurement: 8'-2"</p>	<p><input type="checkbox"/> NO</p>		<p>Photo #:</p>	<ul style="list-style-type: none"> • Remove object • Add tactile warning such as permanent planter or partial walls

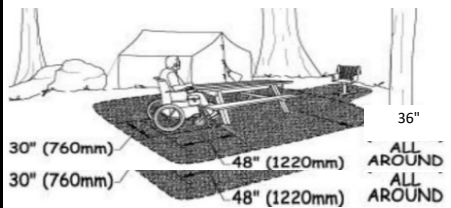

Priority 2 Access to Picnic Units [F245] (contains outdoor constructed features)					
2.400	Where picnic facilities contain two or fewer picnic units , does each picnic unit provide mobility features complying with F245.2.?	<input type="checkbox"/> YES <input checked="" type="checkbox"/> NO Total #: 2 Acsbl#: 0			<ul style="list-style-type: none"> Modify unit(s) Provide new unit(s)
2.401	Where picnic facilities contain more than two picnic units , do at least 20 percent, but not less than two, of the picnic units provide mobility features complying with F245.2.?	<input type="checkbox"/> YES <input type="checkbox"/> NO Total #: Acsbl#: N/A		Photo #:	<ul style="list-style-type: none"> Modify unit(s) Provide new unit(s)
2.402	Are the accessible picnic units dispersed throughout the picnic facility providing a variety of choices?	<input checked="" type="checkbox"/> YES <input type="checkbox"/> NO 2 ADJCT UNITS		Photo #:	<ul style="list-style-type: none"> Modify unit(s) Provide new unit(s)
2.403	Where provided, is at least one of each type of outdoor constructed feature compliant with 1011?	<input type="checkbox"/> YES <input checked="" type="checkbox"/> NO Total #: 6 Acsbl#: 0	OUTDOOR CONSTRUCTED FEATURES: Picnic Tables Fire Rings or Grills Trash and Recycling Water Hydrants Benches Viewing Scopes Outdoor Rinsing Shower	Photo #:	<ul style="list-style-type: none"> Modify unit(s) Provide new unit(s)

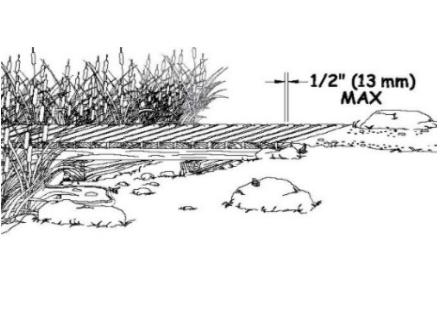

<p>2.404</p>	<p>OR- Where more than one of the same type of outdoor constructed feature is provided, are at least two of the same type of outdoor constructed features compliant with 1011.</p>	<p><input type="checkbox"/> YES <input checked="" type="checkbox"/> NO</p> <p>Total #:</p> <p>Acsbl#:</p>	<p><input checked="" type="checkbox"/> NO</p>	<p>OUTDOOR CONSTRUCTED FEATURES: Picnic Tables Fire Rings or Grills Trash and Recycling Water Hydrants Benches Viewing Scopes Outdoor Rinsing Shower</p>	<p>Photo #:</p>	<ul style="list-style-type: none"> • Modify unit(s) • Provide new unit(s)
<p>2.405</p>	<p>Where provided in common use and public use areas that serve picnic units with mobility features, are at least 20 percent, but not less than one, of each type of outdoor constructed feature provided at each location compliant with 1011.6</p>	<p><input type="checkbox"/> YES <input checked="" type="checkbox"/> NO</p> <p>Total #:</p> <p>Acsbl#:</p>	<p><input checked="" type="checkbox"/> NO</p>		<p>Photo #:</p>	<ul style="list-style-type: none"> • Modify unit(s) • Provide new unit(s)
<p>Parking Spaces [1012]</p>						
<p>2.406</p>	<p>If parking spaces for vehicles, other than recreational vehicles, are provided, are they 16 feet (4880 mm) wide minimum? [1012.3]</p>	<p><input type="checkbox"/> YES <input checked="" type="checkbox"/> NO</p> <p>Measurement:</p>	<p>10'-0"</p>		<p>Photo #:</p>	<ul style="list-style-type: none"> • Enlarge space • Provide new space
<p>2.407</p>	<p>If two adjacent parking spaces are provided for vehicles other than recreational vehicles, is one parking space 8 feet (2440 mm) wide minimum? [1012.3]</p>	<p><input type="checkbox"/> YES <input type="checkbox"/> NO</p> <p>Measurement:</p>	<p>N/A</p>		<p>Photo #:</p>	<ul style="list-style-type: none"> • Enlarge space • Provide new space
<p>2.408</p>	<p>Is the parking surface firm and stable? [1012.4]</p>	<p><input checked="" type="checkbox"/> YES <input type="checkbox"/> NO</p> <p>Material:</p>	<p>ASPHALT</p>		<p>Photo #:</p>	<ul style="list-style-type: none"> • Modify surface • Replace Surface

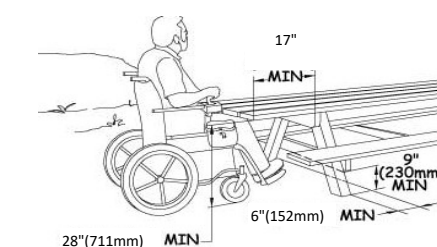
2.409	Is the slope of the surface of parking spaces and pull-up spaces less than 1:48 in any direction? [1012.5] or	<input checked="" type="checkbox"/> YES <input type="checkbox"/> NO Measure ment: 1.8%		Photo #:	• Regrade
	Where the surface is other than asphalt, concrete, or boards, are the slopes less than 1:20 for drainage?	<input type="checkbox"/> YES <input type="checkbox"/> NO Measure ment: N/A		Photo #:	• Regrade
Trash and recycling					
2.410	Is there a clear ground space 36 inches (915 mm) by 48 inches (1220 mm) positioned for forward approach to the receptacle opening; or 30 inches (760 mm) by 60 inches (1525 mm) positioned for a parallel approach to the receptacle opening? [1011.2.1]	<input checked="" type="checkbox"/> YES <input type="checkbox"/> NO Measure ment:			• Add or Relocate bins

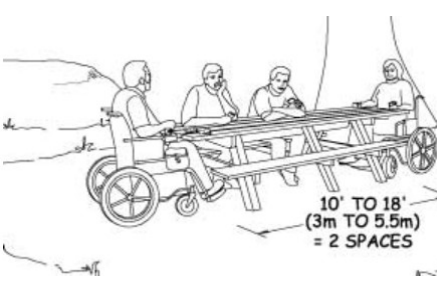
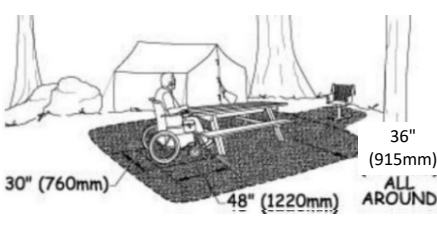
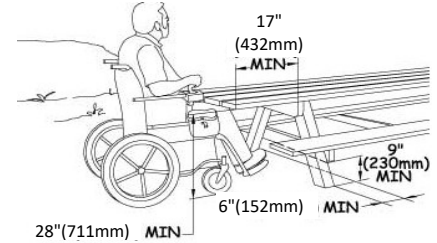
Picnic Tables [1011.4]					
2.420	Is there 36 inches (915 mm) minimum on all usable sides of the table measured from the back edge of the benches? [1011.2.1]	<input checked="" type="checkbox"/> YES <input type="checkbox"/> NO Measure ment:			<ul style="list-style-type: none"> • Replace table • Provide new table
2.421	Is the surface of the clear ground space firm and stable? [1011.2.2]	<input checked="" type="checkbox"/> YES <input type="checkbox"/> NO Material CONC		Photo:	<ul style="list-style-type: none"> • Replace surface
2.422	Is the slope of the clear ground space surface no steeper than 1:48 in any direction? [1011.2.3] or	<input checked="" type="checkbox"/> YES <input type="checkbox"/> NO Measure ment:		Photo:	<ul style="list-style-type: none"> • Level the area
	If the surface is other than asphalt, concrete, or boards, is the slope no steeper than 1:20 if necessary for drainage?	<input type="checkbox"/> YES <input type="checkbox"/> NO Measure ment: N/A		Photo:	<ul style="list-style-type: none"> • Level the area

<p>2.423</p>	<p>If openings (grates) are present in the clear ground space surface, are they sized so they do not allow the passage of a sphere more than 1/2 inch (13 mm) in diameter? And</p>	<p><input type="checkbox"/> YES <input type="checkbox"/> NO Measure ment: N/A</p>		<p>Photo:</p>	<ul style="list-style-type: none"> • Modify surface • Replace Boards
	<p>Are elongated openings placed so that the long dimension is perpendicular, or as close to perpendicular as possible, to the dominant direction of travel?</p>	<p><input type="checkbox"/> YES <input type="checkbox"/> NO N/A</p>		<p>Photo:</p>	<ul style="list-style-type: none"> • Replace Grate
<p>2.424</p>	<p>Are the tops of picnic tables 28 inches (710 mm) minimum and 34 inches (865 mm) maximum above the finish floor or ground? [1011.4.1]</p>	<p><input checked="" type="checkbox"/> YES <input type="checkbox"/> NO Measure ment: 30 1/2"</p>		<p>Photo:</p>	<ul style="list-style-type: none"> • Replace table • Provide new table

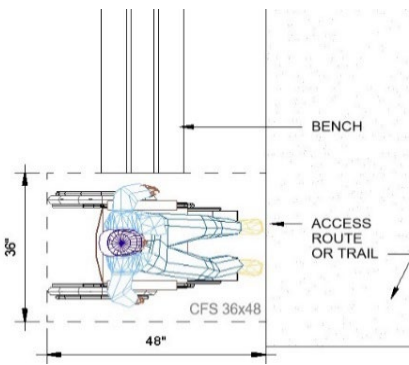
<p>2.425</p>	<p>For each 24 linear feet (7320 mm) of usable picnic table surface perimeter, is there at least one wheelchair space? [1011.4.2] (Note: Tables over 9' long need two WC spaces)</p>	<p><input type="checkbox"/> YES <input checked="" type="checkbox"/> NO Measurement:</p>		<p>Photo:</p>	<ul style="list-style-type: none"> • Replace table • Provide new table
<p>2.426</p>	<p>Is the wheelchair space 30 inches (760mm) minimum by 48 inches (1220 mm) minimum and positioned for a forward approach to the table? [1011.4.2]</p>	<p><input type="checkbox"/> YES <input checked="" type="checkbox"/> NO Measurement: LEGS IMPEDE</p>		<p>Photo:</p>	<ul style="list-style-type: none"> • Replace table • Provide new table
<p>and</p>	<p>provide knee and toe clearance complying with 306 under the table? [1011.4.2]</p>	<p><input type="checkbox"/> YES <input checked="" type="checkbox"/> NO Measurement: 28 1/2" H but 11" D</p>			<ul style="list-style-type: none"> • Replace table • Provide new table

Benches					
2.470	Where benches are provided, is there clear ground space 36 inches (915 mm) by 48 inches (1220 mm) positioned near the bench with one side of the space adjoining an outdoor recreation access route or trail, as applicable? [1011.2.1]	<input type="checkbox"/> YES <input checked="" type="checkbox"/> NO Measurement: OFF PATH IN GRASS	 <p>The diagram shows a bench with a clear ground space of 36 inches by 48 inches. An access route or trail is shown running parallel to the bench. The clear ground space is labeled 'CFS 36x48'.</p>	 <p>Photo #:</p>	<ul style="list-style-type: none"> • Modify space • Provide new unit(s)
2.471	Is the clear ground space located such that it does not overlap the outdoor recreation access route or trail, or another clear ground space?	<input type="checkbox"/> YES <input checked="" type="checkbox"/> NO	 <p>The illustration shows a person in a wheelchair sitting on a bench. The bench is positioned on a clear ground space that does not overlap with an access route or trail.</p>	<p>Photo #:</p>	<ul style="list-style-type: none"> • Enlarge space • Provide new space
2.472	Is the surface of the clear ground space firm and stable? [1011.2.2]	<input type="checkbox"/> YES <input checked="" type="checkbox"/> NO Material GRASS		<p>Photo #:</p>	<ul style="list-style-type: none"> • Modify surface • Replace Surface
2.473	Is the slope of the clear ground space surface no steeper than 1:48 in any direction? [1011.2.3] or	<input checked="" type="checkbox"/> YES <input type="checkbox"/> NO Measurement:		<p>Photo #:</p>	<ul style="list-style-type: none"> • Level the area
	If the surface is other than asphalt, concrete, or boards, is the slope no steeper than 1:20 if necessary for drainage?	<input checked="" type="checkbox"/> YES <input type="checkbox"/> NO Measurement:		<p>Photo #:</p>	<ul style="list-style-type: none"> • Level the area



6. South Guest Dock 2 (Accessible Dock)

DATE OF EVALUATION

1/20/2021

Figure 6. Recreational Facilities to Be Assessed for ADA Compliance - Phase I



ADA Evaluation

FOR
South Guest Dock 2
(Accessible Dock)

Port of Everett

ADA Transition Plan



Based on the 2010 ADA Standards for Accessible Design

Completed by:

design2 LAST, inc
534 Main St, Suite 101
Edmonds, WA 98020

Notes Regarding ADA Evaluation for this facility

Each file contains an aerial view of the site as shown on Google. If plans for the facilities were available, they are included. If room names or numbers are not indicated on those plans, fictional room names and numbers were given to spaces to correlate them to the enclosed checklists. These are intended to be used for the purpose of locating which rooms pertain to which portion of the checklist, and may or may not represent the actual room numbers and names at the facility.

How to read these checklists:

1. The 1st column is the identity mark, typically the priority number (1, 2, 3, or 4) followed by an identifying number. These may or may not be in order depending on whether non relevant rows have been hidden.
2. The 2nd column describes the compliance issue in the form of a question. The compliant measurement or count is identified in the question. If the response to the question is 'yes' the issue is compliant.
3. The 3rd and 4th columns are the 'yes' and 'no' responses, and measurements taken in the field. If the issue is compliant and the 'yes' box is checked, there may or may not be a measurement included. If the 'no' box is checked, the issue is non-compliant, and a measurement or count will indicate how the issue is noncompliant.

ADA Checklist for Existing Facilities

The Americans with Disabilities Act (ADA) requires state and local governments, businesses and non-profit organizations to provide goods, services and programs to people with disabilities on an equal basis with the rest of the public.

Some people think that only new construction and alterations need to be accessible and that older facilities are "grandfathered," but that's not true. Because the ADA is a civil rights law and not a building code, older facilities are often required to be accessible to ensure that people with disabilities have an equal opportunity to participate.

The ADA has different requirements for state and local governments and for places of public accommodation (businesses and non-profit organizations that serve the public).

Requirements for State and Local Governments

State and local governments must ensure that services, programs and activities, when viewed in their entirety, are accessible to people with disabilities. This is part of public entities' program accessibility obligations. Alterations to older buildings may be needed to ensure program accessibility. Generally this is a greater obligation than "readily achievable barrier removal" the standard that applies to public accommodations. State and local governments are not required to take any action that would result in undue financial and administrative burdens.

State and local governments' ADA obligations for program accessibility are in the Department of Justice's ADA Title II regulations 28 CFR Part 35.150.

Requirements for Places of Public Accommodation

Businesses and non-profit organizations that serve the public must remove architectural barriers when it is "readily achievable" to do so; in other words, when barrier removal is "easily accomplishable and able to be carried out without much difficulty or expense."

The decision of what is readily achievable is made considering the size, type, and overall finances of the public accommodation and the nature and cost of the access improvements needed. Barrier removal that is difficult now may be readily achievable in the future as finances change.

4. The 5th column may contain a pictogram or drawing of the issue being evaluated. This may also contain a sketch of what the evaluator found in the field as it related to the condition being evaluated.
5. The 6th column may contain a photo of the field condition. Only a select number of conditions are photographed to keep the file size manageable.
6. The last column may contains a list of suggested corrections. These are helpful to the cost estimating team but may not reflect the amount of work required to move or replace an item to bring it into compliance. There may be some economy when multiple non-compliance issues can be completed with one action. There may also be several ways to make corrective changes. How changes and corrections are made will depend on several things, most importantly the existing conditions. These typically are addressed in a design process.
7. Some cells are highlighted yellow. The highlighted cells are identifying non-compliance issues. The yellow is used simply to make the non-compliant issues easier to find among the large number of pages.
8. If no boxes are checked , or there is a slash thru the compliance issue, that particular issue does not apply to the instance being evaluated.

Public accommodations' ADA obligations for barrier removal are in the Department of Justice's ADA Title III regulations 28 CFR Part 36.304.

Priorities for Accessibility

The checklist follows the four priorities that are listed in the Department of Justice ADA Title III regulations. These priorities are equally applicable to state and local government facilities.

Priority 1 - Accessible approach and entrance

Priority 2 - Access to goods and services

Priority 3 - Access to public toilet rooms

Priority 4 - Access to other items such as water fountains and public telephones

2010 ADA Standards for Accessible Design

The checklist is based on the 2010 ADA Standards for Accessible Design (2010 Standards). The checklist may not include all sections of the 2010 Standards. Consult the 2010 Standards for situations not covered in the checklist. Full compliance with the 2010 Standards is required only for new construction and alterations.

Safe Harbor – Construction Prior to March 15, 2012

Elements in facilities built or altered before March 15, 2012 that comply with the 1991 ADA Standards for Accessible Design (1991 Standards) are not required to be modified to specifications in the 2010 Standards. For example, the 1991 Standards allow 54 inches maximum for a side reach range to a control such as the operating part of a paper towel dispenser. The 2010 Standards lower that side reach range to 48 inches maximum. If a paper towel dispenser was installed prior to March 15, 2012 with the highest operating part at 54 inches, the paper towel dispenser does not need to be lowered to 48".

What this Checklist is Not

The ADA Title II and III regulations require more than program accessibility and barrier removal. The regulations include requirements for nondiscriminatory policies and practices and for the provision of auxiliary aids and services, such as sign language interpreters for people who are deaf and material in Braille for people who are blind. This checklist does not cover those requirements.

Since this checklist does not include all of the 2010 Standards it is not intended to determine compliance for new construction or facilities being altered.

Resources**U.S. Department of Justice ADA Information**

800-514-0301 voice: 800-514-0383 TTY
www.ada.gov

ADA National Network

800-949-4232 voice/TTY connects to
 your regional ADA Center:
www.adata.org

U.S. Access Board

800- 872-2253 voice: 800-993-2822 TTY
www.access-board.gov

[ADA Title III Regulations 28 CFR Part 36
\[www.ada.gov/regs2010/titleIII_2010/titleII_2010_regulations.htm\]\(http://www.ada.gov/regs2010/titleIII_2010/titleII_2010_regulations.htm\)](http://www.ada.gov/regs2010/titleIII_2010/titleII_2010_regulations.htm)

[2010 ADA Standards for Accessible
 Design
\[www.ada.gov/2010ADASTandards_index.htm\]\(http://www.ada.gov/2010ADASTandards_index.htm\)](http://www.ada.gov/2010ADASTandards_index.htm)

[1991 ADA Standards for Accessible
 Design
\[www.ada.gov/stdspdf.htm\]\(http://www.ada.gov/stdspdf.htm\)](http://www.ada.gov/stdspdf.htm)

Acknowledgements

The Institute for Human Centered Design and the New England ADA Center created the ADA Checklists. Originals can be accessed at www.adachecklist.org.

What are Public Accommodations?

Under the ADA public accommodations are private entities that own, lease, lease to or operate a place of public accommodation. This means that both a landlord who leases space in a building to a tenant and the tenant who operates a place of public accommodation have responsibilities to remove barriers.

A place of public accommodation is a facility whose operations affect commerce and fall within at least one of the following 12 categories:

- 1) Places of lodging (e.g., inns, hotels, motels, except for owner-occupied establishments renting fewer than six rooms)
- 2) Establishments serving food or drink (e.g. , restaurants and bars)
- 3) Places of exhibition or entertainment (e.g. , motion picture houses, theaters, concert halls, stadiums)
- 4) Places of public gathering (e.g. , auditoriums, convention centers, lecture halls)
- 5) Sales or rental establishments (e.g. , bakeries, grocery stores, hardware stores, shopping centers)
- 6) Service establishments (e.g. , laundromats, dry-cleaners, banks, barber shops, beauty shops, travel services, shoe repair services, funeral parlors, gas stations, offices of accountants or lawyers, pharmacies, insurance offices, professional offices of health care providers, hospitals)
- 7) Public transportation terminals, depots, or stations (not including facilities relating to air transportation)
- 8) Places of public display or collection (e.g. , museums, libraries, galleries)
- 9) Places of recreation (e.g. , parks, zoos, amusement parks)
- 10) Places of education (e.g. , nursery schools, elementary, secondary, undergraduate, or postgraduate private schools)
- 11) Social service center establishments (e.g. , day care centers, senior citizen centers, homeless shelters, food banks, adoption agencies)
- 12) Places of exercise or recreation (e.g. , gymnasiums, health spas, bowling alleys, golf courses).

Many of the illustrations are from the U.S. Department of Justice and the U.S. Access Board or are based on illustrations produced by the U.S. Access Board and the U.S. Department of Justice.

New sections added to Appendix A to Chapter 10

F201.4 Requirements Apply to Facilities Constructed or Altered by or on Behalf of Federal

Agencies. The requirements in F216.13, F244 through F248, and 1011 through 1019 shall apply only to facilities constructed or altered by federal agencies or by non-federal entities on federal land on behalf of federal agencies pursuant to a concession contract, partnership agreement, or similar arrangement.

F201.4.1 Documentation and Notification When Exceptions Used for Trails and Beach Access

Routes. Federal agencies shall document the basis for not fully complying with a specific provision in 1017 or 1018 on a portion of a trail or beach access route based on Exception 1 in 1017 or Exception 1 in 1018, and shall maintain the documentation with the records for the trail or beach project. Federal agencies shall notify the Access Board if an entire trail is exempted from complying with 1017 based on Exception 2 in 1017.1, and if a beach access route is not provided based on Exception 2 in 1018.1.6)

F202.3 Alterations. * * * * *

EXCEPTIONS: * * * * *

4. Where elements or spaces are altered in camping facilities, picnic facilities, viewing areas, or trailheads and the circulation path to the altered element or space is not altered, the circulation path shall not be required to comply with 1016.

F202.4 Alterations Affecting Primary Function Areas. * * * * *

EXCEPTIONS: * * * * *

2. Camping facilities, picnic facilities, viewing areas, trailheads, trails, and beach access routes shall not be required to comply with F202.4.

F206.1 General. * * * * *

EXCEPTIONS: 1. Accessible routes shall not be required where outdoor recreation access routes are provided at camping facilities in accordance with F244.5, picnic facilities in accordance with F245.4, viewing areas in accordance with F246.3, or trailheads in accordance with F247.3.2.

2. Accessible routes shall not be required where camping facilities, picnic facilities, viewing areas, or outdoor constructed features are provided on trails.

3. Accessible routes shall not be required where beach access routes are provided in accordance with F248.

F212.3 Sinks. * * * * *

EXCEPTIONS: * * * * *

2. In camping facilities and picnic facilities, sinks shall not be required to comply with F212.3 where a cooktop or conventional range is not provided.

F213.1 General. * * * * *

EXCEPTION: Pit toilets provided on trails and in camping facilities shall not be required to comply with F213

F216.13 Trailhead Signs. Where new trail information signs are provided at trailheads on newly constructed or altered

SUMMARY

South Guest Dock 2 (Accessible Dock)

The South Guest Dock 2 is located in the South Marina along the Marina Waterfront Trail System. The access consists of five sloped gangways leading down to the float. The landings between the gangways are all compliant, as are the gangways.

The curbs on the float were found to be non-compliant. This means none of the launch points are accessible. The grip strut grating also has openings greater than 1/2" in the direction of travel, although the width of the openings are perpendicular to the direction of travel.

Replacing the curbs is a simple and inexpensive correction to bring this facility into compliance.

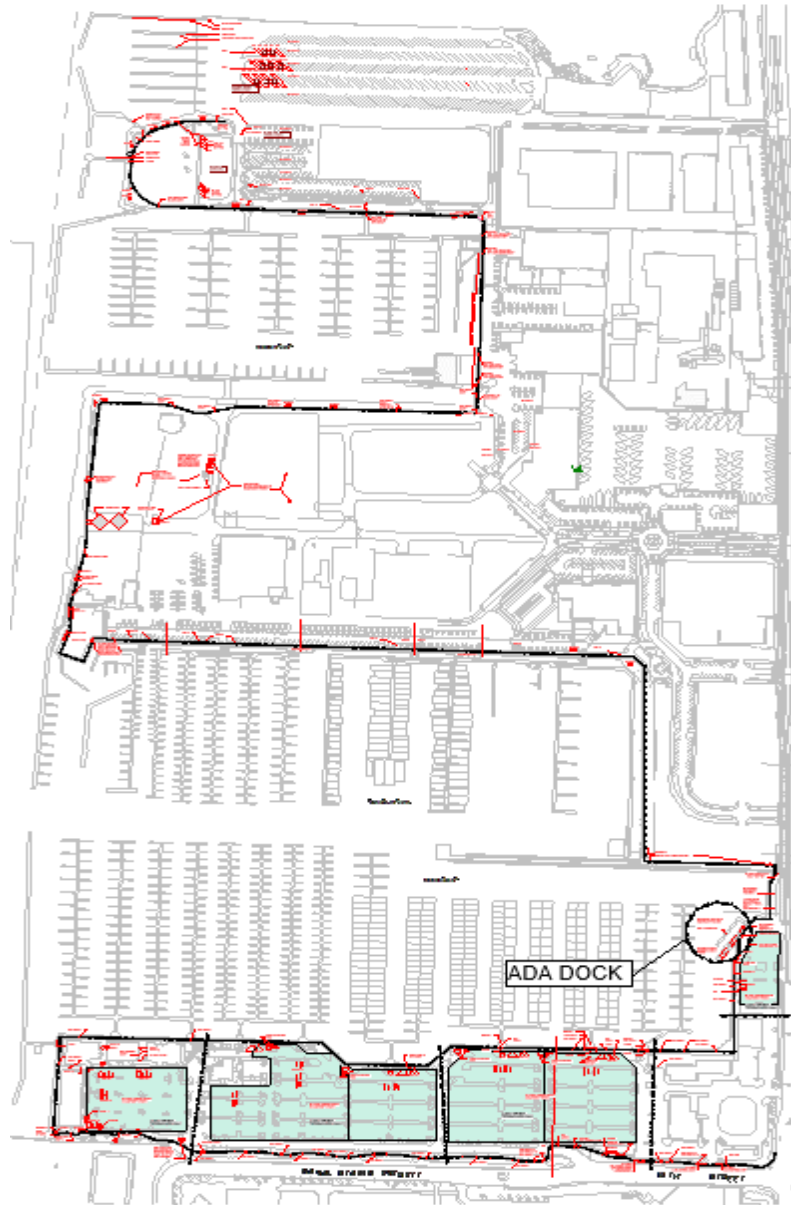

ADA BOAT LAUNCH AND BOARDING PIER -
OVERALL PORT PLAN

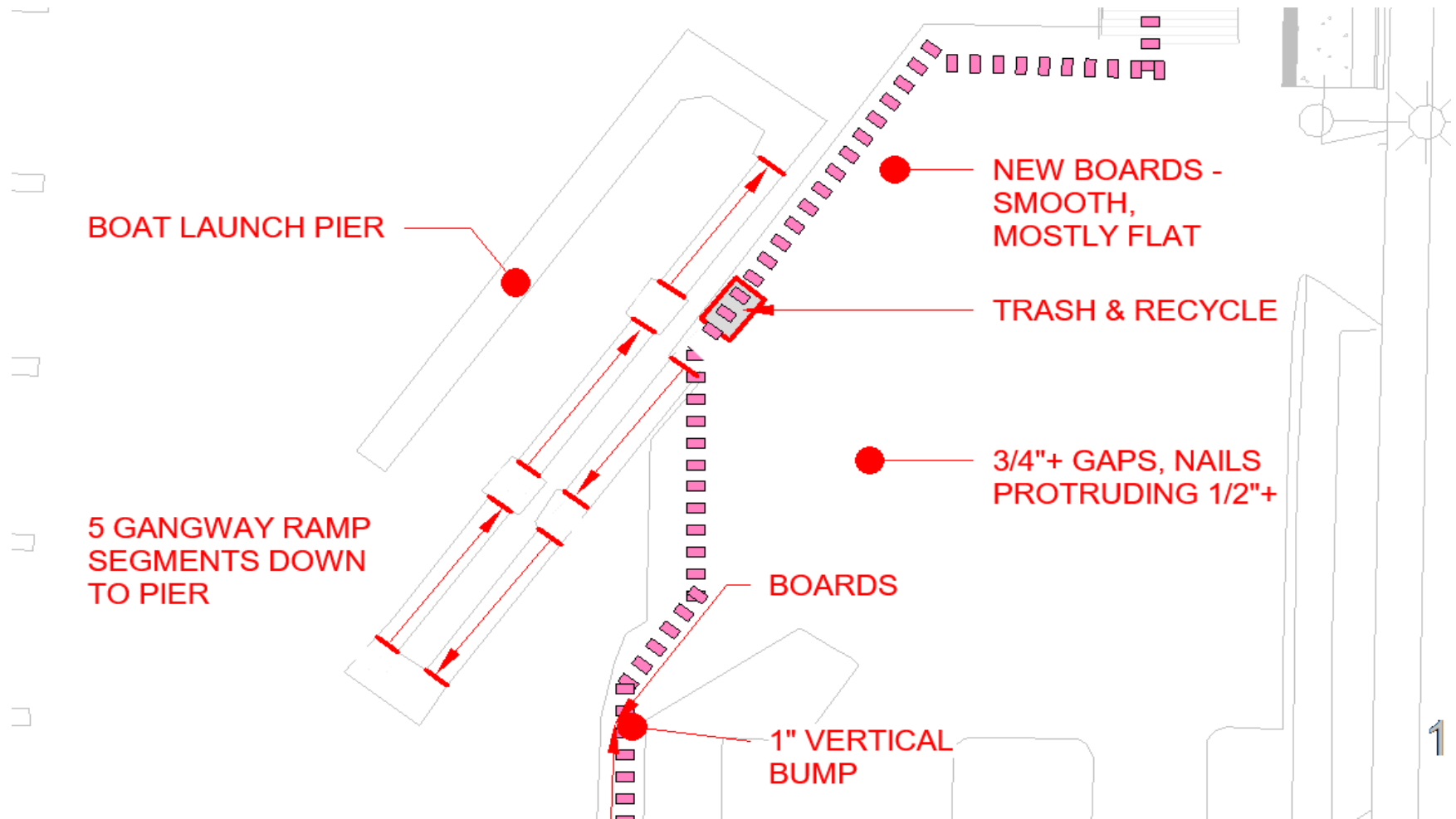

ADA BOAT LAUNCH AND BOARDING PIER

ADA Checklist for Existing

Priority 1 - Approach & Entrance

Based on the 2010 ADA Standards for Accessible Design



Project: ADA Transition Plan

Building: South Guest Dock 2 (Accessible Dock)

Location: Everett, WA

Date: 1/20/2021

Surveyors: Lauri Strauss, AIA, LEED AP BD&C
President, CEO, design2 LAST, inc



Contact Information: o. 425-673-7269 c. 907-317-5040



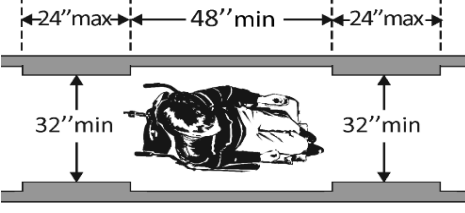
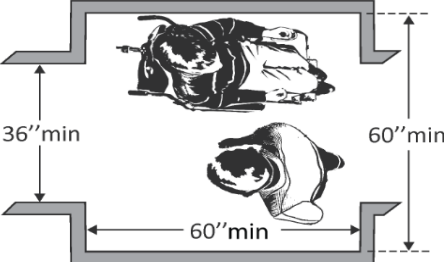

543 Main St, Suite 101, Edmonds, WA 98020

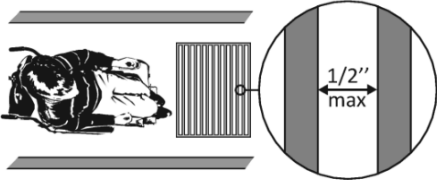
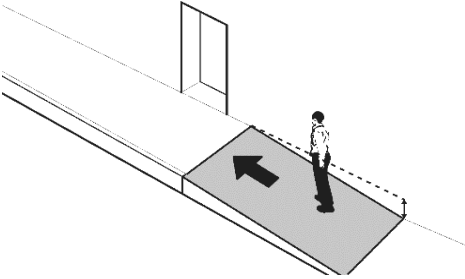
An accessible route from site arrival points and an accessible entrance should be provided for everyone.

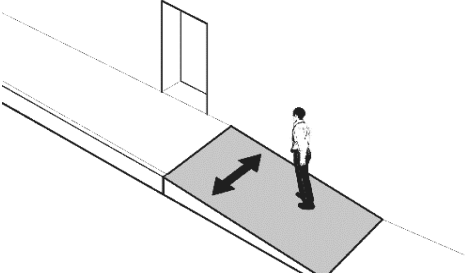
Priority 1 - Approach & Entrance					Comments	Possible Solutions
1.001	Is there at least one route from site arrival points (parking, passenger loading zones, public sidewalks and public transportation stops) that does not require the use of stairs? [See 2010 ADA Standards for Accessible Design – 206.2.1]	<input checked="" type="checkbox"/> YES If yes, location of route:	<input type="checkbox"/> NO		Photo:	<ul style="list-style-type: none"> • Add a ramp • Regrade to 1:20 maximum slope • Add a lift if site constraints prevent other solutions

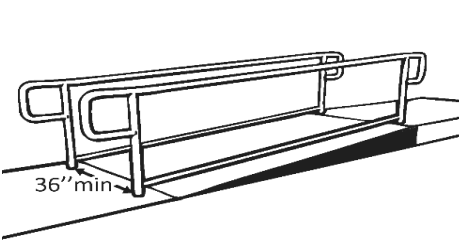
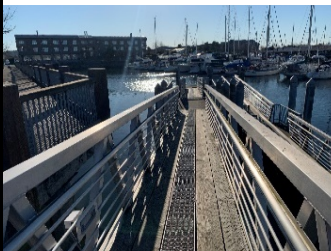
Accessible Route to Recreational Boating Facilities						
1.120	Is the route stable, firm and slip-resistant? [302.1]	<input checked="" type="checkbox"/> YES <input type="checkbox"/> NO	Measure ment:		Photo #:	<ul style="list-style-type: none"> • Repair uneven paving • Fill small bumps and breaks with patches • Replace gravel with asphalt or other surface
1.121	Is the route at least 36 inches wide? [403.5.1]	<input checked="" type="checkbox"/> YES <input type="checkbox"/> NO	Measure ment: 46"		Photo #:	<ul style="list-style-type: none"> • Change or move landscaping, furnishings or other items • Widen route
	Note: The accessible route can narrow to 32 inches min. for a max. of 24 inches. These narrower portions of the route must be at least 48 inches from each other.	<input type="checkbox"/> YES <input type="checkbox"/> NO	Measure ment: N/A		Photo #:	<ul style="list-style-type: none"> • Change or move obstacles or other items • Widen route
1.122	If the route is greater than 200 feet in length and less than 60 inches wide, is there a passing space no less than 60 x 60 inches? [403.5.3]	<input checked="" type="checkbox"/> YES <input type="checkbox"/> NO	Measure ment: 93 1/2" X 84" BOTH		Photo #:	<ul style="list-style-type: none"> • Widen route for passing space

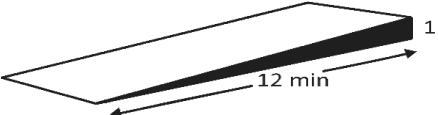

<p>1.123</p>	<p>If there are grates or openings on the route, are the openings no larger than 1/2 inches?</p>	<p><input type="checkbox"/> YES <input checked="" type="checkbox"/> NO Measurement: GRIP STRUT</p>		<p>Photo #:</p>	<ul style="list-style-type: none"> • Replace or move grate
<p>1.124</p>	<p>Is the long dimension perpendicular to the dominant direction of travel? [302.3]</p> <p>Is the running slope no steeper than 1:20, i.e. for every inch of height change there are at least 20 inches of route run? [403.3]</p> <p>Note: If the running slope is steeper than 1:20, treat as a ramp and add features such as edge protection and handrails.</p>	<p><input checked="" type="checkbox"/> YES <input type="checkbox"/> NO Measurement: 7.9%</p>		 <p>Photo #:</p>	<ul style="list-style-type: none"> • Regrade to 1:20 max.
<p>1.125</p>	<p>Is the cross slope no steeper than 1:48? [403.3]</p>	<p><input checked="" type="checkbox"/> YES <input type="checkbox"/> NO Measurement:</p>		<p>Photo #:</p>	<ul style="list-style-type: none"> • Regrade to 1:48 max.

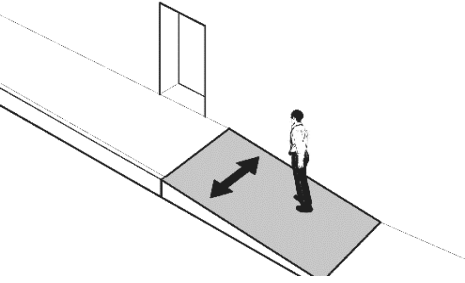
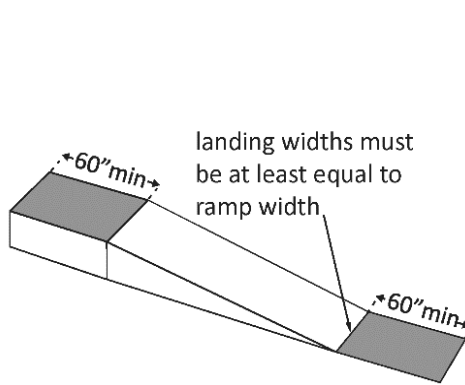
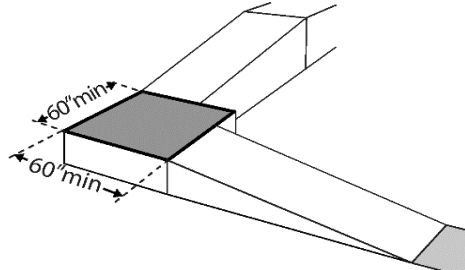
Ramps and Gangways					
1.130	<p>If there is a ramp is it at least 36 inches wide? [405.5]</p> <p>Note: If there are handrails, measure between the handrails.</p>	<p><input checked="" type="checkbox"/> YES <input type="checkbox"/> NO</p> <p>Measure ment:</p>			<ul style="list-style-type: none"> • Alter ramp
1.131	<p>Is the surface stable, firm and slip resistant? [405.4]</p>	<p><input checked="" type="checkbox"/> YES <input type="checkbox"/> NO</p> <p>Material</p>			<ul style="list-style-type: none"> • Resurface ramp
1.132	<p>For each section of the ramp or Gangway, is the running slope no greater than 1:12, i.e. for every inch of height change there are at least 12 inches of ramp run? [405.2] AND</p>	<p><input checked="" type="checkbox"/> YES <input type="checkbox"/> NO</p> <p>Measure ment: 7.6%TOP 9.3%MID 5%BOT</p>		<p>Photo #:</p>	<ul style="list-style-type: none"> • Relocate ramp • Lengthen ramp to decrease slope <p>NOTE: Where the total length of a gangway or series of gangways serving as part of a required accessible route is 80 feet (24 m) minimum, gangways shall not be required to comply with 405.2.</p>
	<p>(Except for Gangways) No greater than 30" rise? [405.6]</p> <p>Note: Rises no greater than 3 inches with a slope no steeper than 1:8 and rises no greater than 6 inches with a slope no steeper than 1:10 are permitted when such slopes are necessary due to space limitations.</p>	<p><input checked="" type="checkbox"/> YES <input type="checkbox"/> NO</p> <p>Measure ment: GANGWAY</p>		 <p>Photo #:</p>	<p>Where facilities contain fewer than 25 boat slips and the total length of the gangway or series of gangways serving as part of a required accessible route is 30 feet (9145 mm) minimum, gangways shall not be required to comply with 405.2.</p>

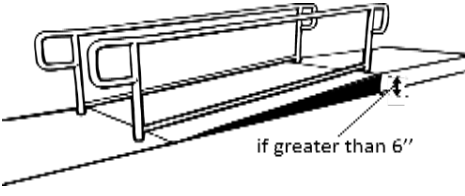
<p>1.133</p>	<p>Is the cross slope no steeper than 1:48? [405.3]</p>	<p><input checked="" type="checkbox"/> YES <input type="checkbox"/> NO Measure ment:</p>		<p>Photo #:</p>	<ul style="list-style-type: none"> • Modify to 1:48 max. <p>NOTE: The cross slope specified in 403.3 and 405.3 for gangways, transition plates, and floating piers that are part of accessible routes shall be measured in the static position</p>
<p>1.134</p>	<p>Is there a level landing that is at least 60 inches long and at least as wide as the ramp: At the top of the ramp?</p>	<p><input checked="" type="checkbox"/> YES <input type="checkbox"/> NO Measure ment:</p>		<p>Photo #:</p>	<ul style="list-style-type: none"> • Alter ramp • Relocate ramp <p>NOTE: Where gangways connect to transition plates, landings specified by 405.7 shall not be required.</p>
<p>1.135</p>	<p>At the bottom of the ramp? [405.7.2, 405.7.3]</p>	<p><input checked="" type="checkbox"/> YES <input type="checkbox"/> NO Measure ment:</p>		<p>Photo #:</p>	<ul style="list-style-type: none"> • Alter ramp • Increase landing size

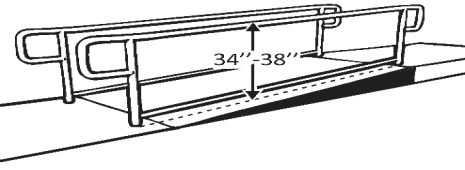
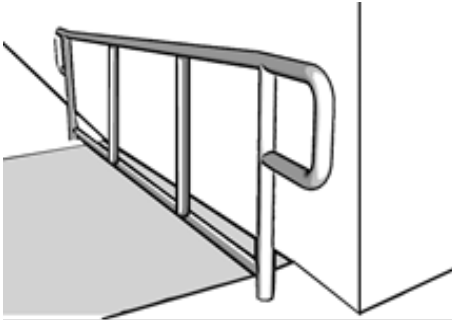
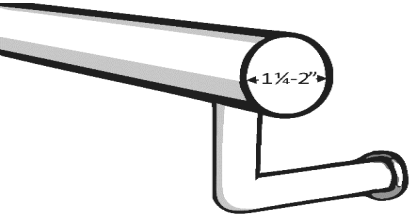
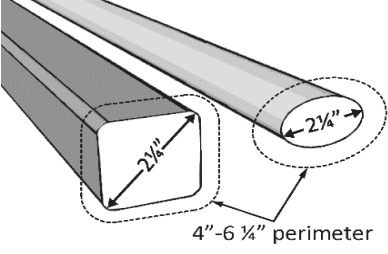
<p>1.136</p>	<p>If the ramp has a rise higher than 6 inches, are there handrails on both sides? [405.8]</p> <p>Note: Curb ramps are not required to have handrails.</p>	<p><input checked="" type="checkbox"/> YES <input type="checkbox"/> NO</p> <p>Measure ment:</p>		<p>Photo #:</p>	<ul style="list-style-type: none"> • Add handrails
---------------------	--	---	--	-----------------	---

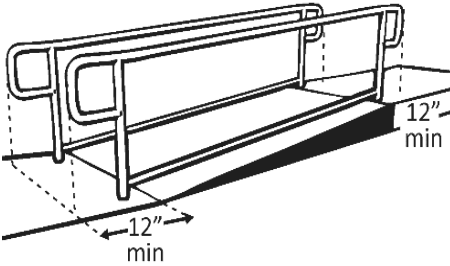
<p>1.137</p>	<p>Is the top of the handrail gripping surface no less than 34 inches and no greater than 38 inches above the ramp surface? [505.4]</p>	<p><input checked="" type="checkbox"/> YES <input type="checkbox"/> NO Measure ment: 33 3/4"</p>		<p>Photo #:</p>	<ul style="list-style-type: none"> • Reconfigure or replace handrails • Adjust handrail height
<p>1.138</p>	<p>Is the handrail gripping surface continuous and not obstructed along the top or sides? [505.3]</p>	<p><input checked="" type="checkbox"/> YES <input type="checkbox"/> NO</p>		<p>Photo #:</p>	<ul style="list-style-type: none"> • Reconfigure or replace handrails
<p>1.139</p>	<p>If there are obstructions, is the bottom of the gripping surface obstructed no greater than 20%? [505.6]</p>	<p><input type="checkbox"/> YES <input type="checkbox"/> NO Measure ment: N/A</p>		<p>Photo #:</p>	<ul style="list-style-type: none"> • Replace handrails
<p>1.140</p>	<p>If the handrail gripping surface is non-circular: Is the perimeter no less than 4 inches and no greater than 6 1/4 inches? Is the cross section no greater than 2 1/4 inches? [505.7.2]</p>	<p><input type="checkbox"/> YES <input type="checkbox"/> NO Measure ment: N/A</p> <p><input type="checkbox"/> YES <input type="checkbox"/> NO N/A ment:</p>		<p>Photo #:</p>	<ul style="list-style-type: none"> • Replace handrails

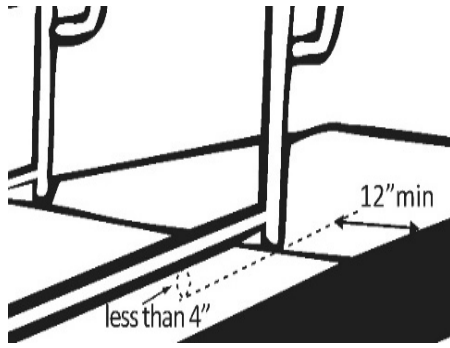
<p>1.141</p>	<p>Does the handrail: Extend at least 12 inches horizontally beyond the top of the ramp? and Bottom of the ramp? Return to a wall, guard, or landing surface? [505.10.1] Note: If a 12 inch extension would be a hazard (in circulation path) it is not required.</p>	<p><input checked="" type="checkbox"/> YES <input type="checkbox"/> NO Measure ment:</p> <p><input checked="" type="checkbox"/> YES <input type="checkbox"/> NO Measure ment:</p> <p><input checked="" type="checkbox"/> YES <input type="checkbox"/> NO Measure ment:</p>		 <p>Photo #:</p>	<ul style="list-style-type: none"> • Alter handrails • Replace Handrails <p>NOTE: Where gangways and transition plates connect and are required to have handrails, handrail extensions shall not be required. Where handrail extensions are provided on gangways or transition plates, the handrail extensions shall not be required to be parallel with the ground or floor surface.</p>
<p>1.142</p>	<p>To prevent wheelchair casters and crutch tips from falling off: Does the surface of the ramp extend at least 12 inches beyond the inside face of the handrail? Or Is there a curb or barrier that prevents the passage of a 4-inch diameter sphere? [405.9.1, 405.9.2]</p>	<p><input type="checkbox"/> YES <input type="checkbox"/> NO Measure ment:</p> <p>N/A</p> <p><input checked="" type="checkbox"/> YES <input type="checkbox"/> NO Measure ment:</p> <p>2 3/4"</p>		<p>Photo #:</p>	<ul style="list-style-type: none"> • Add curb • Add barrier • Extend ramp width

ADA Checklist for Existing

Priority 2 - Access to Goods & Services

Based on the 2010 ADA Standards for Accessible Design

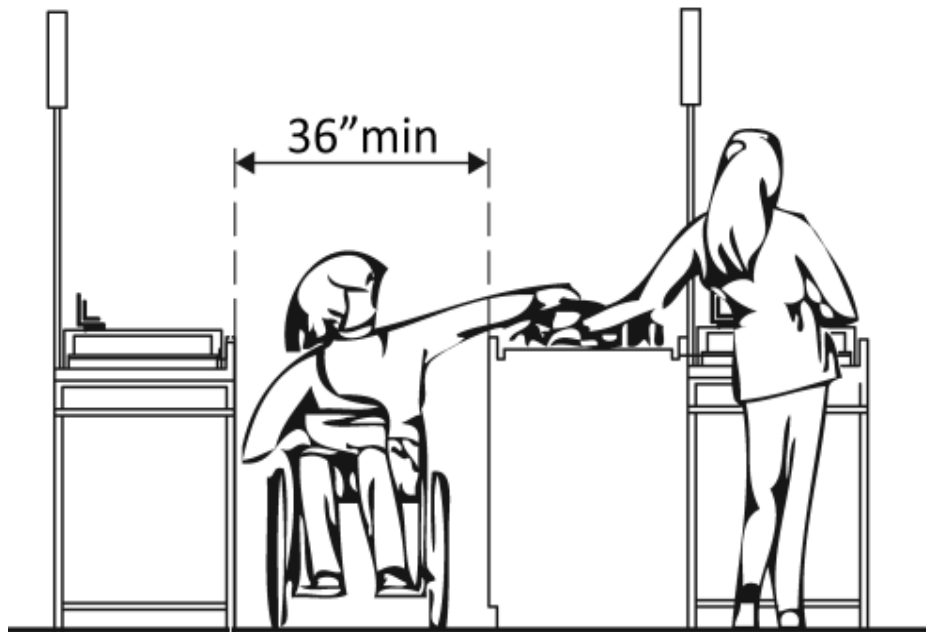

Project: ADA Transition Plan

Building: South Guest Dock 2 (Accessible Dock)

Location: Everett, WA

Date: 1/20/2021

Surveyors: Lauri Strauss, AIA, LEED AP BD&C
President, CEO, design2 LAST, inc

Contact Information: o. 425-673-7269 c. 907-317-5040

543 Main St, Suite 101, Edmonds, WA 98020

The layout of the building should allow people with disabilities to obtain goods and services and to participate in activities without assistance.

Recreational Boating Facilities																																	
<p>2.300</p>	<p>Is there an adequate number of accessible Boat Slips provided? (235.2) NOTE: Where the number of boat slips is not identified, each 40 feet (12m) of boat slip edge provided along the perimeter of the pier shall be counted as one boat slip</p>	<p><input type="checkbox"/> YES <input checked="" type="checkbox"/> NO Number TOTAL: 15 ACCBL: 0</p>	<table border="1"> <thead> <tr> <th>Total Number of Boat Slips Provided in Facility</th> <th>Minimum Number of Required Accessible Boat Slips</th> </tr> </thead> <tbody> <tr><td>1 to 25</td><td>1</td></tr> <tr><td>26 to 50</td><td>2</td></tr> <tr><td>51 to 100</td><td>3</td></tr> <tr><td>101 to 150</td><td>4</td></tr> <tr><td>151 to 300</td><td>5</td></tr> <tr><td>301 to 400</td><td>6</td></tr> <tr><td>401 to 500</td><td>7</td></tr> <tr><td>501 to 600</td><td>8</td></tr> <tr><td>601 to 700</td><td>9</td></tr> <tr><td>701 to 800</td><td>10</td></tr> <tr><td>801 to 900</td><td>11</td></tr> <tr><td>901 to 1000</td><td>12</td></tr> <tr><td>1001 and over</td><td>12, plus 1 for every 100, or fraction thereof, over 1000</td></tr> </tbody> </table>	Total Number of Boat Slips Provided in Facility	Minimum Number of Required Accessible Boat Slips	1 to 25	1	26 to 50	2	51 to 100	3	101 to 150	4	151 to 300	5	301 to 400	6	401 to 500	7	501 to 600	8	601 to 700	9	701 to 800	10	801 to 900	11	901 to 1000	12	1001 and over	12, plus 1 for every 100, or fraction thereof, over 1000	<p>Photo #:</p>	<ul style="list-style-type: none"> • Add more slips • Modify existing slips
Total Number of Boat Slips Provided in Facility	Minimum Number of Required Accessible Boat Slips																																
1 to 25	1																																
26 to 50	2																																
51 to 100	3																																
101 to 150	4																																
151 to 300	5																																
301 to 400	6																																
401 to 500	7																																
501 to 600	8																																
601 to 700	9																																
701 to 800	10																																
801 to 900	11																																
901 to 1000	12																																
1001 and over	12, plus 1 for every 100, or fraction thereof, over 1000																																
<p>2.301</p>	<p>Are the accessible Boat Slips dispersed throughout the various types of boat slips provided?</p>	<p><input checked="" type="checkbox"/> YES <input type="checkbox"/> NO ALL THE SAME</p>	<p>Types Include: single berths and double berths shallow water or deep water, transient or longer-term lease, covered or uncovered; and whether slips are equipped with features such as telephone, water, electricity or cable connections.</p>	<p>Photo #:</p>	<ul style="list-style-type: none"> • Add more slips • Modify existing slips 																												
<p>2.302</p>	<p>Are at least 5 percent, but no fewer than one, of the boarding piers accessible?</p>	<p><input checked="" type="checkbox"/> YES <input type="checkbox"/> NO Number TOTAL: ACCBL:</p>		<p>Photo #:</p>	<ul style="list-style-type: none"> • Modify pier • Provide new pier 																												

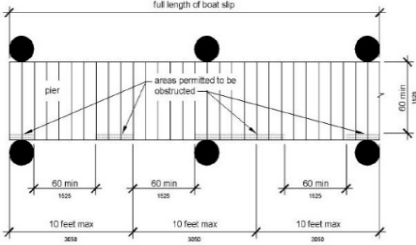
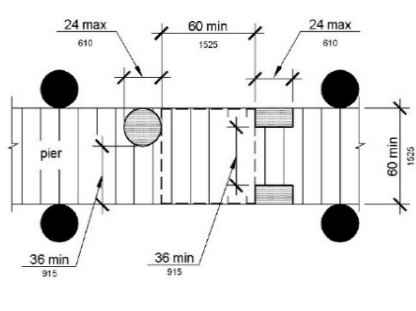
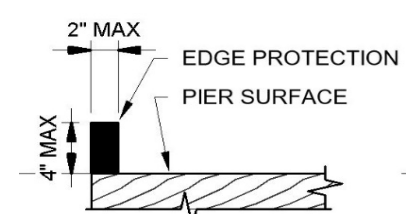
Boat Slips					
2.303	Does each Boat slip provide no less than 60" wide clear pier space?	<input type="checkbox"/> YES <input checked="" type="checkbox"/> NO Measurement:			<ul style="list-style-type: none"> • Add more slips • Modify existing slips
	and Is the Pier Space at least as long as the boat slips?	<input type="checkbox"/> YES <input checked="" type="checkbox"/> NO Measurement:		Photo:	
2.304	Does each 10 feet (3050 mm) maximum of linear pier edge serving boat slips contain at least one continuous clear opening 60 inches (1525 mm) wide minimum?	<input type="checkbox"/> YES <input checked="" type="checkbox"/> NO Measurement:		Photo #:	<ul style="list-style-type: none"> • Modify pier • Provide new pier
2.305	If the clear pier space is no less than 36 inches (915 mm) wide minimum, for a length of 24 inches (610 mm) maximum, are the 36" wide segments separated by segments that are 60 inches (1525 mm) wide minimum and 60 inches (1525 mm) long minimum?	<input checked="" type="checkbox"/> YES <input type="checkbox"/> NO Measurement: 7'-3" 5'-0"		Photo #:	<ul style="list-style-type: none"> • Modify pier • Remove obstacles • Provide new pier
2.306	If edge protection is provided at the clear openings, is it no more than 4 inches (100 mm) high maximum and 2 inches (51 mm) wide maximum?	<input type="checkbox"/> YES <input checked="" type="checkbox"/> NO Measurement: 3 1/2" W. 3 1/2" GAP		Photo #:	<ul style="list-style-type: none"> • Modify edge • Remove edge protection

Boarding Piers						
2.307	Does each Boarding Pier provide no less than 60" wide clear pier space?	<input type="checkbox"/> YES <input checked="" type="checkbox"/> NO Measurement:			Photo:	<ul style="list-style-type: none"> • Add more slips • Modify existing slips
	and Is the Boarding Pier Space at least as long as the boat slips?	<input type="checkbox"/> YES <input checked="" type="checkbox"/> NO Measurement:				
2.308	Does each 10 feet (3050 mm) maximum of linear boarding pier edge contain at least one continuous clear opening 60 inches (1525 mm) wide minimum?	<input type="checkbox"/> YES <input checked="" type="checkbox"/> NO Measurement:		Photo #:	<ul style="list-style-type: none"> • Modify pier • Provide new pier 	
2.309	If the clear pier space is no less than 36 inches (915 mm) wide minimum, for a length of 24 inches (610 mm) maximum, are the 36" wide segments separated by segments that are 60 inches (1525 mm) wide minimum and 60 inches (1525 mm) long minimum?	<input type="checkbox"/> YES <input checked="" type="checkbox"/> NO Measurement:		Photo #:	<ul style="list-style-type: none"> • Modify pier • Remove obstacles • Provide new pier 	

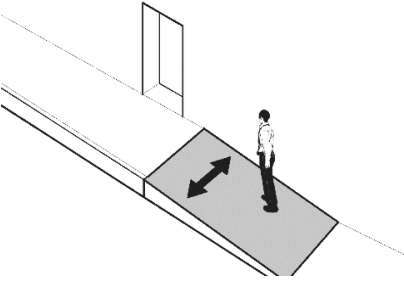
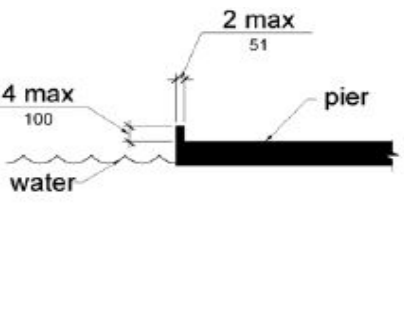
<p>2.310</p>	<p>Is the cross slope of the floating pier no steeper than 1:48 (measured in the static position?) [403.3]</p>	<p><input checked="" type="checkbox"/> YES <input type="checkbox"/> NO Measure ment:</p>		<p>Photo #:</p>	<ul style="list-style-type: none"> • Replace/repair dock floats to correct slope to 1:48 max. in static position
<p>2.311</p>	<p>If edge protection is provided at the clear openings, is it no more than 4 inches (100 mm) high maximum and 2 inches (51 mm) wide maximum?</p>	<p><input type="checkbox"/> YES <input checked="" type="checkbox"/> NO Measure ment: 3 1/2" W. 3 1/2" GAP</p>		<p>Photo #:</p>	<ul style="list-style-type: none"> • Modify edge • Remove edge protection



7. South Marina Parking Lot

DATE OF EVALUATION

1/20/2021

Figure 6. Recreational Facilities to Be Assessed for ADA Compliance - Phase I



ADA Evaluation

FOR

South Marina Parking Lot

Port of Everett

ADA Transition Plan



Based on the 2010 ADA Standards for Accessible Design

Completed by:

design2 LAST, inc
 534 Main St, Suite 101
 Edmonds, WA 98020

Notes Regarding ADA Evaluation for this facility

Each file contains an aerial view of the site as shown on Google. If plans for the facilities were available, they are included. If room names or numbers are not indicated on those plans, fictional room names and numbers were given to spaces to correlate them to the enclosed checklists. These are intended to be used for the purpose of locating which rooms pertain to which portion of the checklist, and may or may not represent the actual room numbers and names at the facility.

How to read these checklists:

1. The 1st column is the identity mark, typically the priority number (1, 2, 3, or 4) followed by an identifying number. These may or may not be in order depending on whether non relevant rows have been hidden.
2. The 2nd column describes the compliance issue in the form of a question. The compliant measurement or count is identified in the question. If the response to the question is 'yes' the issue is compliant.
3. The 3rd and 4th columns are the 'yes' and 'no' responses, and measurements taken in the field. If the issue is compliant and the 'yes' box is checked, there may or may not be a measurement included. If the 'no' box is checked, the issue is non-compliant, and a measurement or count will indicate how the issue is noncompliant.

ADA Checklist for Existing Facilities

The Americans with Disabilities Act (ADA) requires state and local governments, businesses and non-profit organizations to provide goods, services and programs to people with disabilities on an equal basis with the rest of the public.

Some people think that only new construction and alterations need to be accessible and that older facilities are "grandfathered," but that's not true. Because the ADA is a civil rights law and not a building code, older facilities are often required to be accessible to ensure that people with disabilities have an equal opportunity to participate.

The ADA has different requirements for state and local governments and for places of public accommodation (businesses and non-profit organizations that serve the public).

Requirements for State and Local Governments

State and local governments must ensure that services, programs and activities, when viewed in their entirety, are accessible to people with disabilities. This is part of public entities' program accessibility obligations. Alterations to older buildings may be needed to ensure program accessibility. Generally this is a greater obligation than "readily achievable barrier removal" the standard that applies to public accommodations. State and local governments are not required to take any action that would result in undue financial and administrative burdens.

State and local governments' ADA obligations for program accessibility are in the Department of Justice's ADA Title II regulations 28 CFR Part 35.150.

Requirements for Places of Public Accommodation

Businesses and non-profit organizations that serve the public must remove architectural barriers when it is "readily achievable" to do so; in other words, when barrier removal is "easily accomplishable and able to be carried out without much difficulty or expense."

The decision of what is readily achievable is made considering the size, type, and overall finances of the public accommodation and the nature and cost of the access improvements needed. Barrier removal that is difficult now may be readily achievable in the future as finances change.

4. The 5th column may contain a pictogram or drawing of the issue being evaluated. This may also contain a sketch of what the evaluator found in the field as it related to the condition being evaluated.
5. The 6th column may contain a photo of the field condition. Only a select number of conditions are photographed to keep the file size manageable.
6. The last column may contains a list of suggested corrections. These are helpful to the cost estimating team but may not reflect the amount of work required to move or replace an item to bring it into compliance. There may be some economy when multiple non-compliance issues can be completed with one action. There may also be several ways to make corrective changes. How changes and corrections are made will depend on several things, most importantly the existing conditions. These typically are addressed in a design process.
7. Some cells are highlighted yellow. The highlighted cells are identifying non-compliance issues. The yellow is used simply to make the non-compliant issues easier to find among the large number of pages.
8. If no boxes are checked , or there is a slash thru the compliance issue, that particular issue does not apply to the instance being evaluated.

Public accommodations' ADA obligations for barrier removal are in the Department of Justice's ADA Title III regulations 28 CFR Part 36.304.

Priorities for Accessibility

The checklist follows the four priorities that are listed in the Department of Justice ADA Title III regulations. These priorities are equally applicable to state and local government facilities.

Priority 1 - Accessible approach and entrance

Priority 2 - Access to goods and services

Priority 3 - Access to public toilet rooms

Priority 4 - Access to other items such as water fountains and public telephones

2010 ADA Standards for Accessible Design

The checklist is based on the 2010 ADA Standards for Accessible Design (2010 Standards). The checklist may not include all sections of the 2010 Standards. Consult the 2010 Standards for situations not covered in the checklist. Full compliance with the 2010 Standards is required only for new construction and alterations.

Safe Harbor – Construction Prior to March 15, 2012

Elements in facilities built or altered before March 15, 2012 that comply with the 1991 ADA Standards for Accessible Design (1991 Standards) are not required to be modified to specifications in the 2010 Standards. For example, the 1991 Standards allow 54 inches maximum for a side reach range to a control such as the operating part of a paper towel dispenser. The 2010 Standards lower that side reach range to 48 inches maximum. If a paper towel dispenser was installed prior to March 15, 2012 with the highest operating part at 54 inches, the paper towel dispenser does not need to be lowered to 48".

What this Checklist is Not

The ADA Title II and III regulations require more than program accessibility and barrier removal. The regulations include requirements for nondiscriminatory policies and practices and for the provision of auxiliary aids and services, such as sign language interpreters for people who are deaf and material in Braille for people who are blind. This checklist does not cover those requirements.

Since this checklist does not include all of the 2010 Standards it is not intended to determine compliance for new construction or facilities being altered.

Resources**U.S. Department of Justice ADA Information**

800-514-0301 voice: 800-514-0383 TTY
www.ada.gov

ADA National Network

800-949-4232 voice/TTY connects to your regional ADA Center: www.adata.org

U.S. Access Board

800- 872-2253 voice: 800-993-2822 TTY
www.access-board.gov

[ADA Title III Regulations 28 CFR Part 36
www.ada.gov/regs2010/titleIII_2010_regulations.htm](http://www.ada.gov/regs2010/titleIII_2010_regulations.htm)

[2010 ADA Standards for Accessible Design
www.ada.gov/2010ADASTandards_index.htm](http://www.ada.gov/2010ADASTandards_index.htm)

[1991 ADA Standards for Accessible Design
www.ada.gov/stdspdf.htm](http://www.ada.gov/stdspdf.htm)

Acknowledgements

The Institute for Human Centered Design and the New England ADA Center created the ADA Checklists. Originals can be accessed at www.adachecklist.org.

What are Public Accommodations?

Under the ADA public accommodations are private entities that own, lease, lease to or operate a place of public accommodation. This means that both a landlord who leases space in a building to a tenant and the tenant who operates a place of public accommodation have responsibilities to remove barriers.

A place of public accommodation is a facility whose operations affect commerce and fall within at least one of the following 12 categories:

- 1) Places of lodging (e.g., inns, hotels, motels, except for owner-occupied establishments renting fewer than six rooms)
- 2) Establishments serving food or drink (e.g., restaurants and bars)
- 3) Places of exhibition or entertainment (e.g., motion picture houses, theaters, concert halls, stadiums)
- 4) Places of public gathering (e.g., auditoriums, convention centers, lecture halls)
- 5) Sales or rental establishments (e.g., bakeries, grocery stores, hardware stores, shopping centers)
- 6) Service establishments (e.g., laundromats, dry-cleaners, banks, barber shops, beauty shops, travel services, shoe repair services, funeral parlors, gas stations, offices of accountants or lawyers, pharmacies, insurance offices, professional offices of health care providers, hospitals)
- 7) Public transportation terminals, depots, or stations (not including facilities relating to air transportation)
- 8) Places of public display or collection (e.g., museums, libraries, galleries)
- 9) Places of recreation (e.g., parks, zoos, amusement parks)
- 10) Places of education (e.g., nursery schools, elementary, secondary, undergraduate, or postgraduate private schools)
- 11) Social service center establishments (e.g., day care centers, senior citizen centers, homeless shelters, food banks, adoption agencies)
- 12) Places of exercise or recreation (e.g., gymnasiums, health spas, bowling alleys, golf courses).

Many of the illustrations are from the U.S. Department of Justice and the U.S. Access Board or are based on illustrations produced by the U.S. Access Board and the U.S. Department of Justice.

New sections added to Appendix A to Chapter 10

F201.4 Requirements Apply to Facilities Constructed or Altered by or on Behalf of Federal Agencies.

The requirements in F216.13, F244 through F248, and 1011 through 1019 shall apply only to facilities constructed or altered by federal agencies or by non-federal entities on federal land on behalf of federal agencies pursuant to a concession contract, partnership agreement, or similar arrangement.

F201.4.1 Documentation and Notification When Exceptions Used for Trails and Beach Access

Routes. Federal agencies shall document the basis for not fully complying with a specific provision in 1017 or 1018 on a portion of a trail or beach access route based on Exception 1 in 1017 or Exception 1 in 1018, and shall maintain the documentation with the records for the trail or beach project. Federal agencies shall notify the Access Board if an entire trail is exempted from complying with 1017 based on Exception 2 in 1017.1, and if a beach access route is not provided based on Exception 2 in 1018.1.6)

F202.3 Alterations. * * * * *

EXCEPTIONS: * * * * *

4. Where elements or spaces are altered in camping facilities, picnic facilities, viewing areas, or trailheads and the circulation path to the altered element or space is not altered, the circulation path shall not be required to comply with 1016.

F202.4 Alterations Affecting Primary Function Areas. * * * * *

EXCEPTIONS: * * * * *

2. Camping facilities, picnic facilities, viewing areas, trailheads, trails, and beach access routes shall not be required to comply with F202.4.

F206.1 General. * * * * *

EXCEPTIONS: 1. Accessible routes shall not be required where outdoor recreation access routes are provided at camping facilities in accordance with F244.5, picnic facilities in accordance with F245.4, viewing areas in accordance with F246.3, or trailheads in accordance with F247.3.2.

2. Accessible routes shall not be required where camping facilities, picnic facilities, viewing areas, or outdoor constructed features are provided on trails.

3. Accessible routes shall not be required where beach access routes are provided in accordance with F248.

F212.3 Sinks. * * * * *

EXCEPTIONS: * * * * *

2. In camping facilities and picnic facilities, sinks shall not be required to comply with F212.3 where a cooktop or conventional range is not provided.

F213.1 General. * * * * *

EXCEPTION: Pit toilets provided on trails and in camping facilities shall not be required to comply with F213

F216.13 Trailhead Signs. Where new trail information signs are provided at trailheads on newly constructed or altered



SUMMARY

South Marina Parking Lot

STANDARD PARKING SPACES BY LOT	ACCESSIBLE
SM-1 = 168	11
SM-2 = 402	10
SM-3 = 412	8
SM-4 = 55	2
TOTAL = 1037	31

For every 6 or fraction of 6 parking spaces, at least 1 should be a van accessible space.

Reference also the Walker Report dated August 2020 for additional measurements of accessible spaces.

For the purposes of this evaluation and due to its size, the South Marina Parking Lot has been split into 4 sections: West (SM-1), West-Center (SM-2), East-Center, (SM-3) and East (SM-4). The areas associated with this evaluation are highlighted in green on the plan sheets in **Appendix C**. See **Figure 7**. Notes: Three (3) sets of accessible parking spaces and 1 related curb ramp were measured for this evaluation, and are identified on the plans and on the spreadsheets as SM PKG (#). Some of the accessible parking spaces and their curb ramps associated with the Marina Waterfront Trail System are included in that evaluation file. Those are identified as PKG (#).

The South Marina Parking Lot contains approximately 1037 parking spaces, with 31 spaces signed as accessible. Per the table to the left, each lot identifies the correct ratio of accessible spaces to total number of parking spaces. However, within the accessible spaces, there are not enough van accessible spaces. Not all identified spaces (shown on the evaluation plan sheets) have compliant identification markings. Curb cuts from the accessible spaces near the center of the lots need to be reconstructed as they are not accessible in their current configuration.

The West lot (SM-1) is adjacent to several buildings (including Anthony’s Homeport) and has several accessible spaces dispersed throughout the lot. This is compliant with locating the accessible spaces closest to the building entries.

The West-Center lot (SM-2) also has one building in the NE corner that features marina restrooms, showers, laundry and a leased space. For the purposes of this evaluation, the spaces around that building are not included, as they will be evaluated with that building in a future evaluation phase.

The East-Center lot (SM-3) has the most parking spaces, with the fewest number of marked accessible spaces. One additional space should be added to make this lot compliant.

Only the north end of the East lot (SM-4) is included in this evaluation. The spaces surrounding the buildings in this area will be evaluated with the buildings in a future evaluation phase. The East lot is closest to the Port’s ADA accessible dock (South Guest Dock 2). The accessible spaces are not, however, the closet spaces to the dock’s gangway. These should be relocated.

In general, all the accessible parking spaces in the south lot need to be re-striped and marked with compliant signage. Some will also need to be re-paved for compliant slopes (<2% in all directions). Van accessible spaces need to be added to achieve compliant numbers.

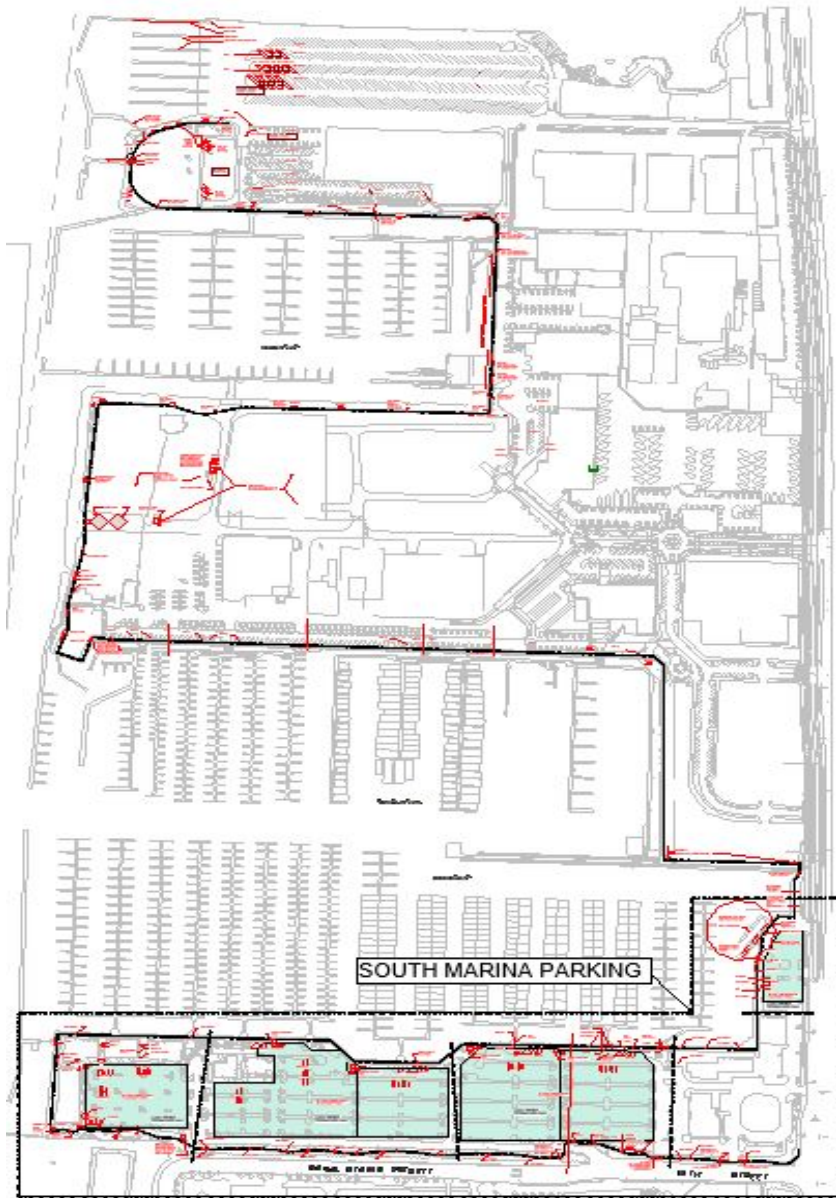

NOTE: WHERE RED TEXT IS CUT OFF OR NOT LEGIBLE, IT APPLIES TO OTHER EVALUATIONS USING THE SAME MAPS

SOUTH MARINA PARKING LOT
OVERALL PORT PLAN

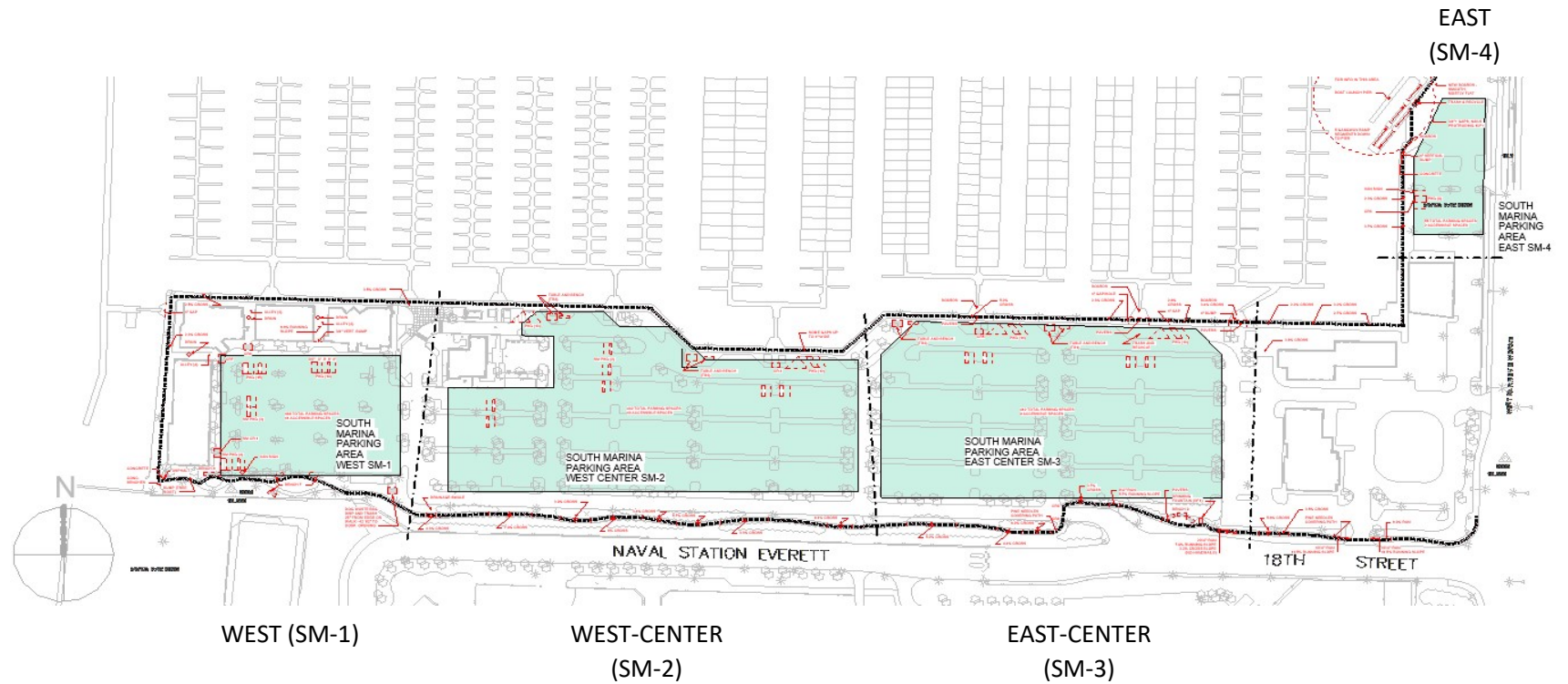

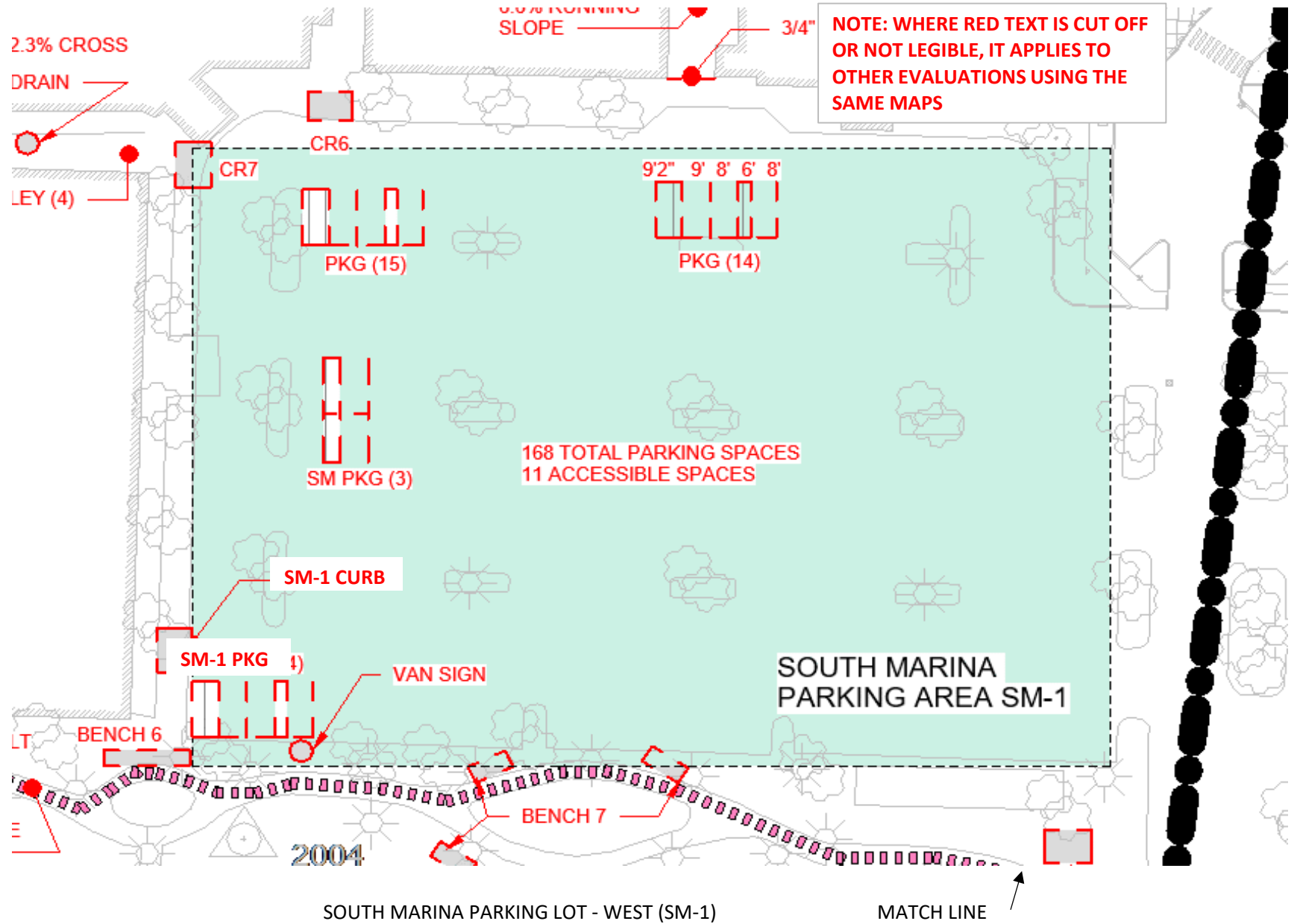

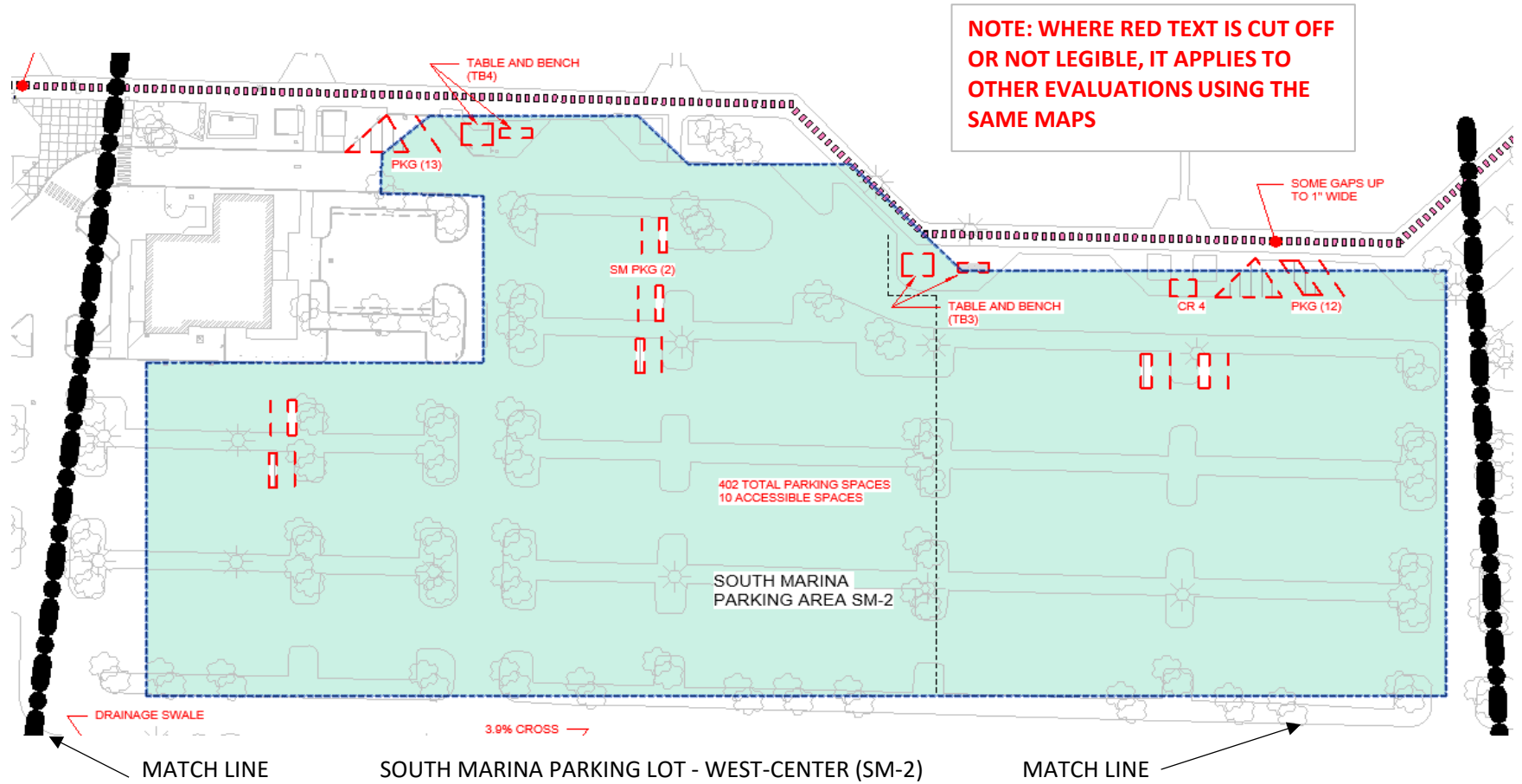

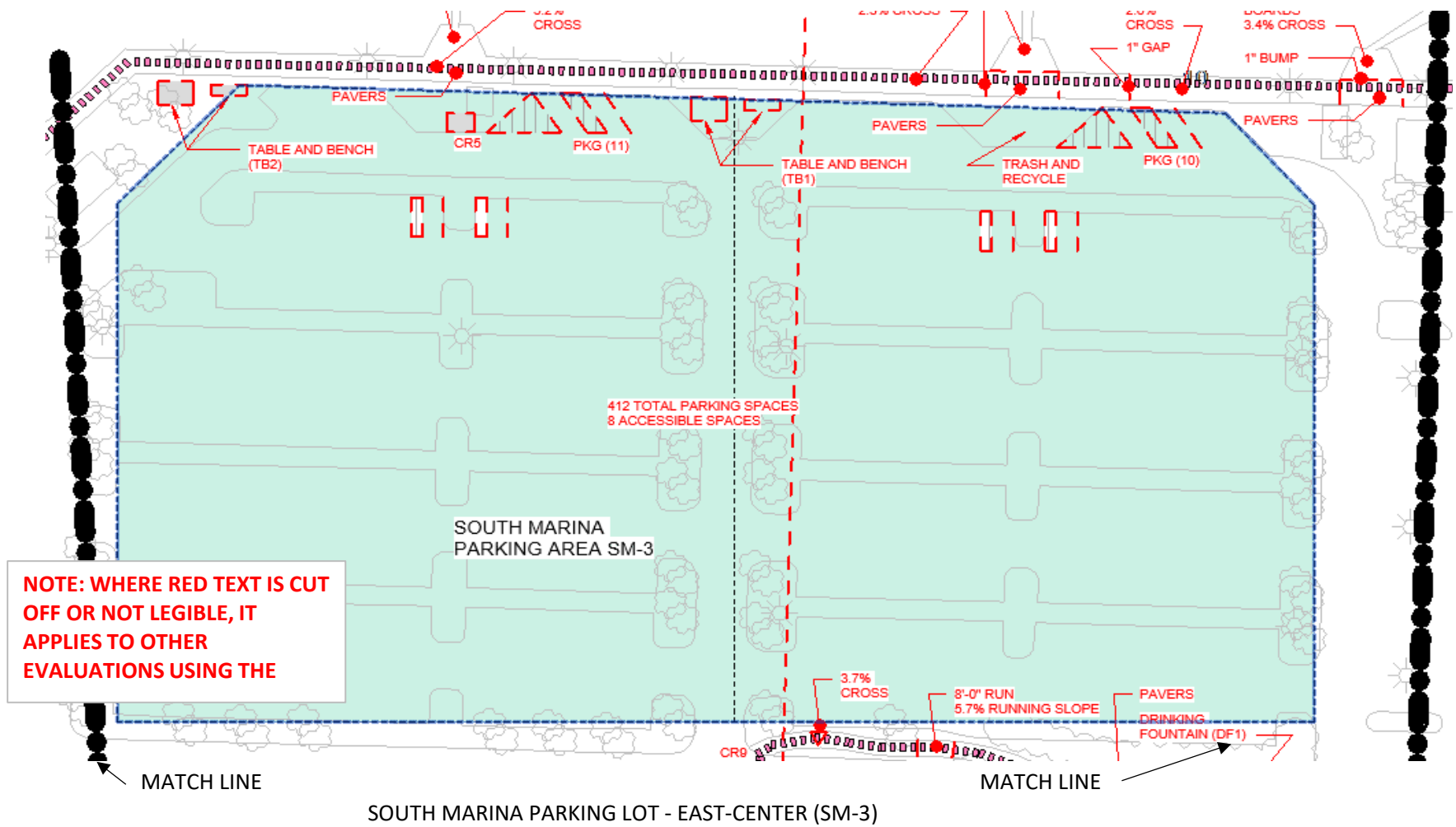

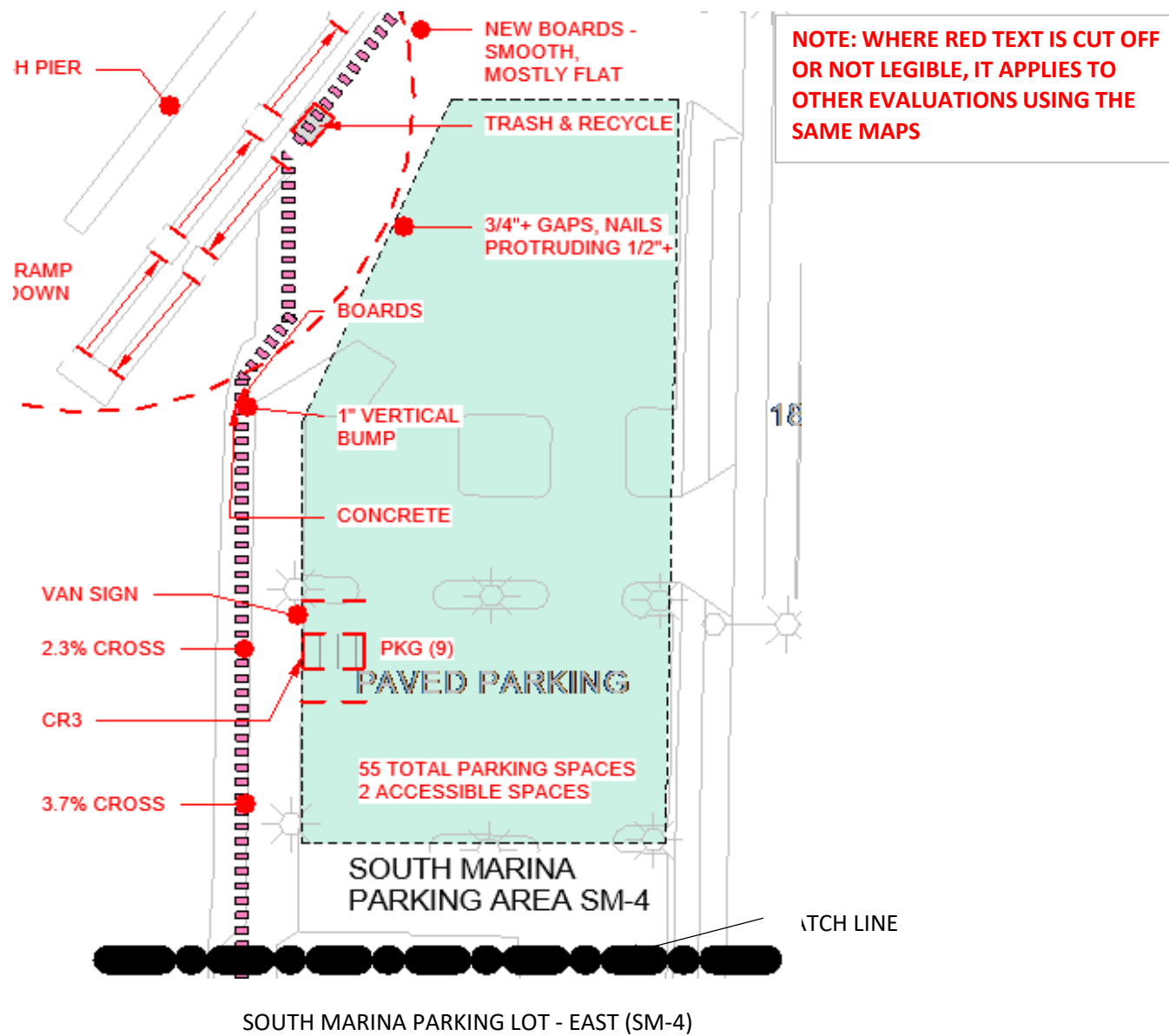

ADA Checklist for Existing

Priority 1 - Approach & Entrance

Based on the 2010 ADA Standards for Accessible Design



Project: ADA Transition Plan

Building: South Marina Parking Lot

Location: Everett, WA

Date: 1/20/2021

Surveyors: Lauri Strauss, AIA, LEED AP BD&C
President, CEO, design2 LAST, inc

Contact Information: o. 425-673-7269 c. 907-317-5040

543 Main St, Suite 101, Edmonds, WA 98020

An accessible route from site arrival points and an accessible entrance should be provided for everyone.

Priority 1 - Approach & Entrance					Comments	Possible Solutions
1.001	Is there at least one route from site arrival points (parking, passenger loading zones, public sidewalks and public transportation stops) that does not require the use of stairs? [See 2010 ADA Standards for Accessible Design – 206.2.1]	<input checked="" type="checkbox"/> YES If yes, location of route:	<input type="checkbox"/> NO		Photo:	<ul style="list-style-type: none"> • Add a ramp • Regrade to 1:20 maximum slope • Add a lift if site constraints prevent other solutions

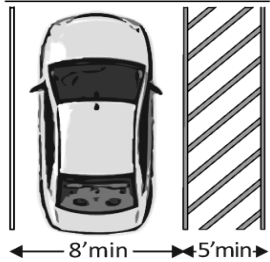

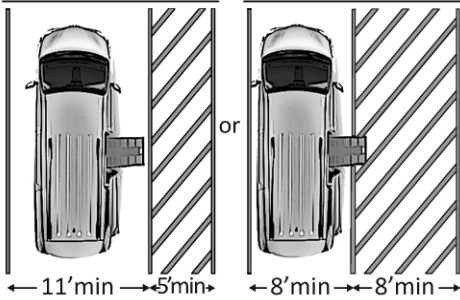
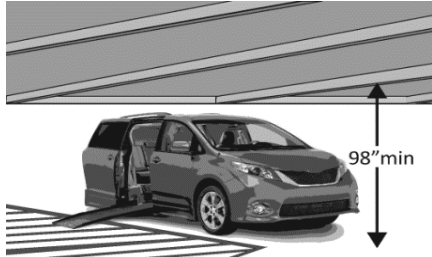
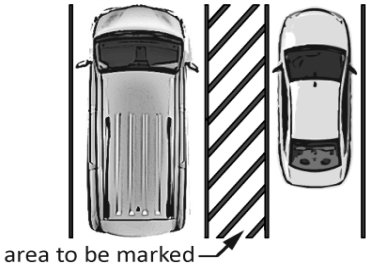
Parking Accessible parking spaces should be identified by size, access aisle and signage.																			
1.100	If parking is provided for the public, are an adequate number of accessible spaces provided? (208.2)	<input type="checkbox"/> YES <input type="checkbox"/> NO Total #: Acsbl #:	<table border="1"> <thead> <tr> <th>Total Spaces</th> <th>Accessible Spaces</th> </tr> </thead> <tbody> <tr> <td>1 - 25</td> <td>1</td> </tr> <tr> <td>26 - 50</td> <td>2</td> </tr> <tr> <td>51 - 75</td> <td>3</td> </tr> <tr> <td>76 - 100</td> <td>4</td> </tr> <tr> <td>1200</td> <td>22</td> </tr> <tr> <td colspan="2">100+ see 2010 Standards 208.2</td> </tr> </tbody> </table>	Total Spaces	Accessible Spaces	1 - 25	1	26 - 50	2	51 - 75	3	76 - 100	4	1200	22	100+ see 2010 Standards 208.2			<ul style="list-style-type: none"> • Repconfigure by repainting lines
Total Spaces	Accessible Spaces																		
1 - 25	1																		
26 - 50	2																		
51 - 75	3																		
76 - 100	4																		
1200	22																		
100+ see 2010 Standards 208.2																			
1.101	Of the accessible spaces, is at least one a van accessible space? [208.2.4]	<input type="checkbox"/> YES <input type="checkbox"/> NO	*For every 6 or fraction of 6 parking spaces required by the table above, at least 1 should be a van accessible space.		<ul style="list-style-type: none"> • If constructed before 3/15/2012, parking is compliant if at least 1 in every 8 accessible spaces is van accessible • Repconfigure by repainting lines 														
1.102	Are accessible spaces at least 8 feet wide with an access aisle at least 5 feet wide? [502.2, 502.3] Note: Two spaces may share an access aisle. Check state/local requirements; some specify that each space have its own aisle.	<input type="checkbox"/> YES <input type="checkbox"/> NO Measure ment:	 <p style="text-align: center;">← 8' min → ↔ 5' min ↔</p>		<ul style="list-style-type: none"> • Repconfigure by repainting lines 														

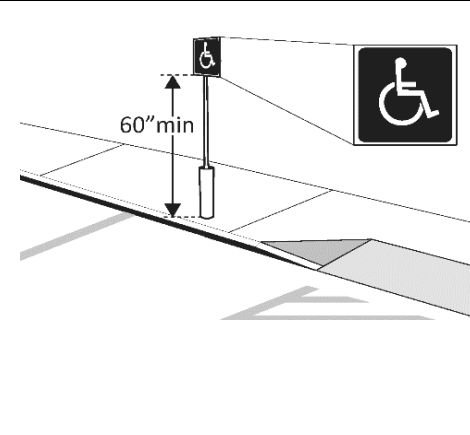
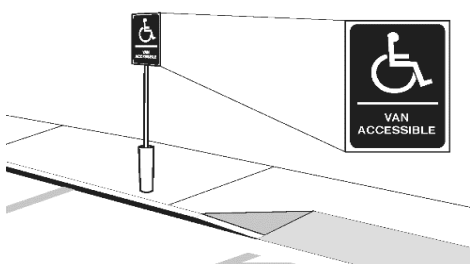

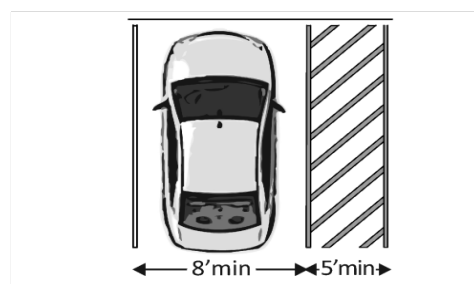
<p>1.103</p>	<p>Is the van accessible space: At least 11 feet wide with an access aisle at least 5 feet wide? Or At least 8 feet wide with an access aisle at least 8 feet wide? [502.2]</p>	<p><input type="checkbox"/> YES <input type="checkbox"/> NO Measure ment:</p>			<ul style="list-style-type: none"> • Reconfigure by repainting lines
<p>1.104</p>	<p>Is at least 98 inches of vertical clearance provided for the van accessible space? [502.5]</p>	<p><input type="checkbox"/> YES <input type="checkbox"/> NO Measure ment:</p>			<ul style="list-style-type: none"> • Reconfigure to provide van-accessible space(s)
<p>1.105</p>	<p>Are the access aisles marked so as to discourage parking in them? [502.3.3] Note: The marking method and color may be addressed by state/local requirements.</p>	<p><input type="checkbox"/> YES <input type="checkbox"/> NO Measure ment:</p>			<ul style="list-style-type: none"> • Mark access aisles
<p>1.106</p>	<p>Is the slope of the accessible parking spaces and access aisles no steeper than 1:48 in all directions? [502.4]</p>	<p><input type="checkbox"/> YES <input type="checkbox"/> NO Measure ment:</p>			<ul style="list-style-type: none"> • Regrade surface

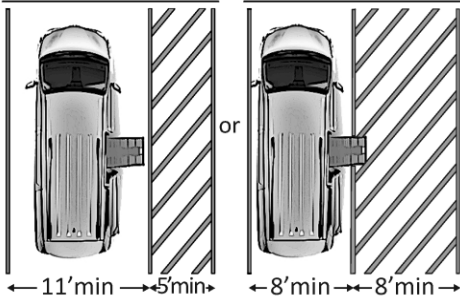
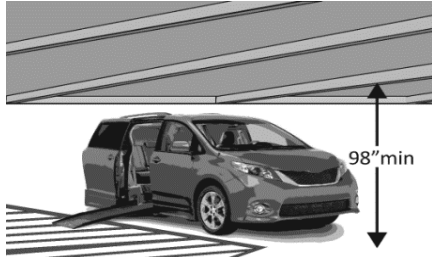
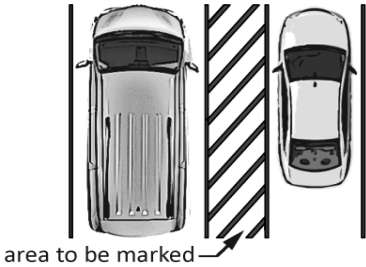
<p>1.107</p>	<p>Do the access aisles adjoin an accessible route? [502.3]</p>	<p><input type="checkbox"/> YES <input type="checkbox"/> NO</p>			<ul style="list-style-type: none"> • Create accessible route • Relocate accessible space
<p>1.108</p>	<p>Are accessible spaces identified with a sign that includes the International Symbol of Accessibility?</p>	<p><input type="checkbox"/> YES <input type="checkbox"/> NO</p>			<ul style="list-style-type: none"> • Install signs
	<p>Is the bottom of the sign at least 60 inches above the ground? [502.6] Note: The International Symbol of Accessibility is not required on the ground.</p>	<p><input type="checkbox"/> YES <input type="checkbox"/> NO</p>			
<p>1.109</p>	<p>Are there signs reading “van accessible” at van accessible spaces? [502.6]</p>	<p><input type="checkbox"/> YES <input type="checkbox"/> NO</p>			<ul style="list-style-type: none"> • Install signs
<p>1.110</p>	<p>Of the total parking spaces, are the accessible spaces located on the closest accessible route to the accessible entrance(s)? [208.3.1] Note: If parking serves multiple entrances, accessible parking should be dispersed.</p>	<p><input type="checkbox"/> YES <input type="checkbox"/> NO</p>			<ul style="list-style-type: none"> • Reconfigure spaces

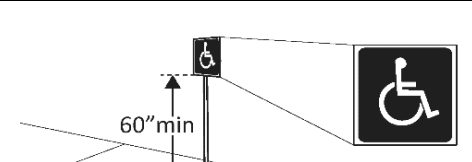
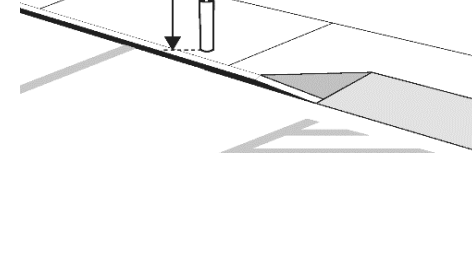
Parking Accessible parking spaces should be identified by size, access aisle and signage.																	
1.100	If parking is provided for the public, are an adequate number of accessible spaces provided? (208.2)	<input checked="" type="checkbox"/> YES <input type="checkbox"/> NO Total #: 402 Acsbl #: 10 (3 @ THIS LOC.)	<table border="1"> <thead> <tr> <th>Total Spaces</th> <th>Accessible Spaces</th> </tr> </thead> <tbody> <tr> <td>1 - 25</td> <td>1</td> </tr> <tr> <td>26 - 50</td> <td>2</td> </tr> <tr> <td>51 - 75</td> <td>3</td> </tr> <tr> <td>76 - 100</td> <td>4</td> </tr> <tr> <td>401 to 500</td> <td>9</td> </tr> <tr> <td colspan="2">100+ see 2010 Standards 208.2</td> </tr> </tbody> </table>	Total Spaces	Accessible Spaces	1 - 25	1	26 - 50	2	51 - 75	3	76 - 100	4	401 to 500	9	100+ see 2010 Standards 208.2	
Total Spaces	Accessible Spaces																
1 - 25	1																
26 - 50	2																
51 - 75	3																
76 - 100	4																
401 to 500	9																
100+ see 2010 Standards 208.2																	
 <p>Photo:</p>	<ul style="list-style-type: none"> • Reconfigure by repainting lines 																
1.101	Of the accessible spaces, is at least one a van accessible space?* [208.2.4]	<input type="checkbox"/> YES <input checked="" type="checkbox"/> NO	*For every 6 or fraction of 6 parking spaces required by the table above, at least 1 should be a van accessible space.														
<p>Photo:</p>	<ul style="list-style-type: none"> • If constructed before 3/15/2012, parking is compliant if at least 1 in every 8 accessible spaces is van accessible • Reconfigure by repainting lines 																
1.102	Are accessible spaces at least 8 feet wide with an access aisle at least 5 feet wide? [502.2, 502.3] Note: Two spaces may share an access aisle. Check state/local requirements; some specify that each space have its own aisle.	<input type="checkbox"/> YES <input checked="" type="checkbox"/> NO Measurement: [8'-3" S 4'-6" A] [8'-0" S 4'-8" A] [8'-3" S 4'-4" A]															
<p>Photo:</p>	<ul style="list-style-type: none"> • Reconfigure by repainting lines 																

<p>1.103</p>	<p>Is the van accessible space: At least 11 feet wide with an access aisle at least 5 feet wide? Or</p>	<p><input type="checkbox"/> YES <input checked="" type="checkbox"/> NO Measurement:</p>		<p>Photo:</p>	<ul style="list-style-type: none"> • Reconfigure by repainting lines
	<p>At least 8 feet wide with an access aisle at least 8 feet wide? [502.2]</p>	<p><input type="checkbox"/> YES <input checked="" type="checkbox"/> NO Measurement:</p>		<p>Photo:</p>	
<p>1.104</p>	<p>Is at least 98 inches of vertical clearance provided for the van accessible space? [502.5]</p>	<p><input checked="" type="checkbox"/> YES <input type="checkbox"/> NO Measurement:</p>		<p>Photo:</p>	<ul style="list-style-type: none"> • Reconfigure to provide van-accessible space(s)
<p>1.105</p>	<p>Are the access aisles marked so as to discourage parking in them? [502.3.3] Note: The marking method and color may be addressed by state/local requirements.</p>	<p><input checked="" type="checkbox"/> YES <input type="checkbox"/> NO Measurement:</p>		<p>Photo:</p>	<ul style="list-style-type: none"> • Mark access aisles
<p>1.106</p>	<p>Is the slope of the accessible parking spaces and access aisles no steeper than 1:48 in all directions? [502.4]</p>	<p><input type="checkbox"/> YES <input checked="" type="checkbox"/> NO Measurement: UP TO 2.5% IN CENTER</p>		<p>Photo:</p>	<ul style="list-style-type: none"> • Regrade surface

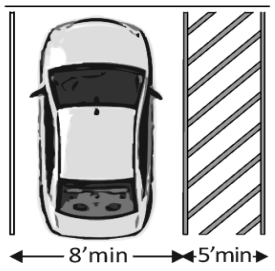
1.107	Do the access aisles adjoin an accessible route? [502.3]	<input type="checkbox"/> YES	<input checked="" type="checkbox"/> NO ROUTE IS NOT ACCESSIBLE		Photo:	<ul style="list-style-type: none"> • Create accessible route • Relocate accessible space
1.108	Are accessible spaces identified with a sign that includes the International Symbol of Accessibility?	<input checked="" type="checkbox"/> YES	<input type="checkbox"/> NO		Photo:	<ul style="list-style-type: none"> • Install signs
	Is the bottom of the sign at least 60 inches above the ground? [502.6] Note: The International Symbol of Accessibility is not required on the ground.	<input type="checkbox"/> YES	<input checked="" type="checkbox"/> NO 32"		Photo:	
1.109	Are there signs reading "van accessible" at van accessible spaces? [502.6]	<input type="checkbox"/> YES	<input checked="" type="checkbox"/> NO		Photo:	<ul style="list-style-type: none"> • Install signs
1.110	Of the total parking spaces, are the accessible spaces located on the closest accessible route to the accessible entrance(s)? [208.3.1] Note: If parking serves multiple entrances, accessible parking should be dispersed.	<input checked="" type="checkbox"/> YES	<input type="checkbox"/> NO TRAIL		Photo:	<ul style="list-style-type: none"> • Reconfigure spaces

Parking Accessible parking spaces should be identified by size, access aisle and signage.																	
<p>1.100</p>	<p>If parking is provided for the public, are an adequate number of accessible spaces provided? (208.2)</p>	<p><input checked="" type="checkbox"/> YES <input type="checkbox"/> NO</p> <p>Total #: 168</p> <p>Acsbl #: 11 (2 THIS LOC)</p>	<table border="1"> <thead> <tr> <th>Total Spaces</th> <th>Accessible Spaces</th> </tr> </thead> <tbody> <tr> <td>1 - 25</td> <td>1</td> </tr> <tr> <td>26 - 50</td> <td>2</td> </tr> <tr> <td>51 - 75</td> <td>3</td> </tr> <tr> <td>76 - 100</td> <td>4</td> </tr> <tr> <td>151 to 200</td> <td>6</td> </tr> <tr> <td colspan="2">100+ see 2010 Standards 208.2</td> </tr> </tbody> </table>	Total Spaces	Accessible Spaces	1 - 25	1	26 - 50	2	51 - 75	3	76 - 100	4	151 to 200	6	100+ see 2010 Standards 208.2	
Total Spaces	Accessible Spaces																
1 - 25	1																
26 - 50	2																
51 - 75	3																
76 - 100	4																
151 to 200	6																
100+ see 2010 Standards 208.2																	
<p>1.101</p>	<p>Of the accessible spaces, is at least one a van accessible space?* [208.2.4]</p>	<p><input type="checkbox"/> YES <input checked="" type="checkbox"/> NO</p>	<p>*For every 6 or fraction of 6 parking spaces required by the table above, at least 1 should be a van accessible space.</p>														
<p>1.102</p>	<p>Are accessible spaces at least 8 feet wide with an access aisle at least 5 feet wide? [502.2, 502.3] Note: Two spaces may share an access aisle. Check state/local requirements; some specify that each space have its own aisle.</p>	<p><input checked="" type="checkbox"/> YES <input type="checkbox"/> NO</p> <p>Measure ment: 9'-0" S 9'-0" A</p>															
		 <p>Photo:</p>	<ul style="list-style-type: none"> • Reconfigure by repainting lines 														
		<p>Photo:</p>	<ul style="list-style-type: none"> • If constructed before 3/15/2012, parking is compliant if at least 1 in every 8 accessible spaces is van accessible • Reconfigure by repainting lines 														
		<p>Photo:</p>	<ul style="list-style-type: none"> • Reconfigure by repainting lines 														

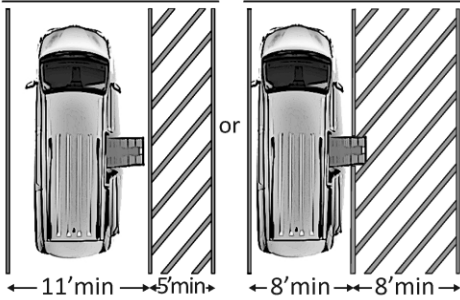
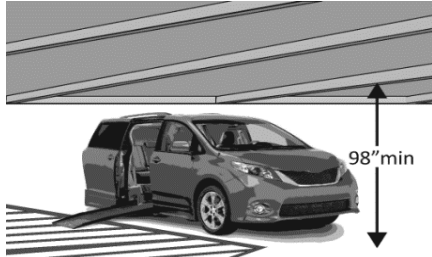
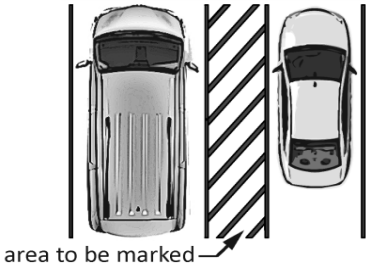

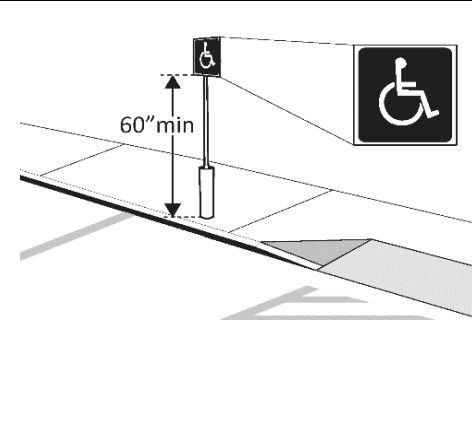
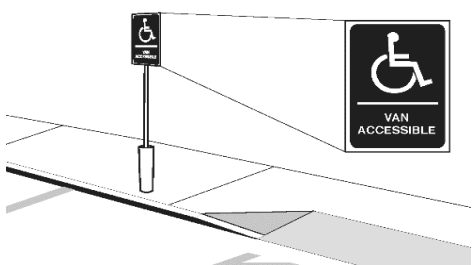
<p>1.103</p>	<p>Is the van accessible space: At least 11 feet wide with an access aisle at least 5 feet wide? Or</p>	<p><input type="checkbox"/> YES <input checked="" type="checkbox"/> NO Measure ment:</p>		<p>Photo:</p>	<ul style="list-style-type: none"> • Reconfigure by repainting lines
	<p>At least 8 feet wide with an access aisle at least 8 feet wide? [502.2]</p>	<p><input type="checkbox"/> YES <input checked="" type="checkbox"/> NO Measure ment:</p>		<p>Photo:</p>	
<p>1.104</p>	<p>Is at least 98 inches of vertical clearance provided for the van accessible space? [502.5]</p>	<p><input checked="" type="checkbox"/> YES <input type="checkbox"/> NO Measure ment:</p>		<p>Photo:</p>	<ul style="list-style-type: none"> • Reconfigure to provide van-accessible space(s)
<p>1.105</p>	<p>Are the access aisles marked so as to discourage parking in them? [502.3.3] Note: The marking method and color may be addressed by state/local requirements.</p>	<p><input checked="" type="checkbox"/> YES <input type="checkbox"/> NO Measure ment:</p>		<p>Photo:</p>	<ul style="list-style-type: none"> • Mark access aisles
<p>1.106</p>	<p>Is the slope of the accessible parking spaces and access aisles no steeper than 1:48 in all directions? [502.4]</p>	<p><input type="checkbox"/> YES <input checked="" type="checkbox"/> NO Measure ment: 2.7%</p>		<p>Photo:</p>	<ul style="list-style-type: none"> • Regrade surface

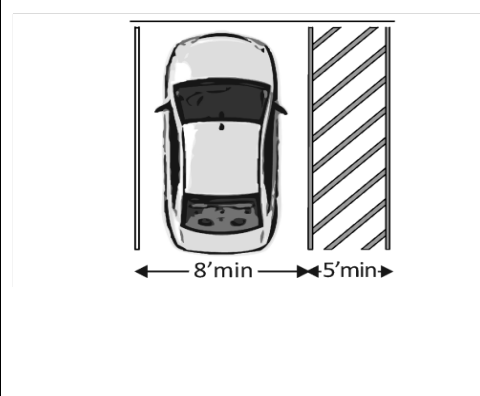

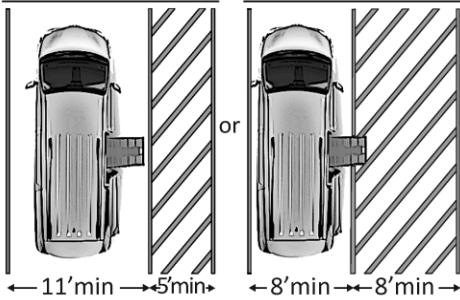
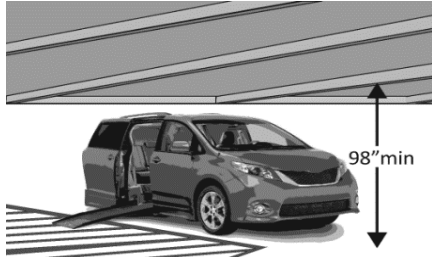
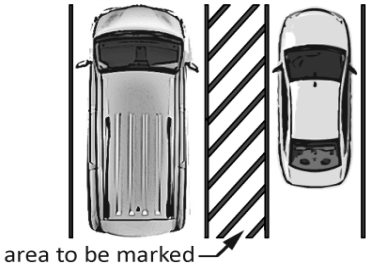
1.107	Do the access aisles adjoin an accessible route? [502.3]	<input type="checkbox"/> YES	<input checked="" type="checkbox"/> NO		Photo:	<ul style="list-style-type: none"> • Create accessible route • Relocate accessible space
1.108	Are accessible spaces identified with a sign that includes the International Symbol of Accessibility? Is the bottom of the sign at least 60 inches above the ground? [502.6] Note: The International Symbol of Accessibility is not required on the ground.	<input checked="" type="checkbox"/> YES	<input type="checkbox"/> NO		Photo:	<ul style="list-style-type: none"> • Install signs
1.109	Are there signs reading "van accessible" at van accessible spaces? [502.6]	<input type="checkbox"/> YES	<input checked="" type="checkbox"/> NO		Photo:	<ul style="list-style-type: none"> • Install signs
1.110	Of the total parking spaces, are the accessible spaces located on the closest accessible route to the accessible entrance(s)? [208.3.1] Note: If parking serves multiple entrances, accessible parking should be dispersed.	<input type="checkbox"/> YES	<input checked="" type="checkbox"/> NO ONE SPC CLOSER IS FOR "TELEM ED"		Photo:	<ul style="list-style-type: none"> • Reconfigure spaces

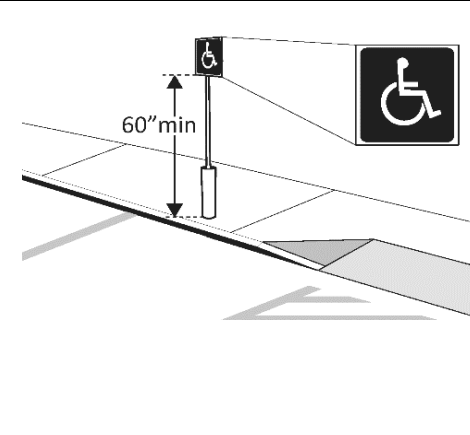
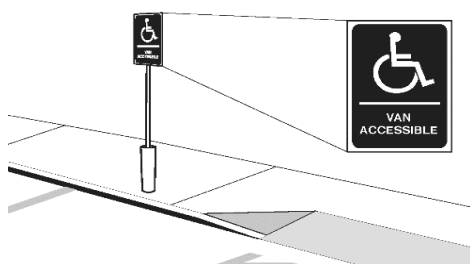
Parking Accessible parking spaces should be identified by size, access aisle and signage.																	
1.100	If parking is provided for the public, are an adequate number of accessible spaces provided? (208.2)	<input checked="" type="checkbox"/> YES <input type="checkbox"/> NO Total #: 168 Acsbl #: 11 (3 THIS LOC)	<table border="1"> <thead> <tr> <th>Total Spaces</th> <th>Accessible Spaces</th> </tr> </thead> <tbody> <tr> <td>1 - 25</td> <td>1</td> </tr> <tr> <td>26 - 50</td> <td>2</td> </tr> <tr> <td>51 - 75</td> <td>3</td> </tr> <tr> <td>76 - 100</td> <td>4</td> </tr> <tr> <td>151 to 200</td> <td>6</td> </tr> <tr> <td colspan="2">100+ see 2010 Standards 208.2</td> </tr> </tbody> </table>	Total Spaces	Accessible Spaces	1 - 25	1	26 - 50	2	51 - 75	3	76 - 100	4	151 to 200	6	100+ see 2010 Standards 208.2	
Total Spaces	Accessible Spaces																
1 - 25	1																
26 - 50	2																
51 - 75	3																
76 - 100	4																
151 to 200	6																
100+ see 2010 Standards 208.2																	
 <p>Photo:</p>	<ul style="list-style-type: none"> • Reconfigure by repainting lines 																
1.101	Of the accessible spaces, is at least one a van accessible space?* [208.2.4]	<input checked="" type="checkbox"/> YES <input type="checkbox"/> NO	*For every 6 or fraction of 6 parking spaces required by the table above, at least 1 should be a van accessible space.														
<p>Photo:</p>	<ul style="list-style-type: none"> • If constructed before 3/15/2012, parking is compliant if at least 1 in every 8 accessible spaces is van accessible • Reconfigure by repainting lines 																
1.102	Are accessible spaces at least 8 feet wide with an access aisle at least 5 feet wide? [502.2, 502.3] Note: Two spaces may share an access aisle. Check state/local requirements; some specify that each space have its own aisle.	<input checked="" type="checkbox"/> YES <input type="checkbox"/> NO Measure ment:															
<p>Photo:</p>	<ul style="list-style-type: none"> • Reconfigure by repainting lines 																

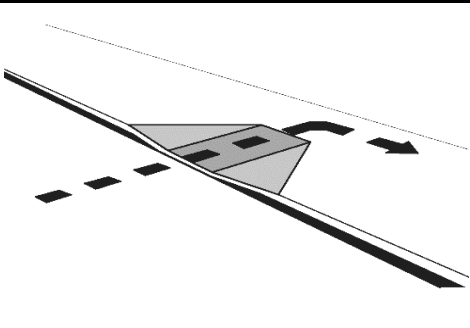
<p>1.103</p>	<p>Is the van accessible space: At least 11 feet wide with an access aisle at least 5 feet wide? Or At least 8 feet wide with an access aisle at least 8 feet wide? [502.2]</p>	<p><input type="checkbox"/> YES <input type="checkbox"/> NO Measure ment: N/A</p>		<p>Photo:</p>	<ul style="list-style-type: none"> • Reconfigure by repainting lines
<p>1.104</p>	<p>Is at least 98 inches of vertical clearance provided for the van accessible space? [502.5]</p>	<p><input checked="" type="checkbox"/> YES <input type="checkbox"/> NO Measure ment:</p>		<p>Photo:</p>	<ul style="list-style-type: none"> • Reconfigure to provide van-accessible space(s)
<p>1.105</p>	<p>Are the access aisles marked so as to discourage parking in them? [502.3.3] Note: The marking method and color may be addressed by state/local requirements.</p>	<p><input checked="" type="checkbox"/> YES <input type="checkbox"/> NO Measure ment: PAINT IS FADED</p>		<p>Photo:</p>	<ul style="list-style-type: none"> • Mark access aisles
<p>1.106</p>	<p>Is the slope of the accessible parking spaces and access aisles no steeper than 1:48 in all directions? [502.4]</p>	<p><input type="checkbox"/> YES <input checked="" type="checkbox"/> NO Measure ment: UP TO 3.8%</p>		<p>Photo:</p>	<ul style="list-style-type: none"> • Regrade surface

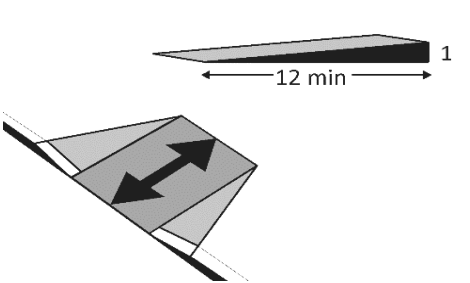
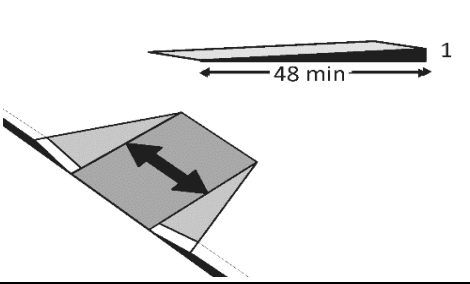
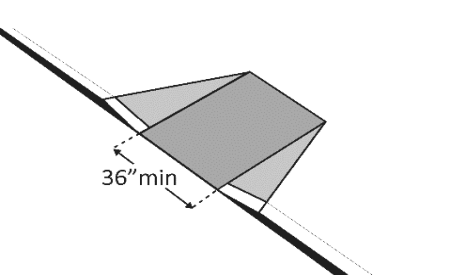
1.107	Do the access aisles adjoin an accessible route? [502.3]	<input checked="" type="checkbox"/> YES <input type="checkbox"/> NO CURB RAMP		Photo:	<ul style="list-style-type: none"> • Create accessible route • Relocate accessible space
1.108	Are accessible spaces identified with a sign that includes the International Symbol of Accessibility? Is the bottom of the sign at least 60 inches above the ground? [502.6] Note: The International Symbol of Accessibility is not required on the ground.	<input checked="" type="checkbox"/> YES <input type="checkbox"/> NO <input type="checkbox"/> YES <input checked="" type="checkbox"/> NO 55"		Photo:	<ul style="list-style-type: none"> • Install signs
1.109	Are there signs reading "van accessible" at van accessible spaces? [502.6]	<input checked="" type="checkbox"/> YES <input type="checkbox"/> NO		Photo:	<ul style="list-style-type: none"> • Install signs
1.110	Of the total parking spaces, are the accessible spaces located on the closest accessible route to the accessible entrance(s)? [208.3.1] Note: If parking serves multiple entrances, accessible parking should be dispersed.	<input checked="" type="checkbox"/> YES <input type="checkbox"/> NO		Photo:	<ul style="list-style-type: none"> • Reconfigure spaces

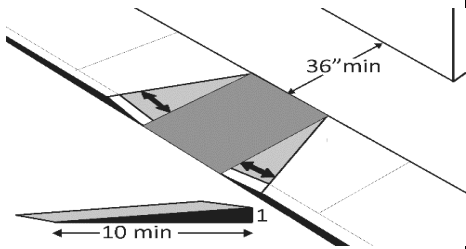
Curb Ramps					
1.111	If the accessible route crosses a curb, is there a curb ramp? [402.2]	<input checked="" type="checkbox"/> YES <input type="checkbox"/> NO		 <p>Photo #:</p>	<ul style="list-style-type: none"> • Install curb ramp
1.112	Is the running slope of the curb ramp no steeper than 1:12, i.e. for every inch of height change there are at least 12 inches of curb ramp run? [406.1, 405.2]	<input type="checkbox"/> YES <input checked="" type="checkbox"/> NO Measure ment: 9.6%		<p>Photo #:</p>	<ul style="list-style-type: none"> • Regrade curb ramp
.113	Is the cross slope of the curb ramp, excluding flares, no steeper than 1:48? [406.1, 405.3]	<input checked="" type="checkbox"/> YES <input type="checkbox"/> NO Measure ment: 1.5%		<p>Photo #:</p>	<ul style="list-style-type: none"> • Regrade curb ramp
1.114	Is the curb ramp, excluding flares, at least 36 inches wide? [406.1, 405.5]	<input checked="" type="checkbox"/> YES <input type="checkbox"/> NO Measure ment:		<p>Photo #:</p>	<ul style="list-style-type: none"> • Widen curb ramp

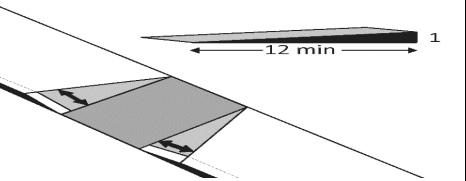
<p>1.115</p>	<p>At the top of the curb ramp is there a level landing (slope no steeper than 1:48 in all directions) that is at least 36 inches long and at least as wide as the curb ramp? [406.4]</p>	<p><input type="checkbox"/> YES <input checked="" type="checkbox"/> NO</p> <p>Measure ment: 2.6%</p>			<ul style="list-style-type: none"> • Reconfigure • Add ramp flares
<p>1.116</p>	<p>If the landing at the top is less than 36 inches long, are there curb ramp flares? [406.3]</p>	<p><input type="checkbox"/> YES <input checked="" type="checkbox"/> NO</p> <p>Measure ment: NONE</p>			
<p>1.116</p>	<p>If the landing at the top is less than 36 inches long, are there curb ramp flares? [406.4]</p>	<p><input type="checkbox"/> YES <input checked="" type="checkbox"/> NO</p> <p>Measure ment: N/A</p>			<ul style="list-style-type: none"> • Add ramp flares • Regrade flares



Appendix D

Public Outreach Documentation

ArcGIS Survey123[®] Survey
ArcGIS Survey123[®] Findings
SurveyMonkey[®] Survey with Findings
Virtual Public Workshop Presentation
Virtual Public Workshop Minutes



ArcGIS Survey123 Survey

ArcGIS Survey123 Port of Everett ADA Barrier Survey

In 2021, the Port of Everett is seeking public input to identify barriers to accessibility for persons with disabilities in our community.

We want your feedback on barriers you experience in the Port's physical transportation network and recreational facilities as well as communicative barriers.

Physical Americans with Disabilities Act (ADA) barriers may include but are not limited to inaccessible curb ramps, sidewalks and/or pedestrian crossings.

Communicative ADA barriers may include but are not limited to lack of access to Port website information in alternative formats or lack of accommodation to participate in Port activities.

This survey has 10 questions and should take approximately 5 minutes to complete. You may take the survey more than once to identify additional barriers.

Please note that any submission is subject to Washington State Public Records Act as they apply to the Port of Everett.

Thank you very much for your time and input!

1. ADA Barrier Map Location

Please locate the barrier you would like the Port to investigate on the below map. To set the blue marker pin, click the mouse at the desired location. Use the plus (+) and minus (-) buttons to zoom in and out.

[Map Tool Powered by [Esri](#)]

2. Barrier Description

Please describe the ADA access barrier and share any additional information about the specific location of the barrier such as an address, nearby street intersections or landmarks. For communicative barriers, please describe the situation and Port parties involved.

3. Barrier Photo

If available, please upload a photo of the barrier.

Select image file

4. Which barriers do you want removed before others?

Please rank the following barriers in order of importance for barrier removal (1 = most important):

- Outdoor physical barriers (lack of curb ramps, fixed objects in path of travel, cracks in sidewalks, etc.)
- Indoor physical barriers (inaccessible building entrances, restroom facilities, service counters)
- Communicative barriers (website accessibility, lack of alternative formats or accommodations)
- Other

5. Where is it important to remove barriers?

Please rank the following locations in order of importance for barrier removal (1 = most important):

- Port buildings
- Other
- Beach access
- Marina Docks
- Port bathroom facilities
- Parking
- Paved pedestrian routes (sidewalks, shared use paths)
- Unpaved pedestrian routes (trails)

6. Is there anything else you want us to know?

This is an optional, open-ended question. If you answered "other" to the above questions, please provide more information here.

7. Upcoming Virtual Public Workshop in February 2021

Would you be interested in attending our Virtual Public Workshop?

Date: February 18, 2021

Time: 5-6pm PST

If you click yes, please visit the ADA Transition Plan project webpage AFTER completing this survey. A link for the project webpage and workshop details will be provided after you click "Submit" at the end of the survey.

- Yes
- No

8. Virtual Public Workshop - Request for Accommodation

If you are interested in participating in our virtual public workshop and need accommodation to participate, please let us know your needs below.

9. Contact Information (optional)

Please enter your contact information below for tracking purposes. You may be contacted with questions about the information submitted.

- First Name (optional)
- Please provide your first name.
- Please provide your last name.
- Please provide your email address.
- Please provide your phone number including area code.
- Please provide your mailing address including street (and unit# if applicable), city, state, and zip code.

10. Best Method of Contact?

- Please select one below.
- Mailing Address
- Email Address
- Phone
- Do not contact me

Thank you for your input!

Submit

Port of Everett - ADA Transition Plan
April 2021



ArcGIS Survey123[®] Findings

Port of Everett
 ADA Transition Plan
 ArcGIS Survey 123 Survey

ObjectID	CreationDate	2. Barrier Description	4. Which barriers do you want removed before others?	5. Where is it important to remove barriers?	6. Is there anything else you want us to know?
1	2/11/2021 21:00	Long term ADA parking spots must be provided for disabled resident that lives part time on Hat Island.	Other,Outdoor_physical_barriers_lack_, Indoor_physical_barriers_inacca,Communicative_barriers_website_	Parking,Unpaved_pedestrian_routes_trail,Other,Marina_Docks,Paved_pedestrian_routes_sidewal,Port_bathroom_facilities,Beach_access,Port_buildings	ADA parking without fees must be provided for disabled Hat Island residents
2	2/22/2021 19:47				Get rid of that silly old, fire hazard of a boat. Almost no one cares that RLS sat on it once.
3	2/22/2021 20:00	There needs to be an easier, dedicated location for people with kayaks, canoes, etc to put in. It should be designed with people with disabilities in-mind, recognizing that most would have assistance in putting in. The distance from a parked car to the input point should be reduced (so watercraft doesn't have to be carried as far), and there should be a boat ramp reserved exclusively for kayaks/canoes. In addition, lighting could be improved throughout the Port's lands.	Outdoor_physical_barriers_lack_,Other, Indoor_physical_barriers_inacca,Communicative_barriers_website_	Marina_Docks,Paved_pedestrian_routes_sidewal,Other,Port_bathroom_facilities,Port_buildings,Unpaved_pedestrian_routes_trail,Beach_access,Parking	As someone without physical disabilities, I'm not sure what the most pressing issues are. My experience is with dining at Scuttlebutt, launching my kayak from the boat launch, checking out the parks & Weyerhaeuser house, and hearing of fixed-route transit issues (long walk from bus stop on West Marine View Drive). I'll admit, I haven't paid close enough attention to the curb ramps, crosswalks, and sidewalks, as well as the interior design of the Port's buildings. So, as someone who gives voice to issues of disability barriers in my capacity at the Snohomish County Transportation Coalition, I'm hopeful that groups like The Arc of Snohomish County, Homage Senior Services, Everett Senior Center (well, folks previously with the center), Disability Rights Washington, and Lighthouse for the Blind have been proactively engaged and perhaps brought on-site to conduct walking & rolling audits.

Port of Everett - ADA Transition Plan
April 2021



SurveyMonkey® Survey with Findings

#1

COMPLETE

Collector: Web Link 1 (Web Link)
Started: Saturday, February 06, 2021 1:02:24 PM
Last Modified: Saturday, February 06, 2021 1:07:32 PM
Time Spent: 00:05:07
IP Address: 73.140.16.71

Page 1

Q1

Please describe the ADA access barrier. Please share any additional information about the specific location of the barrier such as an address, nearby street intersections or landmarks. For communicative barriers, please describe the situation and Port parties involved.

Jetty access for people with mobility disabilities

Q2

Which barriers do you want removed before others? Please rank the following barriers in order of importance for barrier removal (1 = most important).

- | | |
|--|----------|
| Outdoor physical barriers (lack of curb ramps, fixed objects in path of travel, cracks in sidewalks, etc.) | 2 |
| Indoor physical barriers (inaccessible building entrances, restroom facilities, service counters, etc.) | 3 |
| Communicative barriers (website accessibility, lack of alternative formats or accommodations, etc.) | 4 |
| Other | 1 |
-

Q3

Where is it important to remove barriers? Please rank the following locations in order of importance for barrier removal (1 = most important).

- | | |
|---|----------|
| Port buildings | 6 |
| Beach access | 1 |
| Paved pedestrian routes (sidewalks, shared use paths) | 7 |
| Unpaved pedestrian routes (trails) | 2 |
| Port bathroom facilities | 4 |
| Marina Docks | 3 |
| Parking | 5 |
| Other | 8 |
-

Q4

Is there anything else you want us to know? This is an open-ended question. If you answered "other" to the above questions, please provide more information here.

There is no way for someone who uses mobility aids (e.g. wheelchair, scooter, walker) to visit the Jetty.

Q5

Yes

Upcoming 2021 Virtual Public Workshop. Would you be interested in attending our Virtual Public Workshop on Thursday, February 18th, from 5-6pm PST? If you click yes, please visit the ADA Transition Plan project webpage AFTER completing this survey. Link for project webpage: www.portofeverett/adatransitionplan.

Q6

Respondent skipped this question

Virtual Public Workshop - Request for Accommodation. If you are interested in attending our virtual workshop and need accommodation to participate, please let us know your needs below.

Q7

First name (optional). Please enter name and your contact information below for tracking purposes. You may be contacted with questions about the information submitted.

Zoann

Q8

Last name (optional).

Murphy

Q9

Contact information (optional).

Email Address

zm_mph2002@yahoo.com

Phone Number

907-355-2139

Q10

Respondent skipped this question

Mailing address (optional).

Q11

Email address

Best Method of Contact? (optional). Please select one below.

Port of Everett - ADA Transition Plan
April 2021



Virtual Public Workshop Presentation



ADA Self Evaluation & Transition Plan Virtual Public Workshop

Presented by
Jennifer Salemann, Transportation Solutions, Inc.
Laura Gurley, Port of Everett, Planner

February 18, 2021



@portofeverett | #portofeverett

Facebook, Instagram, Twitter, YouTube icons

1

Workshop Format

<h3>Short Presentation</h3> <ul style="list-style-type: none">• What is an ADA Self Evaluation and Transition Plan?• Why do we need it?• What are the parts of the Plan?• What is the process to adopt the Plan?• What are we asking you to do?• What will we do with the input you provide?	<h3>Share your Input</h3> <ul style="list-style-type: none">• What can you tell us about barriers you experience at the Port?• Raise hand or write question in Q/A
---	---



2

What is an ADA Self-Evaluation & Transition Plan?

An Americans with Disabilities Act (ADA) Self-Evaluation & Transition Plan is a document that outlines how a jurisdiction transitions toward compliance with the American with Disabilities Act (ADA). The Plan is based on guidance from the Department of Justice. At a minimum, the Plan shall:

- **Identify physical and communicative barriers** that limit accessibility of the Port's programs, services and activities.
- **Describe the methods** to be used to make the facilities, programs, services or activities accessible;
- **Provide a schedule** for making necessary modifications to provide better access and achieve compliance; and
- **Identify the public officials responsible** for implementation of the Plan.

3

Why do we need it?

The ADA Title II Self-Evaluation & Transition Plan is mandatory to partially fulfill the requirements set forth in Title II of the ADA. The ADA states that:

“A public entity must reasonably modify its policies, practices, or procedures to avoid discrimination against people with disabilities.”

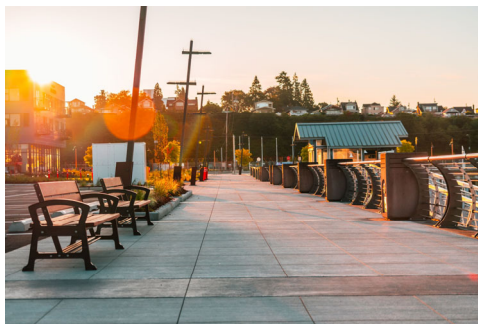

ADA Title II Self-Evaluation & Transition Plan:

- Ensures that we address citizen concerns and meet the accessibility needs of persons with disabilities in the community.
- Ensures that we are in compliance with the ADA.
- Ensures that we meet Washington DOT requirements for grant recipients.

4

Parts of the Plan -1

Self-Evaluation

The Port must evaluate its existing facilities and programs to identify any barriers to accessibility. The Port is using a phased approach over multiple years to evaluate all its facilities, activities, programs, and services.

Phase One (2021) includes areas within the Port's destination waterfront from 10th to 18th Streets, west of West Marine View Drive, which include:

- Trails
- Curb ramps
- Sidewalks
- Crosswalks
- Outdoor recreational areas (excluding docks in this initial phase)
- High priority policies and procedures

Subsequent phases intend to further identify and address barriers in remaining Port facilities including docks other recreational sites, building facilities, and Port services, programs and activities.

5

Parts of the Plan - 2

ADA Coordinator

If a public entity has 50 or more employees it is required to designate at least one responsible employee to coordinate ADA compliance.

Public Notice of ADA Provisions

This notice declares the public agency's commitment to non-discrimination on the basis of disability and addresses the agency's associated policies regarding employment, effective communication, modifications to policies and procedures, provision of auxiliary aids, scope of the ADA, complaints, and provision of aid/services at no additional cost. The intent is to reach anyone who may potentially interact with the Port and must be accessible to all.

Grievance Procedures and Complaint Records

Establishes a system for resolving complaints of disability discrimination in a prompt and fair manner.

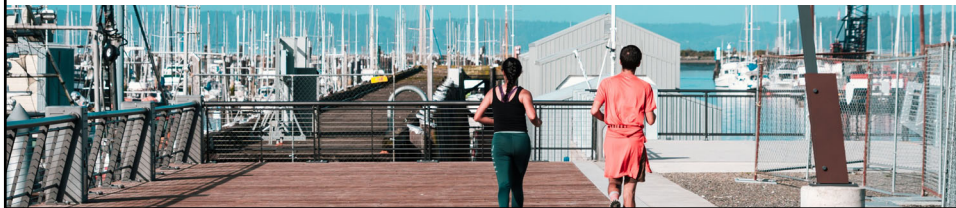

6

Parts of the Plan - 3

Public Outreach

- New webpage describing the process and how to get involved
- On-line survey requesting input from the public
- Outreach in Port publications
- Virtual Public Workshop February 18th from 5:00 to 6:00PM
- Port Commission meeting opportunities to comment

Project Webpage with Survey Links

www.portofeverett.com/adatransitionplan

7

Parts of the Plan - 4



Barrier Prioritization

Prioritization of identified barriers will be based on feedback from the public, severity of the barrier and other factors (subsequent years will include cost estimates).

Barrier Removal Schedule

Begin correcting identified barriers based on the prioritization framework and available funds (subsequent years will refine barrier removal schedule and funding framework).

8

Adoption Process and Schedule

Milestones

- 1/31: Launch webpage for ADA Transition Plan including online survey(s), and ADA Workshop platform
- Early February: Public Outreach – (i.e. Commission meeting, Port Side newsletter to all Port District residents, Herald Business Journal Port Report insert, Key Communicator, neighborhood associations, marina slipholders via e-mail, social media, various agencies in Snohomish County)
- 2/18: Virtual Workshop 5:00 - 6:00 p.m.
- 3/30: Post Draft ADA Transition Plan to website for public comment
- 4/8: Port staff provides Port Commission with draft Final ADA Transition Plan inclusive of public comment feedback
- 4/13: Port Commission review draft Final ADA Transition Plan and provides comments to Port staff
- 5/4: Port Commission formally adopts Final ADA Transition Plan

9

What are we asking you to do?

Identify Barriers to Accessibility

We would like to hear from you regarding barriers experienced by persons with disabilities or those who care for/provide services to the local ADA community.

Barriers may include:

Outdoor physical barriers, Indoor physical barriers, & Communicative barriers

Comment on Final Plan

A draft Plan with Appendixes will be made available for further public comment.



10

What will we do with the input you provide?

Consider Public Feedback in Prioritization of Barriers

The Plan will recommend that prioritization decisions be guided by the overarching principle that barriers identified and/or experienced by people within the ADA community are of higher priority than other barriers. Other factors such as planned capital improvements projects, funding, cost, etc., will also influence the prioritization of barriers.

Document Public Input in Final Plan

Public feedback from this workshop, the online surveys, and comments on the Draft Plan will be documented in the Final Plan.

11

Share Your Input - 1

What types of outdoor physical barriers do you experience at the Port?

- Missing curb ramps?
- Fixed objects or vegetation blocking your path of travel?
- Cracks/bumps/gaps in sidewalks?
- Trail or Beach access?
- Other?

12

Share Your Input - 2

What types of indoor physical barriers do you experience at the Port?

- Inaccessible building entrances?
- Inaccessible restroom facilities?
- Inaccessible service counters?
- Other?

13

Share Your Input - 3

What types of communicative barriers do you experience accessing Port services, activities or programs?

- Inaccessible webpages?
- Lack of alternative formats to access information?
- Lack of accommodation to participate in activities?
- Other?

14



Port of
EVERETT

WATERFRONT
PLACE
© PORT OF EVERETT

Please encourage others
to take our online survey:

<https://www.portofeverett.com/adatransitionplan>

Thank you!



@portofeverett | #portofeverett

Facebook, Instagram, Twitter, YouTube icons

Port of Everett - ADA Transition Plan
April 2021



Virtual Public Workshop Minutes

Port of Everett – ADA Transition Plan Virtual Public Workshop Minutes
Thursday, February 18, 2021 - 5-6pm

Attendees

City Staff

Laura Gurley (LG) - Planner/Project Manager
Catherine Soper (CS) - Public Affairs Manager
Kate Anderson (KA) - Communications Specialist

Transportation Solutions, Inc.

Kirk Harris (KH) - Engineer
Jennifer Salemann (JS) - Planner

Public Participants

Christina Curtis (CC) - City of Everett employee working on City ADA Transition Plan
Zoann Murphy (ZM) - Interested Everett resident; power scooter user
Tammi Olson (TO) - affiliated with Northwest ADA Network
Leigh Spruce (LS) - affiliated with Arc of Snohomish County; local Transportation committees and boards

Slide Presentation by (JS)

Introduction Slide
Workshop Format
What is an ADA Self-Evaluation & Transition Plan?
Why do we need it?
Parts of the Plan - 1
Parts of the Plan -2
Parts of the Plan - 3
Parts of the Plan - 4
Adoption Process and Schedule
What are we asking you to do?
What will we do with the input you provide?
Share Your Input - 1

(LS) Does the Plan only cover outdoor areas?

(LG) Yes. Based on available funding, outdoor spaces where there are the most people/users were chosen. The Port still needs to do the buildings and it is expected to take at least three years to address remaining facilities.

(LS) would like to see the following:

- Accessible parking near ramps
- Sidewalks with smooth surfaces that are not rocky
- Big lettering on signage and visually stimulating wayfinding
- For visitors with autism, lights/sound may have impact; pictorial and audible cues are helpful
- Non-slip surfaces: has seen progress and wants to see more universal design applications

(CS) mentioned how weather impacts the Plan and the importance of salting

(ZM) Cannot give specific examples but recommends

- Maps - is there an accessibility map? Especially for parking stalls?
- Names of different Plans
- Definition of a "trail"
- Access between parking stalls, paths and trails (safety concerns for family with small kids)
- Agrees with (LS) on more signage especially for parking
- Wood as a surface is not a good combination with a motor scooter
- Had no idea about ADA dock; are there accommodations for the blind/those with hearing disabilities?
- Focus on what the Port does offer/what does exist
- Would like new ADA parking map and signage
- North Marina Boat Launch: lack of marked pedestrian route across parking lanes
- Lack of Jetty Island access; getting to Island and while on Island

(LG) Responses

- Plan is working on safe corridors and marked pedestrian routes between accessible parking and launches
- Will take request to City as the City operates the ferry. There may have been a dune buggy wheelchair; unsure if still provided. Will look for ways for cross-jurisdictional cooperation.

(JS) Boat launch PAR will be identified as a need in the Plan

(CS) There is an ADA ramp onto the Ferry; would like to know full logistics dock to dock and on-island navigation

(ZM) Happy to volunteer for island site visit

(CC) shared City of Everett's process stage:

- City of Everett will conduct stakeholder outreach February 26
- Online Open House scheduled for March 1
- Mid-March: similar public workshop meeting likely
- Final Plan end of April

(CS) would like to use information to inform Port's Plan; goal for sharing feedback and cross-referencing

(TO) on Parking

- Recommends providing more than minimum parking requirements. Feel free to contact her.

(LS) Beach Access

- Cannot walk or use wheelchair at beaches
- Would like to get down at closer range to beach rather than embankment view only.

(LG) Beach Access is common request from persons with and without disabilities

- Ideas perpetually on the table for water access including river environments

(LS) Additional comments

- Kauai experience of accessible surfing opportunity with volunteer physical therapists
- Arc in the Park event at Forest Park in Mukilteo; picnic to enjoy community life not necessarily focused on talking about autism
- Has partnered with Imagine Children's organization
- Accessible Theme Park built by father for daughter in Texas in accordance with universal design

(CS) Autism from an events perspective:

- Holiday in the Bay - quiet rooms for sensory crafts
- Would like to reach out to Imagine Children's organization to coordinate

(LG) follow up

- Potential Movie Night partnership with Arc
- Look into hours of events

Share Your Input - 2

Share Your Input - 3

Conclusion Slide

(JS) Please share project webpage with colleagues/friends and encourage to take online survey



Appendix E

Updated Administrative Policies and Procedures Documentation

Public Notice of ADA Provisions
ADA Grievance Procedure
ADA Grievance Record Template
Accessible Pedestrian Signal (APS) Policy
Programmatic Self-Assessment Questionnaire

Port of Everett - ADA Transition Plan
April 2021



Public Notice of ADA Provisions



Public Notice under the ADA

In accordance with the requirements of title II of the Americans with Disabilities Act of 1990 ("ADA"), the Port of Everett will not discriminate against qualified individuals with disabilities on the basis of disability in its services, programs, or activities.

Employment: The Port of Everett does not discriminate on the basis of disability in its hiring or employment practices and complies with all regulations promulgated by the U.S. Equal Employment Opportunity Commission under title I of the ADA.

Effective Communication: The Port of Everett will generally, upon request, provide appropriate aids and services leading to effective communication for qualified persons with disabilities so they can participate equally in the Port of Everett's programs, services, and activities, including qualified sign language interpreters, documents in Braille, and other ways of making information and communications accessible to people who have speech, hearing, or vision impairments.

Modifications to Policies and Procedures: The Port of Everett will make all reasonable modifications to policies and programs to ensure that people with disabilities have an equal opportunity to enjoy all of its programs, services, and activities. For example, individuals with service animals are welcomed in the Port of Everett offices, even where pets are generally prohibited.

Anyone who requires an auxiliary aid or service for effective communication, or a modification of policies or procedures to participate in a program, service, or activity of the Port of Everett should contact the office of Laura Gurley, ADA Coordinator (425-388-0720 or via email to ADACoordinator@portofeverett.com) as soon as possible but no later than 48 hours before the scheduled event.

The ADA does not require the Port of Everett to take any action that would fundamentally alter the nature of its programs or services, or impose an undue financial or administrative burden.

Complaints that a program, service, or activity of the Port of Everett is not accessible to persons with disabilities should be directed to Laura Gurley, ADA Coordinator (425-388-0720 or via email to ADACoordinator@portofeverett.com)

The Port of Everett will not place a surcharge on a particular individual with a disability or any group of individuals with disabilities to cover the cost of providing auxiliary aids/services or reasonable modifications of policy, such as retrieving items from locations that are open to the public but are not accessible to persons who use wheelchairs.



ADA Grievance Procedure



**Port of Everett
Grievance Procedure under
The Americans with Disabilities Act**

This Grievance Procedure is established to meet the requirements of the Americans with Disabilities Act of 1990 ("ADA"). It may be used by anyone who wishes to file a complaint alleging discrimination on the basis of disability in the provision of services, activities, programs, or benefits by the **Port of Everett**. The **Port's** Personnel Policy governs employment-related complaints of disability discrimination.

The complaint should be in writing and contain information about the alleged discrimination such as name, address, phone number of complainant and location, date, and description of the problem. Alternative means of filing complaints, such as personal interviews or a tape recording of the complaint, will be made available for persons with disabilities upon request.

The complaint should be submitted by the grievant and/or his/her designee as soon as possible but no later than 60 calendar days after the alleged violation to:

Laura Gurley
ADA Coordinator
P.O. Box 538, Everett, WA 98206
425-388-0720
TTY 7-1-1
adacoordinator@portofeverett.com

Within 15 calendar days after receipt of the complaint, **the ADA Coordinator** or **their** designee will meet with the complainant to discuss the complaint and the possible resolutions. Within 15 calendar days of the meeting, **the ADA Coordinator** or **their** designee will respond in writing, and where appropriate, in a format accessible to the complainant, such as large print, Braille, or audio tape. The response will explain the position of the **Port of Everett** and offer options for substantive resolution of the complaint.

If the response by **the ADA Coordinator** or **their** designee does not satisfactorily resolve the issue, the complainant and/or his/her designee may appeal the decision within 15 calendar days after receipt of the response to the Port's Executive Director or **their** designee.

Within 15 calendar days after receipt of the appeal, the Executive Director or **their** designee will meet with the complainant to discuss the complaint and possible resolutions. Within 15 calendar days after the meeting, the Executive Director or **their** designee will respond in writing, and, where appropriate, in a format accessible to the complainant, with a final resolution of the complaint.

All written complaints received by **the ADA Coordinator** or **their** designee, appeals to the **Executive Director** or **their** designee, and responses from these two offices will be retained by the **Port of Everett** for at least three years.



ADA Grievance / Complaint Procedure and Instructions

The Port is required to apprise the public of the protections against discrimination afforded to them by Title II of the ADA, including information about how Title II requirements apply to its particular programs, services, and activities [28 C.F.R. § 35.106].

Step 1: File ADA Complaint / Grievance Form

The complainant should fill out the ADA Complaint / Grievance Form shown below, giving all of the information requested. The ADA Complaint / Grievance Form should be filed in writing with the ADA Coordinator within 60 days of the alleged disability-related discrimination. Upon request, reasonable accommodations will be provided in completing the form, or alternative formats of the form will be provided. The ADA Complaint / Grievance Procedure and Form may be obtained from and sent to the Port.

Step 2: An Investigation is Conducted

A notice of receipt shall be mailed to the complainant via first-class mail postage prepaid within five days of the receipt of the complaint or grievance, and the ADA Coordinator or another authorized representative shall begin an investigation into the merits of the complaint within 60 days. If necessary, the ADA Coordinator or another authorized representative may contact the complainant directly to obtain additional facts or documentation relevant to the grievance. If the complainant alleges misconduct on the part of the ADA Coordinator, another authorized representative may be appointed by the Executive Director to undertake the investigation if the allegations can be substantiated. If the complainant does not wish to be contacted personally, he/she should indicate it on the ADA Complaint / Grievance Form.

Step 3: A Written Decision is Prepared and Forwarded to the Complainant

The ADA Coordinator shall prepare a written decision, after full consideration of the grievance merits, no later than 75 days following the receipt of the grievance. If the complaint alleges misconduct on the part of the ADA Coordinator, another authorized representative may be appointed by the Executive Director to prepare the written decision if the allegations can be substantiated. A copy of the written decision shall be mailed to the complainant via first-class mail postage prepaid no later than five days after preparation of the written decision.

Step 4: A Complainant May Appeal the Decision

If the complainant is dissatisfied with the written decision, the complainant may file a written appeal with the Executive Director no later than 30 days from the date that the decision was mailed. See ADA Complaint/Grievance Appeal Form below. The appeal must contain a statement of the reasons why the complainant is dissatisfied with the written decision, and must be signed by the complainant, or by someone authorized to sign on the complainant's behalf. A notice of receipt shall be mailed to the complainant via first-class mail postage prepaid within five days of the receipt of the appeal. The appeal reviewers, consisting of the ADA Coordinator and the Executive Director, shall act upon the appeal no later than 60 days after receipt, and a copy of the appeal reviewers' written decision shall be mailed to the complainant via first-class mail postage prepaid no later than five days after preparation of the decision. The decision of the appeal reviewer shall be final.



The ADA Coordinator shall maintain the confidentiality of all files and records relating to grievances filed unless disclosure is authorized or required by law. Any retaliation, coercion, intimidation, threat, interference, or harassment for the filing of a grievance, or used to restrain a complainant from filing, is prohibited and should be reported immediately to the ADA Coordinator.



Port of Everett, WA - ADA Complaint/Grievance Form

Complainant Name:

Designee Preparing Complaint (if different from Complainant):

Designee's Relationship to Complainant:

Street Address & Apt. No.:

City:

State:

Zip:

Phone: ()

E-mail:

Please provide a complete description of the specific complaint or grievance:

Please specify any location(s) related to the complaint or grievance (if applicable):

Please state what you think should be done to resolve the complaint or grievance:

Please attached additional pages as needed.

Please do not contact me personally.

Signature: _____ Date: _____

Return to: Port of Everett, Laura Gurley, ADA Coordinator, P.O. Box 538, Everett, Washington 98206, 425-388-0720, TTY 7-1-1, ADACoordinator@portofeverett.com.

Upon request, reasonable accommodation will be provided in completing this form, or copies of the form will be provided in alternative formats. Contact Port of Everett, Emily Hammer, Executive Assistant, P.O. Box 538, Everett, WA 98206, 425-388-0625, TTY 7-1-1, emilyh@portofeverett.com.



Port of Everett, WA - ADA Complaint /Grievance Appeal Form

Complainant Name: _____

Designee Name (if applicable): _____

Designee Relationship to Complainant (if applicable): _____

Contact Information (please check one): Complainant Designee

Address: _____

Phone: () _____ E-Mail: _____

PLEASE PROVIDE A DETAILED EXPLANATION OF WHY YOU BELIEVE THE RESPONSE FROM THE PORT'S ADA COORDINATOR DID NOT SATISFACTORILY RESOLVE YOUR COMPLAINT (Please attach a complete copy of your initial complaint and the response resolution letter from the Port's ADA Coordinator):

APPEAL REMEDY REQUESTED:

Complainant or Designee Signature: _____ Date: _____

RETURN TO: Port of Everett, Laura Gurley, ADA Coordinator, P.O. Box 538, Everett, Washington 98206, 425-388-0720, TTY 7-1-1, ADACoordinator@portofeverett.com.

Upon request, reasonable accommodation will be provided in completing this form, or copies of the form will be provided in alternative formats. Contact Port of Everett, Emily Hammer, Executive Assistant, P.O. Box 538, Everett, Washington 98206, 425-388-0625, TTY 7-1-1, emilyh@portofeverett.com.



ADA Grievance Record Template

ADA GRIEVANCE/COMPLAINT RECORD

All written complaints received by the ADA Coordinator or designee, appeals to the Port of Everett Executive Director, and responses from these two offices will be retained by the Port for at least three years.

GRIEVANCE PROCEDURE RESPONSE TIMELINE		
Day 1	Date - Grievance Filed	Must be within 60 days after alleged violation.
Day 15	Date - Port's First Meeting with Complainant	Must be within 15 calendar days of Date Grievance Filed
Day 30	Date - Port's First Resolution	Must be within 15 calendar days of Port's First Meeting with Complainant
Day 45	Date - Complainant Appeal Recvd	Must be within 15 calendar days of Date Port's First Resolution
Day 60	Date - Port Executive Director Appeal Mte with Complainant	Must be within 15 calendar days of Complainant Appeal Received
Day 75	Date - Port Executive Director Appeal Resolution	Must be within 15 calendar days of Port Executive Director Meeting with Complainant

Record No.	Date - Grievance Filed	COMPLAINANT CONTACT INFORMATION			ALLEGED VIOLATION DETAILS			GRIEVANCE RESPONSE RECORD								
		Name	Email Address	Phone Number	Date	Location	Description	Name - ADA Coordinator or Designee Responder	Date - First Complainant Meeting	Date - First Resolution	Resolution Description	Date - Complainant Appeal Received	Date -Appeal Meeting	Date - Appeal Resolution	Appeal Resolution Description	



Accessible Pedestrian Signal (APS) Policy



Policy Regarding the Installation of Accessible Pedestrian Signals (APS)

Intent: It is the Port's intention to be consistent with the most current version of the WSDOT Local Agency Guideline Chapter 29.4¹, WSDOT Design Manual 22-01 Chapter 1510.05², and the Public Right of Way Access Guidelines (PROWAG 2011)³ in the provision and location of accessible pedestrian signals and pushbuttons. Further guidance is available in 28 CFR Part 36 and MUTCD section 4E.09.

Purpose: The purpose of this policy is to establish a reasonable and consistent policy for installing APS to ensure that access for persons with disabilities is provided. Note: As of January 2021, the Port does not own any APS. All existing and planned signals adjacent the Port are, or will be, owned, operated and maintained by City of Everett or WSDOT.

Scope: Both the Rehabilitation Act of 1973 (Section 504) and the Americans with Disabilities Act of 1990 require that facilities, programs, and services be accessible to persons with disabilities. Both require that all new construction and alterations be accessible to persons with disabilities. This requirement means that pedestrian signals in new construction and alterations must be accessible to persons with disabilities, including vision impairment, vision and hearing impairment, cognitive impairment, and mobility impairment. Pedestrian signals are required to communicate WALK signal information in both audible and vibrotactile modes so they are usable by pedestrians with vision impairment, and vision and hearing impairment. Pushbuttons to actuate pedestrian signals must be able to be located by persons with vision impairments and able to be actuated by persons with mobility impairments.

- A. New Signals:** All new signals and pedestrian actuated beacons are to be constructed with full APS.
- B. Existing Signals:** As of December 2020, there are no existing signals or pedestrian actuated beacons on Port of Everett property. Therefore, policy details associated with prioritization of upgrades to existing signal systems is not applicable.
- C. Requests from the Public:** If the request is for an APS signal or pedestrian actuated beacon at a location where none exists, the Port will go through a process, as determined by the Port, to determine how, if, and/or when it can add the requested ADA facility to the Port's ADA Transition Plan, Capital Facilities Plan and budget.

¹ See WSDOT Local Agency Guidelines M36-63.37 CHAPTER 29 - Section 504 and the Americans with Disabilities Act. Pages 29-4 to 29-6. <https://www.wsdot.wa.gov/Publications/Manuals/M36-63.htm>

² See WSDOT Design Manual M 22-01, Chapter 1510.05 (2)(a) Requirements for Crossings with Pedestrian Pushbuttons. <https://www.wsdot.wa.gov/Publications/Manuals/M22-01.htm>.

³ See also United States Access Board. Proposed Rights of Way Guidelines (2011): Chapter R2: Scoping Requirements. <https://www.access-board.gov/guidelines-and-standards/streets-sidewalks/public-rights-of-way/proposed-rights-of-way-guidelines/chapter-r2-scoping-requirements>.

Port of Everett - ADA Transition Plan
April 2021



Programmatic Self-Assessment Questionnaire

Port of Everett
Internal Programmatic ADA Compliance Checklist Tool

Contact Information and Department			Answers
	1	Name	
	2	Department	
	3	Role	
ADA Coordinator, Public Notice under the ADA, Grievance Procedure (28 CFR Part 35.106-35.107)			Date Completed/Initials
ADA/504 Coordinator (28 CFR Part 35.107 (a) & 49 CFR Part 27.13(a))	4	Staff know where to find the name, office address and phone number of your agency's ADA/504 Coordinator (published internally and externally such as on your agency's website).	
Public Notice Under the ADA (28 CFR 35.106)	5	Staff know where to find the Notice Under the ADA online (notice explains how the agency will address ADA Accessibility in its employment, communication, policies, and resolution of complaints).	
	6	Staff know how to produce the Notice Under the ADA in alternate formats - i.e. large print, Braille or rich text/screen-reader-friendly format, audio format, and/or accessible electronic format.	
Grievance Policy & Procedure (28 CFR Part 35.107 (a) and 49 CFR Part 27.13 (b))	7	Staff are familiar with the Grievance Policy and Procedure that: 1) describes how and where a complaint may be filed; 2) provides alternative means of filing; 3) describes time frames and processes to be followed by complainant and government entity; 4) describes how to appeal an adverse decision; and 5) states how long complaints will be retained.	
	8	Staff know where to find the Grievance Policy and Procedure publicly available online and in public areas.	
	9	Staff know how to produce the Grievance Procedure in alternate formats - i.e. large print, Braille or rich text/screen-reader-friendly format, audio format, and/or accessible electronic format.	
	10	Staff have been instructed to keep a record of filed grievances and responses and annually reviews the log to check for patterns/make service improvements.	
Effective Communication - "Communication with persons with disabilities shall be as effective as communications with others" (28 CFR Part 35.160) and ADA Title II Tutorial			
Auxiliary Aids and Services	11	Your staff are aware of the public entity's obligation to provide auxiliary aids and services.	
	12	Your staff are aware that people with disabilities may not be charged a fee to cover the cost of measures, such as the provision of auxiliary aids or program accessibility, to the programs and services offered by your agency.	
Aids for People who are Deaf or Hard of Hearing	13	Your staff know how to provide upon request at least the following starred (*) auxiliary aids for people who are deaf or hard of hearing. (Other items listed below may be requested by members of the public. Your agency is encouraged to provide as wide a variety of accessible formats/technologies as are feasible in order to accommodate requester's preferred format. Your staff may deny a requester's preferred format if : 1) it causes undue financial burden, and/or 2) would fundamentally alter the program, and 3) another accessible format alternative is made available.)	
	-	*Qualified sign language, oral, and cued speech interpreters	
	-	*Qualified notetakers	
	-	*Assistive listening devices	
	-	*Open and closed captioning of videos and television programs produced by your agency and videos on your agency's website	
	-	*Use of the 711 Telecommunications Relay Services (TRS)	
	-	*Use of a (TTY) Text Telephone or (TDD) Telecommunication Device	
	-	Telephone handset amplifiers	
	-	Computer-assisted real-time transcription (CART) services	
	-	Real time captioning of television programs	
	-	Video Interpreting Services (VIS) or Video remote interpreting (VRI) services	
	-	Closed-caption decoders	

Port of Everett
Internal Programmatic ADA Compliance Checklist Tool

Aids for People who are Blind or Visually Impaired	14	Your staff know how to provide upon request at least the following starred (*) auxiliary aids for people who are blind or visually impaired and others with print reading disabilities . (Other items listed below may be requested by members of the public. Your agency is encouraged to provide as wide a variety of accessible formats/technologies as are feasible in order to accommodate requester's preferred format. Your staff may deny a requester's preferred format if : 1) it causes undue financial burden, and/or 2) would fundamentally alter the program, and 3) another accessible format alternative is made available.)	
	-	*Documents and/or information in large print.	
	-	*Documents and/or information in Braille.	
	-	*Information in audio recorded format.	
	-	*Documents and/or information in accessible electronic formats that can be accessed in plain text or HTML.	
	-	*Screen reader software installed on a computer that is used by the public.	
	-	Magnification software installed on a computer that is used by the public.	
	-	Optical readers.	
Service Animals	15	Your staff are aware that a public employee may only ask two questions related to a service animal: A) If the animal is required because of a disability; and B) What work or task the animal has been trained to perform).	
Television and Video	16	If your agency produces public television programs or videos, your staff is aware that it must comply with the agency's website accessibility policy to ensure that publicly accessible filmed content is available with captioning and audio- descriptive formats.	
Telephone Communications (28 CFR Part 35.161)	17	If your department has telephones available to the public for making outgoing calls, your staff know the location(s) of text telephone (TTY) equipment or 711 Telecommunications Relay Services (TRS) upon request for people with hearing and speech disabilities.	
	18	Your staff know where to find the City's text telephone (TTY) number and 711 Telecommunications Relay Service (TRS) information and the phone number and address of the person responsible to respond to requests for accommodation, and that these numbers are included on your department's hard copy and website publications wherever the City's telephone number is publicized.	
	19	Your staff know how to accept relayed calls (i.e. to ensure that deaf people are allowed to handle matters over the phone as is allowed for others).	
Sign Language Interpreters	20	Your staff know how to provide access to requests for qualified sign language interpreters or have arrangements with one or more vendors to provide interpreting services when needed (within a reasonable time frame).	
Qualified (versus Certified) Interpreter	21	Your staff are aware that a sign language interpreter must be qualified to convey communications effectively, accurately, and impartially and use any necessary specialized vocabulary (but is not required to have certification).	
	22	Your staff are aware that it is inappropriate to request that family members and friends of people who are deaf serve as sign language interpreters, except in emergencies or if the individual wants the family member or friend to interpret and it is appropriate to do so.	
Qualified (versus Certified) Reader	23	Your staff are aware that a reader must be qualified to convey communications effectively, accurately, and impartially and use any necessary specialized vocabulary and be capable of assisting individuals in completing forms by accurately reading instructions and recording information on each form per the form's instructions and the instructions provided by the individual who requires the assistance (but the reader is not required to have certification).	
Primary Consideration	24	Your staff know to give primary consideration to the preferred type of auxiliary aid requested by the person with a disability when determining what type of auxiliary aid or service to provide.	
Situations When Granting Primary Consideration is Not Required	25	Your staff are aware of the following situations when granting a request for primary consideration (preferred auxiliary aid type) is not required: 1) The public entity can demonstrate that another equally effective means of communication is available; 2) Use of the preferred means would result in a fundamental alteration in the service/program/activity; 3) the preferred means would result in an undue financial and administrative burden.	

Port of Everett
Internal Programmatic ADA Compliance Checklist Tool

Policies and Procedures	26	Your staff know where to access the effective communication policy (see Notice Under the ADA in question 5 above) on your agency's public website and can provide it in an accessible format so people with disabilities know about any reasonable advance notice requirements that your entity adopts.	
	27	Your staff know the policies and procedures in place to respond to requests from the general public for documents in Braille, large print, audio recording, and/or accessible electronic format (email, compact disk, USB drive containing the document in plain text, word processing format, HTML or some other format that can be accessed with screen reader software).	
	28	Your staff know the policies and procedures in place to respond to requests from the general public for sign language, oral and cued speech interpreters that: a) specifies a time frame for reasonable advance notice; b) makes clear it is generally inappropriate to request family members and companions of deaf persons to serve as sign language interpreters; and c) specifies that deaf persons requesting interpreters should not be charged for the cost of the interpreter; and d) specifies how the agency, should provision of an interpreter result in undue financial and administrative burden, nevertheless ensures an individual with a disability receives benefits/services accompanied by a written statement of the reasons for denying an interpreter after considering all resources available for use.	
	29	Your staff know the policies and procedures in place to respond to requests from the general public for note-takers, computer-assisted real-time transcription services, or other aids/services for providing effective communication.	
Training	30	Staff who answer the telephone have been trained to ensure that incoming calls made through a relay service are handled as quickly and effectively as other calls.	
	31	Staff who interact with the public have been trained on the compliant policies and procedures to follow when a person requests an interpreter or another auxiliary aid/service.	
Inventory Lists of Communication Items and Technologies	32	Your department keeps a list of printed materials provided by the dept to the public and indicate whether those materials are: 1) provided, upon request, in an alternate accessible format; and 2) include the name and address of the person responsible for accommodating requests for alternative formats; and 3) includes TTY and 711 Telecommunications Relay Service numbers wherever an agency phone number is provided.	
	33	Your department maintains a list of any videos or television programs produced by your department and indicates whether these videos or programs have captioning and audio descriptions.	
	34	Your department has a list of where text telephones/teletypewriters (TTYs) are provided in your dept/agency.	
Website Accessibility (Section 508, 29 USC 794(2); 36 CFR 1194. Must provide access or alternative access option that is equal in terms of hours of operation and the range of options and programs available on website. See guidelines in <i>Accessibility of State and Local Web sites to People with Disabilities (June 2003)</i> available at http://www.ada.gov/websites2.htm).			
Policy & Procedures	35	Your staff know where to find the Website Accessibility Policy posted on your agency's website and can direct members of the public to it when requested.	
	36	Your staff know the procedures in place for submitting website content to the appropriate department to be checked for accessibility compliance.	
	37	Your agency's website home page includes easy-to-locate information, including a telephone number and email address, for use in reporting website accessibility problems and requesting accessible services and information.	
	38	You have procedures in place to assure a quick response to website visitors with disabilities who are having difficulty accessing information or services available via the website.	
Website Accessible Features - Complete if your department manages any website content	39	The top of each page with navigation links has a "skip navigation" link (This feature directs screen readers to bypass the row of navigation links and start at the webpage content, thus enabling people who use screen readers to avoid having to listen to all the links each time they move to a new page).	
	40	All links have a text description that can be read by a screen reader.	

Port of Everett
Internal Programmatic ADA Compliance Checklist Tool

	41	All of the photographs, maps, graphics and other images on the website currently have HTML tags (such as an "alt" tag or a long description tag) with text equivalents of the material being visually conveyed.	
	42	All the documents posted on your website including those in PDF format are also available in HTML or another text-based format such as rich text format (RTG) or word processing format.	
	43	If your website has online forms, HTML tags describe all of the controls (including all text fields, check boxes, drop-down lists, and buttons) that people can use in order to complete and submit the forms.	
	44	If a webpage has data charts or tables, HTML is used to associate all data cells within column and row identifiers.	
	45	All video files on your website have audio descriptions of what is being displayed to provide access to visually convey information for people who are blind or have low vision.	
	46	All website videos have written captions of spoken communication synchronized with the action to provide access for people who are deaf or hard of hearing.	
	47	All audio files on your website have written captions of spoken communication to provide access to people who are deaf or hard of hearing.	
	48	All webpages been designed so they can be viewed using visitors' web browser and operating system settings for color and font.	
	49	Alternative ways of accessing web-based information, programs, activities, and services are available for people with disabilities who cannot use computers.	
	50	A designated/qualified staff member checks the HTML of all new webpages to confirm accessibility before the pages are posted.	
Plan to Make All Website Content Accessible	51	If your website contains inaccessible content, there is a specific written plan including timeframes in place now to make all of your existing webcontent accessible.	
Training	52	In-house and contracted staff have received appropriate training on the website accessibility policy and procedures for how to ensure website accessibility (see the DOJ's technical assistance document "Accessibility of State and Local Government Websites to People with Disabilities").	
Emergency Services including Communication, Evacuation and Maintenance (28 CFR, 35.130, 35.133, 35.149, 35.160 and ADA Title II Tutorial)			
Service	53	The hours of operation of the telephone emergency services provided for TTY users are equal to the hours of operation of the telephone emergency services provided to others.	
	54	If the telephone emergency services provide additional features (such as automatic number identification, automatic location identification, automatic call distribution), the features provided to TTY users are equal to the features provided to others to provide swift and effective emergency response. (Feasibility should be determined based on the availability of technology in the marketplace to perform the function for communications received from TTY users.)	
Equipment and Maintenance	55	Every call-taking position within your agency's PSAP (Public Safety Answering Point) or equivalent have its own TTY or TTY-compatible equipment.	
	56	The accessible features and equipment are in operable working condition.	
	57	Your agency has procedures for maintaining TTY or TTY-compatible equipment that are equally effective as the maintenance procedures for voice telephone equipment.	
	58	Your department conducts unannounced tests of your telephone emergency services to ensure direct, equal access for people using TTYs (and keep records of the results of all test calls to check for compliance with standard operating procedures).	
Procedures	59	Your agency has procedures for back-up TTY or TTY-compatible equipment in case of malfunctions, telephone line malfunctions, or power failure that are equally effective as the procedures for back-up provided for voice telephone equipment.	
	60	Call takers respond to each silent, open line call by querying the line with a TTY.	
	61	Call takers can switch back and forth easily between TTY mode and voice mode during the same call.	

Port of Everett
Internal Programmatic ADA Compliance Checklist Tool

Training	62	TTY training is mandatory for all emergency communications services personnel who may have contact with individuals from the public who have hearing or speech disabilities.	
	63	Telephone emergency services requires or offer refresher training for TTYs at least as often as they require or offer training for voice calls.	
Emergency Evacuation	64	Staff know procedures for assisting in the evacuation of individuals with disabilities during an emergency (If emergency warning systems are provided, then they shall include both audible alarms and visual alarms).	
Employment Procedures (29 CFR Part 35.140, Title I of the ADA, and ADA Title II Tutorial)			
Identify Employees w/ Decision Making Responsibility	65	There is a roster of all agency employees with decision making responsibility for the employment process.	
Job Advertisements/ Announcements	66	Your agency's employment advertisements/announcements that include a telephone number also include a text telephone (TTY) number and the 711 Telecommunications Relay Service number.	
	67	Your agency's employment advertisements/announcements identify the essential functions of the job for applicants who have appropriate qualifications.	
	68	Information about job openings is accessible in alternative formats.	
Application Process	69	Application forms do not ask applicants to identify the presence of a disability.	
Interview Process	70	Interviews are conducted in accessible locations.	
	71	Your agency is prepared to provide a qualified sign language interpreter if requested by an applicant (with reasonable advance notice per the agency's effective communication policy).	
	72	All staff who may be conducting pre-employment interviews have been trained in what questions may or may not be asked in the pre-employment process.	
	73	All staff who may be conducting pre-employment interviews been made aware that medical examinations may not be conducted until after a conditional job offer has been made.	
Employee Records	74	Staff are aware that confidential, disability-related materials must be kept in secure files separate from other employment and personnel files.	
Training	75	Your agency ensures that all employees with decision making responsibilities for the employment process are aware of, and comply with, the ADA-mandated nondiscrimination requirements. (Recommended Tutorial for ADA Title II requirements: https://www.adatitle2.org/)	
Eligibility and Participation Requirements for Services/Programs/Activities (28 CFR Part 35.130, ADA Title II Tutorial)			
	76	Staff may not refuse to allow a person with a disability to participate in a service, program, or activity simply because the person has a disability.	
	77	Staff may not require a person with a disability to participate in a program or service specifically designed for individuals with disabilities.	
	78	Staff must provide programs and services in an integrated setting, unless separate or different measures are necessary to ensure equal opportunity.	
	79	Staff shall operate their programs so that, when viewed in their entirety, they are readily accessible to and usable by individuals with disabilities.	
	80	Staff must eliminate eligibility standards or rules that deny individuals with disabilities an equal opportunity to enjoy their services, programs, or activities unless such standards or rules are essential for the provision of the service, program or activity (Note: safety requirements that are necessary for the safe operation of the program in question, such as vision standards for eligibility for drivers' licenses, may be imposed if they are based on actual risks and not on mere speculation, stereotypes, or generalizations about individuals with disabilities.)	
	81	Staff may not establish requirements that tend to screen out individuals with disabilities, such as requiring a driver's license as the only acceptable means of identification.	

Port of Everett
Internal Programmatic ADA Compliance Checklist Tool

	82	Staff are required to make reasonable modifications in policies, practices, and procedures that deny equal access to individuals, unless a fundamental alternation in the program would result.	
	83	Staff must furnish auxiliary aids and services, such as alternate formats, assistive listening devices, or qualified interpreters, when necessary to ensure effective communication, unless an undue burden or fundamental alteration would result.	
	84	Staff may provide programs, services and activities, beyond those required by the regulation, to individuals with disabilities, but they may not require that individuals with disabilities participate in such programs, services and activities, rather than in those available to the general public.	
	85	Staff may not place special charges on individuals with disabilities to cover the costs of measures necessary to ensure nondiscriminatory treatment, such as making modifications required to provide program accessibility or providing qualified interpreters.	
Existing Facilities Used (28 CFR Part 35.150)			
	86	Staff are aware of and comply with the following: Public entities may provide program accessibility by a number of methods including alteration of existing facilities (including existing parks and recreational sites), acquisition or construction of additional facilities, relocation of a service or program to an accessible facility, or provision of services at alternate accessible sites. Title II's program access requirement does not require a public entity to make each of its facilities physically accessible, as long as the program is accessible when viewed in its entirety . However, in determining which structures must be altered to provide physical accessibility, the equal opportunity requirement also applies. "When viewed in its entirety" means that the location of the accessible facility (or facilities) is comparable in convenience to those facilities that are inaccessible, and the range of programs and services offered at both is equivalent. This obligation does not necessarily require a city to make each and every park or recreational facility accessible.	
Tours and Transportation (28 CFR Part 35.130, ADA Title II Tutorial)			
	87	Staff are aware of and comply with the following: For City-administered services, programs, and activities-such as tours or field trips-that include transportation as part of the event, accessible modes of transportation must be provided at no additional cost to eligible* participants with the disabilities. *If one of the eligibility requirements is payment of a participation fee, persons with disabilities must pay the participation fee as do persons without disabilities.	
Public Meetings (28 CFR Part 35.130, ADA Title II Tutorial)			
	88	Staff ensure that: 1) advertisements for public meetings include the name and contact information needed for making requests for accommodation (per the Notice Under the ADA policies referenced in question 5); 2) the TTY and 711 Telecommunication Relay Service numbers are included wherever a City phone number is provided; and 3): meetings occur in physically accessible locations.	
Use of Contracted Services and Purchasing (28 CFR Part 35.130)			
	89	In the selection of procurement contractors, staff does not use criteria that subject qualified individuals with disabilities to discrimination on the basis of disability.	
	90	Staff share the Public Notice Under the ADA with procurement contractors and inform contractors of their responsibility to comply with the stated policies within the Public Notice under the ADA in their services, programs, and activities (Title II requires public entities to ensure contractors operating services and programs on their behalf comply with the ADA.)	
not			
Accessible Pedestrian Signal (APS) Policy	91	Staff are aware of the Public Works Department's "reasonable and consistent" policy for installing accessible pedestrian signals and pushbuttons should members of the general public inquire.	