

# Catalogue 2020

Europe, Middle East and Africa



Since 1955, Cole-Parmer has been a leading global source of Fluid Handling, Test & Measurement and Biosciences products, instrumentation, equipment and supplies. We are proven experts in the fields of temperature measurement, spectroscopy, fluid handling, sample preparation & handling and chromatography. Our products & instruments are used extensively in the industrial, pharmaceutical, life sciences, environmental and food & beverage industries. Our portfolio of unique industry-leading brands includes Argos Technologies®, Digi-Sense®, Electrothermal®, Environmental Express®, Ismatec®, Jenway®, Kinesis®, Masterflex®, Oakton®, PCRmax®, Stuart®, Techne®, TELOS®, Traceable®, VapLock™ and partner with a number of key suppliers with industry leading products.

Cole-Parmer is globally renowned for our highly responsive customer service and experienced Application Specialists providing exceptional technical support. Pipette Service and Calibration and Instrument Service facilities are also available in our North America and European locations.

## Smart Connected Devices



### MASTERFLEXLIVE™

MasterflexLive™ alerts users & gives remote real-time access to all critical peristaltic pump processes so that they can be adjusted from anywhere at any time.



### CPLive™

Jenway® 74 and 76 spectrophotometers are CPLive™ enabled for remote access & comprise: Visible, UV/Vis & a UV/Vis Nano which handles low volumes (0.5 µL).



### TraceableLive®

TraceableLive®-capable and ILAC MRA, NIST-traceable calibrated data loggers securely & wirelessly monitor critical environments, alerting users to parameter breaches & minimising sample loss.



#### UK

T: +44 (0) 1480 272279  
E: info@coleparmer.co.uk

#### Germany

T: +49 (0) 9377 92030  
E: sales@coleparmer.de

#### France

T: +33 (0) 1486 37800  
E: cpcontact@coleparmer.com

#### Italy

T: +39 (0) 1313 89513  
E: itsales@coleparmer.com

#### USA

T: +1 847 549 7600  
E: sales@coleparmer.com



# HOT PRODUCTS

---

## Cole-Parmer® Gear Pumps

Compact and cost-effective, offering simple variable speed control for many fluid handling applications requiring flow rates as high as 5850-mL/min.



## Digi-Sense™ TraceableOne™ & TraceableGO™ Data Loggers

For monitoring conditions during shipment and storage. Single-use USB and ILAC MRA, NIST-traceable Bluetooth®-enabled data loggers that store alarm events.



## Kinesis® TELOS® MicroPlate™

A precision built product for small biological fluid samples, which is versatile, cost-effective, and capable of high throughput, with reduced loss.



## Stuart® Hotplate Stirrers

Built for safety & customisable with an online configurator giving a large choice of model type, interface, surface, and colour.



## VapLock™ Closed Systems

Engineered for ease of use and flexibility. These systems minimise leaks, spills, and vapour escape from HPLC solvent waste containers and reagent vessels.



## Environmental Express® HotBlock® Digestion Systems

Units are built from Kydex® and PTFE-coated graphite to limit contamination & provide fast, clean & cost-effective metals digestions.

# Table of Contents

Airflow Measurement . . . . .	3	Flowmeters . . . . .	68–70	Recorders . . . . .	154–155
Balances . . . . .	4–9	Furnaces . . . . .	71	Refractometers . . . . .	156
Baths & Circulators . . . . .	10–13	Gloves . . . . .	71	Refrigeration . . . . .	157
Beakers . . . . .	14–16	Heating Equipment . . . . .	72–77	Sample Prep . . . . .	158–159
Bottles . . . . .	17–19	Homogenisers . . . . .	78	Scoops & Spoons . . . . .	160
Burettes . . . . .	20	Hoods . . . . .	79–80	Shakers . . . . .	161–162
Calibration . . . . .	21	Humidity / Moisture . . . . .	81–82	Sieves . . . . .	163
Centrifuges . . . . .	21–23	Hydrometers . . . . .	83–84	Spectroscopy . . . . .	164–167
Chromatography . . . . .	24–36	Incubators . . . . .	85	Stirrers & Hot Plates . . . . .	168–173
Clamps & Supports . . . . .	37	Melting Point . . . . .	86–87	Tachometers & Stroboscopes . . . . .	174
Cleaning Solutions . . . . .	38	Microbiology . . . . .	88–92	Temperature . . . . .	175–184
Compressors . . . . .	39	Microscopes . . . . .	93	Timers . . . . .	185–186
Conductivity . . . . .	40–44	Mills . . . . .	94	Titration . . . . .	187
Controlled Environment . . . . .	45	Mixers . . . . .	94–95	Tubing . . . . .	187–194
Cryogenics . . . . .	46–48	Ovens . . . . .	96	Tweezers & Forceps . . . . .	195
Cylinders . . . . .	49	Oxygen . . . . .	97	Ultrasonic Cleaners . . . . .	196
Data Loggers . . . . .	50–53	PCR . . . . .	98–100	Vacuum Pumps . . . . .	197–198
Desiccators . . . . .	54	pH . . . . .	101–111	Valves . . . . .	199
Electrical . . . . .	55–56	Pipettes & Pipettors . . . . .	112–114	Viscometers . . . . .	200–201
Electrophoresis . . . . .	57	Pressure . . . . .	115–116	Water Purification . . . . .	202–203
Environmental Monitoring . . . . .	58	Pumps		Water Sampling . . . . .	204
Environmental Testing . . . . .	59–61	Masterflex® . . . . .	117–140		
Evaporators . . . . .	62	Ismatec® . . . . .	141–150		
Filtration . . . . .	63–65	Centrifugal . . . . .	151		
Flame Photometers . . . . .	66	Drum & Hand . . . . .	151		
Flasks . . . . .	67	Gear . . . . .	152–153		

Find even more at [ColeParmer.com](http://ColeParmer.com)

1 resource  
100,000 products

See our latest catalogue version on:  
<https://www.coleparmer.com/catalog-request>

Plus, convenient  
tools to help you:



Research  
specs &  
technical articles



Watch  
videos to do  
it right





## Digi-Sense™ Precalibrated Professional CFM/CMM Vane Thermoanemometer

### Store up to 16 measurements

- Reliable measurements, guaranteed! Precalibrated to ILAC MRA, NIST-traceable standards
- User-selectable units of measure eliminate the need for conversion
- Large dual-function 4-digit LCD with backlight for easy reading
- Auto power-off extends battery life
- Fits comfortably in your hand

The large dual display allows you to simultaneously read air velocity or airflow, and air temperature.



Description	Professional CFM/CMM vane thermoanemometer	
<b>Catalogue number</b>	<b>MY-20250-15</b>	
Air velocity	Range	0.4 to 30 m/s
	Resolution	0.01 m/s
	Accuracy	±(3% + 0.20 m/s)
Airflow	Range	0 to 999,900 CMM
	Resolution	0.001 to 100 CFM/CMM
Temperature	Range	0 to 50°C
	Resolution	0.1°C
	Accuracy	±2.0°C
Units, selectable	ft/min, m/s, mph, km/h, knots, CFM, CMM, °F, °C	
Airflow memory	16 commonly used area sizes (8 for CFM and 8 for CMM)	
Sampling rate	Approximately once per second	
Power	One 9 V battery, 80 hours typical	

## Digi-Sense™ Precalibrated CFM/CMM Hot-Wire Thermoanemometer

### High precision at very low air velocities and flow rates

- Reliable measurements, guaranteed! Precalibrated to ILAC MRA, NIST-traceable standards
- Slim telescoping hot-wire probe for hard-to-reach areas
- Large dual-function LCD with backlight
- Auto power-off extends battery life

Designed for precision air velocity and airflow measurements in seven user-selectable units. Simultaneously reads air velocity or airflow, and air temperature and shows real time, maximum, minimum, and average values for the parameters under investigation. Slim telescopic probe reaches into small openings.



Description	CFM/CMM hot-wire thermoanemometer	
<b>Catalogue number</b>	<b>MY-20250-16</b>	
Air velocity	Range	0.1 to 25 m/s
	Resolution	0.01 m/s
	Accuracy	±(5% + 1 digit) reading or ±(1% + 1 digit) full scale, whichever is greater
Airflow	Range	0 to 99,999 CMM
	Resolution	0.001 to 100 CFM/CMM
Temperature	Range	0 to 50°C
	Resolution	0.1°C
	Accuracy	±1.0°C
Units, selectable	ft/min, m/s, mph, km/h, knots, CFM, CMM, °F, °C	
Memory	Maximum and minimum with recall	
Sampling rate	Approximately once per 0.8 second	
Power	One 9 V battery	

## Digi-Sense™ Precalibrated Compact Vane Anemometer

### Lightweight and pocket-sized for convenient field use

- Reliable measurements, guaranteed! Precalibrated to ILAC MRA, NIST-traceable standards
- Backlight sensor is automatically activated by low-light conditions
- Max/Avg functions to easily manage airflow measurement



Description	Compact vane anemometer
<b>Catalogue number</b>	<b>MY-20250-23</b>
Range	1.1 to 30 m/s
Resolution	0.01 m/s
Accuracy	±(3% + 0.20 m/s)
Units, selectable	ft/min, m/s, mph, km/h, knots
Sampling rate	Approximately once per second
Power	One 9 V battery

## Digi-Sense™ Precalibrated Data Logging Anemometer

### Handheld or mountable for versatile sampling

- Reliable measurements, guaranteed! Precalibrated to ILAC MRA, NIST-traceable standards
- Analyse and graph logged data using included software
- Two start modes: automatic and manual
- User-defined high and low alarm levels with visual LED indication
- Articulated screw-on mounting stand provides flexible positioning



Description	Data logging anemometer
<b>Catalogue number</b>	<b>MY-20250-22</b>
Range	1.1 to 20 m/s
Resolution	0.01 m/s
Accuracy	±(3% + 0.20 m/s)
Units, selectable	ft/min, m/s, mph, km/h, knots
Memory	32,000 readings
Sampling rate	Once every 2 seconds to once every 24 hours
Power	One 3.6 V lithium battery

## Cole-Parmer® Symmetry® PT Toploading Balances

### Large weighing surface allows placement of a variety of samples

- Weighing modes include parts counting, percent weighing, checkweighing, animal/dynamic weighing and density determination
- USB and RS-232 interfaces offer connection to a computer or printer for GLP/GMP-compliant outputs
- Sealed keypad, splashproof design, and removable stainless steel weighing pan
- An oversized backlit LCD provides clear visibility of weighing results
- Digital filters compensate for vibration, drafts or temperature changes
- Fast stabilisation and response time

Symmetry®

**What's included:** AC power adapter. The 210-g and 410-g models also include a draft shield.



#### Specifications

**Calibration:** Internal or external with calibration mass

**Weighing units:** g, ct, oz, dwt, mg, grains, ozt, custom

**Power:** 115/220 VAC power adapter and built-in rechargeable battery pack (battery function not available on models 10001-06, -07, -13)

Capacity	Readability	Repeatability	Linearity	Pan size	Catalogue number
<b>Internal calibration</b>					
210 g	0.001 g	±0.002 g	±0.002 g	13 x 13 cm	MY-10001-10
410 g	0.001 g	±0.002 g	±0.002 g		MY-10001-11
2200 g	0.01 g	±0.02 g	±0.02 g	19 x 16 cm	MY-10001-12
4200 g	0.01 g	±0.02 g	±0.02 g		MY-10001-13
<b>External calibration</b>					
210 g	0.001 g	±0.002 g	±0.002 g	13 x 13 cm	MY-10001-02
410 g	0.001 g	±0.002 g	±0.002 g		MY-10001-03
2200 g	0.01 g	±0.02 g	±0.02 g	19 x 16 cm	MY-10001-04
4200 g	0.01 g	±0.02 g	±0.02 g		MY-10001-05
5000 g	0.1 g	±0.2 g	±0.4 g		MY-10001-06
15000 g	0.1 g	±0.2 g	±0.4 g		MY-10001-07

#### Accessories

MY-11120-78 Compact thermal printer  
 MY-10000-47 Kensington™ type security lock and cable  
 MY-17101-52 ILAC MRA, NIST-traceable calibration with data for balances

## Cole-Parmer® Symmetry® PA Analytical Balances

### Affordable, advanced, accurate—for small samples

- Three-door glass draft shield provides easy access inside the weighing chamber
- Oversized backlit LCD provides clear visibility of weighing results
- Sealed keypad, splashproof design, and removable stainless steel weighing pan offer safeguards in a messy lab environment
- Weighing modes include parts counting, percent weighing and checkweighing
- USB and RS-232 interfaces offer connection to a computer or printer for GLP/GMP-compliant output
- Digital filters compensate for vibration, drafts or temperature changes
- Selectable multi-language display and output
- Fast stabilisation and response time

Symmetry®

**What's included:** AC power adapter and draft shield.



#### Specifications

**Calibration:** Internal or external with calibration mass

**Weighing units:** g, ct, oz, dwt, mg, grains, ozt, custom

**Power:** 115/220 VAC power adapter

Capacity	Readability	Repeatability	Linearity	Pan size	Catalogue number
<b>Internal calibration</b>					
120 g	0.0001 g	±0.0002 g	±0.0002 g	9 cm	MY-10001-08
220 g	0.0001 g	±0.0002 g	±0.0002 g		MY-10001-09
<b>External calibration</b>					
120 g	0.0001 g	±0.0002 g	±0.0002 g	9 cm	MY-10001-00
220 g	0.0001 g	±0.0002 g	±0.0002 g		MY-10001-01

#### Accessories

MY-11120-78 Compact thermal printer  
 MY-10000-47 Kensington™ type security lock and cable  
 MY-17101-52 ILAC MRA, NIST-traceable calibration with data for balances



# Cole-Parmer® Symmetry® TT Precision Toploading and TA Analytical Touch-Screen Balances

## Advanced weighing features at an affordable price

- IR proximity sensors offer touch-free balance control
- Colour capacitive touch-screen display provides clear visibility of weighing results
- Get secure data connections via USB, RS-232, Ethernet, and Wi-Fi interfaces
- Easily adjust filter settings depending on your working environment
- Customise the menu screen to meet your everyday needs
- Use statistics working mode to quickly analyse data from series of measurements
- Multiple working modes handle a variety of weighing functions
- Quickly diagnose weighing errors with autotest GLP function
- Industry-leading 5-year warranty

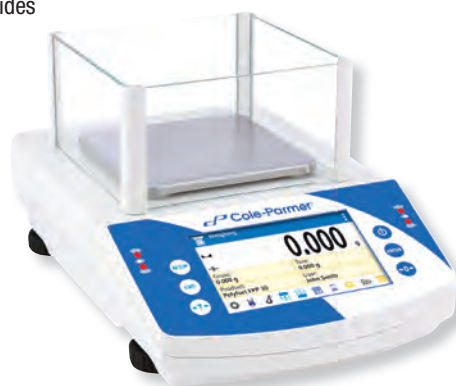

TT toploading model



TA analytical model

Large colour capacitive touch-screen display features a status bar, weighing result window, editable information fields, and editable tool bar. The area beneath the weight indication display can be customised to meet your personal programming needs.

Two built-in infrared (IR) proximity sensors can be programmed with different functions for each working mode enabling touch-free balance control, while minimising cross-contamination and wear and tear on the buttons.

Working modes include weighing, parts counting, check weighing, dosing, percent weighing, density of solids, density of liquids, animal weighing, statistics, peak hold, and formulations.

Several databases allow you to record products, users, packaging, customers, formulations, formulation reports, ambient conditions, and weighing. Only users with appropriate access can add new records, export data, import data, delete records, and print saved data. Use the simple external connections to a computer or printer for GLP/GMP-compliant output.

Two programmable IR sensors—perform common functions with a swipe of your hand.

### Symmetry®



#### Specifications

**Weighing units:** g, mg, ct, lb, oz, ozt, dwt, tlb, tlb, tlb, tlb, mom, gr, ti, N, baht, tola, msg, u1, u2

**Stability indicator:** yes

**Output:** USB interface (2), RS-232 (2), Ethernet, and Wi-Fi (internal cal only)

**Power:** universal AC power adapter (included)

#### With Internal Calibration and Wi-Fi Interface

Capacity	Readability	Repeat-ability	Linearity	Pan size	Catalogue number
<b>TT toploading balances</b>					
360 g	0.001 g	±0.001 g	±0.002 g	12.8 x 12.8 cm	MY-10102-04 <sup>‡</sup>
600 g		±0.0015 g			MY-10102-05
1000 g		±0.0015 g			MY-10102-06
2100 g	0.01 g	±0.01 g	±0.01 g	19.5 x 19.5 cm	MY-10102-07
4500 g		±0.015 g			MY-10102-08
6000 g		±0.015 g			MY-10102-09
10,000 g		±0.03 g			MY-10102-10
<b>TA analytical balances</b>					
82/220 g	0.01/ 0.0001 g	±0.01/ 0.0001 g	±0.0002 g	9 cm	MY-10102-00 <sup>†</sup>
160 g	0.0001 g	±0.0001 g	±0.0002 g	10 cm	MY-10102-01 <sup>†</sup>
220 g					MY-10102-02 <sup>†</sup>
310 g					MY-10102-03 <sup>‡</sup>

<sup>†</sup>Include tall enclosed glass draft shield with three doors.

<sup>‡</sup>Include short draft ring.

#### With External Calibration

Capacity	Readability	Repeatability	Linearity	Pan size	Catalogue number
<b>TT toploading balances</b>					
360 g	0.001 g	±0.001 g	±0.002 g	12.8 x 12.8 cm	MY-10102-15 <sup>‡</sup>
600 g		±0.0015 g			MY-10102-16 <sup>‡</sup>
1000 g		±0.0015 g			MY-10102-17 <sup>‡</sup>
2100 g	0.01 g	±0.01 g	±0.02 g	19.5 x 19.5 cm	MY-10102-18
4500 g		±0.015 g			MY-10102-19
6000 g		±0.015 g			MY-10102-20
10,000 g		±0.08 g			MY-10102-22
<b>TA analytical balances</b>					
62 g	0.0001 g	±0.0001 g	±0.00006 g	9 cm	MY-10102-11 <sup>†</sup>
160 g			±0.0002 g		MY-10102-12 <sup>†</sup>
220 g			10 cm	±0.0002 g	MY-10102-13 <sup>†</sup>
310 g					MY-10102-14 <sup>†</sup>

<sup>†</sup>Include tall enclosed glass draft shield with three doors.

<sup>‡</sup>Include short draft ring.

#### Accessories

MY-10100-85 Impact printer

MY-10100-86 Printer paper. Pack of 3

MY-10100-87 Density determination kit for TA series

MY-10100-88 Density determination kit for 12.8 x 12.8 cm weighing pan

MY-10100-90 Lock-down cable, 91.4 x 0.3 cm

MY-10100-91 Protective balance cover

MY-10100-93 Draft shield for 12.8 x 12.8 cm weighing pan

MY-17101-52 ILAC MRA, NIST-traceable calibration with data for balances

## Cole-Parmer® Symmetry® LA Analytical Balances

### Quality and precision at an affordable price

- Get secure data connections via USB, RS-232, Ethernet, and Wi-Fi interfaces
- Easily adjust filter settings depending on your working environment
- Fast stabilisation and response time
- Quickly diagnose weighing errors with autotest GLP function
- Industry-leading 5-year warranty

Working modes include weighing, parts counting, check weighing, dosing, percent weighing, density of solids, density of liquids, animal weighing, statistics, totalising, and peak hold.

LA Precision toploading and NTEP-approved models are available online.

Symmetry®



10102-23



#### Specifications

**Weighing units:** g, mg, kg, ct, lb, oz, ozt, dwt, tih, tls, tit, tic, mom, gr, N, ti, baht, tola, msg, u1, u2

**Stability indicator:** yes

**Output:** RS-232 (2), USB-A, USB-B, Ethernet, and Wi-Fi (internal cal only)

**Power:** 100/240 VAC, 50/60 Hz

Capacity	Readability	Repeatability	Linearity	Pan size	Internal calibration and Wi-Fi interface	
					Catalogue number	External calibration Catalogue number
62 g	0.0001 g	±0.00003 g	±0.00006 g	9 cm	—	MY-10102-33†
82/220 g	0.00001/0.0001 g	±0.00001 g	±0.0002 g		MY-10102-23‡	—
160 g	0.0001 g	±0.0001 g	±0.0002 g	10 cm	MY-10102-24‡	MY-10102-34‡
220 g					MY-10102-25‡	MY-10102-35‡
310 g					MY-10102-26‡	MY-10102-36‡

†Includes short open-air draft shield.

‡Includes tall enclosed glass draft shield with three doors.

## Cole-Parmer® Symmetry® ISW Washdown Industrial Bench Scales

### Lightweight and waterproof

- Rugged 304 stainless steel pan and ABS plastic base—sealed to IP66-rating
- Colour-coded keys provide quick access to weighing units
- Programmable backlit LCD with capacity tracker easily monitors possible overloads
- Check-weighing is quick and easy with built-in colour indicators

Symmetry®



#### Specifications

**Calibration:** external, with calibration mass

**Weighing units:** g, kg, lb, oz, lb:oz

**Output:** none

**Power:** 220 VAC, AC power adapter and rechargeable battery (included)

Capacity	Readability	Repeatability	Linearity (±)	Pan size (L x W)	Catalogue number
3 kg	0.5 g	0.5 g	1 g	21 x 17.3 cm	MY-11001-46
6 kg	1 g	1 g	2 g		MY-11001-47
12 kg	2 g	2 g	4 g		MY-11001-48

MY-17101-52 ILAC MRA, NIST-traceable calibration for balances

## Cole-Parmer® Symmetry™ PBH High-Capacity Portable Toploading Balances

### Easily weigh heavy dynamic loads

- Collect and export data for further analysis with included software
- Connect to printer or PC with RS-232 interface
- Weighing modes include parts counting, percent weighing, totalising, check weighing, peak hold, and animal weighing
- Industry-leading 5-year warranty

NTEP-approved models are available online.

Symmetry®



**What's included:** built-in rechargeable lead acid battery and power adapter with plug set.

#### Specifications

**Weighing units:** g, ct, lb

**Output:** RS-232

**Power:** 100 to 240 VAC, 50/60 Hz or built-in rechargeable battery

Capacity	Readability	Repeatability	Linearity	Platform size	Calibration	Catalogue number
1 kg	0.01 g	±0.03 g	±0.03 g	19.5 x 19.5 cm	External	MY-10402-58
2 kg	0.01 g	±0.03 g	±0.03 g		Internal	MY-10402-63
					External	MY-10402-59
6 kg	0.1 g	±0.1 g	±0.1 g		Internal	MY-10402-64
					External	MY-10402-60
10 kg	0.1 g	±0.2 g	±0.2 g		Internal	MY-10402-65
					External	MY-10402-61
20 kg	0.1 g	±0.3 g	±0.3 g		External	MY-10402-62



## Cole-Parmer® Symmetry® EC Toploading Balances

### Quality and affordable precision weighing

- Internal rechargeable battery for portability and convenience
- RS-232 interface allows for communication with a printer
- Print function for GLP compliance
- Capacity tracker warns of approaching overloads
- Security lock-down port

Symmetry®

**What's included:** draft shield, built-in rechargeable battery, and AC power adapter.



#### Specifications

**Calibration:** external, with calibration mass

**Weighing units:** g, lb<sup>t</sup>, oz, ct, dr, ozt, gn, N, tl T, tl H, tl S, custom

**Power:** 230 VAC; AC adapter or internal rechargeable battery

Capacity	Readability	Repeatability	Linearity	Platform size (dia.)	Catalogue number
100 g	0.001 g	±0.002 g	± 0.003 g	12.0 cm	MY-20000-33
200 g	0.01 g	±0.02 g	± 0.02 g	12.0 cm	MY-20000-35
300 g	0.1 g	±0.2 g	±0.2 g	12.0 cm	MY-20000-49
400 g	0.01 g	±0.02 g	± 0.02 g	12.0 cm	MY-20000-37
500 g	0.1 g	±0.2 g	±0.2 g	12.0 cm	MY-20000-52
800 g	0.01 g	±0.02 g	± 0.03 g	12.0 cm	MY-20000-39
1200 g	0.1 g	±0.1 g	± 0.2 g	12.0 cm	MY-20000-41
2000 g	0.1 g	±0.2 g	± 0.2 g	14.5 cm	MY-20000-43
4000 g	0.1 g	±0.2 g	± 0.2 g	14.5 cm	MY-20000-45
6000 g	1 g	±1 g	± 2 g	14.5 cm	MY-20000-47

Tib not available on 100 g models

#### Accessories

MY-11120-78 Compact thermal printer

MY-10000-47 Kensington™-type security lock and cable

MY-17101-52 ILAC MRA, NIST-traceable calibration with data for balances

## OHAUS® Adventurer™ AX Toploading and Analytical Balances

### The perfect balance of modern connectivity and advanced applications

- Perform advanced functions: part counting, percent, dynamic, density, check weighing, totalisation, and formulation modes
- Colour touch screen offers easy and fast operation with or without gloves
- GLP/GMP compliance via real-time clock and recording of sample, project names, and balance ID
- Two USB ports (one on the front and one on the back) provide connectivity with both a PC and a portable external device at the same time
- Cloning feature saves settings to USB flash drive for transfer to other Adventurer balances



Capacity	Readability	Repeatability	Linearity	Pan size	Internal calibration	External calibration
					Catalogue number	Catalogue number
<b>Toploading balances</b>						
120 g	0.0001 g	±0.0001 g	±0.0002 g	8.9 cm	MY-11019-00	MY-11019-01
220 g					MY-11019-03	MY-11019-04
320 g					MY-11019-05	—
<b>Analytical balances</b>						
220 g	0.001 g	±0.001 g	±0.002 g	13 cm	MY-11019-06	MY-11019-07
420 g					MY-11019-09	MY-11019-10
520 g					MY-11019-13	MY-11019-14
1520 g					MY-11019-19	MY-11019-20
2200 g	0.01 g	±0.01 g	±0.02 g	17.5 x 19.5 cm	MY-11019-22	MY-11019-23
4200 g					MY-11019-25	MY-11019-26
5200 g					MY-11019-28	MY-11019-30
4200 g					MY-11019-29	—
8200 g	0.1 g	±0.1 g	±0.2 g	—	MY-11019-31	MY-11019-32



#### Specifications

**Calibration:** internal or external mass

**Weighing units:** g, mg, ct, oz, lb, mom, N, dwt, gn, oz t, m, tl, t, tical, baht, custom

**Power:** 100 to 240 VAC, 50/60 Hz

#### Accessories

MY-11610-68 Impact printer

MY-11800-15 Density determination kit

MY-17101-52 ILAC MRA, NIST-traceable calibration with data for balances

## Sartorius Entris® Toploading and Analytical Balances

Go beyond basic—get affordability, reliability, and quality

- Backlit high-contrast display delivers excellent viewability in any lighting condition
- Below balance, counting, percent, animal weighing, and density determination functions
- Document critical weights in GLP mode via RS-232 communication with PC or printer
- Functional in 7 languages

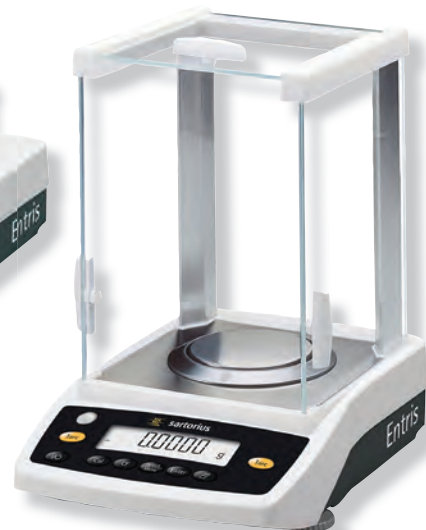

### Specifications

**Calibration:** external, with calibration mass

**Output:** RS-232

**Weighing units:** g, kg, ct, lb, oz, oz t, t, tals, grains, mg, parts/lb, mommes, Austrian carat, tola, baht, mesghal, tons, lb:oz, N

**Power:** 100 to 240 VAC (universal); optional rechargeable battery

Capacity	Readability	Repeatability	Linearity	Pan size	Catalogue number
<b>Toploading balances</b>					
150 g	0.001 g	±0.001 g	±0.002 g	11.5 cm	MY-11955-23
320 g					MY-11955-24
620 g					MY-11955-26
820 g	0.01 g	±0.01 g	±0.03 g	15 cm	MY-11955-27
2200 g					MY-11955-28
4200 g					MY-11955-31
5200 g	0.1 g	±0.1 g	±0.3 g	18 x 18 cm	MY-11955-34
<b>Analytical balances</b>					
60 g	0.1 mg	±0.1 mg	±0.2 mg	8.9 cm	MY-11955-19
120 g					MY-11955-21
220 g					MY-11955-22

### Accessories

- MY-11800-65 Standard compact printer
- MY-11800-75 Optional external rechargeable battery kit
- MY-11800-98 Density weighing kit
- MY-11800-97 USB to RS-232 cable
- MY-11200-50 Kensington™-type security lock and cable
- MY-17101-52 ILAC MRA, NIST-traceable calibration with data for balances

## Sartorius Practum® Toploading and Analytical Balances

Start weighing right—ideal for standard applications

- Touch-screen with intuitive graphical interface walks you through standard applications
- Peak Hold function locks in highest reading
- USB interface port enables communication with a PC or printer, allowing automatic data transfer to Excel
- Supervisor lock to prevent unintentional menu changes
- Built-in overload protection



### Specifications

**Calibration:** external, with calibration mass

**Output:** mini-USB interface

**Weighing units:** g, kg, ct, lb, oz, oz t, tals, grains, mg, parts/lb, mommes, Austrian carat, tola, baht, mesghal, tons, lb:oz, N

**Power:** 100 to 240 VAC (universal); optional rechargeable battery

Capacity	Readability	Repeatability	Linearity	Pan size	Catalogue number
<b>Toploading balances</b>					
210 g	0.001 g	±0.001 g	±0.002 g	11.4 cm	MY-11800-91
310 g					MY-11800-90
510 g					MY-11955-13
610 g	0.01 g	±0.01 g	±0.02 g	17.8 cm	MY-11800-94
2100 g					MY-11800-92
3100 g					MY-11955-15
5100 g	0.1 g	±0.1 g	±0.2 g	17.8 cm	MY-11800-95
6100 g	0.1 g	±0.1 g	±0.3 g		MY-11955-17
<b>Analytical balances</b>					
120 g	0.1 mg	±0.1 mg	±0.2 mg	8 cm	MY-11800-89
220 g					MY-11800-88

### Accessories

- MY-11800-65 Standard compact printer
- MY-11800-75 External rechargeable battery kit
- MY-11800-98 Density weighing kit
- MY-11800-97 USB to RS-232 cable
- MY-17101-52 ILAC MRA, NIST-traceable calibration with data for balances



## Disposable Aluminum Weigh Dishes

### No more washing sample containers

Choose from crimped-walled with side finger tab handle, smooth-walled weighing dishes, or slightly tapered dishes for moisture determination. All styles offer smooth bottom and may be used in a wide variety of applications.



Weigh capacity	Dimensions (dia x D)	Qty/pk	Catalogue number	Qty/pk	Catalogue number
<b>Crimped-walled dishes with tab</b>					
8 mL	29 x 10 mm	—	—	500	MY-01018-26
20 mL	51 x 13 mm	100	MY-01018-51	1000	MY-01017-51
60 mL	64 x 15 mm	100	MY-01018-50	1000	MY-01017-50
80 mL	76 x 15 mm	100	MY-01018-52	1000	MY-01017-52
<b>Smooth-walled dishes</b>					
80 mL	73 x 17 mm	100	MY-01018-28	1000	MY-01018-29
150 mL	102 x 19 mm	100	MY-01018-32	1000	MY-01018-31
<b>Slightly tapered dishes for moisture determination</b>					
1.2 gr	70 x 6 mm	50	MY-01018-19	500	MY-01018-20
2.5 gr	102 x 8 mm	50	MY-01018-23	500	MY-01018-24
3.3 gr	127 x 5 mm	100	MY-01018-21	1000	MY-01018-22

## Cole-Parmer® Balance Draft Shield

### Clear acrylic prevents drafts from affecting weighings

- Minimises air movement around your balance for faster, more stable readings
- No assembly required
- Mouse hole in back panel for power cords
- Raised edges on top of enclosure allow secure placement of frequently used weighing accessories



**Cole-Parmer®**

Shield 01019-02  
(balance not included)

Size	Dimensions (W x H x D)	Catalogue number
Small	33.0 x 34.3 x 37.5 cm	MY-01019-02
Medium	38.1 x 39.4 x 42.5 cm	MY-01019-04
Large	45.7 x 47.0 x 50.2 cm	MY-01019-06

## Troemner Cal-Paks™ Calibration Mass Sets

### Handy for daily verifications

- USB flash drive with electronic NVLAP Certificate
- Use with all balance manufacturers' makes and models
- Weights 1-g through 1-kg are made of #8 alloy stainless steel



Three high-quality precision mass standards with the lowest measurement uncertainties possible enable you to meet all of your regulatory and audit needs. Cal-Pak components and master carrying case are linked through the use of a unique serial number.

**What's included:** rugged master case with each individual weight in its own polycarbonate case, and accessories needed for proper handling and care of weights.

Masses	Catalogue number
<b>ASTM Class 1 mass sets with NVLAP certificate</b>	
20 g, 2 g, 20 mg	MY-11967-34
20 g, 2 g, 200 mg	MY-11967-35
50 g, 5 g, 2 g	MY-11967-05
50 g, 5 g, 200 mg	MY-11967-07
100 g, 10 g, 2 g	MY-11967-02
100 g, 10 g, 200 mg	MY-11967-01
100 g, 10 g, 20 mg	MY-11967-11
200 g, 20 g, 2 g	MY-11967-09
200 g, 20 g, 200 mg	MY-11967-06
500 g, 50 g, 2 g	MY-11967-10
500 g, 50 g, 200 mg	MY-11967-15
500 g, 50 g, 20 mg	MY-11967-18
1 kg, 100 g, 20 g	MY-11967-03
1 kg, 100 g, 2 g	MY-11967-12
2 kg, 200 g, 20 g	MY-11967-04
2 kg, 200 g, 2 g	MY-11967-08
5 kg, 200 g, 2 g	MY-11967-38
5 kg grip handle, 200 g, 2 g	MY-11967-39
5 kg, 200 g, 20 g	MY-11967-40
5 kg grip handle, 200g, 20g	MY-11967-41
5 kg, 500 g, 20 g	MY-11967-13
5 kg, 500 g, 2 g	MY-11967-16
5 kg grip handle, 500 g, 2 g	MY-11967-36
5 kg grip handle, 500 g, 20 g	MY-11967-37
<b>ASTM Class 0 mass sets with NVLAP certificate</b>	
2 g, 200 mg, 1 mg	MY-11967-14
5 g, 500 mg, 1 mg	MY-11967-17

## Square Weigh Boats

### Minimise sample loss

- Flexible, antistatic polystyrene material
- Rounded corners simplify transfer of powdered or granular samples



Size	Weigh capacity	White	Blue
		Catalogue number	Catalogue number
Small, 4.13 x 0.79	20 mL	MY-01017-05	MY-01017-07
Medium, 8.89 x 2.54	100 mL	MY-01017-15	MY-01017-17
Large, 13.97 x 2.22	330 mL	MY-01017-25	MY-01017-27

## Cole-Parmer® StableTemp® Digital Utility Water Baths

Get digital accuracy at an analogue price

- Recall settings at the touch of a button
- Know when process is complete with built-in timer

Dual thermostat baths provide  $\pm 0.1^\circ\text{C}$  precision and over-temperature safety feature prevents over-heating. Seamless tank eliminates rusting and is easy to clean.



**StableTemp**

ISO9001:2008 CERTIFIED SUPPLIER

### Specifications

**Temperature range:**  $5^\circ\text{C}$  above ambient to  $100^\circ\text{C}$   
**Temperature stability:**  $\pm 0.1^\circ\text{C}$   
**Temperature uniformity:**  $\pm 0.2^\circ\text{C}$   
**Wetted materials:** 304 SS  
**High-temperature cutoff:** yes

Bath capacity	Opening (L x W)	Working depth	Power	Catalogue number
2 L	9.8 x 11 cm	14 cm	240 VAC, 50 Hz	MY-14576-02
5 L	12.7 x 27.5 cm	14 cm	240 VAC, 50 Hz	MY-14576-06

## Cole-Parmer® Polystat® Cooling/Heating Recirculators

Save time with quick ramp up and cool-down

- Don't lose valuable bench space—powerful unit in a compact design
- Internal circulating tank design was built to minimise fluid evaporation
- Easy cooling for smaller instruments, jacketed reactors, and rotary evaporators
- Reliable, robust system maintains temperature to  $\pm 0.1^\circ\text{C}$  and pumps to 21-L/min
- Includes funnel and 8- and 12-mm hose barb fittings



**polystat**

UL US CE

### Specifications

**Internal reservoir capacity:** 2.8-L **Temperature stability:**  $\pm 0.1^\circ$

Cooling capacity at $20^\circ\text{C}$	Temperature range	Power	Catalogue number
<b>Force pump;</b> 17 L/min flow rate; 4.4 psi (300 mbar) max pressure			
250 W	-10 to $80^\circ\text{C}$	240 VAC, 50 Hz	MY-13042-03
500 W	-10 to $80^\circ\text{C}$	240 VAC, 50 Hz	MY-13042-19
<b>Force/suction pump;</b> 21 L/min flow rate; 11 psi (805 mbar) max pressure			
250 W	-10 to $80^\circ\text{C}$	240 VAC, 50 Hz	MY-13042-07
500 W	-10 to $80^\circ\text{C}$	240 VAC, 50 Hz	MY-13042-23

## Cole-Parmer® Polystat® Cooling/Heating Circulating Baths

Get excellent cooling across range of temperatures

- Two-speed pump with up to 21-L/min flow
- Maximise bench space with compact size
- Protect samples and bath with high-temperature and low-level cut offs

**Standard Digital Controller Baths** feature five programmable set points, adjustable high-temperature cutoff, user-settable Min/Max temperature limits, and an adjustable pump nozzle. **Advanced Digital Controller Baths** offer all the features of the Standard Digital models (except adjustable pump nozzle) plus five programmable set points, a two-stage (force/suction) pump for greater circulation capacity, and a USB port.

**What's included:** lid, 1.8-m (6-ft) power cord with plug, M16 x 1 pump connection and 8- and 12-mm hose barb fittings with clamps for external circulation.

### Specifications

**Wetted materials:** stainless steel, polymers **Low-level cutoff:** yes

**polystat**

ISO9001:2008 CERTIFIED SUPPLIER



Bath capacity	Temperature range	Stability	Cooling capacity at $20^\circ\text{C}$	Pump type	Max pump pressure psi (mbar)	Max pump flow (L/min)	Working area (W x L x D)	Power (VAC, Hz)	Catalogue number
<b>Standard digital controller baths</b>									
6.5 L	-20 to $100^\circ\text{C}$	$\pm 0.05^\circ\text{C}$	250 W	Force	4.4 (310)	17	13.5 x 12.2 x 15 cm (5 $\frac{1}{16}$ " x 4 $\frac{13}{16}$ " x 5 $\frac{7}{8}$ ")	230, 50	MY-12122-04
8.6 L	-28 to $100^\circ\text{C}$	$\pm 0.05^\circ\text{C}$	500 W	Force	4.4 (310)	17	17.3 x 18.3 x 15 cm (6 $\frac{13}{16}$ " x 7 $\frac{3}{16}$ " x 5 $\frac{7}{8}$ ")	230, 50	MY-12122-34
8.6 L	-28 to $150^\circ\text{C}$	$\pm 0.05^\circ\text{C}$	500 W	Force	4.4 (310)	17	17.3 x 18.3 x 15 cm (6 $\frac{13}{16}$ " x 7 $\frac{3}{16}$ " x 5 $\frac{7}{8}$ ")	230, 50	MY-12122-38
<b>Advanced digital controller baths</b>									
6.5 L	-20 to $100^\circ\text{C}$	$\pm 0.025^\circ\text{C}$	250 W	Force/suction	11.7 (750)	21	13.5 x 12.2 x 15 cm (5 $\frac{1}{16}$ " x 4 $\frac{13}{16}$ " x 5 $\frac{7}{8}$ ")	230, 50	MY-12122-14
6.5 L	-20 to $100^\circ\text{C}$	$\pm 0.025^\circ\text{C}$	250 W	Force/suction	11.7 (750)	21	13.5 x 12.2 x 15 cm (5 $\frac{1}{16}$ " x 4 $\frac{13}{16}$ " x 5 $\frac{7}{8}$ ")	230, 50	MY-12122-28
8.6 L	-28 to $200^\circ\text{C}$	$\pm 0.025^\circ\text{C}$	500 W	Force/suction	11.7 (750)	21	17.3 x 18.3 x 15 cm (6 $\frac{13}{16}$ " x 7 $\frac{3}{16}$ " x 5 $\frac{7}{8}$ ")	230, 50	MY-12122-44
8.6 L	-35 to $200^\circ\text{C}$	$\pm 0.025^\circ\text{C}$	800 W	Force/suction	11.7 (750)	21	17.3 x 18.3 x 15 cm (6 $\frac{13}{16}$ " x 7 $\frac{3}{16}$ " x 5 $\frac{7}{8}$ ")	230, 50†	MY-12122-58

†Requires 20 amp current.

# Stuart® Shaking Water Bath

## Customise to your needs with platforms and racks

- No need for tricky fittings—strong magnets make changing platforms easy
- Analogue controls and digital temperature display simplify operation
- Over-temperature and low-level cut-offs improve safety

Versatile water bath can be a linear (reciprocating) or orbital shaker, or used as a static bath, depending on the platform you choose. The two shaking platforms come with high-tension springs which accommodate most bottle and flask sizes; with capacity of 8 x 250-mL, 6 x 500-mL, or 4 x 1000-mL Erlenmeyer flasks. For tubes and smaller vessels, order an optional stainless steel rack.



- REQUIRED System Components**
- 1) Water bath
  - 2) Platform
  - OPTIONAL
  - 3) Racks



### Specifications

**Temperature range:** ambient +5°C to 95°C† **Wetted materials:** 304 stainless steel  
**Temperature stability:** ±0.25°C

Bath capacity	Bath opening (L x W)	Working depth	Shaking speed	Stroke length/ orbit size	Power		Catalogue number
					VAC	Hz	
24 L	30 x 50 cm (12" x 19 5/8")	20 cm (7 7/8")	20 to 150 rpm	20 mm (3/4")	220	60	MY-12152-01
					230	50	MY-12152-02

†An accessory bath cover is required to reach temperatures above 90°C.

### Accessories

**MY-12152-99 Hinged polycarbonate bath cover** reduces heat loss and evaporation

### Platforms (one required)

Description	Catalogue number
Reciprocating shaking action	MY-12152-90
Orbital shaking action	MY-12152-91
Perforated, for use as a nonshaking bath	MY-12152-92

### Optional Tube Racks

Accommodates	Catalogue number
Centrifuge tubes, 25 x 50 mL	MY-12152-93
Microcentrifuge tubes, 143 x 1.5 mL	MY-12152-94
Culture tubes, 120 x 13 mm dia	MY-12152-95
Culture tubes, 72 x 16 mm dia	MY-12152-96
Culture tubes, 56 x 15 mL	MY-12152-97
Culture tubes, 30 x 26 mm dia	MY-12152-98

# Techne® Unheated Water Baths

## Corrosion-resistant stainless steel for easy cleaning

- Constructed of durable stainless steel with rugged splash-proof case
- Integrated carrying handle for added safety

Designed to be used with a Techne clip-on immersion circulator (sold separately on page 12), these water baths are supplied with bridge mounting plate to hold the circulator.



Model number	B-8	B-12	B-18	B-26	B-48
Catalogue number	MY-16104-53	MY-16101-88	MY-16112-01	MY-16101-89	MY-16104-45
Capacity	8 L	12 L	18 L	26 L	48 L
Working area (L x W)	115 x 300 mm	205 x 300 mm	380 x 300 mm	380 x 300 mm	430 x 330 mm
Working depth (min/max)	100 / 130 mm	100 / 130 mm	100 / 130 mm	150 / 180 mm	224 / 255 mm
Overall dimensions (W x H x D)	325 x 172 x 265 mm	325 x 172 x 354 mm	325 x 172 x 530 mm	325 x 222 x 530 mm	365 x 298 x 594 mm



## Techne® Immersion Circulators

### Remain in control with higher stability

**Basic Digital Circulator** offers precise PID temperature control at a competitive price. Unit also features digital LED display,  $\pm 0.01^\circ\text{C}$  stability, over-temperature indicator light, pressure pump, and low-liquid level cut-off.

**Standard Digital Circulator** provides high  $\pm 0.005^\circ\text{C}$  temperature stability, plus RS-232 interface capability. Bidirectional RS-232 lets you control bath remotely and download data to a computer for further analysis. Unit also features digital LED display, over-temperature indicator light, pressure pump, and low-liquid level cut-off.

**What's included:** 2.3-m (7½-ft) cord with European plug and a thermometer holder.



#### Specifications

**Wetted materials:** 316 stainless steel and PPS (polyphenylene sulphide)

**Immersion depth:** 10.2 to 12.7 cm (4" to 5")

Controller type	Temperature range	Stability	Pump type	Max pump pressure psi (mbar)	Max flow (L/min)	Low-level cutoff	Power (VAC, Hz)	Catalogue number
Basic digital	Ambient +5 to 120°C	$\pm 0.01^\circ\text{C}$	Force	2.1 (145)	10	Yes	240, 50/60	MY-01262-07
Standard digital	Ambient +5 to 200°C	$\pm 0.005^\circ\text{C}$	Force	2.1 (145)	10	Yes	240, 50/60	MY-01262-15

## Stuart® Recirculating Coolers

### Powerful cooling in a compact footprint

- Optimise accuracy with easy temperature offset calibration
- Worry-free operation—visual safety alarm indicates overload
- Easily read current temperature readout on LED display

These reliable, easy-to-use recirculating coolers offer accurate and powerful cooling for an external device. Coolers can achieve temperatures down to  $-20^\circ\text{C}$ , making them ideal for controlling equipment in temperature-sensitive applications. Units feature LED digital display, alarm indicator, temperature set point control, and calibration. The 9-mm ID hose barb inlet/outlet ports allow connection to a variety of external equipment.

**Note:** Do not use water in cooler for low temperatures. Requires use of an antifreeze-type liquid such as ethylene glycol solution.

**What's included:** bath cover and power cord with UK 3-pin and Schuko 2-plug plugs.



#### Specifications

**Temperature range:**  $-20$  to  $30^\circ\text{C}$

**Control accuracy:**  $\pm 2^\circ\text{C}$



Reservoir capacity	Cooling capacity at 10°C	Flow rate (L/min)	External dimensions (W x H x D)	Power (VAC, Hz)	Catalogue number
3.2 L	450 W	9	20.5 x 54.5 x 44.5 cm	230, 50	MY-12152-77
14 L	1200 W	18	35.4 x 85.1 x 38.4 cm	230, 50	MY-12152-78

MY-017001-13 ILAC MRA, NIST-traceable calibration with data for chiller

## Cole-Parmer® Polystat® High-Capacity Recirculating Chillers

### Cool across a wider range

- High and low temperature alarms
- Front-mount pressure gauge for easy view of pressure readings
- Eliminate tap water waste
- Large fill port for easy spill-proof filling

polystat®

Robust pump performance for closed loop recirculation up to 2.0 kW. Three pump options handle a variety of application requirements. These chillers have an intuitive digital controller with a seamless moisture-resistant keypad. Illuminated icons simplify monitoring and adjusting operation parameters. You can adjust display resolution of 1° or 0.1°C.

**What's included:** power cord and male pipe adapters with barbed fittings for 1/2" ID tubing.



#### Specifications

**Wetted materials:** polyethylene, brass, copper, PVC, stainless steel      **Refrigerant:** R-134a



Reservoir capacity	Temperature range	Compressor hp	Cooling capacity (watts)			Max pump pressure psi (mbar)	Max flow at 0 head	Power (VAC, Hz, amps)	Catalogue number
			0°C	10°C	20°C				
7.6 L	-10 to 30°C	1/4	175	410	600	95 (6550)	6.4 L/min	230, 50, 5.1	MY-12911-02
7.6 L	-10 to 30°C	1/3	240	375	900	95 (6550)	6.4 L/min	230, 50, 6.3	MY-12911-06
7.6 L	-10 to 30°C	1/2	240	375	900	95 (6550)	14 L/min	230, 50, 7.6	MY-12911-10
18.9 L	-10 to 30°C	3/4	375	1100	2000	95 (6550)	6.4 L/min	208-230, 60, 8.8	MY-12911-16
			325	1025	1900			230, 50, 8.8	MY-12911-18
18.9 L	-10 to 30°C	3/4	375	1100	2000	95 (6550)	14 L/min	208-230, 60, 10.1	MY-12911-20
			325	1025	1900			230, 50, 10.1	MY-12911-22

## Julabo FL-Series Recirculating Industrial Chillers

### Reach temperatures down to -20°C

- Powerful circulating pumps with gauge and bypass valve to adjust pressure
- Overload protection for pump motor and cooling unit
- "Black box" function with error memory for remote diagnosis
- Environmentally friendly operation with low energy consumption

Easy-to-setup PID temperature control with an LED display and a one point temperature calibration provide maximum accuracy. RS-232 interface allows quick temperature data transfer.

These powerful recirculating chillers are ergonomically designed for easy operation. Features include rollers for easy movement; easy filling with fill-level indicator; accessible drain tap; no side vents, so can be placed against other instruments; and removable grid venting makes it easy to keep the condenser clean and running at full cooling capacity.

Choose from air- and water-cooled models. See our full offering online.

**What's included:** two barbed fittings for 3/4" ID tubing for pump connections and 1.8-m (6-ft) power cord.



#### Specifications

**Reservoir capacity:** 30 L      **Wetted materials:** stainless steel  
**Temperature range:** -20 to 40°C      **Drain valve:** yes  
**Temperature stability:** ±0.5°C



Cooling capacity (watts)			Max pump pressure psi (mbar)	Max flow (L/min)	Power (VAC, Hz)	Catalogue number
-10°C	0°C	20°C				
<b>Air-cooled models</b>						
1.2	1.5	2.5	43 (2900)	40	240, 50	MY-12149-22
1.5	2.4	4	43 (2900)	40	240, 50	MY-12149-25
<b>Water-cooled models</b>						
1.0	1.7	2.7	43 (2900)	40	240, 50	MY-12149-32
1.3	2.2	4.3	43 (2900)	40	240, 50	MY-12149-36

## Cole-Parmer® elements™ Griffin Low-Form Graduated Beakers, Glass

Suitable for all lab procedures

- Easy-read graduations and marking area
- Withstands wide temperature range –50 to 550°C
- Graduated tolerances from ±0.02 to ±0.05 depending on size
- Autoclavable

Borosilicate 3.3 glass beakers with pour spout provide excellent general use at an economical price.



Capacity mL (oz)	Graduation range (mL)	Graduation interval (mL)	Qty/pk	Catalogue number
10 (1/8)	—	10	12	MY-34502-20
20 (3/8)	5 to 20	5		MY-34502-36
25 (7/8)	5 to 25	5		MY-34502-37
30 (1)	10 to 30	5		MY-34502-38
50 (1 1/4)	10 to 50	10		MY-34502-39
100 (3)	20 to 100	10	12	MY-34502-40
150 (5)	25 to 150	12.5		MY-34502-41
200 (6)	50 to 200	25		MY-34502-42
250 (8)	50 to 250	25		MY-34502-43
300 (10)	50 to 300	25	8	MY-34502-44
400 (13)	100 to 400	50		MY-34502-45
500 (16)	100 to 500	50		MY-34502-46
600 (20)	100 to 600	50		MY-34502-47
800 (27)	200 to 800	100	6	MY-34502-48
1000 (32)	200 to 1000	100		MY-34502-49
1500 (51)	300 to 1500	100	2	MY-34502-50
2000 (64)	400 to 2000	200		MY-34502-51
3000 (96)	500 to 2500	250	1	MY-34502-52
4000 (128)	500 to 3500	250		MY-34502-53
5000 (160)	500 to 4500	500		MY-34502-54

## PYREX® Brand 1000 Griffin Low-Form Beakers

Stand up to thermal shock

- Uniform wall thickness offers optimal balance of thermal shock resistance and mechanical strength
- Know how much is left and how much is gone—double graduation scale indicates approximate content (on 250- to 400-mL sizes only)
- No mystery liquids—extra-large marking spot for easy identification
- Reference: ASTM E-960



Capacity mL (oz)	Graduation range (mL)	Graduation interval (mL)	Qty/pk	Catalogue number
10 (1/8)	—	—	12	MY-34502-01
20 (3/8)	5 to 15	5		MY-34502-02
30 (1)	5 to 25	10		MY-34502-03
50 (1 1/4)	10 to 40	10		MY-34502-04
100 (3)	20 to 80	10	12	MY-34502-05
150 (5)	20 to 140	10		MY-34502-06
250 (8)	25 to 200	25		MY-34502-07
400 (13)	25 to 325	25		MY-34502-08
600 (20)	50 to 500	50	6	MY-34502-09
800 (27)	50 to 750	50	6	MY-34502-10
1000 (32)	50 to 1000	50	6	MY-34502-11
2000 (64)	200 to 2000	100	4	MY-34502-13
3000 (96)	250 to 2500	125	1	MY-34502-14
4000 (128)	500 to 3500	250	1	MY-34502-15
10 (1/8)	—	—	48	MY-34502-21
20 (3/8)	5 to 15	5		MY-34502-22
30 (1)	5 to 25	10		MY-34502-23
50 (1 1/4)	10 to 40	10		MY-34502-24
100 (3)	20 to 80	10	48	MY-34502-25
150 (5)	20 to 140	10		MY-34502-26
250 (8)	25 to 200	25		MY-34502-27
400 (13)	25 to 325	25		MY-34502-28
600 (20)	50 to 500	50	36	MY-34502-29
800 (27)	50 to 750	50	24	MY-34502-30
1000 (32)	50 to 1000	50	24	MY-34502-31
2000 (64)	200 to 2000	100	8	MY-34502-33
3000 (96)	250 to 2500	125	6	MY-34502-34
4000 (128)	500 to 3500	250	6	MY-34502-35
Starter set contains one each of 50 mL, 100 mL, 250 mL, 600 mL, 1000 mL			5	MY-34502-90

## Cole-Parmer® Class A Griffin Low-Form Beakers, Glass

Easy readings and exceptional durability

- Double-scale graduations for easy measuring while pouring in or out
- Meet ASTM E960 specifications for Class A borosilicate glass beakers
- Stand up to temperatures of 230°C for long-term, or 400°C for short-term
- Autoclavable

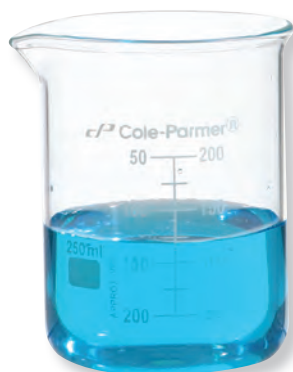

Capacity mL (oz)	Graduation interval (mL)	Qty/pk	Catalogue number
10 (1/8)	—	12	MY-34503-42†
25 (7/8)	5	12	MY-34503-44
50 (1 1/4)	10	12	MY-34503-46
100 (3)	10	12	MY-34503-48
150 (5)	20	12	MY-34503-50
250 (8)	25	12	MY-34503-52
400 (13)	25	12	MY-34503-54
600 (20)	50	6	MY-34503-56
1000 (32)	50	6	MY-34503-58
2000 (64)	100	4	MY-34503-60
3000 (96)	125	1	MY-34503-62
5000 (160)	250	1	MY-34503-64

†The 10-mL beaker does not have graduations.



## Disposable Griffin Low-Form Beakers, PP

Moulded-in graduations won't wear off

- No need to convert volumes—graduated in mL and oz
- Won't stick together—stacking rib for easier separation
- Autoclavable



Capacity mL (oz)	Graduations (mL)	Qty/pk	Catalogue number
15 (0.5)	5	100	MY-06006-12
15 (0.5)	5	1000	MY-06006-15
30 (1)	5	100	MY-06006-22
30 (1)	5	1000	MY-06006-25
50 (1.7)	5	100	MY-06006-32
50 (1.7)	5	1000	MY-06006-35
100 (3.5)	5	100	MY-06006-42
100 (3.5)	5	1000	MY-06006-45
150 (5)	5	100	MY-06006-52
150 (5)	5	1000	MY-06006-55
250 (8)	10	50	MY-06006-63
250 (8)	10	500	MY-06006-65
400 (13)	25	50	MY-06006-72
400 (13)	25	500	MY-06006-75
600 (20)	25	25	MY-06006-83
600 (20)	25	500	MY-06006-85

## Cole-Parmer® Tri-Corner Beakers, PP

Easy pouring from three sides

- Easily mix on stirrer—flat bottom keeps stir bars centered
- Accurate to  $\pm 5\%$ ; moulded graduations
- Withstand temperatures to 121°C
- Autoclavable



Capacity mL (oz)	Graduations (mL)	Qty/pk	Catalogue number
50 (1.5)	10	100	MY-06020-01
100 (3.5)	10		MY-06020-03
250 (8)	20		MY-06020-05
400 (13)	40	100	MY-06020-07
800 (26)	50		MY-06020-09
1000 (32)	50		MY-06020-11
Five of each above	—	30	MY-06010-07

## Cole-Parmer® elements™ Graduated Beakers, PP

Moulded-in graduations will not wear off

- Graduated in mL and oz for easy conversion
- Stacking ribs provide easy separation so beakers will not stick together
- Accurate to  $\pm 2.5\%$
- Withstands temperatures from -15 to 150°C



Capacity mL (oz)	Graduations (mL)	Qty/pk	Catalogue number
15 (½)	5	100	MY-06200-02
30 (1)	5		MY-06200-04
50 (1¼)	5		MY-06200-06
100 (3½)	5		MY-06200-08
150 (5)	5		MY-06200-10
250 (8)	10	50	MY-06200-12
400 (13)	25	25	MY-06200-14
600 (20)	25		MY-06200-16

## Cole-Parmer® Broad-Spout Beakers, PTFE

Stand up to the harshest chemicals

- Pour easily with broad spout
- Heatable beakers can be used on hot plates to 270°C
- Autoclavable

Heatable beaker 06300-02 has a PTFE carbon base.



Capacity mL (oz)	Beaker		Optional cover	
	Qty/pk	Catalogue number	Qty/pk	Catalogue number
<b>Heatable beakers with PTFE-carbon base, for use on hot plates</b>				
100 (3)	1	MY-06300-02	1	MY-06300-87
250 (8)	1	MY-06300-04	1	MY-06300-91
400 (13)	1	MY-06300-06	1	MY-06300-93
<b>Beakers</b>				
1 (0.03)	2	MY-06300-62	2	MY-06300-79
5 (1.17)	2	MY-06300-64	2	MY-06300-81
10 (0.3)	2	MY-06300-66	2	MY-06300-81
25 (0.8)	2	MY-06300-68	2	MY-06300-83
50 (1.6)	1	MY-06300-74	1	MY-06300-85
100 (3)	1	MY-06300-76	1	MY-06300-87
150 (5)	1	MY-06300-78	1	MY-06300-89
250 (8)	1	MY-06300-82	1	MY-06300-91
400 (13)	1	MY-06300-84	1	MY-06300-93
500 (16)	1	MY-06300-86	1	MY-06300-93
600 (20)	1	MY-06300-88	1	MY-06300-95
1000 (32)	1	MY-06300-92	1	MY-06300-95
2000 (64)	1	MY-06300-94	1	MY-06300-97
5000 (170)	1	MY-06300-96	1	MY-06300-99

## Cole-Parmer® elements™ Graduated Beakers with Handle, PP

Moulded-in handle for easy transport and pouring of contents

- Moulded-in graduations will not wear off
- Withstands temperatures from -15 to 150°C



Capacity mL (oz)	Graduations (mL)	Qty/pk	Catalogue number
250 (8)	50	5	MY-06200-18
500 (16)	50	5	MY-06200-19
1000 (32)	50	5	MY-06200-20
2000 (64)	100	4	MY-06200-21
3000 (96)	50	5	MY-06200-22
5000 (160)	100	5	MY-06200-23

## Cole-Parmer® Beakers and Covers, 304 SS (medium gauge)

Recessed covers for easy storage



Capacity L (qt)	Qty/pk	Beakers	Optional covers
		Catalogue number	Catalogue number
1.2 (1¼)	1	MY-07206-10	MY-07207-10
1.9 (2)	1	MY-07206-20	MY-07207-20
3.1 (3¼)	1	MY-07206-30	MY-07207-30
4.5 (4¾)	1	MY-07206-40	MY-07207-40
5.8 (6¼)	1	MY-07206-60	MY-07207-60
7.6 (8)	1	MY-07206-80	MY-07207-80
11.4 (12)	1	MY-07206-90	MY-07207-90

## Cole-Parmer® Covered Containers, 304 SS (medium gauge)

No more contamination of samples

- Keep dirt and other contaminants out with included lid
- Non-corrosive stainless steel
- Easy to clean
- Withstand temperatures to 182°C



Capacity, L (qt)	Qty/pk	Catalogue number
0.3 (¾)	1	MY-07250-00
1 (1¼)		MY-07251-00
1.5 (1½)		MY-07252-00
2.6 (2¾)	1	MY-07253-00
4 (4¼)		MY-07254-00
7 (7¾)		MY-07258-00

## Cole-Parmer® Griffin Low Form Beakers, SS (medium gauge)

Get durable, economical mixing capabilities

- Sturdy vessels for general stirring or measuring of solutions



Capacity, mL (oz)	Qty/pk	Catalogue number
125 (4.2)	1	MY-07205-30
250 (8.5)	1	MY-07205-40
600 (20.3)	1	MY-07205-50
1200 (40.6)	1	MY-07205-60
2000 (67.6)	1	MY-07205-70
3000 (101.4)	1	MY-07205-80
4000 (135.3)	1	MY-07205-90

## Cole-Parmer® Graduated Pouring Beakers, SS (medium gauge)

Easily measure and pour samples

- Measure volumes easily with internal graduation markers
- Great for higher temperatures— withstand temperatures up to 182°C



Capacity, mL (oz)	Graduations, mL (oz)	Qty/pk	Catalogue number
500 (16)	50 (2)	1	MY-07220-00
1000 (32)	100 (2)	1	MY-07222-00
2000 (64)	100 (4)	1	MY-07224-00
5000 (160)	200 (4)	1	MY-07226-00



## Cole-Parmer® Pouring Beakers, 304 SS (medium gauge)

No more struggling to pour

- Attached handle lets you grip beaker easily



Capacity, L (qt)	Qty/pk	Catalogue number
2 (1.9)	1	MY-07208-20
3 (2.8)		MY-07208-30
3.7 (4)		MY-07208-50

## Cole-Parmer® Wide-Mouth Bottles, LDPE, HDPE, PP

### Wide-mouth opening provides easier filling and sampling

- Offered in pack quantities or bulk pack quantities to meet your specific requirements
- Reliable and sturdy
- Choose from three materials; all include a leakproof PP closure

**HDPE Bottles** are manufactured with FDA-compliant resin for noncontaminating storage of chemicals and food-grade products.

**LDPE Bottles** are translucent and ideal for food and general-use laboratory applications.

**PP Bottles** are rigid and offer superior chemical resistance; perfect for storage and sampling of liquids and solids. **Autoclavable.**



Capacity mL (oz)	Cap size	Qty/pk	Catalogue number	Qty/pk	Catalogue number
<b>HDPE</b>					
60 (2)	22 mm	12	MY-06045-18	72	MY-06045-23
125 (4)	28 mm	12	MY-06045-24	72	MY-06045-25
250 (8)	28 mm	12	MY-06045-26	72	MY-06045-27
500 (16)	28 mm	12	MY-06045-28	48	MY-06045-29
1000 (32)	28 mm	6	MY-06045-44	24	MY-06045-31
2000 (64)	45 mm	1	MY-06045-46	6	MY-06045-33
<b>LDPE</b>					
60 (2)	22 mm	12	MY-06045-02	72	MY-06045-03
125 (4)	28 mm	12	MY-06045-04	72	MY-06045-05
250 (8)	28 mm	12	MY-06045-06	72	MY-06045-07
500 (16)	28 mm	12	MY-06045-08	48	MY-06045-09
1000 (32)	28 mm	6	MY-06045-14	6	MY-06045-11
<b>PP</b>					
30 (1)	22 mm	12	MY-06045-48	72	MY-06045-41
60 (2)	22 mm	12	MY-06045-56	72	MY-06045-43
125 (4)	28 mm	12	MY-06045-58	72	MY-06045-45
250 (8)	28 mm	12	MY-06045-62	72	MY-06045-47
500 (16)	28 mm	12	MY-06045-66	48	MY-06045-49
1000 (32)	28 mm	6	MY-06045-68	24	MY-06045-51
2000 (64)	45 mm	1	MY-06045-74	6	MY-06045-53

## Wheaton BOD Bottles with Stopper

### Easily identify samples

- Clear glass BOD bottles come with glass stoppers and a white write-on marking space

53200-18



Capacity mL (oz)	Stopper type	Number sequence	Qty/cs	Catalogue number
60 (2)	Glass pennyhead	Unnumbered	36	MY-53200-18
300 (10)	Glass robotic	Unnumbered	24	MY-03660-15
300 (10)	Glass robotic	1–24	24	MY-03660-16
		25–48		MY-03660-17
		49–72		MY-03660-18
		73–96		MY-03660-19

## Environmental Express® Disposable BOD Bottles

### Reduce contamination and increase test accuracy

- No pre-cleaning required!
- Laboratory tested and US EPA approved
- Packed in plastic-lined boxes to eliminate dust and residue

These PET bottles offer a specially formulated carbon coating that prevents oxygen from diffusing into or out of your sample, unlike ordinary plastic bottles. The unique amorphous carbon inner wall is just 1000 angstroms thick, but it provides a superior barrier resulting in uniform blanks, precise standard recoveries, and quality test data. Accepts glass or acrylic stoppers.



**ENVIRONMENTAL EXPRESS®**

## Environmental Express® 300-mL Glass BOD Bottle with Stopper

### Improved shoulder design removes entrapped air

- Flared mouth design prevents air from entering sample during incubation
- Displace excess sample with conical extension on stopper
- Conforms to ASTM E438, Type I, Class B, borosilicate glass
- Unnumbered; with glass pennyhead stopper

These bottles are designed for sampling and for incubation of aqueous samples for biochemical oxygen demand (BOD) analysis for reference Method 5210-B: 5-Day BOD Test (*Standard Methods for Examination of Water and Wastewater*).



**ENVIRONMENTAL EXPRESS®**

Capacity	Numbered	Qty/pk	Catalogue number
300 mL	Individually	100	MY-53200-02

**MY-53200-12 BOD bottle stopper**, acrylic robotic-style. Pack of 25

**MY-53200-14 BOD overcap** prevents evaporation. Pack of 50

Capacity	Stopper type	Qty/cs	Catalogue number
300 mL	Glass pennyhead	24	MY-53200-19



## PYREX® Brand 1395 Media Bottles

Permanent white graduations won't wear off

- Use for mixing or storing of your solutions—full capacity indicated by bead line on 100-mL to 2-L sizes
- Linerless, autoclavable polypropylene screw cap included on each bottle
- Colour code your samples with optional colour-coded PP caps

**Caution:** Bottles larger than 2 litres should not be used under vacuum pressure, as breakage may occur. Do not tighten caps immediately after autoclaving.



Capacity mL (oz)	Graduation range (mL)	Thread size	Neck ID	Qty/cs	Catalogue number
25 (¾)	10 to 25	GL25	14.5 mm	10	MY-34514-20
50 (1½)	20 to 50	GL32	16.5 mm	10	MY-34514-21
100 (3)	40 to 80	GL45	29 mm	10	MY-34514-22
250 (8)	50 to 200	GL45	29 mm	10	MY-34514-23
500 (16)	100 to 400	GL45	29 mm	10	MY-34514-24
1000 (32)	100 to 900	GL45	29 mm	10	MY-34514-25
2000 (64)	400 to 1800	GL45	29 mm	4	MY-34514-26
5000 (160)	500 to 4500	GL45	29 mm	1	MY-34514-28
10,000 (320)	2000 to 9000	GL45	29 mm	1	MY-34514-30

### Accessories

- MY-34514-50 Polypropylene cap, orange, GL45. Cs of 20
- MY-34514-53 Polypropylene cap, green, GL45. Cs of 20
- MY-34514-54 Polypropylene cap, gray membrane, GL45. Cs of 10
- MY-34514-55 Polypropylene cap, red high-temp. GL45. Cs of 10
- MY-34514-60 Pouring ring, clear, low temperature. Cs of 50
- MY-34514-65 Pouring ring, red, high temperature. Cs of 50

## Graduated Sample Containers, PP

Graduated for easier sampling

- Durable design—translucent, unbreakable, and chemical resistant
- Sterile containers are individually wrapped



**STERILE**

Capacity mL (oz)	Description	Qty/pk	Catalogue number
118 (4)	Sterile, no tab	100	MY-06049-40
118 (4)	Nonsterile with white tab	500	MY-06049-50

## Scienceware® Wash Bottles, LDPE

No leaking while dispensing

- One-piece polyallomer (PA) cap/delivery tube eliminates leaks
- Precise delivery with needle-thin stream



Capacity mL (oz)	Qty/pk	Catalogue number
125 (4)	12	MY-06053-21
250 (8)		MY-06053-41
500 (16)		MY-06053-61
1000 (32)		MY-06053-81

## Cole-Parmer® Lab Markers

Fine-point fiber tip writes on cold, wet surfaces. Quick-drying ink permanently marks plastic; washes off glass, metal, or porcelain.

 Cole-Parmer®

Colour	Qty/pk	Catalogue number
Black	10	MY-09964-00
Blue		MY-09964-10
Green		MY-09964-15
Red		MY-09964-20



## Cole-Parmer® Pre-cleaned EPA Sample Containers

No contaminants—pre-cleaned and ready to use

- Include certificate of conformance to EPA specifications
- Identify samples easier with included labels (unattached)

**A-D. Glass Bottles, Jars, and Jugs** are processed and certified to meet the requirements of the current US EPA “Specifications and Guidance for Contaminant-Free Sample Containers” document for semi-volatile organics, pesticides, PCBs, metals, cyanide, fluoride, nitrate and nitrite analyses. Include PTFE-lined caps.



**E. Glass Septa Jars** are processed and certified to meet the requirements of the current US EPA “Specifications and Guidance for Contaminant-Free Sample Containers” document for purgeable volatile organic analysis. Include PTFE-lined silicone septa bonded to open-top caps.



Capacity mL (oz)	Neck size	Qty/cs	Catalogue number
<b>A. Clear wide-mouth glass jars</b>			
60 (2)	53 mm	24	MY-99540-40
125 (4)	58 mm	24	MY-99540-41
250 (8)	70 mm	12	MY-99540-42
500 (16)	89 mm	12	MY-99540-43
950 (32)	89 mm	12	MY-99540-44
<b>B. Amber narrow-mouth glass bottles</b>			
125 (4)	22 mm	24	MY-99540-30
250 (8)	24-414	12	MY-99540-31
500 (16)	28 mm	12	MY-99540-32
1000 (34)	33-430	12	MY-99540-33
<b>C. Amber wide-mouth glass bottles</b>			
125 (4)	38 mm	12	MY-99540-51
250 (8)	45 mm	12	MY-99540-53
500 (16)	53 mm	12	MY-99540-55
950 (32)	53 mm	12	MY-99540-57
<b>D. Amber narrow-mouth glass jugs</b>			
2500 (80)	38-430	6	MY-99540-34
4000 (135)	38-430	4	MY-99540-35
<b>E. Clear wide-mouth glass septa jars</b>			
60 (2)	53 mm	24	MY-99540-20
125 (4)	58 mm	24	MY-99540-21

## Scienceware® Safety-Labeled Wash Bottles, LDPE

Keep solutions close at hand with easy identification

- Quickly identify contents by large lettering and colour-coded caps
- These 500-mL bottles include a leakproof polyallomer (PA) cap and nozzle
- Assortment pack allows for easy ordering—includes one each of water, acetone, ethanol, isopropanol, methanol, and toluene†



Labeled chemical	Cap colour	Qty/pk	Catalogue number
Water	Blue	6	MY-06256-30
Distilled water	Blue		MY-06256-20
Deionised water	Blue		MY-06256-14
Acetone	Red	6	MY-06256-40
Methanol	Green		MY-06256-50
Isopropanol	Yellow		MY-06256-60
Toluene†	Red		MY-06256-70
70% ethanol	Natural		MY-06256-13
100% ethanol	Natural	MY-06256-81	
Bleach	Blue	6	MY-06256-90
Methyl ethyl ketone	Green		MY-06256-10
Soap	Blue		MY-06256-11
Assortment pack for water, acetone, ethanol, isopropanol, methanol, and toluene†	—	6	MY-06256-00

†Not recommended for long-term storage of toluene.

## Cole-Parmer® Trigger Spray Bottle, HDPE

Get the stream you need

- Adjusts from fine mist to powerful stream
- Polypropylene cap and spray assembly with stainless steel bearings



Capacity mL (oz)	Qty/pk	Catalogue number
650 (22)	4	MY-06091-05

## Cole-Parmer® Class B Burettes

Get reliable, accurate draining

- White, permanent graduations for easy reading won't rub off
- Non-contaminating PTFE stopcock with 2-mm straight bore
- Durable borosilicate glass



Kit 25000-55

Capacity	Graduation interval	Tolerance	Catalogue number
10 mL	0.05 mL	±0.04 mL	MY-63100-34
25 mL	0.1 mL	±0.1 mL	MY-63100-36
50 mL	0.1 mL	±0.1 mL	MY-63100-38
100 mL	0.2 mL	±0.2 mL	MY-63100-40

### Accessories

**MY-25000-55 Burette and stand kit;** includes 50-mL burette, stand and clamp

## PYREX® Brand 2103 Class A Burettes

No more hard-to-read aliquots

- Get better readings with large, easy-to-read numbers and sharp lines
- Be more accurate—capacity tolerance calibrated to ASTM E 287, burettes calibrated to ASTM E 542
- Leak-resistant PTFE stopcock has 2-mm bore
- Maintain fluid integrity with included dust cover

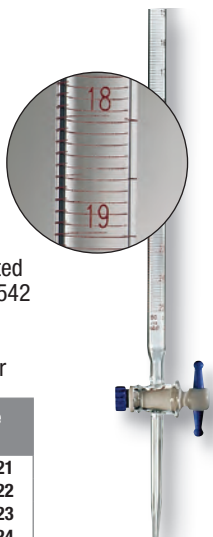

Capacity	Graduation interval	Tolerance	Catalogue number
10 mL	0.05 mL	±0.02 mL	MY-34543-21
25 mL	0.10 mL	±0.03 mL	MY-34543-22
50 mL	0.10 mL	±0.05 mL	MY-34543-23
100 mL	0.20 mL	±0.10 mL	MY-34543-24

## Automatic Self-Zeroing, Self-Supporting Burettes

Prevent contamination from outside elements

- Get easy, drop-by-drop delivery with unique push-button stopcock
- Quickly repeat titration by presetting drop speed
- Easy-to-read blue graduations

**What's included:** LDPE bottle, base, and tube; vinyl stopper; glass burette; and PP stopcock.



Capacity	Subdivisions	Reservoir	Catalogue number
10 mL	0.05 mL	500 mL	MY-07879-10
15 mL	0.1 mL	500 mL	MY-07879-20
25 mL	0.1 mL	1000 mL	MY-07879-30
50 mL	0.1 mL	1000 mL	MY-07879-40

## Thermo Scientific™ Nalgene™ Automatic Self-Zeroing Burettes

No lubrication of PTFE plug needed

- Won't break—made of clear acrylic body, PTFE stopcock, and PMP tip
- Individually calibrated for accuracy to meet ASTM E 287 requirements

Unaffected by most dilute acids and bases (except HF and ammonium hydroxide). Use over full pH range. Not designed for use with alcohols or organic solvents. Includes a cover, a squeeze bottle with closure, and 1 m of vinyl tubing.

Burette 06209-30 shown with stand 06703-00 and clamp 06703-10



Capacity	Graduation intervals	Reservoir	Catalogue number
10 mL	0.1 mL	500 mL	MY-06209-10
25 mL	0.1 mL	500 mL	MY-06209-20
50 mL	0.1 mL	1000 mL	MY-06209-30

### Accessories

**MY-06703-00 Support stand** with center rod; 76 cm L x 1.3 cm dia  
**MY-06703-10 Single burette clamp**, HDPE

## Titrette® Digital Bottletop Electronic Burettes

Easily calibrate for GLP and ISO compliance

- No more wasting titrant with SafetyPrime™ valve
- Eliminate meniscus reading errors—dispensed results displayed on LCD with 0.01-mL resolution
- Mount directly to bottle (not included), reducing liquid transfer
- Always view bottle label with 360° rotatable valve block
- Suitable for solutions up to 2N

**What's included:** 33-mm, 38-mm, and STJ 29/32 polypropylene (PP) bottle adapters; fine-tip titrating tube, a 195- to 350-mm telescoping filling tube, lithium battery, and a performance certificate.



### Specifications

**Cumulative volume:** up to 99.99 mL in 0.01-mL increments  
**Reproducibility:** ±0.1%  
**Fitting:** fits 45-mm bottle thread

**Wetted materials:** borosilicate glass, PP, PTFE, ETFE, FEP, PFA, platinum-iridium, and ceramic  
**Power:** lithium battery (included) >60,000 titrations

Capacity	Accuracy	Catalogue number
25 mL	±0.2% (±50 µL)	MY-07910-51
50 mL	±0.2% (±100 µL)	MY-07910-53

### Accessories

**MY-07878-53 Drying tube.** Protects sensitive reagents from moisture or CO<sub>2</sub>  
**MY-07193-05 Drierite® drying agent** for 07878-53. Twelve 0.45-kg packs per carton



## Techne® Portable Dry Block Temperature Calibrator

Case is cool to the touch—even at maximum temperatures

- Maximum temperature of 430°C (806°F)
- Fast heat-up and cool-down
- Independent overtemperature cutout
- Temperature sensor burnout protection
- Built rugged to handle portable field use
- Lightweight, only 4-kg (9 lb)

**What's included:** one multi-well insert (3.17-, 4.76-, 6.35-, 7.93- & 9.52-mm well sizes), insert extractor, mains cable, and NIST-traceable calibration report supplied by the manufacturer.



### Optional Inserts

Model	3028950
<b>Catalogue number</b>	<b>MY-16101-98</b>
Minimum temperature	5°C / 9°F above ambient
Maximum temperature	430°C / 806°F
Cooling rate 400 to 100°C	21 min
Heating rate, 20 to 400°C	12 min
Independent overtemp. cutout	Approx. 450°C / 842°F
Display resolution	0.1°C / 0.1°F
Insert immersion depth	11.43 cm (4½")
Stability after 15 minutes	±0.03°C @ 200°C; ±0.05°C @ 400°C
Display accuracy	±0.3°C @ 200°C; ±0.5°C @ 400°C
Well-to-well uniformity	0.015°C @ 200°C; 0.025°C @ 400°C
Dimensions (H x W x D)	222 x 203 x 203 mm (8¾" x 8" x 8")
Power (VAC, Hz, W)	240, 50/60, 900

Model	Description	Catalogue number
7032533	Insert 5 x 0.63 cm	<b>MY-08510-70</b>
7032534	Insert 0.95 cm + 0.79 cm + 0.63 cm +0.47 cm +0.3 cm	<b>MY-16104-25</b>
7032535	Insert 2 x 0.95 cm + 2 x 0.63 cm	<b>MY-16104-26</b>
7032536	Insert 2x 1.27 cm + 2 x 0.63 cm	<b>MY-16104-27</b>
7032537	Insert 1 x 0.63 cm	<b>MY-16104-28</b>
7032538	Insert blank	<b>MY-16104-29</b>
7032574	Insert 1 x 1.42 cm & 1 x 0.63 cm	<b>MY-16104-39</b>
7032575	Insert 1 x 1.58 cm & 1 x 0.63 cm	<b>MY-16104-40</b>
7032576	Insert 1 x 1.74 cm & 1 x 0.63 cm	<b>MY-16104-41</b>
7032577	Insert 1 x 1.9 cm & 1 x 0.63 cm	<b>MY-16104-42</b>

**MY-16104-43 Soft-side carrying case**

**MY-17002-16 ILAC MRA, NIST-traceable recalibration with data**

## Stuart® 8500 Microcentrifuge

Be safe with dual locking lid

- Quickly change rotors with quick-release adapter—no tools required
- Built-in recessed rotor bowl contains spills for easy cleanup
- Small footprint—the perfect unit for your personal workspace
- Spin samples rapidly or be used in applications where greater g-force is required
- Automatic shut-off discontinues operation after 60 minutes of continuous use



The Stuart 8500 microcentrifuge, with enhanced safety features, provides high speed centrifugation while protecting you and your samples. Spin samples rapidly to be used in applications where greater g-force is required. The innovative dual safety lock lid prevents you from accidentally opening the unit. It will only spin when the lid is closed and will automatically shut off after 60 minutes of continuous use. The rubber-coated base allows for enhanced stability and reduced vibration.



### Specifications

**Rotors (included):** fixed-angle, 8 x 1.5- to 2.0-mL tubes; 32 x 0.2-mL strip tubes

**Power:** 100 to 240 VAC, 50/60 Hz

Speed range	Max RCF x g	Catalogue number
8500 rpm	3884	<b>MY-17414-70</b>

## Cole-Parmer® Personal Microcentrifuges

Quickly and efficiently spin down samples

- Includes two rotors: one for 1.5- to 2.0-mL tubes and one for PCR tubes (0.4 mL)
- On/off switch lets you stop rotor before opening lid

Operation is extremely simple, just close the lid and the rotor accelerates quickly to 6000 rpm. Small footprint with rubber feet keep unit stable.



### Specifications

**Rotors (included):** fixed-angle, 6 x 1.5- to 2.0-mL tubes; 2 x 0.2-mL strip tubes

**Power:** 220 VAC, 50/60 Hz

Speed range	Max RCF x g	Catalogue number
6000 rpm	2000	<b>MY-17310-15</b>

# Cole-Parmer® MP and MPR Series Multipurpose Centrifuges

## Rugged construction without sacrificing reliable performance

- Extra-thick stainless steel chamber and zinc-coated alloy and steel frame increase durability for inorganic separations requiring strong solvents
- Industrial-grade inverter drive (VFD) and brushless motor provide a long service life
- User-accessible service sections allow on-site maintenance
- Programmable memory quickly administers routine tests and accommodates multiple users
- Pulse feature lets you perform very short runs to 90 seconds, perfect for fast pelleting

This Cole-Parmer multipurpose (MP and MPR) series of benchtop centrifuges features advanced safety elements, including lid with multipoint lock and gas struts, emergency lid release during power failure, and barrier ring to protect the chamber. Multiple sensors prevent damage to centrifuge in case of misuse or malfunction: lid lock detector ensures lid is secure before running, imbalance detector guarantees samples are loaded correctly, and overspeed and motor overheating sensors warn of mechanical or electronic failures.

Basic models feature three LED displays showing temperature, rpm, and time. Memory supports ten programs including acceleration and deceleration rates. Advanced models feature a large touch-screen LCD with memory for 108 programs. The refrigerated models (MPR) deliver accurate cooling to protect your valuable samples from heat.

**Basic MP16 and MPR16 models** include a fixed-angle rotor holding eight 50-mL tubes—perfect for civil, environmental, and water supply engineering applications.

**Basic MPR315 model** adds the automatic rotor recognition function. Automatic rotor recognition provides safety and convenience when different rotors are used. The installed rotor is recognised at the beginning of a run and is automatically limited to its rated maximum speed.

**Advanced MPR115 model** adds automatic rotor recognition function. Plus, the large intuitive touch-screen LCD is simple to navigate, saving you time in the lab. Programmable memory supports 108 programs including acceleration and deceleration rates for routine tasks, or use the W2t functionality normally found only on ultracentrifuges.

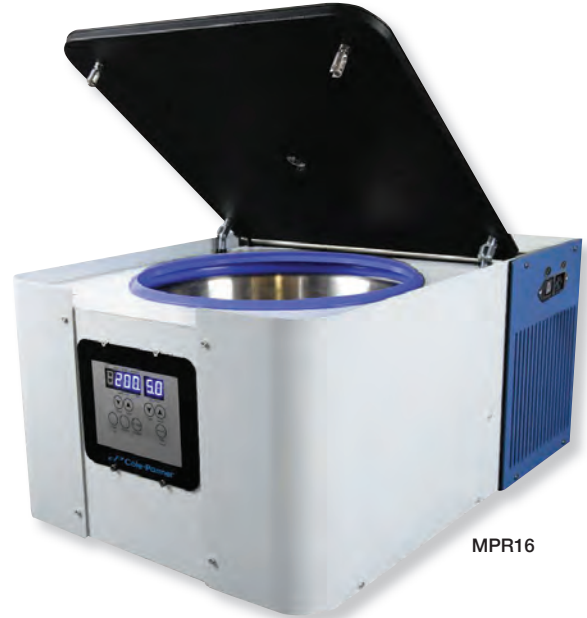

MPR16



MPR115



ISO9001:2008  
CERTIFIED SUPPLIER



Model	Interface	Max speed (rpm)	Max RCF x g	Max capacity	Timer	Rotors included	Power	Catalogue number
<b>Nonrefrigerated MP model</b>								
MP16	Basic	6000	4800	1 L	0 to 99 minutes, 10-second increments	Fixed-angle rotor (17406-09)	230 VAC, 50 Hz	MY-17406-55
<b>Refrigerated MPR models, -9 to 40°C ( 15.8 to 104°F)</b>								
MPR16	Basic	6000	4800	1 L	0 to 99 minutes, 10-second increments	Fixed-angle rotor (17406-09)	230 VAC, 50 Hz	MY-17406-25
MPR315	Basic	15,000	22,000	3 L	0 to 99 minutes, 1-second increments	Fixed-angle rotor (17406-03) and swing-out rotor (17406-01) with buckets (17406-02) and adapters (17406-04)	230 VAC, 50 Hz	MY-17406-17
MPR115	Advanced	15,000	22,000	1 L	0 to 9999 minutes, 1-second increments	Fixed-angle rotor (17406-13) and swing-out rotor (17406-11) with buckets (17406-12) and adapters (17406-14)	230 VAC, 50 Hz	MY-17406-19

Find even more! Additional centrifuges, rotors, adapters, and reducers are available online.

## Flip-Cap Centrifuge Tubes

### No more lost caps!

- Hinged flip-top cap allows for single-handed use
- Grooved cap surface for easier manipulation
- Guaranteed DNase, RNase, and pyrogen free
- Can be spun up to 9400 g

Centrifuge tubes with hinged flip-top caps allow for easy one-handed opening and closing. No more dropping or losing the tube cap. Bold black graduations are easy to read and accurate to  $\pm 2\%$ . A large frosted marking area allows for permanent sample identification.

The conical-bottom, polypropylene (PP) tubes are compatible with any fixed angle or swing bucket rotor and can withstand temperatures from  $-80$  to  $120^{\circ}\text{C}$ .



Not recommended for use in long term storage or sample transport applications.



Capacity (mL)	Tube material	Max RCF (x g)	Cap included	Sterile	Packaging	Qty/cs	Catalog number
15	PP	9400	Yes	Yes	20 bags of 25	500	MY-04395-55
50	PP	9400	Yes	Yes	20 bags of 25	500	MY-04395-56

## 5-mL Microcentrifuge Tubes

### Perfect for medium-sized samples



- Easy-open attached cap eliminates hand fatigue and maintains sample integrity
- Polypropylene handles autoclaving to  $120^{\circ}\text{C}$  and freezing to  $-90^{\circ}\text{C}$
- Certified RNase-, DNase-, and pyrogen-free

These graduated 5-mL tubes were designed to fill the gap for samples too large for standard microcentrifuge tubes and too small to pipette without contamination from a 15-ml conical tube. Use in centrifuges that accept 15-mL tubes.

Capacity (mL)	Max RCF (x g)	Sterile	Colour	Qty/pk	Catalogue number
5	5000	No	Natural	200	MY-04395-47
		Yes†	Natural	200†	MY-04395-48
		No	Blue	200	MY-04395-49
		No	Yellow	200	MY-04395-50
5	5000	No	Green	200	MY-04395-51
		No	Pink	200	MY-04395-52
		No	Black	200	MY-04395-53

†Sterile tubes are packaged as 10 bags of 20 tubes.

MY-04395-54 Acrylic tube rack holds 10 x 5-mL microcentrifuges

## CapLock™ Microcentrifuge Tube

### Make sure your samples stay secure with double-locking cap

- Polypropylene is autoclavable at  $121^{\circ}\text{C}$  and freezable to  $-100^{\circ}\text{C}$
- Free of RNase, DNase, endotoxins, and human DNA
- Certified TSE/BSE free



Capacity (mL)	Max RCF (x g)	Sterile	Qty/pk	Catalogue number
1.5	30,000	No	1000	MY-04395-57

## Black Microcentrifuge Tubes

### Protect your photosensitive samples

Black tubes provide a completely opaque barrier, protecting even the most light-sensitive compounds. Ideal for use with fluorescent probes or ethidium bromide. Tubes are made of polypropylene with a click-fit cap to prevent accidental opening. Tubes can be stored down to  $-100^{\circ}\text{C}$  and can be autoclaved to  $122^{\circ}\text{C}$ .



Capacity (mL)	Tube material	Max RCF x g	Sterile	Qty/pk	Catalogue number
0.5	PP	15,000	No	500	MY-06333-75
1.5	PP	15,000	No	500	MY-06333-80
15	PP	8,400	No	50	MY-06344-30
30	PP	10,000	No	50	MY-06344-35

## BackSpring™ Tube

### Easy opening and closing tubes

- RNase-free, DNase-free, and non-pyrogenic
- Boil-proof and withstands freezing to  $-90^{\circ}\text{C}$

This unique 1.5-mL microcentrifuge tube lets you open it from the back with just one hand, versus the traditional front-open style. Pivot design allows the tube to snap open when pressure is applied to the back of the cap—enabling quick, comfortable opening and closing of the lid. Tube features easy-puncture top, graduations, and frosted writing surface. **Autoclavable.**



Capacity (mL)	Tube material	Max RCF (x g)	Colour	Cap included	Sterile	Qty/pk	Catalogue number
1.5	Homopolymer plastic	30,000	Clear	Yes	No	500	MY-22999-00



## Kinesis® TELOS® neo™ SPE Fixed 96-Well Microplates

### Quickly obtain clean extracts

- Faster method development saves you money
- Water-wettable polymer is not affected by drying out

TELOS neo 96-well plates are ideal for high throughput assays, saving you time. Polymer-based sorbents have no silanol interactions, excellent flow characteristics, and pH stability providing highly reproducible results. Elution volumes are kept to a minimum by allowing maximum interaction between the analyte and sorbent.

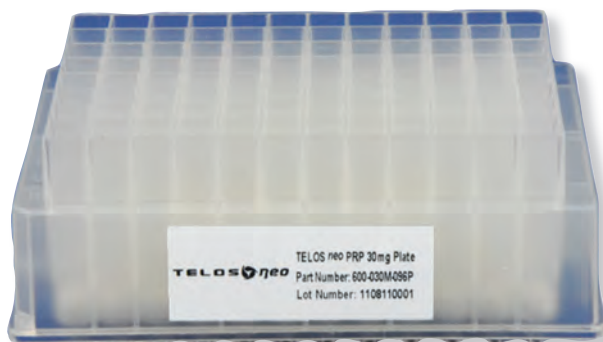

**Kinesis®**

Sorbent	Interaction	Sorbent mass	Catalogue number
PRP	Non-polar	10 mg	<b>MY-06474-57</b>
		30 mg	<b>MY-06474-45</b>
PCX	Mixed-mode, strong cation exchange	10 mg	<b>MY-06474-47</b>
		30 mg	<b>MY-06474-48</b>
WCX	Mixed-mode, weak cation exchange	10 mg	<b>MY-06474-42</b>
		30 mg	<b>MY-06474-28</b>
PAX	Mixed-mode, strong anion exchange	10 mg	<b>MY-06474-54</b>
		30 mg	<b>MY-06474-39</b>
WAX	Mixed-mode, weak anion exchange	10 mg	<b>MY-06474-40</b>
		30 mg	<b>MY-06474-33</b>

## Kinesis® Glass-Lined Polypropylene Collection Plates

### Glass lining provides excellent chemical resistance

**Kinesis®**

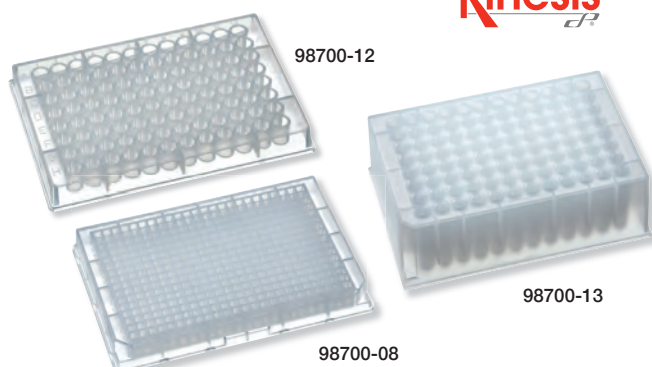

Available with three well shapes: V-bottom wells let you completely retrieve well content; U-bottom wells optimise coating and washing; and flat-bottom wells maximise light transmission.

No. of wells	Well shape	Well volume	Qty/pk	Catalogue number
96	Round, V bottom	220 µL	10	<b>MY-98700-14</b>
		300 µL	10	<b>MY-98700-12</b>
	Round, U bottom	1.2 mL	10	<b>MY-98700-13</b>
		370 µL	10	<b>MY-98700-10</b>
384	Round, flat bottom	2.4 mL	10	<b>MY-98700-11</b>
		120 µL	10	<b>MY-98700-08</b>
		240 µL	6	<b>MY-98700-09</b>

## Kinesis® TELOS® neo™ MicroPlate™ SPE 96-Well Microplates

### 50 µL elution volume for minimal sample dilution and reduced evaporation time

- Versatile 96-well format for small volume biological fluid samples
- Optimised well geometry for 5- and 10-mg sorbent masses
- Use with vacuum or positive pressure

The internal diameter, frit design, and sorbent material of the TELOS MicroPlate 96-well plates allow for maximum recovery with minimal sample dilution and reduced evaporation time. A well packed with 5-mg sorbent allows analytes to be eluted in as little as 50-µL. Full or partially populated plates can be processed using either vacuum or positive pressure.

Select from populated plates or loose wells. Populated plates come with 96 wells already in place and are ideal for high throughput assays. Use the loose wells for assays when the sample numbers vary, populating the base plate with only the required number of wells. Order base plates separately to use with the loose wells. The method development kit includes a base plate, sealing strips and 20 wells of each of five SPE sorbents to build a method development plate to meet your needs.



**Kinesis®**

Sorbent	Interaction	Sorbent mass	Populated plates (1/pk)	Loose wells† (100/pk)
			Catalogue number	Catalogue number
PRP	Non-polar	5 mg	<b>MY-06474-21</b>	<b>MY-06474-20</b>
		10 mg	<b>MY-06474-13</b>	<b>MY-06474-12</b>
PCX	Mixed-mode, strong cation exchange	5 mg	<b>MY-06474-15</b>	<b>MY-06474-14</b>
		10 mg	<b>MY-06474-09</b>	<b>MY-06474-04</b>
WCX	Mixed-mode, weak cation exchange	5 mg	<b>MY-06474-05</b>	<b>MY-06474-16</b>
		10 mg	<b>MY-06474-06</b>	<b>MY-06474-17</b>
PAX	Mixed-mode, strong anion exchange	5 mg	<b>MY-06474-02</b>	<b>MY-06474-01</b>
		10 mg	<b>MY-06474-07</b>	<b>MY-06474-10</b>
WAX	Mixed-mode, weak anion exchange	5 mg	<b>MY-06474-18</b>	<b>MY-06474-62</b>
		10 mg	<b>MY-06474-03</b>	<b>MY-06474-08</b>

†Loose wells require a base plate.

#### Accessories

**MY-06474-19 TELOS MicroPlate method development kit** for loose wells, 10 mg. Contains 20 x 10 mg wells of TELOS neo PRP, PCX, WCX, PAX, and WAX; base plate; base plate sealing strips; and well removing tool

**MY-06474-60 TELOS MicroPlate base plate.** Required for loose wells. Pack of 5

**MY-06474-11 TELOS MicroPlate base plate sealing strip.** Pack of 24

**MY-06474-61 Well removing tool** for populated MicroPlate plates

## Kinesis® TELOS® Silica-Based SPE 96-Well Microplates

Optimised for sample processing and extraction of small-volume biological fluids

- Select from three main retention mechanisms: non-polar, ion exchange, or polar
- Use with vacuum or positive pressure



The internal diameter, frit design, and sorbent material of the TELOS 96-well microplates allow for maximum recovery with minimal sample dilution and reduced evaporation time. Populated MicroPlate™ plates come with 96 wells already in place yet allow the flexibility to remove any unwanted wells.

Select endcapped sorbents for applications requiring minimal secondary silanol interactions to enhance compound retention and elution. C4 (WP) sorbents with average pore size of 300 Å are ideal for compounds with molecular weight >10,000. Use C18 (AQ) with samples with large volumes of water.



Retention type	Sorbent	Sorbent mass	Endcapped	Carbon loading	Catalogue number
<b>Fixed-well plates</b>					
Non-polar	C18	5 mg	No	17.5%	MY-06476-54
			Yes	18%	MY-06476-75
		10 mg	No	17.5%	MY-06476-57
			Yes	18%	MY-06476-77
		25 mg	Yes	18%	MY-06476-78
		30 mg	No	17.5%	MY-06476-58
	C4 (WP)	50 mg	No	17.5%	MY-06476-59
			Yes	18%	MY-06476-80
		100 mg	No	17.5%	MY-06476-64
			Yes	18%	MY-06476-84
C2	25 mg	No	10%	MY-06477-23	
				MY-06477-26	
	100 mg	Yes	6%	MY-06477-31	
Ion exchange	SAX	25 mg	—	—	MY-06477-63
		50 mg	—	—	MY-06477-67
		100 mg	—	—	MY-06477-78
Polar	Silica	350 mg	—	—	MY-06477-49
		100 mg	—	—	MY-06476-07
	NH2	350 mg	—	—	MY-06476-11
		50 mg	—	—	MY-06476-17
<b>Populated plates</b>					
Non-polar	C18	5 mg	No	17.5%	MY-06476-53
			Yes		MY-06476-56
		10 mg	Yes	18%	MY-06476-76
	C18 (AQ)	5 mg	Yes	18%	MY-06476-94
		10 mg			MY-06476-96

### Accessories

- MY-06474-11 TELOS MicroPlate base plate sealing strip. Pack of 24
- MY-06474-61 Well removing tool for populated MicroPlate plates

## Kinesis® TELOS® Filtration MicroPlate™ Microplates

Designed for routine filtration and sample preparation

- Includes 20 µm polyethylene frits
- Use for gravity or vacuum application



The individual well of the microplate is designed to ensure elution volumes are kept to a minimum. Select from populated or loose-well design. Populated plates come with 96 wells already in place yet allow the flexibility to remove any unwanted wells—ideal for high throughput assays. Use the loose wells for assays when the sample numbers vary, populating the base plate with only the required number of wells. Order base plates 06474-60 (required) separately to use with the loose wells.



Description	Well volume	Frit size	Qty/pk	Catalogue number
Loose-well plate	600 µL	20 µm	100†	MY-06479-74
Populated plate			1	MY-06479-91

† Comes with 100 loose wells.

### Accessories

- MY-06474-60 TELOS MicroPlate base plate. Required for loose wells. Pack of 5
- MY-06474-11 TELOS MicroPlate base plate sealing strip. Pack of 24
- MY-06474-61 Well removing tool for populated MicroPlate plates

## Kinesis® TELOS® PPT Protein Precipitation Plate and Column

No filtrate breakthrough



- Clean-up biological fluid samples, such as plasma
- In situ protein precipitation—no vortex mixing required

Complete protein precipitation process takes place in the column or the well—no offline liquid handling and centrifugation steps are required. Specially designed double frits provide fast and trouble-free protein precipitation. One frit holds up the precipitation solvent, acetonitrile, while the other frit with larger porosity prevents blocking, allowing reproducible collection of the subsequent filtrate.



Description	Qty/pk	Catalogue number
Protein precipitation 96-well plate	1	MY-06482-28
Protein precipitation 1-mL column	100	MY-06482-37

## Kinesis® TELOS® SLE Columns and Plates

Perfectly suited for automation and high throughput procedures

- Efficient extraction
- High analyte recovery with no emulsion formation

Use supported liquid extraction (SLE) columns and plates when you need to extract samples quickly and effectively. Columns and wells are packed with diatomaceous earth, a neutral matrix, to provide support to absorb the aqueous sample. Once the aqueous sample is fully absorbed, a water immiscible organic solvent is used to elute the analytes. High analyte recoveries are obtained without any offline steps such as protein precipitation, and sample extracts are free of proteins and phospholipids. A hydrophilic top frit lets the sample pass through while minimising any blockage.

Use Neutral Matrix (NM) columns in analytical applications such as isolating drugs from biological fluids.

The 96 well microplates come packed with either NM or NM 545E. The NM 545E uses a larger particle size material for easier flow. The 600 mg plates come with 96 wells already in place yet offer the flexibility to remove any unwanted wells. Use loose wells 06482-03 with base plate 06474-60 (required) to populate with only the desired number of wells.



**Kinesis®**

Sorbent	Sorbent mass	Sample volume	Qty/pk	Catalogue number
NM columns	2.5 g	25 mL	20	MY-06482-02
	10 g	150 mL	8	MY-06482-01
	20 g	70 mL	10	MY-06482-05
NM 545 columns	2.5 g	25 mL	20	MY-06482-31
	10 g	150 mL	8	MY-06482-29
NM 96-well plates; pH 7	200 mg	—	1	MY-06482-33
	400 mg	—	1	MY-06482-06
	600 mg	—	1	MY-06482-09
NM 96-well plates; pH 9	100 mg	—	1	MY-06482-07
	200 mg	—	1	MY-06482-08
	400 mg	—	1	MY-06482-35
NM 545E plates	50 mg	—	1 <sup>†</sup>	MY-06482-04
			100 <sup>‡</sup>	MY-06482-03

<sup>†</sup>One 96-well fixed plate.

<sup>‡</sup>Loose wells. Requires MicroPlate base plate 06474-60.

### Accessories

**MY-06474-60 TELOS MicroPlate base plate.** Required for loose wells. Pack of 5

**MY-06474-11 TELOS MicroPlate base plate sealing strip.** Pack of 24

**MY-06474-61 Well removing tool** for populated MicroPlate plates

## Kinesis® KX Deep-Well Microplates

Don't compromise your research

- RNase, DNase, and endotoxin free for higher purity and better results
- Polypropylene material is compatible with solvents and additives
- Withstand temperatures from –80 to 120°C, ideal for both molecular and storage applications

These 96 well microplates are manufactured from 100% virgin polypropylene (PP), with a toughened option available for long-term storage. Select round-bottom plates for more efficient resuspension or V-bottom plates for precise sample recovery. Plates are free of RNase, DNase, and endotoxins to ensure purity and improve results of PCR and other molecular techniques. Use with microplate sealing mats to reduce evaporation and contamination; order separately below.

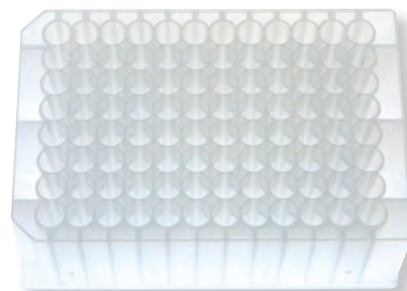

**Kinesis®**

No. of wells	Well style	Material	Bottom shape	Working well volume	Qty/pk	Catalogue number
96	Round	PP	Round	2.0 mL	50	MY-12920-08
	Round, low profile	PP	Round	1.0 mL	32	MY-12920-09
	Square	PP	V	2.0 mL	50	MY-12920-11
	Square	PP, toughened	V	2.0 mL	50	MY-12920-21

## Kinesis® KX Microplate Sealing Mats

Ensure purity and prevent loss

- Silicone reseals effectively to maintain sample purity
- Individual well plugs eliminate cross-contamination
- Pre-slit option available for easier penetration

Use these microplate sealing mats with well plates for storage prior to analysis. Silicone reseals after injections and pipetting for contamination-free sample preservation. Mats fit standard 96- and 384-well microplates.

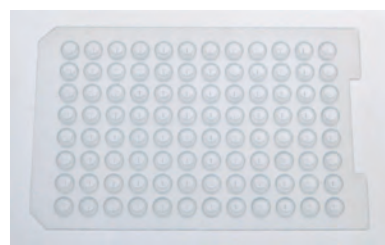

**Kinesis®**

For well style	Mat material	Qty/pk	Catalogue number
<b>96-Well sealing mats</b>			
Round	Silicone	5	MY-12920-16
	Silicone <sup>†</sup>	5	MY-12920-06
	Silicone, low-bleed	5	MY-12920-17
Round, low-profile deep-well	Silicone <sup>†</sup>	20	MY-12920-07
Round, shallow-well	Silicone <sup>†</sup>	5	MY-12920-19
Square	Silicone	5	MY-12920-18
	Silicone <sup>†</sup>	5	MY-12920-13
<b>384-Well sealing mats</b>			
Square	Silicone	5	MY-12920-12
	Silicone <sup>†</sup>	5	MY-12920-14

<sup>†</sup>Mat is pre-slit to facilitate easier pipetting from the injection devices.



# Kinesis® TELOS® Disposable Flash Chromatography Columns

## Optimised column geometry for maximum purity

- Moisture content is carefully controlled and tested to ensure reproducible retention from batch to batch
- Particle size distribution is controlled to ensure normal back pressures are attained
- Three formats to fit most instrument types
- Get quick and easy coupling with Luer connections
- Columns are made from polypropylene; frits are polyethylene
- Packed with silica, NH<sub>2</sub>, or C18



TELOS Flash-LL format

**Kinesis**  
CP



TELOS Flash format

### TELOS Flash Format Columns

TELOS Flash columns have Luer-Lok® inlet and a Luer-slip outlet. Compatible with flash chromatography instruments including the CombiFlash® systems from Teledyne ISCO.

Sorbent	Sorbent mass	Qty/pk	Catalogue number
Silica	4 g	20	MY-06474-64
	12 g	20	MY-06474-69
	20 g	20	MY-06474-71
	25 g	10	MY-06474-73
	40 g	10	MY-06474-77
	45 g	10	MY-06474-78
	80 g	5	MY-06474-82
	120 g	5	MY-06474-84
NH <sub>2</sub>	220 g	1	MY-06474-85
	330 g	1	MY-06474-86
	4 g	20	MY-06474-88
	12 g	20	MY-06474-92
	20 g	20	MY-06474-94
	40 g	10	MY-06474-98
	80 g	5	MY-06475-02
	120 g	5	MY-06475-04
C18	220 g	1	MY-06475-05
	4 g	20	MY-06475-06
	12 g	20	MY-06475-10
	23 g	20	MY-06475-19
	45 g	10	MY-06475-21
	90 g	5	MY-06475-28
	140 g	5	MY-06475-30
	375 g	1	MY-06475-31

### TELOS Flash-LL Format Columns

TELOS Flash-LL columns have Luer-Lok® on both inlet and outlet. Compatible with flash chromatography instruments including the Isolera™ systems from Biotage®.

Sorbent	Sorbent mass	Qty/pk	Catalogue number
Silica	12 g	20	MY-06474-68
	20 g	20	MY-06474-70
	40 g	10	MY-06474-76
	80 g	5	MY-06474-81
	120 g	5	MY-06474-83
NH <sub>2</sub>	12 g	20	MY-06474-91
	20 g	20	MY-06474-93
	40 g	10	MY-06474-97
	80 g	5	MY-06475-01
C18	120 g	5	MY-06475-03
	12 g	20	MY-06475-09
	23 g	20	MY-06475-12
	45 g	10	MY-06475-20
	90 g	5	MY-06475-27
	140 g	5	MY-06475-29

### Sorbent Types

- Use **silica** for purification of a wide range of synthetic and natural compounds—ideal for conventional applications.
- **NH<sub>2</sub>** (bonded aminopropyl) can be used to separate primary, secondary, and tertiary amines. NH<sub>2</sub> shows better peak shapes with polar and basic compound—ideal for carbohydrates.
- **C18** is a bonded octadecyl stationary phase offering reverse phase flash capabilities. Flash C18 is non-encapped, has a pore size of 60Å, and a carbon loading of ≈18%.

### TELOS SPE Format Columns

Ideal for first stage clean-up columns post synthesis using a vacuum manifold (see manifolds below), or on a rack or stand using gravity flow. Columns have a Luer slip outlet connection. Compatible with flash chromatography systems with a common plunger such as the FlashMaster™ II holder from Biotage®.

Sorbent	Sorbent mass	Sample volume	Qty/pk	Catalogue number
Silica	2 g	15 mL	20	MY-06474-63
	5 g	25 mL	20	MY-06474-65
	10 g	25 mL	20	MY-06474-66
	10 g	70 mL	16	MY-06474-67
	20 g	70 mL	16	MY-06474-72
	25 g	70 mL	16	MY-06474-74
	25 g	150 mL	8	MY-06474-75
	50 g	150 mL	8	MY-06474-79
NH <sub>2</sub>	70 g	150 mL	8	MY-06474-80
	2 g	15 mL	20	MY-06474-87
	5 g	25 mL	20	MY-06474-89
	10 g	70 mL	16	MY-06474-90
	20 g	70 mL	16	MY-06474-95
	25 g	70 mL	16	MY-06474-96
	50 g	150 mL	8	MY-06474-99
C18	70 g	150 mL	8	MY-06475-00
	5 g	25 mL	20	MY-06475-07
	10 g	70 mL	16	MY-06475-08
	20 g	70 mL	16	MY-06475-11
	50 g	150 mL	8	MY-06475-22
	70 g	150 mL	8	MY-06475-23

**Kinesis Sample Processing Vacuum Manifolds** for SPE sample preparation, filtration, and elution. Save time by processing multiple samples simultaneously. Manifolds come complete with everything you need—glass tank, lid, PP needles, stopcocks, rack (1.6 x 10-cm), vacuum gauge, waste collection container, and plates for accepting different size tubes.

Description	Catalogue number
12-position sample processing manifold	MY-06480-04
24-position sample processing manifold	MY-06479-29

## Kinesis® KX Non-Sterile Syringe Filters

Maximise product recovery, reliability, and reproducibility

- Solvent-resistant polypropylene (PP) housing with nominal extractables
- Leak-free Luer-Lok® and Luer-slip connections for easy, quick and tight connections to tubing, syringes, or needles
- Resealable storage container prevents contamination after opening



Colour coded for easy identification and minimal error



Go online for our comprehensive offering of Kinesis KX syringe filters and membranes.

### Specifications

Diameter	Sample volume	Retention volume	Burst pressure	Filter area (cm <sup>2</sup> )	Housing material	Connection (inlet/outlet)
4 mm	2 mL	8 µL	75 psi	0.1	PP	Female Luer-Lok® / male Luer-slip
13 mm	6 mL	30 µL	100 psi	0.65		
25 mm	70 mL	120 µL	100 psi	3.9		
30 mm	90 mL	140 µL	100 psi	4.5		

Diameter (mm)	Pore size (µm)	Qty/pk	Glass fibre	Mixed cellulose ester (MCE)	Nylon	PES	PP	PTFE	PVDF	
			Catalogue number	Catalogue number	Catalogue number	Catalogue number	Catalogue number	Catalogue number	Catalogue number	Catalogue number
4	0.22	100	MY-12915-22	MY-12915-53	MY-12915-76	MY-12916-06	MY-12916-30	MY-12916-56	MY-12916-98	
		1000	MY-12919-54	MY-12915-54	MY-12915-77	MY-12916-07	MY-12916-31	MY-12916-57	MY-12916-99	
	0.45	100	MY-12915-23	MY-12915-55	MY-12915-78	MY-12916-08	MY-12916-32	MY-12916-58	MY-12917-00	
		1000	MY-12919-55	MY-12915-56	MY-12915-79	MY-12916-09	MY-12916-33	MY-12916-59	MY-12917-01	
13	0.22	100	MY-12915-24	MY-12915-57	MY-12915-80	MY-12916-10	MY-12916-34	MY-12916-60	MY-12917-02	
		1000	MY-12915-25	MY-12915-58	MY-12915-81	MY-12916-11	MY-12916-35	MY-12916-61	MY-12917-03	
	0.45	100	MY-12915-26	MY-12915-60	MY-12915-83	MY-12916-13	MY-12916-36	MY-12916-63	MY-12917-05	
		1000	MY-12915-27	MY-12915-61	MY-12915-84	MY-12916-14	MY-12916-37	MY-12916-64	MY-12917-06	
	25	0.22	100	MY-12915-34	MY-12915-63	MY-12915-87	MY-12916-16	MY-12916-38	MY-12916-66	MY-12917-08
			500	MY-12915-35	MY-12915-64	MY-12915-88	MY-12916-17	MY-12916-39	MY-12916-67	MY-12917-09
0.45		100	MY-12915-36	MY-12915-66	MY-12915-90	MY-12916-19	MY-12916-40	MY-12916-69	MY-12917-11	
		500	MY-12915-37	MY-12915-67	MY-12915-91	MY-12916-20	MY-12916-41	MY-12916-70	MY-12917-12	
30	0.22	100	MY-12915-43	MY-12915-70	MY-12915-99	MY-12916-22	MY-12916-43	MY-12916-74	MY-12917-17	
		500	MY-12915-44	MY-12915-71	MY-12916-00	MY-12916-23	MY-12916-44	MY-12916-75	MY-12917-18	
	0.45	100	MY-12915-45	MY-12915-73	MY-12916-02	MY-12916-25	MY-12916-46	MY-12916-77	MY-12917-20	
		500	MY-12915-46	MY-12915-74	MY-12916-03	MY-12916-26	MY-12916-47	MY-12916-78	MY-12917-21	

Other materials available: Cellulose acetate, regenerated cellulose, hydrophilic PP, hydrophilic PTFE, hydrophilic PVDF, and PET.

Note: All 13, 25, and 30 mm filters are available with an integral pre-filter (1 µm glass fibre); ideal for solutions with a high viscosity like oils or high particulate samples.

## Kinesis® Deuterium Lamps for Chromatography Systems

Economical replacement lamps save you money

- Select from standard (typical 1000 hours) or long-life (typical 2000 hours) lamps



Compatible instrument brand	Fits models	Type	Catalogue number
ABI Analytical	757, 759, 783A, 785A, 1000S, 980, 120A, 130A	Standard	MY-11941-10
	1100 VWD, 1200, 1260	Long life	MY-11941-11
Agilent	1100 DAD, 8453	Standard	MY-11941-12
	1100/1200 DAD (to fit G1315/1365 A & B series detectors)	Long life	MY-11941-13
	1100/1200 DAD (to fit G1315/1365 C & D series detectors)	Long life	MY-11941-14
	1260, 1290	Long life	MY-11941-15
	SP1/4, Isolera™	Standard	MY-11941-16
Dionex™	UltiMate™ 3000, 3000RS, 3100, 3400	Long life	MY-11941-17
Dionex/Gynkotek	UVD160, 170S, 170U, 320, 340S, 340U	Long life	MY-11941-20
Gilson®	170 DAD	Standard	MY-11941-18
	170 DAD	Long life	MY-11941-19
Interchim	PuriFlash (PF) 215, PF430, PF450, PF800, PF4100, PF1, SP2	Standard	MY-11941-21
Merck Hitachi	L & U series	Long life	MY-11941-22
PerkinElmer®	Series 200	Standard	MY-11941-23
	LAMBDA 2 to 45, 800, 900, Bio, 55X series, LC480	Standard	MY-11941-24
	SPD-10A, AVP, AV, AVVP, M10AVP, 20A, 20AV, M20A	Long life	MY-11941-26
Shimadzu	Spectrophotometers	Long life	MY-11941-27
	LC2010	Long life	MY-11941-28
Thermo Scientific™	TSP UV100, 150, 200, 1000, 2000, 3000	Standard	MY-11941-29
	TSP SA6510, SP770, SP970, SP8480XR, SP8773XR	Standard	MY-11941-30
Thermo Scientific™ Unicam	Thermo Unicam 4225	Standard	MY-11941-25
Varian	UV50, 100, 200, 9050, Prostar 310	Long life	MY-11941-31
	ProStar 325, 335	Long life	MY-11941-33
	ProStar 330 DAD	Long life	MY-11941-32
	ProStar 340, 345	Standard	MY-11941-34
Waters	996, 2996 PDA	Long life	MY-11941-35
	2487	Long life	MY-11941-36

## Advantec® Glass and Stainless Steel Microanalysis Filter Holders

Perfect for small to medium volumes of liquid

- Standard size for microbiology and particulate analysis
- Available with sintered glass, stainless steel, or PTFE support

The glass filter holders feature borosilicate glass funnel and base, silicone rubber stopper, and anodised aluminum clamp. The 90 mm holders are ideal for large-volume viscous samples or those with a heavy particle or bioburden that would clog a 47-mm filter.

Model 06645-98 is for sterility testing of antibiotics and pharmaceuticals; it features a silicone funnel cover and tubing, glass stopcock, stainless steel injector needle, and 13-mm holder. Use with sterility test manifold at right.

Model 06644-80 features an unbreakable 304 stainless steel funnel/base/support and a PTFE gasket—the entire holder can be flame sterilised to sanitise between samplings. Set pins and a locking nut on the funnel prevent twisting and tearing of the membrane.



Sintered glass filter holder 06644-84



All-stainless-steel filter holder 06644-80

Membrane size	Support	Filtration area	Funnel size	Stopper size	Catalogue number
<b>Standard glass filter holders</b>					
13 mm	Sintered glass	1.2 cm <sup>2</sup>	100 mL	No. 5	MY-06644-81
			500 mL		MY-06644-82
			1000 mL		MY-06644-83
			13/100 mL <sup>†</sup>		MY-06644-84 <sup>†</sup>
25 mm	Sintered glass	2.1 cm <sup>2</sup>	15 mL	No. 5	MY-06645-13
			150 mL		MY-06645-23
			300 mL		MY-06645-25
25 mm	Stainless steel	2.1 cm <sup>2</sup>	15 mL	No. 5	MY-06645-95
			150 mL		MY-06645-96
			300 mL		MY-06645-31
47 mm	Sintered glass	9.6 cm <sup>2</sup>	100 mL	No. 8	MY-06644-88
			300 mL		MY-06644-85
			500 mL		MY-06644-91
			1000 mL		MY-06644-94
47 mm	Stainless steel	9.6 cm <sup>2</sup>	100 mL	No. 8	MY-06644-89
			300 mL		MY-06644-86
			500 mL		MY-06644-92
			1000 mL		MY-06644-95
47 mm	PTFE	9.6 cm <sup>2</sup>	100 mL	No. 8	MY-06644-90
			300 mL		MY-06644-87
			500 mL		MY-06644-93
90 mm	Sintered glass	43 cm <sup>2</sup>	1000 mL	No. 8	MY-06644-97
			1000 mL		MY-06644-98
<b>Glass sterility test filter holder</b>					
47 mm	Sintered glass	9.6 cm <sup>2</sup>	300 mL	No. 8	MY-06645-98
<b>All-stainless-steel filter holder with SS funnel and base</b>					
47 mm	Stainless steel	9.3 cm <sup>2</sup>	500 mL	No. 8	MY-06644-80

<sup>†</sup>Model 06644-84 has a two-part funnel connected by a ground-glass joint.

## Advantec® Vacuum Filtration Manifolds

Significantly reduce process time compared to gravity methods

- Connect three or six filter holders to one vacuum source



**Stainless Steel Manifolds** have two- or three-way PTFE valves for each branch to provide individual control of vacuum and air venting. Branches accept size 8 stoppers. Hose barb accepts 3/8" ID vacuum tubing. Autoclavable.

**Sterility Test Manifolds** feature an extra flushing manifold for sterile buffer. Specifications are the same as SS models described above except each branch has a 1/4" hose barb connection to flushing manifold. Use with sterility test filter holder 06645-98 at left. Autoclavable.

**PVC Manifolds** have branches with two-way PTFE valves for independent control of vacuum. Hose barb accepts 1/4" ID tubing. Branches accept size 8 stoppers. Sanitise with ethanol or formaldehyde; do not autoclave. Max temperature is 60°C (140°F).

Valve type	No. of branches	Dimensions (L x W x H)		Catalogue number
		cm	in.	
<b>Stainless steel manifolds</b>				
2-way	3	45.7 x 12.1 x 17.8	18 x 4 3/4 x 7	MY-02924-20
	6	72.4 x 12.1 x 17.8	28 1/2 x 4 3/4 x 7	MY-02924-30
3-way	3	45.7 x 12.1 x 17.8	18 x 4 3/4 x 7	MY-02924-85
	6	72.4 x 12.1 x 17.8	28 1/2 x 4 3/4 x 7	MY-02924-95
<b>Sterility test manifolds</b>				
3-way	3	45.1 x 12.1 x 17.8	17 3/4 x 4 3/4 x 7	MY-02924-00
	6	72.4 x 12.1 x 17.8	28 1/2 x 4 3/4 x 7	MY-02924-10
<b>PVC manifolds</b>				
2-way	3	45.1 x 12.1 x 17.8	17 3/4 x 4 3/4 x 7	MY-02924-40
	6	87.6 x 12.1 x 17.8	34 1/2 x 4 3/4 x 7	MY-02924-50

## Advantec® High-Pressure Stainless Steel Filter Holder

Operates at pressures up to 1400 psi (100 kg/cm<sup>2</sup>)

This filter holder is constructed of type 304 stainless steel and has FPM O-rings, making it compatible with many aggressive liquids and gases. Back pressure support screen prevents membrane rupture and deflects flow at very high pressures. Holder has 1/4" NPT(F) inlet and outlet. Membrane prefilter size is 38-mm. Upstream dead volume is 3-mL and downstream volume is 6.5-mL.



Filter diameter	Filtration area	Catalogue number
47 mm	11.2 cm <sup>2</sup>	MY-06644-50



# Kinesis® Autosampler Vials and Closures

## Compatible with all autosamplers

Autosampler vials are constructed of type I borosilicate glass to provide excellent chemical resistance to acid and neutral solutions. Traditional crimp vials offer reliable use with autosamplers. Short thread vials have a wide opening (6.0-mm) with a unique thread design that allows you to screw on the caps and still use them in a robotic autosampler; the thread sits much higher on the vial allowing space between the bottom of the thread and the shoulder of the vial. Snap cap vials feature caps that can be applied and removed by hand—a suitable alternative when a crimping tool is not available.

Closures are available in different colors and septum materials to suit your application. UltraBond™ cap and septum form a one-piece unit with a bonding process without adhesives for contamination-free results. UltraClean™ high-purity septa are optimised for GC and headspace analysis. Red rubber/PTFE: improved level of cleanliness compared to natural rubber and PTFE coating ensures compatibility. Natural rubber/TEF: features excellent resealing properties. Silicone/PTFE: cleanest solution for contaminant-free sample handling. PTFE/silicone/PTFE: PTFE laminated to both sides of high-purity silicone prevents coring.

Limited-volume inserts are used with autosampler vials to allow for small volume sample analysis.



### Vials

Capacity	Colour	Vials description	Qty/pk	Catalogue number
<b>Crimp vials</b>				
2 mL	Clear	No label	1000	MY-98705-53
		Label and filling lines	1000	MY-98705-57
	Amber	Label and filling lines	1000	MY-98705-58
1.1 mL	Clear	High recovery	1000	MY-98705-67
<b>Short thread vials</b>				
2 mL	Clear	No label	1000	MY-98702-65
		Label and filling lines	1000	MY-98702-67
	Amber	Label and filling lines	1000	MY-98702-68
1.5 mL	Clear	High recovery	1000	MY-98702-97
0.9 mL	Clear	Total recovery	1000	MY-98702-99
<b>Snap cap vials</b>				
2 mL	Clear	No label	1000	MY-98705-16
		Label and filling lines	1000	MY-98705-17
	Amber	Label and filling lines	1000	MY-98705-18
0.9 mL	Clear	Total recovery	1000	MY-98705-34



Crimp vial  
98705-53

Crimp vial  
98705-58

Short thread  
vial 98702-99



Short thread  
vial 98702-67

Short thread  
vial 98702-65

Snap cap  
vial  
98705-16

Snap cap vial  
98705-18

### Closures

Cap description	Septum description	Septum thickness	Septum hardness	Qty/pk	Catalogue number
<b>Crimp caps, aluminum</b>					
Silver	Natural rubber/transparent PTFE	1.0 mm	60° shore A	1000	MY-98704-34
	Red PTFE/white silicone/red PTFE	1.0 mm	45° shore A	1000	MY-98704-46
	UltraClean white silicone/red PTFE	1.5 mm	45° shore A	1000	MY-98704-54
<b>Short thread caps, polypropylene</b>					
Transparent, open	Natural rubber/transparent TEF	1.0 mm	60° shore A	1000	MY-98703-33
Blue, open	Red PTFE/white silicone/red PTFE	1.0 mm	45° shore A	1000	MY-98703-42
UltraClean, open	White silicone/red PTFE	1.0 mm	55° shore A	1000	MY-98703-48
UltraBond, open	White silicone/red PTFE	1.3 mm	45° shore A	1000	MY-98703-63
<b>Snap caps, polyethylene</b>					
Transparent	Natural rubber/TEF	1.0 mm	60° shore A	1000	MY-98706-34
Blue	PTFE red/silicone white/PTFE red	1.0 mm	45° shore A	1000	MY-98706-41
	UltraClean silicone white/PTFE red	1.3 mm	45° shore A	1000	MY-98706-45



Crimp cap  
98704-54

Short  
thread  
cap  
98703-42

Snap  
cap  
98706-34



### Accessories

**MY-98700-93 Limited-volume insert**, glass, conical bottom, 15 mm taper, 0.1 mL.  
Pack of 1000

**MY-98700-97 Limited-volume insert**, glass, conical bottom, 12mm taper, 0.1 mL.  
Pack of 1000

## Kinesis® Headspace Vials and Closures

Designed for use in headspace analysers

- Made from type I Class 51 borosilicate glass
- Select from 20 mm crimp neck or 18 mm screw neck vials

Type I Class 51 borosilicate glass provide excellent chemical resistance to various solutions. Vial design ensures full automation compatibility for headspace analysers for both handling and needle positioning. UltraClean™ high-purity septa are optimised for GC and headspace analysis.



**Kinesis**  
EP

### Vials

Capacity	Colour	Description	Dimensions (mm)		Qty/pk	Catalogue number
			H	OD		
20 mL	Clear	Round bottom, standard crimp neck	76	23	1000	<b>MY-98700-28</b>
	Amber				1000	<b>MY-98700-29</b>
20 mL	Clear	Round bottom, DIN crimp neck	76	23	1000	<b>MY-98700-30</b>
	Amber				1000	<b>MY-98700-31</b>
20 mL	Clear	Round bottom, screw neck	76	23	1000	<b>MY-98700-36†</b>
20 mL	Clear	Round bottom, magnetic screw cap	76	23	1000	<b>MY-98700-37</b>
	Amber				1000	<b>MY-98700-38</b>

†Use only with polypropylene screw cap 98706-71.

### Closures

Cap description	Septum description	Septum thickness	Septum hardness	Qty/pk	Catalogue number
Aluminum, 20 mm crimp	Pharma-Fix red butyl/grey PTFE	3.0 mm	50° shore A	1000	<b>MY-98704-65</b>
	Natural PTFE/clear silicone	3.0 mm	50° shore A	1000	<b>MY-98704-67</b>
Polypropylene, 18 mm screw	Red butyl/grey PTFE	1.6 mm	55° shore A	1000	<b>MY-98706-71</b>
Magnetic aluminum, 18 mm screw	UltraClean transparent blue silicone/white PTFE	1.3 mm	45° shore A	1000	<b>MY-98706-78</b>

## Kinesis® EPA Vials and Closures

Meets EPA requirements for testing environmental contaminants

- Made of type I borosilicate glass for testing of potentially harmful environmental contaminants in water or soil samples
- Vials meet the requirements of the US Environmental Protection Agency (EPA) for contamination-free containers

These flat-bottom EPA vials are free of substances that might influence sample analysis. Chemically inert type I borosilicate glass is ideal for soil and water samples. Vials are available in clear glass or amber glass for light-sensitive samples.



**Kinesis**  
EP

### Vials

Capacity	Colour	Dimensions (mm)		Neck diameter	Qty/pk	Catalogue number
		H	OD			
20 mL	Clear	57	28	24 mm	1000	<b>MY-98700-49</b>
	Amber				1000	<b>MY-98700-47</b>
40 mL	Clear	95	28	24 mm	1000	<b>MY-98700-58</b>
	Amber				1000	<b>MY-98700-55</b>
60 mL	Clear	140	28	24 mm	1000	<b>MY-98700-67</b>
	Amber				1000	<b>MY-98700-63</b>

### Closures

Septa description	Septa		Cap		Qty/pk	Catalogue number
	Thick-ness	Hard-ness	Colour	Neck dia.		
Silicone white/PTFE beige, center hole	3.2 mm	45° shore A	White	24 mm	1000	<b>MY-98700-71</b>
Butyl red/PTFE gray, center hole	2.5 mm	55° shore A	White	24 mm	1000	<b>MY-98704-19</b>
Butyl red/PTFE gray, closed cap					1000	<b>MY-98704-20</b>
PTFE blue/EPDM black/PTFE blue, closed cap	2.0 mm	65° shore A	White	24 mm	1000	<b>MY-98704-21</b>

## Kinesis® Manual Crimpers and Decappers

Achieve a dependable and secure seal every time

- Perfect for chromatography and general applications

All crimpers and decappers are manufactured with a chemical-resistant finish and alloy crimping jaws. The 11-, 13-, and 20-mm crimping tools feature a hex screw to adjust the crimping pressure and height, accommodating various neck designs and septa thicknesses.



**Kinesis**  
EP

Cap size	Crimpers	Decappers
	Catalogue number	Catalogue number
8 mm	<b>MY-98706-83</b>	<b>MY-98706-84</b>
11 mm	<b>MY-98706-85</b>	<b>MY-98706-86</b>
13 mm	<b>MY-98706-87</b>	<b>MY-98706-88</b>
20 mm	<b>MY-98706-81</b>	<b>MY-98706-82</b>
32 mm	<b>MY-98706-89</b>	<b>MY-98706-90</b>

## Cole-Parmer® VapLock™ Closed Systems

### Protect lab personnel from hazardous solvent vapours

- Minimise chemical exhaust from solvent reservoir bottles and waste containers—ideal for HPLC and other analytical testing instruments
- Avoid costly fines by maintaining regulatory compliance
- Achieve repeatable results and ensure reagent purity is maintained
- Simply attach to any standard solvent bottle and waste container
- Versatile—large selection of components provides a solution for virtually any system

#### Solvent Delivery

- Cap forms a secure seal preventing contamination and evaporation
- Integral check valve prevents vapours from escaping
- Filtered air automatically replaces fluid withdrawn from the container, preventing pump cavitation
- Simple and quick bottle changes—easy to remove without tangling or twisting reagent tubes



**Solvent Delivery Container Caps.** PTFE cap body, PP spin collar, PTFE/SS integrated air inlet valve, and 50 µm PTFE intake filter. Caps are available in multiple colours to help visually identify reagent bottle contents.

Cap size	Ports	Seal material	Colour	Catalogue number
GL45	(2) 6.4 mm (1/4") -28 UNF(F)	FFKM	Yellow	MY-12018-08
		EPDM	Green	MY-12018-06
	(4) 6.4 mm (1/4") -28 UNF(F)	FFKM	Yellow	MY-12018-09
		EPDM	Green	MY-12018-07

#### Waste Collection

- Fully enclosed and sealed system collects waste while containing harmful vapours
- Manifolds include multiple connection ports to adapt to your system; free-spinning collar allows quick disconnect
- Exhaust filter adsorbs solvent vapours to prevent escaping to the environment; use the optional breakthrough indicator to know when to replace
- Kits include everything needed for closed waste containment—select a waste manifold kit to use with your existing container, or choose a system with waste container included

**Waste Manifold Kits.** Include a 10-port manifold [6 ports x 1/4"-28 UNF(F), 3 ports x 1/4" NPT(F), and 1 port x 1/2" NPT(F)], fittings, plugs for unused ports, tubing with connections, and exhaust filter with breakthrough indicator.

Cap size	Manifold material	Catalogue number
38-430	PTFE	MY-12018-63
Wako 38 mm	PP	MY-12018-68
Wako 38 mm	PTFE	MY-12018-69
GL45	PTFE	MY-12018-75
DIN 45	PP	MY-12018-80

**Solvent Waste Systems.** Include container, manifold, fittings, plugs for unused ports, tubing with connections, and exhaust filter with breakthrough indicator.

Container	Manifold	Fittings	Catalogue number
20-L capacity, translucent PE, FM approved, OSHA, NFPA, and EPA compliant	10 ports, PP	Quick-disconnect, PP	MY-12020-69
	10 ports, PTFE	Quick-disconnect, SS	MY-12020-70



For a full selection, please go online.

#### Breakthrough Filter Indicator

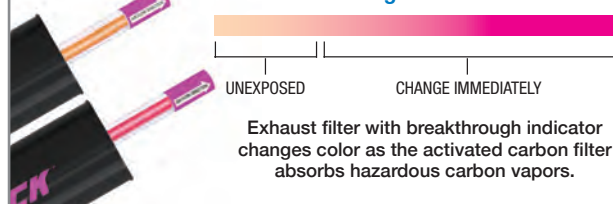

Exhaust filter with breakthrough indicator changes color as the activated carbon filter absorbs hazardous carbon vapors.

**Replacement Exhaust Filters.** Activated carbon, HDPE cartridge, 1/4" NPT(F) port. Average usage before replacement is 3 to 4 months, dependent upon application conditions.

Description	Qty	Catalogue number
75 g filter	1	MY-12019-79
	5	MY-12019-81
75 g filter with breakthrough indicator	1	MY-12019-80



# Typical Chromatography System

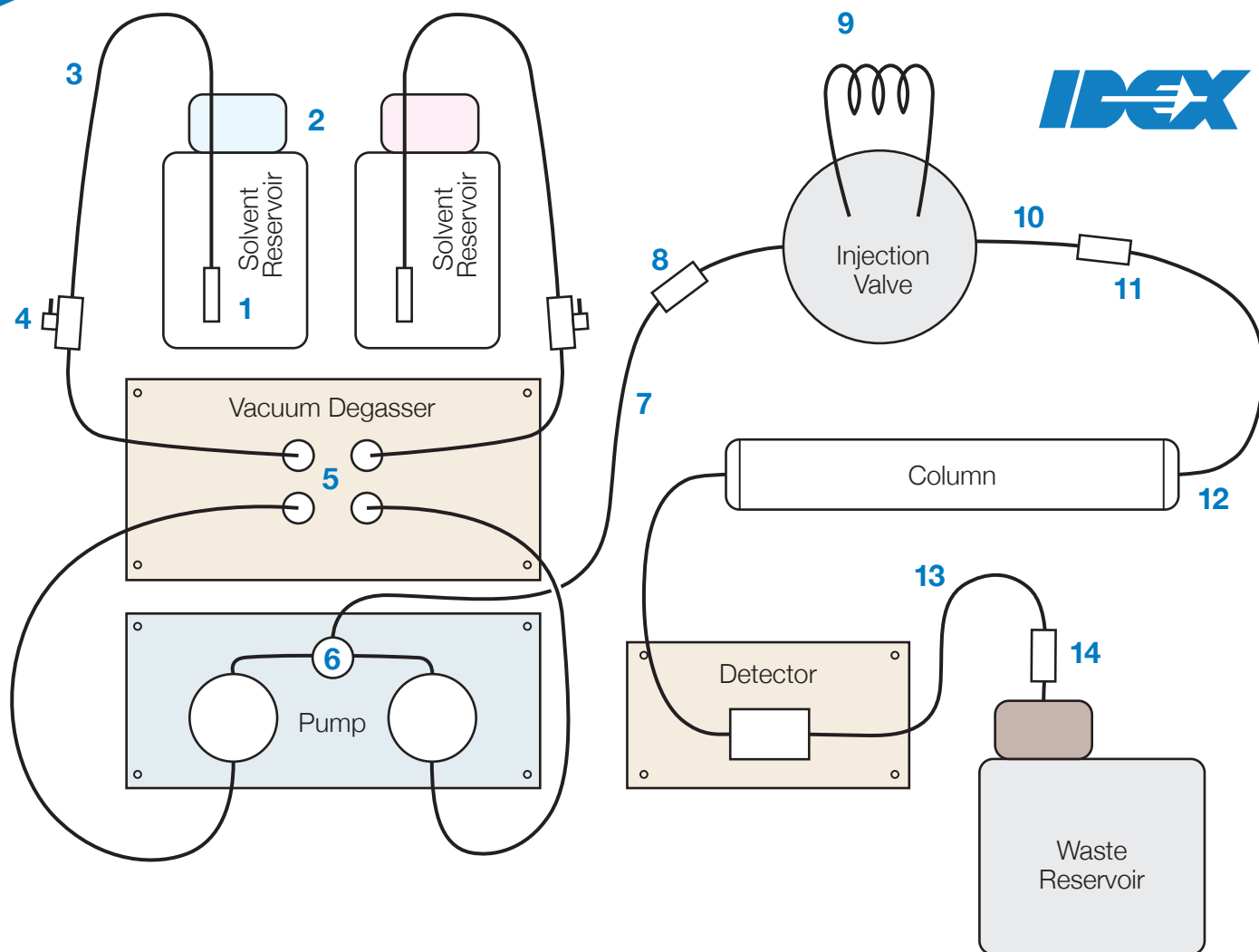

- |  |  |
|--|--|
| <b>1</b> Inlet Solvent Filter            | <b>8</b> High-Pressure Inline Filter       |
| <b>2</b> Bottle Caps                     | <b>9</b> Sample Loop                       |
| <b>3</b> FEP Tubing                      | <b>10</b> Narrow-Bore High-Pressure Tubing |
| <b>4</b> Shut-Off Valve                  | <b>11</b> Pre-Column Filter                |
| <b>5</b> Super Flangeless™ Fittings      | <b>12</b> Marvel XACT® Fitting             |
| <b>6</b> Stainless Steel Fittings        | <b>13</b> 1/16" OD FEP Tubing              |
| <b>7</b> 1/16" OD Stainless Steel Tubing | <b>14</b> Back Pressure Regulator          |

Check out [ColeParmer.com/idx](https://www.coleparmer.com/idx) for our complete selection of chromatography accessories from IDEX Health & Science

## Diba Omnifit® EZ and EZ SolventPlus™ Chromatography Columns

### Ergonomically designed endpieces provide simple and quick height adjustment

- Precision borosilicate glass columns provide inertness, visibility, and performance
- PEEK™ column threads offer outstanding durability
- Superior frit placement adds bed support and even distribution of sample flow
- Reusable columns let you pack your own media specific to your application

**Ergonomically designed EZ columns** are easy to use yet provide excellent results. Columns are ideal for low- to medium-pressure applications and are resistant to many solvents used in liquid chromatography. Modular design gives you the flexibility to mix and match column sizes with different endpiece types to meet your specific requirements.

Order **EZ SolventPlus columns** for techniques using organic solvents such as reversed phase chromatography. EZ SolventPlus columns have only the most chemically inert materials in the fluid path—borosilicate glass, PTFE, ETFE, and Chemraz®—ensuring the utmost chemical resistance.

Select from three endpiece configurations to suit your application—one fixed and one adjustable, two adjustable, or two fixed. Each adjustable endpiece gives you the flexibility to modify the bed length up to 80 mm in height (up to 160 mm with two adjustable endpieces). Once in place, fine adjustments can be made to position the endpiece to cause minimal disturbance to the packed bed. Each column is supplied assembled and ready to use, with all the tubing, fittings, and connections needed to get started.

**What's included:** a frit kit (contains two each of 10 µm PE, 10 µm PTFE, and 30 µm PTFE frits), a Click-N-Seal® 10-32 PEEK conical port fitting, and two 1.6 mm (1/16") OD PTFE tubing assemblies with 1/4-28 UNF fitting at one end (PP for EZ columns and ETFE for EZ SolventPlus columns).



#### Specifications

Materials	EZ columns	EZ SolventPlus columns
Column	Borosilicate glass	Borosilicate glass
Endpiece & plunger	PTFE	PTFE
Threaded ends	PEEK	PEEK
Frit (bed support)	PE	PTFE
O-ring	FKM/FPM	Chemraz
Adjusting nut	Acetal	Acetal
Retaining nut	Acetal	Acetal
Connection cap	Glass-filled PP	ETFE
Fitting nuts	Glass-filled PP	ETFE

#### Omnifit EZ Columns

Column ID	Column length	Max pressure	One fixed & one adjustable endpieces	Two adjustable endpieces	Two fixed endpieces
			Catalogue number	Catalogue number	Catalogue number
6.6 mm	100 mm	900 psi	MY-11942-94	MY-11942-93	MY-11942-95
	250 mm		MY-11943-00	MY-11942-99	MY-11943-01
10 mm	250 mm	600 psi	MY-11943-15	MY-11943-14	MY-11943-16
	500 mm		MY-11943-24	MY-11943-23	MY-11943-25
15 mm	250 mm	300 psi	MY-11943-33	MY-11943-32	MY-11943-34
	400 mm		MY-11943-39	MY-11943-38	MY-11943-40
25 mm	250 mm	150 psi	MY-11943-51	MY-11943-50	MY-11943-52
	500 mm		MY-11943-60	MY-11943-59	MY-11943-61
35 mm	250 mm	150 psi	MY-11943-66	MY-11943-65	MY-11943-67
	330 mm		MY-11943-69	MY-11943-68	MY-11943-70
50 mm	250 mm	75 psi	MY-11943-75	MY-11943-74	MY-11943-76

#### Omnifit EZ SolventPlus Columns

Column ID	Column length	Max pressure	One fixed & one adjustable endpieces	Two adjustable endpieces	Two fixed endpieces
			Catalogue number	Catalogue number	Catalogue number
6.6 mm	100 mm	900 psi	MY-11943-90	MY-11943-89	MY-11943-91
	400 mm		MY-11944-02	MY-11944-01	MY-11944-03
10 mm	150 mm	600 psi	MY-11944-08	MY-11944-07	MY-11944-09
15 mm	250 mm	300 psi	MY-11944-29	MY-11944-28	MY-11944-30
25 mm	250 mm	150 psi	MY-11944-47	MY-11944-46	MY-11944-48
35 mm	250 mm	150 psi	MY-11944-62	MY-11944-61	MY-11944-63
50 mm	250 mm	75 psi	MY-11944-71	MY-11944-70	MY-11944-72

#### Configurations

All Omnifit columns are supplied assembled and ready for use, with tubing and fittings to connect the column into an existing system. Three configurations are available:

- One fixed endpiece as a bed support and one adjustable endpiece (plunger) to adjust the bed height. The adjustable endpiece is designed to give the user fine control over the movement of the endpiece, minimising the risk of disturbance to the packed bed and giving 80-mm of height adjustment.
- Two adjustable endpieces for maximum flexibility in bed height. With an adjustable endpiece at both ends of the column, the user gains 160-mm of adjustment, offering a wide range of bed lengths and volumes.
- Non-adjustable with two fixed endpieces, a cost-effective option when height adjustment is not important.

**Additional sizes are available—go online for the full selection.**

## Diba Omnifit® Replacement Parts and Accessories

The glass tubes and accessories listed below are compatible with the Omnifit EZ and EZ SolventPlus™ chromatography columns. The modular design offers the ultimate flexibility—you can mix and match column sizes with different endpiece types to your specific requirements.

Replacement empty glass tubes are available in a wide range of internal diameters and lengths. This not only enables you to replace a column should breakage occur, but allows you to obtain several different length columns to use with endpieces you already have for that bore size. Use the packing sleeves to join two columns for packing and repacking.

Description	Length / Bore	6.6 mm	10 mm	15 mm	25 mm	35 mm	50 mm
Replacement glass tubes for EZ and EZ SolventPlus columns	50 mm	MY-11942-27	—	—	—	—	—
	100 mm	MY-11942-28	MY-11942-33	MY-11942-39	MY-11942-45	—	—
	150 mm	MY-11942-29	MY-11942-34	MY-11942-40	MY-11942-46	MY-11942-51	—
	250 mm	MY-11942-30	MY-11942-35	MY-11942-41	MY-11942-47	MY-11942-52	MY-11942-55
	330 mm	MY-11942-31	MY-11942-36	MY-11942-42	MY-11942-48	MY-11942-53	MY-11942-56
	400 mm	MY-11942-32	MY-11942-37	MY-11942-43	MY-11942-49	MY-11942-54	MY-11942-57
Replacement endpieces for EZ columns	Adjustable	MY-11942-00	MY-11942-01	MY-11942-02	MY-11942-03	MY-11942-04	MY-11942-05
	Fixed	MY-11942-08	MY-11942-09	MY-11942-10	MY-11942-11	MY-11942-12	MY-11942-13
Replacement endpieces for EZ SolventPlus columns	Adjustable	MY-11942-59	MY-11942-60	MY-11942-61	MY-11942-62	MY-11942-63	MY-11942-64
	Fixed	MY-11942-66	MY-11942-67	MY-11942-68	MY-11942-69	MY-11942-70	MY-11942-71
Replacement frits (PE) for EZ columns	25 µm	MY-11944-98	MY-11945-04	MY-11945-10	MY-11945-16	MY-11945-22	MY-11945-28
Replacement frits (PTFE) for EZ SolventPlus columns	5 µm	MY-11944-95	MY-11945-01	MY-11945-07	MY-11945-13	MY-11945-19	MY-11945-25
	10 µm	MY-11944-96	MY-11945-02	MY-11945-08	MY-11945-14	MY-11945-20	MY-11945-26
	20 µm	MY-11944-97	MY-11945-03	MY-11945-09	MY-11945-15	MY-11945-21	MY-11945-27
	30 µm	MY-11944-99	MY-11945-05	MY-11945-11	MY-11945-17	MY-11945-23	MY-11945-29
	50 µm	MY-11945-00	MY-11945-06	MY-11945-12	MY-11945-18	MY-11945-24	MY-11945-30
Replacement O-rings (FKM/FPM) for EZ columns	—	MY-11945-46	MY-11945-48	MY-11945-50	MY-11945-52	MY-11945-54	MY-11945-56
Replacement O-rings (Chemraz®) for EZ SolventPlus columns	—	MY-11945-45	MY-11945-47	MY-11945-49	MY-11945-51	MY-11945-53	MY-11945-55
Packing sleeves for EZ and EZ SolventPlus columns	—	MY-11942-15	MY-11942-16	MY-11942-17	MY-11942-18	MY-11942-19	MY-11942-20

# HAMILTON®

Hamilton syringes are the finest precision fluid measuring devices available. Top quality materials and skilled workmanship ensure Hamilton syringes consistently deliver the highest possible performance for reliable analyses. With proper care and handling, Hamilton syringes provide unsurpassed performance for many years.

Hamilton  
full range now  
available from  
Cole-Parmer





## Kinesis TELOS® QuEChERS Extraction Kits

Quickly and economically extract the required analytes into solution

- Salt pack helps transfer salt to the centrifuge tube quickly and easily with minimal waste
- Conform with documented AOAC 2007.01 and EN 15662 protocols



TELOS QuEChERS extraction kits offer the first stage clean-up for many sample types. This initial crude extraction and partitioning step uses organic solvent and salt solution to extract the required analytes into solution. Select from kits without tubes, with 50-mL centrifuge tubes, or with tubes and homogeniser beads. Beads aid in breaking up more complex sample types.

Methodology	Description	Qty/pk	Catalogue number
<b>4 g MgSO<sub>4</sub> (anhydrous), 1 g NaAc (anhydrous)</b>			
AOAC 2007.01	Without tubes	50	<b>MY-06478-96</b>
	With tubes	50	<b>MY-06478-95</b>
	With tubes and beads	50	<b>MY-06478-97</b>
<b>6 g MgSO<sub>4</sub> (anhydrous), 1.5 g NaAc (anhydrous)</b>			
AOAC 2007.01	Without tubes	50	<b>MY-06478-89</b>
	With tubes	50	<b>MY-06478-88</b>
	With tubes and beads	50	<b>MY-06478-90</b>
<b>6 g MgSO<sub>4</sub> (anhydrous), 1.5 g NaAc 3H<sub>2</sub>O</b>			
AOAC 2007.01	Without tubes	50	<b>MY-06478-83</b>
	With tubes	50	<b>MY-06478-82</b>
	With tubes and beads	50	<b>MY-06478-84</b>
<b>4 g MgSO<sub>4</sub> (anhydrous), 1 g NaCl, 0.5 g disodium citrate sesquihydrate (TSCD), 1 g sodium citrate (DHS)</b>			
EN 15662	Without tubes	50	<b>MY-06479-01</b>
	With tubes	50	<b>MY-06479-00</b>
	With tubes and beads	50	<b>MY-06479-02</b>

## Kinesis TELOS® QuEChERS Clean-Up Kits

Perform more advanced clean-up for cleaner samples

- Remove pigments, acids, and fats using three different combinations of SPE sorbents
- Anhydrous magnesium sulfate removes any excess water



Further clean-up of samples is easy with TELOS QuEChERS clean-up kits. After initial sample prep with the extraction kit, a more advanced clean-up is often required for the removal of interferences such as pigments, organic acids, and fats. The removal of these interferences is carried out using a combination of three different SPE sorbents (see below). Each clean-up kit comes with 2-mL or 15-mL centrifuge tubes, depending on the sample volume and methodology followed.

**TELOS PSA:** removes organic acids

**TELOS C18:** removes non-polar interferences, including fats

**TELOS PestiCarb:** removes pigments, including chlorophyll and carotenoids

Methodology	Sorbent	Included tube size	Qty/pk	Catalogue number
<b>General clean-up kits</b>				
AOAC 2007.01	150 mg MgSO <sub>4</sub> (anhydrous) & 50 mg PSA	2 mL	100	<b>MY-06479-04</b>
	1.2 g MgSO <sub>4</sub> (anhydrous) & 400 mg PSA	15 mL	50	<b>MY-06479-07</b>
EN 15662	150 mg MgSO <sub>4</sub> (anhydrous) & 25 mg PSA	2 mL	100	<b>MY-06479-05</b>
	900 mg MgSO <sub>4</sub> (anhydrous) & 150 mg PSA	15 mL	50	<b>MY-06479-06</b>
<b>Removal of fats and proteins</b>				
AOAC 2007.01	150 mg MgSO <sub>4</sub> (anhydrous), 50 mg PSA, & 50 mg C18	2 mL	100	<b>MY-06478-65</b>
	1.2 g MgSO <sub>4</sub> (anhydrous), 400 mg PSA, & 400 mg C18	15 mL	50	<b>MY-06478-68</b>
EN 15662	150 mg MgSO <sub>4</sub> (anhydrous), 25 mg PSA, & 25 mg C18	2 mL	100	<b>MY-06478-66</b>
	900 mg MgSO <sub>4</sub> (anhydrous), 150 mg PSA, & 150 mg C18	15 mL	50	<b>MY-06478-77</b>
NYT 1380-2007	300 mg MgSO <sub>4</sub> (anhydrous), 100 mg PSA, & 100 mg C18	15 mL	50	<b>MY-06478-67</b>
<b>Removal of pigments</b>				
AOAC 2007.01	150 mg MgSO <sub>4</sub> (anhydrous), 50 mg PSA, & 50 mg PestiCarb	2 mL	100	<b>MY-06479-09</b>
	1.2 g MgSO <sub>4</sub> (anhydrous), 400 mg PSA, & 400 mg PestiCarb	15 mL	50	<b>MY-06479-14</b>
EN 15662	150 mg MgSO <sub>4</sub> (anhydrous), 25 mg PSA, & 2.5 mg PestiCarb	2 mL	100	<b>MY-06479-10</b>
	150 mg MgSO <sub>4</sub> (anhydrous), 25 mg PSA, & 7.5 mg PestiCarb	2 mL	100	<b>MY-06479-11</b>
<b>Removal of fats, proteins, and pigments</b>				
AOAC 2007.01	150 mg MgSO <sub>4</sub> (anhydrous), 50 mg PSA, 50 mg C18, & 50 mg PestiCarb	2 mL	100	<b>MY-06478-78</b>
	1.2 g MgSO <sub>4</sub> (anhydrous), 400 mg PSA, 400 mg C18, & 400 mg PestiCarb	15 mL	50	<b>MY-06478-80</b>

## Cole-Parmer® Jiffy-Jack® Lab Jacks

### Safely position sample or equipment

- Easily position equipment or sample with a twist of the knob
- Rugged construction stands up to heavy loads
- Add optional support rod for probes, clamps, or other items



Model 08057-20 supports up to 60 kg.

Top plate dimensions	Open height	Closed height	Max support static load	Catalogue number
<b>Plastic lab jack</b>				
20.3 x 20.3 cm	30.5 cm	7.6 cm	6 kg	MY-08055-50
<b>Aluminum lab jacks</b>				
10.2 x 10.2 cm	12.7 cm	6.4 cm	30 kg	MY-08057-10
15.2 x 15.2 cm	24.8 cm	7.6 cm	60 kg	MY-08057-20
20.3 x 20.3 cm	33.0 cm	8.9 cm	80 kg	MY-08057-30
25.4 x 25.4 cm	33.0 cm	8.9 cm	90 kg	MY-08057-40
<b>Stainless steel heavy-duty lab jacks</b>				
7.6 x 7.6 cm	12.7 cm	6.4 cm	9.0 kg	MY-08057-12
10.2 x 10.2 cm	12.7 cm	6.4 cm	13.6 kg	MY-08057-14
15.2 x 15.2 cm	24.8 cm	7.6 cm	15.8 kg	MY-08057-16
20.3 x 20.3 cm	33.0 cm	8.9 cm	25.0 kg	MY-08057-18
25.4 x 25.4 cm	33.0 cm	8.9 cm	36.3 kg	MY-08057-22
30.5 x 30.5 cm	49.5 cm	10.2 cm	68.0 kg	MY-08057-24
40.6 x 40.6 cm	49.5 cm	10.2 cm	81.6 kg	MY-08057-26

#### Accessories

**MY-08057-50 Ratchet tool** adds extra leverage to models 08057-24 and -26

**MY-08057-52 Support rod kit** allows you to mount a 43.2 cm L vertical support rod to models 08057-16, -18, -22, -24, and -26

## Keck® Connectors, Clamps, and Clips

### Keep connections together

#### A. Keck Original Standard Taper Clips

Economical standard taper clips securely hold conical joints under pressure without damaging glass. The polyoxymethylene (POM) acetal resin clips are safe to 150°C. Resistant to concentrated alkalis and dilute acids (not resistant to halogen gases and concentrated acids).

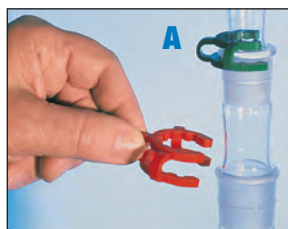

Plastic taper clips are easy to attach and remove.

Joint size no.	Colour	Qty/pk	Catalogue number
10	Green	12	MY-06839-90
12	Violet		MY-06839-95
14	Yellow		MY-06840-05
19	Blue	12	MY-06840-10
24	Green		MY-06840-15
29	Red		MY-06840-20
34	Orange	12	MY-06840-25
40	Yellow		MY-06840-30
45	Brown		MY-06840-35

#### Accessories

**MY-06840-00 Standard taper clip assortment pack.**

Six each of sizes 14, 19, 24, and 29 (24 total)

**MY-06840-50 Standard taper clip assortment pack.**

Three each of all nine sizes in table above (27 total)

#### B. Keck Metal Standard Taper Clips

Durable nickel-plated steel taper clips securely hold conical joints under pressure. Clips offer superior chemical and temperature resistance—withstanding temperatures to 500°C.



Joint size no.	Qty/pk	Catalogue number
14	6	MY-06836-05
19		MY-06836-10
24		MY-06836-15
29		MY-06836-20

#### C. Keck Ball-Joint Clips

Secure ball and socket joints—no locking screw required. Polyoxymethylene (POM) acetal resin clips are safe to 150°C. Resistant to concentrated alkalis and dilute acids (not resistant to halogen gases or concentrated acids).



Joint size no.	Colour	Qty/pk	Catalogue number
13	Violet	12	MY-06838-10
19	Blue		MY-06838-15
29	Red		MY-06838-20
35	Orange		MY-06838-25

## Cole-Parmer® Cleaning Products

### Easily clean glass, metal, plastic, rubber, and other hard materials

- Safe and effective cleaning products
- Highly concentrated, aqueous solutions are free-rinsing
- Meet USDA guidelines for incidental contact with food processing systems
- Do not contain CFCs, phosphates, silicates, halogens, or phenols



Cleaner	Type	Cleaning applications	Dilution	pH	Packaging	Catalogue number	Qty/cs	Catalogue number
Micro-90®	Ionic, nonionic, USDA authorised	Manual or ultrasonic; removes most biological materials; cleans glass, most metals, plastic, and rubber†	1:100 to 2:100	9.5	1 L	<b>MY-18100-05</b>	12	<b>MY-18100-04</b>
					4 L	—	4	<b>MY-18100-11</b>
					18.9 L	—	1	<b>MY-18100-20</b>
					208 L drum	<b>MY-18100-30</b>	—	—
Zymit®	Enzymatic, USDA authorised	Machine, manual, or ultrasonic; dissolves protein and starch-based soils; may use for delicate materials	1:100	7.5	1 L	<b>MY-18101-30</b>	12	<b>MY-18101-20</b>
LF2100™	Low-sudsing, anionic, nonionic, amphoteric, USDA authorised	Automatic washers, high-pressure and high agitation applications†	1:100	9.7	1 L	<b>MY-18102-00</b>	12	<b>MY-18102-10</b>
Surface-Cleanse/930®	Nonionic, USDA authorised	Cleans grease, petroleum, oils from glass, aluminum, lead, zinc, and plastic without surface damage	1:200	7.0	1 L	<b>MY-18103-00</b>	12	<b>MY-18103-10</b>
					20 L	<b>MY-18103-30</b>	—	—
Micro-A07®	Citric acid, nonionic, USDA authorised	Removes millstone, hard water scale, rust, mineral deposits, and other inorganic soils from filter membranes, labware, and industrial equipment	1:100 to 2:100	2.5	1 L	<b>MY-18104-00</b>	12	<b>MY-18104-01</b>
					20 L	<b>MY-18104-30</b>	—	—

†Do not use on zinc, magnesium, or aluminum.

## DisCide® ULTRA Disinfecting Towelettes and Sprays

### No wasting time—works in just one minute!

- No mixing or measuring—solutions are ready to use
- Eliminate separate towel requirements with towelettes



Description	Packaging	Qty/cs	Catalogue number
Towelettes, 15.2 x 17.1 cm	Canister of 160	12	<b>MY-86306-03</b>
Towelettes, 26.7 x 26.7 cm	Canister of 60	12	<b>MY-86306-05</b>
Spray bottle	1 L bottle	12	<b>MY-86306-13</b>
Refill bottle	4 L bottle	4	<b>MY-86306-15</b>

## Bacdown® Hand Soap

### Won't dry your skin

- Formulated specifically for those washing frequently to minimise dry, chapped skin
- Protects against Gram-negative and Gram-positive bacteria, as well as yeast and fungi

Packaging	Catalogue number
500 mL	<b>MY-86115-02</b>
1 L	<b>MY-86115-06</b>
5 L	<b>MY-86115-10</b>



## CONFLIKT® Detergent Disinfectant

### No need to dilute—ready to use

- Don't worry about contaminants—easily and effectively decontaminates surfaces
- Ammonium-based detergent disinfects and cleans hard surfaces

This prediluted detergent is effective against a wide range of viruses, bacteria, pathogenic fungi, mould, and mildew. USDA approved and EPA registered.

Packaging	Catalogue number
946 mL spray bottle	<b>MY-86115-40</b>
3.7 L refill	<b>MY-86115-44</b>





## Cole-Parmer® Ultra-Quiet Mini Lab Compressors

### Get compressed air anywhere you need it

- Quick-connect port provides simple plug-and-play use of hoses and tools
- Control outlet pressure with the turn of a dial—up to 70 psi (4.8 bar)
- Easy maintenance—filters have long service lives

These versatile lab compressors are designed for point-of-use applications—move station with the integrated handle or optional transport cart. The built-in sound enclosure allows for ultra-quiet operation, and the compact design and low-vibration performance allow placement anywhere needed.

Quick-release coupling port comes with a 9.5-mm (3/8") ID hose barb insert for easy tubing connection. Quickly see outlet pressure on the analogue pressure gauge and use the control knob for adjustment up to 4.8 bar (70 psi)—ideal for cleaning dust off sensitive equipment and components.



 Cole-Parmer®

#### Specifications

**Maximum pressure:** 101.5 psi (7 bar) operating; 5 bar (70 psi) outlet  
**Tank capacity:** 2 L (0.52 gal.)  
**Inlet port:** 10 mm OD compression  
**Duty cycle:** continuous

Max flow at 0 psi (0 bar)		Port size	hp	Noise level	Dimensions (L x W x H)		Power			Catalogue number
cfm	L/min				cm	in.	VAC	Hz	Amps	
1.48	42	7.2 mm	0.5	53 dB	39.6 x 32.1 x 29.5	15% x 12% x 11%	230	50	3.2	MY-16351-88
2.71	77		0.75	54 dB			230	50	4.8	MY-16351-89

MY-22222-31 Air gun with hose, for cleaning

MY-22222-32 Nozzle kit with eight nozzles

## Cole-Parmer® Ultra-Quiet Lab Compressors

### Quiet enough for benchtop use

- Run up to two air tools at once—quick-connect ports provide simple plug-and-play use
- Proprietary internally coated air tank and built-in membrane dryer deliver clean air for your lab needs
- Control outlet pressure with the turn of a dial—up to 8 bar
- Easy maintenance—filters are easy to replace and have long service lives

These versatile compressors are designed for point-of-use applications—take it wherever needed! Compact design and low-vibration performance allow placement on top of or under a lab bench. The built-in sound enclosure and swivel wheels allow for ultra-quiet, portable operation.

Quick-release coupling ports come with a 6.4-mm (1/4") ID hose barb insert for easy tubing connection. An additional port can be found on the rear of the unit for attachment of a second tool.

View outlet pressure on the analogue pressure gauge and use the control knob for adjustment up to 6 bar. The anti-corrosion, anti-bacterial coated air tank works with the membrane dryer (2 µm pore filter) to provide odour-free, clean air to your application.



#### Specifications

**Maximum pressure:** 8 bar (116 psi) operating; 6 bar (87 psi) outlet  
**Tank capacity:** 25 L (6.6 gal.)  
**Inlet port:** 10 mm OD compression  
**Duty cycle:** continuous

Max flow	Port size	hp	Noise level	Dimensions (L x W x H)		Power			Catalogue number
				cm	in.	VAC	Hz	Amps	
73 L/min (2.5 cfm) at 0 bar (0 psi), 36 L/min (1.27 cfm) at 5 bar (72 psi), 30 L/min (1.06 cfm) at 7 bar (101 psi)	7.2 mm Quick Connect	0.75	49 dB	51 x 58 x 65.3	20 <sup>1</sup> / <sub>16</sub> x 22 <sup>1</sup> / <sub>16</sub> x 25 <sup>23</sup> / <sub>32</sub>	230	50	5.6	MY-16351-86
105 L/min (3.7 cfm) at 0 bar (0 psi), 67 L/min (2.37 cfm) at 5 bar (72 psi), 54 L/min (1.91 cfm) at 7 bar (101 psi)		1.54	53 dB					230	50

MY-22222-31 Air gun with hose, for cleaning

MY-22222-32 Nozzle kit with eight nozzles

## Oakton® Waterproof EcoTestr™ CTS Pocket Meter

### Better results—easier and faster

- Conductivity, TDS, and salinity combined into one meter
- Large dual-line display shows parameter and temperature readings simultaneously
- Easier, more intuitive interface and indicators for battery life, readiness, and calibration
- Use redesigned cap as sample cup and as a stabilising base to stand the meter upright
- Convenient—attach a lanyard to prevent losing or dropping in the field

“Easy to use.”



ISO9001:2008  
CERTIFIED SUPPLIER



Description		EcoTestr (CTS) Con/TDS/Salinity
<b>Catalogue number</b>		<b>MY-35462-11</b>
Range	Conductivity	0.00 to 20.00 mS/cm
	TDS	0.00 to 20.00 ppt (with TDS factor 1.0)
	Salinity	0.0 to 10.0 ppt
	Temperature	0.0 to 50.0°C (32.0 to 122.0°F)
Resolution	Conductivity	10 µS, 0.1 mS
	TDS	10 ppm, 0.1 ppt
	Salinity	0.1 ppt
	Temperature	0.1°
Accuracy	Conductivity	±2% full-scale ±1 LSD
	TDS	±2% full-scale ±1 LSD
	Salinity	±2% full-scale ±1 LSD
	Temperature	0.5°C + 1 LSD
Temperature compensation		Automatic
Calibration		Single point
Power		Four 1.5 V miniature batteries (included)

## Oakton® CTSTestr™ 50 Pocket Testers

### Get benchtop accuracy in the field

- Measure conductivity, TDS, and salinity with ±1% FS accuracy
- Save money—replaceable sensor lets you use tester body over and over again
- Set up and calibrate quickly with easy-to-navigate interface
- Selectable TDS factor adds versatility
- Leakproof, stabilising cap—use to calibrate, stand upright, and store sensor
- Waterproof IP67-rated and factory calibrated



ISO9001:2008  
CERTIFIED SUPPLIER



Model		CTSTestr 50P (pin-style sensor)	CTSTestr 50C (cup-style sensor)
<b>Catalogue number</b>		<b>MY-35634-55</b>	<b>MY-35634-65</b>
Range	Conductivity	0.0 to 200.0 µS, 200 to 2000 µS; 2.00 to 20.00 mS	
	TDS	0.0 to 100.0 ppm, 100 to 1000 ppm; 0.10 to 10.00 ppt (TDS factor 0.5)	
	Salinity	0.00 to 10.00 ppt	
	Temperature	0 to 60°C (32 to 140°F)	
Accuracy		±1% full-scale (conductivity, TDS, and salinity)	
Calibration		Up to 3 points (conductivity and TDS); 1 point (salinity)	
TDS factor		0.40 to 1.00 (selectable)	
Temp. compensation		Automatic	
Power		Four AAA 1.5 V batteries (included)	

## Oakton® Waterproof EcoTestr™ Conductivity Pocket Testers

### Durable and easy to use

- View measurements clearly on large, dual-line LCD
- IP67-rated housing is waterproof, dustproof, and floats in water
- Leakproof cap with fill line functions as a sample/calibration and hydrating cup
- Secure—attach a lanyard to prevent losing or dropping in the field



35634-08

Model		EC1	TDS1	Salt1
<b>Catalogue number</b>		<b>MY-35634-06</b>	<b>MY-35634-08</b>	<b>MY-35634-12</b>
Range	Conductivity	0.1 to 200.0 µS/cm, 0 to 2000 µS/cm, 0.00 to 20.00 mS/cm	—	—
	TDS	—	0.0 to 100.0 ppm, 0 to 1000 ppm, 0.00 to 10.00 ppt	—
	Salinity	—	—	0.00 to 10.00 ppt
	Temperature	0.0 to 50.0°C (32.0 to 122.0°F)		
Accuracy	Conductivity	±1% full-scale ±1 digit	—	—
	TDS	—	±1% full-scale	—
	Salinity	—	—	±1% full-scale
	Temperature	±0.5°C	±0.5°C	±0.5°C
Temp. compensation		Automatic, 0 to 50°C		
Calibration		1 or 2 points		
Power		Four AAA batteries (included), 400 hours of continuous use		

## Oakton® Waterproof CTSTestr™ 5 Pocket Tester

### Save money by replacing sensor, not tester!

- Replaceable sensor lets you use the tester body over and over again
- Two-colour backlight indicates operating mode—blue for measurement, green for calibration
- Rugged IP67-rated housing is waterproof, dustproof, and floats in water when sensor cap is on
- Leakproof cap with fill line functions as a sample/calibration and hydrating cup



Model		CTS5
<b>Catalogue number</b>		<b>MY-35634-42</b>
Range	Conductivity	0.1 to 200.0 µS/cm, 0 to 2000 µS/cm, 0.00 to 20.00 mS/cm
	TDS	0.0 to 100.0 ppm, 0 to 1000 ppm, 0.00 to 10.00 ppt
	Salinity	0.00 to 10.00 ppt
	Temperature	0.0 to 50.0°C (32.0 to 122.0°F)
Accuracy	Conductivity	±1% full-scale
	TDS	±1% full-scale
	Salinity	±1% full-scale
	Temperature	±0.5°C
Temp. compensation		Automatic, 0 to 50°C
Calibration		1 to 3 points, automatic recognition of standards
Power		Four AAA batteries (included)

# Oakton® CON 6+ and TDS 6+ Meter Kits

## Easy, push-button calibration

- High accuracy at an affordable price, ±1% across full scale
- Five auto-ranging measurement modes—up to 200.0 mS (200.0 ppt)
- Get more accurate calibration for all five ranges
- Get temperature readings at the touch of a button

Additional features include a convenient Hold function and auto-off function that shuts meter off after 20 minutes of nonuse. Programming functions allow customization of meter for temperature compensation, temperature coefficient, normalization, cell constant, and conductivity-to-TDS conversion factor (TDS 6+) for better accuracy in varying applications.

**What's included:** protective rubber boot with stand, conductivity/TDS/temperature probe (K = 1.0), calibration solutions, sample bottles, rinse bottle, hard plastic carrying case, and four AAA batteries.



Rubber boot protects meter and doubles as a convenient stand



Description	CON 6+ kit	Precalibrated CON 6+ kit	TDS 6+ kit	Precalibrated TDS 6+ kit
<b>Catalogue number</b>	<b>MY-35604-04</b>	<b>MY-35604-05</b>	<b>MY-35604-24</b>	<b>MY-35604-25</b>
Range	Conductivity	0 to 20.00, 0 to 200.0, 0 to 2000 µS; 0 to 20.00, 0 to 200.0 mS	—	—
	TDS	—	0 to 10.00, 10 to 100.0, 100 to 1000 ppm; 1.00 to 10.00, 10.0 to 100.0, up to 200.0 ppt†	—
	Temperature	-10.0 to 110.0°C	-10.0 to 110.0°C	—
Accuracy	Conductivity	±1% full-scale	—	—
	Temperature	±0.5°C	±0.5°C	—
Temp. compensation	Automatic or manual from 0.0 to 50.0°C			
Cell constant (K)	Selectable, 0.1, 1, and 10			
Conductivity-to-TDS conversion factor	—	—	0.4 to 1.00 adjustable	
Calibration points	5 maximum, one per range			
Power	Four AAA batteries (included)			

†With K = 10 probe

**Save time, save money!**

**Choose Precalibrated**

Includes a data-rich, ISO 17025-compliant certificate!

Precalibrated by **INNOCAL**  
INNOVATIVE CALIBRATION SOLUTIONS

### Accessories

- MY-35606-53 Conductivity probe, K = 0.1**
- MY-35606-55 Repl. conductivity probe, K = 1.0**
- MY-35606-57 Conductivity probe, K = 10**
- MY-09376-00 Replacement batteries, AAA. Pk of 12**
- MY-17090-30 ILAC MRA, NIST-traceable calibration with data for conductivity meters**

# MYRON L Analog Conductivity, Resistivity, TDS, and Multiparameter Meters

## No maintenance required

- Maintenance-free, built-in electrodes do not require replating
- Don't worry about fluctuations in temperature with automatic temperature compensation

Analyze your samples on-site with these portable meters. Optional conductivity range extender expands range by a factor of 10. Minimum sample volume is 25 mL.



Description	Conductivity meters			Conductivity/resistivity meter	Total dissolved solid meters		pH/conductivity meter
<b>Catalogue number</b>	<b>MY-01489-10</b>	<b>MY-01489-20</b>	<b>MY-01489-35</b>	<b>MY-01489-30</b>	<b>MY-01489-15</b>	<b>MY-01489-25</b>	<b>MY-01489-62</b>
Range	Conductivity	0 to 50 µS, 0 to 500 µS, 0 to 5000 µS	0 to 10 µS, 0 to 100 µS, 0 to 1000 µS, 0 to 10,000 µS	0 to 0.5 µS, 0 to 5 µS, 0 to 50 µS, 0 to 500 µS, 0 to 5000 µS	—	—	0 to 10,000 µS
	Resistivity	—	—	2 to 30 MΩ	—	—	—
	TDS	—	—	—	0 to 5000 ppm	0 to 50 ppm, 0 to 500 ppm, 0 to 5000 ppm	—
	pH	—	—	—	—	—	—
Temperature compensation	Automatic from 10 to 71°C	Automatic from 10 to 71°C	Automatic from 10 to 71°C	Automatic from 0 to 49°C	Automatic from 10 to 71°C	Automatic from 10 to 71°C	Automatic from 10 to 71°C
Power	One 9 V battery (included)		Two 9 V batteries (included)		One 9 V battery (included)		Two 9 V batteries (included)

**MY-01489-50 Range extender** increases conductivity range by 10x (for example, 0 to 50,000 µS for model 01489-10)

**MY-01489-48 Hard carrying case**

**MY-01489-51 Calibration kit** for model 01489-62

**MY-01489-63 Replacement pH sensor** for model 01489-62



## Oakton® Waterproof CON 150 Meter

### Get more for your money

- Best value for an IP67-rated waterproof meter
- Know the status of your probe—intuitive, user-friendly icon displays cell constant
- Get quick and easy electrode attachment to a beaker or container with Grip-Clip™ holder
- Recall more data with expanded data logging for up to 150 data sets
- Versatile power supply—battery or AC

Rugged, waterproof housing is ideal for use in any environment. View more data simultaneously with large, three-line LCD providing conductivity or TDS measurement with temperature. Get faster calibration with auto-ranging and auto-cal functions for one calibration point per measurement range.

Features include adjustable conductivity-to-TDS factor, selectable temperature coefficient, ready (stability) indicator, smart averaging, hold function, calibration alarm (visible), battery life indicator, and probe status.

**Meter includes:** conductivity cell (K = 1.0), holder, and two batteries.  
**Kit adds:** two calibration standards and hard carrying case.



## Oakton® Waterproof CON 450 Meter

### Easy to read in any environment

- Intuitive, user-friendly icon displays cell constant
- Easily attach electrode to a beaker or container with Grip-Clip™ holder
- Download and analyse up to 500 data sets with USB or RS-232 output
- ATC—more accuracy even in fluctuating temperatures

Waterproof, IP67-rated meter is ideal for even the harshest environments. View the main measurement simultaneously with temperature on backlit display. Get faster calibration with auto-cal function, which permits one calibration point per measurement range.

Features include adjustable conductivity-to-TDS factor, selectable temperature coefficient, ready (stability) indicator, smart averaging, hold function, calibration alarm, battery life-indicator, and electrode status.

**Meter includes:** conductivity cell (K = 1.0), holder, and batteries.  
**Kit adds:** calibration standards and hard carrying case.



Easy one-button data logging



Description	CON 150 meter with probe	CON 150 meter kit
Catalogue number	MY-35607-32	MY-35607-90
Precalibrated cat. no.	MY-35607-34	MY-35607-91
Range	Conductivity	0 to 200 mS
	TDS	0 to 200 ppt
	Temperature	-10.0 to 110.0°C (-17.0 to 230.0°F)
Resolution	Conductivity	0.01 µS to 0.1 mS
	TDS	0.01 ppm to 0.1 ppt
	Temperature	0.1°C
Accuracy	Conductivity	±1% full-scale
	TDS	±1% full-scale
	Salinity	±1% full-scale
	Temperature	±0.5°C
Calibration	Conductivity	Auto/manual; 1 point/range
	TDS	Auto/manual; 1 point/range
	Temperature	Offset 0.1 increments
Temperature compensation	Automatic or manual from -10 to 110°C	
Conductivity-to-TDS factor	0.4 to 1.0	
Data logging	Stores up to 150 data sets	
Power	Two AA batteries (included); universal power adapter (optional)	

#### Accessories

- MY-35608-55 Conductivity cell, K = 0.1
- MY-35608-50 Replacement conductivity cell, K = 1.0
- MY-35608-51 Conductivity cell, K = 10
- MY-35614-51 Hard carrying case
- MY-35420-72 Optional power adapter, 110/220 VAC
- MY-17090-30 ILAC MRA, NIST-traceable calibration with data for conductivity meter



Description	CON 450 meter with probe	CON 450 meter kit
Catalogue number	MY-35608-32	MY-35608-80
Precalibrated cat. number	MY-35608-34	MY-35608-81
Range	Conductivity	0 to 200 mS
	TDS	0 to 200 ppt
	Salinity	0 to 50 ppt
	Temperature	-10.0 to 110.0°C (-17.0 to 230.0°F)
Resolution	Conductivity	0.01 µS to 0.1 mS
	TDS	0.01 ppm to 0.1 ppt
	Temperature	0.1°C
Accuracy	Conductivity	±1% full-scale
	TDS	±1% full-scale
	Salinity	±1% full-scale
	Temperature	±0.5°C
Calibration	Conductivity	Auto/manual; 1 point/range
	TDS	Auto/manual; 1 point/range
	Salinity	Auto/manual; 1 point/range
	Temperature	±5.0° offset
Temperature compensation	Automatic or manual from -10 to 110°C	
Data logging	Stores up to 500 data sets	
Output	USB or RS-232	
Power	Two AA batteries (included); AC adapter (optional)	

#### Accessories

- MY-35608-55 Conductivity cell, K = 0.1
- MY-35608-50 Replacement conductivity cell, K = 1.0
- MY-35608-51 Conductivity cell, K = 10
- MY-35614-51 Hard carrying case
- MY-35630-53 Data cable for USB connectivity
- MY-35420-01 Data cable for RS-232 connectivity
- MY-35420-72 Optional power adapter, 110/220 VAC

## Oakton® CON 550 Benchtop Conductivity Meter

### Economical, compact choice

- Automatically recognises calibration solutions
- Data logging allows you to store and recall up to 50 groups of data
- IP54-rated housing is dust- and spill-proof

Meter features a microprocessor chip which provides automatic calibration, automatic temperature compensation, data storage, parameter setup, and Max/Min readings. Meter reads 0 to 200 mS/cm across four ranges and the four-point conductivity calibration, with automatic solution recognition, makes calibration easy. Advanced digital processing technology improves meter response time and measuring accuracy. Stable reading display icon appears when the measuring value is stable.

**Kit includes:** plastic combination conductivity holder, conductivity standard calibration solutions (84 µS/1413 µS/12.88 mS; 50 mL each), and power adapter.



Model		CON 550
Catalogue number		MY-35419-35
Range	Conductivity	0 to 199.99 µS/cm, 200 to 1999 µS/cm; 2 to 19.99 mS/cm, 20 to 199.9 mS/cm
	TDS	0 to 99.9 mg/L, 100 to 999 mg/L; 1 to 9.99 g/L, 10 to 100 g/L
	Temperature	0 to 100°C (32 to 212°F)
Resolution	Conductivity	0.1, 1 µS/cm; 0.01, 0.1 mS/cm
	TDS	0.1, 1 mg/L; 0.01, 0.1 g/L
	Temperature	0.1°C (0.1/1°F)
Accuracy	Conductivity	±1.0% full-scale ±1 digit
	Temperature	±0.5°C ±1 digit
Temp. compensation		Automatic or manual, from 0 to 50°C
Calibration		1 to 3 points, automatic recognition of standards
Data logging		50 groups of data
Power		9 VAC DC power adapter

## Oakton® Benchtop CON 700 and 2700 Meters

### Don't waste your valuable bench space

- Space-saving design takes up less bench space
- No more squinting—large display allows for reading across the room
- Get the best resolution—autoranging feature reads 0 to 200.0 mS across five ranges
- More accurate—adjustable temperature coefficient, selectable cell constant, and automatic temperature compensation
- Store up to 500 readings for later retrieval

Oakton CON 2700 meter has advanced features for GLP-compliant readings—all calibration and stored data are stamped with time/date. Advanced setup options let you customise the meter to your needs. Informative display shows measurements together with temperature, electrode status, calibration points, time, and date all at once! Programmable functions include data logging intervals, limit alarms, and password protection. Data is easily exported to a computer via RS-232 port (order cable and adapter separately below).

**What's included:** conductivity/temperature probe 35608-74 (CON 700) or 35412-10 (CON 2700), electrode stand, and universal 100/240 VAC power supply.



Features water-resistant keypad and pull-out reference guide.



Description	CON 700 meter	Precalibrated CON 700 meter	CON 2700 meter	Precalibrated CON 2700 meter
Catalogue number	MY-35411-00	MY-35411-01	MY-35412-00	MY-35412-01
Range	Conductivity	0.0 to 20.00, 0 to 200.0, 0 to 2000 µS; 0 to 20.00, 0 to 200.0 mS		0.0 to 20.00, 0 to 200.0, 0 to 2000 µS; 0 to 20.00, 0 to 500.0 mS
	TDS	0.00 to 100.0 ppt		0.050 to 500.0 ppt
	Salinity	—		0.0 to 80.0 ppt
	Resistivity	—		2.000 Ω to 20.0 MΩ
	Temperature	0.0 to 100.0°C (32.0 to 212°F)		0.0 to 100.0°C (32.0 to 212°F)
Resolution	Conductivity	0.01, 0.1, 1 µS; 0.01, 0.1 mS		0.01, 0.1 µS; 0.001, 0.01, 0.1 mS
	TDS	0.01, 0.1, 1 ppm; 0.01, 0.1 ppt		0.01, 0.1 ppm; 0.001, 0.01, 0.1 ppt
	Salinity	—		0.01, 0.1 ppm; 0.001, 0.01, 0.1 ppt
	Resistivity	—		0.01 MΩ, 0.001, 0.01 kΩ, 0.01, 0.1 Ω
	Temperature	0.1°C or °F		0.1°C or °F
Accuracy	Conductivity	±1% full-scale		±1% full-scale
	TDS	±1% full-scale		±1% full-scale
	Salinity	—		±1% full-scale
	Resistivity	—		±1% full-scale
	Temperature	±0.5°C		±0.3°C
Temperature compensation	Automatic or manual, adjustable from 0.0 to 10% per °C		Automatic or manual, adjustable from 0.0 to 10% per °C	
Cell constant (K)	Select from K = 0.1, 1.0, or 10		0.010 to 10.000	
Conductivity-to-TDS factor	Adjustable from 0.4 to 1.0		Adjustable from 0.4 to 1.0	
Data logging	100 data sets		500 data sets	
Output	—		RS-232	
Power	100/240 VAC with universal adapter (included)		100/240 VAC with universal adapter (included)	

### Conductivity Probes

Cell constant (K)	Body/electrode	Catalogue number
<b>2-cell conductivity probes for CON 700 or CON 2700 meters</b>		
0.1	Epoxy/platinum	MY-35608-72
1.0	Ultem®/stainless steel	MY-35608-74
1.0	Glass/platinum	MY-35608-76
10	Epoxy/platinum	MY-35608-78
<b>4-cell conductivity probes for CON 2700 meter only</b>		
0.1	Epoxy/platinum	MY-35608-90
1.0	Epoxy/graphite	MY-35412-10
1.0	Glass/platinum	MY-35608-92
10	Epoxy/platinum	MY-35608-94

### Accessories

- MY-35420-01 RS-232 cable for 2700 series meters
- MY-35630-53 USB cable for 2700 series meters
- MY-17090-30 ILAC MRA, NIST-traceable calibration with data for conductivity meters

## Oakton® Calibration Solutions, ILAC MRA, NIST-Traceable Reference Materials

### Economical

- KCl, NaCl, and 442 conversions and temperature corrections printed right on the 500-mL bottle



Conductivity (µS)	Conductivity-to-TDS calibration values			Catalogue number
	ppm KCl	ppm NaCl	ppm 442	
23	11.6	10.7	14.74	MY-00653-23
84	40.38	38.04	50.5	MY-00653-16
447	226	215	300	MY-00653-47
1413	745	702	1000	MY-00653-18
1500	757	737	1050	MY-00653-15
2070	1045	1041	1500	MY-00653-27
2764	1382	1414	2062	MY-00653-20
8974	5101	4487	7608	MY-00653-89
12,880	7447	7230	11,367	MY-00606-10
15,000	8759	8532	13,455	MY-00653-50
80,000	52,168	48,384	79,688	MY-00653-32

## Oakton® Conductivity Calibration Pouches

### Calibrate on the go!

- Single-use pouches for easy calibrations
- Quick-reference conversion table printed on each pack



Conductivity (µS)	Conductivity-to-TDS calibration values			Catalogue number
	ppm KCL	ppm NaCl	ppm 442	
10	4.8	4.7	7.0	MY-35653-09
84	40.3	39.5	58.8	MY-35653-08
447	226	216	300	MY-35653-10
1413	745	702	1000	MY-35653-11
2764	1382	1414	2062	MY-35653-12
12,880	7470	7341	11,592	MY-35653-14
15,000	8759	8532	13,445	MY-35653-13
Rinse solution	—	—	—	MY-35653-00

## Cole-Parmer® Extended-Life Conductivity Standards

### Extend shelf life to 5 years!

- Sealed, metal-lined storage envelope eliminates transpiration—store up to 5 years before opening
- Open sealed envelope to begin the 1-year shelf life—bottle and Certificate of Analysis have a convenient marking area to write the new expiration date
- ILAC MRA, NIST-traceable calibration report from an ISO Guide 34 and ISO 17025 accredited laboratory included with each 500-mL bottle



Conductivity (µS)	Resistivity (MΩ·cm)	Conductivity-to-TDS calibration values (ppm KCl)	Catalogue number
2	0.5	0.3	MY-00651-41
10	0.1	4.4	MY-00651-42
100	0.01	51	MY-00651-43
147	0.007	73	MY-00651-44
1000	0.001	524	MY-00651-45
1413	0.00071	745	MY-00651-46
10,000	0.0001	5695	MY-00651-47
100,000	0.00001	65,611	MY-00651-48

## Oakton® Traceable® Conductivity Solutions, ILAC MRA, NIST-Traceable Reference Materials

### Trust your standards—high accuracy

- Up to ±0.25% accuracy verified by an ISO Guide 34 and ISO 17025 accredited lab

#### A. Batch-Tested Bottles, 500 mL

- Easy calibration with included instructions and temperature compensation chart
- Includes ILAC MRA, NIST-traceable certificate and batch testing information



#### B. Individually Tested Bottles, 500 mL

- Each bottle individually calibrated—ILAC MRA, NIST-traceable certificate included with serial number and testing information

- Easy calibration with step-by-step instructions and included temperature compensation chart

#### C. One-Shot® Vials, pack of six 100 mL vials

- Fresh solution each time you calibrate—single-use vials eliminate contamination

- Grab it and go—convenient for field use; calibrate right in vial

- Includes ILAC MRA, NIST-traceable calibration report and temperature compensation chart



Conductivity (µS)	Resistivity (MΩ·cm)	TDS (ppm)	Catalogue number
<b>A. Batch tested, one 500 mL bottle</b>			
1	1	0.66	MY-00652-20
5	0.2	3.3	MY-00652-22
10	0.1	6.6	MY-00652-24
100	0.01	66	MY-00652-26
1000	0.001	666	MY-00652-28
1413	0.00071	933	MY-00652-30
10,000	0.0001	6666	MY-00652-32
100,000	0.00001	66,666	MY-00652-34
150,000	0.0000066	100,000	MY-00652-53
200,000	0.000005	133,333	MY-00652-55
<b>B. Individually tested, one 500 mL bottle</b>			
1	1	0.66	MY-00652-40
5	0.2	3.3	MY-00652-42
10	0.1	6.6	MY-00652-44
100	0.01	66	MY-00652-46
1000	0.001	666	MY-00652-48
1413	0.00071	933	MY-00652-50
10,000	0.0001	6666	MY-00652-52
100,000	0.00001	66,666	MY-00652-54
150,000	0.0000066	100,000	MY-00652-56
200,000	0.000005	133,333	MY-00652-58
<b>C. One-Shot®, pack of six 100 mL vials</b>			
5	0.2	3.3	MY-00652-60
10	0.1	6.6	MY-00652-62
100	0.01	66	MY-00652-64
1000	0.001	666	MY-00652-66
1413	0.00071	933	MY-00652-68
10,000	0.0001	6666	MY-00652-70
100,000	0.00001	66,666	MY-00652-72
150,000	0.0000066	100,000	MY-00652-76
200,000	0.000005	133,333	MY-00652-78
Assortment†	—	—	MY-00652-74

†Assortment has one 100-mL vial each of 10, 100, 1000, 1413, 10,000, and 100,000 µS.



# Texwipe® Cleanroom Swabs















## Meet your validation requirements

– Ideal for cleaning small surface areas and for cleaning validation

Sealed swab handles are thermo-formed. Swabs with ESD handles eliminate damage from static electricity and are effective in all humidities.

**Fabric Swabs** have excellent chemical compatibility. Sealed swabs contain low chloride and other ionic contaminants.

**Foam Swabs** have sealed handles and are constructed from 100 pores-per-inch reticulated urethane foam—ideal for solvent dispersion and low-viscosity adhesives. Sealed foam swabs are perfect for removal of solvents and fluxes. Cleanfoam® swabs feature low levels of nonvolatile residue, particle generation, and are constructed of open-cell polyurethane foam for excellent solvent capacity.

Swab tip	Tip description	Handle description	Tip length	Swab length	Compliance	Qty/pk	Catalogue number
<b>Fabric swabs</b>							
	Knit polyester	Sealed polypropylene	1 cm (0.39")	7 cm (2.75")	—	50	<b>MY-33676-01</b>
	Knit polyester	Sealed polypropylene	1.7 cm (0.66")	16.2 cm (6.39")	—	100	<b>MY-33676-07</b>
	Knit polyester	Sealed polypropylene	0.4 cm (0.16")	7 cm (2.76")	ISO Class 3	500	<b>MY-33677-58</b>
	Knit polyester	Sealed polypropylene	0.7 cm (0.27")	16.2 cm (6.39")	ISO Class 3	100	<b>MY-33677-60</b>
	Knit polyester	Sealed polypropylene	1.3 cm (0.5")	12.7 cm (5.00")	ISO Class 3	100	<b>MY-33677-62</b>
	Knit polyester	Sealed polypropylene	1.3 cm (0.5")	12.7 cm (5.00")	—	100	<b>MY-33677-63</b>
	Knit polyester	Sealed polypropylene	2.6 cm (1.01")	12.8 cm (5.02")	—	20	<b>MY-33677-64</b>
	Knit polyester	Sealed polypropylene	2.6 cm (1.01")	12.8 cm (5.02")	—	20	<b>MY-33677-65</b>
<b>Foam swabs</b>							
	Foam bud	Hardwood	2.8 cm (1.10")	15.4 cm (6.06")	—	500	<b>MY-33676-03</b>
	Cleanfoam	Polypropylene	0.3 cm (0.13")	7 cm (2.75")	ISO Class 5	500	<b>MY-33677-50</b>
	Flexible cleanfoam	Polypropylene	0.3 cm (0.13")	6.8 cm (2.67")	ISO Class 5	500	<b>MY-33677-52</b>
	Cleanfoam	Polypropylene	0.6 cm (0.25")	16.2 cm (6.37")	ISO Class 5	500	<b>MY-33677-55</b>
	Circular foam	Sealed polypropylene	2.1 cm (0.81")	13.2 cm (5.20")	ISO Class 5	100	<b>MY-33677-56</b>
	Cleanfoam	ESD	0.4 cm (0.14")	8.9 cm (3.50")	ISO Class 5	500	<b>MY-33677-72</b>
	Cleanfoam	ESD	0.4 cm (0.15")	7 cm (2.75")	ISO Class 5	500	<b>MY-33677-74</b>

# Kimberly-Clark® Critical Task Wipes

## Low-lint, absorbent, soft, and nonabrasive

- Won't scratch delicate surfaces
- Single- and two-ply delicate task wipes are made of a finely textured tissue
- Solvent-resistant Kimtech CL4 wipes are made of a single-ply, nonwoven fabric specially bonded to eliminate surface fibers and trap particles

Description	Compliance	Wipe size	Qty/bx	Box/cs	Catalogue number
<b>Delicate task wipes</b>					
Kimwipes® EX-L, 1 ply	—	11.5 x 21.5 cm	280	1	<b>MY-25000-35</b>
		11.5 x 21.5 cm	280	6	<b>MY-25000-37</b>
		11.5 x 21.5 cm	280	60	<b>MY-33670-04</b>
		38 x 42.5 cm	140	15	<b>MY-33670-06</b>
Kaydry® EX-L, 2 ply	—	38 x 42.5 cm	90	15	<b>MY-33670-10</b>
<b>Cleanroom wipes</b>					
Kimtech CL4 Cleanroom	ISO Class 4	30.5 x 30.5 cm	100	5	<b>MY-33670-20</b>



Go online to search more than 100,000 products.

## Worthington Storage Dewars

### Get maximum holding times with superior construction

- Maximum insulation with sealed vacuum space between inner and outer shells and advanced insulation
- Durable, lightweight aluminum construction
- Reduce liquid nitrogen loss with necktube core design
- Move larger capacity Dewars easily with optional roller base



03773-51



03773-57



Capacity (L)	Neck ID	Static holding time <sup>†</sup>	Evaporation (L/day) <sup>†</sup>	Outer dim. (H x dia)	Catalogue number
4	3.0 cm	10 days	0.40	43.2 x 19.4 cm	MY-03773-51
5	14.3 cm	6 days	0.77	43.2 x 19.4 cm	MY-03773-53
10	5.1 cm	45 days	0.22	59.7 x 28.9 cm	MY-03773-55
25	6.4 cm	109 days	0.23	65.5 x 39.7 cm	MY-03773-57
35	6.4 cm	152 days	0.23	66.8 x 47.8 cm	MY-03773-59
50	6.4 cm	122 days	0.41	82.2 x 47.8 cm	MY-03773-61

<sup>†</sup>Static holding times and evaporation rates are nominal.

#### Accessories

**MY-03773-63 Dipper** removes 12 mL of liquid nitrogen from 10-, 25-, 35-, and 50-liter Dewars without tipping the flask

**MY-03773-70 Tipping stand** supports the weight of the Dewar while you safely tip the unit. For model 03773-57 only

## Insulated Containers

### Store samples properly



**A. Tabletop Ice Storage Chest** has dry ice sublimation rate less than 1.1 kg per day at full 22.7 kg capacity. Chest is constructed from rugged polyethylene; molded bottom won't scratch tabletop.

B

**B. Insulated Field Carrier** has efficient, 5.7mm-thick polyurethane foam insulation core and rugged, double-wall polyethylene construction. Includes carrying handle, hinged lid, and adjustable latches.

**C. Large-Capacity Dry Ice Storage Chests** contain extra-thick foam plastic insulation core. Six days for 40.8 kg of dry ice to sublimate to 2.3 kg in model 03721-02; 10 days for 70.3 kg in model 03721-00; and 15 days for 97.5 kg in model 03720-00.



Key	Capacity		Inside dimensions (L x W x H)		Catalogue number
	cu ft	lb	cm	in.	
<b>A</b>	—	—	29.2 x 24.8 x 23.5	11½ x 9¾ x 9¼	MY-03719-00
<b>B</b>	—	—	42.2 x 26.0 x 27.3	16½ x 10¼ x 10¾	MY-03720-20
<b>C</b>	1.6	90	38.7 x 35.6 x 38.7	15¼ x 14 x 15¼	MY-03721-02
	2.5	155	44.1 x 42.8 x 41.9	17¾ x 16¾ x 16½	MY-03721-00
	5	215	53.3 x 34.3 x 61.0	21 x 13½ x 24	MY-03720-00

**MY-03721-10 Dolly** for 03721-00 and -02 containers

**MY-03720-10 Dolly** for 03720-00 container

## Lab-Grade Dewar Flasks

### Move samples with less spillage

- Weighted base reduces spillage
- Dewars feature low heat conductivity, high vacuum and vented polyethylene stopper for minimal evaporation



Volume (mL)	Dimensions <sup>†</sup> (cm, in.)				Catalogue number
	ID	OD	Depth	Ht	
350	7.2 (2 <sup>13</sup> / <sub>16</sub> )	8.6 (3 <sup>3</sup> / <sub>8</sub> )	12.4 (4 <sup>7</sup> / <sub>8</sub> )	15.7 (6 <sup>1</sup> / <sub>8</sub> )	MY-03766-10
665			19.5 (7 <sup>11</sup> / <sub>16</sub> )	24.1 (9 <sup>1</sup> / <sub>2</sub> )	MY-03766-20
1000	7.2 (2 <sup>13</sup> / <sub>16</sub> )	8.6 (3 <sup>3</sup> / <sub>8</sub> )	30.1 (11 <sup>7</sup> / <sub>8</sub> )	33.8 (13 <sup>3</sup> / <sub>16</sub> )	MY-03766-30
1900	11.9 (4 <sup>11</sup> / <sub>16</sub> )	14.9 (5 <sup>7</sup> / <sub>8</sub> )	19.1 (7 <sup>1</sup> / <sub>2</sub> )	25.1 (9 <sup>9</sup> / <sub>16</sub> )	MY-03767-10
4300	14.3 (5 <sup>5</sup> / <sub>8</sub> )	17.8 (7)	30.5 (12)	36.6 (14 <sup>3</sup> / <sub>8</sub> )	MY-03767-20

<sup>†</sup>All dimensions are ±0.2".

## Cole-Parmer® Transportable Dewar Flasks

### Keep lid on tight

- Insulated lid locks in place with two spring clips
- Rugged design features galvanized steel plate with baked enamel finish



**Cole-Parmer®**

Volume (L)	Dimensions (cm, in.)				Catalogue number
	ID	OD	Depth	Ht	
1	10.2 (4)	14.9 (5 <sup>7</sup> / <sub>8</sub> )	16.8 (6 <sup>5</sup> / <sub>8</sub> )	18.6 (7 <sup>3</sup> / <sub>8</sub> )	MY-03772-10
2	14.0 (5 <sup>1</sup> / <sub>2</sub> )	16.0 (6 <sup>3</sup> / <sub>8</sub> )	16.9 (6 <sup>11</sup> / <sub>16</sub> )	21.6 (8 <sup>1</sup> / <sub>2</sub> )	MY-03772-20
4	14.0 (5 <sup>1</sup> / <sub>2</sub> )	16.0 (6 <sup>3</sup> / <sub>8</sub> )	31.0 (12 <sup>3</sup> / <sub>8</sub> )	36.6 (14 <sup>3</sup> / <sub>8</sub> )	MY-03772-40

## All-Plastic Dewar Flasks

### Implosion proof

- Safe to use with LN<sub>2</sub>, dry ice, solvent mixtures, and hot fluids, will not implode
- Double-wall HDPE construction with broad base for reduced spills
- Keep lid in place with metal tabs



Volume (L)	Dimensions (cm, in.)				Catalogue number
	ID	OD	Depth	Ht	
1	9.5 (3 <sup>3</sup> / <sub>4</sub> )	15.9 (6 <sup>1</sup> / <sub>4</sub> )	19.1 (7 <sup>1</sup> / <sub>2</sub> )	22.9 (9)	MY-06726-20
2	12.1 (4 <sup>3</sup> / <sub>4</sub> )	18.4 (7 <sup>1</sup> / <sub>4</sub> )	22.9 (9)	26.0 (10 <sup>1</sup> / <sub>4</sub> )	MY-06726-40
4	14.6 (5 <sup>3</sup> / <sub>4</sub> )	22.9 (9)	28.6 (11 <sup>1</sup> / <sub>4</sub> )	32.4 (12 <sup>3</sup> / <sub>4</sub> )	MY-06726-60
10	19.7 (7 <sup>3</sup> / <sub>4</sub> )	30.5 (12)	39.4 (15 <sup>1</sup> / <sub>2</sub> )	45.7 (18)	MY-06726-80

## PolarSafe® Fiberboard Cryogenic Storage Boxes and Dividers

### Customize to fit your needs

- Snug-fitting lid prevents accidental separation if dropped
- Bottom drain holes allow safe drainage of liquid nitrogen and prevent moisture buildup
- Moisture repellent coating for use in mechanical freezers or liquid nitrogen tanks to  $-196^{\circ}\text{C}$

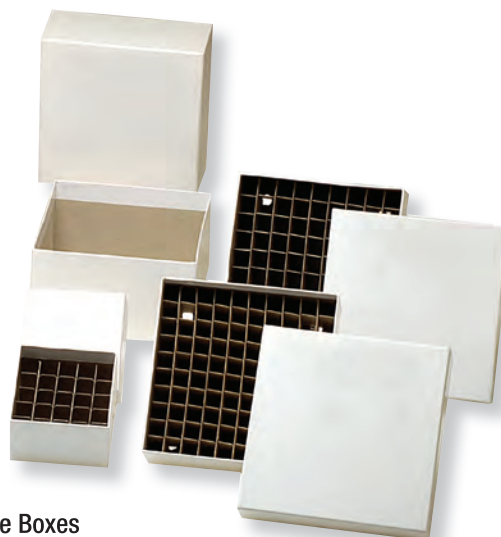

#### Cell Dividers

For box model(s)	Vial size	Vials held	Dimensions (L x W x H)	Catalogue number
06755-74	0.5, 1.5, 2 mL	25	6.7 x 6.7 x 3.2 cm	<b>MY-06755-80</b>
06755-75	50 mL	16	13.6 x 13.6 x 6.9 cm	<b>MY-06755-78</b>
	15 mL	36		<b>MY-06755-79</b>
06755-76, 06755-77	50 mL	25	12.4 x 12.4 x 3.3 cm	<b>MY-06755-81</b>
	1.5, 2 mL	49		<b>MY-06755-82</b>
	1.5, 2 mL	64		<b>MY-06755-83</b>
	0.5, 1.5, 2.0 mL	81	<b>MY-06755-84</b>	
	0.5, 1.5 mL	100	<b>MY-06755-85</b>	
	0.5, 1.5 mL	144	<b>MY-06755-86</b>	

#### Storage Boxes

Description	Vial size	Vials held	Dimensions (L x W x H)	Catalogue number
Boxes with cell dividers	0.5, 1.5, 2 mL	25	7.6 x 7.6 x 5.1 cm	<b>MY-06755-71</b>
	0.5, 1.5, 2 mL	81	13.3 x 13.3 x 5.1 cm	<b>MY-06755-72</b>
	0.5, 1.5 mL	100	13.3 x 13.3 x 5.1 cm	<b>MY-06755-73</b>
Boxes without cell dividers	—	—	7.6 x 7.6 x 5.1 cm	<b>MY-06755-74</b>
	—	—	14.6 x 14.6 x 12.4 cm	<b>MY-06755-75</b>
	—	—	13.3 x 13.3 x 5.1 cm	<b>MY-06755-76</b>
	—	—	13.3 x 13.3 x 7.6 cm	<b>MY-06755-77</b>

## Magne-Box™ Cryo-Boxes

### Magnetic closure keeps your samples secure

- Clear lids with coloured inserts and numbered grids for easy sample identification
- Polycarbonate design for use from  $-196$  to  $121^{\circ}\text{C}$
- Slot openings on the bottom of boxes allow for drainage
- Fits in standard-size freezer rack
- Available with 25-, 81-, and 100-place divisions to accommodate 2-mL cryovials; 81-tall boxes accommodate 4- to 5-mL cryovials

**MAGNE-BOX™**



No. of tubes	Colour	Dimensions (inches)	Qty/ pk	Catalogue number
25	Orange	7.6 x 7.6 x 5.2 cm	8	<b>MY-04200-03</b>
81	Assorted (purple, green, blue, orange)	13.3 x 13.3 x 5.2 cm	4	<b>MY-04200-04</b>
81-tall	Blue	13.3 x 13.3 x 9.5 cm	4	<b>MY-04200-05</b>
100	Green	13.3 x 13.3 x 5.2 cm	4	<b>MY-04200-06</b>

## Cryo-Glove® Cryogenic Gloves

### Keep hands from freezing

- Protect as low as  $-160^{\circ}\text{C}$  ( $-256^{\circ}\text{F}$ )
- Maximum protection while remaining flexible

**Water-Resistant Gloves** provide protection in closed systems. A stay-dry lining keeps you warm and comfortable. **Waterproof Gloves** have a nylon exterior and a seamless waterproof lining. Gloves keep you dry and wick moisture away from your hands.

**Cryo-Industrial® Gloves** feature a rugged, abrasion-resistant outer shell that protects the glove and provides an excellent grip for heavy-duty applications. Waterproof liner protects against cryogenic splashes while the inner lining wicks moisture from your hands for enhanced comfort.

**Note:** Do not immerse gloves in liquid nitrogen.

CE



Description	Size	Length	Catalogue number
<b>Water-resistant Cryo-Glove gloves</b>			
Wrist	Medium	30 cm (12")	<b>MY-09113-02</b>
	Large		<b>MY-09113-04</b>
Mid-arm	Medium	38 cm (15")	<b>MY-09113-12</b>
	Large		<b>MY-09113-14</b>
	X-large		<b>MY-09113-16</b>
Elbow	Medium	48 cm (19")	<b>MY-09113-22</b>
	Large		<b>MY-09113-24</b>
	X-large		<b>MY-09113-26</b>
<b>Waterproof Cryo-Glove gloves</b>			
Mid-arm	Medium	38 cm (15")	<b>MY-09113-30</b>
	Large		<b>MY-09113-32</b>
	X-large		<b>MY-09113-34</b>
Elbow	Medium	48 cm (19")	<b>MY-09113-35</b>
	Large		<b>MY-09113-37</b>
	X-large		<b>MY-09113-39</b>
<b>Cryo-Industrial heavy-duty gloves</b>			
Mid-arm	Medium	38 cm (15")	<b>MY-09113-62</b>
	Large		<b>MY-09113-64</b>
	X-large		<b>MY-09113-66</b>



## PolarSafe® Dot- and Strip-Style Cryogenic Labels

### No need to self-laminate

- Inert polyester with a unique adhesive adheres to glass, plasticware, and most metals
- Same label works for cryogenics, ultralow freezers, and incubators
- Available on rolls for individual labeling or on sheets for use with laser printers



PolarSafe labels withstand conventional freezing ( $-80^{\circ}\text{C}$ ) but can also be used for most cryogenic storage applications (vapour phase nitrogen storage at  $-196^{\circ}\text{C}$ ). The wide range of sizes allows you to label your whole experiment permanently.

The 3.3 x 1.3 cm strips are ideal for 1.5- and 2-mL tubes; the 2.4 x 1.3 cm strips are good for 0.5- and 1.5-mL tubes; the 6.7 x 2.5 cm strips can be used for racks and boxes. The dots are suitable for use on cryotubes, glass vials, and microcentrifuge tubes.

## PolarSafe® EPS Microtube Rack

### Secure, stackable freezer storage

- Accommodates both microtubes and cryovials up to 2.0-mL
- Snug-fitting lid remains in place during handling
- Grippable indentations allow easy removal from freezer
- Alphanumeric index in base lets you quickly locate tubes

This rack and storage box of expanded polystyrene (EPS) holds 100 microcentrifuge tubes and cryovials up to 2.0-mL. Stacking design features circular feet on the bottoms that mate with circular depressions on the lids.



Deep wells with conical bottoms securely hold both microtubes and cryovials.

Vial size	Vials held	Dimensions (L x W x H)	Qty/pk	Catalogue number
0.5 to 2.0 mL	100	36.8 x 10.5 x 7.6 cm (14½" x 4½" x 3")	10	MY-06755-01

Label size (cm, in.)	Colour	Qty/pk	Catalogue number
<b>Dots on rolls</b>			
0.37 (0.95) dia	White	1000	MY-04396-68
0.37 (0.95) dia	White	5000	MY-04396-69
0.37 (0.95) dia	Blue	1000	MY-04396-86
0.37 (0.95) dia	Yellow	1000	MY-04396-89
0.37 (0.95) dia	Assorted	5000	MY-04396-85
0.5 (1.3) dia	White	1000	MY-04396-65
0.75 (1.9) dia	White	1000	MY-04396-70
0.75 (1.9) dia	White	5000	MY-04396-71
<b>Dots on sheets for laser printers</b>			
0.37 (0.95) dia	White	3840	MY-04396-64
0.75 (1.9) dia	White	2160	MY-04396-72
<b>Strips on rolls</b>			
0.78 W x 0.24 H (2.0 x 0.6)	White	1000	MY-04396-67
1.3 W x 0.5 H (3.3 x 1.3)	White	1000	MY-04396-66
<b>Strips on sheets for laser printers</b>			
0.94 W x 0.5 H (2.4 x 1.3)	White	2380	MY-04396-75
1.3 W x 0.5 H (3.3 x 1.3)	White	1700	MY-04396-73
1.3 W x 0.5 H (3.3 x 1.3)	Assorted	2125	MY-04396-74
2.6 W x 0.98 H (6.7 x 2.5)	White	600	MY-04396-76

### Accessories

**MY-04396-91 Label dispenser**, blue acrylic. Accommodates up to 6 rolls of cryogenic dots or strips

## PolarSafe® EVA Ice Containers

### Mess-free insulation for any cryogenic medium

- Thick, nontoxic EVA material is leakproof and will not "sweat"
- Compatible with ice, dry ice, liquid nitrogen, alcohol, and saline solutions
- Ergonomic handles on bases and lids are glove friendly
- Integral pour spouts make cleanup easy

Ethylene vinyl acetate (EVA) foam buckets and pans are ideally suited to benchtop chilling applications. Container bottom is designed to be nonslip. Lids are included.



Capacity	Overall dimensions†	Colour	Catalogue number
<b>Round buckets (OD x H)</b>			
2.5 L	30.6 x 13.8 cm	Blue	MY-04393-88
		Green	MY-04393-90
		Purple	MY-04393-93
4 L	30.6 x 18.3 cm	Green	MY-04394-02
		Purple	MY-04394-06
		Black	MY-04394-09
<b>Rectangular pans (L x W x H)</b>			
1 L	14.6 x 14.6 x 11.5 cm	Green	MY-04393-54
		Purple	MY-04393-57
		Black	MY-04393-60
4 L	34.7 x 22.7 x 12.9 cm	Blue	MY-04393-64
		Green	MY-04393-66
		Purple	MY-04393-69
9 L	45.2 x 33.9 x 12.2 cm	Blue	MY-04393-76
		Green	MY-04393-78
		Purple	MY-04393-81

†Without lid.

## Cole-Parmer® elements™ Graduated Cylinders, Glass

Hexagonal base prevents cylinder from tipping over

- Durable borosilicate 3.3 glass
- Easy-read graduations
- Withstands wide temperature range –50 to 550°C
- Graduated tolerances from  $\pm 0.1$  to  $\pm 20$  depending on size
- Autoclavable

elements™  
Cole-Parmer



Capacity (mL)	Graduations (mL)	Tolerance (mL)	Qty/pk	Catalogue number
5	0.1	$\pm 0.1$	2	MY-34502-68
10	0.2	$\pm 0.2$		MY-34502-69
25	0.5	$\pm 0.5$	1	MY-34502-70
50	1	$\pm 1$		MY-34502-71
100	1	$\pm 1$		MY-34502-72
250	2	$\pm 2$		MY-34502-73
500	5	$\pm 5$	1	MY-34502-74
1000	10	$\pm 10$		MY-34502-75
2000	20	$\pm 20$		MY-34502-76

## Cole-Parmer® elements™ Graduated Cylinders, PP

Moulded one piece for enhanced durability

- Wide hexagonal base provides stability
- Accurate to  $\pm 2.5\%$
- Moulded-in graduations will not wear off
- Bulk packed for greater savings

Featuring pour spouts, moulded-in graduations, and heat resistance from –15 to 150°C, these translucent polypropylene (PP) cylinders are excellent for general use in the lab.

elements™  
Cole-Parmer



Capacity mL (oz)	Graduation interval (mL)	Tolerance ( $\pm$ mL)	Qty/pk	Catalogue number
50 (1.7)	1	$\pm 2.5\%$	10	MY-06200-24
100 (3.5)	1			MY-06200-25
250 (8)	5			MY-06200-26

## Cole-Parmer® Serialised Class A Graduated Cylinders, Glass

Feel more confident about your aliquots—meet ISO 9000 requirements

- Easy-to-read single white metric scale
- Autoclavable

Choose cylinders with a report of traceability to NIST standards or with a report of calibration and traceability. Models with report of calibration and traceability feature fused-in serial numbers. All cylinders support ISO 9000 requirements and are calibrated in accordance with ASTM E 542. Cylinders meet ASTM E 694 specifications and accuracy requirements of ASTM 1272. Cylinder glass meets ASTM E 438.

Capacity (mL)	Graduations (mL)	Tolerance (mL)	With report of traceability		With reports of calibration and traceability	
			Qty/pk	Catalogue number	Qty/pk	Catalogue number
<b>Cylinders calibrated "To Contain"</b>						
10	0.1	$\pm 0.10$	1	MY-34300-17	1	—
25	0.2	$\pm 0.17$		MY-34300-19		MY-34300-20
50	1	$\pm 0.25$		MY-34300-21		MY-34300-22
100	1	$\pm 0.40$		MY-34300-23		MY-34300-24
250	2	$\pm 0.80$	1	MY-34300-25	1	MY-34300-26
500	5	$\pm 1.30$		MY-34300-27		MY-34300-28
1000	10	$\pm 3.0$		MY-34300-29		MY-34300-30
2000	20	$\pm 5.0$		MY-34300-31		MY-34300-32
<b>Cylinders calibrated "To Deliver"</b>						
10	0.1	$\pm 0.10$	1	MY-34300-01	1	—
25	0.2	$\pm 0.17$		MY-34300-03		MY-34300-04
50	1	$\pm 0.25$		MY-34300-05		MY-34300-06
100	1	$\pm 0.40$		MY-34300-07		MY-34300-08
250	2	$\pm 0.80$	1	MY-34300-09	1	MY-34300-10
500	5	$\pm 1.3$		MY-34300-11		MY-34300-12
1000	10	$\pm 3.0$		MY-34300-15		MY-34300-16
2000	20	$\pm 5.0$		MY-34300-13		MY-34300-14

Cole-Parmer®



34300-27  
calibrated  
"To Contain"

34300-15 calibrated  
"To Deliver"

# Digi-Sense™ Data Loggers with TraceableLIVE® Wireless Technology

## Get alerts before you lose valuable samples

- Remotely monitor your critical environments 24/7 via Wi-Fi\*
- View current conditions anywhere – cloud-based interface sends email, text, and push notifications
- Securely connect to data via smartphone, tablet, or PC
- No software required – web, Android™, Apple® iOS data visibility
- Ensure accurate, reliable measurements with included ILAC MRA, NIST-traceable calibration

Digi-Sense data loggers with TraceableLIVE wireless technology provide a simple, efficient, and reliable way to ensure your critical samples are not compromised due to parameter variations. This latest technology is ideal for monitoring a process in real time, any time. Plus you get the value, accuracy, and peace of mind of ILAC MRA, NIST-traceable calibration at a noncalibrated price.

A-B. Digi-Sense Ultra-Low Temperature Data Loggers



C. Digi-Sense Refrigerator/Freezer Data Loggers



D. Digi-Sense Temperature/Humidity Data Loggers



E. Digi-Sense Multiparameter Data Loggers

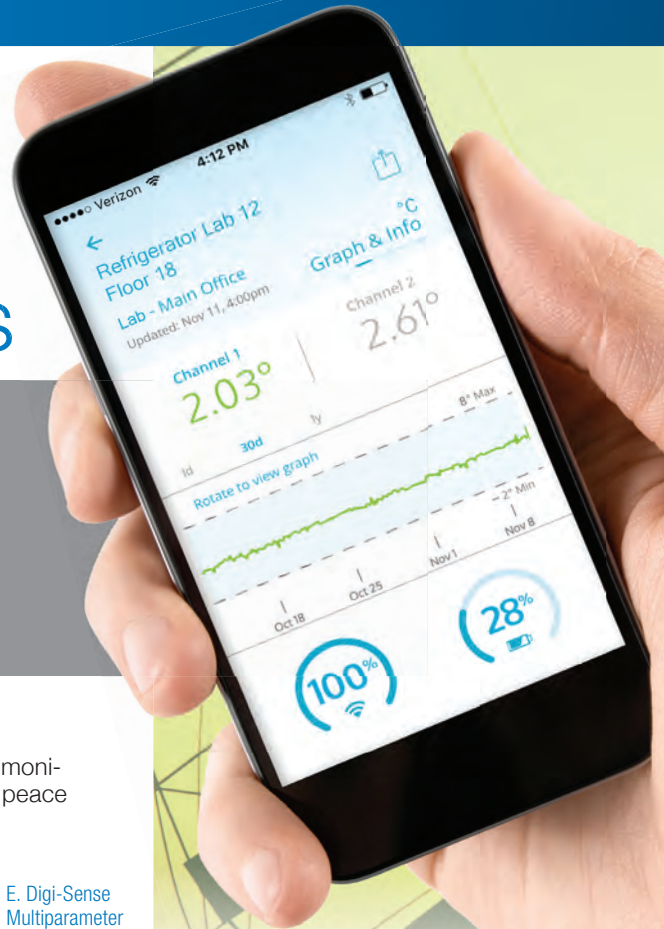

### Specifications

- Sampling rate: 9 to 12 seconds
- Memory: 672 (7 days if set to 15-minute intervals)
- Max number of stored alarms: 100
- Power: four AAA batteries (included)

Sensor included	Parameters			Catalogue number
	Range	Resolution	Accuracy	
<b>A. Cryogenic data loggers</b>				
One 316 SS probe with 1.8-m cable	-200 to 105°C (-328 to 221°F)	0.01°	±0.25°C (±0.4°F)	MY-18001-08
Two 316 SS probes with 1.8-m cable				MY-18001-09
<b>B. Ultra-low temperature data loggers</b>				
One 316 SS probe with 1.8-m cable	-90 to 105°C (-130 to 221°F)	0.01°	±0.1°C (±0.18°F)	MY-18000-27
Two 316 SS probes with 1.8-m cable				MY-18000-28
<b>C. Refrigerator/freezer data loggers</b>				
Two bottle probes	-50 to 60°C (-58 to 140°F)	0.01°	±0.25°C (±0.4°F)	MY-99460-00
One bottle probe and one bullet probe with detachable sensor and 3-m cable				MY-99460-05
Two bullet probes				MY-99460-10
Two SS probes with detachable sensor and 3-m cable				MY-99460-15
<b>D. Temperature/humidity data loggers</b>				
Ambient sensor dongle	Temp: 0 to 55°C (32 to 131°F) Humidity: 0 to 100% RH	Temp: 0.01° Humidity: 0.1%	Temp: ±0.4°C (±0.72°F) Humidity: ±3% (20 to 80% RH), ±5% (remaining)	MY-18000-29
External probe with 3-m cable				MY-18000-30
<b>E. Multiparameter data loggers</b>				
Ambient sensor dongle for temperature/humidity/CO <sub>2</sub>	Temp: 0 to 55°C (32 to 131°F) Humidity: 0 to 95% RH CO <sub>2</sub> : 0 to 10,000 ppm	Temp: 0.01° Humidity: 0.01% CO <sub>2</sub> : 5% reading + 70 ppm	Temp: ±0.4°C (±0.72°F) Humidity: ±3% (5 to 75% RH), ±5% (remaining) CO <sub>2</sub> : 1 ppm	MY-18000-31
External probe with 0.9-m cable for temperature/humidity/CO <sub>2</sub>	Temp: 0 to 55°C (32 to 131°F) Humidity: 0 to 95% RH CO <sub>2</sub> : 0 to 20%	Temp: 0.01° Humidity: 0.01% CO <sub>2</sub> : 5% reading + 1 digit	Temp: ±0.4°C (±0.72°F) Humidity: ±3% (5 to 75% RH), ±5% (remaining) CO <sub>2</sub> : 0.01%	MY-18000-32
Ambient sensor dongle for temperature/humidity/barometric pressure	Temp: 0 to 55°C (32 to 131°F) Humidity: 0 to 100% RH Barometric pressure: 500 to 1100 mbar	Temp: 0.01° Humidity: 0.01% Barometric pressure: 1 mbar	Temp: ±0.4°C (±0.72°F) Humidity: ±3% (5 to 75% RH), ±5% (remaining) Barometric pressure: ±4 mbar	MY-18000-33

\*Requires a TraceableLIVE subscription.



## Digi-Sense® Traceable® Data Logging Thermometers

### Get multiple readings simultaneously

- Simultaneously view high, low, and current temperature
- Keep samples safe—programmable alarm alerts when temperature deviates from set point
- Monitor conditions—Min/Max feature stores the highest and lowest readings until cleared
- Get more done—monitor multiple applications with dual-probe units

High-accuracy thermometers display the exact time/date when alarms are triggered. Record up to 525,600 data points to be transferred to a computer using a USB flash drive. The alarm tracking feature stores up to 10 unique alarm events. “Memory lock” option does not allow the internal memory to be cleared, and logging capacity increases to 1 million data points.

**What's included:** one AA battery and ILAC MRA, NIST-traceable calibration certificate.



Application	Sensor type	Range	Resolution	Accuracy	Without “memory lock” option	With “memory lock” option
					Catalogue number	Catalogue number
Refrigerator/freezer	One bottle probe	-50 to 70°C	0.01°	±0.25°C	MY-94460-07	MY-94460-37
Refrigerator/freezer	Two bottle probes				MY-94460-09	MY-94460-39
General purpose	One wire probe				MY-94460-11	MY-94460-41
General purpose	Two wire probes				MY-94460-14	MY-94460-43
General purpose and refrigerator/freezer	One wire and one bottle probe				MY-94460-18	MY-94460-47
General purpose	One solid SS probe				MY-94460-16	MY-94460-44
General purpose	Two solid SS probes				MY-94460-17	MY-94460-46

## Digi-Sense™ Temperature/Humidity Touch-Screen Recorder

### Virtually unlimited data logging with 8 GB of on-board memory

- Use right out of the box with resident self-booting software—no installation necessary!
- Quickly download data in .csv format via included USB cable

This tablet-based instrument measures, displays, and logs temperature, relative humidity, and dew point conditions. Measured values are simultaneously displayed both graphically and digitally on a high-resolution, color display. Easily program sample frequency, sample size, alarm settings, start mode, and units of measure through the intuitive touch-screen menu. Monitor conditions related to pharmaceutical, food, and chemical processing and storage; also ideal for use in greenhouses, museums, and labs.

**What's included:** tablet with built-in stand, temperature/RH sensor, 1.8-m sensor extension cable, USB cable, wall-mounting bracket, power supply, and ILAC MRA, NIST-traceable calibration certificate.

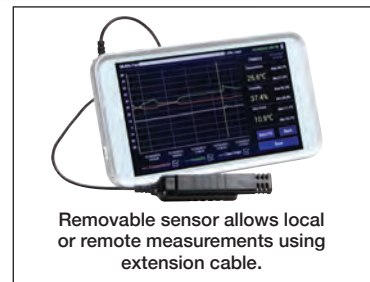

Removable sensor allows local or remote measurements using extension cable.



#### Accessories

**MY-20250-47** Additional extension cable for sensor, 1.8 m

#### Specifications

<b>Memory:</b> 8 GB	<b>Display:</b> 15.2 x 8.9 cm color LCD, with 1024 x 600 resolution	<b>Dimensions (W x H x D):</b> 19.3 x 10.8 x 1.6 cm	<b>Power:</b> 110 VAC; 2500 mAH rechargeable battery backup
---------------------	---	---	---

Parameters	Range	Resolution	Accuracy	Catalogue number
Temperature	-10 to 80°C (14 to 176°F)	0.1°C (0.1°F)	±0.5°C (±0.9°F)	MY-20250-40
Humidity	0 to 100% RH, noncondensing	0.1%	±2.0% at 25°C, 20% to 80% RH; ±2.5% for remaining	

## Digi-Sense™ USB Temperature and Temp/RH Data Loggers

### Use just about anywhere!

- Store, download, and analyse up to 32,000 data points with included software for analysis, graphing, printing
- Select your sample rate, start-up mode, and level alarms with user-definable settings



20250-41



20250-43

Description	Temperature	Temperature/RH	Temperature/RH with LCD	Temperature with 38° type K thermocouple probe
<b>Cat. no.</b>	MY-20250-41	MY-20250-42	MY-20250-43	MY-20250-44
<b>Range</b>	-40 to 70°C	-40 to 70°C; 0 to 100% RH (non condensing)	-200 to 1370°C	-200 to 1370°C
<b>Memory</b>	32,000 data points	32,000 data points (16,000 per channel)	32,000 data points	32,000 data points
<b>Reading rate</b>	1 reading every 2 seconds to 1 reading every 24 hours; user selectable			



## Digi-Sense™ Traceable® Data Loggers with TraceableGO™ Capability

### Easily access collected data between destinations

- Connect to your data via smartphone or tablet—any Bluetooth®-enabled device—using a downloadable Bluetooth® app
- View and download data with free TraceableGO App
- Get an immediate response to see if your contents have been exposed to conditions outside the set parameters
- Data loggers store up to 90 alarm events
- Calibrated for accurate, reliable measurements out of the box

Track environmental conditions of reagents, clinical samples, vaccines, pharmaceuticals, and food items during transport to any location. Easily configure the data loggers from your device using the TraceableGO app. Compact, IP66-rated waterproof data loggers fit almost anywhere—even inside a small cooler.

You have the option to subscribe to cloud-based TraceableLIVE® service to upload data to cloud—ideal for tracking data from multiple loggers or to comply with regulatory agency requirements. The low-cost TraceableLIVE subscription provides unlimited trip data to be saved, as well as ability to send a report to an email.

Choose from an integrated sensor or external probe depending on your samples. Use model 18004-28 with bullet probe to monitor air and liquids; both the sensor and cable may be completely immersed. Model 18004-29 features a temperature-buffered bottle probe which is ideal for vaccines in transit. Model 18004-30 with platinum RTD sensor lets you monitor a wider temperature range with greater accuracy.

**What's included:** two AAA batteries, free TraceableGO app, and ILAC MRA, NIST-traceable calibration certificate.



#### Specifications

- Resolution:** 0.1°; 0.1%
- Sampling rate:** 1 minute to 12 hours, 1-minute steps
- Memory:** 64K (65,536) data points, 7.5 months on a 5-minute logging interval



Description	Temperature data loggers				Temperature/humidity data logger
Catalogue number	MY-18004-12	MY-18004-28	MY-18004-29	MY-18004-30	MY-18004-13
Sensor type	Integrated (ambient)	Bullet	Bottle	Platinum RTD sensor; 316 SS tip	Integrated (ambient)
Cable	None	3-m immersible	3-m micro	2.7-m FEP coated	None
Temperature range	-20 to 70°C (-4 to 158°F)	-50 to 70°C (-58 to 158°F)	-50 to 70°C (-58 to 158°F)	-90 to 100°C (-130 to 212°F)	-20 to 70°C (-4 to 158°F)
Temperature accuracy	±0.4°C (±0.7°F)	±0.3°C (±0.5°F)	±0.3°C (±0.5°F)	±0.2°C (±0.4°F)	±0.4°C from -10 to 70°C, otherwise ±0.5°C (±0.7°F from 14 to 158°F; otherwise ±0.9°F)
Humidity range	—	—	—	—	0 to 95% RH, noncondensing
Humidity accuracy	—	—	—	—	±3% RH from 5 to 75%, otherwise ±5% RH

## Digi-Sense® TraceableOne™ USB Temperature Data Loggers

### Ensure effective cold chain management

- Ready to use with preprogrammed alarm parameters
- Automatically generate a PDF report via USB port
- Protective plastic pouch maintains waterproof IP67-rating—ideal for use with ice and cold packs

Use these single-use USB data loggers to track temperatures during shipments, storage, or experiments. Ideal for food, pharmaceutical, or laboratory use—for any application where a small accurate data logger is required. No software or driver is needed for setup or data download. Bar code allows in-house scanning.

**What's included:** Li-ion battery and ILAC MRA, NIST-traceable calibration certificate.



#### Specifications

- Temperature accuracy:** ±0.5°C (0.9°F) from -20 to 40°C (68 to 104°F); ±1°C (1.8°F) remainder
- Sampling rate:** 10 seconds to 12 hours
- Memory:** 16,000 data points

Alarms (low to high)	Logging cycle	Logging interval	Catalogue number (Pack of 10)
12 to 14°C (53.6 to 57.2°F)	10 days	1 min	MY-18004-14
	30 days	3 min	MY-18004-17
	60 days	6 min	MY-18004-20
	90 days	10 min	MY-18004-23
2 to 8°C (35.6 to 46.4°F)	10 days	1 min	MY-18004-15
	30 days	3 min	MY-18004-18
	60 days	6 min	MY-18004-21
	90 days	10 min	MY-18004-24
-20 to -15°C (-4 to 5°F)	10 days	1 min	MY-18004-16
	30 days	3 min	MY-18004-19
	60 days	6 min	MY-18004-22
	90 days	10 min	MY-18004-25

Note: Also available in packs of 40 on our website.

## Digi-Sense® Data Logging Refrigerator Thermometers with TraceableLIVE® Wireless Technology

### Get alerts before you lose valuable samples

- Remotely monitor your critical environments 24/7 via Wi-Fi†
- View current conditions anywhere—cloud-based interface sends email, text, and push notifications
- Securely connect to data via smartphone, tablet, or PC
- No software required—web, Android™, Apple® iOS data visibility
- Models with bottle probes are temperature-buffered to protect sensor from rapid changes when refrigerator door is opened.
- Use included Velcro® strip and magnetic strip for surface mounting, or use the built-in stand on a shelf

Digi-Sense data loggers with TraceableLIVE wireless technology provide a simple, efficient, and reliable way to ensure your critical samples are not compromised due to parameter variations. Plus you get the value, accuracy, and peace of mind of ILAC MRA, NIST-traceable calibration at a noncalibrated price.

TraceableLIVE allows you to view current conditions from anywhere with a cloud-based interface. Once setup is complete, you can view conditions in real time; set alarm parameters; view data logging history; generate data reports in real time; get email, text and push notifications; and receive alerts for temperature alarm, connectivity interruption and low battery.

†Requires a low-cost TraceableLIVE subscription.



#### Specifications

<b>Range:</b> -50 to 60°C (-58 to 140°F)	<b>Max storage:</b> 672 records (7 days if set to 15-minute intervals)
<b>Resolution:</b> 0.01°	<b>Max stored alarms:</b> 100
<b>Accuracy:</b> ±0.25°C (±0.45°F)	<b>Power:</b> four AAA batteries (included)
<b>Sample rate:</b> 12 sec	

Sensor type	Catalogue number
2 Bottle probes	MY-99460-00
1 Bottle and 1 bullet probe	MY-99460-05
2 Bullet probes	MY-99460-10
2 Stainless steel probes	MY-99460-15

## Digi-Sense® Traceable® Temperature Data Loggers

### No need to download data first—display shows measurements and alarm duration

- Be alerted to out-of-limit conditions of sensitive items
- Download and analyse data with time-and-date stamp via required software
- Program and edit programs via software, even on multiple units

**Temperature Data Logger** is reusable and reprogrammable, ideal for the monitoring of perishable items during transport. **Temperature/Relative Humidity Data Logger** is ideal for transportation temperature monitoring, and for use with products that are sensitive to humidity levels. **Cryogenic Temperature Data Logger** has an external, 110.5-mm long stainless steel temperature probe—perfect for monitoring cryo-materials, reagents, samples, pharmaceuticals, and frozen food items.

**What's included:** battery and individually serialised ILAC MRA NIST-traceable calibration certificate. Kit 18005-01 comes with five temperature data loggers, one copy of data download and analysis software, and one cradle with USB cable.



Description	Temperature data logger	Temperature data logger kit	Temperature/RH data logger	Cryogenic temperature data logger
<b>Catalogue number</b>	MY-18005-00†	MY-18005-01	MY-18005-05†	MY-18005-06†
Temperature range	-35 to 50°C (-31 to 122°F)		-29 to 72°C (-20.2 to 161.6°F)	-200 to 72°C (-328 to 161.6°F)
Temp resolution	0.1°		0.1°	0.1°
Temp accuracy	±0.2°C (±0.4°F) from 0 to 10°C (32 to 50°F); ±1°C (±2°F) otherwise		±0.2°C (±0.4°F) from 0 to 10°C (32 to 50°F); ±0.5°C (±1°F) otherwise	±0.2°C (±0.4°F) from 0 to 30°C (32 to 86°F); ±1°C (±2°F) otherwise
RH range	—		0 to 100%	—
Memory capacity	7680 readings		30,720 readings	64,000 readings
Sampling rate	Adjustable from every 2 seconds to every 24 hours			
Required for data transfer†	Cradle 18005-03; Software 18005-04	Cradle and software included	Cable 18005-07; Software 18005-04	Cable 18005-07; Software 18005-04
Power	CR2450 3V lithium coin cell battery (included)			

†Order required items separately at right.

**MY-18005-03 Cradle and USB cable** for temperature data logger

**MY-18005-07 USB cable** for temp/RH and cryogenic data loggers

**MY-18005-04 Software** for data analysis and setting parameters

**MY-18005-02 Data logger sleeves.** Pack of 100

**MY-17102-20 ILAC MRA, NIST-traceable recalibration** for temperature data logger



## Scienceware® Vacuum Desiccators, PP/PC

### No need for grease

- Maximise interior space with high crowned lid
- Control vacuum draw via stopcock, holds 74 cm Hg for 24 hours
- Includes perforated plate
- Room temperature use only—do not autoclave



Plate dia (mm)	Total height (mm)	Clearance above plate (mm)	Qty/pk	Catalogue number
140	206	122	1	MY-06514-10
190	260	157		MY-06514-20
230	311	198		MY-06514-30

## Cole-Parmer® Desiccators, PP/PC

### Secure, tight seal

- Neoprene O-ring provides tight seal—add grease for complete air tight storage
- Perforated plate holds samples above desiccant
- Desiccator has a chemical-resistant polypropylene (PP) body and polycarbonate (PC) cover

A neoprene O-ring offers a secure seal. Use grease on the flanges to make the unit completely airtight. Includes PP plate.



**Cole-Parmer®**

Plate dia (mm)	Total height (mm)	Clearance above plate (mm)	Catalogue number
138	204	123	MY-06525-22
190	257	166	MY-06525-24
248	315	207	MY-06525-26

## Vacuum Desiccators, Glass

### Pull more vacuum

- Holds maximum vacuum of 76 cm Hg
- No need for grease to create tight seal
- Order desiccator plate separately

**Warning:** Do not heat or subject to pressure.



Plate dia (mm)	Bowl capacity	Total height (mm)	Clearance above plate (mm)	Catalogue number
140	2400 mL	239	81	MY-34548-27
190	5800 mL	296	115	MY-34548-28
230	10,500 mL	344	120	MY-34548-29

**MY-06518-30 Desiccator plate;** porcelain, 140 mm dia

**MY-06518-40 Desiccator plate;** porcelain, 190 mm dia

**MY-06518-50 Desiccator plate;** porcelain, 230 mm dia

## Drierite® Desiccants

### Use wherever you need it

Use Drierite desiccants (anhydrous calcium sulfate) in desiccators, drying columns, or drying tubes. Choose indicating or non-indicating desiccant—indicating desiccant starts blue, then turns pink when regeneration or renewal is necessary.

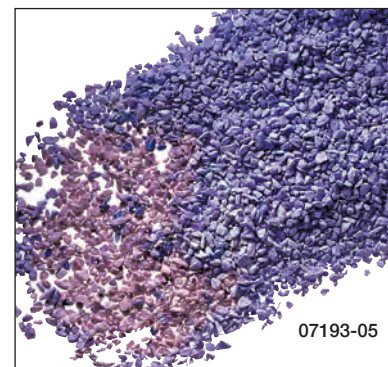

07193-05

Packaging	Mesh size	Qty/pk	Catalogue number
<b>Indicating Drierite desiccant<sup>†</sup></b>			
1 lb pks	8 mesh	12	MY-07193-05
5 lb pks		4	MY-07193-15
25 lb can		1	MY-07193-18
<b>Nonindicating Drierite desiccant<sup>‡</sup></b>			
1 lb pks	8 mesh	12	MY-07193-20
5 lb pks		4	MY-07193-25
25 lb can		1	MY-07193-30

<sup>†</sup>Drying capacity is 10 to 14% of its weight for water and gases.

<sup>‡</sup>Drying capacity is 6% of its weight for water and gases.

## Digi-Sense™ 1000 A AC and AC/DC Clamp Meters

### Instantly view power variations on the analog bar graph

- Reliable measurements, guaranteed! Precalibrated to ILAC MRA, NIST-traceable standards
- Conveniently hold or “freeze” a reading for times when you can’t see the display
- Rugged double-molded housing and ergonomic grip

Perfect for everyday use, the units measure AC current, voltage (AC and DC), resistance, capacitance, frequency, and duty cycle. Features include autoranging, data Hold, Max/Min readings, diode test, audible continuity check, and overload protection. The 30-mm (1 3/16") jaw opening is ideal for getting inside small compartments or boxes with tightly arranged electrical wires. Model 20250-58 is a true workhorse—it adds on DC current measurement to 1000 A DC, True RMS for more accurate current readings, and temperature measurement via a type K thermocouple.

**What’s included:** test leads, temperature probe (20250-58 only), carrying case, 9 V battery, and ILAC MRA, NIST-traceable calibration report.



Description	AC clamp meter	AC/DC clamp meter
<b>Catalogue number</b>	<b>MY-20250-57</b>	<b>MY-20250-58</b>
AC current	1000 A	1000 A (True RMS)
DC current	—	1000 A
AC voltage	750 V	750 V (True RMS)
DC voltage	1000 V	800 V
Resistance	60 MΩ	60 MΩ
Capacitance	4000 μF	100 μF
Frequency	10 MHz	10 MHz
Duty cycle	5.0 to 94.9%	0.5 to 99.0%
Continuity/Diode	Yes	Yes
Temperature (type K)	—	–20 to 1000°C (–4 to 1832°F)
Display	6000-count LCD, with backlight and analog bar graph	
Power	One 9 V battery (included)	

## FLIR® Industrial Thermal Imaging AC/DC Clamp Meter

### Store data or share wirelessly for improved workflow

- Quickly identify problems you can’t see with a standard clamp meter
- IGM™ infrared technology visually guides you to the precise location of a potential electrical problem
- Work safely—scan a panel or cabinet for hazards using IGM without direct contact
- Easily access difficult locations with the compact form-factor and narrow jaw
- Laser and crosshair pinpoint problem locations through thermal images
- Wirelessly connect your meter to FLIR Tools or FLIR InSite™ workflow management app

**What’s included:** silicone test leads, soft carrying case, and three AAA batteries.



Model	CM275
<b>Catalogue number</b>	<b>MY-35725-28</b>
AC current	600 A
Basic AC accuracy	±2.0%
DC current	600 A
AC voltage	0 to 1000 V
DC voltage	0 to 1000 V
Resistance	0 to 6 kΩ
Capacitance	0 to 1000 μF
Frequency	0 to 10 kHz
Temperature range (IR)	–10 to 150°C (14 to 302°F)
Temperature accuracy	±3°C or 3%
Thermal image resolution	19,200 pixels (160 x 120)
Field of view	38.6° x 50.0°
Thermal sensitivity (NETD)	150 mK
Emissivity	4 presets with custom adjustments

- MY-20048-92 Flex current probe, 3000 A; 25 cm (10")**
- MY-20048-94 Flex current probe, 3000 A; 45 cm (18")**
- MY-20070-01 Optional lithium polymer rechargeable battery kit**
- MY-09376-00 Replacement batteries, AAA. Pack of 12**
- MY-17090-00 ILAC MRA, NIST-traceable calibration with data**

## Digi-Sense™ 400 A AC and AC/DC Clamp Meters

### Compact—fits into tight places

- Reliable measurements, guaranteed! Precalibrated to ILAC MRA, NIST-traceable standards
- Autorange automatically selects optimal measuring range
- Bright red indicator alerts you to live AC voltage
- Increased durability with double-molded plastic housing and jaw

These smaller-sized clamp meters feature diode testing, continuity check with a buzzer sound at 50 Ω, and a built-in noncontact AC voltage detector. Additional functions include data Hold, overrange and low-battery indication. Model 20250-56 also measures DC current and capacitance, and features a Peak hold function that captures the peak AC current or voltage reading.

**What’s included:** test leads, temperature probe, carrying case, 9 V battery, and ILAC MRA, NIST-traceable calibration report.



Description	AC clamp meter	AC/DC clamp meter
<b>Catalogue number</b>	<b>MY-20250-55</b>	<b>MY-20250-56</b>
AC current	400 A	400 A (True RMS)
DC current	—	400 A
AC voltage (True RMS)	600 V	600 V
DC voltage	600 V	600 V
Resistance	40 MΩ	40 MΩ
Capacitance	—	4 mF
Frequency	10 to 10,000 Hz	10 to 100,000 Hz
Continuity/Diode	Yes	
Temperature (type K)	–20 to 760°C (–4 to 1400°F)	
Display	4000-count LCD	
Power	One 9 V battery (included)	

**MY-17090-04 ILAC MRA, NIST-traceable recalibration with data**

## Digi-Sense™ Compact Digital Multimeters

### Pocket sized

- Reliable measurements, guaranteed! Precalibrated to ILAC MRA, NIST-traceable standards
- Overload protection: stay safe, prevent damage
- Increased durability with double-moulded plastic housing
- Tilt stand for easy hands-free viewing



**Model 20250-50** offers manual ranging and a dedicated battery test function lets you check the quality of your 9 V and 1.5 V batteries. **Full-featured model 20250-51** has autoranging for optimal measuring range for max resolution.

**What's included:** test leads, type K temperature probe (20250-51), carrying case, 9 V battery, and ILAC MRA, NIST-traceable calibration report.



Description	Manual ranging DMM	Autoranging DMM
<b>Catalogue number</b>	<b>MY-20250-50</b>	<b>MY-20250-51</b>
AC current	—	10 A
DC current	10 A	10 A
AC voltage	600 V	600 V
DC voltage	600 V	600 V
Resistance	2.000 MΩ	40.00 MΩ
Capacitance	—	200.0 μF
Frequency	—	9.999 MHz
Duty cycle	—	0.1 to 99.9%
Continuity	Yes	Yes
Diode	Yes	Yes
Temp. (type K thermocouple)	—	–20 to 760°C (–4 to 1400°F)
Display	2000-count LCD	4000-count LCD

**MY-17090-00** ILAC MRA, NIST-traceable recalibration with data

## Portable Gauss/Tesla Meter

### Get benchtop performance in your hand

- Digital signal processor provides the latest measurement technology

These autoranging meters measure in gauss and tesla, and feature auto zero, min/max and peak hold readings, relative mode and built-in software for easy field calibration.

Model 20001-29 also measures in ampere/ meters and features an analog output and USB communication port for downloading measurements to your PC.



**What's included:** 10.2 cm (4") L transverse probe, zero gauss chamber, four AA batteries, and carrying case.

Model	5170	5170 W/STD18-040
<b>Catalogue number</b>	<b>MY-20001-28</b>	<b>MY-20001-29</b>
Gauss	Range	200 G; 2, 20 kG
	Resolution	0.1, 1.0, 10 G
Tesla	Range	20, 200 mT; 2T
	Resolution	10, 100 μT; 1 mT
Ampere/ meters	Range	—
	Resolution	—
Accuracy	±2%	±1%
Bandwidth	0 to 20 kHz	0 to 40 kHz
Outputs	—	±3 V, USB
Power	Four AA batteries (included)	

- MY-20043-27 Repl. transverse probe** for model 20001-28; 10.2 cm L
- MY-20001-31 Repl. transverse probe** for model 20001-29; 10.2 cm L
- MY-20001-30 Axial probe** for model 20001-28; 10.2 cm L
- MY-20043-28 Axial probe** for model 20001-29; 10.2 cm L

## Digi-Sense™ Industrial Digital Multimeters

### Tough and reliable

- Reliable measurements, guaranteed! Precalibrated to ILAC MRA, NIST-traceable standards
- Impact-resistant housing is IP67-rated
- Bright, large 4000-count LCD with backlight
- Flashing red LED alerts you to live voltage
- Automatically select the optimal measuring range with autoranging feature
- Model 20250-53 provides relative and % duty cycle measurements
- True RMS model 20250-54 provides improved reading accuracy in the presence of harmonic distortions present in electrical loads



**What's included:** test leads, type K temperature probe (20250-54), carrying case, 9 V battery, and ILAC MRA, NIST-traceable calibration report.



Description	Industrial DMM	True RMS Industrial DMM
<b>Catalogue number</b>	<b>MY-20250-53</b>	<b>MY-20250-54</b>
AC current	10 A	10 A
DC current	10 A	10 A
AC voltage	1000 V	1000 V
DC voltage	1000 V	1000 V
Resistance	40.00 MΩ	40.00 MΩ
Capacitance	40.00 mF	40.00 mF
Frequency	10.00 MHz	10.00 MHz
Duty cycle	0.1 to 99.9%	—
Continuity	Yes	Yes
Diode	Yes	Yes
Temp. (type K thermocouple)	—	–4 to 1400°F (–20 to 760°C)
Display	4000-count LCD	4000-count LCD with analog bar graph

**MY-17090-00** ILAC MRA, NIST-traceable recalibration with data

## Digi-Sense™ Insulation Tester

### Multiple safety features

- Live circuit detection prevents testing if voltage is present
- Automatic discharge of stored voltage for added protection
- Data Hold and test lock functions allow hands-free operation
- View measurements clearly on large dual-line backlit LCD, check trends on analog bar graph



**What's included:** test leads, plastic carrying case, and six AA batteries.



Description	Insulation tester	
<b>Catalogue number</b>	<b>MY-20250-60</b>	
Insulation resistance	Range	4, 40, 400, 4000 MΩ
	Resolution	1 KΩ to 1 MΩ
	Accuracy	±2.0% ± 6
AC voltage	Range	750 V
	Max resolution	1 V
	Accuracy	±1.2% ± 10
DC voltage	Range	1000 V
	Resolution	1 V
	Accuracy	±0.8% ± 3
Resistance	Range	40 to 400 Ω
	Resolution	0.01 to 0.1 Ω
	Accuracy	±1.5% ± 6
Test voltage and current	125 V, 250 V, 500 V, 1000 V, and 1 mA nominal	
Continuity test	Active sound level: <40 Ω, Test current: <200 mA	
Power	Six AA batteries (included)	



## Cole-Parmer® Horizontal Mini-Quick Gel Electrophoresis System

### Stop waiting for results—takes less than an hour

- Save on reagents—require maximum of 50-mL of agarose
- Monitor sample easily with UV transparent base
- Minimise prep work—cast gels easily with snap-in PVC dams

The mini-quick horizontal system is designed for easy, simple, and safe runs. The uniplanar design has a buffer chamber only slightly longer than the gel itself, minimising the amount of buffer required. Use one or two comb positions for up to a max of 40 sample output. Get elution of DNA in dialysis bags in less than fifteen minutes.

**What's included:** UV transparent base with grooves for gel casting dams, built-in storage compartment, two gel casting dams, and safety cover with attached leads. Two PVC combs are included with the system; specify comb size at time of order. Order additional comb sizes or gel casting dams below.

 Cole-Parmer®

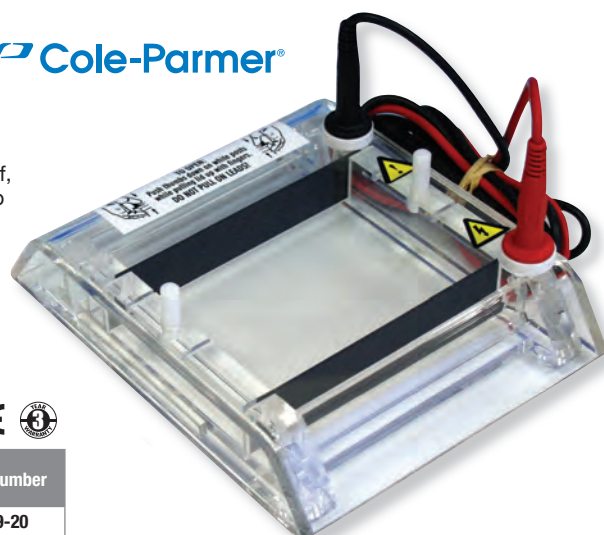

Gel size (W x L)	Buffer required (mL)	Cell dimensions (L x W x H)	Voltage limit	Catalogue number
7.5 x 10 cm	50	17 x 14 x 8 cm	100 VDC	MY-28559-20

#### Combs

Number of wells	1.0-mm combs		2.0-mm combs	
	Maximum vol./well	Catalogue number	Maximum vol./well	Catalogue number
4	82 µL	MY-28559-90	163 µL	—
8	36 µL	—	72 µL	—
16	13 µL	—	26 µL	MY-28559-96
20	22 µL	MY-28559-93	44 µL	MY-28559-97

#### Search

Please go online for our full selection of electrophoresis products.

## Cole-Parmer® Horizontal Mid-Size Gel Electrophoresis Systems

### Faster sequencing with reduced gel path

- No need for sealing or taping with tapered-baffle design
- No more floating gels with anchors within UV-transparent tray
- Pour two gels simultaneously with optional gel casters

**What's included:** safety cover with attached power leads; tapered baffles for casting gels, UV-transparent gel tray, and long-life platinum electrodes.

 Cole-Parmer®



Gel size (W x L)	Buffer required	Cell dimensions (L x W x H)	Catalogue number
14 x 10 cm	700 mL	21.6 x 16.5 x 14.0 cm	MY-28560-00
14 x 16 cm	750 mL	27.3 x 16.5 x 14.0 cm	MY-28560-10
14 x 20 cm	1500 mL	34.9 x 15.2 x 10.2 cm	MY-28561-00

**Gel Sealing Tape** for sealing glass plate assemblies.

**MY-28565-40 Gel sealing tape;** 2.5 cm (1") wide. Roll of 66 m (72 yards)

**MY-28565-41 Gel sealing tape;** 3.8 cm (1.5") wide. Roll of 66 m (72 yards)

**Combs** are single sided and height adjustable; available in three thicknesses to accommodate different sample volumes. The 13- and 27-well combs are spaced to allow sample loading with multi-channel pipettors.

Number of wells	1.0-mm combs	1.5-mm combs	2.0-mm combs
	Catalogue number	Catalogue number	Catalogue number
10	MY-28560-50	MY-28560-55	MY-28560-60
13	MY-28560-51	MY-28560-56	MY-28560-61
16	MY-28560-52	MY-28560-57	MY-28560-62
20	MY-28560-53	MY-28560-58	MY-28560-63
27	MY-28560-54	MY-28560-59	MY-28560-64

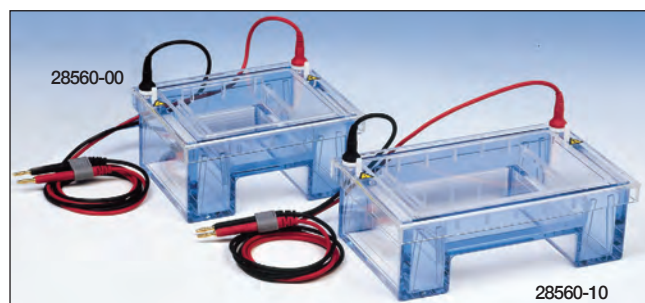

**Gel Trays** let you pour gels in the unit using the tapered baffles; outside of the unit by taping the ends of the tray; or outside of the unit using gel casters (sold below). Trays are UV-transparent acrylic. Multiple comb slots let you cast gels for simultaneous short runs.

**MY-28560-70 Gel tray** for model 28560-00. With two comb slots; pathlength of 3.6 cm/slot

**MY-28560-72 Gel tray** for model 28560-10. With four comb slots; pathlength of 3.1 cm/slot

**MY-28561-50 Gel tray** for model 28561-00. With six comb slots, pathlength of 2.6 cm/slot

**Gel Casters** allow you to precast consistently flat, even gels using the gel trays sold above. Casters accommodate either one or two trays. Casters feature a three-point leveling base and soft, coated neoprene side gaskets that secure trays in place and effectively seal their ends during casting—eliminating the need for taping.

Number of places	For 28560-00	For 28560-10	For 28561-00
	Catalogue number	Catalogue number	Catalogue number
1	MY-28560-74	MY-28560-78	MY-28561-60
2	MY-28560-76	MY-28560-79	MY-28561-62

## Digi-Sense™ Precalibrated Data Logging Light Meter

Don't get blinded—ensure safe environmental conditions

- Have confidence in your readings—precalibrated before you get it!
- Perfect for most applications—measures from 0 to 400 klux
- Count on your reading—accurate to ±3% with silicon photo diode and spectral response filter
- Record/analyse your data for future recall—stores up to 87,000 measurements
- More in-depth data analysis with included software right on your desktop



Description	Data logging light meter
<b>Catalogue number</b>	<b>MY-20250-00</b>
Range	0 to 400,000 lux; 0 to 40,000 ftc
Resolution	0.01 lux/ftc
Accuracy	±3% rdg ±0.5% full-scale (<10,000 lux), ±4% rdg ± 10 digits (>10,000 lux)
Data logging	Up to 87,000 measurements
Functions	Data logging, record/recall, Min/Max/Hold, auto power-off
Output	USB
Power	Three AAA batteries (included)

## Illuminance Meters

Assess PWM-controlled lighting

- Don't worry about multipoint measurement needs—provides 2 to 30 points of data
- Get accurate measurements of next-generation lamps
- Conform to JIS Class AA and DIN Class B requirements
- Get in hard-to-reach places with mini-receptor on model T-10MA

Use the optional data management software to import your results into Excel® for report generation and analysis.



Description	T-10A with integral sensor	T-10MA with remote mini-receptor
<b>Catalogue number</b>	<b>MY-50537-07</b>	<b>MY-50537-08</b>
Range	fc: 0.001 to 29,990; Lux: 0.01 to 299,900	
Resolution	0.001 fc/lux	
Accuracy	±2% ±1 digit of displayed value	
Auto-range	Five manual ranges at the time of analog output	
Cosine response (f <sub>2</sub> )	Within 3%	
User calibration function	CCF (color correction factor) setting function: measurement value = 0.500 to 2.000	
Digital output	USB	
Analog output	1 mV / digit, 3 V at max reading; output impedance: 10 kΩ	
Power	Two AA batteries (included)	

### Accessories

MY-50537-09 Optional data management software

MY-09376-01 Replacement batteries, AA. 4/pk

MY-17101-44 ILAC MRA, NIST-traceable calibration with data

## Digi-Sense™ Precalibrated Data Logging Sound Level Meter

Four ranges provide flexibility

- Reliable measurements, guaranteed! Precalibrated to ILAC MRA, NIST-traceable standards
- Programmable sample rates for a wide range of applications
- Meets ANSI and IEC Type 2 standards
- Expanded memory up to 32,700 readings
- Included data logging software with graphical display for quick and easy analysis
- Tripod mountable—ideal for field use

Get precision sound decibel measurements for product noise certification and reduction applications. Meter conforms to Class 2 standards, ideal for OSHA and IEC surveys. Features A and C weighting capabilities for measuring noise levels from industrial machinery or equipment to residential/commercial environments ensuring noise level standards and compliance. Use the included software to view data in graphical format as well as record and download data via USB to your PC for further analysis.

Additional features include Max/Min and Hold functions, over- and under-range indication, fast/slow response, analogue AD/DC outputs, and USB connectivity. Automatic power-off conserves battery life. Plus the ILAC MRA, NIST-traceable precalibration means you get reliable measurements right out of the box!

**What's included:** windscreen, 3.5-mm earphone plug, screwdriver, software, USB cable, three AAA batteries, and ILAC MRA, NIST-traceable calibration report with data supplied.



Description	Type 2 data logging sound level meter
<b>Catalogue number</b>	<b>MY-20250-29</b>
Range	Low: 30 to 80 dB; Medium: 50 to 100 dB; High: 80 to 130 dB; Automatic: 30 to 130 dB
Resolution	0.1 dB
Accuracy	±1.4 dB
Weighting	A and C
Response time	Fast and slow
Functions	Max/Min, hold, data logging, auto power off
Outputs	Analog AD/DC, USB
Data logging	32,700 readings
Display	4-digit backlit LCD with analog bar graph
Dimensions (L x W x H)	23.5 x 6.1 x 2.7 cm
Power	Three AAA batteries (included)

## Environmental Express® HotBlock® Digestion Systems

### Perform digestions faster, cleaner, and more reliably

- Eliminate corrosion and sample contamination—made of PTFE-coated graphite and other nonmetallic materials
- No additional cables or controllers—all electronics housed below unit
- Get uniform heating to all samples, up to 150°C
- Easily transport samples with included polycarbonate transfer racks

HotBlock digestion systems are EPA approved for all methods approved for hot plate digestions including, but not limited to, methods 3005, 3010, 3050B, 200.2, 200.7, 200.8, 7470A, 7471A, 245.1 and 245.7.



Sample size†	Number of wells	Uniformity	Maximum temperature	Dimensions (W x H x D)	Catalogue number
15 mL	96	±1.5°C	150°C	38 x 23 x 54 cm	MY-53205-01
50 mL	36	±1.5°C	150°C	38 x 23 x 38 cm	MY-53205-03
50 mL	54	±1.5°C	150°C	38 x 23 x 54 cm	MY-53205-05
100 mL	25	±1.5°C	150°C	38 x 23 x 38 cm	MY-53205-07
100 mL	35	±1.5°C	150°C	38 x 23 x 54 cm	MY-53205-12

†Order PP cups separately on page 60.



## Environmental Express® HotBlock® 200 Digestion Systems

### Uniform heating, up to 200°C

- Eliminate corrosion and sample contamination—made of nonmetallic materials
- Easily transport samples with included polycarbonate transfer racks
- Mount external controller safely outside the hood



Easy-to-use external controllers feature automatic shut-off, alarms, and ability to save profiles with ramp and soak settings. Order heating block and controller separately below.



#### Specifications

**Temperature range:** ambient to 200°C† **Temperature uniformity:** ±0.2°C  
**Temperature resolution:** 0.1°C **Temperature element:** RTD

### 1. Heating Blocks

Sample size†	Wells	Dimensions (L x W)	Power (VAC)	Catalogue number
15 mL	96	54.6 x 38.1	240	MY-53206-03
	36	38.1 x 38.1		MY-53206-05
50 mL	54	54.6 x 38.1		MY-53206-07
	25	38.1 x 38.1		MY-53206-09
100 mL	35	54.6 x 38.1		MY-53206-11

†For temperatures ≥130°C, use glass or PTFE digestion cups. For temperature <130°C, use PP cups (order on page 60).

### 2. Controllers

Number of blocks accepted	Dimensions (L x W)	Catalogue number
1	15.2 x 17.8 cm	MY-53206-00
2		MY-53206-02

## Environmental Express® FilterMate® Filtration Systems

### Eliminate sample transfer—filter and digest in the same cup

- Filter 15- and 50-mL samples within sample cups
- Simple to use—attach FilterMate plunger to filter assembly, then press down on plunger
- No need for separate filtration devices before analysing samples

These easy-to-use filtration systems filter within vessels so you don't need to do a separate filtration of sample before analysis.

**What's included:** 100 filter assemblies and plungers.



Optional holder keeps FilterMate stable



Membrane type	Pore size (µm)	Lot certified	Applications	Qty/pk	Catalogue number
PTFE-faced polypropylene	2	No	Most laboratory applications	100	MY-35202-00
Acid-washed glass fiber with polyethylene frit	0.7	No	TCLP extractions	100	MY-35202-01
PVDF with PTFE prefilter	0.45	No	Dissolved metals only	100	MY-35202-02
Certified PTFE	2	Yes	Trace level analysis	100	MY-35202-03
PVDF with PTFE prefilter	0.45	Yes	Dissolved metals only	100	MY-35202-04
Polyethylene frit	2	No	Use with 15-mL digestion cups	100	MY-35202-05

**MY-35202-06 Holder for FilterMate filtrations**, secures the 50-mL digestion cup during filtration. HDPE material

**MY-35202-07 Replacement plunger** fits 50-mL cup. Pack of 500



## Environmental Express® Digestion Cups

### Graduated for better sample dilutions

- Digestion vessel, graduated cylinder, or storage container and fit perfectly into the HotBlock® systems
- Certified with low metals background and EPA approved for digestions
- UltimateCup™ cups are redesigned for increased durability, stability, and a tighter seal

Environmental Express digestion cups are approved for hot plate digestions†, and certified for volume to 0.5%. The accurate graduations eliminate the need for graduated cylinders and transfer steps, saving you both time and labor costs. The clarified homopolymer polypropylene (PP) construction has greater chemical resistance and heat tolerance than commonly used co-polymer polypropylene.

All Ultimate cups are packaged using metals-free materials and include a Certificate of Analysis for 68 trace metals. The Ultimate Clean™ Cup is specially capped, racked and wrapped to ensure minimal exposure to possible sources of contamination and is certified to parts-per-billion and parts-per-trillion levels.

Description	Total capacity	Graduations	Size	Cap	Qty/cs	Catalogue number
15-mL digestion cup	18 mL	To 15 mL	17.5 x 105 mm	Natural, no liner	1000	MY-53201-01
50-mL Ultimate Clean digestion cup	68 mL	To 50 mL	30 x 106 mm	Natural, no liner	150	MY-53204-17
50-mL UltimateCup digestion cup	68 mL	To 50 mL	30 x 106 mm	—	500	MY-53203-03
				Green with PE liner	500	MY-53203-13
				White with PE liner	500	MY-53203-15
				Natural, no liner	500	MY-53203-17
50-mL UltimateCup digestion cup with Rack Lok	68 mL	To 50 mL	30 x 106 mm	—	500	MY-53203-23
				White with PE liner	500	MY-53203-25
				Natural, no liner	500	MY-53203-27
100-mL digestion cup	125 mL	To 100 mL	46 x 100 mm	White with PE liner	225	MY-53201-07



**ENVIRONMENTAL EXPRESS®**

†Approved for, but not limited to, EPA Methods 3005, 3010, 3050B, 200.2, 200.7, 200.8, 7470A, 7471A, 245.1, and 245.7.

## Environmental Express® SimpleDist® Distillation System

### Perform safe and easy ammonia and cyanide distillations

- Minimise clean-up—only glassware to clean is the boiling tube
- No chiller or water lines required—distilled ammonia and cyanide collected right in the trap
- Conforms to established methods—uses the same reagents in the same molar concentrations as EPA Method 335.4 and Standard Method 4500-CN-C for Cyanide as well as EPA Method 350.1 and Standard Methods 4500-NH3 for ammonia



This complete SimpleDist system comes with a 12-place HotBlock® digestion system and a 12-valve manifold kit. Order additional accessories separately to optimise the system for your needs.

**SimpleDist®**

**CE**  
For HotBlock®

Description	Power	Catalogue number
SimpleDist complete 12-valve system	240 VAC, 3 A	MY-35209-85

Description	Qty/pk	Cat. no.
Boiling tube, borosilicate glass, 30 x 200 mm	1	MY-35205-72
Collection traps, 25 mL	100	MY-35209-90
Reagent addition tube with funnel tip	100	MY-35209-91
Screw cap, open-top, polypropylene, 38 mm	6	MY-35209-92
Black washer, neoprene, for 38-mm screw caps	6	MY-35209-93
Two-port cap insert, for 38-mm screw caps	6	MY-35209-94

## Environmental Express® SimpleDist® Micro Distillation System

### Eliminate broken glassware

- Accepts disposable polypropylene distillation micro tubes—no more costly glass apparatus to clean or replace
- Save time—smaller sample size means quicker distillations
- Reduce waste—requires just 6-mL of sample
- No need for cooling water



SimpleDist Micro heating block shown with disposable micro tubes—order separately below.

**SimpleDist®**  
*Micro*

The EPA approves the use of micro distillation systems with disposable tubes for reporting of cyanide; system can be adapted for ammonia reporting. Everything is done in the micro tube! Simply add sample, heat, and bring the distillate to volume in the collection part of the tube.

Description	Number of wells	Temperature range	Power	Catalogue number
SimpleDist Micro heating block	26	Ambient to 150°C	240 VAC	MY-35202-38

### Disposable Micro Tubes

Qty/pk	Ammonia tubes	Cyanide tubes	Phenol tubes
	Catalogue number	Catalogue number	Catalogue number
26	MY-35202-92	MY-35202-72	MY-35202-82
100	MY-35202-93	MY-35202-73	MY-35202-83

## Environmental Express® HotBlock® Hot Plate

Heat vessels with flat bottoms with ease

- Durable graphite and Kydex® construction
- Uniform heating of samples
- Low-wattage mat uses a maximum of 1065 watts of power



Temperature range	Dimensions (W x H x D)	Power			Catalogue number
		VAC	Hz	Amps	
Ambient to 150°C (302°F)	38 x 23 x 54 cm (15" x 9" x 21½")	240	50	7	MY-53205-11

## Polycarbonate Transfer Racks

Safely place multiple samples into heating block

- No more moving one sample at a time
- Resists heat and acids



Description	Sample size	Number of racks/pk	Catalogue number
(3) 32-place racks	15 mL	3 racks	MY-53205-49
(1) 18-place rack	50 mL	1 rack	MY-53201-11
(1) 15-place and (1) 10-place rack	100 mL	2 racks	MY-53201-13
(1) 15-place and (2) 10-place rack	100 mL	3 racks	MY-53205-48

## Ribbed Watch Glasses

Achieve partial reflux during digestion

- Easily place and remove watch glass with center stem
- Free of contaminants—made of polypropylene



Description	Diameter	Qty/pk	Catalogue number
For 15-mL digestion cups	19.5 mm	1000	MY-53201-02
For 50-mL digestion cups	44 mm	1000	MY-53201-04
For 100-mL digestion cups	52 mm	500	MY-53201-08

## Disposable Reflux Cap

Center hole for smooth addition of reagents

- Fits 50-mL digestion cup
- Achieve equal reflux as the ribbed watch glasses

Diameter	Qty/pk	Catalogue number
34 mm	1000	MY-53201-06



## Stuart® Rotary Evaporator

### Efficient flask and vapour tube ejection system

- Digital control for reproducible results
- Versatile—can be orientated for left or right handedness
- Simple, counterbalanced lift mechanism
- PTFE/glass liquid pathway for chemical inertness
- Long-life graphite-impregnated PTFE vacuum seal

Stuart laboratory evaporator offers simple control and three glassware configurations—diagonal, vertical, or cold finger condensing—depending on your application and space requirements. All configurations are available with plastic-coated glass† for additional safety.

Choose the diagonal condenser where height space is limited, while the vertical condenser is suitable where bench space is limited or in fume hoods. The cold finger condenser is the option to select if you don't have a constant water supply for cooling the evaporated solvent.

**What's included:** rotary evaporator with power cord, glassware set (condenser, 1-L pear-shaped sample flask, and 1-L round bottom receiving flask), and clips.



#### REQUIRED System Components

- 1) Rotary evaporator
- 2) Bath
- 3) Vacuum pump
- 4) Recirculating cooler

stuart®



16340-57

#### Specifications

**Speed range:** 10 to 310 rpm      **Lift distance:** 18 cm (7")  
**Speed resolution:** 1 rpm      **Power:** 100 to 240 VAC, 50/60 Hz  
**Vacuum:** 3 mm Hg (0.12" Hg)



Type	Uncoated glassware	Plastic-coated glassware†
	Catalogue number	Catalogue number
Diagonal condenser	MY-16340-57	MY-16340-60
Vertical condenser	MY-16340-58	MY-16340-61
Cold finger (Dewar)	MY-16340-59	MY-16340-62

†Plastic-coated glassware is limited to 80°C (176°F); use only with water bath 16340-64.

#### Accessories

**MY-99966-96 Vacuum pump:** 12 mbar pressure; 230 VAC, 50/60 Hz, 150 W



16340-58



16340-59

## Stuart® Digital Baths

### Be safe with “cool-touch” outer housing

- Precise digital temperature display
- Corrosion-resistant bowl is easy to clean
- Safety features include high temperature alarm and overheating protection

These precision digital baths have been specifically designed to be used with the Stuart rotary evaporators above to give maximum efficiency in the smallest footprint. The clear LED digital display shows the actual bath temperature or the set temperature.

Choose from two bath options. The 90°C bath has a 304 stainless steel bowl and integrated carrying handle and is for water only, suitable for low boiling point applications. The higher temperature 180°C bath has an aluminium bowl with PTFE coating and can be used with both water and oil, ideal for higher boiling point liquids.

**What's included:** bath cover and power cords (Euro and UK).



Description	Digital water bath	Digital water / oil bath
Catalogue number	MY-16340-64	MY-16340-65
Temperature range	Ambient to 90°C	Ambient to 180°C
Display resolution	1°C	1°C
Temperature control	±1°C	±1.5°C (water) / ±3°C (oil)
Capacity	4.3 litres	5 litres
Heater power	1400 W	1400 W
Power supply	230 VAC, 50 Hz	230 VAC, 50/60 Hz

stuart®



16340-64



16340-65



## Disposable In-Line Gas/Liquid Filters

Choose opaque PVDF for the best chemical compatibility or transparent nylon for lower cost

Filter gases or liquids with these microfiber filters. All models have a borosilicate glass filter membrane. See table below for applications and efficiency ratings. Liquid efficiency ratings are 98% retention of particles of noted size; gas efficiency ratings are percentage retention of 0.01 µm particles.

Nylon and PVDF filters with ¼" OD and ½" OD ports accept flexible tubing for low pressure applications; use compression fittings for higher pressure applications. Models 02909-15, -35, and -55 have a stepped barb connector for secure connection of ¼" and ⅜" ID flexible tubing.

Maximum pressure for filters with ¼" OD ports is 125 psi (8.5 bar); maximum pressure for filters with ½" OD ports is 50 psi (3.4 bar). Maximum differential pressure for all filters is 40 psi (60 psi for 0.01 µm units).

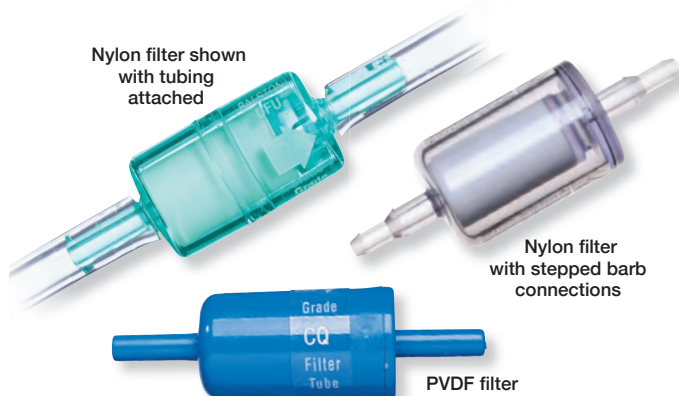

Application	Material	Gas efficiency	Liquid efficiency	Air flow at 2 psi drop at indicated pressure (scfm)			Water flow at indicated pressure drop (GPH)		Max temp (at 0 psi)	Ports	Qty/pk	Catalogue number
				2 psi	60 psi	100 psi	1 psi	5 psi				
High purity compressed gas; absolute filtration to 0.01 µm	Nylon	100% at 0.01 µm	—	0.3	1.7	2	—	—	110°C (230°F)	¼" OD	5	MY-02917-60
Gas/air filtration—general-purpose use. Liquid filtration—remove most visible particles.	Nylon	93%	25 µm	1.2	5.4	8.3	12	30	110°C (230°F)	¼" OD	5	MY-02909-10
	Nylon	93%	25 µm	1.2	5.4	8.3	12	30	110°C (230°F)	¼" and ⅜" barb	10	MY-02909-15
	Nylon	93%	25 µm	—	—	—	54	129	66°C (150°F)	½" OD	1	MY-02909-17
	Nylon	98%	8 µm	1.0	125	6.9	10	25	110°C (230°F)	¼" OD	5	MY-02909-20
	PVDF	93%	25 µm	1.2	5.4	8.3	12	30	135°C (275°F)	¼" OD	5	MY-02908-40
	PVDF	98%	8 µm	1.0	125	6.9	10	25	135°C (275°F)	¼" OD	5	MY-02908-50
Gas/air filtration—complete oil and water droplet removal. Liquid filtration—remove all visible particles and most colloidal haze.	Nylon	99.99%	2 µm	0.8	3.6	5.4	3	15	110°C (230°F)	¼" OD	5	MY-02909-30
	Nylon		2 µm	0.8	3.6	5.4	3	15	110°C (230°F)	¼" and ⅜" barb	10	MY-02909-35
	Nylon		2 µm	—	—	—	13	56	66°C (150°F)	½" OD	1	MY-02909-37
	Nylon		2 µm	0.8	3.6	5.4	—	—	110°C (230°F)	¼" OD	5	MY-02909-40‡
	PVDF		2 µm	0.8	3.6	5.4	3	15	135°C (275°F)	¼" OD	5	MY-02908-60
Gas/air filtration—with carbon granules for removal of trace oil vapours	Nylon	99%	—	0.5	2.6	4.0	—	—	82°C (180°F)	¼" OD	10	MY-02908-62
Gas/air filtration—with silica gel for removal of water vapour	Nylon	99%	—	0.5	2.6	4.0	—	—	82°C (180°F)	¼" OD	10	MY-02908-64‡
Gas/air filtration—with mixed sodium and calcium hydroxides for removal of acidic gases	Nylon	99%	—	0.5	2.6	4.0	—	—	82°C (180°F)	¼" OD	10	MY-02908-66
Gas/air sterilizing. Liquid filtration—remove most bacteria.	Nylon	99.9999+%	0.9 µm	0.4	1.8	2.7	1.5	7.3	110°C (230°F)	¼" OD	5	MY-02909-50
	Nylon	99.9999+%	0.9 µm	0.4	1.8	2.7	1.5	7.3	110°C (230°F)	¼" and ⅜" barb	10	MY-02909-55
	Nylon	99.9999+%	0.3 µm	0.1	0.45	0.68	0.4	1.9	110°C (230°F)	¼" OD	5	MY-02909-60
	PVDF	99.9999+%	0.9 µm	0.4	1.8	2.7	1.5	7.3	135°C (275°F)	¼" OD	5	MY-02908-80
	PVDF	99.9999+%	0.3 µm	0.1	0.45	0.68	0.4	1.9	135°C (275°F)	¼" OD	5	MY-02908-90

‡Turns red when saturated.

## Advantec® Filter Holders

### Easy assembly

Polypropylene (PP) holders are ideal for ultracleaning and sterilising liquids under pressure, or for aseptic sampling of liquids and gases. Holders feature PP dual support screens and silicone O-rings. Dual support screens allow for flow in both directions. Assemble holders quickly and efficiently without membrane tears with specially designed inlet cap and exterior lock.

The 25 mm holder features a female Luer-Lok® on the inlet and a male luer-slip on the outlet. The 47-mm holder features a ¼" NPT(M) thread on the inlet and a ¼" NPT(M)-female luer-slip on the outlet. Both are autoclavable.



Type of holder	Diameter	Qty/pk	Catalogue number
Syringe	25 mm	6	MY-06623-32
In-line	47 mm	1	MY-06623-22

MY-02930-95 Support screen, 25 mm. Pack of 8

MY-06645-90 Support screen, 47 mm. Pack of 4

## Environmental Express® ProWeigh® and ProWeigh® Double Filters

### No more washing, drying, and preweighing filters—it's already done for you!

- Get individual weights immediately—filter ID and weight is printed on each individual pan
- Eliminate loose fibers and inaccurate weights with precise, laser cut edges

Save time and get faster results with these prepared filters. Each filter is washed, dried, and weighed robotically to the nearest 0.1-mg, then transferred to an aluminum dish that is printed with a barcode and the filter weight. Simply record the weight, filter your sample, dry the filter, and weigh the final product. ProWeigh filters are prepared and approved for use in *Standard Methods*.

**ProWeigh Filters for Volatiles** are specifically treated for use to determine fixed or volatile solids. After rinsing and drying, the filters are then heated to 550°C in a muffle furnace to drive off any volatile materials. They are then desiccated, weighed to 0.1-mg and quality inspected for accuracy.

**ProWeigh Double Filters** are weighed twice to ensure accuracy. After the initial weighing and labeling, the filters are reweighed to ensure a stable weight!



Each filter is supplied in an aluminum dish.

#### Standard Methods Approved for (Since 1997):

Parameter	EPA Method	Standard Method
Total Dissolved Solids	160.1	2540C
Total Suspended Solids	160.2	2540D
Volatile Suspended Solids	160.4	2540E



Description	Pore size (µm)	Filter size	Qty/pk	Catalogue number
ProWeigh filters for total suspended solids (TSS)	1.5	32 mm	100	MY-53200-51
	1.5	42 mm	100	MY-53200-52
	1.5	47 mm	100	MY-53200-53
	1.5	55 mm	100	MY-53200-54
	1.5	70 mm	100	MY-53200-55
	1.5	76 mm	100	MY-53200-56
	1.5	90 mm	100	MY-53200-57
ProWeigh filters for volatiles	1.5	110 mm	100	MY-53200-58
	1.5	42 mm	100	MY-53200-62
	1.5	47 mm	100	MY-53200-63
	1.5	55 mm	100	MY-53200-64
	1.5	70 mm	100	MY-53200-65
	1.5	76 mm	100	MY-53200-66
ProWeigh Double filters for total suspended solids (TSS)	1.5	90 mm	100	MY-53200-67
	1.5	110 mm	100	MY-53200-68
	1.5	47 mm	100	MY-53200-73
ProWeigh Double filters for volatiles	1.5	76 mm	100	MY-53200-76
	1.5	90 mm	100	MY-53200-77
	1.5	47 mm	100	MY-53200-83

No need to prepare your filters before use—it's already done for you!



Each ProWeigh filter is washed under vacuum three times with 20 mL aliquots of deionized water.



Filter drying in horizontal flow mechanical ovens ensures uniform drying with no dead spots.



Cooling in a desiccator provides moisture-free, stable filter weights.

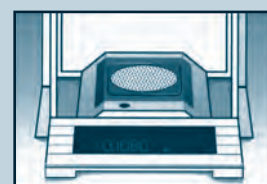

All ProWeigh filters are weighed on certified electronic analytical balances.

## Advantec® Mixed Cellulose Ester Membranes

### High quality at low prices

- Made from over 90% cellulose nitrate for strength and thermostability

These MCE membranes can be exposed to temperatures up to 266°C (130°F). Ideal for filter sterilising biological fluids, microbiology, contamination analysis, and air monitoring.



Pore size (µm)	Bubble point (psi)	Flow (L/min/cm <sup>2</sup> )		13 mm (100/pk)	25 mm (100/pk)	47 mm (100/pk)	90 mm (25/pk)	142 mm (25/pk)	293 mm (25/pk)
		H <sub>2</sub> O†	Air	Cat. no.	Cat. no.	Cat. no.	Cat. no.	Cat. no.	Cat. no.
0.10	35.3	0.027	0.67	MY-06639-25	MY-06639-28	MY-06639-31	MY-06639-34	MY-06639-41	MY-36230-81
0.20	54.5	0.018	2.4	MY-06639-01	MY-06639-05	MY-06639-13	MY-06639-35	MY-06639-17	MY-36230-82
0.45	35.0	0.045	3.7	MY-06639-02	MY-06639-06	MY-06639-14	MY-06639-36	MY-06639-18	MY-36230-83
0.80	16.4	0.165	15.0	MY-06645-30	MY-06645-32	MY-06645-34	MY-06645-36	MY-06645-38	MY-36230-84
1.00	13.9	0.220	20.4	MY-06639-47	MY-06639-49	MY-06639-51	MY-06639-55	MY-06639-53	MY-36230-85
3.00	10.2	0.300	28.3	MY-06639-26	MY-06639-29	MY-06639-32	MY-06639-39	MY-06639-42	MY-36230-86
5.00	8.5	0.400	40.9	MY-06639-27	MY-06639-30	MY-06639-33	MY-06639-40	MY-06639-43	MY-36230-87

†Using water prefiltered to 0.1 µm at 10 psi.

## Cole-Parmer® High-Flow Bottletop Filtration Systems

Eliminate leakage with moulded one-piece funnel design

- Extra space in the bottle allows up to a 15% dilution
- Polystyrene funnel and bottle have large raised graduations for easy reading
- Entire assembly is gamma sterilised

Large diameter 0.2 µm PES membrane covers the entire round bottom of the funnel, allowing you to obtain high throughput and fast flow rates. Cap features write-on surface and gripping area for easy handling. Receiving bottle also features moulded-in finger grips.



Connect the funnel to a vacuum hose in three separate ways. Use the included vacuum hose adapter to make a direct connection. Order the optional pedestal or cradle ring to create a convenient docking station for hands free filtering.



Description	Capacity	Pore size	Membrane dia	Qty/pk	Catalogue number
Complete assembly	250 mL	0.2 µm	66 mm	12	MY-06060-57
	500 mL		90 mm		MY-06060-58
	1000 mL		90 mm		MY-06060-56
Funnel only	250 mL	0.2 µm	66 mm	12	MY-06060-60
	500 mL		90 mm		MY-06060-61
	1000 mL		90 mm		MY-06060-59

**MY-06060-95 Pedestal stand** provides a permanent vacuum connection. Front on/off control knob

**MY-06060-96 Cradle ring** attaches to any standard lab stand. Side on/off control knob

## Cole-Parmer® Vacuum Filtration Assemblies

Presterilised to reduce contamination

- Made with a low protein binding and surfactant free PES membrane
- Funnel and bottle are made of clear polystyrene material
- Centrifuge tube systems filter directly into tube, reducing the risk of spills
- Use with the optional pedestal or cradle ring to create a hands-free filtration system



Reservoir capacity (mL)	Pore size (µm)	Membrane dia (mm)	Qty/cs	Catalogue number
<b>Vacuum filtration system with upper funnel, cap, and easy-grip media bottle</b>				
250	0.1	66	12	MY-06062-79
	0.45			MY-06062-80
500	0.1	90	12	MY-06062-81
	0.45			MY-06062-82
1000	0.1	90	12	MY-06062-77
	0.45			MY-06062-78
<b>Centrifuge tube filtration system with upper funnel and centrifuge tube</b>				
15	0.1	40	24	MY-06062-99
	0.2			MY-06062-85
	0.45			MY-06062-86
50	0.1	40	24	MY-06063-00
	0.2			MY-06062-83
	0.45			MY-06062-84

**MY-06060-95 Pedestal stand** provides a permanent vacuum connection. Front on/off control knob

**MY-06060-96 Cradle ring** attaches to any standard lab stand. Side on/off control knob

## Cole-Parmer® Vacuum Filtration Funnels

Reach higher throughput and faster flow rates

- Reduce the risk of spills by eliminating unnecessary fluid transfer
- Avoid possible contamination with gamma sterilised polystyrene housing funnels
- Use polypropylene funnels for harsh solvent filtration

These disposable plastic funnels contain a membrane for filtration of solvents, buffers, media, and other laboratory solutions.



The sterile polystyrene housing material funnels all have an asymmetric PES membrane material, which is low binding and surfactant free.

The polypropylene housing material funnels are designed to withstand the harsh solvents that would normally degrade polystyrene. The GL45 thread fits most laboratory bottles.



Housing material	Capacity (mL)	Pore size (µm)	Membrane dia (mm)	Membrane material	Qty/cs	Catalogue number
Polystyrene, sterile	15	0.1	40	PES	48	MY-06062-93
		0.2			48	MY-06062-94
		0.45			48	MY-06062-95
	50	0.1	40	PES	48	MY-06062-96
		0.2			48	MY-06062-97
		0.45			48	MY-06062-98
	250	0.1	66	PES	12	MY-06062-89
		0.45			12	MY-06062-90
	500	0.1	90	PES	12	MY-06062-91
		0.45			12	MY-06062-92
	1000	0.1	90	PES	12	MY-06062-87
		0.45			12	MY-06062-88
Polypropylene	500	0.2	90	Nylon	12	MY-06063-01
				PES	12	MY-06063-02
		0.45	90	Nylon	12	MY-06063-03
				PTFE	12	MY-06063-04
	1000	0.2	90	Nylon	12	MY-06063-05
				PES	12	MY-06063-06
		0.45	90	Nylon	12	MY-06063-07
				PTFE	12	MY-06063-08



## Jenway® Economical Flame Photometer

Simple operation gives you fast and accurate results

- Automatic gas shutoff feature ensures operator safety
- Unit comes with Na<sup>+</sup>, K<sup>+</sup>, Ca<sup>+</sup>, Li<sup>+</sup>, and Ba<sup>+</sup> filters



Jenway®



### REQUIRED System Components

- 1) Pump
- 2) Regulator
- 3) Calibration standards
- 4) Cleaning solutions

Use this economical flame photometer for routine determinations of sodium and potassium in industrial and educational applications.

### Specifications

**Measuring range:** 0 to 199.9 ppm

**Sensitivity**

Na<sup>+</sup> and K<sup>+</sup> filters: 3 to 100 ppm  
Ca<sup>+</sup> and Li<sup>+</sup> filters: 5 to 100 ppm  
Ba<sup>+</sup> filter: 100 to 200 ppm

**Specificity:** less than 0.5% interference when concentrations are equal to test sample concentrations

**Reproducibility:** better than ±1% C.V.

**Linearity:** better than ±2%

**Aspiration rate:** 2 to 6 mL/min

**Reading stabilisation:** approximately 8 seconds

**Recorder output:** 100 mV

**Air supply (required):** 6 liters/min at 14 psi, oil and moisture free

**Fuel supply:** high-grade propane, butane, or propane/butane mixture regulated at approximately 30 psi; natural gas at 3 to 10" W.G.

Description	Power (VAC/Hz)	Catalogue number
Economical flame photometer	230, 50/60	MY-83055-05

### Required Components for all Flame Photometers

#### 1. Vacuum/Compressor Air Pump

Description	Catalogue number
Vacuum/compressor air pump with regulator	MY-07061-40

#### 2. Primary Regulators

Gas	Cylinder	Catalogue number
Propane	5/8" BSP	MY-02655-20
Butane	"Gaz" type	MY-02655-24
Natural	—	MY-02655-26
Propane	7.5 cu ft, disposable	MY-02655-30

#### 3. Calibration Standards. Packaged in six 100-mL bottles.

Type	Concentration	Catalogue number
Sodium	1000 ppm	MY-02655-70
Potassium	1000 ppm	MY-02655-71
Lithium	1000 ppm	MY-02655-72
Calcium	1000 ppm	MY-02655-73

#### 4. Cleaning Solutions. Order at ColeParmer.co.uk

## Cole-Parmer® Flame Photometers

Determine levels of sodium, calcium, potassium, and lithium

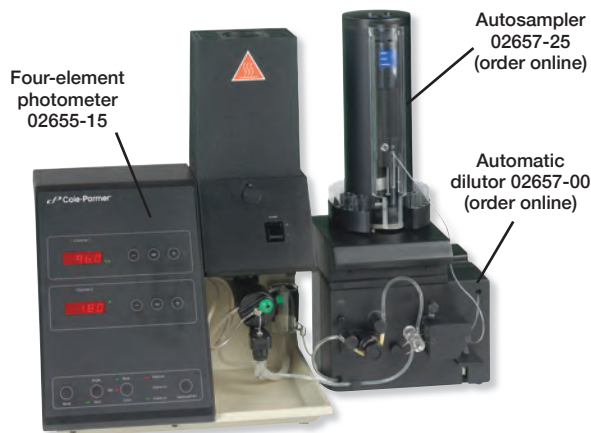

Cole-Parmer®

- Four-element model features additional calcium channel and lithium internal standard
- Use with autosampler—for your long sample runs



### REQUIRED System Components

- 1) Pump
- 2) Regulator
- 3) Calibration standards
- 4) Cleaning solutions

#### Dual-Channel Three-Element Flame Photometer

features include automatic ignition sequence, lithium internal standard, monitoring and control software, and dual-channel display. Built-in linearising software allows sodium measurements up to 40 ppm.

Obtain Na<sup>+</sup> and K<sup>+</sup> results simultaneously. The lithium internal standard signal reduces fluctuation in flame conditions, drift, and dilution errors—ensures reproducible results and precise measurements. The fully automatic ignition and flame optimisation sequences reduce set up and calibration time. An automatic gas shutoff mechanism activates if the flame is accidentally extinguished or if air pressure drops. Monitoring and control software allow measurements only after blanking and calibration.

**Dual-Channel Four-Element Flame Photometer** offers the same great features found above, plus a calcium channel and direct measurement of Ca<sup>+</sup> with K<sup>+</sup>, which are two vital elements for soil analysis. Unit allows you to measure Ca<sup>+</sup> in combination with Na<sup>+</sup>, and also with Li<sup>+</sup> without an internal standard. Use this flame photometer as a detector in combination with multichannel analysers from SEAL Analytical, Skalar, and Lachat. This system includes its own protocols for calibration, and features a special mode allowing you to set up the flame photometer within these protocols. User-selectable signal averaging is designed into the system allowing you to use these protocols along with analogue output.

### Specifications

**Specificity:** less than 0.5% interference when concentrations are equal to test sample concentrations

**Linearity:** less than ±1% at mid-point with 3 ppm K<sup>+</sup> set at 100

**Aspiration rate:** 3 to 6 mL/min

**Fuel supply:** high-grade propane, butane, or propane/butane mixture regulated at approx 30 psi (natural gas—only with single-channel photometer)

Description	Dual-channel three-element	Dual-channel four-element
<b>Catalogue number</b>	<b>MY-02655-10</b>	<b>MY-02655-15</b>
Elements analysed	Na <sup>+</sup> , K <sup>+</sup> (with Li <sup>+</sup> internal standard), Li <sup>+</sup>	Na <sup>+</sup> , Ca <sup>+</sup> , K <sup>+</sup> (with Li <sup>+</sup> internal standard), Li <sup>+</sup>
Measuring ranges	ppm: all 1.00–9.99, 10.0–199.9 mmol/L: as above; Li <sup>+</sup> only 1.00–5.00	
Readout	No units or mmol/L	No units or mmol/L
Sensitivity (100 displayed)	Na <sup>+</sup> and K <sup>+</sup> = 0.5 ppm; Li <sup>+</sup> = 2 ppm	Na <sup>+</sup> and K <sup>+</sup> = 0.5 ppm; Ca <sup>+</sup> = 5 ppm; Li <sup>+</sup> = 2 ppm
Reproducibility	Less than ±0.5%	Less than ±0.5%
Reading stabilisation	Variable software command	Variable software command
Recorder output	Two outputs: 50 mV to 7.5 V via software command	
Air supply (required)	6 liters/min at 12 psi, oil and moisture free	6 liters/min at 15 psi, oil and moisture free

## Cole-Parmer® elements™ Erlenmeyer Flasks, Glass

### Economical option for everyday lab use

- Easy-read graduations and marking area
- Withstands wide temperature range –50 to 550°C; autoclavable
- Graduated tolerances to ±0.05

Made with durable borosilicate 3.3 glass and featuring a heavy-duty rim with narrow-mouth opening, there are very few applications these flasks cannot handle.

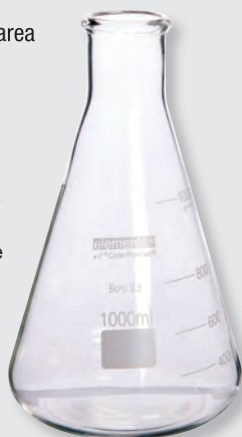

Capacity mL (oz)	Graduation range (mL)	Graduation interval (mL)	Qty/pk	Catalogue number
25 (¾)	10 to 25	5	24	MY-34502-55
50 (1¾)	20 to 50	10		MY-34502-56
100 (3)	40 to 100	20	12	MY-34502-57
125 (4)	50 to 125	20		MY-34502-58
250 (8)	100 to 250	50		MY-34502-59
300 (10)	100 to 300	50	8	MY-34502-60
500 (16)	200 to 500	100		MY-34502-61
1000 (32)	400 to 1000	100	6	MY-34502-62
2000 (64)	800 to 2000	400		MY-34502-63
3000 (96)	1000 to 3000	500		MY-34502-64
4000 (128)	2000 to 4000	500	1	MY-34502-65
5000 (160)	2000 to 5000	500		MY-34502-66
6000 (192)	3000 to 6000	500		MY-34502-67

## Cole-Parmer® elements™ Volumetric Flasks, Glass

### Quality borosilicate 3.3 glass

- White easy-read marking for volume
- Calibrated "To Contain" (IN) by DIN at 20°C
- Withstands wide temperature range –50 to 550°C; autoclavable
- Tight tolerances from ±0.015 to ±1.2 depending on size
- With glass pennyhead stoppers



Capacity (mL)	Tolerance (mL)	Qty/pk	Catalogue number
2	±0.015		MY-34502-77
5	±0.02	10	MY-34502-78
10	±0.025		MY-34502-79
20	±0.030	2	MY-34502-80
25	±0.04		MY-34502-81
50	±0.05		MY-34502-82
100	±0.1		MY-34502-83
200	±0.15	2	MY-34502-84
250	±0.15		MY-34502-85
500	±0.2		MY-34502-86
1000	±0.4		MY-34502-87
2000	±0.6	1	MY-34502-88
5000	±1.2		MY-34502-89

## Cole-Parmer® Class A Erlenmeyer Flasks, Glass

### Don't break the bank

- Easy-reading, white enamel graduations
- Stands up to the heat—400°C (752°F) for short-term exposure and 230°C (445°F) for long-term exposure
- Class A borosilicate glass meets ASTM E 1404, DIN 12380 specifications
- Autoclavable

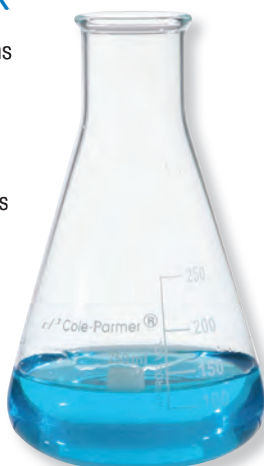

Capacity (mL)	Stopper no.	Graduation range (mL)	Graduation (mL)	Qty/pk	Catalogue number
100	5	50 to 100	25	12	MY-34506-10
250	6	50 to 200	25	12	MY-34506-12
500	7	100 to 500	50	6	MY-34506-14
1000	9	250 to 1000	50	6	MY-34506-16
2000	10	600 to 1900	100	1	MY-34506-18
3000	10	1000 to 3000	500	1	MY-34506-20

## PYREX® Brand 5580 Volumetric Flasks, Glass

### Easy and accurate dilutions—sharp line for precise volume

- Durable construction for repeated use
- Class A glassware
- Snap caps included on 10- to 2000-mL sizes



Capacity (mL)	Tolerance (±mL)	Qty/pk	Catalogue number	Qty/cs	Catalogue number
1	0.01	6	MY-34560-01	12	MY-34560-21
2	0.015	6	MY-34560-02	12	MY-34560-22
10	0.02	—	—	12	MY-34560-24
25	0.03	6	MY-34560-05	12	MY-34560-25
50	0.05	6	MY-34560-06	12	MY-34560-26
100	0.08	6	MY-34560-07	12	MY-34560-27
200	0.10	6	MY-34560-08	12	MY-34560-28
250	0.12	6	MY-34560-09	12	MY-34560-29
500	0.20	6	MY-34560-10	12	MY-34560-30
1000	0.30	1	MY-34560-11	6	MY-34560-31
2000	0.50	1	MY-34560-12	4	MY-34560-32

# Cole-Parmer® Acrylic Variable-Area Flowmeters for Bench or Panel Mount

## Don't sacrifice durability for precision

- Easily and precisely control flow of your application via manual valve
- Durable acrylic bodies with integral metering tubes for accurate readings
- Stand up to even aggressive plant environments
- Versatile—easy panel installation or move from bench to bench with optional tripod base 32462-50 (order separately at online).



### Specifications

<b>Accuracy:</b> 50-mm and 2" models: ±5% FS 100-mm and 4" models: ±3% FS 127-mm and 5" models: ±2% FS	<b>Max operating temp:</b> 65°C (150°F)		
<b>Media type:</b> liquids or gases	<b>Connections:</b> 50-mm, 100-mm, 2", and 4" models: 1/8" NPT(F) <sup>†</sup> 127-mm and 5" models: 1" NPT(F)		
<b>Max pressure:</b> 100 psi (6.9 bar)			
<b>Materials of construction</b>			
Part	50 mm and 2"      100 mm and 4"      127 mm and 5"		
Body	Acrylic		
Fittings	Brass		PVC
O-rings	Buna N		
Float	Black glass (BG), Aluminum (AL)	316 Stainless steel (SS)	

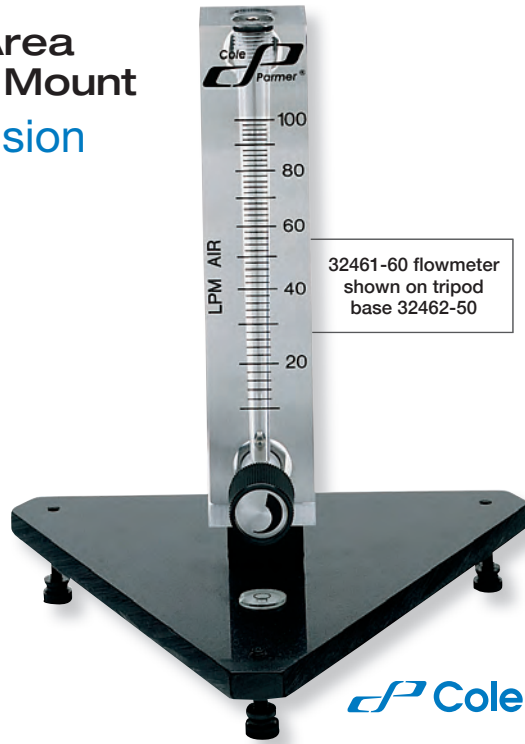

Cole-Parmer®

### Flowmeters with Valves; Metric-Unit Scales

Float <sup>‡</sup>	For liquid applications		For air applications	
	Flow range (mL/min)	Catalogue number	Flow range (LPM)	Catalogue number
<b>Flowmeters with 50-mm scale</b>				
BG	—	—	0.04 to 0.5	MY-32460-40
SS	10 to 100	MY-32460-32	0.1 to 1	MY-32460-42
SS	20 to 240	MY-32460-34	0.4 to 5	MY-32460-44
SS	—	—	1 to 10	MY-32460-46
AL	—	—	2 to 25	MY-32460-48
SS	—	—	4 to 50	MY-32460-50
SS	—	—	10 to 100	MY-32460-52
<b>Flowmeters with 100-mm scale</b>				
SS	4 to 50	MY-32461-30	0.4 to 5	MY-32461-50
SS	10 to 120	MY-32461-32	1 to 10	MY-32461-52
BG	25 to 225	MY-32461-34	2 to 20	MY-32461-54
SS	40 to 400	MY-32461-36	3 to 30	MY-32461-56
SS	40 to 660	MY-32461-38	4 to 50	MY-32461-58
SS	100 to 1500	MY-32461-40	10 to 100	MY-32461-60
SS	200 to 3000	MY-32461-42	14 to 140	MY-32461-62 <sup>†</sup>
SS	0.8 to 9 LPM	MY-32461-44 <sup>†</sup>	30 to 280	MY-32461-64 <sup>†</sup>
SS	1.5 to 20 LPM	MY-32461-46 <sup>†</sup>	—	—
<b>Flowmeters with 127-mm scale</b>				
SS	4 to 36 LPM	MY-32466-54	100 to 700	MY-32466-66
SS	—	—	400 to 3400	MY-32466-70

### Flowmeters without Valves; Metric-Unit Scales

Float <sup>‡</sup>	For liquid applications		For air applications	
	Flow range (mL/min)	Catalogue number	Flow range (LPM)	Catalogue number
<b>Flowmeters with 50-mm scale</b>				
BG	—	—	0.04 to 0.5	MY-32457-40
BG	10 to 100	MY-32457-32	0.1 to 1	MY-32457-42
SS	20 to 240	MY-32457-34	0.4 to 5	MY-32457-44
SS	—	—	1 to 10	MY-32457-46
<b>Flowmeters with 100-mm scale</b>				
BG	4 to 50	MY-32458-30	0.4 to 5	MY-32458-50
SS	10 to 120	MY-32458-32	1 to 10	MY-32458-52
BG	25 to 225	MY-32458-34	2 to 20	MY-32458-54
SS	40 to 400	MY-32458-36	3 to 30	MY-32458-56
SS	40 to 660	MY-32458-38	4 to 50	MY-32458-58
SS	100 to 1500	MY-32458-40	10 to 100	MY-32458-60
SS	200 to 3000	MY-32458-42	14 to 140	MY-32458-62 <sup>†</sup>
SS	0.8 to 9 LPM	MY-32458-44 <sup>†</sup>	30 to 280	MY-32458-64 <sup>†</sup>
SS	1.5 to 20 LPM	MY-32458-46 <sup>†</sup>	80 to 560	MY-32458-65 <sup>†</sup>
<b>Flowmeters with 127-mm scale</b>				
SS	1 to 15 LPM	MY-32462-20	100 to 700	MY-32462-30
SS	4 to 36 LPM	MY-32462-22	100 to 1400	MY-32462-32
SS	5 to 75 LPM	MY-32462-24	400 to 3000	MY-32462-34

### Flowmeters with Valves; English-Unit Scale

Float <sup>‡</sup>	For liquid applications		For air applications	
	Flow range	Catalogue number	Flow range	Catalogue number
<b>Flowmeters with 2" scale</b>				
BG	0.2–2 GPH	MY-32460-00	0.1–1 scfh	MY-32460-10
SS	0.4–5 GPH	MY-32460-02	0.2–2 scfh	MY-32460-12
BG	1–10 GPH	MY-32460-04	0.4–5 scfh	MY-32460-14
SS	2–20 GPH	MY-32460-06	0.5–10 scfh	MY-32460-16
BG	—	—	4–50 scfh	MY-32460-22
SS	4–40 GPH	MY-32460-08	10–100 scfh	MY-32460-24
<b>Flowmeters with 4" scale</b>				
SS	1–10 GPH	MY-32461-00	0.4–5 scfh	MY-32461-10
SS	2–25 GPH	MY-32461-02	1–10 scfh	MY-32461-12
SS	6–60 GPH	MY-32461-06	4–40 scfh	MY-32461-16
SS	0.2–2.5 GPM	MY-32461-07 <sup>†</sup>	10–100 scfh	MY-32461-18
SS	0.4–5 GPM	MY-32461-08 <sup>†</sup>	20–200 scfh	MY-32461-22
AL	—	—	0.5–5 scfm	MY-32461-24 <sup>†</sup>
SS	—	—	1–10 scfm	MY-32461-26 <sup>†</sup>
<b>Flowmeters with 5" scale</b>				
SS	1–10 GPM	MY-32466-50	3–25 scfm	MY-32466-60
SS	2–20 GPM	MY-32466-52	4–50 scfm	MY-32466-62

<sup>†</sup>These models have dual scale: GPM/GPH, scfm/scfh, LPM/LPH; they also have 1/4" NPT(F) connections and use optional tripod base 32462-60 sold separately online.  
<sup>‡</sup>Float material key: BG = black glass, SS = stainless steel, AL = aluminum.

### Flowmeters without Valves; English-Unit Scales

Float <sup>‡</sup>	For liquid applications		For air applications	
	Flow range	Catalogue number	Flow range	Catalogue number
<b>Flowmeters with 4" scale</b>				
SS	1–10 GPH	MY-32458-00	0.4–5 scfh	MY-32458-10
SS	—	—	0.5–5 scfm	MY-32458-24 <sup>†</sup>
SS	—	—	1–10 scfm	MY-32458-26 <sup>†</sup>
<b>Flowmeters with 5" scale</b>				
SS	0.4–5 GPM	MY-32462-00	3–25 scfm	MY-32458-10
SS	2–20 GPM	MY-32462-04	—	—



# Cole-Parmer® Flowmeters and Proportional Controllers for Gases

## Measure up to 130 standard gases—selectable from the display

- Accuracy of  $\pm 0.8\%$  of reading  $+0.2\%$  full-scale; repeatability of  $\pm 0.2\%$
- 100 to 1 turndown with ranges of 1 SCCM full-scale up to 1000 SLPM
- Models with 4 to 20 mA output or totaliser are available

These meters measure flow via pressure drop across a laminar flow element (LFE). Because the flow element makes the flow stream laminar, placement in the process does not require straight pipe runs upstream or downstream of the meter, greatly simplifying installation. As compared to thermal mass technologies, the LFE design provides an ultrafast response within 10 milliseconds and offers “instant on” with no warm-up time.

An integrated keypad around the display is all that is required to program the unit for service. The 0 to 5 VDC output allows transmission of the flow value to a remote display, recorder, or controller regulating a valve or pump.

Flow controllers feature an integrated PID to direct the unit’s response to process changes. Flow set-point is established with keypad, the optional set-point control module, a 0 to 5 V signal, or an RS-232 input signal. Order set-point control modules separately from the table. For portable flow metering applications, order the battery pack listed below table.

**What’s included:** 120/230 VAC power adapter with communications cable 32929-89 and ILAC MRA, NIST-traceable calibration report supplied by the manufacturer.



Flow controller 32907-51



Mass flowmeter 32908-59 shown with optional battery pack 32929-50

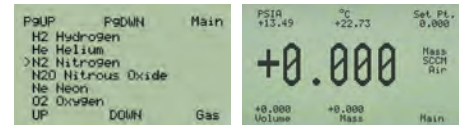

Meters and controllers feature a dynamic display that simultaneously shows flow rate, line pressure, fluid temperature, and (for controllers) the set-point. For the units shown, both power and input/output signals are transmitted through a single multi-pin connector.



### Specifications

- Max particulate size:**
  - Up to 1 LPM: 20  $\mu\text{m}$
  - >1 LPM to 1000 LPM: 50  $\mu\text{m}$
- Accuracy:**  $\pm 0.8\%$  of reading,  $+0.2\%$  full-scale
- Repeatability:**  $\pm 0.2\%$
- Response time:**
  - Flowmeters: 10 ms
  - Flow controllers: 50 ms
- Operating temperature:**  $-10$  to  $50^\circ\text{C}$  ( $14$  to  $122^\circ\text{F}$ )
- Max pressure:** 9.9 bar (145 psig)

- Pressure drop:** 0.8 to 3.2 psig (flowmeter)
- Output signal:** 0 to 5 VDC, RS-232
- Input signal:** 0 to 5 VDC and RS-232
- Wetted materials:**
  - Flowmeters: 302 and 303 SS, Viton®, silicone RTV, and glass-reinforced nylon, aluminum
  - Flow controllers: 302, 303; Viton, silicone RTV, glass-reinforced nylon, aluminum, brass, 410 SS, silicon, glass

- Power:**
  - Flowmeters: 7 to 30 VDC at 30 mA
  - Flow controllers
    - Models  $\leq 10$  LPM: 12 to 30 VDC at 250 mA
    - Models  $\leq 50$  LPM: 24 to 30 VDC at 750 mA
- Display type:** four-digit, seven-line LCD; 0.63 cm H flow display
- Connections:**
  - $\leq 10$  mL/min: 10-32 UNF
  - 50 mL/min to 10 LPM:  $\frac{1}{8}$ " NPT(F)
  - 50 to 100 LPM:  $\frac{1}{4}$ " NPT(F)
  - 100 and 250 LPM:  $\frac{1}{2}$ " NPT(F)
  - 500 and 1000 LPM:  $\frac{3}{4}$ " NPT(F)

Flow range	Mass flowmeters	Mass flow controllers	Set-point modules†
	Catalogue number	Catalogue number	Catalogue number
0.01 to 1 mL/min	MY-32908-51	MY-32907-51	MY-32907-83
0.05 to 5 mL/min	MY-32908-53	MY-32907-53	MY-32907-85
0.1 to 10 mL/min	MY-32908-55	MY-32907-55	MY-32907-87
0.5 to 50 mL/min	MY-32908-57	MY-32907-57	MY-32907-89
1 to 100 mL/min	MY-32908-59	MY-32907-59	MY-32907-91
2 to 200 mL/min	MY-32908-61	MY-32907-61	MY-32907-93
5 to 500 mL/min	MY-32908-63	MY-32907-63	MY-32907-97
0.01 to 1 LPM	MY-32908-67	MY-32907-67	MY-32907-83
0.05 to 5 LPM	MY-32908-69	MY-32907-69	MY-32907-85
0.1 to 10 LPM	MY-32908-71	MY-32907-71	MY-32907-87
0.5 to 50 LPM	MY-32908-73	MY-32907-73	MY-32907-89
1 to 100 LPM	MY-32908-75	MY-32907-75	MY-32907-91
2.5 to 250 LPM	MY-32908-77	MY-32907-77	MY-32907-95
5 to 500 LPM	MY-32908-79	MY-32907-79	MY-32907-97
10 to 1000 LPM	MY-32908-81	MY-32907-81	MY-32907-99

†May be ordered as an option.

MY-17080-10 ILAC MRA, NIST-traceable recalibration

MY-32929-50 Battery pack, for portable operation of mass or volumetric flowmeter only

MY-32929-89 Replacement communication cable, 8-DIN to stripped ends

## Masterflex® Ultrasonic Flow Sensors

### Maintain accurate flow rates without affecting working fluid

- Non-invasive design eliminates contact with working fluid—ideal for applications with strict hygienic standards
- Provides accurate readings not affected by fluid colour, tube colour, or electromagnetic properties of liquids
- Continuously monitor peristaltic pump flow rates and send data directly to your computer with optional communications package
- Ready to use out of the box—calibrated for use with Masterflex L/S® and I/P® platinum-cured silicone tubing
- Easily adapt your application settings using optional communications package

Each sensor comes calibrated to national measurement standards for the appropriately sized Masterflex platinum-cured silicone tubing when water is the working fluid and across the full flow range. Adapt for use with other working fluids or Masterflex tubing materials of the same size with the optional communications package.

**What's included:** flow sensor, cable, and calibration certificate.



Clamp-on sensor design makes setup easy—simply place the tubing in the sensor channel and close the lid.

**MASTERFLEX®**



#### Specifications

**Accuracy:** ±2 to 4% after using calibration software  
**Output:** RS-485, 4 to 20 mA, 0 to 20 kHz, or PNP-NPN  
**Enclosure rating:** IP65

For Masterflex tubing size	Max flow rate†		Min flow rate		Catalogue number
	GPH	mL/min	GPH	mL/min	
<b>Engineered for L/S Precision tubing</b>					
14	2.06	130	0.48	30	MY-33501-14
16	7.61	480	0.48	30	MY-33501-16
17	26.95	1700	0.48	30	MY-33501-17
<b>Engineered for L/S High-Performance Precision tubing</b>					
15	14.4	1100	0.48	30	MY-33501-15
24	28.53	1800	0.48	30	MY-33501-24
35	41.21	2600	0.48	30	MY-33501-35
<b>Engineered for I/P Precision tubing</b>					
73	126.8	8000	0.48	30	MY-33501-73

†Higher flow rates can be measured, the stated maximum flow rate is that of the tubing.

**MY-33501-96 Communications package** for Masterflex ultrasonic flow sensors. Includes software for data capture and calibration on USB drive and connector cable

## Cole-Parmer® Heavy-Duty Flowmeters/Totalisers

### Eliminate the need for expensive wiring with battery power

- Two totalisers allow for process or period-specific volume monitoring
- Measure linearly across a range and record a cumulative volume



**Cole-Parmer®**

These heavy-duty in-line flowmeters/totalisers display flow rate and accumulated flow in GPM or LPM. The compact yet robust design makes them ideal for use in manufacturing, pilot-plant, or quality control areas. Meters are factory calibrated using water, but can store two application-specific K-factors determined in process. To conserve power, the six-digit display automatically turns on with flow and then turns off four minutes after flow ceases.



#### Specifications

**Fluid types:** Low-viscosity liquids  
**Accuracy:** Models up to 76 LPM (20 GPM) : ±2% of reading; remaining models: ±1.5% of reading  
**Repeatability:** ±0.1% of reading  
**Display:** 6-digit LCD, 1.3 cm H (with floating decimal)  
**Operating temperature:** -10 to 60°C (14 to 140°F)  
**Maximum particulate size:**  
 Models with ≤50 GPM max flow rate: 125 µm  
 Models with >50 GPM max flow rate: 500 µm  
**Power:** Two 3 V lithium batteries (included)  
**Battery life:** 9000 hours nominal

Flow range	Connections	Body material	Catalogue number
1 to 10 GPM (3.8 to 37.9 LPM)	1/2" NPT(F)	Aluminum	MY-05609-01
	1/2" NPT(F)	316 SS	MY-05609-03
	3/4" Sanitary†	316 SS	MY-05609-05
2 to 20 GPM (7.6 to 75.7 LPM)	3/4" NPT(F)	Aluminum	MY-05609-07
	3/4" NPT(F)	316 SS	MY-05609-09
	1" Sanitary†	316 SS	MY-05609-11
5 to 50 GPM (18.9 to 190 LPM)	1" NPT(F)	Aluminum	MY-05609-13
	1" NPT(F)	316 SS	MY-05609-15
	1 1/2" Sanitary†	316 SS	MY-05609-17
	1" ANSI‡	316 SS	MY-05609-19
10 to 100 GPM (38 to 380 LPM)	1 1/2" NPT(F)	Aluminum	MY-05609-21
	1 1/2" NPT(F)	316 SS	MY-05609-23
	2" Sanitary†	316 SS	MY-05609-25
	1 1/2" ANSI‡	316 SS	MY-05609-27
20 to 200 GPM (6 to 760 LPM)	2" NPT(F)	Aluminum	MY-05609-29
	2" NPT(F)	316 SS	MY-05609-31
	2 1/2" Sanitary†	316 SS	MY-05609-33
	2" ANSI‡	316 SS	MY-05609-35

†Sanitary flange ‡150# ANSI flange

## Cole-Parmer® StableTemp™ Muffle Furnaces

### Get up to temperature fast

- Reach maximum temperature in as fast as 25 minutes
- Autotune feature helps eliminate temperature overshoot
- Energy efficient insulation keeps exterior safe to touch
- Models available with extensive programming capabilities

### StableTemp



The fully embedded heating elements maintain temperature uniformity. A door switch cuts power to the heating elements when the door is opened minimising your exposure to hot temperatures and extending the life of the heating elements.

**Basic Control Furnaces** feature a single LED display that toggles between actual and set point temperatures. **Single Set Point Control Furnaces** have two LED displays to simultaneously display actual and set point temperatures. **Programmable Control Furnaces** have two LED displays to simultaneously display actual and set point temperatures. These furnaces can store up to 31 programs with up to 126 segments total.†

### Specifications

**Operating temperature range:** 100 to 1100°C    **Temperature control accuracy:** ±1°C    **Temperature uniformity:** ±5°C



Description	Capacity (L)	Chamber dimensions (W x H x D)	Overall dimensions (W x H x D)	Rise time to 1050°C	Power (VAC, Hz)	Power (watts)	Shpg wt (kg)	Catalogue number
Basic control furnaces	5.3	15.2 x 15.2 x 22.9 cm	43.2 x 54.6 x 53.3 cm	25 minutes	240, 50/60	1800	49.9	MY-33858-05
	18.4	22.9 x 22.9 x 35.6 cm	53.3 x 66.0 x 65.4 cm	35 minutes	208/240, 50/60	3500	68.1	MY-33858-10
	42.48	30.5 x 30.5 x 45.7 cm	61.0 x 71.1 x 76.2 cm	45 minutes	208/240, 50/60	5600	74.9	MY-33858-20
Single set point control furnaces	18.4	22.9 x 22.9 x 35.6 cm	53.3 x 66.0 x 65.4 cm	35 minutes	208/240, 50/60	3500	68.1	MY-33858-40
	42.48	30.5 x 30.5 x 45.7 cm	61.0 x 71.1 x 76.2 cm	45 minutes	208/240, 50/60	5600	74.9	MY-33858-50
	1.6	15.2 x 15.2 x 22.9 cm	43.2 x 54.6 x 53.3 cm	25 minutes	240, 50/60	1800	49.9	MY-33858-65
Programmable control furnaces†	18.4	22.9 x 22.9 x 35.6 cm	53.3 x 66.0 x 65.4 cm	35 minutes	208/240, 50/60	3500	68.1	MY-33858-70
	42.48	30.5 x 30.5 x 45.7 cm	61.0 x 71.1 x 76.2 cm	45 minutes	208/240, 50/60	5600	74.9	MY-33858-80

†Program capacity is dependent on memory (351 byte maximum available). For example: furnaces can store one program with up to 116 segments (using 349 bytes), or four programs with up to 28 segments each (using 340 bytes).

**MY-33858-90 RS-485 communications port** lets you use furnace with computer. Factory-installed; must be ordered at same time as furnace. Order software separately

**MY-33858-92 Cable**, 7.6-m L. Required to connect furnace to computer  
**MY-33910-52 Cable**, daisy chain

## Ansell TNT™ Blue Disposable Nitrile Gloves

### Durable and comfortable

- Static dissipative to eliminate static electricity
- Textured fingertips for better gripping
- Powder-free
- Ambidextrous



**Compliance:** FDA regulations for food contact.

Size	Length	Thickness	Qty/bx	Catalogue number
Small	24 cm	5 mm	100	MY-81601-04
Medium				MY-81601-05
Large				MY-81601-06
X-large				MY-81601-07

## Ansell Touch N Tuff™ Nitrile Gloves

### Keep dexterity without sacrificing safety

- Thin formulation, yet resists punctures and tears
- No fillers—gloves are 100% nitrile
- Ambidextrous



Description	Size	Length	Thickness	Qty/bx	Cat. no.
Powdered gloves	Small	24 cm	4 mm	100	MY-81602-40
	Medium				MY-81602-50
	Large				MY-81602-60
	X-large				MY-81602-70
Powder-free gloves	Small	24 cm	4 mm	100	MY-81602-45
	Medium				MY-81602-55
	Large				MY-81602-65
	X-large				MY-81602-75

## Cole-Parmer® Nitrile Gloves

### Don't lose your grip

- Soft feel with textured fingertips for better grip
- Powder-free
- Ambidextrous



Size	Length	Thickness	Qty	Catalogue number
Small	24 cm	4.0 mm	1 box of 100	MY-15954-42
Medium				MY-15954-43
Large				MY-15954-44
X-large	24 cm	4.0 mm	10 boxes of 100 (1000 total)	MY-15954-45
Small				MY-15954-24
Medium				MY-15954-25
Large				MY-15954-26
X-large				MY-15954-46

## Microflex® MidKnight™ Black Nitrile Gloves

### Won't show stains

- Fully textured for consistently reliable gripping
- Powder-free
- Ambidextrous



Size	Length	Thickness	Qty/case	Catalogue number
Small	24 cm	5.5 mm	1000	MY-86445-15
Medium				MY-86445-16
Large				MY-86445-17
X-large				MY-86445-18



# Techne® Dri-Block® Heaters

## Engineered for accuracy

- Versatile—work with many size sample tubes and plates
- Lightweight and flat top surface allow heaters to be stacked taking up less space
- Independent indicator lights show power, heater action, and overtemperature cut-out



### REQUIRED System Components

- 1) Block heater
- 2) Heating blocks



### 1. Block Heaters

**Analogue Heaters** let you set the temperature in 2°C increments using a calibrated rotary dial. Excellent stability at 40°C for two-block model and at 40°C for three-block model.

**Digital Heaters** produce a fast heat-up rate (7 to 9 minutes from 25 to 100°C) and achieve temperature stability at 37°C. Quickly set and view temperature on LED display. Side panels help dissipate heat from the outer surfaces. Adjust the countdown timer between 1 minute and 100 hours in 1-minute increments.

Select a dual-control unit to independently control the temperature of two blocks—ideal for multiple users or for applications where samples have to be transferred quickly between temperatures. Use three- and four-block models for high-throughput applications. Model 36620-16 has an RS-232 connection so you can set and receive block temperature using your computer.

**What's included:** block extraction tool and power cord.



Max temp	Uniformity	No. of blocks accepted <sup>†</sup>	Power (50/60 Hz)		Catalogue number
			VAC	Watts	
<b>Analogue dry block heaters</b>					
100°C	0.2°C between block at 40°C	2	230	300	MY-36620-12
200°C		3	230	450	MY-36620-14
<b>Digital dry block heaters</b>					
100°C	0.2°C within the block at 37°C; 0.5°C between block at 37°C	2	230	300	MY-36620-00
		2 (dual controls)	230	300	MY-36620-02
		3	230	450	MY-36620-04
		4	230	600	MY-36620-06
200°C	0.2°C within the block at 37°C; 0.5°C between block at 37°C	2	230	300	MY-36620-08
		3	230	450	MY-36620-10
		3 (RS-232 output)	230	450	MY-36620-16

<sup>†</sup>Indicates the number of single-width blocks accepted by each block heater. A heater that accepts two single-width blocks will accept one double-width block.

### Sample Concentrators

Use only with three-block heaters to quickly concentrate multiple samples at once. Concentrator blows gas over the surface of your samples through stainless steel needles (order separately). Insert needles into a silicone membrane in virtually any configuration. Fully adjustable gas reservoir provides accurate height control. Choose PTFE-coated needles for use with corrosive samples.

**MY-36620-40 Sample concentrator** for use with test tubes

**MY-36620-41 Sample concentrator** for use with 96-well plates

**MY-36620-96 Stainless steel needle**, 127 mm long. 100/pk

**MY-36620-97 Stainless steel needle**, 127 mm long. 100/pk

**MY-36620-99 PTFE-coated SS needle**, 76 mm long. 100/pk

**MY-36620-98 PTFE-coated SS needle**, 127 mm long. 100/pk

### 2. Interchangeable Heating Blocks

Aluminum heating blocks provide excellent thermal conductivity. Depending on the combination of blocks selected, plastic spacers can be used to fill a half-width recess for optimal thermal performance. Most blocks have a separate hole to accept a thermometer.

Flexi-block inserts hold multiple size tubes, vials, or cuvettes at once. They use high-density, autoclavable ceramic beads and come in double or triple width. Unskirted PCR plates can be heated in either size flexi-block. Skirted microtiter plates, deep-well plates, and PCR plates can only be incubated in the triple-width version.

Accommodates	Number of wells	Well depth	Well shape	Catalogue number
<b>Single-width heating blocks</b>				
6-mm dia tubes	30	38 mm	Tapered	MY-36620-51
7-, 9-mm dia tubes	20, 10	38 mm	Conical	MY-36620-62 <sup>‡</sup>
10-mm dia tubes	20	48 mm	Conical	MY-36620-52
12-mm dia tubes	20	20 mm	Flat	MY-36620-87
12-mm dia tubes	20	24 mm	Flat	MY-36620-85
12-mm dia tubes	20	24 mm	Conical	MY-36620-82
12-mm dia tubes	20	48 mm	Conical	MY-36620-53
13-mm dia tubes	20	48 mm	Conical	MY-36620-54
15-mm dia tubes	12	30 mm	Flat	MY-36620-86
15-mm dia tubes	12	48 mm	Conical	MY-36620-55
16-mm dia tubes	12	25 mm	Flat	MY-36620-89
16-mm dia tubes	12	48 mm	Conical	MY-36620-56
19-mm dia tubes	8	48 mm	Conical	MY-36620-57
20-mm dia tubes	8	48 mm	Conical	MY-36620-81
24-mm dia tubes	6	48 mm	Conical	MY-36620-63
25-mm dia tubes	6	48 mm	Conical	MY-36620-58
26-mm dia tubes	6	48 mm	Conical	MY-36620-64
30-mm dia tubes	5	48 mm	Conical	MY-36620-79
43-mm dia tubes	2	45 mm	Flat	MY-36620-80
0.2-mL tubes	72	13.8 mm	Tapered	MY-36620-72
0.5-mL tubes	30	27 mm	Tapered	MY-36620-66
1.5-mL tubes	20	35 mm	Tapered	MY-36620-65
2.0-mL tubes	20	35 mm	Conical	MY-36620-71
50-mL tubes	5	48 mm	Conical	MY-36620-77
Gelation timer	1	—	Flat	MY-36620-75
10-mm cuvettes (13 mm W)	2 channels	38 mm	Flat	MY-36620-59
Solid (no holes)	—	—	—	MY-36620-50 <sup>‡</sup>
Solid (no holes)	—	—	—	MY-36620-61
<b>Double-width heating blocks</b>				
96-well PCR plate	96	17.3 mm	Tapered	MY-36620-73
384-well PCR plate	384	7 mm	Tapered	MY-36620-76
96-well culture plate	96	—	Round	MY-36620-69
96-well culture plate	96	—	Flat wells	MY-36620-70
96-well high-temp	96	—	Round	MY-36620-68
96-well plate	Flat perimeter ridge	Flat bottom	—	MY-36620-78
1.0-mL Porvair plate	96	—	—	MY-36620-74 <sup>‡</sup>
Flexi-block	—	—	—	MY-36620-90
<b>Triple-width heating blocks</b>				
20-mm dia tubes	18	35 mm	Flat	MY-36620-83
43-mm dia bottles	4	85 mm	Flat	MY-36620-84
Flexi-block	—	—	—	MY-36620-91
Solid (no holes)	—	—	—	MY-36620-60

<sup>‡</sup>No thermometer hole.

**MY-36620-67 Plastic spacers**, half-width. Measure 95 x 37 x 50 cm. Pack of 2

# Cole-Parmer® StableTemp™ Dry Block Heaters

## Adjust to your needs

- Customisable to your needs—blocks available (below) for microtubes, centrifuge tubes, vials, microplates, and PCR strips or tube

**Analogue Dry Block Heaters.** Economical temperature controllers are adjustable with separate high and low temperature control knobs.

**Digital Dry Block Heaters.** Proportional Integrative Derivative (PID) controller allows you to select a particular temperature with ease, enables rapid heat-up, and provides excellent stability to maintain results. No hot spots—units have exceptional temperature uniformity and digital display shows set and actual temperature. Additional features include timer, audible alarm, and built-in temperature calibration mode.

**External Temperature Probe Kit** enables the digital heaters to read block or sample temperature and display it on the control panel. The RTD probe fits into the thermometer well located within each modular block.

**Caution!** To avoid possible electrical hazard, do not fill well or block opening with water or other fluids. Unit is designed to run as a dry bath/incubator.



Interchangeable blocks—change as your needs change

**StableTemp**



36600-02 shown with 36600-68

Accessories

MY-36600-68 Optional external temperature probe kit



Number of blocks accepted	Uniformity	Temperature range	Power		Catalogue number
			VAC	Watts	
<b>Analogue dry block heaters</b>					
1	±0.1° within the block at 37°C (98°F)	Low range: ambient to 212°F (ambient +5°C to 100°C) High range: 167 to 302°F (75 to 150°C)	230	110	MY-36600-13
2	±0.1° within the block at 37°C (98°F), ±0.1° across similar blocks at 37°C (98°F)		230	210	MY-36600-15
3	±0.1° within the block at 37°C (98°F), ±0.15° across similar blocks at 37°C (98°F)		230	210	MY-36600-17
<b>Digital dry block heaters</b>					
1	±0.1° within the block at 37°C (98°F)	Ambient to 120°C (ambient to 248°F)	230	110	MY-36600-02
2	±0.1° within the block at 37°C (98°F), ±0.1° across similar blocks at 37°C (98°F)		230	210	MY-36600-04
3	±0.1° within the block at 37°C (98°F), ±0.15° across similar blocks at 37°C (98°F)		230	210	MY-36600-07
<b>Digital dry block heater with heated lid</b>					
2	±0.1° within the block at 37°C (98°F), ±0.1° across similar blocks at 37°C (98°F)	Ambient to 120°C (ambient to 248°F)	230	400	MY-36600-70

# Cole-Parmer® StableTemp™ Modular Blocks for Dry Block Heaters

## No need to buy a new heater—easy switchout for new requirements

- Get maximum heat-up and retention with close contact of tubes to wall
- Constructed of solid anodised aluminium for durability
- Know the actual temperature of your wells—thermometer well for easy block temperature measurement

Single block dimensions (L x W x H): 9.5 x 7.6 x 5.1 cm (3¾" x 3" x 2"). Double block sizes are available online to fit 2/4/6-block heaters.

### Microcentrifuge Tube Blocks (single block size)

Accommodates	Number of wells	Well dia.	Well depth	Catalogue number
0.5 mL tube	30	7.9 mm	27.6 mm	MY-36600-22
1.5 mL tube	20	11.1 mm	39.1 mm	MY-36600-23
1.5 mL Eppendorf® tube	20	11.5 mm	36.9 mm	MY-36600-24
2 mL Eppendorf tube	20	11.5 mm	38.1 mm	MY-36600-25
2 mL Corning® tube	20	10.9 mm	38.1 mm	MY-36600-26



36600-22

36600-26

36600-29

36600-28

### Conical-Bottom Centrifuge Tube Blocks (single block size)

Accommodates	Number of wells	Well dia.	Well depth	Catalogue number
15 mL tube	12	17.1 mm	44.5 mm	MY-36600-28
50 mL tube	5	29 mm	47.6 mm	MY-36600-29

Please go online to see more block options.

## Electrothermal Electromantle Extraction Heaters and Heater/Stirrers

### No need for multiple units

- Simultaneously heat samples with different boiling points with independent temperature controllers
- Don't get burnt—case remains cool-to-the-touch
- Ideal for routine extraction tests
- Accomodate flask capacities from 100- to 1000-mL



**What's included:** three 12.7-mm (½") dia support rods, and an EU power cord and a UK power cord. Call our Application Specialists to order replacement heating element cartridges.

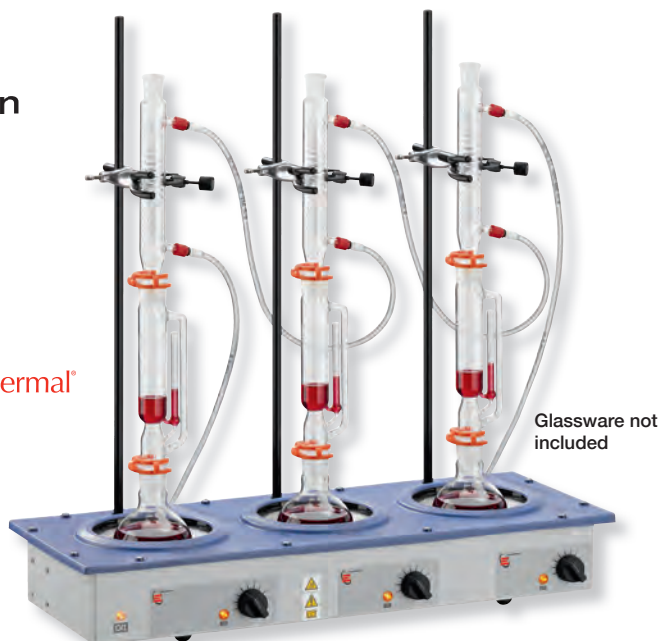

Glassware not included

#### Specifications

**Maximum element temperature:** 450°C (842°F)  
**Housing material:** powder-coated aluminium surfaces and polypropylene top cover  
**Thermal insulation:** ceramic fiber/mineral wood  
**Stirring speed range (combination models only):** 50 to 1000 rpm

Number of positions	Flask capacity (mL)	Power (VAC, Hz)	Dimensions (W x H x D) cm	Heaters		Heater/stirrers	
				Watts	Catalogue number	Watts	Catalogue number
Three	100	230, 50/60	64.0 x 11.0 x 27.0	180	MY-03076-01	220	MY-03076-13
	250	230, 50/60	64.0 x 11.0 x 27.0	450	MY-03076-04	490	MY-03076-16
	500	230, 50/60	75.5 x 13.0 x 28.5	600	MY-03076-07	640	MY-03076-19
	1000	230, 50/60	75.5 x 13.0 x 28.5	900	MY-03076-10	940	MY-03076-22
Six	100	230, 50/60	121.0 x 11.0 x 27.0	420	MY-03076-25	500	MY-03076-37
	250	230, 50/60	121.0 x 11.0 x 27.0	900	MY-03076-28	980	MY-03076-40
	500	230, 50/60	145.0 x 13.0 x 28.5	1200	MY-03076-31	1280	MY-03076-43
	1000	230, 50/60	145.0 x 13.0 x 28.5	1800	MY-03076-34	1880	MY-03076-46

## Electrothermal EM Series Electromantles

### Safe and robust

- Ceramic fiber insulation, unique ventilation slots, and durable, chemical-resistant polypropylene housing keeps exterior case cool
- Coiled heating element is suspended within a thermal insulating cartridge to provide maximum heat transfer and support; its flexibility ensures minimum risk of flask breakage
- Controlled electromantles feature a built-in power regulator and safety earth (ground) screen
- Heater/stirrer models in 50- to 2000-mL capacities are also available

Built-in power controller has dial from 1 to 10 for repeatability. Mantles feature indicator lights: a clear "power on" light and amber "heater on" light. All mantles are double fused and include a single support rod clamp that accepts a 13-mm rod. Heating mantles accept round-bottom, and volumetric flasks. Mantles include 2-m UK and European mains cord set. Call our Application Specialists to order replacement heating element cartridges.

**Note:** Multi-volume, spill-proof and V-shaped models are available in volumes from 50- to 5000-mL; designed for use with round-bottom and pear-shaped flasks and 60° funnels.



Flask size (mL)	Maximum temperature	Dimensions (W x H x D) cm	Watts	VAC	Catalogue number
50	450°C (842°F)	17.5 x 12.7 x 26.0	60	230	MY-36002-02
100	450°C (842°F)	17.5 x 12.7 x 26.0	60	230	MY-36002-06
250	450°C (842°F)	17.5 x 12.7 x 26.0	150	230	MY-36002-10
500	450°C (842°F)	23.8 x 14.5 x 31.0	200	230	MY-36002-14
1000	450°C (842°F)	23.8 x 14.5 x 31.0	300	230	MY-36002-18
2000	450°C (842°F)	35.0 x 19.0 x 40.0	500	230	MY-36002-22
3000	450°C (842°F)	35.0 x 19.0 x 40.0	500	230	MY-36002-26
5000	450°C (842°F)	35.0 x 19.0 x 40.0	800	230	MY-36002-30

## Electrothermal CMU Series Heating Mantles

### Robust, reliable and hand-made in the UK

- Holds round-bottom and volumetric flasks
- Maximum element temperature of 450°C (842°F)
- Built-in energy regulator

Controlled electric heating mantles incorporate a heating element suspended within a ceramic fiber insulating material for safe, efficient heat transfer. They have a stainless steel grounded earth screen covering the element and are double-fused for added safety. Units have a built-in power controller with a 1 to 10 scale. The metal case remains "cool to the touch" when in operation. Lights indicate "power on" and "heat on." Single support rod clamp accepts a 13-mm rod.



Flask size (mL)	Maximum element temperature	Dimensions (W x H x D) cm	Watts	VAC	Catalogue number
50	450°C (842°F)	17.5 x 15.0 x 17.5	75	230	MY-03012-13
100	450°C (842°F)	17.5 x 15.0 x 17.5	100	230	MY-03012-23
250	450°C (842°F)	17.5 x 15.0 x 17.5	150	230	MY-03012-33
500	450°C (842°F)	22.0 x 17.0 x 22.0	200	230	MY-03012-43
1000	450°C (842°F)	22.0 x 17.0 x 22.0	300	230	MY-03012-53

**Note:** Uncontrolled heating models are available in volumes from 50 to 5000 mL. Controlled heating/stirring models are available in volumes from 100 to 5000 mL. Controlled large-volume heating models are available in volumes from 10 to 22 L.



## Electrothermal Electric Bunsen Burner

### Provides clean and easy operation

- Top cowl deflects heat away from hands
- Air circulation from the vented housing keeps base cool to the touch
- Efficient—only consumes 400 W of power

Electric Bunsen burner combines the advantages of a regular gas burner with the clean and easy operation of a heating mantle. Corrosion-resistant, stainless steel burner features a cone-shaped coiled resistance heater which directs radiant heat to the top cavity. Ideal for noncontact radiant heating of materials in test tubes, crucibles, small flasks, and beakers. Heating of a test tube sample may be done above the top of the burner or just inside the mouth of the ceramic heating bowl for quick heating. Remove the cowl to create a broader heating area—ideal for heating crucibles, flasks and beakers.

To regulate the power input and temperature of the Bunsen burner, a heating controller is recommended. The Bunsen burner can be purchased with or without a controller.

**What's included:** detachable cowl and UK and EU mains cord.



Description	Maximum temperature	Dimensions (H x dia)	Power		Catalogue number
			VAC, Hz	Watts	
Without controller	800°C (1472°F)	17.7 x 12.0 cm (7" x 4¾")	230, 50/60	480	MY-36135-01
With controller 36223-04 (see below)					MY-36135-02



electrothermal

## Electrothermal Analogue Heating Controllers

### Take control of uncontrolled heating mantles

- Provide manual control of heating mantles, tapes, and electric Bunsens
- Compact—use on benchtop or mount to frame

External one-way controllers allow you to manually regulate the power input to your laboratory heating equipment. Indicator lights include a white “power on” and amber “heater on” light. The white light will indicate “power on”. As you turn the control dial clockwise to increase power, the amber indicator light begins to pulsate. The pulse frequency will decrease as the control dial setting is increased. Once maximum power is reached, the light will glow continually.

**What's included:** support clamp at rear for standard 13-mm dia rod (not included) and mains cord set.



Watts	Dimensions (W x H x D)	Power (VAC Hz)	Catalogue number
800	9.5 x 10.5 x 13.0 cm (3¾" x 4½" x 5½")	230, 50/60	MY-36223-04
1800		230, 50/60	MY-36223-02
2300	12.0 x 8.0 x 11.5 cm (4¾" x 3½" x 4½")	230, 50/60	MY-36223-00



electrothermal

## Electrothermal Digital Heating Controller

### Versatile, three-way temperature control

- Three-digit LED display allows you to set a 1°C resolution over a range of –10 to 800°C
- Front-panel up/down controls make for easy programming
- Ideal for heating mantles or electric Bunsens

Benchtop digital heating controller can be used three ways: in on/off mode with the hysteresis loop controlling power switching, as a PID controller, or simply as a temperature measuring device using a probe. Rugged zinc die-cast outer housing is suitable for benchtop use or wall mounting. Rear clamp accepts a standard 13 mm rod to mount on a support stand or frame.

Included PTFE-covered thermometer probe is suitable for measurements up to 250°C or order optional temperature probe 32587-98 for measurements up to 800°C. There is a 5-pin DIN socket on the controller for the probe.

**What's included:** platinum RTD thermometer probe (250°C max), wall-mounting bracket, and mains cord set.



Specifications			
<b>Control type:</b> on/off mode with hysteresis loop controlling power, PID	<b>Input type:</b> 100 Ω Pt RTD, 5 pin DIN	<b>Resolution:</b> 1°C	
	<b>Temperature range:</b> –10 to 800°C (14 to 1472°F)		
Control output	Dimensions (W x H x D)	Power (VAC, Hz)	Catalogue number
1500 W	12.0 x 8.0 x 10.0 cm (4¾" x 3¾" x 3½")	230, 50/60	MY-32587-00



electrothermal

#### Accessories

- MY-32587-98 Temperature probe,** platinum RTD, 800°C max, 140 mm L x 7.0 mm dia
- MY-32587-99 Temperature probe,** platinum RTD, 250°C max, 380 mm L x 6.0 mm dia
- MY-99965-02 Temperature probe,** platinum RTD, 250°C max, 260 mm L x 5.0 mm dia
- MY-99965-03 Temperature probe,** platinum RTD, 400°C max, 280 mm L x 5.0 mm dia

## Electrothermal Grounded Heating Tapes

### Flexible heaters—fit metal pipes and glassware

- Maximum element temperature of 450°C

The flexible fiberglass heating tapes are ideal for heating columns, pipes, valves, and transfer lines, especially when applications need to be observed. The heating element and braided ground wire are wound on a fiberglass core and covered in braided fiberglass outer sleeve. Tapes are for use in dry conditions only. Supplied with 9-cm insulated unheated flexible leads at each end.

**Warning:** Heating tapes should not be overlapped. Heating tapes must be connected to an external temperature or power control device (not included). Our recommended power controllers can be found on page 75. For instructions on connecting your heating tape to a power controller, please visit our website or contact your local Cole-Parmer representative.

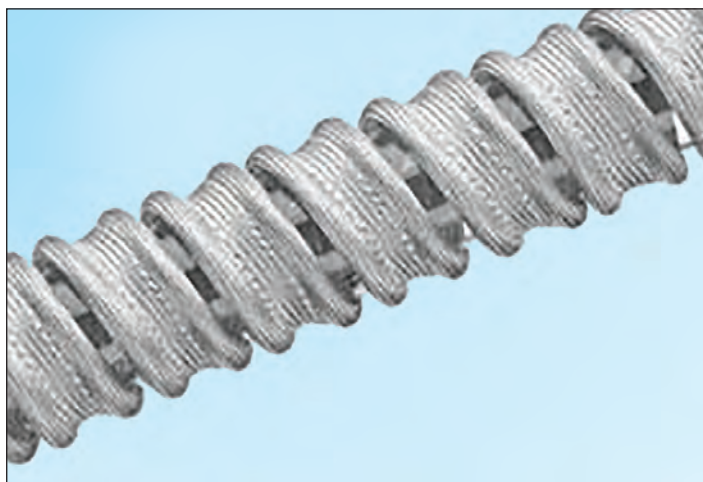

electrothermal



Watts	Dimensions length x width	Max temperature	Volts	Catalogue number
100	61 cm x 2.5 cm	450°C	230	MY-36220-00
150	91 cm x 2.5 cm			MY-36220-02
200	122 cm x 2.5 cm			MY-36220-04
300	183 cm x 2.5 cm			MY-36200-06
400	244 cm x 2.5 cm			MY-36200-08
600	366 cm x 2.5 cm			MY-36220-10
800	488 cm x 2.5 cm			MY-36200-12
1200	732 cm x 2.5 cm			MY-36200-14
1600	976 cm x 2.5 cm			MY-36200-15

## Electrothermal STEM RS Series Parallel Reaction Stations

### Run multiple reactions in a single station, saving you time and money

- Excellent temperature uniformity across the block
- Soft-start feature minimises splashing

These energy-efficient reaction stations let you easily carry out parallel synthesis by offering the same controlled temperature and stirring rates at several positions simultaneously. High-performance magnetic stirrers ensure maximum coupling. Easily set and view temperature and stir rate on the digital display. The rugged, well-insulated stations stay cool to the touch for safe handling and the PTFE coating protects the unit from chemical spills.



36630-11

36630-13

electrothermal



Model	Stirred positions	Sample volume	Tube diameter (mm)	Stir speed range (rpm)	Temperature range	Temperature stability	Power (230 V)	Catalogue number
RS600	6	Up to 250 mL	57.5	400 to 2000	Ambient to 250°C	±0.5°C	600 W	MY-36630-13
RS1000	10	1 to 25 mL	25	400 to 2000	Ambient to 150°C	±0.5°C	300 W	MY-36630-11
RS9000	(Order block separately below)	Block dependent	Up to 24 mm	100 to 600 (agitation)	Ambient to 150°C	Block dependent	900 W	MY-99968-12

**MY-99968-07 Heating block** for model RS9000; holds 96 x 16-mm tubes

**MY-99968-08 Heating block** for model RS9000; holds 40 x 24-mm tubes

**MY-99968-11 Heating block** for model RS9000; holds 96 x 1.5-mL tubes

**MY-99968-05 Heating block** for model RS9000; holds 4 x PTFE 96-well microplates

**MY-36630-62 External temperature probe, RTD**

# Electrothermal PS20000 Integrity 10 Reaction Station

## Individually control temperature and stirring rate for each cell

- Perform 10 independent experiments simultaneously saving you time and money
- View the results of your experiments in real time on the monitor
- Easily transfer data to a PC via a USB port
- Optional attachment available for refluxing and working under inert conditions

The Integrity 10 reaction station enables you to conduct 10 different reactions simultaneously within the same reaction unit, each reaction being conducted within its own cell, at its own individual temperature and stir rate. If desired, fast heating and cooling rates can be selected, with controlled temperature ramps of between 0.1°C/min to 5°C/min. Extreme temperature accuracy is guaranteed, with a temperature stability of  $\pm 0.5^\circ\text{C}$  and a maximum set point overshoot of 0.5°C. The Integrity 10 is an excellent tool for establishing ideal process conditions.

Each cell features an individually controlled magnetic stirrer (12 x 4.5 mm cylindrical or 10 x 6 mm oval stir bars are recommended). Order tapered test tubes and reducing sleeves to accommodate sample volumes down to 1 mL. Use the optional reflux/inerting head when you need to run parallel reactions over long time periods, as is commonly required in organic chemistry experiments.



 electrothermal



### Specifications

<b>Number of positions:</b> 10	Temperature overshoot: 0.5°C (maximum)
<b>Cell cavity diameter:</b> 25.5 mm	<b>Maximum controlled heating cooling ramp rate:</b> 0.1 to 5°C/min in 0.1 steps
<b>Sample volume:</b> 1 to 25 mL (down to 1 mL with optional reducing sleeve)	<b>Stir speed range:</b> 350 to 1200 rpm
<b>Temperature range*:</b> -30 to 150°C	<b>Viscosity capacity:</b> glycerine at 25°C
<b>Temperature accuracy:</b> $\pm 0.5^\circ\text{C}$	<b>Output:</b> USB, RS-232, and RS-485
<b>Possible temperature difference between adjacent positions:</b> 180°C	<b>Power:</b> 110/115/230 VAC, 50/60 Hz

\*Chilled water supply required to run the Integrity 10.

Description	Quantity	Catalogue number
Integrity 10 reaction station with 10 individually controlled cells*	1	MY-36630-00
Integrity 10 software	1	MY-36630-92
Cole-Parmer® Polystat® recirculating chiller, 1 HP, 83 psi, 11 LPM, 240 V/50 Hz	1	MY-12910-95
Small-volume test tubes, 1 mL, 24 to 11 mm taper	10	MY-36630-87
Small-volume test tubes, 3 mL, 24 to 16 mm taper	10	MY-36630-83
Reducing sleeves for 1-mL test tubes	10	MY-36630-86
Reducing sleeves for 3-mL test tubes	10	MY-36630-84
Stirrer bars, 10 x 6 mm	10	MY-36630-98
Stirrer bars, 12 x 4.5 mm	10	MY-36630-99
Reflux/inerting head	1	MY-36630-97
Inerting cap for reflux/inerting head, SVL 22 thread	10	MY-36630-94
Inerting cap for reflux/inerting head, Kimble type	10	MY-36630-95
Glass tubes, 24 x 150 mm, SVL 22 thread	10	MY-36630-85
Glass tubes, 24 x 150 mm, Kimble type	10	MY-36630-96
Temperature probe	6	MY-36630-81
Temperature probe	10	MY-36630-82
Multi-temp 10 plug-in box	1	MY-36630-80
Non-intrusive IR sensor	1	MY-36630-90
Small intrusive IR probe in stainless steel PID-NIR5-BNSD	1	MY-36630-88
Large intrusive IR/NIR probe	1	MY-36630-91
Multi-IR plug-in box	1	MY-36630-89

\*Chilled water supply required to run the Integrity 10 station; we recommend recirculating chiller 12910-95 sold above.

### Don't Forget...

**IR/NIR probe**  
(part no. 36630-91) custom made for Integrity 10

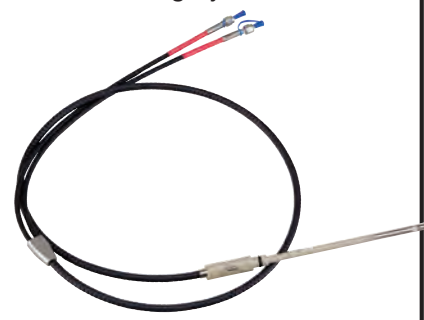

For help configuring the Integrity 10 Reaction Station system to your application, contact your local Cole-Parmer representative.



## Stuart® Variable-Speed Homogenisers

### Control speed to optimise shear rate

- Quiet <72 dB noise level will not disrupt your laboratory
- Stainless steel rotor probes are well-suited for larger and tougher samples
- Disposable polycarbonate probes reduce cross-contamination—autoclave and reuse up to seven times

**A. Handheld Homogeniser** features an ergonomic design and easily manageable weight for handheld operation, but also works with a support stand (order separately) for longer processing times. The 125-watt motor provides plenty of torque to process hard, frozen, and fibrous tissues. Includes two plastic disposable probes and adapter.

**B. Benchtop Homogeniser** offers digital control for better repeatability and accuracy. Powerful 850-watt motor processes virtually any sample from emulsions to protein extraction. Soft start ensures smooth operation without splashing. Set the built-in timer from seconds to minutes—also features a 30-second countdown for remote applications in fume hoods or biosafety cabinets. Includes stand and clamp.



#### REQUIRED System Components

- 1) Homogeniser
- 2) Probe(s)

stuart®



**A**

04720-01

**B**

04720-00



**2**

### 1. Homogenisers



Description	A. Handheld homogeniser		B. Benchtop homogeniser
<b>Catalogue number</b>	<b>MY-04720-01</b>	<b>MY-04720-02</b>	<b>MY-04720-00</b>
Speed range	5000 to 35,000 rpm		5000 to 25,000 rpm
Batch volume range	0.03 to 100 mL		0.2 to 2000 mL
Wattage	125 W		850 W
Power	220 to 240 VAC, 50 Hz		220 to 240 VAC, 50 Hz
Plug type	UK	Euro	UK and Euro

#### Accessories

**MY-04720-08 Probe adapter** required to use disposable probes

**MY-04720-09 Homogeniser stand**, 22 x 30 x 61 cm

### 2. Probes

Material	Processing range	Type	Dimensions (L x OD)	Qty/pk	Catalogue number
Stainless steel	0.03 to 5 mL	Flat head	75 x 5 mm	1	<b>MY-04720-03</b>
	0.25 to 30 mL	Saw tooth	115 x 7 mm	1	<b>MY-04720-04</b>
	1.5 to 100 mL	Saw tooth	115 x 10 mm	1	<b>MY-04720-05</b>
	50 to 2000 mL	Saw tooth	195 x 20 mm	1	<b>MY-04720-06†</b>
Polycarbonate	0.25 to 30 mL	Saw tooth	110 x 7 mm	25	<b>MY-04720-07</b>

†Probe 04720-06 can only be used with the benchtop homogeniser 04720-00.

## Cole-Parmer® LabGEN® 850 Homogeniser

### Process virtually any laboratory sample in seconds

- Variable-speed range performs from 5000 to 25,000 rpm
- Versatile—use as a handheld unit or mount to optional stand for hands-free operation

An advanced, integrated push-button digital control system ensures accuracy and repeatability. The digital timer can be set from seconds to minutes, and includes a 30-second countdown timer, which is great for remote applications in fume hoods or biosafety cabinets. Smooth-start feature minimizes splashing and provides steady processing.

Use the homogeniser with either the stainless steel rotor-stator generators or the plastic tip probes (tip adapter 04727-88 required). Order components separately.

**What's included:** cross rod, stand clamp, tool kit, and power cord.



#### REQUIRED System Components

- 1) Homogeniser
  - 2) Rotor-stator generator OR
  - 3) Plastic tip probes and required tip adaptor 04727-88
- OPTIONAL**
- 4) Stand and Motor support rod

**1**

**2**

**4**

Stand  
04727-89

LabGEN®



### 1. Homogeniser



Sample volume	Power	Motor	Catalogue number
0.02 mL to 5 L	220 VAC, 50/60 Hz	850 W	<b>MY-04727-29</b>

### 2. Stainless Steel Rotor-Stator Generators

Dispersion type	Sample volume range	Diameter	Length	Catalogue number
Fine	0.02 to 5 mL	5 mm	75 mm	<b>MY-04727-31</b>
Fine	0.05 to 5 mL	5 mm	75 mm	<b>MY-04727-60</b>
Fine	0.25 to 30 mL	7 mm	115 mm	<b>MY-04727-33</b>
Coarse				<b>MY-04727-35</b>
Fine	1.5 to 100 mL	10 mm	115 mm	<b>MY-04727-37</b>
Coarse				<b>MY-04727-39</b>
Fine	100 to 2000 mL	20 mm	195 mm	<b>MY-04727-41</b>
Coarse				<b>MY-04727-43</b>
Fine	200 to 5000 mL	30 mm	195 mm	<b>MY-04727-45</b>
Coarse				<b>MY-04727-46</b>

### 3. Plastic Tip Probes

Sample volume	Tissue type	Tip size (L x dia)	Qty/pk	Catalogue number
0.25 to 30 mL	Hard	110 x 7 mm	25	<b>MY-04727-84</b>
			50	<b>MY-04727-85</b>

**MY-04727-88 Tip adapter**, required for use with plastic tip probes

### 4. Optional Stand

**MY-04727-89 Homogeniser stand** with support rod

# Erlab Captair Smart Ductless Fume Hoods

## Simplify lab safety with Smart Technology™

- Audible and visual alerts warn you when there is a problem or malfunction
- Mobile app lets you monitor and control conditions remotely
- Single-button activation begins air purification quickly and easily

Create a comprehensive air purification solution in your laboratory with this series of smart fume hoods and an optional Halo™ laboratory-grade air filtration system.

Ductless filtering fume hoods provide a safe working environment for chemical handling, featuring either a hinged angled sash with arm ports or a vertical sliding sash. The versatile filtering unit (order filters separately) can be configured to handle gases, solvents, powders, and particulates and meet ANSI/AFNOR standards for filtration efficiency (Classes 1 and 2). An electronic anemometer automatically monitors face velocity.

Each hood features Smart Technology—an exclusive set of tools comprised of smart-light communication™, chemical sensors, real-time status, and the eGuard app. Simply press a button to activate—a soft band of light at the top of the hood lets you know the unit is operating safely. The band of light will slowly pulse to let you know if the airflow is compromised, if there is a fan failure, or it is time to change your filters. Use the app to remotely control and monitor the hood, change the settings, and deliver safety alerts.



### REQUIRED System Components

- 1) Hood
- 2) Filter(s)
- 3) Work surface
- 4) Base

## 1. Ductless Fume Hoods

Model	Description	Airflow	Face velocity	Dimensions (W x H x D)	Power		Catalogue number
					VAC	Hz	
321	Hinged angled sash with arm ports	220 m³/h	0.4 to 0.6 m/s	78 x 128.5 x 62 cm	80 to 220	50 to 60	MY-33520-01
391				100 x 128.5 x 62 cm			MY-33520-03
481				126 x 128.5 x 62 cm			MY-33520-05
392	Vertical sliding sash	440 m³/h	0.4 to 0.6 m/s	100.5 x 151.5 x 75 cm	80 to 220	50 to 60	MY-33520-04
483		660 m³/h		128 x 151.5 x 75 cm			MY-33520-06
633		660 m³/h		160 x 151.5 x 75 cm			MY-33520-07
714		880 m³/h		180 x 151.5 x 75 cm			MY-33520-11

## 2. Filters

MY-33520-35 Solvent detector sensor

MY-33520-26 HEPA particulate filter; 0.01 µm, 99.995% efficiency

MY-33520-90 Filter for acid, inorganic, organic, and solvent vapours

MY-33520-98 Filter for organic vapours

## 3. Work Surfaces

For hood model	Tempered glass with rounded edges	Phenolic resin with built-in retention tray
	Catalogue number	Catalogue number
321	MY-33520-39	MY-33520-43
391	MY-33520-45	MY-33520-49
392	MY-33520-53	MY-33520-55
481	MY-33520-59	MY-33520-61
483	MY-33520-63	MY-33520-64
633	MY-33520-66	MY-33520-67
714	MY-33520-69	MY-33520-70

## 4. Bases

For hood model	Description	Catalogue number
321	Metal rolling cart; 4 wheels, 2 locking	MY-33520-41
391		MY-33520-47
392		MY-33520-51
481	Metallic fixed bench, height adjustable	MY-33520-57
483		MY-33520-62
633		MY-33520-65
714		MY-33520-68

## Halo™ Laboratory Air Filtration System

Continuously eliminate noxious fumes and improve air quality by safely capturing chemicals and recirculating clean air back into your laboratory—soft LED lights will pulse to let you know the air is being cleaned. System is easily installed in the ceiling, but does not need to be tied in to existing HVAC. As a stand-alone unit, it can be placed anywhere that would be most effective and you can use multiple units to cover larger areas. Choose from two filter options using semiconductor sensors for detection and Neutrodyne carbon filters for purification.

Description	Airflow	Dimensions (W x H x D)	Power	Catalogue number
Broad spectrum semiconductor detection and filtration (Chemplus filter included)	220 m³/h	89.2 x 59.2 x 26 cm	80 to 240 VAC, 50/60 Hz	MY-33520-31
Volatile organic carbon semiconductor detection and filtration (VOC filter included)				MY-33520-33



## Labconco® Basic 119 and 178 cm Fume Hoods

Maintain your safety while handling chemicals

- Safe light-duty chemical handling for a broad range of applications

These hoods utilise by-pass airflow design to assure safe continuous ventilation regardless of sash height. All models incorporate advanced design features such as a removable curved air foil and an adjustable two-piece baffle to ensure optimal air routing.

All fume hoods include a 0.5-cm thick tempered safety glass counter-balanced sash and a 25.4-cm diameter duct collar.

Hoods are constructed of glacier white epoxy-coated 16 gauge steel. Hoods do not include a cabinet or work surface—order both online.

The 115 VAC models are shipped fully assembled; 220 VAC models require assembly. Cord and plug are not included.



### REQUIRED System Components

- 1) Hoods . . . . . **below**
- 2) Work surface . . . . . **online**
- 3) Cabinet . . . . . **online**



### Specifications

Fume hood size	119 cm	178 cm
Blower size	1/3-hp motor (Spark proof models: 1/2-hp)	3/4-hp motor
Construction	Epoxy-coated steel	
Ductwork size	25 cm	25 cm
Fixtures	Optional electrical outlet, air/gas/vacuum/water service connections, and cupsink and faucet—call our Application Specialists for details.	
Light†	One 100-watt incandescent bulb (included)	
Switches (included)	No-blower models: two Standard models: two Spark proof models: none	No-blower models: two Standard models: two Spark proof models: none
Overall dimensions‡ (W x H x D)	119 x 122 x 64 cm	178 x 122 x 64 cm

†Spark-proof models have one 100-watt explosion-proof incandescent light.  
‡Models with blower module are 135 cm H.

Blower	Power		Shpg wt	Catalogue number
	VAC	Hz		
<b>119 cm conventional Basic fume hoods</b>				
None†	220	50	123 kg	<b>MY-33503-05</b>
Standard	220	50	123 kg	<b>MY-33503-15</b>
Spark proof	115/230	60	206 kg	<b>MY-33503-20</b>
	220	50		<b>MY-33503-25</b>
<b>178 cm conventional Basic fume hoods</b>				
None†	220	50	193 kg	<b>MY-33504-05</b>
Standard	220	50	205 kg	<b>MY-33504-15</b>
Spark proof	115/230	60	213 kg	<b>MY-33504-20</b>
	220	50		<b>MY-33504-25</b>

†Hood must be used with an existing blower only.

Go online to search more than 100,000 products.

## Cole-Parmer® Compact Fume Hoods

Don't order separate components

- Complete with dished composite resin work surface, vapour proof light, and built-in exhaust blower

Fume chamber features molded seamless construction with coved corners, factory mounted with a chemical-resistant composite resin work surface to contain spills. VaraFlow baffle system is designed to efficiently direct air through the chamber. Blower rated for 3.6-m maximum duct run.



33731-05 shown on cabinet 33731-70



Hood width	Dimensions (W x H x D)	Power (VAC, Hz)	Shpg wt		Catalogue number
			lb	kg	
76 cm	76 x 114 x 66 cm	230, 50	194	88	<b>MY-33731-05</b>
91 cm	91 x 114 x 66 cm	230, 50	243	110	<b>MY-33731-15</b>
122 cm	122 x 114 x 66 cm	230, 50	280	127	<b>MY-33731-25</b>

### Cabinets

Hood width	Acid-storage base cabinets	Base cabinets
	Catalogue number	Catalogue number
76 cm	<b>MY-33731-70</b>	<b>MY-33731-72</b>
91 cm	<b>MY-33731-74</b>	<b>MY-33731-76</b>
122 cm	<b>MY-33731-78</b>	<b>MY-33731-80</b>

## Cole-Parmer® Ducted and Ductless Benchtop Fume Hoods

Stay safe just about anywhere

- Exhaust low-level corrosive vapours, heat, steam, fumes, and odours
- Interior fiberglass material provides good chemical resistance
- Recessed resin work surfaces contain spills

**What's included:** flexible ductwork, exhaust blower, and a light. Ductless model also includes a carbon filter for small-scale operations.



Description	Dimensions (W x H x D)	Power		Catalogue number
		VAC	Hz	
Ducted	61 x 61 x 38 cm	220	50	<b>MY-33730-05</b>
Ductless	61 x 61 x 38 cm	220	50	<b>MY-33730-15</b>



# Digi-Sense™ Traceable® Digital Thermohygrometers

## Don't let the humidity get to you



### A. Thermohygrometer with Dew Point and Wet Bulb

This thermohygrometer monitors temperature, humidity, dew point, and wet bulb. Displays current conditions along with minimum and maximum readings. High/low alarm for all four readings (temperature in °C or °F, humidity, dew point, and wet bulb) may be set in 0.1 increments. Alarm will sound for one minute and the red LED light will flash until readings return to a non-alarm condition. Wall mount or place on desktop.

Includes two AA batteries and ILAC MRA, NIST-traceable calibration report.



### C. Thermohygrometer with Minimum/Maximum Function

Thermohygrometer displays temperature-compensated relative humidity in % RH, and temperature in °C or °F. Stores minimum and maximum RH and temperature readings—just press the front-panel MIN and MAX buttons to read stored values. Press the RESET button to continue displaying current RH and temperature conditions.

Thermohygrometer features an integral stand for easy desktop viewing and a wall mounting bracket. Includes ILAC MRA, NIST-traceable calibration report.



### B. Jumbo Display Thermohygrometer

This thermohygrometer is perfect for both indoor and outdoor applications. Large, 2.9 cm high display can be read as far as 10 meters away!

Thermohygrometer includes a submersible temperature sensor on a 3-meter cable and one AAA battery. Unit features ABS plastic housing. Wall-mount the thermohygrometer or use the flip-open stand. Includes ILAC MRA, NIST-traceable calibration report.



### D. Handheld Thermohygrometer with Data Output

Measure and download temperature and humidity with these thermohygrometers.

Meters feature data hold, min/max, memory storage, selectable °C/°F, and auto-off. Model 37950-11 also calculates dew point and features an alarm for out-of-range conditions.

Includes hard case and one 9 V battery.



Key letter	A	B	C	D	
Catalogue number	MY-90080-03	MY-03313-86	MY-37101-00	MY-37950-03	MY-37950-11
Humidity	Range	1 to 99%	25 to 95%	10 to 95%	
	Resolution	0.10%	1%	0.1%	
	Accuracy	±4% from 20 to 80%	±2% at 60%, ±4% for remaining range	±4% from 40 to 80%, 7% for remaining range	±3% from 20 to 90% at 25°C (77°F)
Temp	Range	-40 to 70°C (-40 to 158°F)	0 to 50°C† (32 to 122°F)	0 to 50°C (32 to 122°F)	-18 to 93°C (0 to 199°F)
	Resolution	0.1°C (0.1°F)	0.1°C (1°F)	0.1°C (1°F)	0.1°C (0.1°F)
	Accuracy	±1°C (±1.8°F)	±1°C (±2°F)	±1°C (±2°F) from 0 to 40°C (32 to 104°F); ±2°C (±4°F) for remaining range	±0.5° from 0 to 50°C (32 to 122°F)
Dew point	Calculated†	—	—	—	0 to 50°C
Wet bulb	Calculated†	—	—	—	0 to 50°C
Response time	30 seconds to 3.5 minutes	30 seconds to 3.5 minutes	30 seconds to 3.5 minutes	8 seconds	
Output	—	—	—	RS-232	
Power	Two AA batteries (included)		Two AAA batteries (included)	One 9 V battery (included)	One 9 V battery (included)
Replacement batteries	MY-09376-01	MY-09376-00	MY-09376-00	MY-09376-04	MY-09376-04

†Meter takes the information gathered from the sensors and calculates dew point and wet bulb.

‡RH range at temperatures from 15 to 40°C.

#### Accessories

MY-17030-28 ILAC MRA, NIST-traceable calibration with data for standard thermohygrometers

## Digi-Sense™ Precalibrated Pocket Size Moisture Meter

Don't let moisture get to your sample

- Reliable measurements, guaranteed! Precalibrated to NIST-traceable standards
- Measure the moisture level in wood and hardened materials with one hand
- Don't let battery die on you—low-battery indicator alerts to concern



This pin-style meter is ideal for measuring the moisture level in wood products (sawn timber, cardboard, and paper) and hardened materials (plaster, concrete, and mortar). Advanced features include °C/°F unit selection, wood or material humidity measurement mode, backlit display, low-battery indicator, and auto power-off.

**What's included:** four LR44 batteries and NIST-traceable calibration report with data supplied by InnoCal.



Moisture range	Moisture accuracy	Temperature range	Catalogue number
Wood: 6 to 44%; Material: 0.2 to 2.0%	Wood: ±2%, Material: ±0.2%	0 to 50°C (32 to 122°F)	<b>MY-20250-35</b>

### Accessories

- MY-86531-52 Replacement pins. Pk of 50
- MY-09376-14 Replacement battery

## Oakton® Thermohygrometer with Digital Thermometer

No maintenance

- Remains accurate and stable without adjustments
- Switchable °C/°F scale
- Corrosion-resistant ABS plastic



**What's included:** one AA battery, mounting bracket, and screws.



Mode	Humidity	Temperature
<b>Cat. no.</b>	<b>MY-35700-00</b>	
Range	20 to 100%	-18 to 72°C (0 to 160°F)
Resolution	2%	0.1°C (0.1°F)
Accuracy	±4%, 20 to 90%; ±8%, 90 to 100%	±1.0°C (±1.8°F)
Response time	1 minute	
Power	One AA battery (included)	

### Accessories

- MY-09376-01 Replacement batteries, AA. Pack of 4
- MY-17030-28 ILAC MRA, NIST-traceable calibration with data for standard thermohygrometers

## Digi-Sense™ Precalibrated Humidity/Temperature Indicators

Accurately gauge proper humidity levels

- Environment comfort indicator warns of comfortable, wet, or dry conditions
- °F/°C unit selection, Min/Max reading, and clock with alarm and date

“Small, accurate, easy to use.”



### Specifications

Parameters	Range	Resolution
Humidity	10 to 90% RH	0.1%
Temperature (internal sensor)	0 to 50°C (32 to 120°F)	0.1°C/F
Temperature (external sensor, model 20250-31 only)	-50 to 70°C (-58 to 158°F)	0.1°C/F

Description	Catalogue number
Humidity/temperature indicator	<b>MY-20250-30</b>
Humidity/temperature indicator with external temperature probe	<b>MY-20250-31</b>

## FLIR® Thermal Imaging Moisture Meters

Get right to the problem spot

- Quickly scan and target moisture issues with IGM™ infrared technology
- Document thermal images and moisture readings on screen, and generate reports
- Flexible—take either nonintrusive or intrusive moisture measurements

Meters feature a built-in thermal camera to visually guide you to problem areas for more confident moisture readings, and the integrated laser and crosshair let you easily reference problem areas. Once you've located the optimal testing location, measure moisture content with the integrated pinless sensor or an external pin probe. Both meters have data Hold, Min/Max, store, and recall functions.



**What's included:** standard pin probe, FLIR Tools reporting software, USB cable, and micro-USB rechargeable battery.



Model number	MR160	MR176
<b>Catalogue number</b>	<b>MY-37802-06</b>	<b>MY-37802-13</b>
Moisture range – pinless	0 to 100 relative measurement	
Moisture range – pin	0 to 100% WME ±5%	
Air temperature	—	0 to 50°C / ±0.6°C
Relative humidity	—	0 to 100% RH / ±2.5% RH
Dew point	—	-30 to 50°C / ±1.0°C
Vapor pressure	—	0 to 12 kPa / ±0.05 kPa
Mixing ratio	—	0 to 80 g/kg (0 to 566 GPP) / 0.25 g/kg (±2 GPP)
Thermal detector type	FLIR Lepton™ microbolometer	
Thermal image resolution	4800 pixels (80 x 60)	
Field of view	51° x 38°	
Thermal sensitivity (NETD)	≤150 mK	
Display type	5.8 cm colour TFT	

- MY-37802-08 Protective carrying case
- MY-37802-07 Impact pin probe for high-density materials
- MY-37802-15 Hammer probe for subfloor and flooring
- MY-37802-14 Wall cavity pin probe for drywall
- MY-37802-16 Combination hammer and wall cavity probe kit

# H-B Instrument DURAC® Hydrometers

## Calcium Chloride Salt Glass Hydrometers (Salometer)

- Determine percent of saturation, specific gravity, or freezing point of calcium chloride (CaCl<sub>2</sub>)

Range	Divisions	Length	Catalogue number
0 to 120% saturation	1%	300 mm	<b>MY-08299-21</b>
1.000 to 1.280 specific gravity; -40 to -1°C freezing point	0.2 specific gravity; -15°C freezing point	300 mm	<b>MY-08299-22</b>



## Soil Glass Hydrometers

- Easy measurement of specific gravity of soil in suspension

ASTM no.	Range	Divisions	Length	Catalogue number
151H	0.995 to 1.038 specific gravity	0.001	280 mm	<b>MY-08297-40</b>
152H	-5 to 60 g/L	1	280 mm	<b>MY-08297-42</b>



## Polycarbonate Hydrometers

- Won't break when dropped

Type	Range	Divisions	Length	Catalogue number
Specific gravity	0.920 to 1.080	0.002	300 mm	<b>MY-08298-39</b>
	1.000 to 1.180	0.002	300 mm	<b>MY-08298-38</b>
	1.050 to 1.220	0.002	300 mm	<b>MY-08298-40</b>
	1.200 to 1.420	0.002	300 mm	<b>MY-08298-41</b>
	1.400 to 1.620	0.002	300 mm	<b>MY-08298-42</b>
Baumé	0 to 12°	0.2°	255 mm	<b>MY-08298-26</b>
	9 to 21°	0.2°	255 mm	<b>MY-08298-28</b>
	19 to 31°	0.2°	255 mm	<b>MY-08298-30</b>
Brix	0 to 35°	0.5°	300 mm	<b>MY-08298-36</b>
	15 to 50°	0.5°	300 mm	<b>MY-08298-37</b>
Salt brine	0 to 80%	1%	300 mm	<b>MY-08298-43</b>
	10 to 100%	1%	300 mm	<b>MY-08298-44</b>
Sodium chloride	4 to 26.5%	0.2%	300 mm	<b>MY-08298-45</b>



## Alcohol Glass Hydrometers

- Determine proof of ethyl alcohol spirits
- Tolerances listed for these hydrometers are those outlined in Circular 555 of the National Bureau of Standards, Testing of Hydrometers

The dual-scale alcohol hydrometer features both Proof and Tralle scales. The Proof scale indicates the proof of alcohol at 15.6°C (60°F); the Tralle scale indicates percent ethyl alcohol by weight in water.

Internal Rev. code	Range	Divisions	Length	Catalogue number
<b>Proof hydrometers</b>				
F	0 to 20%	0.2%	300 mm	<b>MY-08296-01</b>
G	20 to 40%	0.2%	300 mm	<b>MY-08296-03</b>
H	40 to 60%	0.2%	300 mm	<b>MY-08296-05</b>
I	60 to 80%	0.2%	300 mm	<b>MY-08296-07</b>
K	75 to 95%	0.2%	300 mm	<b>MY-08296-09</b>
L	90 to 110%	0.2%	300 mm	<b>MY-08296-11</b>
M	105 to 125%	0.2%	300 mm	<b>MY-08296-13</b>
N	125 to 145%	0.2%	300 mm	<b>MY-08296-15</b>
P	145 to 165%	0.2%	300 mm	<b>MY-08296-17</b>
Q	165 to 185%	0.2%	300 mm	<b>MY-08296-19</b>
R	185 to 206%	0.2%	300 mm	<b>MY-08296-21</b>
<b>Dual-scale Proof/Tralle hydrometer</b>				
—	Proof scale: 0 to 200%; Tralle scale: 0 to 100%	Proof scale: 2%; Tralle scale: 1%	305 mm	<b>MY-08285-58</b>



## Hydrometer Storage Cases

- Keep hydrometers safe

These sturdy storage cases protect your hydrometers from shock or rough handling. Heavy-wall Polyvinyl Chloride (PVC) tube is fully cushioned with foam padding and has a twist-lock cap.



Accommodates	Catalogue number
One hydrometer up to 190 mm (8") L	<b>MY-08285-98</b>
One hydrometer up 381 mm (15") L	<b>MY-08285-97</b>

## Hydrometer Racks

- Keep hydrometers close at hand

These polypropylene hydrometer racks securely hold up to 18 hydrometers. Wide base 21.0 x 21.6 cm (8¼" x 8½") prevents rack from tipping. Autoclavable.



For hydrometer length	Catalogue number
>280 mm	<b>MY-06695-00</b>
<280 mm	<b>MY-06695-10</b>



## H-B Instrument DURAC® Specific Gravity Glass Hydrometers

- Temperature standard is 15.6°C (60°F)
- Plain form hydrometers are individually serialised for easy identification
- Ensure accuracy with multi-language statement of accuracy supplied by manufacturer
- All hydrometers are 100% mercury free

**Precision Hydrometers, plain form**, have 0.0005 divisions and feature metal ballast.

**ASTM Hydrometers, plain form**, are designed to conform to the accuracy requirements of ASTM, and have their scales affixed using a clear epoxy for increased durability. Feature metal ballast.

**Precision Hydrometers, combined form**, fuse together a hydrometer and thermometer into one convenient unit. These thermohydrometers have an organic performance liquid that is 100% mercury free and feature wax paraffin and steel shot ballast.



### For Liquids Lighter than Water

#### General-Purpose Hydrometers, plain form

Range	Divisions	Length	Catalogue number
0.600 to 0.670	0.001	165 mm	MY-08298-46
0.640 to 0.710	0.001	165 mm	MY-08298-47
0.650 to 1.000	0.005	300 mm	MY-08299-09
0.690 to 0.800	0.002	165 mm	MY-08298-11
0.700 to 0.770	0.001	165 mm	MY-08298-17
0.700 to 0.810	0.001	300 mm	MY-08298-27
0.760 to 0.830	0.001	165 mm	MY-08298-19
0.790 to 0.900	0.002	165 mm	MY-08298-13
0.800 to 0.910	0.001	300 mm	MY-08298-29
0.820 to 0.890	0.001	165 mm	MY-08298-21
0.880 to 0.950	0.001	165 mm	MY-08298-23
0.890 to 1.000	0.002	165 mm	MY-08298-15
0.900 to 1.000	0.001	300 mm	MY-08298-31
0.940 to 1.010	0.001	165 mm	MY-08298-25

#### Precision Hydrometers, plain form

Range	Divisions	Length	Catalogue number
0.600 to 0.670	0.0005	325 mm	MY-08298-51
0.640 to 0.710	0.0005	325 mm	MY-08298-53
0.700 to 0.770	0.0005	325 mm	MY-08298-55
0.760 to 0.830	0.0005	325 mm	MY-08298-57
0.820 to 0.890	0.0005	325 mm	MY-08298-59
0.880 to 0.950	0.0005	325 mm	MY-08298-61
0.940 to 1.010	0.0005	325 mm	MY-08298-63

#### ASTM Hydrometers, plain form

ASTM no.	Range	Divisions	Length	Catalogue number
82H	0.650 to 0.700	0.0005	330 mm	MY-08297-81
83H	0.700 to 0.750	0.0005	330 mm	MY-08297-83
84H	0.750 to 0.800	0.0005	330 mm	MY-08297-85
85H	0.800 to 0.850	0.0005	330 mm	MY-08297-87
86H	0.850 to 0.900	0.0005	330 mm	MY-08297-89
87H	0.900 to 0.950	0.0005	330 mm	MY-08297-91
88H	0.950 to 1.000	0.0005	330 mm	MY-08297-93
89H	1.000 to 1.050	0.0005	330 mm	MY-08297-95
102H	0.650 to 0.700	0.001	260 mm	MY-08297-97
103H	0.700 to 0.750	0.001	260 mm	MY-08297-99
104H	0.750 to 0.800	0.001	260 mm	MY-08298-01
105H	0.800 to 0.850	0.001	260 mm	MY-08298-03
106H	0.850 to 0.900	0.001	260 mm	MY-08298-05
107H	0.900 to 0.950	0.001	260 mm	MY-08298-07
108H	0.950 to 1.000	0.001	260 mm	MY-08298-09

#### Precision Hydrometers, combined form

Range	Divisions	Temperature range	Divisions	Length	Catalogue number
0.700 to 0.810	0.001	0 to 150°F	2°F	381 mm	MY-08297-57
0.800 to 0.910	0.001	0 to 150°F	2°F	381 mm	MY-08297-59
0.900 to 1.000	0.001	0 to 150°F	2°F	381 mm	MY-08297-61

### For Liquids Heavier than Water

#### General-Purpose Hydrometers, plain form

Range	Divisions	Length	Catalogue number
1.000 to 1.070	0.001	165 mm	MY-08298-60
1.000 to 1.220	0.002	300 mm	MY-08298-84
1.000 to 1.250	0.005	165 mm	MY-08298-50
1.000 to 1.600	0.005	300 mm	MY-08298-80
1.000 to 2.000	0.01	300 mm	MY-08298-94
1.060 to 1.130	0.001	165 mm	MY-08298-62
1.120 to 1.190	0.001	165 mm	MY-08298-64
1.180 to 1.250	0.001	165 mm	MY-08298-66
1.200 to 1.420	0.002	300 mm	MY-08298-86
1.200 to 1.450	0.005	165 mm	MY-08298-52
1.240 to 1.310	0.001	165 mm	MY-08298-68
1.300 to 1.370	0.001	165 mm	MY-08298-70
1.360 to 1.430	0.001	165 mm	MY-08298-48
1.400 to 1.620	0.002	300 mm	MY-08298-88
1.400 to 1.650	0.005	165 mm	MY-08298-54
1.420 to 1.490	0.001	165 mm	MY-08298-72
1.480 to 1.550	0.001	165 mm	MY-08298-74
1.540 to 1.610	0.001	165 mm	MY-08298-76
1.500 to 2.000	0.005	300 mm	MY-08298-82
1.600 to 1.670	0.001	165 mm	MY-08298-78
1.600 to 1.820	0.002	300 mm	MY-08298-90
1.600 to 1.850	0.005	165 mm	MY-08298-56
1.660 to 1.730	0.001	165 mm	MY-08298-49
1.720 to 1.790	0.001	165 mm	MY-08294-91
1.780 to 1.850	0.001	165 mm	MY-08294-93
1.800 to 2.000	0.002	300 mm	MY-08298-92
1.800 to 2.000	0.001	165 mm	MY-08298-58
1.840 to 1.920	0.001	165 mm	MY-08294-95
1.900 to 1.970	0.001	165 mm	MY-08298-96
1.970 to 2.040	0.001	165 mm	MY-08298-97

#### Precision Hydrometers, plain form

Range	Divisions	Length	Catalogue number
1.000 to 1.070	0.0005	325 mm	MY-08298-65
1.060 to 1.130	0.0005	325 mm	MY-08298-67
1.120 to 1.190	0.0005	325 mm	MY-08298-69
1.180 to 1.250	0.0005	325 mm	MY-08298-71
1.240 to 1.310	0.0005	325 mm	MY-08298-73
1.300 to 1.370	0.0005	325 mm	MY-08298-75
1.360 to 1.430	0.0005	325 mm	MY-08298-77
1.420 to 1.490	0.0005	325 mm	MY-08298-79
1.480 to 1.550	0.0005	325 mm	MY-08298-81
1.540 to 1.610	0.0005	325 mm	MY-08298-83
1.600 to 1.670	0.0005	325 mm	MY-08298-85
1.660 to 1.730	0.0005	325 mm	MY-08299-01
1.720 to 1.790	0.0005	325 mm	MY-08298-87
1.780 to 1.850	0.0005	325 mm	MY-08298-89
1.840 to 1.920	0.0005	325 mm	MY-08299-03

#### ASTM Hydrometers, plain form

ASTM no.	Range	Divisions	Length	Catalogue number
125H	1.000 to 1.050	0.001	260 mm	MY-08297-80
126H	1.050 to 1.100	0.001	260 mm	MY-08297-82
127H	1.100 to 1.150	0.001	260 mm	MY-08297-84
128H	1.150 to 1.200	0.001	260 mm	MY-08297-86
129H	1.200 to 1.250	0.001	260 mm	MY-08297-88
130H	1.250 to 1.300	0.001	260 mm	MY-08297-90
131H	1.300 to 1.350	0.001	260 mm	MY-08297-92
133H	1.400 to 1.450	0.001	260 mm	MY-08297-94

#### Precision Hydrometers, combined form

Range	Divisions	Temperature range	Divisions	Length	Catalogue number
1.000 to 1.220	0.002	0 to 150°F	2°F	381 mm	MY-08297-63
1.200 to 1.420	0.002	0 to 150°F	2°F	381 mm	MY-08297-65
1.400 to 1.620	0.002	0 to 150°F	2°F	381 mm	MY-08297-67
1.600 to 1.820	0.002	0 to 150°F	2°F	381 mm	MY-08297-69
1.800 to 2.000	0.002	0 to 150°F	2°F	381 mm	MY-08299-07

### For Liquids Considerably Heavier than Water

#### General-Purpose Hydrometers, plain form

Range	Divisions	Length	Catalogue number
2.000 to 3.000	0.01	300 mm	MY-08298-98

## Stuart® Hybridisation Incubator/Shaker

### Versatile—features both rotisserie and rocking motions

- Forced air circulation combined with microprocessor control results in excellent temperature uniformity
- Ideal for nucleic acid hybridisation applications such as Northern (RNA) blots, Southern (DNA) blots, and Western (protein) blots

Rotisserie shaker has a rotational speed from 2 to 10 rpm while the platform shaker has a rocking speed from 5 to 70 oscillations/minute. Double-glazed smoked acrylic and polycarbonate door provides radiation protection. Stainless steel interior is easy to clean. Safety features include overtemperature protection and power cut-off.

Hybridisation bottles (order separately) are made from Pyrex® borosilicate glass and are autoclavable. Thermoplastic polyester caps are rigid and will not distort during repeated heating in the incubator. PTFE insert makes a tight seal preventing leakage.

**What's included:** rotisserie 39454-95.



stuart®



#### Specifications

<b>Temperature range:</b> ambient +8°C to 80°C	<b>Temperature variation:</b> ±0.5°C
<b>Temperature fluctuation:</b> ±0.1°C at 37°C	<b>Chamber dimensions (W x H x D):</b> 28.6 x 20 x 23 cm
	<b>Overall dimensions (W x H x D):</b> 38 x 43.5 x 38 cm

Capacity	Power (VAC, Hz)	Catalogue number
20 L	230, 50	<b>MY-39454-05</b>

#### Accessories

Description	Catalogue number
<b>Rotisseries</b>	
Holds seven 40-mm dia bottles	<b>MY-39454-95†</b>
Holds two 75-mm dia bottles	<b>MY-39454-96</b>
<b>Hybridization bottles</b>	
40 mm OD x 260 mm L	<b>MY-39454-97</b>
40 mm OD x 170 mm L	<b>MY-39454-99</b>
75 mm OD x 260 mm L	<b>MY-39454-98</b>

†Included with hybridization incubator.

## Stuart® Orbital Shaking Incubators

### Easily reach samples at the back with retractable platform

- Microprocessor controlled shaking speed ensures accuracy
- Forced air circulation provides uniform temperature inside the entire chamber
- Set and view temperature and speed on the digital display; timer can be set from 1 second to 9 days
- Built-in USB connection and dedicated software allow long-term monitoring of temperature via a PC
- Order models with IQ/OQ (Installation Qualification/Operational Qualification) documentation to help you comply with regulatory agency requirements

**A. Microplate Incubator Shaker** provides high-speed orbital shaking action between 250 and 1250 rpm. The tight 1.5-mm orbit allows even the smallest vessel to be mixed well. Stainless steel water tray helps maintain a humidity level up to 80% for minimal sample evaporation. Platform with nonslip mat holds up to four microplates.

**B. Incubator Shakers** provide orbital shaking motion between 30 to 300 rpm with a gentle start action. Smoked acrylic windows in the door and sides let you view your samples easily. The 51-L model secures flasks up to 1-L capacity, typically accommodating 12 x 250-mL, 9 x 500-mL, or 4 x 1000-mL Erlenmeyer flasks. The 115-L model secures flasks up to 2-L capacity, typically accommodating 6 x 2000-mL, 8 x 1000-mL, or 15 x 500-mL Erlenmeyer flasks.

**C. Refrigerated Incubator Shaker** has all the features of the incubator shakers above plus the ability to operate at temperatures down to 15°C below ambient (minimum 5°C) when combined with a recirculating cooler (12122-04)—ideal for cell-based protein expression. Viewing windows are double glazed to prevent condensation buildup during sub-ambient use.

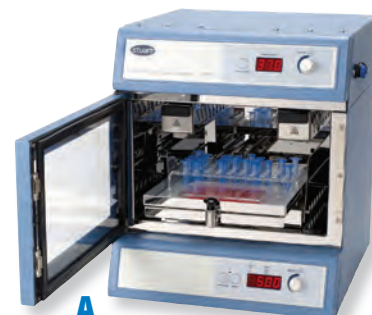

stuart®



Capacity	Temperature range	Temperature accuracy	Orbit dia.	Platform size	Dimensions (W x H x D)		Power	Catalogue number
					Chamber	Overall		
<b>A. Microplate incubator shaker</b>								
Four microplates or two microtube racks	Ambient +7°C to 60°C	±0.5°C at 37°C	1.5 mm	22 x 22 cm	30.7 x 19 x 30 cm	36.1 x 43 x 40.5 cm	230, 50	<b>MY-79520-10</b> <b>MY-79520-12†</b>
<b>B. Incubator shakers</b>								
51 L	Ambient +5°C to 60°C	±0.5°C	16 mm	33.5 x 33.5 cm	42.2 x 29.7 x 40.8 cm	45 x 52.2 x 47.4 cm	230, 50	<b>MY-79520-04</b> <b>MY-79520-06†</b>
115 L	Ambient +5°C to 60°C	±0.5°C	16 mm	52.6 x 39 cm	62.3 x 39.5 x 46.5 cm	67.5 x 64.2 x 54.2 cm	230, 50	<b>MY-79520-16</b> <b>MY-79520-18†</b>
<b>C. Refrigerated incubator shaker (not shown)</b>								
115 L	15°C below ambient to 60°C	±0.5°C	16 mm	52.6 x 39 cm	62.3 x 39.5 x 46.5 cm	67.5 x 64.2 x 54.2 cm	230, 50	<b>MY-79520-22</b> <b>MY-79520-24†</b>

†These models come with comprehensive IQ/OQ documentation to help you comply with regulatory agency requirements.

#### Racks for Models B and C

Capacity	Catalogue number
64 x 1.5 mL microtubes	<b>MY-79520-96</b>
25 x 15 mL centrifuge tubes	<b>MY-79520-97</b>
12 x 50 mL centrifuge tubes	<b>MY-79520-98</b>
16 x 30 mL tubes	<b>MY-79520-99</b>

#### Accessories for Model C only

**MY-12122-04 Refrigerated recirculating bath,**  
–20 to 100°C; 230 VAC, 50 Hz

## Stuart® Analog Melting Point Apparatus

Don't waste time—measure up to three samples at once



- No complicated programming—place sample in capillary tube, set heating rate, and watch for melt
- Monitor sample through magnifying lens and read temperature on included spirit-filled thermometer
- See sample more easily with integrated LED lamp

Unit includes open-ended capillary tubes—seal one end before using. Process multiple runs faster by cooling sample with optional cooling plug.

**What's included:** thermometer and pack of 100 capillary tubes (open at both ends).

### Specifications

**Temperature range:** 50 to 250°C  
**Heat-up time:** 1 to 20°C per minute

Number of samples	Power (VAC, Hz)	Catalogue number
Up to 3 simultaneously	240, 50/60	MY-03013-61

## Stuart® Digital Melting Point Apparatus

No more reading glass thermometers



- Get more accuracy—select, measure, and display temperature digitally
- Be more productive—test two samples simultaneously
- Easily see melt via magnifying lens with built-in illumination

Save time by setting a plateau temperature for initial warm-up, with heating rate continuing at 2°C until melt temperature is reached. Extendable back feet optimise viewing angle.

**What's included:** pack of 100 capillary tubes (open at one end).

### Specifications

**Temperature range:** ambient to 300°C  
**Temperature accuracy:** ±1.0°C at 20°C, ±2.5°C at 300°C  
**Heat-up time:** 20°C per minute to plateau, 2°C per minute to melt

Number of samples	Power (VAC, Hz)	Catalogue number
2 simultaneously	240, 50	MY-03011-41

## Stuart® Automatic Digital Melting Point Apparatus

Capture and display a video of the melt



- Accurately identify the melting point with advanced digital image processing
- Get up and running quickly—intuitive setup and navigation on large colour touch screen
- Use the rapid ramp mode to take a fast scan of the full temperature range
- Conforms to USP and GLP requirements

Advanced features with icon-driven interface make this the ideal melting point apparatus for your pharmaceutical, raw material, and quality control applications. Video image of melt provides proof of measurement—observe in real time or post melt. Download videos and reports to a USB flash drive or use the optional printer for direct printing of results. Stored video results are stamped with melt temperature.

**What's included:** pack of 100 capillary tubes (open at one end), and storage compartment with glass cutter.

### Specifications

**Number of samples:** up to 3 simultaneously  
**Temperature range:** ambient to 400°C  
**Temperature resolution:** 0.1°C  
**Ramp rate:** 0.1 to 20°C per min (0.1°C increments)  
**Heat-up time:** 6 min from 50 to 350°C  
**Display:** 17.8 cm (7") color touch screen  
**Memory:** 8 GB (approx. 300 results with video)  
**Output:** USB, for flash drive  
**Power:** 120/230 VAC, 50/60 Hz

Description	Catalogue number
Automatic digital melting point apparatus	MY-03013-02
Automatic digital melting point apparatus with IQ/OQ documentation	MY-03013-03

### Accessories

MY-83056-79 Optional printer

### Don't Forget These Accessories

- MY-03013-62 Thermometer, spirit filled, 0 to 250°C
- MY-03013-63 Capillary tubes, open both ends. Pack of 100
- MY-03013-64 Capillary tubes, open one end. Pack of 100
- MY-03013-65 Capillary tubes, closed both ends. Pack of 100
- MY-03013-66 Brass cooling plug



# Electrothermal Digital Melting Point Apparatuses

## Ensure comfortable viewing for multiple users

- Ergonomically designed with height-adjustable extension arm and rotating viewing head
- Digital microprocessor provides fast warm-up and accurate temperature control
- Simultaneously view up to three capillary tubes
- Extension arm folds flat for compact storage
- Audible beeps indicate when temperature is stable and ready for sample
- Programmable models feature internal batch memory capability for storage of results

Our family of digital melting point apparatuses is designed for your general-purpose laboratory use. An advanced microcontroller and step-through menu system allows you to accurately control oven temperature and ramp rate. The keypad is conveniently located to ensure that temperatures can be recorded without looking away from the sample. An integral light and wide angle 8x viewing magnifier enhance sample observation, so that all three samples can be viewed without eye strain.

**Fixed Ramp Rate Models** offer two ramp rates and is ideal for basic melting point testing of up to three samples. A fixed 1°C/minute ramp heats sample. Use the 10°C/minute search ramp to quickly analyse sample if the melt temperature is unknown. Store up to four temperatures in temporary memory. The Mel-Temp® model has a temperature resolution of 1°C while the IA9100 model has 0.1°C.

**Programmable Ramp Rate Model** features five preset temperature ramps. You can program any rate from 0.2°C/minute to 10°C/minute in 0.1°C increments. Store up to four temperatures in a temporary memory; batch memory permanently stores up to 1000 sets of results with date, time, and batch number. Connect unit to computer or printer via RS-232 interface.

**Programmable Ramp Rate Model** for Pharmacopeia Requirements offers selectable ramp rates between 0.2°C/minute to 10°C/minute with a degree setting of 1°C/minute. Store up to two sets (beginning and ending temperatures) of three temperatures in temporary memory; batch memory permanently stores up to 500 sets of results. Unit connects to computer or printer via RS-232 interface.

**What's included:** 100 capillary tubes and a power supply with EU, UK and US power leads.



03010-15



03010-41



Description	Mel-Temp fixed ramp rate	Fixed ramp rate	Programmable ramp rate	Beginning/ending recordings for pharmacopeia requirements	
Model number	1101D	IA9100	IA9200	IA9300	IA9300/IQQ
Catalogue number	<b>MY-03010-15</b>	<b>MY-03010-51</b>	<b>MY-03010-41</b>	<b>MY-03010-59</b>	<b>MY-03010-64<sup>†</sup></b>
Temperature range	Ambient + 5 to 400°C		23 to 400°C		
Temperature resolution	1°C		0.1°C		
Temperature accuracy	±1% of set temperature		±0.5°C ±1 digit at 20°C; ±1.0°C ±1 digit at 350°C		
Temperature sensor	100 Ω Pt RTD		100 Ω Pt RTD		
Ramp rate	1° or 10°C/min (selectable)	1.0° or 10°C/min (selectable)	0.2 to 10°C/min (default 0.2°C/min)	0.2 to 10°C/min (default 1.0°C/min)	
Melt memory	4 x 1	4 x 1	4 x 1	3 x 2	
Batch memory	—	—	1000 melts	500 melts	
Printer output	—	—	Yes	Yes	
Number of samples	Up to three, simultaneously				
Lens magnification	8x, adjustable focus				
Display	Dual-line LCD, backlit				
Dimensions (W x H x D)	20 x 8 x 35.5 cm (with arm closed)				
Power (VAC, Hz, W)	100 to 240, 50/60, 45				

<sup>†</sup>Includes IQ/OQ documentation and calibration key kit.

### Accessories

**MY-03010-63 Cold finger**

**MY-03010-65 Calibration key**

**MY-03010-67 Replacement capillary tubes**, 1.5 mm dia. Pack of 1000

**MY-03010-68 Capillary tubes**, 2.0 mm dia. Pack of 1000

**MY-03010-69 Serial printer** for 03010-59 and -64

## Cole-Parmer® Dehydrated Culture Media

### Consistent, reliable results

- Use when ready or dehydrated culture extends shelf life
- Individually numbered with certificate of compliance expiration date, and shelf-life guarantee
- Quick dissolve for faster processing
- For laboratory use only

Sold in a 500-g container, except 14202-77 which is 2 kg.



Media	Description	Cat. no.
Agar, bacteriological	This clear gel agar is high-grade and manufactured using the ice method	MY-14200-10
Brain Heart Infusion Broth	Use to cultivate fastidious aerobic and anaerobic bacteria	MY-14202-05
Brilliant Green Bile Broth	A standard methods medium for confirmed and completed tests for coliforms in water	MY-14200-14
Buffered Peptone Water	Helps in the recovery of <i>Salmonella</i> from foods after preservation techniques	MY-14202-08
D/E Neutralising Broth	Especially for environmental sampling where neutralisation of chemical is important determinate in bactericidal activity	MY-14202-11
EC	Use to isolate <i>Escherichia coli</i> from water, milk, and shellfish; and differentiation of coliform bacteria at 37°C and <i>E. coli</i> at 45.5°C	MY-14202-12
Lactose Broth	A standard methods medium for the growth of coliform bacteria from water, food, and dairy	MY-14202-26
Lauryl Tryptose Broth	A standard methods medium for the growth of coliform bacteria in water and food	MY-14202-30
Lethen Broth Base, AOAC	Use to test items sanitised with quaternary ammonium compounds	MY-14202-34
m-FC Agar	Use to detect fecal coliforms at elevated temperatures by membrane filter technique	MY-14200-44
Mannitol Salt Agar	Use this selective medium to isolate and enumerate <i>Staphylococci</i> . Recommended by the USP for microbial limit tests.	MY-14202-44
Nutrient Agar	A general-purpose medium for the cultivation of nonfastidious organisms	MY-14200-24
Pancreatic Digest of Gelatin	This general-purpose peptone promotes growth in various media formulations	MY-14202-54
Phosphate Buffer; pH 7.2	Use to prepare dilution blanks for samples of water, food, and dairy products	MY-14200-54
Potato Dextrose Agar	Use this standard methods medium to culture yeasts/moulds from dairy and other food products	MY-14200-28
Sabouraud Dextrose Agar	Use this USP medium to perform total combined yeast and mould counts (microbial limit tests)	MY-14202-62
Selenite Cystine Broth	Use this USP and AOAC enrichment medium to detect <i>Salmonella</i> in food and dairy products, and other materials	MY-14202-64
Standard Methods Agar	Use this standard methods medium to analyse water, food, and dairy products	MY-14200-32
Tetraphionate Broth Base	Use this standard methods medium for the enrichment of <i>Salmonella</i> from samples of water, food, and research material	MY-14200-48
Tryptic Soy Agar	Use this USP medium for the total aerobic portion of microbial limit testing. Also as a primary media for preparing blood plates.	MY-14200-34
Tryptic Soy Broth	A USP soybean-casein digest broth for sterility testing and general-purpose use	MY-14200-36 MY-14202-77

**Warning**—These products are not approved or intended for, and should not be used for, medical, clinical, surgical or other patient oriented applications.

## CELLTREAT® Petri Dishes, PS

### Optically clear for improved imaging and observation



- Consistent flatness allows for even media distribution
- Manufactured from virgin polystyrene; supplied sterile (gamma irradiated)

**Treated Surface Petri Dishes** provide a hydrophilic surface to promote cell attachment and growth. Lids feature moulded spacers to allow gas exchange and stacking rings for increased stability. The 35-mm dish has an offset bottom for improved handling.

**Untreated Petri Dishes** are hydrophobic making them ideal for cell culture suspensions. Lids have moulded spacers (except 01932-17) to reduce condensation and allow air circulation. Stacking rings on the lids (except 01932-30) provide increased stability. The 35-mm dishes have an offset bottom for improved handling.

Order heavy-duty petri dishes made with thick plastic for increased durability. General-purpose and slippable dishes feature flared lid skirt and squared corners for easy one-handed operation, even while wearing gloves. Use slippable dishes with automated filling and streaking systems; they feature side arrows and ISO Market Target for automation. Special slideable dishes have a partial edge ring on base which allows a single dish to be slid from a large stack and enhances stability when stacked. Compartment dishes let you perform multiple experiments in one dish, saving you money.

### Treated Surface Petri Dishes



Dia x H (mm)	Working volume	Growth area	Qty/bag	Qty/cs	Catalogue number
35 x 11	5 mL	8.5 cm <sup>2</sup>	10 <sup>†</sup>	500	MY-01932-12
60 x 15	7 to 8 mL	21 cm <sup>2</sup>	10 <sup>†</sup>	500	MY-01932-18
70 x 15	7 to 8 mL	36.3 cm <sup>2</sup>	10 <sup>†</sup>	500	MY-01932-21
100 x 15	15 to 16 mL	55 cm <sup>2</sup>	10 <sup>†</sup>	500	MY-01932-25
100 x 20	15 to 16 mL	60.5 cm <sup>2</sup>	10 <sup>†</sup>	300	MY-01932-10
150 x 20	25 to 28 mL	143 cm <sup>2</sup>	1	60	MY-01932-14
150 x 20	25 to 28 mL	143 cm <sup>2</sup>	5 <sup>†</sup>	100	MY-01932-15

<sup>†</sup>Packaged in resealable bag.

### Compartmentalised Treated Surface Petri Dishes



No. of compartments	Dia x H (mm)	Working volume <sup>††</sup>	Qty/bag	Qty/cs	Catalogue number
2	100 x 15	7 to 8 mL	25	500	MY-01932-22
3	100 x 15	5 mL	25	500	MY-01932-23
4	100 x 15	4 mL	25	500	MY-01932-24

<sup>††</sup>Volume per compartment.

### Untreated Petri Dishes



Description	Dia x H (mm)	Working volume	Qty/bag	Qty/cs	Catalogue number
Heavy duty, vented lid	35 x 10	5 mL	10	960	MY-01932-13
	60 x 15	7 to 8 mL	10	500	MY-01932-19
	100 x 15	15 to 16 mL	10	300	MY-01932-26
	100 x 15	15 to 16 mL	10	500	MY-01932-27
	100 x 20	15 to 16 mL	10	300	MY-01932-11
	150 x 20	25 to 28 mL	5	100	MY-01932-16
HD, nonvented lid	150 x 20	25 to 28 mL	5	100	MY-01932-17
General use	60 x 15	7 to 8 mL	20	500	MY-01932-20
	100 x 15	15 to 16 mL	25	500	MY-01932-29
Slippable	100 x 15	15 to 16 mL	25	500	MY-01932-30
Slideable	100 x 15	15 to 16 mL	20	500	MY-01932-28

## Prepared Media Plates

### Save time and money

- Consistent, reliable performance

Each includes a certificate of compliance and quality control that shows lot numbers, expiration dates, and shelf-life guarantee.

**Pack of 10.**



Media	Description	Catalogue number
TSA	General growth medium for the isolation and cultivation of microorganisms	MY-14201-42
Standard Methods Agar	Determine the microbial content in dairy products, food, water and other material of sanitary importance	MY-14201-44
Baird Parker Agar	Selective medium for the detection and enumeration of coagulase-positive <i>Staphylococci</i> from food samples	MY-14201-48
PDA (Potato Dextrose Agar)	For cultivation of yeasts and mould and for the inducement of sporulation	MY-14201-52
HE Enteric Agar	Selective and differential medium for the isolation and differentiation of Gram-negative enteric pathogens	MY-14201-56
MacConkey Agar with Sorbital	Selective and differential medium for the detection of enterohemorrhagic <i>Escherichia coli</i> O157:H7	MY-14201-58
Centrimide Agar	Recommended for the selective isolation and identification of <i>Pseudomonas aeruginosa</i>	MY-14201-62

**Warning**—These products are not approved or intended for, and should not be used for, medical, clinical, surgical or other patient oriented applications.

## Contact Plate Media

### Cultivate microorganisms from environmental surfaces

These high-quality, economical plates feature a specified grid moulded into the bottom of the plate for easy colony counting. **10/pack (except -28; 20/pack).**

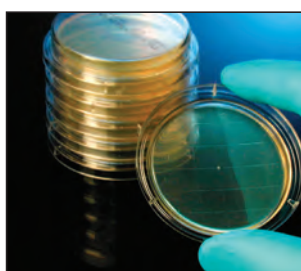

Media	Description	Catalogue number
TSA with Lecithin & Tween 80	For the cultivation of microorganisms from environmental surfaces.	MY-14201-20
SabDex with Lecithin & Tween 80	For the cultivation of fungi.	MY-14201-24
Blood Agar, 5%	For cultivation of microorganisms from environmental surfaces.	MY-14201-28
Baird Parker Agar	For the selective isolation and enumeration of coagulase positive <i>Staphylococci</i> from food and environmental surfaces.	MY-14207-06
Eosin Methylene Blue, EMB	For isolation and differentiation of Gram-negative Bacilli.	MY-14201-32
Rose Bengal Agar	For the selective isolation and enumeration of yeasts and moulds.	MY-14201-36

## Prefilled Dilution Vials

### Easy-open design

- Flip top lid, 145-mL vials for easy handling
- Prediluted with final pH of 7.2 ±0.2 at 25°C
- Lab use only



Application	Fill capacity	Qty/pk	Catalogue number
<b>Butterfield's phosphate buffer</b>			
Foods, dairy products, water, wastewater	99 mL	50	MY-36150-00
	90 mL	50	MY-36150-02
<b>Phosphate buffer with magnesium chloride</b>			
Beverages, dairy products	99 mL	50	MY-36150-10
	90 mL	50	MY-36150-12
<b>Peptone water, gamma irradiated</b>			
Foods, dairy products	99 mL	50	MY-36150-20
	90 mL	50	MY-36150-22
<b>Buffered peptone water, gamma irradiated</b>			
Foods, dairy products	99 mL	50	MY-36150-30
	90 mL	50	MY-36150-32

## Cole-Parmer® Digital Counter-Pen™

### Ensure accurate counts

- Easy-to-read LCD displays up to 99,999 units
- Counter beeps each time a mark is made

Features single button reset and comes with cap.



**Cole-Parmer®**

Description	Catalogue number
Digital counter pen	MY-20610-30

MY-20610-31 Replacement ink cartridge, black

## Cole-Parmer® Sterile Cell Lifters

### Easily harvest cells from culture dishes, plates, and tubes

Double-ended lifters have a 19-mm beveled edge blade on one end and a narrow blade or J-hook on the other end. Use the tapered narrow blade for 96-well plates or microcentrifuge tubes. The curved end of the J-hook blade is ideal for 6-, 12-, 24-, and 48-well plates. Each lifter is made of high-density polyethylene; sterilised by gamma irradiation and come individually wrapped.

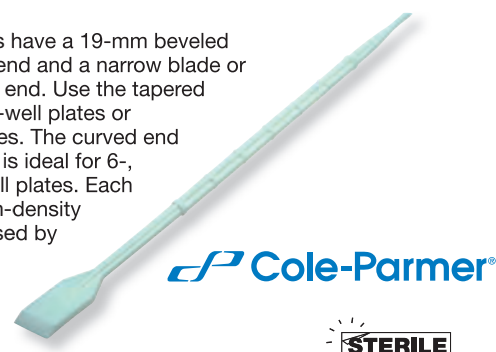

Description	Overall length	Qty/cs	Catalogue number
Narrow blade	9" (23 cm)	100	MY-01959-14
J-hook blade		100	MY-01959-16



## CELLTREAT® Cell Scrapers

Maximise recovery with soft, pliable blades

"Scraper" blade is parallel to the handle for a windshield-wiper-like scraping. "Lifter" blade is perpendicular to the handle for use with a raking motion. "Pivoting" blade adjusts to the desired position providing access to all corners of the flask or tissue culture vessel. Scrapers feature ABS handle and TPE blade. Certified non-pyrogenic and packaged sterile (gamma irradiated) in individual wrappers.



Description	Blade length	Handle length	Qty/cs	Catalogue number
Scraper blade	20 mm	25 cm	100	MY-01959-30
	30 mm	39 cm	100	MY-01959-36
Lifter blade	20 mm	25 cm	100	MY-01959-32
	30 mm	39 cm	100	MY-01959-38
Pivoting blade	20 mm	30 cm	100	MY-01959-34

## Cell Spreaders

Spread bacterial cultures evenly

- Apply cultures over an entire petri dish or plate with the L-shaped spreader
- Reduce the risk of damaging the agar—smooth spreading surface with slight upward return
- Composed of polypropylene and presterilised in bags of 10 or packaged individually



Material	Sterile	Qty/bag	Qty/cs	Catalogue number
PP	Yes	10	500	MY-04396-51
		1	100	MY-04396-52

## Cole-Parmer® Slideable Sterile Petri Dish, PS

Easily slide a single dish from a large stack

- Ventilation ribs reduce condensation and allow air circulation
- Partial edge ring on base allows a single dish to be slid from a large stack and enhances stability when stacked
- Consistent flatness provides for even media distribution



Dia x H (mm)	Working volume	Cell growth area	Packaging	Qty/cs	Catalogue number
100 x 15	15 to 16 mL	55 cm <sup>2</sup>	20/bag	500	MY-01932-31

## Sterile Petri Dishes, PS

Stacks won't tip over—convenient stacking ridges for better stability

- Use what you need—packaged in bags of 20 dishes
- Save time—already sterilised by gamma irradiation

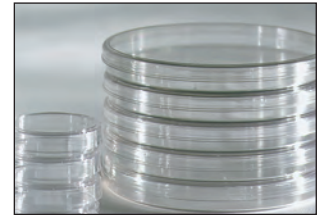

Dia x H (mm)	Qty/pk	Catalogue number
60 x 15	500	MY-06139-01
100 x 15	500	MY-06139-00
150 x 20	100	MY-06139-02

## Oxford® Bacti-Cinerator® IV

No more cross-contamination

- Safely and conveniently sterilise platinum loops and needles
- Don't waste time—sterilise in just 5 to 7 seconds
- Infrared heat has optimum sterilising temperature of 815°C (1500°F)



Description	Power (VAC,Hz)	Catalogue number
Bacti-Cinerator IV	220, 50/60	MY-01850-24

MY-01850-28 Replacement heater element for 01850-24

## Advantec® Disposable 50-mm Sterile Petri Dishes, PS

No need to presterilise

- Sterilised dishes are ready to use
- Use only what you need—come in convenient packs of 20
- Polystyrene dishes come with or without 47-mm absorbent cellulose pad and hold 1.8- to 2.0-mL of liquid media
- Ridges for easy stacking

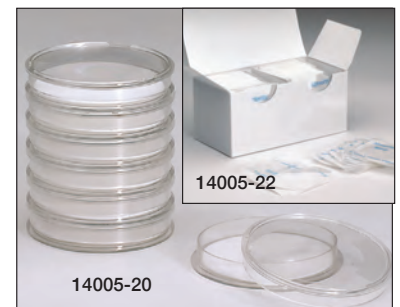

Description	Dia x H (mm)	Qty/cs	Catalogue number
Petri dish with pad	50 x 11	100	MY-14005-20
		500	MY-14005-28
Petri dish without pad	50 x 11	100	MY-14005-24
		500	MY-14005-26

MY-14005-22 Presterilised absorbent pads. Box of 100 individual packages

## Inoculation Loops and Needles

### A. Platinum Calibrated Loops

The 1- $\mu$ L loops are made of B&S platinum wire with 15% iridium. The 10- $\mu$ L loops are made of B&S platinum wire with 5% rhodium. Order insulated loop and needle holder separately below.

Contained volume	Inside dia	B&S gauge	Length	Catalogue number
1 $\mu$ L	1.45 mm	26	70 mm	MY-01850-00
10 $\mu$ L	4 mm	19	25 mm	MY-01850-02

### B. Platinum Loops and Needles

Use for transferring bacterial cultures. These loops and needles are made of B&S platinum wire with 15% iridium added for rigidity, permitting a thinner wire for delicate work. Loops are fused to form a "perfect circle" with an inside tolerance of  $\pm 0.02$  mm to ensure accurate delivery. Order insulated loop and needle holder separately below.

Description	Inside dia	B&S gauge	Length	Catalogue number
Loop	2 mm	24	45 mm	MY-01850-04
	3 mm			MY-01850-06
	5 mm			MY-01850-08
	3 mm			MY-01850-10
Needle	3 mm	26	70 mm	MY-01850-12
	3 mm			MY-01850-14

### C. Inoculating Loops

These loops are manufactured to very close tolerance levels and can be used for semi-quantitative counting of bacteria. Made of 26-gauge wire. Order insulated loop and needle holder for individual loop separately below ("E").

Description	Loop length	Contained volume	Qty/pk	Catalogue number
<b>Calibrated inoculating loops</b>				
No handle	76 mm	1 $\mu$ L	1	MY-14203-31
15.2 cm insulated handle	44 mm	1 $\mu$ L	1	MY-14203-25
		10 $\mu$ L	1	MY-14203-26
<b>Inoculating loops</b>				
No handle	2 mm	—	12	MY-14203-27
	3 mm	—	12	MY-14203-28
	4 mm	—	12	MY-14203-29
	5 mm	—	12	MY-14203-30

### D. Inoculating Loops and Needles with Handles

Ideal for use in semi-quantitative procedures, these loops and needles are 7.0-cm long with 15.2-cm or 20.3-cm handle. The 24 gauge is the most durable; the 25 gauge is for general use; and 26 gauge is designed for rapid cooling. Choose from insulated or non-insulated aluminium handles.

Description	Inside dia.	Handle length and type	B&S wire gauge	Qty/pk	Catalogue number
Loop	2 mm	20.3 cm, insulated	26	6	MY-14203-24
	3 mm	20.3 cm, insulated	26	6	MY-14203-23
	3 mm	15.2 cm, noninsulated	24	12	MY-14203-20
	3 mm	20.3 cm, noninsulated	25	12	MY-14203-22
	4 mm	20.3 cm, noninsulated	24	12	MY-14203-21
Needle	—	15.2 cm, noninsulated	24	12	MY-14203-32
	—	20.3 cm, insulated	24	6	MY-14203-33

### E. Insulated Brass Loop and Needle Holder

Holder is constructed of durable, heat-resistant brass with insulating sleeve. Works with all gauges of Oxford and Nichrome V loops and needles.

**MY-14203-34 Insulated brass holder.** Measures 20.3 cm L

### F. Inoculating Needle and Loop

Prevent the risk of cross-contamination with these sterile, disposable needles and loops. Colour coded for easy identification. **Box of 960** (32 per bag, 30 bags per box).



Description	Colour	Dimensions	Catalogue number
Needle	White	229 mm L	MY-06231-11
1 $\mu$ L loop	Blue	229 mm L x 1 mm ID loop	MY-06231-21
10 $\mu$ L loop	Yellow	229 mm L x 4 mm ID loop	MY-06231-31

### G. Combination Inoculating Needle/Loop

Flexible polystyrene inoculating device has needle on one end, loop on the other. Colour coded for easy identification. **Case of 1000** (20 per bag, 50 bags per case).



Description	Capacity	Colour	Dimensions	Catalogue number
Needle/loop	10 $\mu$ L	Blue	197 mm L x 4 mm ID loop	MY-14200-00
Needle/loop	1 $\mu$ L	Clear	197 mm L x 1 mm ID loop	MY-14200-01

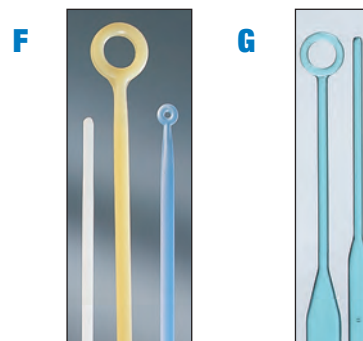
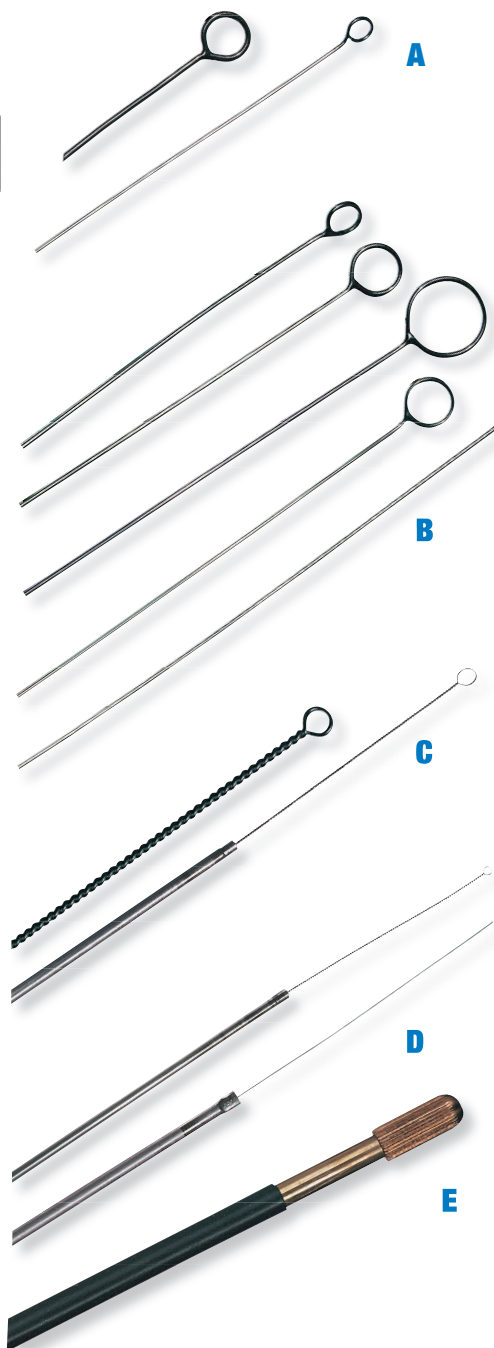

## Electrothermal Wax Dispenser

### Prevent wax blockage with heated tap

- Accurate temperature control with digital display
- Constructed of stainless steel with antimicrobial coating to inhibit bacterial growth
- Enhanced safety with high temperature cutoff at 120°C
- Prevent heat loss with fully insulated 7.5-L tank

This paraffin wax dispenser provides ultrafast heating for on-demand molten wax. Convenient "wax on tap" is available for an even flow of wax, ideal for your histology and pathology applications. The heated tap eliminates the possibility of wax blockage and the 0.5-mm mesh filter screen prevents coarse particles from entering the tap. The non-drip lever has three settings: off, on-demand pull dispense, and continuous flow.

The set temperature can be controlled via the control panel, and allows for a temperature range ambient to 70°C. When set at 65°C, the unit will take approximately 90 minutes to fully melt 5 kg of pelletised wax.



Capacity (L)	Temperature range	Temperature resolution	Temperature accuracy	Dimensions (W x H x D)	Power (VAC, Hz)	Catalogue number
7.5	Ambient to 70°C	1°C	±1°C	18.1 x 45.5 x 50 cm	230, 50/60	MY-85230-07

## Electrothermal Slide Warmer

### Get faster output—holds up to fifty slides!

- Mount tissue and stain slides easier
- Easy-set dial



#### Specifications

**Capacity:** fifty 75 x 25 mm (3" x 1") slides



Temperature range	Power	Catalogue number
Ambient to 100°C (212°F)	230 VAC, 50/60 Hz	MY-48573-06

## Electrothermal Tissue Float Bath

### View tissue cuttings more easily

### View tissue cuttings more easily

- Improved visibility with black anodised bath surface
- Easily set temperature from 40 to 75°C (104 to 167°F) with analogue dial
- Dry slides easily on convenient edge



#### Specifications

**Internal dimensions (H x dia):** 7.6 x 22 cm (3" x 8 1/16")



Bath capacity	Power	Catalogue number
2.25 liters	230 VAC, 50/60 Hz	MY-48572-55

**MY-88010-50 Gelatin;** granular 500 g. Case of 6

**MY-08008-01 Thermometer,** 140 mm; -20 to 110°C



## Handheld Digital USB Microscopes

### Put the world of microphotography at your fingertips!

- Active Pixel Technology produces sharp images and accurate colour reproduction
- Six built-in lights with adjustable brightness ensure proper illumination
- Includes software for image/video capture and measurement

For versions with the 10x to 200x magnification range, magnification automatically adjusts based on the distance from the object. Units include a basic stand with adjustable height.



Magnification	10x to 200x	500x	10x to 200x	10x to 200x	10x to 200x	10x to 200x
<b>Catalogue number</b>	<b>MY-48708-20</b>	<b>MY-48708-22</b>	<b>MY-48708-23</b>	<b>MY-48708-25</b>	<b>MY-48708-26</b>	<b>MY-48708-28</b>
Lighting	Six LEDs	Six LEDs	UV bulbs (405 nm)	Six LEDs w/polarizer	Six near-infrared LEDs	Six LEDs
Imaging sensor	¼" CMOS	¼" CMOS	¼" CMOS	¼" CMOS	½" CMOS	¼" CMOS
Pixels	1,300,000	1,300,000	1,300,000	1,300,000	1,300,000	5,000,000
Resolution	1280 x 1024	1280 x 1024	1280 x 1024	1280 x 1024	1280 x 1024	2048 x 1536
Output	USB 2.0	USB 2.0	USB 2.0	USB 2.0	USB 2.0	USB 2.0
Power	5 VDC, via USB	5 VDC, via USB	5 VDC, via USB	5 VDC, via USB	5 VDC, via USB	5 VDC, via USB

**MY-48708-24** Optional boom stand

**MY-48708-27** Optional gooseneck stand

**MY-48708-29** Optional dual-view stand

We offer a full line of microscopes and magnifiers.  
Please go online for complete product details.

## Compound Microscopes with LCD Tablet and Camera

### Include everything you need to view and capture images

- Edit images directly on the tablet touch-screen
- View images comfortably on large, 20.3 cm (8") tablet display
- Share images with others using built-in Wi-Fi

These microscopes are an all-in-one image capture solution—built-in 20.3 cm (8") LCD allows you to view your specimen while the internal camera captures the image. Edit, measure, and annotate saved images directly on the touchscreen or on a computer with the included software. Display features an Android™ operating system and a micro-SD card for additional memory. Wi-Fi signal connects to a computer for image download and sharing.

Siedentopf binocular head allows for easy adjustability and the 20-mm eyepieces provide an increased field of view. Choose from semi-plan, plan, and phase contrast models; semi-plan and plan versions include an Abbe condenser; the phase-contrast version has a multi-phase, rack and pinion condenser.

**What's included:** software, 4 GB Micro SD card, calibration slide, and dust cover.



#### Specifications

**Display resolution:** 1280 x 800      **Imaging sensor:** 5.0 megapixels      **Cables:** USB, HDMI  
**Stage dimensions (W x D):** 142 mm x 140 mm      **Output:** USB, HDMI, SD card, Wi-Fi

Total magnification	Head	Eyepiece	Illumination	Power	Catalogue number
40x, 100x, 400x, 1000x (semi-plan)	Trinocular	Widefield 10x/20 mm	3 W LED, variable	110/220 VAC	<b>MY-48925-11</b>
40x, 100x, 400x, 1000x (plan)					<b>MY-48925-12</b>
40x, 100x, 400x, 1000x (phase contrast)					<b>MY-48925-13</b>

## Compound Microscopes with Digital Camera

### Get high-image quality and flatness of field

Powerful software tools make image analysis easy: view live images on your PC; accurately measure and quantify your specimen and export results in an Excel® format for analysis; count and evaluate cell quantity with the Auto Segmentation and Calculation tool; combine two images to bring out differences; add text, symbols, and even sound recordings to your image.

#### Specifications

**Objectives:** achromatic      **Output:** USB      **Data transfer:** 480 MB/sec  
**Imaging sensor:** 3 megapixel      **Cable:** USB      **Operating requirements:** Windows®: XP or Vista, 1GHz, 256 MB RAM, USB 2.0 Mac: OSX, 1GHz, 256 MB RAM, USB 2.0

Total magnification	Head	Head	Stage dimensions (W x D)	Illumination	Power	Catalogue number
40x, 100x, 400x, 1000x (ef-plan)	Binocular	Widefield 10x/20 mm	140 x 135 mm	30 W halogen with intensity control	100 to 240 VAC, 50/60 Hz	<b>MY-03911-40</b>
40x, 100x, 400x, 1000x (ef-plan)			160 x 140 mm	30 W halogen with intensity control and Koehler illumination	100 to 240 VAC, 50/60 Hz	<b>MY-03911-45</b>



## IKA® Economical Analytical Mill

### Grind dry, brittle, fibrous, or moist materials

- Grind substances of up to 6 Mohs hardness with 420 SS beater
- Process up to 80-mL sample in heavy-duty chamber
- Eliminate misuse with safety switch
- Fits in one hand.



#### Specifications

Speed: 28,000 rpm (fixed)



Sample capacity	Feed particle size	Final particle size	Power (VAC, Hz)	Catalogue number
80 mL	10 mm maximum	<500 µm	230, 50/60	MY-04300-15

**Wait!**

**There's More online**

- ✓ Search **100,000+** products
  - ✓ Find full **product details**
- And much more!



## IKA® RW 20 Digital Dual-Range Mixer

### Two speed ranges for a variety of applications

- No difficult controls—easy-to-use knob and LED display for accurate setting
- No need to move mixer head to reposition propeller—through-shaft design allows for easy movement
- Maintenance-free motor for continuous duty

Use this versatile, affordable mixer for liquid volumes up to 18.9 liters (5 gallons) and viscosities up to 10,000 cps (approximately the viscosity of honey). Select speed from 60 to 2000 rpm in two ranges for a variety of applications.

**Complete system includes:** mixer, chuck (accepts up to 10-mm [3/8"] dia shafts), 159-mmL x 10-mm dia ( 6 1/4"L x 1/2" dia) mounting rod, four-blade propeller mixer stand, and clamp.

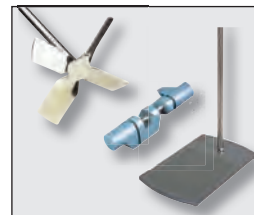

Speed (rpm)	hp	Max torque (in-oz)	Power (VAC, Hz)	Catalogue number
60 to 500/240 to 2000	1/25	259	230, 50/60	MY-50705-10

## IKA® Heavy-Duty Analytical Mill

### Keep samples cool with water-jacketed chambers

- Handles up to 250-mL samples and grinds in seconds
- Auto shut-off safeguards against overheating and overloading

Durable chamber and blade care are made of 304 stainless steel. Water jacketed chamber accepts 3/8" ID tubing via barbed fittings



#### Specifications

Speed: 20,000 rpm



Sample capacity	Feed particle size	Final particle size	Power (VAC, Hz)	Catalogue number
250 mL	20 mm maximum	1 to 100 µm	230, 50/60	MY-04301-15

#### Accessories

**MY-04300-24 Tungsten-carbide blade** for grinding materials with a hardness factor up to 9 Mohs

**MY-04300-26 Star-shaped 301 SS blade** for grinding fibrous materials such as paper and vegetation

**MY-04300-28 Additional grinding chamber**, 304 SS. Order blade separately

**MY-04300-52 Replacement blade**, 304 SS grinds materials with a hardness factor up to 5 Mohs



## Accessories for Laboratory Mixers

**A. Shafts.** All 10-mm ( $\frac{3}{8}$ " ) dia shafts are machined on one end to accept a 8-mm ( $\frac{5}{16}$ " ) bore dia propeller.

Key	Shaft dimensions, dia x L, mm (in.)	Catalogue number
A	8 x 305 ( $\frac{5}{16}$ x 12)	MY-04552-20
	8 x 457 ( $\frac{5}{16}$ x 18)	MY-04552-30
	10 x 305 ( $\frac{3}{8}$ x 12)	MY-04552-25
	10 x 457 ( $\frac{3}{8}$ x 18)	MY-04552-35
	10 x 610 ( $\frac{3}{8}$ x 24)	MY-04552-00
	10 x 762 ( $\frac{3}{8}$ x 30)	MY-04552-05

**B. Turbine Propellers** are for airless mixing in deep containers.

**C. Marine-Style Propellers** are for general-purpose mixing. Use alone or mount several on a single shaft for thorough agitation.

**D. Folding Propeller** is for use in narrow-mouth vessels. Folded diameter is 18-mm ( $\frac{11}{16}$ " ).

Key	Description	Bore dia mm (in.)	Overall dia mm (in.)	Catalogue number
B	Turbine style	9.5 ( $\frac{3}{8}$ )	2 (51)	MY-04552-15
		8 ( $\frac{5}{16}$ )	2 (51)	MY-04552-10
		8 ( $\frac{5}{16}$ )	1 (25)	MY-04552-40
C	Marine style	8 ( $\frac{5}{16}$ )	1½ (38)	MY-04552-45
		8 ( $\frac{5}{16}$ )	2 (51)	MY-04552-50
		9.5 ( $\frac{3}{8}$ )	2 (51)	MY-04552-55
		8 ( $\frac{5}{16}$ )	3 (76)	MY-04552-60
		8 ( $\frac{5}{16}$ )	2 (51) open	MY-04543-00
D	Folding style	8 ( $\frac{5}{16}$ )	2 (51) open	MY-04543-00

**E-G. Clamps** ensure a sturdy connection between mixer and stands.

Key	Catalogue number
E	MY-08041-22
F	MY-04340-50
G	MY-04560-24

**H. Stand.** Corrosion resistant, electropolished cast steel base; 303 SS support rod. Both legs accept an extra support rod.

**I. Mixer Stand** has a cast-iron base and a stainless steel rod.

**J. 316 SS Mixer Stand** accepts extra screw-in support rods in both legs.

Key	Dimensions H x dia, mm (in.)	Stand	
		Catalogue number	Extra support rod Catalogue number
H	737 x 16 (29 x $\frac{5}{8}$ )	MY-04552-80	MY-04552-85
I	610 x 16 (24 x $\frac{5}{8}$ )	MY-04546-00	—
J	737 x 16 (29 x $\frac{5}{8}$ )	MY-04344-00	MY-04344-10

### K-P. Plastic Mixing Paddle Assemblies

Use these plastic paddle assemblies for mixing most acids and corrosive solutions. Plastic-coated steel assemblies provide better chemical resistance than stainless steel alone.

Material	Shaft, dia x L, mm (in.)	Max paddle dia, mm (in.)	Catalogue number
<b>K. Fixed, dual-blade paddle assembly</b> —for mixing medium-viscosity liquids			
Polypropylene	8 x 350 ( $\frac{5}{16}$ x 13½)	41 (1½)	MY-06367-10
<b>L. A-shaped, blade paddle assembly</b> —for mixing highly viscous liquids			
Polypropylene	8 x 350 ( $\frac{5}{16}$ x 13½)	67 (2½)	MY-06367-20
<b>M. Swing-out, dual-blade paddle assembly</b> —for use in narrow-necked vessels			
Polypropylene	8 x 350 ( $\frac{5}{16}$ x 13½)	60 (2½)	MY-06367-40
	8 x 350 ( $\frac{5}{16}$ x 13½)	102 (4)	MY-06367-60
<b>N. Three-blade paddle assembly</b> —for general-purpose mixing			
PTFE	8 x 305 ( $\frac{5}{16}$ x 12)	51 (2)	MY-04449-06
PTFE	8 x 457 ( $\frac{5}{16}$ x 18)	51 (2)	MY-04449-10
<b>O. Anchor-style paddle assembly</b> —for mixing medium- to high-viscosity liquids			
PTFE	10 x 559 ( $\frac{3}{8}$ x 22)	102 (4)	MY-06367-70
<b>P. Four-blade paddle assembly</b> —for mixing low- to medium-viscosity liquids			
PTFE	10 x 562 ( $\frac{3}{8}$ x 22½)	60 (2½)	MY-06367-80





## Cole-Parmer® StableTemp™ Mechanical Convection Ovens

### Dry samples faster

- Get greater drying efficiency with fast heat-up and uniform temperature
- Forced-air convection with a noiseless fan ensures good mixing and strong dispersion
- Corrosion-resistant Incoloy® sheath heating element and stainless steel interior
- Foamed silicone rubber door gasket creates a tight seal for excellent insulation

Ovens are programmable for delayed start and stop. Timer offers you the convenience of unattended operation. The dual-wall door opens 180° for greater access to the chamber.

**What's included:** two stainless steel wire shelves and power cord.



#### Specifications

**Temperature range:** ambient +10°C to 250°C

**Resolution:** 1°C

**Temperature control accuracy:** ±1°C at 100°C

**Temperature display:** digital LED

**Interface:** RS-232 with controlling software

**Timer:** 1 min to 99 hrs, 59 min



**StableTemp**

Capacity L (cu ft)	Temperature uniformity	Rise time (minutes)	Shelf positions	Dimensions (W x H x D), cm (in.)		Shpg wt kg (lb)	Power	Catalogue number
				Chamber	Overall			
59.5 (2.1)	±1°C at 100°C	15 to 100°C	8	40 x 42 x 36 (15¼ x 16½ x 14¼)	58 x 76 x 64 (22¾ x 30 x 25¼)	138 (63)	230 VAC, 50/60 Hz	<b>MY-52412-80</b>
101.9 (3.6)			12	48 x 52 x 41 (19 x 20½ x 16)	66 x 87 x 70 (26 x 34¼ x 27¼)	166 (76)	230 VAC, 50/60 Hz	<b>MY-52412-81</b>
150.1 (5.3)			16	56 x 60 x 46 (22 x 23½ x 18)	73 x 97 x 74 (28¾ x 38¼ x 29¼)	210 (96)	230 VAC, 50/60 Hz	<b>MY-52412-82</b>

**MY-79510-04 Wire shelf** for 2.1 cu ft units

**MY-79510-12 Wire shelf** for 3.6 cu ft units

**MY-79510-20 Wire shelf** for 5.3 cu ft units

**MY-17002-30 ILAC MRA, NIST-traceable calibration** with data for ovens

## Lab Companion® Vacuum Ovens

### Get better control of your application

- Heat-tempered full-view window allows continuous monitoring of chamber
- User-friendly digital control panel simplifies operation

Separate vacuum and vent ports allow greater control of vacuum rates. Vacuum levels are maintained by a tightly sealed door gasket and push-button latch. Block heaters and anodised aluminium plate shelves provide uniform heating throughout the oven chamber. Includes two or three aluminium plate shelves and power cord.



#### Specifications

**Temperature range:** 5° above ambient to 250°C

**Temperature control accuracy:** ±2°C at 100°C

**Vacuum range:** 0 to 0.1 Mpa

**Timer:** 1 min to 99 hr, 59 min with delayed on/off



Capacity L (cu ft)	Temperature uniformity	Rise time to 100°C (minutes)	Shelves positions	Dimensions (W x H x D), cm (in.)		Power (VAC, Hz)	Shpt wt kg (lb)	Catalogue number
				Chamber	Overall			
28.3 (1)	±2°C at 100°C	70 min	2	30 x 30 x 30 (12 x 12 x 12)	68 x 49 x 46 (27 x 19½ x 18)	230, 50/60	63 (139)	<b>MY-52402-97</b>
65.1 (2.3)	±2°C at 100°C	85 min	3	40 x 40 x 41 (15¾ x 15¾ x 16)	80 x 60 x 56 (31¾ x 23½ x 22)	230, 50/60	103 (227)	<b>MY-52402-98</b>

**MY-17002-30 ILAC MRA, NIST-traceable calibration** with data for ovens

## SalvisLab Thermocenter Mechanical Convection Ovens

### Get the ultimate in efficiency

- SalvisTEQ touch-screen controller continually monitors what it has done, where it is, and where it wants to go!

Short heating and precise temperature control make these ovens ideal for a variety of heating and drying tasks. High-quality insulation and airtight design prevent heat loss. The intuitive SalvisTEQ controller features real-time temperature monitoring during the heat-up phase, set point temperature, gradient and actual temperature.

Oversized heat ring and adjustable-speed fan ensure excellent uniformity. Other features include programmable timer, real-time clock, alarms, self-diagnostics, and USB connection. Stainless steel interior and shelves resist aggressive substances. Include one shelf.



Capacity L (cu ft)	Max temperature	Temperature uniformity	Rise time (minutes)	Shelf positions	Dimensions (W x H x D), cm (in.)		Power (VAC, Hz)	Shpg wt kg (lb)	Catalogue number
					Chamber	Overall			
40 (1.4)	200°C	±1.5°C at 150°C	24	8	34 x 37 x 33 (13¾ x 14¾ x 13)	46 x 49 x 53 (18¼ x 19¼ x 20¾)	220, 50/60	45 (99)	<b>MY-52403-06</b>
100 (3.5)	200°C	±1.7°C at 150°C	35	8	45 x 50 x 46 (17¾ x 19¾ x 18½)	57 x 62 x 66 (22¾ x 24¾ x 25¾)	220, 50/60	60 (132)	<b>MY-52403-16</b>

# Oakton® Waterproof DO 450 Dissolved Oxygen Meter

## Eliminate maintenance time and costs

- Affordable optical RDO technology reduces maintenance time and costs
- Rugged, waterproof, and dustproof with IP67-rating for use in any environment
- More accurate readings with barometric pressure and salinity correction
- Download and analyse data easily with USB and RS-232 output for up to 500 data sets
- Take it with you—500 hours battery life or optional universal power adapter

Get faster response, long-term stability, and minimal maintenance with optical measurement technology. Ensure measurement accuracy with Automatic Temperature Compensation (ATC), barometric pressure compensation, and salinity correction. View % saturation or mg/L (ppm) simultaneously with temperature on the large LCD screen. Additional features include ready (stability) indicator, smart averaging, hold function, calibration alarm, and battery-life indicator.

**Meter only includes:** two AA batteries.

**Kit adds:** RDO probe (35640-53), sensor cap (35640-51), RDO weight, RDO calibration chamber, sample bottles, and hard carrying case.



Description	DO 450 meter only	DO 450 meter kit
Catalogue number	MY-35640-32	MY-35640-90
Precalibrated catalog number	—	MY-35640-91
Range	Dissolved oxygen: 0 to 20 ppm; 0 to 200% Temperature: -10.0 to 110.0°C (-17.0 to 230.0°F)	
Resolution	Dissolved oxygen: 0.1 ppm; 0.10% Temperature: 0.1°C/°F	
Accuracy	Dissolved oxygen: ±2% Temperature: ±0.5°C (±0.9°F)	
Calibration	Dissolved oxygen: Zero and saturation Temperature: ±5.0° offset	
Barometric pressure compensation	Manual	
Salinity correction	Manual; 0 to 45	
Temperature compensation	Automatic or manual from -10 to 110°C	
Data logging	Stores up to 500 data sets	
Output	USB or RS-232	
Power	Two AA batteries (included), >500 hours continuous use; AC adapter (optional)	

### Accessories

- MY-35640-51 Replacement RDO sensor cap**
- MY-35640-53 Replacement RDO probe**, 3 m (10 ft) cable
- MY-35640-55 RDO probe**, 6 m (20 ft) cable
- MY-35640-57 RDO probe**, 15 m (50 ft) cable
- MY-35640-58 RDO calibration chamber**
- MY-35640-59 RDO weight**, screw thread to attach to probe
- MY-35630-53 Data cable** for USB connectivity
- MY-35420-01 Data cable** for RS-232 connectivity
- MY-35420-72 Optional AC adapter**, 110/220 VAC

# Oakton® DO 6+ Dissolved Oxygen Meter

## High accuracy without a high price

- No warm-up time required
- No need to hold meter—protective rubber boot is also a stand
- Low-maintenance, galvanic probe
- Choose display—ppm or mg/L

Six simple buttons for freezing measurements, toggling between units and temperature results, setup, calibration, and automatic barometric and salinity compensation. View electrode slope, zero offset, and millivolt values for electrode diagnostics.

**Meter includes:** electrolyte solution, membrane cap, protective rubber boot/stand, and four AAA batteries.

**Kit adds:** two membrane caps, solution bottles, rinse bottle, and hard plastic carrying case.



Protective boot also functions as a stand.

### Save time, save money!

#### Choose Precalibrated

Includes a data-rich, ISO 17025-compliant certificate!

Precalibrated by **INNOCAL**  
INNOVATIVE CALIBRATION SOLUTIONS



### Specifications

Mode	mg/L (ppm)	% O <sub>2</sub> saturation	Temperature (°C)
Range	0.00 to 20.00	0.0 to 200.0	0.0 to 50.0
Resolution	0.01	0.1	0.1
Accuracy	±1.5% full-scale	±1.5% full-scale	±0.5

**Temperature compensation:** automatic from 0 to 50°C

**Salinity compensation:** Manual input, automatic correction  
Range: 0.0 to 50.0 ppt  
Resolution: 0.1 ppt

**Barometric pressure compensation:** Manual input, automatic correction  
Range: 500 to 1499 mm Hg  
Resolution: 1 mm Hg

**Memory:** none

**Power:** four AAA batteries (included)

Description	Meter	Precalibrated meter
	Catalogue number	Catalogue number
DO 6+ meter only	MY-35643-10	MY-35643-11
DO 6+ meter with probe 35642-50	MY-35643-12	MY-35643-13
DO 6+ meter kit	MY-35643-14	MY-35643-15

### Accessories

- MY-35642-50 Replacement DO probe** with 0.9 m (3 ft) cable
- MY-35642-52 DO probe** with 3 m (10 ft) cable
- MY-35642-54 DO probe** with 9 m (30 ft) cable
- MY-35642-55 Replacement DO probe maintenance kit** includes one membrane cap and 10 mL of electrolyte solution
- MY-09376-00 Replacement batteries;** AAA. Pack of 12

## PCRmax® Eco 48 Real-Time PCR System

### Save time and money with unique plate geometry

- Fast cycling—runs 40 cycles in 15 minutes when optimised
- Uses four colours for easy multiplexing
- Offers ±0.1°C temperature uniformity

Compact footprint with MIQE compliant open license software for publishing your data. High-resolution melt (HRM) functionality is standard and can discriminate class IV SNP 99.9% of the time. The PCRmax Eco 48 features industry-leading ±0.1°C temperature uniformity with no settle time (recorded at 95°C).

Fastest block-based qPCR system with the ability to run 40 cycles in 15 minutes (or less when optimised). With an open platform, it can utilise any chemistry, dye or PCR reagent. No need to run triplicates, to compensate for poor thermal uniformity of block. Calibrated for SYBR®, FAMTM, HEXTM, VICTM, ROXTM and Cy<sup>5</sup> fluorescent dyes.

**What's included:** dock and squeegee, EcoControl and EcoStudy software USB stick, 50 PCR plates, 50 plate seals, Ethernet cable, and power cord.



PCRmax®

Temperature range	Temperature accuracy	Ramp rate	Block uniformity	Block description	Memory	Power	Catalogue number
35 to 100°C	±0.25°C	5.5°C/sec	±0.1°C	Proprietary hollow silver/gold block, Peltier-based system with conductive fluid, 48 wells	Unit saves the run data of last experiment, or unlimited via USB	100 to 240 VAC, 50/60 Hz	MY-93947-00

## PCRmax® Alpha Cyclers

### Easily create, modify and access programs, saving time

- Flexible—your choice of one, two, or four block capacities in 96-well, 384-well, or mixed formats
- Independently control each block for simplified temperature and protocol optimisation
- Software allows quick access to commonly used protocols
- Save precious lab space with 2- or 4-block systems
- Gradient as standard

These compact thermal cyclers deliver reproducible results every run—with little to no training needed. Features include a clear responsive touch-screen, secure user-specific programming, adjustable heated lid, and active sample cooling for sharper amplification.

A Program Wizard generates a protocol specific to your sequence in seconds—a quick way to optimise new assays. Units also retain approximately 1000 reports for reviewing at a later date and run on an intuitive, HD Android™ tablet interface. Save your personal settings to your USB drive; sign-in is as simple as inserting your USB drive, no password needed.

Choose multiple-block systems to save bench space and money. Control each block separately for added versatility and use by more than one person at a time, or run on the same program to increase throughput. Each block also has its own independent heated lid—no interruption of assays running at different settings.



93945-06



93945-00

PCRmax®

#### Specifications

<b>Block temperature range:</b> 10 to 100°C (4°C final hold)	<b>Heated lid temp:</b> 35 to 115°C, or off
<b>Max heating rate:</b> 3.4°C per sec.	<b>Heated lid pressure:</b> adjustable
<b>Block uniformity at 55°C:</b> ±0.3°C	<b>Max programs stored:</b> 1000
<b>Temp. accuracy at 50°C:</b> ±0.25°C	<b>Data transfer:</b> USB port
<b>Thermal gradient:</b> 29°C maximum, 1°C minimum	<b>Auto restart on power failure:</b> yes
	<b>Power:</b> 100 to 230 VAC, 50/60 Hz



Model	Block format	Dimensions (W x H x D)	Catalogue number
Alpha Cyclers 1	(1) 384-well block	43 x 26 x 33 cm (16 <sup>15</sup> / <sub>16</sub> " x 10 <sup>1</sup> / <sub>4</sub> " x 13")	MY-93945-00
	(1) 96-well blocks		MY-93945-02
	(2) 384-well blocks		MY-93945-28
Alpha Cyclers 2	(2) 96-well blocks	47 x 53.5 x 33 cm (18 <sup>1</sup> / <sub>2</sub> " x 21 <sup>1</sup> / <sub>16</sub> " x 13")	MY-93945-22
	(1) 384-well block, (1) 96-well block		MY-93945-20
Alpha Cyclers 4	(4) 384-well blocks	70 x 53.5 x 33 cm (27 <sup>9</sup> / <sub>16</sub> " x 21 <sup>1</sup> / <sub>16</sub> " x 13")	MY-93945-08
	(3) 384-well blocks, (1) 96-well block		MY-93945-04
	(2) 384-well blocks, (2) 96-well block		MY-93945-06
	(1) 384-well block, (3) 96-well blocks		MY-93945-10
	(4) 96-well blocks		MY-93945-12



## Techne® Prime Thermal Cyclers

### No more condensation in your samples

- Adjustable temperature and heated lid eliminate formation of condensation
- Intuitive software and touch-screen for effortless programming of up to 1000 programs
- High performance and reliable—utilise the Peltier effect
- Transfer programs between PC and unit with USB-port

### 3 Prime Personal and Mid-Sized Thermal Cyclers

- Small space-saving footprint is ideal for research and educational laboratories
- Get fast ramping—heating and cooling rates up to 3.0°C/second

### Prime Full-Size Thermal Cycler

- Get more samples processed in less time—high throughput with large number of samples in parallel
- See your experiment progress in real time via graphic display
- Quicker ramping of heating and cooling of up to 3.4°C/second

Large-format blocks accept nearly any plate type including skirted and nonskirted plates. The Combi-Block holds both 33 x 0.2 mL and 33 x 0.5 mL tubes.

#### Specifications



<b>Block temperature range:</b> 4 to 100°C	<b>Gradient range:</b> 30 to 80°C
<b>Block uniformity at 50°C:</b> ±0.3°C	<b>Program interface:</b> color touch screen with graphical display
<b>Temperature accuracy at 50°C:</b> ±0.2°C	<b>Maximum number of programs stored:</b> 1000, or unlimited via USB
<b>Heated lid temperature:</b> 100 to 115°C or off, selectable	<b>Data transfer:</b> USB port
	<b>Power:</b> 100 to 230 VAC, 50/60 Hz



93945-01

Description	Block format (included)	Thermal gradient	Catalogue number
Personal	24 x 0.2 mL tubes (also 8 tube strips)	No	MY-93945-01
	18 x 0.5 mL tubes	No	MY-93945-03
Mid-size with extended capacity	48 x 0.2 mL tubes (also half 96-well plate, horizontal)	No	MY-93945-05
		Yes	MY-93945-09
Full size	30 x 0.5 mL tubes	No	MY-93945-07
		Yes	MY-93945-11
	96 x 0.2 mL tubes	No	MY-93945-13
		Yes	MY-93945-19
	60 x 0.5 mL tubes	No	MY-93945-15
		Yes	MY-93945-21
	384-well plates	No	MY-93945-17
		Yes	MY-93945-23
Combi-block (33 x 0.2 mL and 33 0.5 mL tubes)	No	MY-93945-71	
	Yes	MY-93945-73	

**Warning**—These products are not approved or intended for, and should not be used for, medical, clinical, surgical or other patient oriented applications.

## Techne® Pro 48 Real-Time PCR System

### Get quicker, more precise cycles from one temperature to the next

- Fast cycling — runs 40 cycles in under 20 minutes when optimised
- Uses four colours for easy multiplexing
- Offers ±0.1°C temperature uniformity
- No need to run duplicates

Compact real-time thermal cycler can accommodate a 48-well polypropylene PCR plate using the same geometry as standard 384-well plates, but is only 1/8 of the size. An advanced high-performance optical system delivers precise and sensitive fluorescence detection, facilitating all four color multiplex applications. The qPRC unit is MIQE compliant, features an adaptive LED control and high-resolution melt (HRM) functionality.

Easy-to-use software provides instrument control, data collection, and data analysis. An ergonomic plate loading dock allows for quick loading of the plate and is backlit for clear visibility.

**What's included:** dock and squeegee, ProControl and ProStudy software USB stick, 50 PCR plates, 50 plate seals, Ethernet cable, and power cord.



#### Specifications

<b>Capacity:</b> 48-well plate, 5 to 20 µL per well	<b>Average ramp rate:</b> 5.5°C/sec
<b>Temperature range:</b> 30 to 100°C	<b>Memory:</b> saves the run data of last experiment, or unlimited via USB
<b>Temp accuracy:</b> ±0.25°C	<b>Power:</b> 120 to 240 VAC, 50/60 Hz
<b>Block uniformity:</b> ±0.1°C	

Description	Catalogue number
Pro 48 real-time PCR system	MY-93945-14

## PCRmax® Delta Seek qPCR Detection Kits

Crucial tool for fast and accurate verification

- No need to refrigerate—all contents are lyophilised for simple transport and storage
- Positive copy number standard curve provides accurate quantification
- Great value at 100 or 150 tests per kit



Each kit is designed to ensure the broadest possible detection profile. Order a complete kit with mastermix, or a kit without mastermix and use your own.



**What's included:** lyophilised primer probe mix, positive control for standard curve, internal extraction control DNA, endogenous control, and RNase/DNase-free water. Kits with mastermix also include lyophilised mastermix, lyophilised ROX, and resuspension buffer.

Description	Nucleic acid	Tests per kit	Kits with mastermix	Kits without mastermix
			Catalogue number	Catalogue number
<b>Agriculture species</b>				
<i>Bos taurus</i> (bovine/beef)	DNA	100	MY-93944-65	MY-93944-64
<b>Bacteria species</b>				
<i>Escherichia coli</i>	DNA	150	MY-93946-78	MY-93946-77
<b>Virus species</b>				
Canine herpes virus	DNA	150	MY-93948-36	MY-93948-35
Hepatitis A virus	RNA	150	MY-93942-37	MY-93942-36
Zaire ebolavirus	RNA	150	MY-93951-18	MY-93951-17

## PCRmax® Transparent PCR Plates

Ultrathin walls provide faster heat transfer and cycle times

- Quality polypropylene for optimal clarity and solvent resistance
- Certified free of RNase, DNase, endotoxins, and human DNA
- Autoclavable



Description	No. of wells	Well volume	Qty/cs	Catalogue number
Full skirt, low profile	96	0.2 mL	50	MY-67104-21
Half skirt, standard profile	96	0.2 mL	50	MY-67104-23
Half skirt, low profile	96	0.2 mL	50	MY-67104-25
Half skirt, low profile, elevated rim	96	0.2 mL	50	MY-67104-27
Unskirted, standard profile	96	0.2 mL	50	MY-67104-29
Unskirted, low profile	96	0.2 mL	50	MY-67104-31

## Arcis Sample Prep Kit

Amplify sample in less than 3 minutes



- Simple 2-step process
- No instrumentation required
- Stable DNA for 30 days; RNA for 8 days
- No refrigeration needed—shipped/stored at ambient temperatures

Convenient sample preparation kit allows fast analysis and identification without the need for isolation or purification. The complete, ready-to-use system enables you to go from sample to amplifiable DNA and RNA in less than 3 minutes.

The sample is prepared and stabilised without need for heating or cooling steps and there are no spins—it's a simple 2-step tube protocol. The sample is suitable for use in PCR, qPCR, and sequencing reactions using standard and fast cycling protocols.

**What's included:** 1 tube of lysis buffer and 1 tube of wash buffer.

Description	No. of reactions	Catalogue number
Sample prep kit	50	MY-13204-52
Demo sample prep kit	12 x 3	MY-13204-53

## PCRmax® PCR Tube and Cap Strips

Five color choices for quick identification

- Constructed of pure high-quality polypropylene without any additives
- Ultrathin walls for optimal heat transfer
- Certified RNase, DNase, and endotoxin free
- Autoclavable at 121°C for 20 minutes

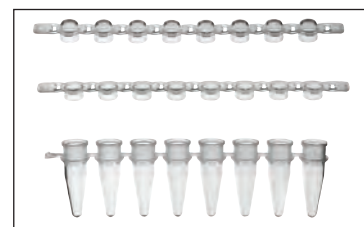

Suitable for use in common thermal cyclers, these strip tubes are available in PCR as well as qPCR options. Both options come in a strip of 8 connected tubes. Corresponding caps provide a tight seal to prevent sample loss; order separately.

Description	Max well volume	Colour	Qty/cs	Cat. no.
8-tube strips, PCR	0.2 mL	Clear	125	MY-67104-07
		Pink		MY-67104-08
		Yellow		MY-67104-09
		Green		MY-67104-11
		Blue		MY-67104-12
Strip of 8 domed caps, PCR	—	Clear	125	MY-67104-15
		Pink		MY-67104-16
		Yellow		MY-67104-17
		Green		MY-67104-18
8-tube strips, qPCR	0.2 mL	White	125	MY-67104-13
Strip of 8 flat caps, PCR/qPCR	—	Clear	125	MY-67104-14

## Oakton® Waterproof EcoTestr™ pH1 Pocket Tester

### Economical, easy to use

- Automatically recognises pH buffer standards
- Rugged IP67-rated housing is waterproof, dustproof, and floats in water
- Leakproof cap with fill line functions as a sample/calibration and hydrating cup



Model		EcoTestr pH1
<b>Catalogue number</b>		<b>MY-35634-05</b>
Range	pH	0 to 14.0 pH
	Temperature	0 to 50°C (32 to 122°F)
Resolution	pH	0.1 pH
	Temperature	0.1°C/°F
Accuracy	pH	±0.1 pH
	Temperature	±0.5°C (0.9°F)
Temperature compensation		Automatic, 0 to 50°C (32 to 122°F)
Calibration		1 to 3 points
Buffer recognition		USA, NIST
Power		Four AAA batteries (included), 400 hours of continuous use



## Oakton® Waterproof Testr™ 5 Pocket Testers

### Save money by replacing sensor, not the tester

- Unique three-colour backlight indicates operating mode
- Simple to calibrate with automatic standard recognition—USA and NIST
- Rugged IP67-rated housing is waterproof, dustproof, and floats in water with sensor cap on
- Leakproof cap with fill line functions as a sample/calibration and hydrating cup
- Choose model with flat probe for surface or micro-volume testing, or spear tip for testing semisolid and solid materials



Model	pH5	pH5F	pH5S	ORP5
<b>Catalogue number</b>	<b>MY-35634-16</b>	<b>MY-35634-46</b>	<b>MY-35634-52</b>	<b>MY-35634-54</b>
Sensor type	Glass bulb	Flat surface	Spear tip	Glass bulb
Range	pH	-2 to 16 pH		—
	ORP	±1000 mV		±1000 mV
	Temp	0 to 50°C (32 to 122°F)		
Resolution	pH	0.01 pH		—
	ORP	1 mV		1 mV
	Temp	0.1°C/°F		
Accuracy	pH	±0.01 pH ±1 digit		—
	ORP	±0.2% FS		±0.2% FS
	Temp	±0.5°C (0.9°F)		
Temp compensation		Automatic, 0 to 50°C (32 to 122°F)		
Calibration		1 to 3 points		1 point
Power		Four AAA batteries (included), 400 hours continuous use		

Go online to search more than 100,000 products.

## Oakton® Waterproof EcoTestr™ pH2+ Pocket Tester

### Better results—easier and faster

- Large dual-line display shows pH and temperature readings simultaneously
- Automatic temperature compensation ensures accuracy
- Easier, more intuitive interface and indicators for calibration, readiness, and battery life
- Use redesigned cap as sample cup and as a stabilising base to stand the meter upright
- Secure—attach a lanyard to prevent dropping in the field



Model		EcoTestr pH2+
<b>Catalogue number</b>		<b>MY-35423-01</b>
Range	pH	0.0 to 14.0 pH
	Temperature	0.0 to 50.0°C (32.0 to 122.0°F)
Resolution	pH	0.1 pH
	Temperature	0.1°C (0.1°F)
Accuracy	pH	±0.1 pH
	Temperature	±0.5°C (0.9°F) + 1 LSD
Temperature compensation		Automatic
Calibration		Up to 3 points
Buffer recognition		USA, NIST
Power		Four 1.5 V miniature alkaline batteries (included)

## Oakton® Waterproof pHTestr™ 30 Pocket Tester

### Use with confidence

- Features ±0.01 pH accuracy—suitable for most ASTM and EPA test procedures
- Resistant to most chemicals with Valox® sensor housing
- Autobuffer recognition for calibration up to 3 points
- Don't let temperature interfere with readings—ATC minimises impact

Double-junction electrode sensor handles wastewater and solutions containing sulfides, heavy metals, and Tris buffers. Replaceable electrode sensor features a clog-resistant Kynar® PVDF junction and a recessed, glass pH bulb to prevent breakage.



Model		pHTestr 30
<b>Catalogue number</b>		<b>MY-35634-30</b>
Range	pH	-1.00 to 15.00 pH
	Temperature	0 to 50°C (32 to 122°F)
Resolution	pH	0.01 pH
	Temperature	0.1°C/°F
Accuracy	pH	±0.01 pH
	Temperature	±0.5°C (0.9°F)
Temperature compensation		Automatic, 0 to 50°C (32 to 122°F)
Calibration		Up to 3 pH points
Buffer recognition		4.01, 7.00, 10.01 USA; 4.01, 6.86, 9.18 NIST
Power		Four 1.5 V button cell batteries (included)



## Oakton® PCTSTestr™ 50 Multiparameter Pocket Tester

### One tester measures it all!

- Versatile tester combines up to five measurements in one pocket-sized meter
- Parameters include pH, conductivity, TDS, salinity, and temperature
- Compatible with a wide range of samples with long-life pH electrode and stainless steel pin-style conductivity sensor
- Features up to 3-point pH calibration with NIST or USA autobuffer recognition, user-adjustable temperature coefficient, and self-adjusting TDS and salinity factor
- Leakproof cap functions as a sample/calibration cup, hydrating cup and as a stabilising base to stand the meter upright
- Easy-to-replace sensor module lets you use tester body over and over again



Model	PCTSTestr 50	
<b>Catalogue number</b>	<b>MY-35634-35</b>	
Range	pH	-1.00 to 15.00 pH
	Conductivity	0.0 to 200.0 µS, 200 to 2000 µS; 2.00 to 20.00 mS
	TDS	0.0 to 100.0 ppm, 100 to 1000 ppm; 0.10 to 10.00 ppt (TDS factor 0.5)
	Salinity	0.00 to 10.00 ppt
	Temperature	0 to 60°C (32 to 140°F)
Resolution	pH	0.01 pH
	Conductivity	0.1 µS, 1 µS; 0.01 mS
	TDS	0.1 ppm, 1 ppm; 0.01 ppt
	Salinity	0.10 ppt
	Temperature	0.1°C/°F
Accuracy	pH	±0.01 pH
	Conductivity	±1% full-scale
	TDS	±1% full-scale
	Salinity	±1% full-scale
	Temperature	±0.5°C (0.9°F) from 0 to 50°C (32 to 122°F); ±1.0°C (1.8°F) from 50 to 60°C (122 to 140°F)
Temperature compensation	Automatic, 0 to 60°C (32 to 144°F)	
Calibration	3 points (pH, conductivity, TDS); 1 point (salinity)	
Buffer recognition	USA 4.01, 7.00, 10.01; NIST 4.01, 6.86, 9.18	
Power	Four AAA 1.5 V batteries (included)	

MY-35634-37 Replacement sensor

## Oakton® Waterproof pH 450 Meter

### Easy-to-read measurements

- Use it in any environment with backlit display and rugged design
- Intuitive, user-friendly icons show electrode status as pH slope
- Easily attach electrode to a beaker or container with Grip-Clip™ holder
- Download and analyse up to 500 data sets with USB or RS-232 output
- Use as a benchtop meter as well—built-in stand and wall-mount option



Waterproof, IP67-rated meter is ideal for even the harshest environments. View the main measurement simultaneously with temperature and calibration data with % slope on the large, backlit LCD. Be more accurate with up to six calibration points from USA, NIST, DIN, and custom pH buffers. Automatic temperature compensation (ATC) ensures measurement accuracy even in fluctuating temperatures.

**Meter only includes:** Grip-Clip holder and two AA batteries.  
**Meter with probe adds:** "All-in-one" pH/temperature electrode.  
**Meter kit further adds:** pH buffer solutions, storage solution, rinse solution, and hard carrying case.



Meter only

Description	Meter only	Meter with probe	Meter kit
<b>Model</b>	<b>pH 450</b>		
<b>Catalogue number</b>	<b>MY-35618-32</b>	<b>MY-35618-30</b>	<b>MY-35618-90</b>
<b>Precalibrated cat. no.</b>	<b>MY-35618-34</b>	<b>MY-35618-33</b>	<b>MY-35618-91</b>
Range	pH	-2.00 to 16.00	
	mV	±2000 mV	
	Ion	0.0 to 19,999	
	Temperature	-10.0 to 110.0°C (-17.0 to 230.0°F)	
	Accuracy	pH	±0.01
Accuracy	mV	±0.2 mV ±2 LSD or ±0.5% of reading; whichever is greater	
	Ion	±0.5% full-scale (monovalent); ±1% full-scale (divalent)	
	Temperature	±0.5°C (±0.9°F)	
Temperature compensation	Automatic or manual from -10 to 110°C		
Output	USB or RS-232		
Data logging	500 data sets		
Power	Two AA batteries (included) or optional universal power adapter (sold on page 103)		

## Oakton® pHTestr® 50 Pocket Tester

### Bring the performance of your lab instruments into the field

- High ±0.01 pH accuracy—suitable for most ASTM and EPA test procedures
- Clog-resistant, double-junction pH electrode sensor is dependable and long-lasting!
- Use with confidence—even with demanding samples containing sulfides, heavy metals, organics, Tris buffer, or protein solutions
- Save money—replaceable sensor module lets you use tester body over and over again
- Set up and calibrate quickly with easy-to-navigate interface
- Don't let temperature interfere—ATC minimises impact
- Leakproof, stabilising cap—use to calibrate, stand upright, and store sensor
- Waterproof, IP67-rated housing resists most chemicals



Model	pHTestr 50	
<b>Catalogue number</b>	<b>MY-35634-15</b>	
Range	pH	-1.00 to 15.00 pH
	Temperature	0 to 60°C (32 to 140°F)
Resolution	pH	0.01 pH
	Temperature	0.1°C/°F
Accuracy	pH	±0.01 pH
	Temperature	±0.5°C (0.9°F) + 1 LSD from 0 to 50°C (32 to 122°F); ±1.0°C (1.8°F) + 1 LSD from 50 to 60°C (122 to 140°F)
		Temperature compensation
Calibration	Up to 3 points	
Buffer recognition	USA 4.01, 7.00, 10.01; NIST 4.01, 6.86, 9.18	
Power	Four AAA 1.5 V batteries (included)	

MY-35634-17 Replacement sensor

## Oakton® pH 5+ and pH 6+ Meters

### Get high accuracy at low prices

- Autobuffer recognition for up to five-point calibration provides  $\pm 0.01$  pH accuracy
- Take this compact unit anywhere
- Get pH and temperature readings at the push of a button
- Improve your accuracy with automatic temperature compensation (ATC) from 0 to 100°C
- Protect your unit with protective rubber boot that doubles as a stand
- Choose the pH 6+ meter to also read mV



**Meter includes:** ATC probe, protective rubber boot, and batteries.

**Meter with probe adds:** pH electrode 59001-65.

**Meter kit adds:** "All-in-one" pH electrode, pH buffer solutions, sample bottles, rinse bottle, and carrying case.

## Oakton® Waterproof pH 150 Meter

### Get more for your money!

- Intuitive, user-friendly icons show electrode status as pH slope
- Get quick and easy electrode attachment to a beaker or container with Grip-Clip™ holder
- Recall more data with expanded data logging for up to 150 data sets
- mV offset for calibration of ORP standards, zeroing mV value, and pH diagnostics
- Use as a benchtop meter as well—built-in stand or wall-mount option



View more simultaneously with large, three-line LCD providing pH or mV measurement with temperature and calibration % slope. Get faster calibration with auto buffer recognition which identifies the correct pH buffer. Be more accurate with up to six calibration points from USA, NIST, and DIN pH buffer sets and automatic temperature compensation (ATC).

Additional features include ready (stability) indicator, smart averaging, hold function, calibration alarm (visible), battery-life indicator, and electrode status.

**Meter only includes:** Grip-Clip holder and two AA batteries.

**Meter with probe adds:** "All-in-One" pH electrode (35808-71).

**Meter kit further adds:** pH buffers, storage solution, rinse solution, and hard carrying case.



Description	Meter only	Meter with probe	Meter kit
<b>Model</b>	pH 150		
<b>Catalogue number</b>	<b>MY-35614-32</b>	<b>MY-35614-30</b>	<b>MY-35614-90</b>
<b>Precalibrated cat. no.</b>	<b>MY-35614-34</b>	<b>MY-35614-33</b>	<b>MY-35614-91</b>
Range	pH	-2.00 to 16.00	
	mV	$\pm 2000$ mV	
	Temperature	-10.0° to 110.0°C (-17.0° to 230.0° F)	
Resolution	pH	0.01	
	mV	0.1 mV $\pm 999.9$ mV; 1 mV beyond	
	Temperature	0.1°C/F	
Accuracy	pH	$\pm 0.01$	
	mV	$\pm 0.2$ mV $\pm 2$ LSD or $\pm 0.5\%$ of reading; whichever is greater	
	Temperature	$\pm 0.5^\circ\text{C}$ ( $\pm 0.9^\circ\text{F}$ )	
Calibration	pH	Up to 6 points: USA, NIST, DIN	
	mV	$\pm 200$ mV	
	Temperature	Offset 0.1 increments	
Temperature compensation	Automatic or manual from -10 to 110°C		
Data logging	Stores up to 150 data sets		
Power	Two AA batteries (included); universal adapter (optional)		

#### Accessories

**MY-35808-71 Replacement "All-in-One" combination pH electrode** with built-in ATC; single-junction, epoxy body, BNC connector

**MY-35618-05 ATC probe.** Use with any standard pH electrode for temperature compensation

**MY-35614-50 Replacement Grip-Clip,** holder attaches probe to side of container for hands-free measurement

**MY-35614-51 Hard carrying case,** for 150/450 meters

**MY-35420-72 Optional power adapter,** 110/220 VAC

**MY-09376-01 Replacement batteries,** AA. Pack of 4

**MY-17106-20 ILAC MRA, NIST-traceable calibration** with data for pH meter

#### Save time, save money!

**Choose Precalibrated**  
Includes a data-rich,  
ISO 17025-compliant certificate!

Precalibrated by **INNOCAL**  
INNOVATIVE CALIBRATION SOLUTIONS

**OAKTON**

ISO 9001:2008 CERTIFIED SUPPLIER CE Meter only

#### Specifications

Mode	pH	mV (pH 6+ only)	Temperature
Range	0.00 to 14.00 pH	$\pm 1000$ mV or rel mV	0 to 100.0°C
Resolution	0.01 pH	1 mV	0.1°C
Accuracy	$\pm 0.01$ pH	$\pm 2$ mV	$\pm 0.5^\circ\text{C}$
Calibration	Up to five points: pH 1.68, 4.01, 7.00, 10.00, 12.45 (USA); pH 1.68, 4.01, 6.86, 9.18, 12.45 (NIST) pH 4.10, 6.97 (Pb)	$\pm 20$ mV	Offset 0.1°C increments

**Temp compensation:** automatic with ATC probe, 0 to 100°C

**Power:** four AAA batteries (included)

Model	Description	Meter		Precalibrated	
		Catalogue number	Catalogue number	Catalogue number	Catalogue number
pH 5+	Meter only	<b>MY-35613-50</b>	<b>MY-35613-51</b>		
pH 6+		<b>MY-35613-20</b>	<b>MY-35613-41</b>		
pH 5+	Meter with probe	<b>MY-35613-52</b>	<b>MY-35613-53</b>		
pH 6+		<b>MY-35613-22</b>	<b>MY-35613-42</b>		
pH 5+	Meter kit	<b>MY-35613-54</b>	<b>MY-35613-55</b>		
pH 6+		<b>MY-35613-24</b>	<b>MY-35613-44</b>		

#### Accessories

**MY-59001-65 Replacement pH electrode;** single-junction, gel-filled. Epoxy body, BNC connector

**MY-35811-71 "All-in-one" combination pH probe** with built-in ATC; single-junction sealed, epoxy body, BNC connector

**MY-35811-72 "All-in-one" combination pH probe** with built-in ATC; double-junction sealed, epoxy body, BNC connector

**MY-35613-05 Replacement ATC probe,** stainless steel

**MY-09376-00 Replacement batteries,** AAA. Pack of 12

## Oakton® PH 550 Benchtop pH Meter

### Economical choice for benchtop pH measurement

- Automatically recognises calibration solutions (USA and NIST)
- Compact design saves valuable benchtop space
- Data logging allows you to store and recall up to 50 groups of data
- IP54-rated housing is dust- and spill-proof

This benchtop pH meter features automatic temperature compensation, data storage, parameter setup, and Max/Min reading display. The advanced digital processing technology improves meter response time and measuring accuracy. A stable reading display icon appears when the measuring value is stable.

**Kit includes:** 3-in-1 combination pH/temperature electrode, electrode holder, pH standard buffer solutions (4.00/7.00/10.01 pH, 50 mL each), and power adapter.



**OAKTON®**



Model		PH 550
<b>Catalogue number</b>		<b>MY-35419-30</b>
Range	pH	0 to 14.0
	mV	-1999 to 1999
	Temperature	0 to 100°C (32 to 212°F)
Resolution	pH	0.01/0.1
	mV	1
	Temperature	0.1°C (0.1/1°F)
Accuracy	pH	±0.01 pH ±1 digit
	mV	±0.1% full-scale ±1 digit
	Temperature	±0.5°C ±1 digit
Temperature compensation		Automatic or manual, from 0 to 100°C
Calibration		1 to 3 points, auto-calibration
Data logging		50 groups of data
Dimensions (L x W x H)		23.3 x 15.2 x 6.4 cm
Power		9 VAC DC power adapter

#### Accessories

**MM-35419-30 Replacement pH electrode**

**MM-17106-20 ILAC MRA, NIST-traceable calibration** for pH meters, handheld/benchtop

## Oakton® Benchtop pH 700 and Ion 700 Meters

### No more lost data—store and recall up to 100 data sets

- Takes up less bench space—40% smaller than comparable models
- Super-large dual-line display is easy to read
- Ion 700 adds ion concentration measurement and reads directly in ppm
- Simple calibrations with 5-point automatic pH buffer recognition for USA and NIST buffers
- More accurate measurements with up to 5-point calibration for ion concentration on Ion 700 model
- ATC maintains reading accuracy even with fluctuating temperatures
- Versatile—use with any pH, ORP, or ISE electrodes with BNC connector



#### Specifications

Range	pH	-2.00 to 16.00
	mV/rel mV	±2000
	ISE (Ion 700 only)	0.01 to 2000 ppm
	Temperature	0.0 to 100.0°C (32 to 100°F)
Accuracy	pH	±0.01 pH
	mV/rel mV	±0.2 within ±199.9 mV, ±2 beyond 199.9 mV
	ISE (Ion 700 only)	±0.5% rdg (monovalent); ±1% rdg (divalent)
	Temperature	±0.5°C (±0.9°F)
Temperature compensation	Automatic or manual from 0 to 100°C (32 to 100°F)	
Buffer recognition	USA or NIST buffer sets	
Data logging	100 data sets	
Power	100/240 VAC, 50/60 Hz	

**OAKTON®**

**ISO9001:2008**  
CERTIFIED SUPPLIER

**CE** Meter only



Model	Description	Meter	
		Catalogue number	Precalibrated meter Catalogue number
pH 700	Meter only	<b>MY-35419-00</b>	<b>MY-35419-01</b>
pH 700	Meter with "all-in-one" pH/ATC electrode	<b>MY-35419-03</b>	<b>MY-35419-05</b>
Ion 700		<b>MY-35419-23</b>	<b>MY-35419-27</b>
pH 700	Meter with double-junction pH electrode, ATC probe, and removable electrode holder	<b>MY-35419-10</b>	<b>MY-35419-11</b>
Ion 700		<b>MY-35419-20</b>	<b>MY-35419-24</b>
pH 700	Meter with removable electrode holder	<b>MY-35419-12</b>	<b>MY-35419-15</b>
Ion 700		<b>MY-35419-22</b>	<b>MY-35419-26</b>



# Oakton® Benchtop PC 700 and PC 2700 Meters

## Get all the readings you need in one compact unit

- Economical PC 700 for basic every day laboratory use
- Advanced PC 2700 for research-grade use with ion capability

**PC 2700 Meter** meets GLP requirements; meter stamps all calibration and stored data with time/date. Data are easily exported to a computer via RS-232 port. Order RS-232 and optional RS-232-to-USB adapter separately.

**Meter only includes:** universal power supply and electrode stand. **Meter with probes adds:** combination pH electrode and conductivity/temperature probe.

**Save time, save money!**

**Choose Precalibrated**  
Includes a data-rich, ISO 17025-compliant certificate!

Precalibrated by **INNOCAL®**  
INNOVATIVE CALIBRATION SOLUTIONS



Advanced PC 2700

### Specifications

Model	PC 700	PC 2700	
Range	pH	-2.00 to 16.00	-2.000 to 20.000
	mV/Rel mV	±2000	±2000.0
	ISE	—	0.001 to 19999 ppm
	Conductivity	0.0 µS to 200 mS	0.050 µS to 500.0 mS
	TDS	0.00 ppm to 100.0 ppt at 0.5 factor	0.050 to 500.0 ppt
	Salinity	—	0.0 to 80.0 ppt
	Resistivity	—	2.000 Ω to 20.0 MΩ
	Temperature	0 to 100°C (32 to 212°F)	0 to 100°C (32 to 212°F)
Accuracy	pH	±0.01 pH	±0.002 pH
	mV/Rel mV	±0.2 within ±199.9 mV, ±2 beyond 199.9 mV	±0.2 mV
	ISE	—	0.5% FS (monovalent), 1% FS (divalent)
	Conductivity	±1% full-scale	±1% full-scale
	TDS	±1% full-scale	±1% full-scale
	Salinity	—	±1% full-scale
	Resistivity	—	±1% full-scale
	Temperature	±0.5°C (±0.9°F)	±0.3°C (±0.5°F)
Calibration points	Up to 5 (USA, NIST)	Up to 6 (USA, NIST, DIN)	
Temp compensation	Automatic or manual	Automatic or manual	
Data logging	100 data sets	500 data sets	
Output	—	RS-232	
Power	110/240 VAC universal adapter		

**OAKTON®** **ISO9001:2008** CERTIFIED SUPPLIER **CE** **Meter only**

Model	Description	Meters	
		Catalogue number	Precalibrated meters Catalogue number
PC 700	Meter only	<b>MY-35413-20</b>	<b>MY-35413-21</b>
	Meter with probes	<b>MY-35413-00</b>	<b>MY-35413-01</b>
PC 2700	Meter only	<b>MY-35414-20</b>	<b>MY-35414-21</b>
	Meter with probes	<b>MY-35414-00</b>	<b>MY-35414-01</b>

**MY-35420-01 RS-232 cable** for 2700-series meter  
**MY-35630-53 USB cable** for 2700-series meter

# Thermo Scientific™ Orion™ Star™ A-Series

## Benchtop pH and pH/Ion Meters

### Stable readings locked in with Auto-Read™ function

- Star A111 basic meter is perfect for simple and accurate pH measurements
- Star A211 and A214 provide advanced data security and data logging

**Meters include:** electrode arm with probe holder and power adapter.  
**Meter kits add:** appropriate probes, pH buffers, storage solution, and cleaning solution.

Star A214



**ISO9001:2008** CERTIFIED SUPPLIER **GS**

**CE** **IP 54** **Meter only**

Model	A111 pH meter only	A111 pH meter kit	A211 pH meter only	A211 pH meter kit	A214 pH/ion meter only	A214 pH/ion meter kit
<b>Catalogue number</b>	<b>MY-58825-02</b>	<b>MY-58825-04</b>	<b>MY-58825-22</b>	<b>MY-58825-24</b>	<b>MY-58825-26</b>	<b>MY-58825-28</b>
Parameters	pH/mV/temperature		pH/mV/temperature		pH/mV/ion/temperature	
	-2.00 to 16.00		-2.000 to 20.000		-2.000 to 20.001	
	±1600.0 mV; ±1999.9 rel mV		±2000.0 mV		±2000.0 mV	
	—		—		0 to 19999	
Range	Temperature		Temperature		Temperature	
	-5 to 105°C (23 to 221°F)		-5 to 105°C (23 to 221°F)		-5 to 105°C (23 to 221°F)	
	pH		pH		pH	
	±0.01		±0.002		±0.002	
Accuracy	mV		mV		mV	
	±0.2 or 0.05% of reading		±0.2 or 0.05% of reading		±0.2 or 0.05% of reading	
	ISE		ISE		ISE	
	—		—		±0.2 mV or 0.05% of reading	
Temperature		Temperature		Temperature		
±0.1°		±0.1°		±0.1°		
Calibration points	Up to 3; USA, NIST, DIN buffers		Up to 5; USA, NIST, DIN buffers		Up to 5; USA, NIST, DIN buffers	
Temperature compensation	Automatic or manual		Automatic or manual		Automatic or manual	
Data logging	50 points		2000 points with time/date stamp		2000 points with time/date stamp	
Output	—		RS-232, USB		RS-232, USB	
Power	100 to 240 VAC (power adapter included) or four AA batteries (not included)					

# Cole-Parmer® Epoxy-Body Combination pH and ORP Electrodes

## Get fast, stable readings



- Impact resistant—epoxy-body housing for added strength
- Ideal for your general-purpose applications in the lab or field
- Compatible with most brands of pH meter

These electrodes are ideal for prolonged pH or ORP readings. Electrodes with sealed, gel-filled design require virtually no maintenance. Electrodes with PTFE reference-junction offer extended electrode life. All listed electrodes have Ag/AgCl reference cells.

**What's included:** 1-m (3.3-ft) cable with BNC connector.

**See How to...**

**Maintain it!**  
ColeParmer.com/PHmaintain

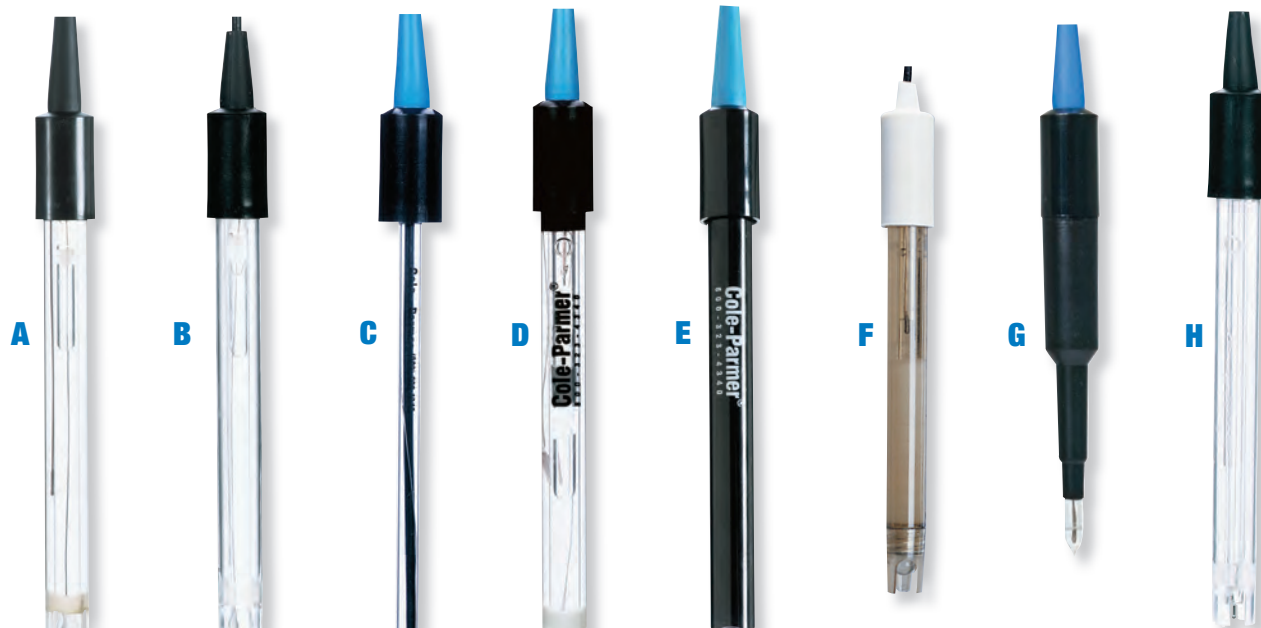

Key	Description	Reference junction	Type	Maximum temperature	Length x dia (mm)	Catalogue number
<b>General-purpose pH electrodes</b>						
<b>A</b>	General purpose For dirty samples	Single	Sealed	80°C (176°F)	127 x 12	MY-59001-65
		Double				MY-59001-70
<b>B</b>	General purpose, refillable For dirty samples, refillable	Single	Refillable†	80°C (176°F)	148 x 12	MY-05992-30
		Double				MY-05991-12
<b>C</b>	Extra-long neck for test tube sampling	Single	Sealed	80°C (176°F)	220 x 6	MY-05990-45
<b>D</b>	Flat tip for surface or low-volume sampling	Single	Sealed	80°C (176°F)	127 x 12	MY-05990-65
<b>PTFE reference-junction pH electrodes (clog resistant)</b>						
<b>E</b>	General purpose For dirty samples	Single	Sealed	100°C (212°F)	110 x 12	MY-05992-00
		Double				MY-05992-02
<b>Special-purpose pH electrodes</b>						
<b>F</b>	Coiled-cable for dirty samples				140 x 12	MY-05993-28
<b>G</b>	Spear-tip for dirty samples	Double	Sealed	80°C (176°F)	110 x 10	MY-59002-24
<b>ORP electrodes</b>						
<b>A</b>	General purpose For dirty samples	Single	Sealed	80°C (176°F)	127 x 12	MY-59001-75
		Double				MY-59001-77
<b>H</b>	General purpose, refillable	Single	Refillable††	80°C (176°F)	155 x 12	MY-05990-55

†Use fill solution 05992-48    ††Use fill solution 05992-47

- MY-05992-48 Reference fill solution**, 4-M KCl. Two 125-mL bottles
- MY-05992-47 Reference fill solution**, 3.8-M KCl with AgCl. Two 125-mL bottles
- MY-05983-25 Adapter**, BNC to US standard plug meter

## Oakton® Flexible Electrode Holder

### Keep electrodes in position

- Holds up to four standard-size electrodes and one ATC probe.
- Weighted base pivots 360° for added convenience



Description	Catalogue number
Electrode holder	MY-35617-50

## Thermo Scientific™ Orion™ ROSS™ and ROSS Ultra™ pH Electrodes

Don't worry about drift—drift is less than 0.002 pH per day

- Get fast, accurate, and stable pH readings
- Ideal for food, pharmaceuticals, or biological samples

These pH electrodes offer a great mercury-free alternative to calomel electrodes—excellent for use in Tris buffer. The double-junction design protects the inner reference solution and prolongs the life of the electrode. Readings stabilise to 0.01 pH in less than 30 seconds—even with a 50°C temperature change. Electrodes read pH from 0 to 14. Maximum temperature is 100°C (212°F).

**ROSS pH Electrodes** utilise a platinum wire with 3-M KCl to prevent sample contamination with silver and mercury ions. All ROSS pH electrodes have BNC connector.

**What's included:** 1-m (3.3-ft) cable and BNC connector, and 60-mL of 3-M KCl filling solution.

**ROSS Ultra pH Electrodes** use a nonmetallic reference system featuring instantaneous liquid-liquid equilibration for contamination-free sampling, greater stability, and more accurate results. Maintains 0.01 pH precision over long periods of time. Backed by 2-year replacement warranty.

**What's included:** 1-m (3.3-ft) cable and the exclusive Star™ Series waterproof BNC connector (compatible with any pH meter that accepts BNC input), and 60-mL of 3-M KCl filling solution.

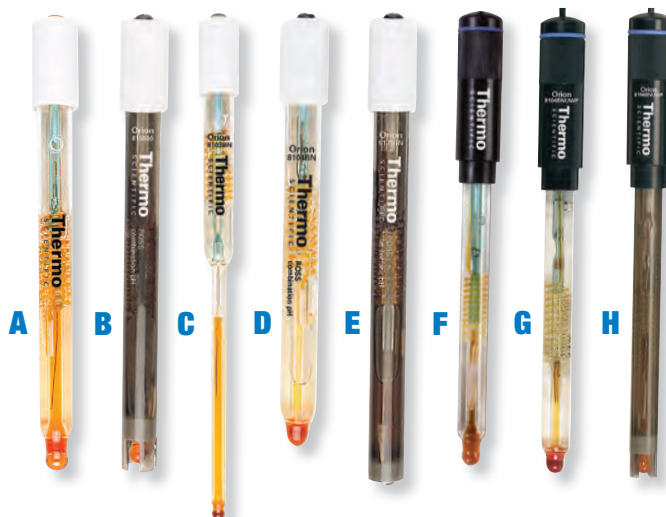

ISO9001:2008  
CERTIFIED SUPPLIER



Applications	Description	Length x dia (mm)	ROSS pH electrodes		ROSS Ultra pH electrodes	
			Key	Catalogue number	Key	Catalogue number
General-purpose, Tris buffers, nonaqueous solutions, and DI water	Glass body	120 x 12	A	MY-05718-02	F	MY-05718-70
For rugged general-purpose use, Tris buffers, nonaqueous solutions, and DI water	Epoxy body	120 x 12	B	MY-05718-07	G	MY-05718-77
Small sample size or samples in small-diameter vessels	Glass body	165 (total); 95 x 6	C	MY-05718-16	—	—
Rugged general-purpose and field use, nonaqueous solutions, and DI water	Glass body with rugged bulb	120 x 12	D	MY-05718-27	H	MY-05718-73
Soft, moist surfaces of solids or semisolids such as agar plates	Epoxy body, flat surface	120 x 12	E	MY-05718-32	—	—

### Accessories

**MY-05730-52 Filling solution** for all ROSS and ROSS Ultra Electrodes, 3-M KCl. Case of five 60-mL bottles

**MY-05730-60 ROSS pH Electrode storage solution**, 475-mL bottle

## Thermo Scientific™ Orion™ ROSS™ Triode™ pH Electrodes

Be more accurate with automatic temperature compensation (ATC)

- Best temperature response of any pH electrode available
- Built-in temperature for use with Thermo Scientific Orion meters
- No waiting—stable readings to 0.01 pH in less than 30 seconds

Measure both pH and temperature in one convenient 12-mm electrode. Mercury-free, double-junction reference is compatible with samples containing Tris, sulfides, and proteins. Glass-body electrode is available as a refillable junction. Epoxy-body electrodes are available in long-lasting refillable and low-maintenance sealed (gel-filled) options.

**What's included:** 1-m (3.3-ft) cable, BNC pH connector, and a MiniDIN ATC connector for use with Orion Star Series™ pH meters.

ISO9001:2008  
CERTIFIED SUPPLIER

Key	Description	ATC connector	Catalogue number
A	Glass body, refillable	MiniDIN for Star Series pH meters	MY-05718-28
B	Epoxy body, refillable	MiniDIN for Star Series pH meters	MY-05718-34
C	Epoxy body, gel-filled	MiniDIN for Star Series pH meters	MY-05718-44



**MY-05730-52 Filling solution** for all ROSS and ROSS Ultra Electrodes, 3-M KCl. Case of five 60-mL bottles



# Cole-Parmer® Combination Ion-Selective Electrodes and Solutions

## Save money and frustration— cost effective and easy to use

– Easily fit into small spaces—no additional reference electrode is needed

Electrodes are double-junction combination ion-selective electrodes and are convenient to use in places where two electrodes won't fit. Use with a meter that has a resolution of 0.1-mV for the most accurate results; a meter with direct readings in ppm is preferred. For monitoring ions not listed below or for more electrode application information, call our Application Specialists.

**Economy Epoxy Electrodes** have a durable epoxy body and are well-suited for portable field applications. Outer reference chamber is silver-free and resists contamination. These electrodes are refillable.

**Laboratory Glass Electrodes** are double-junction in design, with a glass body that provides high-quality measurements for your laboratory applications. Improved glass seal enhances performance and reliability. Sealed inner junctions and refillable outer junctions accommodate special reference fill solutions—ideal for low-concentration measurements.

**What's included:** a 15-mL bottle of reference solution, a reference filling pipette, and a 1-m (3.3-ft) cable and BNC connector. Solid-state electrodes also have twelve polishing strips.



Epoxy solid-state chloride electrode 27504-08

Glass solid-state fluoride electrode 27502-19

Epoxy glass membrane sodium electrode 27504-30

“Fast and stable.”



**Cole-Parmer®**

Ion-selective electrode	Type	Concentration range	Temperature/pH range <sup>†</sup>	Interferences <sup>‡</sup>	Economy epoxy electrodes	Laboratory glass electrodes
					Catalogue number	Catalogue number
Ammonia (NH <sub>3</sub> )	See page 109 for ordering information					
Ammonium (NH <sub>4</sub> <sup>+</sup> )	PVC membrane	5 x 10 <sup>-6</sup> to 1.0 M (0.1 to 18,000 ppm)	0 to 50°C/ 4 to 10	K <sup>+</sup>	MY-27504-00	MY-27502-03
Bromide (Br <sup>-</sup> )	Solid-state	5 x 10 <sup>-6</sup> to 1.0 M (0.4 to 79,900 ppm)	0 to 80°C/ 2 to 14	S <sup>-2</sup> , I <sup>-</sup> , CN <sup>-</sup> ; high Cl <sup>-</sup> and NH <sub>3</sub> levels	MY-27504-02	MY-27502-05
Cadmium (Cd <sup>+2</sup> )	Solid-state	10 <sup>-7</sup> to 10 <sup>-1</sup> M (0.01 to 11,200 ppm)	0 to 80°C/ 2 to 12	Ag <sup>+</sup> , Hg <sup>+2</sup> , Cu <sup>+2</sup> ; high Pb <sup>+2</sup> and Fe <sup>+2</sup> levels	MY-27504-04	MY-27502-07
Calcium (Ca <sup>+2</sup> )	PVC membrane	5 x 10 <sup>-6</sup> to 1.0 M (0.2 to 40,000 ppm)	0 to 50°C/ 3 to 10	Pb <sup>+2</sup> , Hg <sup>+2</sup> , Cu <sup>+2</sup> , Ni <sup>+2</sup> , Fe <sup>+2</sup> , Mg <sup>+2</sup> , Zn <sup>+2</sup> , Ba <sup>+2</sup> , K <sup>+2</sup> , K <sup>+</sup> , Na <sup>+</sup>	MY-27504-06	MY-27502-09
Chloride (Cl <sup>-</sup> )	Solid-state	5 x 10 <sup>-5</sup> to 1.0 M (1.8 to 35,500 ppm)	0 to 80°C/ 2 to 12	S <sup>-2</sup> , I <sup>-</sup> , CN <sup>-</sup> , Br <sup>-</sup> , OH <sup>-</sup> , NH <sub>3</sub> , S <sub>2</sub> O <sub>3</sub> <sup>-2</sup>	MY-27504-08	MY-27502-13
Copper (Cu <sup>+2</sup> )	Solid-state	10 <sup>-8</sup> to 10 <sup>-1</sup> M (0.0006 to 6350 ppm)	0 to 80°C/ 2 to 12	Ag <sup>+</sup> , Hg <sup>+2</sup> , high Cl <sup>-</sup> , Br <sup>-</sup> , Fe <sup>+2</sup> , and Cd <sup>+2</sup> levels	MY-27504-10	MY-27502-15
Cyanide (CN <sup>-</sup> )	Solid-state	5 x 10 <sup>-6</sup> to 10 <sup>-2</sup> M (0.1 to 260 ppm)	0 to 80°C/ 11 to 13	S <sup>-2</sup> , I <sup>-</sup> , Br <sup>-</sup> , Cl <sup>-</sup>	MY-27504-12	MY-27502-17
Fluoride (F <sup>-</sup> )	Solid-state	10 <sup>-6</sup> to saturated (0.02 to saturated)	0 to 80°C/ 5 to 8	OH <sup>-</sup>	MY-27504-14	MY-27502-19
Iodide (I <sup>-</sup> )	Solid-state	5 x 10 <sup>-8</sup> to 1.0 M (0.006 to 127,000 ppm)	0 to 80°C/ 0 to 14	S <sup>-2</sup> , CN <sup>-</sup> , Br <sup>-</sup> , Cl <sup>-</sup> , NH <sub>3</sub> , S <sub>2</sub> O <sub>3</sub> <sup>-2</sup>	MY-27504-18	MY-27502-23
Lead (Pb <sup>+2</sup> )	Solid-state	10 <sup>-6</sup> to 10 <sup>-1</sup> M (0.2 to 20,700 ppm)	0 to 80°C/ 3 to 8	Ag <sup>+2</sup> , Hg <sup>+2</sup> , Cu <sup>+2</sup> , high Cd <sup>+2</sup> and Fe <sup>+2</sup> levels	MY-27504-20	MY-27502-25
Nitrate (NO <sub>3</sub> <sup>-</sup> )	PVC membrane	7 x 10 <sup>-6</sup> to 1.0 M (0.5 to 62,000 ppm)	0 to 50°C/ 2.5 to 11	ClO <sub>4</sub> <sup>-</sup> , I <sup>-</sup> , CN <sup>-</sup> , BF <sub>4</sub> <sup>-</sup>	MY-27504-22	MY-27502-31
Perchlorate (ClO <sub>4</sub> <sup>-</sup> )	PVC membrane	7 x 10 <sup>-6</sup> to 1.0 M (0.7 to 98,000 ppm)	0 to 50°C/ 2.5 to 11	NO <sub>3</sub> <sup>-</sup> , NO <sub>2</sub> <sup>-</sup> , CN <sup>-</sup> , ClO <sub>3</sub> <sup>-</sup> , I <sup>-</sup>	MY-27504-24	MY-27502-35
Potassium (K <sup>+</sup> )	PVC membrane	10 <sup>-6</sup> to 1.0 M (0.04 to 39,000 ppm)	0 to 50°C/ 2 to 12	Cs <sup>+</sup> , NH <sub>4</sub> <sup>+</sup> , Tl <sup>+</sup> , H <sup>+</sup> , Ag <sup>+</sup> , Li <sup>+</sup> , Na <sup>+</sup> , Tris <sup>1+</sup>	MY-27504-26	MY-27502-39
Silver/Sulfide (Ag <sup>+</sup> /S <sup>-2</sup> )	Solid-state	10 <sup>-7</sup> to 1.0 M (Ag <sup>+</sup> , S <sup>-2</sup> ) (0.01 to 107,900 ppm Ag <sup>+</sup> ; 0.003 to 32,100 ppm S <sup>-2</sup> )	0 to 80°C/ 2 to 12	Hg <sup>+2</sup>	MY-27504-28	MY-27502-41
Sodium (Na <sup>+</sup> )	Glass membrane	10 <sup>-6</sup> M to saturated (0.02 ppm to saturated)	0 to 80°C/ 5 to 12	H <sup>+</sup> , K <sup>+</sup> , Li <sup>+</sup> , Ag <sup>+</sup> , NH <sub>4</sub> <sup>+</sup> , Rb <sup>+</sup> , Cs <sup>+</sup> , Tl <sup>+</sup>	MY-27504-30	MY-27502-43
Surfactant (X <sup>-</sup> /X <sup>-</sup> )	PVC membrane	10 <sup>-5</sup> to 5 x 10 <sup>-2</sup> M (1.0 to 12,000 ppm)	2 to 12	Similar types of surfactants	MY-27504-32	MY-27502-45
Water hardness (Ca <sup>+2</sup> /Mg <sup>+2</sup> )	PVC membrane	10 <sup>-5</sup> to 1.0 M (0.4 to 40,000 ppm as Ca <sup>+2</sup> )	0 to 50°C/ 5 to 10	Cu <sup>+2</sup> , Zn <sup>+2</sup> , Ni <sup>+2</sup> , Fe <sup>+2</sup>	MY-27504-34	MY-27502-49

<sup>†</sup>Optimal pH range for direct measurement.

<sup>‡</sup>These ions are listed in order of decreasing concentrations of interference.

**Solution Kits** sold separately below include all of the solutions needed for accurate measurements. Each kit includes one reference filling pipette, one 60-mL bottle of reference fill solution, one 475-mL bottle of 1000 ppm standard solution, and one 475-mL bottle of ionic strength adjustor (except models 27502-69 and 27502-91, which come in a 3.8-L bottle).

Replacement ionic strength adjustors come in 475-mL bottles (except model 27503-58, which comes in a 3.8-L bottle).



Solution kit 27502-63 and ISA bottle 27503-51

Ion	Standards and fill solution kits		Replacement ionic strength adjustors†	
	Catalogue number	Formulations for fill/standard solutions	Catalogue number	Solution formulation
NH <sub>3</sub>	See adjacent ad for ordering information			
NH <sub>4</sub> <sup>+</sup>	MY-27502-53	0.1 M NaCl/ 1000 ppm as N	MY-27503-53	5 M NaCl
Br <sup>-</sup>	MY-27502-55	1 M KNO <sub>3</sub> / 1000 ppm as Br <sup>-</sup>	MY-27503-51	5 M NaNO <sub>3</sub>
Cd <sup>+</sup>	MY-27502-57	1 M KNO <sub>3</sub> ‡	MY-27503-51	5 M NaNO <sub>3</sub>
Ca <sup>+2</sup>	MY-27502-59	4 M KCl/ 1000 ppm as Ca <sup>+2</sup>	MY-27503-52	4 M KCl
Cl <sup>-</sup>	MY-27502-63	1 M KNO <sub>3</sub> / 1000 ppm as Cl <sup>-</sup>	MY-27503-51	5 M NaNO <sub>3</sub>
Cu <sup>+2</sup>	MY-27502-65	1 M KNO <sub>3</sub> / 1000 ppm as Cu <sup>+2</sup>	MY-27503-51	5 M NaNO <sub>3</sub>
CN <sup>-</sup>	—	—	—	—
F <sup>-</sup>	MY-27502-69	4 M KCl/ 1000 ppm as F <sup>-</sup>	MY-27503-58	TISAB I
I <sup>-</sup>	MY-27502-73	1 M KNO <sub>3</sub> / 1000 ppm as I <sup>-</sup>	MY-27503-51	5 M NaNO <sub>3</sub>
Pb <sup>+2</sup>	—	—	MY-27503-56	5 M NaClO <sub>4</sub>
NO <sub>3</sub> <sup>-</sup>	MY-27502-79	0.1 M (NH <sub>4</sub> ) <sub>2</sub> SO <sub>4</sub> / 1000 ppm as NO <sub>3</sub> <sup>-</sup>	MY-27503-60	2 M (NH <sub>4</sub> ) <sub>2</sub> SO <sub>4</sub>
ClO <sub>4</sub> <sup>-</sup>	MY-27502-85	0.1 M (NH <sub>4</sub> ) <sub>2</sub> SO <sub>4</sub> / 1000 ppm as ClO <sub>4</sub> <sup>-</sup>	MY-27503-60	2 M (NH <sub>4</sub> ) <sub>2</sub> SO <sub>4</sub>
K <sup>+</sup>	MY-27502-89	0.1 M NaCl/ 1000 ppm as K <sup>+</sup>	MY-27503-53	5 M NaCl
Ag <sup>+</sup> / S <sup>-2</sup>	MY-27502-91	1 M KNO <sub>3</sub> / 1000 ppm as Ag <sup>+</sup>	MY-27503-51	5 M NaNO <sub>3</sub>
Na <sup>+</sup>	MY-27502-93	0.1 M NH <sub>4</sub> Cl/ 1000 ppm as Na <sup>+</sup>	MY-27503-54	4 M NH <sub>4</sub> Cl with 4 M NH <sub>4</sub> OH
X <sup>+</sup> /X <sup>-</sup>	MY-27502-95	4 M KCl/ 0.05 M Hyamine® and 0.01 M SLS††	—	—
Ca <sup>+2</sup> / Mg <sup>+2</sup>	MY-27502-99	4 M KCl/ 1000 ppm as Ca <sup>+2</sup>	MY-27503-52	4 M KCl

†A 475-mL bottle of ionic strength adjustor is supplied with kit.

‡Customer-formulated standard solution required. ††None required.

## Cole-Parmer® Ammonia Ion-Selective Electrodes

### Combines reference electrode and half-cell

- Fast and accurate readings in less than 30 seconds
- Save money with easily changeable membranes
- Measure concentrations to 17,000 ppm

Single-junction ammonia electrodes feature durable, epoxy bodies. The electrode with loose membranes is for users who prefer that style of installation. The electrode with pre-membraned caps makes electrode membrane replacement easier. Use electrodes with almost any existing meter.

**What's included:** 1-m (3.3-ft) cable and BNC connector, 15 mL of electrolyte, replacement membrane, and filling pipette. Order standards, ionic strength adjustors, and fill solution separately below.

Cole-Parmer®

“Excellent performance.”



27512-00 with membrane cap

Type	Concentration range	Temp/ pH range <sup>†</sup>	Inter- ferences	Catalogue number
<b>Electrode with loose membranes</b>				
Gas sensing	5 x 10 <sup>-7</sup> to 1.0 M (0.01 to 17,000 ppm)	0 to 50°C/ above 11	Volatile amines	MY-27502-00
<b>Electrode with pre-membraned cap</b>				
Gas sensing	5 x 10 <sup>-7</sup> to 1.0 M (0.01 to 17,000 ppm)	0 to 50°C/ above 11	Volatile amines	MY-27512-00

†Optimal pH range for direct measurement

#### Accessories

**MY-27503-00 Ammonia standard**, 0.1 M NH<sub>4</sub>Cl, 475-mL bottle

**MY-27503-93 Ammonia standard**, 1000 ppm ammonia as nitrogen, 475-mL bottle

**MY-27503-94 Ammonia standard**, 100 ppm ammonia as nitrogen, 475-mL bottle

**MY-05730-51 Ionic strength adjustor**, NaOH and EDTA, 475-mL bottle

**MY-27503-71 Ammonia fill solution**, 0.1 M NH<sub>4</sub>Cl, 125-mL bottle

**MY-27503-95 Replacement membranes**. Ten membrane tapes, one O-ring, and tweezers

**MY-27512-95 Replacement membrane caps** for 27512-00. Pack of 3

# Cole-Parmer® Glass-Body Combination pH and ORP Electrodes

## Faster response and increased stability across 0 to 14 pH range

- More durable—dome bulb for better protection from breakage
- Withstand higher temperatures and chemical attack
- Get more stability in low-ionic strength solutions
- Resistant to Na<sup>+</sup> ion interferences
- Compatible with most brands of pH meters

Available as refillable or sealed design for single, double, and annular Ag/AgCl junctions. Single-junction is ideal for clean samples; double junction is compatible with sulfates, Tris, and proteins; and annular junction is ideal for dirty samples.

**What's included:** 1-m (3.3-ft) cable and BNC connector.



 Cole-Parmer®

Key	Description	Reference junction	Type	Maximum temperature	Length x dia (mm)	Catalogue number
<b>General-purpose pH electrodes</b>						
<b>A</b>	General-purpose, laboratory	Single	Refillable	100°C (212°F)	154 x 12	<b>MY-05991-22</b>
	General-purpose for TRIS, sulfates, proteins	Double			154 x 12	<b>MY-59001-34</b>
<b>B</b>	Rugged, low maintenance	Single	Sealed	100°C (212°F)	123 x 9.5	<b>MY-05991-81</b>
	Rugged for TRIS, sulfates, proteins	Double			124 x 9.5	<b>MY-59001-36</b>
<b>C</b>	General-purpose, thin neck	Single	Refillable†	100°C (212°F)	154 x 8	<b>MY-05991-42</b>
<b>D</b>	Long neck for small test tubes				210 x 6	<b>MY-05991-61</b>
<b>E</b>	Long neck for large test tubes				210 x 8	<b>MY-05991-51</b>
<b>F</b>	Extra-long neck for flasks and bottles				326 x 8	<b>MY-05990-40</b>
<b>Special-purpose pH electrodes</b>						
<b>G</b>	High temperature, KNO <sub>3</sub> gel	Double	Sealed	120°C (248°F)	130 x 12	<b>MY-05998-30</b>
<b>H</b>	Spear tip for piercing semisolids and foods	Single	Sealed	100°C (212°F)	159 x 8	<b>MY-05998-20</b>
<b>I</b>	Soil electrode, eliminates "suspension effect"	Annular	Refillable†	100°C (212°F)	145 x 12	<b>MY-05992-62</b>
<b>J</b>	Flat-tip for surface or low volume sampling	Double	Refillable†	100°C (212°F)	130 x 12	<b>MY-05991-44</b>
<b>ORP electrodes</b>						
<b>A</b>	General purpose	Single	Sealed	100°C (212°F)	110 x 12	<b>MY-05991-08</b>
	For dirty samples	Double				<b>MY-05991-18</b>

†Use fill solution 05992-47.

### Accessories

**MY-05992-47 Reference fill solution** for refillable electrodes, 3.8-M KCl with AgCl. Two 125-mL bottles

**MY-05983-25 Adapter**, BNC to US standard plug meter



## Oakton® pH Buffer Solutions

Keep your readings accurate with these quality buffers

– Standardised against ILAC MRA, NIST-traceable pH references for meters with 0.01 resolution



Save by ordering larger sizes or by the case!

pH	500-mL bottles		1-L bottles	4-L bottles	
	Catalogue number	Catalogue number	Catalogue number	Catalogue number	Catalogue number
1.68	MY-00654-01	—	—	—	—
4.01	MY-00654-00	MY-05942-21	MY-05942-22	MY-05942-24	MY-05942-25
6.86	MY-00654-03	—	—	—	—
7.00	MY-00654-04	MY-05942-41	MY-05942-42	MY-05942-44	MY-05942-45
9.18	MY-00654-07	—	—	—	—
10.00	MY-00654-08	MY-05942-61	MY-05942-62	MY-05942-64	MY-05942-65
12.45	MY-00654-12	—	—	—	—



## Oakton® Traceable® pH Buffers, ILAC MRA, NIST-Traceable Reference Materials

Feel more confident about accuracies

- Calibrated by ISO 17034 and ISO 17025 accredited laboratory—includes ILAC MRA, NIST-traceable certificate supplied by manufacturer
- Easy calibrations—include instructions and temperature compensation chart



pH	500-mL bottles	1-L bottles	4-L bottles
	Catalogue number	Catalogue number	Catalogue number
<b>Colourless buffers</b>			
4.01	MY-00651-00	MY-00651-30	MY-00651-70
7.00	MY-00651-02	MY-00651-32	MY-00651-72
10.00	MY-00651-04	MY-00651-34	MY-00651-74
<b>Colour-coded buffers</b>			
4.01 (red)	MY-00651-06	MY-00651-36	MY-00651-76
7.00 (yellow)	MY-00651-08	MY-00651-38	MY-00651-78
10.00 (blue)	MY-00651-10	MY-00651-40	MY-00651-80

## pH Buffer Capsules

No more wasted buffer

- Make only the buffer you need—empty one capsule into 100-mL of water and stir
- Accurate to ±0.02 pH

pH	Colour	Catalogue number
4.0	Orange	MY-05977-12
7.0	Green	MY-05977-14
9.0	Yellow	MY-05977-16
10.0	Blue	MY-05977-18



## Oakton® pH Buffer Pouches

Accuracy even on the go!

- Single-use pouch—just tear, dip, calibrate
- Standardised to ILAC MRA, NIST-traceable pH references



pH	Catalogue number
4.01	MY-35653-01
7.00	MY-35653-02
10.00	MY-35653-03
Rinse solution	MY-35653-00

MY-35653-04 Buffer pouch assortment pack; contains five pouches each of pH 4, 7, and 10 buffers and rinse solution

## Oakton® pH Buffer and pH Solution Packs

Maintain accuracy and your budget

- Save money by purchasing buffer pack—includes 500-mL bottle of pH 4, 7, and 10 ILAC MRA, NIST-traceable buffers
- Keep electrodes clean and stored correctly—purchase solution pack which adds 500-mL bottles of cleaning and storage solutions



Description	Qty/pk	Catalogue number
pH buffer pack	3 bottles	MY-05942-10
pH solution pack	5 bottles	MY-05942-15

## Oakton® Electrode Cleaning and Storage Solutions

Clean electrodes make clean measurements

- Easily remove grease, protein, and other deposits with cleaning solution
- Make electrode last longer—store in our storage solution
- Choose 500-mL bottle or case of 24 500-mL bottles



Solution type	1 bottle	24 bottles
	Catalogue number	Catalogue number
Cleaning	MY-00653-06	—
Storage	MY-00653-04	MY-35655-04

## Cole-Parmer® Serological Pipettes, PS Fits just about any pipettor

These serological pipettes are made from transparent polystyrene (PS), sterilised by gamma irradiation, and designed for quick and accurate fluid dispensing. The highly legible permanent graduations prevent ambiguity and guarantee precise dispensing to ±2%. Graduations show volume removed or remaining on all pipettes larger than 1-mL. Generous negative graduations provide additional pipetting volume.

Filter plug eliminates lint fibers and ensures the plug stays in place to prevent overfilling. The uniform mouth piece fits all major pipettors and has colour-coded TD rings for easy identification. Each lot is tested for endotoxins and cytotoxicity, and guaranteed nonhemolytic—ideal for your tissue culture applications.

The individually wrapped pipettes are supplied in a fiber-free paper/plastic combination that is easy to open. The dispenser box allows you to remove pipettes without opening the top. Universal stacking requires less space and each box is colour coded for quick recognition.



Capacity (mL)	Graduation interval (mL)	Tip style	Colour ring	Individually wrapped		Bulk wrapped		
				Qty/cs	Catalogue number	Qty/bag	Qty/cs	Catalogue number
1	0.01	Standard	Yellow	500	<b>MY-13002-12</b>	25	1000	<b>MY-13002-24</b>
1	0.1	Standard	Red	500	<b>MY-13002-14</b>	25	1000	<b>MY-13002-26</b>
2	0.01	Standard	White	500	<b>MY-13002-15</b>	25	1000	<b>MY-13002-28</b>
5	0.1	Standard	Blue	200	<b>MY-13002-16</b>	25	500	<b>MY-13002-29</b>
10	0.1	Standard	Orange	200	<b>MY-13002-17</b>	25	400	<b>MY-13002-30</b>
10	0.1	Wide	Orange	—	—	25	400	<b>MY-13002-32</b>
25	0.2	Standard	Green	150	<b>MY-13002-19</b>	10	150	<b>MY-13002-36</b>
50	0.5	Standard	Purple	100	<b>MY-13002-20</b>	10	100	<b>MY-13002-37</b>

## Mini Serological Pipettes 10-cm shorter than standard pipettes

- Easy-to-read graduations from +1 to 2%
- Identify pipettes easily with colour-coded rings
- No lint fibers—unique, stay-put filter plug
- Gamma-sterilised polystyrene is non-pyrogenic
- Shorter length reduces distance between sample and pipettor, aiding in more ergonomic pipetting



Capacity	Graduation (mL)	Color ring	Qty/cs	Catalogue number
5 mL	0.1	Blue	200	<b>MY-22999-30</b>
10 mL	0.2	Orange	150	<b>MY-22999-31</b>
25 mL	0.5	Green	100	<b>MY-22999-32</b>

## BioSafe Serological Pipettes, PS Filtered for sample integrity and user safety

- Eliminate cross-contamination—barrier filter plug prevents overaspiration
- Sterile, individually wrapped, and disposable
- Ideal for use with potentially hazardous or dangerous biological fluids
- Use in place of filtered pipette tips



These Polystyrene (PS) Serological pipettes feature a special filter plug that locks in fluid and vapors if overaspiration occurs. Come individually wrapped.



Capacity (mL)	Negative graduation (mL)	Graduation interval (mL)	Accuracy (mL)	Qty/cs	Catalogue number
5	0.1	0.1	±0.1	200	<b>MY-13002-52</b>
10	0.1	0.1	±0.2	200	<b>MY-13002-53</b>
25	0.2	0.2	±0.5	150	<b>MY-13002-54</b>

## Trifill Reservoir

### Three reagent basins in one unit

- Use one side for single-channel pipettor, or flip over to use for 8- and 12-channel pipettors
- Multichannels are individually numbered for quick reagent identity



Compartments	Material	Qty/pk	Catalogue number
One 50-mL graduated reservoir; eight 5-mL channels, twelve 5-mL channels	Polypropylene	10	<b>MY-25200-71</b>

## Cole-Parmer® Transfer Pipettes

### No more breakage or cross-contamination

- Translucent, shatterproof LDPE is nontoxic and biologically inert
- Nonbinding for cells and proteins to prevent sample loss
- Heat sealable and liquid nitrogen compatible



Key	Description	Graduations		Bulb Draw (µL)	Total capacity	Drops per mL	Length mm (in.)	Qty/pk	Catalogue number
		Increments	Maximum						
A	Mini, short stem	—	—	0.9 µL	1.2 mL	25	6.4 (2.5)	500	MY-06226-30
		—	—	0.9 µL	1.7 mL	25	87 (3.4)	500	MY-06226-21
B	Short narrow stem	—	—	3 µL	4 mL	25	86 (3.4)	500	MY-06226-27
C	Large bulb narrow stem	—	—	8 µL	15 mL	19	155 (6.125)	250	MY-06226-32
D	General purpose	—	—	1.9 µL	5 mL	25	155 (6.125)	500	MY-06226-25
		—	—	3.2 µL	7.5 mL	20	155 (6.125)	500	MY-06226-11
		—	—	3.2 µL	7.5 mL	20	155 (6.125)	500	MY-06226-31
		—	—	1 mL	1.5 mL	50	104 (4.1)	500	MY-06226-34
		—	—	3.3 mL	5.8 mL	50	157 (6.18)	500	MY-06226-33
E	Small bulb, graduated	0.1 mL	0.3 mL	0.8 µL	1.5 mL	21	116 (4.6)	500	MY-06226-13
		0.5 mL	2 mL	1.9 µL	5 mL	25	155 (6.125)	500	MY-06226-03
		0.25 mL	1 mL	2.1 µL	3 mL	25	138 (5.4)	500	MY-06226-23
		0.25 mL	1 mL	2.1 µL	3 mL	25	140 (5.5)	500	MY-06226-29
F	Large bulb, graduated	0.25 mL	1 mL	3.4 µL	5 mL	25	155 (6.125)	500	MY-06226-12
		0.5 mL	3 mL	3.2 µL	7.5 mL	20	155 (6.125)	500	MY-06226-01
		0.25 mL	1 mL	3.4 µL	5 mL	25	155 (6.125)	500	MY-06226-15
G	Large bulb, double graduated	0.25 mL	1 mL	3.4 µL	5 mL	25	155 (6.125)	500	MY-06226-19
H	General purpose, wide bulb	—	—	—	7 mL	—	125 (5)	500	MY-06226-35
I	General purpose, extra long	—	—	2.3 µL	6 mL	25	230 (9)	500	MY-06226-22
		—	—	7.3 µL	23 mL	20	300 (12)	100	MY-06226-24

## Cole-Parmer® Autoclavable Ergonomic Pipettors

### Get optimal performance with stainless steel piston

- Ergonomic, lightweight design and soft plunger movement
- Fully autoclavable—no disassembly required
- Available in fixed and adjustable-volume styles

These fully autoclavable pipettors are equipped with a stainless steel piston for improved accuracy, precision, and performance. Two-stage plunger operation provided for last-drop blow-out and reverse pipetting. Separate, streamlined tip ejector designed for access into narrow-neck containers and tubes. Individually calibrated in accordance with DIN 12650 Standards and supplied with a computer-generated calibration report and calibration tool. Nozzle accepts Cole-Parmer and universal tips.



#### Specifications

Wetted materials: polypropylene  
 Tip ejector: yes  
 Autoclavable: yes

#### Tips, Polypropylene

Volume (µL)	Qty/pk	Catalogue number
0.2 to 10	Bag of 1000	MY-25711-06
0 to 200	Bag of 1000	MY-25711-12
	10 racks of 96	MY-25711-14
50 to 1000	Bag of 1000	MY-18889-08
1000 to 5000	Bag of 1000	MY-25711-70
	Bag of 500	MY-25711-71
	Bag of 250	MY-25711-72

Volume	Increments	Accuracy	Reproducibility	Catalogue number
<b>Fixed-volume pipettors</b>				
100 µL	—	±0.3%	≤0.2%	MY-21600-50
200 µL				MY-21600-52
500 µL				MY-21600-54
1000 µL				MY-21600-56
5000 µL				MY-21600-58
<b>Adjustable-volume pipettors</b>				
0.1 to 10 µL	0.1 µL	±5.0% to ±1.0%	≤2.8% to ≤0.4%	MY-21600-60
2.0 to 20 µL	0.1 µL	±5.0% to ±1.0%	≤1.5% to ≤0.3%	MY-21600-62
5.0 to 50 µL	1 µL	±2.5% to ±0.7%	≤1.5% to ≤0.3%	MY-21600-64
10 to 100 µL	1 µL	±2.0% to ±0.8%	≤0.7% to ≤0.2%	MY-21600-66
20 to 200 µL	1.0 µL	±1.5% to ±0.6%	≤0.3% to ≤0.2%	MY-21600-68
100 to 1000 µL	10.0 µL	±1.3% to ±0.5%	≤0.3% to ≤0.2%	MY-21600-70
500 to 5000 µL	100.0 µL	±0.8% to ±0.6%	≤0.2% to ≤0.2%	MY-21600-72
1000 to 10,000 µL	100.0 µL	±1.2% to ±0.6%	≤0.2% to ≤0.2%	MY-21600-74



# Kinesis<sup>®</sup>

# Pipette Service

Specialists in Service, Repair & Calibration

Supporting all major pipette brands & official service provider for BRAND<sup>®</sup> products

## Why service your pipettes?

- Extend your pipettes' lifespan
- Avoid poor performance & leaks
- Eliminate cross-contamination
- Achieve reproducible results

## Why choose Kinesis<sup>®</sup> Pipette Service?

Complete inspection, cleaning & seal overhaul, genuine manufacturer parts used, uncertainty measurement calculated, ISO 17025 and 8655 protocols adhered to.

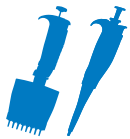

We service all single, multi-channel, manual & electronic pipettes including bottle-top dispensers & pipette controllers



Why not trade in your pipettes for newer models? Contact us today about our recycling offer!



Worry-free management: we can organise your onsite clinics, or complete calibration in our lab facilities



All calibration certificates are online, with full service history details so your pipettes are traceable



For more information visit [ColeParmer.com](http://ColeParmer.com) or contact one of our state-of-the-art facilities

### Germany

In accordance with  
ISO8655:2002  
+49 (0) 9377 920369  
[sales@coleparmer.de](mailto:sales@coleparmer.de)

### UK

UKAS accredited to ISO 17025:2005  
& ISO8655:2002 specifications  
+44 (0) 1480 277802  
[pipette.service@coleparmer.com](mailto:pipette.service@coleparmer.com)



International  
Organization for  
Standardization

## Ashcroft® Digital Pressure Gauges with Backlight

### Simple three-button programming

- Easy-to-read, five-digit display with backlight and 20-segment bar graph
- Stainless steel sensor; IP67-rated case
- Features tare, min/max memory, and nine engineering plus one custom engineering units



ISO9001:2008 CERTIFIED SUPPLIER

#### Specifications

**Accuracy:** ±0.5% full-scale  
**Dial size:** 64 mm (2½")  
**Operating temp:** -20 to 60°C (-4 to 140°F)  
**Units of measure:** psi, " Hg, cm Hg, mm Hg, kPa, mPa, bar, kg/cm², ft H₂O, and user-defined unit

**Wetted materials:** 17-4 ph and 316L stainless steel  
**Lens:** polycarbonate  
**Process connection:** ¼" NPT(M)  
**Power:** two AA batteries (included)

Range	Resolution	Catalogue number
0 to 30" Hg	0.01" Hg	MY-68334-01
30" Hg to 30 psi	0.01" Hg	MY-68334-03
30" Hg to 100 psi	0.01" Hg	MY-68334-07
0 to 15 psi	0.001 psi	MY-68334-09
0 to 30 psi	0.001 psi	MY-68334-11
0 to 60 psi	0.001 psi	MY-68334-13
0 to 100 psi	0.01 psi	MY-68334-15
0 to 200 psi	0.01 psi	MY-68334-17
0 to 300 psi	0.01 psi	MY-68334-19
0 to 500 psi	0.01 psi	MY-68334-21
0 to 1000 psi	0.1 psi	MY-68334-25
0 to 5000 psi	0.1 psi	MY-68334-27
0 to 10,000 psi	1 psi	MY-68334-31

MY-09376-01 Batteries, AA. Pk of 4

MY-17040-12 ILAC MRA, NIST-traceable calibration with data

## Handheld Differential Pressure Meters

### Intrinsically safe models for hazardous use

- Select one of nine units
- Feature zero, hold, maximum, minimum, and out-of-range, functions
- Smooth fluctuating pressure readings with filter function
- Displays average of last sixteen pressure readings



#### Specifications

**Accuracy:** ±0.2% full scale  
**Operating temperature:** 0 to 50°C (32 to 122°F)  
**Temperature range (compensated):** 20 to 30°C (68 to 86°F)  
**Media compatibility:** clean, non-corrosive, inert gases

**Process connections:** ⅛" BSP  
**Units of measure:** psi, " H₂O, cm H₂O, " Hg, mm Hg, mbar, torr, kPa, and kg/cm²  
**Power:** one 9 V battery (included)  
**Approval (intrinsically safe models):** EEx Ia IIC T4

Range	Resolution	Catalogue number
<b>Intrinsically safe differential pressure gauges</b>		
-5 to 5 psid	0.001 psi	MY-68600-06
-30 to 30 psid	0.01 psi	MY-68600-02
-100 to 100 psid	0.1 psi	MY-68600-04
<b>Non-intrinsically safe differential pressure gauges</b>		
-5 to 5 psid	0.001 psi	MY-68600-10
-30 to 30 psid	0.01 psi	MY-68600-12
-100 to 100 psid	0.1 psi	MY-68600-14

MY-95616-00 PVC tubing, 4 mm ID x 6 mm OD. Pack of 25 ft.

MY-17090-31 ILAC MRA, NIST-traceable calibration with data

## WIKA® 3A Sanitary Gauges

### Get better readings

- Glycerin fill reduces fluctuations
- Manufactured for Clean-in-Place (CIP) applications
- All-welded gauge assembly contains an external flush diaphragm
- Assembly meets the criteria set forth by 3A standards



ISO9001:2008 CERTIFIED SUPPLIER

#### Specifications

**Accuracy:** ±3-2-3% of span  
**Operating temp:** 10 to 125°C (50 to 257°F)

**Wetted materials:** 316L SS  
**Lens:** polycarbonate

**Process connection:** ¾" Tri-Clamp®  
**Casing:** 304 SS  
**Dial size:** 64 mm (2½")

Range	Resolution	Catalogue number
30 psi	0.5 psi	MY-68056-72
60 psi	1 psi	MY-68056-74
100 psi	2 psi	MY-68056-76
160 psi	2 psi	MY-68056-78

MY-17040-10 ILAC MRA, NIST-traceable calibration with data

## Cole-Parmer® Sealed SS Pressure Transducers

### No epoxies to cause signal instability or drift

- Stainless steel (SS) diaphragm and polysilicon strain gauge are bonded by vapour deposition



#### Specifications

**Temp range (compensated):** -20 to 80°C (-4 to 176°F)  
**Process connection:** ¼" NPT(M)  
**Power:** 9 to 30 VDC  
**Output:** 4 to 20 mA (call for models with 1 to 5 V output)  
**Wetted materials:** PH 17-4 SS  
**Dimensions (L x dia):** 7 x 3.8 cm (2¾" x 1½")

Range	Catalogue number
<b>Vacuum and compound transducer; ±0.4% accuracy (BFSL)</b>	
30" Hg to 0 psi	MY-07356-10
<b>Pressure transducers; ±0.4% accuracy (BFSL)</b>	
0 to 60 psi	MY-07356-52
0 to 100 psi	MY-07356-53
0 to 300 psi	MY-07356-54
0 to 750 psi	MY-07356-55
0 to 1000 psi	MY-07356-56
<b>Pressure transducer; ±0.25% accuracy (BFSL); with NIST-traceable calibration report</b>	
0 to 100 psi	MY-68001-04

## Cole-Parmer® Low-Pressure Mechanical Gauges

Perfect for accurately measuring pressures below 10 psi

- Manufactured with a chrome-plated case, use these gauges to measure low pressure in filter systems, cleanrooms, or fluidic systems



### Specifications

<b>Accuracy:</b> ±1½% full scale	<b>Wetted materials:</b> brass
<b>Dial size:</b> 64 mm (2½")	<b>Lens:</b> polycarbonate
<b>Operating temp:</b> 0 to 66°C (0 to 150°F)	<b>Process connection:</b> ¼" NPT(M)
	<b>Casing:</b> black steel

Range	Catalogue number
0 to 10" H <sub>2</sub> O	MY-68357-00
0 to 15" H <sub>2</sub> O	MY-68357-02
0 to 30" H <sub>2</sub> O	MY-68357-04
0 to 60" H <sub>2</sub> O	MY-68357-06
0 to 100" H <sub>2</sub> O	MY-68357-08
0 to 3 psi	MY-68357-14
0 to 5 psi	MY-68357-16
0 to 10 psi	MY-68357-18

MY-17040-10 ILAC MRA, NIST-traceable calibration with data

## Ashcroft® Digital Sanitary Pressure Gauges

Get more flexibility

- Offer 3A rating with the functionality of a digital gauge
- Get readings how you need them—ten engineering units
- Unlimited deadband throughout its range



### Specifications

<b>Accuracy:</b> ±0.25% full-scale	<b>Display:</b> 5-digit LCD, 0.88"H
<b>Dial size:</b> 89 mm (3½")	<b>Process connection:</b> ½" sanitary Tri-Clamp®
<b>Operating temp:</b> 10 to 60°C (14 to 140°F)	<b>Wetted materials:</b> 316 stainless steel
<b>Units of measure:</b> psi, " H <sub>2</sub> O, ft H <sub>2</sub> O, mPa, mbar, kPa, kg/cm <sup>2</sup> , bar, " Hg, mm Hg	<b>Casing:</b> 300 stainless steel
	<b>Lens:</b> polyester
	<b>Power:</b> two C batteries

Range	Resolution	Catalogue number
30 to 0" Hg	0.0001" Hg	MY-68901-50
0 to 30 psi	0.0001 psi	MY-68901-51
0 to 60 psi	0.005 psi	MY-68901-52
0 to 100 psi	0.005 psi	MY-68901-53
0 to 200 psi	0.01 psi	MY-68901-54

MY-17040-12 ILAC MRA, NIST-traceable calibration with data

## Cole-Parmer® High-Accuracy Pressure Transducers

Be more accurate, affordably

- SS sensor attached to SS electrode forms a variable capacitor



### Specifications

<b>Accuracy:</b> ±0.25% full-scale	<b>Power:</b> 9 to 30 VDC
<b>Temp range (compensated):</b> –20 to 80°C (–4 to 176°F)	<b>Wetted materials:</b> PH 17-4 SS
<b>Process connection:</b> ¼" NPT(M)	<b>Dimensions (L x dia):</b> 7 x 3.8 cm (2¾" x 1½")

Range	4 to 20 mA output	0.5 to 5.5 V output
	Catalogue number	Catalogue number
<b>Compound transmitters</b>		
–14.7 to 0 psi	MY-68075-00	MY-68075-30
–14.7 to 15 psi	MY-68075-02	MY-68075-32
<b>Gauge pressure transmitters</b>		
0 to 5 psi	MY-68075-10	MY-68075-40
0 to 10 psi	MY-68075-12	MY-68075-42
0 to 25 psi	MY-68075-14	MY-68075-44
0 to 50 psi	MY-68075-16	MY-68075-46
0 to 100 psi	MY-68075-18	MY-68075-48
0 to 250 psi	MY-68075-20	MY-68075-50

## Cole-Parmer® Economical Pressure Transducers

Accuracy in a compact, durable package

- High-performance ASIC married to a very stable polysilicon thin-film pressure sensor
- Sensor is electron-beam welded to a SS pressure fitting for high overpressure capability and outstanding durability against shock and vibration
- Circuitry is held securely within an internal cage and housed in a reinforced nylon enclosure



### Specifications

<b>Accuracy:</b> ±1% span	<b>Power:</b> 9 to 36 VDC
<b>Temp range (compensated):</b> –40 to 125°C (–40 to 257°F)	<b>Wetted materials:</b> PH 17-4 SS
<b>Process connection:</b> ¼" NPT (M)	<b>Dimensions (dia x L):</b> 2.5 x 6.4 cm (1" x 2½")

Range	4 to 20 mA output	1 to 5 VDC output
	Catalogue number	Catalogue number
30" Hg to 30 psi	MY-68900-48	MY-68900-62
0 to 30 psi	MY-68900-50	MY-68900-64
0 to 100 psi	MY-68900-52	MY-68900-66
0 to 200 psi	MY-68900-54	MY-68900-68
0 to 500 psi	MY-68900-56	MY-68900-70
0 to 1000 psi	MY-68900-58	MY-68900-72
0 to 3000 psi	MY-68900-60	MY-68900-74



# Why MASTERflex® Peristaltic Pumps?

## 1

### Easy

- Quick installation
- Low maintenance
- Easy tubing changeover

## 2

### Durable

- Trusted for over 60 years
- Broad chemical compatibility

## 3

### Versatile

- From research to process scale
- Handle just about any fluid
- Multichannel capabilities

## 4

### Customisable

- Configurable systems
- Many tubing options
- Easy scale-up

## 5

### Accurate

- Flow ranges from 0.0006- mL/min to 42-L/min
- Rigorous design and testing standards
- Tubing is custom manufactured to precise tolerances



## Selecting a Masterflex® Pump: *As-Easy-As*

### Application Requirements

- What is my required flow rate?
- What chemical am I pumping?
- Do conditions such as viscosity or back pressure play an important role in my decision?

### Base a Pump Series on Your Flow Rate

- Use the table below to find the pump series that best fits your flow rate needs

### Complete Your System

- L/S and I/P pump series are divided into three components—pump head, tubing, and drive
- Select the three components from the same series or choose a complete preconfigured system

Masterflex pump series	Features	Flow range	Speed		Remote control capability	Multichannel capabilities	Page(s)
			Fixed	Variable			
<b>C/L®</b>	Compact, low-flow pump that easily fits on benchtop or mounts within a panel	0.002 to 43 mL/min		✓	Yes	Yes	137
<b>L/S®</b>	High-accuracy drives for precise flow control and dispensing	0.00001 to 3400 mL/min	✓	✓	Yes	Yes	121–133
<b>I/P®</b>	Powerful systems that provide better protection from possible hazards such as dust and water	0.0006 to 26 LPM	✓	✓	Yes	Yes	134–135
<b>B/T®</b>	Highest flow rates—ideal for large batch fluid transfer with excellent hazard protection	0.71 to 42 LPM	✓	✓	Yes	Yes	136

## Custom **OEM** Pump Systems

When you need more than an off-the-shelf solution, you can look to Cole-Parmer as a trusted partner

With more than 100 years of combined experience, our design engineers will work directly with you to create the exact pump you need. Contact our Application Specialists to get started!

For more information, go to  
**ColeParmer.com/Masterflex**

# MASTERFLEXLIVE™

## Masterflex® Cloud-Enabled Drives Featuring MasterflexLive™

Real-time remote pump control  
and monitoring

- Secure, cloud-enabled platform for control and monitoring of select L/S® and I/P® pumps
- Get real-time control of all pump parameters, including speed, flow rate, dispense volume, and more
- Push notifications alert you to operating conditions and error messages
- Monitor and adjust critical processes running 24/7—no need to be onsite
- “Hands-free” operation lets you control pumps operating inside cleanrooms, glove boxes or isolation chambers
- Access from your PC, tablet or smartphone (iOS™ and Android™ compatible)
- Internet connection via standard Ethernet (RJ45) jack on rear of drive



EU Annex 11  
compliant





# Monitor and control your pumps via the cloud.

## 24/7 remote access from anywhere

Create a free account

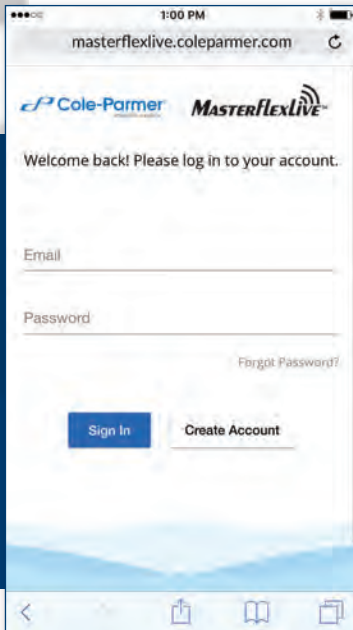

Manage & control pump parameters

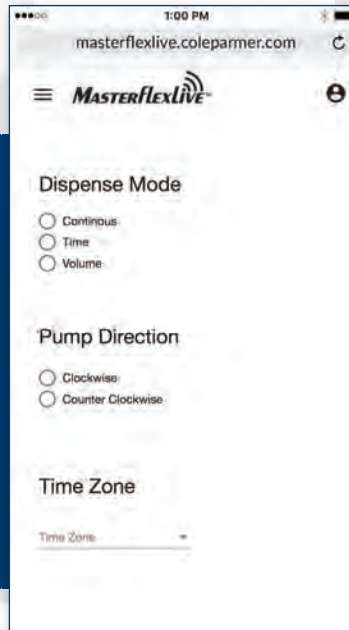

Get alerts & notifications

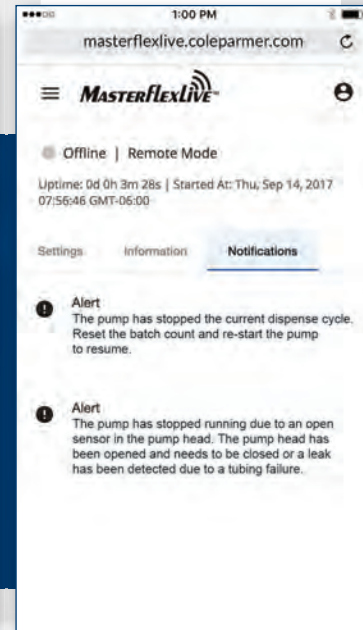

rpm	Flow range (mL/min)	Speed control (resolution)	Open-head sensor	Pump heads accepted	Motor size	IP rating	Power (50/60 Hz)	Catalogue number
<b>L/S cloud-enabled digital drive</b>								
0.02 to 100	0.001 to 588	±0.1%	Yes	2	1/10 hp (75 W)	IP33	90 to 260 VAC	MY-07551-60
0.1 to 600	0.006 to 3400							MY-07551-50
<b>L/S cloud-enabled digital process drive with 316 stainless steel housing</b>								
0.1 to 600	0.006 to 3400	±0.1%	Yes	2	1/10 hp (75 W)	IP66	90 to 260 VAC	MY-07575-70
<b>L/S cloud-enabled digital process drive with powder-coat steel housing</b>								
0.1 to 600	0.006 to 3400	±0.1%	Yes	2	1/10 hp (75 W)	IP66	90 to 260 VAC	MY-07575-72
<b>I/P cloud-enabled digital process drive with 316 stainless steel housing</b>								
0.1 to 650	0.6 to 26,000	±0.1%	Yes	2	3/8 hp (280 W)	IP66	90 to 260 VAC	MY-77420-50
<b>I/P cloud-enabled digital process drive with powder-coat steel housing</b>								
0.1 to 650	0.6 to 26,000	±0.1%	Yes	2	3/8 hp (280 W)	IP66	90 to 260 VAC	MY-77420-60

For more information go to  
[ColeParmer.com/MasterflexLive](http://ColeParmer.com/MasterflexLive)



# Masterflex® L/S® Variable-Speed Console Drives

- Compact, cost-effective for general fluid transfer applications
- Flow range: 0.42 to 2900 mL/min
- Simple operation with single-turn speed control
- Separate power switch enables you to maintain speed setting when turning drive on/off; front-panel LED indicates power on
- Reversible motor lets you easily prime/purge tubing and pump in either direction
- Remote control of start/stop via DB9 connector on back of drive

Drives accept nine different pump head types: Standard, Easy-Load®, Easy-Load II, Easy-Load 3, Multichannel, High-Performance, Cartridge, PTFE tubing, and PTFE-diaphragm. Drive 07555-05 is not recommended for use with the PTFE-tubing and PTFE-diaphragm pump heads.

**What's included:** 1.8-m (6-ft) line cord with IEC 320/CEE22 socket. Shipped with country-specific cord/plug set; please specify ultimate destination when ordering.

## FEATURES

- ✓ Compact and cost effective
- ✓ Reversible motor accepts up to two pump heads
- ✓ Remote start/stop

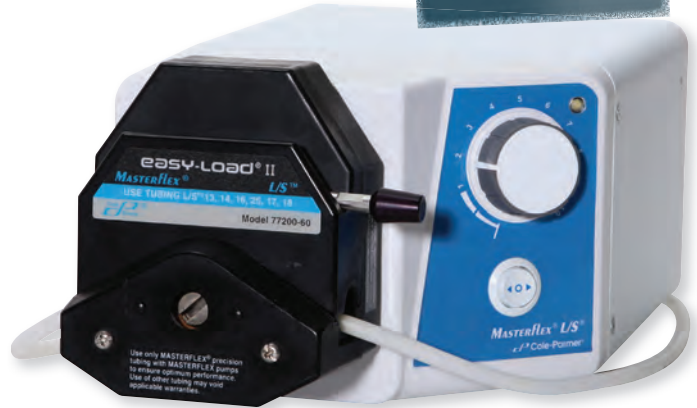

Shown with L/S Easy-Load II pump head 77200-60

### Flow Rates in mL/min (flow rates in parentheses can only be obtained with the High-Performance pump head—see page 131)

rpm	Precision pump tubing						High-performance precision pump tubing			
	L/S 13	L/S 14	L/S 16	L/S 25	L/S 17	L/S 18	L/S 15	L/S 24	L/S 35	L/S 36
	Standard <sup>†</sup> , Easy-Load®, Easy-Load II, Easy-Load 3						Multichannel <sup>‡</sup> , Standard, Easy-Load II, Easy-Load 3, High-Performance			
	Cartridge, Multichannel			Cartridge			Easy-Load			
20 to 600	1.2 to 36	4.2 to 130	16 to 480	34 to 1000	56 to 1700	76 to 2300	34 to 1000	56 to 1700	76 to 2300	96 to 2900
7 to 200	0.42 to 12	1.4 to 43	5.6 to 160	12 to 330	20 to 570	27 to 770	12 to 330 (13 to 370)	20 to 570 (21 to 600)	27 to 770 (30 to 870)	34 to 970 (41 to 1130)

<sup>†</sup>The Standard pump head is not available for L/S 25. <sup>‡</sup>Multichannel head is not available for L/S 36.



rpm	Speed control (resolution)	Pump heads accepted	Motor size	IP rating	Dimensions (L x W x H)	Power (50/60 Hz)		Catalogue number
						VAC	Amps	
20 to 600	±5%	1	½ hp (37 W)	IP22	23 x 18.3 x 13.4 cm (9.1" x 7.2" x 5.3")	180 to 260	0.8	<b>MY-07555-05</b>
7 to 200		2				180 to 260	0.8	<b>MY-07555-15</b>

### Accessories

**MY-77595-35 Foot switch**, DB9 male, 1.8-m (6-ft) cable  
**MY-07528-80 Handheld remote controller**; for control of start/stop, route tubing through handle for dispensing into containers

**MY-17050-01 ILAC MRA, NIST-traceable calibration** for peristaltic pump drive

## Choose a convenient Complete System

One catalogue number includes all 3!

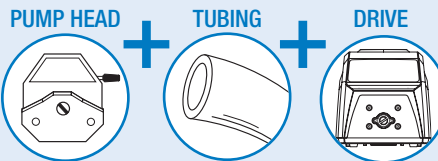

System	Flow range	What's included			Power	Catalogue number
		Pump head	Tubing	Drive		
	16 to 480 mL/min	Easy-Load® II 77200-60	C-Flex® ULTRA L/S 16 tubing 06434-16 3 m (10 ft)	Console drive 07555-05 20 to 600 rpm	230 VAC, 50/60 Hz	<b>MY-77910-45</b>
	56 to 1700 mL/min	Easy-Load II 77200-62	C-Flex ULTRA L/S 24 tubing 06434-24 3 m (10 ft)	Console drive 07555-05 20 to 600 rpm	230 VAC, 50/60 Hz	<b>MY-77910-55</b>

# Masterflex® L/S® Computer-Compatible Digital Drives

## Automate your process by interfacing drives with a computer

- Flow rate: 0.001 to 3400-mL/min with L/S tubing
- Interface drive to your PC via DB9 serial or USB connector
- Graphical LCD shows four operating modes: continuous run, time dispense, copy dispense, and volume dispense
- View pump performance continually
- Antidrip function ensures dispensing accuracy
- Remote control capabilities via DB25 female connector on drive

**FEATURES**

- ✓ Flow rates: 0.001 to 3400 mL/min
- ✓ Variable speed from 0.02 to 600 rpm
- ✓ Programmable, reversible motor accepts up to four pump heads
- ✓ Remote functionality

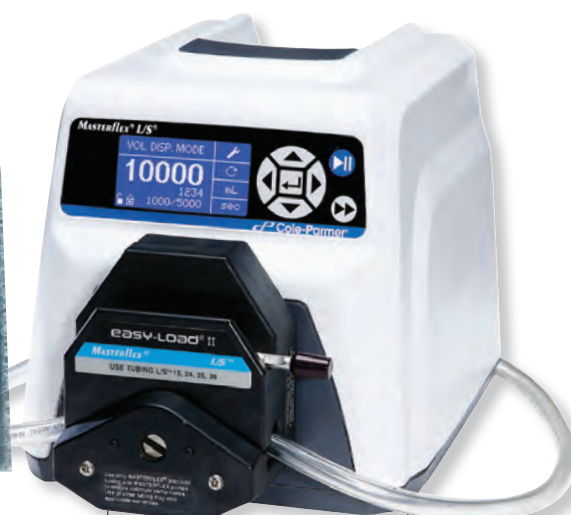

Drive 07551-20 shown with L/S Easy-Load II pump head 77200-62

Drives offer analogue remote control options and simple programming—ideal for automated process applications. Precise PWM speed control ( $\pm 0.1\%$ ) maximises accuracy and efficiency while the brushless motor gives you quiet, maintenance-free reliability.

**What's included:** 1.8-m (6-ft) line cord with IEC 320/EE22 socket. Shipped with country-specific plug/cord set; please specify ultimate destination when ordering.



rpm	Speed control (resolution)	Open-head sensor	Pump heads accepted	Motor size	IP rating	Dimensions (L x W x H)	Power (50/60 Hz)		Catalogue number
							VAC	Amps	
0.1 to 600	$\pm 0.1\%$ (0.1 rpm at 600 rpm; 0.01 rpm at 100 rpm)	No	2	1/10 hp (75 W)	IP33	25.4 x 21.6 x 21.6 cm (10" x 8 1/2" x 8 1/2")	90 to 260 VAC	1.1 at 230 VAC	MY-07551-20
0.02 to 100		No	4						MY-07551-30

### Accessories

- MY-07523-92 Foot switch**, momentary start/stop; 1.8-m (6-ft) cable
- MY-07523-94 DB25 male connector**. Use to create your own cable
- MY-07523-95 Cable assembly**, DB25 male connector and 7.9-m (25-ft) cable with stripped wire ends for remote control

- MY-07523-98 Tilt bail**, use to securely elevate front of drive
- MY-07523-97 Handheld remote controller**, DB9; for on/off control; route tubing through handle for filling and dispensing applications
- MY-17050-01 ILAC MRA, NIST-traceable calibration** with data for peristaltic pump drive

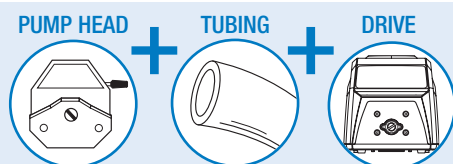

Choose a convenient Complete System  
One catalogue number includes all 3!

System	Flow range	What's included			Power	Catalogue number
		Pump head	Tubing	Drive		
	0.08 to 480-mL/min	Easy-Load® 3 77800-60	C-Flex® ULTRA L/S 16 tubing 06434-16 3-m (10 ft)	Computer-compatible drive 07551-20 0.1 to 600 rpm	115/230 VAC, 50/60 Hz	MY-77924-55
	0.28 to 1700-mL/min	Easy-Load II 77200-62	C-Flex® ULTRA L/S 24 tubing 06434-24 3-m (10 ft)			MY-77924-65

# Masterflex® L/S® Precision Variable-Speed Console Drives

## Don't lose control of your metering applications—digital display gives you repeatable control

- Accurate and repeatable settings with 3-digit LED display of rpm
- Pump fluid in either direction with reversible motor—perfect for purging tubing
- Save space and increase productivity by stacking 2 or 4 pump heads on the same drive to create a multichannel pump system
- Maximise processes in a minimal footprint by stacking splash-resistant, IP33-rated drives
- Two ways to control speed, direction, and start/stop—use either the membrane keypad or remote control capabilities
- Customise for your application—drives accept nine pump head types: Standard, Easy-Load®, Easy-Load II, Easy-Load 3, Multichannel, High-Performance, Cartridge, PTFE-Tubing, and PTFE-Diaphragm

**FEATURES**

- ✓ Flow rates: 0.06 to 3400 mL/min
- ✓ Variable speed from 1 to 600 rpm
- ✓ Reversible motor accepts up to four pump heads



Stack up to 4 heads to maximise productivity in less space



### Flow Rates in mL/min (flow rates in parentheses can only be obtained with the High-Performance pump head—see page 131)

rpm	Precision pump tubing						High-performance precision pump tubing			
	L/S 13	L/S 14	L/S 16	L/S 25	L/S 17	L/S 18	L/S 15	L/S 24	L/S 35	L/S 36
	Standard†, Easy-Load, Easy-Load II, Easy-Load 3						Multichannel†, Standard†, Easy-Load II, Easy-Load 3, High-Performance			
	Cartridge, Multichannel			Cartridge			Easy-Load			
6 to 600	0.36 to 36	1.3 to 130	4.8 to 480	10 to 1000	17 to 1700	23 to 2300	10 to 1000 (11 to 1100)	17 to 1700 (18 to 1800)	23 to 2300 (26 to 2600)	29 to 2900 (34 to 3400)
1 to 100	0.06 to 6	0.21 to 21	0.8 to 80	1.7 to 170	2.8 to 280	3.8 to 380	1.7 to 170 (1.8 to 180)	2.8 to 280 (3.0 to 300)	3.8 to 380 (4.3 to 430)	4.8 to 480 (5.8 to 580)

†The Standard pump head is not available for L/S 25. ‡Multichannel head is not available for L/S 36. Multichannel and Cartridge heads are available for microbore tubing.



rpm	Speed control (resolution)	Pump heads accepted	Motor size	IP rating	Dimensions (L x W x H)	Power (50/60 Hz)		Catalogue number
						VAC	Amps	
6 to 600	±0.25% (1 rpm at 600 rpm; 0.1 rpm at 100 rpm)	2	1/10 hp (75 W)	IP33	25.4 x 21.6 x 21.6 cm (10" x 8.5" x 8.5")	90 to 260	1.2 at 230 VAC	MY-07528-10
3 to 300		2						MY-07528-20
1 to 100		4						MY-07528-30

### Accessories

- MY-07595-45 Connector**, DB9 male. Use for 4 to 20 mA remote control
- MY-07595-47 Cable assembly**, DB9 male connector and 7.9-m (25-ft) cable with stripped wire terminal ends. Use for remote control
- MY-77595-35 Foot switch**, DB9 male

- MY-07528-80 Handheld remote controller**; for remote control of start/stop, route tubing through handle for dispensing into containers
- MY-17050-01 ILAC MRA, NIST-traceable calibration** with data for peristaltic pump drive

## Choose a convenient Complete System

One catalogue number includes all 3!

**PUMP HEAD**

**TUBING**

**DRIVE**

System	Flow range	What's included			Power	Catalogue number
		Pump head	Tubing	Drive		
	4.8- to 480-mL/min	Easy-Load® 3 77800-60	C-Flex® ULTRA L/S 16 tubing 06434-16 3 m (10 ft)	Precision console drive 07528-10 6 to 600 rpm	90 to 260 VAC, 50/60 Hz	MY-77916-10
	17- to 1700-mL/min	Easy-Load II 77200-62	C-Flex® ULTRA L/S 24 tubing 06434-24 3 m (10 ft)			MY-77916-20



# Masterflex® L/S® Variable-Speed Digital Drives

## Versatile, worry-free operation

- Brushless, maintenance-free motor provides ±0.1% speed control accuracy with 6000:1 turndown ratio
- Bright graphical LCD offers easy programming, four operating modes, and seven languages
- Get more accurate dispensing with preprogrammed calibration
- Drives accept all L/S pump heads for more pumping versatility
- Models equipped with open-head sensor stop drive motor when pump head is opened—pair with an open-head sensor equipped pump head (see pages 130–131)
- Operate remotely via DB25 female connector

**FEATURES**

- ✓ Flow rates: 0.001 to 3400 mL/min
- ✓ Variable speed from 0.02 to 600 rpm
- ✓ Programmable, reversible motor accepts up to four pump heads
- ✓ Ensure dispensing accuracy with antidrip function
- ✓ Hands-free dispensing via time interval dispense cycles

Four operating modes for more functionality: continuous run, time dispense, copy dispense, and volume dispense



rpm	Speed control (resolution)	Open-head sensor	Pump heads accepted	Motor size	IP rating	Dimensions (L x W x H)	Power	Catalogue number
0.1 to 600	±0.1% (0.1 rpm at 600 rpm; 0.01 rpm at 100 rpm)	No	2	1/10 hp (75 W)	IP33	25.4 x 21.6 x 21.6 cm (10" x 8.5" x 8.5")	90 to 260 VAC, 50/60 Hz	MY-07522-20
		Yes						MY-07522-28
0.02 to 100		No	4	1/10 hp (75 W)	IP33	25.4 x 21.6 x 21.6 cm (10" x 8.5" x 8.5")	90 to 260 VAC, 50/60 Hz	MY-07522-30
		Yes						MY-07522-38

**MY-07523-92 Foot switch**, momentary start/stop; 1.8-m (6-ft) cable  
**MY-07523-94 DB25 male connector**. Use to create your own cable  
**MY-07523-95 Cable assembly** for remote control; DB25 male connector and 7.9-m (25-ft) cable with stripped wire ends

**MY-07523-97 Handheld remote controller**; route tubing through handle for dispensing into containers  
**MY-17050-01 ILAC MRA, NIST-traceable calibration** with data for peristaltic pump drive

PUMP HEAD

TUBING

DRIVE

## Choose a convenient Complete System

One catalogue number includes all 3!

System	Flow range	What's included			Power	Catalogue number
		Pump head	Tubing	Drive		
	0.08 to 480-mL/min	Easy-Load® 3 77800-60	C-Flex® ULTRA L/S 16 tubing 06434-16 3-m (10 ft)	Digital drive 07522-20 0.1 to 600 rpm	90 to 260 VAC, 50/60 Hz	MY-77921-65
	0.28 to 1700-mL/min	Easy-Load II 77200-62	C-Flex ULTRA L/S 24 tubing 06434-24 3-m (10 ft)			MY-77921-75

**Application Solution**

### Challenge

A manufacturer of safety glass and laminated glass was looking for a pump that could dispense coating resins for plate glass to provide protection and build shatter resistance. The resins used in the process could be polyurethane, epoxy, or other coatings, and in the past the resins ate through dispensing tubing. As a result, the manufacturer needed to find a pump system with tubing that had the appropriate chemical compatibility. Likewise, the pump system needed to offer quick maintenance for tube changes.

### Solution

The customer tested silicone tubing for chemical resistance and found it to be suitable for the resins being dispensed. The customer then chose the L/S variable-speed digital drive 07522-20 for its precision pumping and speed control. The manufacturer also selected an Easy-Load II pump head for quick maintenance and reduced downtime during tubing changes.

## Masterflex® L/S® Digital Modular Dispensing Drives

### Three dispensing modes and precision low-maintenance motor

- Graphical LCD shows four operating modes: continuous run, timed dispense, copy dispense, volume dispense
- Dispense by mL—volume in mL of each dispense, 0.001 to 9999 mL; Copy—1 to 9999 dispense cycles; or SEC—time interval between each dispense cycle (1 to 9999 secs)
- Antidrip function ensures dispense accuracy
- Brushless, maintenance-free motor offers ±0.1% speed control accuracy and a 6000 to 1 turndown ratio

**A. Modular Drive with Benchtop Controller** features a stackable, splash-resistant ABS plastic controller housing and epoxy finished steel drive housing.

**B. Washdown Modular Drive with Wall-Mount Controller** has a powder-coated aluminum controller housing and powder-coated steel drive housing.

**What's included:** 1.8-m (6-ft) cable to connect drive and controller and 1.8-m (6-ft) line cord with IEC 320/CEE22 socket. Shipped with country-specific plug/cord set; please specify destination when ordering.



#### FEATURES

- ✓ Flow rates: 0.001 to 3400 mL/min depending on drive rpm and tubing size
- ✓ Variable speed
- ✓ Programmable, reversible motor accepts up to two pump heads and offers remote functionality

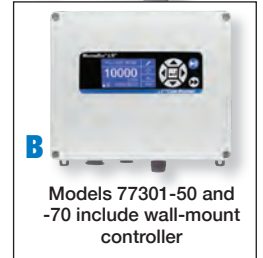

Models 77301-50 and -70 include wall-mount controller



rpm	Speed control	Pump heads accepted	Motor size	IP rating	Dimensions (L x W x H)	Power (50/60 Hz)		Catalogue number
						VAC	Amps	
<b>A. Digital modular drive with benchtop controller</b>								
0.1 to 600	±0.1%	2	1/10 hp (75 W)	IP33	Controller: 26.7 x 21 x 12.7 cm (10 1/2" x 8 1/4" x 5") Drive: 26.7 x 9.7 x 11.7 cm (10 1/2" x 3 13/16" x 4 5/8")	90 to 260	1.1 at 230 VAC	MY-77301-40
0.02 to 100		4						MY-77301-60
<b>B. Digital washdown modular drive with washdown, wall-mount controller</b>								
0.1 to 600	±0.1%	2	1/10 hp (75 W)	IP66/ NEMA 4X	Controller: 23 x 30 x 11.4 cm (9" x 11 3/4" x 4 1/2") Drive: 39.5 x 17.8 x 15.2 cm (15 9/16" x 7" x 6")	90 to 260	1.1 at 230 VAC	MY-77301-50
0.02 to 100		4						MY-77301-70

## Masterflex® L/S® Digital Console Process Drives

### Transfer, dispense, and meter in lab, process and washdown environments

- IP66 and NEMA 4X rated. Sealed housing and sealed keypad—simply hose down to clean
- Flow rate: 0.001 to 3400-mL/min with L/S tubing depending on drive rpm and tubing size
- Graphical LCD shows six different parameters: motor rpm, flow rate, dispense volume, cumulative volume, dispense interval time, and copy number.
- Dispense by: volume, copy, or time with programmable delay interval
- Remote control capabilities via waterproof connection
- Models equipped with open-head sensor stop drive motor when pump head is opened—pair with an open-head sensor equipped pump head

**What's included:** 1.8-m (6-ft) line cord—features IEC 320/CEE 22 connector coupler; watertight cord connection. Please specify destination country when ordering; drive is shipped with country-specific plug/cord set.

#### FEATURES

- ✓ Flow rates: 0.001 to 3400 mL/min
- ✓ IP66 and NEMA 4X rated
- ✓ Programmable, reversible motor accepts two or four pump heads and offers remote functionality



Drive 07575-38 shown with L/S Easy-Load II pump head 77200-32



rpm	Speed control (resolution)	Open-head sensor	Pump heads accepted	Motor size	IP rating	Dimensions (L x W x H)	Power	Catalogue number
<b>Digital process drive with 316 stainless steel housing</b>								
0.1 to 600	±0.1%	No	2	1/10 hp (75 W)	IP66	30.5 x 22.9 x 23.6 cm (12" x 9" x 9 5/16")	90 to 260 VAC, 50/60 Hz	MY-07575-30
0.02 to 100		Yes						4
<b>Digital process drive with powder-coat steel housing</b>								
0.1 to 600	±0.1%	No	2	1/10 hp (75 W)	IP66	30.5 x 22.9 x 23.6 cm (12" x 9" x 9 5/16")	90 to 260 VAC, 50/60 Hz	MY-07575-40
0.02 to 100		Yes						4
<b>MY-07575-84 Washdown foot switch, momentary start/stop; 1.8-m (6-ft) cable</b>								
<b>MY-07575-80 Cable assembly for remote control; 31-pin round connector and 7.9-m (25-ft) cable with stripped wire ends</b>								
<b>MY-17050-01 ILAC MRA, NIST-traceable calibration with data for peristaltic pump drive</b>								

## Masterflex® L/S® Precision Variable-Speed Modular Drives

### Ideal for limited spaces, hoods, or isolation chambers

- Three-digit LED display shows motor rpm—confirm speed setting at a glance
- Remote control capabilities: speed, direction, and start/stop
- ±0.25% speed control for precise flow regulation—ideal for metering

#### A. Modular Drives with Benchtop Controller

feature a stackable, splash-resistant ABS plastic controller housing and epoxy-finished steel drive housing. Remote control via a DB9 female connector on back of controller.

#### B. Washdown Modular Drives with Wall-Mount Controller

have a powder-coated aluminum controller housing and powder-coated steel drive housing. Remote control via weather-resistant connection on controller.

#### FEATURES

- ✓ Flow rates: 0.06 to 3400 mL/min
- ✓ Easy up-front control of speed, direction, and start/stop
- ✓ Reversible motor—purge tubing before or after pumping; pump fluid in either direction

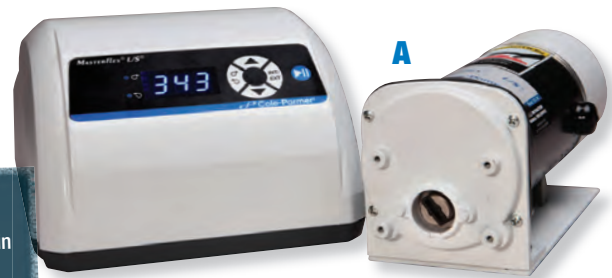

**B**  
Models 07557-60 and -70 include wall-mount controller



rpm	Speed control (resolution)	Pump heads accepted	Motor size	IP rating	Dimensions (L x W x H)	Power (50/60 Hz)		Catalogue number
						VAC	Amps	
<b>A. Precision modular drives with benchtop controller</b>								
6 to 600	±0.25% (1 rpm at 600 rpm; 0.1 rpm at 100 rpm)	2	1/10 hp (75 W)	IP33	Controller: 3.2 x 2.5 x 1.5 m Drive: 3.3 x 1.3 x 1.4 m	90 to 260	1.1 at 230 VAC	MY-07557-00
1 to 100		4						MY-07557-10
<b>B. Precision washdown modular drives with washdown wall-mount controller</b>								
6 to 600	±0.25% (1 rpm at 600 rpm; 0.1 rpm at 100 rpm)	2	1/10 hp (75 W)	IP66/ NEMA 4X	Controller: 2.7 x 3.6 x 1.4 m Drive: 4.7 x 2.1 x 1.8 m	90 to 260	1.1 at 230 VAC	MY-07557-60
1 to 100		4						MY-07557-70

**MY-07557-51 Extension cable**, 2.7-m (9-ft); extend distance between motor and controller

**MY-07595-47 Cable assembly**, for benchtop modular drives; DB9 male connector and 7.9-m (25-ft) cable with stripped wire terminal ends. Use for remote control

**MY-77300-32 Cable assembly**, for washdown modular drives; 18-pin round connector and 7.9-m (25-ft) cable with stripped wire terminal ends. Use for remote control

**MY-17050-01 ILAC MRA, NIST-traceable calibration** with data for peristaltic pump drive

## Masterflex® L/S® Precision Console Process Drives

### Stand up to process and washdown applications

- IP66 and NEMA 4X rated; sealed housing and sealed membrane keypad
- Three-digit LED display lets you confirm speed setting at a glance
- Open-head sensor stops drive motor when pump head is opened—pair with an open-head sensor equipped pump head
- Remote control capabilities via a watertight connector on back of drive

Accurate console drives have powerful motors, speed display, and ±0.25% speed control for precise flow regulation—ideal for metering applications. Separate speed and power (on/off) control lets you maintain speed setting while turning pump on/off. Remote speed control requires cable assembly 77300-32.

**What's included:** 1.8-m (6-ft) line cord with IEC 320/CEE22 socket. Shipped with country-specific plug/cord set; please specify ultimate destination when ordering.

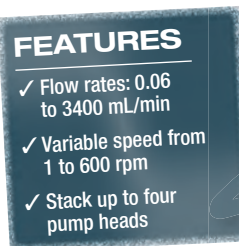

Drive 07528-40 shown with L/S Easy-Load® II pump head 77200-32



rpm	Speed control (resolution)	Open-head sensor	Pump heads accepted	Motor size	IP rating	Dimensions (L x W x H)	Power	Catalogue number
<b>Precision process drives with 316 stainless steel housing</b>								
6 to 600	±0.25%	Yes	2	1/10 hp (75 W)	IP66/ NEMA 4X	30.5 x 22.9 x 23.6 cm (12" x 9" x 9 5/16")	90 to 260 VAC, 50/60 Hz	MY-07528-40
1 to 100			4					MY-07528-45
<b>Precision process drives with powder-coat steel housing</b>								
6 to 600	±0.25%	Yes	2	1/10 hp (75 W)	IP66/ NEMA 4X	30.5 x 22.9 x 23.6 cm (12" x 9" x 9 5/16")	90 to 260 VAC, 50/60 Hz	MY-07528-50
1 to 100			4					MY-07528-55

#### Accessories

**MY-77300-32 Cable assembly**, for precision process drives; 18-pin round connector and 7.9-m (25-ft) cable with stripped wire ends

**MY-17050-01 ILAC MRA, NIST-traceable calibration** for peristaltic pump drive



## Masterflex® L/S® Variable-Speed Economy Modular Drives

### Versatile with a wide flow range and simple controls

- Separate motor and controller are connected via a 1.9-m (6-ft) cable—place components where convenient or where space allows
- Single-turn speed control and on/off switch with green power indicator—maintain speed setting while turning pump on and off
- Painted steel housing is IP33 rated

A perfect upgrade from a fixed-speed drive, these variable-speed drives offer a wider rpm range, ±2% speed regulation, and ETL and CE listings. For added versatility, drives accept all L/S pump heads.



#### FEATURES

- ✓ Flow rates: 0.06 to 3400 mL/min
- ✓ Variable speed—1 to 100 or 6 to 600 rpm
- ✓ Convenient modular design

MASTERFLEX®

#### Flow Rates in mL/min (flow rates in parentheses can only be obtained with the High-Performance pump head—see page 131)

rpm	Precision pump tubing						High-performance precision pump tubing			
	L/S 13	L/S 14	L/S 16	L/S 25	L/S 17	L/S 18	L/S 15	L/S 24	L/S 35	L/S 36
	Standard†, Easy-Load®, Easy-Load II, Easy-Load 3						Multichannel‡, Standard†, Easy-Load II, Easy-Load 3, High-Performance			
	Cartridge, Multichannel			Cartridge			Easy-Load			
6 to 600	0.36 to 36	1.3 to 130	4.8 to 480	10 to 1000	17 to 1700	23 to 2300	10 to 1000 (11 to 1100)	17 to 1700 (18 to 1800)	23 to 2300 (26 to 2600)	29 to 2900 (34 to 3400)
1 to 100	0.06 to 6	0.21 to 21	0.8 to 80	1.7 to 170	2.8 to 280	3.8 to 380	1.7 to 170 (1.8 to 180)	2.8 to 280 (3.0 to 300)	3.8 to 380 (4.3 to 430)	4.8 to 480 (5.8 to 580)

†The Standard pump head is not available for L/S 25.

‡Multichannel head is not available for L/S 36. Multichannel and Cartridge heads are available for microbore tubing.

ISO9001:2008  
CERTIFIED SUPPLIER



rpm	Speed control (resolution)	Pump heads accepted	Motor size	IP rating	Dimensions (L x W x H)	Power (50/60 Hz)		Catalogue number
						VAC	Amps	
6 to 600	±2%	2	1/10 hp (75 W)	Controller: IP33 Motor: IP21	Controller: 20.4 x 16.4 x 8.7 cm (8" x 6.4" x 3.4") Motor: 19.8 x 9.7 x 11.5 cm (7.8" x 3.8" x 4.5")	190 to 260	1.2 at 230 VAC	MY-07559-05
1 to 100	±2%	4	1/10 hp (75 W)	Controller: IP33 Motor: IP21	Controller: 20.4 x 16.4 x 8.7 cm (8" x 6.4" x 3.4") Motor: 19.8 x 9.7 x 11.5 cm (7.8" x 3.8" x 4.5")	190 to 260	1.2 at 230 VAC	MY-07559-15

MY-17050-01 ILAC MRA, NIST-traceable calibration with data for peristaltic pump

## Masterflex® L/S® High-Pressure Pumps

### Pump at pressures up to 125 psi (8.5 bar)

- Three-digit LED display shows motor rpm—confirm speed setting at a glance
- High-performance pump head offers automatic occlusion—optimised when pump head is closed and latched—load tubing in 15 seconds or less
- Pump at pressures up to 125 psi (8.5 bar) with included L/S 16HP tubing—ideal for feed, filtration, and metering applications
- Models equipped with open-head sensor stop the drive motor when pump head is opened



MASTERFLEX®

77914-25,  
-27

ISO9001:2008  
CERTIFIED SUPPLIER



System	Flow range	What's included			Power	Catalogue number
		Pump head	Tubing	Drive		
	0.9 to 90 mL/min	High-Performance 77252-72		Precision console drive with ABS plastic housing 07528-30 1 to 100 rpm		MY-77914-20
	0.9 to 90 mL/min	High-Performance (open-head sensor) 77252-62	PharMed BPT L/S 16HP high-pressure tubing 05664-16 2.4-m (8 ft)	Precision process drive with powder-coat steel housing 07528-55 1 to 100 rpm	90 to 260 VAC, 50/60 Hz	MY-77914-25
	0.9 to 90 mL/min			Precision process drive with stainless steel housing 07528-45 1 to 100 rpm		MY-77914-27

## Masterflex® L/S® Fixed-Speed Drives

### Get consistent, repeatable flow rates

- Stackable drives are ideal for field or lab use
- Lighted power switch on front of drive indicates that pump is running
- Accept five different pump head types: Standard, Easy-Load®, Easy-Load II, Easy-Load 3, and Cartridge

**What's included:** 1.8-m (6-ft) line cord, European plug.

#### FEATURES

- ✓ Flow rates: 0.06 to 290 mL/min
- ✓ General, intermittent-duty fluid transfer applications



Drive 07540-01 shown with Easy-Load II pump head 77200-62

#### Flow Rates in mL/min<sup>††</sup>

rpm	Precision pump tubing					
	L/S 13	L/S 14	L/S 16	L/S 25	L/S 17	L/S 18
	Standard <sup>†</sup> , Easy-Load, Easy-Load II, Easy-Load 3					
	Cartridge <sup>‡</sup>					
1	0.06	0.21	0.8	1.7	2.8	3.8
2	0.12	0.42	1.6	3.4	5.6	7.6
6	0.36	1.3	4.8	10	17	23
12	0.72	2.5	9.6	20	34	46
20	1.2	4.2	16	34	56	76
30	1.8	6.3	24	50	84	110
60	3.6	13	48	100	170	230

rpm	High-Performance Precision pump tubing			
	L/S 15	L/S 24	L/S 35	L/S 36
	Standard, Easy-Load II, Easy-Load 3			
	Easy-Load			
1	1.7	2.8	3.8	4.8
2	3.4	5.6	7.6	9.6
6	10	17	23	29
12	20	34	46	58
20	34	56	76	96
30	50	84	110	140
60	100	170	230	290

<sup>†</sup>Standard pump head is not available for L/S 25. <sup>‡</sup>Cartridge heads are available for microbore tubing. <sup>††</sup>Motor rpm and flow rates for the 230 VAC, 50 Hz economy drives are approximately 5% of values shown.

MASTERFLEX®

ISO9001:2008 CERTIFIED SUPPLIER cULus CE

rpm	Speed control	Pump heads accepted	Motor size	IP rating	Dimensions (L x W x H)	Catalogue number
<b>230 VAC/50 Hz models</b>						
1	None <sup>††</sup>	2	Sub-fractional (<1/25 hp) <sup>†††</sup>	IP22	15.2 x 13.4 x 11.9 cm (6" x 5 1/4" x 4 3/8")	MY-07542-01
2						MY-07542-02
5						MY-07542-06
10						MY-07542-12
17						MY-07542-20
25	MY-07542-30					
50	1	MY-07542-60				

<sup>††</sup>Drive speed may vary ±15%, subject to fluctuations in line voltage and frequency. <sup>†††</sup>Maximum power required is 70 W or less.

## Masterflex® L/S® Digital Miniflex® Pumps

### Small footprint, yet delivers accurate flow over a wide range

- Flow range of 0.005 to 381 mL/min (depending on tubing size)
- Tubing calibration function ensures accuracy
- Open-head sensor stops drive when pump head is opened
- Remote control via 25-pin connector on back of drive
- Automatic tubing retention makes tube loading quick and easy

Compact, stackable pump with durable ABS housing is easy to wipe down. The Miniflex pump head features a wide occlusion angle that prevents fluid backflow up to the rated pressure of the tubing. Self-lubricating thermoplastic polyester rollers are low friction and long wearing for smooth operation and long life.

#### Flow Rates (mL/min) at 0.1 to 300 rpm

Pump model	Precision pump tubing			
	L/S 13	L/S 14	L/S 16	L/S 25
07525-20	0.005 to 14	0.018 to 55	0.061 to 184	0.127 to 381
07525-40	0.005 to 14	0.018 to 55	0.061 to 184	—

Number of channels	rpm	Speed control (repeatability)	Reversible motor	IP rating	Dimensions (L x W x H)	Power (50/60 Hz)		Catalogue number
						VAC	Amps	
1	0.1 to 300	±0.1%	Yes	IP33	23.9 x 14.0 x 15.7 cm (9.4" x 5.5" x 6.2")	90 to 260	0.2 at 230 VAC	MY-07525-20
2								MY-07525-40

**MY-07523-92 Foot switch**, momentary start/stop; DB25 male; 1.8-m (6-ft) cable  
**MY-07523-95 Cable assembly**, DB25 male connector and 7.9-m (25-ft) cable with stripped wire ends



#### FEATURES

- ✓ Flow rates: 0.005 to 381 mL/min
- ✓ Intuitive icon-driven programming
- ✓ Tubing calibration for accuracy
- ✓ Single- or dual-channel models

MASTERFLEX®

Power supplies are:

ISO9001:2008 CERTIFIED SUPPLIER cULus CE

**MY-07523-97 Handheld remote controller**, DB25 male, route tubing through handle for dispensing applications; 1.8-m (6-ft) cable  
**MY-17050-01 ILAC MRA, NIST-traceable calibration** with data for peristaltic pump drive

# Masterflex® Drives Powering Quattroflow™ Pumps

## Move your delicate biological fluids

- Diaphragms enable soft, gentle pumping through the strokes generated by the eccentric shaft
- No mechanical seal or rotating parts that can fail—only the diaphragm and body come in contact with the fluid

**Quattroflow Pumps** offer a unique four diaphragm (chamber) design, providing the constant low-pulsation, low-shear pumping needed for your biological fluids. In addition, the quaternary diaphragm design enables risk-free dry-running, self-priming, and a high turn-down ratio. Both the single-use and multiple-use models safely and reliably pump plasma products, proteins, monoclonal antibodies, vaccines, and more.

Single-use pump heads have a disposable wetted chamber constructed of solid polypropylene (PP) that can be replaced as a complete unit—eliminating the cleaning validation, sterilisation process. You can quickly turn around equipment from one batch to the next, maximising production operations. Come pre-sterilised and double bagged.

Multiple-use pump systems ensure total product containment without abrasion and minimal particle creation. Stainless steel construction handles higher pressure applications including cross-flow filtration and chromatography columns.

**Special Masterflex Drives** were developed to best take advantage of the operating parameters of the Quattroflow pumps. Drives feature an intuitive interface, remote control functionality, and a brushless, maintenance-free motor with  $\pm 0.1\%$  speed control accuracy. The graphical LCD shows six different parameters: motor rpm, flow rate, dispense volume, cumulative volume, dispense interval time, and copy number.

Plastic-enclosed drive has an IP33 rating for benchtop lab applications and has been combined with the lower flow QF150 series pump head.

Stainless steel drives have IP66 and NEMA 4X ratings and are designed for both the QF150 and QF1200 series. Sealed stainless steel housing and sealed keypad are protected from dust, water, and chemicals in the washdown environment—simply hose down to clean.



### Applications

- Cross-flow systems
- Tangential flow filtration
- Chromatography systems
- Reaction dosing
- Virus or sterile filtration
- Buffer mixing systems
- Virus cultures
- Bacterial and viral vaccines
- Cell cultures
- Cell culture supernatants
- Enzyme solutions
- Antibodies
- Virus inactivation

Systems			Replacement pump heads
Pump head model	Drive type	Catalogue number	Catalogue number
QF150SU (single use)	ABS plastic, IP33	<b>MY-74000-35</b>	<b>MY-76000-00</b>
	Stainless steel, IP66 and NEMA 4X	<b>MY-74000-37</b>	<b>MY-76000-00</b>
QF150S (multiple use)	ABS plastic, IP33	<b>MY-74000-31</b>	<b>MY-76000-06</b>
	Stainless steel, IP66 and NEMA 4X	<b>MY-74000-33</b>	<b>MY-76000-06</b>
QF1200SU (single use)	Stainless steel, IP66 and NEMA 4X	<b>MY-74000-47</b>	<b>MY-76000-02</b>
QF1200S (multiple use)	Stainless steel, IP66 and NEMA 4X	<b>MY-74000-43</b>	<b>MY-76000-08</b>

### Specifications for Quattroflow Pumps

Model	QF150SU (single use)	QF150S (multiple use)	QF1200SU (single use)	QF1200S (multiple use)
Flow range	1 to 180 L/h (0.26 to 48 GPH)	1 to 180 L/h (0.26 to 48 GPH)	20 to 960 L/h (5.3 to 253 GPH)	20 to 960 L/h (5.3 to 253 GPH)
Max pressure	For fluid temp <40°C (104°F) 4 bar (58 psi)	4 bar (58 psi)	4 bar (58 psi)	6 bar (87 psi)
	For fluid temp >40°C (104°F) 4 bar (58 psi)	4 bar (58 psi)	4 bar (58 psi)	4 bar (58 psi)
Max fluid temperature	60°C (140°F)	80°C (176°F)	60°C (140°F)	80°C (176°F)
Suction lift at 300 rpm	2 to 3 m (6.6 to 9.8 ft)	2 to 3 m (6.6 to 9.8 ft)	2 to 3 m (6.6 to 9.8 ft)	2 to 3 m (6.6 to 9.8 ft)
Volume per revolution	At free output 1.2 mL	1.2 mL	9.6 mL	9.6 mL
	Without connector 15 mL	15 mL	75 mL	75 mL
Connection type	6.4 mm (¼") Tri-Clamp®	6.4 mm (¼") Tri-Clamp	19 mm (¾") Tri-Clamp	19 mm (¾") Tri-Clamp
Position of connectors	In-line	In-line	In-line	In-line
Connector direction options	4	4	4	4
Wetted materials	PP (housing, valve plate), TPE (diaphragm), EPDM (valves, O-rings)	316L SS (housing, valve plate), TPE (diaphragm), EPDM (valves, O-rings)	PP (housing, valve plate), TPE (diaphragm), EPDM (valves, O-rings)	316L SS (housing, valve plate), TPE (diaphragm), EPDM (valves, O-rings)

### Specifications for Masterflex Drives

Description	ABS plastic drive for QF150	Stainless steel drive for QF150	Stainless steel drive for QF1200
Speed	3000 rpm	3000 rpm	1700 rpm
Speed control	$\pm 0.1\%$	$\pm 0.1\%$	$\pm 0.1\%$
Motor size	½ hp (0.05 kW)	½ hp (0.05 kW)	¾ hp (0.26 kW)
IP rating	IP33	IP66 and NEMA 4X	IP66 and NEMA 4X
Dispense modes	Motor rpm, flow rate, dispense volume, cumulative volume, dispense interval time, and copy number		
Input/output communications	Speed control: scalable 0 to 20 mA, 4 to 20 mA, 0 to 10 V; Pumping direction: requires open collector or contact enclosure; Start/stop/purge: requires open collector or contact closure; Tachometer output: scalable 0 to 20 mA, 4 to 20 mA, 0 to 10 V		
Power	90 to 260 VAC		



# Masterflex® Drives Enhance Worker Protection

You take your safety seriously, and so do we.

You review every step of the process to take care of your staff and to benefit your business. We've added a new option to our Masterflex product line to help enhance protection in your workplace.

## Open-Head Interlock Sensor Technology

Available integrated into select L/S® and I/P® drives or as a retrofit system, the open-head interlock sensors add an extra level of protection for operators who maintain pumps. When paired with an open-head sensor equipped pump head, the drive automatically shuts down when the pump head is opened, eliminating exposure to the moving rollers connected to the drive shaft.

Read the article *How Masterflex Pumps with Open Head Sensors Enhance Worker Protection* on our web site at <https://www.coleparmer.co.uk/tech-article/enhanced-worker-safety-open-head-interlock-sensor>

## Masterflex products with integrated open-head sensors

L/S Computer-Compatible Digital Drives [page 121](#)

L/S Variable-Speed Digital Drives [page 122](#)

L/S Digital Console Process Drives [page 124](#)

L/S Precision Console Process Drives [page 125](#)

L/S High-Pressure Pumps [page 126](#)

L/S Digital Miniflex® Pumps [page 127](#)

L/S Easy-Load® II Pump Heads [page 130](#)

L/S High-Performance Pump Heads [page 131](#)

L/S Easy-Load Pump Heads [page 132](#)

I/P Digital Console Process Drives [page 134](#)

I/P Easy-Load Pump Head [page 135](#)



## Upgrade your Existing Drives

Use the retrofit system controller to incorporate open-head sensors into pump systems you already have. The system includes a control box that easily connects to your drive and an open-head sensor equipped pump head. If pump head is opened during operation, the interlock control box instantly shuts down the drive.

The retrofit system is compatible with select L/S and I/P drives. Controller 77097-00 includes power cables and a single extension cable to connect one sensor-equipped pump head. Order optional extension cable 77097-20 to connect a second pump head.

MY-77097-00 Open-head interlock sensor control box

MY-77097-20 Optional extension cable, 1.8-m (6-ft)



To learn more about Masterflex Open-Head Interlock Sensor technology, visit [ColeParmer.com/masterflex](https://www.coleparmer.com/masterflex)

## Masterflex® L/S® Standard Pump Heads

Ideal for accurate and repeatable fluid transfer applications

- PC housing allows you to see pump in operation; PPS housing and SS rotors have excellent chemical resistance

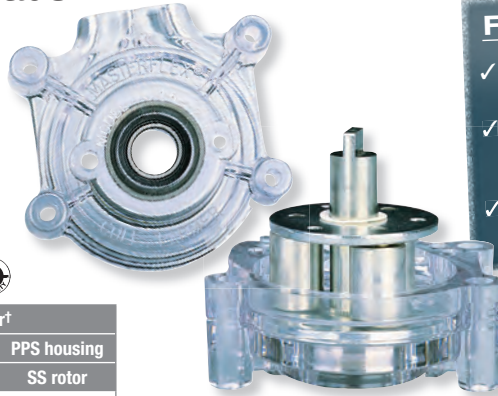

### FEATURES

- ✓ Best overall pump head performance
- ✓ Designed and optimised for one tubing size
- ✓ Stack up to four heads

Pump tubing size	mL per rev	Flow rates in mL/min			Max system pressure bar (psi)	Catalogue number†		
		0.02 to 100 rpm	6 to 600 rpm	2.7 (40)		PC housing		PPS housing
						CRS rotor	SS rotor	SS rotor
<b>A. Standard pump heads for Precision pump tubing</b>								
L/S 13	0.06	0.001 to 6	0.36 to 36	2.7 (40)	MY-07013-20	MY-07013-21	MY-07013-52	
L/S 14	0.21	0.004 to 21	1.3 to 130	2.7 (40)	MY-07014-20	MY-07014-21	MY-07014-52	
L/S 16	0.8	0.016 to 80	4.8 to 480	2.7 (40)	MY-07016-20	MY-07016-21	MY-07016-52	
L/S 17	2.8	0.059 to 280	17 to 1700	1.4 (20)	MY-07017-20	MY-07017-21	MY-07017-52	
L/S 18	3.8	0.077 to 380	23 to 2300	1.0 (15)	MY-07018-20	MY-07018-21	MY-07018-52	
<b>B. Standard pump heads for High-Performance Precision pump tubing</b>								
L/S 15	1.7	0.033 to 170	10 to 1000	2.7 (40)	MY-07015-20	MY-07015-21	MY-07015-52	
L/S 24	2.8	0.057 to 280	17 to 1700	2.7 (40)	MY-07024-20	MY-07024-21	MY-07024-52	
L/S 35	3.8	0.077 to 380	23 to 2300	2.4 (35)	MY-07035-20	MY-07035-21	—	
L/S 36	4.8	0.096 to 480	29 to 2900	1.4 (20)	MY-07036-30	MY-07036-31	—	

†PC = polycarbonate PPS = polyphenylene sulfide CRS = cold-rolled steel SS = stainless steel

### Mounting Hardware

Stack up to four L/S Standard pump heads on one drive. Mounting hardware is stainless steel.

For tubing size	Heads to be mounted	Catalogue number
L/S 13 to L/S 35	One	MY-07013-04
	Two	MY-07013-05
	Three	MY-07013-08
	Four	MY-07013-09
L/S 36	One	MY-07036-01
	Two	MY-07036-02

## Masterflex® L/S® Easy-Load® II Pump Heads

Automatic retention holds tubing securely in place

- Reduced pulsation and improved pressure performance and mechanical stability with standard four-roller rotor
- Choice of rotors—economical CRS rotors or SS rotors for better chemical resistance and durability
- Don't let pressure get to you. Choose models with adjustable occlusion—tighten for higher pressure, loosen for longer tubing life
- Models with open-head interlock sensor stop drive motor when pump head is open (when used with sensor-equipped drives)

### FEATURES

- ✓ Load tubing easily
- ✓ Accepts several tubing sizes for a wide flow range
- ✓ Stack up to four heads
- ✓ Durable PPS housing



**What's included:** single-channel mounting hardware and a 38-cm (15") length of silicone pump tubing. Pump head comes ready to mount to drive.



Pump tubing size	mL per rev	Flow rates in mL/min			Max system pressure† bar (psi)	Fixed occlusion			Adjustable occlusion
		1 to 100 rpm	6 to 600 rpm	2.7 (40)		CRS‡ rotor	SS‡ rotor	SS‡ rotor and open-head sensor	SS‡ rotor
						Cat. no.	Cat. no.	Cat. no.	Cat. no.
<b>A. Easy-Load II pump heads for Precision pump tubing (not shown)</b>									
L/S 13	0.06	0.06 to 6	0.36 to 36	2.7 (40)	MY-77200-50	MY-77200-60	MY-77200-30	MY-77201-60	
L/S 14	0.21	0.21 to 21	1.3 to 130	2.7 (40)					
L/S 16	0.8	0.8 to 80	4.8 to 480	2.7 (40)					
L/S 25	1.7	1.7 to 170	10 to 1000	2.4 (35)					
L/S 17	2.8	2.8 to 280	17 to 1700	1.4 (20)					
L/S 18	3.8	3.8 to 380	23 to 2300	1.0 (15)					
<b>B. Easy-Load II pump heads for High-Performance Precision pump tubing</b>									
L/S 15	1.7	1.7 to 170	10 to 1000	2.7 (40)	MY-77200-52	MY-77200-62	MY-77200-32	MY-77201-62	
L/S 24	2.8	2.8 to 280	17 to 1700	2.7 (40)					
L/S 35	3.8	3.8 to 380	23 to 2300	2.4 (35)					
L/S 36	4.8	4.8 to 480	29 to 2900	1.4 (20)					
<b>C. Two-channel Easy-Load II pump heads for Precision pump tubing</b>									
L/S 13	0.06	0.06 to 6	0.36 to 36	2.7 (40)	MY-77202-50	MY-77202-60	—	—	
L/S 14	0.21	0.21 to 21	1.3 to 130	2.7 (40)					
L/S 16	0.8	0.8 to 80	4.8 to 480	2.7 (40)					
L/S 25	1.7	1.7 to 170	10 to 1000	2.4 (35)					

†Actual performance varies depending on pump tubing formulation—values shown are for firm pump tubing. ‡CRS = cold-rolled steel SS = stainless steel

**Mounting Hardware.** Mount up to four L/S Easy-Load II pump heads on a single drive. Mounting hardware is stainless steel.

Heads to be mounted	One	Two	Three	Four
Catalogue number	MY-77200-01	MY-77200-02	MY-77200-03	MY-77200-04

## Masterflex® L/S® High-Performance Pump Heads

All-new design offers faster tubing changes and improved ergonomics

- Simply close the pump head and tubing occlusion is optimal and automatic
- Flow rates up to 3400-mL/min with L/S high-performance precision tubing
- Reinforced nylon housing and occlusion bed with stainless steel rotor/roller assembly
- Models with open-head interlock sensor stop drive motor when pump head is open (when used with sensor-equipped drives)
- Compatible with all L/S drives that accept two or more pump heads

### FEATURES

- ✓ Pressures up to 150 psi with L/S high-pressure (HP) pump tubing
- ✓ Automatic tubing occlusion—no need to adjust
- ✓ ATEX Zone 2 rated models available



**What's included:** mounting hardware and 38 cm (15") of pump tubing.

**MASTERFLEX®**

**ISO9001:2008**  
CERTIFIED SUPPLIER

**ATEX**  
Zone 2  
77252-80, 82



Pump tubing size	mL per rev	Flow rates in mL/min		Max system pressure bar (psi)	Catalogue number		
		0.02 to 100 rpm	0.1 to 600 rpm		High-Performance pump head with open-head sensor	High-Performance pump head	ATEX-approved High-Performance pump head
<b>High-performance pump heads for Precision pump tubing</b>							
L/S 16	0.9	0.018 to 90	0.09 to 614	2.7 (40)	MY-77252-60	MY-77252-70	MY-77252-80
L/S 25	1.9	0.038 to 187	0.19 to 1278	2.7 (40)			
L/S 17	3.0	0.06 to 307	0.30 to 1883	1.4 (20)			
L/S 18	3.8	0.076 to 377	0.38 to 2812	2.7 (40)			
<b>High-performance pump heads for High-Performance Precision pump tubing</b>							
L/S 14HP†	0.3	0.006 to 30	Not recommended	10.3 (150)	MY-77252-62	MY-77252-72	MY-77252-82
L/S 16HP†	0.9	0.018 to 90	Not recommended	8.5 (125)			
L/S 15HP†	1.7	0.034 to 170	Not recommended	6.8 (100)			
L/S 24HP†	2.4	0.048 to 240	Not recommended	5.5 (80)			
L/S 15	1.8	0.036 to 180	0.18 to 1100	2.7 (40)			
L/S 24	3.0	0.06 to 300	0.30 to 1800	2.7 (40)			
L/S 35	4.3	0.086 to 430	0.43 to 2600	2.4 (35)			
L/S 36	5.8	0.116 to 580	0.58 to 3400	1.4 (20)			

†L/S 14HP, L/S 15HP, L/S 16HP and L/S 24HP pump tubing is for use only with the L/S High-Performance pump head mounted on any L/S 100 rpm drive capable of running two or more pump heads. **Note:** High-Performance pump heads are not stackable.

## Masterflex® L/S® Easy-Load® 3 Pump Heads

No tools or hardware needed

- Mount and stack heads in seconds with twist-lock mounting feature
- CRS rotor is more economical while SS offers greater durability and chemical resistance
- Included mounting plate adapts Easy-Load 3 pump heads to L/S drives—mount up to four pump heads without tools or hardware

### FEATURES

- ✓ Same side tubing entry/exit for space-limited applications
- ✓ Automatic tubing retention
- ✓ Stack up to four heads



**MASTERFLEX®**

**ISO9001:2008**  
CERTIFIED SUPPLIER



Pump tubing sizes	mL per rev	Flow rates in mL/min		Max system pressure† bar (psi)	Catalogue number‡	
		1 to 100 rpm	6 to 600 rpm		CRS rotor	SS rotor
<b>Easy-Load 3 pump heads for Precision pump tubing</b>						
L/S 13	0.06	0.06 to 6	0.36 to 36	2.7 (40)	MY-77800-50	MY-77800-60
L/S 14	0.22	0.22 to 22	1.3 to 130	2.7 (40)		
L/S 16	0.8	0.8 to 80	4.8 to 480	2.7 (40)		
L/S 25	1.7	1.7 to 170	10 to 1000	2.4 (35)		
L/S 17	2.8	2.8 to 280	17 to 1700	1.4 (20)		
L/S 18	3.8	3.8 to 380	23 to 2300	1.0 (15)		
<b>Easy-Load 3 pump heads for High-Performance Precision pump tubing</b>						
L/S 15	1.7	1.7 to 170	10 to 1000	2.0 (30)	MY-77800-52	MY-77800-62
L/S 24	2.8	2.8 to 280	17 to 1700	2.0 (30)		
L/S 35	3.8	3.8 to 380	23 to 2300	1.7 (25)		
L/S 36	4.8	4.8 to 480	29 to 2900	1.4 (20)		

†Actual performance varies depending on pump tubing formulation—values shown are for firm pump tubing.

‡CRS = cold-rolled steel SS = stainless steel

**MY-77800-00 Replacement mounting kit**, for mounting Easy-Load 3 pump head to Masterflex L/S pump drives. Includes mounting plate and four screws



## Masterflex® L/S® Easy-Load® Pump Heads

### New design, with smaller footprint, reduced pulsation and even faster tubing changes!

- No need to remove head to change tubing
- SS rotor offers durability and chemical resistance
- Polyarylamide (PARA) housing offers strength and durability
- Get four separate pumping channels by mounting up to four heads on one drive

What's included: single-channel mounting hardware.



MASTERFLEX®

Mounting Hardware. Stack up to four L/S Easy-Load pump heads on one drive. Hardware is stainless steel.

Heads to be mounted	Catalogue number
One	MY-07514-04
Two	MY-07013-05
Three	MY-07013-08
Four	MY-07013-09

Pump tubing sizes	mL per rev	Flow rates in mL/min		Max system pressure bar (psi)	Catalogue number†	
		0.02 to 100 rpm	0.1 to 600 rpm		PARA housing SS rotor	PARA housing with open head sensor SS rotor
<b>Easy-Load pump heads for Precision pump tubing</b>						
L/S 13	0.06	0.001 to 6	0.006 to 36	2.7 (40)	MY-07514-10	MY-07514-30
L/S 14	0.21	0.004 to 21	0.02 to 130	2.7 (40)		
L/S 16	0.8	0.016 to 80	0.08 to 480	2.7 (40)		
L/S 25	1.7	0.034 to 170	0.17 to 1000	2.4 (35)		
L/S 17	2.8	0.056 to 280	0.28 to 1700	1.4 (20)		
L/S 18	3.8	0.076 to 380	0.38 to 2300	1.0 (15)		
<b>Easy-Load pump heads for High-Performance Precision pump tubing</b>						
L/S 15	1.7	0.034 to 170	0.17 to 1000	2.7 (40)	MY-07514-12	MY-07514-32
L/S 24	2.8	0.056 to 280	0.28 to 1700	2.7 (40)		

†PARA = Polyarylamide SS = stainless steel

## Masterflex® L/S® PTFE-Tubing Pump Head

### Ideal for high-purity fluids and aggressive organic solvents

- PTFE tubing is the only wetted part; anodised aluminum and acetal body; stainless steel rotor assembly
- Compatible with L/S drives that accept two or more pump heads (1/10 hp min); For best results, run at 1 to 300 rpm

Note: PTFE-tubing pump head accepts **only** the Masterflex L/S PTFE tubing sets sold below; ordinary PTFE tubing cannot be substituted.

MASTERFLEX®



Flow rates (mL/min at 1 to 300 rpm)		Max continuous pressure	Max suction lift	Avg tubing life (100 rpm, 0 psi)	Number of rollers	Catalogue number
4-mm OD tubing	6-mm OD tubing					
0.06 to 17	0.25 to 65	6.9 bar (100 psi)	2.4 m (8 ft)	500 hours	Six	MY-77390-00

PTFE-Tubing Sets include two 38 cm (15") lengths, cannot be substituted with ordinary PTFE tubing.

MY-77390-50 PTFE-tubing set. 2-mm ID, 4-mm OD. Set of 2

MY-77390-60 PTFE-tubing set. 4-mm ID, 6-mm OD. Set of 2

Compression Fittings adapt tubing sets to your system.

For 4-mm OD PTFE-Tubing Sets

MY-31321-61 Straight connector, 2.8 bar (40 psi) max

MY-06605-53 PTFE extension tubing, 4-mm OD. Pack of 7.6 m (25 ft)

For 6-mm OD PTFE-Tubing Sets

MY-31321-64 Straight connector, 9.2 bar (135 psi) max

MY-06605-54 PTFE extension tubing, 6-mm OD. Pack of 7.6 m (25 ft)

## Masterflex® L/S® Cytoflow™ Pump Heads

### Gentler on live cells

- Low-speed pumping lets you maintain the consistency and characteristics of shear-sensitive fluids
- Choose 2 rollers for maximum flow rate, 3 rollers for less pulsation
- Compatible with all Masterflex L/S drives that accept two or more pump heads

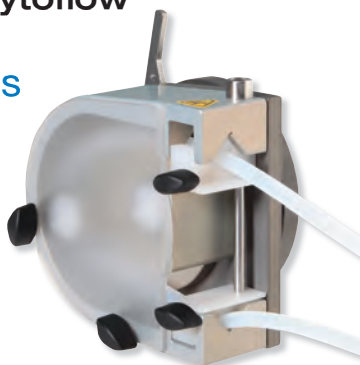

MASTERFLEX®



Pump tubing size	mL per rev	Flow rates in mL/min		Max system pressure bar (psi)	Catalogue number
		0.02 to 100 rpm	0.1 to 600 rpm		
<b>2-roller pump heads for High-Performance Precision pump tubing</b>					
L/S 15	4.0	0.08 to 390	0.40 to 2300	1.5 (22)	MY-77253-02
L/S 24	6.2	0.12 to 600	0.62 to 3700	1.5 (22)	
L/S 35	9.5	0.19 to 930	0.95 to 5600	1.5 (22)	
L/S 36	12.8	0.26 to 1270	1.3 to 7600	1.5 (22)	
<b>3-roller pump heads for High-Performance Precision pump tubing</b>					
L/S 15	3.5	0.07 to 340	0.35 to 2000	1.5 (22)	MY-77253-12
L/S 24	5.7	0.11 to 570	0.57 to 3400	1.5 (22)	
L/S 35	7.8	0.16 to 780	0.78 to 4600	1.5 (22)	
L/S 36	9.6	0.19 to 950	0.96 to 5700	1.5 (22)	

# Masterflex® L/S® Multichannel Pump Heads

## Get low-pulsation synchronous flow in multiple channels without cartridges

- Load the tubing, latch the occlusion bed, and run the pump—two-stop tubing gives you optimal tension with no adjustment
- Stackable two, four, or eight-channel heads for up to 24 channels
- Six roller heads deliver low-pulsation flow; three-roller heads offer higher flow rates
- Heads for L/S Precision pump tubing accept two-stop tubing set sizes L/S 13, L/S 14, and L/S 16; heads for L/S High-Performance Precision pump tubing accept two-stop tubing set sizes L/S 15, L/S 24, and L/S 35
- Compatible with L/S drives that accept two or more pump heads; 1/10 hp min



MASTERFLEX®

### FEATURES

- ✓ Stackable for up to 24 synchronous flow channels
- ✓ Models that accept L/S two-stop tubing sets available
- ✓ Durable stainless steel and anodised aluminum construction



Stack heads for even more channels!

**What's included:** mounting hardware and hex key tool.

ISO9001:2008  
CERTIFIED SUPPLIER



Number of channels	Number of rollers	Max channels with stacked heads†		Catalogue number
		100 rpm drive	600 rpm drive	
<b>A. L/S Multichannel pump heads for Precision pump tubing, sizes L/S 13, L/S 14, L/S 16</b>				
Four	Six	24	12	MY-07535-04
Eight				MY-07535-08
<b>B. L/S Multichannel pump heads for High-Performance Precision pump tubing, sizes L/S 15, L/S 24, L/S 35</b>				
Two	Three	12	Six	MY-07536-02
Four				MY-07536-04

†Maximum channel capacity depends on drive torque capability and tubing formulation used.

### L/S Two-Stop Precision Tubing Sets Ordering Information for 07535- and 07536-series pump heads

Pump tubing formulation	L/S Precision pump tubing	L/S Precision pump tubing			L/S High-Performance Precision pump tubing		
		L/S 13	L/S 14	L/S 16	L/S 15	L/S 24	L/S 35
Tygon® E-LFL		MY-06447-13 Pk of 8	MY-06447-14 Pk of 8	MY-06447-16 Pk of 8	MY-06447-15 Pk of 4	MY-06447-24 Pk of 4	MY-06447-35 Pk of 4
Silicone (platinum-cured)		MY-06421-13 Pk of 8	MY-06421-14 Pk of 8	MY-06421-16 Pk of 8	MY-06421-15 Pk of 4	MY-06421-24 Pk of 4	MY-06421-35 Pk of 4
BioPharm Plus Silicone (platinum-cured)		MY-96116-13 Pk of 8	MY-96116-14 Pk of 8	MY-96116-16 Pk of 8	MY-96116-15 Pk of 4	MY-96116-24 Pk of 4	MY-96116-35 Pk of 4
PharMed® BPT		MY-96114-13 Pk of 8	MY-96114-14 Pk of 8	MY-96114-16 Pk of 8	MY-96114-15 Pk of 4	MY-96114-24 Pk of 4	MY-96114-35 Pk of 4
Chem-Durance® Bio		MY-96117-13 Pk of 8	MY-96117-14 Pk of 8	MY-96117-16 Pk of 8	MY-96117-15 Pk of 4	MY-96117-24 Pk of 4	MY-96117-35 Pk of 4
Viton®		MY-96428-13 Pk of 8	MY-96428-14 Pk of 8	MY-96428-16 Pk of 8	MY-96428-15 Pk of 4	MY-96428-24 Pk of 4	MY-96428-35 Pk of 4

### Flow Rates per Channel in mL/min with L/S Two-Stop Precision Pump Tubing Sets above

Drive rpm	Precision pump tubing			High-Performance Precision pump tubing		
	L/S 13	L/S 14	L/S 16	L/S 15	L/S 24	L/S 35
1 to 100	0.045 to 4.5	0.16 to 16	0.47 to 47	1.6 to 160	2.8 to 280	3.8 to 380
6 to 600	0.27 to 27	0.96 to 96	2.8 to 280	10 to 1000	17 to 1700	23 to 2300



Application Solution

### Challenge

A pharmaceutical manufacturer needed to dispense volumes of 300-mL in 15 seconds or less repeating three times per minute; and 20-mL in 2 seconds or less repeating 20 times per minute. The desired accuracy target for both applications was ±1.5%. The efficiency of simultaneously pumping multiple channels was critical.

### Solution

The manufacturer now uses a Masterflex L/S digital drive with an L/S four-channel pump head 07536-04. Size L/S 15 two-stop silicone tubing (06421-15) met the smaller flow requirement; while size L/S 35 two-stop silicone tubing (06421-35) met the larger flow requirement. Careful calibration of the drive, and the synchronous multichannel flow capability of the pump head enabled the manufacturer to meet the accuracy target.

# Masterflex® I/P® Digital Console Process Drives

## Maintenance-free drives built for process applications

- Graphical LCD shows four operating modes: continuous run, timed dispense, copy dispense, volume dispense
- Dispense by volume, copy, or time with programmable delay interval
- Models equipped with open-head sensor stop drive motor when pump head is opened—pair with an open-head sensor equipped pump head (see page 135)

**Models 77420-10 and -18** feature a 316 stainless steel housing with an anodised aluminum base. Ideal for pharmaceutical, dairy, biotech, and food and beverage applications.

**Models 77420-20 and -28** feature a powder-coated steel housing with anodised aluminum base. Use in process, manufacturing, and water-treatment applications where stainless steel is not a critical requirement.

**What's included:** 1.8-m (6-ft) line cord with IEC 320/CEE22 socket. Shipped with country-specific plug/cord set; please specify ultimate destination when ordering.



### FEATURES

- ✓ Flow rates: 0.0006 to 19 LPM
- ✓ Accuracy of ±0.1% speed control
- ✓ Four-line graphical display
- ✓ Reversible motor
- ✓ IP66-rated for easy washdown
- ✓ Accept up to 2 pump heads

77420-10 shown with I/P High-Performance pump head 77600-62



rpm	Speed control (resolution)	Open-head sensor	Pump heads accepted	Motor size	IP rating	Dimensions (L x W x H)	Power	Catalogue number
<b>Digital process drive with 316 stainless steel housing</b>								
0.1 to 650	±0.1%	No	Two	¾ hp (280 W)	IP66	42.4 x 28.3 x 7.3 cm (16 <sup>1</sup> / <sub>16</sub> " x 11 <sup>1</sup> / <sub>8</sub> " x 12 <sup>7</sup> / <sub>8</sub> "	90 to 260 VAC, 50/60 Hz	MY-77420-10
		Yes						MY-77420-18
<b>Digital process drive with powder-coat steel housing</b>								
0.1 to 650	±0.1%	No	Two	¾ hp (280 W)	IP66	42.4 x 28.3 x 7.3 cm (16 <sup>1</sup> / <sub>16</sub> " x 11 <sup>1</sup> / <sub>8</sub> " x 12 <sup>7</sup> / <sub>8</sub> "	90 to 260 VAC, 50/60 Hz	MY-77420-20
		Yes						MY-77420-28

**MY-07575-84 Washdown foot switch**, momentary start/stop, 1.8-m (6-ft) cable  
**MY-07575-80 Cable assembly**, 31-pin round connector and 7.9-m (26-ft) cable with stripped wire ends for remote control

**MY-17050-01 ILAC MRA, NIST-traceable calibration** for peristaltic pump drive

# Masterflex® I/P® Precision Process Drives

## Powerful, low-maintenance drives keep you pumping

- Don't worry about moisture, chemicals, or dust—IP55-rated nonchip epoxy-coated steel housing
- Goes where you need it—compact and light enough to carry with one hand, powerful enough to drive two pump heads
- Get up to speed quickly—easy to adjust speed knob and LED display for improved repeatability

### FEATURES

- ✓ Flow rates: 0.2 to 19 LPM
- ✓ Accuracy of ±0.25% speed control
- ✓ LED display
- ✓ Reversible motor and remote control capabilities
- ✓ Accept up to 2 pump heads



Motor speed (rpm)	Speed control (repeatability)	Pump heads accepted	Motor size	Dimensions	Power (50/60 Hz)		Catalogue number
					VAC	Amps	
<b>Variable-speed brushless process drive</b>							
33 to 650	±0.25% (2% of max rpm)	Two	½ hp (0.25 kW)	35.6 x 25.4 x 22.9 cm (14"L x 10"W x 9"H)	90 to 260	2.6 at 230 VAC	MY-77410-10
<b>Variable-speed brushless process drive with remote input/output</b>							
33 to 650	±0.25% (2% of max rpm)	Two	½ hp (0.25 kW)	35.6 x 25.4 x 22.9 cm (14"L x 10"W x 9"H)	90 to 260	2.6 at 230 VAC	MY-77411-00

**MY-07595-43 Washdown foot switch** for model 77411-00

**MY-77300-32 Remote cable kit.** Required for model 77411-00 to operate the remote inputs and outputs



## Masterflex® I/P® High-Performance Pump Heads

### Get higher flow rates and pressure

- Easily transfer viscous fluids
- Pump up to 19-LPM for higher volume processing
- Durable design for longer life—made of stainless steel rollers, bearings, rotor plates, and rotor shaft. Occlusion bed is made of thermoset polyester
- Compatible with I/P drives that accept two or more pump heads; pump head is not stackable



**MASTERFLEX®**

ISO9001:2008  
CERTIFIED SUPPLIER

ATEX  
Zone 2  
77600-82



Pump tubing sizes accepted	mL per rev	Flow rates (LPM) at 20 to 650 rpm	Maximum system bar (psi)	Catalogue number†	
				Polyester and SS housing, SS rotor	ATEX-approved; polyester and SS housing, SS rotor
I/P 70	12.3	0.26 to 8	2.7 (40)	MY-77600-62	MY-77600-82
I/P 88	26.2	0.4 to 17	2.4 (35)		
I/P 89	29.2	0.52 to 19	1.4 (20)		

†SS = stainless steel

#### FEATURES

- ✓ Easy to load tubing
- ✓ Adjustable tubing retention
- ✓ “C”-shaped design—tubing enters/exits the same side
- ✓ ATEX Zone 2 rated model available

## Masterflex® I/P® Easy-Load® Pump Heads

### Minimise downtime with faster tubing changes

- Optimise pressure capabilities and tubing life with adjustable occlusion
- Less maintenance and quieter operation
- Adjust flow rate to your needs—can pump from 0.01 to 13-LPM
- PPS housing with CRS or SS rotor available. CRS rotors have sealed bearings; SS rotors have PTFE-sealed bearings
- Model with open-head interlock sensor stops drive motor when pump head is open (when used with sensor-equipped drives)

#### FEATURES

- ✓ Load tubing without removing pump head from drive
- ✓ Automatic tubing retention
- ✓ Stack up to two pump heads
- ✓ ATEX Zone 2 rated model available



**MASTERFLEX®**

ISO9001:2008  
CERTIFIED SUPPLIER

ATEX  
Zone 2  
77602-80



Pump tubing sizes accepted	mL per rev	Flow rates (LPM) at indicated rpm			Maximum system bar (psi)	Catalogue number†				
		100	540	20 to 650		White PPS housing			Black PPS housing	ATEX-approved; PPS housing
						CRS rotor	SS rotor	SS rotor and open-head sensor	SS rotor	SS rotor
I/P 26	6.15	0.6	3.2	0.12 to 4	2.7 (40)	MY-77602-00	MY-77602-10	MY-77602-30	MY-77601-60	MY-77602-80
I/P 73	12.3	1.2	6.8	0.2 to 8						
I/P 82	20.0	2.0	11.0	0.4 to 13						

†PPS = polyphenylene sulfide CRS = cold-rolled steel SS = stainless steel

MY-77601-96 Dual-channel mounting hardware for two pump heads, stainless steel

## Masterflex® B/T® Fixed- and Variable-Speed Pumps

Achieve the highest flow rates of any Masterflex pump—up to 42-LPM

### Fixed-Speed Pumps

- Economical and easy to operate
- Reversible motor: purge before or after pumping, pump fluid in either direction
- IP55-rated motor—wash off dirt and debris

### Air-Powered Pump

- Use in locations where electricity is unsafe or impractical
- Includes pressure regulator—control your compressor air to match pump requirements
- 24-cfm (0.68 m<sup>3</sup>), 6.9 bar (100 psi) minimum air required, supply your own compressor to power pump
- IP56-rated motor protects against dust and strong water jets
- Rated for ATEX Zone 2 EEx II 3 G c IIC T6; NEC Class 1, Division 2, Groups A, B, C, D, T6

### Variable-Speed Modular Pump

- Place washdown controller wherever it's convenient
- Controller with 4.9-m (16-ft) cord mounts on pump or wall
- IP56-rated motor protects against dust and strong water jets
- Reversible motor: purge before or after pumping, pump fluid in either direction

### Variable-Speed Modular Digital Pump

- High-volume, high-accuracy dispensing
- Dispense by volume or time, or pump continuously
- Separate motor and controller by up to 1.8-meters (6-feet) for convenient operation
- IP56-rated controller and motor protect against dust and water

**What's included:** a Rapid-Load® pump head, 1 m (3 ft) of Tygon® E-LFL B/T 91 pump tubing, and a 1.8-m (6-ft) power cord 230 VAC: European plug.



Fixed-speed pump  
77111-60



Variable-speed  
modular digital pump  
77111-70

### FEATURES

- ✓ Flow rates up to 42 LPM
- ✓ Interlock switch shuts off power when pump head is opened
- ✓ Washdown pumps handle the toughest process and production applications, then clean up with ease
- ✓ Gentle peristaltic action is ideal for pumping shear-sensitive or viscous fluids (up to 10,000 cps)
- ✓ Rotor and occlusion bed design allow easier tube loading and prevent "tubing roll" during operation

### Flow Rates in LPM (GPM)

rpm	PerfectPosition® pump tubing	
	B/T 87	B/T 91
321	18.9 (5.0)	42 (11.1)
271	16.0 (4.2)	35 (9.4)
35 to 321	1.9 to 17.7 (0.5 to 4.7)	4.0 to 37 (1.06 to 9.8)
12 to 321	0.71 to 18.9 (0.19 to 5.0)	1.4 to 42 (0.4 to 11.1)



77111-37, -67, -77, -80    Zone 2 77111-80    77111-30, -37    Except 77111-30, -37

Motor type	Motor size	rpm	IP rating	Mounting type	Dimensions (L x W x H)	Power		Catalogue number
						VAC (Hz)	Amps	
Fixed-speed	1 hp (0.75 kW)	271	IP55	Direct-drive	68.6 x 40 x 38.4 cm (27" x 15.8" x 15.1")	220 (50)	6.3	MY-77111-37
Variable-speed, air powered	¾ hp (0.56 kW)	35 to 321	IP56	Direct-drive	68.6 x 40 x 38.4 cm (27" x 15.8" x 15.1")	Requires 24 cfm (0.68 m <sup>3</sup> ) 100 psi (6.9 bar) minimum		MY-77111-80
Variable-speed (±5%)	½ hp (0.37 kW)	12 to 321	Controller: IP56 Drive: IP56	Direct-drive	68.6 x 40 x 38.4 cm (27" x 15.8" x 15.1")	230 (50/60)	3.3	MY-77111-67
Variable-speed digital (±0.3%)	¾ hp (0.56 kW)	12 to 321		Direct-drive	Controller: 22.9 x 27.9 x 11.4 cm (9" x 11" x 4½") Drive: 68.6 x 40 x 38.4 cm (27" x 15.8" x 15.1")	190 to 260 (50/60)	5.7	MY-77111-77

**MY-77300-32 Remote cable**, required for remote control operation of models 77111-70 and -77; 7.9-m (25-ft)

**MY-77111-90 Bracket for digital controller** on models 77111-70 and -77

# Masterflex® C/L® Variable-Speed Compact Pumps

## Pump in even the tightest spaces!

- Pump fluids in either direction—easily switchable reversing motor
- Easy tubing changes—open cover and release occlusion bed in one motion

### A. C/L Single-Channel Pumps

- Stop/start remotely via contact closure
- MAX button quickly primes or purges tubing
- Pump from 0.002- to 43-mL/min

### B. C/L Digital Microflex® Pump

- Icon-driven menu allows quick programming and setup
- Flow range of 0.00013- to 43-mL/min
- Copy dispense function for filling and dispensing applications
- Remote control of speed, direction, and start/stop/prime via 25-pin connector on back of drive
- Microflex pump head accepts continuous lengths of tubing for clean flow paths
- Tubing calibration ensures accuracy



A



B

**FEATURES**

- ✓ Flow range: 0.00013 to 43 mL/min
- ✓ Reversible pumping
- ✓ Remote control capabilities



Power supplies are:



rpm	Speed control (repeatability)	Number of channels	Number of rollers	Reversible motor	IP rating	Dimensions—¼ DIN (L x W x H)	Power		Catalogue number
							VAC, Hz	Amps	
<b>A. C/L single-channel compact pumps</b>									
1.7 to 10	±5%	One	Four	Yes	IP22	17.8 x 9.5 x 8.9 cm (7" x 3¾" x 3½")	90 to 260, 50/60 12 VDC†	250 mA at 230 VAC	MY-77122-04
13 to 80			Three				90 to 260, 50/60 12 VDC†	250 mA at 230 VAC	MY-77122-14
50 to 300			90 to 260, 50/60 12 VDC†				250 mA at 230 VAC	MY-77122-24	
<b>B. C/L digital Microflex pump</b>									
0.1 to 300	±0.1%	One	Three	Yes	IP33	20.5 x 14 x 15.7 cm (8⅞" x 5½" x 6⅜")	90 to 260	0.34 at 115 VAC, 0.2 at 230 VAC	MY-77123-00

†Power supply not included with 12 VDC models.

**MY-17050-01 ILAC MRA, NIST-traceable calibration** with data for peristaltic pump drive

**For A models:**

**MY-77120-03 Brackets** for panel mounting. Set of 2

**MY-77200-07 Replacement power supply**, 100 to 240 VAC, for pump 77122-24

**MY-77120-11 Replacement power supply**, 100 to 240 VAC, for pumps 77122-04, -14

**For B model:**

**MY-07523-92 Foot switch**, momentary start/stop; DB25 male; 1.8-m (6-ft) cable

**MY-07523-95 Cable assembly**, DB25 male connector and 7.9-m (25-ft) cable with stripped wire ends

**MY-07523-97 Handheld remote controller**, DB25 male, route tubing through handle for dispensing applications; 1.8-m (6-ft) cable

**MY-77123-80 Replacement single-channel Microflex pump head**

**MY-07525-90 Replacement power supply**, 90 to 260 VAC

Tube ID (mm)	Tygon® E-Lab	Silicone (platinum-cured)	Silicone (peroxide-cured)	PharMed® BPT	Tygon E-LFL (long flex life)	Viton®	Puri-Flex™	C-Flex®	Solvent/hydrocarbon
0.19	MY-06460-10	—	MY-07625-10	MY-95809-10	MY-06449-10	—	MY-96418-10	MY-95718-10	MY-95712-10
0.25	MY-06460-12	—	MY-07625-12	MY-95809-12	MY-06449-12	—	MY-96418-12	MY-95718-12	MY-95712-12
0.51	MY-06460-18	MY-95590-18	MY-07625-18	MY-95809-18	MY-06449-18	MY-97632-18	MY-96418-18	MY-95718-18	MY-95712-18
0.89	MY-06460-26	MY-95590-26	MY-07625-26	MY-95809-26	MY-06449-26	MY-97632-26	MY-96418-26	MY-95718-26	MY-95712-26
1.14	MY-06460-30	MY-95590-30	MY-07625-30	MY-95809-30	MY-06449-30	MY-97632-30	MY-96418-30	MY-95718-30	MY-95712-30
1.42	MY-06460-34	MY-95590-34	MY-07625-34	MY-95809-34	MY-06449-34	MY-97632-34	MY-96418-34	MY-95718-34	MY-95712-34
2.06	MY-06460-42	MY-95590-42	MY-07625-42	MY-95809-42	MY-06449-42	MY-97632-42	MY-96418-42	MY-95718-42	MY-95712-42
2.79	MY-06460-48	MY-95590-48	MY-07625-48	MY-95809-48	MY-06449-48	MY-97632-48	MY-96418-48	MY-95718-48	MY-95712-48
Length/pk	30.4 m (100 ft)	15.2 m (50 ft)	15.2 m (50 ft)	30.4 m (100 ft)	30.4 m (100 ft)	15.2 m (50 ft)	15.2 m (50 ft)	15.2 m (50 ft)	15.2 m (50 ft)

### Flow Rates in mL/min

rpm	Microbore pump tubing size (ID)								
	0.19 mm	0.25 mm	0.51 mm	0.89 mm	1.14 mm	1.42 mm	2.06 mm	2.79 mm	
1.7 to 10	0.002 to 0.013	0.004 to 0.022	0.015 to 0.087	0.041 to 0.25	0.064 to 0.39	0.09 to 0.57	0.18 to 1.05	0.28 to 1.65	
13 to 80	0.017 to 0.10	0.03 to 0.18	0.12 to 0.70	0.33 to 2.0	0.52 to 3.1	0.75 to 4.5	1.4 to 8.5	1.8 to 11.0	
50 to 300	0.06 to 0.39	0.11 to 0.66	0.43 to 2.6	1.2 to 7.5	1.9 to 11.4	2.8 to 17.1	5.3 to 32	7.2 to 43	
0.1 to 300	0.00013 to 0.39	0.0002 to 0.66	0.0009 to 2.6	0.003 to 7.5	0.004 to 11.4	0.006 to 17.1	0.011 to 32	0.014 to 43	



## Masterflex® Pump Tubing

### Ensure optimal performance from your Masterflex pump

#### Silicone (platinum-cured)

- Low protein binding, fungus resistant, phthalate and latex-free
- Accommodates a wide temperature range
- USP Class V, EP, FDA, REACH, RoHS, ADF

#### Silicone (peroxide-cured)

- Greater physical compression capability
- Economical, longer tubing life
- USP Class VI, EP, FDA, 3A, REACH, RoHS, ADF

#### BioPharm Silicone (platinum-cured)

- Low absorption; excellent biocompatibility
- Very low extractable; weather, ozone, corona, radiation resistant
- USP Class VI, EP, FDA, 3A, REACH, RoHS, ADF

#### BioPharm Plus Silicone (platinum-cured)

- Ultra-smooth—minimises particle entrapment
- Very low extractable—ideal for lab, biotech, and pharmaceutical
- USP Class VI, EP, FDA, REACH, RoHS, ADF

#### Puri-Flex™

- Heat sealable, weldable, and economical
- Long pump life when compared to silicone or many other TPE tubings
- USP Class VI, FDA, 3A, REACH, RoHS, ADF

#### C-Flex®

- Heat sealable, weldable, economical
- Better resistance to pH fluctuations
- USP Class VI, EP, REACH, RoHS, ADF

#### C-Flex® ULTRA

- Longest life of any C-Flex formulation
- Lowest spallation and reduced residue
- USP Class VI, EP, REACH, RoHS, ADF

#### PharMed® BPT

- >10,000 hours of tubing life; sealable, weldable
- Ideal for tissue and cell culture work
- USP Class VI, EP, FDA, NSF, REACH, RoHS

#### PharmaPure®

- Non-toxic and non-hemolytic biocompatible
- Long life even under pressure with very low spallation
- USP Class VI, EP, FDA, REACH, RoHS

#### GORÉ® STA-PURE® Series PCS

- Long life—even in pressures up to 100 psi
- Excellent flow stability
- USP Class VI

#### GORÉ® STA-PURE® Series PFL

- Long life—even in pressures up to 100 psi
- Excellent biocompatibility and flow stability
- USP Class VI

#### Chem-Durance® Bio

- Excellent chemical compatibility and biocompatibility
- Excellent life and durability under pressure
- USP Class VI, FDA, REACH, RoHS

#### Tygon® E-LFL

- Longest life of all Tygon formulations
- Broad chemical resistance
- USP Class VI, EP, FDA, EU Food, REACH, RoHS, ADF

#### Tygon E-Food (B-44-4X)

- Smooth inner surface unaffected by commercial sanitisers
- Non-toxic; will not affect taste or odour
- FDA, EU Food, NSF, 3A, REACH, RoHS, ADF

#### Tygon E-Lab (E-3603)

- Ideal for general transfer use
- Nonaging, nonoxidising, low gas permeability
- USP Class VI, FDA, EU Food, NSF, REACH, RoHS, ADF

#### Tygon Fuel & Lubricant (F-4040-A)

- Formulated to transport hydrocarbons, petroleum products, and distillates
- Low gas permeability
- REACH, RoHS, ADF

#### Tygon Chemical (2001)

- Excellent chemical resistance
- Plasticiser-free with low gas permeability
- FDA 21 CFR 175.300, REACH, RoHS, ADF

#### Norprene® (A-60 G)

- Up to 10,000 hours of tubing life
- Excellent choice for pressure/vacuum applications
- NSF, REACH, RoHS

#### Norprene Food (A 60 F)

- Ideal for high-temperature food applications
- Resists heat, ozone, acids, and alkalis
- FDA, 3A, NSF, REACH, RoHS

#### Viton®

- Perfect for applications where FDA and chemical compatibility is needed
- Resists corrosives, solvents, and oils at elevated temperatures
- FDA, ADF

**MASTERFLEX®**

## Masterflex® Gamma Irradiated Tubing

### Reduce the risk of microbial contamination

- Save time—many sizes of packaged and pretreated tubing available for quick shipment!
- Tubing is double bagged prior to gamma irradiation
- Irradiation at 32.5 kGy offers optimal microbial control for the tubing's critical fluid pathway
- Gamma-sensitive labeling confirms treatment
- Select from popular biocompatible tubing formulations

Formulation	Qty/pk	L/S 16	L/S 15	L/S 24	I/P 73	I/P 82
		Catalogue number	Catalogue number	Catalogue number	Catalogue number	Catalogue number
Silicone (platinum-cured)	7.6 m (25 ft)	MY-96119-16	MY-96119-15	MY-96119-24	MY-96119-73	MY-96119-82
PharMed® BPT	7.6 m (25 ft)	MY-96122-16	MY-96122-15	MY-96122-24	MY-96122-73	MY-96122-82
C-Flex®	7.6 m (25 ft)	MY-96123-16	MY-96123-15	MY-96123-24	MY-96123-73	MY-96123-82

		L/S® Precision Pump Tubing						L/S® High-Performance Precision Pump Tubing			
		L/S 13	L/S 14	L/S 16	L/S 25	L/S 17	L/S 18	L/S 15	L/S 24	L/S 35	L/S 36
		0.06 to 36 mL/min	0.21 to 130 mL/min	0.8 to 480 mL/min	1.7 to 1000 mL/min	2.8 to 1700 mL/min	3.8 to 2300 mL/min	1.7 to 1000 mL/min (1.8 to 1100 mL/min)	2.8 to 1700 mL/min (3.0 to 1800 mL/min)	3.8 to 2300 mL/min (4.3 to 2600 mL/min)	4.8 to 2900 mL/min (5.8 to 3400 mL/min)
	Qty/pk										
Silicone (platinum-cured)	7.6 m (25 ft)	MY-96410-13	MY-96410-14	MY-96410-16	MY-96410-25	MY-96410-17	MY-96410-18	MY-96410-15	MY-96410-24	MY-96410-35	MY-96410-36
Silicone (peroxide-cured)	7.6 m (25 ft)	MY-96400-13	MY-96400-14	MY-96400-16	MY-96400-25	MY-96400-17	MY-96400-18	MY-96400-15	MY-96400-24	MY-96400-35	MY-96400-36
BioPharm Silicone (platinum-cured)	7.6 m (25 ft)	MY-96420-13	MY-96420-14	MY-96420-16	MY-96420-25	MY-96420-17	MY-96420-18	MY-96420-15	MY-96420-24	MY-96420-35	MY-96420-36
BioPharm Plus Silicone (platinum-cured)	7.6 m (25 ft)	MY-96440-13	MY-96440-14	MY-96440-16	MY-96440-25	MY-96440-17	MY-96440-18	MY-96440-15	MY-96440-24	MY-96440-35	MY-96440-36
Puri-Flex™	7.6 m (25 ft)	MY-96419-13	MY-96419-14	MY-96419-16	MY-96419-25	MY-96419-17	MY-96419-18	MY-96419-15	MY-96419-24	MY-96419-35	MY-96419-36
C-Flex®	7.6 m (25 ft)	MY-06424-13	MY-06424-14	MY-06424-16	MY-06424-25	MY-06424-17	MY-06424-18	MY-06424-15	MY-06424-24	MY-06424-35	MY-06424-36
C-Flex® ULTRA	7.6 m (25 ft)	—	MY-06434-14	MY-06434-16	MY-06434-25	MY-06434-17	MY-06434-18	MY-06434-15	MY-06434-24	MY-06434-35	MY-06434-36
PharMed® BPT	7.6 m (25 ft)	MY-06508-13	MY-06508-14	MY-06508-16	MY-06508-25	MY-06508-17	MY-06508-18	MY-06508-15	MY-06508-24	MY-06508-35	MY-06508-36
PharmaPure®	7.6 m (25 ft)	MY-06435-13	MY-06435-14	MY-06435-16	MY-06435-25	MY-06435-17	MY-06435-18	MY-06435-15	MY-06435-24	—	—
GORE® STA-PURE® Series PCS	35.6 cm (14")	—	MY-96211-14	MY-96211-16	MY-96211-25	MY-96211-17	MY-96211-18	MY-96211-15	MY-96211-24	MY-96211-35	MY-96211-36
GORE® STA-PURE® Series PFL	35.6 cm (14")	—	MY-96212-24	MY-96212-35	MY-96212-36	MY-96212-17	MY-96212-18	MY-96212-15	MY-96212-24	MY-96212-35	MY-96212-36
Chem-Durance® Bio	15.2 m (50 ft)	MY-06442-13	MY-06442-14	MY-06442-16	MY-06442-25	MY-06442-17	MY-06442-18	MY-06442-15	MY-06442-24	MY-06442-35	MY-06442-36
Tygon® E-LFL	7.6 m (25 ft)	MY-06440-13	MY-06440-14	MY-06440-16	MY-06440-25	MY-06440-17	MY-06440-18	MY-06440-15	MY-06440-24	MY-06440-35	MY-06440-36
Tygon E-Food (B-44-4X)	15.2 m (50 ft)	MY-06418-13	MY-06418-14	MY-06418-16	MY-06418-25	MY-06418-17	MY-06418-18	MY-06418-15	MY-06418-24	MY-06418-35	MY-06418-36
Tygon E-Lab (E-3603)	15.2 m (50 ft)	MY-06509-13	MY-06509-14	MY-06509-16	MY-06509-25	MY-06509-17	MY-06509-18	MY-06509-15	MY-06509-24	MY-06509-35	MY-06509-36
Tygon Fuel & Lubricant (F-4040-A)	15.2 m (50 ft)	MY-06401-13	MY-06401-14	MY-06401-16	MY-06401-25	MY-06401-17	MY-06401-18	MY-06401-15	MY-06401-24	MY-06401-35	MY-06401-36
Tygon Chemical (2001)	15.2 m (50 ft)	MY-06475-13	MY-06475-14	MY-06475-16	MY-06475-25	MY-06475-17	MY-06475-18	MY-06475-15	MY-06475-24	—	—
Norprene® (A-60 G)	15.2 m (50 ft)	MY-06404-13	MY-06404-14	MY-06404-16	MY-06404-25	MY-06404-17	MY-06404-18	MY-06404-15	MY-06404-24	MY-06404-35	MY-06404-36
Norprene Food (A 60 F)	15.2 m (50 ft)	MY-06402-13	MY-06402-14	MY-06402-16	MY-06402-25	MY-06402-17	MY-06402-18	MY-06402-15	MY-06402-24	MY-06402-35	MY-06402-36
Viton®	7.6 m (25 ft)	MY-96412-13	MY-96412-14	MY-96412-16	MY-96412-25	MY-96412-17	MY-96412-18	MY-96412-15	MY-96412-24	MY-96412-35	MY-96412-36

		I/P® Precision Pump Tubing			I/P® High-Performance Precision Pump Tubing			B/T® PerfectPosition® Pump Tubing			
		I/P 26	I/P 73	I/P 82					B/T 87	B/T 91	
		0.01 to 4 LPM 0.002 to 1.1 GPM	0.01 to 8 LPM 0.002 to 2.1 GPM	0.02 to 13 LPM 0.005 to 3.5 GPM	Qty/pk	0.01 to 8 LPM 0.002 to 2.1 GPM	0.02 to 17 LPM 0.005 to 4.5 GPM	0.03 to 19 LPM 0.007 to 5.0 GPM	Qty/pk	0.67 to 18.9 LPM 0.17 to 5.0 GPM	1.4 to 42 LPM 0.4 to 11.1 GPM
	Qty/pk										
Silicone (platinum-cured)	7.6 m (25 ft)	MY-96410-26	MY-96410-73	MY-96410-82	3 m (10 ft)	MY-96510-70	MY-96510-88	MY-96510-89	3 m (10 ft)	MY-96510-87	MY-96510-91
Silicone (peroxide-cured)	7.6 m (25 ft)	MY-96400-26	MY-96400-73	MY-96400-82	—	—	—	—	3 m (10 ft)	MY-96400-87	MY-96400-91
BioPharm Silicone (platinum-cured)	7.6 m (25 ft)	MY-96420-26	MY-96420-73	MY-96420-82	3 m (10 ft)	MY-96421-70	MY-96421-88	MY-96421-89	—	—	—
BioPharm Plus Silicone (platinum-cured)	7.6 m (25 ft)	MY-96440-26	MY-96440-73	MY-96440-82	3 m (10 ft)	MY-96441-70	MY-96441-88	MY-96441-89	3 m (10 ft)	MY-96445-87	MY-96445-91
Puri-Flex™	7.6 m (25 ft)	MY-96419-26	MY-96419-73	MY-96419-82	3 m (10 ft)	MY-96419-70	MY-96419-88	MY-96419-89	3 m (10 ft)	MY-96419-87	MY-96419-91
C-Flex®	7.6 m (25 ft)	MY-06424-26	MY-06424-73	MY-06424-82	3 m (10 ft)	MY-06424-70	MY-06424-88	MY-06424-89	3 m (10 ft)	MY-06424-87	MY-06424-91
PharMed® BPT	7.6 m (25 ft)	MY-06508-26	MY-06508-73	MY-06508-82	7.6 m (25 ft)	MY-06508-70	MY-06508-88	—	3 m (10 ft)	MY-06507-87	MY-06507-91
PharmaPure®	7.6 m (25 ft)	MY-06435-26	MY-06435-73	MY-06435-82	—	—	—	—	3 m (10 ft)	MY-06437-87	MY-06437-91
GORE® STA-PURE® Series PCS	0.6 m (2 ft)	MY-96211-26	MY-96211-73	MY-96211-82	0.6 m (2 ft)	—	MY-96211-88	MY-96211-89	—	—	—
GORE® STA-PURE® Series PFL	0.6 m (2 ft)	MY-96212-26	MY-96212-73	MY-96212-82	0.6 m (2 ft)	—	MY-96212-88	MY-96212-89	—	—	—
Chem-Durance® Bio	15.2 m (50 ft)	MY-06442-26	MY-06442-73	MY-06442-82	15.2 m (50 ft)	MY-06442-70	MY-06442-88	MY-06442-89	3 m (10 ft)	MY-06443-87	MY-06443-91
Tygon® E-LFL	7.6 m (25 ft)	MY-06440-26	MY-06440-73	MY-06440-82	7.6 m (25 ft)	MY-06440-70	MY-06440-88	MY-06440-89	3 m (10 ft)	MY-06440-87	MY-06440-91
Tygon E-Food (B-44-4X)	15.2 m (50 ft)	MY-06418-26	MY-06418-73	MY-06418-82	15.2 m (50 ft)	MY-06418-70	MY-06418-88	MY-06418-89	3 m (10 ft)	MY-06418-87	MY-06418-91
Tygon E-Lab (E-3603)	15.2 m (50 ft)	MY-06509-26	MY-06509-73	MY-06509-82	15.2 m (50 ft)	MY-06509-70	MY-06509-88	MY-06509-89	15.2 m (50 ft)	—	—
Norprene® (A-60 G)	15.2 m (50 ft)	MY-06404-26	MY-06404-73	MY-06404-82	7.6 m (25 ft)	MY-06404-70	MY-06404-88	MY-06404-89	7.6 m (25 ft)	—	—
Norprene Food (A 60 F)	15.2 m (50 ft)	MY-06402-26	MY-06402-73	MY-06402-82	7.6 m (25 ft)	—	MY-06402-88	MY-06402-89	3 m (10 ft)	MY-06399-87	MY-06399-91

## Masterflex® Pump Accessories

### A. Pulse Dampener

Virtually eliminates pulsation in output flow. Five pairs of fittings and PTFE-pipe thread tape are included. Accepted tubing: all L/S® sizes, I/P® 26, nominal from 1.6 to 9.5 mm ID (1/16" to 3/8" ID). Fittings included (tubing ID x NPT(M) thread): 1/16" x 1/8", 1/8" x 1/8", 3/16" x 1/8", 1/4" x 1/8", and 3/8" x 1/8". Dampener connections: 1/8" NPT(F). Dead volume: 190-mL. Max pressure: 60 psi (4.3 bar). Polyethylene body.



Description	Catalogue number
Pulse dampener	MY-07596-20

### B. On/Off Foot Switches

Foot switches allow for remote control of specific functions of your Masterflex drive. All units have a 1.8-m (6-ft) cord. Verify the connector type on your drive before ordering.



Description	Catalogue number
DB9 male connector; for 07528-, 07557-, and 07591-series Masterflex drives	MY-77595-35
DB25 male connector; for 07522-, 07523-, 07551-, 77301-, and 07594-series Masterflex drives	MY-07523-92
18-pin round water-tight connector; for 07557-, 07591-, and 77411-series Masterflex drives	MY-07595-43
31-pin round water-tight connector; for 07575-, 77301-, 07594-, and 77420-series Masterflex drives	MY-07575-84

### C. DB9 Cable Assembly

Use these 9-pin interface cable assemblies with Masterflex L/S® drives (07550- and 07551-series). Cable measures 1.8-m (6-ft) long.



Description	Catalogue number
Interface cable with DB9 (M/F)	MY-22050-54

### D. USB to DB9(M) RS-232 Serial Adapter Cable

Use this cable to connect the Masterflex 07550- and 07551-series Computer Compatible drives to a PC with USB port. Will also connect other peripheral devices equipped with RS-232 serial interface including balances, printers, scanners, and PDA's. Includes 0.6-m (2-ft) cable and driver software. Supports data transfer speeds up to 12 Mbps; compatible with Windows® 2000/XP/Vista/7.



Description	Catalogue number
USB to DB9(M) RS-232 serial adapter cable	MY-22050-58

### E. Remote Control Connectors

Combine these connectors with 20 to 22 gauge shielded wire to create your own interface cable. Maximum cable length is 300-m (1000 ft).



Description	Catalogue number
DB9 male connector. Wire only the pins needed	MY-07595-45
DB25 male connector. Wire only the pins needed	MY-07523-94

### F. Handheld Remote Controllers

These handheld controllers are designed to control basic drive operations. Route tubing through the handle for filling and dispensing applications. Handles accept Masterflex tubing sizes L/S® 13, L/S 14, L/S 16, L/S 25, L/S 17, L/S 18, L/S 15, and L/S 24 (up to 11.1 cm nominal OD).

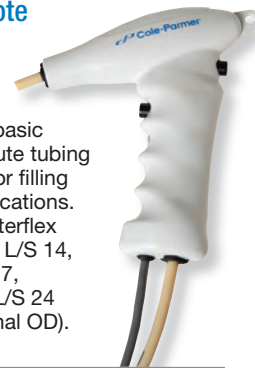

Description	Catalogue number
DB9 male connector; for 07528-series Masterflex L/S drives; control start/stop and direction	MY-07528-80
DB25 male connector; for 07523-series and 07551-series Masterflex L/S drives; control start/stop, direction, and prime	MY-07523-97
Stripped wire ends; control start/stop, direction, and prime	MY-07595-62

### G. Remote Control Cable Assemblies

Cable assemblies include terminal connector and 7.9-m (25 ft) cable with stripped wire ends. Verify the connector type on your drive before ordering.



Description	Catalogue number
DB9 male connector; for 07528-, 07557-, and 07591-series Masterflex drives	MY-07595-47
DB25 male connector; for 07522-, 07523-, 07551-, 77301-, and 07594-series Masterflex drives	MY-07523-95
18-pin round water-tight connector; for 07557-, 07591-, and 77411-series Masterflex drives	MY-77300-32
31-pin round water-tight connector; for 07575-, 77301-, 07594-, and 77420-series Masterflex drives	MY-07575-80

## Overlook Filler/Dispensing Nozzles

- Maximise the speed, precision, and accuracy of dispensing and filling applications
- Dimensional tolerances of ±0.05% for assured repeatability

Nozzles feature a 316L stainless steel needle and a polycarbonate base with hose barb adapter. Materials meet FDA, USDA and USP Class VI requirements. Sterilise by ethylene oxide, autoclaving, or gamma irradiation.

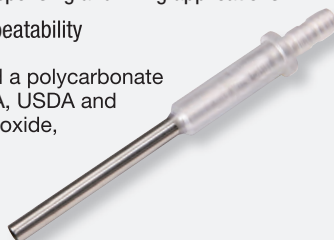

Tubing ID	Catalogue number
1/32"	MY-30619-06
1/16"	MY-30619-01
1/8"	MY-30619-07
3/16"	MY-30619-02
1/4"	MY-30619-08
5/16"	MY-30619-03
3/8"	MY-30619-09
1/2"	MY-30619-04
5/8"	MY-30619-10
3/4"	MY-30619-05



# Ismatec® Reglo Independent Channel Control (ICC) Pumps

## Pump each channel at different speeds and directions!

- Each pump performs the job of up to four separate pumps
- Additional options in channel and roller configurations allow balanced pulsation control at desired flow rate
- USB interface for quick computer connections using redesigned graphical user-interface

These two-, three- and four-channel peristaltic pumps let you individually control the flow and direction of each channel from the intuitive keypad or via your computer—expanding your benchtop pumping capabilities with a single compact unit! Pump delivers continuous pumping or precision dispensing up to 43-mL/min with the capability of bidirectional flow in each channel. Plus, independent channel calibration minimises tube-to-tube differences, resulting in high calibration accuracy.

Deliver or dispense at multiple flow rates—all from a single space-saving pump.



### Specifications

**Speed:** 0.1 to 100 rpm      **Pressure:** up to 1.0 bar (14.5 psi)  
**Accuracy:** ±1%



Channels	Rollers	Tubing	Power (VAC, Hz)	Catalogue number
<b>Benchtop pumps</b>				
Two	Six	Three-stop	100 to 240, 50/60	MY-78001-58
	Eight			MY-78001-60
	12			MY-78001-62
Three	Six	Three-stop	100 to 240, 50/60	MY-78001-68
	Eight			MY-78001-70
	12			MY-78001-72
Four	Six	Three-stop	100 to 240, 50/60	MY-78001-78
	Eight			MY-78001-80
	12			MY-78001-82
<b>Panel-mount pumps</b>				
Two	Eight	Three-stop	100 to 240, 50/60	MY-78001-43
Three	Eight			MY-78001-45
Four	Eight			MY-78001-47
Four	12			MY-78001-49

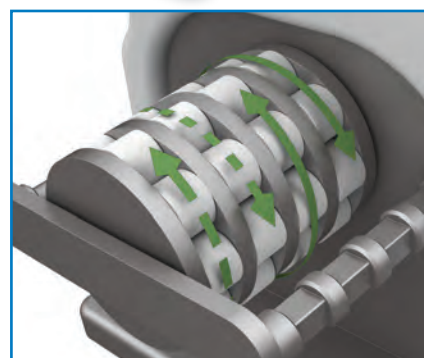

### Independent Channel Design

- ✓ Up to four independently controllable channels
- ✓ Flexibility of bidirectional flow in each channel
- ✓ Continuous pumping or precision dispensing
- ✓ Enhanced accuracy through separate channel calibration

### Accessories

MY-78016-98 Replacement Click'n'go™ tubing cassette, POM-C  
 MY-78016-96 Click'n'go™ tubing cassette, PVDF

### Flow Ranges (mL/min per channel)

Tubing ID (mm)	6 rollers	8 rollers	12 rollers
0.13	0.0002 to 0.14	0.0002 to 0.11	0.0001 to 0.093
0.51	0.0019 to 1.9	0.0017 to 1.7	0.0016 to 1.6
0.57	0.0024 to 2.4	0.0021 to 2.1	0.0019 to 1.9
0.64	0.0030 to 3.0	0.0026 to 2.6	0.0024 to 2.4
0.95	0.0064 to 6.4	0.0056 to 5.6	0.0050 to 5.0
1.02	0.0073 to 7.3	0.0063 to 6.3	0.0056 to 5.6
1.42	0.013 to 13	0.011 to 11	0.0094 to 9.4
1.75	0.019 to 19	0.016 to 16	0.013 to 13
1.85	0.021 to 21	0.017 to 17	0.014 to 14
2.54	0.033 to 33	0.027 to 27	0.019 to 19
2.79	0.036 to 36	0.031 to 31	0.021 to 21
3.17	0.043 to 43	0.035 to 35	0.024 to 24

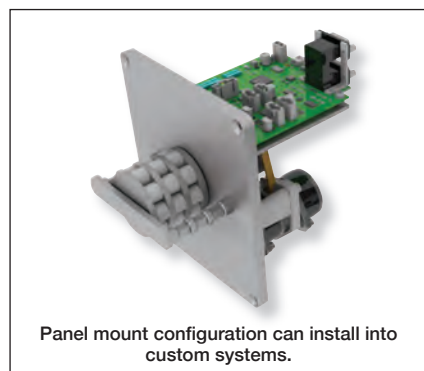

Panel mount configuration can install into custom systems.

# Ismatec® IPC Low-Flow High-Accuracy Pumps

## Fewer tubing changes

- Planetary drive for less pulsation and longer tubing life
- Smooth rotation and accurate liquid flow provided by eight SS rollers
- Easy repeatability with four-digit LED
- Simple to use
- Five modes for pumping or dispensing including flow rate, time, batches, drip-free, and volume
- Control via keypad, computer, or remote control
- IP and IP-N analogue pumps available online



Choose from 4, 8, 12, 16 and 24 channel configurations for application flexibility.

4 channel



8 channel



12 channel



16 channel



24 channel



See pages 146-147.

### Specifications

<b>Accuracy:</b> better than $\pm 1\%$	<b>Pressure</b> Click'n'go cassettes: up to 14.5 psi (1 bar) Pressure lever cassettes: up to 22 psi (1.5 bar)
--	---



Flow range per channel (mL/min)	Channels	Rollers	Speed (rpm)	Cassette style	Tubing	Power (VAC, Hz)	Catalogue number
<b>IPC-N models</b>							
0.0004 to 11	Four	Eight	0.11 to 11.25	Click'n'go	Two-stop	230, 50/60	<b>MY-78001-06</b>
	Eight					230, 50/60	<b>MY-78001-16</b>
	12					230, 50/60	<b>MY-78001-26</b>
	16					230, 50/60	<b>MY-78001-36</b>
0.0004 to 11	24	Eight	0.11 to 11.25	Pressure lever (adjustable occlusion)	Two-stop	230, 50/60	<b>MY-78001-46</b>
	Eight					230, 50/60	<b>MY-78000-17</b>
	16					230, 50/60	<b>MY-78000-37</b>
	24					230, 50/60	<b>MY-78000-47</b>
<b>IPC models</b>							
0.002 to 44	Four	Eight	0.4 to 45	Click'n'go	Two-stop	230, 50/60	<b>MY-78001-08</b>
	Eight					230, 50/60	<b>MY-78001-18</b>
	12					230, 50/60	<b>MY-78001-28</b>
	16					230, 50/60	<b>MY-78001-38</b>
0.002 to 44	24	Eight	0.4 to 45	Pressure lever (adjustable occlusion)	Two-stop	230, 50/60	<b>MY-78001-48</b>
	Four					230, 50/60	<b>MY-78000-09</b>
	Eight					230, 50/60	<b>MY-78000-19</b>
	12					230, 50/60	<b>MY-78000-29</b>
0.002 to 44	16	Eight	0.4 to 45	Pressure lever (adjustable occlusion)	Two-stop	230, 50/60	<b>MY-78000-39</b>
	24					230, 50/60	<b>MY-78000-49</b>

Order extra cartridges/adapters when fast tubing changes are crucial.

**MY-78001-95 Replacement Click'n'go™ cartridge, POM-C**  
**MY-78001-90 Repl. adjust. occlusion cartridge with pressure lever**

**MY-07618-71 Replacement adapters** hold two-stop colour-coded tubing in cartridge. Two adapters required per cartridge. Pack of 12

### Planetary Drive System

With the planetary drive system, each roller is directly driven by the sun wheel. This mechanism prevents axial push-pull friction on the tubing—resulting in longer tubing life, lower pulsation, and high repeatability.

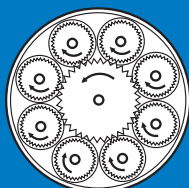

### Pressure Lever Cassettes

These cassettes feature a pressure lever that allows you to set a different tubing pressure for each channel. Depending on the application, tubing material, and diameter, you can adjust to optimal tubing pressure for your requirements.

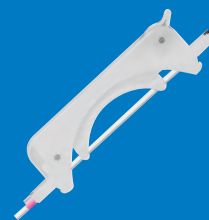

## Ismatec® ecoline Pumps

### Save space—pumps stack easily

- Durable stainless steel housing and four stabilising feet for easier stacking
- Simple setup and operation—start, stop, and reverse flow with a single switch
- Configurations available to support standard, Masterflex, and stopped tubing

Pumps are controllable remotely via an analog input signal (0 to 5 VDC, 0 to 10 VDC, 0 to 20 mA, or 4 to 20 mA); start/stop drive or reverse direction via contact closure (eight-pin DIN). Input signals from your existing instruments actuate drive functions.

#### A–C. Drive with Single-Channel Pump Head

- Minimise tubing wear and ensure automatic centering with convex roller

#### D. Drive with Masterflex® L/S® Easy-Load® Pump Head

- Change tubing quickly with easily accessible head
- Polysulfone housing and stainless steel rotor

#### E. Drive with Minicartridge Pump Head

- No adjustments needed—spring-loaded cassettes for optimal occlusion at all times Get consistent, low-pulse flow with 6 or 12 rollers

**ISMATEC®**

ISO9001:2008  
CERTIFIED SUPPLIER

Key	Flow range per channel (mL/min)	Channels	Rollers	Speed	Tubing	Power (VAC, Hz)	Catalogue number
<b>Drive with single-channel pump head</b>							
<b>A</b>	1.7 to 5400	One	Two	3.5 to 350 rpm	Pump (pg 147)	230, 50/60	<b>MY-78022-12</b>
<b>B</b>	1.6 to 5000		Three			230, 50/60	<b>MY-78022-22</b>
<b>C</b>	0.25 to 1300		Three			230, 50/60	<b>MY-78022-32</b>
<b>Drive with Easy-Load pump head</b>							
<b>D</b>	0.23 to 1600	One	Three	3.5 to 350 rpm	Masterflex® (pgs 138–139)	230, 50/60	<b>MY-78022-52</b>
<b>Drive with Minicartridge pump head and Click'n'go cassettes</b>							
<b>E</b>	0.01 to 130	Eight	Six	3.5 to 350 rpm	Three-stop (pgs 146–147)	230, 50/60	<b>MY-78022-42</b>
	0.0075 to 75	Four	12			230, 50/60	<b>MY-78022-62</b>

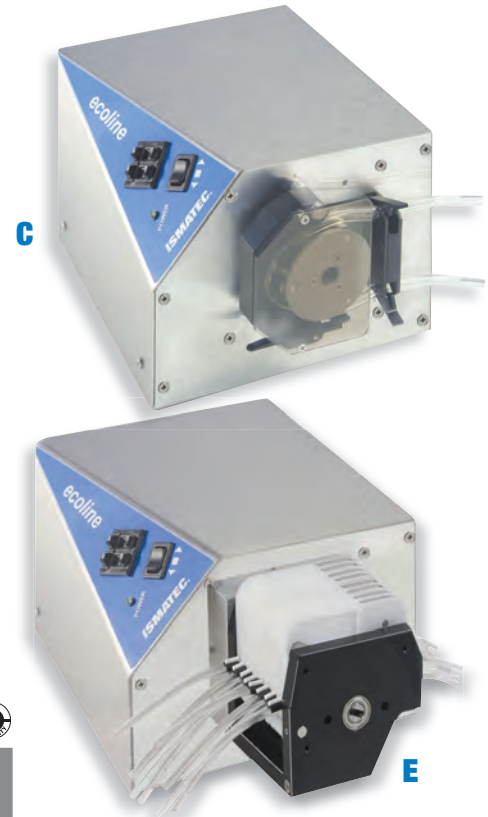

#### Accessories

**MY-07624-64** Optional adjustable occlusion cassette with pressure lever, POM-C

**MY-78016-98** Replacement Click'n'go™ cassette, POM-C

**MY-07610-25** Foot switch, momentary contact

**MY-17050-01** ILAC MRA, NIST-traceable calibration with data for peristaltic pump drive

## Ismatec® Reglo Compact Multichannel Pumps

### No more inconsistent results

- Consistent flow and reduced tubing wear for improved results
- Very small footprint for a stand-alone “smart” pump
- Easy channel changes—Click'n'go™ minicartridges snap in place

**A. Reglo Analog Pumps.** Speed is adjustable in 1% steps (2 to 100%) via two-digit potentiometer. Control speed remotely. Start/stop pump or change direction via contact closure; monitor speed through frequency output.

**B. Reglo Digital Programmable Pumps.** Continuously pump or dispense in any of four modes—flow rate, time, batches, or drip-free. Pumps feature analog input and output controls, as well as an RS-232 interface for control by a computer. Remote control capable.



**ISMATEC®**



ISO9001:2008  
CERTIFIED SUPPLIER

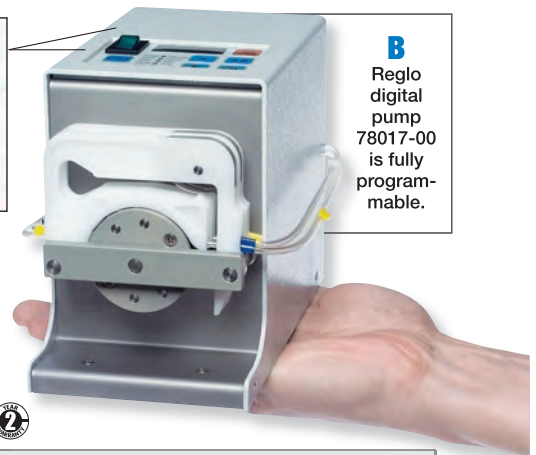

**B**  
Reglo digital pump 78017-00 is fully programmable.

Channels	Rollers	Speed (rpm)	Tubing	A. Reglo Analog pumps			B. Reglo Digital programmable pumps with calibrating function		
				Flow range per channel (mL/min)	Power (VAC, Hz)	Catalogue number	Flow range per channel (mL/min)	Power (VAC, Hz)	Catalogue number
Two	Six	3.2 to 160	Three-stop (pgs 146–147)	0.005 to 68	230, 50/60	<b>MY-78016-02</b>	0.003 to 68	115/230, 50/60	<b>MY-78016-42</b>
	Eight			0.004 to 57	230, 50/60	<b>MY-78016-12</b>	0.002 to 57	115/230, 50/60	<b>MY-78017-02</b>
	12			0.003 to 38	230, 50/60	<b>MY-78017-27</b>	0.002 to 38	115/230, 50/60	<b>MY-78016-47</b>
Four	Six	2.0 to 100	Three-stop (pgs 146–147)	0.003 to 43	230, 50/60	<b>MY-78017-32</b>	0.002 to 43	115/230, 50/60	<b>MY-78017-42</b>
	Eight			0.003 to 35	230, 50/60	<b>MY-78016-32</b>	0.002 to 35	115/230, 50/60	<b>MY-78017-12</b>
	12			0.002 to 24	230, 50/60	<b>MY-78017-37</b>	0.001 to 24	115/230, 50/60	<b>MY-78017-22</b>

#### Minicartridges

Optional adjustable-occlusion minicartridge to manually vary pressure on each channel.

**MY-07624-64** Optional adjustable occlusion cassette with pressure lever, POM-C

**MY-07624-96** Replacement Click'n'go cassette, PVDF



# Ismatec® BVP and MCP Quick-Couple Drives

## Create a custom system with interchangeable pump heads

- Mount pump heads quickly with turn-and-lock mounting system
- Select from interchangeable tubing pump heads to achieve flow rates from 0.003 to 3700-mL/min
- Remote control and programming options add versatility
- Process washdown drives are IP65 rated

### BVP Standard and Process Drives

- Prime, flush, or prevent overflow with Max/Slow toggle switch

**BVP Standard Drive** features analog input that remote control of speed, start/stop or flow direction. **BVP Process Washdown Drive** is similar to the BVP Standard model, plus has a digital display for speed. The IP65-rated housing is ideal for dusty, humid, or corrosive environment and in cleanroom areas. The stainless steel housing is sealed for added durability.

### MCP Standard and Process Programmable Digital Drives

- Save time—recall and store up to four programs
- Preprogrammed with tubing sizes and heads for faster setup
- Use the RS-232 interface to automate your lab or operate independently via the keypad—RS-232 in for remote operation; RS-232 out for cascading pumps

**MCP Standard Drive** is programmable to dispense by volume, time, flow rate, batches with variable pause time, stored programs, roller back steps, or number of dispensing cycles. Digital display shows speed, flow rate, dispensing volume, dispensing time, and pause time. **MCP Process Washdown Drive** adds an IP65-rated housing for washdown applications—ideal for dispensing and filling in dusty, humid, or corrosive environment and in cleanroom areas. The stainless steel housing is sealed for added durability.



BVP Standard drive 78002-10



MCP Standard programmable digital drive 78002-00 can store four programs downloaded from your computer.



BVP Process washdown drive 78003-10



### REQUIRED System Components

- 1) Quick-couple drive . . . 144
- 2) Pump head . . . . 144-145
- 3) Tubing . . . . . 146-147

### Specifications

Duty cycle: continuous



Model	BVP Standard drive	BVP Process washdown drive	MCP Standard drive	MCP Process washdown drive
Catalogue number	MY-78002-12	MY-78003-10	MY-78002-02	MY-78003-08
Programmable	No	No	Yes	Yes
Speed	2.4 to 240 rpm (indicated as 1 to 99.9%)	1 to 240 rpm	1 to 240 rpm	1 to 240 rpm
Resolution	0.1% via 3-digit potentiometer	0.1 rpm	0.1 rpm	0.1 rpm
Flow range/channel	0.003 to 3700 mL/min	0.001 to 3700 mL/min	0.001 to 3700 mL/min	0.001 to 3700 mL/min
Flow rate settings	—	—	µL/min, mL/min, L/min	µL/min, mL/min, L/min
Remote control capabilities	Speed control: 0 to 5 VDC, 0 to 10 VDC, 0 to 20 mA, 4 to 20 mA Speed output: 0 to 10 VDC or 0 to 12 kHz Start/stop, rotation direction	Speed control: 0 to 5 VDC, 0 to 10 VDC, 0 to 20 mA, 4 to 20 mA Speed output: 0 to 10 VDC or 0 to 7.2 kHz Start/stop, rotation direction, autostart	RS-232 (1 in, 1 out), 1 analogue Speed control: 0 to 5 VDC, 0 to 10 VDC, 0 to 20 mA, 4 to 20 mA Speed output: 0 to 10 VDC or 0 to 12 kHz Start/stop, rotation direction, autostart	RS-232 (1 in, 1 out), 1 analogue Speed control: 0 to 5 VDC, 0 to 10 VDC, 0 to 20 mA, 4 to 20 mA Speed output: 0 to 10 VDC or 0 to 7.2 kHz Start/stop, rotation direction, autostart
IP rating	IP30	IP65	IP30	IP65
Power	230 VAC, 50/60 Hz	230 VAC, 50/60 Hz	230 VAC, 50/60 Hz	115 to 230 VAC, 50/60 Hz

## Pump Heads for Quick-Couple Drives

### A. Washdown Pump Heads

**Dismantle for easy cleaning**—ideal for hygienic applications. Convex rollers and concave tube-bed maintain the integrity of material being pumped. Coated aluminum with stainless steel rollers.

Flow range (mL/min)	Channels	Rollers	Tubing	Wall thickness	Max pressure	Catalogue number
0.49 to 3700	One	Two	Pump (page 147)	1.6 mm	1.5 bar (22 psi)	MY-78002-11
3.6 to 3100	One	Two		2.4 mm	2.5 bar (36 psi)	MY-78002-13
0.45 to 3400	One	Three		1.6 mm	1.5 bar (22 psi)	MY-78002-16
3.3 to 2900	One	Three		2.4 mm	2.5 bar (36 psi)	MY-78002-14



## B. Minicartridge Pump Heads

**Minimise pulsation with more rollers.** Get up to 24 channels with 78002-50 and 07623-00 below. Get up to 16 channels of the smoothest flow with 78002-90 and 07623-30 below.

Flow range (mL/min)	Channels	Rollers	Tubing	Max pressure	Catalogue number
0.002 to 100	Eight (up to 24)	Six	Three-stop (pages 146–147)	1.0 bar (14.5 psi) <sup>†</sup>	<b>MY-78002-50</b>
0.001 to 57	Four (up to 16)	12			<b>MY-78002-90</b>

<sup>†</sup>22 psi (1.5 bar) achievable with pressure lever cassettes.

**MY-07623-00 Eight-channel extension pump head.** Use up to two with 78002-50 to get 24 channels

**MY-07623-30 Four-channel extension pump head.** Use up to three with 78002-90 to get 16 channels

## C. Standard Cartridge Pump Heads

**Ideal pump head for multichannel applications at higher flow rates.** Click'n'go™ cartridges allow quick and easy tubing changes.

Flow range (mL/min)	Channels	Rollers	Tubing	Max pressure	Catalogue number
0.002 to 230	Eight	Eight	Two-stop (pages 146–147)	1.0 bar (14.5 psi) <sup>†</sup>	<b>MY-78002-34</b>
	12				<b>MY-78002-36</b>

<sup>†</sup>22 psi (1.5 bar) achievable with pressure lever cassettes.

## D. Tubing Bed Pump Heads

**Ideal for delicate substances which require gentle occlusion setting.** Spring-loaded tubing bed adjusts occlusion for optimum pressure and tubing.

Flow range (mL/min)	Channels	Rollers	Tubing	Max pressure	Catalogue number
1.1 to 1110	Two	Six	Pump (page 147)	1.5 bar (22 psi)	<b>MY-07611-10</b>
0.09 to 530	Three				<b>MY-07611-15</b>

## E. Quick-Change Pump Heads

**Hinged tube-bed allows rapid tube change-over.** Easily accessible pump head. Self-centering tube-track results in longer tubing-life. Stainless steel rollers.

Flow range (mL/min)	Channels	Rollers	Tubing	Max pressure	Catalogue number
0.08 to 880	One	Three	Pump (page 147)	1.5 bar (22 psi)	<b>MY-78002-22</b>
0.44 to 2800					<b>MY-78002-20</b>

## F. High-Viscosity Pump Head

**Ideal for media with high viscosity or with a certain level of solid content.** Accepts tubing with 1.6-mm and 2.4-mm wall thickness (for elevated differential pressures). Stainless steel rollers. Pressure on tubing adjustable via rollers.

Flow range (mL/min)	Channels	Rollers	Tubing	Max pressure	Catalogue number
0.41 to 3600	One	Three	Pump (page 147)	36 psi	<b>MY-78002-60</b>

## G. Masterflex® Easy-Load® Pump Heads

**Allows for fast and easy tubing changes.** Accepts Masterflex L/S® pump tubing (see pages 138–139). Requires mounting plate below.

Flow range (mL/min)	Channels	Rollers	Tubing	Max pressure	Catalogue number
3.4 to 672	One (up to two)	Three	L/S 15, L/S 24	20 psi	<b>MY-07514-12</b>
0.12 to 912			L/S 13, L/S 14, L/S 16, L/S 17, L/S 18, L/S 25		<b>MY-07514-10</b>

**MY-78020-90 Mounting plate** for Masterflex Easy-Load pump head

**MY-07013-05 Mounting hardware** to stack two Easy-Load pump heads

## H. PTFE-Diaphragm Pump Heads

**Pump almost any fluid** with these chemically inert PTFE-diaphragm pump heads. Pump heads withstand temperatures up to 66°C (150°F). Requires adapter 78002-70 to mount to Quick-Couple drives.

Flow range (mL/min)	Ball check	Rollers	Tubing	Max pressure	Catalogue number
0.5 to 60	Glass	1/8" NPT(M)	Pump (page 147)	75 psi	<b>MY-07090-62</b>
4 to 480	PTFE	1/4" NPT(M)		50 psi	<b>MY-07090-42</b>

**MY-78002-70 Adapter** for mounting PTFE Diaphragm pump heads onto 78002- and 78003-series drives

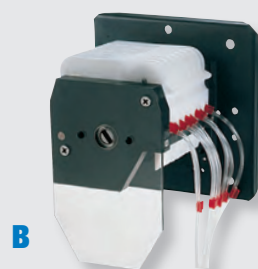

B



C



D

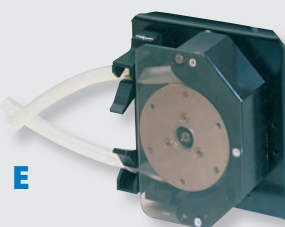

E

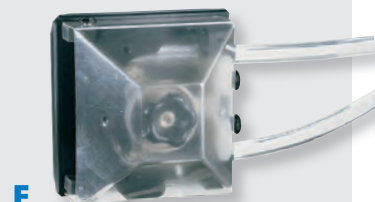

F



G



H

# Two- and Three-Stop Colour-Coded Tubing for Ismatec® Pumps

## Don't confuse your tubing— colour-coded stops for easy identification

**STEP 1:** Choose a tubing material & select the catalogue number prefix.

Make sure to choose two-stop or three-stop tubing based on what your pump uses!

**STEP 3:** Complete your system with extension tubing.

Connect stopped and extension tubing with barbed fittings or splicing.

Material	Description	Suffixes for the available sizes	No. of tubes per pack (length)	Two-Stop Tubing	Three-Stop Tubing	Extension Tubing	
				Cat. no. prefix	Cat. no. prefix	Length/pk	Cat. no. prefix
Tygon® E-LFL	<ul style="list-style-type: none"> <li>Complies with USP Class VI, EP, FDA, EU food, REACH, RoHS, ADFC</li> <li>Longest life of all Tygon formulations</li> <li>Broad chemical resistance</li> </ul>	10, 12, 14, 18, 22, 24, 26, 28, 30, 31, 33, 34, 36, 37, 40, 42, 43, 47, 48	12 tubes (40.6 cm)	MY-96449-XX	MY-96450-XX	100 ft	MY-06449-XX
Tygon® E-Food	<ul style="list-style-type: none"> <li>Complies with FDA, EU Food, NSF, 2A, REACH, RoHS, ADFC</li> <li>Smooth inner surface; non-toxic</li> </ul>	10, 12, 18, 26, 30, 34, 42, 48	12 tubes (40.6 cm)	MY-96457-XX	MY-96458-XX	100 ft	MY-06457-XX
Tygon® E-Lab	<ul style="list-style-type: none"> <li>Complies with USP Class VI, FDA, EU Food, NSF, REACH, RoHS, ADFC</li> <li>Ideal for general transfer applications</li> <li>Non-ageing/non-oxidizing, low gas permeability</li> </ul>	09, 10, 12, 14, 16, 18, 19, 22, 24, 26, 27, 28, 29, 30, 31, 32, 34, 36, 38, 39, 40, 42, 44, 46, 48, 49	12 tubes (40.6 cm)	MY-96460-XX	MY-96461-XX	100 ft	MY-06460-XX
Silicone (peroxide cured)	<ul style="list-style-type: none"> <li>Complies with USP Class VI, EP, FDA, 3A, REACH, RoHS, ADFC</li> <li>Greater physical compression capability</li> <li>Economical, long tubing life</li> </ul>	10, 12, 14, 18, 22, 24, 26, 28, 30, 32, 34, 36, 38, 40, 42, 44, 46, 48	Six tubes (40.6 cm)	MY-07616-XX	MY-07624-XX	50 ft	MY-07625-XX
Silicone (platinum cured)	<ul style="list-style-type: none"> <li>Complies with USP Class V, EP, FDA, REACH, RoHS, ADFC</li> <li>Low protein binding, fungus-resistant, phthalate and latex free</li> </ul>	22, 24, 26, 28, 30, 32, 34, 36, 38, 40, 42, 44, 46, 48	Six tubes (40.6 cm)	MY-95602-XX	MY-95603-XX	50 ft	MY-95612-XX
Viton®	<ul style="list-style-type: none"> <li>Complies with FDA, ADFC</li> <li>Resists corrosives, solvents, and oils at elevated temperatures</li> </ul>	18, 22, 24, 26, 30, 34, 38, 42, 46, 48	12 tubes (30.5 cm)	MY-97628-XX	MY-97629-XX	50 ft	MY-97632-XX
PharMed® BPT	<ul style="list-style-type: none"> <li>Complies with USP Class VI, EP, FDA, NSF, REACH, RoHS</li> <li>Over 10,000 hours of tubing life, sealable, weldable</li> <li>Ideal for tissue and cell culture work</li> </ul>	10, 12, 14, 18, 22, 24, 26, 28, 30, 32, 34, 36, 38, 40, 42, 44, 46, 48	12 tubes (40.6 cm)	MY-95723-XX	MY-95714-XX	100 ft	MY-95809-XX
Autoclavable PharMed® BPT		12, 32, 48	Six tubes (40.6 cm)	MY-95692-XX	MY-95693-XX		
PVC Solvent/hydrocarbon	<ul style="list-style-type: none"> <li>Resistant to ozone and UV light</li> <li>Resists to cracking, swelling, hardening</li> <li>Ideal for fuels, distillates, lubricants, and glycol-based coolants</li> </ul>	10, 12, 14, 18, 22, 24, 26, 28, 30, 32, 34, 36, 38, 40, 42, 44, 46, 48	12 tubes (40.6 cm)	MY-95606-XX	MY-95605-XX	50 ft	MY-95712-XX
Chem-Durance® Bio	<ul style="list-style-type: none"> <li>Suitable for acetone, MEK, and other highly aggressive chemicals</li> <li>Long life and outstanding fatigue resistance</li> </ul>	14, 18, 24, 26, 30, 34, 36, 42, 48	Six tubes (40.6 cm)	MY-96327-XX	MY-96328-XX	None (PharMed BPT recommended for extension tubing; see 95809-XX above)	

**STEP 2:**

Find your desired flow rate and select the catalogue number suffix. See page 147 for more.

Flow rate <sup>1</sup> (mL/min) with Fixed-Speed Pumps (order online)								Cat. no. suffix	ID (mm)	Colour-coded stops
78012-00, 78012-05	78012-20, 78012-25	78012-30, 78012-35	78012-40, 78012-45	78012-50, 78012-55	78012-60, 78012-65	78012-80, 78012-85	78012-90, 78012-95			
0.047	0.14	0.047	0.093	0.056	0.11	0.17	0.056	-10	0.19	O/R
0.081	0.24	0.08	0.16	0.1	0.19	0.29	0.1	-12	0.25	O/B
0.19	0.56	0.19	0.37	0.22	0.43	0.65	0.22	-14	0.38	O/G
0.25	0.75	0.25	0.5	0.29	0.58	0.86	0.29	-16	0.44	G/Y
0.34	1	0.34	0.67	0.38	0.77	1.2	0.38	-18	0.51	O/Y
0.52	1.6	0.52	1	0.6	1.2	1.8	0.6	-22	0.64	O/W
0.73	2.2	0.73	1.5	0.84	1.7	2.5	0.84	-24	0.76	Bk/Bk
1	2.9	1	2	1.1	2.3	3.4	1.1	-26	0.89	O/O
1.3	3.8	1.3	2.5	1.5	2.9	4.4	1.5	-28	1.02	W/W
1.6	4.7	1.6	3.1	1.8	3.6	5.4	1.8	-30	1.14	R/R
2	5.9	2	3.9	2.3	4.6	6.9	2.3	-32	1.3	GR/GR
2.3	6.8	2.3	4.6	2.7	5.4	8	2.7	-34	1.42	Y/Y
2.6	7.7	2.6	5.1	3	6	9.1	3	-36	1.52	Y/B
2.9	8.8	2.9	5.8	3.5	6.9	10	3.5	-38	1.65	B/B
3.5	10	3.5	7	4.2	8.4	13	4.2	-40	1.85	G/G
4.1	12	4.1	8.2	5	10	15	5	-42	2.06	P/P
4.8	14	4.8	9.5	5.8	12	17	5.8	-44	2.29	P/Bk
5.5	16	5.5	11	6.6	13	20	6.6	-46	2.54	P/O
6.2	19	6.2	12	7.4	15	22	7.4	-48	2.79	P/W

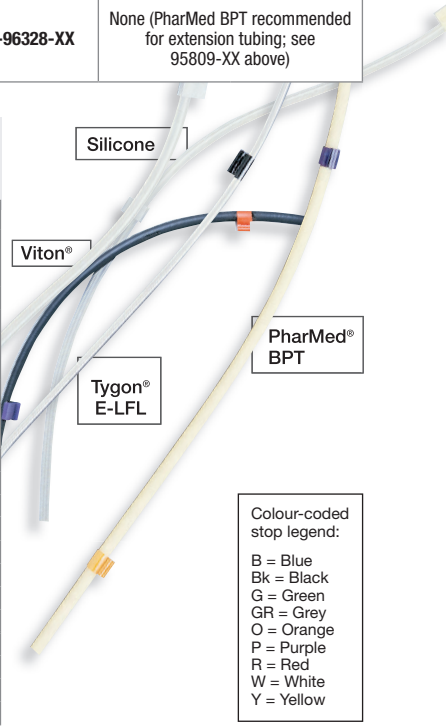



**STEP 2 (continued):** Find your desired flow rate and select the catalogue number suffix.

Flow ranges <sup>†</sup> (mL/min) with indicated pump system (page 143 and online)													Cat. no. suffix	ID (mm)	Colour-coded stops
78016-00, 78016-02	78016-10, 78016-12	78016-30, 78016-32	78016-42	78017-02	78017-10, 78017-12	78017-20, 78017-22	78017-25, 78017-27	78017-30, 78017-32	78017-35, 78017-37	78017-45, 78017-47	78022-40, 78022-42	78022-60, 78022-62			
0.009-0.45	0.008-0.37	0.005-0.23	0.005-0.45	0.004-0.37	0.003-0.23	0.003-0.21	0.007-0.34	0.006-0.28	0.005-0.21	0.004-0.34	0.01-0.98	0.0075-0.75	-10	0.19	O/R
0.015-0.76	0.013-0.65	0.009-0.41	0.008-0.76	0.007-0.65	0.005-0.41	0.004-0.38	0.012-0.61	0.01-0.48	0.008-0.38	0.007-0.61	0.017-1.7	0.013-1.3	-12	0.25	O/B
0.035-1.7	0.03-1.5	0.019-0.94	0.017-1.7	0.015-1.5	0.01-0.94	0.009-0.88	0.028-1.4	0.022-1.1	0.018-0.88	0.014-1.4	0.038-3.8	0.031-3.1	-14	0.38	O/G
0.046-2.3	0.04-2	0.025-1.3	0.023-2.3	0.02-2	0.013-1.3	0.012-1.2	0.038-1.9	0.029-1.4	0.024-1.2	0.019-1.9	0.05-5	0.041-4.1	-16	0.44	G/Y
0.061-3.1	0.054-2.7	0.034-1.7	0.031-3.1	0.027-2.7	0.017-1.7	0.016-1.6	0.05-2.5	0.038-1.9	0.031-1.6	0.025-2.5	0.067-6.7	0.055-5.5	-18	0.51	O/Y
0.096-4.8	0.084-4.2	0.052-2.6	0.048-4.8	0.042-4.2	0.026-2.6	0.024-2.4	0.077-3.9	0.06-3	0.048-2.4	0.039-3.9	0.1-10	0.085-8.5	-22	0.64	O/W
0.13-6.7	0.12-5.8	0.073-3.6	0.067-6.7	0.058-5.8	0.036-3.6	0.33-3.3	0.11-5.3	0.084-4.2	0.067-3.3	0.053-5.3	0.15-15	0.12-12	-24	0.76	Bk/Bk
0.18-9	0.16-7.9	0.098-4.9	0.09-9	0.079-7.9	0.049-4.9	0.044-4.4	0.14-7.1	0.11-5.7	0.088-4.4	0.071-7.1	0.2-20	0.15-15	-26	0.89	O/O
0.23-12	0.2-10	0.13-6.3	0.12-12	0.1-10	0.063-6.3	0.056-5.6	0.18-9	0.15-7.3	0.11-5.6	0.09-9	0.26-26	0.2-20	-28	1.02	W/W
0.29-14	0.25-12	0.16-7.8	0.14-14	0.12-12	0.078-7.8	0.067-6.7	0.22-11	0.18-9	0.13-6.7	0.11-11	0.32-32	0.24-24	-30	1.14	R/R
0.37-18	0.31-16	0.2-10	0.18-18	0.16-16	0.1-10	0.083-8.3	0.26-13	0.23-11	0.17-8.3	0.13-13	0.4-40	0.29-29	-32	1.3	GR/GR
0.43-21	0.37-18	0.23-11	0.21-21	0.18-18	0.11-11	0.094-9.4	0.3-15	0.27-13	0.19-9.4	0.15-15	0.47-47	0.33-33	-34	1.42	Y/Y
0.48-24	0.41-20	0.26-13	0.24-24	0.2-20	0.13-13	0.1-10	0.33-17	0.3-15	0.21-10	0.17-17	0.53-53	0.36-36	-36	1.52	Y/B
0.56-28	0.47-23	0.29-15	0.28-28	0.23-23	0.15-15	0.12-12	0.37-19	0.35-17	0.23-12	0.19-19	0.61-61	0.41-41	-38	1.65	B/B
0.67-34	0.56-28	0.35-17	0.34-34	0.28-28	0.17-17	0.13-13	0.43-21	0.42-21	0.27-13	0.21-21	0.73-73	0.47-47	-40	1.85	G/G
0.79-40	0.66-33	0.41-20	0.4-40	0.33-33	0.2-20	0.15-15	0.49-24	0.5-25	0.3-15	0.24-24	0.87-87	0.53-53	-42	2.06	P/P
0.92-46	0.76-38	0.48-24	0.46-46	0.38-38	0.24-24	0.17-17	0.55-27	0.58-29	0.34-17	0.27-27	1-100	0.6-60	-44	2.29	P/Bk
1.1-53	0.88-44	0.55-27	0.53-53	0.44-44	0.27-27	0.19-19	0.62-31	0.66-33	0.39-19	0.31-31	1.2-120	0.68-68	-46	2.54	P/O
1.2-59	0.99-50	0.62-31	0.59-59	0.5-50	0.31-31	0.21-21	0.69-34	0.74-37	0.43-21	0.34-34	1.3-130	0.75-75	-48	2.79	P/W

Flow ranges <sup>†</sup> (mL/min) with indicated pump (pages 142, 145, and online)						Cat. no. suffix	ID (mm)	Colour-coded stops
IPC-N models	IPC models	78002-34	78002-36	78002-50	78002-90			
0.0007-0.066	0.003-0.26	0.004-0.94	0.004-0.94	0.003-0.67	0.003-0.51	-10	0.19	O/R
0.001-0.1	0.005-0.41	0.008-1.8	0.008-1.8	0.005-1.1	0.004-0.91	-12	0.25	O/B
0.003-0.22	0.009-0.86	0.019-4.5	0.019-4.5	0.011-2.6	0.009-2.1	-14	0.38	O/G
0.003-0.28	0.011-1.1	0.025-6.1	0.025-6.1	0.014-3.5	0.012-2.8	-16	0.44	G/Y
0.004-0.38	0.015-1.5	0.034-8.2	0.034-8.2	0.019-4.6	0.016-3.8	-18	0.51	O/Y
0.006-0.58	0.023-2.3	0.053-13	0.053-13	0.03-7.2	0.024-5.8	-22	0.64	O/W
0.009-0.81	0.032-3.2	0.074-18	0.074-18	0.042-10	0.033-8	-24	0.76	Bk/Bk
0.011-1.1	0.044-4.4	0.1-24	0.1-24	0.057-14	0.044-11	-26	0.89	O/O
0.014-1.4	0.057-5.7	0.13-31	0.13-31	0.073-18	0.056-13	-28	1.02	W/W
0.017-1.7	0.07-7	0.16-38	0.16-38	0.09-22	0.067-16	-30	1.14	R/R
0.022-2.2	0.089-8.9	0.2-47	0.2-47	0.11-27	0.083-20	-32	1.3	GR/GR
0.026-2.6	0.11-11	0.23-55	0.23-55	0.13-32	0.094-23	-34	1.42	Y/Y
0.03-3	0.12-12	0.26-62	0.26-62	0.15-36	0.1-25	-36	1.52	Y/B
0.035-3.5	0.14-14	0.3-71	0.3-71	0.17-42	0.12-28	-38	1.65	B/B
0.43-4.3	0.17-17	0.36-86	0.36-86	0.21-50	0.13-32	-40	1.85	G/G
0.52-5.2	0.21-21	0.43-100	0.43-100	0.25-59	0.15-37	-42	2.06	P/P
0.062-6.2	0.25-25	0.51-120	0.51-120	0.29-69	0.17-41	-44	2.29	P/Bk
0.075-7.5	0.3-30	0.63-150	0.62-150	0.33-79	0.19-46	-46	2.54	P/O
0.088-8.8	0.35-35	0.74-180	0.74-180	0.37-89	0.21-52	-48	2.79	P/W

<sup>†</sup>Flow ranges (mL/min) are nominal. Actual flow depends on factors such as occlusion, fluid viscosity, temperature, and pressure.

### How to order two- and three-stop tubing

**Step 1:** Choose a tubing material and select the corresponding catalogue number prefix from the table on page 146. Make sure to choose two-stop or three-stop tubing based on what your pump uses!

**Step 2:** Find your pump system and desired flow rate and select the catalogue number suffix from the tables on pages 146–147.

**Step 3:** Complete your system with extension tubing from page 146. You can connect stopped tubing and extension tubing with hose barb fittings or by splicing together.

## Pump Tubing for Ismatec® Pumps

ID (mm)	OD (mm)	Wall (mm)	Tygon® E-Lab		Silicone (peroxide cured)		Silicone (platinum cured)		Norpren®		Viton®	
			Ft/pk	Cat. no.	Ft/pk	Cat. no.	Ft/pk	Cat. no.	Ft/pk	Cat. no.	Ft/pk	Cat. no.
0.8	4.0	1.6	50	MY-06509-13	25	MY-96400-13	25	MY-95802-01	50	MY-06404-13	25	MY-96412-13
1.6	4.8	1.6	50	MY-06407-72	25	MY-96400-14	25	MY-96410-14	50	MY-06410-01	25	MY-96412-14
3.2	6.4	1.6	50	MY-06407-76	25	MY-06411-67	25	MY-95802-05	50	MY-06410-02	—	—
4.8	8.0	1.6	50	MY-06407-78	25	MY-06411-03	25	MY-95802-09	50	MY-06410-04	25	MY-96412-25
6.4	9.5	1.6	50	MY-06407-80	25	MY-06411-71	25	MY-95802-12	50	MY-06410-05	25	MY-96412-18
6.4	11.1	2.4	50	MY-06509-24	25	MY-06411-72	25	MY-95802-13	50	MY-06410-06	25	MY-96412-24
8.0	11.2	1.6	50	MY-06407-83	25	MY-06411-75	25	MY-95802-15	50	MY-06410-08	25	MY-06434-05
9.5	12.7	1.6	50	MY-06407-86	25	MY-06411-12	25	MY-95802-18	50	MY-06410-10	25	MY-06434-06
11.1	14.3	1.6	50	MY-06407-87	—	—	—	—	50	MY-06410-13	—	—
12.8	16.0	1.6	25	MY-06407-90	25	MY-06411-80	25	MY-95802-21	50	MY-06410-14	25	MY-06434-07
16.0	22.4	3.2	—	—	25	MY-06411-58	25	MY-95802-25	50	MY-06410-17	25	MY-06434-08

ID (mm)	Flow ranges (mL/min) with indicated pump system <sup>††</sup> (pages 143,145, and online)								
	78025-00, -05	78022-10, -12	78022-20, -22	78022-30, -32	07611-10 <sup>‡</sup>	07611-15 <sup>‡</sup>	78002-20 <sup>‡</sup>	78002-22 <sup>‡</sup>	78002-60 <sup>‡</sup>
0.8	—	—	—	0.25 to 25	—	0.22 to 22	—	0.072 to 17	—
1.6	—	1.7 to 170	1.6 to 160	0.9 to 90	—	0.63 to 63	0.44 to 100	0.026 to 62	0.41 to 99
3.2	—	6.6 to 660	5.9 to 590	3.5 to 350	2.6 to 260	2.4 to 240	1.7 to 400	1.0 to 240	1.5 to 370
4.8	—	15.0 to 1500	13.0 to 1300	7.7 to 770	5.5 to 550	5.3 to 530	3.6 to 860	2.2 to 530	3.4 to 830
6.4	37 to 3700	25.0 to 2500	23.0 to 2300	13.0 to 1300	8.9 to 890	—	6.0 to 1400	3.7 to 880	6.2 to 1500
8.0	—	37.0 to 3700	34.0 to 3400	—	11.1 to 1110	—	8.8 to 2100	—	9.5 to 2300
9.5	80 to 8000	48.0 to 4800	44.0 to 4400	—	—	—	12 to 2800	—	13 to 3000
11.1	—	54.0 to 5400	50.0 to 5000	—	—	—	—	—	15 to 3600
12.8	100 to 10000	—	—	—	—	—	—	—	—
16.0	130 to 13000	—	—	—	—	—	—	—	—

<sup>††</sup>Note: Lower flow rates achievable with digital drives. <sup>‡</sup>Flow rate with Digital Drive 78002-10; lower flow rate achievable with Programmable Drive 78002-00.

# Ismatec® Gear Pumps

## High-performance drives with numerous features

- Magnetically driven pump heads provide smooth, accurate, pulseless fluid delivery
- Remote control and programming options add versatility
- Adapter plate to accept either A or B Mount gear pump heads is included

### Reglo-Z/ZS Analogue Drives

- Two-digit potentiometer provides a 100:1 turndown
- Four analogue signal plus relay contact permit remote control from a variety of instruments
- **Reglo-Z Analogue:** compact enough to fit in the palm of your hand
- **Reglo-ZS Analogue:** modular design has drive and controller separated by a 2-m long cable

### Reglo-Z/ZS Digital Drives

- Program pump for dispensing fluids by flow rate, volume, time or number of dispensing cycles
- Drip-free dispensing—program pump to draw back fluid (only compatible with certain heads)
- RS-232 interface allows control via a PC
- **Reglo-Z Digital:** compact yet lets you operate in multiple modes
- **Reglo-ZS Digital:** modular design has drive and controller separated by a 2-m long cable

### BVP-Z Standard Drive

- Economical yet versatile drive lets you adjust speed in 0.1% steps
- Press the MAX button for extra rpm and quick pump priming
- Electronic feedback system compensates for changes in load to maintain ±1% speed accuracy

### MCP-Z Series Drives

- Dispense by time, volume, flow rate, batches with variable pause time, stored programs, roller backsteps, or number of dispensing cycles
- Use the RS-232 interface to automate your lab or operate independently via the keypad
- Digital display shows speed, flow rate, dispensing volume, dispensing time, and pause time
- Store and recall up to four programs
- **MCP-Z Process:** IP65-rated stainless steel housing is ideal for dusty, humid, or corrosive environments and cleanroom areas



BVP-Z Standard



Reglo-Z Digital



MCP-Z Process



Reglo-ZS Analogue



### REQUIRED System Components

- 1) Drive ..... below
- 2) Pump head ..... 150
- 3) Tubing ..... online

### Specifications

Duty cycle: continuous



Model	Reglo-Z Analogue	Reglo-ZS Analogue	Reglo-Z Digital	Reglo-ZS Digital	BVP-Z Standard	MCP-Z Standard	MCP-Z Process
Catalogue number	MY-78008-05	MY-78008-25	MY-78008-15	MY-78008-35	MY-78004-17	MY-78004-37	MY-78004-47
Programmable	No		Yes		No	Yes	
Speed	50 to 5000 rpm (indicated as 1 to 99%)		50 to 5000 rpm		60 to 6000 rpm (indicated as 1 to 99.9%)	60 to 6000 rpm	
Resolution	0.1% via 2-digit potentiometer		1 rpm		0.1% via 3-digit potentiometer	0.1 rpm	
Flow rate settings	—		mL/min (flow), mL (dispensing)		—	µL/min, mL/min, L/min	
Remote control capabilities	Speed control: 0 to 5 VDC, 0 to 10 VDC, 0 to 20 mA, 4 to 20 mA Speed output: 0 to 10 kHz Start/stop		RS-232 Speed output: 0 to 12 kHz Start/stop, autostart		Speed control: 0 to 5 VDC, 0 to 10 VDC, 0 to 20 mA, 4 to 20 mA Speed output: 0 to 10 VDC or 0 to 12 kHz Start/stop	RS-232 (1 in, 1 out), 1 analogue Speed control: 0 to 5 VDC, 0 to 10 VDC, 0 to 20 mA, 4 to 20 mA Speed output: 0 to 10 VDC or 0 to 12 kHz Start/stop, autostart	
IP rating	IP30		IP30		IP30	IP30	IP65
Power	230 VAC, 50 Hz		230 VAC, 50 Hz		230 VAC, 50 Hz	230 VAC, 50 Hz	

### Accessories

**MY-78016-91 Foot switch** for Reglo-Z/ZS Analogue drives. On/off control, 1.8-m cable  
**MY-78016-93 Foot switch** for Reglo-Z/ZS Digital drives. On/off control, 1.8-m cable

**MY-78016-91 Foot switch** for BVP-Z drive. Start/stop operation, 1.8-m cable  
**MY-78003-07 Foot switch** for MCP-Z drives. Start/stop operation, 1.8-m cable

# Ismatec® Piston Pumps

## No valves to clog or wear out

- Get high pressure, accurate dispensing, and great repeatability—all with one pump system
- Only one moving part—the piston
- Remotely control speed, start/stop flow, or change fluid direction
- Differential pressure up to 6.9 bar (100 psi)
- Applications include dispensing of organic solvents, acids/bases, and highly corrosive acids including HF

### Reglo-CPF Analogue Drive

- Two-digit potentiometer provides a 100:1 turndown
- Four analogue signal plus relay contact permit remote control from a variety of instruments
- Compatible with RH pump heads for flow rates up to 180-mL/min



Reglo-CPF Analogue

Reglo-CPF Digital

### Reglo-CPF Digital Drive

- Program pump for dispensing fluids by flow rate, volume, time, or number of dispensing cycles
- Drip-free dispensing—program pump to draw back fluid
- RS-232 interface allows control via a PC
- Compatible with RH pump heads for flow rates up to 180-mL/min

### MCP-CPF Process Drive

- IP65 rated, stainless steel housing—ideal for pumping in dusty, humid, or corrosive environment and in cleanroom areas
- Dispense by time, volume, flow rate, batches with variable pause time, stored programs, roller backsteps, or number of dispensing cycles
- Use the RS-232 interface to automate your lab or operate independently via the keypad
- Digital display shows speed, flow rate, dispensing volume, dispensing time, and pause time
- Store and recall up to four programs
- Compatible with the full range of RH and Q series of pump heads for higher overall flow rates to 2300-mL/min



MCP-CPF Process



### REQUIRED System Components

- 1) Drive ..... below
- 2) Pump head ..... 150
- 3) Tubing ..... below

### Specifications

Duty cycle: continuous



Model	Reglo-CPF Analogue	Reglo-CPF Digital	MCP-CPF Process
Catalogue number	MY-78020-47	MY-78020-52	MY-78020-30
Programmable	No	Yes	Yes
Speed	18 to 1800 rpm (indicated as 1 to 99%)	40 to 1800 rpm	10.0 to 1800 rpm
Resolution	1% via 2-step potentiometer	0.1 rpm	0.1 rpm
Flow rate settings	—	µL/min, mL/min	µL/min, mL/min, L/min
Remote control capabilities	Speed control: 0 to 5 VDC, 0 to 10 VDC, 0 to 20 mA, 4 to 20 mA Speed output: 0 to 9 kHz Start/stop, rotation direction	RS-232 Speed control: 0 to 5 VDC, 0 to 10 VDC, 0 to 20 mA, 4 to 20 mA Speed output: 0 to 9 kHz Start/stop, autostart, rotation direction	RS-232 (1 in, 1 out), 1 analogue Speed control: 0 to 5 VDC, 0 to 10 VDC, 0 to 20 mA, 4 to 20 mA Speed output: 0 to 10 VDC or 0 to 12 kHz Start/stop, autostart, rotation direction
IP rating	IP30	IP30	IP65
Power	230 VAC, 50 Hz	230 VAC, 50 Hz	115 to 230 VAC, 50/60 Hz

### Accessories

- MY-78016-91 Foot switch** for Reglo-CPF Analogue drive. On/off control, 1.8-m cable
- MY-78016-93 Foot switch** for Reglo-CPF Digital drive. On/off control, 1.8-m cable
- MY-78003-07 Foot switch** for MCP-CPF Process drive. Start/stop operation, 1.8-m cable

### Tubing

Description	Length	Catalogue number
PTFE tubing coil, 4.48 mm ID x 6 mm OD	7.5 m	MY-06605-54
Lab tubing coil, 3.2 mm ID	15 m	MY-06507-05
Lab tubing coil, 6.4 mm ID	15 m	MY-06507-11
Lab tubing coil, 9.5 mm ID	15 m	MY-06507-15



## Micropump® B-Mount Gear Pump Heads for Ismatec® Drives on page 148

- Compact and easy to service
- Hermetically sealed and magnetically coupled pump heads offer leak- and contamination-free pumping

**Suction Shoe Pump Heads** provide enhanced pumping performance at elevated differential pressures and are well-suited for higher temperature ranges. Not recommended for applications requiring suction lift.

**Cavity-Style Pump Heads** produce smooth, precise flow with low friction and offer excellent chemical resistance. Recommended for applications requiring a modest suction lift.

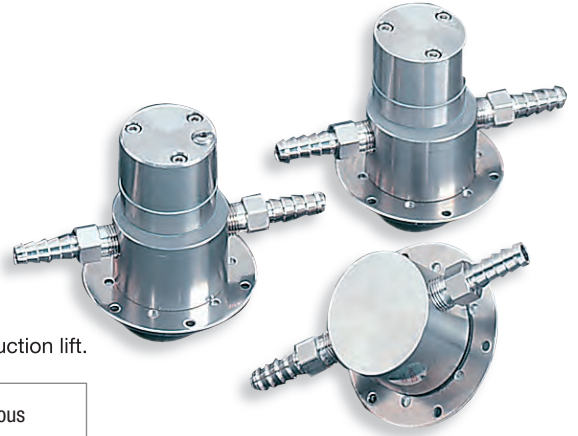

### Specifications

<b>Max viscosity:</b> 0.2 to 1500 cp	<b>Suction lift:</b> Suction shoe: 30.5 cm H <sub>2</sub> O at 3450 rpm Cavity shoe: 61 cm H <sub>2</sub> O at 1750 rpm	<b>Duty cycle:</b> continuous
---	---	-------------------------------

mL/rev	Flow rate† (mL/min)		Max differential pressure	Max system pressure	Gear material	Seals	Housing	Temperature range	Internal bypass	Port size	Catalogue number
	Min	Max									
<b>Suction shoe pump heads</b>											
0.017	0.85	102‡	20.3 psi	304.6 psi	Graphite	PTFE	316 SS	-46 to 177°C	—	1/8" NPT(F)	MY-74004-23
0.042	2.1	252‡	40.6 psi	304.6 psi	Graphite	PTFE	316 SS	-46 to 177°C	—	1/8" NPT(F)	MY-74004-29
0.084	4.2	504‡	40.6 psi	304.6 psi	Graphite	PTFE	316 SS	-46 to 177°C	—	1/8" NPT(F)	MY-74004-31
0.092	4.6	552‡	75.4 psi	304.6 psi	PPS	PTFE	316 SS	-46 to 177°C	—	1/8" NPT(F)	MY-74004-33
0.084	4.2	504‡	75.4 psi	304.6 psi	PEEK	PTFE	316 SS	-46 to 177°C	—	1/8" NPT(F)	MY-74004-73
0.58	29	3190††	50.8 psi	304.6 psi	PPS	Viton®	316 SS	-29 to 177°C	Yes	1/8" NPT(F)	MY-74004-19
0.58	29	3190††	50.8 psi	304.6 psi	PEEK	Viton	316 SS	-29 to 177°C	—	1/8" NPT(F)	MY-74004-77
1.17	58.5	6435††	50.8 psi	304.6 psi	PPS	Viton	316 SS	-29 to 177°C	Yes	1/8" NPT(F)	MY-74004-21
<b>Cavity style pump heads</b>											
0.64	32	3520††	50.8 psi	304.6 psi	PTFE	PTFE	316 SS	-50 to 130°F	Yes	1/8" NPT(F)	MY-74004-01
0.64	32	3520††	50.8 psi	304.6 psi	PTFE	PTFE	316 SS	-50 to 130°F	—	1/8" NPT(F)	MY-74004-09
0.64	32	3520††	81.2 psi	304.6 psi	PEEK	PTFE	316 SS	-50 to 130°F	—	1/8" NPT(F)	MY-74004-75
0.91	45.5	5005††	50.8 psi	304.6 psi	PTFE	PTFE	316 SS	-50 to 130°F	—	1/8" NPT(F)	MY-74004-11
0.64	32	3520††	75.4 psi	304.6 psi	PPS	PTFE	316 SS	-50 to 130°F	Yes	1/8" NPT(F)	MY-74004-05
0.64	32	3520††	75.4 psi	319.1 psi	PPS	PTFE	316 SS	-50 to 130°F	—	1/8" NPT(F)	MY-74004-17

†Flow rates without differential pressure.

‡Based on max rpm of 6000.

††Based on max rpm of 5500.

## RH-Series Piston Pump Heads for All Ismatec® Drives on page 149

- Small displacement provides excellent precision
- Fully adjustable from zero to maximum

Type	RH0		RH1		
Catalogue number	MY-07117-59*	MY-07117-55	MY-07117-69*	MY-07117-65	MY-07117-63
Stroke volume	5 to 50 µL		10 to 100 µL		
Flow range, Reglo-CPF Analogue	0.09 to 90 mL/min		0.18 to 180 mL/min		
Flow range, Reglo-CPF Digital	0.2 to 90 mL/min		0.4 to 180 mL/min		
Flow range, MCP-CPF Process	0.050 to 90 mL/min		0.1 to 180 mL/min		
Piston	Ceramic	Ceramic	Ceramic	Ceramic	Ceramic
Cylinder case	PVDF	PVDF	PVDF	PVDF	ETFE
Cylinder liner	Ceramic	Ceramic	Ceramic	Ceramic	Ceramic
Lip seals	Rulon® AR	Rulon AR	Rulon AR	Rulon AR	Rulon AR
Gland washers	PTFE	PTFE	PTFE	PTFE	PTFE
Max temperature	100°C	100°C	100°C	100°C	100°C
Max differential pressure	100 psi	100 psi	100 psi	100 psi	100 psi
Flow ports	1/4" NPT(F)†	Two compression fittings for 6 to 6.4 mm OD tubing	1/4" NPT(F)†	Two compression fittings for 6 to 6.4 mm OD tubing	Two compression fittings for 6 to 6.4 mm OD tubing

\*For low flow rates, 1/4"-28 (female) adapters are recommended.

†Tubing adapters are sold separately online.



Go online for our comprehensive selection of Piston Pump Heads for Ismatec Drives.

## Q-Series Piston Pump Heads for Ismatec® MCP-CPF Process Drive on page 149

Type	Q0	Q1		Q2		Q3
Catalogue number	MY-07104-50	MY-07104-56	MY-07104-54	MY-07104-66	MY-07104-64	MY-07104-53
Stroke volume	3.2 to 80 µL	12.8 to 320 µL		28.8 to 720 µL		51.2 to 1280 µL
Flow range	0.04 to 144 mL/min	0.04 to 144 mL/min		0.29 to 1300 mL/min		0.51 to 2300 mL/min
Piston	316 SS	Ceramic	Ceramic	Ceramic	Ceramic	Ceramic
Cylinder case	316 SS	316 SS	PVDF	316 SS	PVDF	PVDF
Cylinder liner	Carbon	Ceramic	Ceramic	Ceramic	Ceramic	Ceramic
Lip seals	Rulon® J	Rulon AR	Rulon AR	Rulon AR	Rulon AR	Rulon AR
Gland washers	PTFE	PTFE	PTFE	PTFE	PTFE	PTFE
Cylinder head seal	PTFE	PTFE	None	PTFE	None	None
Max temperature	100°C	177°C	100°C	177°C	100°C	100°C
Max differential pressure	100 psi	100 psi	60 psi	100 psi	60 psi	24.6 psi <1600 rpm, 7.3 psi >1600 rpm)
Flow ports	1/4" NPT(F)†	1/4" NPT(F)†	1/4" NPT(F)†	1/4" NPT(F)†	1/4" NPT(F)†	1/4" NPT(F)†

†Tubing adapters are sold separately online.



# Magnetic Drive Centrifugal Pumps with Enclosed Motors

## Handles thrust loads easily

- Quiet, energy efficient, and compact
- Internal cooling circuit reduces bearing temperature
- Enclosed motor for use in harsh environments

These moderate-flow polypropylene centrifugal pumps are ideal for process, recirculation, or transfer applications where continuous flow and excellent chemical resistance are needed.

High-head polypropylene pumps with a closed impeller design to significantly increase output pressure are available online.



### Specifications

#### Wetted parts:

Front/rear casings and impeller/magnet capsule: glass fiber-reinforced polypropylene  
 Spindle and thrust ring: alumina ceramic 99.5%  
 Casing O-ring: Viton®  
 Bearing: PTFE

**Duty cycle:** continuous

Max flow		Max head		Max pressure		Max temp		Connections		Motor		Power		Dimensions (L x W x H)		Catalogue number
LPM	GPM	m	ft	bar	psi	°C	°F	Hose barb	NPT(M)	hp	rpm	VAC	Amps	cm	in.	
11.7	3.1	2.1	6.8	0.3	4.3	80	176	½	—	1/125	3400	220	0.20	10.5 x 7.6 x 9.5	4 1/8 x 3 x 3 3/4	MY-72010-15
18.9	5	3.4	11.1	0.5	7.2	80	176	½	—	1/75	3400	220	0.15	18.1 x 9.5 x 11.4	7 1/8 x 3 3/4 x 4 1/2	MY-72010-25
37.9	10	5.4	17.7	0.8	11.6	80	176	—	¾	1/16	3400	220	0.55	25.7 x 12.1 x 10.5	10 1/8 x 4 3/4 x 4 1/8	MY-72010-45
134.8	35.6	11.9	39	1.8	25.6	80	176	—	1	1/3	3400	220	1.70	32.4 x 15.9 x 17.8	12 3/4 x 6 1/4 x 7	MY-72010-85

# Plastic Hand-Operated Drum Pumps

## No need for electricity

### A. Siphon/Lift Pail Pump

- Suitable for pumping petroleum or water
- Cut inlet tube to fit your container
- Maximum suction lift is 3.0-m (10 ft)

### B. Threaded Hand Pump

- Pump detergents, water, dilute alkalis, and waxes from drums or pails—¾" NPT(M) intake threads permit semi-permanent attachment
- Optional adapters securely attach pump to a variety of containers—order online

### C. Water and Chemical Siphons

- Portable and self-priming
- Water siphon (70607-00) includes 152 cm (60") outlet hose—cut to fit your application
- Chemical siphons (70607-10, -12) are suitable for acid and alkali transfer

### D. HDPE Hand Pump

- Pump acids, alcohols, and alkalis from carboys, drums, or tanks
- Self-cleaning ball valve ensures free flow and long pump life
- Order optional LDPE adapter to securely mount pump on drums (order online)

### E. Heavy-Duty Acid-Transfer Pumps

- Withstand temperatures up to 49°C (120°F)
- Self-priming, will not siphon

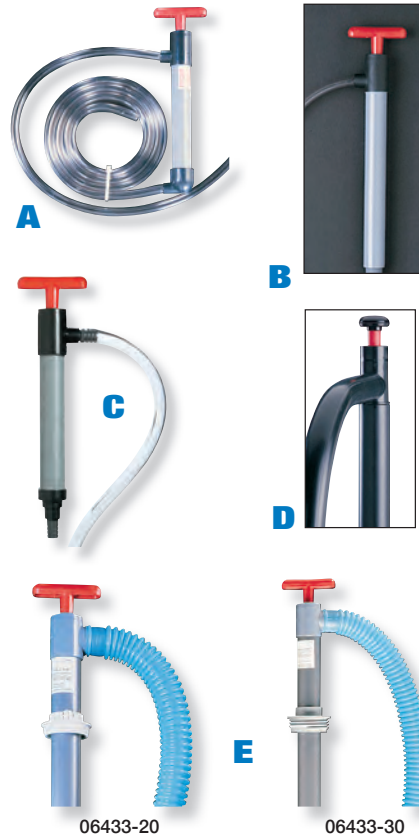

Key	Strokes/L (gal.)	Wetted materials	Container adapter	Inlet tube		Outlet hose		Dimensions		Catalogue number
				L cm (in.)	OD cm (in.)	L cm (in.)	OD cm (in.)	L cm (in.)	Dia in. (cm)	
A	9 (32)	PVC barrel/hose, urethane-buna valves/seals	—	182.9 (72")	1.3 (½")	91.4 (36")	1.3 (½")	22.9 (9")	3.2 (1¼")	MY-06437-00
B	7 (26)	PVC body/hose, Hypalon® valves/seals, LDPE tube	¾" NPT(M)	45.7 (18")	1.4 (9/16")	22.9 (9")	1.4 (9/16")	30.5 (12")	3.2 (1¼")	MY-06433-60
C	9 (32)	PVC barrel, shaft, and hose	—	—	—	152.4 (60")	1.4 (9/16")	22.9 (9")	3.2 (1¼")	MY-70607-00
	7 (26)	PVC barrel/hose, LDPE tube	—	45.7 (18")	1.4 (9/16")	121.9 (48")	1.4 (9/16")	30.5 (12")	3.2 (1¼")	MY-70607-10
	4 (12)	PVC barrel/hose, PVC tube	50.8 mm (2") IPS	—	—	121.9 (48")	1.4 (9/16")	91.4 (36")	3.2 (1¼")	MY-70607-12
D	2 (6)	All HDPE parts	None	86.4 (34")	3.8 (1½")	35.6 (14")	3.8 (1½")	96.5 (38")	4.6 (1 13/16")	MY-06425-05
E	2 (6)	Solvent-welded PVC body and shaft, Viton valves and seals	—	—	—	91.4 (36")	3.2 (1¼")	96.5 (38")	3.8 (1½")	MY-06433-10
			50.8 mm (2") IPS	—	—	91.4 (36")	3.2 (1¼")	96.5 (38")	3.8 (1½")	MY-06433-20
			Buttress Dell drum (M)	—	—	91.4 (36")	3.2 (1¼")	96.5 (38")	3.8 (1½")	MY-06433-30

## Cole-Parmer® Digital Gear Drive with Remote Control

### Easier setup and operation

- Graphical LCD shows four operating modes: continuous run, timed dispense, copy dispense, volume dispense
- Get pulse-free flow in combination with Micropump® A-mount head
- Maximise bench space by stacking up to three drives
- Control speed, direction, and more remotely via DB25 female connector on drive

Analogue remote control options and simple programming make this drive ideal for automated process applications. Drive features set time interval between dispense cycles for hands-free dispensing. Batch count function counts down and displays batches completed. Cumulative volume function enables you to track total volume dispensed over multiple cycles.

**What's included:** 1.8-m (6-ft) line cord with IEC 320/CEE22 socket. These models are shipped with country specific plug/cord set; please specify ultimate destination when ordering.



Motor rpm	Motor hp	Motor type	Power VAC	Power Hz	Catalogue number
36 to 3600	1/10	PMDC	90 to 260	50/60	MY-75211-70

**MY-07523-92 Foot switch** for momentary start/stop; 1.8-m (6-ft) cable

**MY-07523-94 Male connector, DB25.** Use to create your own cable



## Micropump® A-Mount Gear Pump Heads

### Achieve leak-free, pulseless flow

Magnetic drive and static seals keep fluids securely inside and potential contaminants out. Chemical resistant materials handle a wide range of materials (due to wetted parts). Pump heads are compact and easy to service. Modular design offers flexibility—configure to your specific needs.

**Cavity-style pump heads** are designed to handle higher inlet pressures. Models without internal bypass are reversible.

**Suction shoe pump heads** provide higher delivery pressures and temperatures, plus increased efficiency.

#### Specifications

**Port size:** 1/8" NPT(F)

**Max viscosity:** 0.2 to 1500 cp

**Duty cycle:** continuous

#### Suction lift

Cavity style: 60.9 mm (24") of H<sub>2</sub>O (at 1750 rpm)

Suction shoe: 30.4 mm (12") of H<sub>2</sub>O (at 3450 rpm)



73011-00

73004-00

Go online to search more than 100,000 products.

Flow rates (mL/min) <sup>†</sup>			Max pressure psi (bar)		Wetted parts			Temperature range	Internal bypass	Max speed (rpm)	Catalogue number	Service kits Catalogue number				
mL/rev	at 50 rpm	at 5000 rpm	Diff	System	Body	Gears	Seals									
<b>Cavity-style pump heads</b> reversible units without internal bypass																
0.32	16	1600	80 (5.5)	300 (20.7)	316 SS	PEEK	PTFE	-43 to 77°C (-45 to 170°F)	No	10,000	MY-73011-00	—				
			80 (5.5)			PEEK			Yes				MY-73011-02	—		
			50 (3.4)			PTFE			Yes				MY-07002-17	MY-07144-38		
0.64	32	3200	50 (3.4)	300 (20.7)	316 SS	PTFE	PTFE	-43 to 54°C (-45 to 130°F)	Yes	10,000	MY-07002-23	—				
			80 (5.5)			PPS							Yes	MY-07001-80	MY-07001-89	
			75 (5.2)			PEEK							No	MY-73011-08	MY-73011-84	
0.64	32	3200	80 (5.5)	300 (20.7)	316 SS	PTFE	PTFE	-43 to 77°C (-45 to 170°F)	Yes	10,000	MY-73011-10	MY-73011-84				
			80 (5.5)			PEEK			No				MY-73011-16	—		
			50 (3.4)			PEEK			Yes				MY-73011-18	—		
0.91	45.5	4550	80 (5.5)	300 (20.7)	316 SS	PTFE	PTFE	-43 to 54°C (-45 to 130°F)	Yes	10,000	MY-07001-40	MY-07001-41				
			80 (5.5)			PEEK			No				—	—		
			50 (3.4)			PEEK			Yes				—	—		
<b>Suction shoe pump heads</b> provide higher delivery pressures and superior priming performance																
0.017	0.85	85	20 (1.4)	300 (20.7)	316 SS	Graphite	PTFE	-46 to 120°C (-50 to 250°F)	No	8000	MY-07002-25	MY-07144-42				
0.042	2.10	210	40 (2.8)						No	8000	MY-07002-26	—				
0.084	4.20	420	40 (2.8)						No	8000	MY-07002-27	MY-07144-47				
0.092	4.60	460	75 (5.2)	300 (20.7)	316 SS	PEEK	PTFE	-46 to 120°C (-50 to 250°F)	No	8000	MY-73003-14	—				
0.261	13.05	1305	125 (8.6)	300 (20.7)	316 SS	PPS							MY-07002-14	MY-07144-34		
0.58	29.00	2900	125 (8.6)	300 (20.7)	316 SS	PEEK	Viton®	-46 to 120°C (-50 to 250°F)	Yes	10,000	MY-73004-00	—				
			75 (5.2)			PEEK							Yes	10,000	MY-73004-02	—
			75 (5.2)			PPS										
1.17	58.50	5850	60 (4.1)	300 (20.7)	316 SS	PEEK	Viton	-46 to 120°C (-50 to 250°F)	Yes	10,000	MY-73004-04	—				
						PPS							MY-07003-04	MY-07003-14		

**Note:** Viscosity for all models is dependent on the parameters (flow rate, pressures, etc.) of the specific application.

<sup>†</sup>Flow rates based on water at room temperature and no back pressure.



## Cole-Parmer® Console Gear Pump Drive

### Optimise performance of long-term applications

- 100:1 speed-control range controls flow over a wide range for applications from filtration to chemical injection
- Easy operation with single-turn speed control
- Separate on-off switch maintains speed (flow) setting when drive is powered down
- Maximum continuous-duty flow rates possible with Micropump® A-mount pump heads (order on page 152)

**What's included:** 1.8-m (6-ft) modular line power cord with IEC 320/CEE 22 connector (specify country to obtain correct plug).



Micropump pump head is not included; order on page 152



#### Specifications

**Duty cycle:** continuous **Max system temperature:** 40°C (104°F)  
**Remote control:** (input/output) none

Motor			Power		Catalogue number
rpm	hp	Type	VAC	Hz	
50 to 5000	0.07	PMDC	230	50/60	MY-75211-17

## Cole-Parmer® Digital Gear Pump Benchtop Systems

### Ready to use—drive and pump head included!

- Operate in continuous run, volume dispense, copy dispense, and timed dispense modes with precise, pulseless batching and dispensing
- IP33-rated enclosure protects the internal components from dust and splashes



#### Specifications

**Remote control:** (input) on/off by contact closure (0 to 10 VDC, 0 to 20 mA, 4 to 20 mA), and remote output  
**Speed:** 36 to 3600 rpm  
**Power:** 90 to 260 VAC

mL/rev	Flow rates (mL/min) <sup>†</sup>		Max pressure		Wetted parts			Catalogue number
	at 50 rpm	at 3600 rpm	Diff (psi)	System (psi)	Body	Gears	Seals	
0.017	0.85	85	20	300	316 SS	Graphite	PTFE	MY-74014-72
0.092	4.60	331.2	75	300	316 SS	PPS	PTFE	MY-74014-02
0.092	4.60	331.2	75	300	316 SS	PPS	PPS	MY-74014-62
0.261	13.05	939.6	125	300	316 SS	PEEK	Viton®	MY-74014-52
0.316	15.8	1137.6	75	300	316 SS	PPS	PTFE	MY-74014-12
0.64	32.0	2304	75	300	316 SS	PPS	PTFE	MY-74014-22
0.91	45.5	3276	75	300	316 SS	PPS	PTFE	MY-74014-32
1.17	58.5	4212	60	300	316 SS	PPS	Viton	MY-74014-42

<sup>†</sup>Flow rates in mL/min are based on water at room temperature and no back pressure.

- MY-07523-92 Foot switch, momentary start/stop, 1.8-m cable
- MY-06385-10 Male pipe adapter (straight); PP, ¼" OD x 3/8" NPT(M). Pk of 10
- MY-40610-36 Male pipe adapter; natural PP, 1/8" NPT(M) x 1/4" ID. Pk of 10

## Ismatec® Compact Programmable Digital Gear Pump Drive

### Dispense by flow rate, volume, time, or number of cycles

- No more dripping—program pump to draw back fluid
- Control via a PC with RS-232 interface
- Get more accuracy with calibration of flow rate and dispensing volume

Multiple operating modes allow for continuous pumping by drive speed, flow rate, volume, time, volume within a preset time or interval dispensing by volume with a pause or time with a pause. The number of dispensing cycles may also be programmed into the pump. Pump is capable of reversible rotation (only with cavity style pump heads that indicate reversible operation). Both dispensing and pause time settings are from 0.1 seconds up to 999 hours.



#### Specifications

**Duty cycle:** continuous from 50 to 5000 rpm  
**Remote control (input):** Speed control: RS-232 (DB9F) for pump control via PC. 9600 baud, 8 bit, 1 stopbit, no parity  
 On/off control: TTL contact (for footswitch) 0 to 10 kHz for speed monitoring  
**Remote control (output):** RS-232 (DB9M) for cascading of up to 8 pumps  
**Max temperature:** 40°C (104°F)  
**IP rating:** IP30



Motor rpm	Power	Catalogue number
50 to 5000	90 to 264 VAC, 47 to 63 Hz	MY-78008-15

MY-70738-94 Replacement adapter plate; for mounting Micropump A-mount pump heads (except models 07003-02, 07003-04, 73004-00, 73004-02, 73004-04)



Programmable digital drive 78008-15 with Micropump pump head 07002-14 (head not included; order on page 152)

**What's included:** an adapter plate for mounting Micropump® A pump heads (except 07003-02, 07003-04, 73004-00, 73004-02, and 73004-04), a driving magnet and a 1.8-m (6-ft) power cord with plug.

## Honeywell® DR4500A 5.0 cm Recorders

No need to order multiple chart types

- One pen creates chart, data, and up to four traces as data are collected—eliminates offset errors due to multiple pen design
- Configurable to your changing needs—options available online
- Don't have multiple power supplies—excitation voltage for up to two transmitters
- Configurable alarms and password protection for added protection
- Meet NEMA 3 requirements



80663-00 "One-pen" printhead produces up to four traces and prints alphanumeric chart data

### Specifications

#### Input ranges

DC voltage: 0 to 50 mV, 1 to 5 V  
Current: 4 to 20 mA  
Thermocouples: J, K, T, E, R, S, B, NNM, NIC, W5  
RTD: 100 Ω Pt, 500 Ω Pt

**Accuracy:** ±0.1% of span

**Chart size:** 30.5 cm diameter

**Chart speed:** 6 to 744 hr/revolution

**Power:** 102 to 132/204 to 264 VAC, 50/60 Hz

**Panel cut-out dimensions (W x H):** 32.3 x 32.3 cm (12¾" x 12¾")

Number of channels	Catalogue number
One	MY-80663-00
Two	MY-80663-10
Three	MY-80663-20
Four	MY-80663-30

### Accessories

**MY-80663-90 Replacement thermal paper.** Pack of 100 sheets

**MY-80663-92 Replacement thermal pen**

**MY-17100-00 ILAC MRA, NIST-traceable calibration** with data for recorders

## Honeywell® DR4300 25.4 cm Recorders

Be certain of your readings—universal input and self-test built-in

- Configurable to your application
- Meet NEMA 3 requirements



**Basic Recorders** are fully programmable in the field via DIP switches. Select pre-configured input type, range, and chart speed.

### Digital Display

**Recorders** let you view results on their bright, vacuum fluorescent display. Configure recorder via integral keypad; choose from a wider selection of input types, ranges, and chart speeds.

### Specifications

#### Input ranges

DC voltage: 0 to 10 mV, 0 to 100 mV, 0 to 200 mV; 0 to 1 V, 0 to 2 V, 0 to 5 V, 1 to 5 V, 0 to 10 V

Current: 0 to 20 mA, 4 to 20 mA

Thermocouples: J, K, T, E, R, S, B, NNM, NIC, W5  
RTD: 100 Ω Pt

#### Accuracy

Basic recorder: ±0.35% of span  
Recorder with display: ±0.10% of span (field calibrated)

**Panel cut-out dimensions (W x H):** 32.3 x 32.3 cm (12¾" x 12¾")

**Chart size:** 25.4 cm diameter

#### Chart speed

Basic recorder: 24 hrs, 7 days  
Recorder with display: 1 to 744 hours

**Power:** 100 to 240 VAC, 50/60 Hz

Model	Number of channels	Catalogue number
Basic recorder	One	MY-80661-00
	Two	MY-80661-10
Recorder with digital display	One	MY-80661-20
	Two	MY-80661-30

**MY-80661-92 Replacement pen,** for channel one; purple. Pack of 6

**MY-80661-90 Replacement pen,** for channel two; red. Pack of 6

**MY-80661-80 Replacement chart paper,** 7-day, 100 divisions. Pack of 100 sheets

**MY-17100-00 ILAC MRA, NIST-traceable recalibration** with data for recorders

## Cole-Parmer® Disposable Temperature Recorders

Save money while knowing temperature of samples

- Simple to use—just pull out tab to start recorder
- Unique identifier and tamper-evident seal makes sure data is not corrupt
- Water and shock resistant



### Specifications

**Range:** –28 to 38°C (–20 to 100°F)

**Chart:** pressure-sensitive 91.4 cm strip chart

**Accuracy:** Temperature: ±1°C (±2°F)  
Time: ±20 seconds per month average

**Power:** one AA alkaline battery (included)

**Dimensions (W x H x D):** 10.2 x 14.0 x 6.4 cm (4" x 5½" x 2½")

Create a permanent record of temperature conditions during shipment.

Chart speed	Catalogue number
Five days	MY-80150-40
Ten days	MY-80150-50
Twenty days	MY-80150-60
Thirty days	MY-80150-70



## Dickson 20.3 cm Temperature/Humidity Recorders

View temperature and humidity/dew point simultaneously

- Selectable units and scales—choose chart paper based on your needs
- No inadvertent changes with lock-out dip switch

Model 81001-51 features a large digital display. Model 80001-53 features a large digital display, audible/visual high/low alarms, and sensor probe with 3.0-m cable. All models have a green “power on” light.



**What's included:** red, blue pens, 120 VAC adapter, probe with 3.0-m (10-ft) cable (model 80001-53), and one 9 V battery.

### Specifications

<b>Temperature accuracy:</b> ±1°C (±1.8°F)	<b>Dew point accuracy:</b> 10 to 95% RH, ±4°C (±7.2°F)
<b>Humidity range:</b> 0 to 100% (noncondensing)	<b>Power:</b> 9 V battery or 120 VAC, 50/60 Hz
<b>Humidity accuracy:</b> ±2% from 0 to 60%, ±3% from 60 to 95%	<b>Dimensions (W x H x D):</b> 33.7 x 26.7 x 7.0 cm (13¼" x 10½" x 2¾")
<b>Dew point range:</b> -30 to 50°C (-22 to 122°F)	



Type	Catalogue number
Recorder with digital display	<b>MY-80001-51</b>
Recorder with digital display, alarms, and remote probe	<b>MY-80001-53</b>

Measuring range	Chart paper (pk of 60)		
	24-hour	7-day	31-day
	Catalogue number	Catalogue number	Catalogue number
32 to 120°F	<b>MY-80013-01</b>	<b>MY-80013-11</b>	<b>MY-80013-21</b>
40 to 110°F	<b>MY-80013-05</b>	<b>MY-80013-15</b>	<b>MY-80013-23</b>
0 to 50°C	<b>MY-80013-03</b>	<b>MY-80013-13</b>	<b>MY-80013-25</b>
5 to 40°C	<b>MY-80013-07</b>	<b>MY-80013-17</b>	<b>MY-80013-27</b>
-20 to 120°F	<b>MY-80013-01</b>	<b>MY-80013-11</b>	<b>MY-80013-21</b>
0 to 185°F	<b>MY-80013-09</b>	<b>MY-80013-48</b>	—
40 to 110°F	<b>MY-80013-05</b>	<b>MY-80013-15</b>	<b>MY-80013-23</b>
-20 to 50°C	<b>MY-80013-03</b>	<b>MY-80013-13</b>	<b>MY-80013-25</b>
5 to 40°C	<b>MY-80013-07</b>	<b>MY-80013-17</b>	<b>MY-80013-27</b>

**MY-08498-50 Replacement pen, red**

**MY-08498-51 Replacement pen, blue**

**MY-09376-04 Replacement batteries, 9 V. Pack of 4**

**MY-17030-26 ILAC MRA, NIST-traceable calibration**  
with data for temperature/humidity recorders

## Cole-Parmer® Economical 100- and 200-mm Flatbed Recorders

Cost-effective way to record your data

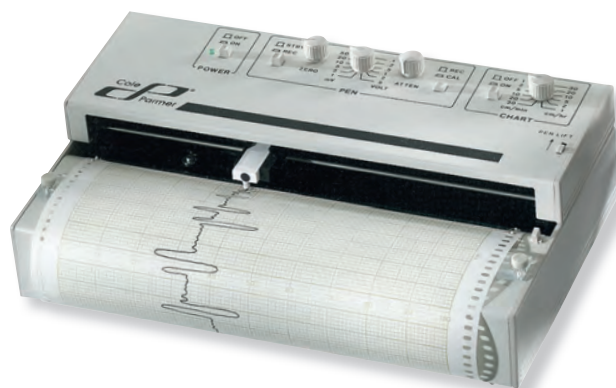

Cole-Parmer 100- and 200-mm flatbed recorders combine accuracy with value. Measure reliably using the recorders' zero control, 12 selectable input ranges, and adjustable 5:1 attenuation.

**What's included:** 115 VAC adapter, one roll of paper, and pen.



### Specifications

<b>Input ranges:</b> 1, 2, 5, 10, 20, 50, 100, 200, 500 mV; 1, 2, 5 V	<b>Input impedance:</b> >1 MΩ
<b>Accuracy:</b> ± 0.5% full-scale	<b>Attenuation:</b> 5:1
<b>Chart size:</b> 100 or 200 mm	<b>Pen response:</b> 0.5 sec full-scale
<b>Chart speeds:</b> 1, 2, 5, 10, 20, 30 cm/min and cm/hr	<b>Power:</b> 115 VAC, 12 VAC, or 12 to 15 VDC

Number of channels	Chart width	Catalogue number
One	100 mm	<b>MY-80550-00</b>
Two	100 mm	<b>MY-80550-10</b>
One	200 mm	<b>MY-80550-20</b>
Two	200 mm	<b>MY-80550-30</b>



## Cole-Parmer® Analogue Refractometers

### Quick and easy operation with reliable measurements

- Easy calibration via the calibration screw for enhanced accuracy
- No more worrying about temperature fluctuations with the Automatic Temperature Compensation (ATC) models

These units come in many Brix, Salinity, and Refractive index ranges for all applications. The models that feature ATC allow you to concentrate on the measurements without worrying about the temperature. The compensation range is 10 to 30°C (50 to 86°F).



All models also feature a zero % adjust with distilled water. This allows for immediate and easy calibration for precise measurements at all times.



#### Brix Refractometers

Range	Resolution	Accuracy	ATC	Catalogue number
0 to 10% Brix	0.10%	±0.1%	No	MY-81150-23
			Yes	MY-81150-34
0 to 18% Brix	0.10%	±0.1%	No	MY-81150-24
			Yes	MY-81150-35
0 to 32% Brix	0.20%	±0.2%	No	MY-81150-25
			Yes	MY-81150-36
0 to 60% Brix	0.50%	±0.3%	No	MY-81150-29
28 to 62% Brix	0.20%	±0.2%	No	MY-81150-26
			Yes	MY-81150-37
0 to 80% Brix	0.50%	±0.3%	No	MY-81150-31
0 to 50%, 50 to 80% Brix	0.50%	±0.3%	No	MY-81150-30
45 to 82% Brix	0.50%	±0.3%	No	MY-81150-27
			Yes	MY-81150-38
0 to 90% Brix	0.50%	±0.3%	No	MY-81150-32
0 to 42%, 45 to 71%, 71 to 90% Brix	0.20%	±0.2%	No	MY-81150-33
			Yes	MY-81150-39
58 to 92% Brix	0.20%	±0.2%	No	MY-81150-28
			Yes	MY-81150-39

#### Salt/Combination Refractometers

Range	Resolution	Accuracy	ATC	Catalogue number
0 to 28% salinity	0.20%	±0.2%	No	MY-81150-41
			Yes	MY-81150-45
0 to 28% salinity; 0 to 32% Brix	0.20%	±0.2%	No	MY-81150-43
			Yes	MY-81150-47
0 to 100% salinity; 1.000 to 1.070 RI	1%; 0.005	±0.5%; ±0.001	No	MY-81150-40
			Yes	MY-81150-44
0 to 100% salinity; 1.000 to 1.070 RI; 0 to 10% Brix	1%; 0.005; 0.10%	±0.5%; ±0.001; ±0.1%	No	MY-81150-42
			Yes	MY-81150-46

#### Accessories

MY-17105-00 ILAC MRA, NIST-traceable calibration with data for refractometers

MY-06226-13 Transfer pipette, 1.5 mL. Box of 500

Go online to see full product details.

## Cole-Parmer® Digital Refractometers

### Never wait for readings again

- Rugged design is IP65-rated
- Easy calibration for precise results at all times
- No more worrying about temperature fluctuations with built-in ATC



These digital refractometers feature an LCD, eliminating reading errors common with handheld refractometers. All models feature built-in Automatic Temperature Compensation (ATC) which removes temperature fluctuations allowing the user to concentrate on the measurements. The compensation range is 5 to 40°C (41 to 104°F).

Many range options are available for measurements within any application. All models also feature a zero % adjust with distilled water, allowing for immediate and easy calibration for precise measurements at all times.

**What's included:** soft and clean cloth, carrying case, and two AAA batteries.

#### Specifications

<b>Temperature range:</b> 0 to 40°C (32 to 104°F)	<b>Response time:</b> ≤3 seconds
<b>Temperature accuracy:</b> ±0.5°C (1°F)	<b>Power:</b> two AAA batteries
<b>Sample volume:</b> 0.3 mL	<b>Battery life:</b> ≥5000 readings

Range	Resolution	Accuracy	Catalogue number
0 to 45% Brix, 1.3330 to 1.4098 RI	0.1, 0.0001	±0.2, ±0.0003	MY-81150-48
0 to 85% Brix, 1.3330 to 1.5100 RI	0.1, 0.0001	±0.2, ±0.0003	MY-81150-55
0 to 95% Brix, 1.3330 to 1.5400 RI	0.1, 0.0001	±0.2, ±0.0003	MY-81150-56
0 to 28% salinity, 1.330 to 1.4100 RI	0.1, 0.0001	±0.1, ±0.0003	MY-81150-49
0 to 45% Brix, 0 to 28% salinity, 1.3330 to 1.4100 RI	0.1, 0.1, 0.0001	±0.2, ±0.1, ±0.0003	MY-81150-57
0 to 14 g/dl serum protein, 1.3330 to 1.3900 RI	0.2, 0.0001	±0.2, ±0.0003	MY-81150-51
0 to 60% v/v, w/w ethyl alcohol	0.1	±0.3	MY-81150-52
0 to 60% v/v, w/w isopropyl alcohol; –50 to 0°C (–58 to 32°F)	0.1	±0.5	MY-81150-53
0 to 75% ethylene glycol, –50 to 0°C (–58 to 32°F)	0.1	±0.3, ±1°F, ±0.5°C	MY-81150-54

#### Accessories

MY-09376-00 Replacement batteries, AAA. Pack of 12

MY-17105-00 ILAC MRA, NIST-traceable calibration with data for refractometers

MY-06226-13 Transfer pipette, 1.5 mL. Box of 500

## Cole-Parmer® StableTemp™ Laboratory Refrigerators

### Ideal for the requirements of daily lab applications

- Fully insulated chamber ensures minimal temperature fluctuation
- Sliding wire shelves pull out fully for easy access to all samples
- Thermal line recorder for easy tracking of temperature

Our complete line of refrigerators provides the reliability that is essential for your valuable samples in the 2 to 10°C (35 to 50°F) range. Performance is driven on all models by a high-efficiency evaporation system made with low corrosive materials and a fully insulated stainless steel chamber. An intuitive easy-to-use control panel has VFD and touch-sensitive buttons for controlling all the essential functions.

Adjustable full-extension sliding shelves provide efficient and customisable use of interior space and easy access to stored samples. Built-in 50-mm diameter cable port allows use of external temperature probes. Bright fluorescent lighting (except 52412-00 to -02) for convenient viewing of samples. Safety features include high/low temperature and overcurrent protection, open door alarm, automatic fan stop, keypad lock function, and built-in door lock with key permit access control.

**What's included:** plastic-coated wire sliding shelves and brackets, thermal line recorder, and power cord with plug.

**StableTemp**



Capacity	Temperature range	Dimensions (W x H x D)		No. of doors	No. of shelves	Max no. of shelves	Power†			Shpg wt (kg) (lb)	Catalogue number
		Interior	Exterior				VAC	Hz	Amps		
156-L (5.5 cu ft)	2 to 10°C (35.6 to 50°F)	55 x 58 x 49 cm	68.3 x 79.1 x 87 cm	One	Two	Four	230	50	2.5	115 (253)	MY-52412-02
303-L (10.7 cu ft)	2 to 10°C (35.6 to 50°F)	21.7 x 21.7 x 39.4 cm	67 x 77 x 151.5 cm	One	Three	Seven	230	50	2.5	145 (319)	MY-52412-05
603-L (21.3 cu ft)	2 to 10°C (35.6 to 50°F)	65 x 64 x 145 cm	77 x 86.5 x 196.5 cm	One	Three	11	230	50	4	224 (495)	MY-52412-08
805-L (28.4 cu ft)	2 to 10°C (35.6 to 50°F)	75 x 74 x 145 cm	87 x 96.5 x 196.5 cm	One	Three	11	230	50	4	274 (605)	MY-52412-11
1327-L (46.9 cu ft)	2 to 10°C (35.6 to 50°F)	143 x 64 x 145 cm	155 x 86.5 x 196.5 cm	Two	Six	22	230	50	7.5	399 (880)	MY-52412-14

†Additional voltages available; call for details.

## Cole-Parmer® StableTemp™ -86°C Upright ULT Freezers

### Optimal efficiency with minimal temperature loss

- Eye-level controls for quick programming and easy viewing
- Individually sealed inner doors minimise frost build-up and temperature loss when open
- Outer door has four gaskets for maximum thermal efficiency
- Multiple alarm features mean you are always aware of any operation errors

These ULT freezers are designed to meet your cold storage needs down to -86°C. High-performance insulation panels in the cabinet minimise heat gain improving temperature stability. Separate inner storage chambers have their own insulated doors which offer independent access to storage space, minimising frost build-up inside the chambers and providing maximum protection of stored samples. The outer door seal's unique design reduces temperature loss while the door is open, and a robust door latch keeps the door securely closed.

Microprocessor controller is simple to use with push-button control and has an easy-to-read operational status display. Large LED show internal temperature, set temperature, ambient temperature, and input voltage for quick viewing of operation parameters. Other features include USB port for downloading data, sample port for external temperature probe, heated pressure equalisation port for easy door opening, and casters for smooth portability.

**What's included:** power cord and plug.

**StableTemp**



Capacity	Temperature range	Dimensions (W x H x D)		No. of doors	No. of shelves	Power†			Shpg wt (kg) (lb)	Catalogue number
		Interior	Exterior			VAC	Hz	Amps		
338 L (11.9 cu ft)	-86 to -40°C (-122 to -40°F)	46.5 x 116.5 x 63 cm	81.2 x 184.6 x 89.3 cm	1 outer, 2 inner	Three	220	50	7.5	612 (277)	MY-44260-01
486 L (17.1 cu ft)	-86 to -40°C (-122 to -40°F)	59 x 131 x 63 cm	94.5 x 198 x 90 cm	1 outer, 4 inner	Three	220	50	9	683 (309)	MY-44260-04
578 L (20.4 cu ft)	-86 to -40°C (-122 to -40°F)	62 x 131 x 71.6 cm	89.5 x 198 x 98 cm	1 outer, 4 inner	Three	220	50	9	727 (329)	MY-44260-11
728 L (25.7 cu ft)	-86 to -40°C (-122 to -40°F)	76.6 x 131 x 71.6 cm	104.1 x 198 x 98 cm	1 outer, 4 inner	Three	220	50	9	848 (384)	MY-44260-17
828 L (29.2 cu ft)	-86 to -40°C (-122 to -40°F)	87 x 131 x 71.6 cm	114.5 x 198 x 98 cm	1 outer, 4 inner	Three	220	50	9	903 (409)	MY-44260-21

†Additional voltages available; call for details.

# Vision® G2 Dissolution Testers

Designed with over 60 years of dissolution expertise and know-how

## Vision Elite 8™

Versatile and high-quality

The G2 Elite 8's ergonomic design and workhorse performance make it ideal for unattended automation, hands-free sampling and extended applications as well as for manual sampling. The G2 Elite 8 meets & exceeds worldwide standards. These systems are packed full of innovative technology, including Easi-Lock™ vessel plate, Easi-Lift™ drive head and Auto-Probes.

- Scalable design easily configured for automated, hands-free sampling
- 8-position Easi-Lock™ vessel plate ensures precise vessel centering
- Easi-Lift™ drive head with multi-lock positions allows for quick, repeatable position changes
- Can be configured for unattended automatic introduction of the dosage form when media has reached the user-specified temperature or time
- "Quick Test" feature begins tests immediately with the push of a button
- Optional Auto-Probes reduce hydrodynamic interference by automatically exiting the vessels after sampling, unlike stationary probes that remain in the vessel throughout the dissolution process



## Vision Classic 6™

Compact, rugged workhorse

The G2 Classic 6 is precision engineered to ease the rigours of manual dissolution testing and is ideal for creating, managing, and saving protocols whilst changing between apparatus flexibly and easily. Meeting and exceeding worldwide standards, this system features the Easi-Lock™ vessel plate and fixed drive head.

- Award-winning design, 2 across x 3 deep, provides easy access to all vessels
- Compact footprint saves valuable bench space
- 6-position Easi-Lock™ vessel plate ensures correct vessel centering
- Create, manage, and save up to 100 protocols stored
- Fixed drive head guarantees repeatable, drive head positioning
- "Quick Test" feature begins tests immediately with the push of a button
- Adaptable for automated sampling





# Phoenix™ Diffusion Dry Heat Systems



**Phoenix Dry Heat Diffusion Cell** is designed for precision and versatility in diffusion testing labs. Cell preparation, including dosage application, bubble detection, and bubble removal, is fast and easy.



**Phoenix DB-6 Manual Sampling System** provides a compact footprint for 6-cell testing. Precision heating and stirring units contained within the block make the system fully portable, able to be placed in any position the analyst chooses for faster, easier cell preparation. With precise control of mixing speeds from 200 rpm to 900 rpm, and temperatures from 25°C to 40°C, the system meets or exceeds USP <1724> specifications.

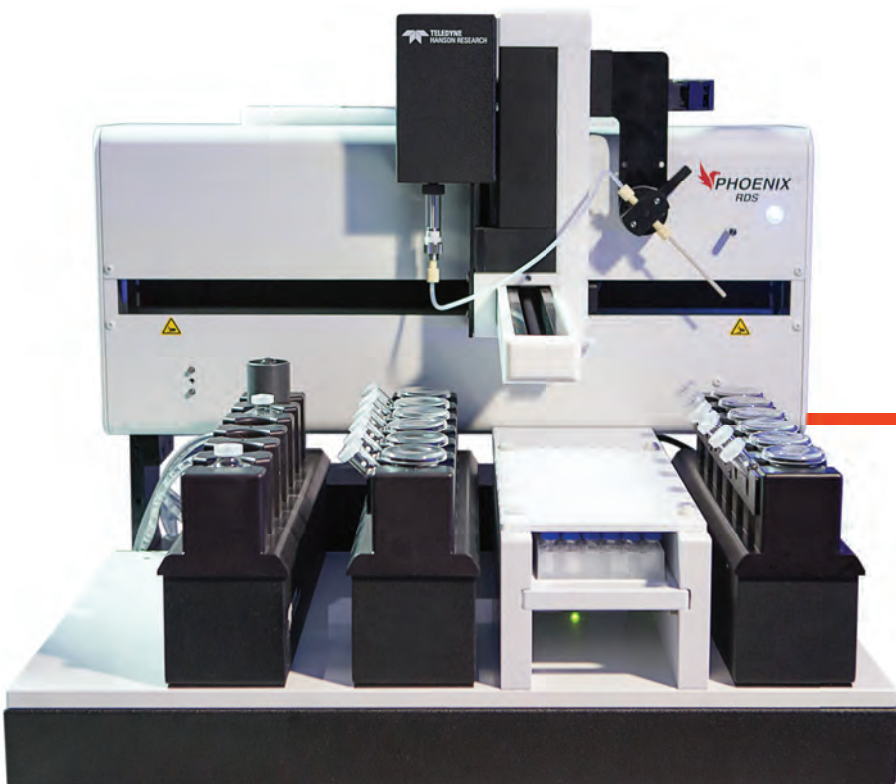

## Phoenix RDS Robotic Diffusion Station

- Fully automated sampling and collection system, with reduced variance and enhanced consistency
- Capable of testing up to 24 diffusion cells at once
- Sophisticated Diffusion Master software to control a syringe driven probe on an XYZ platform
- Mimics the way sampling, collection, and media replace are performed manually by laboratory analysts
- Modular design, allowing easy scale up to higher numbers of experiments



**TELEDYNE  
HANSON RESEARCH**  
Everywhereyoulook™

## Sterile Sampling Scoops, PS

Comfortable, curved handle

- Flat bottom surface helps prevent spillage
- Sterilised by gamma irradiation and packaged individually in sealed easy-open bags



Capacity mL (oz)	Size (L x W)		Handle length		Qty/cs	Catalogue number
	cm	in.	cm	in.		
60 (2)	20.3	3	12.7	5	100	MY-06260-01
120 (4)	22.9	3½	12.7	5	100	MY-06260-02

## Scienceware® Sterile Sampling Scoops, PS

No need to presterilise

- Come sterilised in individual polyethylene bags
- Ideal for single use



Capacity mL (oz)	Scoop (L x W)		Handle length		Qty/cs	Catalogue number
	cm	in.	cm	in.		
60 (2)	7.6 x 2.5	3 x 1	10.2	4	100	MY-06260-10
120 (4)	8.9 x 2.5	3½ x 1				MY-06260-20

## Lab Spatulas, Nickel/Stainless Steel

Get precise sampling of powders or salts

- Easy-to-clean finish
- Choose the right end style for your needs



A B C D E F G H

End styles	Overall length		Qty/pk	Catalogue number
	cm	in.		
A. Spooned†/flat	14.6	5¾	3	MY-06369-09†
B. V-shaped/sharpened bent tip	15.9	6¼	3	MY-06369-08
C. Spooned†/plastisol handle	16.5	6½	3	MY-06369-03†
D. Tapered/rounded	20.3	8	3	MY-06369-06
E. Rounded/rounded	21.0	8¼	3	MY-06369-05
F. Tapered/rounded	18.1	7½	3	MY-06369-07
G. Squared/rounded	19.1	7½	3	MY-06369-18
H. Spooned/squared	22.5	8¾	3	MY-06369-16

†Hayman type end

## Smart Spatula™ Disposable Spatulas, PP

Reduce cross-contamination

- Each spatula has scoop and spatula ends for better sampling
- Flexible design will not shatter even if exposed to liquid nitrogen
- Autoclavable



Description	Overall length		Qty/pk	Catalogue number
	cm	in.		
A. Blue	22.2	8¾	300	MY-06265-18
B. Opaque	22.2	8¾	300	MY-06265-12
C. Opaque, antistatic	14.0	5½	300	MY-06265-14
D. Green, large	31.1	12¼	150	MY-06265-16
E. Opaque, sterile	22.2	8¾	100	MY-06265-20

## Scienceware® Sterile Sampling Spatula, PS

Get more volume per scoop

- Designed to hold twice the volume of standard spatulas
- Break up caked material easily with sturdy edge
- Individually sterilised and bagged



Overall length	Qty/cs	Catalogue number
22.9 cm (9")	100	MY-06262-00

## Cole-Parmer® Double-Ended Spoon Set, 304 SS

Sample from both ends

- Minimise discomfort—solid rounded shafts for more comfortable handling

Set contains three spoons: a 14.9-cm (5⅞") long spoon with 0.5-mL and 2.0-mL bowls, a 21-cm (8¼") long spoon with 1.6-mL and 5.0-mL bowls, and a 30.2-cm (11⅞") long spoon with 2.0-mL and 8.0-mL bowls.



Set contains three spoon sizes



Qty/set	Catalogue number
Three spoons	MY-06261-00

## Stuart® Slow-Speed Rocking Shakers

### Preserve viability with gentle whirling or rocking

- Adjust tilt angle for optimal mixing
- Built-in timer and digital speed display provide reproducible results

**Gyrational Motion Shakers** delicately swirl solutions for low-foaming requirements such as cell culturing, DNA extractions, and histological staining procedures.

**See-Saw Shakers** produce a rolling wave in your vessel, perfect for culture flasks and petri dishes.

Choose small 3-kg capacity for tight spaces. Larger 10-kg capacity shakers suit larger laboratories and high-throughput applications. Optional tier system triples capacity and is held in place with magnets, so it easily disassembles for cleaning.



stuart®

## Stuart® Roller Shakers

### Gently perform complete mixing

- Rocking and rolling action creates minimum aeration
- Ideal for viscous substances and liquid-solid suspensions
- Safe for use in cold rooms or incubators
- Expand capacity and save space with optional stacking kit

The 6-roller units offer space-saving footprint—ideal for incubators. The 9-roller units provide higher throughput. Both shakers accommodate most tube and bottle sizes.

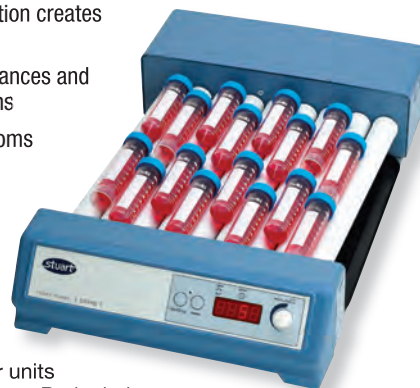

stuart®



#### Specifications

**Speed range:** 5 to 70 rpm  
**Angle of tilt:**  
 Gyrotory models: 3° to 12°  
 See-saw models: 7°



Max load	Platform dimensions (L x W)	Power	Catalogue number
<b>Gyrotory shakers (not shown)</b>			
3 kg	23.5 x 23.5 cm	230 VAC, 50 Hz	<b>MY-51900-26</b>
10 kg	35.5 x 35.5 cm	230 VAC, 50 Hz	<b>MY-51900-28</b>
<b>See-saw shakers</b>			
3 kg	23.5 x 23.5 cm	230 VAC, 50 Hz	<b>MY-51900-30</b>
10 kg	35.5 x 35.5 cm	230 VAC, 50 Hz	<b>MY-51900-32</b>

#### Accessories

**MY-51700-94 Optional tier system** for small-capacity rockers  
**MY-51700-93 Optional tier system** for large-capacity rockers

#### Specifications

**Timer (digital models only):**  
 1 second to 9 hours  
**Ambient temperature:** 4 to 60°C  
**Overall dimensions (W x H x D):**  
 6-rollers: 59.5 x 11 x 25.5 cm  
 9-rollers: 59.5 x 11 x 37.5 cm

Speed range	Number of rollers	Power		Catalogue number
		VAC	Hz	
<b>Analog shakers</b>				
Fixed at 33 rpm	6	230	50	<b>MY-04653-02</b>
	9	230	50	<b>MY-04653-04</b>
<b>Digital shakers</b>				
Adjustable from 5 to 60 rpm	6	230	50	<b>MY-04653-06</b>
	9	230	50	<b>MY-04653-08</b>

#### Accessories

**MY-04653-09 Stacking kit** includes four blocks. One kit will stack two shakers; order two kits to stack three shakers

## Stuart® Tube Rotators

### Gentle and effective mixing—ideal for biological suspensions

- Suspend cultures without compromising viability
- Fully adjustable rotation angle optimises mixing for any sample

**Fixed-speed rotator** offers easy repeatable operation at 20 rpm for routine tasks.

**Variable-speed rotator** is best suited to more dynamic laboratory environments with different or changing protocols requiring 2 to 40 rpm. Features a digital speed display and timer providing better repeatability for optimal results.

**Discs.** Mix and match from six tube holder discs (order separately). Quickly and easily remove and replace tube holders without tools. Use two tube holders simultaneously with the optional dual disc adapter.

#### 1. Rotator Drive



Speed range	Speed control	Timer	Dimensions (W x H x D)	Power		Catalogue number
				VAC	Hz	
20 rpm	—	—	20 x 23 x 27 cm	230	50	<b>MY-07650-11</b>
2 to 40 rpm	Digital	1–999 minutes		230	50	<b>MY-07650-13</b>

#### 2. Tube Holder Discs

Description	Tube diameter	No. of tubes	Cat. no.
1.5-mL micro tube holder	10 to 11.5 mm	46	<b>MY-00077-11</b>
Test tube holder	9 to 20 mm	20	<b>MY-00077-15</b>
50-mL centrifuge tube holder	25 to 35 mm	12	<b>MY-00077-13</b>
Culture tube holder	12 mm	63	<b>MY-00077-17</b>
Culture tube holder	16 mm	63	<b>MY-00077-19</b>
Culture tube holder	26 mm	30	<b>MY-00077-21</b>

stuart®



#### Accessories

**MY-00077-23 Dual disc adapter.** Stacks two discs for increased capacity  
**MY-00077-25 Additional clips** for micro tube holder 00077-11. Pack of 20



## Stuart® Vortex Mixers

### Compact—perfect for individual workstations

- Choose from fixed-speed 2500 rpm or variable-speed 200 to 2500 rpm agitation
- Mix a wide variety of tube sizes and shapes with the included rubber cup head
- Heavy die-cast body won't dance across your bench
- Use for continuous mixing—housing design supports use with a lab rod

Both vortex mixers feature a robust die-cast body to prevent traveling while on, and have an integrated port to support a lab rod for holding vessels in place during continuous operation.

**Model 04729-01** provides hands-free operation at a fixed 2500 rpm—simply press your test tube to the rubber head for "touch" on operation.

**Variable-speed model 04729-03** provides you with more control—use 200 rpm for more gentle mixing all the way up to 2500 rpm for vigorous agitation. Additionally, choose between "touch" on or continuous modes.

The accessory pack of heads\* (sold separately) lets you mix in a standard microplate, a beaker or flask (up to 500-mL), eight 0.2-/0.5-mL microtubes, sixteen 1.5-mL microcentrifuge tubes, or make your own custom holder with the blank foam.

\*Accessory pack 04729-07 is only compatible with the variable-speed model 04729-03.

**What's included:** standard rubber cup.

#### Specifications

**Orbit size:** 4.2 mm (5/32") dia      **Dimensions (W x H x D):** 7.8 x 13.5 x 21.5 cm (3" x 5 1/8" x 8 1/2")

Speed range	Power			Catalogue number
	VAC	Hz	Amps	
Fixed at 2500	120 to 230	50/60	0.2	<b>MY-04729-01</b>
200 to 2500 rpm	120 to 230	50/60	0.2	<b>MY-04729-03</b>

#### Accessories

**MY-04729-07 Accessory head pack**, for variable-speed model 04729-03 only



04729-01



04729-03

## Stuart® Orbital Shakers

### Maintain consistent shaking speeds—even with continuous use

- Smooth, uniform circular motion for larger samples and multiwell plates
- Ideal for culturing and aeration applications—fit into incubators and cold chambers

**Compact Shaker** with nonslip mat holds up to four standard-sized, multiwell plates, dishes, and petri dishes. Optional expansion platform doubles plate capacity. Optional cradle platform holds four 250-mL flasks or other taller vessels.

**Large-Capacity Shaker** includes a four-bar, cradle-type platform for use with a variety of bottles and flasks. Use optional six-bar cradle platform for larger applications.

#### Specifications

**Speed range:** 30 to 300 rpm      **Timer:** 1 to 999 minutes  
**Orbit size:** 16 mm (5/8") dia

Max load	Platform dimensions	Power		Catalogue number
		VAC	Hz	
3 kg	22 x 22 cm	230	50	<b>MY-51900-20</b>
10 kg	33.5 x 33.5 cm	230	50	<b>MY-51900-22</b>



51900-20

51900-22

stuart®

#### For Compact Shaker

- MY-51700-97 Cradle platform** with four rubber securing bars
- MY-51700-98 Expansion platform** with nonslip rubber mat. Holds 8 microplates
- MY-51700-99 Plastic cover**

#### For Large-Capacity Shaker

- MY-51700-95 Cradle platform** with six rubber securing bars, measures 51 x 51 cm (20" x 20"). Max speed is 150 rpm
- MY-51700-96 Flat platform** with nonslip rubber mat. Holds 12 microplates

# W. S. Tyler® Ro-Tap® E, Ro-Tap®, and Ro-Tap II® Sieve Shakers

Get reproducible hand-sieving without the hand shaking

- Set the time and walk away—99-minute digital timer with 0.1-second accuracy

**Ro-Tap Sieve Shakers** for 20.3 cm (8") dia sieves hold up to six full-height or 13 half-height sieves with top cover and receiving pan. Shakers for 30.5 cm (12") dia sieves hold up to four full-height or ten half-height sieves with top cover and receiving pan.

**Ro-Tap II Sieve Shakers** double your shaking capacity while maintaining the accuracy of a single mechanical shaker. Dual-capacity shakers hold up to 12 full-height sieves or 26 half-height sieves.

Ro-Tap shaker 59986-60



Ro-Tap II dual-capacity shaker 59986-50



ISO9001:2008  
CERTIFIED SUPPLIER

rpm	Power (VAC/Hz)	Dimensions (W x H x D)	Shpg wt (kg (lb))	Catalogue number
<b>Ro-Tap shakers for 20.3 cm (8") dia sieves</b>				
1450	220/50	71.1 x 63.5 x 53.3 cm	77.2 (170)	MY-59986-62
<b>Ro-Tap shakers for 30.5 cm (12") dia sieves</b>				
1450	220/50	71.1 x 63.5 x 53.3 cm	102 (225)	MY-59996-62
<b>Ro-Tap II shakers for 20.3 cm (8") dia sieves</b>				
1450	220/50	76.2 x 66.0 x 68.6 cm	99.8 (220)	MY-59986-52

## Cole-Parmer® Brass and Stainless Steel Testing Sieves

Meet ASTM E11 specifications for compliance

These 20.3 cm (8") diameter testing sieves are serialized and come with test sieve certificate. For our full selection of sieves, including 30.5 cm (12") diameter sieves and sieves with ILAC MRA, NIST-traceable calibration report, go to [ColeParmer.co.uk/sieves](http://ColeParmer.co.uk/sieves).



Cole-Parmer®

ISO9001:2008  
CERTIFIED SUPPLIER

Sieve opening (mm)	US standard	Tyler standard	Brass frame/brass wire		SS frame/SS wire		Brass frame/SS mesh	
			Full height†	Half height†	Full height†	Half height†	Full height†	Half height†
			Catalogue number	Catalogue number	Catalogue number	Catalogue number	Catalogue number	Catalogue number
2.36	No. 8	8 mesh	MY-59980-00	MY-59981-00	MY-59984-00	MY-59985-00	MY-59940-00	MY-59941-00
2.00	No. 10	9 mesh	MY-59980-01	MY-59981-01	MY-59984-01	MY-59985-01	MY-59940-01	MY-59941-01
1.70	No. 12	10 mesh	MY-59980-02	MY-59981-02	MY-59984-02	MY-59985-02	MY-59940-02	MY-59941-02
1.40	No. 14	12 mesh	MY-59980-03	MY-59981-03	MY-59984-03	MY-59985-03	MY-59940-03	MY-59941-03
1.18	No. 16	14 mesh	MY-59980-04	MY-59981-04	MY-59984-04	MY-59985-04	MY-59940-04	MY-59941-04
1.00	No. 18	16 mesh	MY-59980-05	MY-59981-05	MY-59984-05	MY-59985-05	MY-59940-05	MY-59941-05
0.850	No. 20	20 mesh	MY-59980-06	MY-59981-06	MY-59984-06	MY-59985-06	MY-59940-06	MY-59941-06
0.710	No. 25	24 mesh	MY-59980-07	MY-59981-07	MY-59984-07	MY-59985-07	MY-59940-07	MY-59941-07
0.600	No. 30	28 mesh	MY-59980-08	MY-59981-08	MY-59984-08	MY-59985-08	MY-59940-08	MY-59941-08
0.500	No. 35	32 mesh	MY-59980-09	MY-59981-09	MY-59984-09	MY-59985-09	MY-59940-09	MY-59941-09
0.425	No. 40	35 mesh	MY-59980-10	MY-59981-10	MY-59984-10	MY-59985-10	MY-59940-10	MY-59941-10
0.355	No. 45	42 mesh	MY-59980-11	MY-59981-11	MY-59984-11	MY-59985-11	MY-59940-11	MY-59941-11
0.300	No. 50	48 mesh	MY-59980-12	MY-59981-12	MY-59984-12	MY-59985-12	MY-59940-12	MY-59941-12
0.250	No. 60	60 mesh	MY-59980-13	MY-59981-13	MY-59984-13	MY-59985-13	MY-59940-13	MY-59941-13
0.212	No. 70	65 mesh	MY-59980-14	MY-59981-14	MY-59984-14	MY-59985-14	MY-59940-14	MY-59941-14
0.180	No. 80	80 mesh	MY-59980-15	MY-59981-15	MY-59984-15	MY-59985-15	MY-59940-15	MY-59941-15
0.150	No. 100	100 mesh	MY-59980-16	MY-59981-16	MY-59984-16	MY-59985-16	MY-59940-16	MY-59941-16
0.125	No. 120	115 mesh	MY-59980-17	MY-59981-17	MY-59984-17	MY-59985-17	MY-59940-17	MY-59941-17
0.106	No. 140	150 mesh	MY-59980-18	MY-59981-18	MY-59984-18	MY-59985-18	MY-59940-18	MY-59941-18
0.090	No. 170	170 mesh	MY-59980-19	MY-59981-19	MY-59984-19	MY-59985-19	MY-59940-19	MY-59941-19
0.075	No. 200	200 mesh	MY-59980-20	MY-59981-20	MY-59984-20	MY-59985-20	MY-59940-20	MY-59941-20
0.063	No. 230	250 mesh	MY-59980-21	MY-59981-21	MY-59984-21	MY-59985-21	MY-59940-21	MY-59941-21
0.053	No. 270	270 mesh	MY-59980-22	MY-59981-22	MY-59984-22	MY-59985-22	MY-59940-22	MY-59941-22
0.045	No. 325	325 mesh	MY-59980-23	MY-59981-23	MY-59984-23	MY-59985-23	MY-59940-23	MY-59941-23
0.038	No. 400	400 mesh	—	MY-59981-24	—	MY-59985-24	MY-59940-24	MY-59941-24

†Full height sieves measure 5 cm (2") deep; half height sieves measure 2.5 cm (1") deep.



# Spectrophotometers



Intuitive Cloud-enabled technology



## The 74 series

Single-beam standard and Nano spectrophotometers. Visible and UV/visible.

## The 76 series

Split-beam spectrophotometers. UV/visible.

Versatile Sample Chamber



Precision Nano Read-head

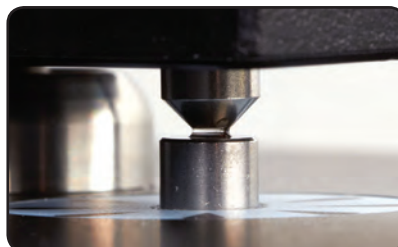

Intuitive 7" HD Touchscreen

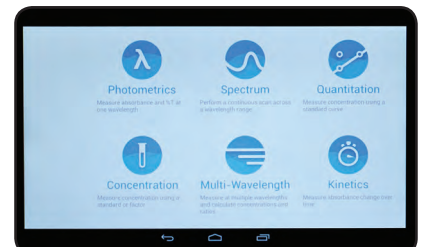

### Measurement Modes

**All variants:** photometrics, full spectrum scan, quantitation, concentration, multi-wavelength and kinetics.

**Nano variant:** also includes nucleic acid and protein methods.



# Jenway® Genova Plus and Genova Nano UV/Vis Spectrophotometers

## Versatile—get life science specific analysis in addition to standard functions

- Meet the requirements of any busy laboratory—ideal for DNA, RNA, and protein measurements, but function as standard spectrophotometers
- Detects DNA concentrations as low as 2 ng/μL
- Save your methods and results to USB memory stick
- Icon-driven software with large graphical display and intuitive navigation

**Genova Plus Spectrophotometer (model 83070-00)** offers enhanced optics dedicated to life science analysis, allowing the measurement of DNA concentrations and purity ratios using wavelengths recorded at 260, 280 and 230 nm, with an optional correction at 320 nm. Or use as a standard spectrophotometer with measurement modes for photometrics, concentration, multi-wavelength, spectrum scanning, quantitation, and kinetics.

This life science spectrophotometer is preprogrammed with methods for protein analysis in addition to nucleic acid concentrations. The OD measurement mode lets you measure optical density at 600 nm for cell harvesting. The purity scan across the entire wavelength range from 198 to 1000 nm displays any distorted peaks, easily identifying impurities.

Optional accessories let you choose the best way to measure your samples. The TrayCell accessory (83070-29) enables you to measure sample volumes as low as 0.7 μL and is ideal for RNA, DNA, and protein measurements requiring 1:10 or 1:50 dilutions.

**Genova Nano Spectrophotometer (model 83070-02)** offers the same features as the Genova Plus but adds a preinstalled pedestal platform which allows you to measure sample volumes as low as 0.5 μL—conserving your precious samples. Measuring small sample volumes eliminates the need to perform dilutions or use cuvettes, saving you time and money.

The versatile Genova Nano measures sample volumes with a high degree of accuracy and reproducibility in less than 6.5 seconds. Its stainless steel read head with an embedded quartz lens uses the natural surface tension of the droplet to form the bond between the read head surfaces for optimal results. When your reading is complete, simply wipe the sample with a microfiber cloth to remove all trace of the sample. The ease of cleaning allows faster changeover between samples, increasing sample throughput.

**What's included:** Model 83070-00 includes a 10 x 10-mm cuvette holder, micro-cuvette holder, 4 GB USB memory stick, 100 disposable micro-cuvettes, and universal power supply. Model 83070-02 includes a micro-volume accessory, 10 x 10-mm cuvette holder, micro-cuvette holder, 4 GB USB memory stick, and universal power supply.



Spectrophotometer  
83070-02

Jenway®



### Accessories

**MY-83070-29 TrayCell accessory for Genova Plus (83070-00)**, for microvolume samples from 0.7 μL to 5 μL

**MY-83070-31 Automatic eight-cell cuvette holder** for multiple sample measurements. Accepts 10 x 10 mm pathlength cuvettes

**MY-83070-33 Sipper pump**, requires flow-through cuvette

**MY-83070-35 Peltier temperature controller**, 20 to 50°C

**MY-83070-37 Combined sipper pump/Peltier temperature control**

**MY-83070-39 Printer** for instant results. Fits into top of spectrophotometer to save space

**MY-83070-41 Replacement cuvette holder**, 10 x 10 mm pathlength

**MY-83070-43 Test tube and cuvette holder**, 13/16/24-mm diameter x 100 mm height; compatible with 10 mm square cuvettes

**MY-83070-45 Test tube and cuvette holder**, 13 mm dia; compatible with 10 mm square cuvettes

**MY-83056-80 Cuvette holder**, 10 x 100 mm pathlength

**MY-83056-82 Replacement micro-cuvette holder**, for small sample volumes down to 50 μL

**MY-83070-51 Water-heated cuvette holder**, 10 x 10 mm pathlength (requires heated circulating bath for operating temperatures from 5 to 50°C)



### Specifications

**Measurement time:** <6.5 seconds

**Sample pedestal material of construction (model 83070-02):** stainless steel and quartz

Description		Genova Plus	Genova Nano
<b>Catalogue number</b>		<b>MY-83070-00</b>	<b>MY-83070-02</b>
Sample mode(s)		Cuvette	Cuvette and pedestal
Minimum sample size		0.7 μL†	0.5 μL at 2.0 mm, 1.0 μL at 0.5 mm
Maximum sample size		5 mL	5.0 μL
Bandwidth		5 nm (spectral)	
Path length		10 mm	0.2 or 0.5 mm (auto-ranging)
Wavelength	Transmittance	0 to 199.9%	
	Range	198 to 1000 nm	
	Resolution	±2 nm	
	Accuracy	1 nm	
Source lamp		Press-to-read Xenon lamp	
Detector		Photo-diode detector	
Detection limit		—	2.0 ng/μL (dsDNA) at 0.2 mm pathlength
Measurement	Range	-0.300 to 2.500 A (10-mm pathlength equivalent = -15.0 to 125.0 A)	
	Precision	<0.005 A between 0 and 1 A (at 260 nm and 0.5 mm)	
	Accuracy	±1% T, ±0.01 A at 1.000 A	±2% at 1 A
Maximum concentration		—	6000 ng/μL (dsDNA)
DNA measurement modes		dsDNA, ssDNA, RNA, oligonucleotides, 260/280, 260/230, variable ratio	
Protein measurement modes		BCA, Bradford, Lowry, Biuret, Direct UV	
Memory		Up to 312 methods (including preprogrammed methods)	
Input/Output		USB, analogue, RS-232, and optional integral printer	
Power (VAC, Hz)		90 to 260, 50 to 60	

†The 0.7 μL sample volume requires TrayCell accessory 83070-29 sold separately at right.

## Jenway® 72 Series and Genova Bio Scanning Spectrophotometers

### Scan entire wavelength range in as little as six seconds

- Colour touchscreen and user-friendly interface make setup and navigation easy
- Multiple measurement modes for broad application compatibility
- Save quantitation curves to USB memory stick—no need to recreate for each measurement
- Two USB ports for data storage and printer connectivity
- Flexible and versatile—compatible with a wide range of interchangeable cell holders

The multi-element detector on the scanning spectrophotometers measures the entire wavelength range at once, reducing wait times. Plus, each dataset contains readings from the complete spectrum, making the data readily available for future analysis. The detector's orientation shields the array from stray light, allowing you to perform measurements with the lid open, quickly exchange samples, and decreases user errors in results.

Large 10.1-cm display allows full spectrum scans, quantitation curves and kinetics runs to be viewed easily. The touchscreen capability lets you zoom in and out and select spectral analysis points all by simply tapping the screen. Measurement modes include photometrics, concentration, optical density (OD at 600 nm), quantitation, spectrum scanning, and kinetics.

Compact design with small footprint takes up less space on your benchtop. The large sample chamber permits easy access for loading samples. The USB port on the rear connects with a printer (order separately), while the USB on the front accepts flash drives for data storage, quantitation curve uploads, and firmware updates.

**Genova Bio**, a dedicated life science UV/Vis spectrophotometer, is preprogrammed with methods for measuring nucleic acid concentrations, protein assays, and optical density of bacterial cell cultures such as *E. coli* and yeast cells. Compatible with ultra-micro, semi-micro, micro, and macro cuvettes.

**What's included:** standard 10 x 10 mm cuvette holder for models 83056-01 and -02, micro-cuvette holder for model 83056-04, USB memory stick, and power adapter with three plugs (EU, UK, and US).



CE Meter and xenon lamp

Model	7200 (Vis)	7205 (UV/Vis)	Genova Bio (UV/Vis)
Catalogue number	MY-83056-01	MY-83056-02	MY-83056-04
Minimum sample size	0.7 µL†	0.7 µL†	0.7 µL†
Maximum sample size	4 mL	4 mL	4 mL‡
Bandwidth (spectral)	7 nm	5 nm	3 nm
Pathlength	10 mm	10 mm	10 mm
Wavelength	Range	335 to 800 nm	
	Accuracy	±2 nm	
	Repeatability	±2 nm	
Photometrics	Transmittance	0 to 199.9%	
	Absorbance	-0.300 to 2.500 A	
	Accuracy	±0.01 A at 1.0 A and 546 nm	
	Stability (A)	±0.005 A/h at 0.04 A and 546 nm	
	Noise	±0.002 A at 0.04 A and ±0.02 A at 2.0 A and 546 nm	
	Stray light at 340 nm, %T	<1% T according to ANSI/ASTM E387-72	
Beam height	15 mm		
Source lamp	Tungsten halogen lamp	Xenon lamp	
Scan time	6 seconds		
Memory	Dependent on attached mass storage device		
Outputs	(2) USB		
Power (VAC, Hz)	100 to 240, 50 to 60		

†The 0.7 µL sample volume requires TrayCell accessory 83070-29 sold separately.

‡Model 83056-04 comes fitted with the micro-cuvette holder; would require cuvette holder 83070-41 for a 4-mL sample size.



Built-in cuvette rack keeps your benchtop clutter-free.

Jenway®



Large chamber allows easy access for loading and unloading samples, plus it accommodates the optional heated cuvette and adjustable pathlength holders.

#### Accessories

**MY-83070-41 Single cuvette holder**, 10 x 10 mm

**MY-83056-06 Micro-cuvette holder** for cuvettes with 8.5-mm beam height

**MY-83056-82 Micro-cuvette holder with reduced aperture**, for cuvettes with 15-mm beam height

**MY-83056-77 Heated cuvette holder** for 10 x 10 mm cuvettes, 32 to 42°C

**MY-83056-80 Adjustable pathlength cuvette holder**, 10- to 100-mm

**MY-83070-43 Test tube holder**; accepts 10-mm square cuvettes and 16- and 24-mm diameter test tubes

**MY-83070-29 TrayCell accessory** for ultra-micro sample volumes, supplied with caps for 1 and 0.2 mm

**MY-83056-79 External printer** with battery and power adapter with three plugs (EU, US, and UK)

**MY-99959-81 Print paper**. One roll

**MY-99610-33 Plastic cuvettes**, visible only; 10-mm path, 3 mL. Pack of 100

**MY-06343-73 Plastic cuvettes**, UV/Vis; 10-mm path, 3 mL. Pack of 100

**MY-83070-38 Plastic micro-cuvettes**, UV/Vis; 70 µL to 1.5 mL. Pack of 100

## Cole-Parmer® Visible Spectrophotometers

### Get precise results

- Save time and reduce errors with auto-zeroing
- Maintain calibration and prevent damage with end-of-range stop on adjustment knob
- No manual adjustments—built-in filters automatically switch to accommodate wavelength setting



**What's included:** twelve 10-mm diameter test tubes cuvettes, cuvette adapter, dust cover, and 2.1-m (7-ft) cord with a US standard plug.



ISO9001:2008  
CERTIFIED SUPPLIER



Bandwidth	20 nm	10 nm
<b>Catalogue number</b>	<b>MY-83055-10</b>	<b>MY-83055-20</b>
Wavelength range	335 to 1000 nm	
Wavelength accuracy	±2 nm	
Photometric ranges	Transmittance	0 to 125% T
	Absorbance	0 to 2 A
	Concentration	0 to 1999 C
Output	USB RS-232 / USB	
Power (50/60 Hz)	115/230 VAC switchable	

**MY-83055-21 PC application software** for model 83055-20. Standard Curve, Abs.-%T/Conc., and Abs. vs. Time; for Windows® 95, 98, and XP. Includes serial cable 83055-24

**MY-83055-24 RS-232 cable** for model 83055-20. Female 9-pin to female 9-pin

**MY-83055-22 Printer cable** for model 83055-20. Male 25-pin to female 9-pin

## Cole-Parmer® UV/Visible Spectrophotometer

### Store and recall 200 test methods

- Leverage software for DNA/RNA/protein and kinetics analysis
- Be more productive with included four-position cuvette holder
- Responds precisely to transmittance changes for better results
- Optional Peltier temperature controller and/or sipper system for total utility
- Create standard curves and get wavelength scanning feature with optional software



**What's included:** a 2.1-m (7-ft) detachable cord, dust cover, two-position 10-mm cuvette holder, four glass cuvettes, and two quartz cuvettes.



ISO9001:2008  
CERTIFIED SUPPLIER



Bandwidth	4 nm	
<b>Catalogue number</b>	<b>MY-83059-15</b>	
Wavelength range	200 to 1000 nm	
Wavelength accuracy	±2 nm	
Photometric ranges	Transmittance	0 to 125% T
	Absorbance	-0.1 to 2.5 A
	Concentration	0 to 1999 C
Memory capability	Up to 200 standard curves	
Output	RS-232/USB	
Power (50 Hz)	230 VAC	

**MY-83057-65 Software, graphics.** Standard curve, Abs.-%T/Conc., Abs. vs time; for Windows® XP

**MY-83057-74 Sipper system,** 230 VAC. With external controller unit and peristaltic pump; requires flow cell and tubing

**MY-83057-78 Flow cell,** glass (visible spectra)

**MY-83057-79 Flow cell,** quartz (UV spectra)

**MY-83057-64 Two-position long cuvette holder,** 100 mm max

## Disposable Cuvettes

### No more washing cuvettes!

Use these economical, single-use cuvettes to obtain consistent spectrophotometric data. Use polystyrene cuvettes for visible spectral analysis; polymethacrylate cuvettes are preferred for UV range testing. Pathlength: 10 mm.

Type	Capacity (mL)	No. of clear sides	Dimensions W x H x D (mm)	Polystyrene	Methacrylate
				Catalogue number	Catalogue number
Standard	4.5	Two	12.5 x 45 x 12.5	<b>MY-06343-10</b>	<b>MY-06343-15</b>
Semi-micro	1.5			<b>MY-06343-20</b>	<b>MY-06343-70</b>
Fluorometry	4.5	Four	12.5 x 45 x 12.5	<b>MY-06343-60</b>	<b>MY-06343-80</b>

**MY-06343-31 Cuvette caps,** LDPE. Case of 1000

**MY-06343-35 Cuvette stirring spatulas,** PS. Case of 1000

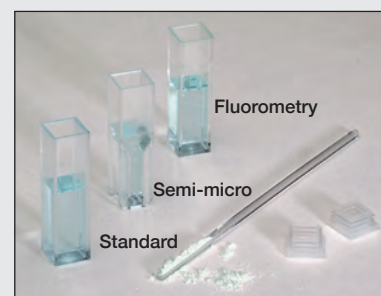



# Stuart® configurable stirrers, hot plates and stirring hot plates



Designed by You. Built by Us.



Design your unit in **5 easy steps**  
using our online configurator

- 1** Start with a type
- 2** Select an interface
- 3** Choose your plate material
- 4** Pick a body colour
- 5** Select the voltage

Type	Stirring (200–2000 rpm)			Hot Plate			Stirring (200–2000 rpm) + Hot Plate			
Interface	Analogue	Analogue	Digital	Premium	Analogue	Digital	Premium			
Top plate material	Ceramic or Stainless steel	Ceramic (450°C) or Aluminum (300°C)		Aluminum (300°C)	Ceramic (450°C) or Aluminum (300°C)					
Body colour	Blue, white, or black	Blue, white, or black		Blue, white, black, avocado, red, tangerine, violet, or pink	Blue, white, or black			Blue, white, black, avocado, red, tangerine, violet, or pink		
Power	115–230 VAC, 50/60 Hz		120 VAC or 230 VAC, 50/60 Hz			120 VAC or 230 VAC, 50/60 Hz				

## Cole-Parmer® StableTemp™ Stirrers and Stirring Hot Plates

Precision control ensures accurate, repeatable results

- Stay safe—hot surface warning until plate cools below 50°C
- Don't worry about spills—raised display diverts liquids away from critical components
- Optional temperature probe maintains your sample at the set temperature

**Advanced Stirrer and Stirring Hot Plate** offers greater accuracy and repeatability for advanced applications. You can view actual and set values simultaneously, and set ramp/dwell programs and save settings for quick repeat.

**What's included:** PTFE-coated stir bar and detachable power cord with EU plug. Advanced stirring hot plate also includes a temperature probe kit.

StableTemp



Top plate		Heating		Stirring		Power		Catalogue number
Dimensions	Material	Temperature range	Max load	Speed range (rpm)	Max capacity	VAC	Hz	
<b>Stirrers</b>								
10.8 x 10.8 cm	Ceramic	—	11.4 kg	50 to 1500	1-L	230	50/60	MY-03406-06
18.4 x 18.4 cm	Ceramic	—	11.4 kg	50 to 1500	4-L	230	50/60	MY-03406-16
26 x 26 cm	Ceramic	—	11.4 kg	50 to 1500	6-L	230	50/60	MY-03406-36
<b>Stirring hot plates</b>								
10.8 x 10.8 cm	Ceramic	30 to 540°C	11.4 kg	50 to 1500	1-L	230	50/60	MY-03407-06
18.4 x 18.4 cm	Ceramic	30 to 540°C	11.4 kg	50 to 1500	4-L	230	50/60	MY-03407-16
26 x 26 cm	Ceramic	30 to 400°C	11.4 kg	50 to 1500	6-L	230	50/60	MY-03407-36
<b>Advanced stirrer and stirring hot plate</b>								
18.4 x 18.4 cm	Ceramic	—	11.4 kg	50 to 1500	4-L	230	50/60	MY-03406-46
18.4 x 18.4 cm	Ceramic	30 to 450°C	11.4 kg	50 to 1500	4-L	230	50/60	MY-03407-46

†Based on water contained in a 20-L glass flat-bottom flask.

### Accessories

**MY-04600-88 Transparent splash shield** for 10.8 x 10.8 cm units

**MY-04600-89 Transparent splash shield** for 18.4 x 18.4 cm units

**MY-04600-90 Transparent splash shield** for 26 x 26 cm units

**MY-04600-91 External temperature probe**, 100 Ω Pt, SS, 0 to 400°C

**MY-04600-92 External temperature probe**, 1000 Ω Pt, SS, 0 to 400°C

**MY-04600-93 External temperature probe**, 1000 Ω Pt, Hastelloy®, 0 to 400°C

**MY-04600-98 Support rod** for securing sample containers

**MY-04600-99 Clamp and holder** for securing sample containers

## Cole-Parmer® Stirrers, Hot Plates, and Stirring Hot Plates

Compact—reduce clutter in your workspace

- Heat one large vessel or several small ones—easily accommodate four 250-mL beakers
- Be safe—flashing light warns when top plate is hot (>50°C), even when unplugged
- Unique housing allows legs of a support stand to slide underneath
- Choose ceramic top for better chemical resistance and higher temperatures

All units feature powerful magnets and motor. **Advanced Analogue Units** have an innovative LED temperature indicator scale, which lights up in coloured increments as the top plate heats up, and shows you when the plate has reached its temperature set point. Use with the optional digital temperature controller to accurately regulate sample temperature. **Advanced Digital Units** indicate surface temperature on an LED, ensuring high repeatability and accuracy. Compatible with the optional controller for precise sample temperatures.

Cole-Parmer®



Top plate		Temperature range	Stirring		Power		Catalogue number
Dimensions	Material		Speed range	Max capacity†	VAC	Hz	
<b>Analogue stirrers</b>							
15 x 15 cm	Ceramic	—	100 to 2000 rpm	15-L	230	50	MY-04801-52
	Stainless steel	—					MY-04801-56
<b>Advanced analogue hot plates</b>							
15 x 15 cm	Ceramic	Ambient to 450°C	—	—	230	50	MY-04801-22
	Coated aluminum	Ambient to 325°C					MY-04801-26
<b>Advanced analogue stirring hot plates</b>							
15 x 15 cm	Ceramic	Ambient to 450°C	100 to 2000 rpm	15-L	230	50	MY-04801-62
	Coated aluminum	Ambient to 325°C					MY-04801-67
<b>Advanced digital stirring hot plates</b>							
15 x 15 cm	Ceramic	Ambient to 450°C	100 to 2000 rpm	15-L	230	50	MY-04801-66
	Coated aluminum	Ambient to 325°C					MY-04801-70

†Based on water contained in a 20-L glass flat-bottom flask.

**MY-04801-80 Digital temperature controller** for advanced models only. Operates from 20 to 200°C with ±0.5°C accuracy.

## Stuart® Analogue Stirrers, Hot Plates, and Stirring Hot Plates

### Designed for safety and performance

- Heat one large vessel or several small ones
- High-capacity models heat up to thirty 100-mL beakers simultaneously
- Flashing light warns when top plate is hot (above 50°C), even when turned off
- Chemical-resistant ceramic top plate reaches higher temperatures yet stays cool around the edges to help prevent accidental burns
- Rugged aluminum top plate offers even temperature distribution across the whole surface of the plate

Advanced units feature an innovative LED temperature indicator scale, which lights up in coloured increments as the top plate heats up, to indicate when the plate has reached its temperature set point. Use with the optional digital temperature controller for precise sample temperatures.

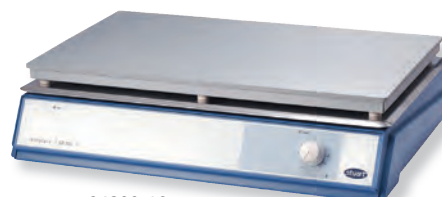

04800-13



04800-07



04805-14



Top plate		Heating Temp range	Stirring		Power		Catalogue number
Dimensions	Material		Speed range	Max capacity	VAC	Hz	
<b>Stirrers</b>							
15 x 15 cm	Ceramic	—	100 to 2000 rpm	15-L	230	50	SE-04805-07
	Stainless steel	—	100 to 2000 rpm	15-L	230	50	SE-04805-13
<b>Hot plates</b>							
30 x 30 cm	Ceramic	Ambient to 450°C	—	—	230	50/60	SE-04800-07
	Coated aluminum	Ambient to 300°C	—	—	230	50/60	SE-04801-07
<b>High-capacity hot plates</b>							
30 x 50 cm	Ceramic	Ambient to 375°C	—	—	230	50/60	SE-04800-11
	Coated aluminum	Ambient to 300°C	—	—	230	50/60	SE-04800-13
<b>Advanced hot plates</b>							
15 x 15 cm	Ceramic	Ambient to 450°C	—	—	230	50	SE-04805-08
	Coated aluminum	Ambient to 325°C	—	—	230	50	SE-04805-14
<b>Stirring hot plates</b>							
30 x 30 cm	Ceramic	Ambient to 450°C	100 to 1500 rpm	15-L	230	50	SE-04800-01
	Coated aluminum/silicon	Ambient to 300°C	100 to 1500 rpm	15-L	230	50	SE-04801-01
<b>Advanced stirring hot plates</b>							
15 x 15 cm	Ceramic	Ambient to 450°C	100 to 2000 rpm	15-L	230	50	SE-04805-58
	Coated aluminum/silicon	Ambient to 325°C	100 to 2000 rpm	15-L	230	50	SE-04805-66

MY-04805-92 Digital temperature controller for advanced units

## Stuart® Digital Hot Plate

### Digital, microprocessor control for high performance

- Accurate digital setting and control of temperature for rapid heating across the entire plate
- Flashing light warns when top plate is hot (above 50°C)



Angled housing is shaped for stability while deflecting spills away from the controls. An independent safety circuit protects against overheating and internal electronic components are protected against corrosion.



Top plate		Temperature range	Power		Catalogue number
Dimensions	Material		VAC	Hz	
15 x 15 cm	Coated aluminum	50 to 300°C	230	50/60	MY-04805-29

## Large Volume Stir Bars

- Strong alnico V magnets encased in chemically inert PTFE

MY-04627-00 Large volume stir bar, 10.8-cm L x 1.7-cm dia

MY-04627-10 Large volume stir bar, 15.9-cm L x 1.7-cm dia



## Stir Bar Retrievers

Retrieve stir bars without messy spills or breakage. Alnico V magnet is completely enclosed. Model 08555-20 features a flexible shaft of PTFE for odd-shaped, and narrow-mouth containers.

MY-08555-20 Stir bar retriever, flexible shaft; PTFE, 37.5-cm L

MY-08555-40 Stir bar retriever, polyethylene, 43.2-cm L



08555-20

08555-40



## Velp® Compact Magnetic Stirrers

### Won't overheat even after hours of continuous operation

- White surface lets you easily see particles and colour changes

**Analogue model** features a speed control knob with a numerical division scale to ensure repeatable results.

**Digital model** features a digital display of rpm. A timer allows you to do other work without having to monitor the sample. Auto-reverse function alternates stirring direction at a programmable interval.



Description	Analogue	Digital
Catalogue number	MY-86579-15	MY-86579-05
Top plate	12 x 14.5 cm	12 x 14.5 cm
Material	Technopolymer	Technopolymer
Speed range	0 to 1100 rpm	0 to 1500 rpm
Max stirring capacity	5-L	5-L
Timer	—	1 to 900 minutes
Power	100 to 240 VAC, 50/60 Hz	

## Stuart® Advanced Digital Stirring Hot Plates

### Stores safely on its side—ideal for large or educational labs

- Warning indicator stays lit when top plate is above 50°C, even if power is off
- Compact space-saving design is suitable for limited workspaces such as fume hoods



Get the simplicity of analogue control with the accuracy of digital feedback. To further increase heating accuracy, the optional digital temperature controller (order separately) controls the heating element based on the temperature of your sample. Integral fitting accommodates a support rod.



Top plate		Heating	Stirring		Power		Catalogue number
Dimensions	Material	Temp range	Speed range	Max capacity	VAC	Hz	
15 x 15 cm	Glass ceramic	Ambient to 450°C	100 to 2000 rpm	15-L	230	50	MY-04805-84
	Coated aluminum/silicon	Ambient to 325°C			230	50	MY-04805-90

**MY-04805-92 Digital temperature controller** for advanced digital stirring hot plates

## Cole-Parmer® Battery-Powered Magnetic Stirrer

### Portable—ideal for field analysis

- Stepless speed control to 700 rpm

Take this compact, battery-powered magnetic stirrer anywhere or use it in the lab and eliminate the need for cumbersome extension cords. Stirrer features stepless speed control knob, corrosion-resistant epoxy-coated metal case, nonskid rubber top plate, and four rubber feet.

**What's included:** two AA batteries.



Top plate		Speed range	Max load	Max stirring capacity	Catalogue number
Dimensions	Material				
9.5 x 9.5 cm	Metal	200 to 700 rpm	4.5 kg	2.5-L	MY-04804-01

## Corning® Economical Large-Capacity Stirrer

### Stir up to 38 liters of aqueous solution

- Handles many applications that previously required an overhead mixer
- Ideal for carboy/vessel mixing and seed culture flasks

Powerful "rare earth" magnet automatically pulls stir bar into position and stays coupled even under the most demanding stirring conditions. Stirrer accommodates stir bars up to 7.6 cm L.

**What's included:** a 1.8-m power cord with plug.



Top plate dimensions	Top plate material	Speed range	Max load	Max stirring capacity	Power		Catalogue number
					VAC	Hz	
27.9 x 27.9 cm	ABS plastic	100 to 1500 rpm	45 kg	38-L	120	50/60	MY-84302-30

**MY-17050-04 ILAC MRA, NIST-traceable calibration** with data for stirrers

## IKA® Multiposition Stirrers and Stirring Hot Plates

Maintain consistent and silent operation with wear-free and maintenance-free motor

- Stir consistently in all positions
- Adjust speed in 10-rpm increments—speed remains constant
- Stirring hot plates feature synchronous heating and stirring, and homogeneous temperature distribution

**What's included:** RO models include a removable transparent antislip cover, power cord and adapters to work with US, EU, UK, Canada, and Australia outlets. RT models include a power cord and plug.



Stirring positions	Top plate		Temperature range	Speed range	Volume per position	Power		Catalogue number
	Dimensions	Material				VAC	Hz	
<b>RO multiposition stirrers</b>								
5	12 x 47 cm	Stainless steel	—	0 to 1200 rpm	400-mL	100 to 240	50/60	MY-04671-91
10	19 x 47 cm							MY-04671-92
15	28 x 47 cm							MY-04671-93
<b>RT multiposition stirring hot plates</b>								
5	11 x 49.5 cm	Stainless steel	Ambient to 120°C	0 to 1100 rpm	400-mL	230	50/60	MY-04671-95
10	18 x 49.5 cm							MY-04671-97
15	27 x 49.5 cm							MY-04671-99

### Accessories

- MY-17050-04 ILAC MRA, NIST-traceable calibration with data for stirrer
- MY-17002-27 ILAC MRA, NIST-traceable calibration with data for stirrer and hot plate

## IKA® RCT and RET Basic IKAMAG® Round-Top Digital Stirring Hot Plates

Safe for unsupervised operation

- Both units have a high safety level due to their improved heat control technology
- Stronger motor for higher speed range—up to 1700 rpm

Platinum RTD temperature sensor ensures precise temperature control. You can digitally set safety temperature limit. Hot top indicator warns to prevent burns.

**RCT basic model** features a polished aluminum round top plate which provides more efficient heat transfer than standard top plates. Hot plate features an over-temperature safety circuit adjustable from 50 to 360°C to protect your samples from overheating. Adjustable speed up to 1500 rpm.

**RET basic model** offers the same features of the RCT basic model (above) plus a stainless steel top plate for better chemical resistance and higher temperatures. Speed range is up to 1700 rpm for more demanding applications.

**What's included:** 1000 Ω Pt external temperature sensor and 1.5-m cord.



04671-23



Top plate		Temperature range	Speed range	Max stirring capacity	Overall dimensions (W x H x D)	Power				Catalogue number
Dimensions	Material					VAC	Hz	Amps	Watts	
<b>RCT basic stirring hot plate</b>										
12.7 cm dia	Aluminum alloy	50 to 360°C	50 to 1500 rpm	20-L	15.9 x 9.5 x 26.7 cm	230	50/60	0.1	600	MY-04671-23
<b>RET basic stirring hot plate</b>										
12.7 cm dia	Stainless steel	50 to 340°C	50 to 1700 rpm	20-L	15.9 x 9.5 x 26.7 cm	230	50/60	0.1	600	MY-04671-27

## Cole-Parmer® Slim-Line® Stir Bars

Get complete mixing

- Slimmer profile and larger length to diameter ratio



Size		With spinning ring	Without spinning ring
Length	Diameter†	Catalogue number	Catalogue number
25.4 mm	7.9 mm	MY-04775-45	MY-04775-40
38.1 mm		MY-04775-55	MY-04775-50
50.8 mm		MY-04775-65	MY-04775-60

†Diameter given does not include the diameter of the spinning ring.

## Programmable Digital Hot Plates

### Don't keep reprogramming—stores up to 10 programs

- Worry-free operation—unit monitors program and runs automatically so you can focus on other things
- Get heating faster—maximum temperature is reached in approximately two minutes
- Get more precision with platinum RTD temperature sensor for  $\pm 1\%$  accuracy

Features timed operation to 99 hours, 59 minutes with auto-off option. Unit can be programmable or non-programmable in operation. Offers RS-232 interface for control or recording data via a computer. Choose between a chemical-resistant ceramic top plate or milled aluminum for fast and accurate heat disbursement.

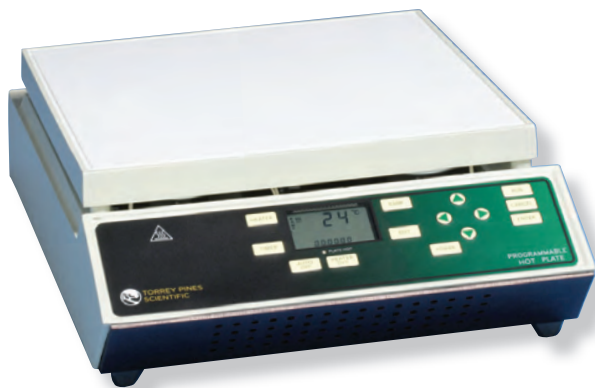

Top plate		Temperature range	Power		Catalogue number
Dimensions	Material		VAC	Hz	
15.2 x 15.2 cm	Ceramic	Ambient to 450°C	230	50/60	MY-51808-93
	Aluminum				MY-51808-97
30.5 x 30.5 cm	Ceramic	Ambient to 450°C	230	50/60	MY-51809-01
	Aluminum				MY-51809-05

**Ceramic top plates** are chemical resistant, heat up very quickly, and are easy to clean.

**Aluminum top plates** offer a more uniform heating surface and they will not crack or chip.

## Thermo Scientific™ Cast-Aluminum Hot Plates

### Eliminate unwanted hot spots

- Hot plates feature uniform heating across entire surface
- Won't buckle under heavy loads—handles up to 18 kg
- Stainless steel construction resists spills and corrosion

Top plate		Temperature range	Max load	Power		Certification	Catalogue number
Dimensions	Material			VAC	Hz		
15.9 x 15.9 cm	Aluminum	38 to 371°C	9 kg	240	50	CSA-certified	MY-03400-10
				240	60	None	MY-03400-02
30.5 x 30.5 cm	Aluminum	38 to 371°C	18 kg	240	60	UL-listed, CSA-certified	MY-03452-00
61 x 30.5 cm	Aluminum	38 to 371°C	18 kg	240	60	UL-listed, CSA-certified	MY-03462-00



## Cole-Parmer® Mono-Mold® Stir Bars

### Resist spin out at high speeds

- Super-strong alnico V magnets remain coupled to drive magnets even at high speeds
- Chemically inert, low-friction, leakproof PTFE coating provides smooth spinning and maximum energy transfer

Size		With spinning ring	Without spinning ring
Length	Diameter†	Catalogue number	Catalogue number
11.1 mm	4.8 mm	—	MY-04775-10
12.7 mm	7.9 mm	MY-08548-00	MY-04770-20
15.9 mm	7.9 mm	MY-08549-00	MY-04770-30
25.4 mm	9.5 mm	MY-08550-00	MY-04770-40
38.1 mm	9.5 mm	MY-08551-00	MY-04770-50
50.8 mm	9.5 mm	MY-08552-00	MY-04770-60
63.5 mm	9.5 mm	MY-04775-75	—
63.5 mm	12.7 mm	—	MY-04770-70
76.2 mm	12.7 mm	MY-04612-30	MY-04612-40

†Diameter given does not include the diameter of the spinning ring.

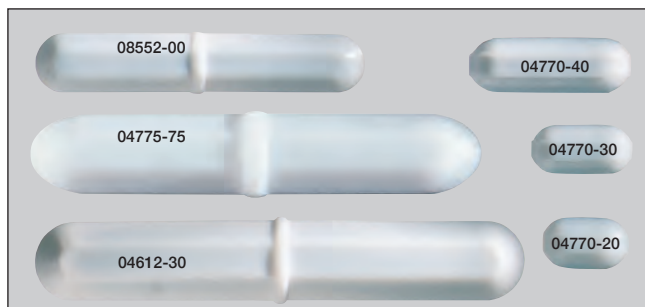



## Digi-Sense™ Precalibrated Digital Contact/Photo Tachometer

### Eliminate costly repairs



- Reliable measurements, guaranteed! Precalibrated to NIST-traceable standards
- Get more accurate readings with microprocessor-based design and accuracy of  $\pm 0.05\%$
- Stores up to 20 last average measurements for additional flexibility
- Large backlit display is perfect for poorly lit environments

Easily configure for either contact or noncontact measurements. Use the included adapters in contact mode for quickly taking measurements; take measurements from a distance (50 cm, 19 $\frac{1}{16}$ " ) when in photo mode for use on dangerous running equipment.

Meter features include max, min, and values stored, autoranging, and built-in memory recall of up to twenty last average measurements.

**What's included:** contact converter, surface speed wheel, rpm contact adapter, large male rpm rubber cone, small male rpm rubber cone, female rpm rubber cone, reflective tape (60 cm, 23 $\frac{5}{8}$ " ), four set screws, carrying case, four AA batteries, and NIST-traceable calibration certificate.



Description	Digital contact/photo tachometer	
<b>Catalogue number</b>	<b>MY-20250-26</b>	
Mode	Contact	Photo
Range	0.5 to 19,999 rpm	2.5 to 99,999 rpm
Resolution	0.1 rpm (0.5 to 999.9 rpm); 1 rpm (over 1000 rpm)	0.1 rpm (2.5 to 999.9 rpm); 1 rpm (over 1000 rpm)
Accuracy	$\pm(0.05\% + 1 \text{ digit})$	$\pm(0.05\% + 1 \text{ digit})$
Surface speed	0.2 to 6561 ft/min; 0.05 to 1999.9 m/min	
Sampling time	0.8 second (over 60 rpm)	
Detecting distance	—	50 to 500 mm
Display	5-digit LCD with backlit display	
Dimensions (L x W x H)	21 x 7.4 x 3.7 cm (8 $\frac{1}{4}$ " x 2 $\frac{7}{8}$ " x 1 $\frac{1}{2}$ " )	
Power	Four AA batteries (included)	

## Pocket Stroboscope

### Get high performance in an affordable unit

- Internal lithium-ion battery provides two hours of continuous operation
- Can operate continuously using supplied AC adapter
- Fits in pocket or can be worn on optional belt holster
- Accepts input from sensor for external flash triggering



The Pocket Stroboscope is a highly stable instrument for taking noncontact rpm measurements and inspecting moving parts by “freezing” or “slowing down” the action. The pocket stroboscope requires only one hand to operate, yet delivers performance comparable to much larger and more expensive “pistol-grip”-type models.

**What's included:** External triggering jack, hard-shell carrying case, universal AC adapter/charger with plug adapter, and calibration document supplied by the manufacturer.

Model number	PK2X-N
<b>Catalogue number</b>	<b>MY-53561-00</b>
Flash range	30 to 12,500 FPM
Flash brightness	1200 lux (@ 4500 FPM from 8" distance)
Resolution	$\pm 1$ FPM over the entire range
Accuracy	$\pm 0.01\%$ over the entire range $\pm 1$ digit
Flash energy	170 mJ maximum
Flash tube longevity	200 million flashes
External trigger	0 to 5 volt, DTL/TTL compatible $\frac{1}{8}$ " jack
Power	Rechargeable internal lithium-ion battery (2-hr run time regardless of flash rate) or universal 100–240 VAC adapter (continuous use)

## Digi-Sense™ Traceable® Noncontact Laser Tachometer

### Take rpm readings safely from a distance

- Get accurate, reliable measurements with included ILAC MRA, NIST-traceable calibration
- Obtain speed readings in two seconds; HOLD button freezes results
- Compact—fits easily in your hand, pocket, or toolbox

This handheld, point-and-shoot tachometer targets a rotating object and provides instant results—simply place a piece of reflective tape on the object to be measured. Speed readings are provided in two seconds over a range of ten to 99,999 rpm. Ideal for measuring speed on centrifuges, pumps, rollers, shafts, gears, motors, and moving surfaces.



**What's included:** reflective tape (2 ft/0.6 m), one 9 V battery, and ILAC MRA, NIST-traceable calibration certificate.



Description	Noncontact laser tachometer
<b>Catalogue number</b>	<b>MY-98767-08</b>
Range	10 to 99,999 rpm
Resolution	0.001/0.01/0.1 rpm depending on rpm displayed
Accuracy	$\pm 0.04\%$ of reading
Display	5-digit LCD, $\frac{1}{2}$ " H
Sampling time	1 sec (>60 rpm), >1 sec (10 to 60 rpm)
Dimensions (L x W x H)	12.1 x 4.4 x 3.2 cm (4 $\frac{3}{4}$ " x 1 $\frac{3}{4}$ " x 1 $\frac{1}{4}$ " )
Power	One 9 V battery (included)

**MY-98768-37 Reflective tape**

# Digi-Sense® Irreversible High-Temperature Labels

## Save time and money due to costly recalls

- Use as a quick inspection tool that the product is in usable condition during the shipping and receiving process

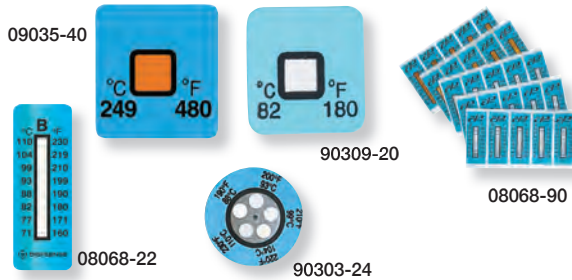

Self-adhesive labels are made up of a series of temperature-sensitive elements sealed between heat-resistant substrates with transparent windows. Each element changes colour distinctly as its rated temperature is met or exceeded. The changes to the label are irreversible, providing a temperature history of the surface being monitored. The labels will not delaminate when removed, allowing them to be attached to an inspection report to serve as a permanent record. Ideal for use in the food, automotive, moulding and metal working industries. Accuracy is  $\pm 1^\circ\text{C}$  from 29 to  $99^\circ\text{C}$ ,  $\pm 1.5^\circ\text{C}$  from 100 to  $154^\circ\text{C}$ , and  $\pm 1\% + 1^\circ\text{C}$  from 160 to  $280^\circ\text{C}$ . Shelf life: one year after date of purchase.

### One-Temperature Point—Square Labels

Temperature point		Dimensions (W x H)		Catalogue number
$^\circ\text{C}$	$^\circ\text{F}$	mm	in.	
29	84	13 x 13	$\frac{1}{2}$ x $\frac{1}{2}$	MY-08068-31†
34	93			MY-08068-32†
37	99			MY-08068-33†
40	104			MY-08068-34†
42	108	13 x 13	$\frac{1}{2}$ x $\frac{1}{2}$	MY-08068-35†
44	111			MY-08068-36†
46	115	13 x 13	$\frac{1}{2}$ x $\frac{1}{2}$	MY-90309-00†
49	120			MY-09035-26
54	129			MY-09035-27
60	140			MY-90309-05
65	149	13 x 13	$\frac{1}{2}$ x $\frac{1}{2}$	MY-09035-28
71	160			MY-90309-10
77	171	13 x 13	$\frac{1}{2}$ x $\frac{1}{2}$	MY-90309-15
82	180			MY-90309-20
88	190			MY-90309-25
93	199			MY-09035-29
99	210	13 x 13	$\frac{1}{2}$ x $\frac{1}{2}$	MY-90309-30
104	219			MY-09035-30
110	230			MY-90309-35
116	241			MY-09035-31
121	250	13 x 13	$\frac{1}{2}$ x $\frac{1}{2}$	MY-90309-40
127	261			MY-90309-45
138	280			MY-09035-32
149	300			MY-09035-33
160	320	13 x 13	$\frac{1}{2}$ x $\frac{1}{2}$	MY-90309-50
171	340			MY-09035-34
182	360			MY-09035-35
193	380			MY-09035-36
204	399	13 x 13	$\frac{1}{2}$ x $\frac{1}{2}$	MY-09035-37
216	421			MY-09035-38
232	450			MY-09035-39
249	480			MY-09035-40
260	500	13 x 13	$\frac{1}{2}$ x $\frac{1}{2}$	MY-09035-41
280	536			MY-09035-42
290	554			MY-09035-43



### Multi-Temperature Points

Temperature points		Dimensions (W x H)	Catalogue number
$^\circ\text{C}$	$^\circ\text{F}$		
<b>Four-temperature points—micro horizontal labels (pack of 10)</b>			
—	104, 108, 111, 115	4 x 13 mm ( $\frac{5}{32}$ " x $\frac{1}{2}$ " )	MY-08068-41†
—	120, 129, 140, 149		MY-08068-42†
—	160, 171, 180, 190	4 x 13 mm ( $\frac{5}{32}$ " x $\frac{1}{2}$ " )	MY-08068-43
—	199, 210, 219, 230		MY-08068-44
—	241, 250, 261, 270	4 x 13 mm ( $\frac{5}{32}$ " x $\frac{1}{2}$ " )	MY-08068-45
—	280, 289, 300, 309		MY-08068-46
—	320, 331, 340, 351		MY-08068-47
—	320, 331, 340, 351		MY-08068-47
<b>Four-temperature points—horizontal labels (pack of 10)</b>			
37, 44, 49, 54	99, 111, 120, 129	22 x 44 mm ( $\frac{7}{8}$ " x $1\frac{3}{4}$ " )	MY-90308-40†
60, 65, 71, 77	140, 149, 160, 171		MY-90308-45
82, 88, 93, 99	180, 190, 199, 210	22 x 44 mm ( $\frac{7}{8}$ " x $1\frac{3}{4}$ " )	MY-90308-50
104, 110, 116, 121	219, 230, 241, 250		MY-90308-55
127, 132, 138, 143	261, 270, 280, 289	22 x 44 mm ( $\frac{7}{8}$ " x $1\frac{3}{4}$ " )	MY-90308-60
149, 154, 160, 166	300, 309, 320, 331		MY-90308-65
171, 177, 182, 188	340, 351, 361, 370	22 x 44 mm ( $\frac{7}{8}$ " x $1\frac{3}{4}$ " )	MY-90308-70
193, 199, 204, 210	379, 390, 399, 410		MY-90308-75
<b>Five-temperature points—round labels (pack of 25)</b>			
40, 43, 46, 49, 54	105, 110, 115, 120, 130	20 mm dia	MY-90303-20†
60, 65, 71, 77, 82	140, 150, 160, 170, 180		MY-90303-22
88, 93, 99, 104, 110	190, 200, 210, 220, 230		MY-90303-24
116, 121, 127, 132, 138	240, 250, 260, 270, 280		MY-90303-26
143, 149, 154, 160, 166	290, 300, 310, 320, 330	20 mm dia	MY-90303-28
171, 177, 182, 188, 193	340, 350, 360, 370, 380		MY-90303-30
199, 204, 210, 216, 224	390, 399, 410, 421, 435	20 mm dia	MY-08068-21
232, 241, 249, 254, 260	450, 466, 480, 489, 500		MY-08068-23
232, 241, 249, 254, 260	450, 466, 480, 489, 500		MY-08068-23
<b>Five-temperature points—vertical labels (pack of 10)</b>			
37, 40, 42, 44, 46	99, 104, 109, 111, 115	19 x 38 mm ( $\frac{3}{4}$ " x $1\frac{1}{2}$ " )	MY-09035-09†
49, 54, 60, 65, 71	120, 129, 140, 149, 160		MY-09035-10
77, 82, 88, 93, 99	171, 180, 190, 199, 210		MY-09035-19
104, 110, 116, 121, 127	219, 230, 241, 250, 261	19 x 38 mm ( $\frac{3}{4}$ " x $1\frac{1}{2}$ " )	MY-09035-20
132, 138, 142, 149, 154	270, 280, 289, 300, 309		MY-09035-21
160, 166, 171, 177, 182	320, 331, 340, 351, 360		MY-09035-22
188, 193, 199, 204, 210	370, 379, 390, 399, 410		MY-09035-23
216, 224, 232, 241, 249	421, 435, 450, 466, 480	19 x 38 mm ( $\frac{3}{4}$ " x $1\frac{1}{2}$ " )	MY-09035-24
249, 254, 260, 280, 290	480, 489, 500, 536, 554		MY-09035-25
<b>Six-temperature points—horizontal labels (pack of 10)</b>			
29, 33, 34, 37, 40, 42	84, 91, 93, 99, 104, 108	13 x 32 mm	MY-90308-91†
44, 46, 49, 54, 60, 62	111, 115, 120, 129, 140, 144		MY-90308-92†
65, 71, 77, 82, 88, 93	149, 160, 171, 180, 190, 199	13 x 32 mm	MY-90308-93
99, 104, 110, 116, 121, 127	210, 219, 230, 241, 250, 261		MY-90308-94
132, 138, 143, 149, 154, 160	270, 280, 289, 300, 309, 320	13 x 32 mm	MY-90308-95
166, 171, 177, 182, 188, 193	331, 340, 351, 360, 370, 379		MY-90308-96
199, 204, 210, 216, 224, 232	390, 399, 410, 421, 435, 450	13 x 32 mm	MY-90308-97
240, 249, 254, 260, 280, 290	460, 480, 489, 500, 536, 554		MY-90308-98
<b>Eight-temperature points—vertical labels (pack of 25)</b>			
37, 40, 43, 46, 49, 54, 60, 65	100, 105, 110, 115, 120, 130, 140, 150	19 x 51 mm ( $\frac{3}{4}$ " x 2")	MY-08068-20†
71, 77, 82, 88, 93, 99, 104, 110	160, 170, 180, 190, 200, 210, 220, 230		MY-08068-22
116, 121, 127, 132, 138, 143, 149, 154	240, 250, 260, 270, 280, 290, 300, 310	19 x 51 mm ( $\frac{3}{4}$ " x 2")	MY-08068-24
160, 166, 171, 177, 182, 188, 193, 199	320, 330, 340, 350, 360, 370, 380, 390		MY-08068-26
<b>Nine-temperature points—vertical label (pack of 25)</b>			
204, 210, 216, 224, 232, 240, 249, 254, 260	400, 410, 420, 435, 450, 465, 480, 490, 500	19 x 51 mm ( $\frac{3}{4}$ " x 2")	MY-08068-28
<b>Eight- and nine-point label kit (5 of each 5 types)</b>			MY-08068-90†
<b>Ten-temperature points—horizontal labels (pack of 10)</b>			
40, 42, 44, 46, 49, 54, 60, 62, 65, 71	104, 108, 111, 115, 120, 129, 140, 144, 149, 160	19 x 51 mm ( $\frac{3}{4}$ " x 2")	MY-09035-00†
77, 82, 88, 93, 99, 104, 110, 116, 121, 127	171, 180, 190, 199, 210, 219, 230, 241, 250, 261		MY-09035-06
132, 138, 143, 149, 154, 160, 166, 171, 177, 182	270, 280, 289, 300, 309, 320, 331, 340, 351, 360	19 x 51 mm ( $\frac{3}{4}$ " x 2")	MY-09035-07
188, 193, 199, 204, 210, 216, 224, 232, 241, 249	370, 379, 390, 399, 410, 421, 435, 450, 466, 480		MY-09035-08

\*Note: Express shipping by air is required to prevent activation while in transit.

## Digi-Sense® Blue Spirit PFA-Coated Safety Glass Thermometers

### Stop contamination with PFA jacket

- Mercury free blue spirit liquid
- Statement of accuracy included



PFA coating contains broken liquid and glass, preventing contamination or injury. Thermometers feature permanently fused markings, blue spirit liquid, white background glass; are also individually serial numbered. Include a statement of accuracy supplied by manufacturer and a triangular-style anti-roll fitting.



Temperature range	Scale divisions	Accuracy	Length	Partial immersion		Total immersion
				Catalogue number	Immersion depth	Catalogue number
<b>Celsius-scale thermometers</b>						
-10 to 110°C	2°	1.5°	200 mm	<b>MY-08077-65</b>	50 mm	<b>MY-08077-79</b>
-10 to 150°C	2°	1.5°, 2° above 100°C	200 mm	<b>MY-08077-66</b>	50 mm	<b>MY-08077-80</b>
-20 to 110°C	1°	±1.5°	300 mm	<b>MY-08077-68</b>	76 mm	<b>MY-08077-81</b>
-20 to 150°C	1°	1.5°, 2° above 100°C	300 mm	<b>MY-08077-76</b>	76 mm	<b>MY-08077-82</b>
<b>Fahrenheit-scale thermometers</b>						
0 to 230°F	2°	3°, 4° above 212°F	300 mm	<b>MY-08077-77</b>	76 mm	<b>MY-08077-83</b>
0 to 300°F	2°	3°, 4° above 212°F	300 mm	<b>MY-08077-78</b>	76 mm	—

## Digi-Sense® Blue Spirit Verification Bottle Thermometers

### Minimise fluctuations of readings

- Mercury free blue spirit liquid on white background for easy reading
- Statement of accuracy and individual serial number for better record keeping



All thermometers are supplied in a glass bead filled unbreakable plastic bottle and can be removed from the bottle for recalibration. Use the magnetic attachment with pressure-sensitive backing to attach the bottle to a metal wall or door.

Thermometers 08077-21, -22 and -23 are supplied with a ILAC MRA, NIST-traceable calibration report supplied by the manufacturer with stated corrections to one-tenth of the smallest division.



Temperature range	Application	Bottle fill	Scale divisions	Accuracy	Length	Calibration points	Catalogue number
<b>Precision accuracy thermometers with ILAC MRA NIST-traceable calibration report</b>							
-25 to -5°C	Freezer	Glass beads	0.1°	±0.4°	210 mm	-20, 10°C	<b>MY-08077-21</b>
-2 to 10°C	Refrigerator	Glass beads	0.1°	±0.4°	180 mm	0, 5°C	<b>MY-08077-22</b>
25 to 45°C	Incubator	Glass beads	0.1°	±0.4°	190 mm	30, 40°C	<b>MY-08077-23</b>
<b>Precision accuracy thermometers</b>							
-25 to -5°C	Freezer	Glass beads	0.1°	±0.4°	210 mm	—	<b>MY-08077-31</b>
-2 to 10°C	Refrigerator	Glass beads	0.1°	±0.4°	180 mm	—	<b>MY-08077-32</b>
15 to 30°C	Incubator	Glass beads	0.1°	±0.4°	180 mm	—	<b>MY-08077-33</b>
25 to 45°C	Incubator	Glass beads	0.1°	±0.4°	190 mm	—	<b>MY-08077-34</b>
95 to 115°C	Oven	Glass beads	0.1°	±0.4°	200 mm	—	<b>MY-08077-35</b>
<b>Standard accuracy thermometers</b>							
-90 to 25°C	Ultra low freezer	Glass beads	1°	±1.5°C, 2.5 below -50°C	145 mm	—	<b>MY-08077-41</b>
-30 to 1°C	Freezer	Glass beads	0.5°	±0.75°	135 mm	—	<b>MY-08077-42</b>
-5 to 20°C	Refrigerator	Glass beads	0.5°	±0.75°	135 mm	—	<b>MY-08077-43</b>
-5 to 15°C	Refrigerator	Glass beads	0.5°	±0.75°	125 mm	—	<b>MY-08077-44</b>
10 to 45°C	Incubator	Glass beads	0.5°	±0.75°	125 mm	—	<b>MY-08077-45</b>
15 to 50°C	Incubator	Glass beads	0.5°	±0.75°	135 mm	—	<b>MY-08077-46</b>
20 to 130°C	Oven	Glass beads	1°	±1.5°, 2° above 105°C	145 mm	—	<b>MY-08077-47</b>
50 to 200°C	High-temp oven	Glass beads	2°	±2.5°, 5° above 130°C	145 mm	—	<b>MY-08077-48</b>
<b>PFA-coated standard accuracy thermometers with liquid-filled bottle</b>							
-90 to 25°C	Ultralow freezer	Propylene glycol	1°	±2°, 3° below -50°C	145 mm	—	<b>MY-90300-69</b>
-5 to 20°C	Refrigerator	Ethylene glycol	0.5°	±1°	135 mm	—	<b>MY-90300-72</b>
-30 to 1°C	Freezer	Propylene glycol	0.5°	±1°	135 mm	—	<b>MY-90300-70</b>
-5 to 15°C	Refrigerator	Ethylene glycol	0.5°	±1°	125 mm	—	<b>MY-90300-67</b>
15 to 50°C	Incubator	Ethylene glycol	0.5°	±1°	135 mm	—	<b>MY-90300-68</b>
20 to 130°C	Oven	Vermiculite	1°	±2°	145 mm	—	<b>MY-90300-71</b>
50 to 200°C	High-temp oven	Vermiculite	2°	±4°, 6° above 130°C	145 mm	—	<b>MY-90300-73</b>



Go online to search more than 100,000 products.



# NSF-Approved Digital Pocket Thermometers

## Maintain product safety with accurate readings

- Antimicrobial protection inhibits bacterial and fungal growth
- 304 stainless steel penetration stem
- All include a protective case with pocket clip and a battery

**A. Taylor® Flat-Edged Dial Safe-T-Guard Thermometer** is waterproof for dependable use in kitchen or lab environments. Field calibratable. °C/°F switchable. Auto-off feature saves on battery life.

**B. Taylor Easy-Read Reduced-Tip Pen-Style Safe-T-Guard Thermometer** is waterproof and dishwasher safe. Field calibratable. Features °C/°F switchable ranges, Max and Hold functions, 1.5-mm FDA-recommended step-down tip, back-lit LCD, and auto-off. Includes lanyard.

**C. Cooper-Atkins® Reduced-Tip Pen-Style Waterproof Thermometer** is factory calibrated to three temperature points and guaranteed to never need field adjustment. Features include IP67 rating, stainless steel shaft, six-second response time, °C/°F switchable ranges, hold function, min/max reading, and auto-off.

**D. Cooper-Atkins Reduced-Tip Waterproof Thermometer** with alarm. Same features as "C" plus the addition of a unique adjustable alarm function. Dishwasher-safe.

**E. Comark® Reduced-Tip Waterproof Thermometer** has a 68.5 mm (2¾") long stem and a 1.5 mm (0.6") diameter tip. This field-calibratable meter features °C/°F switchable ranges, hold function, display that updates every 1.5 seconds and low battery indicator.

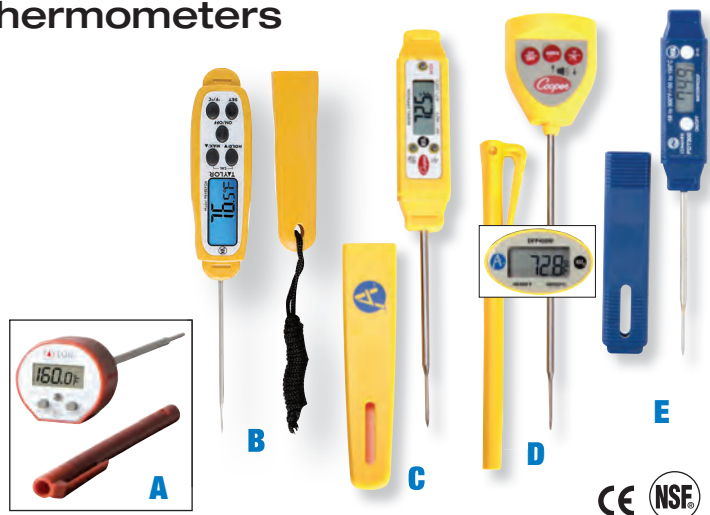

Key letter	Range	Resolution	Accuracy†	Probe		Catalogue number
				Length	Dia.	
A	-40 to 230°C (-40 to 450°F)	0.1°C (0.1°F)	±0.6°C (±1°F)	12.7 cm	0.38 cm	MY-90000-60
B	-40 to 230°C (-40 to 450°F)	0.1°C (0.1°F)	±1°C (±1°F)	6.35 cm	0.4 cm	MY-90000-68
C	-40 to 150°C (-40 to 392°F)	0.1°C (0.1°F)	±1°C (±2°F)	7 cm	0.4 cm	MY-90025-02
D	-40 to 232°C (-40 to 450°F)	0.1°C (0.1°F)	±1°C (±2°F)	11.7 cm	0.36 cm	MY-90025-01
E	-40 to 230°C (-40 to 450°F)	0.1°C (0.1°F)	±1°C (±2°F)	6.9 cm	1.5 cm	MY-90000-62

†Basic accuracy shown, full accuracy is available online

MY-17003-00 ILAC MRA, NIST-traceable calibration with data for pocket thermometers

## Digi-Sense® Traceable® Table/Wall-Mount Thermometers

### Don't be caught off-guard

- Alarm provides alert when temperature rises above or falls below a set point

Display simultaneously shows maximum, minimum, and current probe temperatures. Min/max monitors high/low readings for any time period. Model 94460-74 is supplied with the temperature sensor enclosed in a non-toxic glycol-filled bottle, protecting it from rapid temperature changes when refrigerator door is opened. Model 94460-73 has the temperature sensor enclosed in a 5-mL bottle, allowing it to fit into a tray while protecting it from rapid temperature changes.



**What's included:** Velcro® and magnetic strips, one AAA alkaline battery, and ILAC MRA, NIST-traceable calibration certificate.



Application	Sensor type	Range	Resolution	Accuracy	Catalogue number
General purpose	Wire probe	-50 to 70°C (-58 to 158°F)	0.1°	±0.5°	MY-94460-88
Refrigerator/freezer	Bottle probe				MY-94460-74
Refrigerator/freezer	5-mL bottle probe				MY-94460-73

MY-09376-00 Replacement batteries, AAA. Pack of 12

MY-17101-61 ILAC MRA, NIST-traceable recalibration with data for digital indicator

## Digi-Sense® Traceable® Pocket Thermometers with Calibration

### Small and lightweight—easy to take anywhere

- Get accurate, reliable measurements with included ILAC MRA NIST-traceable calibration
- Unique flat-profile design
- Features MIN/MAX, HOLD, and selectable °C/°F



**What's included:** probe guard, pocket clip, battery, and ILAC MRA, NIST-traceable calibration certificate with data.



#### Specifications

**Display:** 3½ digit LCD, 0.64 cm H  
**Dimensions:**  
 Head (L x W x H): 8.9 x 2.9 x 1.9 cm (3½" x 1½" x ¾")  
 Probe (L x dia): 8.9 x 0.4 cm (3½" x 0.14")  
 Overall length, with probe guard: 27.3 cm (10¾")  
**Power:** one button cell battery (included)

Description	Range	Resolution	Accuracy	Catalogue number
Pocket thermometer	-50 to 300°C (-58 to 572°F)	0.1° from -19.9 to 199.9°; otherwise 1°	±1.5°C (±2.7°F)	MY-90205-15
Pocket Ultra™ thermometer			±0.4°C (±0.7°F) at tested points; otherwise ±2.7°F (±1.5°C)	MY-98767-36

MY-09376-14 Replacement batteries; button cell, 1.5 V

MY-17003-00 ILAC MRA, NIST-traceable recalibration with data for pocket thermometers

## Digi-Sense® Traceable® Mini Thermometers with Remote Probe

### Easily read temperature from a distance

– 304 stainless steel penetration stem



**A. Standard Remote Probe Thermometer** has a 0.9-m flexible cord and °C/°F switchable ranges. Magnetic back allows for placement on metal surfaces such as freezers, incubators, or water baths. Includes flip-open stand, and spring fastener for clipping onto any edge.

**B. Deluxe Remote Probe Thermometer** features a 0.9-m flexible cord, °C/°F switchable ranges, display updates every second, high/low alarm, min/max memory, and Hold function. Magnetic back allows for placement on metal surfaces; freezers, incubators or water baths. Includes a flip-open stand, and spring fastener for clipping on to any edge.

**C. Waterproof Remote Probe Thermometer** has a 3-m flexible cord, °C/°F switchable ranges, a display that updates every second, and min/max memory. Perfect for wet areas—case is water/shockproof and probe is impervious to acid and solvents. Supplied with suction cups, magnet, and self-adhesive hook and loop tabs to attach to any surface.

**D. Panel-Mount Remote Probe Thermometer** features a 3-m flexible cord, °C/°F switchable ranges, a large easy-view LCD, and records minimum and maximum readings over time. Versatile panel-mount module snaps into place or can be used as a stand-alone unit.

**E. Stick-Style Remote Probe Thermometers** have a 0.9-m flexible cord, min/max memory, and simultaneous display of probe and ambient temperatures. Meter is chemical-resistant and shockproof; comes with a remote sensor and cable that can be submerged. Use as a pocket thermometer or mount for continuous use with the supplied self-adhesive hook and loop tabs.

**What's included:** battery and ILAC MRA, NIST-traceable calibration certificate.

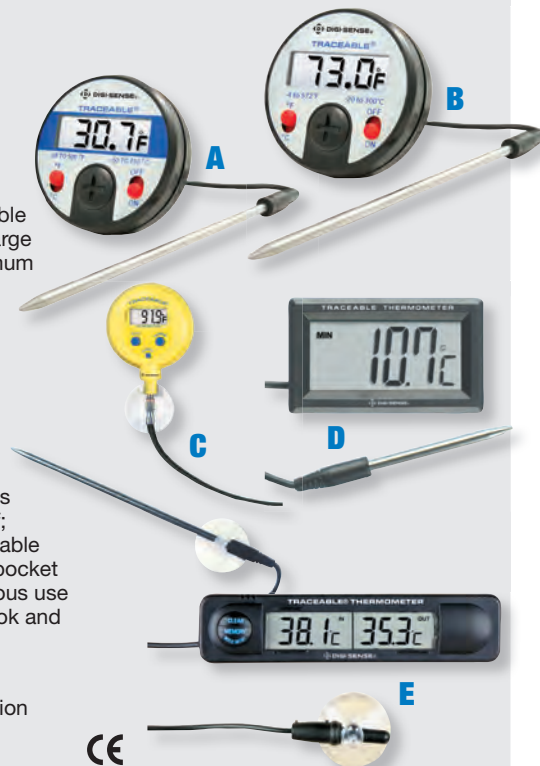

Key letter	Range	Resolution	Accuracy	Probe		Catalogue number	Replacement batteries
				Length	Dia.		Catalogue number
A	-50 to 250°C (-58 to 500°F)	0.1°C (0.1°F)	±1°C between -20 to 100°C, otherwise ±1.5° outside range	13.9 cm	0.36 cm	MY-90205-20	MY-09376-14
B	-50 to 300°C (-58 to 572°F)	0.1°C (0.1°F)	±1°C between -20 to 100°C, otherwise ±1.5° outside range	13.9 cm	0.36 cm	MY-90205-21	MY-09376-14
C	-50 to 300°C (-58 to 572°F)	0.1° from -19 to 199.9°; 1° outside this range	±1°C (±2.0°F)	12.7 cm	0.36 cm	MY-90205-22	MY-09377-16/for pk of 6
D	-50 to 300°C (-58 to 572°F)	0.1° from -20 to 200°; 1° outside this range	±1°C between -20 to 100°C, otherwise ±1.5° outside range	6.9 cm	0.36 cm	MY-90205-26	MY-09376-14
E	-50 to 70°C (-58 to 158°F)	0.1°F	±1.0°F	—	0.5 cm	MY-90205-24	MY-09376-14
		0.1°C	±1.0°C			MY-90205-23	

MY-17003-00 ILAC MRA, NIST-traceable recalibration with data for pocket thermometers

## Digi-Sense® Traceable® Jumbo-Display Dial Thermometers with Calibration

### Easily view temperature reading on the large display

- Get accurate, reliable measurements with included ILAC MRA NIST-traceable calibration
- Display updates every second
- Stainless steel piercing probe is perfect for measuring semisolids
- Flat-surface probe available
- °C/°F switchable
- ON/OFF switch to preserve battery life



**What's included:** protective probe sleeve, battery, and ILAC MRA, NIST-traceable calibration certificate with data.



#### Specifications

**Display:** 3½-digit LCD; 0.95 cmH  
**Dimensions:**  
 Head (dia): 5.4 cm (2¼")  
 Probe (L x dia): 13.3 x 0.4 cm (5¼" x 0.14");  
 36842-95 has 1.3 cm (½") dia metal disk at the end of probe  
**Power:** one 1.5 V battery

Description	Range	Resolution	Accuracy	Catalogue number
Jumbo-display thermometer with piercing probe	-50 to 150°C (-58 to 302°F)	0.1° (from -19.9 to 199.9°); otherwise 1°	±1°C between -20 and 100°C	MY-98767-22
Jumbo-display Ultra™ thermometer with piercing probe			±0.3°C at tested points; otherwise ±1°C	MY-98767-41
Jumbo-display thermometer with surface probe			±1°C between -20 and 100°C	MY-36842-95

MY-09376-14 Replacement batteries, 1.5 V

MY-17003-00 ILAC MRA, NIST-traceable calibration with data for pocket thermometers

# Digi-Sense® Traceable® General-Purpose and Refrigerator/Freezer Thermometers

## Get multiple readings simultaneously

- Simultaneously view high, low, and current temperature
- Keep samples safe—programmable alarm alerts when temperature deviates from set point
- Monitor conditions—min/max feature stores the highest and lowest readings until cleared
- Get more done—monitor multiple applications with dual-probe units
- Versatile units are mountable on wall or benchtop

### Standard Refrigerator/Freezer Thermometers

provide accurate readings even when door is opened, as temperature sensor is enclosed within a glycol-filled bottle.

**Advanced Thermometers** feature high accuracy, one-button field calibration, and date/time stamp. Unit displays the exact time and date when thermometer alarms are triggered. RTD thermometers provide greater accuracy and a unique min/max feature that displays temperatures for previous 24 hours (each hour) or previous 31 days (for each day).

**Data Logging Thermometers** record up to 525,600 data points to be transferred to a computer using a USB flash drive. The alarm tracking feature stores up to ten unique alarm events. “Memory lock” option does not allow the internal memory to be cleared, and logging capacity increases to one million data points.

**What's included:** one AA battery and ILAC MRA, NIST-traceable calibration certificate.

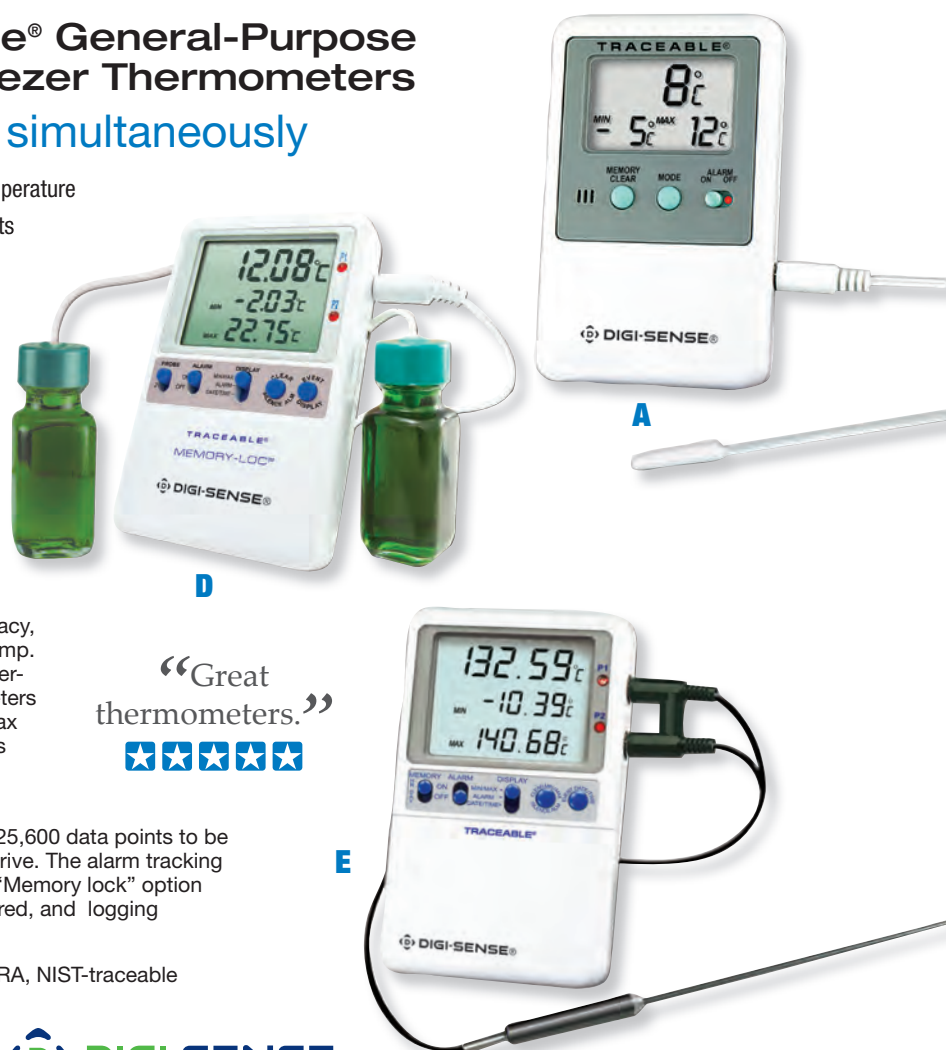

Application	Sensor type	Range	Resolution	Accuracy	Power	Catalogue number
<b>A. Standard thermistor models</b>						
Refrigerator/freezer	One bottle probe	-50 to 70°C (-58 to 158°F)	1°	±1°C	One AA battery (included)	MY-94460-72
Refrigerator/freezer	One 5-mL bottle probe					MY-94460-71
General purpose	One wire probe					MY-94460-70
<b>B. Advanced thermistor models with improved accuracy (not shown)</b>						
Refrigerator/freezer	Two bottle probes	-50 to 70°C (-58 to 158°F)	0.01°	±0.30°C	One AA battery (included)	MY-94460-92
General purpose	Two wire probes					MY-94460-91
General purpose	One solid SS probe					MY-94460-98
General purpose	Two solid SS probe					MY-94460-99
<b>C. Advanced thermistor models with improved accuracy and data logging (not shown)</b>						
Refrigerator/freezer	One bottle probe	-50 to 70°C (-58 to 158°F)	0.01°	±0.25°C	One AA battery (included)	MY-94460-07
Refrigerator/freezer	Two bottle probes					MY-94460-09
General purpose	One wire probe					MY-94460-11
General purpose	Two wire probes					MY-94460-14
General purpose and refrigerator/freezer	One wire and one bottle probe					MY-94460-18
General purpose	One solid SS probe					MY-94460-16
General purpose	Two solid SS probes					MY-94460-17
<b>D. Advanced thermistor models with improved accuracy and “memory lock” data logging</b>						
Refrigerator/freezer	One bottle probe	-50 to 70°C (-58 to 158°F)	0.01°	±0.25°C	One AA battery (included)	MY-94460-37
Refrigerator/freezer	Two bottle probes					MY-94460-39
General purpose	One wire probe					MY-94460-41
General purpose	Two wire probes					MY-94460-43
General purpose and refrigerator/freezer	One wire and one bottle probe					MY-94460-47
General purpose	One solid SS probe					MY-94460-44
General purpose	Two solid SS probes					MY-94460-46
<b>E. Advanced RTD high-accuracy models</b>						
Refrigerator/freezer	One bottle probe	-50 to 70°C (-58 to 158°F)	0.01°	±0.1°C	One AA battery (included)	MY-37803-88
General purpose	One wire probe					MY-37804-03
General purpose	One wire probe	-100 to 70°C (-148 to 158°F)				MY-37804-05
General purpose	One solid SS probe	-100 to 199.99°C (-148 to 199.99°F)				MY-37804-04



# Don't Get Burned—Gain More Confidence in Your Readings

- ✓ **Save time and money**—precalibrated to ILAC MRA, NIST-traceable standards before you receive it
- ✓ **Don't let probe errors interfere with readings**—electronic offset compensates for errors
- ✓ **Choose your readout**—measures in °C, °F, or Kelvin (K) with 0.1 resolution
- ✓ **Features for your convenience:**
  - Min/Max/Avg
  - Hold
  - Relative time stamp
  - Auto-off to save battery life
- ✓ **Take measurements from a distance with optional infrared wand on Professional series**

Precalibration provided by  
**INNOCAL**®  
 Precalibration | Recalibration  
 1-866-InnoCal (1-866-466-6225)  
 InnoCalSolutions.com

## Digi-Sense® Precalibrated Thermocouple Thermometers

- Compact, affordable units provide accurate and dependable readings
- No need to worry about reading measurements—large, backlit LCD makes readings easy

**General-Purpose Thermocouple Thermometers** accept both type K or J thermocouple probes with miniconnector. The two- and four-channel models provide data logging of up to 18,000 readings; USB interface lets you easily download data to a PC for analysis with included software.

**Professional Thermocouple Thermometers with IR Input** deliver accurate readings in an ergonomic design. Models accept type K probes and an optional infrared (IR) wand for non-contact measurements from a distance. Two- and four-channel models continually scan each channel for real-time measurements. Data logging models allow you to download and analyse data fully.



Description	General-purpose thermometers			Professional thermocouple thermometers with IR input			
	MY-20250-01	MY-20250-02	MY-20250-03	MY-20250-18	MY-20250-17	MY-20250-19	MY-20250-20
Catalogue number	1 (type K or J)	2 (type K or J)	4 (type K or J)	1 (type K)	2 (type K)	2 (type K)	4 (type K)
Thermocouple (T/C) inputs	1 (type K or J)	2 (type K or J)	4 (type K or J)	1 (type K)	2 (type K)	2 (type K)	4 (type K)
T/C range	K: -200 to 1372°C (-328 to 2501°F) J: -210 to 1100°C (-346 to 2012°F)			K: -200 to 1372°C (-328 to 2501°F)			
IR range	—			-35 to 550°C (-31 to 1022°F), with optional IR wand 20250-24			
Resolution	0.1°C/F below 1000°, 1°C/F above 1000°			0.1°C/F below 1000°, 1°C/F above 1000°			
T/C accuracy	Above -100°C (-148°F): ±[0.5% rdg + 1°C (1.8°F)] Below -100°C (-148°F): ±[0.5% rdg + 2°C (3.6°F)] Differentials: ±[0.5% rdg + 2°C (3.6°F)]			Above -100°C (-148°F): ±[0.15% rdg + 1°C (1.8°F)] Below -100°C (-148°F): ±[0.5% rdg + 2°C (3.6°F)] Differentials: ±[0.5% rdg + 1°C (1.8°F)]			
IR accuracy	—			Above -10°C (14°F): ±[2.0% rdg + 2°C (3.6°F)]; Below -10°C (14°F): ±5°C (9°F); T/C-IR differentials: ±[2.0% rdg + 3°C (5.4°F)] above -10°C (14°F); ±6°C (11°F) below -10°C (14°F)			
Data logging	No	18,000 points		No	18,000 points		10,000 points
USB interface	No	Yes		No	Yes		Yes
Temp differential	No	Yes		Yes			
Scan function	No			No	Yes		Yes

**MY-20250-24 Optional infrared wand** for professional thermocouple thermometers only. Features 8:1 distance-to-spot ratio. Measures 16.4 x 5 x 4 cm (6½" x 2" x 1½"). Includes one 9 V battery

## Some of Our Most Popular Thermocouple Probes

All probes include a 1.5-m coiled cord with strain relief spring that protects from repeated flexing and tugging. Ergonomic, easy-to-grip glass-filled nylon handle provides maximum insulation and impact resistance; fingerstops prevent fingers from sliding and prevent probe from rolling. Rugged thermoset plastic miniconnector also included.

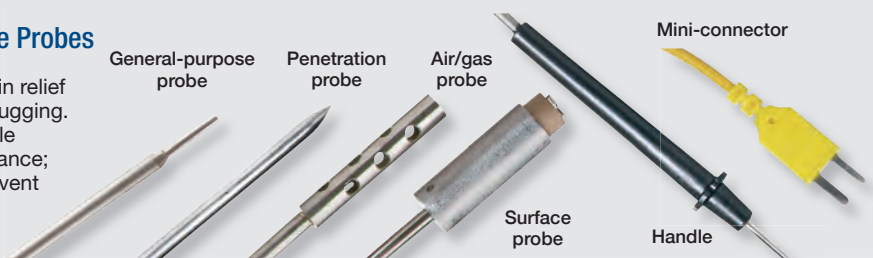

Probe Type	General-purpose probes (12.7 cm L)		Penetration probes (10.1 cm L)		Air/gas probes (21.6 cm L)		Surface probes (25.1 cm L)	
	Max temp	Cat. no.	Max temp	Cat. no.	Max temp	Cat. no.	Max temp	Cat. no.
J	760°C (1400°F)	MY-08517-55	760°C (1400°F)	MY-08517-65	537°C (1000°F)	MY-08517-75	649°C (1200°F)	MY-08517-60
K	900°C (1652°F)	MY-08516-55	900°C (1652°F)	MY-08516-65	537°C (1000°F)	MY-08516-75	649°C (1200°F)	MY-08516-60
T	400°C (752°F)	MY-08500-55	400°C (752°F)	MY-08500-65	537°C (1000°F)	MY-08500-75	343°C (650°F)	MY-08500-60

## Digi-Sense® Benchtop Temperature Control Consoles

Direct plug-in of heating or cooling devices

### TC9100 Model (Thermocouple)

- Simple on/off to sophisticated PID control
- Simultaneous view of both the measured and set point on the two-line alphanumeric display
- Offset function allows you to correct for probe error
- Front panel indicates output and alarm conditions
- Mount to lab frame or grid with built-in support bracket



### TC9600 Data Logging Model (Thermocouple, RTD, Thermistor)

Offers all the features of the TC9100 controller, plus nine-segment ramp and soak profiling for more complex processes, USB computer interface, and free software that features real-time visual of set points and process activity, along with data logging.

- Ramp rate and ramp-and-soak profiling for more complicated processes
- USB computer interface and free software that features real-time graphing and programming setup
- Data log more than 100 K data points in adjustable increments from 1 second to 999 seconds



### Specifications

Input type	Range
J	-190 to 1000°C (-310 to 1832°F)
K	-200 to 1372°C (-328 to 2502°F)
T	-200 to 400°C (-328 to 752°F)
E	-200 to 1000°C (-328 to 1832°F)
N	-200 to 1300°C (-328 to 2372°F)
B	200 to 1800°C (392 to 3272°F)
R	0 to 1768°C (32 to 3214°F)
S	0 to 1768°C (32 to 3214°F)
Thermistor†	400 series: -30 to 100°C (-22 to 212°F) 700 series: -15 to 100°C (5 to 212°F)
100 Ω Pt RTD†	-200 to 800°C (-328 to 1472°F)

†For TC9600 model only.

**Resolution:** 0.1°; 1° above 999.9° and below -99.9°

**Alarm output (TC9600 only):**  
SPT relay rated for 24 VAC, 1 A max

**Communication (TC9600):** USB

**Accuracy:** [span equals 540°C (1000°F) min]

Types J, K, T, E, and N: ±0.1% of span

Types B, R, and S: ±0.2% of span

Thermistor: ±0.4% of span

0.5°C (0.7°F)

RTD: ±0.1% of span

Model	Control output (50/60 Hz)‡	Control output load	Power‡	Catalogue number
TC9100 (thermocouple)	240 VAC	10 A max	240 VAC	MY-89800-12
TC9600 (thermocouple, thermistor, RTD)	240 VAC	10 A max	240 VAC	MY-89800-14

‡For 240 VAC models, the power and heater/cooler output uses IEC plugs. You may need to order an adapter sold separately per your local requirements.

MY-17101-63 ILAC MRA, NIST-traceable calibration with data

## Digi-Sense® Precalibrated Thermometers

Perfect for the lab to production floor

- Reliable measurements, guaranteed! Precalibrated to ILAC MRA, NIST-traceable standards
- Electronic offset function allows compensation of probe errors
- Robust, reliable handheld temperature meters work in tough environments



**Single-Input Thermometers** feature an easy-to-use control panel, Min/Max and Hold functions, offset adjustment, °C/°F selection, backlit display, low-battery indicator, and auto shut-off.

### Dual-Input Data Logging Thermometers

store up to 16,000 sets of readings in real time, and data can be downloaded to your PC via a USB port. Logging interval is selectable from 1 second to 60 minutes. Meters also feature min/max, hold, and average functions; differential temperature; offset adjustment; °C/°F selection; time stamp/clock; out-of-range alarm with audible/visible indicator; backlit display; low-battery indicator; and auto shut-off.

**What's included:** protective rubber armour boot with built-in stand, one 9 V battery, and ILAC MRA, NIST-traceable calibration report. Data logging models 20250-92, -94, and -96 also include a USB cable and software.



### Specifications

Input type	Range
J	-200 to 1000°C (-328 to 1832°F)
K	-250 to 1372°C (-418 to 2501°F)
T	-250 to 400°C (-418 to 752°F)
Thermistor	-40 to 125°C (-40 to 257°F)
RTD	-200 to 850°C (-320 to 1562°F)

**Power:** one 9 V battery (included)

**Models 20250-92, -94, -96:**  
Data logging: 16,000 sets of readings

Description	Resolution	Accuracy	Catalogue number
<b>Thermocouple meters</b>			
Single input	0.1°C (0.1°F) from -99.9 to 999.9°C (-148 to 1832°F); 1°C (1°F) outside range	±1% of reading + 1°C (1.8°F) below -99.9°C (-148°F); ±1% of reading + 0.5°C (0.9°F) above -99.9°C (-148°F)	MY-20250-91
Dual input with data logging	0.1°C (0.1°F)	±0.5°C (±0.9°F) from 0 to 70°C (32 to 158°F); ±1°C (2°F) outside range	MY-20250-92
<b>Thermistor meters</b>			
Single input	0.1°C (0.1°F)	±0.5°C (±0.9°F) from 0 to 70°C (32 to 158°F); ±1°C (2°F) outside range	MY-20250-93
Dual input with data logging	0.1°C (0.1°F)	±0.5°C (±0.9°F) from 0 to 70°C (32 to 158°F); ±1°C (2°F) outside range	MY-20250-94
<b>RTD meters</b>			
Single input	0.1°C (0.1°F) from -99.9 to 850°C (-148 to 1562°F); 1°C (1°F) outside range	±0.8°C (1.5°F) from -99.9 to 199.9°C (-148 to 392°F); ±1°C (2°F) ±0.5% of reading outside range	MY-20250-95
Dual input with data logging	0.1°C (0.1°F)	±0.8°C (1.5°F) from -99.9 to 199.9°C (-148 to 392°F); ±1°C (2°F) ±0.5% of reading outside range	MY-20250-96

## Digi-Sense® TraceableOne™ USB Temperature Data Loggers

### Ensure effective cold chain management

- Ready to use with preprogrammed alarm parameters
- Automatically generate a PDF report via USB port
- Protective plastic pouch maintains waterproof IP67 rating—ideal for use with ice and cold packs



Use these single-use USB data loggers to track temperatures during shipments, storage, or experiments. Sold in a pack of ten.<sup>†</sup>

**What's included:** Li-ion battery and ILAC MRA, NIST-traceable calibration certificate.



#### Specifications

**Temperature accuracy:** ±0.5°C (0.9°F) from -20 to 40°C (68 to 104°F); ±1°C (1.8°F) remainder  
**Sampling rate:** 10 seconds to 12 hours  
**Memory:** 16,000 data points

Alarms (low to high)	Logging cycle	Logging interval	Catalogue number
12 to 14°C (53.6 to 57.2°F)	10 days	1 min	<b>MY-18004-14</b>
	30 days	3 min	<b>MY-18004-17</b>
	60 days	6 min	<b>MY-18004-20</b>
	90 days	10 min	<b>MY-18004-23</b>
2 to 8°C (35.6 to 46.4°F)	10 days	1 min	<b>MY-18004-15</b>
	30 days	3 min	<b>MY-18004-18</b>
	60 days	6 min	<b>MY-18004-21</b>
	90 days	10 min	<b>MY-18004-24</b>
-20 to -15°C (-4 to 5°F)	10 days	1 min	<b>MY-18004-16</b>
	30 days	3 min	<b>MY-18004-19</b>
	60 days	6 min	<b>MY-18004-22</b>
	90 days	10 min	<b>MY-18004-25</b>

<sup>†</sup>Also available in packs of 40 on our website.

## Comark® Foodservice Thermocouple Thermometer

### Ensure food safety with antimicrobial protection

- IP67-rated case is water- and dustproof
- NSF-approved with BioCote® antimicrobial protection

This thermometer produces a high degree of accuracy with a rapid response time. The meter features °C/°F selectable units, data hold, auto-off function, clock, multifunction countdown timer, and built-in protective boot. Designed to accept any type K thermocouple probe with miniature connection.

**What's included:** protective boot, certificate of conformity, and two AA batteries.



#### Specifications

**Resolution**  
 Below 100°C (100°F): 0.1°  
 Above 100°C (100°F): 1°  
**Accuracy:** ±0.1% of reading, ±0.2°C/±0.4°F  
**Power:** two AA batteries (included)

Type	Range	Catalogue number
Single input, K	-200 to 600°C (-328 to 1112°F)	<b>MY-90025-34</b>

#### Accessories

**MY-90025-41 Wall bracket** for 90025-34

**MY-09376-01 Replacement batteries**, AA. Pack of four

**MY-17002-10 ILAC MRA, NIST-traceable calibration** for thermocouple system (meter and probe)

## Digi-Sense® Thermocouple Thermometers

### Reliable, robust meters in an ergonomic design

- Withstand the toughest conditions—splash-resistant ABS plastic housing and rubber armour boot
- Individually calibrated and easy-to-use automatic field calibration ensures accurate readings
- Large, easy-to-read LCD with backlight

**Single-Input Thermometers** feature an easy-to-use control panel; min/max and hold functions; °C/°F selection; low-battery indicator; and auto shutoff. **Dual-Input Thermometer** is designed for either single or simultaneous dual readings. Store up to 1000 sets of readings in the nonvolatile memory. Take differential temperature measurements with the T1/T2 function. Meter resolution is keypad selectable. **Data Logging Thermometer** can manually store or automatically log up to 2000 sets of readings in real time, and data can be downloaded to your PC via a USB port. These meters also feature min/max, hold, and average functions; °C/°F selection; time stamp/clock; countdown timer; out-of-range alarm with audible/visible indicator; low-battery indicator; and auto shutoff.



**What's included:** protective rubber armour boot with built-in stand and three AA batteries.



Description	Range	Resolution	Accuracy	Catalogue number
Single input	Type J: -210 to 1200°C (-346 to 2192°F)	0.1°C/°F between -199.9 to 999.9°, 1° below -199.9° and above 999.9°	Below -150°C (-238°F): ±0.25% of reading ±1°C (±2°F) Above -150°C (-238°F): ±0.1% of reading ±0.4°C (±0.7°F)	<b>MY-91428-00</b>
	Type K: -250 to 1372°C (-418 to 2501°F)			<b>MY-91428-01</b>
	Type T: -250 to 400°C (-418 to 752°F)			<b>MY-91428-02</b>
Dual input	Type J: -210°C to 1200°C (-346°F to 2192°F) Type K: -250°C to 1372°C (-418°F to 2501°F) Type T: -250°C to 400°C (-418°F to 752°F) Type E: -250°C to 1000°C (-418°F to 1832°F)	0.1°C/°F between -99.9 to 999.9°, 1° below -99.9° and above 999.9°	Below -99.9°C (-148°F): ±0.25% of reading ±1°C (±2°F) Above -99.9°C (-148°F): ±0.1% of reading ±0.4°C (±0.7°F)	<b>MY-91428-03</b>
Dual input with data logging	Type J: -210 to 1200°C (-346 to 2192°F) Type K: -250 to 1372°C (-418 to 2501°F) Type T: -250 to 400°C (-418 to 752°F) Type E: -250 to 1000°C (-418 to 1832°F) Type R: 0 to 1768°C (32 to 3214°F) Type S: 0 to 1768°C (32 to 3214°F) Type N: -250 to 1300°C (-418 to 2372°F) Type B: 200 to 1800°C (392 to 3272°F)	0.1°C/°F between -199.9 to 999.9°, 1° below -199.9° and above 999.9°	Type J, K, T, E, and N: ±0.25% of reading ±1°C (±2°F) below -99.9°C (-148°F), ±0.1% of reading ±0.4°C (±0.7°F) above -150°C (-238°F) Type R, S, and B: ±0.1% of reading ±1°C (±2°F)	<b>MY-91428-04</b>

**MY-35427-85 Optional "hands-free" kit** includes two magnets and hook-and-loop strap

**MY-35427-86 USB cable** for data logging models

**MY-17000-10 ILAC MRA, NIST-traceable calibration** with data for thermocouple meter



## Digi-Sense® TempTestr® Infrared Thermometer

Take quick surface temperatures affordably

- Get readings in less than one second
- Point, press button, and read
- Selectable °C/°F reading

**Super-Mini TempTestr includes** built-in pocket clip, wrist strap, and two batteries.

**Min TempTestr includes** metal case, wrist strap, and spare battery.



“Excellent little unit.”



Model	Super-Mini TempTestr	Mini TempTestr
<b>Catalogue number</b>	<b>MY-39642-01</b>	<b>MY-39642-00</b>
Range	–33 to 110°C (–27 to 230°F).	–33 to 220°C (–30 to 430°F).
Resolution	0.2°C (0.5°F) of reading	0.2°C (0.5°F) of reading
Accuracy	±2.5% of reading or 2.0°C (3.6°F)	±2% of reading or ±2°C (4°F)
Response time	Less than one second for 95% of reading	Less than one second
Emissivity	0.95 fixed	Adjustable from 0.01 to 1.00
Distance-to-target ratio	1:1	1:1
Power	Two LR44/359 batteries (included)	One 3V battery (included)

## Digi-Sense® Precalibrated Infrared Stick Thermometers

Get quick and easy, one-button reading

- Reliable measurements, guaranteed! Precalibrated to ILAC MRA, NIST-traceable standards
- Unique ergonomic stick-style design fits comfortably in your hand
- Water- and dust-resistant IP54 rating
- Laser sighting to pinpoint the center of the measurement area
- Safely and easily locate hot and cold spots, preventing problems and saving costs



Unit features automatic data Hold, selectable °C/°F units, fixed emissivity, and backlit display.

**What's included:** lanyard, battery, and ILAC MRA, NIST-traceable calibration report with data.



Description	Precalibrated IR stick thermometers	
	MY-20250-09	MY-35625-16
Range	–18 to 302°C (0 to 575°F)	
Resolution	0.1°C/F	
Accuracy	±2°C (3.6°F) or ±2% of reading	
Response time	Less than 500 ms	
Emissivity	Fixed at 0.95	
Laser sighting	Single laser	
Distance-to-sight ratio	8:1	4:1
Power	One 9 V battery (included)	
Dimensions (L x W x H)	17.8 x 4.4 x 3.8 cm (7" x 1 3/4" x 1 1/2")	

**MY-35625-80 Soft carrying case**

**MY-09376-04 Replacement batteries, 9V. Pack of four**

## Digi-Sense® Precalibrated Infrared Thermometers

Save money and prevent breakdowns—easily locate hot and cold spots

- Reliable measurements—guaranteed! Precalibrated to ILAC MRA, NIST-traceable standards
- Get easy readings from a distance—just aim, pull trigger and read!
- Continuous scanning via trigger lock

**General-Purpose IR models** feature min/max and hold functions, °C/°F units, single targeting laser, and large backlit LCD for easy reading. Models 20250-05 and -06 also offer adjustable emissivity and temperature alarm with indicator.

**Professional IR models** provide high distance-to-sight ratio and enhanced temperature range in a heavy-duty housing. Get a more precise measurement area with dual targeting lasers and external type K thermocouple (one included). min/max/avg and hold, temperature differential, high/low alarms, adjustable emissivity, data logging, and more!



Description	General-purpose infrared thermometers			Professional infrared thermometers	
	MY-20250-04	MY-20250-05	MY-20250-06	MY-20250-07	MY-20250-08
Range (IR)	–20 to 332°C (–4 to 630°F)	–35 to 537°C (–31 to 1000°F)	–35 to 800°C (–31 to 1472°F)	–50 to 1650°C (–58 to 3002°F)	–50 to 1850°C (–58 to 3362°F)
Resolution	0.1°C/F	0.1°C/F below 1000°, 1°C/F		0.1°C/F below 1000°, 1°C/F above 1000°	
Response time	Less than 1 sec	Less than 300 ms		Less than 150 ms	
Distance-to-sight ratio	10:1	12:1	20:1	30:1	50:1
Emissivity	0.95 fixed	0.10 to 1.0 adjustable		0.10 to 1.0 adjustable	
Laser sighting		Single Class II laser		Dual Class II laser	
Temperature alarm	No		Yes	Yes	
USB interface		No		Yes (cable and software included)	
Data logging		No		Yes, 100 internal readings	
Power		One 9 V battery		One 9 V battery	

## FLIR® ONE® Pro LT Thermal Imaging Camera Attachments

Capture vivid thermal images instantly on your smartphone

The FLIR ONE Pro LT thermal imaging camera attachments allow you to see in the dark, observe invisible heat sources, and compare relative temperatures. The micro cameras are ideal for inspecting electrical panels, discovering HVAC problems, or finding water damage.

Enhance your experience with the free FLIR ONE app. It provides a simple and intuitive user interface to measure multiple temperatures or regions of interest at once, collect and share thermal images on social media, and stream to your smartwatch for remote viewing.

FLIR ONE Pro LT features 80 x 60 IR resolution at a thermal sensitivity of 100 mK. An on-screen spot thermometer provides real-time temperatures between -4 to 248°F (-20 to 120°C).

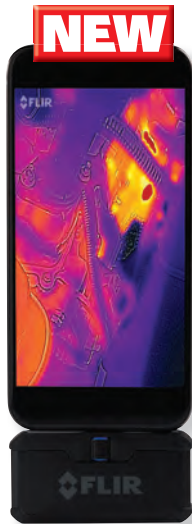

Phone not included.

### Specifications

Description		FLIR ONE Pro LT	
Radiometry	Temperature range	-4 to 248°F (-20 to 120°C)	
	Accuracy	±5.4°F (±3°C) or 5%	
	Thermal sensitivity (NETD)	100 mK	70 mK
Power	Internal battery; approx. 1-hr battery life		

Description	A. FLIR ONE Pro LT
	Catalogue number
For iOS device with Lightning connector	MY-35725-18
For Android device with USB-C connector	MY-35725-19
For Android device with micro-USB connector	MY-35725-20

Note: Available in the United States and Canada only.

## FLIR® C2 Pocket-Size Thermal Imager

Pocket portable—never miss an opportunity to uncover issues

– Radiometric image capable of capturing thermal measurements from -10 to 150°C (14 to 302°F)

– MSX®-enhanced thermal images provide amazing detail to help you identify problem areas via 4800-pixel resolution display

– Stream video via FLIR Tools software for additional analysis

– Bright 7.6 cm (3") intuitive touchscreen with auto orientation for easy viewing



Model number	C2
Catalogue number	MY-39756-64
Range	-10 to 150°C (14 to 302°F)
Accuracy	±2°C (3.6°F) or 2% at 25°C whichever is greater
Resolution (pixels)	4800
Detector size	80 x 60
Measurement modes	Thermal, visual, MSX and gallery
Power	3.7 V rechargeable Li-ion polymer battery

## FLIR® TG165 Imaging Infrared Thermometer

Eliminate targeting guesswork

- Instantly see where the heat is and where to aim
- Measure from -25 to 380°C (-13 to 716°F) with 4800 pixel resolution
- Easy and intuitive—no special training necessary
- See clear thermal patterns of heat problems normally invisible to the eye
- 24:1 distance-to-target ratio and 80 x 60 image resolution help you capture reliable readings from a safe distance



Model number	Description	Catalogue number
TG165	Imaging IR thermometer, 4800 pixels	MY-39755-96
—	Belt holster	MY-39755-98
—	Hard carrying case	MY-39755-97

## FLIR® Ex-Series Point-and-Shoot Thermal Imagers

No need to refer back to visual images

- Exclusive MSX® thermal imaging technology gives more detailed images for better results
- Minimise fatigue with easy-grip handle
- Get hours of operation with robust, Li-ion battery
- Transfer and analyse data easily with web-based software



39753-14

**What's included:** analysis and reporting software, USB cable, hard carry case, AC adapter/charger, and Li-ion rechargeable battery. Model E8 also includes an extra battery and external battery charger.



Model number	E4	E5	E6	E8
Catalogue number	MY-39753-14	MY-39753-15	MY-39753-16	MY-39753-18
Range	-20 to 250°C (-4 to 482°F)			
Accuracy	±2% or 2°C (4°F)			
Resolution (pixels)	4,800	10,800	19,200	76,800
Detector size	80 x 60	120 x 90	160 x 120	320 x 240
Thermal sensitivity (NETD)	<0.15°C at 25°C	<0.10°C at 25°C	<0.06°C at 25°C	
Digital zoom	No	No	No	No
Field of view	45° x 34°	45° x 34°	45° x 34°	45° x 34°
Image annotation	No	No	No	No
Picture-in-picture	No		Yes (fixed)	
Thermal fusion	No		No	

# Digi-Sense™ Traceable® General-Purpose Timers

## Track time, maintain accuracy, and save money

### A. Four-Channel Large-Display Clock/Timer

- Easy monitoring of four experiments simultaneously
- Channels feature distinct alarms that sound for one minute
- Set up to 100 hours in count up or countdown modes
- Time of day in 12- or 24-hour format

**What's included:** magnetic clip, stand, button cell battery, and ILAC MRA, NIST-traceable calibration report.

### B. 100-Hour, Triple-Display Clock/Timer

- Know which channel is done with unique tones
- Use as digital clock, timer, or stopwatch
- Easily recall previous time set via memory
- Alarm condition indicated by flashing LCD

**What's included:** one AAA battery and ILAC MRA, NIST-traceable calibration report.

### C. Jumbo Digit Dual-Channel Clock/Timer

- See time easily—tilts for better viewing
- Use both channels for simultaneous countdown, or time of day with count up timer
- Choose 12- or 14-hour display format
- Alarm sounds at end of cycle and shows elapsed time

**What's included:** wall-mounting bracket, one AAA battery, and ILAC MRA, NIST-traceable calibration report.

### D. Flashing LED Big-Digit Timer

- Never wonder about remaining time again
- Easily view 2.5 cm (1") H display across the room
- LED flashes green for last ten seconds of timer, flashes red when alarm sounds
- Don't annoy others—adjust alarm volume to high, low, or off
- Store three countdown times for easy recall

**What's included:** magnetic back, flip-open easel stand, spring fastener for clipping, an opening for a lanyard, two AAA batteries, and ILAC MRA, NIST-traceable calibration report.

### E. Triple-Display Clock/Timer

- Get timing faster—recall all channels' settings instantly
- Use as a countdown timer, count up stopwatch, or clock
- Count up to 24 hours, count down to 20 hours
- Displays time elapsed since alarm

**What's included:** magnetic clip, one AAA battery, and ILAC MRA, NIST-traceable calibration report..

### F. Dual-Channel Flashing LED Big-Digit Timer

- Flashing red LED when time is up
- View two timers, each with a distinctive alarm
- Alerts to end time with flashing green LED for the last ten seconds
- Adjust the alarm to the right volume—high, low, and off
- Store three countdown times in memory for easy recall

**What's included:** two AAA batteries and ILAC MRA, NIST-traceable calibration report.



A



B



C



D



E



F



Key	A	B	C	D	E	F
Number of channels	Four	Three	Two	One	Three	Two
Timing capacity	100 hours	100 hours	24 hours	100 min	24 hr up/20 hr down	100 hours
Resolution	1 sec	1 sec	1 sec	1 sec	1 sec	1 sec
Accuracy	±0.01%	±0.001%	±0.01%	±0.01%	±0.01%	±0.01%
Count direction	Up/down	Up/down	Up/down	Down	Up/down	Up/down
Display	LCD, ¾"H	LCD, ¾"H	Dual LCD, 1"H	LCD, 1"H	Triple LCD, ¾"H	LCD, ¾"H
Clock	Yes	Yes	Yes	No	Yes	No
Alarm	1 min beep	1 min beep and visual	1 min beep	1 min beep and visual	1 min beep	1 min beep and visual
Battery included	One 1.5 V button cell	One AAA battery	One AAA battery	Two AAA battery	One AAA battery	Two AAA battery
Catalogue number (timer)	MY-90225-35	MY-94411-10	MY-98766-77	MY-94461-15	MY-94440-00	MY-94461-16
Catalogue number (battery)	MY-09377-16	MY-09376-00	MY-09376-00	MY-09376-00	MY-09376-00	MY-09376-00



# Digi-Sense™ Traceable® Digital Stopwatches

## Time the length of any event or activity



### A. Water-Resistant Stopwatches

- Separate start/stop and reset buttons
- Alarm clock shows time of day and day of week
- Split-mode timing to freeze the split-time display while total timing continues
- Model 35002-11 does not include an ILAC MRA, NIST-traceable calibration certificate†

**What's included:** neck cord, battery, and ILAC MRA, NIST-traceable calibration certificate‡.

### B. Waterproof/Shockproof Stopwatch

- Shock-proof case is ideal for lab or plant use
- Displays time of day, date, and day of week
- Time-of-day alarm

**What's included:** neck cord, battery, and ILAC MRA, NIST-traceable calibration certificate.

### C. Big-Digit Stopwatch

- Displays time-of-day, date, and day of week
- Keep track of time with time of day alarm
- Water-, dust-, and shock-resistant

**What's included:** neck cord, clip, Velcro® strip, battery, and ILAC MRA, NIST-traceable calibration certificate.

### D. Stopwatch/Repeat Timer

- Report function is ideal for analysis that must be noted at regular intervals
- Cycles automatically until stopped and displays number of cycles
- Set to countdown from ten hours to one second

**What's included:** neck cord, battery, and ILAC MRA, NIST-traceable calibration certificate.

### E. 60-Memory Stopwatch

- Recall up to 60 events
- Simultaneously displays running time, cumulative split, and interval split
- Set to countdown from ten hours to one second
- Displays time, date, and day of the week

**What's included:** neck cord, battery, and ILAC MRA, NIST-traceable calibration certificate.

### F. 300-Memory All-Function Stopwatch

- Recall up to 300 memories both during and after event timing
- Simultaneously shows running time, cumulative split, and interval split
- Functions include pacer, stroke, and speed calculations
- Displays time, date, and day of the week

**What's included:** neck cord, clip, Velcro® strip, battery, and ILAC MRA, NIST-traceable calibration certificate.

### G. High-Accuracy Stopwatch

- Quartz crystal—over 100 times more accurate than other stopwatches!
- Features 30 memories
- Display count box shows how many times the cycle has been repeated
- Indicates time, date, and day of the week

**What's included:** neck cord, battery, and ILAC MRA, NIST-traceable calibration certificate.



Key	A	B	C	D	E	F	G
Timing modes	Single-event, lap, cumulative split	Single-event, lap, cumulative split	Single-event, pause, cumulative split	Single-event, lap, cumulative split, pacer	Single-event, time-out/time-in, continuous timing, cumulative split, interval split, auto-repeat, sample counter, pacer	Time-out/time-in, continuous timing, cumulative split, interval split, sample counter, pacer	Time-out/time-in, continuous timing, cumulative split, interval split, cycle counter, pacer
Timing capacity	24 hours	24 hours	24 hours	10 hours	10 hours	10 hours	10 hours
Resolution	0.01/1 sec†	0.01/1 sec†	0.01/1 sec†	0.01 sec	0.01 sec	0.01 sec	0.01 sec
Accuracy	±5 sec/day	±0.01	±0.001%	±0.001%	±0.001%	±0.001%	±0.0005%
Count direction	Up	Up	Up	Up/down	Up/down	Up/down	Up/down
Display	LCD, 3/8"H	LCD, 1/2"H	LCD, 5/8"H	2-line LCD, 5/8"H	3-line LCD, 3/8"H	3-line LCD, 1/4"H	3-line LCD, 3/8"H
Clock alarm	1 min beep	1 min beep	1 min beep	1 min beep	3 short beeps	Yes	Audible
Battery included	1.5 V button cell	1.5 V button cell	1.5 V button cell	1.5 V button cell	3 V button cell	3 V button cell	3 V button cell
Catalogue number	MY-35002-11‡ MY-35002-13	MY-94460-55	MY-94460-28	MY-94460-10	MY-98766-02	MY-98766-09	MY-98766-05

†Resolution is 0.01 second for the first 30 minutes of timing and 1 second thereafter. ‡Model 35002-11 does not include a Traceable® ILAC, MRA, NIST-traceable calibration certificate.

## Cou-Lo Aquamax Coulometric Karl Fischer Titrator

Use it wherever you need it!



- Guaranteed synchronisation of electrolysis current produced and count rate displayed with automatic compensation
- Get hard copy of results with built-in high speed printer
- Easy to use for determination of water in liquids, gases, and powders
- Meets ASTM D1533, D4928, D6304, IP 386, API MPMS Chapter 10.9, and BS 60814 test methods

The Cou-Lo Aquamax titrator sets new standards in versatility and ease of operation for determining water content in liquids, gases, and powders. The unique Automatic Compensation of Errors (ACE) control system guarantees that the actual electrolysis current produced and the count rate displayed are always correctly synchronised, regardless of changes to the electrolysis cell resistance.

Titrator displays results in %, ppm, mg/kg, and µg of water. Delayed start, automatic three-fold end point indication, and four different calculation modes accommodate a variety of applications. Printed results show statistics, data input parameters, sample ID numbers, and time-and-date stamp. Results can also be downloaded via the optional Results Manager software package into a PC spreadsheet format.

**What's included:** built-in stirrer, titration vessel, detector electrode, generator electrode, drying tube, injection septa, glass syringe, luer needle, molecular sieve, stir bar, funnel, printer, paper, universal AC voltage adapter, DC car adapter, and internal battery.



### Specifications

<b>Range:</b> 1 µg to 100 mg water	<b>Accuracy</b> From 10 to 100 µg: ±3 µg
<b>Resolution:</b> 0.1 µg	From 100 µg to 1 mg: ±5 µg
<b>Rate:</b> 2.0 mg/min max titration	Above 1 mg: ±0.5%
<b>Moisture range:</b> 1 ppm to 100%	<b>Units displayed:</b> %, ppm, mg/kg, µg

Description	Power	Catalogue number
Cou-Lo Aquamax Coulometric Karl Fischer Titrator	90 to 264 VAC, 47 to 63 Hz	MY-94101-00

### Accessories

- MY-94101-50 Carrying case
- MY-94101-55 Results Manager software package
- MY-94101-60 Replacement reagents pack

## Cole-Parmer® Silicone Tubing

No need to worry about the heat—use for applications up to 238°C

### Peroxide Silicone



- Applications:** Pharmaceutical, biotechnology, food and beverage, aerospace, and general lab applications.
- Characteristics:** Peroxide-cured, excellent heat resistance, low compression set, odourless, non-toxic, translucent.
- Certifications:** Elastomer is FDA-compliant (21 CFR 177.2600) and meets USP Class VI requirements. Tubing is manufactured according to GMP.
- Temperature range:** –51 to 238°C (–60 to 460°F)
- Sterilise:** Autoclave or gamma irradiation.

### Platinum Silicone



- Applications:** Pharmaceutical, biotechnology, aerospace, food and beverage, and general lab applications.
- Characteristics:** Platinum-cured, excellent heat resistance, low compression set, odourless, non-toxic, translucent.
- Certifications:** Elastomer is FDA-compliant (21 CFR 177.2600) and meets USP Class VI. Tubing is manufactured according to GMP.
- Temperature range:** –50 to 230°C (–58 to 446°F)
- Sterilise:** Autoclave or gamma irradiation.



Dimensions: in. (mm)			Max psi at 70°F (21°C)	Peroxide silicone	Platinum silicone
ID	OD	Wall		Cat. no. 25-ft pk	Cat. no. 25-ft pk
1/50 (0.5)	1/12 (2.1)	1/32 (0.8)	30	MY-06411-59	MY-95802-00
1/32 (0.8)	3/32 (2.4)	1/32 (0.8)	30	MY-06411-60	MY-95802-01
1/16 (1.6)	1/8 (3.2)	1/32 (0.8)	15	MY-06411-62	MY-95802-02
3/32 (2.4)	5/32 (4.0)	1/32 (0.8)	15	MY-06411-63	MY-95802-03
1/8 (3.2)	3/16 (4.8)	1/32 (0.8)	10	MY-06411-64	MY-95802-04
1/8 (3.2)	1/4 (6.4)	1/16 (1.6)	20	MY-06411-67	MY-95802-05
1/8 (3.2)	3/8 (9.6)	1/8 (3.2)	25	MY-06411-68	MY-95802-06
5/32 (4.0)	5/32 (4.0)	1/32 (0.8)	10	MY-06411-65	MY-95802-07
3/16 (4.8)	1/4 (6.4)	1/32 (0.8)	9	MY-06411-66	MY-95802-08
3/16 (4.8)	5/16 (8.0)	1/16 (1.6)	13	MY-06411-03	MY-95802-09
3/16 (4.8)	7/16 (11.2)	1/8 (3.2)	22	MY-06411-69	MY-95802-10
1/4 (6.4)	5/16 (8.0)	1/32 (0.8)	9	MY-06411-70	MY-95802-11
1/4 (6.4)	3/8 (9.6)	1/16 (1.6)	10	MY-06411-71	MY-95802-12
1/4 (6.4)	7/16 (11.2)	3/32 (2.4)	17	MY-06411-72	MY-95802-13
1/4 (6.4)	1/2 (12.8)	1/8 (3.2)	17	MY-06411-74	MY-95802-14
5/16 (8.0)	7/16 (11.2)	1/16 (1.6)	10	MY-06411-75	MY-95802-15
5/16 (8.0)	1/2 (12.8)	3/32 (2.4)	16	MY-06411-76	MY-95802-16
5/16 (8.0)	9/16 (14.4)	1/8 (3.2)	20	MY-06411-77	MY-95802-17
3/8 (9.6)	1/2 (12.8)	1/16 (1.6)	10	MY-06411-12	MY-95802-18
3/8 (9.6)	9/16 (14.4)	3/32 (2.4)	12	MY-06411-78	MY-95802-19
3/8 (9.6)	5/8 (16.0)	1/8 (3.2)	15	MY-06411-79	MY-95802-20
1/2 (12.8)	5/8 (16.0)	1/16 (1.6)	9	MY-06411-80	MY-95802-21
1/2 (12.8)	11/16 (17.6)	3/32 (2.4)	10	MY-06411-19	MY-95802-22
1/2 (12.8)	3/4 (19.2)	1/8 (3.2)	12	MY-06411-55	MY-95802-23
5/8 (16.0)	13/16 (20.8)	3/32 (2.4)	10	MY-06411-82	MY-95802-24
5/8 (16.0)	7/8 (22.4)	1/8 (3.2)	12	MY-06411-58	MY-95802-25
3/4 (19.2)	1 (25.4)	1/8 (3.2)	9	MY-06411-83	MY-95802-26

## Tygon® BioPharm Silicone Tubing

Reduce particle entrapment with ultra-smooth inner surface



**Formulation:** Tygon® 3350 silicone, platinum cured.

**Applications:** Pharmaceutical, cosmetic, industrial, and auto-analysis applications.

**Characteristics:** Ultra-smooth inner surface reduces particle entrapment and minimises bacterial growth. Good for mild to medium concentration bases, salts, and alcohols; is odourless, tasteless, and non-toxic. Transparent.

**Certifications:** Elastomer is FDA-compliant (21 CFR 177.2600) and meets USP Class VI requirements, NSF criteria and EP 3.2.9 requirements. Tubing is manufactured according to GMP.

**Temperature range:** -80 to 200°C (-112 to 392°F)

**Sterilise:** Ethylene oxide, gamma irradiation, or autoclave for 30 min, 15 psi (1.0 bar).

Dimensions: in. (mm)			Max psi at 73°F (bar at 23°C)	Cat. no. 50-ft pk
ID	OD	Wall		
1/32 (0.8)	3/32 (2.4)	1/32 (0.8)	16 (1.1)	MY-95702-00
1/16 (1.6)	1/8 (3.2)	1/32 (0.8)	10 (0.7)	MY-95702-01
1/16 (1.6)	3/16 (4.8)	1/16 (1.6)	15 (1.0)	MY-95702-02
3/32 (2.4)	5/32 (4.0)	1/32 (0.8)	7 (0.5)	MY-95702-03
3/32 (2.4)	7/32 (5.6)	1/16 (1.6)	12 (0.8)	MY-95702-04
1/8 (3.2)	3/16 (4.8)	1/32 (0.8)	7 (0.5)	MY-95702-05
1/8 (3.2)	1/4 (6.4)	1/16 (1.6)	9 (0.6)	MY-95702-06
3/16 (4.8)	1/4 (6.4)	1/32 (0.8)	5 (0.3)	MY-95702-08
3/16 (4.8)	5/16 (8.0)	1/16 (1.6)	7 (0.5)	MY-95702-09
3/16 (4.8)	3/8 (9.6)	3/32 (2.4)	9 (0.6)	MY-95702-10
1/4 (6.4)	3/8 (9.6)	1/16 (1.6)	5 (0.3)	MY-95702-13
1/4 (6.4)	7/16 (11.2)	3/32 (2.4)	7 (0.5)	MY-95702-14
5/16 (8.0)	7/16 (11.2)	1/16 (1.6)	5 (0.3)	MY-95702-16
5/16 (8.0)	1/2 (12.8)	3/32 (2.4)	6 (0.4)	MY-95702-17
3/8 (9.6)	1/2 (12.8)	1/16 (1.6)	4 (0.3)	MY-95702-18
3/8 (9.6)	9/16 (14.4)	3/32 (2.4)	5 (0.3)	MY-95702-19
3/8 (9.6)	5/8 (16.0)	1/8 (3.2)	7 (0.5)	MY-95702-20

### Benchtop Tubing Cutter

Steel blade makes right-angle cuts in plastic tubing 1.5 mm to 15.8 mm OD.



Description	Catalogue number
Benchtop cutter	MY-06438-10
Replacement blade	MY-06438-11

## Free Certificate of Compliance

Cole-Parmer will provide a certificate of resin or elastomer compliance FREE at your request with each order of fittings or tubing. Certificates list your company's PO number, order reference number, catalogue number, formulation, compound number, lot number (where applicable), and the regulations and agencies the tubing or fitting complies with, including FDA, USP, USDA, National Formulary, NSF International, GMP, and 3A. Look for the blue "check" icon throughout this catalogue to identify when a certificate of compliance is available.



## Cole-Parmer® Platinum-Cured Reinforced Silicone Tubing

Withstands pressures to 312 psi



**Formulation:** Tygon® 3370 I. B., silicone, platinum cured.

**Applications:** Demanding sanitary high-pressure pharmaceutical, biotechnology, food and beverage, and cosmetic applications.

**Characteristics:** Excellent heat resistance, low compression set, odourless, and non-toxic, translucent.

**Certifications:** Elastomer is FDA-compliant (21 CFR 177.2600) and USP Class V extractables; exceeds Class VI implant; exceeds 3A Sanitary Standards; produced to Bulk Pharmaceutical cGMPs (FDA 21 CFR 210, 211). Tubing is manufactured according to GMP.

**Temperature range:** -51 to 160°C (-60 to 320°F)

**Sterilise:** Autoclave, ethylene oxide, or gamma irradiation.



Dimensions: in. (mm)			Max psi at 70°F (bar at 21°C)	Qty/pk	Catalogue number
ID	OD	Wall			
3/16 (4.8)	7/16 (11.2)	1/8 (3.2)	312 (21.5)	50 ft	MY-95703-00
1/4 (6.4)	1/2 (12.8)	1/8 (3.2)	248 (17.1)	50 ft	MY-95703-01
3/8 (9.6)	5/8 (16.0)	1/8 (3.2)	180 (12.4)	50 ft	MY-95703-02
1/2 (12.8)	13/16 (20.8)	5/32 (4.0)	168 (11.6)	50 ft	MY-95703-03
5/8 (16.0)	15/16 (24.0)	5/32 (4.0)	144 (9.9)	50 ft	MY-95703-04
3/4 (19.1)	1 1/8 (28.6)	3/16 (4.8)	144 (9.9)	50 ft	MY-95703-05
1 1/4 (31.8)	1 5/8 (41.4)	3/16 (4.8)	96 (6.6)	25 ft	MY-95703-07

Find even more information online!  
Go to [ColeParmer.com](http://ColeParmer.com) to see full product details.

## Cole-Parmer® Vinyl Tubing

Ideal for general-purpose applications



**Applications:** General-purpose lab use.

**Characteristics:** Fair chemical and abrasion resistance, odourless, non-toxic and transparent.

**Certifications:** Tubing is manufactured according to GMP.

**Temperature range:** -43 to 82°C (-45 to 180°F)

**Sterilise:** Ethylene oxide.



Dimensions: in. (mm)			Max psi at 70°F (bar at 21°C)	Qty/pk	Catalogue number
ID	OD	Wall			
1/16 (1.6)	1/8 (3.2)	1/32 (0.8)	40 (2.8)	50 ft	MY-06405-01
1/8 (3.2)	1/4 (6.4)	1/16 (1.6)	59 (4.0)	50 ft	MY-06405-02
3/16 (4.8)	5/16 (8.0)	1/16 (1.6)	51 (3.5)	50 ft	MY-06405-03
3/16 (4.8)	7/16 (11.2)	1/8 (3.2)	46 (3.2)	100 ft	MY-06405-04
1/4 (6.4)	3/8 (9.6)	1/16 (1.6)	51 (3.5)	50 ft	MY-06405-06
1/4 (6.4)	7/16 (11.2)	3/32 (2.4)	55 (3.8)	100 ft	MY-06405-07
1/4 (6.4)	1/2 (12.8)	1/8 (3.2)	64 (4.4)	50 ft	MY-06405-08
5/16 (8.0)	7/16 (11.2)	1/16 (1.6)	46 (3.2)	50 ft	MY-06405-09
5/16 (8.0)	1/2 (12.8)	3/32 (2.4)	55 (3.8)	100 ft	MY-06405-10
3/8 (9.6)	1/2 (12.8)	1/16 (1.6)	41 (2.8)	50 ft	MY-06405-12
3/8 (9.6)	5/8 (16.0)	3/32 (2.4)	46 (3.2)	100 ft	MY-06405-15
3/8 (9.6)	5/8 (16.0)	1/8 (3.2)	55 (3.8)	100 ft	MY-06405-16
1/2 (12.8)	5/8 (16.0)	1/16 (1.6)	28 (1.9)	50 ft	MY-06405-18
1/2 (12.8)	1 1/16 (17.6)	3/32 (2.4)	36 (2.5)	100 ft	MY-06405-19
1/2 (12.8)	3/4 (19.1)	1/8 (3.2)	41 (2.8)	50 ft	MY-06405-20
5/8 (16.0)	13/16 (20.8)	3/32 (2.4)	32 (2.2)	100 ft	MY-06405-25
5/8 (16.0)	7/8 (22.4)	1/8 (3.2)	36 (2.5)	50 ft	MY-06405-27
3/4 (19.1)	1 (25.4)	1/8 (3.2)	32 (2.2)	50 ft	MY-06405-31
1 (25.4)	1 1/4 (31.8)	1/8 (3.2)	23 (1.6)	50 ft	MY-06405-36
1 1/4 (31.8)	1 3/4 (44.5)	1/4 (6.4)	41 (2.8)	50 ft	MY-06405-46



## Dow Corning® Pharma-50 Tubing

### No organic additives and low extractables



**Applications:** Pharmaceutical, biotechnology, and ultrapure fluid processing.

**Characteristics:** 50 durometer, translucent platinum-cured silicone tubing with a very low extractable profile. Pharma tubing remains flexible and resilient for long service life. Dow Corning maintains complete traceability from silica to silicone tubing.

**Certifications:** Elastomer exceeds test guidelines for USP Class VI Plastics and the tubing itself meets or exceeds FDA (21 CFR 177.2600), 3A Sanitary Standards and European Pharmacopoeia (EP) requirements. Produced under Bulk Pharmaceutical (BP) and current GMP principles.

**Temperature range:** -51 to 238°C (-60 to 460°F)

**Sterilise:** Autoclave, ethylene oxide, or gamma irradiation.

Dimensions: in. (mm)			Max psi at 70°F (bar at 21°C)	Cat. no. 50-ft pk
ID	OD	Wall		
1/8 (3.2)	1/4 (6.4)	1/16 (1.6)	21 (1.4)	MY-96105-00
3/16 (4.8)	3/8 (9.6)	3/32 (2.4)	16 (1.1)	MY-96105-02
1/4 (6.4)	3/8 (9.6)	1/16 (1.6)	12 (0.8)	MY-96105-03
1/4 (6.4)	7/16 (11.1)	3/32 (2.4)	17 (1.2)	MY-96105-04
1/4 (6.4)	1/2 (12.8)	1/8 (3.2)	17 (1.2)	MY-96105-05
5/16 (8.0)	1/2 (14.0)	1/8 (3.0)	16 (1.1)	MY-96105-06
3/8 (9.6)	9/16 (14.3)	3/32 (2.4)	13 (0.9)	MY-96105-08
3/8 (9.6)	5/8 (16.0)	1/8 (3.2)	14 (1.0)	MY-96105-09
1/2 (12.8)	3/4 (19.1)	1/8 (3.2)	10 (0.7)	MY-96105-11
5/8 (16.0)	7/8 (22.2)	1/8 (3.2)	9 (0.6)	MY-96105-12

## Dow Corning® Pharma-65 Tubing

### Resilient for extended service life



**Characteristics:** 65 durometer, platinum-cured silicone tubing with a very low extractable profile; it contains no phthalates, plasticisers, latex, or other organic additives. Remains flexible and resilient for long service life. Dow Corning maintains complete traceability from silica to silicone tubing.

**Certifications:** Elastomer is FDA-compliant (21 CFR 177.2600) and meets USP Class VI requirements. Meets 3A Sanitary Standards and European Pharmacopoeia (EP) requirements. Tubing is manufactured according to Bulk Pharmaceutical (BP) and current GMP.

**Temperature range:** -51 to 238°C (-60 to 460°F)

**Sterilise:** Autoclave, ethylene oxide, or gamma irradiation.

Dimensions: in. (mm)			Max psi at 70°F (bar at 21°C)	Cat. no. 50-ft pk
ID	OD	Wall		
1/8 (3.2)	1/4 (6.4)	1/16 (1.6)	19 (1.3)	MY-96107-00
3/16 (4.8)	5/16 (8.0)	1/16 (1.6)	13 (0.9)	MY-96107-01
3/16 (4.8)	3/8 (9.6)	3/32 (2.4)	15 (1.0)	MY-96107-02
1/4 (6.4)	7/16 (11.2)	3/32 (2.4)	20 (1.4)	MY-96107-04
1/4 (6.4)	1/2 (12.8)	1/8 (3.2)	19 (1.3)	MY-96107-05
3/8 (9.6)	5/8 (16.0)	1/8 (3.2)	13 (0.9)	MY-96107-09
1/2 (12.8)	3/4 (19.1)	1/8 (3.2)	11 (0.8)	MY-96107-11

## PharMed® BPT Tubing

### Protect your light-sensitive samples

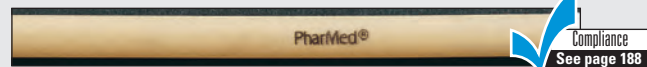

**Applications:** Cell and tissue culture work and pharmaceutical uses. Also good for light-sensitive samples.

**Characteristics:** Non-toxic; non-hemolytic; extremely low permeability; resists acids, alkalies, oxidising agents, and animal and vegetable oils; heat-sealable, bondable, and formable. Opaque beige.

**Certifications:** Elastomer is FDA-compliant (21 CFR 177.2600) and meets USP Class VI and NSF (Standard 51) requirements. Meets EP requirements. Tubing is manufactured according to GMP.

**Temperature range:** -51 to 135°C (-60 to 275°F)

**Sterilise:** Autoclave, ethylene oxide, or gamma irradiation.

Dimensions: in. (mm)			Max psi at 70°F (bar at 21°C)	Cat. no. 25-ft pk
ID	OD	Wall		
1/50 (0.5)	9/64 (3.7)	1/16 (1.6)	50 (3.4)	MY-96880-00
1/32 (0.8)	5/32 (4.0)	1/16 (1.6)	40 (2.8)	MY-96880-02
1/16 (1.6)	3/16 (4.8)	1/16 (1.6)	34 (2.3)	MY-96880-04
1/8 (3.2)	1/4 (6.4)	1/16 (1.6)	19 (1.3)	MY-96880-06
3/16 (4.8)	5/16 (8.0)	1/16 (1.6)	13 (0.9)	MY-96880-08
1/4 (6.4)	3/8 (9.6)	1/16 (1.6)	10 (0.7)	MY-96880-10
1/4 (6.4)	1/2 (12.8)	1/8 (3.2)	19 (1.3)	MY-96880-12
5/16 (8.0)	7/16 (11.2)	1/16 (1.6)	8 (0.6)	MY-96880-14
3/8 (9.6)	5/8 (16.0)	1/8 (3.2)	13 (0.9)	MY-96880-16
1/2 (12.8)	3/4 (19.1)	1/8 (3.2)	11 (0.8)	MY-96880-18
5/8 (16.0)	7/8 (22.4)	1/8 (3.2)	8 (0.6)	MY-96880-20
3/4 (19.1)	1 (25.4)	1/8 (3.2)	7 (0.5)	MY-96880-22

### Microbore PharMed BPT Tubing

Dimensions: in. (mm)			Fits needle gauge	Cat. no. 100-ft pk
ID	OD	Wall		
0.010 (0.25)	0.082 (2.08)	0.036 (0.91)	30	MY-95809-12
0.020 (0.51)	0.096 (2.44)	0.038 (0.97)	24	MY-95809-18
0.035 (0.89)	0.111 (2.82)	0.038 (0.97)	20	MY-95809-26
0.045 (1.14)	0.121 (3.07)	0.038 (0.97)	18	MY-95809-30
0.051 (1.30)	0.127 (3.23)	0.038 (0.97)	18	MY-95809-32
0.056 (1.42)	0.132 (3.35)	0.038 (0.97)	17	MY-95809-34
0.060 (1.52)	0.136 (3.45)	0.038 (0.97)	16	MY-95809-36
0.073 (1.85)	0.149 (3.78)	0.038 (0.97)	15	MY-95809-40

## C-Flex® Tubing

### Meets the demands of various industries

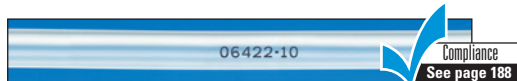

- Available in three formulations—standard, clear, and animal-derived component-free (ADCF)

**Applications:** General-purpose lab uses requiring high performance and long life.

**Characteristics:** Exceptional tensile and tear strength, good biocompatibility, excellent chemical resistance, low gas permeability, and a smooth surface. Standard C-Flex is opaque white; C-Flex Clear and C-Flex ADCF are clear.

**Certifications:** Meets USP Class VI. Tubing is manufactured according to GMP.

**Temperature range:** -45 to 135°C (-50 to 275°F)

**Sterilise:** Autoclave, ethylene oxide, or gamma irradiation.

Dimensions in. (mm)			C-Flex		C-Flex Clear		C-Flex ADCF	
ID	OD	Wall	Max psi at 70°F (21°C)	Cat. no. 25-ft pk	Max psi at 70°F (21°C)	Cat. no. 25-ft pk	Max psi at 70°F (21°C)	Cat. no. 50-ft pk
1/50 (0.5)	1/2 (2.1)	1/32 (0.8)	30	MY-06424-59	50	MY-06422-00	—	—
1/32 (0.8)	3/32 (2.4)	1/32 (0.8)	31	MY-06424-60	51	MY-06422-01	—	—
1/16 (1.6)	1/8 (3.2)	1/32 (0.8)	15	MY-06424-62	25	MY-06422-02	—	—
3/32 (2.4)	5/32 (4.0)	1/32 (0.8)	14	MY-06424-63	23	MY-06422-03	—	—
1/8 (3.2)	3/16 (4.8)	1/32 (0.8)	10	MY-06424-64	17	MY-06422-04	—	—
1/8 (3.2)	1/4 (6.4)	1/16 (1.6)	21	MY-06424-67	35	MY-06422-05	35	MY-06432-50
5/32 (4.0)	7/32 (5.6)	1/32 (0.8)	10	MY-06424-65	17	MY-06422-06	—	—
3/16 (4.8)	1/4 (6.4)	1/32 (0.8)	9	MY-06424-66	15	MY-06422-07	—	—
3/16 (4.8)	5/16 (8.0)	1/16 (1.6)	13	MY-06424-03	22	MY-06422-08	22	MY-06432-51
3/16 (4.8)	7/16 (11.2)	1/8 (3.2)	22	MY-06424-69	36	MY-06422-09	—	—
1/4 (6.4)	3/8 (9.6)	1/16 (1.6)	12	MY-06424-71	20	MY-06422-10	20	MY-06432-53
1/4 (6.4)	7/16 (11.2)	3/32 (2.4)	17	MY-06424-72	28	MY-06422-11	28	MY-06432-54
1/4 (6.4)	1/2 (12.7)	1/8 (3.2)	17	MY-06424-74	28	MY-06422-12	28	MY-06432-55
5/16 (8.0)	7/16 (11.2)	1/16 (1.6)	10	MY-06424-75	17	MY-06422-13	—	—
5/16 (8.0)	1/2 (12.7)	3/32 (2.4)	16	MY-06424-76	27	MY-06422-14	27	MY-06432-56
3/8 (9.6)	1/2 (12.7)	1/16 (1.6)	10	MY-06424-12	17	MY-06422-15	17	MY-06432-57
3/8 (9.6)	5/8 (16.0)	1/8 (3.2)	14	MY-06424-79	23	MY-06422-16	23	MY-06432-59
1/2 (12.7)	1 1/16 (17.6)	3/32 (2.4)	10	MY-06424-19	17	MY-06422-17	17	MY-06432-60
1/2 (12.7)	3/4 (19.1)	1/8 (3.2)	10	MY-06424-81	17	MY-06422-18	17	MY-06432-61

## Tygon® Non-DEHP Lab Tubing

### Pliable formulation for sharp radius bending



**Formulation:** Tygon E-3603

**Applications:** General lab, food and beverage, biopharm, analytical instruments.

**Characteristics:** Non-DEHP, phthalate free. Long-life, chemical resistant, non-oxidising; able to bend to sharp radius curves and easily works with fittings. Transparent.

**Certifications:** FDA-compliant (21 CFR 175.300); meets USP Class VI and NSF 51 requirements.

**Temperature range:** -46 to 74°C (-51 to 165°F)

**Sterilise:** Autoclave or ethylene oxide.

Dimensions: in. (mm)			Max psi at 70°F (bar at 21°C)	Cat. no. 50-ft pk
ID	OD	Wall		
1/32 (0.8)	3/32 (2.4)	1/32 (0.8)	69 (4.8)	MY-06407-70
1/16 (1.6)	1/8 (3.2)	1/32 (0.8)	36 (2.5)	MY-06407-71
1/16 (1.6)	3/16 (4.8)	1/16 (1.6)	69 (4.8)	MY-06407-72
3/32 (2.4)	3/16 (4.8)	1/32 (0.8)	25 (1.7)	MY-06407-73
1/8 (3.2)	3/16 (4.8)	1/32 (0.8)	20 (1.4)	MY-06407-75
1/8 (3.2)	1/4 (6.4)	1/16 (1.6)	36 (2.5)	MY-06407-76
5/32 (4.0)	7/32 (5.6)	1/32 (0.8)	17 (1.2)	MY-06407-77
3/16 (4.8)	5/16 (8.0)	1/16 (1.6)	25 (1.7)	MY-06407-78
3/16 (4.8)	3/8 (9.6)	3/32 (2.4)	36 (2.5)	MY-06407-79
1/4 (6.4)	3/8 (9.6)	1/16 (1.6)	20 (1.4)	MY-06407-80
1/4 (6.4)	7/16 (11.2)	3/32 (2.4)	28 (1.9)	MY-06407-81
1/4 (6.4)	1/2 (12.8)	1/8 (3.2)	35 (2.5)	MY-06407-82
5/16 (8.0)	7/16 (11.2)	1/16 (1.6)	17 (1.2)	MY-06407-83
5/16 (8.0)	1/2 (12.8)	3/32 (2.4)	23 (1.6)	MY-06407-84
5/16 (8.0)	9/16 (14.4)	1/8 (3.2)	30 (2.1)	MY-06407-85
3/8 (9.6)	1/2 (12.8)	1/16 (1.6)	14 (1.0)	MY-06407-86
3/8 (9.6)	5/16 (14.4)	3/32 (2.4)	20 (1.4)	MY-06407-87
3/8 (9.6)	5/8 (16.0)	1/8 (3.2)	25 (1.7)	MY-06407-88
7/16 (11.2)	5/8 (16.0)	1/16 (1.6)	13 (0.9)	MY-06407-89
1/2 (12.8)	5/8 (16.0)	1/16 (1.6)	12 (1.8)	MY-06407-90
1/2 (12.8)	1 1/16 (1.6)	3/32 (2.4)	15 (1.0)	MY-06407-91
1/2 (12.8)	3/4 (19.1)	1/8 (3.2)	20 (1.4)	MY-06407-92
1/2 (12.8)	13/16 (20.8)	5/32 (4.0)	24 (1.7)	MY-06407-93
5/8 (16.0)	13/16 (20.8)	3/32 (2.4)	13 (0.9)	MY-06407-94
5/8 (16.0)	7/16 (11.2)	1/8 (3.2)	17 (1.2)	MY-06407-95
3/4 (19.1)	1 (25.4)	1/8 (3.2)	14 (1.0)	MY-06407-96
3/4 (19.1)	1 1/8 (28.6)	3/16 (4.8)	20 (1.4)	MY-06407-97
1 (25.4)	1 1/4 (31.8)	1/8 (3.2)	12 (0.8)	MY-06407-98
1 (25.4)	1 1/2 (66.8)	1/4 (6.4)	20 (1.4)	MY-06407-99

### Microbore/Autoanalysis Tubing

Dimensions: in. (mm)			Fits needle gauge	Cat. no. 100-ft pk
ID	OD	Wall		
0.008 (0.19)	0.080 (2.03)	0.036 (0.91)	33	MY-06460-10
0.010 (0.25)	0.082 (2.08)	0.036 (0.91)	30	MY-06460-12
0.017 (0.44)	0.093 (2.36)	0.036 (0.91)	26	MY-06460-16
0.020 (0.51)	0.096 (2.44)	0.036 (0.91)	24	MY-06460-18
0.025 (0.64)	0.101 (2.57)	0.036 (0.91)	23	MY-06460-22
0.035 (0.89)	0.111 (2.82)	0.036 (0.91)	20	MY-06460-26
0.040 (1.02)	0.116 (2.95)	0.036 (0.91)	19	MY-06460-28
0.045 (1.14)	0.121 (3.07)	0.036 (0.91)	18	MY-06460-30
0.056 (1.42)	0.132 (3.35)	0.036 (0.91)	17	MY-06460-34
0.081 (2.06)	0.157 (3.99)	0.036 (0.91)	14	MY-06460-42
0.110 (2.79)	0.186 (4.72)	0.036 (0.91)	12	MY-06460-48

## Silastic® Laboratory Tubing

### Resists bacteria and fungus growth



**Applications:** Pharmaceutical, biotech, filtration, and environmental analysis.

**Characteristics:** Platinum-cured silicone, non-pyrogenic, bacteria and fungus-resistant, extremely low extractables, and does not impart a taste or odour.

**Certifications:** Exceeds USP Class VI Plastics Test requirements, elastomer and tubing are manufactured under Bulk Pharmaceutical cGMPs in an FDA-registered, ISO-9002-certified facility.

**Temperature range:** -54 to 249°C (-65 to 480°F)

**Sterilise:** Autoclave or radiation.

Dimensions: in. (mm)			Cat. no. 50-ft pk
ID	OD	Wall	
0.012 (0.3)	0.025 (0.6)	0.0065 (0.2)	MY-96115-00
0.02 (0.5)	0.037 (0.9)	0.0085 (0.22)	MY-96115-02
0.025 (0.6)	0.047 (1.2)	0.011 (0.3)	MY-96115-04
0.03 (0.8)	0.065 (1.7)	0.0175 (0.4)	MY-96115-06
0.04 (1)	0.085 (2.2)	0.0225 (0.6)	MY-96115-08
0.058 (1.5)	0.077 (2.0)	0.0095 (0.2)	MY-96115-10
0.062 (1.6)	0.095 (2.4)	0.0165 (0.4)	MY-96115-12
0.062 (1.6)	0.125 (3.2)	0.0315 (0.8)	MY-96115-14
0.078 (2)	0.125 (3.2)	0.0235 (0.6)	MY-96115-16
0.104 (2.6)	0.192 (4.9)	0.044 (1.1)	MY-96115-18
0.132 (3.4)	0.183 (4.6)	0.0255 (0.6)	MY-96115-20
1/8 (3.2)	1/4 (6.4)	1/16 (1.6)	MY-96115-22
3/16 (4.8)	5/16 (8.0)	1/16 (1.6)	MY-96115-16
3/16 (4.8)	3/8 (9.5)	3/32 (2.4)	MY-96115-26
1/4 (6.4)	3/8 (9.5)	1/16 (1.6)	MY-96115-28
1/4 (6.4)	7/16 (11.2)	3/32 (2.4)	MY-96115-30
1/4 (6.4)	1/2 (12.8)	1/8 (3.2)	MY-96115-32
5/16 (8.0)	1/2 (12.8)	3/32 (2.4)	MY-96115-34
3/8 (9.5)	5/8 (15.9)	3/8 (3.2)	MY-96115-40
1/2 (12.8)	3/4 (19.1)	1/8 (3.2)	MY-96115-44

## Dow Corning® Pharma-80 Tubing

### Economical alternative to reinforced tubing



**Characteristics:** 80 durometer, semi-transparent platinum-cured silicone tubing with a very low extractable profile; it contains no phthalates, plasticisers, latex or other organic additives. Pharma tubing is hydrophobic, and remains flexible and resilient for long service life. Dow Corning maintains complete traceability from silica to silicone tubing.

**Certifications:** Elastomer exceeds test guidelines for USP Class VI Plastics; tubing itself meets or exceeds FDA (21 CFR 177.2600), 3A Sanitary Standards, and European Pharmacopoeia (EP) requirements. Pharma tubing is produced under Bulk Pharmaceutical (BP) current GMP principals.

**Temperature range:** -51 to 238°C (-60 to 460°F)

**Sterilise:** Autoclave, ethylene oxide, or gamma irradiation.

Dimensions: in. (mm)			Max psi at 70°F (bar at 21°C)	Cat. no. 50-ft pk
ID	OD	Wall		
1/8 (3.2)	1/4 (6.4)	1/16 (1.6)	249 (17.2)	MY-96109-00
3/16 (4.8)	5/16 (8.0)	1/16 (1.6)	249 (17.2)	MY-96109-01
1/4 (6.4)	3/8 (9.6)	1/16 (1.6)	249 (17.2)	MY-96109-03
1/4 (6.4)	1/2 (12.8)	1/8 (3.2)	260 (17.9)	MY-96109-05
3/8 (9.6)	5/8 (16.0)	1/8 (3.2)	231 (15.9)	MY-96109-09

## Tygon® High-Purity Reinforced Tubing

### Keeps visual track of samples



**Formulation:** 2475 I.B.

**Applications:** Pharmaceutical and cosmetic processing, deionised water systems, cell harvest and media process systems, chemical transfer, preservative and sterile fill lines.

**Characteristics:** Plasticiser free, smooth inner surface (inhibits particulate build-up and bacterial growth), and non-toxic. Transparent.

**Certifications:** Resin is FDA-compliant (21 CFR 177.1550) and meets NSF criteria and European Pharmacopoeia.

**Temperature range:** -75 to 54°C (-103 to 130°F)

**Sterilise:** Ethylene oxide, gamma irradiation.

Dimensions: in. (mm)			Max psi at 73°F (bar at 23°C)	Qty/ pk	Catalogue number
ID	OD	Wall			
¼ (6.4)	½ (12.8)	⅛ (3.2)	150 (10.3)	50 ft	MY-95360-50
⅜ (9.6)	⅝ (16.0)	⅛ (3.2)	135 (9.3)	50 ft	MY-95360-51
½ (12.8)	¾ (19.1)	⅛ (3.2)	125 (8.6)	50 ft	MY-95360-52
⅝ (16.0)	⅞ (22.4)	⅛ (3.2)	120 (8.3)	50 ft	MY-95360-53
1 (25.4)	1⅝ (35.0)	⅜ (4.8)	112 (7.7)	25 ft	MY-95360-55

## Ratchet Tubing Clamps

Durable Celcon® plastic tubing clamps are autoclavable; won't rust, corrode, or distort. Twelve-position ratchet control adjusts from full flow to complete closure. Mini-clamp is suitable for up to 2.1 mm (⅛") OD tubing. Standard clamp accepts flexible tubing to 12.7 mm (½") OD.



06833-00

**MY-06833-01 Mini tubing clamp.** Pack of 25  
**MY-06833-00 Tubing clamp.** Pack of 25

## Tygon® Microbore Autoanalysis Tubing

### Clear to easily view sample

**Formulation:** ND-100-80

**Applications:** General laboratory and pharmaceutical use, especially with precision injection or dispensing applications. Also excellent with low-flow peristaltic pump applications.

**Characteristics:** Extremely flexible. Non-toxic; non-pyrogenic; biocompatible. Crystal clear.

**Certifications:** FDA-compliant. Resin meets USP Class VI requirements. Tubing is manufactured according to GMP.

**Temperature range:** -31 to 85°C (-25 to 185°F)

**Sterilise:** Autoclave, ethylene oxide, or gamma irradiation.



Dimensions: in. (mm)			Fits needle gauge	Cat. no. 100-ft pk
ID	OD	Wall		
0.010 (0.25)	0.030 (0.76)	0.010 (0.25)	30	MY-06419-00
0.020 (0.51)	0.060 (1.52)	0.020 (0.51)	25	MY-06419-01
0.030 (0.76)	0.090 (2.29)	0.030 (0.76)	20 to 21	MY-06419-03
0.040 (1.02)	0.070 (1.78)	0.015 (0.38)	18 to 19	MY-06419-04
0.050 (1.27)	0.090 (2.29)	0.020 (0.51)	17 to 18	MY-06419-05

**MY-06418-10 Tygon® microbore tubing assortment pack.** One 30.4-m (100-ft) roll of 06418-01, -02, -03, -04, and -05 (152.4-m [500-ft] total)

## Tygon® High-Purity Tubing

### Resists build-up and bacterial growth



**Formulation:** 2475

**Applications:** Sensitive fluid transfer applications requiring high purity.

**Characteristics:** Plasticiser free, smooth inner surface (inhibits particulate build-up and bacterial growth), safely dispose through incineration. Non-toxic. Transparent.

**Certifications:** Resin is FDA-compliant (21 CFR 177.1520) and meets USP 23 Class VI requirements. Tubing is manufactured according to GMP.

**Temperature range:** -70 to 52°C (-94 to 125°F)

**Sterilise:** Ethylene oxide or gamma irradiation.

Dimensions: in. (mm)			Max psi at 70°F (bar at 21°C)	Qty/ pk	Catalogue number
ID	OD	Wall			
⅛ (1.6)	⅜ (4.8)	⅛ (1.6)	49 (3.4)	50 ft	MY-95635-50
⅜ (3.2)	¼ (6.4)	⅛ (1.6)	27 (1.9)	50 ft	MY-95635-51
⅜ (4.8)	⅝ (8.0)	⅛ (1.6)	19 (1.3)	50 ft	MY-95635-52
¼ (6.4)	⅝ (9.6)	⅛ (1.6)	16 (1.1)	50 ft	MY-95635-53
⅝ (8.0)	⅞ (11.2)	⅛ (1.6)	13 (0.9)	50 ft	MY-95635-54
⅝ (9.6)	½ (12.8)	⅛ (1.6)	11 (0.8)	50 ft	MY-95635-55
½ (12.8)	¾ (19.1)	⅜ (3.2)	15 (1.0)	50 ft	MY-95635-56
⅝ (16.0)	⅞ (22.4)	⅜ (3.2)	13 (0.9)	50 ft	MY-95635-57
¾ (19.1)	1 (25.4)	⅜ (3.2)	11 (0.8)	50 ft	MY-95635-58
1 (25.4)	1⅝ (35.0)	⅜ (4.8)	11 (0.8)	25 ft	MY-95635-59

## Platinum-Cured Silicone Spools

### Cut tubing to your needs

Reduce unpacking time, save money on shipping, and ensure that you always have enough tubing on hand with bulk tubing.



Dimensions in. (mm)		Length per spool	Catalogue number
ID	OD		
½ (0.8)	¾ (2.4)	500 ft (152 m)	MY-98906-00
⅛ (1.6)	⅝ (3.2)		MY-98906-02
⅛ (3.2)	¼ (6.4)	300 ft (91 m)	MY-98906-04
⅜ (4.8)	⅝ (8.0)		MY-98906-06
¼ (6.4)	⅝ (9.6)		MY-98906-08
⅝ (9.6)	⅞ (16.0)		MY-98906-10
⅝ (16.0)	⅞ (22.4)		MY-98906-12

## Viton® Tubing

### Worry-free acid transfer



**Applications:** Acid and solvent transfer; high-temperature work.

**Characteristics:** Opaque black.

**Certifications:** Tubing is manufactured according to GMP.

**Temperature range:** -13 to 204°C (8 to 400°F)

**Sterilise:** Not recommended.

ISO9001:2008  
CERTIFIED SUPPLIER

Dimensions: in. (mm)			Max psi at 70°F (bar at 21°C)	Cat. no. 25-ft pk
ID	OD	Wall		
⅛ (1.6)	⅜ (3.2)	⅛ (0.8)	23 (1.6)	MY-06434-01
⅜ (3.2)	⅝ (4.8)	⅛ (0.8)	21 (1.4)	MY-06434-02
⅜ (4.8)	⅞ (6.4)	⅛ (0.8)	19 (1.3)	MY-06434-03
¼ (6.4)	⅞ (8.0)	⅛ (0.8)	17 (1.2)	MY-06434-04
⅝ (8.0)	⅞ (11.2)	⅛ (1.6)	20 (1.4)	MY-06434-05
⅝ (9.6)	½ (12.8)	⅛ (1.6)	18 (1.2)	MY-06434-06
½ (12.8)	⅞ (16.0)	⅛ (1.6)	16 (1.1)	MY-06434-07
⅝ (16.0)	⅞ (22.4)	⅜ (3.2)	17 (1.8)	MY-06434-08
¾ (19.1)	1 (25.4)	⅜ (3.2)	15 (1.0)	MY-06434-09



## Cole-Parmer® PFA Tubing

### Withstands highly corrosive materials



**Applications:** Demanding lab, chemical, electrical, mechanical, pharmaceutical, and automotive applications. For the transfer of high-temperature or highly corrosive materials. Also good for high-purity work.

**Characteristics:** Chemically inert, non-toxic, and virtually non-porous. Excellent crack- and stress-resistance. Low coefficient of friction. Translucent.

**Certifications:** Resin is FDA-compliant (21 CFR 177.1550). Tubing is manufactured in ISO 9001-2008 approved facility.

**Temperature range:** -195 to 260°C (-320 to 500°F)

**Sterilise:** Autoclave, ethylene oxide, or dry heat.



Dimensions: in. (mm)			Max psi at 70°F (bar at 21°C)	Cat. no. 25-ft pk
ID	OD	Wall		
1/32 (0.8)	1/16 (1.6)	1/64 (0.4)	600 (41.4)	MY-06371-00
1/16 (1.6)	1/8 (3.2)	1/32 (0.8)	592 (40.8)	MY-06375-01
3/32 (2.4)	5/32 (4.0)	1/32 (0.8)	471 (32.5)	MY-06371-01
1/8 (3.2)	3/16 (4.8)	1/32 (0.8)	385 (26.5)	MY-06371-02
1/8 (3.2)	1/4 (6.4)	1/16 (1.6)	600 (41.4)	MY-06371-21
5/32 (4.0)	1/4 (6.4)	3/64 (1.2)	421 (29.0)	MY-06375-02
3/16 (4.8)	1/4 (6.4)	1/32 (0.8)	280 (19.3)	MY-06371-03
3/16 (4.8)	5/16 (8.0)	1/16 (1.6)	471 (32.5)	MY-06371-22
1/4 (6.4)	5/16 (8.0)	1/32 (0.8)	220 (15.2)	MY-06371-04
1/4 (6.4)	3/8 (9.6)	1/16 (1.6)	388 (26.8)	MY-06375-05
19/64 (7.5)	3/8 (9.6)	3/128 (1.0)	229 (15.8)	MY-06371-23
5/16 (8.0)	3/8 (9.6)	1/32 (0.8)	180 (12.4)	MY-06371-05
5/16 (8.0)	7/16 (11.2)	1/16 (1.6)	324 (22.3)	MY-06371-24
3/8 (9.6)	1/2 (12.8)	1/16 (1.6)	283 (19.5)	MY-06375-07
25/64 (10.2)	1/2 (12.8)	1/20 (1.2)	220 (9.5)	MY-06371-25
7/16 (11.2)	1/2 (12.8)	1/32 (0.8)	133 (9.2)	MY-06371-07
1/2 (12.8)	3/8 (9.6)	1/16 (1.6)	220 (15.2)	MY-06371-26
5/8 (16.0)	3/4 (19.0)	1/16 (1.6)	150 (10.3)	MY-06375-08
11/16 (17.5)	3/4 (19.0)	1/32 (0.8)	87 (6.0)	MY-06371-28
3/4 (19.0)	7/8 (22.2)	1/16 (1.6)	153 (10.5)	MY-06371-29

## Cole-Parmer® PTFE Tubing

### Won't crack under heat or pressure



**Applications:** Demanding lab, chemical, electrical, mechanical, and pharmaceutical applications. High-purity work. Extreme temperatures.

**Characteristics:** Chemically inert, non-toxic, and virtually non-porous. Excellent crack- and stress-resistance. Low coefficient of friction. Translucent.

**Certifications:** Resin is FDA-compliant (21 CFR 177.1550).

**Temperature range:** -240 to 260°C (-400 to 500°F)

**Sterilise:** Autoclave, ethylene oxide, or dry heat.



Dimensions: in. (mm)			Max psi at 70°F (bar at 21°C)	Cat. no. 25-ft pk
ID	OD	Wall		
1/32 (0.8)	1/16 (1.6)	1/64 (0.4)	370 (25.5)	MY-06407-41
1/16 (1.6)	1/8 (3.2)	1/32 (0.8)	370 (25.5)	MY-06605-27
3/32 (2.4)	5/32 (4.0)	1/32 (0.8)	294 (20.3)	MY-06605-28
1/8 (3.2)	3/16 (4.8)	1/32 (0.8)	240 (16.5)	MY-06605-29
1/8 (3.2)	1/4 (6.4)	1/16 (1.6)	375 (25.9)	MY-06605-30
5/32 (4.0)	1/4 (6.4)	3/64 (1.2)	274 (18.9)	MY-06605-31
3/16 (4.8)	1/4 (6.4)	1/32 (0.8)	175 (12.1)	MY-06605-32
3/16 (4.8)	5/16 (8.0)	1/16 (1.6)	294 (20.3)	MY-06605-33
1/4 (6.4)	5/16 (8.0)	1/32 (0.8)	137 (9.4)	MY-06605-34
1/4 (6.4)	3/8 (9.6)	1/16 (1.6)	240 (16.5)	MY-06605-35
19/64 (7.5)	3/8 (9.6)	1/25 (1.0)	143 (9.9)	MY-06605-36
5/16 (8.0)	3/8 (9.6)	1/32 (0.8)	113 (7.8)	MY-06605-37
3/8 (9.6)	7/16 (11.2)	1/32 (0.8)	96 (6.6)	MY-06605-39
3/8 (9.6)	1/2 (12.8)	1/16 (1.6)	175 (12.1)	MY-06605-40
25/64 (10.2)	1/2 (12.8)	1/20 (1.2)	137 (9.4)	MY-06605-41
7/16 (11.2)	1/2 (12.8)	1/32 (0.8)	83 (5.7)	MY-06605-42
1/2 (12.8)	5/16 (14.3)	1/32 (0.8)	73 (5.0)	MY-06605-44
1/2 (12.8)	3/8 (9.6)	1/16 (1.6)	137 (9.4)	MY-06605-45
5/16 (8.0)	3/8 (9.6)	1/32 (0.8)	66 (4.6)	MY-06605-46
5/8 (16.0)	11/16 (17.5)	1/32 (0.8)	59 (4.1)	MY-06605-48
5/8 (16.0)	3/4 (19.2)	1/16 (1.6)	113 (7.8)	MY-06605-49
3/4 (19.2)	7/8 (22.2)	1/16 (1.6)	96 (6.6)	MY-06605-51

## Tygon® Ultra Chemical-Resistant Tubing

### Won't allow particulate build-up



**Formulation:** Tygon 2375

**Applications:** For use with highly aggressive chemicals—acids, bases, ketones, salts, and alcohols.

**Characteristics:** Plasticiser free, smoother inner surface (inhibits particulate build-up), hydrophobic, minimal outgassing, safe disposal via incineration, and non-toxic. Transparent.

**Certification:** FDA-(21 CFR 177.1550) and REACH-compliant. Meets NSF 51 Standard.

**Temperature range:** -78 to 54°C (-108 to 130°F)

**Sterilise:** Ethylene oxide or gamma irradiation.

Dimensions: in. (mm)			Max psi at 70°F (bar at 21°C)	Cat. no. 50-ft pk
ID	OD	Wall		
1/16 (1.6)	1/8 (3.2)	1/32 (0.8)	33 (2.8)	MY-95630-10
1/16 (1.6)	3/16 (4.8)	1/16 (1.6)	55 (3.8)	MY-95630-11
3/32 (2.4)	5/32 (4.0)	1/32 (0.8)	22 (1.5)	MY-95630-12
1/8 (3.2)	1/4 (6.4)	1/16 (1.6)	33 (2.8)	MY-95630-13
5/32 (4.0)	1/2 (12.8)	1/32 (0.8)	16 (1.1)	MY-95630-14
3/16 (4.8)	5/16 (8.0)	1/16 (1.6)	22 (1.5)	MY-95630-15
1/4 (6.4)	3/8 (9.6)	1/16 (1.6)	19 (1.3)	MY-95630-16
5/16 (8.0)	7/16 (11.2)	1/16 (1.6)	16 (1.1)	MY-95630-17
3/8 (9.6)	1/2 (12.8)	1/16 (1.6)	14 (1.0)	MY-95630-18
3/8 (9.6)	5/8 (16.0)	1/8 (3.2)	24 (1.6)	MY-95630-19
1/2 (12.8)	3/4 (19.1)	1/8 (3.2)	19 (1.3)	MY-95630-20
5/8 (16.0)	7/8 (22.4)	1/8 (3.2)	16 (1.1)	MY-95630-21
3/4 (19.1)	1 (25.4)	1/8 (3.2)	14 (1.1)	MY-95630-22
1 (25.4)	1 1/8 (35.0)	3/16 (4.8)	15 (1.0)	MY-95630-23

## Tygon® Non-DEHP Tubing

### Drains completely



**Formulation:** Tygon ND-100-65

**Characteristics:** Non-DEHP, phthalate free. Non-wetted surface permits complete drainage. Bondable, weldable. Clear.

**Certifications:** USP Class VI, REACH, ISO 10993

**Temperature range:** -42 to 74°C (-44 to 165°F)

**Sterilise:** Autoclave, ethylene oxide, or irradiation.

Dimensions: in. (mm)			Max psi at 73°F (bar at 23°C)	Cat. no. 50-ft pk
ID	OD	Wall		
1/32 (0.8)	3/32 (2.4)	1/32 (0.8)	100 (6.9)	MY-95666-00
1/16 (1.6)	1/8 (3.2)	1/32 (0.8)	55 (3.8)	MY-95666-01
3/32 (2.4)	5/32 (4.0)	1/32 (0.8)	40 (2.8)	MY-95666-03
3/32 (2.4)	7/32 (5.6)	1/16 (1.6)	70 (4.8)	MY-95666-04
1/8 (3.2)	3/16 (4.8)	1/32 (0.8)	30 (2.1)	MY-95666-05
1/8 (3.2)	1/4 (6.4)	1/16 (1.6)	55 (3.8)	MY-95666-06
5/32 (4.0)	7/32 (5.6)	1/32 (0.8)	25 (1.7)	MY-95666-07
3/32 (4.0)	9/32 (7.1)	1/16 (1.6)	45 (4.3)	MY-95666-08
3/16 (4.8)	1/4 (6.4)	1/32 (0.8)	20 (1.4)	MY-95666-09
3/16 (4.8)	5/16 (8.0)	1/16 (1.6)	40 (2.8)	MY-95666-10
3/16 (4.8)	3/8 (9.6)	3/32 (2.4)	55 (3.8)	MY-95666-11
1/4 (6.4)	3/8 (9.6)	1/16 (1.6)	30 (2.1)	MY-95666-14
1/4 (6.4)	7/16 (11.2)	3/32 (2.4)	45 (1.7)	MY-95666-15
1/4 (6.4)	1/2 (12.8)	1/8 (3.2)	55 (3.8)	MY-95666-16
3/8 (9.6)	5/16 (14.3)	3/32 (2.4)	30 (2.1)	MY-95666-21
3/8 (9.6)	5/8 (16.0)	1/8 (3.2)	40 (2.8)	MY-95666-22
1/2 (12.8)	11/16 (17.6)	3/32 (2.4)	25 (1.7)	MY-95666-27
1/2 (12.8)	3/4 (19.1)	1/8 (3.2)	30 (2.1)	MY-95666-28

## Cole-Parmer® PTFE Microbore Tubing

Minimise friction, maximise chemical resistance

Use this translucent tubing in extreme temperatures and in harsh chemical environments. It's chemically inert, has low permeability, and has the lowest friction coefficient of any tubing. Temperature range is -240 to 260°C (-400 to 500°F); melts at 327°C (620°F). Tensile strength is 2500 to 4000 psi. PTFE tubing resin is UL-recognised and complies with FDA (21 CFR 177.1550) and USP Class VI requirements.



Dimensions			Fits needle gauge	Cat. no. 100-ft pk
ID	OD	Wall		
<b>Ultramicrobore PTFE tubing</b> (finer than a human hair)				
0.002"	0.014"	0.006"	44	MY-06417-70
0.004"	0.016"	0.006"	38	MY-06417-72
0.006"	0.016"	0.005"	34	MY-06417-74
0.008"	0.016"	0.004"	33	MY-06417-76
<b>Microbore PTFE tubing</b>				
0.012"	0.030"	0.009"	30	MY-06417-11
0.022"	0.042"	0.010"	24	MY-06417-21
0.032"	0.056"	0.012"	21	MY-06417-31
0.042"	0.066"	0.012"	18	MY-06417-41
0.052"	0.076"	0.012"	16	MY-06417-51

**MY-06417-60 Microbore tubing assortment pack.** One 30.4-m (100-ft) roll each of 06417-11, -21, -31, -41, and -51 (152.4-m [500-ft] total)

## Cole-Parmer® Corrugated FEP Tubing

No kinks or distortion

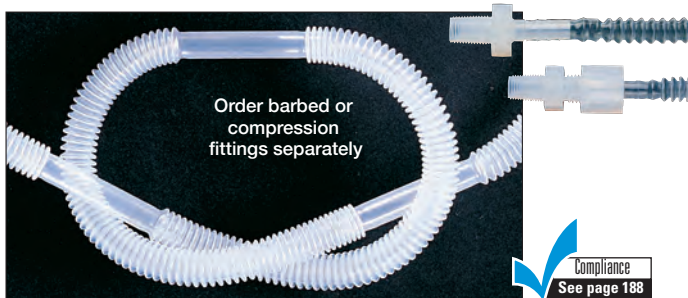

Order barbed or compression fittings separately

High flexibility and excellent chemical resistance. Corrugations prevent kinking and help tubing retain its shape without limiting pressure or vacuum abilities. Simply cut this custom-extruded tubing to desired length. Sold in 1.5-m lengths; each length has alternating sections of corrugated (254-cm L) and noncorrugated (50.8-mm L) tubing, with noncorrugated 25.4 mm L sections at both ends. Temperature range: -184 to 204°C (-300 to 400°F). Withstands 68.6 cm of Hg vacuum.



Cuff ID	Cuff OD	Wall	Max psi at 70°F (bar at 21°C)	Cat. no. 5-ft length
<b>Tubing compatible with barbed fittings</b>				
1/4"	9/32"	1/64"	250 (17.2)	MY-06407-50
3/8"	13/32"	1/32"	200 (13.8)	MY-06407-52
<b>Tubing compatible with compression fittings</b>				
7/32"	1/4"	1/64"	250 (17.2)	MY-06407-60
21/64"	3/8"	1/32"	200 (13.8)	MY-06407-62
29/64"	1/2"	1/32"	170 (11.7)	MY-06407-64
11/16"	3/4"	1/32"	120 (8.3)	MY-06407-66

## Cole-Parmer® FEP Tubing

Does not deteriorate with age



**Applications:** Demanding lab, chemical, electrical, mechanical, pharmaceutical, and automotive applications. Excellent for the transfer of extreme temperature or highly corrosive materials. Also good for high-purity work.

**Characteristics:** Chemically inert, non-toxic, heat resistant, with a low coefficient of friction. Doesn't deteriorate with age. Tough, but bends even at -270°C (-454°F). Translucent.

**Certifications:** Resin is FDA-compliant (21 CFR 177.1550). Tubing is manufactured in ISO 9001-2008 approved facility.

**Temperature range:** -270 to 204°C (-454 to 400°F)

**Sterilise:** Autoclave, ethylene oxide, or dry heat.



Dimensions: in. (mm)			Max psi at 70°F (bar at 21°C)	Cat. no. 25-ft pk
ID	OD	Wall		
1/32 (0.8)	1/16 (1.6)	1/64 (0.4)	500 (34.5)	MY-06406-60
1/16 (1.6)	1/8 (3.2)	1/32 (0.8)	444 (30.6)	MY-06406-62
3/32 (2.4)	5/32 (4.0)	1/32 (0.8)	353 (24.3)	MY-06406-63
1/8 (3.2)	3/16 (4.8)	1/32 (0.8)	289 (19.9)	MY-06406-64
1/8 (3.2)	1/4 (6.4)	1/16 (1.6)	450 (31.0)	MY-06450-05
5/32 (4.0)	1/4 (6.4)	3/64 (1.2)	329 (22.7)	MY-06450-04
3/16 (4.8)	1/4 (6.4)	1/32 (0.8)	209 (14.4)	MY-06406-66
3/16 (4.8)	5/16 (8.0)	1/16 (1.6)	353 (24.3)	MY-06450-06
1/4 (6.4)	5/16 (8.0)	1/32 (0.8)	150 (10.3)	MY-06406-72
1/4 (6.4)	3/8 (9.6)	1/16 (1.6)	288 (19.9)	MY-06450-07
19/64 (7.5)	3/8 (9.6)	5/128 (1.0)	172 (11.9)	MY-06450-02
5/16 (8.0)	3/8 (9.6)	1/32 (0.8)	140 (9.7)	MY-06406-74
5/16 (8.0)	7/16 (11.2)	1/16 (1.6)	243 (16.8)	MY-06450-08
3/8 (9.6)	7/16 (11.2)	1/32 (0.8)	110 (7.6)	MY-06406-12
3/8 (9.6)	1/2 (12.8)	1/16 (1.6)	210 (14.5)	MY-06450-09
7/16 (11.1)	1/2 (12.8)	1/32 (0.8)	102 (7.0)	MY-06406-76
7/16 (11.1)	9/16 (14.3)	1/16 (1.6)	185 (12.8)	MY-06450-14
1/2 (12.8)	9/16 (14.3)	1/32 (0.8)	88 (6.1)	MY-06406-18
1/2 (12.8)	5/8 (16.0)	1/16 (1.6)	165 (11.4)	MY-06450-15
5/8 (16.0)	11/16 (17.5)	1/32 (0.8)	71 (4.9)	MY-06450-00
5/8 (16.0)	3/4 (19.2)	1/16 (1.6)	135 (9.3)	MY-06450-17
11/16 (17.5)	3/4 (19.2)	1/32 (0.8)	65 (4.5)	MY-06450-01
3/4 (19.2)	7/8 (22.2)	1/16 (1.6)	115 (7.9)	MY-06450-19

## Tygon® FEP-Lined Tubing

Keep samples free of odours and taste



**Formulation:** Tygon SE-200

**Applications:** Chemical and pharmaceutical processing, beverage dispensing, paint and solvent production, semiconductor processing.

**Characteristics:** Bio-based, phthalate-free. Flexible, chemically resistant, inert, non-contaminating. Odourless, non-toxic, and taste free. Clear.

**Certifications:** FDA-compliant (21 CFR 177.1550) for contact food products.

**Temperature range:** -45 to 74°C (-49 to 165°F)

**Sterilise:** Ethylene oxide.

Dimensions: in. (mm)			Max psi at 73°F (bar at 23°C)	Cat. no. 50-ft pk
ID	OD	Wall		
1/16 (1.5)	1/8 (3.2)	1/32 (0.7)	100 (6.9)	MY-95713-50
1/8 (3.2)	1/4 (6.4)	1/16 (1.5)	85 (5.9)	MY-95713-00
3/16 (4.8)	5/16 (8.0)	1/16 (1.5)	75 (5.2)	MY-95713-10
1/4 (6.4)	3/8 (9.6)	1/16 (1.5)	55 (3.8)	MY-95713-20
3/8 (9.6)	5/8 (12.8)	3/32 (2.3)	50 (3.4)	MY-95713-30
1/2 (12.8)	3/4 (19.1)	1/8 (3.1)	45 (3.1)	MY-95713-41
3/4 (19.0)	1 (25.4)	1/8 (3.1)	30 (2.1)	MY-95713-60

# Your Complete Source for Fluid Handling Products



**Get Pumping:**  
>2300 Pumps



**See it Through:**  
>170 Tubing Formulations plus Custom Cut Sizes



**The Right Fit:**  
4500+ Fitting Options

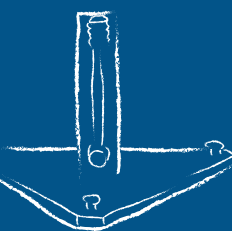

**In the Flow:**  
More than 3200 Flowmeter Options



**Pressure Relief:**  
Select from 3000+ Pressure Gauges



**Control your Flow:**  
More than 1000 Valves

**MORE ONLINE** ► [ColeParmer.com](http://ColeParmer.com)

## Tubing Accessories

### Handheld Tubing Cutter

Steel blade coated with PTFE resin produces clean, straight cuts through tubing up to 3.1-mm OD (cuts polyethylene tubing up to 3.8 mm OD). Order carrying pouch and replacement blade separately below.



**MY-06438-90 Handheld tubing cutter**  
**MY-06438-81 Tubing cutter pouch**  
**MY-06438-92 Replacement blade**

### Stainless Steel Hose Clamps

SS strap and screw housing with a steel screw. Band-type worm drive. Sold in pack of ten.



Clamp diameter		Catalogue number
Min	Max	
5.6 mm (7/32")	15.9 mm (5/8")	<b>MY-06403-11</b>
17.5 mm (11/16")	31.8 mm (1 1/4")	<b>MY-06403-12</b>
20.6 mm (13/16")	44.4 mm (1 3/4")	<b>MY-06403-13</b>
27 mm (1 1/16")	50.8 mm (2")	<b>MY-06403-14</b>
33.3 mm (1 5/16")	57.1 mm (2 1/4")	<b>MY-06403-15</b>
50.8 mm (2")	69.8 mm (2 3/4")	<b>MY-06403-16</b>
69.8 mm (2 3/4")	88.9 mm (3 1/2")	<b>MY-06403-21</b>
88.9 mm (3 1/2")	111.2 mm (4 3/8")	<b>MY-06403-22</b>
111.1 mm (4 3/8")	130.2 mm (5 1/8")	<b>MY-06403-23</b>
130.2 mm (5 1/8")	149.2 mm (5 7/8")	<b>MY-06403-24</b>
139.7 mm (5 1/2")	158.7 mm (6 1/4")	<b>MY-06403-25</b>

### Benchtop Tubing Cutter

Steel blade makes right-angle cuts in plastic tubing 1.5-mm to 15.8-mm OD.



**MY-06438-10 Benchtop cutter**  
**MY-06438-11 Replacement blade**

### Plastic Clamp Ties

Perfect for flexible fuel line, water line, and vacuum line applications. Special curved clamp tie head ensures a tight seal. Ties measure 203.2-mm L x 4.5-mm W; maximum diameter of 44.5-mm. Black resin resists UV degradation.

**MY-95615-00 Clamp ties, white.** Pack of 100  
**MY-95615-10 Clamp ties, black.** Pack of 100



### Cole-Parmer® Plastic Hose Clamps and Kits

Reusable white acetal copolymer clamps will not rust or corrode. Recommended for continuous use from ambient temperature to 93°C. Clamps are nonconducting and stable in a wide variety of chemicals.

Once set, clamps stay put. To use, just position clamp on hose or tubing bundle and press the jaws together with a pair of pliers. Order clamps individually or in a handy kit.



Inside diameter				Qty/pk	Catalogue number
Min	Max	Min	Max		
5.8 mm	6.5 mm	0.228"	0.256"	100	<b>MY-06832-01</b>
6.8 mm	7.4 mm	0.269"	0.291"	100	<b>MY-95614-00</b>
7.8 mm	8.7 mm	0.307"	0.342"	100	<b>MY-06832-03</b>
8.9 mm	10.0 mm	0.351"	0.394"	100	<b>MY-06832-02</b>
9.8 mm	11.2 mm	0.387"	0.440"	100	<b>MY-95614-01</b>
10.3 mm	11.5 mm	0.404"	0.452"	100	<b>MY-06832-04</b>
11.4 mm	13.0 mm	0.449"	0.511"	100	<b>MY-06832-06</b>
13.0 mm	14.9 mm	0.513"	0.586"	100	<b>MY-06832-08</b>
14.5 mm	16.5 mm	0.569"	0.650"	100	<b>MY-06832-10</b>
15.7 mm	18.0 mm	0.616"	0.707"	100	<b>MY-06832-12</b>
17.8 mm	20.4 mm	0.702"	0.801"	100	<b>MY-06832-14</b>
19.3 mm	21.5 mm	0.759"	0.848"	100	<b>MY-06832-16</b>
19.8 mm	22.8 mm	0.779"	0.899"	100	<b>MY-06832-18</b>
21.8 mm	25.1 mm	0.859"	0.989"	100	<b>MY-06832-20</b>
23.6 mm	27.2 mm	0.928"	1.072"	100	<b>MY-06832-22</b>
25.0 mm	28.8 mm	0.985"	1.135"	100	<b>MY-06832-24</b>
28.5 mm	32.9 mm	1.123"	1.296"	50	<b>MY-06832-28</b>
30.9 mm	35.7 mm	1.218"	1.405"	50	<b>MY-06832-32</b>

**MY-06832-99 White acetal copolymer hose-clamp kit** includes 170 assorted clamps from 5.8-mm to 35.7-mm ID.



# General-Purpose Tweezers and Forceps, Stainless Steel (SS) and Plastic

## Get a more precise grip

**SS Tweezers,** straight tips and finger serrations.



Length	Qty/pk	Catalogue number
17.8 cm	12	MY-07288-04

**SS Straight: Thick, Flat Strong Tips,** serrated tips and grips. Style OOD.



Length	Qty/pk	Catalogue number
12.1 cm	1	MY-07287-03

**SS Self-Locking Tweezers,** straight narrow tips.



Length	Qty/pk	Catalogue number
10.8 cm	12	MY-07288-01

**SS Tweezers,** smooth spade tips.



Length	Qty/pk	Catalogue number
10.8 cm	12	MY-07288-07

**SS Solder Utility Tweezers,** curved tips and finger serrations.



Length	Qty/pk	Catalogue number
17.8 cm	12	MY-07288-03

**SS Tweezers,** curved serrated tips.



Length	Qty/pk	Catalogue number
10.8 cm	12	MY-07288-05

**SS Forceps,** straight serrated tips.



Length	Qty/pk	Catalogue number
15.2 cm	1	MY-07288-12
30.5 cm	1	MY-07288-14

**SS Forceps,** plastic-coated rounded tips.



Length	Qty/pk	Catalogue number
30.5 cm	1	MY-07288-10

**PTFE-Covered Nickel-Plated Forged Steel Forceps** are heat and chemical resistant. **Autoclavable.**



Length	Qty/pk	Catalogue number
10.8 cm	2	MY-06440-00

**Reinforced Nylon Forceps** have corrugated handles, serrated blades, and rounded tips. **Autoclavable.** Sterile—individually wrapped.



Sterile	Length	Qty/pk	Catalogue number
No	12.4 cm	100	MY-06443-15
Yes	12.4 cm	100	MY-06443-26

**Nylon Forceps** feature corrugated handles and serrated blades. **Autoclavable.** Sterile—individually wrapped.

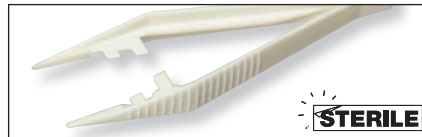

Sterile	Length	Qty/pk	Catalogue number
No	10.8 cm	100	MY-06443-25
Yes	10.8 cm	70	MY-06443-27

**PA (Polyamide) Tweezers,** rounded tips.



Length	Qty/pk	Catalogue number
17.8 cm	1	MY-06446-20

**Polystyrene Disposable Sterile Forceps** feature corrugated handles and rounded serrated tips. Sterile—come individually wrapped.

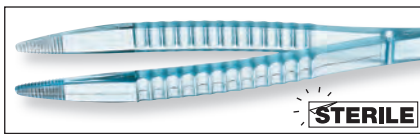

Length	Qty/pk	Catalogue number
12.4 cm	100	MY-06443-20

**Plastic Curved: Smooth Rounded Tips 2AB**



Length	Qty/pk	Catalogue number
11.4 cm	12	MY-07290-06

**Plastic Curved: Very Fine and Smooth Tips 7-STD**

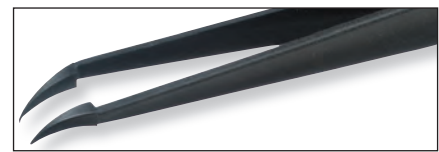

Length	Qty/pk	Catalogue number
11.4 cm	12	MY-07290-08

\*Quantity discount does not apply.

## Cole-Parmer® Ultrasonic Cleaners

### Quicker cleaning and degassing of samples

- High-frequency sound waves provide greater cleaning and reliability
- Gentle cleaning with 40 kHz sound waves won't damage delicate items
- Durable, leakproof design for worry-free cleaning

#### Basic Ultrasonic Cleaners

- Set timer and don't worry—control cleaning cycles up to 60 minutes
- Get better cleaning with optional heater models—heat to 69°C (156°F) with overtemperature protection

#### Advanced Ultrasonic Cleaners

- Easily control your precise applications—feature digital timer, power tracking, sleep, and degas mode
- Worry-free processes—set timer for up to 90 minutes, unit automatically compensates for heavier loads
- Get deeper cleaning with optional heater option



08895-43



Capacity (L)	Tank dimensions (L x W x H)	Power (50/60 Hz)	Basic cleaner with mechanical timer		Basic cleaner with mechanical timer and heater		Advanced cleaner with digital timer, power tracking, and degas		Advanced cleaner with digital timer, power tracking, high/low power, degas and heater	
			Amps	Catalogue number	Amps	Catalogue number	Amps	Catalogue number	Amps	Catalogue number
1.9 <sup>†</sup>	15.2 x 14 x 10.2 cm	230 VAC	0.4	MY-08895-29	0.7	MY-08895-31	0.4	MY-08895-33	0.7	MY-08895-35
2.8 <sup>†</sup>	24.1 x 14 x 10.2 cm	230 VAC	0.6	MY-08895-45	1.1	MY-08895-47	0.6	MY-08895-49	1.1	MY-08895-51
5.7 <sup>‡</sup>	29.2 x 15.2 x 15.2 cm	230 VAC	0.6	MY-08895-61	1.5	MY-08895-63	0.6	MY-08895-65	1.6	MY-08895-67
9.5 <sup>‡</sup>	29.2 x 24.1 x 15.2 cm	230 VAC	0.8	MY-08895-77	2.1	MY-08895-79	0.8	MY-08895-81	2.1	MY-08895-83
20.8 <sup>‡</sup>	49.5 x 27.9 x 15.2 cm	230 VAC	1.4	MY-08895-93	4	MY-08895-95	1.4	MY-08895-97	4	MY-08895-99

<sup>†</sup>The 1.9- and 2.8-L cleaners have a pour spout. <sup>‡</sup>The 5.7-, 9.5-, and 20.8-L cleaners have a built-in pour drain.

## Cole-Parmer® SS Ultrasonic Cleaners

### Stainless steel durability at a great price

- Multiple power settings handle both normal or delicate cleaning
- Degas mode for improved cleaning efficiency and easy sample prep
- Timed operation from 1 to 99 minutes or continuous
- Adjustable heating to 80°C (176°F) for deeper cleaning

Cole-Parmer Ultrasonic Cleaners are extremely effective at removing dirt and grime which would normally require tedious manual cleaning. The 40 kHz high-frequency ultrasonic wave vibrations create microscopic bubbles that implode violently causing the cavitation which creates an intense scrubbing action on the surface of the item being cleaned. The microscopic nature of the bubbles ensures that even the tiniest crevices will be cleaned thoroughly. These units can clean almost any nonporous item that can normally be immersed in water.

These stainless steel cleaners feature a bright LED display for time and temperature and easy push-button control. Sturdy rubber feet prevent movement while in use, handles allow easy portability, and the larger sizes (6-Litre and above) have external drains for easy replenishment of cleaning solutions.

**What's included:** lid, mesh basket, outlet filter, and power cord with plug.



Capacity (L)	Tank dimensions (L x W x H)	Overall dimensions (L x W x H)	Power (VAC, Hz)	Catalogue number
2	15 x 14 x 10 cm	19 x 17 x 22 cm	240, 50	MY-08895-03
3	24 x 14 x 10 cm	27 x 17 x 24 cm	240, 50	MY-08895-07
6	30 x 15.5 x 15 cm	33 x 18 x 31 cm	240, 50	MY-08895-11
9	30 x 24 x 15 cm	33 x 27 x 31 cm	240, 50	MY-08895-15
13	33 x 30 x 15 cm	36 x 33 x 31 cm	240, 50	MY-08895-19
20	50 x 30 x 15 cm	55 x 33 x 31 cm	240, 50	MY-08895-74
27	50 x 30 x 20 cm	55 x 33 x 36 cm	240, 50	MY-08895-78

# Cole-Parmer® Air Cadet® Vacuum/Pressure Pumps

## Get better results with minimal dead space

- Minimises dead space and air entrapment with unique cavity configuration
- No maintenance needed—motors are brushless with sealed ball bearings
- Worry-free pumping with reduced stress, wear, and heat buildup



### A–B. Single- and Dual-Head Pumps

- Handle tough applications easily
- Increase your capacity with dual-head model independently pumping or connected in series

**What's included:** PTFE thread tape and polyethylene 3/8" NPT(M) x 3/8" hose barb adapters.

### C. Vacuum/Pressure Stations

- Increase productivity—evacuate or pressurise two systems simultaneously with auxiliary port
- Get control with built-in bronze and brass gauge and stainless steel regulator

**What's included:** PTFE thread tape, two polyethylene 3/8" NPT(M) x 3/8" hose barb adapters, and one polyethylene 1/4" NPT(M) x 3/8" hose barb adapter (for auxiliary port).

### D. OEM Vacuum/Pressure Pumps

- Get long, reliable operation—continuous operation up to 18 psi for 4000 service hours
- Provides pumping with minimal stress and heat buildup

ISO9001:2008  
CERTIFIED SUPPLIER



Free-air capacity LPM (cfm)	Max vacuum " Hg (Torr)	Max pressure psi (bar)	Wetted parts	Noise rating	Port size	Power	Catalogue number
<b>A. Single-head pumps</b>							
13 (0.45)	20 (508)	18 (1.24)	Noryl® pump head, FKM diaphragm, PTFE valves, and polyethylene (PE) adapters	72 dB(A)	3/8" hose barb	230 VAC, 50 Hz	<b>MY-07532-45</b>
<b>B. Dual-head pumps</b>							
26 (0.91) <sup>†</sup>	20 (508)	18 (1.24)	Noryl pump head, FKM diaphragm, PTFE valves, and PE adapters	76 dB(A)	3/8" hose barb	230 VAC, 50 Hz	<b>MY-07532-65<sup>‡</sup></b>
<b>C. Vacuum/pressure stations</b>							
11.3 (0.4)	20 (508)	18 (1.24)	FKM diaphragm, SS regulator, bronze/brass gauge, and PE adapters	73 dB(A)	3/8" hose barb	230 VAC, 50 Hz	<b>MY-07532-85</b>
<b>D. OEM vacuum/pressure pumps</b>							
17 (0.6)	18 (457.2)	15 (1.03)	Noryl pump head, FKM diaphragm, PTFE valves, and PE adapters	72 dB(A)	3/8" NPT(F)	12 VDC	<b>MY-07532-25</b>

<sup>†</sup> Total free-air capacity. Single-channel capacity is half this value. <sup>‡</sup>Power switch not available on this model. **Note:** Do not use metal fittings with any Air Cadet pump.

### Accessories

**MY-07395-20 Vacuum/pressure gauge connector kit**, brass. Contains two PE adapters and one each of bushing, pipe tee, and adapter for pipe mount

**MY-07530-06 Service kit**. Contains long-life nitrile diaphragm, Noryl pump head, two PTFE valves, and two Noryl retainers

### Replacement Parts

**MY-07530-77 Pump head assembly**, Valox®. Includes valves and retainers. For continuous pressures greater than 14 psi

**MY-07530-71 Diaphragm clamp assembly**; includes diaphragm clamp and shaft, and eccentric assembly

**MY-07530-79 Diaphragm shaft**

**MY-07530-75 Eccentric assembly**

**MY-08270-33 Thread sealer tape** of PTFE resin.

Each roll measures 660 cm L x 1.27 cm W. Pack of 10 rolls



# Standard-Duty Dry Vacuum Piston Pumps

## Great for filtering, aspirating, degassing, and desiccating

- Oil free for life science applications
- Water trap prevents liquid from being drawn into the pump
- Muffler provides quiet operation

Use the convenient gauge and control knob to adjust vacuum level. Single-head models also provide pressure. Avoid using pump with organic, acidic, or basic vapors.

**What's included:** gauge, control knob, water trap, carrying handle, suction cup feet, on/off switch, two 1/4" barbed fittings, and a 1.8-m (6-ft) cord with a European (Schuko) plug.

**Service kits include** all components commonly required for refurbishment.



79204-05



79204-75

These dry vacuum piston pumps work great when paired with vacuum-rated ovens for anaerobic incubation.



Free-air capacity L/min (cfm)	Ultimate <sup>†</sup> vacuum	Maximum pressure	Wetted parts	Motor hp	Noise rating	Port size (tube ID)	Power (VAC, Hz)	Catalogue number	Service kits
									Catalogue number
<b>Single-head pumps</b>									
19 (0.67)	26.0" Hg (100 Torr)	6.89 bar (100 psig)	Aluminum (treated for corrosion resistance), SS, and PTFE	1/8	62 dB(A)	1/4"	230,50	MY-79204-05	MY-79204-01
28 (0.99)	27.2" Hg (70 Torr)	3.45 bar (50 psig)		1/8		1/4"	230,50	MY-79204-15	MY-79204-11
38 (1.34)	27.6" Hg (60 Torr)	6.89 bar (100 psig)		1/4		1/4"	230,50	MY-79204-25	MY-79204-21
<b>Dual-head pumps</b>									
50 (1.8)	29.8" Hg (5 Torr)	—	Aluminum (treated for corrosion resistance), SS, and PTFE	1/3	58 dB(A)	3/8"	230,50	MY-79204-35	MY-79204-31
168 (5.9)	27.6" Hg (60 Torr)	—		1/3		3/8"	230,50	MY-79204-75	—

<sup>†</sup>Ultimate total vacuum

MY-06414-20 Tygon® non-DEHP vacuum tubing, 1/4" ID x 5/8" OD. Pack of 3.0 m (10 ft)

# High-Capacity Vacuum/Pressure Pumps

## Won't get overloaded

- Shaded-pole fan-cooled motor has thermal overload switch to protect your pump system
- Heads on pump 07061-05 are connected in parallel for higher capacity; heads on 07061-13 are connected in series for greater vacuum
- Select pumps with or without gauges, regulators, and valves
- Free-air capacities up to 2.2 cfm (62.3-L/min)

**What's included:** 1.8-m (6-ft), three-wire cord. Model 07061-13 includes a filter/muffler.



07061-42

ISO9001:2008  
CERTIFIED SUPPLIER



Pump head configuration	Free-air capacity L/min (cfm)	Max vacuum	Max pressure	Wetted parts	Motor hp	Port size	Noise rating	Power (VAC, Hz)	Catalogue number
<b>Pump without gauges or regulators</b> (order regulators separately below; order gauges with 1/4" NPT(M) connections online)									
Single	28.3 (1.0)	24.0" Hg	4.14 bar (60 psi)	Aluminum, stainless steel, Nordel®, and Nomex®	1/8	1/4" NPT(F), 3/8" hose barb on gauges	68 dB(A)	220/240, 50	MY-07061-22
<b>Pumps with gauges, regulators, and adjustable relief valve</b>									
Single	28.3 (1.0)	24.0" Hg	4.14 bar (60 psi)	Aluminum, stainless steel, Nordel, and Nomex	1/8	1/4" NPT(F), 3/8" hose barb on gauges	68 dB(A)	220/240, 50	MY-07061-42
Dual/parallel	51.0 (1.8)	24.0" Hg	4.14 bar (60 psi)		1/4			220, 50	MY-07061-05
<b>Pump with vacuum gauge only</b>									
Dual/series	24.0 (0.85)	28.0" Hg	—	Aluminum, stainless steel, Nordel, and Nomex	1/4	1/4" NPT(F), 3/8" hose barb on gauges	68 dB(A)	220, 50	MY-07061-13

MY-07061-32 Pressure regulator assembly for pump 07061-22

MY-07061-30 Vacuum regulator assembly for pump 07061-22

MY-07061-01 Service kit for all pumps

MY-07061-03 Service kit for dual-head pumps. Pumps 07061-05 and -13 also require kit 07061-01

MY-07061-06 Diaphragm for all models, neoprene/nylon

MY-07061-04 Replacement diaphragm for all models, Nordel/Nomex

## Cole-Parmer® Two- and Three-Way Direct Lift Solenoid Valves

Ideal with high-purity or corrosive fluids—made of inert PTFE

- Minimise trapped liquids with minimal dead volume
- Mount almost anywhere—lightweight and compact

Models with a 1/16" orifice have mounting holes at the bottom only and models with a 5/32" orifice have mounting holes at the top and bottom. Optional mounting clip 01540-50 can be used to mount valves with a 1/16" orifice in any position.

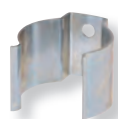

Mounting clip  
01540-50



Mounting flange  
01540-55



### Specifications

**Vacuum rating:** 26" Hg    **Maximum fluid temperature:** 70°C (158°F)    **Lead wire length:** 38 cm (15")

Ports NPT(F)	Orifice	Max psi	Response time	Watts	12 VDC		24 VDC	
					Catalogue number	Catalogue number	Catalogue number	Catalogue number
<b>Two-way solenoid valves; normally closed</b>								
1/4-28	1/16"	30	20 ms	4.0	MY-01540-01		MY-01540-02	
1/4-28	1/16"	60	25 ms	8.0	MY-01540-03		MY-01540-04	
1/8	5/32"	18	30 ms	8.0	MY-01540-07		MY-01540-08	
<b>Two-way solenoid valves; normally open</b>								
1/4-28	1/16"	30	20 ms	4.0	MY-01540-09		MY-01540-10	
<b>Three-way solenoid valves</b>								
1/4-28	1/16"	30	20 ms	4.0	MY-01540-11		MY-01540-12	
1/4-28	1/16"	60	25 ms	8.0	MY-01540-13		MY-01540-14	
1/8	5/32"	18	30 ms	8.0	MY-01540-17		MY-01540-18	

MY-01540-50 Mounting clip for two- and three-way valves

MY-01540-55 Mounting flange for two- and three-way valves

## Miniature Check Valves

Install in any position—  
use with liquids and gases



Breaking pressure is 0.18 psi, closing pressure is 0.014 psi. Maximum temperature (at maximum psi) is 121°C (250°F) for "A" and "C"; 93°C (200°F) for "B."

**Note:** Valves require 1 psi back pressure for a tight seal.

Tubing ID	C <sub>v</sub>	Working pressure	Catalogue number
<b>A. Nylon body and fluorosilicone diaphragm</b>			
1/8"	0.12	0.2 to 0.3 bar (3 to 5 psi)	MY-98553-00
3/16"	0.13		MY-98553-01
1/4"	0.13		MY-98553-02
<b>B. PP body and Viton® diaphragm</b>			
1/8"	0.11	0.2 to 0.3 bar (3 to 5 psi)	MY-98553-10
3/16"	0.12		MY-98553-11
1/4"	0.12		MY-98553-12
5/16"	0.13		MY-98553-13
<b>C. PVDF body and Viton diaphragm</b>			
3/16"	0.12	0.2 to 0.3 bar (3 to 5 psi)	MY-98553-21
1/4"	0.12		MY-98553-22
3/8"	0.12		MY-98553-34

## Cole-Parmer® Solenoid-Operated 2- and 3-Way Pinch Valves

No contamination of valve

- Control flow in your tubing without direct contact between the fluid and the valve
- Fast response time
- Low-power consumption and high-cycle life
- Excellent for sanitary and pharmaceutical applications



**What's included:** 38 cm 26-gauge PTFE-coated lead wires. Two-way valves include a 30.5 length of silicone tubing; three-way valves include two 15.2 cm (6") lengths of tubing with a "Y" connector.



Tubing size (ID x OD)	Max pressure	Watts	12 VDC		24 VDC	
			Cat. no.	Cat. no.	Cat. no.	Cat. no.
<b>Two-way pinch valves; normally closed</b>						
1/32" x 3/32"	1 bar (15 psi)	2.6	MY-98302-00		MY-98302-10	
1/16" x 1/8"	1 bar (15 psi)	2.6	MY-98302-02		MY-98302-12	
1/8" x 1/4"	1.4 bar (20 psi)	4.0	MY-98302-06		MY-98302-16	
<b>Two-way pinch valves; normally open</b>						
1/32" x 3/32"	1 bar (15 psi)	2.6	MY-98302-20		MY-98302-30	
1/16" x 1/8"	1 bar (15 psi)	2.6	MY-98302-22		MY-98302-32	
1/8" x 1/4"	1.4 bar (20 psi)	4.0	MY-98302-26		MY-98302-36	
<b>Three-way pinch valves; one normally open, one normally closed</b>						
1/32" x 3/32"	1 bar (15 psi)	2.6	MY-98302-40		MY-98302-48	
1/16" x 1/8"	1 bar (15 psi)	2.6	MY-98302-42		MY-98302-50	
1/8" x 1/4"	1.4 bar (20 psi)	4.0	MY-98302-46		MY-98302-54	

MY-01540-50 Mounting clip for 2- and 3-way valves

MY-01540-55 Mounting flange for 2- and 3-way valves

## Cole-Parmer® Rotational Viscometers

### Include 316 stainless steel spindles for most applications!

- Select from ten language options
- Ensure accurate readings by calibrating your viscometer to a known standard

Determine the dynamic viscosity of samples in applications such as food (sauces, juices, and syrups), adhesives, petroleum products, biofuels, paints, pharmaceuticals, chemicals, and more! Over/under range alarm sounds when your sample is too high/low for the spindle selected. All models feature ten language options (English, French, German, Italian, Japanese, Spanish, Portuguese, Dutch, Polish, and Catalan), push-button control with easy-to-use menu system, motor self-test, user calibration to a known standard, and universal power supply.

**Basic Viscometers** are an economical choice for fast, accurate viscosity readings. Feature a four-line display that shows selected speed, selected spindle, viscosity, and % of full scale.

**Basic Viscometers with USB Output** include software to download data through the USB output to your PC for analysis. Store up to ten user programs for repeated tests. Display selected speed, selected spindle, viscosity, % torque, shear rate, and shear stress on the five-line display. Enter the sample density, and the unit calculates and displays kinematic viscosity (cSt) as well.

**Advanced Viscometers with Temperature Probe** have three times the speed selections and double the speed range of the basic models. Monitor and display temperature with the included RTD temperature probe. Program features include time to torque, time to stop, ramp, and multistep.

**Programmable Viscometers** feature 2600 speed selections and the highest speed range, up to 250 rpm. Monitor and display temperature with the included RTD temperature probe. Control the viscometer through a PC using the included software; also includes curves, graphs, and database references.

**Optional low viscosity adapters** allow measurement down to 1 cp when used with low range viscometers and 3.2 cp when used with medium range viscometers. Model 98965-54 includes a water jacket for attachments to an external circulating bath (not included).

**What's included:** 316 stainless steel spindles (four spindles for the low range and six for the other ranges), spindle protector, stand, carrying case, and universal power supply. Models 98965-43 through -48 also include data logging software; USB cable. Models 98965-49 through -51 also include control software, data logging software, and USB cable.



Cole-Parmer®

#### Specifications

**Accuracy:** ±1% full-scale

**Resolution**

<10,000 cp: 0.1 cp

≥10,000 cp: 1 cp

**Reproducibility:** ±0.2%

**Temperature probe (indicated models):**

100 Ω Pt RTD; 0 to 100°C (32 to 212°F)

**Power:** 100 to 240 VAC, 50/60 Hz

Viscosity range	Rotational speed range	Number of selectable speeds	Output	Catalogue number
<b>Basic viscometers</b>				
20 to 2,000,000 cp (low)	0.3 to 100 rpm	18	None	MY-98965-40
100 to 13,000,000 cp (medium)				MY-98965-41
200 to 106,000,000 cp (high)				MY-98965-42
<b>Basic viscometers with data logging software and USB cable</b>				
20 to 2,000,000 cp (low)	0.3 to 100 rpm	18	USB	MY-98965-43
100 to 13,000,000 cp (medium)				MY-98965-44
200 to 106,000,000 cp (high)				MY-98965-45
<b>Advanced viscometers with temperature probe, data logging software, and USB cable</b>				
20 to 6,000,000 cp (low)	0.01 to 200 rpm	54	USB	MY-98965-46
100 to 40,000,000 cp (medium)				MY-98965-47
200 to 106,000,000 cp (high)				MY-98965-48
<b>Programmable viscometers with temperature probe, control software, data logging software, and USB cable</b>				
20 to 6,000,000 cp (low)	0.01 to 250 rpm	2600	USB	MY-98965-49
100 to 40,000,000 cp (medium)				MY-98965-50
200 to 106,000,000 cp (high)				MY-98965-51

#### Accessories

MY-98965-54 Low-viscosity adapter with water jacket

MY-98965-55 Low-viscosity adapter

MY-17107-01 ILAC MRA, NIST-traceable calibration with data for viscometers



## Viscosity Cups

Get precise measurements affordably

- Stainless steel cup and handle
- Orifice is machined to ensure the length of the orifice and a symmetrical efflux stream
- Cups conform to ASTM 816, D1084, and D4212
- $\pm 3\%$  production tolerance

To take a measurement, simply scoop the test liquid into the cup; the liquid will stream out of the opening on the bottom. Measure the time until the first break in the flow of liquid. A conversion table supplied with each cup will tell you viscosity in centistokes from the elapsed time.



## Thermo Scientific™ HAAKE™ Portable Viscometers

No clumsy cords—battery powered for quick tests anywhere

- No more difficult setup—simple, one-button operation for quicker testing
- Get more accurate readings with digital display

Lightweight, digital, rotational viscometers can be operated handheld or on optional stand for your convenience. Use for quick viscosity tests for process optimisation, machine adjustment, or to ensure your product is within specification. Possible handling errors as well as service information are shown on the display.

**What's included:** Three rotors, sample cup(s), carrying case, and four AA batteries.



Model	Cup number	Range	Catalogue number
EZ1	1	10 to 36 cSt	MY-08700-00
EZ2	2	19 to 156 cSt	MY-08700-10
EZ3	3	64 to 596 cSt	MY-08700-20
EZ4	4	79 to 784 cSt	MY-08700-30
EZ5	5	161 to 1401 cSt	MY-08700-40

Go online for our full selection of viscometers, accessories, and viscosity standards.

Model number	VT01	VT02
<b>Catalogue number</b>	<b>MY-08705-01</b>	<b>MY-08705-02</b>
Range	1.5 to 330 cP	30 to 400,000 cP
Temperature	Up to 150°C (302°F)	
Rotor speed	62.5 rpm	
Reproducibility	$\pm 1\%$ full scale	
Accuracy	$\pm 5\%$ full scale	
Power	Four AA batteries (included)	

### Accessories

MY-04546-00 Stand, 73.7 cm H x 1.6 cm dia

MY-09376-01 Replacement batteries, AA. Pack of four

## Consistometer

Verify consistency, viscosity, and flow rate of viscous material

- Meets military specification R-81294B for paint manufacturing

Use this consistometer to determine the consistency of viscous materials by measuring the distance that the material flows under its own weight in a given time interval. Ideal for predetermining product formulas to standardise production lots.

Consistometer requires only 75-mL of sample for measurement. Engraved graduations in 0.5-cm divisions ensure accurate results; spring-loaded gate prevents premature sample flow. Leveling screws and built-in spirit level help achieve repeatable results. Stainless steel construction prevents corrosion.



Sample size	Graduations	Dimensions (L x W x H)	Catalogue number
75 mL	0.5 cm	35.6 x 8.9 x 14.0 cm (14" x 3½" x 5½")	MY-59950-00

## Techne® Gelation Timers

Maintain stricter quality control

- Ideal for adhesives and resins
- Requires only 100 mL of sample
- Audible and visual alarms confirm transition from liquid to solid

**What's included:** stainless steel paddle and power cord with stripped ends. Stand and clamp are sold separately.



Timing range	Resolution	Accuracy	Power		Catalogue number
			VAC	Hz	
0.1 to 999.9 minutes	0.1 minute	$\pm 2\%$	230	50	MY-98930-41
1 to 9999 minutes	1 minute	$\pm 2\%$	230	50	MY-98930-43

### Accessories

MY-98930-47 Sample cups. Pack of 240

MY-04546-00 Stand, 73.7 cm H x 1.6 cm dia

MY-04340-50 Clamp

MY-98930-44 Replacement stainless steel plunger, 22 mm

## Stuart® Aquatron® Automatic Water Stills

### Produces cold distilled water for immediate use

- Provides highest purity from virtually any raw water supply
- Reservoir water level sensor turns still off when reservoir is full
- Simple conversion to pretreated feed
- Safety features allow for unattended operation

The Aquatron cabinet-style water stills are available in either single or double distilled water models—choose the double distilled model for higher purity levels. The stills, constructed of borosilicate glassware coupled with silica-sheathed heaters enclosed in a protective cabinet, deliver pyrogen-free distillate of the highest purity from virtually any raw water supply. The condenser is designed to make sure droplets of distilled water remain in contact with the cooling coil for an extended period ensuring maximum energy transfer and production of cold distilled water for immediate use.

All-glass construction allows for rapid descaling using strong mineral acids. The units can be safely and easily cleaned without dismantling the glassware. A large bore stopcock with PTFE key is fitted for easy draining of chemicals after cleaning. Safety features include flow sensor, overtemperature thermostat, acrylic screen, cabinet lid, and screw threads on all water connections.

In addition, a reservoir water level sensor automatically switches off the heaters and coolant water supply when the reservoir is filled with distilled water. It automatically restarts the still when the distilled water level drops in the reservoir.

**What's included:** wall-mounting bracket (for single distilled models only), reservoir water level sensor, hose kit, funnel, and power cord with stripped ends.



99294-05



Description	Capacity	Resistivity	Cooling water	Water pressure	Dimensions (W x H x D)	Power (VAC, Hz)	Watts	Catalogue number
Single distilled	4 L/hr	0.5 to 1.0 MΩ-cm	60 L/hr consumption	3 to 100 psi (20 to 700 kPa)	55 x 41 x 24 cm	240, 50/60	3 W	MY-99294-05
	8 L/hr		120 L/hr consumption			240, 50/60	6 W	MY-99294-25
Double distilled	4 L/hr	0.7 to 1.0 MΩ-cm	120 L/hr consumption		55 x 41 x 41 cm	240, 50/60	6 W	MY-99294-15

#### Accessories

MY-99967-85 Reservoir assembly, 20-L capacity

MY-99294-99 Stand for reservoir assembly

## Stuart® Merit Economy Water Still

### Save money while maintaining high performance

- Two independent thermostats prevent overheating
- Features a sturdy metal stand for either wall or bench mounting
- Operate directly from tap water

This basic economical water still is perfect for general laboratory and educational distillations. Boiler and high-efficiency condenser are both constructed of borosilicate glass to ensure the highest in distillate purity. Long-life chromium-plated metal heater is protected by twin safety thermostats. Condenser features screw thread connections and plastic 3/8" ID hose barb fittings to quickly and safely change tubing without worrying about breaking the glassware.

Built-in acid addition funnel and wastewater drain stopcock located below the level of the still allow for easy descaling without dismantling the glassware.

**What's included:** support stand with two boiler straps, hose kit, gasket kit, and power cord with stripped ends.



99295-06



Description	Capacity	Resistivity	Cooling water	Water pressure	Dimensions (W x H x D)	Power (VAC, Hz)	Watts	Catalogue number
Single distilled	4 L/hr	0.25 to 0.3 MΩ-cm	60 L/hr consumption	3 to 100 psi (20 to 700 kPa)	50 x 45 x 15 cm	220, 50/60	3 kW	MY-99295-06
						240, 50/60	3 kW	MY-99293-00

# Cole-Parmer® Ion-X-Changer Filter Cartridges

## Customise to your exact needs

- Design your system with any combination of up to four different cartridges
- Purify water up to 15 MΩ-cm
- Know when to change cartridges—resins go from purple to brown when replacement is needed†
- Use mounting brackets for installation

**Mounting Bracket Kit** comes with two mounting brackets, faucet diverter assembly with 1.2 m (4 ft) of ¼" OD white vinyl tubing, and 3.6 m (12 ft) of ¼" OD polyethylene connection/dispensing tubing. Use one bracket for single cartridge installation or two for tandem cartridge installation.



### Specifications

**Pressure drop per cartridge:** 0.3 bar (5 psi)  
**Maximum working temperature:** 23.9°C (75°F)

**Cartridge dimensions (L x dia):**  
 17.6 x 8.3 cm (18¾" x 3¼")

Cartridge type	Application	Max flow rate	Inlet pressure		Max inlet water temp	Capacity grains as CaCO <sub>3</sub>	Catalogue number
			Max	Min			
Adsorber	Pretreatment: removes most organic compounds, free chlorine, and chloramines	27.3 L/hr (7.2 GPH)	6.9 bar (100 psi)	0.3 bar (5 psi)	37.8°C (100°F)	—	<b>MY-01506-15</b>
Metex	Removes most metallic ions, ammonia, other cations; recovers precious metals					3200	<b>MY-01506-45</b>
Universal	Produces water equivalent to single-distilled water					1600	<b>MY-01506-25</b>
Research	Produces water ionically equivalent to triple-distilled water					1000	<b>MY-01506-35</b>

†Except for Adsorber cartridge 01506-15, which needs to be replaced when approximately 5600 litres (1500 gallons) of water have flowed through the cartridge.

**MY-01506-60 Mounting bracket kit**

## Monobed Deionisers

### Remove harmful ions in your system

- Visually monitor water quality

**Deioniser with Large-Capacity Housing** incorporates an ultrapure mixed bed ion exchange resin which contains a 1:1 chemical equivalent of cation and anion resins with a maximum capacity of 1400 grains as CaCO<sub>3</sub>.

A built-in monitor turns red if the resistivity falls below 0.2 MΩ-cm. Order the resin refill to replace the exhausted resin quickly during a momentary shutdown of the system. For a faster, more convenient resin replacement, use the ultrapure resin cartridge below (capacity when used with cartridge is 1050 grains as CaCO<sub>3</sub>). The resin for both the refill and cartridge is an FDA-grade ultra-clean resin designed for ultrapure water systems.

**What's included:** mounting bracket and two polypropylene elbows (¾" NPT(M) x ⅝" hose barb) that accept ⅝" ID tubing.



Deioniser 01503-00

**Deioniser with Clear Housing** lets you see when the resin is exhausted. The deioniser is loaded with a mixed bed resin (1:1 equivalent) with a maximum capacity of 700 grains as CaCO<sub>3</sub>. The resin is specially treated to yield a gradual colour change from dark blue to amber to indicate the level of exhaustion (spending). Change the resin when all but 2.5 cm (1") of resin is amber. Replace exhausted resin quickly during a momentary shutdown of the water system. Order resin separately below (deioniser requires up to two resin refills).

**What's included:** mounting bracket and two polypropylene elbows (¾" NPT(M) x ⅝" hose barb) that accept ⅝" ID tubing.



Deioniser 01503-20 shown with resin 01503-30

Max resistivity	Max flow rate	Min/max inlet pressure	Inlet water temperature	Inlet connections	Dimensions (H x Dia)	Capacity grains CaCO <sub>3</sub>	Power (VAC)	Catalogue number
<b>Large-capacity monobed deionisers</b>								
18 MΩ-cm	227 L/hr (60 GPH)	8.6 bar (125 psi)	38°C (100°F)	¾" NPT(F)	59 x 17.8 cm (23¼" x 7")	1050	220	<b>MY-01503-05</b>
<b>Monobed deioniser with clear housings</b>								
15 MΩ-cm	57 L/hr (15 GPH)	8.6 bar (125 psi)	32°C (90°F)	¾" NPT(F)	32.1 x 13.3 cm (12⅝" x 5¼")	700	—	<b>MY-01503-20</b>

**MY-01503-10 Resin refill**, ultrapure mixed bed, for model 01503-05

**MY-01503-30 Resin refill**, mixed bed, for model 01503-20, with colour indicator

**MY-01503-12 Ultrapure resin cartridge**, for model 01503-05



## Masterflex® E/S® Portable Sampling Pumps

### E/S Portable Sampling Drive

- Flow rate: 4.2 to 1100-mL/min; depends on tubing size
- Sample depths down to 7.9-m (26-ft)†. Simple to use in wells, sewers, or lakes. Reversible flow and prime/purge function
- Variable-speed portable sampling drive operates on internal battery, your 12 V car battery, or from an AC outlet



Portable sampling drive shown with Easy-Load® pump head (sold separately below).

Accepts three pump head types: Standard, Easy-Load®, and PTFE-tubing (pump heads sold separately).

### E/S Composite Sampler

- Program to meet EPA requirements—sample size and time, delayed start, remote contact closure, momentary and maintained sampling
- Flow rate is 435 to 1650-mL/min depending on tubing size, lift height
- Includes Masterflex Easy-Load pump head, 9-litre HDPE carboy, 12 VDC rechargeable battery, 115/230 VAC power converter and 7.6-m (25-ft) of L/S® 24 peroxide-cured silicone tubing
- Rechargeable battery for field applications



Composite sampler



Power supplies are:



rpm	Nominal voltage	IP rating	Dimensions (L x W x H)	Power† VAC (50/60 Hz)	Catalogue number
<b>E/S portable sampling drive</b>					
70 to 400	12 VDC or AC line	IP54	28 x 25.4 x 40.6 cm	12 VDC or 115	<b>MY-07571-00</b>
				12 VDC or 230	<b>MY-07571-05</b>
<b>E/S composite sampler</b>					
600	12 VDC or AC line	IP56	28 x 34 x 44 cm	12 VDC or 115/230	<b>MY-07580-00</b>

†Maximum sampling depth can be achieved with L/S® 15 or L/S® 24 Standard pump head  
 ‡Drives run from 12 VDC internal rechargeable batteries, external 12 VDC source (order automotive adapter separately below), or from VAC line source.

**MY-07514-12 Easy-Load pump head**, for use with L/S sizes 15 and 24 tubing

**MY-07015-20 Standard pump head**, for use with L/S size 15

**MY-07024-20 Standard pump head**, for use with L/S size 24

**MY-07571-50 Automotive power adapter**, 7.6 m (25-ft) cable

**MY-77390-00 PTFE tubing pump head**, optional

**MY-77390-50 PTFE tubing set**. 2-mm ID, 4-mm OD. Set of 2

**MY-77390-60 PTFE tubing set**. 4-mm ID, 6-mm OD. Set of 2

### Masterflex High-Performance Precision Pump Tubing

Tubing type	Tubing	Qty/pk	Catalogue number
Silicone (peroxide-cured)	L/S 15	7.6 m (25 ft)	<b>MY-96400-15</b>
	L/S 24		<b>MY-96400-24</b>
Tygon® E-Lab	L/S 15	15.2 m (50 ft)	<b>MY-06509-15</b>
	L/S 24		<b>MY-06509-24</b>
Tygon E-LFL	L/S 15	7.6 m (25 ft)	<b>MY-06440-15</b>
	L/S 24		<b>MY-06440-24</b>

## Sludge Judge® Sludge Samplers

### No more straining

- Add middle sections to take samples from any distance
- Order a complete system or customise to your needs
- Just dip and sample—ball valve opens when lowered into sample
- Know sample volume with easy-read 0.3-m increment markings

Basic Sludge Judge and Sludge Judge Ultra versions have 1.9 cm (3/4") diameter pipe sections and hold approximately 89 mL (3 oz) of fluid per foot. Sludge Judge II version has 3.2 cm (1 1/4") diameter pipe sections doubling the overall capacity of the sampler. Sludge Judge Ultra additionally features an ultraviolet stabiliser which reduces material degradation from UV light.



Description	Length	Catalogue number
<b>Sludge Judge sampler, 1.9 cm (3/4") diameter</b>		
Sludge Judge; top, middle, bottom sections	3 x 1.5 m (5 ft)	<b>MY-05465-70</b>
Replacement bottom section with valve	1.5 m (5 ft)	<b>MY-05465-72</b>
Replacement middle section/extension section	1.5 m (5 ft)	<b>MY-05465-74</b>
Replacement top section with nylon rope	1.5 m (5 ft)	<b>MY-05465-76</b>
<b>Sludge Judge II sampler, 3.2 cm (1 1/4") diameter</b>		
Sludge Judge II; top, middle, bottom sections	3 x 1.5 m (5 ft)	<b>MY-05465-30</b>
Replacement bottom section with valve	1.5 m (5 ft)	<b>MY-05465-31</b>
Replacement middle section/extension section	1.5 m (5 ft)	<b>MY-05465-32</b>
Replacement top section with nylon rope	1.5 m (5 ft)	<b>MY-05465-33</b>
<b>Sludge Judge Ultra sampler, 1.9 cm (3/4") diameter, UV resistant</b>		
Sludge Judge Ultra; top, middle, bottom sections	3 x 1.5 m (5 ft)	<b>MY-05465-40</b>
Replacement bottom section with valve	1.5 m (5 ft)	<b>MY-05465-41</b>
Replacement middle section/extension section	1.5 m (5 ft)	<b>MY-05465-42</b>
Replacement top section with nylon rope	1.5 m (5 ft)	<b>MY-05465-43</b>

**MY-05465-77 Canvas carrying case**

**MY-05465-78 Cleaning brush**

## Scienceware® Dippers with Replaceable Cup

### Easily pour from either side

- Long handles for easy sampling

Lightweight, yet sturdy, dippers feature a polypropylene (PP) cup that screws onto the handle. High-density polyethylene (HDPE) handles are ribbed for a sure grip; end has hook for hanging.



Screw-on cups let you easily take multiple samples.



Capacity mL (oz)	Dipper dia	Handle length	Qty/pk	Catalogue number
<b>Dippers with replaceable cup</b>				
500 (16)	9.8 cm (3 7/8")	0.9 m (36")	1	<b>MY-06282-00</b>
		1.8 m (72")		<b>MY-06282-05</b>
<b>Extra/replacement screw-on PP cup</b>				
500 (16)	9.8 cm (3 7/8")	—	1	<b>MY-06282-50</b>



# Instrument Service

## Specialists in Service, Repair & Qualification

For High Performance Liquid Chromatography (HPLC), Gas Chromatography (GC), Mass Spectrometry (GCMS, LCMS), automated SPE and CTC PAL autosamplers, Dissolution and Diffusion equipment.



### CUSTOM SERVICE PACKAGES AVAILABLE



1. Request a Service Quote



2. An expert responds within 48 hrs to tailor the service to your needs



3. Send item back to us or we will come to you



4. Efficient turnaround with access to full supply of replacement parts



5. Completed service includes automated engineer report

+44 (0) 1480 277802

[instrumentservice@coleparmer.com](mailto:instrumentservice@coleparmer.com)





## UK (Europe, Middle East & Africa Head Office)

**+44 (0) 1480 272279**

Email: [info@coleparmer.co.uk](mailto:info@coleparmer.co.uk)

**ColeParmer.co.uk**

Orion Court, Ambuscade Road, Colmworth Business Park.  
St Neots, Cambs PE19 8YX UK

---

## Germany

**+49 (0) 9377 92030**

Email: [sales@coleparmer.de](mailto:sales@coleparmer.de)

**ColeParmer.de**

Futtererstraße 16, 97877 Wertheim, Germany

---

## France

**+33 (0) 1486 37800**

Email: [cpcontact@coleparmer.com](mailto:cpcontact@coleparmer.com)

**ColeParmer.fr**

BP 55437 Villepinte, 95944 Roissy CDG, France

---

## Italy

**+39 (0) 1313 89513**

Email: [itsales@coleparmer.com](mailto:itsales@coleparmer.com)

**ColeParmer.com**

ABreg s.r.l. Via Brescia, 39 -20063, Cernusco S.N. (MI), Italy

---

## USA (Global Head Office)

**+1 847 549 7600**

Email: [sales@coleparmer.com](mailto:sales@coleparmer.com)

**ColeParmer.com**

625 East Bunker Ct, Vernon Hills, IL 60061, United States

[ColeParmer.com](http://ColeParmer.com)