



BioPharma Processing

Meeting your needs from **Laboratory** to **Fill/Finish**

development



L/S[®]

scale-up



I/P[®]

production



B/T[®]

Find
>100,000 products
at **ColeParmer.com**

1-800-323-4340

Expert product assistance
Katie, Application Specialist



Fermentation

At the heart of your process, fermentation creates the proteins for your therapies. Careful monitoring and precise addition of media and other additives are essential for effective growth. Cole-Parmer has what you need for optimal output.

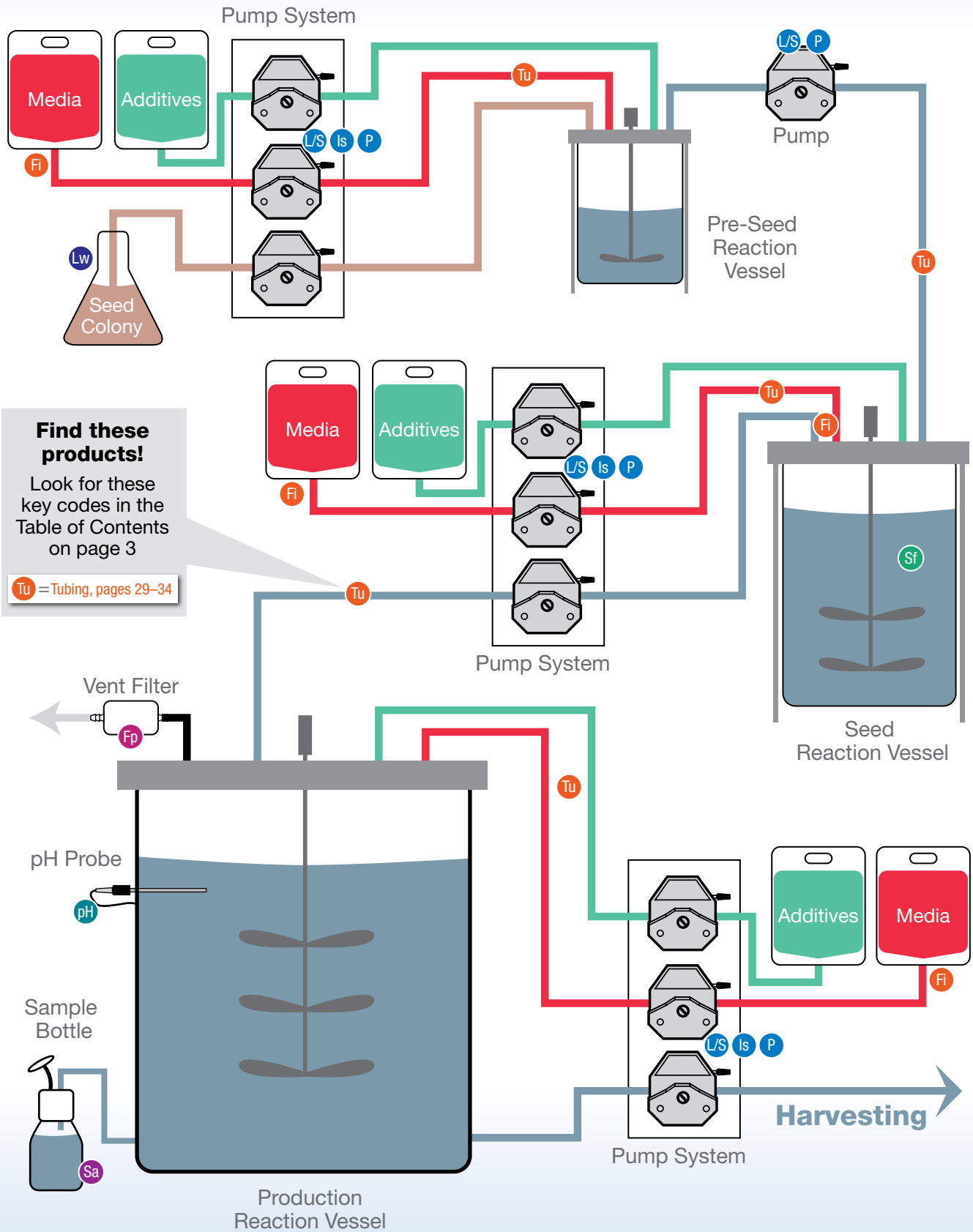

Harvesting

From washing to buffer injection to filtering, the steps in harvesting begin to separate the protein from the cells. Look to our pumps for fluid transfer capabilities as well as single-use lines between filters and vessels. Depending on your production scale, our filtration products may also provide critical performance in your process.

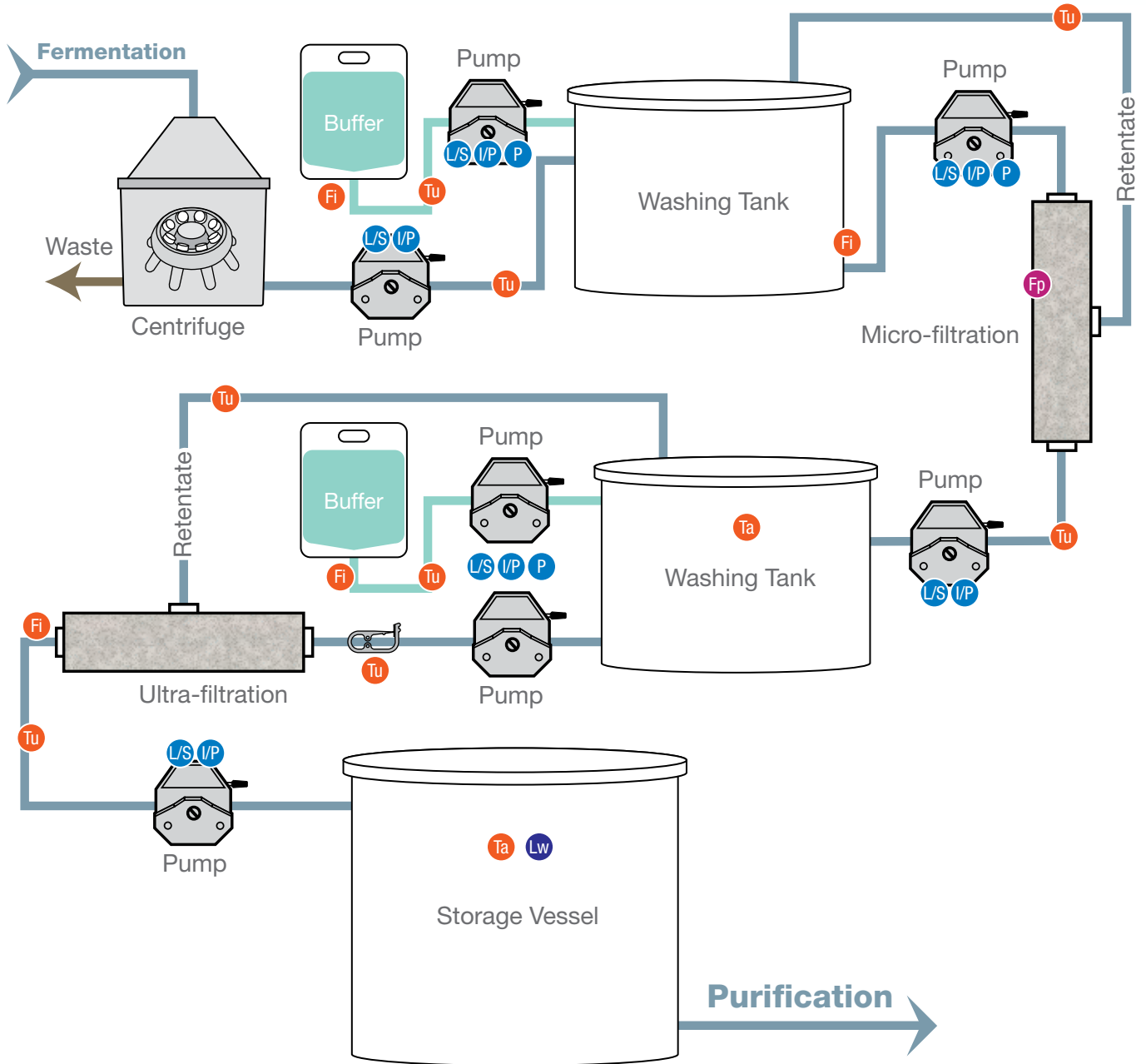

“Gone are the days when upstream scientists could modify their process and ignore the repercussions in manufacturing.”

—Cell Culture World, Congress 2016 Conference Overview

An integrated approach to research and production planning that utilizes products of like materials can ensure efficient and rapid scale-up, with no concerns of revalidation or other regulatory paperwork. You can rely on Cole-Parmer to meet these needs. We offer equipment and consumables that handle small volumes on the laboratory benchtop, to medium volumes during scale-up, to full production.

Purification

Separate your final product from all remaining contaminants and effluvia. Concentrate and refine the proteins to prepare them for final product fill/finish.

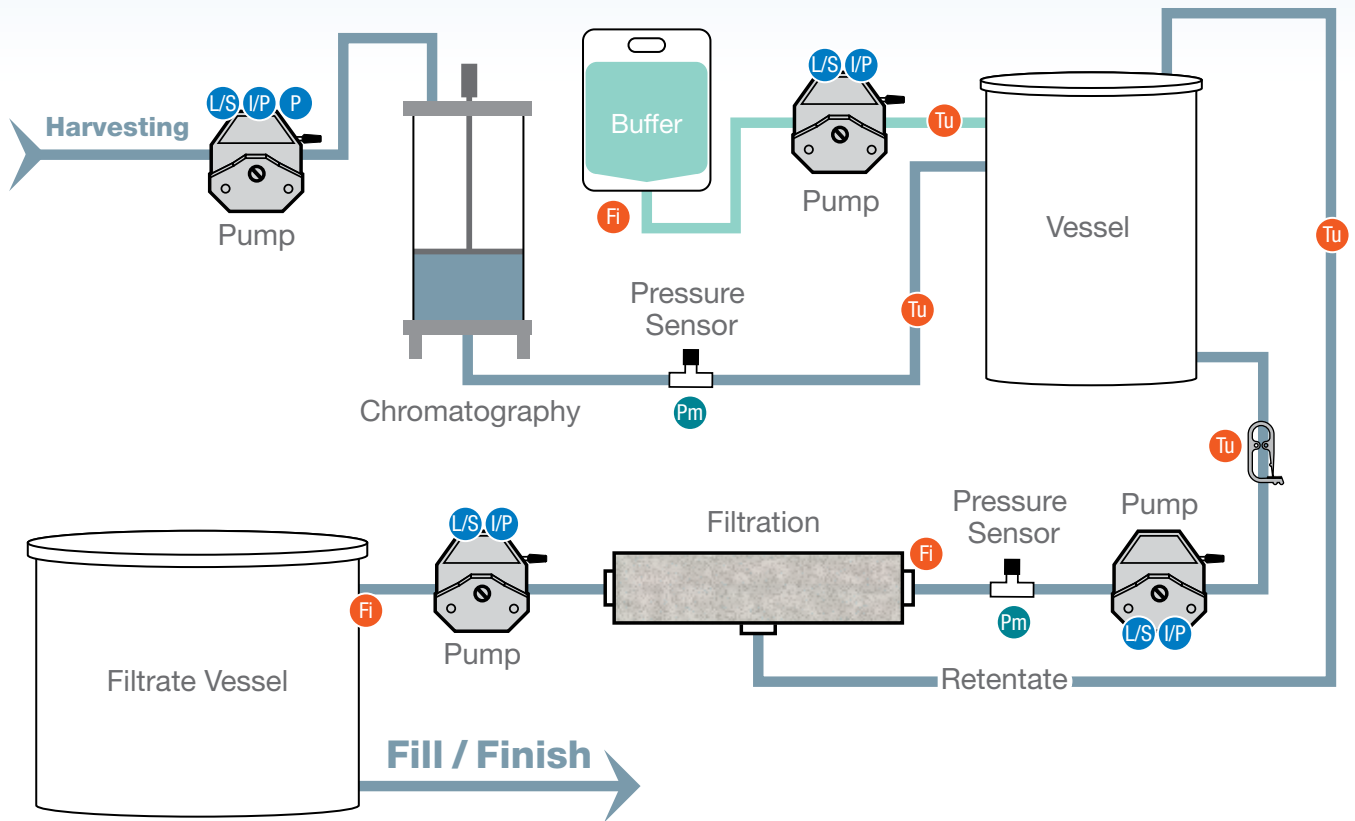

Other Processes

Whether for quality control, process monitoring, research and development, or worker and process environment protection, look to Cole-Parmer for your needs.

Can't find the exact item you need in this catalog? Visit ColeParmer.com for more options!

Table of Contents

Fluid Transfer		Sf Fermentation 49–51	Stirrers 71–73
L/S Masterflex® L/S® Pumps 5–11		Fp Filtration & Purification . . . 53–58	Baths & Circulators 74
I/P Masterflex® I/P® Pumps 12–14		Process Monitoring	Shakers 76–79
B/T Masterflex® B/T® Pumps 15		Pm Pressure 60–61	Viscometers 80
Masterflex® Tubing 18–21		Flowmeters 62	Turbidity 81
Is Ismatec® Pumps 24–25		M Mixers 63–64	Homogenizers 82
P Pumps 26–27		pH pH Laboratory Electrodes 65	Spectroscopy 83–84
Fluid Path		Temperature 66	Balances 85–86
Tu Tubing 29–34		Fluid Testing & Analysis	Cleanroom 88–92
Fi Fittings 35–45		Pipettes & Pipettors 68	Lw Labware & Supplies 94–96
Valves 46		Microbiology 69–70	
Ta Tanks 47		Sa Sampling Assemblies 71	

Fluid Transfer

Move fluid with confidence and precision

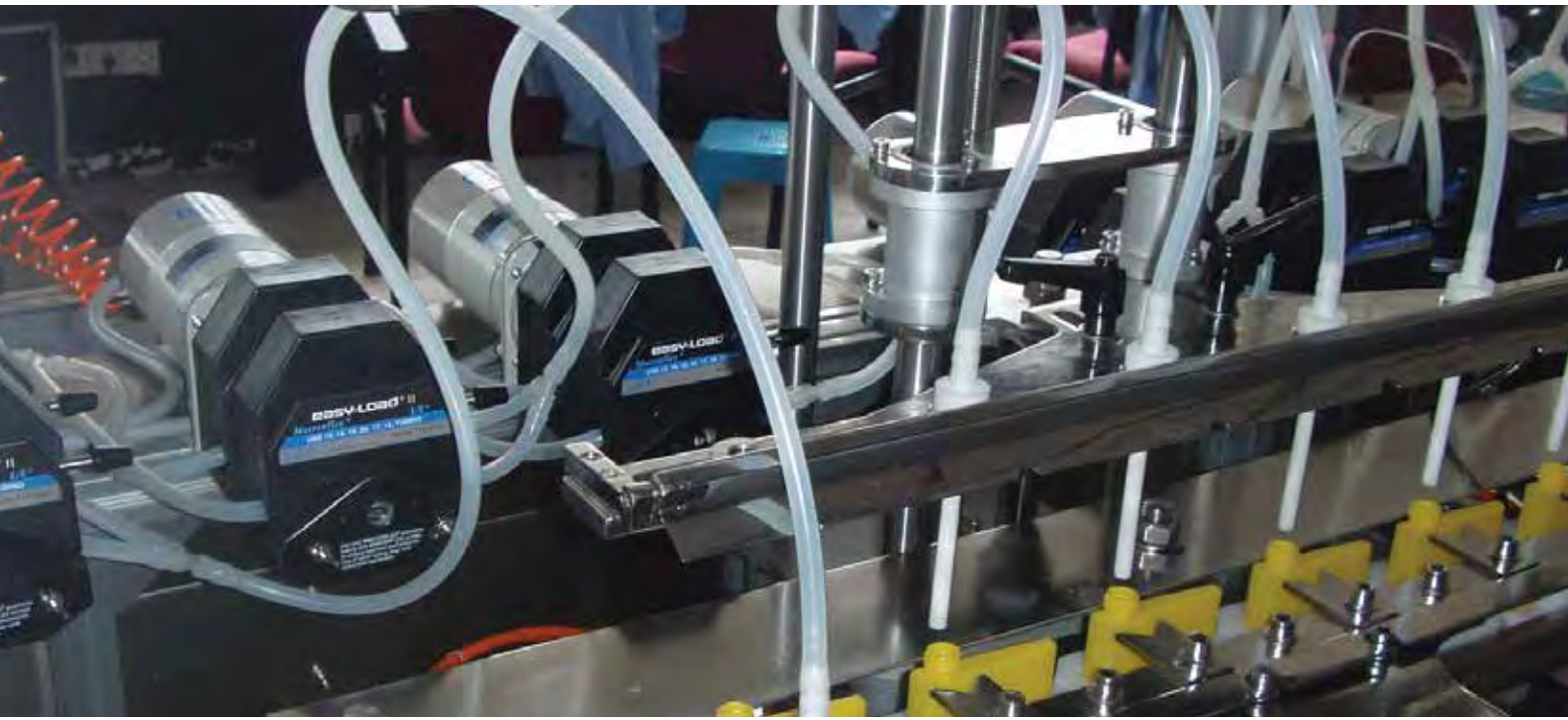

Pumps to meet your exact specifications from development to media preparation to final fill/finish

Masterflex® and Ismatec® pump systems and tubing for transfer, additions, filtration, and more . . . 5–25

Meet filtration pressure demands with gear or piston pumps 26

Handle full-scale production volumes with centrifugal pumps or rotary lobe pumps 27

“Specialist was willing to listen to my specific requirement and after understanding our needs: worked diligently and professionally to spec the correct equipment to meet our needs.”



Product Selection | Troubleshooting | And More...

Not sure what to choose?
Our expert Application Specialists can help you find the right product for your application.

1-800-323-4340
or Ch@t Live

Masterflex® L/S® Digital Miniflex® Pumps

Small footprint, yet delivers accurate flow over a wide range

- Flow range of 0.004 to 315 mL/min (depending on tubing size)
- Tubing calibration function ensures accuracy
- Open-head sensor stops drive when pump head is opened
- Remote control via 25-pin connector on back of drive
- Automatic tubing retention makes tube loading quick and easy

Compact, stackable pump with durable ABS housing is easy to wipe down. The Miniflex pump head features a wide occlusion angle that prevents fluid backflow up to the rated pressure of the tubing. Self-lubricating thermoplastic polyester rollers are low friction and long wearing for smooth operation and long life.

Flow Rates (mL/min) at 0.1 to 300 rpm

Pump model	Precision pump tubing			
	L/S 13	L/S 14	L/S 16	L/S 25
07525-20	0.004 to 12	0.014 to 42	0.05 to 162	0.11 to 315
07525-40	0.004 to 12	0.014 to 42	0.05 to 162	—

NEW



FEATURES

- ✓ Flow rates: 0.004 to 315 mL/min
- ✓ Intuitive icon-driven programming
- ✓ Tubing calibration for accuracy
- ✓ Single- or dual-channel models

MASTERFLEX®

ISO9001:2008
CERTIFIED SUPPLIER

Power supplies are:



Number of channels	rpm	Speed control (repeatability)	Reversible motor	IP rating	Dimensions (L x W x H) 9.4" x 5.5" x 6.2" (23.9 x 14.0 x 15.7 cm)	Power (50/60 Hz)		Catalog number	Price
						VAC	Amps		
1	0.1 to 300	±0.1%	Yes	IP33		90 to 260	0.34 at 115 VAC, 0.2 at 230 VAC	RB-07525-20	
2								RB-07525-40	

RB-07523-92 Foot switch, momentary start/stop; DB25 male; 6-ft (1.8-m) cable

RB-07523-95 Cable assembly, DB25 male connector and 25-ft (7.9-m) cable with stripped wire ends

RB-07523-97 Handheld remote controller, DB25 male, route tubing through handle for dispensing applications; 6-ft (1.8-m) cable

RB-17050-01 NIST-traceable calibration with data for peristaltic pump drive

Masterflex® L/S® Precision Variable-Speed Console Pumps

Don't lose control of your metering applications—digital display gives you repeatable control

- Accurate and repeatable settings with 3-digit LED display of rpm
- Pump fluid in either direction with reversible motor—perfect for purging tubing
- Maximize processes in a minimal footprint by stacking splash-resistant, IP33-rated drives
- Two ways to control speed, direction, and start/stop—use either the membrane keypad or remote control capabilities
- Save space and increase productivity by stacking 2 or 4 pump heads on the same drive to create a multichannel pump system

MASTERFLEX®



ISO9001:2008
CERTIFIED SUPPLIER



System	Flow range	What's included			Power	Catalog number	Price
		Pump head	Tubing	Drive			
	4.8 to 480 mL/min	Easy-Load® 3 77800-60	C-Flex® ULTRA L/S 16 tubing 06434-16 10 ft (3 m)	Precision console drive 07528-10 6 to 600 rpm	90 to 260 VAC, 50/60 Hz	RB-77916-10	
	17 to 1700 mL/min	Easy-Load II 77200-62	C-Flex® ULTRA L/S 24 tubing 06434-24 10 ft (3 m)			RB-77916-20	

Masterflex® L/S® Precision Variable-Speed Modular Pumps Ideal for limited spaces such as pump skids or hoods

- Flow rates: 0.06 to 3400 mL/min
- Easy up-front control of speed, direction, and start/stop
- Reversible motor—purge tubing before or after pumping; pump fluid in either direction
- Three-digit LED display shows motor rpm—confirm speed setting at a glance
- Remote control capabilities: speed, direction, and start/stop
- ±0.25% speed control for precise flow—ideal for metering applications

A. Modular Drives with Benchtop Controller

- Splash-resistant ABS plastic controller housing is IP33 rated; drive housing is epoxy finished steel, IP33 rated
- Remote control capabilities via a DB9 female connector on back of controller

B. Washdown Modular Drive with Wall-Mount Controller

- Wall-mount controller housing is powder-coated aluminum, IP66 / NEMA 4X rated for washdown; powder-coated steel drive housing is IP66 / NEMA 4X rated for washdown
- Remote control capabilities via connection on controller

APPLICATIONS



- ✓ Epoxy resin delivery
- ✓ Bulk container pump
- ✓ Coolant/recirculation pump
- ✓ FDA tablet coating
- ✓ Adhesive resin delivery
- ✓ Packaging process pump
- ✓ Fermentation additions

MASTERFLEX®



ISO9001:2008
CERTIFIED SUPPLIER



System	Flow range	What's included			Power	Catalog number	Price
		Pump head	Tubing	Drive			
A. Precision modular drives with benchtop controller							
	4.8 to 480 mL/min	Easy-Load® 3 77800-60	C-Flex® ULTRA L/S 16 tubing 06434-16 10 ft (3 m)	Modular drive 07557-00 6 to 600 rpm	90 to 260 VAC, 50/60 Hz	RB-77913-60	
	17 to 1700 mL/min	Easy-Load II 77200-62	C-Flex ULTRA L/S 24 tubing 06434-24 10 ft (3 m)	Modular drive 07557-00 6 to 600 rpm	90 to 260 VAC, 50/60 Hz	RB-77913-70	
B. Precision washdown modular drive with washdown wall-mount controller							
	17 to 1700 mL/min	Easy-Load II 77200-62	C-Flex ULTRA L/S 24 tubing 06434-24 10 ft (3 m)	Modular drive 07557-60 6 to 600 rpm	90 to 260 VAC, 50/60 Hz	RB-77913-80	

Accessories

[RB-07557-51](#) Extension cable, 9 ft (2.7 m); extend distance between motor and controller

[RB-07595-47](#) Cable assembly, for benchtop modular drives; DB9 male connector and 25 ft (7.9 m) cable with stripped wire terminal ends. Use for remote control

[RB-77300-32](#) Cable assembly, for washdown modular drives; 18-pin round connector and 25 ft (7.9 m) cable with stripped wire terminal ends. Use for remote control

[RB-17050-01](#) NIST-traceable calibration with data for peristaltic pump drive

Wait!

There's More...

Our Masterflex pumps can be configured to your exact need. Choose the pump head, drive, and tubing you want!

Go to [ColeParmer.com](#)

Masterflex® L/S® Variable-Speed Digital Pumps

Versatile, worry-free operation

- Brushless, maintenance-free motor provides ±0.1% speed control accuracy with 6000:1 turndown ratio
- Bright graphical LCD offers easy programming and four operating modes
- Ensure dispensing accuracy with antidrip function
- Get more accurate dispensing with preprogrammed calibration
- Change based on your needs—drives accept all L/S pump heads for more pumping versatility
- Programmable, reversible motor accepts up to four pump heads
- Choose how you want to dispense: volume, copy cycles, or time
- Hands-free dispensing via time interval dispense cycles
- Operate remotely via DB25 female connector

Four operating modes for more functionality: continuous run, time dispense, copy dispense, and volume dispense



MASTERFLEX®

APPLICATIONS

- ✓ Acid/base pH control
- ✓ Media dispensing
- ✓ Automated fermentation

Flow Rates in mL/min (flow rates in parentheses attained with High-Performance pump head—at ColeParmer.com)

rpm	Precision pump tubing						High-performance precision pump tubing			
	L/S 13	L/S 14	L/S 16	L/S 25	L/S 17	L/S 18	L/S 15	L/S 24	L/S 35	L/S 36
	Standard†, Easy-Load, Easy-Load II, Easy-Load 3						Multichannel‡, Standard, Easy-Load II, Easy-Load 3, High-Performance			
	Cartridge, Multichannel			Cartridge			Easy-Load			
0.1 to 600	0.006 to 36	0.021 to 130	0.08 to 480	0.17 to 1000	0.28 to 1700	0.38 to 2300	0.17 to 1000 (0.18 to 1100)	0.28 to 1700 (0.30 to 1800)	0.38 to 2300 (0.43 to 2600)	0.48 to 2900 (0.57 to 3400)
0.02 to 100	0.001 to 6	0.004 to 21	0.016 to 80	0.033 to 170	0.057 to 280	0.077 to 380	0.033 to 170 (0.036 to 183)	0.057 to 280 (0.057 to 300)	0.077 to 380 (0.086 to 433)	0.096 to 480 (0.113 to 566)

†The Standard pump head is not available for L/S® 25.

‡Multichannel head is not available for L/S 36. Multichannel and Cartridge heads are available for microbore tubing.



System	Flow range	What's included			Power	Catalog number	Price
		Pump head	Tubing	Drive			
	0.08 to 480 mL/min	Easy-Load® 3 77800-60	C-Flex® ULTRA L/S 16 tubing 06434-16 10 ft (3 m)	Digital drive 07522-20 0.1 to 600 rpm	90 to 260 VAC, 50/60 Hz	RB-77921-65	
	0.28 to 1700 mL/min	Easy-Load II 77200-62	C-Flex ULTRA L/S 24 tubing 06434-24 10 ft (3 m)			RB-77921-75	

RB-07523-92 Foot switch, momentary start/stop; 6-ft (1.8-m) cable

RB-07523-94 DB25 male connector. Use to create your own cable

RB-07523-95 Cable assembly, DB25 male connector and 25 ft (7.9 m) cable with stripped wire ends for remote control

RB-07523-97 Handheld remote controller; route tubing through handle for dispensing into containers

RB-17050-01 NIST-traceable calibration with data for peristaltic pump drive

Masterflex® Advantage

Masterflex vs Gear Pumps

Application

A pharmaceutical engineer needs to draw a constant volume of 800 mL/min of water with particulates. The engineer needs variable speed and is drawing the fluid through a particle sensor.

Masterflex Advantages

- Handles particulates
- Easy to change out tubing and clean pump
- Runs dry
- Maintains sterility of fluid (fluid only contacts the tubing)

Gear Pump Disadvantages

- Does not handle particulates
- Difficult to clean
- Can't run dry
- Does not provide sterility conditions (fluid contacts internal pump parts)

Masterflex Products Applied

- 77800-62 L/S Easy-Load® 3 pump head
- 06424-36 C-Flex® L/S 36 High-performance precision tubing
- 07522-20 L/S digital console drive
- 07596-20 Pulse dampener

Masterflex® L/S® Digital Console Process Pumps

Transfer, dispense, and meter in lab, process and washdown environments

- IP66 and NEMA 4X rated. Sealed housing and sealed keypad are protected from dust, water, and chemicals in the washdown environment—simply hose down to clean.
- Models are equipped with open-head sensor that will stop drive motor when pump head is opened
- Programmable, reversible motor accepts up to two pump heads and offers remote functionality
- Flow rate: 0.006 to 3400 mL/min with L/S tubing
- Graphical LCD shows six different parameters: motor rpm, flow rate, dispense volume, cumulative volume, dispense interval time, and copy number.
- Brushless, maintenance-free motor with $\pm 0.1\%$ speed control accuracy and a 6000:1 turndown
- Dispense by: volume—in milliliters (0.001 to 99,999), liters, and gallons; copy—1 to 99,999 dispense cycles. Set time interval of on/off cycles; 1 sec to 99 hr, 59 min, 59 sec.
- Remote control capabilities via 31-pin circular waterproof connection



APPLICATIONS



- ✓ Pumping buffer solution
- ✓ Filling/emptying media bags
- ✓ Sterile filtration; sterile fluid transfer
- ✓ Filtration

MASTERFLEX®

What's included: 6-ft (1.8-m) line cord—features IEC 320/CEE 22 connector coupler; watertight cord connection. Please specify destination country when ordering; drive is shipped with country-specific plug/cord set.

ISO9001:2008
CERTIFIED SUPPLIER



System	Flow range	What's included			Power	Catalog number	Price
		Pump head	Tubing	Drive			
	0.28 to 1700 mL/min	Easy-Load® II with open-head sensor 77200-32	C-Flex® ULTRA L/S 24 tubing 06434-24 10 ft (3 m)	Digital console process drive with 316 SS housing 07575-38 0.1 to 600 rpm	90 to 260 VAC, 50/60 Hz	RB-77975-29	
	0.28 to 1700 mL/min	Easy-Load II with open-head sensor 77200-32	C-Flex ULTRA L/S 24 tubing 06434-24 10 ft (3 m)	Digital console process drive with powder-coat steel housing 07575-48 0.1 to 600 rpm	90 to 260 VAC, 50/60 Hz	RB-77975-49	

RB-07575-84 Washdown foot switch, momentary start/stop; 6-ft (1.8-m) cable

RB-07575-80 Cable assembly, 31-pin round connector and 25-ft (7.9-m) cable with stripped wire ends for remote control

RB-17050-01 NIST-traceable calibration with data for peristaltic pump drive

Overlook Filler/Dispensing Nozzles

- Maximize the speed, precision, and accuracy of dispensing and filling applications
- Dimensional tolerances of $\pm 0.05\%$ for assured repeatability

Nozzles feature a 316L stainless steel needle and a polycarbonate base with hose barb adapter. Materials meet FDA, USDA and USP Class VI requirements. Sterilize by ethylene oxide, autoclaving, or gamma irradiation.

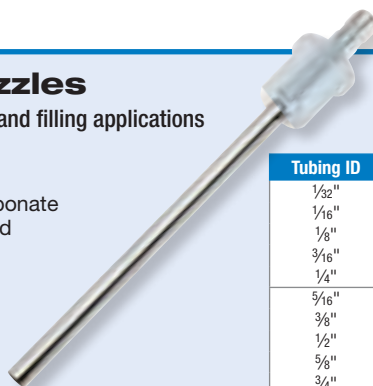

Tubing ID	Catalog number	Price/ea
1/32"	RB-30619-06	
1/16"	RB-30619-01	
1/8"	RB-30619-07	
3/16"	RB-30619-02	
1/4"	RB-30619-08	
5/16"	RB-30619-03	
3/8"	RB-30619-09	
1/2"	RB-30619-04	
5/8"	RB-30619-10	
3/4"	RB-30619-05	

Masterflex® L/S® Digital Modular Dispensing Pumps

Three dispensing modes and precision low-maintenance motor

- Graphical LCD shows four operating modes: continuous run, timed dispense, copy dispense, volume dispense
- Antidrip function ensures dispense accuracy
- Brushless, maintenance-free motor offers $\pm 0.1\%$ speed control
- Remote control capabilities: speed, direction, start/stop/prime, tach output

A. Modular Drive with Benchtop Controller

- Stackable, splash-resistant ABS plastic controller housing is IP33 rated; drive housing is epoxy finished steel, IP33 rated

B. Washdown Modular Drive with Wall-Mount Controller

- Wall-mount controller housing is powder-coated aluminum, IP66 / NEMA4X rated for washdown; powder-coated steel drive housing is IP66 / NEMA4X rated for washdown

What's included: 6-ft (1.8-m) cable to connect drive and controller and 6-ft (1.8-m) line cord with IEC 320/CEE22 socket. Shipped with country-specific plug/cord set; please specify destination when ordering.



APPLICATIONS

- ✓ Process feed and transfer
- ✓ Dosing/metering additives
- ✓ Container filling

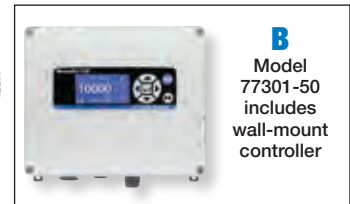

B
Model
77301-50
includes
wall-mount
controller



System	Flow range	What's included			Power	Catalog number	Price
		Pump head	Tubing	Drive			
	0.28 to 1700 mL/min	Easy-Load® II 77200-62	C-Flex® ULTRA L/S 24 tubing 06434-24 10 ft (3 m)	Digital modular drive 77301-40 0.1 to 600 rpm	90 to 260 VAC, 50/60 Hz	RB-77923-80	
	0.28 to 1700 mL/min	Easy-Load II 77200-62	C-Flex ULTRA L/S 24 tubing 06434-24 10 ft (3 m)	Digital washdown modular drive 77301-50 0.1 to 600 rpm	90 to 260 VAC, 50/60 Hz	RB-77923-90	

RB-07523-95 Cable assembly, for benchtop modular drive 77301-40; DB25 male connector and 25-ft (7.9-m) cable with stripped wire ends for remote control

RB-07575-80 Remote control cable for washdown modular drive 77301-50; wire to controller/PLC; 25-ft (8.3-m) length

RB-77301-82 Extension cable, 9 ft (2.7 m) extends distance between motor and controller

RB-17050-01 NIST-traceable calibration for peristaltic pump drive

Masterflex® L/S® High-Pressure Pump

Handles continuous pressures up to 125 psi

- No more cleaning gears, valves, seals, or diaphragms
- Ideal for chemical injection, metering, and filtration
- Reversible motor for pumping in either direction
- Easy keypad control of pump speed and direction—view speed via LED display
- Smooth operation and long service life with soft start and back EMF for $\pm 0.25\%$ speed control
- Stackable housing is also splash- and fire-resistant

APPLICATIONS

- ✓ Chromatography
- ✓ Pressure filtration
- ✓ Sterile filtration

MASTERFLEX®

The Masterflex L/S high-pressure pump system enables peristaltic fluid transfer using flexible tubing—at higher pressures. This innovative pump system transfers fluids at continuous pressure up to 125 psi (8.5 bar). It is also ideal for chemical injection or sterile filtration because the fluid remains in the tubing at all times, with absolutely no contact with pump's moving parts.



Flow range	What's included			Power	Catalog number	Price
	Pump head	Tubing	Drive			
0.9 to 240 mL/min	High-Performance 77250-62	PharMed® BPT L/S 16HP high-pressure tubing 95664-16, 8 ft (2.4 m)	Precision console drive 07528-30 1 to 100 rpm	90 to 260 VAC, 50/60 Hz	RB-77914-10	

Masterflex® Drives with **Advanced Networking & Communication**

Faster, less expensive automation integration—no need for gateways or adapters

- Native Ethernet/IP or Profibus communication for industrial networking, bioprocessing, plant automation, or water/wastewater applications
- Bluetooth Low Energy (BLE) connectivity and iOS-based mobile app permit local pump monitoring and control
- Cloud-based remote pump monitoring capability provides operational status and alerts
- Compatible with most of today's advanced automation control systems, such as Allen-Bradley®, Siemens®, Emerson®, and Honeywell®
- Ask about upgrade incentives for your currently installed pumps

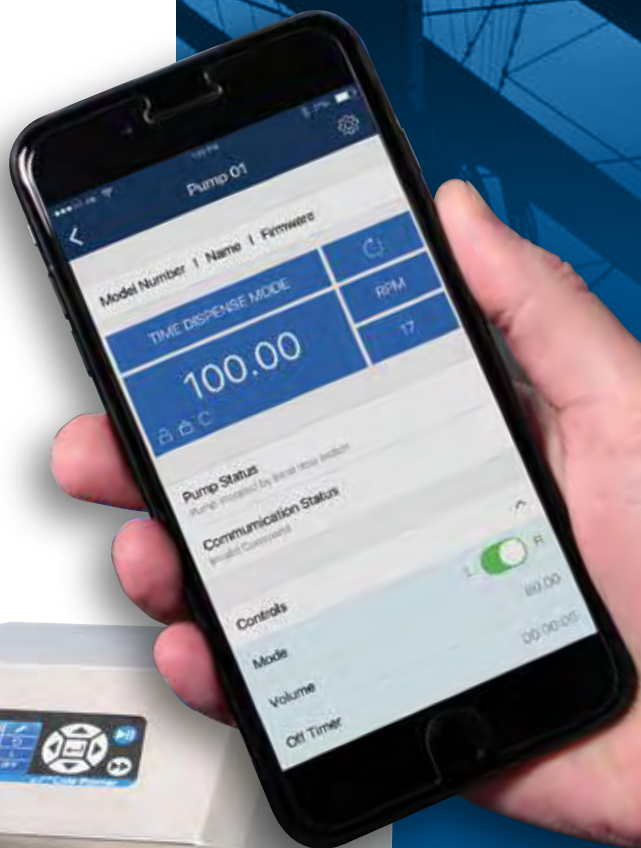

Available on Masterflex® L/S® and I/P® drives in either a benchtop console or a process-suitable NEMA 4X (IP66) enclosure.

To learn more, go to ColeParmer.com/Masterflex-Comms

Cole-Parmer® Single-Use Pump Head for Masterflex® L/S® Drives

Get steady, pulseless flow with the convenience of snap-in disposable heads

- Ideal cost-effective solution for single-use or single-campaign fluid transfer
- Disposable—eliminate cross-contamination and cleaning
- Steady, repeatable flow is ideal for dosing applications

Achieving steady pulseless fluid transfer couldn't be easier—simply mount the reusable adapter to your Masterflex L/S drive and snap in a clean disposable pump head. Standard luer connectors enable quick and secure connections to inlet and outlet tubing. Rotary, volumetric pistons produce pulseless flow up to 500 mL/min with high volume and flow rate accuracy. The consistent rate of flow over time from the dual pumping chambers minimizes the need for calibration.

Note: Maximum recommended speed is 100 rpm for optimal life and performance.



Description	Single-use pump head kit
Catalog number	RB-07539-20
mL/rev	5.0
Flow range	0.5 to 500 mL/min
Flow accuracy	±3% (<2.5 mL); ±1% (>2.5 mL)
Max pressure	36 psi (2.5 bar)
Max vacuum	-10 psi (-0.7 bar)
Max viscosity	70 cps
Materials of construction	Aluminum adapter, co-polyester pump head with FKM gaskets
Connections	Female luer lock
Price	

RB-07539-30 Single-use disposable pump head. Pack of 1

RB-07539-32 Single-use disposable pump head. Pack of 3

RB-07539-34 Single-use disposable pump head. Pack of 6



Kit 07539-20 includes pump head mounting adapter and three single-use pump heads

Masterflex® Drives Powering Quattroflow™ Pumps

Specifically designed to move delicate biological fluids

- Safely and reliably pump plasma products, proteins, monoclonal antibodies, vaccines, and more
- Diaphragms enable soft, gentle pumping through the strokes generated by the eccentric shaft
- No mechanical seal or rotating parts that can fail—only the diaphragm and body come in contact with the fluid
- Risk-free dry running, self priming, and high turn-down ratio

Quattroflow Pumps offer a unique four diaphragm (chamber) design, providing the constant low-pulsation, low-shear pumping needed for your biological fluids. These single-use pump head models have a disposable wetted chamber constructed of solid polypropylene that can be replaced as a complete unit. This saves you time and money by eliminating the cleaning validation, sterilization process normally associated with permanent systems. You can quickly turn around equipment from one batch to the next, maximizing production operations. Plus, fluid path integrity and sterility is ensured with no chance of cross-batch or cross-product contamination. Come presterilized and double bagged.

System shown with single-use pump head and stainless steel drive. Call for information on multiple-use heads.

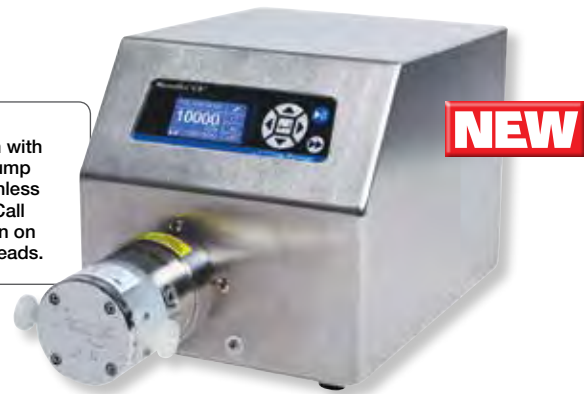

Special Masterflex Drives were designed to best take advantage of the operating parameters of the Quattroflow pumps. Drives feature an intuitive interface, remote control functionality, and a brushless, maintenance-free motor with ±0.1% speed control accuracy. Graphical LCD shows six different parameters: motor rpm, flow rate, dispense volume, cumulative volume, dispense interval time, and copy number. Dispense by volume or time with a user-defined time interval between cycles. 90–260 VAC operation.

Choose a plastic-enclosed drive for benchtop lab applications or a sealed stainless steel drive for use in a washdown environment—simply hose down to clean.



Systems (Quattroflow pump + Masterflex drive)								Replacement pump heads		
Pump model	Flow range	Max pressure	Max fluid temp	Suction lift	Connection	Drive	Cat. no.	Price	Cat. no.	Price
QF150SU (single use)	1 to 180 L/h (0.26 to 48 GPH)	58 psi (4 bar)	140°F (60°C)	6.6 to 9.8 ft (2 to 3 m)	¼" Tri-Clamp®	ABS plastic, IP33 rated, 3000 rpm	RB-74000-35		RB-76000-00	
QF1200SU (single use)	20 to 960 L/h (5.3 to 253 GPH)	58 psi (4 bar)	140°F (60°C)	13.1 to 14.7 ft (4 to 4.5 m)	¾" Tri-Clamp	Stainless steel, IP66 and NEMA 4X rated, 1700 rpm	RB-74000-47		RB-76000-02	

Masterflex® I/P® Process Pumps

Powerful, low-maintenance drives keep you pumping

- Don't worry about moisture, chemicals, or dust—IP55-rated nonchip epoxy-coated steel housing
- Goes where you need it—compact and light enough to carry with one hand, powerful enough to drive two pump heads
- Get up to speed quickly—easy to adjust speed knob and LED display for improved repeatability
- Model 77411-00 offers remote control of speed, direction, and start/stop
- Accept up to two pump heads

What's included: 6-ft (1.8-m) line cord with IEC320/GEE 22 connector coupler. Please specify final destination country to receive the correct plug/cord set.



APPLICATIONS

- ✓ Media transfer
- ✓ Purification/filtration/media transfer
- ✓ Filling/emptying large carboys and bags
- ✓ Pumping antifoaming agents
- ✓ Pumping fermentation chemicals
- ✓ Production filtration

MASTERFLEX®

System	Flow range	What's included			Power	Catalog number	Price
		Pump head	Tubing	Drive			
	0.4 to 8 LPM	Easy-Load® 77602-10	C-Flex® ULTRA I/P 73 tubing 06434-73 10 ft (3 m)	Brushless process drive 77410-10 33 to 650 rpm	90 to 260 VAC, 50/60 Hz	RB-77963-10	
				Brushless process drive with remote I/O 77411-00 33 to 650 rpm			
	0.7 to 17 LPM	High-Performance 77600-62	Tygon® E-LFL I/P 88 tubing 06440-88 3 ft (1 m)	Brushless process drive 77410-10 33 to 650 rpm	90 to 260 VAC, 50/60 Hz	RB-77963-20	
				Brushless process drive with remote I/O 77411-00 33 to 650 rpm			

Accessories

[RB-07595-43](#) Washdown foot switch for model 77411-00

[RB-77300-32](#) Remote cable kit. Required for model 77411-00 to operate the remote inputs and outputs



Media Preparation Pump

In the modern flexible production suite, minimizing setup time for any operation is critical to optimizing production output. The Masterflex I/P pump system 77963-10 meets your needs. Compared to other peristaltic pumps of similar flow range, the 77963-10 is lighter and therefore easier to carry or relocate. Simple pump controls make it easy to operate. Tubing changes are quick with the Easy-Load pump head design. Biocompatible C-Flex ULTRA offers low leachables/extractables and low spallation to guard the purity of your media. Finally, when media preparation is finished and cleanup begins, the IP55 rating offers efficient and quick washdown.

System 77963-10 includes:



Easy-Load pump head 77602-10



C-Flex ULTRA I/P 73 Tubing 06434-73



I/P Brushless process drive 77410-10

Masterflex® I/P® Digital Console Process Pumps

Maintenance-free drives built for process applications

- Graphical LCD shows four operating modes: continuous run, timed dispense, copy dispense, volume dispense
- Dispense by mL—volume in mL of each dispense, 0.001 to 9999 mL; Copy—1 to 9,999 dispense cycles; or SEC—time interval of on/off cycles (1 sec to 99 hr, 59 min, 59 sec per cycle)
- Models are equipped with open-head sensor that will stop drive motor when pump head is opened
- Accepts up to two pump heads
- NEMA 4X and IP66-rated for easy washdown

Drive 77420-18 features a 316 stainless steel housing with an anodized aluminum base. Ideal for pharmaceutical, dairy, biotech, and food and beverage applications.

Drive 77420-28 features a powder-coated steel housing with anodized aluminum base. Use in process, manufacturing, and water-treatment applications where stainless steel is not a critical requirement.

What's included: 6-ft (1.8-m) line cord with IEC 320/CEE22 socket. These models are shipped with country-specific plug/cord set; please specify ultimate destination when ordering.





APPLICATIONS

- ✓ Automated process pump
- ✓ Dosing/metering additives
- ✓ Bulk media transfer and dispensing
- ✓ Large-volume buffer transfer
- ✓ Pilot scale fermentation

MASTERFLEX®



System	Flow range	What's included			Power	Catalog number	Price
		Pump head	Tubing	Drive			
	0.001 to 8.0 LPM	Easy-Load® with open-head sensor 77602-30	C-Flex® ULTRA I/P 73 tubing 06434-73 10 ft (3 m)	Digital process drive with stainless steel housing 77420-18 0.1 to 650 rpm	90 to 260 VAC, 50/60 Hz	RB-77964-28	
	0.001 to 8.0 LPM	Easy-Load with open-head sensor 77602-30	C-Flex ULTRA I/P 73 tubing 06434-73 10 ft (3 m)	Digital process drive with powder-coat steel housing 77420-28 0.1 to 650 rpm	90 to 260 VAC, 50/60 Hz	RB-77964-38	

Pure-Fit® Tru Valve

Easy implementation in your system

- Reusable for multiple cycles and applications

The valve's butterfly design allows easy installation to existing lines; purity is maintained because the valve goes around the exterior of the tubing and never comes in contact with process fluid.

Simple threaded handle and calibrated scale ensure accurate control of flow and can also be written into validation protocols. The valve also features lockout positioning for use in steam-in-place (SIP) cycles. Withstands autoclaving or gamma irradiation. Accommodates any flexible tubing up to 17.8 mm (0.700") in outer diameter.

Fits Masterflex® tubing sizes	Material	Catalog number	Price
L/S® 13, 14, 15, 16, 17, 18, 24, 25, 35, 36; I/P® 26, 73	Glass-reinforced nylon	RB-20002-00	



Masterflex® I/P® Variable-Speed Modular Digital Dispensing Pumps

Place motor and controller where convenient—ideal for limited or awkward spaces

- Graphical LCD shows four operating modes: continuous run, timed dispense, copy dispense, and volume dispense
- Programmable dispense interval lets you set the delay between dispense cycles for convenient, automated dispensing by time or by volume
- Brushless motor gives you quiet, maintenance-free reliability
- Accept up to two pump heads

A. Modular Drive with Benchtop Controller

- Splash-resistant ABS plastic controller housing is IP33 rated; drive housing is epoxy finished steel, IP33 rated
- 6-ft (1.8-m) cable connects drive and controller; optional extension cable is available
- Remote control capabilities via a DB25 female connector on controller

B. Washdown Modular Drive with Wall-Mount Controller

- Wall-mount controller housing is powder-coated aluminum, IP66 / NEMA 4X rated for washdown; powder-coated steel drive housing is IP66 / NEMA 4X rated for washdown
- 6-ft (1.8-m) cable connects drive and controller; optional extension cable is available
- Remote control capabilities via 31-pin round connection on controller

APPLICATIONS

- ✓ Nutrient addition
- ✓ Buffer injection
- ✓ Fermentation transfer



B
Model 77970-50 includes wall-mount controller



MASTERFLEX®

ISO9001:2008
CERTIFIED SUPPLIER



IP 66
07594-10



System	Flow range	What's included			Power	Catalog number	Price
		Pump head	Tubing	Drive			
	0.001 to 8 LPM	Easy-Load® 77602-10	C-Flex® ULTRA I/P 73 tubing 06434-73 10 ft (3 m)	Digital dispensing drive with benchtop controller 07594-00 0.1 to 650 rpm	90 to 260 VAC, 50/60 Hz	RB-77970-40	
	0.001 to 8 LPM	Easy-Load 77602-10	C-Flex ULTRA I/P 73 tubing 06434-73 10 ft (3 m)	Digital dispensing drive with wall-mount controller 07594-10 0.1 to 650 rpm	90 to 260 VAC, 50/60 Hz	RB-77970-50	

RB-77301-82 Extension cable, 9 ft (2.7 m); extend distance between motor and controller

RB-07523-95 Cable assembly for benchtop drive 07594-00; DB25 male connector and 25-ft (7.9-m) cable with stripped wire ends for remote control

RB-07575-80 Cable assembly for washdown drive 07594-10; 31-pin round connector and 25-ft (7.9-m) cable with stripped wire ends for remote control

RB-17050-01 NIST-traceable calibration for peristaltic pump drive

Dispensing Benefits of Peristaltic Pumps

- Fluid does not contact any part of the pump except the tubing
- Easy and fast product change—simply change tubing—no cross-contamination
- One continuous piece of tubing from inlet to outlet lets you minimize obstructions and interruptions in the fluid path
- Some tubing materials can be easily sterilized
- Gentle pumping action is ideal for shear-sensitive fluids containing proteins and other large molecules
- Wide range of flow rates provides flexibility in volume and time of dispense
- Simple and reliable calibration to ensure accuracy and repeatability
- Nonsiphoning; prevents backflow and enhances dispensing accuracy
- Multiple channel applications with either synchronous or independently controlled channels

Masterflex® B/T® Fixed- and Variable-Speed Pumps

Achieve the highest flow rates of any Masterflex pump—up to 42 LPM (11.1 GPM)

Fixed-Speed Pumps

- Economical and easy to operate
- Reversible motor: purge before or after pumping, pump fluid in either direction
- IP55-rated motor—wash off dirt and debris

Air-Powered Pump

- Use in locations where electricity is unsafe or impractical
- Includes pressure regulator—control your compressor air to match pump requirements
- 24 cfm (0.68 m³), 100 psi (6.9 bar) minimum air required, supply your own compressor to power pump
- IP56-rated motor protects against dust and strong water jets
- Rated for ATEX Zone 2 EEx II 3 G c IIC T6; NEC Class 1, Division 2, Groups A, B, C, D, T6

Variable-Speed Modular Pump

- Place washdown controller wherever it's convenient
- Controller with 16-ft (4.9-m) cord mounts on pump or wall
- IP56-rated motor protects against dust and strong water jets
- Reversible motor: purge before or after pumping, pump fluid in either direction

Variable-Speed Modular Digital Pump

- High-volume, high-accuracy dispensing
- Dispense by volume or time, or pump continuously
- Separate motor and controller by up to 6 feet (1.8 m) for convenient operation
- IP56-rated controller and motor protect against dust and water

What's included: a Rapid-Load® pump head, 3 ft (1 m) of Tygon® E-LFL B/T 91 pump tubing, and a 6-ft (1.8-m) power cord (115 VAC: US standard plug; 230 VAC: European plug).

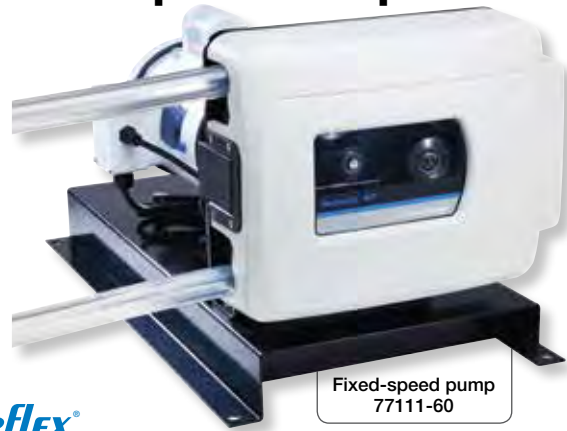

Fixed-speed pump
77111-60

MASTERFLEX®



Variable-speed
modular digital pump
77111-70

FEATURES

- ✓ Flow rates up to 42 LPM
- ✓ Interlock switch shuts off power when pump head is opened
- ✓ Washdown pumps handle the toughest process and production applications, then clean up with ease
- ✓ Gentle peristaltic action is ideal for pumping shear-sensitive or viscous fluids (up to 10,000 cps)
- ✓ Rotor and occlusion bed design allow easier tube loading and prevent "tubing roll" during operation

Flow Rates in LPM (GPM)

rpm	PerfectPosition® pump tubing	
	B/T 87	B/T 91
321	18.9 (5.0)	42 (11.1)
271	16.0 (4.2)	35 (9.4)
35 to 321	1.9 to 17.7 (0.5 to 4.7)	4.0 to 37 (1.06 to 9.8)
12 to 321	0.71 to 18.9 (0.19 to 5.0)	1.4 to 42 (0.4 to 11.1)



77111-37, Zone 2 77111-30, Except
-67, -77, -80 77111-80 -37 77111-30, -37

Motor type	Motor size	rpm	IP rating	Mounting type	Dimensions (L x W x H)	Power		Catalog number	Price
						VAC (Hz)	Amps		
Fixed-speed	1 hp (0.75 kW)	321	IP55	Direct-drive	27" x 15.8" x 15.1" (68.6 x 40 x 38.4 cm)	115 (60)	12.6	RB-77111-30	
		271				220 (50)	6.3	RB-77111-37	
Variable-speed, air powered	¾ hp (0.56 kW)	35 to 321	IP56	Direct-drive	27" x 15.8" x 15.1" (68.6 x 40 x 38.4 cm)	Requires 24 cfm (0.68 m ³) 100 psi (6.9 bar) minimum		RB-77111-80	
Variable-speed (±5%)	½ hp (0.37 kW)	12 to 321	Controller: IP56 Drive: IP56	Direct-drive	27" x 15.8" x 17.4" (68.6 x 40 x 44.2 cm)	115 (50/60)	6.5	RB-77111-60	
						230 (50/60)	3.3	RB-77111-67	
Variable-speed digital (±0.3%)	¾ hp (0.56 kW)	12 to 321	Controller: IP56 Drive: IP56	Direct-drive	Controller: 9" x 11" x 4½" (22.9 x 27.9 x 11.4 cm) Drive: 27" x 15¾" x 15" (68.6 x 40.0 x 38.4 cm)	90 to 130 (50/60)	10.5	RB-77111-70	
						190 to 260 (50/60)	5.7	RB-77111-77	

RB-77300-32 Remote cable, required for remote control operation of models 77111-70 and -77; 25 ft (7.6 m)

RB-77111-90 Bracket for digital controller on models 77111-70 and -77

Masterflex® Drives Enhance Worker Protection

You take your safety seriously, and so do we.

You review every step of the process to take care of your staff and to benefit your business. We've added a new option to our Masterflex product line to help enhance protection in your workplace.

Open-Head Interlock Sensor Technology

Available integrated into select L/S and I/P drives or as a retrofit system, the open-head interlock sensors add an extra level of protection for operators who maintain pumps. When paired with an open-head sensor equipped pump head, the drive automatically shuts down when the pump head is opened, eliminating exposure to the moving rollers connected to the drive shaft.

Masterflex products with integrated open-head sensors

- L/S Digital Miniflex® Pumps [page 5](#)
- L/S Computer-Compatible Digital Drives [online](#)
- L/S Digital Console Process Drives [page 8](#)
- L/S Variable-Speed Digital Drives [online](#)
- L/S Precision Console Process Drives [online](#)
- L/S Easy-Load II Pump Heads [online](#)
- I/P Digital Console Process Drives [page 13](#)
- I/P Easy-Load Pump Head [online](#)

Upgrade your Existing Drives

Use the retrofit system controller to incorporate open-head sensors into pump systems you already have. The system includes a control box that easily connects to your drive and an open-head sensor equipped pump head. If pump head is opened during operation, the interlock control box instantly shuts down the drive.

The retrofit system is compatible with select L/S and I/P drives. Controller 77097-00 includes power cables and a single extension cable to connect one sensor-equipped pump head. Order optional extension cable 77097-20 to connect a second pump head.

[RB-77097-00](#) Open-head interlock sensor control box

[RB-77097-02](#) Power cable for hard-wired 115 VAC drives

[RB-77097-20](#) Optional extension cable, 6 ft (1.8 m)





Masterflex® Ultrasonic Flow Sensors

Ensure consistent flow rates

- **Noninvasive design** eliminates contact with the fluid being monitored
- Ideally suited for applications with **strict hygienic standards**
- **Continuously monitor** flow rates in peristaltic pump tubing and send data directly to your computer
- **Compact** aluminum sensor body clamps around the tubing
- **Integrated electronics**—no external electronic board is needed
- Specifically **calibrated for use** with Masterflex L/S® and I/P® platinum-cured silicone tubing

Ask about customization for our full range of Masterflex tubing formulations



Flow Sensors for Platinum-Cured Silicone Tubing

Calibrated for tubing size	Catalog number	Price
L/S 13	RB-33500-13	
L/S 14	RB-33500-14	
L/S 16	RB-33500-16	
L/S 25	RB-33500-25	
L/S 17	RB-33500-17	
L/S 18	RB-33500-18	
L/S 15	RB-33500-15	
L/S 24	RB-33500-24	
L/S 35	RB-33500-35	
L/S 36	RB-33500-36	
I/P 26	RB-33500-26	
I/P 73	RB-33500-73	

Masterflex® Pump Tubing

Ensure optimal performance from your Masterflex Pump

Silicone (platinum-cured)

- Low protein binding, fungus resistant, phthalate and latex-free
- Accommodates a wide temperature range
- USP Class V, EP, FDA, REACH, RoHS, ADF

Silicone (peroxide-cured)

- Greater physical compression capability
- Economical, longer tubing life
- USP Class VI, EP, FDA, 3A, REACH, RoHS, ADF

BioPharm Silicone (platinum-cured)

- Low absorption; excellent biocompatibility
- Very low extractable; weather, ozone, corona, radiation resistant
- USP Class VI, EP, FDA, 3A, REACH, RoHS, ADF

BioPharm Plus Silicone (platinum-cured)

- Ultra-smooth—minimizes particle entrapment
- Very low extractable—ideal for lab, biotech, and pharmaceutical
- USP Class VI, EP, FDA, REACH, RoHS, ADF

Puri-Flex™

- Heat sealable, weldable, and economical
- Long pump life when compared to silicone or many other TPE tubings
- USP Class VI, FDA, 3A, REACH, RoHS, ADF

C-Flex®

- Heat sealable, weldable, economical
- Better resistance to pH fluctuations
- USP Class VI, EP, REACH, RoHS, ADF

C-Flex® ULTRA

- Longest life of any C-Flex formulation
- Lowest spallation and reduced residue
- USP Class VI, EP, REACH, RoHS, ADF

PharMed® BPT

- >10,000 hours of tubing life; sealable, weldable
- Ideal for tissue and cell culture work
- USP Class VI, EP, FDA, NSF, REACH, RoHS

PharmaPure®

- Nontoxic and nonhemolytic biocompatible
- Long life even under pressure with VERY low spallation
- USP Class VI, EP, FDA, REACH, RoHS

GORÉ® STA-PURE® Series PCS

- Long life—even in pressures up to 100 psi
- Excellent flow stability
- USP Class VI

GORÉ® STA-PURE® Series PFL

- Long life—even in pressures up to 100 psi
- Excellent biocompatibility and flow stability
- USP Class VI

Chem-Durance® Bio

- Excellent chemical compatibility and biocompatibility
- Excellent life and durability under pressure
- USP Class VI, FDA, REACH, RoHS

Solve-Flex®

- Excellent chemical resistance, especially solvents
- Fluoropolymer lined with low spallation
- USP Class VI

Tygon® E-LFL

- Longest life of all Tygon formulations
- Broad chemical resistance
- USP Class VI, EP, FDA, EU Food, REACH, RoHS, ADF

Tygon E-Food (B-44-4X)

- Smooth inner surface unaffected by commercial sanitizers
- Nontoxic; will not affect taste or odor
- FDA, EU Food, NSF, 3A, REACH, RoHS, ADF

Tygon E-Lab (E-3603)

- Ideal for general transfer use
- Nonaging, nonoxidizing, low gas permeability
- USP Class VI, FDA, EU Food, NSF, REACH, RoHS, ADF

Tygon Fuel & Lubricant (F-4040-A)

- Formulated to transport hydrocarbons, petroleum products, and distillates
- Low gas permeability
- REACH, RoHS, ADF

Tygon Chemical (2001)

- Excellent chemical resistance
- Plasticizer-free with low gas permeability
- FDA 21 CFR 175.300, REACH, RoHS, ADF

Norprene® (A-60 G)

- Up to 10,000 hours of tubing life
- Excellent choice for pressure/vacuum applications
- NSF, REACH, RoHS

Norprene Food (A 60 F)

- Ideal for high-temperature food applications
- Resists heat, ozone, acids, and alkalis
- FDA, 3A, NSF, REACH, RoHS

Viton®

- Perfect for applications where FDA and chemical compatibility is needed
- Resists corrosives, solvents, and oils at elevated temperatures
- FDA, ADF

Masterflex® Gamma Irradiated Tubing

Reduce the risk of microbial contamination

- Save time—many sizes of packaged and pretreated tubing available for quick shipment!
- Tubing is double bagged prior to gamma irradiation
- Irradiation at 32.5 kGy offers optimal microbial control for the tubing's critical fluid pathway
- Gamma-sensitive labeling confirms treatment
- Select from popular biocompatible tubing formulations

Formulation	Qty/pk	L/S 16		L/S 15		L/S 24		I/P 73		I/P 82	
		Cat. no.	Price	Cat. no.	Price	Cat. no.	Price	Cat. no.	Price	Cat. no.	Price
Silicone (platinum-cured)	7.6 m (25 ft)	RB-96119-16		RB-96119-15		RB-96119-24		RB-96119-73		RB-96119-82	
PharMed® BPT	7.6 m (25 ft)	RB-96122-16		RB-96122-15		RB-96122-24		RB-96122-73		RB-96122-82	
C-Flex®	7.6 m (25 ft)	RB-96123-16		RB-96123-15		RB-96123-24		RB-96123-73		RB-96123-82	

	Qty/pk	L/S® Precision Pump Tubing						L/S® High-Performance Precision Pump Tubing			
		L/S 13	L/S 14	L/S 16	L/S 25	L/S 17	L/S 18	L/S 15	L/S 24	L/S 35	L/S 36
		0.06 to 36 mL/min	0.21 to 130 mL/min	0.8 to 480 mL/min	1.7 to 1000 mL/min	2.8 to 1700 mL/min	3.8 to 2300 mL/min	1.7 to 1000 mL/min (1.8 to 1100 mL/min)	2.8 to 1700 mL/min (3.0 to 1800 mL/min)	3.8 to 2300 mL/min (4.3 to 2600 mL/min)	4.8 to 2900 mL/min (5.8 to 3400 mL/min)
Silicone (platinum-cured)	7.6 m (25 ft)	RB-96410-13	RB-96410-14	RB-96410-16	RB-96410-25	RB-96410-17	RB-96410-18	RB-96410-15	RB-96410-24	RB-96410-35	RB-96410-36
Silicone (peroxide-cured)	7.6 m (25 ft)	RB-96400-13	RB-96400-14	RB-96400-16	RB-96400-25	RB-96400-17	RB-96400-18	RB-96400-15	RB-96400-24	RB-96400-35	RB-96400-36
BioPharm Silicone (platinum-cured)	7.6 m (25 ft)	RB-96420-13	RB-96420-14	RB-96420-16	RB-96420-25	RB-96420-17	RB-96420-18	RB-96420-15	RB-96420-24	RB-96420-35	RB-96420-36
BioPharm Plus Silicone (platinum-cured)	7.6 m (25 ft)	RB-96440-13	RB-96440-14	RB-96440-16	RB-96440-25	RB-96440-17	RB-96440-18	RB-96440-15	RB-96440-24	RB-96440-35	RB-96440-36
Puri-Flex™	7.6 m (25 ft)	RB-96419-13	RB-96419-14	RB-96419-16	RB-96419-25	RB-96419-17	RB-96419-18	RB-96419-15	RB-96419-24	RB-96419-35	RB-96419-36
C-Flex®	7.6 m (25 ft)	RB-06424-13	RB-06424-14	RB-06424-16	RB-06424-25	RB-06424-17	RB-06424-18	RB-06424-15	RB-06424-24	RB-06424-35	RB-06424-36
C-Flex® ULTRA	7.6 m (25 ft)	—	RB-06434-14	RB-06434-16	RB-06434-25	RB-06434-17	RB-06434-18	RB-06434-15	RB-06434-24	RB-06434-35	RB-06434-36
PharMed® BPT	7.6 m (25 ft)	RB-06508-13	RB-06508-14	RB-06508-16	RB-06508-25	RB-06508-17	RB-06508-18	RB-06508-15	RB-06508-24	RB-06508-35	RB-06508-36
PharmaPure®	7.6 m (25 ft)	RB-06435-13	RB-06435-14	RB-06435-16	RB-06435-25	RB-06435-17	RB-06435-18	RB-06435-15	—	—	—
GORE® STA-PURE® Series PCS	35.6 cm (14")	—	RB-96211-14	RB-96211-16	RB-96211-25	RB-96211-17	RB-96211-18	RB-96211-15	RB-96211-24	RB-96211-35	RB-96211-36
GORE® STA-PURE® Series PFL	35.6 cm (14")	—	RB-96212-24	RB-96212-35	RB-96212-36	RB-96212-17	RB-96212-18	RB-96212-15	RB-96212-24	RB-96212-35	RB-96212-36
Chem-Durance® Bio	15.2 m (50 ft)	RB-06442-13	RB-06442-14	RB-06442-16	RB-06442-25	RB-06442-17	RB-06442-18	RB-06442-15	RB-06442-24	RB-06442-35	RB-06442-36
Solve-Flex®	3.6 m (12 ft)	—	—	—	—	RB-96446-17	—	—	RB-96446-24	—	—
Tygon® E-LFL	7.6 m (25 ft)	RB-06440-13	RB-06440-14	RB-06440-16	RB-06440-25	RB-06440-17	RB-06440-18	RB-06440-15	RB-06440-24	RB-06440-35	RB-06440-36
Tygon E-Food (B-44-4X)	15.2 m (50 ft)	RB-06418-13	RB-06418-14	RB-06418-16	RB-06418-25	RB-06418-17	RB-06418-18	RB-06418-15	RB-06418-24	RB-06418-35	RB-06418-36
Tygon E-Lab (E-3603)	15.2 m (50 ft)	RB-06509-13	RB-06509-14	RB-06509-16	RB-06509-25	RB-06509-17	RB-06509-18	RB-06509-15	RB-06509-24	RB-06509-35	RB-06509-36
Tygon Fuel & Lubricant (F-4040-A)	15.2 m (50 ft)	RB-06401-13	RB-06401-14	RB-06401-16	RB-06401-25	RB-06401-17	RB-06401-18	RB-06401-15	RB-06401-24	RB-06401-35	RB-06401-36
Tygon Chemical (2001)	15.2 m (50 ft)	RB-06475-13	RB-06475-14	RB-06475-16	RB-06475-25	RB-06475-17	RB-06475-18	RB-06475-15	RB-06475-24	—	—
Norprene® (A-60 G)	15.2 m (50 ft)	RB-06404-13	RB-06404-14	RB-06404-16	RB-06404-25	RB-06404-17	RB-06404-18	RB-06404-15	RB-06404-24	RB-06404-35	RB-06404-36
Norprene Food (A 60 F)	15.2 m (50 ft)	RB-06402-13	RB-06402-14	RB-06402-16	RB-06402-25	RB-06402-17	RB-06402-18	RB-06402-15	RB-06402-24	RB-06402-35	RB-06402-36
Viton®	7.6 m (25 ft)	RB-96412-13	RB-96412-14	RB-96412-16	RB-96412-25	RB-96412-17	RB-96412-18	RB-96412-15	RB-96412-24	RB-96412-35	RB-96412-36

	Qty/pk	I/P® Precision Pump Tubing			Qty/pk	I/P® High-Performance Precision Pump Tubing			Qty/pk	B/T® PerfectPosition® Pump Tubing	
		I/P 26	I/P 73	I/P 82		I/P 70	I/P 88	I/P 89		B/T 87	B/T 91
		0.01 to 4 LPM 0.002 to 1.1 GPM	0.01 to 8 LPM 0.002 to 2.1 GPM	0.02 to 13 LPM 0.005 to 3.5 GPM		0.01 to 8 LPM 0.002 to 2.1 GPM	0.02 to 17 LPM 0.005 to 4.5 GPM	0.03 to 19 LPM 0.007 to 5.0 GPM		0.67 to 18.9 LPM 0.17 to 5.0 GPM	1.4 to 42 LPM 0.4 to 11.1 GPM
Silicone (platinum-cured)	7.6 m (25 ft)	RB-96410-26	RB-96410-73	RB-96410-82	3 m (10 ft)	RB-96510-70	RB-96510-88	RB-96510-89	3 m (10 ft)	RB-96400-87	RB-96400-91
Silicone (peroxide-cured)	7.6 m (25 ft)	RB-96400-26	RB-96400-73	RB-96400-82	—	—	—	—	3 m (10 ft)	RB-96400-87	RB-96400-91
BioPharm Silicone (platinum-cured)	7.6 m (25 ft)	RB-96420-26	RB-96420-73	RB-96420-82	3 m (10 ft)	RB-96421-70	RB-96421-88	RB-96421-89	—	—	—
BioPharm Plus Silicone (platinum-cured)	7.6 m (25 ft)	RB-96440-26	RB-96440-73	RB-96440-82	3 m (10 ft)	RB-96441-70	RB-96441-88	RB-96441-89	3 m (10 ft)	RB-96445-87	RB-96445-91
Puri-Flex™	7.6 m (25 ft)	RB-96419-26	RB-96419-73	RB-96419-82	3 m (10 ft)	RB-96419-70	RB-96419-88	RB-96419-89	3 m (10 ft)	RB-96419-87	RB-96419-91
C-Flex®	7.6 m (25 ft)	RB-06424-26	RB-06424-73	RB-06424-82	3 m (10 ft)	RB-06424-70	RB-06424-88	RB-06424-89	3 m (10 ft)	RB-06424-87	RB-06424-91
PharMed® BPT	7.6 m (25 ft)	RB-06508-26	RB-06508-73	RB-06508-82	7.6 m (25 ft)	RB-06508-70	RB-06508-88	—	3 m (10 ft)	RB-06507-87	RB-06507-91
PharmaPure®	7.6 m (25 ft)	RB-06435-26	RB-06435-73	RB-06435-82	—	—	—	—	3 m (10 ft)	RB-06437-87	RB-06437-91
GORE® STA-PURE® Series PCS	0.6 m (2 ft)	RB-96211-26	RB-96211-73	RB-96211-82	0.6 m (2 ft)	—	RB-96211-88	RB-96211-89	—	—	—
GORE® STA-PURE® Series PFL	0.6 m (2 ft)	RB-96212-26	RB-96212-73	RB-96212-82	0.6 m (2 ft)	—	RB-96212-88	RB-96212-89	—	—	—
Chem-Durance® Bio	15.2 m (50 ft)	RB-06442-26	RB-06442-73	RB-06442-82	15.2 m (50 ft)	RB-06442-70	RB-06442-88	RB-06442-89	3 m (10 ft)	RB-06443-87	RB-06443-91
Tygon® E-LFL	7.6 m (25 ft)	RB-06440-26	RB-06440-73	RB-06440-82	7.6 m (25 ft)	RB-06440-70	RB-06440-88	RB-06440-89	3 m (10 ft)	RB-06440-87	RB-06440-91
Tygon E-Food (B-44-4X)	15.2 m (50 ft)	RB-06418-26	RB-06418-73	RB-06418-82	15.2 m (50 ft)	RB-06418-70	RB-06418-88	RB-06418-89	3 m (10 ft)	RB-06418-87	RB-06418-91
Tygon E-Lab (E-3603)	15.2 m (50 ft)	RB-06509-26	RB-06509-73	RB-06509-82	15.2 m (50 ft)	RB-06509-70	RB-06509-88	RB-06509-89	15.2 m (50 ft)	—	—
Norprene® (A-60 G)	15.2 m (50 ft)	RB-06404-26	RB-06404-73	RB-06404-82	7.6 m (25 ft)	RB-06404-70	RB-06404-88	RB-06404-89	7.6 m (25 ft)	—	—
Norprene Food (A 60 F)	15.2 m (50 ft)	RB-06402-26	RB-06402-73	RB-06402-82	7.6 m (25 ft)	—	RB-06402-88	RB-06402-89	3 m (10 ft)	RB-06399-87	RB-06399-91

Masterflex® L/S® Spooled Pump Tubing

Save money—buy in bulk

- Reduce scrap—cut only as much as you need
- Ensure that you always have enough tubing on hand

Spooled pump tubing provides continuous lengths of pump tubing on convenient, manageable spools that are easy to transport and require less storage space than the equivalent amount of individual tubing coils.

Nearly any Masterflex pump tubing formulation can be spooled. If the formulation you need is not listed below, call our Application Specialists for a quote or to place a special order.



MASTERFLEX®

Tubing size	Peroxide-cured silicone (96400-series)			Platinum-cured silicone (96410-series)			PharMed® BPT (06508-series)			BioPharm Silicone (96420-series) 121.9 m (400 ft)		C-Flex® (06424-series) 121.9 m (400 ft)	
	m (ft)	Cat. no.	Price	m (ft)	Cat. no.	Price	m (ft)	Cat. no.	Price	Cat. no.	Price	Cat. no.	Price
L/S 13	76.2 (250)	RB-96407-13		152.4 (500)	RB-96403-13		—	—	—	—	—	RB-06427-13	
L/S 14	76.2 (250)	RB-96407-14		152.4 (500)	RB-96403-14		152.4 (500)	RB-95687-14		RB-96423-14		RB-06427-14	
L/S 16	76.2 (250)	RB-96407-16		152.4 (500)	RB-96403-16		152.4 (500)	RB-95687-16		RB-96423-16		RB-06427-16	
L/S 25	76.2 (250)	RB-96407-25		152.4 (500)	RB-96403-25		—	—		RB-96423-25		RB-06427-25	
L/S 17	76.2 (250)	RB-96407-17		152.4 (500)	RB-96403-17		152.4 (500)	RB-95687-17		RB-96423-17		RB-06427-17	
L/S 18	61.0 (200)	RB-96407-18		121.9 (400)	RB-96403-18		121.9 (400)	RB-95687-18		RB-96423-18		RB-06427-18	
L/S 15	76.2 (250)	RB-96407-15		121.9 (400)	RB-96403-15		121.9 (400)	RB-95687-15		RB-96423-15		RB-06427-15	
L/S 24	61.0 (200)	RB-96407-24		91.4 (300)	RB-96403-24		91.4 (300)	RB-95687-24		RB-96423-24		RB-06427-24	
L/S 35	—	—	—	91.4 (300)	RB-96403-35		91.4 (300)	RB-95687-35		—	—	RB-06427-35	
L/S 36	—	—	—	30.5 (100)	RB-96403-36		30.5 (100)	RB-95687-36		—	—	RB-06427-36	

Masterflex® L/S® Bulk-Packed Pump Tubing

Prevent contamination with individually bagged coils

- Keep tubing sealed until ready to use
- Reduce storage space requirements
- Save money and shipping fees by buying in bulk

Ideal for large-volume pump tubing users, bulk packs contain individually bagged, sealed 7.6-m (25-ft) coils of tubing, all from a single manufacturing lot. Because bulk packs use less packaging, they require less storage space for the same amount of tubing, and are the best choice for storerooms or other areas where space is at a premium.

Most Masterflex pump tubing formulations can be bulk-packed. If the formulation you need is not listed below, call our Application Specialists for a quote or to place a special order.

MASTERFLEX®



Pump tubing size	Number of 7.6-m (25-ft) bags per box	Platinum-cured silicone (96410-series)		C-Flex® (06424-series)	
		Catalog number	Price/bx	Catalog number	Price/bx
L/S 13	20	RB-96404-13		RB-06436-13	
L/S 14	20	RB-96404-14		RB-06436-14	
L/S 16	20	RB-96404-16		—	—
L/S 25	20	RB-96404-25		RB-06436-25	
L/S 17	20	RB-96404-17		RB-06436-17	
L/S 18	10	RB-96404-18		—	—
L/S 15	20	RB-96404-15		RB-06436-15	
L/S 24	20	RB-96404-24		RB-06436-24	
L/S 35	10	RB-96404-35		RB-06436-35	
L/S 36	10	RB-96404-36		RB-06436-36	

Masterflex® L/S® Sanitary Pump Tubing Assemblies

Get quicker connection of tubing

Features/Benefits

- Meets stringent demands of biotechnology and pharmaceutical industries
- Smooth, pre-molded tubing ends allow quick connection to an adapter or to another length of sanitary tubing
- Connectors help maintain cleanliness and purity of your fluids
- Sanitary tubing is less thermally conductive than metallic tubing systems and not subject to galvanic action, RFI, or EMI
- All L/S platinum-cured silicone and PharMed® BPT sanitary tubing conforms to USP Class VI and FDA standards
- FREE Certificate of resin or elastomer Compliance is available upon request

How to Connect Tubing

- Each length of tubing features pre-molded ends. Tubing with 1/2" mini-connections uses molded-in gasket at one end to ensure quality seal
- Pre-molded ends allow quick connection to an adapter or additional length of sanitary tubing. Order adapters below, right.
- Join 1/2" mini-connection to another 1/2" mini-connection, adapter, or to your system with a push/pull clamp

How to Order

1. Order your desired tubing formulation and length. Choose tubing size based on flow range.
2. Order PVDF push/pull clamp (separately below).
3. Order silicone or Viton® gaskets as needed to connect to your system or to adapters
4. Select sanitary adapters as needed

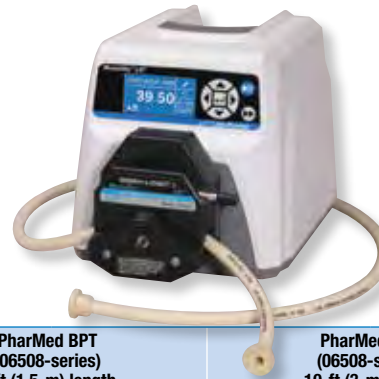
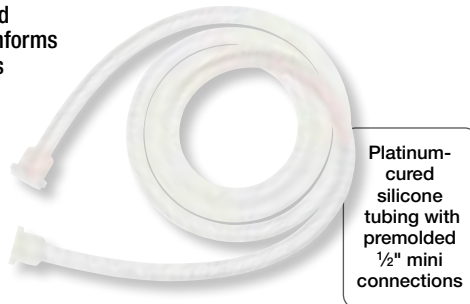

MASTERFLEX®

Tubing size	Platinum-cured silicone (96410-series) 5-ft (1.5-m) length		Platinum-cured silicone (96410-series) 10-ft (3-m) length		PharMed BPT (06508-series) 5-ft (1.5-m) length		PharMed BPT (06508-series) 10-ft (3-m) length	
	Catalog number	Price	Catalog number	Price	Catalog number	Price	Catalog number	Price
L/S Precision sanitary pump tubing								
L/S 13	RB-96100-13		RB-96101-13		RB-96112-13		RB-96113-13	
L/S 14	RB-96100-14		RB-96101-14		RB-96112-14		RB-96113-14	
L/S 16	RB-96100-16		RB-96101-16		RB-96112-16		RB-96113-16	
L/S 25	RB-96100-25		RB-96101-25		RB-96112-25		RB-96113-25	
L/S 17	RB-96100-17		RB-96101-17		RB-96112-17		RB-96113-17	
L/S 18	RB-96100-18		RB-96101-18		RB-96112-18		RB-96113-18	
L/S High-Performance Precision sanitary pump tubing								
L/S 15	RB-96100-15		RB-96101-15		RB-96112-15		RB-96113-15	
L/S 24	RB-96100-24		RB-96101-24		RB-96112-24		RB-96113-24	
L/S 35	—	—	—	—	RB-96112-35		RB-96113-35	
L/S 36	—	—	—	—	RB-96112-36		RB-96113-36	

Accessories for Masterflex® L/S® Sanitary Pump Tubing



RB-31201-88 Push/pull clamp, PVDF. For quick joining of two 1/2" mini connections

Gaskets. Order gaskets to join 1/2" mini connection without molded-in gasket to another 1/2" mini connection without molded-in gasket or to an adapter (sold separately at right).

RB-30548-00 Silicone gasket for use with sanitary silicone (platinum-cured) tubing. Pack of 10

RB-30548-20 Viton® gasket for use with sanitary PharMed® BPT tubing. Pack of 10

Adapters

Adapter connections	Polypropylene		PVDF	
	Cat. no.	Price	Cat. no.	Price
1/2" mini to 1/8" NPT(M)	RB-31200-00		RB-31201-00	
1/2" mini to 1/8" NPT(F)	RB-31200-10		—	—
1/2" mini to 1/4" NPT(M)	RB-31200-01		RB-31201-01	
1/2" mini to 1/4" NPT(F)	RB-31200-11		RB-31201-11	
1/2" mini to 1/4" hose barb	RB-31805-25		RB-31808-25	
1/2" mini to 3/8" NPT(M)	RB-31200-02		RB-31201-02	
1/2" mini to 3/8" NPT(F)	RB-31200-12		RB-31201-12	
1/2" mini to 3/8" hose barb	RB-31805-26		RB-31808-26	
1/2" mini to 1/2" NPT(M)	RB-31200-03		RB-31201-03	
1/2" mini to 1/2" NPT(F)	RB-31200-13		RB-31201-13	
1/2" mini to 1/2" hose barb	RB-31805-27		—	—
1/2" mini to 1" maxi	RB-31200-30		—	—
1/2" mini to 1" ladish	RB-31805-05		RB-31201-40	
1/2" mini to female luer lock	RB-31200-50		RB-31201-50	

Tech Info

Choosing Pump Tubing

- Consider key aspects of your application: flow rate, pressure, temperature, viscosity, duty and control requirements
- If your application requires the generation of high pressure, a strong vacuum/suction lift, or involves viscous fluids, consider using High-Performance Precision tubing
- PharMed® BPT and Tygon® are the firmest formulations we offer; C-Flex® and silicone are the softest. Firm tubing has better pressure generation, stronger vacuum/suction lift, and lower gas permeability.
- Review the tubing compatibility charts at ColeParmer.com/mflexchem
- Always test tubing before extended use

Note: Use High-Performance Precision tubing only with the High-Performance pump head.

Masterflex® I/P® Bulk-Packed Pump Tubing

Individually bagged to prevent contamination

- Prevent contamination—tubing coils are individually bagged and sealed
- Use as many or as few as you need, and store the rest
- Save money by buying and shipping in bulk
- Bulk packs contain ten individually bagged, sealed 25-ft (7.6-m) coils of tubing, all from a single manufacturing lot



Bulk packs offer individually sealed bags of tubing at a lower price per pack than individual packs—so you save money!

MASTERFLEX®

Tubing size	Number of 25-ft (7.6-m) bags per box	Platinum-cured silicone (96410-series)		PharMed® BPT (06508-series)		C-Flex® (06424-series)	
		Catalog number	Price	Catalog number	Price	Catalog number	Price
I/P 26	10	RB-96404-26	—	—	—	RB-06436-26	—
I/P 73	10	RB-96404-73	—	—	—	RB-06436-73	—
I/P 82	10	RB-96404-82	—	RB-95691-82	—	RB-06436-82	—

Masterflex® I/P® Spooled Pump Tubing

Use only the required length

- Eliminate waste by cutting to the exact length needed for your application
- Continuous lengths of tubing are convenient and cost-effective
- Spools contain up to 400 ft (121.9 m) of continuous pump tubing, depending on size
- Save space and shipping costs by buying in bulk
- Good choice for applications requiring long, continuous runs of tubing, or which use odd-size lengths that generate scrap when using standard 25- or 50-ft (7.6- or 15.2-m) coils

MASTERFLEX®



Tubing size	Peroxide-cured silicone (96400-series)			Platinum-cured silicone (96410-series)			PharMed® BPT (06508-series)			BioPharm Silicone (96420-series and 96421-series*)			C-Flex® (06424-series)		
	ft (m)	Catalog number	Price	ft (m)	Catalog number	Price	ft (m)	Catalog number	Price	ft (m)	Catalog number	Price	ft (m)	Catalog number	Price
I/P 26	—	—	—	200 (61.0)	RB-96403-26	—	—	—	—	400 (121.9)	RB-96423-26	—	400 (121.9)	RB-06427-26	—
I/P 73	150 (45.7)	RB-96402-73	—	45.7 (150)	RB-96403-73	—	45.7 (150)	RB-95687-73	—	100 (30.5)	RB-96423-73	—	100 (30.5)	RB-06427-73	—
I/P 82	100 (30.5)	RB-96402-82	—	100 (30.5)	RB-96403-82	—	100 (30.5)	RB-95687-82	—	—	—	—	100 (30.5)	RB-06427-82	—
I/P 88	—	—	—	—	—	—	—	—	—	100 (30.5)	RB-96423-88*	—	—	—	—
I/P 89	—	—	—	—	—	—	—	—	—	100 (30.5)	RB-96423-89*	—	—	—	—

Masterflex® I/P® Sanitary Pump Tubing Assemblies

Get quick and easy connections

Features/Benefits

- Ideal for biotech and pharmaceutical processing applications
- Pre-molded tubing ends with ½" mini-connection for bacteria-free fluid transfer
- Sanitary tubing is less thermally conductive than metallic tubing systems and not subject to galvanic action, RFI, or EMI

How to Connect Tubing

- Each length of tubing features pre-molded ends with ½" mini-connection. One end has molded-in gasket to ensure quality seal.
- Pre-molded ends allow quick connection to an adapter or to additional length of sanitary tubing
- Join ½" mini-connection to another ½" mini-connection, adapter, or to system with a push/pull clamp. Clamped connection withstands greater pressures than tubing.

How to Order

1. Order your desired tubing formulation and length. Choose tubing size based on flow range (see chart on page 19).
2. Order PVDF push/pull clamp (separately below).
3. Order silicone or Viton® gaskets as needed to connect to your system or to adapters.
4. Select sanitary adapters as needed.



I/P PharMed® BPT sanitary tubing features pre-molded ends with ½" mini-connection.

MASTERFLEX®



Tubing size	Platinum-cured silicone (96410-series) 5-ft (1.5-m) length		Platinum-cured silicone (96410-series) 10-ft (3-m) length		PharMed® BPT (06508-series) 5-ft (1.5-m) length		PharMed® BPT (06508-series) 10-ft (3-m) length	
	Catalog number	Price	Catalog number	Price	Catalog number	Price	Catalog number	Price
I/P Precision sanitary pump tubing								
I/P 26	RB-96100-26		RB-96101-26		RB-96112-26		RB-96113-26	
I/P 73	RB-96100-73		RB-96101-73		RB-96112-73		RB-96113-73	
I/P 82	RB-96100-82		RB-96101-82		RB-96112-82		RB-96113-82	
I/P High-Performance Precision sanitary pump tubing								
I/P 70	—	—	—	—	RB-96112-70		RB-96113-70	
I/P 88	—	—	—	—	RB-96112-88		RB-96113-88	

Accessories for Masterflex® I/P® Sanitary Pump Tubing

RB-31201-88 Push/pull clamp, PVDF. For quick joining of two ½" mini connections

Gaskets. Order gaskets to join ½" mini connection without molded-in gasket to another ½" mini connection without molded-in gasket or to an adapter (sold separately below).

RB-30548-00 Silicone gasket for use with sanitary silicone (platinum-cured) tubing. Pack of 10.

RB-30548-20 Viton® gasket for use with sanitary PharMed® BPT tubing. Pack of 10



Adapters

Adapter connections	Polypropylene		PVDF	
	Cat. no.	Price	Cat. no.	Price
½" mini to ¼" NPT(M)	RB-31200-01		RB-31201-01	
½" mini to ¼" NPT(F)	RB-31200-11		RB-31201-11	
½" mini to ¼" hose barb	RB-31805-25		RB-31808-25	
½" mini to ⅜" NPT(M)	RB-31200-02		RB-31201-02	
½" mini to ⅜" NPT(F)	RB-31200-12		RB-31201-12	
½" mini to ⅜" hose barb	RB-31805-26		RB-31808-26	
½" mini to ½" NPT(M)	RB-31200-03		RB-31201-03	
½" mini to ½" NPT(F)	RB-31200-13		RB-31201-13	
½" mini to 1" lardish	RB-31805-05		RB-31201-40	
½" mini to female luer lock	RB-31200-50		RB-31201-50	



Adapters

Application Tip

How to Increase Tubing Life

- Run larger tubing sizes at slower speeds
- Reduce occlusion
- Use Masterflex High-Performance precision tubing
- Select longer life material (Norprene®, PharMed® BPT, Tygon® E-LFL, BioPharm Plus)
- Reduce pressure in system
- Stop pump periodically, move tubing 20–25 cm (8–10 in.) forward

BarbLock™ Ultra-Secure Tubing Retainers

Get leak-free connection to barbed fittings

- Easy to install—ensures that tubing and fitting will not disengage
- Provides seven times the pull resistance of cable ties without crimps or distortion
- Compatible with single- or multi-tiered barbed fittings

BarbLock assemblies provide uniform 360° mechanical compression for a leak-free, durable seal, unlike cable ties or clamps. Fitting will not leak or blow off. Ideal for filtration, since retainer holds tight even with increasing back pressure as filter clogs.

BarbLock assemblies meet USP Class VI standards. Sterilize by irradiation, steam, or ethylene oxide (EtO) gas.

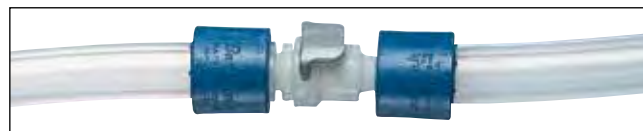

Platinum-cured silicone tubing 96410-73 shown with BarbLock retainer 30604-04 and quick-disconnect fitting 06360-91.

Tubing Retainers

Use with Masterflex® pump tubing size	Use with fitting type	Catalog number	Price
L/S® 16	Any barbed fitting	RB-30604-01	
L/S 17 and L/S 15		RB-30604-00	
L/S 24		RB-30604-02	
I/P® 73		RB-30604-04	
I/P 82 and I/P 70		RB-30604-06	
I/P 82 and I/P 70	Quick-disconnects only (see pages 35–36 or ColeParmer.com)	RB-30604-08	

Retainer Tools

BarbLock assembly tool for use with	Catalog number	Price
L/S 16 tubing	RB-30604-18	
L/S 15, L/S 17, and L/S 24 tubing	RB-30604-10	
I/P 73 tubing	RB-30604-12	
I/P 82 tubing	RB-30604-14	
Universal BarbLock removal tool	RB-30604-16	

Ismatec® Flowmaster™ Pump

Stainless steel construction—ideal for sanitary fluid transfer

- Easy cleaning—housing is IP65 rated for washdown
- Change tubing in just seconds!
- Easy to disassemble for cleaning
- Meets requirements of the biotech, food and beverage, and pharmaceutical industries

Single-channel pump head accommodates tubing with 6.4 to 15.9 mm ID and 3.2 mm wall thickness. Accepts a 0 to 5 VDC, 0 to 10 VDC, 1 to 20 mA, or 4 to 20 mA input signal for remote speed control. Features multiple overload protection and an extensive analog interface with status information for process control systems.



ISMATEC®

ISO9001:2008 CERTIFIED SUPPLIER CE IP 65

Flow range	Rollers	Speed	Tubing	Power	Catalog number	Price
37 mL/min to 13 L/min	3	5 to 500 rpm	Pump (see page 25)	115 VAC, 50/60 Hz	RB-78025-00	
				230 VAC, 50/60 Hz	RB-78025-05	

[RB-17050-01](#) NIST-traceable calibration with data for peristaltic pump drive

Convex Rollers

Convex rollers extend tubing life and are gentle on fluid.

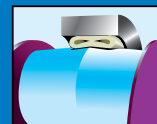
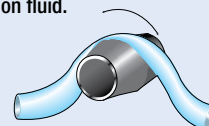

Ismatec® BVP and MCP Quick-Couple Pump Systems

Small footprint ideal for confined spaces

- Mount pump heads quickly with turn-and-lock mounting system
- Remote control and programming options add versatility
- Process washdown drives are IP65 rated
- Stainless steel housing is sealed for added durability

BVP Process Drive

- Prime, flush, or prevent overflow with Max/Slow toggle switch

Pump features analog input for remote control of speed, start/stop or flow direction and has a digital display for speed.

MCP Process Programmable Digital Drive

- Save time—recall and store up to four programs
- Preprogrammed with tubing sizes and heads for faster setup
- Use the RS-232 interface to automate your lab or operate independently via the keypad—RS-232 in for remote operation; RS-232 out for cascading pumps

Pump is programmable to dispense by volume, time, flow rate, batches with variable pause time, stored programs, roller back steps, or number of dispensing cycles. Digital display shows speed, flow rate, dispensing volume, dispensing time, and pause time.

APPLICATIONS

- ✓ Dispensing/filling
- ✓ Nutrient addition
- ✓ Media transfer



78003-10



ISMATEC®

Fluid Transfer

Ismatec® Pumps

Specifications

Duty cycle: continuous

ISO9001:2008
CERTIFIED SUPPLIER



Model	BVP Process washdown drive		MCP Process washdown drive
Catalog number	RB-78003-10	RB-78003-12	RB-78003-08
Programmable	No		Yes
Speed	1 to 240 rpm		1 to 240 rpm
Resolution	0.1 rpm		0.1 rpm
Flow range/channel	0.001 to 3700 mL/min		0.001 to 3700 mL/min
Flow rate settings	—		µL/min, mL/min, L/min
Remote control capabilities	Speed control: 0 to 5 VDC, 0 to 10 VDC, 0 to 20 mA, 4 to 20 mA Speed output: 0 to 10 VDC or 0 to 7.2 kHz Start/stop, rotation direction, autostart		RS-232 (1 in, 1 out), 1 analog Speed control: 0 to 5 VDC, 0 to 10 VDC, 0 to 20 mA, 4 to 20 mA Speed output: 0 to 10 VDC or 0 to 7.2 kHz Start/stop, rotation direction, autostart
IP rating	IP65		IP65
Power	115 VAC, 50/60 Hz	230 VAC, 50/60 Hz	115–230 VAC, 50/60 Hz
Price			

Washdown Pump Heads

Dismantle for easy cleaning—heads are ideal for hygienic applications. Convex rollers and concave tube-bed maintain the integrity of material being pumped. Coated aluminum with stainless steel rollers.

Flow range (mL/min)	Channels	Rollers	Tubing	Wall thickness	Max pressure	Catalog number	Price
0.49 to 3700	1	2	Pump (below)	1.6 mm	22 psi (1.5 bar)	RB-78002-11	
3.6 to 3100	1	2		2.4 mm	36 psi (2.5 bar)	RB-78002-13	
0.45 to 3400	1	3		1.6 mm	22 psi (1.5 bar)	RB-78002-16	
3.3 to 2900	1	3		2.4 mm	36 psi (2.5 bar)	RB-78002-14	



Pump Tubing

ID (mm)	OD (mm)	Wall (mm)	Tygon® E-Lab			Silicone (peroxide cured)			Silicone (platinum cured)			Norpren®			Viton®		
			Cat.no.	Ft/pk	Price/pk*	Cat.no.	Ft/pk	Price/pk*	Cat.no.	Ft/pk	Price/pk*	Cat.no.	Ft/pk	Price/pk*	Cat.no.	Ft/pk	Price/pk*
0.8	4.0	1.6	RB-06509-13	50		RB-96400-13	25		RB-95802-01	25		RB-06404-13	50		RB-96412-13	25	
1.6	4.8	1.6	RB-06407-72	50		RB-96400-14	25		RB-96410-14	25		RB-06410-01	50		RB-96412-14	25	
3.2	6.4	1.6	RB-06407-76	50		RB-06411-67	25		RB-95802-05	25		RB-06410-02	50		—	—	—
4.8	8.0	1.6	RB-06407-78	50		RB-06411-03	25		RB-95802-09	25		RB-06410-04	50		RB-96412-25	25	
6.4	9.5	1.6	RB-06407-80	50		RB-06411-71	25		RB-95802-12	25		RB-06410-05	50		RB-96412-18	25	
6.4	11.1	2.4	RB-06509-24	50		RB-06411-72	25		RB-95802-13	25		RB-06410-06	50		RB-96412-24	25	
8.0	11.2	1.6	RB-06407-83	50		RB-06411-75	25		RB-95802-15	25		RB-06410-08	50		RB-06434-05	25	
9.5	12.7	1.6	RB-06407-86	50		RB-06411-12	25		RB-95802-18	25		RB-06410-10	50		RB-06434-06	25	
11.1	14.3	1.6	RB-06407-87	50		—	—	—	—	—	—	RB-06410-13	50		—	—	—
12.8	16.0	1.6	RB-06407-90	25		RB-06411-80	25		RB-95802-21	25		RB-06410-14	50		RB-06434-07	25	
16.0	22.4	3.2	—	—	—	RB-06411-58	25		RB-95802-25	25		RB-06410-17	50		RB-06434-08	25	

*Discounts: Save 10% on 20–49 pks, 15% on 50–99 pks, 20% on 100+ pks in any combination.

Cole-Parmer® Digital Gear Pump Systems

Order one part number, get a complete system—drive and pump head

- View pump performance continually—graphical LCD shows four operating modes: continuous run, timed dispense, copy dispense, and volume dispense
- Systems deliver pulse-free flow in combination with Micropump® A-mount head; retrieve displacement and flow values by pump head size
- IP33-rated enclosure ensures splash and dust resistance
- Drive has a DB25F connection to the optional foot switch for hands-free on/off control (order foot switch separately)



Cole-Parmer®



Specifications

Viscosity: 0.2 to 1500 cp	Duty cycle: continuous	Remote control: (input) on/off by contact closure 0 to 10 VDC, 0 to 20 mA, 4 to 20 mA, and remote output	Max operating temperature: 60°C (104°F)
Suction lift: 0.6 m of H ₂ O (at 1750 rpm)	Port size: 1/8" NPT(F)		Speed: 36 to 3600 rpm

Flow rates (mL/min) [†]			Max pressure		Wetted parts			Benchtop digital systems			Service kits	
mL/rev	at 50 rpm	at 3600 rpm	Diff (bar)	System (bar)	Body	Gears	Seals	Catalog number	Power (VAC)	Price	Catalog number	Price
0.017	0.85	85	1.38	20.68	316 SS	Graphite	PTFE	RB-74014-72	90 to 260		RB-07144-42	
0.092	4.60	331.2	5.17	20.68	316 SS	PPS	PTFE	RB-74014-02	90 to 260		—	—
0.092	4.60	331.2	5.17	20.68	316 SS	PPS	PPS	RB-74014-62	90 to 260		—	—
0.261	13.05	939.6	8.61	20.68	316 SS	PEEK	Viton®	RB-74014-52	90 to 260		RB-74012-52	
0.316	15.8	1137.6	5.17	20.68	316 SS	PPS	PTFE	RB-74014-12	90 to 260		—	—
0.64	32.0	2304	5.17	20.68	316 SS	PPS	PTFE	RB-74014-22	90 to 260		RB-74012-22	
0.91	45.5	3276	5.17	20.68	316 SS	PPS	PTFE	RB-74014-32	90 to 260		—	—
1.17	58.5	4212	4.14	20.68	316 SS	PPS	Viton	RB-74014-42	90 to 260		—	—

[†]Flow rates in mL/min are based on water at room temperature and no back pressure.

[RB-07523-92](#) Foot switch, momentary start/stop, 1.8-m cable

[RB-06385-10](#) Male pipe adapter (straight); PP, 1/4" OD x 1/8" NPT(M). Pk of 10

[RB-30621-31](#) Male pipe adapter; HDPE, 1/8" NPT(M) x 1/4" ID. Pk of 10

[RB-40610-36](#) Male pipe adapter; natural PP, 1/8" NPT(M) x 1/4" ID. Pk of 10

Cole-Parmer® High-Pressure Piston Pumps

Precision pumping for your HPLC application

- Digital stepper motor ensures accuracy at low flow rates
- Self-flush feature washes piston with every stroke
- Interactive keypad controls make programming at the pump easy
- Pressure and leak sensors (except single-head pumps) alert you to malfunctions
- Remotely control pump with a PC via RS-232 and micro USB



Cole-Parmer®



Specifications

Wetted parts: synthetic ruby, sapphire, UHMWPE, PTFE	Duty cycle: continuous
Maximum temperature (fluid): 212°F (100°C)	Self-priming: no
	Power: 100 to 240 VAC, 50/60 Hz

Single-Head Pumps precisely meter and dispense chemicals, perfect for small-scale laboratory fluid transfers and HPLC applications. Small footprint saves bench and fume hood space. **High-Flow Dual-Head Pumps** are ideally suited to preparative and simulated moving bed chromatography applications and other high throughput processes. **High-Performance Isocratic Pumps** are best suited to semi-prep and other small-scale HPLC separations, and general metering and dispensing applications. **Low-Pulsation Dual-Head Pump** provides virtually pulse-free operation with a low dead-volume pulse dampener, automatic pressure compensation, and advanced linear cam technology.

Description	Single-head pumps			High-flow dual-head pumps			High-performance isocratic pumps		Low-pulsation dual-head pump
Catalog number	RB-74931-00	RB-74931-01	RB-74931-20	RB-74931-10	RB-74931-11	RB-74931-12	RB-74931-25	RB-74931-45	RB-74931-30
Pump head material	PEEK	316 SS	316 SS	PEEK	316 SS	316 SS	316 SS	316 SS	316 SS
Flow Range (mL/min)	0 to 10			0 to 100			0 to 100	0 to 10	0 to 12
Flow Accuracy	±2% of set point			±3% of set point			±3% of set point	±2% of set point	±2% of set point
Flow Repeatability	±1%		±0.2%	±0.5%			±0.5%		±0.2%
Pressure range (psi)	0 to 2000		0 to 6000	0 to 4000		0 to 1000	0 to 4000	0 to 5000	0 to 6000
Pulse dampener	No		Yes	Yes	No	No	Yes		Yes
Output	RS-232, micro USB, run/stop		RS-232, micro USB, voltage flow control, run/stop	RS-232, micro USB, voltage flow control, run/stop			RS-232, micro USB, voltage flow control, run/stop		RS-232, micro USB, voltage flow control, run/stop
Price									

Sanitary Centrifugal Pumps

Eliminate piping changes with interchangeable design

- Clean-in-place (CIP) 3A sanitary transfer pump
- 316L stainless steel liquid end construction
- Washdown motors available in either white epoxy (available online) or stainless steel
- Heavy-duty pumps have a casing that is twice the thickness of the standard versions
- Heavy-duty pumps are designed for Steam-in-Place (SIP) as well



Models are available with inlets up to 6". Contact our Application Specialists for assistance in sizing the proper pump for your system.

What's included: conduit box for hardwiring.

Specifications

Wetted parts

Casing: 316L stainless steel
Backplate, impeller, shaft: 316 stainless steel
Adapter: 304 stainless steel

Duty cycle: continuous

Max temperature: 212°F (100°C)



Heavy-duty models only

Max flow		Max head		Max pressure		Tri-Clamp® connections		Motor		Power			Catalog number	Price		
GPM	LPM	ft	m	psi	bar	Inlet	Outlet	hp	rpm	VAC	Hz	Amps				
Sanitary centrifugal pumps																
62	234.7	22	6.7	125	8.6	1½"	1½"	½	3600	208-230/460	60	2.0-2.0 / 1.0	RB-76720-00			
									1800			115/208-230		11.2 / 5.6-5.6	RB-76720-05	
105	397.5	45	13.7			2	1½"	3	3600	208-230/460	60	9.6-9.6 / 4.8	23.0 / 11.5-11.5	RB-76720-10		
148	560.2	73	22.3										2	1800	6.8-6.8 / 3.4	RB-76720-20
130	492.1	40	12.2										RB-76720-35			
Heavy-duty sanitary centrifugal pumps																
50	189.3	46	14.0	125	8.6	1½"	1½"	1	3600	208-230/460	60	1.3	RB-76713-00			
32	121.1	15	4.6						1800			1.6	RB-76713-05			
55	208.2	65	19.8						3600			2.3	RB-76713-10			
60	227.1	29	8.8			2	1½"	1	1800	208-230/460	60	3.7	1.3	RB-76713-25		
110	416.4	73	22.3						3				3600	3.7	RB-76713-30	
115	435.3	105	32.0						5				3600	6.5	RB-76713-40	

Sanitary Washdown Rotary Lobe Pumps

Low-maintenance pumps conform to 3A Sanitary Standards

- Easily replace shaft shields from front of pump—no need to disturb piping in process line
- No timing adjustments needed for bi-wing rotors
- High-pressure capability with heavy-duty shaft design

Pumps are approved to EHEDG (European Hygienic Equipment Design Group) and CIP/SIP standards. Remove pump casing for quick maintenance. Reduced noise and cavitation provide for a safe and comfortable working environment. Risk of particles being shed into fluid stream is reduced with noncontacting rotors. Mount pump heads either vertically or horizontally. Pumps include NEMA 4 washdown motors and NEMA 4 washdown variable-speed controllers. Variable-speed operation is digital and via a keypad mounted to the motor.

What's included: hard-wired conduit box.



Liquid end only shown; system includes skid-mounted motor.

Specifications

Viscosity: up to 10,000 cp† **Duty cycle:** continuous **Run dry:** no

Max GPM (LPM)	Max psi (bar)	Port size (Tri-Clamp®)	Max temp	Wetted parts‡	Motor					Catalog number	Price
					hp	Power	Amps	Phase	Speed		
36 (136.3)	225 (15.5)	1"	284°F (140°C)	316 SS, carbon vs 316 SS with food-grade nitrile elastomers‡	2	115 VAC	17.6	1	1750 rpm	RB-75201-60	
						230 VAC	8.8			RB-75201-62	
					230 VAC	5.4	3	RB-75201-65			
					460 VAC	2.7	3	RB-75201-67			
58 (219.6)	115 (7.9)	1½"	284°F (140°C)	316 SS, carbon vs 316 SS with food-grade nitrile elastomers‡	3	115 VAC	23.6	1	1750 rpm	RB-75201-70	
						230 VAC	11.8			3	RB-75201-72
					230 VAC	8.2	3	RB-75201-75			
					460 VAC	4.1	3	RB-75201-77			

†For pumps with higher viscosity ratings, please call our Application Specialists.

‡Other wetted materials available; please call our Application Specialists for selections.



Fluid Path

Protect your culture from seed to final fill

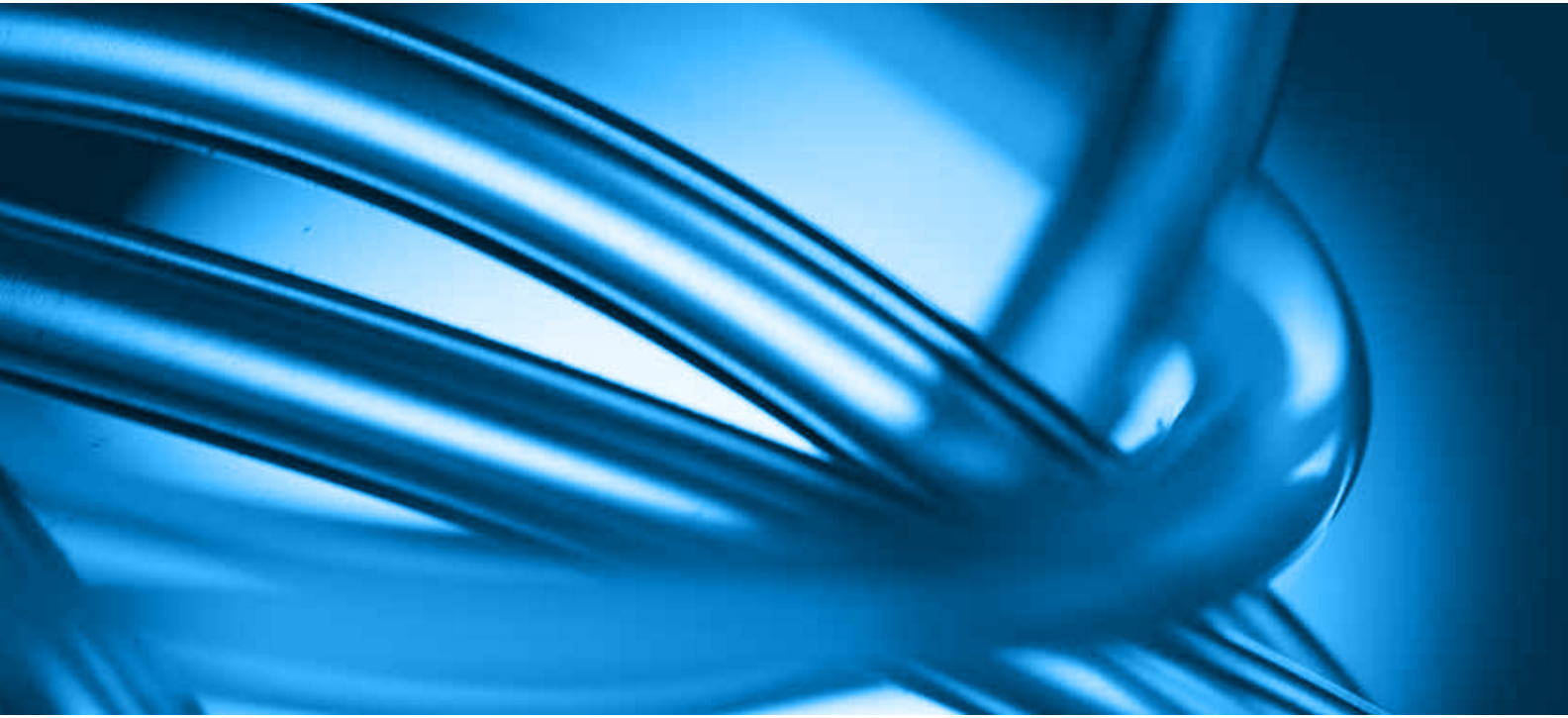

All the fluid path components you need that meet applicable regulatory requirements

Ensure purity with silicone tubing	29–31
Customize the fluid path to your needs with weldable, sealable tubings	32
Mate lines virtually anywhere with all-plastic quick disconnects.	37
Fermentation vessel connections are made easy with sanitary adapters	40–41
Store and protect media with tanks and single use liners	47



Product Selection | Troubleshooting | And More...

Not sure what to choose?

Our expert Application Specialists can help you find the right product for your application.

1-800-323-4340

or Ch@t Live

Cole-Parmer® Silicone Tubing

No need to worry about the heat—
use for applications up to 460°F

Peroxide Silicone



Characteristics: Peroxide-cured, excellent heat resistance, low compression set, odorless, nontoxic, translucent.

Certifications: Elastomer is FDA-compliant (21 CFR 177.2600) and meets USP Class VI requirements. Tubing is manufactured according to GMP.

Temperature range: -60 to 460°F (-51 to 238°C)

Sterilize: Autoclave or gamma irradiation.

Platinum Silicone



Characteristics: Platinum-cured, excellent heat resistance, low compression set, odorless, nontoxic, translucent.

Certifications: Elastomer is FDA-compliant (21 CFR 177.2600) and meets USP Class VI. Tubing is manufactured according to GMP.

Temperature range: -58 to 446°F (-50 to 230°C)

Sterilize: Autoclave or gamma irradiation.

Cole-Parmer®

Buy More...Save More!
\$ 20% off on 20+
15% off on 10 to 19
10% off on 4 to 9 packs

Dimensions: in. (mm)			Max psi at 70°F (21°C)	Peroxide silicone		Platinum silicone	
ID	OD	Wall		Catalog number	Price/25-ft pk	Catalog number	Price/25-ft pk
1/50 (0.5)	1/12 (2.1)	1/32 (0.8)	30	RB-06411-59		RB-95802-00	
1/32 (0.8)	3/32 (2.4)	1/32 (0.8)	30	RB-06411-60		RB-95802-01	
1/16 (1.6)	1/8 (3.2)	1/32 (0.8)	15	RB-06411-62		RB-95802-02	
3/32 (2.4)	5/32 (4.0)	1/32 (0.8)	15	RB-06411-63		RB-95802-03	
1/8 (3.2)	3/16 (4.8)	1/32 (0.8)	10	RB-06411-64		RB-95802-04	
1/8 (3.2)	1/4 (6.4)	1/16 (1.6)	20	RB-06411-67		RB-95802-05	
1/8 (3.2)	3/8 (9.6)	1/8 (3.2)	25	RB-06411-68		RB-95802-06	
5/32 (4.0)	5/32 (4.0)	1/32 (0.8)	10	RB-06411-65		RB-95802-07	
3/16 (4.8)	1/4 (6.4)	1/32 (0.8)	9	RB-06411-66		RB-95802-08	
3/16 (4.8)	5/16 (8.0)	1/16 (1.6)	13	RB-06411-03		RB-95802-09	
3/16 (4.8)	7/16 (11.2)	1/8 (3.2)	22	RB-06411-69		RB-95802-10	
1/4 (6.4)	5/16 (8.0)	1/32 (0.8)	9	RB-06411-70		RB-95802-11	
1/4 (6.4)	3/8 (9.6)	1/16 (1.6)	10	RB-06411-71		RB-95802-12	
1/4 (6.4)	7/16 (11.2)	3/32 (2.4)	17	RB-06411-72		RB-95802-13	
1/4 (6.4)	1/2 (12.8)	1/8 (3.2)	17	RB-06411-74		RB-95802-14	
5/16 (8.0)	7/16 (11.2)	1/16 (1.6)	10	RB-06411-75		RB-95802-15	
5/16 (8.0)	1/2 (12.8)	3/32 (2.4)	16	RB-06411-76		RB-95802-16	
5/16 (8.0)	9/16 (14.4)	1/8 (3.2)	20	RB-06411-77		RB-95802-17	
3/8 (9.6)	1/2 (12.8)	1/16 (1.6)	10	RB-06411-12		RB-95802-18	
3/8 (9.6)	9/16 (14.4)	3/32 (2.4)	12	RB-06411-78		RB-95802-19	
3/8 (9.6)	5/8 (16.0)	1/8 (3.2)	15	RB-06411-79		RB-95802-20	
1/2 (12.8)	5/8 (16.0)	1/16 (1.6)	9	RB-06411-80		RB-95802-21	
1/2 (12.8)	11/16 (17.6)	3/32 (2.4)	10	RB-06411-19		RB-95802-22	
1/2 (12.8)	3/4 (19.2)	1/8 (3.2)	12	RB-06411-55		RB-95802-23	
5/8 (16.0)	13/16 (20.8)	3/32 (2.4)	10	RB-06411-82		RB-95802-24	
5/8 (16.0)	7/8 (22.4)	1/8 (3.2)	12	RB-06411-58		RB-95802-25	
3/4 (19.2)	1 (25.4)	1/8 (3.2)	9	RB-06411-83		RB-95802-26	

DON'T RISK IT!

Our chemical compatibility database provides important information on chemical resistance—check it out at ColeParmer.com/ChemChart



Cole-Parmer® Peroxide-Cured Reinforced Silicone Tubing

Low compression formulation keeps its shape and cleanliness



Characteristics: Excellent heat resistance, low compression set, odorless, nontoxic, low tackiness, translucent.

Certifications: Elastomer is FDA-compliant (21 CFR 177.2600) and meets USP Class VI. Tubing is manufactured according to GMP.

Temperature range: -60 to 400°F (-51 to 204°C)

Sterilize: Autoclave or gamma irradiation.

Cole-Parmer®

Buy More...Save More!
\$ 20% off on 20+
15% off on 10 to 19
10% off on 4 to 9 packs

Dimensions: in. (mm)			Max psi at 70°F (bar at 21°C)	Catalog number	Price/pk
ID	OD	Wall			
1/16 (1.8)	5/16 (8.0)	1/8 (3.2)	175 (12.1)	RB-95623-00	/25-ft
1/8 (3.2)	3/8 (9.6)	1/8 (3.2)	175 (12.1)	RB-95623-01	/25-ft
1/4 (6.4)	9/16 (14.4)	5/32 (4.0)	155 (10.7)	RB-95623-03	/25-ft
5/16 (8.0)	19/32 (15.1)	9/64 (3.6)	145 (10.0)	RB-95623-04	/25-ft
3/8 (9.6)	11/16 (17.6)	5/32 (4.0)	138 (9.5)	RB-95623-05	/25-ft
1/2 (12.8)	13/16 (20.8)	5/32 (4.0)	125 (8.6)	RB-95623-06	/25-ft
3/4 (19.1)	1 1/8 (28.6)	3/16 (4.8)	57 (3.9)	RB-95623-08	/25-ft
7/8 (22.2)	1 1/4 (31.8)	3/16 (4.8)	119 (8.2)	RB-95623-09	/25-ft
1 (25.4)	1 3/8 (35.0)	3/16 (4.8)	113 (7.8)	RB-95623-10	/10-ft

Silastic® Laboratory Tubing

Resists bacteria and fungus growth



Characteristics: Platinum-cured silicone, nonpyrogenic, bacteria and fungus-resistant, extremely low extractables, and does not impart a taste or odor.

Certifications: Exceeds USP Class VI Plastics Test requirements, elastomer and tubing are manufactured under Bulk Pharmaceutical cGMPs in an FDA-registered, ISO-9002-certified facility.

Temperature range: -65 to 480°F (-54 to 249°C)

Sterilize: Autoclave or radiation.

Buy More...Save More!
\$ 20% off on 20+
15% off on 10 to 19
10% off on 4 to 9 packs

Dimensions: in. (mm)			Catalog number	Price/50-ft pk
ID	OD	Wall		
0.012 (0.3)	0.025 (0.6)	0.0065 (0.2)	RB-96115-00	
0.02 (0.5)	0.037 (0.9)	0.0085 (0.22)	RB-96115-02	
0.025 (0.6)	0.047 (1.2)	0.011 (0.3)	RB-96115-04	
0.03 (0.8)	0.065 (1.7)	0.0175 (0.4)	RB-96115-06	
0.04 (1)	0.085 (2.2)	0.0225 (0.6)	RB-96115-08	
0.058 (1.5)	0.077 (2.0)	0.0095 (0.2)	RB-96115-10	
0.062 (1.6)	0.095 (2.4)	0.0165 (0.4)	RB-96115-12	
0.062 (1.6)	0.125 (3.2)	0.0315 (0.8)	RB-96115-14	
0.078 (2)	0.125 (3.2)	0.0235 (0.6)	RB-96115-16	
0.104 (2.6)	0.192 (4.9)	0.044 (1.1)	RB-96115-18	
0.132 (3.4)	0.183 (4.6)	0.0255 (0.6)	RB-96115-20	
1/8 (3.2)	1/4 (6.4)	1/16 (1.6)	RB-96115-22	
3/16 (4.8)	5/16 (8.0)	1/16 (1.6)	RB-96115-24	
3/16 (4.8)	3/8 (9.5)	3/32 (2.4)	RB-96115-26	
1/4 (6.4)	3/8 (9.5)	1/16 (1.6)	RB-96115-28	
1/4 (6.4)	7/16 (11.2)	3/32 (2.4)	RB-96115-30	
1/4 (6.4)	1/2 (12.8)	1/8 (3.2)	RB-96115-32	
5/16 (8.0)	1/2 (12.8)	3/32 (2.4)	RB-96115-34	
3/8 (9.5)	5/8 (15.9)	1/8 (3.2)	RB-96115-40	
1/2 (12.8)	3/4 (19.1)	1/8 (3.2)	RB-96115-44	

Cole-Parmer® Platinum-Cured Reinforced Silicone Tubing

Won't crack under pressure—
withstands pressures to 312 psi



Formulation: Tygon® 3370 I. B., silicone, platinum cured.

Characteristics: Excellent heat resistance, low compression set, odorless, and nontoxic, translucent.

Certifications: Elastomer is FDA-compliant (21 CFR 177.2600) and USP Class V extractables; exceeds Class VI implant; exceeds 3A Sanitary Standards; produced to Bulk Pharmaceutical cGMPs (FDA 21 CFR 210, 211). Tubing is manufactured according to GMP.

Temperature range: -60 to 320°F (-51 to 160°C)

Sterilize: Autoclave, ethylene oxide, or gamma irradiation.

Buy More...Save More!
 20% off on 20+
 15% off on 10 to 19
 10% off on 4 to 9 packs



Dimensions: in. (mm)			Max psi at 70°F (bar at 21°C)	Qty/pk	Catalog number	Price/pk
ID	OD	Wall				
3/16 (4.8)	7/16 (11.2)	1/8 (3.2)	312 (21.5)	50 ft	RB-95703-00	
1/4 (6.4)	1/2 (12.8)	1/8 (3.2)	248 (17.1)	50 ft	RB-95703-01	
3/8 (9.6)	5/8 (16.0)	1/8 (3.2)	180 (12.4)	50 ft	RB-95703-02	
1/2 (12.8)	13/16 (20.8)	5/32 (4.0)	168 (11.6)	50 ft	RB-95703-03	
5/8 (16.0)	15/16 (24.0)	5/32 (4.0)	144 (9.9)	50 ft	RB-95703-04	
3/4 (19.1)	1 1/8 (28.6)	3/16 (4.8)	144 (9.9)	50 ft	RB-95703-05	
1 1/4 (31.8)	1 5/8 (41.4)	3/16 (4.8)	96 (6.6)	25 ft	RB-95703-07	

Dow Corning® Pharma-80 Tubing

Economical alternative to reinforced tubing



Characteristics: 80 durometer, semi-transparent platinum-cured silicone tubing with a very low extractable profile; it contains no phthalates, plasticizers, latex or other organic additives. Pharma tubing is hydrophobic, and remains flexible and resilient for long service life. Dow Corning maintains complete traceability from silica to silicone tubing.

Certifications: Elastomer exceeds test guidelines for USP Class VI Plastics; tubing itself meets or exceeds FDA (21 CFR 177.2600), 3A Sanitary Standards, and European Pharmacopoeia (EP) requirements. Pharma tubing is produced under Bulk Pharmaceutical (BP) current GMP principals.

Temperature range: -60 to 460°F (-51 to 232°C)

Sterilize: Autoclave, ethylene oxide, or gamma irradiation.

Buy More...Save More!
 20% off on 20+
 15% off on 10 to 19
 10% off on 4 to 9 packs

Dimensions: in. (mm)			Max psi at 70°F (bar at 21°C)	Catalog number	Price/50-ft pk
ID	OD	Wall			
1/8 (3.2)	1/4 (6.4)	1/16 (1.6)	249 (17.2)	RB-96109-00	
3/16 (4.8)	5/16 (8.0)	1/16 (1.6)	249 (17.2)	RB-96109-01	
1/4 (6.4)	3/8 (9.6)	1/16 (1.6)	249 (17.2)	RB-96109-03	
1/4 (6.4)	1/2 (12.8)	1/8 (3.2)	260 (17.9)	RB-96109-05	
3/8 (9.6)	5/8 (16.0)	1/8 (3.2)	231 (15.9)	RB-96109-09	

Dow Corning® Pharma-65 Tubing

Resilient for extended service life



Characteristics: 65 durometer, platinum-cured silicone tubing with a very low extractable profile; it contains no phthalates, plasticizers, latex, or other organic additives. Remains flexible and resilient for long service life. Dow Corning maintains complete traceability from silica to silicone tubing.

Certifications: Elastomer is FDA-compliant (21 CFR 177.2600) and meets USP Class VI requirements. Meets 3A Sanitary Standards and European Pharmacopoeia (EP) requirements. Tubing is manufactured according to Bulk Pharmaceutical (BP) and current GMP.

Temperature range: -60 to 460°F (-51 to 232°C)

Sterilize: Autoclave, ethylene oxide, or gamma irradiation.

Buy More...Save More!
 20% off on 20+
 15% off on 10 to 19
 10% off on 4 to 9 packs

Dimensions: in. (mm)			Max psi at 70°F (bar at 21°C)	Catalog number	Price/50-ft pk
ID	OD	Wall			
1/8 (3.2)	1/4 (6.4)	1/16 (1.6)	19 (1.3)	RB-96107-00	
3/16 (4.8)	5/16 (8.0)	1/16 (1.6)	13 (0.9)	RB-96107-01	
3/16 (4.8)	3/8 (9.6)	3/32 (2.4)	15 (1.0)	RB-96107-02	
1/4 (6.4)	7/16 (11.2)	3/32 (2.4)	20 (1.4)	RB-96107-04	
1/4 (6.4)	1/2 (12.8)	1/8 (3.2)	19 (1.3)	RB-96107-05	
3/8 (9.6)	5/8 (16.0)	1/8 (3.2)	13 (0.9)	RB-96107-09	
1/2 (12.8)	3/4 (19.1)	1/8 (3.2)	11 (0.8)	RB-96107-11	

Dow Corning® Pharma-50 Tubing

No organic additives and low extractables



Characteristics: 50 durometer, translucent platinum-cured silicone tubing with a very low extractable profile. Pharma tubing remains flexible and resilient for long service life. Dow Corning maintains complete traceability from silica to silicone tubing.

Certifications: Elastomer exceeds test guidelines for USP Class VI Plastics and the tubing itself meets or exceeds FDA (21 CFR 177.2600), 3A Sanitary Standards and European Pharmacopoeia (EP) requirements. Produced under Bulk Pharmaceutical (BP) and current GMP principles.

Temperature range: -60 to 460°F (-51 to 232°C)

Sterilize: Autoclave, ethylene oxide, or gamma irradiation.

Buy More...Save More!
 20% off on 20+
 15% off on 10 to 19
 10% off on 4 to 9 packs

Dimensions: in. (mm)			Max psi at 70°F (bar at 21°C)	Catalog number	Price/50-ft pk
ID	OD	Wall			
1/8 (3.2)	1/4 (6.4)	1/16 (1.6)	21 (1.4)	RB-96105-00	
3/16 (4.8)	3/8 (9.6)	3/32 (2.4)	16 (1.1)	RB-96105-02	
1/4 (6.4)	3/8 (9.6)	1/16 (1.6)	12 (0.8)	RB-96105-03	
1/4 (6.4)	7/16 (11.1)	3/32 (2.4)	17 (1.2)	RB-96105-04	
1/4 (6.4)	1/2 (12.8)	1/8 (3.2)	17 (1.2)	RB-96105-05	
5/16 (8.0)	1/2 (14.0)	1/8 (3.0)	16 (1.1)	RB-96105-06	
3/8 (9.6)	9/16 (14.3)	3/32 (2.4)	13 (0.9)	RB-96105-08	
3/8 (9.6)	5/8 (16.0)	1/8 (3.2)	14 (1.0)	RB-96105-09	
1/2 (12.8)	3/4 (19.1)	1/8 (3.2)	10 (0.7)	RB-96105-11	
5/8 (16.0)	7/8 (22.2)	1/8 (3.2)	9 (0.6)	RB-96105-12	

Fluid Path

Tubing

Wait!

There's More at
ColeParmer.com

Browse 100,000+ products plus find
Technical Resources to help you choose

Platinum-Cured Silicone Tubing Spools

Cut tubing to your needs

Reduce unpacking time, save money on shipping, and ensure that you always have enough tubing on hand with bulk tubing.



Dimensions in. (mm)		Length per spool	Catalog number	Price
ID	OD			
1/32 (0.8)	3/32 (2.4)	500 ft (152 m)	RB-98906-00	
1/16 (1.6)	1/8 (3.2)		RB-98906-02	
1/8 (3.2)	1/4 (6.4)	300 ft (91 m)	RB-98906-04	
3/16 (4.8)	5/16 (8.0)		RB-98906-06	
1/4 (6.4)	3/8 (9.6)		RB-98906-08	
3/8 (9.6)	5/8 (16.0)		RB-98906-10	
5/8 (16.0)	7/8 (22.4)		RB-98906-12	

Tygon® BioPharm Silicone Tubing

Reduce particle entrapment with ultra-smooth inner surface



Formulation: Tygon® 3350 silicone, platinum cured.

Characteristics: Ultra-smooth inner surface reduces particle entrapment and minimizes bacterial growth. Good for mild to medium concentration bases, salts, and alcohols; is odorless, tasteless, and nontoxic. Transparent.

Certifications: Elastomer is FDA-compliant (21 CFR 177.2600) and meets USP Class VI requirements and EP 3.2.9 requirements. Tubing is manufactured according to GMP.

Temperature range: -112 to 392°F (-80 to 200°C)

Sterilize: Ethylene oxide, gamma irradiation, or autoclave for 30 min, 15 psi (1.0 bar).

Buy More...Save More!

20% off on 20+
15% off on 10 to 19
10% off on 4 to 9 packs

Free Certificate of Compliance

Cole-Parmer will provide a certificate of resin or elastomer compliance FREE at your request with each order of fittings or tubing. Certificates list your company's PO number, order reference number, catalog number, formulation, compound number, lot number (where applicable), and the regulations and agencies the tubing or fitting complies with, including FDA, USP, USDA, National Formulary, NSF International, GMP, and 3A. Look for the blue "check" icon throughout this catalog to identify when a certificate of compliance is available.



Dimensions: in. (mm)			Max psi at 73°F (bar at 23°C)	Catalog number	Price/50-ft pk
ID	OD	Wall			
1/32 (0.8)	3/32 (2.4)	1/32 (0.8)	16 (1.1)	RB-95702-00	
1/16 (1.6)	1/8 (3.2)	1/32 (0.8)	10 (0.7)	RB-95702-01	
1/16 (1.6)	3/16 (4.8)	1/16 (1.6)	15 (1.0)	RB-95702-02	
3/32 (2.4)	5/32 (4.0)	1/32 (0.8)	7 (0.5)	RB-95702-03	
3/32 (2.4)	7/32 (5.6)	1/16 (1.6)	12 (0.8)	RB-95702-04	
1/8 (3.2)	3/16 (4.8)	1/32 (0.8)	7 (0.5)	RB-95702-05	
1/8 (3.2)	1/4 (6.4)	1/16 (1.6)	9 (0.6)	RB-95702-06	
3/16 (4.8)	1/4 (6.4)	1/32 (0.8)	5 (0.3)	RB-95702-08	
3/16 (4.8)	5/16 (8.0)	1/16 (1.6)	7 (0.5)	RB-95702-09	
1/4 (6.4)	3/8 (9.6)	3/32 (2.4)	9 (0.6)	RB-95702-10	
1/4 (6.4)	3/8 (9.6)	1/16 (1.6)	5 (0.3)	RB-95702-13	
1/4 (6.4)	7/16 (11.2)	3/32 (2.4)	7 (0.5)	RB-95702-14	
5/16 (8.0)	7/16 (11.2)	1/16 (1.6)	5 (0.3)	RB-95702-16	
5/16 (8.0)	1/2 (12.8)	3/32 (2.4)	6 (0.4)	RB-95702-17	
3/8 (9.6)	1/2 (12.8)	1/16 (1.6)	4 (0.3)	RB-95702-18	
3/8 (9.6)	9/16 (14.4)	3/32 (2.4)	5 (0.3)	RB-95702-19	
3/8 (9.6)	5/8 (16.0)	1/8 (3.2)	7 (0.5)	RB-95702-20	

C-Flex® Tubing

Meets the demands of various industries

– Available in three formulations—standard, clear, and animal-derived component-free (ADCF)

Characteristics: Exceptional tensile and tear strength, good biocompatibility, excellent chemical resistance, low gas permeability, and a smooth surface. Standard C-Flex is opaque white; C-Flex Clear and C-Flex ADCF are clear.

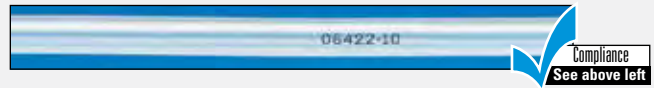

Certifications: Meets USP Class VI.

Tubing is manufactured according to GMP.

Temperature range: -50 to 275°F (-45 to 135°C)

Sterilize: Autoclave, ethylene oxide, or gamma irradiation.

Buy More...Save More!

20% off on 20+
15% off on 10 to 19
10% off on 4 to 9 packs

Dimensions in. (mm)			C-Flex			C-Flex Clear			C-Flex ADCF		
ID	OD	Wall	Catalog number	Max psi at 70°F (21°C)	Price/25-ft pk	Catalog number	Max psi at 70°F (21°C)	Price/25-ft pk	Catalog number	Max psi at 70°F (21°C)	Price/50-ft pk
1/50 (0.5)	1/2 (2.1)	1/32 (0.8)	RB-06424-59	30		RB-06422-00	50		—	—	—
1/32 (0.8)	3/32 (2.4)	1/32 (0.8)	RB-06424-60	31		RB-06422-01	51		—	—	—
1/16 (1.6)	1/8 (3.2)	1/32 (0.8)	RB-06424-62	15		RB-06422-02	25		—	—	—
3/32 (2.4)	5/32 (4.0)	1/32 (0.8)	RB-06424-63	14		RB-06422-03	23		—	—	—
1/8 (3.2)	3/16 (4.8)	1/32 (0.8)	RB-06424-64	10		RB-06422-04	17		—	—	—
1/8 (3.2)	1/4 (6.4)	1/16 (1.6)	RB-06424-67	21		RB-06422-05	35		RB-06432-50	35	—
5/32 (4.0)	7/32 (5.6)	1/32 (0.8)	RB-06424-65	10		RB-06422-06	17		—	—	—
3/16 (4.8)	1/4 (6.4)	1/32 (0.8)	RB-06424-66	9		RB-06422-07	15		—	—	—
3/16 (4.8)	5/16 (8.0)	1/16 (1.6)	RB-06424-03	13		RB-06422-08	22		RB-06432-51	22	—
3/16 (4.8)	7/16 (11.2)	1/8 (3.2)	RB-06424-69	22		RB-06422-09	36		—	—	—
1/4 (6.4)	3/8 (9.6)	1/16 (1.6)	RB-06424-71	12		RB-06422-10	20		RB-06432-53	20	—
1/4 (6.4)	7/16 (11.2)	3/32 (2.4)	RB-06424-72	17		RB-06422-11	28		RB-06432-54	28	—
1/4 (6.4)	1/2 (12.7)	1/8 (3.2)	RB-06424-74	17		RB-06422-12	28		RB-06432-55	28	—
5/16 (8.0)	7/16 (11.2)	1/16 (1.6)	RB-06424-75	10		RB-06422-13	17		—	—	—
5/16 (8.0)	1/2 (12.7)	3/32 (2.4)	RB-06424-76	16		RB-06422-14	27		RB-06432-56	27	—
3/8 (9.6)	1/2 (12.7)	1/16 (1.6)	RB-06424-12	10		RB-06422-15	17		RB-06432-57	17	—
3/8 (9.6)	5/8 (16.0)	1/8 (3.2)	RB-06424-79	14		RB-06422-16	23		RB-06432-59	23	—
1/2 (12.7)	1 1/16 (17.6)	3/32 (2.4)	RB-06424-19	10		RB-06422-17	17		RB-06432-60	17	—
1/2 (12.7)	3/4 (19.1)	1/8 (3.2)	RB-06424-81	10		RB-06422-18	17		RB-06432-61	17	—

C-Flex® ULTRA Tubing

Excellent resistance to concentrated acids and alkalis

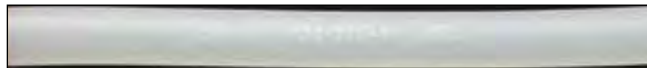

Characteristics: Animal-derived component-free (ADCF). Sealable and weldable. Noncytotoxic and nonpyrogenic.

Certifications: Meets USP24/NF19, Class VI standards.

Temperature range: -58 to 122°F (-50 to 50°C)

Sterilize: Autoclave.

**ANIMAL DERIVED
INGREDIENT FREE**

Buy More...Save More!
 20% off on 20+
 15% off on 10 to 19
 10% off on 4 to 9 packs

Dimensions: in. (mm)			Max psi at 70°F (bar at 21°C)	Catalog number	Price/ 50-ft pk
ID	OD	Wall			
1/8 (3.18)	1/4 (6.35)	1/16 (1.59)	19 (1.3)	RB-06432-40	
3/16 (4.76)	3/8 (9.52)	3/32 (2.38)	24 (1.7)	RB-06432-42	
1/4 (6.35)	3/8 (9.52)	1/16 (1.59)	14 (1.0)	RB-06432-43	
1/4 (6.35)	1/2 (12.7)	1/8 (3.18)	25 (1.7)	RB-06432-45	
5/16 (7.94)	1/2 (12.7)	3/32 (2.38)	17 (1.2)	RB-06432-46	
3/8 (9.52)	1/2 (12.7)	1/16 (1.59)	10 (0.7)	RB-06432-47	
3/8 (9.52)	5/8 (15.88)	1/8 (3.18)	20 (1.4)	RB-06432-48	
1/2 (12.7)	3/4 (19.05)	1/8 (3.18)	14 (1.0)	RB-06432-49	

Cole-Parmer® Flexible PVC Tubing

Stop oxidation and bacteria problems



Characteristics: Extremely flexible. Resistant to oxidation, chemicals and bacteria. Transparent.

Certifications: FDA-compliant (21 CFR 175.300) and meets USP Class VI requirements; meets 3A sanitary standards.

Temperature range: -41 to 165°F (-41 to 74°C)

Sterilize: Ethylene oxide or gamma irradiation.

Cole-Parmer®

Buy More...Save More!
 20% off on 20+
 15% off on 10 to 19
 10% off on 4 to 9 packs

Dimensions: in. (mm)			Max psi at 68°F (bar at 20°C)	Catalog number	Price/ 50-ft pk
ID	OD	Wall			
1/8 (3.2)	1/4 (6.4)	1/16 (1.6)	68 (4.7)	RB-96605-01	
3/16 (4.8)	5/16 (8.0)	1/16 (1.6)	55 (3.8)	RB-96605-02	
1/4 (6.4)	3/8 (9.6)	1/16 (1.6)	55 (3.8)	RB-96605-03	
1/4 (6.4)	1/2 (12.8)	1/8 (3.2)	70 (4.8)	RB-96605-05	
3/16 (8.0)	7/16 (11.2)	1/16 (1.6)	50 (3.4)	RB-96605-06	
3/8 (9.6)	1/2 (12.8)	1/16 (1.6)	40 (2.8)	RB-96605-08	
3/8 (9.6)	5/8 (16.0)	1/8 (3.2)	65 (4.5)	RB-96605-10	
1/2 (12.8)	5/8 (16.0)	1/16 (1.6)	30 (2.1)	RB-96605-11	
1/2 (12.8)	3/4 (19.1)	1/8 (3.2)	45 (3.1)	RB-96605-13	
5/8 (16.0)	7/8 (22.4)	1/8 (3.2)	40 (2.8)	RB-96605-15	
3/4 (19.1)	1 (25.4)	1/8 (3.2)	35 (2.4)	RB-96605-16	
1 (25.4)	1 1/4 (31.8)	1/8 (3.2)	28 (1.9)	RB-96605-19	
1 1/4 (31.8)	1 3/4 (44.5)	1/4 (6.4)	45 (3.1)	RB-96605-25	

Flexelene™ SFX Soft Flexible Polyethylene Tubing

No need to worry about extractables



Characteristics: Good chemical resistance. Ultra-low extractables. Heat-sealable. Translucent.

Certifications: Meets USP Class VI requirements.

Temperature range: -40 to 110°F (-40 to 37°C)

Sterilize: Ethylene oxide or gamma irradiation.

Buy More...Save More!
 20% off on 20+
 15% off on 10 to 19
 10% off on 4 to 9 packs

Dimensions: in. (mm)			Max psi at 70°F (bar at 21°C)	Catalog number	Price/ 100-ft pk
ID	OD	Wall			
1/16 (1.6)	1/8 (3.2)	1/32 (0.8)	210 (14.5)	RB-96180-01	
3/32 (2.4)	5/32 (4.0)	1/32 (0.8)	210 (14.5)	RB-96180-02	
1/8 (3.2)	1/4 (6.4)	1/16 (1.6)	225 (15.5)	RB-96180-03	
3/16 (4.8)	5/16 (8.0)	1/16 (1.6)	160 (11.0)	RB-96180-04	
1/4 (6.4)	3/8 (9.6)	1/16 (1.6)	110 (7.6)	RB-96180-05	
5/16 (8.0)	7/16 (11.2)	1/16 (1.6)	80 (5.5)	RB-96180-06	
3/8 (9.6)	1/2 (12.8)	1/16 (1.6)	80 (5.5)	RB-96180-07	

PharMed® BPT Tubing

Protect your light-sensitive samples



Characteristics: Nontoxic; nonhemolytic; extremely low permeability; resists acids, alkalies, oxidizing agents, and animal and vegetable oils; heat-sealable, bondable, and formable. Opaque beige.

Certifications: Elastomer is FDA-compliant (21 CFR 177.2600) and meets USP Class VI requirements. Meets EP requirements. Tubing is manufactured according to GMP.

Temperature range: -60 to 275°F (-51 to 135°C)

Sterilize: Autoclave, ethylene oxide, or gamma irradiation.

Buy More...Save More!
 20% off on 20+
 15% off on 10 to 19
 10% off on 4 to 9 packs

Dimensions: in. (mm)			Max psi at 70°F (bar at 21°C)	Catalog number	Price/ 25-ft pk
ID	OD	Wall			
1/50 (0.5)	9/64 (3.7)	1/16 (1.6)	50 (3.4)	RB-96880-00	
1/32 (0.8)	5/32 (4.0)	1/16 (1.6)	40 (2.8)	RB-96880-02	
1/16 (1.6)	3/16 (4.8)	1/16 (1.6)	34 (2.3)	RB-96880-04	
1/8 (3.2)	1/4 (6.4)	1/16 (1.6)	19 (1.3)	RB-96880-06	
3/16 (4.8)	5/16 (8.0)	1/16 (1.6)	13 (0.9)	RB-96880-08	
1/4 (6.4)	3/8 (9.6)	1/16 (1.6)	10 (0.7)	RB-96880-10	
1/4 (6.4)	1/2 (12.8)	1/8 (3.2)	19 (1.3)	RB-96880-12	
5/16 (8.0)	7/16 (11.2)	1/16 (1.6)	8 (0.6)	RB-96880-14	
3/8 (9.6)	5/8 (16.0)	1/8 (3.2)	13 (0.9)	RB-96880-16	
1/2 (12.8)	3/4 (19.1)	1/8 (3.2)	11 (0.8)	RB-96880-18	
5/8 (16.0)	7/8 (22.4)	1/8 (3.2)	8 (0.6)	RB-96880-20	
3/4 (19.1)	1 (25.4)	1/8 (3.2)	7 (0.5)	RB-96880-22	

Fluid Path

Tubing



Need Help Selecting?

Trust our **expert** Application Specialists to help you find the right product.

1-800-323-4340 sales@coleparmer.com [ColeParmer.com](#)

Kim, 12 years of experience

Chemfluor® FEP Tubing

Effectively transfer abrasive fluids



Characteristics: Good chemical resistance at a low cost, temperature-resistant, and low coefficient of friction, semi-flexible. Transparent.

Certifications: FDA-compliant (21 CFR 177.1550). Meets USP Class VI.

Temperature range: -454 to 400°F (-270 to 205°C)

Sterilize: Autoclave, ethylene oxide, or dry heat.

Buy More...Save More!

20% off on 20+
15% off on 10 to 19
10% off on 4 to 9 packs

Dimensions: in. (mm)			Max psi at 70°F (bar at 21°C)	Catalog number	Price/ 50-ft pk
ID	OD	Wall			
1/16 (1.6)	1/8 (3.2)	1/32 (0.8)	213 (14.7)	RB-96001-02	
1/16 (1.6)	3/16 (4.8)	1/16 (1.6)	283 (19.5)	RB-96001-04	
3/32 (2.4)	5/32 (4.0)	1/32 (0.8)	170 (11.7)	RB-96001-06	
1/8 (3.2)	3/16 (4.8)	1/32 (0.8)	142 (9.8)	RB-96001-08	
1/8 (3.2)	1/4 (6.4)	1/16 (1.6)	213 (14.7)	RB-96001-10	
5/32 (4.0)	1/4 (6.4)	3/64 (1.2)	159 (11.0)	RB-96001-12	
3/16 (4.8)	1/4 (6.4)	1/32 (0.8)	106 (7.3)	RB-96001-14	
3/16 (4.8)	5/16 (7.9)	1/16 (1.6)	170 (11.7)	RB-96001-16	
1/4 (6.4)	5/16 (7.9)	1/32 (0.8)	85 (5.9)	RB-96001-18	
1/4 (6.4)	3/8 (9.5)	1/16 (1.6)	142 (9.8)	RB-96001-20	
5/16 (7.9)	3/8 (9.5)	1/32 (0.8)	71 (4.9)	RB-96001-22	
5/16 (7.9)	7/16 (11.1)	1/16 (1.6)	121 (8.3)	RB-96001-24	
3/8 (9.5)	7/16 (11.1)	1/32 (0.8)	61 (4.2)	RB-96001-26	
3/8 (9.5)	1/2 (12.7)	1/16 (1.6)	106 (7.3)	RB-96001-28	
7/16 (11.1)	1/2 (12.7)	1/32 (0.8)	53 (3.7)	RB-96001-30	
7/16 (11.1)	9/16 (14.3)	1/16 (1.6)	94 (6.5)	RB-96001-32	
1/2 (12.7)	9/16 (14.3)	1/32 (0.8)	47 (3.2)	RB-96001-34	
1/2 (12.7)	5/8 (15.9)	1/16 (1.6)	85 (5.9)	RB-96001-36	
5/8 (15.9)	11/16 (17.5)	1/32 (0.8)	39 (2.7)	RB-96001-42	
5/8 (15.9)	3/4 (19.0)	1/16 (1.6)	71 (4.9)	RB-96001-44	
11/16 (17.5)	13/16 (20.6)	1/16 (1.6)	65 (4.5)	RB-96001-48	
3/4 (19.0)	7/8 (22.2)	1/16 (1.6)	61 (4.2)	RB-96001-52	
7/8 (22.2)	1 (25.4)	1/16 (1.6)	53 (3.7)	RB-96001-56	
1 (25.4)	1 1/8 (28.6)	1/16 (1.6)	47 (3.2)	RB-96001-60	

Chemfluor® PFA Tubing

Tough yet flexible

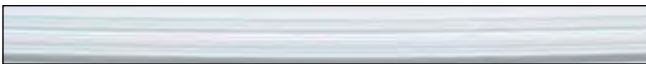

Characteristics: Excellent temperature range, chemically inert, tough, flexible, low friction coefficient, ozone-, UV-, stress- and crack-resistant. Translucent.

Certifications: FDA-compliant (21 CFR 177-1550). Meets USP Class VI.

Temperature range: -320 to 500°F (-195 to 260°C)

Sterilize: Autoclave, ethylene oxide, or dry heat.

Buy More...Save More!

20% off on 20+
15% off on 10 to 19
10% off on 4 to 9 packs

Dimensions: in. (mm)			Max psi at 70°F (bar at 21°C)	Catalog number	Price/ 50-ft pk
ID	OD	Wall			
1/8 (3.2)	3/16 (4.8)	1/32 (0.8)	150 (10.3)	RB-96005-08	
1/8 (3.2)	1/4 (6.4)	1/16 (1.6)	225 (15.5)	RB-96005-10	
5/32 (4.0)	1/4 (6.4)	3/64 (1.2)	169 (11.7)	RB-96005-12	
3/16 (4.8)	5/16 (7.9)	1/16 (1.6)	180 (12.4)	RB-96005-16	
1/4 (6.4)	5/16 (7.9)	1/32 (0.8)	90 (6.2)	RB-96005-18	
1/4 (6.4)	3/8 (9.5)	1/16 (1.6)	150 (10.3)	RB-96005-20	
3/8 (9.5)	7/16 (11.1)	1/32 (0.8)	64 (4.4)	RB-96005-26	
3/8 (9.5)	1/2 (12.7)	1/16 (1.6)	113 (7.8)	RB-96005-28	
7/16 (11.1)	1/2 (12.7)	1/32 (0.8)	56 (3.9)	RB-96005-30	
1/2 (12.7)	5/8 (15.9)	1/16 (1.6)	90 (6.2)	RB-96005-36	
5/8 (15.9)	3/4 (19.0)	1/16 (1.6)	75 (5.2)	RB-96005-44	
3/4 (19.0)	7/8 (22.2)	1/16 (1.6)	64 (4.4)	RB-96005-52	



Tygon® Non-DEHP Tubing

Drains completely



Formulation: Tygon ND-100-65

Characteristics: Non-DEHP, phthalate free. Non-wetted surface permits complete drainage. Bondable, weldable. Clear.

Certifications: USP Class VI, REACH, ISO 10993

Temperature range: -44 to 165°F (-42 to 74°C)

Sterilize: Autoclave, ethylene oxide, or irradiation.

Buy More...Save More!

20% off on 20+
15% off on 10 to 19
10% off on 4 to 9 packs

Dimensions: in. (mm)			Max psi at 73°F (bar at 23°C)	Catalog number	Price/ 50-ft pk
ID	OD	Wall			
1/32 (0.8)	3/32 (2.4)	1/32 (0.8)	100 (6.9)	RB-95666-00	
1/16 (1.6)	1/8 (3.2)	1/32 (0.8)	55 (3.8)	RB-95666-01	
3/32 (2.4)	5/32 (4.0)	1/32 (0.8)	40 (2.8)	RB-95666-03	
3/32 (2.4)	7/32 (5.6)	1/16 (1.6)	70 (4.8)	RB-95666-04	
1/8 (3.2)	3/16 (4.8)	1/32 (0.8)	30 (2.1)	RB-95666-05	
1/8 (3.2)	1/4 (6.4)	1/16 (1.6)	55 (3.8)	RB-95666-06	
5/32 (4.0)	7/32 (5.6)	1/32 (0.8)	25 (1.7)	RB-95666-07	
5/32 (4.0)	9/32 (7.1)	1/16 (1.6)	45 (3.2)	RB-95666-08	
3/16 (4.8)	1/4 (6.4)	1/32 (0.8)	20 (1.4)	RB-95666-09	
3/16 (4.8)	5/16 (8.0)	1/16 (1.6)	40 (2.8)	RB-95666-10	
3/16 (4.8)	3/8 (9.6)	3/32 (2.4)	55 (3.8)	RB-95666-11	
1/4 (6.4)	3/8 (9.6)	1/16 (1.6)	30 (2.1)	RB-95666-14	
1/4 (6.4)	7/16 (11.2)	3/32 (2.4)	45 (1.7)	RB-95666-15	
1/4 (6.4)	1/2 (12.8)	1/8 (3.2)	55 (3.8)	RB-95666-16	
3/8 (9.6)	5/16 (14.3)	3/32 (2.4)	30 (2.1)	RB-95666-21	
3/8 (9.6)	3/4 (19.0)	1/8 (3.2)	40 (2.8)	RB-95666-22	
1/2 (12.8)	1 1/16 (17.6)	3/32 (2.4)	25 (1.7)	RB-95666-27	
1/2 (12.8)	3/4 (19.1)	1/8 (3.2)	30 (2.1)	RB-95666-28	

Tygon® Non-DEHP Lab Tubing

Pliable formulation for sharp radius bending



Formulation: Tygon E-3603

Characteristics: Non-DEHP, phthalate free. Long-life, chemical resistant, nonoxidizing; able to bend to sharp radius curves and easily works with fittings. Transparent.

Certifications: FDA-compliant (21 CFR 175.300); meets USP Class VI requirements.

Temperature range: -51 to 165°F (-46 to 74°C)

Sterilize: Autoclave or ethylene oxide.

Buy More...Save More!

20% off on 20+
15% off on 10 to 19
10% off on 4 to 9 packs

Dimensions: in. (mm)			Max psi at 70°F (bar at 21°C)	Catalog number	Price/ 50-ft pk
ID	OD	Wall			
1/32 (0.8)	3/32 (2.4)	1/32 (0.8)	69 (4.8)	RB-06407-70	
1/16 (1.6)	1/8 (3.2)	1/32 (0.8)	36 (2.5)	RB-06407-71	
1/16 (1.6)	3/16 (4.8)	1/16 (1.6)	69 (4.8)	RB-06407-72	
3/32 (2.4)	5/32 (4.0)	1/32 (0.8)	25 (1.7)	RB-06407-73	
1/8 (3.2)	3/16 (4.8)	1/32 (0.8)	20 (1.4)	RB-06407-75	
1/8 (3.2)	1/4 (6.4)	1/16 (1.6)	36 (2.5)	RB-06407-76	
5/32 (4.0)	7/32 (5.6)	1/32 (0.8)	17 (1.2)	RB-06407-77	
3/16 (4.8)	5/16 (8.0)	1/16 (1.6)	25 (1.7)	RB-06407-78	
3/16 (4.8)	3/8 (9.6)	3/32 (2.4)	36 (2.5)	RB-06407-79	
1/4 (6.4)	3/8 (9.6)	1/16 (1.6)	20 (1.4)	RB-06407-80	
1/4 (6.4)	7/16 (11.2)	3/32 (2.4)	28 (1.9)	RB-06407-81	
1/4 (6.4)	1/2 (12.8)	1/8 (3.2)	35 (2.5)	RB-06407-82	
5/16 (8.0)	7/16 (11.2)	1/16 (1.6)	17 (1.2)	RB-06407-83	
5/16 (8.0)	1/2 (12.8)	3/32 (2.4)	23 (1.6)	RB-06407-84	
5/16 (8.0)	9/16 (14.4)	1/8 (3.2)	30 (2.1)	RB-06407-85	
3/8 (9.6)	1/2 (12.8)	1/16 (1.6)	14 (1.0)	RB-06407-86	
3/8 (9.6)	9/16 (14.4)	3/32 (2.4)	20 (1.4)	RB-06407-87	
3/8 (9.6)	3/4 (19.0)	1/8 (3.2)	25 (1.7)	RB-06407-88	
7/16 (11.2)	9/16 (14.4)	1/16 (1.6)	13 (0.9)	RB-06407-89	
1/2 (12.8)	5/8 (16.0)	1/16 (1.6)	12 (1.8)	RB-06407-90	
1/2 (12.8)	1 1/16 (1.6)	3/32 (2.4)	15 (1.0)	RB-06407-91	
1/2 (12.8)	3/4 (19.1)	1/8 (3.2)	20 (1.4)	RB-06407-92	
1/2 (12.8)	13/16 (20.8)	5/32 (4.0)	24 (1.7)	RB-06407-93	
5/8 (16.0)	13/16 (20.8)	3/32 (2.4)	13 (0.9)	RB-06407-94	
5/8 (16.0)	7/16 (11.2)	1/8 (3.2)	17 (1.2)	RB-06407-95	
3/4 (19.1)	1 (25.4)	1/8 (3.2)	14 (1.0)	RB-06407-96	
3/4 (19.1)	1 1/8 (28.6)	3/16 (4.8)	20 (1.4)	RB-06407-97	
1 (25.4)	1 1/4 (31.8)	1/8 (3.2)	12 (0.8)	RB-06407-98	
1 (25.4)	1 1/2 (66.8)	1/4 (6.4)	20 (1.4)	RB-06407-99	

Cole-Parmer® Kynar® PVDF Tubing

Fluoropolymer tubing at less cost



Characteristics: Polyvinylidene fluoride (PVDF) material is kink resistant; has excellent chemical resistance, and is odorless and nontoxic. Translucent.

Certifications: Resin is FDA-compliant (21 CFR 177.2600); meets USP Class VI requirements.

Temperature range: -40 to 260°F (-40 to 127°C)

Sterilize: Autoclave and gamma irradiation.

Buy More...Save More!

20% off on 20+
15% off on 10 to 19
10% off on 4 to 9 packs

Cole-Parmer®

Dimensions: in. (mm)			Max psi at 70°F (bar at 21°C)	Catalog number	Price/ 25-ft pk
ID	OD	Wall			
1/8 (3.2)	1/4 (6.4)	1/16 (1.6)	350 (24.1)	RB-95100-00	
11/64 (4.2)	1/4 (6.4)	3/64 (1.2)	180 (12.4)	RB-95100-02	
3/16 (4.8)	5/16 (8.0)	1/16 (1.6)	290 (20.0)	RB-95100-04	
1/4 (6.4)	3/8 (9.6)	1/16 (1.6)	240 (16.5)	RB-95100-06	
3/8 (9.6)	1/2 (12.8)	1/16 (1.6)	180 (12.4)	RB-95100-10	
1/2 (12.8)	5/8 (16.0)	1/16 (1.6)	145 (10.0)	RB-95100-12	
5/8 (16.0)	3/4 (19.2)	1/16 (1.6)	120 (8.3)	RB-95100-14	
3/4 (19.2)	7/8 (22.2)	1/16 (1.6)	100 (6.9)	RB-95100-16	

Heavy-Duty Tubing Closure

Handle higher working pressures

- Quick installation with positive swing-away locking screw
- Smooth contours allow for easy cleaning



Use this clamp with tubing or hose—it meets the working pressure of either item. High-strength polysulfone closure provides excellent durability, can be continually reused, and resists most chemicals. Simply align the hose within the clamp; mating surfaces on the clamp indicate complete closure. Typical applications include sterile filling, media bag connections, pumping, liquid control, and high-purity fluid transfers. FDA-compliant polysulfone material can be sterilized by autoclave or gamma irradiation.

Wall thickness range		Catalog number	Price/ea
Unreinforced	Reinforced		
0.090" to 0.190" (2.3 to 4.8 mm)	0.090" to 0.180" (2.3 to 4.6 mm)	RB-20001-00	

Tubing Pinch Clamps

Open or close with a push of the latch

- Thumb latch allows for easy opening or closing from any angle
- Reduce strain on tubing line due to opening or closing

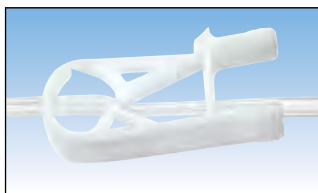

Tubing pinch clamps provide quick and easy on/off flow control of fluids in flexible tubing.

Max tubing OD	Catalog number	Price/pk of 25
0.118" (3.0 mm)	RB-95785-00	
0.125" (3.6 mm)	RB-95785-02	
0.197" (5.0 mm)	RB-95785-04	
0.250" (6.3 mm)	RB-95785-06	

Handheld Tubing Cutter

Steel blade coated with PTFE resin produces clean, straight cuts through tubing up to 1 1/4" OD (cuts polyethylene tubing up to 1 1/2" OD). Order carrying pouch and replacement blade separately below.



Description	Catalog number	Price
Handheld tubing cutter	RB-06438-90	
Tubing cutter pouch	RB-06438-81	
Replacement blade	RB-06438-92	

Benchtop Tubing Cutter

Steel blade makes right-angle cuts in plastic tubing 1/16" to 5/8" OD.



Description	Catalog number	Price
Benchtop cutter	RB-06438-10	
Replacement blade	RB-06438-11	

Plastic Clamp Ties



Perfect for flexible fuel line, water line, and vacuum line applications. Special curved clamp tie head ensures a tight seal. Ties measure 8"L x 0.18"W; maximum diameter of 1 3/4". Black resin resists UV degradation.

Description	Catalog number	Qty/pk	Price/pk
Clamp ties, white	RB-95615-00	100	
Clamp ties, black	RB-95615-10	100	

Screw Clamp

Clamp is made of Delrin® acetal. Control flow in flexible tubing up to 1/2" (13 mm) OD. Install without disconnecting tubing. Autoclavable.



Description	Catalog number	Qty/pk	Price/pk
Screw clamp	RB-06833-10	3	

Ratchet Tubing Clamps

Durable Celcon® plastic clamp is autoclavable; won't rust, corrode, or distort. Mini-clamp is suitable for up to 1/8" OD tubing. Standard clamp accepts flexible tubing to 1/2" OD.



Description	Catalog number	Qty/pk	Price/pk
Mini tubing clamp	RB-06833-01	25	
Tubing clamp	RB-06833-00	25	

Barbed Fittings

No tools needed for assembly

Barbed fittings are designed for quick and easy assembly without tools. Combine these simple, economical fittings with our flexible tubing for use in your low-pressure applications (generally less than 30 psi).



Buy More...Save More!

20% off on 100+
15% off on 50 to 99
10% off on 10 to 49 packs

Specifications

PVDF. Excellent chemical resistance.

Temp range: -80 to 265°F (-62 to 129°C). Sterilize by ethylene oxide or autoclave.

Polypropylene (PP). Very good chemical resistance.

Temp range: 9 to 180°F (-13 to 66°C). Sterilize by ethylene oxide or gamma irradiation.

Tubing ID	Material	Catalog number	Qty/pk	Price/pk
A. Straight connectors				
1/16"	PP	RB-40622-49	10	
1/16"	PVDF	RB-30703-00	10	
3/32"	PP	RB-40622-46	10	
3/32"	PVDF	RB-30703-01	10	
1/8"	PP	RB-41518-05	10	
1/8"	PVDF	RB-30703-02	10	
5/32"	PP	RB-40622-52	10	
5/32"	PVDF	RB-30703-03	10	
3/16"	PP	RB-40622-57	10	
3/16"	PVDF	RB-30703-04	10	
1/4"	PP	RB-40610-00	10	
1/4"	PVDF	RB-30703-05	10	
5/16"	PP	RB-40610-01	10	
5/16"	PVDF	RB-30703-06	10	
3/8"	PP	RB-40610-02	10	
3/8"	PVDF	RB-30703-07	10	
1/2"	PP	RB-40610-03	10	
1/2"	PVDF	RB-30703-08	10	
5/8"	PP	RB-40610-04	10	
5/8"	PVDF	RB-30703-09	10	
3/4"	PP	RB-40610-05	5	
3/4"	PVDF	RB-30703-10	5	
1"	PP	RB-40610-06	5	
1"	PVDF	RB-30703-11	5	

Tubing ID	Material	Catalog number	Qty/pk	Price/pk
B. Reducing connectors				
3/32" x 1/16"	PP	RB-40621-95	25	
3/32" x 1/16"	PVDF	RB-30703-40	10	
1/8" x 1/16"	PP	RB-40622-23	25	
1/8" x 1/16"	PVDF	RB-30703-41	10	
1/8" x 3/32"	PP	RB-40622-21	25	
1/8" x 3/32"	PVDF	RB-30703-42	10	
3/16" x 1/16"	PVDF	RB-30703-46	10	
3/16" x 3/32"	PVDF	RB-30703-47	10	
3/16" x 1/8"	PP	RB-41518-34	10	
3/16" x 1/8"	PVDF	RB-30703-48	10	
3/16" x 5/32"	PVDF	RB-30703-49	10	
1/4" x 1/8"	PP	RB-41518-36	10	
1/4" x 1/8"	PVDF	RB-30703-50	10	
1/4" x 5/32"	PP	RB-40622-26	10	
1/4" x 5/32"	PVDF	RB-30703-51	10	
1/4" x 3/16"	PP	RB-40622-32	10	
1/4" x 3/16"	PVDF	RB-30703-52	10	
5/16" x 1/4"	PP	RB-40610-07	10	
5/16" x 1/4"	PVDF	RB-30703-53	10	
3/8" x 1/4"	PP	RB-40610-08	10	
3/8" x 1/4"	PVDF	RB-30703-54	10	
3/8" x 5/16"	PP	RB-40610-09	10	
3/8" x 5/16"	PVDF	RB-30703-55	10	
5/32" x 1/16"	PVDF	RB-30703-43	10	
5/32" x 3/32"	PVDF	RB-30703-44	10	
5/32" x 1/8"	PP	RB-40622-19	10	
5/32" x 1/8"	PVDF	RB-30703-45	10	
1/2" x 1/4"	PP	RB-40610-10	10	
1/2" x 1/4"	PVDF	RB-30703-56	10	
1/2" x 5/16"	PP	RB-40610-11	10	
1/2" x 5/16"	PVDF	RB-30703-57	10	
1/2" x 3/8"	PP	RB-40610-12	10	
1/2" x 3/8"	PVDF	RB-30703-58	10	
5/8" x 1/4"	PP	RB-40610-13	10	
5/8" x 1/4"	PVDF	RB-30703-59	10	
5/8" x 5/16"	PP	RB-40610-14	10	
5/8" x 5/16"	PVDF	RB-30703-60	10	
5/8" x 3/8"	PP	RB-40610-15	10	
5/8" x 3/8"	PVDF	RB-30622-01	10	
5/8" x 1/2"	PP	RB-40610-16	10	
5/8" x 1/2"	PVDF	RB-30703-62	10	
3/4" x 3/8"	PP	RB-40610-17	5	
3/4" x 3/8"	PVDF	RB-30703-63	5	
3/4" x 1/2"	PP	RB-40610-18	5	
3/4" x 1/2"	PVDF	RB-30703-64	5	
3/4" x 5/8"	PP	RB-40610-19	5	
3/4" x 5/8"	PVDF	RB-30703-65	5	
1" x 1/2"	PP	RB-40610-20	5	
1" x 1/2"	PVDF	RB-30703-66	5	
1" x 5/8"	PP	RB-40610-21	5	
1" x 5/8"	PVDF	RB-30703-67	5	
1" x 3/4"	PP	RB-40610-22	5	
1" x 3/4"	PVDF	RB-30703-68	5	

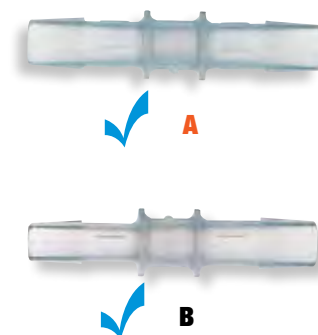

Application Tip

Single barb fittings seal better than multi-barb fittings because they allow the tubing to relax around the barb.

Fluid Path

Fittings

Free Certificate of Compliance

Cole-Parmer will provide a certificate of resin or elastomer compliance FREE at your request with each order of fittings or tubing. Certificates list your company's PO number, order reference number, catalog number, formulation, compound number, lot number (where applicable), and the regulations and agencies the tubing or fitting complies with, including FDA, USP, USDA, National Formulary, NSF International, GMP, and 3A. Look for the blue "check" icon throughout this catalog to identify when a certificate of compliance is available.



See next page for more...

Wait!

There's More at
[ColeParmer.com](#)

Browse 100,000+ products plus find
Technical Resources to help you choose

Barbed Fittings (continued)

Barbed fittings are designed for quick and easy assembly without tools. Combine these simple, economical fittings with our flexible tubing for use in your low-pressure applications (generally less than 30 psi).



Buy More... Save More!
20% off on 100+
15% off on 50 to 99
10% off on 10 to 49 packs



C



D



E



F



G

Specifications

PVDF. Excellent chemical resistance.
Temp range: -80 to 265°F (-62 to 129°C).
Sterilize by ethylene oxide or autoclave.

Polypropylene (PP). Very good chemical resistance.
Temp range: 9 to 180°F (-13 to 66°C).
Sterilize by ethylene oxide or gamma irradiation.

Tubing ID	Material	Catalog number	Qty/ pk	Price/ pk
C. Elbow connectors				
1/16"	PVDF	RB-30703-20	10	
3/32"	PP	RB-40622-64	10	
3/32"	PVDF	RB-30703-21	10	
1/8"	PP	RB-40623-19	10	
1/8"	PVDF	RB-30703-22	10	
3/16"	PP	RB-40622-75	10	
3/16"	PVDF	RB-30622-73	10	
1/4"	PP	RB-40610-23	10	
1/4"	PVDF	RB-30703-25	10	
3/8"	PP	RB-40610-24	10	
3/8"	PVDF	RB-30703-27	10	
1/2"	PP	RB-40610-25	10	
1/2"	PVDF	RB-30703-28	10	
5/8"	PP	RB-40610-26	10	
5/8"	PVDF	RB-30703-29	10	
3/4"	PP	RB-40610-27	5	
3/4"	PVDF	RB-30703-30	5	
1"	PP	RB-40610-28	5	
1"	PVDF	RB-30703-31	5	
D. T connectors				
1/16"	PP	RB-40624-30	10	
1/16"	PVDF	RB-30703-70	10	
3/32"	PP	RB-40623-57	10	
3/32"	PVDF	RB-30703-71	10	
1/8"	PP	RB-40623-66	25	
1/8"	PVDF	RB-30703-72	10	
3/16"	PP	RB-40623-70	25	
3/16"	PVDF	RB-30624-31	10	
1/4"	PP	RB-40610-30	10	
1/4"	PVDF	RB-30703-75	10	
5/16"	PP	RB-40623-76	10	
5/16"	PVDF	RB-30623-74	10	
3/8"	PP	RB-40610-31	10	
3/8"	PVDF	RB-30703-77	10	
1/2"	PP	RB-40610-32	10	
1/2"	PVDF	RB-30703-78	10	

Tubing ID	Material	Catalog number	Qty/ pk	Price/ pk
D. T connectors (continued)				
5/8"	PP	RB-40610-33	10	
5/8"	PVDF	RB-30703-79	10	
3/4"	PP	RB-40610-34	5	
3/4"	PVDF	RB-30703-80	5	
1"	PP	RB-40610-35	5	
1"	PVDF	RB-30703-81	5	
E. Reducing T connectors (straight x branch)				
3/4" x 3/8"	PVDF	RB-30703-96	10	
5/8" x 3/8"	PVDF	RB-30703-95	10	
F. Y connectors				
1/16"	PP	RB-40726-41	10	
1/16"	PVDF	RB-30703-90	10	
3/32"	PP	RB-40726-42	10	
3/32"	PVDF	RB-30703-91	10	
1/8"	PP	RB-40726-43	10	
1/8"	PVDF	RB-30703-92	10	
3/16"	PP	RB-40726-44	10	
3/16"	PVDF	RB-30726-64	10	
1/4"	PP	RB-40726-45	10	
1/4"	PVDF	RB-30726-65	10	
3/8"	PP	RB-40726-46	10	
3/8"	PVDF	RB-30703-93	10	
1/2"	PP	RB-40726-47	10	
1/2"	PVDF	RB-30703-94	10	
5/8"	PP	RB-30726-48	10	
5/8"	PVDF	RB-30726-68	10	
G. Press-in plugs				
1/16"	PVDF	RB-31220-21	10	
3/32"	PVDF	RB-31220-22	10	
1/8"	PVDF	RB-31220-23	10	
5/32"	PVDF	RB-31220-24	10	
3/16"	PVDF	RB-31220-25	10	
1/4"	PVDF	RB-31220-26	10	

Fluid Path

Fittings

Polypropylene Sanitary Adapters

No BSE documentation required!

- Meets USP Class VI requirements
- No sharp edges in the flow path, so cleaning is very easy; may be sterilized by gamma irradiation

PP adapters offer good chemical resistance and are the perfect transition from sanitary clamp connections to a barb for flexible tubing. All feature a radiused flow surface controlled to 15 micron Ra to ensure a smooth, uninterrupted flow and no particulate buildup. Material is free of animal-derived ingredients.

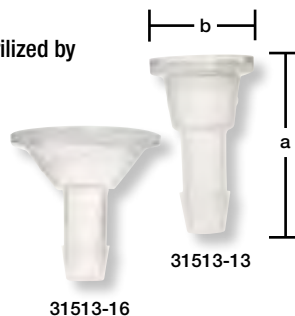

Clamp size	Tubing ID	Dimensions			Catalog number	Price
		a	b	Orifice		
1/2"	3/8"	1.64"	0.98"	0.30"	RB-31513-13	
1/2"	1/2"	1.87"	0.98"	0.42"	RB-31513-14	
1 1/2"	1/2"	1.64"	1.99"	0.30"	RB-31513-15	
1 1/2"	1/2"	1.87"	1.99"	0.44"	RB-31513-16	

- [RB-30548-00](#) Gasket, 1/2", platinum-cured silicone. Pack of 10
- [RB-30548-04](#) Gasket, 1 1/2", platinum-cured silicone. Pack of 10
- [RB-31201-88](#) Push/pull sanitary mini clamp, PVDF
- [RB-30508-23](#) Sanitary clamp, 1 1/2", nylon

Roughness Average (Ra) is the arithmetic mean of the peaks and valleys on the surface of the fitting. The lower the Ra reading, the smoother the surface.

ANIMAL DERIVED
INGREDIENT FREE

CPC™ Plastic Quick-Disconnect Fittings

Fittings connect in a snap

- Acetal fittings are ideal for use with corrosive fluids
- Polycarbonate and polysulfone materials meet USP Class VI requirements

Simply press the thumb latch to disconnect coupling halves. Polycarbonate and polysulfone materials meet USP Class VI requirements and pass all physicochemical, cytotoxicity, leachables, and extractables tests. Order complete couplings or separate bodies and inserts from the tables below.

Note: Standard bodies and inserts fit together; won't work with large bodies and inserts and vice versa.



Buy More... Save More!

20% off on 100+
15% off on 50 to 99
10% off on 10 to 49 packs

Specifications

Body material	Acetal	Polycarbonate (PC)	Polysulfone (PSF)
Temperature range	-40 to 180°F (-40 to 82°C)	-40 to 250°F (-40 to 121°C)	-40 to 300°F (-40 to 148°C)
Max pressure	120 psi	125 psi†	120 psi
Max vacuum	28" Hg	25" Hg	25" Hg
Sterilization	Autoclave or EtO	Autoclave, EtO, or gamma irradiation	Autoclave, EtO, or gamma irradiation

†Max pressure for 1/2" polycarbonate fittings is 60 psi.



Complete Couplings

Key	Catalog number	Size	Material	Length	Qty/pk	Price/pk
A	RB-06360-90	1/4" tubing ID	Acetal	—	10	
	RB-31305-00		PC	—	10	
	RB-06360-91		Acetal	—	10	
	RB-31305-05	3/8" tubing ID	PC	—	10	
	RB-31306-05		PSF	—	10	

Standard Bodies and Caps

Key	Catalog number	Size	Material	Length	Qty/pk	Price/pk
Barbed bodies						
B	RB-06360-94	1/4" tubing ID	Acetal	1.31"	10	
	RB-31311-11		PC	(33.3 mm)	5	
	RB-31311-21		PSF		5	
	RB-06360-95	3/8" tubing ID	Acetal	1.31"	10	
	RB-31311-12		PC	(33.3 mm)	5	
	RB-31311-22		PSF		5	
Hose barb coupling bodies with lock						
C	RB-31311-16	1/4" tubing ID	PC	1.31"	5	
	RB-31311-26		PSF	(33.3 mm)	5	
	RB-31311-17	3/8" tubing ID	PC	1.31"	5	
	RB-31311-27		PSF	(33.3 mm)	5	
BSP straight-through bodies						
D	RB-06360-01	1/4" BSP	Acetal	1.31"	10	
	RB-06360-02	3/8" BSP		(33.3 mm)	10	
NPT(M) bodies						
E	RB-06360-00	1/4" NPT	Acetal	1.31"	10	
	RB-06360-96	3/8" NPT		(33.3 mm)	10	
Compression coupling bodies						
F	RB-06360-06	1/4" OD	Acetal	1.31"	10	
	RB-06360-08	3/8" OD		(33.3 mm)	10	
Sealing caps						
G	RB-31311-64	1/4"	PC	1.31"	5	
	RB-31311-74	1/4"	PSF	(33.3 mm)	5	
Sealing caps with lock						
H	RB-31311-67	1/4"	PC	1.31"	5	
	RB-31311-77	1/4"	PSF	(33.3 mm)	5	

Standard Inserts and Plugs

Key	Catalog number	Size	Material	Length	Qty/pk	Price/pk
Barbed inserts						
I	RB-06360-92	1/4" tubing ID	Acetal	1.28"	10	
	RB-31311-61		PC	(32.5 mm)	5	
	RB-31311-71		PSF		5	
	RB-06360-93	3/8" tubing ID	Acetal	1.28"	10	
	RB-31311-62		PC	(32.5 mm)	5	
	RB-31311-72		PSF		5	
BSP straight-through inserts						
J	RB-06360-27	1/4" BSP	Acetal	1.28"	10	
	RB-06360-97	3/8" BSP		(32.5 mm)	10	
NPT(M) inserts						
K	RB-06360-16	1/4" NPT	Acetal	1.28"	10	
	RB-06360-18	3/8" NPT		(32.5 mm)	10	
Compression coupling inserts						
L	RB-06360-21	1/4" OD	Acetal	1.28"	10	
	RB-06360-24	3/8" OD		(32.5 mm)	10	
Sealing caps						
M	RB-06360-31	1/4" OD	Acetal	1.28"	10	
	RB-06360-34	3/8" OD		(32.5 mm)	10	
Plugs with lock						
N	RB-31311-68	1/4"	PC	1.20"	5	
	RB-31311-78	1/4"	PSF	(30.5 mm)	5	

Large Bodies and Inserts (use these bodies and inserts together)

Key	Catalog number	Size	Material	Length	Qty/pk	Price/pk
Barbed bodies						
O	RB-31311-13	1/2" tubing ID	PC	1.96"	5	
	RB-31311-23		PSF	(49.8 mm)	5	
Hose barb coupling bodies with lock						
P	RB-31311-18	3/8" tubing ID	PC	1.96"	5	
	RB-31311-28		PSF	(49.8 mm)	5	
Barbed inserts						
Q	RB-31311-63	1/2" tubing ID	PC	1.90"	5	
	RB-31311-73		PSF	(48.3 mm)	5	

CPC™ High-Flow Quick-Disconnect Couplings

No more leaks—valved couplings automatically shut off flow

Buy More...Save More!
\$ 20% off on 100+
15% off on 50 to 99
10% off on 10 to 49 packs

A complete quick-disconnect fitting consists of a body and an insert (order fitting halves separately). Plug insert into coupling body to connect—fitting halves lock into place immediately. To disconnect, simply press the button on the coupling body.

Valved models have a spring-operated 316 SS valve that seals the flow path when fitting halves are disengaged. All fitting bodies have 316 SS latch springs and EPDM seals.

Specifications

	Polypropylene	Polysulfone
Body material	Polypropylene	Polysulfone
Temperature range	32 to 160°F (0 to 71°C)	-40 to 280°F (-40 to 137°C)
Max pressure	60 psi	125 psi
Max vacuum	27.5" Hg	27.5" Hg
Sterilization	EtO or gamma	Autoclave, EtO, or gamma

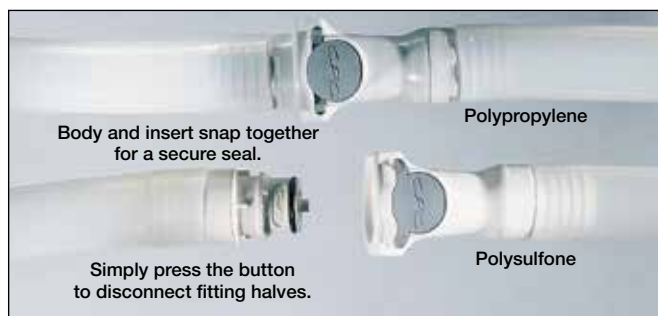

Quick-Disconnect Bodies (Female Coupling Halves)

A. Threaded Adapter Bodies

Flow size	NPT(M)	Polypropylene		Polysulfone	
		Catalog number	Price/pk of 1	Catalog number	Price/pk of 1
Valved fittings					
3/8"	3/8"	RB-31303-00		RB-31307-00	
3/8"	1/2"	RB-31303-01		RB-31307-01	
3/8"	3/4"	RB-31303-02		RB-31307-02	
Straight-through fittings					
3/8"	3/8"	RB-31303-05		RB-31307-05	
3/8"	1/2"	RB-31303-06		RB-31307-06	
3/8"	3/4"	RB-31303-07		RB-31307-07	

B. Hose Barb Bodies

Flow size	Tube ID	Polypropylene		Polysulfone	
		Catalog number	Price/pk of 1	Catalog number	Price/pk of 1
Valved fittings					
3/8"	3/8"	RB-31303-10		RB-31307-10	
3/8"	1/2"	RB-31303-11		RB-31307-11	
3/8"	3/8"	RB-31303-12		RB-31307-12	
3/8"	3/4"	RB-31303-13		RB-31307-13	
Straight-through fittings					
3/8"	3/8"	RB-31303-15		RB-31307-15	
3/8"	1/2"	RB-31303-16		RB-31307-16	
3/8"	3/8"	RB-31303-17		RB-31307-17	
3/8"	3/4"	RB-31303-18		RB-31307-18	

C. Bulkhead Panel Mount Hose Barb Bodies

Flow size	Tube ID	Polypropylene		Polysulfone	
		Catalog number	Price/pk of 1	Catalog number	Price/pk of 1
Valved fittings					
3/8"	3/8"	RB-31303-20		RB-31307-20	
3/8"	1/2"	RB-31303-21		RB-31307-21	
3/8"	3/8"	RB-31303-22		RB-31307-22	
3/8"	3/4"	RB-31303-23		RB-31307-23	
Straight-through fittings					
3/8"	3/8"	RB-31303-25		RB-31307-25	
3/8"	1/2"	RB-31303-26		RB-31307-26	
3/8"	3/8"	RB-31303-27		RB-31307-27	
3/8"	3/4"	RB-31303-28		RB-31307-28	

Quick-Disconnect Inserts (Male Coupling Halves)

D. Male Threaded Inserts

Flow size	NPT(M)	Polypropylene		Polysulfone	
		Catalog number	Price/pk of 1	Catalog number	Price/pk of 1
Valved fittings					
3/8"	3/8"	RB-31303-35		RB-31307-35	
3/8"	1/2"	RB-31303-36		RB-31307-36	
3/8"	3/4"	RB-31303-37		RB-31307-37	
Straight-through fittings					
3/8"	3/8"	RB-31303-30		RB-31307-30	
3/8"	1/2"	RB-31303-31		RB-31307-31	
3/8"	3/4"	RB-31303-32		RB-31307-32	

E. Hose Barb Inserts

Flow size	Tube ID	Polypropylene		Polysulfone	
		Catalog number	Price/pk of 1	Catalog number	Price/pk of 1
Valved fittings					
3/8"	3/8"	RB-31303-45		RB-31307-45	
3/8"	1/2"	RB-31303-46		RB-31307-46	
3/8"	3/8"	RB-31303-47		RB-31307-47	
3/8"	3/4"	RB-31303-48		RB-31307-48	
Straight-through fittings					
3/8"	3/8"	RB-31303-40		RB-31307-40	
3/8"	1/2"	RB-31303-41		RB-31307-41	
3/8"	3/8"	RB-31303-42		RB-31307-42	
3/8"	3/4"	RB-31303-43		RB-31307-43	

F. Elbow Hose Barb Inserts

Flow size	Tube ID	Polypropylene		Polysulfone	
		Catalog number	Price/pk of 1	Catalog number	Price/pk of 1
Valved fittings					
3/8"	3/8"	RB-31303-55		RB-31307-55	
3/8"	1/2"	RB-31303-56		RB-31307-56	
Straight-through fittings					
3/8"	3/8"	RB-31303-50		RB-31307-50	
3/8"	1/2"	RB-31303-51		RB-31307-51	

Find even more online! Go to ColeParmer.com to search more than 100,000 products.

CPC™ AseptiQuik™ Connectors

Make easy, secure sterile connections

- Quick, three-step connection process reduces risk of operator error
- Large housing size allows easy installation

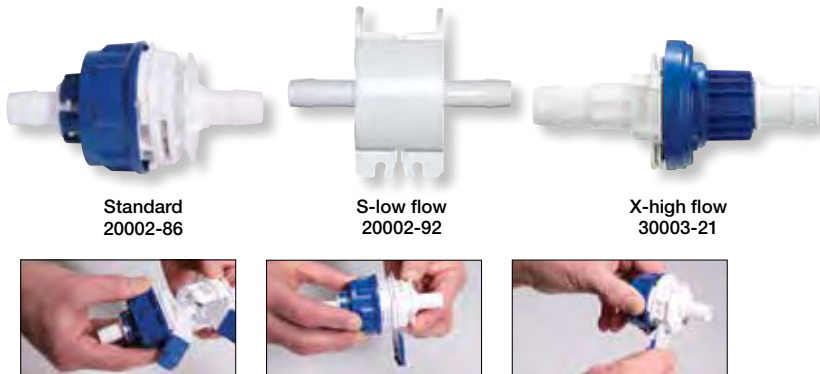

Manufactured from sturdy polycarbonate, these connectors come clean. Use connectors with filters, tubing, and process containers to create systems for upstream or downstream processes.

Simply fit the connector half in your tubing line. Push the male and female connectors together; an audible snap confirms a tight connection. Align and snap membrane connectors together; pull from connector. Twist blue lock ring clockwise to hear another audible click. Alignment of the ring rib with the body's arrow indicator confirms final, secure connection.

Specifications

Type	Standard	High Temperature
Body material	Polycarbonate	
Seal material	Platinum-cured silicone	
Temp range	39 to 104°F (4 to 40°C)	
Max pressure	60 psi (4.4 bar)	
Sterilization	Gamma irradiation	Autoclave or gamma irradiation

AseptiQuik-Standard

Bodies (female coupling halves)

Size	Description	Cat. no.	Price/ea
3/8" ID	Hose barb	RB-20002-90	
	Hose barb high temperature	RB-20002-91	
1/2" ID	Hose barb	RB-20002-86†	
	Hose barb high temperature	RB-20002-87	

Inserts (male coupling halves)

Size	Description	Cat. no.	Price/ea
3/8" ID	Hose barb	RB-20002-94	
	Hose barb high temperature	RB-20002-95	
1/2" ID	Hose barb	RB-20002-88†	
	Hose barb high temperature	RB-20002-89	

†Sold in a pack of 5.

AseptiQuik S-low flow, genderless

Size	Description	Cat. no.	Price/ea
1/8" ID	Hose barb	RB-20002-92	
1/4" ID	high temperature	RB-20002-93	
3/4" Mini Tri-Clamp®	Sanitary high temperature	RB-20002-96	

AseptiQuik X-high flow

Bodies (female coupling halves)

Size	Description	Cat. no.	Price/ea
3/4" ID	Hose barb	RB-30003-21	
	Hose barb high temperature	RB-30003-22	
1" ID	Hose barb	RB-30003-23	
	Hose barb high temperature	RB-30003-24	
1 1/2" ID	Sanitary	RB-30003-25	
	Sanitary high temperature	RB-30003-26	

Inserts (male coupling halves)

Size	Description	Cat. no.	Price/ea
3/4" ID	Hose barb	RB-30003-31	
	Hose barb high temperature	RB-30003-32	
1" ID	Hose barb	RB-30003-33	
	Hose barb high temperature	RB-30003-34	
1 1/2" ID	Sanitary	RB-30003-35	
	Sanitary high temperature	RB-30003-36	

CPC™ Polysulfone Quick-Disconnect Couplings

Protect against lost media

- USP Class VI compliant
- Automatic shutoff valves
- BSE/TSE-free material in bodies and seals

For a complete quick-disconnect fitting, order both a body and insert separately. An audible click confirms a secure, leak-free connection. The automatic shutoff valve closes off the flow path at disconnection, protecting valuable media while eliminating the need for pinch clamps. Thumb latch enables easy one-handed operation.



Specifications

Body material	Polysulfone
O-ring material	Silicone, platinum-cured
Valve spring	316 stainless steel
Temperature range	-40 to 280°F (-40 to 138°C)
Pressure range	Vacuum to 125 psi (8.62 bar)
Sterilization	Autoclave or gamma irradiation

A. Hose Barb Bodies

Tubing ID	Catalog number	Price
1/4"	RB-31313-01	
3/8"	RB-31313-02	
1/2"	RB-31313-03	

B. Hose Barb Inserts

Tubing ID	Catalog number	Price
1/4"	RB-31313-21	
3/8"	RB-31313-22	
1/2"	RB-31313-23	

CPC™ Steam-in-Place Connectors

Ensure a sterile connection

- One disposable connector for steam sterilization and microbial process
- Reduce downtime and cleaning expenses

Innovative product design allows for a one-step process for sterilization and media transfer while eliminating dead spots, reducing the number of connections, and eliminating the need for a laminar flow hood. Terminations on these connectors are set to industry standards for bioreactors and are available in popular sizes of flexible tubing. All wetted surfaces meet requirements for USP Class VI physicochemical tests. All units are made of animal-free polysulfone resin



31604-10

Original Steam-Thru Connectors feature a three-port design that allows steam to pass directly through the power ports to “steam on” to stainless equipment. Once the SIP cycle is completed, remove the tear-away sleeve to actuate the valve and create a sterile flow path. Once actuated, the connection cannot be reversed because valve actuation punctures the internal membrane to allow flow of media. When the process is complete, the connector may be safely disposed.

Steam-Thru II Connectors offer the additional benefit of both “steam on” and “steam off” functionality. The valve can return to the steam position to allow a second steam cycle after media transfer.



Specifications

Pressure rating

Steam position: 30 psi (2.1 bar)
Flow position: vacuum to 20 psi (1.4 bar)

Temperature rating

Steam position: 266°F (130°C) for up to 60 min
Flow position: 39 to 104°F (4 to 40°C)

Materials

Body: polysulfone body
Sleeve: PE (31604-10 thru -16) or PC (31604-18 thru -24)
Membrane: silicone membrane

Tech info

Types of Processes

Steam Process (1)

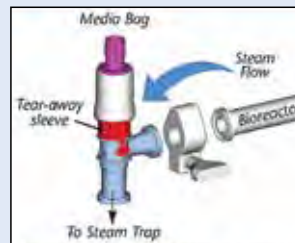

Steam flows from the bioreactor through the connector to sterilize the connection. With the tear-away sleeve in place, the transfer of fluid to or from the bioreactor is prevented.

Flow Process (2)



When the tear-away sleeve is removed and the connector is actuated, the connection to the steam trap is disabled and the media flow bath and the media flow bath to or from the bioreactor is accessible.

Steam inlet	Connections		Sterilization methods†	Catalog number	Price
	Bioreactor	Hose barb			
Steam-Thru connectors (single cycle)					
3/4" Tri-Clamp®	3/4" Tri-Clamp	1/2"	SIP, G	RB-31604-10	
		3/8"		RB-31604-12	
3/4" Tri-Clamp	1 1/2" Tri-Clamp	1/2"	SIP, G	RB-31604-14	
		3/8"		RB-31604-16	
3/4" Tri-Clamp	3/4" Tri-Clamp	1/2"	SIP, G, A	RB-31604-18	
		3/8"		RB-31604-20	
3/4" Tri-Clamp	1 1/2" Tri-Clamp	1/2"	SIP, G, A	RB-31604-22	
		3/8"		RB-31604-24	
Steam-Thru II (two cycle)					
3/4" Tri-Clamp	3/4" Tri-Clamp	1/2"	SIP, G	RB-31604-36	
	1 1/2" Tri-Clamp	3/8"		RB-31604-38	

†SIP = steam-in-place process up to 266°F (130°C) for 60 minutes;
G = gamma radiation up to 50 kGy for one cycle;
A = autoclave at 265°F (128°C) for 30 minutes up to two cycles.

CPC™ Quick-Disconnect Sanitary Couplings

Attach directly to your sanitary hardware assemblies!

- USP Class IV materials
- Fully sterilizable

These couplings allow you to integrate disposables with your existing stainless steel processing equipment. Both couplings and inserts are available with standard sanitary terminations to attach to your system with a sanitary gasket and tri-clover clamps. All models feature USP Class VI platinum-cured silicone gaskets.



31604-26

31604-28

31604-34

31311-71

Bodies (Female Coupling Halves)

Size	Compatible	Material	Catalog number	Price
3/4" sanitary	Large	PSF	RB-31604-26	
1" sanitary	Standard		RB-31604-28	

Inserts (Male Coupling Halves)

Size	Compatible	Material	Catalog number	Price
1/4" tubing ID	Standard	PSF	RB-31311-71	
3/8" tubing ID			RB-31311-72	
1/2" tubing ID			RB-31311-73	
3/4" sanitary	Standard	316 SS	RB-31604-30	
1" sanitary			RB-31604-32	
1 1/2" sanitary	Large		RB-31604-34	

Specifications

Body material	Polysulfone (PSF)	316 stainless steel
O-ring material	USP Class VI platinum-cured silicone	
Temperature range	–40 to 300°F (–40 to 149°C)	
Max pressure	60 psi (4.1 bar)	
Sterilization	Autoclave, gamma irradiation, ETO, or ebeam	Autoclave or gamma irradiation

Cole-Parmer® Polypropylene (PP) and PVDF Sanitary Clamp Fittings

Maintain sanitary conditions in your processes

- Meet USP Class VI standards
- All fittings are compatible with Tri-Clamp® fittings
- Excellent chemical resistance; low leachable characteristics

Note: Though both materials may be autoclaved, PVDF tolerates high temperatures better than PP does and will perform more consistently after repeated autoclaving.

Clamp size	PP		PVDF	
	Cat. no.	Price	Cat. no.	Price
A. Eccentric reducers				
1½" x ¾" mini	RB-31805-01		RB-31808-01	
B. Concentric reducers				
1" ladish x ¾" mini	RB-31805-05		RB-31808-05	
1½" x ¾" mini	RB-31805-06		RB-31808-06	
1½" x 1" ladish	RB-31805-10		RB-31808-10	
2" x 1" ladish	RB-31805-11		RB-31808-11	
2" x 1½"	RB-31805-14		RB-31808-14	
C. Barbed adapters, clamp x tubing ID				
¾" mini x ⅛"	RB-31805-24		RB-31808-24	
¾" mini x ¼"	RB-31805-25		RB-31808-25	
¾" mini x ⅜"	RB-31805-26		RB-31808-26	
¾" mini x ½"	RB-31805-27		RB-31808-27	
¾" mini x ⅝"	RB-31805-28		RB-31808-28	
¾" mini x ¾"	RB-31805-29		RB-31808-29	
1" ladish x ⅛"	RB-31805-30		RB-31808-30	
1" ladish x ¼"	RB-31805-31		RB-31808-31	
1" ladish x ⅜"	RB-31805-32		RB-31808-32	
1" ladish x ½"	RB-31805-33		RB-31808-33	
1" ladish x ⅝"	RB-31805-34		RB-31808-34	
1" ladish x 1"	RB-31805-35		RB-31808-35	
1½" x 1"	RB-31805-41		RB-31808-41	
2" x 1"	RB-31805-47		RB-31808-47	
D. Pipe thread adapters, clamp x NPT(M)				
1" ladish x ⅝"	RB-31805-56		RB-31808-56	
1" ladish x ¼"	RB-31805-57		RB-31808-57	
1" ladish x ⅜"	RB-31805-58		RB-31808-58	
1" ladish x ½"	RB-31805-59		RB-31808-59	
1" ladish x ¾"	RB-31805-60		RB-31808-60	
1" ladish x 1"	RB-31805-61		RB-31808-61	
1" ladish x 1¼"	RB-31805-62		RB-31808-62	
1" ladish x 1½"	RB-31805-63		RB-31808-63	
1½" x ¾"	RB-31805-68		RB-31808-68	
1½" x 1"	RB-31805-69		RB-31808-69	
1½" x 1¼"	RB-31805-70		RB-31808-70	
1½" x 1½"	RB-31805-71		RB-31808-71	
2" x 1"	RB-31805-77		RB-31808-77	
2" x 1¼"	RB-31805-78		RB-31808-78	
2" x 1½"	RB-31805-79		RB-31808-79	
2" x 2"	RB-31805-80		RB-31808-80	
E. Pipe thread adapters, clamp x NPT(F)				
1" ladish x ¾"	RB-31806-04		RB-31809-04	
1" ladish x 1"	RB-31806-05		RB-31809-05	
1½" x 1½"	RB-31806-15		RB-31809-15	
F. 90° elbows				
¾" mini	RB-31806-41		RB-31809-41	
1" ladish	RB-31806-42		RB-31809-42	
1½"	RB-31806-43		RB-31809-43	
2"	RB-31806-44		RB-31809-44	
G. 45° elbows				
¾" mini	RB-31806-51		RB-31809-51	
1" ladish	RB-31806-52		RB-31809-52	
1½"	RB-31806-53		RB-31809-53	
2"	RB-31806-54		RB-31809-54	
H. Standard tees				
¾" mini	RB-31806-61		RB-31809-61	
1" ladish	RB-31806-62		RB-31809-62	
1½"	RB-31806-63		RB-31809-63	
2"	RB-31806-64		RB-31809-64	
I. Clamps				
¾" mini	—	—	RB-31811-00	
1" and 1½"	—	—	RB-31811-01	
2"	—	—	RB-31811-02	
2½"	—	—	RB-31811-03	



Specifications

Clamp size	Inner dimension (based on SS tube ID)
¾" mini	9/16"
1" maxi	7/8"
1" ladish†	7/8"
1½"	1 1/8"
2"	1 7/8"
2½"	2 3/8"
3"	2 7/8"

†Choose 1" ladish fittings for a direct match with 1" stainless steel sanitary connections.

Chemical resistance

PP: very good PVDF: excellent

Temperature range

PP: 15 to 180°F (-9 to 82°C)

PVDF: -40 to 280°F (-40 to 138°C)

Max pressure

In ambient conditions, using plastic true union style clamp

PP: 125 psi PVDF: 150 psi

Sterilization: EtO or autoclave

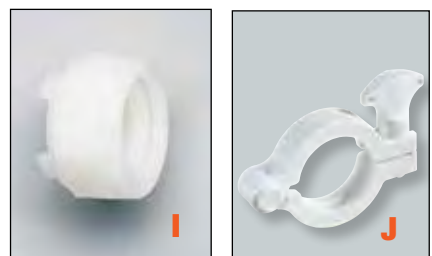
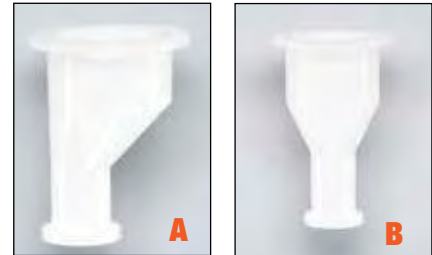

J. Nylon Clamps

Clamp size	Catalog number	Price
½" to ¾"	RB-30508-21	
1" to 1½"	RB-30508-23	
2"	RB-30508-25	
3"	RB-30508-27	
4"	RB-30508-29	

Gaskets (not shown)

Gasket size	Catalog number	Price
Platinum-cured silicone		
¾" mini	RB-30548-00	
1" ladish	RB-30548-02	
1½"	RB-30548-04	
2"	RB-30548-06	
2½"	RB-30548-08	
Viton®		
¾" mini	RB-30548-20	
1" ladish	RB-30548-22	
1½"	RB-30548-24	
2"	RB-30548-26	
2½"	RB-30548-28	
Buna N		
¾" mini	RB-30548-40	
1" ladish	RB-30548-42	
1½"	RB-30548-44	
2"	RB-30548-46	
2½"	RB-30548-48	
EPDM		
¾" mini	RB-30548-60	
1" ladish	RB-30548-62	
1½"	RB-30548-64	
2"	RB-30548-66	
2½"	RB-30548-68	
PTFE		
¾" mini	RB-30548-80	
1" ladish	RB-30548-82	
1½"	RB-30548-84	
2"	RB-30548-86	
2½"	RB-30548-88	

Wait! There's More...

For sanitary gaskets, see page 43.

Fluid Path

Fittings



Tech info

Sanitary Tri-Clamp® Fitting Sizing

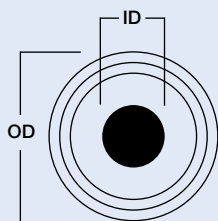

Tri-Clamp nominal size	Fitting ID	Fitting OD
1/4"	0.187"	0.984"
3/8"	0.227"	
1/2"	0.375"	
3/4"	0.625"	
1"	0.870"	1.984"
1 1/2"	1.360"	
2"	1.870"	
2 1/2"	2.370"	
3"	2.870"	

Cole-Parmer® 316L Stainless Steel Sanitary Clamp Couplings

Meet FDA requirements and 3A Sanitary Standards

– All couplings are compatible with standard 304L fittings clamps

316L stainless steel couplings are ideal for the pharmaceutical industry; they offer great chemical compatibility for use with corrosive acids and bases.



Clamp size	Catalog number	Price
A. Concentric reducers		
1" x 3/4"	RB-30700-50	
1 1/2" x 1"	RB-30700-51	
2" x 1"	RB-30700-52	
2" x 1 1/2"	RB-30700-53	
B. Eccentric reducers		
1" x 3/4"	RB-30700-54	
1 1/2" x 1"	RB-30700-55	
2" x 1"	RB-30700-56	
2" x 1 1/2"	RB-30700-57	
C. Barbed adapters		
3/4" x 1/8"	RB-30700-58	
3/4" x 1/4"	RB-30700-59	
3/4" x 3/8"	RB-30700-60	
3/4" x 1/2"	RB-30700-61	
3/4" x 3/4"	RB-30700-62	
1" x 1"	RB-30700-63	
1 1/2" x 1 1/2"	RB-30700-64	
2" x 2"	RB-30700-65	
D. Threaded adapters, clamp x NPT(M)		
3/4" x 1/8"	RB-30700-66	
3/4" x 1/4"	RB-30700-67	
3/4" x 3/8"	RB-30700-68	
3/4" x 1/2"	RB-30700-69	
3/4" x 3/4"	RB-30700-70	
1" x 3/4"	RB-30700-71	
1" x 1"	RB-30700-72	
1" x 1 1/2"	RB-30700-74	
1" x 2"	RB-30700-75	
1 1/2" x 3/4"	RB-30700-76	
1 1/2" x 1"	RB-30700-77	
1 1/2" x 1 1/4"	RB-30700-78	
1 1/2" x 1 1/2"	RB-30700-79	
E. 90° elbows		
3/4"	RB-30700-80	
1"	RB-30700-81	
1 1/2"	RB-30700-82	
2"	RB-30700-83	
F. 45° elbows		
3/4"	RB-30700-84	
1"	RB-30700-85	
1 1/2"	RB-30700-86	
2"	RB-30700-87	
G. Tees		
3/4"	RB-30700-88	
1"	RB-30700-89	
1 1/2"	RB-30700-90	
2"	RB-30700-91	
H. Crosses		
1"	RB-30700-92	
1 1/2"	RB-30700-93	
2"	RB-30700-94	
I. Clamps (304L SS)		
1/2" to 3/4"	RB-30800-74	
1" to 1 1/2"	RB-30800-75	
2"	RB-30800-76	
2 1/2"	RB-30800-77	
3"	RB-30800-78	
4"	RB-30800-80	

Fluid Path

Fittings

Cole-Parmer® Gaskets for Tri-Clamp® Sanitary Fittings

Ensure a tight seal

- Meet FDA CFR Title 21 CFR 177.2600, 3A, and cGMP criteria
- Gaskets are free of animal-derived ingredients and meet USP Class VI, EP 3.1.9, and cytotoxicity criteria

Platinum-Cured Silicone is ideal for most pharmaceutical, food, and beverage processing applications. Odorless and tasteless to ensure media purity. Usable from –58 to 446°F (–50 to 230°C). Maybe undergo SIP.

EPDM offers good chemical resistance. An economical choice for water, acetone, or ketone applications. Usable from –65 to 212°F (–54 to 100°C).

FKM offers excellent chemical resistance, especially to many acids and alkalis. Best choice for many pharmaceutical, chemical, automotive, or fuel applications. Usable from –25 to 400°F (–32 to 204°C). Sterilization is not recommended.

PTFE offers excellent chemical compatibility. Highly resistant to stress cracking and corrosion. Usable from –450 to 550°F (–268 to 288°C).



30548-04

30548-64



30548-24

30548-84



ANIMAL DERIVED
INGREDIENT FREE

Size	Platinum-cured silicone		EPDM		FKM		PTFE	
	Catalog number	Price/pk of 10	Catalog number	Price/pk of 10	Catalog number	Price/pk of 10	Catalog number	Price/pk of 10
3/4"	RB-30548-00		RB-30548-60		RB-30548-20		RB-30548-80	
1"	RB-30548-02		RB-30548-62		RB-30548-22		RB-30548-82	
1 1/2"	RB-30548-04		RB-30548-64		RB-30548-24		RB-30548-84	
2"	RB-30548-06		RB-30548-66		RB-30548-26		RB-30548-86	
2 1/2"	RB-30548-08		RB-30548-68		RB-30548-28		RB-30548-88	

Plastic Luer Stopcocks and Manifolds

Regulate flow without any leaking

Buy More...Save More!

- 20% off on 100+
- 15% off on 50 to 99
- 10% off on 10 to 49 packs



30600-00

30600-01

30600-02

30600-03

30600-04

30600-23

30600-12

Polycarbonate Stopcocks

HDPE handles rotate 360° on one-way stopcocks, 180° on three-way stopcocks, and 360° on four-way stopcocks.

Type	Description	Pack of 10		Pack of 100	
		Catalog number	Price	Catalog number	Price
Standard stopcocks					
1-way	Male lock	RB-30600-00		RB-30600-05	
1-way	Male luer	RB-30600-01		RB-30600-06	
3-way	Male lock	RB-30600-02†		RB-30600-07	
4-way	Male luer	RB-30600-03		RB-30600-08	
4-way	Male lock	RB-30600-04		RB-30600-09	
Large-bore stopcocks					
3-way	Male lock	RB-30600-23		RB-30600-25	
4-way	Male lock	RB-30600-12		RB-30600-17	

†Locking ring does not rotate.

PVDF Stopcocks

PVDF body with polypropylene insert.

Type	Description	Catalog number	Price†
2-way	Female luer lock	RB-31200-70	
3-way	Female luer lock	RB-31200-80	



31200-70

†Quantity discounts do not apply to these items.

HiRB-Pressure Polycarbonate Stopcocks

Pressure rating up to 1050 psi.

Type	Description	Catalog number	Price/pk of 10
2-way	Male luer lock x female luer	RB-30526-32	
3-way	Female luer (2) x male luer lock	RB-30526-34	

Polycarbonate Manifolds

Manifolds have polyurethane stems, HDPE handles, and female ports.



Ports	Rotation	Individual manifolds		Pack of 10	
		Catalog number	Price	Catalog number	Price
2	180°	RB-06464-81		RB-30600-44	
3	360°	RB-06464-83		RB-30600-41	
4	180°	RB-06464-85		RB-30600-42	
5	360°	RB-06464-87		RB-30600-43	

Cole-Parmer® Premium Luer Fittings

Ensure your process integrity with full material traceability

– Manufactured from 100% virgin raw materials in a Class 100,000 environment

These luer fittings are ideal for a variety of critical applications, including syringes or small tubing. Manufactured in compliance with ISO 594-1 standards, these fittings are inspected to be free from contaminants, and are fully traceable. All parts meet tight dimensional tolerances for increased reliability and process purity. Choose from a range of sizes, 1/16" to 1/4", with a variety of connection options. **Sold in pack of 25.**

Buy More...Save More!

20% off on 100+
15% off on 50 to 99
10% off on 10 to 49 packs

FREE
certificate
of compliance
for these fittings

Cole-Parmer®

Key	Description	Polypropylene		Polycarbonate		Nylon		PVDF	
		Catalog number	Price/pk	Catalog number	Price/pk	Catalog number	Price/pk	Catalog number	Price/pk
Female luer x standard hose barb adapters									
A	Female luer x 1/16" hose barb	RB-45508-00		RB-45501-00		RB-45502-00		RB-45512-00	
	Female luer x 3/32" hose barb	RB-45508-02		RB-45501-02		RB-45502-02		RB-45512-02	
	Female luer x 1/8" hose barb	RB-30800-08		RB-45501-04		RB-45502-04		RB-45512-04	
	Female luer x 3/32" hose barb	RB-45508-06		RB-45501-06		RB-45502-06		RB-45512-06	
	Female luer x 3/16" hose barb	RB-45508-08		RB-45501-08		RB-45502-08		RB-45512-08	
	Female luer x 1/4" hose barb	RB-30800-06		RB-45501-20		RB-45502-20		—	—
Female luer x hose barb adapters (smooth bore)									
B	Female luer x 1/16" hose barb	RB-45508-50		RB-45501-50		RB-45502-50		—	—
	Female luer x 3/32" hose barb	RB-45508-52		RB-45501-52		RB-45502-52		—	—
	Female luer x 1/8" hose barb	RB-45508-54		RB-45501-54		RB-45502-54		—	—
Female luer x hose barb adapters (wide bore)									
C	Female luer x 1/16" hose barb	RB-45508-01		RB-45501-01		RB-45502-01		—	—
	Female luer x 3/32" hose barb	RB-45508-03		RB-45501-03		RB-45502-03		—	—
	Female luer x 1/8" hose barb	RB-30800-02		RB-45501-05		RB-45502-05		—	—
Female luer x hose barb adapters (low-profile barb)									
D	Female luer x 1/16" hose barb	RB-45508-12		RB-45501-12		RB-45502-12		—	—
	Female luer x 3/32" hose barb	RB-45508-14		—	—	RB-45502-14		RB-45512-14	
	Female luer x 1/8" hose barb	RB-45508-16		RB-45501-16		RB-45502-16		RB-45512-16	
	Female luer x 0.17" hose barb	RB-45508-18		—	—	RB-45502-18		RB-45512-18	
Female luer x thread adapters									
E	Female luer x 10-32 special tapered thread	RB-45508-70		RB-45501-70		RB-45502-70		—	—
	Female luer x 10-32 UNF thread	RB-45508-60		RB-45501-60		RB-45502-60		—	—
	Female luer x 1/4-28 UNF thread	RB-45508-66		RB-45501-66		RB-45502-66		RB-45512-66	
	Female luer x 1/4-28 UNF bottom sealing thread	RB-45508-76		—	—	RB-45505-76		RB-45513-76	
	Female luer x 1/8-27 NPT thread	RB-30800-00		—	—	RB-45505-78		RB-45513-78	
F	Female luer x 1/8-27 NPT thread elbow	RB-45518-80		—	—	RB-45505-80		RB-45513-80	
Female luer bulkhead x hose barb adapters									
G	Female luer x 1/4-28 UNF thread to 1/16" hose barb	RB-45508-30		RB-45501-30		RB-45502-30		RB-45512-30	
	Female luer x 1/4-28 UNF thread to 3/32" hose barb	RB-45508-32		RB-45501-32		RB-45502-32		RB-45512-32	
	Female luer x 1/4-28 UNF thread to 1/8" hose barb	RB-45508-34		RB-45501-34		RB-45502-34		RB-45512-34	
Female adapters									
H	Female luer x female luer	RB-45508-22		RB-45501-22		RB-45502-22		RB-45512-22	
I	Female tee	RB-45508-56		RB-45501-56		RB-45502-56		—	—
J	Female elbow	RB-45508-26		RB-45501-26		RB-45502-26		RB-45512-26	
K	Female luer x cap	RB-30800-12		RB-45501-28		RB-45502-28		RB-45512-28	
L	Female luer x cap with tether loop	RB-45508-64		RB-45501-64		RB-45502-64		RB-45512-64	
Male x female adapters									
M	Male luer x female luer coupler	RB-45508-82		RB-45501-82		RB-45502-82		RB-45512-82	
N	Male luer with lock ring x female luer coupler	RB-45508-80		RB-45501-80		RB-45502-80		—	—
O	Male luer x female luer elbow	RB-45508-84		RB-45501-84		RB-45502-84		—	—
P	Male x female x female tee	RB-45508-85		RB-45501-85		RB-45502-85		—	—
Q	Male x male x female tee	RB-45508-75		RB-45501-75		RB-45502-75		—	—

Fluid Path

Fittings

Specifications

Polypropylene (PP). Manufactured of animal-free natural polypropylene. Meets USP Class VI specifications. Very good chemical resistance. Max temperature 190°F (87°C). Sterilize by ethylene oxide and gamma irradiation (not recommended for autoclaving).

Polycarbonate (PC). Good chemical resistance. Max temperature 273°F (133°C). Sterilize by ethylene oxide and gamma irradiation (not recommended for autoclaving).

Nylon. Good chemical resistance. Max temperature 455°F (235°C). Sterilize by autoclave, ethylene oxide, or gamma irradiation.

PVDF. Excellent chemical resistance. Animal-derived ingredient-free. Max temperature 244°F (117°C). Sterilize by autoclave, ethylene oxide, or gamma irradiation.

Key	Description	Polypropylene		Polycarbonate		Nylon		PVDF	
		Catalog number	Price/pk	Catalog number	Price/pk	Catalog number	Price/pk	Catalog number	Price/pk
Male luer lock x standard hose barb adapters									
R	Male luer lock x 1/16" hose barb	RB-45518-00		RB-45504-00		RB-45505-00		RB-45513-00	
	Male luer lock x 3/32" hose barb	RB-45518-02		RB-45504-02		RB-45505-02		RB-45513-02	
	Male luer lock x 1/8" hose barb	RB-30800-24		RB-45504-04		RB-45505-04		RB-45513-04	
	Male luer lock x 5/32" hose barb	RB-45518-06		RB-45504-06		RB-45505-06		RB-45513-06	
	Male luer lock x 3/16" hose barb	RB-45518-08		RB-45504-08		RB-45505-08		RB-45513-08	
	Male luer lock x 1/4" hose barb	RB-30800-22		RB-45504-19		RB-45505-19		—	—
Male luer lock x hose barb adapters (wide bore)									
S	Male luer x 1/16" hose barb (wide bore)	RB-30800-16		—	—	RB-45505-31		—	—
	Male luer x 3/32" hose barb (wide bore)	—	—	—	—	RB-45505-32		—	—
	Male luer x 1/8" hose barb (wide bore)	RB-30800-18		—	—	RB-45505-33		—	—
Male luer lock x hose barb adapters (low-profile barb)									
T	Male luer x 1/16" hose barb	RB-45518-07		RB-45504-07		RB-45505-07		—	—
	Male luer x 3/32" hose barb	RB-30800-28		—	—	RB-45505-09		RB-45513-09	
	Male luer x 1/8" hose barb	RB-45518-11		RB-45504-11		RB-45505-11		RB-45513-11	
	Male luer x 0.17" hose barb	RB-45518-13		RB-45504-13		RB-45505-13		—	—
Male luer x hose barb adapters (for use with separate rotating lock ring "W")									
U	Male luer x 1/16" hose barb	RB-45518-40		RB-45504-40		RB-45505-40		—	—
	Male luer x 3/32" hose barb	RB-45518-42		RB-45504-42		RB-45505-42		—	—
	Male luer x 1/8" hose barb	RB-45518-44		RB-45504-44		RB-45505-44		—	—
	Male luer x 5/32" hose barb	RB-45518-46		RB-45504-46		RB-45505-46		—	—
	Male luer x 3/16" hose barb	RB-45518-48		RB-45504-48		RB-45505-48		—	—
	Male luer x 1/4" hose barb	RB-45518-50		RB-45504-50		RB-45505-50		—	—
Male luer x hose barb adapters (wide-bore), (for use with separate rotating lock ring "W")									
V	Male luer x 1/16" hose barb	RB-45518-41		RB-45504-41		RB-45505-41		—	—
	Male luer x 3/32" hose barb	RB-45518-43		—	—	—	—	—	—
	Male luer x 1/8" hose barb	RB-45518-45		RB-45504-45		RB-45505-45		—	—
W	Snap luer lock ring	RB-45518-74		RB-45504-74		RB-45505-74		—	—
Male slip luer x hose barb adapters (no lock ring)									
X	Male luer x 1/16" hose barb	RB-45518-22		RB-45504-22		RB-45505-22		RB-45513-22	
	Male luer x 3/32" hose barb	RB-45518-24		RB-45504-24		RB-45505-24		RB-45513-24	
	Male luer x 1/8" hose barb	RB-45518-26		RB-45504-26		RB-45505-26		RB-45513-26	
	Male luer x 5/32" hose barb	RB-45518-28		RB-45504-28		RB-45505-28		RB-45513-28	
	Male luer x 3/16" hose barb	RB-45518-52		RB-45504-52		RB-45505-52		—	—
	Male luer x 1/4" hose barb	RB-45518-54		RB-45504-54		RB-45505-54		—	—
Male adapters									
Y	Male luer x male luer	RB-30800-14		RB-45504-72		RB-45505-72		RB-45513-72	
Z	Male luer lock plug	RB-30800-30		RB-45504-56		RB-45505-56		RB-45513-56	
AA	Male luer plug	RB-45518-58		RB-45504-58		RB-45505-58		—	—
AB	Male luer plug with tether loop	RB-45518-70		RB-45504-70		RB-45505-70		—	—
AC	Male luer with lock ring and 5/16" hex to 1/4-28 UNF	RB-45518-81		—	—	—	—	RB-45513-81	
Male luer with integral lock ring x thread adapters									
AD	Male luer x 1/4-28 UNF thread	RB-45518-82		RB-45504-82		RB-45505-82		RB-45513-82	
AE	Male luer x 10-32 special tapered thread	RB-45518-84		RB-45504-84		RB-45505-84		—	—
AF	Male luer x 7/16" hex x 1/8-27 NPT thread	RB-45518-86		—	—	RB-45505-86		RB-45513-86	
AG	Male luer x 3/16" hex x 1/4-18 NPT thread	RB-45518-88		—	—	RB-45505-88		—	—

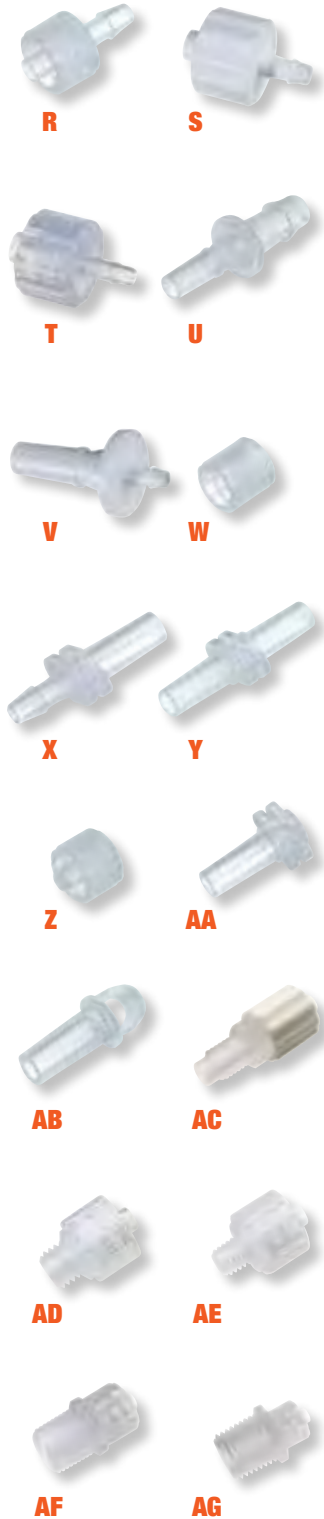

Fluid Path

Fittings

Accessories

[RB-45509-00](#) Panel-mount lock ring, black nylon. Pack of 25

[RB-45509-02](#) Panel-mount ring, black nylon. Pack of 25

[RB-45509-04](#) Panel-mount lock nut; 1/4-28 UNF, black nylon. Pack of 25

High-Purity Plastic Diaphragm Valves

Eliminate leaks

- Fully drainable mechanical valves are easy to maintain
- Models with PVDF body offer additional chemical resistance
- Handle maximum viscosity of 400 cSt



98520-00

Specifications

Wetted parts: polypropylene or PVDF body, EPDM diaphragm

Connections	Cv	Working pressure	Temperature range	Catalog number	Price
High-purity polypropylene valves					
3/4"	4.0	60 to 125 psi (4.1 to 8.6 bar)	-5 to 175°F (-20 to 79°C)	RB-98520-00	
1"	12.3			RB-98520-01	
1 1/2"	21.0			RB-98520-02	
2"	29.2			RB-98520-03	
High-purity PVDF valves					
3/4"	4.0	60 to 125 psi (4.1 to 8.6 bar)	-5 to 210°F (-20 to 99°C)	RB-98520-10	
1"	12.3			RB-98520-11	
1 1/2"	21.0			RB-98520-12	

Sanitary Plastic Ball Valves

Precision machined and tested to ensure leak-free connections

- Tri-Clamp® connections are easy to plumb into sanitary fluid paths
- Smooth flow path minimizes turbulence and pressure loss
- FDA 21 CFR 177.1520 compliant; NSF listed
- Valve design permits full flow and pressure in either direction



These industry standard valves feature PTFE bearings and seats to virtually eliminate friction and minimize wear. Fully concentric polished ball further ensures leak-free performance.

Clamp size	Cv	Max working pressure at 70°F (21°C)	Maximum temperature	Catalog number	Price
Polypropylene valve body and EPDM seals					
3/4" mini	20	140 psi (9.5 bar)	180°F (82°C)	RB-30532-01	
1" maxi	40			RB-30532-03	
1" Ladish	40			RB-30532-05	
1 1/2"	100	120 psi (8.6 bar)		RB-30532-07	
2"	120			RB-30532-09	
PVDF valve body and EPDM seals					
3/4" mini	20	240 psi (16.3 bar)	280°F (138°C)	RB-30532-11	
1" maxi	40			RB-30532-13	
1" Ladish	40			RB-30532-15	
1 1/2"	100			RB-30532-17	
2"	120			RB-30532-19	

316 SS Sanitary Ball and Butterfly Valves

Install in any position

- Compatible with Tri-Clamp® fittings
- Meet USDA requirements
- Wetted parts: 316 stainless steel with a sanitary finish, PTFE seals (ball valves), silicone seals (butterfly valves)

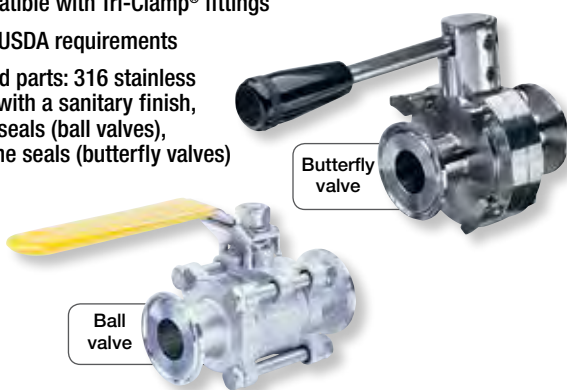

Butterfly valve

Ball valve

Clamp size	Cv	Max pressure	Max temperature	Catalog number	Price
Ball valves					
3/4"	40	1000 psi at 70°F (21°C)	400°F (204°C)	RB-30530-00	
1"	70			RB-30530-01	
1 1/2"	120			RB-30530-02	
2"	340			RB-30530-03	
Butterfly valves					
1"	—	145 psi at 68°F (20°C)	200°F (93°C)	RB-30531-01	
1 1/2"	—			RB-30531-02	
3"	—			RB-30531-05	
4"	—			RB-30531-07	

Burkert Type 3233 316L Stainless Steel Diaphragm Valves

Protect your process

- Zero dead volume
- Autoclavable
- Can mount to be self-draining

These compact, manually operated diaphragm valves consist of a flow-optimized stainless steel body, diaphragm, and a manual actuator. The diaphragm is both a switch element and a sealing element and can be easily replaced.



Specifications

Body material: forged 316L SS, ASME BPE specification
Internal finish: 0.6 µL in Ra

External finish: 0.4 µL in Ra (as forged)
Actuator/bonnet: PPS/316L SS
Diaphragm material: PTFE/EPDM

Tri-Clamp® connection	Cv	Maximum pressure	Temperature range	Catalog number	Price
1/4"	1.2	145 psi (9.9 bar)	14 to 266°F (-14 to 130°C)	RB-98516-56	
3/8"	1.2			RB-98516-58	
1/2"	1.2			RB-98516-60	
1/2"	6.9	150 psi (10.3 bar)		RB-98516-62	
3/4"	13.9			RB-98516-64	
1"	18.5			RB-98516-66	
1 1/2"	33.5			RB-98516-68	
2"	62.4	101 psi (6.9 bar)		RB-98516-70	

Sterile Single-Use Tank Liners, LLDPE

No more washing, cleaning, or revalidation

- Ready for immediate use
- Save money and time—no need for expensive equipment
- Manufactured with LLDPE, liners are pyrogen-free



Gallons (liters)	Dimensions	Catalog number	Qty/pk	Price/pk
13.2 (50)	27"H x 13" OD	RB-06310-01	40	
34.4 (130)	30"H x 18" OD	RB-06310-02	20	
52.8 (200)	36"H x 22" OD	RB-06310-04	20	
79.3 (300)	48"H x 24" OD	RB-06310-06	20	
106 (401)	44"H x 28" OD	RB-06310-08	20	
148 (560)	49"H x 31" OD	RB-06310-10	10	
198 (750)	51"H x 36" OD	RB-06310-12	10	
264 (1000)	49"H x 42" OD	RB-06310-14	10	
343 (1298)	49"H x 48" OD	RB-06310-16	10	

Wait!

There's More at ColeParmer.com

Find all the product specs you need!

Conical-Bottom Tank Systems, LPE

No need to order separate items

Complete tank systems include tank, carbon steel stand with agitator mounting, LDPE cover, and bulkhead fitting—indicate fitting placement at time of order.

Linear polyethylene tanks have conical bottoms for complete drainage of fluids and are impact and chemical resistant. Tanks can withstand continuous operating temperature of 150°F (65°C). Translucent sides let you observe liquid levels.



Gallons (liters)	Dimensions† (H x dia)	Outlet NPT(F)	Catalog number	Price
Tank systems				
15 (57)	22 ⁵ / ₈ " x 18 ¹ / ₂ "	1"	RB-06925-00	
30 (114)	33 ³ / ₄ " x 21 ⁷ / ₈ "	1"	RB-06925-05	
55 (208)	37" x 26"	1"	RB-06925-10	
100 (379)	40 ⁷ / ₈ " x 34 ³ / ₄ "	1 ¹ / ₂ "	RB-06925-15	
200 (757)	66 ⁷ / ₈ " x 35"	1 ¹ / ₂ "	RB-06925-20	
250 (946)	54 ¹ / ₈ " x 47 ³ / ₈ "	1 ¹ / ₂ "	RB-06925-25	
Replacement tanks				
15 (57)	22 ⁵ / ₈ " x 18 ¹ / ₂ "	1"	RB-06925-02	
30 (114)	33 ³ / ₄ " x 21 ⁷ / ₈ "	1"	RB-06925-07	
55 (208)	37" x 26"	1"	RB-06925-12	
100 (379)	40 ⁷ / ₈ " x 34 ³ / ₄ "	1 ¹ / ₂ "	RB-06925-17[‡]	
200 (757)	66 ⁷ / ₈ " x 35"	1 ¹ / ₂ "	RB-06925-22[‡]	
250 (946)	54 ¹ / ₈ " x 47 ³ / ₈ "	1 ¹ / ₂ "	RB-06925-27[‡]	

†Values are approximate; for overall height add 15" to the height for the stand.
‡Must ship via motor freight.

Cylindrical Tanks with Cover, HDPE and PP

Sturdy design complies with FDA 21 CFR 177.1520

- Contain drips with stepped-flange design
- Get easier sampling of liquids—tanks over 30 gallons are designed for near-total drainage
- No separate part number for lid—all tanks include lid of same wall thickness
- Rated for use with 1.8 specific gravity media
- High-density polyethylene (HDPE) tanks have good chemical resistance and max temperature of 150°F (65°C)
- Polypropylene (PP) tanks offer good stress-crack and chemical resistance; maximum service temperature is 220°F (104°C)



APPLICATIONS

- ✓ Media/nutrient storage
- ✓ Biobag support

ISO9001:2008
CERTIFIED SUPPLIER

Gallons (liters)	Dimension (H x OD)†	Graduation gal. (liters)	Shpg wt lb (kg)	HDPE tanks			PP tanks		
				Cat. no.	Wall	Price	Cat. no.	Wall	Price
5 (19)	15" x 11"	0.5 (2)	6 (3)	RB-06317-50	3/16"		RB-06317-53	3/16"	
7.5 (28)	18" x 12"	0.5 (N/A)	8 (4)	RB-06317-55	3/16"		RB-06317-58	3/16"	
10 (38)	20" x 13"	1 (N/A)	9 (4)	RB-06317-60	3/16"		RB-06317-63	3/16"	
15 (57)	27" x 13"	1 (4)	12 (5)	RB-06317-65	3/16"		RB-06317-68	3/16"	
30 (114)	30" x 18"	2.5 (10)	18 (8)	RB-06317-70	3/16"		RB-06317-73	3/16"	
55 (208)	36" x 22"	2.5 (10)	31 (14) [‡]	RB-06317-75	1/4"		RB-06317-78	1/4"	
80 (303)	48" x 24"	5 (20)	42 (19) [‡]	RB-06317-80	1/4"		RB-06317-83	1/4"	
100 (379)	44" x 28"	5 (20)	49 (22) [‡]	RB-06317-10	1/4"		RB-06317-13	1/4"	
150 (568)	49" x 31"	10 (40)	77 (35) [‡]	RB-06317-20	1/4"		RB-06317-23	1/4"	
200 (757)	51" x 36"	25 (100)	136 (62) [‡]	RB-06317-31	1/4"		RB-06317-34	1/4"	
275 (1041)	49" x 42"	25 (100)	193 (88) [‡]	RB-06317-41	1/4"		—	—	—
360 (1363)	49" x 48"	25 (100)	206 (93) [‡]	RB-06317-85	1/4"		RB-06317-88	1/4"	
500 (1893)	62" x 53"	25 (100)	600 (272) [‡]	RB-06318-86	5/16"		—	—	—

†Measured at bottom of tank. Add 2" for approximate OD at top of tank.

‡Ship by motor freight only.

Fermentation

Ensure maximum cell growth and harvest



Bioreactors and fermentation vessels from seed culture to 15 L production volumes

Optimize seed culture growth trajectories with lab reactor bundles.	49
Control conditions with simple touchscreen panel systems.	50
Customize your vessel with these easy accessories	51



Product Selection | Troubleshooting | And More...

Not sure what to choose?
Our expert Application Specialists can help you find the
right product for your application.

1-800-323-4340
or Ch@t Live

Applikon® MiniBio Lab Reactor Bundles

Minimize costs while saving bench space

- Mimic lab-scale bioreactors on a small scale
- Simple installation and setup—ready to use “out-of-the-box”
- Cultivate using less bench space and less medium
- Generate more data in less time

The MiniBio range of bioreactors achieve high-throughput bioreactor cultivation without sacrificing the quality of your experiment. All materials of construction are nontoxic and chemically inert. The MiniBio is a cost-effective solution that can be customized to fit the demands of any lab.

The mechanically coupled agitator allows mixing up to 2000 rpm, even in viscous media or high-density cultures. The head plate includes ports for pH, DO sensors, a septum, overlay, chemostat, thermowell for temperature sensor, sparger aeration (porous sparger), multiple liquid inlets, sample pipe and exhaust condenser.

Easily handle data through the intuitive *my-Control* controller with six control loops (pH, temperature, dissolved oxygen, foam, level, and rpm). A single interface can control up to 32 parallel *my-Controllers*. Control parameters include batch, fed-batch, perfusion, and continuous cultivation. Choose to operate through your web browser, iPod®, iPhone®, iPad®, Android™, or Windows® system.

Each MiniBio bundle comes with the BioXpert Lite software for data acquisition, which is compatible with Windows 7, Vista, or XP operating systems.

What's included: bioreactor vessel and integrated stirrer, *my-Control* controller, BioXpert Lite software, probes and cables, headplate, start-up kit (tubing for pumps and gas flow lines, tubing clamps, replacement septa for septum holder, various O-rings, 100 sample tubes), two gas filters (for air outlet and sparger assembly), and a 5-ft (1.5-m) power cord with plug for *my-Control* controller.



Specifications

ISO 9001:2008 CERTIFIED SUPPLIER U L S P CE

Wetted materials: 316L stainless steel, EPDM, silicone rubber, and borosilicate glass.‡

Vessel material†: borosilicate glass
Headplate material: 316L stainless steel (Ra < 0.8 µm)

Description	250-mL cell culture MiniBio bundle	500-mL cell culture MiniBio bundle	1-liter cell culture MiniBio bundle	2-liter cell culture MiniBio bundle	3-liter cell culture MiniBio bundle
Catalog number	RB-29206-03	RB-29206-06	RB-29206-08	RB-29206-11	RB-29206-13
Total volume	250 mL	500 mL	1000 mL	2000 mL	3000 mL
Working volume	200 mL	400 mL	900 mL	1700 mL	2700 mL
Minimum working volume	50 mL	100 mL	300 mL	300 mL	600 mL
Height-to-diameter ratio at the max weight volume	1.6	1.6	1.6	1.6	1.6
Head plate ports					
Sensor holder: 6.4 mm (pH and DO)	2	2	2	2	2
Additional ports (3 mm)	4	4	4	4	4
Lipseal stirrer with adjustable-height impeller	•	•	•	•	•
Scoping marine impeller	•	•	•	•	•
pH probe holder	6.4 mm	6.4 mm	12 mm	12 mm	12 mm
DO probe holder	6.4 mm	6.4 mm	12 mm	12 mm	12 mm
Thermometer pocket	3 x 140 mm	3 x 140 mm	12 x 140 mm	12 x 140 mm	12 x 140 mm
pH electrode	6.4 x 140 mm	6.4 x 140 mm	12 x 154 mm	12 x 154 mm	12 x 235 mm
DO probe	6.4 x 140 mm	6.4 x 140 mm	12 x 154 mm	12 x 154 mm	12 x 235 mm
Temperature probe	3 x 140 mm	3 x 140 mm	3 x 140 mm	12 x 140 mm	12 x 140 mm
Cooling temperature control	Electric Peltier cooling (optional†)	Electric Peltier cooling (optional†)	Electric Peltier cooling (optional†)	Electric Peltier cooling (optional†)	Electric Peltier cooling (optional†)
Heating temperature control	Electric heating blanket	Electric heating blanket	Electric heating blanket	Electric heating blanket	Electric heating blanket
Sparger type	Porous sparger	Porous sparger	Porous sparger	Porous sparger	Porous sparger
Air overlay pipe	Optional†	Optional†	Optional†	Optional†	Optional†
Air outlet condenser	Electric Peltier cooling (optional†)	Electric Peltier cooling (optional†)	12 mm (optional†)	12 mm (optional†)	12 mm (optional†)
Medium inlet	•	•	•	•	•
Septum holder	•	•	•	•	•
Sample pipe	•	•	•	•	•
Adjustable sample pipe	Optional†	Optional†	Optional†	Optional†	Optional†
Software	Data acquisition (SCADA optional†)	Data acquisition (SCADA optional†)	Data acquisition (SCADA optional†)	Data acquisition (SCADA optional†)	Data acquisition (SCADA optional†)
Power (VAC, Hz)‡	115, 60	115, 60	115, 60	115, 60	115, 60
Price					

• = Included. †A single glass vessel is standard; contact our Application Specialists for other options. ‡Contact our Application Specialists for options and different materials and voltages.

Applikon® BioBundle™ Fermentation Systems Comes ready to assemble for easy installation

- Control pH, temperature DO, foam/level and agitation through a simple ez-Control touchscreen panel
- Affordable and complete—systems include everything you need for a wide range of applications
- Setup requires no special skills or tools

Get your fermentation projects up and running. All materials in contact with the bioreactor vessel are constructed of either 316L stainless steel, EPDM, silicone rubber, PTFE, or borosilicate glass. Built-in ez-Control features a color touch screen that monitors and controls your most important process parameters. ez-Control uses a USB interface connection, allowing data transfer anywhere in your network. Motor includes a 6:1 gear reduction to provide higher torque capability.



Fermentor Headplate contains the following nonremovable components:

- Thermometer pocket
- Inoculation pipe
- Air overlay pipe
- Sample pipe
- Sparger pipe
- Heat exchanger with two baffles

Start-Up Kit consists of the following items:

- Assorted O-rings (24) for port assemblies
- Rubber septa (5) for septum holder
- Clamping rings (2) for pH holder
- Lipseals (6) for stirrer assembly
- Allen key, 1.5 mm
- Tee connector, 1/8" x 1/8" x 1/8"
- Tubing clamps (6)
- 12½-ft tubing, Norprene®, ID = 0.12"
- 12½-ft tubing, Norprene, ID = 0.19"
- 5-ft silicone tubing for headplate ring

Description	1-liter cell culture BioBundle	3-liter cell culture BioBundle	7-liter cell culture BioBundle	15-liter cell culture BioBundle
Catalog number	RB-29206-40	RB-29206-44	RB-29206-48	RB-29206-52
Total volume	1.25 liter	3.2 liter	7 liter	16 liter
Working volume	900 mL	2.7 liter	5.2 liter	12 liter
Minimum working volume	350 mL	0.47 liter	2 liter	2.5 liter
Available headplate ports	6 ports	18 ports	18 ports	18 ports
Lipseal stirrer	•	•	•	•
Bladed marine impeller	•	•	•	•
Motor, speed controller, cable	100-W motor	100-W motor	100-W motor	100-W motor
Liquid addition bottle	1 each, 0.5 liter	1 each, 0.5 liter	1 each, 0.5 liter	1 each, 1 liter
Syringe filters	3	3	3	3
Sparger pipe	•	•	•	•
Sparger pipe with porous nozzle	•	•	•	•
Septum holder	•	•	•	•
Air outlet condenser (SS)	•	•	•	•
Air overlay pipe	•	•	•	•
Sample pipe	•	•	•	•
Thermometer pocket	•	•	•	•
Reagent inlet assembly with three pipes	•	•	•	•
Baffles	3	—	—	—
Power unit for controller	•	•	•	•
PC configuration software for controller	•	•	•	•
Gas selection manifold	•	•	•	•
Control valve for rotameter	2	2	2	2
Blind plug for 6-mm ports	—	3	—	—
Blind plug for 10-mm ports	—	2	6	6
Blind plug for 12-mm ports	—	2	2	2
Blind plug for 18-mm ports	—	1	1	—
Blind plug for 27-mm ports	—	—	—	1
pH sensor, holder, cable	•	•	•	•
Dissolved O ₂ sensor, holder, cable	•	•	•	•
Temperature sensor	•	•	•	•
Bioreactor system controller	•	•	•	•
Rotameter for air	100 mL/min	500 mL/min	1 L/min	5 L/min
Rotameter for oxygen	—	—	—	—
Rotameter for CO ₂	50 mL/min	100 mL/min	100 mL/min	500 mL/min
BioConsole, ADI 1025†	•	•	•	•
Fixed-speed pumps, pump heads, tubing	1	1	1	1
Heating blanket	•	•	•	•
Start-up kit	•	•	•	•
Power	110 VAC	110 VAC	110 VAC	110 VAC
Price				

• = Included †The ADI 1025 BioConsole is the cabinet that houses the pumps, rotameters, etc.

Fermentation Accessories

Customize to your process needs

Reagent Addition

A. Reagent Addition Bottles come in four sizes. Use small glass bottles for acids or bases; use large glass bottles to hold fresh media. Stainless steel transfer pipes and sterile 0.2 µm PTFE filter with 50-mm PP housing included. Autoclavable.

Capacity	Catalog number	Price
1.0 liter	RB-01919-91	
5.0 liters	RB-01919-92	
20 liters	RB-01919-93	



B. Septum Needle is for dosing liquids or adding chemicals through the septum into your fermentation culture. Needle has a 3/16" OD stainless steel pipe for optional tubing hookup.

Description	Catalog number	Price
Septum needle	RB-01919-20	



RB-29207-50 Replacement septa for 2-, 3-, 5-, and 7-liter vessels. Bag of 50

RB-29207-52 Replacement septa for 15-liter vessels. Bag of 50

C. Addition Pipe is specially angled to allow reagent to drop gently on media—won't harm cells growing near top of vessel.

Port size	Catalog number	Price
10 mm	RB-01919-94	



D. Assembly Holder easily accommodates 6-mm piping into your fermentation system. Simply screw this assembly holder onto a 10-mm port and connect the 6-mm tubing. Includes silicone O-ring.

Description	Catalog number	Price
Assembly holder	RB-01919-17	



Sampling

E. Sampling System lets you easily remove a 60-mL sterile sample from your fermentation vessel without removing the headplate. Attach system to the sample pipe via 1/4" ID tubing. Includes a 60-mL glass bottle with stainless steel fittings.

Description	Catalog number	Price
Sampling system	RB-01919-19	

RB-01919-43 Optional bottle, 30 mL

RB-01919-44 Replacement bottle, 60 mL



F. Sample Screens filter media flowing through your sample pipe assembly.

Capacity	Catalog number	Price
13 µm	RB-01919-22	
25 µm	RB-01919-23	
76 µm	RB-01919-24	
125 µm	RB-01919-25	



G. Chemostat Tube is used with a Masterflex® tubing pump (sold separately) to draw off harvested media or to add fresh media to maintain constant media level.

Vessel size (L)	Port size	Catalog number	Price
15	27 mm	RB-01919-46	

G

H. Transport Cart makes moving your 15-liter fermentation system easy.

Description	Catalog number	Price
Transport cart	RB-01919-99	

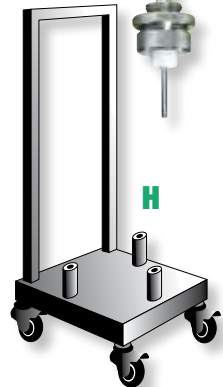

H

I. Blind Caps (stainless steel) cover unused ports. Include O-rings.

Port size	Catalog number	Price
6 mm	RB-01919-16	
10 mm	RB-01919-18	
12 mm	RB-01919-48	
M18 x 1.5 mm	RB-01919-13	
3/4 inch	RB-01919-47	



J. Porous Sparger Tip for the sparger found in every system. Tip should be replaced if it breaks or clogs.

Description	Catalog number	Price
Porous sparger tip	RB-01919-98	

Fermentation



Questions?

Trust our **expert** Application Specialists to help you find the right product.

Polo, 8 years of experience

Call: 1-800-323-4340
E-mail: sales@coleparmer.com
Chat live: ColeParmer.com

Filtration & Purification

Protect and purify for better yields



From vents to in-line prefiltration to final clarification

- Protect against external contaminants with vent filters. 54
- Form a sterile barrier for media feed lines with hollow fiber filters 56
- Prefilter to sterile filtration with liquid filter systems in sequence. 58

Filters listed in this section reference absolute pore size; use the cross-reference chart below to determine whether this meets your needs:

Type of filtration	Ultrafiltration	Microfiltration	Macrofiltration
Units	Dalton (MW)	Microns (µm)	50 µm or greater, visible to the human eye
Particle examples and sizes	Trypsin (24,000) Serum albumin (67,000) Gamma globulin (169,000) Viruses (600,000 to 30,000) Endotoxins (500,000 to 12,000)	Mycoplasm (0.08 to 0.4) Proteins (0.0005 to 0.5) Fungi (0.7 to 3) Yeasts (0.6 to 4) Bacteria (0.3 to 12)	Spores Pollen Human hair Sands



Product Selection | Troubleshooting | And More...

Not sure what to choose?
 Our expert Application Specialists can help you find the right product for your application.

1-800-323-4340
 or Ch@t Live

Whatman™ 50-mm In-Line Filters

Versatile and cost-effective for large-volume samples

Filter up to one liter with one device; filtration area is 16 cm². Use with 6 to 10 mm hose. Autoclavable. Hold up volume with air purge is less than 0.1 mL. Maximum operating pressure is 60 psi (4.1 bar).

PTFE membrane filters are ideal for chemically aggressive solutions. Use as protective vents or for in-line filtration and isolation applications. Filter 29700-76 features a polypropylene prefilter.

PES aqueous solution filters are low protein binding and contains no surfactants. A glass microfiber prefilter extends the life of the membrane.

Polypropylene filters have excellent flow rate characteristics and are ideal for filtering up to 1 L of aqueous and solvent samples.



Membrane	Pore size	Sterile	Catalog number	Qty/pk	Price/pk
PTFE	0.1 µm	No	RB-29700-70	10	
	0.2 µm	No	RB-29700-72		
	0.45 µm	No	RB-29700-74		
PES/GMF†	0.2 µm	Yes	RB-29700-78	10	
	0.45 µm	Yes	RB-29700-80		
PP	5.0 µm	No	RB-29700-86	10	
	10.0 µm	No	RB-29700-88		

†GMF = glass microfilter

MediaKap® Hollow Fiber Media Filters

Sterilize and clarify cell culture media and buffers quickly

- Use as pressure filters with peristaltic pumps, pressure vessels, or repeating syringes
- PVC filling bell maintains downstream sterility

MediaKap hollow fiber media filters provide biocompatibility, low extractables, and high flow rates. Polypropylene autovent prevents air locking. Naturally hydrophilic, 0.2 µm microporous membrane.



Specifications

Maximum temperature: 182°F (83°C)

Maximum pressure: 50 psi (3.4 bar)

Water flow rate at 10 psi	Through-put†	Connections (inlet/outlet)	Filling bell	Catalog number	Qty/box	Price/box
400 mL/min	0.2 to 2 L	Female luer/male luer	Yes	RB-29510-20	12	
			No	RB-29510-00	18	
750 mL/min	2 to 5 L		Yes	RB-29510-22	12	
			No	RB-29510-02	18	
1000 mL/min	5 to 10 L	¼" hose barbs	Yes	RB-29510-14	12	
1400 mL/min	10 to 25 L	¼" to ⅜" hose barbs	Yes	RB-29510-06	6	
2000 mL/min	25 to 50 L		Yes	RB-29510-08	3	

†Serum-free DMEM

Whatman™ Disposable Capsule Filters

PTFE or polypropylene (PP) membranes available

PTFE membrane is ideal for venting, in-line filtration, and isolation (gas pass, liquids, and aerosol stopped). Use PP membrane for solvents, clean air/gas, prefiltration, and sample preparation.

All capsules feature sturdy PP housings with fused seals—no glues or adhesives to contaminate filtrate.

Capsules include a luer lock vent to guarantee that no filtration area is wasted. Use vent to draw solution into the capsule or let air escape from the capsule or sample port.



Pore size	Effective filter area	Sterile	Hose connections	Catalog number	Price
PTFE membrane—autoclavable					
0.2 µm	500 cm ²	No	¼" to ⅜" stepped barb	RB-29700-00	
1.0 µm		No		RB-29700-02	
0.1 µm	1000 cm ²	No	¼" to ⅜" stepped barb	RB-29700-10	
0.2 µm		No		RB-29700-12	
0.45 µm		No		RB-29700-14	
1.0 µm	1000 cm ²	No	½" stepped barb	RB-29700-16	
Polypropylene membrane—autoclavable					
1.0 µm	385 cm ²	No	¼" to ⅜" stepped barb	RB-29700-20	
5.0 µm		No		RB-29700-22	
1.0 µm	805 cm ²	No	½" stepped barb	RB-29700-30	
5.0 µm		No		RB-29700-32	
10.0 µm	400 cm ²	No	¼" to ⅜" stepped barb	RB-29701-40	

Whatman™ Venting Filters

Manufactured under strict cleanroom conditions and totally biosafe

- Biotech: sterile vents and exhausts for growth environments
- Pharmaceutical and diagnostics: vents for liquid vessels

Use filters in venting and isolation applications to protect vessel contents from external contaminants. Filters are also used to protect the environment from contaminants within the vessel. Filter features a polypropylene housing and a 0.2 µm PTFE membrane, allowing easy scale up within the range based on vessel capacity and air flow rate required. Filters are bidirectional and autoclavable.



Housing type	Pore size	Filtration area	Dia (mm)	Connections	Catalog number	Qty/pk	Price/pk
Disc	0.2 µm	4 cm ²	25	Female luer lock, male slip luer	RB-29700-60	50	
		16 cm ²	50	Stepped hose barb for 6 to 10 mm ID tubing	RB-29700-62	10	
Capsule	0.2 µm	500 cm ²	—	Stepped hose barb for 6 to 10 mm ID tubing	RB-29700-64	1	
		1000 cm ²	—	Stepped hose barb for 10 to 13 mm tubing	RB-29700-66	1	

Whatman™ HEPA-VENT™ and HEPA-CAP™ Filters

Prevent bacterial, algal, or fungal contamination in fermenters or incubators

- Retains 99.97% of airborne particles ≥0.3 µm
- High flow rates with low pressure drop across the filter media
- Allows bidirectional flow



These in-line filter devices are particularly suitable for the sterile venting of fermenters or reaction vessels. Applications include tissue culture, in-line filtration, and removal of particulates from gas/air stream. These lightweight filters have a polypropylene housing and are available in disc and capsule formats. The devices contain glass microfiber filtration media, which is mildly hydrophobic for resistance to bacterial growth and has been laminated on both sides to prevent fiber release. Repeatedly autoclave for ensured sterility.

Description	Filtration area	Connections	Catalog number	Qty/pk	Price/pk
HEPA-VENT 50-mm disc	16 cm ²	Stepped hose barb for 6- to 10-mm ID tubing	RB-29700-90	10	
HEPA-CAP 36 capsule	625 cm ²	Stepped hose barb for 6- to 10-mm ID tubing	RB-29700-92	1	
HEPA-CAP 75 capsule	1300 cm ²	Barb for 12-mm ID tubing	RB-29700-94	1	

Minntech® Hollow Fiber Filter Capsules

Provide high flow rates with low pressure drop

- Steam sterilize capsules in-line or autoclave off-line
- Polysulfone membrane offers low protein binding

These hollow fiber filters offer superior performance in a compact size. Filters have up to six times more surface area compared to other pleated membrane filters, providing greater capacity and longer filter life. The unique membrane structure helps remove bacteria, high-level endotoxins, spores, and pyrogens†—ideal for a variety of water purification applications. Maximum differential pressure is 30 psi (2 bar). Capsules have a polycarbonate case and end caps and polyurethane end seals. Capsules are provided nonsterile.



Pore size (absolute)	Effective filtration area	Connections	Catalog number	Qty/cs	Price/cs
Medium flow: 0.5 to 2.5 LPM					
0.05 µm	1858 cm ²	3/8" hose barb	RB-29880-06	6	
		1/4" NPT(M)	RB-29880-12		
0.1 µm	1858 cm ²	3/8" hose barb	RB-29880-14	6	
		1/4" NPT(M)	RB-29880-08		
0.2 µm	1858 cm ²	3/8" hose barb	RB-29880-10	6	
		1/4" NPT(M)	RB-29880-22		
High flow: 1 to 5.7 LPM					
0.05 µm	5575 cm ²	1/4" NPT(M)	RB-29880-28	6	
		3/8" NPT(M)	RB-29880-30		
0.1 µm	5575 cm ²	1/4" NPT(M)	RB-29880-32	6	
		3/8" NPT(M)	RB-29880-34		
0.2 µm	5575 cm ²	1/4" NPT(M)	RB-29880-36	6	
		3/8" NPT(M)	RB-29880-38		

†Only 0.05 and 0.1 µm pore size membrane filters remove pyrogens.

Whatman™ Polycap™ TC Filter Capsules

Presterilized polyethersulfone (PES) membrane

These capsules contain two layers of polyethersulfone (PES) membrane, which is inherently hydrophilic, low in extractables, and offers excellent flow rates. The membrane also exhibits low protein binding characteristics making it ideal for use with biologically sensitive solutions. The device is supplied presterilized and has a vent to evacuate any air to allow fast filtration. The outlet of the capsule is protected to prevent touch contamination during setup and has standard hose barb connections. Select capsules with filling bell for cleanliness assurance during filling.



Pore size	Filtration area	Filling bell	Connections	Sterile	Catalog number	Price/ea
0.65/0.45 µm	550 cm ²	No	¼" to ⅜" stepped barb	Yes	RB-29701-46	
0.2 µm	550 cm ²	Yes	¼" to ⅜" stepped barb	Yes	RB-29701-48	
0.8/0.2 µm	380 cm ²				RB-29701-50	
0.65/0.45 µm	550 cm ²				RB-29701-52	
0.2 µm	1100 cm ²	No	¼" to ⅜" stepped barb	Yes	RB-29701-54	
0.2 µm	1100 cm ²	Yes	¼" to ⅜" stepped barb	Yes	RB-29701-58	
0.8/0.2 µm	760 cm ²				RB-29701-60	
0.2 µm	2200 cm ²				RB-29701-64	
0.65/0.45 µm	2200 cm ²	No	⅜" to ½" stepped barb	Yes	RB-29701-66	
0.2 µm	2200 cm ²	Yes	⅜" to ½" stepped barb inlet, ¼" to ⅜" stepped barb outlet	Yes	RB-29701-68	
0.8/0.2 µm	1140 cm ²				RB-29701-70	



Filtration & Purification

Filtration

Single-Open-End Absolute-Rated Cartridge Systems

Meet your regulatory needs

These SOE cartridges have a 222 O-ring configuration to create a tight seal and prevent influent bypass. They are autoclavable to 250°F (121°C) and in-line sterilizable to 257°F (125°C) for up to 30-minute cycles; 10 hours total. May also be sanitized with compatible chemical agents. Suitable to 180°F (82°C) at 10 psid.

The cartridges comply with USP Class VI-121°C Plastics guidelines and pass the MEM Elution Cytotoxicity Test. Aqueous extracts contain less than 0.25 EU/mL and typically exhibit low levels of non-volatile residues.

Use a cartridge-sump adapter kit (sold below) to secure cartridges within housings.

Multilayer Nylon Cartridges. Two pleated nylon membranes; top layer acts as a prefilter to increase cartridge life and efficiency.

Polypropylene (PP) Cartridges. Thermally bonded high-purity PP fiber. Also suitable for air/gas filtration. All materials FDA-compliant. Hydrophobic—prewet before liquid filtration.†

Pleated PTFE Cartridges. Ideal for more aggressive liquid or air/gas filtration. Hydrophobic—prewet before liquid filtration.†

Cartridge type	Pore size††	Filtration area	Length	Catalog number	Price
Serial nylon	0.20 µm	6.9 sq ft	10" (25.4 cm)	RB-06479-18	
	0.45 µm			RB-06479-22	
Polypropylene	1.0 µm	4.0 sq ft	10" (25.4 cm)	RB-06479-34	
	3.0 µm	4.7 sq ft		RB-06479-38	
	5.0 µm	5.5 sq ft		RB-06479-42	
	10 µm	5.6 sq ft		RB-06479-46	
PTFE	0.1 µm	5.9 sq ft	10" (25.4 cm)	RB-06479-50	
	0.2 µm	5.9 sq ft		RB-06479-54	
	0.45 µm	5.9 sq ft		RB-06479-58	

†To use with aqueous solutions, prewet with methanol, then rinse with water before use.

††Pore sizes for polypropylene cartridges are nominal.

Accessories

RB-01508-96 SOE Cartridge-sump adapter kit, fills the variable gap left by various manufacturers' SOE cartridges when used in a 12" polypropylene housing



High-Purity SOE Housing

Designed for use with 222 O-ring sealing cartridges. Pure polypropylene with no fillers, colorants, plasticizers or lubricants. Molded with ultra-smooth contact surfaces to prevent bacterial adhesion and build-up.

Inlet/outlet ports are ¾". Housings include ¼" plugged inlet, outlet, and sump ports for sampling or differential pressure monitoring. Suitable to 100°F (38°C); max pressure is 100 psi; Viton® seal.

RB-01508-24 High-purity polypropylene housing for use with SOE 222 O-ring cartridges (at left)



CultureGard Hollow Fiber Filter

Reduce the risk of contamination

Naturally hydrophilic cellulose hollow fiber membrane exhibits low extractables and high biocompatibility. Use two filters in series to form a sterile barrier when feeding media to the bioreactor. Easily change the first filter if it becomes plugged while the second continues to maintain culture sterility.

Fiber filter is made of polysulfone housing and end caps, and features polypropylene autovent to prevent air locking—operate filter in any position. Includes 1/8" hose adapters and clamps. Nonsterile and autoclavable.

APPLICATIONS

- ✓ Perfusion
- ✓ Bioreactor feed

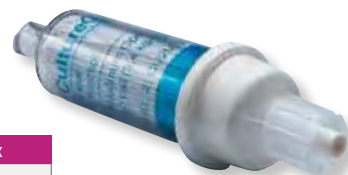

Specifications

Maximum temperature: 113°F (45°C) **Housing/end caps:** polysulfone
Maximum pressure: 30 psig

Pore size	Connections (inlet/outlet)	Catalog number	Qty/bx	Price/bx
0.2 µm	Female luer lock/male luer lock	RB-29510-50	12	

Sanitary Strainers

Protect products and expensive process equipment from coarse or fine particulates

- 316 stainless steel wetted surfaces are polished to a smooth, blemish-free finish
- Mesh overscreens are hemmed smooth with no stray wire ends
- Mesh overscreens are available in a variety of mesh sizes to meet your specific application
- Standard clamp sizes allow easy installation or retrofit

Sanitary strainers are ideal for particulate removal or prefiltration. Housings are available in in-line and side-inlet configurations. Side-inlet design lets you clean housing and change screens without disconnecting the strainer from your process line.

What's included: strainer assemblies include housing, perforated core, internal cap and spring, assembly clamp, and gasket. Order wire mesh overscreens and replacement perforated cores separately.



In-line strainer
29590-02



Side-inlet strainer
29590-54

Connection size (Tri-Clamp®)	Core perforations	Length	Catalog number	Price	Replacement cores	
					Catalog number	Price
In-line strainer assemblies						
1"	1/8"	15 3/4" (40.0 cm)	RB-29590-00		RB-29590-20	
1.5"			RB-29590-02			
2"			RB-29590-04			
1"	1/4"	15 3/4" (40.0 cm)	RB-29590-10		RB-29590-22	
1.5"			RB-29590-12			
2"			RB-29590-14			
Side-inlet strainer assemblies						
1"	1/8"	15 3/4" (40.0 cm)	RB-29590-50		RB-29590-70	
1.5"			RB-29590-52			
2"			RB-29590-54			
1"	1/4"	15 3/4" (40.0 cm)	RB-29590-60		RB-29590-72	
1.5"			RB-29590-62			
2"			RB-29590-64			



Perforated core
29590-22



Mesh overscreen
29590-31

Mesh Overscreens, 10 7/8" (27.6 cm) L x 3" (7.6 cm) dia

Mesh size	Wire diameter (inches)	Opening size inches (microns)	Open area	Catalog number	Price
20 x 20	0.016	0.0340 (864)	46.20%	RB-29590-31	
30 x 30	0.013	0.0203 (516)	37.10%	RB-29590-32	
40 x 40	0.010	0.0150 (381)	36.00%	RB-29590-33	
60 x 60	0.0075	0.0092 (234)	30.50%	RB-29590-35	
80 x 80	0.0055	0.0070 (178)	31.40%	RB-29590-36	
100 x 100	0.0045	0.0055 (140)	30.30%	RB-29590-37	
150 x 150	0.0026	0.0041 (104)	37.40%	RB-29590-39	

Advantec® Pressure Filtration Holders

Stainless steel type 304 or 316 minimizes resistance and maximizes flow rate

Sanitary pressure filtration holders maximize flow rates by applying positive pressure to the fluid over a broad membrane surface. Holders are autoclavable with one filter membrane that is sealed with removable wing nuts. All holders vent to release pressure.

Holders have PTFE gaskets, silicone O-rings, and PTFE-coated photoetched stainless steel support screens to prevent nitrocellulose membranes from sticking. Holders process samples from an in-line system or pressure vessel.

Sanitary inlet and outlet connections can be completely disassembled for thorough cleaning. Filter from 20 to 100 liters with model 29900-00 pressure holder. Top plate has knobs for easy positioning over membrane.



Sanitary holders feature connections that completely disassemble for easy cleaning.

Holder material	Filter dia	Prefilter dia	Filtration area	Max pressure psi (bar)	Included adapter size (mm ID)	Dimensions (H x dia)	Catalog number	Price
316 SS	90 mm	75 mm	45.0 cm ²	100 (7)	1½" sanitary to 11	14" x 5¼" (35.6 x 13.3 cm)	RB-29900-00	
304 SS	142 mm	124 mm	113.0 cm ²	100 (7)	1½" sanitary to 11	16¾" x 7¼" (42.5 x 18.4 cm)	RB-29900-06	
316 SS							RB-29900-05	
304 SS	293 mm	257 mm	530.0 cm ²	100 (7)	1½" sanitary to 11	16" x 14" (40.6 x 35.6 cm)	RB-29900-08	
316 SS							RB-29900-10	

Pressure Vessels

Use these electropolished stainless steel pressure vessels to propel filtration fluids through pressure holders by applying external pressure from compressed gases. Increasing pressure increases the efficiency of the EPR (ethylene propylene rubber) O-ring seal.

Vessels feature 5⅞" x 4⅞" (14.9 x 12.3 cm) wide-mouth opening for easy cleaning, SS dip tube, and molded neoprene rubber base for stability. Intake for the dip tube, located at the deepest point in the vessel, minimizes fluid loss to 6.0 mL. Sterilize vessels at 250°F (121°C) for 30 minutes. Make connections to four ¼" NPT(F) ports. Pressure vessels are ASME certified.



29902-02

Material	304 SS	316 SS	304 SS	316 SS	304 SS	316 SS	304 SS	316 SS
Catalog number	RB-29902-00	RB-29902-90	RB-29902-02	RB-29902-92	RB-29902-04	RB-29902-94	RB-29902-96	RB-29902-98
Capacity	1 gal. (3.78 L)		3 gal. (11.3 L)		5 gal. (18.9 L)		8 gal. (30.2 L)	
Height	8½" (21.6 cm)		15½" (39.4 cm)		22½" (57.2 cm)		21⅞" (53.5 cm)	
Inside diameter	9" (22.9 cm)		9" (22.9 cm)		9" (22.9 cm)		12" (30.5 cm)	
Max temperature	300°F (149°C)		300°F (149°C)		300°F (149°C)		300°F (149°C)	
Max pressure	125 psi (8.5 bar)		125 psi (8.5 bar)		125 psi (8.5 bar)		110 psi (7.5 bar)	
Price								

Filtration & Purification

Filtration



Need Help Selecting?

Trust our **expert** Application Specialists to help you find the right product.

1-800-323-4340 sales@coleparmer.com ColeParmer.com

Kim, 12 years of experience



01507-82



01507-85

In-Line Filtration Systems

A complete solution with pre- and post-filters

- A variety of sizes to meet your capacity needs
- Ideal choice for post-RO, under-sink, ice-maker, and foodservice applications

Each in-line filter includes an injection-molded polypropylene body and cap, and pre- and post-filters. Choose from either FPT connections or John Guest® push-to-connect fittings. All filters have a maximum temperature rating of 100°F (38°C) and 125 psi pressure rating. Filters meet NSF standards.



Max flow L/min (GPM)	Cartridge size (L x dia)		Micron rating, µm	Port size	Catalog number	Price
For removal of chlorine taste and odor						
2 (0.5)	10" x 2"	25.4 x 5.1 cm	1	¼" John Guest	RB-01507-95	
2 (0.5)	10" x 2"	25.4 x 5.1 cm	1	⅜" John Guest	RB-01507-96	
2 (0.5)	6" x 2"	15.2 x 5.1 cm	5	¼" NPT(F)	RB-01507-80	
2 (0.5)	6" x 2"	15.2 x 5.1 cm	5	⅜" NPT(F)	RB-01507-81	
2 (0.5)	6" x 2"	15.2 x 5.1 cm	5	¼" John Guest	RB-01507-82	
2 (0.5)	10" x 2"	25.4 x 5.1 cm	5	¼" FPT	RB-01507-83	
2 (0.5)	10" x 2"	25.4 x 5.1 cm	5	⅜" FPT	RB-01507-84	
2 (0.5)	10" x 2"	25.4 x 5.1 cm	5	¼" John Guest	RB-01507-85	
2 (0.5)	10" x 2"	25.4 x 5.1 cm	5	⅜" John Guest	RB-01507-86	
4 (1)	11" x 2.5"	27.9 x 6.4 cm	5	¼" FPT	RB-01507-87	
4 (1)	14" x 2.5"	35.6 x 6.4 cm	5	⅜" FPT	RB-01507-88	
4 (1)	14" x 2.5"	35.6 x 6.4 cm	5	¼" John Guest	RB-01507-89	
For removal of sediment and rust particulates						
2 (0.5)	6" x 2"	15.2 x 5.1 cm	5	¼" FPT	RB-01507-61	
2 (0.5)	6" x 2"	15.2 x 5.1 cm	5	¼" John Guest	RB-01507-62	
4 (1)	10" x 2"	25.4 x 5.1 cm	5	⅜" FPT	RB-01507-63	
4 (1)	10" x 2"	25.4 x 5.1 cm	5	¼" John Guest	RB-01507-64	
8 (2)	11" x 2.5"	27.9 x 6.4 cm	5	¼" John Guest	RB-01507-65	
10 (2.5)	14" x 2.5"	35.6 x 6.4 cm	5	⅜" John Guest	RB-01507-66	

Quick-Change Filtration Systems

Quick filter change with a simple quarter-turn

- Automatic shut-off feature on filter head eliminates the need for additional valves

Simple-to-install design and several cartridge types will meet your water quality needs. Connections on inlets and outlets are available with ¼" NPT fittings, or ¼" and ⅜" John Guest® push-to-connect fittings.

Each quick-change system includes a cartridge, filter head, and mounting bracket for use as a single unit; single cartridge systems are NSF certified. You can also combine cartridges in a series of up to three filters with the optional double and triple bracketed heads (sold separately below).



01507-11

Head 01507-92 shown with cartridges

Head 01507-94 shown with cartridges



Single systems only

Application (removal of)	Cartridge type	Micron rating (µm)	Max flow L/min (GPM)	Service life L (gal.)	Connection type						Replacement cartridge	
					¼" NPT		¼" John Guest		⅜" John Guest		Cat. no.	Price
					Cat. no.	Price	Cat. no.	Price	Cat. no.	Price		
Chlorine taste and odor, sediment, lead, atrazine, lindane, cyst, and turbidity	Carbon block	0.5	1.9 (0.5)	1890 (500)	RB-01507-11		RB-01507-21		RB-01507-31		RB-01507-41	
Chlorine taste and odor	Carbon block	5	1.9 (0.5)	5670 (1500)	—	—	RB-01507-22		—	—	RB-01507-42	
Chlorine taste and odor	Granular activated carbon	20	2.8 (0.75)	9460 (2500)	—	—	RB-01507-23		—	—	RB-01507-43	
Chlorine taste and odor	Granular carbon	50	2.8 (0.75)	6435 (1700)	—	—	RB-01507-24		RB-01507-34		RB-01507-44	
Chlorine taste and odor, and sediment	Carbon block	1	2.3 (0.6)	37,850 (10,000)	—	—	RB-01507-25		—	—	RB-01507-45	

[RB-01507-90](#) Replacement single bracketed head with ¼" John Guest connections

[RB-01507-91](#) Double bracketed head with ¼" John Guest connections

[RB-01507-92](#) Double bracketed head with ⅜" John Guest connections

[RB-01507-93](#) Triple bracketed head with ¼" John Guest connections

[RB-01507-94](#) Triple bracketed head with ⅜" John Guest connections

Process Monitoring

Accurate measurements and control lead to better yields



Whether in single-use or hard-piped production systems, monitoring process conditions such as pressure, flow, or temperature will optimize output

Pressure monitoring systems	60
Pressure gauges with sanitary connections	61
Flowmeters with sanitary connections.	62
Mixers	63–64
pH electrodes and cells	65

Product Selection | Troubleshooting | And More...

Not sure what to choose?

Our expert Application Specialists can help you find the right product for your application.

1-800-323-4340
or Ch@t Live



PendoTECH Pressure Monitoring and Transmitting System

Monitor process pressure accurately

– Ideal for applications such as tangential flow filtration, cross flow filtration, depth filtration, bioreactor monitoring, and chromatography



Applications

- ✓ TFF
- ✓ Bioreactor monitoring
- ✓ Depth filtration

Adapter tee 19406-34 assembled to luer sensor 19406-32

1. PressureMAT™ Monitor

- Data output capability to a PC or control system
- User-configurable min/max alarm set points

The PressureMAT combines a pressure monitor, data logger, alarm, and transmitter in one simple control box. Designed for use with single-use, in-line pressure sensors. Each channel takes pressure readings once per second. Process pressure is displayed on the easy-to-read LCD. System is easily calibrated to zero through a single button. The PressureMAT may also transmit output via a 4 to 20 mA signal or can provide RS-232 data transfer for use in common PC applications, such as the PressureMAT Data Acquisition Software or Excel®, through WinWedge or Hyper Terminal software.



Number of process sensor inputs	Number of outputs	Accuracy	Power	Catalog number	Price
2 pressure	2 relay, 2 analog, or 4 relay	±0.1% full-scale	12 to 24 VDC	RB-19406-03	
4 pressure	4 analog			RB-19406-07	
3 pressure; 1 flow	4 analog			RB-19406-11	

[RB-19406-70](#) PressureMAT data acquisition software

[RB-19406-82](#) RS-232 to USB serial adapter cable, 6 ft (1.8 m)

[RB-19406-87](#) Masterflex® interface cable for L/S pump

[RB-19406-95](#) PressureMAT stand



REQUIRED System Components

- 1) PressureMAT™ monitor
- 2) Single-use pressure sensor(s)

2. Single-Use Pressure Sensors

- Economical alternative to stainless steel sensors currently in the market
- Sensors priced for single-use systems but may be reused

Sensors measure static and dynamic process pressure and are perfect components for disposable systems requiring sterilization but also minimal downtime. Sensors feature an integral flow sensor with no dead legs and no fluid path obstructions. All pressure sensors are manufactured in a FDA-registered, ISO 13485-certified facility; in an ISO Class 8 cleanroom. Sensors are made from USP Class VI-compliant polycarbonate or caustic-resistant polysulfone. Both materials are gamma stable. Sensors are 100% tested for accuracy and leaks during the manufacturing process. Connect sensor to PressureMAT monitor with 3.6-m reusable cable. Sensors are designed for use up to a maximum pressure of 5.3 bar.

Process-Scale Sensors connect directly to the tubing line and are available up to 1" hose barb (see [ColeParmer.com](#)).

Small-Scale Sensors are available with luer connections and may connect directly to the fluid line with luer adapters or indirectly by using a 1/4" or 3/8" barbed adapter tee. Both connection setups have been tested for accuracy.

Material	Connection	Catalog number	Price/ea
Process-scale sensors			
Polycarbonate, non-sterile	1/4" tubing ID	RB-19406-21	
	3/8" tubing ID	RB-19406-23	
	1/2" tubing ID	RB-19406-28	
Polysulfone, non-sterile	3/4" tubing ID	RB-19406-29	
	1" tubing ID	RB-19406-27	
	3/8" tubing ID	RB-19406-25	
Polysulfone, non-sterile	1/2" tubing ID	RB-19406-22	
	3/4" tubing ID	RB-19406-24	
Small-scale sensors			
Polycarbonate, sterile	Female luer	RB-19406-32	
Polysulfone, non-sterile	Female luer	RB-19406-20	

Note: The single-use sensors will work with third-party pressure monitors. Please contact Cole-Parmer for more information about adapting the sensors to existing monitors.

[RB-19406-34](#) Adapter tee, 1/4" barb x 1/4" barb x male luer, polycarbonate; for 19406-22, -32

[RB-19406-36](#) Adapter tee, 3/8" barb x 3/8" barb x male luer, polycarbonate; for 19406-22, -32

[RB-19406-35](#) Adapter tee, 1/2" barb x 1/2" barb x male luer, polycarbonate; for 19406-22, -32

[RB-19406-80](#) Sensor cable with wire leads for third-party monitors, 12 ft (3.6 m)

Where can I use PendoTECH products?

A better question is where can't you use PendoTECH pressure monitors! The single-use design for sensors make them an easy addition both upstream and downstream:

- Line pressure before and after a chromatography column
- Back pressure monitoring in filtration feed lines
- Inlet pressure for a circulation pump during filtration
- Line pressure monitoring to a filtrate vessel
- Vent line gas pressure from a bioreactor
- Centrifugation output
- Perfusion

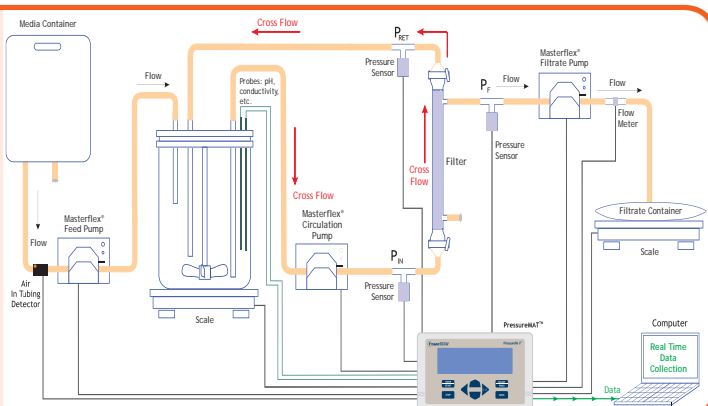

Ashcroft® 3½" (89 mm) Sanitary Gauges

No stop pin to mask false zero reading

- Meet USDA and FDA requirements and 3A Sanitary Standard 74-00
- Glycerin filled gauges use USP grade glycerin (99.5% pure)



Specifications

Accuracy: ±1.5% from 100 to 400 psi; 2% from 0 to 100 psi (ANSI/ASME Grade 1A)	Wetted materials: 316L SS
Operating temp: –50 to 270°F (–45 to 132°C)	Lens: polycarbonate
	Process connection: 1½" Tri Clamp®
	Casing: 300-series SS
	Dial size: 3½" (89 mm)

Range	Catalog number	Price
Dry-case gauges		
0 to 30 psi	RB-68806-10	
0 to 60 psi	RB-68806-11	
0 to 100 psi	RB-68806-12	
Glycerin-filled gauges		
0 to 30 psi	RB-68802-10	
0 to 60 psi	RB-68802-11	
0 to 100 psi	RB-68802-12	

[RB-17040-10](#) NIST-traceable calibration with data

WIKA® 3A Sanitary Gauges

Get better readings

- Glycerin fill reduces fluctuations
- Manufactured for clean-in-place (CIP) applications
- All-welded gauge assembly contains an external flush diaphragm
- Assembly meets the criteria set forth by 3A standards



Specifications

Accuracy: ±3-2-3% of span	Process connection: ¾" Tri-Clamp®
Operating temp: 50 to 257°F (10 to 125°C)	Casing: 304 SS
Wetted materials: 316L SS	Dial size: 2½" (64 mm)
Lens: polycarbonate	

Range	Resolution	Catalog number	Price
30 psi	0.5 psi	RB-68056-72	
60 psi	1 psi	RB-68056-74	
100 psi	2 psi	RB-68056-76	
160 psi	2 psi	RB-68056-78	

[RB-17040-10](#) NIST-traceable calibration with data

Application Tip

Are you protecting your process line?

For hard-piped production lines, pressure gauges help monitor flow conditions to prevent costly equipment damage or process inefficiencies. They are a very easy way to improve process efficiency and increase your relative yields.

Pressure gauges protect your pump which drives the entire system. If the line flow is too low at the inlet, the pump may starve, leading to cavitation and potential damage. If back pressure at the outlet builds due to line blockage, the pump may again be damaged and cause injury to employees. A simple yet cost-effective method of protecting your sanitary pump is installing pressure gauges in the line before and after the pump.

Pressure gauges also alert you to clogged filters. Pressure gauges measure line back pressure in filtration and growing back pressure may indicate the need for a new filter.

But have you ever consider protecting your gauge? To maintain gauge accuracy and guard against buildup of film in the process line that may hinder proper readings, use an isolator gasket. An isolator gasket provides a full membrane made from the same material as the sanitary seal.

To protect the gauge's sensitive pressure-sensing membrane during transport after disassembly or for maintenance, use a protector cap. The protector cap is removed during operation but features a silicone loop to stay with the gauge when it is placed back in service.

[RB-30565-02](#) Gauge guard isolator gasket, platinum-cured silicone, ¾" clamp size

[RB-30565-06](#) Gauge guard isolator gasket, platinum-cured silicone, 1½" clamp size

[RB-30565-12](#) Gauge guard protector cap, silicone with stainless steel mesh, ¾" clamp size

[RB-30565-14](#) Gauge guard protector cap, silicone with stainless steel mesh, 1½" clamp size

Note: For other materials and sizes, please visit ColeParmer.com.

Ashcroft® Digital Sanitary Pressure Gauges

Get more flexibility

- Offer 3A rating with the functionality of a digital gauge
- Get readings how you need them—ten engineering units
- Unlimited deadband throughout its range



Specifications

Accuracy: ±0.25% full-scale	Display: 5-digit LCD, 0.88"H
Dial size: 3½" (89 mm)	Process connection: 1½" sanitary Tri-Clamp®
Operating temp: 14 to 140°F (10 to 60°C)	Wetted materials: 316 stainless steel
Units of measure: psi, " H ₂ O, ft H ₂ O, mPa, mbar, kPa, kg/cm ² , bar, " Hg, mm Hg	Casing: 300 stainless steel
	Lens: polyester
	Power: two C batteries

Range	Resolution	Catalog number	Price
30 to 0" Hg	0.0001" Hg	RB-68901-50	
0 to 30 psi	0.0001 psi	RB-68901-51	
0 to 60 psi	0.005 psi	RB-68901-52	
0 to 100 psi	0.005 psi	RB-68901-53	
0 to 200 psi	0.01 psi	RB-68901-54	

[RB-17040-12](#) NIST-traceable calibration with data

Precision Turbine Flowmeters

Monitor flow with highest accuracy and full-featured electronics

- Assembled and ready to install
- 4 to 20 mA models feature easy push-button programming and electronic lockout

These full-featured turbine meters come complete and assembled—easy to install in your process application. The electronics package is compact, low-profile and weathertight to NEMA 4 standards.

Models with display offer gallon and liter indication, as well as flow rate and two totals (cumulative and batch). Meters feature easy-to-use, well-marked terminals and can be configured to meet most desired needs. If no signal is required, a battery-powered or external-powered display is available.

Models offering 4 to 20 mA output offer the “easiest in the industry” push-button programming and feature an electronic lockout to ensure against tampering or resetting. These meters operate off the power loop, so no additional power is required.



Specifications

Accuracy: ±0.5%	Max pressure: 450 psi	Input power: 8.5 to 35 VDC, two-wire
Repeatability: ±0.1%	Display: 6-digit LCD, ½"H	Wetted parts: 316 SS housing, shaft, and rotor supports; PTFE sleeve bearings; acetal thrust bearings; CD4MCu SS rotor
Temperature range: –100 to 185°F (–74 to 85°C)	Output signal: 4 to 20 mA or scaled pulse	

Flow range	Connections	Flow diameter	Max particulate size	Meters with display				Meters without display			
				No output		4 to 20 mA output		4 to 20 mA output		Scaled pulse output	
				Cat. no.	Price	Cat. no.	Price	Cat. no.	Price	Cat. no.	Price
0.6 to 6.0 GPM	¾" sanitary	½"	420 µm	RB-32610-64		RB-32610-71		RB-32610-78		RB-32610-85	
0.8 to 6.0 GPM	1" sanitary	½"	420 µm	RB-32610-65		RB-32610-72		RB-32610-79		RB-32610-86	
1.6 to 16.0 GPM	1½" sanitary	¾"	420 µm	RB-32610-66		RB-32610-73		RB-32610-80		RB-32610-87	
2.32 to 23.0 GPM	1½" sanitary	¾"	420 µm	RB-32610-67		RB-32610-74		RB-32610-81		RB-32610-88	
6.7 to 67.0 GPM	1½" sanitary	1"	420 µm	RB-32610-68		RB-32610-75		RB-32610-82		RB-32610-89	
17.7 to 177.0 GPM	1½" sanitary	1½"	1000 µm	RB-32610-69		RB-32610-76		RB-32610-83		RB-32610-90	
33.0 to 330.0 GPM	2" sanitary	2"	1410 µm	RB-32610-70		RB-32610-77		RB-32610-84		RB-32610-91	

Cole-Parmer® Heavy-Duty Flowmeters/Totalizers

Battery powered—no wiring required

- Display flow rate and accumulated flow in gallons or liters
- Record a cumulative volume plus a resettable volume

To conserve power, the six-digit display automatically turns on with flow and then turns off four minutes after flow ceases. Internal parts are simple to replace for easy maintenance. Meters operate on two lithium batteries (included). Remote installation of the flowmeter body is possible using the optional remote installation kit 05609-93 (order separately below).



APPLICATIONS

- ✓ Pilot plant
- ✓ Full-scale process



Specifications

Repeatability: ±0.1% of reading	Wetted materials: 316 SS housing, PVDF rotor and supports, tungsten carbide shaft, 316 SS retainers, and ceramic bearings	Display: 6-digit LCD, ½"H (with floating decimal)
Maximum pressure: 450 psig (31 bar)		Approvals: EEx II 3 G IIC T4
Operating temp: 14 to 140°F (–10 to 60°C)		

Flow range	Connections	Max particulate size	Accuracy	Catalog number	Price
1 to 10 GPM (3.8 to 37.9 LPM)	¾" sanitary	125 µm	±2% of reading	RB-05609-05	
2 to 20 GPM (7.6 to 75.7 LPM)	1" sanitary	125 µm	±2.0% of reading	RB-05609-11	
5 to 50 GPM (18.9 to 190 LPM)	1½" sanitary	125 µm	±1.5% of reading	RB-05609-17	
10 to 100 GPM (38 to 380 LPM)	2" sanitary	500 µm	±1% of reading	RB-05609-25	
20 to 200 GPM (6 to 760 LPM)	2½" sanitary	500 µm	±1% of reading	RB-05609-33	

RB-05610-70 Calibration container; HDPE, 5-gal. (19 L) capacity

RB-05610-96 Replacement battery kit

RB-05609-93 Remote installation kit. Mount display up to 100 feet (30 m) from sensor—ideal for measuring flow in hot pipes (up to 250°F/121°C) or in inaccessible areas. Kit includes a sensor cover with 10-ft (3-m) cable, remote display housing, and installation hardware

RB-05609-91 Output module, pulse output. Module provides a digital open collector output for interfacing with compatible instrumentation

RB-05609-92 Output module, 4 to 20 mA or 5 to 20 volts. Module provides an output for interfacing with compatible instrumentation

RB-17080-12 NIST-traceable calibration

Cole-Parmer® Digital Reversing Mixer

Time your cycles for more efficient mixing

- Won't lose speed—brushless, 142 in-oz torque motor maintains speed
- Minimize aeration and vortexing—reversing feature alters mixing pattern for better mixing
- No more moving mixer head to change impeller depth—through-shaft housing for easier positioning
- No more motor burn out—overload protection if torque exceeds ratings
- See what you're mixing—integrated sample light illuminates sample area

Mix samples up to 20,000 cps or up to 6.6 gallons (25 liters) easily and effectively. Repeat mixing conditions accurately with LED display, with control to ± 1 rpm or 3% of reading. Set timer from 1 to 2000 minutes, with audible alert when complete.

Complete system includes: mixer head, adjustable chuck (accepts rod up to $\frac{3}{8}$ " [9.5 mm] dia), chuck key, mounting support rod, propeller/shaft, support stand, clamp, external power supply, and grounded power cord with plug assembly.



Description	Speed (rpm)	hp	Max torque (in-oz)	Power (VAC, Hz)	Catalog number	Price
Complete system	40 to 2010	$\frac{1}{10}$	142	100 to 230, 50/60	RB-50004-10	

Accessories

[RB-17050-03](#) NIST-traceable calibration for mixers

APPLICATIONS

- ✓ Seed culture
- ✓ Small vessel agitation

Complete system 50004-10 includes mixer, support stand, clamp, and mixer propeller.



Cole-Parmer® Digital Batch Mixer

Tackle volumes up to 52 gallons (200 L)

- User-friendly operation—PLC/PC programmability, data logging, and intuitive graphic touch-screen interface
- Two-speed transmission provides smooth, quiet operation
- Through-shaft design allows for easy impeller adjustment, less downtime

This portable batch mixer has enough power to mix up to 52 gallons (200 L) and viscosity up to 180,000 cps. Enclosed fan-cooled brushless DC motor maintains a constant power transfer to the shaft at speeds up to 1500 rpm. Adjustable chuck accommodates up to $\frac{5}{8}$ " (15.8 mm) dia impeller shaft.

Ideal for both laboratory and industrial uses, the mixer features RS-232 and USB interfaces to record date, time, speed, and torque data. Easy-to-use resistive digital touch-screen control enables you to select time and speed with a gloved hand or pencil tip. Other functions include alarms, timers, torque zero, torque min/max setting, and clockwise and counterclockwise rotation.

Safety features include a shaft/check guard, chemical-resistant housing, and overload, overheat and vibration protection. A safety screen protects the display from splashes.

What's included: chuck (accepts $\frac{1}{2}$ " and $\frac{5}{8}$ " dia shafts), memory stick, mounting bolts, and power cord.



Speed range (rpm)	hp	Max torque (in-oz)	Power (VAC, Hz)	Catalog number	Price
50 to 1500	$\frac{1}{2}$	4248	120, 60	RB-50009-00	

NEW



Accessories

- [RB-50019-94](#) Stainless steel plate mount
- [RB-50019-95](#) Replacement screen protector kit
- [RB-50019-96](#) Stainless steel multiposition C-clamp set
- [RB-50019-97](#) Stainless steel chuck with key, 16-mm shaft diameter
- [RB-50019-98](#) Chuck shaft guard
- [RB-50019-99](#) Stainless steel chuck key

IKA® EUROSTAR Digital Mixers

Mix viscous samples up to 30,000 cps

- Speed won't change even as viscosity changes
- Won't overheat—thermal overload shut-off for safety
- Maintenance-free design for continuous duty

EUROSTAR 20 Digital Mixer handles volumes up to 4 gallons (15 liters) and viscosities up to 10,000 cps.

EUROSTAR 40 Digital Mixer will mix volumes up to 6.6 gallons (25 liters) and viscosities up to 30,000 cps.

What's included: chuck (accepts up to 3/8" [10 mm] dia shaft) and 6 1/4" L x 1/2" dia (159 mm x 13 mm) mounting rod.



Speed (rpm)	hp	Max torque (in-oz)	Power (VAC, Hz)	Catalog number	Price
Eurostar 20 digital mixer					
30 to 2000	1/16	28.3	115, 50/60	RB-50702-30	
			230, 50/60	RB-50702-35	
Eurostar 40 digital mixer					
30 to 2000	1/8	56.6	115, 50/60	RB-50702-40	
			230, 50/60	RB-50702-45	

IKA® RW 20 Digital Dual-Range Mixer

Two speed ranges for a variety of applications

- No difficult controls—easy-to-use knob and LED display for accurate setting
- No need to move mixer head to reposition propeller—through-shaft design allows for easy movement
- Maintenance-free motor for continuous duty

Use this versatile, affordable mixer for liquid volumes up to 5 gallons (18.9 liters) and viscosities up to 10,000 cps (approximately the viscosity of honey). Select speed from 60 to 2000 rpm in two ranges for a variety of applications.

Complete system includes: mixer, chuck (accepts up to 3/8" [10 mm] dia shafts), 6 1/4" L x 1/2" dia (159 mm L x 10 mm dia) mounting rod, four-blade propeller mixer stand, and clamp.



Speed (rpm)	hp	Max torque (in-oz)	Power (VAC, Hz)	Catalog number	Price
60 to 500/ 240 to 2000	1/25	259	115, 50/60	RB-50705-00	
			230, 50/60	RB-50705-10	

IKA® Mixer Accessories

Get the most out of your mixer!

A. Three-Blade Propellers for use at medium to high speeds.

B. Turbine Propellers create minimal shearing forces. Use at medium to high speeds.

C. Folding Two-Blade Propellers are perfect for stirring in round vessels with narrow necks. Medium to high speeds are required.

D. Paddle Stirrers create tangential flow, minimum turbulence, good heat exchange, and gentle treatment of fluid. Use at low to medium speeds.

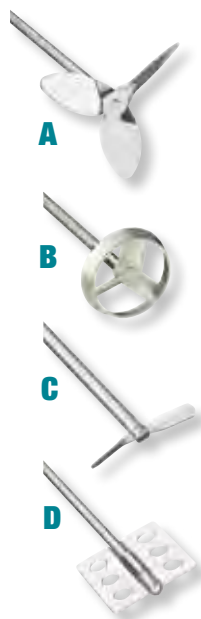

Key	Material	Shaft, dia x L, in. (mm)	Paddle dia, in. (mm)	Catalog number	Price
A	316 SS	1 1/32 x 13 3/4 (8 x 350)	1 3/4 (45)	RB-50703-30	
	316 SS	1 1/32 x 13 3/4 (8 x 350)	2 7/32 (56)	RB-50703-31	
	316 SS	1 3/32 x 21 21/32 (10 x 550)	5 1/2 (140)	RB-50703-32	
	316 SS	1 3/32 x 31 1/2 (10 x 800)	5 1/2 (140)	RB-50703-33	
	PTFE-coated SS	1 1/32 x 13 3/4 (8 x 350)	3 (75)	RB-50703-34	
B	316 SS	1 1/32 x 13 3/4 (8 x 350)	1 7/32 (31)	RB-50703-35	
	316 SS	1 1/32 x 13 3/4 (8 x 350)	2 (50)	RB-50703-36	
	316 SS	1 3/32 x 15 3/4 (10 x 400)	2 3/4 (70)	RB-50703-37	
C	316 SS	1 1/32 x 13 3/4 (8 x 350)	1 9/32 to 2 13/32 (15 to 61)	RB-50703-45	
	316 SS	1 1/32 x 21 21/32 (8 x 550)	1 to 4 (24 to 100)	RB-50703-46	
D	316 SS	1 1/32 x 21 21/32 (8 x 550)	2 3/4 (70)	RB-50703-51	
	316 SS	1 3/32 x 21 21/32 (10 x 550)	5 7/8 (150)	RB-50703-52	

E. Mixer Plate Stands come with slip-resistant foil and a support rod with diameter of 5/8" (16 mm).

Key	Height, in. (mm)	Catalog number	Price
E	22 (560)	RB-50703-90	
	31 1/2 (800)	RB-50703-91	
	39 13/32 (1000)	RB-50703-92	



Flow-Through pH Cells

Ideal for fermentation applications

- Accurate to ± 0.1 pH units
- Choose 316 stainless steel cell for long-lasting durability

1. Flow-Through Cells

Key	Material	Volume	Tubing connection ID	Catalog number	Price
A	Glass	6000 μ L	7 mm	RB-05662-40	
B	316 SS	6000 μ L	6 mm	RB-05662-42	
C	Glass	800 μ L	3 mm	RB-05662-48	

2. Electrodes for Flow-Through Cells

For flow cell	Combination electrode type	Junction	Auto-clavable	Catalog number	Price
A	Sealed, Ag/AgCl	Double	Yes	RB-05662-44	
	Refillable, Ag/AgCl	Double	Yes	RB-05662-45	
B	Sealed, Ag/AgCl	Double	Yes	RB-05662-80	
	Sealed, Ag/AgCl	Double	Yes	RB-05662-51	
C	Sealed, Ag/AgCl	Double	Yes	RB-05662-51	
	Refillable, Ag/AgCl	Double	Yes	RB-05662-52	

3. Detachable Cables

Plug type	Length	Catalog number	Price
BNC	3 ft (0.9 m)	RB-05662-55	
	10 ft (3 m)	RB-05662-56	

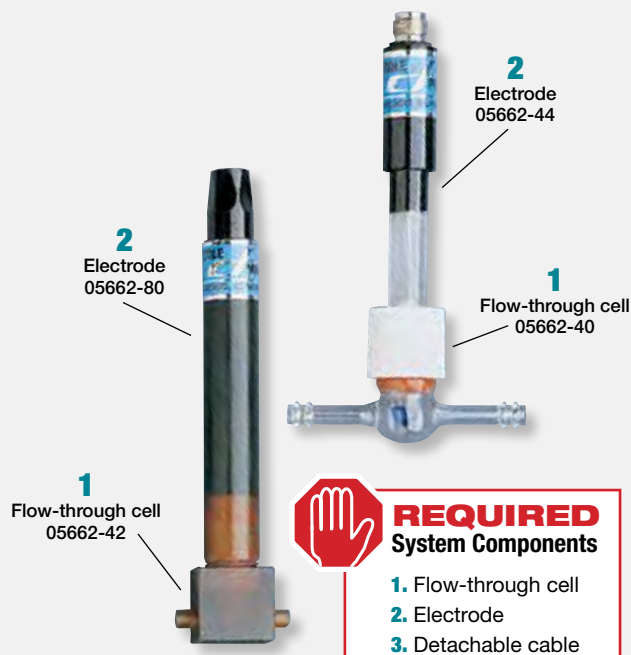

REQUIRED System Components

1. Flow-through cell
2. Electrode
3. Detachable cable

Cole-Parmer® Autoclavable Fermentation pH Electrodes

Get precise readings affordably

- No more clogging—glass body with annular ceramic junction
- Use when you need it—operates from 23 to 266°F (-5 to 130°C)

Order detachable cables separately below to autoclave glass-bodied electrode and vessel as a single unit—simply detach cable and place a protective cap over the cable connector before sterilizing.

1. Double-Junction Glass Electrodes

These electrodes are designed for insertion in Radiometer® mountings or Ingold® nonpressurized assemblies 761-351, 761-31, 761-361, and 761CH-31 (12 mm dia). Sealed, gel-filled, reference electrodes require no refilling, and offer long-term stability and extended service life.

Probe immersion length	Catalog number	Price
Refillable electrodes		
120 mm	RB-05661-25	
150 mm	RB-05661-02	
180 mm	RB-29041-00	
210 mm	RB-05661-04	
250 mm	RB-29041-02	
320 mm	RB-29041-04	
420 mm	RB-29041-06	
Sealed electrodes		
150 mm	RB-05993-95	
180 mm	RB-29041-50	
210 mm	RB-05993-96	
250 mm	RB-29041-52	
320 mm	RB-29041-54	
420 mm	RB-29041-56	

RB-05661-68 Reference filling solution for inner cell of refillable electrodes. High-temperature 3 M KCl gel saturated with AgCl; 125 mL

RB-05661-70 Reference filling solution for outer cell of refillable electrodes. High-temperature 3 M KCl gel; 125 mL

RB-05661-03 Spare protective cap for cable connector

RB-05983-21 DIN connector to female BNC plug

2. Mini Glass Electrodes

Ideal for narrow or crowded culture flasks and fermentors (6 mm dia). Double-junction reference offers stability and extended service life. Sealed, autoclavable.

Probe immersion length	Catalog number	Price
150 mm	RB-05662-15	
180 mm	RB-29044-50	
210 mm	RB-05662-16	

3. Detachable Cables

Plug type	Length	Catalog number	Price
BNC	5 ft (1.5 m)	RB-05661-08	
	10 ft (3 m)	RB-05661-09	
Stripped ends†	5 ft (1.5 m)	RB-29073-00	
	10 ft (3 m)	RB-29073-02	

†Stripped end cables are not for temperature compensated use.

Detachable Cable Adapter

allows you to use a Cole-Parmer detachable-cable type electrode with your Ingold series-K9 cable.

RB-29040-00 Detachable-cable adapter

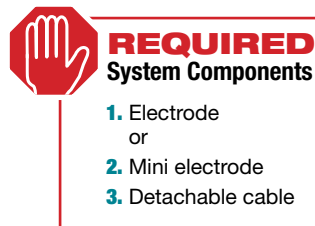

REQUIRED System Components

1. Electrode or
2. Mini electrode
3. Detachable cable



Digi-Sense® Precalibrated Thermometers

Perfect for the lab to production floor

- Reliable measurements, guaranteed! Precalibrated to NIST-traceable standards
- Available in thermocouple, thermistor, or RTD configuration
- Electronic offset function allows compensation of probe errors

These robust, reliable handheld temperature meters work in tough environments. Sturdy construction protects against knocks and jars. These thermometers produce a high degree of accuracy, with a rapid response time, and exceptional battery life of up to 3000 hours. Digi-Sense thermometers come precalibrated, saving you hundreds of dollars and extra waiting time to calibrate separately.

Single-Input Thermometers feature an easy-to-use control panel, Min/Max and Hold functions, offset adjustment, °F/°C selection, backlit display, low-battery indicator, and auto shutoff.

Dual-Input Data Logging Thermometers store up to 16,000 sets of readings in real time, and data can be downloaded to your PC via a USB port. Logging interval is selectable from 1 second to 60 minutes. Meters also feature Min/Max, Hold, and average functions; differential temperature; offset adjustment; °F/°C selection; time stamp/clock; out-of-range alarm with audible/visible indicator; backlit display; low-battery indicator; and auto shutoff.

What's included: protective rubber armor boot with built-in stand, one 9 V battery, and NIST-traceable calibration report with data supplied by InnoCal. Data logging models 20250-92, -94, and -96 also include a USB cable and software.



Process Monitoring

Temperature

Specifications

Power: one 9 V battery (included)

Models 20250-92, -94, -96:

Data logging: 16,000 sets of readings

Logging interval: 1 second to 60 minutes

Output: USB



Description	Range	Resolution	Accuracy	Catalog number	Price
Thermocouple meters					
Single input	Type J: -328 to 1832°F (-200 to 1000°C) Type K: -418 to 2501°F (-250 to 1372°C) Type T: -418 to 752°F (-250 to 400°C)	0.1°F (0.1°C) from -148 to 1832°F (-99.9 to 999.9°C); 1°F (1°C) outside range	±1% of reading + 1.8°F (1°C) below -148°F (-99.9°C); ±1% of reading + 0.9°F (0.5°C) above -148°F (-99.9°C)	RB-20250-91	
Dual input with data logging				RB-20250-92	
Thermistor meters					
Single input	-40 to 257°F (-40 to 125°C)	0.1°F (0.1°C)	±0.9°F (±0.5°C) from 32 to 158°F (0 to 70°C); ±2°F (1°C) outside range	RB-20250-93	
Dual input with data logging				RB-20250-94	
RTD meters					
Single input	-320 to 1562°F (-200 to 850°C)	0.1°F (0.1°C) from -148 to 1562°F (-99.9 to 850°C); 1°F (1°C) outside range	±1.5°F (0.8°C) from -148 to 392°F (-99.9 to 199.9°C); ±2°F (1°C) ±0.5% of reading outside range	RB-20250-95	
Dual input with data logging				RB-20250-96	

[RB-09376-04](#) Replacement batteries, 9 V. Pack of 4

Some of Our Most Popular Thermocouple Probes

All probes include a 5-ft coiled cord with strain relief spring that protects from repeated flexing and tugging. Ergonomic, easy-to-grip glass-filled nylon handle provides maximum insulation and impact resistance; fingerstops prevent fingers from sliding and prevent probe from rolling. Rugged thermoset plastic miniconnector also included.

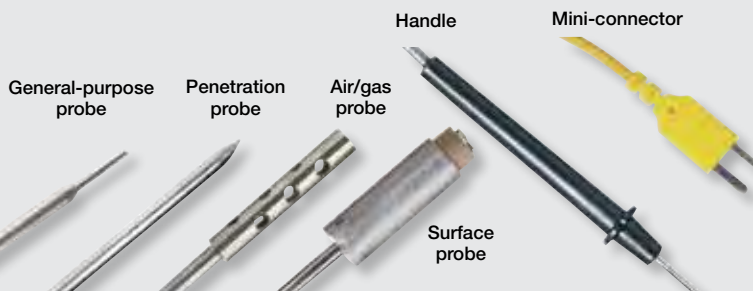

Probe Type	General-purpose probes (5" L)			Penetration probes (4" L)			Air/gas probes (8.5" L)			Surface probes (9.9" L)		
	Max temp	Cat. no.	Price	Max temp	Cat. no.	Price	Max temp	Cat. no.	Price	Max temp	Cat. no.	Price
J	1400°F (760°C)	RB-08517-55		1400°F (760°C)	RB-08517-65		1000°F (537°C)	RB-08517-75		1200°F (649°C)	RB-08517-60	
K	1652°F (900°C)	RB-08516-55		1652°F (900°C)	RB-08516-65		1000°F (537°C)	RB-08516-75		1200°F (649°C)	RB-08516-60	
T	752°F (400°C)	RB-08500-55		752°F (400°C)	RB-08500-65		1000°F (537°C)	RB-08500-75		650°F (343°C)	RB-08500-60	

Fluid Testing & Analysis

Ensure quality throughout the process



Make sure your validated process executes according to parameters!

Pipettes & Pipettors	68
Cell culture dishes, needles, and loops	69–70
Sampling bottle assemblies	71
Stirrers	69–73
Baths & Circulators	74
Shakers	76–79
Viscometers	80
Turbidimeters	81
Homogenizers	82
Spectrophotometers	83–84
Balances	85–86

Product Selection | Troubleshooting | And More...

1-800-323-4340
or Ch@t Live

Not sure what to choose?
Our expert Application Specialists can help you find the right product for your application.



Eppendorf® Research® plus Adjustable-Volume Pipettors

Eliminate wrist stress and fatigue

– Requires up to 50% less pipetting force

Spring-loaded tip cone achieves optimal tightness and minimal attachment forces—doing most of the work for you! Make your volume adjustments with just one hand, only a few turns will get you to your desired volume. Four-digit volume display is easy to view. Multichannel pipettors offer channel indicators, in addition to flexibility of removing any of the independent channels—use as many as you need. Secondary adjustment gives you greater accuracy for specific liquid types.

Applications

- ✓ Reaction monitoring
- ✓ Plate fill
- ✓ Cell culture testing



ISO9001:2008
CERTIFIED SUPPLIER



Volume	Increments	Accuracy†	Precision†	Control button color	Catalog number	Price
Single-channel pipettors						
0.1 to 2.5 µL	0.002 µL	±1.4%	±0.7%	Dark gray	RB-24505-01	
0.5 to 10 µL	0.01 µL	±1%	±0.4%	Gray	RB-24505-02	
2 to 20 µL	0.02 µL	±1%	±0.3%	Light gray	RB-24505-03	
2 to 20 µL	0.02 µL	±1%	±0.3%	Yellow	RB-24505-04	
10 to 100 µL	0.1 µL	±0.8%	±0.2%	Yellow	RB-24505-05	
20 to 200 µL	0.2 µL	±0.6%	±0.2%	Turquoise	RB-24505-06	
30 to 300 µL	0.2 µL	±0.6%	±0.2%	Orange	RB-24505-07	
100 to 1000 µL	1 µL	±0.6%	±0.2%	Blue	RB-24505-08	
0.5 to 5 mL	5 µL	±0.6%	±0.15%	Violet	RB-24505-09	
1 to 10 mL	10 µL	±0.6%	±0.15%	Turquoise	RB-24505-11	
Eight-channel pipettors						
0.5 to 10 µL	0.01 µL	±2%	±1%	Gray	RB-24505-12	
10 to 100 µL	0.1 µL	±0.6%	±0.3%	Yellow	RB-24505-13	
30 to 300 µL	0.2 µL	±0.8%	±0.3%	Orange	RB-24505-14	
Twelve-channel pipettors (not shown)						
0.5 to 10 µL	0.01 µL	±2%	±1%	Gray	RB-24505-15	
10 to 100 µL	0.1 µL	±0.6%	±0.3%	Yellow	RB-24505-16	
30 to 300 µL	0.2 µL	±0.8%	±0.3%	Orange	RB-24505-17	

†Accuracy and precision values given at maximum volume of pipettor.

Specifications

Calibration: user
Tip ejector: yes
Material of construction: Fortron® PPS
Autoclavable: yes, fully

Eppendorf® epTIPS

Minimize waste

Eppendorf epTIPS—Totally Integrated Pipetting System—satisfy the stringent requirements of dependability, reproducibility, and smaller sample volumes.

The epTIPS system provides an alternative to throwing out an entire box when the tips run out. The **Reload set** enables contamination-free transfer of fresh tip trays into the reusable box used for loading your pipettor. To begin using this system, order a **Set**, which includes a reusable box and five trays of 96 tips (five trays of 24 tips for 18888-64). For one-time use tip boxes, order a **Rack**.

Search

epTIPS filter tips are available at ColeParmer.com



Set includes a reusable box and five trays of epTIPS.



ISO9001:2008
CERTIFIED SUPPLIER

Compatible with pipettors	Volume	Rack color	Length	Pack description	Catalog number	Price/pk
Research 0.1 to 2.5 µL and 0.5 to 10 µL	0.1 to 10 µL	Dark gray	1½" (34 mm)	Reloads†, 10 trays of 96 tips	RB-18888-66	/pk of 960
				Set	RB-18888-50	/pk of 480
Research 0.1 to 2.5 µL and 0.5 to 10 µL	0.1 to 20 µL	Gray	1¾" (40 mm)	Bulk pack of 1000	RB-18889-00	/pk of 1000
				Reloads†, 10 trays of 96 tips	RB-18888-68	/pk of 960
				Set	RB-18888-52	/pk of 480
				Rack‡, 10 racks of 96 tips	RB-18889-18	/pk of 960
				Reloads†, 10 trays of 96 tips	RB-18888-72	/pk of 960
Research 2 to 20 µL, 10 to 100 µL, 20 to 200 µL	2 to 200 µL	Yellow	2¼" (53 mm)	Set	RB-18888-56	/pk of 480
				Bulk pack of 1000	RB-18889-06	/pk of 1000
	20 to 300 µL	Orange	2½" (55 mm)	Reloads†, 10 trays of 96 tips	RB-18888-74	/pk of 960
				Set	RB-18888-58	/pk of 480
				Rack‡, 10 racks of 96 tips	RB-18889-24	/pk of 960
Research 100 to 1000 µL and 0.5 to 10 µL	50 to 1000 µL	Blue	2¾" (71 mm)	Bulk pack of 1000	RB-18889-08	/pk of 1000
				Reloads†, 10 trays of 96 tips	RB-18888-76	/pk of 960
				Set	RB-18888-60	/pk of 480
				Rack‡, 10 racks of 96 tips	RB-18889-26	/pk of 960
				Bulk pack of 1000	RB-18889-10	/pk of 1000
Research 100 to 1000 µL	50 to 1250 µL	Green	3" (76 mm)	Reloads†, 10 trays of 96 tips	RB-18888-78	/pk of 960
				Set	RB-18888-62	/pk of 480
				Rack‡, 10 racks of 96 tips	RB-18889-28	/pk of 960

†epTIPS Reloads are also available in PCR Clean purity level.

‡epTIPS Racks are also available in sterile, PCR Clean, and Eppendorf Biopur® purity levels.

Advantec® Disposable 50-mm Sterile Petri Dishes, PS

No need to presterilize

- Sterilized dishes are ready to use
- Use only what you need—come in convenient packs of 20
- Polystyrene dishes come with or without 47-mm absorbent cellulose pad that hold 1.8 to 2.0 mL of liquid media
- Ridges for easy stacking

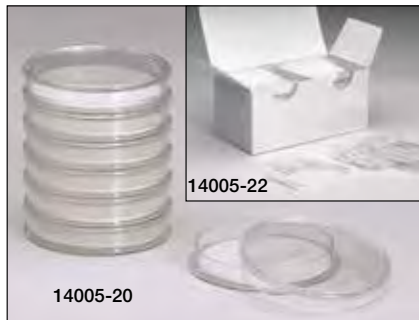

Description	Dia x H (mm)	Qty/cs	Catalog number	Price/cs
Petri dish with pad	50 x 11	100	RB-14005-20	
		500	RB-14005-28	
Petri dish without pad	50 x 11	100	RB-14005-24	
		500	RB-14005-26	

[RB-14005-22](#) Presterilized absorbent pads. Box of 100 individual packages

Thermo Scientific™ Nalgene™ Sterile Media Bottles, PETG

No prewashing needed

- Radiation-sterilized and nonpyrogenic—no need to wash, depyrogenate, or autoclave
- PETG bottle with HDPE closures for long term storage and sterility



Capacity mL (oz)	Closure size	Qty/cs	Catalog number	Price/cs
30 (1)	20 mm	96	RB-06254-00	
60 (2)	24 mm	96	RB-06254-10	
125 (4)	38-430 mm	48	RB-06254-20	
250 (8)	38-430 mm	48	RB-06254-30	
500 (16)	38-430 mm	24	RB-06254-40	
1000 (32)	38-430 mm	24	RB-06254-50	
2000 (128)	53B mm	12	RB-06254-60	

Wait!

There's More at [ColeParmer.com](#)

- ✓ Search 100,000+ products
 - ✓ Find full product details
- And much more!

Thermo Scientific™ Nunc™ Lab-Tek™ Sterile Petri Dishes, PS

Get better cultures

- Sterilized by gamma irradiation



Dia x H (mm)	Vented	Stacking ring	Qty/cs	Catalog number	Price/cs
100 x 15	Yes	No	320	RB-14007-01	
100 x 25	No	Yes	300	RB-14007-04	
140 x 20	Yes	No	80	RB-14007-05	
150 x 25	No	No	72	RB-14007-14	
100 x 15	Yes	No	500	RB-14007-10[†]	

[†]Model 14007-10 is square in shape

Sterile Petri Dishes, PS

Stacks won't tip over—convenient stacking ridges for better stability

- Use what you need—packaged in bags of 20 dishes
- Save time—already sterilized by gamma irradiation



Buy More...Save More!

- 20% off on 120+
- 15% off on 30 to 119
- 10% off on 6 to 29 packs or cases

Dia x H (mm)	Qty/pk	Catalog number	Price/pk
60 x 15	500	RB-06139-01	
100 x 15	500	RB-06139-00	
150 x 20	100	RB-06139-02	

Oxford® Bacti-Cinerator® IV

No more cross-contamination

- Safely and conveniently sterilize platinum loops and needles
- Don't waste time—sterilize in just 5 to 7 seconds
- Infrared heat has optimum sterilizing temperature of 1500°F



Description	Power(VAC,Hz)	Catalog number	Price
Bacti-Cinerator IV	120, 60	RB-01850-22	
	220, 50/60	RB-01850-24	

[RB-01850-26](#) Replacement heater element for 01850-22

[RB-01850-28](#) Replacement heater element for 01850-24

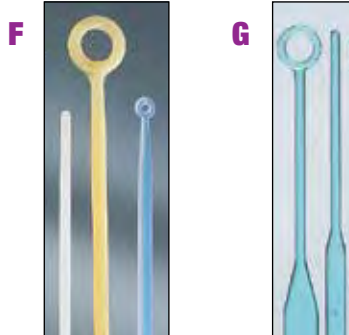
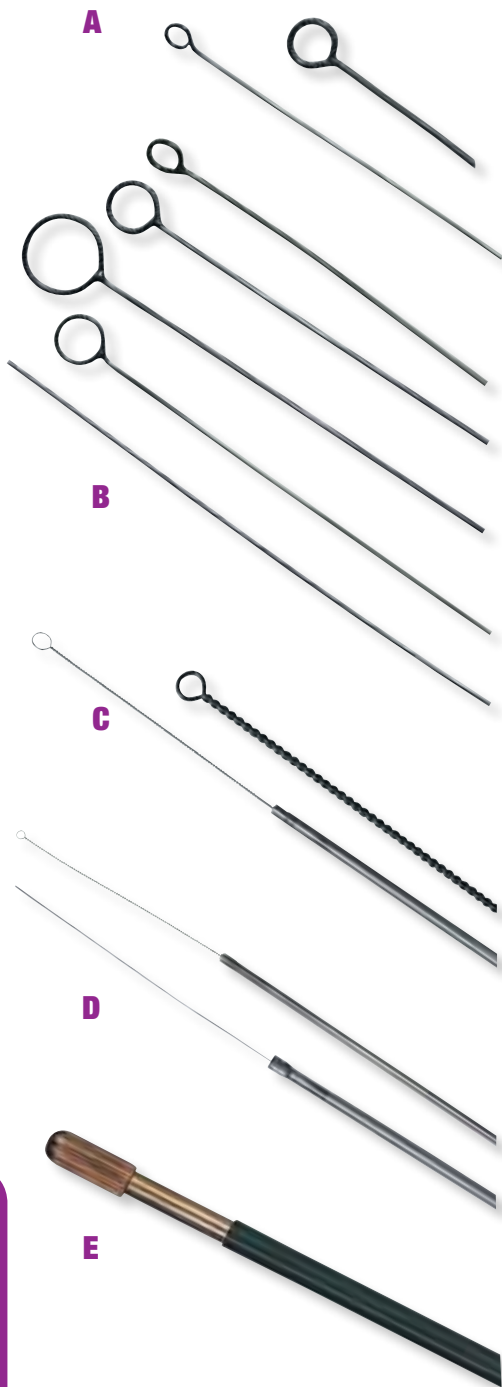

Inoculation Loops and Needles

A. Platinum Calibrated Loops

The 1- μ L loops are made of B&S platinum wire with 15% iridium. The 10- μ L loops are calibrated to American Public Health Association (APHA) standards and made of B&S platinum wire with 5% rhodium. Order insulated loop and needle holder separately below.

Contained volume	Inside dia	B&S gauge	Length	Catalog number	Price/ea
1 μ L	1.45 mm	26	70 mm	RB-01850-00	
10 μ L	4 mm	19	25 mm	RB-01850-02	

B. Platinum Loops and Needles

Use for transferring bacterial cultures. These loops and needles are made of B&S platinum wire with 15% iridium added for rigidity, permitting a thinner wire for delicate work. Loops are fused to form a "perfect circle" with an inside tolerance of ± 0.02 mm to ensure accurate delivery. Order insulated loop and needle holder separately below.

Description	Inside dia	B&S gauge	Length	Catalog number	Price/ea
Loop	2 mm	24	45 mm	RB-01850-04	
	3 mm			RB-01850-06	
	5 mm			RB-01850-08	
	3 mm			RB-01850-10	
Needle	3 mm	26	70 mm	RB-01850-12	
	3 mm			RB-01850-14	

C. Inoculating Loops

These loops are manufactured to very close tolerance levels and can be used for semi-quantitative counting of bacteria. Calibrated loops meet APHA standards. Made of 26-gauge wire. Order insulated loop and needle holder for individual loop separately below ("E").

Description	Loop length	Contained volume	Catalog number	Price
Calibrated inoculating loops				
No handle	3"	1 μ L	RB-14203-31	/ea
6" (15.2 cm) insulated handle	1 3/4"	1 μ L	RB-14203-25	/ea
		10 μ L	RB-14203-26	/ea
Inoculating loops				
No handle	2 mm	—	RB-14203-27	/pk of 12
	3 mm	—	RB-14203-28	/pk of 12
	4 mm	—	RB-14203-29	/pk of 12
	5 mm	—	RB-14203-30	/pk of 12

D. Inoculating Loops and Needles with Handles

Ideal for use in semi-quantitative procedures, these loops and needles are 2 3/4" (7.0 cm) L with 6" (15.2 cm) or 8" (20.3 cm) handle. The 24 gauge is the most durable; the 25 gauge is for general use; and 26 gauge is designed for rapid cooling. Choose from insulated or noninsulated aluminum handles.

Description	Inside dia.	Handle length and type	B&S wire gauge	Qty/pk	Catalog number	Price/pk
Loop	2 mm	8" (20.3 cm), insulated	26	6	RB-14203-24	
	3 mm	8" (20.3 cm), insulated	26	6	RB-14203-23	
	3 mm	6" (15.2 cm), noninsulated	24	12	RB-14203-20	
	3 mm	8" (20.3 cm), noninsulated	25	12	RB-14203-22	
	4 mm	8" (20.3 cm), noninsulated	24	12	RB-14203-21	
Needle	—	6" (15.2 cm), noninsulated	24	12	RB-14203-32	
	—	8" (20.3 cm), insulated	24	6	RB-14203-33	

E. Insulated Brass Loop and Needle Holder

Holder is constructed of durable, heat-resistant brass with insulating sleeve. Works with all gauges of Oxford and Nichrome V loops and needles.

[RB-14203-34](#) Insulated brass holder. Measures 8" (20.3 cm) L

F. Inoculating Needle and Loop

Prevent the risk of cross-contamination with these sterile, disposable needles and loops. Color coded for easy identification. **Box of 960** (32 per bag, 30 bags per box).



Description	Color	Dimensions	Catalog number	Price/bx
Needle	White	9"	RB-06231-11	
1 μ L loop	Blue	9" L x 1 mm ID loop	RB-06231-21	
10 μ L loop	Yellow	9" L x 4 mm ID loop	RB-06231-31	

G. Combination Inoculating Needle/Loop

Flexible polystyrene inoculating device has needle on one end, loop on the other. Color coded for easy identification. **Case of 1000** (20 per bag, 50 bags per case).



Description	Capacity	Color	Dimensions	Catalog number	Price/cs
Needle/loop	10 μ L	Blue	7 1/2" L x 4 mm ID loop	RB-14200-00	
Needle/loop	1 μ L	Clear	7 1/2" L x 1 mm ID loop	RB-14200-01	

Sterilized Sampling Bottle Assemblies

Safely transfer, sample, and store biopharmaceutical products and reagents

- Ideal for cell count, sterility testing, metabolic testing, and more
- Secure, single-piece cap/tubing assembly eliminates contamination and product loss due to loose connections
- Presterilized by gamma irradiation—eliminates labor and validation costs associated with assembly and cleaning

Cap assembly includes a seamless liner with premolded C-Flex® fill and vent tubes to create an unobstructed fluid path. The 18" (45.7 cm) fill tube is plugged at the terminal end to maintain assembly sterility until use. Vent tube includes a 0.2-micron Pall® Acrodisc PTFE vent filter to prevent infiltration by contaminants. Vent filter is hydrophobic to guard against loss of costly product or media during filling or emptying. The one-piece liner eliminates the risk of bacterial entrapment and contamination and forms an elastomeric seal between cap and bottle rim.

C-Flex tubing is manufactured according to cGMP and meets USP Class VI and USDA requirements. Tubing can withstand temperatures from -100 to 275°F (-73 to 135°C). Offers exceptional tensile and tear strength, extremely low extractables, and excellent biocompatibility. The smooth inner surface reduces absorption and protein binding.

What's included: Thermo Scientific™ Nalgene™ clear PETG bottle, 38-mm cap, C-Flex tube/liner assembly with 1/8" ID x 1/4" OD tubing, and 0.2-micron vent filter.

Applications

- ✓ Fermentation
- ✓ Purification
- ✓ Final filling



STERILE

Bottle volume	Catalog number	Price
125 mL	RB-95644-00	
250 mL	RB-95644-02	
500 mL	RB-95644-04	
1000 mL	RB-95644-06	
2000 mL	RB-95644-08	

IKA® Multiposition Stirrers and Stirring Hot Plates

Maintain consistent and silent operation with wear-free and maintenance-free motor

- Stir consistently in all positions
- Adjust speed in 10-rpm increments—speed remains constant
- Stirring hot plates feature synchronous heating and stirring, and homogeneous temperature distribution

What's included: RO models include a removable transparent antislip cover, power cord and adapters to work with US, EU, Canada, Australia and UK outlets. RT models include a power cord and plug.



Stirring positions	Top plate	Power		Catalog number	Price
	Dimensions (W x D)	VAC	Hz		
RO multiposition stirrers; 0 to 1200 rpm					
5	4 3/4" x 18 1/2" (12 x 47 cm)	100-240	50/60	RB-04671-91	
10	7 1/2" x 18 1/2" (19 x 47 cm)			RB-04671-92	
15	11" x 18 1/2" (28 x 47 cm)			RB-04671-93	
RT multiposition stirring hot plates; 0 to 1100 rpm; ambient to 248°F (120°C)					
5	4 5/16" x 19 1/2" (11 x 49.5 cm)	115	50/60	RB-04671-94	
		230		RB-04671-95	
10	7 7/8" x 19 1/2" (18 x 49.5 cm)	115	50/60	RB-04671-96	
		230		RB-04671-97	
15	10 5/8" x 19 1/2" (27 x 49.5 cm)	115	50/60	RB-04671-98	
		230		RB-04671-99	



Specifications

Top plate material: stainless steel
Volume per position: 400 mL

Accessories

[RB-17050-04](#) NIST-traceable calibration with data for stirrers
[RB-17002-27](#) NIST-traceable calibration with data for stirrer and hot plate

Sampling Assemblies / Stirrers

Fluid Testing & Analysis

Wait!

There's More at
ColeParmer.com

Browse **100,000+** products plus find
Technical Resources to help you choose

IKA® Large-Capacity Digital Stirrers

Digital control for carboys and bottles

– Effectively stir up to 40 gallons (150 liters)

Powerful magnetic stirrers feature a flat, sturdy stainless steel casing—ideal for your reaction vessels. Digital LED display allows for exact control. Unit features a timer for up to 56 minutes or set for continuous run.

Applications

- ✓ Seed culture flasks
- ✓ Carboy/vessel mixing



Top plate		Speed range	Max stirring capacity	Power		Catalog number	Price
Dimensions	Material			VAC	Hz		
13" x 13" (33.0 x 33.0 cm)	Stainless steel	0 to 1000 rpm	50 L	120	50/60	RB-04671-81	
19" x 19" (48.3 x 48.3 cm)	Stainless steel	0 to 600 rpm	150 L	120 230	50/60	RB-04671-82 RB-04671-83	

RB-04627-00 Large-volume stir bar, measures 4¼"L x 1¼" dia (10.8 x 2.7 cm)

Corning® Economical Large-Capacity Stirrer

Stir up to 38 liters (10 gallons) of aqueous solution

– Handles many applications that previously required an overhead mixer

Powerful "rare earth" magnet automatically pulls stir bar into position and stays coupled even under the most demanding stirring conditions. Stirrer accommodates stir bars up to 3" (7.6 cm) L.

What's included: a 6-ft (1.8-m) power cord with plug.

Applications

- ✓ Seed culture flasks
- ✓ Carboy/vessel mixing

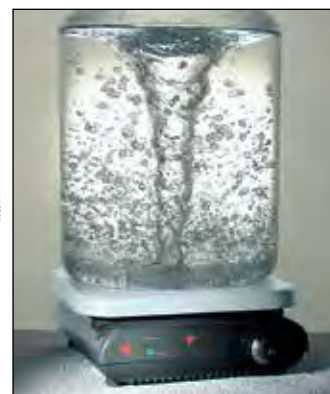

Top plate		Speed range	Max load	Max stirring capacity	Power		Catalog number	Price
Dimensions	Material				VAC	Hz		
11" x 11" (27.9 x 27.9 cm)	ABS plastic	100 to 1500 rpm	100 lb (45 kg)	38 L	120	50/60	RB-84302-30	

RB-17050-04 NIST-traceable calibration with data for stirrers

Lab Companion® Multiposition Stirrers

Independently set and control each position

- Ergonomic, lightweight, and low profile to conserve bench space
- Multifunctional with four operating modes and a timer

These multiposition stirrers have four user-friendly operating modes that allow the selection of specific rows and columns, individual stirring of each position, or simultaneous stirring of all positions. The advanced microprocessor PID controls accurately control stirring speed. Top plates are stainless steel for excellent chemical resistance. Gradual start-up, built in thermal shutdown, and current limit protection device provide user safety.



No. of stirring positions	Volume per position	Top plate		Speed range	Power		Catalog number	Price
		Dimensions (W x D)	Material		VAC	Hz		
5	1.25 L	4⅞" x 19⅞" (12.4 x 48.5 cm)	Stainless steel	30 to 2000 rpm	100-240	50/60	RB-51460-00	
10	2.5 L	9⅞" x 19⅞" (24.6 x 48.5 cm)			100-240	50/60	RB-51460-02	
15	3.75 L	14½" x 19⅞" (36.7 x 48.5 cm)			100-240	50/60	RB-51460-04	

RB-17050-04 NIST-traceable calibration with data for stirrers

Wait!

There's More at
[ColeParmer.com](#)

Thousands of labware options to choose from

Egg-Shaped Stir Bars

Ensure complete mixing

- Egg-shaped stir bars have oval magnets—ideal for use in round-bottom flasks
- Shape conforms to flask bottom

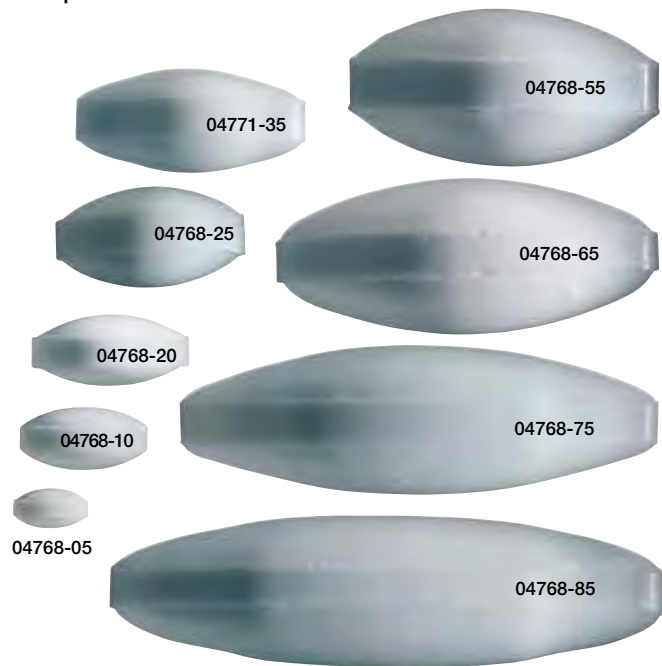

Length	Diameter	For flask sizes	Catalog number	Price
3/8" (9.5 mm)	3/16" (4.8 mm)	10 to 20 mL	RB-04768-05	
5/8" (15.9 mm)	1/4" (6.4 mm)	50 to 100 mL	RB-04768-10	
13/16" (20.6 mm)	3/8" (9.5 mm)	100 to 200 mL	RB-04768-20	
1" (25.4 mm)	1/2" (12.7 mm)	100 to 200 mL	RB-04768-25	
1 1/4" (31.8 mm)	5/8" (15.9 mm)	300 to 500 mL	RB-04771-35	
1 5/8" (41.3 mm)	3/4" (19.1 mm)	500 to 1000 mL	RB-04768-55	
2" (50.8 mm)	3/4" (19.1 mm)	2000 to 5000 mL	RB-04768-65	
2 1/2" (63.5 mm)	3/4" (19.1 mm)	2000 to 5000 mL	RB-04768-75	
3" (76.2 mm)	3/4" (19.1 mm)	5000 to 10000 mL	RB-04768-85	

Cole-Parmer® Slim-Line® Stir Bars

Get complete mixing

- Slimmer profile and larger length to diameter ratio
- Available with or without spinning rings

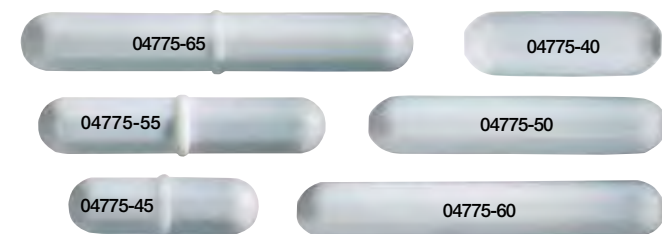

Size		With spinning ring		Without spinning ring	
Length	Diameter†	Cat. no.	Price	Cat. no.	Price
1" (25.4 mm)		RB-04775-45		RB-04775-40	
1 1/2" (38.1 mm)	5/16" (7.9 mm)	RB-04775-55		RB-04775-50	
2" (50.8 mm)		RB-04775-65		RB-04775-60	

†Diameter given does not include the diameter of the spinning ring.

Cole-Parmer® Mono-Mold® Stir Bars

Resist spin out at high speeds

- Super-strong alnico V magnets remain coupled to drive magnets even at high speeds
- Chemically inert, low-friction, leakproof PTFE coating provides smooth spinning and maximum energy transfer

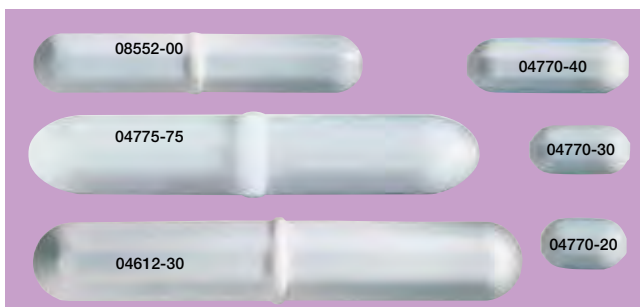

Size		With spinning ring		Without spinning ring	
Length	Diameter†	Cat. no.	Price	Cat. no.	Price
7/16" (11.1 mm)	3/16" (4.8 mm)	—	—	RB-04775-10	
1/2" (12.7 mm)	5/16" (7.9 mm)	RB-08548-00		RB-04770-20	
5/8" (15.9 mm)	5/16" (7.9 mm)	RB-08549-00		RB-04770-30	
1" (25.4 mm)	3/8" (9.5 mm)	RB-08550-00		RB-04770-40	
1 1/2" (38.1 mm)	3/8" (9.5 mm)	RB-08551-00		RB-04770-50	
2" (50.8 mm)	3/8" (9.5 mm)	RB-08552-00		RB-04770-60	
2 1/2" (63.5 mm)	3/8" (9.5 mm)	RB-04775-75		—	—
2 1/2" (63.5 mm)	1/2" (12.7 mm)	—	—	RB-04770-70	
3" (76.2 mm)	1/2" (12.7 mm)	RB-04612-30		RB-04612-40	

†Diameter given does not include the diameter of the spinning ring.

Cole-Parmer® Micro Stir Bars

Mix in small-diameter vessels

- Strong alnico V magnets with one-piece coating of PTFE

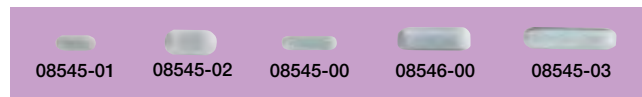

Length x diameter	Catalog number	Qt/pk	Price/pk
5 x 2 mm	RB-08545-01	1	
6.35 x 3 mm	RB-08545-02		
7 x 2 mm	RB-08545-00	1	
10 x 3 mm	RB-08546-00		
12.7 x 3 mm	RB-08545-03		

Stir Bar Retrievers

Retrieve stir bars without messy spills or breakage. Alnico V magnet is completely enclosed. Model 08555-20 features a flexible shaft of PTFE for odd-shaped, and narrow-mouth containers.

08555-20

[RB-08555-20](#) Stir bar retriever, flexible shaft; PTFE, 14 3/4" L (37.5 cm)

[RB-08555-40](#) Stir bar retriever, polyethylene, 17" L (43.2 cm)



08555-40

Cole-Parmer® Polystat® Heating Immersion Circulators

Accurately control temperature to 200°C

- Easy-to-use PID controller with LCD featuring three languages and up to five temperature set points
- Pump connections for circulation to external applications

Applications

- ✓ Sample treatment
- ✓ Quality control testing

Standard and Standard Plus Controllers feature five programmable set points, a two-speed pump, and an adjustable pump nozzle.

Advanced Controller offers tighter control with $\pm 0.025^\circ$ stability. It features five programmable set points, a two-stage pump (force and suction for extra capacity with external open- or closed-loop applications), and a USB port.

What's included: 6-ft (1.8-m) power cord with plug, M16 x 1 pump connections, and 8- and 12-mm hose barb fittings with clamps for external circulation.



12120-01

polystat®

Specifications

Wetted materials: stainless steel, polymers **Immersion depth:** 5¾" (14.6 cm)

ISO 9001:2008
CERTIFIED SUPPLIER



Controller type	Temperature range	Stability	Pump type	Max pump pressure psi (mbar)	Max flow (L/min)	Low-level cutoff	Power (VAC, Hz)	Catalog number	Price
Immersion circulators with clamp for attachment to side of tank									
Standard	Ambient +10 to 100°C	$\pm 0.05^\circ\text{C}$	Force	4.5 (310)	17	Yes	115, 60	RB-12120-01	
							230, 50	RB-12120-02	
Standard Plus	Ambient +10 to 150°C	$\pm 0.05^\circ\text{C}$	Force	4.5 (310)	17	Yes	115, 60	RB-12120-03	
							230, 50	RB-12120-04	
Immersion circulators with bridge that spans across the tank; adjustable bridge from 12" to 31½" (30.5 to 80 cm)									
Standard	Ambient +10 to 100°C	$\pm 0.05^\circ\text{C}$	Force	4.5 (310)	17	Yes	115, 60	RB-12120-08	
							230, 50	RB-12120-09	
Standard Plus	Ambient +10 to 150°C	$\pm 0.05^\circ\text{C}$	Force	4.5 (310)	17	Yes	115, 60	RB-12120-11	
							230, 50	RB-12120-12	
Advanced	Ambient +10 to 200°C†	$\pm 0.025^\circ\text{C}$	Force/suction	10.8 (750)	21	Yes	115, 60	RB-12120-13	

†Pump at low speed

Baths & Circulators

Cole-Parmer® Polystat® Cooling/Heating Circulating Baths

Get excellent cooling across operating range

- Two-speed pump with up to 21 L/min flow
- Maximize bench space with compact size
- Protect samples and bath with high-temperature and low-level cut offs

Standard Digital Controller Baths feature five programmable set points, adjustable high-temperature cutoff, user-settable Min/Max temperature limits, and an adjustable pump nozzle. **Advanced Digital Controller Baths** offer all the features of the Standard Digital models (except adjustable pump nozzle) plus five programmable set points, a two-stage (force/suction) pump for greater circulation capacity, and a USB port.

What's included: lid, 6-ft (1.8-m) power cord with plug, M16 x 1 pump connection and 8- and 12-mm hose barb fittings with clamps for external circulation.

Specifications

Wetted materials: stainless steel, polymers **Low-level cutoff:** yes

polystat®

ISO 9001:2008
CERTIFIED SUPPLIER



Bath capacity	Temperature range	Stability	Cooling capacity at 20°C	Pump type	Max pump pressure psi (mbar)	Max pump flow (L/min)	Working area (W x L x D)	Power (VAC, Hz)	Catalog number	Price
Standard digital controller baths										
6.5 L	-20 to 100°C	$\pm 0.05^\circ\text{C}$	250 W	Force	4.4 (310)	17	5½" x 4¼" x 5⅞" (13.5 x 12.2 x 15 cm)	115, 60	RB-12122-02	
								230, 50	RB-12122-04	
8.6 L	-28 to 100°C	$\pm 0.05^\circ\text{C}$	500 W	Force	4.4 (310)	17	6¼" x 7¾" x 5⅞" (17.3 x 18.3 x 15 cm)	115, 60	RB-12122-32	
								230, 50	RB-12122-34	
8.6 L	-28 to 150°C	$\pm 0.05^\circ\text{C}$	500 W	Force	4.4 (310)	17	6¼" x 7¾" x 5⅞" (17.3 x 18.3 x 15 cm)	115, 60	RB-12122-36	
								230, 50	RB-12122-38	
Advanced digital controller baths										
6.5 L	-20 to 100°C	$\pm 0.025^\circ\text{C}$	250 W	Force/suction	11.7 (750)	21	5½" x 4¼" x 5⅞" (13.5 x 12.2 x 15 cm)	115, 60	RB-12122-12	
								230, 50	RB-12122-14	
6.5 L	-20 to 100°C	$\pm 0.025^\circ\text{C}$	250 W	Force/suction	11.7 (750)	21	5½" x 4¼" x 5⅞" (13.5 x 12.2 x 15 cm)	115, 60	RB-12122-26	
								230, 50	RB-12122-28	
8.6 L	-28 to 200°C	$\pm 0.025^\circ\text{C}$	500 W	Force/suction	11.7 (750)	21	6¼" x 7¾" x 5⅞" (17.3 x 18.3 x 15 cm)	115, 60	RB-12122-42	
								230, 50	RB-12122-44	
8.6 L	-35 to 200°C	$\pm 0.025^\circ\text{C}$	800 W	Force/suction	11.7 (750)	21	6¼" x 7¾" x 5⅞" (17.3 x 18.3 x 15 cm)	115, 60†	RB-12122-56	
								230, 50†	RB-12122-58	

†Requires 20 amp current.

Fluid Testing & Analysis

More than **30,000** Chemicals

Choose from various grades, package sizes, and delivery options



- Basic reagents
- Buffers
- Sorbents
- Standards (AA & ICP)
- Bioreagents

**Consistent quality,
available when you need it**

Most ship within 48 hours of ordering!

Custom blending services and express delivery also available.

Choose from these **customer favorites...**

Description	Volume/Mass	Catalog number	Price
Sodium Hydroxide, 1.0 Normal	1 L	RB-88400-89	
Water, ACS Reagent Grade, ASTM Type I	4 L	RB-88401-21	
Isopropanol, 70% (v/v) Aqueous Solution	1 gal.	RB-88400-48	
Acetone, ACS Grade, Poly Bottle	4 L	RB-88406-15	
Sulfuric Acid Solution, 1.00 Normal	1 L	RB-88401-09	
Reagent Alcohol, ACS Reagent Grade, Anhydrous, Absolute	1 gal.	RB-88400-66	
Hydrochloric Acid, 1.00 Normal	1 L	RB-88400-40	
Iodine (Iodine-Iodide), 0.100 Normal (N/10)	32 oz	RB-88400-47	
Silver Nitrate, 0.100 Normal (N/10)	1 L	RB-88400-70	
Acetic Acid, Glacial, ACS Grade	2.5 L	RB-88401-62	
Sodium Chloride, ACS Grade	500 g	RB-88404-60	

...or find them all at ColeParmer.com/Chemicals

Lab Companion® Benchtop Incubating/Refrigerating Shakers

Get stable worry-free operation, automatically

- Platform starts and stops at center position every time—ideal for repetitive tasks
- Transparent lid with gas spring supports for excellent visibility and easy sample access

Use the intuitive touch-screen LCD controller to perform automatic runs, auto-tuning, and temperature calibration. Three-step adjustable fan and airtight silicone door seal provide uniform temperature distribution and recovery. Smooth start and stop helps prevent spills from flasks or test tubes. Order universal platform and attachments separately right.



79510-01

Universal Platforms

Description	Catalog number	Price
For model A	RB-79510-40	
For model B	RB-79510-56	

Clamps for Flat-Bottomed Erlenmeyer Flasks

Flask volume	Catalog number	Price
50 mL	RB-79510-94	
100 mL	RB-79510-96	
250 mL	RB-79510-98	
500 mL	RB-79511-00	
1000 mL	RB-79511-02	
2000 mL	RB-79511-04	

Test Tube Racks

Capacity	Catalog number	Price
86 holes, up to 8-mm dia	RB-79511-14	
86 holes, up to 10-mm dia	RB-79511-16	
58 holes, up to 12-mm dia	RB-79511-18	
58 holes, up to 14-mm dia	RB-79511-20	
32 holes, up to 16-mm dia	RB-79511-22	
19 holes, up to 25-mm dia	RB-79511-24	

Specifications

Orbit size: 0.75" (19.1 mm) **Temperature uniformity at 37°C in flask:** ±0.5°C
Shaking speed: 10 to 500 rpm (±1% of set speed) **Timer:** 1 minute to 999 hours, 59 minutes
Temperature accuracy at 37°C in flask: ±0.1°C **External ports:** RS-232 and USB

Type	Temperature range	Capacity	Dimensions (W x H x D)		Power (VAC, Hz)	Catalog number	Price
			Chamber	Platform			
A. Benchtop models with 22-lb (10-kg) maximum load and 1.9-cu ft (53-L) chamber volume							
Heated	Ambient +5°C to 80°C	4 x 1-L flask, 2 x 2-L flask	16" x 12½" x 16" (41 x 32 x 41 cm)	13¾" x 13¾" (35 x 35 cm)	120, 60	RB-79510-01	
Refrigerated	Ambient -15°C (min 15°C) to 80°C				120, 60	RB-79510-07	
B. Benchtop models with 30.9-lb (14-kg) maximum load and 2.9-cu ft (83-L) chamber volume							
Heated	Ambient +5°C to 80°C	7 x 1-L flask, 5 x 2-L flask	20" x 12½" x 20" (51 x 32 x 51 cm)	17¾" x 17¾" (45 x 45 cm)	120, 60	RB-79510-13	
Refrigerated	Ambient -15°C (min 15°C) to 80°C				120, 60	RB-79510-19	

Thermo Scientific™ MaxQ™ 2000 & 3000 Open Air Platform Shakers

Configure to your exact needs

- Will not vibrate even under full or unbalanced loads

Analog Shaker features a DC motor and variable-speed control from 40 to 400 rpm, controlled by rotary dial. Integrated tachometer monitors and displays speed in rpm to guarantee an accurate setting. Operate shaker in continuous mode or set timer from 1 to 60 minutes.

Digital Shaker features variable speed control from 15 to 500 rpm and continuous and timed runs from 0.1 to 999 hours. Eliminate splashing of vessel contents with soft-start feature. Displayed time counts up during continuous operation and counts down during timed runs. Shaker shuts down and audible/visual alarms signal if unit operates ±10% of set point speed. RS-232 interface allows remote monitoring of speed and time.

What's included: 8-ft cord with US standard plug; order platforms and clamps separately at right.

Shaker 51706-20 with platform 51706-50 and flask clamps 51706-84



Universal Platforms

Size	Catalog number	Price
For small shakers		
11" x 13" (27.9 x 33.0 cm)	RB-51706-50	
18" x 18" (45.7 x 45.7 cm)	RB-51706-52	
18" x 24" (45.7 x 61.0 cm)	RB-51706-54	
For large shakers		
36" x 24" (91.4 x 61.0 cm)	RB-51706-62	

Clamps for Universal Platforms

Flask size	Maximum number of clamps per platform size						Catalog number	Price
	11" x 13" (27.9 x 33.0 cm)	18" x 18" (45.7 x 45.7 cm)	18" x 24" (45.7 x 61.0 cm)	30" x 18" (76.2 x 45.7 cm)	36" x 24" (91.4 x 61.0 cm)			
For microplate/deep-well plates								
—	5	10	15	18	29	RB-51706-70		
For Erlenmeyer flasks								
10 mL	60	113	157	112	160	RB-51706-72		
25 mL	60	64	80	112	160	RB-51706-74		
50 mL	30	32	40	112	160	RB-51706-76		
125 mL	13	32	40	44	80	RB-51706-78		
250 mL	9	16	23	24	40	RB-51706-80		
500 mL	6	16	20	18	40	RB-51706-84		
1 L	4	9	10	12	21	RB-51706-86		
2 L	1	6	5	6	11	RB-51706-88		

Specifications

Speed range
 Analog shaker: 40 to 400 rpm
 Digital shaker: 15 to 500 rpm with ±1 rpm accuracy

Maximum load
 Small shaker: 35 lb (15.9 kg)
 Large shaker: 50 lb (22.7 kg)

Orbit size	Power		Catalog number	Price
	VAC	Hz		
Analog shaker, large				
1" (25 mm) dia	120	50/60	RB-51706-10	
Digital shaker, small				
¾" (19 mm) dia	120	50/60	RB-51706-20	



Cole-Parmer® Orbital Shakers

Designed for problem-free continuous use

- Smooth, uniform circular motion—perfect for both multiwell plates and large flasks
- Fit into environmental chambers and incubators for culturing and aeration applications
- Easily set and read speed and time on the digital display



Compact Shaker is ideal for smaller sample sizes of 0.5 to 5 mL in multiwell plates, dishes, and petri dishes. Included flat platform holds up to four standard-sized microwell plates on a nonslip rubber mat. Or order the optional expansion platform to double the plate capacity to eight plates. Choose the optional cradle-type platform with adjustable rubber bars to securely hold four 250-mL flasks or any combination of vessel sizes for maximum flexibility.

Large-Capacity Shaker includes a cradle-type platform with four adjustable rubber bars to hold a variety of bottles and flasks; accommodates twelve 250-mL, nine 500-mL, six 1000-mL, or two 2000-mL Erlenmeyer flasks. A larger cradle platform with six bars is available. Or order the optional flat platform for processing up to twelve standard microwell plates simultaneously.

Specifications

Speed range: 30 to 300 rpm **Timer:** 1 to 999 minutes
Orbit size: 5/8" (16 mm) dia



Platform dimensions	Max load	Overall dimensions (W x H x D)	Power		Catalog number	Price
			VAC	Hz		
Compact shaker						
8 ² / ₃₂ " x 8 ² / ₃₂ " (22 x 22 cm)	6.6 lb (3 kg)	9 ¹ / ₂ " x 5 ¹ / ₂ " x 11 ¹ / ₈ " (24 x 14 x 30 cm)	120	60	RB-51700-13	
			230	50	RB-51700-14	
Large-capacity shaker						
13 ³ / ₁₆ " x 13 ³ / ₁₆ " (33.5 x 33.5 cm)	22 lb (10 kg)	14 ¹ / ₈ " x 10 ⁵ / ₈ " x 16 ¹ / ₂ " (36 x 27 x 42 cm)	120	60	RB-51700-15	
			230	50	RB-51700-16	

For Compact Shaker

- [RB-51700-97](#) Cradle platform with four rubber securing bars
- [RB-51700-98](#) Expansion platform with nonslip rubber mat. Holds 8 microwell plates
- [RB-51700-99](#) Plastic cover

For Large-Capacity Shaker

- [RB-51700-95](#) Cradle platform with six rubber securing bars, measures 20" x 20" (51 x 51 cm). Max speed is 150 rpm
- [RB-51700-96](#) Flat platform with nonslip rubber mat. Holds 12 microwell plates

Cole-Parmer® Tube Roller Shakers

Get complete mixing

- Rocking and rolling action is ideal when minimum aeration is needed—like viscous substances or liquid-solid suspensions
- Solid construction—use in cold rooms or incubators
- Expand your capacity with optional stacking kit

The 6-roller units offer a space-saving design perfect for incubator use while the larger 9-roller units offer high throughput. Both accommodate most tube and bottle sizes.



Cole-Parmer®



Speed range	Number of rollers	120 VAC, 60 Hz		230 VAC, 50 Hz	
		Catalog number	Price	Catalog number	Price
Analog tube roller shakers					
Fixed at 33 rpm	6	RB-04750-22		RB-04750-20	
	9	RB-04750-30		RB-04750-28	
Digital tube roller shakers with built-in timer					
Adjustable from 5 to 60 rpm	6	RB-04750-26		RB-04750-24	
	9	RB-04750-34		RB-04750-32	

RB-04653-09 Stacking kit includes four blocks. One kit will stack two shakers; order two kits to stack three shakers

Cole-Parmer® Vortex Shaker

Adjustable speed for more control

- Use at 200 rpm for more gentle mixing, all the way up to 2500 rpm for vigorous agitation
- Heavy die-cast body won't dance across your bench
- Choose between "touch" on or continuous modes



What's included:
standard rubber cup.

Cole-Parmer®



Orbit size	Speed range	Power		Catalog number	Price
		VAC	Hz		
5/32" (4.2 mm) dia	200 to 2500 rpm	90 to 240	50/60	RB-04750-51	

RB-04729-07 Accessory pack includes heads for standard microplate, beaker or flask (up to 500 mL), 8 x 0.2-/0.5-mL microtubes, 16 x 1.5-mL microcentrifuge tubes, and customizable blank foam

Cole-Parmer® 3-D Shakers

Gentle gyratory motion for low-foaming agitation

- Adjust the angle of tilt to optimize mixing
- Platform lip and nonslip mat hold flat-sided vessels secure
- Built-in timer and digital speed display ensure repeatable results
- Triple the capacity with optional tier system



Specifications

Speed range: 5 to 70 rpm Angle of tilt: 3° to 12°



Max load	Platform dimensions	Power		Catalog number	Price
		VAC	Hz		
Small shaker					
6.6 lb (3 kg)	9 1/4" x 9 1/4" (23.5 x 23.5 cm)	120	60	RB-51700-17	
		230	50	RB-51700-18	
Large shaker					
22 lb (10 kg)	14" x 14" (35.5 x 35.5 cm)	120	60	RB-51700-19	
		230	50	RB-51700-20	

RB-51700-93 Magnetic tier system for small shaker; two platforms, 4 1/16" (12.5 cm) high per tier

RB-51700-94 Magnetic tier system for large shaker; two platforms, 4 1/16" (12.5 cm) high per tier

Cole-Parmer® Rocking Shakers

Mix live cultures without agitation

- See-saw rocking action produces a rolling wave in your samples, ideal for washing
- Firmly grip flat-bottom flasks and plates on nonslip mat
- Get repeatable results with digital speed display and built-in timer
- Triple your capacity with optional magnetic tier—no tools needed



Specifications

Speed range: 5 to 70 rpm Angle of tilt: 7°



Max load	Platform dimensions	Power		Catalog number	Price
		VAC	Hz		
Small shaker					
6.6 lb (3 kg)	9 1/4" x 9 1/4" (23.5 x 23.5 cm)	120	60	RB-51700-21	
		230	50	RB-51700-22	
Large shaker					
22 lb (10 kg)	14" x 14" (35.5 x 35.5 cm)	120	60	RB-51700-23	
		230	50	RB-51700-24	

RB-51700-93 Magnetic tier system for small shaker; two platforms, 4 1/16" (12.5 cm) high per tier

RB-51700-94 Magnetic tier system for large shaker; two platforms, 4 1/16" (12.5 cm) high per tier

Cole-Parmer® Reciprocating Shaker

Securely mix a variety of vessels

- Microprocessor-controlled speed maintains consistent shaking
- Prevent sample loss with soft-start function

Shaker features adjustable speed with fixed stroke length, mixing gently to vigorously. Built-in digital timer and continuous operation mode adapt to any mixing protocol. The cradle-type platform with four adjustable rubber bars holds a variety of bottle and flask sizes for maximum flexibility.



Specifications

Speed range: 25 to 250 rpm
Stroke length: 3/4" (20 mm)
Max load: 22 lb (10 kg)



Max load	Platform dimensions	Power		Catalog number	Price
		VAC	Hz		
22 lb (10 kg)	13 1/16" x 13 1/16" (33.5 x 33.5 cm)	120	60	RB-51700-08	
		230	50	RB-51700-10	

Cole-Parmer® Microplate Shakers

Mix micro-volumes effectively

- Digital display ensures reproducible results
- Platform with lip and nonskid mat holds plates securely
- Set built-in timer for up to 9999 minutes or use continuous mode

This shaker operates with a small orbit at high speed. Program a saved time and speed profile for routine tasks with the user-friendly interface. Optional tube adapter racks hold microcentrifuge tubes.



Specifications

Speed range: 250 to 1250 rpm Orbit size: 1/16" (1.5 mm)



Number of plates	Max load	Platform dimensions	Power		Catalog number	Price
			VAC	Hz		
4	2.2 lb (1 kg)	8 5/8" x 8 5/8" (22 x 22 cm)	120	60	RB-51900-57	
			230	50	RB-51900-55	
8	4.4 lb (2 kg)	12 1/16" x 12 1/16" (30.6 x 30.6 cm)	120	60	RB-51900-51	
			230	50	RB-51900-53	

RB-51900-97 Tube holder rack, 50 x 1.5 mL

RB-51900-98 Tube holder rack, 50 x 0.5 mL

RB-51900-99 Tube holder rack, 50 x 0.2 mL

Vortex-Genie Shakers

Maximize high-speed touch mixing

– Won't "walk" across your benchtop

Vortex-Genie® 1 Shaker has a single high-speed mixing action that eliminates operator error for highly reproducible results. Includes pop-off cup; 3" (7.6-cm) platform sold separately below.

Vortex-Genie® 2 Shaker allows you to control speed intensity by varying pressure to the head. The variable speed shaking allows you to adjust the level of mixing from gentle shaking to vigorous vortexing. Easy-to-change platforms allow you to adapt your shaker to a variety of applications. Shaker comes with a pop-off cup for single tube shaking and a standard 3" (7.6-cm) platform for multiple tube or flask shaking. Order optional platform starter kits below to customize the shaker for your application.

Vortex-Genie® 2T Shaker features both touch and hands-free operation. Shake samples from 1 to 60 seconds in touch mode, 1 to 60 minutes in hands-free mode, or continuously in the automatic untimed mode. The 2T shaker accepts all standard Genie attachments and accessories making it an economical addition to your laboratory. Includes pop-off cup and 3" (7.6-cm) platform.

Digital Vortex-Genie® 2 Shaker features both touch and hands-free operation with increased timer range. Shake samples from 1 to 99 seconds in touch mode, 1 to 99 minutes in hands-free mode, or continuously in the automatic untimed mode. Digital display provides accuracy, reproducibility, and repeatability. Accepts all standard Genie attachments and accessories and includes pop-off cup and 3" (7.6-cm) platform.

Vortex-Genie® Pulse Shaker offers true pulsing action, providing more collisions and random motion. Ideal for applications requiring more aggressive action than standard vortexing. Fully programmable—the variable run/stop time provides quick pulsing or interval mixing to keep samples in suspension, or use in continuous mode for vortexing. Featuring digital control and display of speed and time, this shaker will deliver reproducible and accurate mixing. Accepts all standard Genie attachments and accessories and includes pop-off cup and 3" (7.6-cm) platform.

What's included: power cord with plug (no plug on 230 VAC models).



Speed range	Timer range		Platform dimensions	Power			Catalog number	Price
	Touch mode	Hands-free mode		VAC	Hz	Amps		
Vortex-Genie 1 shaker								
600 to 3200 rpm	—	—	1½" dia pop-off cup	120	60	0.65	RB-04724-10	
600 to 2700 rpm	—	—	1½" dia pop-off cup	230	50/60	0.5	RB-04724-15	
Vortex-Genie 2 shaker								
600 to 3200 rpm	—	—	1½" dia pop-off cup,	120	60	0.65	RB-04724-00	
600 to 2700 rpm	—	—	3" dia platform	230	50/60	0.5	RB-04724-05	
Vortex-Genie 2T shaker								
600 to 3200 rpm	1 to 60	1 to 60	1½" dia pop-off cup,	120	60	0.65	RB-04724-20	
600 to 2700 rpm	seconds	minutes	3" dia platform	230	50/60	0.5	RB-04724-25	
Digital Vortex-Genie 2 shaker								
500 to 3000 rpm	1 to 99	1 to 99	1½" dia pop-off cup,	120	60	0.65	RB-04724-40	
	seconds	minutes	3" dia platform	230	50/60	0.5	RB-04724-45	
Vortex-Genie Pulse shaker								
500 to 3000 rpm	0.1 sec to 99	1 to 99	1½" dia pop-off cup,	120	60	0.65	RB-04724-38	
	minutes	minutes	3" dia platform	230	50/60	0.5	RB-04724-39	

[RB-04724-61](#) Platform with cover, 3" (7.6-cm) dia

[RB-04724-60](#) Replacement cup for single tube shaking

[RB-04724-70](#) Thermoplastic rubber cover protects standard 3" (7.6-cm) platform

[RB-04724-54](#) Small ampule shaker attachment

[RB-04724-55](#) Large ampule shaker attachment

[RB-04724-57](#) TurboMix™ shaker attachment

[RB-04724-63](#) Microtube holder for 12 x 2-mL tubes

[RB-04724-64](#) Vertical tube holder. Holds 3 x 50-mL tubes

[RB-04724-65](#) Vertical tube holder. Holds 6 x 15-mL tubes

[RB-04724-89](#) Vertical tube holder. Holds 6 x 50-mL, 6 x 15-mL, and 12 microtubes

[RB-04724-66](#) Vertical microtube holder. Holds 9 microtubes

[RB-04724-67](#) Molded bottom closure and screw kit

[RB-04724-83](#) Platform, 6" (15.2 cm)

[RB-04724-84](#) Recessed platform

[RB-04724-85](#) Tube insert†, foam; 9–16 mm. Set of 2

[RB-04724-86](#) Tube insert†, foam; 14–29 mm. Set of 2

[RB-04724-87](#) Tube insert†, foam; 29–37 mm. Set of 2

[RB-04724-88](#) Blank insert†, foam. Set of 2

†Requires recessed platform 04724-84 (sold separately above).



Beaker/Tube Platform Starter Kit includes one recessed platform for beakers up to 250 mL, two elastic bands, and one tube insert assortment set (Set includes one foam insert each for 9 to 16 mm, 14 to 29 mm, and 29 to 37 mm tubes; and one blank insert).

[RB-04724-80](#) Beaker/tube platform starter kit

[RB-04724-82](#) Replacement elastic bands†. Set of 2

[RB-04724-81](#) Replacement tube insert assortment†. Set of 4

†Requires recessed platform 04724-84 (sold separately at left).

Microtube/Microwell Plate Platform Starter Kit contains one 6" (15.2 cm) platform, one 6" (15.2 cm) foam insert for 60 microcentrifuge tubes, and one 6" (15.2 cm) foam insert for a single microwell plate.

[RB-04724-50](#) Microtube/microwell plate platform starter kit

[RB-04724-51](#) Replacement micro tube inserts† hold up to 60 microtubes. Pack of 2

[RB-04724-53](#) Double-tier microwell plate insert

‡Requires platform 04724-83 (sold separately at left).

Cole-Parmer® Rotational Viscometers

Include 316 stainless steel spindles for better resistance

- Select from 10 language options
- Ensure accurate readings by calibrating your viscometer to a known standard

Determine the dynamic viscosity of samples. Over/under range alarm sounds when your sample is too high/low for the spindle selected. All models feature push-button control with easy-to-use menu system, motor self-test, user calibration to a known standard, and universal power supply.

Basic Viscometers are an economical choice for fast, accurate viscosity readings. Feature a 4-line display that shows selected speed, selected spindle, viscosity, and % of full scale.

Basic Viscometers with USB Output include software to download data through the USB output to your PC for analysis. Store up to 10 user programs for repeated tests. Display selected speed, selected spindle, viscosity, % torque, shear rate, and shear stress on the 5-line display. Enter the sample density, and the unit calculates and displays kinematic viscosity (cSt) as well.

Advanced Viscometers with Temperature Probe have three times the speed selections and double the speed range of the basic models. Monitor and display temperature with the included RTD temperature probe. Program features include time to torque, time to stop, ramp, and multistep.

Programmable Viscometers feature 2600 speed selections and the highest speed range, up to 250 rpm. Monitor and display temperature with the included RTD temperature probe. Control the viscometer through a PC using the included software; also includes curves, graphs, and database references.

Optional low viscosity adapters allow measurement down to 1 cp when used with low range viscometers and 3.2 cp when used with medium range viscometers. Model 98965-54 includes a water jacket for attachments to an external circulating bath (not included; go to www.coleparmer.com for our full selection).

What's included: 316 stainless steel spindles (four spindles for the low range and six for the other ranges), spindle protector, stand, carrying case, and universal power supply. Models 98965-43 through -48 also include data logging software; USB cable. Models 98965-49 through -51 also include control software, data logging software, and USB cable.



Applications

- ✓ Viscosity for antibodies
- ✓ Formulation



Viscosity range	Rotational speed range	Number of selectable speeds	Output	Catalog number	Price
Basic viscometers					
20 to 2,000,000 cp (low)	0.3 to 100 rpm	18	None	RB-98965-40	
100 to 13,000,000 cp (medium)					
200 to 106,000,000 cp (high)					
Basic viscometers with data logging software and USB cable					
20 to 2,000,000 cp (low)	0.3 to 100 rpm	18	USB	RB-98965-43	
100 to 13,000,000 cp (medium)					
200 to 106,000,000 cp (high)					
Advanced viscometers with temperature probe, data logging software, and USB cable					
20 to 6,000,000 cp (low)	0.01 to 200 rpm	54	USB	RB-98965-46	
100 to 40,000,000 cp (medium)					
200 to 106,000,000 cp (high)					
Programmable viscometers with temperature probe, control software, data logging software, and USB cable					
20 to 6,000,000 cp (low)	0.01 to 250 rpm	2600	USB	RB-98965-49	
100 to 40,000,000 cp (medium)					
200 to 106,000,000 cp (high)					

Specifications

Accuracy: ±1% full-scale

Resolution

<10,000 cp: 0.1 cp
≥10,000 cp: 1 cp

Reproducibility: ±0.2%

Temperature probe (indicated models):

100 Ω Pt RTD; 32 to 212°F (0 to 100°C)

Power: 100 to 240 VAC, 50/60 Hz

Search

For our full selection of viscometer accessories, go to...

ColeParmer.com/Viscometers

Hach® 2100 AN Laboratory Turbidimeters

Get accurate, stable readings

- Smart self-diagnostics alert you to problems including using the wrong calibration standard
- Model 99512-15 meets ISO 7027 turbidity measurement standards and uses a monochromatic light-emitting diode (LED) as a light source

These benchtop turbidity meters offer the most versatile and advanced instruments available for nephelometric measurement. Push-button calibration and operation eliminates manual adjustments or zeroing. The optical system provides accurate results over a wide range of samples and turbidity, simplifying routine laboratory work.

What's included: six sample cells; 30 mL each of <0.1, 20, 200, 1000, and 4000 NTU StablCal® stabilized formazin primary standards; silicone oil and oiling cloth; dust cover; and power cord. The deluxe meter also includes a built-in printer and a 7500 NTU StablCal® stabilized formazin vial.

Applications

- ✓ Infusion quality control
- ✓ Final product stability in storage
- ✓ Cell harvest



Deluxe model 99512-10 with built-in printer

Standard Meter

- Wide measuring range using three selectable readout modes—0 to 4000 nephelometric turbidity units, 0 to 26,800 NEPH (Nephelos), and 0 to 980 EBC (European Brewing Convention)
- Optional ratioing switches instrument from multidetector ratio mode to nonratio
- Signal averaging minimizes noise and display fluctuations
- Air purge system connection purges the optical compartment with dry air and minimizes condensation on the sample cell

Deluxe Meters include all the features of the standard model plus:

- A wider measuring range—0 to 10,000 NTU, and 0 to 2450 EBC
- Four measurement modes—NTU, absorbance, percentage transmittance, and platinum and cobalt color units (99512-10 only)
- Programmable signal averaging
- Built-in printer and recorder output



Description	Standard turbidimeter		Deluxe turbidimeters	
	RB-99512-00	RB-99512-07	RB-99512-10	RB-99512-15
Catalog number	RB-99512-00	RB-99512-07	RB-99512-10	RB-99512-15
Measurement modes	NTU, EBC, or Nephelo		NTU, EBC, Nephelo, ABS, %T, CU, two user-defined units	FNU, FAU, NTU, EBC, ABS, %T, two user-defined units
NTU mode	Ratio on	0 to 0.999, 0 to 9.99, 0 to 99.9, 0 to 4000	0 to 0.999, 0 to 9.99, 0 to 99.9, 0 to 10,000	0 to 10,000
	Ratio off	0 to 40.0	0 to 40.0	0 to 1000
Nephelo mode	Ratio on	0 to 9.99, 0 to 99.9, 0 to 26,800	0 to 9.99, 0 to 99.9, 0 to 67,000	—
	Ratio off	0 to 268	0 to 268	—
EBC mode	Ratio on	0 to 0.999, 0 to 9.99, 0 to 99.9, 0 to 980	0 to 0.999, 0 to 9.99, 0 to 99.9, 0 to 2450	—
	Ratio off	0 to 9.8	0 to 9.8	—
Light source	Tungsten lamp	Tungsten lamp	Tungsten lamp	LED
Photodetector	Silicon photodiode		Silicon photodiode	
Absorbance	—	—	Manual: 0.0 to 0.999 ABS, 0 to 2.00 ABS	—
Transmittance	—	—	Range: 0.0 to 200 %T; resolution: 0.1 %T	—
Color (at 455 nm)	—	—	Range: 0 to 500 CU	—
Accuracy†	Turbidity	±2% of reading plus 0.01 NTU from 0 to 1000 NTU, ±5% of reading from 1000 to 4000 NTU	±2% of reading plus 0.01 NTU from 0 to 1000 NTU, ±5% of reading from 1000 to 4000 NTU, ±10% of reading from 4000 to 10,000 NTU	
	Color measurements	—	±2% CU from 0 to 30 (calibrated at 15 CU), ±5% CU from 0 to 500 (calibrated at 500 CU)	—
Sample volume	30 mL required		30 mL required	
Sample cell size	Seven, 25 mm dia x 95 mm H		Seven, 25 mm dia x 95 mm H	
Printer	—	—	Built-in graphics capable 28 column	
Output	RS-232 serial interface (bidirectional)		RS-232 serial interface (bidirectional)	
Recorder output	0 to 1 V programmable limits		0 to 1 V programmable limits	
Power	110 VAC	230 VAC	110 VAC	230 VAC
Price				

†Reference conditions: 23°C ±2°C; 50% RH ±10 RH noncondensing; 115/230 VAC, ±17%, 50/60 Hz.

Accessories

- [RB-99512-50](#) Calibration sets for 99512-00, -07
- [RB-99512-52](#) Calibration sets for 99512-10, -15
- [RB-99512-66](#) Filter modules
- [RB-99512-68](#) Degassing kit
- [RB-99512-70](#) Sample cells. Pack of 6
- [RB-99512-72](#) Sample cell oiling cloth
- [RB-99512-75](#) Replacement silicone oil; 15 mL
- [RB-99512-78](#) Sample cell adapter, 19 mm

Wait!

There's More at ColeParmer.com

Find all the product specs you need!

Turbidity
Fluid Testing & Analysis

Cole-Parmer® LabGEN® 7 Homogenizers

Don't be tied to a stand—unit can be mounted or handheld

- No more wasted time—processes 0.25- to 30-mL samples in less than one minute
- No more hand stress—lightweight unit is easy to clean and disassemble
- Powerful, yet quiet—variable speed from 5000 to 35,000 rpm

The LabGEN 7 homogenizer operates with a powerful 125-watt motor; ideal for most tissue samples. The portable LabGEN 7b is powered by a rechargeable battery for freedom of movement and to process soft tissues.

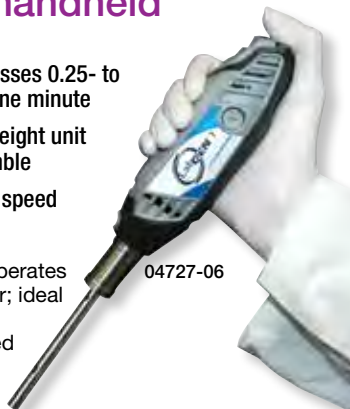

04727-06

What's included: 7-mm generator probe and tool kit.

LabGEN



Description	Probe included (L x dia)	Power	Catalog number	Price
LabGEN 7	3 1/8" x 7/64" (85 x 7 mm)	115 VAC	RB-04727-06	
		220 VAC	RB-04727-07	
Portable LabGEN 7b	3 1/8" x 7/64" (85 x 7 mm)	115 VAC	RB-04727-08	
		220 VAC	RB-04727-09	

[RB-04727-16](#) Homogenizer stand

[RB-04727-17](#) Spare rechargeable battery for LabGEN 7b

Tissue Tearor™ Homogenizer

Handle volumes from 0.5 to 50 mL

This variable-speed homogenizer rapidly homogenizes, disperses, and emulsifies small-volume samples in aqueous media. Homogenizer features a switch that lets you adjust speed from 4500 to 30,000 rpm.

Liquid media is drawn into and repeatedly cycled through the stator. The high-speed rotor rapidly disperses and disintegrates material suspended in the media. All wetted materials are 316 stainless steel (SS). **Note:** Not intended for use with flammable solvents or in the absence of liquid media.

What's included: stand, 8.3 cm long x 7.0 mm diameter SS probe, and 5-ft (1.5-m) cord; 120 VAC unit has a standard plug, no plug on 220/240 VAC unit.



04750-91

04750-90



Power	Catalog number	Price
120 VAC, 50/60 Hz, 1.2 A	RB-04750-50	
220/240 VAC, 50 Hz, 0.6 A	RB-04750-55	

Replacement Probes

Diameter (cm)	Sample volume range (mL)	Length (cm)	Catalog number	Price
4.5	0.2 to 5.0	4.8	RB-04750-90	
7	0.5 to 50	10.9	RB-04750-91	

IKA® T25 ULTRA-TURRAX® Digital High-Speed Homogenizer

Choose from five generators with 1 to 2000 mL sample volumes

- Ideal for tough solids or large-volume samples
- Generators are made of 316 stainless steel and PTFE, providing excellent chemical compatibility

This system is ideal for batch homogenizing of cell tissues, emulsifying suspended solids, and air pollution filter extraction. The key component is the rotor-stator generator. (Order rotor-stator generators separately below.) Shielded in a 316 stainless steel shaft, the rotor acts as a centrifugal pump to recirculate the liquid and suspended solids through the generator, where shear, impact, collision, and cavitation provide rapid homogenization.

What's included: 10-ft (3-m) power cord (the 115 VAC model has a standard US plug; the 230 VAC model has a European plug).



1
04739-21

2

REQUIRED System Components

- 1) Homogenizer
- 2) Rotor-stator generator
- 3) Stand and clamps

1. Homogenizer



Description	Homogenizer	
Catalog number	RB-04739-21	RB-04739-22
Speed range	500 to 25,000 rpm	
Batch volume range	1 to 2000 mL	
Noise rating	73 dB	
Speed adjustment	Stepless	
Wattage	800 input, 500 output	
Power	115 VAC, 50/60 Hz	220 VAC, 50/60 Hz
Price		

2. Rotor-Stator Generators

Specifications

Solution compatibility: Aqueous and organic

Wetted materials: PTFE, 316 SS
Max temp: 302°F (150°C)

Sample volume range	Ultimate fineness	Dimensions (L x OD)	Catalog number	Price
1 to 50 mL	10 µm	108 x 8 mm	RB-04720-11	
1 to 100 mL	10 µm	105 x 10 mm	RB-04720-10	
10 to 1500 mL	10 µm	194 x 18 mm	RB-04720-12	
50 to 2000 mL	10 µm	194 x 25 mm	RB-04719-52	
100 to 2000 mL	5 µm	194 x 25 mm	RB-04719-53	

3. Stands and Clamps

- [RB-50703-90](#) Plate stand, 22" high
- [RB-50703-91](#) Plate stand, 31 1/2" high
- [RB-50703-92](#) Plate stand, 39 1/2" high
- [RB-50703-96](#) Boss head clamp
- [RB-50703-70](#) Strap clamp

Jenway Genova Plus and Genova Nano UV/Vis Spectrophotometers

Versatile—get life science specific analysis as well as standard functions

- Meet the requirements of any busy laboratory—ideal for DNA, RNA, and protein measurements, but function as standard spectrophotometers
- Detects DNA concentrations as low as 2 ng/μL
- Save your methods and results to USB memory stick
- Icon-driven software with large graphical display and intuitive navigation

Genova Plus Spectrophotometer (model 83070-00) offers enhanced optics dedicated to life science analysis, allowing the measurement of DNA concentrations and purity ratios using wavelengths recorded at 260, 280 and 230 nm, with an optional correction at 320 nm. Or use as a standard spectrophotometer with measurement modes for photo-metrics, concentration, multi-wavelength, spectrum scanning, quantitation, and kinetics.

This life science spectrophotometer is preprogrammed with methods for protein analysis in addition to nucleic acid concentrations. The OD measurement mode lets you measure optical density at 600 nm for cell harvesting. The purity scan across the entire wavelength range from 198 to 1000 nm displays any distorted peaks, easily identifying impurities.

Optional accessories let you choose the best way to measure your samples. The TrayCell accessory (83070-29) enables you to measure sample volumes as low as 0.7 μL and is ideal for RNA, DNA, and protein measurements requiring 1:10 or 1:50 dilutions.

Genova Nano Spectrophotometer (model 83070-02) offers the same features as the Genova Plus but adds a preinstalled pedestal platform which allows you to measure sample volumes as low as 0.5 μL—conserving your precious samples. Measuring small sample volumes eliminates the need to perform dilutions or use cuvettes, saving you time and money.

The versatile Genova Nano measures sample volumes with a high degree of accuracy and reproducibility in less than 6.5 seconds. Its stainless steel read head with an embedded quartz lens uses the natural surface tension of the droplet to form the bond between the read head surfaces for optimal results. When your reading is complete, simply wipe the sample with a microfiber cloth to remove all trace of the sample. The ease of cleaning allows faster changeover between samples, increasing sample throughput.

What's included: Model 83070-00 includes a 10 x 10 mm cuvette holder, micro-cuvette holder, 4 GB USB memory stick, 100 disposable micro-cuvettes, and universal power supply. Model 83070-02 includes a micro-volume accessory, 10 x 10 mm cuvette holder, micro-cuvette holder, 4 GB USB memory stick, and universal power supply.



Spectrophotometer
83070-02



Accessories

RB-83070-29 TrayCell accessory for Genova Plus (83070-00), for microvolume samples from 0.7 μL to 5 μL

RB-83070-31 Automatic eight-cell cuvette holder for multiple sample measurements. Accepts 10 x 10 mm pathlength cuvettes

RB-83070-33 Sipper pump, requires flow-through cuvette

RB-83070-35 Peltier temperature controller, 20 to 50°C

RB-83070-37 Combined sipper pump/Peltier temperature control

RB-83070-39 Printer for instant results. Fits into top of spectrophotometer to save space

RB-83070-41 Replacement cuvette holder, 10 x 10 mm pathlength

RB-83070-43 Test tube and cuvette holder, 13/16/24-mm diameter x 100 mm height; compatible with 10-mm square cuvettes

RB-83070-45 Test tube and cuvette holder, 13-mm dia; compatible with 10-mm square cuvettes

RB-83056-80 Cuvette holder, 10 x 100 mm pathlength

RB-83056-82 Replacement micro-cuvette holder, for small sample volumes down to 50 μL

RB-83070-51 Water-heated cuvette holder, 10 x 10 mm pathlength (requires heated circulating bath for operating temperatures from 5 to 50°C)

JENWAY

Specifications

Measurement time: <6.5 seconds

Sample pedestal material of construction (model 83070-02): stainless steel and quartz



Description	Genova Plus	Genova Nano
Catalog number	RB-83070-00	RB-83070-02
Sample mode(s)	Cuvette	Cuvette and pedestal
Minimum sample size	0.7 μL†	0.5 μL at 2.0 mm, 1.0 μL at 0.5 mm
Maximum sample size	5 mL	5.0 μL
Bandwidth		5 nm (spectral)
Path length	10 mm	0.2 or 0.5 mm (auto-ranging)
Wavelength	Transmittance	0 to 199.9%
	Range	198 to 1000 nm
	Resolution	±2 nm
	Accuracy	1 nm
Source lamp		Press-to-read Xenon lamp
Detector		Photo-diode detector
Detection limit	—	2.0 ng/μL (dsDNA) at 0.2 mm pathlength
Measurement	Range	–0.300 to 2.500 A (10-mm pathlength equivalent = –15.0 to 125.0 A)
	Precision	—
	Accuracy	±1% T, ±0.01 A at 1.000 A
Maximum concentration	—	6000 ng/μL (dsDNA)
DNA measurement modes		dsDNA, ssDNA, RNA, oligonucleotides, 260/280, 260/230, variable ratio
Protein measurement modes		BCA, Bradford, Lowry, Biuret, Direct UV
Memory		Up to 312 methods (including preprogrammed methods)
Input/Output		USB, analog, RS-232, and optional integral printer
Power (VAC, Hz)		90 to 260, 50 to 60
Price		

†The 0.7 μL sample volume requires TrayCell accessory 83070-29 sold separately at right.

Disposable Cuvettes

No more washing cuvettes

Use these economical, single-use cuvettes to obtain consistent spectrophotometric data. Available in standard, semi-micro, and fluorometry configurations. Use polystyrene cuvettes for visible spectral analysis; polymethacrylate cuvettes are preferred for UV range testing.

Specifications

Polystyrene:

% Transmission: maximum from 340 to 800 nm

Methacrylate:

% Transmission: maximum from 285 to 750 nm

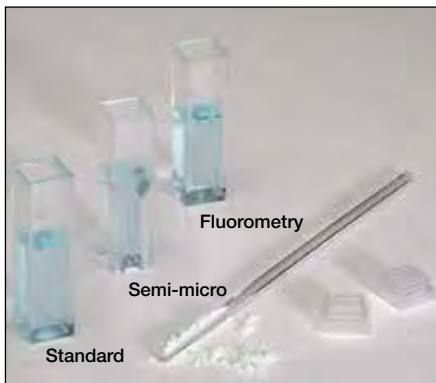

Tech Info

Methacrylate material provides a higher % transmission over a wider spectral range.

Wavelength (nm)	% Transmission	
	Polystyrene	Methacrylate
800	88	90
700	88	90
600	85	90
500	85	90
400	85	90
380	85	90
360	80	89
350	80	88
340	75	86
320	65	85
300	35	82
280	—	55

Type	Capacity (mL)	Path-length (mm)	Number of clear sides	Dimensions W x H x D (mm)	Polystyrene		Methacrylate	
					Catalog number	Price/pk of 500*	Catalog number	Price/pk of 500*
Standard	4.5	10	2	12.5 x 45 x 12.5	RB-06343-10		RB-06343-15	
Semi-micro	1.5	10	2	12.5 x 45 x 12.5	RB-06343-20		RB-06343-70	
Fluorometry	4.5	10	4	12.5 x 45 x 12.5	RB-06343-60		RB-06343-80	

*Discounts: Save 10% on 2-9 pks, 15% on 10-39 pks, and 20% on 40+ pks.

[RB-06343-31](#) Cuvette caps, LDPE. Case of 1000

[RB-06343-35](#) Cuvette stirring spatulas, PS. Case of 1000

Paired Glass and Quartz Cuvettes

Get less variability with matched pairs

- Matched to give the same value for the same solution within 1% tolerance



Specifications

Glass (visible):

% Transmission: guaranteed 82% at 320 nm
Tolerance: within 1%

Quartz (UV):

% Transmission: guaranteed 80% at 200 nm
Tolerance: within 1%

Capacity (mL)	Path-length (mm)	No. of clear sides	Dimensions W x H x D (mm)	Top of PTFE	Glass (visible)		Quartz (UV)	
					Catalog number	Price/pk of 2	Catalog number	Price/pk of 2
Standard-sized cuvettes								
3.5	10	2	12.5 x 45 x 12.5 12.5 x 49 x 12.5	Cover Stopper	RB-83200-20 RB-83200-70		RB-83200-02 RB-83200-72	
Microcuvettes with frosted thick wall								
1.4 0.7	10	2	12.5 x 45 x 12.5	Cover	RB-83200-30 RB-83200-40		RB-83200-32 RB-83200-42	
Self-masking microcuvettes								
1.4 0.7	10	2	12.5 x 45 x 12.5	Cover	— —		RB-83200-52 RB-83200-62	
Fluorimeter cuvettes								
3.5	10	4	12.5 x 45 x 12.5 12.5 x 49 x 12.5	Cover Stopper	RB-83200-10 RB-83200-80		RB-83200-12 RB-83200-82	

Spectroscopy

Fluid Testing & Analysis

Gas Cells

Easy assembly

Features Pyrex® body with two stems fitted with replaceable rubber septa, and Viton® O-rings. Requires two NaCl windows; order separately below table.



Description	Pathlength	Cat. no.	Price
Gas cell	10 cm	RB-83004-00	

[RB-83001-56](#) NaCl window, 25 x 4 mm. Order two

[RB-83004-50](#) Replacement Pyrex body

Cell Holder Kit

Quick sample placement

Simply place sample between two NaCl windows separated by spacers, install in retainer and place in mount. Requires two NaCl windows; order separately below table.



What's included: removable cell mount, 12 assorted PTFE spacers, and slide plate retainer.

Description	Catalog number	Price
Cell holder kit	RB-83001-00	

[RB-83001-56](#) NaCl window, 25 x 4 mm. Order two

KBr Bolt Press

Make 7-mm pellets effortlessly

This 316 press has a stainless steel barrel and two hardened 316 stainless steel bolts. Remove bolts and mount press directly onto spectrophotometer for analysis.



What's included: barrel, bolts, and slide holder.

Description	Catalog number	Price
KBr bolt press	RB-83002-00	
KBr bolt press, evacuable	RB-83001-10	

[RB-83002-52](#) Bench wrench kit; includes bench wrench, combination wrench, and mounting screws

Cole-Parmer® Symmetry® PA Analytical Balances

Discover Symmetry—affordable, advanced, accurate



- USB and RS-232 interfaces offer connection to a computer or printer for GLP/GMP-compliant output
- Three-door glass draft shield provides easy access inside the weighing chamber
- Oversized backlit LCD provides clear visibility of weighing results
- Sealed keypad, splashproof design, and removable stainless steel weighing pan offer safeguards in a messy lab environment
- Weighing modes include parts counting, percent weighing and checkweighing
- Fast stabilization and response time—digital filters compensate for vibration, drafts or temperature changes
- Selectable multi-language display and output

What's included: AC power adapter and draft shield.

Specifications

Calibration: Internal or external with calibration mass
Weighing units: g, ct, oz, dwt, mg, grains, oz, ozt, dwt, custom
Power: 115/220 VAC power adapter



Capacity	Readability	Repeat-ability	Linearity	Pan size	Catalog number	Price
Internal calibration						
120 g	0.0001 g	±0.0002 g	±0.0002 g	3½" dia (9.0 cm)	RB-10001-08	
220 g	0.0001 g	±0.0002 g	±0.0002 g		RB-10001-09	
External calibration						
120 g	0.0001 g	±0.0002 g	±0.0002 g	3½" dia (9.0 cm)	RB-10001-00	
220 g	0.0001 g	±0.0002 g	±0.0002 g		RB-10001-01	

Cole-Parmer® Symmetry® PT Toploading Balances

Large weighing surface allows placement of a variety of samples



- Weighing modes include parts counting, percent weighing, checkweighing, animal/dynamic weighing and density determination
- USB and RS-232 interfaces offer connection to a computer or printer for GLP/GMP-compliant outputs
- Sealed keypad, splashproof design, and removable stainless steel weighing pan
- An oversized backlit LCD provides clear visibility of weighing results
- Fast stabilization and response time—digital filters compensate for vibration, drafts or temperature changes

What's included: AC power adapter. The 210-g and 410-g models also include a draft shield.

Specifications



Calibration: Internal or external with calibration mass
Weighing units: g, ct, oz, dwt, mg, grains, oz, ozt, dwt, custom
Power: 115/220 VAC power adapter and built-in rechargeable battery pack (battery function not available on models 10001-06, -07, -13)

Capacity	Readability	Repeatability	Linearity	Pan size	Cat. no.	Price
Internal calibration						
210 g	0.001 g	±0.002 g	±0.002 g	5½" x 5½" (13.0 x 13.0 cm)	RB-10001-10	
410 g	0.001 g	±0.002 g	±0.002 g		RB-10001-11	
2200 g	0.01 g	±0.02 g	±0.02 g	7½" x 6¼" (19.0 x 16.0 cm)	RB-10001-12	
4200 g	0.01 g	±0.02 g	±0.02 g		RB-10001-13	
External calibration						
210 g	0.001 g	±0.002 g	±0.002 g	5½" x 5½" (13.0 x 13.0 cm)	RB-10001-02	
410 g	0.001 g	±0.002 g	±0.002 g		RB-10001-03	
2200 g	0.01 g	±0.02 g	±0.02 g		RB-10001-04	
4200 g	0.01 g	±0.02 g	±0.02 g	7½" x 6¼" (19.0 x 16.0 cm)	RB-10001-05	
5000 g	0.1 g	±0.2 g	±0.4 g		RB-10001-06	
15000 g	0.1 g	±0.2 g	±0.4 g		RB-10001-07	

Application Tip

Does your balance conform?

Accurate weighing is critical to accurate measurement of production results. Balances play an integral role in quality control throughout most processes. According to standards outlined in USP 29 General Chapter 41,

"Repeatability is satisfactory if two times the standard deviation of the weighed value, divided by the desired smallest net weight, does not exceed 0.10%."

Critical to keeping your balance in compliance with these standards is regular calibration. InnoCal, an accredited metrology lab, offers NIST-traceable calibrations for balances, as well as other equipment and instrumentation. For more information, contact us or visit [InnoCalSolutions.com](#).

Weighing Dishes



A. Hexagonal Weigh Dishes are designed to flex for easy dispensing or pouring liquids or solids. Made of translucent white, anti-static, polystyrene that is resistant to most dilute acids, aqueous solutions, and alcohol bases.

Description	Capacity	Dimensions	Catalog number	Qty/pk	Price
Small	20 mL	1¼" dia x ¾"D (4.4 x 1.0 cm)	RB-01018-10	500	
Medium	50 mL	3" dia x ¾"D (7.6 x 1.9 cm)	RB-01018-12		
Large	200 mL	4¾" dia x 7/8"D (12.1 x 2.2 cm)	RB-01018-14		
Extra-large	350 mL	5½" dia x 1¼"D (14.0 x 3.2 cm)	RB-01018-16		



B. Square Polystyrene Weighing Dishes have a flat bottom with contoured sides and are designed to flex for easy pouring. Made of rubberized anti-static, polystyrene that can withstand temperatures up to 180°F and are resistant to most dilute acids, aqueous solutions, and alcohol bases. Available in translucent white or high contrasts blue that is ideal for use with white powders for increased sample visibility.

Description	Capacity	Dimensions	Catalog number	Qty/pk	Price	Catalog number	Qty/pk	Price
Small, white	20 mL	1½" x 5/16" (4.1 x 0.8 cm)	RB-01017-04	100		RB-01017-05	500	
Small, blue			RB-01017-06	100		RB-01017-07		
Small, white	50 mL	3½" x ¼" (8.9 x 2.5 cm)	—	—	—	RB-01017-13		
Medium, white			100 mL	3½" x 1" (8.9 x 2.5 cm)	RB-01017-14	100		
Medium, blue	RB-01017-16	100			RB-01017-17			
Large, white	330 mL	5½" x 7/8" (14.0 x 2.2 cm)	RB-01017-24	100		RB-01017-25		
Large, blue			RB-01017-26	100		RB-01017-27		



C. "Canoe" Polystyrene Weighing Dishes with Pour Spout, designed specifically for pouring and dispensing without the need to flex the dish. Made of anti-static, polystyrene that can withstand temperatures up to 200°F and are 20% thicker than standard weighing dishes.

Description	Capacity	Dimensions	Catalog number	Qty/pk	Price
Small	20 mL	1½" x 1¼" x 5/16" (4.1 x 3.2 x 0.8 cm)	RB-01018-02	250	
Medium	140 mL	5¼" x 3½" x 1" (13.3 x 8.9 x 2.5 cm)	RB-01018-04		
Large	270 mL	7¾" x 4¾" x 1" (19.7 x 12.1 x 2.5 cm)	RB-01018-06		



D. Vessel Polystyrene Weighing Dishes with Pour-Spout, designed specifically for pouring and dispensing. Made of translucent white, anti-static, polystyrene that is resistant to most dilute acids, aqueous solutions, and alcohol bases.

Description	Capacity	Dimensions	Catalog number	Qty/pk	Price
Small	20 mL	2½"L x 1½"W x ½"D (5.4 x 3.81 x 1.27 cm)	RB-01018-07	500	
Medium	120 mL	5¼"L x 3¼"W x 1"D (13.3 x 8.25 x 2.5 cm)	RB-01018-08		
Large	240 mL	7"L x 4¼"W x 1"D (17.7 x 10.8 x 2.5 cm)	RB-01018-09		



E. Glassine Weighing Papers keep balance pans clean. Moisture-resistant, nonabsorbent papers have a smooth glassine surface to ensure complete sample transfer.

Description	Capacity	Dimensions	Catalog number	Qty/pk	Price
Small	—	3" x 3" (7.6 x 7.6 cm)	RB-01338-00	500	
Medium	—	4" x 4" (10.2 x 10.2 cm)	RB-01338-02		
Large	—	6" x 6" (15.2 x 15.2 cm)	RB-01338-04		



F. Round Crimped-Walled Aluminum Weighing Dishes with Tabs for a wide variety of applications including weighing, moisture testing, wastewater analysis, chemical and pharmaceutical. Each dish features a crimped angled wall and flat bottom with a large finger-tab to accommodate sample numbers. Oil-free and non-coated.

Description	Capacity	Dimensions	Catalog number	Qty/pk	Price	Catalog number	Qty/pk	Price
Small	8 mL	1½" dia x ¾" D (2.9 x 1.0 cm)	—	—	—	RB-01018-26	500	
Medium	20 mL	1¾" dia x ½"D (4.3 x 1.3 cm)	RB-01018-51	100		RB-01017-51	1000	
Large	60 mL	2¼" dia x 5/8"D (5.7 x 1.6 cm)	RB-01018-50	100		RB-01017-50	1000	
Extra-Large	80 mL	2¾" dia x 5/8"D (7.0 x 1.6 cm)	RB-01018-52	100		RB-01017-52	1000	



G. Round Smooth-Walled Aluminum Weighing Dishes. Smooth-sided, flat bottom, multipurpose "utility" dish. Ideal for storage, dispensing, general purpose testing and weighing. Oil-free and non-coated.

Description	Capacity	Dimensions	Catalog number	Qty/pk	Price	Catalog number	Qty/pk	Price
Large	80 mL	2¾" dia x ¾"D (7.3 x 1.7 cm)	RB-01018-28	100		RB-01018-29	1000	
Extra-large	150 mL	4" dia x ¾"D (10.3 x 1.9 cm)	RB-01018-32	100		RB-01018-31	1000	



H. Round Aluminum Weighing/Drying Liners. Designed for moisture determination balances. No coating, oil free. Slightly tapered for stacking.

Description	Capacity	Dimensions	Catalog number	Qty/pk	Price	Catalog number	Qty/pk	Price
Universal	1.2 gr	2½" dia x ¼"D (7.0 x 0.6 cm)	RB-01018-19	50		RB-01018-20	500	
Sartorius style	2.5 gr	4" dia x 5/16"D (10.2 x 0.8 cm)	RB-01018-23	50		RB-01018-24	500	
Ohaus style*	3.3 gr	5" dia x 3/16"D (12.7 x 0.5 cm)	RB-01018-21	100		RB-01018-22	1000	

Cleanroom

Protect against foreign contaminants



Personal protective equipment (PPE) and cleaning supplies and cleaning validation products

What are the cleanroom class standards? A cleanroom class is determined by the number of particles present per unit volume. A class is met if the measured concentration is within the limits of a specified particle size. Use this chart to confirm any specifications presented in this section:

ISO standard	Class name		Particle count limit*
	SI	English	
ISO 3	M 1.5	Class 1	1
ISO 4	M 2.5	Class 10	10
ISO 5	M 3.5	Class 100	100
ISO 6	M 4.5	Class 1000	1000
ISO 7	M 5.5	Class 10,000	10,000
ISO 8	M 6.5	Class 100,000	100,000

*Particles 0.5 microns or larger in a cubic foot of air.

- Personal protective equipment . . . 88–89
- Cleaning supplies 89–91
- Cleaning validation 91–92

Product Selection | Troubleshooting | And More...

1-800-323-4340
or Ch@t Live

Not sure what to choose?
Our expert Application Specialists can help you find the right product for your application.

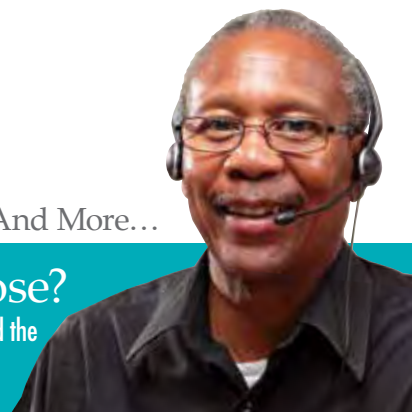

DuPont™ Tyvek® Shoe Cover

Protect against punctures and tears



- Elastic opening at the ankle allows quick and easy removal

Description	Size	Qty/cs	Catalog number	Price/cs
Tyvek shoe covers	Universal	100 pairs	RB-86225-50	

Polypropylene (PP) Shoe Covers

Contain particulates from shoe soles



- 100% spunbond PP
- Available in regular or skid-free

Description	Size	Qty/cs	Catalog number	Price per case	
				1 cs	12 cs
Regular sole	Extra large	150 pairs	RB-86227-82		
Skid-free sole			RB-86227-92		

DuPont™ Tyvek® Boot Cover

Easy to put on



- Elastic opening makes cover easy to put on and take off

Description	Size	Qty/cs	Catalog number	Price/cs
Tyvek boot covers	Universal	50 pairs	RB-86225-10	

DuPont™ ProClean® Cleanroom Boot Covers

Extend protection against contaminants



- Resist slipping with PVC soles
- Elastic top and ankle make them easy to put on

Compliance: ISO Class 5

Size	Qty/cs	Catalog number	Price/cs
Medium	50 pairs	RB-33684-35	
Large		RB-33684-36	
X-large		RB-33684-37	

Microflex® Cleanroom Gloves

Eliminate contamination

- Low residues including particulates
- Textured surface for better gripping
- Latex-free to eliminate adverse reactions
- Ambidextrous



Compliance: ISO Class 4 or 5



Size	Length	Thickness	Qty/bg	Catalog number	Price per bag	
					1 bg	10 bg
Latex ISO Class 4 cleanroom gloves						
Small	12" (30 cm)	6.3 mil	100	RB-86313-35		
Medium				RB-86313-36		
Large				RB-86313-37		
X-large				RB-86313-38		
Nitrile ISO Class 4 cleanroom gloves						
Small	12" (30 cm)	5.2 mil	100	RB-86313-45		
Medium				RB-86313-46		
Large				RB-86313-47		
X-large				RB-86313-48		
Latex ISO Class 5 cleanroom gloves						
Small	12" (30 cm)	6.3 mil	100	RB-86313-15		
Medium				RB-86313-16		
Large				RB-86313-17		
X-large				RB-86313-18		
Nitrile ISO Class 5 cleanroom gloves						
Small	12" (30 cm)	5.2 mil	100	RB-86313-25		
Medium				RB-86313-26		
Large				RB-86313-27		
X-large				RB-86313-28		

KimTech Pure® G3 Sterile Critical Nitrile Gloves

Protect sensitive samples

- Individually packed in pairs, gloves are sterilized for safety
- Lightly textured for better gripping
- Get better mobility with hand specific design
- Powder-free

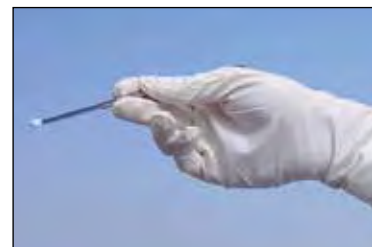

Compliance: Sterilized by gamma irradiation to meet ISO 11137 standards.

Size	Length	Thickness	Qty/bg	Catalog number	Price per bag	
					1 bg	10 bg
Small	12" (30 cm)	5 mil	20 pairs	RB-86486-00		
Medium				RB-86486-01		
Large				RB-86486-02		
X-large				RB-86486-03		

MicroGuard CE™ Cleanroom Coveralls

Protect workers in comfort

- Constructed of a soft, nonwoven polypropylene combined with a microporous film
- Enhanced breathability with a soft interior

Bound seams and tunnelized elastic ensure extremely low linting. Clean processed and individually packaged.

Compliance: ISO Class 5

Description	Qty/cs	Medium	Large	X-Large	XX-Large
Coveralls with elastic wrists and ankles	25	RB-33683-11 /cs	RB-33683-12 /cs	RB-33683-13 /cs	RB-33683-14 /cs
Coveralls with elastic wrists, hood, and boots	25	RB-33683-21 /cs	RB-33683-22 /cs	RB-33683-23 /cs	RB-33683-24 /cs



GammaGuard® Sterile Cleanroom Coveralls

Protect against contamination

- Sterility assurance of 10⁻⁶
- Low linting
- Strong tear resistance

Special fold design protects against potential contamination during gowning. Coveralls feature bound seams, and elastic wrists and ankles. Manufactured in an ISO-certified facility, clean processed, and individually packaged under cleanroom conditions. Recyclable.

Compliance: ISO Class 4



Description	Size	Qty/cs	Catalog number	Price/cs
Coveralls with elastic wrists and ankles	Medium	25	RB-33684-31	
	Large		RB-33684-32	
	X-Large		RB-33684-33	
	XX-Large		RB-33684-34	



Wearwell® PermaTack Tacky Mats

Prevent debris and bacteria from entering sterile areas

- Reusable and economical—replace your multilayer adhesive mats
- Permanently tacky surface removes particles off shoes and wheels; contaminants remain trapped until mat is cleaned
- Removes 98 to 100% of particles if each foot touches the mat three times
- Regenerate the tack by simply cleaning the mat and allowing it to dry
- Adhesive backing allows easy installation and prevents mat movement
- Surface is static dissipative; RTT = 1 x 10⁹ to 1 x 10¹⁰ ohms

Size (W x L)	Color	Thickness	Catalog number	Price
27" x 48" (69 x 122 cm)	Blue	1/8" (0.32 cm)	RB-84580-20	
27" x 72" (69 x 183 cm)			RB-84580-21	
36" x 54" (91 x 137 cm)			RB-84580-22	
27" x 10 ft (69 cm x 3 m)	Blue	1/8" (0.32 cm)	RB-84580-23	
54" x 10 ft (137 cm x 3 m)			RB-84580-24	



Cleanroom

Controlled Environment

DisCide® ULTRA Disinfecting Towelettes and Sprays

No wasting time—works in just one minute!

- No mixing or measuring—solutions are ready to use
- Eliminate separate towel requirements with towelettes



Description	Packaging	Qty/cs	Catalog number	Price
Towelettes, 6" x 6¼" (15.2 x 17.1 cm)	Canister of 160	12	RB-86306-03	
Towelettes, 10½" x 10½" (26.7 x 26.7 cm)	Canister of 60	12	RB-86306-05	
Spray bottle	1 quart bottle	12	RB-86306-13	
Refill bottle	1 gallon bottle	4	RB-86306-15	

Adhesive Roll Mops

Quickly clean surfaces of dust and lint

- Adhesive traps dirt and removes it easily
- Simply peel back layer to expose clean sheet
- Perforated rolls for easy tearing—each roll contains 20 sheets



Roll mop with 7-ft telescopic handle 09411-60



Handheld roll mop 09411-50

Find even more online! Go to [ColeParmer.com](#) to search more than 100,000 products.

Description	Roll mops			Refills	
	Size (W)	Cat. no.	Price	Cat. no.	Price
Handheld	3" (7.6 cm)	RB-09411-40		RB-09411-43	
	9" (22.9 cm)	RB-09411-50		RB-09411-53	
Telescopic handle	18" L x 9" W (45.7 x 22.9 cm)	RB-09411-60		RB-09411-63	

Cole-Parmer® Clean-Wipes™

Won't scratch delicate surfaces

- No residual lint—made of strong, nonwoven cellulose and polyester
- No more struggling with solutions and separate towels—ready to use
- Individually sealed containers for use in cleanrooms



Choose wipes that are premoistened or dry. Convert dry wipes to moistened wipes by adding 8 oz of fluid to container.



Description	Wipe size	Packaging	Catalog number	Price
Premoistened with 70% isopropyl alcohol and 30% deionized water	6" x 9" (15.2 x 22.9 cm)	Canister of 100	RB-33675-03	
Premoistened with 100% deionized water			RB-33675-05	
Dry			RB-33675-07	

Contec® EasySat™ Bucketless Floor Mop

No more buckets and wringers

- Easily clean up to 500 ft² with just one tank of solution
- Dispense only what you need with easy trigger mechanism
- All hardware is autoclavable at 121°C for 30 minutes
- Mop heads are sold separately
- Sterile mop heads are gamma irradiated to 10⁻⁶ Sterility Assurance Level per AAMI/ISO 11137:2006 guides

REQUIRED System Components

- 1) Floor mop
- 2) Mop head



Description	Qty/pk	Catalog number	Price/pk
Bucketless floor mop, 21½" x 57½" x 4¼" (54.6 x 146 x 10.8 cm)	1	RB-09411-30	
Mop head	32	RB-09411-31	
Mop head, textured	32	RB-09411-35	
Mop head, sterile	28	RB-09411-36	
Mop head, textured and sterile	28	RB-09411-37	

TEXWIPE® Cleanroom Swabs















Meet your validation requirements

– Ideal for cleaning small surface areas and for cleaning validation

Sealed swab handles are thermo-formed. Swabs with ESD handles eliminate damage from static electricity and are effective in all humidities.

Fabric Swabs have excellent chemical compatibility. Sealed swabs contain low chloride and other ionic contaminants.

Foam Swabs have sealed handles and are constructed from 100 pores per inch reticulated urethane foam—ideal for solvent dispersion and low-viscosity adhesives. Sealed foam swabs are perfect for removal of solvents and fluxes. Cleanfoam® swabs feature low levels of nonvolatile residue, particle generation, and are constructed of open-cell polyurethane foam for excellent solvent capacity.

Swab tip	Tip description	Handle description	Tip length	Swab length	Compliance	Qty/pk	Catalog number	Price/pk
Fabric swabs								
	Knit polyester	Sealed polypropylene	0.39" (1 cm)	2.75" (7 cm)	—	50	RB-33676-01	
	Knit polyester	Sealed polypropylene	0.66" (1.7 cm)	6.39" (16.2 cm)	—	100	RB-33676-07	
	Knit polyester	Sealed polypropylene	0.16" (0.4 cm)	2.76" (7 cm)	ISO Class 3	500	RB-33677-58	
	Knit polyester	Sealed polypropylene	0.27" (0.7 cm)	6.39" (16.2 cm)	ISO Class 3	100	RB-33677-60	
	Knit polyester	Sealed polypropylene	0.5" (1.3 cm)	5.00" (12.7 cm)	ISO Class 3	100	RB-33677-62	
	Knit polyester	Sealed polypropylene	0.5" (1.3 cm)	5.00" (12.7 cm)	—	100	RB-33677-63	
	Knit polyester	Sealed polypropylene	1.01" (2.6 cm)	5.02" (12.8 cm)	—	20	RB-33677-64	
	Knit polyester	Sealed polypropylene	1.01" (2.6 cm)	5.02" (12.8 cm)	—	20	RB-33677-65	
Foam swabs								
	Foam bud	Hardwood	1.10" (2.8 cm)	6.06" (15.4 cm)	—	500	RB-33676-03	
	Cleanfoam	Polypropylene	0.13" (0.3 cm)	2.75" (7 cm)	ISO Class 5	500	RB-33677-50	
	Flexible cleanfoam	Polypropylene	0.13" (0.3 cm)	2.67" (6.8 cm)	ISO Class 5	500	RB-33677-52	
	Cleanfoam	Polypropylene	0.25" (0.6 cm)	6.37" (16.2 cm)	ISO Class 5	500	RB-33677-55	
	Circular foam	Sealed polypropylene	0.81" (2.1 cm)	5.20" (13.2 cm)	ISO Class 5	100	RB-33677-56	
	Cleanfoam	ESD	0.14" (0.4 cm)	3.50" (8.9 cm)	ISO Class 5	500	RB-33677-72	
	Cleanfoam	ESD	0.15" (0.4 cm)	2.75" (7 cm)	ISO Class 5	500	RB-33677-74	

Kimberly-Clark® Critical Task Wipes

Low-lint, absorbent, soft, and nonabrasive

- Won't scratch delicate surfaces
- Single- and two-ply delicate task wipes are made of a finely textured tissue
- Solvent-resistant Kimtech CL4 wipes are made of a single-ply, nonwoven fabric specially bonded to eliminate surface fibers and trap particles

Description	Compliance	Wipe size	Qty/bx	Box/cs	Cat. no.	Price/cs*
Delicate task wipes						
Kimwipes® EX-L, 1 ply	—	4 1/2" x 8 1/2"	280	1	RB-25000-35	
		4 1/2" x 8 1/2"	280	6	RB-25000-37	
		4 1/2" x 8 1/2"	280	60	RB-33670-04	
		15" x 16 3/4"	140	15	RB-33670-06	
Kaydry® EX-L, 2 ply	—	15" x 16 3/4"	90	15	RB-33670-10	
Cleanroom wipes						
Kimtech CL4 Cleanroom	ISO Class 4	12" x 12"	100	5	RB-33670-20	

*Discounts: Save 10% on 10 to 49 cases and 15% on 50 or more cases.



Find even more online! Go to [ColeParmer.com](#) to search more than 100,000 products.

MAS-100™ Eco Air Sampler

Easily and reliably detect hazardous airborne microorganisms

- Deliver high-accuracy microbial air monitoring in cleanrooms
- Programmable sampling delay up to 60 minutes eliminates remote control devices
- Audible alarm indicates the interruption of a sampling cycle
- Set the sampling volume in 1-L increments or use the convenient preset volumes
- Intelligent charger ensures long battery life—approximately 10 years
- Comply with ISO 14698 part 1 and 2 guidelines



This quality, portable air sampler is easy to handle and delivers highly accurate, reproducible results. Based on the widely accepted Andersen principle, sampler collection apertures correspond to Andersen Level 5 for excellent recovery of viable particles as small as 1 µm. During sample collection, airflow is constantly regulated at 100 L/min for precise counts.

Calibration is made easy with the battery-operated DA-100™ NT digital anemometer (sold separately) and a calibration “reminder” feature. Both the sampler and lid cover are made of anodized aluminum; the lid and dust cover are autoclavable.

Unit uses standard 100-mm petri dishes, providing a low operating cost. Handle doubles as a stand to allow different sampling angles. Software is easily accessed and controlled using single-touch “yes” or “no” responses.

What's included: perforated lid, dust cover, hard carrying case, battery, and universal AC charger.

ISO9001:2008 CERTIFIED SUPPLIER  Air sampler only

Description	MAS-100 Eco air sampler
Catalog number	RB-39152-80
Nominal airflow	100 L/min +2.5%
Preset sampling volumes	50, 100, 250, 500, 1000 L
User-definable sampling volumes	0 to 2000 L
Display	Alphanumeric LCD, 32 characters
Perforated lid	400 holes
Sampling head (dia)	4" (10 cm)
Overall dimensions (H x dia)	9 7/8" x 4 3/8" (25 x 11 cm)
Price	

[RB-39152-90](#) Digital vane anemometer (DA-100 NT), 9 V battery operation. Use to calibrate MAS-100 Eco

[RB-39182-84](#) Aluminum perforated lid

[RB-39182-86](#) Replacement dust cover

[RB-39182-94](#) Replacement battery pack

[RB-39182-88](#) Tripod adapter for MAS-100 Eco

SAS Super 100 Digital Microbial Air Samplers

Collect and quantify microbes in air

- Choose from eight preset sample volumes (10, 20, 30, 50, 100, 200, 500, or 1000 liters) or program up to eight custom sample volumes
- Detachable metal cover with specially designed intake holes creates laminar air flow; flow rate is 100 L/min



Sampler with stainless steel head 33687-02

Set parameters and view readings on the easy-to-read digital display; unit retains previous sample volume. Sample 45,000 liters of air per battery charge. Microbes are driven onto the surface of petri plate for incubation and analysis.

Air sampler with stainless steel head is ideal for cleanroom, pharmaceutical, and electronics applications; meets material requirements for cleanrooms.

Air sampler with aluminum head is ideal for food testing and processing applications.

What's included: a rechargeable NiMH battery pack, battery charger, carrying case, and NIST-traceable certificate of calibration.



Head material	Dimensions	Power	Catalog number	Price
Stainless steel	12 3/4" W x 4 3/4" H x 4 1/4" D	110 to 220 VAC	RB-33687-02	
Aluminum	(31.4 x 10.4 x 10.7 cm)		RB-33687-12	

[RB-33687-52](#) Petri head adapter for 100 x 15 mm petri plates

[RB-33687-50](#) Tripod; with adapter for quick release of air sampler

VERiclean™ Rapid Surface Hygiene Indicator Kit

No need for costly equipment

- Quick food residue detection in just 10 to 60 seconds
- Make sure sanitation processes are followed and in compliance
- Easy to use—spray on surface and swab, results shown on swab

What's included: 60 tests and a bottle of wetting liquid with atomizer.

Contents	Catalog number	Price
60 tests	RB-14040-30	



Labware & Supplies

Essentials for process start-up,
analysis, and quality control



For research, scale-up, pilot operations, and quality control, laboratory supplies are essential. Go to ColeParmer.com for more options.

Carboys	94
Bottles & Beakers	95
Cable ties	96
Sampling bags	96

Product Selection | Troubleshooting | And More...

1-800-323-4340
or Ch@t Live

Not sure what to choose?
Our expert Application Specialists can help you find the right product for your application.



Thermo Scientific™ Nalgene™ Carboys, PC

Maintain visibility of your solution

- Know your fluid levels using 1-gallon and 5-liter increments
- Transport easily with leakproof, polypropylene cap
- Easily dispense with spigot models
- Autoclavable



Buy More...Save More!
20% off on 120+ 15% off on 30 to 119 10% off on 6 to 29 packs or cases

Liters (gallons)	Cap size	Catalog number	Qty/pk	Price/pk
Carboys				
10 (2½)	83B	RB-06063-60	1	
20 (5)	83B	RB-06063-62		
Carboys with spigot				
10 (2½)	83B	RB-06063-80	1	
20 (5)	83B	RB-06063-82		

[RB-06070-22](#) Replacement spigot, PP

[RB-06258-30](#) Replacement caps; PP, 83B. Pack of 2

Cole-Parmer® Economical Heavy-Duty Carboys with Shoulder Handle, PP

Sturdy, octagonal design for added rigidity

- Easier filling and pouring with offset neck
- Leakproof spigot models have tube fitting for easier filling of containers
- Polypropylene closure reduces evaporation
- Autoclavable



Cole-Parmer®

Buy More...Save More!
20% off on 120+ 15% off on 30 to 119 10% off on 6 to 29 packs or cases

Liters (gallons)	Cap size	Catalog number	Qty/pk	Price/pk
Heavy-duty carboys with shoulder handle				
5 (1¼)	45 mm	RB-62507-00	1	
10 (2½)	90 mm	RB-62507-10	1	
20 (5¼)	90 mm	RB-62507-20	1	
Heavy-duty carboys with shoulder handle and spigot				
5 (1¼)	45 mm	RB-62507-05	1	
10 (2½)	90 mm	RB-62507-15	1	
20 (5¼)	90 mm	RB-62507-25	1	

Bio-Simplex™ Carboys, PP

Don't compromise sterility—completely autoclavable

- Eliminate contaminations—select C-Flex® or Sani-Tech® high-purity closures
- No more difficult transporting—handles on top and bottom make carrying easy
- No more leaks—EZ Top® closure provides leakproof top connections
- Chemical resistant polypropylene (PP) is BPA-free and can be heated to 275°F (135°C)



Buy More...Save More!

20% off on 120+ 15% off on 30 to 119 10% off on 6 to 29 packs or cases

Liters (gallons)	Cap size	Spigot	Catalog number	Price/pk
10 (2.6)	83 mm	No	RB-62500-01	
		Yes	RB-62500-03	
20 (5.3)	120 mm	No	RB-62500-05	
		Yes	RB-62500-07	
40 (10.5)	120 mm	No	RB-62500-09	
		Yes	RB-62500-11	

High-Purity EZ Top® Container Closures

Fits carboy size	Material	No. of ports	Catalog number	Price
10 L (2.6 gal.)	C-Flex	2	RB-62500-47	
	Sani-Tech	3	RB-62500-53	
20 L (5.3 gal.)	C-Flex	2	RB-62500-49	
	Sani-Tech	3	RB-62500-55	
40 L (10.5 gal.)	C-Flex	2	RB-62500-51	
	Sani-Tech	3	RB-62500-57	

[RB-62500-41](#) Replacement EZ Top closed top cap, 83 mm. 2/pk

[RB-62500-43](#) Replacement EZ Top closed top cap, 120 mm. 2/pk

[RB-62500-45](#) Replacement spigot, fits all sizes. 2/pk

Thermo Scientific™ Nalgene™ FDA-Compliant Carboys, PP

Get a better grip with two-handle construction

- Dispense solutions more quickly with optional spigot models—accept ¼", ½", or ⅝" ID tubing
- Leakproof polypropylene (PP) cap
- Autoclavable



Buy More...Save More!

20% off on 120+ 15% off on 30 to 119 10% off on 6 to 29 packs or cases

Liters (gallons)	Cap size	Catalog number	Qty/pk	Price/pk
FDA-compliant carboys, USP Class VI				
10 (2½)	83B	RB-06063-12	1	
20 (5)	83B	RB-06063-22		
50 (13)	83B	RB-06063-32		
FDA-compliant carboys with spigot, USP Class VI				
10 (2½)	83B	RB-06064-50	1	
20 (5)	83B	RB-06064-60		
50 (13)	83B	RB-06064-70		

Thermo Scientific™ Nalgene™ Filling/Venting Caps, PP

Easy aseptic liquid transfer

Filling/Venting Caps allow aseptic liquid transfer. Include 6" (15 cm) and 30" (76 cm) lengths of platinum-cured silicone tubing. Autoclavable.

Fitting Kits include two PP fittings, two acetal nuts, two silicone gaskets, thermoplastic elastomer (TPE) port cap, instructions, and template. Autoclavable.

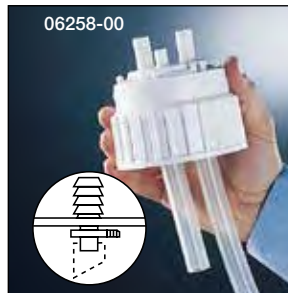

Buy More...Save More!
20% off on 120+ 15% off on 30 to 119 10% off on 6 to 29 packs or cases

Tubing ID	Ports	Cap size	Catalog number	Qty/pk	Price/pk
Filling/venting caps					
1/2"	2 tubing, 1 venting	83B	RB-06258-00	1	
1/4"		53B	RB-06258-10	1	
1/4"		83B	RB-06258-20	1	
Barbed bulkhead fitting kits					
1/4"	—	—	RB-06259-10	2	
1/2"	—	—	RB-06259-00	2	

Thermo Scientific™ Nalgene™ Heavy-Duty Bottles, PP

Withstand repeated full vacuum applications

- Use under repeated full vacuum for 24 hours at 68°F (20°C)
- PP closure with thermoplastic elastomer (TPE) gasket
- Autoclavable



Buy More...Save More!
20% off on 120+ 15% off on 30 to 119 10% off on 6 to 29 packs or cases

Capacity, mL (oz)	Cap size	Catalog number	Qty/pk	Price/pk
250 (8)	53B	RB-06257-05	6	
1000 (32)		RB-06257-10	6	
2000 (64)		RB-06257-20	2	
4000 (128)	83B	RB-06257-00	1	
5000 (160)		RB-06257-30		

Sample Bottles, HDPE

Store samples without breaking your budget

- Provide good chemical resistance for a wide range of uses
- Bottles are made of HDPE; included cap is made of polypropylene and lined with polyethylene foam
- Easy mailing with optional mailing tube



Buy More...Save More!
20% off on 120+ 15% off on 30 to 119 10% off on 6 to 29 packs or cases

Capacity mL (oz)	Qty/pk	Catalog number	Price/pk
180 (6)	300	RB-06043-01	
250 (8)	329	RB-06049-01	
500 (16)	198	RB-06050-05	

[RB-06049-30](#) Mailing tubes for bottle 06049-01. Carton of 240

Graduated Sample Containers, PP

Graduated for easier sampling

- Durable design—translucent, unbreakable, and chemical resistant
- Sterile containers are individually wrapped



Buy More...Save More!

20% off on 120+
15% off on 30 to 119
10% off on 6 to 29 packs or cases



Capacity mL (oz)	Description	Catalog number	Qty/pk	Price/pk
118 (4)	Sterile, no tab	RB-06049-40	100	
118 (4)	Nonsterile with white tab	RB-06049-50	500	

Low-Form Beakers with Handles, PP

Get a grip! Molded handles for easy pouring

- Graduations in milliliters and liters
- Withstand temperatures to 275°F (135°C)
- Autoclavable



Buy More...Save More!
20% off on 120+ 15% off on 30 to 119 10% off on 6 to 29 packs or cases

Capacity mL (oz)	Catalog number	Qty/pk	Price/pk
500 (1/2)	RB-61000-22	4	
1000 (1)	RB-61000-30	1	
2000 (2)	RB-61000-42	2	
3000 (3)	RB-61000-52	2	
5000 (5)	RB-61000-62	1	

Cole-Parmer® Tri-Corner Beakers, PP

Easy pouring from three sides

- Ideal for stirrers—flat bottom keeps stir bars centered
- Accurate to ±5%; molded graduations
- Autoclavable; withstand temperatures to 250°F (121°C)



Buy More...Save More!
20% off on 120+ 15% off on 30 to 119 10% off on 6 to 29 packs or cases

Capacity mL (oz)	Graduations (mL)	Cat. no.	Qty/pk	Price/pk
50 (1.5)	10	RB-06020-01	100	
100 (3.5)	10	RB-06020-03		
250 (8)	20	RB-06020-05		
400 (13)	40	RB-06020-07	100	
800 (26)	50	RB-06020-09		
1000 (32)	50	RB-06020-11		
Five of each above	—	RB-06010-07	30	

Autoclavable Solid-Design Cable Ties, PP

Keep items bundled during autoclaving

Polypropylene (PP) cable ties resist a number of chemicals and are UV-resistant.



Length	Bundle dia	Tensile strength	Color	Catalog number	Price/pk of 1000
4" (10.2 cm)	3/4" (1.9 cm)	11 lb	Natural	RB-06830-85	
8" (20.3 cm)	1 1/4" (4.4 cm)	25 lb	Black	RB-06830-95	

Solid-Design Cable Ties, Nylon

Won't corrode or stretch—made from injection-molded plastic

- Simply bend tip and pull through locking mechanism to secure
- Won't lose tension—even in vibrating, oily, or wet environments
- Withstand temperatures to 185°F (85°C), with melting point of 495°F (257°C)

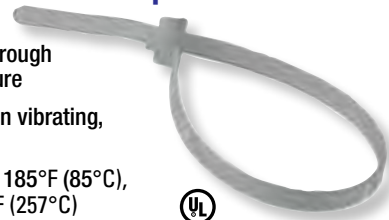

Length	Bundle dia	Color	Catalog number	Qty/pk	Price/pk
Miniature, 18-lb tensile strength					
4" (10.2 cm)	7/8" (2.2 cm)	White	RB-06830-52	1000	
Intermediate, 40-lb tensile strength					
5 1/2" (14.0 cm)	1 1/4" (3.2 cm)	White	RB-06830-54	1000	
8" (20.3 cm)	2 1/8" (5.4 cm)	White	RB-06830-30	1000	
Standard, 50-lb tensile strength					
7 1/2" (19.1 cm)	1 3/4" (4.4 cm)	White	RB-06830-56	1000	

WHIRL-PAK® Sterile Sampling Bags, LDPE

Keep samples safe—easy-seal bags hold solids and liquids

- Quick and easy sealing—flip bag around wire/tape and bend to seal
- No more poking—puncture-proof tabs keep wire intact even after extensive use

High-temperature bag is for hot fill samples with a temperature up to 215°F (102°C). The FDA-compliant film is a blend of low-density polyethylene and nylon that will hold liquids, solids, sauces, gravies, and other samples having a high temperature. Bag is self standing and does not need a rack or special holder to keep it upright, making sample collection safe and easy. With white labeling area. **Caution:** Do not put bag in boiling water.

Buy More...Save More!
20% off on 120+ 15% off on 30 to 119 10% off on 6 to 29 packs or cases

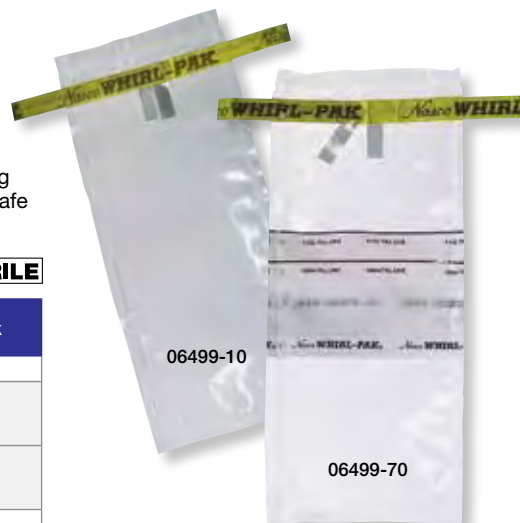

Capacity oz (mL)	Size (W x L)	Thickness (mil)	Catalog number	Qty/pk	Price/pk
Sampling bags without white labeling area					
4 (118)	3" x 7 1/4" (7.6 x 18.4 cm)	2.25	RB-06499-10	500	
18 (532)	4 1/2" x 9" (11.4 x 22.9 cm)	2.5	RB-06499-20	500	
24 (710)	6" x 9" (15.2 x 22.9 cm)	3.0	RB-06499-30	500	
36 (1065)	5" x 15" (12.7 x 38.1 cm)	3.0	RB-06499-40	500	
42 (1242)	6" x 15" (15.2 x 38.1 cm)	3.0	RB-06499-50	500	
69 (2041)	7 1/2" x 15" (19.1 x 38.1 cm)	3.0	RB-06499-54	500	
Stand-up sampling bags with white labeling area					
4 (118)	3" x 7 1/4" (7.6 x 18.4 cm)	2.5	RB-06499-16	500	
18 (532)	4 1/2" x 9" (11.4 x 22.9 cm)	3.0	RB-06499-21	500	
24 (710)	6" x 9" (15.2 x 22.9 cm)	3.0	RB-06499-31	500	
27 (798)	5" x 12" (12.7 x 30.5 cm)	3.0	RB-06499-32	250	
36 (1065)	5" x 15" (12.7 x 38.1 cm)	4.0	RB-06499-33	250	
42 (1242)	6" x 15" (15.2 x 38.1 cm)	4.0	RB-06499-34	250	
69 (2041)	7 1/2" x 15" (19.1 x 38.1 cm)	4.0	RB-06499-35	250	
Sampling bags with white labeling area					
2 (58)	3" x 5" (7.6 x 12.7 cm)	2.5	RB-06499-60	500	
4 (118)	3" x 7 1/4" (7.6 x 18.4 cm)	2.25	RB-06499-70	500	
7 (207)	3 3/4" x 7" (9.5 x 17.8 cm)	2.5	RB-06499-72	500	
13 (384)	5 1/4" x 7 1/2" (13.3 x 19.1 cm)	2.5	RB-06499-74	500	
18 (532)	4 1/2" x 9" (11.4 x 22.9 cm)	2.5	RB-06499-80	500	
24 (710)	6" x 9" (15.2 x 22.9 cm)	3.0	RB-06499-85	500	
27 (798)	5" x 12" (12.7 x 30.5 cm)	3.0	RB-06499-87	500	
69 (2041)	7 1/2" x 15" (19.1 x 38.1 cm)	3.0	RB-06499-89	500	
92 (2721)	10" x 15" (25.4 x 38.1 cm)	4.0	RB-06499-94	250	
123 (3637)	10" x 20" (25.4 x 50.8 cm)	4.0	RB-06499-98	250	
184 (5441)	15" x 20" (38.1 x 50.8 cm)	4.0	RB-06499-99	100	
High-temperature bag					
18 (532)	4 1/2" x 9" (11.4 x 22.9 cm)	3.0	RB-06498-16	500	



Standup bags stay upright



Water scoop holds bag open for easy filling



Rack

RB-66203-10 Carrying rack for 2- and 4-oz bags. Double-grid design keeps bags upright and has 15 compartments. Vinyl coated, autoclavable

RB-66203-00 Carrying rack for 18-oz bags. Double-grid design keeps bags upright. Rack has 20 compartments. Vinyl coated, autoclavable

RB-06498-12 Water scoop, 18" (45.7 cm) L coated handle. Two alligator clips hold a variety of bag sizes



Your Source for Custom Bioprocess Solutions

- ◆ **Save valuable time**—get custom assemblies crafted to your exact specifications
- ◆ **Choose your components**—select from your trusted brands
- ◆ Ensure **quality and regulatory compliance** with complete validation





- ✓ Correct this address
- ✓ Unsubscribe from future mailings
- ✓ Remove name gone from organization

Simply go to www.wastefreemail.com and enter code from green box below left or fax this cover to 571-970-6072

Presorted Standard
U.S. Postage
PAID
Cole-Parmer
Instrument Company

Printed in U.S.A.

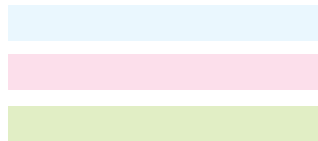

99999-91

4355

Look inside find products you need from Laboratory to Fill/Finish

Introducing **New** and **Innovative Products** from **MASTERFLEX®**

Masterflex Open-Head Interlock Sensor Technology

Enhance worker protection with drives that automatically shut down when the pump head is opened

See page 2



Masterflex Drives with Advanced Networking & Communication

Faster, less expensive automation integration—no gateways or adapters needed

See page 2



Masterflex Drives with Quattroflow™ Pump Heads

The perfect pair for pumping delicate biologic fluids

See page 14



Masterflex Ultrasonic Flow Sensors

Ensure consistent flow rates

See page 21

