

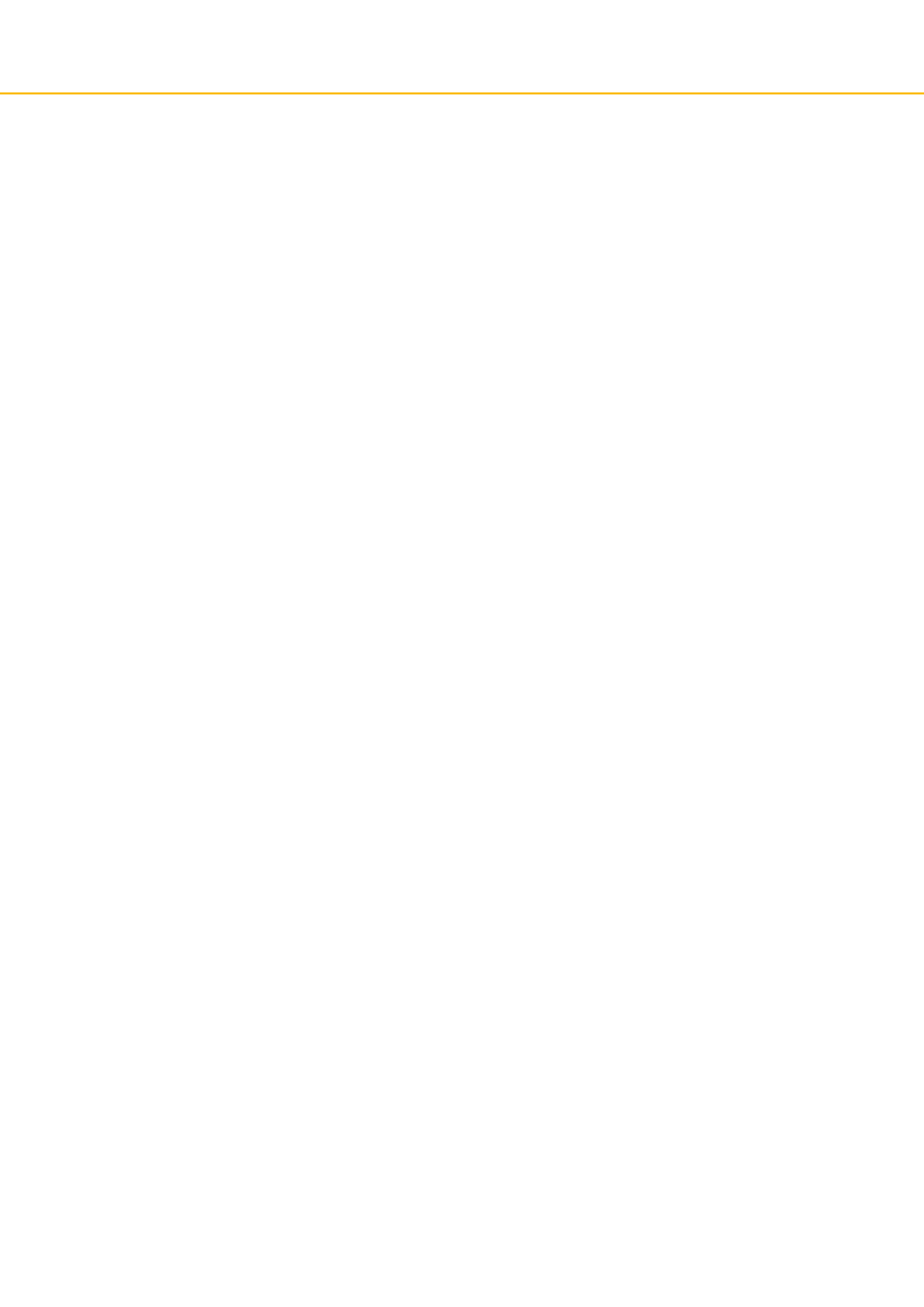

Metal Seals

Design Guide





Introduction	4	Temperature Capabilities – Nickel Alloys	D-54
Section A – General Information		Temperature Capabilities – Cobalt Alloys	D-55
Advantages of Metal Seals	A-8	Temperature Capabilities – Other Materials	D-55
How to Use the Design Guide	A-9	Aerospace Material Specification (AMS) Reference	D-56
Market Applications	A-10	Yield Strength, Relaxation & Springback	D-56
Section B – Metal Seal Type Selection		Platings, Coatings and Finishes	
Selecting the Metal Seal Type for Your Application	B-11	Temper Codes	D-58
Seal Selection at a Glance	B-14	Finish Codes	D-59
Section C – Size Selection		Finish Thickness Selecting Guidelines	D-60
Face Seals		Silver-Indium Plating	D-61
MCI Metal C-Ring, Internal Pressure Face Seal	C-16	TriCom® Plating	D-62
MCE Metal C-Ring, External Pressure Face Seal	C-18	TriCom-HT™ Plating	D-64
MSI Spring Energized Metal C-Ring, Internal Pressure Face Seal	C-20	Section E – Technical Information Performance Data	
MSE Spring Energized Metal C-Ring, External Pressure Face Seal	C-22	Load, Deflection and Springback / Terminology	E-68
MEI Metal E-Ring, Internal Pressure Face Seal	C-24	Metal C-Ring Performance	E-70
MEE Metal E-Ring, External Pressure Face Seal	C-26	Metal E-Ring Performance	E-72
MOI Metal O-Ring, I.D. Vented, Internal Pressure Face Seal	C-28	Metal U-Ring Performance	E-73
MON Metal O-Ring, Plain, Internal Pressure Face Seal	C-28	Metal O-Ring Performance	E-74
MOP Metal O-Ring, Pressure Filled, Internal Pressure Face Seal	C-28	Metal Energized C-Ring Performance	E-76
MOE Metal O-Ring, O.D. Vented, External Pressure Face Seal	C-30	Metal Wire Ring Performance	E-77
MOM Metal O-Ring, Plain, External Pressure Face Seal	C-30	Leak Rate Information	E-78
MOR Metal O-Ring, Pressure Filled, External Pressure Face Seal	C-30	Fatigue and Stress Relaxation	E-79
MUI Metal U-Ring, Internal Pressure Face Seal	C-32	Installation Guidelines	
MUE Metal U-Ring, External Pressure Face Seal	C-34	Surface Roughness	E-80
MWI Metal Wire Ring, Internal Pressure Face Seal	C-36	Surface Flatness	E-80
MWE Metal Wire Ring, External Pressure Face Seal	C-38	Surface Hardness	E-81
Axial Seals		Compression Limiters	E-81
MCA Metal C-Ring, Axial Seal	C-40	Bolt Load and Tightening Torque Guidelines	E-82
Seals for Standard Applications		Seal Shaping Requirements for Non-Circular Seals	E-84
Boss Seal for MS-33649 Fluid Connection Boss and MS-33514/33656 Fitting Ends	C-42	Manufacturing Specifications	
Metal E-Ring for AS1895 Flanges	C-44	Roundness and Flatness	E-85
Metal O-Ring for Aerospace Standards	C-45	Surface Finish	E-85
		Metal O-Ring Weld Finish	E-85
Section D – Material Selection Process		Preferred C-Ring and Spring Energized C-Ring Sizes	E-86
Selecting the Material		Tolerance Reference Table	E-92
Material Codes for Non-Spring Energized Seals	D-52	Conversion Tables	E-93
Material Codes for Spring Energized Seals	D-53	Section F – Additional Styles	
Temperature Capabilities – Stainless Steel	D-53	Formed Seals	F-96
		Precision Machined Seals	F-96
		Beaded Gaskets	F-97
		Additional E-Ring Styles	F-98
		Frequently Asked Questions	F-99
		Application Data Sheets	
		Face Seal	F-103
		Axial Seal	F-104
		Parker’s safety programme	F-105

The Global Leader in Sealing Technology



Parker Hannifin specializes in high performance engineered seals and sealing systems. The Advanced Products Business Unit was founded in 1954 and is headquartered in North Haven, Connecticut where a 60,000 square foot facility is home to a state-of-the-art metal seal plant, with fully integrated engineering analysis, design, production, assembly and test.

In addition to its diversified line of sealing components, Parker Hannifin offers fully engineered sealing systems for specialty applications over a wide range of challenging environments. Parker Hannifin's highly respected jet engine seals are widely used in commercial and aerospace engines and include E-rings, C-rings, O-rings and AS1895 seals. Parker also supplies cryogenic and high temperature metallic seals for the space shuttle main engine and other major rocket programs.

Parker Hannifin holds ISO 9001, AS9100, FAA approvals and various NADCAP approvals for special processes.



Your True Partner for Sealing Solutions

We focus on serving the fluid containment needs of high-technology industries demanding absolute integrity and reliability. With our extensive and integrated line of seals and sealing systems we are able to design, test, analyze and produce the total fluid containment and sealing needs for extreme environments.

We have a reputation for innovative designs, high quality products, responsive support and a long history of producing customized solutions for unique extreme environments. You will find our company a vigorous partner in both development and production of your sealing system.



Serving the Needs of High-Technology Industries

Dependable Sealing Systems for Safety-Critical and Extreme Environments

Making dependable sealing systems for safety-critical and extreme applications goes beyond excellence in design and manufacturing. It also means a deep commitment to quality... as a way of life.

Our company's diversification includes a wide variety of industries such as aerospace, semiconductor, oil and gas, power generation, military, transportation and automotive.

Complete Sealing Systems

High Performance Engineered Seals and Sealing Systems

A sealing system consists of the main sealing elements such as our metal and polymer seals. These are mated with other system components such as flanges, clamps, connectors, valve bodies, to create a complete sealing system.

We are your partner for the entire sealing systems process from concept, design and development, through qualification and production. We provide expertise in complete project management, engineering, production, assembly and test in order to provide you a turnkey solution.



Contract R&D

We offer our services in the research and development of materials and sealing technology. Our team of experienced engineers and scientists are able to develop and test new products and materials, perform extensive research and create new technology.



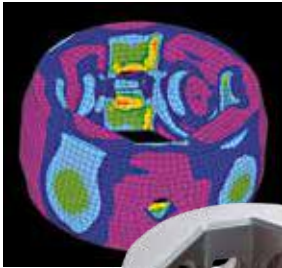

State-of-the-Art Engineering

Dependable Sealing Systems for Safety-Critical and Extreme Environments

Our technical strength comes from a broad based R&D and engineering staff with specialties across many scientific disciplines and engineering fields. Our engineering capabilities include:

- Fatigue and stress relaxation analysis
- Complete sealing system design, development and qualification testing in accordance with various industry design codes, including, American Petroleum Institute API 6A and API 17D, American Society of Mechanical Engineers ASME B31.3, ASME Section III, ASME Section VIII, Society of Automotive Engineers and Aerospace Standards
- Classical stress analysis
- Non-linear finite element analysis (FEA), 2-D and 3-D
- 3-D solid modeling and design of sealing systems components
- Modeling of loads, pressure effects and system dynamics for determining deflection and pressure induced stresses

Materials Research

Comprehensive research, analysis and testing of metals, polymers, thermoplastics and composites enables us to develop and utilize materials that are best suited for your application. Factors such as strength, hardness, corrosion, temperature, fatigue, wear, friction, lubricity, elongation and extrusion are considered. Mindful of commercial issues, our material evaluation process also takes into consideration issues such as cost, availability and sourcing.

Metallurgy

Our ongoing research program is focused on increasing the working temperature limits for seals. Exploring both metal and metal composite technologies that are less prone to stress relaxation at high temperatures, we are developing seals for tomorrow's gas turbine and rotary engines.

Tribology

Studying the interaction of sliding surfaces, we employ multiple disciplines including the physics of friction, material science of wear and chemistry of lubrication. Testing diverse combinations of materials, heat treatments, surface treatments and coatings ensures our sealing systems will endure the dynamic requirements of the application and meet your requirements for performance and integrity.



Manufacturing Technologies

Our core manufacturing technologies include metal roll and die forming, various fusion weld methods, CNC machining of metals, polymers and thermoplastics, vacuum heat treatment and electroplating. Production engineering skills include CAE development of roll and die forming tools, as well as the design and development of specialized forming machines and proprietary welding processes.

Test Capabilities

An important part of the development process of a sealing system is the rigorous testing of the new design. We perform comprehensive qualification testing of the sealing systems as well as 100 % functional testing of production units prior to delivery if desired.

Our extensive testing capabilities include:

- Pressure testing: 10^{-5} torr to 140 MPa (20,000 psi)
- Helium mass spectroscopy leakage testing: 10^{-11} mbar \times liter/sec
- Temperature range: Cryogenic to 982 °C (1800 °F)
- High cycle fatigue testing
- Dynamic wear, friction and torque testing
- Extrusion testing
- Load versus deflection seal testing and measurement

We are also able to design elaborate test fixtures and equipment to meet the testing and functional requirements of your unique sealing system. When necessary, we collaborate with outside test facilities, universities, and our customer's own engineering departments and laboratories for specialized performance and qualification testing.



Total Project Management – Budgeting, Scheduling & Planning

The Key to Successful Projects

Every Parker sealing system is treated with a complete project management approach to ensure all aspects of the program run smoothly, efficiently and in strict adherence to your schedule requirements. The project manager is your single point contact; however, you also have access to our engineering staff throughout the program.

Our project manager develops a comprehensive program schedule identifying all project milestones and the “critical path”. The project manager then coordinates the responsibilities of all functional teams including engineering, manufacturing, purchasing and quality control ensuring all tasks are performed on time. We believe the philosophy of a dedicated project manager is key to the success of the program.





The Parker Metal Seal

The most extreme environments demand metal seal sealing solutions. Resilient metal seals meet the challenges of high temperatures or cryogenics, high pressures or hard vacuum, corrosive chemicals and even intense levels of radiation performing dependably year after year.

Advantages of Metal Seals

- **Independent Optimization of Functional Components** means each discrete function including load, springback and outer sealing layer ductility/hardness can be optimized to ensure highest seal performance in every situation.
- **Directly Bonded Electroplating** onto the load bearing substrate eliminates unnecessary parts and failure modes.
- **Pressure Energization** uses internal hydrostatic pressures beneficially to supplement the self-energization forces from the tubing, jacket or spring. This becomes particularly helpful at high pressures over 21 MPa (3,000 psi) enabling metal seals to seal at 170 MPa (25,000 psi) and beyond, without risk of blow-by during proof or burst testing.
- **Total Metal Seal Service** covers custom and standard sized seals from 6 mm to 7.60 m (0.250" to 300"), including circular and non-circular shapes. We also offer the complete range of MS metal O-ring sizes, all AS1895 E-ring sizes, and the fastest delivery of C-rings from our preferred size list (see page E-86).
- **Rapid Response and JIT** (just-in-time) deliveries are assured due to design, testing and all manufacturing processes (including roll and die-forming, machining, welding, heat-treatment, electroplating) being performed within our own facilities.

Metal Seals are the Preferred Solution in many jet engine and space applications as well as oil, gas, and chemical equipment, plastic molding, diesel engines and a growing variety of industrial equipment. With ever more stringent pollution and leakage legislation, plus the demand for greater efficiency and lifetime reliability, metal seals provide the highest integrity sealing solutions for today's world and tomorrow's.

How To Use the Design Guide

The Advanced Products Business Unit's line of resilient metal seals are offered in a variety of sizes, shapes, cross sections and materials to satisfy the sealing needs of your extreme environments.

The metal seal part number defines all of the key design elements as indicated on the following page.

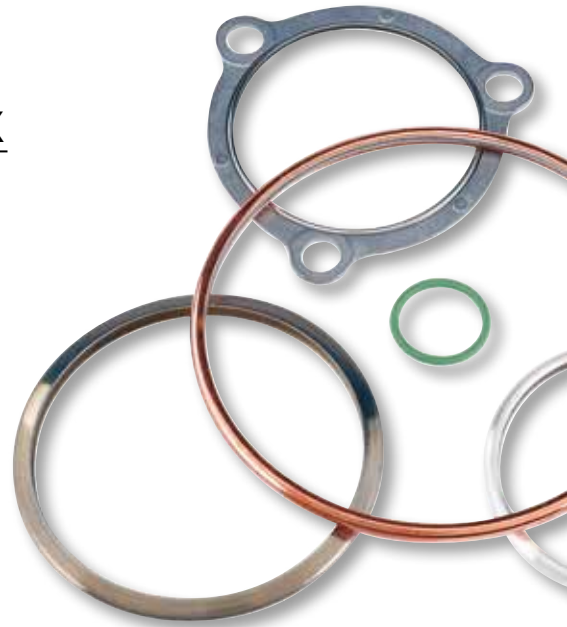
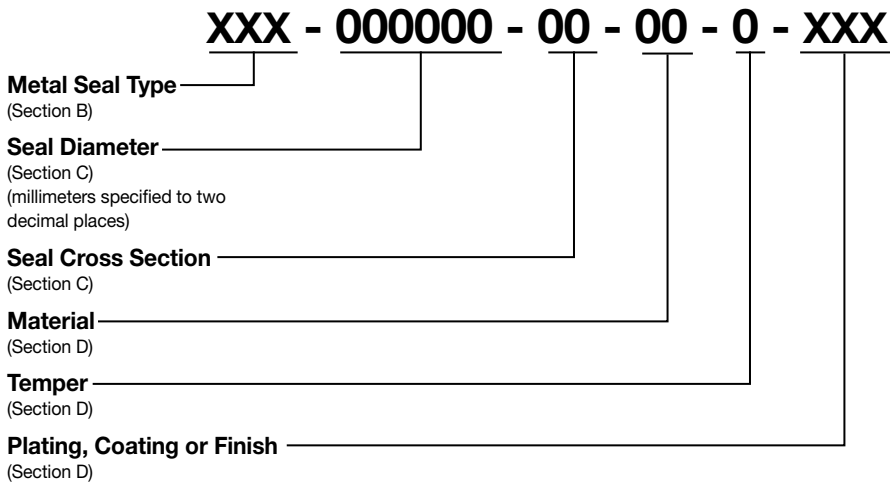

This design guide provides a rapid, unambiguous, self-selection process with all the features, applications and limitations of each product clearly stated. The guide is organized into sections which easily allows you to determine the part number of the metal seal that is right for your application.

- Section B** helps you to determine which metal seal type is most appropriate for your application.
- Section C** is organized by metal seal type. Having selected the best metal seal type from Section B, simply turn to the page in Section C for the seal selected and you will find all the groove and metal seal dimensions you need.
- Section D** lists the many available metal seal materials and assists you in determining which combination of materials is most appropriate for your sealing environment.
- Section E** provides supporting technical information and recommendations.
- Section F** shows a number of other metal seal designs which are available for unique applications when only a special seal will do. In these cases, please contact one of our applications engineers at any of our worldwide offices and we will be happy to assist you. Please send us your application data sheet (Page F-103 & F-104) for a fast, complete response.

Section A – General Information

Market Applications

Aerospace						
Application	C-Seal	E-Seal	O-Ring	Mil Std	Boss Seal	Engineered
Accessories	✓					
Gas Turbine Bleed Air		✓		✓		
Gas Turbine Compressor Sections		✓				
Gas Turbine Cooling Air		✓				✓
Gas Turbine Fuel Nozzles						✓
Gas Turbine Fuel Systems	✓		✓			✓
Gas Turbine, Turbine Sections		✓				
Hydraulic Systems	✓					
MS 33649 Fluid Connection Boss					✓	
MS Standards				✓		
Probe and Sensors	✓					
Rocket Fuel Systems	✓					✓
V-Band Coupling		✓				
Oil & Gas, Power Generation						
Application	C-Seal	E-Seal	O-Ring	Mil Std	Boss Seal	Engineered
Gas Turbine Casing	✓					✓
Gas Turbine Combustor						✓
Gas Turbine Compressor Sections		✓				
Gas Turbine Cooling Air		✓				✓
Gas Turbine Fuel Nozzles	✓					✓
Gas Turbine Fuel Systems	✓					
Gas Turbine, Turbine Sections		✓				✓
Gas Turbine Vane Seal		✓				✓
Heat Exchangers	✓		✓			
MS 33649 Fluid Connection Boss					✓	
Nuclear Waste Container Casks	✓	✓				✓
Oil Field Control Systems						✓
Piping and Flanges	✓					
Steam Turbine Casing Seals	✓					✓
Valve Seats	✓					
Valves	✓	✓				✓
Military						
Application	C-Seal	E-Seal	O-Ring	Mil Std	Boss Seal	Engineered
Aerospace Standards				✓		
Imaging Devices	✓					✓
Missiles	✓	✓	✓	✓		✓
MS 33649 Fluid Connection Boss					✓	
Satellite Systems	✓					✓
Vehicle Engine Exhaust Systems	✓					✓
Weapons	✓					✓
Semiconductor						
Application	C-Seal	E-Seal	O-Ring	Mil Std	Boss Seal	Engineered
Gas Delivery Systems						✓
Heavy Duty Mobile, Transportation Automotive						
Application	C-Seal	E-Seal	O-Ring	Mil Std	Boss Seal	Engineered
Turbochargers	✓					✓
Engine Exhaust Systems	✓					✓

Selecting the Metal Seal Type for Your Application

Metal seals are produced in a number of standard designs which are appropriate for use in a broad spectrum of the most commonly encountered applications. The **Metal Seal Type** is designated in the part number as shown below.

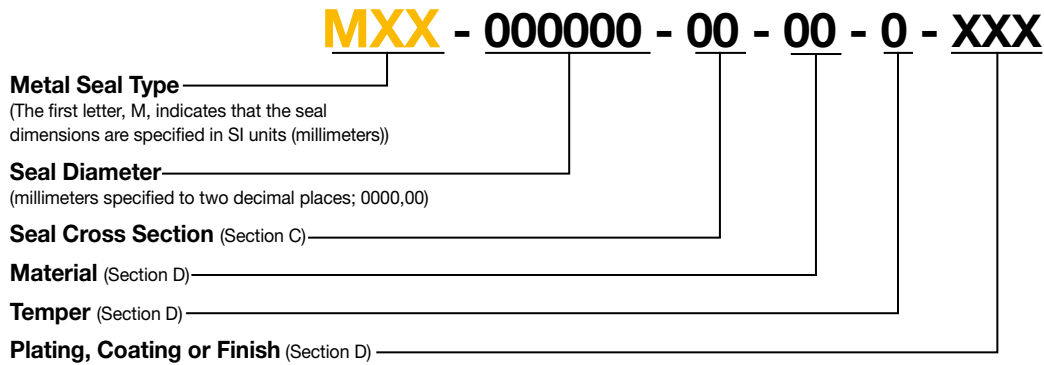

The flow diagrams on the following pages are designed to provide guidance to the appropriate metal seal type for your application. There are two basic types of applications:

Face Seal Applications

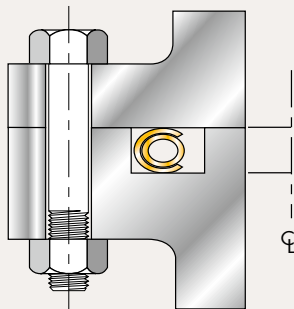

High Load
Generally, the high load seals provide greater leak tightness and are preferred when there is sufficient seating load (the load required to compress the seal) and little flange movement due to thermal excursions, vibrations, etc.
See page B-12.

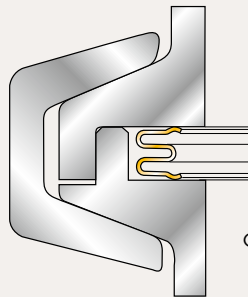

High Elasticity
Lower load seals are frequently used when resiliency or springback is needed to maintain effective sealing during flange separation or rotation. Additionally, low load seals are suitable for applications where seating load is limited or there is concern about yielding or damaging the mating hardware surfaces.
See page B-13.

Axial Seal Applications

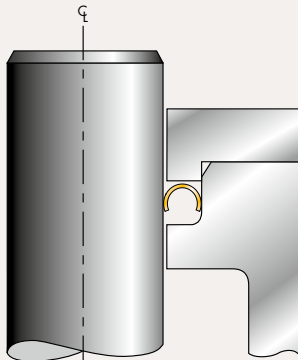

MCA, Axial C-Ring
can be used as either a static seal or in semi-dynamic applications such as a quarter-turn valve stem seal.
See page C-41.

Face Seals for Higher Seating Loads & Lowest Leakage Rates

(Greater than 17.5 N/mm circumference)

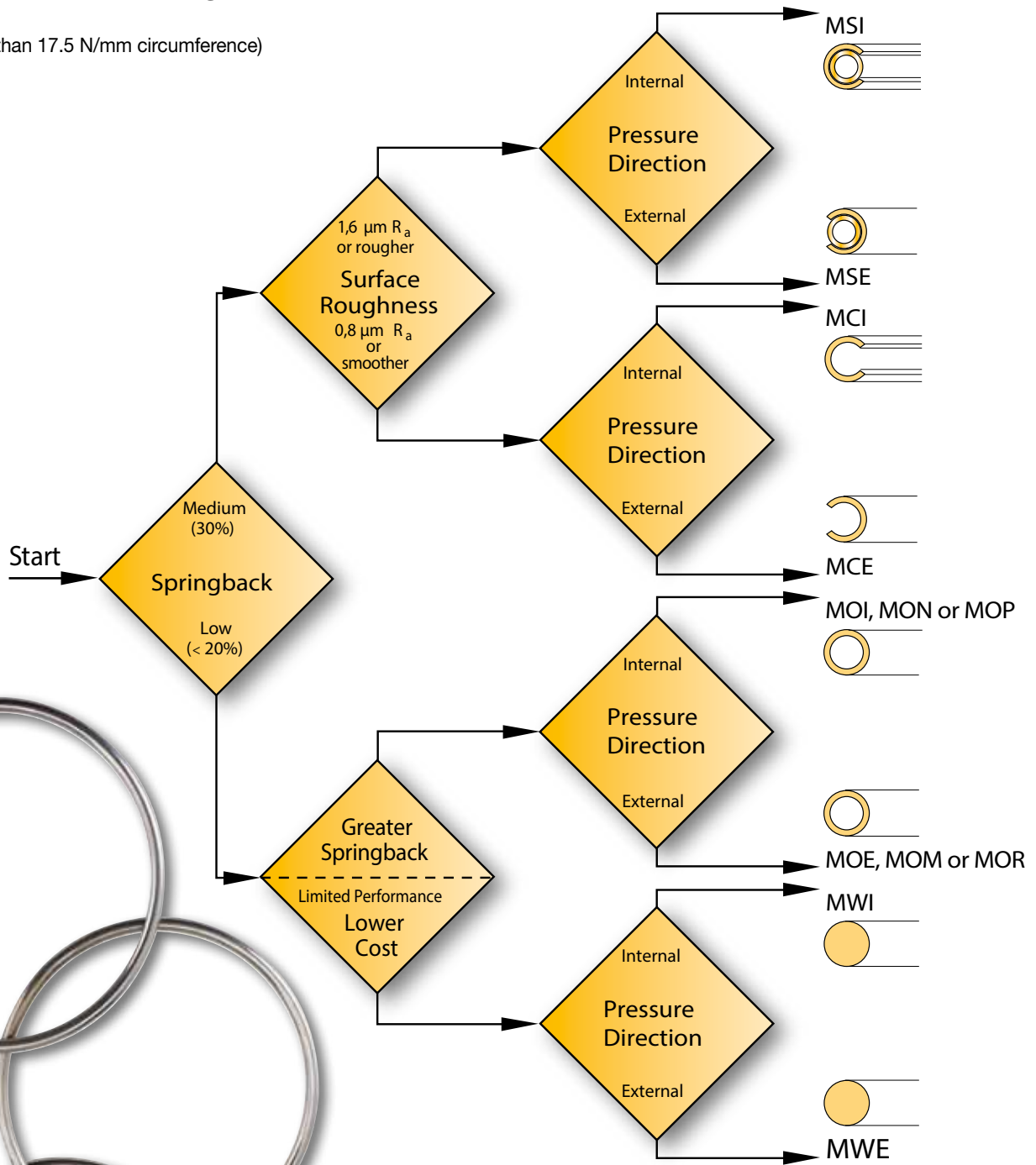

Face Seals for Lower Seating Loads & Higher Springback

(Less than 17.5 N/mm circumference)

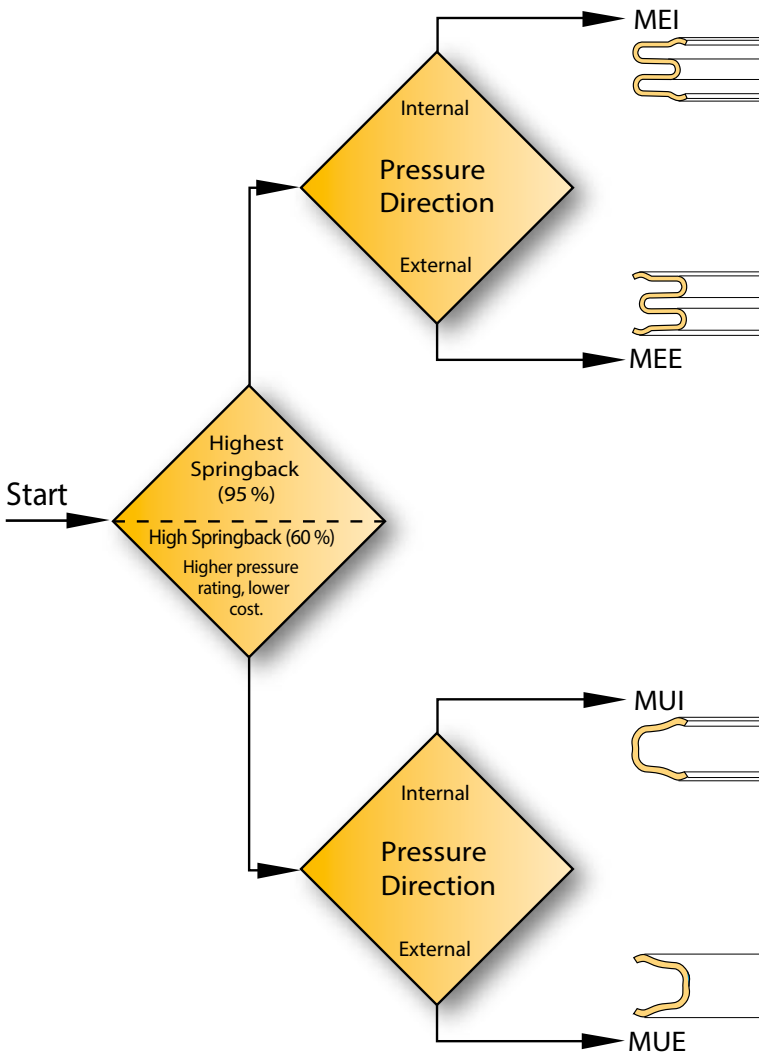

Seal Selection at a Glance

In addition to the metal seal selection flow diagrams on the preceding pages, the following rating table provides simple guidelines which can be used to confirm the appropriate metal seal selection. Refer to the table below for a comparison of metal seal types.

- Ratings:**
- Excellent
 - Very Good
 - Good
 - Fair
 - ⊘ Not Recommended

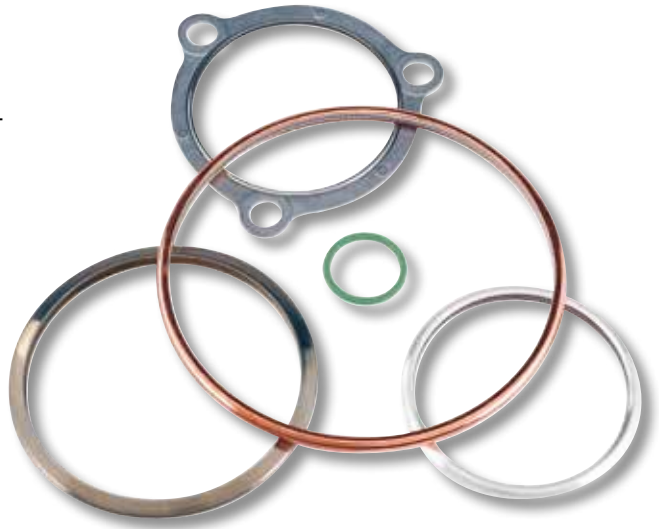

Seal Type	Sealing Requirements					
	High Springback	Low Load	High Load	Low Leak Rate	Pressure Capability	Low Cost
Metal C-Ring	○	○	○	●	●	●
Metal E-Ring	●	●	⊘	○	○	○
Metal O-Ring	○	⊘	●	●	●	●
Metal U-Ring	●	●	⊘	○	●	○
Metal Wire Ring	⊘	⊘	●	○	●	●
Spring Energized C-Ring	○	⊘	●	●	●	○



Standard Metal Seals for Specific and Standard Applications

The metal seal type for these applications are listed below.

Seal Description	Metal Seal Type
Boss Seal for MS-33649 Fluid Connection	
Boss and MS-33514/33656 Fitting Ends.....	MCI
Metal E-Ring for AS1895 Flanges.....	MEI
Metal O-Ring for Aerospace Standards.....	MON

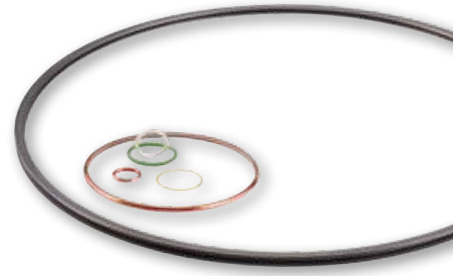

Selecting the Size for Your Application

Metal seals are available in any diameter from 6.35 mm to 8 m and a variety of free heights to fit the various cavity sizes you may have.

The metal seal size is designated in the part number as shown below.

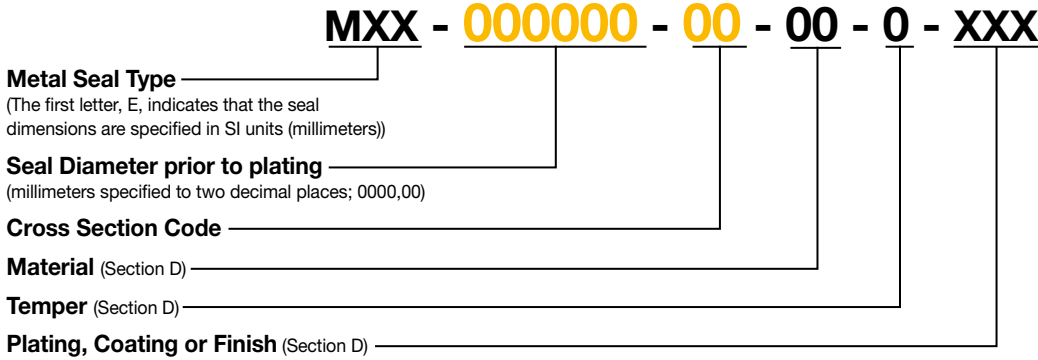

Refer to the page of the metal seal type selected for your application to determine the appropriate seal diameter, cross section and cavity dimensions. Cavity, seal dimensions and seal performance data for the standard metal seals can be found on the following pages:

Seal Type	Seal Description	Page
Face Seals		
MCI	Metal C-Ring, External Pressure Face Seal.....	C-16
MCE	Metal C-Ring, External Pressure Face Seal.....	C-18
MSI	Spring Energized Metal C-Ring, Internal Pressure Face Seal.....	C-20
MSE	Spring Energized Metal C-Ring, External Pressure Face Seal.....	C-22
MEI	Metal E-Ring, Internal Pressure Face Seal.....	C-24
MEE	Metal E-Ring, External Pressure Face Seal.....	C-26
MOI	Metal O-Ring, I.D. Vented, Internal Pressure Face Seal.....	C-28
MON	Metal O-Ring, Plain, Internal Pressure Face Seal.....	C-28
MOP	Metal O-Ring, Pressure Filled, Internal Pressure Face Seal.....	C-28
MOE	Metal O-Ring, O.D. Vented, External Pressure Face Seal.....	C-30
MOM	Metal O-Ring, Plain, External Pressure Face Seal.....	C-30
MOR	Metal O-Ring, Pressure Filled, External Pressure Face Seal.....	C-30
MUI	Metal U-Ring, Internal Pressure Face Seal.....	C-32
MUE	Metal U-Ring, External Pressure Face Seal.....	C-34
MWI	Metal Wire Ring, Internal Pressure Face Seal.....	C-36
MWE	Metal Wire Ring, External Pressure Face Seal.....	C-38
Axial Seals		
MCA	Metal C-Ring, Axial Seal.....	C-40
Seals for Standard Applications		
Boss Seal	for MS-33649 Fluid Connection Boss and MS-33514/33656 Fitting Ends.....	C-42
Metal E-Ring	for AS1895 Flanges.....	C-44
Metal O-Ring	for Aerospace Standards.....	C-45

Section C
Seal Size Selection

MCI Metal C-Ring Internal Pressure Face Seal

Applications:

- Excellent internally pressurized static face seal for valve assemblies, pressure vessels, jet engines, fuel injectors, separable fittings, etc.
- Moderate load permits the use of lighter flanges and fewer bolts.
- Good springback properties to accommodate thermal cycles and joint separation.
- Temperature range from cryogenics to 870 °C.
- Pressure range from vacuum to 524 MPa and above.

Features:

- Wide range of 10 standard free heights from 0.79 mm to 12.7 mm.
- Available in any diameter from 6.35 mm to 3 m, plus hundreds of preferred sizes (refer to page E-86).
- Relatively flexible for use with non-flat flanges.
- Multiple material choices for high temperature strength, good spring back, corrosion and fatigue resistance.
- Optimized one piece construction for low cost.
- Wide range of plating options (refer to page D-59) for superior sealing.
- Uses jacket strength and hydrostatic forces additively to increase sealing forces at higher pressures.
- Circular, race-track and other custom shapes available. Tri-lobed or elliptical C-rings available for snap-in/snap-out convenience.

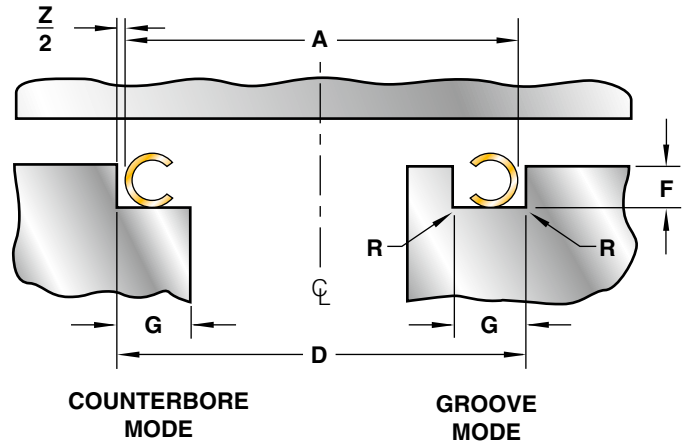

Cavity Dimensions				
Nominal Cross Section	D	F	G	R
	O.D. Range Tolerance H10	Depth Range	Minimum Width	Maximum Radius
0.79	6.00 – 25.00	0.64 – 0.69	1.02	0.25
1.19	8.00 – 50.00	0.94 – 1.02	1.40	0.30
1.57	10.00 – 200.00	1.27 – 1.37	1.91	0.38
2.39	13.00 – 400.00	1.91 – 2.01	2.67	0.51
3.18	25.00 – 600.00	2.54 – 2.67	3.43	0.76
3.96	32.00 – 750.00	3.18 – 3.30	4.32	1.27
4.76	75.00 – 900.00	3.84 – 3.99	5.08	1.27
6.35	100.00 – 1200.00	5.08 – 5.28	6.60	1.52
9.53	300.00 – 2000.00	7.62 – 8.03	9.65	1.52
12.70	600.00 – 3000.00	10.16 – 10.67	12.70	1.52

All dimensions are in millimeters.
The tolerance reference table can be found on page E-92.

Part Numbering:

Refer to Section A, page A-9 for part numbering convention. The seal size is specified in the part number as follows:

MCI - 000000 - 00 - 00 - 0 - XXX

Seal O.D. prior to plating (dimension A) to two decimal places. (Example: A 30.00 mm seal is specified as 003000)

Metal Seal Cross Section Code

Material (Section D)

Temper (Section D)

Plating, Coating or Finish (Section D)

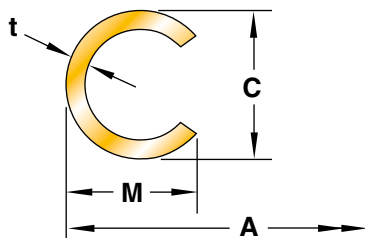

Seal and Cavity Sizing:

Seal free height is based on cavity diameter and depth alone. Seal diameter (dimension A) is derived below.

$$A = D - Z - 2P_{max}$$

(tolerance h11, see page E-92)

Where: D = Minimum cavity O.D.

Z = Diametral clearance between cavity and seal

P_{max} = Maximum plating thickness (from page D-60)

Section C
Seal Size Selection

Seal Dimensions					
Nominal Cross Section	Z	M	C	t	Cross Section Code
	Diametral Clearance	Maximum Radial Width	Free Height	Material Thickness	
0.79	0.08	0.71	0.79 ±0.05	0.15	01
				0.18	02
1.19	0.13	0.96	1.19 ±0.05	0.15	03
				0.20	04
1.57	0.15	1.26	1.57 ±0.05	0.15	05
				0.25	06
2.39	0.20	1.91	2.39 ±0.05	0.25	07
				0.38	08
3.18	0.30	2.54	3.18 ±0.08	0.38	09
				0.51	10
3.96	0.41	3.17	3.96 ±0.08	0.41	11
				0.61	12
4.78	0.46	3.82	4.78 ±0.10	0.51	13
				0.76	14
6.35	0.51	5.08	6.35 ±0.10	0.64	15
				0.97	16
9.53	0.76	7.62	9.53 ±0.10	0.97	17
				1.27	18
12.70	1.02	10.16	12.70 ±0.13	1.27	19
				1.65	20

Performance		
Seating Load (N/mm circumference)	Springback (mm)	Working* Pressure Rating (MPa)
28	0.04	530
41	0.03	690
20	0.05	290
41	0.05	430
15	0.08	200
50	0.05	400
28	0.15	230
70	0.13	390
53	0.18	260
105	0.15	390
46	0.23	220
105	0.18	370
62	0.25	220
130	0.20	390
70	0.33	210
175	0.23	360
105	0.51	210
260	0.38	300
140	0.64	210
300	0.51	290

All dimensions are in millimeters and prior to plating. Performance data is based on Alloy 718 material with -6 treatment. Seal performance is discussed in Section E. *If working pressures exceed these ratings consult Parker for recommendations.

MCE Metal C-Ring External Pressure Face Seal

Applications:

- Excellent externally pressurized static face seal.
- Moderate load permits the use of lighter flanges and fewer bolts.
- Good springback properties to accommodate thermal cycles and joint separation.
- Temperature range from cryogenics to 870 °C.
- Pressure range from vacuum to 524 MPa and above.

Features:

- Wide range of 10 standard free heights from 0.79 mm to 12.7 mm.
- Available in any diameter from 6.35 mm to 3 m, plus hundreds of preferred sizes (refer to page E-89).
- Relatively flexible for use with non-flat flanges.
- Multiple material choices for high temperature strength, good springback, corrosion and fatigue resistance.
- Optimized one piece construction for low cost.
- Wide range of plating options (refer to page D-59) for superior sealing.
- Uses jacket strength and hydrostatic forces additively to increase sealing forces at higher pressures.
- Circular, race-track and other custom shapes available. Tri-lobed or elliptical C-rings available for snap-in/snap-out convenience.

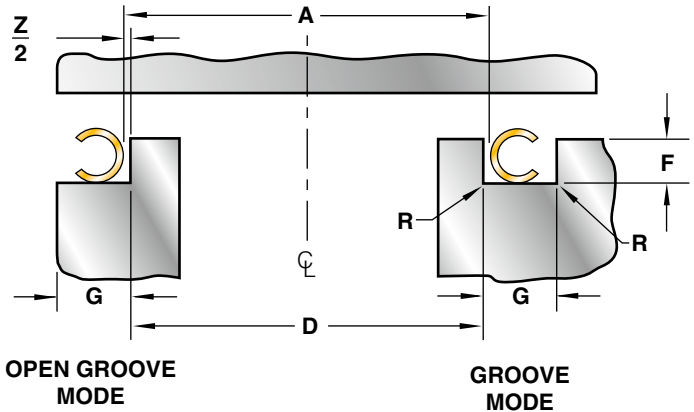

Cavity Dimensions				
Nominal Cross Section	D	F	G	R
	I.D. Range Tolerance h10	Depth Range	Minimum Width	Maximum Radius
0.79	5.00 – 25.00	0.64 – 0.69	1.02	0.25
1.19	8.00 – 50.00	0.94 – 1.02	1.40	0.30
1.57	9.00 – 200.00	1.27 – 1.37	1.91	0.38
2.39	10.00 – 400.00	1.91 – 2.01	2.67	0.51
3.18	20.00 – 600.00	2.54 – 2.67	3.43	0.76
3.96	32.00 – 750.00	3.18 – 3.30	4.32	1.27
4.76	75.00 – 900.00	3.84 – 3.99	5.08	1.27
6.35	100.00 – 1200.00	5.08 – 5.28	6.60	1.52
9.53	300.00 – 2000.00	7.62 – 8.03	9.65	1.52
12.70	600.00 – 3000.00	10.16 – 10.67	12.70	1.52

All dimensions are in millimeters.
The tolerance reference table can be found on page E-92.

Part Numbering:

Refer to Section A, page A-9 for part numbering convention. The seal size is specified in the part number as follows:

MCE - 000000 - 00 - 00 - 0 - XXX

Seal I.D. prior to plating (dimension A) to two decimal places. (Example: A 30.00 mm seal is specified as 003000)

Metal Seal Cross Section Code

Material (Section D)

Temper (Section D)

Plating, Coating or Finish (Section D)

Seal and Cavity Sizing:

Seal free height is based on cavity diameter and depth alone. Seal diameter (dimension A) is derived below.

$$A = D + Z + 2P_{max}$$

(tolerance H11, see page E-92)

Where: D = Maximum cavity I.D.

Z = Diametral clearance between cavity and seal

P_{max} = Maximum plating thickness (from page D-60)

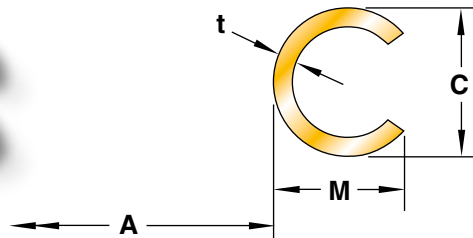
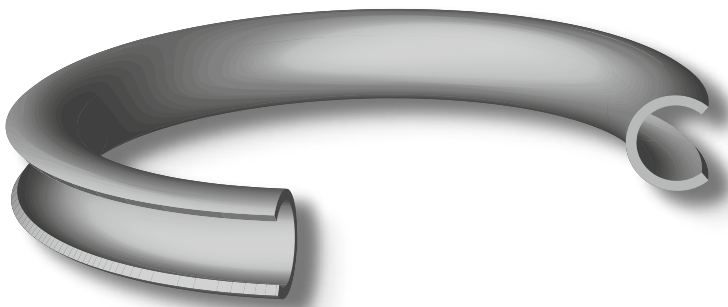

Seal Dimensions					
Nominal Cross Section	Z	M	C	t	Cross Section Code
	Diametral Clearance	Maximum Radial Width	Free Height	Material Thickness	
0.79	0.08	0.71	0.79 ±0.05	0.15	01
				0.18	02
1.19	0.13	0.96	1.19 ±0.05	0.15	03
				0.20	04
1.57	0.15	1.26	1.57 ±0.05	0.15	05
				0.25	06
2.39	0.20	1.91	2.39 ±0.05	0.25	07
				0.38	08
3.18	0.30	2.54	3.18 ±0.08	0.38	09
				0.51	10
3.96	0.41	3.17	3.96 ±0.08	0.41	11
				0.61	12
4.78	0.46	3.82	4.78 ±0.10	0.51	13
				0.76	14
6.35	0.51	5.08	6.35 ±0.10	0.64	15
				0.97	16
9.53	0.76	7.62	9.53 ±0.10	0.97	17
				1.27	18
12.70	1.02	10.16	12.70 ±0.13	1.27	19
				1.65	20

Performance		
Seating Load (N/mm circumference)	Springback (mm)	Working* Pressure Rating (MPa)
28	0.04	530
41	0.03	690
20	0.05	290
41	0.05	430
15	0.08	200
50	0.05	400
28	0.15	230
70	0.13	390
53	0.18	260
105	0.15	390
46	0.23	220
105	0.18	370
62	0.25	220
130	0.20	390
70	0.33	210
175	0.23	360
105	0.51	210
260	0.38	300
140	0.64	210
300	0.51	290

All dimensions are in millimeters and prior to plating.

Performance data is based on Alloy 718 material with -6 treatment. Seal performance is discussed in Section E.

*If working pressures exceed these ratings consult Parker for recommendations.

MSI Spring Energized Metal C-Ring Internal Pressure Face Seal

Applications:

- Similar to MCI, but higher loads for use with rougher mating surfaces.
- Excellent for pressure vessel closures; manways, hand-holes; steam generators, gasoline/diesel engine fire rings, exhaust joints, flanges with a rougher surface finish.
- Best choice for non-flat mating surfaces.
- For internally pressurized joints.
- For externally pressurized joints to avoid passage of working fluid into the seal cavity (reduced working pressure rating).

Features:

- Lowest leak rate.
- Internal Spring provides high pressure capabilities of up to 262 MPa and above.
- All plating options available.
- Excellent footprint with good plastic flow of plating material.
- Available in any diameter from 19.05 mm to 3 m, plus hundreds of preferred sizes (see page E-88).
- Wide range of eight standard free heights from 1.58 mm to 12.7 mm.
- Multiple material choices for high temperature strength, good spring-back, corrosion and fatigue resistance.
- Uses jacket forces, spring forces and hydrostatic forces additively to increase sealing forces at higher pressures.
- Circular, race-track and other custom shapes available. Tri-lobed or elliptical Spring Energized C-rings available for snap-in/snap-out convenience.

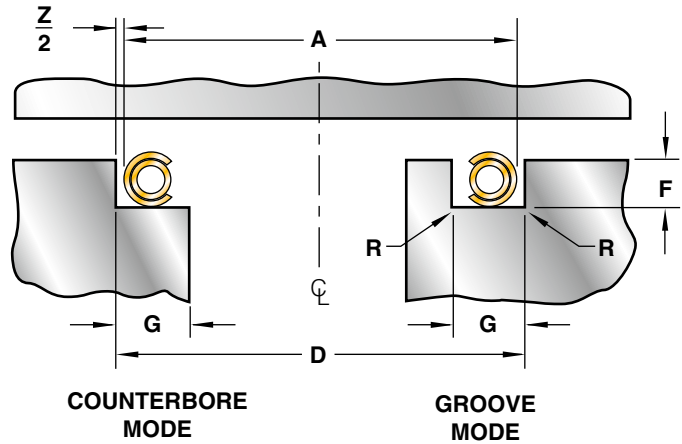

Cavity Dimensions

Nominal Cross Section	D	F	G	R
	O.D. Range Tolerance H10	Depth Range	Minimum Width	Maximum Radius
1.57	19.00 – 200.00	1.27 – 1.37	2.29	0.38
2.39	25.00 – 400.00	1.91 – 2.01	3.18	0.51
3.18	25.00 – 600.00	2.54 – 2.67	4.06	0.76
3.96	32.00 – 750.00	3.18 – 3.30	5.08	1.27
4.78	75.00 – 900.00	3.84 – 3.99	6.35	1.27
6.35	100.00 – 1800.00	5.08 – 5.28	8.89	1.52
9.53	300.00 – 3000.0	7.62 – 8.03	12.70	1.52
12.70	600.00 – 7600.00	10.16 – 10.67	16.51	1.52

All dimensions are in millimeters.
The tolerance reference table can be found on page E-92.

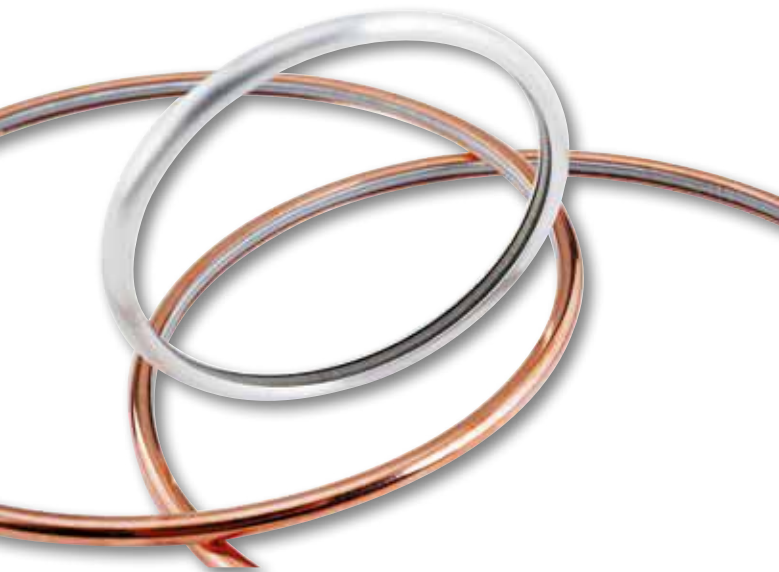

Part Numbering:

Refer to Section A, page A-9 for part numbering convention. The seal size is specified in the part number as follows:

MSI - 000000 - 00 - 00 - 0 - XXX

Seal O.D. prior to plating (dimension A) to two decimal places. (Example: A 30.00 mm seal is specified as 003000)

Metal Seal Cross Section Code

Material (Section D)

Temper (Section D)

Plating, Coating or Finish (Section D)

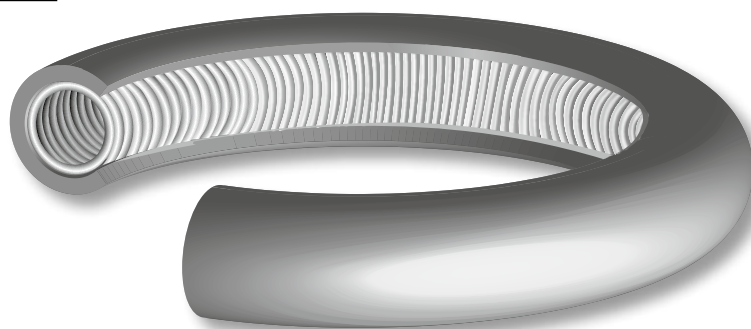
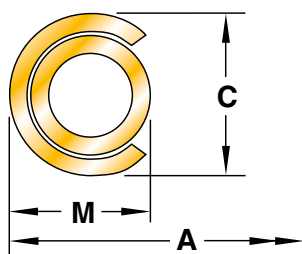

Seal and Cavity Sizing:

Seal free height is based on cavity diameter and depth alone. Seal diameter (dimension A) is derived below.

$$A = D - Z - 2P_{max}$$

(tolerance h11, see page E-92)

Where: D = Minimum cavity O.D.

Z = Diametral clearance between cavity and seal

P_{max} = Maximum plating thickness (from page D-60)

Section C
Seal Size Selection

Seal Dimensions				
Nominal Cross Section	Z	M	C	Cross Section Code
	Diametral Clearance	Maximum Radial Width	Free Height	
1.57	0.15	1.50	1.57 ^{+0.08} / _{-0.05}	05
2.39	0.20	2.21	2.39 ^{+0.10} / _{-0.05}	07
3.18	0.30	2.90	3.18 ^{+0.10} / _{-0.08}	09
3.96	0.41	3.66	3.96 ^{+0.10} / _{-0.08}	11
4.78	0.46	4.39	4.78 ^{+0.13} / _{-0.10}	13
6.35	0.51	5.84	6.35 ^{+0.15} / _{-0.10}	15
9.53	0.76	8.69	9.53 ^{+0.20} / _{-0.10}	17
12.70	1.02	11.58	12.70 ^{+0.25} / _{-0.13}	19

Performance		
Seating Load (N/mm circumference)	Springback (mm)	Working Pressure Rating (MPa)
90	0.08	200
150	0.13	225
170	0.15	260
230	0.20	215
260	0.23	225
350	0.28	205
440	0.43	210
510	0.56	205

All dimensions are in millimeters and prior to plating. Performance data is based on Alloy 750 jacket and spring. Seal performance is discussed in Section E. If working pressures exceed these ratings consult Parker for recommendations.

MSE Spring Energized Metal C-Ring External Pressure Face Seal

Applications:

- Similar to MCE, but higher loads for use with rougher mating surfaces.
- Externally pressurized joints. Flanges with a rougher surface finish.
- Internally pressurized joints to avoid passage of working fluid into the seal cavity (reduced working pressure rating).

Features:

- Lowest leak rate.
- Internal spring provides high pressure capabilities of up to 262 MPa.
- All plating options available.
- Excellent footprint with good plastic flow of plating material.
- Available in any diameter from 16.51 mm to 3 m, plus hundreds of preferred sizes (see page E-90).
- Wide range of eight standard free heights from 1.58 mm to 12.70 mm.
- Multiple material choices for high temperature strength, good spring-back, corrosion and fatigue resistance.
- Uses jacket forces, spring forces and hydrostatic forces additively to increase sealing forces at higher pressures when used with external pressurization.
- Circular, race-track and other custom shapes available. Tri-lobed or elliptical Spring Energized C-rings available for snap-in/snap-out convenience.

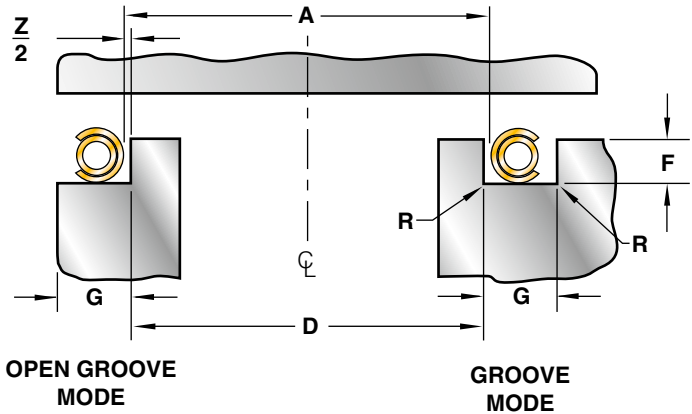

Cavity Dimensions				
Nominal Cross Section	D	F	G	R
	I.D. Range Tolerance h10	Depth Range	Minimum Width	Maximum Radius
1.57	16.50 – 200.00	1.27 – 1.37	2.29	0.38
2.39	23.00 – 400.00	1.91 – 2.01	3.18	0.51
3.18	25.00 – 600.00	2.54 – 2.67	4.06	0.76
3.96	32.00 – 750.00	3.18 – 3.30	5.08	1.27
4.78	75.00 – 900.00	3.84 – 3.99	6.35	1.27
6.35	100.00 – 1800.00	5.08 – 5.28	8.89	1.52
9.53	300.00 – 3000.00	7.62 – 8.03	12.70	1.52
12.70	600.00 – 3000.00	10.16 – 10.67	16.51	1.52

All dimensions are in millimeters.
The tolerance reference table can be found on page E-92.



Part Numbering:

Refer to Section A, page A-9 for part numbering convention. The seal size is specified in the part number as follows:

MSE - 000000 - 00 - 00 - 0 - XXX

Seal I.D. prior to plating (dimension A) to two decimal places. (Example: A 30.00 mm seal is specified as 003000)

Metal Seal Cross Section Code

Material (Section D)

Temper (Section D)

Plating, Coating or Finish (Section D)

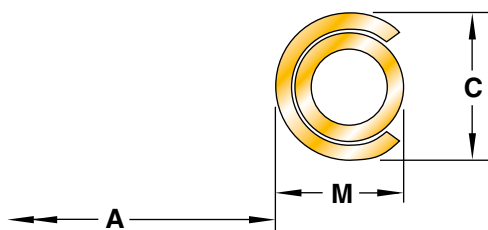

Seal and Cavity Sizing:

Seal free height is based on cavity diameter and depth alone. Seal diameter (dimension A) is derived below.

$$A = D + Z + 2P_{\max}$$

(tolerance H11, see page E-92)

Where: D = Maximum cavity I.D.

Z = Diametral clearance between cavity and seal

P_{max} = Maximum plating thickness (from page D-60)

Section C
Seal Size Selection

Seal Dimensions				
Nominal Cross Section	Z	M	C	Cross Section Code
	Diametral Clearance	Maximum Radial Width	Free Height	
1.57	0.15	1.50	1.57 ^{+0.08} / _{-0.05}	05
2.39	0.20	2.21	2.39 ^{+0.10} / _{-0.05}	07
3.18	0.30	2.90	3.18 ^{+0.10} / _{-0.08}	09
3.96	0.41	3.66	3.96 ^{+0.10} / _{-0.08}	11
4.78	0.46	4.39	4.78 ^{+0.13} / _{-0.10}	13
6.35	0.51	5.84	6.35 ^{+0.15} / _{-0.10}	15
9.53	0.76	8.69	9.53 ^{+0.20} / _{-0.10}	17
12.70	1.02	11.58	12.70 ^{+0.25} / _{-0.13}	19

Performance		
Seating Load (N/mm circumference)	Springback (mm)	Working Pressure Rating (MPa)
90	0.08	200
150	0.13	225
170	0.15	260
230	0.20	215
260	0.23	225
350	0.28	205
440	0.43	210
510	0.56	205

All dimensions are in millimeters. Performance data is based on Alloy X-750 jacket and spring. Seal performance is discussed in Section E. If working pressures exceed these ratings consult Parker for recommendations.

MEI Metal E-Ring Internal Pressure Face Seal

Applications:

- High temperature pneumatic joints, turbine engine bleed air ducting joints, turbine engine cases, very low load flanges and/or joints with considerable movement.
- Multi-convolution E-rings available for very high deflection applications.
- Available internally pressure-energized or pressure neutral for reversing pressures.
- Resonant frequency of E-ring may be customized to avoid destructive resonance in high vibration applications.
- Available in standard sizes to fit all AS1895 flanges (refer to page C-44).
- For temperatures up to 870 °C.

Features:

- Optimized one piece construction for lower costs.
- Highly compliant, very low load seal.
- Generally used unplated.
- Many custom cross sections available. See page F-98 for a selection of more popular styles.
- Diameters from 44.45 mm to 1.2 m (larger on request).
- Radiused footprint area protects mating surfaces.
- Fully elastic working envelope for consistent performance over many compression/extension cycles.
- Defined fatigue life.
- Available in a choice of high strength/high temperature nickel and cobalt alloys.
- Available with HVOF (High Velocity Oxygen Flame) anti-wear coating.
- Electro deposited anti-wear coatings as well.

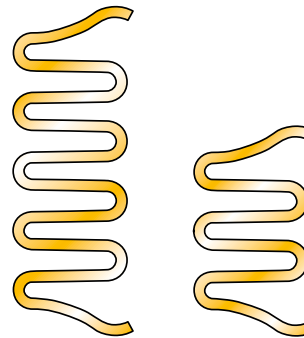
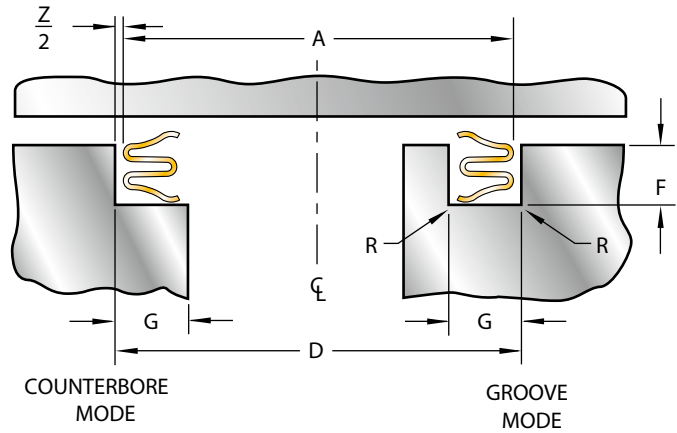

E-rings are available with additional convolutions for even greater springback.

See page F-98 for additional styles.

Cavity Dimensions				
Nominal Cross Section	D	F	G	R
	O.D. Range Tolerance H10	Depth Range	Minimum Width	Maximum Radius
1.88	45.00 – 200.00	1.55 – 1.60	2.29	0.38
	50.00 – 300.00	2.16 – 2.21	2.92	0.51
2.74	57.00 – 300.00	2.16 – 2.26	4.32	0.51
	50.00 – 300.00	2.16 – 2.26	2.92	0.51
3.55	50.00 – 600.00	2.95 – 3.05	4.19	0.76
	50.00 – 600.00	2.95 – 3.05	4.19	0.76
5.54	85.00 – 900.00	4.55 – 4.65	5.84	1.02
7.49	150.00 – 1200.00	6.20 – 6.35	8.00	1.52

All dimensions are in millimeters.
The tolerance reference table can be found on page E-92.

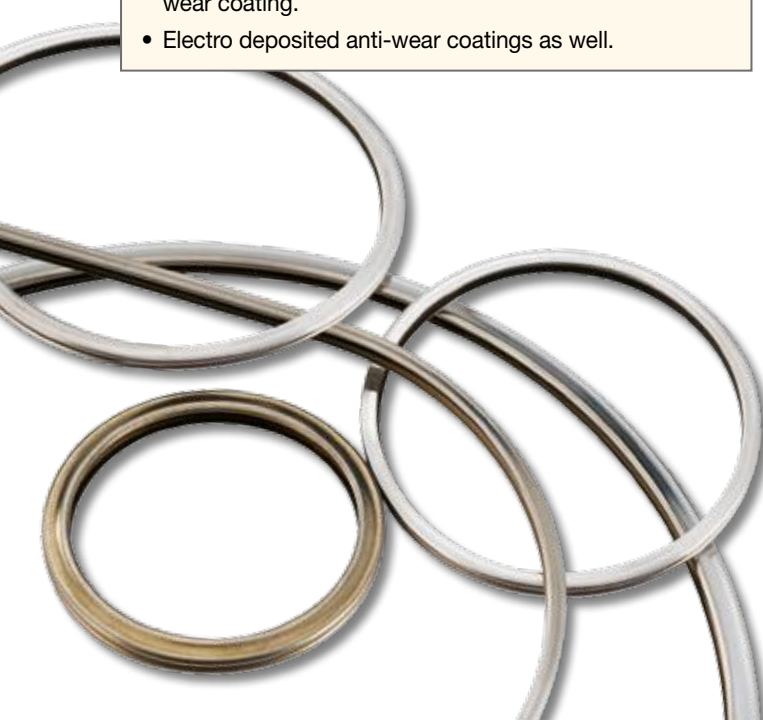

Part Numbering:

Refer to Section A, page A-9 for part numbering convention. The seal size is specified in the part number as follows:

MEI - 000000 - 00 - 00 - 0 - XXX

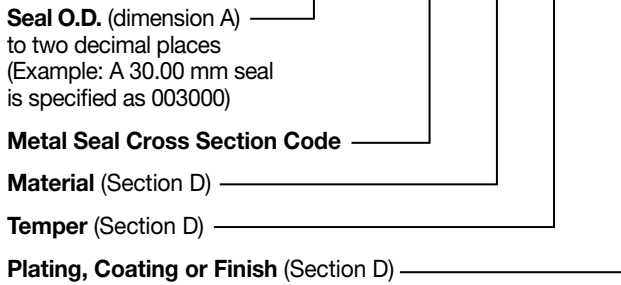

Seal and Cavity Sizing:

Seal free height is based on cavity diameter and depth alone. Seal diameter (dimension A) is derived below.

$$A = D - Z$$

(tolerance h11, see page E-92)

Where: D = Minimum cavity O.D.

Z = Diametral clearance between cavity and seal

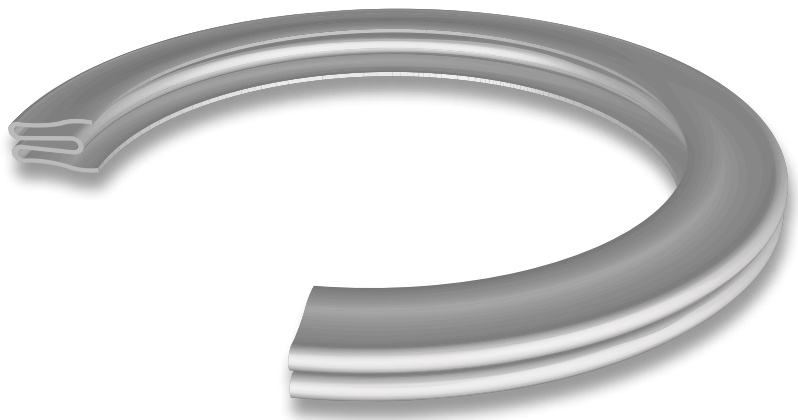
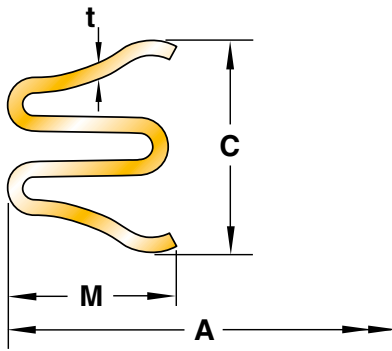

Section C
Seal Size Selection

Seal Dimensions					
Nominal Cross Section	Z	C	t	M	Cross Section Code
	Diametral Clearance	Free Height	Material Thickness	Maximum Radial Width	
1.88	0.08	1.88 ± 0.08	0.13	1.68	05
2.74	0.08	2.59 ± 0.13	0.25	2.31	06
		2.74 ± 0.13	0.23	3.68	07
		2.74 ± 0.13	0.25	2.31	08
3.55	0.13	3.55 ± 0.10	0.30	3.10	10
		3.35 ± 0.13	0.38	3.10	11
5.54	0.15	5.54 ± 0.13	0.38	4.83	13
7.49	0.20	7.49 ± 0.15	0.51	6.78	15

Performance		
Seating Load (N/mm circumference)	Springback (mm)	Working Pressure Rating (MPa)
5	0.30	10
5	0.38	10
7	0.53	10
16	0.46	34
11	0.56	24
13	0.35	37
9	0.94	13
14	1.22	13

All dimensions are in millimeters. Performance data is based on Alloy 718 material with -6 temper. Seal performance is discussed in Section E. If working pressures exceed these ratings consult Parker for recommendations.

MEE Metal E-Rings External Pressure Face Seal

Applications:

- High temperature pneumatic joints with external pressurization and/or joints with considerable movement.
- Multi-convolution E-rings available for very high deflection applications.
- Available externally pressure-energized or pressure neutral for reversing pressures.
- Resonant frequency of E-ring may be customized to avoid destructive resonance in high vibration applications.
- For temperatures up to 870 °C.

Features:

- Optimized one piece construction for lower costs.
- Highly compliant, very low load seal.
- Generally used unplated.
- Many custom cross sections available. See page F-98 for a selection of more popular styles.
- Diameters from 44.45 mm to 1.2 m (larger on request).
- Radiused footprint area protects mating surfaces.
- Fully elastic working envelope for consistent performance over many compression/extension cycles.
- Defined fatigue life.
- Available in a choice of high strength/high temperature nickel and cobalt alloys.
- Available with HVOF (High Velocity Oxygen Flame) anti-wear coating.
- Electro deposited anti-wear coatings as well.

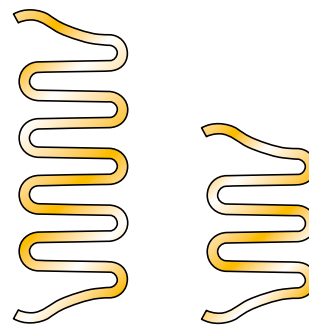
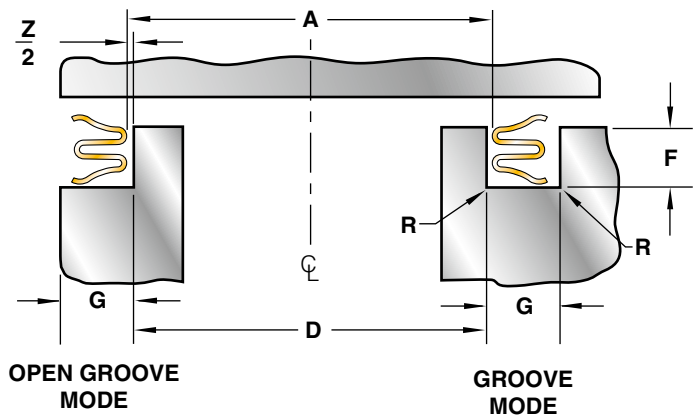

E-rings are available with additional convolutions for even greater springback.

See page F-98 for additional styles.

Cavity Dimensions				
Nominal Cross Section	D	F	G	R
	I.D. Range Tolerance h10	Depth Range	Minimum Width	Maximum Radius
1.88	45.00 – 200.00	1.55 – 1.60	2.29	0.38
	50.00 – 300.00	2.16 – 2.21	2.92	0.51
2.74	57.00 – 300.00	2.16 – 2.26	4.32	0.51
	50.00 – 300.00	2.16 – 2.26	2.92	0.51
3.55	50.00 – 600.00	2.95 – 3.05	4.19	0.76
	50.00 – 600.00	2.95 – 3.05	4.19	0.76
5.54	85.00 – 900.00	4.55 – 4.65	5.84	1.02
7.49	150.00 – 1200.00	6.20 – 6.35	8.00	1.52

All dimensions are in millimeters.
The tolerance reference table can be found on page E-92.



Part Numbering:

Refer to Section A, page A-9 for part numbering convention. The seal size is specified in the part number as follows:

MEE - 000000 - 00 - 00 - 0 - XXX

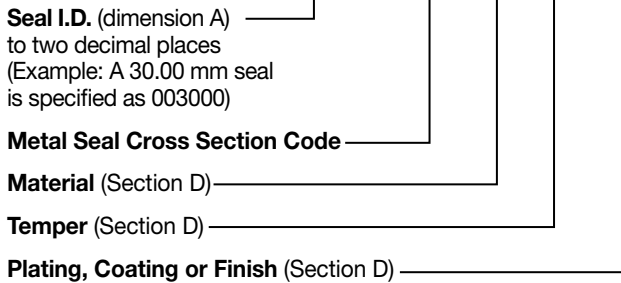

Seal and Cavity Sizing:

Seal free height is based on cavity diameter and depth alone. Seal diameter (dimension A) is derived below.

A = D + Z

(tolerance H11, see page E-92)

Where: D = Maximum cavity I.D.

Z = Diametral clearance between cavity and seal

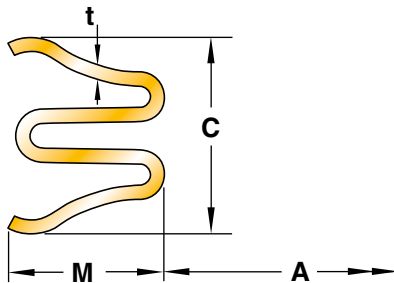

Section C
Seal Size Selection

Seal Dimensions					
Nominal Cross Section	Z	C	t	M	Cross Section Code
	Diametral Clearance	Free Height	Material Thickness	Maximum Radial Width	
1.88	0.08	1.88 ± 0.08	0.13	1.68	05
2.74	0.08	2.59 ± 0.13	0.25	2.31	06
		2.74 ± 0.13	0.23	3.68	07
		2.74 ± 0.13	0.25	2.31	08
3.55	0.13	3.55 ± 0.10	0.30	3.10	10
		3.35 ± 0.13	0.38	3.10	11
5.54	0.15	5.54 ± 0.13	0.38	4.83	13
7.49	0.20	7.49 ± 0.15	0.51	6.78	15

Performance		
Seating Load (N/mm circumference)	Springback (mm)	Working Pressure Rating (MPa)
5	0.30	10
5	0.38	10
7	0.53	10
16	0.46	34
11	0.56	24
13	0.35	37
9	0.94	13
14	1.22	13

All dimensions are in millimeters and prior to plating. Performance data is based on Alloy 718 material with -6 treatment. Seal performance is discussed in Section E. If working pressures exceed these ratings consult Parker for recommendations.

MOI, MON & MOP Metal O-Rings Internal Pressure Face Seal

Applications:

- Heavy joints with minimum movement.
- Static, low leakage face sealing.
- Contiguous sealing surface permits use within triple-surface, chamfered joints and non-rectangular section grooves.

Features:

- Many tubing material choices and plating options available for widest media compatibility.
- Standard metal O-rings available for all ‘MS’ sizes and configurations (see pages C-45 to C-50).
- All welds are 100% fluorescent penetrant inspected.
- Eight standard free heights and any diameter from 6.35 mm to 7.6 m.
- High sealing load creates excellent plating compression and superior sealing.
- Robust, high integrity seal for ease of handling, even in largest sizes.

Selection of Types:

MOI (preferred): Internally vented and pressure-energized: recommended for high pressures. (Refer to performance table on facing page).

MON* (preferred): Non-vented, non-filled: avoids ingress of working fluid(s) into the seal, lowest cost, but pressure capability is reduced. (Refer to performance table on facing page).

MOP* (optional): Non-vented, gas pressure-filled. Good for bi-directional (reversing) pressures. Avoids ingress of working fluid(s) into the seal. Enhances load at high temperatures.

*Not for use in applications with a very high ambient pressure (drill string equipment and undersea applications).

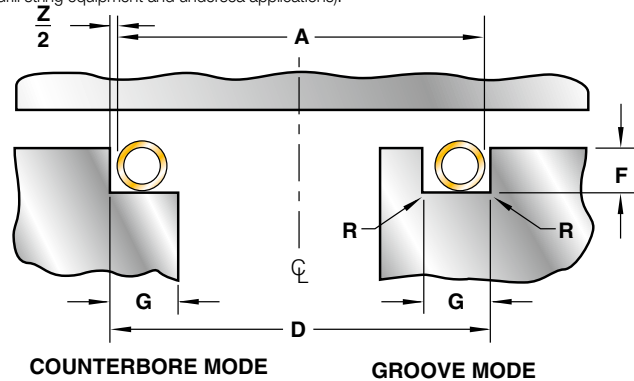

Cavity Dimensions				
Nominal Cross Section	D	F	G	R
	O.D. Range Tolerance H10	Depth Range	Minimum Width	Maximum Radius
0.89	6.35 – 25.00	0.64 – 0.69	1.40	0.25
1.19	10.00 – 50.00	0.94 – 1.02	1.78	0.30
1.57	13.00 – 200.00	1.14 – 1.27	2.29	0.38
2.39	25.00 – 400.00	1.88 – 2.01	3.18	0.51
3.18	38.00 – 600.00	2.54 – 2.67	4.06	0.76
3.96	75.00 – 750.00	3.18 – 3.30	5.08	1.27
4.78	100.00 – 900.00	3.84 – 3.99	6.35	1.27
6.35	200.00 – 1200.00	5.08 – 5.28	8.89	1.52

All dimensions are in millimeters.
The tolerance reference table can be found on page E-92.



Part Numbering:

Refer to Section A, page A-9 for part numbering convention. The seal size is specified in the part number as follows:

MO [I, N, P] - 000000 - 00 - 00 - 0 - XXX

Seal O.D. prior to plating (dimension A) to two decimal places. (Example: A 30.00 mm seal is specified as 003000)

Metal Seal Cross Section Code

Material (Section D)

Temper (Section D)

Plating, Coating or Finish (Section D)

Seal and Cavity Sizing:

Seal free height is based on cavity diameter and depth alone. Seal diameter (dimension A) is derived below.

Seal Tolerance	
Free Height	Seal Diameter Tolerance (-0.000)
0.89 - 4.77	+0.13
6.35	+0.20
9.52 - 15.87	+0.25

$$A = D - Z - 2P_{max}$$

Where: D = Minimum cavity O.D.

Z = Diametral clearance between cavity and seal

P_{max} = Maximum plating thickness (from page D-60)

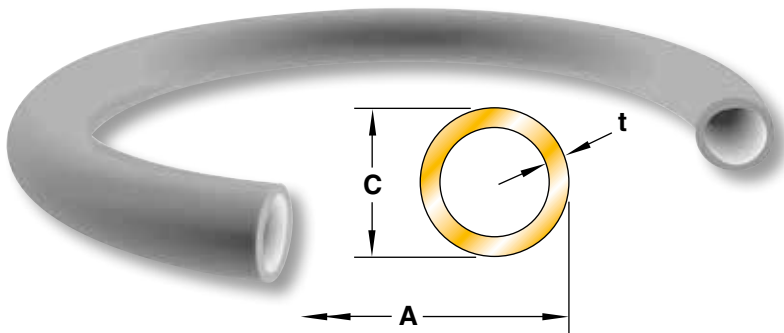

Seal Dimensions					
Nominal Cross Section	Z	C	t	Cross Section Code	
	Diametral Clearance	Free Height	Material Thickness		
0.89	0.18	0.89	+0.08 -0.03	0.15	01
1.19	0.20	1.19	+0.08 -0.03	0.18	29
1.57	0.20	1.57	+0.08 -0.03	0.15	02
				0.25	03
				0.30	31
				0.35	08
2.39	0.23	2.39	+0.08 -0.03	0.15	04
				0.25	05
				0.30	32
				0.46	09
3.18	0.28	3.18	+0.08 -0.03	0.20	06
				0.25	07
				0.30	25
				0.51	10
3.96	0.33	3.96	+0.10 -0.00	0.41	11
				0.51	12
4.78	0.35	4.78	+0.13 -0.00	0.51	13
				0.63	14
6.35	0.46	6.35	+0.13 -0.00	0.63	15
				0.81	16

Performance							
Seating Load (N/mm circ.)		Springback (mm)		Working Pressure Rating (MPa)			
				Vented		Non-Vented	
304SS/ 321SS	Alloy X-750/ Alloy 718	304SS/ 321SS	Alloy X-750/ Alloy 718	304SS/ 321SS	Alloy X-750/ Alloy 718	304SS/ 321SS	Alloy X-750/ Alloy 718
70	96	0.01	0.01	70	100	5	7
70	96	0.03	0.03	50	70	5	7
45	61	0.04	0.05	30	45	4	6
96	130	0.03	0.04	75	110	5	7
140	190	0.03	0.03	100	140	5	8
190	260	0.03	0.03	120	170	6	8
26	35	0.05	0.05	10	15	5	7
52	70	0.05	0.05	30	40	6	8
70	96	0.03	0.04	40	70	6	8
210	280	0.03	0.04	110	170	6	9
17	24	0.10	0.13	15	30	3	5
26	35	0.08	0.10	30	40	3	5
49	70	0.05	0.08	40	70	4	6
160	210	0.05	0.05	110	170	5	7
70	96	0.10	0.13	30	40	5	7
130	175	0.08	0.10	90	140	5	8
78	105	0.10	0.13	30	40	5	7
120	170	0.08	0.10	100	150	5	8
78	105	0.13	0.15	30	40	5	7
170	230	0.10	0.13	90	140	5	8

All dimensions are in millimeters and prior to plating. Performance data is based on Alloy 718 material with -6 treatment. Seal performance is discussed in Section E. If working pressures exceed these ratings consult Parker for recommendations.

MOE, MOM & MOR Metal O-Rings External Pressure Face Seal

Applications:

- Heavy joints with minimum movement.
- Static, low leakage face sealing.
- Contiguous sealing surface permits use within triple-surface, chamfered joints and non-rectangular section grooves.

Features:

- Many tubing material choices and plating options available for widest media compatibility.
- All welds are 100% fluorescent penetrant inspected.
- Eight standard free heights and any diameter from 4.57 mm to 7.6 m.
- High sealing load creates excellent plating compression and superior sealing.
- Robust, high integrity seal for ease of handling, even in largest sizes.

Selection of Types:

MOE (preferred): Externally vented and pressure-energized: recommended for high pressures. (Refer to performance table on facing page).

MOM* (preferred): Non-vented, non-filled: avoids ingress of working fluid(s) into the seal, lowest cost, but reduces pressure capability. (Refer to performance table on facing page).

MOR* (optional): Non-vented, gas pressure-filled. Good for bi-directional (reversing) pressures. Avoids ingress of working fluid(s) into the seal. Enhances load at high temperatures.

*Not for use in applications with a very high ambient pressure (drill string equipment and undersea applications).

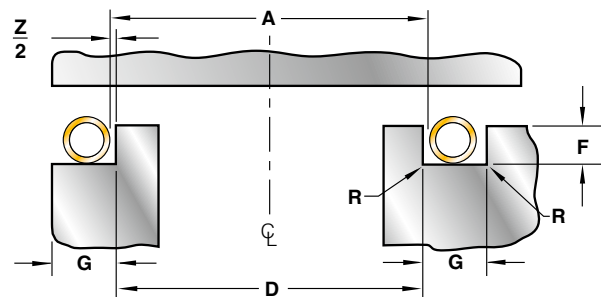

OPEN GROOVE MODE

GROOVE MODE



Cavity Dimensions

Nominal Cross Section	D	F	G	R
	I.D. Range Tolerance h10	Depth Range	Minimum Width	Maximum Radius
0.89	4.50 – 25.00	0.64 – 0.69	1.4	0.25
1.19	7.60 – 50.00	0.94 – 1.02	1.78	0.30
1.57	9.50 – 200.00	1.14 – 1.27	2.29	0.38
2.39	20.00 – 400.00	1.88 – 2.01	3.18	0.51
3.18	33.00 – 600.00	2.54 – 2.67	4.06	0.76
3.96	70.00 – 750.00	3.18 – 3.30	5.08	1.27
4.78	95.00 – 900.00	3.84 – 3.99	6.35	1.27
6.35	190.00 – 1200.00	5.08 – 5.28	8.89	1.52

All dimensions are in millimeters.
The tolerance reference table can be found on page E-92.

Part Numbering:

Refer to Section A, page A-9 for part numbering convention. The seal size is specified in the part number as follows:

MO [E, M, R] - 000000 - 00 - 00 - 0 - XXX

Seal I.D. prior to plating (dimension A) to two decimal places. (Example: A 30.00 mm seal is specified as 003000)

Metal Seal Cross Section Code

Material (Section D)

Temper (Section D)

Plating, Coating or Finish (Section D)

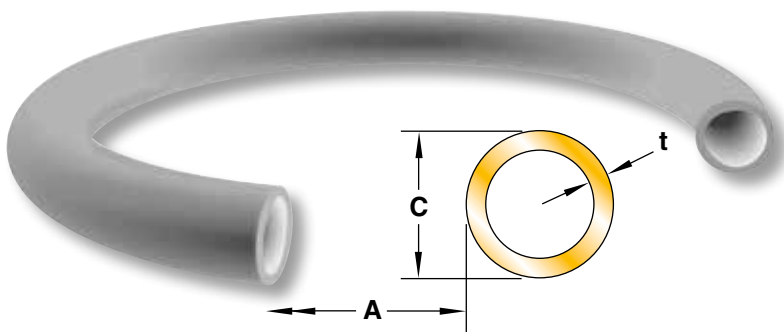

Seal and Cavity Sizing:

Seal free height is based on cavity diameter and depth alone. Seal diameter (dimension A) is derived below.

Seal Tolerance	
Free Height	Seal Diameter Tolerance (-0.000)
0.89 - 4.77	+0.13
6.35	+0.20
9.52 - 15.87	+0.25

$$A = D + Z + 2P_{max}$$

Where: D = Maximum cavity I.D.

Z = Diametral clearance between cavity and seal

P_{max} = Maximum plating thickness (from page D-60)

Seal Dimensions					
Nominal Cross Section	Z	C	t	Cross Section Code	
	Diametral Clearance	Free Height	Material Thickness		
0.89	0.18	0.89	+0.08 -0.03	0.15	01
1.19	0.20	1.19	+0.08 -0.03	0.18	29
1.57	0.20	1.57	+0.08 -0.03	0.15	02
				0.25	03
				0.30	31
				0.35	08
2.39	0.23	2.39	+0.08 -0.03	0.15	04
				0.25	05
				0.30	32
				0.46	09
3.18	0.28	3.18	+0.08 -0.03	0.20	06
				0.25	07
				0.30	25
				0.51	10
3.96	0.33	3.96	+0.10 -0.00	0.41	11
				0.51	12
4.78	0.35	4.78	+0.13 -0.00	0.51	13
				0.63	14
6.35	0.46	6.35	+0.13 -0.00	0.63	15
				0.81	16

Performance							
Seating Load (N/mm circ.)		Springback (mm)		Working Pressure Rating (MPa)			
304SS/ 321SS	Alloy X-750/ Alloy 718	304SS/ 321SS	Alloy X-750/ Alloy 718	Vented		Non-Vented	
				304SS/ 321SS	Alloy X-750/ Alloy 718	304SS/ 321SS	Alloy X-750/ Alloy 718
70	96	0.01	0.01	70	100	5	7
70	96	0.03	0.03	50	70	5	7
45	61	0.04	0.05	30	45	4	6
96	130	0.03	0.04	75	110	5	7
140	190	0.03	0.03	100	140	5	8
190	260	0.03	0.03	120	170	6	8
26	35	0.05	0.05	10	15	5	7
52	70	0.05	0.05	30	40	6	8
70	96	0.03	0.04	40	70	6	8
210	280	0.03	0.04	110	170	6	9
17	24	0.10	0.13	15	30	3	5
26	35	0.08	0.10	30	40	3	5
49	70	0.05	0.08	40	70	4	6
160	210	0.05	0.05	110	170	5	7
70	96	0.10	0.13	30	40	5	7
130	175	0.08	0.10	90	140	5	8
78	105	0.10	0.13	30	40	5	7
120	170	0.08	0.10	100	150	5	8
78	105	0.13	0.15	30	40	5	7
170	230	0.10	0.13	90	140	5	8

All dimensions are in millimeters and prior to plating. Performance data is based on Alloy 718 material with -6 treatment. Seal performance is discussed in Section E. If working pressures exceed these ratings consult Parker for recommendations.

MUI Metal U-Ring Internal Pressure Face Seal

Applications:

- High temperature joints with significant movement.
- Up to 870 °C.
- Retrofittable in (2.38 mm cross section and larger) metal O-ring grooves for lower load and greater springback.

Features:

- Compliant low load seal, generally used unplated.
- Strongly pressure energized.
- Four standard sections and any diameter from 44.45 mm to 1.2 m.
- Radiused footprint area protects mating surfaces.
- Well supported heel and sides ensure highest pressure capability.
- Good all round performance, economically priced.

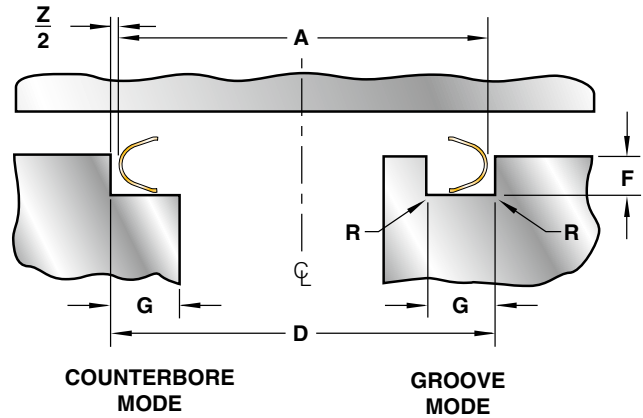

Cavity Dimensions

Nominal Cross Section	D	F	G	R
	O.D. Range Tolerance H10	Depth Range	Minimum Width	Maximum Radius
2.36	57.00 – 400.00	1.88 – 2.03	3.18	0.51
3.18	65.00 – 600.00	2.54 – 2.72	4.06	0.76
4.70	85.00 – 900.00	3.81 – 3.99	6.35	1.27
6.27	150.00 – 1200.00	5.08 – 5.28	8.89	1.52

All dimensions are in millimeters.
The tolerance reference table can be found on page E-92.

Part Numbering:

Refer to Section A, page A-9 for part numbering convention. The seal size is specified in the part number as follows:

MUI - 000000 - 00 - 00 - 0

Seal O.D. (dimension A) to two decimal places. (Example: A 30.00 mm seal is specified as 003000)

Metal Seal Cross Section Code

Material (Section D)

Temper (Section D)

Seal and Cavity Sizing:

Seal free height is based on cavity diameter and depth alone. Seal diameter (dimension A) is derived below.

A = D - Z

(tolerance h11, see page E-92)

Where: D = Minimum cavity O.D.

Z = Diametral clearance between cavity and seal

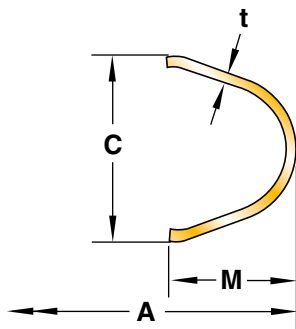

Section C
Seal Size Selection

Seal Dimensions					
Nominal Cross Section	Z	C	t	M	Cross Section Code
	Diametral Clearance	Free Height	Material Thickness	Maximum Radial Width	
2.36	0.08	2.36 ± 0.10	0.25	2.49	07
3.18	0.13	3.18 ± 0.13	0.30	3.33	09
4.70	0.15	4.70 ± 0.13	0.38	5.03	13
6.27	0.20	6.27 ± 0.15	0.51	6.65	15

Performance		
Seating Load (N/mm circumference)	Springback (mm)	Working* Pressure Rating (MPa)
8	0.25	82
9	0.36	82
9	0.51	55
12	0.66	55

All dimensions are in millimeters. Performance data is based on Alloy 718 material with -6 treatment. Seal performance is discussed in Section E. *If working pressures exceed these ratings consult Parker for recommendations.

MUE Metal U-Ring External Pressure Face Seal

Applications:

- High temperature joints with significant movement.
- Up to 870 °C.
- Retrofittable in (2.38 mm cross section and larger) metal O-ring grooves for lower load and greater springback.

Features:

- Compliant low load seal, generally used unplated.
- Strongly pressure energized.
- Four standard sections and any diameter from 44.45 mm to 1.2 m.
- Radiused footprint area protects mating surfaces.
- Well supported heel and sides ensure highest pressure capability.
- Good all round performance, economically priced.

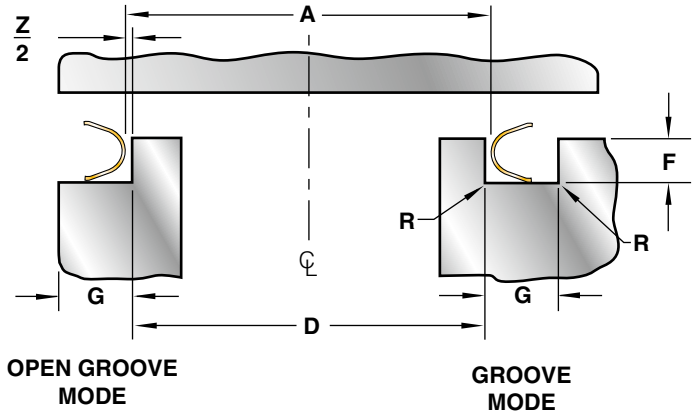

Cavity Dimensions				
Nominal Cross Section	D	F	G	R
	I.D. Range Tolerance h10	Depth Range	Minimum Width	Maximum Radius
2.36	57.00 – 400.00	1.88 – 2.03	3.18	0.51
3.18	65.00 – 600.00	2.54 – 2.72	4.06	0.76
4.70	85.00 – 900.00	3.81 – 3.99	6.35	1.27
6.27	150.00 – 1200.00	5.08 – 5.28	8.89	1.52

All dimensions are in millimeters.
The tolerance reference table can be found on page E-92.

Part Numbering:

Refer to Section A, page A-9 for part numbering convention. The seal size is specified in the part number as follows:

MUE - 000000 - 00 - 00 - 0

Seal I.D. (dimension A) to two decimal places. (Example: A 30.00 mm seal is specified as 003000)

Metal Seal Cross Section Code

Material (Section D)

Temper (Section D)

Seal and Cavity Sizing:

Seal free height is based on cavity diameter and depth alone. Seal diameter (dimension A) is derived below.

A = D + Z

(tolerance H11, see page E-92)

Where: D = Maximum cavity I.D.

Z = Diametral clearance between cavity and seal

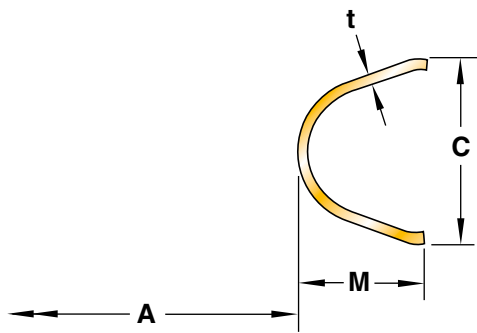

Section C
Seal Size Selection

Seal Dimensions					
Nominal Cross Section	Z	C	t	M	Cross Section Code
	Diametral Clearance	Free Height	Material Thickness	Maximum Radial Width	
2.36	0.08	2.36 ± 0.10	0.25	2.49	07
3.18	0.13	3.18 ± 0.13	0.30	3.33	09
4.70	0.15	4.70 ± 0.13	0.38	5.03	13
6.27	0.20	6.27 ± 0.15	0.51	6.65	15

Performance		
Seating Load (N/mm circumference)	Springback (mm)	Working Pressure Rating (MPa)
8	0.25	82
9	0.36	82
9	0.51	55
12	0.66	55

All dimensions are in millimeters. Performance data is based on Alloy 718 material with -6 treatment. Seal performance is discussed in Section E. If working pressures exceed these ratings consult Parker for recommendations.

MWI Metal Wire Ring Internal Pressure Face Seal

Applications:

- Low cost, high load ‘crush’ sealing.
- Contiguous sealing surface permits use within triple-surface, chamfered joints and non-rectangular section grooves.
- Best with rigid mating surfaces with minimum relative movement.
- Small process valves.
- Fits standard metal O-ring grooves.

Features:

- Wide variety of material options.
- High pressure rating.
- Many other custom cross sections are available.

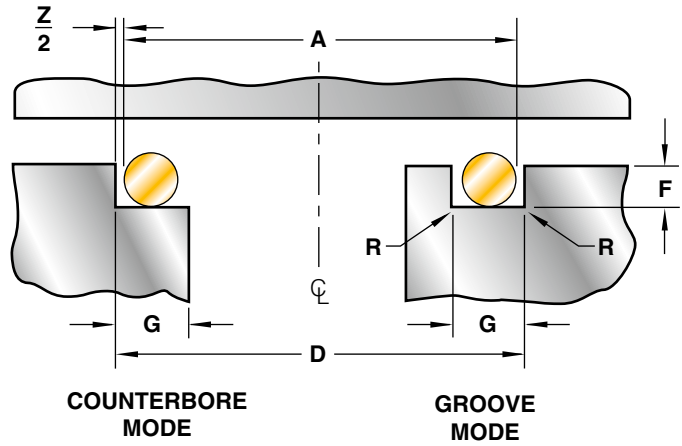

Cavity Dimensions				
Nominal Cross Section	D	F	G	R
	O.D. Range Tolerance H10	Depth Range	Minimum Width	Maximum Radius
0.89	6.35 – 25.00	0.64 – 0.69	1.40	0.25
1.57	13.00 – 200.00	1.14 – 1.27	2.29	0.38
2.39	25.00 – 400.00	1.88 – 2.01	3.81	0.51
3.18	38.00 – 600.00	2.54 – 2.67	4.06	0.76

All dimensions are in millimeters.
The tolerance reference table can be found on page E-92.

Part Numbering:

Refer to Section A, page A-9 for part numbering convention. The seal size is specified in the part number as follows:

MWI - 000000 - 00 - 00 - 0

Seal O.D. (dimension A) ————
to two decimal places.
(Example: A 30.00 mm seal is specified as 003000)

Metal Seal Cross Section Code ————

Material (Section D) ————

Temper (Section D) ————

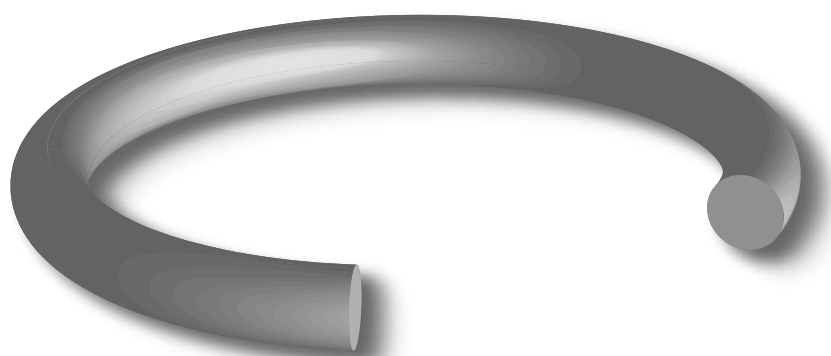
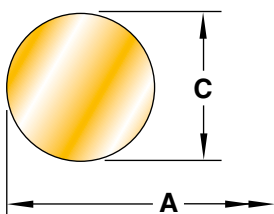

Seal and Cavity Sizing:

Seal free height is based on cavity diameter and depth alone. Seal diameter (dimension A) is derived below.

$$A = D - Z$$

(tolerance ± 0.13)

Where: D = Minimum cavity O.D.

Z = Diametral clearance between cavity and seal

Section C
Seal Size Selection

Seal Dimensions			
Nominal Cross Section	Z	C	Cross Section Code
	Diametral Clearance	Free Height	
0.89	0.20	0.89 ^{+0.08} / _{-0.03}	03
1.57	0.28	1.57 ^{+0.08} / _{-0.03}	05
2.39	0.33	2.39 ^{+0.08} / _{-0.03}	06
3.18	0.43	3.18 ^{+0.08} / _{-0.03}	07

Performance		
Seating Load (N/mm circumference)	Springback (mm)	Working Pressure Rating (MPa)
740	0.00	140
1050	0.01	140
1050	0.03	140
1050	0.05	140

All dimensions are in millimeters. Performance data is based on annealed 304 Stainless Steel. Seal performance is discussed in Section E.

MWE Metal Wire Ring External Pressure Face Seal

Applications:

- Low cost, high load ‘crush’ sealing.
- Contiguous sealing surface permits use within triple-surface, chamfered joints and non-rectangular section grooves.
- Best with rigid mating surfaces with minimum relative movement.
- Small process valves.
- Fits standard metal O-ring grooves.

Features:

- High pressure rating.
- Many other custom cross sections are available. Contact your local representative.

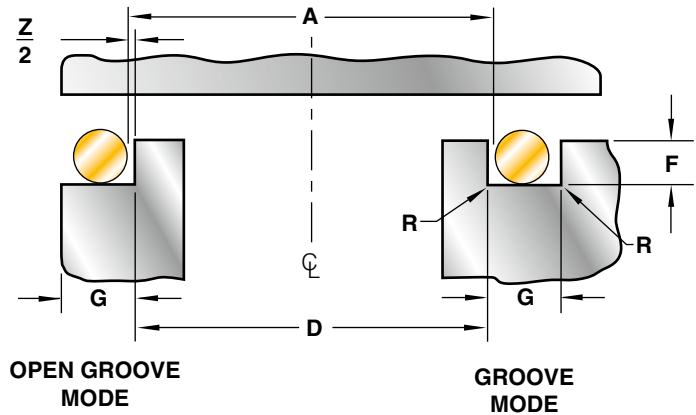

Cavity Dimensions				
Nominal Cross Section	D	F	G	R
	I.D. Range Tolerance h10	Depth Range	Minimum Width	Maximum Radius
0.89	4.50 – 25.00	0.64 – 0.69	1.40	0.25
1.57	10.00 – 200.00	1.14 – 1.27	2.29	0.38
2.39	20.00 – 400.00	1.88 – 2.01	3.81	0.51
3.18	32.00 – 600.00	2.54 – 2.67	4.06	0.76

All dimensions are in millimeters.
The tolerance reference table can be found on page E-92.

Part Numbering:

Refer to Section A, page A-9 for part numbering convention. The seal size is specified in the part number as follows:

MWE - 000000 - 00 - 00 - 0

Seal I.D. (dimension A) to two decimal places. (Example: A 30.00 mm seal is specified as 003000)

Metal Seal Cross Section Code

Material (Section D)

Temper (Section D)

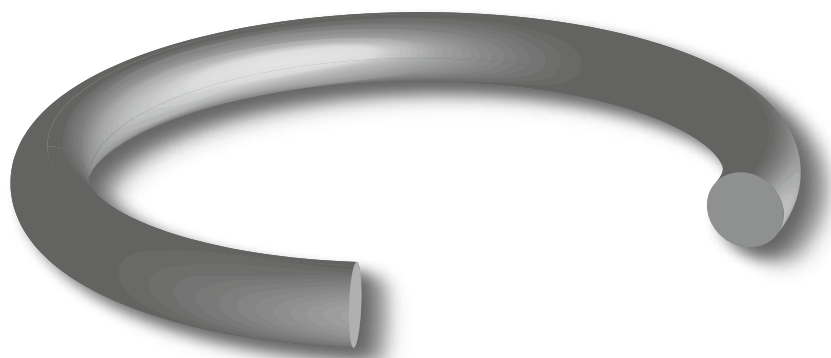
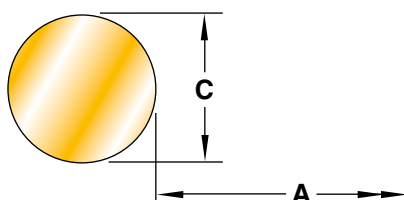

Seal and Cavity Sizing:

Seal free height is based on cavity diameter and depth alone. Seal diameter (dimension A) is derived below.

$$A = D + Z$$

(tolerance $\pm 0,13$ mm)

Where: D = Maximum cavity I.D.

Z = Diametral clearance between cavity and seal

Section C
Seal Size Selection

Seal Dimensions			
Nominal Cross Section	Z	C	Cross Section Code
	Diametral Clearance	Free Height	
0.89	0.20	0.89 ^{+0.08} / _{-0.03}	03
1.57	0.28	1.57 ^{+0.08} / _{-0.03}	05
2.39	0.33	2.39 ^{+0.08} / _{-0.03}	06
3.18	0.43	3.18 ^{+0.08} / _{-0.03}	07

Performance		
Seating Load (N/mm circumference)	Springback (mm)	Working Pressure Rating (MPa)
740	0.00	140
1050	0.01	140
1050	0.03	140
1050	0.05	140

All dimensions are in millimeters. Performance data is based on annealed 304 Stainless Steel. Seal performance is discussed in Section E.

MCA Metal C-Ring Axial Seal

Applications:

- Static and low cycle dynamic axial sealing.
- Fire-safe quarter turn valve stem sealing: up to 30,000 operating cycles.
- ‘Plug-in’ connector sealing.
- High temperature sealing of mechanical seal to shaft interface.

Features:

- Close tolerance seal for light installation loads.
- Plating partially transfers to stem for low wear characteristics on quarter turn applications.

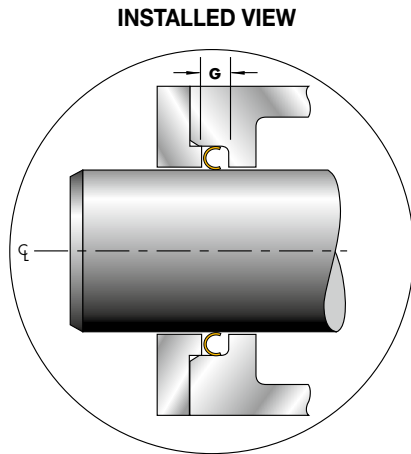

Cavity Requirements:

- Requires careful control of diametral tolerances and concentricity.

Bore Diameter (mm) D	Concentricity (mm) ⊙
≤ 82.55	0.013
> 82.55	0.03

- Static mating surfaces should be 0.2 – 0.4 μm R_a, 60 R_c.
- Dynamic mating surfaces should be 0.1– 0.2 μm R_a, 60 R_c.

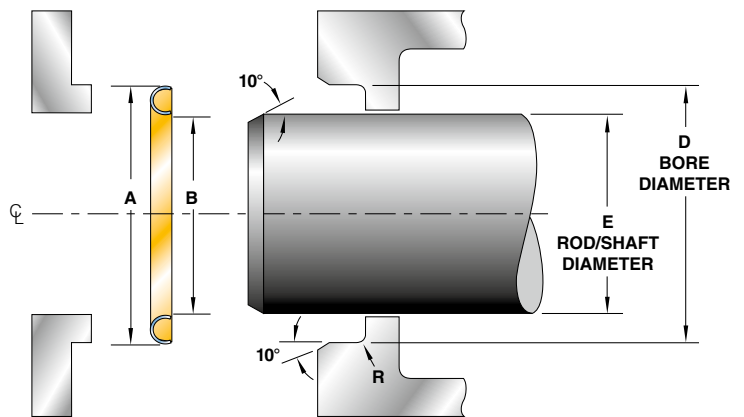

Cavity Dimensions						
Nominal Cross Section	D		E		G	R
	Bore Diameter		Rod/Shaft Diameter		Min. Width	Max. Radius
	Range	tol.	tol.			
1.57	12.70 – 38.10	+0.03 -0.00	D _{min} -3.12	+0.00 -0.03	1.30	0.38
	38.11 – 45.00	+0.03 -0.00	D _{min} -3.07	+0.00 -0.03		
2.39	30.17 – 38.10	+0.03 -0.00	D _{min} -4.70	+0.00 -0.03	1.98	0.51
	38.11 – 85.00	+0.03 -0.00	D _{min} -4.65	+0.00 -0.03		
3.18	50.80 – 82.55	+0.03 -0.00	D _{min} -6.25	+0.00 -0.03	2.64	0.76
	82.56 – 152.40	+0.05 -0.00	D _{min} -6.15	+0.00 -0.05		
	152.41 – 200.00	+0.05 -0.00	D _{min} -6.05	+0.00 -0.05		
3.96	82.55 – 152.40	+0.05 -0.00	D _{min} -7.72	+0.00 -0.05	3.28	1.27
	152.41 – 250.00	+0.05 -0.00	D _{min} -7.62	+0.00 -0.05		
4.78	101.60 – 152.40	+0.05 -0.00	D _{min} -9.32	+0.00 -0.05	3.96	1.27
	152.41 – 300.00	+0.05 -0.00	D _{min} -9.22	+0.00 -0.05		
6.35	152.40 – 300.00	+0.05 -0.00	D _{min} -12.40	+0.00 -0.05	5.28	1.52

All dimensions are in millimeters.

Part Numbering:

Refer to Section A, page A-9 for part numbering convention. The seal size is specified in the part number as follows:

MCA - 000000 - 00 - 00 - 0 - XXN

Seal O.D. prior to plating (dimension A) to two decimal places (Example: A 30.00 mm seal is specified as 003000)

Metal Seal Cross Section Code

Material (Section D)

Temper (Section D)

Standard plating thickness for ECA seal is 0.03 mm to 0.05 mm (thickness code N)

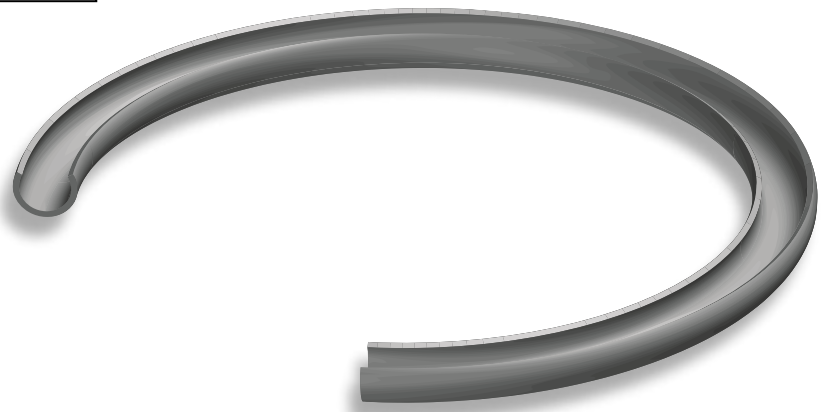
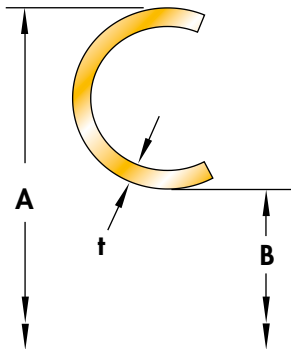

Section C
Seal Size Selection

Seal Dimensions					Pressure Rating
Nominal Cross Section	A	B	t	Cross Section Code	Working Pressure Rating (MPa)
	Seal O.D.	Seal I.D.	Material Thickness		
	tol.	tol.			
1.57	$D_{min}+0.08 \pm 0.03$	$A - 3.28 \pm 0.03$	0.15	05	390
	$D_{min}+0.10 \pm 0.03$	$A - 3.28 \pm 0.03$			
2.39	$D_{min}+0.08 \pm 0.03$	$A - 4.85 \pm 0.03$	0.25	07	160
	$D_{min}+0.08 \pm 0.03$	$A - 4.85 \pm 0.03$			
3.18	$D_{min}+0.10 \pm 0.03$	$A - 6.45 \pm 0.03$	0.38	09	260
	$D_{min}+0.15 \pm 0.05$	$A - 6.45 \pm 0.05$			
	$D_{min}+0.20 \pm 0.05$	$A - 6.45 \pm 0.05$			
3.96	$D_{min}+0.15 \pm 0.05$	$A - 8.03 \pm 0.05$	0.41	11	210
	$D_{min}+0.20 \pm 0.05$	$A - 8.03 \pm 0.05$			
4.78	$D_{min}+0.15 \pm 0.05$	$A - 9.63 \pm 0.05$	0.51	13	220
	$D_{min}+0.20 \pm 0.05$	$A - 9.63 \pm 0.05$			
6.35	$D_{min}+0.20 \pm 0.05$	$A - 12.80 \pm 0.05$	0.64	15	200

All dimensions are in millimeters and prior to plating.

Boss Seal

for MS-33649 Fluid Connection Boss & MS-33514/33656 Fitting Ends

Applications:

- Direct replacement/upgrade for elastomeric O-rings on MS-33514 flared and MS-33656 flareless fitting ends, installed into MS-33649 fluid bosses.
- Temperatures to 650 °C.
- System pressures to 35 MPa and above. (Seal is capable of higher pressures. Boss or fitting may be limiting item. Consult your local representative for assistance if pressures exceed 35 MPa).

Features:

- No rework of boss or fitting is necessary.
- Utilizes proven silver plated alloy X-750 C-ring technology.
- Washer engages with fitting threads for centering the seal in the boss.
- Designed for installation in either direction.
- Internally pressure-energized to maintain sealing stress. No need to retorque.
- Cannot extrude or fail due to ageing, pressure impulses, proof testing or extreme temperatures.
- Fully compatible with all hydraulic fluids and fuels. One seal type works for all fluids.
- Easy selection for all standard dash sizes.

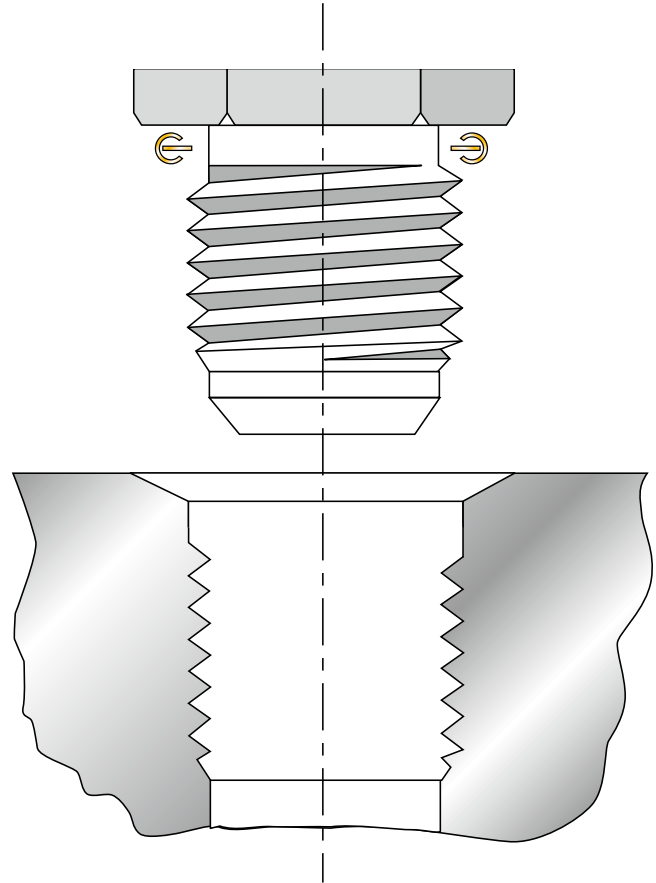

Boss Seal for MS-33649 Fluid Connection Boss & MS-33514/33656 Fitting Ends

Part Number/Ordering:

Simply refer to the table below to determine the appropriate boss seal part number for the specific MS Dash Number.

The standard boss seal is made from Alloy X-750, work hardened, and silver plated to a thickness of 0.01 to 0.03 mm.

Other materials are available. Please contact your local representative for assistance.

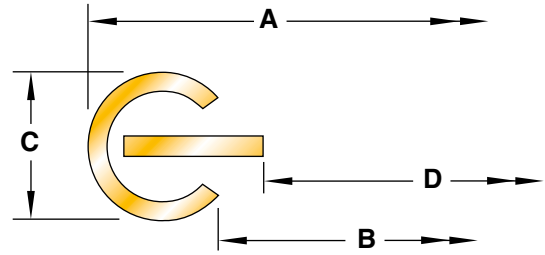

MS Dash Number	Boss Seal Part Number	Seal Dimensions				
		A O.D. (tol. +0.00 - 0.13)	B Seal I.D. (min.)	C Free Height (tol. ± 0.05)	Material Thickness	D Washer I.D. Ref
- 02	66690-02-07-1-SPA	9.68	7.67	1.19	0.15	7.06
- 03	66690-03-07-1-SPA	11.28	9.27	1.19	0.15	8.66
- 04	66690-04-07-1-SPA	12.85	10.85	1.19	0.15	10.08
- 05	66690-05-07-1-SPA	14.45	12.45	1.19	0.15	11.66
- 06	66690-06-07-1-SPA	16.03	14.02	1.19	0.15	13.13
- 07	66690-07-07-1-SPA	17.63	15.62	1.19	0.15	14.71
- 08	66690-08-07-1-SPA	20.80	18.80	1.19	0.15	17.75
- 09	66690-09-07-1-SPA	22.40	20.40	1.19	0.15	19.33
- 10	66690-10-07-1-SPA	23.98	21.97	1.19	0.15	20.75
- 11	66690-11-07-1-SPA	27.94	25.93	1.19	0.15	23.67
- 12	66690-12-07-1-SPA	29.36	26.70	1.57	0.25	25.27
- 14	66690-14-07-1-SPA	32.54	29.87	1.57	0.25	28.45
- 16	66690-16-07-1-SPA	35.71	33.05	1.57	0.25	31.62
- 18	66690-18-07-1-SPA	40.46	37.80	1.57	0.25	36.37
- 20	66690-20-07-1-SPA	43.64	40.97	1.57	0.25	39.55
- 24	66690-24-07-1-SPA	49.99	47.32	1.57	0.25	45.90
- 28	66690-28-07-1-SPA	59.51	56.85	1.57	0.25	55.42
- 32	66690-32-07-1-SPA	65.89	63.22	1.57	0.25	61.77

All dimensions are in millimeters and prior to plating.

Section C
Seal Size Selection

Metal E-Ring, for AS1895 Flanges

- Specially sized E-rings are listed below to fit all AS1895 (dash number -100 to -750) flanges.
- E-rings are manufactured from unplated Alloy 718, solution annealed and age-hardened in the standard configuration. Other high strength/higher temperature nickel alloys are available including Waspaloy and Rene 41.

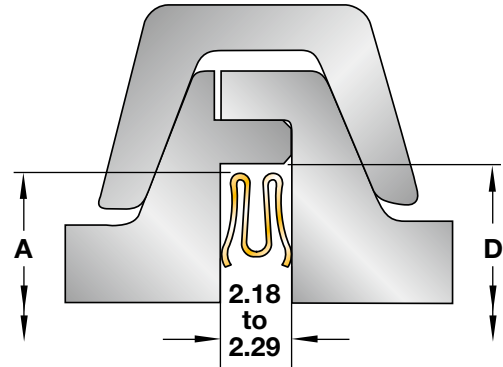

AS1895 Dash Number	D Cavity (+0.003 -0.000)	E-Ring Part Number	A Seal O.D. (Tol. h11)	C Seal Free Height ±0.13
-100	31.75	69025 -100 - XX	31.67	2.74
-125	38.10	69025 -125 - XX	38.02	2.74
-150	44.45	69025 -150 - XX	44.37	2.74
-175	50.80	69025 -175 - XX	50.72	2.74
-200	57.15	69025 -200 - XX	57.07	2.74
-225	63.50	69025 -225 - XX	63.42	2.74
-250	69.85	69025 -250 - XX	69.77	2.74
-275	76.20	69025 -275 - XX	76.12	2.74
-300	82.55	69025 -300 - XX	82.47	2.74
-325	88.90	69025 -325 - XX	88.82	2.74
-350	95.25	69025 -350 - XX	95.17	2.74
-400	107.95	69025 -400 - XX	107.87	2.74
-450	120.65	69025 -450 - XX	120.57	2.74
-500	133.35	69025 -500 - XX	133.27	2.74
-550	146.05	69025 -550 - XX	145.97	2.74
-600	158.75	69025 -600 - XX	158.67	2.74
-650	171.45	69025 -650 - XX	171.37	2.74
-700	184.15	69025 -700 - XX	184.07	2.74
-750	196.85	69025 -750 - XX	196.77	2.74

All dimensions are in millimeters.
The tolerance reference table can be found on page E-92.

Material Code Choice (XX):

Material	Material Code
Alloy 718	14
Waspaloy	23
Rene 41	29

Metal O-Rings for U.S. Aerospace Standards

AS9141 Parker Part Number EON – Seal diameter code from table below – 01 - 03 - 1

AS Dash Number	Seal Diameter Code
-03	000250
-04	000281
-05	000312
-06	000344
-07	000375
-08	000406
-09	000438

AS Dash Number	Seal Diameter Code
-10	000469
-11	000500
-12	000562
-13	000625
-14	000688
-15	000750
-16	000812

AS Dash Number	Seal Diameter Code
-17	000875
-18	000938
-19	001000
-20	001125
-21	001250
-22	001375
-23	001500

AS Dash Number	Seal Diameter Code
-24	001625
-25	001750
-26	001875
-27	002000

AS9142 Parker Part Number EON – Seal diameter code from table below – 02 - 03 - 1

AS Dash Number	Seal Diameter Code
-013	000438
-014	000469
-015	000500
-016	000531
-017	000562
-018	000594
-019	000625
-020	000656
-021	000688
-022	000719
-023	000750
-024	000781
-025	000812
-026	000844
-027	000875
-028	000906
-029	000938
-030	000969
-031	001000

AS Dash Number	Seal Diameter Code
-032	001031
-033	001062
-034	001094
-035	001125
-036	001156
-037	001188
-038	001219
-039	001250
-040	001312
-041	001375
-042	001438
-043	001500
-044	001562
-045	001625
-046	001688
-047	001750
-048	001812
-049	001875
-050	001938

AS Dash Number	Seal Diameter Code
-051	002000
-052	002062
-053	002125
-054	002188
-055	002250
-056	002312
-057	002375
-058	002438
-059	002500
-060	002562
-061	002625
-062	002688
-063	002750
-064	002812
-065	002875
-066	002938
-067	003000
-069	003125
-071	003250

AS Dash Number	Seal Diameter Code
-073	003375
-075	003500
-077	003625
-079	003750
-081	003875
-083	004000
-085	004125
-087	004250
-089	004375
-091	004500
-093	004625
-095	004750
-097	004875
-099	005000

Section C
Seal Size Selection

AS9202 Parker Part Number EON – Seal diameter code from table below – 03 - 03 - 1

AS Dash Number	Seal Diameter Code
-013	000438
-014	000469
-015	000500
-016	000531
-017	000562
-018	000594
-019	000625
-020	000656
-021	000688
-022	000719
-023	000750
-024	000781
-025	000812
-026	000844
-027	000875
-028	000906
-029	000938
-030	000969
-031	001000
-032	001031
-033	001062
-034	001094
-035	001125
-036	001156
-037	001188

AS Dash Number	Seal Diameter Code
-038	001219
-039	001250
-040	001312
-041	001375
-042	001438
-043	001500
-044	001562
-045	001625
-046	001688
-047	001750
-048	001812
-049	001875
-050	001938
-051	002000
-052	002062
-053	002125
-054	002188
-055	002250
-056	002312
-057	002375
-058	002438
-059	002500
-060	002562
-061	002625
-062	002688

AS Dash Number	Seal Diameter Code
-063	002750
-064	002812
-065	002875
-066	002938
-067	003000
-069	003125
-071	003250
-073	003375
-075	003500
-077	003625
-079	003750
-081	003875
-083	004000
-085	004125
-087	004250
-089	004375
-091	004500
-093	004625
-095	004750
-097	004875
-099	005000
-101	005125
-103	005250
-105	005375
-107	005500

AS Dash Number	Seal Diameter Code
-109	005625
-111	005750
-113	005875
-115	006000
-117	006125
-119	006250
-121	006375
-123	006500
-125	006625
-127	006750
-129	006875
-131	007000
-133	007125
-135	007250
-137	007375
-139	007500
-141	007625
-143	007750
-145	007875
-147	008000

Section C – Seal Size Selection

Metal O-Rings for U.S. Aerospace Standards

AS9203 *Parker Part Number EON – Seal diameter code from table below – 04 - 03 - 1*

AS Dash Number	Seal Diameter Code
-010	001000
-012	001031
-013	001062
-014	001094
-015	001125
-016	001156
-017	001188
-018	001219
-019	001250
-020	001281
-021	001312
-022	001344
-023	001375
-024	001406
-025	001438
-026	001469
-027	001500
-028	001562
-029	001625
-030	001688
-031	001750
-032	001812
-033	001875
-034	001938
-035	002000
-036	002062

AS Dash Number	Seal Diameter Code
-037	002125
-038	002188
-039	002250
-040	002312
-041	002375
-042	002438
-043	002500
-044	002562
-045	002625
-046	002688
-047	002750
-048	002812
-049	002875
-050	002938
-051	003000
-052	003062
-053	003125
-054	003188
-055	003250
-056	003312
-057	003375
-058	003438
-059	003500
-060	003562
-061	003625
-062	003688

AS Dash Number	Seal Diameter Code
-063	003750
-064	003812
-065	003875
-066	003938
-067	004000
-069	004125
-071	004250
-073	004375
-075	004500
-077	004625
-079	004750
-081	004875
-083	005000
-085	005125
-087	005250
-089	005375
-091	005500
-095	005750
-099	006000
-103	006250
-107	006500
-111	006750
-115	007000
-119	007250
-123	007500
-127	007750

AS Dash Number	Seal Diameter Code
-131	008000
-135	008250
-139	008500
-143	008750
-147	009000
-151	009250
-155	009500
-159	009750
-163	010000
-167	010250
-171	010500
-175	010750
-179	011000
-183	011250
-187	011500
-191	011750
-195	012000
-203	012500
-211	013000
-219	013500
-227	014000

AS9204 *Parker Part Number EON – Seal diameter code from table below – 05 - 03 - 1*

AS Dash Number	Seal Diameter Code
-010	001000
-012	001031
-013	001062
-014	001094
-015	001125
-016	001156
-017	001188
-018	001219
-019	001250
-020	001281
-021	001312
-022	001344
-023	001375
-024	001406
-025	001438
-026	001469
-027	001500
-028	001562
-029	001625
-030	001688
-031	001750
-032	001812
-033	001875
-034	001938
-035	002000
-036	002062

AS Dash Number	Seal Diameter Code
-037	002125
-038	002188
-039	002250
-040	002312
-041	002375
-042	002438
-043	002500
-044	002562
-045	002625
-046	002688
-047	002750
-048	002812
-049	002875
-050	002938
-051	003000
-052	003062
-053	003125
-054	003188
-055	003250
-056	003312
-057	003375
-058	003438
-059	003500
-060	003562
-061	003625
-062	003688

AS Dash Number	Seal Diameter Code
-063	003750
-064	003812
-065	003875
-066	003938
-067	004000
-069	004125
-071	004250
-073	004375
-075	004500
-077	004625
-079	004750
-081	004875
-083	005000
-085	005125
-087	005250
-089	005375
-091	005500
-095	005750
-099	006000
-103	006250
-107	006500
-111	006750
-115	007000
-119	007250
-123	007500
-127	007750

AS Dash Number	Seal Diameter Code
-131	008000
-135	008250
-139	008500
-143	008750
-147	009000
-151	009250
-155	009500
-159	009750
-163	010000
-167	010250
-171	010500
-175	010750
-179	011000
-183	011250
-187	011500
-191	011750
-195	012000
-203	012500
-211	013000
-219	013500
-227	014000

Metal O-Rings for U.S. Aerospace Standards

AS9205

Parker Part Number **EON** – Seal diameter code from table below – 07 - 03 - 1

AS Dash Number	Seal Diameter Code
-010	002000
-011	002062
-012	002125
-013	002188
-014	002250
-015	002312
-016	002375
-017	002438
-018	002500
-019	002562
-020	002625
-021	002688
-022	002750
-023	002812
-024	002875
-025	002938
-026	003000
-027	003062
-028	003125
-029	003188
-030	003250
-031	003312
-032	003375
-033	003438
-034	003500
-035	003562
-036	003625
-037	003688
-038	003750
-039	003812
-040	003875
-041	003938
-042	004000
-043	004062
-044	004125
-045	004188
-046	004250
-047	004312
-048	004375
-049	004438
-050	004500
-051	004562
-052	004625
-053	004688
-054	004750
-055	004812
-056	004875
-057	004938

AS Dash Number	Seal Diameter Code
-058	005000
-059	005062
-060	005125
-061	005188
-062	005250
-063	005312
-064	005375
-065	005438
-066	005500
-067	005562
-068	005625
-069	005688
-070	005750
-071	005812
-072	005875
-073	005938
-074	006000
-076	006125
-078	006250
-080	006375
-082	006500
-084	006625
-086	006750
-088	006875
-090	007000
-092	007125
-094	007250
-096	007375
-098	007500
-100	007625
-102	007750
-104	007875
-106	008000
-108	008125
-110	008250
-112	008375
-114	008500
-116	008625
-118	008750
-120	008875
-122	009000
-124	009250
-130	009500
-134	009750
-138	010000
-142	010250
-146	010500
-150	010750

AS Dash Number	Seal Diameter Code
-154	011000
-158	011250
-162	011500
-166	011750
-170	012000
-174	012250
-178	012500
-182	012750
-186	013000
-190	013250
-194	013500
-198	013750
-202	014000
-206	014250
-210	014500
-214	014750
-218	015000
-222	015250
-226	015500
-230	015750
-234	016000
-238	016250
-242	016500
-246	016750
-250	017000
-254	017250
-258	017500
-262	017750
-266	018000
-270	018250
-274	018500
-278	018750
-282	019000
-286	019250
-290	019500
-294	019750
-298	020000
-306	020500
-314	021000
-322	021500
-330	022000
-338	022500
-346	023000
-354	023500
-362	024000
-370	024500
-378	025000
-386	025500

AS Dash Number	Seal Diameter Code
-394	026000
-402	026500
-410	027000
-418	027500
-426	028000
-434	028500
-442	029000
-450	029500
-458	030000
-466	030500
-474	031000
-482	031500
-490	032000
-498	032500
-506	033000
-514	033500
-522	034000
-530	034500
-538	035000
-546	035500
-554	036000
-562	036500
-570	037000
-578	037500
-586	038000
-594	038500
-602	039000
-610	039500
-618	040000
-634	041000
-650	042000
-666	043000
-682	044000
-698	045000
-714	046000
-730	047000
-746	048000
-762	049000
-778	050000

Section C – Seal Size Selection

Metal O-Rings for U.S. Aerospace Standards

AS9371 *Parker Part Number EON – Seal diameter code from table below – 01 - 03 - 1 - SPB*

AS Dash Number	Seal Diameter Code
-03	000250
-04	000281
-05	000312
-06	000344
-07	000375
-08	000406
-09	000438

AS Dash Number	Seal Diameter Code
-10	000469
-11	000500
-12	000562
-13	000625
-14	000688
-15	000750
-16	000812

AS Dash Number	Seal Diameter Code
-17	000875
-18	000938
-19	001000
-20	001125
-21	001250
-22	001375
-23	001500

AS Dash Number	Seal Diameter Code
-24	001625
-25	001750
-26	001875
-27	002000

AS9372 *Parker Part Number EON – Seal diameter code from table below – 02 - 03 - 1 - SPB*

AS Dash Number	Seal Diameter Code
-013	000438
-014	000469
-015	000500
-016	000531
-017	000562
-018	000594
-019	000625
-020	000656
-021	000688
-022	000719
-023	000750
-024	000781
-025	000812
-026	000844
-027	000875
-028	000906
-029	000938
-030	000969
-031	001000

AS Dash Number	Seal Diameter Code
-032	001031
-033	001062
-034	001094
-035	001125
-036	001156
-037	001188
-038	001219
-039	001250
-040	001312
-041	001375
-042	001438
-043	001500
-044	001562
-045	001625
-046	001688
-047	001750
-048	001812
-049	001875
-050	001938

AS Dash Number	Seal Diameter Code
-051	002000
-052	002062
-053	002125
-054	002188
-055	002250
-056	002312
-057	002375
-058	002438
-059	002500
-060	002562
-061	002625
-062	002688
-063	002750
-064	002812
-065	002875
-066	002938
-067	003000
-069	003125
-071	003250

AS Dash Number	Seal Diameter Code
-073	003375
-075	003500
-077	003625
-079	003750
-081	003875
-083	004000
-085	004125
-087	004250
-089	004375
-091	004500
-093	004625
-095	004750
-097	004875
-099	005000

AS9373 *Parker Part Number EON – Seal diameter code from table below – 03 - 03 - 1 - SPB*

AS Dash Number	Seal Diameter Code
-013	000438
-014	000469
-015	000500
-016	000531
-017	000562
-018	000594
-019	000625
-020	000656
-021	000688
-022	000719
-023	000750
-024	000781
-025	000812
-026	000844
-027	000875
-028	000906
-029	000938
-030	000969
-031	001000
-032	001031
-033	001062
-034	001094
-035	001125
-036	001156
-037	001188

AS Dash Number	Seal Diameter Code
-038	001219
-039	001250
-040	001312
-041	001375
-042	001438
-043	001500
-044	001562
-045	001625
-046	001688
-047	001750
-048	001812
-049	001875
-050	001938
-051	002000
-052	002062
-053	002125
-054	002188
-055	002250
-056	002312
-057	002375
-058	002438
-059	002500
-060	002562
-061	002625
-062	002688

AS Dash Number	Seal Diameter Code
-063	002750
-064	002812
-065	002875
-066	002938
-067	003000
-069	003125
-071	003250
-073	003375
-075	003500
-077	003625
-079	003750
-081	003875
-083	004000
-085	004125
-087	004250
-089	004375
-091	004500
-093	004625
-095	004750
-097	004875
-099	005000
-101	005125
-103	005250
-105	005375
-107	005500

AS Dash Number	Seal Diameter Code
-109	005625
-111	005750
-113	005875
-115	006000
-117	006125
-119	006250
-121	006375
-123	006500
-125	006625
-127	006750
-129	006875
-131	007000
-133	007125
-135	007250
-137	007375
-139	007500
-141	007625
-143	007750
-145	007875
-147	008000

Metal O-Rings for U.S. Aerospace Standards

AS9374 Parker Part Number EON – Seal diameter code from table below – 04 - 03 - 1 - SPB

AS Dash Number	Seal Diameter Code
-010	001000
-012	001031
-013	001062
-014	001094
-015	001125
-016	001156
-017	001188
-018	001219
-019	001250
-020	001281
-021	001312
-022	001344
-023	001375
-024	001406
-025	001438
-026	001469
-027	001500
-028	001562
-029	001625
-030	001688
-031	001750
-032	001812
-033	001875
-034	001938
-035	002000

AS Dash Number	Seal Diameter Code
-036	002062
-037	002125
-038	002188
-039	002250
-040	002312
-041	002375
-042	002438
-043	002500
-044	002562
-045	002625
-046	002688
-047	002750
-048	002812
-049	002875
-050	002938
-051	003000
-052	003062
-053	003125
-054	003188
-055	003250
-056	003312
-057	003375
-058	003438
-059	003500
-060	003562

AS Dash Number	Seal Diameter Code
-061	003625
-062	003688
-063	003750
-064	003812
-065	003875
-066	003938
-067	004000
-069	004125
-071	004250
-073	004375
-075	004500
-077	004625
-079	004750
-081	004875
-083	005000
-085	005125
-087	005250
-089	005375
-091	005500
-095	005750
-099	006000
-103	006250
-107	006500
-111	006750
-115	007000

AS Dash Number	Seal Diameter Code
-119	007250
-123	007500
-127	007750
-131	008000
-135	008250
-139	008500
-143	008750
-147	009000
-151	009250
-155	009500
-159	009750
-163	010000
-167	010250
-171	010500
-175	010750
-179	011000
-183	011250
-187	011500
-191	011750
-195	012000

AS9375 Parker Part Number EON – Seal diameter code from table below – 05 - 03 - 1 - SPB

AS Dash Number	Seal Diameter Code
-010	001000
-012	001031
-013	001062
-014	001094
-015	001125
-016	001156
-017	001188
-018	001219
-019	001250
-020	001281
-021	001312
-022	001344
-023	001375
-024	001406
-025	001438
-026	001469
-027	001500
-028	001562
-029	001625
-030	001688
-031	001750
-032	001812
-033	001875
-034	001938
-035	002000

AS Dash Number	Seal Diameter Code
-036	002062
-037	002125
-038	002188
-039	002250
-040	002312
-041	002375
-042	002438
-043	002500
-044	002562
-045	002625
-046	002688
-047	002750
-048	002812
-049	002875
-050	002938
-051	003000
-052	003062
-053	003125
-054	003188
-055	003250
-056	003312
-057	003375
-058	003438
-059	003500
-060	003562

AS Dash Number	Seal Diameter Code
-061	003625
-062	003688
-063	003750
-064	003812
-065	003875
-066	003938
-067	004000
-069	004125
-071	004250
-073	004375
-075	004500
-077	004625
-079	004750
-081	004875
-083	005000
-085	005125
-087	005250
-089	005375
-091	005500
-095	005750
-099	006000
-103	006250
-107	006500
-111	006750
-115	007000

AS Dash Number	Seal Diameter Code
-119	007250
-123	007500
-127	007750
-131	008000
-135	008250
-139	008500
-143	008750
-147	009000
-151	009250
-155	009500
-159	009750
-163	010000
-167	010250
-171	010500
-175	010750
-179	011000
-183	011250
-187	011500
-191	011750
-195	012000

Section C – Seal Size Selection

Metal O-Rings for U.S. Aerospace Standards

AS9376 Parker Part Number **EON** – Seal diameter code from table below – **07 - 03 - 1 - SPB**

AS Dash Number	Seal Diameter Code
-010	002000
-011	002062
-012	002125
-013	002188
-014	002250
-015	002312
-016	002375
-017	002438
-018	002500
-019	002562
-020	002625
-021	002688
-022	002750
-023	002812
-024	002875
-025	002938
-026	003000
-027	003062
-028	003125
-029	003188
-030	003250
-031	003312
-032	003375
-033	003438
-034	003500
-035	003562
-036	003625

AS Dash Number	Seal Diameter Code
-037	003688
-038	003750
-039	003812
-040	003875
-041	003938
-042	004000
-043	004062
-044	004125
-045	004188
-046	004250
-047	004312
-048	004375
-049	004438
-050	004500
-051	004562
-052	004625
-053	004688
-054	004750
-055	004812
-056	004875
-057	004938
-058	005000
-059	005062
-060	005125
-061	005188
-062	005250
-063	005312

AS Dash Number	Seal Diameter Code
-064	005375
-065	005438
-066	005500
-067	005562
-068	005625
-069	005688
-070	005750
-071	005812
-072	005875
-073	005938
-074	006000
-076	006125
-078	006250
-080	006375
-082	006500
-084	006625
-086	006750
-088	006875
-090	007000
-092	007125
-094	007250
-096	007375
-098	007500
-100	007625
-102	007750
-104	007875
-106	008000

AS Dash Number	Seal Diameter Code
-108	008125
-110	008250
-112	008375
-114	008500
-116	008625
-118	008750
-120	008875
-122	009000
-124	009250
-130	009500
-134	009750
-138	010000
-142	010250
-146	010500
-150	010750
-154	011000
-158	011250
-162	011500
-166	011750
-170	012000

Introduction to the Material Selection Process

With the seal type, diameter and cross-section already determined, the following pages (D-52 to D-65) provide specific guidance in selecting the appropriate material(s), temper and finish.

Comprehensive data is given to ensure an optimum match between the many material choices and the application. However, we are always pleased to offer additional technical consulting and advice if required. To obtain the fastest response please send us your completed application data sheet (see page F-103, F-104), for immediate review by our product specialists and engineering staff.

Metal seal material, temper and finish are designated in the part number as shown below.

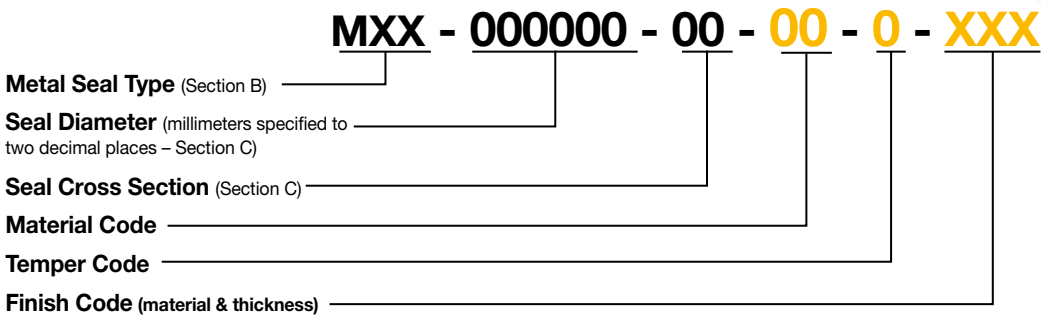

This section includes:	Page
Selecting the Metal Seal Material	
Material Codes for Non-Spring Energized Seals.....	D-52
Material Codes for Spring Energized Seals.....	D-53
Temperature Capabilities – Stainless Steel.....	D-53
Temperature Capabilities – Nickel Alloys.....	D-54
Temperature Capabilities – Cobalt Alloys.....	D-55
Temperature Capabilities – Other Materials.....	D-55
Aerospace Material Specification (AMS) Reference.....	D-56
Yield Strength, Relaxation & Springback.....	D-56
Metal Seal, Platings, Coatings and Finishes	
Temper Codes.....	D-58
Finish Codes.....	D-59
Finish Thickness Selecting Guidelines.....	D-60
Silver-Indium Plating.....	D-61
TriCom® Plating.....	D-62
TriCom-HT™ Plating.....	D-64

Section D
Material Selection

Selecting the Metal Seal Material



The tables below and opposite list all the available materials for non-spring energized seals and spring energized seals.





Starting in the column appropriate to the chosen metal seal type, make the primary material selection by choosing a “preferred”, or possibly “optional” material compatible with the maximum working temperature in the application. Information on temperature resistance is given on the following pages.

Other factors that may also require consideration include ‘NACE’ approval (corrosion resistance) and chemical compatibility. Additional guidance on the effects of material choices on seal performance (load, springback and pressure rating) may be found on pages E-69 to E-77.

Special materials are also available to meet unusually severe operational requirements, or unique procurement specifications. Generally, these will not be stock item materials and may be subject to some additional lead time and material lot charges.

MXX - 000000 - 00 - 00 - 0 - XXX

Material Code _____

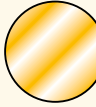

Non-Spring Energized Seals							
Material Code	Material (Common Designation)	NACE Approved (See Note 3)	 C-Ring	 E-Ring	 O-Ring	 U-Ring	 Wire Ring
01	304 Stainless Steel				Preferred ¹		Preferred
02	316 Stainless Steel				Special		Special
03	321 Stainless Steel				Preferred ¹		Special
04	347 Stainless Steel				Special		Special
15	Stainless Steel Alloy A-286		Special				
16	17-4 PH Stainless Steel		Special				
06	Alloy 600				Special		
25	Alloy 625		Special				
14	Alloy 718	Yes	Preferred	Preferred	Optional ²	Preferred	Special
07	Alloy X-750		Optional	Optional	Optional ²	Optional	Special
20	Hastelloy C-276	Yes	Special				
23	Waspaloy		Optional	Optional		Optional	
29	Rene 41		Special	Special		Special	
05	Monel 400				Special		Special
39	Haynes 188		Special			Special	
09	Haynes 25		Special		Special		
08	Aluminum Alloy 1100						Preferred ⁴
12	Copper						Special
13	Nickel						Preferred ⁴

1: 321 Stainless Steel is standard for 3.18 mm and smaller free height metal O-rings. 304 Stainless Steel is standard for 3.96 mm and larger free height metal O-rings.

2: Alloy X-750 is optional for 6.35 mm and smaller free height metal O-rings. Alloy 718 is optional for 9.53 mm and larger free height metal O-rings.

3: Approved for use in corrosive seal service per NACE MR-01-075 specification.

4: 2.39 mm free height wire rings are only available in stainless steel, nickel, and nickel alloys.

Spring Energized Seals					
Material Code	Jacket/Spring Material Combination (Common Designation)		NACE Metal C-Ring Approved (See Note 3 on previous page)	Spring Energized Metal C-Ring 	Spring Energized Metal O-Ring 
	Jacket/Spring				
01	304 Stainless Steel / 304 Stainless Steel			Optional	Preferred
02	304 Stainless Steel / Cobalt Chromium-Nickel Alloy			Special	
03	Alloy X-750 / Cobalt Chromium-Nickel Alloy			Special	
04	Aluminum Al 1100-0 / 304 Stainless Steel			Special	
05	Alloy X-750 / 304 Stainless Steel			Special	
06	Alloy X-750 / Alloy X-750			Preferred	Special
07	304 Stainless Steel / Alloy X-750			Optional	
08	304 Stainless Steel / Nimonic 90			Special	
09	Alloy X-750 / Nimonic 90			Special	
10	Alloy X-750 / Alloy 718			Optional	
11	Alloy 718 / Alloy 718		Yes	Optional	
12	Alloy 718 / Alloy X-750		Yes	Optional	
13	Nickel / Alloy X-750			Special	
14	Alloy 718 / Cobalt Chromium-Nickel Alloy			Special	
15	Cobalt Chromium-Nickel Alloy / Cobalt Chromium-Nickel Alloy			Special	
16	Alloy C-276 / Alloy C-276			Special	
17	Alloy 625 / Alloy 625			Special	

Other materials are available upon special request. Please contact one of our applications engineers for assistance.

Temperature Capability								
Stainless Steel								
Material	UNS No.	AMS Specifications				Description	Maximum Recommended Service Temperature	Typical Usage
		Strip & Sheet	Tubing	Wire				
				Wire Rings	Spring			
304/304L	S30400	AMS 5511, AMS 5513	AMS 5560, AMS 5565	AMS 5697	AMS 5857	The most commonly used stainless steel alloy. Excellent formability and good corrosion resistance. Found in a wide variety of commercial, industrial and consumer applications.	316 °C (600 °F)	C-rings, O-rings and wire rings in cryogenic to moderate temperature applications requiring mild corrosion resistance.
316/316L	S31600		AMS 5597	AMS 5690		The addition of molybdenum offers improved corrosion resistance when compared to 304/304L. These alloys also offer enhanced creep, stress-to-rupture, and tensile strengths at elevated temperatures.	316 °C (600 °F)	
17-4PH	S17400	AMS 5604				A chromium-nickel-copper, precipitation hardenable martensitic stainless steel used for applications requiring high strength and a moderate level of corrosion resistance.	316 °C (600 °F)	
321	S32100		AMS 5570, AMS 5576	AMS 5689		Stabilized by the addition of titanium, this alloy provides excellent resistance to intergranular corrosion following prolonged exposure to elevated service temperatures.	427 °C (800 °F)	
347	S34700			AMS 5674		Stabilized by the addition of columbium and tantalum. Offers increased resistance to sensitization compared to alloy 321.	427 °C (800 °F)	
Alloy 286	S66286	AMS 5525				Designed for applications requiring high strength with good corrosion and oxidation resistance at moderately high temperatures. This precipitation-hardenable alloy provides a high degree of uniformity in developing maximum strength, which can be duplicated application after application.	649 °C (1200 °F)	C-rings in more severe environments requiring enhanced strength, corrosion and oxidation resistance.

Selecting the Metal Seal Material

Temperature Capability								
Nickel Alloys								
Material	UNS No.	AMS Specifications			Description	Maximum Recommended Service Temperature	Typical Usage	
		Strip & Sheet	Tubing	Wire				
				Wire Rings				Spring
Monel® 400	N04400		AMS 4574	AMS 4730	A ductile nickel-copper solid-solutioned-strengthened alloy with good general corrosion resistance in a wide range of media. Slightly magnetic at room temperature.	316 °C (600 °F)	C-ring applications requiring corrosion resistance to specific environments.	
Alloy 276	N10276	AMS 5530			A nickel-molybdenum-chromium alloy offering superior corrosion resistance. Excellent resistance to pitting and stress corrosion cracking. Suitable for a wide variety of chemical processing environments.	538 °C (1000 °F)	C-ring applications requiring the utmost in corrosion protection.	
Alloy 600	N07600		AMS 5580		A nickel-chromium alloy with good oxidation resistance at moderate service temperatures. Good resistance to carburizing and chloride containing environments.	538 °C (1000 °F)	C-ring applications requiring corrosion resistance to specific environments.	
Alloy 625	N07625	AMS 5599			A solid-solution-strengthened, nickel-chromium-molybdenum alloy with good high-temperature strength. Offers good oxidation resistance and excellent corrosion resistance.	538 °C (1000 °F)		
Nimonic® 90	N07090			AMS 5829	A nickel-chromium-cobalt alloy being precipitation hardenable, having high stress-rupture strength and creep resistance at high temperatures	538 °C (1000 °F)	Spring material for spring-energized C-rings.	
Alloy X750	N07750	AMS 5598	AMS 5582	AMS 5699	An age-hardenable nickel-based superalloy with good high-temperature strength. Readily cold-formed using standard forming techniques.	593 °C (1100 °F)	These materials are useful for all seal types up to their maximum service temperature. Particularly suitable for gas turbine and aerospace applications with large thermal and mechanical transients.	
Alloy 718	N07718	AMS 5596	AMS 5590		An age-hardenable nickel superalloy with excellent high-temperature strength and good oxidation resistance. Excellent cold-forming characteristics. Higher strength than Alloy X750 with improved weldability.	649 °C (1200 °F)		
Waspaloy	N07701	AMS 5544			An age-hardenable nickel-based superalloy with very good high-temperature strength and oxidation resistance at service temperatures up to 732 °C (1350 °F). Strength is superior to Alloy 718 above 621 °C (1150 °F).	732 °C (1350 °F)		
Rene 41	N07041	AMS 5545			An age-hardenable nickel-based superalloy with superior strength up to 788 °C (1450 °F).	788 °C (1450 °F)		
Haynes® 230	N06230	AMS 5878			A solid-solutioned-strengthened, nickel-chromium-tungsten-molybdenum alloy with good high-temperature strength and excellent oxidation resistance. Excellent thermal stability and resistance to nitriding environments.	871 °C (1600 °F)		
Haynes® 214	N/A (DIN 17744-2.4646)				A nickel-chromium-aluminum-iron alloy with superior high-temperature oxidation resistance and very good high-temperature strength. Highly resistant to carburizing and nitriding environments.	982 °C (1800 °F)	Not as strong as the age-hardenable nickel alloys, these materials are useful where long term oxidation resistance is a prime concern.	

Material Selection Process I Selecting the Material

Temperature Capability [cont.]								
Cobalt Alloys								
Material	UNS No.	AMS Specifications				Description	Maximum Recommended Service Temperature	Typical Usage
		Strip & Sheet	Tubing	Wire				
				Wire Rings	Spring			
Elgiloy® Cobalt-Chromium-Nickel Alloy	R30003	AMS 5876			AMS 5833	This cobalt-chromium-nickel alloy gives a combination of high strength, ductility and good mechanical properties and is age hardenable. Excellent fatigue life and corrosion resistance in numerous environments.	371 °C (700 °F)	Approved high strength spring material for sour gas application.
Haynes® 25	R30605	AMS 5537				A solid-solution-strengthened, cobalt-nickel-chromium-tungsten alloy with very good resistance to high-temperature oxidizing environments. Largely replaced by Haynes 188 and Haynes 230.	871 °C (1600 °F)	High temperature C-ring applications. High wear C-ring applications.
Haynes® 188	R30188	AMS 5608				A cobalt-nickel-chromium-tungsten alloy with very good resistance to high-temperature oxidizing environments. Better thermal stability than Haynes 25 with similar high-temperature strength.	871 °C (1600 °F)	High temperature C-ring applications.

Temperature Capabilities								
Other Materials								
Material	UNS No.	AMS Specifications				Description	Maximum Recommended Service Temperature	Typical Usage
		Strip & Sheet	Tubing	Wire				
				Wire Rings	Spring			
Indium	N/A					Commercially pure (> 99.9%) Indium	66 °C (150 °F)	Electroplated in various combinations to provide ductile outer layer that enhances seal-ability and/or corrosion. Occasionally used for wire rings.
Lead	N/A					Commercially pure (> 99.9%) Lead	204 °C (400 °F)	
PTFE	N/A					Chemically inert polymer. Highly resistant to chemical attack.	260 °C (500 °F)	Near net-shape electroplated anti-wear coatings. Used to prolong seal life in applications with high thermal, mechanical or vibrational movement.
Copper	C11000					Commercially pure (> 99.0% copper). Fair corrosion resistance.	316 °C (600 °F)	Electroplated in various combinations to provide ductile outer layer that enhances seal-ability and/or corrosion. Occasionally used for wire rings.
Nickel 200	N02200					Commercially pure (> 99.9%) Nickel	316 °C (600 °F)	Low-temperature wire rings.
Aluminum Alloy 1100	A91100					Commercially pure (> 99.0%) aluminum. Good corrosion resistance and high formability.	538 °C (1000 °F)	Machined seals.
Silver	N/A					Commercially pure (> 99.9%) Silver	260 °C (500 °F) Oxidizing; 650 °C (1200 °F) non-oxidizing	Electroplated in various combinations to provide ductile outer layer that enhances seal-ability and/or corrosion. Occasionally used for wire rings.
TriCom®	N/A					A cobalt-chrome-carbide anti-wear coating with a low coefficient of friction and good oxidation resistance.	649 °C (1200 °F)	Near net-shape electroplated anti-wear coatings. Used to prolong seal life in applications with high thermal, mechanical or vibrational movement.
Nickel 201	N02201					Low-carbon version of Nickel 200. Preferable for application temperatures above 316 °C (600 °F).	760 °C (1400 °F)	High-temperature wire rings.
Gold	N/A					Commercially pure (> 99.9%) Gold	927 °C (1700 °F)	Electroplated in various combinations to provide ductile outer layer that enhances seal-ability and/or corrosion. Occasionally used for wire rings.
Tribaloy® T-400	N/A					Cobalt-chromium-molybdenum alloys offering excellent wear resistance at extreme temperatures.	982 °C (1800 °F)	HVOF plasma-sprayed anti-wear coatings for extreme environments. May require post-coating machining to meet design tolerances.
Tribaloy® T-800	N/A						982 °C (1800 °F)	
Nickel	N/A					Commercially pure (> 99.9%) Nickel	1204 °C (2200 °F)	Electroplated in various combinations to provide ductile outer layer that enhances seal-ability and/or corrosion. Occasionally used for wire rings.

Aerospace Material Specification (AMS) Reference

Our material procurement specifications ensure that we receive only the highest quality materials in a condition best suited for seal manufacture. This ensures that you receive the highest quality seals with consistent performance. Our procurement specifications comply with (but are frequently more stringent than) the following AMS specifications.

Material (Common Designation)	Strip & Sheet	Tubing	Wire	
	C-Rings, E-Rings, U-Rings	O-Rings	Wire Rings	Springs
304 Stainless Steel	AMS 5511	AMS 5560, 5565	AMS 5697	AMS 5857
316 Stainless Steel		AMS 5584	AMS 5690	
17-4 PH Stainless Steel				
Monel 400		AMS 4574	AMS 4730	
Cobalt Chromium-Nickel Alloy	AMS 6876			AMS 5833
321 Stainless Steel		AMS 5570, 5576	AMS 5689	
347 Stainless Steel		AMS 5575	AMS 5674	
Alloy 600		AMS 5580		
Alloy 625	AMS 5599			
Aluminum Al 1100-0	AMS 4001			
Hastelloy C-276	AMS 5530			
Alloy X-750	AMS 5598	AMS 5582		AMS 5699
Alloy 718	AMS 5596	AMS 5590		
Stainless Steel Alloy A-286	AMS 5525			
Waspaloy	AMS 5544			
Rene 41	AMS 5545			
Haynes 188	AMS 5608			

Yield Strength, Relaxation & Springback

Yield strength and stress relaxation are particularly important in the design and application of resilient metal seals for elevated temperatures. For any given seal design, springback is a function of yield strength and stress relaxation (as well as modulus of elasticity).

A useful estimation of springback for short term exposure to elevated temperatures may be obtained by derating the published springback by the ratio of the yield strength at the elevated temperature to the yield strength at ambient temperature.

$$SB_A = \frac{YS_T}{YS_{RT}} SB_o$$

Where: SB_A = Springback adjusted
 YS_T = Yield Strength at elevated temperature
 YS_{RT} = Yield Strength at room temperature
 SB_o = Original Springback

Stress relaxation occurs when material is exposed to long term elevated temperatures. This results in reduced load and springback.

Material Selection Process | Aerospace Material Specification (AMS) Reference

Temperature Capability – Yield Strength								
Temperature	Alloy 718 HT'd per AMS 5596 (MPa)	Alloy X750 HT'd per AMS 5598 (MPa)	Waspaloy HT'd per AMS 5544 (MPa)	Rene 41 Yield (MPa)	Haynes 188 Yield (MPa)	Haynes 214 Yield (MPa)	Haynes 230 Yield (MPa)	Haynes 25 Yield (MPa)
Deg. °C	(MPa)	(MPa)	(MPa)	(MPa)	(MPa)	(MPa)	(MPa)	(MPa)
21	1230	973	909	820	464	604	392	476
538	993	861	863	793	290	544	274	331
593	996	849	818	779	282	552	272	331
649	998	836	772	765	274	559	269	331
760	749	634	771	752	268	543	284	283
816	480	466	592	665	258	427	254	265
871	211	297	414	579	248	310	223	248
927	150	180	274	427	190	182	179	186
982	90	63	135	276	131	54	119	124

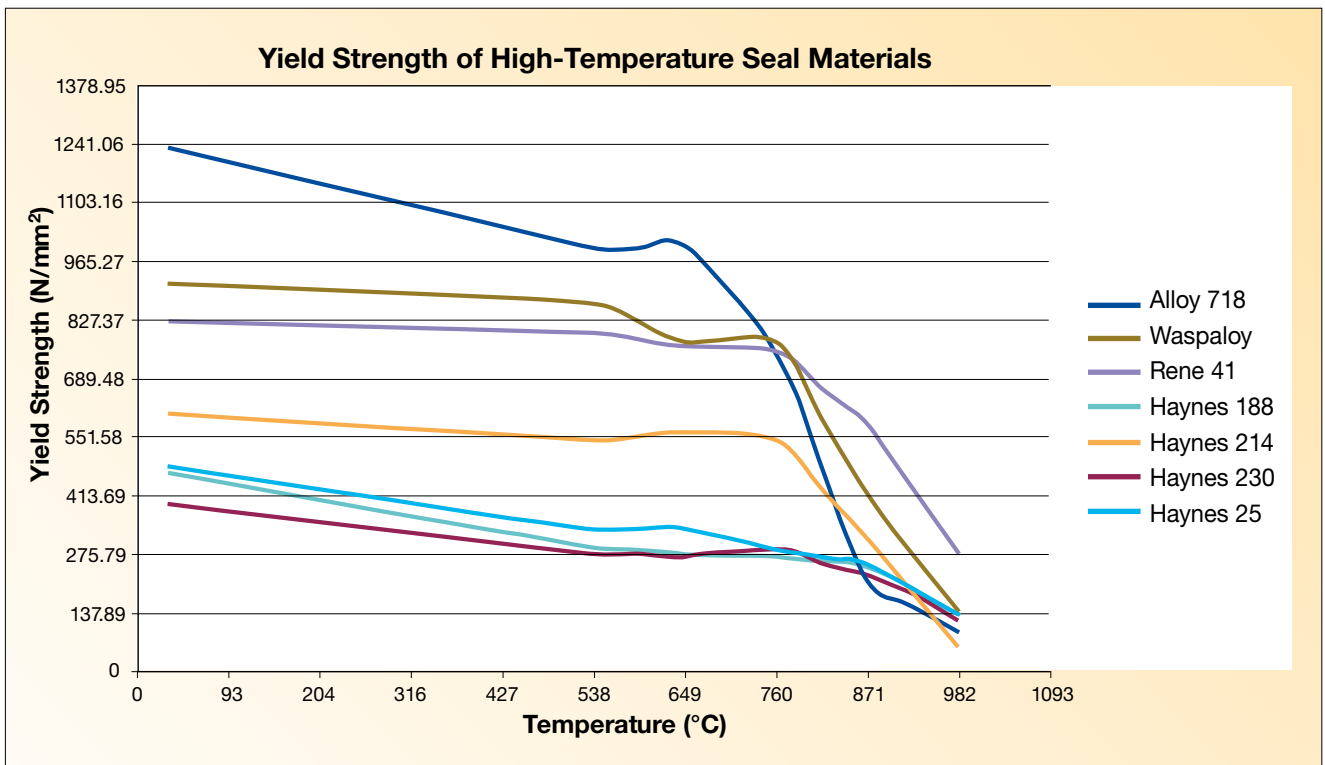

Section D
Material Selection

Metal Seal Material Temper







We provide clear recommendations on the best choice of material condition for the type of seal selected and material type. For high performance resilient metal seals manufactured from nickel alloys such as X-750, 718 and Waspaloy, we recommend a solution annealed and age hardened heat treatment to our standard (-6) condition after forming. This increases springback and load by increasing yield strength, as well as improving fatigue resistance and creep resistance. Metal O-Rings and Spring Energized C-Rings are frequently manufactured from austenitic stainless steels which are not precipitation hardenable. These seals are supplied in the work hardened condition.

MXX - 000000 - 00 - 00 - 0 - XXX

Temper Code

Temper Code	Temper Description
1	Work Hardened
2	Age Hardened
4	Annealed
6	Solution Heat Treat, (Stabilization Heat Treat if applicable), and Precipitation Heat Treat
8	Temper For Service Per NACE MR0175 Specification

Temper Codes for Non-Spring Energized Seals

Material Code	Material (Common Designation)	 C-Ring (Face Seal)	 Axial C-Ring	 E-Ring	 O-Ring	 U-Ring	 Wire Ring
01	304 Stainless Steel				1		4
02	316 Stainless Steel				1		4
03	321 Stainless Steel				1		4
04	347 Stainless Steel				1		4
05	Monel 400				1		4
06	Alloy 600				1		
07	Alloy X-750	6	1		1 [†]		
08	Aluminum Alloy 1100						4
09	Haynes 25				1		
10	Gold						4
11	Silver						4
12	Copper						4
13	Nickel						4
14	Alloy 718	6*	1 or 6*	6*	1 [†]	6*	
15	Stainless Steel Alloy A-286	6	1				
16	17-4 PH Stainless Steel	6	1				
20	Hastelloy C-276	1	1				
23	Waspaloy	6	6	6		6	
25	Alloy 625	6	1				
29	Rene 41	6	6	6		6	
39	Haynes 188	1	1			1	

*NACE APPROVAL – For approval in corrosive service per NACE MR-01-075 Specification, specify temper code 8.

[†]Alloy X-750 and 718 O-Rings are available in -6 and -2 tempers for increased fatigue and stress relaxation resistance and seating load.

Temper Codes for Spring Energized Seals

The -1 Work Hardened temper code is standard for all Spring Energized Seals. All springs are supplied in an appropriate spring temper prior to installation in the seal jacket. The -6 Solution Annealed and Age Hardened temper code is available for increased fatigue resistance of the jacket/spring combinations (at right) in cyclic operating conditions such as piston engines.

Material Code	Jacket/Spring Materials
06	Alloy X-750/Alloy X-750
11	Alloy 718/Alloy 718

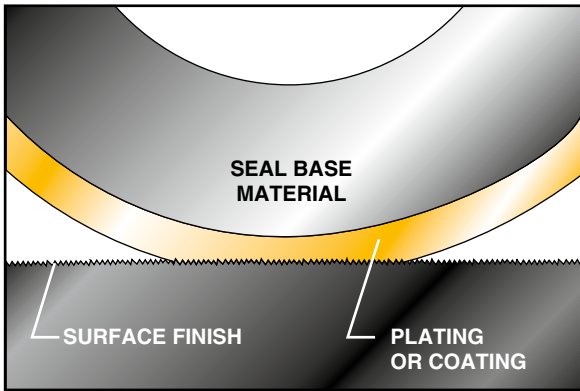

MXX - 000000 - 00 - 00 - 0 - XXX

Finish Code _____
 Finish Thickness _____

Specialized platings and coatings allow us to modify the surface properties of a metal seal to create a ductile, low hardness outer surface layer. This acts as an integral “gasket” and ensures optimum sealing despite mating surface imperfections. However, unlike a large surface area traditional flat gasket, the narrow footprint of a metal seal produces a high localized contact stress without excessive bolt-up loads.

Platings and coatings can also improve seal performance by reducing the coefficient of friction of the seal and preventing galling. This assists the seal to slide and “seat down” properly during initial compression or permit, for example, limited dynamic use as a valve stem seal.

In addition to the primary physical properties of ductility and softness, seal coatings are also chosen to withstand high temperatures and often corrosive or oxidizing environments. With a wide choice of surface coatings available, we recommend the selection be made by the following process of elimination.

1. Eliminate all platings and coatings with inadequate high temperature capability (see table below).
2. Eliminate all coatings chemically incompatible with the fluid medium.
3. Choose the softest remaining coating able to withstand the seating stresses. (Ultra soft materials such as Indium and Lead are very easily damaged and subject to creep if overstressed. They should only be selected for specially critical applications with well controlled handling and installation instructions.)
4. NOTE: Silver remains, for many applications, the preferred choice.

Finish Code	Finish Material	Properties, Uses And Limitations	Maximum Temp °C	Maximum Seal Load N/mm
	Unplated	Typically air applications where total leak tightness is not required. Lowest cost. Contact your local representative for anti-gall coating options.	depends on base	not limited
SFX (unplated) SSX (Silver) SGX (Gold) etc.	Super-Finishing	Spin-polished substrate sealing surfaces with a circular lay. Improves leakage control on unplated or low load seals, or for high vacuum.	depends on base & plating	depends on plating
IP	Indium (In)	Extremely soft metal, excellent for cryogenics, low strength flanges, optical components and vacuum. Not for use with high load seals or at high pressures, due to creep and extrusion.	66	61
LP	Lead (Pb)	Similar properties to Indium, although slightly harder and higher temperature capability. Not for use with high load seals.	204	70
PC	Tin (Sn)	Very soft metal, excellent for cryogenics, low strength flanges, optical components and vacuum. Not for use with high load seals or at high pressures, due to creep and extrusion.	204	70
TC	PTFE	Chemically inert soft polymer. Not for use with high load seals. Permits some permeation of gases.	232	79
SP	Silver (Ag)	Closest to an ideal plating material and therefore most frequently selected for a wide variety of applications. Soft in its pure and annealed form. Good corrosion and temperature resistance. Used in nuclear seals/borated water. Excellent anti-galling properties. Inexpensive.	260 (oxidizing) 649 (non-oxidizing)	not limited
AP	Gold under Silver	Oxidizing environments above 260 °C (500 °F). As high temperature oxygen permeates the outer silver layer the thin gold layer ensures proper adhesion of the silver.	649	not limited
GP	Gold (Au)	Soft metal with excellent chemical and oxidation resistance and very high temperature capability. Expensive for larger sizes.	927	not limited
CP	Copper (Cu)	Relatively soft and inexpensive plating. Good high temperature resistance. Not for use with Waspaloy.	927	not limited
NP	Nickel (Ni)	Very high temperature capability, but harder than either Silver or Copper even when annealed. Used instead of silver in hot, oxidizing environments.	1204	not limited

Finish Thickness Selection Guidelines

Finish of the mating surfaces is an important factor in selecting the most appropriate plating or coating thickness. Generally, rougher surfaces require thicker finishes to ensure proper sealing. Refer to the appropriate seal cross section in the bar chart below. Locate the flange surface finish in the bar above the seal free height to determine the appropriate finish thickness on the left.

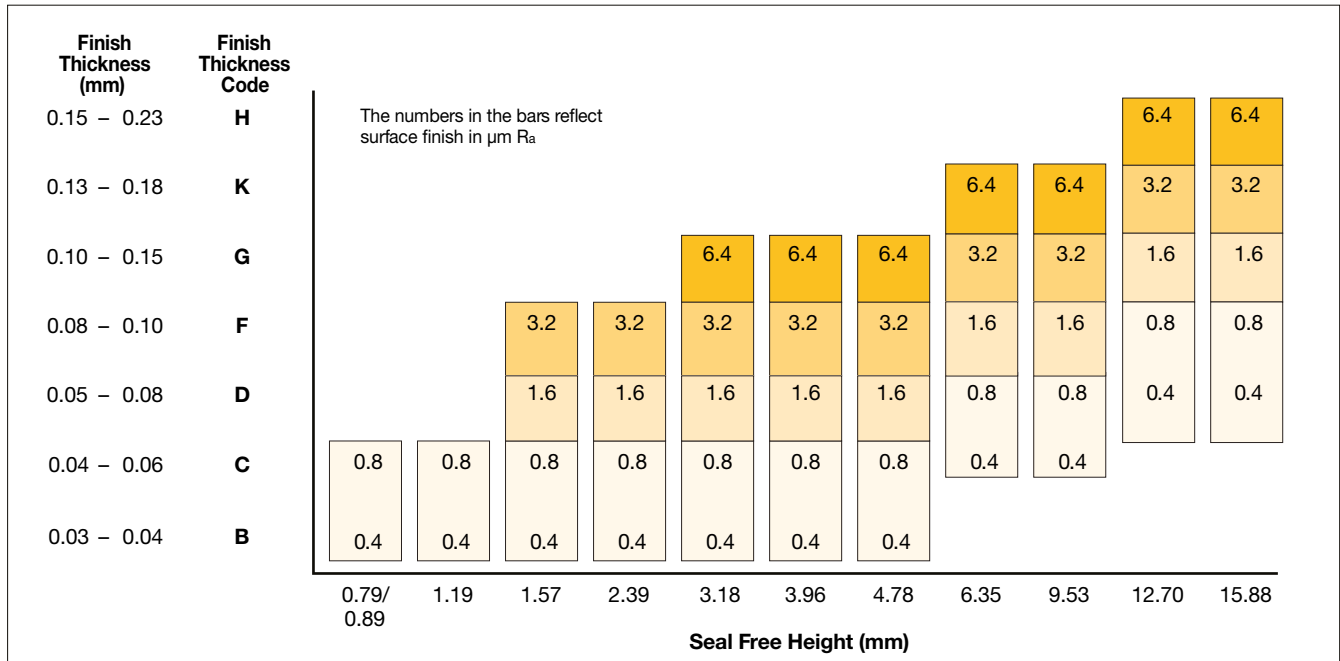

Available Finish Thicknesses	
Finish Thickness Code	P Finish Thickness (mm)
A	0.01 - 0.03
B	0.03 - 0.04
C	0.04 - 0.06
D	0.05 - 0.08
E	0.06 - 0.09
F	0.08 - 0.10
G	0.10 - 0.15
H	0.15 - 0.23
J	0.09 - 0.13
K	0.13 - 0.18
M	0.10 - 0.13
N	0.03 - 0.05

Plating Information Silver-Indium

Overview:

Parker Hannifin's Silver-Indium diffused plating is a patent-pending electro-deposited plating process developed for metal seals exposed to hot, oxidizing environments. This new coating is specifically engineered to minimize the blistering and subsequent delamination often seen with plain silver or silver-gold composite coatings.



Figure 1: Blisters seen on a standard silver plated seal after 1,000 hours in air at 260 °C (500 °F)



Figure 2: Parker Hannifin's Silver-Indium diffused plating

Current Plating Technology:

Silver plating is typically used to improve the performance of static metal seals by providing a ductile, low-hardness outer layer capable of conforming to irregularities in the mating surfaces. However, silver is easily permeated by oxygen at elevated temperatures, leading to oxidation of the underlying substrate. This oxidation causes the silver plating to lose adhesion and blister. As a result, silver and silver gold composite coatings are generally limited to application temperatures less than 260 °C (500 °F).

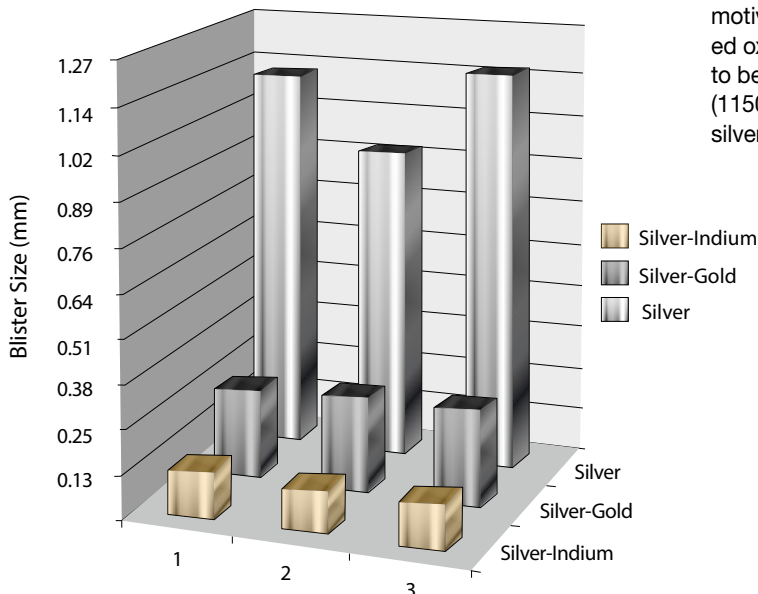

Figure 3: Blister size of Silver, Silver-Gold, and Silver-Indium samples after 500 hours in air at 621 °C (1150 °F).

One method used to combat silver blistering is to add a thin layer of gold between the substrate and the silver plate. The dense gold layer retards the diffusion of oxygen, thereby reducing the incidence of blisters. Although this method is highly effective, it is prohibitively expensive for general or high volume use.

The Parker Solution:

Parker's solution incorporates a unique heat treatment process to diffuse a thin layer of indium into the silver plating, producing a soft but robust surface that is more resistant to high temperature blistering than either silver or silver-gold composite coatings. The diffused indium prevents oxygen diffusion through the plating layer in two ways. First, the indium binds to oxygen at both the surface and within the plating matrix, forming stable oxides. Second, the indium fills inter-spatial voids within the silver plating, effectively blocking atomic diffusion of oxygen atoms, thereby preventing them from reaching the underlying substrate.

Performance:

Long-term testing confirms that Parker's new Silver-Indium diffused plating is significantly better at reducing blister formation and subsequent delamination when compared to plain silver or silver gold composite coatings. And, because Silver-Indium retains its ductility during and after high-temperature exposure, sealing performance is fully maintained.

Applications:

Silver-Indium plating is suitable for use in applications currently using plain silver or silver-gold composite coatings for enhanced sealing performance, including aerospace, automotive, and heavy diesel applications. In addition, the added oxidation resistance provided by Silver-Indium allows it to be used in high temperature applications (up to 621 °C (1150 °F)) well beyond the capability of standard silver and silver gold composite coatings.

Metal Seal Platings, Coatings and Finishes TriCom®

TriCom is a proprietary electrodeposited composite tribological coating developed to provide excellent wear and oxidation protection for metallic sealing systems. TriCom comprises a unique matrix of cobalt co-deposited with chromium carbide (Cr_3C_2) particles to create a wear and oxidation resistant system for prolonged use at 621 °C (1150 °F) and limited use at 677 °C (1250 °F).

TriCom is designed to significantly reduce the wear of metallic sealing elements and the respective mating surfaces caused by thermal expansion and vibrational movement.

The unique wear characteristics, excellent bond strength, and ease of application of TriCom make it an excellent candidate for application on thin flexible sealing members. These characteristics provide TriCom a competitive advantage when compared with other coating alternatives. Bond strength testing has been performed to show that TriCom will continue to adhere to a seal under bending loads that would cause a comparable thermal sprayed coating to spall.

Table 1 – TriCom Characteristics	
Hardness (as-coated)	300 – 350 HVN 29 – 35 HRC
As-Coated Surface Finish	0.8 μm R_a or better
Coating Thickness	As specified 0.001 to 0.005 in. typical)
Service Temperature	621 °C (1250 °F) Max.

Coating Structure:

TriCom is a composite coating containing finely dispersed chromium carbide particles (Figure 1). Cobalt in the coating matrix provides high temperature lubricity. Chromium carbide reduces the wear rate by acting as a solid lubricant when partially oxidized. When TriCom is heated in air, cobalt oxide and chromium oxide is formed on the surface of the coating creating a lubricious oxide glaze that protects the coating and counter face from wear. The oxide glaze physically separates the parts and allows them to glide over each other, minimizing wear on both surfaces while preserving sealing integrity.

Coating Performance:

Extensive testing has been performed at ambient and elevated temperatures to characterize the capabilities and service limits of TriCom.

The results of independent ambient temperature wear tests of uncoated, TriCom coated, and Tribaloy T-800 coated samples are presented in (Figure 2). Samples were weighed before and after a linear reciprocating wear test to determine mass lost to wear. TriCom reduced wear of coated and uncoated counter faces to levels lower than T-800 or systems without coatings.



Figure 1: TriCom is a composite coating consisting of a cobalt matrix with chromium-carbide reinforcing phase.



Figure 2: Pin on Flat Wear Test Results for Alloy 718 Coated with TriCom and Tribaloy T-800.

TriCom® (cont.)

TriCom has also performed well in elevated temperature tests. A coated 10 mm diameter ball was tested in linear reciprocating contact at 732 °C (1350 °F). The sample was worn against an uncoated Alloy 718 at a contact stress of 317 MPa (46 ksi) for a total distance of 7,9 km (4.9 miles) without wearing through the coating (Figure 3).

Table 2 – Test Parameters for Oscillating Wear Tests	
Test Laboratory	IMR Labs, Ithaca, NY
Motion	Oscillatory – 2.54 mm (0.1 in) stroke
Frequency	15 cycles/min.
Test Duration	1,000 cycles
Temperature	20 °C (68 °F)
Contact	Chamfered pin against flat
Contact Stress	100 MPa (14.5 ksi)

In high frequency wear tests at 732 °C (1350 °F) (modified ASTM D5707 method), TriCom caused less wear on the counter face than other nickel-cobalt based anti-wear coatings.

Benefits Over Thermal Spray Coatings

Thermal sprayed coatings often need grinding or polishing to meet tight tolerances and ensure a good surface finish. TriCom coated parts are typically coated to net shape with no necessary secondary operations. The coating may be polished or ground to meet a customer’s specific requirements if necessary.

The TriCom coating process will not deform thin parts. The thermal spray process will cause dimensional distortion in thin sections as the spray jet impinges upon the part.

Table 3 – Test Parameters for High Temperature Wear Tests	
Test Laboratory	Parker Hannifin Advanced Products, North Haven, CT
Motion	Linear Reciprocating (6.35 mm stroke)
Frequency	145 cycles/min.
Test Duration	622,500 cycles (72 hours)
Temperature	621 °C (1150 °F)
Contact	10 mm ball on flat
Contact Stress	317 MPa (46.0 ksi)

Applications:

TriCom is typically applied to temperature resistant metals including stainless steel, nickel and cobalt super alloys. TriCom is suitable for use in mildly oxidizing environments, such as air, and carburizing atmospheres including exhaust gases. Common applications include resilient metal sealing components in land based and aviation gas turbines.

TriCom wears well against most metals, including stainless steel, nickel and cobalt alloys, and cast iron. TriCom should be used in high contact stress systems that experience wear due to differential thermal expansion and vibration. TriCom is best suited for predominately static applications but has been utilized successfully in low speed dynamic systems.

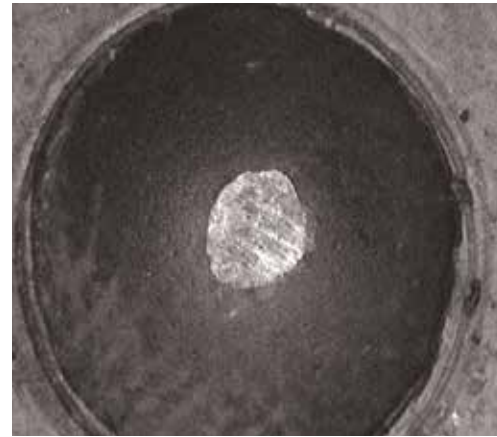
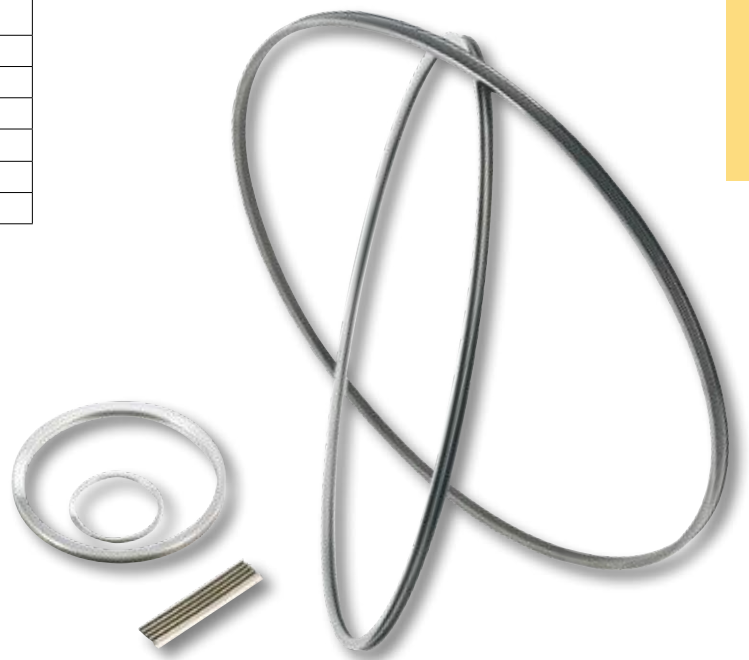

Figure 3: TriCom exhibited excellent wear resistance at 621 °C (1150 °F), surviving 7.9 km (4.9 miles) of sliding wear on a 10mm ball. Wear scar diameter is 0.56 mm.



Metal Seal Platings, Coatings and Finishes TriCom-HT™

TriCom-HT is a proprietary electro-deposited coating developed to provide excellent wear and oxidation resistance for high temperature metal seals and sealing components. TriCom-HT comprises a unique cobalt-nickel alloy matrix co-deposited with chromium carbide (Cr_3C_2) and MCrAlY particles to provide a wear and oxidation resistant system for prolonged use at 760 °C (1400 °F) and limited exposure up to 843 °C (1550 °F).

TriCom-HT is designed to significantly reduce the wear of metallic sealing elements caused by thermal expansion and vibrational movement between mating surfaces.

Coating Structure:

TriCom-HT is a composite tribological coating containing finely dispersed reinforcing phases of chromium carbide and MCrAlY particles (Figure 1). Cobalt in the coating matrix provides high temperature lubricity while nickel provides ductility, oxidation resistance and increased hardness to prevent abrasive wear. Chromium carbide reduces the wear rate by acting as a solid lubricant when partially oxidized. MCrAlY is used as a vehicle to introduce strong oxide forming metals into the coating to increase oxidation resistance and coating adhesion to the substrate. Upon heating in air, chromium oxide, alumina and yttria form within the coating matrix, slowing further oxidation of the coating. Cobalt oxide and chromium oxide also form on the coating surface, providing a lubricious oxide glaze that decreases both the coating and counter face wear rates (Figure 2).

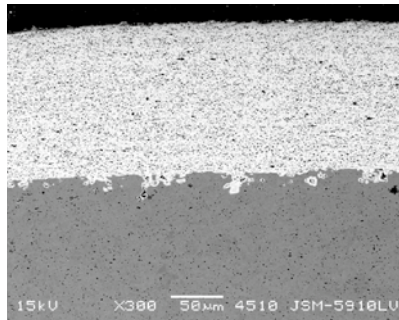

Figure 1: TriCom-HT is a composite coating consisting of a cobalt-nickel matrix with chromium carbide and MCrAlY reinforcing phases.

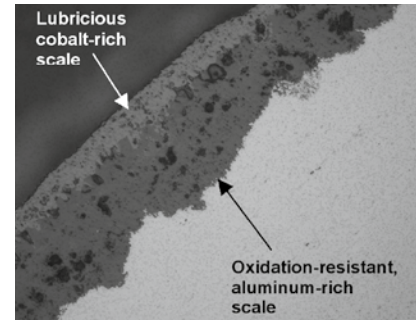

Figure 2: TriCom-HT forms a multi-layer oxide scale at service temperatures to simultaneously slow oxidation and wear.

Coating Performance:

TriCom-HT is designed to balance wear resistance with oxidation resistance to provide a long lasting solution to high temperature wear. TriCom-HT was tested using a high temperature linear reciprocating wear tester to fully evaluate the coating at each stage of development.

The unique composition of TriCom-HT significantly improves oxidation and wear behavior compared to typical cobalt chromium carbide coatings (Figure 3), extending the service temperature and life of the coating. In high temperature, high frequency friction and wear tests (modified ASTM D 5707 method) TriCom-HT coated samples exhibited less wear than samples coated with a cobalt chromium carbide coating. The wear rate of TriCom-HT coated samples remained stable throughout the test temperature range of 732 °C to 816 °C (1350 °F to 1500 °F).



TriCom-HT™ (cont.)

Table 3 compares the oxidation behavior of TriCom-HT to competitive wear resistant coatings at 732 °C (1350 °F). The oxidation rate of TriCom-HT approximates that of nickel-based coatings, and is an order of magnitude better than typical cobalt chromium carbide coatings.

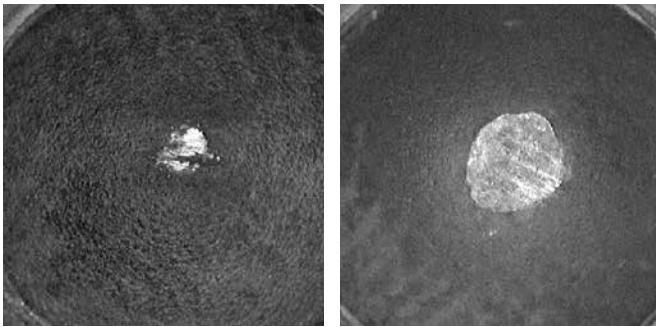

Figure 3: Wear scar on coated spheres from high temperature ball-on-flat wear tests. TriCom-HT (at left) exhibits significantly less wear after 72-hours at 732 °C (1350 °F) than a typical cobalt chromium carbide coating (right). Contact stress was 317 MPa (46 ksi) and total wear distance was 7.9 km (4.9 miles).

Applications:

TriCom-HT is typically applied to temperature resistant metals including stainless steels, nickel and cobalt superalloys. TriCom-HT works well in both oxidizing environments, such as air, and carburizing atmospheres including exhaust gases.

TriCom-HT is suitable for any high temperature static sealing application where differential thermal expansion or vibrational wear may occur. Typical applications include resilient metal seals, sealing components for land based and aviation gas turbines, and diesel exhaust components.

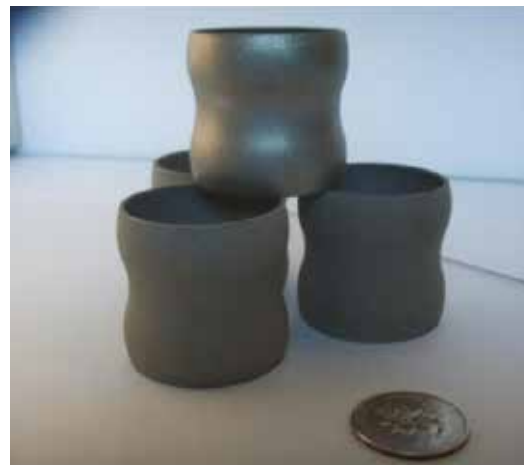

Figure 4: TriCom-HT prevents wear in high load metal to metal sealing applications such as these automotive exhaust manifold couplers.

Table 1: TriCom-HT Characteristics

Hardness	450 – 500 HVN 45 – 49 HRC
As-Coated Surface Finish	1.6 µm (64 µin) Ra or Better
Coating Thickness	As Specified 0.025 to 0.127 mm (0.001 to 0.005 in.) Typical
Service Temperature	760 °C (1400 °F) Continuous 843 °C (1550 °F) Maximum

Table 2: Test Parameters for High Temperature Wear Tests

Test Laboratory	Parker Hannifin Advanced Products – North Haven, CT
Motion	Linear Reciprocating (6.35 mm stroke)
Frequency	145 cycles/min
Test Duration	622,500 cycles (72 hours)
Temperature	732 °C (1350 °F)
Contact	10 mm ball-on-flat
Contact Stress	317 MPa (46.0 ksi)

Table 3: Oxidation Testing at 732 °C for 72 Hours in Air

Coating	Scale Thickness
TriCom-HT	147.32 × 10 ⁻⁴ mm
Cobalt Chromium Carbide Coating	48.26 × 10 ⁻³ mm
Nickel Chromium Carbide Coating	88.90 × 10 ⁻⁴ mm

Section D – Material Selection Process

This section provides additional information about Metal Seal design, use and performance. It allows the design engineer to fine tune the cavity requirements to ensure optimum seal performance.

This section includes:	Page
Performance Data	
Load, Deflection and Springback / Terminology	E-68
Metal C-Ring Performance	E-70
Metal E-Ring Performance	E-72
Metal U-Ring Performance	E-73
Metal O-Ring Performance	E-74
Metal Energized C-Ring Performance	E-76
Metal Wire Ring Performance	E-77
Leak Rate Information	E-78
Fatigue and Stress Relaxation	E-79
Installation Guidelines	
Surface Roughness	E-80
Surface Flatness	E-80
Surface Hardness	E-81
Compression Limiters	E-81
Bolt Load and Tightening Torque Guidelines	E-82
Seal Shaping Requirements for Non-Circular Seals	E-84
Manufacturing Specifications	
Roundness and Flatness	E-85
Surface Finish	E-85
Metal O-Ring Weld Finish	E-85
Preferred C-Ring and Spring Energized C-Ring Sizes	E-86
Tolerance Reference Table	E-92
Conversion Tables	E-93

Section E – Technical Information

Load, Deflection and Springback

All metal seals, except for metal wire rings, are designed to undergo both plastic and elastic deformation when installed. (Wire rings are essentially limited to plastic deformation only.)

Plastic deformation of the jacket, or O-ring tubing, enlarges the contact area, or “footprint”, to bridge across surface imperfections or tool marks in the mating surfaces. It also creates a reduced gradient in the load/deflection curve to permit a wide tolerance in the working height, resulting in a robust sealing process. High integrity sealing is ensured by the ductile outer layer or coating which, being inelastic and of low compressive yield strength, flows into and fills the mating surface crevices.

Elastic deformation provides elastic recovery or “springback” to maintain good sealing, despite separation of the mating surfaces due to the effects of thermal cycling, flange rotation, applied mechanical or hydrostatic loads or creep.

Terminology

Free Height: The cross-sectional height of an uncompressed seal. This is conventionally stated before platings or coatings.

Working Height: The cross-sectional height of an installed seal, which is equivalent to the groove depth. Many metal seals allow wide tolerance in the permissible working height to accommodate tolerance stack ups.

Seating Load: The load required to compress a seal to the working height. For convenience, all loads are conventionally stated per unit circumferential length. Generally, a higher seating load will ensure greater leak tightness.

Springback: The difference between the working height and the (reduced) free height after all applied loads have been released: this represents the total elastic recovery of the seal.

Useful Springback: That portion of the spring-back curve where the load exceeds 20–25% of the load at working height. Below this, the load may be insufficient to maintain good seal performance.

Working, Proof and Burst Pressures: The working pressures given in this design guide are the maximum for both steady-state and cyclical pressures (subject to fatigue considerations) with the groove to seal diametrical clearances recommended in Section C.

Where high pressure transients are expected, or installed seals are subject to a proof test (as part of a 100% acceptance test, not a type test), designers should select a metal seal with a working pressure sufficient to accommodate such high pressure exposures.

Burst testing may be performed at pressures higher than the rated working pressure. Experience has shown that pressure energized metal seals will seal effectively at pressures significantly beyond their working pressure, although some permissible permanent deformation of the seal may occur.

Leakage failure may occur at extremely high pressures, however, this is typically the result of flange or joint separation or distortion, due to the high hydrostatic loads under such conditions. The onset of leakage will be detected when such flange separation exceeds the useful springback of the seal.



Load, Deflection and Springback

Load vs Deflection Comparison

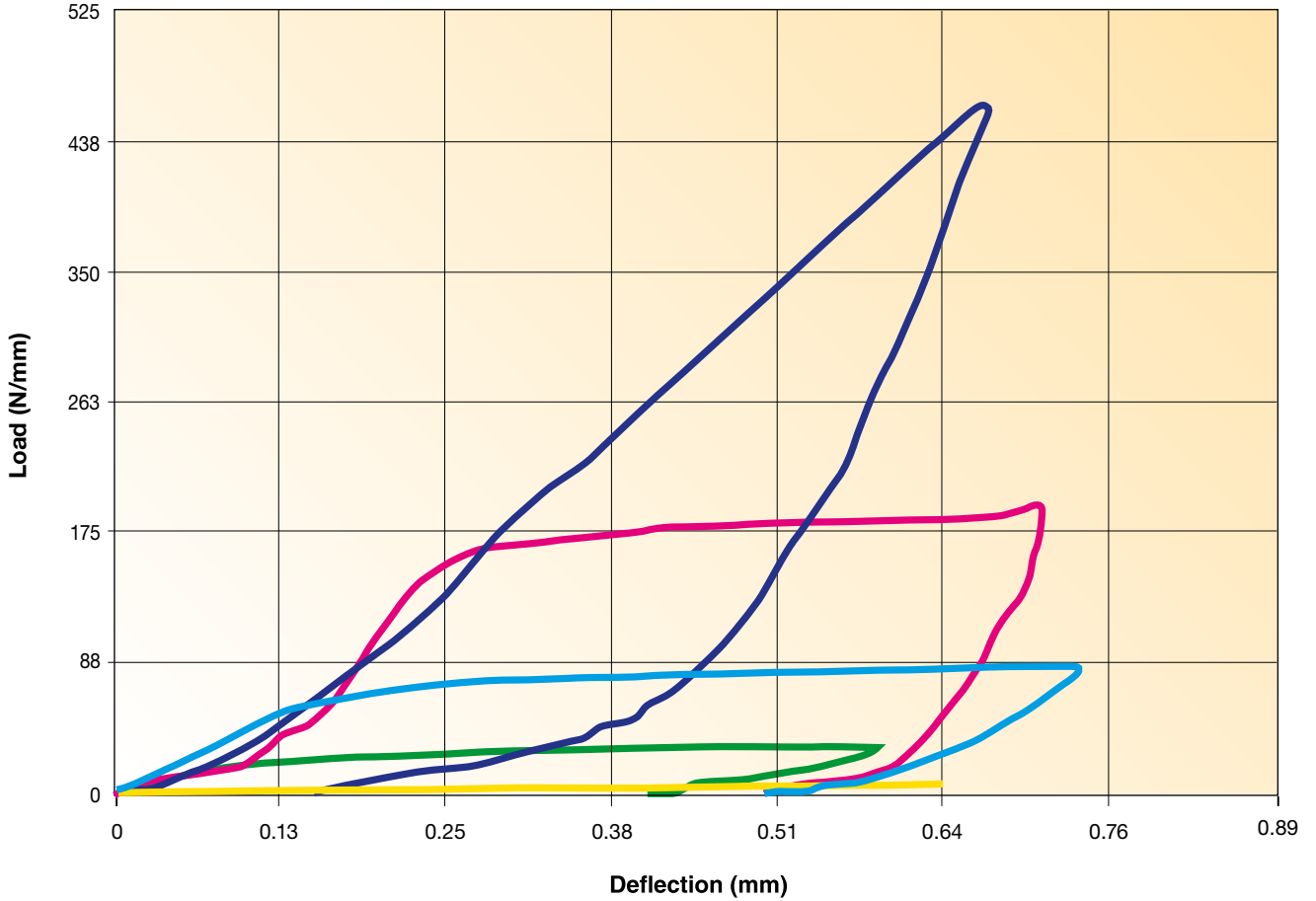

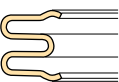
- 

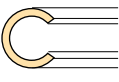
MEI: metal E-ring
- 

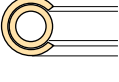
MCI: metal C-Ring
- 

MSI: spring energized metal C-ring
- 

MOI: metal O-ring
- 

MWI: metal wire ring

 MCI Metal C-Ring Performance

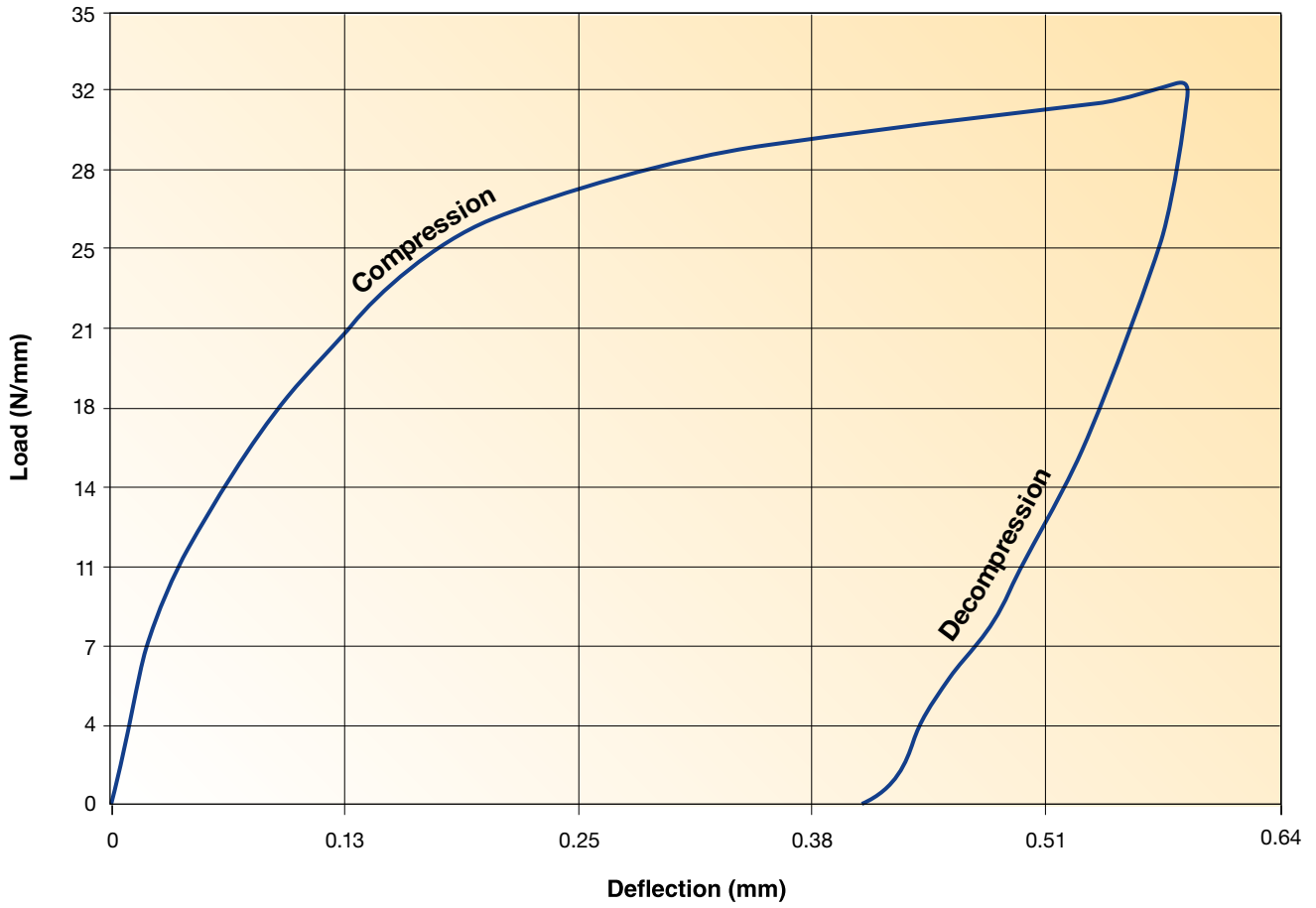

Based on nominal seal dimensions, recommended cavity dimensions and ambient temperature. If working pressures exceed the above ratings consult us for recommendations.

Metal C-Ring Performance								
Nominal Cross Section (mm)	Free Height (mm)	Material Thickness (mm)	Cross Section Code	Temper Code	Material	Seating Load (N/mm)	Springback (mm)	Working Pressure Rating (MPa)
0.79	0.79	0.15	01	-6	Alloy X-750	24	0.04	460
					Alloy 718	28	0.04	530
					Waspaloy	24	0.04	410
		0.18	02	-6	Alloy X-750	35	0.03	600
					Alloy 718	41	0.03	690
					Waspaloy	35	0.03	530
1.19	1.19	0.15	03	-6	Alloy X-750	15	0.05	250
					Alloy 718	20	0.05	290
					Waspaloy	15	0.05	230
		0.20	04	-6	Alloy X-750	35	0.05	380
					Alloy 718	41	0.05	430
					Waspaloy	35	0.05	340
1.57	1.57	0.15	05	-6	Alloy X-750	12	0.08	180
					Alloy 718	15	0.08	200
					Waspaloy	12	0.08	160
		0.25	06	-6	Alloy X-750	43	0.05	350
					Alloy 718	50	0.05	400
					Waspaloy	43	0.05	310
2.39	2.39	0.25	07	-6	Alloy X-750	24	0.13	200
					Alloy 718	28	0.15	230
					Waspaloy	24	0.13	180
		0.38	08	-6	Alloy X-750	61	0.10	340
					Alloy 718	70	0.13	390
					Waspaloy	61	0.10	300
3.18	3.18	0.38	09	-6	Alloy X-750	45	0.15	230
					Alloy 718	53	0.18	260
					Waspaloy	45	0.15	210
		0.51	10	-6	Alloy X-750	96	0.13	350
					Alloy 718	105	0.15	390
					Waspaloy	96	0.13	300
3.96	3.96	0.41	11	-6	Alloy X-750	38	0.20	190
					Alloy 718	46	0.23	220
					Waspaloy	38	0.20	170
		0.61	12	-6	Alloy X-750	96	0.15	330
					Alloy 718	105	0.18	370
					Waspaloy	96	0.15	290
4.78	4.78	0.51	13	-6	Alloy X-750	52	0.23	200
					Alloy 718	62	0.25	220
					Waspaloy	52	0.23	180
		0.76	14	-6	Alloy X-750	113	0.18	340
					Alloy 718	130	0.20	390
					Waspaloy	113	0.18	300
6.35	6.35	0.64	15	-6	Alloy X-750	61	0.28	180
					Alloy 718	70	0.33	210
					Waspaloy	61	0.28	160
		0.97	16	-6	Alloy X-750	148	0.20	320
					Alloy 718	175	0.23	360
					Waspaloy	148	0.20	280
9.53	9.53	0.97	17	-6	Alloy X-750	87	0.43	190
					Alloy 718	105	0.51	210
					Waspaloy	87	0.43	170
		1.27	18	-6	Alloy X-750	227	0.33	270
					Alloy 718	260	0.38	300
					Waspaloy	227	0.33	240
12.70	12.70	1.27	19	-6	Alloy X-750	122	0.55	180
					Alloy 718	140	0.64	210
					Waspaloy	122	0.55	160
			20	-6	Alloy X-750	262	0.43	260
					Alloy 718	300	0.51	290
					Waspaloy	262	0.43	230

Section E – Technical Information

Metal E-Ring Performance								
Nominal Cross Section (mm)	Free Height (mm)	Material Thickness (mm)	Cross Section Code	Temper Code	Material	Seating Load (N/mm)	Springback (mm)	Working Pressure Rating (MPa)
1.88	1.88	0.13	05	-6	Alloy 718	5	0.23	10
					Waspaloy	4	0.20	10
2.74	2.74	0.25	07	-6	Alloy 718	7	0.46	10
		Waspaloy	6	0.38	10	10		
3.55	3.55	0.25	08	-6	Alloy 718	16	0.33	34
		Waspaloy	13	0.28	34	34		
5.54	5.54	0.30	09	-6	Alloy 718	8	0.53	10
		Waspaloy	7	0.46	10	10		
5.54	5.54	0.30	10	-6	Alloy 718	11	0.51	34
		Waspaloy	9	0.43	34	34		
7.49	7.49	0.38	13	-6	Alloy 718	9	0.89	13
					Waspaloy	8	0.76	13
7.49	7.49	0.51	15	-6	Alloy 718	14	1.17	13
					Waspaloy	12	1.02	13

Based on nominal seal dimensions, recommended cavity dimensions and ambient temperature. If working pressures exceed the above ratings consult Parker for recommendations. Refer to Page E-68 for a definition of the above performance terminology.



MEI Metal E-Ring Performance

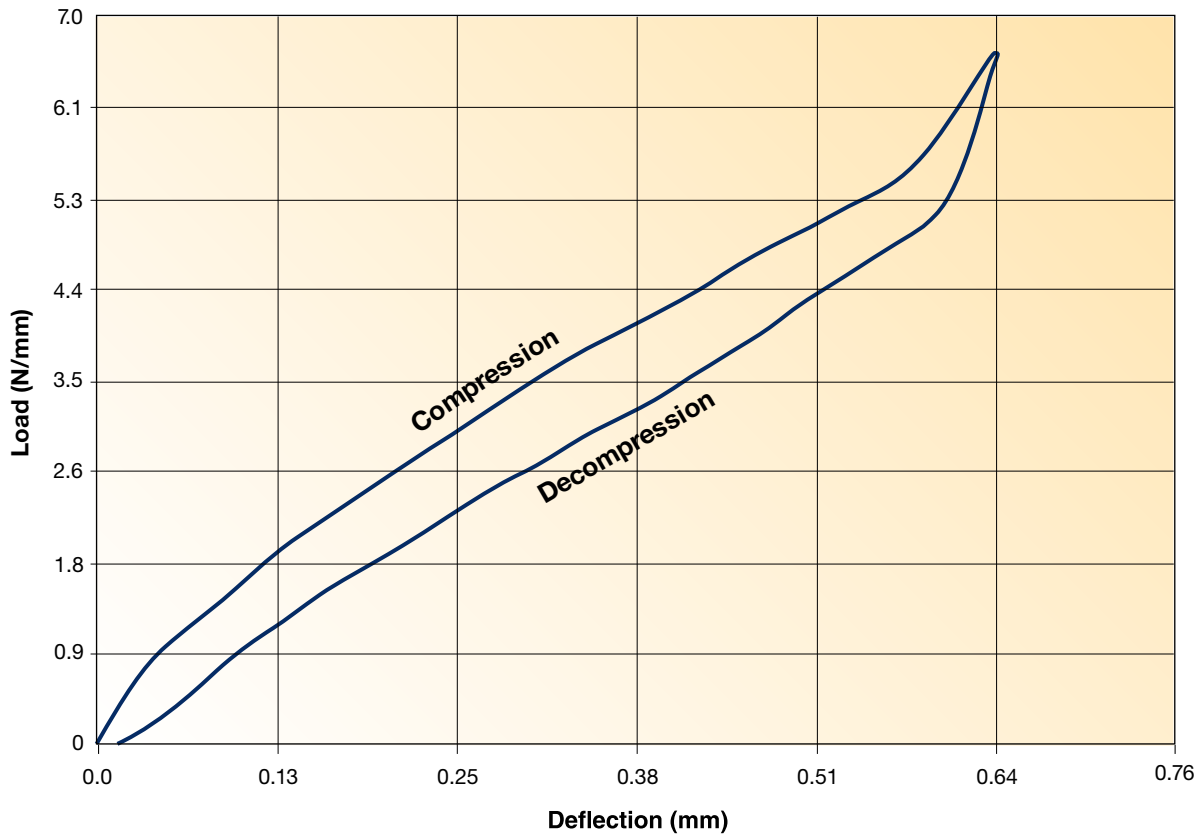

Metal U-Ring Performance								
Nominal Cross Section (mm)	Free Height (mm)	Material Thickness (mm)	Cross Section Code	Temper Code	Material	Seating Load (N/mm)	Springback (mm)	Working Pressure Rating (MPa)
1.60	1.60	0.13	05	-6	Alloy 718 Waspaloy	5 4	0.15 0.13	68 68
2.36	2.36	0.23	07	-6	Alloy 718 Waspaloy	7 7	0.25 0.23	82 82
3.18	3.18	0.30	09	-6	Alloy 718 Waspaloy	9 8	0.35 0.30	82 82
4.70	4.70	0.38	13	-6	Alloy 718 Waspaloy	9 8	0.51 0.43	55 55
6.27	6.27	0.51	15	-6	Alloy 718 Waspaloy	12 11	0.66 0.58	55 55

Based on nominal seal dimensions, recommended cavity dimensions and ambient temperature.

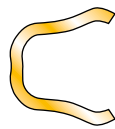

MUI Metal U-Ring Performance

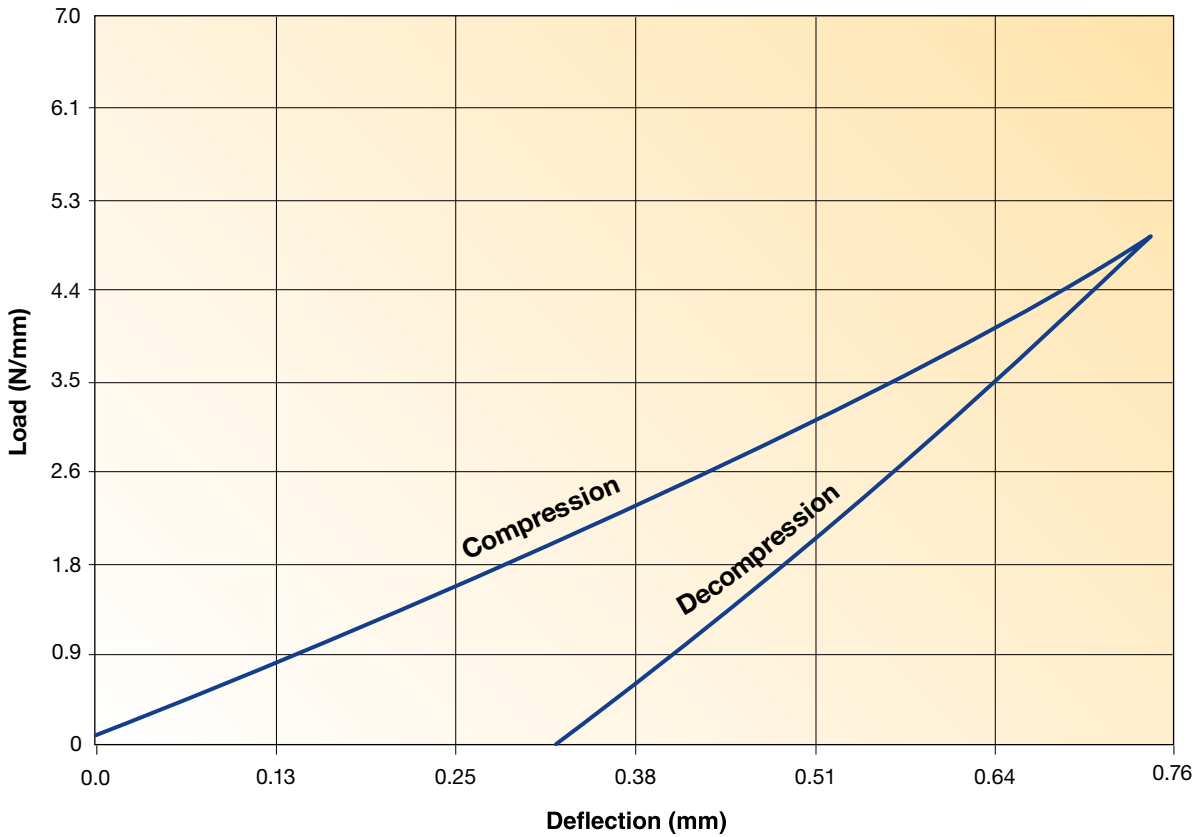

Section E – Technical Information

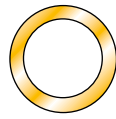

MOI Metal O-Ring Performance

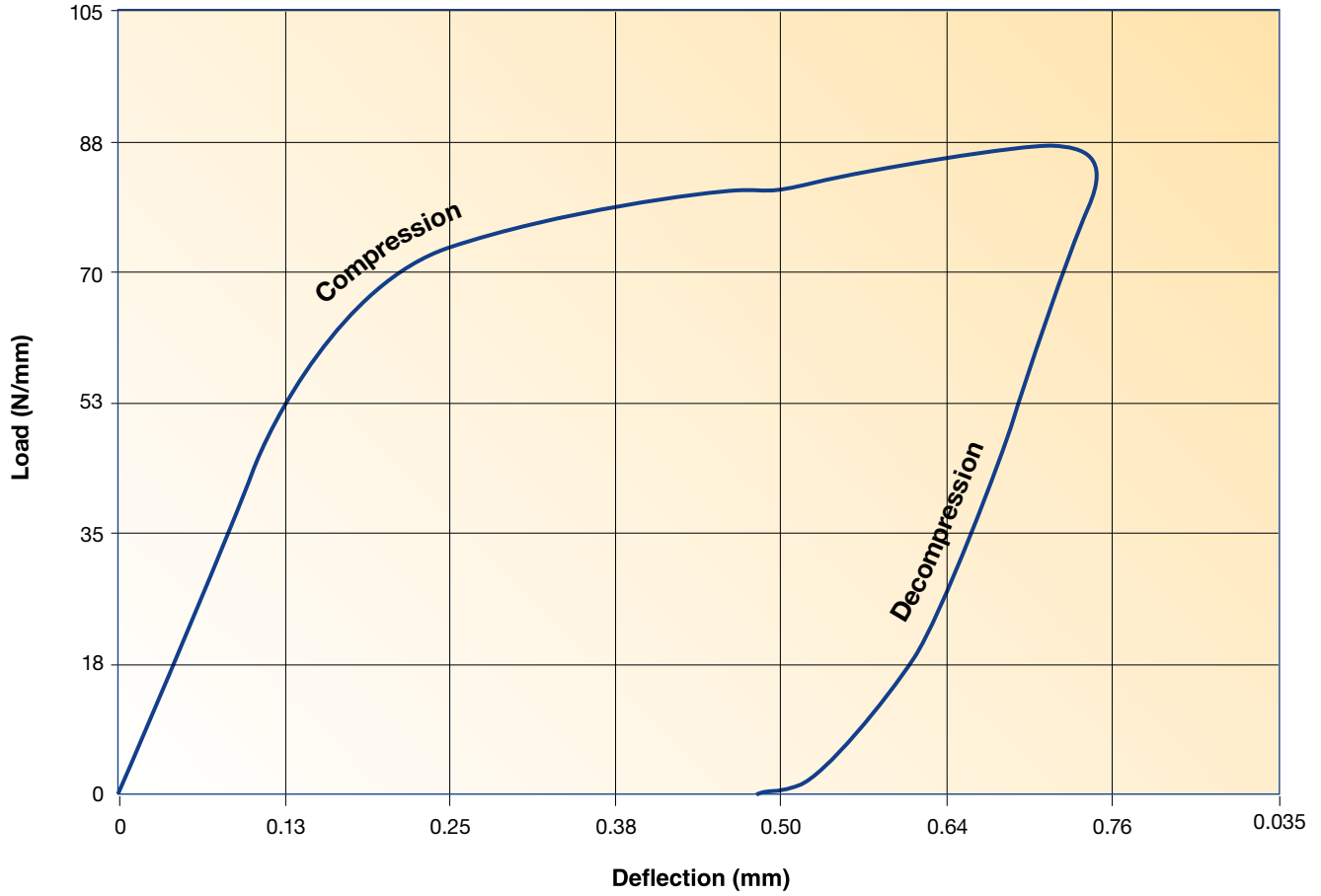

Technical Information I Performance Data

Metal O-Ring Performance									
Nominal Cross Section (mm)	Free Height (mm)	Material Thickness (mm)	Cross Section Code	Temper Code	Material	Seating Load (N/mm)	Springback (mm)	Working Pressure Rating (MPa)	
								Vented	Non-Vented
0.89	0.89	0.15	01	-1	321 SS	70	0.01	70	5
					Alloy X-750	96	0.01	100	7
1.19	1.19	0.18	29	-1	321 SS	70	0.03	50	5
					Alloy X-750	96	0.03	70	7
1.57	1.57	0.15	02	-1	321 SS	45	0.04	30	4
			Alloy X-750	61	0.05	45	6		
		0.25	03	-1	321 SS	96	0.03	75	5
			Alloy X-750	130	0.04	110	7		
0.30	31	-1	321 SS	140	0.03	100	5		
			Alloy X-750	190	0.03	140	8		
0.36	08	-1	321 SS	192	0.03	120	6		
			Alloy X-750	260	0.03	170	8		
2.39	2.39	0.15	04	-1	321 SS	26	0.05	10	5
			Alloy X-750	35	0.05	15	7		
		0.25	05	-1	321 SS	52	0.05	30	6
			Alloy X-750	70	0.05	40	8		
0.30	32	-1	321 SS	70	0.03	40	6		
			Alloy X-750	96	0.04	70	8		
0.46	09	-1	321 SS	210	0.03	110	6		
			Alloy X-750	280	0.04	170	9		
3.18	3.18	0.20	06	-1	321 SS	17	0.10	15	3
			Alloy X-750	24	0.13	30	5		
		0.25	07	-1	321 SS	26	0.08	30	3
			Alloy X-750	35	0.10	40	5		
0.30	25	-1	321 SS	49	0.05	40	4		
			Alloy X-750	70	0.08	70	6		
0.51	10	-1	321 SS	160	0.05	110	5		
			Alloy X-750	210	0.05	170	7		
3.96	3.96	0.41	11	-1	304 SS	70	0.10	30	5
			Alloy X-750	96	0.13	40	7		
0.51	12	-1	304 SS	130	0.08	90	5		
			Alloy X-750	175	0.10	140	8		
4.78	4.78	0.51	13	-1	304 SS	78	0.10	30	5
			Alloy X-750	105	0.13	40	7		
0.64	14	-1	304 SS	120	0.08	100	5		
			Alloy X-750	170	0.10	150	8		
6.35	6.35	0.64	15	-1	304 SS	78	0.13	30	5
			Alloy X-750	105	0.15	40	7		
0.81	16	-1	304 SS	170	0.10	90	5		
			Alloy X-750	230	0.13	140	8		
9.53	9.53	0.97	17	-1	304 SS	110	0.15	27	7
			Alloy 718	175	0.23	55	11		
1.24	18	-1	304 SS	190	0.13	50	8		
			Alloy 718	295	0.18	10	13		
12.70	12.70	1.27	19	-1	304 SS	175	0.23	27	7
			Alloy 718	420	0.43	55	11		
1.65	20	-1	304 SS	295	0.18	50	8		
			Alloy 718	665	0.30	100	13		
15.88	15.88	1.60	21	-1	304 SS	245	0.28	27	7
			Alloy 718	575	0.51	55	11		

Based on nominal seal dimensions, recommended cavity dimensions, and ambient temperature. If working pressures exceed the above ratings consult us for recommendations. Refer to Page E-68 for a definition of the above performance terminology.

Section E – Technical Information

Spring Energized Metal C-Ring Performance							
Nominal Cross Section (mm)	Free Height (mm)	Cross Section Code	Temper Code	Material		Seating Load (N/mm)	Springback (mm)
				Jacket	Spring		
1.57	1.57	05	-1	304 SS	304 SS	79	0.08
				Alloy X-750	Alloy X-750	90	0.08
				Alloy 718	Alloy 718	96	0.08
2.39	2.39	07	-1	304 SS	304 SS	140	0.10
				Alloy X-750	Alloy X-750	150	0.13
				Alloy 718	Alloy 718	158	0.15
3.18	3.18	09	-1	304 SS	304 SS	158	0.13
				Alloy X-750	Alloy X-750	170	0.15
				Alloy 718	Alloy 718	175	0.18
3.96	3.96	11	-1	304 SS	304 SS	210	0.18
				Alloy X-750	Alloy X-750	230	
				Alloy 718	Alloy 718	145	0.23
4.78	4.78	13	-1	304 SS	304 SS	245	
				Alloy X-750	Alloy X-750	260	0.23
				Alloy 718	Alloy 718	280	0.25
6.35	6.35	15	-1	304 SS	304 SS	330	0.25
				Alloy X-750	Alloy X-750	350	0.28
				Alloy 718	Alloy 718	367	0.30
9.53	9.53	17	-1	304 SS	304 SS	420	0.38
				Alloy X-750	Alloy X-750	440	0.43
				Alloy 718	Alloy 718	455	0.46
12.70	12.70	19	-1	304 SS	304 SS	490	0.51
				Alloy X-750	Alloy X-750	510	0.56
				Alloy 718	Alloy 718	540	0.61

Based on nominal seal dimensions, recommended cavity dimensions and ambient temperature. If working pressures exceed the above ratings consult Parker for recommendations. Refer to Page E-68 for a definition of the above performance terminology.



MSI Spring Energized Metal C-Ring Performance

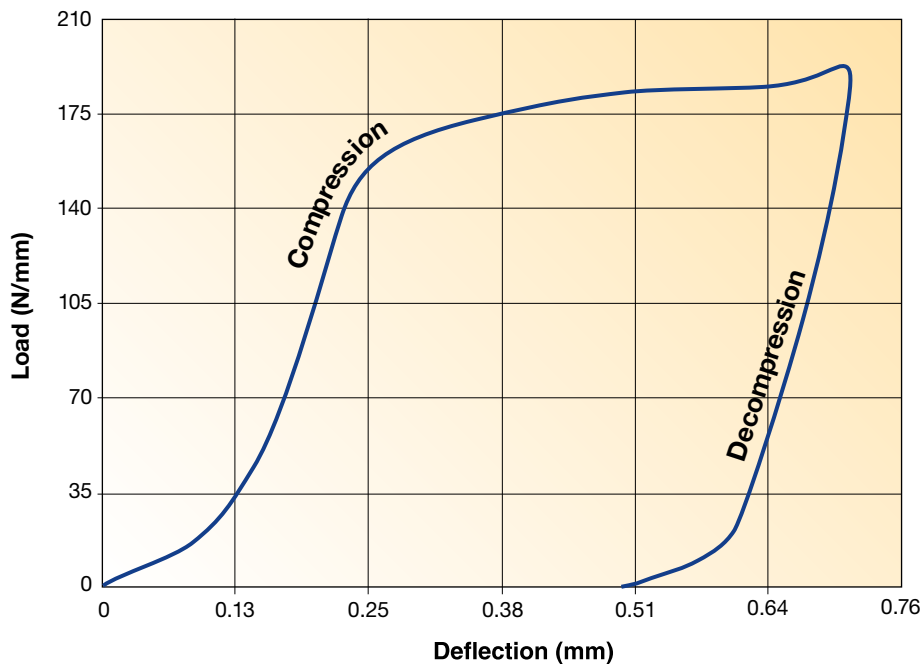

Metal Wire Ring Performance							
Nominal Cross Section (mm)	Free Height (mm)	Cross Section Code	Temper Code	Material	Seating Load (N/mm)	Springback (mm)	Working Pressure Rating (MPa)
0.89	0.89	03	-4	Silver/Gold	160	0	51
				Aluminum	175	0	51
				Copper	420	0	103
				Nickel	530	0	140
				304 Stainless Steel	740	0	140
1.57	1.57	05	-4	Silver/Gold	210	0.01	51
				Aluminum	250	0	51
				Copper	600	0	103
				Nickel	740	0	140
				304 Stainless Steel	1050	0.01	140
2.39	2.39	06	-4	Silver/Gold	210	0.03	51
				Aluminum	250	0.01	51
				Copper	600	0.01	103
				Nickel	740	0.01	140
				304 Stainless Steel	1050	0.03	140
3.18	3.18	07	-4	Silver/Gold	210	0.05	51
				Aluminum	250	0.03	51
				Copper	600	0.03	103
				Nickel	740	0.03	140
					1050	0.05	140

Based on nominal seal dimensions, recommended cavity dimensions and ambient temperature. If working pressures exceed the above ratings consult Parker for recommendations. Refer to Page E-68 for a definition of the above performance terminology.

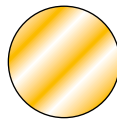

MWE Metal E-Ring Performance

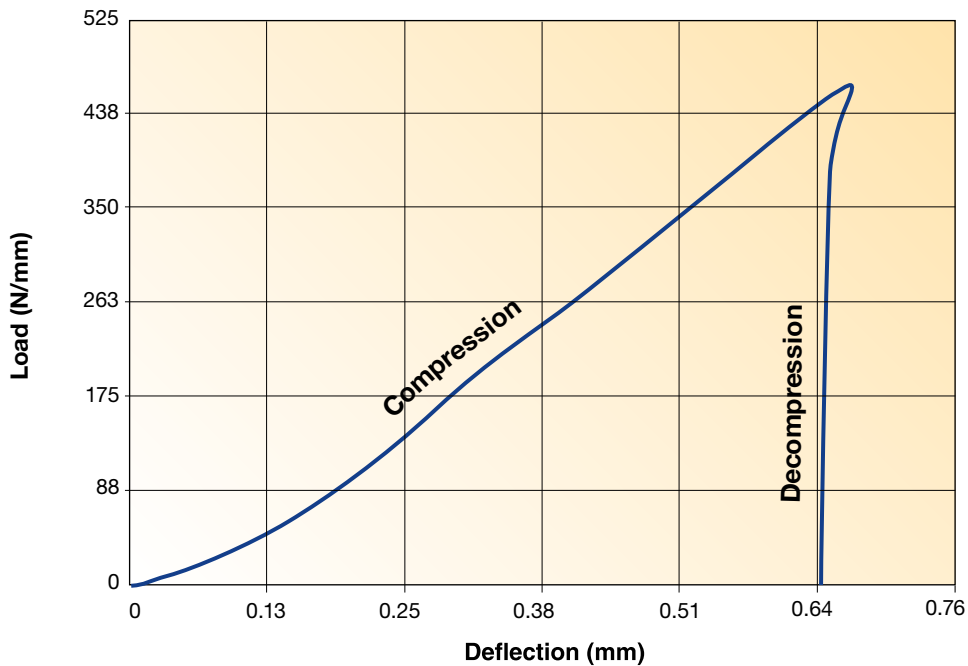

Leak Rate Information

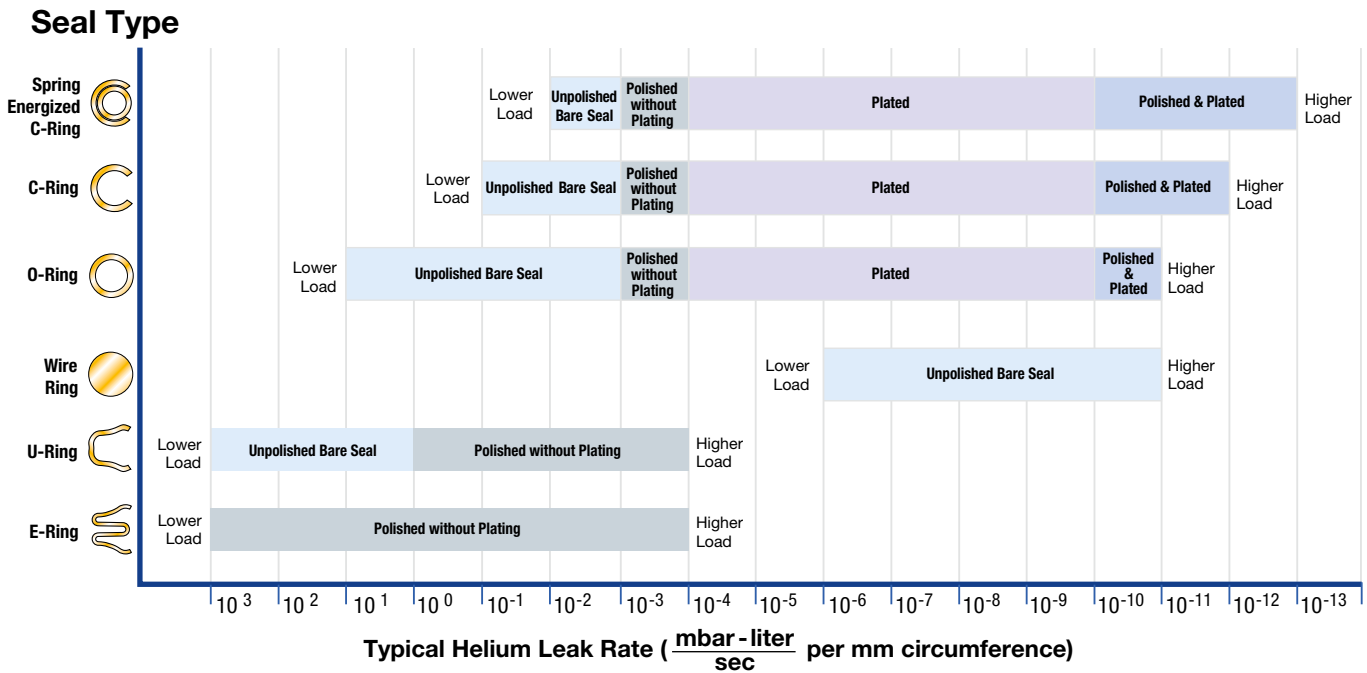

Equivalent leak rates for other gases: Multiply the helium leakage rate by the following factors to obtain the leakage rate of the following gases.

Oxygen: 0.35

Nitrogen: 0.37

Hydrogen: 1.42

Air: 0.37

The graph above shows typical ranges of leakage rates that may be expected with various types of seals. Testing was performed using helium mass-spectroscopy leakage detection. A standardized condition of 1 atmosphere differential pressure at 21 °C was used in all cases. Test procedures and installation parameters were in accordance with the recommendations given in this design guide including a surface roughness of 0.4 - 0.8 $\mu\text{m R}_a$.

The widths of the horizontal bars indicate the spread of leakage values that may be expected depending on the specific plating selection and surface condition. (It should be noted that these results are not directly applicable to liquids, since the much higher viscosities and surface tension will generally prevent leakage entirely).

As a service to our customers, we are pleased to offer specific seal performance testing and analysis for unusually challenging and “mission critical” applications. Testing can be set up to reproduce the actual conditions expected in service. Please contact your local Parker representative.

Leak Rate Equivalents					
$\frac{\text{cc}}{\text{sec}}$	$\frac{\text{mbar} \cdot \text{liter}}{\text{sec}}$	$\frac{\text{Torr} \cdot \text{liter}}{\text{sec}}$	$\frac{\text{Pa} \cdot \text{m}^3}{\text{sec}}$	Approximate Equivalent	Approximate 1 mm ³ Bubble Equivalent
1	1.01	7.6×10^{-1}	1.01×10^{-1}	$5,7 \times 10^{-5}$ SCFM	Steady Stream
1×10^{-1}	1.01×10^{-1}	7.6×10^{-2}	1.01×10^{-2}	1 cc every 10 seconds	Steady Stream
1×10^{-2}	1.01×10^{-2}	7.6×10^{-3}	1.01×10^{-3}	1 cc every 100 seconds	10 per second
1×10^{-3}	1.01×10^{-3}	7.6×10^{-4}	1.01×10^{-4}	3 cc per hour	1 per second
1×10^{-4}	1.01×10^{-4}	7.6×10^{-5}	1.01×10^{-5}	1 cc every 3 hours	1 every 10 seconds
1×10^{-5}	1.01×10^{-5}	7.6×10^{-6}	1.01×10^{-6}	1 cc every 24 hours	1 every 100 seconds
1×10^{-6}	1.01×10^{-6}	7.6×10^{-7}	1.01×10^{-7}	1 cc every 2 weeks	3 per hour
1×10^{-7}	1.01×10^{-7}	7.6×10^{-8}	1.01×10^{-8}	3 cc per year	Bubbles too infrequent to observe
1×10^{-8}	1.01×10^{-8}	7.6×10^{-9}	1.01×10^{-9}	1 cc every 3 years	
1×10^{-9}	1.01×10^{-9}	7.6×10^{-10}	1.01×10^{-10}	1 cc every 30 years	
1×10^{-10}	1.01×10^{-10}	7.6×10^{-11}	1.01×10^{-11}	1 cc every 300 years	
1×10^{-11}	1.01×10^{-11}	7.6×10^{-12}	1.01×10^{-12}	1 cc every 3000 years	

Fatigue and Stress Relaxation

Fatigue

Fatigue is the main failure mechanism in a material that is subjected to fluctuating loads. Under cyclic loading, localized slip bands can form in regions of high localized stresses. As fluctuating loading continues, these bands increase in number and small microscopic cracks form. Given enough time and stress amplitude, the cracks will grow and propagate through the wall of the seal resulting in a fatigue failure and leakage.

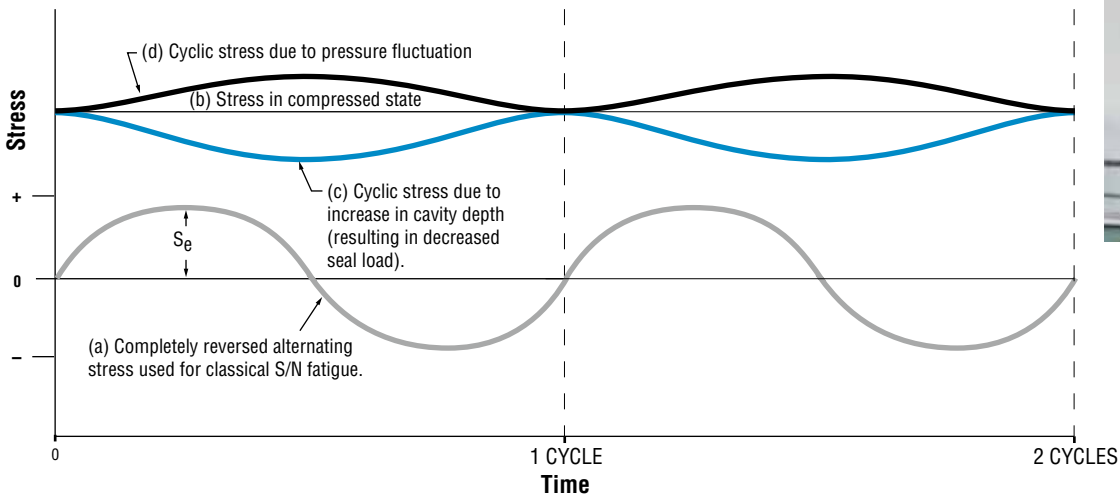

There are several types of loading that can result in fatigue failure, the most common type being alternating tension and compression or reversed loading. Loading of this type is illustrated in line (a) in the figure above, and is the type used in fatigue testing to develop the endurance or fatigue limits (S_e) of materials. The endurance limit is the stress below which fatigue failure will not occur, regardless of the number of applied cycles (generally considered 10^7 cycles).

Another type of loading results in stresses modulating from one magnitude to another, in the same direction (low to high tensile stress). This is the type of loading most commonly seen in resilient metal seals. Referring to the figure, the seal is deflected or compressed at installation to a stress level corresponding to line (b). If the seal is then exposed to fluctuating flange separation or cavity growth, the stresses in the seal decrease, then increase as illustrated in line (c). If the seal is subjected to pressure cycling, the stresses in the seal can increase beyond the assembly stresses as illustrated in line (d).

Seals designed for greater springback are more resistant to fatigue due to a combination of cross sectional geometry and material properties including temper.

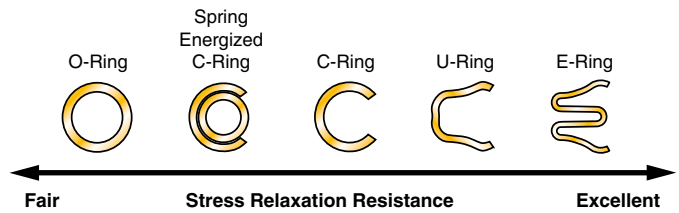

Stress Relaxation

Any highly stressed component, held at high temperatures, is subject to a form of permanent deformation known as stress relaxation. Unlike creep, stress relaxation occurs in a relatively short period of time, typically in as little as 100 hours of exposure time. This is an important design consideration in any critical sealing application at elevated temperature. Stress relaxation compromises both the sealing load and springback properties of the seal, impacting its ability to maintain sealing integrity under both static and dynamic conditions.

Parker Hannifin has extensive experience designing and testing seals to combat the negative effects of stress relaxation. Our seals are designed to optimize resistance to stress relaxation through careful consideration of geometry, materials and appropriate heat treatment.

Installation Guidelines

In addition to the required cavity dimensions provided in Section C, there are other important cavity design issues which affect seal performance.

Application/Medium Being Sealed	Surface Roughness. R_a	
	μm	$\mu inch$
Dynamic Axial Seal Vacuum Applications	0.1 – 0.2 0.2 – 0.4	4 – 8 8 – 16
Helium Gas Hydrogen Gas Freon	0.2 – 0.4	8 – 16
Air Nitrogen Gas Argon Natural Gas Fuel (aircraft and automotive)	0.4 – 0.8	16 – 32
Water Hydraulic Oil Crude Oil Sealants	0.4 – 1.6	16 – 63

Surface Roughness Recommendations

The roughness of the mating surfaces directly affects the leak rate when using unplated seals. Selecting high load seals with appropriate plating can substantially offset the affects of rough finishes; however, the guidelines in the table, left should be followed whenever possible. We also recommend a turned finish with a circular lay. This is always preferable to a random or radial lay. Discontinuities, radial scratches or pits may be blended, subject to the flatness recommendations given below.

Surfaces with a smoother finish than recommended may actually impair sealing. With the optimum surface roughness and circular lay, the finish embeds within the seal surface. Each ridge of the surface roughness acts as a stress riser and as an independent, redundant sealing line.







To select the appropriate plating or coating material and thickness refer to Page D-60 in the metal seal material selection section.

Surface Flatness Recommendations

Metal seals can accommodate some degree of waviness, or lack of flatness of the mating surfaces. Spring energized seals offer the greatest amount of compliance since each coil of the spring acts as an independent force to assist the jacket in conforming to the mating surface.

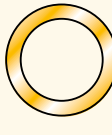
Specific surface flatness recommendations:

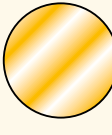
- Maximum waviness of the cavity mating surfaces must be within the limits given in the table below.
- The sum of the flatness tolerances of the opposing mating surfaces shall not exceed 4% of the seal free height.
- The cavity depth limits provided in Section C shall not be exceeded.

Maximum Waviness of Cavity Mating Surfaces						
Seal Free Height						
	C-Ring	E-Ring	O-Ring	U-Ring	Wire Ring	Spring Energized C-Ring
Maximum Gradient						
Less than 2.74 mm	0.002	0.004	0.001	0.002	0.001	0.003
Greater than or equal to 2.74 mm	0.004	0.007	0.002	0.004	0.002	0.005

Surface Hardness Recommendations

Many metal seals are designed to produce high seating loads against the mating surfaces to meet ultra low leakage requirements. To withstand these high compressive stresses, without damage to the sealing surfaces, requires these surfaces to have a hardness of at least 35 Rc. This is particularly important when the seal seating load exceeds 35 N/mm (200 lb/inch) of circumference. Dynamic axial seals require a hardness of at least 60 Rc.

Compression Limiters

Section C provides the required cavity depths for each type of metal seal. Using the specified groove depths results in optimal seal compression with the proper seating load and excellent resiliency. Excessive compression can actually reduce sealing stress by creating an excessively broad, or even double footprint. Additionally, the seal may be crushed so that normal springback cannot occur. Equally, under-compression must also be avoided, since it results in low sealing stresses and potential leakage. When it is not possible or practical to machine the required hardware cavity or cavity depth, a compression limiter may be used. Two types of limiters are available:

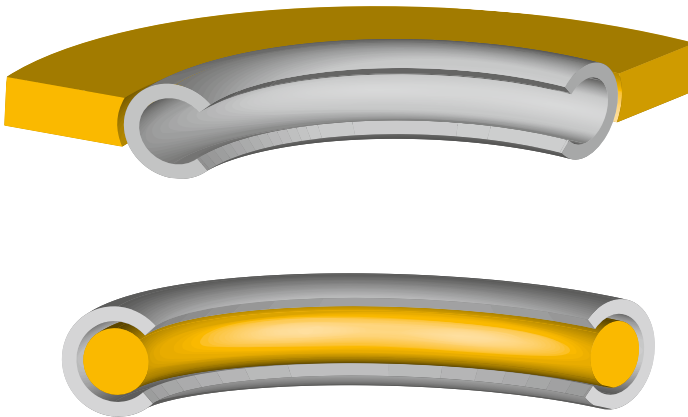

External Limiter:

The external limiter is a metal plate manufactured to a thickness corresponding to the required working height of the seal. This is the preferred type of compression limiter. It is designed with a large surface area which does not compress even under the highest of compressive loads thus always ensuring proper seal compression. This type of limiter also supports the seal against hoop stresses from internal pressures as well as providing convenient centering within a bolt circle. External limiters are available with a relieved inside diameter which allows the seal to snap into the limiter resulting in a convenient one piece assembly.

Internal Limiter:

A solid wire installed within the seal serves as an internal limiter and prevents over-compression of the seal. This method is available with all C-Rings, O-Rings, and Spring Energized C-Rings. Because the wire will also compress under high loads, seal compression with this method may not be as consistent as with the external limiter. Seating loads over 175 N/mm (1000 lb/inch) of circumference may result in excessive compression of the seal and reduced seal performance. The internal limiter also offers no support to the seal against pressure induced hoop stresses and will require a groove for high pressure applications.

Availability of Limiters

External and Internal limiters can be custom designed for all applications. Contact Parker for more information.

Installation Guidelines

Bolt Load & Tightening Torque Guidelines

The metal seal seating load, or load required to compress the seal, is typically achieved by tightening a number of bolts spaced around the flange. The number, size, and grade of these bolts must be sufficient to compress the seal during installation and withstand the system operating pressure which acts upon the surface of the flange.

Note: These bolt load and tightening torque guidelines are not intended to be used as design criteria and are only offered as a general guide. Many other factors such as flange thickness, flange rotation, thermal cycling, bolt stress relaxation, externally applied loads, temperature derating, impulse and fatigue, etc., must be considered by the design engineer to ensure proper bolt and torque selection.

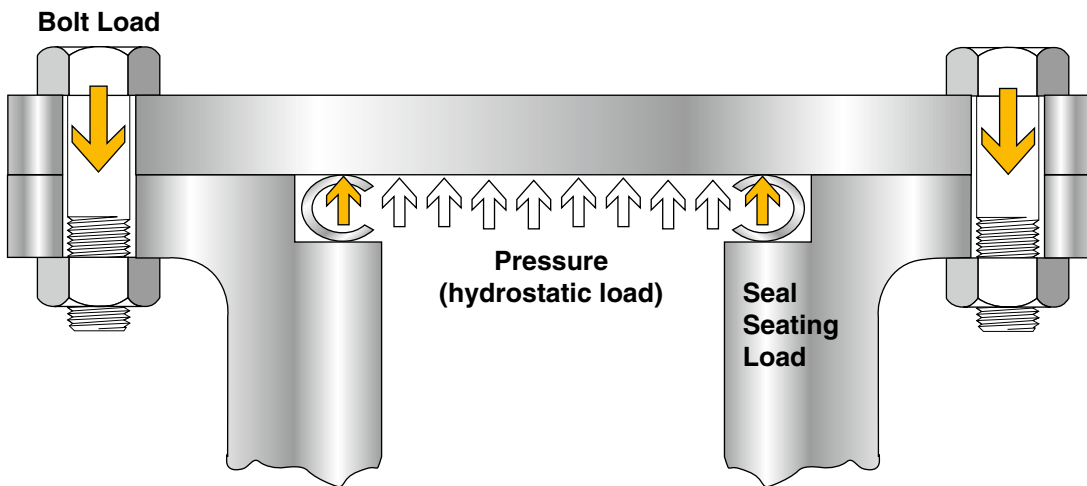

Bolt Load Required \geq Hydrostatic Load + Seal Seating Load + Safety Margin



The equation below provides the tightening torque required to produce a bolt load for various bolt geometries.

$$T = \frac{L}{1000} \left(0.16p + \mu \left(0.58d + \frac{D}{2} \right) \right)$$

Where: T = torque applied to the bolt, (Nm)

L = bolt load, (N)

p = bolt thread pitch, (mm)

μ = coefficient of friction
(assumes thread coefficient = bearing circle coefficient)

d = bolt pitch diameter, (mm)

D = mean bearing circle diameter, (mm)

Technical Information | Installation Guidelines

The table below was generated from the equation on the previous page for Unified and American National threads. This table can be used as a guideline for estimating the bolt load and tightening torque requirements.

Seal Seating Load:

Step 1: Obtain the seal seating load (N/mm circumference) from the tables on pages C-16 through C-39.

Step 2: Multiply the seating load by the seal circumference, (mm) to obtain the total seal seating load (N).

Hydrostatic Load:

Step 3: Calculate the differential area: (in mm²):
 $(\pi/4) \times (\text{Seal O.D.})^2$

Step 4: Multiply the pressure (MPa) by the differential area to obtain the hydrostatic load (N).





Number of Bolts required:

Step 5: Total clamping load = seal seating load + hydrostatic load.

Step 6: Divide total clamping load by the maximum clamping load for the chosen bolt size from the table to obtain the number of bolts required.

Apply suitable safety and design margin:

Step 7: The design engineer must consider other influences such as elevated temperatures and pressure impulses. A sufficient safety margin should be applied when determining the required number of bolts in order to meet Code or other design requirements.

Size	Bolt Stress Area (sq. mm)	 DIN 13 Grade 6.9 Bolts			 DIN 13 Grade 8.8 Bolts			 DIN 13 Grade 10.9 Bolts			 DIN 13 Grade 12.9 Bolts		
		Maximum Bolt Clamping Load (N)	Torque Dry (N×m)	Torque Lubricated (N×m)	Maximum Bolt Clamping Load (N)	Torque Dry (N×m)	Torque Lubricated (N×m)	Maximum Bolt Clamping Load (N)	Torque Dry (N×m)	Torque Lubricated (N×m)	Maximum Bolt Clamping Load (N)	Torque Dry (N×m)	Torque Lubricated (N×m)
M4 × 0.7	8.78	3400	2.4	2.3	4000	2.9	2.7	5650	4.1	3.8	6750	4.9	4.6
M5 × 0.8	14.2	5550	5.0	4.7	6550	6.0	5.5	9200	8.5	8.0	11100	10	9.5
M6 × 1.0	20.1	7800	8.5	8.0	9250	10	9.5	13000	14	13	15600	17	16
M8 × 1.25	36.6	14300	21	19	17000	25	23	23900	35	32	28700	41	39
M10 × 1.5	58.0	22800	41	39	27100	49	46	38000	69	64	45700	83	77
M12 × 1.75	84.3	33400	72	67	39500	86	80	55500	120	110	66700	145	135
M14 × 2.0	115	45600	115	105	54000	135	125	76000	190	180	91300	230	215
M16 × 2.0	157	63000	180	165	75000	210	195	105000	295	275	126000	355	330
M18 × 2.5	192	76500	245	225	90500	290	270	127000	405	390	153000	485	455
M20 × 2.5	245	98500	345	325	117000	410	385	164000	580	540	197000	690	650
M22 × 2.5	303	123000	465	435	145000	550	510	205000	780	720	245000	930	870
M24 × 3.0	353	142000	600	560	169000	710	660	237000	1000	930	284000	1200	1100
M27 × 3.0	459	187000	890	830	221000	1050	980	311000	1500	1400	374000	1800	1650
M30 × 3.5	561	227000	1200	1100	269000	1450	1350	379000	2000	1850	454000	2400	2250

Dry torque assumes $\mu = 0.14$

Lubricated torque assumes $\mu = 0.125$

Seal Shaping Requirements for Non-Circular Seals

All standard metal seals can be formed into various shapes. The illustration below shows some of the many shapes in which metal seals can be made.

For applications as varied as fuel nozzle mounting flanges on aircraft gas turbine engines, or dies for extrusion of plastic film, the availability of specially shaped metal seals offers the greatest design flexibility.

The table (below) provides the minimum outer corner radius for the various cross sections of metal C-rings, O-rings, spring energized C-rings, wire rings, E-rings and U-rings. All shaped seals are custom designed by our engineers. Please send us your completed “application data sheet” provided on pages F-103 and F-104 of this design guide including a sketch of the non-circular cavity and we will assist you in determining the best seal type and shape for your application.

Minimum Inside Bend Radius of Seal (mm)						
Cross Section Code	C-Ring	E-Ring	O-Ring	U-Ring	Spring Energized C-Ring	Wire Ring
01	5.0		10.0			
02	5.0		15.0			
03	5.0		15.0			10.0
04	5.0		23.0			
05	7.5	18.0	23.0	18.0	10.0	15.0
06	7.5	23.0	33.0			
07	12.5	38.0	33.0	25.5	15.0	23.0
08	12.5	23.0	10.0			
09	15.0	48.0	15.0	33.0	20.5	33.0
10	15.0	30.0	20.5			
11	20.5	30.0	40.0		23.0	
12	20.5		23.0			
13	23.0	48.0	48.0	50.0	28.0	
14	23.0		28.0			
15	30.0	68.0	63.0	66.0	38.0	
16	30.0		38.0			
17	45.0		96.0		58.0	
18	45.0		58.0			
19	60.0		127.0		76.0	
20	60.0		76.0			
21			160.0			
25			33.0			
29			12.5			
31			15.0			
32			23.0			

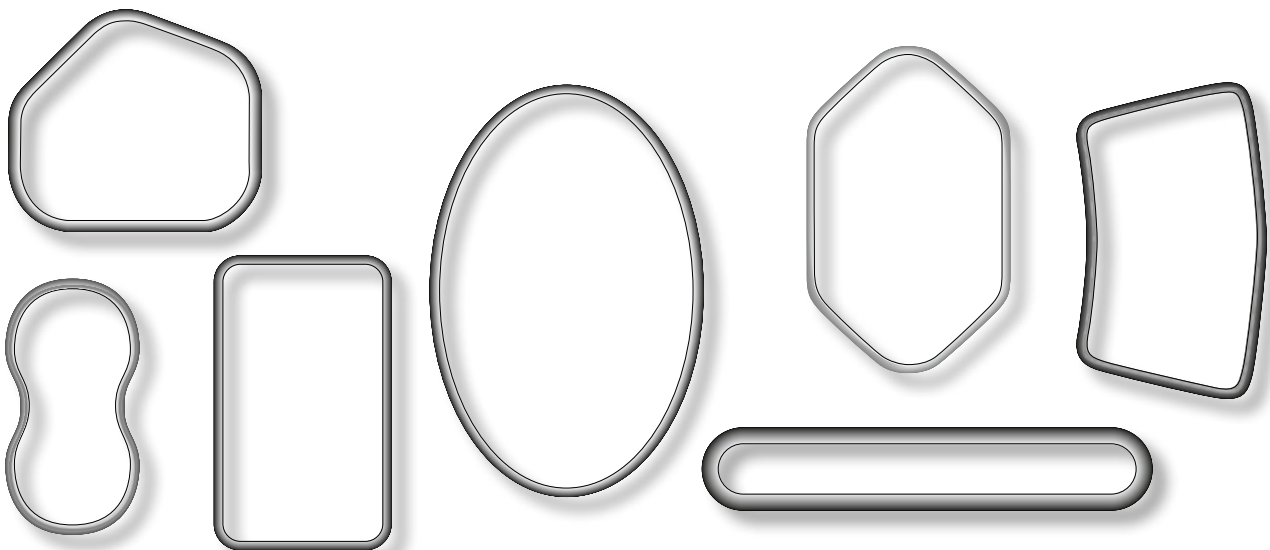

Metal Seal Manufacturing Specifications

The table below provides the allowable roundness and flatness for standard metal seals: C-rings, E-rings, O-rings, U-rings, wire rings, spring energized C-rings, and spring energized O-rings in an unrestrained state. When restrained, the seal diameter shall be within the limits specified in Section C.

Definition of Roundness

Difference between the largest measured reading and the lowest measured reading.

Metal Seal Roundness & Flatness	
Seal Diameter Range (millimeters)	Roundness & Flatness (millimeters)
4.57 - 25.40	0.51
25.41 - 63.50	0.76
63.51 - 127.00	1.52
127.01 - 254.00	2.29
254.01 - 304.80	3.18
304.81 - 355.60	3.81
355.61 - 406.40	4.45
406.41 - 457.20	5.08
457.21 - 558.80	6.35
558.81 - 914.40	12.70

Metal Seal Surface Finish

All unplated and plated metal seals are produced with a 0.4 µm R_a surface finish.

Metal O-Ring Weld Finishing

The Metal O-Ring weld process results in a weld fillet which is finished and smoothed to the adjacent surfaces. The surface at the blend area shall not be more than 0.05 mm below the adjacent surfaces.

Section E – Technical Information

Preferred C-Ring Sizes Internal Pressure Face Seal

Parker C-rings and spring energized C-rings are available in a virtually unlimited number of sizes. Each uniquely sized seal is produced with tooling specifically made for that size. Choosing one of the diameters listed below typically will result in a cost saving and reduced delivery times. The following is a list of the preferred C-ring and spring energized C-ring sizes.

Preferred C-Ring Sizes Internal Pressure Face Seal												
Seal Type	Free Height (mm)	Cross Section Code	Preferred Seal Diameters (all dimensions are in millimeters)									
MCI	0.79	01 & 02	3.81	6.48	7.29	8.18	10.47	11.81	13.79	17.65	19.94	24.41
			4.70	6.53	7.70	8.26	10.57	12.55	14.67	18.39	20.22	25.30
			5.49	6.58	7.72	8.31	10.97	12.85	14.73	19.00	20.75	26.26
			5.61	6.60	7.92	8.61	11.30	12.90	15.47	19.36	21.57	
			5.99	6.63	7.98	9.70	11.38	13.44	16.10	19.56	23.01	
			6.10	6.83	8.10	10.31	11.63	13.59	16.79	19.63	23.09	
MCI	1.19	03 & 04	7.87	10.49	14.55	18.31	22.50	24.13	30.60	39.37	49.76	113.46
			8.46	11.00	14.96	19.99	23.11	24.77	31.04	41.00	58.42	121.92
			8.74	11.10	16.03	20.52	23.17	25.50	32.56	41.58	58.65	
			8.94	11.28	16.74	20.62	23.52	25.52	34.77	41.71	71.17	
			9.60	11.46	17.02	20.80	23.62	28.90	35.00	42.90	87.05	
			9.68	12.22	17.63	21.41	24.03	29.00	38.58	48.54	98.81	
MCI	1.57	05 & 06	6.88	13.89	19.43	23.90	29.77	35.99	46.08	57.00	75.11	121.74
			7.85	14.50	19.79	24.11	30.00	36.07	46.13	57.66	75.74	130.66
			8.59	14.68	19.96	24.38	30.15	36.27	46.99	59.11	77.24	133.73
			8.79	14.99	19.99	24.69	31.06	36.63	47.50	59.36	78.00	137.85
			9.04	15.06	20.24	24.74	31.09	37.85	47.70	59.51	80.44	138.02
			9.65	15.27	20.32	24.99	31.45	38.02	47.85	60.45	83.44	140.16
			10.01	15.39	20.80	25.15	31.88	39.34	48.69	60.50	86.00	147.22
			10.08	15.55	21.01	25.22	32.44	39.50	48.92	60.63	93.14	147.29
			11.18	15.93	21.31	25.35	32.54	39.55	49.10	61.60	96.75	148.11
			11.76	16.21	21.59	25.50	32.77	39.78	49.73	63.42	97.56	158.75
			12.27	16.51	21.74	26.01	33.33	40.00	49.99	64.75	98.43	163.63
			12.50	16.99	21.79	26.67	33.53	40.46	50.72	65.02	99.97	168.71
			12.52	17.53	21.97	26.75	33.55	40.49	50.95	65.89	101.24	180.34
			12.65	17.58	22.00	26.98	33.66	41.15	52.30	66.68	101.35	187.12
			12.83	17.60	22.25	27.00	33.73	41.76	52.63	67.23	102.79	201.68
			12.88	17.63	22.30	27.07	33.99	41.86	52.86	67.74	106.30	203.71
			12.93	17.86	22.38	27.86	34.11	42.09	53.72	68.58	109.45	228.47
			13.01	18.01	22.43	27.99	34.19	42.93	53.77	69.01	111.25	255.75
			13.21	18.11	22.48	28.50	34.21	43.64	53.85	70.33	112.88	362.92
			13.34	18.62	22.94	28.65	34.70	43.76	54.61	71.15	114.78	
13.48	18.87	23.27	29.24	35.48	44.63	55.80	71.83	115.24				
13.51	19.05	23.42	29.36	35.71	45.92	56.06	73.53	117.12				
13.54	19.20	23.50	29.62	35.87	46.05	56.52	75.00	119.81				
MCI	2.39	07 & 08	9.50	18.16	24.69	30.73	35.38	42.11	47.83	54.79	60.07	68.43
			10.03	18.77	25.15	31.12	35.54	42.19	48.46	55.55	60.12	68.71
			11.61	19.81	25.93	31.17	36.50	42.32	49.76	55.73	60.22	69.39
			11.74	20.12	26.39	31.29	36.63	42.70	49.91	55.78	60.48	69.44
			12.24	20.35	26.72	31.34	37.19	43.00	50.34	56.74	61.01	69.67
			12.37	20.70	26.98	31.50	37.44	44.12	50.55	56.77	62.08	69.95
			12.42	21.01	27.03	31.70	37.77	44.20	50.57	57.00	62.99	70.23
			14.78	21.95	27.46	32.00	37.90	44.37	50.67	57.30	63.32	70.61
			15.60	22.12	27.51	32.13	38.08	45.14	51.00	57.40	63.65	70.64
			15.72	22.15	27.61	32.31	38.53	45.21	51.74	57.99	63.86	71.17
			15.80	22.73	28.45	32.36	39.42	45.29	51.89	58.32	64.39	71.60
			16.38	23.37	28.78	32.99	39.88	45.77	52.12	58.90	65.25	73.18
			16.56	23.55	28.96	33.07	40.01	45.87	53.52	58.95	65.84	73.99
			17.17	23.62	29.11	33.20	40.46	46.18	53.59	59.00	66.83	74.19
			17.22	23.72	29.67	34.01	40.64	46.36	53.65	59.64	67.01	74.78
			17.35	23.88	29.72	34.44	41.02	46.58	53.90	59.79	68.12	78.99
			17.68	24.21	29.92	34.67	41.10	47.19	53.98	60.00	68.20	79.53
			17.96	24.33	30.51	35.31	41.22	47.37	54.15	60.05	68.25	80.49

Technical Information | Preferred C-Ring Sizes Internal Pressure Face Seal

Preferred C-Ring Sizes Internal Pressure Face Seal												
Seal Type	Free Height (mm)	Cross Section Code	Preferred Seal Diameters (all dimensions are in millimeters)									
			MCI [cont.]	2.39	07 & 08	80.67	88.19	94.01	102.54	113.08	119.33	123.60
			80.98	88.65	94.21	105.92	114.73	119.99	123.70	131.17	145.44	160.27
			82.70	89.05	97.00	107.77	114.81	120.47	123.80	133.17	147.22	176.00
			85.85	90.65	100.25	108.41	115.49	121.01	124.99	134.87	147.85	184.30
			85.88	91.01	101.35	109.91	117.47	121.13	126.67	135.71	149.94	203.20
			87.00	91.11	101.42	111.15	119.20	121.74	129.31	136.35	152.22	209.55
			87.38	93.83	102.44	113.00	119.30	122.81	130.30	139.24	153.67	273.58
			22.00	40.59	55.32	64.82	74.35	89.81	103.10	122.99	145.62	171.45
			24.71	41.71	55.60	65.61	74.91	91.24	104.52	125.40	146.05	173.20
			26.31	41.81	55.83	65.99	75.41	91.82	104.77	125.60	146.51	174.68
			27.10	41.91	56.72	66.29	75.77	92.00	105.31	125.73	148.01	179.22
			28.60	43.71	56.77	66.42	75.84	92.84	106.10	125.78	149.48	179.40
			28.68	43.82	56.90	66.50	76.00	93.22	106.58	126.31	150.34	184.00
			29.54	44.60	57.99	67.16	76.58	93.40	108.33	127.38	150.88	184.61
			29.69	45.36	59.69	68.00	77.01	94.74	109.91	128.57	151.21	190.55
			30.05	45.72	59.79	68.22	77.52	94.89	111.25	128.90	151.76	191.82
			31.01	46.33	60.07	68.33	77.60	95.00	112.32	129.24	152.60	193.19
			32.66	46.94	61.11	68.81	79.12	95.38	113.16	129.26	153.54	194.82
			32.72	47.12	61.34	69.06	80.49	96.57	114.20	129.41	153.85	197.87
			33.27	47.55	61.49	69.60	80.70	98.17	114.22	130.56	155.57	202.95
			35.13	48.26	61.72	69.90	82.37	98.45	116.10	130.99	155.85	209.55
			35.56	48.62	61.80	70.23	82.63	99.06	116.54	131.95	156.03	228.83
			35.84	50.01	62.03	71.04	82.80	99.24	117.60	132.87	156.82	252.88
			36.14	50.17	62.10	71.30	84.46	99.47	117.78	136.65	157.00	
			36.60	50.22	62.94	71.32	84.51	99.75	117.86	136.80	158.55	
			36.93	50.39	63.07	71.91	84.63	99.82	119.79	137.01	162.31	
			37.41	51.99	63.20	72.01	85.42	100.61	119.81	137.16	165.10	
			37.64	53.21	63.25	72.78	85.52	101.22	119.89	138.10	167.39	
			37.80	53.23	63.37	73.03	85.62	102.41	120.52	139.52	167.59	
			39.01	54.89	64.14	73.89	87.94	102.77	120.65	142.75	169.49	
			39.90	54.94	64.26	73.99	89.54	102.92	120.83	143.41	170.99	
			32.46	53.47	69.65	77.22	89.99	104.27	114.10	130.00	147.50	179.02
			37.47	56.01	69.72	77.78	91.44	106.48	115.87	130.33	147.70	183.31
			40.26	59.49	70.99	79.50	94.41	106.83	117.22	132.00	147.80	185.75
			44.12	59.94	72.47	82.45	94.77	108.43	119.76	135.10	151.16	196.60
			45.03	64.52	73.41	83.57	98.86	109.60	121.87	138.71	151.66	212.72
			46.41	65.41	75.64	86.11	101.14	110.59	127.46	139.50	161.49	
			52.38	68.43	75.87	86.41	102.46	111.99	128.98	139.75	161.72	
			52.45	69.57	77.19	87.17	102.62	113.77	129.44	139.83	175.01	
			43.74	96.14	104.44	116.81	128.19	144.20	154.99	169.67	190.14	
			50.42	97.33	105.46	117.96	129.97	146.94	158.93	173.33	202.74	
			52.45	97.54	108.58	119.91	131.27	146.96	159.49	174.37	225.22	
			66.50	101.83	108.76	120.01	131.90	147.65	160.40	177.55	234.98	
			69.42	101.98	109.80	123.57	133.60	149.94	160.53	180.72	263.52	
			74.17	103.45	110.87	126.42	135.99	150.06	161.82	182.40		
			82.27	103.68	112.75	126.54	137.01	150.14	167.08	182.58		
			91.90	103.89	114.05	127.94	139.80	152.88	167.23	183.26		
MCI	6.35	15 & 16	99.44	119.71	124.36	132.69	138.56	145.67	167.13			
			119.38	123.62	129.69	137.21	144.07	153.09	213.61			
MCI	9.53	17 & 18	151.61									

Continued on next page.

Preferred C-Ring Sizes Internal Pressure Face Seal

Preferred Spring Energized C-Ring Sizes Internal Pressure Face Seal												
Seal Type	Free Height (mm)	Cross Section Code	Preferred Seal Diameters (all dimensions are in millimeters)									
MSI	1.57	05	14.58	27.71								
			16.36	44.25								
			17.32	45.39								
			19.76	91.95								
			19.99	93.80								
			24.69									
MSI	2.39	07	18.72	29.64	37.82	44.83	51.69	57.71	65.99	84.81	116.79	
			20.65	31.65	37.95	45.47	51.82	58.32	68.71	85.37	116.89	
			22.56	33.20	39.68	45.80	52.43	60.40	68.86	99.85	133.05	
			23.87	33.81	41.25	46.00	52.58	60.71	72.01	102.69	137.59	
			25.65	35.56	41.33	48.01	54.15	61.60	75.06	104.55	153.59	
			26.16	35.71	42.32	49.33	54.81	62.00	75.69	105.99	185.67	
			27.81	35.84	43.69	49.63	57.68	64.54	80.34	108.08		
			25.81	33.60	48.00	62.38	73.36	88.01	111.51	135.56	155.30	
			26.01	34.87	53.24	62.94	77.37	91.87	114.00	136.27	157.94	
			27.61	39.62	56.41	63.58	79.10	92.00	120.62	138.00	164.31	
MSI	3.18	09	28.93	43.82	56.82	65.81	79.40	97.43	120.85	138.84	164.90	
			29.39	44.81	59.72	66.47	79.91	97.99	120.88	141.00	171.58	
			29.90	46.36	60.71	68.99	84.00	100.91	121.79	147.45	171.70	
			30.12	47.50	61.70	69.24	84.33	104.57	127.10	151.99		
			33.12	47.90	62.00	70.36	85.90	108.99	129.59	152.43		
			47.60	59.67	82.58	116.38	138.00	159.74				
			47.70	70.51	84.23	122.00	138.51	178.61				
MSI	3.96	11	49.43	72.01	84.99	123.24	138.71	189.74				
			54.76	75.74	85.28	124.00	142.93	200.00				
			56.74	76.99	85.62	130.00	145.21	214.78				
			63.45	82.12	119.99	147.52						
MSI	4.78	13	69.75	85.65	120.27	152.12						
			72.85	109.04	122.12	154.99						
			74.47	111.12	140.92	190.68						
			75.08	113.41	141.12	216.71						
			109.22	137.21								
MSI	6.35	15	126.49	139.29								
			129.69	144.70								

Technical Information | Preferred C-Ring Sizes Internal Pressure Face Seal

Preferred C-Ring Sizes External Pressure Face Seal															
Seal Type	Free Height (mm)	Cross Section Code	Preferred Seal Diameters (all dimensions are in millimeters)												
			4.95	7.19	7.65	9.78	11.25	12.70	15.09	20.37	24.77				
MCE	0.79	01 & 02	5.08	7.24	7.82	9.93	11.86	14.35	15.98	21.92	29.87				
			6.40	7.32	8.00	10.36	11.96	14.86	19.30	22.35	33.10				
MCE	1.19	03 & 04	5.59	9.98	14.43	17.27	22.99	27.15	29.49	31.57	39.22				
			8.13	12.75	15.01	20.22	24.00	27.43	30.02	32.84	41.61				
			8.28	12.95	16.71	20.27	24.89	28.17	30.23	34.65	46.51				
			8.66	14.20	17.20	22.96	26.06	29.21	30.51	37.21					
MCE	1.57	05 & 06	4.52	11.07	16.25	20.65	26.42	31.85	40.28	58.80	74.47	103.17			
			4.75	11.23	17.47	20.83	26.72	33.00	40.49	59.18	75.95	106.38			
			5.31	11.43	17.78	21.13	27.33	33.38	42.16	59.59	76.20	109.65			
			6.02	12.14	18.06	21.36	27.76	33.63	44.17	60.33	78.00	119.63			
			6.55	12.60	18.08	21.51	28.25	34.93	44.22	61.93	84.15	126.70			
			6.73	13.41	18.21	22.23	28.32	36.83	44.45	61.98	85.73	126.77			
			7.90	13.69	18.77	22.27	28.42	38.10	44.70	63.40	87.40	133.35			
			9.25	13.77	19.25	24.92	29.79	38.15	47.63	63.50	88.65	145.75			
			9.53	14.45	19.40	25.02	30.07	38.56	51.28	66.75	88.90	151.49			
			9.58	15.62	19.94	25.25	30.71	39.55	55.40	70.00	89.51	187.38			
			10.11	15.70	20.50	25.55	31.75	40.13	57.15	71.73	92.23	213.36			
			10.59	15.75	20.55	25.65	31.80	40.18	57.28	72.97	101.60				
			MCE	2.39	07 & 08	3.51	19.00	27.81	31.60	39.75	46.46	57.10	71.10	89.48	112.73
10.16	19.05	27.89				31.70	40.31	46.76	59.69	73.03	91.52	116.00			
11.51	19.89	28.19				31.80	40.64	47.57	60.38	73.10	91.69	117.35			
11.99	20.04	28.58				32.26	41.33	47.68	62.48	76.00	92.08	117.47			
12.19	20.70	28.73				33.81	42.01	47.80	62.74	76.28	92.15	124.94			
13.11	22.20	29.19				35.18	43.05	47.88	63.45	76.38	95.00	127.00			
15.14	22.28	29.79				35.81	43.84	49.15	63.65	76.81	95.25	131.95			
16.00	23.06	29.90				36.25	43.99	49.25	65.00	77.55	95.71	139.83			
17.40	23.80	30.15				37.85	44.02	50.88	68.22	80.52	95.76	142.87			
18.36	24.66	30.25				37.95	44.07	52.40	68.33	81.28	104.90	149.22			
18.44	25.45	30.43				38.10	44.20	53.26	69.85	81.41	105.00	166.75			
18.92	26.29	31.17				38.51	45.77	54.05	69.93	84.00	107.95	196.85			
18.95	26.82	31.24				38.63	45.82	55.80	70.87	87.50	111.86	215.90			
MCE	3.18	09 & 10				22.50	36.22	57.35	71.43	91.92	113.00	126.49	140.00	158.72	208.97
						23.50	38.79	58.17	71.81	93.68	114.38	126.95	141.35	158.85	209.88
			24.94	40.06	58.19	73.08	95.12	114.45	127.81	143.13	159.03	222.33			
			26.49	42.19	58.78	74.85	97.23	116.99	128.52	143.89	161.98	235.03			
			26.95	43.71	60.40	76.33	97.49	117.55	129.01	145.29	164.29	355.55			
			27.79	44.86	62.13	76.35	97.99	120.78	133.22	146.05	168.27				
			28.12	45.52	63.58	79.38	99.47	121.82	133.73	146.43	173.71				
			31.29	48.44	63.63	80.82	100.28	123.34	134.29	150.16	173.86				
			31.98	49.94	63.81	81.08	100.96	124.00	135.00	152.40	174.04				
			32.18	50.62	64.97	81.20	103.99	125.32	135.20	152.48	177.80				
			32.51	52.22	65.08	82.30	104.14	125.45	135.28	154.30	181.79				
			32.69	53.98	66.19	83.29	105.33	125.50	136.68	155.57	182.12				
			33.45	54.99	67.31	85.73	109.37	125.63	137.39	156.01	188.90				
			34.98	56.24	70.00	88.98	111.12	126.19	139.70	157.91	190.75				
			MCE	3.96	11 & 12	29.97	48.67	60.45	73.10	100.15	108.20	117.50	130.17	140.56	181.38
30.12	53.01	61.39				75.44	104.04	108.89	117.58	130.25	150.01	243.23			
37.34	53.80	70.21				86.82	104.85	111.20	122.22	130.40	155.24	269.24			
45.03	59.56	70.74				99.80	105.05	115.24	123.24	132.84	156.01				
MCE	4.78	13 & 14	44.83	82.86	98.50	105.51	125.22	151.51	176.91	191.54					
			52.50	86.46	100.00	106.86	132.59	153.80	181.13	197.13					
			65.58	91.67	104.70	111.00	140.06	168.35	181.38	206.45					
			82.75	94.95	104.85	123.90	142.80	168.50	190.50						
MCE	6.35	15 & 16	132.92	150.01	199.59										
			140.97	162.71											
			141.05	185.45											
			141.10	186.00											

Preferred C-Ring Sizes External Pressure Face Seal

Preferred Spring Energized C-Ring Sizes External Pressure Face Seal												
Seal Type	Free Height (mm)	Cross Section Code	Preferred Seal Diameters (all dimensions are in millimeters)									
MSE	1.57	05	8.43 24.21 27.94 31.90	34.19 34.29 40.69 50.19	71.76 78.26 97.79							
MSE	2.39	07	5.97 16.15 20.04 23.65 24.89	25.43 25.58 27.20 27.56 30.33	30.91 32.00 34.19 37.21 40.06	42.19 43.74 44.70 48.77 54.31	54.79 59.31 60.10 62.89 65.51	66.07 67.31 72.21 73.48 80.19	88.93 89.00 90.07 91.69 92.08	101.85 102.06 105.21 106.35 110.26	118.26 124.21 135.08 141.02 141.58	196.29 201.70
MSE	3.18	09	19.36 19.91 22.33 23.52 24.82	28.12 28.40 32.21 33.58 34.21	34.47 41.20 45.21 46.10 49.81	50.19 52.50 54.05 55.19 60.25	66.70 69.85 74.65 80.01 83.29	94.01 97.69 100.10 100.30 103.76	110.92 118.01 120.29 130.23 130.99	132.71 134.70 140.41 145.39 145.77	162.00 162.10 167.00 171.53 180.01	
MSE	3.96	11	36.65 41.50 58.17 58.42	70.21 71.50 83.01 89.99	91.26 100.53 108.89 110.01	111.51 112.27 117.96 135.00	143.28 159.64 162.99 184.99	196.01				
MSE	4.78	13	47.75 68.17 94.89 98.45	104.14 123.22 131.24 142.80	145.01							
MSE	6.35	15	56.59 114.60 121.59 138.61	153.31 161.01 188.26								

Technical Information | Preferred C-Ring Sizes Internal Pressure Face Seal

Preferred Axial C-Ring Sizes												
Seal Type	Free Height (mm)	Cross Section Code	Preferred Seal Diameters (all dimensions are in millimeters)									
			MCA	0.79	01	5.56 6.35	7.95 8.38	13.61 17.47	18.24 27.23			
MCA	1.19	03	7.14 8.89	10.80 15.11	15.88 15.90	16.66 18.29	19.08 20.65	23.83 24.56	24.84 28.60	31.32 37.31		
MCA	1.57	05	8.08 9.40 9.55 10.82 10.85 10.90	11.13 11.91 12.73 12.78 14.00 14.28	14.33 15.95 16.08 16.69 17.07 17.42	19.10 20.09 20.19 21.21 22.25 22.33	22.40 22.86 22.91 23.04 24.11 25.38	25.40 25.43 25.81 26.01 27.00 27.58	28.63 28.70 30.18 31.83 31.93 32.08	34.06 34.95 35.08 38.18 38.20 40.87	41.38 44.91 54.03 58.04 71.53	
MCA	2.39	07	14.94 21.72 23.83 23.85 24.59 25.04	26.77 27.58 28.83 29.72 30.28 31.50	32.23 33.35 33.40 34.24 34.93 35.00	35.99 36.53 36.55 39.62 39.70 39.75	40.08 41.28 41.35 41.50 42.60 42.77	42.88 43.84 44.50 44.53 45.24 47.35	49.23 49.28 49.33 50.27 50.44 51.08	51.28 53.19 54.31 54.76 55.52 55.58	58.75 59.87 65.00 66.12 70.79 72.95	74.63 76.40 78.03 80.01 81.36 91.29
MCA	3.18	09	22.30 31.78 37.49 38.05 44.48 50.80 52.48 54.00 54.08	54.99 57.20 59.44 63.48 63.53 65.08 65.91 66.68 66.70	69.95 69.98 71.22 71.27 71.91 72.29 73.15 73.51 74.30	74.98 75.01 75.59 76.23 76.30 76.99 77.72 77.90 79.45	79.50 80.80 82.50 82.55 82.70 85.60 85.70 87.33 87.76	88.88 89.41 90.30 91.62 92.05 92.10 94.97 95.23 95.40	96.11 98.40 100.20 101.07 101.52 101.57 102.23 114.27 114.30	117.45 120.65 120.80 121.41 122.28 123.19 124.61 126.01 126.97	131.11 133.32 135.38 139.67 145.64 146.02 151.28 154.18 154.41	158.95 181.33 194.26 200.00 278.82 283.90
MCA	3.96	11	60.40 104.01 115.09	119.51 122.07 123.47	129.57 133.78 142.62	143.61 144.42 147.62	156.46 161.92 165.28	160.32 168.00 179.25	184.15 187.53 198.27	220.19 222.25 229.59	239.12 324.21	
MCA	4.78	13	75.03 133.50 136.45	145.59 159.11 165.35	170.38 172.06 174.60	176.20 177.90 180.47	183.77 184.18 187.30	195.35 200.63 219.05	231.75 236.02 250.01	269.42 284.20 304.80	308.31	
MCA	6.35	15	41.40 124.66	228.60 234.52	263.73 280.16	309.50 330.20	387.76 416.18					

Preferred Spring Energized Axial C-Ring												
Seal Type	Free Height (mm)	Cross Section Code	Preferred Seal Diameters (all dimensions are in millimeters)									
			-	1.19	03	10.41						
MSA	1.57	05	14.07	23.22	34.98	41.30	79.43					
MSA	2.39	07	94.29									
MSA	3.18	09	41.68	68.07	121.01	139.78	150.93	157.12				
MSA	4.78	13	75.08	283.72								

Section E – Technical Information

Tolerance Reference Tables

The tolerance tables below are consistent with the American National Standard Tolerances (ANSI B4.1) and the British Standard for Metric ISO Limits and Fits (BS 4500).

ANSI B4.1				
Nominal Diameter (inches) Over To	Tolerance Grade			
	h10 Cavity ID	H10 Cavity OD	h11 Seal OD	H11 Seal ID
	(Dimensions are in 0.001 inches)			
0 – 0.12	+0.0/ - 1.6	-0.0/ + 1.6	+0.0/ - 2.5	-0.0/ + 2.5
0.12 – 0.24	+0.0/ - 1.8	-0.0/ + 1.8	+0.0/ - 3.0	-0.0/ + 3.0
0.24 – 0.40	+0.0/ - 2.2	-0.0/ + 2.2	+0.0/ - 3.5	-0.0/ + 3.5
0.40 – 0.71	+0.0/ - 2.8	-0.0/ + 2.8	+0.0/ - 4.0	-0.0/ + 4.0
0.71 – 1.19	+0.0/ - 3.5	-0.0/ + 3.5	+0.0/ - 5.0	-0.0/ + 5.0
1.19 – 1.97	+0.0/ - 4.0	-0.0/ + 4.0	+0.0/ - 6.0	-0.0/ + 6.0
1.97 – 3.15	+0.0/ - 4.5	-0.0/ + 4.5	+0.0/ - 7.0	-0.0/ + 7.0
3.15 – 4.73	+0.0/ - 5.0	-0.0/ + 5.0	+0.0/ - 9.0	-0.0/ + 9.0
4.73 – 7.09	+0.0/ - 6.0	-0.0/ + 6.0	+0.0/ - 10.0	-0.0/ + 10.0
7.09 – 9.85	+0.0/ - 7.0	-0.0/ + 7.0	+0.0/ - 12.0	-0.0/ + 12.0
9.85 – 12.41	+0.0/ - 8.0	-0.0/ + 8.0	+0.0/ - 12.0	-0.0/ + 12.0
12.41 – 15.75	+0.0/ - 9.0	-0.0/ + 9.0	+0.0/ - 14.0	-0.0/ + 14.0
15.75 – 19.69	+0.0/ - 10.0	-0.0/ + 10.0	+0.0/ - 16.0	-0.0/ + 16.0
19.69 – 30.09	+0.0/ - 12.0	-0.0/ + 12.0	+0.0/ - 20.0	-0.0/ + 20.0
30.09 – 41.49	+0.0/ - 16.0	-0.0/ + 16.0	+0.0/ - 25.0	-0.0/ + 25.0
41.49 – 56.19	+0.0/ - 20.0	-0.0/ + 20.0	+0.0/ - 30.0	-0.0/ + 30.0
56.19 – 76.39	+0.0/ - 25.0	-0.0/ + 25.0	+0.0/ - 40.0	-0.0/ + 40.0

BS 4500				
Nominal Diameter (mm) Over To	Tolerance Grade			
	h10 Cavity ID	H10 Cavity OD	h11 Seal OD	H11 Seal ID
	(Dimensions are in 0.001 millimeters)			
0 – 3	+0.0/ - 40	-0.0/ + 40	+0.0/ - 60	-0.0/ + 60
3 – 6	+0.0/ - 48	-0.0/ + 48	+0.0/ - 75	-0.0/ + 75
6 – 10	+0.0/ - 58	-0.0/ + 58	+0.0/ - 90	-0.0/ + 90
10 – 18	+0.0/ - 70	-0.0/ + 70	+0.0/ - 110	-0.0/ + 110
18 – 30	+0.0/ - 84	-0.0/ + 84	+0.0/ - 130	-0.0/ + 130
30 – 50	+0.0/ - 100	-0.0/ + 100	+0.0/ - 160	-0.0/ + 160
50 – 80	+0.0/ - 120	-0.0/ + 120	+0.0/ - 190	-0.0/ + 190
80 – 120	+0.0/ - 140	-0.0/ + 140	+0.0/ - 220	-0.0/ + 220
120 – 180	+0.0/ - 160	-0.0/ + 160	+0.0/ - 250	-0.0/ + 250
180 – 250	+0.0/ - 185	-0.0/ + 185	+0.0/ - 290	-0.0/ + 290
250 – 315	+0.0/ - 210	-0.0/ + 210	+0.0/ - 320	-0.0/ + 320
315 – 400	+0.0/ - 230	-0.0/ + 230	+0.0/ - 360	-0.0/ + 360
400 – 500	+0.0/ - 250	-0.0/ + 250	+0.0/ - 400	-0.0/ + 400
500 – 760	+0.0/ - 300	-0.0/ + 300	+0.0/ - 500	-0.0/ + 500
760 – 1050	+0.0/ - 400	-0.0/ + 400	+0.0/ - 630	-0.0/ + 630
1050 – 1425	+0.0/ - 500	-0.0/ + 500	+0.0/ - 760	-0.0/ + 760
1425 – 1940	+0.0/ - 630	-0.0/ + 630	+0.0/ - 1000	-0.0/ + 1000

All tolerances above heavy line are in accordance with American-British-Canadian (ABC) Agreements.

Conversion Tables

Pressure										
to obtain	atmosphere	bar	inches of mercury	inches of water	millimeters of mercury (Torr)	millimeters of water	kPa	MPa	Newtons/m ² (Pascal)	pounds/square inch
atmosphere by	1	1.0133	29.9210	4.0678×10 ²	7.6000×10 ²	1.0332×10 ⁴	1.0133×10 ⁻¹	1.0133×10 ⁻¹	1.0133×10 ⁵	14.6960
bar by	9.8692×10 ⁻¹	1	29.5300	4.0146×10 ²	7.5006×10 ²	1.0197×10 ⁴	1.000×10 ⁻²	1.0000×10 ⁻¹	1.0000×10 ⁵	14.5038
inches of mercury by	3.3421×10 ⁻²	3.3864×10 ⁻²	1	13.5950	25.4000	3.4532×10 ²	3.3864	3.3864×10 ⁻³	3.3864×10 ³	4.9116×10 ⁻¹
inches of water by	2.4584×10 ⁻³	2.4840×10 ⁻³	7.3556×10 ⁻²	1	1.8685	25.4000	2.4910×10 ⁻¹	2.4910×10 ⁻²	2.4910×10 ²	3.6128×10 ⁻²
mm of mercury (Torr) by	1.3158×10 ⁻³	1.3332×10 ⁻³	3.9370×10 ⁻²	5.3520×10 ⁻¹	1	13.5950	1.3332×10 ⁻¹	9.8068	1.3332×10 ²	1.9337×10 ⁻²
millimeters of water by	9.6787×10 ⁻⁵	9.8068×10 ⁻⁵	2.8959×10 ⁻³	3.9370×10 ⁻²	7.3556×10 ⁻²	1	9.8068×10 ⁻³	1.0000×10 ⁻³	9.8068	1.4223×10 ⁻³
kPa by	9.8692×10 ⁻³	1.0000×10 ⁻²	2.9530×10 ⁻¹	4.0146	7.5006	1.0197×10 ⁻²	1	1.0000×10 ⁻⁶	1.0000×10 ³	1.4504×10 ⁻¹
MPa by	9.8692	10.0000	2.9530×10 ²	4.0146×10 ³	7.5006×10 ³	1.0197×10 ⁵	1.0000×10 ⁻⁶	1	1.0000×10 ⁹	1.4504×10 ²
Newtons/m ² (Pascal) by	9.8692×10 ⁻⁶	1.0000×10 ⁻⁵	2.9530×10 ⁻⁴	4.0146×10 ⁻³	7.5006×10 ⁻³	1.0197×10 ⁻¹	6.8948×10 ⁻³	6.8948×10 ⁻³	1	1.4504×10 ⁻⁴
pounds/square inch by	6.8046×10 ⁻²	6.8947×10 ⁻²	2.0360	27.6810	51.7144	7.0310×10 ²	6.8948	6.8948×10 ⁻³	6.8948×10 ³	1

Temperature

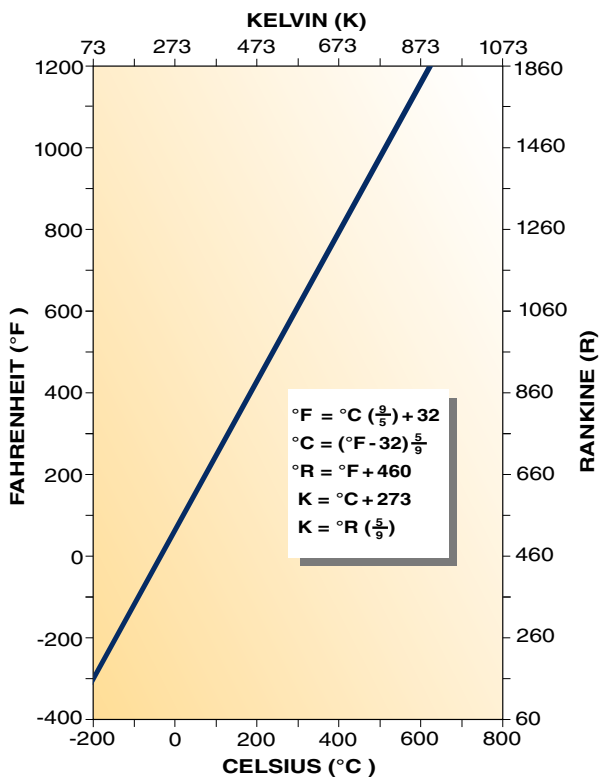

Torque [Moment]

to obtain	N-m	kg-m	kg-cm	ft-lb	Inch-lb
N-m by	1	0.1020	10.1970	0.7376	8.8509
kg-m by	9.8068	1	100.0000	7.2330	86.7942
kg-cm by	0.0981	0.0100	1	0.0723	0.8679
ft-lb by	1.3558	0.1383	13.8255	1	12.0000
inch-lb by	0.1130	0.0115	1.1522	0.0833	1

Force

to obtain	newton	kilogram	pound
newton by	1	0.1020	0.2248
kilogram by	9.8068	1	2.2046
pound by	4.4482	0.4536	1

Distributed Force [Force per unit length]

to obtain	N/mm	kg/cm	lb/in
N/mm by	1	1.0197	5.7102
kg/cm by	0.9807	1	5.5997
lb/in by	0.1751	0.1786	1

For leakage rate conversion refer to page E-80.

Section F – Additional Metal Seal Styles

The seals shown and described in Section C of this design guide have been designed, tested and carefully selected as our standard line of metal seals. Using the standard metal seals will satisfy the vast majority of applications and sealing requirements.

There are however, applications which have unique demands and we are pleased to offer our sealing expertise in developing sealing solutions for your specialized applications. Our extensive manufacturing capabilities allow us to quickly produce prototype seals which can be tested in our laboratories to verify leak rate, compressive load and springback.

For over 50 years we have been designing and manufacturing customized seals along with our standard product line. Please advise us of your requirements by filling out a copy of the “Application Data Sheet” included as pages F-103 and F-104 of this design manual. Please send the completed “Application Data Sheet” to Parker. We will respond quickly with detailed recommendations.

The following pages provide a brief overview of the wide range of unique seals we can offer, including:

- Various Formed Seals
- Precision Machined Seals
- Beaded Gaskets



This section includes:	Page
Formed Seals	F-96
Precision Machined Seals	F-96
Beaded Gaskets	F-97
Additional E-Ring Styles	F-98
Frequently Asked Questions	F-99
Application Data Sheets	
Face Seal	F-103
Axial Seal	F-104

Formed Seals

Formed seals are produced from metal strip which is formed into various cross sectional sizes and shapes to suit the needs of the application.

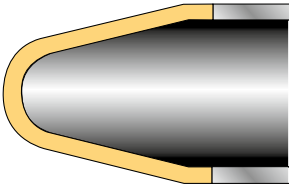

The **formed V-ring** is a low load, versatile seal which can be manufactured for a wide range of cavity sizes and depths. It has excellent springback.

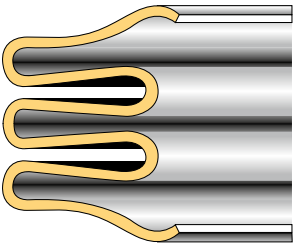

The customized **E-ring** can be designed with a large number and variety of convolutions. These seals provide exceptional springback when flange separation is of primary concern.

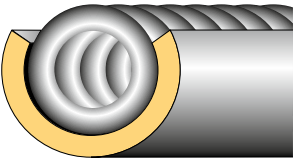

The **spring energized axial C-ring** is very similar to the standard, non-spring energized axial C-Ring. However, due to the additional sealing stress created by the spring, it is capable of sealing higher reversing pressures.

Precision Machined Seals

The seal below is an example of the type of seal that is produced in our machine shop. It is machined to very tight tolerances and is available in sizes that are smaller than formed seals.

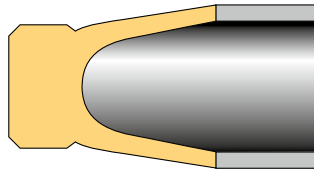

The **machined V-ring** is a popular seal intended for use in precision flanges with surface finishes of 0.1–0.4 μm (4–16 μinch) R_a . The “heel” end is designed to serve as a compression limiter allowing the seal to be used without a groove.

Beaded Gaskets

Beaded gaskets are inexpensively laser cut or stamped from a metal sheet. They are then embossed with a ridge, or “bead” which acts as the sealing surface of the gasket. The seals can be cut to virtually any shape and include bolt holes to facilitate installation. As the mating flanges are bolted together the raised bead of the gasket produces a higher sealing stress than a plain flat gasket.

Two typical beaded gaskets are shown below. Simply send a copy of your flange drawing to Parker and we will design a beaded gasket for you.

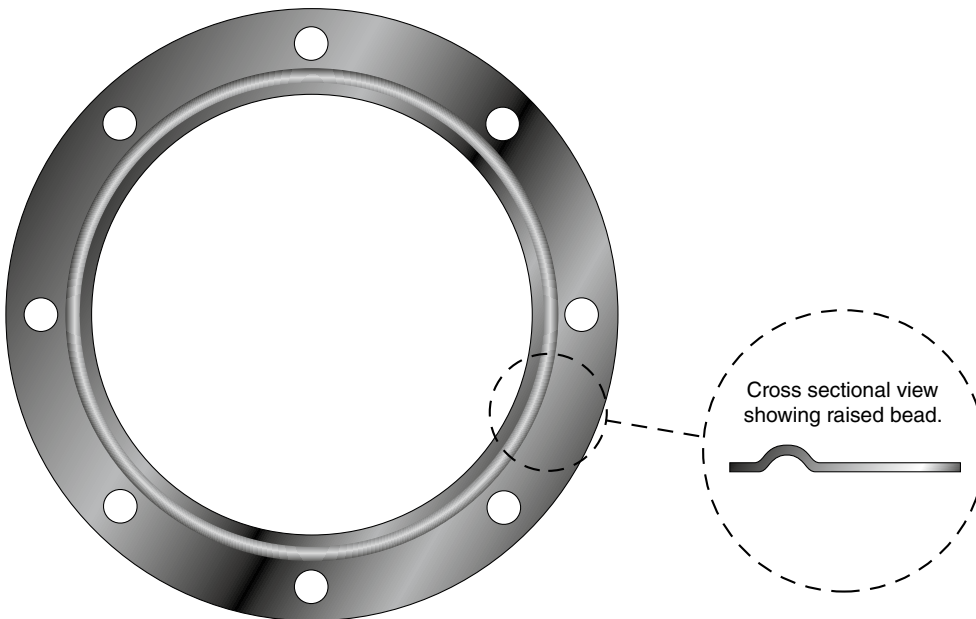
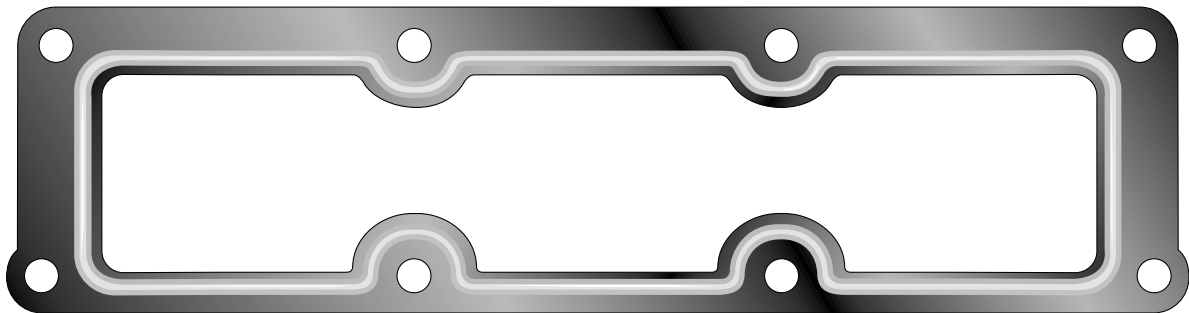

Cross sectional view showing raised bead.

Section F – Additional Seal Styles

Additional E-Ring Styles

Many custom cross sections are available.

33101 	69222 	69294 	69375 	69432 	69518 	69883
33124 	69223 3/32-7	69295 	69385 	69434 	69550 	69982
33126 	69224 3/32-8	69298 	69397 	69436 	69552 	69986
40060 	69225 	69312 	69425 	69437 	69597 	69987
40293 	69226 1/16-5	69315 	69426 	69439 	69642 	69990
690118 	69228 1/4-15	69317 	69428 	69440 	69654 	79002 3/32-7
690127 	69241 	69323 	69429 	69445 	69659 	79003 1/8-9
690195 	69253 	69373 	69430 	69447 	69812 	79004
69221 3/16-13	69292 	69374 	69431 1/8-11	69488 	69881 	79005

Frequently Asked Questions

How do I choose the right metal seal?

Selecting the most appropriate seal for your application can save a lot of money by eliminating the tremendous costs associated with machine downtime, unscheduled service, and spill remediation.

We offer a wide variety of metal seals designed to meet the challenges of high temperatures or cryogenics, high pressures, vacuum, corrosive chemicals and even intense levels of radiation. Unlike rubber, composite, asbestos, and other organic gaskets, metal seals do not deteriorate over time due to compacting, outgassing or blowouts.

In addition, because the seating loads for metal seals can be significantly less than those required for crush-type gaskets, the strength and mass of the flanges can be reduced. This is particularly important to designers concerned with reducing size and weight.

Different Needs

C-ring – provides a good combination of leak tightness and springback. It is one of the most popular designs.

E-ring – offers the greatest amount of springback of all metal seals.

Metal O-ring – used for over 50 years and remains an economical choice for high-load, high pressure sealing.

Spring energized C-ring – is similar to the standard C-ring, but it has an internal spring that produces much greater load for sealing against rough surfaces or when extreme leak tightness is required.

Wire ring – is a low cost, high load, crush type seal used with smooth mating surfaces and minimum relative movement.

Face seal / axial seal – keep in mind that metal face seals, which are ideal for static applications, are compressed by approximately 10% to 20% of their original free height to produce preferred sealing loads for optimized performance. Axial seals can be used in either static or semi-dynamic applications to seal against shafts and bores.

Due to the relative rigidity of metal seals in comparison to elastomeric and polymeric seals, the axial seals must be produced to tighter tolerances than face seal grooves. Face seals are generally preferred instead of axial seals due to their relative ease of gland manufacture, installation and seal performance.

High Load vs High Elasticity – high load metal seals are designed for extreme leak tightness. High elasticity seals provide resiliency or springback needed to maintain effective sealing during mating surface separation, such as with thermal cycling.



Frequently Asked Questions

A Variety of Metals

Metal seals are produced with a wide variety of materials including high performance nickel alloys such as Alloy 718, Alloy X-750 and Waspaloy. Heat treated to increase seating load and springback, these high-strength metals improve fatigue and creep resistance. Metal O-rings and spring energized C-rings are also often manufactured from austenitic stainless steels.

Material selection is based on operating conditions such as temperature and pressure as well as performance issues such as seating load and springback. Other factors that should be considered in the selection process are corrosion resistance and chemical compatibility. Special materials are available to meet unusually severe operational requirements.

Are metal seals reusable?

This is one of the most common questions asked by our customers. Generally, metal seals are not considered to be reusable and are replaced after each use. However, after considering a few important issues, the customer must ultimately be the one who answers the question for themselves.

Issues to consider:

1) What type of seal is it?

An E-ring provides nearly full elastic recovery after the compressive force is removed. E-rings usually are left unplated meaning there is no ductile outer surface which can be deformed into the hardened mating surface by compression. As a result, unplated E-rings and other low load seals are more suited for reuse than other metal seals. O-rings and C-rings undergo mostly plastic deformation and therefore are usually discarded after one use.

2) What is the surface roughness of the mating hardware?

A rough surface will mean an equally rough impression into the soft plated surface of the seal. Reinstalling the seal will result in a mismatch of the plated surfaces and mating hardware surfaces. The surface roughness impression made in the plating upon initial installation may act as leak paths upon subsequent installations. Smooth surfaces will minimize this effect and improve the chances for seal reuse.

3) How flat are the surfaces of the mating hardware?

When a seal is compressed it conforms to the waviness of the mating surfaces. When the seal is reinstalled it is likely that the waviness of the flange will not match with the waviness of the seal. This waviness mismatch may result in leak paths and non-uniform sealing forces on the circumference of the seal. Flat surfaces will increase the possibility for seal reuse.

4) What if the seal leaks upon reuse?

In some applications the time, effort and cost of assembling the equipment or machinery is very high. The money saved by reusing the seal is minimal compared to the cost for

disassembly and reassembly if the seal needs to be replaced. Most customers are not willing to risk the cost of the labor replacing the seal to save on the price of a seal. However, if the consequences of a leaking seal are small then the customer will likely be willing to reuse the seal.

After considering these issues the customer can decide whether or not to reuse the seal. Most customers will conclude that the seal should be replaced after each use.

Why use a -8 heat treatment?

Sulfide stress cracking (SSC) is a special corrosion type, a form of stress corrosion cracking commonly found in oil field applications where hydrogen sulfide (H_2S) may be present. Susceptible alloys, especially steels, react with hydrogen sulfide, forming metal sulfides and elementary atomic hydrogen. The atomic hydrogen diffuses into the metal matrix.

Stress corrosion cracking requires three simultaneous factors – surface tensile stress, alloy and environment. The alteration or elimination of any one of them can prevent this attack. Where possible, the alteration of the environment or the choice of a different alloy is the best solution. Elimination of stress is usually attempted through heat treatment.

Choosing materials with a high nickel content can greatly improve the resistance to sulfide stress cracking. Heat treating a high nickel content material such as Alloy 718 to reduce the tensile stress to meet the requirements of NACE MR0175 can greatly reduce sulfide stress cracking corrosion.

NACE standard MR0175 does not give a recipe for heat treatment. But it does state that a material such as Alloy 718 should not have a hardness greater than 40HRC. Our -8 heat treatment removes the tensile stress enough to meet the requirement, but still give some strength. The -8 heat treatment will have a reduced seating load of about 30% over our standard -6 solution anneal and age hardened heat treatment.

What is leakage?

Leakage describes the unwanted loss, or leak of matter as it escapes its proper location. The matter may be liquid, gas or even solid in the form of powder for example.

It is a fact that every single seal on the planet has a measurable leakage rate. The leakage rate may be zero for some materials, such as liquid water or petroleum hydrocarbons with a relatively large molecular size, but will be more than zero for very small molecules such as helium or hydrogen gas. It is possible to manufacture a seal that has a leakage rate of 1×10^{-11} cc/sec/mm of helium. This is equivalent to the loss of a cubic centimeter of helium every 3000 years. It's an extremely low number but it is not the same as zero. Leakage is more properly thought of as a continuous spectrum of rates.

Questions About Tooling

Parker is already tooled for a vast majority of standard sizes and cross sections. Sometimes it may be necessary to manufacture new tooling when the customer has special needs. The following guideline can help the customer understand when tooling may be necessary.

There are two primary types of seal tooling. Roll form tooling and die form tooling.

Roll form tooling uses a series of rolls to make a particular cross section in any diameter needed. For example a 3.18 mm cross section C-ring roll form tooling can make a part that is 241.30 mm in diameter or 1029.30 mm in diameter.

There is virtually no limitation on how large of a diameter can be roll formed. There are practical guidelines in the catalog pages however from a handling point of view, too small of a cross section with too large of a diameter may be difficult to handle without bending.

The diameter of the roll form also limits the lower end of the diameter. It is not possible to roll form a part with a smaller diameter than the diameter of the roll form. This catalog lists those guidelines as well.

Die form tooling makes one size diameter and one cross section. C-ring tooling that makes Internal pressure C-rings with a cross section of 3.18 mm and a diameter of 38.10 mm cannot be used to make any other diameter.

C-seal (face seals - MCI, MCE, MSI and MSE)

C-rings under 200 mm are primarily die formed. This design guide lists the die sizes currently available. If an application requires a diameter not found on the list, then tooling may have to be made.

C-rings larger than 200 mm are primarily roll formed. All the standard cross section sizes have roll form tooling already made.

C-seal (axial seals – MCA and MSA)

Axial C-rings require very tight tolerances. All axial C-rings are made using die form tooling. Available tooling sizes are listed on page E-91. If the required seal size is not listed then tooling will have to be manufactured.

E-seal (face seals - MEI and MEE)

E-seals are manufactured using a series of roll forms. The number of roll stages depends on the number of the convolutions and the complexity of the cross section. This number can range from four to as many as 25 roll stages.

Parker has designed over 60 different cross sections as of the date of this catalog. This design guide lists only six cross sections as standard cross sections on pages C-24 to C-27. Some of the additional designs may be found on page F-98. E-seal applications tend to be unique and challenging, requiring careful selection to fit the appropriate cross section.

U-seals (face seals – MUI and MUE)

U-seals are manufactured using a series of roll forms. They are simpler in nature than E-seals.

O-rings (face seals MOI, MON, MOP, MOE, MOM and MOR)

O-rings are manufactured by winding tubing around an arbor. Parker has all of the tooling necessary to make any size.

Wire rings (face seals – MWI and MWE)

Wire rings are manufactured by winding wire around an arbor. Parker has all of the tooling necessary to make any size.

How to troubleshoot a seal

It must be understood that a seal is only one component of the hardware necessary to contain the medium leaking. Seals are placed against flanges or shafts /bores and that hardware is just as important to prevent the loss of medium as the seal. The seal must be properly matched with appropriate hardware. Together they function as a team, and an issue with either part may cause the customer to experience more leakage than desired.

If a customer is experiencing an issue with leakage then there are several questions that must be addressed.

1) What is the expectation for leakage?

As written above this might be zero for some applications, but it also may be a specific number for others. A customer may not want to see a pool of oil under machinery and the expectation may be zero leakage of oil. If, however, the customer is trying to contain air from leaking from one part of a jet engine to another part, there may be a measured amount that is allowed.

2) Has the seal type been properly selected for the application?

Different types of seals have different abilities. Some applications require a seal with a low load and high amounts of springback. Some seals have very high seating load and it may not be possible to bolt the hardware down. Some types of seals do not have enough springback for certain applications.

3) Has the seal been properly sized for the application?

Metal seals are less forgiving of sizing error than polymer seals. The seal needs to be correctly sized by taking into account:

- Cavity depth
- Cavity dimension tolerances
- The amount of flange separation that the application may experience

Frequently Asked Questions

4) Has the correct seal material been chosen for the application?

Proper material selection is critical. Materials must be selected for stress relaxation at temperature. Some materials are more appropriate than others for corrosion resistance, fatigue strength and chemical compatibility.

5) Has the customer hardware been examined?

- a. Is the surface finish appropriate for the level of leakage desired? For example, is the customer using a circular lay face seal groove?
- b. Is the hardware tolerance understood and accounted for?
- c. Is there enough seating load for the seal? For example, are there enough bolts to compress the seal and are they the right size and grade?
- d. Do the customer flanges have the correct hardness? For example, seals with a seating load of 35025.36 N/m requires mating surface hardness of at least 35 Rc.
- e. Are there radial scratches or digs in the flange sealing surface?

6) Has the seal been examined?

- a. Does the seal show signs of abuse or mishandling?
- b. Are radial scratches visible on the sealing surface?
- c. Has the seal been compressed to the proper cavity depth? Seals such as C-rings operate in the plastic region of the material and will take a set. When measured the seal should show that it has been compressed and the amount of springback should be taken into account.
- d. Is there a visible footprint where the seal made contact with the flange hardware? Is this footprint continuous? Does the footprint look the same on all parts of the seal that come into contact with the hardware?
- e. Was the seal properly sized? Has the seal diameter been measured?

Section F – Additional Seal Styles

Application Data Sheet *Please photocopy for future use!*

		Axial Seal			Date _____										
Customer	Company _____			Phone _____											
	Address _____			Fax _____											
	City _____	St. _____	Zip _____	E-Mail _____											
	Contact _____			Title _____											
Operating Conditions	Application/Equipment _____														
	Existing Seal _____		Customer Part Number _____		Parker Part Number _____										
	Insertion Location _____		<input type="checkbox"/> Cavity	<input type="checkbox"/> Shaft											
	Seal Type _____		<input type="checkbox"/> Uni-Directional	<input type="checkbox"/> Bi-Directional											
	<input type="checkbox"/> Static	<input type="checkbox"/> Rotating	<input type="checkbox"/> Reciprocating	<input type="checkbox"/> Oscillatory											
	RPM _____		Stroke Length _____	Rotation _____											
			Velocity _____	Velocity _____											
			Cycle Rate _____	Cycle Rate _____											
			Service Life _____	Service Life _____											
	Fluid Medium _____		Maximum Allowable Leakage: Liquid _____		Gas _____										
	Special Testing Requirements _____														
	Cavity Materials: Cavity _____			Shaft _____											
	Surface Finishes: Cavity _____			Shaft _____											
	Additional Information _____														
(state all units)		At Assembly	Minimum	Maximum	Operating										
Installation/Operating Loads															
Temperature															
Pressure															
Shaft O.D. "D" (± Tol.)															
Cavity I.D. "E" (± Tol.)															
Cavity Length "G" (± Tol.)															
Sketch of Application	<table border="1" style="width:100%; border-collapse: collapse;"> <tr> <td colspan="2">Ports Passed Over During Installation</td> <td colspan="3">During Operation</td> </tr> <tr> <td colspan="2">Quotation Quantities</td> <td colspan="3">Annual Quantity Potential</td> </tr> </table>					Ports Passed Over During Installation		During Operation			Quotation Quantities		Annual Quantity Potential		
	Ports Passed Over During Installation		During Operation												
	Quotation Quantities		Annual Quantity Potential												

Warning - user responsibility

This document and other information from Parker Hannifin Corporation, its subsidiaries and authorized distributors provide product or system options for further investigation by users having technical expertise.

The user, through its own analysis and testing, is solely responsible for making the final selection of the system and components and assuring that all performance, endurance, maintenance, safety and warning requirements of the application are met. The user must analyze all aspects of the application, follow applicable industry standards, and follow the information concerning the product in the current product catalogue and in any materials provided by Parker or its subsidiaries or authorized distributors. To the extent that Parker or its subsidiaries or authorized distributors provide component or system options based upon data or specifications provided by the user, the user is responsible for determining that such data and specifications are suitable and sufficient for all applications and responsibly foreseeable uses of the components or systems.

Range of application

Our seals may only be used within the application parameters stated in our documents as regards compatibility with contact media, pressures, temperatures and time of storage. Application or use outside of the specified application parameters as well as the selection of different compounds by mistake may result in damage to life, the environment and/or equipment and facilities.

The information contained in our publications is based on know-how developed over decades of experience in the manufacturing and application of seals. Despite this experience, unknown factors arising out of the practical application of seals may considerably affect the overall applicability of this information in such a way that the recommendations provided herein are not to be considered generally binding.

The data for operating pressure, operating temperature, and surface speed stated in the columns represent maximum values and are interrelated. Under extreme working conditions it is recommended not to use all maximum values simultaneously.

For special requirements (pressure, temperature, speed, etc.) please contact our consultancy service, so that suitable materials and/or designs can be recommended.

Compatibility of seals and operating media / cleaning agents

Due to the great diversity of operational parameters affecting fluidic devices and their impact on seals, it is absolutely imperative that manufacturers of these devices approve seals for functional and operational suitability under field conditions.

Furthermore, in view of the consistent increase of newly available media used as hydraulic oils, lubricants, and cleaning agents, special attention is invited to the aspect of compatibility with sealing elastomers currently in use.

Additives contained in base media in order to enhance certain functional characteristics may affect compatibility characteristics of sealing materials.

For this reason, it is imperative that any product equipped with our seals be tested for compatibility with operational media or cleaning agents approved or specified by you either at your plant or by means of field tests prior to any field use.

We kindly ask you to comply with this notice since, as a manufacturer of seals, we are not in a position, as a matter of principle, to perform simulations of any and all conditions present in the final application nor of knowing the composition of the operational media and cleaning agents used.

Design modifications

We reserve the right to make design modifications without prior notification.

Prototypes and samples

Prototypes and samples are produced from experimental moulds. The subsequent series production may differ in terms of production techniques from the prototype production unless specific agreement to the contrary was reached beforehand.

Delivery and services

The delivery guarantee (availability of moulds) for individual dimensions of our range of products is limited to a period of 7 years.

Damaged moulds, including standard items, can only be replaced in case of sufficient demand. Most of the dimensions stated in this catalogue are normally (but not as a matter of course) available ex stock.

For the production of smaller quantities, special compounds, and in case of special production procedures, we reserve the right of charging a prorated share of set-up costs.

All deliveries and services are subject to our terms.

Quality systems

Our manufacturing sites are certified according to ISO 9001 and/or ISO/TS 16949.

Copyright

All rights reserved by Parker Hannifin Corporation. Extracts may only be taken with permission. Modification rights reserved.

Validity

This edition supersedes all prior documents.



Parker-Prädifa worldwide

Europe, Middle East, Africa

AE – United Arab Emirates,
Dubai

Tel: +971 4 8127100
parker.me@parker.com

AT – Austria, Wiener Neustadt

Tel: +43 (0)2622 23501-0
parker.austria@parker.com

AT – Eastern Europe, Wiener
Neustadt

Tel: +43 (0)2622 23501 900
parker.easteurope@parker.com

AZ – Azerbaijan, Baku

Tel: +994 50 2233 458
parker.azerbaijan@parker.com

BE/LU – Belgium, Nivelles

Tel: +32 (0)67 280 900
parker.belgium@parker.com

BG – Bulgaria, Sofia

Tel: +359 2 980 1344
parker.bulgaria@parker.com

BY – Belarus, Minsk

Tel: +375 17 209 9399
parker.belarus@parker.com

CH – Switzerland, Etoy

Tel: +41 (0)21 821 87 00
parker.switzerland@parker.com

CZ – Czech Republic, Klecany

Tel: +420 284 083 111
parker.czechrepublic@parker.com

DE – Germany, Kaarst

Tel: +49 (0)2131 4016 0
parker.germany@parker.com

DK – Denmark, Ballerup

Tel: +45 43 56 04 00
parker.denmark@parker.com

ES – Spain, Madrid

Tel: +34 902 330 001
parker.spain@parker.com

FI – Finland, Vantaa

Tel: +358 (0)20 753 2500
parker.finland@parker.com

FR – France, Contamine s/Arve

Tel: +33 (0)4 50 25 80 25
parker.france@parker.com

GR – Greece, Athens

Tel: +30 210 933 6450
parker.greece@parker.com

HU – Hungary, Budaörs

Tel: +36 23 885 470
parker.hungary@parker.com

IE – Ireland, Dublin

Tel: +353 (0)1 466 6370
parker.ireland@parker.com

IT – Italy, Corsico (MI)

Tel: +39 02 45 19 21
parker.italy@parker.com

KZ – Kazakhstan, Almaty

Tel: +7 7273 561 000
parker.easteurope@parker.com

NL – The Netherlands, Oldenzaal

Tel: +31 (0)541 585 000
parker.nl@parker.com

NO – Norway, Asker

Tel: +47 66 75 34 00
parker.norway@parker.com

PL – Poland, Warsaw

Tel: +48 (0)22 573 24 00
parker.poland@parker.com

RO – Romania, Bucharest

Tel: +40 21 252 1382
parker.romania@parker.com

RU – Russia, Moscow

Tel: +7 495 645-2156
parker.russia@parker.com

SE – Sweden, Spånga

Tel: +46 (0)8 59 79 50 00
parker.sweden@parker.com

SK – Slovakia, Banská Bystrica

Tel: +421 484 162 252
parker.slovakia@parker.com

SL – Slovenia, Novo Mesto

Tel: +386 7 337 6650
parker.slovenia@parker.com

TR – Turkey, Istanbul

Tel: +90 216 4997081
parker.turkey@parker.com

UA – Ukraine, Kiev

Tel: +380 44 494 2731
parker.ukraine@parker.com

UK – United Kingdom, Warwick

Tel: +44 (0)1926 317 878
parker.uk@parker.com

ZA – South Africa, Kempton Park

Tel: +27 (0)11 961 0700
parker.southafrica@parker.com

North America

CA – Canada, Milton, Ontario

Tel: +1 905 693 3000

US – USA, Cleveland

Tel: +1 216 896 3000

Asia Pacific

AU – Australia, Castle Hill

Tel: +61 (0)2-9634 7777

CN – China, Shanghai

Tel: +86 21 2899 5000

HK – Hong Kong

Tel: +852 2428 8008

IN – India, Mumbai

Tel: +91 22 6513 7081-85

JP – Japan, Tokyo

Tel: +81 (0)3 6408 3901

KR – South Korea, Seoul

Tel: +82 2 559 0400

MY – Malaysia, Shah Alam

Tel: +60 3 7849 0800

NZ – New Zealand, Mt Wellington

Tel: +64 9 574 1744

SG – Singapore

Tel: +65 6887 6300

TH – Thailand, Bangkok

Tel: +662 186 7000-99

TW – Taiwan, Taipei

Tel: +886 2 2298 8987

South America

AR – Argentina, Buenos Aires

Tel: +54 3327 44 4129

BR – Brazil,

Sao Jose dos Campos
Tel: +55 800 727 5374

CL – Chile, Santiago

Tel: +56 2 623 1216

MX – Mexico, Toluca

Tel: +52 72 2275 4200