



RAZER CHROMA HDK

MASTER GUIDE

The Razer Chroma Hardware Development Kit (HDK) is designed to give you the ultimate immersive gaming experience with highly versatile LED strips anywhere in and around your gaming setup. With individually controllable LEDs that can be customized with 16.8 million colors, the Razer Chroma HDK fits perfectly inside your PC case and anywhere beyond. With Razer Synapse, choose to synchronize preset lighting effects across all your Razer Chroma enabled devices or create your own unique light show with the power of the Razer Chroma SDK.

CONTENTS

1. PACKAGE CONTENTS / SYSTEM REQUIREMENTS	3
2. REGISTRATION / TECHNICAL SUPPORT.....	4
3. TECHNICAL SPECIFICATIONS.....	5
4. DEVICE LAYOUT.....	6
5. SETTING UP YOUR RAZER CHROMA HDK	8
6. INSTALLING RAZER SYNAPSE 3 FOR YOUR RAZER CHROMA HDK	11
7. CONFIGURING YOUR RAZER CHROMA HDK	12
8. SAFETY AND MAINTENANCE	23
9. LEGALESE.....	24

1. PACKAGE CONTENTS / SYSTEM REQUIREMENTS

PACKAGE CONTENTS

- Razer Chroma HDK module
- 2x 16-LED strips
- 2x LED extension cables
- Molex to DC Cable
- USB to Micro-USB cable
- USB to DC cable
- Power adapter*
- Important Product Information Guide

*May include interchangeable adapter plugs for specific regions.

SYSTEM REQUIREMENTS

PRODUCT REQUIREMENTS

- Power outlet / Power Supply Unit (PSU) with a free Molex socket
- PC with a free USB port

RAZER SYNAPSE 3 REQUIREMENTS

- Windows® 7 (or higher)
- Internet connection
- 500 MB of free hard disk space

2. REGISTRATION / TECHNICAL SUPPORT

REGISTRATION

Register your product online at razer-id.razerzone.com/warranty using your Razer ID to get real-time information on your product's warranty status.

If you haven't registered for a Razer ID yet, register now at razerzone.com/razer-id to get a wide range of Razer benefits.

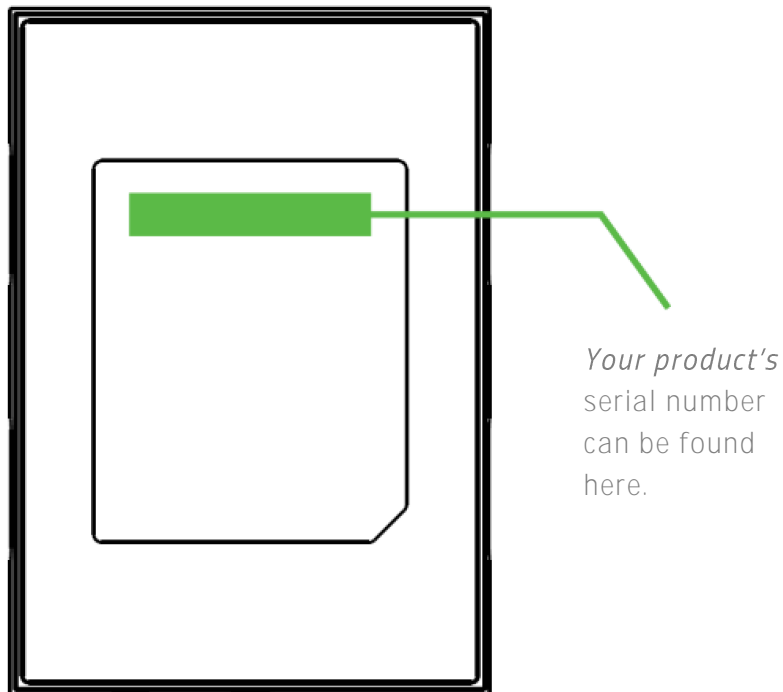

TECHNICAL SUPPORT

What you'll get:

- 1 year limited manufacturer's warranty for the Razer Chroma HDK Module.
- 6 months limited manufacturer's warranty for the LED strips.
- Free online technical support at razersupport.com

3. TECHNICAL SPECIFICATIONS

TECHNICAL SPECIFICATIONS

- Razer Chroma HDK with 4 channel lighting output
- USB connection for data and power
- DC output for additional power and brightness
- Included Molex to DC power adapter for internal case lighting
- Double sided adhesive tape for mounting
- Razer Synapse enabled
- Razer Chroma SDK enabled

APPROXIMATE SIZE & WEIGHT

Razer Chroma HDK module

- Length: 10 cm / 3.9 in
- Width: 7 cm / 2.7 in
- Height: 1.5 cm / 0.6 in
- Weight: 75 g / 0.17 lbs

Cable lengths

- 16-LED strip: 50 cm / 19.6 in
- LED extension cable: 50 cm / 19.69 in
- Molex to DC Cable: 30 cm / 11.81 in
- USB to Micro-USB cable: 100 cm / 39 in
- USB to DC cable: 150 cm / 59 in

4. DEVICE LAYOUT

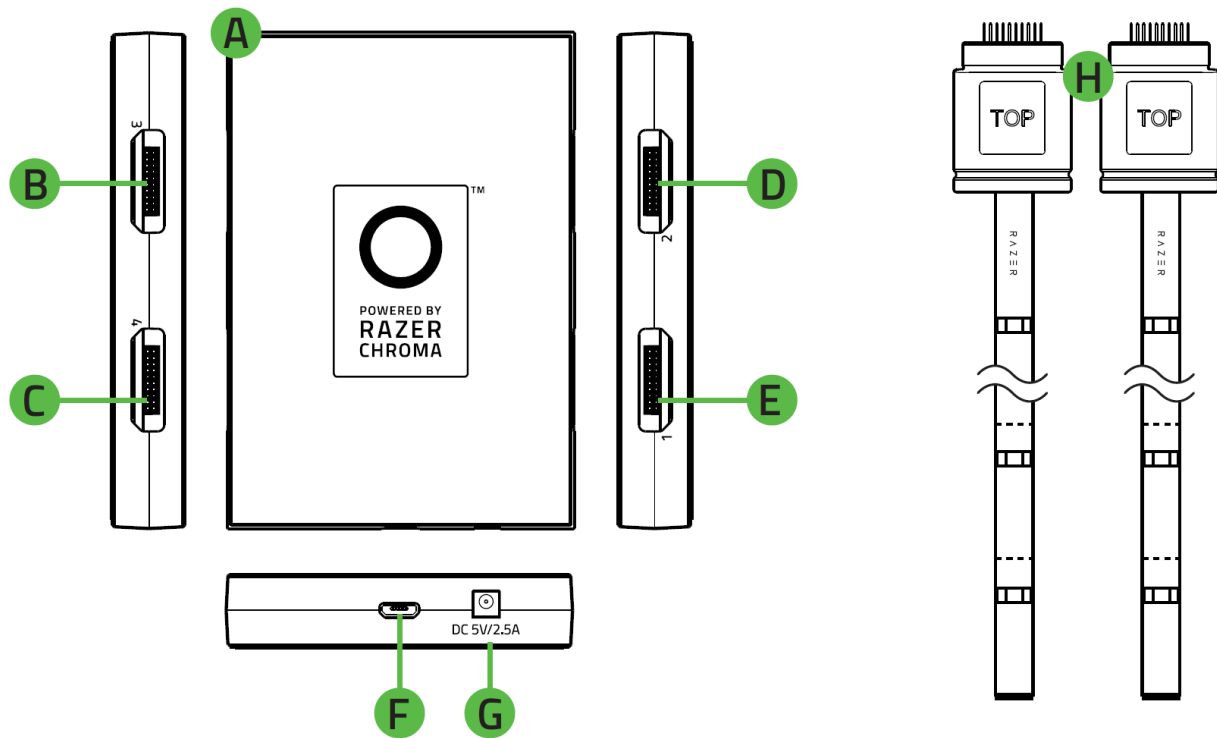

- A. Razer Chroma HDK module
- B. LED channel 3 port
- C. LED channel 4 port
- D. LED channel 2 port
- E. LED channel 1 port
- F. Micro-USB port
- G. Power port
- H. 2x 16-LED strips

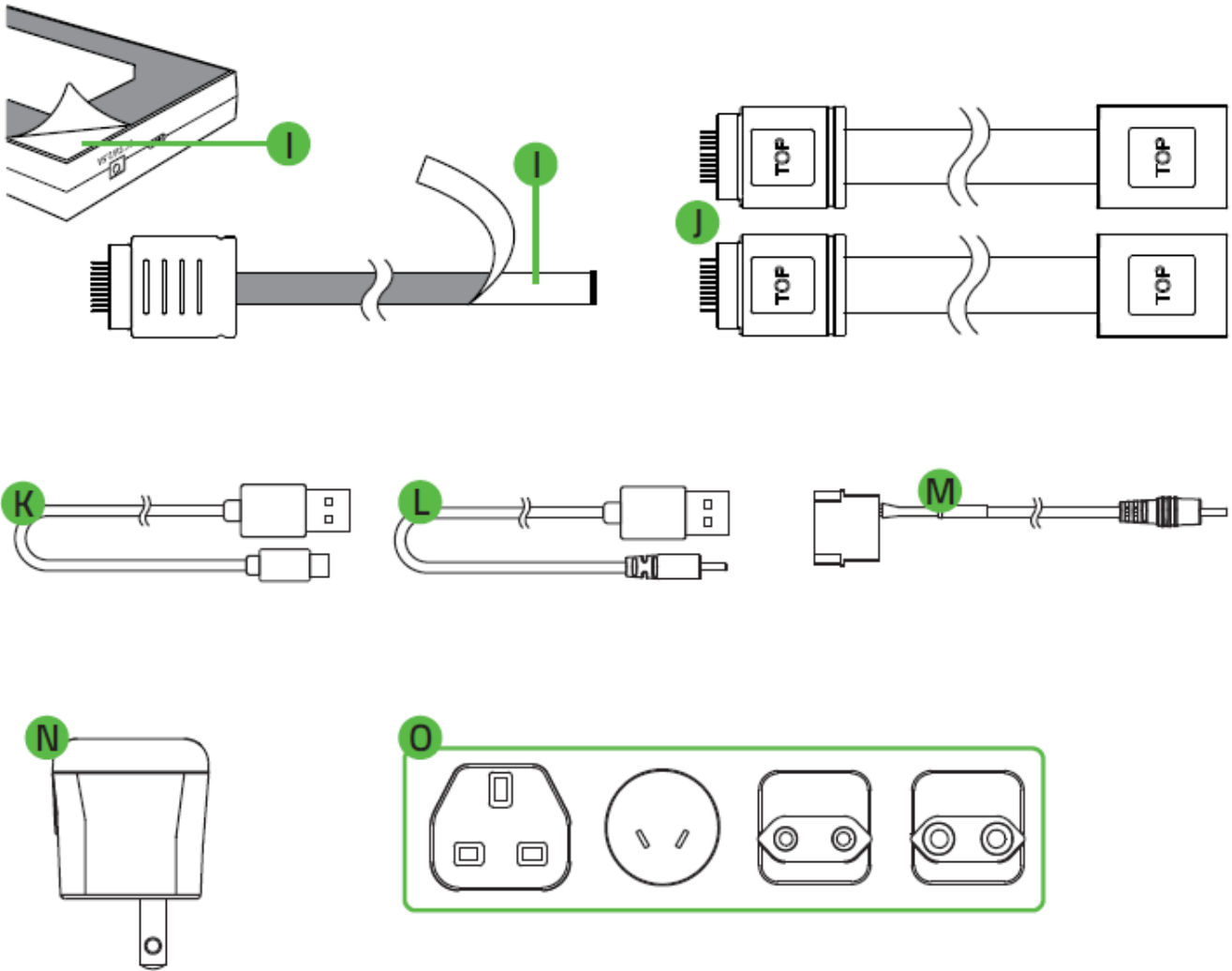

- I. Adhesive tapes
- J. 2x LED extension cables
- K. USB to Micro-USB cable
- L. USB to DC cable
- M. Molex to DC cable
- N. Power adapter
- O. Interchangeable plugs

5. SETTING UP YOUR RAZER CHROMA HDK

To set up your Razer Chroma HDK, simply do the following:

1. Connect an LED strip's connector to any of the Razer Chroma HDK module's LED channel ports.

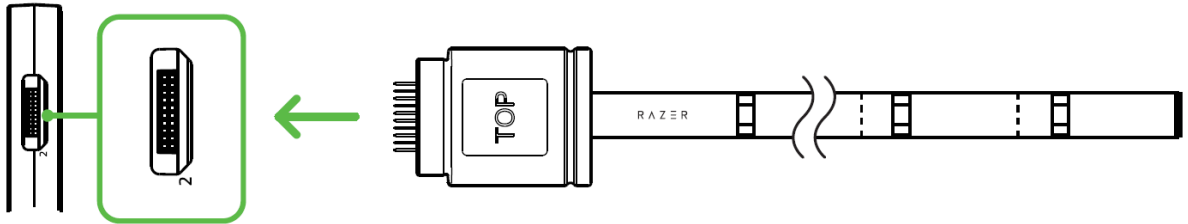

i Note: Align the connector to the desired port first before plugging it in, to avoid damaging the connector's pins.

2. You may customize the length of an LED strip by using the included LED extension cables and/or by trimming an LED strip on any of its designated cutting areas.

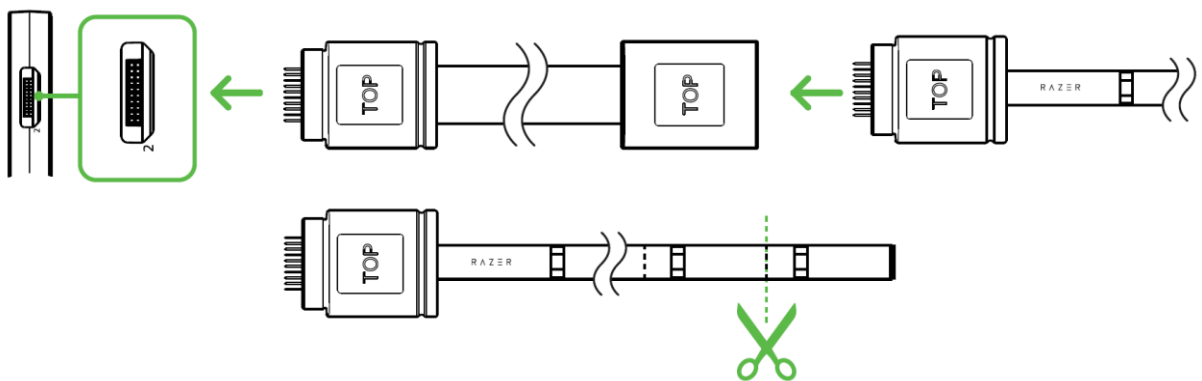

i Note: Only use the designated cutting areas of an LED strip. Once removed, the trimmings of an LED strip can neither be reattached nor reused.

3. You may use the adhesive layers on both the Razer Chroma HDK module and the LED strips to fasten each component to a clean, dry, and flat surface.

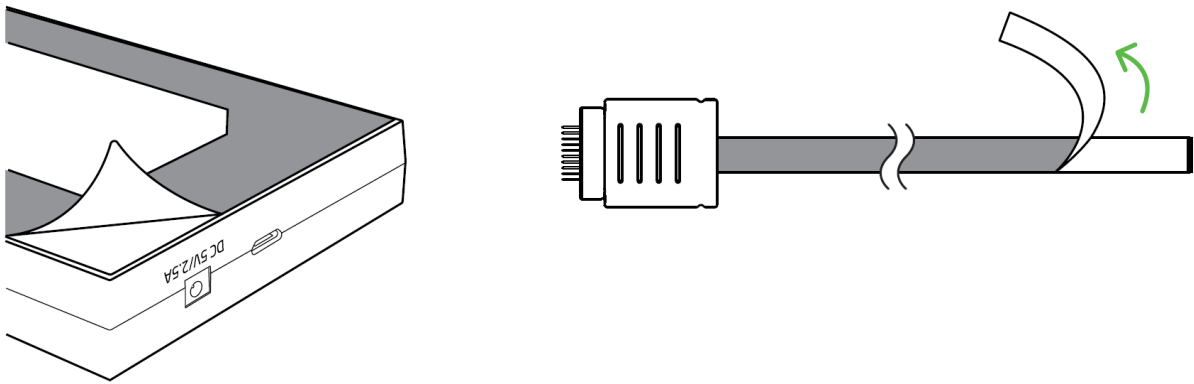

4. Power your Razer Chroma HDK using any of the methods below that best fits your setup:

METHOD 1: VIA POWER OUTLET

Select the appropriate power plug for your region and attach it to the power adapter. You may then connect the power adapter to the Razer Chroma HDK module using the included USB to DC cable, and plug it to a power outlet.

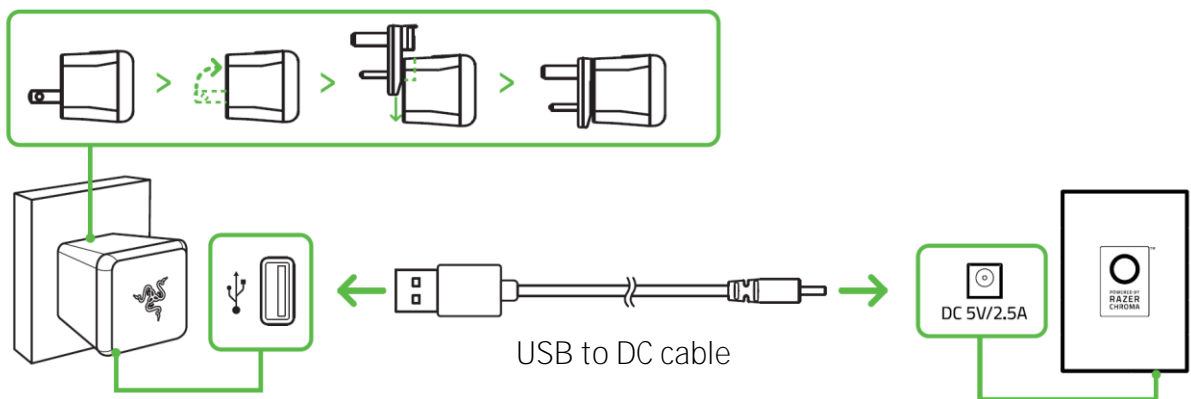

METHOD 2: VIA INTERNAL PC POWER SUPPLY

Warning: Please turn off your PC before proceeding with this method to avoid electric shocks.

This method is recommended if you plan to situate the LED strips **inside your PC's chassis**. Connect the Razer Chroma HDK module to the Molex socket of your PC's power supply unit using the included Molex to DC cable.

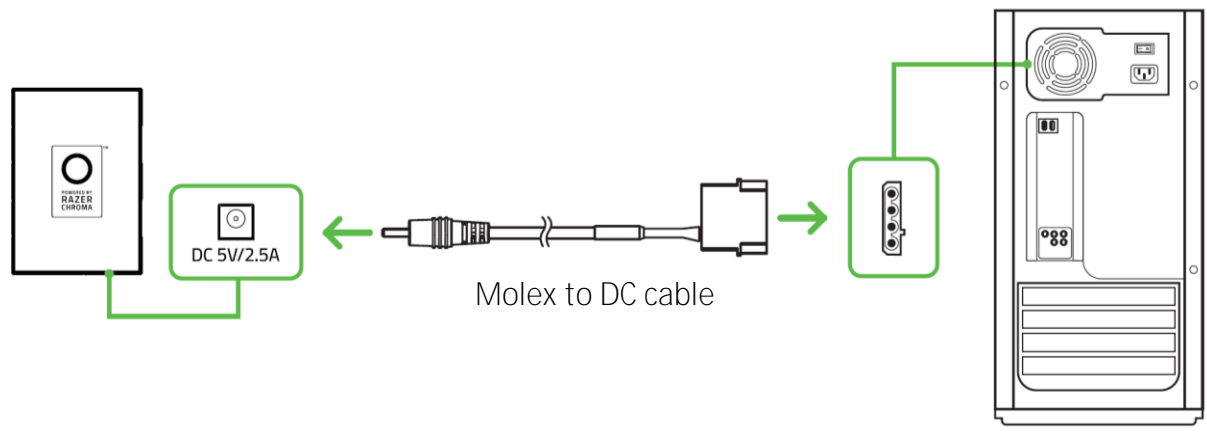

5. Connect the Razer Chroma HDK module to your PC using the included USB to Micro-USB cable.

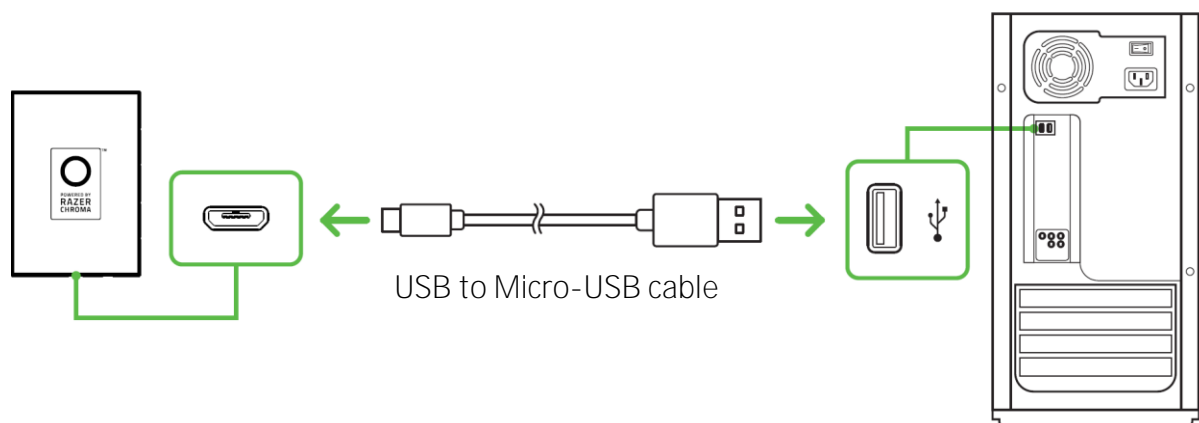

i Note: In the event that none of the powering methods are present, this connection can be used as an optional power source for your Razer Chroma HDK. However, it is recommended to use this connection together with the power port to maximize the brightness levels of all connected LED strips.

6. INSTALLING RAZER SYNAPSE 3 FOR YOUR RAZER CHROMA HDK

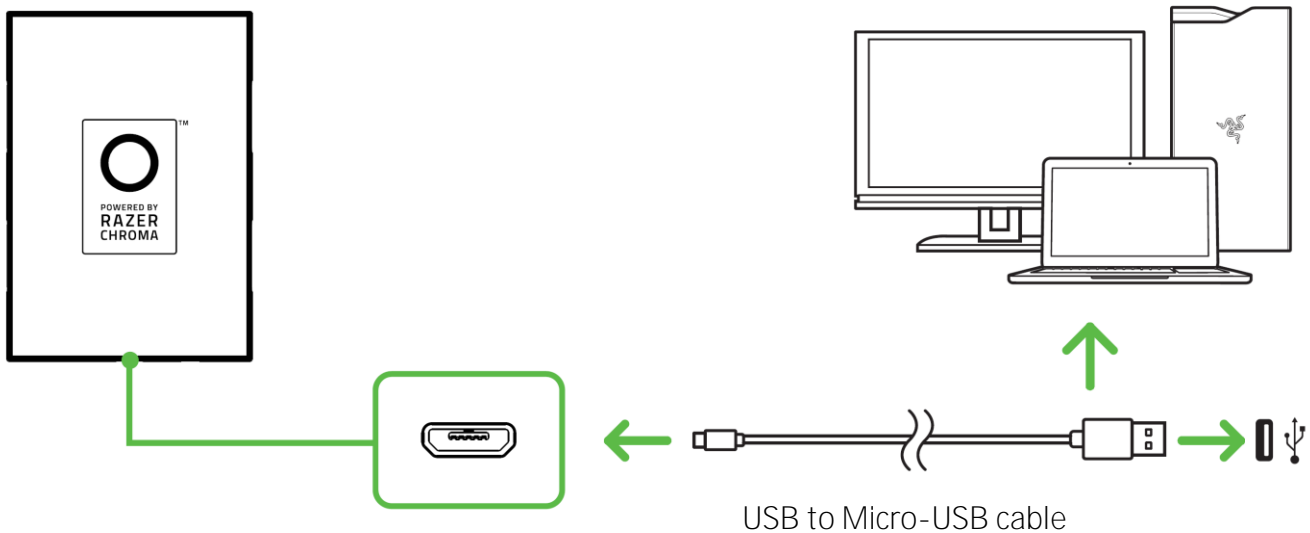

Step 1: Make sure that the Razer Chroma HDK is connected to your PC using the included USB to Micro-USB cable.

Step 2: Install Razer Synapse 3 when prompted* or download the installer from razerzone.com/synapse3.

Step 3: Register for a Razer ID or log in with an existing Razer ID.

*Applicable for Windows 8 or later.

7. CONFIGURING YOUR RAZER CHROMA HDK

Disclaimer: The features listed here require you to log into Razer Synapse 3. These features are also subject to change based on the current software version and your Operating System.

SYNAPSE TAB

The Synapse tab is your default tab when you first launch Razer Synapse 3.

Dashboard

The Dashboard subtab is an overview of your Razer Synapse 3 where you can access all your Razer devices, modules, and online services.

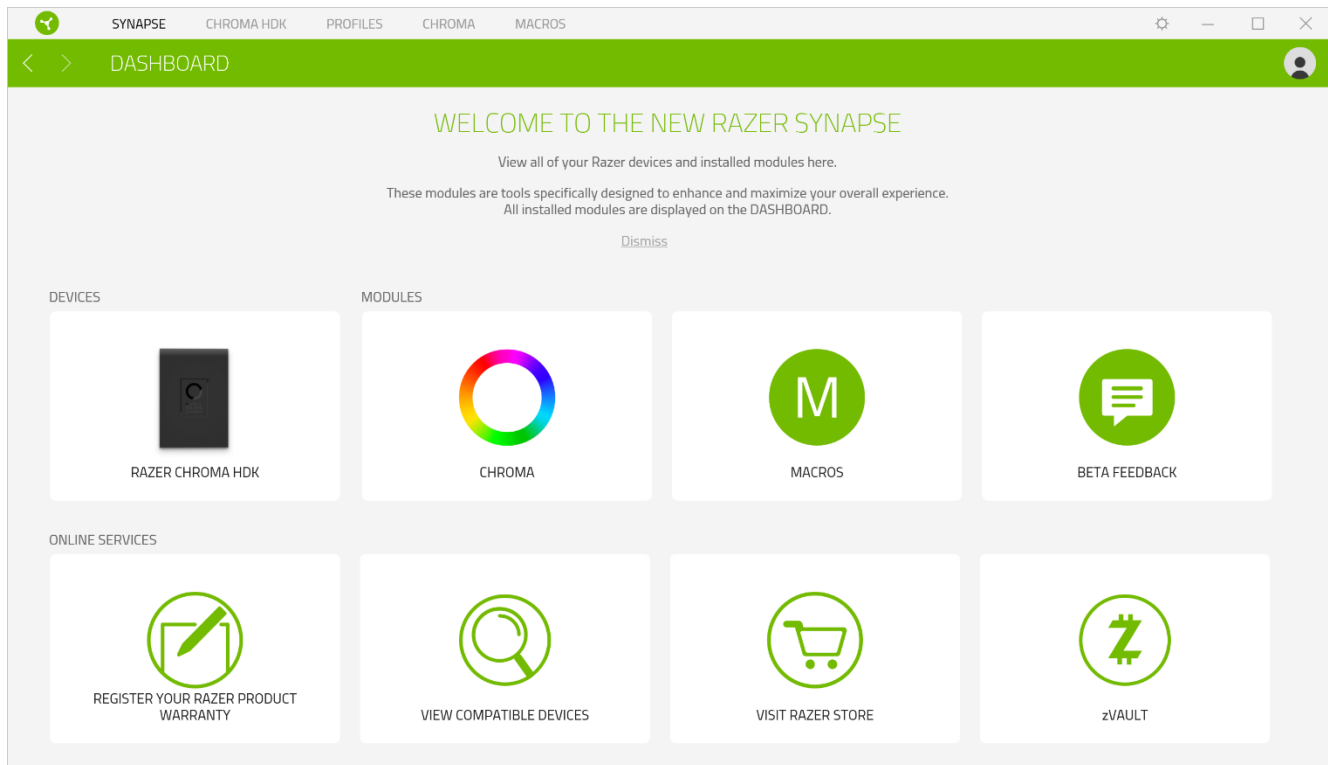

CHROMA HDK

The Chroma HDK tab is the main tab for your Razer Chroma HDK. From here, you can customize the LED strips' lighting properties such as its brightness, lighting behavior and effects. Changes made under this tab are automatically saved to your system and cloud storage.

Lighting

The Lighting subtab enables you to **modify your Razer device's** light settings.

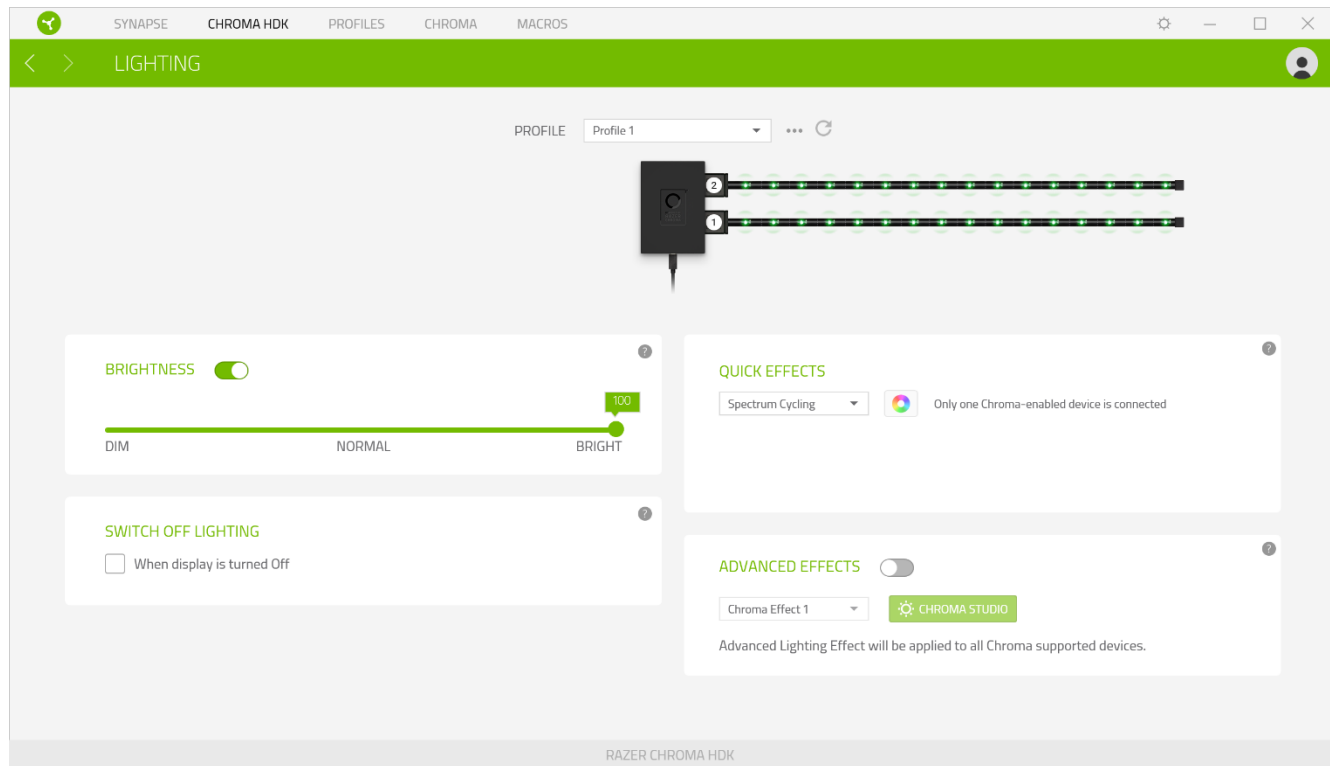

i Note: The lighting effect will revert to the default setting (spectrum cycling), whenever the Razer Chroma HDK module's USB connection to your computer is removed.

Profile

Profile is a data storage for keeping all your Razer device's settings. By default, the profile name is based on your system's name. To add, rename, duplicate, or delete a profile, simply press the Miscellaneous button (•••).

Refresh Trigger Strips

If you have connected an LED strip to the Razer Chroma HDK module, pressing the Refresh button (↻) will update the reflected number of LED strips connected to the Razer Chroma HDK module. Alternatively, you may also press F5 to refresh the displayed LED strips.

Brightness

You can turn off your Razer device's lighting by toggling the Brightness option or increase/decrease the luminance using the slider.





i Note: To maximize the brightness levels of the LED strips, we suggest using the USB to Micro-USB connection with other powering methods.

Switch Off Lighting

This is a power saving tool which allows you to **disable your device's** lighting in response to your system's display turning off.

Quick Effects

A number of quick effects can be selected and applied to the LED strips, as listed here:

	Name	Description	How to set up
	Spectrum cycling	The LEDs will cycle between 16.8 million colors indefinitely	No further customization required
	Wave	The lighting will scroll using the direction selected	Select a wave direction
	Static	The LEDs will remain lit in the selected color	Select a color
	Breathing	The lighting will fade in and out of the selected color(s)	Select up to 2 colors or randomize colors
	Starlight	The LEDs will have a chance of fading in and out at a random time and duration	Select up to 2 colors or randomize colors and select a duration

If you have other supported Razer Chroma-enabled devices, you can synchronize their quick effects with your Razer device by clicking the Chroma Sync button ().

Advanced Effects

The Advanced Effects option allows you to choose a Chroma Effect you want to use on your Razer Chroma-enabled device. You may also create a Chroma Effect using the Chroma Studio button

(). [Click here to learn more about the Chroma Studio](#)

PROFILES TAB

The Profiles tab is a convenient way of managing all your profiles and linking them to your games and applications.

Devices

View which Razer device is using a specific profile using the Devices subtab. To create a new profile within the selected device, simply click the add button (+). To rename, duplicate, or delete a profile, simply press the Miscellaneous button (⋮). Each profile can be set to automatically activate when you run an application using the Link Games option.

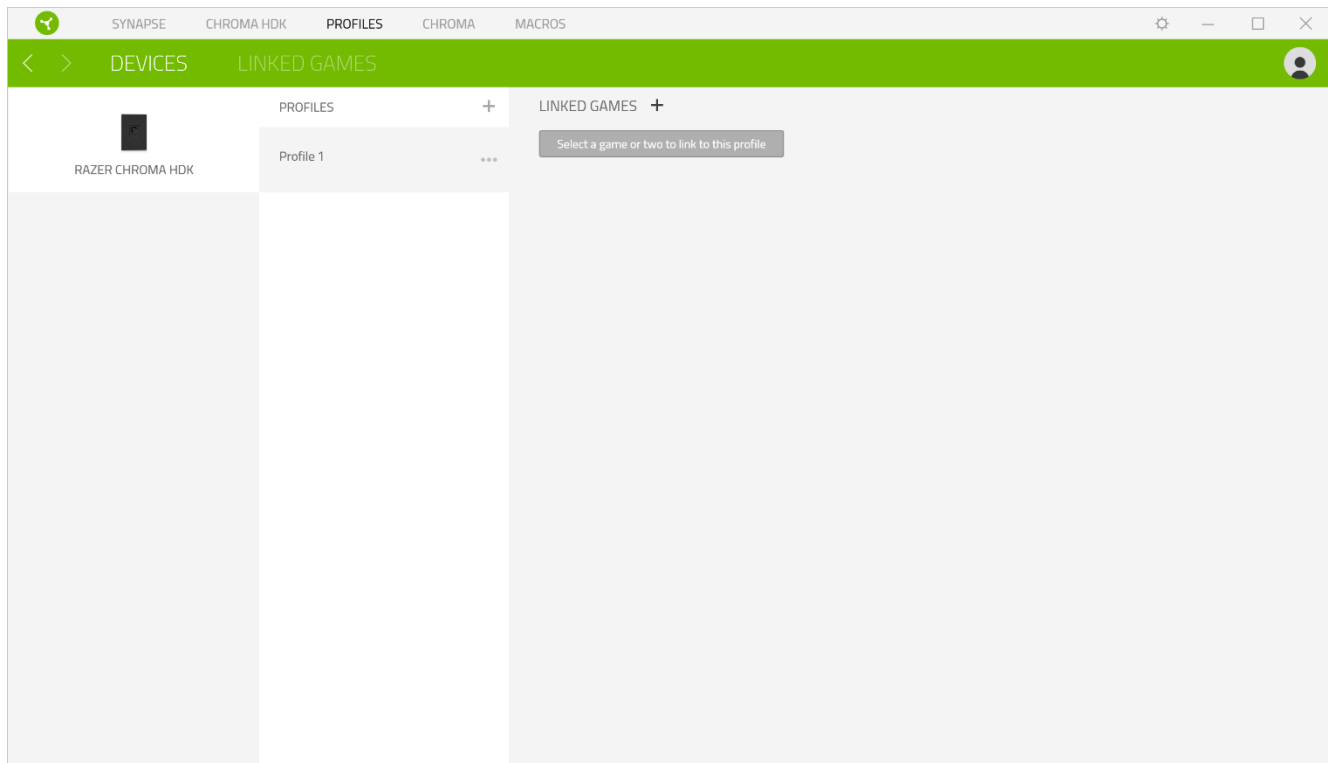



Linked Games

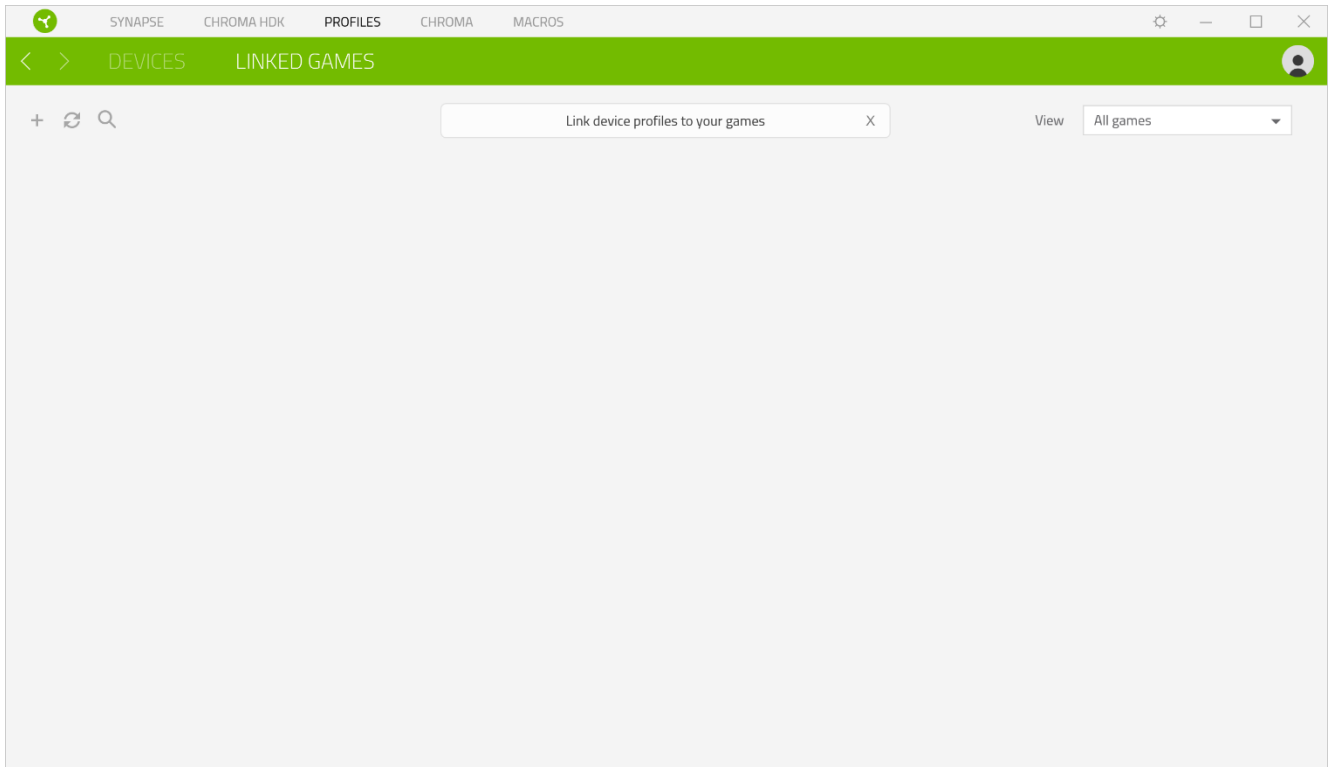

The Linked Games subtab gives you the flexibility to add games, view devices that are linked to games, or search for added games. You can also sort games based on alphabetical order, last played, or most played. Added games will still be listed here even if it is not linked to a Razer device.



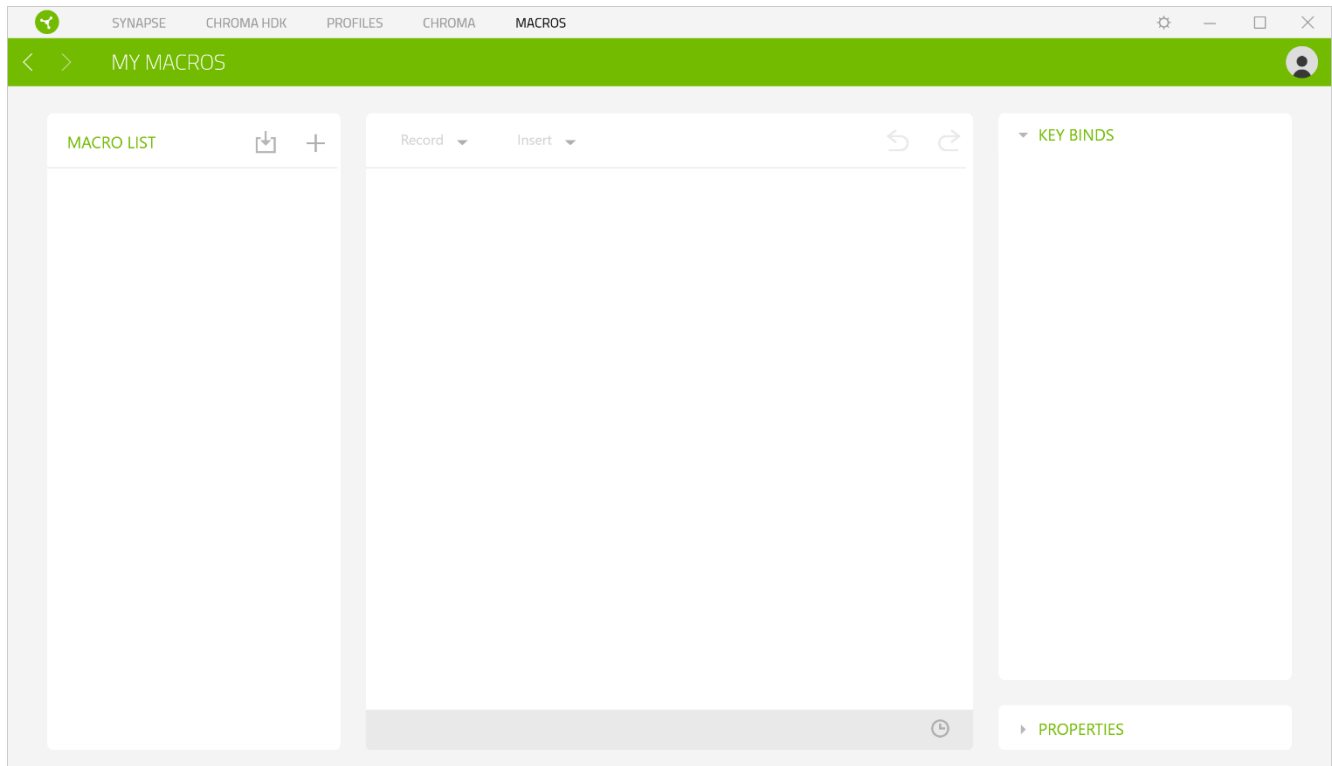

MACROS TAB

If you need to accurately execute a series of complex commands then you need a Macro. A macro is a set of recorded keystrokes, button presses, and cursor movements. The Macros tab allows you to create, edit, and organize these macros so that you can assign them to your mouse buttons. You can also share macros with others using the import button () and export button ().



There are also other options available in the macro section such as creating a new macro by clicking the add button (), deleting the current macro by clicking the trash button (), and duplicating the current macro using the copy button ().

To create a macro, simply select a macro name to store your commands, then click the Record menu. Assign a key or button for the macro on Shortcut Key field, select a delay, and select if you want to include mouse movement tracking. Once you have chosen the settings for the macro, click the Start button (). After a brief countdown, all your keystrokes and button presses will be recorded on the macro screen. When you are done recording your macro commands, click on the Stop button () to end the session.

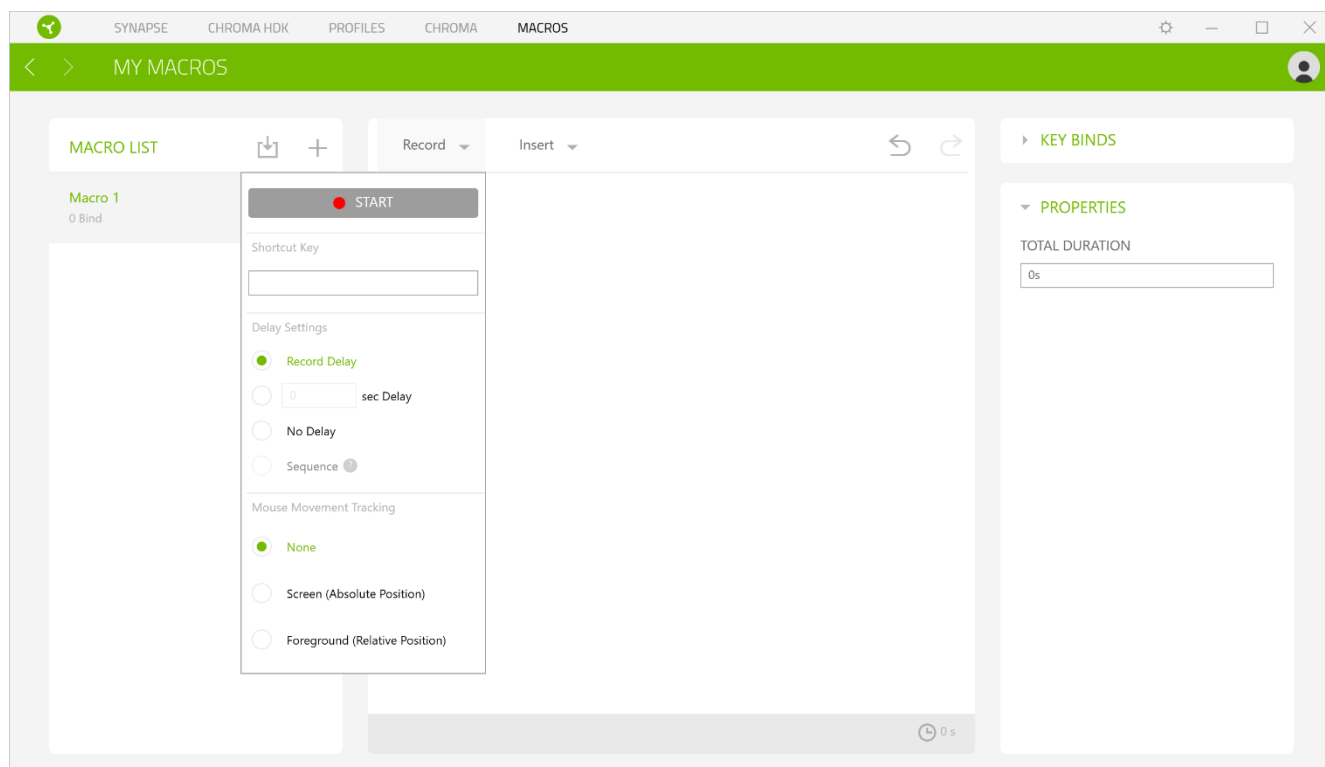

Once you have recorded a macro, you may edit the commands you have entered by selecting each command on the macro screen. Each keystroke or button press is arranged sequentially with the first command shown at the top of the screen. The Insert menu allows you to put in additional keystrokes, button presses, type texts, run commands, loop a set of commands, or insert an entire macro group.

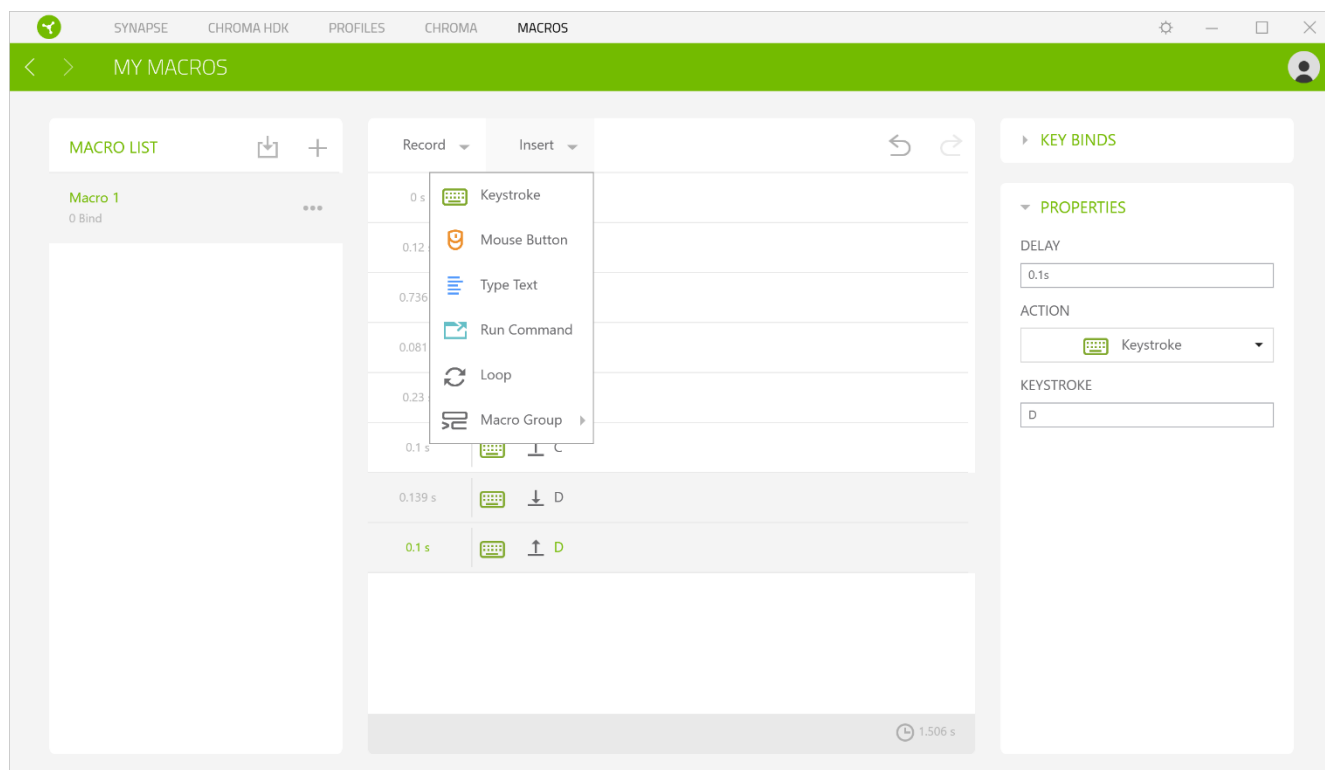

Key Binds

The Key binds option allows you to view the Shortcut Keys for the selected macro.

Properties

The Properties option enables you to individually edit commands, adjust their delay, change actions, and also change the total duration of the macro so that it executes faster or slower.

CHROMA TAB

The Chroma tab enables you to either create advanced lighting effects through Chroma Studio or enable/disable third party integrated apps to all Razer Chroma-enabled devices for a truly immersive lighting and gaming experience.

Studio

The Studio tab enables you to create and edit your own Chroma Effects which you can apply to all supported Razer Chroma-enabled devices. **This tab can also be accessed under the Dashboard's Chroma module.**

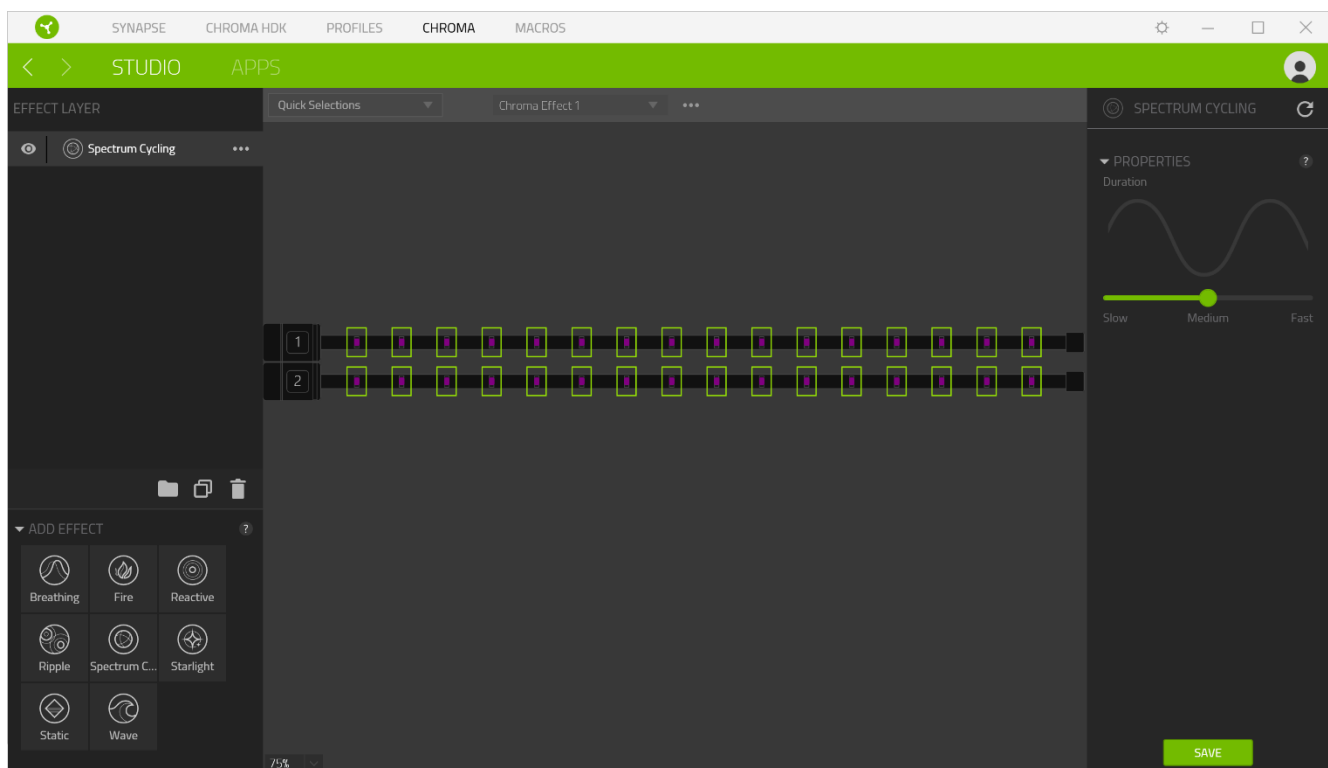

To add, rename, duplicate, or delete a Chroma Effect, simply click the Miscellaneous button (⋮). To revert the selected layer to its original setting, click the Reset button (↺). And to apply and save a modified layer, click the Save button (SAVE).



Quick Selections

The Quick Selections menu are a preset of lighting regions which you can use to easily customize your Razer device. Alternatively, you can individually select an LED by clicking on the area or select multiple LEDs by using click and drag.

Effect Layer

Lighting effects are arranged in layers wherein the topmost layer takes priority. You can group multiple lighting effects by clicking the Add Group button () and dragging the layers you want to group to the newly added folder, duplicate a layer by clicking the Copy button (), or delete a layer by clicking the Trash button (). Some layers may have overlapping effects so you may need to arrange layers in a specific order.

Add Effect

All supported quick effects are listed under the Add Effect option which you can click to insert onto the Effect Layer. Quick Effects can be edited on the Chroma Studio by allowing you to change its preset color, properties, and playback options.

Apps

The Apps subtab is where you can enable or disable third party integrated apps for your Razer Chroma-enabled devices. The Apps tab can also direct you to the Chroma Workshop where you can download these third party apps.

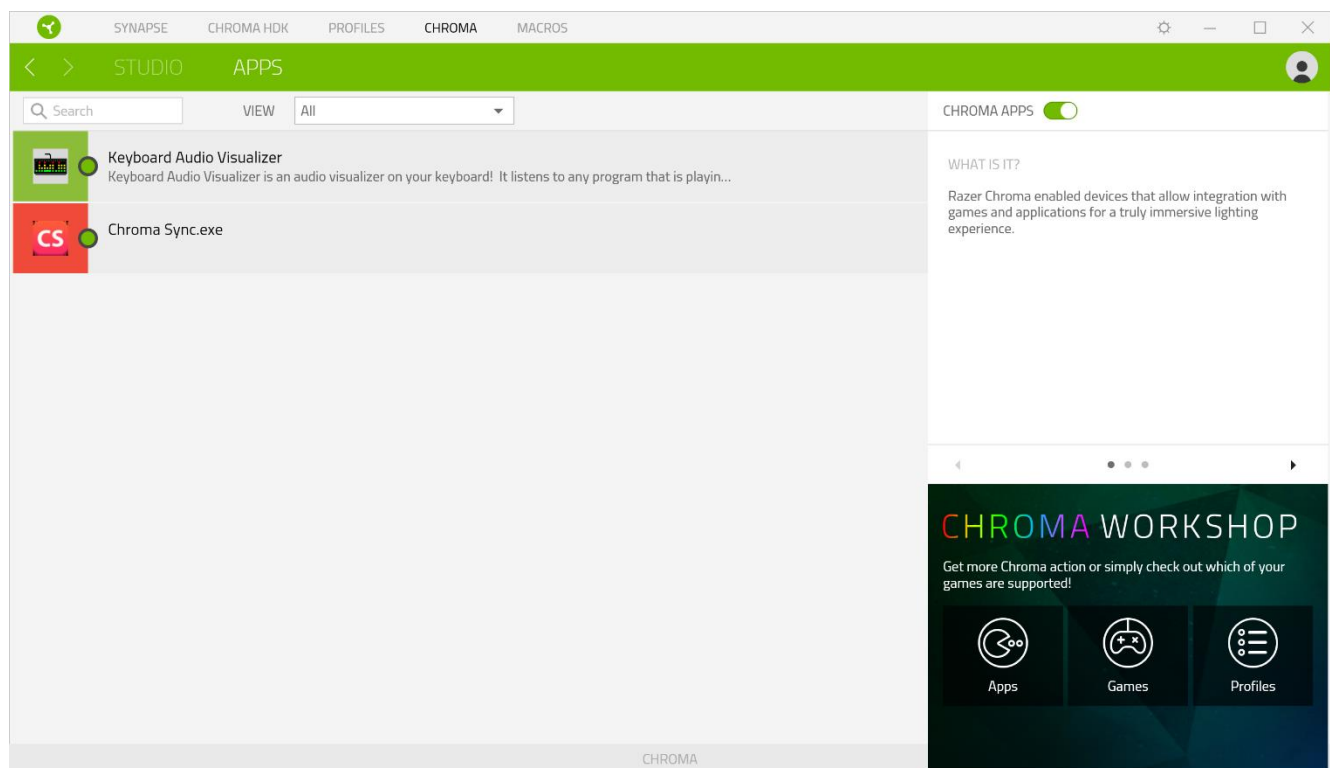

SETTINGS WINDOW

The Settings window, accessible by clicking the Settings button (⚙️) on Razer Synapse, enables you to configure the startup behavior and display language of Razer Synapse 3, view any of the connected Razer devices' master guide, or perform factory reset on any connected Razer device.

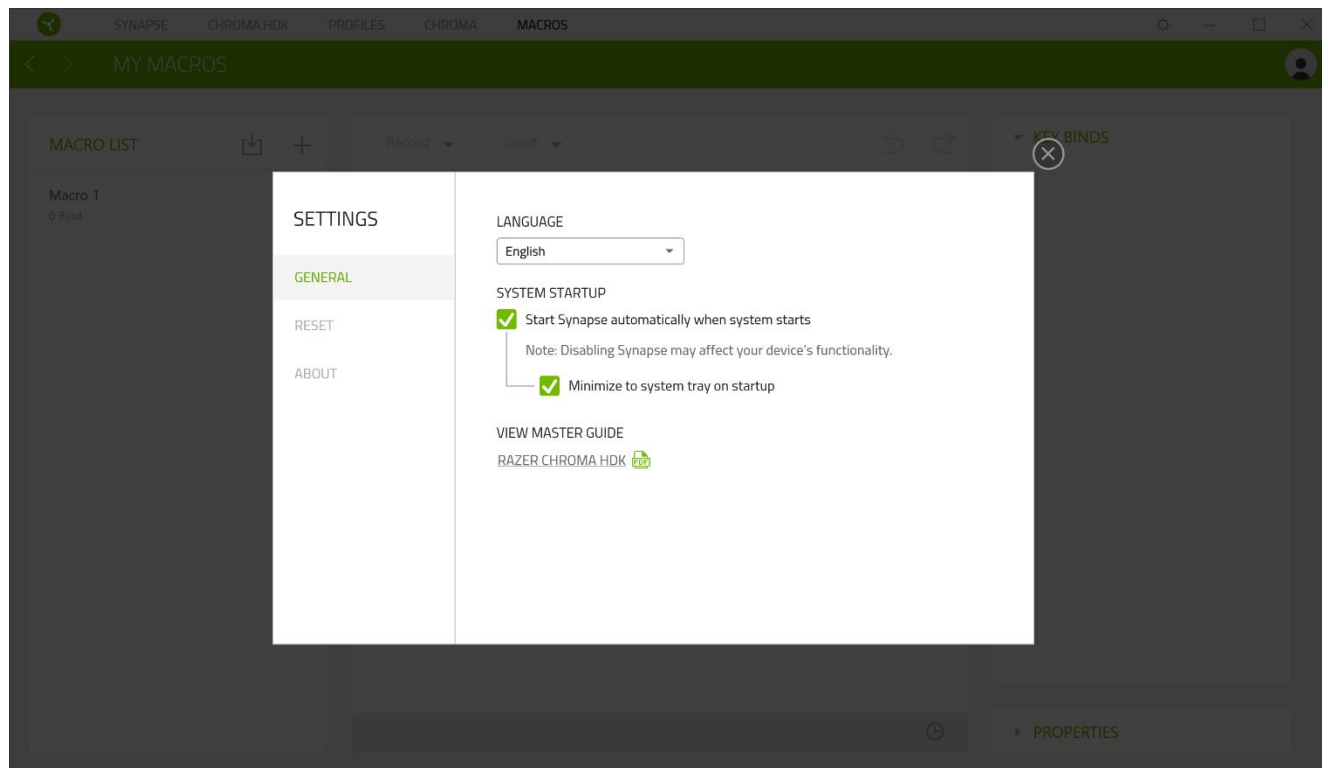

General

The default tab of the Settings window, The General tab enables you to change the software's display language and start-up behavior, or view the master guide of all connected Razer devices.

Reset

The Reset tab allows you to perform a factory reset on all connected Razer devices with on-board memory. All profiles stored on the selected device's on-board memory will be erased.

Note: Performing a factory reset on devices without on-board memory will only create a new profile for your device on Razer Synapse 3 using the default settings.

About

The About tab displays brief software information and copyright statement, and also provides relevant links for its terms of use. You may also use this tab to check for software updates, or as a quick access to Razer's social communities.

8. SAFETY AND MAINTENANCE

SAFETY GUIDELINES

In order to achieve maximum safety while using the Razer Chroma HDK, we suggest that you adopt the following guidelines:

1. Should you have trouble operating the device properly and troubleshooting does not work, unplug the device and contact the Razer hotline or go to [razersupport.com](https://razer.com/support) for support. Do not attempt to service or fix the device yourself at any time.
2. Do not take apart the device (doing so will void your warranty) and do not attempt to operate it under abnormal current loads.
3. Power off the device before making any modifications and/or disconnecting the LED strip(s).
4. Only use the cables provided with the product.
5. Do not use or attach the LED strips to areas where these will be repeatedly exposed to pinching, bending, twisting, folding, squeezing, or constant pressure.
6. Always handle the LED strips with care. Do not pull them with excessive force. Do not fold the LED strips or bend/twist them more than 90°.
7. **When connecting the Razer Chroma HDK to your PC's power supply unit and/or connecting LED strips to the device powered by this method, please turn off your PC first to avoid electric shocks.**
8. Do not use or install the device and its components near water, moisture, solvents, or other wet surfaces, nor expose these components to high temperatures or direct sunlight for an extended period of time.
9. Keep the device and its components away from liquid, humidity or moisture. Operate the device and its components only within the specific temperature range of 0°C (32°F) to 40°C (104°F). Should the temperature exceed this range, unplug and switch off the device in order to let the temperature stabilize to an optimal level.

MAINTENANCE AND USE

The Razer Chroma HDK requires minimum maintenance to keep it in optimal condition. Once a month we recommend you unplug the Razer Chroma HDK from the USB port and power source, remove all connected LED strips and cables, then clean each component as needed using a soft cloth or cotton swab to prevent dirt buildup. Do not use soap or harsh cleaning agents.

9. LEGALESE

COPYRIGHT AND INTELLECTUAL PROPERTY INFORMATION

©2017 Razer Inc. All rights reserved. Razer, the triple-headed snake logo, Razer logo, “For Gamers. By Gamers.”, and “Powered by Razer Chroma” logo are trademarks or registered trademarks of Razer Inc. and/or affiliated companies in the United States or other countries. All other trademarks and trade names are the property of their respective owners and other company and product names mentioned herein may be trademarks of their respective companies.

Windows and the Windows logo are trademarks of the Microsoft group of companies.

Razer Inc. (“Razer”) may have copyright, trademarks, trade secrets, patents, patent applications, or other intellectual property rights (whether registered or unregistered) concerning the product in this guide. furnishing of this guide does not give you a license to any such copyright, trademark, patent or other intellectual property right. The Razer Chroma HDK (the “Product”) may differ from pictures whether on packaging or otherwise. Razer assumes no responsibility for such differences or for any errors that may appear. Information contained herein is subject to change without notice.

LIMITED PRODUCT WARRANTY

For the latest and current terms of the Limited Product Warranty, please visit razerzone.com/warranty.

LIMITATION OF LIABILITY

Razer shall in no event be liable for any lost profits, loss of information or data, special, incidental, indirect, punitive or consequential or incidental damages, arising in any way out of distribution of, sale of, resale of, **use of, or inability to use the Product. In no event shall Razer’s liability exceed the retail purchase price of the Product.**

COSTS OF PROCUREMENT

For the avoidance of doubt, in no event will Razer be liable for any costs of procurement unless it has been advised of the possibility of such damages, and in no case shall Razer be liable for any costs of procurement liability exceeding the retail purchase price of the Product.

GENERAL

These terms shall be governed by and construed under the laws of the jurisdiction in which the Product was purchased. If any term herein is held to be invalid or unenforceable, then such term (in so far as it is invalid or unenforceable) shall be given no effect and deemed to be excluded without invalidating any of the remaining terms. Razer reserves the right to amend any term at any time without notice.