

# **USER MANUAL**

# ***ProLite***

## **LCD Monitor**

ENGLISH

***ProLite TF2234MC***  
***ProLite TF2234MSC***

Thank you very much for choosing the iiyama LCD monitor.

We recommend that you take a few minutes to read this comprehensive manual carefully before installing and switching on the monitor. Please keep this manual in a safe place for your future reference.



**Dear user, we congratulate you on the purchase of your iiyama LCD.**

For details on warranty and locally used pixel policies that apply directly after installation of your product please check the iiyama website.

**To report a fault, please contact your local support centre found at [www.iiyama.com/service](http://www.iiyama.com/service)**

**Things to check before you call the iiyama information line**

- | if the power cable is connected securely and turned on?
- | if the display has been turned on?
- | if the signal cable is connected securely and the correct input selected?
- | if the computer has been restarted with the display connected?
- | if the graphics card is correctly installed with the latest drivers possible?
- | if the correct native resolution has been selected via 'Display Properties'?
- | if the R/G/B signal configuration is correct?
- | if the displays On Screen Menu is shown?
- | if the correct brightness and contrast settings have been set?
- | if given display tolerances and compatibility have been considered?
- | if via the On Screen Menu you have performed a Factory Reset/Recall?

**Before reporting the screen defect, please prepare the following information/evidence:**

- | model number \*
- | purchase receipt and serial number \*
- | name and address for collection
- | telephone/fax number, for availability during the day
- | convenient collection date (date, time)
- | short description of the defect

**Important Note:**

If there is no fault found in the collected equipment after inspection, the transferring party shall incur charges for transport and administration.

If you have checked all of the above and there is still no picture, call our information line for assistance in your country.

\* see the identification plate on the back of the case.

## CE MARKING DECLARATION OF CONFORMITY

This LCD monitor complies with the requirements of the EC/EU Directive 2014/30/EU "EMC Directive", 2014/35/EU "Low Voltage Directive", 2009/125/EC "ErP Directive" and 2011/65/EU "RoHS Directive".

The electro-magnetic susceptibility has been chosen at a level that gives correct operation in residential areas, business and light industrial premises and small-scale enterprises, inside as well as outside of the buildings. All places of operation are characterised by their connection to the public low voltage power supply system.

IYAMA CORPORATION: Wijkemeerstraat 8, 2131 HA Hoofddorp, The Netherlands

Model No. : PLC2234



We recommend recycling of used product. Please contact your dealer or iiyama service center. Recycle information is obtained via the Internet, using the address: <http://www.iiyama.com>

You can access the Web page of different countries from there.

- We reserve the right to change specifications without notice.
- All trademarks used in this user manual are the property of their respective owners.

# TABLE OF CONTENTS

FOR YOUR SAFETY.....	1
SAFETY PRECAUTIONS.....	1
SPECIAL NOTES ON LCD MONITORS.....	3
CUSTOMER SERVICE.....	3
CLEANING.....	3
BEFORE YOU OPERATE THE MONITOR.....	4
FEATURES.....	4
CHECKING THE CONTENTS OF THE PACKAGE.....	4
WALL MOUNTING.....	5
BUILT-IN EQUIPMENT.....	5
CONTROLS AND CONNECTORS.....	6
SPECIAL NOTES.....	7
CONNECTING YOUR MONITOR.....	9
COMPUTER SETTING.....	11
OPERATING THE MONITOR.....	12
ADJUSTMENT MENU CONTENTS.....	13
SCREEN ADJUSTMENTS.....	18
POWER MANAGEMENT FEATURE.....	21
TROUBLE SHOOTING.....	22
RECYCLING INFORMATION.....	23
APPENDIX.....	24
SPECIFICATIONS :	
ProLite TF2234MC-B1X / ProLite TF2234MC-B2X.....	24
SPECIFICATIONS : ProLite TF2234MC-B3X.....	25
SPECIFICATIONS :	
ProLite TF2234MC-B1AGB / ProLite TF2234MC-B3AGB.....	26
SPECIFICATIONS :	
ProLite TF2234MSC-B1X / ProLite TF2234MSC-B3X.....	27
DIMENSIONS : ProLite TF2234MC.....	28
DIMENSIONS : ProLite TF2234MSC.....	28
DIMENSIONS : L-BRACKET.....	29
COMPLIANT TIMING.....	29

# FOR YOUR SAFETY

## SAFETY PRECAUTIONS

### WARNING

#### STOP OPERATING THE MONITOR WHEN YOU SENSE TROUBLE

If you notice any abnormal phenomena such as smoke, strange sounds or fumes, unplug the monitor and contact your dealer or iiyama service center immediately. Further use may be dangerous and can cause fire or electric shock.

#### NEVER REMOVE THE CABINET

High voltage circuits are inside the monitor. Removing the cabinet may expose you to the danger of fire or electric shock.

#### DO NOT PUT ANY OBJECT INTO THE MONITOR

Do not put any solid objects or liquids such as water into the monitor. In case of an accident, unplug your monitor immediately and contact your dealer or iiyama service center. Using the monitor with any object inside may cause fire, electric shock or damage.

#### INSTALL THE MONITOR ON A FLAT, STABLE SURFACE

The monitor may cause an injury if it falls or is dropped.

#### DO NOT USE THE MONITOR NEAR WATER

Do not use where water may be splashed or spilled onto the monitor as it may cause fire or electric shock.

#### OPERATE UNDER THE SPECIFIED POWER SUPPLY

Be sure to operate the monitor only with the specified power supply. Use of an incorrect voltage will cause malfunction and may cause fire or electric shock.

#### CORRECT USE OF THE AC ADAPTER

Use only the AC Adapter provided by iiyama. Any deviation from this by using another type of adapter may result in damage to the accessory and the monitor by fire or electric shock.

#### DO NOT DISASSEMBLE THE AC ADAPTER

Disassembling the AC Adapter may expose you to the danger of fire or electric shock.

#### PROTECT THE CABLES

Do not pull or bend the AC adapter, the power cable and signal cable. Do not place the monitor or any other heavy objects on the cables. If damaged, the cables may cause fire or electric shock.

#### ADVERSE WEATHER CONDITIONS

It is advisable not to operate the monitor during a heavy thunder storm as the continual breaks in power may cause malfunction. It is also advised not to touch the plug in these circumstances as it may cause electric shock.

## CAUTION

### INSTALLATION LOCATION

Do not install the monitor where sudden temperature changes may occur, or in humid, dusty or smoky areas as it may cause fire, electric shock or damage. You should also avoid areas where the sun shines directly on the monitor.

### DO NOT PLACE THE MONITOR IN A HAZARDOUS POSITION

The monitor may topple and cause injury if not suitably located. Please also ensure that you do not place any heavy objects on the monitor, and that all cables are routed such that children may not pull the cables and possibly cause injury.

### MAINTAIN GOOD VENTILATION

Ventilation slots are provided to keep the monitor from overheating. Covering the slots may cause fire. To allow adequate air circulation, place the monitor at least 10 cm (or 4 inches) from any walls. Do not remove the tilt stand when operating the monitor. Ventilation slots on the back of the cabinet will be blocked and the monitor may overheat if the stand is removed. This may cause fire or damage. Operating the monitor on its back, side, upside down or on a carpet or any other soft material may also cause damage.

### DISCONNECT THE CABLES WHEN YOU MOVE THE MONITOR

When you move the monitor, turn off the power switch, unplug the monitor and be sure the signal cable is disconnected. If you do not disconnect them, it may cause fire or electric shock.

### UNPLUG THE MONITOR

If the monitor is not in use for a long period of time it is recommended that it is left unplugged to avoid accidents.

### HOLD THE PLUG WHEN DISCONNECTING

To disconnect the AC adapter, the power cable or signal cable, always pull it by the plug. Never pull on the cable itself as this may cause fire or electric shock.

### DO NOT TOUCH THE PLUG WITH WET HANDS

Pulling or inserting the plug with wet hands may cause electric shock.

### WHEN YOU INSTALL THE MONITOR ON YOUR COMPUTER

Be sure the computer is strong enough to hold the weight of the monitor, otherwise, you may damage your computer.

### REMARK FOR 24/7 USAGE

This product is not specifically designed for 24/7 usage in all environments.

## OTHERS

### ERGONOMIC RECOMMENDATIONS

To eliminate eye fatigue, do not operate the monitor against a bright background or in a dark room. For optimal viewing comfort, the monitor should be just below eye level and 40-60 cm (16-24 inches) away from your eyes. When using the monitor over a prolonged time, a ten minute break every hour is recommended as looking at the screen continuously can cause eye strain.

## SPECIAL NOTES ON LCD MONITORS

The following symptoms are normal with LCD monitors and do not indicate a problem.

### NOTE

- When you first turn on the LCD monitor, the picture may not fit in the display area because of the type of computer that is used. In this case, adjust the picture position to the correct position.
- You may find slightly uneven brightness on the screen depending on the desktop pattern you use.
- Due to the nature of the LCD screen, an afterimage of the previous screen may remain after switching the image, when the same image is displayed for hours. In this case, the screen is recovered slowly by changing the image or turning off the Power Switch for some hours.

## CUSTOMER SERVICE

### NOTE

- If you have to return your unit for service and the original packaging has been discarded, please contact your dealer or iiyama service center for advice or replacement packaging.

## CLEANING

### WARNING

- If you drop any materials or liquids such as water into the monitor when cleaning, unplug the power cable immediately and contact your dealer or iiyama service center.

### NOTE

- To protect the Touch screen surface, do not scratch or rub the screen with a hard object.
- Never use any of the following strong solvents. These will damage the cabinet and the Touch screen surface.  
Abrasive cleaner Wax Solvent
- Touching the cabinet with any product made from rubber or plastic for a long time may cause degeneration or loss of paint on the cabinet.

### CABINET

Stains can be removed with a cloth lightly moistened with a mild detergent solvent. Then wipe the cabinet with a soft dry cloth.

### TOUCH SCREEN

Touch screen surface may be cleaned using a soft clean cloth moistened with mild window glass commercial cleaners or 50/50 mixture of water and isopropyl alcohol.

# BEFORE YOU OPERATE THE MONITOR

## FEATURES

- ◆ Supports Resolutions up to 1920 × 1080
- ◆ High Contrast 1000:1 (Typical) / Brightness 250cd/m<sup>2</sup> (Typical) :  
ProLite TF2234MC-B1X / ProLite TF2234MC-B2X / ProLite TF2234MC-B3X /  
ProLite TF2234MSC-B1X / ProLite TF2234MSC-B3X
- ◆ High Contrast 1000:1 (Typical) / Brightness 350cd/m<sup>2</sup> (Typical) :  
ProLite TF2234MC-B1AGB / ProLite TF2234MC-B3AGB
- ◆ Digital Character Smoothing
- ◆ Automatic Set-up
- ◆ Stereo Speakers : ProLite TF2234MSC  
2 × 3W Stereo Speakers
- ◆ Plug & Play VESA DDC2B Compliant  
Windows<sup>®</sup> XP/Vista/7/8/8.1/10 Compliant
- ◆ Power Management (VESA DPMS Compliant)
- ◆ VESA Mounting Standard (100mm×100mm) Compliant
- ◆ IP65 Standard Compliant (Only front face)

### ■ Windows8/8.1/10 touch environment

Basic touch operations can be performed under Windows 8/8.1/10.

However, please be informed that full touch functionality and normal operational performance are not guaranteed.

## CHECKING THE CONTENTS OF THE PACKAGE

The following accessories are included in your package. Check to see if they are enclosed with the monitor. If anything is missing or damaged, please contact your local iiyama dealer or regional iiyama office.

- |                                 |                     |                                      |
|---------------------------------|---------------------|--------------------------------------|
| ■ Power Cable*1                 | ■ AC Adapter*1      | ■ VGA(D-sub) Signal Cable            |
| ■ DVI-D Cable                   | ■ USB Cable         | ■ Audio Cable*3                      |
| ■ Cable Cover Screw (M3x6 1pcs) |                     | ■ L-Bracket (2pairs)                 |
| ■ Bracket Screw (M4×8 8pcs)     |                     | ■ Touch Panel Driver Disk (CD-ROM)*2 |
| ■ Safety Guide                  | ■ Quick Start Guide | ■ MOUNTING KITS User manual          |

### CAUTION

#### \*1 1. TO USERS IN 120V AREA

The rating of the Power Cable enclosed in 120V area is 10A/125V. If you are using a power supply higher than this rating, then a power cable with a rating of 10A/250V must be used. However, all guarantees and warranties are void for any problems or damage caused by a power cable or AC adapter not supplied by iiyama.

#### 2. Applicable AC Adapter

AC Adapter Type Name : ADP-50YH B (DELTA ELECTRONICS, INC.)

\*2 This CD-ROM contains the touch screen driver software.

Install the Touch Panel Driver Disk after connecting the computer to the monitor with USB Cable. For the details, see Readme file in the Touch Panel Driver Disk.

\*3 Accessory for ProLite TF2234MSC.



## WALL MOUNTING

**WARNING** When you use with the wall mounting, in consideration of thickness of the mounting stage, tighten the M4 Screw with washer which “L” length is 8mm to fasten the monitor. Using the screw longer than this may cause electric shock or damage because it may contact with the electrical parts inside the monitor.

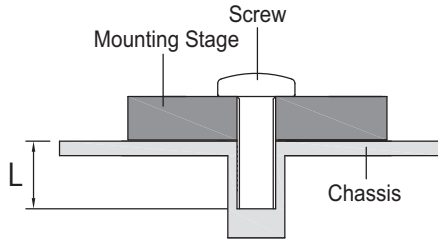

## BUILT-IN EQUIPMENT

**WARNING** This product is not designed for the purpose of being used in high temperature environment.

If the product is placed in an external cabinet, you need to design cooling fans and vents to keep the temperature low enough to fit in the product temperature specification.

## CONTROLS AND CONNECTORS

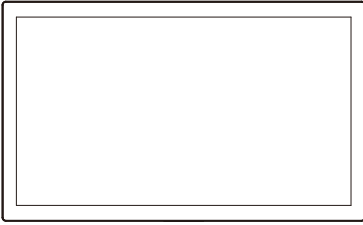

<Front>

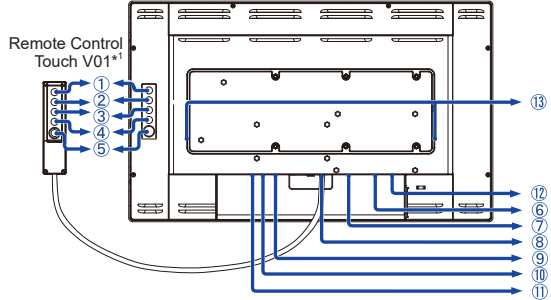

<Back>

- ① Menu Button (MENU)\*<sup>1</sup>
  - ② Scroll Up / Brightness Button (△)\*<sup>1</sup>
  - ③ Scroll Down / Contrast Button (▽)\*<sup>1,2</sup>  
Scroll Down / Mute Button (▽)\*<sup>1,3</sup>
  - ④ Select Button (SELECT)\*<sup>1</sup>
  - ⑤ Power Switch (⏻)\*<sup>1</sup>
  - ⑥ VGA(D-sub) mini 15pin Connector
  - ⑦ DVI-D 24pin Connector
  - ⑧ Remote Control Touch V01 Connector
  - ⑨ USB Connector
  - ⑩ Connector for AC Adapter
  - ⑪ Power Indicator
- NOTE** Green: Normal operation  
Orange: Power Management
- ⑫ Audio Connector\*<sup>3</sup>
  - ⑬ Speakers\*<sup>3</sup>

\*<sup>1</sup> Remote Control Touch V01 is optional.

\*<sup>2</sup> Available for ProLite TF2234MC only.

\*<sup>3</sup> Available for ProLite TF2234MSC only.

## SPECIAL NOTES

L-Brackets and screws are necessary to install an open frame monitor.

**CAUTION** ■ The L-Brackets are designed to be mounted to specific wall types and hardware, in accordance with the installation instructions supplied with the Mounting Kit.

■ Using L-Bracket or screws other than those specified in the installation instructions may damage the monitor.

① As shown in figure below, tighten Bracket A to B using the screws supplied (2 pairs of 2 pcs).

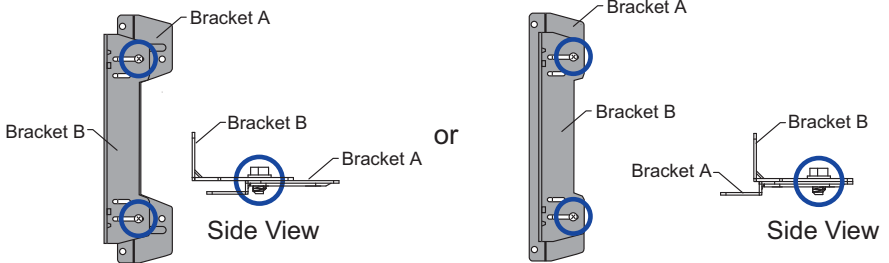

② Depending on the monitor orientation (portrait or landscape) you choose, mount the L-Brackets to the left and right hand sides or the upper and lower sides of the monitor and tighten them with screws supplied (2 pairs of 2 pcs).

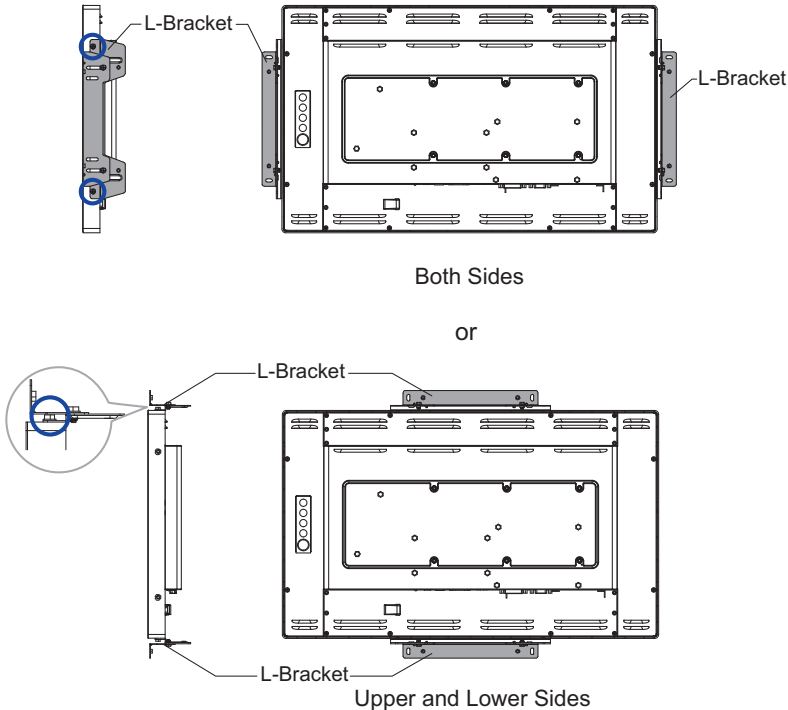

**NOTE**

- You will need a screwdriver to mount the L-Bracket.
- L-Brackets and screws are necessary to install an open frame monitor. For details regarding open frame monitor temperature and humidity operating conditions, see the User Manual on IYAMA website. <http://www.iiyama.com>.
- The position of the L-bracket can be either 2.9 mm or 44.9 mm from the front of the monitor depending on which screw holes you choose for mounting it.

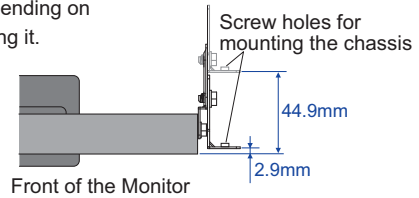

## CONNECTING YOUR MONITOR

- ① Ensure that both the computer and the monitor are switched off.
- ② Connect the computer to the monitor with the signal cable.
- ③ Connect the monitor to the audio equipment with the Audio Cable for computer when using the audio features.\*
- ④ Connect the computer to the monitor with the USB Cable.
- ⑤ Connect the monitor cable to the Remote Control Touch V01 (option), if necessary.
- ⑥ Connect the AC Adapter to the monitor and the Power Cable to the AC Adapter first and then connect to the power supply.
- ⑦ Turn on your monitor and computer.

### NOTE

- The signal cables used for connecting the computer and monitor may vary with the type of computer used. An incorrect connection may cause serious damage to both the monitor and the computer. The cable supplied with the monitor is for a standard connector. If a special cable is required please contact your local iiyama dealer or regional iiyama office.
- For connection to Macintosh computers, contact your local iiyama dealer or regional iiyama office for a suitable adaptor.
- Make sure you tighten the finger screws at each end of the Signal Cable.

[Example of Connection]

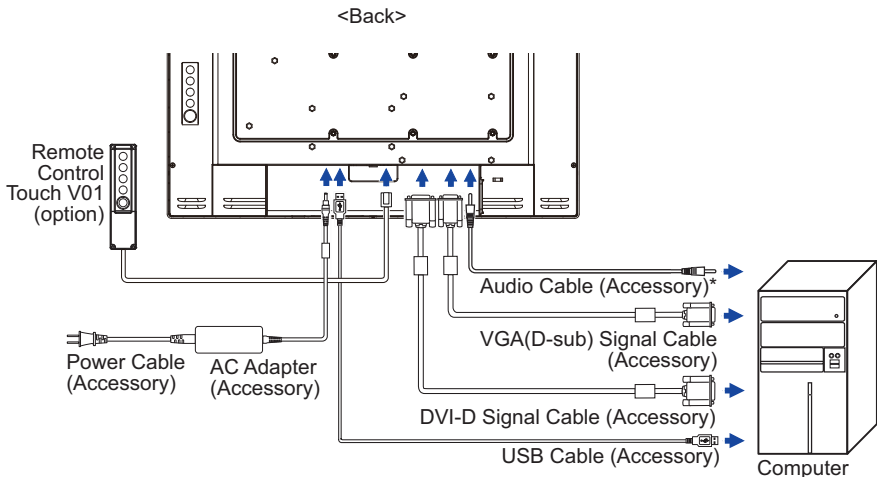

\* Available for ProLite TF2234MSC only.

**[Fitting and Removal of Cable Cover]**

Put a piece of soft cloth on the table beforehand to prevent the monitor from being scratched. Lay the monitor flat on a table with front face down.

**< Removal >**

- ① Remove the cable cover as shown in Step1.

**< Fitting >**

- ① Connect the cables, as shown in Step2, place the cable cover and fix it firmly using a screw.

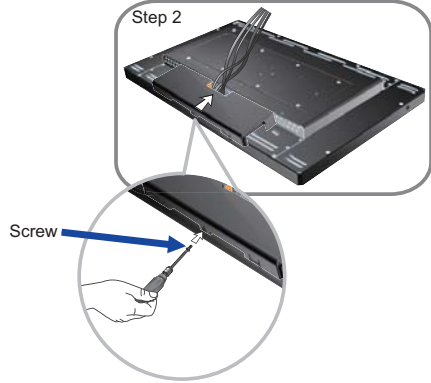

## COMPUTER SETTING

■ **Signal Timing**

Change to the desired signal timing listed on page 29: COMPLIANT TIMING.

■ **Windows XP/Vista/7/8/8.1/10 Plug & Play**

The iiyama LCD monitor complies with DDC2B of VESA standard. The Plug & Play function runs on Windows XP/Vista/7/8/8.1/10 by connecting the monitor to DDC2B compliant computer with the Signal Cable supplied.

For installation on Windows XP: The monitor Information File for iiyama monitors may be necessary for your computer and obtained via the Internet, using the address:

<http://www.iiyama.com>

**NOTE**

- For additional information on how to download the driver for your touch screen monitor, please access the internet site noted above.
- Monitor Drivers are not required in most cases for Macintosh or Unix operating systems. For further information, please contact your computer dealer first for advice.

■ **Procedure for turning ON the Power Switch**

Turn ON the monitor first, and then the computer.

■ **Touch screen driver software**

Touch screen driver software and system may not start when you start your computer while touching the screen.

Touch screen driver software may not run due to the power saving function depending on the BIOS of your computer. In this case, set the power saving function to off.

■ **TOUCH support operation system**

Microsoft Windows XP (64 bit and 32 bit)  
 Microsoft Windows 7 (64 bit and 32 bit)  
 Microsoft Windows CE 2.13 / 3.0, net 6.0  
 Linux (Kernel2.4, 2.6x) & above

Microsoft Windows Vista (64 bit and 32 bit)  
 Microsoft Windows 8 / 8.1 / 10 (64 bit and 32 bit)  
 Mac OS9.x, OS X V10.4/10.5/10.6 & above  
 Not support earlier versions.

	Windows8/8.1/10	Windows7*5	Windows7*4	Vista	XP
Default mouse*1	○	○	○	○	○
Touch digitizer*2	○	○	○	○	×
Windows7 gestures*3	○	○	×	×	×

	2K	Windows CE	XP Embedded	Mac OS9,OSX	Linux
Default mouse*1	○	○	○	○	○
Touch digitizer*2	×	×	×	×	×
Windows7 gestures*3	×	×	×	×	×

\*1 Default mouse (click, drag, double-click and right-click)

\*2 Touch digitizer (click, drag /selection, double-click, right-click, flick and visual feedback)

\*3 Digitizer with Windows7 touch gestures

\*4 Windows 7 - Starter and Home Basic version

\*5 Windows 7 - Home Premium, Professional, Enterprise and Ultimate versions

## OPERATING THE MONITOR

To create the best picture, your iiyama LCD monitor has been preset at the factory with the COMPLIANT TIMING shown on page 29. You are also able to adjust the picture by following the button operation shown below. For more detailed adjustments, see page 18 for SCREEN ADJUSTMENTS.

- ① Press the MENU Button to start the On Screen Display feature. There are additional Menu items which can be switched by using the  $\Delta$  /  $\nabla$  Buttons.



- ② Select the Menu item which contains the adjustment icon relating to the adjustment you want to make. Use the SELECT Button to highlight the desired adjustment icon.
- ③ Use the  $\Delta$  /  $\nabla$  Buttons to make the appropriate adjustment or setting.
- ④ Press the MENU Button to leave the menu, and the settings you just made would be automatically saved.

For example, to correct for vertical position, select Menu item of . Then, select V-POSITION by using the SELECT Button.

Use the  $\Delta$  /  $\nabla$  Buttons to change the vertical position settings. The vertical position of the overall display should be changing accordingly while you are doing this.

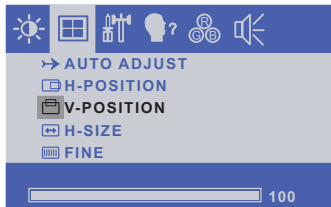









Press the MENU Button lastly, it ends, all changes are saved in the memory.

### NOTE

- When button operations are aborted during adjustment, On-Screen Display disappears when the time set for the OSD TIMEOUT has passed.
- MENU button can be used to return previous menu item.
- Any changes are automatically saved in the memory when the On Screen Display disappears. Turning off the power should be avoided while using the Menu.
- Adjustments for H/V-POSITION, H-SIZE and FINE are saved for each signal timing. Except for these adjustments, all other adjustments have only one setting which applies to all signal timings.



## ADJUSTMENT MENU CONTENTS

 <p>The screenshot shows the OSD menu with a sun icon on the left. The menu items are CONTRAST and BRIGHTNESS. At the bottom, it displays resolution 1280x1024, FH: 63KHz, and FV: 59.9Hz.</p>		
Adjustment Item	Problem / Option	Button to Press
CONTRAST <b>Direct</b>	Too dull Too intense	   
BRIGHTNESS * <b>Direct</b>	Too dark Too bright	   

\* Adjust the Brightness when you are using the monitor in a dark room and feel the screen is too bright.

### Direct

You can skip the Menu items and display an adjustment scale directly by using the following button operations.

- CONTRAST: Press the ▽ Button when the Menu is not displayed. (Available for ProLite TF2234MC only.)
- BRIGHTNESS: Press the △ Button when the Menu is not displayed.

### Direct











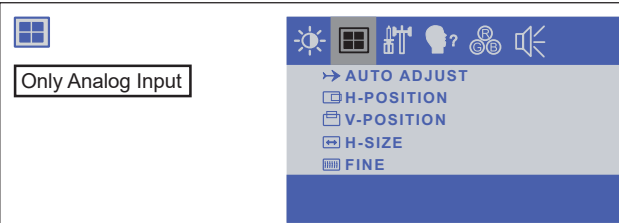



- LOCK MODE:  
Simultaneously press the MENU button and the ▽ button when an image is displayed through VGA or DVI.

\* The OSD menu is not displayed when the OSD is locked. Press the MENU button and the ▽ button simultaneously again.

The following OSD menu is displayed.

Adjustment Item	Problem / Option	
POWER	LOCK	The POWER SWITCH is Locked.
	UNLOCK	The POWER SWITCH is Unlocked.
OSD	LOCK	The OSD menu is Locked.
	UNLOCK	The OSD menu is Unlocked.

- TOUCH FANCTION DISABLE:  
 ON: Pressing and holding of the MENU Button and the SELECT Button at the same time when the Menu is not displayed, message "TOUCH DISABLE" will appear on the top right corner.  
 OFF: Pressing and holding of the MENU Button and the SELECT Button at the same time for about 5 seconds when the Menu is not displayed, till "TOUCH DISABLE" disappears.

Adjustment Item	Problem / Option	Button to Press
 <p>Only Analog Input</p> <ul style="list-style-type: none"> <li>→ AUTO ADJUST</li> <li>H-POSITION</li> <li>V-POSITION</li> <li>H-SIZE</li> <li>FINE</li> </ul>	<p>Adjust H/V-POSITION, H-SIZE and FINE automatically.</p>	
<p>H-POSITION</p>	<p> Too left   Too right</p>	<p> △   ▽</p>
<p>V-POSITION</p>	<p> Too low   Too high</p>	<p> △   ▽</p>
<p>H-SIZE *<sup>2</sup></p>	<p> Too narrow   Too wide</p>	<p> △   ▽</p>
<p>FINE *<sup>2</sup></p>	<p>To correct flickering text or lines</p>	<p> △   ▽</p>

\*<sup>1</sup> For best results, use the Auto Adjust in conjunction with the adjustment pattern. See page 18 for SCREEN ADJUSTMENTS.

\*<sup>2</sup> See page 18 for SCREEN ADJUSTMENTS.

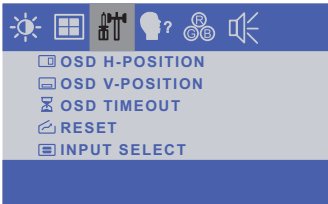

Adjustment Item	Problem / Option		Button to Press
OSD H-POSITION	OSD is too left OSD is too right		△ ▽
OSD V-POSITION	OSD is too low OSD is too high		△ ▽
OSD TIMEOUT	You can set the OSD display duration time between 5 and 60 seconds.		△ ▽
RESET	Factory-preset data is restored.		
INPUT SELECT <b>Direct</b>	AUTO	Search for an available input source and select automatically.	
	VGA	Select the analog input.	
	DVI	Select the digital input.	
<b>NOTE</b> However it will automatically be selected when just one source is using. In Power Management Mode input switching is disabled. Input source is fixed, not selected automatically when VGA and DVI which are selected.			



## Direct

You can skip the Menu items and display an adjustment scale directly by using the following button operations.

- **INPUT SELECT:** Pressing and holding of the SELECT Button for about 5 seconds when the Menu is not displayed. When both VGA and DVI signal inputs are connected to a signal source, you can switch between them by successively pressing the SELECT Button.

Adjustment Item	Problem / Option Button to Press																
OSD LANGUAGE	<table border="1"> <tr> <td>ENGLISH</td> <td>English</td> <td>ESPAÑOL</td> <td>Spanish</td> </tr> <tr> <td>FRANÇAIS</td> <td>French</td> <td>日本語</td> <td>Japanese</td> </tr> <tr> <td>DEUTSCH</td> <td>German</td> <td>繁體字</td> <td>Traditional Chinese</td> </tr> <tr> <td>ITALIANO</td> <td>Italian</td> <td>简体字</td> <td>Simplified Chinese</td> </tr> </table>	ENGLISH	English	ESPAÑOL	Spanish	FRANÇAIS	French	日本語	Japanese	DEUTSCH	German	繁體字	Traditional Chinese	ITALIANO	Italian	简体字	Simplified Chinese
	ENGLISH	English	ESPAÑOL	Spanish													
	FRANÇAIS	French	日本語	Japanese													
	DEUTSCH	German	繁體字	Traditional Chinese													
ITALIANO	Italian	简体字	Simplified Chinese														

Adjustment Item	Problem / Option Button to Press																	
COLOR TEMP.	<table border="1"> <tr> <td>9300</td> <td>Bluish white</td> </tr> <tr> <td>6500</td> <td>Reddish white</td> </tr> <tr> <td>5500</td> <td>Greenish white</td> </tr> <tr> <td>7500</td> <td>Yellowish white</td> </tr> <tr> <td>USER</td> <td> <table border="1"> <tr> <td>RED</td> <td rowspan="3">Too weak</td> <td rowspan="3"> </td> </tr> <tr> <td>GREEN</td> </tr> <tr> <td>BLUE</td> <td>Too strong</td> <td> </td> </tr> </table> </td> </tr> </table>	9300	Bluish white	6500	Reddish white	5500	Greenish white	7500	Yellowish white	USER	<table border="1"> <tr> <td>RED</td> <td rowspan="3">Too weak</td> <td rowspan="3"> </td> </tr> <tr> <td>GREEN</td> </tr> <tr> <td>BLUE</td> <td>Too strong</td> <td> </td> </tr> </table>	RED	Too weak		GREEN	BLUE	Too strong	
	9300	Bluish white																
	6500	Reddish white																
	5500	Greenish white																
	7500	Yellowish white																
USER	<table border="1"> <tr> <td>RED</td> <td rowspan="3">Too weak</td> <td rowspan="3"> </td> </tr> <tr> <td>GREEN</td> </tr> <tr> <td>BLUE</td> <td>Too strong</td> <td> </td> </tr> </table>	RED	Too weak		GREEN	BLUE	Too strong											
RED	Too weak																	
GREEN																		
BLUE			Too strong															

Adjustment Item		Problem / Option		Button to Press
VOLUME		Too soft Too loud		 △  ▽
MUTE	<b>Direct</b>	ON	Turn off the sound temporarily.	
		OFF	Return the sound volume to the previous level.	

\* Available for ProLite TF2234MSC only.

**Direct**

You can skip the Menu items and display an adjustment scale directly by using the following button operations.

- MUTE: Press the ▽ Button when the Menu is not displayed.  
ON and OFF are switched as follows by pressing the ▽ Button successively.

## SCREEN ADJUSTMENTS

Adjust the image by following the procedure below to get the desired picture when selecting Analog input.

- The screen adjustments described in this manual are designed to set image position and minimize flicker or blur for the particular computer in use.
- The monitor is designed to provide the best performance at resolution of 1920 × 1080, but can not provide the best at resolutions of less than 1920 × 1080 because the picture is automatically stretched to fit the full screen. It is recommended to operate at resolution of 1920 × 1080 in normal use.
- Displayed text or lines will be blurred or irregular in thickness when the picture is stretched due to the screen enlargement process.
- It is preferable to adjust the image position and frequency with the monitor controls, rather than the computer software or utilities.
- Perform adjustments after a warm-up period of at least thirty minutes.
- Additional adjustments may be required after the Auto Adjust depending on the resolution or signal timing.
- The Auto Adjust may not work correctly when displaying the picture other than the screen adjustment pattern. In this case, manual adjustments are required.

There are two ways to adjust the screen. One way is automatic adjustment for H/V-POSITION, H-SIZE and FINE. The other way is performing each adjustment manually.

Perform the Auto Adjust first when the monitor is connected to a new computer, or resolution is changed. If the screen has a flicker or blur, or the picture does not fit in the display area after performing the Auto Adjust, manual adjustments are required. Both adjustments should be made by using the screen adjustment pattern (Test.bmp) obtained via the IYAMA web site (<http://www.iiyama.com>).

Adjust the image by following the procedure below to get the desired picture.

This manual explains adjustment under Windows® OS.

- ① **Display the picture at the optimum resolution.**
- ② **Enter the Test.bmp (screen adjustment pattern) to wallpaper.**

### NOTE

- Consult the appropriate documentation for doing this.
- Test.bmp is made at resolution of 1280 × 1024. Set the display position to center in the wallpaper setting dialogue box. If you use Microsoft® PLUS! 95/98 cancel the setting of "Stretch desktop wallpaper to fit the screen".

[Adjustment pattern]

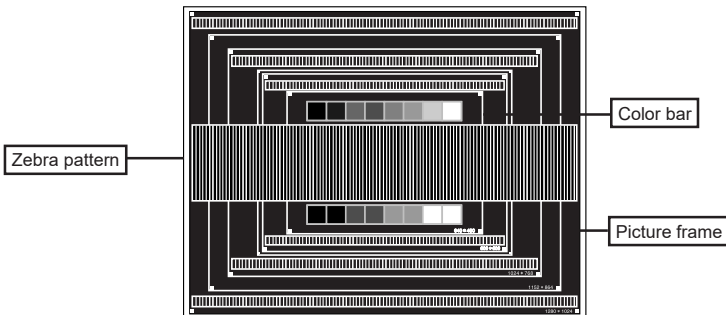

- ③ Press the SELECT Button. (AUTO ADJUST)
- ④ Adjust the image manually by following procedure below when the screen has a flicker or blur, or the picture does not fit in the display area after performing the Auto Adjust.
- ⑤ Adjust the V-POSITION so that the top and bottom of the picture frame will fit to the display area.

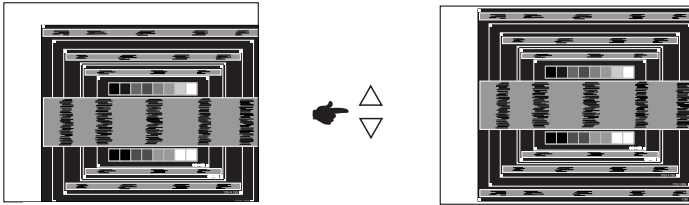

- ⑥ 1) Adjust the H-POSITION so that the left side of the picture frame will move to the left edge of the display area.

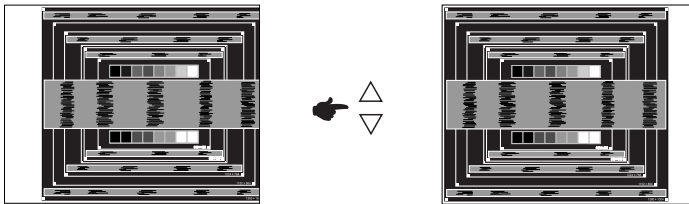

- 2) Stretch the right side of the picture frame to the right edge of the display area by adjusting the H-SIZE.

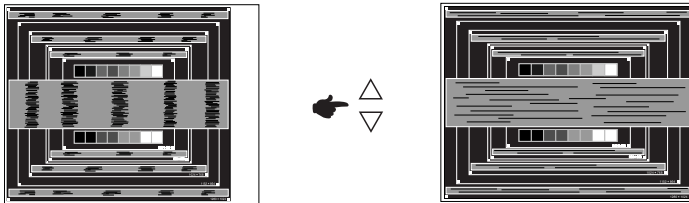
**NOTE**

- When the left side of the picture frame moves apart from the left edge of the display area during the H-SIZE adjustment, adjust steps 1) and 2).
- Another way to make the H-SIZE adjustment is to correct the vertical wavy lines in the zebra pattern.
- The picture may flicker during the H-SIZE, H/V-POSITION adjustment.
- In case the picture frame is bigger or smaller than the data display area after the H-SIZE adjustment, repeat steps from ③.

- ⑦ Adjust the FINE to correct horizontal wavy noise, flicker or blur in the zebra pattern.

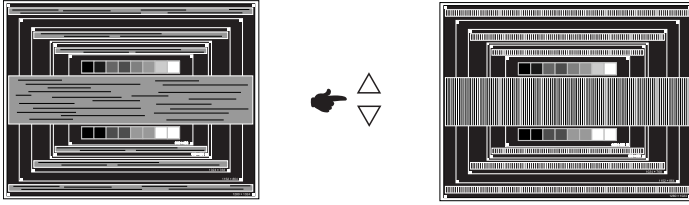
**NOTE**

- In case the strong flicker or blurs remain on a part of the screen, repeat steps ⑥ and ⑦ because the H-SIZE may not be adjusted correctly. If the flicker or blurs still remain, set the refresh rate of computer to low (60Hz) and repeat steps from ③ again.
- Adjust the H-POSITION after the FINE adjustment if the horizontal position moves during the adjustment.

- ⑧ Adjust the Brightness and Color to get the desired picture after you complete the H-SIZE and FINE adjustments.

Put back your favorite wallpaper.



## POWER MANAGEMENT FEATURE

When your computer is not in use, the power management feature will automatically reduce the power consumption of your monitor.

To use the feature, the monitor needs to be connected to a VESA DPMS compliant computer. There is a power management step the monitor takes as described below. The power management function, including any timer settings is configured by the operating system. Check your operating system manual for information on how this can be configured.

### ■ Power Management Mode

When the H-sync signal / V-sync signal / H and V sync signals from the computer are off, the monitor enters into Power Management Mode which reduces the power consumption to less than 2W. The screen becomes dark. From Power Management Mode, the image reappears in several seconds when either the keyboard or the mouse are touched again.

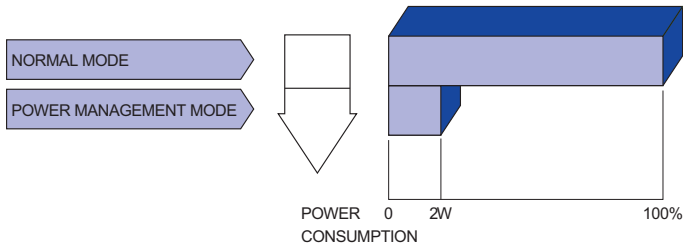

### NOTE

- Even when using the power management mode, the monitor consumes electricity. Turn off the Power Switch whenever the monitor is not in use, during the night and weekends, to avoid unnecessary power consumption.
- It is possible that the video signal from the computer may be on while the H or V sync signal is missing. In this instance, the POWER MANAGEMENT feature may not work properly.

## TROUBLE SHOOTING

If the monitor fails to operate correctly, please follow the steps below for a possible solution.

1. Perform the adjustments described in OPERATING THE MONITOR, depending on the problem you have. If the monitor does not get a picture, skip to 2.
2. Consult the following items if you cannot find an appropriate adjustment item in OPERATING THE MONITOR or if the problem persists.
3. If you are experiencing a problem which is not described below or you cannot correct the problem, discontinue using the monitor and contact your dealer or iiyama service center for further assistance.

<b>Problem</b>	<b>Check</b>
① The picture does not appear.	<input type="checkbox"/> The AC Adapter is firmly seated in the connector. <input type="checkbox"/> The Power Cable is firmly seated in the socket of the AC Adapter. <input type="checkbox"/> The Power Cable is firmly seated in the socket. <input type="checkbox"/> The Power Switch is turned ON. <input type="checkbox"/> The AC socket is live. Please check with another piece of equipment. <input type="checkbox"/> If the blank screen saver is in active mode, touch the keyboard or the mouse. <input type="checkbox"/> Increase the Contrast and/or Brightness. <input type="checkbox"/> The computer is ON. <input type="checkbox"/> The Signal Cable is properly connected. <input type="checkbox"/> The signal timing of the computer is within the specification of the monitor. <input type="checkbox"/> If the monitor is in power management mode, touch the keyboard or the mouse.
② The screen is not synchronized.	<input type="checkbox"/> The Signal Cable is properly connected. <input type="checkbox"/> The signal timing of the computer is within the specification of the monitor. <input type="checkbox"/> The video output level of the computer is within the specification of the monitor.
③ The screen position is not in the center.	<input type="checkbox"/> The signal timing of the computer is within the specification of the monitor.
④ The screen is too bright or too dark.	<input type="checkbox"/> The video output level of the computer is within the specification of the monitor.
⑤ The screen is shaking.	<input type="checkbox"/> The power voltage is within the specification of the monitor. <input type="checkbox"/> The signal timing of the computer is within the specification of the monitor.
⑥ The touch screen shows no response.	<input type="checkbox"/> The USB Cable is firmly seated in the socket. <input type="checkbox"/> Touch screen driver software is installed.
⑦ The touch position does not deviate.	<input type="checkbox"/> The calibration function set up correctly.

## RECYCLING INFORMATION

For better environment protection please don't dispose your monitor.  
Please visit our web site: [www.iiyama.com/recycle](http://www.iiyama.com/recycle) for monitor recycling.

# APPENDIX

Design and specifications are subject to change without prior notice.

## SPECIFICATIONS : ProLite TF2234MC-B1X / ProLite TF2234MC-B2X

ENGLISH

Model Name		ProLite TF2234MC-B1X	ProLite TF2234MC-B2X
Touch Screen	Technology	Projected capacitive 10pt touch	
	Light transmission	90%	
	Hardness	7H	
	Thickness	2.5mm	1.24mm
	Communication system	USB	
Size Category		22"	
LCD Panel	Panel technology	IPS	
	Size	Diagonal: 21.5" (55cm)	
	Pixel pitch	0.247mm H × 0.247mm V	
	Brightness	250cd/m <sup>2</sup> (Typical), 225cd/m <sup>2</sup> (with Touch panel)	
	Contrast ratio	1000 : 1 (Typical: with Touch panel)	
	Viewable angle	Horizontal : 178 degrees, Vertical: 178 degrees (Typical)	
	Response time	8ms (Gray to Gray Typical)	
Display Colors		Approx.16.7M	
Sync Frequency		Horizontal: 31.5-82.3kHz, Vertical: 56-75Hz	
Maximum Resolution		1920 × 1080, 2.1 MegaPixels	
Input Connector		VGA(D-sub) mini 15 pin, DVI-D 24 pin	
Plug & Play		VESA DDC2B™	
Input Sync Signal		Separate sync: TTL, Positive or Negative	
Input Video Signal		Analog: 0.7Vp-p (Standard), 75Ω, Positive Digital: DVI (Digital Visual Interface Standard Rev.1.0) compliance	
Maximum Screen Size		476.6mm W × 268.1mm H / 18.8" W × 10.6" H	
Power Source		12VDC, 4A	
AC Adapter (accessory)		Input: 100-240VAC, 50/60Hz	
Power Consumption*1		27W typical, Power management mode: 2W maximum	
Dimensions / Net Weight		517.5 × 313.5 × 46.0mm / 20.4 × 12.3 × 1.8" (W×H×D) 4.4kg / 9.7lbs	
Environmental Considerations		Operating: Temperature 0 to 40°C / 32 to 104°F Humidity 20 to 80% (No condensation) Storage: Temperature -20 to 60°C / -4 to 140°F Humidity 10 to 90% (No condensation)	
Approvals		CE, TÜV-Bauart, cULus, VCCI, CU, IP65*2	

**NOTE** \*1 USB peripherals is not connected.

\*2 IP65 Standard Compliant : Only front face

## SPECIFICATIONS : ProLite TF2234MC-B3X

Touch Screen	Technology	Projected capacitive 10pt touch
	Light transmission	87%
	Hardness	6H
	Thickness	1.5mm
	Communication system	USB
Size Category		22"
LCD Panel	Panel technology	IPS
	Size	Diagonal: 21.5" (55cm)
	Pixel pitch	0.247mm H × 0.247mm V
	Brightness	250cd/m <sup>2</sup> (Typical), 220cd/m <sup>2</sup> (with Touch panel)
	Contrast ratio	1000 : 1 (Typical: with Touch panel)
	Viewable angle	Horizontal : 178 degrees, Vertical: 178 degrees (Typical)
	Response time	8ms (Gray to Gray Typical)
Display Colors		Approx. 16.7M
Sync Frequency		Horizontal: 31.5-82.3kHz, Vertical: 56-75Hz
Maximum Resolution		1920 × 1080, 2.1 MegaPixels
Input Connector		VGA(D-sub) mini 15 pin, DVI-D 24 pin
Plug & Play		VESA DDC2B™
Input Sync Signal		Separate sync: TTL, Positive or Negative
Input Video Signal		Analog: 0.7Vp-p (Standard), 75Ω, Positive Digital: DVI (Digital Visual Interface Standard Rev.1.0) compliance
Maximum Screen Size		476.6mm W × 268.1mm H / 18.8" W × 10.6" H
Power Source		12VDC, 4A
AC Adapter (accessory)		Input: 100-240VAC, 50/60Hz
Power Consumption* <sup>1</sup>		27W typical, Power management mode: 2W maximum
Dimensions / Net Weight		517.5 × 313.5 × 46.0mm / 20.4 × 12.3 × 1.8" (W×H×D) 4.4kg / 9.7lbs
Environmental Considerations		Operating: Temperature 0 to 40°C / 32 to 104°F Humidity 20 to 80% (No condensation) Storage: Temperature -20 to 60°C / -4 to 140°F Humidity 10 to 90% (No condensation)
Approvals		CE, TÜV-Bauart, cULus, VCCI, CU, IP65* <sup>2</sup>

**NOTE** \*<sup>1</sup> USB peripherals is not connected.

\*<sup>2</sup> IP65 Standard Compliant : Only front face

## SPECIFICATIONS : ProLite TF2234MC-B1AGB / ProLite TF2234MC-B3AGB

ENGLISH

Model Name		ProLite TF2234MC-B1AGB	ProLite TF2234MC-B3AGB
Touch Screen	Technology	Projected capacitive 10pt touch	
	Light transmission	86%	83%
	Hardness	7H	6H
	Thickness	2.5mm	1.5mm
	Communication system	USB	
Size Category		22"	
LCD Panel	Panel technology	IPS	
	Size	Diagonal: 21.5" (55cm)	
	Pixel pitch	0.247mm H × 0.247mm V	
	Brightness	350cd/m <sup>2</sup> (Typical), 300cd/m <sup>2</sup> (with Touch panel + AG coating)	350cd/m <sup>2</sup> (Typical), 290cd/m <sup>2</sup> (with Touch panel + AG coating)
	Contrast ratio	1000 : 1 (Typical: with Touch panel)	
	Viewable angle	Horizontal : 178 degrees, Vertical: 178 degrees (Typical)	
	Response time	8ms (Gray to Gray Typical)	
Display Colors		Approx.16.7M	
Sync Frequency		Horizontal: 31.5-82.3kHz, Vertical: 56-75Hz	
Maximum Resolution		1920 × 1080, 2.1 MegaPixels	
Input Connector		VGA(D-sub) mini 15 pin, DVI-D 24 pin	
Plug & Play		VESA DDC2B™	
Input Sync Signal		Separate sync: TTL, Positive or Negative	
Input Video Signal		Analog: 0.7Vp-p (Standard), 75Ω, Positive Digital: DVI (Digital Visual Interface Standard Rev.1.0) compliance	
Maximum Screen Size		476.6mm W × 268.1mm H / 18.8" W × 10.6" H	
Power Source		12VDC, 4A	
AC Adapter (accessory)		Input: 100-240VAC, 50/60Hz	
Power Consumption*1		27W typical, Power management mode: 2W maximum	
Dimensions / Net Weight		517.5 × 313.5 × 46.0mm / 20.4 × 12.3 × 1.8" (W×H×D) 4.4kg / 9.7lbs	
Environmental Considerations		Operating:   Temperature   0 to 40°C / 32 to 104°F Humidity       20 to 80% (No condensation) Storage:     Temperature   -20 to 60°C / -4 to 140°F Humidity       10 to 90% (No condensation)	
Approvals		CE, TÜV-Bauart, cULus, VCCI, CU, IP65*2	

**NOTE** \*1 USB peripherals is not connected.

\*2 IP65 Standard Compliant : Only front face

## SPECIFICATIONS : ProLite TF2234MSC-B1X / ProLite TF2234MSC-B3X

Model Name		ProLite TF2234MSC-B1X	ProLite TF2234MSC-B3X	
Touch Screen	Technology	Projected capacitive 10pt touch		
	Light transmission	90%	87%	
	Hardness	7H	6H	
	Thickness	2.5mm	1.5mm	
	Communication system	USB		
Size Category		22"		
LCD Panel	Panel technology	IPS		
	Size	Diagonal: 21.5" (55cm)		
	Pixel pitch	0.247mm H × 0.247mm V		
	Brightness	250cd/m <sup>2</sup> (Typical), 225cd/m <sup>2</sup> (with Touch panel)	250cd/m <sup>2</sup> (Typical), 220cd/m <sup>2</sup> (with Touch panel)	
	Contrast ratio	1000 : 1 (Typical: with Touch panel)		
	Viewable angle	Horizontal : 178 degrees, Vertical: 178 degrees (Typical)		
	Response time	8ms (Gray to Gray Typical)		
Display Colors		Approx. 16.7M		
Sync Frequency		Horizontal: 31.5-82.3kHz, Vertical: 56-75Hz		
Maximum Resolution		1920 × 1080, 2.1 MegaPixels		
Input Connector		VGA(D-sub) mini 15 pin, DVI-D 24 pin		
Plug & Play		VESA DDC2B™		
Input Sync Signal		Separate sync: TTL, Positive or Negative		
Input Video Signal		Analog: 0.7Vp-p (Standard), 75Ω, Positive Digital: DVI (Digital Visual Interface Standard Rev.1.0) compliance		
Input Audio Connector		ø 3.5mm mini jack (Stereo)		
Input Audio Signal		1.0Vrms maximum		
Speakers		3W × 2 (Stereo speakers)		
Maximum Screen Size		476.6mm W × 268.1mm H / 18.8" W × 10.6" H		
Power Source		12VDC, 4A		
AC Adapter (accessory)		Input: 100-240VAC, 50/60Hz		
Power Consumption* <sup>1</sup>		27W typical, Power management mode: 2W maximum		
Dimensions / Net Weight		517.5 × 313.5 × 46.0mm / 20.4 × 12.3 × 1.8" (W×H×D) 4.4kg / 9.7lbs		
Environmental Considerations		Operating:   Temperature   0 to 40°C / 32 to 104°F Humidity       20 to 80% (No condensation) Storage:     Temperature   -20 to 60°C / -4 to 140°F Humidity       10 to 90% (No condensation)		
Approvals		CE, TÜV-Bauart, cULus, VCCI, CU, IP65* <sup>2</sup>		

**NOTE** \*<sup>1</sup> USB peripherals is not connected.

\*<sup>2</sup> IP65 Standard Compliant : Only front face

**DIMENSIONS : ProLite TF2234MC**

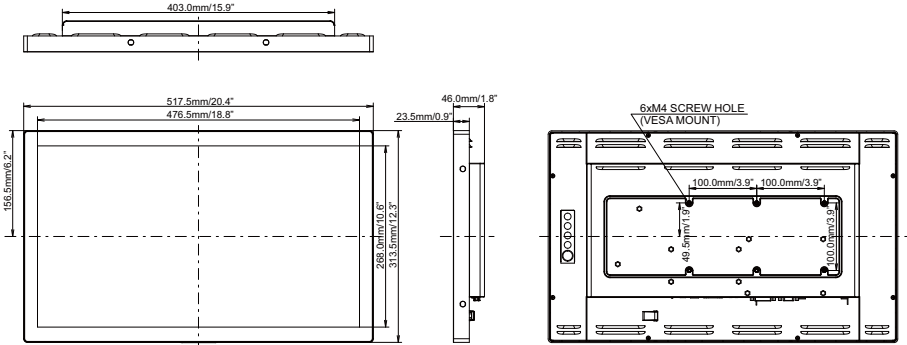

**DIMENSIONS : ProLite TF2234MSC**

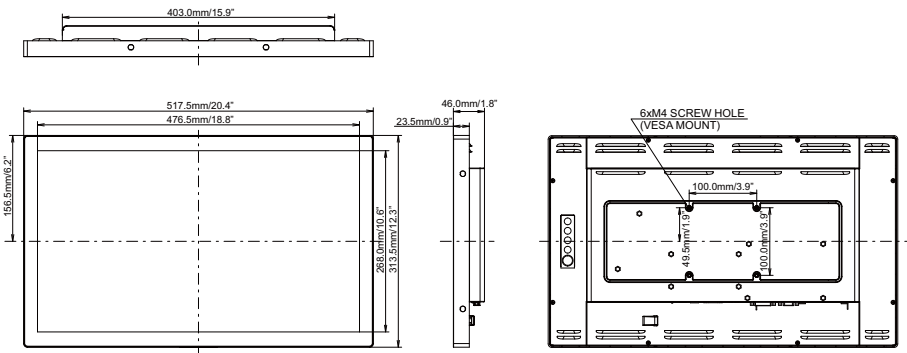



## DIMENSIONS : L-BRACKET

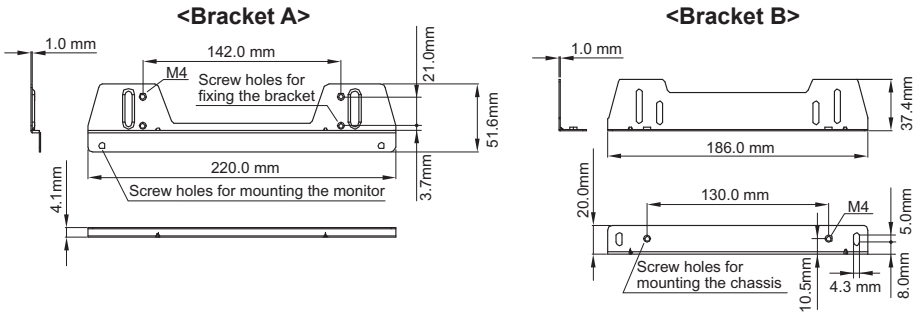

ENGLISH

## COMPLIANT TIMING

Video Mode			Horizontal Frequency	Vertical Frequency	Dot Clock
VESA	VGA	640 × 480	31.469kHz	59.940Hz	25.175MHz
			37.500kHz	75.000Hz	31.500MHz
			37.861kHz	72.809Hz	31.500MHz
	SVGA	800 × 600	35.156kHz	56.250Hz	36.000MHz
			37.879kHz	60.317Hz	40.000MHz
			46.875kHz	75.000Hz	49.500MHz
			48.077kHz	72.188Hz	50.000MHz
	XGA	1024 × 768	48.363kHz	60.004Hz	65.000MHz
			56.476kHz	70.069Hz	75.000MHz
			60.023kHz	75.029Hz	78.750MHz
			63.981kHz	60.020Hz	108.000MHz
	SXGA	1280 × 1024	79.976kHz	75.025Hz	135.000MHz
			55.935kHz	59.887Hz	106.500MHz
	WXGA+	1440 × 900	65.290kHz	59.954Hz	146.250MHz
WSXGA+	1680 × 1050	67.500kHz	60.000Hz	148.500MHz	
Full HD	1920 × 1080				