

Overview

HPE ProLiant ML350 Gen10 Server

Driving a wide range of workloads with a flexible, shorter and rackable chassis design that can fit in different physical environments, the secure 2P HPE ProLiant ML350 Gen10 Server delivers the ideal set of performance and expandability for changing business needs making it the choice for growing SMBs, remote/branch offices of large enterprises and data centers. Choose this 2P tower that grows with you in the digital economy.

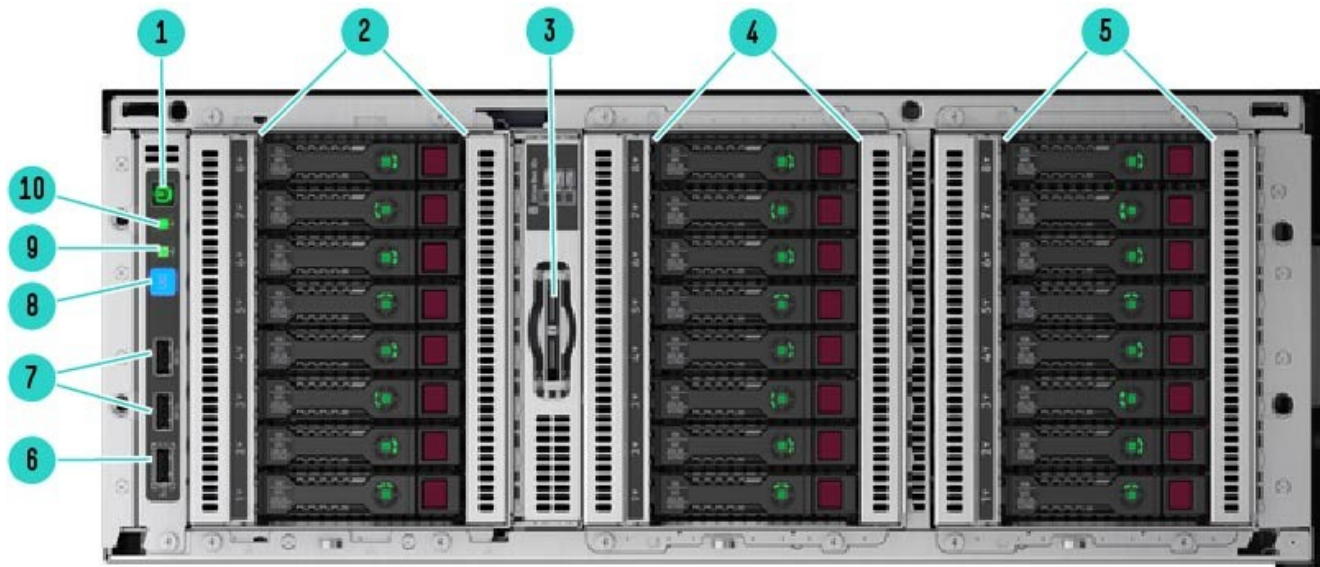

Front View – SFF chassis with optional Gen10 8SFF HDD Cage Kits shown (Rack mode)

- | | |
|--|-----------------------|
| 1. Power On/Stand-by button and System Power LED | 6. iLO Service Port |
| 2. Box1: optional HDD Drive Cage Bay for additional 8 SFF or 4 LFF drives support, or upgradeable to 2 HH media devices + 1 slim-line DVD. | 7. USB 3.0 port x 2 |
| 3. Serial number/iLO information pull tab | 8. UID Button/LED |
| 4. Box2: optional HDD Drive Cage Bay for additional 8 SFF or 4LFF drives support, or upgradeable to 8 SFF NVMe Express Bay | 9. NIC Status LED |
| 5. Box3: default with one 8 SFF HDD Drive Cage | 10. System Health LED |

Notes: Image shown without the security front bezel which is standard in every ML350 Gen10 unit and without the 1U sliding rail tray (of the Tower-to-Rack conversion kit).

Overview

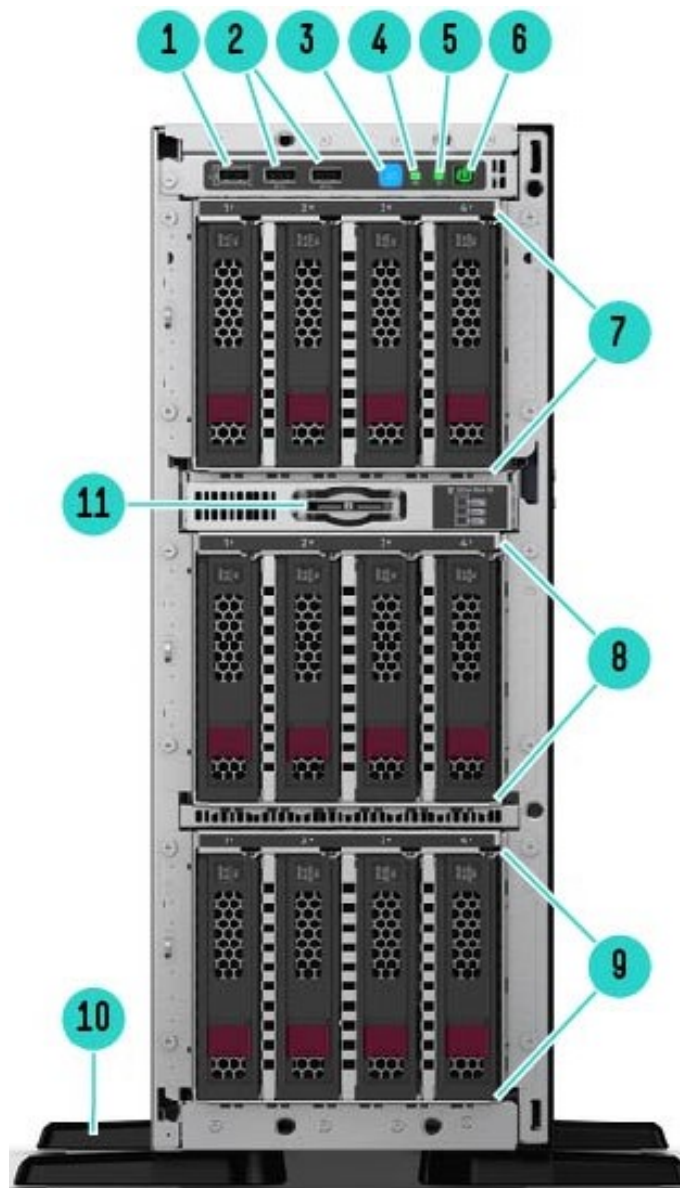

Front View – LFF chassis with optional Gen10 4LFF HDD Cage Kits shown (Tower mode)

- | | |
|--|--|
| 1. iLO Service Port | 7. Box1: optional HDD Drive Cage Bay for additional 4 LFF or 8SFF drives support, or upgradeable to 2 HH media devices + 1 slim-line DVD |
| 2. USB 3.0 port x 2 | 8. Box2: optional HDD Drive Cage Bay for additional 4 LFF or 8 SFF drives support |
| 3. UID Button/LED | 9. Box3: default with one 4LFF HDD Drive Cage |
| 4. NIC Status LED | 10. Tower feet (foldable at servicing) |
| 5. System Health LED | 11. Serial number/iLO information pull tab |
| 6. Power On/Stand-by button and System Power LED | |

Notes:

- For NHP LFF chassis, please find detail in the ML350 Gen10 User Guide.
- Image shown without the security front bezel which is standard in every ML350 Gen10 unit.



Overview

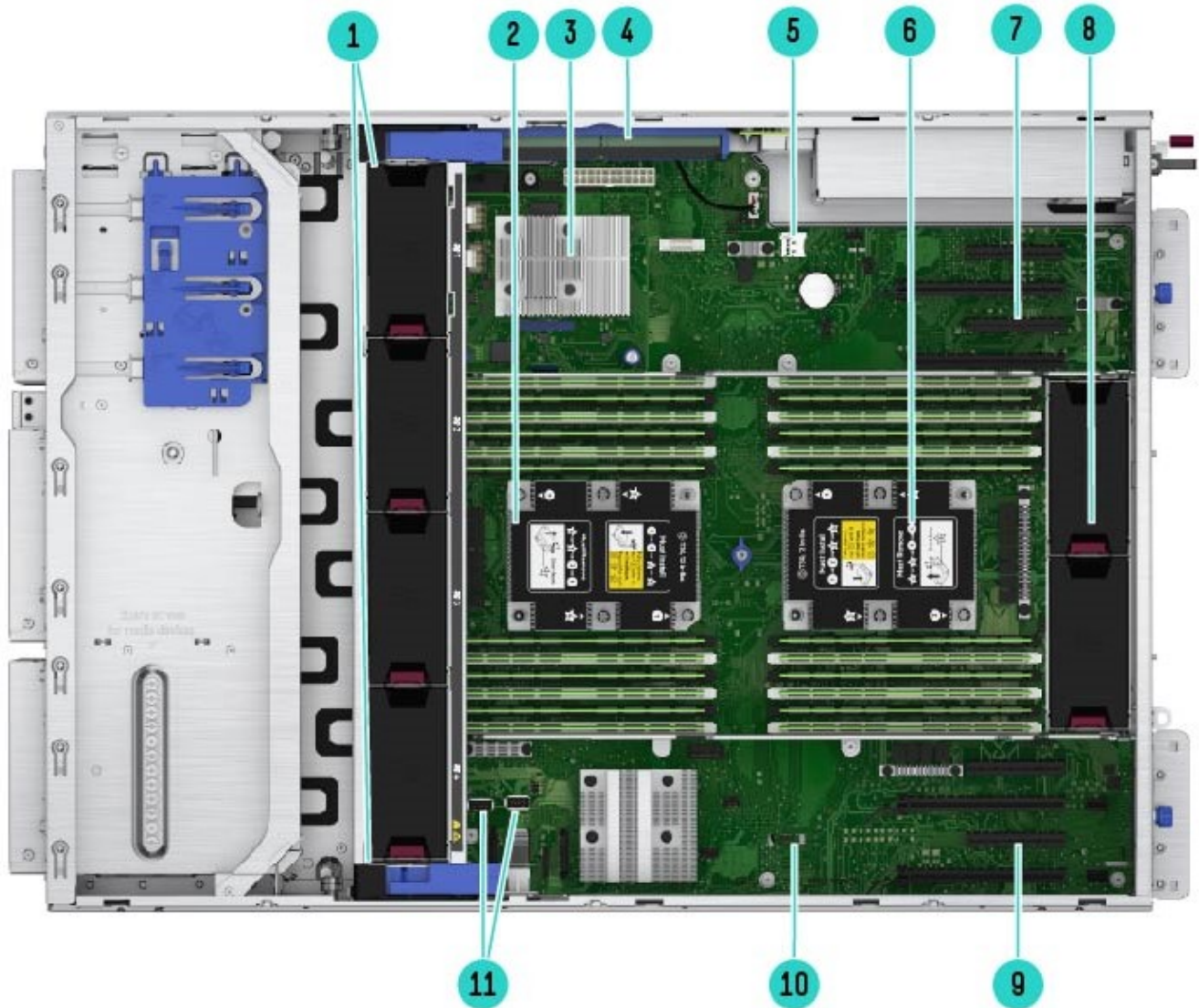

Internal View – with optional 2nd CPU, Smart Array Modular Controller and Redundant Fan Kit shown

- | | |
|---|---|
| <ul style="list-style-type: none"> 1. Redundant fan cage kit with addt'l (4) system fans are shown, supporting 2P and/or advanced cooling requirements. 2. CPU Socket 2 with the 2nd processor and heatsink, (depending on server model, the 2nd processor can be Optional) and 12 DDR4 DIMM slots for RDIMM or LRDIMM 3. HPE Smart Array Modular controller (AROC/Depending on server model, this can be Optional) 4. HPE Smart Storage Battery (Optional depending on model) 5. MicroSD Slot x1 6. CPU Socket 1 with one processor and heatsink, and 12 DDR4 DIMM slots for RDIMM or LRDIMM | <ul style="list-style-type: none"> 7. PCIe Slots (Slot 5-8, coming from CPU2) (requires Optional 2nd processor): Slot 5 and 7 can support Optional GPU 8. System fans: (2) fans along with the air baffle (not shown) are standard for basic cooling 9. PCIe Slots (Slot 1-4, coming from CPU1): Slot 1 and 3 can support Optional GPU 10. TPM Connector 11. Internal USB port x2 (USB3.0 x1 and USB2.0 x1) |
|---|---|



Overview

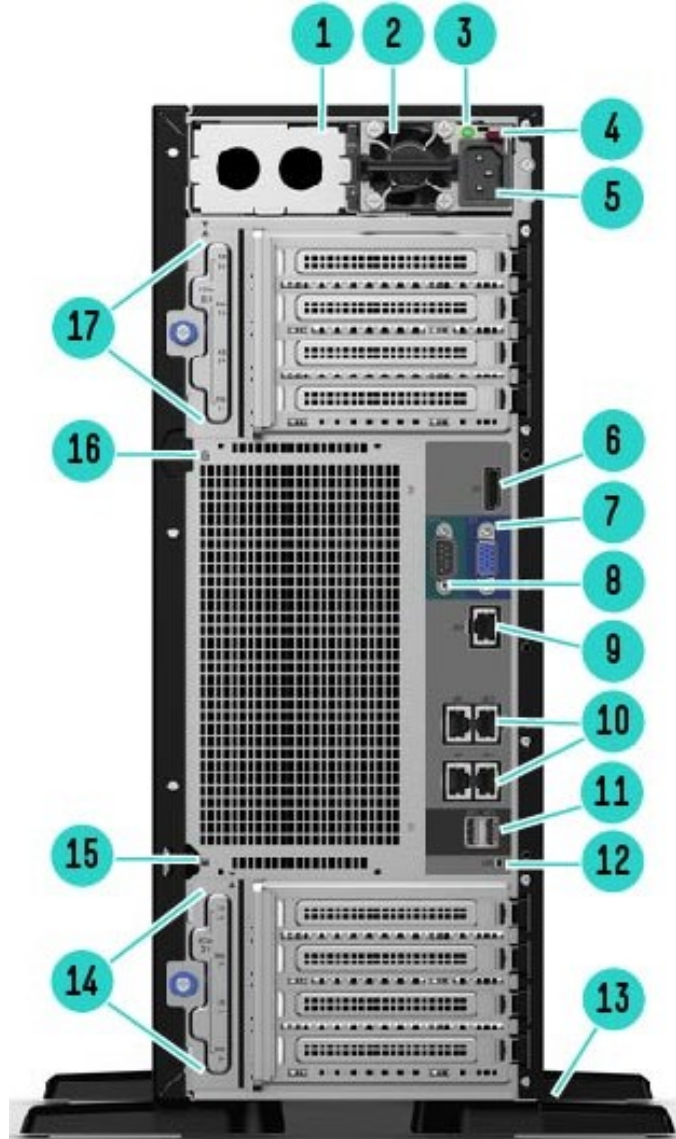

Rear View - With HPE Flex Slot RPS shown.

- | | |
|---|--|
| 1. HPE Flexible Slot 2 (Optional - empty with power supply blank shown) | 10. Embedded 4 x 1GbE Network ports |
| 2. HPE Flexible Slot 1 Power Supply | 11. USB 3.0 port x 2 |
| 3. Power supply Power LED | 12. Unit ID LED |
| 4. Power supply handle (with red touch-point) | 13. Tower feet (foldable at servicing) |
| 5. Power supply Power connection | 14. PCI Slots (Slots 1-4) - Slot 1 and 3 can support Optional GPU |
| 6. Display Port | 15. Padlock eye |
| 7. VGA Port | 16. Kensington security slot |
| 8. Serial Port | 17. PCI Slots (Slots 5-8) (requires Optional second processor) - Slot 5 and 7 can support Optional GPU |
| 9. Dedicated iLO Management Port (RJ45) | |



Overview

What's New:

- Supports additional Intel® Second Generation Xeon® Scalable processors with exceptional performance gains.
- Supports the new 16 TB LFF SATA / SAS HDDs boosting internal storage capacity up to 192 TB in LFF configuration.
- Enhanced iLO 5 security features such as Server Configuration Lock, iLO Security Dashboard and One Button Secure Erase.
- HPE InfoSight provides a cloud-based analytics tool that predicts and prevents problems before your business is impacted.
- Supports the new HPE NVidia Quadro P1000 and P2200 GPU modules for low end graphics. HPE NVidia Tesla T4 (16GB) universal GPU module which supports multiple types of workloads including ML (Machine Learning) / DL (Deep Learning) Training and Inference, HPC, Rendering and Graphics.

Platform Information

Form Factor

4U tower with rack conversion capability

Notes: When deployed as a Rack model, this system will take up 5U-height space in a standard data center rack facility.

Chassis Types

- 8 SFF chassis with optional SFF or LFF HDD cage kit (s), NVMe Express Bay, half-height (5.25") media bay up to 2, and 1 slim-line DVD bay kit options
- 4 LFF chassis with optional LFF or SFF HDD cage kit (s), half-height (5.25") media bay up to 2, and 1 slim-line DVD bay kit options
- 4 LFF NHP chassis with optional LFF NHP HDD cage kit (s), half-height (5.25") media bay up to 2, and 1 slim-line DVD bay kit options

Notes:

- The 8 SFF chassis can be upgraded with SFF HDD cage kit (s) to 16 or 24 SFF. Note a field upgrade to 24 SFF will require redundant fan kit (874572-B21).
- The 8 SFF NVMe Express Bay option (874569-B21) can only be leveraged in the SFF chassis and installed in Box 2. Maximum of 8 SFF NVMe PCIe drives are supported when two ML350 Gen10 NVMe Riser boards (shipped in 874569-B21) are populated. When only one Riser board is populated, then 4 NVMe drives are supported. Note a field upgrade to NVMe Express Bay will require redundant fan kit (874572-B21).
- The 4 LFF HP or NHP chassis can be upgraded with LFF HDD cage kit (s) or LFF NHP HDD cage kit (s) to 8 or 12 LFF. Note a field upgrade to 12 LFF either in LFF hot-plug or LFF non-hot-plug chassis will require redundant fan kit (874572-B21).
- The 8 SFF or 4 LFF or 4 LFF NHP chassis can be upgraded to add half-height media bay up to 2, and/or 1 slim-line DVD in Box1. Note a field upgrade to fully populate front storage bays (Box1, 2 and 3 fully loaded) will require redundant fan kit (874572-B21).
- Now the system can support mixed SFF and LFF HDD cages in one system, for example, 4LFF + 8SFF + 4LFF based on a 4 LFF chassis. If the max. number of drives are installed in all three drive boxes, the redundant fan cage kit (874572-B21) is required.

System Fans

Standard – fan types included

Notes:

- 1P models typically ship with 2 standard fans located at system rear. These two fans are default inside every ML350 Gen10 unit and do NOT support hot-plug operations.
- 2P models typically ship with 6 standard fans which provides N+1 redundant fan feature in most of the situations. For support detail or restriction, refer to ML350 Gen10 User Guide.
- Optional redundant fan kit (874572-B21) provides advanced cooling and redundancy functionality in heavier configurations. Configurations that require this kit are provided in later sections. Refer to the User Guide for special configuration scenarios where this kit is required but does not provide redundancy feature.



Standard Features

Processors – Up to 2 of the following depending on model.

Notes: For more information regarding Intel Xeon processors, please see the following

<https://www.intel.sg/content/www/xa/en/processors/xeon/scalable/xeon-scalable-platform.html>.

Intel Xeon® Scalable Processors – Naming Decoder		
Processor Suffix	Description	Offering
No suffix	-	Up to 1.0 TB addressable memory per socket
L	Large memory tier	Up to 4.5 TB addressable memory per socket
M	Medium memory tier	Up to 2.0 TB addressable memory per socket (up to 1.5TB for 1st generation Intel Xeon Scalable Processors denoted with the “M” suffix)
N	NFV Optimized	Targeted at Network Function Virtualization (NFV) workloads. Intel® SST-BF improves performance by directing base frequency to high priority/bottleneck cores. Other workloads may see throttling, more details to be provided in upcoming documentation.
R	Refresh	Refreshed SKUs based on existing Intel® 2 nd Generation Xeon® Scalable Processor models
U	1 Socket Optimized	Focused on single socket (1P) configurations, delivering performance at competitive price points. Does not support two socket (2P) arrangements.
V	VM Optimized	Fosters enhanced VM density, allowing to support more/largervirtual machines per host.
Y	Speed Select	Intel® SST-PP increases base frequency when fewer cores are enabled. Allows greater flexibility, deployment options and platform longevity.

Intel Second Generation Xeon® Scalable Processors – Refresh							
Intel Xeon Models	CPU Frequency	Cores	L3 Cache	Power	UPI	DDR4	Memory per socket
Gold Processors							
Gold 6258R Processor	2.7 GHz	28	38.5 MB	205W	2 @ 10.4 GT/s	2933 MT/s	1 TB
Gold 6256 Processor*	3.6 GHz	12	33.00 MB	205W	3 @ 10.4 GT/s	2933 MT/s	1 TB
Gold 6250L Processor*	3.9 GHz	8	35.75 MB	185W	3 @ 10.4 GT/s	2933 MT/s	4.5 TB
Gold 6250 Processor*	3.9 GHz	8	35.75 MB	185W	3 @ 10.4 GT/s	2933 MT/s	1 TB
Gold 6248R Processor	3.0 GHz	24	35.75 MB	205W	2 @ 10.4 GT/s	2933 MT/s	1 TB
Gold 6246R Processor	3.4 GHz	16	35.75 MB	205W	2 @ 10.4 GT/s	2933 MT/s	1 TB
Gold 6242R Processor	3.1 GHz	20	35.75 MB	205W	2 @ 10.4 GT/s	2933 MT/s	1 TB
Gold 6240R Processor	2.4 GHz	24	35.75 MB	165W	2 @ 10.4 GT/s	2933 MT/s	1 TB
Gold 6238R Processor	2.2 GHz	28	38.5 MB	165W	2 @ 10.4 GT/s	2933 MT/s	1 TB
Gold 6230R Processor	2.1 GHz	26	35.75 MB	150W	2 @ 10.4 GT/s	2933 MT/s	1 TB
Gold 6226R Processor	2.9 GHz	16	22.00 MB	150W	2 @ 10.4 GT/s	2933 MT/s	1 TB
Gold 6208U Processor	2.9 GHz	16	22.00 MB	150W	0	2933 MT/s	1 TB
Gold 5220R Processor	2.2 GHz	24	35.75 MB	150W	2 @ 10.4 GT/s	2666 MT/s	1 TB
Gold 5218R Processor	2.1 GHz	20	27.50 MB	125W	2 @ 10.4 GT/s	2666 MT/s	1 TB
Silver Processors							
Silver 4215R Processor	3.2 GHz	8	11.00 MB	130W	2 @ 9.6 GT/s	2400 MT/s	1 TB
Silver 4214R Processor	2.4 GHz	12	16.50 MB	100W	2 @ 9.6 GT/s	2400 MT/s	1 TB
Silver 4210R Processor	2.4 GHz	10	13.75 MB	100W	2 @ 9.6 GT/s	2400 MT/s	1 TB
Bronze Processors							
Bronze 3206R Processor	1.9 GHz	8	11.00 MB	85W	2 @ 9.6 GT/s	2133 MT/s	1 TB

Standard Features

Notes:

- Refreshing Intel Second Generation Xeon® Scalable Processors Gold 6 & 5, Silver and Bronze segments.
- Gold – 6200 Series – 2 Socket supports 3 UPI links at 10.4 GT/s, supports 6-Channel DDR4 @ 2933 MT/s at 1DPC and 2666 MT/s at 2DPC, providing up to 1 TB memory capacity per socket (2 TB and 4.5 TB on select processor skus and if DCPMM is selected). Intel Turbo Boost Technology, Intel Hyper-Threading Technology supported. Intel AVX-512 (2x 512-bit FMA), 48 lanes PCIe 3.0, Node Controller Support, advanced RAS, VNNI/DL Boost.
- For 6256 & 6250/6250L, there are specific ambient temp. requirements per system thermal configuration setting. Refer to the Thermal Configuration table below for detail.

Processor	Thermal Configuration & Ambient Temp. Requirement			
	Optimal Cooling	Increased Cooling	Maximum Cooling	Enhanced CPU Cooling
Gold 6256	Not supported	25C	30C	25C
Gold 6250	Not supported	24C	29C	24C
Gold 6250L	Not supported	24C	29C	24C

Remark: The thermal configuration setting can be adjusted via the RBSU tool.

- Gold – 5200 Series – 2 Socket supports 2 UPI links at 10.4 GT/s, supports 6-Channel DDR4 @ 2666 MT/s providing up to 1 TB memory capacity per socket (2 TB and 4.5 TB on select processor skus and if DCPMM is selected). Intel Turbo Boost Technology, Intel Hyper-Threading Technology, Intel AVX-512 (1x 512-bit FMA) (SKU 5222 supports 2x 512 bit FMA), 48 lanes PCIe 3.0, advanced RAS supported, VNNI/DL Boost.
- Silver – 4200 Series – 2 Socket supports 2 UPI links @ 9.6 GT/s, 6-Channel DDR4 @ 2400 MT/s providing up to 1 TB memory capacity per socket. Intel Turbo Boost Technology, Intel Hyper-Threading Technology, Intel AVX-512(1x 512-bit FMA), 48 lanes PCIe 3.0, standard RAS supported, VNNI/DL Boost.
- Bronze – 3200 Series – 2 Socket supports 2 UPI links @ 9.6 GT/s, supports 6-Channel DDR4 @ 2133 MT/s providing up to 1 TB memory capacity per socket. Intel AVX-512 (1x 512-bit FMA), 48 lanes PCIe 3.0, standard RAS supported, VNNI/DL Boost.
- The “memory per socket” info shown in the table above is the processor specification. Max. memory capacity supported in ML350 at Gen10 Intel Second Generation Intel Xeon® Scalable Processor launch is 3 TB – 2 sockets populated with select processors and 128GB DDR4 DIMMs, which counts with DDR4 memory only. Support of larger than 3 TB will be at post launch.

Intel Second Generation Xeon® Scalable Processors							
Intel Xeon Models	CPU Frequency	Cores	L3 Cache	Power	UPI	DDR4	Memory per socket
Platinum Processors							
Platinum 8280L Processor	2.7 GHz	28	38.50 MB	205W	3 @ 10.4 GT/s	2933 MT/s	4.5 TB
Platinum 8280M Processor	2.7 GHz	28	38.50 MB	205W	3 @ 10.4 GT/s	2933 MT/s	2 TB
Platinum 8280 Processor	2.7 GHz	28	38.50 MB	205W	3 @ 10.4 GT/s	2933 MT/s	1 TB
Platinum 8276L Processor	2.2 GHz	28	38.50 MB	165W	3 @ 10.4 GT/s	2933 MT/s	4.5 TB
Platinum 8276M Processor	2.2 GHz	28	38.50 MB	165W	3 @ 10.4 GT/s	2933 MT/s	2 TB
Platinum 8276 Processor	2.2 GHz	28	38.50 MB	165W	3 @ 10.4 GT/s	2933 MT/s	1TB
Platinum 8270 Processor	2.6 GHz	26	35.75 MB	205W	3 @ 10.4 GT/s	2933 MT/s	1 TB
Platinum 8268 Processor	2.9 GHz	24	35.75 MB	205W	3 @ 10.4 GT/s	2933 MT/s	1 TB
Platinum 8260L Processor	2.4 GHz	24	35.75 MB	165W	3 @ 10.4 GT/s	2933 MT/s	4.5 TB
Platinum 8260M Processor	2.4 GHz	24	35.75 MB	165W	3 @ 10.4 GT/s	2933 MT/s	2 TB
Platinum 8260Y Processor	2.4 GHz	24/20/ 16	35.75 MB	165W	3 @ 10.4 GT/s	2933 MT/s	1 TB
Platinum 8260 Processor	2.4 GHz	24	35.75 MB	165W	3 @ 10.4 GT/s	2933 MT/s	1 TB
Platinum 8256 Processor	3.8 GHz	4	16.50 MB	105W	3 @ 10.4 GT/s	2933 MT/s	1 TB
Platinum 8253 Processor	2.2 GHz	16	22.00 MB	125W	3 @ 10.4 GT/s	2933 MT/s	1 TB

Standard Features

Gold Processors							
Gold 6262V Processor	1.9 GHz	24	33.00 MB	135W	3 @ 10.4 GT/s	2400 MT/s	1 TB
Gold 6254 Processor	3.1 GHz	18	24.75 MB	200W	3 @ 10.4 GT/s	2933 MT/s	1 TB
Gold 6252N Processor	2.3 GHz	24	35.75 MB	150W	3 @ 10.4 GT/s	0	
Gold 6252 Processor	2.1 GHz	24	35.75 MB	150W	3 @ 10.4 GT/s	2933 MT/s	1 TB
Gold 6248 Processor	2.5 GHz	20	27.50 MB	150W	3 @ 10.4 GT/s	2933 MT/s	1 TB
Gold 6246 Processor	3.3 GHz	12	24.75 MB	165W	3 @ 10.4 GT/s	2933 MT/s	1 TB
Gold 6244 Processor	3.6 GHz	8	24.75 MB	150W	3 @ 10.4 GT/s	2933 MT/s	1 TB
Gold 6242 Processor	2.8 GHz	16	22.00 MB	150W	3 @ 10.4 GT/s	2933 MT/s	1 TB
Gold 6240L Processor	2.6 GHz	18	24.75 MB	150W	3 @ 10.4 GT/s	2933 MT/s	4.5 TB
Gold 6240M Processor	2.6 GHz	18	24.75 MB	150W	3 @ 10.4 GT/s	2933 MT/s	2 TB
Gold 6240 Processor	2.6 GHz	18	24.75 MB	150W	3 @ 10.4 GT/s	2933 MT/s	1 TB
Gold 6238L Processor	2.1 GHz	22	27.50 MB	140W	3 @ 10.4 GT/s	2933 MT/s	4.5 TB
Gold 6238M Processor	2.1 GHz	22	27.50 MB	140W	3 @ 10.4 GT/s	2933 MT/s	2 TB
Gold 6238 Processor	2.1 GHz	22	27.50 MB	140W	3 @ 10.4 GT/s	2933 MT/s	1 TB
Gold 6234 Processor	3.3 GHz	8	24.75 MB	130W	3 @ 10.4 GT/s	2933 MT/s	1 TB
Gold 6230 Processor	2.1 GHz	20	27.50 MB	125W	3 @ 10.4 GT/s	2933 MT/s	1 TB
Gold 6226 Processor	2.7 GHz	12	19.25 MB	125W	3 @ 10.4 GT/s	2933 MT/s	1 TB
Gold 6222V Processor	1.8 GHz	20	27.50 MB	115W	3 @ 10.4 GT/s	2933 MT/s	1 TB
Gold 6212U Processor	2.4 GHz	24	35.75 MB	165W	0	2933 MT/s	1 TB
Gold 6210U Processor	2.5 GHz	20	27.50 MB	150W	0	2933 MT/s	1 TB
Gold 6209U Processor	2.1 GHz	20	27.50 MB	125W	0	2933 MT/s	1 TB
Gold 5222 Processor	3.8 GHz	4	16.50 MB	105W	2 @ 10.4 GT/s	2933 MT/s	1 TB
Gold 5220 Processor	2.2 GHz	18	24.75 MB	125W	2 @ 10.4 GT/s	2666 MT/s	1 TB
Gold 5218 Processor	2.3 GHz	16	22.00 MB	125W	2 @ 10.4 GT/s	2666 MT/s	1 TB
Gold 5218B Processor	2.3 GHz	16	22.00 MB	125W	2 @ 10.4 GT/s	2666 MT/s	1 TB
Gold 5217 Processor	3.0 GHz	8	11.00 MB	115W	2 @ 10.4 GT/s	2666 MT/s	1 TB
Gold 5215L Processor	2.5 GHz	10	13.75 MB	85W	2 @ 10.4 GT/s	2666 MT/s	4.5 TB
Gold 5215M Processor	2.5 GHz	10	13.75 MB	85W	2 @ 10.4 GT/s	2666 MT/s	2 TB
Gold 5215 Processor	2.5 GHz	10	13.75 MB	85W	2 @ 10.4 GT/s	2666 MT/s	1 TB
Silver Processors							
Silver 4216 Processor	2.1 GHz	16	22.00 MB	100W	2 @ 9.6 GT/s	2400 MT/s	1 TB
Silver 4215 Processor	2.5 GHz	8	11.00 MB	85W	2 @ 9.6 GT/s	2400 MT/s	1 TB
Silver 4214 Processor	2.2 GHz	12	16.50 MB	85W	2 @ 9.6 GT/s	2400 MT/s	1 TB
Silver 4210 Processor	2.2 GHz	10	13.75 MB	85W	2 @ 9.6 GT/s	2400 MT/s	1 TB
Silver 4208 Processor	2.1 GHz	8	11.00 MB	85W	2 @ 9.6 GT/s	2400 MT/s	1 TB
Bronze Processors							
Bronze 3204 Processor	1.9 GHz	6	8.25 MB	85W	2 @ 9.6 GT/s	2133 MT/s	1 TB

Notes:

- Platinum – 8200 Series – 2 Socket supports 3 UPI links at 10.4 GT/s, supports 6-Channel DDR4 @ 2933 MT/s at 1DPC and 2666 MT/s at 2DPC, providing up to 1 TB memory capacity per socket (2 TB and 4.5 TB on select processor skus and if DCPMM is selected.). Intel Turbo Boost Technology, Intel Hyper-Threading Technology supported. Intel AVX-512 (2x 512-bit FMA), 48 lanes PCIe 3.0, Node Controller Support, advanced RAS, VNNI/DL Boost.
- Gold – 6200 Series – 2 Socket supports 3 UPI links at 10.4 GT/s, supports 6-Channel DDR4 @ 2933 MT/s at 1DPC and 2666 MT/s at 2DPC, providing up to 1 TB memory capacity per socket (2 TB and 4.5 TB on select processor skus and if DCPMM is selected). Intel Turbo Boost Technology, Intel Hyper-Threading Technology supported. Intel AVX-512 (2x 512-bit FMA), 48 lanes PCIe 3.0, Node Controller Support, advanced RAS, VNNI/DL Boost.
- Gold – 5200 Series – 2 Socket supports 2 UPI links at 10.4 GT/s, supports 6-Channel DDR4 @ 2666 MT/s (SKU 5222=supports 2933 @1DPC) providing up to 1 TB memory capacity per socket (2 TB and 4.5 TB on select processor skus and if DCPMM is selected). Intel Turbo Boost Technology, Intel Hyper-Threading Technology, Intel AVX-512 (1x 512-bit FMA) (SKU 5222 supports 2x 512 bit FMA), 48 lanes PCIe 3.0, advanced RAS supported, VNNI/DL Boost.

Standard Features

- Silver – 4200 Series – 2 Socket supports 2 UPI links @ 9.6 GT/s, 6-Channel DDR4 @ 2400 MT/s providing up to 1 TB memory capacity per socket. Intel Turbo Boost Technology, Intel Hyper-Threading Technology, Intel AVX-512(1x 512-bit FMA), 48 lanes PCIe 3.0, standard RAS supported, VNNI/DL Boost.
- Bronze – 3200 Series – 2 Socket supports 2 UPI links @ 9.6 GT/s, supports 6-Channel DDR4 @ 2133 MT/s providing up to 1 TB memory capacity per socket. Intel AVX-512 (1x 512-bit FMA), 48 lanes PCIe 3.0, standard RAS supported, VNNI/DL Boost.
- The “memory per socket” info shown in the table above is the processor specification. Max. memory capacity supported in ML350 at Gen10 Intel Second Generation Intel Xeon® Scalable Processor launch is 3 TB – 2 sockets populated with select processors and 128GB DDR4 DIMMs, which counts with DDR4 memory only. Support of larger than 3 TB will be at post launch.
- For Intel Xeon® Scalable Processor family SKU numbering convention, refer to the chart below.

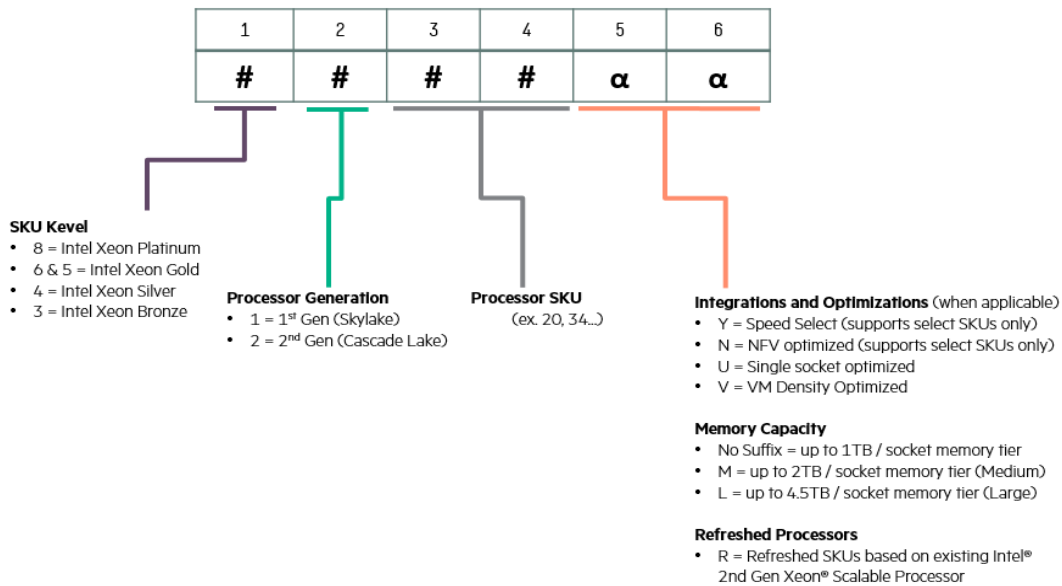

Chipset

Intel C622 Chipset

Notes: For more information regarding Intel® chipsets, please see the following

URL: <http://www.intel.com/products/server/chipsets/>

On System Management Chipset

HPE iLO 5 ASIC

Notes: Read and learn more in the [iLO QuickSpecs](#).

Memory

One of the following depending on model.

Type:	HPE DDR4 SmartMemory, Registered (RDIMM)	Load Reduced (LRDIMM)
DIMM Slots Available	24	12 DIMM slots per processor, 6 channels per processor, 2 DIMMs per channel
Maximum capacity (LRDIMM)	3 TB	24 x 128 GB LRDIMM @ 2933 MT/s
Maximum capacity (RDIMM)	1.5 TB	24 x 64 GB RDIMM @ 2933 MT/s

Notes:

- The maximum memory by socket is limited by the processor selection.
- Mixing of RDIMM and LRDIMM memory is not supported.



Standard Features

Memory Protection

For details on the HPE Server Memory Options RAS feature, visit: <http://www.hpe.com/docs/memory-ras-feature>.

Expansion Slots

Slots #	Technology	Bus Width	Connector Width	Slot Form Factor	Notes
1	PCIe 3.0	X16	X16	Full-height,full-length slot	Proc 1
2	PCIe 3.0	X4	X8	Full-height,full-length slot	Proc 1
3	PCIe 3.0	X16	X16	Full-height,full-length slot	Proc 1
4	PCIe 3.0	X4	X8	Full-height,full-length slot	Proc 1

Notes:

- Bus Width Indicates the number of physical electrical lanes running to the connector.
- Slot 4 is routed from the PCH.

Slots #	Technology	Bus Width	Connector Width	Slot Form Factor	Notes
5	PCIe 3.0	X16	X16	Full-height,full-length slot	Proc 2
6	PCIe 3.0	X8	X8	Full-height,full-length slot	Proc 2
7	PCIe 3.0	X16	X16	Full-height,full-length slot	Proc 2
8	PCIe 3.0	X8	X8	Full-height,full-length slot	Proc 2

Notes:

- Bus Width Indicates the number of physical electrical lanes running to the connector.
- Max. 8 PCIe slots are available on the ML350 Gen10.

Storage Controllers

The Gen10 controller naming framework has been updated to simplify identification as depicted below. For a more detailed breakout of the available Gen10 Smart Array controllers visit the [HPE Smart Array Gen10 Controllers Data Sheet](#).

One of the following depending on model.

Software RAID

HPE Smart Array S100i SR Gen10 SW RAID

Notes:

- HPE Smart Array S100i SR Gen10 SW RAID will operate in UEFI mode only. For legacy support an additional controller will be needed, and for CTO orders please also select the Legacy mode settings part, 758959-B22.
- HPE Smart Array S100i SR Gen10 SW RAID is off by default and must be enabled.
- HPE Smart Array S100i SR Gen10 Software RAID, supporting 6Gb/s SATA, is an entry-level solution for supporting RAID 0, 1, 5, and 10 on SATA drives connected to the embedded SATA ports on the system board.
- Customers using Linux and VMware can use the embedded SATA ports in AHCI mode. In AHCI mode S100i Software RAID is not enabled.
- The S100i only supports Windows. For Linux users, HPE offers a solution that uses in-distro open-source software to create a two-disk RAID 1 boot volume. For more information visit: <https://downloads.linux.hpe.com/SDR/project/lsrrb/>



Standard Features

Essential RAID Controller

- HPE Smart Array E208i-a SR Gen10 Controller
- HPE Smart Array E208i-p SR Gen10 Controller
- HPE Smart Array E208e-p SR Gen10 Controller

Performance RAID Controller

- HPE Smart Array P408i-a SR Gen10 Controller
- HPE Smart Array P408i-p SR Gen10 Controller
- HPE Smart Array P408e-p SR Gen10 Controller
- HPE Smart Array P816i-a SR Gen10 Controller
- HPE Smart Array P824i-p MR Gen10 Controller

Notes:

- Performance RAID Controllers require the HPE Smart Storage Battery (P01367-B21) or HPE Smart Storage Hybrid Capacitor (P02381-B21) which is sold separately.
- Separate cable kit will be required depending on configuration requirement. Refer to the later section for more information.

Internal Storage Devices

One of the following depending on model

Optical Drive

- Optional slim-line DVD-ROM/DVD-RW up to 1
- Optional half-height (5.25") RDX or tape/LTO devices up to 2

Hard Drive Cages

- 8 SFF Hot-Plug SAS/SATA HDD cages; upgradeable to 24 SFF drives
- 4 LFF Hot-Plug SAS/SATA HDD cages; upgradeable to 12 LFF drives
- 4 LFF Non-Hot-Plug SATA HDD cages; upgradeable to 12 LFF drives
- 8 SFF PCIe NVMe Express Bay; upgradeable to 8 SFF NVMe SSDs

Notes: All Pre-configured Models come with some hard drive blanks installed. Should the customer need additional hard drive blanks, they can order more using either P/N 666987-B21: HPE SFF HDD Blank Kit or P/N 807878-B21: HPE LFF HDD Spade Blank Gen9 Kit. HDD blanks are not needed in the NHP LFF system.

Hard Drives

None ship standard

Maximum Internal Storage

Internal Storage	Capacity	Configuration
Hot Plug SFF SAS	48.0 TB	24 x 2 TB
Hot Plug SFF SATA	48.0 TB	24 x 2 TB
Hot Plug LFF SAS	192.0 TB	12 x 16 TB
Hot Plug LFF SATA	192.0 TB	12 x 16 TB
Hot Plug SFF SAS SSD	184.32 TB	24 x 7.68 TB
Hot Plug SFF SATA SSD	184.32 TB	24 x 7.68 TB
Hot Plug LFF SAS SSD	46.08 TB	12 x 3.84 TB
Hot Plug LFF SATA SSD	46.08 TB	12 x 3.84 TB
Non Hot Plug LFF SATA	48.0 TB	12 x 4 TB
Hot Plug SFF NVMe PCIe SSD	32 TB NVMe	8 x 4 TB NVMe

Notes: NHP LFF SKU supports SATA hard disk drives only.



Standard Features

Interfaces

Serial	1 standard (at system rear)
VGA Port	1 standard (at system rear)
Display Port	1 standard (at system rear)
Notes: The system can support dual monitors on duplication mode thru these standard ports of VGA and Display Port without adding additional graphic cards.	
Embedded Network Ports	4 x 1 Gb ports shipping standard, with optional stand up card
HPE iLO Remote Management Network Port	1 Gb Dedicated
Front iLO Service Port	1 standard
Micro SD Slot	1 Micro SD (internal)
Notes: The Micro SD slot is not a hot-pluggable device. Customers should not attempt to plug an SD card into the SD slot while the server is powered.	
USB 3.0/2.0	6 total, standard: 2 front (USB 3.0), 2 rear (USB 3.0), 2 internal (1 x USB 3.0 & 1 x USB 2.0)

Graphics

Integrated Video Standard

- Video modes up to 1920 x 1200@60Hz (32 bpp)
- 16MB Video Memory

HPE iLO 5 on system management memory

- 32 MB Flash
- 4 Gbit DDR 3 with ECC protection

Embedded Management

HPE Integrated Lights-Out (HPE iLO)

Monitor your servers for ongoing management, service alerting, reporting and remote management with HPE iLO. Learn more at <http://www.hpe.com/info/ilo>.

Operating Systems and Virtualization Software Support for ProLiant Servers

- **Windows Server 2012 R2** (Most Recent Version)
- **Windows Server 2016 LTSC** (Most Recent Version)
- Windows Server 2019 LTSC (Most Recent Version)
- Microsoft Hyper-V Server 2012 R2, 2016 & 2019
- **VMware vSphere 6.0 U3, 6.5 U2 & 6.7 U1**
- **Red Hat Enterprise Linux (RHEL) 7.6 with Kbase (includes KVM) SUSE Linux Enterprise Server (SLES) 12 SP3, 12 SP4, 15,** (includes KVM)
- **ClearOS/ClearVM 7.6, 8.0**

HPE and ClearCenter will help you lower the cost of building on-premise solutions without sacrificing security and ease of use. HPE ProLiant servers with ClearOS give you a simple, secure, and affordable operating system with an intuitive web based graphical user interface that provides a cloud-like experience on-premise, and an Application Marketplace with over 100 apps and growing. Whether you're starting out or scaling, you decide what applications you need and pay as you grow.

Notes: ClearOS allows you to build a fully functional server that is just right for you at no upfront cost.

For more information on ClearOS, please visit <http://www.hpe.com/servers/clearos>.



Standard Features

Power Supply

- HPE 500W Standard Non-Hot-Plug Power Supply Kit

Notes:

- Non Redundant Power Supply
- Available in 92% efficiency and supported in pre-configured models only. This power supply is available in one of the pre-built system SKUs. Customers can still choose to upgrade to HPE Flex Slot RPS later by installing the ML350 Gen10 RPS enablement kit (874571-B21).
- Starting from March 1, 2020, this power supply and the pre-configured server model that carries it inside is
- Orderable in EMEA region due to the new ErP Lot 9 requirement. Please visit:

<https://www.hpe.com/us/en/about/environment/msds-specs-more.html> for more information.

- HPE 500W Flex Slot Platinum Hot Plug Low Halogen Power Supply Kit

Notes: Available in 94% efficiency.

- HPE 800W Flex Slot Platinum Hot Plug Low Halogen Power Supply Kit

Notes:

- Available in 94% and 96% efficiency.
- Also available in -48VDC and 227VAC/380VDC power inputs.

- HPE 1600W Flex Slot Platinum Hot Plug Low Halogen Power Supply Kit

Notes: Available in 94% efficiency.

HPE Flexible Slot (Flex Slot) Power Supplies share a common electrical and physical design that allows for hot plug, tool-less installation into HPE ProLiant Gen10 Performance Servers. Flex Slot power supplies are certified for high-efficiency operation and offer multiple output power options, allowing users to "right-size" a power supply for specific server configurations. This flexibility helps to reduce power waste, lower overall energy costs, and avoid "trapped" power capacity in the data center.

All pre-configured servers ship with a country-specific AC power cord in Tower models; while in the Rack model, a standard 6-foot IEC C-13/C-14 jumper cord (416151-B21) is included. If a different power cord is required, please check the **ProLiant Power Cables** web page.

To review the power requirements for your selected system, please use the **HPE Power Advisor Tool**.

For information on power specifications and technical content visit **HPE Server power supplies**.

HPE Server UEFI/Legacy ROM

Unified Extensible Firmware Interface (UEFI) is an industry standard that provides better manageability and more secured configuration than the legacy ROM while interacting with your server at boot time. HPE ProLiant Gen10 servers have a UEFI Class 2 implementation and support both UEFI Mode (default) and Legacy BIOS Mode.

Notes: The UEFI System Utilities tool is analogous to the HPE ROM-Based Setup Utility (RBSU) of legacy BIOS. For more information, please visit <http://www.hpe.com/servers/uefi>.

UEFI enables numerous new capabilities specific to HPE ProLiant servers such as:

- Secure Boot and Secure Start enable for enhanced security
- Operating system specific functionality
- Support for > 2.2 TB (using GPT) boot drives
- USB 3.0 Stack
- Embedded UEFI Shell
- Mass Configuration Deployment Tool using iLO RESTful API that is Redfish API Conformant
- PXE boot support for IPv6 networks
- Workload Profiles for simple performance optimization



Standard Features

UEFI Boot Mode only:

- TPM 2.0 Support
- NVMe Boot Support
- Platform Trust Technology (PTT) can be enabled.
- iSCSI Software Initiator Support.
- HTTP/HTTPS Boot support as a PXE alternative.
- Boot support for option cards that only support a UEFI option ROM

Notes:

- For UEFI Boot Mode, boot environment and OS image installations should be configured properly to support UEFI.
- UEFI FIO Setting (758959-B22) can be selected to configure the system in Legacy mode in the factory for your HPE ProLiant Gen10 Server.

CentOS 7.6

Notes: CentOS is not directly supported / Community Supported (Based on RHEL so RHEL testing and enablement applicable to CentOS) CentOS 6.9 / CentOS 7.3 / CentOS 7.4.

The HPE Software RAID S100i only supports Windows. For Linux users, HPE offers a solution that uses in-distro open-source software to create a two-disk RAID 1 boot volume. For more information visit:

<https://downloads.linux.hpe.com/SDR/project/lsrrb/>

For more information on Hewlett Packard Enterprise Certified and Supported ProLiant Servers for OS and Virtualization Software and latest listing of software drivers available for your server. <http://www.hpe.com/info/ossupport>

UEFI

Configure and boot your servers securely with industry standard Unified Extensible Firmware Interface (UEFI).

Learn more at <http://www.hpe.com/servers/uefi>

Intelligent Provisioning

Hassle free server and OS provisioning for 1 or more servers with Intelligent Provisioning.

Learn more at <http://www.hpe.com/servers/intelligentprovisioning>

iLO RESTful API

iLO RESTful API is Redfish API conformance and offers simplified server management automation such as configuration and maintenance tasks based on modern industry standards. Learn more at <http://www.hpe.com/info/restfulapi>

Server Utilities

Active Health System

The HPE Active Health System (AHS) is an essential component of the iLO management portfolio that provides continuous, proactive health monitoring of HPE servers. Learn more at <http://www.hpe.com/servers/ahs>

Active Health System Viewer

Use the Active Health System Viewer, a web-based portal, to easily read AHS logs and speed problem resolution with HPE self-repair recommendations, to learn more visit: <http://www.hpe.com/servers/ahsv>

Smart Update

Keep your servers up to date with the HPE Smart Update solution by using Smart Update Manager (SUM) to optimize the firmware and driver updates of the Service Pack for ProLiant (SPP).

Learn more at <https://buy.hpe.com/b2c/us/en/software/infrastructure-management-software/system-server-management-software/hpe-system-server-software-management-software/smart-update-manager-%28sum%29/p/5182020>.



Standard Features

Industry Standard Compliance

- ACPI 6.1 Compliant
- PCIe 3.0 Compliant
- WOL Support
- Microsoft® Logo certifications
- PXE Support
- VGA Display Port
- USB 3.0 Compliant
- USB 2.0 Compliant
- Energy Star
- SMBIOS 3.1
- UEFI 2.6
- Redfish API
- IPMI 2.0
- Secure Digital 2.0
- Advanced Encryption Standard (AES)
- Triple Data Encryption Standard (3DES)
- SNMP v3
- TLS 1.2
- DMTF Systems Management Architecture for Server Hardware Command Line Protocol (SMASH CLP)
- Active Directory v1.0
- ASHRAE A3/A4
Notes: For additional technical thermal details regarding ambient temperatures, humidity and features support please visit: <http://www.hpe.com/servers/ashrae>.
- UEFI (Unified Extensible Firmware Interface Forum)
Notes: UEFI is the default setting for the ML350 Gen10. Legacy mode can be selected in the field or as a CTO option (758959-B22).
- European Union (EU) eco-design regulations for server and storage products, known as ErP Lot 9, go into effect on March 1st, 2020. Among other requirements, for servers this directive establishes power thresholds for idle state, as well as efficiency and performance in active state which vary among configurations. HPE ProLiant Gen10 servers are compliant with Lot9 requirements. Please visit: <https://www.hpe.com/us/en/about/environment/msds-specs-more.html> for more information regarding HPE Lot 9 conformance.

iLO Amplifier Pack

Designed for large enterprise and service provider environments with hundreds of HPE servers, the iLO Amplifier Pack is a free, downloadable open virtual application (OVA) that delivers the power to discover, inventory and update Gen8, Gen9 and Gen10 HPE servers at unmatched speed and scale. Use with an iLO Advanced License to unlock full capabilities.

Learn more at <http://www.hpe.com/servers/iLOamplifierpack>

HPE iLO Mobile Application

Enables the ability to access, deploy, and manage your server anytime from anywhere from select smartphones and mobile devices. For additional information please visit: <http://www.hpe.com/info/ilo/mobileapp>

RESTful Interface Tool

RESTful Interface tool (iLOREST) is a single scripting tool to provision using iLO RESTful API to discover and deploy servers at scale. Learn more at <http://www.hpe.com/info/resttool>

Scripting Tools

Provision one to many servers using your own scripts to discover and deploy with Scripting Tool (STK) for Windows and Linux or Scripting Tools for Windows PowerShell. Learn more at <http://www.hpe.com/servers/powershell>



Standard Features

HPE OneView Standard

HPE OneView Standard can be used for inventory, health monitoring, alerting, and reporting without additional fees. It can monitor multiple HPE server generations. The user interface is similar to the HPE OneView Advanced version, but the software-defined functionality is not available. Learn more at <http://www.hpe.com/info/oneview>.

HPE Systems Insight Manager (HPE SIM)

Ideal for environments already using HPE SIM, it allows you to monitor the health of your HPE ProLiant Servers and HPE Integrity Servers. Also provides you with basic support for non-HPE servers. HPE SIM also integrates with Smart Update Manager to provide quick and seamless firmware updates. Learn more at <http://www.hpe.com/info/hpesim>.

Security

- Server Configuration Lock – protect systems in transit (new iLO security feature thru iLO Advanced)
 - Security Dashboard (new), standard
 - UEFI Secure Boot and Secure Start support
 - Immutable Silicon Root of Trust
 - FIPS 140-2 validation
 - Common Criteria certification
 - Configurable for PCI DSS compliance
 - Advanced Encryption Standard (AES) and Triple Data Encryption Standard (3DES) on browser
 - Support for Commercial National Security Algorithms (CNSA)
 - Tamper-free updates – components digitally signed and verified
 - Secure Recovery – recover critical firmware to known good state on detection of compromised firmware
 - Ability to rollback firmware
 - One Button Secure Erase – secure erase of NAND/User data back to factory defaults
 - TPM (Trusted Platform Module) 1.2 option
 - TPM (Trusted Platform Module) 2.0 option
 - Front bezel key-lock feature – standard, available in both Tower and Rack models
 - Padlock slot, standard
 - Kensington Lock slot, standard
-

Warranty

This product is covered by a global limited warranty and supported by HPE Services and a worldwide network of HPE Authorized Channel Partners resellers. Hardware diagnostic support and repair is available for three years from date of purchase. Support for software and initial setup is available for 90 days from date of purchase. Enhancements to warranty services are available through HPE Pointnext operational services or customized service agreements. Hard drives have either a one year or three year warranty; refer to the specific hard drive QuickSpecs for details.

Notes: Server Warranty includes 3-Year Parts, 3-Year Labor, 3-Year Onsite support with next business day response. Warranty repairs may be accomplished through the use of Customer Self Repair (CSR) parts. These parts fall into two categories: 1) Mandatory CSR parts are designed for easy replacement. A travel and labor charge will result when customers decline to replace a Mandatory CSR part; 2) Optional CSR parts are also designed for easy replacement but may involve added complexity. Customers may choose to have Hewlett Packard Enterprise replace Optional CSR parts at no charge. 3) Non CSR parts must be serviced by a trained authorized service engineer. Additional information regarding worldwide limited warranty and technical support is available at: <http://h17007.www1.hpe.com/us/en/enterprise/servers/warranty/>.



Optional Features

Server Management

HPE iLO Advanced

HPE iLO Advanced licenses offer smart remote functionality without compromise, for all HPE ProLiant servers. The license includes the full integrated remote console, virtual keyboard, video, and mouse (KVM), multi-user collaboration, console record and replay, and GUI-based and scripted virtual media and virtual folders. You can also activate the enhanced security and power management functionality.

HPE OneView Advanced-

HPE OneView brings a new level of automation to infrastructure management by taking a template driven approach to provisioning, updating, and integrating compute, storage, and networking infrastructure. It provides full-featured licenses which can be purchased for managing Gen8, Gen9 and Gen10 servers. To learn more visit <http://www.hpe.com/info/oneview>.

HPE InfoSight for Servers

HPE InfoSight for Servers combines the cloud-based machine learning of InfoSight with the health and performance monitoring of Active Health System (AHS) and iLO to optimize performance and predict and prevent problems. The end result is an intelligent environment that modernizes IT operations and enhances the support experience by predicting and preventing the infrastructure issues that lead to application disruptions, wasted IT staff time and missed business opportunities.

Learn more at <https://www.hpe.com/servers/infosight>

HPE Insight Cluster Management Utility (CMU)

HPE Insight Cluster Management Utility is a HyperScale management framework that includes software for the centralized provisioning, management and monitoring of nodes and infrastructure. Learn more at <http://www.hpe.com/info/cmu>.

Accelerator and GPGPU Information

Hewlett Packard Enterprise supports various accelerators on select HPE ProLiant servers to support different workloads. The accelerators enable seamless integration of GPU computing with HPE ProLiant servers for high-performance computing, large data center graphics, deep learning and virtual desktop deployments. These accelerators deliver all of the standard benefits of GPU computing while enabling maximum reliability and tight integration with system monitoring and management tools such as HPE Insight Cluster Management Utility.

Rack and Power Infrastructure

The story may end with servers, but it starts with the foundation that makes compute go – and business grow. We've reinvented our entire portfolio of rack and power products to make IT infrastructure more secure, more practical, and more efficient. In other words, we've created a stronger, smarter, and simpler infrastructure to help you get the most out of your IT equipment. As an industry leader, Hewlett Packard Enterprise is uniquely positioned to address the key concerns of power, cooling, cable management and system access.

HPE G2 Advanced and Enterprise Racks are perfect for the server room or today's modern data center with enhanced airflow and thermal management, flexible cable management, and a 10 year Warranty to support higher density computing.

HPE G2 PDUs offer reliable power in flexible form factors that operate at temperatures up to 60°, include color-coded outlets and load segments and a low-profile design for optimal access to the rack and support for dense rack environments.

HPE Uninterruptible Power Systems are cost-effective power protection for any type workload. Some UPSs include options for remote management and extended runtime modules so your critical dense data center is covered in power outages.

HPE KVM Solutions include a console and switches designed to work with your server and IT equipment reliably. We've got a cost-effective KVM switch for your first rack and multiple connection IP switches with remote management and security capabilities to keep your data center rack up and running.

Learn more about HPE Racks, KVM, PDUs and UPSs at [HPE Rack and Power Infrastructure](#).



Optional Features

One Config Simple (SCE)

SCE is a guided self-service tool to help sales and non-technical people provide customers with initial configurations in 3 to 5 minutes. You may then send the configuration on for configuration help, or use in your existing ordering processes. If you require "custom" rack configuration or configuration for products not available in SCE, please contact Hewlett Packard Enterprise Customer Business Center or an Authorized Partner for assistance.

<https://h22174.www2.hpe.com/SimplifiedConfig/Welcome>



Service and Support

HPE Pointnext - Service and Support

Protect your business beyond warranty with HPE Pointnext Operational Service

HPE Pointnext provides a comprehensive portfolio including Advisory and Transformational, Professional, and Operational Services to help accelerate your digital transformation. From the onset of your transformation journey, Advisory and Transformational Services focus on designing the transformation and creating a solution roadmap. Professional Services specializes in creative configurations with flawless and on-time implementation, and on-budget execution. Finally, operational services provides innovative new approaches like Flexible Capacity and Datacenter Care, to keep your business at peak performance. HPE is ready to bring together all the pieces of the puzzle for you, with an eye on the future, and make the complex simple.

Connect your devices:

Unlock all of the benefits of your technology investment by connecting your products to Hewlett Packard Enterprise. Achieve up to 77%¹ reduction in down time, near 100%² diagnostic accuracy and a single consolidated view of your environment. By connecting, you will receive 24x7 monitoring, pre-failure alerts, automatic call logging, and automatic parts dispatch. HPE Proactive Care Service and HPE Datacenter Care Service customers will also benefit from proactive activities to help prevent issues and increase optimization. All of these benefits are already available to you with your server storage and networking products, securely connected to HPE support.

Notes:

- ¹IDC
- ²HP CSC reports 2014 – 2015

Learn more about getting connected at <http://www.hpe.com/services/getconnected>.

Recommended Services

HPE Proactive Care* with 6 hour call-to-repair commitment, three year Support Service

HPE Proactive Care gives customers an enhanced call experience. When your products are connected to HPE, Proactive Care helps prevent problems and maintains IT stability by utilizing personalized proactive reports with recommendations and advice. This Service combines three years' proactive reporting and advice with our highest level of hardware support - HPE's 24x7, six hour hardware call-to-repair. HPE is the only leading manufacturer who makes this level of coverage available as a standard service offering for your most valuable servers. This service also includes collaborative software support for Independent Software Vendors (ISVs), (Red Hat, VMWare, Microsoft, etc.) running on your HPE servers.

<https://www.hpe.com/h20195/v2/GetPDF.aspx/4AA3-8855ENW.pdf>

HPE Proactive Care* with 24x7 coverage, three year Support Service

HPE Proactive Care gives customers an enhanced call experience. When your products are connected to HPE, Proactive Care helps prevent problems and maintains IT stability by utilizing personalized proactive reports with recommendations and advice. This Service combines three years proactive reporting and advice with our 24x7 coverage, four hour hardware response time when there is a problem. This service also includes collaborative software support for Independent Software Vendors (ISVs), (Red Hat, VMWare, Microsoft, etc.) running on your HPE servers. [https://www.hpe.com/h20195/v2/GetPDF.aspx/4AA3-](https://www.hpe.com/h20195/v2/GetPDF.aspx/4AA3-8855ENW.pdf)

[8855ENW.pdf](https://www.hpe.com/h20195/v2/GetPDF.aspx/4AA3-8855ENW.pdf)

HPE Proactive Care* - Next Business Day service, three year Support Service

HPE Proactive Care gives customers an enhanced call experience. When your products are connected to HPE, Proactive Care helps prevent problems and maintains IT stability by utilizing personalized proactive reports with recommendations and advice. This service combines three years of Hardware Support where an HPE authorized representative will arrive at the Customer's site during the onsite coverage window to begin hardware maintenance service the next coverage day after the service request has been logged. This service also includes collaborative software support for Independent Software Vendors (ISVs), (Red Hat, VMWare, Microsoft, etc.) running on your HPE servers. <https://www.hpe.com/h20195/v2/GetPDF.aspx/4AA3-8855ENW.pdf>

Notes: *HPE Proactive Care and HPE Proactive Care Advanced require that the customer connect their devices to make the most of these services and receive all the deliverables.



Service and Support

Other related Services

HPE Server Hardware Installation

Provides for the basic hardware installation of HPE branded servers, storage devices and networking options to assist you in bringing your new hardware into operation in a timely and professional manner.

<https://www.hpe.com/h20195/V2/GetPDF.aspx/5981-9356ENW.pdf>

HPE Installation and Startup Service

Provides for the installation of your HPE hardware according to product specifications including options. The HPE service delivery technician will connect the product to a LAN as appropriate and enable remote support to allow for automatic case creation for hardware failures. Installation and start up services also includes the installation of one supported operating system type (Windows® or Linux).

HPE Datacenter Care service

HPE Datacenter Care helps improve IT stability and security, increase the value of IT, and enable agility and innovation. It is a structured framework of repeatable, tested, and globally available services “building blocks.” You can deploy, operate, and evolve your datacenter wherever you are on your IT journey. With HPE Datacenter Care, you benefit from a personalized relationship with HPE via a single point of accountability for HPE and others’ products.

For more information, visit <http://www.hpe.com/services/datacentercare>

HPE GreenLake Flex Capacity

With HPE GreenLake Flex Capacity, you get the speed, scalability, and economics of the public cloud in the privacy of your data center. Gain the advantages of the public cloud—consumption-based payment, rapid scalability without worrying about capacity constraints. Reduce the “heavy lifting” needed to operate a data center. And retain the advantages that IT provides the business (i.e., control, security). Deliver the right user experience, choose the right technology for the business, manage privacy and compliance, and manage the cost of IT. And, you have the option to use the public cloud when needed.

DC for Hyperscale

Datacenter Care for Hyperscale is available for Service Providers and HPC customers who use a scale out approach to computing with a high volume homogenous infrastructure and resilient architecture can take advantage of this environment support tailored to their operating model.

HPE Factory Express for Servers and storage

HPE Factory Express offers configuration, customization, integration and deployment services for HPE servers and storage products. Customers can choose how their factory solutions are built, tested, integrated, shipped and deployed.

Factory Express offers service packages for simple configuration, racking, installation, complex configuration and design services as well as individual factory services, such as image loading, asset tagging, and custom packaging. HPE products supported through Factory Express include a wide array of servers and storage: HPE Integrity, HPE ProLiant, HPE Apollo, HPE ProLiant Server Blades, HPE BladeSystem, HPE 9000 servers as well as the MSAxxxx3PAR suite, XP, rackable tape libraries and configurable network switches.

HPE Service Credits

HPE Service Credits offers flexible services and technical skills to meet your changing IT demands. With a menu of service that is tailored to suit your needs, you get additional resources and specialist skills to help you maintain peak performance of your IT. Offered as annual credits, you can plan your budgets while proactively responding to your dynamic business.

HPE Education Services

Keep your IT staff trained making sure they have the right skills to deliver on your business outcomes. Book on a class today and learn how to get the most from your technology investment. <http://www.hpe.com/ww/learn>



Service and Support

HPE Support Center

The HPE Support Center is a personalized online support portal with access to information, tools and experts to support HPE business products. Submit support cases online, chat with HPE experts, access support resources or collaborate with peers.

Learn more <http://www.hpe.com/support/hpesc>.

HPE's Support Center Mobile App* allows you to resolve issues yourself or quickly connect to an agent for live support. Now, you can get access to personalized IT support anywhere, anytime.

HPE Insight Remote Support and HPE Support Center are available at no additional cost with a HPE warranty, HPE Support Service or HPE contractual support agreement.

Notes:*HPE Support Center Mobile App is subject to local availability.

For more information: <http://www.hpe.com/services>.

Notes: HPE ProLiant ML350 Gen10 Server is covered under the HPE Service Contract applied to the HPE ProLiant Server. No separate HPE support services need to be purchased.

Warranty and Support Services will extend to include HPE options configured with your server or storage device. The price of support service is not impacted by configuration details. HPE sourced options that are compatible with your product will be covered under your server support at the same level of coverage allowing you to upgrade freely. Installation for HPE options is available as needed. To keep support costs low for everyone, some high value options will require additional support. Additional support is only required on select high value workload accelerators, fibre switches, InfiniBand and UPS batteries over 12KVA. See the specific high value options that require additional support. [here](#).

Parts and Materials

Hewlett Packard Enterprise will provide HPE-supported replacement parts and materials necessary to maintain the covered hardware product in operating condition, including parts and materials for available and recommended engineering improvements.

Parts and components that have reached their maximum supported lifetime and/or the maximum usage limitations as set forth in the manufacturer's operating manual, product quick-specs, or the technical product data sheet will not be provided, repaired, or replaced as part of these services.

The defective media retention service feature option applies only to Disk or eligible SSD/Flash Drives replaced by Hewlett Packard Enterprise due to malfunction.



Pre-configured Models

For the Standard Features shipped in the "Factory Integrated Models", please see the "Configuration Information - Factory Integrated Models" section.

1. Pre-configured models ship with the configurations below. Options can be selected from the Core or Additional options section of this QuickSpecs.
2. Hewlett Packard Enterprise does not allow factory integration of options into pre-configured models. Any additional options purchased will be shipped separately.
3. If you desire a custom configuration please see "Configuration Information - Factory Integrated Models" section of this QuickSpecs

Notes: European Union (EU) eco-design regulations for server and storage products, known as Lot 9, go into effect on March 1st, 2020. Among other requirements, for servers this directive establishes power thresholds for idle state, as well as efficiency and performance in active state which vary among configurations. HPE ProLiant Gen10 servers are compliant with Lot9 requirements. For more information regarding HPE Lot 9 conformance, please visit:

<https://www.hpe.com/us/en/about/environment/msds-specs-more.html>

The Second Generation Intel Xeon® Scalable Processor-based WW BTO SKUs – Refresh			
	Entry LFF Model	Base SFF Model	Base SFF Model
SMB Offer – BASE	Performance 1	Performance 2	Performance 3
[SKU Number]	P21786-xx1	P22094-xx1	P21788-xx1
Localization	US, EU, AP, Japan & China	US, EU, AP, Japan & China	US, EU, AP, Japan & China
Model Name	HPE ML350 Gen10 3206R 1P 16G 4LFF S100i 500W FS RPS Entry Tower Server	HPE ML350 Gen10 4208 1P 16G 8SFF P408i-a 800W FS RPS Base Tower Server	HPE ML350 Gen10 4210R 1P 16G 8SFF P408i-a 800W FS RPS Base Tower Server
Processor	3206R (8-Core, 1.9 GHz, 85W)	4208 (8-Core, 2.1 GHz, 85W)	4210R (10-Core, 2.4 GHz, 100W)
Number of Processors	One processor		
	Notes: Add HPE ML350 Gen10 Xeon-B 3206R Kit (P19789-B21) for 2 nd processor upgrade.	Notes: Add HPE ML350 Gen10 Xeon-S 4208 Kit (P10938-B21) for 2 nd processor upgrade.	Notes: Add HPE ML350 Gen10 Xeon-S 4210R Kit (P19791-B21) for 2 nd processor upgrade.
Memory	16 GB RDIMM SR 2933 MT/s (1x 16 GB) Notes: running at 2133 MT/s per processor support	16 GB RDIMM SR 2933 MT/s (1x 16 GB) Notes: running at 2400 MT/s per processor support	
Network Controller	Embedded 4-Port 1GbE HPE Ethernet 1Gb 4-port 369i Adapter Notes: embedded 4x1GbE HPE Ethernet 1Gb 4-port 369i Adapter does not support speeds of 100MB/s and 10MB/s.		
Storage Controller	Embedded 14-Port S100i Notes: <ul style="list-style-type: none"> – SATA only. – The HPE ML350 Gen10 LFF Embedded SATA Cable Kit (877578-B21) is required when upgrading to add the 2nd and 3rd HDD cage kit, using S100i controller. – Field upgradeable to SAS by selecting HPE modular Smart Array controller. 	P408i-a Notes: <ul style="list-style-type: none"> – 8-Port Modular Smart Array. Supports SAS/SATA with performance RAID – Smart Storage battery included. 	
Hard Drive	None ship as standard		



Pre-configured Models

Internal Storage	4 LFF HP Chassis with optional 4 LFF HDD Cage Kit (874566-B21) to be selected. Upgradeable to 12 LFF max. Notes: <ul style="list-style-type: none"> The HPE ML350 Gen10 LFF Embedded SATA Cable Kit (877578-B21) is required when upgrading to add the 2nd and 3rd HDD cage kits, using S100i controller. Now the system can support mixed LFF and SFF HDD cages in one system. The optional SFF HDD Cage Kit part number is 874568-B21. If the max. number of drives are installed in all three drive boxes, the redundant fan cage kit (874572-B21) is required. 	8 SFF chassis with optional SFF HDD Cage Kit (874568-B21), upgradeable to 24 SFF. Opt. 8 SFF NVMe Express Bay Kit (874569-B21) Notes: Now the system can support mixed SFF and LFF HDD cages in one system. The 4 LFF HDD Cage Kit part number is 874566-B21.
Optical Drive Bay	Optional Slimline ODD Bay Kit (874577-B21) for SATA DVD-ROM/DVD-RW optical drive Optional Media Drive Support Kit (874570-B21) for RDX or tape/LTO devices, up to 2	
Optical Drive	None ship as standard	
PCI-Express Slots	4-slots (x16, x8, x16, x8) as standard Notes: PCIe slots 5 – 8 require the second optional processor.	
Power Supply	1x 500W HPE FlexSlot Power Supply Notes: Add a second 500W FlexSlot power supply to get 1+1 power redundancy feature.	1x 800W HPE FlexSlot Power Supply Notes: Add a second 800W FlexSlot power supply to get 1+1 power redundancy feature.
Fans	2 standard fans; Optional redundant fan cage kit (874572-B21, add'l 4 fans)	6 standard fans
Management	HPE iLO Standard with Intelligent Provisioning (embedded), HPE OneView Standard (requires download); HPE iLO Advanced and HPE OneView Advanced (require licenses)	
Energy Star	2.1 certified	
ErP Lot 9	ErP Lot 9 compliant	
Form Factor	4U Tower Notes: Optional Tower-to-Rack conversion kit (874578-B21) to convert the unit to a 5U Rack-mount server.	
Warranty	3-year parts, 3-year labor, 3-year onsite support with next business day response.	



Pre-configured Models

Performance SFF Tower Model		High Performance Tower Model
SMB Offer – BASE	Performance 4	Performance 5
[SKU Number]	P21789-xx1	P25008-XX1
Localization	US, EU, AP & Japan	US, EU, AP & Japan
Model Name	HPE ML350 Gen10 4214R 1P 32G 8SFF P408i-a 1x800W FS RPS Performance SFF Tower Server	HPE ML350 Gen10 5218R 1P 32G 8SFF P408i-a 2x800W FS RPS High Performance SFF Tower Server
Processor	4214R (12-Core, 2.4 GHz, 100W)	5218R (20-Core, 2.1 GHz, 125W)
Number of Processors	One processor	
	Notes: Add HPE ML350 Gen10 Xeon-S 4214R Kit (P19792-B21) for 2 nd processor upgrade.	Notes: Add HPE ML350 Gen10 Xeon-G 5218R Kit (P24169-B21) for 2 nd processor upgrade.
Memory	32 GB RDIMM DR 2933 MT/s (1x 32 GB) Notes: running at 2400 MT/s per processor support	32 GB RDIMM DR 2933 MT/s (1x 32 GB) Notes: running at 2666 MT/s per processor support
Network Controller	Embedded 4-Port 1GbE HPE Ethernet 1Gb 4-port 369i Adapter Notes: embedded 4x1GbE HPE Ethernet 1Gb 4-port 369i Adapter does not support speeds of 100MB/s and 10MB/s.	
Storage Controller	P408i-a Notes: – 8-Port Modular Smart Array. Supports SAS/SATA with performance RAID – Smart Storage battery included.	
Hard Drive	None ship as standard	
Internal Storage	8 SFF chassis with optional SFF HDD Cage Kit (874568-B21), upgradeable to 24 SFF. Opt. 8 SFF NVMe Express Bay Kit (874569-B21) Notes: Now the system can support mixed SFF and LFF HDD cages in one system. The 4 LFF HDD Cage Kit part number is 874566-B21.	
Optical Drive Bay	Optional Slimline ODD Bay Kit (874577-B21) for SATA DVD-ROM/DVD-RW optical drive Optional Media Drive Support Kit (874570-B21) for RDX or tape/LTO devices, up to 2	
Optical Drive	None ship as standard	
PCI-Express Slots	4-slots (x16, x8, x16, x8) as standard Notes: PCIe slots 5 – 8 require the second optional processor.	
Power Supply	1x 800W HPE FlexSlot Power Supply Notes: Add a second 800W FlexSlot power supply to get 1+1 power redundancy feature.	2x 800W HPE FlexSlot power supply (1+1)
Fans	6 standard fans	
Management	HPE iLO Standard with Intelligent Provisioning (embedded), HPE OneView Standard (requires download); HPE iLO Advanced, and HPE OneView Advanced (require licenses)	
Energy Star	2.1 certified	
ErP Lot 9	ErP Lot 9 Compliant	
Form Factor	4U Tower Notes: Optional Tower-to-Rack conversion kit (874578-B21) to convert the unit to a 5U Rack-mount server.	
Warranty	3-year parts, 3-year labor, 3-year onsite support with next business day response	



Pre-configured Models

The Second Generation Intel Xeon® Scalable Processor-based WW BTO SKUs			
	Sub-Entry NHP LFF Model	Entry LFF Model	Base LFF Model
SMB Offer – BASE	Entry	Performance 1	Performance 2
[SKU Number]	P11048-xx1	P11049-xx1	P11050-xx1
Localization	US, AP & Japan	US, EU, AP, Japan & China	US, EU, AP, Japan & China
Model Name	HPE ML350 Gen10 3204 1P 8G 4LFF NHP S100i 500W PS Sub-Entry Tower Server	HPE ML350 Gen10 3204 1P 16G 4LFF S100i 500W FS RPS Entry Tower Server	HPE ML350 Gen10 4208 1P 16G 4LFF E208i-a 500W FS RPS Base Tower Server
Processor	3204 (6-Core, 1.9 GHz, 85W)	3204 (6-Core, 1.9 GHz, 85W)	4208 (8-Core, 2.1 GHz, 85W)
Number of Processors	One processor		
	Notes: Add HPE ML350 Gen10 Xeon-B 3204 Kit (P10937-B21) for 2 nd processor upgrade.	Notes: Add HPE ML350 Gen10 Xeon-B 3204 Kit (P10937-B21) for 2 nd processor upgrade.	Notes: Add HPE ML350 Gen10 Xeon-S 4208 Kit (P10938-B21) for 2 nd processor upgrade.
Memory	8 GB RDIMM SR 2933 MT/s (1x 8 GB) Notes: running at 2133 MT/s per processor support	16 GB RDIMM SR 2933 MT/s (1x 16 GB) Notes: running at 2133 MT/s per processor support	16 GB RDIMM SR 2933 MT/s (1x 16 GB) Notes: running at 2400 MT/s per processor support
Network Controller	Embedded 4-Port 1GbE HPE Ethernet 1Gb 4-port 369i Adapter Notes: embedded 4x1GbE HPE Ethernet 1Gb 4-port 369i Adapter does not support speeds of 100MB/s and 10MB/s.		
Storage Controller	Embedded 14-Port S100i Notes: – SATA only. – NOT field upgradeable to SAS or hardware RAID capability.	Embedded 14-Port S100i Notes: – SATA only. – The HPE ML350 Gen10 LFF Embedded SATA Cable Kit (877578-B21) is required when upgrading to add the 2 nd and 3 rd HDD cage kit, using S100i controller. – Field upgradeable to SAS by selecting HPE modular Smart Array controller.	E208i-a Notes: 8-Port Modular Smart Array. Supports SAS/SATA with essential RAID.
Hard Drive	None ship as standard		
Internal Storage	4 LFF NHP chassis with optional 4 LFF NHP HDD Cage Kit (874567-B21) to be selected. Upgradeable to 12 LFF max.	4 LFF HP Chassis with optional 4 LFF HDD Cage Kit (874566-B21) to be selected. Upgradeable to 12 LFF max. Notes: – The HPE ML350 Gen10 LFF Embedded SATA Cable Kit (877578-B21) is required when upgrading to add the 2 nd and 3 rd HDD cage kits, using S100i controller. – Now the system can support mixed LFF and SFF HDD cages in one system. The optional SFF HDD Cage Kit part number is 874568-B21. If the max. number of drives are installed in all three drive boxes, the redundant fan cage kit (874572-B21) is required.	
Optical Drive Bay	Optional Slimline ODD Bay Kit (874577-B21) for SATA DVD-ROM/DVD-RW optical drive Optional Media Drive Support Kit (874570-B21) for RDX or tape/LTO devices, up to 2		
Optical Drive	None ship as standard		
PCI-Express Slots	4-slots (x16, x8, x16, x8) as standard Notes: PCIe slots 5 – 8 require the second optional processor.		

Pre-configured Models

Power Supply	1x 500W HPE Standard Non-Hot-Plug/non-RPS Power Supply	1x 500W HPE FlexSlot Power Supply Notes: Add a second 500W FlexSlot power supply to get 1+1 power redundancy feature.	1x 500W HPE FlexSlot Power Supply Notes: Add a second 500W FlexSlot power supply to get 1+1 power redundancy feature.
Fans	2 standard fans; Optional redundant fan cage kit (874572-B21, add'l 4 fans)		
Management	HPE iLO Standard with Intelligent Provisioning (embedded), HPE OneView Standard (requires download); HPE iLO Advanced and HPE OneView Advanced (require licenses)		
Energy Star	2.1 certified		
ErP Lot 9 compliance	No*	ErP Lot 9 compliant	ErP Lot 9 compliant
Form Factor	4U Tower Notes: Optional Tower-to-Rack conversion kit (874578-B21) to convert the unit to a 5U Rack-mount server.		
Warranty	3-year parts, 3-year labor, 3-year onsite support with next business day response.		

Base SFF Tower Model	Performance SFF Tower Model	High Performance Tower Model	
SMB Offer – BASE	Performance 3	Performance 4	Performance 5
[SKU Number]	P11051-xx1	P11052-xx1	P11053-xx1
Localization	US, EU, AP, Japan & China	US, EU, AP & Japan	US, EU, AP & Japan
Model Name	HPE ML350 Gen10 4210 1P 16G 8SFF P408i-a 1x800W FS RPS Base SFF Tower Server	HPE ML350 Gen10 4214 1P 32G 8SFF P408i-a 1x800W FS RPS Performance SFF Tower Server	HPE ML350 Gen10 5218 1P 32G 8SFF P408i-a 2x800W FS RPS High Performance SFF Tower Server
Processor	4210 (10-Core, 2.2 GHz, 85W)	4214 (12-Core, 2.2 GHz, 85W)	5218 (16-Core, 2.3 GHz, 125W)
Number of Processors	One processor		
	Notes: Add HPE ML350 Gen10 Xeon-S 4210 Kit (P10939-B21) for 2 nd processor upgrade.	Notes: Add HPE ML350 Gen10 Xeon-S 4214 Kit (P10940-B21) for 2 nd processor upgrade.	Notes: Add HPE ML350 Gen10 Xeon-G 5218 Kit (P10945-B21) for 2 nd processor upgrade.
Memory	16 GB RDIMM SR 2933 MT/s (1x 16 GB) Notes: running at 2400 MT/s per processor support	32 GB RDIMM DR 2933 MT/s (1x 32 GB) Notes: running at 2400 MT/s per processor support	32 GB RDIMM DR 2933 MT/s (1x 32 GB) Notes: running at 2666 MT/s per processor support
Network Controller	Embedded 4-Port 1GbE HPE Ethernet 1Gb 4-port 369i Adapter Notes: embedded 4x1GbE HPE Ethernet 1Gb 4-port 369i Adapter does not support speeds of 100MB/s and 10MB/s.		
Storage Controller	P408i-a Notes: – 8-Port Modular Smart Array. Supports SAS/SATA with performance RAID – Smart Storage battery included.		
Hard Drive	None ship as standard		
Internal Storage	8 SFF chassis with optional SFF HDD Cage Kit (874568-B21), upgradeable to 24 SFF. Opt. 8 SFF NVMe Express Bay Kit (874569-B21) Notes: Now the system can support mixed SFF and LFF HDD cages in one system. The 4 LFF HDD Cage Kit part number is 874566-B21.		



Pre-configured Models

Optical Drive Bay	Optional Slimline ODD Bay Kit (874577-B21) for SATA DVD-ROM/DVD-RW optical drive Optional Media Drive Support Kit (874570-B21) for RDX or tape/LTO devices, up to 2	
Optical Drive	None ship as standard	
PCI-Express Slots	4-slots (x16, x8, x16, x8) as standard Notes: PCIe slots 5 – 8 require the second optional processor.	
Power Supply	1x 800W HPE FlexSlot Power Supply Notes: Add a second 800W FlexSlot power supply to get 1+1 power redundancy feature.	2x 800W HPE FlexSlot power supply (1+1)
Fans	6 standard fans	
Management	HPE iLO Standard with Intelligent Provisioning (embedded), HPE OneView Standard (requires download); HPE iLO Advanced, and HPE OneView Advanced (require licenses)	
Energy Star	2.1 certified	
ErP Lot 9	ErP Lot 9 compliant	
Form Factor	4U Tower Notes: Optional Tower-to-Rack conversion kit (874578-B21) to convert the unit to a 5U Rack-mount server.	
Warranty	3-year parts, 3-year labor, 3-year onsite support with next business day response	

Country Code Key

xx1 = 001	US
xx1 = 031	UK
xx1 = 421	EU/UK
xx1 = 371	AP
xx1 = 291	Japan
xx1 = AA1	PRC
xx1 = B21	Worldwide

Notes:

- Not all models are available in all regions. Check with your local country Hewlett Packard Enterprise offices for availability.
- ***Important information for EU/EMEA:** P11048-421 (EU/UK SKU) went obsolete on February 29, 2020 to cope with the regional regulatory changes per the new ErP Lot 9 requirements in EU (European Union) countries. Rest of the P11048-xx1 will continue to ship in their pre-defined regions or countries outside of EMEA. Refer to the country code key summary above.
- For HPE channel partners / distributors, OEM partners, or any customers that have the need to re ship these server units into EU after March 1, 2020, please review relevant regulatory requirements to ensure your solutions are Lot 9 compliant and meet all local / regional requirements.
Please visit: <https://www.hpe.com/us/en/about/environment/msds-specs-more.html> for more information.



Configuration Information

This section lists some of the steps required to configure a Factory Integrated Model. To ensure only valid configurations are ordered, Hewlett Packard Enterprise recommends the use of an HPE approved configurator. Contact your local sales representative for information on configurable product offerings and requirements.

1. Factory Integrated Models must start with a CTO Server.
2. FIO indicates that this option is only available as a factory installable option.
3. All Factory Integrated Models will be populated with sufficient hard drive blanks based on the number of initial hard drives ordered with the server.
4. Some options may not be integrated at the factory. Contact your local sales representative for additional information.

European Union (EU) eco-design regulations for server and storage products, known as Lot 9, go into effect on March 1st, 2020. Among other requirements, for servers this directive establishes power thresholds for idle state, as well as efficiency and performance in active state which vary among configurations. HPE ProLiant Gen10 servers are compliant with Lot9 requirements. For more information regarding HPE Lot 9 conformance, please visit:

<https://www.hpe.com/us/en/about/environment/msds-specs-more.html>

Step 1: Base Configuration (choose one of the following configurable models)

CTO Server	HPE ML350 Gen10 4 LFF CTO Server	HPE ML350 Gen10 8 SFF CTO Server	HPE ML350 Gen10 8 SFF Rack CTO Server
SKU Number	877625-B21	877626-B21	877627-B21
Processor Sockets	Two as standard	Two as standard	Two as standard
Processor	Not included as standard	Not included as standard	Not included as standard
DIMM Slots	24-DIMM slots	24-DIMM slots	24-DIMM slots
Storage Controller	Embedded SW RAID S100i with 14 SATA ports, choice of HPE modular Smart Array (AROC) and/or PCIe Standup controller card (s)		
PCIe	8 PCIe Gen3 slots (x16, x8, x16, x8, x16, x8, x16, x8) as standard Notes: PCIe slots 5 – 8 require the second processor to enable.		
Drive Cage - included	4 LFF	8 SFF	8 SFF
Network Controller	Embedded 4x1GbE HPE Ethernet 1Gb 4-port 369i Adapter with optional 1/10/25Gb Standup card Notes: embedded 4x1GbE HPE Ethernet 1Gb 4-port 369i Adapter does not support speeds of 100MB/s and 10MB/s.		
Fans	2-Standard	2-Standard	6-Standard
Power Supply Cage included	HPE Flex Slot RPS cage and PDB included	HPE Flex Slot RPS cage and PDB included	HPE Flex Slot RPS cage and PDB included
Management	HPE iLO with Intelligent Provisioning (standard), iLO Advances and OneView (optional)		
USB	6x 3.0/2.0 standard plus front iLO Service Port	6x 3.0/2.0 standard plus front iLO Service Port	6x 3.0/2.0 standard plus front iLO Service Port
Tower-to-Rack conversion kit	Optional Notes: Please select 874578-B21 (Tower-to-Rack Conversion kit) under the Ad-Hoc category. This way the system will not trigger build error under CLIC check.	Optional Notes: Please select 874578-B21 (Tower-to-Rack Conversion kit) under the Ad-Hoc category. This way the system will not trigger build error under CLIC check.	Easy Install rack-rail tray (1U) with CMA included as mandatory (must-select) accessories

Notes: Refer to HPE Power Advisor Tool to review the power requirement for your selected configuration and determine what power supply module(s) to select.



Configuration Information

Additional drive cages	Optional 4xLFF HDD Cage kit, up to 2 (total of 3) Notes: For mixed SFF and LFF HDD configuration, please select 4 LFF CTO Server as the base configuration.	Optional 8xSFF HDD Cage kit, up to 2 (total of 3)	Optional 8xSFF HDD Cage kit, up to 2 (total of 3)
Half-Height Media Bay	2 Optional	2 Optional	2 Optional
ODD	1 Optional	1 Optional	1 Optional
Redundant Fan Cage Kit	Optional	Optional	Included as standard – total 6 fans included
8 SFF NVMe Express Bay	Not available	Optional, up to 1	Optional, up to 1

Notes:

- This applies to CTO configurations, field upgrades may differ depending on field configuration.
- The HH Media Bay (2) and slim ODD Bay together takes up the space of one 4 LFF or 8 SFF drive cage, which means when media bay, ODD or both is selected, the max. drive cage installation will be 2.
- To get advanced cooling in richer configurations and/or under certain ambient environmental conditions, the Redundant Fan Cage Kit (874572-B21) which consists of one fan cage with 4 additional fans, is REQUIRED. This kit is automatically selected when the Rack CTO SKU is selected. Refer to the Redundant Fan Kit section or ML350 Gen10 User Guide for detail.
- When the 8SFF Rack CTO Server (877627-B21) is selected, the Redundant Fan Cage Kit (874572-B21) and ML350 Gen10 T/R Conversion Kit (874578-B21) will be automatically selected.
- Now the system can support mixed SFF and LFF HDD cages in one system. Please select the 4 LFF CTO Server (877625-B21) as the base configuration to start with.

Step 2a: Choose Required Options - Processors (only one of the following unless otherwise noted)

Please select one –L21 processor required below.

For second processor, please select the same processor model with –B21 from Core Options – HPE Processors section.

For example: first processor, select 874752-L21 then for second processor, select 874752-B21.

Notes:

- 1P models typically ship with 2 standard fans. 2P models will require selection of the Redundant Fan Cage kit (874572-B21) which contains one fan cage along with 4 additional fans – total number of fans required in the system will be 6.
- Maximum memory capacity per processor is dependent on processor models. All processors support up to 768 GB max memory per processor except “M” model processors will support up to 1.5 TB max memory per processor.
- Mixing of 2 different processor models are NOT allowed.
- DDR4 speed is the maximum memory speed of the processor. Actual memory speed may depend on the quantity and type of DIMMs installed.
- Processors higher than 85W will ship with the Performance heat sink. All other processors will ship with the Standard heat sink.

Processor Option Kits – Intel Second Generation Xeon® Scalable Processors – Refresh

Gold Processors

Intel Xeon-Gold 6258R (2.7GHz/28-core/205W) FIO Processor Kit for HPE ProLiant ML350 Gen10	P24177-L21
Intel Xeon-Gold 6256 (3.6GHz/12-core/205W) FIO Processor Kit for HPE ProLiant ML350 Gen10	P23353-L21

Notes

- For 6256 & 6250, there are specific ambient temp. requirements per system thermal configuration setting. Refer to the Thermal Configuration table below.
- High frequency/low core count model for latency sensitive workloads.



Configuration Information

Intel Xeon-Gold 6250 (3.9GHz/8-core/185W) FIO Processor Kit for HPE ProLiant ML350 Gen10

P23352-L21

Notes:

- High frequency/low core count model for latency sensitive workloads.
- For 6256 & 6250, there are specific ambient temp. requirements per system thermal configuration setting. Refer to the Thermal Configuration table below.

Processor	Thermal Configuration & Ambient Temp. Requirement			
	Optimal Cooling	Increased Cooling	Maximum Cooling	Enhanced CPU Cooling
Gold 6256	Not supported	25C	30C	25C
Gold 6250	Not supported	24C	29C	24C
Gold 6250L	Not supported	24C	29C	24C

Notes: The thermal configuration setting can be adjusted via the RBSU tool.

Intel Xeon-Gold 6248R (3.0GHz/24-core/205W) FIO Processor Kit for HPE ProLiant ML350 Gen10

P24176-L21

Intel Xeon-Gold 6246R (3.4GHz/16-core/205W) FIO Processor Kit for HPE ProLiant ML350 Gen10

P24175-L21

Intel Xeon-Gold 6242R (3.1GHz/20-core/205W) FIO Processor Kit for HPE ProLiant ML350 Gen10

P24174-L21

Intel Xeon-Gold 6240R (2.4GHz/24-core/165W) FIO Processor Kit for HPE ProLiant ML350 Gen10

P24173-L21

Intel Xeon-Gold 6238R (2.2GHz/28-core/165W) FIO Processor Kit for HPE ProLiant ML350 Gen10

P24172-L21

Intel Xeon-Gold 6230R (2.1GHz/26-core/150W) FIO Processor Kit for HPE ProLiant ML350 Gen10

P24171-L21

Intel Xeon-Gold 6226R (2.9GHz/16-core/150W) FIO Processor Kit for HPE ProLiant ML350 Gen10

P24170-L21

Intel Xeon-Gold 6208U (2.9GHz/16-core/150W) FIO Processor Kit for HPE ProLiant ML350 Gen10

P24179-L21

Notes: Single Socket processor model with no 2nd socket upgrade capability.

Intel Xeon-Gold 5220R (2.2GHz/24-core/150W) FIO Processor Kit for HPE ProLiant ML350 Gen10

P19795-L21

Intel Xeon-Gold 5218R (2.1GHz/20-core/125W) FIO Processor Kit for HPE ProLiant ML350 Gen10

P24169-L21

Silver Processors

Intel Xeon-Silver 4215R (3.2GHz/8-core/130W) FIO Processor Kit for HPE ProLiant ML350 Gen10

P24168-L21

Intel Xeon-Silver 4214R (2.4GHz/12-core/100W) FIO Processor Kit for HPE ProLiant ML350 Gen10

P19792-L21

Intel Xeon-Silver 4210R (2.4GHz/10-core/100W) FIO Processor Kit for HPE ProLiant ML350 Gen10

P19791-L21

Bronze Processors

Intel Xeon-Bronze 3206R (1.9GHz/8-core/85W) FIO Processor Kit for HPE ProLiant ML350 Gen10

P19789-L21

Processor Option Kits – Intel Second Generation Xeon® Scalable Processors

Platinum Processors

Intel Xeon-Platinum 8280 (2.7GHz/28-core/205W) FIO Processor Kit for HPE ProLiant ML350 Gen10

P10958-L21

Intel Xeon-Platinum 8280M (2.7GHz/28-core/205W) FIO Processor Kit for HPE ProLiant ML350 Gen10

P10963-L21

Intel Xeon-Platinum 8280L (2.7GHz/28-core/205W) FIO Processor Kit for HPE ProLiant ML350 Gen10.

P10968-L21

Intel Xeon-Platinum 8276L (2.2GHz/28-core/165W) FIO Processor Kit for HPE ProLiant ML350 Gen10.

P10967-L21

Platinum Processors

Intel Xeon-Platinum 8276M (2.2GHz/28-core/165W) FIO Processor Kit for HPE ProLiant ML350 Gen10.

P10962-L21

Intel Xeon-Platinum 8276 (2.2GHz/28-core/165W) FIO Processor Kit for HPE ProLiant ML350 Gen10.

P10957-L21

Intel Xeon-Platinum 8270 (2.7GHz/26-core/205W) FIO Processor Kit for HPE ProLiant ML350 Gen10.

P10956-L21

Intel Xeon-Platinum 8268 (2.9GHz/24-core/205W) FIO Processor Kit for HPE ProLiant ML350 Gen10.

P10955-L21

Intel Xeon-Platinum 8260 (2.4GHz/24-core/165W) FIO Processor Kit for HPE ProLiant ML350 Gen10.

P10954-L21

Intel Xeon-Platinum 8260M (2.4GHz/24-core/165W) FIO Processor Kit for HPE ProLiant ML350 Gen10.

P10961-L21

Intel Xeon-Platinum 8260L (2.4GHz/24-core/165W) FIO Processor Kit for HPE ProLiant ML350 Gen10.

P10966-L21

Configuration Information

Intel Xeon-Platinum 8260Y (2.4GHz/24-core/165W) FIO Processor Kit for HPE ProLiant ML350 Gen10.	P12292-L21
Notes: Speed Select Processor model enhanced by Intel® Speed Select Technology to run at three distinct operating points.	
Intel Xeon-Platinum 8256 (3.8GHz/4-core/105W) FIO Processor Kit for HPE ProLiant ML350 Gen10.	P12029-L21
Intel Xeon-Platinum 8253 (2.2GHz/16-core/125W) FIO Processor Kit for HPE ProLiant ML350 Gen10.	P12028-L21
Gold Processors	
Intel Xeon-Gold 6262V (1.9GHz/24-core/135W) FIO Processor Kit for HPE ProLiant ML350 Gen10.	P12294-L21
Notes: VM Density Specialized Processor model.	
Intel Xeon-Gold 6254 (3.1GHz/18-core/200W) FIO Processor Kit for HPE ProLiant ML350 Gen10.	P10953-L21
Intel Xeon-Gold 6252N (2.3GHz/24-core/150W) FIO Processor Kit for HPE ProLiant ML350 Gen10	P12295-L21
Notes: NFV or Networking Specialized Processor model offering higher performance on NFV (Network Function Virtualization) or Networking workloads than comparable SKU.	
Intel Xeon-Gold 6252 (2.1GHz/24-core/150W) FIO Processor Kit for HPE ProLiant ML350 Gen10.	P10952-L21
Intel Xeon-Gold 6248 (2.5GHz/20-core/150W) FIO Processor Kit for HPE ProLiant ML350 Gen10.	P10951-L21
Intel Xeon-Gold 6246 (3.3GHz/12-core/165W) FIO Processor Kit for HPE ProLiant ML350	P16454-L21
Intel Xeon-Gold 6244 (3.6GHz/8-core/150W) FIO Processor Kit for HPE ProLiant ML350 Gen10.	P10950-L21
Intel Xeon-Gold 6242 (2.8GHz/16-core/150W) FIO Processor Kit for HPE ProLiant ML350 Gen10.	P10949-L21
Intel Xeon-Gold 6240L (2.6GHz/18-core/150W) FIO Processor Kit for HPE ProLiant ML350 Gen10.	P12033-L21
Intel Xeon-Gold 6240M (2.6GHz/18-core/150W) FIO Processor Kit for HPE ProLiant ML350 Gen10.	P12031-L21
Intel Xeon-Gold 6240 (2.6GHz/18-core/150W) FIO Processor Kit for HPE ProLiant ML350 Gen10.	P10948-L21
Intel Xeon-Gold 6238L (2.1GHz/22-core/140W) FIO Processor Kit for HPE ProLiant ML350 Gen10.	P12032-L21
Intel Xeon-Gold 6238M (2.1GHz/22-core/140W) FIO Processor Kit for HPE ProLiant ML350 Gen10.	P12030-L21
Intel Xeon-Gold 6238 (2.1GHz/22-core/140W) FIO Processor Kit for HPE ProLiant ML350 Gen10.	P12027-L21
Intel Xeon-Gold 6234 (3.3GHz/8-core/130W) FIO Processor Kit for HPE ProLiant ML350 Gen10	P12026-L21
Intel Xeon-Gold 6230 (2.1GHz/20-core/125W) FIO Processor Kit for HPE ProLiant ML350 Gen10.	P10947-L21
Intel Xeon-Gold 6226 (2.7GHz/12-core/125W) FIO Processor Kit for HPE ProLiant ML350 Gen10	P12025-L21
Intel Xeon-Gold 6222V (1.8GHz/20-core/115W) FIO Processor Kit for HPE ProLiant ML350 Gen10.	P12293-L21
Notes: VM Density Specialized Processor model.	
Intel Xeon-Gold 6210U (2.5GHz/20-core/150W) FIO Processor Kit for HPE ProLiant ML350 Gen10.	P12035-L21
Notes: Single Socket processor model with no 2 nd socket upgrade capability.	
Intel Xeon-Gold 6212U (2.4GHz/24-core/165W) FIO Processor Kit for HPE ProLiant ML350 Gen10.	P12036-L21
Notes: Single Socket processor model with no 2 nd socket upgrade capability.	
Intel Xeon-Gold 6209U (2.1GHz/20-core/125W) FIO Processor Kit for HPE ProLiant ML350 Gen10.	P12034-L21
Notes: Single Socket processor model with no 2 nd socket upgrade capability.	
Intel Xeon-Gold 5222 (3.8GHz/4-core/105W) FIO Processor Kit for HPE ProLiant ML350 Gen10.	P12024-L21
Intel Xeon-Gold 5220 (2.2GHz/18-core/125W) FIO Processor Kit for HPE ProLiant ML350 Gen10.	P10946-L21
Intel Xeon-Gold 5218B (2.3GHz/16-core/125W) FIO Processor Kit for HPE ProLiant ML350 Gen10.	P12618-L21
Notes: The only difference of 5218B vs. the standard 5218 SKU is, this processor model is based on HCC (high core count) die package while 5218 is XCC (Extreme Core Count). Rest of features are the same.	
Intel Xeon-Gold 5218 (2.3GHz/16-core/125W) FIO Processor Kit for HPE ProLiant ML350 Gen10	P10945-L21
Intel Xeon-Gold 5217 (3.0GHz/8-core/115W) FIO Processor Kit for HPE ProLiant ML350 Gen10	P10944-L21
Intel Xeon-Gold 5215 (2.5GHz/10-core/85W) FIO Processor Kit for HPE ProLiant ML350 Gen10.	P10943-L21
Intel Xeon-Gold 5215M (2.5GHz/10-core/85W) FIO Processor Kit for HPE ProLiant ML350 Gen10.	P10959-L21
Intel Xeon-Gold 5215L (2.5GHz/10-core/85W) FIO Processor Kit for HPE ProLiant ML350 Gen10.	P10964-L21

Configuration Information

Silver Processors

Intel Xeon-Silver 4216 (2.1GHz/16-core/100W) FIO Processor Kit for HPE ProLiant ML350 Gen10.	P10942-L21
Intel Xeon-Silver 4215 (2.5GHz/8-core/85W) FIO Processor Kit for HPE ProLiant ML350 Gen10	P10941-L21
Intel Xeon-Silver 4214 (2.2GHz/12-core/85W) FIO Processor Kit for HPE ProLiant ML350 Gen10.	P10940-L21
Intel Xeon-Silver 4210 (2.2GHz/10-core/85W) FIO Processor Kit for HPE ProLiant ML350 Gen10.	P10939-L21
Intel Xeon-Silver 4208 (2.1GHz/8-core/85W) FIO Processor Kit for HPE ProLiant ML350 Gen10.	P10938-L21

Bronze Processors

Intel Xeon-Bronze 3204 (1.9GHz/6-core/85W) FIO Processor Kit for HPE ProLiant ML350 Gen10	P10937-L21
---	------------

Step 2b: Choose Memory Options

Please select one or more memory from below.

For new Gen10 memory population rule whitepaper and optimal memory performance guidelines, please go to:

<https://www.hpe.com/docs/memory-population-rules>

For Gen10 memory speed table, please go to: <https://www.hpe.com/docs/memory-speed-table>

For memory Reliability, Accessibility, Serviceability (RAS) features whitepaper like Gen10 Fast Fault Tolerance and legacy mirrored memory feature etc. please go to: <http://www.hpe.com/docs/memory-ras-feature>

Notes:

- Memory DIMM availability with a server platform is dependent upon completion of certification testing.
- The maximum memory speed is a function of the memory type, memory configuration, and processor model.
- The new HPE 2933 DIMMs are for the Second generation Intel Xeon® Scalable Processors; while the 2666 DIMMs for the 1st generation.
- The 8GB DIMM is identified as non-Lot 9 compliant component and is not orderable in EU/EMEA starting from March 1, 2020. For exceptional deal support, please contact HPE product management team. For more information regarding HPE Lot 9 conformance, please visit: <https://www.hpe.com/us/en/about/environment/msds-specs-more.html>.

Memory – for the Second Generation Intel Xeon® Scalable Processors

Description	SKU
HPE 8GB (1x8GB) Single Rank x8 DDR4-2933 CAS-21-21-21 Registered Smart Memory Kit	P00918-B21
Notes: The 8GB DIMM is identified as non-Lot 9 compliant component and is not orderable in EU/EMEA starting from March 1, 2020. For exceptional deal support, please contact HPE product management team. For more information regarding HPE Lot 9 conformance, please visit: https://www.hpe.com/us/en/about/environment/msds-specs-more.html .	
HPE 16GB (1x16GB) Single Rank x4 DDR4-2933 CAS-21-21-21 Registered Smart Memory Kit	P00920-B21
HPE 16GB (1x16GB) Dual Rank x8 DDR4-2933 CAS-21-21-21 Registered Smart Memory Kit	P00922-B21
HPE 32GB (1x32GB) Dual Rank x4 DDR4-2933 CAS-21-21-21 Registered Smart Memory Kit	P00924-B21
HPE 64GB (1x64GB) Dual Rank x4 DDR4-2933 CAS-21-21-21 Registered Smart Memory Kit	P00930-B21
HPE 64GB (1x64GB) Quad Rank x4 DDR4-2933 CAS-21-21-21 Load Reduced Smart Memory Kit	P00926-B21
HPE 128GB (1x128GB) Octal Rank x4 DDR4-2933 CAS-24-21-21 Load Reduced 3DS Smart Memory Kit	P00928-B21

Step 2c: Choose Power Supplies

Notes:

- Mixing of 2 different power supplies is NOT allowed.
- Selection of two HPE Flex Slot power supplies provides 1+1 power redundancy.
- To review the power requirements for your selected configuration, please use the [HPE Power Advisor Tool](#).

Power Supplies

HPE 500W Flex Slot Platinum Hot Plug Low Halogen Power Supply Kit	865408-B21
HPE 800W Flex Slot Titanium Hot Plug Low Halogen Power Supply Kit	865438-B21

Configuration Information

HPE 800W Flex Slot Platinum Hot Plug Low Halogen Power Supply Kit	865414-B21
HPE 800W Flex Slot -48VDC Hot Plug Low Halogen Power Supply Kit	865434-B21
HPE 800W Flex Slot Universal Hot Plug Low Halogen Power Supply Kit	865428-B21
HPE 1600W Flex Slot Platinum Hot Plug Low Halogen Power Supply Kit	830272-B21

Step 3: Choose Additional Factory Integratable Options

One of the following from each list may be selected if desired at time of factory integration.

HPE Unique Options

HPE ML350 Gen10 8SFF Hot Plug Drive Backplane Cage Kit	874568-B21
--	------------

Notes: Add additional 8 SFF hot-plug hard drive cage, allowing for up to 24 SFF drive support (8+8+8).

HPE ML350 Gen10 4LFF Hot Plug Drive Backplane Cage Kit	874566-B21
--	------------

Notes: Add additional 4 LFF hot-plug hard drive cage, allowing for up to 12 LFF drive support (4+4+4).

HPE ML350 Gen10 8SFF NVMe SSD Express Bay Enablement Kit with 2x4NVMe Risers and Support Cables	874569-B21
---	------------

Notes:

- This kit contains one 8xSFF NVMe SSD Express Bay (drive cage), two x4 Direct Attach PCIe NVMe Riser Boards with each supporting up to 4 drives. When both Riser Boards are installed, the system supports up to 8 SFF NVMe drives.
- NVMe SSDs to be ordered separately.
- NVMe drives require the addition of HPE ML350 Gen10 Redundant Fan Cage Kit (874572-B21).

HPE ML350 Gen10 RDX/LTO Media Drive Support Cable Kit with Fan Blank for Long LTO	874570-B21
---	------------

Notes:

- Supporting cables to add additional RDX/tape devices for data backup or archiving.
- RDX/tape devices to be ordered separately
- In the case when LTO Internal Tape is selected along with the Fan Redundant Kit, Fan#1 will need to be removed and the Fan Blank provided in this option kit will need to be installed in Fan#1 location. This configuration will run without fan redundancy. Refer to [ML350 Gen10 User Guide](#) for more detail.

HPE ML350 Gen10 Slimline ODD Bay and Support Cable Kit	874577-B21
--	------------

Notes: Mechanical converter with supporting cable.

HPE Factory Configuration Setting

HPE Legacy FIO Mode Setting	758959-B22
-----------------------------	------------

Notes: UEFI is the default, this FIO part can be used for CTO to enable Legacy mode.

HPE Smart Memory Fast Fault Tolerance FIO Setting	875293-B21
---	------------

HPE iLO Common Password FIO Setting	P08040-B21
-------------------------------------	------------

Notes: For customers who want to choose their own custom default password from the HPE Factory Express Integration Services to replace iLO (default) randomized password.

HPE Converged Infrastructure Management Software

HPE OneView for ProLiant DL Server including 3yr 24x7 Support FIO Bundle Physical 1-server LTU	E5Y43A
--	--------

HPE OneView w/o iLO including 3yr 24x7 Support 1-server FIO LTU	P8B31A
---	--------

Step 4: Choose additional options for Factory Integration from Core and Additional Options sections below



Core Options

Some options may not be integrated at the factory. To ensure only valid configurations are ordered, Hewlett Packard Enterprise recommends the use of an HPE approved configurator. Contact your local sales representative for additional information. Note the **User Guide (UG)** can help to explain the cable routing for each option.

Description	SKU
HPE Unique Options HPE ML350 Gen10 8SFF Hot Plug Drive Backplane Cage Kit Notes: Add additional 8 SFF Hot-Plug Hard Drive Cage, allowing for up to 24 SFF Drive support (8+8+8).	874568-B21
HPE ML350 Gen10 4LFF Hot Plug Drive Backplane Cage Kit Notes: Add additional 4 LFF Hot-Plug Hard Drive Cage, allowing for up to 12 LFF Drive support (4+4+4).	874566-B21
HPE ML350 Gen10 4LFF Non Hot Plug Drive Cage Kit Notes: Field upgrade only. NHP drive cage is for NHP server only. Add additional 4 LFF Non-Hot-Plug Hard Drive Cage, allowing for up to 12 LFF NHP Drive support (4+4+4).	874567-B21
HPE ML350 Gen10 8SFF NVMe SSD Express Bay Enablement Kit with 2x4NVMe Risers and Support Cables Notes: <ul style="list-style-type: none"> – This kit contains two x4 Direct Attach PCIe NVMe Riser Boards with each supporting up to 4 drives. When both Risers are installed, it supports 8 SFF NVMe drives. – SFF NVMe SSDs to be ordered separately. – NVMe drives require the addition of HPE ML350 Gen10 Redundant Fan Cage Kit (874572-B21). 	874569-B21
HPE ML350 Gen10 Embedded SATA Cable Kit for LFF Configuration Notes: This cable kit is used to support the embedded SATA controller with S100i SW RAID.	877578-B21
HPE ML350 Gen10 Embedded SATA Cable Kit for SFF Configuration Notes: This cable kit is used to support the embedded SATA controller with S100i SW RAID.	877579-B21
HPE ML350 Gen10 AROC Mini-SAS Cable Kit for LFF Configuration Notes: This cable kit is used to support the HPE modular storage controller (AROC). One cable kit is required for one controller. Refer to the storage controller section for more information.	874573-B21
HPE ML350 Gen10 AROC Mini-SAS Cable Kit for SFF Configuration Notes: This cable kit is used to support the HPE modular storage controller (AROC). One cable kit is required for one controller. Refer to the storage controller section for more information.	877575-B21
HPE ML350 Gen10 Smart Array/HBA Mini-SAS Cable Kit for LFF Configuration Notes: This cable kit is used to support the HPE stand-up storage controller. One cable kit is required for one controller. Refer to the storage controller section for more information.	874574-B21
HPE ML350 Gen10 Smart Array/HBA Mini-SAS Cable Kit for SFF Configuration Notes: This cable kit is used to support the HPE stand-up storage controller. One cable kit is required for one controller. Refer to the storage controller section for more information.	874575-B21
HPE ML350 Gen10 12Gb SAS Expander Card Kit with Cables Notes: <ul style="list-style-type: none"> – Add this SAS Expander option kit to upgrade your ML350 Gen10 SFF system pre-configured with either P408i-a or E208i-a (or any P or E-series card), to support 24 SFF drives. – This option is not supported with LFF configurations. 	874576-B21
HPE ML350 Gen10 Redundant Fan Cage Kit with 4 Fan Modules Notes: Add additional 4 hot-plug fans installed in the fan cage to get N+1 fan redundancy and/or for advanced cooling. Refer to later section for detail.	874572-B21
HPE ML350 Gen10 Flex Slot Redundant Power Supply Cage Kit with Power Distribution Board Notes: For field upgrade only. Allowing field upgrade from the 500W standard PSU/non-hot-plug/non-RPS to support HPE Flex Slot RPS.	874571-B21

Core Options

HPE ML350 Gen10 GPU External Power Cable Kit 877628-B21

Notes: Consists of two external power cables to feed power to GPU modules with TDP larger than 75W – that is, this GPU external power cable kit is required except for HPE NVIDIA Quadro P2000, HPE NVIDIA Tesla T4, the new HPE NVIDIA Quadro P1000 (R3K70C) or HPE NVIDIA Quadro P2200 (R2U55C) GPU modules. The longer GPU power cable is intended to support GPU installation in PCIe slot 1 or 3 (slots coming from CPU 1); while the other shorter cable to support slot 5 or 7 (slots coming from CPU 2).

HPE ML Gen10 Tower to Rack Conversion Kit with Sliding Rail Rack Shelf and Cable Management Arm 874578-B21

Notes: This kit is supported in both ML350 and ML110 Gen10.

HPE ML350 Gen10 RDX/LTO Media Drive Support Cable Kit with Fan Blank for Long LTO 874570-B21

Notes:

- Supporting cables to add additional RDX/tape devices for data backup or archiving.
- RDX/tape devices to be ordered separately.
- In the case when LTO Internal Tape is selected along with the Fan Redundant Kit, Fan#1 will need to be removed and the Fan Blank provided in this option kit will need to be installed in Fan#1 location. This configuration will run without fan redundancy. Refer to **ML350 Gen10 User Guide** for more detail.

HPE ML350 Gen10 Slimline ODD Bay and Support Cable Kit 874577-B21

Notes: Mechanical converter with supporting cable.

Notes:

- Choose one of the following xxxxxx-B21 processor kits for the 2nd processor socket. The xxxxxx-L21 is the first processor to select for a CTO configuration (refer to the CTO information in prior section for support detail.). The xxxxxx B21 is the 2nd processor to select for CTO configuration in a 2P model. It is also the processor kit to select for the 2nd CPU upgrade for field installation.
- Mixing of 2 different processor models are NOT allowed.
- 2P models will require selection of the Redundant Fan Cage Kit (874572-B21) which contains one fan cage along with 4 additional fans – total number of fans required in the system will be 6.
- Maximum memory per socket depends on the processor selected.
- Processors above 85W use a Performance Heatsink.

Processor Option Kits – Intel Second Generation Xeon® Scalable Processors – Refresh

HPE Processors

Description

SKU

Gold Processors

Intel Xeon-Gold 6258R (2.7GHz/28-core/205W) Processor Kit for HPE ProLiant ML350 Gen10 P24177-B21

Intel Xeon-Gold 6256 (3.6GHz/12-core/205W) Processor Kit for HPE ProLiant ML350 Gen10 P23353-B21

Notes: High frequency/low core count model for latency sensitive workloads.

Intel Xeon-Gold 6250 (3.9GHz/8-core/185W) Processor Kit for HPE ProLiant ML350 Gen10 P23352-B21

Notes:

- High frequency/low core count model for latency sensitive workloads.
- *: For 6256, 6250 & 6250L, there are specific ambient temp. requirements per system thermal configuration setting. Refer to the Thermal Configuration table below for detail.

Thermal Configuration & Ambient Temp. Requirement				
Processor	Optimal Cooling	Increased Cooling	Maximum Cooling	Enhanced CPU Cooling
Gold 6256	Not supported	25C	30C	25C
Gold 6250	Not supported	24C	29C	24C
Gold 6250L	Not supported	24C	29C	24C

- The thermal configuration setting can be adjusted via the RBSU tool.

Intel Xeon-Gold 6248R (3.0GHz/24-core/205W) Processor Kit for HPE ProLiant ML350 Gen10 P24176-B21

Core Options

Intel Xeon-Gold 6246R (3.4GHz/16-core/205W) Processor Kit for HPE ProLiant ML350 Gen10	P24175-B21
Intel Xeon-Gold 6242R (3.1GHz/20-core/205W) Processor Kit for HPE ProLiant ML350 Gen10	P24174-B21
Intel Xeon-Gold 6240R (2.4GHz/24-core/165W) Processor Kit for HPE ProLiant ML350 Gen10	P24173-B21
Intel Xeon-Gold 6238R (2.2GHz/28-core/165W) Processor Kit for HPE ProLiant ML350 Gen10	P24172-B21
Intel Xeon-Gold 6230R (2.1GHz/26-core/150W) Processor Kit for HPE ProLiant ML350 Gen10	P24171-B21
Intel Xeon-Gold 6226R (2.9GHz/16-core/150W) Processor Kit for HPE ProLiant ML350 Gen10	P24170-B21
Intel Xeon-Gold 5220R (2.2GHz/24-core/150W) Processor Kit for HPE ProLiant ML350 Gen10	P19795-B21
Intel Xeon-Gold 5218R (2.1GHz/20-core/125W) Processor Kit for HPE ProLiant ML350 Gen10	P24169-B21

Silver Processors

Intel Xeon-Silver 4215R (3.2GHz/8-core/130W) Processor Kit for HPE ProLiant ML350 Gen10	P24168-B21
Intel Xeon-Silver 4214R (2.4GHz/12-core/100W) Processor Kit for HPE ProLiant ML350 Gen10	P19792-B21
Intel Xeon-Silver 4210R (2.4GHz/10-core/100W) Processor Kit for HPE ProLiant ML350 Gen10	P19791-B21

Bronze Processors

Intel Xeon-Bronze 3206R (1.9GHz/8-core/85W) Processor Kit for HPE ProLiant ML350 Gen10	P19789-B21
--	------------

Processor Option Kits – the Intel Second Generation Xeon® Processors

Description	SKU
Platinum Processors	
Intel Xeon-Platinum 8280 (2.7GHz/28-core/205W) Processor Kit for HPE ProLiant ML350 Gen10.	P10958-B21
Intel Xeon-Platinum 8280M (2.7GHz/28-core/205W) Processor Kit for HPE ProLiant ML350 Gen10.	P10963-B21
Intel Xeon-Platinum 8280L (2.7GHz/28-core/205W) Processor Kit for HPE ProLiant ML350 Gen10.	P10968-B21
Intel Xeon-Platinum 8276L (2.2GHz/28-core/165W) Processor Kit for HPE ProLiant ML350 Gen10	P10967-B21
HPE ML350 Gen10 Intel Xeon-Platinum 8276M (2.2GHz/28-core/165W) Processor Kit	P10962-B21
HPE ML350 Gen10 Intel Xeon-Platinum 8276 (2.2GHz/28-core/165W) Processor Kit	P10957-B21
Intel Xeon-Platinum 8270 (2.7GHz/26-core/205W) Processor Kit for HPE ProLiant ML350 Gen10.	P10956-B21
Intel Xeon-Platinum 8268 (2.9GHz/24-core/205W) Processor Kit for HPE ProLiant ML350 Gen10	P10955-B21
HPE ML350 Gen10 Intel Xeon-Platinum 8260 (2.4GHz/24-core/165W) Processor Kit	P10954-B21
HPE ML350 Gen10 Intel Xeon-Platinum 8260M (2.4GHz/24-core/165W) Processor Kit	P10961-B21
HPE ML350 Gen10 Intel Xeon-Platinum 8260L (2.4GHz/24-core/165W) Processor Kit	P10966-B21
Intel Xeon-Platinum 8260Y (2.4GHz/24-core/165W) Processor Kit for HPE ProLiant ML350 Gen10	P12292-B21
Notes: Speed Select Processor model enhanced by Intel® Speed Select Technology to run at three distinct operating points.	
Intel Xeon-Platinum 8256 (3.8GHz/4-core/105W) Processor Kit for HPE ProLiant ML350 Gen10	P12029-B21
Intel Xeon-Platinum 8253 (2.2GHz/16-core/125W) Processor Kit for HPE ProLiant ML350 Gen10	P12028-B21
Gold Processors	
Intel Xeon-Gold 6262V (1.9GHz/24-core/135W) Processor Kit for HPE ProLiant ML350 Gen10	P12294-B21
Notes: VM Density Specialized Processor model.	
Intel Xeon-Gold 6254 (3.1GHz/18-core/200W) Processor Kit for HPE ProLiant ML350 Gen10.	P10953-B21
Intel Xeon-Gold 6252N (2.3GHz/24-core/150W) Processor Kit for HPE ProLiant ML350 Gen10	P12295-B21
Notes: NFV or Networking Specialized Processor model offering higher performance on NFV (Network Function Virtualization) or Networking workloads than comparable SKU.	
Intel Xeon-Gold 6252 (2.1GHz/24-core/150W) Processor Kit for HPE ProLiant ML350 Gen10	P10952-B21
Intel Xeon-Gold 6248 (2.5GHz/20-core/150W) Processor Kit for HPE ProLiant ML350 Gen10	P10951-B21
Intel Xeon-Gold 6246 (3.3GHz/12-core/165W) Processor Kit for HPE ProLiant ML350	P16454-B21
Intel Xeon-Gold 6244 (3.6GHz/8-core/150W) Processor Kit for HPE ProLiant ML350 Gen10	P10950-B21
Intel Xeon-Gold 6242 (2.8GHz/16-core/150W) Processor Kit for HPE ProLiant ML350 Gen10.	P10949-B21
Intel Xeon-Gold 6240L (2.6GHz/18-core/150W) Processor Kit for HPE ProLiant ML350 Gen10	P12033-B21

Core Options

Intel Xeon-Gold 6240M (2.6GHz/18-core/150W) Processor Kit for HPE ProLiant ML350 Gen10	P12031-B21
Intel Xeon-Gold 6240 (2.6GHz/18-core/150W) Processor Kit for HPE ProLiant ML350 Gen10	P10948-B21
Intel Xeon-Gold 6238L (2.1GHz/22-core/140W) Processor Kit for HPE ProLiant ML350 Gen10	P12032-B21
Intel Xeon-Gold 6238M (2.1GHz/22-core/140W) Processor Kit for HPE ProLiant ML350 Gen10	P12030-B21
Intel Xeon-Gold 6238 (2.1GHz/22-core/140W) Processor Kit for HPE ProLiant ML350 Gen10	P12027-B21
Intel Xeon-Gold 6234 (3.3GHz/8-core/130W) Processor Kit for HPE ProLiant ML350 Gen10	P12026-B21
Intel Xeon-Gold 6230 (2.1GHz/20-core/125W) Processor Kit for HPE ProLiant ML350 Gen10	P10947-B21
Intel Xeon-Gold 6226 (2.7GHz/12-core/125W) Processor Kit for HPE ProLiant ML350 Gen10	P12025-B21
Intel Xeon-Gold 6222V (1.8GHz/20-core/115W) Processor Kit for HPE ProLiant ML350 Gen10	P12293-B21

Notes: VM Density Specialized Processor model.

Intel Xeon-Gold 5222 (3.8GHz/4-core/105W) Processor Kit for HPE ProLiant ML350 Gen10	P12024-B21
Intel Xeon-Gold 5220 (2.2GHz/18-core/125W) Processor Kit for HPE ProLiant ML350 Gen10	P10946-B21
Intel Xeon-Gold 5218B (2.3GHz/16-core/125W) Processor Kit for HPE ProLiant ML350 Gen10	P12618-B21

Notes: The only difference of 5218B vs. the standard 5218 SKU is, this processor model is based on HCC (high core count) die package while 5218 is XCC (Extreme Core Count). Rest of features are the same.

Intel Xeon-Gold 5218 (2.3GHz/16-core/125W) Processor Kit for HPE ProLiant ML350 Gen10	P10945-B21
Intel Xeon-Gold 5217 (3.0GHz/8-core/115W) Processor Kit for HPE ProLiant ML350 Gen10	P10944-B21
Intel Xeon-Gold 5215 (2.5GHz/10-core/85W) Processor Kit for HPE ProLiant ML350 Gen10	P10943-B21
Intel Xeon-Gold 5215M (2.5GHz/10-core/85W) Processor Kit for HPE ProLiant ML350 Gen10.	P10959-B21
HPE ML350 Gen10 Intel Xeon-Gold 5215L (2.5GHz/10-core/85W) Processor Kit	P10964-B21

Silver Processors

Intel Xeon-Silver 4216 (2.1GHz/16-core/100W) Processor Kit for HPE ProLiant ML350 Gen10	P10942-B21
HPE ML350 Gen10 Intel Xeon-Silver 4215 (2.5GHz/8-core/85W) Processor Kit	P10941-B21
HPE ML350 Gen10 Intel Xeon-Silver 4214 (2.2GHz/12-core/85W) Processor Kit	P10940-B21
Intel Xeon-Silver 4210 (2.2GHz/10-core/85W) Processor Kit for HPE ProLiant ML350 Gen10	P10939-B21
Intel Xeon-Silver 4208 (2.1GHz/8-core/85W) Processor Kit for HPE ProLiant ML350 Gen10	P10938-B21

Bronze Processors

Intel Xeon-Bronze 3204 (1.9GHz/6-core/85W) Processor Kit for HPE ProLiant ML350 Gen10	P10937-B21
---	------------

Memory Selection

To streamline the configuration process for HPE ProLiant Gen10 servers and to provide the best product availability, HPE recommends memory from the list located here: <http://www.hpe.com/products/recommend>. Best product availability is limited to US, Canada, and Latin America at this time.

HPE Memory – for the Second Generation Intel Xeon® Scalable Processors

HPE 8GB (1x8GB) Single Rank x8 DDR4-2933 CAS-21-21-21 Registered Smart Memory Kit	P00918-B21
---	------------

Notes: The 8GB DIMM is not orderable in EU/EMEA starting from March 1, 2020. For exceptional deal support, please contact HPE product management team. For more information regarding HPE Lot 9 conformance, please visit: <https://www.hpe.com/us/en/about/environment/msds-specs-more.html>.

HPE 16GB (1x16GB) Single Rank x4 DDR4-2933 CAS-21-21-21 Registered Smart Memory Kit	P00920-B21
HPE 16GB (1x16GB) Dual Rank x8 DDR4-2933 CAS-21-21-21 Registered Smart Memory Kit	P00922-B21
HPE 32GB (1x32GB) Dual Rank x4 DDR4-2933 CAS-21-21-21 Registered Smart Memory Kit	P00924-B21
HPE 64GB (1x64GB) Dual Rank x4 DDR4-2933 CAS-21-21-21 Registered Smart Memory Kit	P00930-B21
HPE 64GB (1x64GB) Quad Rank x4 DDR4-2933 CAS-21-21-21 Load Reduced Smart Memory Kit	P00926-B21
HPE 128GB (1x128GB) Octal Rank x4 DDR4-2933 CAS-24-21-21 Load Reduced 3DS Smart Memory Kit	P00928-B21

HPE Optical Drives

HPE 9.5mm SATA DVD-ROM Optical Drive	726536-B21
--------------------------------------	------------

Notes: The HPE ML350 Gen10 Slimline ODD Bay Kit (874577-B21) is required for this option.



Core Options

HPE 9.5mm SATA DVD-RW Optical Drive 726537-B21

Notes: The HPE ML350 Gen10 Slimline ODD Bay Kit (874577-B21) is required for this option.

HPE Mobile USB DVD-RW Optical Drive 701498-B21

Notes:

- This is only supported on USB 3.0 ports.
- When front drive cages are fully populated (Box 1 – 3) and there is still the requirement for DVD-RW support, this external USB DVD-RW option will meet that need.

HPE Drives

Notes: HPE ML350 Gen10 Redundant Fan Cage Kit (874572-B21) is required for 10K, 15K or higher RPM SAS drives.

Description	SKU
Enterprise - 12G SAS - SFF Drives	
HPE 300GB SAS 12G Enterprise 15K SFF (2.5in) SC 3yr Wty Digitally Signed Firmware HDD	870753-B21
HPE 300GB SAS 12G Enterprise 10K SFF (2.5in) SC 3yr Wty Digitally Signed Firmware HDD	872475-B21
HPE 600GB SAS 12G Enterprise 15K SFF (2.5in) SC 3yr Wty Digitally Signed Firmware HDD	870757-B21
HPE 600GB SAS 12G Enterprise 10K SFF (2.5in) SC 3yr Wty Digitally Signed Firmware HDD	872477-B21
HPE 900GB SAS 12G Enterprise 15K SFF (2.5in) SC 3yr Wty Digitally Signed Firmware HDD	870759-B21
HPE 1.2TB SAS 12G Enterprise 10K SFF (2.5in) SC 3yr Wty Digitally Signed Firmware HDD	872479-B21
HPE 1.8TB SAS 12G Enterprise 10K SFF (2.5in) SC 3yr Wty 512e Digitally Signed Firmware HDD	872481-B21
HPE 2.4TB SAS 12G Enterprise 10K SFF (2.5in) SC 3yr Wty 512e Digitally Signed Firmware HDD	881457-B21
Notes: HPE ML350 Gen10 Redundant Fan Cage Kit (874572-B21) is required for 10K, 15K or higher RPM SAS drives.	
Midline - 12G SAS - SFF Drives	
HPE 1TB SAS 12G Midline 7.2K SFF (2.5in) SC 1yr Wty Digitally Signed Firmware HDD	832514-B21
HPE 2TB SAS 12G Midline 7.2K SFF (2.5in) SC 1yr Wty 512e HDD	765466-B21
Midline - 12G SAS - LFF Drives	
HPE 2TB SAS 12G Midline 7.2K LFF (3.5in) LP 1yr Wty Digitally Signed Firmware HDD	833926-B21
HPE 4TB SAS 12G Midline 7.2K LFF (3.5in) LP 1yr Wty Digitally Signed Firmware HDD	833928-B21
HPE 6TB SAS 12G Midline 7.2K LFF (3.5in) LP 1yr Wty 512e HDD	861746-B21
HPE 8TB SAS 12G Midline 7.2K LFF (3.5in) LP 1yr Wty 512e Digitally Signed Firmware HDD	834031-B21
HPE 12TB SAS 12G Midline 7.2K LFF (3.5in) LP 1yr Wty Helium 512e Digitally Signed Firmware HDD	881781-B21
HPE 14TB SAS 12G Midline 7.2K LFF (3.5in) LP 1yr Wty Helium 512e Digitally Signed Firmware HDD	P09155-B21
HPE 16TB SAS 12G Business Critical 7.2K LFF (3.5in) LP 1yr Wty 512e ISE HDD	P23608-B21
Midline - 6G SATA - SFF Drives	
HPE 1TB SATA 6G Midline 7.2K SFF (2.5in) SC 1yr Wty Digitally Signed Firmware HDD	655710-B21
HPE 2TB SATA 6G Midline 7.2K SFF (2.5in) SC 1yr Wty 512e Digitally Signed Firmware HDD	765455-B21
Midline - 6G SATA - LFF Drives	
HPE 1TB SATA 6G Midline 7.2K LFF (3.5in) LP 1yr Wty Digitally Signed Firmware HDD	861686-B21
HPE 2TB SATA 6G Midline 7.2K LFF (3.5in) LP 1yr Wty Digitally Signed Firmware HDD	861681-B21
HPE 4TB SATA 6G Midline 7.2K LFF (3.5in) LP 1yr Wty Digitally Signed Firmware HDD	861683-B21
HPE 6TB SATA 6G Midline 7.2K LFF (3.5in) LP 1yr Wty 512e HDD	861742-B21
HPE 8TB SATA 6G Midline 7.2K LFF (3.5in) LP 1yr Wty 512e Digitally Signed Firmware HDD	834028-B21
HPE 12TB SATA 6G Midline 7.2K LFF (3.5in) LP 1yr Wty Helium 512e Digitally Signed Firmware HDD	881787-B21
HPE 14TB SATA 6G Midline 7.2K LFF (3.5in) LP 1yr Wty Helium 512e Digitally Signed Firmware HDD	P09165-B21
HPE 16TB SATA 6G Business Critical 7.2K LFF (3.5in) LP 1yr Wty 512e ISE HDD	P23449-B21
6G SATA - LFF NHP/Raw Drives	
HPE 1TB SATA 6G Midline 7.2K LFF (3.5in) RW 1yr Wty HDD	801882-B21

Core Options

HPE 1TB SATA 6G Entry 7.2K LFF (3.5in) RW 1yr Wty HDD	843266-B21
HPE 4TB SATA 6G Midline 7.2K LFF (3.5in) RW 1yr Wty HDD	801888-B21

SSD Selection

To streamline the configuration process for HPE ProLiant Gen10 servers and to provide the best product availability, HPE recommends SSDs from the list located here: <http://www.hpe.com/products/recommend>. Best product availability is limited to US, Canada, and Latin America at this time.

To further assist with configuration, HPE also offers an SSD Selector Tool located here: <http://ssd.hpe.com>.

Description

SKU

Write Intensive – 12G SAS - SFF - Solid State Drives

HPE 400GB SAS 12G Write Intensive SFF (2.5in) SC 3yr Wty Digitally Signed Firmware SSD	P04541-B21
HPE 800GB SAS 12G Write Intensive SFF (2.5in) SC 3yr Wty Digitally Signed Firmware SSD	P04543-B21
HPE 1.6TB SAS 12G Write Intensive SFF (2.5in) SC 3yr Wty Digitally Signed Firmware SSD	P04545-B21
HPE 3.2TB SAS 12G Write Intensive SFF (2.5in) SC 3yr Wty Digitally Signed Firmware SSD	P04547-B21
HPE 400GB SAS 12G Write Intensive SFF (2.5in) SC 3yr Wty Digitally Signed Firmware SSD	P09098-B21
HPE 800GB SAS 12G Write Intensive SFF (2.5in) SC 3yr Wty Digitally Signed Firmware SSD	P09100-B21
HPE 1.6TB SAS 12G Write Intensive SFF (2.5in) SC 3yr Wty Digitally Signed Firmware SSD	P09102-B21

Read Intensive - 12G SAS - SFF - Solid State Drives

HPE 960GB SAS 12G Read Intensive SFF (2.5in) SC 3yr Wty Digitally Signed Firmware SSD	P06584-B21
HPE 1.92TB SAS 12G Read Intensive SFF (2.5in) SC 3yr Wty Digitally Signed Firmware SSD	P06586-B21
HPE 3.84TB SAS 12G Read Intensive SFF (2.5in) SC 3yr Wty Digitally Signed Firmware SSD	P06588-B21
HPE 7.68TB SAS 12G Read Intensive SFF (2.5in) SC 3yr Wty Digitally Signed Firmware SSD	P06590-B21
HPE 960GB SAS 12G Read Intensive SFF (2.5in) SC 3yr Wty Digitally Signed Firmware SSD	P04517-B21
HPE 1.92TB SAS 12G Read Intensive SFF (2.5in) SC 3yr Wty Digitally Signed Firmware SSD	P04519-B21
HPE 3.84TB SAS 12G Read Intensive SFF (2.5in) SC 3yr Wty Digitally Signed Firmware SSD	P04521-B21
HPE 7.68TB SAS 12G Read Intensive SFF (2.5in) SC 3yr Wty Digitally Signed Firmware SSD	P04523-B21

Read Intensive - 6G SATA - SFF - Solid State Drives

HPE 240GB SATA 6G Read Intensive SFF (2.5in) SC 3yr Wty Digitally Signed Firmware SSD	P04556-B21
HPE 240GB SATA 6G Read Intensive SFF (2.5in) SC 3yr Wty Digitally Signed Firmware SSD	875503-B21
HPE 480GB SATA 6G Read Intensive SFF (2.5in) SC 3yr Wty Digitally Signed Firmware SSD	P06194-B21
HPE 480GB SATA 6G Read Intensive SFF (2.5in) SC 3yr Wty Digitally Signed Firmware SSD	P04560-B21
HPE 960GB SATA 6G Read Intensive SFF (2.5in) SC 3yr Wty Digitally Signed Firmware SSD	P06196-B21
HPE 960GB SATA 6G Read Intensive SFF (2.5in) SC 3yr Wty Digitally Signed Firmware SSD	P04564-B21
HPE 1.92TB SATA 6G Read Intensive SFF (2.5in) SC 3yr Wty Digitally Signed Firmware SSD	P06198-B21
HPE 1.92TB SATA 6G Read Intensive SFF (2.5in) SC 3yr Wty Digitally Signed Firmware SSD	P04566-B21
HPE 480GB SATA 6G Read Intensive SFF (2.5in) SC 3yr Wty Digitally Signed Firmware SSD	P04474-B21
HPE 960GB SATA 6G Read Intensive SFF (2.5in) SC 3yr Wty Digitally Signed Firmware SSD	P04476-B21
HPE 1.92TB SATA 6G Read Intensive SFF (2.5in) SC 3yr Wty Digitally Signed Firmware SSD	P04478-B21
HPE 3.84TB SATA 6G Read Intensive SFF (2.5in) SC 3yr Wty Digitally Signed Firmware SSD	P04480-B21
HPE 3.84TB SATA 6G Read Intensive SFF (2.5in) SC 3yr Wty Digitally Signed Firmware SSD	P04570-B21
HPE 240GB SATA 6G Read Intensive SFF (2.5in) SC 3yr Wty SSD	P19935-B21
HPE 480GB SATA 6G Read Intensive SFF (2.5in) SC 3yr Wty SSD	P19937-B21
HPE 960GB SATA 6G Read Intensive SFF (2.5in) SC 3yr Wty SSD	P19939-B21
HPE 1.92TB SATA 6G Read Intensive SFF (2.5in) SC 3yr Wty SSD	P19941-B21
HPE 3.84TB SATA 6G Read Intensive SFF (2.5in) SC 3yr Wty SSD	P19943-B21
HPE 7.68TB SATA 6G Read Intensive SFF (2.5in) SC 3yr Wty SSD	P19945-B21

Read Intensive - 6G SATA - SFF - Solid State Drives

HPE 3.84TB SATA 6G Read Intensive SFF (2.5in) SC 3yr Wty Digitally Signed Firmware SSD	P06200-B21
HPE 7.68TB SATA 6G Read Intensive SFF (2.5in) SC 3yr Wty Digitally Signed Firmware SSD	P04482-B21

Core Options

HPE 240GB SATA 6G Read Intensive SFF (2.5in) SC 3yr Wty Multi Vendor SSD	P18420-B21
HPE 480GB SATA 6G Read Intensive SFF (2.5in) SC 3yr Wty Multi Vendor SSD	P18422-B21
HPE 960GB SATA 6G Read Intensive SFF (2.5in) SC 3yr Wty Multi Vendor SSD	P18424-B21
HPE 1.92TB SATA 6G Read Intensive SFF (2.5in) SC 3yr Wty Multi Vendor SSD	P18426-B21
HPE 3.84TB SATA 6G Read Intensive SFF (2.5in) SC 3yr Wty Multi Vendor SSD	P18428-B21
HPE 7.68TB SATA 6G Read Intensive SFF (2.5in) SC 3yr Wty Multi Vendor	P18430-B21
Read Intensive & Mixed Use - 6G SATA - LFF - Solid State Drives	
HPE 1.92TB SATA 6G Mixed Use LFF (3.5in) LPC 3yr Wty Digitally Signed Firmware SSD	P07934-B21
HPE 480GB SATA 6G Read Intensive LFF (3.5in) LPC 3yr Wty Digitally Signed Firmware SSD	P04499-B21
HPE 1.92TB SATA 6G Read Intensive LFF (3.5in) LPC 3yr Wty Digitally Signed Firmware SSD	P04501-B21
HPE 960GB SATA 6G Read Intensive LFF (3.5in) LPC 3yr Wty Digitally Signed Firmware SSD	P09691-B21
HPE 1.92TB SATA 6G Mixed Use LFF (3.5in) LPC 3yr Wty Digitally Signed Firmware SSD	P09726-B21
HPE 960GB SATA 6G Mixed Use LFF (3.5in) LPC 3yr Wty SSD	P19980-B21
HPE 1.92TB SATA 6G Mixed Use LFF (3.5in) LPC 3yr Wty SSD	P19984-B21
HPE 480GB SATA 6G Read Intensive LFF (3.5in) LPC 3yr Wty SSD	P19974-B21
HPE 1.92TB SATA 6G Read Intensive LFF (3.5in) LPC 3yr Wty SSD	P19976-B21
Mixed Use - 12G SAS - SFF - Solid State Drives	
HPE 400GB SAS 12G Mixed Use SFF (2.5in) SC 3yr Wty Digitally Signed Firmware SSD	P04525-B21
HPE 800GB SAS 12G Mixed Use SFF (2.5in) SC 3yr Wty Digitally Signed Firmware SSD	P04527-B21
HPE 1.6TB SAS 12G Mixed Use SFF (2.5in) SC 3yr Wty Digitally Signed Firmware SSD	P04533-B21
HPE 3.2TB SAS 12G Mixed Use SFF (2.5in) SC 3yr Wty Digitally Signed Firmware SSD	P04537-B21
HPE 6.4TB SAS 12G Mixed Use SFF (2.5in) SC 3yr Wty Digitally Signed Firmware SSD	P04539-B21
HPE 400GB SAS 12G Mixed Use SFF (2.5in) SC 3yr Wty Digitally Signed Firmware SSD	P09088-B21
HPE 800GB SAS 12G Mixed Use SFF (2.5in) SC 3yr Wty Digitally Signed Firmware SSD	P09090-B21
HPE 1.6TB SAS 12G Mixed Use SFF (2.5in) SC 3yr Wty Digitally Signed Firmware SSD	P09092-B21
HPE 3.2TB SAS 12G Mixed Use SFF (2.5in) SC 3yr Wty Digitally Signed Firmware SSD	P09094-B21
HPE 6.4TB SAS 12G Mixed Use SFF (2.5in) SC 3yr Wty Digitally Signed Firmware SSD	P09096-B21
Mixed Use - 6G SATA - SFF - Solid State Drives	
HPE 3.84TB SATA 6G Mixed Use SFF (2.5in) SC 3yr Wty Digitally Signed Firmware SSD	P00896-B21
HPE 480GB SATA 6G Mixed Use SFF (2.5in) SC 3yr Wty Digitally Signed Firmware SSD	P07922-B21
HPE 960GB SATA 6G Mixed Use SFF (2.5in) SC 3yr Wty Digitally Signed Firmware SSD	P07926-B21
HPE 1.92TB SATA 6G Mixed Use SFF (2.5in) SC 3yr Wty Digitally Signed Firmware SSD	P07930-B21
HPE 480GB SATA 6G Mixed Use SFF (2.5in) SC 3yr Wty Digitally Signed Firmware SSD	P09712-B21
HPE 960GB SATA 6G Mixed Use SFF (2.5in) SC 3yr Wty Digitally Signed Firmware SSD	P09716-B21
HPE 1.92TB SATA 6G Mixed Use SFF (2.5in) SC 3yr Wty Digitally Signed Firmware SSD	P09722-B21
HPE 480GB SATA 6G Mixed Use SFF (2.5in) SC 3yr Wty Multi Vendor SSD	P18432-B21
HPE 960GB SATA 6G Mixed Use SFF (2.5in) SC 3yr Wty Multi Vendor SSD	P18434-B21
HPE 1.92TB SATA 6G Mixed Use SFF (2.5in) SC 3yr Wty Multi Vendor SSD	P18436-B21
HPE 3.84TB SATA 6G Mixed Use SFF (2.5in) SC 3yr Wty Multi Vendor SSD	P18438-B21
HPE 480GB SATA 6G Mixed Use SFF (2.5in) SC 3yr Wty SSD	P19947-B21
HPE 960GB SATA 6G Mixed Use SFF (2.5in) SC 3yr Wty SSD	P19949-B21
HPE 1.92TB SATA 6G Mixed Use SFF (2.5in) SC 3yr Wty SSD	P19951-B21
HPE 3.84TB SATA 6G Mixed Use SFF (2.5in) SC 3yr Wty SSD	P19953-B21
Mixed Use - 12G SAS - LFF - Solid State Drives	
HPE 800GB SAS 12G Mixed Use LFF (3.5in) LPC 3yr Wty Digitally Signed Firmware SSD	P04531-B21
HPE 1.6TB SAS 12G Mixed Use LFF (3.5in) LPC 3yr Wty Digitally Signed Firmware SSD	P04535-B21
Mixed Use - 6G SATA - M.2 - Solid State Drives	
HPE 240GB SATA 6G Mixed Use M.2 2280 3yr Wty Digitally Signed Firmware SSD	875488-B21

Core Options

HPE 480GB SATA 6G Mixed Use M.2 2280 3yr Wty Digitally Signed Firmware SSD	875490-B21
HPE 960GB SATA 6G Mixed Use M.2 2280 3yr Wty Digitally Signed Firmware SSD	875492-B21

Notes:

- Requires the M.2 universal enablement card kit (878783-B21) and use S100i SATA controller only.
- M.2 supports Software RAID only.
- HPE ML350 Gen10 Redundant Fan Cage Kit (874572-B21) is required for M.2 drives.
- HPE has qualified the M.2 drive portfolio using the Operating System inbox drivers, full detail on the [HPE Solid State Drive QuickSpecs](#).

Read Intensive - 6G SATA - M.2 - Solid State Drives

HPE 480GB SATA 6G Read Intensive M.2 2280 3yr Wty Digitally Signed Firmware SSD	875498-B21
HPE 960GB SATA 6G Read Intensive M.2 2280 3yr Wty Digitally Signed Firmware SSD	875500-B21
HPE 240GB SATA 6G Read Intensive M.2 2280 3yr Wty SSD	P19888-B21
HPE 480GB SATA 6G Read Intensive M.2 2280 3yr Wty SSD	P19890-B21
HPE 960GB SATA 6G Read Intensive M.2 2280 3yr Wty SSD	P19892-B21

Notes:

- HPE Universal SATA HHLH 3yr Wty M.2 Kit (878783-B21) and use S100i SATA controller only.
- M.2 supports Software RAID only.
- HPE ML350 Gen10 Redundant Fan Cage Kit (874572-B21) is required for M.2 drives.
- HPE has qualified the M.2 drive portfolio using the Operating System inbox drivers, full detail on the [HPE Solid State Drive QuickSpecs](#).

NVMe - SFF - Solid State Drives

HPE 375GB NVMe x4 Lanes Write Intensive SFF (2.5in) SCN 3yr Wty Digitally Signed Firmware SSD	878014-B21
HPE 1.6TB NVMe x4 Lanes Mixed Use SFF (2.5in) SCN 3yr Wty Digitally Signed Firmware SSD	P10222-B21
HPE 1.92TB NVMe x4 Lanes Read Intensive SFF (2.5in) SCN 3yr Wty Digitally Signed Firmware SSD	P10214-B21
HPE 960GB NVMe x4 Lanes Read Intensive SFF (2.5in) SCN 3yr Wty Digitally Signed Firmware SSD	P10208-B21
HPE 1.92TB NVMe x4 Lanes Read Intensive SFF (2.5in) SCN 3yr Wty Digitally Signed Firmware SSD	P10210-B21
HPE 3.84TB NVMe x4 Lanes Read Intensive SFF (2.5in) SCN 3yr Wty Digitally Signed Firmware SSD	P10212-B21
HPE 800GB NVMe x4 Lanes Mixed Use SFF (2.5in) SCN 3yr Wty Digitally Signed Firmware SSD	P07179-B21
HPE 1.6TB NVMe x4 Lanes Mixed Use SFF (2.5in) SCN 3yr Wty Digitally Signed Firmware SSD	P07181-B21
HPE 3.2TB NVMe x4 Lanes Mixed Use SFF (2.5in) SCN 3yr Wty Digitally Signed Firmware SSD	P07183-B21
HPE 960GB NVMe x4 Lanes Read Intensive SFF (2.5in) SCN 3yr Wty Digitally Signed Firmware SSD	P07190-B21
HPE 1.92TB NVMe x4 Lanes Read Intensive SFF (2.5in) SCN 3yr Wty Digitally Signed Firmware SSD	P07192-B21
HPE 3.84TB NVMe x4 Lanes Read Intensive SFF (2.5in) SCN 3yr Wty Digitally Signed Firmware SSD	P07194-B21
HPE 750GB NVMe x4 Lanes Write Intensive SFF (2.5in) SCN 3yr Wty Digitally Signed Firmware SSD	P06952-B21

Notes:

- HPE ML350 Gen10 8SFF NVMe SSD Express Bay Enablement Kit with 2x4 NVMe Risers and Support Cables (874569-B21) is required to support installation of these drives.
- Max. support is one Gen10 ML350 NVMe 8SFF Exp Bay Kit (874569-B21) which can support up to 8 NVMe solid state drives.
- NVMe drives require the addition of HPE ML350 Gen10 Redundant Fan Cage Kit (874572-B21).
- When used to run high-performance workloads, NVMe SSDs can cause the fans to operate at high speeds to maintain optimum system cooling. This high-speed fan operation leads to a sound pressure level of between 50 dB(A) to 55 dB(A). Hewlett Packard Enterprise recommends taking this possible acoustic condition into consideration when selecting a site for a server that has NVMe SSDs installed.
- Not supported by HPE Smart Array controllers.
- HPE has qualified the NVMe drive portfolio using the Operating System inbox drivers, full detail on the [HPE Solid State Drive QuickSpecs](#).
- Alternatively, customers can choose the NVMe SSDs in PCIe adapter cards form factor. Refer to the next session for option support detail.

Core Options

NVMe – PCIe Adapter Cards - Solid State Drives

HPE 1.6TB NVMe x8 Lanes Mixed Use HHHL 3yr Wty Digitally Signed Firmware Card	P10264-B21
HPE 3.2TB NVMe x8 Lanes Mixed Use HHHL 3yr Wty Digitally Signed Firmware Card	P10266-B21
HPE 6.4TB NVMe x8 Lanes Mixed Use HHHL 3yr Wty Digitally Signed Firmware Card	P10268-B21

Hard Drive Kits

HPE ML350 Gen10 8SFF Hot Plug Drive Backplane Cage Kit	874568-B21
--	------------

Notes: Add add'l 8 SFF Hot-Plug Hard Drive Cage, allowing for up to 24 SFF Drive support (8+8+8).

HPE ML350 Gen10 4LFF Hot Plug Drive Backplane Cage Kit	874566-B21
--	------------

Notes: Add add'l 4 LFF Hot-Plug Hard Drive Cage, allowing for up to 12 LFF Drive support (4+4+4).

HPE ML350 Gen10 4LFF Non Hot Plug Drive Cage Kit	874567-B21
--	------------

Notes: Field upgrade only. Add add'l 4 LFF Non-Hot-Plug Hard Drive Cage, allowing for up to 12 LFF Drive support (4+4+4). NHP drive cage is for NHP server only.

HPE Universal SATA HHHL 3yr Wty M.2 Kit	878783-B21
---	------------

Notes:

- HPE M.2 universal enablement card kit (878783-B21), which is required for SATA M.2 support.
- Installation of this M.2 enablement card kit is limited to PCIe slot 1, 2, 3 or 4. Max. in ML350 Gen10 is one M.2 enablement card kit.
- HPE ML350 Gen10 Redundant Fan Cage Kit (874572-B21) is required when this card kit is selected/installed for M.2 SSD support.

HPE ML350 Gen10 8SFF NVMe SSD Express Bay Enablement Kit with 2x4NVMe Risers and Support Cables	874569-B21
---	------------

Notes:

- This kit contains two x4 Direct Attach PCIe NVMe Riser Boards with each supporting up to 4 NVMe drives. When both Risers are installed, it supports 8 SFF NVMe drives.
- Max. support is one Gen10 ML350 NVMe 8SFF Exp Bay Kit (874569-B21) with installation limited to Box 2 based on cable routing requirement.
- SFF NVMe SSDs to be ordered separately.
- NVMe support is limited in SFF systems.
- NVMe drives require the addition of HPE ML350 Gen10 Redundant Fan Cage Kit (874572-B21).

Media/ODD Bay Kits

HPE ML350 Gen10 RDX/LTO Media Drive Support Cable Kit with Fan Blank for Long LTO	874570-B21
---	------------

Notes:

- Supporting cables to add additional RDX/tape devices for data backup or archiving.
- RDX/tape devices to be ordered separately.
- In the case when LTO Internal Tape is selected along with the Fan Redundant Kit, Fan#1 will need to be removed and the Fan Blank provided in this option kit will need to be installed in Fan#1 location. This configuration will run without fan redundancy. Refer to [ML350 Gen10 User Guide](#) for more detail.

HPE ML350 Gen10 Slimline ODD Bay and Support Cable Kit	874577-B21
--	------------

Notes: Mechanical converter with supporting cable, required for installation of slimline DVD-ROM/DVD-RW.

Hard Drive Blank Kits

HPE Small Form Factor Hard Drive Blank Kit	666987-B21
--	------------

HPE Gen9 LFF HDD Spade Blank Kit	807878-B21
----------------------------------	------------

HPE Networking

1 Gigabit Ethernet adapters

HPE Ethernet 1Gb 4-port 331T Adapter	647594-B21
--------------------------------------	------------

HPE Ethernet 1Gb 4-port 366T Adapter	811546-B21
--------------------------------------	------------

HPE Ethernet 1Gb 2-port 332T Adapter	615732-B21
--------------------------------------	------------

HPE Ethernet 1Gb 2-port 361T Adapter	652497-B21
--------------------------------------	------------

Core Options

10 Gigabit Ethernet adapters

HPE Ethernet 10Gb 2-port 530T Adapter	656596-B21
HPE Ethernet 10Gb 2-port 535T Adapter	813661-B21
HPE Ethernet 10Gb 2-port 530SFP Adapter	652503-B21
HPE Ethernet 10Gb 2-port 521T Adapter	867707-B21

Notes: HPE ML350 Gen10 Redundant Fan Cage Kit with 4 Fan Modules (874572-B21) is required when this SKU is selected.

HPE Ethernet 10Gb 2-port 562T Adapter	817738-B21
HPE Ethernet 10Gb 2-port 562SFP+ Adapter	727055-B21
HPE Ethernet 10Gb 2-port 524SFP+ Adapter	P08446-B21
HPE Ethernet 10Gb 2-port 548SFP+ Adapter	P11338-B21

25 Gigabit Ethernet adapters

HPE Ethernet 10/25Gb 2-port 631SFP28 Adapter	817718-B21
HPE Ethernet 10/25Gb 2-port 640SFP28 Adapter	817753-B21
HPE Ethernet 10/25Gb 2-port 621SFP28 Adapter	867328-B21

Notes: HPE ML350 Gen10 Redundant Fan Cage Kit with 4 Fan Modules (874572-B21) is required when this SKU is selected.

100 Gigabit Ethernet adapters

HPE Ethernet 100Gb 1-port 842QSFP28 Adapter	874253-B21
---	------------

Notes: HPE ML350 Gen10 Redundant Fan Cage Kit with 4 Fan Modules (874572-B21) is required when this SKU is selected.

HPE InfiniBand

HPE 100Gb 1-port OP101 QSFP28 x16 PCIe Gen3 with Intel Omni-Path Architecture Adapter	829335-B21
---	------------

Notes: HPE ML350 Gen10 Redundant Fan Cage Kit with 4 Fan Modules (874572-B21) is required to support this card.

HPE InfiniBand FDR/Ethernet 10Gb/40Gb 2-port 544+QSFP Adapter	764284-B21
HPE InfiniBand EDR/Ethernet 100Gb 1-port 840QSFP28 Adapter	825110-B21

Notes: HPE ML350 Gen10 Redundant Fan Cage Kit with 4 Fan Modules (874572-B21) is required to support this card.

HPE InfiniBand EDR/Ethernet 100Gb 2-port 840QSFP28 Adapter	825111-B21
--	------------

Notes: HPE ML350 Gen10 Redundant Fan Cage Kit with 4 Fan Modules (874572-B21) is required to support this card.

HPE Ethernet 100Gb 1-port 842QSFP28 Adapter	874253-B21
---	------------

Notes: HPE ML350 Gen10 Redundant Fan Cage Kit with 4 Fan Modules (874572-B21) is required to support this card.

HPE Power Supplies

HPE 500W Flex Slot Platinum Hot Plug Low Halogen Power Supply Kit	865408-B21
---	------------

Notes: Flex Slot Platinum power supplies support power efficiency of up to 94% and include a standard C-14 power inlet connector.

HPE 800W Flex Slot Titanium Hot Plug Low Halogen Power Supply Kit	865438-B21
---	------------

Notes: Flex Slot Titanium power supplies support power efficiency of up to 96% and include a standard C-14 power inlet connector.

HPE 800W Flex Slot Platinum Hot Plug Low Halogen Power Supply Kit	865414-B21
---	------------

Notes: Flex Slot Platinum power supplies support power efficiency of up to 94% and include a standard C-14 power inlet connector.



Core Options

HPE 800W Flex Slot -48VDC Hot Plug Low Halogen Power Supply Kit 865434-B21

Notes: Flex Slot -48VDC power supplies support power efficiency of up to 94%.

HPE 800W Flex Slot Universal Hot Plug Low Halogen Power Supply Kit 865428-B21

Notes: Flex Slot universal power supplies support power efficiency of up to 94% and support both 277VAC/380VDC power inputs.

HPE 1600W Flex Slot Platinum Hot Plug Low Halogen Power Supply Kit 830272-B21

Notes: Available in 94% efficiency.

HPE Power Supply Options

HPE ML350 Gen10 Flex Slot Redundant Power Supply Cage Kit with Power Distribution Board 874571-B21

Notes: Field upgrade only. Allowing field upgrade from the 500W standard PSU/non-RPS, non-hot-plug to support HPE Flex Slot RPS.



Core Options

GPGPU Information

Part Number	Card	TDP	Max. Qty. Support	PCIe Speed	ML350 Gen10 Configuration						
					8SFF	16SFF	16SFF + 8NVM e	24SFF	4LFF	8LFF	12LFF
Q0V77A	HPE NVIDIA Quadro P2000 GPU Module	75W	4	Gen3	35C	35C	35C*	35C***	35C	35C	35C
Q0V78A	HPE NVIDIA Quadro P4000 GPU Module	105W	3	Gen3	35C	35C	35C*	35C***	35C	35C	35C
Q0V76A	HPE NVIDIA Quadro P6000 GPU Module	250W	3	Gen3	35C	35C	35C*	35C***	35C	35C	35C
Q0J62C	HPE NVIDIA Tesla M10 Quad GPU Module	225W	2	Gen3	35C	30C	30C	30C	35C	30C	30C
Q0V80C	HPE NVIDIA Tesla P40 24 GB Module	250W	2	Gen3	25C	20C	20C*	20C***	25C	20C	20C
Q1K34A	HPE NVIDIA Quadro GV100 GPU Module	250W	3	Gen3	20C/30C**	20C/30C**	20C*	20C***	20C/30C**	20C/30C**	20C
Q2N67A	HPE NVIDIA GV100 Nvlink Bridge Kit	n/a	2	NVLink	n/a	n/a	n/a	n/a	n/a	n/a	n/a
R0Z45C	HPE NVIDIA Quadro RTX6000 GPU Module	260W	2	Gen3	35C	35C	35C*	35C***	35C	35C	35C
R1F97C	HPE NVIDIA Quadro RTX8000 GPU Module	260W	2	Gen3	35C	35C	35C*	35C***	35C	35C	35C
R1F96C	HPE NVIDIA Quadro RTX NVLink Bridge	n/a	2	NVLink	n/a	n/a	n/a	n/a	n/a	n/a	n/a
R0W29C	HPE NVIDIA Tesla T4 16GB Module	70W	4	Gen3	25C/28C**	20C/25C**	35C*	25C/28C**&***	30C/35C**	25C/35C**	25C/35C**
R1F95C	HPE NVIDIA Quadro RTX4000 GPU Module	125W	4	Gen3	35C	35C	35C*	35C***	35C	35C	35C
R3K70C	HPE NVIDIA Quadro P1000 GPU Module	47W	4	Gen3	35C	35C	35C	35C	35C	35C	35C
R2U55C	HPE NVIDIA Quadro P2200 GPU Module	75W	4	Gen3	35C	35C	35C	35C	35C	35C	35C

Core Options

Notes:

- The 1600W RPS is recommended when the system is configured with high power GPU. The 800W RPS will work too (per GPU) – depending on configuration. Please do check the total power requirement of your selected configuration with the GPU(s) supported in this platform with the HPE Power Advisor Tool located at <http://www.hpe.com/info/hppoweradvisor>.
- The ML350 Gen10 Redundant Fan Cage Kit (874572-B21) is required for ALL GPU installations. (Note, the redundant fan kit ships as standard with the two 2P Performance models and the Rack CTO).
- Mixing of GPUs is not supported.
- These GPUs are not recommended for use in office environment especially under stress mode when system fans are running at full speed.
- HPE ML350 Gen10 GPU Ext Power Cable Kit (877628-B21) is required for GPU TDP larger than 75W – that is, this GPU external power cable kit is required except for HPE NVIDIA Quadro P2000 (QOV77A), HPE NVIDIA Tesla T4 (ROW29C), HPE NVIDIA Quadro P1000 (R3K70C) or HPE NVIDIA Quadro P2200 (R2U55C).
- For 16SFF + 8 NVMe configuration, the two PCIe NVMe Riser Boards are required to install in PCIe slot 1 and 3. Therefore, the max. GPU quantity to be supported will vary.
- ** Higher ambient temps are supported with “increased cooling” statically set in the RBSU.
- *** For 24SFF configuration, requires the SAS Expander be installed in PCIe slot 4. Therefore, the max. GPU quantity to be supported will vary.

HPE Computation and Graphics Accelerators

NVIDIA Tesla M10 Quad GPU Module

QOJ62C

Notes:

- HPE ML350 Gen10 GPU External Power Cable Kit (877628-B21) is required.
- HPE ML350 Gen10 Redundant Fan Cage Kit (874572-B21) is required.

HPE NVIDIA Tesla P40 24GB Computational Accelerator

QOV80C

Notes:

- HPE ML350 Gen10 GPU External Power Cable Kit (877628-B21) is required
- HPE ML350 Gen10 Redundant Fan Cage Kit (874572-B21) is required.

HPE NVIDIA Quadro RTX 6000 Graphics Accelerator

ROZ45C

Notes:

- HPE ML350 Gen10 GPU External Power Cable Kit (877628-B21) is required.
- HPE ML350 Gen10 Redundant Fan Cage Kit (874572-B21) is required.
- Maximum number to select in CTO orders is limited to 2 when the HPE NVIDIA Quadro RTX NVLink Bridge (R1F96C) is in the configuration (one NVLink bridge to integrate two RTX6000 modules). In the case of BTO for customer/field upgrade, max. is 4 (with or without the NVLink Bridges) depending on the specific GPU workload.
- This GPU model is supported with the 2nd generation of Intel Xeon® Scalable Processors only. It was tested with the 1st generation of Intel Xeon® Scalable Processors also, but support is limited to LVO and private only.

HPE NVIDIA Quadro RTX 8000 Graphics Accelerator

R1F97C

Notes:

- HPE ML350 Gen10 GPU External Power Cable Kit (877628-B21) is required.
- HPE ML350 Gen10 Redundant Fan Cage Kit (874572-B21) is required.
- Maximum number to select in CTO orders is limited to 2 when the HPE NVIDIA Quadro RTX NVLink Bridge (R1F96C) is in the configuration (one NVLink bridge to integrate two RTX8000 modules). In the case of BTO for customer/field upgrade, max. is 4 (with or without the NVLink Bridges) depending on the specific GPU workload.
- This GPU model is supported with the 2nd generation of Intel Xeon® Scalable Processors only. It was tested with the 1st generation of Intel Xeon® Scalable Processors also, but support is limited to LVO and private only.



Core Options

HPE NVIDIA Quadro RTX x16 2-way 2-slot NVLink Bridge R1F96C

Notes:

- Used to combine 2 HPE NVIDIA Quadro RTX6000 or RTX8000 GPU modules. 1 HPE NVIDIA RTX Nvlink Bridge Kit is required for every pair of RTX6000 or RTX8000 PCIE cards.
- This GPU model is supported with the 2nd generation of Intel Xeon® Scalable Processors only.
- Maximum number to select in CTO orders is limited to 1 (integrating two RTX6000 or RTX8000 modules). In the case of BTO for customer/field upgrade, max. is 2 (to integrate two pairs of RTX6000 or RTX8000 GPU modules) depending on GPU workload.
- This GPU model is supported with the 2nd generation of Intel Xeon® Scalable Processors only. It was tested with the 1st generation of Intel Xeon® Scalable Processors also but support is limited to LVO and private only.

HPE NVIDIA Quadro RTX 4000 Graphics Accelerator R1F95C

Notes:

- HPE ML350 Gen10 GPU External Power Cable Kit (877628-B21) is required.
- HPE ML350 Gen10 Redundant Fan Cage Kit (874572-B21) is required.
- This GPU model is supported with the 2nd generation of Intel Xeon® Scalable Processors only.

HPE NVIDIA Tesla T4 16GB Computational Accelerator ROW29C

Notes:

- HPE ML350 Gen10 Redundant Fan Cage Kit (874572-B21) is required.
- This GPU model is supported with the 2nd generation of Intel Xeon® Scalable Processors only. It was tested with the 1st generation of Intel Xeon® Scalable Processors also but support is limited to LVO and private only.

NVIDIA Quadro P1000 Graphics Accelerator R3K70C

Notes:

- HPE ML350 Gen10 Redundant Fan Cage Kit (874572-B21) is required.
- This GPU model is supported with the 2nd generation of Intel Xeon® Scalable Processors only.

NVIDIA Quadro P2200 Graphics Accelerator R2U55C

Notes:

- HPE ML350 Gen10 Redundant Fan Cage Kit (874572-B21) is required.
- This GPU model is supported with the 2nd generation of Intel Xeon® Scalable Processors only.

Graphics Cable Kits

HPE ML350 Gen10 GPU External Power Cable Kit 877628-B21

Notes: This kit consists of two external power cables to feed power to GPU modules with TDP larger than 75W that is, this GPU external power cable kit is required except for HPE NVIDIA Quadro P2000 (QOV77A), HPE NVIDIA Tesla T4 (ROW29C), HPE NVIDIA Quadro P1000 (R3K70C) or HPE NVIDIA Quadro P2200 (R2U55C). The longer GPU power cable is intended to support GPU installation in PCIe slot 1 or 3 (slots coming from CPU 1); while the other shorter cable to support slot 5 or 7 (slots coming from CPU 2).

PCIe Accelerators

HPE 750GB PCIe x4 Lanes Write Intensive HHL 3yr Wty Digitally Signed Firmware Card 878038-B21

Notes: HPE ML350 Gen10 Redundant Fan Cage Kit with 4 Fan Modules (874572-B21) is required.



Core Options

HPE Cooling Options

HPE ML350 Gen10 Redundant Fan Cage Kit with 4 Fan Modules

874572-B21

Notes:

- This kit is required for elevated Ambient temperature environments.
 - Add add'l 4x hot-plug fans which are installed in the fan cage to get N+1 fan redundancy and advanced cooling.
 - The performance 2P BTO models and the Rack CTO model will already include this kit to include 6 fans total.
 - The ML350 Gen10 Redundant Fan Kit (874572-B21) is required for one of the following configurations or situations: 2P configuration.
 - When the unit is configured to use in Rack mode.
 - When front storage is fully populated with (3) 4LFF or (3) 8SFF drive cages or (2) LFF or SFF drive cages along with (2) media bays and (1) DVD.
 - When ML350 Gen10 is used in ASHRAE 3 or 4 environment.
 - When the unit is configured with higher RPM SAS HDDs (10K, 15K or higher).
 - When the unit is configured with NVMe Express Bay for NVMe SSD support.
 - When M.2 is selected.
 - The ML350 Gen10 Redundant Fan Cage Kit is also needed to support certain higher end PCIe expansion cards for example, GPU (Graphic Processing Unit), advanced PCIe accelerators, InfiniBand cards, higher-end network adapters and storage controllers P816i-a and P824i-pcontroller.
 - Please refer to the User Guide for special configuration scenarios where the redundant fan option is required but does not provide redundancy function.
-



Additional Options

Some options may not be integrated at the factory. To ensure only valid configurations are ordered, Hewlett Packard Enterprise recommends the use of an HPE approved configurator. Contact your local sales representative for additional information.

Embedded Management

HPE iLO Advanced

Description

Description	SKU
HPE iLO Advanced Electronic License with 1yr Support on iLO Licensed Features	E6U59ABE
HPE iLO Advanced 1-server License with 1yr Support on iLO Licensed Features	512485-B21
HPE iLO Advanced Flexible Quantity License with 1yr Support on iLO Licensed Features	512486-B21
HPE iLO Advanced AKA Tracking License with 1yr Support on iLO Licensed Features	512487-B21
HPE iLO Advanced Electronic License with 3yr Support on iLO Licensed Features	E6U64ABE
HPE iLO Advanced 1-server License with 3yr Support on iLO Licensed Features	BD505A
HPE iLO Advanced Flexible Quantity License with 3yr Support on iLO Licensed Features	BD506A
HPE iLO Advanced AKA Tracking License with 3yr Support on iLO Licensed Features	BD507A

HPE Converged Infrastructure Management Software

HPE OneView Physical Media Kit LTU	E5Y37A
HPE OneView including 3yr 24x7 Support Physical 1-server LTU	E5Y34A
HPE OneView including 3yr 24x7 Support Flexible Quantity E-LTU	E5Y35AAE
HPE OneView w/o iLO including 3yr 24x7 Support Track 1-server LTU	P8B25A
HPE OneView w/o iLO including 3yr 24x7 Support 1-server LTU	P8B24A
HPE OneView w/o iLO including 3yr 24x7 Support Flexible Quantity E-LTU	P8B26AAE
HPE OneView w/o iLO including 3yr 24x7 Support 1-server FIO LTU	P8B31A
HPE OneView for ProLiant DL Server including 3yr 24x7 Support FIO Bundle Physical 1-server LTU	E5Y43A

Notes: Licenses ship without media. The HPE OneView Media Kit can be ordered separately, or can be [downloaded](#).

HPE Security

HPE Trusted Platform Module 2.0 Gen10 Option	864279-B21
--	------------

Notes:

- HPE Trusted Platform Module 2.0 option works with Gen10 servers with UEFI Mode not Legacy Mode. It is not compatible with HPE ProLiant Gen8 servers or earlier generation variants.
- HPE server systems can have a TPM module (of any type) installed only once. It cannot be replaced with any other TPM module.
- There is a FIO setting to allow this TPM module to operate in a TPM 1.2 mode (872108-B21).

HPE Gen10 TPM 1.2 FIO Setting	872108-B21
-------------------------------	------------

HPE Smart Array Controllers

The Gen10 controller naming framework has been updated to simplify identification as depicted below. For a more detailed breakout of the available Gen10 Smart Array controllers visit the [HPE Smart Array Gen10 Controllers Data Sheet](#).

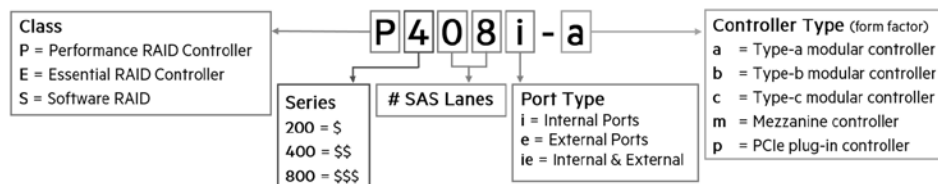

Additional Options

Performance RAID Controllers

Notes: All performance RAID controllers are supported by the HPE Smart Storage Battery (P01367-B21), or HPE Smart Storage Hybrid Capacitor (P02381-B21) which supports multiple devices and is sold separately.

HPE Smart Array P816i-a SR Gen10 (16 Internal Lanes/4GB Cache/SmartCache) 12G SAS Modular Controller 804338-B21

Notes:

- Does not occupy a PCIe expansion slot and includes SmartCache license.
- HPE ML350 Gen10 SFF AROC Cable Kit (877575-B21) for SFF chassis configuration or HPE ML350 Gen10 LFF AROC Cable Kit (874573-B21) for LFF chassis configuration is required.
- HPE ML350 Gen10 Redundant Fan Cage Kit (874572-B21) is required for P816i-a.
- For information on the HPE Smart Array P816i-a SR Gen10 Controller please refer to their [QuickSpecs](#).

HPE Smart Array P408i-a SR Gen10 (8 Internal Lanes/2GB Cache) 12G SAS Modular Controller 804331-B21

Notes:

- Does not occupy a PCIe expansion slot.
- HPE ML350 Gen10 SFF AROC Cable Kit (877575-B21) for SFF chassis configuration or HPE ML350 Gen10 LFF AROC Cable Kit (874573-B21) for LFF chassis configuration is required.
- For information on the HPE Smart Array P408i-a SR Gen10 Controller please refer to their [QuickSpecs](#).

HPE Smart Array P408i-p SR Gen10 (8 Internal Lanes/2GB Cache) 12G SAS PCIe Plug-in Controller 830824-B21

Notes:

- HPE ML350 Gen10 Smart Array/HBA Mini-SAS Cable Kit for SFF Configuration (874575-B21) for SFF chassis configuration or HPE ML350 Gen10 LFF SA/HBA Cable Kit (874574-B21) for LFF chassis configuration is required.
- For information on the HPE Smart Array P408i-p SR Gen10 Controller please refer to their [QuickSpecs](#).

HPE Smart Array P408e-p SR Gen10 (8 External Lanes/4GB Cache) 12G SAS PCIe Plug-in Controller 804405-B21

Notes: For information on the HPE Smart Array P408e-p SR Gen10 Controller please refer to their [QuickSpecs](#).

HPE Smart Array P824i-p MR Gen10 (24 Internal Lanes/4GB Cache/CacheCade) 12G SAS PCIe Controller 870658-B21

Notes:

- HPE D38X/580/560/ML350 24P Cable Kit (P00614-B21) is required when this controller is selected.
- HPE ML350 Gen10 Redundant Fan Cage Kit (874572-B21) is required for P824i-p.
- This controller is supported in ML350 Gen10 SFF configurations in both CTO orders and BTO customer self upgrade, supporting up to 24 SAS/SATA drives. The support is available in LFF configurations only in BTO customer/field upgrade.
- For information on the HPE Smart Array P824i-p MR Gen10 Controller, please refer to their [QuickSpecs](#)

Essential RAID Controllers

HPE Smart Array E208i-p SR Gen10 (8 Internal Lanes/No Cache) 12G SAS PCIe Plug-in Controller 804394-B21

Notes:

- HPE ML350 Gen10 Smart Array/HBA Mini-SAS Cable Kit for SFF Configuration (874575-B21) for SFF chassis configuration or HPE ML350 Gen10 LFF SA/HBA Cable Kit (874574-B21) for LFF chassis configuration is required.
- For information on the HPE Smart Array E208i-p SR Gen10 Controller please refer to their [QuickSpecs](#).

HPE Smart Array E208e-p SR Gen10 (8 External Lanes/No Cache) 12G SAS PCIe Plug-in Controller 804398-B21

Notes: For information on the HPE Smart Array E208e-p SR Gen10 Controller please refer to their [QuickSpecs](#).



Additional Options

Essential RAID Controllers

HPE Smart Array E208i-a SR Gen10 (8 Internal Lanes/No Cache) 12G SAS Modular Controller 804326-B21

Notes:

- Does not occupy a PCIe expansion slot.
- HPE ML350 Gen10 SFF AROC Cable Kit (877575-B21) for SFF chassis configuration or HPE ML350 Gen10 LFF AROC Cable Kit (874573-B21) for LFF chassis configuration is required.
- For information on the HPE Smart Array E208i-a SR Gen10 Controller please refer to their [QuickSpecs](#)

HPE Cable Options and SAS Expander Kit

HPE ML350 Gen10 Embedded SATA Cable Kit for LFF Configuration 877578-B21

Notes: This cable kit is used to support the embedded SATA controller with S100i SW RAID.

HPE ML350 Gen10 Embedded SATA Cable Kit for SFF Configuration 877579-B21

Notes: This cable kit is used to support the embedded SATA controller with S100i SW RAID.

HPE ML350 Gen10 AROC Mini-SAS Cable Kit for LFF Configuration 874573-B21

Notes: This cable kit is used to support the HPE modular storage controller (AROC). One cable kit is required for one controller.

HPE ML350 Gen10 AROC Mini-SAS Cable Kit for SFF Configuration 877575-B21

Notes: This cable kit is used to support the HPE modular storage controller (AROC). One cable kit is required for one controller.

HPE ML350 Gen10 Smart Array/HBA Mini-SAS Cable Kit for LFF Configuration 874574-B21

Notes: This cable kit is used to support the HPE stand-up PCIe storage controller. One cable kit is required for one controller.

HPE ML350 Gen10 Smart Array/HBA Mini-SAS Cable Kit for SFF Configuration 874575-B21

Notes: This cable kit is used to support the HPE stand-up PCIe storage controller. One cable kit is required for one controller.

HPE DL38X/560/580/ML350 Gen10 P824i-p Cable Kit P00614-B21

Notes:

- This cable kit must be selected when P824i-p card is ordered. One P824i-p requires one cable kit.
- For details on cabling options and cable routing instructions, refer to [HPE ML350 Gen10 User Guide](#)

HPE ML350 Gen10 12Gb SAS Expander Card Kit with Cables 874576-B21

Notes:

- Add this SAS Expander option kit to upgrade your ML350 Gen10 SFF system pre-configured with either P408i-a or E208i-a (or any P or E-series card), to support 24 SFF drives.
- This option is not supported with LFF configurations.

Optional Software

HPE Smart Array SR Secure Encryption (Data at Rest Encryption/per Server Entitlement) E-LTU Q2F26AAE

HPE Smart Array SR SmartCache (Single Key/Single Server) LTU D7S26A

HPE Smart Array SR SmartCache (Single Key/Multiple Servers) LTU D7S27A

HPE Smart Array SR SmartCache (Single Key/Multiple Servers) E-LTU D7S27AAE

Notes: SmartCache is offered on HPE Smart Array performance RAID controllers and comes standard (no licensing is required) if the HPE Smart Array P816i-a SR Gen10 Controller is installed in the server.

Optional Upgrades

HPE 96W Smart Storage Lithium-ion Battery with 260mm Cable Kit P01367-B21

Notes: Provides backup power for multiple HPE Smart Array controllers or other devices. Is required with performance RAID controllers. This product replaces 875242-B21.



Additional Options

HPE Smart Storage Hybrid Capacitor with 260mm Cable Kit

P02381-B21

Notes: The HPE Smart Storage Hybrid Capacitor is only supported on Gen10 servers or newer. Before installing the hybrid capacitor module, please verify that the system BIOS meets the minimum firmware requirements to support the capacitor pack. Not for use with servers that use NVDIMMs.

HPE Tape Backup

- Internal half-height (5.25") tape devices are supported in ML350 Gen10 and require the HPE ML350 Gen10 Media Drive Support Kit (874570-B21).
- In the case when LTO Internal Tape is selected along with the Fan Redundant Kit, Fan#1 will need to be removed and the Fan Blank provided in this option kit will need to be installed in Fan#1 location.
- This configuration will run without fan redundancy. Refer to **ML350 Gen10 User Guide** for more detail.
- Installation of the internal LTO tape drive is limited in media bay 1.
- Change the Thermal Configuration to Increased Cooling mode in BIOS/Platform Configuration (RBSU) menu when internal internal LTO tape is installed
- For the complete range of tape drives, autoloaders, libraries and media see:
<https://www.hpe.com/us/en/storage/storeever-tape-storage.html>.
- For hardware and software compatibility of Hewlett Packard Enterprise tape backup products
<http://www.hpe.com/storage/BURACompatibility>.

HPE Tape Drives

HPE LTO-7 Ultrium 15000 Internal Tape Drive	BB873A
HPE StoreEver LTO-7 Ultrium 15000 External Tape Drive	BB874A
HPE LTO-6 Ultrium 6250 Internal Tape Drive	EH969A
HPE StoreEver LTO-6 Ultrium 6250 External Tape Drive	EH970A
HPE StoreEver LTO-5 Ultrium 3000 SAS Internal Tape Drive	EH957B
HPE StoreEver LTO-5 Ultrium 3000 SAS External Tape Drive	EH958B

HPE Tape Drives

HPE StoreEver LTO-8 Ultrium 30750 Internal Tape Drive	BC022A
HPE StoreEver LTO-8 Ultrium 30750 External Tape Drive	BC023A

HPE Tape Backup Products

HPE StoreEver MSL LTO-8 Ultrium 30750 FC Drive Upgrade Kit	Q6Q67A
HPE StoreEver MSL LTO-8 Ultrium 30750 SAS Drive Upgrade Kit	Q6Q68A
HPE StoreEver MSL3040 Scalable Library Expansion Module	Q6Q63A
HPE StoreEver MSL LTO-7 Ultrium 15000 FC Drive Upgrade Kit	N7P36A
HPE StoreEver MSL LTO-7 Ultrium 15000 SAS Drive Upgrade Kit	N7P37A
HPE StoreEver MSL LTO-6 Ultrium 6250 SAS Drive Upgrade Kit	C0H27A
HPE StoreEver MSL LTO-6 Ultrium 6250 Fibre Channel Drive Upgrade Kit	C0H28A
HPE StoreEver MSL LTO-5 Ultrium 3000 SAS Drive Upgrade Kit	BL540B
HPE StoreEver MSL2024 0-drive Tape Library	AK379A
HPE StoreEver MSL6480 Scalable Base Module	QU625A
HPE StoreEver Mini-SAS High Density to 4-lane Mini-SAS External Fanout 2m Cable	K2R09A
HPE StoreEver Mini-SAS High Density to 4-lane Mini-SAS External Fanout 4m Cable	K2R10A

HPE RDX Products

HPE RDX 1TB External Disk Backup System	B7B69B
HPE RDX External Docking Station	C8S07B
HPE RDX 2TB External Disk Backup System	E7X53B
HPE RDX 1TB Internal Disk Backup System	B7B67A

Additional Options

HPE RDX Internal Docking Station	C8S06A
HPE RDX 4TB Internal Disk Backup System	Q2R32A
HPE RDX 4TB External Disk Backup System	Q2R33A
HPE RDX 2TB Internal Disk Backup System	E7X52A

HPE RDX Products

HPE RDX 4TB Removable Disk Cartridge	Q2048A
HPE RDX 2TB Removable Disk Cartridge	Q2046A
HPE RDX 3TB Removable Disk Cartridge	Q2047A
HPE RDX 500GB Removable Disk Cartridge	Q2042A
HPE RDX 1TB Removable Disk Cartridge	Q2044A

HPE Storage Options

Emulex Fibre Channel HBAs

HPE StoreFabric SN1200E 16Gb Single Port Fibre Channel Host Bus Adapter	Q0L13A
HPE StoreFabric SN1200E 16Gb Dual Port Fibre Channel Host Bus Adapter	Q0L14A
HPE StoreFabric SN1600E 32Gb Single Port Fibre Channel Host Bus Adapter	Q0L11A
HPE StoreFabric SN1600E 32Gb Dual Port Fibre Channel Host Bus Adapter	Q0L12A
HPE SN1610E 32Gb 1-port Fibre Channel Host Bus Adapter	R2J62A
HPE SN1610E 32Gb 2-port Fibre Channel Host Bus Adapter	R2J63A

QLogic Fibre Channel HBAs

HPE StoreFabric SN1100Q 16Gb Single Port Fibre Channel Host Bus Adapter	P9D93A
HPE StoreFabric SN1100Q 16Gb Dual Port Fibre Channel Host Bus Adapter	P9D94A
HPE StoreFabric SN1600Q 32Gb Single Port Fibre Channel Host Bus Adapter	P9M75A
HPE StoreFabric SN1600Q 32Gb Dual Port Fibre Channel Host Bus Adapter	P9M76A
HPE SN1610Q 32Gb 1-port Fibre Channel Host Bus Adapter	R2E08A
HPE SN1610Q 32Gb 2-port Fibre Channel Host Bus Adapter	R2E09A

Converged Network Adapters

HPE StoreFabric CN1100R Dual Port Converged Network Adapter	QW990A
HPE StoreFabric CN1100R 10GBASE-T Dual Port Converged Network Adapter	N3U52A
HPE StoreFabric CN1200E 10GBASE-T Dual Port Converged Network Adapter	N3U51A
HPE StoreFabric CN1200E 10Gb Converged Network Adapter	E7Y06A
HPE StoreFabric CN1200R 10GBASE-T Converged Network Adapter	Q0F26A
HPE StoreFabric CN1300R 10/25Gb Dual Port Converged Network Adapter	Q0F09A

Notes: For the complete listing of Fibre Channel Converged Network Adapters please see:

<https://www.hpe.com/us/en/product-catalog/servers/adapters>

HPE Racks

Please see the [HPE Advanced Series Racks QuickSpecs](#) for information on additional racks options and rack specifications.

Please see the [HPE Enterprise Series Racks QuickSpecs](#) for information on additional racks options and rack specifications.

Please see the [HPE Standard Series Racks QuickSpecs](#) for information on additional racks options and rack specifications.



Additional Options

HPE Power Distribution Units (PDUs)

Please see the [HPE Basic Power Distribution Units \(PDU\) QuickSpecs](#) for information on these products and their specifications.

Please see the [HPE Metered Power Distribution Units \(PDU\) QuickSpecs](#) for information on these products and their specifications.

Please see the [HPE Intelligent Power Distribution Unit \(PDU\) QuickSpecs](#) for information on these products and their specifications.

Please see the [HPE Metered and Switched Power Distribution Units \(PDU\) QuickSpecs](#) for information on these products and their specifications.

HPE Uninterruptible Power Systems (UPS)

To learn more, please visit the [HPE Uninterruptible Power Systems \(UPS\) web page](#).

Please see the [HPE DirectFlow Three Phase Uninterruptible Power System QuickSpecs](#) for information on these products and their specifications.

Please see the [HPE Line Interactive Single Phase UPS QuickSpecs](#) for information on these products and their specifications.

HPE T750 Gen5 NA/JP UPS with Management Card Slot	Q1F47A
HPE T750 Gen5 INTL UPS with Management Card Slot	Q1F48A
HPE T1000 Gen5 NA/JP UPS with Management Card Slot	Q1F49A
HPE T1000 Gen5 INTL UPS with Management Card Slot	Q1F50A
HPE T1500 Gen5 NA/JP UPS with Management Card Slot	Q1F51A
HPE T1500 Gen5 INTL UPS with Management Card Slot	Q1F52A

HPE Rack Options

Please see the [HPE KVM Switches web page](#) for information on these products and their specifications.

Rail Kits

HPE ML Gen10 Tower to Rack Conversion Kit with Sliding Rail Rack Shelf and Cable Management Arm	874578-B21
---	------------

Notes: Easy install rack rail tray which takes up 1U height in a standard rack facility. This kit is supported in both ML350 and ML110 Gen10 for tower to rack conversion. This kit includes CMA and is shipped as standard in the 2P Performance Rack SKU and SFF Rack CTO.

HPE USB and SD Options

HPE 32GB microSD Flash Memory Card	700139-B21
HPE 8GB microSD Flash Memory Card	726116-B21
HPE 8GB microSD Flash USB Drive	737953-B21
HPE 8GB Dual microSD Flash USB Drive	741279-B21
HPE 32GB microSD RAID 1 USB Boot Drive	P21868-B21

HPE Support Services

HPE 3 Year Proactive Care 24x7 ML350 Gen10 Service	H9GF8E
HPE 3 Year Proactive Care 24x7 with DMR ML350 Gen10 Service	H9GF9E
HPE 3 Year Proactive Care 24x7 with CDMR ML350 Gen10 Service	H9GG0E
HPE 3 Year Proactive Care Call-To-Repair ML350 Gen10 Service	H9GG7E
HPE 3 Year Proactive Care Call-To-Repair 24x7 with DMR ML350 Gen10 Service	H9GG8E
HPE 3 Year Proactive Care Call-To-Repair with CDMR ML350 Gen10 Service	H9GG9E
HPE Installation and Startup ML350(p) Service	U4523E

Notes: For a full listing of support services available for this server, please visit <https://ssc.hpe.com/>



Memory

Memory Population guidelines

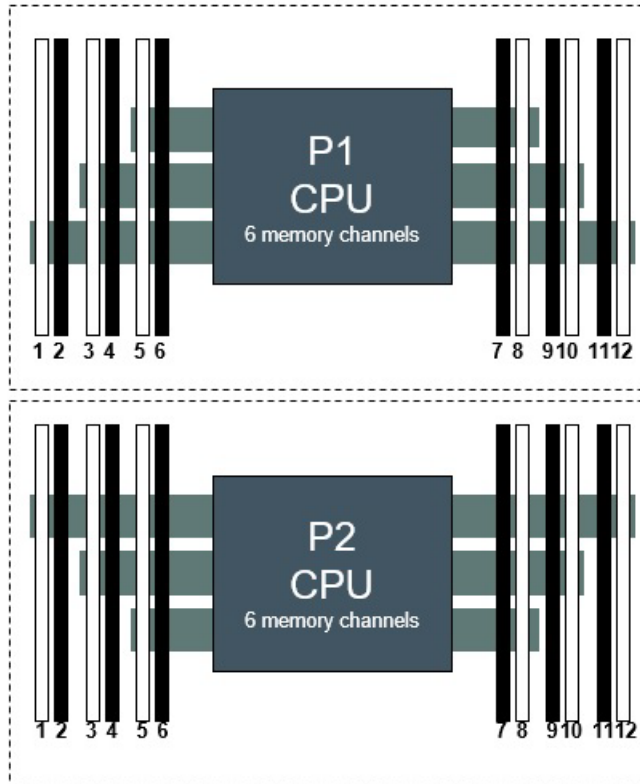

HPE ML350 Gen10 Server(Front Server)

Notes: 2 Slots per channel

1 DIMM							8				
2 DIMM s							8		10		
3 DIMM s							8		10		12
4 DIMM s			3		5		8		10		
5 DIMM s*			3		5		8		10		12
6 DIMM s	1		3		5		8		10		12
7 DIMM s*	1		3		5		7	8		10	12
8 DIMM s			3	4	5	6	7	8	9	10	
9 DIMM s*	1		3		5		7	8	9	10	11
10 DIMM s*	1		3	4	5	6	7	8	9	10	12
11 DIMM s*	1		3	4	5	6	7	8	9	10	11
12 DIMM s	1	2	3	4	5	6	7	8	9	10	11

HPE ProLiant Gen10 12 slot per CPU DIMM Population Order

Notes:*Unbalanced, not recommended



Memory

General Memory Population Rules and Guidelines:

- Install DIMMs only if the corresponding processor is installed.
- If only one processor is installed in a two-processor system, only half of the DIMM slots are available.
- To maximize performance, it is recommended to balance the total memory capacity between all installed processors.
- When two processors are installed, balance the DIMMs across the two processors.
- White DIMM slots denote the first slot to be populated in a channel.
- Mixing of DIMM types (UDIMM, RDIMM, and LRDIMM) is not supported.
- The maximum memory speed is a function of the memory type, memory configuration, and processor model.
- The maximum memory capacity is a function of the number of DIMM slots on the platform, the largest DIMM capacity qualified on the platform, the number and model of installed processors qualified on the platform.
- For details on the HPE Server Memory Options Population Rules, visit: <http://www.hpe.com/docs/memory-population-rules>.
- To realize the performance memory capabilities listed in this document, HPE DDR4 SmartMemory is required. For additional information, please see the [HPE DDR4 SmartMemory QuickSpecs](#).

Notes: The maximum memory speed is a function of the memory type, memory configuration, and processor model.

For details on the HPE Server Memory speed, visit: <https://www.hpe.com/docs/memory-speed-table>.

Standard and Maximum Memory Capacity (Pre-configured Models)

For the Second Generation of Intel Xeon® Scalable Processors – Refresh			
Pre Configured Models	Standard Memory	Maximum Memory Plus Optional Memory	Standard Memory Replaced with Optional Memory
3206R	16 GB (1x16 GB RDIMM SR)	384 GB (24x 16 GB)	3072 GB (24x 128 GB)
4210R	16 GB (1x16 GB RDIMM SR)	384 GB (24x 16 GB)	3072 GB (24x 128 GB)
4214R	32 GB (1x32 GB RDIMM DR)	768 GB (24x 32 GB)	3072 GB (24x 128 GB)
5218R	32 GB (1x32 GB RDIMM DR)	768 GB (24x 32 GB)	3072 GB (24x 128 GB)

For the Second Generation of Intel Xeon® Scalable Processors			
Pre Configured Models	Standard Memory	Maximum Memory Plus Optional Memory	Standard Memory Replaced with Optional Memory
3204	8GB (1x8 GB RDIMM SR)	192 GB (24x 8 GB)	3072 GB (24x 128 GB)
4208	16 GB (1x16 GB RDIMM SR)	384 GB (24x 16 GB)	3072 GB (24x 128 GB)
4210	16 GB (1x16 GB RDIMM SR)	384 GB (24x 16 GB)	3072 GB (24x 128 GB)
4214	32 GB (1x32 GB RDIMM DR)	768 GB (24x 32 GB)	3072 GB (24x 128 GB)
5218	32 GB (1x32 GB RDIMM DR)	768 GB (24x 32 GB)	3072 GB (24x 128 GB)

Notes: The 13th – 24th DIMM support requires installation of the second processor.

DDR4 memory options part number decoder

Notes: Capacity references are rounded to the common gigabyte (GB) values. 8GB = 8,192 MB

- 16GB = 16,384 MB
- 32GB = 32,768 MB
- 64GB = 65,536 MB
- 128 GB = 131,072 MB

For more information on memory, please see the Memory QuickSpecs: [HPE DDR4 SmartMemory](#).

Storage

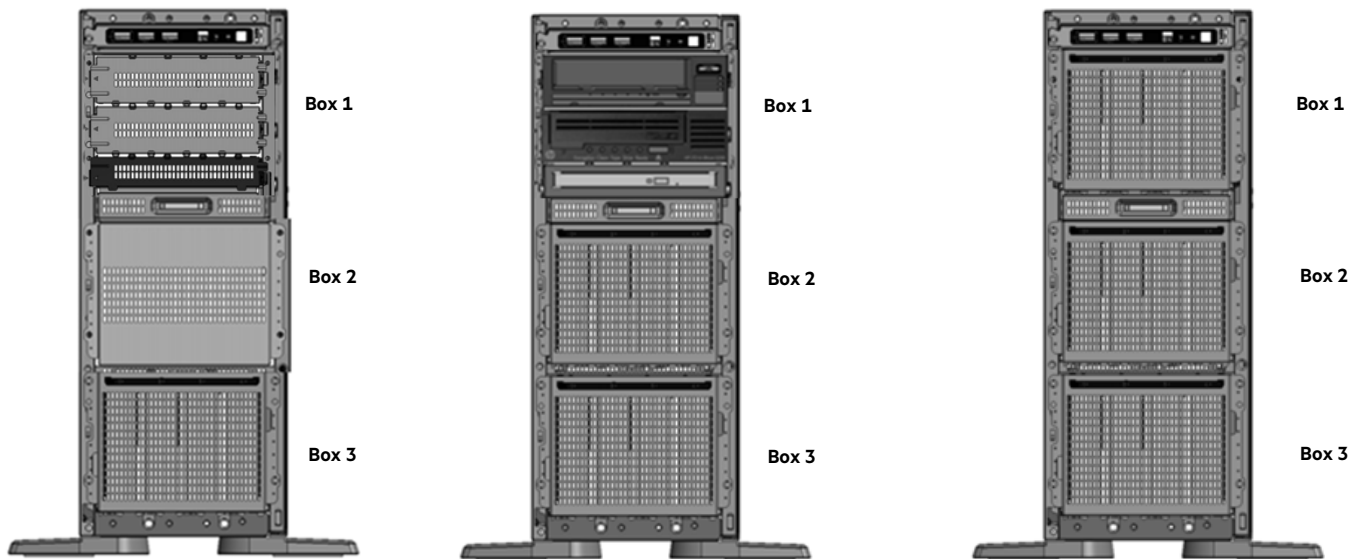
**4 LFF non-hot-plug drive model:**

Tower – shown with the tower feet.

- 1 x 4 LFF SAS/SATA non-hot-pluggable HDD/SSD Cage Kit in Box 3.
- HDD Cage Blank in Box 2.
- Media Bay Blanks (2) and DVD blank (1) in Box 1.

8 LFF non-hot-plug drive + media bay (2) and DVD (1) model:

Tower – shown with the tower feet.

- 1 – 2 4 LFF SAS/SATA non-hot-pluggable HDD/SSD Cage Kit
- HH Media Bay up to 2 and/or 1 DVD in Box 1

12 LFF non-hot-plug drive model:

Tower – shown with the tower feet.

- 1 – 3 4 LFF SAS/SATA non-hot-pluggable HDD/SSD Cage Kit (s)

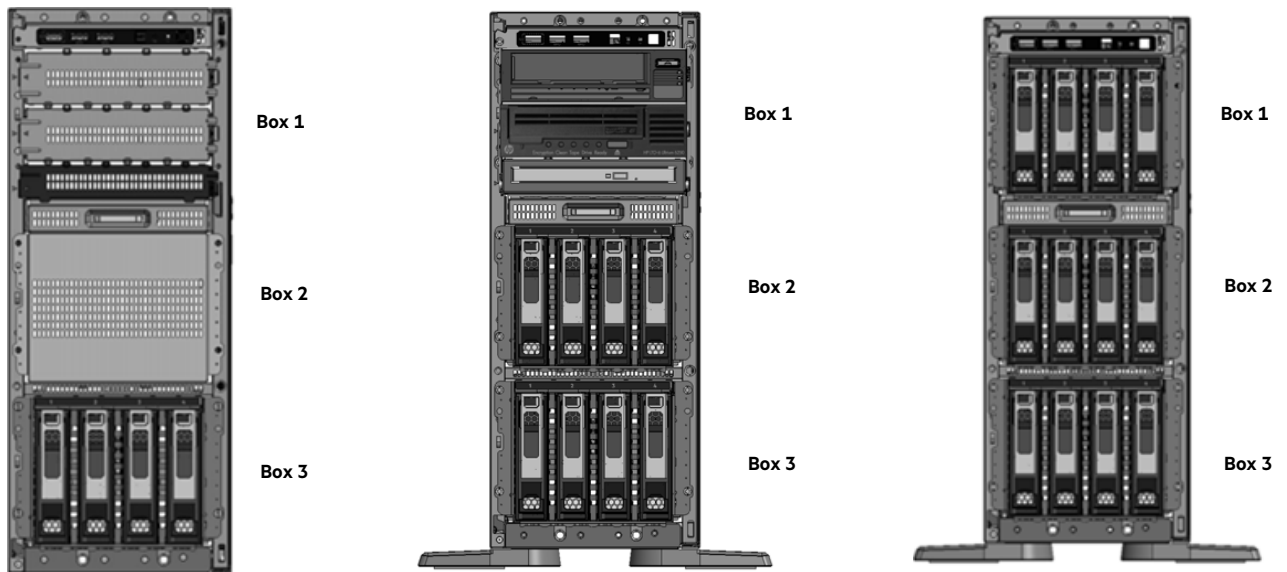

Storage

**4 LFF hot-plug drive model:**

Tower – shown without the tower feet.

- 1 x 4 LFF SAS/SATA hot-pluggable HDD/SSD Cage Kit in Box 3.
- HDD Cage Blank in Box 2.
- Media Bay Blanks (2) and DVD blank (1) in Box 1.

8 LFF hot-plug drives + media bay (2) and DVD (1) model:

Tower – shown with the tower feet.

- 1 – 2 4 LFF SAS/SATA hot-pluggable HDD/SSD Cage Kit (2)
- HH Media Bay up to 2 and/or 1 DVD in Box 1.

12 LFF hot-plug drive model:

Tower – shown with the tower feet.

- 1 – 3 4 LFF SAS/SATA hot-pluggable HDD/SSD Cage Kit (s)



Storage

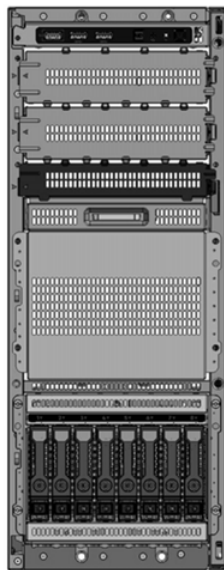

Box 1

Box 2

Box 3



Box 1

Box 2

Box 3

8 SFF hot-plug drive model:

Tower – shown without the tower feet.

- 1 x 8 SFF SAS/SATA hot-pluggable HDD/SSD Cage Kit in Box 3.
- HDD Cage Blank in Box 2.
- Media Bay Blanks (2) and DVD blank (1) in Box 1.

16 SFF hot-plug drives + media bay (2) and DVD (1) model:

Tower – shown without the tower feet.

- 1 – 2 8 SFF SAS/SATA hot-pluggable HDD/SSD Cage Kit (2)
- HH Media Bay up to 2 and/or 1 DVD in Box 1.



Storage



Box 1

Box 2

Box 3

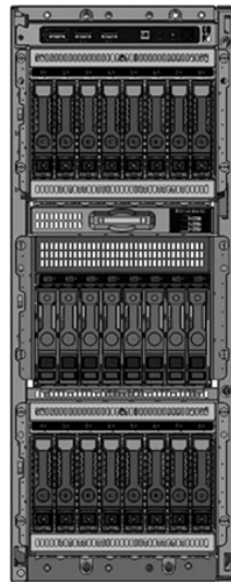

Box 1

Box 2

Box 3



Box 1

Box 2

Box 3

24 SFF hot-plug drive model:

Tower – shown without the tower feet.

- 1 – 3 8 SFF SAS/SATA hot-pluggible HDD/SSD Cage Kit (s).

16 SFF hot-plug drive + 8 NVMe SSD model:

Tower – shown without the tower feet.

- 1 – 2 8 SFF SAS/SATA hot-pluggible HDD/SSD Cage Kit (s)
- 1x 8 SFF NVMe Express Bay Kit in Box 2 for optional NVMe PCIe SSD, up to 8.

8 SFF hot-plug drive + 8 NVMe SSD + media bay (2) and DVD (1) model:

Tower – shown without the tower feet.

- 1x 8 SFF SAS/SATA hot-pluggible HDD/SSD Cage Kit
- 1x 8 SFF NVMe Express Bay Kit in Box 2 for optional NVMe PCIe SSD, up to 8
- HH Media Bay up to 2 and/or 1 DVD in Box 1.



Technical Specifications

System Unit

Dimensions

- **Tower**
46.25 (H) x 64.8 (D) x 17.4 (W) cm
18.2 (H) x 25.51 (D) x 6.85 (W) in
- **Rack – System only**
17.4 (H/4U) x 64.8 (D) x 44.5 (W) cm
6.85 (H) x 25.51 (D) x 17.52 (W) in
- **Tower-to-Rack Conversion Kit (1U)**
4.445 (H/1U) x 69.2 (D/without CMA. Depth with CMA: 83.5) x 45.2 (W) cm
1.75 (H/1U) x 27.23 (D/without CMA. Depth with CMA: 32.89) x 17.795 (W) in

Weight (approximate)

- **Minimum:**
8 SFF or 4LFF chassis with 1x SFF or LFF HDD and HDD blanks, 1x HDD Drive Cage blank, 2x Media Bay blanks, 1x DVD bay blank, 1x processor including standard heatsink, 2 DIMMs, 1x power supply (plus blank), 1x Modular Smart Array (AROC), Cables for the above.
 - 21 kg
46.30 lb
- **Maximum**
Fully loaded system: 24 SFF or 12 LFF hard drives, 4 DW GPUs (or 8 standard PCIe expansion cards), 2x processors including 2 performance heatsinks, 24 DIMMs, 2x power supplies, 1x Modular Smart Array (AROC), Cables for the above.
 - 42 kg
92.59 lb

Input Requirements (per power supply)

- **Rated Line Voltage**
100 to 120 VAC
200 to 240 VAC

BTU Rating

Maximum

- For 800W Power Supply: 3067 BTU/hr (at 100 VAC), 2958 BTU/hr (at 200 VAC), 2949 BTU/hr (at 240 VAC)
- For 500W Power Supply: 1902 BTU/hr (at 100 VAC), 1840 BTU/hr (at 200 VAC), 1832 BTU/hr (at 240 VAC)
- For 1600W Power Supply: 5918 BTU/hr (at 200 VAC), 5884 BTU/hr (at 240 VAC)

Power Supply Output (per power supply)

Rated Steady-State Power

- For 1600W Power Supply: 1600W (at 240 VAC), 1600W (at 240 VAC)
- For 800W Power Supply: 800W (at 100 VAC), 800W (at 240 VAC), 800W (at 240 VAC)
- For 500W Power Supply: 500W (at 100 VAC), 500W (at 240 VAC), 500W (at 240 VAC)

Maximum Peak Power

- For 1600W Power Supply: 1600W (at 200 to 240 VAC), 1600W (at 240 VAC)
- For 800W Power Supply: 800W (at 100 to 127 VAC), 800W (at 200 to 240 1VAC), 800W (at 240 VAC)
- For 500W Power Supply: 500W (at 100 to 127 VAC), 500W (at 200 to 240 VAC), 500W (at 240 VAC)



Technical Specifications

System Inlet Temperature

- **Standard Operating Temperature**

10° to 35°C (50° to 95°F) at sea level with an altitude derating of 1.0°C per every 305 m (1.8°F per every 1000 ft) above sea level to a maximum of 3050 m (10,000 ft), no direct sustained sunlight. Maximum rate of change is 20°C/hr (36°F/hr). The upper limit and rate of change may be limited by the type and number of options installed. System performance during standard operating support may be reduced if operating with a fan fault or above 30°C (86°F).

- **Extended Ambient Operating Temperature**

For approved hardware configurations, the supported system inlet range is extended to be: 5° to 10°C (41° to 50°F) and 35° to 40°C (95° to 104°F) at sea level with an altitude derating of 1.0°C per every 175 m (1.8°F per every 574 ft) above 900 m (2953 ft) to a maximum of 3050 m (10,000 ft). The approved hardware configurations for this system are listed at the URL: <http://www.hpe.com/servers/ashrae>

For approved hardware configurations, the supported system inlet range is extended to be: 40° to 45°C (104° to 113°F) at sea level with an altitude derating of 1.0°C per every 125 m (1.8°F per every 410 ft) above 900 m (2953 ft) to a maximum of 3050 m (10,000 ft). The approved hardware configurations for this system are listed at the URL: <http://www.hpe.com/servers/ashrae>

System performance may be reduced if operating in the extended ambient operating range or with a fan fault.

- **Non-operating**

-30° to 60°C (-22° to 140°F). Maximum rate of change is 20°C/hr (36°F/hr).

Relative Humidity (non-condensing)

- **Operating**

8% to 90% - Relative humidity (Rh), 28°C maximum wet bulb temperature, non-condensing.

- **Non-operating**

5 to 95% relative humidity (Rh), 38.7°C (101.7°F) maximum wet bulb temperature, non-condensing.

Altitude

- **Operating**

3050 m (10,000 ft). This value may be limited by the type and number of options installed. Maximum allowable altitude change rate is 457 m/min (1500 ft/min).

- **Non-operating**

9144 m (30,000 ft). Maximum allowable altitude change rate is 457 m/min (1500 ft/min).

Emissions Classification (EMC) Regulatory Information

To view the regulatory information for your product, view the Safety and Compliance Information for Server, Storage, Power, Networking, and Rack Products, available at the Hewlett Packard Enterprise Support Center:

<http://www.hpe.com/support/Safety-Compliance-EnterpriseProducts>

Environment-friendly Products and Approach End-of-life Management and Recycling

Hewlett Packard Enterprise offers **end-of-life product return, trade-in, and recycling programs** in many geographic areas, for our products. Products returned to Hewlett Packard Enterprise will be recycled, recovered or disposed of in a responsible manner.

The EU WEEE directive (2002/95/EC) requires manufacturers to provide treatment information for each product type for use by treatment facilities. This information (product disassembly instructions) is posted on the Hewlett Packard Enterprise web site. These instructions may be used by recyclers and other WEEE treatment facilities as well as Hewlett Packard Enterprise OEM customers who integrate and re-sell Hewlett Packard Enterprise equipment.



Technical Specifications

Acoustic Noise

Listed are the declared A-Weighted sound power levels (L_{WAd}) and declared average bystander position A-Weighted sound pressure levels (L_{pAm}) when the product is operating in a 23°C ambient environment. Noise emissions were measured in accordance with ISO 7779 (ECMA 74) and declared in accordance with ISO 9296 (ECMA 109). The listed sound levels apply to standard shipping configurations. Additional options may result in increased sound levels, for example, higher-end graphic processing units (GPU), NVMe SSD or NVMe M.2. Please have your HPE representative provide information from the HPE EMESC website for further technical details regarding the configurations listed below.

Acoustic Noise	
Idle	
LWAd	<ul style="list-style-type: none"> • 4.0 B Entry • 3.9 B Base • 4.4 B Perf
LpAm	<ul style="list-style-type: none"> • 28 dBA Entry • 27 dBA Base • 31 dBA Perf
Operating	
LWAd	<ul style="list-style-type: none"> • 4.2 B Entry • 4.3 B Base • 4.4 B Perf
LpAm	<ul style="list-style-type: none"> • 29 dBA Entry • 30 dBA Base • 32 dBA Perf

Notes:

- Acoustics levels presented here are generated by the test configuration only. Acoustics levels will vary depending on system configuration. Values are subject to change without notification and are for reference only.
- Product conformance to cited product specifications is based on sample (type) testing, evaluation, or assessment. This product or family of products is eligible to bear the appropriate compliance logos and statements.
- The Listed sound levels apply to standard shipping configurations. Additional options may result in increased sound levels, for example, higher-end graphic processing units (GPU), NVMe SSD or NVMe M.2.



Summary of Changes

Date	Version History	Action	Description of Change
01-Jun-2020	Version 22	Changed	Standard Features, Core Options and Additional Options sections were updated.
06-Apr-2020	Version 21	Changed	Overview, Standard Features, Pre-configured Models, Configuration Information, Core Options and Memory sections were updated. Added new Cascade Lake Refresh CPUs and WW BTO SKUs Overview, Standard Features, Configuration Information and Memory sections were updated accordingly Added new SSDs incl. SATA M.2 SSDs
02-Mar-2020	Version 20	Changed	Overview, Standard Features, Pre-configured Models, Configuration Information, Core Options and Memory sections were updated. Added more Lot 9 relevant info incl. Industry Standards compliance section, 8GB DIMM reminder, PS, etc. Removed the 500W standard NHP PS FIO kit and added a Lot 9 reminder in this PS section. Removed Skylake processor kits for CTO and 2933 DIMMs. Revised the GPU ambient temp. table and added a remark in the GPU section regarding no. of GPU support of P40 & RTX6000/8000.
03-Feb-2020	Version 19	Changed	New 16TB LFF SATA/SAS HDD New remark relevant to the upcoming ErP Lot 9 for EU/EMEA region Obsolete SKUs were removed Skylake-based BTO removed – reaching OBS
02-Dec-2019	Version 18	Changed	Overview, Configuration Information, Core Options and Additional Options sections were updated. Updated the GPU thermal information table with the new GPU modules Added new option kits incl. HPE NVIDIA P1000 and P2200 GPU modules, new 32Gb FC HBAs, 32GB micro-SD RAID1 USB boot drive and the new iLO FIO setting part
04-Nov-2019	Version 17	Changed	Core Options section was updated Added NVMe SSD PCIe adapter cards session
07-Oct-2019	Version 16	Changed	Added two new FC HBAs Core Options and Additional Options sections were updated. Obsolete SKUs were removed from the QuickSpecs.
05-Aug-2019	Version 15	Changed	Added new NVIDIA Quadro RTX8000 GPU support Added a new note under SAS expander kit - not supported w/ LFF Spade carriers Added new SSD options Updated 6226 CPU frequency in the proc table Updated GPU ambient temp. requirement table Removed extension -031 from CLX BTO offering Obsolete SKU was removed.
03-Jun-2019	Version 14	Changed	New Intel Cascade Lake wave-2 processors New GPU RTX4000 New NVMe SSD, new NIC options, OneView options, RDX devices, UPS options OBS-ed HDD/SSD, etc 5215L & 5215M GHz info in page#8 updated The U.S. version of QuickSpecs is no longer being updated, please reference the Worldwide QuickSpecs for latest information.



Summary of Changes

Date	Version History	Action	Description of Change
02-Apr-2019	Version13	Changed	Intel Cascade Lake added with new 2933 DIMMs New GPU incl. RTX6000, RTX NVlink bridge and Tesla T4 support Max. internal storage capacity updated w/ the 14TB drives OS support updated Updated or added notes here and there to provide more config. requirements
05-Feb-2019	Version12	Changed	Added NVIDIA Quadro P4000 GPU support. Added 12TB SAS LFF HDD. Added new LTO-8 tape drive support. Added PCIe Accelerator option category, new StoreFabric CNA, etc. Added notes in embedded NIC support. Added notes in Smart Array controller/s to select cables. Removed hyperlink to Cable Matrix but directed to User Guide.
03-Dec-2018	Version11	Changed	New SSD options, new storage CNAs, RDX cartridges in the newly added RDX option category. TPM1.2 FIO part added.
15-Oct-2018	Version 10	Changed	Core Options and Additional Options were Updated. SKU descriptions updated. Obsolete SKUs were removed from the QuickSpecs.
01-Oct-2018	Version 9	Changed	Added new NVIDIA Quadro GV100 and NVLink Bridge support Added new SFF and LFF SSD models Added S100i OS limitation under the OS section Updated OS support section Updated header on page#18, 19 & 67 to ML350 Gen10 Updated the pre-configured SKU model section, removing the note in the sub-entry SKU Updated the note related to internal media drive support kit & RDX
06-Aug-2018	Version 8	Changed	Added new NVIDIA Quadro P2000 GPU support. Added new SFF SATA SSD models. Added new 100Gb adapter. Added cabling requirement for S100i/embedded SATA controller config. Configuration Information – Factory Integrated Models, Core Options, Additional Options were revised.
04-Jun-2018	Version 7	Changed	Added the new P824i-p info in the controller section. Added new RI SFF SSD in the SSD section. Added 4TB NVMe SSD and revise the max. NVMe capacity supported. Configuration Information – Factory Integrated Models, Core Options, Additional Options, and Memory were revised. Obsolete SKUs were removed from the QuickSpecs
02-Apr-2018	Version 6	Changed	Added one new Solution SKU to pre-configured models. Added new supported SSDs. Added IST support in the what's new section. Removed discontinued NHP/raw HDDs. Power cord support in pre-config models was revised. CTO Rack model support was revised. Internal LTO/RDX along with fan redundant kit support was revised.



Summary of Changes

Date	Version History	Action	Description of Change
05-Feb-2018	Version 5	Changed	Added NVIDIA Quadro P4000 GPU support. Added 12TB SAS LFF HDD. Added new LTO-8 tape drive support. Added PCIe Accelerator option category, new StoreFabric CNA, etc. Added notes in embedded NIC support. Added notes in Smart Array controller/s to select cables. Removed hyperlink to Cable Matrix but directed to User Guide.
04-Dec-2017	Version 4	Changed	Added 128GB DDR4 LRDIMM support. Added new 12TB SATA LFF HDD support – max. 144TB in LFF config. Updated the Smart Storage Battery with the new part number. Updated SW RAID S100i Linux OS support note. Removed the old Smart Storage Battery part.
23-Oct-2017	Version 3	Changed	Memory speed table was updated to display the 61XX processors running at 2666MT/s.
16-Oct-2017	Version 2	Changed	Added HPE Support Services.
25-Sep-2017	Version 1	New	New QuickSpecs.



Copyright

Make the right purchase decision.
Contact our presales specialists.



Chat



Email



Call



Get updates



© Copyright 2020 Hewlett Packard Enterprise Development LP. The information contained herein is subject to change without notice. The only warranties for Hewlett Packard Enterprise products and services are set forth in the express warranty statements accompanying such products and services. Nothing herein should be construed as constituting an additional warranty. Hewlett Packard Enterprise shall not be liable for technical or editorial errors or omissions contained herein.

Intel® and Xeon® are registered trademarks of Intel Corporation in the U.S. and other countries. Microsoft®, Windows®, and Windows Server® are U.S. registered trademarks of the Microsoft group of companies.

For hard drives, 1GB = 1 billion bytes. Actual formatted capacity is less.

a00021852enw - 16055 - Worldwide - V22 - 01-June-2020