

pro^{sense} MPS25 Series Mechanical Pressure Switches



The ProSense MPS25 series mechanical pressure switches are designed for the toughest applications where conventional pressure switch designs often don't measure up. These cost effective switches, depending on the pressure range, have either an all welded 316 stainless steel sealed diaphragm actuator design or a direct acting 316 stainless steel piston design with a Buna-N O-ring. The rugged 316 stainless steel enclosure provides uncompromising protection and long life in difficult environments. The robust design is resistant to vibration and shock, and provides reliable operation over a wide operating temperature range. Pressure ranges from vacuum to 7500 psig are available along with a 1/4 inch NPT male threaded process connection and a precision snap-acting SPDT, 3 Amp, mechanically operated switch output. Choose from either an integral 6-foot (1.5m) cable with 1/2 inch NPT male conduit connection or a DIN 175301-803C L-connector.

Applications

- Process control & automation
- Pump & compressors
- Hydraulic systems
- Pneumatic systems
- Engine monitoring
- Presses
- Machine tools

Features

- Compact size
- 316 stainless steel enclosure
- All stainless welded diaphragm or stainless piston and Buna-N O-ring
- Pressure ranges from -15 psig vacuum to 7500 psig
- Tamper resistant field adjustment
- *Integral 6-foot cable with 1/2 inch NPT male conduit connection or DIN form C electrical connections
- 1/4 inch NPT male process connection
- Wide operating temperature range
- Precision snap-acting SPDT, 3 Amp mechanically operated switch
- UL*, CSA, CE and RoHS compliant
- 3-year warranty



#E320431

*UL only applies to the MPS25 series units with integral cable



MPS25 Series Mechanical Pressure Switches						
Part Number	Description	Actuator Type	Electrical Connection	Pcs/Pkg	Wt(lb)	Price
MPS25-1C-DV15A	Pressure switch, -15 psig vacuum to 15 psig setpoint range, 1/4" NPT male port, 3A SPDT switch output	316 stainless steel welded diaphragm	1/2" NPT male conduit connection, integral 6-foot (1.5 meter) 4 conductor cable with 18AWG leads	1	0.9	\$129.00
MPS25-1C-D30A	Pressure switch, 6 to 30 psig setpoint range, 1/4" NPT male port, 3A SPDT switch output			1	0.9	\$129.00
MPS25-1C-D60A	Pressure switch, 8 to 60 psig setpoint range, 1/4" NPT male port, 3A SPDT switch output			1	0.9	\$129.00
MPS25-1C-D100A	Pressure switch, 10 to 100 psig setpoint range, 1/4" NPT male port, 3A SPDT switch output			1	0.9	\$129.00
MPS25-1C-P200A	Pressure switch, 40 to 200 psig setpoint range, 1/4" NPT male port, 3A SPDT switch output	316 stainless steel piston with Buna-N O-ring	DIN 175301-803C L-Connector (8mm)	1	0.9	\$130.00
MPS25-1C-P500A	Pressure switch, 50 to 500 psig setpoint range, 1/4" NPT male port, 3A SPDT switch output			1	0.9	\$129.00
MPS25-1C-P1000A	Pressure switch, 100 to 1000 psig setpoint range, 1/4" NPT male port, 3A SPDT switch output			1	0.9	\$129.00
MPS25-1C-P2000A	Pressure switch, 200 to 2000 psig setpoint range, 1/4" NPT male port, 3A SPDT switch output			1	0.9	\$129.00
MPS25-1C-P5000A	Pressure switch, 500 to 5000 psig setpoint range, 1/4" NPT male port, 3A SPDT switch output			1	0.9	\$129.00
MPS25-1C-P7500A	Pressure switch, 750 to 7500 psig setpoint range, 1/4" NPT male port, 3A SPDT switch output	1	0.9	\$129.00		
MPS25-1C-DV15D	Pressure switch, -15 psig vacuum to 15 psig setpoint range, 1/4" NPT male port, 3A SPDT switch output	316 stainless steel welded diaphragm	DIN 175301-803C L-Connector (8mm)	1	0.5	\$121.00
MPS25-1C-D30D	Pressure switch, 6 to 30 psig setpoint range, 1/4" NPT male port, 3A SPDT switch output			1	0.5	\$121.00
MPS25-1C-D60D	Pressure switch, 8 to 60 psig setpoint range, 1/4" NPT male port, 3A SPDT switch output			1	0.5	\$121.00
MPS25-1C-D100D	Pressure switch, 10 to 100 psig setpoint range, 1/4" NPT male port, 3A SPDT switch output			1	0.5	\$121.00
MPS25-1C-P200D	Pressure switch, 40 to 200 psig setpoint range, 1/4" NPT male port, 3A SPDT switch output	316 stainless steel piston with Buna-N O-ring	DIN 175301-803C L-Connector (8mm)	1	0.5	\$121.00
MPS25-1C-P500D	Pressure switch, 50 to 500 psig setpoint range, 1/4" NPT male port, 3A SPDT switch output			1	0.5	\$121.00
MPS25-1C-P1000D	Pressure switch, 100 to 1000 psig setpoint range, 1/4" NPT male port, 3A SPDT switch output			1	0.5	\$121.00
MPS25-1C-P2000D	Pressure switch, 200 to 2000 psig setpoint range, 1/4" NPT male port, 3A SPDT switch output			1	0.5	\$121.00
MPS25-1C-P5000D	Pressure switch, 500 to 5000 psig setpoint range, 1/4" NPT male port, 3A SPDT switch output			1	0.5	\$121.00
MPS25-1C-P7500D	Pressure switch, 750 to 7500 psig setpoint range, 1/4" NPT male port, 3A SPDT switch output	1	0.5	\$121.00		

ProSense® MPS25 Series Mechanical Pressure Switches

ProSense MPS25 Series General Specifications	
Setpoint	Field adjustable (factory default 50% of full scale)
Setpoint Repeatability	±2% of range above 100 psig and ±5% for 100 psig and below (Additional setpoint shift of ±2% of range per 40°F from initial setpoint set at 70°F typical)
Vibration	Passed ML-STD-202G
Shock	75G's 10 milliseconds 3-axis
Piston Actuator	Stainless steel with Buna-N O-ring, 200 to 7500 psig
Mechanical Life Piston Design	> 1,000,000 operations typical
Diaphragm Actuator	316L SS, up to 100 psig
Mechanical Life Diaphragm Design	> 400,000 operations typical
Enclosure Material	316L SS
Enclosure Rating	NEMA 6, IP 67
Pressure Connection	1/4" NPT Male
Electrical Output	SPDT 3A @ 125 VAC / 2A @ 30VDC resistive
Electrical Termination	1/2" NPT Male conduit connection or Micro DIN 175301-803C with mating connector
Agency Approvals	UL (#E320431) cable version only, CSA, CE, RoHS

MPS25 Series Mechanical Pressure Switch Performance Characteristics									
Part Number	Setpoint Adjustability			Setpoint Repeatability			Deadband*		
	psig	bar, kg/cm2	kPa	psig	bar, kg/cm2	kPa	psig	bar, kg/cm2	kPa
MPS25-1C-DV15x	-15/15	-1/1	-100/100	±1.5	±0.1	±10	1-5	0.07-0.35	7-35
MPS25-1C-D30x	6-30	0.4-2	4-200	±1.5	±0.1	±10	1-5	0.07-0.35	7-35
MPS25-1C-D60x	8-60	0.6-4	60-400	±3	±0.2	±20	2-10	0.14-0.70	14-70
MPS25-1C-D100x	10-100	0.7-7	70-700	±5	±0.35	±35	3-15	0.2-1.0	20-100
MPS25-1C-P200x	40-200	2.8-14	280-1400	±4	±0.28	±28	3-30	0.2-2.0	20-200
MPS25-1C-P500x	50-500	3.5-35	350-3500	±10	±0.70	±70	20-100	1.4-7.0	140-700
MPS25-1C-P1000x	100-1000	7-70	700-7000	±20	±1.40	±140	25-150	1.7-10	170-1000
MPS25-1C-P2000x	200-2000	14-140	1400-14000	±40	±2.8	±280	30-300	2-20	200-2000
MPS25-1C-P5000x	500-5000	35-350	3500-35000	±100	±7.0	±700	75-750	5-50	500-5000
MPS25-1C-P7500x	750-7500	50-500	5000-50000	±150	±10.0	±1000	110-1100	7.5-75	750-7500

* Due to the mechanical design of the MPS25 switch, the actual deadband will vary from one switch to another but will be within the specified deadband range. Generally, the expected deadband for a setpoint at the lower end of the range will trend towards the lower end for the deadband range. The deadband for a setpoint at the upper end of the range will trend towards the upper end for the deadband range.

Material & Temperature		
Ranges	Wetted Material	Temperature Range
Up to 100#	SS	-40-100°C (-40-212°F)
200#	SS, BUNA	-28-100°C (-18.4-212°F)
500# to 7500#	SS, BUNA	-40-100°C (-40-212°F)

Proof Pressure			
Ranges (listed in psig)	psig	bar, kg/cm2	kPa
Up to 100#	1000	70	7000
200#	2000	140	14000
500 to 2000#	8000	500	55000
5000 to 7500#	15000	1000	100000

Burst Pressure			
Ranges (listed in psig)	psig	bar, kg/cm2	kPa
Up to 100#	>9500	>655	>65500
200#	>10000	>700	>70000
500 to 2000#	>30000	>2100	>210000
5000 to 7500#	>50000	>3500	>350000

Electrical Connections



1/2" NPT male conduit connector with 6-foot (1.5m) integral cable

Wire Color / Function	
Wire Color	Function
Red	Normally Closed
White	Common
Blue	Normally Open
Green	Ground



DIN 175301-803C L-Connector

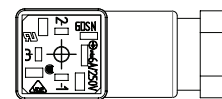

- 1 – COMMON
- 2 – NORMALLY CLOSED
- 3 – NORMALLY OPEN
- 4 – GROUND

pro^{sense} MPS25 Series Mechanical Pressure Switches

Actuator Design

The MPS25 series actuator responds to changes in pressure and operates the internal micro switch in response to these changes. The actuator is normally exposed to the process media and must be chemically compatible with it. The MPS25 series is available with a welded stainless steel diaphragm (no O-ring) in pressure ranges up to 100 psig. A stainless steel piston with Buna-N O-ring is available for pressure ranges from 200 to 7500 psig.

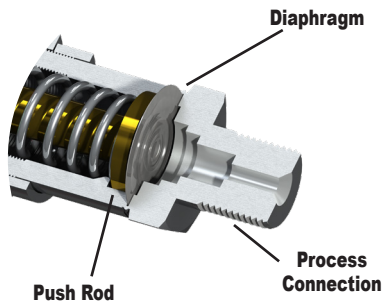

Diaphragm Actuator Type
Up to 100 psig

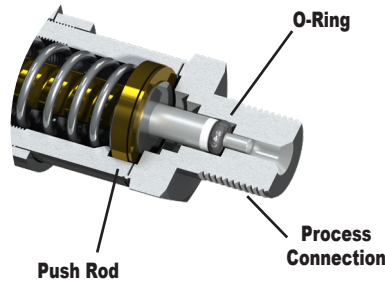

Piston Actuator Type
200 to 7500 psig

Dimensions

inches [mm]

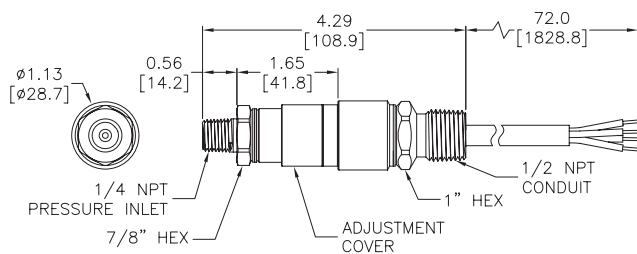

MPS25 Cable Units

See our website www.AutomationDirect.com for complete Engineering drawings.

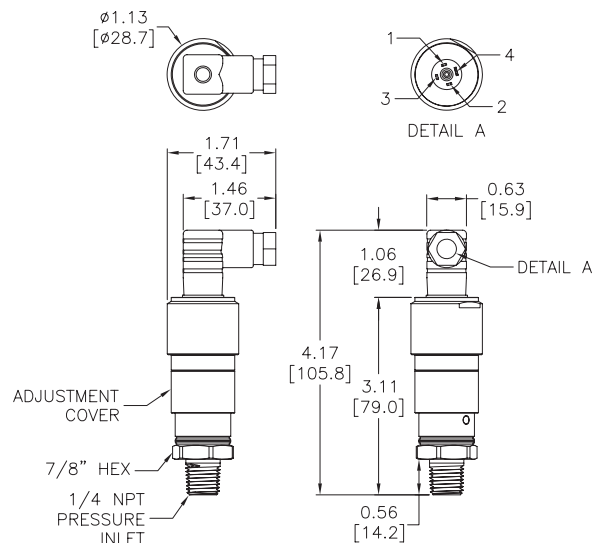

MPS25 DIN Connector Units

DIN Connector Specifications	
Number of contacts	3 + PE
Cable glands	PG 7
Conductor size max.	0.75 mm ² / 18AWG
Type of termination	Screw
Suitable cables	4.5 mm to 6mm
Standard DIN	EN 175 301-803-C

pro^{sense} MPS25 Series Mechanical Pressure Switches

Field Adjustable Setpoint

The MPS25 series switches have a field adjustable setpoint. To adjust the setpoint, follow the instructions in the diagram. The pressure switch operates as follows:

The Normally Open contact will close when the pressure is raised from 0 psig to the setpoint. The reset point is then measured from the setpoint, reducing the pressure until the Normally Open contact opens.

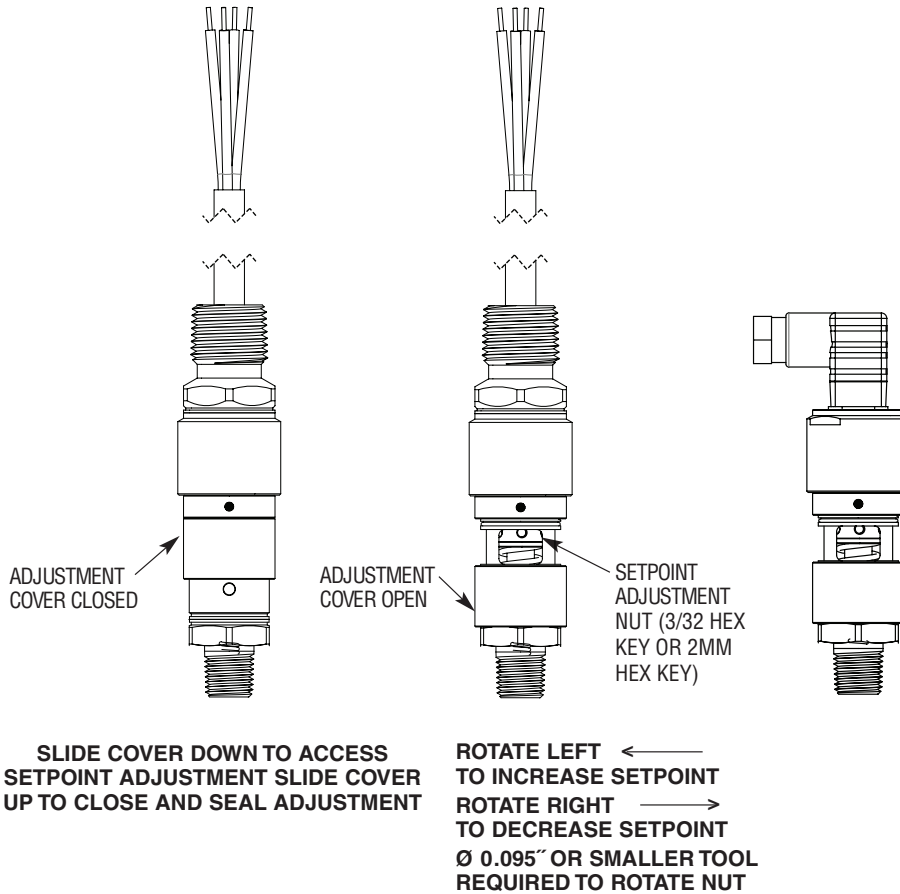

Click on the thumbnail or go to <https://www.automationdirect.com/VID-PR-0005> for a short video on How to Calibrate a MPS Series ProSense Pressure Switch

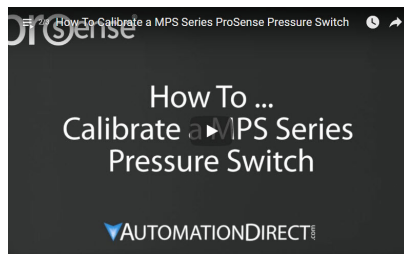

Note: As with any instrument, it is recommended that regular inspections of operation and set points are performed.