

# SOLO

## Temperature Controller

Manual Number: SL-USER-M



## ⚡ WARNING ⚡

Thank you for purchasing automation equipment from AutomationDirect.com™, doing business as AutomationDirect. We want your new automation equipment to operate safely. Anyone who installs or uses this equipment should read this publication (and any other relevant publications) before installing or operating the equipment.

To minimize the risk of potential safety problems, you should follow all applicable local and national codes that regulate the installation and operation of your equipment. These codes vary from area to area and usually change with time. It is your responsibility to determine which codes should be followed, and to verify that the equipment, installation, and operation is in compliance with the latest revision of these codes.

At a minimum, you should follow all applicable sections of the National Fire Code, National Electrical Code, and the codes of the National Electrical Manufacturer's Association (NEMA). There may be local regulatory or government offices that can also help determine which codes and standards are necessary for safe installation and operation.

Equipment damage or serious injury to personnel can result from the failure to follow all applicable codes and standards. We do not guarantee the products described in this publication are suitable for your particular application, nor do we assume any responsibility for your product design, installation, or operation.

Our products are not fault-tolerant and are not designed, manufactured or intended for use or resale as on-line control equipment in hazardous environments requiring fail-safe performance, such as in the operation of nuclear facilities, aircraft navigation or communication systems, air traffic control, direct life support machines, or weapons systems, in which the failure of the product could lead directly to death, personal injury, or severe physical or environmental damage ("High Risk Activities"). AutomationDirect specifically disclaims any expressed or implied warranty of fitness for High Risk Activities.

For additional warranty and safety information, see the Terms and Conditions section of our catalog. If you have any questions concerning the installation or operation of this equipment, or if you need additional information, please call us at 770-844-4200.

This publication is based on information that was available at the time it was printed. At AutomationDirect we constantly strive to improve our products and services, so we reserve the right to make changes to the products and/or publications at any time without notice and without any obligation. This publication may also discuss features that may not be available in certain revisions of the product.

## Trademarks

This publication may contain references to products produced and/or offered by other companies. The product and company names may be trademarked and are the sole property of their respective owners. AutomationDirect disclaims any proprietary interest in the marks and names of others.

**Copyright 2007-2018, AutomationDirect.com™ Incorporated  
All Rights Reserved**

No part of this manual shall be copied, reproduced, or transmitted in any way without the prior, written consent of AutomationDirect.com™ Incorporated. AutomationDirect retains the exclusive rights to all information included in this document.

## ⚡ AVERTISSEMENT ⚡

Nous vous remercions d'avoir acheté l'équipement d'automatisation de AutomationDirect.com™, en faisant des affaires comme AutomationDirect. Nous tenons à ce que votre nouvel équipement d'automatisation fonctionne en toute sécurité. Toute personne qui installe ou utilise cet équipement doit lire la présente publication (et toutes les autres publications pertinentes) avant de l'installer ou de l'utiliser.

Afin de réduire au minimum le risque d'éventuels problèmes de sécurité, vous devez respecter tous les codes locaux et nationaux applicables régissant l'installation et le fonctionnement de votre équipement. Ces codes diffèrent d'une région à l'autre et, habituellement, évoluent au fil du temps. Il vous incombe de déterminer les codes à respecter et de vous assurer que l'équipement, l'installation et le fonctionnement sont conformes aux exigences de la version la plus récente de ces codes.

Vous devez, à tout le moins, respecter toutes les sections applicables du Code national de prévention des incendies, du Code national de l'électricité et des codes de la National Electrical Manufacturer's Association (NEMA). Des organismes de réglementation ou des services gouvernementaux locaux peuvent également vous aider à déterminer les codes ainsi que les normes à respecter pour assurer une installation et un fonctionnement sûrs.

L'omission de respecter la totalité des codes et des normes applicables peut entraîner des dommages à l'équipement ou causer de graves blessures au personnel. Nous ne garantissons pas que les produits décrits dans cette publication conviennent à votre application particulière et nous n'assumons aucune responsabilité à l'égard de la conception, de l'installation ou du fonctionnement de votre produit.

Nos produits ne sont pas insensibles aux défaillances et ne sont ni conçus ni fabriqués pour l'utilisation ou la revente en tant qu'équipement de commande en ligne dans des environnements dangereux nécessitant une sécurité absolue, par exemple, l'exploitation d'installations nucléaires, les systèmes de navigation aérienne ou de communication, le contrôle de la circulation aérienne, les équipements de survie ou les systèmes d'armes, pour lesquels la défaillance du produit peut provoquer la mort, des blessures corporelles ou de graves dommages matériels ou environnementaux («activités à risque élevé»). La société AutomationDirect nie toute garantie expresse ou implicite d'aptitude à l'emploi en ce qui a trait aux activités à risque élevé.

Pour des renseignements additionnels touchant la garantie et la sécurité, veuillez consulter la section Modalités et conditions de notre documentation. Si vous avez des questions au sujet de l'installation ou du fonctionnement de cet équipement, ou encore si vous avez besoin de renseignements supplémentaires, n'hésitez pas à nous téléphoner au 770-844-4200.

Cette publication s'appuie sur l'information qui était disponible au moment de l'impression. À la société AutomationDirect, nous nous efforçons constamment d'améliorer nos produits et services. C'est pourquoi nous nous réservons le droit d'apporter des modifications aux produits ou aux publications en tout temps, sans préavis ni quelque obligation que ce soit. La présente publication peut aussi porter sur des caractéristiques susceptibles de ne pas être offertes dans certaines versions révisées du produit.

## Marques de commerce

La présente publication peut contenir des références à des produits fabriqués ou offerts par d'autres entreprises. Les désignations des produits et des entreprises peuvent être des marques de commerce et appartiennent exclusivement à leurs propriétaires respectifs. AutomationDirect nie tout intérêt dans les autres marques et désignations.

**Copyright 2007-2018, AutomationDirect.com™ Incorporated**

**Tous droits réservés**

Nulle partie de ce manuel ne doit être copiée, reproduite ou transmise de quelque façon que ce soit sans le consentement préalable écrit de la société AutomationDirect.com™ Incorporated. AutomationDirect conserve les droits exclusifs à l'égard de tous les renseignements contenus dans le présent document.



# SOLOTEMPERATURE CONTROLLER USER MANUAL

Please include the Manual Number and the Manual Issue, both shown below, when communicating with Technical Support regarding this publication.

**Manual Number:** SL-USER-M  
**Issue:** 2nd Edition Rev. D  
**Issue Date:** 04/18

| Publication History |       |  |
|---------------------|-------|--|
| Issue               | Date  | Description of Changes   |
| First Edition       | 06/07 | Original Issue   |
| Rev. A              | 09/07 | Revised parameter ranges, made corrections, added Index                              |
| Rev. B              | 11/07 | Revised analog parameters, updated specifications table                              |
| Rev. C              | 07/08 | Revised analog parameters, updated specifications table                              |
| Rev D               | 06/10 | Revised PC connection information  |
| Rev. E              | 10/10 | Added ungrounded thermocouple note   |
| Rev. F              | 12/10 | Added note to Analog High and Analog Low Adjustment.                                 |
| 2nd Edition         | 07/11 | Added DC controllers   |
| Rev. A              | 12/11 | Revised wiring diagrams  |
| Rev. B              | 12/15 | Revised Relay output specification for SL4848 and SL4896.                            |
| Rev. C              | 04/18 | Revised Chapter 6. Most content included in online help. Comm Port settings updated. |
| Rev. D              | 04/18 | Added PV Offset parameter tables. Revised manual layout.                             |

# TABLE OF CONTENTS

---



## Chapter 1: Getting Started

|  |            |
|--|------------|
| <b>Manual Overview .....</b>                           | <b>1-2</b> |
| Overview of this Publication.....                      | 1-2        |
| Who Should Read This Manual.....                       | 1-2        |
| Technical Support.....                                 | 1-2        |
| Supplemental Manuals.....                              | 1-2        |
| Special Symbols.....                                   | 1-2        |
| <b>SOLO Temperature Controller Introduction.....</b>   | <b>1-3</b> |
| General Description .....                              | 1-3        |
| Unpacking.....   | 1-3        |
| Serial Number Label Information:.....                  | 1-4        |
| Model Number Explanation.....                          | 1-4        |
| <b>SOLO Temperature Controller Specifications.....</b> | <b>1-5</b> |

## Chapter 2: Installation and Wiring

|   |            |
|---|------------|
| <b>Ambient Conditions .....</b>                     | <b>2-2</b> |
| <b>Installation Considerations.....</b>             | <b>2-2</b> |
| <b>Mounting Instructions .....</b>                  | <b>2-3</b> |
| <b>Controller and Panel Cutout Dimensions .....</b> | <b>2-4</b> |
| <b>Safety Information .....</b>                     | <b>2-6</b> |
| <b>Terminal Identification.....</b>                 | <b>2-8</b> |

|                            |      |
|----------------------------|------|
| SL4824 Series Inputs ..... | 2-8  |
| SL4824 Series Wiring ..... | 2-9  |
| SL4848 Series Inputs ..... | 2-10 |
| SL4848 Series Wiring ..... | 2-11 |
| SL4896 Series Inputs ..... | 2-12 |
| SL4896 Series Wiring ..... | 2-13 |
| SL9696 Series Inputs ..... | 2-14 |
| SL9696 Series Wiring ..... | 2-15 |

### Chapter 3: Keypad Operation and Setup Parameters

|                                  |      |
|----------------------------------|------|
| Display, LED and Keypad .....    | 3-2  |
| Keypad Operation .....           | 3-3  |
| Setup Parameter Listing .....    | 3-4  |
| Regulation Mode Parameters ..... | 3-7  |
| Operation Mode Parameters .....  | 3-17 |
| Initial Setting Parameters ..... | 3-19 |
| Reset to Factory Default .....   | 3-24 |

### Chapter 4: Controller Inputs and Outputs

|                            |     |
|----------------------------|-----|
| Control Input Types .....  | 4-2 |
| Event Inputs .....         | 4-3 |
| Control Output Types ..... | 4-4 |
| Alarm Outputs .....        | 4-8 |

### Chapter 5: Control Modes

|                           |     |
|---------------------------|-----|
| PID Control .....         | 5-2 |
| On / Off Control .....    | 5-4 |
| Ramp / Soak Control ..... | 5-5 |

|                                 |     |
|---------------------------------|-----|
| Manual Control.....             | 5-5 |
| Error Display Information ..... | 5-6 |

## Chapter 6: Configuration Software

|                             |     |
|-----------------------------|-----|
| PC Connection.....          | 6-2 |
| Software Installation ..... | 6-3 |
| Starting SL-SOFT .....      | 6-6 |
| SL-SOFT Online Help .....   | 6-6 |

## Chapter 7: Modbus Communication

|   |      |
|---|------|
| Modbus Protocol .....   | 7-2  |
| Registers .....   | 7-2  |
| Connection with the DirectLOGIC PLC.....                        | 7-8  |
| Connection with the C-more and C-more Micro HMI panels<br>..... | 7-10 |

## Appendix: Modbus Address Map for Ramp / Soak Control

|                           |     |
|---------------------------|-----|
| Last Step Number.....     | A-2 |
| Additional Cycles.....    | A-2 |
| Next Pattern Number ..... | A-2 |
| Ramp / Soak SV .....      | A-3 |
| Ramp / Soak Time .....    | A-4 |

## Index

# GETTING STARTED

---



# CHAPTER

# 1

## In this Chapter...

|  |            |
|--|------------|
| <b>Manual Overview .....</b>                           | <b>1-2</b> |
| Overview of this Publication.....                      | 1-2        |
| Who Should Read This Manual.....                       | 1-2        |
| Technical Support.....                                 | 1-2        |
| Supplemental Manuals.....                              | 1-2        |
| Special Symbols.....                                   | 1-2        |
| <b>SOLO Temperature Controller Introduction.....</b>   | <b>1-3</b> |
| General Description .....                              | 1-3        |
| Unpacking.....   | 1-3        |
| Serial Number Label Information:.....                  | 1-4        |
| Model Number Explanation.....                          | 1-4        |
| <b>SOLO Temperature Controller Specifications.....</b> | <b>1-5</b> |



# Manual Overview

### Overview of this Publication

The SOLO Temperature Controller User Manual describes the installation, configuration, and methods of operation of the SOLO Temperature Controller.

### Who Should Read This Manual

This manual contains important information for those who will install, maintain, and/or operate any of the SOLO Temperature Controllers.

### Technical Support

**By Telephone: 770-844-4200**

(Mon.-Fri., 9:00 a.m.-6:00 p.m. E.T.)

**On the Web: [support.automationdirect.com](http://support.automationdirect.com)**

Our technical support group is glad to work with you in answering your questions. If you cannot find the solution to your particular application, or, if for any reason you need additional technical assistance, please call technical support at **770-844-4200**. We are available weekdays from 9:00 a.m. to 6:00 p.m. Eastern Time.

We also encourage you to visit our web site where you can find technical and non-technical information about our products and our company. Visit us at **[www.automationdirect.com](http://www.automationdirect.com)**.

### Supplemental Manuals

If you are familiar with industrial control type devices, you may be able to get up and running with just the aide of the Quick Start Guide that is included with each SOLO Temperature Controller.

### Special Symbols



---

When you see the “notepad” icon in the left-hand margin, the paragraph to its immediate right will be a special note.

---

---



---

When you see the “exclamation mark” icon in the left-hand margin, the paragraph to its immediate right will be a warning. This information could prevent injury, loss of property, or even death (in extreme cases).

---

---

# SOLO Temperature Controller Introduction

## General Description

The SOLO Temperature Controller is a single loop dual output temperature controller that can control both heating and cooling simultaneously. There are four types of control modes: PID, ON / OFF, Manual, and Ramp / Soak control. Depending upon the particular model of controller, the available outputs include relay, voltage pulse, current, and linear voltage. There are up to three alarm outputs available to allow seventeen alarm types in the initial setting mode. SOLO can accept various types of thermocouple, RTD, or analog inputs, and has a built in RS-485 interface using Modbus slave (ASCII or RTU) communication protocol.

Other features include:

- 1/32, 1/16, 1/8 and 1/4 DIN panel sizes
- 2 line x 4 character 7-segment LED display for Process Value (PV): Red color, and Set Point (SV): Green color
- Auto Tuning (AT) function with PID control
- Selectable between °C and °F for thermocouple or RTD inputs
- 0 to 50 °C (32 to 122 °F) operating temperature range
- UL, CUL and CE agency approvals

## Unpacking

After receiving the SOLO Temperature Controller, please check for the following:

- Make sure that the package includes the Controller, the mounting brackets and hardware, a 249 ohm resistor and the Quick Start Guide.
- Inspect the unit to insure it was not damaged during shipment.
- Make sure that the part number indicated on the serial number label corresponds with the part number of your order.

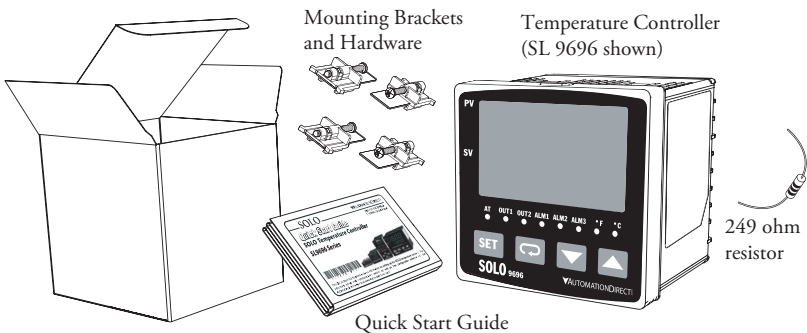

### Serial Number Label Information:

#### SL4824 Series Serial Number Label

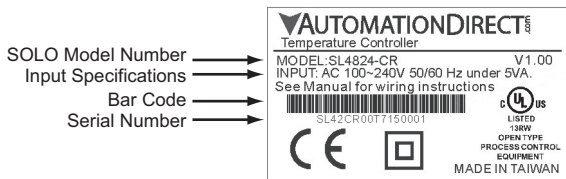

#### SL4848, SL4896, and SL9696 Series Serial Number Label



### Model Number Explanation

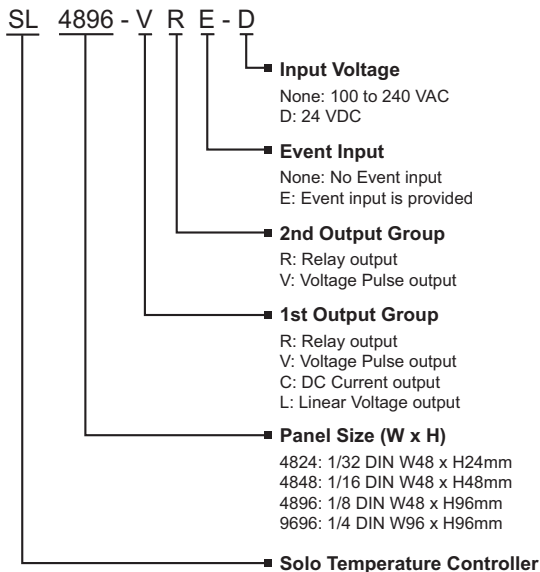

# SOLO Temperature Controller Specifications

| Specifications                            |   |
|---|---|
| Input Power Requirements                  | 100 to 240 VAC 50 / 60 Hz or 24 VDC   |
| Operation Voltage Range                   | 85 to 264 VAC or 21.6 to 26.4 VDC   |
| Power Consumption                         | 5 VA Max  |
| Memory Protection                         | EEPROM 4K bit, number of writes 100,000   |
| Control Mode                              | PID, ON/OFF, Ramp / Soak control or Manual  |
| Input Accuracy                            | Less than $\pm 0.2\%$ full scale (except thermocouple R, S, & B types)<br>Max $\pm 3^\circ$ (thermocouple R, S, & B types)  |
| Vibration Resistance                      | 10 to 55 Hz, 10 m/s <sup>2</sup> for 10 min, each in X, Y and Z directions  |
| Shock Resistance                          | Max. 300 m/s <sup>2</sup> , 3 times in each 3 axes, 6 directions  |
| Ambient Temperature Range                 | 32°F to 122°F (0°C to 50°C)   |
| Storage Temperature Range                 | -4°F to 149°F (-20°C to 65°C)   |
| Altitude                                  | 2000m or less   |
| Relative Humidity                         | 35% to 80% (non-condensing)   |
| RS-485 Communication                      | Modbus slave ASCII / RTU protocol   |
| Transmission Speed                        | 2400, 4800, 9600, 19.2K, 38.4K bps  |
| IP Rating                                 | IP65: Complete protection against dust and low pressure spraying water from all directions. (inside suitable enclosure)   |
| Agency Approvals                          | UL, CUL, CE (UL file number E311366)  |
| Pollution Degree                          | Degree 2 - Normally, only non-conductive pollution occurs.<br>Temporary conductivity caused by condensation is to be expected   |
| <b>Input Types</b>                        |   |
| • Thermocouple*                           | K, J, T, E, N, R, S, B, L, U, TXK   |
| • Platinum RTD                            | 3-wire Pt100, JPt100  |
| • Analog                                  | 0-50 mV, 0-5V, 0-10V, 0-20 mA, 4-20 mA (sinking)<br>(Current input requires the installation of the supplied 249 $\Omega$ resistor)   |
| <b>Input Sampling Rates</b>               |   |
| • Thermocouple                            | 400 ms / per scan   |
| • Platinum RTD                            | 400 ms / per scan   |
| • Analog                                  | 150 ms / per scan   |
| <b>Control Output Options</b>             |   |
| • Relay (R)                               | SL4824: SPST max. resistive load 3A @ 250 VAC<br>SL4848: SPST max. resistive load 5A @ 250 VAC<br>SL4896, SL9696: SPDT max. resistive load 5A @ 250 VAC<br>SL4824: SPST max. resistive load 3A @ 30 VDC<br>SL4848: SPST max. resistive load 5A @ 30 VDC<br>SL4896, SL9696: SPDT max. resistive load 5A @ 30 VDC |
| • Voltage Pulse (V)                       | DC 14V Max, output current 40mA Max   |
| • Current (C)                             | DC 4-20 mA output (sourcing) (Load resistance: Max 600 $\Omega$ )   |
| • Linear Voltage (L)                      | DC 0-10V (Load resistance Min 1K $\Omega$ )   |
| *Note: Use only ungrounded thermocouples. |   |

# INSTALLATION AND WIRING

---



# CHAPTER 2

## In this Chapter...

|   |            |
|---|------------|
| <b>Ambient Conditions .....</b>                     | <b>2-2</b> |
| <b>Installation Considerations.....</b>             | <b>2-2</b> |
| <b>Mounting Instructions .....</b>                  | <b>2-3</b> |
| <b>Controller and Panel Cutout Dimensions .....</b> | <b>2-4</b> |
| <b>Safety Information .....</b>                     | <b>2-6</b> |
| <b>Terminal Identification.....</b>                 | <b>2-8</b> |
| SL4824 Series Inputs.....                           | 2-8        |
| SL4824 Series Wiring.....                           | 2-9        |
| SL4848 Series Inputs.....                           | 2-10       |
| SL4848 Series Wiring.....                           | 2-11       |
| SL4896 Series Inputs.....                           | 2-12       |
| SL4896 Series Wiring.....                           | 2-13       |
| SL9696 Series Inputs.....                           | 2-14       |
| SL9696 Series Wiring.....                           | 2-15       |

### Ambient Conditions

| Ambient Conditions        |  |
|---------------------------|--|
| Ambient Temperature Range | 32°F to 122°F (0°C to 50°C)  |
| Storage Temperature Range | -4°F to 149°F (-20°C to 65°C)  |
| Relative Humidity         | 35% to 80% (non-condensing)  |
| Altitude                  | 2000m or lower above sea level, keep from corrosive gas, liquid and dust   |
| Pollution Degree          | Degree 2 - Normally, only non-conductive pollution occurs. Temporary conductivity caused by condensation is to be expected       |
| Vibration Resistance      | 10 to 55 Hz, 10 m/s <sup>2</sup> for 10 min, each in X, Y and Z directions   |
| Shock Resistance          | Max. 300 m/s <sup>2</sup> , 3 times in each 3 axes, 6 directions   |
| IP Rating                 | IP65: Complete protection against dust and low pressure spraying water from all directions when mounted in a suitable enclosure. |

### Installation Considerations

Improper installation of the controller will greatly reduce its life. Be sure to observe the following precautions when selecting a mounting location:



**Warning: Failure to observe these precautions may damage the controller and void the warranty!**

- Do not mount the controller near heat-radiating elements or in direct sunlight.
- Do not install the controller in a place subjected to high temperature, high humidity, excessive vibration, corrosive gases or liquids, or airborne dust or metallic particles.
- Do not restrict the air flow to the vent opening on the controller housing
- This controller is an open-type unit and must be placed in an enclosure to ensure proper operation and maintain the IP65 rating.

## Mounting Instructions

### SL4824 Series

Series SL4824 temperature controllers should be mounted through a cutout in an enclosure or panel by using the dimensions shown on page 2–4. The directions for mounting the controller through a cutout are...

1. Insert the temperature controller through the panel cutout.
2. Slide the M3X0.5 nut into the opening in the top of the mounting bracket and insert the M3X0.5 X 30mm mounting screw in the mounting bracket.
3. Slide the mounting bracket onto the controller and push the mounting bracket forward until the bracket stops.
4. Tighten the M3X0.5 X 30mm screw to secure temperature controller in place.

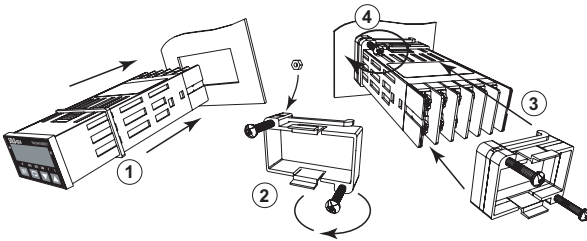

### SL4848, SL4896, SL9696 Series

Series SL4848, SL4896 and SL9696 temperature controllers should be mounted through a cutout in an enclosure or panel by using the dimensions shown on page 2–4 and page 2–5. The directions for mounting the controller through a cutout are...

1. Insert the temperature controller through the panel cutout.
2. Slide the M3X0.5 nut into the opening in the top of the mounting bracket and insert the M3X0.5 X 30mm mounting screw in the mounting bracket.
3. Insert the mounting bracket into the mounting groove at the top and bottom of the controller, and push the mounting bracket forward until the bracket stops.
4. Tighten top and bottom screws evenly to secure temperature controller in place.

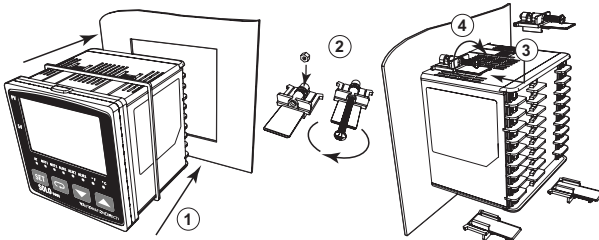

## Controller and Panel Cutout Dimensions

### SL4824 Series

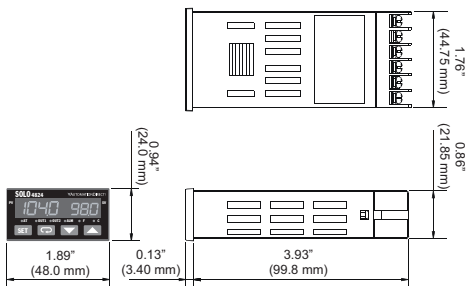

### Minimum Cutout and Spacing

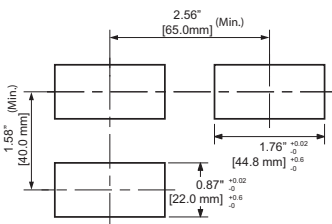

### SL4848 Series

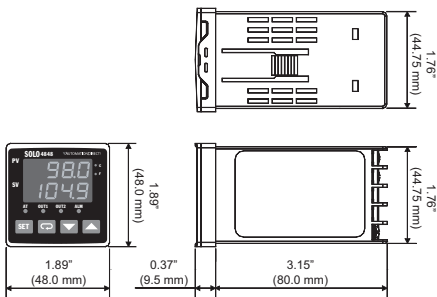

### Minimum Cutout and Spacing

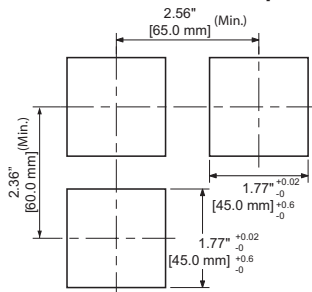



# Controller and Panel Cutout Dimensions, cont'd

## SL4896 Series

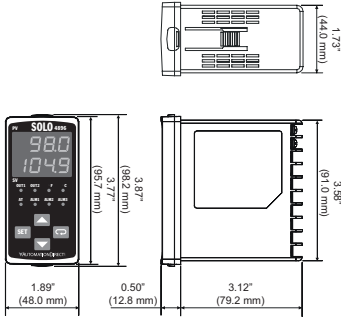

## Minimum Cutout and Spacing

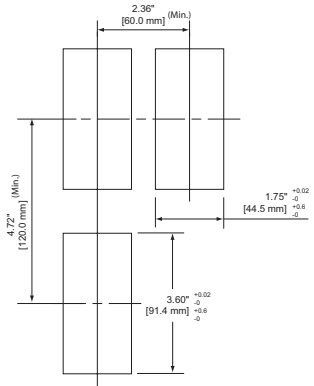

## SL9696 Series

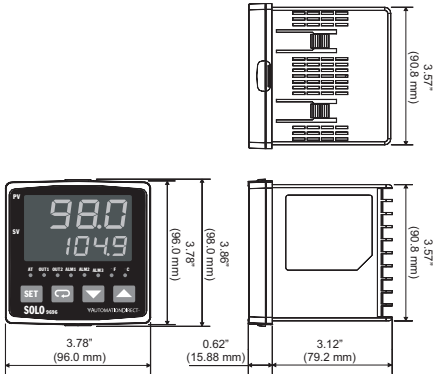

## Minimum Cutout and Spacing

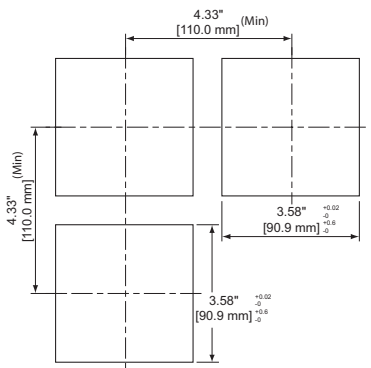

# Safety Information

## DANGER!



**Warning:** To minimize the risk of potential safety problems, you should follow all applicable local and national codes that regulate the installation and operation of your equipment. These codes vary from area to area and it is your responsibility to determine which codes should be followed, and to verify that the equipment, installation, and operation are in compliance with the latest revision of these codes



**Warning:** To prevent electric shock, do not touch the AC terminals while power is supplied to the controller.



**Warning:** This controller is an open-type temperature controller. make sure to evaluate any dangerous application in which a serious human injury or serious property damage may occur.

### Wiring Notes: PLEASE READ PRIOR TO INSTALLATION.

*Equipment damage or serious injury to personnel can result from the failure to follow all applicable codes and standards. We do not guarantee the products described in this publication are suitable for your particular application, nor do we assume any responsibility for your product design, installation, or operation.*

If you have any questions concerning the installation or operation of this equipment, or if you need additional information, please call us at 1-800-633-0405 or 770-844-4200.

This publication is based on information that was available at the time it was printed. At AutomationDirect.com® we constantly strive to improve our products and services, so we reserve the right to make changes to the products and/or publications at any time without notice and without obligation. This publication may also discuss features that may not be available in certain revisions of the product.

1. Always use recommended solder-less terminals: Fork terminal with isolation (M3 screw, width is 7.0mm, hole diameter 3.2mm). Screw size: M3 x 6.5 (With 6.8 x 6.8 square washer). Recommended tightening torque: 0.4 Nm (4kgfcm). Applicable wire: Solid/twisted wire of 2 mm, 12AWG to 24AWG. Choose AutomationDirect fork terminals part numbers BM-00120, BM-00220 or BM-00320 depending on wire size. Be sure to tighten them properly.
2. Protect the controller from dust or foreign objects as they can cause the controller to malfunction.
3. Never modify or disassemble the controller.
4. Do not connect anything to the “Not used” terminals.
5. Make sure all wires are connected to the correct polarity of terminals.
6. Do not install and/or use the controller in places subject to: (a) Dust or corrosive gases and liquid (b) High humidity (c) Vibration or shock (d) EMI / RFI (e) high temperature.
7. Power must be turned off when wiring or changing a sensor.

### Safety Information, cont'd

8. Be sure to use wires that match the thermocouple types when extending or connecting thermocouple wires.
9. Use wires with correct resistance when extending or connecting a RTD.
10. Keep the wire as short as possible when wiring a RTD to the controller and route power wires as far as possible from sensor wires to prevent interference and induced noise.
11. This controller is an open-type unit and must be placed in an enclosure to ensure proper operation and maintain the IP65 rating.
12. Make sure power cables and signals from instruments are all installed properly before energizing the controller, otherwise serious damage may occur.
13. To prevent electric shock, do not touch the terminals on the controller or try to repair the controller when power is applied.
14. Do not use acid or alkaline liquids for cleaning. Use a soft, dry cloth to clean the controller.
15. This instrument is not furnished with a power switch or fuse. Therefore, if a fuse or power switch is required, install the protection close to the instrument. Recommended fuse rating: Rated voltage 250 V, Rated current 1 A. Fuse type: Time-delay fuse. See the AutomationDirect catalog for the appropriate fuse for the specific application.
16. Note: This controller does not provide overcurrent protection. Use of this product requires that suitable overcurrent protection device(s) must be added to ensure compliance with all relevant electrical standards and codes. (Rated 250 V, 15 Amps max). A suitable disconnecting device should be provided near the controller in the end-use installation.

## Terminal Identification

### SL4824 Series Inputs

#### Power Input

AC Models Power Input

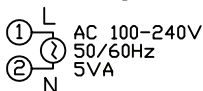

DC Models Power Input

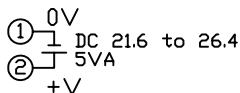

#### Sensor Input

0 – 10 VDC

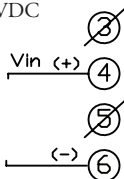

4-20 mA

For 4-20mA sensor input install supplied 249Ω resistor.

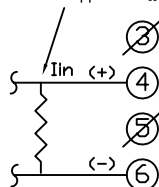

2-wire RTD

Install jumper when using 2 wire RTD

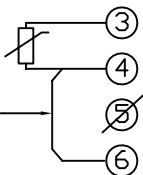

3-wire RTD

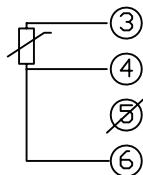

Thermocouple

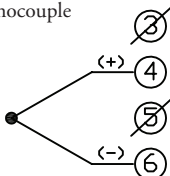

## Terminal Identification cont'd

## SL4824 Series Wiring

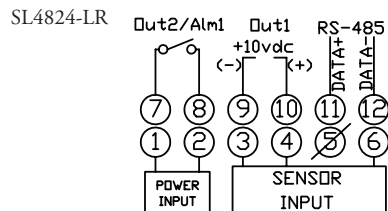
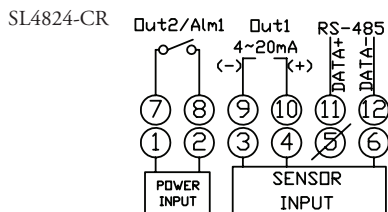
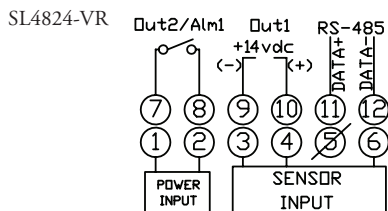
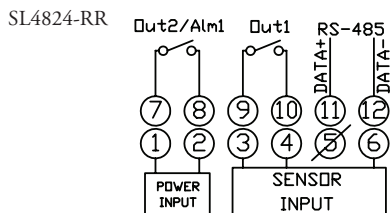

## Terminal Identification, cont'd

### SL4848 Series Inputs

#### Power Input

AC Models Power Input

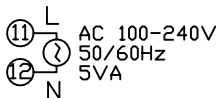

DC Models Power Input

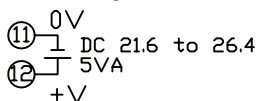

#### Sensor Input

0 – 10 VDC

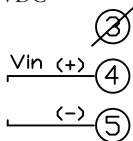

4-20 mA

For 4~20mA sensor input install supplied 249Ω resistor.

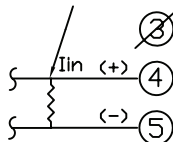

2-wire RTD

Install jumper when using 2 wire RTD

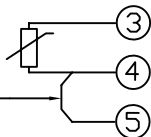

3-wire RTD

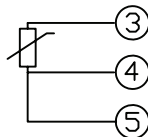

Thermocouple

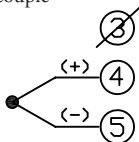

## Terminal Identification, cont'd

## SL4848 Series Wiring

SL4848-RR

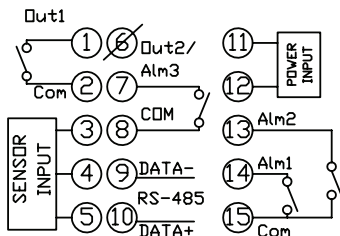

SL4848-LV &amp; SL4848-VV

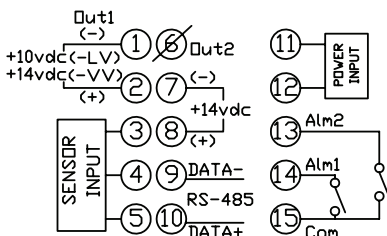

SL4848-VR

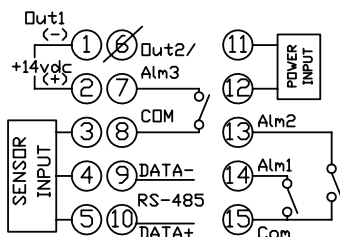

SL4848-CR

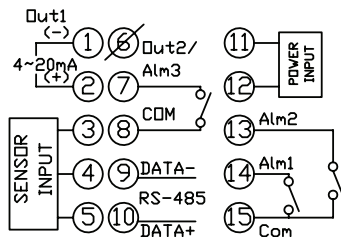

SL4848-CV

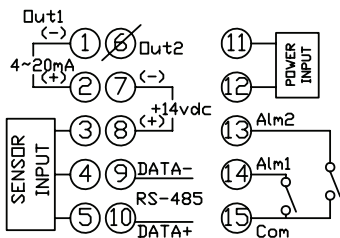

SL4848-LR

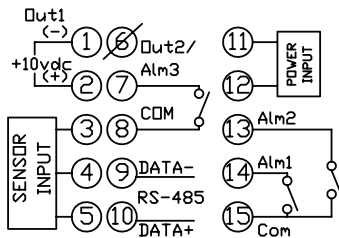

## Terminal Identification, cont'd

### SL4896 Series Inputs

#### Power Input

AC Models Power Input

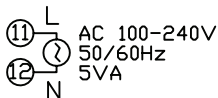

DC Models Power Input

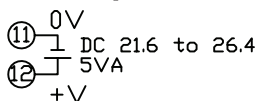

#### Sensor Input

0 – 10 VDC

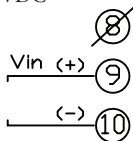

4-20 mA

For 4~20mA sensor input  
install supplied 249Ω resistor.

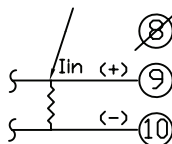

2-wire RTD

Install jumper when using  
2 wire RTD

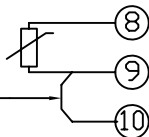

3-wire RTD

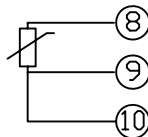

Thermocouple

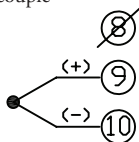



# Terminal Identification, cont'd

## SL4896 Series Wiring

SL4896-RRE

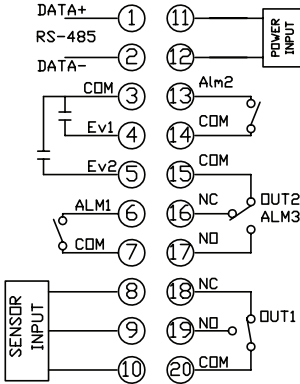

SL4896-CRE

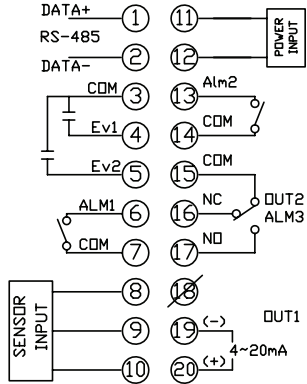

SL4896-VRE

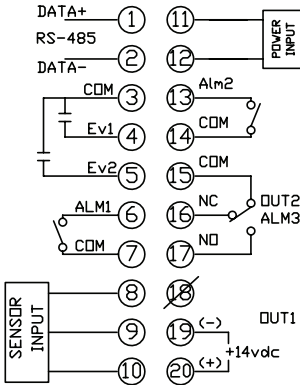

SL4896-LRE

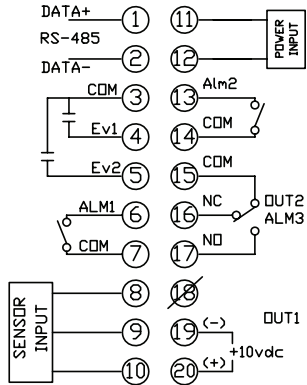

## Terminal Identification, cont'd

### SL9696 Series Inputs

#### Power Input

##### AC Models Power Input

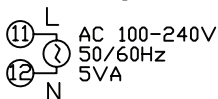

##### DC Models Power Input

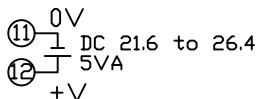

##### 0 – 10 VDC

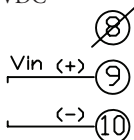

##### 4-20 mA

For 4~20mA sensor input install supplied 249Ω resistor.

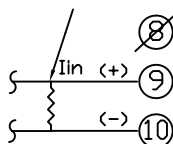

##### 2-wire RTD

Install jumper when using 2 wire RTD

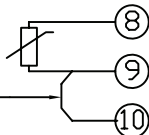

##### 3-wire RTD

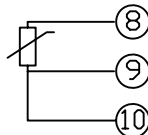

##### Thermocouple

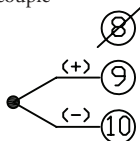

## Terminal Identification, cont'd

## SL9696 Series Wiring

SL9696-RRE

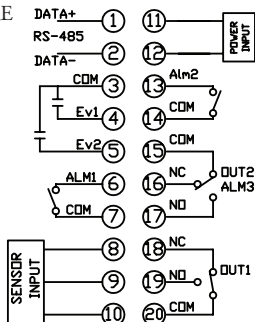

SL9696-LRE

SL9696-VRE

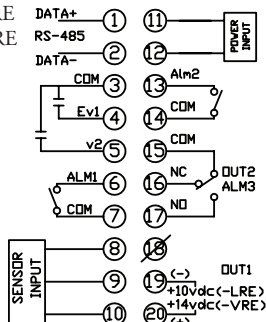

SL9696-CRE

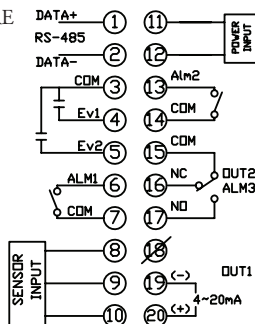

SL9696-CVE

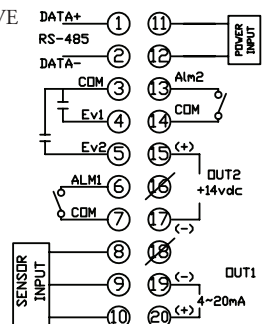

SL9696-VVE

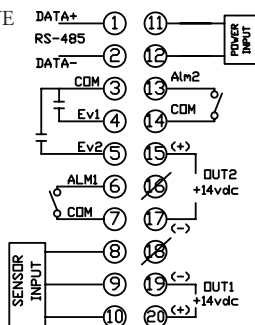

SL9696-LVE

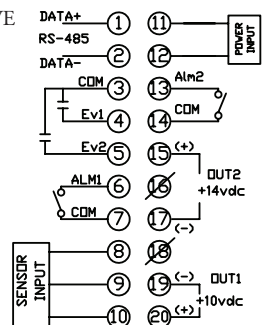

# KEYPAD OPERATION AND SETUP PARAMETERS

---



# CHAPTER 3

## In this Chapter...

|                                  |      |
|----------------------------------|------|
| Display, LED and Keypad .....    | 3-2  |
| Keypad Operation .....           | 3-3  |
| Setup Parameter Listing .....    | 3-4  |
| Regulation Mode Parameters ..... | 3-7  |
| Operation Mode Parameters.....   | 3-17 |
| Initial Setting Parameters.....  | 3-19 |
| Reset to Factory Default .....   | 3-24 |

### Display, LED and Keypad

The SOLO temperature controller has a two color seven segment LED display, four types of LED status indicators and four function buttons.

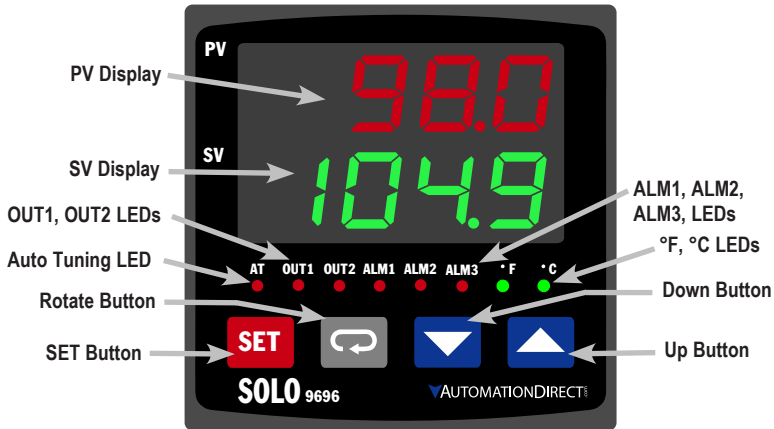

#### PV Display

The Process Value Display. Displays the value from the input source or the parameter source.

#### SV Display

The Set Value Display. Displays the set point of the process, the parameter operation read value, manipulated variable, or the set value of the parameter.

#### AT LED Indicator

Auto Tuning LED flashes when the Auto Tuning operation is ON.

#### OUT1, OUT2 LED Indicators

Output 1 and Output 2 LED indicators light when the output is ON.

#### °F, °C LED Indicators

Temperature unit LED. °C: Celsius, °F: Fahrenheit

#### ALM1, ALM2, ALM3 LED Indicators

Alarm output LED indicators light when appropriate alarm is activated. ALM2 and ALM3 indicators are available on series SL4896 and SL9696 only.

## Keypad Operation

### Function Buttons



SET Button

Press the SET button to select the desired function mode and confirm the setting value.



Rotate Button

Press the Rotate button to select parameters within the function mode.



Down Button

Press the Down button to decrease values displayed on the SV display. Hold down this button to speed up the decrement.



Up Button

Press the Up button to increase values displayed on the SV display. Hold down this button to speed up the increment.

### Initial Power up

When power is first applied to the temperature controller, the module information splash screen appears. This screen shows the firmware version on the PV display and the two output types for that particular model on the SV display. After three seconds, the controller will automatically proceed to the Operation mode main screen.

### Keypad Operation

The temperature controller has three function modes: Initial Setting mode, Operation mode and Regulation mode. Press and hold the SET button for three seconds to go into the Initial Setting mode. Press the SET button for less than three seconds to access the Regulation mode. Press the Rotate button while inside any of the three function modes to scroll through the individual parameters for each function mode. Use the Up and Down buttons to change the individual parameter values. Pressing the SET button saves the parameter values. Press the SET button again to return the controller to the Operation mode main screen.

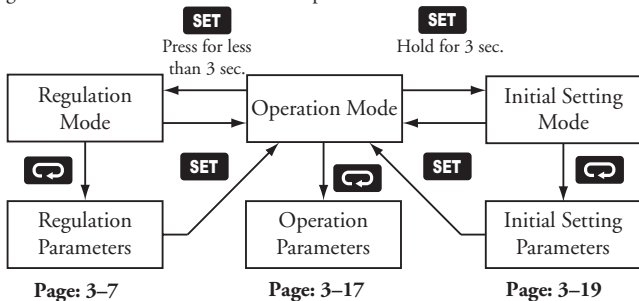

## Setup Parameter Listing













### Regulation Mode Parameters

Press the **SET** button to access these parameters.

| Regulation Mode Parameter Availability |             |                             |                 |       |       |       |       |       |              |     |         |        |                   |         |         |                   |
|--|-------------|-----------------------------|-----------------|-------|-------|-------|-------|-------|--------------|-----|---------|--------|-------------------|---------|---------|-------------------|
| ID #                                   | Display     | Parameter Name              | Controller Type |       |       |       |       |       | Control Mode |     |         |        | Heating / Cooling |         |         |                   |
|  |             |                             | RR(E)           | VR(E) | VV(E) | CR(E) | CV(E) | LR(E) | LV(E)        | PID | ON /OFF | Manual | Ramp / Soak       | Heating | Cooling | Heating / Cooling |
| P1-1                                   | <b>RL</b>   | Auto Tuning                 | ✓               | ✓     | ✓     | ✓     | ✓     | ✓     | ✓            | -   | -       | -      | ✓                 | ✓       | ✓       | ✓                 |
| P1-2                                   | <b>PLdn</b> | PID Parameter Group         | ✓               | ✓     | ✓     | ✓     | ✓     | ✓     | ✓            | -   | -       | ✓      | ✓                 | ✓       | ✓       | ✓                 |
| P1-3                                   | <b>SVn</b>  | Target SV                   | ✓               | ✓     | ✓     | ✓     | ✓     | ✓     | ✓            | -   | -       | ✓      | ✓                 | ✓       | ✓       | ✓                 |
| P1-4                                   | <b>Pn</b>   | Proportion Band             | ✓               | ✓     | ✓     | ✓     | ✓     | ✓     | ✓            | -   | -       | ✓      | ✓                 | ✓       | ✓       | ✓                 |
| P1-5                                   | <b>In</b>   | Integral Time               | ✓               | ✓     | ✓     | ✓     | ✓     | ✓     | ✓            | -   | -       | ✓      | ✓                 | ✓       | ✓       | ✓                 |
| P1-6                                   | <b>dn</b>   | Derivative Time             | ✓               | ✓     | ✓     | ✓     | ✓     | ✓     | ✓            | -   | -       | ✓      | ✓                 | ✓       | ✓       | ✓                 |
| P1-7                                   | <b>PDof</b> | PD Control Offset           | ✓               | ✓     | ✓     | ✓     | ✓     | ✓     | ✓            | -   | -       | ✓      | ✓                 | ✓       | ✓       | ✓                 |
| P1-8                                   | <b>LoFn</b> | Integral Offset             | ✓               | ✓     | ✓     | ✓     | ✓     | ✓     | ✓            | -   | -       | -      | ✓                 | ✓       | ✓       | ✓                 |
| P1-9                                   | <b>HLS</b>  | Heating Hysteresis          | ✓               | ✓     | ✓     | ✓     | ✓     | ✓     | -            | ✓   | -       | -      | ✓                 | -       | ✓       | ✓                 |
| P1-10                                  | <b>CLS</b>  | Cooling Hysteresis          | ✓               | ✓     | ✓     | ✓     | ✓     | ✓     | -            | ✓   | -       | -      | -                 | ✓       | ✓       | ✓                 |
| P1-11                                  | <b>HtPd</b> | Output 1 Heating Period     | ✓               | ✓     | ✓     | ✓     | ✓     | ✓     | ✓            | -   | ✓       | ✓      | ✓                 | -       | ✓       | -                 |
| P1-12                                  | <b>CLPd</b> | Output 1 Cooling Period     | ✓               | ✓     | ✓     | ✓     | ✓     | ✓     | ✓            | -   | ✓       | ✓      | -                 | ✓       | -       | ✓                 |
| P1-13                                  | <b>HCPd</b> | Output 2 Period             | ✓               | ✓     | ✓     | ✓     | ✓     | ✓     | ✓            | -   | ✓       | ✓      | -                 | -       | ✓       | ✓                 |
| P1-14                                  | <b>LoEF</b> | Proportion Band Coefficient | ✓               | ✓     | ✓     | ✓     | ✓     | ✓     | ✓            | -   | -       | ✓      | -                 | -       | ✓       | ✓                 |
| P1-15                                  | <b>DEAd</b> | Dead Band                   | ✓               | ✓     | ✓     | ✓     | ✓     | ✓     | ✓            | ✓   | -       | ✓      | -                 | -       | ✓       | ✓                 |
| P1-16                                  | <b>EPoF</b> | PV Offset                   | ✓               | ✓     | ✓     | ✓     | ✓     | ✓     | ✓            | ✓   | ✓       | ✓      | ✓                 | ✓       | ✓       | ✓                 |
| P1-17                                  | <b>CHL</b>  | Analog High Adjustment      | -               | -     | -     | ✓     | ✓     | ✓     | ✓            | ✓   | ✓       | ✓      | ✓                 | ✓       | ✓       | ✓                 |
| P1-18                                  | <b>CLo</b>  | Analog Low Adjustment       | -               | -     | -     | ✓     | ✓     | ✓     | ✓            | ✓   | ✓       | ✓      | ✓                 | ✓       | ✓       | ✓                 |

### Operation Mode Parameters

Press the  button to access these parameters.

| Operation Mode Parameter Availability |   |                              |                 |       |       |       |       |       |              |     |         |        |                   |         |         |                   |
|---------------------------------------|---|------------------------------|-----------------|-------|-------|-------|-------|-------|--------------|-----|---------|--------|-------------------|---------|---------|-------------------|
| ID #                                  | Display   | Parameter Name               | Controller Type |       |       |       |       |       | Control Mode |     |         |        | Heating / Cooling |         |         |                   |
|                                       |   |                              | RR(E)           | VR(E) | WV(E) | CR(E) | CV(E) | LR(E) | LV(E)        | PID | ON /OFF | Manual | Ramp / Soak       | Heating | Cooling | Heating / Cooling |
| P2-1                                  |  | Run / Stop                   | ✓               | ✓     | ✓     | ✓     | ✓     | ✓     | ✓            | ✓   | ✓       | ✓      | ✓                 | ✓       | ✓       | ✓                 |
| P2-2                                  |  | Starting Ramp / Soak Pattern | ✓               | ✓     | ✓     | ✓     | ✓     | ✓     | ✓            | -   | -       | -      | ✓                 | ✓       | ✓       | ✓                 |
| P2-3                                  |  | Decimal Point Position       | ✓               | ✓     | ✓     | ✓     | ✓     | ✓     | ✓            | ✓   | ✓       | ✓      | ✓                 | ✓       | ✓       | ✓                 |
| P2-4                                  |  | Alarm 1 High Limit           | ✓               | ✓     | ✓     | ✓     | ✓     | ✓     | ✓            | ✓   | ✓       | ✓      | ✓                 | ✓       | ✓       | ✓                 |
| P2-5                                  |  | Alarm 1 Low Limit            | ✓               | ✓     | ✓     | ✓     | ✓     | ✓     | ✓            | ✓   | ✓       | ✓      | ✓                 | ✓       | ✓       | ✓                 |
| P2-6                                  |  | Alarm 2 High Limit           | ✓               | ✓     | ✓     | ✓     | ✓     | ✓     | ✓            | ✓   | ✓       | ✓      | ✓                 | ✓       | ✓       | ✓                 |
| P2-7                                  |  | Alarm 2 Low Limit            | ✓               | ✓     | ✓     | ✓     | ✓     | ✓     | ✓            | ✓   | ✓       | ✓      | ✓                 | ✓       | ✓       | ✓                 |
| P2-8                                  |  | Alarm 3 High Limit           | ✓               | ✓     | ✓     | ✓     | ✓     | ✓     | ✓            | ✓   | ✓       | ✓      | ✓                 | ✓       | -       | -                 |
| P2-9                                  |  | Alarm 3 Low Limit            | ✓               | ✓     | ✓     | ✓     | ✓     | ✓     | ✓            | ✓   | ✓       | ✓      | ✓                 | ✓       | -       | -                 |
| P2-10                                 |  | Lock Mode                    | ✓               | ✓     | ✓     | ✓     | ✓     | ✓     | ✓            | ✓   | ✓       | ✓      | ✓                 | ✓       | ✓       | ✓                 |
| P2-11                                 |  | Output 1 Level               | ✓               | ✓     | ✓     | ✓     | ✓     | ✓     | ✓            | ✓   | -       | ✓      | ✓                 | ✓       | ✓       | ✓                 |
| P2-12                                 |  | Output 2 Level               | ✓               | ✓     | ✓     | ✓     | ✓     | ✓     | ✓            | ✓   | -       | ✓      | ✓                 | -       | -       | ✓                 |



### Initial Setting Parameters

Press the **SET** button for more than three seconds to access these parameters.

| Initial Setting Mode Parameter Availability   |         |                       |                 |       |       |       |       |       |              |        |        |             |                   |         |                   |                   |   |
|---|---------|-----------------------|-----------------|-------|-------|-------|-------|-------|--------------|--------|--------|-------------|-------------------|---------|-------------------|-------------------|---|
| ID #  | Display | Parameter Name        | Controller Type |       |       |       |       |       | Control Mode |        |        |             | Heating / Cooling |         |                   |                   |   |
|   |         |                       | RR(E)           | VR(E) | WV(E) | CR(E) | CV(E) | LR(E) | PID          | ON/OFF | Manual | Ramp / Soak | Heating           | Cooling | Heating / Cooling | Cooling / Heating |   |
| P3-1  | INPT    | Input Type            | ✓               | ✓     | ✓     | ✓     | ✓     | ✓     | ✓            | ✓      | ✓      | ✓           | ✓                 | ✓       | ✓                 | ✓                 | ✓ |
| P3-2  | TEMP    | Temperature Unit      | ✓               | ✓     | ✓     | ✓     | ✓     | ✓     | ✓            | ✓      | ✓      | ✓           | ✓                 | ✓       | ✓                 | ✓                 | ✓ |
| P3-3  | EP-H    | Input Range High      | ✓               | ✓     | ✓     | ✓     | ✓     | ✓     | ✓            | ✓      | ✓      | ✓           | ✓                 | ✓       | ✓                 | ✓                 | ✓ |
| P3-4  | EP-L    | Input Range Low       | ✓               | ✓     | ✓     | ✓     | ✓     | ✓     | ✓            | ✓      | ✓      | ✓           | ✓                 | ✓       | ✓                 | ✓                 | ✓ |
| P3-5  | CTRL    | Control Mode          | ✓               | ✓     | ✓     | ✓     | ✓     | ✓     | ✓            | ✓      | ✓      | ✓           | ✓                 | ✓       | ✓                 | ✓                 | ✓ |
| P3-6  | RAMP    | Ramp / Soak Pattern*  | ✓               | ✓     | ✓     | ✓     | ✓     | ✓     | ✓            | ✓      | ✓      | ✓           | ✓                 | ✓       | ✓                 | ✓                 | ✓ |
| P3-7  | SHC     | Heating / Cooling     | ✓               | ✓     | ✓     | ✓     | ✓     | ✓     | ✓            | ✓      | ✓      | ✓           | ✓                 | ✓       | ✓                 | ✓                 | ✓ |
| P3-8  | ALARM1  | Alarm 1               | ✓               | ✓     | ✓     | ✓     | ✓     | ✓     | ✓            | ✓      | ✓      | ✓           | ✓                 | ✓       | ✓                 | ✓                 | ✓ |
| P3-9  | ALARM2  | Alarm 2               | ✓               | ✓     | ✓     | ✓     | ✓     | ✓     | ✓            | ✓      | ✓      | ✓           | ✓                 | ✓       | ✓                 | ✓                 | ✓ |
| P3-10   | ALARM3  | Alarm 3               | ✓               | ✓     | ✓     | ✓     | ✓     | ✓     | ✓            | ✓      | ✓      | ✓           | ✓                 | ✓       | ✓                 | ✓                 | ✓ |
| P3-11   | SYSTEM  | System Alarm          | ✓               | ✓     | ✓     | ✓     | ✓     | ✓     | ✓            | ✓      | ✓      | ✓           | ✓                 | ✓       | ✓                 | ✓                 | ✓ |
| P3-12   | COSSH   | On-Line Configuration | ✓               | ✓     | ✓     | ✓     | ✓     | ✓     | ✓            | ✓      | ✓      | ✓           | ✓                 | ✓       | ✓                 | ✓                 | ✓ |
| P3-13   | MODBUS  | Modbus Protocol       | ✓               | ✓     | ✓     | ✓     | ✓     | ✓     | ✓            | ✓      | ✓      | ✓           | ✓                 | ✓       | ✓                 | ✓                 | ✓ |
| P3-14   | NETNO   | Network Address       | ✓               | ✓     | ✓     | ✓     | ✓     | ✓     | ✓            | ✓      | ✓      | ✓           | ✓                 | ✓       | ✓                 | ✓                 | ✓ |
| P3-15   | BAUD    | Baud Rate             | ✓               | ✓     | ✓     | ✓     | ✓     | ✓     | ✓            | ✓      | ✓      | ✓           | ✓                 | ✓       | ✓                 | ✓                 | ✓ |
| P3-16   | LEN     | Bit Length            | ✓               | ✓     | ✓     | ✓     | ✓     | ✓     | ✓            | ✓      | ✓      | ✓           | ✓                 | ✓       | ✓                 | ✓                 | ✓ |
| P3-17   | PARITY  | Parity                | ✓               | ✓     | ✓     | ✓     | ✓     | ✓     | ✓            | ✓      | ✓      | ✓           | ✓                 | ✓       | ✓                 | ✓                 | ✓ |
| P3-18   | STOP    | Stop Bit              | ✓               | ✓     | ✓     | ✓     | ✓     | ✓     | ✓            | ✓      | ✓      | ✓           | ✓                 | ✓       | ✓                 | ✓                 | ✓ |
| *Once a Ramp / Soak pattern (P3-6) is selected, the following parameters are available. |         |                       |                 |       |       |       |       |       |              |        |        |             |                   |         |                   |                   |   |
| P3-19   | RAMP    | Ramp / Soak SV        | ✓               | ✓     | ✓     | ✓     | ✓     | ✓     | -            | -      | -      | ✓           | ✓                 | ✓       | ✓                 | ✓                 | ✓ |
| P3-20   | TEMP    | Ramp / Soak Time      | ✓               | ✓     | ✓     | ✓     | ✓     | ✓     | -            | -      | -      | ✓           | ✓                 | ✓       | ✓                 | ✓                 | ✓ |
| P3-21   | STEP    | Last Step Number      | ✓               | ✓     | ✓     | ✓     | ✓     | ✓     | -            | -      | -      | ✓           | ✓                 | ✓       | ✓                 | ✓                 | ✓ |
| P3-22   | CYC     | Additional Cycles     | ✓               | ✓     | ✓     | ✓     | ✓     | ✓     | -            | -      | -      | ✓           | ✓                 | ✓       | ✓                 | ✓                 | ✓ |
| P3-23   | PATN    | Next Pattern Number   | ✓               | ✓     | ✓     | ✓     | ✓     | ✓     | -            | -      | -      | ✓           | ✓                 | ✓       | ✓                 | ✓                 | ✓ |

## Regulation Mode Parameters

Press the **SET** button to access these parameters.

**AL****Auto Tuning****ID Number P1-1**

Range: On - Auto Tuning activated  
Off - Auto Tuning deactivated

When this parameter is set to On, the controller begins auto tuning. After auto tuning is complete, the parameter is set to Off automatically. If this parameter is set to Off during the auto tuning process, the controller stops the auto tuning process immediately and does not change any PID parameter.

**PIDn****PID Parameter Group****ID Number P1-2**

This parameter name will be displayed as one of the following.

- PID0** PID Parameter Group 0
- PID1** PID Parameter Group 1
- PID2** PID Parameter Group 2
- PID3** PID Parameter Group 3
- PID4** PID Parameter Group Auto Select
- PID** PID Parameter Group for Event 2 Input

Range: PID0 to PID4

The SOLO controller can store up to 4 PID parameter groups (**PID0** - **PID3**) for regular operation. The PID Parameter Group parameter sets which PID group (**PID0** - **PID3**) to use for control. The SV display shows the Target SV assigned to the PID group. (For more information about the Target SV, refer to P1-3 Target SV)

When **PID4** is selected as the PID parameter group, the controller automatically chooses the one PID parameter group (**PID0** - **PID3**) that has a Target SV that is the nearest to the SV set by the operator and uses that group for control.

**PID** is a special PID parameter group for the SL4896 and SL9696 series controllers Event inputs. This is the PID group that the controller uses when the Event 2 input is on. To configure the PID parameter for this parameter group, the Event 2 input must be active.

**SVn****Target SV****ID Number P1-3**

This parameter name will be displayed as one of the following. Only the Target SV for the selected PID Parameter Group (**PID0**, P1-2) will be displayed when accessing this parameter.

|            |  |
|------------|--|
| <b>SV0</b> | Target SV of PID Parameter Group 0                 |
| <b>SV1</b> | Target SV of PID Parameter Group 1                 |
| <b>SV2</b> | Target SV of PID Parameter Group 2                 |
| <b>SV3</b> | Target SV of PID Parameter Group 3                 |
| <b>SV</b>  | Target SV of PID Parameter Group for Event 2 Input |

Range: -99.9 to 999.9

(For more information about the parameter groups, refer to P1-2 PID Parameter Group.)

The Target SV is the setting value that each parameter group works toward. When the Target SV is the closest to the SV of the PID groups, this value is used to select which tuning parameters are used by the controller. The controller can store up to four PID parameter groups (**PCDB**, - **PCDB**) for regular operation. One of the PID parameter groups can be selected manually, or the controller selects the PID parameter group that has a Target SV that is the nearest to the SV set by the operator. If there are two or more PID parameter groups that have SV values equally close to the current PV, the controller uses the lowest number parameter group (eg. If parameter groups 0 - 3 have the same Target SV, the controller uses the parameter group 0).

The parameter **SV** is the Target SV of the PID parameter group for Event 2 input. This parameter is only displayed when the Event 2 input is on. The Event 2 input is only available on the SL4896 and SL9696 series controllers.



### Proportion Band

ID Number P1-4

This parameter name will be displayed as one of the following. Only the Proportion Band for the selected PID Parameter Group (**PCDB**, P1-2) will be displayed when accessing this parameter.

|           |  |
|-----------|--|
| <b>P0</b> | Proportion Band of PID Parameter Group 0                 |
| <b>P1</b> | Proportion Band of PID Parameter Group 1                 |
| <b>P2</b> | Proportion Band of PID Parameter Group 2                 |
| <b>P3</b> | Proportion Band of PID Parameter Group 3                 |
| <b>P</b>  | Proportion Band of PID Parameter Group for Event 2 Input |

Range: 0.1 to 999.9

(For more information about the parameter groups, refer to P1-2 PID Parameter Group.)

The Proportion Band is a parameter group used for PID control. The controller can store up to four PID parameter groups (**PCDB**, - **PCDB**) for regular operation. One of the PID parameter groups can be selected manually, or the controller selects the PID parameter group that has a Target SV that is the nearest to the SV set by the operator.

The parameter **P2** is the Proportion Band of the PID parameter group for Event 2 input. This parameter is only displayed when the Event 2 input is on. The Event 2 input is only available on the SL4896 and SL9696 series controllers.

### **Integral Time** ID Number P1-5

This parameter name will be displayed as one of the following. Only the Integral Time for the selected PID Parameter Group (**P1-00**, P1-2) will be displayed when accessing this parameter.

- P0** Integral Time of PID Parameter Group 0
- P1** Integral Time of PID Parameter Group 1
- P2** Integral Time of PID Parameter Group 2
- P3** Integral Time of PID Parameter Group 3
- P** Integral Time of PID Parameter Group for Event 2 Input

Range: 0 to 9999 (Sec)

(For more information about the parameter groups, refer to P1-2 PID Parameter Group.)

The Integral Time is a parameter group used for PID control. The controller can store up to four PID parameter groups (**P1-00**, - **P1-03**) for regular operation. One of the PID parameter groups can be selected manually, or the controller selects the PID parameter group that has a Target SV that is the nearest to the SV set by the operator.

The parameter **P2** is the Integral Time of the PID parameter group for Event 2 input. This parameter is only displayed when the Event 2 input is on. The Event 2 input is only available on the SL4896 and SL9696 series controllers.

### **Derivative Time** ID Number P1-6

This parameter name will be displayed as one of the following. Only the Derivative Time for the selected PID Parameter Group (**P1-00**, P1-2) will be displayed when accessing this parameter.

- D0** Derivative Time of PID Parameter Group 0
- D1** Derivative Time of PID Parameter Group 1
- D2** Derivative Time of PID Parameter Group 2
- D3** Derivative Time of PID Parameter Group 3
- D** Derivative Time of PID Parameter Group for Event 2 Input

Range: 0 to 9999 (Sec)

(For more information about the parameter groups, refer to P1-2 PID Parameter Group.)

The Derivative Time is a parameter group used for PID control. The controller can store up to four PID parameter groups (**P1-00**, - **P1-03**) for regular operation. One of the PID parameter groups can be selected manually, or the controller selects the PID parameter group

that has a Target SV that is the nearest to the SV set by the operator.

The parameter **Pdof** is the Derivative Time of the PID parameter group for Event 2 input. This parameter is only displayed when the Event 2 input is on. The Event 2 input is only available on the SL4896 and SL9696 series controllers.

**Pdof**

**PD Control Offset**

**ID Number P1-7**

Range: 0.0 to 100.0 (%)

The PD Control Offset parameter is available when the P or PD control is selected [Integral Time parameter (**Intn**, P1-5) is zero].

This parameter defines the offset of the output. When the P or PD control is used, the control cannot stabilize the PV at the SV because the output is zero when the PV is equal to the SV. This parameter modifies the output level when the PV is equal to the SV.

**Intofn**

**Integral Offset**

**ID Number P1-8**

This parameter name will be displayed as one of the following.

- Intof0** Integral Offset of PID Parameter Group 0
- Intof1** Integral Offset of PID Parameter Group 1
- Intof2** Integral Offset of PID Parameter Group 2
- Intof3** Integral Offset of PID Parameter Group 3
- Intof** Integral Offset of PID Parameter Group for Event 2 Input

Range: 0.0 to 100.0 (%)

(For more information about the parameter groups, refer to PID Parameter Group, P1-2.)

The Integral Offset parameter is available when the PI or PID control is selected. [Integral Time parameter (**Intn**, P1-5) is not zero.]

The Auto Tuning process will decide the offset value automatically.

If this parameter is not used (**Intof** = 0), the output is zero when the PV is equal to the SV. If the Integral Time parameter (**Intn**, P1-5) is used only to eliminate the steady error, it may take a long time to reach the SV because it needs time to accumulate the error. In this case, this parameter is useful. This parameter defines the default output level on start up. It will improve the speed that the PV reaches the SV.

The parameter **Intof** is the Integral Offset of the PID parameter group for Event 2 input. This parameter is only displayed when the Event 2 input is on. The Event 2 input is only available on the SL4896 and SL9696 series controllers.

|            |                           |                |
|------------|---------------------------|----------------|
| <b>HLS</b> | <b>Heating Hysteresis</b> | ID Number P1-9 |
|------------|---------------------------|----------------|

Range: 0.0 to 999.9

The Heating Hysteresis parameter defines the amount that the PV must go below the SV before the output turns on. This parameter is available only for On / Off control with an output programmed for heating.

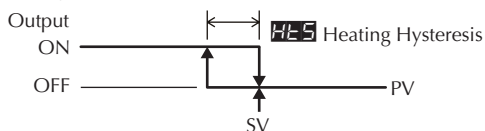

|            |                           |                 |
|------------|---------------------------|-----------------|
| <b>CLS</b> | <b>Cooling Hysteresis</b> | ID Number P1-10 |
|------------|---------------------------|-----------------|

Range: 0.0 to 999.9

The Cooling Hysteresis parameter defines the amount that the PV must go above the SV before the output turns on. This parameter is available only for On / Off control with an output programmed for cooling.

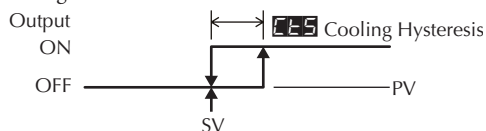

|             |                                |                 |
|-------------|--------------------------------|-----------------|
| <b>HLPd</b> | <b>Output 1 Heating Period</b> | ID Number P1-11 |
|-------------|--------------------------------|-----------------|

Range: 0.5 to 99 seconds

The Output 1 Heating parameter defines one output period or the duration of one on / off cycle for Output 1.



This parameter is available when Output 1 is programmed as a heating output in the PID or Ramp / Soak mode.

|             |                                |                 |
|-------------|--------------------------------|-----------------|
| <b>CLPd</b> | <b>Output 1 Cooling Period</b> | ID Number P1-12 |
|-------------|--------------------------------|-----------------|

Range: 0.5 to 99 seconds

The Output 1 Cooling parameter defines one output period or the duration of one on / off cycle for Output 1.



This parameter is available when Output 1 is programmed as a cooling output in the PID or Ramp / Soak mode.

**HCPd**

## Output 2 Period

ID Number P1-13

Range: 0.5 to 99 seconds

The Output 1 Cooling parameter defines one output period or the duration of one on / off cycle for Output 2.

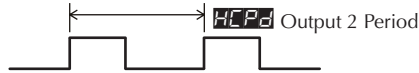

This parameter is available when Output 2 is programmed as a heating or cooling output in the PID or Ramp / Soak mode.

**CoEF**

## Proportion Band Coefficient

ID Number P1-14

Range: 0.01 to 99.99

This Proportion Band Coefficient parameter is available when a dual output mode (heating and cooling) is selected. This parameter allows the second output control to have a different proportional setting than the first output control. The first output control proportional band setting is multiplied by this parameter to create a proportional band setting for the second output control.

**(First Output) Proportion Band \* Proportion Band Coefficient = Second Proportional Band**

(Pn, P1-4)

(CoEF, P1-14)

**DEAD**

## Dead Band

ID Number P1-15

Range: The range varies according to the Decimal Point Position (SP, P2-3).

| SP   | 0          | 1              | 2              | 3              |
|------|------------|----------------|----------------|----------------|
| DEAD | -99 to 999 | -99.9 to 999.9 | -9.99 to 99.99 | -.999 to 9.999 |

The dead band zone is the area around the SV where the output is not effected by the proportional control value (PV). For PID control, as long as the PV remains within the dead band zone, the output is not affected by the proportional control. The integral and derivative controls ignore the dead band setting and may cause the output to be on within the dead band zone.

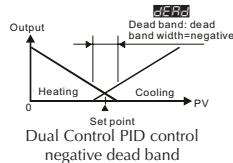
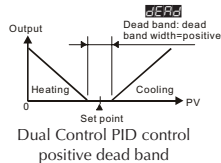

For On / Off type control the Dead Band parameter defines the area around the SV where the output remains off. The PV must go beyond the dead band range in order for either output 1 or output 2 to turn on.

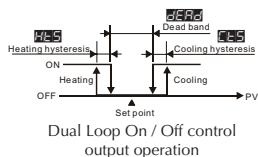

**EPoF**

**PV Offset**

**ID Number P1-16**

Range: The range varies according to the Decimal Point Position (59, P2-3).

| SL4824                |                  |           |           |          |
|-----------------------|------------------|-----------|-----------|----------|
| EPoF                  | Decimal Position |           |           |          |
|                       | 0 (****)         | 1 (*.***) | 2 (**.**) | 3 (**.*) |
| 0~50 mV               | 0                | 0.0       | 00.00     | 0.000    |
| 4~20 mA               | 0                | 0.0       | 00.00     | n/a      |
| 0~20 mA               | 0                | 0.0       | 00.00     | n/a      |
| 0V~10V                | 0                | 0.0       | 00.00     | n/a      |
| 0V~5V                 | 0                | 0.0       | 00.00     | n/a      |
| (Pt100)               | 0                | 0.0       | n/a       | n/a      |
| (JPt100)              | 0                | 0.0       | n/a       | n/a      |
| Thermocouple type TXK | 0.0              | 0.0       | n/a       | n/a      |
| Thermocouple type U   | 0.0              | 0.0       | n/a       | n/a      |
| Thermocouple type L   | 0.0              | 0.0       | n/a       | n/a      |
| Thermocouple type B   | 0.0              | n/a       | n/a       | n/a      |
| Thermocouple type S   | 0.0              | n/a       | n/a       | n/a      |
| Thermocouple type R   | 0.0              | n/a       | n/a       | n/a      |
| Thermocouple type N   | 0.0              | 0.0       | n/a       | n/a      |
| Thermocouple type E   | 0.0              | 0.0       | n/a       | n/a      |
| Thermocouple type T   | 0.0              | 0.0       | n/a       | n/a      |
| Thermocouple type J   | 0.0              | 0.0       | n/a       | n/a      |
| Thermocouple type K   | 0.0              | 0.0       | n/a       | n/a      |



| SL4848 / SL4896 / SL9696 |                  |          |         |          |
|--------------------------|------------------|----------|---------|----------|
| EPOF                     | Decimal Position |          |         |          |
|                          | 0 (****)         | 1 (****) | 2 (***) | 3 (****) |
| 0~50 mV                  | 0                | 0.0      | 00.00   | 0.000    |
| 4~20 mA                  | 0                | 0.0      | 00.00   | 00.00    |
| 0~20 mA                  | 0                | 0.0      | 00.00   | 00.00    |
| 0V~10V                   | 0                | 0.0      | 00.00   | 00.00    |
| 0V~5V                    | 0                | 0.0      | 00.00   | 00.00    |
| (Pt100)                  | 0                | 0.0      | n/a     | n/a      |
| (JPt100)                 | 0                | 0.0      | n/a     | n/a      |
| Thermocouple type TXK    | 0.0              | 0.0      | n/a     | n/a      |
| Thermocouple type U      | 0.0              | 0.0      | n/a     | n/a      |
| Thermocouple type L      | 0.0              | 0.0      | n/a     | n/a      |
| Thermocouple type B      | 0.0              | n/a      | n/a     | n/a      |
| Thermocouple type S      | 0.0              | n/a      | n/a     | n/a      |
| Thermocouple type R      | 0.0              | n/a      | n/a     | n/a      |
| Thermocouple type N      | 0.0              | 0.0      | n/a     | n/a      |
| Thermocouple type E      | 0.0              | 0.0      | n/a     | n/a      |
| Thermocouple type T      | 0.0              | 0.0      | n/a     | n/a      |
| Thermocouple type J      | 0.0              | 0.0      | n/a     | n/a      |
| Thermocouple type K      | 0.0              | 0.0      | n/a     | n/a      |

This parameter is used to add an offset value to the PV.



### Analog High Adjustment

ID Number P1-17

The Analog High Adjustment parameter is used to adjust the actual analog output value when the output is 100%. To set up this parameter, place the SOLO controller in the Manual control mode and set the Output 1 Level (OLE, P2-11) to 100% then increase / decrease the parameter value to get the desired analog output value.

The tables below show the approximate Analog High Adjustment values needed to obtain the desired output value. The actual controller output will vary. Check and adjust the values until the desired output level is achieved.

| Current Output |       |       |       |       |       |       |       |       |
|----------------|-------|-------|-------|-------|-------|-------|-------|-------|
|                | 0mA   | 1mA   | 2mA   | 3mA   | 4mA   | 5mA   | 6mA   | 7mA   |
| [rHL]          | -7198 | -6838 | -6478 | -6118 | -5758 | -5398 | -5038 | -4678 |
|                | 8mA   | 9mA   | 10mA  | 11mA  | 12mA  | 13mA  | 14mA  | 15mA  |
| [rHL]          | -4319 | -3959 | -3599 | -3239 | -2879 | -2519 | -2159 | -1799 |
|                | 16mA  | 17mA  | 18mA  | 19mA  | 20mA  |       |       |       |
| [rHL]          | -1440 | -1080 | -720  | -360  | 0     |       |       |       |

| Voltage Output |       |       |       |       |       |       |       |       |
|----------------|-------|-------|-------|-------|-------|-------|-------|-------|
|                | 0V    | 1V    | 2V    | 3V    | 4V    | 5V    | 6V    | 7V    |
| [rHL]          | -7589 | -6830 | -6071 | -5312 | -4553 | -3795 | -3036 | -2277 |
|                | 8V    | 9V    | 10V   |       |       |       |       |       |
| [rHL]          | -1518 | -758  | 0     |       |       |       |       |       |

*Note: When decreasing the parameter value for Analog High Adjustment below -1999, the SOLO display will “roll over” to -0, indicating a value of -2000. Two “roll overs” equal a value of -4000 and so forth. For example, to enter a value of -5312 for Analog High Adjustment, hold the  button until the SOLO display “rolls over” two times and the display reads -1312.*

*Note: The output may be saturated before it reaches the minimum or maximum value.*

This parameter is available when Output 1 is Current or Linear Voltage.





### Analog Low Adjustment

ID Number P1-18

The Analog Low Adjustment parameter is used to adjust the actual analog output value when the output is 0%. To set up this parameter, place the SOLO controller in the Manual control mode and set the Output 1 Level (, P2-11) to 0% then increase / decrease the parameter value to get the desired analog output value.

The tables below show the approximate Analog Low Adjustment values needed to obtain the desired output value. The actual controller output will vary. Check and adjust the values until the desired output level is achieved.

| Current Output |       |       |      |      |      |      |      |      |
|----------------|-------|-------|------|------|------|------|------|------|
|                | 0mA   | 1mA   | 2mA  | 3mA  | 4mA  | 5mA  | 6mA  | 7mA  |
| [rLo]          | -1440 | -1080 | -720 | -360 | 0    | 360  | 720  | 1080 |
|                | 8mA   | 9mA   | 10mA | 11mA | 12mA | 13mA | 14mA | 15mA |
| [rLo]          | 1440  | 1799  | 2159 | 2519 | 2879 | 3239 | 3599 | 3959 |
|                | 16mA  | 17mA  | 18mA | 19mA | 20mA |      |      |      |
| [rLo]          | 4319  | 4678  | 5038 | 5398 | 5758 |      |      |      |

| Voltage Output  |      |      |      |      |      |      |      |      |
|---|------|------|------|------|------|------|------|------|
|   | 0V   | 1V   | 2V   | 3V   | 4V   | 5V   | 6V   | 7V   |
|  | 0    | 759  | 1518 | 2277 | 3036 | 3795 | 4553 | 5312 |
|   | 8V   | 9V   | 10V  |      |      |      |      |      |
|  | 6071 | 6830 | 7589 |      |      |      |      |      |



*Note: When increasing the parameter value of Analog Low Adjustment above 9999, the SOLO display will “roll up” to 0000, indicating a value of 10000. For example, to enter a value of 10625 for Analog Low Adjustment, hold the  button until the SOLO display reads 0625.*



*Note: The output may be saturated before it reaches the minimum or maximum value.*

This parameter is available when Output 1 is Current or Linear Voltage.

## Operation Mode Parameters

Press the **↵** button to access these parameters.

**r-s**
**Run / Stop**
**ID Number P2-1**

The Run / Stop parameter is used to control the operational status of the SOLO Controller. The available range varies according to the control mode and the status of the EVENT 1 input. The Event 1 input is available only for the SL4896 and SL9696 series controllers.

| PID, On / Off and Manual Control Modes          |            |                         |
|---|------------|-------------------------|
|   | Run        | Stop                    |
| Event 1 input is off. (Event 1 input is open.)  | <b>rUn</b> | <b>uSTp</b>             |
| Event 1 input is on. (Event 1 input is closed.) | N/A        | <b>StoP</b> <b>ESTP</b> |

| Ramp / Soak Control Mode                        |            |             |                         |
|---|------------|-------------|-------------------------|
|   | Run        | Hold        | Stop                    |
| Event 1 input is off. (Event 1 input is open.)  | <b>rUn</b> | <b>PHoD</b> | <b>uSTp</b> <b>PSTP</b> |
| Event 1 input is on. (Event 1 input is closed.) | N/A        | N/A         | <b>StoP</b> <b>ESTP</b> |

**rUn**

Run mode

**uSTp**

Stop mode

**StoP**

Stop mode (The controller was in Stop mode when the Event 1 input was closed.)

**ESTP**

Stop mode (The controller was in Run mode when the Event 1 input was closed.)

**PHoD**

Ramp / Soak control is on hold. The controller keeps the current Ramp / Soak step number and time. Ramp / Soak control continues when the mode is changed to Run.

**PSTP**

Ramp / Soak control is stopped. The controller restarts the Ramp / Soak control at the first step when the mode is changed to Run.

**PtErn**
**Starting Ramp / Soak Pattern**
**ID Number P2-2**

Range: 0 to 7

Select the Ramp / Soak pattern number to start the Ramp / Soak control.

**SP**
**Decimal Point Position**
**ID Number P2-3**

Range: 0 (\*\*\*\*)  
 1 (\*\*\*\*)  
 2 (\*\*.\*\*)  
 3 (\*.\*\*)

This parameter defines the decimal point position on the PV and SV display.

**AL 1H**
**Alarm 1 High Limit**
**ID Number P2-4**

This parameter is used to set the high limit for Alarm 1. The range varies according to other parameter values.

**AL 1L** Alarm 1 Low Limit ID Number P2-5

This parameter is used to set the low limit for Alarm 1. The range varies according to other parameter values.

**AL 2H** Alarm 2 High Limit ID Number P2-6

This parameter is used to set the high limit for Alarm 2. The range varies according to other parameter values.

**AL 2L** Alarm 2 Low Limit ID Number P2-7

This parameter is used to set the low limit for Alarm 2. The range varies according to other parameter values.

**AL 3H** Alarm 3 High Limit ID Number P2-8

This parameter is used to set the high limit for Alarm 3. The range varies according to other parameter values.

**AL 3L** Alarm 3 Low Limit ID Number P2-9

This parameter is used to set the low limit for Alarm 3. The range varies according to other parameter values.

**LoC** Lock Mode ID Number P2-10

Range: **OFF** The Lock feature is disabled.

**LoC 1** Lock Mode 1

**LoC 2** Lock Mode 2

Lock Mode 1: All key pad operation is ignored. Press the **SET** key and the **LoC** key at the same time to cancel this lock mode.

Lock Mode 2: All key pad operation is ignored except changing the SV. Press the **SET** key and the **LoC** key at the same time to cancel this lock mode.

**OUT 1** Output 1 Level ID Number P2-11

Range: 0.0 to 100 (%)

The value for this parameter can be changed in the Manual control mode. In other control modes, this parameter is read-only.

**OUT 2** Output 2 Level ID Number P2-12

Range: 0.0 to 100 (%)

This parameter is available when Output 2 is used. Refer to the Heating / Cooling parameter (**S-HC**, P3-7) to disable / enable Output 2. The value for this parameter can be changed in the Manual control mode. In other control modes, this parameter is read-only.

## Initial Setting Parameters

Press the **SET** button for more than three seconds to access these parameters.

**Input Type**

Input Type

ID Number P3-1

This parameter defines the input signal type.

| Thermocouple* Type and Temperature Range |             |                               |
|--|-------------|-------------------------------|
| Input Temperature Sensor Type            | LED Display | Temperature Range             |
| Thermocouple TXK type                    | <b>TXK</b>  | -328 ~ 1472°F (-200 ~ 800°C)  |
| Thermocouple U type                      | <b>U</b>    | -328 ~ 932°F (-200 ~ 500°C)   |
| Thermocouple L type                      | <b>L</b>    | -328 ~ 1562°F (-200 ~ 850°C)  |
| Thermocouple B type                      | <b>B</b>    | 212 ~ 3272°F (100 ~ 1800°C)   |
| Thermocouple S type                      | <b>S</b>    | 32 ~ 3092°F (0 ~ 1700°C)      |
| Thermocouple R type                      | <b>R</b>    | 32 ~ 3092°F (0 ~ 1700°C)      |
| Thermocouple N type                      | <b>N</b>    | -328 ~ 2372°F (-200 ~ 1300°C) |
| Thermocouple E type                      | <b>E</b>    | 32 ~ 1112°F (0 ~ 600°C)       |
| Thermocouple T type                      | <b>T</b>    | -328 ~ 752°F (-200 ~ 400°C)   |
| Thermocouple J type                      | <b>J</b>    | -148 ~ 2192°F (-100 ~ 1200°C) |
| Thermocouple K type                      | <b>K</b>    | -328 ~ 2372°F (-200 ~ 1300°C) |
| RTD Type and Temperature Range           |             |                               |
| Input Temperature Sensor Type            | LED Display | Temperature Range             |
| Platinum Resistance (Pt100)              | <b>PT</b>   | -328 ~ 1112°F (-200 ~ 600°C)  |
| Platinum Resistance (JPt100)             | <b>JPT</b>  | -4 ~ 752°F (-20 ~ 400°C)      |
| Voltage Input Type and Input Range       |             |                               |
| Voltage Input Type                       | LED Display | Temperature Range             |
| 0~50mV Analog Input                      | <b>05</b>   | -999 ~ 9999                   |
| 0V~10V Analog Input                      | <b>010</b>  | -999 ~ 9999                   |
| 0V~5V Analog Input                       | <b>05</b>   | -999 ~ 9999                   |
| Current Input Type and Input Range       |             |                               |
| Current Input Type                       | LED Display | Temperature Range             |
| 4~20mA Analog Input                      | <b>420</b>  | -999 ~ 9999                   |
| 0~20mA Analog Input                      | <b>020</b>  | -999 ~ 9999                   |

\*Note - Use only ungrounded thermocouples

**Temperature Unit**

Temperature Unit

ID Number P3-2

Range: F, C

This parameter is available when the parameter Input Type is a thermocouple or RTD.

### **EP-H**      **Input Range High**      **ID Number P3-3**

Range: From the value of Input Range Low to 9999.

This parameter defines the high limit of the PV. This is the maximum value of the operational temperature range. In operation, if the PV value is higher than the **EP-H** value, the PV flashes to indicate an error and the controller outputs shut off. The SV value cannot exceed the **EP-H** value. This parameter cannot be lower than the Input Range Low parameter (**EP-L**, P3-4).

### **EP-L**      **Input Range Low**      **ID Number P3-4**

Range: From -999 to the value of Input Range High.

This parameter defines the low limit of the PV. This is the minimum value of the operational temperature range. In operation, if the PV value is lower than the **EP-L** value, the PV flashes to indicate an error and the controller outputs shut off. The SV value cannot be set lower than the **EP-L** value. This parameter cannot be higher than the Input Range High parameter (**EP-H**, P3-3).

### **Ctrl**      **Control Mode**      **ID Number P3-5**

Range: **PID**    PID control mode  
**oFF**    On / Off control mode  
**MANU**    Manual control mode  
**R-oB**    Ramp / Soak control mode

This parameter is used to select one of the control modes. See Chapter 5 for a complete description of each control mode.

### **PATn**      **Ramp / Soak Pattern**      **ID Number P3-6**

Range: oFF    Ramp / Soak pattern is not selected.  
0 to 7    Ramp / Soak pattern number.

This parameter is used to select the appropriate Ramp / Soak pattern number for setting up its individual parameters. Once a Ramp / Soak pattern number (0-7) is selected, the controller only displays the following pattern setup parameters until the **SET** key is pressed.

|                     | Ramp / Soak Pattern Number |      |      |      |      |      |      |      |
|---------------------|----------------------------|------|------|------|------|------|------|------|
|                     | 0                          | 1    | 2    | 3    | 4    | 5    | 6    | 7    |
| Step 0 SV           | SP00                       | SP10 | SP20 | SP30 | SP40 | SP50 | SP60 | SP70 |
| Step 0 Time         | ET00                       | ET10 | ET20 | ET30 | ET40 | ET50 | ET60 | ET70 |
| Step 1 SV           | SP01                       | SP11 | SP21 | SP31 | SP41 | SP51 | SP61 | SP71 |
| Step 1 Time         | ET01                       | ET11 | ET21 | ET31 | ET41 | ET51 | ET61 | ET71 |
| Step 2 SV           | SP02                       | SP12 | SP22 | SP32 | SP42 | SP52 | SP62 | SP72 |
| Step 2 Time         | ET02                       | ET12 | ET22 | ET32 | ET42 | ET52 | ET62 | ET72 |
| Step 3 SV           | SP03                       | SP13 | SP23 | SP33 | SP43 | SP53 | SP63 | SP73 |
| Step 3 Time         | ET03                       | ET13 | ET23 | ET33 | ET43 | ET53 | ET63 | ET73 |
| Step 4 SV           | SP04                       | SP14 | SP24 | SP34 | SP44 | SP54 | SP64 | SP74 |
| Step 4 Time         | ET04                       | ET14 | ET24 | ET34 | ET44 | ET54 | ET64 | ET74 |
| Step 5 SV           | SP05                       | SP15 | SP25 | SP35 | SP45 | SP55 | SP65 | SP75 |
| Step 5 Time         | ET05                       | ET15 | ET25 | ET35 | ET45 | ET55 | ET65 | ET75 |
| Step 6 SV           | SP06                       | SP16 | SP26 | SP36 | SP46 | SP56 | SP66 | SP76 |
| Step 6 Time         | ET06                       | ET16 | ET26 | ET36 | ET46 | ET56 | ET66 | ET76 |
| Step 7 SV           | SP07                       | SP17 | SP27 | SP37 | SP47 | SP57 | SP67 | SP77 |
| Step 7 Time         | ET07                       | ET17 | ET27 | ET37 | ET47 | ET57 | ET67 | ET77 |
| Last Step Number    | SP40                       | SP41 | SP42 | SP43 | SP44 | SP45 | SP46 | SP47 |
| Additional Cycles   | CYC0                       | CYC1 | CYC2 | CYC3 | CYC4 | CYC5 | CYC6 | CYC7 |
| Next Pattern Number | LN0                        | LN1  | LN2  | LN3  | LN4  | LN5  | LN6  | LN7  |

Below is an example of a typical Ramp / Soak Pattern.

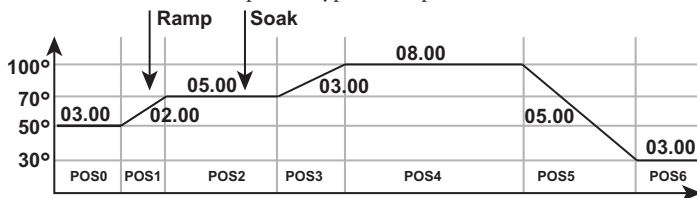

|                                    |                                    |                                    |
|------------------------------------|------------------------------------|------------------------------------|
| <b>SP00</b> Step00 = 50°           | <b>SP03</b> Step03 = 100°          | <b>SP06</b> Step06 = 30°           |
| <b>ET00</b> Time00 = 3 hrs 00 min. | <b>ET03</b> Time03 = 3 hrs 00 min. | <b>ET06</b> Time06 = 3 hrs 00 min. |
| <b>SP01</b> Step01 = 70°           | <b>SP04</b> Step04 = 100°          | <b>PS40</b> Process Step = 6       |
| <b>ET01</b> Time01 = 2 hrs 00 min. | <b>ET04</b> Time04 = 8 hrs 00 min. | <b>CYC0</b> Cycle times = 0        |
| <b>SP02</b> Step02 = 70°           | <b>SP05</b> Step05 = 30°           | <b>LN0</b> Link = OFF              |
| <b>ET02</b> Time02 = 5 hrs 00 min. | <b>ET05</b> Time05 = 5 hrs 00 min. |                                    |



### **S-HC** Heating / Cooling ID Number P3-7

Range: **HEAT** Output 1 = Heating, Output 2 = Unused  
**COOL** Output 1 = Cooling, Output 2 = Unused  
**H1C2** Output 1 = Heating, Output 2 = Cooling  
**H2C1** Output 1 = Cooling, Output 2 = Heating

The Heating / Cooling parameter defines whether one or two outputs will be controlled and what type of control they will perform.

*Note: Unused Output 2 can be used as an Alarm.*



|             |         |                 |
|-------------|---------|-----------------|
| <b>ALA1</b> | Alarm 1 | ID Number P3-8  |
| <b>ALA2</b> | Alarm 2 | ID Number P3-9  |
| <b>ALA3</b> | Alarm 3 | ID Number P3-10 |

Range: 0 to 18

The SOLO controllers support 3 alarm outputs. (The SL4824 series supports only one alarm output.) The Alarm1, Alarm2 and Alarm3 parameters are used to select the alarm type. Refer to Chapter 4 for details.

### **SALA** System Alarm ID Number P3-11

Range: **OFF** System Alarm feature is disabled  
**ALA1** Alarm 1  
**ALA2** Alarm 2  
**ALA3** Alarm 3

This parameter defines which Alarm output is used for the system alarm. The System Alarm parameter defines an alarm output if there is an input error or process control failure. Refer to Chapter 4 for complete details.

## Initial Setting Communication Parameters

### **COSH** On-Line Configuration ID Number P3-12

Range: **OFF** Do not allow changes to the parameters through the RS-485 port.  
**ON** Allow changes to the parameters through the RS-485 port.

### **C-SL** Modbus Protocol ID Number P3-13

Range: **ASCII** Modbus ASCII  
**RTU** Modbus RTU



**[-no]**      **Network Address**      **ID Number P3-14**

Range: 1 to 247

This is the Modbus network address of the SOLO Controller.

*Note: Each controller on the same network must have a unique Modbus network address*

**[bPS]**      **Baud Rate**      **ID Number P3-15**

Range: **2400** 2400 bps  
**4800** 4800 bps  
**9600** 9600 bps  
**1920** 19200 bps  
**3840** 38400 bps

**[LEn]**      **Bit Length**      **ID Number P3-16**

Range: 7, 8

**[PrtY]**      **Parity**      **ID Number P3-17**

Range: None, Even, Odd

**[Stop]**      **Stop Bit**      **ID Number P3-18**

Range: 1, 2

### Initial Setting Ramp / Soak Parameters

**[SPmn]**      **Ramp / Soak SV**      **ID Number P3-19**

Range: -99.9 to 999.9

This parameter is the set point value (SV) of each Ramp / Soak step.

This parameter can be displayed as **[SP00]** to **[SP77]**. The third character indicates the Ramp / Soak pattern number (*m*) and the last digit indicates the step number (*n*).

e.g. **[SP35]** = SV set point value of Step 5 of the Ramp / Soak pattern 3.

**[ETmn]**      **Ramp / Soak Time**      **ID Number P3-20**

Range: 00.00 to 15.00 (0 to 15 hours) [Format: hours.minutes]

This parameter is the time duration of each Ramp / Soak step.

This parameter can be displayed as **[ET00]** to **[ET77]**. The third character indicates the Ramp / Soak pattern number (*m*) and the last digit indicates the step number (*n*).

e.g. **[ET35]** = SV set point value of Step 5 of the Ramp / Soak pattern 3.

### Last Step Number ID Number P3-21

Range: 0 to 7

Each Ramp / Soak pattern can have up to seven steps. This parameter is the last step number that is to be used in the Ramp / Soak pattern. When the parameter value is set to 0, the SOLO controller executes only step 0 when the Ramp / Soak pattern is selected. When the value is 7, the controller executes step 0 through step 7 when the Ramp / Soak pattern is selected.

### Additional Cycles ID Number P3-22

Range: 0 to 199

As the default, the SOLO controller executes a Ramp /Soak pattern only once. Use this parameter to set the number of additional times a Ramp / Soak pattern will execute. When the parameter value is set to 0, the SOLO controller executes the Ramp / Soak pattern one time. When this parameter value is 2, the Ramp / Soak pattern will execute two additional times for a total of three executions.

### Next Pattern Number ID Number P3-22

Range: 0 to 7, OFF

This parameter is used to select a Ramp / Soak pattern that will execute after the current Ramp / Soak pattern is completed. If the parameter value is set to OFF, the SOLO controller will not begin another Ramp / Soak pattern after the current pattern.

## Reset to Factory Default















*Note: Resetting the Temperature Controller back to factory default erases all of the values entered by the user. Record any necessary settings before proceeding*



**Warning: Erasing the user entered values may result in a safety hazard and system malfunction.**

The following instructions reset the controller to the factory default.

1. Press the  button until the parameter  appears. Use the  button to select . Press the  button.
2. Press and hold the  and  buttons simultaneously for one second and release.
3. Press the  button until the PV display shows . Use the  button to change the value on the SV display to . Press the  button.
4. Cycle power on the Controller to reset to factory default mode. All user set values are erased.

# **CONTROLLER INPUTS AND OUTPUTS**

---



# **CHAPTER 4**

## **In this Chapter...**

|                                  |            |
|----------------------------------|------------|
| <b>Control Input Types.....</b>  | <b>4-2</b> |
| <b>Event Inputs.....</b>         | <b>4-3</b> |
| <b>Control Output Types.....</b> | <b>4-4</b> |
| <b>Alarm Outputs.....</b>        | <b>4-8</b> |

## Control Input Types

### Thermocouple or RTD Input

The SOLO temperature controller can accept input from eleven types of thermocouples and two types of Platinum RTD sensors. Select the sensor type by using the parameter Input Type (**INPE**, P3-1).

| Thermocouple* Type and Temperature Range |             |                               |
|--|-------------|-------------------------------|
| Input Temperature Sensor Type            | LED Display | Temperature Range             |
| Thermocouple TXK type                    | <b>TXK</b>  | -328 ~ 1472°F (-200 ~ 800°C)  |
| Thermocouple U type                      | <b>U</b>    | -328 ~ 932°F (-200 ~ 500°C)   |
| Thermocouple L type                      | <b>L</b>    | -328 ~ 1562°F (-200 ~ 850°C)  |
| Thermocouple B type                      | <b>B</b>    | 212 ~ 3272°F (100 ~ 1800°C)   |
| Thermocouple S type                      | <b>S</b>    | 32 ~ 3092°F (0 ~ 1700°C)      |
| Thermocouple R type                      | <b>R</b>    | 32 ~ 3092°F (0 ~ 1700°C)      |
| Thermocouple N type                      | <b>N</b>    | -328 ~ 2372°F (-200 ~ 1300°C) |
| Thermocouple E type                      | <b>E</b>    | 32 ~ 1112°F (0 ~ 600°C)       |
| Thermocouple T type                      | <b>T</b>    | -328 ~ 752°F (-200 ~ 400°C)   |
| Thermocouple J type                      | <b>J</b>    | -148 ~ 2192°F (-100 ~ 1200°C) |
| Thermocouple K type                      | <b>K</b>    | -328 ~ 2372°F (-200 ~ 1300°C) |
| RTD Type and Temperature Range           |             |                               |
| Input Temperature Sensor Type            | LED Display | Temperature Range             |
| Platinum Resistance (Pt100)              | <b>PE</b>   | -328 ~ 1112°F (-200 ~ 600°C)  |
| Platinum Resistance (JPt100)             | <b>JPE</b>  | -4 ~ 752°F (-20 ~ 400°C)      |

\*Note - Use only ungrounded thermocouples

### Analog Input

The SOLO temperature controller can accept input from the following analog input sources. Select the output type by using the parameter Input Type (**INPE**, P3-1).

| Voltage Input Type and Input Range  |             |                   |
|-------------------------------------|-------------|-------------------|
| Voltage Input Type                  | LED Display | Temperature Range |
| 0~50mV Analog Input                 | <b>AV</b>   | -999 ~ 9999       |
| 0V~10V Analog Input                 | <b>AV10</b> | -999 ~ 9999       |
| 0V~5V Analog Input                  | <b>AV5</b>  | -999 ~ 9999       |
| Current Input Type and Input Range* |             |                   |
| Current Input Type                  | LED Display | Temperature Range |
| 4~20mA Analog Input                 | <b>CA4</b>  | -999 ~ 9999       |
| 0~20mA Analog Input                 | <b>CA0</b>  | -999 ~ 9999       |

\*Note: For Current Input operation, the supplied 249 Ω resistor should be installed as shown on page 4-3.



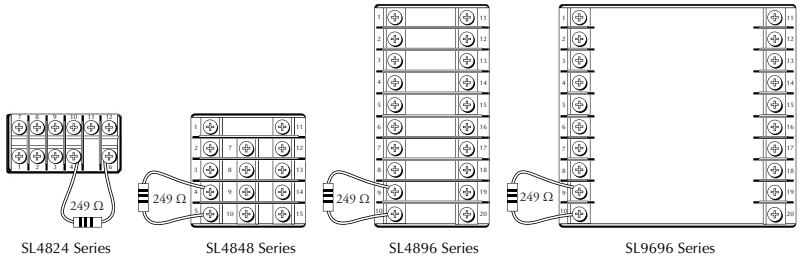

## Event Inputs

The SL4896 and SL9696 series SOLO controllers support two Event inputs, Event 1 and Event 2. When an Event input is not connected to anything (open), the status of the Event input is off. When the Event input terminal is connected to the signal ground terminal (SG), the status of the Event input is on.

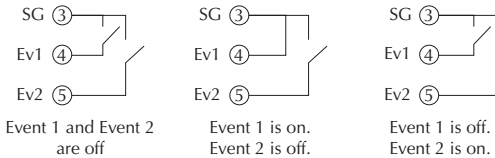

Event 1 and Event 2 have different functions.

### Event 1 Input

Once the Event 1 input is turned on, both control outputs OUT1 and OUT2 are turned off. This does not effect the status of the alarm outputs. If an alarm output is on when the Event 1 input is turned on, the alarm output remains on as long as the condition of the alarm is true.

This Event 1 input can be used to shut down the control outputs quickly with an external input like a pushbutton or sensor.

### Event 2 Input

All SOLO controllers support four PID parameter groups. The SL4896 and SL9696 series SOLO controllers support an additional PID parameter group. When the Event 2 input is on, the SOLO controller uses the additional PID parameter group.

| SL4824 / SL4848       |
|-----------------------|
| PID Parameter group 0 |
| PID Parameter group 1 |
| PID Parameter group 2 |
| PID Parameter group 3 |

| SL4896 / SL9696                     |
|-------------------------------------|
| PID Parameter group 0               |
| PID Parameter group 1               |
| PID Parameter group 2               |
| PID Parameter group 3               |
| PID Parameter group (Event 2 is on) |



*Note: The additional PID parameter group can be accessed only when the Event 2 input is on. To edit the PID Parameter group for Event 2 input, Event 2 input must be on.*

The Event 2 input can be used to force the Process Value (PV) to reach the predefined Set Value (SV) when an external input is turned on, but still using the PID control.

## Control Output Types

The SOLO temperature controller supports four types of control outputs depending on the model chosen. The available outputs are Relay, Voltage Pulse, Current and Linear Voltage as shown in the controller part number.

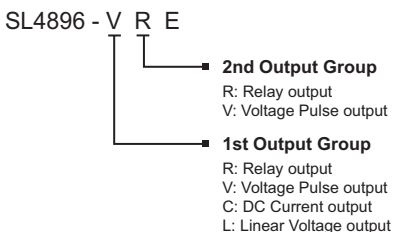

### Relay Output

The relay used for the relay output in model SL4824 is rated at a maximum 250 VAC and 3A resistive load. The relay used for the relay output in models SL4848, SL4896 and SL9696 is rated at a maximum 250 VAC and 5A resistive load. The electrical life expectancy is 100,000 operations.

The operation cycle of the Relay output is controlled by two factors, Output Level and Output Period.

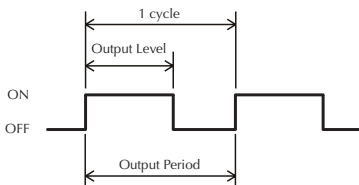

For example, when the Output Level is 60% and the Output Period is 10 seconds, the output relay is turned on for 6 seconds in the cycle.

There are five parameters that define these two factors.

### Output Level

Output 1 Level (**OUT1**, P2-11) Range: 0.0 to 100%

Output 2 Level (**OUT2**, P2-12) Range: 0.0 to 100%

### Output Period

Output 1 Heating Period (**HLPd**, P1-11) Range: 0.5 to 99 seconds

Output 1 Cooling Period (**CLPd**, P1-12) Range: 0.5 to 99 seconds

Output 2 Period (**HCPd**, P1-13) Range: 0.5 to 99 seconds



*Note: The electrical life expectancy of the relay output is 100,000 cycles. To maximize the life of the relay output, set a longer time value for the Output Period.*

### Voltage Pulse Output

The Voltage Pulse output generates 40 mA pulses. The pulse high level is 14 VDC and the low level is 0VDC.

The operation cycle of the Voltage Pulse output is controlled by two factors, Output Level and Output Period.

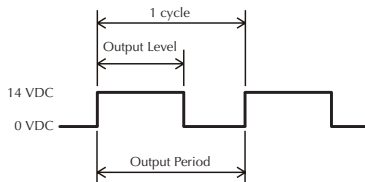

For example, when the Output Level is 60% and the Output Period is 10 seconds, the Voltage Pulse output is turned on for 6 seconds in the cycle.

There are five parameters that define these two factors.

### Output Level

Output 1 Level (**OLE**, P2-11) Range: 0.0 to 100%

Output 2 Level (**OLE**, P2-12) Range: 0.0 to 100%

### Output Period

Output 1 Heating Period (**HLPd**, P1-11) Range: 0.5 to 99 seconds

Output 1 Cooling Period (**CLPd**, P1-12) Range: 0.5 to 99 seconds

Output 2 Period (**HCPd**, P1-13) Range: 0.5 to 99 seconds

### Current Output

The Current output generates analog DC current with a range of 4-20 mA. The maximum load resistance is 600  $\Omega$ .

The output current is controlled by four factors, Analog High Adjustment, Analog Low Adjustment, Output Level and Output Period.



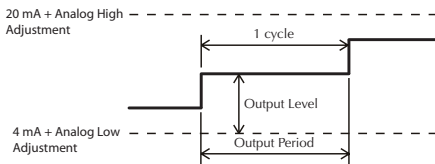

The Analog High Adjustment value may be changed to adjust the output current when the Output Level is 100%. The adjustment needs to be done in the Manual mode.

The Analog Low Adjustment value may be changed to adjust the output current when the Output Level is 0%. The adjustment also needs to be done in the Manual mode.

The Output Level determines the output current level between “20mA + Analog High Adjustment” and “4mA + Analog Low Adjustment”. The output current will be 10 mA in the following example.

$$20\text{mA} + \text{Analog High Adjustment} = 18\text{mA}$$

$$4\text{mA} + \text{Analog Low Adjustment} = 2\text{mA}$$

$$\text{Output Level} = 50\%$$

The Output Period sets how often the SOLO controller updates the output value.

There are five parameters that define these four factors.

### Analog High Adjustment

Analog High Adjustment (**CrHc**, P1-17)

### Analog Low Adjustment

Analog Low Adjustment (**CrLo**, P1-18)

### Output Level

Output 1 Level (**OLL**, P2-11) Range: 0.0 to 100%

### Output Period

Output 1 Heating Period (**HLPd**, P1-11) Range: 0.5 to 99 seconds

Output 1 Cooling Period (**CLPd**, P1-12) Range: 0.5 to 99 seconds

## Linear Voltage Output

The Linear Voltage output generates analog voltage from 0-10 VDC. The minimum load resistance is 1k $\Omega$ .

The output voltage is controlled by four factors, Analog High Adjustment, Analog Low Adjustment, Output Level and Output Period.

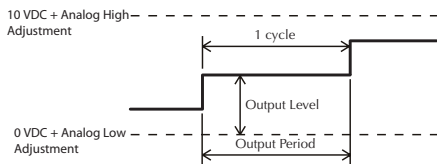

The Analog High Adjustment value may be changed to adjust the output voltage when the Output Level is 100%. The adjustment needs to be done in the Manual mode.

The Analog Low Adjustment value may be changed to adjust the output voltage when the Output Level is 0%. The adjustment needs to be done in the Manual mode.

The Output Level determines the output voltage level between “10 VDC + Analog High Adjustment” and “0VDC + Analog Low Adjustment”. The output voltage will be 4 VDC in the following example.

$$\begin{aligned} 10 \text{ VDC} + \text{Analog High Adjustment} &= 7\text{VDC} \\ 0\text{VDC} + \text{Analog Low Adjustment} &= 1\text{VDC} \\ \text{Output Level} = 50\% \end{aligned}$$

The Output Period sets how often the SOLO controller updates the output value.

There are five parameters that define these two factors.

### Analog High Adjustment

Analog High Adjustment (**EHAdj**, P1-17)

### Analog Low Adjustment

Analog Low Adjustment (**ELAdj**, P1-18)

### Output Level

Output 1 Level (**OUTL**, P2-11) Range: 0.0 to 100%

### Output Period

Output 1 Heating Period (**HLPer**, P1-11) Range: 0.5 to 99 seconds

Output 1 Cooling Period (**CLPer**, P1-12) Range: 0.5 to 99 seconds

### Alarm Outputs

The SL4848, SL4896 and SL9696 series SOLO controllers support three alarm output groups (ALA1, ALA2, ALA3) and one system alarm output (SALA). The SL4824 series SOLO controller supports one alarm output group (ALA1) and one system alarm output (SALA). ALA1 and ALA2 are both SPST normally open relay outputs. ALA3 uses the same output as Output 2 and is the same type of output.



---

*Note: The system alarm does not have a dedicated output that can be used only for the system alarm. One of the alarm outputs can be used for the system alarm. See page 4-11.*

---





---

*Note: When Output 2 is used, ALA3 is disabled. ALA3 is available only when single output control is selected.*

---

**See the Alarm Output Chart on the following page.**

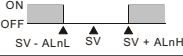
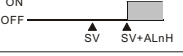
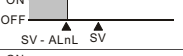
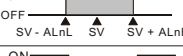
## Alarm Output Types

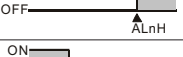
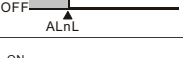
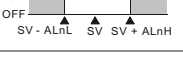
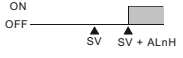
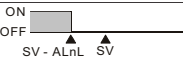
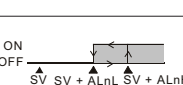
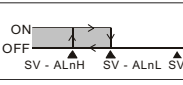
| Set Value                         | Alarm Type   | Alarm Output Operation  |
|-----------------------------------|--|---|
| 0                                 | Alarm function disabled  | Output is OFF   |
| 1                                 | Deviation upper and lower limit:<br>This alarm output activates when the PV value is higher than the setting value SV + ALnH or lower than the setting value SV - ALnL.  | ON OFF   |
| 2                                 | Deviation upper-limit:<br>This alarm output activates when the PV value is higher than the setting value SV + ALnH.  | ON OFF   |
| 3                                 | Deviation lower limit:<br>This alarm output activates when the PV value is lower than the setting value SV - ALnL.   | ON OFF   |
| 4                                 | Reverse deviation upper and lower limit:<br>This alarm output activates when the PV value is in the range of the setting value SV + ALnH and the setting value SV - ALnL.  | ON OFF   |
| 5                                 | Absolute value upper and lower limit:<br>This alarm output activates when the PV value is higher than the setting value ALnH or lower than the setting value ALnL.   | ON OFF   |
| 6                                 | Absolute value upper-limit:<br>This alarm output activates when the PV value is higher than the setting value ALnH   | ON OFF   |
| 7                                 | Absolute value lower limit:<br>This alarm output activates when the PV value is lower than the setting value ALnL  | ON OFF   |
| 8                                 | Deviation upper and lower limit with standby sequence:<br>After the PV reaches the SV once, this alarm output activates when the PV value reaches the set point (SV value) and the reached value is higher than the setting value SV + ALnH or lower than the setting value SV - ALnL. | ON OFF   |
| 9                                 | Deviation upper limit with standby sequence:<br>After the PV reaches the SV once, this alarm output activates when the PV value reaches the set point (SV value) and the reached value is higher than the setting value SV + ALnH.   | ON OFF   |
| 10                                | Deviation lower limit with standby sequence:<br>After the PV reaches the SV once, this alarm output activates when the PV value reaches the set point (SV value) and the reached value is lower than the setting value SV - ALnL.  | ON OFF   |
| 11                                | Hysteresis upper-limit alarm output:<br>This alarm output activates when the PV value is higher than the setting value SV + ALnH. This alarm output is OFF when the PV value is lower than the setting value SV + ALnL.  | ON OFF   |
| 12                                | Hysteresis lower-limit alarm output:<br>This alarm output activates when the PV value is lower than the setting value SV - ALnH. This alarm output is OFF when the PV value is higher than the setting value SV - ALnL.  | ON OFF  |
| 13                                | N/A  |   |
| <b>Ramp / Soak Program Alarms</b> |  |   |
| 14                                | This alarm activates when the Ramp / Soak program has ended.   |   |
| 15                                | This alarm activates while the program is in RAMP UP status.   |   |
| 16                                | This alarm activates while the program is in RAMP DOWN status.   |   |
| 17                                | This alarm activates while the program is in SOAK status.  |   |
| 18                                | This alarm activates while the program is in RUN status.   |   |



*Note: ALnH includes AL1H, AL2H and AL3H. ALnL includes AL1L, AL2L and AL3L.*

### System Alarm Output

The system alarm can be used to indicate the following system error.

**System Error:** The SOLO controller checks the control outputs for correct operation by monitoring the PV value. If the heating output is on but the PV keeps dropping for two minutes, the system alarm turns on. Or, if the cooling output is on but the PV continues to increase for two minutes, the system alarm turns on.



*Note: The SOLO controller checks the PV every 15 seconds. If the PV continues increasing / decreasing eight times when the controller checks the PV, the system alarm turns on. (15 seconds x 8 = 2 minutes). If the PV does not increase / decrease when the controller checks it, the controller resets the counter. The PV would have to increase / decrease for an additional two minutes to activate the alarm.*

On series SL4848, SL4896 and SL9696 controllers, the system alarm can be assigned to one of the alarm outputs 1 - 3. Series SL4824 supports only one alarm output. Use the System Alarm Parameter (**SALRA**, P3-11) to set the alarm output number. The system alarm can be disabled by setting the System Alarm (**SALRA**, P3-11) to OFF.

When the system alarm output is on, the corresponding Alarm Output is on and the PV display on the controller starts flashing.



# CONTROL MODES

---



# CHAPTER

# 5

## In this Chapter...

|                                 |     |
|---------------------------------|-----|
| PID Control.....                | 5-2 |
| On / Off Control .....          | 5-4 |
| Ramp / Soak Control.....        | 5-5 |
| Manual Control.....             | 5-5 |
| Error Display Information ..... | 5-6 |

The SOLO controller can be configured for any of the following control modes.

- PID control
- On / Off control
- Ramp / Soak control
- Manual control

## PID Control

All of the SOLO controllers can store up to four PID parameter groups (PID parameter groups 0 - 3)

|                 | Group 0 | Group 1 | Group 2 | Group 3 |
|-----------------|---------|---------|---------|---------|
| Set Value       | SV0     | SV1     | SV2     | SV3     |
| Proportion Band | P0      | P1      | P2      | P3      |
| Integral Time   | I0      | I1      | I2      | I3      |
| Derivative Time | D0      | D1      | D2      | D3      |
| Integral Offset | IOF0    | IOF1    | IOF2    | IOF3    |



---

*Note: Other parameters are shared among all PID parameter groups.*

---

The operator can select any of the parameter groups for PID control. The individual groups can be manually selected by changing **PCdn** to **PCd0** - **PCd3**. The selected group is the active group. Only the selected groups specific parameters show on the menu when that group is selected. The SOLO controller also supports the PID parameter group 4. This is the auto PID group. When this group is selected the active group (**PCd0** - **PCd3**) parameters will be shown in the menu structure. This is based on the group setpoints and the current system setpoint. When the PID parameter group 4 is selected, the controller checks the SV of each parameter group and uses the parameter group which has a SV that is the closest to the SV set by the operator. If there are two or more PID parameter groups that have SV values equally close to the SV, the controller uses the lowest number parameter group (eg. If parameter groups 0 - 3 have the same SV, the controller uses the parameter group 0).



---

*Note: When at the half way point between two parameter groups SV's, when both are equally close to the current SV, the current SV takes precedence. The change over will not occur until the set SV is closer to the new parameter group.*

---

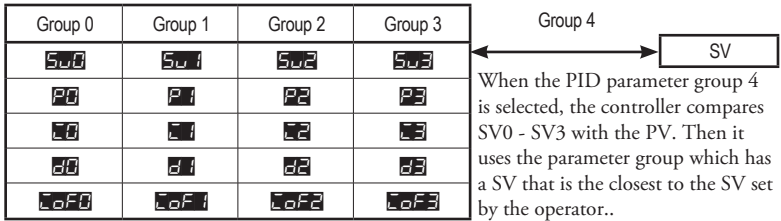

Having PID parameter groups automatically selected for different input ranges allows the system to be more finely tuned or to react differently during the PID or ramp/soak controlled process.

To auto tune groups 0-3 the user must first assign the groups setpoint **SVn** a value. Then the temperature setpoint would be set to equal each value one by one and the auto tune process completed for each group. For example, the individual performing the tuning could set **SV0** to 100, **SV1** to 300, **SV2** to 550, and **SV3** to 800. Then they would select **SV0** and set the temperature setpoint to 100. Next set **AE** to **on** and wait for the process to complete. Then the group would be changed to **SV1** and the setpoint would be changed to 300. **AE** would be set to **on** again and the auto tune process would be allowed to complete. This would be completed for each of the remaining groups.

The SL4896 and SL9696 series controller also support an additional PID parameter group. The parameter group is used with the Event2 input. When Event2 input is on, the SOLO controller uses the additional PID group for the PID control.

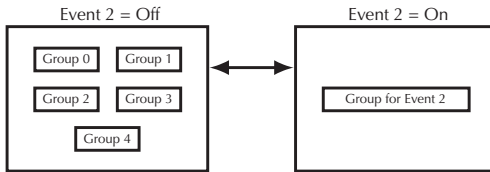

### Auto Tuning

All SOLO controllers support the Auto Tuning feature to set up the following PID parameters automatically.

- P** Proportional Band (**Pn**, P1-4)
- I** Integral Time (**In**, P1-5)
- D** Derivative Time (**Dn**, P1-6)
- COF** Integral Offset (**COFn**, P1-8)
- COEF** Proportional Band Coefficient (**COEFn**, P1-14)

To start the Auto Tuning, set the parameter Auto Tuning (**AE**, P1-1) to on. the controller automatically controls the output to change the PV as shown below.



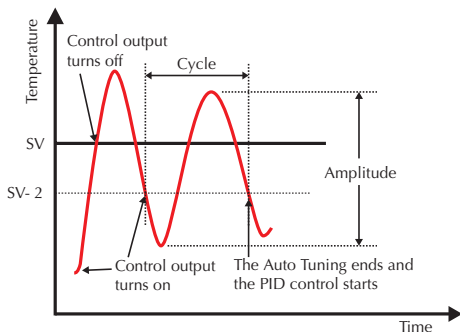

Once the Auto Tuning process is completed, the SOLO controller calculates the above PID parameters for the currently selected group (**Pcd0** - **Pcd3**) and starts the PID control with the new parameter values immediately.

### On / Off Control

In the On / Off control mode the output is controlled according to the difference between the SV and the PV. If the PV is lower than the SV, the heating output is turned on. If the PV is higher than the SV, the cooling output is turned on. The Heating / Cooling Hysteresis and the Dead Band setups can be used to avoid output chatter.

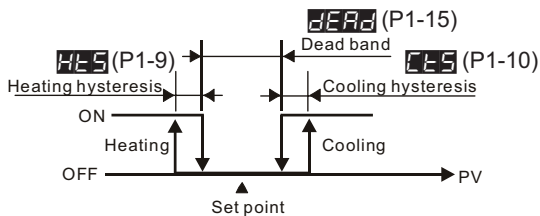

### Hysteresis

There are two types of hysteresis, heating and cooling. If the heating hysteresis is set, the heating output turns on using the following formula.

$$PV < SV - (\text{DEAD} / 2) - \text{HES}$$

If the cooling hysteresis is set, the cooling output turns on using the following formula.

$$PV > SV + (\text{DEAD} / 2) + \text{CES}$$

## Dead Band

The Dead Band is the range around the PV in which the heating / cooling outputs remain off. The Dead Band is defined by the formula.

$$SV \pm (\text{DEAD} / 2)$$

## Ramp / Soak Control

The Ramp / Soak control mode is used to control the outputs according to the preprogrammed SV patterns with the PID control method. The SOLO controllers support up to eight Ramp / Soak patterns. Each Ramp / Soak pattern can store up to eight steps. Each step has its target SV and the time duration setups. You can set up each Ramp / Soak step.

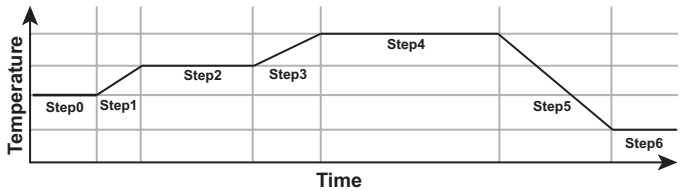

You can select which Ramp / Soak pattern the SOLO controller will execute first. The Ramp / Soak patterns can be executed in series, so the Ramp / Soak control can execute up to 64 steps (8 steps x 8 patterns). You can select which Ramp / Soak pattern will execute next or the controller stops after executing the current pattern. The SOLO controller can execute the same Ramp / Soak pattern up to 200 times before it stops or moves to the next Ramp / Soak pattern.

### Ramp / Soak Display

There are three Ramp / Soak display modes possible with the SOLO controller. From the controller main screen press the and buttons to choose from these three optional display modes.

**P-5L** - Pattern Number - Step Number

**SP** - Set Point

**R-TL** - Remaining time in current step











Press the **SET** button to save the selection.

## Manual Control

In the Manual control mode, the outputs of the controller are manipulated manually by the operator. Adjust the values of the parameters Output 1 Level (**OUT1L**, P2-11) and / or Output 2 Level (**OUT2L**, P2-12) to control the output levels. Output 2 Level is only available when you select a dual output mode.

## Error Display Information

The chart below illustrates the possible error displays shown on the SOLO Temperature controller.

| Controller Error Display |   |   |  |   |
|--------------------------|---|---|--|---|
| Display Position         | Display   | Meaning   | Cause  | Corrective Action   |
| PV                       |  | Initialization<br>PV = Firmware version<br>SV = Module type | The controller is in the initialization process. | The SOLO controller displays this information for a few seconds after power up. If the controller continues displaying this information, check the input wiring. If the problem still exists, replace the sensor or the controller.   |
| SV                       |  |   |  |   |
| PV                       |  | No sensor input   | The input terminals are open.                    | Check the input wiring. If the problem still exists, replace the sensor or the controller.  |
| SV                       |  |   |  |   |
| PV                       |  | Input error   | The controller cannot read the input value       | Check the sensor and the input wiring. If the problem still exists, replace the sensor or the controller.   |
| SV                       |  |   |  |   |
| PV                       |  | EEPROM error  | There is an error with the EEPROM                | Cycle the power to the SOLO controller. If the problem still exists, replace the controller.  |
| SV                       |  |   |  |   |
| PV                       | Flashing PV   | PV out of range   | The PV is out of range                           | Check the PV range. The Input Range High (  P3-3) and the Input Range Low (  P3-4) parameters define the range. Refer to section 12-1, 12-2 or 12-3 for directions on how to access these parameters. |
| SV                       |   |   |  |   |

# CONFIGURATION SOFTWARE

---



# CHAPTER 6

## In this Chapter...

|                            |     |
|----------------------------|-----|
| PC Connection.....         | 6-2 |
| Software Installation..... | 6-3 |
| Starting SL-SOFT .....     | 6-6 |
| SL-SOFT Online Help .....  | 6-6 |

### PC Connection

To connect a PC to the SOLO controller, you will need the following component from AutomationDirect.

- SL-SOFT Configuration and Monitoring software
- USB-485M (USB to RS-485 communication adapter)

Use the supplied black 2-wire cable to connect the USB adapter to the SOLO controller. Plug the adapter into one of the PC's USB ports.

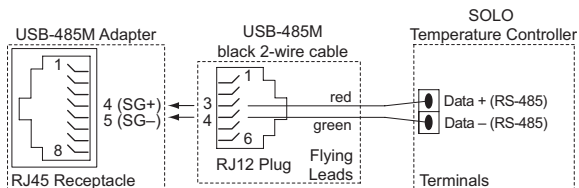

## Software Installation

To download the SL-SOFT software:

1. From the **AutomationDirect** software download page (<http://support.automationdirect.com/demos.html>), scroll down to **SOLO Temperature Controllers** and click the link.
2. Download slsoft.exe from the above URL and copy the content onto your computer at the location you prefer.
3. Unzip the installation file to a known location.
4. Double-click on **SL-SOFT Install.exe**.
5. Follow the on-screen instructions to complete the installation.

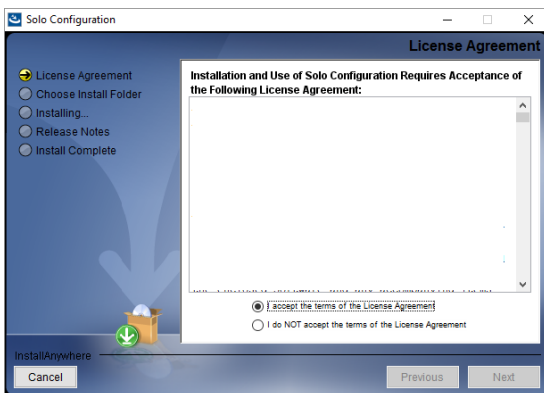
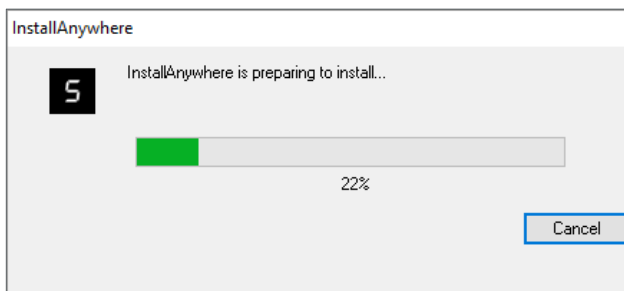

6. Read the **License Agreement**, and if you agree to the terms, click **Next**.

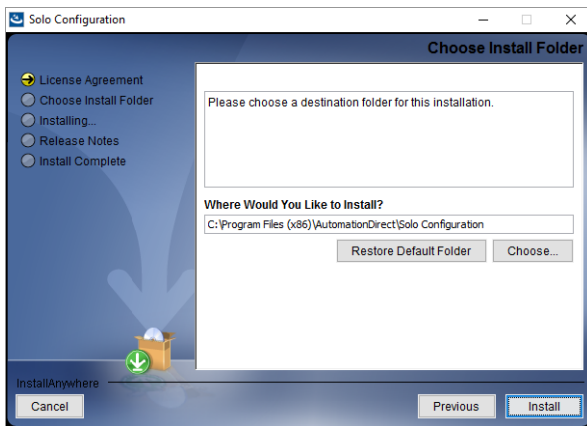

7. You may use either the default location or choose a different location by clicking **Choose** and browsing to the location. Then click **Install**.

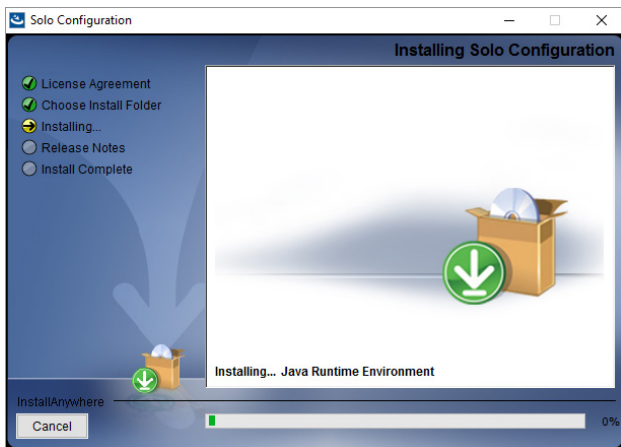

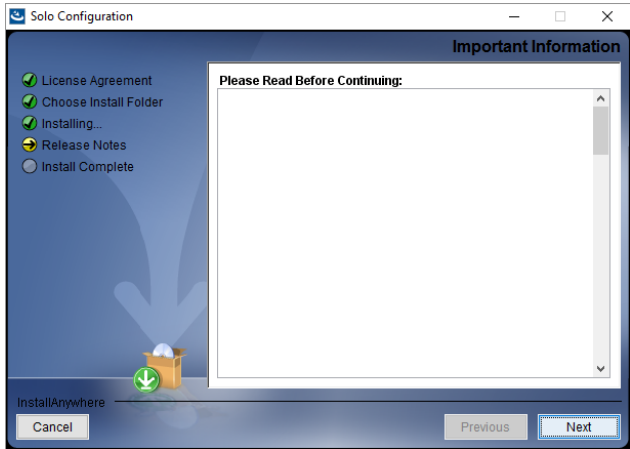

8. Read the **Release Note**, then click **Next**.

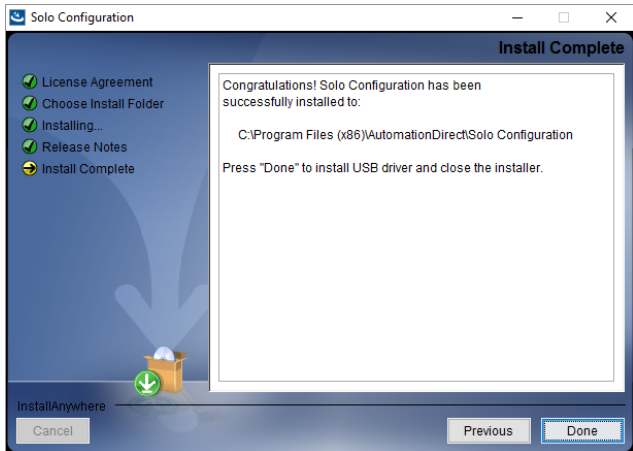

The installation of SL-SOFT is now complete. Although not required, it is recommended to use the AutomationDirect USB-485M Modbus adapter to communicate with the SOLO Temperature Controllers.

The driver for the USB-485M Modbus adapter can be found on AutomationDirect's website at <http://support.automationdirect.com/downloads.html>. If a different Modbus communication device is used, please ensure the drivers are installed prior to using SL-SOFT for the first time.



### Starting SL-SOFT

After installing the SL-SOFT software, click on the SL-SOFT icon to start using the software.



SL-SOFT allows multiple instances to run simultaneously, but care should be taken in selecting which communication ports are used because each instance must connect to its own communication port. No communication port sharing is allowed.

### SL-SOFT Online Help

After starting the SL-SOFT software, click the Help button for the following:

- Downloading the USB-485M adapter driver software
- Connecting the USB-485M adapter to your PC
- Navigating the SL-SOFT interface
- Setting up communications with the SOLO Temperature Controller
- Connecting the SOLO Temperature Controller to your PC
- Configuring the SOLO Temperature Controller
- Reading and writing values to and from the SOLO Temperature Controller
- Using real time and historical graphs to monitor trends
- Displaying the status of the connected SOLO Temperature Controller
- Linking to resources such as the *SOLO Temperature Controller Hardware Manual* and *Quick Start Guides*

# MODBUS COMMUNICATION

---



## In this Chapter...

|   |      |
|---|------|
| Modbus Protocol .....   | 7-2  |
| Registers .....   | 7-2  |
| Connection with the DirectLOGIC PLC.....                                | 7-8  |
| Connection with the <i>C-more</i> and <i>C-more</i> Micro HMI panels .. | 7-10 |

# Modbus Protocol

All of the SOLO controllers have a 2-wire RS-485 serial communication port. The supported protocols are Modbus RTU and Modbus ASCII. The following communication port settings are possible.

|                 | Protocol                                   |                     |
|-----------------|--|---------------------|
|                 | Modbus RTU                                 | <i>Modbus ASCII</i> |
| Network Address | 1 to 247                                   |                     |
| Baud Rate       | 2400, 4800, <b>9600</b> , 19200, 38400 bps |                     |
| Bit Length      | 8 bits                                     | 7, 8 bits           |
| Parity          | None, <b>Even</b> , Odd                    |                     |
| Stop Bit        | 1, 2 bits                                  |                     |



***Bold Italic text above represent default values in the SOLO controller.***

## Registers

The SOLO controllers support two types of registers that are accessible through the Modbus communication.

- Data Registers
- Bit Registers

These registers support the following Modbus function codes.

### Data Registers

- 03: Read Holding Registers (maximum limit is read of eight registers)
- 06: Write Single Register
- 16: Write Multiple Registers (maximum limit is eight)

### Bit Registers

- 01: Read Coils
- 02: Read Discrete Inputs (Both Function Code 1 & 2 read the same memory area.)
- 05: Write Single Coil (Write FF00H to set the coil or 0000H to reset the coil.)

The following tables show all the Modbus addresses that are accessible through the Modbus network. For the details of each parameter, please refer to Chapter 3.



***Note: Make sure the On-Line Configuration parameter (E05H, P3-12) is set to ON. The parameters in the SOLO controllers can be changed by the MODBUS network master only when the parameter is ON. (It is OFF as the factory default.)***

| Data Registers |  |  |     |             |                |                     |
|----------------|--|--|-----|-------------|----------------|---------------------|
| ID             | Parameter Name                                       | Description  | R/W | Hexadecimal | Modbus Decimal | PLC Address (Octal) |
| N/A            | Process Value (PV)                                   | If this register has one of the following values, it means there is an error:<br><br>8002H = Initial process (Temperature value is not yet available.)<br>8003H = Temperature sensor is not connected.<br>8004H = Temperature sensor input error<br>8006H = Cannot get temperature value, ADC input error<br>8007H Memory read / write error | R   | 1000        | 44097          | V10000              |
| N/A            | Set Point Value (SV)                                 | Unit is 0.1 (°C or °F)   | R/W | 1001        | 44098          | V10001              |
| P3-3           | Input Range High                                     | The data content should not be higher than the temperature range.  | R/W | 1002        | 44099          | V10002              |
| P3-4           | Input Range Low                                      | The data content should not be lower than the temperature range.   | R/W | 1003        | 44100          | V10003              |
| P3-1           | Input Type   | Please refer to the "Temperature Sensor Type and Temperature Range" table for details.   | R/W | 1004        | 44101          | V10004              |
| P3-5           | Control Mode   | 0 = PID control<br>1 = On / Off control<br>2 = Manual control<br>3 = Ramp / Soak   | R/W | 1005        | 44102          | V10005              |
| P3-7           | Heating / Cooling                                    | 0 = Heating<br>1 = Cooling<br>2 = Heating / Cooling<br>3 = Cooling / Heating   | R/W | 1006        | 44103          | V10006              |
| P1-11<br>P1-12 | Output 1 Heating Period /<br>Output 1 Cooling Period | 0 = 0.5 sec<br>1 - 99 = 1 - 99 sec   | R/W | 1007        | 44104          | V10007              |
| P1-13          | Output 2 Period                                      | 0 = 0.5 sec<br>1 - 99 = 1 - 99 sec   | R/W | 1008        | 44105          | V10010              |
| P1-4           | Proportion Band                                      | 0.1 - 999.9  | R/W | 1009        | 44106          | V10011              |
| P1-5           | Integral Time  | 0 - 9999   | R/W | 100A        | 44107          | V10012              |
| P1-6           | Derivative Time                                      | 0 - 9999   | R/W | 100B        | 44108          | V10013              |
| P1-8           | Integral Offset                                      | 0.0 - 100.0%   | R/W | 100C        | 44109          | V10014              |
| P1-7           | PD Control Offset                                    | 0.0 - 100.0%   | R/W | 100D        | 44110          | V10015              |
| P1-14          | Proportion Band Coefficient                          | 0.01 - 99.99   | R/W | 100E        | 44111          | V10016              |
| P1-15          | Dead Band  | -999 - 9999  | R/W | 100F        | 44112          | V10017              |

### Data Registers cont.

| ID    | Parameter Name         | Description  | R/W | Hexadecimal | Modbus Decimal | PLC Address (Octal) |
|-------|------------------------|--|-----|-------------|----------------|---------------------|
| P1-9  | Output 1 Hysteresis    | 0 - 9999   | R/W | 1010        | 44113          | V10020              |
| P1-10 | Output 2 Hysteresis    | 0 - 9999   | R/W | 1011        | 44114          | V10021              |
| P2-11 | Output 1 Level         | Unit is 0.1%, write operation is valid under manual tuning mode only.                            | R/W | 1012        | 44115          | V10022              |
| P2-12 | Output 2 Level         | Unit is 0.1%, write operation is valid under manual tuning mode only.                            | R/W | 1013        | 44116          | V10023              |
| P1-17 | Analog High Adjustment | 1 Unit = 2.8uA (Current Output)<br>1 Unit = 1.3 mV (Linear Voltage Output)                       | R/W | 1014        | 44117          | V10024              |
| P1-18 | Analog Low Adjustment  | 1 Unit = 2.8uA (Current Output)<br>1 Unit = 1.3 mV (Linear Voltage Output)                       | R/W | 1015        | 44118          | V10025              |
| P1-16 | PV Offset              | -999 - 999   | R/W | 1016        | 44119          | V10026              |
| P2-3  | Decimal Point Position | 0 - 3  | R/W | 1017        | 44120          | V10027              |
| P1-2  | PID Parameter Group    | 0 - 3 = PID parameter group<br>0 - 3.<br>4 = PID paramter group auto select                      | R/W | 101C        | 44125          | V10034              |
| P1-3  | Target SV              | Only valid within available range, unit: 0.1 scale   | R/W | 101D        | 44126          | V10035              |
| P3-8  | Alarm 1                | 0 = Alarm 1 is disabled.<br>1- 18 = Alarm type number  | R/W | 1020        | 44129          | V10040              |
| P3-9  | Alarm 2                | 0 = Alarm 1 is disabled.<br>1- 18 = Alarm type number  | R/W | 1021        | 44130          | V10041              |
| P3-10 | Alarm 3                | 0 = Alarm 1 is disabled.<br>1- 18 = Alarm type number  | R/W | 1022        | 44131          | V10042              |
| P3-11 | System Alarm           | 0 = System Alarm is disabled. (default)<br>1 - 3 = Alarm number to also be used as system alarm. | R/W | 1023        | 44132          | V10043              |
| P2-4  | Alarm 1 High Limit     | Please refer to the contents of the "Alarm Outputs" for details.                                 | R/W | 1024        | 44133          | V10044              |
| P2-5  | Alarm 1 low Limit      | Please refer to the contents of the "Alarm Outputs" for details.                                 | R/W | 1025        | 44134          | V10045              |
| P2-6  | Alarm 2 High Limit     | Please refer to the contents of the "Alarm Outputs" for details.                                 | R/W | 1026        | 44135          | V10046              |
| P2-7  | Alarm 2 Low Limit      | Please refer to the contents of the "Alarm Outputs" for details.                                 | R/W | 1027        | 44136          | V10047              |

| Data Registers cont. |                              |  |     |             |                |                     |
|----------------------|------------------------------|--|-----|-------------|----------------|---------------------|
| ID                   | Parameter Name               | Description  | R/W | Hexadecimal | Modbus Decimal | PLC Address (Octal) |
| P2-8                 | Alarm 3 High Limit           | Please refer to the contents of the "Alarm Outputs" for details.   | R/W | 1028        | 44137          | V10050              |
| P2-9                 | Alarm 3 Low Limit            | Please refer to the contents of the "Alarm Outputs" for details.   | R/W | 1029        | 44138          | V10051              |
| N/A                  | LED Status                   | Bit 0 = ALM3<br>Bit 1 = ALM2<br>Bit 2 = °F<br>Bit 3 = °C<br>Bit 4 = ALM1<br>Bit 5 = OUT2<br>Bit 6 = OUT1<br>Bit 7 = AT | R   | 102A        | 44139          | V10052              |
| N/A                  | Pushbutton Status            | Bit 0 = SET<br>Bit 1 = Rotate<br>Bit 2 = Up<br>Bit 3 = Down<br>If the button is pressed, the bit is off.               | R   | 102B        | 44140          | V10053              |
| P2-10                | Lock Mode                    | 0 = OFF<br>1 = Lock Mode 1<br>11 - Lock Mode 2   | R/W | 102C        | 44141          | V10054              |
| N/A                  | Firmware Version             | V1.00 indicates 0x100  | R   | 102F        | 44144          | V10057              |
| P2-2                 | Starting Ramp / Soak Pattern | 0 - 7  | R/W | 1030        | 44145          | V10060              |
| N/A                  | Step Time in Seconds         | Current Step Time Remaining in Seconds   | R   | 1032        | 44147          | V10062              |
| N/A                  | Step Time in Minutes         | Current Step Time Remaining in Minutes   | R   | 1033        | 44148          | V10063              |
| N/A                  | Current Step Number          | Current Step Number  | R   | 1034        | 44149          | V10064              |
| N/A                  | Current Pattern Number       | Current Pattern Number   | R   | 1035        | 44150          | V10065              |
| P3-21                | Last Step Number             | 0 - 7 = The last step number of the pattern  | R/W | 1040~1047*  | 44161~44168*   | V10100~V10107*      |
| P3-22                | Additional Cycles            | 0 - 199  | R/W | 1050~1057*  | 44177~44184*   | V10120~V10127*      |
| P3-23                | Next Pattern Number          | 0 - 7 = Next pattern number<br>8 = There is no next pattern.   | R/W | 1060~1067*  | 44193~44200*   | V10140~V10147*      |
| P3-19                | Ramp / Soak SV               | -999 - 9999  | R/W | 2000~203F*  | 48193~48256*   | V20000~V20077*      |
| P3-20                | Ramp / Soak Time             | 0 - 1500 (15 hours 0 minutes)  | R/W | 2080~20BF*  | 48321~48384*   | V20200~V20277*      |



\*Note: The Appendix covers the Modbus address map for the Ramp / Soak Control.

| Bit Registers |                                    |   |     |             |                |                     |
|---------------|------------------------------------|---|-----|-------------|----------------|---------------------|
| ID            | Parameter Name                     | Description   | R/W | Hexadecimal | Modbus Decimal | PLC Address (Octal) |
| N/A           | AT LED status                      | 0 = Off, 1 = On   | R   | 0800        | 2049           | Y0                  |
| N/A           | Output 1 LED status                | 0 = Off, 1 = On   | R   | 0801        | 2050           | Y1                  |
| N/A           | Output 2 LED status                | 0 = Off, 1 = On   | R   | 0802        | 2051           | Y2                  |
| N/A           | Alarm 1 LED status                 | 0 = Off, 1 = On   | R   | 0803        | 2052           | Y3                  |
| N/A           | °F LED status                      | 0 = Off, 1 = On   | R   | 0804        | 2053           | Y4                  |
| N/A           | °C LED status                      | 0 = Off, 1 = On   | R   | 0805        | 2054           | Y5                  |
| N/A           | Alarm 2 LED status                 | 0 = Off, 1 = On   | R   | 0806        | 2055           | Y6                  |
| N/A           | Alarm 3 LED status                 | 0 = Off, 1 = On   | R   | 0807        | 2056           | Y7                  |
| N/A           | SET key status                     | 0 = Pressed, 1 = Not Pressed  | R   | 0808        | 2057           | Y10                 |
| N/A           | Function key status                | 0 = Pressed, 1 = Not Pressed  | R   | 0809        | 2058           | Y11                 |
| N/A           | UP key status                      | 0 = Pressed, 1 = Not Pressed  | R   | 080A        | 2059           | Y12                 |
| N/A           | DOWN key status                    | 0 = Pressed, 1 = Not Pressed  | R   | 080B        | 2060           | Y13                 |
| N/A           | Event 1 input status               | 0 = Disabled, 1 = Enabled   | R   | 080C        | 2061           | Y14                 |
| N/A           | Event 2 input status               | 0 = Disabled, 1 = Enabled   | R   | 080D        | 2062           | Y15                 |
| N/A           | System Alarm Status                | 0 = Off, 1 = On   | R   | 080E        | 2063           | Y16                 |
| N/A           | Ramp / Soak Control status         | 0 = Ramp / Soak disabled<br>1 = Ramp / Soak enabled   | R   | 080F        | 2064           | Y17                 |
| P3-12         | On-Line Configuration              | 0 = On-Line Configuration is disabled (default)<br>1 = On-Line Configuration is enabled                 | R/W | 0810        | 2065           | Y20                 |
| N/A           | Temperature Unit Display Selection | 0 = °F<br>1 = °C / Linear input (default)   | R/W | 0811        | 2066           | Y21                 |
| P2-3          | Decimal Point Display Selection    | 0 = No decimal<br>1 = 10ths digit decimal<br>(B, S and R type thermocouples use only 0 decimal display. | R/W | 0812        | 2067           | Y22                 |
| P1-1          | Auto Tuning                        | 0 = Off (default)<br>1 = On   | R/W | 0813        | 2068           | Y23                 |
| P2-1          | Run / Stop the Control             | 0 = STOP<br>1 = RUN (default)   | R/W | 0814        | 2069           | Y24                 |
| P2-1          | Stop the Ramp / Soak Control       | 0 = RUN (default)<br>1 = STOP   | R/W | 0815        | 2070           | Y25                 |
| P2-1          | Hold the Ramp / Soak Control       | 0 = RUN (default)<br>1 = HOLD   | R/W | 0816        | 2071           | Y26                 |

| Temperature Sensor Type and Temperature Range |                |         |                               |
|---|----------------|---------|-------------------------------|
| Hex - Address 1004                            |                |         |                               |
| Input Sensor type                             | Register Value | Display | Temperature Range             |
| 0 ~ 50 mV Analog Input                        | 17             | 70      | -999 ~ 9999                   |
| 4 ~ 20 mA Input                               | 16             | 774     | -999 ~ 9999                   |
| 0 ~ 20 mA Input                               | 15             | 770     | -999 ~ 9999                   |
| 0 ~ 10 VDC Input                              | 14             | 010     | -999 ~ 9999                   |
| 0 ~ 5 VDC Input                               | 13             | 05      | -999 ~ 9999                   |
| RTD (Pt100) type                              | 12             | PT      | -328 ~ 1112°F (-200 ~ 600°C)  |
| RTD (JPt100) type                             | 11             | JPT     | -4 ~ 752°F (-20 ~ 400°C)      |
| Thermocouple TXK type                         | 10             | TXK     | -328 ~ 1472°F (-200 ~ 800°C)  |
| Thermocouple U type                           | 9              | U       | -328 ~ 932°F (-200 ~ 500°C)   |
| Thermocouple L type                           | 8              | L       | -328 ~ 1562°F (-200 ~ 850°C)  |
| Thermocouple B type                           | 7              | B       | 212 ~ 3272°F (100 ~ 1800°C)   |
| Thermocouple S type                           | 6              | S       | 32 ~ 3092°F (0 ~ 1700°C)      |
| Thermocouple R type                           | 5              | R       | 32 ~ 3092°F (0 ~ 1700°C)      |
| Thermocouple N type                           | 4              | N       | -328 ~ 2372°F (-200 ~ 1300°C) |
| Thermocouple E type                           | 3              | E       | 32 ~ 1112°F (0 ~ 600°C)       |
| Thermocouple T type                           | 2              | T       | -328 ~ 752°F (-200 ~ 400°C)   |
| Thermocouple J type                           | 1              | J       | -148 ~ 2192°F (-100 ~ 1200°C) |
| Thermocouple K type                           | 0              | K       | -328 ~ 2372°F (-200 ~ 1300°C) |



## Connection with the DirectLOGIC PLC

The following DirectLOGIC PLCs can communicate with the SOLO controller. The DL06 or D2-260 PLCs are preferred for connection with the SOLO controller because they have a built in RS-485 communication port support function code 05.

| DirectLogic PLC | Com port                    | Restriction  | Instructions to use | Wiring Diagram |
|-----------------|-----------------------------|--|---------------------|----------------|
| DL05            | Port 2 + FA-ISOCON          | Can't write to the bit registers because the DL05 does not support the function code 05. Modbus RTU only                           | RX, WX              | Figure 1       |
|                 | D0-DCM Port2                | Can't write to the bit registers if installed in the DL05 because the DL05 does not support the function code 05. Modbus RTU only. | RX, WX              | Figure 2       |
| DL06            | Port 2                      | Modbus RTU only  | MRX, MWX            | Figure 2       |
|                 | D0-DCM Port2                | Modbus RTU only  | MRX, MWX            | Figure 2       |
| D2-250-1        | Port 2 + FA-ISOCON +FA-15HD | Can't write to the bit registers because the D2-250-1 does not support the function code 05.                                       | RX, WX              | Figure 3       |
| D2-260          | Port 2                      | Modbus RTU only  | MRX, MWX            | Figure 2       |
| D3-350          | Port 2 + FA-ISOCON          | Can't write to the bit registers because the D3-350 does not support the function code 05. Modbus RTU only.                        | RX, WX              | Figure 4       |
| D4-450          | Port 1 + FA-ISOCON          | Can't write to the bit registers because the D4-450 does not support the function code 05. Modbus RTU only.                        | RX, WX              | Figure 5       |

Figure 1

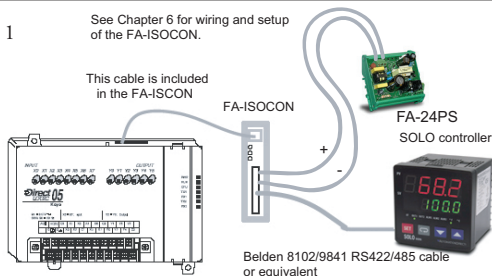

Figure 2

You will need to make this custom cable

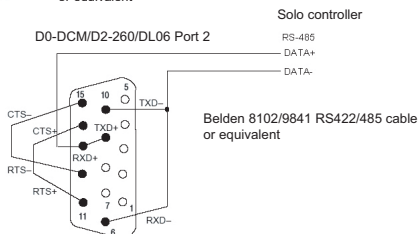

Figure 3

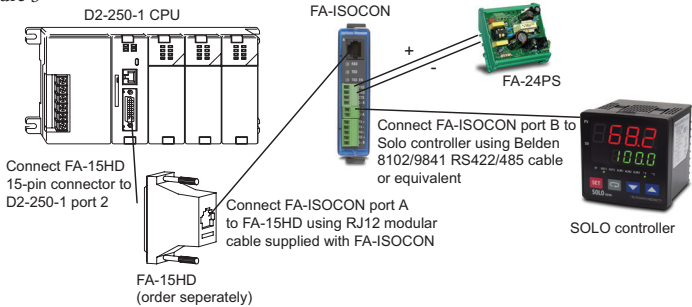

Figure 4

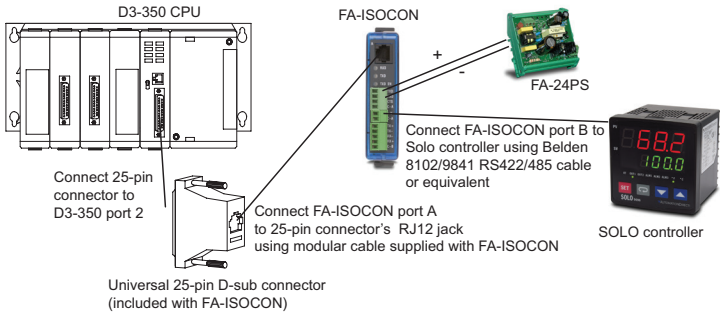
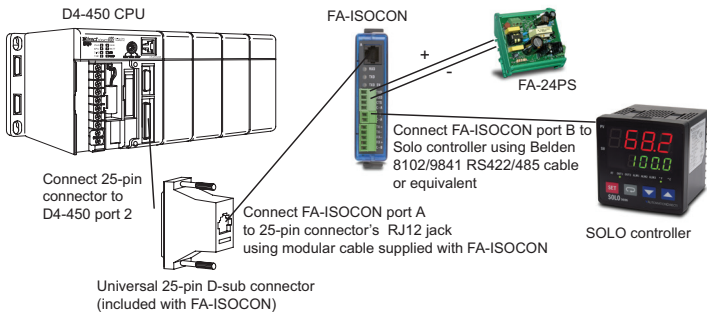
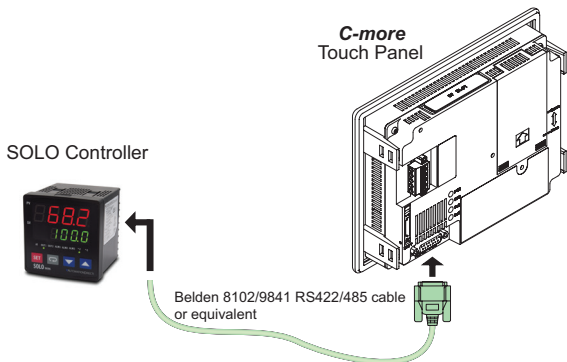

Figure 5



## Connection with the C-more and C-more Micro HMI panels

Any of the *C-more* and *C-more* Micro-Graphic HMI panels can be connected to the SOLO controllers. The *C-more* HMI panels have a built in RS-485 port. The *C-more* 3" Micro-Graphic panels require an optional module (EA-MG-SP1).



Serial Communications

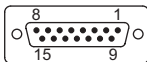

| Pin | Signal     | Pin | Signal         | Pin | Signal         |
|-----|------------|-----|----------------|-----|----------------|
| 1   | Frame GND  | 6   | LE             | 11  | TXD+ (422/485) |
| 2   | TXD (232C) | 7   | CTS (232C)     | 12  | TXD- (422/485) |
| 3   | RXD (232C) | 8   | RTS (232C)     | 13  | Term. Resistor |
| 4   | Vcc        | 9   | RXD+ (422/485) | 14  | do not use     |
| 5   | Logic GND  | 10  | RXD- (422/485) | 15  | do not use     |

*C-more* and *C-more* Micro-Graphic Panel RS-485 port

# MODBUS ADDRESS MAP FOR RAMP / SOAK CONTROL

---

# APPENDIX

## In this Appendix...

|                           |     |
|---------------------------|-----|
| Last Step Number.....     | A-2 |
| Additional Cycles.....    | A-2 |
| Next Pattern Number ..... | A-2 |
| Ramp / Soak SV .....      | A-3 |
| Ramp / Soak Time .....    | A-4 |

### Last Step Number

(ID: **5P4n**, P3-21)

| Pattern Number | Hexadecimal | Modbus Decimal | PLC Address (Octal) |
|----------------|-------------|----------------|---------------------|
| Pattern 0      | 1040        | 44161          | V10100              |
| Pattern 1      | 1041        | 44162          | V10101              |
| Pattern 2      | 1042        | 44163          | V10102              |
| Pattern 3      | 1043        | 44164          | V10103              |
| Pattern 4      | 1044        | 44165          | V10104              |
| Pattern 5      | 1045        | 44166          | V10105              |
| Pattern 6      | 1046        | 44167          | V10106              |
| Pattern 7      | 1047        | 44168          | V10107              |

### Additional Cycles

(ID: **44n**, P3-22)

| Pattern Number | Hexadecimal | Modbus Decimal | PLC Address (Octal) |
|----------------|-------------|----------------|---------------------|
| Pattern 0      | 1050        | 44177          | V10120              |
| Pattern 1      | 1051        | 44178          | V10121              |
| Pattern 2      | 1052        | 44179          | V10122              |
| Pattern 3      | 1053        | 44180          | V10123              |
| Pattern 4      | 1054        | 44181          | V10124              |
| Pattern 5      | 1055        | 44182          | V10125              |
| Pattern 6      | 1056        | 44183          | V10126              |
| Pattern 7      | 1057        | 44184          | V10127              |

### Next Pattern Number

(ID: **44n**, P3-23)

| Pattern Number | Hexadecimal | Modbus Decimal | PLC Address (Octal) |
|----------------|-------------|----------------|---------------------|
| Pattern 0      | 1060        | 44193          | V10140              |
| Pattern 1      | 1061        | 44194          | V10141              |
| Pattern 2      | 1062        | 44195          | V10142              |
| Pattern 3      | 1063        | 44196          | V10143              |
| Pattern 4      | 1064        | 44197          | V10144              |
| Pattern 5      | 1065        | 44198          | V10145              |
| Pattern 6      | 1066        | 44199          | V10146              |
| Pattern 7      | 1067        | 44200          | V10147              |

## Ramp / Soak SV

(ID: **SPmn**, P3-19)

### Hexadecimal

|        | Pattern 0 | Pattern 1 | Pattern 2 | Pattern 3 | Pattern 4 | Pattern 5 | Pattern 6 | Pattern 7 |
|--------|-----------|-----------|-----------|-----------|-----------|-----------|-----------|-----------|
| Step 0 | 2000      | 2008      | 2010      | 2018      | 2020      | 2028      | 2030      | 2038      |
| Step 1 | 2001      | 2009      | 2011      | 2019      | 2021      | 2029      | 2031      | 2039      |
| Step 2 | 2002      | 200A      | 2012      | 201A      | 2022      | 202A      | 2032      | 203A      |
| Step 3 | 2003      | 200B      | 2013      | 201B      | 2023      | 202B      | 2033      | 203B      |
| Step 4 | 2004      | 200C      | 2014      | 201C      | 2024      | 202C      | 2034      | 203C      |
| Step 5 | 2005      | 200D      | 2015      | 201D      | 2025      | 202D      | 2035      | 203D      |
| Step 6 | 2006      | 200E      | 2016      | 201E      | 2026      | 202E      | 2036      | 203E      |
| Step 7 | 2007      | 200F      | 2017      | 201F      | 2027      | 202F      | 2037      | 203F      |

### Modbus Decimal

|        | Pattern 0 | Pattern 1 | Pattern 2 | Pattern 3 | Pattern 4 | Pattern 5 | Pattern 6 | Pattern 7 |
|--------|-----------|-----------|-----------|-----------|-----------|-----------|-----------|-----------|
| Step 0 | 48193     | 48201     | 48209     | 48217     | 48225     | 48233     | 48241     | 48249     |
| Step 1 | 48194     | 48202     | 48210     | 48218     | 48226     | 48234     | 48242     | 48250     |
| Step 2 | 48195     | 48203     | 48211     | 48219     | 48227     | 48235     | 48243     | 48251     |
| Step 3 | 48196     | 48204     | 48212     | 48220     | 48228     | 48236     | 48244     | 48252     |
| Step 4 | 48197     | 48205     | 48213     | 48221     | 48229     | 48237     | 48245     | 48253     |
| Step 5 | 48198     | 48206     | 48214     | 48222     | 48230     | 48238     | 48246     | 48254     |
| Step 6 | 48199     | 48207     | 48215     | 48223     | 48231     | 48239     | 48247     | 48255     |
| Step 7 | 48200     | 48208     | 48216     | 48224     | 48232     | 48240     | 48248     | 48256     |

### PLC Address (Octal)

|        | Pattern 0 | Pattern 1 | Pattern 2 | Pattern 3 | Pattern 4 | Pattern 5 | Pattern 6 | Pattern 7 |
|--------|-----------|-----------|-----------|-----------|-----------|-----------|-----------|-----------|
| Step 0 | V20000    | V20010    | V20020    | V20030    | V20040    | V20050    | V20060    | V20070    |
| Step 1 | V20001    | V20011    | V20021    | V20031    | V20041    | V20051    | V20061    | V20071    |
| Step 2 | V20002    | V20012    | V20022    | V20032    | V20042    | V20052    | V20062    | V20072    |
| Step 3 | V20003    | V20013    | V20023    | V20033    | V20043    | V20053    | V20063    | V20073    |
| Step 4 | V20004    | V20014    | V20024    | V20034    | V20044    | V20054    | V20064    | V20074    |
| Step 5 | V20005    | V20015    | V20025    | V20035    | V20045    | V20055    | V20065    | V20075    |
| Step 6 | V20006    | V20016    | V20026    | V20036    | V20046    | V20056    | V20066    | V20076    |
| Step 7 | V20007    | V20017    | V20027    | V20037    | V20047    | V20057    | V20067    | V20077    |

### Ramp / Soak Time

(ID: **mn**, P3-20)

Hexadecimal

|        | Pattern 0 | Pattern 1 | Pattern 2 | Pattern 3 | Pattern 4 | Pattern 5 | Pattern 6 | Pattern 7 |
|--------|-----------|-----------|-----------|-----------|-----------|-----------|-----------|-----------|
| Step 0 | 2080      | 2088      | 2090      | 2098      | 20A0      | 20A8      | 20B0      | 20B8      |
| Step 1 | 2081      | 2089      | 2091      | 2099      | 20A1      | 20A9      | 20B1      | 20B9      |
| Step 2 | 2082      | 208A      | 2092      | 209A      | 20A2      | 20AA      | 20B2      | 20BA      |
| Step 3 | 2083      | 208B      | 2093      | 209B      | 20A3      | 20AB      | 20B3      | 20BB      |
| Step 4 | 2084      | 208C      | 2094      | 209C      | 20A4      | 20AC      | 20B4      | 20BC      |
| Step 5 | 2085      | 208D      | 2095      | 209D      | 20A5      | 20AD      | 20B5      | 20BD      |
| Step 6 | 2086      | 208E      | 2096      | 209E      | 20A6      | 20AE      | 20B6      | 20BE      |
| Step 7 | 2087      | 208F      | 2097      | 209F      | 20A7      | 20AF      | 20B7      | 20BF      |

Modbus Decimal

|        | Pattern 0 | Pattern 1 | Pattern 2 | Pattern 3 | Pattern 4 | Pattern 5 | Pattern 6 | Pattern 7 |
|--------|-----------|-----------|-----------|-----------|-----------|-----------|-----------|-----------|
| Step 0 | 48321     | 48329     | 48337     | 48345     | 48353     | 48361     | 48369     | 48377     |
| Step 1 | 48322     | 48330     | 48338     | 48346     | 48354     | 48362     | 48370     | 48378     |
| Step 2 | 48323     | 48331     | 48339     | 48347     | 48355     | 48363     | 48371     | 48379     |
| Step 3 | 48324     | 48332     | 48340     | 48348     | 48356     | 48364     | 48372     | 48380     |
| Step 4 | 48325     | 48333     | 48341     | 48349     | 48357     | 48365     | 48373     | 48381     |
| Step 5 | 48326     | 48334     | 48342     | 48350     | 48358     | 48366     | 48374     | 48382     |
| Step 6 | 48327     | 48335     | 48343     | 48351     | 48359     | 48367     | 48375     | 48383     |
| Step 7 | 48328     | 48336     | 48344     | 48352     | 48360     | 48368     | 48376     | 48384     |

PLC Address (Octal)

|        | Pattern 0 | Pattern 1 | Pattern 2 | Pattern 3 | Pattern 4 | Pattern 5 | Pattern 6 | Pattern 7 |
|--------|-----------|-----------|-----------|-----------|-----------|-----------|-----------|-----------|
| Step 0 | V20200    | V20210    | V20220    | V20230    | V20240    | V20250    | V20260    | V20270    |
| Step 1 | V20201    | V20211    | V20221    | V20231    | V20241    | V20251    | V20261    | V20271    |
| Step 2 | V20202    | V20212    | V20222    | V20232    | V20242    | V20252    | V20262    | V20272    |
| Step 3 | V20203    | V20213    | V20223    | V20233    | V20243    | V20253    | V20263    | V20273    |
| Step 4 | V20204    | V20214    | V20224    | V20234    | V20244    | V20254    | V20264    | V20274    |
| Step 5 | V20205    | V20215    | V20225    | V20235    | V20245    | V20255    | V20265    | V20275    |
| Step 6 | V20206    | V20216    | V20226    | V20236    | V20246    | V20256    | V20266    | V20276    |
| Step 7 | V20207    | V20217    | V20227    | V20237    | V20247    | V20257    | V20267    | V20277    |

# INDEX



## A

- Additional Cycles, 3-6, 3-19, 3-22, A-2
- Alarm 1, 3-6, 3-15, 3-16, 3-20, 4-8
- Alarm 1 High Limit, 3-5, 3-15
- Alarm 1 Low Limit, 3-5, 3-16
- Alarm 2, 3-6, 3-16, 3-20, 4-8
- Alarm 2 High Limit, 3-5, 3-16
- Alarm 2 Low Limit, 3-5, 3-16
- Alarm 3, 3-6, 3-16, 3-20
- Alarm 3 High Limit, 3-5, 3-16
- Alarm 3 Low Limit, 3-5, 3-16
- Ambient Conditions
  - Altitude, 2-2
  - Ambient Temperature Range, 2-2
  - IP Rating, 2-2
  - Relative Humidity, 2-2
  - Shock Resistance, 2-2
  - Storage Temperature Range, 2-2
  - Vibration Resistance, 2-2
- Analog High Adjustment, 3-4, 3-13, 3-14, 4-5, 4-6, 4-7
- Analog Low Adjustment, 3-4, 4-5, 4-6, 4-7
- Auto Tuning, 3-2, 3-4, 3-7, 3-10, 5-3

## B

- Baud Rate, 3-6, 3-21, 7-2

- Bit Length, 3-6, 3-21, 7-2
- Bit Registers, 7-2, 7-6, 7-7

## C

- Com port Settings, 6-4
- Configuration Window, 6-4
- Connection with the C-more and C-more Micro HMI panels, 7-9
- Connection with the DirectLogic PLC, 7-7
- Control Mode, 3-4, 3-5, 3-6, 3-18, 5-2, 5-3, 5-4, 5-5
- Controller and Panel Cutout Dimensions
  - SL4824 Series, 2-4
  - SL4848 Series, 2-4
  - SL4896 Series, 2-5
  - SL9696 Series, 2-5
- Cooling Hysteresis, 3-4, 3-11, 5-4
- Current Input, 4-2

## D

- Data Registers, 7-2, 7-3, 7-4, 7-5
- Dead Band, 3-4, 3-12, 5-4
- Decimal Point Position, 3-5, 3-15
- Derivative Time, 3-4, 3-9, 5-3
- Down Button, 3-2, 3-3



## E

- Error Display Information, 5–5
- Event Inputs
  - Event 1 Input, 4–3
  - Event 2 Input, 4–3

## G

- General Description, 1–3

## H

- Heating / Cooling, 3–4, 3–5, 3–6, 3–19, 3–20
- Heating Hysteresis, 3–4, 3–10, 5–4

## I

- Initial Power up, 3–3
- Initial Setting Parameters, 3–6, 3–17
- Input Range High, 3–6, 3–18
- Input Range Low, 3–6, 3–18
- Input Type, 3–6, 3–17, 4–2
- Input Types
  - Analog, 4–2
    - Current Input, 4–2
    - Voltage Input, 4–2
  - Platinum RTD, 4–2
  - Thermocouple, 4–2
- Installation Considerations, 2–2
- Integral Offset, 3–4, 3–10, 5–3
- Integral Time, 3–4, 3–9, 3–10, 5–3

## K

- Keypad Operation, 3–3
  - Function Buttons, 3–3
    - Down Button, 3–2, 3–3
    - Rotate Button, 3–2, 3–3
    - SET Button, 3–2, 3–3
    - Up Button, 3–2, 3–3

## L

- Last Step Number, 3–6, 3–19, 3–21, A–2
- LED status indicators
  - °F, °C LED Indicators, 3–2
  - ALM1, ALM2, ALM3 LED Indicators, 3–2
  - AT LED Indicator, 3–2
  - OUT1, OUT2 LED Indicators, 3–2
- Lock Mode, 3–5, 3–16

## M

- Manual Control, 5–5
- Modbus Address Map, A–2, A–3, A–4
- Modbus Protocol, 3–6, 3–20, 7–2
- Model Number Explanation, 1–4
- Mounting Instructions
  - SL4824 Series, 2–3
  - SL4848, SL4896, SL9696 Series, 2–3

## N

- Network Address, 3–6, 3–20, 7–2
- Next Pattern Number, 3–6, 3–19, 3–22, A–2

## O

- On / Off Control, 5–3
- On-Line Configuration, 3–6, 3–20
- Operation Mode Parameters, 3–5, 3–15
- Output 1 Cooling Period, 3–4, 3–11, 4–5, 4–6, 4–7
- Output 1 Heating Period, 3–4, 3–11, 4–5, 4–6, 4–7
- Output 1 Level, 3–5, 3–13, 3–16, 4–4, 4–6, 4–7, 5–5
- Output 2 Level, 3–5, 3–16, 4–4, 5–5
- Output 2 Period, 3–4, 3–12, 4–5
- Output Types
  - Current, 4–5
  - Linear Voltage, 4–6
  - Relay, 4–4
  - Voltage Pulse, 4–5

## P

- Parity, 3–6, 3–21, 7–2

PC Connection, 6–2  
PD Control Offset, 3–4, 3–10  
PID Control, 5–2, 5–3, 5–4  
PID Parameter Group, 3–4, 3–7, 3–8, 3–9, 3–10, 5–2  
Proportion Band, 3–4, 3–8, 3–12  
Proportion Band Coefficient, 3–4, 3–12  
Proportional Band, 5–3  
Proportional Band Coefficient, 5–3  
PV Display, 3–2  
PV Monitor, 6–6  
PV Offset, 3–4, 3–13

## Q

Quick Start Guide, 1–2, 1–3

## R

Ramp / Soak Control, 5–4  
Ramp / Soak Pattern, 3–6, 3–15, 3–18, 3–19, 3–21, 3–22, 5–4  
Ramp / Soak SV, 3–6, 3–21, A–3  
Ramp / Soak Time, 3–6, 3–21, A–4  
Recorder Window, 6–7  
Regulation Mode Parameters, 3–4, 3–7  
Reset to Factory Default, 3–24  
Rotate Button, 3–2, 3–3  
RS-485, 6–4, 7–2, 7–7, 7–9  
Run / Stop, 3–5, 3–15

## S

Safety Information, 2–6, 2–7  
Serial Number Label Information  
    SL4824 Series, 1–4  
    SL4848, SL4896, and SL9696 Series, 1–4  
SET Button, 3–2, 3–3  
Software Installation, 6–3  
Special Symbols  
    Notepad, 1–2  
    Warning, 1–2

Starting Ramp / Soak Pattern, 3–5, 3–15  
Stop Bit, 3–6, 3–21, 7–2  
SV Display, 3–2, 3–7  
System Alarm, 3–6, 3–20, 4–8, 4–10

## T

Target SV, 3–4, 3–7, 3–8, 3–9, 3–10  
Technical Support, 1–2  
Temperature Unit, 3–6  
Terminal Identification, 2–8  
    SL4824 Series Inputs, 2–8  
    SL4824 Series Wiring, 2–9  
    SL4848 Series Inputs, 2–10  
    SL4848 Series Wiring, 2–11  
    SL4896 Series Inputs, 2–12  
    SL4896 Series Wiring, 2–13  
    SL9696 Series Inputs, 2–14  
    SL9696 Series Wiring, 2–15

## U

Unpacking, 1–3  
Up Button, 3–2, 3–3

## V

Voltage Input, 4–2

