

# Operations and Maintenance Manual

## Collection and Conveyance System

WASTEWATER & STORMWATER DIVISION

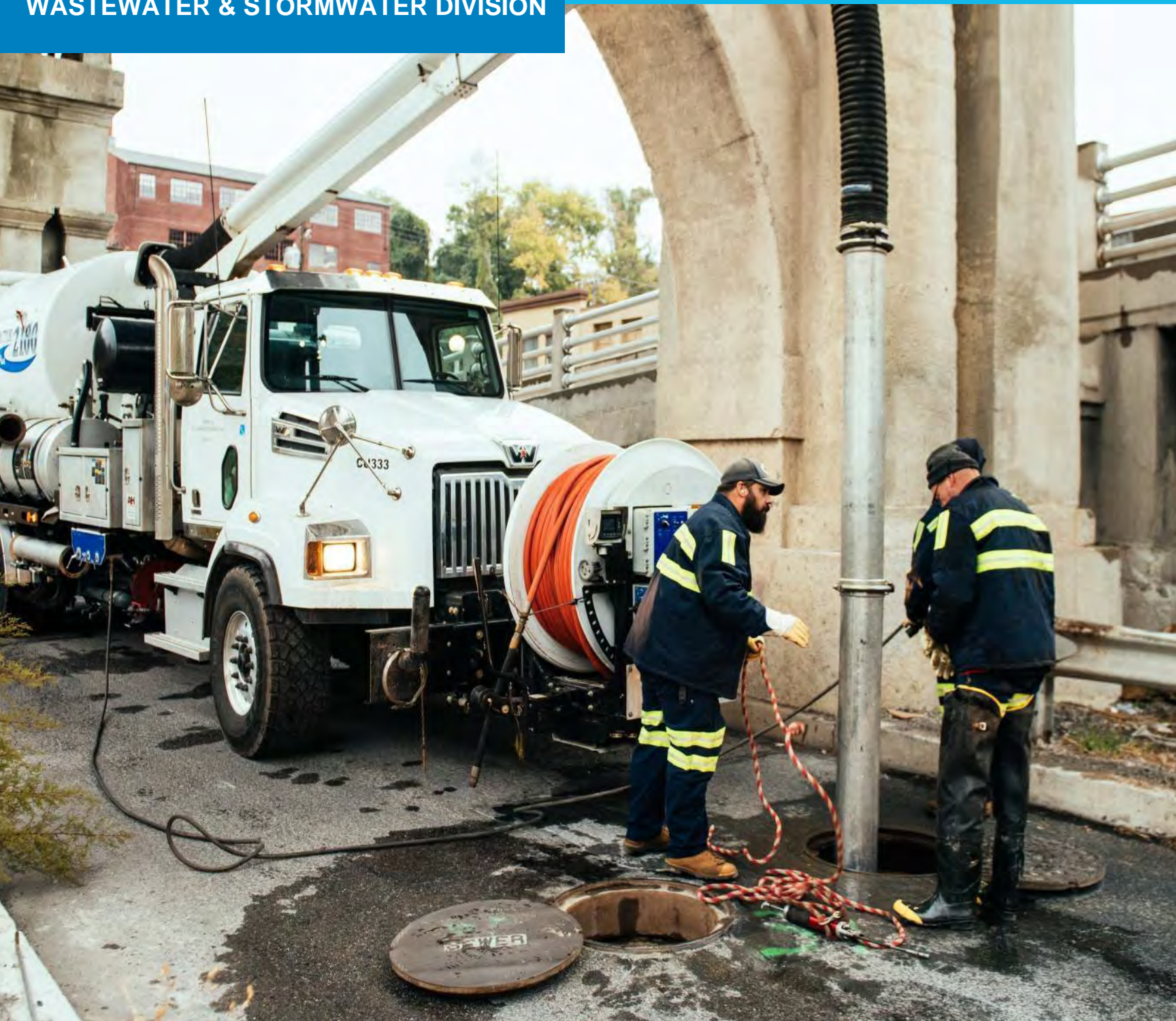

# Table of Contents

<b>Section 1 Introduction and Regulatory Context .....</b>	<b>1</b>
<b>1.1 Capital Region Water .....</b>	<b>1</b>
<b>1.2 Regulatory Context.....</b>	<b>1</b>
<b>1.3 Operation and Maintenance Manual.....</b>	<b>1</b>
<b>Section 2 Organization of the Conveyance and Collection Systems .....</b>	<b>1</b>
<b>Section 3 Facilities Critical to the Performance of the CSO System .....</b>	<b>4</b>
<b>3.1 Facilities Critical to the Performance of the Collection and Conveyance Systems.....</b>	<b>4</b>
<b>3.2 Equipment Critical to the Performance of the Collection and Conveyance Systems.....</b>	<b>4</b>
<b>3.3 Facilities Critical to the Performance of the AWTF .....</b>	<b>5</b>
3.3.1 Discharge Limits and Operational Objectives of CRW's AWTF .....	6
3.3.2 Description of CRW's AWTF.....	7
3.3.2.1 Influent Pump Stations and Force Mains.....	7
3.3.2.2 Wastewater and Solids Handling Processes.....	7
3.3.3 Criteria for Determining Facilities Critical to AWTF Performance.....	10
3.3.4 Definition of Facilities Critical to CRW's AWTF Performance.....	11
<b>3.4 Equipment Critical to the Performance of the AWTF .....</b>	<b>13</b>
3.4.1 Vortex Grit Chambers.....	13
3.4.2 Mechanical Bar Screens.....	14
3.4.2 Primary Clarifiers.....	14
3.4.3 Settled Sewage Pump Station.....	15
3.4.4 High Pure Oxygenation Activated Sludge Reactors.....	15
3.4.5 Bioreactor.....	15
3.4.6 Post-Aeration Channel.....	16
3.4.7 Final Clarifiers .....	16
3.4.8 Chlorine Contact Tanks.....	17
3.4.9 RAS Regeneration Tank.....	17
3.4.10 Chemical Addition for Denitrification.....	17
3.4.11 Chemical Addition for pH and Alkalinity Control.....	18
3.4.12 Chemical Addition for CEPT .....	18
3.4.13 Chemical Addition for CEST.....	18
3.4.14 High Flow Operating Procedures.....	18
<b>Section 4 Conveyance and Collection System O&amp;M Program Activities .....</b>	<b>1</b>
<b>4.1 O&amp;M Activities for CSO Regulator Structures .....</b>	<b>1</b>
4.1.1 Introduction and Overview for CSO Regulator Structures.....	1
4.1.2 CSO Regulator Structure Configurations.....	6
4.1.3 Inspection Preparedness .....	10
4.1.4 Standard Daily CSO Regulator Inspection Activities.....	10
4.1.5 Active CSO Discharge Inspection Activities .....	15
4.1.6 Post-Storm CSO Inspection Activities.....	19

4.1.7	Preventive Maintenance Activities .....	20
4.1.8	O&M Documentation for CSO Regulator Structures.....	22
<b>4.2</b>	<b>O&amp;M Activities for CSO Outfalls and Backflow Prevention Gates.....</b>	<b>23</b>
4.2.1	Introduction and Overview for Outfalls and Backflow Prevention Gates .....	23
4.2.2	Outfall and Backflow Prevention Gate Configurations.....	28
4.2.3	Inspection Preparedness.....	32
4.2.4	CSO Outfall Inspection Activities and Checklist.....	32
4.2.5	Post-Storm Outfall Inspection Activities .....	36
4.2.6	Backflow Prevention Gate Inspection Activities .....	36
4.2.7	Preventive Maintenance Activities .....	36
4.2.8	O&M Documentation for Outfalls and Backflow Prevention Gates.....	38
<b>4.3</b>	<b>O&amp;M Activities for Pump Stations.....</b>	<b>39</b>
4.3.1	Introduction and Overview for Pump Stations.....	39
4.3.2	Inspection Preparedness.....	40
4.3.3	General Pump Station Inspection Activities.....	40
4.3.4	Front Street Pump Station .....	45
	4.3.4.1 General.....	45
	4.3.4.2 Influent Flow Control .....	47
	4.3.4.3 Screening Equipment .....	48
	4.3.4.4 Sewage Pumps.....	50
	4.3.4.5 Station Water System .....	52
	4.3.4.6 Emergency Power .....	52
	4.3.4.7 Flow Metering.....	52
	4.3.4.8 Combustible Gas Monitoring.....	52
	4.3.4.9 Wet Weather Operation / Emergency Bypass.....	53
	4.3.4.10 Inspection, Operation, and Maintenance Activities .....	53
4.3.5	Spring Creek Pump Station .....	58
	4.3.5.1 General.....	58
	4.3.5.2 Influent Flow Control .....	60
	4.3.5.3 Screening Equipment .....	62
	4.3.5.4 Sewage Pumps.....	64
	4.3.5.5 Hydraulic Fluid System.....	65
	4.3.5.6 Station Water System .....	65
	4.3.5.6 Chlorination System.....	65
	4.3.5.7 Emergency Power .....	66
	4.3.5.8 Flow Monitoring.....	67
	4.3.5.9 Combustible Gas Monitoring.....	67
	4.3.5.10 Wet Weather Operation / Emergency Bypass .....	67
	4.3.5.11 Inspection, Operation, and Maintenance Activities .....	67
4.3.6	Market Street Pump Station.....	79
	4.3.6.1 General.....	79
	4.3.6.2 Pumps.....	79
	4.3.6.3 Emergency Power .....	79
	4.3.6.4 Inspection and Maintenance Activities.....	79
4.3.7	Preventative Maintenance Activities .....	80
4.3.8	O&M Documentation for Pump Stations .....	80

<b>4.4 O&amp;M Activities for Interceptor Sewers .....</b>	<b>81</b>
4.4.1 Introduction and Overview for Interceptor Sewers.....	81
4.4.2 Inspection Preparedness .....	81
4.4.3 Inspection Activities .....	82
4.4.3.1 Interceptor Flow Checks.....	82
4.4.3.1 Interceptor Cleaning and Inspections.....	82
4.4.4 Pipe Replacement/Rehabilitation Schedule.....	83
4.4.5 Maintenance Activities.....	83
4.4.6 O&M Documentation for Interceptor Sewers .....	83
<b>4.5 O&amp;M Activities for Force Mains .....</b>	<b>84</b>
4.5.1 Introduction and Overview for Force Mains .....	84
4.5.2 Inspection Preparedness .....	84
4.5.3 Inspection Activities .....	84
4.5.4 Maintenance Activities.....	85
4.5.5 O&M Documentation for Force Mains.....	85
<b>4.6 O&amp;M Activities for Collection System Sewers and Manholes.....</b>	<b>86</b>
4.6.1 Introduction and Overview for Collection System Sewers and Manholes .....	86
4.6.2 Inspection Preparedness .....	86
4.6.3 Inspection Activities .....	86
4.6.3.1 “Hot Spot” Checks .....	86
4.6.3.2 Trunk Sewer Inspections.....	89
4.6.3.3 Manhole Inspection Program .....	89
4.6.4 Maintenance Activities for Collection System Sewers and Manholes .....	89
Line Blockage Procedural Checklist.....	91
4.6.5 Sewer Replacement/Rehabilitation Schedule .....	92
4.6.6 Manhole Rehabilitation Schedule.....	92
4.6.7 O&M Documentation for Local Sewers and Manholes.....	92
<b>4.7 O&amp;M Activities for Inlets and Catch Basins.....</b>	<b>93</b>
4.7.1 Introduction and Overview for Inlets and Catch Basins.....	93
4.7.2 Typical Storm Inlet and Catch Basin Configurations .....	94
4.7.3 Inspection Preparedness .....	94
4.7.4 Inlet and Catch Basin Inspection and Cleaning Activities and Checklist.....	94
4.7.5 Maintenance Activities for Inlets and Catch Basins.....	97
4.7.6 Preventative Maintenance Schedule.....	99
4.7.7 O&M Documentation for Inlets and Catch Basins .....	99
<b>4.8 O&amp;M Activities for MS4 Outfalls.....</b>	<b>100</b>
4.8.3 Inspection Preparedness .....	100
4.8.4 MS4 Outfall Inspection Activities and Checklist .....	100
4.8.4 Preventive Maintenance Activities .....	102
4.8.5 O&M Documentation for MS4 Outfalls.....	102
<b>4.9 Activities for Street Sweeping .....</b>	<b>103</b>
4.9.1 Introduction and Overview for Street Sweeping .....	103
4.9.2 Street Sweeping Equipment and Preparedness .....	103
4.9.3 Street Sweeping Schedule and Map.....	104
4.9.4 Preventive Maintenance.....	105
<b>4.10 Activities for FOG Dischargers.....</b>	<b>106</b>

4.10.1 Introduction and Overview for FOG Inspections..... 106

4.10.2 Education of Newly Identified Dischargers..... 106

4.10.3 Issuing FOG Discharge Permits ..... 106

4.10.4 Conducting FOG Discharger Inspections..... 107

4.10.5 Inspection Assessments and Determination of Non-Compliance ..... 107

4.10.6 Compliance Plans and Follow-Up Inspections..... 108

**4.11 Procedures for Investigations of Illicit or Prohibited Discharges..... 109**

4.11.1 Emergency Response Protocol..... 109

4.11.2 Investigating the Report..... 109

4.11.3 Recordkeeping..... 109

**4.12 Emergency Maintenance Procedures ..... 110**

4.12.1 Emergency Response Protocol..... 110

4.12.2 Chain of Command..... 111

4.12.3 Emergency Maintenance Contractors ..... 112

4.12.4 Authority Notification ..... 112

4.12.5 Documentation of Emergency Maintenance..... 112

4.12.6 Emergency Maintenance on Evenings, Weekends, and Holidays..... 112

**4.13 Emergency Sinkhole or Line Collapse Inspections and Repairs ..... 113**

4.13.1 Sinkhole / Line Collapse Remediation Procedures..... 113

4.13.2 Sinkhole Documentation..... 113

**4.14 O&M Activities for Green Stormwater Infrastructure ..... 114**

**4.15 Customer Service Request Tracking and Reporting Program..... 115**

4.15.1 Current Tracking System ..... 115

**4.16 Education and Training of New and Existing Employees ..... 116**

4.16.1 New Employees..... 116

4.16.2 Employee Advancement..... 117

4.16.3 Operator Licensing Requirements..... 117

4.16.4 MS4 Training..... 118

    Group 1 ..... 118

    Group 2 ..... 118

    Group 3 ..... 118

**4.17 Procedure for Preparing and Approving the Annual O&M Budget..... 118**

4.17.1 Annual Budget Preparation ..... 118

4.17.2 Budgetary Procedures in Emergencies..... 118

## List of Figures

Figure 2.1 Map of the Conveyance System.....	2-3
Figure 3.3-1 Process Flow Diagram for CRW Advanced Wastewater Treatment Plant.....	3-9
Figure 3.4-1 Photo of Vortex Grit Chamber at CRW AWTF .....	3-13
Figure 3.3-2 Photo of Classifier Unit at the CRW AWTF .....	3-14
Figure 3.4-3 Photo of one Chlorine Contact Tank at the CRW AWTF.....	3-17
Figure 4.1-1 CSO Regulator Structure Locations.....	4-2
Figure 4.1-2 Standard Brown and Brown Regulator Configuration (Type A and Type B) .....	4-7
Figure 4.1-3 Standard Fixed Orifice Regulator Configuration (Type C).....	4-7
Figure 4.1-4 Photographs of Typical CRW Regulator Structures.....	4-8
Figure 4.2-1 Representation of Typical CRW Flood Chamber and Outfall Configurations .....	4-28
Figure 4.2-2 Photographs of Typical CRW CSO Outfalls and Flap Gates .....	4-29
Figure 4.3-1 Front Street Pump Station .....	4-45
Figure 4.3-2 Front Street Pump Station Flow Schematic.....	4-47
Figure 4.3-3 Front Street Pump Station – Influent Flow Control.....	4-48
Figure 4.3-4 Front Street Pump Station Bar Screens.....	4-49
Figure 4.3-5 Front Street Pump Station – Screening.....	4-50
Figure 4.3-6 Front Street Pump Station – Wastewater Pumping.....	4-51
Figure 4.3-7 Spring Creek Pump Station.....	4-58
Figure 4.3-8 Spring Creek Pump Station Flow Schematic.....	4-60
Figure 4.3-9 Spring Creek Pump Station – Influent Flow Control .....	4-61
Figure 4.3-10 Spring Creek Pump Station – Influent Chambers.....	4-63
Figure 4.3-11 Front Street Pump Station – Wastewater Pumping.....	4-65
Figure 4.3-12 Front Street Pump Station – Emergency Power Generation.....	4-66
Figure 4.9-1 Street Sweeping Schedule.....	4-104
Figure 4.9-1 Street Sweeping Map.....	4-105
Figure 4.12-1 Chain of Command .....	4-111

## List of Inspection Checklists

CRW Advanced Wastewater Treatment Facility - High Flow Procedures .....	19
Standard Daily CSO Regulator Inspection Activity Checklist.....	12
Active Combined Sewer Overflow Activity Checklist.....	16
Combined Sewer Overflow (Post-Storm) Activity Checklist.....	19
Semi-Annual Preventive Maintenance Activity Checklist .....	21
CSO Outfall and Backflow Prevention Gate Inspection Checklist.....	34
Annual Backflow Prevention Gate Preventative Maintenance Activities Checklist.....	37
General Pump Station Inspection Activities Checklist.....	42
Procedures for Lost Communication to Main Plant SCADA Computer.....	43
Front Street Pump Station – Operating Bar Screens .....	54
Front Street Pump Station – Operating Wastewater Pumps.....	55
Front Street Pump Station – Pump Down Procedure.....	56

Spring Creek Pump Station – Operating Barminutor Screens .....69

Spring Creek Pump Station – Operating Bar Screen .....70

Spring Creek Pump Station – Operating Wastewater Pumps .....71

Spring Creek Pump Station – Changing over to Bar Screen Side .....73

Spring Creek Pump Station – Changing over to Old Side .....74

Spring Creek Pump Station – Pump Down Procedure .....76

Spring Creek Pump Station - High Flow Procedures .....78

Hot Spot Listing, Inspection Frequency, and Delisting Procedure.....88

Inlet and Catch Basin Inspection and Cleaning Activities Checklist.....95

Inlets and Catch Basins (Reconstruction) Checklist.....98

MS4 Outfall Inspection Checklist..... 101

Sinkhole / Line Collapse Remediation Procedural Checklist..... 113

Inspection Preparedness Activity Checklist..... C-1

## Appendices

Appendix A CRW Operation and Maintenance Documents

Appendix B Emergency / CRW Staff Contacts

Appendix C Inspection Preparedness and General Safety Guidelines

Appendix D Sinkhole Master Spreadsheet

Appendix E Inspection Checklists

Appendix F Green Stormwater Infrastructure O&M Manual



# Section 1

## Introduction and Regulatory Context

### 1.1 Capital Region Water

Capital Regional Water (CRW) is a municipal authority that owns, operates, and maintains the water, wastewater, and stormwater facilities in the City of Harrisburg. Within the Wastewater Division this includes an Advanced Wastewater Treatment Facility (AWTF), conveyance system, and collection system (that includes both combined and separate sanitary sewer systems).

### 1.2 Regulatory Context

CRW has entered into a partial Consent Decree (CD) which outlines specific requirements to facilitate compliance with the United States Environmental Protection Agency (EPA) National Combined Sewer Overflow (CSO) Policy. A key component of the partial CD was the development of CSO Operation and Maintenance Manual (OMM), which documents the operation and maintenance practices that are currently in place. Additionally, CRW prepared a Nine Minimum Control (NMC) Plan, which discusses the current practices in place for NMC implementation while referring to this OMM for more specifics. The primary focus of the NMC Plan is to provide the framework and schedules necessary to achieve compliance with the CSO Policy.

### 1.3 Operation and Maintenance Manual

This OMM documents the existing procedures for inspecting and maintaining the combined and separate sanitary sewer system and their related facilities in the CRW system. This OMM is intended to be a reference document for CRW employees.

Specifically, the partial CD requires CRW to prepare, maintain and implement a CSO Operation and Maintenance Manual (OMM) for the conveyance and collection systems, describing the Standard Operating Procedures (SOPs) and schedules for the remedial and routine operation, inspection, and maintenance activities it conducts in compliance with the NMCs. CRW will continue to expand and update their existing protocol documentation to achieve compliance. With CRW assuming O&M responsibility for the conveyance and collection systems from the City of Harrisburg in late 2013, and considering the unknown level of deferred maintenance inherited from City maintenance practices, it is understood and recognized that the OMM, SOP and NMC documentation will continue to evolve over time based upon the experience gained. The OMM was first prepared in August 2015 with updates each year, and this is the 2022 calendar year update reflecting practices through the end of 2022.

## Section 2

# Organization of the Conveyance and Collection Systems

In Harrisburg, like many older cities, the collection of wastewater is mostly conveyed in the same conduits as stormwater. CRW's combined sewer system (CSS) serves approximately 62 percent of the City, where stormwater and wastewater are conveyed through combined sewers, shared conduits which are subject to overflows during periods of wet weather. A portion of the of the CSS is served by a system of partially separated separate sanitary and storm systems, in which sanitary wastewater and/or stormwater discharge to combined sewers. The remaining 38 percent of the City is served by CRW's separate sanitary sewer system, where separate sanitary sewers are directly connected to CRW's conveyance system without passing through a CSO regulator, and CRW or property owner separate stormwater collection systems drain to a receiving water.

**Combined Sewer System:** Combined wastewater and stormwater flows are conveyed to the CRW Advanced Wastewater Treatment Facility (AWTF) through CRW's conveyance system and collection system. The *conveyance system*, shown in **Figure 2.1**, consists of the following components:

- The **Front Street Interceptor** extends along the northeast shore of the Susquehanna River and receives combined flow from the City of Harrisburg and separate sanitary flow from Susquehanna Township.
- The **Paxton Creek Interceptor** receives combined flow from the City of Harrisburg and separate sanitary flow from the Borough of Penbrook, Lower Paxton Township, and Susquehanna Township.
- The **Paxton Creek Relief Interceptor** receives combined flow from the City of Harrisburg and separate sanitary flow from the Borough of Penbrook and Susquehanna Township.
- The **Hemlock Street Interceptor** receives combined flow from the City of Harrisburg and separate sanitary flow from the Borough and Paxtang, Lower Paxton Township, and Swatara Township.
- Combined sanitary and stormwater flows from the Borough of Steelton are pumped directly to the AWTF.
- **Two sewage pump stations** within the CRW system. The Front Street and Spring Street pump stations convey interceptor flow to the AWTF. The City of Harrisburg currently owns the two City Island pumping stations. Although the City is responsible for the operation and maintenance of the City Island pumping stations, CRW is providing interim assistance with operations and maintenance until a permanent arrangement is established for City operation and maintenance of those facilities.

- 59 CSO regulator structures, located where the local combined sewer collection systems are connected to the interceptor sewers, control how much flow is directed to the AWTF, with the remainder discharged to the receiving water.

CRW's **combined collection system** consists of the portions of CRW's collection system upstream of the CSO regulator structures. Previously, CRW personnel operated and maintained the conveyance system while personnel from the City Bureau of Sewerage and Bureau of Neighborhood Services operated and maintained the sewer collection system. Beginning in December 2013, Capital Region Water was created and assumed these O&M responsibilities, as well as ownership, of the collection system and pump stations.

**Separate Sanitary Sewer System:** Approximately 38 percent of the City area is served by CRW's separate sanitary sewer system. All of the satellite service communities are served by separate sanitary sewers except Steelton Borough which has a combined collection system. Wastewater flows from the satellite service communities are conveyed to the CRW AWTF through the following components of the conveyance system (**Figure 2.1**):

- The **Asylum Interceptor** conveys flow from Susquehanna Township to the Paxton Creek Relief Interceptor.
- The **Spring Creek Interceptor** conveys flow from Swatara Township to the Hemlock Street Interceptor.

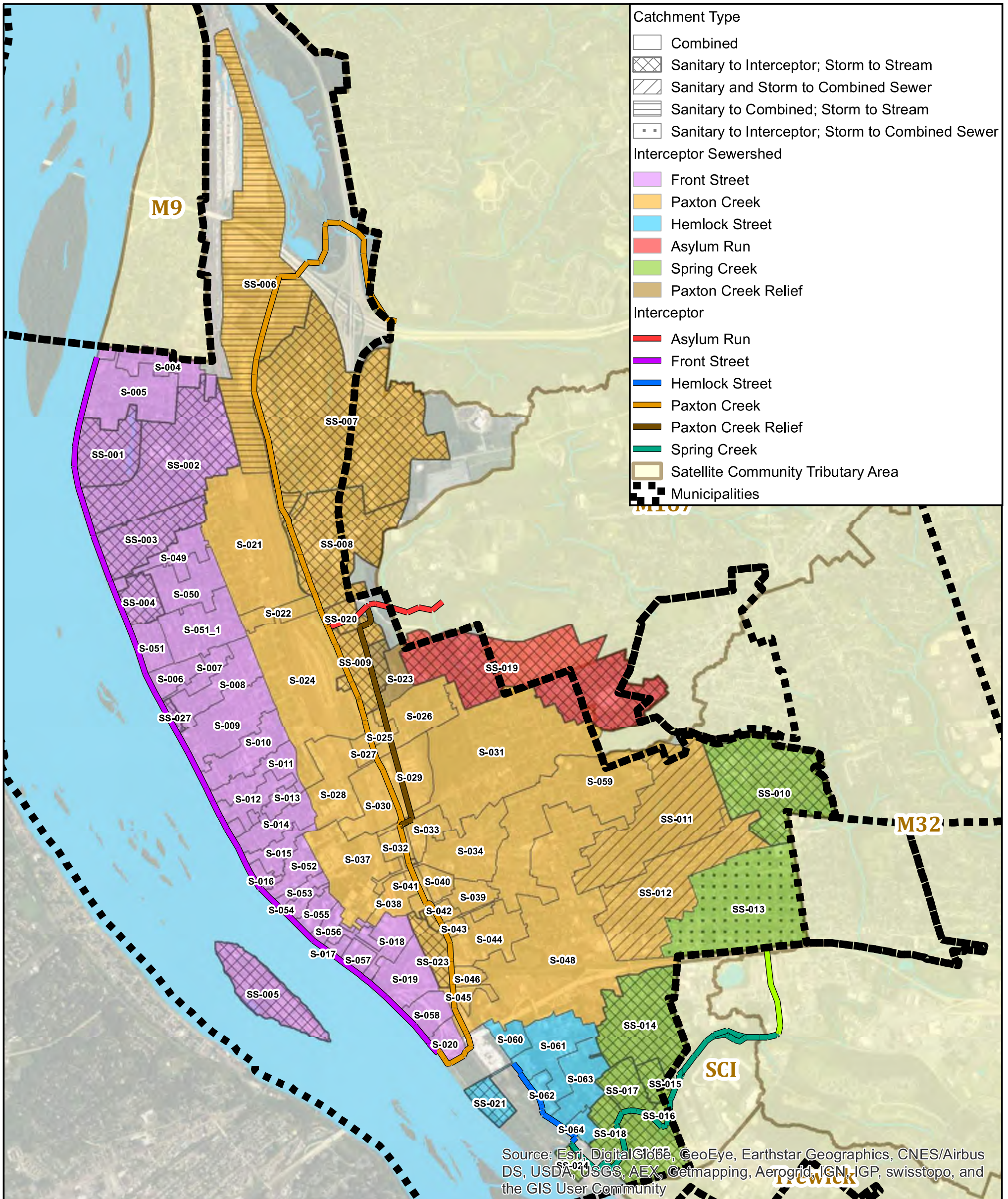

Source: Esri, DigitalGlobe, GeoEye, Earthstar Geographics, CNES/Airbus DS, USDA, USGS, AEX, Getmapping, Aerogrid, IGN, IGP, swisstopo, and the GIS User Community

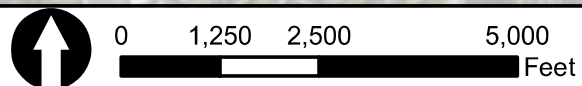

3/8/2017 | PM: JAA | GIS: JWE



Mapping derived from data provided by Dauphin County, Capital Region Water, and the City of Harrisburg.

**Figure 2-1  
Map of Conveyance System**

Capital Region Water  
Dauphin County, Pennsylvania

or.

## Section 3

# Facilities Critical to the Performance of the CSO System

### 3.1 Facilities Critical to the Performance of the Collection and Conveyance Systems

CRW has determined that its entire conveyance system is critical to the performance of its combined sewer system. The critical facilities are comprised of the following conveyance system elements:

- CSO regulator structures
- CSO outfalls
- Backflow prevention gates
- Pump stations
- Interceptor sewers

However, CRW's backflow prevention flap gates are only critical when the receiving waters are above flood stage elevations, as detailed further in Section 4.2.4.

Section 4 provides details on the key role of each component with detailed operation and maintenance procedures for each.

### 3.2 Equipment Critical to the Performance of the Collection and Conveyance Systems

CRW owns the following equipment listed in **Table 3.2-1** for maintaining the combined sewer system. All of this equipment is considered to be critical, due to the variability of the nature of the conveyance and collection system work.

**Table 3.2-1 Equipment Critical to the Performance of the Collection and Conveyance Systems**

<i>Field Operations Equipment</i>	<i>Field Maintenance Equipment</i>
Two 5-Ton Dump Truck	Three Vactor Trucks
Three Pick-Up Trucks	One Jet Truck
One Wheel Front End Loader	Two Utility Trucks
Four Sets of Self Contained Breathing Apparatus	Two Pickup Trucks
Miscellaneous Cleaning Equipment (Brooms, Brushes, Buckers, Hose, Etc.)	Four 5-Ton Dump Trucks
	Two 1-Ton Dump Trucks
	One Backhoe
<b><i>Personal Safety Apparel for Each Employee</i></b>	Two Mini Excavators
Hard Hat	Two Black Top Rollers
Uniform	One Pole Camera
Rain Gear	Three Tripods
Boots	Three Fall Preventers
Fluorescent Vest	One Winch
Gloves	Four Harness/Rope Assemblies
Coveralls	Four Manhole Hooks
Goggles	One Spot Light
	Ten Barricades
<b><i>Maintenance Shop</i></b>	Ten Safety Cones
Fully Equipped for Light Fabrication & Welding	Two Manhole Ventilators
	One Self Contained Breathing Apparatus
	Five Portable Combustible Gas Analyzers
	Shovels, picks, and digging irons
	Two tool box sets
	One Skid Steer Loader
	One Hydro-Excavator
	One CCTV Truck
	One Spare CCTV Camera
	Three Street-Sweepers
	One Lateral Launch CCTV Rover
	One Manhole Cutter
	Hydraulic Shoring

### 3.3 Facilities Critical to the Performance of the AWTF

Capital Region Water owns and operates the Advanced Wastewater Treatment Facility (AWTF) located at 1662 South Cameron Street in Harrisburg, Pennsylvania. The AWTF is a High Purity Oxygen Activated Sludge (HPOAS) plant that treats wastewater from the City of Harrisburg, the Townships of Lower Paxton, Susquehanna, Swatara and the Boroughs of Paxtang, Penbrook and Steelton.

### 3.3.1 Discharge Limits and Operational Objectives of CRW's AWTF

The AWTF discharges treated effluent to the Susquehanna River under a National Pollutant Discharge Elimination System (NPDES) permit issued by the Pennsylvania Department of Environmental Protection (PADEP). The NPDES permit defines the discharge limitations and performance requirements of the AWTF as summarized in **Table 3.3-1**.

**Table 3.3-1 NPDES Discharge Limits for AWTF Effluent**

Discharge Parameter	Unit	Minimum Value	Monthly Average Value	Weekly Average Value	Instantaneous Maximum Value
pH		6.0	-	-	9.0
Dissolved Oxygen	mg/L	5.0	-	-	-
Total Residual Chlorine	mg/L	-	0.5	-	1.6
Total Suspended Solids	mg/L	-	30	45	60
CBOD <sub>5</sub>	mg/L	-	25	40	50
Ammonia-Nitrogen (May 1 to Oct 31)	mg/L	-	11	-	22
Total Phosphorus	mg/L	-	2.0	-	4.0
Fecal Coliform (May 1 to Sept 30)	No./100 mL	-	200	-	-
Fecal Coliform (Oct 1 to April 30)	No./100 mL	-	2000	-	-

The Ammonia and Total Phosphorus discharge limits are established by the PADEP for nutrient removal requirements under the PADEP's Chesapeake Bay Tributary Strategy (CBTS). The annual nitrogen and phosphorus discharge loading limits for the AWTF are 688,575 and 91,810 pounds/year, respectively.

The recently completed AWTF improvements project was designed to meet the stricter nutrient discharge limits, supplemented by nutrient credit trading. The basis of design wastewater flows established for the AWTF improvements are summarized in **Table 3.3-2**.

**Table 3.3-2 AWTF Basis of Design Wastewater Flows<sup>1</sup>**

Design Flow Parameter	Flow, MGD
Annual Average Daily	24.72
Maximum 30-Day Average	36.65
Maximum 7-Day Average	47.88
Maximum Daily Average	67.20

A short-term peak flow capacity of the AWTF has not been firmly established because the hydraulic capacity of the plant is affected by the river stage. It has been estimated that maximum plant flow

<sup>1</sup> Data from "Harrisburg Advanced Wastewater Treatment Facility, Improvements Project, Basis of Design Report" prepared by AECOM, February 2012.

capacity is between 65-70 MGD, but that short term peak flows of up to 78 MGD may be possible through the plant with a secondary bypass of flows above 45 MGD.<sup>2</sup>

### 3.3.2 Description of CRW's AWTF

#### 3.3.2.1 Influent Pump Stations and Force Mains

Wastewater flows are pumped to the AWTF from three pump stations: Front Street, Spring Creek, and Steelton. Flows from the Front Street and Spring Creek Pump Stations combine and enter the facility via a 48-inch diameter force main. Flows from the Steelton Pump Station enter the plant via a 30-inch diameter force main. Wastewater flows are screened at the pump stations by mechanically-cleaned bar screens. The two force mains combine into a 54-inch diameter influent pipe at the AWTF.

#### 3.3.2.2 Wastewater and Solids Handling Processes

The wastewater and solids handling processes for the AWTF are illustrated on **Figure 3.2-1**.

##### *Headworks Facilities*

Wastewater flow passes through Chamber A, then to the influent channel for the four vortex grit removal units. Effluent from the grit removal units flows through Chamber B followed by a venturi flow meter located in the 54-inch pipe in the Control Building which is used to measure total plant flow.

##### *Primary Treatment Facilities*

After the flow meter, wastewater is conveyed to the primary influent channel that distributes flow between the four primary clarifiers. Primary sludge is combined with waste activated sludge, and conveyed to the gravity thickeners. The AWTF has provisions for Chemically Enhanced Primary Treatment (CEPT). Ferric chloride (coagulant) can be added to the 48-inch diameter force main upstream of the vortex grit removal tanks and polymer (flocculant) can be added at the outlet to the vortex grit removal tanks. CEPT is utilized to improve TSS and BOD removal during peak loading periods.

##### *Secondary Treatment Facilities*

Settled wastewater overflows the clarifiers' weirs to an effluent channel leading to Chamber C and the Settled Wastewater Pump Station. All settled wastewater flow, up to 45 mgd, is pumped to the secondary process. Peak flows above 45 mgd are bypassed around the secondary process at Chamber C and directed to the chlorine contact tank for disinfection. Settled wastewater flows to the secondary process through a distribution box where flow is split between the three Oxygenation Tanks. The secondary treatment process is based on High Purity Oxygen Activated Sludge (HPOAS) technology wherein the Oxygenation Tanks are covered and aeration is achieved by high purity oxygen produced by the on-site cryogenic facility.

Each Oxygenation Tank consists of four cells. The first cell of each tank is a pre-anoxic zone to remove a portion of the nitrate from the wastewater. The following three cells are aerobic zones for carbonaceous BOD removal. Mixed liquor from the Oxygenation Tanks is conveyed to a

<sup>2</sup> Draft Report "Act 537 Plan Update Revision/Long-Term Control Plan" prepared by Brinjac Engineering and Malcom Pirnie, August 2005.



Bioreactor comprised of three main zones; aerobic, swing and anoxic zones. The swing zone may be operated as an aerobic or anoxic zone to optimize treatment process performance. A supplemental carbon source (i.e., methanol) can be added to the swing and anoxic zone to complete the nitrogen removal treatment process (denitrification).

**Figure 3.3-1 Process Flow Diagram for CRW Advanced Wastewater Treatment Plant**

Source: Harrisburg Advanced Wastewater Treatment Facility Improvements Project. Basis of Design Report. Prepared by AECOM, February 2012.

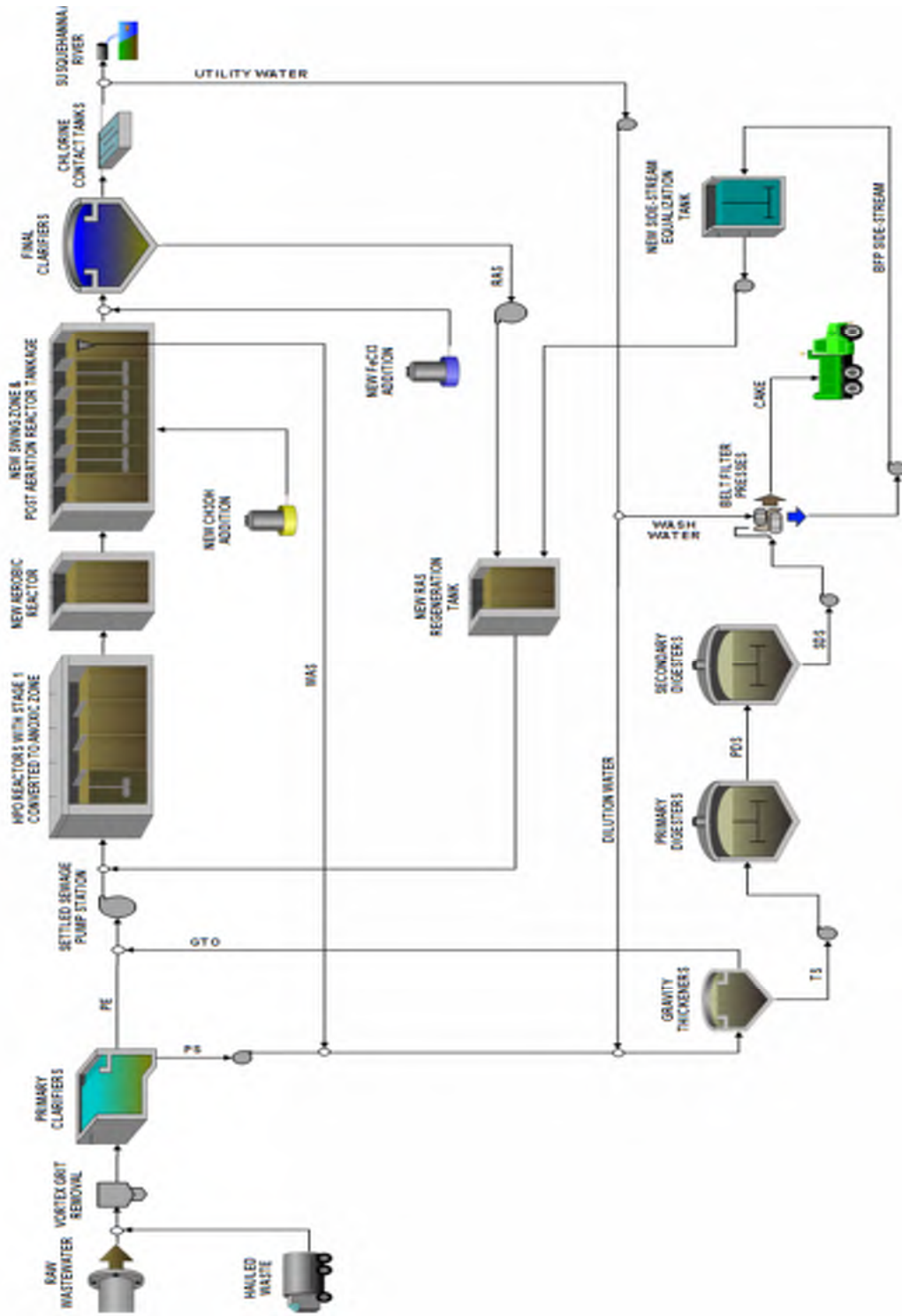

From the Bioreactor, mixed liquor overflows from the last pass of the anoxic zone into the post-aeration channel which is aerated to re-oxygenate and strip dissolved nitrogen gas in the mixed liquor. From the post-aeration channel, mixed liquor flows to the former alum tank and is distributed among the six final settling tanks via weir gates. Manually operated weir gates are used to control flow to each tank. Effluent from the final clarifiers is conveyed to the chlorine contact tanks where it is disinfected using chlorine gas and chlorinators prior to discharge to the Susquehanna River.

#### *Sludge and Solids Handling Facilities*

Return Activated Sludge (RAS) collected in the final settling tanks flows to the RAS pump station wet well where it is pumped to the RAS regeneration tank. This side stream treatment process combines the filtrate from the sludge dewatering belt filter presses with RAS for nitrification treatment in the covered RAS regeneration tank using high pure oxygen. The overflow from the RAS regeneration tank is then distributed between the Oxygenation Tanks.

Waste Activated Sludge (WAS) is removed from the new post-aeration channel and pumped to the gravity thickeners where it is combined with primary sludge. Dilution water (plant effluent utility water) is mixed with the sludge in a 4:1 volume ratio of dilution water-to-sludge for odor control and re-oxygenation. The thickened sludge (approximately 3% to 4% total solids) is pumped to the primary anaerobic digester that is heated and gas mixed. Primary digested sludge overflows to two anaerobic secondary digesters which currently function as sludge storage tanks. The thickener overflow is combined with primary effluent at the settled sewage pump station wet well.

The digested sludge is pumped to the two, 2.5m belt filter presses (BFPs) for dewatering and disposal via land fill or land application. The filtrate and wash water from the BFPs flows to the equalization tank which provides about three days storage of the average return flow from the BFPs. A filtrate pumping station pumps from the equalization tank to the RAS regeneration tank where it is mixed with RAS and then returned to the Oxygenation Tanks. The dewatered sludge is transported by truck to disposal.

### **3.3.3 Criteria for Determining Facilities Critical to AWTF Performance**

For the purpose of this manual, critical facilities for the performance of the AWTF are considered those processes necessary to receive and treat wet weather flows of typical duration and intensity and to meet the following criteria:

- Maintain compliance with NPDES discharge permit limits
- Allows peak flows to pass through the facility without flooding or damaging equipment

The Pennsylvania DEP Bureau of Water Quality Protection publication “Domestic Wastewater Facilities Manual” does not specifically define critical facilities, however, the following design criteria are recommended:

- Must provide disinfection for all flows entering the facility
- Multiple units are recommended for each process
- Redundant (i.e., standby units) are recommended for critical mechanical equipment

### 3.3.4 Definition of Facilities Critical to CRW's AWTF Performance

CRW used the criteria presented in Section 3.3.3 to define facilities critical to performance of its AWTF. This section describes these facilities. The AWTF major process units are summarized in **Table 3.3-3** and identifies those facilities that are considered critical for wet weather operation of the AWTF.

A hydraulic capacity evaluation indicated that the peak flow capacity of the AWTF through primary treatment is between 65 – 70 MGD depending upon river stage.<sup>3</sup> Wastewater flows up to 45 MGD receive full treatment. Peak wet weather flows above 45 MGD bypass secondary treatment and are diverted to the chlorine contact tanks for disinfection following primary treatment.

The solids handling processes (gravity thickener/fermenters, anaerobic digesters, BFPs) are not considered critical facilities during wet weather, since their operation is not essential during a typical wet weather event with a duration of several hours up to a couple of days. Beyond a couple of days, the absence of solids handling facilities would have an impact on the performance of the AWTF as the accumulation of solids in the liquid process train would deteriorate effluent quality.

**Table 3.3-3** also indicates the critical facilities that can hydraulically pass peak flow with the largest unit out of service without damaging the equipment. Most of the facilities that do not have multiple units can be taken out of service using bypass provisions; however, this may adversely impact the overall performance of the AWTF. The Operators should make every effort to keep all critical facilities in service during wet weather in order to maintain treatment performance requirements. Critical facilities should only be taken out of services for maintenance purposes.

---

<sup>3</sup> Draft Report “Act 537 Plan Update Revision/Long-Term Control Plan” prepared by Brinjac Engineering and Malcom Pirnie, August 2005.

**Table 3.3-3 AWTF Treatment Process Units<sup>1</sup>**

Process	No. of Units	Unit Size	Comments	Critical Facilities	Capable of Passing Peak Flow with Largest Unit out of Service
Vortex Grit Removal Chambers	4	16' diameter	Each vortex chamber is rated for 20 MGD flow capacity.	Yes	Fourth Chamber needed over 60 MGD
Mechanical Screens	2	¼-in screen opening; 6-ft wide x 16-ft deep channels	Each screen is rated for 80 mgd.	Yes	Yes
Primary Clarifiers	4	271.5' long x 35' wide 8.2' average depth	Chemically Enhanced Primary Treatment (CEPT) capability being added	Yes	Yes
Settled Sewage Pump Station	4	15,000 gpm capacity each	Three duty pumps/one standby	Yes	Yes
High Pure Oxygenation Activated Sludge (HPOAS) Reactors	3	4-Stages Volume=1.0515MG Total Vol.=3.1545MG	First stages being converted to pre-anoxic zone for nitrate removal.	Yes	Yes
Final Clarifiers	6	102' square with circular collectors	Baffle improvements being made to reduce short-circuiting	Yes	Sixth Clarifier needed over 40 MGD
Chlorine Contact Tanks	4	180,000 gallon volume each	All four tanks required to provide 15 minutes contact time at peak flow rate of 70 MGD.	Yes	Yes, with reduced contact time
Cryogenic Plant	1	50 tons Oxygen/day total capacity	Existing system repair, replacement and upgrades under improvements project	Yes	NA
Gravity Thickeners	2	80' diameter x 10.2' SWD Active Vol.=0.497 MG	Converting to operate as fermenters to provide supplemental carbon source for denitrification.	No	NA
Primary Anaerobic Digesters	2	<u>Nos. 1 &amp; 2 digesters</u> 90' diameter x 35' SWD	Heated and mixed	No	NA
Secondary Anaerobic Digesters	2	<u>No. 3 digester</u> 85' dia. x 28' SWD, fixed cover <u>No. 4 digester</u> 85' dia. x 26' SWD, floating cover	Unheated and unmixed	No	NA
Chemical Addition for Disinfection	2	Chlorine Gas Chlorinators	Addition at the inlet to the chlorine contact tanks	Yes	Yes
Belt Filter Presses (BFPs)	2	2.5 meter units		No	NA
Aerobic Reactor	1	1.0 MG volume	After HPOAS reactors for additional nitrification capacity.	Yes	No, but reactor can be bypassed if taken out of service
Post-Anoxic Reactor	1	0.98 MG volume	After new aerobic reactor for denitrification (i.e., nitrogen removal).	Yes	No, but reactor can be bypassed if taken out of service
Post-Aeration Channel	1	0.4 MG	After Post-Anoxic reactor to re-aerate mixed liquor prior to the final clarifiers	Yes	No, channel must remain in service
BFP Filtrate Equalization Tank	1	0.745 MG volume	Added for BFP operational flexibility	No	NA
RAS Regeneration Tank	1	1.0 MG volume	Side stream treatment to nitrify BFP filtrate	Yes	No, but tank can be bypassed if taken out of service
Chemical Addition for Denitrification	1	Methanol storage and feed system	Supplemental carbon source addition to anoxic zones	Yes	NA
Chemical Addition for pH and alkalinity control	1	Sodium hydroxide storage and feed system	pH adjustment	Yes	NA
Chemical Addition for CEPT	1	Ferric chloride and polymer storage and feed system	Addition prior to primary clarifiers	Yes	NA
Chemical Addition for CEST	1	Ferric chloride and polymer storage and feed system	Addition prior to final clarifiers	Yes	NA

<sup>1</sup> Process Unit Data from "Harrisburg Advanced Wastewater Treatment Facility, Improvements Project, Basis of Design Report" prepared by AECOM dated February 2012.

## 3.4 Equipment Critical to the Performance of the AWTF

In **Section 3.3** the treatment processes critical to performance of the AWTF during wet weather were described. This section identifies the associated equipment necessary for operation of the critical facilities and defines the high flow operating procedures.

### 3.4.1 Vortex Grit Chambers

There are four vortex grit chambers at the AWTF. These grit removal units are each 16 feet in diameter with a maximum water depth of 7 feet (**Figure 3.4-1**). When flow is introduced in these circular chambers, a forced vortex flow pattern causes grit to settle in the center quiescent zone. A rotating paddle in the center of each chamber keeps organic materials in suspension while allowing grit to settle.



**Figure 3.4-1** Photo of Vortex Grit Chamber at CRW AWTF

Grit is removed from each vortex grit chamber using a top-mounted self-priming grit pump. Scour water is run to the bottom of the chamber prior to starting the grit pump in order to fluidize the settled grit for pumping. The grit slurry is pumped to the classifier unit (**Figure 3.4-2**) in the adjacent building where the grit is separated from water and deposited into a dumpster for disposal.



**Figure 3.3-2 Photo of Classifier Unit at the CRW AWTF**

Each vortex grit chamber has a hydraulic capacity of 20 MGD. During dry weather, one or two vortex grit chambers will be in service and the grit pumps are cycled to pump for 10 minutes out of every 30 minutes.

During wet weather, as wastewater flow entering the AWTF increases, additional vortex grit chambers will be brought in service, as follows:

- As flow reaches 40 MGD a third vortex grit chamber will be brought on line.
- As flow reaches 60 MGD the fourth vortex grit chamber will be brought on line.
- With all four vortex grit chamber in service the maximum treatment capacity is 80 MGD.

Also, during wet weather the grit pumps will change to continuous pumping operation to avoid excessive accumulation of grit in the vortex grit chambers.

### 3.4.2 Mechanical Bar Screens

There are two automatic self-cleaning mechanical bar screen units, each with a capacity of 80 MGD to provide full redundancy. The screens have  $\frac{1}{4}$ -in openings and are installed in 6-ft wide, 16-ft deep channels in the new headworks building. The screening facility also includes screening washer/compactors and a screenings handling container system.

### 3.4.2 Primary Clarifiers

There are four rectangular primary clarifiers that are each 270 feet long, 35 feet wide and have an average water depth of 8.2 feet. Wastewater flow is conveyed from the vortex grit chambers to the primary clarifiers' influent channel via a 54 inch diameter pipe. Flow is then distributed to the primary clarifiers through two sluice gates per tank in the influent channel. The inlet channel in each clarifier has orifices along the bottom of the channel to distribute flow across the clarifier. Primary

effluent overflows weirs at the end of each clarifier, entering the primary effluent channel and subsequently flows to Chamber “C” and the Settled Sewage Pump Station.

Chain and flight collector mechanisms in each clarifier pushes the settled sludge into a cross collecting hopper. A cross collector chain and flight mechanism pushes sludge in the cross hopper to the sludge withdrawal hopper from which the sludge is pumped to the gravity thickeners. Scum and floatables are pushed by the chain and flight mechanism to a tipping weir where it is removed from the clarifiers.

### 3.4.3 Settled Sewage Pump Station

Primary Effluent is conveyed through a 54 inch pipe from the Primary Clarifiers to Chamber “C” and then to the Settled Sewage Pump Station. There are four sewage pumps, each having a capacity of 15,000 gpm. This pump station is critical for the operation of the AWTF during wet weather. Three of the four pumps should remain ready for operation to accommodate the peak flow of 45 MGD to the advanced treatment process. In addition to the pumps, the critical equipment for wet weather operation of the Settled Sewage Pump Station is the pumped flow meter and the weir gate in Chamber “C”. Flow to the Settled Sewage Pump Station is controlled automatically through the SCADA system. The SCADA system enters “High Flow Mode” whereby the variable frequency drives at the Settled Sewage Pump Station will change the mode of operation to achieve a pump rate of 45 MGD. All excess flows will be diverted to the chlorine contact tanks.

### 3.4.4 High Pure Oxygenation Activated Sludge Reactors

The High Pure Oxygenation Activated Sludge (HPOAS) Reactors (also referred to as Oxygenation Tanks) include three trains with four stages per train. Each stage is 50 feet square with an average water depth of 14 feet. Oxygen for the activated sludge is provided by the on-site cryogenic plant which has an oxygen generation capacity of 50 tons per day. The first stages are equipped with vertical shaft mixers that allows the first stage to be operated as a pre-anoxic zone. This allows for partial removal of nitrates in the return activated sludge that is introduced into the Oxygenation Tanks in the first stage. The next three stages are equipped with surface aerators. Operation of the HPOAS Reactors is not anticipated to vary significantly during dry or wet weather.

### 3.4.5 Bioreactor

The Bioreactor is located between the HPOAS Reactors and the Final Clarifiers. The Bioreactor consists of three tanks providing separate aerobic zone, swing zones and post-anoxic zone as described below.

*Aerobic Reactor:* The first zone of the Bioreactor is the Aerobic Reactor which has a side water depth (SWD) of 30 feet and a volume of one million gallons (MG). This reactor is aerated using two, variable speed, vertical shaft surface aerators.

*Swing Zones:* Mixed liquor will overflow the Aerobic Reactor into the Swing Zones that consists of a 1.46 MG tank with a SWD of 30 feet. The tank is baffled into three equally sized zones. Each zone has one aerator and two vertical shaft mixers.



*Post-Anoxic Reactor:* Mixed liquor overflows the Swing Zones into the Post-Anoxic Reactor that consists of a 0.97 MG tank with a SWD of 30 feet. A baffle separates the reactor into two zones that each have a fixed speed vertical shaft mixer.

The critical equipment in the Bioreactor are the surface aerators and dissolved oxygen (DO) monitoring system in the aerobic zones used to control the aerator speed to maintain a target DO concentration through the SCADA system. Also critical, is the supplemental carbon chemical feed system that is designed to introduce methanol, or other selected carbon chemical into any of the swing zones and the Post-Anoxic Reactor for the denitrification process. A nitrate monitoring system located at the last pass of the Post-Anoxic Reactor is used to control the carbon chemical feed rate through the SCADA system. Operation of the Bioreactor is not anticipated to vary significantly during dry or wet weather. However, the Bioreactor is designed to allow for varying modes of operation to optimize the nitrification and denitrification treatment processes.

### 3.4.6 Post-Aeration Channel

The Post-Aeration Channel is an 8-ft wide channel that conveys mixed liquor flow from the Post-Anoxic Reactor to the Final Clarifiers. This channel is aerated for re-oxygenating and stripping nitrogen gas from the mixed liquor. The critical equipment for this channel are the two blowers and coarse bubble aeration system. The operation of the Post-Aeration Channel is not expected to vary significant during dry and wet weather. However, the blowers are being furnished with variable frequency drives to adjust the aeration rate for optimum performance.

### 3.4.7 Final Clarifiers

There are six Final Clarifiers at the AWTF that are each 102 feet square with a SWD of 12 feet. Currently, mixed liquor flows from the HPOAS reactors to the Alum Mix Tank. Six electronically actuated weir gates in the Alum Mix Tank control flow distribution to the six Final Clarifiers. Flow meters are installed in the 42 inch pipe to each clarifier. Flow distribution to each clarifier is controlled through the SCADA system to adjust the weir gate position to maintain equal flows to each clarifier as measured by the flow meters.

The Final Clarifiers were upgraded to improve performance including the replacement of sludge collector mechanism and launders, and the addition of density current and mid-radius baffles.

Return Activated Sludge (RAS) from the Final Clarifier is pumped to the RAS Regeneration Tank and then returned to the Oxygenation Tanks.

Waste Activated Sludge (WAS) is pumped from a sludge hopper in the center of each clarifier to the gravity thickeners. There is now an additional solids wasting option to pull mixed liquor from the Post Aeration Channel and pump to the gravity thickeners. The existing WAS wasting facilities are still in place as an emergency back-up system.

All of the final clarification system components are critical to the dry and wet weather operation of the advanced secondary treatment system. It is preferable to keep all six Final Clarifiers in service during wet weather as performance of the system is marginal with one clarifier out of service during wet weather.

### 3.4.8 Chlorine Contact Tanks

Prior to discharge into the Susquehanna River, treated wastewater is disinfected in the chlorine contact tanks (CCT). There are four CCTs at the AWTF, which are each 100 feet long, 24 feet wide and 10 feet deep (**Figure 3.4-3**). Disinfection is maintained year-round at the AWTF.



**Figure 3.4-3 Photo of one Chlorine Contact Tank at the CRW AWTF**

Chlorine gas is stored at the plant in one ton cylinders. The chlorine feed system includes two chlorinators used to dissolve gaseous chlorine into liquid solution for feeding into the CCTs. The CCTs are also aerated using air diffusers that assist in mixing and keeping remaining solids in suspension.

Each CCT has a volume of 180,000 gallons which provides a hydraulic detention time of 15 minutes for a peak flow rate of 70 MGD with all four tanks in service. Normally, all four tanks are kept in service. The CCTs will receive all dry weather flow from the secondary treatment process. During wet weather the CCTs will receive up to 45 MGD of flow from the secondary treatment process and the balance of flow that is diverted around the secondary treatment process via the bypass weir gate in Chamber “C”.

### 3.4.9 RAS Regeneration Tank

The RAS Regeneration Tank receives RAS pumped from the six final clarifiers via the RAS pump station. The critical equipment for this process include the surface aerators and high pure oxygen provided by the existing cryogenic plant. The operation of the RAS Regeneration Tank is not expected to vary significantly between dry and wet weather.

### 3.4.10 Chemical Addition for Denitrification

A carbon chemical storage and feed system provides methanol or alternative commercial carbon source and feeds the chemical solution to the Bioreactor swing zones and anoxic zone to complete the denitrification process. The critical equipment for this chemical system include the storage

tank, dosing pumps and chemical feed pumps. The operation of the chemical feed system for denitrification is not expected to vary significantly between dry and wet weather, other than the dosage/feed rate variation for the increase in flow up to the advanced treatment capacity of 45 MGD.

#### **3.4.11 Chemical Addition for pH and Alkalinity Control**

A Sodium Hydroxide (caustic soda) storage and feed system provides pH and alkalinity adjustment in the HPOAS reactors. It is not anticipated that system will be routinely used; rather it is intended to be an emergency back-up in the event the denitrification process is not performing as needed to maintain required effluent pH.

#### **3.4.12 Chemical Addition for CEPT**

Chemically Enhanced Primary Treatment (CEPT) is a process to increase the removal of total suspended solids (TSS), biochemical oxygen demand (BOD) and nitrogen in primary clarifiers. This process is typically used to reduce pollutant loading on secondary treatment processes. The CRW AWTF has the capability to ferric chloride to the plant influent 48 inch force main passing near the Chemical Storage Building. Polymer storage and feed equipment also add polymer to the wastewater flow stream at the outlet of the vortex grit chambers. The critical equipment for the chemical addition systems include the chemical storage tanks and chemical feed pumps.

#### **3.4.13 Chemical Addition for CEST**

Chemically Enhanced Secondary Treatment (CEST) is used to improve the settling characteristics of activated sludge. The benefits of CEST is it allows greater mixed liquor solids (MLSS) concentrations and greater solids loading rate on the final clarifier. These benefits result in improved nitrification performance and better effluent quality. Ferric chloride will be added to the Post Aeration Channel and polymer will be added in the existing Alum Mix Tank. The critical equipment for the chemical addition systems include the chemical storage tanks and chemical feed pumps.

#### **3.4.14 High Flow Operating Procedures**

High flow operating procedure for the existing AWTF, Front Street Pump Station and Spring Creek Pump Station were documented in the August 2012 Combined Sewer Overflow Operations Manual. These procedures are listed below and will be updated when the AWTF improvements project is completed.

## CRW Advanced Wastewater Treatment Facility - High Flow Procedures

These procedures are designed to manage increased hydraulic loading at the AWTF. This includes the management of the final clarifier blankets, which typically are a source of effluent suspended solids during periods of increased hydraulic loading into the AWTF.

These procedures are meant as guidelines for handling increased hydraulic loading into the plant. All indicated flows are for reference only. They should not be used as absolutes. Do *NOT* wait until the flow reaches the indicated flow to take action. Remember, these are *ONLY* guidelines. Visual observation of the plant and review of weather conditions are necessary to determine the proper action. At *NO* time should the Chamber C bypass be opened without permission of the Operations Supervisor or Temporary Supervisor in charge. If it is determined that a storm is approaching, the Front Street wet well set points need to be adjusted to take the wet well down to 291.5.

### 1. Flows: 28 to 35 MGD

#### Front Street Pump Station:

- The number 1 and 2 variable speed pumps remain in automatic.
- Wet well setting for two pumps running is 291.5 feet in main computer.
- Place Bar Screen into the hand mode from auto mode.
- The 3rd pump (constant speed) set at 296.9 in automatic main computer.
- The 4th pump (constant speed) set at 297.0 in automatic main computer.
- Ensure that number 3 and number 4 pumps are set to the auto position at this time in the Main Computer.

#### Settled Sewage Pump Station:

All Settle Sewage pumps are Variable speed so you may run any two pumps in automatic on the main plant computer.

- Ensure that the other two pumps are off on the main plant computer.

#### Grit Removal System:

- Additional vortex grit chambers are automatically placed into service by the SCADA system at flows of 20, 40, and 60 MGD. Ensure the second chamber has been placed into service.

## 2. Flows from 35 to 55 MGD

### Front Street:

- Ensure that the bar screen is on hand.

### (Warning for Spring Creek)

### Spring Creek:

- If a third pump appears to be needed, place the pump on hand and set output to 160 amps. The main station breaker cannot handle the power requirements of three pumps on maximum.
- Place Bar screen into hand mode from auto mode.

### Grit Removal System

- Additional vortex grit chambers are automatically placed into service by the SCADA system at flows of 20, 40, and 60 MGD. Ensure the third chamber has been placed into service.

### Main Plant:

- Closely monitor the Settled Sewage Pump Station wet well to ensure the two variable speed pumps are maintaining the two pump wet well set point of 8.0 feet.
- Return tubes and Final Blankets: Watch to ensure that the blankets are not in danger of rising into effluent. Monitor both more closely. Increase the return rate slightly to compensate for dilution in the Oxygenation Trains.

**\*At 45 MGD, you can start Blending. At 49 MGD, you *must* start blending.**

- Put Final Influent Gates on High Flow Mode on the Main Plant Computer.
- Set the High Flow Switch at Settled Sewage to on on the Main Plant Computer Record time.
- Set Chlorine up to feed at Chamber D and The Contact Tanks Record time.
- Turn sampler on at contact tanks. Record the time.
- Open the gate at Chamber C. Record the time.
- Turn sampler off at Clarifiers (upper end). Record the time.
- Notify AWTF Laboratory of your start and stop times and record time.

- If on Daylight inform the Pretreatment Coordinator so haulers can be informed not to come in. At no time may a waste hauler be discharged at Chamber B while blending, or until flow has dropped below 37 MGD after a blending event.
- Call DEP and inform them that you have started Blending.
- See the bottom of the blending check list. Record time.
- Log information in logbook and on the blending checklist.

**Chlorine Residual:**

- Maintain at 0.35 mg/L during winter months (October through April), 0.45 mg/L during the summer months (May through September)

**3. Flow Greater than 55 MGD****Front Street:**

- Watch Wet Well level, if the three pumps will not maintain 296.9, ensure the 4th pump comes on at 297.0.
- If the flow reaches 70 MGD for extended periods (72 hours) this may damage the conveyance system at Front Street. Talk to the Shift Supervisor to determine the course of action.

**Spring Creek:**

- No change necessary. (Ensure all prior changes have been made.)

**Grit Removal System**

- Additional vortex grit chambers are automatically placed into service by the SCADA system at flows of 20, 40, and 60 MGD. Ensure the fourth chamber has been placed into service.

**Main Plant:**

**If the high flows are of long duration, consult with the Shift Supervisor on duty or the Operations Supervisor for any different instruction.**

**Note: Maximum sustainable flow at Harrisburg AWTF: At 80 MGD – for short periods of up to several hours, it is possible to keep the entire process operational.**

**65 MGD is the maximum flow for periods of a week to several months which the plant will be able to accommodate with minimal effluent limit violations.**

**4. Flow returns to below 45 MGD: you must stop Blending!**

**Main Plant:**

- Start sample at upper end. Record the time.
- Close gate at Chamber C. Record the time.
- Stop sampler at lower end. Record the time.
- Set Chlorine back to normal. Record Time.
- Take Settled Sewage off of High Flow Mode.
- Take Final Influent Gates off of High Flow Mode.
- Inform AWTF Laboratory of action Record Time.
- Inform DEP when you stopped Blending, and again when Plant Influent Flow has dropped below 37 MGD to inform them that we are now accepting Contract Waste Haulers. Record Time.
- Log information on blending checklist and in logbook.
- Inform Pretreatment Coordinator that we are accepting hauler again.

**Note: At NO time allow final Clarifier Blankets to discharge into effluent. Immediately contact the Shift Supervisor or Operation Supervisor with all data available (i.e. flow, number of tanks, current rain status, etc.) for further instructions.**

**\*NOTE: DEP requires notification on Blending. After blending has begun,(45MGD to 49MGD) Call 705-4785 anytime. Either speak to the person on the phone or leave the following message!**

**(“Identify yourself” from Capital Region Water A.W.T.F. Calling to inform you that we have begun blending at “state time and date”) Also after you stop blending call DEP stop time and date. Additionally, please call DEP again once our flow has dropped below 37MGD to inform them that we are now accepting Contract Waste Haulers.**



## Section 4

# Conveyance and Collection System O&M Program Activities

Section 4 of the Operations and Maintenance Manual (OMM) documents Capital Region Water's (CRW) existing operation and maintenance (O&M) practices relating to the conveyance and collection systems. Each sub-section pertains to an O&M category, which includes motivation for proper O&M procedures, relevant background information, detailed inspection and maintenance activities, and proper documentation and record keeping procedures.

### 4.1 O&M Activities for CSO Regulator Structures

The combined sewer overflow (CSO) regulator structures are considered to be critical to the performance of CRW's combined sewer system. When functioning properly, the regulator structures ensure that all the wastewater flow is diverted to the interceptor sewers and the treatment plant during dry weather, and they control the frequency, duration and volume of overflow discharges to the Susquehanna River and Paxton Creek during wet weather. During dry weather conditions, there should be no overflows, and if a dry weather overflow is detected, the cause needs to be promptly determined, and a correction promptly implemented. Water from the river and creek should not enter the interceptor system, and if this is detected, corrective measures need to be implemented. The proper operation and maintenance (O&M) of these structures is critical to protecting water quality in the river and creek and maintaining the proper operation of the treatment plant. Therefore, these structures are inspected daily, observed conditions are carefully documented, any observed problems are promptly addressed, and both preventative and corrective maintenance activities are scheduled and conducted.

#### 4.1.1 Introduction and Overview for CSO Regulator Structures

CRW operates and maintains 59 CSO regulator structures located along the Front Street, Paxton Creek, and Hemlock Street interceptor sewers, which ultimately direct combined wastewater (sanitary wastewater and stormwater) to the Advanced Wastewater Treatment Facility (AWTF). A map of the structure locations is provided in **Figure 4.1-1**. During dry weather conditions, the CSO regulator structures divert all of the combined wastewater from the trunk sewer lines to the interceptor sewers. During wet weather, the rate and volume of the sanitary and stormwater flow from the system of collector sewers increases significantly and can exceed the capacity of the downstream interceptor sewers and the treatment facility. When this occurs, the CSO regulator structures (sometimes called diversion structures) divert a controlled volume of flow to the interceptor, while untreated excess combined wastewater is discharged to receiving waters. The receiving waters are the Susquehanna River for regulator structures along the Front Street interceptor, and Paxton Creek (a tributary of the Susquehanna) for regulators along the Paxton Creek and Hemlock Street interceptors.

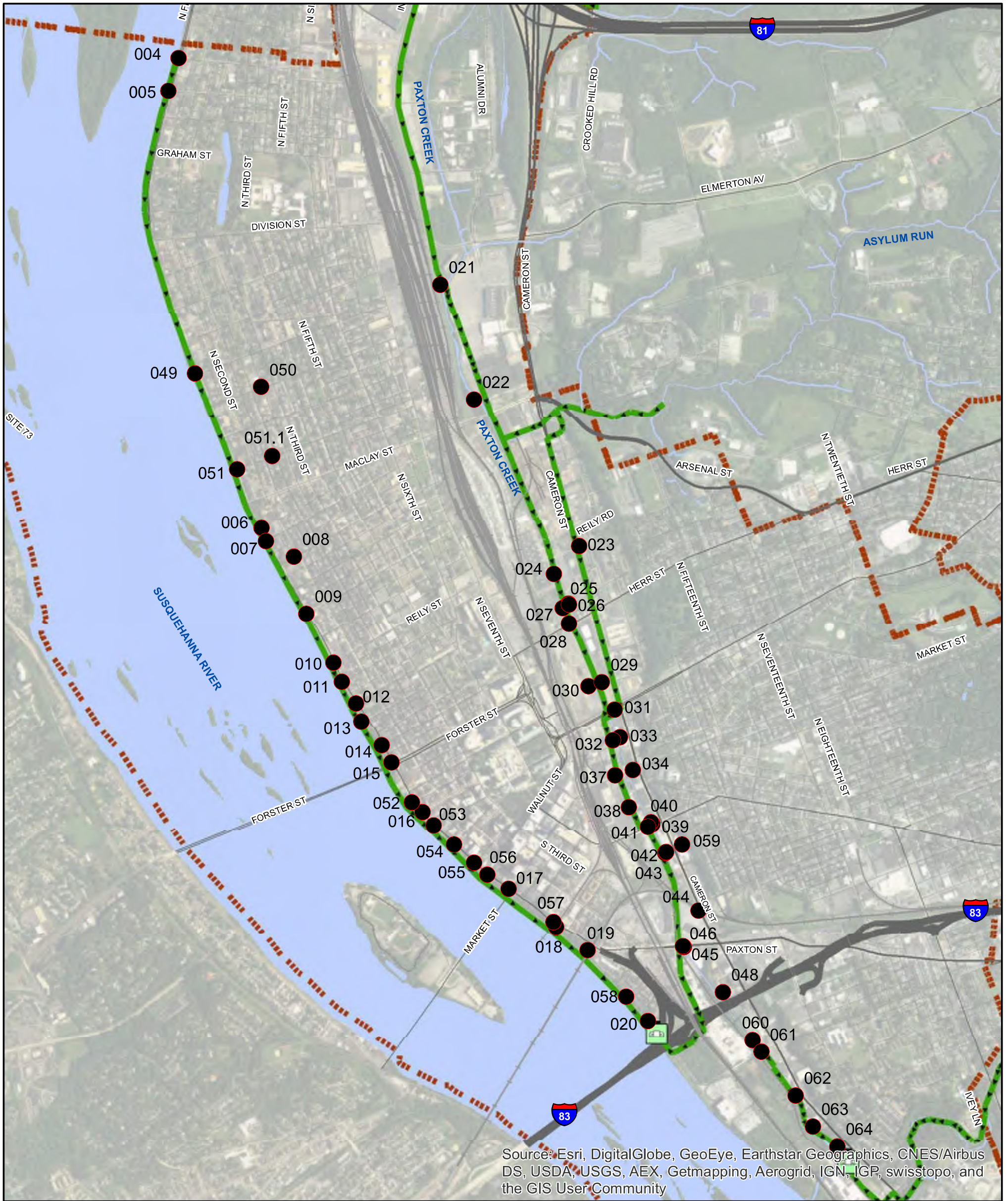

3/8/2017	PM: JAA	GIS: JWE
----------	---------	----------

Mapping derived from data provided by Dauphin County, Capital Region Water, and the City of Harrisburg.

CSO	AWTF
Pump Station	Municipal Boundary
Interceptor	

**Figure 4.1-1**  
**CSO Regulator Structures Locations**  
 Capital Region Water  
 Dauphin County, Pennsylvania

A list of the CSO regulator structures in the CRW system, along with other information on the structures, is provided in **Table 4.1-1**. Each regulator structure has its own unique CSO outfall except for regulator structures 051 and 051.1. The Woodbine Street trunk sewer has two regulator structures along it (the primary regulator at Penn Street and the secondary and lower regulator at Front Street), but the diverted flow from both of the regulator structures enters the interceptor at the same point of connection and the overflows discharge through a common outfall pipe. In addition to the 59 CSO regulator structures and outfalls, there are two additional CSO outfalls at the Front Street pumping station and the Spring Creek pumping station. These are permitted emergency outfalls (CSO-002 and CSO-003) that only activate during a mechanical failure of the pump stations or if the station capacities are exceeded during large storms. There are no regulator structures associated with these outfalls, but they are included in the table list because the outfalls are inspected daily along with the regulators to identify and quantify any dry or wet weather CSO discharges.

A complete inventory of each regulator structure, its dimensions, and photos of its current condition is provided in the document titled ***Regulator Infrastructure Inspection Report*** and dated October 2013.

**Table 4.1-1 CSO Regulator Structures in the CRW System**

CSO ID	LOCATION	REGULATOR CATEGORY	REGULATOR TYPE <sup>(1)</sup>	INTERCEPTOR	RECEIVING WATER
CSO-002	Front St. Pump Station	Emergency Overflow	Not Applicable	Front Street	Susquehanna River
CSO-003	Spring Creek Pump Station	Emergency Overflow	Not Applicable	Paxton Creek	Paxton Creek
CSO-004	Front & Vaughn	Brown and Brown	B	Front Street	Susquehanna River
CSO-005	Front & Lewis	Brown and Brown	A	Front Street	Susquehanna River
CSO-006	Front & Geiger	Brown and Brown	A	Front Street	Susquehanna River
CSO-007	Front & Pepper	Brown and Brown	A	Front Street	Susquehanna River
CSO-008	Front & Muench	Brown and Brown	A	Front Street	Susquehanna River
CSO-009	Front & Hamilton	Brown and Brown	A	Front Street	Susquehanna River
CSO-010	Front & Reilly	Brown and Brown	A	Front Street	Susquehanna River
CSO-011	Front & Calder	Brown and Brown	A	Front Street	Susquehanna River
CSO-012	Front & Verbeke	Brown and Brown	A	Front Street	Susquehanna River
CSO-013	Front & Cumberland	Brown and Brown	A	Front Street	Susquehanna River
CSO-014	Front & Boas	Fixed Orifice	C	Front Street	Susquehanna River
CSO-015	Front & Forster	Brown and Brown	A	Front Street	Susquehanna River
CSO-016	Front & Liberty	Brown and Brown	A	Front Street	Susquehanna River
CSO-017	Front & Market	Brown and Brown	A	Front Street	Susquehanna River
CSO-018	Front & Mulberry	Brown and Brown	A	Front Street	Susquehanna River
CSO-019	Front & Paxton	Brown and Brown	B	Front Street	Susquehanna River
CSO-020	Front & Hanna	Brown and Brown	B	Front Street	Susquehanna River
CSO-021	Cameron & Schuylkill	Brown and Brown	A	Paxton Creek	Paxton Creek
CSO-022	Cameron & Forrest	Brown and Brown	B	Paxton Creek	Paxton Creek
CSO-023	Cameron & Calder	Fixed Orifice	C	Paxton Creek	Paxton Creek
CSO-024	Hill Chamber (T.R.W.)	Fixed Orifice	C	Paxton Creek	Paxton Creek
CSO-025	N. Cameron & Cumberland	Brown and Brown	A	Paxton Creek	Paxton Creek
CSO-026	S. Cameron & Cumberland	Brown and Brown	B	Paxton Creek	Paxton Creek
CSO-027	Ninth & Cumberland	Brown and Brown	B	Paxton Creek	Paxton Creek
CSO-028	Ninth & Herr	Brown and Brown	A	Paxton Creek	Paxton Creek
CSO-029	E. Cameron & North	Brown and Brown	A	Paxton Creek	Paxton Creek
CSO-030	W. Cameron & North	Brown and Brown	A	Paxton Creek	Paxton Creek
CSO-031	Cameron & State	Brown and Brown	A	Paxton Creek	Paxton Creek
CSO-032	W. Cameron & Walnut	Brown and Brown	B	Paxton Creek	Paxton Creek
CSO-033	E. Cameron & Walnut	Brown and Brown	B	Paxton Creek	Paxton Creek
CSO-034	S. Market & Cameron	Brown and Brown	A	Paxton Creek	Paxton Creek

CSO ID	LOCATION	REGULATOR CATEGORY	REGULATOR TYPE <sup>(1)</sup>	INTERCEPTOR	RECEIVING WATER
CSO-037	Tenth & Market	Brown and Brown	A	Paxton Creek	Paxton Creek
CSO-038	Tenth & Chestnut	Brown and Brown	A	Paxton Creek	Paxton Creek
CSO-039	S. Mulberry & Cameron	Brown and Brown	A	Paxton Creek	Paxton Creek
CSO-040	N. Mulberry & Cameron	Brown and Brown	B	Paxton Creek	Paxton Creek
CSO-041	W. Mulberry & Cameron	Brown and Brown	B	Paxton Creek	Paxton Creek
CSO-042	S. Kittatinny & Cameron	Brown and Brown	A	Paxton Creek	Paxton Creek
CSO-043	N. Kittatinny & Cameron	Brown and Brown	A	Paxton Creek	Paxton Creek
CSO-044	Cameron & Berryhill	Fixed Orifice	D	Paxton Creek	Paxton Creek
CSO-045	Paxton Street (South)	Fixed Orifice	D	Paxton Creek	Paxton Creek
CSO-046	Paxton Street (North)	Fixed Orifice	D	Paxton Creek	Paxton Creek
CSO-048	Tenth & Shannon	Brown and Brown	A	Paxton Creek	Paxton Creek
CSO-049	Front & Schuylkill	Brown and Brown	A	Front Street	Susquehanna River
CSO-050	Seneca & Susquehanna	Brown and Brown	A	Front Street	Susquehanna River
CSO-051.1 <sup>(2)</sup>	Woodbine & Green	Brown and Brown	A	Front Street	Susquehanna River
CSO-051 <sup>(2)</sup>	Woodbine & Front	Fixed Orifice	C	Front Street	Susquehanna River
CSO-052	Front & State	Brown and Brown	A	Front Street	Susquehanna River
CSO-053	Front & South	Brown and Brown	A	Front Street	Susquehanna River
CSO-054	Front & Pine	Brown and Brown	A	Front Street	Susquehanna River
CSO-055	Front & Locust	Brown and Brown	A	Front Street	Susquehanna River
CSO-056	Front & Walnut	Brown and Brown	A	Front Street	Susquehanna River
CSO-057	Cherry & Mulberry	Brown and Brown	A	Front Street	Susquehanna River
CSO-058	Front & Tuscarora	Brown and Brown	B	Front Street	Susquehanna River
CSO-059	Kittatinny & Crescent	Fixed Orifice	C	Paxton Creek	Paxton Creek
CSO-060	Salmon Street	Fixed Orifice	C	Hemlock Street	Paxton Creek
CSO-061	Tenth & Sycamore	Fixed Orifice	C	Hemlock Street	Paxton Creek
CSO-062	Shanois Street	Fixed Orifice	C	Hemlock Street	Paxton Creek
CSO-063	Cameron & Hanover	Fixed Orifice	C	Hemlock Street	Paxton Creek
CSO-064	Cameron & Magnolia	Fixed Orifice	C	Hemlock Street	Paxton Creek

<sup>(1)</sup> Note: These designated structure types are described in more detail in Section 4.1.2

Type A: variable control orifices with chain drives.

Type B: variable control orifices with rod drives.

Type C: fixed control orifices with diversion weirs.

Type D: fixed control orifices with elevated outfall pipes.

<sup>(2)</sup> Note: These regulator structures are located along the same trunk sewer and share a common CSO outfall

### 4.1.2 CSO Regulator Structure Configurations

Figures 4.1-2, 4.1-3, and 4.1-4 provide diagrams and images that depict the typical configurations of the CSO regulator structures. There are two main categories of CSO regulator structures in the CRW system: regulators with variable control orifices and those with fixed orifice openings. Most of the CSO regulator structures in the CRW system have variable control orifices where the sizes of the control openings from the diversion chamber to the regulator chamber can increase and decrease under differing flow conditions, and are determined by the mechanical Brown and Brown type regulators. Thirteen of the CSO regulator structures have fixed control orifices and the size of the opening does not change under dry and wet weather conditions. Within these categories there are four designated regulator types:

- **Type A – Variable Control Orifices with Chain Drives:** Type A Structures have a variable control orifice where the Brown and Brown regulator mechanism is driven by a chain. For both Type A and Type B structures, the CSO regulator structure generally consist of a diversion chamber, regulating chamber, float chamber, and flood chamber (some structures do not have a flood chamber). Combined wastewater enters the diversion chamber and under dry weather conditions, all of the flow is diverted away from the trunk sewer and towards the interceptor sewer by a concrete diversion weir (sometimes referred to as a diversion dam). Diverted flow enters the regulating chamber through the variable control orifice or opening. The Type A Brown and Brown regulators have a chain drive connection between the regulating and float chambers which allows the wastewater level in the float chamber to raise the float which reduces the orifice opening. During dry weather conditions, the orifice openings are at their maximum size. Adjustable set points determine the minimum orifice opening during wet weather conditions. Under wet weather conditions, when the influent flow from the trunk line is high enough to trigger the float mechanism to reduce the size of the control orifice, the wastewater level in the structure continues to rise until it reaches the crest of the diversion weir and a portion of the flow is able to pass over the weir discharging to the receiving water.
- **Type B – Variable Control Orifices with Rod Drives:** Type B structures also generally consist of a diversion chamber, regulating chamber, float chamber, and flood chamber. Similar to Type A structures, they also contain a diversion weir and a Brown and Brown orifice with variable set points. The main difference is that the Type B Brown and Brown regulators have a solid rod connection between the regulating and float chambers instead of a chain drive.
- **Type C – Fixed Control Orifices with Diversion Weirs:** Thirteen of the CSO regulator structures have fixed control orifices and the size of the opening does not change under dry and wet weather conditions. The fixed orifice structures are similar to the variable orifice structures except that the size of control orifice openings are fixed and do not change. There is no float chamber in the structure and there is no Brown and Brown mechanical regulator equipment.

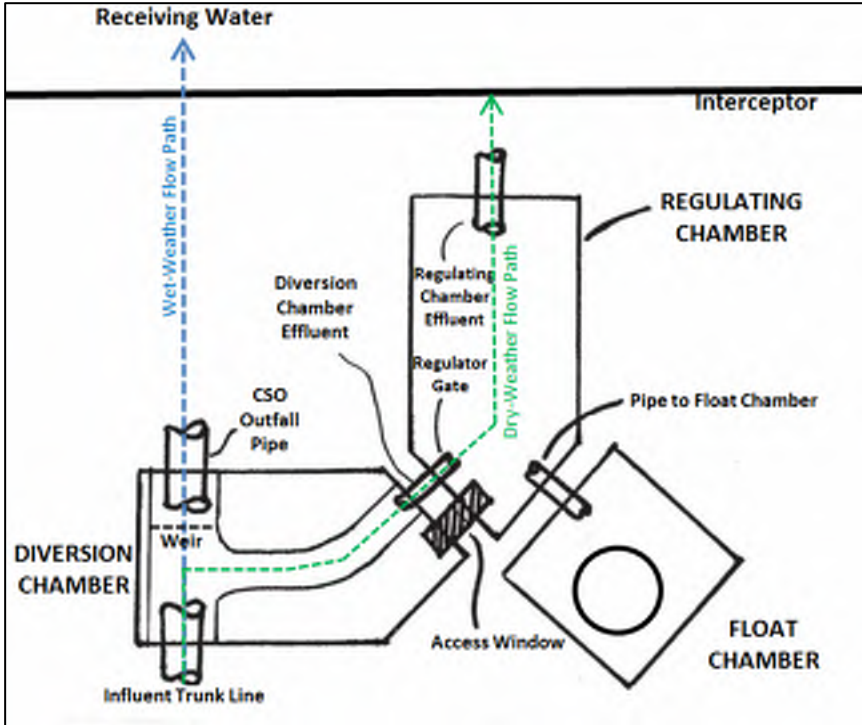

Figure 4.1-2 Standard Brown and Brown Regulator Configuration (Type A and Type B)

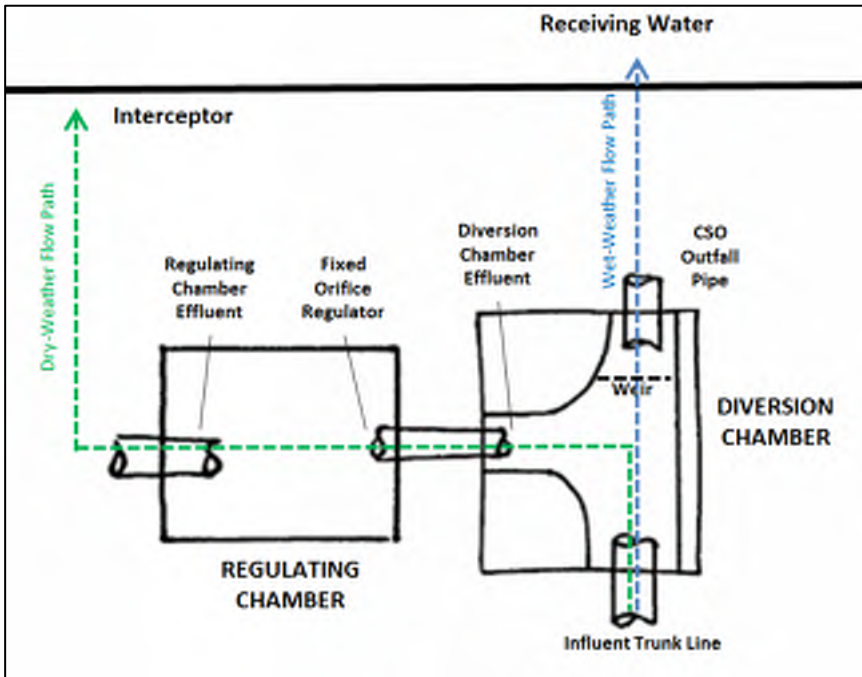

Figure 4.1-3 Standard Fixed Orifice Regulator Configuration (Type C)

CSO Chamber Configuration



CSO Chamber Influent



Diversion Weir / CSO Outfall Pipe



Diversion Chamber Effluent



Regulator Gate (Brown and Brown)



Fixed Orifice



Figure 4.1-4 Photographs of Typical CRW Regulator Structures



**Regulating Chamber Effluent**



**Regulating / Float Chamber Connection**



**Float Chamber (Brown and Brown)**



**Float Assembly (Regulator Gate / Float Connection)**



**Figure 4.1-4 (continued) Photographs of Typical CRW Regulator Structures**

- **Type D – Fixed Control Orifices with Elevated Outfall Pipes:** There are three regulator structures (CSO 044, 045 and 046) that do not have diversion weirs. The CSO outfall pipe is elevated and influent wastewater flow is automatically diverted to the interceptor until the depth exceeds the invert of the elevated CSO outfall pipe.

### 4.1.3 Inspection Preparedness

In **Appendix C, Table C-1** identifies available equipment for field maintenance crews and the *Inspection Preparedness Activity Checklist* lists activities to complete before embarking for the daily inspections. This checklist encompasses preparations for both the inspections of CSO regulator structures and outfalls and backflow prevention gates.

### 4.1.4 Standard Daily CSO Regulator Inspection Activities

#### Introduction and Overview

Inspections of the CSO regulator structures are completed daily by CRW staff to check and verify they are operating properly, identify if a combined sewer overflow occurred since the last inspection, identify if river intrusion has entered into the interceptor system since the last inspection, identify and correct operational problems, and identify and schedule required maintenance. The inspection crew consists of two field maintenance personnel. Inspections are generally conducted from the surface and entry into the structures is not required unless correctable problems are identified. A pole mounted sewer inspection camera is available and could be utilized if better visibility is required to conduct the inspection.

Most of the regulator structures are safely outside of roadway traffic lanes, but care must be taken to protect crew members from oncoming traffic during the daily inspection activities. Be sure to set up traffic cones when necessary, use your vehicle as a physical barrier and turn on the flashing lights. Coordinate with your manager if you have any questions or safety concerns. Routine inspection activities for CSO regulator structures are listed in the following *Standard Daily CSO Regulator Activity Checklist*.

To identify combined sewer overflows which may have occurred between the daily inspections, CRW utilizes overflow detection devices (ODDs). The ODDs consist of a small wooden block positioned on the weir and tethered to the chamber wall. Movement of the ODD is indicative of a possible combined sewer overflow. For CSO regulator structures in which the weir is not easily visible from the manhole, the ODDs are positioned on a platform in the diversion chamber which is mounted to the same height as the weir crest.

If situations having the potential to result in a dry weather overflow are observed (e.g. deteriorating regulator components; sediment/grease buildup prior to scheduled cleanings, etc.) but no CSO discharges are occurring, a determination must be made if immediate maintenance measures are required, or if the situation is not urgent and maintenance measures can be scheduled in the future.

Combined sewer outfalls and backflow prevention gates are also inspected as part of the daily CSO regulator structure inspection activities. For details on outfalls and backflow prevention gates O&M activities, refer to Section 4.2 (*O&M Activities for Outfalls and Backflow Prevention Gates*).

### **Inspection Schedule**

CSO regulator structures are inspected once per day, seven days per week. Daily inspections typically begin around 07:00 AM and are typically completed within four hours. Additional inspection time may be required during high flows within the sewers or receiving waters, inclement weather, or if there are problems identified during inspections.

On rare occasion, an executive decision may be made by the Field Operations Supervisor to forego individual CSO regulator structure inspections due to an emergency resulting in staff limitations (e.g. dry weather overflow at another CSO regulator structure) or during severe flooding when overflows can be reasonably assumed.

## Standard Daily CSO Regulator Inspection Activity Checklist

Complete the following items during a standard daily CSO regulator inspection (i.e. when there are no ongoing or recent CSOs or required maintenance activities):

**NOTE: WHENEVER AN ENTRY IS REQUIRED, BE SURE TO FOLLOW ALL CONFINED SPACE ENTRY GUIDELINES.**

- ❑ Protect crew members from oncoming traffic by using the vehicle as a physical barrier and turning on the flashing lights, as well as setting up traffic cones if extended work is necessary. Open the diversion chamber and visually inspect the chamber for any noticeable problems. Use a pole mounted inspection camera if better visibility is needed. If abnormal conditions are observed in the diversion chamber, then open the manholes on the regulator chamber and the float chamber to visually inspect each chamber for any noticeable problems.
- ❑ Confirm influent (incoming) flow from the trunk sewer line appears “normal”.
  - *NOTE: Lack of flow may be indicative of an upstream blockage.*
  - *NOTE: Excessive flow may indicate a water main break or hydrant flushing somewhere up in the collection system.*
- ❑ Verify the wastewater flow depths, velocities and patterns through the structure appear to be “normal” for that structure (during dry weather).
  - IF not, check for debris/sediment accumulation in each of the chambers via (1) confined space entry, (2) checking the gate with a curved bar to remove a blockage, or (3) checking the outfall of the regulator chamber for debris, silting, or potential blockages that may prevent proper operation of the diversion chambers.
    - IF the potential exists for observed accumulations to prevent proper operation and flow through the structure, the situation becomes a self-implementing work order to clean the chambers.
    - IF there are no CSO discharges, but it is determined that other maintenance measures are required to prevent a possible dry weather overflow, the situation becomes a self-implementing work order to perform the required activities.
    - IF sediment depths are significant, but do not impede proper operation, or risk potential dry weather overflows in the immediate future, document the observed conditions on the **Interceptor Service Report (in Cityworks)**. Return to the structure later in the day (after all the inspections are completed), or return the following day, to remove the observed sediments.

- If there is active flow over the diversion weir, go to Section 4.1.5 and follow the **Active Combined Sewer Overflow Activity Checklist** for the remainder of the inspection.
  - Confirm the connector pipe between the regulator structure and the interceptor sewer (the regulator effluent) is free of debris and appears to be operating “normally”.
  - Confirm the regulator gates appear to be operational (Brown and Brown regulators only).
  - Confirm the float appears operational (Brown and Brown regulators only).
  - Confirm the fixed orifice opening, between the diversion chamber and the regulator chamber, is not partially obstructed or clogged by debris (fixed regulators only).
    - IF debris is observed in the control orifice, and the wastewater depth in the diversion chamber appears to be higher than normal, the debris should be removed.
- Document any movements of the overflow detection devices (ODDs) on the **Interceptor Service Report (in Cityworks)**.
- IF movement is observed, determine whether this was due to overflow at the weir (as opposed to an animal), noting which side of the weir the ODD is on, whether the weir appears wet, or any other indication that the movement was caused by an overflow.
  - IF an active overflow is observed during the inspection, go to Section 4.1.5 for further instructions.
  - IF the movement is determined to be the result of a previous CSO, go to Section 4.1.6 for further instructions.
- Document any instances of backflow from the receiving water body into the CSO regulator structures, or instances of backflow from the interceptor into the CSO regulator structures on the **Interceptor Service Report (in Cityworks)**.
- *NOTE: River water may enter or even fill the overflow pipe, but the water surface should be below the crest of the weir, so that the diversion weir prevents river water from entering the interceptor sewers.*
- Document any observed items that require preventive maintenance on the **Interceptor Service Report (in Cityworks)**.

- Document any routine maintenance activities performed on the ***Interceptor Service Report (in Cityworks)***.
- Document the time of inspection on the ***Interceptor Service Report (in Cityworks)*** along with any additional comments.
- If necessary, reset the overflow detection device (ODD) to the appropriate location.

## 4.1.5 Active CSO Discharge Inspection Activities

### Introduction and Overview

Daily inspection activities at CSO regulator structures are intended to promptly detect when CSO discharges into the Susquehanna River and Paxton Creek are occurring. CSO discharges should only occur as a result of wet weather (rainfall or snowmelt) when the rate and volume of wastewater flow from the upstream collection system exceeds the capacity of the downstream interceptor pipes and the capacity of the treatment plant. If overflow activity persists immediately after a storm, the inspection activities should be able to discern if corrective maintenance could stop the overflow discharge. Dry weather overflows must be promptly corrected and must be promptly reported to the Pennsylvania Department of Environmental Protection (PADEP). The occurrence of wet weather overflows and any necessary maintenance following the CSO is recorded and reported to PADEP in CRW's monthly DMR. Starting in 2016, CRW's H&H model is used to simulate measured rainfall, estimate wet weather CSO volumes and start/stop times, and report findings in CRW's semi-annual Consent Decree status report.

**Note:** If a combined sewer overflow (CSO) is found to be in progress during an inspection, and it is determined that the overflow could be stopped with corrective maintenance, the corrective maintenance activities must be performed as soon as possible. Either a second crew must be dispatched to perform the required maintenance, or the inspection crew must remain at the site, enter the structure, and perform the corrective maintenance activities before moving on to the next inspection. Follow all safety procedures for confined space entries. Dry weather overflows may require back-up support to perform the required investigative work and corrective maintenance. Likewise, any required critical or emergency maintenance identified during an inspection must be immediately addressed.

If a combined sewer overflow (CSO) is identified during a CSO regulator structure inspection the required activities to be performed are provided in the following *Active Combined Sewer Overflow Activity Checklist*.

## Active Combined Sewer Overflow Activity Checklist

### (Wet weather and Dry weather)

Complete the following when there is an ongoing CSO during a visit:

**NOTE: WHENEVER AN ENTRY IS REQUIRED, BE SURE TO FOLLOW ALL CONFINED SPACE ENTRY GUIDELINES.**

- Protect crew members from oncoming traffic by using the vehicle as a physical barrier and turning on the flashing lights, as well as setting up traffic cones if extended work is necessary.
- Confirm there is an active CSO by visually witnessing flow passing over the weir in the diversion chamber.
  - *NOTE: It is possible to observe flow at the outfall without there being an active CSO (e.g. infiltration or stormwater inflow entering the outfall pipe downstream of the weir).*
- Record the start time of the CSO. Since almost all observed CSOs are already in progress upon arrival, the start time is considered to be the arrival time. Estimate and record the depth of flow over the weir in the diversion chamber on the **Interceptor Service Report (in Cityworks)**.
- Determine whether the CSO is a “wet weather” or “correctable” or “dry weather” CSO and follow the subsequent checklist items for the appropriate CSO type. Then proceed with one of the following three approaches outlined below.
  - *NOTE: Wet weather CSOs include overflows due to rain or snow melt (i.e. natural weather activity unrelated to system malfunctions) and stop on their own.*
  - *NOTE: Correctable CSOs are also due to rain or snow melt, but the discharge stops only after corrective maintenance measures are provided.*
  - *NOTE: Dry weather CSOs are related to system malfunctions (e.g. blockages or if Brown and Brown control gates get stuck in the closed position), or excessive non-sewer flow (i.e. hydrant flushing and water main breaks). These overflows are illegal and are considered serious because the combined flow contains a higher concentration of sanitary wastewater.*
- NOTE: If CSO discharges are observed at either of the two pump station emergency overflow outfalls, notify the operators at the AWTF IMMEDIATELY and perform any investigation work they may ask you to conduct.**



**Wet Weather Combined Sewer Overflow (Option 1 of 3)**

- Record observations (time and estimated depth over weir) and move on to the next CSO regulator structure. Maintenance generally cannot be safely performed during active CSO conditions and are conducted after the wet weather flow recedes and conditions become safe.

NOTE: Wet weather CSO frequencies, durations and volumes will be calculated using a model, but field estimates are important to assist with model calibration.

**Correctable Combined Sewer Overflow (Option 2 of 3)**

- Determine if the continuing wet weather CSO activity would stop if corrective maintenance activities were provided.
  - IF the flow is too great, and the CSO discharges cannot be stopped until the flows recede, it is a continuing wet weather overflow.
  - IF the flows have receded, but the CSO discharges continue and the discharges can be stopped with corrective maintenance (i.e. unclogging an orifice opening or corrective maintenance on the Brown and Brown regulators to make them operational) it is a correctable wet weather overflow.
- Confirm the connector pipe between the regulator structure and the interceptor sewer (the regulator effluent) is free of debris and appears to be operating “normally”.
- Confirm the regulator gates appear to be operational (Brown and Brown regulators only).
- Confirm the float appears operational (Brown and Brown regulators only).
- Confirm the fixed orifice opening, between the diversion chamber and the regulator chamber, is not partially obstructed or clogged by debris (fixed regulators only).
- For correctable CSOs, remove any debris obstructing the orifice opening for a connecting pipe between regulator chambers or the connector pipe to the interceptor, and operate the float mechanism to move the Brown and Brown to its maximum (dry weather) opening.
- Record observations (start time, end time, and estimated depth over weir) and move on to the next CSO regulator structure.

**Dry weather Combined Sewer Overflow (Option 3 of 3)**

- Identify the cause of any dry weather CSO overflow immediately.
  - *NOTE: Dry weather overflows become a self-implementing work order and must be addressed before moving on from the site.*
- Address the cause of the dry weather overflow (e.g. clearing blockages, opening Brown and Brown control gates) and remain at the site until the overflow stops.
- Record the stop time of the dry weather CSO.

- Calculate the total volume discharged using the appropriate weir discharge chart found in **Appendix A.**
- Reset the overflow detection device (ODD) to the appropriate location.
- Contact PADEP immediately following a dry weather overflow, including on weekends and holidays.
  - PADEP Phone: 717-705-4785

Report the following information:

- Your name, and identify yourself as a Capital Region Water employee.
- State that a dry weather overflow has occurred.
- Provide the CSO regulator structure ID.
- Provide the corrective actions taken.
- Provide the estimated duration and stop time of the CSO.

## 4.1.6 Post-Storm CSO Inspection Activities

### Introduction and Overview

After storm events are over, and the collection system has returned to normal dry weather flow conditions, the flow conditions within the CSO regulator should have also returned to “normal.” If not, there could be problems with accumulated debris, partially obstructed or blocked orifice openings between the chambers, or problems with the Brown and Brown mechanical system that caused the control gate to get stuck in the smaller opening or wet weather set point position. If overflow activity persists immediately after a storm, the inspection activities should be able to discern if flows have receded enough that corrective maintenance could stop the overflow discharge. Additional inspection activities should be performed following a storm during the next daily inspection.

If it is decided that the overflow is a continuing result of high wastewater flows caused by wet weather conditions, and maintenance measures would or could not stop the discharge activity, it is a wet weather overflow. If the flow has receded, and the continuing overflow can be stopped by removing obstructing debris from an orifice opening or opening the size of the Brown and Brown control orifice, it is a correctable overflow. Document the observed conditions and the decision that it is a wet weather overflow, and move on to the next structure.

### Combined Sewer Overflow (Post-Storm) Activity Checklist

*Complete the following items on the visit following a storm event:*

**NOTE: WHENEVER AN ENTRY IS REQUIRED, BE SURE TO FOLLOW ALL CONFINED SPACE ENTRY GUIDELINES.**

- Check and confirm that debris has not clogged or partially obstructed any of the control openings for connector pipes.
  - IF clogging debris is seen in any of the connecting pipes between the regulator chambers, for the connection to the interceptor, or the v-notch weir before the connection to the interceptor, remove the debris.
- Confirm the Brown and Brown regulator mechanisms have returned the control orifice openings to their fully open set point.
  - IF the float is stuck and the control orifice is in the smaller wet weather set point, corrective maintenance should be conducted.
- Confirm that flow quantities, flow depths and velocities have receded to their normal dry weather conditions.
- Reset any overflow detection devices (ODDs) that were moved during wet weather overflows.
- Remove any debris which has collected in the structures from the storm.

## 4.1.7 Preventive Maintenance Activities

### Introduction and Overview

There are two categories of maintenance activities that are performed by CRW staff on the CSO regulator structures: corrective maintenance activities and preventive maintenance activities. Corrective maintenance measures are implemented to correct a problem that was identified during the daily inspections. Depending on the nature of the observed problem or condition, corrective maintenance may be implemented immediately before leaving the structure, or may be reported, logged, prioritized, and placed on a maintenance schedule for future implementation. CRW staff performs preventive maintenance on CSO regulator structures on a scheduled basis to ensure proper operation during dry and wet weather conditions, to limit the likelihood of dry weather overflows to the receiving waters, and to limit the frequency, duration and volume of CSO discharges during wet weather.

### Preventive Maintenance Schedule

Preventive maintenance is performed on CSO regulator structures at least twice per year. Additionally, some routine maintenance activities are completed more frequently and completed during the daily inspections (i.e. those activities not requiring confined space entry). Maintenance activities are also scheduled based on items identified during daily inspections. Currently, all maintenance activities are documented, and transferred electronically to Cityworks for scheduling required maintenance work and tracking completed maintenance actions. Cityworks also generates the required preventive maintenance work orders.

### Regulator Structure Configuration Type

Maintenance activities for CSO regulator structures vary somewhat according to the CRW-designated CSO “type”. CRW organizes CSO regulator structures, according to the appurtenances of each structure, into types A, B, C, and D. The designated structure types are described in Section 4.1.2 *CSO Regulator Structure Configurations* and listed in Table 4-1 for each CSO regulator structure.

## Semi-Annual Preventive Maintenance Activity Checklist

Complete the following items during the semi-annual preventive maintenance inspection for each CSO regulator structure, noting that each item does not apply to every CSO regulator:

**NOTE: WHENEVER AN ENTRY IS REQUIRED, BE SURE TO FOLLOW ALL CONFINED SPACE ENTRY GUIDELINES.**

Perform the following maintenance activities and document the inspection/maintenance on the **CSO Semi-Annual Inspection and Preventative Maintenance Schedule Form in Cityworks**.

### Diversion Chamber

- Clean the steps, weir, and chamber.
- Remove any significant grease, sediment or debris accumulations.
- Check the CSO effluent opening to the regulator chamber and removing any debris or partial obstructions.

### Regulator Chamber

- Clean/grease the gate assembly and transmission shaft.
- Clean the steps, gate wheel and chain (type A), gate rod (type B), weights, outfall box, and chamber.
- Remove any significant grease, sediment or debris accumulations.
- Check the variable Brown and Brown regulator influent opening (types A and B) and the fixed orifice opening (types C and D) from the diversion chamber and remove any debris or partial obstructions.

### Float Chamber

- Clean/grease the float assembly.
- Clean the steps, float wheel and chain (type A), float rods (type B), and chamber.
- Remove any significant grease, sediment or debris accumulations.
- Check the connecting pipe between the regulator chamber and float chamber and remove any debris or partial obstructions.

### Flood Chamber

- Clean/grease the flood gate (types A and B) or tide gate (types C and D).
- Check the condition of the watertight seals.
- Remove any significant grease, sediment or debris accumulations within the flood chamber or outside the outfall pipe (for Paxton Creek outfalls).
- Clean the steps and chamber.

#### 4.1.8 O&M Documentation for CSO Regulator Structures

The CRW NPDES Permit and the National CSO Policy *Nine Minimum Controls* require that complete and consistent record keeping, and procedures for report development and archiving, are properly developed and implemented. A series of field reports and managerial summary reports have been developed, implemented and archived by CRW personnel to document observed conditions and completed maintenance activities within CSO regulator structures.

The findings from each CSO regulator structure inspection are recorded on the appropriate ***Interceptor Service Report*** that is generated from Cityworks. Recorded information includes confirmation that the inspection was completed; start/stop times, duration, and volume of CSOs; ODD codes; backflow codes, and the crew members who performed the inspections. Any required maintenance identified during inspections is noted in the comments section. The interceptor service reports are included in **Appendix A**.

The findings are transferred electronically into Cityworks, which automatically generates preventive maintenance reports. An example preventive maintenance report is included in **Appendix A**.

Likewise, all maintenance activities are documented, and transferred electronically to Cityworks. Preventive maintenance schedule forms (for each CSO type) are included in **Appendix A**.

## 4.2 O&M Activities for CSO Outfalls and Backflow Prevention Gates

Both the combined sewer overflow (CSO) outfalls and the backflow prevention gates are considered to be critical to the performance of CRW's conveyance and collection system. During wet weather periods, the quantity of combined wastewater and stormwater conveyed by the collection sewers can exceed the capacity of the interceptor sewers and the advanced wastewater treatment facility (AWTF). When this occurs, the excess combined wastewater from the CSO regulator structures is conveyed through the overflow pipe, to the outfall, and into the receiving waters. These outfalls may be exposed or submerged under normal river/creek level conditions. During flood conditions, normally exposed outfalls may become submerged. Submerged outfalls are not a concern as long as the river or creek water is confined to the overflow pipe and does not top the CSO diversion weir, enter the Regulating Chamber, and pour into the interceptor system.

Backflow prevention gates, often called flap gates, are designed to prevent backflow or river intrusion from the receiving waters from entering the CSO regulator structures and entering the interceptor pipes. During normal flow conditions along Paxton Creek, the majority of the CSO outfalls are exposed and creek water is prevented from entering the regulator structures. CSO outfalls along the Susquehanna River are submerged and the lower reaches of the outfall pipes are full of river water. However because of the slope of the outfalls pipes, the river water cannot reach the CSO regulator structure and exceed the crest of the CSO diversion weir, and therefore cannot intrude into the interceptor sewers.

However, during flood stage conditions along Paxton Creek and the Susquehanna River the water surface elevations could potentially rise high enough to top the crests of the CSO diversion weirs, allowing river or creek water to enter the Regulating Chambers, and enter the interceptor system through the normal dry weather flow path. During these flood stages, the flap gates in the flood chambers are intended to prevent river and creek water from flowing into the interceptor system. River intrusion may take up valuable conveyance capacity, increasing the frequency, duration and volume of CSO discharges. During flood conditions, the river stage may exceed the crest elevation of the diversion weir, and only the flap gates would prevent river backflow. Ideally, the flap gates would prevent all water from entering the regulator structure, however it is not uncommon to observe backwater in the outfall pipe on the downstream side of the control weir in the diversion chamber. This is acceptable as long as the backwater level does not become high enough to flow over the weir and into the diversion chamber where it would be directed to the interceptor. This condition is referred to as river intrusion and can place an unnecessary burden on the interceptors, pumping stations, and wastewater treatment plant. The proper operation and maintenance (O&M) of outfall flap gates prevents or reduces river intrusion during flood stage conditions. The O&M activities for outfalls and backflow prevention gates are closely related to the O&M activities for CSO regulator structures, but are discussed separately to highlight the importance of outfalls and flap gates.

### 4.2.1 Introduction and Overview for Outfalls and Backflow Prevention Gates

Capital Region Water (CRW) maintains 58 permitted CSO outfalls which discharge combined wastewater to the Susquehanna River or Paxton Creek (tributary of Susquehanna River). In addition, two emergency outfalls are located at the Front Street Pumping Station and Spring Creek

Pumping Station. Of these 60 CSO outfalls, 28 outfalls discharge to the Susquehanna River and 32 outfalls discharge to Paxton Creek. Most of the CSO outfalls along the Susquehanna River are submerged, while most of those along Paxton Creek are exposed under normal creek elevations. A summary table of CSO outfalls and associated backflow prevention gates in CRW's system is provided in **Table 4.2-1**.

The outfall identification number directly corresponds to the CSO identification number. For example, CSO-051 and CSO-051.1 both direct excess combined wastewater to the same outfall, which is outfall 051. In the future, any previously unknown upstream diversion points which are identified will be numbered in this manner. For example, if another diversion point were to be discovered upstream of outfall 051, it would receive an identification number of CSO-051.2.

CSO outfalls may receive separated stormwater which connects to the outfall pipe downstream of the diversion weir in the CSO regulator structures. In this case, the stormwater does not contribute to the interceptor flow, and the outfall is also considered to be a Municipal Separate Storm Sewer System (MS4) outfall. System configurations should be understood when observing discharge at these types of outfalls.

**Table 4.2-1 CSO Outfalls in the CRW System**

OUTFALL ID	LOCATION	FLAP GATE LOCATION	FLAP GATE ACCESS	OUTFALL ACCESSIBILITY	OUTFALL SIZE	OUTFALL MATERIAL	RECEIVING WATER
002	Front St. Pump Station	River	Diversion Chamber	Submerged	48	CI	Susquehanna River
003	Spring Creek Pump Station	Creek	Diversion Chamber, Creek	Partially Submerged	24	Conc.	Paxton Creek
004	Front & Vaughn	River	Diversion Chamber	Submerged	44 x 54	Conc.	Susquehanna River
005	Front & Lewis	River	Diversion Chamber	Submerged	48 x 60	Conc.	Susquehanna River
006	Front & Geiger	Flood Chamber	Flood Chamber	Submerged	18	CI	Susquehanna River
007	Front & Peffer	Flood Chamber	Flood Chamber	Submerged	24	CI	Susquehanna River
008	Front & Muench	Flood Chamber	Flood Chamber	Submerged	30	CI	Susquehanna River
009	Front & Hamilton	Flood Chamber	Flood Chamber	Submerged	30	CI	Susquehanna River
010	Front & Reilly	Flood Chamber	Flood Chamber	Submerged	36	CI	Susquehanna River
011	Front & Calder	Flood Chamber	Flood Chamber	Submerged	24	TCP	Susquehanna River
012	Front & Verbeke	Flood Chamber	Flood Chamber	Submerged	24	CI	Susquehanna River
013	Front & Cumberland	Flood Chamber	Flood Chamber	Submerged	18	TCP	Susquehanna River



OUTFALL ID	LOCATION	FLAP GATE LOCATION	FLAP GATE ACCESS	OUTFALL ACCESSIBILITY	OUTFALL SIZE	OUTFALL MATERIAL	RECEIVING WATER
014	Front & Boas	Flood Chamber	Flood Chamber	Submerged	24	Conc.	Susquehanna River
015	Front & Forster	Flood Chamber	Flood Chamber	Submerged	30	CI	Susquehanna River
016	Front & Liberty	Flood Chamber	Flood Chamber	Submerged	24	TCP	Susquehanna River
017	Front & Market	Flood Chamber	Flood Chamber	Submerged	30	CI	Susquehanna River
018	Front & Mulberry	Flood Chamber	Flood Chamber	Submerged	24	CI	Susquehanna River
019	Front & Paxton	Flood Chamber	Flood Chamber	Submerged	30	CI	Susquehanna River
020	Front & Hanna	Flood Chamber	Flood Chamber	Submerged	24	TCP	Susquehanna River
021	Cameron & Schuylkill	Flood Chamber	Flood Chamber	Partially Submerged	48	CMP	Paxton Creek
022	Cameron & Forrest	Flood Chamber	Flood Chamber	Partially Submerged	36	Conc.	Paxton Creek
023	Cameron & Calder	Flood Chamber	Flood Chamber	Accessible	12	TC	Paxton Creek
024	Hill Chamber (T.R.W.)	Flood Chamber	Flood Chamber	Accessible	31	Conc.	Paxton Creek
025	N. Cameron & Cumberland	Flood Chamber	Flood Chamber	Accessible	29 x 39	Conc.	Paxton Creek
026	S. Cameron & Cumberland	Flood Chamber	Flood Chamber	Accessible	29	CI	Paxton Creek
027	Ninth & Cumberland	Flood Chamber	Flood Chamber	Accessible	27 x 18	CMP	Paxton Creek
028	Ninth & Herr	Flood Chamber	Flood Chamber	Accessible	40 x 46	Conc.	Paxton Creek
029	E. Cameron & North	Creek	Creek	Accessible	18	Brick	Paxton Creek
030	W. Cameron & North	Creek	Creek	Accessible	48	Conc.	Paxton Creek
031	Cameron & State	Flood Chamber	Flood Chamber	Accessible	48 X 60	Conc.	Paxton Creek
032	W. Cameron & Walnut	Flood Chamber	Flood Chamber	Accessible	21	Conc.	Paxton Creek
033	E. Cameron & Walnut	Flood Chamber	Flood Chamber	Accessible	24	Conc.	Paxton Creek
034	S. Market & Cameron	Flood Chamber	Flood Chamber	Accessible	36	Brick	Paxton Creek

OUTFALL ID	LOCATION	FLAP GATE LOCATION	FLAP GATE ACCESS	OUTFALL ACCESSIBILITY	OUTFALL SIZE	OUTFALL MATERIAL	RECEIVING WATER
037	Tenth & Market	Flood Chamber	Flood Chamber	Accessible	48 x 56	Conc.	Paxton Creek
038	Tenth & Chestnut	Flood Chamber	Flood Chamber	Accessible	26	TC	Paxton Creek
039	S. Mulberry & Cameron	Flood Chamber	Flood Chamber	Accessible	25	CI	Paxton Creek
040	N. Mulberry & Cameron	Flood Chamber	Flood Chamber	Accessible	23	TC	Paxton Creek
041	W. Mulberry & Cameron	Flood Chamber	Flood Chamber	Accessible	24	Brick	Paxton Creek
042	S. Kittatinny & Cameron	Flood Chamber	Flood Chamber	Accessible	20	CI	Paxton Creek
043	N. Kittatinny & Cameron	Flood Chamber	Flood Chamber	Accessible	18	Conc.	Paxton Creek
044	Cameron & Berryhill	Creek	Creek	Accessible	33 x 30	Conc.	Paxton Creek
045	Paxton Street (South)	Diversion Chamber	Diversion Chamber	Accessible	33 x 30	Conc.	Paxton Creek
046	Paxton Street (North)	Diversion Chamber	Diversion Chamber	Accessible	18	CI	Paxton Creek
048	Tenth & Shannon	Creek (Dual Flap Gates)	Creek	Accessible	65 x 76	Conc.	Paxton Creek
049	Front & Schuylkill	River	Not Accessible	Submerged	54	RCP	Susquehanna River
050	Seneca & Susquehanna	Flood Chamber	Flood Chamber	Submerged	36	CMP	Susquehanna River
051	Woodbine & Front	Flood Chamber	CSO-051.1 Outfall Pipe / CSO-051 "Diversion	Submerged	47 x 66	Conc.	Susquehanna River
052	Front & State	No Flap Gate	No Flap Gate	Submerged	24	CI	Susquehanna River
053	Front & South	No Flap Gate	No Flap Gate	Submerged	24	CI	Susquehanna River
054	Front & Pine	No Flap Gate	No Flap Gate	Submerged	20	TCP	Susquehanna River
055	Front & Locust	No Flap Gate	No Flap Gate	Submerged	18	CI	Susquehanna River
056	Front & Walnut	No Flap Gate	No Flap Gate	Submerged	18	CI	Susquehanna River
057	Cherry & Mulberry	Flood Chamber	No Flap Gate	Submerged	12	TCP	Susquehanna River
058	Front & Tuscarora	No Flap Gate	No Flap Gate	Submerged	18	CI	Susquehanna River

OUTFALL ID	LOCATION	FLAP GATE LOCATION	FLAP GATE ACCESS	OUTFALL ACCESSIBILITY	OUTFALL SIZE	OUTFALL MATERIAL	RECEIVING WATER
059	Kittatinny & Crescent	No Flap Gate	No Flap Gate	Partially Submerged	52 x 78	Conc.	Paxton Creek
060	Salmon Street	Flood Chamber	Diversion Chamber, Flood Chamber	Accessible	12	CI	Paxton Creek
061	Tenth & Sycamore	Flood Chamber	Diversion Chamber, Flood Chamber	Accessible	43	Conc.	Paxton Creek
062	Shanois Street	Flood Chamber	Diversion Chamber, Flood Chamber	Accessible	14	PVC	Paxton Creek
063	Cameron & Hanover	Flood Chamber	Diversion Chamber, Flood Chamber	Accessible	23	Conc.	Paxton Creek
064	Cameron & Magnolia	Flood Chamber	Diversion Chamber, Flood Chamber	Accessible	24	CI	Paxton Creek

## 4.2.2 Outfall and Backflow Prevention Gate Configurations

Figures 4.2-1 and 4.2-2 provide diagrams and images that depict the typical configurations of CSO outfalls in relation to flood chambers and CSO diversion chambers. Most CSO regulators/outfalls have a backflow prevention gate, and the diversion weir invert is positioned high enough to prevent backflow into the CSO regulator structures under normal river/creek elevations. The backflow prevention gate (i.e. flap gate) may be located at the outfall point, within the flood chamber (if present), or within the diversion chamber. The flood chamber provides convenient maintenance access to the flap gate for both corrective maintenance and preventive maintenance activities. Flap gates located within flood chambers can be accessed by a removable grate, and some flap gates can also be accessed from the diversion chamber.

The flood chambers contain flood gates, which are always open during normal operations. These flood gates provide a very limited function in that they can protect the interceptor system from river intrusion during flood stage conditions, but only during dry weather conditions. Closing the flood gates would keep flood waters out of the interceptor system, but if a storm event were to occur, the closed gates would also prevent excess wet weather flow from discharging to the outfalls, potentially flooding out the upstream sewer collection sewers and causing basement flooding.

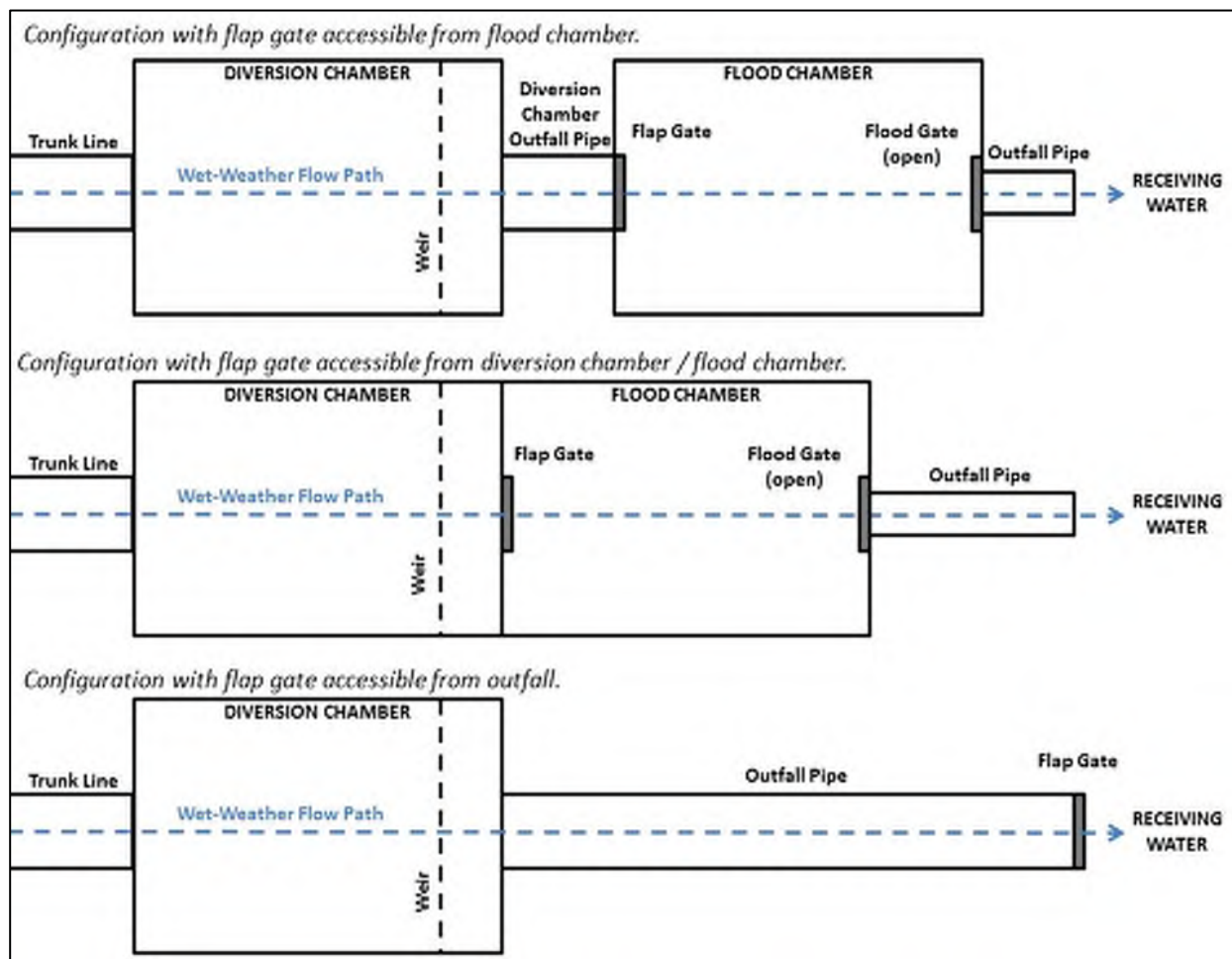

Figure 4.2-1 Representation of Typical CRW Flood Chamber and Outfall Configurations

**CSO Outfall  
(Flap Gate in Flood Chamber)**



**CSO Outfall  
(Flap Gate at Outfall)**



**Flap Gate  
(viewed from outfall)**



**Flap Gate  
(viewed from diversion chamber)**



**Figure 4.2-2 Photographs of Typical CRW CSO Outfalls and Flap Gates**

**Flood Chamber with Flap Gate shown**



**Flood Chamber with Flood Gate shown**



**Figure 4.2-2 (continued) Representation of typical flood chamber and outfall configurations**

In 2015 the outfalls and related backflow prevention devices were inspected. The condition assessment findings were summarized in the February 10, 2016 *CSO Outfall Repair Early Action Project Schedule* submittal. **Figures 4.2-3** and **4.2-4** depict the diversion weir elevations at each diversion chamber relative to multiple flood stages on the respective receiving water body, with the Susquehanna River or Paxton Creek. It is evident from the figures that certain outfalls may be more prone to river intrusion, which should be noted in the daily inspections.

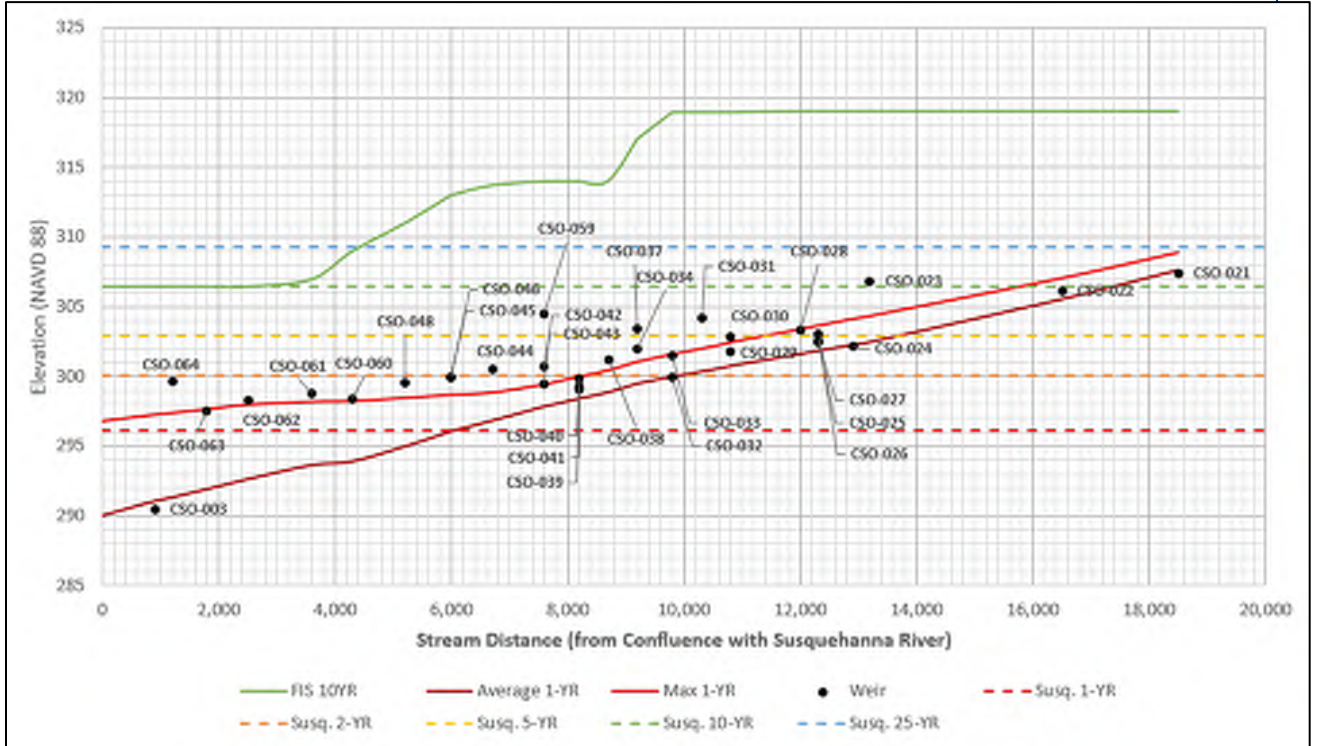

**Figure 4.2-3 Comparison of Weir Elevations to Flood Stage Profiles on the Susquehanna River**

CRW developed a phased approach for regulator modifications following the Front Street Pump Station Upgrade. The Phase 1A regulator modifications involved chaining open selected B&B gates and raising weirs for Hemlock Street Interceptor (HSI) CSO regulators and select CSO regulators prone to Paxton Creek backflow.

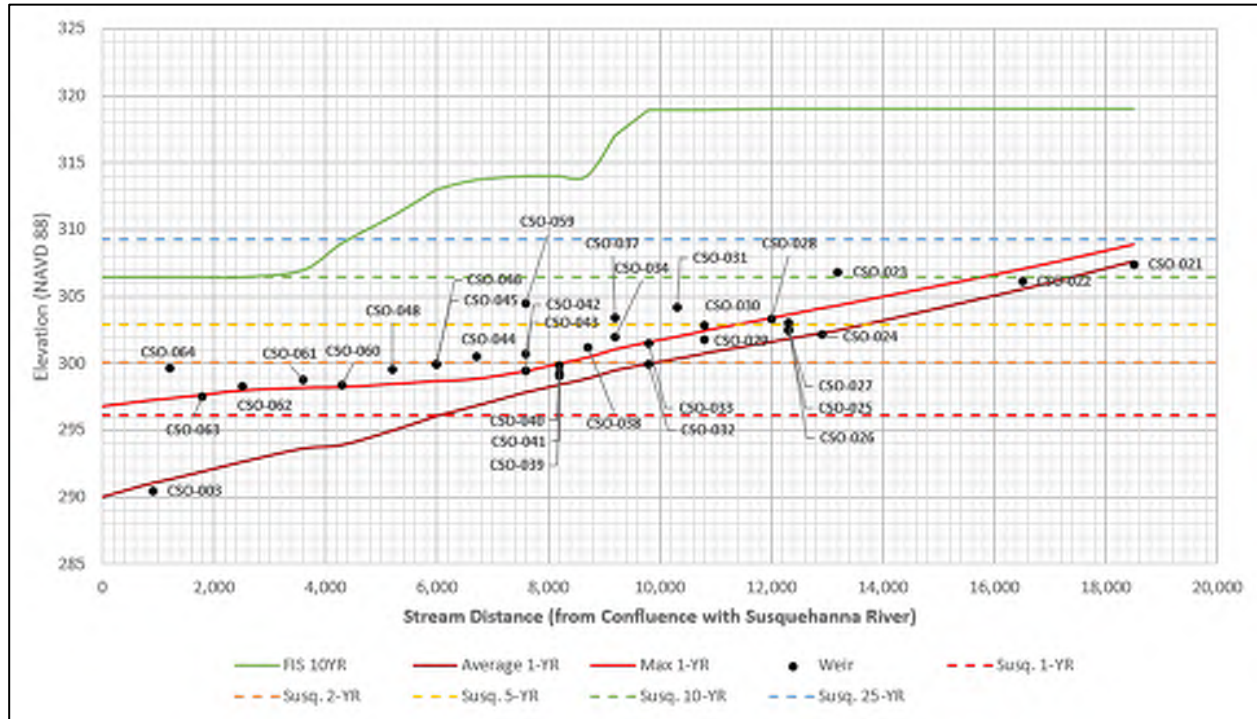

Figure 4.2-4 Comparison of Weir Elevations to Flood Stage Profiles on Paxton Creek

### 4.2.3 Inspection Preparedness

The inspection of outfalls and backflow prevention gates is conducted concurrently with the round of CSO regulator structure inspections if abnormal conditions are noticed. In **Appendix C, Table C-1** identifies available equipment for field maintenance crews and the *Inspection Preparedness Activity Checklist* lists activities to complete before embarking for the daily inspections. This checklist encompasses preparations for both the inspections of CSO regulator structures and outfalls and backflow prevention gates.

Refer to Section 4.1.3 for details on concurrent regulator structure inspection activities.

### 4.2.4 CSO Outfall Inspection Activities and Checklist

#### Introduction and Overview

Inspections of the CSO outfalls are completed when abnormal conditions are noted by CRW staff during the daily regulator inspections to identify correctable combined sewer overflows, dry weather overflows, identify potential for river intrusion into the interceptor system, and remove debris from the outfalls. Some of these items may be observable during the CSO regulator structure inspection, but outfall inspections allow for direct observations of what occurs at the discharge point (i.e. how much debris accumulates at the outfall). River intrusion is checked on a daily basis by inspecting the diversion weirs in the regulator structures.

Daily inspection of the flap gates is not required because the protection they provide from river intrusion is generally only required during times of anticipated flood stage conditions along Paxton Creek or the Susquehanna River. However, if flood stage conditions are predicted along the creek



or the river, the flap gates should be checked using a pole camera to verify the flap gate position is closed and no debris is preventing the flap gate to seal properly.

### **Inspection Schedule**

River intrusion over the diversion weirs is checked as part of the daily CSO regulator structure inspections. The outfalls are inspected following discharge events or during abnormal conditions. Daily inspections typically begin around 07:00 and are typically completed within four hours. Additional inspection time may be required during high flows within the sewers or receiving waters, inclement weather, or if there are problems identified during inspections.

On rare occasion, an executive decision may be made by the Field Operations Supervisor to forego individual CSO regulator structure/outfall inspections due to an emergency resulting in staff limitations (e.g. dry weather overflow at another CSO regulator structure) or during severe flooding when overflows can be reasonably assumed.

**Note:** The O&M of CSO regulator structures and outfalls/backflow prevention gates is closely linked with overlapping activities. The most important checklist item regarding the daily inspection of outfalls is the documentation and remedy of combined sewer overflows. Procedures for wet weather and dry weather overflows are discussed extensively in Section 4.1.5.

**Refer to Section 4.1.5 for details on combined sewer overflow (CSO) procedures.**

## CSO Outfall and Backflow Prevention Gate Inspection Checklist

Complete the following items concurrently with the daily CSO regulator inspections:

**NOTE:** Whenever an entry is required, be sure to follow all confined space entry guidelines.

- Observe flow conditions at the CSO outfall if abnormal conditions are noticed in the regulator chamber or if a discharge event occurred since the previous daily inspection (if the outfall is not submerged).
  - IF an active CSO is observed, follow the protocol identified in the **Combined Sewer Overflow (Ongoing) Checklist (Wet weather and Dry weather)** (Section 4.1).
    - *NOTE: It is possible to observe flow at the outfall without there being an active CSO (e.g. infiltration or stormwater inflow entering the outfall pipe downstream of the weir). Always check the diversion weir if a discharge is observed at the outfall.*
- If present, remove any significant debris present in the immediate vicinity of the CSO outfall. Sewer solids and floatable materials may accumulate at exposed outfalls, and floatables may accumulate at submerged outfalls, but generally should only be observed after a CSO. Notify management of any accumulations that occur without any other indication of a CSO.
- Note high river/creek levels which have the potential to exceed the weir elevation and flow into the CSO regulator structures.
  - IF present, confirm the presence or absence of river intrusion during the CSO regulator inspection by checking to see if river or creek water is back-flowing over the diversion weir into the interceptor system.
    - *NOTE: Some river/creek water in the CSO outfall pipe is to be expected, and does not need to be documented unless river water is flowing over the diversion weir into the interceptor.*
- Document that the outfall was inspected on the **Interceptor Service Report**.

**Following storm events:**

- ❑ Remove any significant debris present in the immediate vicinity of the CSO outfall. Sewer solids and floatable materials may accumulate at exposed outfalls, and floatables may accumulate at submerged outfalls.

**Flap Gate Inspection:**

- ❑ If no river intrusion activity is observed over the crest of the diversion weir, no inspection activities are required for the flap gate.
- ❑ If river intrusion is observed, utilize the pole camera to see if there is debris caught in the flap gate. If debris is observed, promptly remove any debris that may be holding the flap gate partially open and preventing it from sealing properly.
  - *NOTE: A confined space entry may be required to access the flap gate depending on whether it is located at the discharge point, flood chamber, or diversion chamber.*
- ❑ Verify the flap gate appears to be operational.
- ❑ Verify the flap gate maintains a tight seal (or as tight as possible).

### 4.2.5 Post-Storm Outfall Inspection Activities

During storm events, stormwater may carry debris from City streets into the CSO regulator structures. This debris may be carried along in CSO discharges to the outfalls. Outfalls and the area immediately downstream should be inspected and cleared of debris that may have accumulated during the wet weather overflow. These post storm activities should be completed the next day following a wet weather overflow during the routine daily inspections. Post storm activities are detailed in the *Daily CSO Outfall and Backflow Prevention Gate Inspection Checklist*.

Outfalls are closely linked to the CSO regulator structures, so the post storm activities from CSO regulator structures, especially the documentation of wet weather overflows, are applicable to outfall post storm activities.

**Refer to Section 4.1.6 for details on post storm activities for CSO regulator structures.**

### 4.2.6 Backflow Prevention Gate Inspection Activities

Flap gates protect the interceptor system from river intrusion during flood stage conditions along Paxton Creek or the Susquehanna River. If flood stage conditions are predicted along the creek or the river, flap gates should be inspected before flood stages are reached to ensure debris hasn't collected in front of the flap gate or is preventing proper closure of the flap gate. The flap gate needs to be fully closed and sealed to function properly, and conditions within the flap gates can be inspected using a pole camera. There are several structures where the outfalls have a greater chance for experiencing river intrusion due to the crest elevations of the diversion weirs providing a smaller degree of freeboard above the normal pool elevation of the receiving stream. These outfalls are shown in **Figures 4.2-3** and **4.2-4**. The flap gates at these structures should be given a higher priority with the inspections.

### 4.2.7 Preventive Maintenance Activities

**Introduction and Overview:** Due to the relatively simple nature of outfalls and flap gates, extensive preventative maintenance is not required to ensure proper operation. The most critical preventative maintenance item is keeping the flap gate clear of debris in anticipation of flood stage events along Paxton Creek or the Susquehanna River, which is outlined in the *Daily Outfall and Backflow Prevention Gate Inspection Checklist*. The outfall pipes generally do not accumulate sediment because it is flushed out during wet weather overflows, so they usually remain fairly clean without any maintenance.

On an annual basis, the flap gates should be inspected to verify they are operating properly. Visible flap gates without flood chambers should be inspected during periods of low flow along the creek and river to maximize accessibility. Flap gates with flood chambers and flood gates can be inspected during any dry weather period when flood conditions are not occurring along Paxton Creek or the Susquehanna River. Currently, all maintenance activities are documented, and transferred electronically to Cityworks which generates required maintenance work orders and tracks completed maintenance actions.

## Annual Backflow Prevention Gate Preventative Maintenance Activities Checklist

Complete the following items preventative maintenance activities annually for each flap gate. Some items only apply to those locations with flood chambers and flood gates.

**NOTE:** Whenever an entry is required, be sure to follow all confined space entry guidelines.

- Examine the sealing surfaces of the flap gate for pitting or other evidence that the gate is not sealing properly.
- Lubricate the hinges and verify the flap gate can easily open and close.
  - For double hinged flap gates, check the balance and make any adjustments to obtain an ideal balance point that allows the gate to be opened with minimal pressure and seal tightly.
- Document that the outfall was inspected on the ***Flap Gate Annual Preventative Maintenance Form***.

#### 4.2.8 O&M Documentation for Outfalls and Backflow Prevention Gates

The CRW NPDES Permit and the National CSO Policy *Nine Minimum Controls* require that complete and consistent record keeping, and procedures for report development and archiving, are properly developed and implemented. A series of field reports and managerial summary reports have been developed, implemented and archived by CRW personnel to document observed conditions and completed maintenance activities with respect to outfalls and backflow prevention gates.

The findings from CSO outfall inspections are recorded on the appropriate interceptor service report. Recorded information includes confirmation that the outfall inspection was completed; debris removal; inspections of flap gates. The interceptor service report also includes the findings from CSO regulator inspections since they are done concurrently. The interceptor service reports are included in **Appendix A**.

The findings are transferred electronically to Cityworks, which automatically generates preventive maintenance reports. An example preventive maintenance report is included in **Appendix A**. Likewise, all maintenance activities are documented, and transferred electronically Cityworks.

## 4.3 O&M Activities for Pump Stations

The pump stations are critical to the performance of Capital Region Water's (CRW) combined sewer system. When functioning properly, the primary pump stations (Front Street and Spring Creek) receive wastewater from the interceptors; provide preliminary treatment of wastewater; and direct flow to the Advanced Wastewater Treatment Facility (AWTF). Proper operation and maintenance (O&M) of the pump stations is critical to protecting water quality in the river and creek and maintaining the proper operation of the treatment plant. Therefore, regular inspections are conducted, and observed conditions are carefully documented. Any observed problems are promptly addressed, and both preventative and corrective maintenance activities are performed. This section compiles and updates previous O&M manual information for the pump stations prepared for the City of Harrisburg / The Harrisburg Authority in 1981<sup>4</sup> and 2012<sup>5</sup>

### 4.3.1 Introduction and Overview for Pump Stations

CRW owns and operates two wastewater pump stations, the Front Street Pump Station and Spring Creek Pump Station. CRW also owns and operates the Market Street Stormwater Pump Station. The City of Harrisburg currently owns the two City Island pumping stations. Although the City is responsible for the operation and maintenance of the City Island pumping stations, CRW is providing interim assistance with operations and maintenance until a permanent arrangement is established for City operation and maintenance of those facilities. The Trewick Street Pump Station, owned and operated by the Borough of Steelton, also discharges to the CRW collection system. The Front Street Pump Station (Section 4.3.4) and Spring Creek Pump Station (Section 4.3.5) are CRW's primary wastewater pumping stations which together pump flow from the entire CRW conveyance system to the AWTF. Both Front Street and Spring Creek pump stations have facilities to provide screenings removal. The Market Street Stormwater Pump Station (Section 4.3.6) discharges to Paxton Creek. The City Island wastewater pump stations operate on an intermittent basis related to the schedule of games and events on City Island. Discharge from the City Island pump station is directed to the Front Street Interceptor. **Table 4.3-1** provides a brief summary of the pump station capacities.

**Table 4.3-1 Pump Station Capacities**

PUMP STATION	TYPE	NUMBER OF PUMPS	DESIGN AVERAGE (MGD)	DESIGN PEAK (MGD)
Front Street	Combined	4	22	60
Spring Creek	Combined	3	10.0	28.9
Market Street	Stormwater	4	Non-Continuous Operation	12.1 <sup>[1]</sup>
City Island - North	Sanitary	2	Non-Continuous Operation	0.432
City Island - South	Sanitary	2	Non-Continuous Operation	0.432

<sup>4</sup> City of Harrisburg. Operation and Maintenance Manual for Conveyance and Treatment Facilities. Supplement 1. Gannett Fleming, Corddry and Carpenter, Inc. October 1981.

<sup>5</sup> City of Harrisburg. Advanced Wastewater Treatment Facility. Combined Sewer Overflow Operations Manual. August 2012.

1. The total pump capacity of Market Street Pump Station consists of two pumps rated at 3,600 gpm and two pumps rated at 600 gpm.

### 4.3.2 Inspection Preparedness

In **Appendix C, Table C-1** identifies available equipment for field maintenance crews and the *Inspection Preparedness Activity Checklist* lists activities to complete before embarking for the inspection and maintenance activities. The checklist is general and encompasses preparations for most field maintenance activities.

### 4.3.3 General Pump Station Inspection Activities

#### Introduction and Overview

Inspections and preventive maintenance of the pump stations are completed daily by CRW staff to verify they are operating properly. The inspection crew consists of two field maintenance personnel. For safety concerns, **there must be at least two (2) personnel present during the inspections.**

#### Inspection Schedule

Pump stations are inspected every day, seven days per week by AWTF operators. Front Street, Spring Creek, and Market Street Pump Stations are normally inspected twice per shift for a total of four inspections per day. City Island pump stations are inspected once per shift for a total of two inspections per day. Inspections are typically completed around 10:30-11:30 and 17:00-18:00 during the first shift (“A” shift), and around 22:30-23:30 and 05:00-6:00 during the second shift (“B” shift). Routine operational inspection typically takes less than an hour at each pump station. Additional time is required for corrective maintenance and scheduled preventative maintenance. During wet weather, inspection frequency for Front Street, Spring Creek, and Market Street Pump Stations is increased to three times per shift for a total of six inspections per day. Generally, this occurs when blending occurs at the AWTF (main plant influent flows in excess of 45 MGD). The inspection schedule is summarized in **Table 4.3-2**.

**Table 4.3-2 Inspection Schedule**

PUMP STATION	INSPECTION FREQUENCY (NORMAL CONDITIONS)	INSPECTION FREQUENCY (WET WEATHER CONDITIONS)
Front Street	4 times daily (2 per shift)	6 times daily (3 per shift)
Spring Creek	4 times daily (2 per shift)	6 times daily (3 per shift)
Market Street	2 times daily (1 per shift)	6 times daily (3 per shift)
City Island (North and South)	1 time daily (1 per shift)	2 times daily (during games/events)

Checklists and procedures for routine inspection and maintenance at the pump stations include the following:

- ***General Pump Station Inspection Activities Checklist***
- ***Procedures for Lost Communication to Main Plant SCADA Computer***

Procedures specific to individual pump stations are outlined in subsequent sections.



Front Street Pump Station (**Section 4.3.4**):

- *Front Street Pump Station – Operating Bar Screens*
- *Front Street Pump Station – Operating Wastewater Pumps*
- *Front Street Pump Station – Pump Down Procedure*

Spring Creek Pump Station (**Section 4.3.5**):

- *Spring Creek Pump Station – Operating Barminutor Screens*
- *Spring Creek Pump Station – Operating Bar Screens*
- *Spring Creek Pump Station – Operating Wastewater Pumps*
- *Spring Creek Pump Station – Changing over to Bar Screen Side*
- *Spring Creek Pump Station – Changing over to Old Side*
- *Spring Creek Pump Station – High Flow Procedures*

Scheduled preventative maintenance activities for pump stations are outlined in **Section 4.3.8**, and documentation / record keeping is outlined in **Section 4.3.9**.

## General Pump Station Inspection Activities Checklist

Complete the following items during daily pump station inspections.

**NOTE: WHENEVER AN ENTRY IS REQUIRED, BE SURE TO FOLLOW ALL CONFINED SPACE ENTRY GUIDELINES.**

- Observe the exterior of the pump station for broken windows, forced entry, or debris on the grounds.
- An audible and olfactory observation should be made upon immediate entry into the facility. Any unusual sound or smell should be investigated for its origin. This includes any alarms that are activated upon your arrival.
- A visual, audible, and tactile inspection should be made of all running equipment. Remember that the look, listen, and feel of an operator cannot be duplicated by equipment.
  - Confirm that all needed equipment is running.
  - Confirm the pumps are running.
  - Check if any motors or pieces of equipment seem to be running hotter than normal.
  - Confirm all gates are in their proper positions.
- Check the wet well level and confirm the wet well reading on the control panel matches the visual observation of the wet well.
  - NOTE: *This is critically important.*** *If these levels don't match, an overflow could occur without warning from the alarms.*
- Complete any correctable problems identified during the inspection.
- Document any malfunctioning equipment, excessive leaks or any unusual findings that cannot be corrected by the operator(s) in the **Operations Log** (at the AWTF) so a service order can be submitted.

**NOTE:** *Any malfunction that may require bypass pumping or lead to localized flooding must be brought to the attention of the Maintenance Supervisor **IMMEDIATELY.** In the absence of the Maintenance Supervisor, the Operation/Shift Supervisor or Director of Operations must be notified.*

## Procedures for Lost Communication to Main Plant SCADA Computer

Complete the following procedure in the event of a loss of communication to the main plant SCADA computer.

- Check for proper operation of the pump station.

### **If station is not operating on the local controller:**

- Run the station on HAND and man the station as needed.
  - The indication at this point is that the CPU at the pump station is not working.
- Check the telephone line conditioners in the Main Control Building and the pump station for the proper LED blinking sequence:
  - The green and yellow LEDs to the left are illuminated continually.
  - The two green LEDs to the right flash intermittently.
- Call GES immediately **(717) 236-8733** and either tell them we need someone immediately or leave a detailed message for them stating who we are, what the problem is, and what phone number to call to contact someone.

### **If the station is operating on the local control in the automatic mode:**

- Call the telephone company (special services) at **1-800-452-2224** or **1-800-932-0387** and state the problem (i.e., we have a communication failure between the plant and a remote pump station that has a dedicated phone line between them, and both computers appear to be operating properly).

**NOTE:** You will not be able to listen for a dial tone or call these phone numbers as a check for the dial tone.

- The Circuit Numbers (required by the phone company) are:
  - Spring Creek pump station **4 FDDA 303440**
  - Front Street pump station **4 FDDA 303441**
- State the priority that this line serves and ask for a callback as soon as possible.

***NOTE:*** Remember to write down the ticket number for this work.

- Put in a service order on the problem and record any steps you have taken up to this point under the work performed. This should be documented in the Operations Log Book.

**If this does not resolve the situation (or at least provide a short-term resolution), call either the Operations Supervisor or the Director of Operations for further instructions.**

### 4.3.4 Front Street Pump Station

#### 4.3.4.1 General

The Front Street Pump Station (**Figure 4.3-1**) is located at 830 South Front Street and receives combined wastewater from the Front Street interceptor (42" x 42") and Paxton Creek interceptor (60" diameter). The Front Street Pump Station service area encompasses most of the City of Harrisburg, in addition to parts of Lower Paxton Township, Penbrook, and Susquehanna Township. Annual average daily flow is approximately 15 MGD with peak daily flows exceeding 40 MGD. The design average daily flow and peak daily flow are 22 MGD and 60 MGD respectively. Following the Front Street Pumping Station upgrade completed in 2021, the peak design flow was increased from 43.2 to 60 MGD to accommodate future additional captured flow from the combined system. A 48-inch diameter force main, approximately 6,100 feet long, connects the Front Street Pump Station to the AWTF.



**Figure 4.3-1 Front Street Pump Station**

The pump station has four (4) 200 horsepower vertical shaft solids handling pumps rated for 13,889 gpm at 99 feet of head (each). All pumps are equipped with variable frequency drives (VFD). Dry weather flows are typically conveyed with one pump operating while wet weather flows result in two to three pumps operating simultaneously (up to three pumps in parallel at 20 mgd each). The fourth pump operates as a backup pump. Alternatively, all four pumps may operate at 15 MGD

each. However, the station is designed to not exceed 60 MGD. **Table 4.3-3** includes a summary of design data for the Front Street Pump Station. **Figure 4.3-2** shows a general flow schematic of the Front Street Pump Station.

**Table 4.3-3 Front Street Pump Station Design Data**

<b>PUMPING STATION DESIGN DATA</b>	
<b>Flow (MGD)</b>	
Average	22
Peak	60
<b>Sewage Pumps</b>	
Manufacturer	Flowserve
Number of Pumps	4
Type	Vertical Centrifugal, Variable Speed
Motor Horsepower	450
Control	Liquid Level Sensing
<b>Primary Design Point (3 Pumps Operating)</b>	
Unit Capacity (gpm)	13,889
TDH (feet)	99
Motor rpm	711
<b>Secondary Design Point (4 Pumps Operating)</b>	
Unit Capacity (gpm)	10,417
TDH (feet)	53
Motor rpm	523

The Front Street Pump Station was constructed in 1959. Minor upgrades in 1973 included ventilation and valve control improvements and replacement of the screenings compactor and belt conveyors in 1986. A major upgrade, completed in 2021, included installation of new pumps, motors, VFDs, controls, and mechanically cleaned bar screens, as well as HVAC upgrades and structural/architectural repairs.

Detailed operational procedures are under development, as CRW staff are currently optimizing station operation. Major changes are included herein, while additional specifics will be finalized in the next OMM Update.

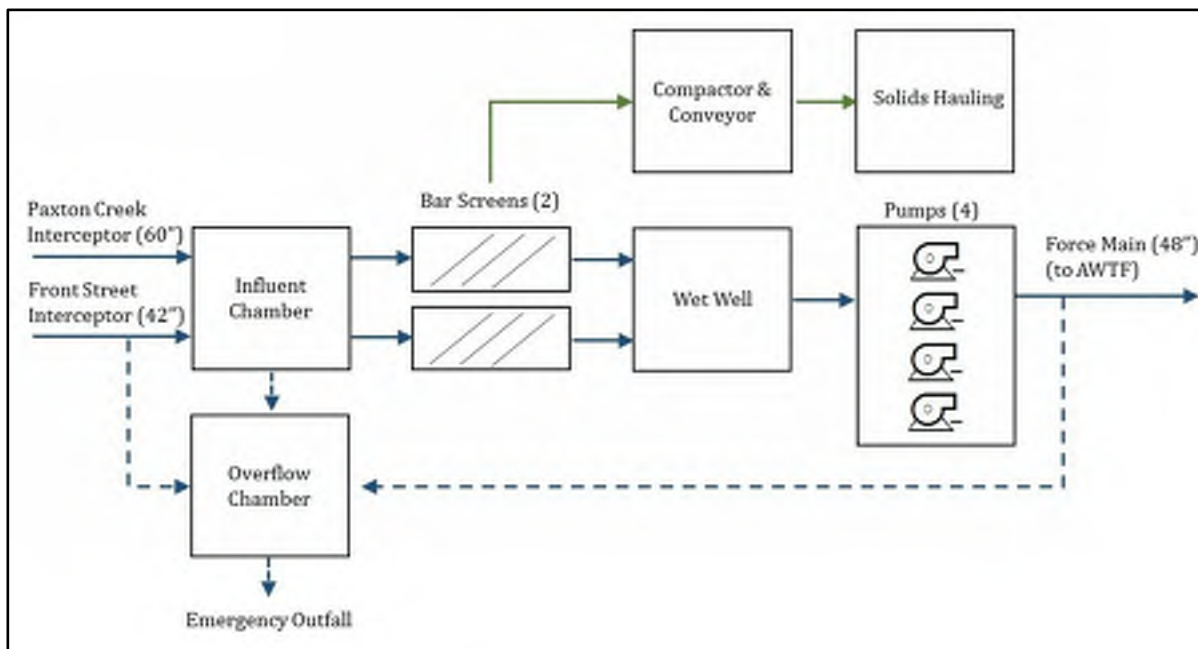

Figure 4.3-2 Front Street Pump Station Flow Schematic

#### 4.3.4.2 Influent Flow Control

The influent chamber (**Figure 4.3-3**) receives wastewater from the Paxton Creek and Front Street interceptors. Wastewater then flows through duplicate parallel bar screen channels before discharging to the wet well.

The influent chamber contains electrically actuated sluice gates on each of the two interceptors entering the chamber, on the entrance to each bar screen channel, and on the overflow connection to the overflow chamber. All electrically actuated sluice gates are controlled manually from the control panel located in the pump room.

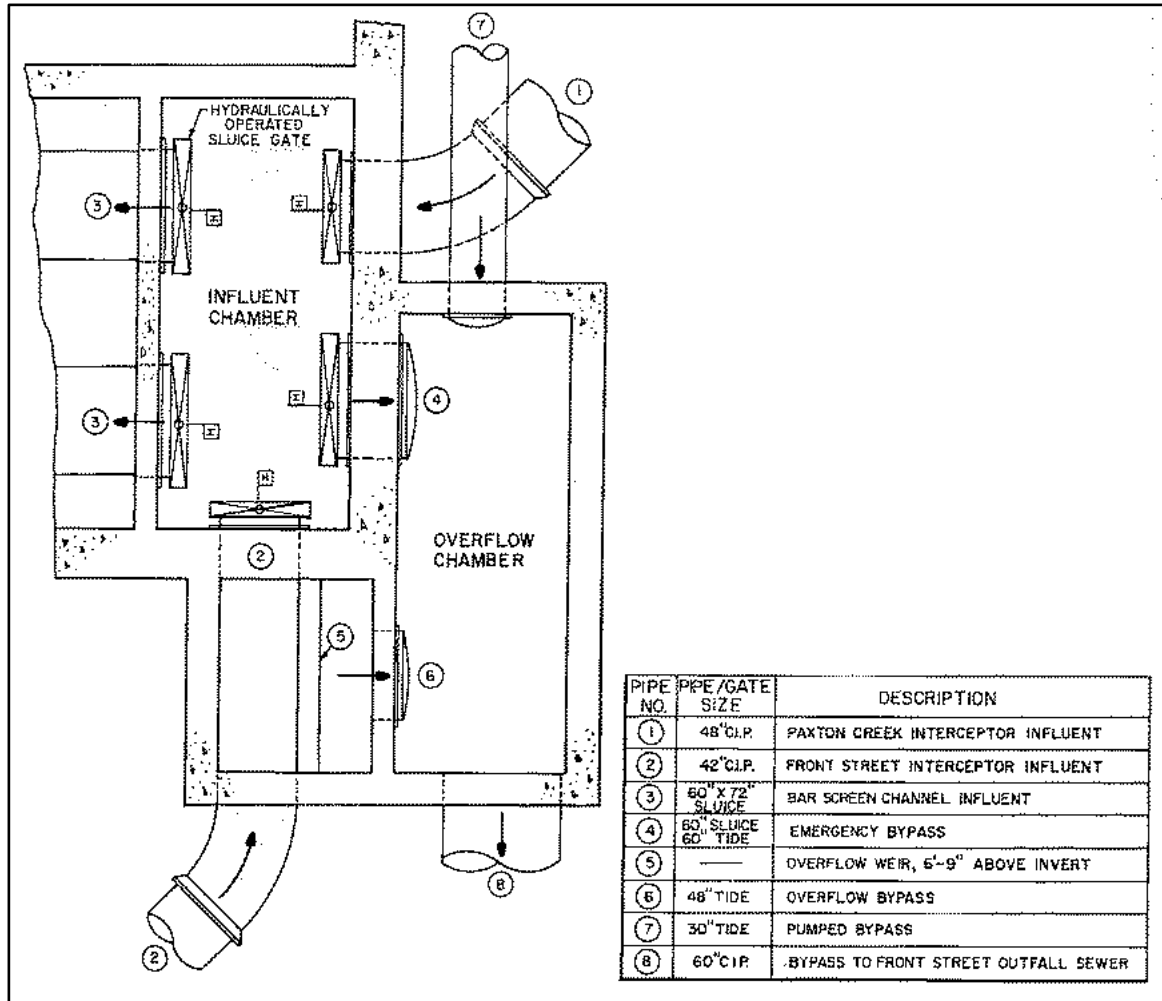

Figure 4.3-3 Front Street Pump Station – Influent Flow Control

Source: City of Harrisburg, Operation and Maintenance Manual for Conveyance and Treatment Facilities, Gannett Fleming Corddry and Carpenter, Inc., October 1981.

#### 4.3.4.3 Screening Equipment

Two multi-rake bar screens (Figures 4.3-4 and 4.3-5) with 3/4" openings are installed at the Front Street Pump Station (one in each bar screen channel). Wastewater from the influent chamber flows into the channels, where the large solids carried in the wastewater are removed by the screens. The collected screenings discharge to a common screw conveyor in the intermediate floor level, which discharges to another screw conveyor located along the west wall in the intermediate floor, which finally discharge into a washer/compactor located at the garage bay. The dumpster is emptied twice a week by the City of Harrisburg Sanitation Department. Each bar screen channel is furnished with an electrically actuated sluce gate (manually controlled) located at the channel outlet to isolate it from the wet well.





**Figure 4.3-4 Front Street Pump Station Bar Screens**

The operation of each bar screen is controlled by a timer and differential level-sensing instrumentation through individual hand-off-auto selector switches. The hand-off-auto selector switches set the mode of operation. With both switches in the HAND position, operation of the bar screen cleaning mechanisms is continuous. In the OFF position, the bar screen cleaning mechanism will not run. With both switches in the AUTO position, the timer controls operation intermittently unless the differential level-sensing control overrides the timer. The differential level sensing control will actuate the cleaning mechanism when the upstream wastewater level exceeds the preset differential value. A limit switch is used in conjunction with the timer and differential level control to stop the cleaning mechanism in a position where the rake arms are not across the face of the bar screen. A shear pin coupling and limit switch shut off the mechanism to protect the drive motor if a rake becomes jammed with screenings or other obstructions. The operation of the screw conveyor and compacting screw conveyor is interlocked to start and stop with the bar screen operation.

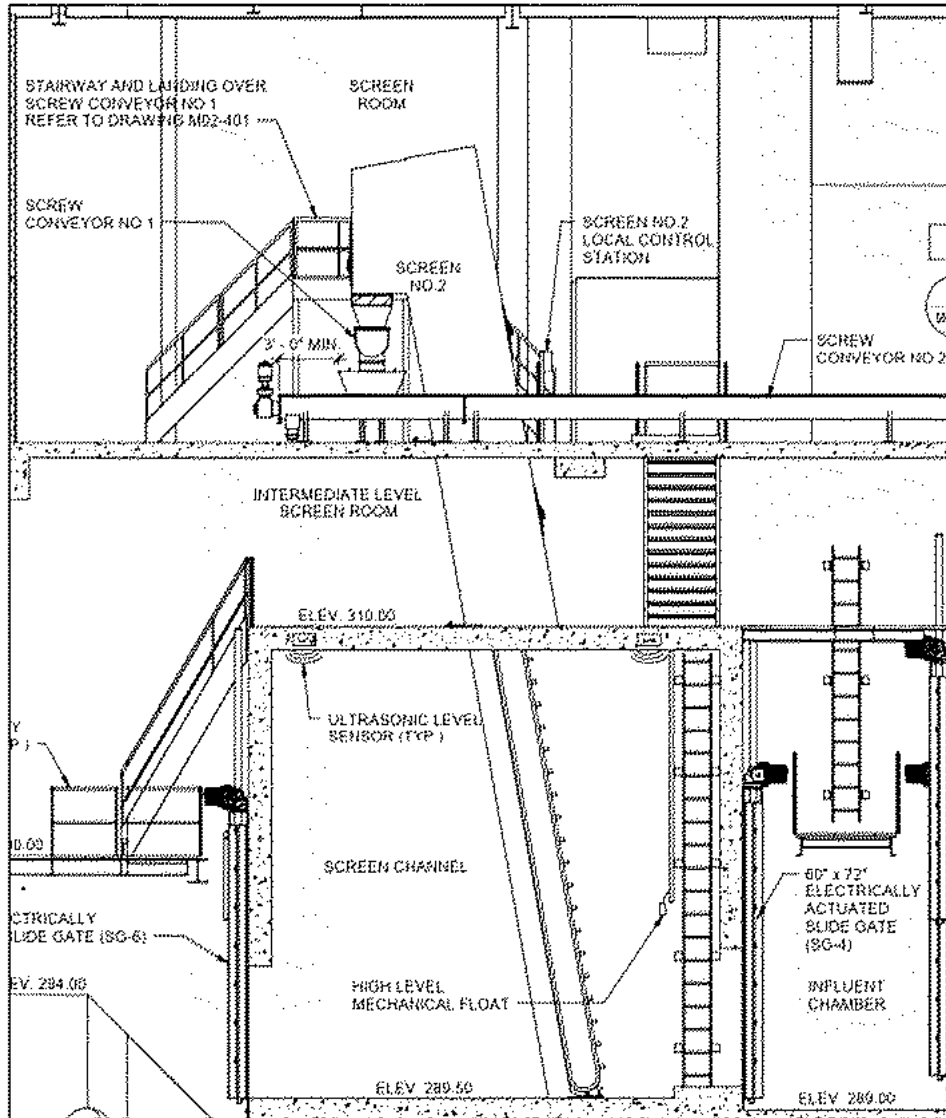

Figure 4.3-5 Front Street Pump Station – Screening

#### 4.3.4.4 Sewage Pumps

Screened wastewater flows directly into the adjacent rectangular wet well (**Figure 4.3-6**). The bottom of the wet well is steeply sloped to the suction of the pumps to minimize settling and deposits in the wet well. Access to the wet well is provided by a steel walk-way and stair from the bar screen room.

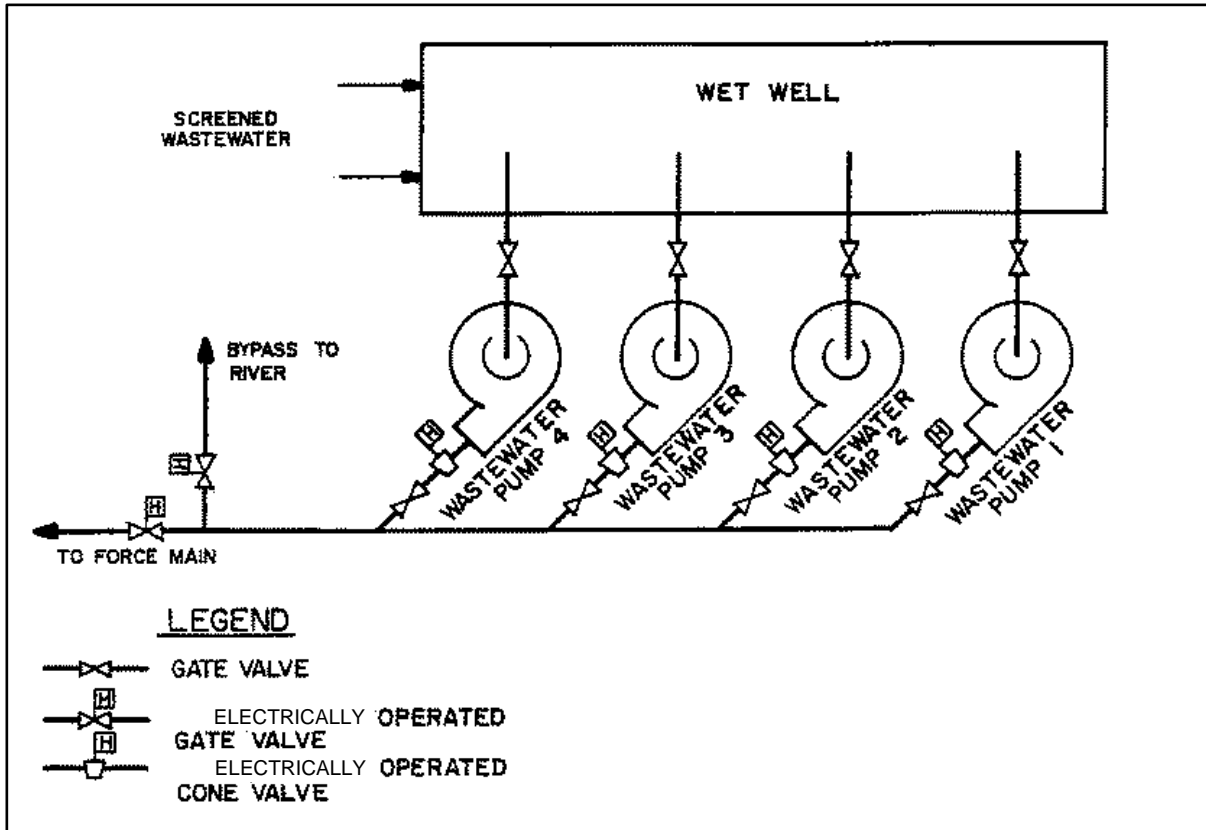

Figure 4.3-6 Front Street Pump Station – Wastewater Pumping

Source: Gannett Fleming Cordory and Carpenter, Inc., October 1981.

The pump station has four (4) 200 horsepower vertical shaft solids handling pumps rated for 13,889 gpm at 99 feet of head (each). All pumps are equipped with variable frequency drives (VFD). Seal water, provided by the station water system, is supplied to each pump.

All pumps are operated from a control center located on the main floor. Pump operation is controlled by a hand-off-auto selector switch located on the pump VFDs. In the HAND position, pump operation is continuous regardless of wet well level. In the OFF position, the pump will not run. In the AUTO position, pump operation is automatically started and stopped in sequence in response to the changing wet well levels sensed by the submersible level transducers (refer to **Table 4.3-4** for wet well operating levels). The Operator shall select the pump order from the operator interface. Mode operations include Lead Pump Alternation (alternates every time the lead pump stops), Time Alternation (alternates every 24 hours), and Manual Alternation.

**Table 4.3-4 Front Street Wet Well Operating Levels**

	RISING WET WELL LEVELS (FT)		DROPPING WET WELL LEVELS (FT)	
Lead Pump	Start @	294.00	Stop @	292.50
1st Lag Pump	Start @	294.50	Stop @	293.75
2nd Lag Pump	Start @	297.50	Stop @	294.50
3rd Lag Pump	Start @	297.70	Stop @	295.00
High Water	Alarm @	297.75		
Low Water	Alarm @	291.00		
Desired Wet Well Level Setpoint = 293.80				
Bottom of wet well = 286.00 ft				

The PLC varies the speed of the pumps as required to approximately match the pump discharge rate to the pumping station influent flow by maintaining a constant level in the wet well. If the lead pump cannot keep up with the influent flow, the water level will continue to rise. Once the 1<sup>st</sup> lag pump setpoint is reached, the PLC will start the 1<sup>st</sup> lag pump and adjust the speeds of the lead and 1<sup>st</sup> lag pumps to match. If water levels continue to rise, the PLC will start the 2<sup>nd</sup> lag pump and adjust the speeds of all pumps to match. If water levels continue to rise, the PLC will start the 3<sup>rd</sup> lag pump and adjust the speeds of all pumps to match. Once water levels decrease, the PLC will shut down each lag pump according to the “stop” setpoints.

In addition to the manually operated suction and discharge gate valves, each pump discharge is fitted with electrically operated check valves. Each check valve is equipped with limit switches (for indicating the open and closed position of the valve). Opening and closing of each valve is accomplished by a valve actuator controlled automatically controlled by the station PLC. The valves can be manually operated via a hand-operated switch.

#### 4.3.4.5 Station Water System

The station water system supplies water to the mechanical seals for each wastewater pump.

#### 4.3.4.6 Emergency Power

There are two redundant primary electrical feeds to the Front Street Pump Station.

**Refer to Section 4.8 for general non-routine and emergency maintenance procedures.**

#### 4.3.4.7 Flow Metering

Wastewater flows at the Front Street Pump Station is monitored by a 48” magnetic flow meter located in the discharge header.

#### 4.3.4.8 Combustible Gas Monitoring

A combustible gas detection system is installed at each pump station. The gas levels are monitored at various locations in the pump stations, and the levels indicated at a control panel in each station. Combustible gas levels of 25, 50, and 75 percent LEL (lower explosive limit) are indicated by an

amber warning light, red alarm light, and a red high-alarm light, respectively, in conjunction with a horn. The monitoring system is checked quarterly by an outside contractor.

#### **4.3.4.9 Wet Weather Operation / Emergency Bypass**

In the event of an emergency, either due to excessively high flows or an equipment failure, where the pump station cannot discharge to the force main, the Front Street Pump Station has a permitted emergency outfall (CSO-002) which discharges wastewater to the Susquehanna River. This action would be taken only under extreme emergency conditions such as a major flood or force main failure.

A 60-inch emergency bypass connects the influent chamber to the overflow chamber, which diverts excess wastewater to the Susquehanna River during extreme wet weather flows (in excess of the pump station capacity) or other emergencies. Additionally, an overflow weir structure located at the connection of the Front Street interceptor diverts excess flow (from the Front Street interceptor) to the overflow chamber.

A 30-inch-diameter bypass connection is provided between the 48-inch-diameter force main and the overflow chamber to allow pumped wastewater to be diverted to the overflow chamber. Electrically actuated gate valves (manually controlled) are located on the force main at the structure wall and on the bypass to the overflow chamber. Closing of the force main gate and opening of the bypass gate will allow pumped wastewater to be diverted to the river through the overflow chamber and emergency outfall.

Tide gates are furnished at all connections to the overflow chamber to prevent river floodwaters from entering the influent chamber, the interceptor, or the force main bypass.

**Refer to Section 4.8 for general non-routine and emergency maintenance procedures.**

#### **4.3.4.10 Inspection, Operation, and Maintenance Activities**

In addition to daily inspections, outlined in the *General Pump Station Activities Checklist*, there are additional inspection/maintenance activities specific to the Front Street Pump Station.

The Front Street Pump Station is the largest pump station in the CRW collection system, and is the most susceptible to flow peaks during wet weather.

Checklists included in this section, specific to Front Street Pump Station procedures, include the following:

- ***Front Street Pump Station – Operating Bar Screen***
- ***Front Street Pump Station – Operating Wastewater Pumps***
- ***Front Street Pump Station – Pump Down Procedure***

## Front Street Pump Station – Operating Bar Screens

This procedure describes the actions necessary to initiate operation of a bar screen.

*Complete the following items to restart the bar screens.*

**NOTE:** *FOLLOW ALL SAFETY GUIDELINES WHEN PERFORMING THE PROCEDURE.*

### Pre-Start Inspection

- Inspect the bar screen channel for debris in front of the bar screens and remove prior to starting equipment.
- Verify equipment is energized, including bar screen and screw conveyor.
- Verify equipment is properly lubricated and is ready for operation. Test the screen and screw conveyor are operable by starting the equipment in manual control.
- Open the sluice gates on the influent and effluent sides of the bar screen channel

### Start-up

- Place equipment control selector switches in the AUTO position
- Verify automatic timer is set to proper cycle time (30 minutes) or as otherwise determined through operating experience.
- Verify differential pressure-level switch is set between 9 and 12 inches.
- Check that the screenings dumpster is in place and is not full.

## Front Street Pump Station – Operating Wastewater Pumps

This procedure describes the actions necessary to initiate operation of the wastewater pumps.

*Complete the following items to restart a wastewater pump.*

**NOTE:** *FOLLOW ALL SAFETY GUIDELINES WHEN PERFORMING THE PROCEDURE.*

### Pre-Start Inspection

- Inspect the wet well for debris that may obstruct the pump suction piping. Remove debris as necessary.
- Check that the screenings equipment is operating satisfactorily.
- Check that the wastewater pump has been properly lubricated and is ready for operation.
- Check the seal water connection to the pump mechanical seal is in operating condition. Need to verify solenoid opened and seal water is flowing when pump is started.
- Check for proper valve position in pump suction and discharge lines (open).
- Check and open the vent line on each pump valve casing.

### Start-up

- At control center on the first floor, a Hand-Off-Auto selector switch control the operating mode of the pump. Pumps are normally operated in the AUTO position wherein operation of the pump is controlled by the wet well level monitoring system.

### After Pump Startup

- Verify pumps are properly operating through automatic controls. Verify pump is operating without excessive vibration or cavitation.
- Inspect check valve on discharge side of pump to verify it opened.

## Front Street Pump Station – Pump Down Procedure

Complete the following items during the pump down procedure for the Front Street Pump Station.

**NOTE:** *WHENEVER AN ENTRY IS REQUIRED, BE SURE TO FOLLOW ALL CONFINED SPACE ENTRY GUIDELINES.*

Pump down should be performed during the last round of the “B shift” on Sunday night since this is usually the lowest flow of week.

### Bar Screens

- Prior to entering the bar screen and wet well area verify the ventilation fans are running and there are no combustible gas alarms at the control panel. If ventilation system is not operational, or there is a combustible gas alarm, do not enter this area without restoring operation of the ventilation system until the alarm condition disappears, or use SCBA equipment and confined space entry procedures.
- Turn both bar screens on HAND using the east-facing control panel on the top floor (to the right of steps leading to bar screens).
- Go down steps leading to the bar screens, verify both channels are in service. If one is not in service, open influent and effluent gates on that channel using levers against eastern wall.
  - **NOTE:** *Open gates on side not currently in service, so both sides will be open.*

### Check Valves

- Verify that the check valves indicator is showing open on the Check Valve panel near the north stairwell of the station.
- Look down over railing to make visually confirm that the check valves have opened (should open automatically when put on HAND).
  - **NOTE:** *You may need to go down to bottom floor to confirm this.*

### Clean-Up

- Push rags through hopper end plate.
- Go to cat walk above wet well, and open the hydrant for the high pressure hose.



- Turn on high pressure pump using switch on wall above wet well (pump itself is located by the seal water tanks down the steps leading to the cone valves).
- Hose down wet well.
- Turn off high pressure pump.
- Close hydrant for high pressure hose.
- Hose around bar screens downstairs and scrap up any rags that fell off of conveyor or out of hopper at end of conveyor.
- Open front of bar screens upstairs and scrape/ hose.
- Hose ladders under grating that leads down to bar screens.

### **Bar Screens**

- If both bar screens are to be left in service, skip this step
- Rotate bar screens by closing the influent and effluent gates of the side that was in service upon arrival and leave the other side in service a few minutes.
- Shut off bar screens on side being taken out of service.
- Put bar screens on side being taken out of service on OFF position.
- Put bar screen to be left in service on AUTO.

### **Main Control Desk**

- Put variable speed pumps #1 and #4 on AUTO and set switch #1 and #4 to AUTO.
- Wait for wet well level to get to 294 feet to make sure pump kicks back on.

### **Oil Check**

- Check oil cups for high pressure pump, and add any oil as needed.

### **Garage**

- Check dumpster in garage and clean up area if needed.

## 4.3.5 Spring Creek Pump Station

### 4.3.4.1 General

The Spring Creek Pump Station (**Figure 4.3-7**) is located off Cameron Street, just south of the intersection of Cameron and Magnolia Street. The Spring Creek Pump Station receives flow from the Hemlock Street Interceptor (24-inch diameter) combined wastewater) and Spring Creek Interceptor (27-inch diameter), sanitary only). The Spring Creek Pump Station service area encompasses parts of Harrisburg, Lower Paxton Township, Paxtang, Penbrook, and Swatara Township, Annual average daily flow is approximately 5 MGD with peak daily flows exceeding 10 MGD. The design average daily flow and peak daily flow are 10.0 MGD and 28.9 MGD, respectively. A 20-inch diameter force main, approximately 65 feet long, connects the Spring Creek Pump Station to the 48-inch diameter force main that conveys wastewater from the Front Street Pump Station to the AWTF.



**Figure 4.3-7 Spring Creek Pump Station**

The pump station has three (3) 250 horsepower vertical shaft solids handling pumps rated for 8,350 gpm at 80 feet of head (each). All three pumps are variable speed. Dry weather flows are typically conveyed with one pump operating while wet weather flows result in two to three pumps operating simultaneously. All three pumps can be operated during high peak flow condition provided one of the pumps is operated at 50-percent speed to remain within the capacity of the electrical service to the pump station. **Table 4.3-5** includes a summary of design data for the Spring Creek Pump Station. **Figure 4.3-8** shows a general flow schematic of the Spring Creek Pump Station.

**Table 4.3-5 Spring Creek Pump Station Design Data**

<b>PUMPING STATION DESIGN DATA</b>	
<b><u>Flow (MGD)</u></b>	
Average	10
Peak	28.9
<b><u>Sewage Pumps</u></b>	
Manufacturer	Yeomans Chicago Dry Pit Pump
Number of Pumps	3
Type	Vertical Centrifugal, Variable Speed
Unit Capacity (gpm)	8,350
TDH (feet)	80
Motor Horsepower	250
Motor rpm	875
Control	Liquid Level Sensing
<b><u>Flow Measurement</u></b>	
Type of Meter	Venturi Tube

The Pump Station was constructed in 1959. An upgrade in 1982 included replacing pumps, check valves, and installation of additional screening capabilities.

The expanded screening capabilities (vertical bar screen) and influent control added in 1982 is informally referred to as the “new side” or “bar screen side”. This is the primary flow path. The original influent path, referred to as the “old side”, serves as alternate flow path. Screening equipment on the “old side” consists of two parallel channels with barminutors.

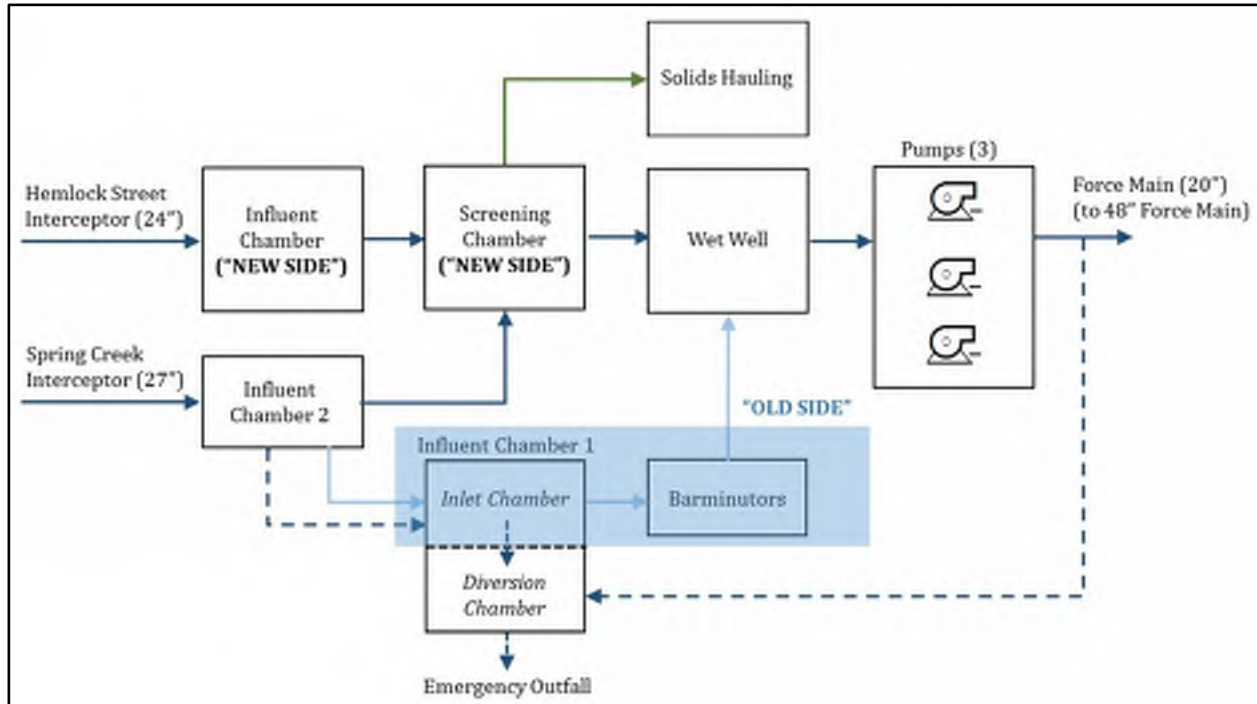

Figure 4.3-8 Spring Creek Pump Station Flow Schematic

#### 4.3.5.2 Influent Flow Control

The Spring Creek Pump Station receives wastewater conveyed by the Spring Creek and Hemlock Street interceptors (Figure 4.3-9). The main influent chamber, located on the “new side” receives wastewater directly from the Hemlock Street interceptor. Wastewater from the Spring Creek interceptor is first conveyed to influent chamber 2, where it may be directed to influent chamber 1 (“old side”) or the main influent chamber (“new side”). Under normal conditions, the Spring Creek interceptor flow is conveyed to the new (bar screen) side.

Influent chamber 2 contains an overflow weir which allows excess flow to overflow to influent chamber 1. Influent chamber 1 is divided into compartments. The inlet compartment contains a hydraulically operated sluice gate which, when closed, directs the overflow from influent chamber 2 to the diversion and outfall compartment or, when open, allows the overflow to enter the pumping station (from the “old side”). From the diversion compartment, overflow is discharged to the outfall compartment where a manually operated sluice gate, when open, diverts it to the Paxton Creek. Also provided is a 12-inch-diameter bypass connection between the 20-inch-diameter force main and the outfall compartment to allow pumped wastewater to be diverted to Paxton Creek. The tide gate prevents creek floodwater from entering influent chambers 1 and 2 and the pumping station.

The inlet to the screening chamber is furnished with a hydraulically operated sluice gate. This gate has a pneumatic level-sensing controller which senses the channel liquid level downstream of the gate and modulates the gate position to maintain the preset 4-foot liquid depth. The controller is provided with a manual override and emergency close feature. The manual override allows the operating personnel to position the gate at any desired setting, while the emergency close feature

automatically closes the gate on electrical power interruption and opens the gate when power is restored. The emergency close feature overrides all other operating modes. In case hydraulic power is lost, the gate is operable by means of a hand pump.

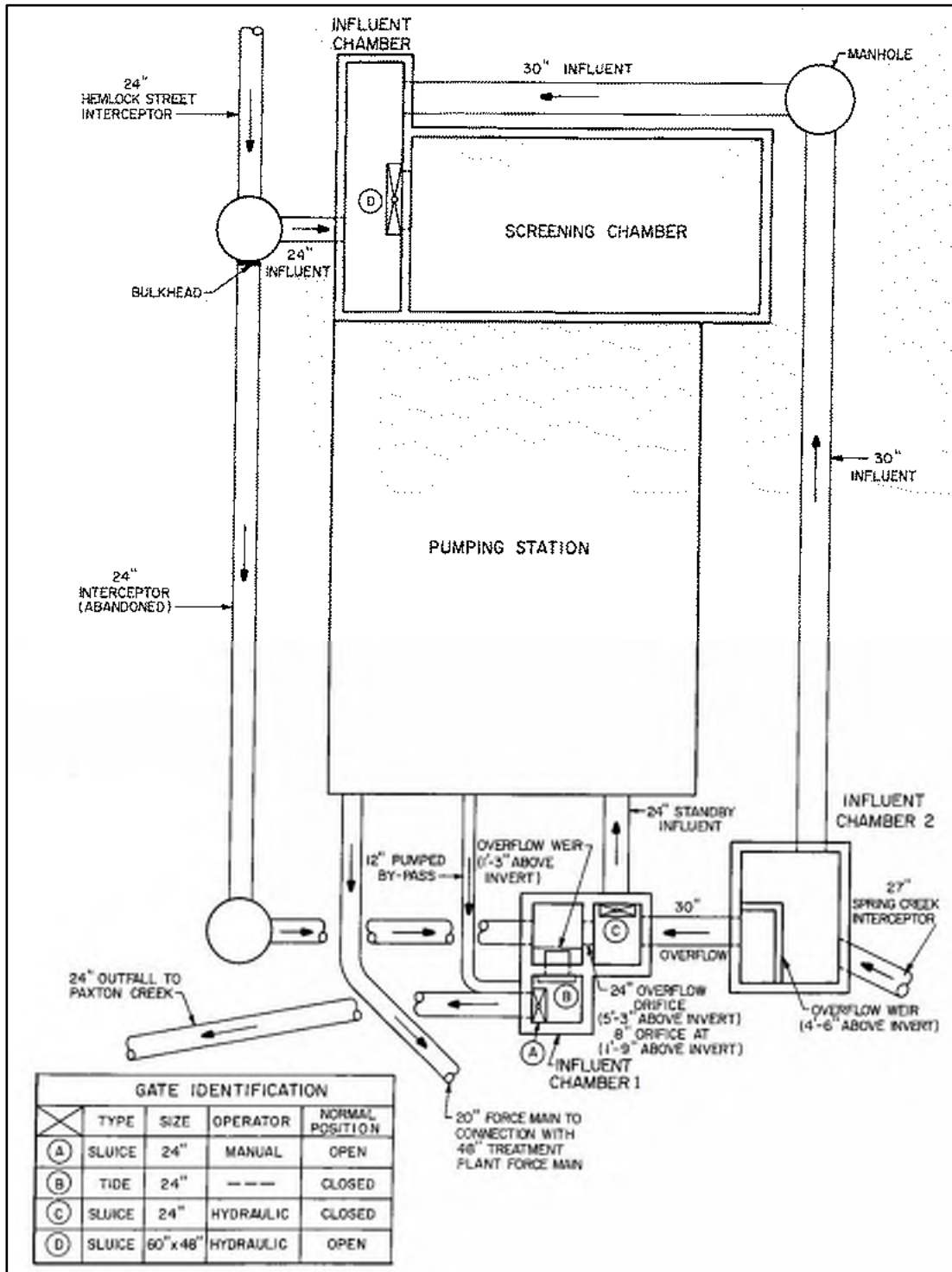

Figure 4.3-9 Spring Creek Pump Station – Influent Flow Control

Source: Gannett Fleming Cordory and Carpenter, Inc., October 1981.

### 4.3.5.3 Screening Equipment

The main screening facility, which operates when the normal flow pattern (“new side”) is being used, consists of a mechanically cleaned bar screen with screenings chute and dumpster container located at ground level (**Figure 4.3-10**). The standby screening facility (“old side”), which operates when the main screening facility must be taken out of service, consists of two barminutors located in parallel channels just upstream of the wet well.

The mechanically cleaned bar screen collects solids and debris carried into the screenings chamber by the influent wastewater. The back-cleaning rake mechanism conveys the solids and debris to the screenings chute, where they are discharged into a dumpster container.

The operation of the bar screen is controlled by a timer and differential level-sensing instrumentation through a hand-off-auto selector switch. The hand-off-auto selector switch sets the mode of operation. With the switches in the HAND position, operation of the cleaning mechanism is continuous. With both switches in the AUTO position, the timer controls operation intermittently unless the differential level-sensing control overrides the timer. The differential level sensing control will actuate the cleaning mechanism when the upstream wastewater level exceeds the preset differential value with respect to the downstream water level. A limit switch is used in conjunction with the timer and differential level control to stop the cleaning mechanism in a position where the rake arms are not across the face of the bar screen. A shear pin coupling and limit switch shut off the mechanism to protect the drive motor when a rake arm becomes jammed with screenings.

The operation of the barminutors in the old side is controlled from panels mounted on the equipment. Each barminutor control panel has a power on-off switch, a run-off-auto selector switch and a pneumatic differential pressure-level switch. The differential pressure is measured upstream and downstream of the barminutors by a bubble tube system. Upon exceeding the differential level set point, the barminutors will start when the control selector switch is in the auto position. In the run position the barminotor will start and continue to run until switched off.

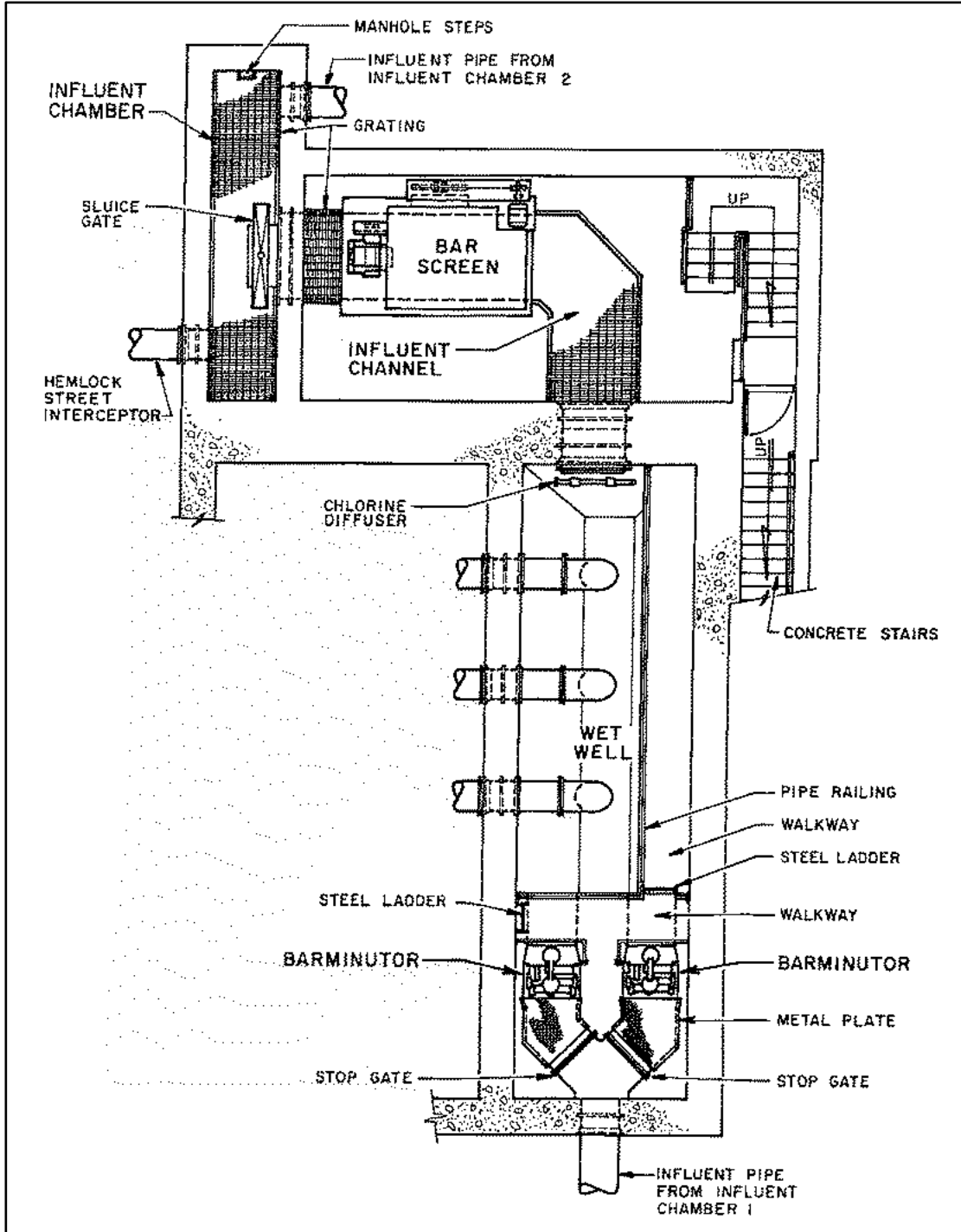

Figure 4.3-10 Spring Creek Pump Station – Influent Chambers

Source: Gannett Fleming Cordory and Carpenter, Inc., October 1981.

#### 4.3.5.4 Sewage Pumps

Screened wastewater is discharged directly to the adjacent rectangular wet well (**Figure 4.3-11**). The bottom of the wet well is steeply sloped to the suction of the pumps to minimize settling and deposits. Access to the wet well is provided by a steel walkway and stair from the ground floor. A ladder must be used to reach the floor of the wet well from the walkway.

The pump station has three (3) 250 horsepower vertical shaft solids handling pumps rated for 8,530 gpm at 80 feet of head (each). All three pumps are variable speed. Automatic pump priming is provided by a vacuum-type priming system to eliminate air binding of the wastewater pumps. Seal water, provided by the station water system, is supplied to each pump.

The wastewater pumps vacuum priming system consists of a duplex automatic pump primer and three air release valves, one for each wastewater pump. The duplex primer consists of two vacuum pumps mounted on a common vacuum receiver, complete with interconnecting piping, controls, and gauges.

All pumps are operated from a control panel located on the intermediate floor of the pumping station. The pump control panel consists of two silicon-controlled rectifier (SCR) speed control modules (one for each variable speed pump) and a wet well level sensing and pump sequencing control module. A continuous air purged bubbler pipe is used for sensing the change in wet well liquid level and for regulating the speed controllers. Either of two air compressors, complete with receiver and air flow controls, supplies air to the bubbler. Pump operation sequencing is accomplished automatically with sequence order dictated by the position of a selector switch (refer to **Table 4.3-6** for wet well operating levels). **Note that the third pump must be placed into service manually.**

In addition to the manually operated suction and discharge gate valves, each pump discharge is fitted with a hydraulically operated cone valve that acts as a check valve. Each cone valve is equipped with limit switches (for indicating the open and closed position of the valve) and a pump shutdown switch. Opening and closing of each valve are accomplished automatically by a four-way, pilot-operated control valve or manually through a hand-operated valve. The pilot valve is of the poppet type and is electric solenoid operated. Speed control is set by manual adjustment of the needle valves.

**Table 4.3-6: Spring Creek Wet Well Operating Levels**

	RISING WET WELL LEVELS (FT)		RISING WET WELL LEVELS (FT)	
Lead Pump	Start @	3.5	Stop @	1.5
1st Lag Pump	Start @	5.0	Stop @	3.0
High Water	Alarm @	5.5		
Low Water	Alarm @	1.0		
Levels referenced to bottom of wet well				



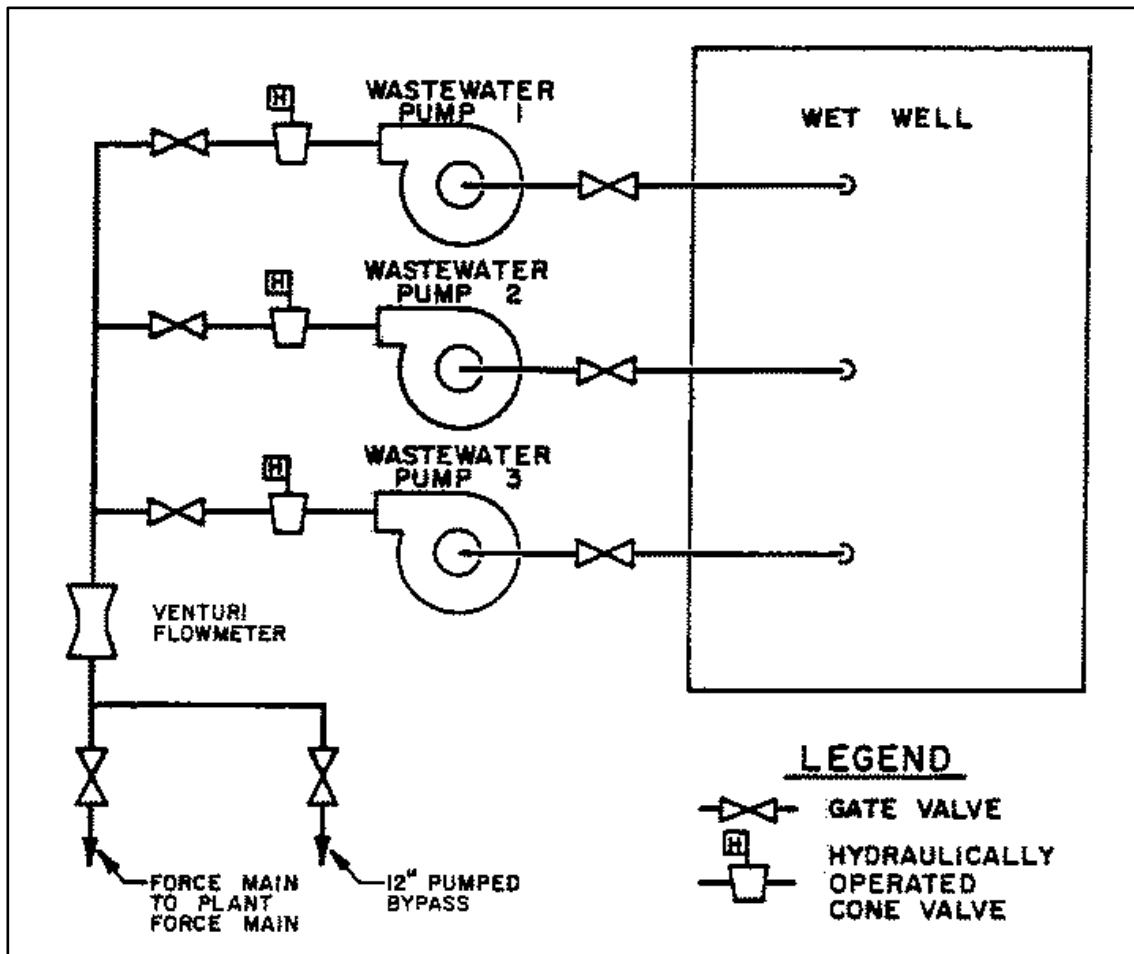

Figure 4.3-11 Front Street Pump Station – Wastewater Pumping

Source: Gannett Fleming Cordory and Carpenter, Inc., October 1981.

Refer to the 1981 Operation and Maintenance Manual for detailed descriptions of the Front Street and Spring Creek auxiliary systems summarized below (Section 4.3.5.5 through 4.3.5.9).

#### 4.3.5.5 Hydraulic Fluid System

The hydraulic fluid system operates cone valves and sluice gates. The system consists of a control panel, fluid reservoir, positive displacement pumps, and nitrogen charged accumulators.

#### 4.3.5.6 Station Water System

The station water system supplies water to the water sealed stuffing boxes of each wastewater pump, level sensing float tubes, screenings grinders, and the flow meter.

#### 4.3.5.6 Chlorination System

The Spring Creek Pump Station previously maintained provisions for chlorination for odor control and disinfection. This system is no longer in use.

#### 4.3.5.7 Emergency Power

In the event of a power failure, an emergency generator provides standby power at the Spring Creek Pump Station (**Figure 4.3-12**). The system is designed to provide 100 percent standby power. The emergency power generating system consists of a diesel engine driven generator set complete with a control panel and an automatic transfer switch. The automatic transfer switch is mounted at the electrical control center. An underground fuel-oil storage tank supplies No. 2 fuel oil to the diesel engine through a fuel-oil day tank located near the generator.

If normal electric power fails, the generator set operating in conjunction with the automatic transfer switch automatically starts when the controller is set for automatic start. After the generator set reaches rated voltage and speed, the transfer switch automatically transfers the connected equipment load to the generator set, which continues to supply electric power to operate and control the wastewater pumps. When normal power resumes, the transfer switch automatically transfers the connected load back to the normal supply. During power interruption, the transfer switch activates a remote alarm and indicates visually the source of electric power, either normal or standby.

**Refer to Section 4.8 for general non-routine and emergency maintenance procedures.**

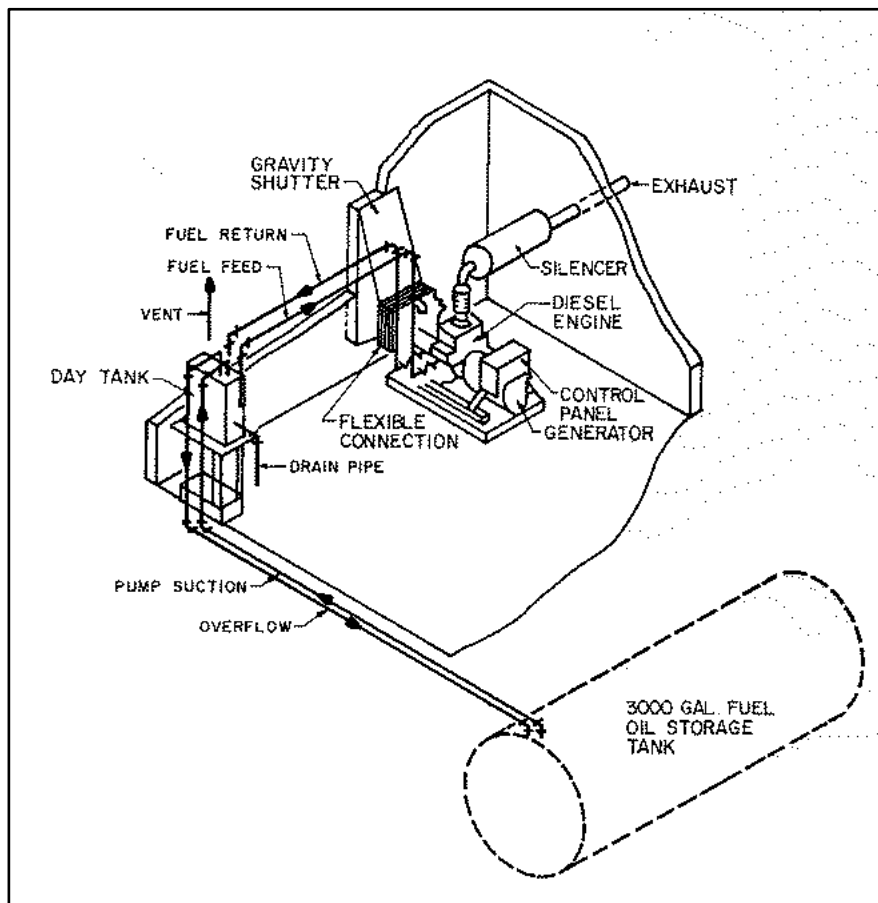

**Figure 4.3-12 Front Street Pump Station – Emergency Power Generation**

**Source: Gannett Fleming Cordory and Carpenter, Inc., October 1981.**

#### 4.3.5.8 Flow Monitoring

Effluent wastewater flow, which includes flow from the Spring Creek and Hemlock Street interceptors, is metered by a Venturi tube mounted in the discharge header, located in the basement of the station. The Venturi tube, with its appurtenant transmitter and receiver, continuously indicates and records the wastewater flow. The Venturi tube is a 20-inch-diameter Model VTS-4A, with a throat diameter of 11.382 inches, manufactured by BIF. The transmitter and receiver are a Model CTUA-4 Chronoflo and a Model CRB-IR Chronoflo, respectively, manufactured by BIF.

#### 4.3.5.9 Combustible Gas Monitoring

A combustible gas detection system is installed at each pump station. The gas levels are monitored at various locations in the pump stations, and the levels indicated at a control panel in each station. Combustible gas levels of 25, 50, and 75 percent LEL (lower explosive limit) are indicated by an amber warning light, red alarm light, and a red high-alarm light, respectively, in conjunction with a horn. The monitoring system is checked quarterly by an outside contractor.

#### 4.3.5.10 Wet Weather Operation / Emergency Bypass

In the event of an emergency, the Spring Creek Pump Station has a permitted emergency outfall (CSO-003) which discharges wastewater to the Susquehanna River.

Manually operated gate valves are located in the force main at the structure wall and in the pumped bypass to influent chamber I. Closing of the force main gate and opening of the bypass gate will allow pumped wastewater to be diverted to the creek through the overflow compartment of influent chamber 1.

**Refer to Section 4.8 for general non-routine and emergency maintenance procedures.**

#### 4.3.5.11 Inspection, Operation, and Maintenance Activities

In addition to daily inspections, outlined in the *General Pump Station Activities Checklist*, there are additional inspection/maintenance activities specific to the Spring Creek Pump Station.

The primary flow path at the Spring Creek Pump Station utilizes the bar screen (“new side”). However, during scheduled maintenance or emergencies, it may be required to switch to the “old side”. Procedures for switching to the “old side”, and switching back to the “new side”, are outlined in this section.

High flow procedures for the Spring Creek Pump Station are documented in this section.

Checklists included in this section, specific to Spring Creek Pump Station procedures, include the following:

- ***Spring Creek Pump Station – Operating Barminutor Screens***
- ***Spring Creek Pump Station – Operating Bar Screen***
- ***Spring Creek Pump Station – Operating Wastewater Pumps***

- ***Spring Creek Pump Station – Changing over to Bar Screen Side***
- ***Spring Creek Pump Station – Changing over to Old Side***
- ***Spring Creek Pump Station – Pump Down Procedure***
- ***Spring Creek Pump Station – High Flow Procedures***

## Spring Creek Pump Station – Operating Barminutor Screens

This procedure describes the actions necessary to initiate operation of the barminutors.

*Complete the following items prior to changing wastewater flow to the old side.*

**NOTE:** FOLLOW ALL SAFETY GUIDELINES WHEN PERFORMING THE PROCEDURE.

### Pre-Start Inspection

- Inspect the channels for debris on the coarse bar screen and in front of the barminutors and remove prior to starting equipment
- Verify equipment is energized.
- Verify equipment is properly lubricated and is ready for operation
- Verify bubble tube level sensing equipment is functioning which is required for automatic operation to the barminutors.

### Start-up

- Switch the power switch on the local control panel to ON position
- Place selector switch in the HAND position and verify barminutor runs properly, then switch to the AUTO position
- Repeat procedure with second barminutor. Note: both barminutors should be placed in operation; avoid running only one unit since that will limit the screening capacity.

### Influent Control

- When equipment is operating properly, complete the *Changing over to Old Side* procedure to direct all influent flow through the barminutors.

## Spring Creek Pump Station – Operating Bar Screen

This procedure describes the actions necessary to initiate operation of the bar screen.

*Complete the following items before changing wastewater flow to the bar screen side.*

**NOTE:** *FOLLOW ALL SAFETY GUIDELINES WHEN PERFORMING THE PROCEDURE.*

### Pre-Start Inspection

- Inspect the bar screen channel for debris in front of the bar screen and remove prior to starting equipment.
- Verify equipment is energized.
- Verify equipment is properly lubricated and is ready for operation

### Start-up

- Place selector switch in the HAND position and verify bar screen runs properly, then switch to the AUTO position
- Verify automatic timer is set to proper cycle time (30 minutes) or as otherwise determined through operating experience.
- Verify differential pressure-level switch is set between 9 and 12 inches.
- Check that the screenings dumpster is in place and is not full.

### Influent Control

- When equipment is operating properly, complete the *Changing over to Bar Screen Side* procedure to direct all influent flow through the barminutors.

## Spring Creek Pump Station – Operating Wastewater Pumps

This procedure describes the actions necessary to initiate operation of the wastewater pumps.

*Complete the following items to restart a wastewater pump.*

**NOTE:** FOLLOW ALL SAFETY GUIDELINES WHEN PERFORMING THE PROCEDURE.

### Pre-Start Inspection

- Inspect the wet well for debris that may obstruct the pump suction piping. Remove debris as necessary.
- Check that the screenings equipment is operating satisfactorily.
- Check that the wastewater pump has been properly lubricated and is ready for operation.
- Check the seal water connection to the pump stuffing box is in operating condition. Need to verify solenoid opened and seal water is flowing when pump is started.
- Check for proper valve position in pump suction and discharge lines (open).
- Check on the vacuum primer system and verify it is operational.

### Start-up

- At control center 9, pumps are controlled by the start-stop-reset pushbuttons for the respective pumps. Pushing start button will manually start the pump. Automatic control is achieved by pushing the Reset and Start pushbuttons for the pump being started.
- Push the Start button to verify pump will start and run.
- Push the Stop button to stop the pump, wait two minutes to allow the pump to stop, and then push the Reset and Start buttons to switch to automatic operation.
- For normal, automatic pump operation, place the speed control manual-off-auto selector switch to Auto position, verify the pump sequence
- The pump selector switch should be set so that one of the variable speed pumps is the LEAD pump. The First Lag pump can be the other variable speed pump or the

constant speed pump. Normally, the second variable speed pump is the First Lag pump. The remaining pump is selected as the Second Lag pump.

### **After Pump Startup**

- Verify pumps are properly operating through automatic controls. Verify pump is operating without excessive vibration or cavitation.
- Check cone valve on discharge side of pump to verify it opened.



## Spring Creek Pump Station – Changing over to Bar Screen Side

The Spring Creek Pump Station is normally operated on the Bar Screen Side. Switching operation to the Old Side is performed when there is a problem with, or maintenance is being performed on the Bar Screen Side. This procedure describes the actions necessary to change operation back to the Bar Screen Side.

*Complete the following items during the procedure to change over to bar screen side.*

**NOTE:** FOLLOW ALL SAFETY GUIDELINES WHEN PERFORMING THE PROCEDURE.

### Bar Screens

- Go to dumpster room on the “new side”, and start bar screen equipment.
- Set bar screens switch to AUTO.

### Influent Gate

- Go inside the building to the hydraulic cabinet (along north wall by the restroom), and open the influent gate.
- Place manual down switch in ON position. Place manual down in UP position, or else it may creep back down.

### Rising Stem

- Close the rising stem valve located near the fence, to the west of the concrete box.

### Influent Valve

- Go onto the concrete box outside, and verify the valve is closed.

### Muffin Monsters

- Go down to wet well on the “old side”, and turn off the muffin monsters.

### Weir

- Open the weir set bypass.
- Go outside to concrete box on the west side of the building, and close the northwestern-most valve.

## Spring Creek Pump Station – Changing over to Old Side

The Spring Creek Pump Station is normally operated on the Bar Screen Side. This procedure describes the actions necessary to change to the Old Side in the event there is a problem with, or maintenance is required on the Bar Screen Side.

*Complete the following items during the procedure to change over to old side.*

**NOTE: FOLLOW ALL SAFETY GUIDELINES WHEN PERFORMING THE PROCEDURE.**

### Weir

- Close the weir set bypass.
- Go outside to concrete box on the west side of the building, and close the northwestern-most valve.

### Muffins Monsters

- Go down to wet well on old side and turn on muffin monsters.

### Influent Gate to Old Side

- Go onto the concrete box outside, and open the valve that feeds the muffins monsters.
- Open rising valve on southeast corner of box (closest valve to the station).
  - **NOTE:** *The valve may already be open since it is okay to leave open when flow is through the new side.*

### Rising Stem Valve

- Open the rising stem valve located near the fence, to the west of the concrete box.

### Bar Screen Influent Gate

- Go inside station to the hydraulic cabinet (along north wall by the restroom), and close influent gate for new side.
- Place manual up switch in manual down position; leave in manual down position; leave in manual or else may creep back up.

## Bar Screen

- Go to dumpster room on new side, and shut down bar screen equipment (can also shut off breakers in main building, but this is not usually done).

## Spring Creek Pump Station – Pump Down Procedure

*Complete the following items during the pump down procedure for the Spring Creek Pump Station.*

**NOTE:** *WHENEVER AN ENTRY IS REQUIRED, BE SURE TO FOLLOW ALL CONFINED SPACE ENTRY GUIDELINES.*

Pump down should be performed during the last round of the “B shift” on Sunday night since this is usually the lowest flow of week. Pump down should also be performed when wet weather is anticipated.

### Bar Screen

- Prior to entering the bar screen and wet well area verify the ventilation fans are running and there are no combustible gas alarms at the control panel. If ventilation system is not operational, or there is a combustible gas alarm, do not enter this area without restoring operation of the ventilation system until the alarm condition disappears, or use SCBA equipment and confined space entry procedures.
- Turn bar screen on HAND.

### Main Control Desk

- At the control room, put one of the variable speed pumps and the constant pump that was in service upon arrival to the HAND position.
- Set switch to MANUAL for pumps #1 and #2
- Set variable speed pump to 100%

### Verify Pump Operation

- Walk down to the pump room to verify that the pumps are running and the check valves are up.

### Clean-Up

- Push rags through hopper end plate.
- Go to cat walk above wet well, and open the hydrant for the high pressure hose.
- Hose down wet well.

- Close hydrant for high pressure hose.
- Clean and hose both levels of the bar screen room.

### **Bar Screens**

- Put bar screen on AUTO.

### **Bubbler System**

- Purge the bubbler system.
- Verify that the bubbler system is giving a correct reading by checking readout and making a visual observation of the wet well.

### **Main Control Desk**

- Put variable speed pumps #1 and #2 on AUTO and set switch #1 and #2 to AUTO.
- Wait for wet well level to get to 3.5 feet to make sure pump kicks back on.

### **Screen Room**

- Check dumpster and clean up area if needed.

## Spring Creek Pump Station - High Flow Procedures

*Complete the following procedures during high flow conditions at the Spring Creek Pumping Station.*

**NOTE:** *FOLLOW ALL SAFETY GUIDELINES WHEN PERFORMING THE PROCEDURE.*

### **AWTF Flows: 35 to 55 MGD**

- If both lead and lag pumps are running at 100%, and the wet well continues to climb and is approaching the high level alarm of 5.5 feet, it will be necessary to put the third pump into service.
- Set output to 160 amps.
  - **NOTE:** *The main station breaker cannot handle the power requirements of three pumps on maximum.*

### **AWTF Flows: > 55 MGD**

- No additional change necessary. (Ensure all prior changes have been made.)

### 4.3.6 Market Street Pump Station

#### 4.3.6.1 General

The Market Street Pump Station (**Figure 4.3-13**) is located off Market Street, just west of the intersection of Market and Ninth Street. The Market Street Pump Station receives stormwater only, which is pumped directly to Paxton Creek at an MS4 outfall beneath the Market Street overpass.



**Figure 4.3-13. Market Street Pump Station**

#### 4.3.6.2 Pumps

The station has a total of four pumps. Two of the pumps have capacities of 3,600 gpm, and the other two pumps have capacities of 600 gpm. The total capacity of the station is 12.1 mgd.

#### 4.3.6.3 Emergency Power

In the event of a power failure, an emergency generator provides standby power at the Market Street Pump Station. The system is designed to provide 100 percent standby power.

#### 4.3.6.4 Inspection and Maintenance Activities

The Market Street Pump Station is inspected twice daily (once per shift) during dry weather. During wet weather, the inspection frequency increased to six times daily (three times per shift). Follow the ***General Pump Station Activities Checklist***.

### 4.3.7 Preventative Maintenance Activities

Routine preventative maintenance is performed on the pump stations. Preventative maintenance activities are scheduled on a weekly, monthly, 3-month, 6-month, and yearly basis. **Table 4.3-7** summarizes the preventative maintenance activities.

**Table 4.3-7: Preventative Maintenance Lubrication Schedule**

PUMP STATION	WEEKLY	MONTHLY	3-MONTH INSPECTION	6-MONTH INSPECTION	YEARLY
Front Street	<ul style="list-style-type: none"> <li>• <b>Bar Screens</b> - grease fittings, drive chain</li> <li>• <b>Belt Conveyor</b> - grease fittings, drive chain</li> </ul>		<ul style="list-style-type: none"> <li>• <b>Pumps</b> – pump bearings and shafts, Rotovalve fittings</li> <li>• <b>Sluice gates</b> – handwheel operators, stem threads</li> </ul>		<ul style="list-style-type: none"> <li>• <b>Pumps</b> - drive motor bearings</li> <li>• <b>Fresh Water Pumps</b> - drive motor bearings</li> <li>• <b>Bar Screens</b> - drive motor bearings, coupling, gear res</li> <li>• <b>Belt Conveyor</b> - gear reducer, grease fittings</li> <li>• <b>Hydraulic System</b> - drive motors</li> <li>• <b>Hydraulic Press</b></li> </ul>
Spring Creek	<ul style="list-style-type: none"> <li>• <b>Bar Screens</b> - grease fittings, drive chain</li> </ul>		<ul style="list-style-type: none"> <li>• <b>Pumps</b> - pump bearings, drive shaft</li> <li>• <b>Seal Water Pump</b></li> </ul>	<ul style="list-style-type: none"> <li>• <b>Sluice Gates</b> – hand wheel operators, screw threads</li> </ul>	<ul style="list-style-type: none"> <li>• <b>Pumps</b> - drive motor bearings</li> <li>• <b>Bar Screen</b> - drive motor bearings, coupling, gear reducer, drive chain</li> <li>• <b>Seal Water Pump</b></li> <li>• <b>Hydraulic System</b> - drive motors</li> <li>• <b>Hydraulic Press</b></li> <li>• <b>Emergency Generator</b> - crank case, grease fittings</li> </ul>
Market Street			<ul style="list-style-type: none"> <li>• <b>Pumps</b> - pump bearings, drive shaft)</li> </ul>	<ul style="list-style-type: none"> <li>• <b>Pumps (#2, #3)</b> - drive motor bearings</li> </ul>	<ul style="list-style-type: none"> <li>• <b>Pumps (#1, #4)</b> - drive motor bearings</li> <li>• <b>Emergency Generator</b> - crank case, grease fittings</li> </ul>
City Island		<ul style="list-style-type: none"> <li>• <b>Air Release Valves</b></li> </ul>		<ul style="list-style-type: none"> <li>• <b>Pumps</b> – oil reservoirs</li> </ul>	

### 4.3.8 O&M Documentation for Pump Stations

Documentation for inspection and maintenance activities related to pump stations includes the following forms. Example documentation is included in **Appendix A**. Completed forms are kept on file and recorded electronically.

- **Pump Station Checklists** – Completion of daily pump station inspections is documented here.



## 4.4 O&M Activities for Interceptor Sewers

The interceptor sewers within the conveyance system are critical to the overall performance of CRW's combined sewer system. The interceptor sewers collect combined wastewater from multiple trunk sewers throughout the system, ultimately collecting and conveying all combined wastewater from the system to the pump stations by gravity, where it is conveyed by force mains to the AWTF. The proper operation and maintenance (O&M) of the conveyance system is critical to protecting water quality in the river and creek, and maintaining the proper operation of the treatment plant.

### 4.4.1 Introduction and Overview for Interceptor Sewers

CRW operates and maintains a total of six (6) interceptor sewers. Conveyance of combined wastewater consists of three (3) of these interceptor sewers, including the Front Street Interceptor, Paxton Creek Interceptor, and Hemlock Street Interceptor. Each of these interceptor sewers receive combined wastewater from trunk lines, and each trunk line has an associated CSO regulator structure and outfall. Additionally, the Spring Creek Interceptor, Paxton Creek Relief Interceptor, and Asylum Run Interceptor convey sanitary wastewater. The Paxton Creek Relief Interceptor and Asylum Run Interceptor connect to the Paxton Creek Interceptor. The Front Street Interceptor and Paxton Creek Interceptor discharge to the Front Street Pump Station, while the Hemlock Street Interceptor and Spring Creek Interceptor discharge to the Spring Creek Pump Station. **Table 4.4-1** summarizes the interceptors in the CRW system.

**Table 4.4-1 Interceptors in the CRW System**

INTERCEPTOR	TYPE	SIZE (IN)	LENGTH (MI)	MATERIAL	NUMBER OF CSO OUTFALLS	CSO DISCHARGE RECEIVING WATER
Front Street (FSI)	Combined	39 x 36; 40; 42	3.95	Concrete, VCP	27	Susquehanna River
Paxton Creek (PCI)	Combined	59 x 48; 60 x 72	5.53	Concrete	25	Paxton Creek
Hemlock Street (HSI)	Combined	24	0.52	Concrete, VCP	5	Paxton Creek
Spring Creek (SCI)	Sanitary	24 - 36	2.03	Concrete, CMP, DIP	0	N/A
Paxton Creek Relief (PCRI)	Sanitary	48	1.15	Concrete	0	N/A
Asylum Run (ARI)	Sanitary	24	0.67	Concrete, VCP	0	N/A

### 4.4.2 Inspection Preparedness

In **Appendix C, Table C-1** identifies available equipment for field maintenance crews and the *Inspection Preparedness Activity Checklist* lists activities to complete before embarking for the inspection and maintenance activities. The checklist is general and encompasses preparations for most field maintenance activities.

### 4.4.3 Inspection Activities

#### 4.4.3.1 Interceptor Flow Checks

The water level (% full) in each interceptor is recorded daily at designated manhole locations. This is recorded on the *Interceptor Service Report*.

Designated locations for interceptor flow checks include the following:

- Front Street Interceptor: Front and Tuscarora
- Paxton Creek Interceptor: 10<sup>th</sup> and Mulberry
- Hemlock Street Interceptor: Hanover and Magnolia
- Spring Creek Interceptor: Cameron and Cameron Parkway
- Asylum Run Interceptor: State Hospital grounds

#### 4.4.3.1 Interceptor Cleaning and Inspections

In 2014, CRW contracted Redzone Robotics to inspect all interceptor sewers using the Cleanflow sewer inspection system. The Cleanflow inspections by Redzone Robotics included closed circuit television (CCTV) video, NASSCO PACP data, sonar, and laser profiling. CDM Smith analyzed the inspection data, and provided recommendations for improvements along with preliminary schedules and costs. The following is a summary of findings and recommendations:

- Several sewers were found to have high risk structural issues including: holes, ovality, significant corrosion/ loss of concrete.
- Pipes with visible corrosion from CCTV video and more than 2 inches of concrete loss were recommended for rehabilitation.
- Several other Level 5 PACP defects such as Hole Void Visible (HVV) and Deformed (D) with longitudinal fractures (FL) in a circular reinforced concrete pipe (RCP) were identified. These pipe segments were recommended for rehabilitation in the next 10 years.
- For pipes that have moderate structural defects, but do not meet these levels of potential failure risk, CDM Smith recommended that they be re-inspected every 5 years.
- Similarly, CDM Smith reviewed the sonar data and developed a threshold of accumulated sediment that was significant enough to warrant cleaning. For these sewers it was found to be at least 15% maximum sediment depth in relation to full flow pipe depth anywhere in a pipe segment or a sediment volume greater than 10 cubic feet of debris. In addition, if one or two pipe segments are between a long stretch of pipe that meets the threshold, these pipes were in the cleaning or repair program.

As a result of the 2014 interceptor inspections that utilized closed circuit television (CCTV) video, NASSCO PACP data, sonar, and laser profiling and the subsequent condition assessment, CRW has recently completed cleaning approximately 34,000 linear feet of its interceptors. The cleaning contract was awarded in January 2016, and cleaning operations commenced in June 2016. Cleaning

operations was completed in March 2017. Approximately 1,500 tons of debris were removed from the interceptors, which exceeded the initial estimates from the 2014 interceptor inspections. The interceptor cleaning project revealed additional defects where material was removed, increasing the length of the Paxton Creek Interceptor rehabilitation by approximately 50% more than originally estimated for a total of 13,500 linear feet of interceptor rehabilitation or replacement.

#### 4.4.4 Pipe Replacement/Rehabilitation Schedule

The schedule for interceptor improvements is shown below:

- *FY 2015-2017: Interceptor Cleaning - COMPLETE*
- FY 2018 – 2032: Paxton Creek Interceptor Rehabilitation
- *FY 2018: Asylum Run Interceptor Rehabilitation - COMPLETE*
- *FY 2018 – FY 2019: Front St. Phase I Interceptor Rehabilitation - COMPLETE*
- FY 2019-2023: Front St. Phase 2 Interceptor Rehabilitation
- FY 2025-2028: Spring Creek Interceptor Rehabilitation

#### 4.4.5 Maintenance Activities

Currently, remedial cleaning and repair is the focus of CRW's Interceptor sewer maintenance activities. In addition, CRW continues to respond to emergency investigations and sewer cleaning with its own equipment. Remedial / emergency maintenance and repair is expected to be CRW's focus for the foreseeable future (e.g., through 2025 and beyond). As remedial maintenance and repair is completed, CRW anticipates that it will be in a position to establish a more routine, preventative maintenance program.

CRW will implement annual manhole inspections to measure the level of debris accumulation. This will be incorporated in Cityworks. CRW will evaluate the impact of debris levels on the interceptor capacity and develop cleaning schedules as deemed appropriate. The initial recommendations are to re-inspect the interceptors every five years.

#### 4.4.6 O&M Documentation for Interceptor Sewers

Documentation for inspection and maintenance activities related to interceptor sewers and trunk sewers includes the following forms. Example documentation is included in **Appendix A**. Completed forms are kept on file and recorded electronically in Cityworks.

- ***Front Street Interceptor Service Report*** – Field form completed daily which documents the inspections of CSO regulator structures along the Front Street Interceptor. Water levels (% full) in the interceptors is also documented on this form.
- ***Paxton Creek Interceptor Service Report*** – Field form completed daily which documents the inspections of CSO regulator structures along the Paxton Creek Interceptor. Water levels (% full) in the interceptors is also documented on this form.

## 4.5 O&M Activities for Force Mains

The force main sewers convey combined wastewater from the pump stations under pressurized flow to the Advanced Wastewater Treatment Facility (AWTF). The proper operation and maintenance (O&M) of the force mains is critical to ensuring proper operation of the pump stations and treatment plant, and avoiding sanitary sewer overflows (SSO) due to force main breaks.

### 4.5.1 Introduction and Overview for Force Mains

CRW operates and maintains a total of two (2) force mains. The primary force main connects the Front Street Pump Station to the AWTF, and is approximately 6000 feet long and 48 inches in diameter. A much shorter force main, approximately 65 feet long and 24 inches in diameter, connects the Spring Creek Pump Station to the Front Street Pump Station force main. In December 2006, a break in the force main resulted in the replacement of approximately 20 feet of pipe.

After being received by either the Front Street Pump Station or Spring Creek Pump Station, the entire flow of combined wastewater in the CRW system passes through these force mains where it is ultimately conveyed to the AWTF through a single influent line. Three (3) air release valves located along the primary force main allow for the removal of entrained air. Additionally, a blow off chamber and drain chamber overflow are located along Spring Creek, just upstream of the Spring Creek Pump Station.

### 4.5.2 Inspection Preparedness

In **Appendix C, Table C-1** identifies available equipment for field maintenance crews and the *Inspection Preparedness Activity Checklist* lists activities to complete before embarking for the inspection and maintenance activities. The checklist is general and encompasses preparations for most field maintenance activities.

### 4.5.3 Inspection Activities

Routine force main inspection activities by field maintenance personnel include the following activities:

- The entire length of the Front Street Pump Station force main is walked annually to look for any indications of leaks.
- In addition to periodic inspections, flow discrepancies observed at the AWTF may prompt force main inspections.
- Any wet spots or other changes in surface conditions that could be related to a leak should be documented on the *Force Main Inspection Form*.

In April 2016, CRW completed the inspection of 7,056 linear feet of force main with an internal acoustic inspection tool that identifies leaks, gas pockets, pipe anomalies and pipe stresses. The inspection results did not identify any leaks or stable gas pockets, and only a few lower priority anomalies were noted in the pipes. The results indicate that further inspection or rehabilitation is not required at this time.

#### 4.5.4 Maintenance Activities

Field maintenance personnel annually exercise and inspect the air release valves and pump out the blow off chambers, if necessary.

Non-routine maintenance activities may require bypassing the force mains, such as pipe rehabilitation or replacement. The Spring Creek Pump Station force main has provisions to bypass pump flow to its connection point along the Front Street Pump Station force main. However, there are no provisions to bypass pump flow from the Front Street Pump Station to the AWTF. If construction on the Front Street Pump Station force main is required, flow is discharged to the Susquehanna River through the emergency outfall, and the situation is treated as a dry weather overflow.

#### 4.5.5 O&M Documentation for Force Mains

Force main inspections are documented on the *Collection System Work Order*. Example documentation is included in **Appendix A**. Completed forms are kept on file and recorded electronically.

## 4.6 O&M Activities for Collection System Sewers and Manholes

CRW's collection system collects sanitary wastewater and/or stormwater from residential, commercial, and industrial users. Flow is conveyed to larger diameter trunk sewers by gravity. Trunk sewers convey flow to the conveyance system where it ultimately reaches the Advanced Wastewater Treatment Facility (AWTF). Proper maintenance of collection system sewers and manholes is necessary to prevent blockages that may sanitary sewer overflows (SSO); excessive fats, oils, and grease (FOG) accumulation; and infiltration/inflow (I/I).

Maintenance responsibility for the collection system was transferred in December 2013 from the City of Harrisburg to Capital Region Water (CRW).

### 4.6.1 Introduction and Overview for Collection System Sewers and Manholes

CRW's collection system consists of approximately 160 miles of sewer, including combined sewer, separate sanitary sewer, and separate storm sewer. Pipe sizes range from 8-inch circular pipes to 78" x 60" rectangular pipes. The collection system is a mix of separated sanitary and combined wastewater sewer. Pipe material of sewers within the CRW system is primarily terracotta, with some brick, concrete, and PVC pipes.

CRW has divided its collection system into trunk sewers and branch sewers based upon criteria provided in the partial CD and to focus LTCP development on its most important elements:

- **Branch sewers** within the combined sewer system collect combined wastewater from individual properties, inlets/catch basins within the public ROW, and other small-diameter sewers, and discharge to the trunk sewers.
- **Trunk sewers** within the combined sewer system collect combined wastewater and stormwater from branch sewers, and discharge to the CSO regulator structures.

### 4.6.2 Inspection Preparedness

In **Appendix C, Table C-1** identifies available equipment for field maintenance crews and the *Inspection Preparedness Activity Checklist* lists activities to complete before embarking for the inspection and maintenance activities. The checklist is general and encompasses preparations for most field maintenance activities.

### 4.6.3 Inspection Activities

#### 4.6.3.1 "Hot Spot" Checks

Manhole inspections of known "hot spots" by field maintenance personnel are conducted on a routine basis, and include the following activities:

- Field maintenance personnel routinely inspect manholes which are known "hot spots" for debris, sediment, or FOG accumulation. The hot spot locations are listed in Appendix A3.3. These locations are inspected either weekly, monthly, or quarterly.
- Any material accumulation observed during inspections should be removed.

- Documentation of which locations were visited each day and any required actions are recorded on the Collection System Inspection Form in Cityworks for the Hot Spots.
- A hot spot is added to the list based on whenever there is an SSO or unauthorized discharge from the occurrence of a line blockage. The hot spot inspection cleaning and inspection intervals are generated via Cityworks. Further details are provided in the following procedure.

## Hot Spot Listing, Inspection Frequency, and Delisting Procedure

*After resolving a sanitary sewer overflow or unauthorized discharge the following procedures shall be employed.*

- Based on the type of blockage that generated the overflow or discharge the Field Operations Supervisor shall select one of the following re-inspection frequencies for the location.
  - Quarterly
  - Monthly
  - Weekly
- Within Cityworks create a hot spot work order at the specified frequency.
- If the inspections identify repetitive issues that require routine cleaning, the location should be added to a cleaning preventative maintenance work order in Cityworks.
  - Once a preventative maintenance work order is developed, remove the location from the hot spot list.
- If the inspections do not identify repetitive issues, decrease the frequency of inspection as required based on the inspection results.
  - If weekly inspections are performed for a 1-month period without identifying issues, the hot spot inspection frequency shall be decrease to monthly.
  - If monthly inspections are performed for a 3-month period without identifying issues, the hot spot inspection frequency shall be decrease to quarterly.
- If quarterly inspections are performed for a 12-month period without identifying issues, the hot spot shall be delisted.



### 4.6.3.2 Trunk Sewer Inspections

Trunk sewers are inspected daily at their discharge to each regulator to verify proper flow conditions, identify potential blockages and sediment accumulation, and address any problems that could lead to a CSO overflow. These are inspected during the CSO regulator inspections. Refer to **Section 4.1.4** for details regarding other activities performed during the daily CSO regulator inspection activities.

Debris and sediment accumulation within trunk sewers typically occur at the downstream end, so most problems can be addressed from within the CSO diversion chamber. If no flow or low flow conditions exist within the CSO diversion chamber, this is indicative of an upstream obstruction. A pole mounted sewer inspection camera can be used to look up the trunk sewer from the surface of the CSO diversion chamber. If the source of no flow or low flow conditions cannot be identified at the CSO diversion chamber, it may be necessary to investigate further upstream the trunk line until the problem can be identified. Upstream blockages/obstructions should be addressed immediately as they have the potential to lead to a sanitary sewer overflow (SSO) upstream of the blockage.

CRW conducts in-house inspection and cleaning of the collection system to resolve blockages and other remedial cleaning and repair issues.

### 4.6.3.3 Manhole Inspection Program

In July 2015, CRW initiated a comprehensive inventory and inspection of its entire collection system. The comprehensive collection system inventory and inspection enabled CRW to advance its GIS of the collection system, identify sewer segments requiring more in-depth investigations into potential structural / maintenance problems, and where possible target sewer segments for cleaning and/or remedial repair.

CRW completed the review of the rapid assessment data in two phases. Initially, the trunk sewers and associated manholes, which correspond to the extent of the H/H model, were reviewed first (approximately 25% of the system). These sewers are considered critical, which warranted comprehensive reviews of inspection data in conjunction with the model development. CRW reviewed the remaining 75% in a prioritized fashion based on initial condition ratings and criticality. Branch sewers and manholes with condition ratings of 4 or 5 were comprehensively reviewed, similar to the trunk sewers. The remaining branch sewers were prioritized using a field-assigned condition assessment score for CCTV inspection, which will support a comprehensive re-prioritization of observed structural/O&M needs.

### 4.6.4 Maintenance Activities for Collection System Sewers and Manholes

Routine preventative maintenance is generally not performed on local sewers and manholes, with the exception of removing debris identified during routine “hot spot” inspections.

From the rapid assessment findings, low priority recommendations will continue to be monitored as part of a preventative maintenance program. In parallel with addressing identified remedial repairs, CRW will continue to televise the system, during which additional high priority repairs may be identified.

In-house capabilities for sewer maintenance requiring excavation is limited to shallow sewers. Construction on sewers greater than approximately eight feet in depth is typically done by contractors.

The following checklist outlines the procedure for investigating a potential line blockage.

## Line Blockage Procedural Checklist

*Upon receipt of a service request for a basement back-up or possible line blockage employ the following practices:*

- Document all pertinent information received from the service request.
- Consult Cityworks and CRW sewer maps.
- Establish expected flow direction. Identify location of upstream and downstream manholes.
- Following all safety guidelines, secure the work area around the manholes.
- Pull respective manhole lids and examine flow conditions.
- If the downstream manhole has little or no flow present, and the upstream manhole is surcharged, this indicates that there is likely a blockage in the line.
  - Removal of these blockages requires the use of a flushing unit and necessary personnel.
  - Attempt to dislodge the blockage from the downstream manhole.
  - Vactor and remove grease and debris as blockage is dislodged.
- Next working day or as soon as practical, CCTV assessment should be performed if the issue was determined to be attributable to the CRW main.
  - Line may need to be reflashed to remove any additional debris, grease, deposits and buildups in order for the line to be examined for structural integrity and defects.
- The homeowner should be informed of the results of the investigation as soon as possible.

#### 4.6.5 Sewer Replacement/Rehabilitation Schedule

CRW performs an annual sewer replacement/rehabilitation project each year for prioritized areas.

#### 4.6.6 Manhole Rehabilitation Schedule

Manhole rehabilitation is included in the annual collection system replacement/rehabilitation projects.

#### 4.6.7 O&M Documentation for Local Sewers and Manholes

Documentation for inspection and maintenance activities related to local sewers and manholes includes the following forms. Example documentation is included in **Appendix A**. Completed forms are kept on file and recorded electronically.

- **Collection System Inspection Form** – Field form documenting the completion of collection system “hot spot” inspections and any action (e.g. debris removal) required.

## 4.7 O&M Activities for Inlets and Catch Basins

Stormwater inlets receive stormwater runoff from City streets and direct the flow into the combined sewer system, ultimately conveying stormwater to the advanced wastewater treatment facility (AWTF) during storm events. Catch basins are a type or subcategory of stormwater inlet that, if properly maintained, trap sediment and debris, reducing the amount that enters the combined sewer system. During a precipitation event, stormwater drains from the streets through the grate opening and into the catch basin box structure. From here, stormwater is directed through a pipe to the combined sewer system. Most stormwater inlets are located and sized to provide adequate hydraulic capacity to limit the width and depth of flow in the gutter alongside the street during a select design storm event, typically a one- to two- year design event. Stormwater inlets that are properly designed and cleaned prevent localized flooding in residential and commercial areas due to urban runoff.

Maintenance responsibility for inlets and catch basins was transferred in December 2013 from the City of Harrisburg to Capital Region Water (CRW). When cleaned, many of these inlets / basins are discovered to have significant structural deficiencies that require immediate repair. Consequently, CRW must perform a multi-year program of remedial cleaning and repair before it can embark on a more preventive inspection and cleaning program. CRW established a goal to clean and inspect all inlets in the combined sewer system by the end of 2020 and completed this task in 2019.

Ultimately, a routine inspection and cleaning schedule, prioritized based on hydraulic and debris management performance and needs, will be prepared. The objective of preventive maintenance is to see that these structures are inspected regularly, observed conditions are carefully documented, any observed problems are promptly addressed, and both preventative and corrective maintenance activities are scheduled and conducted so urban stormwater runoff is properly collected and conveyed.

This section addresses the current maintenance needs of CRW's catch basins and inlets, and the O&M activities the CRW crews perform. The section also addresses how as CRW successfully implements its current multi-year program for the remedial cleaning and repair of clogged inlets and catch basins, CRW will develop a framework plan for preventive maintenance. The experience gained from the currently implemented assessment and rehabilitation procedures will be used to develop and implement future infrastructure condition and criticality assessments, preventive maintenance schedules, and techniques.

### 4.7.1 Introduction and Overview for Inlets and Catch Basins

Capital Region Water maintains approximately 3,900 stormwater inlets as part of its combined sewer system. CRW's inspection and maintenance program is primarily reactive, based primarily on customer complaints. Reactive maintenance performed to date has revealed a significant backlog of remedial maintenance needs.

CRW increased its equipment and staff necessary to complete nearly all inspection and maintenance activities related to inlets and catch basins without the use of outside contractors, including rebuilding stormwater inlets. Recently with a separate crew for inlet inspection and

cleaning and a separate crew for inlet rehabilitation, CRW has significantly increased the rate at which inlets are inspected, cleaned, and repaired.

### 4.7.2 Typical Storm Inlet and Catch Basin Configurations

Harrisburg street stormwater runoff is captured in storm inlets throughout the City. Most if not all of these inlets are catch basin structures. All catch basins in combined sewer areas are configured with a submerged trap to prevent release of sewer gases. Most CRW catch basins are brick construction.

### 4.7.3 Inspection Preparedness

In **Appendix C, Table C\_1** identifies available equipment for field maintenance crews and the *Inspection Preparedness Activity Checklist* lists activities to complete before embarking for the inspection and maintenance activities. The checklist is general and encompasses preparations for most field maintenance activities, including those for inlets and catch basins.

### 4.7.4 Inlet and Catch Basin Inspection and Cleaning Activities and Checklist

Inlets and catch basins are currently inspected and cleaned in response to citizen complaints, and crews also address adjacent inlets if it works with their schedule. The purpose of the inspections is to assess the condition of stormwater inlets and prioritize the need for cleaning and/or rebuilding stormwater inlets. After a catch basin is successfully cleaned and repaired, the adjacent inlets are inspected and cleaned while the crews are in the vicinity, when possible. Inspections and subsequent maintenance activities are tracked for all stormwater inlets in Cityworks.

Citizen complaints are the primary driver for inlet and catch basin cleaning and reconstruction. Complaints may be received by the 24-hour call center or directly by staff at the AWTF. The person who receives the call completes a service request in Cityworks, which details what information needs to be obtained from the person making the complaint. This includes contact information and a detailed description of the problem. Complaints related to blocked stormwater inlets, or related problems, are forwarded to the field maintenance supervisor or field maintenance manager.

Whenever possible, citizen complaints are investigated within 24 hours. Based on how the situation is prioritized among the list of other stormwater inlets requiring cleaning and reconstruction, the problem may not be remedied on the same day. However, it is important to validate citizen complaints, and communicate to homeowners and business owners that CRW will be addressing their concerns.

A checklist for inspection and cleaning activities is provided below in the *Inlet and Catch Basins Activities Checklist*.

## Inlet and Catch Basin Inspection and Cleaning Activities Checklist

Complete the following items during inlet and catch basin inspections. Inspections are completed prior to reactive or preventative maintenance. Inspections can be conducted either by the two-person Vector truck crew or an individual in a pickup truck. Complete the following items when cleaning inlets and catch basins. The approximate time for the two person Vector truck crew to clean an inlet (without reconstruction) is two to six (2 to 6) man-hours.

**NOTE: WHENEVER AN ENTRY IS REQUIRED, BE SURE TO FOLLOW ALL CONFINED SPACE ENTRY GUIDELINES.**

- Protect crew members from oncoming pedestrian and vehicular traffic by setting up traffic cones, using the vehicle as a physical barrier, and turning on the flashing lights.
  - If necessary, provide for any additional traffic control measures necessary to accommodate a safe working area, including lane closures.
- Clear any leaves, twigs, or any other debris within the vicinity of the stormwater inlet.
- Remove the inlet grate and determine how a confined space entry protocol would apply. Catch basins are confined spaces, but would not generally require a permit unless a potential hazard would be present.
  - If necessary, follow all confined space entry procedures. Bad air could potentially exit the combined sewer system to the work space and crew members should always be on the alert.
- Determine the degree to which the stormwater inlet is blocked with debris or sediment. Assign a rating from 1 to 5 with 5 having the highest blockage and most structural deterioration.
- Determine what maintenance items are required, including cleaning and rebuilding
  - If the inlet is blocked, try to determine whether removing the blockage would structurally compromise the inlet. (Use your best judgment, you may not know the extent of structural deterioration until inlet is partially cleaned. By then, it may just need to be rebuilt immediately).

*NOTE: Cleaning of catch basins should be completed when there is a significant sediment buildup (even if there is no blockage).*

- Clear the catch basin box of large floatables and debris.

- Using the Vactor truck, clean the catch basin box and pipe by removing sediment buildup.

*NOTE: Be particularly careful if the blockage appears to be providing structural support.*

- If removing the blockage results in a collapse, remove the collapsed materials from the area.
- Properly dispose of waste collected during cleaning.
- If the GIS database does not include dimensions for a stormwater inlet, measure and record the dimensions and inverts of the catch basin box and pipe.
- Assign a condition score to the stormwater inlet based on structural integrity. This will be used to prioritize maintenance activities.
- Provide information on the type of inlet (open back) and whether it includes a hood.
- Check for evidence of illicit discharges, including oil and grease. Indications of illicit discharges may include sheen on the water surface, discolored water, or unusual odors.

*NOTE: Be particularly careful if the blockage appears to be providing structural support.*

- Document the maintenance activity **in *Cityworks on the Inlet Inspection Form***. **Refer to Appendix A for the Cityworks documentation.**
- Check the vicinity of the location to see if there are nearby stormwater inlets requiring maintenance.
- If time permits, and maintenance can be easily completed (such as those only requiring cleaning), perform maintenance on those nearby stormwater inlets following the same procedure.



### 4.7.5 Maintenance Activities for Inlets and Catch Basins

Upon investigating a complaint or known problem and inspecting the stormwater inlet, a condition score is assigned to prioritize the problem. The condition score is based on the severity of disrepair. If the problem can be easily remedied, the problem may be addressed immediately.

Maintenance activities for inlets and catch basins include cleaning and reconstruction. Cleaning is typically performed as part of the inspection process. While many inlets and catch basins currently require reconstruction, this will be required much less often once the remedial maintenance phase is complete. To rebuild a stormwater inlet, it takes approximately 16 hours of labor (typically a two person crew working for eight hours). Clearing a blockage without having to do any reconstruction requires a two person crew approximately 1 to 3 hours to complete on average, depending on the amount of material to be removed.

A checklist for rebuilding (*Inlets and Catch Basins (Reconstruction) Checklist*) is provided below.

## Inlets and Catch Basins (Reconstruction) Checklist

Complete the following items when reconstructing inlets and catch basins. The approximate time for the two person Vector truck crew to reconstruct an inlet is 16 man-hours.

Depending on the maintenance priority, cleaning and/or reconstruction may or may not be completed immediately following a general inspection.

- Following all safety guidelines, secure the work area around the stormwater inlet.
- If necessary, refer to the *Inlets and Catch Basins Inspection Activities Checklist* for general inspection procedures.
- If cleaning is required prior to reconstruction, refer to the *Inlets and Catch Basins (Cleaning) Checklist* for general cleaning procedures.
- If removing the blockage results in a collapse, remove the collapsed materials from the area.
- Reconstruct the stormwater inlet to a fully operational condition. Specific procedures regarding stormwater inlet reconstruction depend on the configuration and the extent of repairs needed.
- Document the maintenance activity on the ***Collection System Work Order in Cityworks***.
- Check the vicinity of the location to see if there are nearby stormwater inlets requiring maintenance.
  - If time permits, and maintenance can be easily completed (such as those only requiring cleaning), perform maintenance on those nearby stormwater inlets following the same procedure.

#### 4.7.6 Preventative Maintenance Schedule

CRW will be establishing a schedule for preventative maintenance now that the initial remedial cleaning has been completed. This will involve evaluating additional cleaning required and identifying localized areas that are more prone to debris accumulation. Preventative maintenance procedures for green stormwater infrastructure (GSI) inlets are contained in **Appendix F**.

#### 4.7.7 O&M Documentation for Inlets and Catch Basins

Documentation for inspection and maintenance activities related to inlets and catch basins includes the following forms. Example documentation is included in **Appendix A**. Completed forms are kept on file and recorded electronically.

- Service Request Form – General form documenting citizen complaints; includes contact information and a detailed description of the problem; completed by the person who receives the service request.
- Collection System Service Request – Specific service requests generated in Cityworks for Blocked Inlets or Collapsed Inlets; completed in the field by field maintenance personnel.
- Inlet/Catch Basin Inspection Form – Documents the inlet condition, configuration, and features.

## 4.8 O&M Activities for MS4 Outfalls

### 4.8.3 Inspection Preparedness

The inspection of MS4 outfalls is conducted annually in conjunction with CSO regulators and outfalls. In **Appendix C, Table C-1** identifies available equipment for field maintenance crews and the *Inspection Preparedness Activity Checklist* lists activities to complete before embarking for the inspections.

### 4.8.4 MS4 Outfall Inspection Activities and Checklist

#### Introduction and Overview

Inspections of the MS4 outfalls are conducted during dry weather to assess the integrity of the outfall and related structures, look for signs of illicit discharge, and assess erosion, sedimentation, and overgrowth in the vicinity of the outfall.

### MS4 Outfall Inspection Checklist

- Conduct the inspection during dry weather conditions.
- Document any flow that is present at the outfall.
- Check for standing water at the outfall.
- Observe the condition of the outfall pipe and related structures, such as an end wall. Document any defects.
- Observe the area downstream of the outfall and note any erosion or sedimentation that may be attributed to the outfall.
- Check for overgrown vegetation that may be impeding the outfall.
- Check for debris accumulation. If present, remove any significant debris present in the immediate vicinity of the MS4 outfall.
- Check for any signs of illicit discharge, such as residue with a sheen. If an illicit discharge is suspected, notify the Environmental Compliance Inspector immediately.
- Note high water levels that have the potential to prevent stormwater discharge.
- Take photos or provide sketches of the outfall and/or surrounding area for noteworthy items.
- Document the outfall inspection in Cityworks.

#### **4.8.4 Preventive Maintenance Activities**

Due to the relatively simple nature of MS4 outfalls, extensive preventative maintenance is not required to ensure proper operation. The most critical preventative maintenance item is keeping the outfall clear of debris.

#### **4.8.5 O&M Documentation for MS4 Outfalls**

The findings from MS4 outfall inspections will be recorded on the appropriate field forms in Cityworks. Recorded information includes confirmation that the outfall inspection was completed; debris removal; inspections of flap gates.

## 4.9 Activities for Street Sweeping

### 4.9.1 Introduction and Overview for Street Sweeping

CRW performs street sweeping of 492.16 curb miles per month on City of Harrisburg streets within both the combined sewer and separate storm sewer systems. Street sweeping collects debris, sediment, and floatables on the surface to prevent entry into the stormwater collection system via inlets. CRW also performs sweeping at the Advanced Waste Treatment Plant and Water Resource Center as part of the good housekeeping measures for those facilities.

### 4.9.2 Street Sweeping Equipment and Preparedness

CRW has three Elgin Pelican Series NP Sweepers, which are 3-wheel sweepers. Two dump trucks are also utilized for street sweeping activities. The sweepers are equipped with a water spray system to minimize dust generation.

Prior to commencing sweeper operation, the operators conduct a pre-trip inspection that consists of the following:

- Check for first aid kits and fire extinguishers
- Check for tool bag
- Verify hydrostatic system is operation
- Check functionality of lights, including hazards, turn signals, beacons, headlights (low and high), and rear flood.

Daily service checks are also performed, which include the following:

- Verify levels for the (1) engine oil, (2) hydraulic oil, (3) coolant, (4) tire pressure, (5) windshield fluid
- Check the back-up alarm
- Check the front cross view mirrors
- Check the wear and pattern on the gutter broom and main broom
- Wash and flush the lower conveyor roller
- Check the conveyor belt tension and tracking

### 4.9.3 Street Sweeping Schedule and Map

Street sweeping is performed year-round, weather-permitting on Monday through Friday, excluding holidays defined by CRW. Each street is swept twice per month according to the schedule and map provided below. Adjustments are made to the schedule, when necessary to accommodate special events, street closures, or emergencies.

	<p><b>1st &amp; 3rd Mon &amp; Tues- Area 1,6 &amp; 9</b></p> <p><b>Morning</b> 8am-12pm</p> <ul style="list-style-type: none"> <li>Front to N. 7th/ N. City Line to Division</li> <li>Arsenal Blvd to State/ N 17th to N 21st</li> </ul>	<p><b>1st &amp; 3rd Wed &amp; Thurs- Area 2 &amp; 7</b></p> <ul style="list-style-type: none"> <li>Front to Fourth St. /Division to Maclay St.</li> <li>Cameron to 7th St./Market to Derry St.</li> </ul>
	<p><b>Afternoon</b> 12pm-4pm</p> <ul style="list-style-type: none"> <li>Market to Rudy Rd / S. 20th to E. City Line.</li> <li>State to Market / N 17th to N 25th</li> </ul>	<ul style="list-style-type: none"> <li>Fourth to Seventh St./Division to Maclay St.</li> <li>Cameron to 27th St./Derry St. to Expressway</li> </ul>
	<p><b>2nd &amp; 4th Thurs &amp; Fri- Area 3 &amp; 8</b></p> <p><b>Morning</b> 8am-12pm</p> <ul style="list-style-type: none"> <li>Front to Fourth St./Maclay to Forster St.</li> <li>17th to 23rd St./ Market to Derry St.</li> </ul>	<p><b>1st &amp; 3rd Fri / 2nd &amp; 4th Mon- Area 5 &amp; 10</b></p> <ul style="list-style-type: none"> <li>Cameron to 17th St./Market to State St.</li> <li>17th to 29th St./ Derry St. to Expressway</li> </ul>
	<p><b>Afternoon</b> 12pm-4pm</p> <ul style="list-style-type: none"> <li>Fourth to Seventh St./ Maclay to Forster St.</li> <li>23rd to 29th St./ Ruby Rd. to Derry St.</li> </ul>	<ul style="list-style-type: none"> <li>Cameron to 17th St./State to By-Pass</li> <li>17th St. to City Line/ Expressway to City Line</li> </ul>
	<p><b>2nd &amp; 4th Tues &amp; Wed -Area 4</b></p> <p><b>5am-7am</b>     <ul style="list-style-type: none"><li>Forster to Paxton St./ Front to 7th St.</li></ul></p> <p><b>7am-9am</b>     <ul style="list-style-type: none"><li>Paxton St. to South City Line/Cameron St. to West City Line</li></ul> (*Exception: Shipoke 8-9am)</p> <p><b>9am-1pm</b>     <ul style="list-style-type: none"><li>Paxton St. to South City Line/ Cameron to 17th St.</li></ul></p>	

Figure 4.9-1 Street Sweeping Schedule

In addition, the Advanced Waste Treatment Plant is swept weekly and the Water Resource Center is swept monthly. When a specific day falls on a 5th week. CRW will perform sweeping only in specific areas that are not affected by the daily sweeping schedule which is performed Monday thru Friday in a four-week schedule. The mileage varies depending on the specific area assigned.



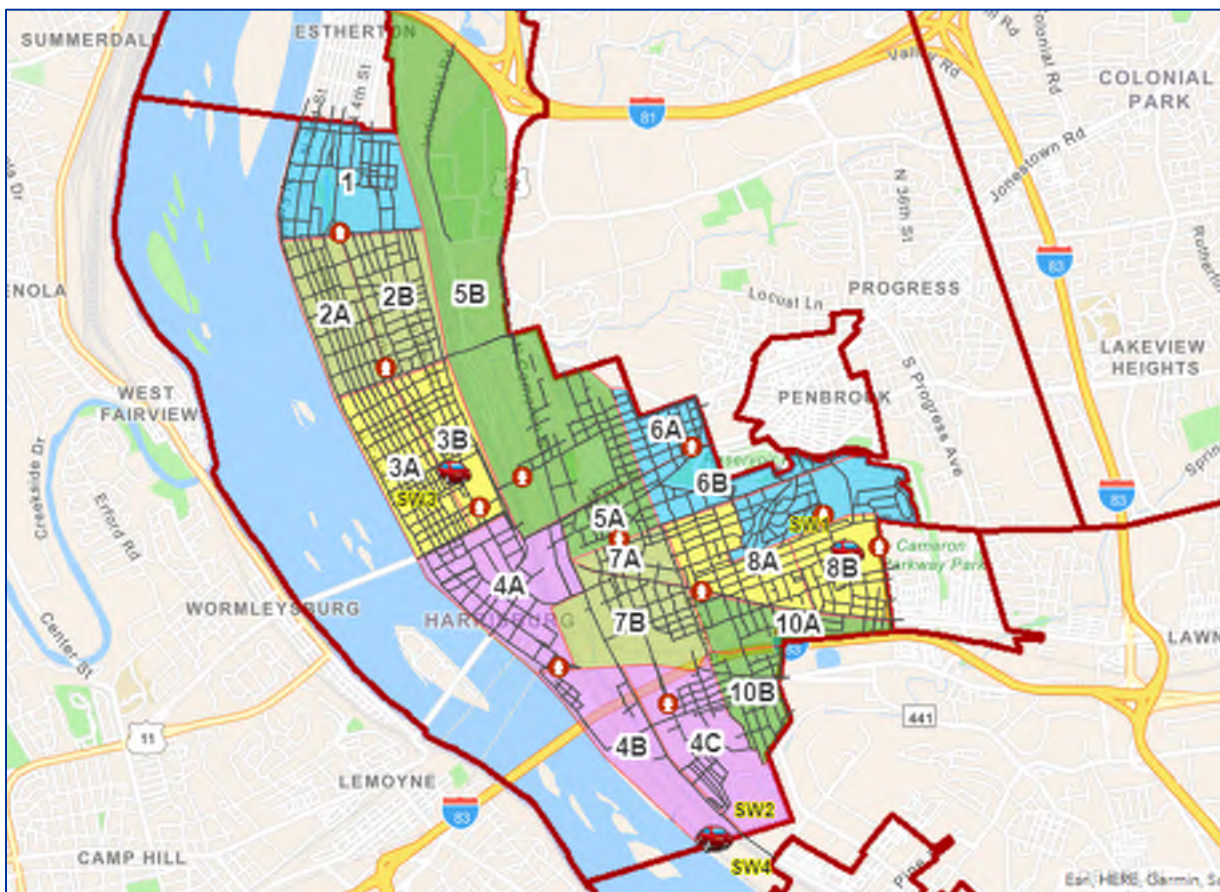

Figure 4.9-1 Street Sweeping Map

#### 4.9.4 Preventive Maintenance

The street sweeper manufacturer also recommends the following periodic service at 50, 150, 500, and 1,000 hours of operation: Inspect spray water pump, water filter, lubricate hopper door hinge, replace drive wheel oil, inspect & clean engine radiator cooling fins, AC condenser cooling fins, inspect engine air intake system, engine drive belt, grease cab doors hinges, grease guide wheel pivot bearings, engine coolant temperature, check drive wheel hub oil, inspect dust filters, service coolant per operator's manual, replace hydraulic oil filter element, drain visually inspect & refill hydraulic reservoir, inspect turbocharger, inspect engine radiator fan & hub, inspect & clean battery, replace drive wheel oil.

## 4.10 Activities for FOG Dischargers

### 4.10.1 Introduction and Overview for FOG Inspections

CRW established a fats, oils, and grease (FOG) program to help control the amount of pollution and buildup in the collections and conveyance system. This program is overseen and conducted by the environmental compliance inspector (ECI) who is responsible for educating local business and the public regarding grease related issues, as well as conducting FOG discharge inspections to ensure all grease control equipment is in place and being maintained properly.

### 4.10.2 Education of Newly Identified Dischargers

FOG dischargers not currently identified and registered in CityWorks are found through various means including social media, news agencies, and word-of-mouth. Once a new FOG discharger is identified, the ECI adds the asset to CityWorks/GIS through the ArcGIS Collector app. When an asset number is assigned, the name of business, physical address, and “Currently Open” are logged into the asset fields. The ECI then contacts the establishment’s owner, manager, or other representative and provides them with an education packet. This folder includes an introduction letter, a FOG Best Management Practices Manual, Section 7.5 of CRW’s Wastewater & Stormwater Rules and Regulations, a FOG discharge permit request, a sample grease trap cleaning log, and an inspection checklist.

The establishment’s representative is educated about the existence of the program and its importance for reducing pollution and maintaining the collections system. The discharge permit request is explained, and verbal instructions are given on how to fill out the form, how to submit it, and the need to have it mailed in within 30 days of receipt. This procedure could be simplified with coordination and cooperation from the City of Harrisburg, and the program is working on completing this goal.

### 4.10.3 Issuing FOG Discharge Permits

When CRW receives a FOG discharge permit request, customer service scans the permit request and e-mails it to the ECI. The hard copy is sent inter-office mail to the ECI. When the ECI receives notification a permit request has been received and the \$50.00 application fee has been paid, they enter a “PAID” in the “Notes” field of the asset assigned to that establishment in CityWorks. The information from the permit request is entered into the respective fields in CityWorks and the electronic copies are submitted to CRW’s GIS manager. All documents pertaining to a FOG discharger including permit requests, discharge permits, and inspection reports are uploaded by the GIS manager to a database. Hard copies of the permit request are filed in the ECI’s office.

During a FOG discharger’s initial inspection, the discharge permit is issued to the establishment, who has an obligation to keep a copy of the permit on premises. Discharge permits are valid for one year and are automatically renewed during the establishment’s annual inspection. The purpose of renewing permits is to maintain a current and accurate record of business and property owner information as well as information regarding the type of grease control equipment currently being utilized.

#### 4.10.4 Conducting FOG Discharger Inspections

Annual inspections are conducted for all identified FOG dischargers in the City of Harrisburg. To prepare for these inspections, the ECI reviews previous inspection reports as well as any other current information about the business including but not limited to their website and social media profiles. This information is especially important for establishments currently holding an “Exemption” status from previous inspections. Menu information will typically indicate if grease control equipment is required.

Inspections are not internally scheduled according to any methodology. Precedence is given to locations whose discharge permits are approaching an expiration date, but inspections are meant to be unpredictable to ensure an accurate assessment of the equipment is obtained. Inspections are typically scheduled with some proximity in mind so time management can be maximized.

After review of establishment information is complete, the ECI travels to the location and contacts the owner, manager, or other representative. The inspector announces his intention to assess the equipment and requests to see current cleaning logs or pumping manifests. If the establishment uses portable grease control equipment, the ECI also requests the owner, manager, or other representative open the equipment for inspection. In the case of portable traps, a rod is used to measure the contents of the device. Underground grease/grit interceptors are visually evaluated to determine compliance.

Once the inspection is completed, the owner, manager, or other representative is notified that they will receive a copy of the inspection report within 24 hours. Any deficiencies are discussed, and continuing education is conducted. In instances of non-compliance, the deficiencies are addressed and an acceptable compliance plan with specific timelines is assigned. The ECI enters all the information in the facility inspection report and forwards this report to the GIS manager to be uploaded. The report is also delivered to the owner, manager, or other representative of the establishment. The results of the inspections are recorded in CityWorks, and any follow-up inspections are scheduled. ***Refer to Appendix A for the Cityworks documentation.***

FOG discharge inspections can also be conducted in response to a service request where the cause of the issue was determined to be grease accumulation. These inspections follow the aforementioned procedure and become child work orders of the parent service request. The purpose of these inspections is to try and locate any grease control equipment not being properly maintained and address the issue.

#### 4.10.5 Inspection Assessments and Determination of Non-Compliance

Whenever an assessment of grease control equipment is conducted the results will follow one of four paths: Exemption, No Action, Non-compliance, and Non-compliance with follow-up inspection. In cases of the last two paths, a compliance plan with timeline is assigned and the owner, manager, or other representative is educated about the deficiencies and what needs to be done to come into compliance.

A determination of “Exemption” is used when a location has the potential to discharge FOG in quantities that could adversely affect the collections system but is not doing so at the time of the inspection. Bakeries and coffee shops typically have exemptions. Establishments that are

exempted are not required to apply for a discharge permit, but they do receive annual inspections to ensure excessive FOG is not being discharge because of a change in business operations. The owner, manager, or other representative will not usually receive a copy of the inspection report.

A determination of “No Action” is used when an establishment is in full compliance with CRW’s Wastewater and Stormwater Rules and Regulations as they pertained to FOG dischargers. The owner, manager, or other representative receives a copy of their inspection report to keep with their files.

A determination of “Non-compliance” is used when one or more items in CRW’s Wastewater and Stormwater Rules and Regulations is in non-compliance. Typically, this would mean the equipment and/or records are not being maintained. In cases where the equipment is not in compliance, follow-up inspections are ordered. When record keeping is not being done properly, the establishment is in non-compliance, but a return to location is not required.

#### **4.10.6 Compliance Plans and Follow-Up Inspections**

When an establishment is determined to be in non-compliance, a plan is put in place to help that location return to compliance. In many cases this requires a change in the cleaning frequency of the grease control equipment. The owner, manager, or other representative is made aware of the grease accumulation in their device and educated about how the equipment works and the necessity of proper maintenance to protect the system and local waterways. When a compliance plan is assigned, a timeline to complete each item is also given. When equipment needs to be cleaned or a new cleaning frequency needs to be implemented, the timeline is “Immediately”, but when record keeping deficiencies are found, the timeline could be three-month or six-month spans.

Follow-up inspections are typically conducted when new equipment must be installed, or new cleaning frequencies are established. This allows the ECI to ensure the compliance plan has been carried out accurately. As with regular inspections, follow-up inspections are not scheduled to ensure an accurate assessment is conducted.

## 4.11 Procedures for Investigations of Illicit or Prohibited Discharges

### 4.11.1 Emergency Response Protocol

The Environmental Compliance Inspector (ECI) may receive reports of illicit or prohibited discharges in many ways. Typically, the Field Operations supervisor is contacted by their staff or CRW's customer service regarding the incident. The Field Ops supervisor then forwards the information on to the ECI. In some cases, other staff members will contact the ECI directly if the incident is taking place at that moment and they have the contact information for the ECI.

### 4.11.2 Investigating the Report

After the ECI receives the report of an illicit or prohibited discharge, they immediately respond to the location of the incident. Each investigation requires a unique approach, but typically all investigations include aspects of gathering information (interviews, surveillance footage, etc.), gathering evidence (samples of discharged substances), and site analysis (examining what collections systems are present and where they discharge).

### 4.11.3 Recordkeeping

After Once all available information is gathered, an Investigation Report is completed by the ECI. This report includes the issue, background, items for consideration, and conclusions/recommendations. Depending on the circumstances of the discharge, this report is then passed on to the Director of Wastewater Operations. The investigation is then entered into CityWorks as a service request – investigation request. ***Refer to Appendix A for the Cityworks documentation.*** The investigation report is added to the request as an attachment and the hours of work are recorded in the labor. Any addition work required due to the discharge (e.g., vactor inlet), are link to the service request as a child work order.

The ECI will prepare Notice of Violation letters and recommend fines, depending on the nature of the discharge. These documents are reviewed and approved by the Director of Operations and CEO.

## 4.12 Emergency Maintenance Procedures

Emergency maintenance protocols are necessary to ensure the proper response to unexpected situations that may arise during O&M activities. While some non-routine activities may have existing protocols in place (such as dry weather CSOs), others do not, and staff must rely on the emergency response protocol and chain of command to address the situation.

**While an emergency may require a speedy response, it is of utmost importance to always follow proper safety guidelines.**

### 4.12.1 Emergency Response Protocol

An emergency may be identified by CRW maintenance staff or reported to CRW by customers or other concerned citizens. Complaints received by CRW (through the 24-hour call center or direct calls to staff) are relayed to the appropriate maintenance management staff. If the nature of the complaint is an emergency, it will be investigated immediately by maintenance crews.

- The Customer Service Center call routing procedures are provided in **Appendix B**.
- Once the situation is investigated, a preliminary determination of action is made (determine the criticality and the equipment/personnel required), and supervisory/management staff are contacted for further direction.
- During an emergency response, the chain of command is followed to ensure proper communication. The first contact shall be the Field/Facility Maintenance Supervisor, followed by the Field/Facility Maintenance Manager (if necessary), and then the Superintendent (if necessary). The chain of command relies on the experience of each person to assess manageable versus unmanageable situations, and to determine when a higher level in the chain of command should be contacted. **Refer to Appendix B for emergency contact information, including CRW staff contacts.**
- If a contact cannot be reached, continue calling management or other senior staff until someone can provide an adequate response to the situation.
- Follow the direction of whoever is ultimately managing the situation; be sure to take notes as the situation progresses. Remember to always follow proper safety guidelines while performing corrective actions.
- Management will allocate additional resources as necessary, including equipment and materials, emergency contractors, and additional staff. During an emergency, on-call maintenance staff may and Water Division staff (if there is proper cross-training) may be contacted for further assistance.
- After the situation has been addressed, if supervisory/management staff were not involved in the situation, inform them of the problem and any corrective actions taken.
- At the direction of management, regulatory agencies may need to be contacted.

There are several typical types of emergencies that CRW has operating procedures for, which are summarized here-in:

- ❑ Back-up or Overflow: Refer to the *Line Blockage Procedural Checklist*
- ❑ Sinkhole or Line Collapse: Refer to the *Sinkhole / Line Collapse Remedial Procedures*
- ❑ Dry Weather Overflow: Refer to the *Active Combined Sewer Overflow Activity Checklist*
- ❑ Pump Station: Refer to *Emergency Shutdown Procedures for the Main Treatment Facilities and Pump Stations*
- ❑ AWTF: Refer to *AWTF Emergency Action Plan & Emergency Shutdown Procedures for the Main Treatment Facilities and Pump Stations*

#### 4.12.2 Chain of Command

During emergency situations, the following chain of command should be followed.

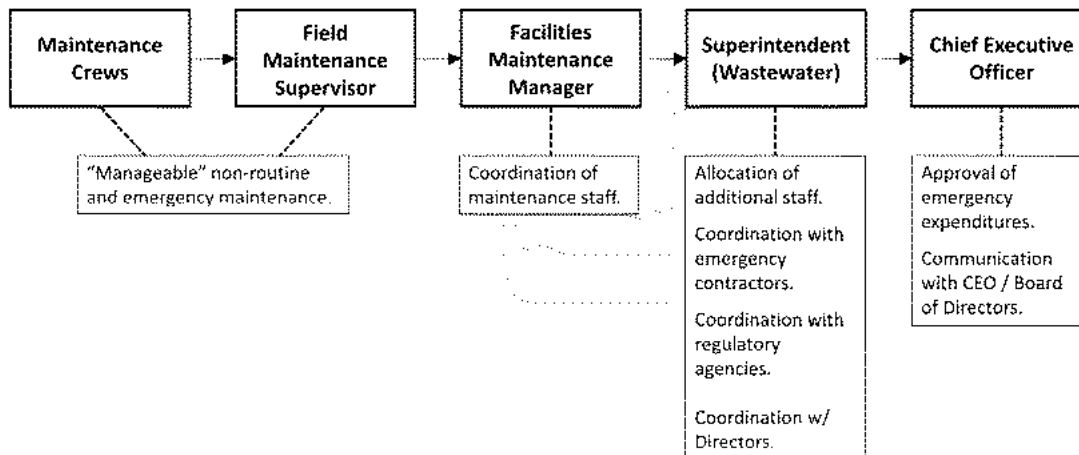

**Figure 4.12-1 Chain of Command**

Generally, "manageable" situations may be handled without the involvement of upper management staff. When a situation requires allocation of additional staff, coordination with outside agents, or approval of emergency expenditures, upper management staff may be involved. At each level of the chain of command, each person is relied upon to know when it is appropriate to involve the next higher level in a non-routine/emergency situation.

The Director of Wastewater Operations and CEO have the authority to approve all emergency maintenance, and while the Board of Directors may be notified of significant expenditures, generally there is not a defined upper limit of expenditures that requires Board approval towards emergency repairs. Budgeting for emergency maintenance grants CRW the flexibility to approve emergency maintenance expenditures. The Director of Wastewater Operations keeps the Board informed of emergency maintenance expenditures, in addition to notifying the Community Outreach Manager.

### 4.12.3 Emergency Maintenance Contractors

Emergency maintenance may require the use of outside contractors to make repairs beyond CRW capabilities, or to accelerate repairs. CRW maintains a pool of emergency contractors that may be contracted to complete emergency maintenance. Emergency contractors should be contacted by management, or by maintenance staff under the direction of management. **Refer to Appendix B for the list of emergency contractor contacts.**

### 4.12.4 Authority Notification

Following an emergency situation, regulatory agencies (particularly PADEP) will need to be contacted if an “environmental release” occurs. Regulatory agencies should be contacted by management, or by maintenance staff under the direction of management. **Refer to Appendix B for the list of regulatory agency contacts.**

### 4.12.5 Documentation of Emergency Maintenance

Depending on the urgency of a situation, the proper documentation of any corrective actions taken may take place after the situation has been resolved. Critical non-routine/emergency situations may result in a self-implementing order (such as dry weather CSOs), and completion of a work order may be foregone.

### 4.12.6 Emergency Maintenance on Evenings, Weekends, and Holidays

For emergencies that may occur during evening, weekends, and holidays, the emergency response generally does not change. While management staff typically work during normal business hours, the chain of command remains the same. The CRW call center is staffed 24 hours per day. Additionally, the AWTF is staffed 24 hours per day, and operators may receive emergency notifications outside normal business hours. However, occasionally staff availability (outside normal business hours) may limit the ability of staff to investigate an emergency (one operator must remain at the AWTF). In this scenario the operation/maintenance staff who receives the notification proceeds with the chain of command, and additional staff/resources are called in to address the situation (if it is considered critical and requiring an immediate response). CRW schedules an employee to be on-call for emergencies.



## 4.13 Emergency Sinkhole or Line Collapse Inspections and Repairs

### 4.13.1 Sinkhole / Line Collapse Remediation Procedures

#### Sinkhole / Line Collapse Remediation Procedural Checklist

*Once a potential sinkhole or line collapse is identified via customer complaints or other means related to the combined/sanitary sewer system, the following investigation and remediation procedures are utilized:*

- Consult Cityworks and CRW sewer maps.
- Establish expected flow direction. Identify location of upstream and downstream manholes.
- Following all safety guidelines, secure the work area around the manholes.
- Pull respective manhole lids and examine flow conditions.
- Employ listening devices to check for an indication of water flow.
- Perform a visual inspection for sewage or water.
- Conduct a CCTV inspection of the sanitary sewer lateral and gravity sewer mains in the vicinity of the sinkhole.
- Utilize a pole camera to conduct further investigations below the ground surface.
- Consult with the geotechnical consultant for sinkholes.
- Repair sinkholes or line deficiencies with CRW equipment if the depth is shallow enough for or employ an outside contractor to perform the repair.

### 4.13.2 Sinkhole Documentation

Each sinkhole investigation and repair is documented in Cityworks. With determination the sinkhole involves CRW infrastructure failure or compromise, CRW will have the sinkhole added to the GIS sinkhole layer, assigning a unique identifier to each sinkhole for perpetuity. **Appendix D** contains the master list of sinkholes that are incorporated in CRW's GIS.

## 4.14 O&M Activities for Green Stormwater Infrastructure

Please refer to **Appendix F** for information on green stormwater infrastructure, including operations and maintenance procedures.

## 4.15 Customer Service Request Tracking and Reporting Program

### 4.15.1 Current Tracking System

Citizens may currently utilize one of three methods to report problems or request service.

- Call 1-888-510-0606; Extensions 2 or 3
- Utilize the SeeClickFix mobile app
- Complete the form available under *Report A Problem* on [www.capitalregionwater.com](http://www.capitalregionwater.com)

Service requests are directed to the appropriate staff based on the *Service Call Routing Lists* provided in **Appendix B**. A *Service Request Call Report* is completed and utilized to generate a *Service Request* in Cityworks. The following types of *Service Requests* are provided in Cityworks.

- Back-up in Residence/Building
- Blocked Inlet
- Collapsed Inlet
- Damaged/Loose Manhole Cover
- Illicit Discharge
- Investigation Request
- Missing Manhole Cover
- Missing/Damaged Cleanout Cap
- Odor Complaint
- Sewer Overflow
- Sinkhole
- Street Sweeping

## 4.16 Education and Training of New and Existing Employees

### 4.16.1 New Employees

All new CRW employees undergo a formalized training program which includes both classroom and on-the-job training. A series of safety training sessions are conducted over a period of several days and include topics such as confined space entries, traffic control, and chemical safety. New employees are also given facility tours so they are familiar with the “within the fence” treatment plant facilities and the “outside the fence” pump station and CSO structure facilities. New employees go through a mandatory six-month probationary period when they are teamed with one of the experienced Field Maintenance Specialists who provide on-the-job training for all aspects of the employee’s job description.

The new employee **training schedule** for Field Maintenance Staff outlined below.

#### Week 1

##### Day 1

- 7:00 am – 8:30 am New employees meet with Human Resources
- Field Maintenance Supervisor meets with employees
- General overview of job
- Hand out personal protective equipment
- Introduction of CSOs field work with Supervisor

##### Day 2-5

- Checking CSOs
- New employees out in the field will be with experienced personnel

##### Things to look at

- CSO Resource Book
- Confined space entry procedures
  - View video
  - Calibration of meters
- Work zone traffic safety
- Cityworks
- Sewer maps
- O&M Manuals
- Basic vector operation

#### Week 2

- Checking CSOs
- Vector Operation
  - CSO cleaning
  - Flushing & cleaning lines
  - Washing down chambers

#### Week 3

- Checking CSOs
- Hot spot checking

#### Week 4

- Checking CSOs
- Assisting with camera truck

CRW also implements a formalized process for ongoing training for the staff who provide O&M services, which is summarized below. Written meeting minutes are prepared to document all the continuing safety and operational training sessions.

On a monthly basis, the designated members of the Safety Committee meet to discuss all aspects of safety, proactively review ongoing trends and/or potential concerns, and to make decisions on what topics should be presented and discussed with the staff at the quarterly meetings. The quarterly meetings are conducted with all the O&M staff, and the presented topics are those selected by the Safety Committee at the monthly meetings.

CRW continues to develop their staff's technical experience through outside seminars. Within the past two years four individuals received the National Association of Sewer Service Companies certification for pipe and manhole inspections.

CRW also conducts an ongoing series of Tool Box Talks. These monthly meetings involve all the O&M staff and focus on operational topics and issues. Written handout materials are obtained from an outside training vendor and are distributed to all the O&M staff and presented by the senior field managers.

CRW also maintains a collection of training videos that are available to O&M staff on DVD, which includes topics such as traffic safety and proper chemical handling.

CRW commenced Nine Minimum Control training in 2017. A half-day workshop was conducted with Field O&M staff and managers, which covered the following topics:

- What are the Nine Minimum Controls?
- How do the NMCs Impact O&M Activities at CRW?
- How do the NMCs Impact O&M Documentation?
- Updates to the O&M Manual

#### **4.16.2 Employee Advancement**

Each CRW employee must successfully demonstrate certain skills and handle specific responsibilities at their current grade level prior to being considered for a promotion within the CRW organization. New employees must successfully complete the formalized six month probationary period which includes both classroom and on-the-job training, and must demonstrate they have the necessary skills to effectively fulfil their job responsibilities and provide the required O&M support services.

#### **4.16.3 Operator Licensing Requirements**

For all CRW positions that require a PADEP operator's license, staff are required to pass the respective licensing/certification exams and maintain the necessary CEUs. Field employees

providing O&M support are encouraged to obtain a Commercial Driver's license and continue on to obtain a PA-DEP Wastewater E-1 license for satellite collection systems. CRW reimburses employees for the successful completion of the training requirements and to obtain the 15 Continuing Education Units that are required on a three year cycle to renew their certification. Operations staff at the AWTF and the pump stations have obtained PA-DEP A-1 certification licenses. Again, CRW reimburses the employees to obtain the 30 Continuing Education Units that are required on a three year cycle to renew their certification.

#### **4.16.4 MS4 Training**

CRW has developed an MS4 training program with three different implementation groups.

##### **Group 1**

Group 1 consists of all CRW Collection Operations Specialists. This training group focuses on specific stormwater pollution practices in the collection system operation and maintenance, as well as an overview of the MS4 MCMs. Green stormwater infrastructure maintenance will also be covered in detail. This training will take place annually, in addition to supplement training for new hires.

##### **Group 2**

Group 2 consists of the Engineering Division, Environmental Compliance Inspector, and Public Outreach Group. Biannual group training will cover implementation of the MCMs with a focus on systemwide operations and integration with other planning/design efforts. Individuals will also take specialized training to support their roles in stormwater design, pollution prevention, and enforcement.

##### **Group 3**

All remaining CRW divisions will participate in biannual MS4 overview training. This group also includes CRW Community Ambassadors, which are Harrisburg residents that advise Capital Region Water on its projects and programs.

### **4.17 Procedure for Preparing and Approving the Annual O&M Budget**

#### **4.17.1 Annual Budget Preparation**

The Director of Wastewater Operations oversees the initial development of the annual O&M budget with close coordination each of the four Supervisors. The draft budget is then coordinated with the Director of Engineering and Chief Financial Officer. The budget is reviewed at the November meeting of the Board of Directors.

#### **4.17.2 Budgetary Procedures in Emergencies**

In the event of an emergency that will require additional funding to resolve the issue, CRW staff notify their supervisors who coordinate directly with the Director of Wastewater Operations. The Director of Wastewater Operations is able to proceed with contracting for the external work as required. As a municipal authority for under the Class Three City Code and the Pennsylvania

Municipal Authority Act, CRW is permitted procure contractors for emergency repair work without soliciting multiple prices or publicly bidding the work.



# Appendix A



# Appendix A

## CRW Operation and Maintenance Documents

**Table A-1 Summary of Operation and Maintenance Documents**

Code	Document	Completed By	Reviewed By	Frequency
<b>1. CSO Regulator Structures / Overflows - Field Forms</b>				
A1-0	<b>CSO Inspection Forms</b> Document CSO regulator conditions; record overflows.	Field Operations	Management	Daily
A1-1	<b>Front Street Interceptor Service Report</b> Document CSO regulator conditions; record overflows.	Field Operations	Management	Daily
A1-2	<b>Paxton Street Interceptor Service Report</b> Document CSO regulator conditions; record overflows.	Field Maintenance	Management	Daily
A1-3	<b>Combined Sewer Overflow Discharge Estimates</b> Estimate overflow volumes for each CSO regulator structure.	-	Field Maintenance	During overflows
A1-4	<b>CSO Semi-Annual Inspection and Preventative Maintenance Schedule Form (Type A)</b> Inspection/maintenance checklist for Type A regulators.	Field Operations	Management	Twice annually
A1-5	<b>CSO Semi-Annual Inspection and Preventative Maintenance Schedule Form (Type B)</b> Inspection/maintenance checklist for Type B regulators.	Field Operations	Management	Twice annually
A1-6	<b>CSO Semi-Annual Inspection and Preventative Maintenance Schedule Form (Type C)</b> Inspection/maintenance checklist for Type C regulators.	Field Operations	Management	Twice annually
A1-7	<b>CSO Semi-Annual Inspection and Preventative Maintenance Schedule Form (Type D)</b> Inspection/maintenance checklist for Type D regulators.	Field Operations	Management	Twice annually
<b>2. CSO Regulator Structures / Overflows - Managerial Reports</b>				
**A2-1	<b>Discharge Monitoring Reports</b> Monthly DMRs submitted to PADEP.	Management	PADEP	Monthly
A2-2	<b>Combined Sewer Overflow Summary Report (All CSOs)</b> Totals flow, duration, and rainfall for all CSOs (for each day in a month). Supplemental report submitted with monthly DMR.	Management	PADEP	Monthly
*A2-3	<b>Combined Sewer Overflow Summary Report (Individual CSOs)</b> Totals flow, duration, and rainfall for all CSOs (for each day in a month). Supplemental report submitted with monthly DMR.	Management	PADEP	Monthly

Code	Document	Completed By	Reviewed By	Frequency
*A2-4	<b>Combined Sewer Overflow Report by Outfalls</b> Report summarizing overflow volumes, durations, and causes for each CSO regulator for the entire year. Submitted with Chapter 94 Report.	Management	PADEP	Annually
*A2-5	<b>Dry Weather Combined Sewer Overflow Report</b> Report summarizing dry weather overflow volumes, durations, and causes for each CSO regulator for the entire year. Submitted with Chapter 94 Report.	Management	PADEP	Annually
*A2-6	<b>Preventative Maintenance Report</b> Report summarizing preventative maintenance performed for each CSO regulator for the entire year. Submitted with Chapter 94 Report.	Management	PADEP	Annually
**A2-7	<b>Precipitation Report</b> Report summarizing daily precipitation for the entire year. Submitted with Chapter 94 Report.	Management	PADEP	Annually
A2-8	<b>Weir Rehabilitation Report</b> Report summarizing the history of weir rehabilitation. Submitted with Chapter 94 Report.	Management	PADEP	Annually
<b>3. Collection System - Field Forms</b>				
A3-1	<b>Customer Service Requests</b> Provides a series of questions and Cityworks forms to document complaints regarding the collection system and create service requests.	Admin.	Maintenance/ Management	Variable
A3-2	<b>Collection System Work Order</b> Documents the reported problem and actions taken to correct the problem.	Field Maintenance	Management	Variable
A3-3	<b>Collection System Inspection ("Hot Spot Checklist")</b> List of known "hot spots" to document flow conditions.	Field Operations	Management	Weekly
A3-4	<b>Inlet/Catch Basin Inspection</b> Documents inlet condition, configuration, and features.	Field Maintenance	Management	Variable
A3-5	<b>Fats, Oils, and Grease (FOG) Inspection</b> Documents FOG inspection findings, including type of facility, facility procedures, grease traps, etc.	Environmenta l Compliance Inspector	Management	Variable
<b>4. Collection System - Managerial Reports / Tracking Spreadsheets<sup>1</sup></b>				
A4-1	<b>Work Report</b> Documents labor, materials, and equipment costs for work performed.	Management	Management	Daily
*A4-2	<b>Collection System Activity Report</b> Report summarizing collection system activities (including inlet cleaning/rebuilding and "hot spot" inspections) for the entire year. Submitted with Chapter 94 Report.	Management	PADEP	Annually
A4-3	<b>Collection System Tracking Spreadsheets</b>	Management	Management	Tracked Continuously

Code	Document	Completed By	Reviewed By	Frequency
	Spreadsheet tracking inlets cleaned, inlets repaired, sewer problems, and sinkholes			
<b>5. Pump Stations – Field Forms<sup>2</sup></b>				
A5-1	<b>Front Street Pump Station Checklist</b> Documents walkthrough inspections for Front Street Pump Station.	Facility Maintenance	Management	4 Times Daily
A5-2	<b>Spring Creek Pump Station Checklist</b> Documents walkthrough inspections for Spring Creek Pump Station.	Facility Maintenance	Management	4 Times Daily
A5-3	<b>City Island Pump Station Checklist</b> Documents walkthrough inspections for City Island Pump Station.	Facility Maintenance	Management	2 Times Daily
A5-4	<b>AWTF Preventative Maintenance Chart – Weekly Inspection</b> Inspection/maintenance checklist for pump stations (also includes AWTF facilities).	Facility Maintenance	Management	Weekly
A5-5	<b>AWTF Preventative Maintenance Chart - Monthly Inspection</b> Inspection/maintenance checklist for pump stations (also includes AWTF facilities).	Facility Maintenance	Management	Monthly
A5-6	<b>AWTF Preventative Maintenance Chart – 3 Month Inspection</b> Inspection/maintenance checklist for pump stations (also includes AWTF facilities).	Facility Maintenance	Management	3 Months
A5-7	<b>AWTF Preventative Maintenance Chart – 6 Month Inspection</b> Inspection/maintenance checklist for pump stations (also includes AWTF facilities).	Facility Maintenance	Management	6 Months
A5-8	<b>AWTF Preventative Maintenance Chart – Yearly Inspection</b> Inspection/maintenance checklist for pump stations (also includes AWTF facilities).	Facility Maintenance	Management	Annually
<b>6. Confined Space Entry – Field Forms<sup>3</sup></b>				
A6-1	<b>Confined Space Permit</b> Documents confined space entries for CRW staff.	Field/Facility Maintenance	Management	As necessary
A6-2	<b>SCBA User Inspection Form</b> Documents inspection of SCBA equipment whenever it is used.	Field/Facility Maintenance	Management	As necessary

\* An abbreviated version is included as a hardcopy in this manual. The full version is included on the CD attached with this manual.

\*\*A hardcopy version of this document is not included, but is available on the CD attached with this manual.

1. The Sinkhole Master Spreadsheet is included in **Appendix D**.

2. CRW also utilizes a bi-monthly AWTF preventative maintenance inspection checklist, but is not included here as it does not pertain to pump station maintenance.

3. Additional safety guidelines for confined space entry are included in **Appendix C**.

**Inspection 19376**  
**Daily CSO Site Inspection**

**Status: CLOSED**

**Priority:** 5

**Location:**

**Inspected By:** Jenkins, Kim

**Projected Start:**

**Projected Finish:** 7/5/2016 10:54:40AM

**Initiated By:** Kneasel, Mike

**Initiated Date:** 7/5/2016 10:54:40AM

**Actual Finish:** 7/5/2016 11:04:53AM

**Insp. Date:** 6/29/2016 11:04:21AM

**Closed By:** Kneasel, Mike

**Date Closed:** 7/5/2016 11:04:53AM

**Work Order Id:** 4030

**Observation:**

**Repairs:**

**Recommendation:**

**Observations:**

**Active CSO:** Yes

**CSO Event Type:** Wet Weather

**PM Activity:**

**Debris Removed (lbs):**

**Wooden Block Codes:** Movement, indication of CSO

**Reset Block?:** Yes

**Replaced Overflow Detection**

**Device:**

**Manhole at Interceptor (%full):**

**Postcard Notification Required?:** Yes

**DEP Notification:** No

**Problems Observed:** Yes

**Overflow Start Time:** 11:00 AM

**Overflow Stop Time:** 11:15 AM

**Duration of Overflow:** .25

**Inches over Weir:** 1/8"

**Estimated Discharge in Gals.:** 30.5

**Trouble Corrected Codes:** Gate Blocked

**Inspection 19412**  
**Daily CSO Default 1**

**Status: CLOSED**

**Priority:** 5

**Location:**

**Inspected By:** Jenkins, Kim

**Projected Start:** 7/5/2016 11:09:19AM

**Projected Finish:** 7/6/2016 11:09:19AM

**Initiated By:** Freysinger, Ken

**Initiated Date:** 7/5/2016 11:09:19AM

**Actual Finish:** 7/5/2016 11:12:37AM

**Insp. Date:** 6/27/2016 11:12:16AM

**Closed By:** Freysinger, Ken

**Date Closed:** 7/5/2016 11:12:37AM

**Work Order Id:** 4027

**Observation:**

**Repairs:**

**Recommendation:**

**Observations:**

**Active CSO - No:** CHECKED

**PM Activity:**

**Debris Removed (lbs):**

**Trouble Corrected Codes:**

**Wooden Block Codes:** No Movement

**Reset Block?:**

**Replaced Overflow Detection  
Device:**

**Inspection 19405**  
**Daily CSO Default 2-4**



**Status: CLOSED**

**Priority:** 5

**Location:**

**Inspected By:** Jenkins, Kim

**Projected Start:** 7/5/2016 11:02:40AM

**Projected Finish:** 7/6/2016 11:02:40AM

**Initiated By:** Morrison, Douglas

**Initiated Date:** 7/5/2016 11:02:40AM

**Actual Finish:** 7/5/2016 11:03:02AM

**Insp. Date:** 6/28/2016 11:02:48AM

**Closed By:** Morrison, Douglas

**Date Closed:** 7/5/2016 11:03:02AM

**Work Order Id:** 4029

**Observation:**

**Repairs:**

**Recommendation:**

**Observations:**

**Active CSO - No:** CHECKED

**Block Movement with No** CHECKED

**Indication of CSO:**

**Reset Block - Yes:** CHECKED

**PM Activity:**

**Debris Removed (lbs):**

**Trouble Corrected Codes:**

**Replaced Overflow Detection**

**Device:**

**Inspection 19409**  
**Daily CSO Default 3-4**

**Status: CLOSED**

**Priority:** 5

**Location:**

**Inspected By:** Jenkins, Kim

**Projected Start:**

**Projected Finish:** 7/6/2016 11:05:51AM

**Initiated By:** Morrison, Douglas

**Initiated Date:** 7/5/2016 11:05:51AM

**Actual Finish:** 7/5/2016 11:08:04AM

**Insp. Date:** 6/28/2016 11:07:46AM

**Closed By:** Morrison, Douglas

**Date Closed:** 7/5/2016 11:08:04AM

**Work Order Id:** 4029

**Observation:**

**Repairs:**

**Recommendation:**

**Observations:**

**Active CSO - No:** CHECKED

**Block Movement with Indication of CSO:** CHECKED

**Reset Block - Yes:** CHECKED

**PM Activity:**

**Debris Removed (lbs):**

**Replaced Overflow Detection Device:**

**Postcard Notification Completed:** CHECKED

**DEP Notification:**

**Unknown Duration of Overflow:** CHECKED

**Unknown Gallons of Flow:** CHECKED

**Trouble Corrected Codes:** Gate Blocked



**Inspection 86376**  
**Daily CSO Default 7 Inflow**



**Status: CLOSED**

**Priority:**                      **Location:** S. MULBERRY & CAMER                      **Inspected By:** Kneasel, Mike

**Projected Start:** 12/3/2018 6:43:41AM                      **Projected Finish:** 12/4/2018 6:43:41AM  
**Initiated By:** Kneasel, Mike                      **Initiated Date:** 12/3/2018 6:43:41AM  
**Actual Finish:** 12/3/2018 6:44:50AM  
**Insp. Date:** 12/2/2018 12:00:00PM  
**Closed By:** Kneasel, Mike                      **Date Closed:** 12/3/2018 6:44:50AM  
**Work Order Id:** 22608  
**Observation:**  
**Repairs:**  
**Recommendation:**

**Observations:**

**Active CSO - No:** CHECKED  
.....  
**Block Movement with No** CHECKED  
**Indication of CSO:** .....

**Reset Block - No:** CHECKED  
.....  
**Debris Removed (lbs):** .....

**Trouble Corrected Codes - Inflow** CHECKED  
**from Creek/River:** .....

**Replaced Overflow Detection**  
**Device:** .....

**PM Activity:** .....

# Front Street Interceptor Service Report

The screenshot displays the Cityworks software interface for a work order. The main window is titled "Work Order" and shows details for a "Daily CIO Inspection Front Street" work order. The work order is in the "Actual" status, initiated by "Sara Long, SWS" on 11/20/14 at 8:25 AM. It is assigned to "Bates, Joseph" and "Prosegar, Ken". The work order includes a list of assets, all labeled "COMBINED SEWER OVERFLOW" with various CIO-004 through CIO-013 identifiers. The "Work Cycle" section shows the work order is "Actual" and started on 11/20/14. Below the main work order details, there are three additional panels: "Related Work Activities" showing a list of related work orders (e.g., 22529, 22542, 22543, etc.), "Attachments" showing a list of related work orders, and "Attachments" showing a list of related work orders. The "Attachments" panel at the bottom shows a list of related work orders with columns for ID, Description, Priority, Status, Submit To, and Proj Start Date. The "Attachments" panel at the bottom shows a list of related work orders with columns for ID, Description, Priority, Status, Submit To, and Proj Start Date.

**Work Order Details:**

- Description: Daily CIO Inspection Front Street
- Number: 400
- Asset Type: Combined Sewer Overflow
- Category: Preventive Maintenance
- Initiated By: Sara Long, SWS | Date: 11/20/14 8:25 AM
- Status: Actual
- Requested By: Bates, Joseph | Supervisor: Bates, Joseph
- Submitted To: Prosegar, Ken | Date: 11/20/14 8:25 AM
- Projected Start: 11/20/14 8:00 AM | Projected Finish: 11/20/14 8:00 AM
- Opened By: Prosegar, Ken | Date: 11/20/14 11:20:30 AM
- Closed By: Prosegar, Ken | Date: 11/20/14 11:20:30 AM
- Completed By: Bates, Joseph | Actual Finish: 11/20/14 10:00 AM
- Stage: Actual | Expense Topic: Maintenance

**Assets:**

Asset ID	Asset CIO	Location	Warranty Date
1	CIO-004		
2	CIO-005		
3	CIO-006		
4	CIO-007		
5	CIO-008		
6	CIO-009		
7	CIO-010		
8	CIO-011		
9	CIO-012		
10	CIO-013		
11	CIO-014		
12	CIO-015		
13	CIO-016		
14	CIO-017		

**Work Cycle:**

- Actual: Actual
- Start: 11/20/14
- From: Projected Start Date
- Next Plan Date: 11/20/14

**Related Work Activities:**

ID	Type	Description	Entity ID	Entity Type
22529	POP	Daily CIO Default 1	CIO-004	COMBINED SEWER OVERFLOW
22542	POP	Daily CIO Default 1	CIO-005	COMBINED SEWER OVERFLOW
22543	POP	Daily CIO Default 1	CIO-006	COMBINED SEWER OVERFLOW
22544	POP	Daily CIO Default 1	CIO-007	COMBINED SEWER OVERFLOW
22545	POP	Daily CIO Default 1	CIO-008	COMBINED SEWER OVERFLOW
22546	POP	Daily CIO Default 1	CIO-009	COMBINED SEWER OVERFLOW
22547	POP	Daily CIO Default 1	CIO-010	COMBINED SEWER OVERFLOW
22548	POP	Daily CIO Default 1	CIO-011	COMBINED SEWER OVERFLOW
22549	POP	Daily CIO Default 1	CIO-012	COMBINED SEWER OVERFLOW
22550	POP	Daily CIO Default 1	CIO-013	COMBINED SEWER OVERFLOW
22551	POP	Daily CIO Default 1	CIO-014	COMBINED SEWER OVERFLOW
22552	POP	Daily CIO Default 1	CIO-015	COMBINED SEWER OVERFLOW
22553	POP	Daily CIO Default 1	CIO-016	COMBINED SEWER OVERFLOW
22554	POP	Daily CIO Default 1	CIO-017	COMBINED SEWER OVERFLOW

**Attachments:**

ID	Description	Priority	Status	Submit To	Proj Start Date
400	Daily CIO Inspection Front Street	CRMS	Prosegar, Ken	11/20/14	

**Attachments:**

- + Add Attachments...
- Remove all attachments
- Drop and drag files here to attach them.

# Work Order #4032

## Daily CSO Inspection Front Street



**Created By:** Byrne-Long, Sheri

**Created Date:** 7/5/2016 9:35:36AM

**Submitted To:** Freysinger, Ken

**Supervisor:** Baker, Joseph

**Projected Start:** 6/30/2016 3:00:00PM

**Priority:**

**Assets:**

Type	AssetID	Location
CSO Site	CSO-004	
CSO Site	CSO-005	
CSO Site	CSO-050	
CSO Site	CSO-051	
CSO Site	CSO-006	
CSO Site	CSO-007	
CSO Site	CSO-008	
CSO Site	CSO-009	
CSO Site	CSO-010	
CSO Site	CSO-011	
CSO Site	CSO-012	
CSO Site	CSO-013	
CSO Site	CSO-014	
CSO Site	CSO-015	
CSO Site	CSO-016	
CSO Site	CSO-017	
CSO Site	CSO-018	
CSO Site	CSO-019	
CSO Site	CSO-020	
CSO Site	CSO-049	
CSO Site	CSO-052	
CSO Site	CSO-053	
CSO Site	CSO-054	
CSO Site	CSO-055	
CSO Site	CSO-056	
CSO Site	CSO-057	
CSO Site	CSO-058	

**Actual Start:**

**Actual Finish:** 6/30/2016 10:04:35AM

**Existing Comments:**

**Work Completed/Comments:**

**Additional Fields:** % Full - Front St 50  
 Weather Conditions \_\_\_\_\_

Labor Hours:	<u>Employee Name</u>	<u>Hours</u>	<u>Cost</u>
	Jenkins, Kim	2.00	\$46.72
		<b>Total Labor Cost:</b>	<b>\$46.72</b>

**Work Order #4032**  
**Daily CSO Inspection Front Street**



<b>Material Quantities:</b>		<b><u>Qty Used</u></b>	<b><u>Cost</u></b>
<b><u>Item Description</u></b>			
			<b><i>Total Cost of Materials:</i></b>
<b>Equipment Hours:</b>		<b><u>Units</u></b>	<b><u>Cost</u></b>
<b><u>Item Description</u></b>			
Service Truck		1.00	\$30.00
<b><i>Total Equipment Costs:</i></b>			<b><i>\$30.00</i></b>
<b>Completed By:</b> Jenkins, Kim			

Paxton Creek Interceptor Service Report

The screenshot displays the Cityworks software interface for a work order. The main window is titled "Work Order" and shows details for work order number 602. The description is "Daily CIO Inspection Paxton Creek". The status is "Open". The work order was created by "Reynolds, Bar" on 11/15/2014 at 9:21 AM. The assigned technician is "Baker, Keith". The work order is categorized as "Preventive Maintenance".

The "Location Information" section shows the address as "Paxton Creek" and "Paxton Creek". The "Assets" section lists 14 assets, all of which are "COMBINED SEWER OVERFLOW" units. The "Work Cycle" section shows the work cycle as "Daily CIO Default 1".

The "Financials" section shows the total cost of the work order as \$46.72, with a labor cost of \$46.00 and a material cost of \$0.00. The "Inspection" section shows a list of 14 inspections, all of which are "Daily CIO Default 1" inspections. The "Work Order" section shows the work order as "Daily CIO Inspection Paxton Creek" with a priority of "OPEN" and a status of "OPEN".

The "Attachments" section shows a list of attachments, including "Daily CIO Inspection Paxton Creek" and "Daily CIO Inspection Paxton Creek".

# Work Order #4033

## Daily CSO Inspection Paxton Creek



**Created By:** Byrne-Long, Sheri

**Created Date:** 7/5/2016 9:35:48AM

**Submitted To:** Freysinger, Ken

**Supervisor:** Baker, Joseph

**Projected Start:** 6/30/2016 3:00:00PM

**Priority:**

**Assets:**

Type	AssetID	Location
CSO Site	CSO-021	
CSO Site	CSO-022	
CSO Site	CSO-023	
CSO Site	CSO-024	
CSO Site	CSO-025	
CSO Site	CSO-026	
CSO Site	CSO-027	
CSO Site	CSO-028	
CSO Site	CSO-029	
CSO Site	CSO-030	
CSO Site	CSO-031	
CSO Site	CSO-032	
CSO Site	CSO-033	
CSO Site	CSO-034	
CSO Site	CSO-037	
CSO Site	CSO-038	
CSO Site	CSO-039	
CSO Site	CSO-040	
CSO Site	CSO-041	
CSO Site	CSO-042	
CSO Site	CSO-059	
CSO Site	CSO-043	
CSO Site	CSO-044	
CSO Site	CSO-045	
CSO Site	CSO-046	
CSO Site	CSO-048	
CSO Site	CSO-060	
CSO Site	CSO-061	
CSO Site	CSO-062	
CSO Site	CSO-063	
CSO Site	CSO-064	

**Actual Start:**

**Actual Finish:** 6/30/2016 10:18:20AM

**Existing Comments:**

**Work Completed/Comments:**

# Work Order #4033

## Daily CSO Inspection Paxton Creek



<b>Additional Fields:</b>	% Full - Paxton Creek	50
	% Full - Spring Creek	50
	% Full - Asylum Run	50
	% Full - Hemlock St	50
	<b>Weather Conditions</b>	Sunny 59

<b>Labor Hours:</b>	<u>Employee Name</u>	<u>Hours</u>	<u>Cost</u>
	Jenkins, Kim	2.00	\$46.72
		<b>Total Labor Cost:</b>	<b>\$46.72</b>

<b>Material Quantities:</b>	<u>Item Description</u>	<u>Qty Used</u>	<u>Cost</u>
<b>Total Cost of Materials:</b>			

<b>Equipment Hours:</b>	<u>Item Description</u>	<u>Units</u>	<u>Cost</u>
	Service Truck	1.00	\$30.00
		<b>Total Equipment Costs:</b>	<b>\$30.00</b>

**Completed By:** Jenkins, Kim

**Capital Region Water**  
**Combined Sewer Overflow Discharge Estimates in Gallons/Hour**

CSO Number	Regulator Location	Interceptor	Effective Weir Length <sup>(1)</sup> (inches)	Depth of Flow Over the Weir Crest				
				1/8"	1/4"	1/2"	3/4"	1"
				CSO Discharge Rate in gallons/hour <sup>(2)</sup>				
CSO-002	Front Street Pump Station	Front Street	108.5	699	2,014	5,799	10,995	17,807
CSO-003	Spring Creek Pump Station	Spring Creek	25	161	464	1,336	2,533	4,103
CSO-004	Front & Vaughn	Front Street	42	271	779	2,245	4,256	6,893
CSO-005	Front & Lewis	Front Street	48.5	312	900	2,592	4,915	7,960
CSO-006	Front & Geiger	Front Street	58.5	377	1,086	3,126	5,928	9,601
CSO-007	Front & Peffer	Front Street	23	148	427	1,229	2,331	3,775
CSO-008	Front & Muench	Front Street	43	277	798	2,298	4,358	7,057
CSO-009	Front & Hamilton	Front Street	30	193	557	1,603	3,040	4,924
CSO-010	Front & Reilly	Front Street	56.5	364	1,049	3,020	5,726	9,273
CSO-011	Front & Calder	Front Street	29.5	190	547	1,577	2,989	4,841
CSO-012	Front & Verbeke	Front Street	36	232	668	1,924	3,648	5,908
CSO-013	Front & Cumberland	Front Street	46	296	854	2,458	4,662	7,549
CSO-014	Front & Boas	Front Street	46	296	854	2,458	4,662	7,549
CSO-015	Front & Forster	Front Street	57	367	1,058	3,046	5,776	9,355
CSO-016	Front & Liberty	Front Street	19	122	353	1,015	1,925	3,118
CSO-017	Front & Market	Front Street	68	438	1,262	3,634	6,891	11,160
CSO-018	Front & Mulberry	Front Street	37.5	242	696	2,004	3,800	6,154
CSO-019	Front & Paxton	Front Street	18	116	334	962	1,824	2,954
CSO-020	Front & Hanna	Front Street	20	129	371	1,069	2,027	3,282
CSO-049	Front & Schuylkill	Front Street	62.5	403	1,160	3,340	6,334	10,257
CSO-050	Seneca & Susquehanna	Front Street	48	309	891	2,565	4,864	7,878
CSO-051	Woodbine & Green	Front Street	48	309	891	2,565	4,864	7,878
CSO-051.1	Woodbine & Front (New)	Front Street	38	245	705	2,031	3,851	6,236
CSO-052	Front & State	Front Street	48.5	312	900	2,592	4,915	7,960
CSO-053	Front & South	Front Street	71	457	1,318	3,795	7,195	11,652
CSO-054	Front & Pine	Front Street	31	200	575	1,657	3,141	5,088
CSO-055	Front & Locust	Front Street	31.5	203	585	1,683	3,192	5,170
CSO-056	Front & Walnut	Front Street	47.5	306	881	2,539	4,814	7,796
CSO-057	Cherry & Mulberry	Front Street	37.5	242	696	2,004	3,800	6,154
CSO-058	Front & Tuscarora	Front Street	44	283	817	2,352	4,459	7,221
CSO-060	Salmon Street	Hemlock Street	13	84	241	695	1,317	2,134
CSO-061	Tenth & Sycamore	Hemlock Street	62	399	1,151	3,314	6,283	10,175
CSO-062	Shanois Street	Hemlock Street	20	129	371	1,069	2,027	3,282
CSO-063	Cameron & Hanover	Hemlock Street	25	161	464	1,336	2,533	4,103
CSO-064	Cameron & Magnolia	Hemlock Street	25	161	464	1,336	2,533	4,103



**Capital Region Water**  
**Combined Sewer Overflow Discharge Estimates in Gallons/Hour**

CSO Number	Regulator Location	Interceptor	Effective Weir Length <sup>(1)</sup> (inches)	Depth of Flow Over the Weir Crest				
				1/8"	1/4"	1/2"	3/4"	1"
				CSO Discharge Rate in gallons/hour <sup>(2)</sup>				
CSO-021	Cameron & Schuylkill	Paxton Creek	40	258	742	2,138	4,054	6,565
CSO-022	Cameron & Forrest	Paxton Creek	36	232	668	1,924	3,648	5,908
CSO-023	Cameron & Calder	Paxton Creek	27	174	501	1,443	2,736	4,431
CSO-024	Hill Chamber (T.R.W.)	Paxton Creek	36	232	668	1,924	3,648	5,908
CSO-025	N. Cameron & Cumberland	Paxton Creek	30.5	196	566	1,630	3,091	5,006
CSO-026	S. Cameron & Cumberland	Paxton Creek	28	180	520	1,496	2,837	4,595
CSO-027	Ninth & Cumberland	Paxton Creek	24	155	445	1,283	2,432	3,939
CSO-028	Ninth & Herr	Paxton Creek	40	258	742	2,138	4,054	6,565
CSO-029	E. Cameron & North	Paxton Creek	18	116	334	962	1,824	2,954
CSO-030	W. Cameron & North	Paxton Creek	47	303	872	2,512	4,763	7,714
CSO-031	Cameron & State	Paxton Creek	46.5	300	863	2,485	4,712	7,631
CSO-032	W. Cameron & Walnut	Paxton Creek	20	129	371	1,069	2,027	3,282
CSO-033	E. Cameron & Walnut	Paxton Creek	24	155	445	1,283	2,432	3,939
CSO-034	S. Market & Cameron	Paxton Creek	34.5	222	640	1,844	3,496	5,662
CSO-037	Tenth & Market	Paxton Creek	43	277	798	2,298	4,358	7,057
CSO-038	Tenth & Chestnut	Paxton Creek	30	193	557	1,603	3,040	4,924
CSO-039	S. Mulberry & Cameron	Paxton Creek	20.5	132	380	1,096	2,077	3,364
CSO-040	N. Mulberry & Cameron	Paxton Creek	23	148	427	1,229	2,331	3,775
CSO-041	W. Mulberry & Cameron	Paxton Creek	20	129	371	1,069	2,027	3,282
CSO-042	S. Kittatinny & Cameron	Paxton Creek	30	193	557	1,603	3,040	4,924
CSO-043	N. Kittatinny & Cameron	Paxton Creek	18	116	334	962	1,824	2,954
CSO-044	Cameron & Berryhill	Paxton Creek	36	232	668	1,924	3,648	5,908
CSO-045	Paxton Street (South)	Paxton Creek	30	193	557	1,603	3,040	4,924
CSO-046	Paxton Street (North)	Paxton Creek	15	97	278	802	1,520	2,462
CSO-048	Tenth & Shannon	Paxton Creek	60	387	1,113	3,207	6,080	9,847
CSO-059	Kittatinny & Crescent (New)	Paxton Creek	44.5	287	826	2,378	4,510	7,303

<sup>(1)</sup>Note: In some cases, an effective weir length needed to be utilized, rather than the actual measured length, to account for weirs that were on an angle to the influent trunk sewer, the CSO discharge pipe, and the direction of flow. Measurements were obtained from the Regulator Infrastructure Inspections, supplemented by inspection results from Flow Assessment Services for newly discovered structures.

<sup>(2)</sup>Note: CSO Discharge rates were calculated from a broad crested weir equation,  $Q = C \times L \times H^{1.5}$  where C varies with depth. Coefficients were obtained from Brater and King, *Handbook of Hydraulics*. Assuming an average breadth of crest of 9", the resulting coefficients were: 2.70 for H = 1/8", 2.75 for H = 1/4", 2.80 for H = 1/2", 2.89 for H = 3/4", and 3.04 for H = 1"

CSO Semi-Annual Inspection and Preventative Maintenance Schedule Form (Type A)

**Cityworks** Home Recent Asset Search Service Requests Work Orders Inspections Project Manager Designer Search

Work Order View Save Close Create

---

**Work Order**

Description: Semi-Annual PMA CSO Type A

Number: 3842

Entry Type: CSO CHAMBER

Category: Preventive Maintenance

Initiated By: Ernie, Scott Date: 4/21/2016 7:23 AM

Status: Closed Priority: High

Requested By: Supervisor:

Submitted To: Freyinger, Kim Date: 5/5/2016 12:27 PM

Proposed Start: 4/28/2016 12:04 AM Projected Finish:

Opened By: Freyinger, Kim Date: 7/13/16 12:42 PM

Closed By: Freyinger, Kim Date: 7/13/16 12:26:57 PM

Completed By: Ernie, Scott Actual Finish: 4/28/2016 7:08 AM

Stage: Actual Expense Type: Maintenance

Add Comments

Existing Comments

Instructions

Resolution: Read Only

**Location Information**

WO Address:

Location Details:

Shop: Pipe Paper:

Site Number: RC-049 Depth: 1.000m

X Location: 2,204,771.06 Y Location: 347,571.9

**Custom Fields**

Category:

---

**Details**

Project: Account:

Project Fee

Contract: Contractor:

Legal Mbl: Contractor Mbl:

Update Map: Cancel Work Order:

Cancelled By: Date:

Cancel Reason:

Units Invoiced: Description:

Lock Units Desc:

Labor Cost: \$124.78 Material Cost: \$5.30

Equipment Cost: \$315.80 Permit Cost: \$5.90

Total WO Cost: \$449.78

**Work Cycle**

Repeat: Every

Interval: 6 Months

From: Invoiced Start Date

Date Invoiced: 7/1/2016 Next Post Date: 9/1/2016

**Related Work Activities**

Add Request:

**Inspections**

Add Inspection:

M	Type	Description	Entry M	Entry Type	Date	Inp
10/13	INSP	Semi-Annual CSO Type A	RC-049	CSO CHAMBER		

---

**Work Orders**

Filter: 222

M	Description	Priority	Status	Submitted To	Proj Start Date
221	Semi-Annual PMA CSO Type A	4	OPEN	Freyinger, Kim	11/08/2016

Cancel WO Cost Code:

Parent:

**Attachments**

+ Add attachments... Remove all attachments

Drag and drop files here to attach them.

# Inspection for Type A

**Cityworks** | Inbox | Recent | Asset Search | Service Requests | Work Orders | Inspections | Project Manager | Designer

Inspection View

**Inspection** | Details

ID: 13035

Location: \_\_\_\_\_

Status: Closed | Resolution: \_\_\_\_\_

Insp. Date: \_\_\_\_\_ | Inspected By: \_\_\_\_\_

**Diversion Chamber**

Inspect Steps	<input checked="" type="radio"/> Yes <input type="radio"/> No	✓
Clean Steps	<input checked="" type="radio"/> Yes <input type="radio"/> No	✓
Inspect Weir	<input checked="" type="radio"/> Yes <input type="radio"/> No	✓
Clean Weir	<input checked="" type="radio"/> Yes <input type="radio"/> No	✓
Inspect Chamber	<input checked="" type="radio"/> Yes <input type="radio"/> No	✓
Clean Chamber	<input checked="" type="radio"/> Yes <input type="radio"/> No	✓
Diversion Chamber Comments	_____	

**Regulator Chamber**

Inspect Gate Assembly	<input checked="" type="radio"/> Yes <input type="radio"/> No	✓
Clean/Grease Gate Assembly	<input checked="" type="radio"/> Yes <input type="radio"/> No	✓
Inspect Transmission Shaft	<input checked="" type="radio"/> Yes <input type="radio"/> No	✓
Inspect Steps	<input checked="" type="radio"/> Yes <input type="radio"/> No	✓
Clean Steps	<input checked="" type="radio"/> Yes <input type="radio"/> No	✓
Inspect Gate Wheel & Chain	<input checked="" type="radio"/> Yes <input type="radio"/> No	✓

**Inspect Float Assembly**  Yes  No ✓

**Clean/Grease Float Assembly**  Yes  No ✓

**Clean Float Wheel and Chain**  Yes  No ✓

**Inspect Chamber**  Yes  No ✓

**Clean Chamber**  Yes  No ✓

**Inspect Connecting Pipe to Regulator Chamber**  Yes  No ✓

**Remove Significant Grease, Sediment, and Debris**  Yes  No ✓

Flood Chamber Comments		✓
<input type="text"/>		
<b>Syphon Chamber</b>		
Inspect Chamber	<input type="radio"/> Yes <input type="radio"/> No	✓
Clean Chamber	<input type="radio"/> Yes <input type="radio"/> No	✓
Syphon Chamber Comments		✓
<input type="text"/>		
<b>Flood Chamber</b>		
Inspect Flood Gate	<input checked="" type="radio"/> Yes <input type="radio"/> No	✓
Clean/Grease Flood Gate	<input checked="" type="radio"/> Yes <input type="radio"/> No	✓
Inspect Chaise	<input checked="" type="radio"/> Yes <input type="radio"/> No	✓
Clean Chaise	<input checked="" type="radio"/> Yes <input type="radio"/> No	✓
Inspect Steps	<input checked="" type="radio"/> Yes <input type="radio"/> No	✓
Clean Steps	<input checked="" type="radio"/> Yes <input type="radio"/> No	✓
Inspect Chamber	<input checked="" type="radio"/> Yes <input type="radio"/> No	✓
Inspect Watertight Seals	<input checked="" type="radio"/> Yes <input type="radio"/> No	✓
Clean Chamber	<input checked="" type="radio"/> Yes <input type="radio"/> No	✓
Remove Significant Grease, Sediment and Debris	<input type="radio"/> Yes <input checked="" type="radio"/> No	✓
Flood Chamber Comments		✓
<input type="text"/>		

<b>Comments</b>	
Observation:	<input type="text"/>
Repairs:	<input type="text"/>
Recommendation:	<input type="text"/>
Cond. Score: 0	

# Work Order #3042

## Semi-Annual PM; CSO Type A



<b>Created By:</b> Rotolo, Scott		<b>Created Date:</b> 4/27/2016 7:15:59AM	
<b>Submitted To:</b> Freysinger, Ken		<b>Supervisor:</b>	
<b>Projected Start:</b> 6/28/2016 10:24:43AM		<b>Priority:</b> 4	
<b><u>Assets:</u></b>			
<b>Type</b>	<b>AssetID</b>	<b>Location</b>	
CSO Chamber	RC-049		
CSO Chamber	CSOC-049		
CSO Chamber	FLC-049		
<b>Actual Start:</b>		<b>Actual Finish:</b> 6/28/2016 7:05:14AM	
<b>Existing Comments:</b>			
<b>Work Completed/Comments:</b>			
<b>Labor Hours:</b>	<b><u>Employee Name</u></b>	<b><u>Hours</u></b>	<b><u>Cost</u></b>
	Kneasel, Mike	3.00	\$49.35
	Fox, Mike	3.00	\$61.74
	Rotolo, Scott	3.00	\$63.69
		<b>Total Labor Cost:</b>	<b>\$174.78</b>
<b>Material Quantities:</b>	<b><u>Item Description</u></b>	<b><u>Qty Used</u></b>	<b><u>Cost</u></b>
		<b>Total Cost of Materials:</b>	
<b>Equipment Hours:</b>	<b><u>Item Description</u></b>	<b><u>Units</u></b>	<b><u>Cost</u></b>
	Service Truck	1.00	\$45.00
	Vactor	1.00	\$270.00
		<b>Total Equipment Costs:</b>	<b>\$315.00</b>
<b>Completed By:</b> Rotolo, Scott			

**Inspection 13535**  
**Semi-Annual, CSO Type A**



**Status: CLOSED**

**Priority:**

**3**

**Location:**

**Inspected By:**

**Projected Start:** 9/7/2016 10:24:43AM

**Projected Finish:** 9/7/2016 10:24:43AM

**Initiated By:** Rotolo, Scott

**Initiated Date:** 4/27/2016 7:15:59AM

**Actual Finish:** 7/1/2016 7:04:55AM

**Insp. Date:**

**Closed By:** Rotolo, Scott

**Date Closed:** 7/1/2016 7:04:55AM

**Work Order Id:** 3042

**Observation:**

**Repairs:**

**Recommendation:**

**Inspection 13535**  
**Semi-Annual, CSO Type A**



**Status: CLOSED**

**Priority:** 3

**Location:**

**Inspected By:**

**Observations:**

**Inspect Steps:** Yes

**Clean Steps:** Yes

**Inspect Weir:** Yes

**Clean Weir:** Yes

**Inspect Chamber:** Yes

**Clean Chamber:** Yes

**Diversion Chamber Comments:**

**Inspect Gate Assembly:** Yes

**Clean/Grease Gate Assembly:** Yes

**Inspect Transmission Shaft:** Yes

**Inspect Steps:** Yes

**Clean Steps:** Yes

**Inspect Gate Wheel & Chain:** Yes

**Clean Gate Wheel & Chain:** Yes

**Inspect Weights:** Yes

**Clean Weights:** Yes

**Inspect Outfall Box:** Yes

**Clean Outfall Box:** Yes

**Inspect Chamber:** Yes

**Clean Chamber:** Yes

**Regulator Chamber Comments:**

**Inspect Float Assembly:** Yes

**Clean/Grease Float Assembly:** Yes

**Clean Float Wheel and Chain:** Yes

**Inspect Chamber:** Yes

**Clean Chamber:** Yes

**Inspect Connecting Pipe to** Yes

**Regulator Chamber:**

**Remove Significant Grease,** Yes

**Sediment, and Debris:**

**Float Chamber Comments:**

**Inspection 13535**  
**Semi-Annual, CSO Type A**

**Status: CLOSED**

**Priority:**

**3**

**Location:**

**Inspected By:**

**Inspect Chamber:** .....

**Inspect Flood Gate:** Yes .....

**Clean/Grease Flood Gate:** Yes .....

**Clean Chamber:** .....

**Syphon Chamber Comments:** .....

**Inspect Chain:** Yes .....

**Clean Chain:** Yes .....

**Inspect Steps:** Yes .....

**Clean Steps:** Yes .....

**Inspect Chamber:** Yes .....

**Inspect Watertight Seals:** Yes .....

**Clean Chamber:** Yes .....

**Remove Significant Grease,** No .....

**Sediment and Debris:** .....

**Flood Chamber Comments:** .....



CSO Semi-Annual Inspection and Preventative Maintenance Schedule Form (Type B)

The screenshot displays the Cityworks software interface for a work order. The main window is titled "Work Order" and contains several panels:

- Work Order Panel:** Includes fields for Description (Semi-Annual PM CSO Type B), Number (438), Entry Type (CSO CHAMBER), Category (Preventive Maintenance), and various dates (Initiated, Requested, Subject, Proposed, Closed, Completed, Actual Start, Stop, Expense Type).
- Location Information Panel:** Includes WQ Address, Location Details, Shop, Pop-Up, Title Number, and Function.
- Assets Panel:** A table listing assets with columns for Asset ID, Asset User, Location, Warranty Date, and Work Complete. Assets include CSO-CHAMBER 806, CSO-CHAMBER 2437, and CSO-CHAMBER 2491.
- Work Cycle Panel:** Includes Periodic Start, Interval (9 Months), and Date Next Due (11/15/2016).
- Estimated Work Activities Panel:** Includes a table for activities with columns for ID, Type, Description, Entry Id, Entry Type, Date, and Inspector.
- Project Tree Panel:** Shows a tree structure for Project Tree, Contract, Liquid Inflation, and Capital Request, with associated costs for Labor, Equipment, Material, and Permit.
- Work Orders Panel:** A table listing work orders with columns for ID, Description, Priority, Status, Submit To, and Proj Start Date.

# Inspection for Type B

Cityworks | Home | Recent | Asset Search | Service Requests | Work Orders | Inspections | Project Manager | Designer | Search

Inspection View

Inspection ID: 582

Location: [ ]

Status: Closed | Resolution: [ ]

Insp. Date: [ ] | Inspected By: [ ]

### Inversion Chamber

Inspect Slaps	<input checked="" type="radio"/> Yes <input type="radio"/> No	✓
Clean Slaps	<input checked="" type="radio"/> Yes <input type="radio"/> No	✓
Inspect Weir	<input checked="" type="radio"/> Yes <input type="radio"/> No	✓
Clean Weir	<input checked="" type="radio"/> Yes <input type="radio"/> No	✓
Inspect Chamber	<input checked="" type="radio"/> Yes <input type="radio"/> No	✓
Clean Chamber	<input checked="" type="radio"/> Yes <input type="radio"/> No	✓
Inversion Chamber Comments	[ ]	

### Regulator Chamber

Inspect Gate Assembly	<input checked="" type="radio"/> Yes <input type="radio"/> No	✓
Clean/Grease Gate Assembly	<input checked="" type="radio"/> Yes <input type="radio"/> No	✓
Inspect Transmission Shaft	<input checked="" type="radio"/> Yes <input type="radio"/> No	✓
Clean/Grease Transmission Shaft	<input checked="" type="radio"/> Yes <input type="radio"/> No	✓
Inspect Slaps	<input checked="" type="radio"/> Yes <input type="radio"/> No	✓

---

Clean Slaps	<input checked="" type="radio"/> Yes <input type="radio"/> No	✓
Inspect Gate Rod	<input checked="" type="radio"/> Yes <input type="radio"/> No	✓
Clean Gate Rod	<input checked="" type="radio"/> Yes <input type="radio"/> No	✓
Inspect Weights	<input checked="" type="radio"/> Yes <input type="radio"/> No	✓
Clean Weights	<input checked="" type="radio"/> Yes <input type="radio"/> No	✓
Inspect Outfall Box	<input checked="" type="radio"/> Yes <input type="radio"/> No	✓
Clean Outfall Box	<input checked="" type="radio"/> Yes <input type="radio"/> No	✓
Inspect Chamber	<input checked="" type="radio"/> Yes <input type="radio"/> No	✓
Clean Chamber	<input checked="" type="radio"/> Yes <input type="radio"/> No	✓
Regulator Chamber Comments	[ ]	

### Flood Chamber

Inspect Float Assembly	<input checked="" type="radio"/> Yes <input type="radio"/> No	✓
Clean/Grease Float Assembly	<input checked="" type="radio"/> Yes <input type="radio"/> No	✓
Clean Float Rods	<input checked="" type="radio"/> Yes <input type="radio"/> No	✓
Inspect Chamber	<input checked="" type="radio"/> Yes <input type="radio"/> No	✓
Clean Chamber	<input checked="" type="radio"/> Yes <input type="radio"/> No	✓
Inspect Connecting Pipe to Regulator Chamber	<input checked="" type="radio"/> Yes <input type="radio"/> No	✓

Remove Significant Grease, Sediment, and Debris  Yes  No ✓

Flood Chamber Comments  ✓

**Syphon Chamber**

Inspect Chamber  Yes  No ✓

Clean Chamber  Yes  No ✓

Syphon Chamber Comments  ✓

**Flood Chamber**

Inspect Flood Gate  Yes  No ✓

Clean/Grease Flood Gate  Yes  No ✓

Inspect Chain  Yes  No ✓

Clean Chain  Yes  No ✓

Inspect Steps  Yes  No ✓

Clean Steps  Yes  No ✓

Inspect Chamber  Yes  No ✓

Clean Chamber  Yes  No ✓

Inspect Watertight Seals  Yes  No ✓

Remove Significant Grease, Sediment and Debris  Yes  No ✓

Flood Chamber Comments  ✓

**Comments**

Observation:

Repairs:

Recommendations:

Cond. Score: 0

# Work Order #428

## Semi-Annual PM; CSO Type B



<b>Created By:</b> <b>Submitted To:</b> Freysinger, Ken <b>Projected Start:</b> 5/18/2016 8:43:21PM	<b>Created Date:</b> 10/19/2015 8:43:33PM <b>Supervisor:</b> <b>Priority:</b> 4		
<b><u>Assets:</u></b>			
<b>Type</b>	<b>AssetID</b>	<b>Location</b>	
CSO Chamber	CSOC-026		
CSO Chamber	RC-026		
CSO Chamber	FLC-026		
<b>Actual Start:</b>		<b>Actual Finish:</b> 5/11/2016 6:41:45AM	
<b>Existing Comments:</b>			
<b>Work Completed/Comments:</b>			
<b>Labor Hours:</b>	<b><u>Employee Name</u></b>	<b><u>Hours</u></b>	<b><u>Cost</u></b>
	Sweger, Joshua	3.00	\$41.64
	Kneasel, Mike	3.00	\$49.35
	Rotolo, Scott	3.00	\$63.69
		<b>Total Labor Cost:</b>	<b>\$154.68</b>
<b>Material Quantities:</b>	<b><u>Item Description</u></b>	<b><u>Qty Used</u></b>	<b><u>Cost</u></b>
		<b>Total Cost of Materials:</b>	
<b>Equipment Hours:</b>	<b><u>Item Description</u></b>	<b><u>Units</u></b>	<b><u>Cost</u></b>
	Service Truck	1.00	\$15.00
	Vactor	1.00	\$90.00
		<b>Total Equipment Costs:</b>	<b>\$105.00</b>
<b>Completed By:</b> Kneasel, Mike			

**Inspection 560**  
**Semi-Annual, CSO Type B**

**Status: CLOSED**

**Priority:**

**3**

**Location:**

**Inspected By:**

**Projected Start:** 5/2/2016 8:43:21PM

**Projected Finish:** 5/2/2016 8:43:21PM

**Initiated By:** cwadmin, cwadmin

**Initiated Date:** 10/19/2015 8:43:33PM

**Actual Finish:** 5/11/2016 2:59:27PM

**Insp. Date:**

**Closed By:** Kneasel, Mike

**Date Closed:** 5/11/2016 3:00:33PM

**Work Order Id:** 428

**Observation:**

**Repairs:**

**Recommendation:**

**Inspection 560**  
**Semi-Annual, CSO Type B**

**Status: CLOSED**

**Priority:** 3

**Location:**

**Inspected By:**

**Observations:**

**Inspect Steps:** Yes

**Clean Steps:** Yes

**Inspect Weir:** Yes

**Clean Weir:** Yes

**Inspect Chamber:** Yes

**Clean Chamber:** Yes

**Diversion Chamber Comments:**

**Inspect Gate Assembly:** Yes

**Clean/Grease Gate Assembly:** Yes

**Inspect Transmission Shaft:** Yes

**Clean/Grease Transmission Shaft:** Yes

**Inspect Steps:** Yes

**Clean Steps:** Yes

**Inspect Gate Rod:** Yes

**Clean Gate Rod:** Yes

**Inspect Weights:** Yes

**Clean Weights:** Yes

**Inspect Outfall Box:** Yes

**Clean Outfall Box:** Yes

**Inspect Chamber:** Yes

**Clean Chamber:** Yes

**Regulator Chamber Comments:**

**Inspect Float Assembly:** Yes

**Clean/Grease Float Assembly:** Yes

**Clean Float Rods:** Yes

**Inspect Chamber:** Yes

**Clean Chamber:** Yes

**Inspect Connecting Pipe to  
Regulator Chamber:** Yes

**Remove Significant Grease,  
Sediment, and Debris:** Yes

**Inspection 560**  
**Semi-Annual, CSO Type B**

**Status: CLOSED**

**Priority:**

**3**

**Location:**

**Inspected By:**

**Float Chamber Comments:**

**Inspect Chamber:** Yes

**Inspect Flood Gate:** Yes

**Clean/Grease Flood Gate:** Yes

**Clean Chamber:** Yes

**Syphon Chamber Comments:**

**Inspect Chain:** Yes

**Clean Chain:** Yes

**Inspect Steps:** Yes

**Clean Steps:** Yes

**Inspect Chamber:** Yes

**Clean Chamber:** Yes

**Inspect Watertight Seals:** Yes

**Remove Significant Grease,  
Sediment and Debris:** Yes

**Flood Chamber Comments:**

CSO Semi-Annual Inspection and Preventative Maintenance Schedule Form (Type C)

The screenshot displays the Cityworks software interface for a 'Work Order' form. The main window is titled 'Work Order' and contains the following sections:

- Work Order Details:**
  - Description: Semi-Annual PM CSO Type C
  - Number: 444
  - Work Type: CSO CHAMBER
  - Category: Preventive Maintenance
  - Initiated By: location, location Date: 10/18/2013 9:29 AM
  - Priority: High
  - Requested By: Subbs, Scott Supervisor: [blank]
  - Submitted To: Subbs, Scott Date: 10/18/2013 9:29 AM
  - Projected Start: 11/22/2013 9:29 AM Projected Finish: [blank]
  - Opened By: HIGGS, SCOTT Date: 11/22/2013 11:23 AM
  - Closed By: [blank] Date: 11/22/2013 11:23 AM
  - Completed By: Subbs, Scott
  - Actual Start: [blank] Actual Finish: 11/22/2013 11:23 AM
  - Stage: Actual Expense Type: Maintenance
  - AM Comments: [blank]
  - Existing Condition: [blank]
  - Instructions: [blank]
  - Restrictions: [blank]
- Location Information:**
  - WO Address: [blank]
  - Location Initials: [blank]
  - Map: [blank] Map Page: [blank]
  - Tra Number: RC-023 District: 4 North Side MS
  - X Location: 2,211,746.96 Y Location: 344,454.87
- Category:** [blank]
- Related Work:**
  - Asset ID Asset Desc Asset Loc Location Warranty Date Work Complete
  - CSO CHAMBER 802 CSOC-023 [blank]
  - CSO CHAMBER 2440 RC-023 [blank]
  - Note: PM notes indicate inventory off under warranty.
- Work Cycle:**
  - Repeat: Every [blank]
  - Interval: 2 Months
  - From: Projected Start Date
  - Next Due Date: 12/22/2013
- Related Work Actions:**
  - Add Request: [blank]
  - Request Item: [blank]
  - Add Inspection: [blank]
- Table:**

ID	Type	Description	Entry ID	Entry Type	Date	Inspected
220	INSP	Semi-Annual CSO Type C	RC-023	CSO-CHAMBER		
- Work Orders:**
  - Parent: 200
  - Table:
 

ID	Description	Priority	Status	Submit To	Req Start Date
200	Semi-Annual PM CSO Type C	H	OPEN	Prepinger, Ben	6/21/2013
  - Parents: [blank]
  - Attachments: [blank]
- Cost Summary:**
  - Link Units Desc: [blank] Description: [blank]
  - Labor Cost: \$37.00 Material Cost: \$0.00
  - Equipment Cost: \$0.00 Rental Cost: \$0.00
  - Total WO Cost: \$37.00



# Inspection for Type C

Cityworks [Home](#) [Reports](#) [Asset Search](#) [Service Requests](#) [Work Orders](#) [Inspections](#) [Project Manager](#) [Designer](#)

Inspection

63 5/6

Location:

Status:  Resubmit:

Insp. Date:  Inspected By:

**Overflows Chamber**

Inspect Steps	<input checked="" type="radio"/> Yes <input type="radio"/> No	<input checked="" type="checkbox"/>
Clean Steps	<input checked="" type="radio"/> Yes <input type="radio"/> No	<input checked="" type="checkbox"/>
Inspect Weir	<input checked="" type="radio"/> Yes <input type="radio"/> No	<input checked="" type="checkbox"/>
Clean Weir	<input checked="" type="radio"/> Yes <input type="radio"/> No	<input checked="" type="checkbox"/>
Inspect Chamber	<input checked="" type="radio"/> Yes <input type="radio"/> No	<input checked="" type="checkbox"/>
Clean Chamber	<input checked="" type="radio"/> Yes <input type="radio"/> No	<input checked="" type="checkbox"/>
Overflows Chamber Comments	<input type="text"/>	

**Regulator Chamber**

Inspect Gate Assembly	<input checked="" type="radio"/> Yes <input type="radio"/> No	<input checked="" type="checkbox"/>
Clean/Unseal Gate Assembly	<input checked="" type="radio"/> Yes <input type="radio"/> No	<input checked="" type="checkbox"/>
Inspect Outfall Box	<input checked="" type="radio"/> Yes <input type="radio"/> No	<input checked="" type="checkbox"/>
Clean Outfall Box	<input checked="" type="radio"/> Yes <input type="radio"/> No	<input checked="" type="checkbox"/>
Inspect Steps	<input checked="" type="radio"/> Yes <input type="radio"/> No	<input checked="" type="checkbox"/>
Clean Steps	<input checked="" type="radio"/> Yes <input type="radio"/> No	<input checked="" type="checkbox"/>

**Regulator Chamber Comments**

**Regulator Chamber**

Inspect Chamber	<input type="radio"/> Yes <input type="radio"/> No	<input checked="" type="checkbox"/>
Clean Chamber	<input type="radio"/> Yes <input type="radio"/> No	<input checked="" type="checkbox"/>
Regulator Chamber Comments	<input type="text"/>	

**Regulator Chamber**

Inspect Chamber	<input type="radio"/> Yes <input type="radio"/> No	<input checked="" type="checkbox"/>
Clean Chamber	<input type="radio"/> Yes <input type="radio"/> No	<input checked="" type="checkbox"/>
Regulator Chamber Comments	<input type="text"/>	

**Flume Chamber**

Inspect Side Gate	<input checked="" type="radio"/> Yes <input type="radio"/> No	<input checked="" type="checkbox"/>
Clean/Unseal Side Gate	<input checked="" type="radio"/> Yes <input type="radio"/> No	<input checked="" type="checkbox"/>
Inspect Chute	<input checked="" type="radio"/> Yes <input type="radio"/> No	<input checked="" type="checkbox"/>
Clean Chute	<input checked="" type="radio"/> Yes <input type="radio"/> No	<input checked="" type="checkbox"/>
Inspect Steps	<input checked="" type="radio"/> Yes <input type="radio"/> No	<input checked="" type="checkbox"/>
Clean Steps	<input checked="" type="radio"/> Yes <input type="radio"/> No	<input checked="" type="checkbox"/>
Inspect Chamber	<input checked="" type="radio"/> Yes <input type="radio"/> No	<input checked="" type="checkbox"/>
Clean Chamber	<input checked="" type="radio"/> Yes <input type="radio"/> No	<input checked="" type="checkbox"/>
Flume Chamber Comments	<input type="text"/>	

**Comments**

Observation:

Report:

Recommendation:

Cont. Spec. #:

# Work Order #611

## Semi-Annual PM; CSO Type C



<p><b>Created By:</b> Baker, Joseph</p> <p><b>Submitted To:</b> Schreffler, Brian</p> <p><b>Projected Start:</b> 4/29/2016 10:36:12AM</p>	<p><b>Created Date:</b> 10/29/2015 1:24:08PM</p> <p><b>Supervisor:</b> Baker, Joseph</p> <p><b>Priority:</b> 4</p>																								
<p><b><u>Assets:</u></b></p> <table style="width: 100%; border-collapse: collapse;"> <thead> <tr> <th style="text-align: left;">Type</th> <th style="text-align: left;">AssetID</th> <th style="text-align: left;">Location</th> </tr> </thead> <tbody> <tr> <td>CSO Chamber</td> <td>RC-057</td> <td></td> </tr> <tr> <td>CSO Chamber</td> <td>CSOC-057</td> <td></td> </tr> <tr> <td>CSO Chamber</td> <td>FLC-057</td> <td></td> </tr> </tbody> </table>		Type	AssetID	Location	CSO Chamber	RC-057		CSO Chamber	CSOC-057		CSO Chamber	FLC-057													
Type	AssetID	Location																							
CSO Chamber	RC-057																								
CSO Chamber	CSOC-057																								
CSO Chamber	FLC-057																								
<p><b>Actual Start:</b> <span style="float: right;"><b>Actual Finish:</b> 4/21/2016 1:15:01PM</span></p>																									
<p><b>Existing Comments:</b></p>																									
<p><b>Work Completed/Comments:</b></p>																									
<table style="width: 100%; border-collapse: collapse;"> <thead> <tr> <th style="text-align: left;">Labor Hours:</th> <th style="text-align: left;"><u>Employee Name</u></th> <th style="text-align: left;"><u>Hours</u></th> <th style="text-align: left;"><u>Cost</u></th> </tr> </thead> <tbody> <tr> <td></td> <td>Schreffler, Brian</td> <td style="text-align: right;">1.00</td> <td style="text-align: right;">\$18.25</td> </tr> <tr> <td></td> <td>Stein, Mitchell</td> <td style="text-align: right;">1.00</td> <td style="text-align: right;">\$23.36</td> </tr> <tr> <td></td> <td>Baker, Joseph</td> <td style="text-align: right;">1.00</td> <td style="text-align: right;">\$45.00</td> </tr> <tr> <td></td> <td>Freysinger, Ken</td> <td style="text-align: right;">1.00</td> <td style="text-align: right;">\$45.00</td> </tr> <tr> <td colspan="3" style="text-align: right;"><b>Total Labor Cost:</b></td> <td style="text-align: right;"><b>\$131.61</b></td> </tr> </tbody> </table>		Labor Hours:	<u>Employee Name</u>	<u>Hours</u>	<u>Cost</u>		Schreffler, Brian	1.00	\$18.25		Stein, Mitchell	1.00	\$23.36		Baker, Joseph	1.00	\$45.00		Freysinger, Ken	1.00	\$45.00	<b>Total Labor Cost:</b>			<b>\$131.61</b>
Labor Hours:	<u>Employee Name</u>	<u>Hours</u>	<u>Cost</u>																						
	Schreffler, Brian	1.00	\$18.25																						
	Stein, Mitchell	1.00	\$23.36																						
	Baker, Joseph	1.00	\$45.00																						
	Freysinger, Ken	1.00	\$45.00																						
<b>Total Labor Cost:</b>			<b>\$131.61</b>																						
<table style="width: 100%; border-collapse: collapse;"> <thead> <tr> <th style="text-align: left;">Material Quantities:</th> <th style="text-align: left;"><u>Item Description</u></th> <th style="text-align: left;"><u>Qty Used</u></th> <th style="text-align: left;"><u>Cost</u></th> </tr> </thead> <tbody> <tr> <td colspan="4" style="text-align: right;"><b>Total Cost of Materials:</b></td> </tr> </tbody> </table>		Material Quantities:	<u>Item Description</u>	<u>Qty Used</u>	<u>Cost</u>	<b>Total Cost of Materials:</b>																			
Material Quantities:	<u>Item Description</u>	<u>Qty Used</u>	<u>Cost</u>																						
<b>Total Cost of Materials:</b>																									
<table style="width: 100%; border-collapse: collapse;"> <thead> <tr> <th style="text-align: left;">Equipment Hours:</th> <th style="text-align: left;"><u>Item Description</u></th> <th style="text-align: left;"><u>Units</u></th> <th style="text-align: left;"><u>Cost</u></th> </tr> </thead> <tbody> <tr> <td></td> <td>Service Truck</td> <td style="text-align: right;">3.00</td> <td style="text-align: right;">\$45.00</td> </tr> <tr> <td></td> <td>Vactor</td> <td style="text-align: right;">1.00</td> <td style="text-align: right;">\$90.00</td> </tr> <tr> <td colspan="3" style="text-align: right;"><b>Total Equipment Costs:</b></td> <td style="text-align: right;"><b>\$135.00</b></td> </tr> </tbody> </table>		Equipment Hours:	<u>Item Description</u>	<u>Units</u>	<u>Cost</u>		Service Truck	3.00	\$45.00		Vactor	1.00	\$90.00	<b>Total Equipment Costs:</b>			<b>\$135.00</b>								
Equipment Hours:	<u>Item Description</u>	<u>Units</u>	<u>Cost</u>																						
	Service Truck	3.00	\$45.00																						
	Vactor	1.00	\$90.00																						
<b>Total Equipment Costs:</b>			<b>\$135.00</b>																						
<p><b>Completed By:</b> Schreffler, Brian</p>																									

**Inspection 576**  
**Semi-Annual, CSO Type C**

**Status: CLOSED**

**Priority:** 3

**Location:**

**Inspected By:**

**Projected Start:** 12/21/2015 9:19:50PM

**Projected Finish:** 12/21/2015 9:19:50PM

**Initiated By:** cwadmin, cwadmin

**Initiated Date:** 10/19/2015 9:20:03PM

**Actual Finish:** 4/27/2016 7:12:31AM

**Insp. Date:**

**Closed By:** Rotolo, Scott

**Date Closed:** 4/27/2016 7:12:31AM

**Work Order Id:** 444

**Observation:**

**Repairs:**

**Recommendation:**

**Inspection 576**  
**Semi-Annual, CSO Type C**

**Status: CLOSED**

**Priority:** 3

**Location:**

**Inspected By:**

**Observations:**

**Inspect Steps:** Yes

**Clean Steps:** Yes

**Inspect Weir:** Yes

**Clean Weir:** Yes

**Inspect Chamber:** Yes

**Clean Chamber:** Yes

**Diversion Chamber Comments:**

**Inspect Gate Assembly:** Yes

**Clean/Grease Gate Assembly:** Yes

**Inspect Outfall Box:** Yes

**Clean Outfall Boc:** Yes

**Inspect Steps:** Yes

**Clean Steps:** Yes

**Inspect Chamber:** Yes

**Clean Chamber:** Yes

**Regulator Chamber Comments:**

**Inspect Chamber:**

**Inspect Tide Gate:** Yes

**Clean/Grease Tide Gate:** Yes

**Clean Chamber:**

**Syphon Chamber Comments:**

**Inspect Chain:** Yes

**Clean Chain:** Yes

**Inspect Steps:** Yes

**Clean Steps:** Yes

**Inspect Chamber:** Yes

**Clean Chamber:** Yes

**Flood Chamber Comments:**

CSO Semi-Annual Inspection and Preventative Maintenance Schedule Form (Type D)

**Work Order**

Description: Sewermain PM CSO Type D  
 Number: 437  
 Entity Type: CSO CHAMBER  
 Category: Preventive Maintenance  
 Initiated By: (current) user  
 Status: Open  
 Requested By: Bob, Joseph  
 Subject To: 95, 9  
 Projected Start: 10/20/2013 8:31 AM  
 Carried By: (N/A)  
 Closed By: Bob, Joseph  
 Completed By: Brian, Kim  
 Actual Start: Actual/Finish: 10/18/2013 8:46 AM  
 Stage: Actual  
 Expense Type: Maintenance

**Location Information**

WFO Address:  
 Location Details:  
 Shop:  
 No Number: RC-45  
 Function: 3,213,406,34  
 File Path:  
 Queue: Preventive  
 Location: 227,407,13

**Assets**

Asset	Asset ID	Asset UoI	Location	Warranty Date	Work Complete
CSO CHAMBER	2460	RC-45, 46			
CSO CHAMBER	1296	CSOC-645			
CSO CHAMBER	1292	CSOC-646			

**Work Cycle**

Repeat: None  
 Interval: 6 Months  
 From: Projected Start Date  
 Date Printed: Next Print Date: 10/17/2013

**Associated Work Activities**

ID	Type	Description	Entity ID	Entity Type	Date	Expense
1234	IMP	Semi-Annual CSO Type D	RC-45,46	CSO CHAMBER	10/18	

**Financials**

Project: [Dropdown]  
 Contract: [Dropdown]  
 Liquid P/B: [Dropdown]  
 Update P/B: [Dropdown]  
 Cancelled By: [Dropdown]  
 Cancel Reason: [Dropdown]  
 Under Agency: [Dropdown]  
 Description: [Dropdown]

Labor Cost: \$391.85  
 Material Cost: \$0.00  
 Equipment Cost: \$745.00  
 Permit Cost: \$0.00  
 Total WFO Cost: \$1136.85

**Work Orders**

ID	Description	Priority	Status	Submit To	Proj Start Date
437	Semi-Annual PM CSO Type D	A	OPEN	Frederick, Kim	10/20/2013

**Attachments**

+ Add attachments...  
 Remove all attachments  
 Drag and Drop Web Files to Attach Here.

# Inspection for Type D

**Cityworks** Home Recent Alert Search Service Requests Work Orders Inspectors Project Manager Designer

Inspection View

**Inspection Details**

ID: 882  
Location:   
Status: **Closed** Resolution:   
Insp. Date:  Inspected By: Jenkins, Kim

**Diversion Chamber**

Inspect Steps	<input checked="" type="radio"/> Yes <input type="radio"/> No	✓
Clean Steps	<input checked="" type="radio"/> Yes <input type="radio"/> No	✓
Inspect Weir	<input checked="" type="radio"/> Yes <input type="radio"/> No	✓
Clean Weir	<input checked="" type="radio"/> Yes <input type="radio"/> No	✓
Inspect Chamber	<input checked="" type="radio"/> Yes <input type="radio"/> No	✓
Clean Chamber	<input checked="" type="radio"/> Yes <input type="radio"/> No	✓
Diversion Chamber Comments	<input type="text"/>	✓

**Syphon Chamber**

Inspect Chamber	<input type="radio"/> Yes <input type="radio"/> No	✓
Clean Chamber	<input type="radio"/> Yes <input type="radio"/> No	✓
Syphon Chamber Comments	<input type="text"/>	✓

**Flood Chamber**

Inspect Tide Gate	<input checked="" type="radio"/> Yes <input type="radio"/> No	✓
Clean/Grease Tide Gate	<input checked="" type="radio"/> Yes <input type="radio"/> No	✓

**Flood Chamber**

Inspect Chain	<input checked="" type="radio"/> Yes <input type="radio"/> No	✓
Clean Chain	<input checked="" type="radio"/> Yes <input type="radio"/> No	✓
Inspect Steps	<input checked="" type="radio"/> Yes <input type="radio"/> No	✓
Clean Steps	<input checked="" type="radio"/> Yes <input type="radio"/> No	✓
Inspect Chamber	<input checked="" type="radio"/> Yes <input type="radio"/> No	✓
Clean Chamber	<input checked="" type="radio"/> Yes <input type="radio"/> No	✓
Flood Chamber Comments	<input type="text"/>	✓

**Comments**

Observation:

Repairs:

Recommendation:

Comp. Score: 0

# Work Order #457

## Semi-Annual PM; CSO Type D

<b>Created By:</b> cwadmin, cwadmin		<b>Created Date:</b> 10/19/2015 9:31:42PM	
<b>Submitted To:</b> 00, G		<b>Supervisor:</b> Baker, Joseph	
<b>Projected Start:</b> 10/26/2015 9:31:42PM		<b>Priority:</b> 4	
<b><u>Assets:</u></b>			
<b>Type</b>	<b>AssetID</b>	<b>Location</b>	
CSO Chamber	RC-45_46		
CSO Chamber	CSOC-045		
CSO Chamber	CSOC-046		
<b>Actual Start:</b>		<b>Actual Finish:</b> 11/18/2015 9:46:17AM	
<b>Existing Comments:</b>			
<b>Work Completed/Comments:</b>			
<b>Labor Hours:</b>	<b><u>Employee Name</u></b>	<b><u>Hours</u></b>	<b><u>Cost</u></b>
	Howe, Cody	5.00	\$90.35
	Ferguson, Keith	5.00	\$93.00
	Morrison, Douglas	5.00	\$93.00
	Jenkins, Kim	5.00	\$115.60
		<b>Total Labor Cost:</b>	<b>\$391.95</b>
<b>Material Quantities:</b>	<b><u>Item Description</u></b>	<b><u>Qty Used</u></b>	<b><u>Cost</u></b>
		<b>Total Cost of Materials:</b>	
<b>Equipment Hours:</b>	<b><u>Item Description</u></b>	<b><u>Units</u></b>	<b><u>Cost</u></b>
	Service Truck	1.00	\$75.00
	Vactor	1.00	\$450.00
		<b>Total Equipment Costs:</b>	<b>\$525.00</b>
<b>Completed By:</b> Jenkins, Kim			

**Inspection 591**  
**Semi-Annual, CSO Type D**



**Status: CLOSED**

**Priority:** 3

**Location:**

**Inspected By:** Jenkins, Kim

**Projected Start:** 10/19/2015 9:31:42PM  
**Initiated By:** cwadmin, cwadmin  
**Actual Finish:** 11/18/2015 9:44:23AM  
**Insp. Date:**  
**Closed By:** 00, G  
**Work Order Id:** 457  
**Observation:**  
**Repairs:**  
**Recommendation:**

**Projected Finish:** 10/19/2015 9:31:42PM  
**Initiated Date:** 10/19/2015 9:31:43PM  
**Date Closed:** 11/19/2015 9:44:23AM

**Observations:**

**Inspect Steps:** Yes  
**Clean Steps:** Yes  
**Inspect Weir:** Yes  
**Clean Weir:** Yes

**Inspect Chamber:** Yes  
**Clean Chamber:** Yes

**Diversion Chamber Comments:**

**Inspect Chamber:**  
**Inspect Tide Gate:** Yes  
**Clean/Grease Tide Gate:** Yes  
**Clean Chamber:**

**Syphon Chamber Comments:**

**Inspect Chain:** Yes  
**Clean Chain:** Yes  
**Inspect Steps:** Yes  
**Clean Steps:** Yes

**Inspect Chamber:** Yes  
**Clean Chamber:** Yes

**Flood Chamber Comments:**



NATIONAL POLLUTANT DISCHARGE ELIMINATION SYSTEM (NPDES)  
DISCHARGE MONITORING REPORT (DMR)

Form Approved  
GMS No. 2000-004

PERMITTEE NAME/ADDRESS (Include Facility Name/Location if Different)  
**NAME:** Harrisburg Authority  
**ADDRESS:** 212 Local Street  
 Harrisburg, PA 17101  
**FACILITY:** HARRISBURG ADVANCED WWTF  
**LOCATION:** 1862 SOUTH CAMERON ST  
 HARRISBURG, PA 17104  
**ATTN:** Shannon G. Williams/CEO

PA0027197	001-A
PERMIT NUMBER	DISCHARGE NUMBER
MONITORING PERIOD	
MMDD/YYYY	MMDD/YYYY
FROM 06/01/2015	TO 06/30/2015

DMR Mailing ZIP CODE: 17101  
 MAJOR (SUBR 03)  
 TOTAL REGULATED DISCHARGE  
 External Outfall

No Discharge

PARAMETER	QUANTITY OR LOADING			QUALITY OR CONCENTRATION			NO. EX	FREQUENCY OF ANALYSIS	SAMPLE TYPE
	VALUE	VALUE	UNITS	VALUE	VALUE	UNITS			
Oxygen, dissolved (DO)	SAMPLE MEASUREMENT	.....	.....	6.1	.....	mg/L	0	6/Day	Grab
00300 A 0 Disinfection, Process Complete	PERMIT REQUIREMENT	.....	.....	5	MIN	mg/L	0	Daily	GRAB
BOD, 5-day, 20 deg. C	SAMPLE MEASUREMENT	258.48	55532	lb/d	.....	mg/L	0	1/Day	Comp24
00310 G 0 Raw Sewage Influent	PERMIT REQUIREMENT	Reg Mon MO AVG	Reg Mon DAILY MX	lb/d	.....	mg/L	0	Three Per Week	Comp24
pH	SAMPLE MEASUREMENT	.....	.....	6.5	.....	su	0	6/Day	Grab
00400 A 0 Disinfection, Process Complete	PERMIT REQUIREMENT	.....	.....	MINIMUM	.....	su	0	Daily	GRAB
Solids, total suspended	SAMPLE MEASUREMENT	2806	3895	lb/d	.....	mg/L	0	1/Day	Comp24
00500 A 0 Disinfection, Process Complete	PERMIT REQUIREMENT	Reg Mon MO AVG	Reg Mon MX WK AV	lb/d	.....	mg/L	0	Daily	Comp24
Solids, total suspended	SAMPLE MEASUREMENT	31546	81140	lb/d	.....	mg/L	0	1/Day	Comp24
00530 G 0 Raw Sewage Influent	PERMIT REQUIREMENT	Reg Mon MO AVG	Reg Mon DAILY MX	lb/d	.....	mg/L	0	Three Per Week	Comp24
Nitrogen, total (as N)	SAMPLE MEASUREMENT	.....	.....	.....	.....	mg/L	0	1/Wk	Calcd
00600 A 0 Disinfection, Process Complete	PERMIT REQUIREMENT	.....	.....	.....	.....	mg/L	0	Monthly	Calcd
Nitrogen, ammonia total (as N)	SAMPLE MEASUREMENT	2941	.....	lb/d	.....	mg/L	1	1/Day	Comp24
00610 A 1 Disinfection, Process Complete	PERMIT REQUIREMENT	Reg Mon MO AVG	Reg Mon MO AVG	lb/d	.....	mg/L	1	1/Day	Comp24
Disinfection, Process Complete	PERMIT REQUIREMENT	3458	.....	lb/d	.....	mg/L	1	Daily	Comp24

NAME/TITLE PRINCIPAL EXECUTIVE OFFICER	LESS ROSCINI, SUPERINTENDENT	SIGNATURE OF PRINCIPAL EXECUTIVE OFFICER OR AUTHORIZED AGENT	TELEPHONE	DATE
Typed or Printed			(717) 939-7270	07/27/2015
Comments and Explanation of any violations (reference all attachments here)				

NATIONAL POLLUTANT DISCHARGE ELIMINATION SYSTEM (NPDES)  
DISCHARGE MONITORING REPORT (DMR)

Form Approved  
OMB No. 2040-0004

PERMITTEE NAME/ADDRESS (Include Facility Name/Location if Different)

NAME: Harrisburg Authority  
ADDRESS: 212 Locust Street  
Harrisburg, PA 17101  
FACILITY: HARRISBURG ADVANCED WWTF  
LOCATION: 1682 SOUTH CAMERON ST  
HARRISBURG, PA 17104  
ATTN: Shannon G. Williams/CEO

PA0027187	001-A
PERMIT NUMBER	DISCHARGE NUMBER

MMDDYYYY	MMDDYYYY
06/01/2015	06/30/2015
FROM	TO

DMR Mailing ZIP CODE: 17101  
MAJOR (SUBR 03)  
TOTAL REGULATED DISCHARGE  
Exhibit Outline

No Discharge

PARAMETER	QUANTITY OR LOADING			QUALITY OR CONCENTRATION			NO. EX	FREQUENCY OF ANALYSIS	SAMPLE TYPE
	VALUE	VALUE	UNITS	VALUE	VALUE	UNITS			
Nitrogen, Kjeldahl, total (as N)	*****	*****	*****	*****	14.9	mg/L	0	1/W/week	Comp24
00626 A.0 Distraction, Process Complete	*****	*****	*****	*****	Reg Mon. MO AVG	mg/L		Weekly	COMF24
Nitrate plus nitrite total 1 det. (as N)	*****	*****	*****	*****	0.51	mg/L	0	1/W/week	Comp24
00630 A.0 Distraction, Process Complete	*****	*****	*****	*****	Reg Mon. MO AVG	mg/L		Weekly	COMF24
Phosphorus, total (as P)	*****	*****	*****	*****	0.8	mg/L	0	1/Day	Comp24
00665 A.0 Distraction, Process Complete	*****	*****	*****	*****	Reg Mon. MO AVG	mg/L		Daily	COMF24
Flow, in conduit or thru treatment plant	*****	*****	*****	*****	28.2	MGD	0	Contin	Measured
00690 A.0 Distraction, Process Complete	*****	*****	*****	*****	Reg Mon. MO AVG	Mg/d		Continous	MEASRD
Chlorine, total residual	*****	*****	*****	*****	0.07	mg/L	0	6/Day	Grab
50080 A.0 Distraction, Process Complete	*****	*****	*****	*****	Reg Mon. MINIMUM	mg/L		Once Per Shift	GRABS
Nitrogen, Total	*****	*****	*****	*****	121029	lb	0	Monthly	Calcd
51445 2.0 Effluent NH	*****	*****	*****	*****	Reg Mon. MO TOTAL	lb		Monthly	Calcd
Nitrogen, Total	*****	*****	*****	*****	121187	lb	0	Monthly	Calcd
51445 A.0 Distraction, Process Complete	*****	*****	*****	*****	Reg Mon. MO TOTAL	lb		Monthly	Calcd

NAME/TITLE PRINCIPAL EXECUTIVE OFFICER	TELEPHONE	DATE
Jess Rosentiel, Superintendent	(717) 939-7270	07/27/2015
TYPED OR PRINTED	AREA CODE	NUMBER
COMMENTS AND EXPLANATION OF ANY VIOLATIONS (reference all attachments here)	SIGNATURE OF PRINCIPAL EXECUTIVE OFFICER OR AUTHORIZED AGENT	MMDDYYYY

NATIONAL POLLUTANT DISCHARGE ELIMINATION SYSTEM (NPDES)  
DISCHARGE MONITORING REPORT (DMR)

Form Approved  
OMB No. 2040-0044

PERMITTEE NAME/ADDRESS (Include Facility Name, section if Different)

NAME: Harrisburg Authority  
ADDRESS: 212 Local Street  
Harrisburg, PA 17101  
FACILITY: HARRISBURG ADVANCED WWTF  
LOCATION: 1662 SOUTH CAMERON ST  
HARRISBURG, PA 17104  
ATTN: Shannon G. Williams/CEO

PA-0027187  
PERMIT NUMBER

001-A  
DISCHARGE NUMBER

MONITORING PERIOD  
MM/DD/YYYY TO MM/DD/YYYY  
FROM 06/01/2015 TO 06/30/2015

DMR Mailing ZIP CODE: 17101  
MAJOR (BUBR 03)  
TOTAL REGULATED DISCHARGE  
External Output

No Discharge

PARAMETER	QUANTITY OR LOADING			QUALITY OR CONCENTRATION			NO. EX	FREQUENCY OF ANALYSIS	SAMPLE TYPE
	VALUE	VALUE	UNITS	VALUE	VALUE	UNITS			
Nitrogen, Ammonia Total	SAMPLE MEASUREMENT 88234	*****	lb	*****	*****	*****	0	Monthly	Calcd
61440 A.0 Disinfection, Process Complete	PERMIT REQUIREMENT Req. Mon. MO TOTAL	*****	B	*****	*****	*****	0	Monthly	Calcd
Nitrogen, Kjeldahl Total	SAMPLE MEASUREMENT 116825	*****	lb	*****	*****	*****	0	Monthly	Calcd
61446 A.0 Disinfection, Process Complete	PERMIT REQUIREMENT Req. Mon. MO TOTAL	*****	B	*****	*****	*****	0	Monthly	Calcd
Nitrite Plus Nitrate Total	SAMPLE MEASUREMENT 4361	*****	lb	*****	*****	*****	0	Monthly	Calcd
61450 A.0 Disinfection, Process Complete	PERMIT REQUIREMENT Req. Mon. MO TOTAL	*****	B	*****	*****	*****	0	Monthly	Calcd
Phosphorus, Total	SAMPLE MEASUREMENT 5496	*****	lb	*****	*****	*****	0	Monthly	Calcd
61451 2.0 Effluent Nsl	PERMIT REQUIREMENT Req. Mon. MO TOTAL	*****	B	*****	*****	*****	0	Monthly	Calcd
Phosphorus, Total	SAMPLE MEASUREMENT 5496	*****	lb	*****	*****	*****	0	Monthly	Calcd
61461 A.0 Disinfection, Process Complete	PERMIT REQUIREMENT Req. Mon. MO TOTAL	*****	B	*****	*****	*****	0	Monthly	Calcd
Calcium, Total	SAMPLE MEASUREMENT *****	*****	*****	*****	*****	*****	0	Monthly	Grab
74055 A.0 Disinfection, Process Complete	PERMIT REQUIREMENT *****	*****	*****	*****	*****	*****	0	Monthly	Grab
BOD, carbonaceous, 05 day, 20 C	SAMPLE MEASUREMENT 1370	*****	lb/d	*****	*****	*****	0	1/Day	Comp24
80382 A.0 Disinfection, Process Complete	PERMIT REQUIREMENT Req. Mon. MO AVG	*****	B/d	*****	*****	*****	0	Three Per Week	Comp24

NAME/TITLE PRINCIPAL EXECUTIVE OFFICER  
Jess Rosemle, Superintendent

TYPE/D OR PRINTED

DATE  
07/27/2015

TELEPHONE  
(717) 939-7270

AREA CODE NUMBER

SIGNATURE OF PRINCIPAL EXECUTIVE OFFICER OR AUTHORIZED AGENT

DATE  
07/27/2015

COMMENTS AND EXPLANATION OF ANY VIOLATIONS (Reference all attachments here)

**CITY OF HARRISBURG  
ADVANCED WASTEWATER TREATMENT FACILITY  
COMBINED SEWER OVERFLOW SUMMARY REPORT**

A2-2

NPDES Permit No.: 0027197

Outfall Nos.: 002 through 064

Permittee: The Harrisburg Authority

Month: JUNE Year 2015

Municipality: City of Harrisburg

County: Dauphin

DAY	FLOW (gal)	DURATION (hr)	RAINFALL (in)	CAUSE	COMMENTS
1	U	U	.66	RAIN	7 RAIN .66 on 6/21/15
2	330126/U	11.25/U	.96	RAIN	7 RAIN .96 on 6/21/15
3	1360/U	5/U	.01	RAIN/1	7 RAIN .96 on 6/22/15 unblock line
4					
5	U	U		RAIN	7 RAIN .01 on 6/23/15
6			.02		
7					
8			1.94		
9	167	.5 HR		RAIN/5	7 RAIN 1.94 on 6/23/15 unblock & open GATES
10					
11					
12			.19		
13	U	U		RAIN	7 RAIN .19 on 6/23/15
14	280	1 HR	1.01	RAIN	7 RAIN .19 on 6/23/15
15	U	U	.14	RAIN/5	7 RAIN 1.01 on 6/24/15 unblock gate open gate
16	U	U		RAIN	7 RAIN .14 on 6/25/15
17			.02		
18	U	U	.4	RAIN	7 RAIN .02 on 6/27/15
19	136	1 HR	.83	RAIN	7 RAIN .4 on 6/28/15
20			2.04		
21	1274	1	.4	RAIN	7 RAIN 2.04 on 6/29/15
22	1274	1		RAIN/12	7 RAIN .4 on 6/29/15
23	3632	8	1.2		RAIN .4 on 6/29/15
24	454	1		RAIN	7 RAIN 1.2 on 6/23/15
25	454	1	.03	RAIN	RAIN 1.2 on 6/23/15
26	U	U		RAIN	7 RAIN .03 on 6/25/15
27			1.15		
28	1274	1	.36	RAIN	RAIN 1.15 on 6/27/15
29	1274	1		RAIN	RAIN .36 on 6/28/15
30	454	1		RAIN	RAIN .36 on 6/28/15
31					

Signature: [Signature]

Date: 7-27-15

Additional Comments: Dry weather CSO flow calculated using a duration of when found or notified, until the problem is corrected, multiplied by a visual estimated of flow going over a weir.

Wet Weather CSO flow calculated using a duration of when found, until either the rainfall event cease or until the overflow is visually observed to have stopped multiplied by a visual estimate of flow going over a weir.

K	1. Line Blocked	3. Gate Blocked	5. Gate Closed	7. Overflow Detection Device
E	2. Box Blocked	4. Float Stuck	6. Weir Blocked	U. Unknown Flow or Duration

COMBINED SEWER OVERFLOW REPORT FOR THE MONTH JUN 2015

NPDES Permit: PA0027197

Outfall Number 002

A2-3

Permittee: The Harrisburg Authority

County: Dauphin

Outfall Name/Description: Front Street Pump Station

Receiving Stream: Susquehanna River

40 15 04 76 52 30

DAY	FLOW (gal)	DURATION (hr)	RAINFALL (in)	CAUSE	COMMENTS
1					
2					
3					
4					
5					
6					
7					
8					
9					
10					
11					
12					
13					
14					
15					
16					
17					
18					
19					
20					
21					
22					
23					
24					
25					
26					
27					
28					
29					
30					
31					

Additional Comments: Dry weather CSO flow calculated using a duration of when found or notified, until the problem is corrected, multiplied by a visual estimated of flow going over a weir.  
 Wet Weather CSO flow calculated using a duration of when found, until either the rainfall event cease or until the overflow is visually observed to have stopped, multiplied by a visual estimate of flow going over a weir.

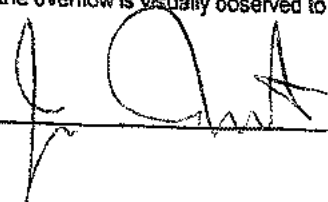
Signature: 

Date: 7-22-15

**CAPITAL REGION WATER**  
**Combined Sewer Overflow Report by Outfalls - Field Observations**  
**01/01/2018-06/30/2018**

A2-4

Inspection Id	Inspection Type	Date Inspected	Work Order #	Comments	Cause
<b>CSO-004 (FRONT &amp; VAUGHN)</b>					
61853	Daily CSO Default 3-4	01/12/2018 12:00	14021	Wooden Block	Rain
61952	Daily CSO Default 3-4	01/13/2018 12:00	14057	Wooden Block	Rain
62654	Daily CSO Default 3-4	01/23/2018 12:45	14244	Wooden Block	Rain
63898	Daily CSO Site Inspection	02/11/2018 13:00	14697	Active CSO	Rain
63979	Daily CSO Default 3-4	02/12/2018 11:00	15181	Wooden Block	Rain
64308	Daily CSO Default 3-4	02/16/2018 12:00	15238	Wooden Block	Rain
64526	Daily CSO Default 3-4	02/20/2018 12:00	15289	Wooden Block	Rain
64893	Daily CSO Default 3-4	02/25/2018 10:30	15378	Wooden Block	Rain
65254	Daily CSO Default 3-4	03/02/2018 11:45	15486	Wooden Block	Rain
69312	Daily CSO Default 3-4	04/02/2018 12:00	16433	Wooden Block	Rain
69401	Daily CSO Site Inspection	04/03/2018 12:00	16470	Active CSO	Rain
69459	Daily CSO Default 3-4	04/04/2018 12:00	16504	Wooden Block	Rain
70219	Daily CSO Site Inspection	04/16/2018 12:00	16748	Active CSO	Rain
70277	Daily CSO Default 3-4	04/17/2018 10:00	16798	Wooden Block	Rain
70898	Daily CSO Default 3-4	04/25/2018 12:00	16978	Wooden Block	Rain
71095	Daily CSO Default 3-4	04/28/2018 08:00	17050	Wooden Block	Rain
71685	Daily CSO Default 3-4	05/06/2018 08:00	17215	Wooden Block	Rain
72164	Daily CSO Default 3-4	05/12/2018 12:00	17336	Wooden Block	Rain
72220	Daily CSO Default 3-4	05/13/2018 12:00	17350	Wooden Block	Rain
72466	Daily CSO Site Inspection	05/16/2018 10:00	17422	Active CSO	Rain
72540	Daily CSO Default 3-4	05/17/2018 12:00	17460	Wooden Block	Rain
72581	Daily CSO Default 3-4	05/18/2018 14:00	17479	Wooden Block	Rain
72660	Daily CSO Site Inspection	05/19/2018 12:00	17501	Active CSO	Rain
72686	Daily CSO Default 3-4	05/20/2018 12:00	17524	Wooden Block	Rain
72919	Daily CSO Default 3-4	05/23/2018 08:00	17602	Wooden Block	Rain
73678	Daily CSO Default 3-4	06/03/2018 12:00	17875	Wooden Block	Rain
74197	Daily CSO Default 3-4	06/11/2018 12:00	18144	Wooden Block	Rain
75111	Daily CSO Default 3-4	06/23/2018 12:00	18516	Wooden Block	Rain
75227	Daily CSO Default 3-4	06/25/2018 12:00	18543	Wooden Block	Rain
75383	Daily CSO Default 3-4	06/28/2018 12:00	18646	Wooden Block	Rain
75482	Daily CSO Default 3-4	06/29/2018 12:00	18675	Wooden Block	Rain
<b>CSO-005 (FRONT &amp; LEWIS)</b>					
61852	Daily CSO Default 3-4	01/12/2018 12:00	14021	Wooden Block	Rain
61951	Daily CSO Default 3-4	01/13/2018 12:00	14057	Wooden Block	Rain
62045	Daily CSO Default 7 Inflow	01/15/2018 10:30	14073	Wooden Block	Inflow from Creek/River
62653	Daily CSO Default 3-4	01/23/2018 12:45	14244	Wooden Block	Rain
63606	Daily CSO Default 3-4	02/07/2018 12:00	14626	Wooden Block	Rain
63899	Daily CSO Site Inspection	02/11/2018 13:00	14697	Active CSO	Rain
63978	Daily CSO Default 3-4	02/12/2018 11:00	15181	Wooden Block	Rain
64307	Daily CSO Default 3-4	02/16/2018 12:00	15238	Wooden Block	Rain
64525	Daily CSO Default 3-4	02/20/2018 12:00	15289	Wooden Block	Rain
64892	Daily CSO Default 3-4	02/25/2018 10:30	15378	Wooden Block	Rain
64948	Daily CSO Default 7 Inflow	02/26/2018 12:00	15379	Wooden Block	Inflow from Creek/River
64994	Daily CSO Default 7 Inflow	02/27/2018 12:00	15395	Wooden Block	Inflow from Creek/River
65253	Daily CSO Default 3-4	03/02/2018 11:45	15486	Wooden Block	Rain
69311	Daily CSO Default 3-4	04/02/2018 12:00	16433	Wooden Block	Rain
69363	Daily CSO Default 3-4	04/03/2018 12:00	16470	Wooden Block	Rain
70218	Daily CSO Site Inspection	04/16/2018 12:00	16748	Active CSO	Rain
70276	Daily CSO Default 3-4	04/17/2018 10:00	16798	Wooden Block	Rain
70897	Daily CSO Default 3-4	04/25/2018 12:00	16978	Wooden Block	Rain
71094	Daily CSO Default 3-4	04/28/2018 08:00	17050	Wooden Block	Rain
71684	Daily CSO Default 3-4	05/06/2018 08:00	17215	Wooden Block	Rain
72163	Daily CSO Default 3-4	05/12/2018 12:00	17336	Wooden Block	Rain
72219	Daily CSO Default 3-4	05/13/2018 12:00	17350	Wooden Block	Rain
72282	Daily CSO Default 3-4	05/14/2018 14:53	17353	Wooden Block	Rain
72463	Daily CSO Default 3-4	05/16/2018 10:00	17422	Wooden Block	Rain
72573	Daily CSO Site Inspection	05/18/2018 14:00	17479	Active CSO	Rain
72659	Daily CSO Site Inspection	05/19/2018 12:00	17501	Active CSO	Rain
72685	Daily CSO Default 3-4	05/20/2018 12:00	17524	Wooden Block	Rain
72811	Daily CSO Default 3-4	05/22/2018 11:30	17549	Wooden Block	Rain
72918	Daily CSO Default 3-4	05/23/2018 08:00	17602	Wooden Block	Rain
73677	Daily CSO Default 3-4	06/03/2018 12:00	17875	Wooden Block	Rain
74195	Daily CSO Default 3-4	06/11/2018 12:00	18144	Wooden Block	Rain
75110	Daily CSO Default 3-4	06/23/2018 12:00	18516	Wooden Block	Rain

**CAPITAL REGION WATER**  
**Combined Sewer Overflow Report by Outfalls - Field Observations**  
**01/01/2018-06/30/2018**

Inspection Id	Inspection Type	Date Inspected	Work Order #	Comments	Cause
75226	Daily CSO Default 3-4	06/25/2018 12:00	18543	Wooden Block	Rain
75382	Daily CSO Default 3-4	06/28/2018 12:00	18646	Wooden Block	Rain
<b>CSO-006 (FRONT &amp; GEIGER)</b>					
61948	Daily CSO Default 3-4	01/13/2018 12:00	14057	Wooden Block	Rain
62043	Daily CSO Default 7 Inflow	01/15/2018 10:30	14073	Wooden Block	Inflow from Creek/River
62072	Daily CSO Default 7 Inflow	01/16/2018 12:00	14080	Wooden Block	Inflow from Creek/River
62655	Daily CSO Site Inspection	01/23/2018 12:45	14244	Active CSO	Rain
63902	Daily CSO Site Inspection	02/11/2018 13:00	14697	Active CSO	Rain
63975	Daily CSO Default 3-4	02/12/2018 11:00	15181	Wooden Block	Rain
64304	Daily CSO Default 3-4	02/16/2018 12:00	15238	Wooden Block	Rain
64404	Daily CSO Default 7 Inflow	02/18/2018 12:00	15283	Wooden Block	Inflow from Creek/River
64459	Daily CSO Default 7 Inflow	02/19/2018 12:00	15286	Wooden Block	Inflow from Creek/River
64986	Daily CSO Default 7 Inflow	02/23/2018 12:00	15348	Wooden Block	Inflow from Creek/River
64859	Daily CSO Default 7 Inflow	02/24/2018 12:00	15375	Wooden Block	Inflow from Creek/River
64872	Daily CSO Default 7 Inflow	02/25/2018 10:30	15378	Wooden Block	Inflow from Creek/River
64947	Daily CSO Default 7 Inflow	02/26/2018 12:00	15379	Wooden Block	Inflow from Creek/River
64989	Daily CSO Default 7 Inflow	02/27/2018 12:00	15395	Wooden Block	Inflow from Creek/River
65087	Daily CSO Default 7 Inflow	02/28/2018 12:00	15424	Wooden Block	Inflow from Creek/River
65146	Daily CSO Default 7 Inflow	03/01/2018 11:35	15457	Wooden Block	Inflow from Creek/River
65250	Daily CSO Default 3-4	03/02/2018 11:45	15486	Wooden Block	Rain
65291	Daily CSO Default 7 Inflow	03/03/2018 12:00	15509	Wooden Block	Inflow from Creek/River
65349	Daily CSO Default 7 Inflow	03/03/2018 12:00	15528	Wooden Block	Inflow from Creek/River
69398	Daily CSO Site Inspection	04/03/2018 12:00	16470	Active CSO	Rain
70215	Daily CSO Site Inspection	04/16/2018 12:00	16748	Active CSO	Rain
70273	Daily CSO Default 3-4	04/17/2018 10:00	16798	Wooden Block	Rain
71091	Daily CSO Default 3-4	04/28/2018 08:00	17050	Wooden Block	Rain
72160	Daily CSO Default 3-4	05/12/2018 12:00	17336	Wooden Block	Rain
72216	Daily CSO Default 3-4	05/13/2018 12:00	17350	Wooden Block	Rain
72279	Daily CSO Default 3-4	05/14/2018 14:53	17353	Wooden Block	Rain
72468	Daily CSO Site Inspection	05/16/2018 10:00	17422	Active CSO	Rain
72539	Daily CSO Default 3-4	05/17/2018 12:00	17460	Wooden Block	Rain
72656	Daily CSO Site Inspection	05/19/2018 12:00	17501	Active CSO	Rain
72682	Daily CSO Default 3-4	05/20/2018 12:00	17524	Wooden Block	Rain
72808	Daily CSO Default 3-4	05/22/2018 11:30	17549	Wooden Block	Rain
72915	Daily CSO Default 3-4	05/23/2018 08:00	17602	Wooden Block	Rain
72982	Daily CSO Default 7 Inflow	05/24/2018 12:00	17633	Wooden Block	Inflow from Creek/River
73674	Daily CSO Default 3-4	06/03/2018 12:00	17875	Wooden Block	Rain
74193	Daily CSO Default 3-4	06/11/2018 12:00	18144	Wooden Block	Rain
75379	Daily CSO Default 3-4	06/28/2018 12:00	18646	Wooden Block	Rain
<b>CSO-007 (FRONT &amp; PEPPER)</b>					
61851	Daily CSO Default 3-4	01/12/2018 12:00	14021	Wooden Block	Rain
61947	Daily CSO Default 3-4	01/13/2018 12:00	14057	Wooden Block	Rain
62042	Daily CSO Default 7 Inflow	01/15/2018 10:30	14073	Wooden Block	Inflow from Creek/River
62650	Daily CSO Default 3-4	01/23/2018 12:45	14244	Wooden Block	Rain
63498	Daily CSO Default 3-4	02/05/2018 12:00	14566	Wooden Block	Rain
63906	Daily CSO Site Inspection	02/11/2018 13:00	14697	Active CSO	Rain
63973	Daily CSO Default 3-4	02/12/2018 11:00	15181	Wooden Block	Rain
64303	Daily CSO Default 3-4	02/16/2018 12:00	15238	Wooden Block	Rain
64864	Daily CSO Default 3-4	02/24/2018 12:00	15375	Wooden Block	Rain
64889	Daily CSO Default 3-4	02/25/2018 10:30	15378	Wooden Block	Rain
64946	Daily CSO Default 7 Inflow	02/26/2018 12:00	15379	Wooden Block	Inflow from Creek/River
64993	Daily CSO Default 7 Inflow	02/27/2018 12:00	15395	Wooden Block	Inflow from Creek/River
65249	Daily CSO Default 3-4	03/02/2018 11:45	15486	Wooden Block	Rain
65348	Daily CSO Default 7 Inflow	03/03/2018 12:00	15528	Wooden Block	Inflow from Creek/River
69308	Daily CSO Default 3-4	04/02/2018 12:00	16433	Wooden Block	Rain
69456	Daily CSO Default 3-4	04/04/2018 12:00	16504	Wooden Block	Rain
70199	Daily CSO Default 3-4	04/16/2018 12:00	16748	Wooden Block	Rain
70272	Daily CSO Default 3-4	04/17/2018 10:00	16798	Wooden Block	Rain
71090	Daily CSO Default 3-4	04/28/2018 08:00	17050	Wooden Block	Rain
72159	Daily CSO Default 3-4	05/12/2018 12:00	17336	Wooden Block	Rain
72215	Daily CSO Default 3-4	05/13/2018 12:00	17350	Wooden Block	Rain
72278	Daily CSO Default 3-4	05/14/2018 14:53	17353	Wooden Block	Rain
72462	Daily CSO Default 3-4	05/16/2018 10:00	17422	Wooden Block	Rain
72655	Daily CSO Site Inspection	05/19/2018 12:00	17501	Active CSO	Rain
72681	Daily CSO Default 3-4	05/20/2018 12:00	17524	Wooden Block	Rain

**CAPITAL REGION WATER**  
**Combined Sewer Overflow Report by Outfalls - Field Observations**  
**01/01/2018-06/30/2018**

Inspection Id	Inspection Type	Date Inspected	Work Order #	Comments	Cause
72807	Daily CSO Default 3-4	05/22/2018 11:30	17549	Wooden Block	Rain
72914	Daily CSO Default 3-4	05/23/2018 08:00	17602	Wooden Block	Rain
73673	Daily CSO Default 3-4	06/03/2018 12:00	17875	Wooden Block	Rain
74192	Daily CSO Default 3-4	06/11/2018 12:00	18144	Wooden Block	Rain
75108	Daily CSO Default 3-4	06/23/2018 12:00	18516	Wooden Block	Rain
75378	Daily CSO Default 3-4	06/28/2018 12:00	18646	Wooden Block	Rain
<b>CSO-008 (FRONT &amp; MUENCH)</b>					
61946	Daily CSO Default 3-4	01/13/2018 12:00	14057	Wooden Block	Rain
62044	Daily CSO Default 7 Inflow	01/15/2018 10:30	14073	Wooden Block	Inflow from Creek/River
62656	Daily CSO Site Inspection	01/23/2018 12:45	14244	Active CSO	Rain
63671	Daily CSO Default 3-4	02/08/2018 13:00	14651	Wooden Block	Rain
63904	Daily CSO Site Inspection	02/11/2018 13:00	14697	Active CSO	Rain
63974	Daily CSO Default 3-4	02/12/2018 11:00	15181	Wooden Block	Rain
64302	Daily CSO Default 3-4	02/16/2018 12:00	15238	Wooden Block	Rain
64403	Daily CSO Default 7 Inflow	02/18/2018 12:00	15283	Wooden Block	Inflow from Creek/River
64458	Daily CSO Default 7 Inflow	02/19/2018 12:00	15286	Wooden Block	Inflow from Creek/River
64523	Daily CSO Default 3-4	02/20/2018 12:00	15289	Wooden Block	Rain
64797	Daily CSO Default 3-4	02/23/2018 12:15	15348	Wooden Block	Rain
64861	Daily CSO Default 7 Inflow	02/24/2018 12:00	15375	Wooden Block	Inflow from Creek/River
64875	Daily CSO Default 7 Inflow	02/25/2018 10:30	15378	Wooden Block	Inflow from Creek/River
64945	Daily CSO Default 7 Inflow	02/26/2018 12:00	15379	Wooden Block	Inflow from Creek/River
65088	Daily CSO Default 7 Inflow	02/28/2018 12:00	15424	Wooden Block	Inflow from Creek/River
65248	Daily CSO Default 3-4	03/02/2018 11:45	15486	Wooden Block	Rain
65290	Daily CSO Default 7 Inflow	03/03/2018 12:00	15509	Wooden Block	Inflow from Creek/River
65573	Daily CSO Default 7 Inflow	03/04/2018 12:00	15528	Wooden Block	Inflow from Creek/River
69307	Daily CSO Default 3-4	04/02/2018 12:00	16433	Wooden Block	Rain
69397	Daily CSO Site Inspection	04/03/2018 12:00	16470	Active CSO	Rain
69455	Daily CSO Default 3-4	04/04/2018 12:00	16504	Wooden Block	Rain
70214	Daily CSO Site Inspection	04/16/2018 12:00	16748	Active CSO	Rain
70271	Daily CSO Default 3-4	04/17/2018 10:00	16798	Wooden Block	Rain
70893	Daily CSO Default 3-4	04/25/2018 12:00	16978	Wooden Block	Rain
71089	Daily CSO Default 3-4	04/28/2018 08:00	17050	Wooden Block	Rain
71681	Daily CSO Default 3-4	05/06/2018 08:00	17215	Wooden Block	Rain
72158	Daily CSO Default 3-4	05/12/2018 12:00	17336	Wooden Block	Rain
72214	Daily CSO Default 3-4	05/13/2018 12:00	17350	Wooden Block	Rain
72277	Daily CSO Default 3-4	05/14/2018 14:53	17353	Wooden Block	Rain
72469	Daily CSO Site Inspection	05/16/2018 10:00	17422	Active CSO	Rain
72538	Daily CSO Default 3-4	05/17/2018 12:00	17460	Wooden Block	Rain
72654	Daily CSO Site Inspection	05/19/2018 12:00	17501	Active CSO	Rain
72680	Daily CSO Default 3-4	05/20/2018 12:00	17524	Wooden Block	Rain
72806	Daily CSO Default 3-4	05/22/2018 11:30	17549	Wooden Block	Rain
72913	Daily CSO Default 3-4	05/23/2018 08:00	17602	Wooden Block	Rain
72983	Daily CSO Default 7 Inflow	05/24/2018 12:00	17633	Wooden Block	Inflow from Creek/River
73672	Daily CSO Default 3-4	06/03/2018 12:00	17875	Wooden Block	Rain
74191	Daily CSO Default 3-4	06/11/2018 12:00	18144	Wooden Block	Rain
75107	Daily CSO Default 3-4	06/23/2018 12:00	18516	Wooden Block	Rain
75174	Daily CSO Default 3-4	06/24/2018 12:00	18540	Wooden Block	Rain
75377	Daily CSO Default 3-4	06/28/2018 12:00	18646	Wooden Block	Rain
75480	Daily CSO Default 3-4	06/29/2018 12:00	18675	Wooden Block	Rain
<b>CSO-009 (FRONT &amp; HAMILTON)</b>					
61850	Daily CSO Default 3-4	01/12/2018 12:00	14021	Wooden Block	Rain
61945	Daily CSO Default 3-4	01/13/2018 12:00	14057	Wooden Block	Rain
62649	Daily CSO Default 3-4	01/23/2018 12:45	14244	Wooden Block	Rain
63668	Daily CSO Default 3-4	02/08/2018 13:00	14651	Wooden Block	Rain
63907	Daily CSO Site Inspection	02/11/2018 13:00	14697	Active CSO	Rain
64197	Daily CSO Default 3-4	02/15/2018 12:00	15226	Wooden Block	Rain
64301	Daily CSO Default 3-4	02/16/2018 12:00	15238	Wooden Block	Rain
64522	Daily CSO Default 3-4	02/20/2018 12:00	15289	Wooden Block	Rain
64736	Daily CSO Default 3-4	02/22/2018 12:00	15327	Wooden Block	Rain
64796	Daily CSO Default 3-4	02/23/2018 12:15	15348	Wooden Block	Rain
64867	Daily CSO Site Inspection	02/25/2018 09:30	15378	Active CSO	Rain
64950	Daily CSO Default 3-4	02/26/2018 12:00	15379	Wooden Block	Rain
65247	Daily CSO Default 3-4	03/02/2018 11:45	15486	Wooden Block	Rain
69305	Daily CSO Default 3-4	04/02/2018 12:00	16433	Wooden Block	Rain
69395	Daily CSO Site Inspection	04/03/2018 12:00	16470	Active CSO	Rain



<u>InspectionID</u>	<u>Inspection Date</u>	<u>Location</u>	<u>Work Order ID</u>	<u>Overflow Start Time</u>	<u>Overflow Stop Time</u>	<u>Duration of Overflow</u>	<u>Estimated Discharge in Gals.</u>	<u>Estimated Discharge in Gals.Unknown</u>	<u>Comments</u>
<b>CSO-005</b>									
79679	08/24/2018	FRONT & LEWIS	19927	1010	1030	0.25	78	<input type="checkbox"/>	Hydrant Flushing
							<b>78.00</b>		
							<b>78.00</b>		
							<b>0.25</b>		
							<b>0.25</b>		
<b>CSO-010</b>									
72084	05/11/2018	FRONT & REILY	17317	9:15	9:20	0.25	91	<input type="checkbox"/>	flow over wier due to fire hydrant flushing
							<b>91.00</b>		
							<b>91.00</b>		
							<b>0.25</b>		
							<b>0.25</b>		
<b>CSO-013</b>									
87072	12/12/2018	FRONT & CUMBERLAND	22802	10:00	10:15	0.25	74	<input type="checkbox"/>	
							<b>74</b>		
							<b>74</b>		
							<b>0.25</b>		
							<b>0.25</b>		
77549	07/30/2018	FRONT & CUMBERLAND	19264	10:15	10:30	0.25	74	<input type="checkbox"/>	River flooding
							<b>74</b>		
							<b>148.00</b>		
							<b>74.00</b>		
							<b>0.50</b>		
							<b>0.25</b>		

<u>InspectionID</u>	<u>Inspection Date</u>	<u>Location</u>	<u>Work Order ID</u>	<u>Overflow Start Time</u>	<u>Overflow Stop Time</u>	<u>Duration of Overflow</u>	<u>Estimated Discharge in Gals.</u>	<u>Estimated Discharge in Gals. Unknown</u>	<u>Comments</u>
<b>CSO-017</b>									
82004	10/01/2018	FRONT & MARKET	20914	10:20	10:50	0.50	219	<input type="checkbox"/>	due to city island pump station
<b>SUMMARY:</b>							<b>219.00</b>		
<b>AVERAGE:</b>							<b>219.00</b>		
<b>CSO-022</b>									
75630	07/02/2018	FORREST & CAMERON	18702	1200	1045	10.75	7,181	<input type="checkbox"/>	contractor replaced upstream plug and CSO stopped leaking
75571	06/30/2018	FORREST & CAMERON	18688	745	1200	16.25	10,855	<input type="checkbox"/>	contractor plugged line to do interceptor rehab. Safety device failed and they abandoned work. Waiting for contractor to remove
75354	06/27/2018	FORREST & CAMERON	18591	8:55	10:55	2.00	464	<input type="checkbox"/>	
75629	07/01/2018	FORREST & CAMERON	18694	1200	11:59	24.00	16,032	<input type="checkbox"/>	waiting on contractor to replace failed safety device(upstream plug) to inspect flow-through plug on discharge side of
<b>SUMMARY:</b>							<b>34,532.00</b>		
<b>AVERAGE:</b>							<b>8,633.00</b>		
<b>CSO-031</b>									
64127	02/14/2018	CAMERON & STATE	15201	10:50	1:30	2.75	825	<input type="checkbox"/>	
<b>SUMMARY:</b>							<b>825.00</b>		
<b>AVERAGE:</b>							<b>825.00</b>		

<u>InspectionID</u>	<u>Inspection Date</u>	<u>Location</u>	<u>Work Order ID</u>	<u>Overflow Start Time</u>	<u>Overflow Stop Time</u>	<u>Duration of Overflow</u>	<u>Estimated Discharge in Gals.</u>	<u>Estimated Discharge in Gals. Unknown</u>	<u>Comments</u>
<b>CSO-034</b>									
81491	09/24/2018	S. MARKET & CAMERON	20743	8:45	10:00	1.25	800	<input type="checkbox"/>	
82026	10/02/2018	S. MARKET & CAMERON	20920	11:15	11:45	0.50	320	<input type="checkbox"/>	
80239	09/06/2018	S. MARKET & CAMERON	20245	8:50	10:50	2.00	444	<input type="checkbox"/>	
<b>CSO-039</b>									
63444	02/04/2018	S. MULBERRY & CAMERON	14564	8:15	11:30	3.25	429	<input type="checkbox"/>	
81881	09/29/2018	S. MULBERRY & CAMERON	20898	8:15	11:15	3.00	1,140	<input type="checkbox"/>	Power outage at Front St. Pump Station
<b>CSO-042</b>									
81882	09/29/2018	N. KITTATINNY & CAMERON	20898	8:00	11:00	3.00	1,002	<input type="checkbox"/>	Power outage at Front St. Pump Station
							<b>SUMMARY:</b>	<b>1,564.00</b>	
							<b>AVERAGE:</b>	<b>521.33</b>	
							<b>SUMMARY:</b>	<b>1,569.00</b>	
							<b>AVERAGE:</b>	<b>784.50</b>	
							<b>SUMMARY:</b>	<b>1,002.00</b>	
							<b>AVERAGE:</b>	<b>1,002.00</b>	

<u>InspectionID</u>	<u>Inspection Date</u>	<u>Location</u>	<u>Work Order ID</u>	<u>Overflow Start Time</u>	<u>Overflow Stop Time</u>	<u>Duration of Overflow</u>	<u>Estimated Discharge in Gals.</u>	<u>Estimated Discharge in Gals. Unknown</u>	<u>Comments</u>
<b>CSO-043</b>									
81884	09/29/2018	S. KITTATINNY & CAMERON	20898	8:00	11:00	3.00	1,671	<input type="checkbox"/>	Power outage at Front St. Pump Station
					<b>SUMMARY:</b>	<b>3.00</b>	<b>1,671.00</b>		
					<b>AVERAGE:</b>	<b>3.00</b>	<b>1,671.00</b>		
<b>CSO-044</b>									
81885	09/29/2018	CAMERON & BERRYHILL	20898	7:50	11:10	3.25	2,171	<input type="checkbox"/>	Power outage at Front St. Pump Station
					<b>SUMMARY:</b>	<b>3.25</b>	<b>2,171.00</b>		
					<b>AVERAGE:</b>	<b>3.25</b>	<b>2,171.00</b>		
<b>CSO-045</b>									
81886	09/29/2018	S. PAXTON STREET	20898	7:45	11:15	3.50	1,950	<input type="checkbox"/>	Power outage at Front St. Pump Station
					<b>SUMMARY:</b>	<b>3.50</b>	<b>1,950.00</b>		
					<b>AVERAGE:</b>	<b>3.50</b>	<b>1,950.00</b>		
<b>CSO-046</b>									
81887	09/29/2018	N. PAXTON STREET	20898	7:45	11:15	3.50	973	<input type="checkbox"/>	Power outage at Front St. Pump Station
					<b>SUMMARY:</b>	<b>3.50</b>	<b>973.00</b>		
					<b>AVERAGE:</b>	<b>3.50</b>	<b>973.00</b>		

<u>InspectionID</u>	<u>Inspection Date</u>	<u>Location</u>	<u>Work Order ID</u>	<u>Overflow Start Time</u>	<u>Overflow Stop Time</u>	<u>Duration of Overflow</u>	<u>Estimated Discharge in Gals.</u>	<u>Estimated Discharge in Gals. Unknown</u>	<u>Comments</u>
<b>CSO-048</b>									
81888	09/29/2018	10TH & SHANNON	20898	7:30	3:00	7.50	8,348	<input type="checkbox"/>	Power outage at Front St. Pump Station
65472	03/06/2018	10TH & SHANNON	15556	8:10	1:15	5.00	5,565	<input type="checkbox"/>	
65427	03/05/2018	10TH & SHANNON	15534	830	800	11.50	12,780	<input type="checkbox"/>	
<b>CSO-057</b>									
86977	12/10/2018	CHERRY & MULBERRY	22743	10:30	11:00	0.50	772	<input type="checkbox"/>	
83714	10/24/2018	CHERRY & MULBERRY	21517	10:15	11:00	0.45	522	<input type="checkbox"/>	
86714	12/06/2018	CHERRY & MULBERRY	22683	1010	1040	0.50	348	<input type="checkbox"/>	
79522	08/28/2018	CHERRY & MULBERRY	19979	10:45	11:15	0.50	121	<input type="checkbox"/>	Rags were stuck in the gate.
							<b>SUMMARY:</b>	<b>26,693.00</b>	
							<b>AVERAGE:</b>	<b>8,897.67</b>	
							<b>SUMMARY:</b>	<b>1,763.00</b>	
							<b>AVERAGE:</b>	<b>440.75</b>	

<u>InspectionID</u>	<u>Inspection Date</u>	<u>Location</u>	<u>Work Order ID</u>	<u>Overflow Start Time</u>	<u>Overflow Stop Time</u>	<u>Duration of Overflow</u>	<u>Estimated Discharge in Gals.</u>	<u>Estimated Discharge in Gals.</u>	<u>Comments</u>
81883	09/29/2018	E. KITTATINNY & CAMERON	20898	8:00	11:00	3.00	2,478	<input type="checkbox"/>	Power outage at Front St. Pump Station

**CSO-059**

**SUMMARY: 3.00 2,478.00**  
**AVERAGE: 3.00 2,478.00**

**CAPITAL REGION WATER**  
**Preventative Maintenance Report**  
**2016 Calendar Year**  
**01/01/2016-12/31/2016**

CSO #	Description	Actual Finish	Address	Comments
4	Semi-Annual PM; CSO Semi-Annual PM; CSO	6/27/2016 11/3/2016	FRONT & VAUGHN	Vactored chamber and washed down. The outfall from flood gate is undermined, concrete should be placed in the spring.
5	Semi-Annual PM; CSO Semi-Annual PM; CSO	6/27/2016 11/3/2016	FRONT & LEWIS	Vactored and washed down chamber.
6	Semi-Annual PM; CSO	12/7/2016	FRONT & GEIGER	Vactored and washed down all chambers. inspected chambers.
7	Semi-Annual PM; CSO Semi-Annual PM; CSO Semi-Annual PM; CSO	3/18/2016 6/28/2016 11/7/2016	FRONT & PEPPER	vactored and washed down chambers.
8	Semi-Annual PM; CSO Semi-Annual PM; CSO	8/7/2016 11/11/2016	FRONT & MUENCH	Vactored and washed down all chambers and performed inspection.
9	Semi-Annual PM; CSO Semi-Annual PM; CSO	7/19/2016 11/7/2016	FRONT & HAMILTON	vactored and washed down chambers.
10	Semi-Annual PM; CSO Semi-Annual PM; CSO	8/6/2016 11/7/2016	FRONT & REILY	Vactored and washed down chamber.
11	Semi-Annual PM; CSO Semi-Annual PM; CSO	8/6/2016 12/7/2016	FRONT & CALDER	Vactored and washed down chambers and performed inspection.
12	Semi-Annual PM; CSO Semi-Annual PM; CSO	8/4/2016 12/7/2016	FRONT & VERBEKE	Vactored and washed down all chambers and performed inspection.
13	Semi-Annual PM; CSO Semi-Annual PM; CSO	8/7/2016 11/4/2016	FRONT & CUMBERLAND	Vactored and washed down chambers.
14	Semi-Annual PM; CSO Semi-Annual PM; CSO	8/3/2016 11/4/2016	FRONT & BOAS	Vactored and washed down chambers.
15	Semi-Annual PM; CSO Semi-Annual PM; CSO	8/6/2016 12/7/2016	FRONT & FORSTER	Performed traffic control. Vactored and washed down chambers, performed inspection.
16	Semi-Annual PM; CSO Semi-Annual PM; CSO	7/20/2016 12/7/2016	FRONT & LIBERTY	Vactored and washed down chambers and performed inspection.
17	Semi-Annual PM; CSO Semi-Annual PM; CSO	8/6/2016 11/9/2016	FRONT & MARKET	Vactored and washed down chambers.
18	Clean CSO Chamber Semi-Annual PM; CSO	8/1/2016 11/1/2016	FRONT & MULBERRY	By Kneasel, Mike: 8/2/2016 2:53:22 PM General cleaning of the CSO. Vactored and washed down chambers.
19	Semi-Annual PM; CSO Semi-Annual PM; CSO	8/1/2016 11/1/2016	FRONT & PAXTON	By Kneasel, Mike: 8/2/2016 2:36:41 PM Cleaned CSO vactored and washed down chambers, Chambers had large mat of grease.

**CAPITAL REGION WATER**  
**Preventative Maintenance Report**  
**2016 Calendar Year**  
**01/01/2016-12/31/2016**

<b>CSO #</b>	<b>Description</b>	<b>Actual Finish</b>	<b>Address</b>	<b>Comments</b>
<b>20</b>	Semi-Annual PM; CSO	8/3/2016	FRONT & HANNA	Vactored and washed down chambers.
	Semi-Annual PM; CSO	11/1/2016		
<b>21</b>	Semi-Annual PM; CSO	7/12/2016	CAMERON & SCHUYLKILL	Vactored chamber, washed down chambers.
	Semi-Annual PM; CSO	11/7/2016		
<b>22</b>	Semi-Annual PM; CSO	8/6/2016	FORREST & CAMERON	Vactored and washed down chambers.
	Semi-Annual PM; CSO	11/7/2016		
<b>23</b>	Semi-Annual PM; CSO	4/19/2016	CAMERON & CALDER	Vactored chamber and washed down .
	Semi-Annual PM; CSO	10/27/2016		
<b>24</b>	Semi-Annual PM; CSO	6/14/2016	HILL CHAMBER T.R.W.	
	Semi-Annual PM; CSO	6/18/2016		
	Semi-Annual PM; CSO	10/24/2016		
<b>25</b>	Semi-Annual PM; CSO	5/11/2016	N. CAMERON & CUMBERLAND	vactored chamber, washed down chambers. Ran siphon line. vactored siphon chamber.
	Semi-Annual PM; CSO	11/2/2016		
<b>26</b>	Semi-Annual PM; CSO	5/11/2016	S. CAMERON & CUMBERLAND	Vactored chamber washed down chambers.
	Semi-Annual PM; CSO	11/2/2016		
<b>27</b>	Semi-Annual PM; CSO	5/11/2016	9TH & CUMBERLAND	vactored chamber, washed down chambers.
	Semi-Annual PM; CSO	11/2/2016		
<b>28</b>	Semi-Annual PM; CSO	5/26/2016	9TH & HERR	
	Semi-Annual PM; CSO	11/2/2016		
<b>29</b>	Semi-Annual PM; CSO	5/11/2016	E. CAMERON & NORTH	vactored chamber, washed down chamber. Ran siphon line.
	Semi-Annual PM; CSO	10/24/2016		
<b>30</b>	Semi-Annual PM; CSO	6/14/2016	W. CAMERON & NORTH	
	Semi-Annual PM; CSO	10/24/2016		
<b>31</b>	Semi-Annual PM; CSO	5/17/2016	CAMERON & STATE	Vactored and washed down chambers, performed inspection of site.
	Semi-Annual PM; CSO	12/9/2016		
<b>32</b>	Semi-Annual PM; CSO	4/25/2016	W. CAMERON & WALNUT	
	Semi-Annual PM; CSO	10/24/2016		
<b>33</b>	Semi-Annual PM; CSO	4/25/2016	E. CAMERON & WALNUT	By Chisnell, Matthew: 9/2/2016 6:49:15 AM Vactored out debris in front of the bar screen and also on the out flow side.
	Semi-Annual PM; CSO	8/31/2016		
<b>34</b>	Semi-Annual PM; CSO	10/24/2016		
	Semi-Annual PM; CSO	6/22/2016	S. MARKET & CAMERON	



**CAPITAL REGION WATER**  
**Preventative Maintenance Report**  
**2016 Calendar Year**  
**01/01/2016-12/31/2016**

<b>CSO #</b>	<b>Description</b>	<b>Actual Finish</b>	<b>Address</b>	<b>Comments</b>
	Semi-Annual PM; CSO	12/9/2016		Vactored and washed down chambers,performed inspection. During inspection vertical cracks were found in chimney of regulator chamber on the west side.
<b>37</b>	Semi-Annual PM; CSO	4/25/2016	10TH & MARKET	
	Semi-Annual PM; CSO	10/25/2016		
<b>38</b>	Semi-Annual PM; CSO	5/12/2016	10TH & CHESTNUT	
	Semi-Annual PM; CSO	10/25/2016		
<b>39</b>	Semi-Annual PM; CSO	5/16/2016	S. MULBERRY & CAMERON	
	Semi-Annual PM; CSO	7/29/2016		
	Semi-Annual PM; CSO	10/27/2016		vactored and washed down chamber.
<b>40</b>	Semi-Annual PM; CSO	5/10/2016	N.MULBERRY & CAMERON	
	Semi-Annual PM; CSO	10/25/2016		
<b>41</b>	Semi-Annual PM; CSO	5/10/2016	W. MULBERRY & CAMERON	
	Semi-Annual PM; CSO	10/27/2016		vactored and washed down chamber.
<b>42</b>	Semi-Annual PM; CSO	4/26/2016	N. KITTATINNY & CAMERON	
	Semi-Annual PM; CSO	11/16/2016		vactored and washed down chambers.
<b>43</b>	Semi-Annual PM; CSO	4/26/2016	S. KITTATINNY & CAMERON	
	Semi-Annual PM; CSO	10/24/2016		
<b>44</b>	Semi-Annual PM; CSO	7/20/2016	CAMERON & BERRYHILL	
	Semi-Annual PM; CSO	10/24/2016		washed chamber down.
<b>45</b>	Semi-Annual PM; CSO	8/7/2016	S. PAXTON STREET	
	Semi-Annual PM; CSO	11/23/2016		vactored and washed down chambers, ran line 0+30
<b>46</b>	Semi-Annual PM; CSO	8/7/2016	N. PAXTON STREET	
	Semi-Annual PM; CSO	11/23/2016		Vactored and washed down chambers, ran Syphon line 0+30 .
<b>48</b>	Semi-Annual PM; CSO	3/18/2016	10TH & SHANNON	
	Semi-Annual PM; CSO	7/11/2016		
	Semi-Annual PM; CSO	12/13/2016		
<b>49</b>	Semi-Annual PM; CSO	4/19/2016	FRONT & SCHUYLKILL	

**CAPITAL REGION WATER**  
**Preventative Maintenance Report**  
**2016 Calendar Year**  
**01/01/2016-12/31/2016**

<b>CSO #</b>	<b>Description</b>	<b>Actual Finish</b>	<b>Address</b>	<b>Comments</b>
	Semi-Annual PM; CSO	6/28/2016		Vactored and washed down chambers.
	Semi-Annual PM; CSO	11/3/2016		
<b>50</b>	Semi-Annual PM; CSO	8/7/2016	SENECA & SUSQUEHANNA	vactored and washed down chambers
	Semi-Annual PM; CSO	11/15/2016		
<b>51</b>	Semi-Annual PM; CSO	8/7/2016	WOODBINE & GREEN	set up to bypass pump for cleaning of chambers. ( pump failed ) Cleaned and washed down chambers.
	Semi-Annual PM; CSO	11/16/2016		
<b>52</b>	Semi-Annual PM; CSO	7/22/2016	FRONT & STATE	Vactored and washed down chambers.
	Semi-Annual PM; CSO	11/9/2016		
<b>53</b>	Semi-Annual PM; CSO	7/21/2016	FRONT & SOUTH	Vactored and washed down chambers.
	Semi-Annual PM; CSO	11/9/2016		
<b>54</b>	Semi-Annual PM; CSO	7/13/2016	FRONT & PINE	Vactored and washed down chambers.
	Semi-Annual PM; CSO	11/9/2016		
<b>55</b>	Semi-Annual PM; CSO	3/18/2016	FRONT & LOCUST	Vactored and washed down chambers
	Semi-Annual PM; CSO	7/22/2016		
	Semi-Annual PM; CSO	11/9/2016		
<b>56</b>	Semi-Annual PM; CSO	7/22/2016	FRONT & WALNUT	Vactored and washed down chambers.
	Semi-Annual PM; CSO	11/9/2016		
<b>57</b>	Semi-Annual PM; CSO	4/21/2016	CHERRY & MULBERRY	Vactored and washed down chambers.
	Semi-Annual PM; CSO	7/22/2016		
	Semi-Annual PM; CSO	11/1/2016		
<b>58</b>	Semi-Annual PM; CSO	8/3/2016	FRONT & TUSCARORA	Vactored and washed down chambers.
	Semi-Annual PM; CSO	11/1/2016		
<b>59</b>	Semi-Annual PM; CSO	7/20/2016	E. KITTATINNY & CAMERON	Vactored and washed down chambers.
	Semi-Annual PM; CSO	10/24/2016		
<b>60</b>	Semi-Annual PM; CSO	4/8/2016	SALMON STREET	
	Semi-Annual PM; CSO	10/24/2016		
<b>61</b>	Semi-Annual PM; CSO	5/9/2016	10TH & SYCAMORE	
	Semi-Annual PM; CSO	10/25/2016		
<b>62</b>	Semi-Annual PM; CSO	4/19/2016	SHANOIS STREET	
	Semi-Annual PM; CSO	10/25/2016		
<b>63</b>	Semi-Annual PM; CSO	4/19/2016	CAMERON & HANOVER	
	Semi-Annual PM; CSO	10/25/2016		
<b>64</b>	Semi-Annual PM; CSO	4/19/2016	CAMERON & MAGNOLIA	
	Semi-Annual PM; CSO	10/24/2016		

# Summary Rainfall Report



Site:  
RG3 AWTF  
AWTP

Harrisburg, PA

Date	Total Rain (in)	Peak Hourly Rain (in)	Peak Interval Rain (in)
1/1/2017 (Sun)	0.00		
1/2/2017 (Mon)	0.10	0.07	0.01
1/3/2017 (Tue)	0.36	0.07	0.02
1/4/2017 (Wed)	0.03	0.02	0.01
1/5/2017 (Thu)	0.00		
1/6/2017 (Fri)	0.01	0.01	0.01
1/7/2017 (Sat)	0.00		
1/8/2017 (Sun)	0.00		
1/9/2017 (Mon)	0.00		
1/10/2017 (Tue)	0.10	0.06	0.02
1/11/2017 (Wed)	0.23	0.11	0.02
1/12/2017 (Thu)	0.10	0.05	<b>0.04</b>
1/13/2017 (Fri)	0.00		
1/14/2017 (Sat)	0.00		
1/15/2017 (Sun)	0.00		
1/16/2017 (Mon)	0.00		
1/17/2017 (Tue)	0.18	0.08	0.02
1/18/2017 (Wed)	0.00		
1/19/2017 (Thu)	0.00		
1/20/2017 (Fri)	0.22	0.07	0.01
1/21/2017 (Sat)	0.02	0.01	0.01
1/22/2017 (Sun)	0.08	0.06	0.01
1/23/2017 (Mon)	<b>0.82</b>	<b>0.23</b>	0.03
1/24/2017 (Tue)	0.04	0.03	0.01
1/25/2017 (Wed)	0.00		
1/26/2017 (Thu)	0.00		
1/27/2017 (Fri)	0.00		
1/28/2017 (Sat)	0.00		
1/29/2017 (Sun)	0.00		
1/30/2017 (Mon)	0.02	0.02	0.01
1/31/2017 (Tue)	0.00		
<b>Total for period</b>	<b>2.31</b>		

# Summary Rainfall Report



Site:  
RG3 AWTF  
AWTP

Harrisburg, PA

Date	Total Rain (in)	Peak Hourly Rain (in)	Peak Interval Rain (in)
2/1/2017 (Wed)	0.00		
2/2/2017 (Thu)	0.00		
2/3/2017 (Fri)	0.00		
2/4/2017 (Sat)	0.00		
2/5/2017 (Sun)	0.00		
2/6/2017 (Mon)	0.00		
2/7/2017 (Tue)	0.33	0.21	0.03
2/8/2017 (Wed)	0.03	0.02	0.01
2/9/2017 (Thu)	0.53	0.19	0.03
2/10/2017 (Fri)	0.00		
2/11/2017 (Sat)	0.00		
2/12/2017 (Sun)	0.21	0.07	0.02
2/13/2017 (Mon)	0.00		
2/14/2017 (Tue)	0.00		
2/15/2017 (Wed)	0.00		
2/16/2017 (Thu)	0.00		
2/17/2017 (Fri)	0.00		
2/18/2017 (Sat)	0.00		
2/19/2017 (Sun)	0.00		
2/20/2017 (Mon)	0.00		
2/21/2017 (Tue)	0.00		
2/22/2017 (Wed)	0.00		
2/23/2017 (Thu)	0.00		
2/24/2017 (Fri)	0.00		
2/25/2017 (Sat)	0.19	0.17	0.10
2/26/2017 (Sun)	0.00		
2/27/2017 (Mon)	0.00		
2/28/2017 (Tue)	0.05	0.04	0.01
<b>Total for period</b>	<b>1.34</b>		

# Summary Rainfall Report



Site:  
RG3 AWTF  
AWTP

Harrisburg, PA

Date	Total Rain (in)	Peak Hourly Rain (in)	Peak Interval Rain (in)
3/1/2017 (Wed)	0.47	0.22	0.08
3/2/2017 (Thu)	0.00		
3/3/2017 (Fri)	0.00		
3/4/2017 (Sat)	0.00		
3/5/2017 (Sun)	0.00		
3/6/2017 (Mon)	0.00		
3/7/2017 (Tue)	0.41	0.15	0.02
3/8/2017 (Wed)	0.00		
3/9/2017 (Thu)	0.00		
3/10/2017 (Fri)	0.23	0.09	0.01
3/11/2017 (Sat)	0.00		
3/12/2017 (Sun)	0.00		
3/13/2017 (Mon)	0.19	0.10	0.02
3/14/2017 (Tue)	1.20	0.18	0.03
3/15/2017 (Wed)	0.00		
3/16/2017 (Thu)	0.00		
3/17/2017 (Fri)	0.00		
3/18/2017 (Sat)	0.07	0.04	0.01
3/19/2017 (Sun)	0.09	0.03	0.01
3/20/2017 (Mon)	0.00		
3/21/2017 (Tue)	0.04	0.02	0.01
3/22/2017 (Wed)	0.00		
3/23/2017 (Thu)	0.00		
3/24/2017 (Fri)	0.00		
3/25/2017 (Sat)	0.00		
3/26/2017 (Sun)	0.01	0.01	0.01
3/27/2017 (Mon)	0.09	0.03	0.01
3/28/2017 (Tue)	0.32	0.12	0.03
3/29/2017 (Wed)	0.00		
3/30/2017 (Thu)	0.04	0.03	0.02
3/31/2017 (Fri)	0.71	0.25	0.05
<b>Total for period</b>	<b>3.87</b>		

## *Weir Rehabilitation Report*

<i>CSO Number</i>	<i>Date</i>	<i>Location</i>	<i>Weir Type</i>	<i>Old Weir Height</i>	<i>Adjustment Amount</i>	<i>New Weir Height</i>	<i>Comments</i>
005	9/7/1991	Front & Lewis	Straight	6.13	5.25	11.38	Raised weir with a redwood cap.
006	9/7/1991	Front & Geiger	Curved	6.13	5.25	11.38	Raised weir with a redwood cap.
006	10/2/2002	Front & Geiger	Curved	11.38	5.62	17.00	Raised weir with a concrete lintel.
007	9/9/1991	Front & Pepper	Curved	5.50	5.25	10.75	Raised weir with a redwood cap.
008	9/7/1991	Front & Muench	Straight	12.00	5.25	17.50	Raised weir with a redwood cap.
008	6/12/2001	Front & Muench	Straight	17.50	2.00	19.50	Raised weir with a concrete lintel.
009	9/8/1991	Front & Hamilton	Straight	9.00	5.25	14.25	Raised weir with a redwood cap.
010	9/10/1991	Front & Reilly	Curved	2.50	5.25	7.75	Raised weir with a redwood cap.
011	9/8/1991	Front & Calder	Curved	12.00	5.25	17.25	Raised weir with a redwood cap.
012	11/7/2002	Front & Verbeke	Straight	3.00	12.00	15.00	Raised weir with a concrete lintel.
013	9/8/1991	Front & Cumberland	Curved	9.25	5.25	14.50	Raised weir with a redwood cap.
014	6/4/2001	Front & Boas	Curved	13.50	5.00	18.50	Raised weir with a concrete lintel.
015	4/3/2001	Front & Forster	Straight	13.50	5.00	18.50	Raised weir with a concrete lintel.
017	6/12/2001	Front & Market	Curved	6.50	8.00	14.50	Raised weir with a concrete lintel.
021	1/14/2010	Cameron & Schuylkill	Straight	11.50	4.50	16.00	Replaced with concrete lintels
023	6/28/2001	Cameron & Calder	Curved	3.50	7.00	10.50	Raised weir with two layers of brick.
026	4/22/1994	Cameron & Cumberland	Straight	2.50	2.50	5.00	Raised weir with plastic.
026	6/26/2001	Cameron & Cumberland	Straight	5.00	16.00	21.00	Raised weir with a concrete lintel.
031	10/10/2003	Cameron & State	Straight	7.00	5.75	12.75	Raised weir with a concrete lintel.
033	6/22/2001	Cameron & Walnut (East	Straight	8.25	5.25	13.50	Raised weir with a redwood cap.
043	9/13/2001	Kittatinny & Cameron (N	Straight	8.75	8.00	16.75	Raised weir with a concrete lintel.
048	8/21/2003	Tenth & Shannon	Straight	11.00	15.00	26.00	Raised weir with concret lintels.
049	9/7/1991	Front & Schuylkill	Straight	6.50	5.25	11.75	Raised weir with a redwood cap.
049	6/1/2001	Front & Schuylkill	Straight	11.75	8.00	19.75	Raised weir with a concrete lintel.
050	9/7/1991	Seneca & Susquehanna	Curved	8.00	5.25	13.25	Raised weir with a redwood cap.
050	5/4/2001	Seneca & Susquehanna	Curved	13.25	2.00	15.25	Raised weir with a concrete lintel.
051	9/7/1991	Woodbine & Green	Straight	5.25	5.25	10.50	Raised weir with a redwood cap.
052	8/19/1991	Front & State	Straight	4.00	1.50	5.50	Raised weir with a redwood cap.
053	6/4/2001	Front & South	Curved	12.50	8.00	20.50	Raised weir with a concrete lintel.
056	5/30/2001	Front & Walnut	Curved	8.00	8.00	16.00	Raised weir with a concrete lintel.
061	10/2/2003	Tenth & Sycamore (059/	Curved	7.00	6.88	13.88	Raised weir with a concrete lintel.
062	5/31/2001	Shanois Street	Straight	3.50	2.00	5.50	Raised weir with aluminum plate.

\* Date:

\* Time:

\* Incident Description:

\* Incident Address:

\* Location Details:

Caller Name:		Citizen	COH Department
	Owner of Property	Property Manager	Tenant of Property
		Realtor	

Caller Address:

Primary Phone #

Alt. Phone #

Follow-up Call Requested:

Yes

No

Comments:

\* Call received by:

*\* indicates required fields*

*For the listed service calls, please see the back page for additional questions to ask the caller.*

## No Water or High/Low Water Pressure:

1. When did you first notice the problem?
2. Does the problem still exist?            Yes            No
3. If the previous answer is no: when did it stop?
4. Is the issue limited to one fixture/floor, or throughout the entire residence/building?
  - The issue is limited to one floor/fixture.
  - The issue effects the entire residence/building.
  - Not sure/Unknown.
5. Has this been a re-occurring problem?            Yes            No
6. Is any work being done on your home?            Yes            No

## Water Leak:

1. When did you first notice the problem?
2. Where is the source of the suspected water leak?
3. Has this been a re-occurring problem?            Yes            No
4. Is any work being done on the residence/building?            Yes            No

## Water Quality:

1. What water problem do you have?            Color            Odor
2. Describe color or odor
3. Is it a cold water or hot water issue?            Cold            Hot
4. Is it sporadic or continuous?            Sporadic            Continuous
5. When did you first notice the problem?
6. Has there been any water pipework done recently?            Yes            No
7. Are any neighbors having similar problems?            Yes            No
8. Is there a residence/building wide water filter in use?            Yes            No

## Backup in Residence/Building:

1. Where is the overflow?
2. Have you had this problem before?            Yes – when?            No
3. When did you first notice the problem?
4. Is any work being done on your home?            Yes            No
5. Have you called a plumber?            Yes            No
6. If yes, have they said your line was clear?            Yes            No
7. Plumber name and contact information.



8. Does your sewer line extend from the front, back or side of your home?

Front                      Back                      Side                      Unknown

9. Are any neighbors having similar problems?                      Yes                      No

**Sinkhole:**

- 1. When did you first notice the sinkhole?
- 2. Have you witnessed the sinkhole growing in size?                      Yes                      No
- 3. Is it in a traffic lane?                      Yes                      No
- 4. Is it an immediate danger to the public?                      Yes                      No

**Additional Space:**

## Questions

### Back-up in resident/Building

Caller Questions & Answers

1 Where is the overflow?

2 Have you had this problem before?

3 When did you first notice the problem?

4 Is any work being done on your home?

5 Have you called a plumber?

6 If yes, have they said your line was clear?

7 Plumber name and contact information:

8 Does your sewer line extend from the front, back or side of your house?

9 Are any neighbors having similar problems?

### Sinkhole

Caller Questions & Answers

1 When did you first notice the sinkhole?

2 Have you witnessed the sinkhole growing in size?

3 Is it in a traffic lane?

4 Is it an immediate danger to the public?

Save Clear

Problem Tree

Domain: CRW

- |       |                              |
|-------|------------------------------|
| Sewer | Backup in Residence/Building |
| Water | Blocked Inlet                |
|       | Collapsed Inlet              |
|       | Damaged/Loose Manhole Cover  |
|       | Illicit Discharge            |
|       | Investigation Request        |
|       | Missing Manhole Cover        |
|       | Missing/Damaged Cleanout Cap |
|       | Odor Complaint               |
|       | Sewer Overflow               |
|       | Sinkhole Investigation       |
|       | Street Sweeping              |

Example of Service Request's

Back up in resident/ building

The screenshot displays the Cityworks software interface for a service request. The main window is titled "Service Request" and contains the following information:

- Description:** Backup in resident's building
- Request No.:** 1000
- Category:** [Dropdown]
- Priority:** Service
- Status:** Open
- Submitted By:** [Name]
- Date:** 02/02/2010 09:21 AM
- Emergency:** [Dropdown]
- NO Needed:** [Dropdown]
- Submit To:** [Name]
- Date:** 02/02/2010 09:21 AM
- Request No.:** [Number]
- Date:** 02/02/2010 09:21 AM
- Project Name:** [Name]
- Req. Comp. Date:** [Date]

The "Project Information" window shows:

- Address:** 1112 North 14th Street
- Alt #:** [Field]
- Alt Number:** [Field]
- Street:** [Field]
- Alt Code:** [Field]
- Landmark:** [Field]
- Shop:** [Field]
- Tel No.:** [Field]
- Map Page:** [Field]
- Number of Copies:** [Field]
- Location:** [Field]
- Details:** This is the third time in a week that he has had backup in his basement. High level and having more items.

The "Category" window shows a dropdown menu for "Category".

The "Calendar" window shows a table of events:

Event Name	Event Name	Alt	Call Date	Call Date	Comments
1000	1000	02/02/2010 09:21 AM	02/02/2010 09:21 AM	02/02/2010 09:21 AM	Submitted by [Name]

The "Request Work Activities" window shows:

- Assign Lines:** Add
- Work Orders:** Add
- NO Template:** [Dropdown]
- Req. Start Date:** [Field]
- Submit To:** [Name]
- Department:** [Field]
- Priority:** Service
- Order:** [Field]

The "Attachments" window shows:

- ADD ATTACHMENTS...**
- REMOVE ALL ATTACHMENTS**
- Drop and drag files here to attach them.**
- Cancel**

The "Requesting Department with the Request Number Field" window shows:

- SEARCH**

# Service Request #1589



## Backup in Residence/Building

**Submit To:** Freysinger, Ken

**Priority:** 5

**Created By:** Rohrer, Brenda

**Date Created:** 6/29/2016 8:21:18AM

**Dispatch To:** Freysinger, Ken

**Details:** this is the third time in a week that he has had backup in his basement. Neighbors are having same issue

**Location Details:**

### Incident Information:

**Address:** 1310 North 16th Street  
Harrisburg,

**Apt #:**

### Callers:

Last Name	First Name	Call Date/Time	Home Phone
SCOTT	DRED	6/28/2016 5:59:41PM	443-804-1324

### Existing Comments:

Caller: SCOTT, DRED:  
Q: Where is the overflow?  
A: Other  
Q: Have you had this problem before?  
A: Yes  
Q: Is any work being done on your home?  
A: No  
Q: Have you called a plumber?  
A: Yes  
Q: If yes, have they said your line was clear?  
A: Yes  
Q:  
Does your sewer line extend from the front, back or side of your house?  
A: Unknown  
Q: Are any neighbors having similar problems?  
A: Yes

**Date Investigated:** \_\_\_\_ / \_\_\_\_ / \_\_\_\_

**Investigation Notes:**

**Work Needed:**

# Blocked Inlet

**Cityworks** | Home | Reports | Blocked Inlets | Request Information | Work Orders | Inspections | Project Manager | Logout

Request View | Save | Close | Delete

### Request Information

Request ID: 239  
Category: **Blocked Inlet**  
Status: **Open**  
Submitted By: [Name] | Date: 4/20/14 10:04 AM  
Assigned To: [Name] | Date: 4/20/14 10:04 AM  
Submittal To: [Name] | Date: 4/20/14 10:04 AM  
Work Order To: [Name] | Date: 4/20/14 10:04 AM  
Project Name: [Name] | Proj. Code: [Code]

### Address Information

Address: 2001 [Address]  
City: [City] | State: [State] | Zip Code: [Zip Code]  
Landmark: [Landmark]  
Map View: [Map View]  
Location: [Location]

### Call Log

Call Time	Line Name	MI	Call Time	Call Type	Comments
4/20/14 10:04 AM	[Name]	[MI]	4/20/14 10:04 AM	[Call Type]	[Comments]

### Related Work Activities

Inspection: [Inspection]  
Work Order: [Work Order]

### Attachments

+ Add attachments... | - Remove all attachments

Drop and drop files here to attach them.

### Related Requests

Calculating requests with this same location code.

# Service Request #1599



## Blocked Inlet

**Submit To:** Freysinger, Ken

**Priority:** 3

**Created By:** Freysinger, Ken

**Date Created:** 6/29/2016 2:31:52PM

**Dispatch To:** Freysinger, Ken

**Details:**

**Location Details:**

### Incident Information:

**Address:** 1811 FOURTH ST

**Apt #:**

### Callers:

Last Name	First Name	Call Date/Time	Home Phone
PADUA	REBECCA	6/29/2016 2:27:35PM	

### Existing Comments:

**Date Investigated:** \_\_\_\_\_ / \_\_\_\_\_ / \_\_\_\_\_

**Investigation Notes:**

**Work Needed:**

# Collapsed Inlet

The screenshot displays the Cityworks software interface for a collapsed inlet. The interface is organized into several panels:

- Top Navigation:** Includes the Cityworks logo and a search bar.
- Left Sidebar:** Contains project information such as 'Project Name', 'Status', and 'Priority'. It also includes a 'Project Flow' section with a 'Number' and 'Count'.
- Main Content Area:**
  - Form Fields:** Includes fields for 'App No.', 'Status', 'Land Use', 'Shop', 'No. Poles', and 'Estimate'.
  - Table:** A table with columns 'Last Name', 'First Name', 'M.I.', 'Cell No.', 'Cell Type', and 'Comments'. It contains one row of data.
  - Work Orders:** A section for managing work orders, including a 'Work Order' table with columns 'ID', 'Description', 'Priority', 'Status', 'Send To', and 'Print/Get'. Below this is a 'Print/Get' section with a 'Print' button.
  - Attachments:** A section for adding and removing attachments, with a 'Print' button below it.
- Right Sidebar:** Contains a 'Details' section with a 'Details' button.



# Service Request #1552



## Collapsed Inlet

**Submit To:** Baker, Joseph

**Priority:** 4

**Created By:** Rohrer, Brenda

**Date Created:** 6/24/2016 8:48:06AM

**Dispatch To:** Baker, Joseph

**Details:** Water Department placed a barricade around it

**Location Details:**

### Incident Information:

**Address:** 20th & Greenwood Streets  
Harrisburg,

**Apt #:**

### Callers:

**Last Name**  
UNKNOWN

**First Name**

**Call Date/Time**  
6/23/2016 5:47:16PM

**Home Phone**

### Existing Comments:

**Date Investigated:** \_\_\_\_\_ / \_\_\_\_\_ / \_\_\_\_\_

**Investigation Notes:**

**Work Needed:**

# Damaged/Loose Manhole Cover

**Cityworks** | Inbox | Recent | Asset Search | Service Requests | Work Orders | Inspections | Project Manager | Designer | Search...

---

**Service Request**

Request ID: 442

Category: **Manhole** | Priority: **Severe**

Status: **Open**

Submitted By: **Kevin, Kevin** | Date: 10/20/2014 8:03 AM

Investigation:  | Date: 10/20/2014 8:03 AM

Emergency:  | NO REQUEST:

Submit To: **Mike, Joseph** | Date: 10/20/2014 8:03 AM

Dispatch To: **David, Dan** | Date: 10/20/2014 8:03 AM

Project Name:  | Proj. Group: **Public** | 10/20/2014 8:03 AM

---

**Project Test**

Project:  | Water:

Created By: **David, Greg** | Date: 10/20/2014 2:04:12 PM

Next Comments:

Start

Existing Comments:

---

Resolution: **10 work orders**

Label: 20.44

**Address Information**

Address: **10000 N. 100th St NE**

City:  | State:  | ZIP Code:

Landmark:

Sheet:  | To File:

Map Filter:  | WALKER:

Inspection:

Service: **DAMAGED MANHOLE COVER OR MISSING**

---

**Assets**

Asset Name	MP Name	MP	Lat/Long	Asset Type	Comments
<input type="checkbox"/>	JOHNSON, JAMES	10000 N 100th St NE	CONDUIT	Item City Co	

New Request From Code:

---

**Associated Work Orders**

Inspector: **ADD**

Clear

Track & History

WO Template:  | Proj. Start Date:

Submit To:  | Supervisor:

Workflow: **Worked** |

**Custom Fields**

Field Name:

**Attachments**

+ Add Attachments... | Remove All Attachments

Drag and drop files here to attach them.

---

**Form**

Clear

---

Existing requests with the same Problem Code

Start

# Service Request #883

## Damaged/Loose Manhole Cover



**Submit To:** Baker, Joseph

**Priority:** 5

**Created By:** Rohrer, Brenda

**Date Created:** 3/9/2016 8:10:56AM

**Dispatch To:** Schreffler, Brian

**Details:** manhole cover is out of place

**Location Details:**

### Incident Information:

**Address:** Morrison Towers off of Chestnut Street  
Harrisburg,

**Apt #:**

### Callers:

Last Name	First Name	Call Date/Time	Home Phone
JOHNSON	JAMIE	3/2/2016 4:09:58PM	

### Existing Comments:

**Date Investigated:** \_\_\_\_\_ / \_\_\_\_\_ / \_\_\_\_\_

**Investigation Notes:**

**Work Needed:**

# Illicit Discharge

The screenshot displays the Cityworks software interface for a service request. The main menu at the top includes: Home, Report, Smart Search, Service Requests, Work Orders, Inspections, Project Manager, and Designer. The service request details are as follows:

- Service Request:** Description: Illicit Discharge; Request ID: 494; Manager: [Name]; Status: [Status]; Priority: [Priority]; Date: 1/20/16 10:50 AM.
- Investigation:** Date: 1/20/16 1:27 PM.
- Inspector:** [Name]; Date: 1/20/16 10:50 AM.
- Location:** Address: Edward Street between 42 & 55 Street; City: [City]; State: [State]; Zip: [Zip]; Map Page: [Page]; Detail: [Detail].

The calendar view shows a date of 1/20/16 with a calendar grid. The inspection log table is as follows:

Inspector	Start Time	End Time	SL	Call Time	Call Type	Com
CLERK, MICHELLE	10:00 AM	11:00 AM	10:00 AM	10:50 AM	CF25H	

Additional interface elements include a 'Request New' button, a 'Cancel Reason' field, a 'Resolution' field, and a 'Print' button. The bottom of the screen shows a 'Print' button and a 'Close' button.

# Service Request #876



## Illicit Discharge

**Submit To:** Baker, Joseph

**Priority:** 5

**Created By:** Rohrer, Brenda

**Date Created:** 3/8/2016 10:53:42AM

**Dispatch To:** Schreffler, Brian

**Details:**

**Location Details:**

### Incident Information:

**Address:** Edward Street between 4th & 5th Street  
Harrisburg,

**Apt #:**

### Callers:

Last Name	First Name	Call Date/Time	Home Phone
CURRY	MICHELLE	3/8/2016 10:51:34AM	756-6873

### Existing Comments:

**Date Investigated:** \_\_\_\_\_ / \_\_\_\_\_ / \_\_\_\_\_

**Investigation Notes:**

**Work Needed:**

# Service Request #2752



## Investigation Request

**Submit To:** Baker, Joseph

**Priority:** 1

**Created By:** Howe, Cody

**Date Created:** 2/15/2017 9:37:58AM

**Dispatch To:** Stein, Mitchell

**Details:** Not a CRW issue

**Location Details:** Plumber reports that inlet on property drains into crw's inlet. Will investigate whether there is a problem with our storm utility which is effecting the proper drainage of properties drain. susquehanna & liberty is location of inlet

### Incident Information:

**Address:** 600 n. third st.

**Apt #:**

### Callers:

**Last Name**

**First Name**

**Call Date/Time**

**Home Phone**

JEFF

2/15/2017 9:16:48AM

### Existing Comments:

Caller: JEFF, :

Q: Requested by:

A: Plumber

**Date Investigated:** \_\_\_\_\_ / \_\_\_\_\_ / \_\_\_\_\_

**Investigation Notes:**

**Work Needed:**

# Missing Manhole Cover

**Cityworks** Home | Reports | Tools | Account Manager | Account Manager | Work Orders | Inspection | Project Manager | Inspection

Request ID: 102 | Category: Asphalt Seal | Status: Closed | Assigned To: Baker, Joseph | Date: 2/17/2016 10:04:16 AM

**Request Information**

Request ID: 102 | Category: Asphalt Seal | Status: Closed | Assigned To: Baker, Joseph | Date: 2/17/2016 10:04:16 AM

Request To: Baker, Joseph | Date: 2/17/2016 10:04:16 AM

Request To: Scheller, Dan | Date: 2/17/2016 10:04:16 AM

Project Name: | Proj. Close Date: 2/17/2016 10:04:16 AM

**Location Information**

Address: 2000 1st Street SW | City: Seattle | State: WA | Zip: 98101

Location: 2000 1st Street SW | City: Seattle | State: WA | Zip: 98101

**Colors**

Last Time	Location	Mile	Call Time	Color Type	Comments
	2000 1st Street SW	1.12121212121212		COLOR	

**Inspection**

ID	Description	Priority	Date	Assigned To

**Work Orders**

ID	Description	Priority	Date	Assigned To

**Attachments**

102 Asphalt Seal Manhole - 4 | Color: Asphalt Seal | Date: 2/17/2016 10:04:16 AM

Download

**Attachments**

+ Add Attachment... | Remove Attachment

Images stop the flow to attach items.

**Print**

Print

# Service Request #715

## Missing Manhole Cover



**Submit To:** Baker, Joseph

**Priority:** 5

**Created By:** Rohrer, Brenda

**Date Created:** 2/11/2016 9:57:02AM

**Dispatch To:** Schreffler, Brian

**Details:**

**Location Details:** Manhole cover was placed on upside down

**Incident Information:**

**Address:** Second and Division Streets  
Harrisburg,

**Apt #:**

**Callers:**

Last Name	First Name	Call Date/Time	Home Phone
UNKNOWN	JAMIE	2/11/2016 9:55:44AM	231-2750

**Existing Comments:**

**Date Investigated:** \_\_\_\_\_ / \_\_\_\_\_ / \_\_\_\_\_

**Investigation Notes:**

**Work Needed:**



# Odor complaint

The screenshot displays the Cityworks software interface for a service request. The main window is titled "Service Request" and contains several panels:

- Service Request Panel:** Includes fields for Description (Odor Complaint), Category (Odor), Status (Open), and various dates (Created, Modified, Dispatched, etc.).
- Location Information Panel:** Shows Address (12345678901234567890), City (Anytown), State (CA), Zip Code (90210), and Location (12345678901234567890).
- Calendar Panel:** Displays a calendar view for the month of October 2010, with a date selected (October 15, 2010).
- Work Order Panel:** Shows fields for Work Order Number (12345678901234567890), Priority (High), and Status (Open).

Below the main window, there are three smaller panels:

- Attachments Panel:** Contains buttons for "Add attachments" and "Remove all attachments", with a message: "Drag and drop files here to attach them."
- Print Panel:** Contains a "Print" button.
- Search Panel:** Contains a "Search" button.

# Service Request #234



## Odor Complaint

**Submit To:** Baker, Joseph

**Priority:** 2

**Created By:** Byrne-Long, Sheri

**Date Created:** 11/9/2015 11:20:00AM

**Dispatch To:** Rotolo, Scott

**Details:** Garage is very smelly.

**Location Details:** 1220 lot & house in back of his garage.

### Incident Information:

**Address:** 1222 CHRISTIAN ST

**Apt #:**

### Callers:

Last Name	First Name	Call Date/Time	Home Phone
SANTIAGO	BENJAMIN	11/9/2015 11:17:43AM	717-232-2533

### Existing Comments:

**Date Investigated:** \_\_\_\_\_ / \_\_\_\_\_ / \_\_\_\_\_

**Investigation Notes:**

**Work Needed:**

# Service Request #2851



## Sewer Overflow

**Submit To:** Freysinger, Ken

**Priority:** 3

**Created By:** Freysinger, Ken

**Date Created:** 3/3/2017 2:21:20PM

**Dispatch To:** Kneasel, Mike

**Details:** Water was observed flowing out of from under SSMH-001818.

**Location Details:**

### Incident Information:

**Address:** 2234 ADRIAN ST

**Apt #:**

### Callers:

**Last Name**

**First Name**

**Call Date/Time**

**Home Phone**

JAN SEIDLER

3/3/2017 2:13:47PM

### Existing Comments:

By Freysinger, Ken: 3/3/2017 2:21:20 PM  
Odor & discharge of stagnant water out of manhole cover.

**Date Investigated:** \_\_\_\_\_ / \_\_\_\_\_ / \_\_\_\_\_

**Investigation Notes:**

**Work Needed:**



# Service Request #1335



## Sinkhole

**Submit To:** Baker, Joseph

**Priority:** 5

**Created By:** Rohrer, Brenda

**Date Created:** 5/16/2016 10:48:56AM

**Dispatch To:** Baker, Joseph

**Details:**

**Location Details:**

### Incident Information:

**Address:** 922 Green Street  
Harrisburg,

**Apt #:**

### Callers:

Last Name	First Name	Call Date/Time	Home Phone
BLISS	ANDREW	5/16/2016 10:48:06AM	

### Existing Comments:

By Beshara, Frederick: 5/25/2016 10:55:59 AM  
this is a test to see if I can add a comment while logged in as fbeshara (water staff) by Yuri H. Evans

By Byrne-Long, Sheri: 6/8/2016 10:01:19 AM  
This is related to SH-000121 which is slated for repair in the General Sewer Repairs Project.

**Date Investigated:** \_\_\_\_\_ / \_\_\_\_\_ / \_\_\_\_\_

**Investigation Notes:**

**Work Needed:**

# Street Sweeping

Inbox Recent Asset Search Service Requests Work Orders Inspections Project Manager
Search...

Request Email Print Save New Close Delete

Service Request

Comments:

Description:  
Street Sweeping

Request#:

Address:  
1820 SPENCER ST, 17104

Apt #:  Zip Code:

Location Details:  
1800 BLK OF SPENCER STREET

X Coord.:  Y Coord.:

Status:  Priority:

Initiated By:  Date Initiated:

Supervisor:

Dispatch To:  Date Dispatched:

Comments:

**Burnett, Nanette** 12/14/2018 9:02 AM

CALLER STATES THAT THE 1800 BLK OF SPENCER NEVER GETS STREET CLEANING OR ENFORCEMENT; SHE WILL CALL THE CITY RE: ENFORCEMENT; STREET CLEANING IS TODAY FROM 8.00AM 12NOON; PLEASE MAKE SURE THIS STREET GETS CLEANED TODAY AND ON A REGULAR BASIS

**Schaffer, Randy** edited 12/14/2018 12:27 PM

Spencer Street: Area 8. After reviewing the DBI map and the CRW Street Sweeping contract, noted that Spencer Street is not listed for sweeping. However, it is signed for sweeping and will be requested to be added to the street sweeping map

Investigation Completed:  Date:

Follow-up Call Requested:

Resolution:

Callers

Name	Call Time	Caller Type
<input type="checkbox"/> TERESA ROBINSON	12/14/2018 8:59:03 AM	OWNER

Caller Name:  Cell Phone:

Home Phone:  Email:

Date Contacted:  Contacted By:

Related Work Activities

Inspections

Add Insp#:

Work Orders

Add WO#:

Attachments

Drag and drop files here to attach them.

Map Layer Fields

Cancel SR

Custom Fields

Request Details

Service Request #: 4799

Status: CLOSED



Street Sweeping

**Incident Information:**

**Address:** 1820 SPENCER ST, 17104

**Apt #:**

**Location Details:** 1800 BLK OF SPENCER STREET

**Date Initiated:** 12/14/2018

**Initiated By:** Burnett, Nanette

**Date Dispatched:** 12/14/2018

**Dispatch To:** Rosentel, Jess

**Caller Information:**

**Caller Name:** TERESA ROBINSON

**Call Date & Time:** 12/14/2018 8:59:03AM

**Home Phone**

**Cell Phone**

**Email**

717 232 4280

**Follow up Call Requested:** NO

**Date Contacted:**

**Comments:** CALLER STATES THAT THE 1800 BLK OF SPENCER NEVER GETS STREET CLEANING OR ENFORCEMENT; SHE WILL CALL THE CITY RE: ENFORCEMENT; STREET CLEANING IS TODAY FROM 8:00AM 12NOON; PLEASE MAKE SURE THIS STREET GETS CLEANED TODAY AND ON A REGULAR BASIS  
Spencer Street: Area 8. After reviewing the DBI map and the CRW Street Sweeping contract, noted that Spencer Street is not listed for sweeping. However, it is signed for sweeping and will be requested to be added to the street sweeping map

**Investigation Details:**

**Date Investigated:** 12/14/2018

**Resolution:** OTHR

**Custom Field:** Zone:

ZONE8A

**Related Work Activities:** Work Order ID: Description: Status:

Inspection ID: Description: Status:

<b>Labor Details:</b>	<b><u>Employee Name</u></b>	<b><u>Hours</u></b>	<b><u>Cost</u></b>
	Schaffer, Randy	0.50	\$22.50
	<b>Labor Total:</b>		\$22.50

A3-2 Collection System Work Order Screenshot Sample, Repair Sewer Pipe, Work Order #10517

Inbox Recent Asset Search Service Requests Work Orders Inspections Project Manager Search...

Work Order Email Print Save Close Delete

### Work Order

Comments:

Description: **Repair Sewer Pipe**

Asset Type: **SANITARY SEWER PIPE** Change Asset

WO#: **10517**

Address:

Kolston to Pemberton st

Location Details:

X Coord: **-8,555,399.492** Y Coord: **4,902,546.179**

Status: **Closed** Priority: **High**

Requested By: **Robalo, Scott** Supervisor: **Baker, Joseph**

Submit To: **Chisnell, Matthew** Submit To Date:

03/30/2017 10:17 AM

Projected Start: **03/27/2017 8:41 AM** Projected Finish: **03/27/2017 8:41 AM**

Actual Start: **03/19/2018 12:32 PM** Actual Finish:

Completed By: **Chisnell, Matthew**

Comments:

- Chisnell, Matthew 03/18/2017 8:23 AM  
Video not coded: can do excavation between 50'-53' no laterals i...
- Chisnell, Matthew 03/19/2018 12:31 PM  
Layout marks saw road begun excavation work dug down to pipe ...
- Chisnell, Matthew 03/19/2018 12:31 PM  
Oils not coded stage 12" vvt a pond excavation found out it was 10"

### Work Order Details

### Work Order Costs

Labor Cost: **\$1,746.72** Material Cost: **\$702.54**

Equipment Cost: **\$6,440.00** Total WO Cost: **\$8,889.26**

Customer Billable:

Cancel WO

Work Cycle

### Custom Fields

Category:

DEP Notification Required?: **No**

DEP Notified?:

Date/Time:

Notified By:

### Assets

Total Entries: 2

Update Work Order XY when adding/removing assets?

Asset	Asset ID	Location Details	Warranty
<input type="checkbox"/> SANITARY SEWER PIPE	SSP-000078		
<input type="checkbox"/> SINK HOLES	SH-000152	1232 Rolleston St	

- Pink rows indicate inventory still under warranty.

### Map Layer Fields

Reset

### Related Work Activities

Service Requests:

Add SR#

Inspections:

Add Insp#

Work Orders:

Parent WO#: **3866**

Create WO

WO#	Description	Priority	Status	Submit To	Proj S
<b>12872</b>	Street Restoration Sewer Pipe	1	CLOSED	Ston, Mitchell	10
<b>16355</b>	Update GIS	1	CLOSED	Evans, Yuri	37

### Attachments

+ Add attachment... Remove all attachments

- IMG\_20180319\_121936.jpeg 1.34 MB Attached by Chisnell, Matthew 03/19/2018 12:31 PM
- IMG\_20180319\_121940.jpeg 1.94 MB Attached by Chisnell, Matthew 03/19/2018 12:31 PM
- IMG\_20180319\_121948.jpeg 1.29 MB Attached by Chisnell, Matthew 03/19/2018 12:31 PM
- SSP-000078\_2a48c64d-2112-4994-b672-c89efb2f9ef4\_22b5198d-e894-4dae-bc86-49ce1927943c.mp4 196.07 MB Attached by Robalo, Scott 07/27/2017 8:41 AM



Work Order #: 10517

Status: CLOSED



**Repair Sewer Pipe**

Rolleston to Pemberton st

**Location Details:**

**Assigned To:** Chisnell, Matthew

**Completed By:** Chisnell, Matthew

**Projected Start Date:** 07/27/2017

**Projected Finish Date:** 07/27/2017

**Actual Start Date:**

**Actual Finish Date:** 03/19/2018

**Project:**

**Assets:** SANITARY SEWER PIPE  
SINK HOLES

SSP-000878  
SH-000152

**Tasks:**

**Comments:** Video not coded. can do excavation between 56'-63' no laterals in the dig area. remaining run can have liner installed. break in taps are ugly.  
Layout marks saw road begun excavation work dug down to pipe cut pipe out put in new pipe and two 10x6 y's tying two laterals. Put mortar around the frencos and 1 b's around the pipe filled hole with 2a and put cold mix on top.  
Gis not correct state 12" vct a pond excavation found out it was 10"

**Additional Details:** DEP Notification Required? No  
DEP Notified?  
Date/Time  
Notified By

<b>Related Work Activities:</b>	<b>Work Order:</b>	<b>Description:</b>	<b>Status:</b>
	12672	Street Restoration Sewer Pipe	CLOSED
	16155	Update GIS	CLOSED

<b>Inspection ID:</b>	<b>Description:</b>	<b>Status:</b>
-----------------------	---------------------	----------------

**Labor Details:**

<b>Date</b>	<b>Employee Name</b>	<b>Hours</b>	<b>Cost</b>
03/19/2018	Howe, Cody	8.00	165.84
03/19/2018	Morrison, Douglas	8.00	165.84
03/19/2018	Schaeffer, Scott	8.00	140.00
03/19/2018	Sweger, Joshua	8.00	165.84
03/19/2018	Howe, Cody	8.00	165.84
03/19/2018	Morrison, Douglas	8.00	165.84
03/19/2018	Schaeffer, Scott	8.00	140.00
03/19/2018	Sweger, Joshua	8.00	165.84
03/19/2018	Howe, Cody	8.00	165.84
03/19/2018	Morrison, Douglas	8.00	165.84
03/19/2018	Schaeffer, Scott	8.00	140.00

Work Order #: 10517

Status: CLOSED



**Repair Sewer Pipe**

Rolleston to Pemberton st

**Total Labor Cost: \$1,746.72**

**Material Details:**

<u>Date</u>	<u>Description</u>	<u>Units</u>	<u>Cost</u>
03/19/2018	10" Fernco Coupling, each	2.00	0.00
03/19/2018	6" Fernco Coupling, each	2.00	25.54
03/19/2018	6" SDR 45 Degree L, each	2.00	0.00
03/19/2018	Cold Patch, ton	3.00	375.00
03/19/2018	Mortar Mix 60-lb bag	3.00	18.00
03/19/2018	Stone, 1B, ton	2.00	44.00
03/19/2018	Stone,2A, ton	12.00	240.00

**Total Material Cost: \$702.54**

**Equipment Details:**

<u>Date</u>	<u>Description</u>	<u>Units</u>	<u>Cost</u>
03/19/2018	Backhoe	1.00	960.00
03/19/2018	Dump Truck	1.00	840.00
03/19/2018	Gas Tamper	1.00	80.00
03/19/2018	Pipe Saw	1.00	240.00
03/19/2018	Service Truck	2.00	720.00
03/19/2018	Trenchbox	1.00	3,600.00

**Total Equipment Cost: \$6,440.00**

**Total Work Order Cost: \$8,889.26**

**Customer Billable: N**

## A3-3 Collection System Inspection Work Order Screenshot, "Hot Spot Checklist"

Cityworks Work Order View

WO #3881 Wily Hotspot

https://ow.cityworks.cityworks\_prod/Default.aspx

Cityworks Inbox Recent Asset Search Service Requests Work Orders Inspections Project Manager Designer

Work Order

Description: Wily Hotspot Manhole Inspections  
 Number: 3881  
 Entity Type: SANITARY SEWER MANHOLE  
 Category: Preventive Maintenance  
 Initiated By: Torkis, Scott Date: 6/21/2016 3:04 PM  
 Status: Closed Priority: High  
 Requested By: Freyinger, Ken Supervisor: Freyinger, Ken  
 Submit To: Raska, Scott Date: 6/26/2016 7:12 AM  
 Projected Start: 6/26/2016 3:04 PM Projected Finish:  
 Opened By: Torkis, Scott Date: 6/28/2016 12:00:21 PM  
 Closed By: Freyinger, Ken Date: 6/28/2016 2:29:53 PM  
 Completed By: Raska, Scott  
 Actual Start: Actual Finish: 6/28/2016 12:08 PM  
 Skaper: Actual Expense Type: Maintenance

Location Information

WO Address:  
 Location Details:  
 Shop: Map Page:  
 Tile Number: District: Uptown  
 X Location: 2,214,892.16 Y Location: 342,881.12

Assets

Asset	Asset Id	Asset Uid	Location	Warranty
<input type="checkbox"/>	SANITARY SEWER MANHOLE	3365	SSMH-001623	
<input type="checkbox"/>	SANITARY SEWER MANHOLE	3196	SSMH-001474	
<input type="checkbox"/>	SANITARY SEWER MANHOLE	3422	SSMH-001670	
<input type="checkbox"/>	SANITARY SEWER MANHOLE	3550	SSMH-001787	
<input type="checkbox"/>	SANITARY SEWER MANHOLE	3612	SSMH-001834	
<input type="checkbox"/>	SANITARY SEWER MANHOLE	3721	SSMH-001911	
<input type="checkbox"/>	SANITARY SEWER MANHOLE	3586	SSMH-001810	
<input type="checkbox"/>	SANITARY SEWER MANHOLE	3555	SSMH-001791	
<input type="checkbox"/>	SANITARY SEWER MANHOLE	3732	SSMH-001919	
<input type="checkbox"/>	SANITARY SEWER MANHOLE	3676	SSMH-001879	
<input type="checkbox"/>	SANITARY SEWER MANHOLE	3733	SSMH-001920	
<input type="checkbox"/>	SANITARY SEWER MANHOLE	3663	SSMH-001872	

- Pink rows indicate inventory still under warranty.

Cityworks Work Order View

WO #3881 Wily Hotspot

https://ow.cityworks.cityworks\_prod/Default.aspx

Cityworks Inbox Recent Asset Search Service Requests Work Orders Inspections Project Manager Designer

Work Order

Instructions:  
 Resolution: Reactive?

Details

Project: Account:  
 Contract: Contractor:  
 Legal Billable: Contractor Billable:  
 Update Map: Cancel Work Order:  
 Cancelled By: Date:  
 Cancel Reason:  
 Units Accomp.: Description:  
 Lock Units Desc.:  
 Labor Cost: \$75.36 Material Cost: \$8.00  
 Equipment Cost: \$210.00 Permit Cost: \$8.00  
 Total WO Cost: \$285.36

Work Cycle

Repeat: Every  
 Interval: 1 Weeks  
 From: Actual Finish Date  
 Date Printed: Next Print Date: 6/27/2016

Related Work Activities

Add Request:  
 Add Inspection:

Id	Type	Description	Entity Id	Entity Type
<input type="checkbox"/>	10932	INSP Weekly HotSpot MH Inspection	SSMH-001623	SANITARY S
<input type="checkbox"/>	10933	INSP Weekly HotSpot MH Inspection	SSMH-001474	SANITARY S
<input type="checkbox"/>	10934	INSP Weekly HotSpot MH Inspection	SSMH-001670	SANITARY S
<input type="checkbox"/>	10935	INSP Weekly HotSpot MH Inspection	SSMH-001787	SANITARY S
<input type="checkbox"/>	10936	INSP Weekly HotSpot MH Inspection	SSMH-001834	SANITARY S
<input type="checkbox"/>	10937	INSP Weekly HotSpot MH Inspection	SSMH-001911	SANITARY S
<input type="checkbox"/>	10938	INSP Weekly HotSpot MH Inspection	SSMH-001810	SANITARY S
<input type="checkbox"/>	10939	INSP Weekly HotSpot MH Inspection	SSMH-001791	SANITARY S
<input type="checkbox"/>	10940	INSP Weekly HotSpot MH Inspection	SSMH-001919	SANITARY S
<input type="checkbox"/>	10941	INSP Weekly HotSpot MH Inspection	SSMH-001879	SANITARY S
<input type="checkbox"/>	10942	INSP Weekly HotSpot MH Inspection	SSMH-001920	SANITARY S
<input type="checkbox"/>	10943	INSP Weekly HotSpot MH Inspection	SSMH-001872	SANITARY S

Remove

File Edit View History Bookmarks Tools Help

WO #3881 Wky Hotspot ... X

https://ow-cityworks.cityworks\_group/Default.aspx

Cityworks **Inbox** Recent Asset Search Service Requests Work Orders Inspections Project Manager Designer Search...

Work Order View Save Close Delete

<input type="checkbox"/>	10322	INSP	Weekly HotSpot MH Inspection	SSMH-001191	SANITARY S
<input type="checkbox"/>	10360	INSP	Weekly HotSpot MH Inspection	SSMH-001919	SANITARY S
<input type="checkbox"/>	10341	INSP	Weekly HotSpot MH Inspection	SSMH-001879	SANITARY S
<input type="checkbox"/>	10342	INSP	Weekly HotSpot MH Inspection	SSMH-001920	SANITARY S
<input type="checkbox"/>	10343	INSP	Weekly HotSpot MH Inspection	SSMH-001872	SANITARY S

Remove

**Work Orders**

Parent: 3880

Id	Description	Priority	Status	Submit To	Proj S
3880	Wky Hotspot Manhole Inspections	4	CLOSED	Kneasel, Mike	7/5/2

Create Child Work Order

**Parents**

Create

**Attachments**

+ Add attachments... Remove all attachments

Drag and drop files here to attach them.

**Custom Fields**

Category:

### A3-3 Weekly HotSpot Inspection Screenshot

This screenshot shows the 'Inspection' form in the Cityworks application. The form is titled 'Inspection' and has a 'Details' tab selected. The main form area is divided into several sections:

- Inspection Details:** Includes fields for ID (12922), Location, Status (Closed), Resolution, Insn. Date (4/26/2016 12:07 PM), and Inspected By (Roth, Scott). There is an 'Apply to All' checkbox.
- Observations:** A section with a red header 'Observed Normal Flow' and a checkmark. Below it are radio buttons for 'Other Flow Type' (No Flow, Low Flow, High Flow) and 'Blockage Type' (Paper, Grease, Sediment, Leaves, Other). There is a text input field for 'Approx lbs of debris removed' and a 'Surcharge' checkbox (No).
- Comments:** A section with three sub-sections: 'Observations', 'Repairs', and 'Recommendation', each with a text input area.

This screenshot shows the 'Inspection' form in the Cityworks application, displaying the 'Details' tab. The form is titled 'Inspection' and has a 'Details' tab selected. The main form area is divided into several sections:

- Inspection Details:** Includes fields for Type (Roads/Highway Inspection), Submit To (Aysinger, Ken), Priority (High), Initiated By (Roth, Scott), Insn. Date (4/26/2016 12:06 PM), Projected Start, Projected Finish (4/26/2016 12:06 PM), Actual Finish (4/26/2016 12:07 PM), Closed By (Roth, Scott), Date Closed (4/26/2016 12:07:30 PM), Cancel Insn? (checkbox), Cancel WOT? (checkbox), Cancel Reason, and Cancelled By.
- Location:** Includes fields for District (Lupton), Sheet, Map Page, and Tile No. There is an 'Update Map' checkbox.
- Entity:** Includes buttons for 'Highlight', 'Get from Map', 'History', 'Remove', and 'Asset Code'. There is a section for 'Editable Fields' with a dropdown menu and a radio button for 'All Fields'. The entity name is 'SANITARY SEWER MANHOLE' with a sub-field 'Man\_Retrieved'.
- Work Cycle:** Includes a dropdown menu for 'Repeat' (New).

File Edit View History Bookmarks Tools Help

Cityworks

Inbox Recent Asset Search Service Requests Work Orders Inspections Project Manager Designer

Inspector View Save Close

Map Page: Tile No:

Update Map

Entity

Highlights Get from Map History Remove Asset Code

Editable Fields: All Fields

**SANITARY SEWER MANHOLE**

Year\_Reviewed

Work Cycle

Repeat: None

Interval: 7 Days

From: Actual/Prob Date

Related Work Activities

Request: Work Order: 381 Open ID

Inspections

Parent: Create Child Inspection

Attachments

+ Add attachments... Remove all attachments

Drag and drop files here to attach them.

# Work Order #3881

## Wkly Hotspot Manhole Inspections



**Created By:** Rotolo, Scott

**Created Date:** 6/21/2016 3:04:24PM

**Submitted To:** Rotolo, Scott

**Supervisor:** Freysinger, Ken

**Projected Start:** 6/28/2016 3:04:16PM

**Priority:** 4

**Assets:**

Type	AssetID	Location
Sanitary Sewer Manhole	SSMH-001623	
Sanitary Sewer Manhole	SSMH-001474	
Sanitary Sewer Manhole	SSMH-001670	
Sanitary Sewer Manhole	SSMH-001787	
Sanitary Sewer Manhole	SSMH-001834	
Sanitary Sewer Manhole	SSMH-001911	
Sanitary Sewer Manhole	SSMH-001810	
Sanitary Sewer Manhole	SSMH-001791	
Sanitary Sewer Manhole	SSMH-001919	
Sanitary Sewer Manhole	SSMH-001879	
Sanitary Sewer Manhole	SSMH-001920	
Sanitary Sewer Manhole	SSMH-001872	
Sanitary Sewer Manhole	SSMH-001882	
Sanitary Sewer Manhole	SSMH-002170	
Sanitary Sewer Manhole	SSMH-002894	
Sanitary Sewer Manhole	SSMH-002138	
Sanitary Sewer Manhole	SSMH-002693	
Sanitary Sewer Manhole	SSMH-002742	
Sanitary Sewer Manhole	SSMH-002273	
Sanitary Sewer Manhole	SSMH-002312	
Sanitary Sewer Manhole	SSMH-002566	
Sanitary Sewer Manhole	SSMH-002372	
Sanitary Sewer Manhole	SSMH-002582	
Sanitary Sewer Manhole	SSMH-002583	
Sanitary Sewer Manhole	SSMH-002569	
Sanitary Sewer Manhole	SSMH-003197	
Sanitary Sewer Manhole	SSMH-000514	
Sanitary Sewer Manhole	SSMH-000592	
Sanitary Sewer Manhole	SSMH-002861	
Sanitary Sewer Manhole	SSMH-000136	
Sanitary Sewer Manhole	SSMH-000084	
Sanitary Sewer Manhole	SSMH-000620	
Sanitary Sewer Manhole	SSMH-002865	
Sanitary Sewer Manhole	SSMH-000492	
Sanitary Sewer Manhole	SSMH-000487	
Sanitary Sewer Manhole	SSMH-003204	

**Actual Start:**

**Actual Finish:** 6/28/2016 12:08:35PM

**Existing Comments:**

**Work Completed/Comments:**

# Work Order #3881

## Wkly Hotspot Manhole Inspections



Labor Hours:		<u>Employee Name</u>	<u>Hours</u>	<u>Cost</u>
		Kneasel, Mike	2.00	\$32.90
		Rotolo, Scott	2.00	\$42.46
			<b>Total Labor Cost:</b>	<b>\$75.36</b>

Material Quantities:		<u>Item Description</u>	<u>Qty Used</u>	<u>Cost</u>
<b>Total Cost of Materials:</b>				

Equipment Hours:		<u>Item Description</u>	<u>Units</u>	<u>Cost</u>
		Service Truck	1.00	\$30.00
		Vactor	1.00	\$180.00
			<b>Total Equipment Costs:</b>	<b>\$210.00</b>

<b>Completed By:</b>	Rotolo, Scott
----------------------	---------------



Capital Region Water

Inlet/Catchbasin Inspection

<b>Inspection</b>	Details	Related Activities
Insp. Type: Inlet/Catchbasin Inspection		
Insp #: 149358		
Location:		
Status: Open	Resolution:	
Prj. Start Date: 03/12/2021 7:23 AM	Prj. Finish Date:	
Insp. Date:	Inspected By:	
<b>Dimensions</b>		
Inlet Grate Length (in)		
Inlet Grate Width (in)		
Inlet Grate Bar Width (in)		
Inlet Grate Opening Width (in)		
Curb Opening Height (in)		
Curb Opening Length (in)		
Catch Basin Length, Inside (in)		
Catch Basin Width, Inside (in)		
Catch Basin Depth (in)		
Depth to Connector Pipe Invert (in)		

Observations

Inlet Material Type

- Brick       Pre-cast       Iron Top on Brick  
 Pre-cast Top       Other

Inlet Type

- A-3       Sidewalk       Other  
 Type C       Type M       Trench  
 Pipe

Number of Pipes

- 1       2       3  
 4       5       6

Bicycle Grate

- Yes       No

Curb Opening Restrictor Plate

- Yes       No

Trap/Hood Present?

- Yes       No

Evidence of Surface Ponding

- Yes       No

Evidence of Illicit Discharge

- Yes       No

Inlet Grate Condition

- Good       Fair       Poor

Curb Opening Condition

- Good       Fair       Poor

Catch Basin Condition

- Good       Fair       Poor

Trap/Hood Condition

- Good       Fair       Poor

Comments

Comments:

Repairs Needed:

Inspection **Details** Related Activities

Priority: **High**

Initiated By: **cvadmin, cvadmin**      Initiated Date: **03/12/2021 7:23 AM**

Submit To: **Freysinger, Ken**      Submit To Date: **03/12/2021 7:23 AM**

Closed By:      Date Closed:

Route:      Maint. Zone:

Shop:      WF Zone:

**Assets**

Highlight Get from Map History Remove Asset Costs

Editable Fields:       All Fields:

**STORM SEWER INLET**

**Attachments**

+ Add attachment... Remove all attachments

Drag and drop files here to attach them.

**Cancel Inspection**

Cancel Insp?       Cancel Date:

Cancel Reason:

Cancelled By:

Inspection Details **Related Activities**

**Related Work Activities**

SRID

**Related Work Orders:**

WOID:

WO Type:

Selection: Create

<input type="checkbox"/>	Work Order Id	Description	Link Type	Priority	Status	Subm
<input type="checkbox"/>	260382 <b>44036</b>	Vactor Inlet	Related	2	OPEN	Freysing

Open WOs Remove

**Related Inspections:**

Create Child Inspection

Inspection: 135559

Status: CLOSED



**Inlet/Catchbasin Inspection**

Priority: 3 Location: Miller St.

Inspected By: Ceasar, Jeffrey

---

**Projected Start:** 9/3/2020 8:12:51AM

**Projected Finish:**

**Initiated By:** cwadmin, cwadmin

**Initiated Date:** 9/3/2020 8:12:51AM

**Actual Finish:** 9/28/2020 11:16:35AM

**Insp. Date:** 9/28/2020 11:16:35AM

**Closed By:** Freysinger, Ken

**Date Closed:** 9/29/2020 8:40:24AM

**Work Order Id:**

**Observation:**

**Repairs:**

**Recommendation:**

Inlet/Catchbasin Inspection

Priority: 3 Location: Miller St.

Inspected By: Ceasar, Jeffrey

Observations:

Inlet Material Type: Brick  
 Inlet Type: Other  
 Number of Pipes: 1  
 Bicycle Grate: No  
 Curb Opening No  
 Restrictor Plate:  
 Trap/Hood Yes  
 Present?:  
 Evidence of No  
 Surface Ponding:  
 Evidence of Illicit No  
 Discharge:  
 Inlet Grate Good  
 Condition:  
 Curb Opening  
 Condition:  
 Catch Basin Fair  
 Condition:  
 Trap/Hood Fair  
 Condition:  
 Inlet Grate Length 30  
 (in):  
 Inlet Grate Width 18  
 (in):  
 Inlet Grate Bar 1.5  
 Width (in):  
 Inlet Grate 1.25  
 Opening Width  
 (in):  
 Curb Opening 0  
 Height (in):  
 Curb Opening 0  
 Length (in):  
 Catch Basin 30.25  
 Length, Inside (in):  
 Catch Basin 18.25  
 Width, Inside (in):  
 Catch Basin Depth 54.5  
 (in):  
 Depth to 28  
 Connector Pipe  
 Invert (in):  
 Depth below 27  
 Connector Pipe  
 Invert (in):  
 Connector Pipe 8  
 Diameter (in):

Inspection: 135559

Status: CLOSED



**Inlet/Catchbasin Inspection**

Priority: 3

Location: Miller St.

Inspected By: Ceasar, Jeffrey

---

**Related Work Orders:**

Work Order ID	Description	Status
39685	Vactor Inlet	CLOSED

### **Fats, Oils, and Grease [FOG] Inspection**

#### **Inspection and Observation Fields:**

<b>Inspection</b>	Details	Related Activities
Insp. Type: FOG Inspection		
Insp #: 121183		
Location: North St.		
Status: Closed	Resolution:	
Prj. Start Date: 03/11/2020 11:31 AM	Prj. Finish Date:	
Insp. Date: 03/10/2020 12:00 PM	Inspected By: Bernstein, Tom	
<b>General</b>		
<b>Type of Facility</b>		
<input checked="" type="radio"/> Full Service Restaurant	<input type="radio"/> Fast Food Restaurant	<input type="radio"/> Carry Out
<input type="radio"/> Food Court	<input type="radio"/> Church	<input type="radio"/> Club/Organization
<input type="radio"/> Bakery	<input type="radio"/> Ice Cream/Yogurt/Gelato	<input type="radio"/> Coffee Shop
<input type="radio"/> Grocery Store	<input type="radio"/> Convenience Store	<input type="radio"/> School
<input type="radio"/> Retirement Home	<input type="radio"/> Hotel	<input type="radio"/> Garage
<input type="radio"/> Car Wash	<input type="radio"/> Other	
<b>Type of Facility (Other)</b>		
<input type="text"/>		
<b>Restaurant Seating</b>		
<input type="text"/>		
<b>Meals served per day</b>		
<input type="text" value="60"/>		
<b>Amount of oil used per month</b>		
<input type="text"/>		

Capital Region Water  
Screenshots for O&M Updates - FOG

Fixture Count	
Deep Fryers	<input type="text" value="2"/>
Grills	<input type="text" value="1"/>
Ovens	<input type="text"/>
Floor Drains	<input type="text"/>
3-Compartment Sinks	<input type="text" value="1"/>
2-Compartment Sinks	<input type="text"/>
1-Compartment Sinks	<input type="text"/>
Pre-wash Sinks	<input type="text"/>
Stove Vents	<input type="text"/>
Mop Sinks	<input type="text"/>
Food Grinders	<input type="text"/>
Dishwashers	<input type="text"/>
Wok Ranges	<input type="text"/>
Hot Dog Rollers	<input type="text"/>
Strainers installed on Floor/Sink Drains?	<input checked="" type="radio"/> Yes <input type="radio"/> No
Detail fixtures that are not connected	<input type="text"/>
<p> Type in list form any fixtures that are not connected or not in use. If none detail 'NONE'</p>	
Dye Test Required?	<input type="radio"/> Yes <input checked="" type="radio"/> No



Capital Region Water  
Screenshots for O&M Updates - FOG

External Grease Interceptor	
Size of Trap; Flow Based Grease Trap	<input type="text"/>
Clean-out Freq. of Flow Based Grease Trap	<input type="text"/>
Grease Logs Posted?	<input type="radio"/> Yes <input type="radio"/> No
Grease Logs Maintained?	<input type="radio"/> Yes <input type="radio"/> No
Serviced By:	<input type="text"/>
Flow Based Grease Trap	
Size of Trap; Flow Based Grease Trap	<input type="text" value="25"/>
Clean-out Freq. of Flow Based Grease Trap	<input type="text" value="Every 4 weeks"/>
Grease Logs Posted?	<input checked="" type="radio"/> Yes <input type="radio"/> No
Grease Logs Maintained?	<input checked="" type="radio"/> Yes <input type="radio"/> No
Serviced By:	<input type="text" value="Associated Products"/>
Interior Active Interceptor	
Size of Vault; Interior Active Interceptor	<input type="text"/>
Clean-out Freq. of Interior Active Interceptor	<input type="text"/>
Grease Logs Posted?	<input type="radio"/> Yes <input type="radio"/> No
Grease Logs Maintained?	<input type="radio"/> Yes <input type="radio"/> No
Serviced By:	<input type="text"/>

Capital Region Water  
Screenshots for O&M Updates - FOG

Automatic Grease Device	
Size of Trap; Automatic Grease Device	<input type="text"/>
Clean-out Freq. of Automatic Grease Device	<input type="text"/>
Grease Logs Posted?	<input type="radio"/> Yes <input type="radio"/> No
Grease Logs Maintained?	<input type="radio"/> Yes <input type="radio"/> No
Serviced By:	<input type="text"/>
Grease Management	
Grease Disposal Location	<input type="text" value="SE corner of Oliver Alley and Susquehanna St. inside wooden fence area"/>
Location Maintained?	<input checked="" type="radio"/> Yes <input type="radio"/> No <input type="radio"/> Unknown
Evidence of Spills?	<input type="radio"/> Yes <input checked="" type="radio"/> No <input type="radio"/> Unknown
Name of Waste Hauler	<input type="text" value="Resource Oil, Inc."/>
Summary of Findings	
Fixture Summary	<input type="text" value="1 - 25 GPM grease trap in basement from 3 - compartment sink"/>
Grease Management Summary	<input type="text" value="Grease trap cleaned every 4 weeks by Associated Products."/>
Assessment	
Final Assessment	<input type="radio"/> Exemption <input checked="" type="radio"/> No Action <input type="radio"/> Follow-up Inspection Required <input type="radio"/> Letter of Violation
Comments	
Comments:	<input type="text"/>
Repairs Needed:	<input type="text"/>

**Other Inspection Details:**

Inspection **Details** Related Activities

Priority: **Moderate** ▼

Initiated By: Bernstein, Tom      Initiated Date: 03/11/2020 11:31 AM

Submit To: Bernstein, Tom ▼      Submit To Date: 03/11/2020 11:31 AM

Closed By: Bernstein, Tom      Date Closed: 3/11/2020 11:35:30 AM

Route:       Maint. Zone:  ▼

Shop:  ▼      WF Zone:

**Assets**

Editable Fields:       All Fields:

**FOGLOCATIONS**

Total_Violations
Waste_Hauler: Resource Oil, Inc

**Attachments**

Drag and drop files here to attach them.

**Cancel Inspection**

Cancel Insp?       Cancel Date:

Cancel Reason:

Cancelled By:

**Inspection Related Activities:**

Inspection **Details** **Related Activities**

**Related Work Activities**

SRID:

**Related Work Orders:**

WOID:

WO Type:  ▼

Selection:

<input type="checkbox"/>	Work Order Id	Description	Link Type	Priority	
<input type="checkbox"/>	229694 <u>34666</u>	Daily FOG Inspection Rounds	Related	2	

**Related Inspections:**

**Daily FOG Inspection Rounds (Work Order):**

This work order activity is used as a container to hold multiple FOG Inspection Activities together for the day's route. No values except for labor documentation are held here, refer to FOG Inspection for observation values against each facility.

Work Order			
Description:	Daily FOG Inspection Rounds		
Asset Type:	FOGLOCATIONS <span>Change</span>		
WO#:	34666		
Address:	North St		
Location Details:	North St.		
X Coord:	2,209,607.495	Y Coord:	340,580.792
Status:	Completed	Priority:	Moderate
Requested By:		Supervisor:	Rosentei, Jess
Submit To:	Bernstein, Tom	Submit To Date:	03/10/2020 11:31 AM
Projected Start:	03/10/2020 11:31 AM	Projected Finish:	03/10/2020 11:31 AM
Actual Start:		Actual Finish:	03/10/2020 12:00 PM
Completed By:	Bernstein, Tom		
Comments:	<input type="button" value="Add Comment"/> <span>Sort ▲</span>		
	no comments		

Work Order Details			
Category:	Wastewater		
Initiated By:	Bernstein, Tom	Initiated Date:	03/11/2020 11:31 AM
Project:		Account #:	
Route:		Maint. Zone:	
Shop:		WF Zone:	
Contract #:		Contractor:	
Closed By:		Closed Date:	

Work Order Costs			
Labor Cost:	\$28.37	Material Cost:	\$0.00
Equipment Cost:	\$0.00	Total WO Cost:	\$28.37
Customer Billable:	<input type="checkbox"/>		

Cancel Work Order	

Work Cycle	
Repeat:	Never
Interval:	2 Months
From:	Projected Start Date

Capital Region Water  
Screenshots for O&M Updates - FOG

Assets ▲

Total Entities: 2

	Asset	Asset Id	Location Details	Warranty Date	Work Com
<input type="checkbox"/>	FOGLOCATIONS	FOG-000129			<input type="checkbox"/>
<input type="checkbox"/>	FOGLOCATIONS	FOG-000128			<input type="checkbox"/>

- Pink rows indicate inventory still under warranty.

Update Work Order XY when adding/removing assets?

---

Map Layer Fields ▲

---

Reservations ▲

Equipment ID	Employee	Start Date	End Date	Comments
No records to display.				

---

Checked Out Equipment ▲

Equipment ID	Employee	Check Out Date	Due Date	Comments
No records to display.				

---

Related Work Activities ▲

Service Requests

Add SR #:

---

Inspections

Add Inspection #:

	Insp#	Description	Link Type	Asset Id	Asset Type	Insp D
<input type="checkbox"/>	<a href="#">121183</a>	FOG Inspection	Related	FOG-000129	FOGLOCATIONS	3/10/2 <span style="float: right;">▲</span>
<input type="checkbox"/>	<a href="#">121184</a>	FOG Inspection	Related	FOG-000128	FOGLOCATIONS	3/10/2 <span style="float: right;">▼</span>

---

Work Orders

Link Work Order:

---

Attachments ▲

Drag and drop files here to attach them.

Inspection: 121183

Status: CLOSED



**FOG Inspection**

Priority:

2

Location: North St.

Inspected By: Bernstein, Tom

---

**Projected Start:** 3/11/2020 11:31:59AM

**Projected Finish:**

**Initiated By:** Bernstein, Tom

**Initiated Date:** 3/11/2020 11:31:59AM

**Actual Finish:** 3/11/2020 11:35:30AM

**Insp. Date:** 3/10/2020 12:00:00PM

**Closed By:** Bernstein, Tom

**Date Closed:** 3/11/2020 11:35:30AM

**Work Order Id:**

**Observation:**

**Repairs:**

**Recommendation:**

Inspection: 121183

Status: CLOSED



**FOG Inspection**

Priority: 2

Location: North St.

Inspected By: Bernstein, Tom

**Observations:**

Type of Facility: Full Service Restaurant

Type of Facility

(Other):

Restaurant

Seating:

Meals served per 60

day:

Amount of oil

used per month:

Deep Fryers: 2

Grills: 1

Ovens:

Floor Drains:

3-Compartment 1

Sinks:

2-Compartment

Sinks:

1-Compartment

Sinks:

Pre-wash Sinks:

Stove Vents:

Mop Sinks:

Food Grinders:

Dishwashers:

Wok Ranges:

Hot Dog Rollers:

Strainers installed Yes

on Floor/Sink

Drains?:

Detail fixtures that  
are not connected:

Dye Test No

Required?:

Size of Trap; Flow

Based Grease

Trap:

Clean-out Freq. of

Flow Based

Grease Trap:

Grease Logs

Posted?:

Grease Logs

Maintained?:

Inspection: 121183

Status: CLOSED



**FOG Inspection**

Priority: 2

Location: North St.

Inspected By: Bernstein, Tom

**Serviced By::**

**Size of Vault;**

**Interior Active**

**Interceptor:**

**Clean-out Freq. of**

**Interior Active**

**Interceptor:**

**Grease Logs**

**Posted?:**

**Grease Logs**

**Maintained?:**

**Serviced By::**

**Size of Trap; Flow** 25

**Based Grease**

**Trap:**

**Clean-out Freq. of** Every 4 weeks

**Flow Based**

**Grease Trap:**

**Grease Logs** Yes

**Posted?:**

**Grease Logs** Yes

**Maintained?:**

**Serviced By::** Associated Products

**Size of Trap;**

**Automatic Grease**

**Device:**

**Clean-out Freq. of**

**Automatic Grease**

**Device:**

**Grease Logs**

**Posted?:**

**Grease Logs**

**Maintained?:**

**Serviced By::**

**Grease Disposal** SE corner of Oliver Alley and Susquehanna St. inside wooden fence area

**Location:**

**Location** Yes

**Maintained?:**

**Evidence of** No

**Spills?:**

**Name of Waste** Resource Oil, Inc.

**Hauler:**

**Fixture Summary:** 1 - 25 GPM grease trap in basement from 3 - compartment sink

**Grease** Grease trap cleaned every 4 weeks by Associated Products.

**Management**

**Summary:**

**Final Assessment:** No Action



Inspection: 121183

Status: CLOSED



**FOG Inspection**

Priority:

2

Location: North St.

Inspected By: Bernstein, Tom

---

**Related Work Orders:**

Work Order ID	Description	Status
34666	Daily FOG Inspection Rounds	COMPLETED

Work Order #: 34666

Status: COMPLETED



Daily FOG Inspection Rounds

North St.

Location Details: North St.

Assigned To: Bernstein, Tom

Completed By: Bernstein, Tom

Projected Start Date: 3/10/2020 11:31:00AM

Projected Finish Date: 3/10/2020 11:31:00AM

Actual Start Date:

Actual Finish Date: 3/10/2020 12:00:00PM

Project:

Assets:	FOGLOCATIONS	FOG-000129
	FOGLOCATIONS	FOG-000128

Tasks:

Comments:

Additional Details:

Related Work Orders:

Parent:	<u>WORKORDERID</u>	<u>DESCRIPTION</u>	<u>STATUS</u>
Child:	<u>WORKORDERID</u>	<u>DESCRIPTION</u>	<u>STATUS</u>

Related Inspections:

<u>INSPECTIONID</u>	<u>INSPTEMPLATENAME</u>	<u>STATUS</u>
121184	FOG Inspection	CLOSED
121183	FOG Inspection	CLOSED

Labor Details:

<u>Date</u>	<u>Employee Name</u>	<u>Hours</u>	<u>Cost</u>
03/11/2020	Bernstein, Tom	1.00	\$28.37

Total Labor Cost: \$28.37

Work Order #: 34666

Status: COMPLETED



**Daily FOG Inspection Rounds**

North St.

---

**Material Details:**

<u>Date</u>	<u>Description</u>	<u>Units</u>	<u>Cost</u>
-------------	--------------------	--------------	-------------

Total Material Cost: \$0.00

**Equipment Details:**

<u>Date</u>	<u>Description</u>	<u>Units</u>	<u>Cost</u>
-------------	--------------------	--------------	-------------

Total Equipment Cost: \$0.00

Total Work Order Cost: \$28.37

Customer Billable: N

**WASTEWATER DIVISION  
WORK REPORT**

A4-1

PROPERTY ADDRESS:

231 Breakwood

PROPERTY NUMBER:

DATE WORK PERFORMED:

7-25-15

PROPERTY OWNER:

MAIL ADDRESS:

DESCRIPTION OF WORK PERFORMED:

Rep. Jet House

INFORMATION PROVIDED BY:

Robulo

**LABOR**

LABORERS	<u>1.5</u>	HOURS	@	\$30.00	=	\$0.00
FM WORKERS	<u>2.5</u>	HOURS	@	\$35.00	=	\$0.00
SUPERVISOR		HOURS	@	\$45.00	=	\$0.00
DIRECTOR		HOURS	@	\$60.00	=	\$0.00

**MATERIALS**

STONE		TONS	@	\$20.00	=	\$0.00
CONCRETE		CU YDS	@	\$250.00	=	\$0.00
BITUMINOUS		TONS	@	\$85.00	=	\$0.00
COLD PATCH		TONS	@	\$125.00	=	\$0.00
BINDER		TONS	@	\$75.00	=	\$0.00
MORTAR MIX 60 LB. BAG		BAGS	@	\$6.00	=	\$0.00
CONCRETE MIX 60 LB. BAG		BAGS	@	\$5.00	=	\$0.00
BRICKS, RED		EACH	@	\$1.00	=	\$0.00
BAGGED COLD PATCH		BAGS	@	\$15.00	=	\$0.00
MISC.						

**EQUIPMENT**

CCTV	<u>1.0</u>	HOURS	@	\$90.00	=	\$0.00
SERVICE TRUCK		HOURS	@	\$15.00	=	\$0.00
DUMP TRUCK		HOURS	@	\$35.00	=	\$0.00
RODDER/FLUSHER		HOURS	@		=	\$0.00
VACTOR	<u>.5</u>	HOURS	@	\$90.00	=	\$0.00
BACKHOE		HOURS	@	\$40.00	=	\$0.00
PAVEMENT SAW		HOURS	@	\$45.00	=	\$0.00
PIPE SAW		HOURS	@	\$15.00	=	\$0.00
GENERATOR		HOURS	@	\$10.00	=	\$0.00
PUMP 4" GORMAN RUPP		HOURS	@	\$15.00	=	\$0.00
PUMP GODWIN DRY PRIME		HOURS	@	\$30.00	=	\$0.00
AIR COMPRESSOR		HOURS	@	\$25.00	=	\$0.00
GAS TAMPER		HOURS	@	\$10.00	=	\$0.00
ROLLER		HOURS	@	\$55.00	=	\$0.00
PLATE TAMPER		HOURS	@	\$15.00	=	\$0.00
TRENCHBOX		HOURS	@	\$225.00	=	\$0.00
HEAVY UTILITY		HOURS	@	\$75.00	=	\$0.00
SOIL PICK		HOURS	@	\$10.00	=	\$0.00
ROADWAY PIN		HOURS	@	\$25.00	=	\$0.00
CHAIN SAW		HOURS	@	\$7.00	=	\$0.00
MISC.						

**FIXED COST**

DESCRIPTION

Fee

Fee

**ADMINISTRATIVE CHARGES (20%)**

TOTAL LABOR	<u>\$0.00</u>		
TOTAL MATERIALS:	<u>\$0.00</u>		
TOTAL EQUIPMENT:	<u>\$0.00</u>		
TOTAL FIXED COST:	<u>\$0.00</u>		
TOTAL FIXED COST:	<u>\$0.00</u>	SUBTOTAL:	<u>\$0.00</u>
ADMIN COST:	<u>\$0.00</u>	TOTAL:	<u>\$0.00</u>



**SEWER**

Description	Work Order ID	Actual Finish	Address	Total Assets
<b>CCTV Sewer Pipe</b>	12055	11/6/2018	Burchfield & Spencer	1
	12365	11/2/2018	13th to Cammeron	1
	13121	11/2/2018	1431 Shoop Street	1
	13263	11/5/2018	1400 Wayne	1
	13416	01/17/2018	7th & Basin	2
	13420	11/9/2018	902 CUMBERLAND ST, 17103	1
	13423	01/18/2018	east from intersection of North & 7th	1
	13424	01/17/2018	at CSO 30 - HARSCO property	1
	13425	01/18/2018	606 CAMERON ST, 17104	1
	13427	01/22/2018	115 PINE ST, 17101	1
	13431	01/17/2018	43 TENTH ST, 17101	1
	13447	01/3/2018	1725 Walnut st	1
	13688	11/26/2018	Sycamore	1
	13824	01/3/2018	2nd st	1
	13825	01/3/2018	2nd st to Shamokin	1
	13826	01/4/2018	2ND	1
	13829	01/4/2018	2nd st	1
	13837	01/3/2018	2430 Brookwood	1
	13859	01/4/2018	Shamokin	1
	13860	01/4/2018	Shamokin to 2nd	1
	13863	01/4/2018	2nd to river alley	1
	13951	01/10/2018	21st and central	1
	13976	01/11/2018	central alley	1
	14036	01/12/2018	Boas and bartine	1
	14089	01/17/2018	Front & Chestnut	1
	14094	01/17/2018	121 Herr	1
	14161	01/18/2018	Radnor to 2nd st	1
	14163	11/26/2018	Radnor to river alley	1
	14187	01/19/2018	Seneca to 2nd	1
	14192	01/19/2018	2311 Penn	1
	14202	01/21/2018	1613 derry (rear)	1
	14203	01/21/2018	1613 derry	1
	14227	01/22/2018	Pine to 2nd	1
	14232	02/14/2018	7th	1
	14235	01/22/2018	7th	1
<b>CCTV Sewer Pipe</b>	14248	01/22/2018	Boyd st to 7th	1
	14254	01/22/2018	7th	1
	14259	01/22/2018	7th to reily st	1
	14278	01/22/2018	crescent and crescent	1
	14339	01/24/2018	derry st	1
	14342	01/24/2018	derry to 15th	1
	14361	01/25/2018	7th to reily st	1
	14364	01/25/2018	market to cameron sinkhole	1
	14366	11/26/2018	market st storm	1
	14368	01/25/2018	2nd and hamilton	1

Capital Region Water  
Collection System Activity Report  
01-01-2018 to 12-31-2018

Description	Work Order ID	Actual Finish	Address	Total Assets
<b>CCTV Sewer Pipe</b>	14371	01/25/2018	2nd st	1
	14388	01/26/2018	Kensington towards 21st	1
	14390	01/26/2018	kensington	1
	14391	01/26/2018	kensington	1
	14396	01/26/2018	meadow and mulberry	1
	14397	01/26/2018	Meadow to 2nd	1
	14399	01/26/2018	15th and swatara	1
	14406	01/27/2018	7th to herr	1
	14407	01/27/2018	7th	2
	14408	01/27/2018	7th	1
	14409	01/27/2018	7th and herr	1
	14410	01/27/2018	7th to unknown in street	1
	14411	01/27/2018	unknown in 7th st to sidewalk	1
	14412	01/27/2018	7th	1
	14414	01/27/2018	2nd st to chestnut	1
	14415	01/27/2018	2nd st	1
	14416	01/27/2018	2nd to mulberry	1
	14420	01/28/2018	16th to 15th on derry st	1
	14423	01/28/2018	2nd st	1
	14424	11/26/2018	2nd	1
	14425	11/26/2018	2nd and strawberry	1
	14449	01/29/2018	2619 Agate st	1
	14470	01/30/2018	hamilton and fulton st (Wexcon)	1
	14504	11/26/2018	2nd and granite	1
	14507	01/31/2018	2nd and kelker	2
	14511	01/31/2018	2nd and dauphin	1
	14512	01/31/2018	2nd st	1
	14513	01/31/2018	2nd st	1
	14519	01/31/2018	2nd	1
	14527	01/31/2018	2nd	1
	14584	02/5/2018	2nd and peffer	1
	14585	02/5/2018	2nd	1
	14589	02/5/2018	2nd	1
	14590	02/5/2018	2nd and peffer	1
	14591	02/5/2018	2nd and Geiger	1
	14609	02/6/2018	3rd and seneca	1
	14615	02/6/2018	2nd and harris	1
	14617	02/6/2018	2nd and harris	1
	14618	02/6/2018	2nd st	1
	14622	02/6/2018	2nd st	1
	14624	02/6/2018	reily to 2nd st	1
	14627	02/6/2018	reily and 2nd	1
	14661	02/8/2018	2017 Swatara	1
<b>CCTV Sewer Pipe</b>	14664	02/8/2018	2nd and calder	1
	14666	02/8/2018	2nd and calder	1
	14667	02/8/2018	2nd st	1
	14669	02/8/2018	2nd st	1
	14672	02/9/2018	3rd st dye test and/or leak notice	1
	14678	02/9/2018	18th and hanover	1
	14694	02/10/2018	2nd and Sayford	1
	14696	02/10/2018	2nd	1
	15167	02/12/2018	2nd st	1
	15170	02/12/2018	2nd to verbeke	1

Capital Region Water  
Collection System Activity Report  
01-01-2018 to 12-31-2018

Description	Work Order ID	Actual Finish	Address	Total Assets
<b>CCTV Sewer Pipe</b>	15171	02/12/2018	2nd st	1
	15216	02/14/2018	2nd st	1
	15219	02/14/2018	2nd st	1
	15232	02/15/2018	249 Seneca	1
	15256	02/16/2018	Cameron to Market	1
	15258	02/16/2018	Cameron and State cso line	1
	15262	02/16/2018	16th and derry	1
	15268	02/16/2018	18th and Rudy	1
	15282	02/20/2018	17th and wayne	1
	15288	02/20/2018	17th	1
	15295	02/20/2018	2nd and cumberland	1
	15305	02/21/2018	1323 Bartine	1
	15329	02/18/2018	27 SEVENTEENTH ST	1
	15332	03/22/2018	east of 7th st in PHEAA parking lot	1
	15334	03/22/2018	PHEAA parking lot to Herr st	1
	15337	02/22/2018	7th and oxford	1
	15349	11/26/2018	18th and Rudy	1
	15350	11/26/2018	7th and Schuykill	1
	15361	02/23/2018	2nd and Boas	1
	15362	02/23/2018	2nd and Boas	1
	15364	02/23/2018	2nd	1
	15365	02/23/2018	2nd	1
	15366	02/23/2018	2nd	1
	15391	02/26/2018	2nd and South st	1
	15444	11/26/2018	blackberry	1
	15445	03/1/2018	blackberry to 2nd	1
	15446	03/14/2018	blackberry	1
	15460	03/1/2018	17th to market	1
	15466	03/1/2018	18th and market	1
	15478	03/4/2018	16th and market	1
	15480	03/1/2018	14th to market	1
	15482	03/1/2018	market st	1
	15518	03/4/2018	19th and market	1
	15519	03/4/2018	16th and market	1
	15520	03/4/2018	market st	1
	15521	03/4/2018	16th to market	1
	15522	03/19/2018	PHEAA lot	1
	15523	03/19/2018	pheaa lot	1
	15524	03/20/2018	pheaa lot	1
	15537	03/5/2018	cameron and magnolia (wexcon)	1
	16027	03/13/2018	Market st	1
	16077	03/13/2018	logan and Boyd	1
	16112	03/14/2018	state st syphon	2
<b>CCTV Sewer Pipe</b>	16131	03/15/2018	kensington st between houses	1
	16197	03/17/2018	13th and market	1
	16241	03/20/2018	Harris st	1
	16304	03/23/2018	1300 17th st	1
	16306	03/23/2018	12th and walnut	2
	16320	03/25/2018	sidewalk off 2nd near market st	1
	16321	03/25/2018	market st	1
	16322	03/25/2018	market st	1
	16323	03/25/2018	2nd and strawberry	1
	16387	03/28/2018	334 rumson	1

## CAPITAL REGION WATER ADVANCED WASTEWATER TREATMENT FACILITY

Field Maintenance Information - 2014

Month	Number of Inlets Cleaned	Number of Inlets Repaired	Number of Sewer Calls Responded to	Sewer Call Problem		Number of Plates Removed	Number of Sinkholes Addressed
				Our	Theirs		
Beginning Totals	35	9	46	11	35	0	0
June	24	11	7	1	6	0	2
July	17	13	12	1	11	4	0
August	31	14	12	2	10	8	15
September	20	1	4	0	4	2	7
October	59	25	12	1	11	7	7
November	12	10	7	0	7	3	1
December	39	5	8	2	6	0	0
<b>TOTAL FOR THE YEAR</b>	<b>237</b>	<b>88</b>	<b>108</b>	<b>18</b>	<b>90</b>	<b>24</b>	<b>32</b>



# CAPITAL REGION WATER ADVANCED WASTEWATER TREATMENT FACILITY

Field Maintenance Information - 2015

Month	Number of Inlets Cleaned	Number of Inlets Repaired	Number of Sewer Calls Responded to	Sewer Call Problem CRW	Sewer Call Problem Theirs	Number of Plates Removed	Number of Sinkholes Addressed	Sewer Lines cctv'd in ft.	Sewer Lines Cleaned in ft.
January	9	0	12	3	9	0	0	0	0
February	2	1	15	2	13	0	0	0	0
March	13	16	21	2	19	2	1	0	0
April	9	15	18	0	18	0	2	3,324	3,324
May	12	13	11	1	10	3	1	420	420
June	10	17	10	3	7	1	7	1,046	1,046
July	64	13	19	1	18	0	4	795	795
August									
September									
October									
November									
December									
<b>TOTAL FOR THE YEAR</b>	<b>119</b>	<b>75</b>	<b>106</b>	<b>12</b>	<b>94</b>	<b>6</b>	<b>15</b>	<b>5,585</b>	<b>5,585</b>



# CAPITAL REGION WATER ADVANCED WASTEWATER TREATMENT FACILITY

## SPRING CREEK PUMP STATION CHECKLIST

DATE	TIME	OPERATOR(S)	WET WELL	BAR	PUMP 1	PUMP 2	PUMP 3	COMMENTS
	IN/OUT	INITIAL(S)	LEVEL	INSPECTION	STATUS	STANDBY	STANDBY	
				VISUAL		RUN/STANDBY	RUN/STANDBY	
7-25-15	5:55-6:00	BB/KE	3.5	OK	new/old	S	OFF	R
7-25-15	6:05-6:50	BB/KE	3.5	OK	new/old	S	OFF	R
7-26-15	6:55-7:40	BB/KE	3.5	OK	new/old	S	OFF	R
7-26-15	11:50	BB/KE	3.5	OK	new/old	S	OFF	R
7-28-15	10:30-11:15	BB/KE	3.5	OK	new/old	S	OFF	R
7-28-15	11:40	BB/KE	3.5	OK	new/old	S	OFF	R
7-29-15	5:29-5:30	BB/KE	3.5	OK	new/old	S	OFF	R
7-29-15	5:40-5:41	BB/KE	3.5	OK	new/old	S	OFF	R
7-30-15	6:05-6:06	BB/KE	3.5	OK	new/old	S	OFF	R
7-31-15	6:30-6:31	BB/KE	3.5	OK	new/old	S	OFF	R
7-31-15	6:41-6:42	BB/KE	3.5	OK	new/old	S	OFF	R
7-31-15	6:53-6:54	BB/KE	3.5	OK	new/old	S	OFF	R
7-31-15	7:03-7:04	BB/KE	3.5	OK	new/old	S	OFF	R
7-31-15	7:13-7:14	BB/KE	3.5	OK	new/old	S	OFF	R
7-31-15	7:23-7:24	BB/KE	3.5	OK	new/old	S	OFF	R
7-31-15	7:33-7:34	BB/KE	3.5	OK	new/old	S	OFF	R
7-31-15	7:43-7:44	BB/KE	3.5	OK	new/old	S	OFF	R
7-31-15	7:53-7:54	BB/KE	3.5	OK	new/old	S	OFF	R
7-31-15	8:03-8:04	BB/KE	3.5	OK	new/old	S	OFF	R
7-31-15	8:13-8:14	BB/KE	3.5	OK	new/old	S	OFF	R
7-31-15	8:23-8:24	BB/KE	3.5	OK	new/old	S	OFF	R
7-31-15	8:33-8:34	BB/KE	3.5	OK	new/old	S	OFF	R
7-31-15	8:43-8:44	BB/KE	3.5	OK	new/old	S	OFF	R
7-31-15	8:53-8:54	BB/KE	3.5	OK	new/old	S	OFF	R
7-31-15	9:03-9:04	BB/KE	3.5	OK	new/old	S	OFF	R
7-31-15	9:13-9:14	BB/KE	3.5	OK	new/old	S	OFF	R
7-31-15	9:23-9:24	BB/KE	3.5	OK	new/old	S	OFF	R
7-31-15	9:33-9:34	BB/KE	3.5	OK	new/old	S	OFF	R
7-31-15	9:43-9:44	BB/KE	3.5	OK	new/old	S	OFF	R
7-31-15	9:53-9:54	BB/KE	3.5	OK	new/old	S	OFF	R
7-31-15	10:03-10:04	BB/KE	3.5	OK	new/old	S	OFF	R
7-31-15	10:13-10:14	BB/KE	3.5	OK	new/old	S	OFF	R
7-31-15	10:23-10:24	BB/KE	3.5	OK	new/old	S	OFF	R
7-31-15	10:33-10:34	BB/KE	3.5	OK	new/old	S	OFF	R
7-31-15	10:43-10:44	BB/KE	3.5	OK	new/old	S	OFF	R
7-31-15	10:53-10:54	BB/KE	3.5	OK	new/old	S	OFF	R
7-31-15	11:03-11:04	BB/KE	3.5	OK	new/old	S	OFF	R
7-31-15	11:13-11:14	BB/KE	3.5	OK	new/old	S	OFF	R
7-31-15	11:23-11:24	BB/KE	3.5	OK	new/old	S	OFF	R
7-31-15	11:33-11:34	BB/KE	3.5	OK	new/old	S	OFF	R
7-31-15	11:43-11:44	BB/KE	3.5	OK	new/old	S	OFF	R
7-31-15	11:53-11:54	BB/KE	3.5	OK	new/old	S	OFF	R
7-31-15	12:03-12:04	BB/KE	3.5	OK	new/old	S	OFF	R
7-31-15	12:13-12:14	BB/KE	3.5	OK	new/old	S	OFF	R
7-31-15	12:23-12:24	BB/KE	3.5	OK	new/old	S	OFF	R
7-31-15	12:33-12:34	BB/KE	3.5	OK	new/old	S	OFF	R
7-31-15	12:43-12:44	BB/KE	3.5	OK	new/old	S	OFF	R
7-31-15	12:53-12:54	BB/KE	3.5	OK	new/old	S	OFF	R

Switched Manual

**CAPITAL REGION WATER  
ADVANCED WASTEWATER TREATMENT FACILITY  
CITY ISLAND PUMP STATION CHECKLIST**

DATE	TIME	OPERATOR(S)	WET WELL LEVEL	WET WELL INSPECTION		PUMP 1 RUN/STANDBY	PUMP 2 RUN/STANDBY	JOG PUMPS	COMMENTS
				VISUAL	INSPECTION				
6-17-15	SSS - 6:00pm	LK, JG	3.1	OK	OK	Auto	Auto	✓	
6-18-15	AM	LK, JG	3.6	OK	OK	Auto	Auto	✓	
6-19-15	06:00/11:00am	BG, KF	3.4	OK	OK	Auto	Auto	✓	
6-20-15	05:00/10:00am	BG, KF	3.4	OK	OK	Auto	Auto	✓	
6-21-15	12:00-12:18P	JG - JG	3.4	OK	OK	Auto	Auto	✓	
6-22-15	10:50	CS, LK	1.9/1.1	CS	CS	Auto	Auto	✓	(10min) Pump 2 Runs off of Pump 1
6-23-15	11:30 am	BG, BG	2.8	BG	BG	Auto	Auto	✓	3.5 - 3.0 GPC
6-24-15	11:40 am	LK, KF	1.8	OK	OK	Auto	Auto	✓	
6-25-15	5:40 pm	Re - LK	2.8	OK	OK	Auto	Auto	✓	3.0 - 2.5
6-26-15	11:00	CS, LK	3.3/2.8	OK	OK	Auto	Auto	✓	10min
6-27-15	11:05-11:15	BG, BG	1.9	BG	BG	Auto	Auto	✓	1.8 - 1.5
6-28-15	9:45 - 9:50	SM, KF	2.2	OK	OK	Auto	Auto	✓	2.3 - 2.7
7-1-15	10:27 - 11:20	BG, LK	1.7	OK	OK	Auto	Auto	✓	1.7 to 1.5
7-2-15	10:10 am	BG, KF	3.2	OK	OK	Auto	Auto	✓	3.2 to 3.8
7-3-15	11:21 am	LK, KF	1.7/1.0	OK	OK	Auto	Auto	✓	1.7 to 1.2
7-4-15	11:31/11:33	CS, KF	2.3	OK	OK	Auto	Auto	✓	2.3 to 2.1
7-4-15	12:35 pm	BG, KF	3.3	OK	OK	Auto	Auto	✓	3.3 to 3.7
7-6-15	11:30 am	Re, BG	3.5	OK	OK	Auto	Auto	✓	3.5 to 3.8
7-6-15	11:35 am	Re, BG	3.4	OK	OK	Auto	Auto	✓	3.4 to 1.8
7-7-15	11:45	BG, KF	3.1	OK	OK	Auto	Auto	✓	
7-14-15	11:15/11:25	BG, KF	3.8	OK	OK	Auto	Auto	✓	3.8 to 3.6
7-14-15	9:12 - 9:25	Re, KF	2.9	OK	OK	Auto	Auto	✓	1.9 to 1.5
7-14-15	1:05 - 1:12	Re, KF	2.5	OK	OK	Auto	Auto	✓	
7-11-15	03:35 - 10:41 P	OK, Re	2.9	OK	OK	Auto	Auto	✓	2.9 - 2.6
7-11-15	11:00	CS, KF	2.4	OK	OK	Auto	Auto	✓	2.4 - 2.0
7-11-15	11:31 - 11:37	LK, BG	3.0	OK	OK	Auto	Auto	✓	3.0 - 2.0
7-11-15	12:35	LK, BG	3.0	OK	OK	Auto	Auto	✓	2.2 - 2.0
7-11-15	12:35	LK, BG	3.0	OK	OK	Auto	Auto	✓	
7-11-15	11:00 am / 1:30 pm	OK, JG	3.2	OK	OK	Auto	Auto	✓	3.2 - 2.0

cont

## AWTF PREVENTIVE MAINTENANCE CHART Weekly Inspection 2013

LOCATIONS	LUBE TYPE	WK1	WK2	WK3	WK4	WK5	WK6	WK7	WK8	WK9	WK10	WK11	WK12
FRONT ST. PUMP STATION		4-Jan	8-Jan	15-Jan	22-Jan	29-Jan	6-Feb	12-Feb	19-Feb	26-Feb	6-Mar	12-Mar	21-Mar
<b>BAR SCREEN #1</b>													
Grease Fittings	EP-2	DS/JZ	JN/JZ	JG/MF	JG/MF	AA/JG	DS/JZ	JN/JZ	JN/JZ	MF/JZ	AA/JN	AA/JZ	JZ/MF
Drive Chain	C&C	DS/JZ	JN/JZ	JG/MF	JG/MF	AA/JG	DS/JZ	JN/JZ	JN/JZ	MF/JZ	AA/JN	AA/JZ	JZ/MF
<b>BAR SCREEN #2</b>													
Grease Fittings	EP-2	DS/JZ	JN/JZ	JG/MF	JG/MF	AA/JG	DS/JZ	JN/JZ	JN/JZ	MF/JZ	AA/JN	AA/JZ	JZ/MF
Drive Chain	C&C	DS/JZ	JN/JZ	JG/MF	JG/MF	AA/JG	DS/JZ	JN/JZ	JN/JZ	MF/JZ	AA/JN	AA/JZ	JZ/MF
<b>BELT CONVEYOR</b>													
Grease Fittings	EP-2	DS/JZ	JN/JZ	JG/MF	JG/MF	AA/JG	DS/JZ	JN/JZ	JN/JZ	MF/JZ	AA/JN	AA/JZ	JZ/MF
Drive Chain	C&C	DS/JZ	JN/JZ	JG/MF	JG/MF	AA/JG	DS/JZ	JN/JZ	JN/JZ	MF/JZ	AA/JN	AA/JZ	JZ/MF
<b>SPRING CREEK PUMP STATION</b>													
<b>BAR SCREEN</b>													
Grease Fittings	EP-2	DS/JZ	JN/JZ	JG/MF	JG/MF	AA/JG	DS/JZ	JN/JZ	JN/JZ	MF/JZ	AA/JN	AA/JZ	JZ/MF
Drive Chain	C&C	DS/JZ	JN/JZ	JG/MF	JG/MF	AA/JG	DS/JZ	JN/JZ	JN/JZ	MF/JZ	AA/JN	AA/JZ	JZ/MF
<b>DORR-OLIVER GRIT CLASSIFIER</b>													
Grease Fittings	EP-2	DS/JZ	JN/JZ	JG/MF	JG/MF	AA/JG	DS/JZ	JN/JZ	JN/JZ	MF/JZ	AA/JN	AA/JZ	JZ/MF
Drive Chain	C&C	DS/JZ	JN/JZ	JG/MF	JG/MF	AA/JG	DS/JZ	JN/JZ	JN/JZ	MF/JZ	AA/JN	AA/JZ	JZ/MF

# AWTF PREVENTIVE MAINTENANCE CHART

## Weekly Inspection

### 2013

LOCATIONS	LUBE TYPE	WK13	WK14	WK15	WK16	WK17	WK18	WK19	WK20	WK21	WK22	WK23	WK24
		26-Mar	2-Apr	12-Apr	17-Apr	23-Apr	30-Apr	7-May	14-May	24-May	31-May	6-Jun	12-Jun
<b>FRONT ST. PUMP STATION</b>													
<b>BAR SCREEN #1</b>													
Grease Fittings	EP-2	MF/JZ	MF/JZ	MF/AA	MF/JZ	MF/JZ	JG/JZ	JG/MF	MF/JZ	JG/AA	JG/AA	MF/JZ	MF/JZ
Drive Chain	C&C	MF/JZ	MF/JZ	MF/AA	MF/JZ	MF/JZ	JG/JZ	JG/MF	MF/JZ	JG/AA	JG/AA	MF/JZ	MF/JZ
<b>BAR SCREEN #2</b>													
Grease Fittings	EP-2	MF/JZ	MF/JZ	MF/AA	MF/JZ	MF/JZ	JG/JZ	JG/MF	MF/JZ	JG/AA	JG/AA	MF/JZ	MF/JZ
Drive Chain	C&C												
<b>BELT CONVEYOR</b>													
Grease Fittings	EP-2	MF/JZ	MF/JZ	MF/AA	MF/JZ	MF/JZ	JG/JZ	JG/MF	MF/JZ	JG/AA	JG/AA	MF/JZ	MF/JZ
Drive Chain	C&C	MF/JZ	MF/JZ	MF/AA	MF/JZ	MF/JZ	JG/JZ	JG/MF	MF/JZ	JG/AA	JG/AA	MF/JZ	MF/JZ
<b>SPRING CREEK PUMP STATION</b>													
<b>BAR SCREEN</b>													
Grease Fittings	EP-2	MF/JZ	MF/JZ	MF/AA	MF/JZ	MF/JZ	JG/JZ	JG/MF	MF/JZ	JG/AA	JG/AA	MF/JZ	MF/JZ
Drive Chain	C&C	MF/JZ	MF/JZ	MF/AA	MF/JZ	MF/JZ	JG/JZ	JG/MF	MF/JZ	JG/AA	JG/AA	MF/JZ	MF/JZ
<b>DORR-OLIVER GRIT CLASSIFIER</b>													
Grease Fittings	EP-2	MF/JZ	MF/JZ	MF/AA	MF/JZ	MF/JZ	JG/JZ	JG/MF	MF/JZ	JG/AA	JG/AA	MF/JZ	MF/JZ
Drive Chain	C&C	MF/JZ	MF/JZ	MF/AA	MF/JZ	MF/JZ	JG/JZ	JG/MF	MF/JZ	JG/AA	JG/AA	MF/JZ	MF/JZ

# AWTF PREVENTIVE MAINTENANCE CHART

## Weekly Inspection

### 2013

LOCATIONS	LUBE TYPE	WK25	WK26	WK27	WK28	WK29	WK30	WK31	WK32	WK33	WK34	WK35	WK36
		14-Jun	27-Jun	3-Jul	11-Jul	18-Jul	23-Jul	31-Jul	6-Aug	13-Aug	29-Aug	3-Sep	10-Sep
<b>FRONT ST. PUMP STATION</b>													
<b>BAR SCREEN #1</b>													
Grease Fittings	EP-2	RR/JZ	AA/JN	AA/JN	JN/JZ	JN/MF	JN/JZ	JN/JZ	JN/MF	MF/JZ	MF/JZ	MF/JZ	MF/JN
Drive Chain	C&C	RR/JZ	AA/JN	AA/JN	JN/JZ	JN/MF	JN/JZ	JN/JZ	JN/MF	MF/JZ	MF/JZ	MF/JZ	MF/JN
<b>BAR SCREEN #2</b>													
Grease Fittings	EP-2	RR/JZ	AA/JN	AA/JN	JN/JZ	JN/MF	JN/JZ	JN/JZ	JN/MF	MF/JZ	MF/JZ	MF/JZ	MF/JN
Drive Chain	C&C	RR/JZ	AA/JN	AA/JN	JN/JZ	JN/MF	JN/JZ	JN/JZ	JN/MF	MF/JZ	MF/JZ	MF/JZ	MF/JN
<b>BELT CONVEYOR</b>													
Grease Fittings	EP-2	RR/JZ	AA/JN	AA/JN	JN/JZ	JN/MF	JN/JZ	JN/JZ	JN/MF	MF/JZ	MF/JZ	MF/JZ	MF/JN
Drive Chain	C&C	RR/JZ	AA/JN	AA/JN	JN/JZ	JN/MF	JN/JZ	JN/JZ	JN/MF	MF/JZ	MF/JZ	MF/JZ	MF/JN
<b>SPRING CREEK PUMP STATION</b>													
<b>BAR SCREEN</b>													
Grease Fittings	EP-2	RR/JZ	AA/JN	AA/JN	JN/JZ	JN/MF	JN/JZ	JN/JZ	JN/MF	MF/JZ	MF/JZ	MF/JZ	MF/JN
Drive Chain	C&C	RR/JZ	AA/JN	AA/JN	JN/JZ	JN/MF	JN/JZ	JN/JZ	JN/MF	MF/JZ	MF/JZ	MF/JZ	MF/JN
<b>DORR-OLIVER GRIT CLASSIFIER</b>													
Grease Fittings	EP-2	RR/JZ	AA/JN	AA/JN	JN/JZ	JN/MF	JN/JZ	JN/JZ	JN	MF/JZ	MF/JZ	MF/JZ	MF/JN
Drive Chain	C&C	RR/JZ	AA/JN	AA/JN	JN/JZ	JN/MF	JN/JZ	JN/JZ	MF	MF/JZ	MF/JZ	MF/JZ	MF/JN

# AWTF PREVENTIVE MAINTENANCE CHART

## Weekly Inspection

### 2013

LOCATIONS	LUBE TYPE	WK37	WK38	WK39	WK40	WK41	WK42	WK43	WK44	WK45	WK46	WK47	WK48
		18-Sep	24-Sep	1-Oct	8-Oct	16-Oct	24-Oct	31-Oct	6-Nov	14-Nov	21-Nov	5-Dec	12-Dec
<b>FRONT ST. PUMP STATION</b>													
<b>BAR SCREEN #1</b>													
Grease Fittings	EP-2	MF/JZ	MF/JZ	MF/JZ	MF/JZ	MF/JZ	MF/JN	MF/JZ	MF/JN	MF/JN	MF/JN	MF/JN	MF
Drive Chain	C&C	MF/JZ	MF/JZ	MF/JZ	MF/JZ	MF/JZ	MF/JN	MF/JZ	MF/JN	MF/JN	MF/JN	MF/JN	MF
<b>BAR SCREEN #2</b>													
Grease Fittings	EP-2	MF/JZ	MF/JZ	MF/JZ	MF/JZ	MF/JZ	MF/JN	MF/JZ	MF/JN	MF/JN	MF/JN	MF/JN	MF
Drive Chain	C&C	MF/JZ	MF/JZ	MF/JZ	MF/JZ	MF/JZ	MF/JN	MF/JZ	MF/JN	MF/JN	MF/JN	MF/JN	MF
<b>BELT CONVEYOR</b>													
Grease Fittings	EP-2	MF/JZ	MF/JZ	MF/JZ	MF/JZ	MF/JZ	MF/JN	MF/JZ	MF/JN	MF/JN	MF/JN	MF/JN	MF
Drive Chain	C&C	MF/JZ	MF/JZ	MF/JZ	MF/JZ	MF/JZ	MF/JN	MF/JZ	MF/JN	MF/JN	MF/JN	MF/JN	MF
<b>SPRING CREEK PUMP STATION</b>													
<b>BAR SCREEN</b>													
Grease Fittings	EP-2	MF/JZ	MF/JZ	MF/JN	MF/JN	MF/JN	MF/JN	MF/JZ	MF/JN	MF/JN	MF/JN	MF/JN	MF
Drive Chain	C&C	MF/JZ	MF/JZ	MF/JN	MF/JN	MF/JN	MF/JN	MF/JZ	MF/JN	MF/JN	MF/JN	MF/JN	MF
<b>DORR-OLIVER GRIT CLASSIFIER</b>													
Grease Fittings	EP-2	MF/JZ	MF/JZ	MF/JN	MF/JN	MF/JN	MF/JN	MF/JZ	MF/JN	MF/JN	MF/JN	MF/JN	MF
Drive Chain	C&C	MF/JZ	MF/JZ	MF/JN	MF/JN	MF/JN	MF/JN	MF/JZ	MF/JN	MF/JN	MF/JN	MF/JN	MF





# AWTF PREVENTIVE MAINTENANCE CHART

## Monthly Inspection

### 2013

LOCATIONS	LUBE TYPE	JAN	FEB	MAR	APR	MAY	JUN	JUL	AUG	SEP	OCT	NOV	DEC
<b>FINAL SETTLING TANKS</b>		15-Jan	26-Feb	22-Mar	22-Apr	29-May	26-Jun	23-Jul	29-Aug	17-Sep	6-Nov	5-Dec	23-Dec
<b>CORNER SWEEPS TANK #1</b>													
Grease Fittings	EP-2	JG/MF	MF/JZ	MF/JZ	MF/JZ	JN/JZ	JN/MF	MF/JZ	MF	MF	MF	JN/MF	MF/MS
<b>CORNER SWEEPS TANK #2</b>													
Grease Fittings	EP-2	JG/MF	MF/JZ	MF/JZ	MF/JZ	JN/JZ	JN/MF	MF/JZ	MF	MF	MF	JN/MF	MF/MS
<b>CORNER SWEEPS TANK #3</b>													
Grease Fittings	EP-2	JG/MF	MF/JZ	MF/JZ	MF/JZ	JN/JZ	JN/MF	MF/JZ	MF	MF	MF	JN/MF	MF/MS
<b>CORNER SWEEPS TANK #4</b>													
Grease Fittings	EP-2	JG/MF	MF/JZ	MF/JZ	MF/JZ	JN/JZ	JN/MF	MF/JZ	MF	MF	MF	JN/MF	MF/MS
<b>CORNER SWEEPS TANK #5</b>													
Grease Fittings	EP-2	JG/MF	MF/JZ	MF/JZ	MF/JZ	JN/JZ	JN/MF	MF/JZ	MF	MF	MF	JN/MF	MF/MS
<b>CORNER SWEEPS TANK #6</b>													
Grease Fittings	EP-2	JG/MF	MF/JZ	MF/JZ	MF/JZ	JN/JZ	JN/MF	MF/JZ	MF	MF	MF	JN/MF	MF/MS
<b>UNOX DEZURIK VALVES</b>		15-Jan	26-Feb	22-Mar	22-Apr	24-May	26-Jun	23-Jul	29-Aug	17-Sep	1-Oct	6-Nov	5-Dec
B111A	EP-2	JG/MF	MF/JZ	MF/JZ	MF/JZ	JN/AA	JN/MF	MF/JZ	MF/JZ	MF/JZ	JN/MF	JN/MF	JN/MF
B112A	EP-2	JG/MF	MF/JZ	MF/JZ	MF/JZ	JN/AA	JN/MF	MF/JZ	MF/JZ	MF/JZ	JN/MF	JN/MF	JN/MF
B113A	EP-2	JG/MF	MF/JZ	MF/JZ	MF/JZ	JN/AA	JN/MF	MF/JZ	MF/JZ	MF/JZ	JN/MF	JN/MF	JN/MF
B114A	EP-2	JG/MF	MF/JZ	MF/JZ	MF/JZ	JN/AA	JN/MF	MF/JZ	MF/JZ	MF/JZ	JN/MF	JN/MF	JN/MF
<b>OXYGENATION TANKS</b>		15-Jan	26-Feb	22-Mar	22-Apr	29-May	26-Jun	23-Jul	29-Aug	17-Sep	31-Oct	5-Dec	17-Jan
<b>OXYGENATION MIXER #1</b>													
Grease fittings	EP-2	JG/MF	MF/JZ	MF/JZ	MF/JZ	JN/JZ	JN/MF	MF/JZ	MF	MF	MF	JN/MF	JN/MF
<b>OXYGENATION MIXER #2</b>													
Grease fittings	EP-2	JG/MF	MF/JZ	MF/JZ	MF/JZ	JN/JZ	JN/MF	MF/JZ	MF	MF	MF	JN/MF	JN/MF
<b>OXYGENATION MIXER #3</b>													
Grease fittings	EP-2	JG/MF	MF/JZ	MF/JZ	MF/JZ	JN/JZ	JN/MF	MF/JZ	MF	MF	MF	JN/MF	JN/MF
<b>OXYGENATION MIXER #4</b>													
Grease fittings	EP-2	JG/MF	MF/JZ	MF/JZ	MF/JZ	JN/JZ	JN/MF	MF/JZ	MF	MF	MF	JN/MF	JN/MF
<b>OXYGENATION MIXER #5</b>													
Grease fittings	EP-2	JG/MF	MF/JZ	MF/JZ	MF/JZ	JN/JZ	JN/MF	MF/JZ	MF	MF	MF	JN/MF	JN/MF
<b>OXYGENATION MIXER #6</b>													
Grease fittings	EP-2	JG/MF	MF/JZ	MF/JZ	MF/JZ	JN/JZ	JN/MF	MF/JZ	MF	MF	MF	JN/MF	JN/MF
<b>OXYGENATION MIXER #7</b>													
Grease fittings	EP-2	JG/MF	MF/JZ	MF/JZ	MF/JZ	JN/JZ	JN/MF	MF/JZ	MF	MF	MF	JN/MF	JN/MF
<b>OXYGENATION MIXER #8</b>													
Grease fittings	EP-2	JG/MF	MF/JZ	MF/JZ	MF/JZ	JN/JZ	JN/MF	MF/JZ	MF	MF	MF	JN/MF	JN/MF
<b>OXYGENATION MIXER #9</b>													
Grease fittings	EP-2	JG/MF	MF/JZ	MF/JZ	MF/JZ	JN/JZ	JN/MF	MF/JZ	MF	MF	MF	JN/MF	JN/MF
<b>OXYGENATION MIXER #10</b>													
Grease fittings	EP-2	JG/MF	MF/JZ	MF/JZ	MF/JZ	JN/JZ	JN/MF	MF/JZ	MF	MF	MF	JN/MF	JN/MF
<b>OXYGENATION MIXER #11</b>													
Grease fittings	EP-2	JG/MF	MF/JZ	MF/JZ	MF/JZ	JN/JZ	JN/MF	MF/JZ	MF	MF	MF	JN/MF	JN/MF
<b>OXYGENATION MIXER #12</b>													
Grease fittings	EP-2	JG/MF	MF/JZ	MF/JZ	MF/JZ	JN/JZ	JN/MF	MF/JZ	MF	MF	MF	JN/MF	JN/MF

LOCATIONS	LUBE TYPE	JAN	FEB	MAR	APR	MAY	JUN	JUL	AUG	SEP	OCT	NOV	DEC
<b>SETTLED SEWAGE PUMP STATIC</b>		15-Jan	26-Feb	22-Mar	22-Apr	29-May	26-Jun	23-Jul	9-Aug	23-Aug	20-Sep	16-Nov	15-Dec
HOFFMAN BLOWER #1													
Blower brgs	EP-2	JG/MF	MF/JZ	MF/JZ	MF/JZ	JN/JZ	JN/MF	MF/JZ	JN/JZ	AA/JZ	MF/JZ	MF/JN	MF/JN
HOFFMAN BLOWER #2													
Blower brgs	EP-2	JG/MF	MF/JZ	MF/JZ	MF/JZ	JN/JZ	JN/MF	MF/JZ	JN/JZ	AA/JZ	MF/JZ	MF/JN	MF/JN
<b>PISTA GRIT BUILDING</b>		15-Jan	26-Feb	22-Mar	22-Apr	29-May	26-Jun	23-Jul	9-Aug	23-Aug	20-Sep	16-Nov	
BLOWER													
Blower Grease Fittings	EP-2	JG/MF	MF/JZ	MF/JZ	MF/JZ	JN/JZ	JN/MF	MF/JZ	MF/JN	MF/JZ	MF/JZ	MF/JN	O/S
<b>CONTROL BUILDING</b>		15-Jan	26-Feb	22-Mar	22-Apr	29-May	26-Jun	23-Jul	9-Aug	23-Aug	20-Sep	6-Nov	23-Dec
<b>ROOTS BLOWER</b>													
Blower Grease Fitting	EP-2	JG/MF	MF/JZ	MF/JZ	MF/JZ	JN/JZ	JN/MF	MF/JZ	JN/MF	MF/JZ	O/S	O/S	MF/MS
Precision Vacuum Pump													
Pump Oil Res	20C	JG/MF	MF/JZ	MF/JZ	MF/JZ	JN/JZ	JN/MF	MF/JZ	JN/MF	MF/JZ	O/S	O/S	MF/MS
<b>CITY ISLAND PUMP STATION # 1</b>													
SEWAGE PUMP # 1													
Air Release Valve	EP-2	JG/MF	MF/JZ	MF/JZ	MF/JZ	JN/JZ	JN/MF	MF/JZ	JN/MF	MF/JZ	JN/MF	MF/JN	MF/MS
SEWAGE PUMP # 2													
Air Release Valve	EP-2	JG/MF	MF/JZ	MF/JZ	MF/JZ	JN/JZ	JN/MF	MF/JZ	JN/MF	MF/JZ	JN/MF	MF/JN	MF/MS
<b>CITY ISLAND PUMP STATION # 2</b>													
SEWAGE PUMP # 1													
Air Release Valve	EP-2	JG/MF	MF/JZ	MF/JZ	MF/JZ	JN/JZ	JN/MF	MF/JZ	JN/MF	MF/JZ	JN/MF	MF/JN	MF/MS
SEWAGE PUMP # 2													
Air Release Valve	EP-2	JG/MF	MF/JZ	MF/JZ	MF/JZ	JN/JZ	JN/MF	MF/JZ	JN/MF	MF/JZ	JN/MF	MF/JN	MF/MS
Water Pump #4													
<b>CONVEYOR BELT</b>		15-Jan	26-Feb	22-Mar	22-Apr	29-May	26-Jun	23-Jul	9-Aug	23-Aug	20-Sep	6-Nov	15-Jan
Drive Chain	C&C	JG/MF	MF/JZ	MF/JZ	MF/JZ	JN/JZ	JN/MF	MF/JZ	MF/JN	MF/JZ	MF/JN	MF/JN	MF/MS

## AWTF PREVENTIVE MAINTENANCE CHART

### 3 Months Inspection

### 2013

LOCATIONS	LUBE TYPE	JAN	FEB	MAR	APR	MAY	JUN	JUL	AUG	SEP	OCT	NOV	DEC
<b>BELT FILTER PRESS BUILDING</b>				15-Mar			15-Jun			27-Sep			14-Jan
<b>BELT FILTER PRESS #1</b>													
Hyd. Filter Screen				MF/JN			JN/MF			MF/JN			MF/BG
Roller Brgs				MF/JN			JN/MF			MF/JN			MF/BG
<b>BELT FILTER PRESS #2</b>													
Hyd. Filter Screen				MF/JN			JN/MF			MF/JN			MF/BG
Roller Brgs				MF/JN			JN/MF			MF/JN			MF/BG
<b>CONVEYOR</b>													
Motor Brgs				MF/JN			JN/MF			MF/JN			MF/BG
Gear Red				MF/JN			JN/MF			MF/JN			MF/BG
Drive Brgs				MF/JN			JN/MF			MF/JN			MF/BG
Tension Brgs				MF/JN			JN/MF			MF/JN			MF/BG
<b>PIPE GALLERY</b>				1-Mar						27-Sep			6-Dec
<b>WASTE SLUDGE PUMP #1</b>													
Pump brg				MF/JZ			DS/JW			MF/JN			MF/JN
<b>WASTE SLUDGE PUMP #2</b>													
Pump brg				MF/JZ			DS/JW			MF/JN			MF/JN
<b>GRIT REMOVAL SYSTEM</b>				1-Mar			26-Jun			Sep-14	1-Oct		
<b>GRIT TANK #1</b>													
Motor Brgs				MF/JZ			JN/MF				JN/MF		
<b>GRIT TANK #2</b>													
Motor Brgs				MF/JZ			JN/MF				JN/MF		
<b>GRIT TANK #3</b>													
Motor Brgs				MF/JZ			JN/MF				JN/MF		
<b>GRIT TANK #4</b>													
Motor Brgs				MF/JZ			JN/MF				JN/MF		
<b>CLASSIFIER #1</b>													
Motor Brgs				MF/JZ			JN/MF				JN/MF		
<b>CLASSIFIER # 2</b>													
Motor Brgs				MF/JZ			JN/MF				JN/MF		
<b>RETURN SLUDGE PUMP STATION</b>				1-Mar			5-Jun			27-Sep			Dec-14
<b>RETURN SLUDGE PUMP #1</b>													
Pump brg				MF/JZ			MF/JZ			MF/JN			MF/JN
<b>RETURN SLUDGE PUMP #2</b>													
Pump brg				MF/JZ			MF/JZ			MF/JN			MF/JN
<b>RETURN SLUDGE PUMP #3</b>													
Pump brg				MF/JZ			MF/JZ			MF/JN			MF/JN
<b>RETURN SLUDGE PUMP #4</b>													
Pump brg				MF/JZ			MF/JZ			MF/JN			MF/JN

LOCATIONS	LUBE TYPE	JAN	FEB	MAR	APR	MAY	JUN	JUL	AUG	SEP	OCT	NOV	DEC
<b>SETTLED SEWAGE PUMP STATION</b>				28-Mar			26-Jun				1-Oct		
<b>DILUENT PUMP #1</b>													
Pump fittings				MF/JZ			JN/MF				JN/MF		
<b>DILUENT PUMP #2</b>													
Pump fittings				MF/JZ			JN/MF				JN/MF		
<b>EFFLUENT PUMP #1</b>													
Pump brg				MF/JZ			JN/MF				JN/MF		
<b>EFFLUENT PUMP #2</b>													
Pump brgs				MF/JZ			JN/MF				JN/MF		
<b>EFFLUENT PUMP #3</b>													
Pump brg				MF/JZ			JN/MF				JN/MF		
<b>SEWAGE PUMP #1</b>													
Motor brgs				MF/JZ			JN/MF				JN/MF		
Pump brgs				MF/JZ			JN/MF				JN/MF		
<b>SEWAGE PUMP #2</b>													
Motor brgs				MF/JZ			JN/MF				JN/MF		
Pump brgs				MF/JZ			JN/MF				JN/MF		
<b>SEWAGE PUMP #3</b>													
Motor brgs				MF/JZ			JN/MF				JN/MF		
Pump brgs				MF/JZ			JN/MF				JN/MF		
<b>SEWAGE PUMP #4</b>													
Motor brgs				MF/JZ			JN/MF				JN/MF		
Pump brgs				MF/JZ			JN/MF				JN/MF		
<b>BOILER BUILDING</b>				28-Mar			26-Jun				1-Oct		12-Dec
<b>HOT WATER CIRC. PUMP #9</b>													
Pump brgs				MF/JZ			JN/MF				JN/MF		MF
<b>HOT WATER CIRC. PUMP #10</b>													
Pump brgs				MF/JZ			JN/MF				JN/MF		MF
<b>FRONT ST. PUMP STATION</b>				28-Mar			5-Jun				24-Sep		
<b>RAW SEWAGE PUMP #1</b>													
Pump Brgs				JZ/MF			JZ/MF				JZ/MF		
Rotovale Fittings				JZ/MF			JZ/MF				JZ/MF		
<b>RAW SEWAGE PUMP #2</b>													
Pump Brgs				JZ/MF			JZ/MF				JZ/MF		
Rotovale Fittings				JZ/MF			JZ/MF				JZ/MF		
<b>RAW SEWAGE PUMP #3</b>													
Pump Brgs				JZ/MF			JZ/MF				JZ/MF		
Rotovale Fittings				JZ/MF			JZ/MF				JZ/MF		
<b>RAW SEWAGE PUMP #4</b>													
Pump Brgs				JZ/MF			JZ/MF				JZ/MF		
Rotovale Fittings				JZ/MF			JZ/MF				JZ/MF		

LOCATIONS	LUBE TYPE	JAN	FEB	MAR	APR	MAY	JUN	JUL	AUG	SEP	OCT	NOV	DEC
<b>SPRING CREEK PUMP STATION</b>				28-Mar			26-Jun			24-Sep			13-Dec
RAW SEWAGE PUMP #1													
Pump Brgs				JZ/MF			JZ/MF			JZ/MF			JZ/MF
Drive Shaft				JZ/MF			JZ/MF			JZ/MF			JZ/MF
RAW SEWAGE PUMP #2													
Pump Brgs				JZ/MF			JZ/MF			JZ/MF			JZ/MF
Drive Shaft				JZ/MF			JZ/MF			JZ/MF			JZ/MF
RAW SEWAGE PUMP #3													
Pump Brgs				JZ/MF			JZ/MF			JZ/MF			JZ/MF
Drive Shaft				JZ/MF			JZ/MF			JZ/MF			JZ/MF
SEAL WATER PUMP													
Pump Brgs				JZ/MF			JZ/MF			JZ/MF			JZ/MF
<b>MAIN BUILDING BASEMENT</b>				21-Mar			26-Jun				1-Oct	6-Nov	
MARLOW SLUDGE PUMPS													
Marlow Sludge Pump #1													
Drive Motor Brgs				MF/JZ			MF/JN			MF/JN		MF	
Marlow Sludge Pump #2													
Drive Motor Brgs				MF/JZ			MF/JN			MF/JN		MF	
Marlow Sludge Pump #3													
Drive Motor Brgs				MF/JZ			MF/JN			MF/JN		MF	
BELT PRESS WATER PUMPS													
Drive Motor Brgs				MF/JZ			MF/JN			MF/JN		MF	
PRECISION VACUUM PUMP													
Pump Oil Res				MF/JZ			MF/JN			MF/JN		MF	
<b>CO-GENERATION BUILDING</b>				29-Mar			20-Jun				1-Oct		
MEZZANINE													
TACO CIRCULATING PUMPS													
PUMP #1 7.5HP													
Pump Brgs				MF/JZ			MF/JN			MF/JN			
PUMP #2 7.5HP													
Pump Brgs				MF/JZ			MF/JN			MF/JN			
<b>MARKET STREET PUMP STATION</b>				29-Mar			5-Jun			26-Sep			6-Dec
SEWAGE PUMP #1													
Drive Shaft Fittings				JZ/MF			JZ/MF			JZ/MF			MF/JN
Pump Brgs				JZ/MF			JZ/MF			JZ/MF			MF/JN
SEWAGE PUMP #2													
Drive Shaft Fittings				JZ/MF			JZ/MF			JZ/MF			MF/JN
Pump Brgs				JZ/MF			JZ/MF			JZ/MF			MF/JN
SEWAGE PUMP #3													
Drive Shaft Fittings				JZ/MF			JZ/MF			JZ/MF			MF/JN
Pump Brgs				JZ/MF			JZ/MF			JZ/MF			MF/JN
SEWAGE PUMP #4													
Drive Shaft Fittings				JZ/MF			JZ/MF			JZ/MF			MF/JN
Pump Brgs				JZ/MF			JZ/MF			JZ/MF			MF/JN

## AWTF PREVENTIVE MAINTENANCE CHART

### 6 Months Inspection

### 2013

LOCATIONS	LUBE TYPE	JAN	FEB	MAR	APR	MAY	JUN	JUL	AUG	SEP	OCT	NOV	DEC	
<b>PIPE GALLERY</b>								1-Jun			6-Dec			
<b>LIMITORQUE VALVES 6</b>														
Grease fittings	EP-2						MF/DS							
<b>RETURN SLUDGE PUMP STATION</b>														
4-Jun														
<b>RETURN SLUDGE PUMP #1</b>														
Motor brg	EP-2						JN/JZ						MF/JN	
Coupling	EP-2						JN/JZ						MF/JN	
<b>RETURN SLUDGE PUMP #2</b>														
Motor brg	EP-2						DS/JW						MF/JN	
Coupling	EP-2						DS/JW						MF/JN	
<b>RETURN SLUDGE PUMP #3</b>														
Motor brg	EP-2						JN/JZ						MF/JN	
Coupling	EP-2						JN/JZ						MF/JN	
<b>RETURN SLUDGE PUMP #4</b>														
Motor brg	EP-2						JN/JZ							
Coupling	EP-2						JN/JZ							
<b>SLUICE GATE OPERATORS</b>														
Screw threads	C&C						JN/JZ							
<b>CHAMBER "A"</b>														
23-Jun														
<b>LIMITORQUE VALVE OPERATORS 2</b>														
Motor brgs	EP-2						MF/JZ							
Grease fittings	EP-2						MF/JZ							
<b>DISTRIBUTION BOX</b>														
23-Jun														
<b>VALVE OPERATORS (3)</b>														
Grease fittings	EP-2						MF/JZ							
Screw threads	C&C						MF/JZ							
<b>CHEMICAL STORAGE BUILDING</b>														
23-Jun														
<b>COOLING WATER PUMPS</b>														
Motor brgs	EP-2						MF/JZ							
<b>SETTLED SEWAGE PUMP STATION</b>														
						23-Jun			17-Sep			5-Dec		
<b>HOFFMAN BLOWER #1</b>														
Motor brgs	EP-2						MF/JZ			MF/JZ			MF/JN	
<b>HOFFMAN BLOWER #2</b>														
Motor brgs	EP-2						MF/JZ			MF/JZ			MF/JN	
<b>CHLORINE CONTACT TANKS</b>														
23-Jun														
<b>VALVE OPER. (8)</b>														
Gear Boxes	EP-2						MF/JZ							
Grease fittings	EP-2						MF/JZ							

LOCATIONS	LUBE TYPE	JAN	FEB	MAR	APR	MAY	JUN	JUL	AUG	SEP	OCT	NOV	DEC
<b>BOILER BUILDING</b>							23-Jun				30-Oct		
<b>WEIL McLEIN BOILER #1</b>													
Oil Pump Motor Brgs	30T						MF/JZ				MF/JN		
<b>WEIL McLEIN BOILER #2</b>													
Oil Pump Motor Brgs	30T						MF/JZ				MF/JN		
<b>SPRING CREEK PUMP STATION</b>							23-Jun				21-Oct		
<b>SLUICE GATES</b>													
Handwheel Operators	EP-2						MF/JZ				MF/JZ		
Screw Threads	C&C						MF/JZ				MF/JZ		
<b>CO-GENERATION BUILDING</b>							23-Jun				1-Oct		
<b>MEZZANINE</b>													
<b>TACO CIRCULATING PUMPS</b>													
<b>PUMP #1 7.5HP</b>													
Drive Motor Brgs	EP-2						MF/JZ				MF/JN		
<b>PUMP #2 7.5HP</b>													
Drive Motor Brgs	EP-2						MF/JZ				MF/JN		
<b>MARKET STREET PUMP STATION</b>							23-Jun						5-Dec
<b>SEWAGE PUMP #2</b>													
Drive Motor Brgs	EP-2						MF/JZ						MF/JN
<b>SEWAGE PUMP #3</b>													
Drive Motor Brgs	EP-2						MF/JZ						MF/JN



## AWTF PREVENTIVE MAINTENANCE CHART

### Yearly Inspection

### 2013

LOCATIONS	LUBE TYPE	JAN	FEB	MAR	APR	MAY	JUN	JUL	AUG	SEP	OCT	NOV	DEC
<b>FINAL SETTLING TANK #1</b>		3-Jun											
Sterling reducer	80-140						MF/JZ						
Drive Worm Res	80-140						MF/JZ						
Spur Gear Res	80-140						MF/JZ						
<b>FINAL SETTLING TANK #2</b>													
Sterling reducer	80-140						MF/JZ						
Drive Worm Res	80-140						MF/JZ						
Spur Gear Res	80-140						MF/JZ						
<b>FINAL SETTLING TANK #3</b>													
Sterling reducer	80-140						MF/JZ						
Drive Worm Res	80-140						MF/JZ						
Spur Gear Res	80-140						MF/JZ						
<b>FINAL SETTLING TANK #4</b>													
Sterling reducer	80-140						MF/JZ						
Drive Worm Res	80-140						MF/JZ						
Spur Gear Res	80-140						MF/JZ						
<b>FINAL SETTLING TANK #5</b>													
Sterling reducer	80-140						MF/JZ						
Drive Worm Res	80-140						MF/JZ						
Spur Gear Res	80-140						MF/JZ						
<b>FINAL SETTLING TANK #6</b>													
Sterling reducer	80-140						MF/JZ						
Drive Worm Res	80-140						MF/JZ						
Spur Gear Res	80-140						MF/JZ						
<b>PIPE GALLEY</b>		15-Mar											
<b>SCUM PUMP #1</b>													
Drive Motor brg	EP-2			JN/JZ									
Pump brg	EP-2			JN/JZ									
<b>SCUM PUMP #1</b>													
Drive Motor brg	EP-2			JN/JZ									
Pump brg	EP-2			JN/JZ									
<b>WASTE SLUDGE PUMP #1</b>													
Motor brg	EP-2			JN/JZ									
Coupling	EP-2			JN/JZ									
<b>WASTE SLUDGE PUMP #2</b>													
Motor brg	EP-2			JN/JZ									
Coupling	EP-2			JN/JZ									
<b>OXYGENATION TANKS</b>		17-Apr											
<b>OXYGENATION MIXER #1</b>													
Motor brg	EP-2			JN/JZ									
Coupling	EP-2			JN/JZ									
Gear box res	80-140			JN/JZ									
<b>OXYGENATION MIXER #2</b>													
Motor brg	EP-2			JN/JZ									

LOCATIONS	LUBE TYPE	JAN	FEB	MAR	APR	MAY	JUN	JUL	AUG	SEP	OCT	NOV	DEC
Coupling	EP-2				JN/JZ								
Gear box res	80-140				JN/JZ								
OXYGENATION MIXER #3													
Motor brg	EP-2				JN/JZ								
Coupling	EP-2				JN/JZ								
Gear box res	80-140				JN/JZ								
OXYGENATION MIXER #4													
Motor brg	EP-2				JN/JZ								
Coupling	EP-2				JN/JZ								
Gear box res	80-140				JN/JZ								
OXYGENATION MIXER #5													
Motor brg	EP-2				JN/JZ								
Coupling	EP-2				JN/JZ								
Gear box res	80-140				JN/JZ								
OXYGENATION MIXER #6													
Motor brg	EP-2				JN/JZ								
Coupling	EP-2				JN/JZ								
Gear box res	80-140				JN/JZ								
OXYGENATION MIXER #7													
Motor brg	EP-2				JN/JZ								
Coupling	EP-2				JN/JZ								
Gear box res	80-140				JN/JZ								
OXYGENATION MIXER #8													
Motor brg	EP-2				JN/JZ								
Coupling	EP-2				JN/JZ								
Gear box res	80-140				JN/JZ								
OXYGENATION MIXER #9													
Motor brg	EP-2				JN/JZ								
Coupling	EP-2				JN/JZ								
Gear box res	80-140				JN/JZ								
OXYGENATION MIXER #10													
Motor brg	EP-2				JN/JZ								
Coupling	EP-2				JN/JZ								
Gear box res	80-140				JN/JZ								
OXYGENATION MIXER #11													
Motor brg	EP-2				JN/JZ								
Coupling	EP-2				JN/JZ								
Gear box res	80-140				JN/JZ								
OXYGENATION MIXER #12													
Motor brg	EP-2				JN/JZ								
Coupling	EP-2				JN/JZ								
Gear box res	80-140				JN/JZ								
EXHAUST FAN UNITS													
Motor brgs	EP-2				JN/JZ								
JOY COMPRESSOR #1													
Motor brg res	20T												
Coupling	EP-2												
Oil pump motor brg	EP-2												

LOCATIONS	LUBE TYPE	JAN	FEB	MAR	APR	MAY	JUN	JUL	AUG	SEP	OCT	NOV	DEC
Compressor res	20C												
<b>JOY COMPRESSOR #2</b>													
Motor brg res	20T												
Coupling	EP-2												
Oil pump motor brg	EP-2												
Compressor res	20C												
<b>MARLEY COOLING TOWER</b>													
Motor brgs	EP-2												
Gear box res	30T												
<b>SETTLED SEWAGE PUMP STATION</b>					19-Apr								
<b>HOFFMAN BLOWER #1</b>													
Coupling	EP-2				AA/JZ								
<b>HOFFMAN BLOWER #2</b>													
Coupling	EP-2				AA/JZ								
<b>DILUENT PUMP #1</b>													
Motor brgs	EP-2				MF/JZ								
Coupling	EP-2				MF/JZ								
<b>DILUENT PUMP #2</b>													
Motor brgs	EP-2				MF/JZ								
Coupling	EP-2				MF/JZ								
<b>EFFLUENT PUMP #1</b>													
Motor brgs	EP-2				MF/JZ								
<b>EFFLUENT PUMP #2</b>													
Motor brgs	EP-2				MF/JZ								
<b>SEWAGE PUMP #1</b>													
Coupling	EP-2				MF/JZ								
<b>SEWAGE PUMP #2</b>													
Coupling	EP-2				MF/JZ								
<b>SEWAGE PUMP #3</b>													
Coupling	EP-2				MF/JZ								
<b>SEWAGE PUMP #4</b>													
Coupling	EP-2				MF/JZ								
<b>CHAMBER "C"</b>					5-Apr								
<b>RODNEY HUNT VALVE OPERATORS</b>													
Grease fittings	EP-2				MF/JZ								
<b>PRIMARY DIGESTERS</b>					5-Apr								
<b>WEMCO PUMP #1</b>													
Drive Motor Brgs	EP-2				MF/JZ								
Pump Oil Res	20T				MF/JZ								
<b>WEMCO PUMP #2</b>													
Drive Motor Brgs	EP-2				MF/JZ								
Pump Oil Res	20T				MF/JZ								
<b>WEMCO PUMP #3</b>													
Drive Motor Brgs	EP-2				MF/JZ								
Pump Oil Res	20T				MF/JZ								
<b>LFE TRANSFER PUMP #1</b>													
Drive Motor Brgs	EP-2				MF/JZ								
<b>LFE TRANSFER PUMP #2</b>													

LOCATIONS	LUBE TYPE	JAN	FEB	MAR	APR	MAY	JUN	JUL	AUG	SEP	OCT	NOV	DEC
Drive Motor Brgs	EP-2				MF/JZ								
TACO CIRCULATING PUMP #1													
Drive Motor Brgs	EP-2				MF/JZ								
TACO CIRCULATING PUMP #2													
Drive Motor Brgs	EP-2				MF/JZ								
TACO CIRCULATING PUMP #3													
Drive Motor Brgs	EP-2				MF/JZ								
SUMP PUMP													
Drive Motor Brgs	EP-2				MF/JZ								
FULLER GAS BLOWER #1													
Drive Motor Brg	EP-2				MF/JZ								
Blower Oil Res	40T				MF/JZ								
FULLER GAS BLOWER #2													
Drive Motor Brg	EP-2	OUT OF SERVICE											
Blower Oil Res	40T												
<b>THICKENED SLUDGE PUMP STATION</b>					11-Apr								
SLUDGE THICKENER #1													
Sterling Reducer	80-140				MF/JZ								
Drive Worm Gear Res	80-140				MF/JZ								
Spur gear Res	80-140				MF/JZ								
SLUDGE THICKENER #2													
Sterling Reducer	80-140				MF/JZ								
Drive Worm Gear Res	80-140				MF/JZ								
Spur gear Res	80-140				MF/JZ								
LFE SCUM PUMP #1													
Drive Motor Brgs	EP-2				MF/JZ								
Pump Brgs	EP-2				MF/JZ								
LFE SCUM PUMP #2													
Drive Motor Brgs	EP-2				MF/JZ								
Pump Brgs	EP-2				MF/JZ								
WEMCO SLUDGE PUMP #1													
Drive Motor Brgs	EP-2				MF/JZ								
Pump Oil Res	20T				MF/JZ								
WEMCO SLUDGE PUMP #2													
Drive Motor Brgs	EP-2				MF/JZ								
Pump Oil Res	20T				MF/JZ								
WEMCO SLUDGE PUMP #3													
Drive Motor Brgs	EP-2				MF/JZ								
Pump Oil Res	20T				MF/JZ								
<b>COMPRESSOR BUILDING</b>													
I.R. GAS COMPRESSOR #1													
Drive Motor Brgs	EP-2				MF/JZ								
Comp Oil Res	30C				MF/JZ								
I.R. GAS COMPRESSOR #2													
Drive Motor Brgs	EP-2				MF/JZ								
Comp Oil Res	30C				MF/JZ								
<b>PRIMARY SETTLING TANKS</b>					10-May						8-Nov		
FRONT COLLECTOR TANK #1													
Drive Motor Brgs	EP-2				MF/JZ							MF	

LOCATIONS	LUBE TYPE	JAN	FEB	MAR	APR	MAY	JUN	JUL	AUG	SEP	OCT	NOV	DEC
Coupling	EP-2					MF/JZ						MF	
Gear Reducer	40T					MF/JZ						MF	
CROSS COLLECTOR													
Drive Motor Brgs	EP-2					MF/JZ						MF	
Coupling	EP-2					MF/JZ						MF	
Gear Reducer	40T					MF/JZ						MF	
MAIN COLLECTOR													
Drive Motor Brgs	EP-2					MF/JZ						MF	
Coupling	EP-2					MF/JZ						MF	
Gear Reducer	40T					MF/JZ						MF	
FRONT COLLECTOR TANK #2													
Drive Motor Brgs	EP-2					MF/JZ						MF	
Coupling	EP-2					MF/JZ						MF	
Gear Reducer	40T					MF/JZ						MF	
CROSS COLLECTOR													
Drive Motor Brgs	EP-2					MF/JZ						MF	
Coupling	EP-2					MF/JZ						MF	
Gear Reducer	40T					MF/JZ						MF	
MAIN COLLECTOR													
Drive Motor Brgs	EP-2					MF/JZ						MF	
Coupling	EP-2					MF/JZ						MF	
Gear Reducer	40T					MF/JZ						MF	
FRONT COLLECTOR TANK #3													
Drive Motor Brgs	EP-2					MF/JZ						MF	
Coupling	EP-2					MF/JZ						MF	
Gear Reducer	40T					MF/JZ						MF	
CROSS COLLECTOR													
Drive Motor Brgs	EP-2					MF/JZ						MF	
Coupling	EP-2					MF/JZ						MF	
Gear Reducer	40T					MF/JZ						MF	
MAIN COLLECTOR													
Drive Motor Brgs	EP-2					MF/JZ						MF	
Coupling	EP-2					MF/JZ						MF	
Gear Reducer	40T					MF/JZ						MF	
FRONT COLLECTOR TANK #4													
Drive Motor Brgs	EP-2					MF/JZ						MF	
Coupling	EP-2					MF/JZ						MF	
Gear Reducer	40T					MF/JZ						MF	
CROSS COLLECTOR													
Drive Motor Brgs	EP-2					MF/JZ						MF	
Coupling	EP-2					MF/JZ						MF	
Gear Reducer	40T					MF/JZ						MF	
MAIN COLLECTOR													
Drive Motor Brgs	EP-2					MF/JZ						MF	
Coupling	EP-2					MF/JZ						MF	
Gear Reducer	40T					MF/JZ						MF	
<b>FRONT ST. PUMP STATION</b>													
11-Apr													
RAW SEWAGE PUMP #1													
Drive Motor Brgs	10T					MF/JZ							

LOCATIONS	LUBE TYPE	JAN	FEB	MAR	APR	MAY	JUN	JUL	AUG	SEP	OCT	NOV	DEC
RAW SEWAGE PUMP #2													
Drive Motor Brgs	10T				MF/JZ								
RAW SEWAGE PUMP #3													
Drive Motor Brgs	EP-2				MF/JZ								
RAW SEWAGE PUMP #4													
Drive Motor Brgs	EP-2				MF/JZ								
FRESH WATER PUMP #1													
Drive Motor Brgs	EP-2				MF/JZ								
FRESH WATER PUMP #2													
Drive Motor Brgs	EP-2				MF/JZ								
FRESH WATER PUMP #3													
Drive Motor Brgs	EP-2				MF/JZ								
FRESH WATER PUMP #4													
Drive Motor Brgs	EP-2				MF/JZ								
FRESH WATER PUMP #5													
Drive Motor Brgs	EP-2				MF/JZ								
BAR SCREEN #1													
Drive Motor Brgs	EP-2				MF/JZ								
Coupling	EP-2				MF/JZ								
Gear Res	40T				MF/JZ								
BAR SCREEN #2													
Drive Motor Brgs	EP-2				MF/JZ								
Coupling	EP-2				MF/JZ								
Gear Res	40T				MF/JZ								
BELT CONVEYOR													
Gear Reducer	40T				MF/JZ								
Grease Fittings	EP-2				MF/JZ								
VICKERS HYDRULIC SYSTEM													
Drive Motor #1	EP-2				MF/JZ								
Drive Motor #2	EP-2				MF/JZ								
HIGHCOR HYD PRESS													
<b>SPRING CREEK PUMP STATION</b>					12-Apr								
RAW SEWAGE PUMP #1													
Drive Motor Brgs	10T				MF/JZ								
RAW SEWAGE PUMP #2													
Drive Motor Brgs	10T				MF/JZ								
RAW SEWAGE PUMP #3													
Drive Motor Brgs	10T				MF/JZ								
BARSCREEN													
Drive motor Brgs	EP-2				MF/JZ								
Coupling	EP-2				MF/JZ								
Gear Reducer	40T				MF/JZ								
Drive Chain	C&C				MF/JZ								
SEAL WATER PUMP													
Drive Motor Brgs	EP-2				MF/JZ								
CHLORINE PUMP													
Drive Motor Brgs	EP-2				MF/JZ								
VICKERS HYDRULIC SYSTEM													
Drive Motor Brgs	EP-2				MF/JZ								

LOCATIONS	LUBE TYPE	JAN	FEB	MAR	APR	MAY	JUN	JUL	AUG	SEP	OCT	NOV	DEC
<b>CAT EMERGENCY GENERATOR</b>													
Crankcase	10-40D				MF/JZ								
Grease Fittings	EP-2				MF/JZ								
<b>DEGRITTER BUILDING</b> 9-Apr													
<b>DORR-OLI VER GRIT CLASSIFIER</b>													
Gear Reducer	80-140				MF/JZ								
Bull Gear	80-140				MF/JZ								
<b>GRIT REMOVAL SYSTEM</b> 15-May													
<b>GRIT TANK #1</b>													
Paddle Drive Motor	EP-2					MF/JZ							
Turntable Brgs	30syn					MF/JZ							
Pump Motor Brgs	EP-2					MF/JZ							
Pump Brgs	30T					MF/JZ							
<b>GRIT TANK #2</b>													
Paddle Drive Motor	EP-2					MF/JZ							
Turntable Brgs	30syn					MF/JZ							
Pump Motor Brgs	EP-2					MF/JZ							
Pump Brgs	30T					MF/JZ							
<b>GRIT TANK #3</b>													
Paddle Drive Motor	EP-2					MF/JZ							
Turntable Brgs	30syn					MF/JZ							
Pump Motor Brgs	EP-2					MF/JZ							
Pump Brgs	30T					MF/JZ							
<b>GRIT TANK #4</b>													
Paddle Drive Motor	EP-2					MF/JZ							
Turntable Brgs	30syn					MF/JZ							
Pump Motor Brgs	EP-2					MF/JZ							
Pump Brgs	30T					MF/JZ							
<b>GRIT BUILDING</b> 15-Mar													
<b>BLOWER</b>													
Drive Motor Brgs	EP-2			MF/JZ									
Blower Oil Res	30T			MF/JZ									
<b>GRIT GARAGE</b> 17-May													
<b>Grit Classifier #1</b>													
Gear Reducer	80-140					MF/JN							
Screw Conveyor Brgs	30syn					MF/JN							
<b>Grit Classifier #2</b>													
Gear Reducer	80-140					MF/JN							
Screw Conveyor Brgs	30syn					MF/JN							
<b>MAIN BUILDING BASEMENT</b> 19-Apr													
<b>WEMCO SLUDGE PUMP #1</b>													
Drive Motor Brgs	EP-2				MS/JZ								
Pump Oil Res	20T				MS/JZ								
<b>WEMCO SLUDGE PUMP #2</b>													
Drive Motor Brgs	EP-2				MS/JZ								
Pump Oil Res	20T				MS/JZ								
<b>PLANT WATER PUMPS</b>													
<b>PUMP #1</b>													
Gear Reducer	30 syn				MS/JZ								

LOCATIONS	LUBE TYPE	JAN	FEB	MAR	APR	MAY	JUN	JUL	AUG	SEP	OCT	NOV	DEC
<b>PUMP #2</b>													
Gear Reducer	30 syn				MS/JZ								
<b>PUMP #3</b>													
Gear Reducer	30 syn				MS/JZ								
<b>VOGELSANG SLUDGE GRINDERS</b>													
<b>Grinder #1</b>													
Gear Reducer	80-90				MS/JZ								
<b>Grinder #2</b>													
Gear Reducer	80-90				MS/JZ								
<b>I-R AIR COMPRESSOR #1</b>													
Drive Motor Brgs	EP-2				MS/JZ								
Crankcase	30C				MS/JZ								
<b>I-R AIR COMPRESSOR #2</b>													
Drive Motor Brgs	EP-2				MS/JZ								
Crankcase	30C				MS/JZ								
<b>ROOTS BLOWER</b>													
Drive Motor Brgs	EP-2				MS/JZ				O/S				
Blower Oil Res	30T				MS/JZ				O/S				
<b>MARLOW SLUDGE PUMPS</b>													
<b>Marlow Sludge Pump #1</b>													
Gear Reducer	80-140				MS/JZ								
<b>Marlow Sludge Pump #2</b>													
Gear Reducer	80-140				MS/JZ								
<b>Marlow Sludge Pump #3</b>													
Gear Reducer	80-140				MS/JZ								
<b>WELCH VACUUM PUMP</b>													
Pump	20C				MS/JZ							12-Nov	
												MF	
<b>MAIN BUILDING 2ND FLOOR</b>													
							7-Jun						
<b>TACO CIRCULATING PUMPS</b>													
<b>PUMP #1</b>													
Motor Oil Cups	30T						MF/JZ						
Pump Res	30T						MF/JZ						
<b>TACO CIRCULATING PUMPS</b>													
<b>PUMP #2</b>													
Motor Oil Cups	30T						MF/JZ						
Pump Res	30T						MF/JZ						
<b>BELT FILTER PRESS BUILDING</b>													
												21-Nov	14-Jan
<b>BELT FILTER PRESS #1</b>													
<b>MAIN BELT DRIVES</b>													
Gear Red	10T						MF/JZ					MF/JN	MF/RR
<b>BELT FILTER PRESS #2</b>													
<b>MAIN BELT DRIVES</b>													
Gear Red	10T						MF/JZ					MF/JN	MF/RR
<b>CONVEYOR BELT</b>													
Gear Box Res	80-140						MF/JZ					MF/JN	MF/RR
<b>POLYMER TRANSFER PUMPS</b>													
<b>Pump # 1</b>													
Gear Reducer	80-140						MF/JZ					MF/JN	MF/RR
<b>Pump # 2</b>													



LOCATIONS	LUBE TYPE	JAN	FEB	MAR	APR	MAY	JUN	JUL	AUG	SEP	OCT	NOV	DEC
Gear Reducer	80-140						MF/JZ						
<b>POLYMER FEED PUMPS</b>													
Pump # 1													
Gear Reducer	80-140						MF/JZ						
Pump # 2													
Gear Reducer	80-140						MF/JZ						
Pump # 3													
Gear Reducer	80-140						MF/JZ						
<b>LIQUID FEED PUMP</b>													
Gear Reducer	80-140						MF/JZ						
<b>DRY POLYMER FEEDER</b>													
Gear Reducer	80-140						MF/JZ						
<b>CO-GENERATION BUILDING</b>							7-Jun						
<b>MEZZANINE</b>													
<b>TACO CIRCULATING PUMPS</b>													
<b>PUMP #3 3HP</b>													
Drive Motor Brgs	30T						MF/JZ						
Pump Brgs	30T						MF/JZ						
<b>PUMP #4 3HP</b>													
Drive Motor Brgs	30T						MF/JZ						
Pump Brgs	30T						MF/JZ						
<b>PUMP #5 .75HP</b>													
Drive Motor Brgs	30T						MF/JZ						
Pump Brgs	30T						MF/JZ						
<b>PUMP #6 .75HP</b>													
Drive Motor Brgs	30T						MF/JZ						
Pump Brgs	30T						MF/JZ						
<b>PUMP #7</b>													
Drive Motor Brgs	30T						MF/JZ						
Pump Brgs	30T						MF/JZ						
<b>PUMP #8</b>													
Drive Motor Brgs	30T						MF/JZ						
Pump Brgs	30T						MF/JZ						
<b>MARKET ST. PUMP STATION</b>			8-Feb										
<b>SEWAGE PUMP #1</b>													
Drive Motor Brgs	EP-2						MF/JZ						
<b>SEWAGE PUMP #4</b>													
Drive Motor Brgs	EP-2						MF/JZ						
<b>CAT EMERGENCY GENERATOR</b>													
Crankcase	10-40D		MS/JZ										
Grease Fittings	EP-2		MS/JZ										
<b>CITY ISLAND PUMP STATION # 1</b>		20-Jan										21-Nov	
<b>SEWAGE PUMP # 1</b>													
Oil Reservoir	30T	AA/JZ										MF/JN	
<b>SEWAGE PUMP # 2</b>													
Oil Reservoir	30T	AA/JZ										MF/JN	
<b>CITY ISLAND PUMP STATION # 2</b>												21-Nov	
<b>SEWAGE PUMP # 1</b>													
Oil Reservoir	30T	AA/JZ										MF/JN	

LOCATIONS	LUBE TYPE	JAN	FEB	MAR	APR	MAY	JUN	JUL	AUG	SEP	OCT	NOV	DEC
SEWAGE PUMP # 2													
Oil Reservoir	30T	AA/JZ										MF/JN	

**City Of Harrisburg  
Advanced Wastewater Treatment Facility  
Confined Space Entry Permit**

Location: S. Cameron & Cumberland Date / Time: 5/18/15 @ 12:30  
 Regulator No.: 020 Purpose of Entry: Vector Chamber grease gate washdown float

**Step I. Evaluation Testing**

**Hazard Evaluation**

Engulfment/Drowning		
Chemical Contact		
Mechanical		
Hot Work		
Other:		

**Atmospheric Test Results**

Oxygen	19.5 - 23.5	20.8	20.8		
Flamable	< 1%	0	0		
H2S	< 10 ppm	0	0		

Monitored By: [Signature]  
 If test results exceed Entry Levels go to Step II.

If Yes, go to Step III.

**Step II. Atmospheric Control**

Ventilation		
Jet Cleaning		
Other:		

Test results exceeding Entry Levels after Corrective Actions require a permit entry. Go to Step III.

**Step III. Permit Entry Requiring Supervisory Approval**

Entry Supervisor: \_\_\_\_\_ Attendant(s): \_\_\_\_\_ Entrant(s): \_\_\_\_\_

	Constant Ventilation (List results in Step II)				Secure Work Site
	Non-Entry Rescue Equipment				SCBA For Entrants/Attendants
	Constant Testing				Electrical Lockout
	Rescue Team				Mechanical Lockout
	Line Blanking				Other:
	Hot Work Safety Procedures				

All items must be checked and signed by Entry Supervisor before entry.

Entry Supervisor Signature: \_\_\_\_\_ Date: \_\_\_\_\_  
 Entrants Signatures: \_\_\_\_\_ Date: \_\_\_\_\_  
 \_\_\_\_\_ Date: \_\_\_\_\_

**IMPORTANT**

Inspections must be made after each use.

Each use must be recorded.

**INSPECTION RECORD**

Date	Finding and Actions Taken	By

**USE RECORD**

Date	By	Date	By

Serial No. \_\_\_\_\_

Identification \_\_\_\_\_



# Appendix B

# Appendix B

## Emergency / CRW Staff Contacts

**Bold = Severe Emergency – Wait for Call to be Answered**

Wastewater		
Condition	Severity	Route Call To:
<b>Backup in Residence/Building</b>	<b>X</b>	<b>Ext. 217, Ken Freysinger. If no answer, Ext. 214, Matt Chisnell. If no answer, Ext. 209, Control Room.</b>
Blocked Inlet		CSR creates service request in Cityworks.
<b>Collapsed Inlet</b>	<b>X</b>	<b>Ext. 214, Matt Chisnell. If no answer, Ext. 217, Ken Freysinger. If no answer, Ext. 209, Control Room.</b>
<b>Damaged/Loose Manhole Cover</b>	<b>X</b>	<b>Ext. 214, Matt Chisnell. If no answer, Ext. 217, Ken Freysinger. If no answer, Ext. 209, Control Room.</b>
<b>Illicit Discharge</b>	<b>X</b>	<b>Ext. 207, Randy Schaffer. If no answer, Ext. 209, Wastewater Control Room.</b>
Investigation Request		Ext. 217, Ken Freysinger. If no answer, Ext. 214, Matt Chisnell.
<b>Missing Manhole Cover</b>	<b>X</b>	<b>Ext. 214, Matt Chisnell. If no answer, Ext. 217, Ken Freysinger. If no answer, Ext. 209, Control Room.</b>
Missing/Damaged Cleanout Cap		CSR creates service request in Cityworks.
Odor Complaint		CSR creates service request in Cityworks.
<b>Sewer Overflow</b>	<b>X</b>	<b>Ext. 217, Ken Freysinger. If no answer, Ext. 214, Matt Chisnell. If no answer, Ext. 209, Control Room.</b>
<b>Sinkhole</b>	<b>X</b>	<b>Ext. 217, Ken Freysinger. If no answer, Ext. 214, Matt Chisnell. If no answer, Ext. 209, Control Room.</b>
Street Sweeping		CSR creates service request in Cityworks and emails service request to Randy Schaffer, <a href="mailto:randy.schaffer@capitalregionwater.com">randy.schaffer@capitalregionwater.com</a> and Michael Joseph at DBI, <a href="mailto:michael.joseph@dbiservices.com">michael.joseph@dbiservices.com</a>
Drinking Water		
Condition	Severity	Action to be Taken:
Appointment Scheduling		CSR creates service request in Cityworks.
Customer Requested Shut Off		CSR creates service request in Cityworks.
<b>Damaged Hydrant</b>	<b>X</b>	<b>CSR creates service request in Cityworks; CSR notifies Maynard Gardner, Ext. 303. If no answer, Ext. 314, Water Control Room.</b>
Disconnect Service		CSR creates service request in Cityworks.
High Bill Investigation		CSR creates service request in Cityworks.
Hydrant Connection		CSR creates service request in Cityworks.
<b>Leaking Hydrant</b>	<b>X</b>	<b>CSR creates service request in Cityworks; CSR notifies Maynard Gardner, Ext. 303. If no answer, Ext. 314, Water Control Room.</b>
Leak Notice		CSR creates service request in Cityworks.
<b>No Water/Low Pressure</b>	<b>X</b>	<b>CSR creates service request in Cityworks; CSR notifies Maynard Gardner, Ext. 303. If no answer, Ext. 314, Water Control Room.</b>
Shut Off for Non-Compliance		CSR creates service request in Cityworks.
<b>Water Leak</b>	<b>X</b>	<b>CSR creates service request in Cityworks; CSR notifies Maynard Gardner, Ext. 303. If no answer, Ext. 314, Water Control Room.</b>
Water Meter Issue		CSR creates service request in Cityworks.
Water Meter Missing		CSR creates service request in Cityworks.
<b>Water Quality</b>	<b>X</b>	<b>CSR creates service request in Cityworks; CSR notifies Kodi Webb, Ext. 313. If no answer, Ext. 314, Water Control Room.</b>



# Appendix C



## Appendix C

# Inspection Preparedness and General Safety Guidelines

### C.1 Inspection Preparedness

A proper operation and maintenance program must have adequate provisions to ensure that the needed tools and equipment are provided for inspection crews to properly and efficiently perform their job responsibilities. This includes the vehicles for transportation, the tools and equipment for maintenance activities, and the necessary safety equipment for confined space entry into the CSO regulator structures.

**Table C-1** provides a list of equipment that is available for field maintenance crews performing inspections and maintenance activities. The *Inspection Preparedness Activity Checklist* provides a list of activities to be completed before embarking on daily CSO regulator inspections.

### Inspection Preparedness Activity Checklist

*Complete the following BEFORE embarking for daily CSO regulator inspections:*

- Calibrate portable gas detection meters.
- Verify critical safety equipment is onboard, including gas detection meters, personal protective equipment, hard hats, tripod, safety harnesses, traffic cones, and first aid kits.
- Verify that all safety equipment needed to follow confined space entry protocol is onboard even if confined space entries are not anticipated.
- Verify the appropriate documentation forms (**Appendix A**) are in hand.
- Verify that the confined space entry permits are in hand and ready to sign off.
- Confer with operations staff to determine if there are any issues which field maintenance staff should be made aware.

**Table C-1 Available Equipment for O&M Activities**

<i>Field Operations Equipment</i>	<i>Field Maintenance Equipment</i>
One 5-Ton Dump Truck	Three Vactor Trucks
Three Pick-Up Trucks	One Jet Truck
One Wheel Front End Loader	Two Utility Trucks
Four Sets of Self Contained Breathing Apparatus	Two Pickup Trucks
Miscellaneous Cleaning Equipment (Brooms, Brushes, Buckers, Hose, Etc.)	Two 5-Ton Dump Trucks
	Two 1-Ton Dump Trucks
<i>Personal Safety Apparel for Each Employee</i>	One Backhoe
Hard Hat	Two Mini Excavators
Uniform	Two Black Top Rollers
Rain Gear	One Pole Camera
Boots	Three Tripods
Fluorescent Vest	Three Fall Preventers
Gloves	One Winch
Coveralls	Four Harness/Rope Assemblies
Goggles	Four Manhole Hooks
	One Spot Light
<i>Maintenance Shop</i>	Ten Barricades
Fully Equipped for Light Fabrication & Welding	Ten Safety Cones
	Two Manhole Ventilators
<i>AWTF Equipment</i>	One Self Contained Breathing Apparatus
One Crane Truck	Five Portable Combustible Gas Analyzers
One Air Compressor	Shovels, picks, and digging irons
One Fork Lift	Two tool box sets
One Skid Steer Loader	One Skid Steer Loader
Four Pickup Trucks	One Hydro-Excavator
Two 4-inch Trash Pumps	
One 3-inch Trash Pump	
One 10-inch Trash Pump	

## C.2 Confined Space Entry Procedures

### PURPOSE

To establish procedures for safe work practice to be utilized when engaged in work activities that may involve confined space entry.

### SCOPE

Provides minimum safety requirements to be followed by CRW employees while entering, exiting and working in confined spaces.

Although this section describes specific safety steps to be taken for entry into confined spaces, it is not intended to preclude the use of any additional measures that may be deemed necessary for a particular situation.

### RESPONSIBILITIES

**Employee:** To report to work wearing clothing suitable for the weather and work as deemed appropriate by the Supervisor; to wear personal protective equipment, if required; to obtain a confined space entry permit when required; to become familiar with and adhere to applicable job related safety requirements, including those of CRW, and Federal, State and Local governments.

**Supervisor:** To arrange employee safety training pertinent to the job, including confined space entry; to assist employees in obtaining personal protective and safety equipment requested for the job; to consult on identification and entry procedures; to assist employees to utilize personal protective and safety equipment, as necessary, and practice sound safety principles.

**Entry Supervisor:** Know the hazards that may be faced during the confined space entry. Verify that the permit has been completed prior to entry (if needed). Terminate the entry and cancel the permit if any of the required provisions of the permit are not met or if additional hazards which affect the safety of the entrants become apparent. Advise the designated rescue service of the entry and confirm that they are available to respond to an emergency. Enforce the removal of unauthorized person who enter or attempt to enter the confined space. Be responsible for the adherence to procedures to insure that all operations remain consistent with the terms of the entry permit and that entry conditions remain acceptable.

### CONFINED SPACE CLASSIFICATION (PERMIT SPACE)

A Permit Required Confined Space (PS) is an enclosed space which has all of the following characteristics:

- A. Is large enough and so configured that an employee can bodily enter and perform assigned work;
- B. Has limited or restricted means for entry or exit (some examples are tanks, vessels, silos, manholes, storage bins, hoppers, vaults, pits, and diked areas);
- C. Is not designed for continuous employee occupancy; and
- D. Has one or more of the following characteristics:

- Contains or has a known potential to contain a hazardous atmosphere;
- Contains a material with the potential to engulf an entrant;
- Has an internal configuration such that an entrant could be trapped or asphyxiated by inwardly converging walls, or a floor which slopes downward and tapers to a smaller cross section;
- Has an energy hazard with can involve contact with electrical equipment, steam or other sources of heat inside the space. This type of equipment can include shafts, augers, mixers or impellers; or
- Contains any other known serious safety or health hazard.

NOTE: If multiple entries are to be made into same type confined spaces (i.e. manholes) throughout the same work shift, it is acceptable to use one (1) form to cover multiple entries. Forms are intended to note that hazards and to format the procedure, not to compile additional paperwork.

A Non-Permit Confined Space (NPCS) is an enclosed space that does not meet the PS definition. If there is any doubt whether or not a confined space may be classified as an NPCS, the employee should request a determination by the Supervisor.

#### **GENERAL PROCEDURES**

- A. Hazards shall be identified for each confined space. The hazard identification process shall include, but not be limited to, a review of the past and current uses of the confined space that may adversely affect the atmosphere of the confined space. This information shall be used to determine testing requirement prior to entry.
- B. Review the means of entry and exit into the confined space and the hazards posed by adjacent spaces and operations.
- C. Field personnel working in or around confined spaces shall have a working knowledge and understanding of the hazards that may exist.
- D. Before entry into a confined space, testing shall be conducted for hazardous atmosphere by a competent team member who has been trained in proper testing techniques. The equipment used must be calibrated to the manufacturer's specifications. At a minimum, testing must monitor oxygen levels, combustible gases, vapors and any toxic materials which are known to exist or may potentially exist in the space. Testing needs to be done prior to entry to assess the conditions and while the space is occupied. The air outside the space should be tested to detect hazards that may affect persons remaining outside the space.

The confined space shall not be entered unless confined space atmosphere testing results are within the following acceptable limits:

- Test for gases in the correct order. Always test for oxygen first. Oxygen content should be between 19.5% and 23.5%. If the oxygen level is low, other meter readings, such as flammables and toxicities, may not be accurate.

- Test for flammability shall be less than 10% of Lower Explosive Level (LEL) or Lower Flammable Level (LFL).
- Test for toxicity shall be less than recognized exposure limits for each monitored substance.

Test the air at several levels in the space. Some gases may be present only at the bottom, other only at the top. Testing at lower, middle and upper levels of the space will detect these differences. Sometimes it is necessary to enter the space to test corners or behind equipment. If entry into the space for testing is required, the tester must wear appropriate respiratory protection equipment.

Initial testing of atmospheric conditions and subsequent testing after a job has been stopped for a significant period of time shall be conducted with ventilation system turned on to verify that the contaminants are removed and the ventilation system is not itself causing a hazardous condition. If the confined space is vacated for any significant period of time, the atmosphere of the confined space shall be retested before re-entry is permitted.

- E. Whenever testing of the atmosphere indicates that levels of oxygen, flammability, or toxicity are not within acceptable limits, entry shall be prohibited. If the source of the contaminant cannot be determined, precautions shall be adequate to deal with the worst possible condition which the contaminant could present in the confined space.
- F. Based on the evaluation of the confined space hazards, a qualified person shall classify the confined space as either a PS or an NPCS. This refers to a "Permit required Space or a No Permit required Confined Space".
- G. Personal protective equipment shall be worn as needed for safe entry and occupancy of the confined space. Personal protective equipment includes but is not limited to: approved respirator, hard hat, safety goggles or safety glasses, gloves and chemical protective clothing. Personal safety equipment is not an adequate substitute for safe working conditions, adequate ventilation or safe working practices.
- H. Approved low-voltage electrical equipment must be used where the atmosphere in the confined area may contain flammable vapors or where the atmosphere could contain solvent vapors within their flammable limits. All electrical outlets and circuits used to energize such equipment shall be equipped with ground fault interrupts.
- I. If initial air monitoring indicates the presence of low oxygen levels or high toxic levels, forced ventilation into the space using adequately sized equipment should be provided. The most effective method of ventilation involves placing an air hose far enough into the space to force the air to the bottom. The air will eventually be vented through an opening in the space.

If the entrant is welding inside the space, it will be more efficient to capture the contaminants at the point of generation and carry them out of the space via flexible piping. If this method is chosen be sure that the exit point is far enough outside the space to keep contaminants from being drawn back down into the space.

If any work is being done outside, be aware of environmental factors such as the direction the wind is blowing. Vent exhaust contaminants downwind from the space. If air is being vented into the space using outside air, be sure the air is taken upwind from any airborne contaminants, this includes but not limited to vehicle exhaust, herbicides and insecticides that have been sprayed in the area, cleaning solvent used in prep work or even something as simple as a storm water inlet where you may be exchanging one confined space atmosphere for another. A special consideration is debris that may be picked up by the inlet to your device supplying the air such as anti-skid material (sand and road grit) which will act as an abrasive to whomever may be on the receiving end of the air supply or debris which may block the intake, such as leaves and grass, which will in effect decrease the effectiveness of your air exchange or completely stop this exchange.

### **PERMIT SPACE PROCEDURES**

A confined space entry permit shall be prepared by the entry supervisor for all Permit Space entries. This document shall include as a minimum the following information:

1. Name and location of the space(s) to be entered.
2. Purpose of the entry.
3. When the entry will be performed including the date and the authorized duration of the entry.
4. Who will be entering the space.
5. Who will be serving as attendant(s).
6. Who is authorizing the entry into the space (who is stating that the atmosphere has been tested and it is safe along with having the proper setup for safe entry).
7. The hazards anticipated inside the space, i.e., atmosphere, fall potential, size of conduit, etc.
8. How the space will be made safe for entry including:
  - lockout and tagout procedures
  - emptying, cleaning or purging the space
  - disconnecting process supply lines
  - insertion of blanks into supply lines (this does not include plugs which actually create potential hazards unless properly shored and retained)
9. The acceptable conditions inside the space prior to the entry such as:
  - acceptable oxygen level
  - acceptable levels of airborne toxic materials
  - acceptable levels of flammable vapors

10. The equipment needed to control the hazards existing in the space and the equipment needed to respond to an emergency situation:

- personal protective equipment
- testing equipment
- communication equipment
- rescue equipment

11. Initial, periodic or continuous monitoring of conditions inside the space, (must be continuous if someone is in the space). Include the name or initials of the person who performed the tests and the times and date the tests were completed.

12. The person who will initiate the rescue procedures and the team that will be called to perform the rescue in an emergency situation. (Can be 911 designated crew).

13. Procedures entrants and attendants will follow.

14. Additional required permits (i.e., street cut and highway occupancy) needed to safely perform work inside and around the space.

NOTE: Each permit is valid for not more than one work shift.

An attendant trained for confined space entry shall be stationed outside any PS. It is important that communication be maintained between team members. If problems arise, the attendant must be able to order the entrant(s), out of the space, or the entrant(s) must be able to summon for help. The entrants and the attendants can maintain visual or voice contact. If the entrant(s) are out of visual range, portable electronic communication equipment can be used. The attendant shall provide standby assistance to occupants entering the confined space, direct occupants entering the confined space, direct occupants to exit the confined space when irregularities are observed, initiate evacuation and emergency procedures. Monitor conditions or changes that could adversely affect the entry and remain at the point unless relieved by another attendant.

All energy sources which are potentially hazardous to confined space entrants shall be secured, relieved, disconnected and/or restrained before personnel are permitted to enter the confined space. Precautions shall be used to prevent flammable, toxic, irritating or oxygen displacing gases and vapors from entering the space. All hazardous material piping, high pressure piping, high temperature piping and other piping that could induce a hazard shall be isolated if possible by utilizing blinding, disconnection, removal or double block and bleed as needed to prevent entry of material and hazardous contaminants.

Procedures and equipment necessary to rescue entrants from a PS must be provided. In PS having a restricted means of access (such as a sewer manhole), any person entering the confined space must be fitted with a safety harness and lifeline. The lifeline should be secured outside the entrance. Where entry into a vessel, manhole, or other confined space must be made through a top opening, a hoisting device or other effective means must be provided to lift employee out of space. Ladders must be in place for entrances and exits where the drop or climb involves a depth of more than 3 feet.

Continuous monitoring of the PS atmosphere is required during occupancy.

### **NPCS PROCEDURES**

When a qualified person determines atmospheric test results are within acceptable limits (Oxygen = 19.5% to 23.5%, Flammability = less than 10% of the lower explosive limit or lower flammable limit, and toxicity less than recognized exposure limits) and there is no known potential for generation of hazards, a confined space permit will not be required.

A qualified person shall determine the need for periodic testing and re-evaluation of the hazards based on possible changes in activities in the space, or other physical or environmental conditions which could adversely affect the space and change the classification.

Continuous monitoring of the NPCS atmosphere is not required during occupancy.

### **C.3 Gas Meter Calibration Procedures**

Calibration procedures are included in the subsequent pages for the following gas meters:

- MSA Altair

### **C.4 Air Mask Checklist**

Procedures for donning air masks (SCBA equipment) are included in the subsequent pages:





Operating Manual

# ALTAIR<sup>®</sup> 4 – Four Gas Multigas Detector



Manufactured by  
**MSA INSTRUMENT DIVISION**  
P.O. Box 427, Pittsburgh, Pennsylvania 15230, USA

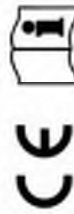

PN 10086975

## **⚠ WARNING**

Read this manual carefully before using the instrument. The instrument will perform as designed only if it is used and maintained in accordance with the manufacturer's instruction. Otherwise, it could fail to perform as designed and persons who rely on this instrument for their safety could sustain serious personal injury or death.

## Contents

<b>1</b>	<b>Instrument Safety</b> .....	<b>5</b>
1.1	Correct Use .....	5
1.2	Safety and Precautionary Measures to be Adopted .....	6
1.3	Warranty.....	9
<b>2</b>	<b>Description</b> .....	<b>10</b>
2.1	Instrument Overview .....	10
2.2	Device Hardware Interfaces .....	11
2.3	Viewing Optional Displays.....	15
2.4	Sensor Missing Alarm .....	19
2.5	Monitoring Toxic Gases.....	19
2.6	Monitoring the Oxygen Concentration .....	20
2.7	Monitoring Combustible Gases .....	21
<b>3</b>	<b>Operation</b> .....	<b>22</b>
3.1	Environmental Factors .....	22
3.2	Turning ON the Instrument.....	23
3.3	Measurement Mode (Normal Operation).....	28
3.4	Instrument Setup .....	29
3.5	Data Logging .....	34
3.6	Function Tests on the Instrument.....	35
3.7	Safe LED.....	35
3.8	Bump Test.....	35
3.9	Calibration .....	37
<b>4</b>	<b>Maintenance</b> .....	<b>41</b>
4.1	Troubleshooting.....	41
4.2	Live Maintenance Procedure - Replacing and Adding a Sensor ....	42
4.3	Cleaning the Instrument.....	43
4.4	Storage.....	43
4.5	Shipment.....	43

<b>5</b>	<b>Technical Specifications/Certifications</b> .....	<b>44</b>
5.1	Technical Specifications.....	44
5.2	Factory-set Alarm thresholds .....	45
5.3	Certifications .....	46
5.4	Performance Specification .....	47
<b>6</b>	<b>Order Information</b> .....	<b>49</b>
<b>7</b>	<b>Appendix – Flow Charts</b> .....	<b>50</b>
7.1	Start Up Sequence (Power ON) .....	50
7.2	Fresh Air Setup .....	51
7.3	Reset Screen Controls .....	52
7.4	Bump Test.....	54
7.5	Options Setup .....	55
7.6	Sensor Setup .....	56
7.7	Calibrations .....	57
7.8	Alarm Setup .....	58
7.9	Time and Date Setup .....	59

### 2.3.3 Minimum Readings (MIN page)

This page shows the lowest level of oxygen recorded by the instrument since turn-ON or since the MIN reading was reset.

The minimum icon ▼ appears on the display.

To reset the MIN reading:

- (1) Access the MIN page.
- (2) Press the [▲] button.

### 2.3.4 Short Term Exposure Limits (STEL page)



#### WARNING

If the STEL alarm activates, leave the contaminated area immediately; the ambient gas concentration has reached the preset STEL alarm level. Failure to follow this warning will cause over-exposure to toxic gases and persons relying on this product for their safety could sustain serious personal injury or death.

The STEL icon ☉ appears on the display to show the average exposure over a 15-minute period.

When the amount of gas detected by the instrument is greater than the STEL limit:

- Alarm sounds
- Alarm LEDs flash
- STEL icon flashes.

To reset the STEL:

- (1) Access the STEL page.
- (2) Press the [▲] button.

The STEL alarm is calculated over a 15-minute exposure.

STEL calculation examples:

Assume the instrument has been running for at least 15 minutes:

**15-minute exposure of 35 ppm:**

$$\frac{(15 \text{ minutes} \times 35 \text{ ppm})}{15 \text{ minutes}} = 35 \text{ ppm}$$

**10-minute exposure of 35 ppm and 5 minutes exposure of 15 ppm:**

$$\frac{(10 \text{ minutes} \times 35 \text{ ppm}) + (5 \text{ minutes} \times 15 \text{ ppm})}{15 \text{ minutes}} = 25 \text{ ppm}$$

### 2.3.5 Time Weighted Average (TWA page)



#### WARNING

If the TWA alarm activates, leave the contaminated area immediately; the ambient gas concentration has reached the preset TWA alarm level. Failure to follow this warning will cause over-exposure to toxic gases and persons relying on this product for their safety could sustain serious personal injury or death.

The TWA icon ☉ appears on the display to show the average exposure since the instrument was turned ON or since the TWA reading was reset. When the amount of gas detected is greater than the eight-hour TWA limit:

- Alarm sounds
- Alarm LEDs flash
- TWA icon flashes.

To reset the TWA:

- (1) Access the TWA page.
- (2) Press the [▲] button.

The TWA alarm is calculated over an eight-hour exposure.

TWA calculation examples:

**1-hour exposure of 50 ppm:**

$$\frac{(1 \text{ hour} \times 50 \text{ ppm}) + (7 \text{ hours} \times 0 \text{ ppm})}{8 \text{ hours}} = 6.25 \text{ ppm}$$

**4-hour exposure of 50 ppm and 4-hour exposure of 100 ppm:**

$$\frac{(4 \text{ hours} \times 50 \text{ ppm}) + (4 \text{ hours} \times 100 \text{ ppm})}{8 \text{ hours}} = 75 \text{ ppm}$$

**12-hour exposure of 100 ppm:**

$$\frac{(12 \text{ hours} \times 100 \text{ ppm})}{8 \text{ hours}} = 150 \text{ ppm}$$

**2.3.6 Time Display**

Current time appears on the display in a 12-hour format by default. A 24-hour format can be selected using MSA Link.

**2.3.7 Date Display**

Current date appears on the display in the format: **MMM-DD-YYYY**.

**2.3.8 Last cal page**

Displays the instrument's last successful calibration date in the format: **MMM-DD-YYYY**

**2.3.9 Cal due page**

Displays the days until the instrument's next calibration is due (user selectable).

**2.3.10 Motion Alert Activation (optional)**

To activate or deactivate the Motion Alert feature, press the [▲] button while the Motion Alert Activation page is displayed. When the Motion Alert feature is active, the ▲ symbol will flash every 3 seconds. The instrument will enter pre-alarm when no motion is detected for 20 seconds. This condition can be cleared by moving the instrument.

After 30 seconds of inactivity, the full Motion Alert alarm is triggered. This alarm can only be cleared by pressing the [▲] button.

**2.4 Sensor Missing Alarm**

The instrument enters the Sensor Missing alarm if the instrument detects that an enabled sensor is not properly installed in the instrument or is not functional.

For O<sub>2</sub>, CO, and H<sub>2</sub>S sensors, the Sensor Missing feature is checked when the instrument is turned ON and when leaving the Setup mode.

The combustible Sensor Missing feature is continuously monitored.

If a sensor is detected as missing, the following occurs:

- "SENSOR ERROR" displays
- The flag above the sensor detected as missing flashes on the display
- Alarm sounds and lights flash.
- If there is a sensor error at startup, the instrument shuts OFF in 60 seconds.

**2.5 Monitoring Toxic Gases**

The instrument can monitor the concentration of the following toxic gases in ambient air:

- Carbon Monoxide (CO)
- Hydrogen Sulfide (H<sub>2</sub>S)

The instrument displays the gas concentration in parts per million (PPM) or mg/m<sup>3</sup> on the Measuring page until another page is selected or the instrument is turned OFF.

**▲ WARNING**

If an alarm is triggered while using the instrument, leave the area immediately.

Remaining on site under such circumstances can cause serious personal injury or death.

The instrument has four gas alarms:

- HIGH Alarm
- LOW Alarm
- STEL Alarm
- TWA Alarm

If the gas concentration reaches or exceeds the alarm set point, the instrument:

- backlight turns on
- a vibrating alarm triggers
- displays and flashes the Alarm icon ▲ and either the Minimum icon ▼ (LOW alarm) or the Maximum icon ▲ (HIGH alarm)
- enters an alarm state.

## 2.6 Monitoring the Oxygen Concentration

The instrument monitors the oxygen concentration in ambient air. The alarm set points can be set to activate on two different conditions:

- Enriched - oxygen concentration > 20.8 % or
- Deficient - oxygen concentration < 19.5 %.



While the instrument can detect up to 25% oxygen in the ambient air, it is approved for use only up to 21% oxygen-content.



### WARNING

If an alarm activates while using the instrument, leave the area immediately.

Remaining on site under such circumstances can cause serious personal injury or death.

When the alarm set point is reached for either of the above conditions:

- an alarm sounds
- alarm LEDs flash
- a vibrating alarm triggers
- instrument displays and flashes the Alarm icon  and either the Minimum icon  (Enriched alarm) or the Maximum icon  (Deficient alarm) along with the corresponding oxygen concentration.

The LOW alarm (oxygen deficient) is latching and will not automatically reset when the O<sub>2</sub> concentration rises above the LOW set point. To reset the alarm press the [] button. If the alarm condition still exists, the [] button only silences the alarm for five seconds.

False oxygen alarms can occur due to changes in barometric pressure (altitude) or extreme changes in ambient temperature.

It is recommended that an oxygen calibration be performed at the temperature and pressure of use. Be sure that the instrument is in known fresh air before performing a calibration.

## 2.7 Monitoring Combustible Gases

The instrument can monitor these concentrations in ambient air:

- Methane
- Combustible gases

The instrument displays the gas concentration in % LEL or % CH<sub>4</sub> on the Measuring page until another page is selected or the instrument is turned OFF.

### WARNING



If an alarm activates while using the instrument, leave the area immediately.

Remaining on site under such circumstances can cause serious damage to health or can even lead to death.

The instrument has two alarm set points:

- HIGH Alarm
- LOW Alarm

If the gas concentration reaches or exceeds the alarm set point, the instrument:

- backlight turns on
- a vibrating alarm triggers
- displays and flashes the alarm icon  and either the minimum icon  (LOW alarm) or the maximum icon  (HIGH alarm)
- enters an alarm state.

When gas reading exceeds 100% LEL or 5.00% CH<sub>4</sub>, the instrument enters a Lock Alarm state and displays “xxx” in place of the actual reading. This state can only be reset by turning the instrument OFF and ON.

### WARNING

A combustible gas reading of “100” or “5.00” indicates the atmosphere is above 100 % LEL or 5.00 % vol CH<sub>4</sub>, respectively, and an explosion hazard exists. Move away from contaminated area immediately.

In such cases, the instrument LockAlarm feature activates.

### 3 Operation

Instrument operation is dialog driven from the display with the aid of the three Function buttons (see Section 2).

#### 3.1 Environmental Factors

A number of environmental factors may effect the gas sensor readings, including changes in pressure, humidity and temperature. Pressure and humidity changes affect the amount of oxygen actually present in the atmosphere.

##### Pressure Changes

If pressure changes rapidly (e.g., stepping through airflow), the oxygen sensor reading may temporarily shift and possibly cause the detector to alarm. While the percentage of oxygen may remain at or near 20.8 vol%, the total amount of oxygen present in the atmosphere available for respiration may become a hazard if the overall pressure is reduced by a significant degree.

##### Humidity Changes

If humidity changes by any significant degree (e.g., going from a dry, air conditioned environment to outdoor, moisture laden air), oxygen readings can be reduced by up to 0.5 %, due to water vapor in the air displacing oxygen.

The oxygen sensor has a special filter to reduce the effects of humidity changes on oxygen readings. This effect will not be noticed immediately, but slowly impacts oxygen readings over several hours.

##### Temperature Changes

The oxygen sensor has built-in temperature compensation. However, if temperature shifts dramatically, the oxygen sensor reading may shift. Zero the instrument at a temperature within 86 °F (30 °C) of the work site temperature for the least effect.

### 3.2 Turning ON the Instrument

Instrument operation is dialog driven from the display with the aid of the three Function buttons (see Section 2.2.1).

For more information, see the flow charts in Section 7.

Turn the instrument ON with the [  ] button.



The instrument performs a self test and then goes to Fresh Air Setup:

- all display segments are activated
- audible alarm sounds
- alarm LEDs light
- vibrating alarm is activated.

During the self test, the instrument checks for missing sensors.

In the case of a missing sensor, the instrument displays the Sensor Missing screen and alarms until it is turned OFF. Otherwise, the turn-ON sequence continues.

The instrument displays:

- Alarm & display self test
- Manufacturer name
- Instrument name
- Software version
- Combustible gas type
- Toxic gas units
- Alarm set points ( , ,  )
- Calibration values
- Date and time display
- Last cal date (if activated)
- CAL due date (if activated)
- Sensor warm-up period
- Fresh Air Setup option.

Refer to flowchart in Appendix, Section 7.1.

### 3.2.1 Screen Displays during Startup

During the power-up sequence, all automatic page display timeouts are preset to a range from two to four seconds.

Several sequences and screens occur during start up:

#### Instrument Self Test

The instrument performs a self test.



#### Instrument Name and Software version

Software version and instrument name display.



#### Combustible Gas Type

Name of Combustible Gas Type displays, e.g. BUTANE.  
Combustible gas type can be changed manually through the SENSOR SETUP menu or the MSA Link software.



#### Toxic Gas Units

Name of Toxic Gas Units displays (ppm or mg/l).  
Toxic units can only be modified through the MSA Link software.

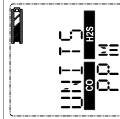

#### Alarm Set points

Alarm set points for all installed and activated sensors display.

LOW alarm set points display, followed by HIGH alarm set points.

Alarm set points can be changed manually through the Setup menu or the MSA Link software.

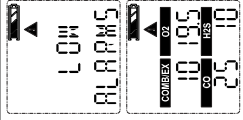

#### STEL and TWA Set points

The preset STEL and TWA values for installed and activated sensors display.



#### Calibration Values

The preset STEL and TWA values for installed and activated sensors display.

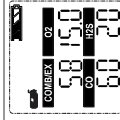

#### Time and Date

The date displays in a month, day and year format.

In the event that the battery is fully discharged, the time and date reset. At startup, the user is prompted to enter the time and date.

If the time and date information is missing, they are reset to [Jan-01-2008] with time stamp [00:00].

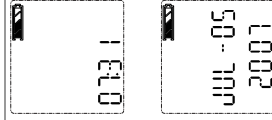

### Last CAL Date and CAL Due

These display options can be set by MSA Link software. If these options are not set, these screens are not displayed.

- By default Last Cal is activated.
- By default Cal Due is deactivated.



### Sensor Warm Up

The remaining time for sensor Warm Up is shown in a countdown format.



### Fresh Air Setup (FAS)

The FAS screen is prompted (see Section 3.2.2)



### 3.2.2 Fresh Air Setup (FAS)

The FAS is for automatic ZERO calibration of the instrument.

The Fresh Air Setup has limits. The zero of any sensor that is outside of these limits will not be adjusted by the FAS command.

If a battery charging cycle is interrupted before it is completed (4 hours for a fully discharged battery), allow the instrument's internal temperature to stabilize for 30 minutes before performing a Fresh Air Setup.

#### ⚠ WARNING

Do not activate the Fresh Air Setup unless you are certain you are in fresh, uncontaminated air; otherwise, inaccurate readings can occur which can falsely indicate that a hazardous atmosphere is safe. If you have any doubts as to the quality of the surrounding air, do not use the Fresh Air Setup feature. Do not use the Fresh Air Setup as a substitute for daily calibration checks. The calibration check is required to verify span accuracy. Failure to follow this warning can result in serious personal injury or death.

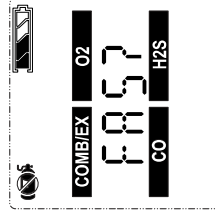

Figure 3-1 Fresh Air Setup

If this option is enabled, the instrument displays "FAS?", prompting the user to perform a Fresh Air Setup (FAS CAL).



- (1) Press the [▲] button to bypass the Fresh Air Setup.
  - The Fresh Air Setup is skipped and the instrument goes to the Measuring page (Main page).
- (2) Press the [⏻] button within 10 seconds to perform the Fresh Air Setup.
  - The instrument starts the FAS.
  - The screen shows a No Gas Symbol, a blinking hourglass, and all enabled gas sensor readings.
  - At the end of the FAS Calibration, the instrument displays "FAS OK" or "FAS ERR". along with the flags of the sensors that were outside of the FAS limits. All sensors that are within the FAS limits will be zeroed.



### 3.3 Measurement Mode (Normal Operation)

In Normal Operation mode, the user can check the Minimum and Peak readings prior to clearing the STEL and TWA values or performing a Span and Zero Calibration.

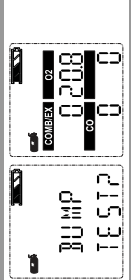
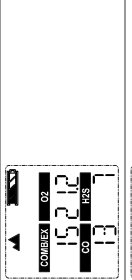
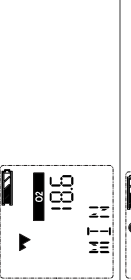
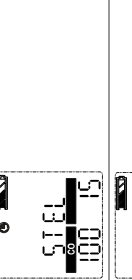
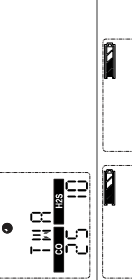
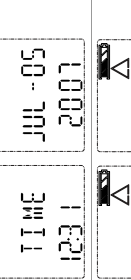
The following options pages can be executed from the Normal Operation screen:

<p><b>Bump Page</b> This page allows the user to perform a bump check.</p>	
<p><b>Peak Page</b> This page shows the peak readings for all sensors.</p>	
<p><b>Min Page</b> This page shows the minimum reading for the oxygen sensor.</p>	
<p><b>STEL Page</b> This page shows the calculated STEL readings of the instrument.</p>	
<p><b>TWA Page</b> This page shows the calculated TWA readings of the instrument.</p>	
<p><b>Time / Date Page</b> This page shows actual time and date settings of the instrument.</p>	
<p><b>Motion Alert (optional)</b> This page allows the Motion Alert Feature to be activated or deactivated.</p>	

Using the three instrument buttons, the user can navigate through each sub-menu in a top/down sequence.

Refer to section 2.3 and 7.3 in the appendix for detailed instructions on navigating through these screens.

### 3.4 Instrument Setup

This section describes the configuration options that are available through the Options Setup menus. These menus can be accessed only when the instrument is turned ON while pressing and holding the [▲] button (see Sections 3.2 and 7.3).

This mode can only be activated at instrument turn-ON.

The operation is as follows:

- (1) Press and hold the [▲] button while turning the instrument ON.
  - Use the [▲] and [▼] buttons to enter the setup password. The default password is "672".
- (2) Press [⏏] button to enter the setup menus.
  - Incorrect password: instrument enters the Measure mode.
  - Correct password: instrument continues/beeps three times.

The password can be changed through the MSA Link software.

In the Setup mode:

- Press the [⏏] button to store chosen value or go to the next page.
- Press [▲] button to increase values by one or toggle a selection ON or OFF.
- Press and hold [▲] button to increase values by 10.
- Press [▼] button to decrease values by one or toggle a selection ON or OFF.

Press and hold [▼] button to decrease values by 10.

The following options are available by pressing the [▼] and [▲] buttons:

- Sensor Setup (SENSOR SETUP) - see Section 3.4.1
- Calibration Setup (CAL SETUP) - see Section 3.4.2
- Alarm Setup (ALARM SETUP) - see Section 3.4.3
- Setup Time and Date (TIME SET) - see Section 3.4.4
- EXIT

### 3.4.1 Sensor Setup

Each sensor can be turned ON or OFF.

For more information, see the flow charts in Section 7.6.

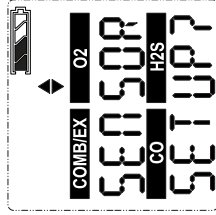

Figure 3-2 Sensor Setup

- (1) To bypass this setup, press the [▼] or [▲] button; otherwise, continue as follows.
- (2) Press the [⏏] button to enter the submenu.
- (3) Use the [▲] or [▼] button to change the option and confirm with the [⏏] button.
- (4) Repeat this procedure for all other sensors.
- (5) After setting the last sensor, continue to Calibration Setup.

### 3.4.2 Calibration Setup

The user can change and set the calibration values for each sensor.

It is also possible to select whether the Cal Due screen is displayed and set the number of days until the next calibration is due.

For more information, see the flow charts in Section 7.7.

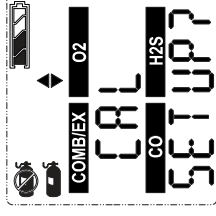

Figure 3-3 Calibration Setup

- (1) To bypass this setup, press the [▼] or [▲] button; otherwise, continue as follows.
- (2) Press the [⏏] button to enter the submenu.
  - The calibration gas concentration of the first sensor is shown.
- (3) Press the [▲] button or the [▼] button to change the value.
- (4) Press the [⏏] button to store the value.
  - Setup screen for the next sensor is displayed.
- (5) Repeat the procedure for all other sensors.
  - After setting the last sensor, the user is prompted to set CALDUE.
- (6) Press the [▲] button or the [▼] button to enable or disable CALDUE. Press the [⏏] button to confirm the selection.
- (7) If CALDUE is set ON, press the [▲] or the [▼] button to select the number of days
- (8) Confirm with the [⏏] button.
- (9) After confirmation, continue to Alarm setup.

### 3.4.3 Alarm Setup

The user can switch all alarms ON or OFF and change the alarm set points for each sensor.

For more information see the flow charts in Section 7.8.

See section 5.2 for alarm adjustment limits. The value of the High Alarm can only be set to a value that is higher than the Low Alarm set point.

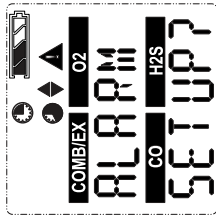

Figure 3-4 Alarm Setup

- (1) To bypass this setup, press the [▼] or [▲] button; otherwise, continue as follows.
- (2) Press the [⏏] button to enter the submenu.
- (3) Set alarms ON or OFF by pressing the [▲] button or the [▼] button. Confirm with the [⏏] button.
  - LOW ALARM settings for the first sensor display
- (4) Press the [▲] button or the [▼] button to change the value.
- (5) Press the [⏏] button to store the value.
  - HIGH ALARM settings for the first sensor display.
- (6) Press the [▲] button or the [▼] button to change the value.
- (7) Press the [⏏] button to store the value.
  - STEL ALARM settings (for toxic sensors only) display.
- (8) Press the [▲] button or the [▼] button to change the value.
- (9) Press the [⏏] button to store the value.
  - TWA ALARM settings (for toxic sensor only) for display.
- (10) Press the [▲] button or the [▼] button to change the value.
- (11) Press the [⏏] button to store the value.
- (12) Repeat the procedure for all other sensors.
- (13) After setting the last sensor, continue to Time and Date setup.

60% L.E.L. or 3.0% volume of methane is the maximum High Alarm set point that can be programmed by the user.

The combustible alarm can be turned OFF by the user in the instrument setup. When the combustible alarm is turned OFF, the only indicator to the user that the combustible alarm is turned OFF occurs during power up of the instrument at which a startup screen will indicate that the combustible alarm is turned OFF. When turned ON, the combustible high alarm is latching. The combustible alarm can be silenced momentarily by pressing the [▲] button. However, if the gas concentration causing the alarm is still present, the unit will go back into alarm.

### 3.4.4 Setup Time and Date

This submenu is for setting date and time.

For more information see the flow charts in Section 7.9.

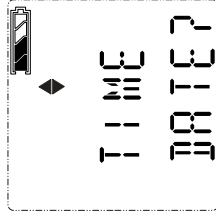

Figure 3-5 Date and Time Setup

- (1) To bypass this setup, press the [▼] or [▲] button; otherwise, continue as follows.
- (2) Press the [⏏] button to enter the submenu.
- (3) Set month by pressing the [▲] button or the [▼] button.
- (4) Press the [⏏] button to confirm month.
- (5) Repeat this procedure for day, year, hours and minutes.
  - By default, time is displayed in 12-hour format.
  - The EXIT screen will be displayed next.
- (6) Confirming this screen with the [⏏] button exits the instrument setup.
  - If the sensors have not warmed up yet, the countdown is displayed.
  - The instrument then goes to Measuring mode.

### 3.5 Data Logging

#### Connecting Instrument to PC

- (1) Switch ON the ALTAIR 4 and align the Datalink Communication port on the ALTAIR 4 to the IR interface of the PC.
- (2) Use the MSA Link software to communicate with the instrument. See MSA Link documentation for detailed instructions.

### 3.6 Function Tests on the Instrument

#### Alarm Test

Turn ON the instrument. Verify that:

- all LCD segments are activated momentarily
- alarm LEDs flash
- horn sounds briefly
- vibrating alarm triggers briefly.

#### 3.7 Safe LED

The instrument is equipped with a green "SAFE LED". This green SAFE LED flashes every 15 seconds under the following conditions:

- the SAFE LED feature is enabled
- instrument is in Measurement Mode (Normal Operation)
- combustible reading is 0% LEL or 0.00%CH<sub>4</sub>
- Oxygen (O<sub>2</sub>) reading is 20.8%
- Carbon Monoxide (CO) reading is 0 ppm
- Hydrogen Sulfide (H<sub>2</sub>S) reading is 0 ppm or 0 mg/m<sup>3</sup>
- no gas alarms are present (low or high)
- instrument is not in Low Battery warning or alarm
- CO, H<sub>2</sub>S, STEL and TWA readings are 0 ppm or 0 mg/m<sup>3</sup>.

#### 3.8 Bump Test



#### WARNING

Perform a Bump Test before each day's use to verify proper instrument operation. Failure to perform this test can result in serious personal injury or death.

This test quickly confirms that the gas sensors are functioning. Perform a full calibration periodically to ensure accuracy and immediately if the instrument fails the Bump Test. The Bump Test can be performed using the procedure below or automatically using the Galaxy Test Stand.

CSA requires (per 22.2 NO. 152) that the instrument's sensitivity be tested before each day's use on a known concentration of methane equivalent to 25-50% of full scale concentration. ACCURACY MUST BE WITHIN 0 to +20% OF ACTUAL. Correct accuracy by performing the calibration procedure within this manual.

### 3.8.1 Equipment.

See accessory section for ordering information for these components.

- Calibration Check Gas Cylinder
- 0.25 liters/min. Flow Regulator
- 1/8" ID Superthane Ester Tubing
- Altair 4 Calibration Cap

### 3.8.2 Performing a Bump Test

To skip the Bump Test procedure, push the [▲] button repeatedly to return to Measuring mode. If no button is pushed for 30 seconds, the instrument returns to the Measuring mode automatically.

- (1) From the normal measure screen press the [▼] button to display "BUMP TEST?".

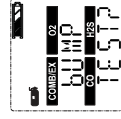

- (2) Verify the gas concentrations displayed match the Calibration Check Gas Cylinder. If they do not, adjust the values through the Calibration Setup menu as described in section 3.4.2.

- (3) Attach the calibration cap to the instrument.

- Insert tab on calibration cap into slot on instrument.
- Press calibration cap as shown until it seats onto instrument.

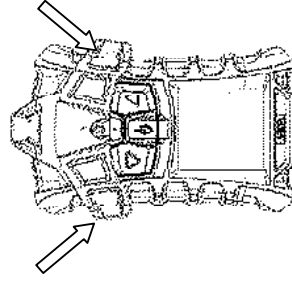
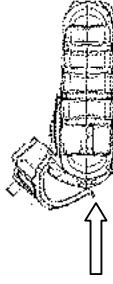

- Press both side tabs down onto instrument until they snap in.
- Ensure that the calibration cap is properly seated.
- Connect one end of the tubing to the calibration cap.
- Connect other end of tubing to the cylinder regulator (supplied in the calibration kit).

- (5) Press the [⏏] button to start the bump test then open the valve on the regulator. The hourglass will flash and the sensors will respond to the gas.

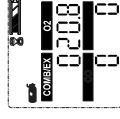

After the Bump Test completes, the instrument momentarily displays "BUMP PASS" or "BUMP ERROR" along with the label of any sensor that failed before returning to Measure mode. If the instrument fails the Bump Test, perform a calibration as described in section 3.9.



The √ symbol will be displayed in the Measure mode for 24 hours after a successful Bump Test.

### 3.9 Calibration

The ALTAIR4 can be calibrated either manually using this procedure or automatically using the Galaxy Test Stand. Refer to 7.7 of the appendix.

Calibration must be performed using a flow regulator with a flow rate set to 0.25 liters per minute.

If a battery charging cycle is interrupted before it is completed (4 hours for a fully discharged battery), allow the instrument's internal temperature to stabilize for 30 minutes before performing a Calibration.

### 3.9.1 Zero Calibration

To skip the ZERO procedure and move directly to the calibration span procedure, push the [▲] button. If no button is pushed for 30 seconds, the instrument prompts user to perform a SPAN calibration before returning to the Normal Operation mode.

- (1) Press and hold the [▲] button in Normal Operation mode for three seconds
- (2) If calibration lockout option is selected, enter password.

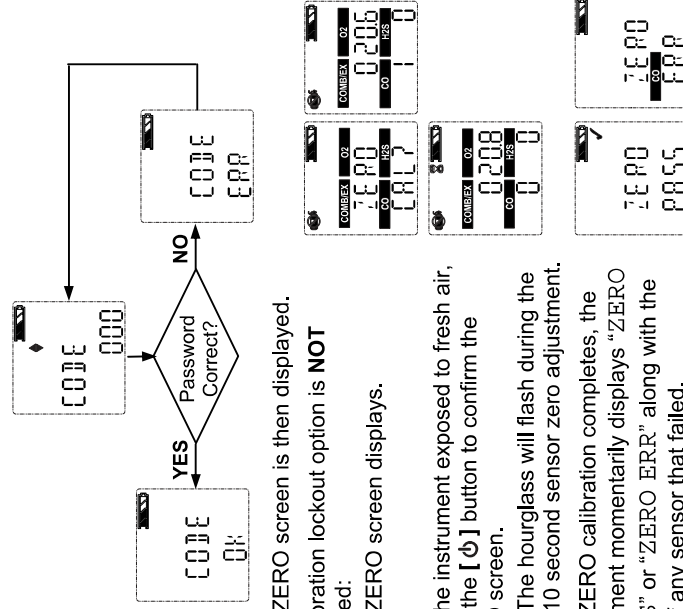

- ZERO screen is then displayed.
- If calibration lockout option is **NOT** selected:
- ZERO screen displays.

- (3) With the instrument exposed to fresh air, press the [⏏] button to confirm the ZERO screen.

- The hourglass will flash during the 10 second sensor zero adjustment.

After ZERO calibration completes, the instrument momentarily displays "ZERO PASS" or "ZERO ERR" along with the flag of any sensor that failed.

### 3.9.2 Span Calibration

To skip the Span procedure, push the [▲] button.

If no button is pushed for 30 seconds, the instrument returns to the Measuring mode.

- (1) Once the zero is set, the span screen displays.
- (2) Connect the appropriate calibration gas to the instrument.
- (3) Attach the calibration cap to the instrument.

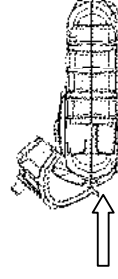
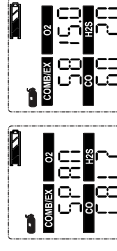

- Insert tab on calibration cap into slot on instrument.
- Press calibration cap as shown until it seats onto instrument.

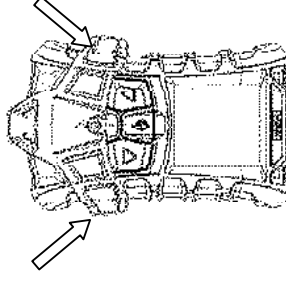

- Press both side tabs down onto instrument until they snap into.
- Ensure that the calibration cap is properly seated.
- Connect one end of the tubing to the calibration cap.
- Connect other end of tubing to the cylinder regulator (supplied in the calibration kit).

- (4) Open the valve on the regulator.

- (5) Press the [⏏] button to calibrate (span) the instrument.

- LEDs flash
- SPAN calibration starts.

After the SPAN calibration completes, the instrument momentarily displays "SPAN PASS" or "SPAN ERR" along with the label of any sensor that failed then returns to the Measuring mode.

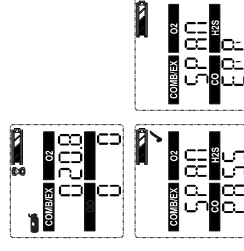

### 3.9.3 Finishing Calibration

- (1) Close the valve on the regulator.
- (2) Remove the calibration cap.

The calibration procedure adjusts the span value for any sensor that passes the calibration test; sensors that fail calibration are left unchanged. Since residual gas may be present, the instrument may briefly go into an exposure alarm after the calibration sequence is completed.

### 3.9.4 Autocalibration Failure

If the instrument cannot calibrate one or more sensor(s), it goes to the SPAN ERR page and remains in alarm until the user presses the [▲] button.

Sensors that could not be calibrated are indicated by flashing sensor icons.

If the combustible sensor fails calibration after the full calibration procedure in this manual has been performed, replace the combustible sensor.

**CAPITAL REGION WATER  
ADVANCED WASTEWATER TREATMENT FACILITY**

**AIR MASK CHECKLIST**

1. Examine mask and hose for contamination, damage and deterioration.
2. Stretch hose and check for tightness of assembly and cracking.
3. Examine harness for wear and function of hardware.
4. Test unit as worn (regulator hooked up to cylinder).
5. Check cylinder gage for full indication (2216 PSI on ultralight units; 4500 PSI on custom 4500 air mask). Replace or recharge cylinder if pressure is less than that stamped on the cylinder. (This procedure should be done at least weekly).
6. With main line (yellow) closed, open cylinder valve to pressurize regulator and hose.
7. Place hand over regulator outlet to block it leak tight.
8. Open the mainline valve.
9. Close cylinder valve. Compare regulator gage to cylinder gage. Plus or minus 100 PSI (200 total) allowable.
10. Watch regulator gage for drop in reading which would indicate leakage. (Check instruction card furnished with apparatus for allowable leakage).
11. Take hand from regulator outlet slightly and check regulator gage for indication of pressure at which alarm rings. Alarm should ring at about ¼ full.
12. With cylinder valve closed, breathe out remaining pressure, if necessary.



# Appendix D

Capital Region Water  
Sinkhole List  
As of March 15 2023

AssetID	Status	Location	PossCause	RepairedBy	Notes
SH-000001	Repaired	Locust St & River Aly	Storm - 2 Pipes	CRW	10/29/14 2 Repairs completed, 2 plates removed.
SH-000002	Repaired	12 N Third St	Sewer - SSP-002000	CRW	08/24/15 Repaired.
SH-000003	Repaired	Cranberry St, #204	Sewer - SSP-004840	Abel Recon	W.O. 5695, 5687 two holes for point repair. Abel Const. Project.
SH-000004	Repaired	Shanklin Aly, #403	Sewer - SSP-006787	CRW	06/10/15 Replaced 10 ft section
SH-000005	Patched	River Aly & Market St	Unknown		No known city sewer down River Aly. 06/03/15 Repaired not by CRW, NE Corner patched.
SH-000006	Patched	River St, #144 N.	Unknown		W.O. 5761, Inspect MH no noted structural damage.
SH-000007	Patched	Court St, #3 S.	Storm - Buried Inlet	CRW	W.O. 3734, 1986.
SH-000008	Repaired	South St, #203	Water - WP-001013	CRW	W.O. 8453, 2779
SH-000009	Repaired	Buttonwood St, #646	Sewer, SSP-004814	CRW & Abel Re	W.O. 12077, 5934, 5933, 5772. Surface repair complete, Lining Project complete 05/19/2019
SH-000010	Patched	Prince Aly, #729	Unknown	COH	05/30/14 CCTV, no issues. 04/08/16 Leak Detection - No leaks
SH-000011	Repaired	Shanklin Aly & Academy Aly	Sewer - SSP-006787	CRW	06/10/15 Repaired by CRW, 10' section collapsed.
SH-000012	Repaired	115 South St	Water - WP-000910	CRW	W.O. 8454, 04/11/16 2 leaks, both mains. 06/01/15 CCTV no issues.
SH-000013	Repaired	Susquehanna St & Dubbs Aly	Storm - 3 Inlets	CRW	11/10/2014 Repaired 3 inlets, removed 3 plates, final street restoration.
SH-000014	Patched	93 Disbrow St	Unknown		W.O. 11154 confirmed patch. 06/01/15 CCTV, no compromise.
SH-000015	Patched	1736 Ethel St	Unknown		No sewer or water pipes in location.
SH-000016	Patched	209 N Fourteenth St	Unknown	COH	W.O. 11147, 5655, 989.
SH-000017	Repaired	N Thirteenth St & Cumberland St	Water - WP-002528 & WH-001408	CRW	W.O. 5770 Repair Hydrant 07/02/15 water main break, 1330 Cumberland.
SH-000018	Patched	1712 Regina St	Unknown		W.O. 11155 - Patched. 06/26/14 CCTV - no issues. 03/06/2015 leak detection - neg.
SH-000019	Repaired	N Seventeenth St & Arsenal Blvd	Unknown	CRW	Completed final Water St Restoration Project. 07/02/15 N 17th & Parkway main break. 06/26/15 CCTV line, no structural issues.
SH-000020	Patched	S Fifteenth St & Drummond St	Unknown		W.O. 11148. SR 1619 sinkhole. Reponsibility of other utility.
SH-000021	Repaired	311 Evergreen St	Storm - SWP-006795	CRW	W.O. 5669, 5783, 5970.

Capital Region Water  
Sinkhole List  
As of March 15 2023

AssetID	Status	Location	PossCause	RepairedBy	Notes
SH-000022	Repaired	S Twenty-Seventh St & Greenwood St	Sewer - SSMH-002295	CRW	W.O. 5784 Manhole repair. 04/13/15 CRW excavated & repaired street.
SH-000023	Repaired	S Fourteenth St & Kittatinny St	Sewer - SSP-005410	CRW	W.O. 11908 Rework, 11906, 3891 Replaced 18" with 8ft of SDR. 05/06/15 CCTV.
SH-000024	Repaired	S Twenty-Sixth St & Duke St	Unknown	CRW	W.O. 5785, 1788 Nov 2014 - CRW completed repair.
SH-000025	Repaired	1525 Sycamore St	Sewer - SSP-000821	Abel Recon	W.O. 7969 & 10971 Lining project completed 05/09/2019, 7946 06/24/15 On-site inv, surface repair complete.
SH-000026	Patched	S Fourteenth St & Howard St	Unknown		04/13/15 cleaned and CCTV, no sewer related issues in area. 07/22/14 CCTV - no compromise, Excavate to rule out lateral, found no cause. Restored street. 01/2014 Evergreen & Thompson main break.
SH-000027	Repaired	126 Evergreen St	Unknown	CRW	
SH-000028	Repaired	1245 Thompson St	Unknown	CRW	01/2014 Evergreen & Thompson, main break
SH-000029	Rough Area	211 S Twentieth St	Strom Leader		Sinkhole in Eugene Alley where 211 S 20th St downspout directed to street. No Sewer line in Eugene Alley. Street failure
SH-000030	Rough Area	2248 Berryhill St	Unknown		W.O. 5799 CRW clear with sewer.
SH-000031	Repaired	Harris St & Fulton St	Water - WP-000652	CRW	W.O. 8478, 2881. Dec 2015 main break at 418 Harris.
SH-000032	Repaired	122 Muench St	Sewer - SSP-001919 & SSMH-004000	CRW & Rogele	W.O. 10698 CRW, WO 3892 Rogele.
SH-000033	Repaired	Verbeke St & Bartine St	Sewer - SSMH-001009	CRW	W.O. 8414, 7338, 2705.
SH-000034	Repaired	Reily St & Susquehanna St	Sewer - SSMH-000922	CRW	W.O. 5807, 7999.
SH-000035	Repaired	107 Reily St	Sewer - SSP000027	CRW & Propert	W.O. 5815. 10/07/16 Roots in lateral at 258 ft. 08/25/14 Repaired bad utility excavations and removed plate.
SH-000036	Repaired	N Second St & Hamilton St	Unknown	CRW	W.O. 5817. 07/22/14 Sinkhole near inlet lateral, excavated found no compromise. Backfilled & restored.
SH-000037	Repaired	James St & Herr St	Sewer - SSP-001364 - Replaced	Rogele	30224, 70979
SH-000038	Repaired	James St, #1020	Sewer - SSP-002006	CRW	W.O. 8415, 3883, 2887.
SH-000039	Repaired	1300 Marion St	Water - WP-005053	CRW	W.O. 6089, 3210 Main Break Repaired
SH-000040	Lining Project	1320 N Third St	2 Sewer Service Laterals, SSP-006784	COH	Id for 2020 Sewer Replacement project. W.O. 11264, 11146, 10673, repair verified. City repaired these taps.
SH-000041	Repaired	Penn St & Calder St	Storm - SWP-001662	CRW	W.O. 1772 effective repairs . 01/2016 Main Break. 09/02/14 WO Repaired storm pipe, inlet on SE corner.

Capital Region Water  
Sinkhole List  
As of March 15 2023

AssetID	Status	Location	PossCause	RepairedBy	Notes
SH-000042	Repaired	Schuylkill St & Reel St	Storm - SWP-000056 & SWP-006463	CRW	W.O. 6173, 2796 , 2795, 2782. 2 Storm pipe repairs.
SH-000043	Repaired	N Fifth St & Alricks St	Water - WP-000096	CRW	W.O. 8497, 5733, No compromise in sewer line.
SH-000044	Repaired	2102 N Fourth St	Water - WP-000511	Rogele	01/2013 Repaired. 12/31/2012 Main Break with multiple issue, a sewer service lateral connection, 2 seperated joints and broken storm pipe.
SH-000045	Patched	Woodbine St & N Third St	Sewer - SSP-002110	CRW	W.O. 7951 included in 3rd st project, 5667 & 5668.
SH-000046	Repaired	Geary St & Agate St	Sewer - SSP-000446	CRW	W.O. 11490, 10977, 10970, 7952
SH-000047	Hole in Street	2308 N Second St	House Leader		04/24/13 CCTV - CRW clear with sewer.
SH-000048	Hole in grass area	2424 N Fifth St	Unknown		05/30/2014 CRW CCTV - Clear, no sewer issues in this area.
SH-000049	Repaired	2245 Elizabeth Aly	Sewer - SSMH-005046	CRW	W.O. 10678, 6433, 5732. No Water Pipes in area.
SH-000050	Repaired	2910 Parkside Ln	Water - WP-003862	CRW	W.O. 3178 Main Repair. No Sewers in Parkside.
SH-000051	Repaired	Mulberry St	Unknown	CRW	04/14/15 CCTV - no issue. 08/12/14 Excavated and backfilled with stone. 12/2008 Main Break 01/02/15 No leaks. 05/20/14 CCTV - no issues. Lines under the chemical building at swimming pool are owner responsibility.
SH-000052	Repaired	S Eighteenth St and Cloverly Ter	Unknown		
SH-000053	Patched	1321 S Twelfth St	Unknown		W.O. 5659,no sewer issue. W.O. 11938 & 10971 repair, 8166 Lining project completed
SH-000054	Repaired	1414 Sycamore St	Sewer - SSP-004020	Abel Recon	04/30/2019, surface repair complete
SH-000055	Repaired	1713 Sycamore St	Sewer - SSP-001070	Abel Recon	W.O. 9814. 6770, 5718, 5670 Lining project
SH-000056	Repaired	1508 S Twelfth St	Sewer - SSP-000721	Abel Recon	W.O. 5702, 5660 Lining project
SH-000057	Repaired	1940 Caledonia St	Sewer - SSP-000891 & SSP-000886	Abel Recon	W.O. 6360, 6320, 3730, 3771 Lining project. SR 514, 03/2014 8 Sinkholes total, 2 main breaks, entire 1400 Block of
SH-000058	Repaired	1440 S Fourteenth St	Water - WP-006009	CRW & Rogele	S 14 th St.
SH-000059	Repaired	147 Balm St	Water - WP-007482 & Sewer SSP-004237	Abel Recon	W.O. 10006 Water St. Restoration, 6768 - Lining project, SR#2161. Main Breaks in area 12/2014 & 01/2015. SR3578, WO 16930,16997, 18531, 18592. 08/29/14 All lines CCTV'd are good or water line leakage. 06/2018 sinkhole open in patch
SH-000060	Plated	204 Locust St	Sewer, SSP-001946		
SH-000061	Repaired	2034 N Fourth St	Sewer - SSP-000477	HRI	W.O. 6772

Capital Region Water  
Sinkhole List  
As of March 15 2023

AssetID	Status	Location	PossCause	RepairedBy	Notes
SH-000062	Repaired	1209 Bailey St	Sewer - SSP-001821 & Water - WP-006861	CRW & HRI	W.O. 9944, 3711-Repair Sewer Pipe 04/20/2015 Main Break
SH-000063	Repaired	N Third St & Seneca St	Strom - SWP-000049	CRW	W.O. 7977, 5979, 5676
SH-000064	Repaired	N Fifth & Strawberry St	Sewer - SSMH-003401	CRW	W.O. 6583, 5679
SH-000065	Repaired	1437 S Fourteenth St	Water - WP-006009	CRW & Rogele	03/2014 8 Sinkholes total, 2 main breaks, entire 1400 Block of S 14 th St.
SH-000066	Repaired	1614 Green St	Sewer - SSP-000057	HRI	W.O. 6773, 5686
SH-000067	Repaired	Capital St & Verbeke St	Water Main Break	CRW	10/21/14 Repaired with 100 lbs stone/80 lbs cold patch. History - 06/25/2012 main break
SH-000068	Repaired	246 Schuylkill St	Unknown	CRW	W.O. 4711, 07/11/14 Filled with stone and patched.
SH-000069	Patched	N Third St & Calder St	Sewer Service Lateral.	Property Owne	Confirmed no sewer issues. 2014 Property owner issue. W.O. 11149, 3894, 5665, 8203, 8216 6798 (Service leak @115
SH-000070	Repaired	113 S Thirteenth St	Water - WLAT-007740	Property Owne	S 13th). Sewer pipes no structural issues.
SH-000071	Repaired	Green St & Woodbine St	WP-008474 & SWP- 000108	CRW	W.O. 6529, 5673 repair storm pipe, 1550 repair main. W.O. 9210, 9030, 6793, 6789, 6790. CRW grouted and Abel
SH-000072	Repaired	S Cameron St & Kittatinny St	Sewer - SSP-001983	CRW & Abel Re	did point repair.
SH-000073	Patched	Liberty St & Adams Aly	Unknown	COH	W.O. 5638, 5745 CCTV - no sewer compromise. W.O. 1779. 09/16/14 Excavation proved no casue, applied
SH-000074	Repaired	1338 Penn St	Unknown	CRW	stone/blacktop. W.O. 6767, 6577, 5731. Abel lined and CRW capped
SH-000075	Repaired	N Third St & Shamokin St	Sewer - SSP-001289 & SSP-005123	CRW & Abel Re	abandoned line.
SH-000076	Repaired	S Sixteenth St & Chestnut St	Sewer, SSP-000995 & SWP-002622	CRW & Abel Re	W.O. 8556, 8555, 6362, 5654 Abel lined, CRW replaced SWP
SH-000077	Patched	312 Graham St	Unknown		W.O. 5677 no structural compromise. W.O. 13683, 11150, 8586, 8554, 8550, 8346, 5743. Prior
SH-000078	Repaired	9 S Thirteenth St	Sewer - SSP-002048	Wexcon	Hydrant leak.. W.O. 11156, 4636. Repair done by COH. Main in good
SH-000079	Patched	1504 North St	Unknown	COH	structural condition. 10/20/16 W.O. 5972, 5675. CCTV verified laterals repaired.
SH-000080	Repaired	2410 Logan St	2 Sewer Service Laterals	Property Owne	2011 & 2014 Main Break repairs at 2417 Logan.

Capital Region Water  
Sinkhole List  
As of March 15 2023

AssetID	Status	Location	PossCause	RepairedBy	Notes
SH-000081	Repaired	650 S Twenty-Seventh St	Sewer - SSMH-002295	CRW	Same as SH-000022. W.O. 5784. 04/13/15 CRW excavated & repaired street.
SH-000082	Repaired	57 N Eighteenth St	Sewer Service Lateral	Property Owne	06/24/15 On-site inv., new lateral cleanouts and patch visible.
SH-000083	No sinkhole locati	2544 N Second St	Unknown		09/30/16 W.O. 5672 Sinkhole, no SH located. History - service leak at 2538/2540 N 2nd.
SH-000084	Repaired	2939 Croyden Rd	Sewer - SSP-001758	Abel Recon	TRENCHLESS LINING. W.O. 8247 completed 04/23/2019, 5658 Patched.
SH-000085	Repaired	1400 Regina St	Water - WP-002253	CRW	W.O. 9874 & 9875, for 1443 & 1445 Regina water service line repairs.
SH-000086	Repaired	2800 Barbara St, #244	Sewer - SSP-001412	CRW	W.O. 5950, 5944, 5682
SH-000087	Patched	Calder St & Wyeth St	Unknown		07/14/15 CCTV not CRW issue. 06/03/15 Site Inv. Patched, from inlet to MH.
SH-000088	Repaired	272 Briggs St	SSP-004568	Abel Recon	W.O. 9813, 7182, 5728, 4640. Pipe was lined.
SH-000089	Repaired	Green St & Hamilton St	Sewer - SSP-000534	CRW	W.O. 10811, 10772, 10770, 61620 07/22/15 Inlet rebuilt.
SH-000090	Patched	1222 Derry St	Unknown		W.O.5666, no sewer line in area. 06/24/15 On-site inv., patch middle of street.
SH-000091	Repaired	Liberty St & Susquehanna St	Sewer - SSP-001935	CRW	W.O. 15223, 4166, 2623. Capped abandoned service lateral.
SH-000092	Repaired	444 Delaware St	Storm - SWINLT-000488	CRW	W.O. 2870, 2871
SH-000093	Repaired	N Second St & Strawberry St	Storm Pipe	CRW	04/22/15 Sealed pipe at bell. 04/08/15 Broken storm pipe from inlet.
SH-000094	Repaired	James St & Snipe Aly	Sewer - SSP-002006	CRW	W.O. 8415, 3883, 2886, 2774, 2727 SR#2031.
SH-000095	Repaired	Wallace St & Muench St	Sewer Main	CRW	06/03/15 CRW Repaired.
SH-000096	Repaired	2005 Lenox St	Sewer Service Lateral	Ed Chambers	W.O. 13733 sewer lateral repair done for 2004 Lenox. WO 8317, 5671 no issues found.
SH-000097	Repaired	N Fifth St & Seneca St	Water Main	CRW	Street Cut Permit Dtd Nov 2014, 02/06/14 water main break
SH-000098	Repaired	918 James St	Sewer - SSP-004795	CRW	W.O. 13757, 10694, 1769.
SH-000099	Repaired	Sayford St & Bartine St	Water - WH-000433	CRW	W.O. 2862, 2508, 2507 & #2506. 07/16/14 Sinkhole excavated and backfilled with stone.
SH-000100	Repaired	123 Hancock St	Sewer - SSP-004381	CRW	W.O. 2996, 1770.
SH-000101	Repaired	Parkway Dr & Briggs St	Storm - SWP-001336	HRI	W.O. 5730, 1795.
SH-000102	Repaired	N Second St & Delaware St	Storm - SWP-000249	CRW	W.O. 11876, 10761, 5674

Capital Region Water  
Sinkhole List  
As of March 15 2023

AssetID	Status	Location	PossCause	RepairedBy	Notes
SH-000103	Repaired	21 N Eighteenth St	Sewer Service Lateral	Property Owne	W.O. 14554, 1771. 48' from SSMH-002239 dirt in lateral. 09/26/14 Sewer Street Cut Permit. 12/05/14 Main break at 43 N 18th
SH-000104	Plated	1619 Regina St	Unknown		04/07/16 W.O. 1773, no compromise, pipe is lined.
SH-000105	Repaired	N Second St & Granite St	Unknown	CRW	07/29/14 W.O. Excavated, backfilled and removed plate
SH-000106	Repaired	Strawberry St & Cowden St	Unknown	CRW	08/14/14 Filled in with stone and compacted.
SH-000107	Repaired	N Third St & Vaughn St	Storm, SWP-006344	CRW	WO28367 Replaced Storm Pipe. 08/18/14 Excavated and repaired broken 10" TCP with wrap around clamp.
SH-000108	Repaired	1604 N Second St	Unkown	CRW	S.R. 1549, prior CCTV & leak detection, no issue. 2014 Filled with cold patch.
SH-000109	Repaired	1010 Susquehanna St	Verizon Vault	CRW	S.R. 2622, Verizon vault issue. 08/21/14 Filled with cold patch.
SH-000110	Repaired	N Second St & Harris St	Sewer - SSP-000065	CRW	W.O. 5726, 3782, 3825
SH-000111	Repaired	217 Calder St	Water - WP-004677	CRW	W.O. 9795, 9826,3074, 2841, 1468 SR#3054. 08/12/16 W.O. 4711 Sewer line in good condition. 06/24/14
SH-000112	Repaired	Schuylkill St & Susquehanna St	Unkown	CRW	Repaired, stone and 200 lbs cold patch
SH-000113	Repaired	Kittatinny St & Fishel Aly	Storm, SWP-006795	CRW	W.O. 11136, 9986, 5669 SR#3067 W.O. 10104 Mac Mor Repair, 10005. 10029, 3336, 1791 &
SH-000114	Repaired	452 Crescent St	Sewer - SSP-005876	Mac Mor & CRW	2791 SR#3070 sinkhole.
SH-000115	Repaired	N Eighteenth St & North St	Storm - SWP-002638	CRW	01/15/2020 repair WO29436. W.O. 1973, 3101, 4917, 4918.
SH-000116	Rough Area	Lewis St & Susquehanna St	Unknown		09/30/16 W.O. 5678 could not locate an area with sinkhole.
SH-000117	Patched	1362 Mayflower St	Unknown		W.O. 11157, 11841, 11961.
SH-000118	Repaired	N Fifth St & Schuylkill St	Sewer - SSP-001478	CRW	W.O. 10106, 9709
SH-000119	Depression	2407 Turner St	Sewer Service Lateral		04/13/15 CCTV line, lat. at Turner & Saul is broken, soil visible, CRW issue. Flushed line. W.O. 14554, 16406, 1771, 4276. 04/15/16 SR#1126 Reopen
SH-000120	Sinking Patch & h	1 S Eighteenth St	Sewer Service Lateral		issue no resolution from SR#150
SH-000121	Repaired	919 Green St	Sewer - SSP-001931	HRI	W.O. 1996, 3818, 5727.
SH-000122	Repaired	Division St & Waldo St	Sewer - SSP-000380	Pipe Data	W.O. 3146, 3895
SH-000123	Sinkhole	2218 Susquehanna St	2 Sewer Service Laterals		W.O. 1761, 1768, 1919
SH-000124	Repaired	S Seventeenth St & Sycamore St	SWP-000690	CRW	W.O. 10953, 10988, 11241. 04/29/15 Hole opened up.

Capital Region Water  
Sinkhole List  
As of March 15 2023

AssetID	Status	Location	PossCause	RepairedBy	Notes
SH-000125	Repaired	Seneca St & Turner St	Verizon Vault		W.O.11158, 11739. 04/2015 MH structurally good. Bell telephone vault has 1'x1' hole in the side
SH-000126	Repaired	S Eighteenth St & Rudy Rd	Sewer - SSP-001572	CRW	W.O. 13814, 13082-repair, 13215, 15272 -extended prior repair, 15271-lining project 06/30/15 video Rudy broken pipe from 6/116 to Holly 12/01/15 Joe B. said he will serve the notice. 06/24/15 On-site inv, sinkhole located. 04/14/15 CCTV to homeowner's lateral - pipe is good, MH is not
SH-000127	Sinkhole in yard	1025 S Seventeenth St	Unknown		
SH-000128	Repaired	N Front St & State St	Water - WLAT005063	CR Powers	W.O. 3244, 3216, 3085, at 106 State St. SR#1549
SH-000129	Patched	1111 N Second St	Other Utility Patch		05/06/15 Pic provided by A. Bliss
SH-000130	Repaired	1508 Briggs St	Water - Service Line	Big Brother	W.O. 2475, 8798, 11646, 10539, 11673 - home owner repaired.
SH-000131	Repaired	Taylor Blvd & Market St	Sewer - SSP-001180	Wexcon	W.O. 12924, 13011
SH-000132	Repaired	Sixteenth St & North St	Storm Pipe	CRW	06/04/15 Repaired, replaced damage pipe. 05/29/15 JB recd call from D. West 8pm Cnty called to inform of sinkhole, C* 08/2016 Water's St. Restoration Project. 05/06/15 EML A. Bliss EML Reappearing sinkhole hear*
SH-000133	Repaired	Christian St & Sylvan Ter	Water	CRW	
SH-000134	Sinkhole	319 Lewis St	Undetermined		W.O. 2878, 11915. CCTV clears CRW.
SH-000135	Patched	S Twenty-Sixth St & Greenwood St	Undetermined		06/26/15 CRW cold patched earlier patch that is sinking. 06/02/15 EML LG, CCTV clears CRW
SH-000136	Sinkhole	Hillside Avenue	Unknown		06/24/15 On-site inv., could not locate sinkhole. 06/09/15 EML softball size hole, middle of st.
SH-000137	Repaired	Darlington Aly & Nineteenth St	Unknown	UGI	06/24/15 On-site inv., UGI working on repair to backfill 06/25/15. Exposed collapsed Y lateral pipe and SE inlet hole in pipe.
SH-000138	Repaired	Fifteenth St & Swatara St	Brick Sewer Main	Rogele	06/24/15 Pipe slipped with SDR 35, CCTV repair and connections.
SH-000139	Repaired	Evergreen St & Kittatiny St	Storm - SWP-006795	CRW	W.O. 5669, 11136
SH-000140	Patched	1418 Liberty St	2 Sewer Service Laterals	COH	07/01/15 Per Joe, updated city 2 COH vacant properties have compromised laterals at the main.
SH-000141	Sinkhole	1714 Walnut St	Sewer Service Lateral		W.O. 4310, 4297 void in pipe at 1736 Walnut die test confirmed.



Capital Region Water  
Sinkhole List  
As of March 15 2023

AssetID	Status	Location	PossCause	RepairedBy	Notes
SH-000142	Repaired	1911 Susquehanna St	Water - WLAT-019291	Construux	W.O. 13742, leak repair at 1907.
SH-000143	Repaired	1800 Logan St	Storm - SWINLT-000619	CRW	W.O. 2686
SH-000144	Repaired	Evergreen St & Haehnlen St	Water - WP-001692	CRW	W.O. 1991, 985
SH-000145	Repaired	1220 Walnut St	Water - WP-002234	CRW	W.O. 3876 Water St Restoration.
SH-000146	Sinkhole	241 Seneca St	Unknown		09/30/15 EML to DE Area Sinking. 07/15/15 Cleaned, CRW cleared. 01/20/2010 Main Break at 243 Seneca
SH-000147	Patched	1734 State St	Other Utility Patch		07/27/15 EML AB with pics
SH-000148	Repaired	1115 S Eighteenth St	Storm - SWP-001079	CRW	W.O. 10952 St. Restor completed 08/15/17, 2471 Repair completed 04/20/16, 2370 S.R. 857
SH-000149	Patched	1739 Susquehanna St	Unknown	COH Patched	08/06/15 CCTV not CRW issue, 12" pipe has no compromise
SH-000150	Repaired	Fourth St & Chestnut St	Storm Pipe	CRW	07/21/15 WO to inv. - lines up with UGI cut
SH-000151	Repaired	215 Market St	Sewer - SSP-004935, SSP-001999	CRW, Abel Recr	8/17/15 CRW concrete over Storm Pipe joint.
SH-000152	Repaired	1232 Rolleston St	Sewer - SSP-000878	CRW	W.O. 18465 - 2019 repair, 8092 - 2017 repair, 8090, 4100
SH-000153	Patched	Fifteenth St & Walnut St	Unknown	Unknown	W.O. 12672, 10517, 3865
SH-000154	Patched	Penn St & Woodbine St	Verizon Vault	Verizon	08/25/15 Site Inv - Patched. 07/21/14 Plate Tracking List - "Undetermined. One call made"
SH-000155	Repaired	Logan St & Clinton St	Sewer - MH	CRW	10/07/15 W.O. Verizon vault responsible for sinkhole.
SH-000156	Repaired	Third St & Walnut St	Water Main Break	CRW	08/25/15 Site Inv - Patched. 07/25/14 Plate Tracking list "Not addressed yet. Vicinity of CSO"
SH-000157	Repaired	Division St & Agate St	Sewer - MH & SWP	CRW	W.O. 3917, S.R. 1546
SH-000158	Repaired	Green St & Edward St	Sewer, SSMH-000076 and SSP-000339	CRW	09/24/14 Repaired broken water main sheared at steam vault. Removed 4' section of 10" pipe.
SH-000159	Repaired	Twentieth St & Paxton St	Storm - SWP-002104	CRW	10/28/14 Repaired & filled void around chimney & reset manhole casing. Restored street.
SH-000160	Sinkhole	Twelvth St & Cumberland St	Unknown		Manhole repair WO#22653, Sanitary Pipe Repair WO#19600, 04/28/16 W.O. 2879, CCTV Sewer Pipe, Closed. 9/15/2015 EML CCTV'd and CRW clear.
SH-000161	Repaired	125 N Summit St	Water - WLAT-014918	CRW	W.O. 708
					08/12/15 CCTV Sanitary Pipe and Storm Lateral, CRW Clear
					W.O. 3156, 4510

Capital Region Water  
Sinkhole List  
As of March 15 2023

AssetID	Status	Location	PossCause	RepairedBy	Notes
SH-000162	Repaired	Susquehanna St & Union St	Water - WP-004885	CRW	W.O. 7745 Repaired failed clamp on water line in verizon vault.
SH-000163	Sinkhole	River St	Bad compaction, other utility		10/09/15 Per Joe B. Hole by previous utility patch.
SH-000164	Repaired	River St & Pine St	Water - WVH-000325	CRW	W.O.1696 ST Restoration, water.
SH-000165	Sinkhole	1004 N Eighteenth	Sewer - SSP-001232		Two factory taps blown out. W.O. 3403 lining project, 2971, 631 S.R. 150, 158
SH-000166	Repaired	Fifth & Boyd	Water - WP000649	CRW	W.O. 1190, 1144 S.R. 920, 439, 294
SH-000167	Repaired	2704 N Fifth St	Sewer - SSP-001497	CRW	W.O. 2972, 8418, 8649, 8734 SR532
SH-000168	Sinkhole	3004 Market St	Unknown		Closed W.O. 3282, dated 05/10/16 Leak Detection - negative, out of CRW sewer service area
SH-000169	Repaired	Pentwater & Briarcliff	Water - WP-008827	CRW	W.O. 10355, 2116 S.R. 846
SH-000170	Repaired	23 & Derry	Sewer - SSMH-005519	CRW	W.O. 3295, S.R. 1223
SH-000171	Repaired	Fulton & Hamilton	Storm - SWP-006535	Wexcon	W.O. 8160, Lining contract work, W.O. 11445 08/28/17 plated, 09/22/17 patched, unkown to patch work
SH-000172	Repaired	Front & Chestnut	Steam Manhole	CRW & NRG	10/19/16, W.O. 5947 - NRG to repair steam manhole. W.O. 3474 3449
SH-000173	Repaired	2313 Logan	Water - WP-004044	CRW	2017 St Restoration WO#8962, 8963 11/18/16, Repair W.O. 6597, 6553 S.R. 2431
SH-000174	Patched	1706 Berryhill St	Sewer SSP-001023		WO18049 temp st restor completed 06/08/18, Repair 8658 S.R. 2863.
SH-000175	Repaired	751 Seventh St	Water - WV-001417	CRW	W.O. 8315 repair valve box, S.R. 2923
SH-000176	Repaired	232 State St	Sewer - SSP-001404	CRW	Repair WO 8390 completed 04/13/17, 8591 St Restor completed 06/23/17 S.R. 2982
SH-000177	Repaired	Twentieth St & Greenwood St	Storm, SWP-000748	CRW	W.O. 8669, 8679, S.R. 3001
SH-000178	Repaired	Penn St & Kelker St	Storm, SWP-006616	CRW	WO9436 repair completed 06/05/17, 9438 St Restor completed 06/23/17, S.R. 3030
SH-000179	Repaired	Sixteenth St & Paxton St	Storm, SWP-000669	Rogele	W.O. 10032, 9751, 9758, S.R. 3058
SH-000180	Sinkhole	3016 N Third St	Sewer, SSP-000343		W.O. 10135, 10136, 10178, 11668, S.R. 3074, 3147
SH-000181	Repaired	2043 Chestnut St	Unknown		WO 11835 review of CCTV no evidence to cause for sinkhole, St Rest WO29725or

Capital Region Water  
Sinkhole List  
As of March 15 2023

AssetID	Status	Location	PossCause	RepairedBy	Notes
SH-000182	Sinkhole	Twenty-Third St & Luce St	Storm, SWP-000899		W.O. 11840, 11839 - Repair, 11881 Lining project candidate S.R. 3153
SH-000183	Repaired	Market and Evergreen	Sewer, SSP-000937	Rogele & Abel	W.O. 12249 exceeds depth, 12611, S.R. 3161
SH-000184	Repaired	2949 Front St	Sewer, SSP-001908	CRW	W.O. 13133, 12519, 12540, 12466, S.R. 3166, in rear of building
SH-000185	Patched	Seventeenth and Market	Sewer, SSP-001009	TBD	WO 12992, 8769 - Repair, S.R. 3179 & 2981 on 03/2017
SH-000186	Repaired	353 Fifteenth St	Sewer, SSP-000900	Rogele - Sewer	W.O. 13737, 13920, S.R. 3208
SH-000187	Repaired	1220 Thompson St	Storm, SWP-006846	CRW	W.O. 14467, 14474, 14477 - Repair, S.R. 3232
SH-000188	Repaired	Twelvth St & Walnut St	Sewer, SSP-000928	CRW	See also SH-000210. W.O. 16259, 16306, 16314, 20501 SR 3277
SH-000189	Repaired	7TH & Schulkill	Storm, SWP-001985	CRW	W.O. 17837, 17957, 17964, 17965, 18042, 18205, 18552 SR 3413
SH-000190	Repaired	209 HUMMEL ST	Sewer, SSP-006057	CRW & Rogele	W.O. 16759, 16769, 16782, 17819 S.R. 3325
SH-000191	Repaired	1400 Block Scott St	Sewer, SSP-001624	CRW	W.O. 17589, 17616, 17595, 17596, S.R. 3386
SH-000192	Repaired	SECOND ST & CUMBERLAND ST	Storm, SWP-003048	CRW	WO 17706, 17713, 17728, 17790, 18032, 18313 S.R. 3393
SH-000193	Repaired	SEVENTEENTH ST & ELM ST	Sewer, SSP-000950	CRW	W.O. 19966, 20001, 5361, 17702, S.R. 3397
SH-000194	Repaired	1245 MULBERRY ST	Water Service, WLAT-007041	Construxx	W.O. 17302, S.R. 3576
SH-000195	Repaired	400 MARKET ST	Storm, SWINLT-005050	CRW	W.O. 18716, S.R. 3631
SH-000196	Repaired	1839 Spencer	Sewer, SSP-002074	Rogele	W.O. 19159, 19251, 19170, 19229, 19252, 24320 SR 3774
SH-000197	Repaired	Geiger	SSP-001794	Rogele	W.O. 19273, 19281, 19290, 19329
SH-000198	Repaired	James St & Calder	STORM - SWP-000319	CRW	W.O. 19611, 19612, 20021, 20613, 20024, 20071, 20173 S.R. 3924, 4039
SH-000199	Repaired	3RD AND SAYFORD	STORM - SWMH-000037	CRW	W.O. 20028, 20029, 20030, 20034, 20188, 20202 20520, SR 4064
SH-000200	Repaired	Park St near 19th St	Storm - SWP-003081	CRW	W.O. 20307, 20308, 20309, 21459, SR4158
SH-000201	Repaired	Susquehanna St near Dubbs Aly	Sewer, SSP-007136	Rogele	W.O. 20026, 19987, 19986, 19985, 19895, 19894. SR 4007
SH-000202	Repaired	Holly & Carlisle	Sewer, SSP-001004	CRW	W.O. 21877, 21848, 21876, 21877, 21879, 23928. SR4585
SH-000203	Repaired	CRESCENT & BERRYHILL	Sewer, SSP-005876	Rogele	W.O. 23647, 23652, 23651, 23641, 17827, 17830, 17843. SR 3407, 3408, 3534.
SH-000204	Repaired	6th & Muench	Sewer, SSP-003543	Rogele	W.O. 24380, 24407, 24386, 24490, 25907 SR5238

Capital Region Water  
Sinkhole List  
As of March 15 2023

AssetID	Status	Location	PossCause	RepairedBy	Notes
SH-000205	Repaired	SUSQUEHANNA ST & CUMBERLAND ST	Sewer, SSP-000655	Rogele	W.O. 21332, 21341, 21379, 21405, 24585, 25733. SR4437
SH-000206	Repaired	THIRD ST & BLACKBERRY ST	Sewer, SSP-002001	BLD	W.O. 21907, 22384 - Repair, 24588 SR4612
SH-000207	Repaired	2716 REEL ST	Water Service, WLAT-000526	CRW	W.O. 10004, 10047, 10387, 10184, 11907, 13815, 24589. SR3069
SH-000208	Repaired	CAMERON ST & MARKET ST	Abandoned Brick Sewer Pipe	CRW	W.O. 18064, 24598. SR3457
SH-000209	Repaired	2459 DERRY ST	Storm - SWINLT-003939	CRW	W.O. 19168, 19257, 19826, 24599 SR3772
SH-000210	Repaired	1198 WALNUT ST	Sewer, SSP-000928	Rogele	See also SH-000188. W.O. 16314, 19240, 24600, 20501 SR3806
SH-000211	Repaired	Front St. & Riley St.	Sewer - SSP-003030	Standard Pipe S	W.O. 24876, 24978, 24976- 03/18/18 Pending, 25474-Repair
SH-000212	Repaired	10th & Market	Sewer - SSP-000701	CRW	W.O. 26210, 26193, 26209, 26214
SH-000213	Repaired	1648 4th St	Sewer - SSP-003430	Rogele	W.O. 26012, 26006, 26211, 26212, 26213, SR 5689
SH-000214	Repaired	620 Geary St.	Water - WP-010999	CRW	W.O. 26586, 26621, 26645, 26648 30749 SR 5849
SH-000215	Replaced Pipe	Meunch & Susquehanna	Sewer, SSP-000081	Rogele	WO 25452, 25457, 25458, 25464, 27921, 41671 SR 5488
SH-000216	Replaced Pipe	Evergreen & Mulberry	Sewer, SSP-006057	Rogele	WO 26805, 26811, 26812, 26826, 26889 SR 5920
SH-000217	Repaired	423 Crescent St.	Water - Failed Patch	CRW	WO27636 SR6158
SH-000218	Repaired	159 Royal Terrace	Storm, SWP-003023	CRW	WO 27813, 27806, 27810, 28993, 30895, 30912 SR6219
SH-000219	Repaired	17th & Elm	Sewer, SSP-004438 & Storm, SWP-000579	Rogele	WO 27711, 27678, 27680, 27681, 27710, 31335, 35377 SR6188
SH-000220	Repaired	Second & Strawberry	Sewer Manhole, SSMH-001198	CRW & Abel Re	WO 27629, 27630, 27631, 27632, 28056, 28216, 28217 SR6166
SH-000221	Repaired	Woodbine & Susquehanna	Storm, SWP-000080	CRW	WO 26805, 26811, 26812, 26826 SR5920, SR8810
SH-000222	Repaired	Williams to Verbeke	Sewer - SSP-002013	CRW	WO 27036, 27037, 27038, 27039, 28069, 28071, 28279, 28280, 29676
SH-000223	Repaired	4th & Sayford	Sewer, SSP-000508	CRW	WO 29333, 29339, 29530, 29578, 29724
SH-000224	Repaired	15th and North	Storm, SWP-000587	CRW	WO 28661, 29551, 29552, 29564, 29565, 29854 SR 6420, 6545
SH-000225	Repaired	4th st near Sayford	SSP-000503	CRW	WO29530 TAY 10/2/19. Possible duplicate of SH-000223 tyork, 02/18/2020.
SH-000226	Temporary patch	21st & Chestnut	SSMH-002278	TBD	WO31255, 34243 SR6994, tyork, 02/18/2020.

Capital Region Water  
Sinkhole List  
As of March 15 2023

AssetID	Status	Location	PossCause	RepairedBy	Notes
SH-000227	Repaired	441 S 15th Street	water, WP-010647		05/08/2020 SR: WO35653, WO35641, SR7823
SH-000228	Repaired	N 7th & Seneca St	SWP-000064	CRW	SR7859, WO36506, WO36253, WO36866
SH-000229	Repaired, CIPP	North St & N 18th St	Sewer, SSP-001195		Same area as SH-000115, WO36695, 32792, 32795. SR7777, WO35115, 35225. Two prior repairs done by CRW on contractor work WO25044, 34171, 35225 (Third), 45607 (Fourth)
SH-000230	Repaired	1527 Catherine St	Water Service, WLAT-009901.	CRW	
SH-000231	Repaired	703 N 17TH ST	Water, WP-002565	CRW	WO35312, 35484 SR7798
SH-000232	Repaired	Wiconisco and Agate	SSMH-000152	CRW	SR 7920, WO 36850, 37199, 37201.
SH-000233	Patched	701 N Front St	Water Service, WLAT-021029	CRW	WO37313 tyork 7/15/2020.
SH-000234	Plated	2nd & Locust	SSP-001946	Rogele	SR 7973, WO 37385, 37424, 37885. tyork 7/17/2020.
SH-000235	Repaired	385 HALE rear	SWP-007865	Verizon	tyork 7/31/2020 Verizon dug through our line. WO38656
SH-000236	Repaired	James & Boas	SWP-007951	CRW	SR 8054, WO 38640, 38658, 39328, 39578 SR8064, WO 6895, 15496, 38712, 40415. WO40416 TAY 9/29/2020.
SH-000237	Repaired	1726 Market St	SSP-000966	TBD	
SH-000238	Plated	Thompson & Summit	SSP-005272	TBD	WO40721, 37238, 26875 TAY 10/14/2020.
SH-000239	Repaired	Penn & Basin	SWINLT-000892	CRW	SR8333, WO41601, 41611, 41649. WO41714 TAY 11/30/2020. SR8354, WO41814, 41809, 42007, 41897 Open Repair.
SH-000240	Repaired	1000 Blk Susquehanna St	SSP-000656	Rogele	WO42879 TAY 2/2/2021.
SH-000241	Repaired	1830 Green St	WLAT-003644	CRW	See SH-000255
SH-000242	Repaired	Green & Cumberland	SSP-000634	CRW	SR8621, WO 44748, 44664, 44903, 44904, 44916
SH-000243	Repaired	Green & Cumberland	SSP-000634	CRW	SR8621, WO 44748, 44664, 44903, 44904, 44916
SH-000244	Repaired	Broad St Market	SSP-004748	CRW	SR8651, WO 44954, 45001, 45002, 45003, 45028, 45081
SH-000245	Repaired	Central St	SSP-001675	CRW	SR8789, WO45814, 45820 45897, 45925 45927, 46182
SH-000246	Repaired	Liberty & Buttonwood	SSP-001399	Rogele	SR8837 WO46302 46300, 46301, 48932, 47652
SH-000247	Repaired	Balm st	SSP-007191	Rogele	SR9040 SR8700, WO45231 45333
SH-000248	Repaired	2229 Logan St.	SSP-000487	CRW	SR8912 WO47579, 47578, 48489, 47572
SH-000249	Repaired	River & Barbara	SSP-001415	Rogele	SR8920, WO47621, 47630, 47631, 47632 SR9004, WO48629, WO48685, 48691, 49126, 48620   REPAIRED IN FRONT OF CURB
SH-000250	Repaired	737 & 739 S 26th St	SSLAT-000181	CRW	
SH-000251	Repaired	Brensinger & Emerald	SSP-005257	Rogele	SR8960, WO48631, 48810, 48947, 49127, 49144

Capital Region Water  
Sinkhole List  
As of March 15 2023

AssetID	Status	Location	PossCause	RepairedBy	Notes
SH-000252	Repaired	1768 Market St	SSP-000966	Rogele	SR8542 WO43380 43427, 43417
SH-000253	Repaired	12th & Cumberland St	SSMH-001443, SSP-000688	CRW	SR8820, WO46391 46392, 47562,
SH-000254	Repaired	Penn & Sayford	SSP-4482, SSMH-000985	CRW	SR8873, WO46488, 46487, 46489, 47613, 46491, 47613
SH-000255	Repaired	Green & Muench	SSP-000082	CRW/Rogele	SR9140 WO4905, 49057, 49058, 49212
SH-000256	Repaired	Walnut & Linden	WP-007123	CRW	SR8907 WO49246, 47564, 47649, 47650, 47651
SH-000257	Repaired	321 Hamilton St	WP-005029	CRW	SR8695 WO45200, 45200, 45885
SH-000258	Repaired	Cameron & Sycamore	WP-001491	CRW	SR8583 WO43920, 45885, 43926
SH-000259	Patched	Flinton St, rear of 1220 Rolleston	Previous CRW repair	CRW	WO52160   Not a pipe issue
SH-000260	Patched	2020 Market St	SSP-001179	CRW	SR9358, WOs 51789, 50802, 13010
SH-000261	Repaired	701 N 2nd St	SSP-004595	CRW	WO's 51083, 51084, 50972, 52394 SR9419
SH-000262	Patched	18th & North	Tap at SWP2639	CRW	SR9439, WOs 52008, 51203, 51189
			SSP-001376 laterals broken off of CRW main		
SH-000263	Repaired	Cumberland and Monroe	main	CRW	SR9446, WOs 51230,51234, 51233, 52381
SH-000264	Repaired	24 N Summit St	SSP-001820	Rogele	SR9467, WOs 51476, 51748
SH-000265	Temporary patch	Front and Chestnut Sts.	SWP-000454	Rogele	SR9697, WOs 52712, 53298, 52740, 52786, 52787
SH-000266	Repaired	2350 Green St	SSP-005230	CRW	SR9815 WOs 53398, 53451, 53961, 54905
SH-000267	Repaired	19 S Summit St	SSP-000938	CRW	SR9939, WOs 54454, 54486, 54887, 54897, 54903, 55052
SH-000268	Repaired	Third and Klemm	SSMH-000066	CRW	WOs 55031, 55036, 55123, 55122
			Goose neck from WLAT15826		
SH-000269	Repaired	1625 Briggs St	WLAT15826	CRW	SR9985, WOs 54548, 58578, 54588
			WLAT-007828		
SH-000270	Temporary patch	1408 THOMPSON ST	gooseneck	CRW	SR10471, WOs 56438, 56509, 56532, 56510
SH-000271	Patched	Susquehanna & Hamilton	WP-004527	CRW	SR10396 10609, 10610, WOs 56135, 57289, 56142
SH-000272	Repaired	Front & Pepper	SSP-003012	TBD	04/06/2022 SR: CRW responsibility, added per WO57861
					SR11006, WOs 58675, 58845, 59002, 58703, 58955, 59062,
SH-000273	Repaired	431 Amity Rd	SSP-006569	Rogele	58675
			Tap break-in from SWP2638		
SH-000274	Repaired	1803 North St	SWP2638	Mr Rehab / CRW	SR11035, WOs 58832, 59842, 58841, 58842
SH-000276	Repaired	S 18th St & Bellevue Rd	WP-002345	CRW	SR11007 WOs 58691, 58735, 58750

Capital Region Water  
Sinkhole List  
As of March 15 2023

AssetID	Status	Location	PossCause	RepairedBy	Notes
SH-000277	Patched	2206 Logan St	Leaking gooseneck	CRW	SR11079 WOs 58994, 59036, 60174
SH-000278	Repaired	2540 N 2nd St	WP-3933 break	CRW	SR11034, WOs 58852, 58873, 59063, 58874
SH-000279	Investigation	1816 STATE ST	Investigation ongoing	TBD	WOs 60200, 60179, 61159
SH-000280	Repaired	N 13th St & Walnut St	Abandoned Leaking Service - WO57422	CRW	SR11120, WOs 57422, 60157, 61074, 61158
SH-000281	Repaired	227 Chestnut St	old lateral main break	CRW	SR10601, WOs 57289,
SH-000282	Patched	2123 Jefferson St	WLAT-019771	CRW	SR10328, WOs 55860, 62005
SH-000283	Filled with stone	121 Conoy St	SSP-004538	CRW	SR11256, WOs 61070, 62019
SH-000284	Repaired	Front & Manor	Junction of SWP8457, SWP8458 and SSP1907	CRW	SR11262, WOs 62065. 62415,
SH-000285	Plated	William & Verbeke	SSP-007396	CRW	WO64211
SH-000286	Active	2229 Logan St.	SSP-000487		
SH-000287	Patched	2112 Susquehanna St	Settlement	CRW	WO65124
SH-000288	Repaired	2nd and Charles (Alley)	SWP348	CRW	WOs 28984, 32837, 32921
SH-000289	Repaired	2229 LOGAN ST	SSLAT305 improper repair by contractor	Lech Bros.	WOs 58994, 65482, 65489, 65490, 65583
SH-000290	Active	Melrose and Greenwood	SWP8599 repair failure		WOs 68224, 68189
SH-000291	Active	1619 Compass	lateral connection		

# Appendix D

## Sinkhole Master Spreadsheet



# Appendix E

# Appendix E

## Inspection Checklists

## CRW Advanced Wastewater Treatment Facility - High Flow Procedures

These procedures are designed to manage increased hydraulic loading at the AWTF. This includes the management of the final clarifier blankets, which typically are a source of effluent suspended solids during periods of increased hydraulic loading into the AWTF.

These procedures are meant as guidelines for handling increased hydraulic loading into the plant. All indicated flows are for reference only. They should not be used as absolutes. Do *NOT* wait until the flow reaches the indicated flow to take action. Remember, these are *ONLY* guidelines. Visual observation of the plant and review of weather conditions are necessary to determine the proper action. At *NO* time should the Chamber C bypass be opened without permission of the Operations Supervisor or Temporary Supervisor in charge. If it is determined that a storm is approaching, the Front Street wet well set points need to be adjusted to take the wet well down to 291.5.

### 1. Flows: 28 to 35 MGD

#### Front Street Pump Station:

- The number 1 and 2 variable speed pumps remain in automatic.
- Wet well setting for two pumps running is 291.5 feet in main computer.
- Place Bar Screen into the hand mode from auto mode.
- The 3rd pump (constant speed) set at 296.9 in automatic main computer.
- The 4th pump (constant speed) set at 297.0 in automatic main computer.
- Ensure that number 3 and number 4 pumps are set to the auto position at this time in the Main Computer.

#### Settled Sewage Pump Station:

All Settle Sewage pumps are Variable speed so you may run any two pumps in automatic on the main plant computer.

- Ensure that the other two pumps are off on the main plant computer.

#### Grit Removal System:

- Additional vortex grit chambers are automatically placed into service by the SCADA system at flows of 20, 40, and 60 MGD. Ensure the second chamber has been placed into service.

## 2. Flows from 35 to 55 MGD

### Front Street:

- Ensure that the bar screen is on hand.

### (Warning for Spring Creek)

### Spring Creek:

- If a third pump appears to be needed, place the pump on hand and set output to 160 amps. The main station breaker cannot handle the power requirements of three pumps on maximum.
- Place Bar screen into hand mode from auto mode.

### Grit Removal System

- Additional vortex grit chambers are automatically placed into service by the SCADA system at flows of 20, 40, and 60 MGD. Ensure the third chamber has been placed into service.

### Main Plant:

- Closely monitor the Settled Sewage Pump Station wet well to ensure the two variable speed pumps are maintaining the two pump wet well set point of 8.0 feet.
- Return tubes and Final Blankets: Watch to ensure that the blankets are not in danger of rising into effluent. Monitor both more closely. Increase the return rate slightly to compensate for dilution in the Oxygenation Trains.

**\*At 45 MGD, you can start Blending. At 49 MGD, you *must* start blending.**

- Put Final Influent Gates on High Flow Mode on the Main Plant Computer.
- Set the High Flow Switch at Settled Sewage to on on the Main Plant Computer Record time.
- Set Chlorine up to feed at Chamber D and The Contact Tanks Record time.
- Turn sampler on at contact tanks. Record the time.
- Open the gate at Chamber C. Record the time.
- Turn sampler off at Clarifiers (upper end). Record the time.
- Notify AWTF Laboratory of your start and stop times and record time.

- If on Daylight inform the Pretreatment Coordinator so haulers can be informed not to come in. At no time may a waste hauler be discharged at Chamber B while blending, or until flow has dropped below 37 MGD after a blending event.
- Call DEP and inform them that you have started Blending.
- See the bottom of the blending check list. Record time.
- Log information in logbook and on the blending checklist.

**Chlorine Residual:**

- Maintain at 0.35 mg/L during winter months (October through April), 0.45 mg/L during the summer months (May through September)

**3. Flow Greater than 55 MGD**

**Front Street:**

- Watch Wet Well level, if the three pumps will not maintain 296.9, ensure the 4th pump comes on at 297.0.
- If the flow reaches 70 MGD for extended periods (72 hours) this may damage the conveyance system at Front Street. Talk to the Shift Supervisor to determine the course of action.

**Spring Creek:**

- No change necessary. (Ensure all prior changes have been made.)

**Grit Removal System**

- Additional vortex grit chambers are automatically placed into service by the SCADA system at flows of 20, 40, and 60 MGD. Ensure the fourth chamber has been placed into service.

**Main Plant:**

**If the high flows are of long duration, consult with the Shift Supervisor on duty or the Operations Supervisor for any different instruction.**

**Note: Maximum sustainable flow at Harrisburg AWTF: At 80 MGD – for short periods of up to several hours, it is possible to keep the entire process operational.**

**65 MGD is the maximum flow for periods of a week to several months which the plant will be able to accommodate with minimal effluent limit violations.**

#### **4. Flow returns to below 45 MGD: you must stop Blending!**

**Main Plant:**

- Start sample at upper end. Record the time.
- Close gate at Chamber C. Record the time.
- Stop sampler at lower end. Record the time.
- Set Chlorine back to normal. Record Time.
- Take Settled Sewage off of High Flow Mode.
- Take Final Influent Gates off of High Flow Mode.
- Inform AWTF Laboratory of action Record Time.
- Inform DEP when you stopped Blending, and again when Plant Influent Flow has dropped below 37 MGD to inform them that we are now accepting Contract Waste Haulers. Record Time.
- Log information on blending checklist and in logbook.
- Inform Pretreatment Coordinator that we are accepting hauler again.

**Note: At NO time allow final Clarifier Blankets to discharge into effluent. Immediately contact the Shift Supervisor or Operation Supervisor with all data available (i.e. flow, number of tanks, current rain status, etc.) for further instructions.**

**\*NOTE: DEP requires notification on Blending. After blending has begun,(45MGD to 49MGD) Call 705-4785 anytime. Either speak to the person on the phone or leave the following message!**

**(“Identify yourself” from Capital Region Water A.W.T.F. Calling to inform you that we have begun blending at “state time and date”) Also after you stop blending call DEP stop time and date. Additionally, please call DEP again once our flow has dropped below 37MGD to inform them that we are now accepting Contract Waste Haulers.**

## Standard Daily CSO Regulator Inspection Activity Checklist

Complete the following items during a standard daily CSO regulator inspection (i.e. when there are no ongoing or recent CSOs or required maintenance activities):

**NOTE: WHENEVER AN ENTRY IS REQUIRED, BE SURE TO FOLLOW ALL CONFINED SPACE ENTRY GUIDELINES.**

- Protect crew members from oncoming traffic by using the vehicle as a physical barrier and turning on the flashing lights, as well as setting up traffic cones if extended work is necessary. Open the diversion chamber and visually inspect the chamber for any noticeable problems. Use a pole mounted inspection camera if better visibility is needed. If abnormal conditions are observed in the diversion chamber, then open the manholes on the regulator chamber and the float chamber to visually inspect each chamber for any noticeable problems.
- Confirm influent (incoming) flow from the trunk sewer line appears “normal”.
  - *NOTE: Lack of flow may be indicative of an upstream blockage.*
  - *NOTE: Excessive flow may indicate a water main break or hydrant flushing somewhere up in the collection system.*
- Verify the wastewater flow depths, velocities and patterns through the structure appear to be “normal” for that structure (during dry weather).
  - IF not, check for debris/sediment accumulation in each of the chambers via (1) confined space entry, (2) checking the gate with a curved bar to remove a blockage, or (3) checking the outfall of the regulator chamber for debris, silting, or potential blockages that may prevent proper operation of the diversion chambers.
    - IF the potential exists for observed accumulations to prevent proper operation and flow through the structure, the situation becomes a self-implementing work order to clean the chambers.
    - IF there are no CSO discharges, but it is determined that other maintenance measures are required to prevent a possible dry weather overflow, the situation becomes a self-implementing work order to perform the required activities.
    - IF sediment depths are significant, but do not impede proper operation, or risk potential dry weather overflows in the immediate future, document the observed conditions on the ***Interceptor Service Report (in Cityworks)***. Return to the structure later in the day (after all the inspections are completed), or return the following day, to remove the observed sediments.



- If there is active flow over the diversion weir, go to Section 4.1.5 and follow the **Active Combined Sewer Overflow Activity Checklist** for the remainder of the inspection.
- Confirm the connector pipe between the regulator structure and the interceptor sewer (the regulator effluent) is free of debris and appears to be operating “normally”.
- Confirm the regulator gates appear to be operational (Brown and Brown regulators only).
- Confirm the float appears operational (Brown and Brown regulators only).
- Confirm the fixed orifice opening, between the diversion chamber and the regulator chamber, is not partially obstructed or clogged by debris (fixed regulators only).
  - IF debris is observed in the control orifice, and the wastewater depth in the diversion chamber appears to be higher than normal, the debris should be removed.
- Document any movements of the overflow detection devices (ODDs) on the **Interceptor Service Report (in Cityworks)**.
  - IF movement is observed, determine whether this was due to overflow at the weir (as opposed to an animal), noting which side of the weir the ODD is on, whether the weir appears wet, or any other indication that the movement was caused by an overflow.
  - IF an active overflow is observed during the inspection, go to Section 4.1.5 for further instructions.
  - IF the movement is determined to be the result of a previous CSO, go to Section 4.1.6 for further instructions.
- Document any instances of backflow from the receiving water body into the CSO regulator structures, or instances of backflow from the interceptor into the CSO regulator structures on the **Interceptor Service Report (in Cityworks)**.
  - *NOTE: River water may enter or even fill the overflow pipe, but the water surface should be below the crest of the weir, so that the diversion weir prevents river water from entering the interceptor sewers.*
- Document any observed items that require preventive maintenance on the **Interceptor Service Report (in Cityworks)**.

- Document any routine maintenance activities performed on the ***Interceptor Service Report (in Cityworks)***.
- Document the time of inspection on the ***Interceptor Service Report(in Cityworks)*** along with any additional comments.
- If necessary, reset the overflow detection device (ODD) to the appropriate location.

## Active Combined Sewer Overflow Activity Checklist

### (Wet weather and Dry weather)

Complete the following when there is an ongoing CSO during a visit:

**NOTE: WHENEVER AN ENTRY IS REQUIRED, BE SURE TO FOLLOW ALL CONFINED SPACE ENTRY GUIDELINES.**

- Protect crew members from oncoming traffic by using the vehicle as a physical barrier and turning on the flashing lights, as well as setting up traffic cones if extended work is necessary.
- Confirm there is an active CSO by visually witnessing flow passing over the weir in the diversion chamber.
  - *NOTE: It is possible to observe flow at the outfall without there being an active CSO (e.g. infiltration or stormwater inflow entering the outfall pipe downstream of the weir).*
- Record the start time of the CSO. Since almost all observed CSOs are already in progress upon arrival, the start time is considered to be the arrival time. Estimate and record the depth of flow over the weir in the diversion chamber on the **Interceptor Service Report (in Cityworks)**.
- Determine whether the CSO is a “wet weather” or “correctable” or “dry weather” CSO and follow the subsequent checklist items for the appropriate CSO type. Then proceed with one of the following three approaches outlined below.
  - *NOTE: Wet weather CSOs include overflows due to rain or snow melt (i.e. natural weather activity unrelated to system malfunctions) and stop on their own.*
  - *NOTE: Correctable CSOs are also due to rain or snow melt, but the discharge stops only after corrective maintenance measures are provided.*
  - *NOTE: Dry weather CSOs are related to system malfunctions (e.g. blockages or if Brown and Brown control gates get stuck in the closed position), or excessive non-sewer flow (i.e. hydrant flushing and water main breaks). These overflows are illegal and are considered serious because the combined flow contains a higher concentration of sanitary wastewater.*
- NOTE: If CSO discharges are observed at either of the two pump station emergency overflow outfalls, notify the operators at the AWTF IMMEDIATELY and perform any investigation work they may ask you to conduct.**

**Wet Weather Combined Sewer Overflow (Option 1 of 3)**

- Record observations (time and estimated depth over weir) and move on to the next CSO regulator structure. Maintenance generally cannot be safely performed during active CSO conditions and are conducted after the wet weather flow recedes and conditions become safe.

NOTE: Wet weather CSO frequencies, durations and volumes will be calculated using a model, but field estimates are important to assist with model calibration.

**Correctable Combined Sewer Overflow (Option 2 of 3)**

- Determine if the continuing wet weather CSO activity would stop if corrective maintenance activities were provided.
  - IF the flow is too great, and the CSO discharges cannot be stopped until the flows recede, it is a continuing wet weather overflow.
  - IF the flows have receded, but the CSO discharges continue and the discharges can be stopped with corrective maintenance (i.e. unclogging an orifice opening or corrective maintenance on the Brown and Brown regulators to make them operational) it is a correctable wet weather overflow.
- Confirm the connector pipe between the regulator structure and the interceptor sewer (the regulator effluent) is free of debris and appears to be operating “normally”.
- Confirm the regulator gates appear to be operational (Brown and Brown regulators only).
- Confirm the float appears operational (Brown and Brown regulators only).
- Confirm the fixed orifice opening, between the diversion chamber and the regulator chamber, is not partially obstructed or clogged by debris (fixed regulators only).
- For correctable CSOs, remove any debris obstructing the orifice opening for a connecting pipe between regulator chambers or the connector pipe to the interceptor, and operate the float mechanism to move the Brown and Brown to its maximum (dry weather) opening.
- Record observations (start time, end time, and estimated depth over weir) and move on to the next CSO regulator structure.

**Dry weather Combined Sewer Overflow (Option 3 of 3)**

- Identify the cause of any dry weather CSO overflow immediately.
  - *NOTE: Dry weather overflows become a self-implementing work order and must be addressed before moving on from the site.*
- Address the cause of the dry weather overflow (e.g. clearing blockages, opening Brown and Brown control gates) and remain at the site until the overflow stops.
- Record the stop time of the dry weather CSO.

- Calculate the total volume discharged using the appropriate weir discharge chart found in **Appendix A.**
- Reset the overflow detection device (ODD) to the appropriate location.
- Contact PADEP immediately following a dry weather overflow, including on weekends and holidays.
  - PADEP Phone: 717-705-4785

Report the following information:

- Your name, and identify yourself as a Capital Region Water employee.
- State that a dry weather overflow has occurred.
- Provide the CSO regulator structure ID.
- Provide the corrective actions taken.
- Provide the estimated duration and stop time of the CSO.

### 4.1.6 Post-Storm CSO Inspection Activities

#### Introduction and Overview

After storm events are over, and the collection system has returned to normal dry weather flow conditions, the flow conditions within the CSO regulator should have also returned to “normal.” If not, there could be problems with accumulated debris, partially obstructed or blocked orifice openings between the chambers, or problems with the Brown and Brown mechanical system that caused the control gate to get stuck in the smaller opening or wet weather set point position. If overflow activity persists immediately after a storm, the inspection activities should be able to discern if flows have receded enough that corrective maintenance could stop the overflow discharge. Additional inspection activities should be performed following a storm during the next daily inspection.

If it is decided that the overflow is a continuing result of high wastewater flows caused by wet weather conditions, and maintenance measures would or could not stop the discharge activity, it is a wet weather overflow. If the flow has receded, and the continuing overflow can be stopped by removing obstructing debris from an orifice opening or opening the size of the Brown and Brown control orifice, it is a correctable overflow. Document the observed conditions and the decision that it is a wet weather overflow, and move on to the next structure.

#### Combined Sewer Overflow (Post-Storm) Activity Checklist

*Complete the following items on the visit following a storm event:*

**NOTE: WHENEVER AN ENTRY IS REQUIRED, BE SURE TO FOLLOW ALL CONFINED SPACE ENTRY GUIDELINES.**

- Check and confirm that debris has not clogged or partially obstructed any of the control openings for connector pipes.
  - IF clogging debris is seen in any of the connecting pipes between the regulator chambers, for the connection to the interceptor, or the v-notch weir before the connection to the interceptor, remove the debris.
- Confirm the Brown and Brown regulator mechanisms have returned the control orifice openings to their fully open set point.
  - IF the float is stuck and the control orifice is in the smaller wet weather set point, corrective maintenance should be conducted.
- Confirm that flow quantities, flow depths and velocities have receded to their normal dry weather conditions.
- Reset any overflow detection devices (ODDs) that were moved during wet weather overflows.
- Remove any debris which has collected in the structures from the storm.

## Semi-Annual Preventive Maintenance Activity Checklist

Complete the following items during the semi-annual preventive maintenance inspection for each CSO regulator structure, noting that each item does not apply to every CSO regulator:

**NOTE: WHENEVER AN ENTRY IS REQUIRED, BE SURE TO FOLLOW ALL CONFINED SPACE ENTRY GUIDELINES.**

Perform the following maintenance activities and document the inspection/maintenance on the **CSO Semi-Annual Inspection and Preventative Maintenance Schedule Form in Cityworks**.

### Diversion Chamber

- Clean the steps, weir, and chamber.
- Remove any significant grease, sediment or debris accumulations.
- Check the CSO effluent opening to the regulator chamber and removing any debris or partial obstructions.

### Regulator Chamber

- Clean/grease the gate assembly and transmission shaft.
- Clean the steps, gate wheel and chain (type A), gate rod (type B), weights, outfall box, and chamber.
- Remove any significant grease, sediment or debris accumulations.
- Check the variable Brown and Brown regulator influent opening (types A and B) and the fixed orifice opening (types C and D) from the diversion chamber and remove any debris or partial obstructions.

### Float Chamber

- Clean/grease the float assembly.
- Clean the steps, float wheel and chain (type A), float rods (type B), and chamber.
- Remove any significant grease, sediment or debris accumulations.
- Check the connecting pipe between the regulator chamber and float chamber and remove any debris or partial obstructions.

### Flood Chamber

- Clean/grease the flood gate (types A and B) or tide gate (types C and D).
- Check the condition of the watertight seals.
- Remove any significant grease, sediment or debris accumulations within the flood chamber or outside the outfall pipe (for Paxton Creek outfalls).
- Clean the steps and chamber.

## CSO Outfall and Backflow Prevention Gate Inspection Checklist

Complete the following items concurrently with the daily CSO regulator inspections:

**NOTE:** Whenever an entry is required, be sure to follow all confined space entry guidelines.

- Observe flow conditions at the CSO outfall if abnormal conditions are noticed in the regulator chamber or if a discharge event occurred since the previous daily inspection (if the outfall is not submerged).
  - IF an active CSO is observed, follow the protocol identified in the **Combined Sewer Overflow (Ongoing) Checklist (Wet weather and Dry weather)** (Section 4.1).
    - *NOTE: It is possible to observe flow at the outfall without there being an active CSO (e.g. infiltration or stormwater inflow entering the outfall pipe downstream of the weir). Always check the diversion weir if a discharge is observed at the outfall.*
- If present, remove any significant debris present in the immediate vicinity of the CSO outfall. Sewer solids and floatable materials may accumulate at exposed outfalls, and floatables may accumulate at submerged outfalls, but generally should only be observed after a CSO. Notify management of any accumulations that occur without any other indication of a CSO.
- Note high river/creek levels which have the potential to exceed the weir elevation and flow into the CSO regulator structures.
  - IF present, confirm the presence or absence of river intrusion during the CSO regulator inspection by checking to see if river or creek water is back-flowing over the diversion weir into the interceptor system.
    - *NOTE: Some river/creek water in the CSO outfall pipe is to be expected, and does not need to be documented unless river water is flowing over the diversion weir into the interceptor.*
- Document that the outfall was inspected on the **Interceptor Service Report**.



**Following storm events:**

- ❑ Remove any significant debris present in the immediate vicinity of the CSO outfall. Sewer solids and floatable materials may accumulate at exposed outfalls, and floatables may accumulate at submerged outfalls.

**Flap Gate Inspection:**

- ❑ If no river intrusion activity is observed over the crest of the diversion weir, no inspection activities are required for the flap gate.
- ❑ If river intrusion is observed, utilize the pole camera to see if there is debris caught in the flap gate. If debris is observed, promptly remove any debris that may be holding the flap gate partially open and preventing it from sealing properly.
  - *NOTE: A confined space entry may be required to access the flap gate depending on whether it is located at the discharge point, flood chamber, or diversion chamber.*
- ❑ Verify the flap gate appears to be operational.
- ❑ Verify the flap gate maintains a tight seal (or as tight as possible).

## Annual Backflow Prevention Gate Preventative Maintenance Activities Checklist

*Complete the following items preventative maintenance activities annually for each flap gate. Some items only apply to those locations with flood chambers and flood gates.*

**NOTE:** *Whenever an entry is required, be sure to follow all confined space entry guidelines.*

- Examine the sealing surfaces of the flap gate for pitting or other evidence that the gate is not sealing properly.
- Lubricate the hinges, and verify the flap gate can easily open and close.
  - For double hinged flap gates, check the balance and make any adjustments to obtain an ideal balance point that allows the gate to be opened with minimal pressure and seal tightly.
- Document that the outfall was inspected on the ***Flap Gate Annual Preventative Maintenance Form***.

## General Pump Station Inspection Activities Checklist

Complete the following items during daily pump station inspections.

**NOTE: WHENEVER AN ENTRY IS REQUIRED, BE SURE TO FOLLOW ALL CONFINED SPACE ENTRY GUIDELINES.**

- Observe the exterior of the pump station for broken windows, forced entry, or debris on the grounds.
- An audible and olfactory observation should be made upon immediate entry into the facility. Any unusual sound or smell should be investigated for its origin. This includes any alarms that are activated upon your arrival.
- A visual, audible, and tactile inspection should be made of all running equipment. Remember that the look, listen, and feel of an operator cannot be duplicated by equipment.
  - Confirm that all needed equipment is running.
  - Confirm the pumps are running.
  - Check if any motors or pieces of equipment seem to be running hotter than normal.
  - Confirm all gates are in their proper positions.
- Check the wet well level and confirm the wet well reading on the control panel matches the visual observation of the wet well.
  - NOTE: This is critically important. If these levels don't match, an overflow could occur without warning from the alarms.**
- Complete any correctable problems identified during the inspection.
- Document any malfunctioning equipment, excessive leaks or any unusual findings that cannot be corrected by the operator(s) in the **Operations Log** (at the AWTF) so a service order can be submitted.

**NOTE:** Any malfunction that may require bypass pumping or lead to localized flooding must be brought to the attention of the Maintenance Supervisor **IMMEDIATELY**. In the absence of the Maintenance Supervisor, the Operation/Shift Supervisor or Plant Superintendent must be notified.

## Procedures for Lost Communication to Main Plant SCADA Computer

Complete the following procedure in the event of a loss of communication to the main plant SCADA computer.

- Check for proper operation of the pump station.

### If station is not operating on the local controller:

- Run the station on HAND and man the station as needed.
  - The indication at this point is that the CPU at the pump station is not working.
- Check the telephone line conditioners in the Main Control Building and the pump station for the proper LED blinking sequence:
  - The green and yellow LEDs to the left are illuminated continually.
  - The two green LEDs to the right flash intermittently.
- Call Tri-Star immediately (**717-944-1234**) and either tell them we need someone immediately, or leave a detailed message for them stating who we are, what the problem is, and what phone number to call to contact someone.

### If the station is operating on the local control in the automatic mode:

- Call the telephone company (special services) at **1-800-452-2224** or **1-800-932-0387** and state the problem (i.e., we have a communication failure between the plant and a remote pump station that has a dedicated phone line between them, and both computers appear to be operating properly).

**NOTE:** You will not be able to listen for a dial tone or call these phone numbers as a check for the dial tone.

- The Circuit Numbers (required by the phone company) are:
  - Spring Creek pump station **4 FDDA 303440**
  - Front Street pump station **4 FDDA 303441**
- State the priority that this line serves and ask for a callback as soon as possible.

**NOTE:** Remember to write down the ticket number for this work.

- Put in a service order on the problem and record any steps you have taken up to this point under the work performed. This should be documented in the Operations Log Book.

**If this does not resolve the situation (or at least provide a short-term resolution), call either the Operations Supervisor or the Superintendent for further instructions.**

## Front Street Pump Station – Operating Bar Screens

This procedure describes the actions necessary to initiate operation of a bar screen.

*Complete the following items to restart the bar screens.*

**NOTE:** *FOLLOW ALL SAFETY GUIDELINES WHEN PERFORMING THE PROCEDURE.*

### Pre-Start Inspection

- Inspect the bar screen channel for debris in front of the bar screens and remove prior to starting equipment.
- Verify equipment is energized, including bar screen, conveyor belt, and screw compacting conveyor.
- Verify equipment is properly lubricated and is ready for operation. Test the screen, belt conveyor, and screw conveyor are operable by starting the equipment in manual control.
- Open the sluice gates on the influent and effluent sides of the bar screen channel

### Start-up

- Place equipment control selector switches in the AUTO position
- Verify automatic timer is set to proper cycle time (30 minutes) or as otherwise determined through operating experience.
- Verify differential pressure-level switch is set between 9 and 12 inches.
- Check that the screenings dumpster is in place and is not full.

## Front Street Pump Station – Operating Wastewater Pumps

This procedure describes the actions necessary to initiate operation of the wastewater pumps.

*Complete the following items to restart a wastewater pump.*

**NOTE:** FOLLOW ALL SAFETY GUIDELINES WHEN PERFORMING THE PROCEDURE.

### Pre-Start Inspection

- Inspect the wet well for debris that may obstruct the pump suction piping. Remove debris as necessary.
- Check that the screenings equipment is operating satisfactorily.
- Check that the wastewater pump has been properly lubricated and is ready for operation.
- Check the seal water connection to the pump stuffing box is in operating condition. Need to verify solenoid opened and seal water is flowing when pump is started.
- Check for proper valve position in pump suction and discharge lines (open).
- Check and open the vent line on each pump valve casing.

### Start-up

- At control center on the first floor, a Hand-Off-Auto selector switch control the operating mode of the pump. Pumps are normally operated in the AUTO position wherein operation of the pump is controlled by the wet well level monitoring system.
- The pump selector switch should be set so that one of the variable speed pumps is the LEAD pump. The First Lead pump can be the other variable speed pump or the constant speed pump. Normally, the second variable speed pump is the First Lag pump. The Second Lag pump can be either the second variable speed pump or one of the constant speed pumps. The remaining pump is selected as the Third Lag Pump.

### After Pump Startup

- Verify pumps are properly operating through automatic controls. Verify pump is operating without excessive vibration or cavitation.
- Check cone valve on discharge side of pump to verify it opened.

## Front Street Pump Station – Pump Down Procedure

Complete the following items during the pump down procedure for the Front Street Pump Station.

**NOTE: WHENEVER AN ENTRY IS REQUIRED, BE SURE TO FOLLOW ALL CONFINED SPACE ENTRY GUIDELINES.**

Pump down should be performed during the last round of the “B shift” on Sunday night since this is usually the lowest flow of week. Pump down should also be performed when wet weather is anticipated.

### Bar Screens

- Prior to entering the bar screen and wet well area verify the ventilation fans are running and there are no combustible gas alarms at the control panel. If ventilation system is not operational, or there is a combustible gas alarm, do not enter this area without restoring operation of the ventilation system until the alarm condition disappears, or use SCBA equipment and confined space entry procedures.
- Turn both bar screens on HAND using the east-facing control panel on the top floor (to the right of steps leading to bar screens).
- Go down steps leading to the bar screens, verify both channels are in service. If one is not in service, open influent and effluent gates on that channel using levers against eastern wall.
  - **NOTE:** Open gates on side not currently in service, so both sides will be open.

### Main Control Desk

- At the main control desk (near the restroom), put one of the variable speed pumps and the constant pump that was in service upon arrival to the HAND position.
- Set switch to MANUAL for pumps #1 and #2
- Set variable speed pump to 100% (check meter on right).

### Electrical Panel

- Go to the electrical panel (right of desk) and confirm that amps are up showing that the constant speed pump is on.

### Cone Valves



- Look down over railing to make sure cone valves have opened (should open automatically when put on HAND).
  - **NOTE:** You may need to go down to bottom floor to confirm this.

### **Clean-Up**

- Push rags through hopper end plate.
- Go to cat walk above wet well, and open the hydrant for the high pressure hose.
- Turn on high pressure pump using switch on wall above wet well (pump itself is located by the seal water tanks down the steps leading to the cone valves).
- Hose down wet well.
- Turn off high pressure pump.
- Close hydrant for high pressure hose.
- Hose around bar screens downstairs and scrap up any rags that fell off of conveyor or out of hopper at end of conveyor.
- Open front of bar screens upstairs and scrape/ hose.
- Hose ladders under grating that leads down to bar screens.

### **Bar Screens**

- If both bar screens are to be left in service, skip this step
- Rotate bar screens by closing the influent and effluent gates of the side that was in service upon arrival and leave the other side in service a few minutes.
- Shut off bar screens on side being taken out of service.
- Put bar screens on side being taken out of service on OFF position.
- Put bar screen to be left in service on AUTO.

### **Main Control Desk**

- Put variable speed pumps #1 and #2 on AUTO and set switch #1 and #2 to AUTO.

- **NOTE:** Sometimes the operators find pump #1 running against a closed cone valve, and then must turn the pump off then on again to get the cone valve working again.

*Other times, the operators find pump #1 not running at all and must manually lower the float (very carefully) to get the pump running again.*

- Rotate the constant speed pumps by taking the one used to pump down off HAND and putting the other pump on AUTO.
- Wait for wet well level to get to 294 feet to make sure pump kicks back on.

### **Oil Check**

- Check oil cups for high pressure pump, and add any oil as needed.

### **Garage**

- Check dumpster in garage and clean up area if needed.

## Spring Creek Pump Station – Operating Barminutor Screens

This procedure describes the actions necessary to initiate operation of the barminutors.

*Complete the following items prior to changing wastewater flow to the old side.*

**NOTE:** *FOLLOW ALL SAFETY GUIDELINES WHEN PERFORMING THE PROCEDURE.*

### Pre-Start Inspection

- Inspect the channels for debris on the coarse bar screen and in front of the barminutors and remove prior to starting equipment
- Verify equipment is energized.
- Verify equipment is properly lubricated and is ready for operation
- Verify bubble tube level sensing equipment is functioning which is required for automatic operation to the barminutors.

### Start-up

- Switch the power switch on the local control panel to ON position
- Place selector switch in the HAND position and verify barminutor runs properly, then switch to the AUTO position
- Repeat procedure with second barminutor. Note: both barminutors should be placed in operation; avoid running only one unit since that will limit the screening capacity.

### Influent Control

- When equipment is operating properly, complete the *Changing over to Old Side* procedure to direct all influent flow through the barminutors.

## Spring Creek Pump Station – Operating Bar Screen

This procedure describes the actions necessary to initiate operation of the bar screen.

*Complete the following items before changing wastewater flow to the bar screen side.*

**NOTE:** *FOLLOW ALL SAFETY GUIDELINES WHEN PERFORMING THE PROCEDURE.*

### Pre-Start Inspection

- Inspect the bar screen channel for debris in front of the bar screen and remove prior to starting equipment.
- Verify equipment is energized.
- Verify equipment is properly lubricated and is ready for operation

### Start-up

- Place selector switch in the HAND position and verify bar screen runs properly, then switch to the AUTO position
- Verify automatic timer is set to proper cycle time (30 minutes) or as otherwise determined through operating experience.
- Verify differential pressure-level switch is set between 9 and 12 inches.
- Check that the screenings dumpster is in place and is not full.

### Influent Control

- When equipment is operating properly, complete the *Changing over to Bar Screen Side* procedure to direct all influent flow through the barminutors.

## Spring Creek Pump Station – Operating Wastewater Pumps

This procedure describes the actions necessary to initiate operation of the wastewater pumps.

*Complete the following items to restart a wastewater pump.*

**NOTE:** FOLLOW ALL SAFETY GUIDELINES WHEN PERFORMING THE PROCEDURE.

### Pre-Start Inspection

- Inspect the wet well for debris that may obstruct the pump suction piping. Remove debris as necessary.
- Check that the screenings equipment is operating satisfactorily.
- Check that the wastewater pump has been properly lubricated and is ready for operation.
- Check the seal water connection to the pump stuffing box is in operating condition. Need to verify solenoid opened and seal water is flowing when pump is started.
- Check for proper valve position in pump suction and discharge lines (open).
- Check on the vacuum primer system and verify it is operational.

### Start-up

- At control center 9, pumps are controlled by the start-stop-reset pushbuttons for the respective pumps. Pushing start button will manually start the pump. Automatic control is achieved by pushing the Reset and Start pushbuttons for the pump being started.
- Push the Start button to verify pump will start and run.
- Push the Stop button to stop the pump, wait two minutes to allow the pump to stop, and then push the Reset and Start buttons to switch to automatic operation.
- For normal, automatic pump operation, place the speed control manual-off-auto selector switch to Auto position, verify the pump sequence
- The pump selector switch should be set so that one of the variable speed pumps is the LEAD pump. The First Lag pump can be the other variable speed pump or the

constant speed pump. Normally, the second variable speed pump is the First Lag pump. The remaining pump is selected as the Second Lag pump.

### **After Pump Startup**

- Verify pumps are properly operating through automatic controls. Verify pump is operating without excessive vibration or cavitation.
  
- Check cone valve on discharge side of pump to verify it opened.

## Spring Creek Pump Station – Changing over to Bar Screen Side

The Spring Creek Pump Station is normally operated on the Bar Screen Side. Switching operation to the Old Side is performed when there is a problem with, or maintenance is being performed on the Bar Screen Side. This procedure describes the actions necessary to change operation back to the Bar Screen Side.

*Complete the following items during the procedure to change over to bar screen side.*

**NOTE: FOLLOW ALL SAFETY GUIDELINES WHEN PERFORMING THE PROCEDURE.**

### Bar Screens

- Go to dumpster room on the “new side”, and start bar screen equipment.
- Set bar screens switch to AUTO.

### Influent Gate

- Go inside the building to the hydraulic cabinet (along north wall by the restroom), and open the influent gate.
- Place manual down switch in ON position. Place manual down in UP position, or else it may creep back down.

### Rising Stem

- Close the rising stem valve located near the fence, to the west of the concrete box.

### Influent Valve

- Go onto the concrete box outside, and verify the valve is closed.

### Muffin Monsters

- Go down to wet well on the “old side”, and turn off the muffin monsters.

### Weir

- Open the weir set bypass.
- Go outside to concrete box on the west side of the building, and close the northwestern-most valve.

## Spring Creek Pump Station – Changing over to Old Side

The Spring Creek Pump Station is normally operated on the Bar Screen Side. This procedure describes the actions necessary to change to the Old Side in the event there is a problem with, or maintenance is required on the Bar Screen Side.

*Complete the following items during the procedure to change over to old side.*

**NOTE: FOLLOW ALL SAFETY GUIDELINES WHEN PERFORMING THE PROCEDURE.**

### Weir

- Close the weir set bypass.
- Go outside to concrete box on the west side of the building, and close the northwestern-most valve.

### Muffins Monsters

- Go down to wet well on old side and turn on muffin monsters.

### Influent Gate to Old Side

- Go onto the concrete box outside, and open the valve that feeds the muffins monsters.
- Open rising valve on southeast corner of box (closest valve to the station).
  - **NOTE:** *The valve may already be open since it is okay to leave open when flow is through the new side.*

### Rising Stem Valve

- Open the rising stem valve located near the fence, to the west of the concrete box.

### Bar Screen Influent Gate

- Go inside station to the hydraulic cabinet (along north wall by the restroom), and close influent gate for new side.
- Place manual up switch in manual down position; leave in manual down position; leave in manual or else may creep back up.



## Bar Screen

- Go to dumpster room on new side, and shut down bar screen equipment (can also shut off breakers in main building, but this is not usually done).

## Spring Creek Pump Station – Pump Down Procedure

*Complete the following items during the pump down procedure for the Spring Creek Pump Station.*

**NOTE:** *WHENEVER AN ENTRY IS REQUIRED, BE SURE TO FOLLOW ALL CONFINED SPACE ENTRY GUIDELINES.*

Pump down should be performed during the last round of the “B shift” on Sunday night since this is usually the lowest flow of week. Pump down should also be performed when wet weather is anticipated.

### Bar Screen

- Prior to entering the bar screen and wet well area verify the ventilation fans are running and there are no combustible gas alarms at the control panel. If ventilation system is not operational, or there is a combustible gas alarm, do not enter this area without restoring operation of the ventilation system until the alarm condition disappears, or use SCBA equipment and confined space entry procedures.
- Turn bar screen on HAND.

### Main Control Desk

- At the control room, put one of the variable speed pumps and the constant pump that was in service upon arrival to the HAND position.
- Set switch to MANUAL for pumps #1 and #2
- Set variable speed pump to 100%

### Verify Pump Operation

- Walk down to the pump room to verify that the pumps are running and the check valves are up.

### Clean-Up

- Push rags through hopper end plate.
- Go to cat walk above wet well, and open the hydrant for the high pressure hose.
- Hose down wet well.

- Close hydrant for high pressure hose.
- Clean and hose both levels of the bar screen room.

### **Bar Screens**

- Put bar screen on AUTO.

### **Bubbler System**

- Purge the bubbler system.
- Verify that the bubbler system is giving a correct reading by checking readout and making a visual observation of the wet well.

### **Main Control Desk**

- Put variable speed pumps #1 and #2 on AUTO and set switch #1 and #2 to AUTO.
- Wait for wet well level to get to 3.5 feet to make sure pump kicks back on.

### **Screen Room**

- Check dumpster and clean up area if needed.

## Spring Creek Pump Station - High Flow Procedures

*Complete the following procedures during high flow conditions at the Spring Creek Pumping Station.*

**NOTE:** *FOLLOW ALL SAFETY GUIDELINES WHEN PERFORMING THE PROCEDURE.*

### **AWTF Flows: 35 to 55 MGD**

- If both lead and lag pumps are running at 100%, and the wet well continues to climb and is approaching the high level alarm of 5.5 feet, it will be necessary to put the third pump into service.
- Set output to 160 amps.
  - **NOTE:** *The main station breaker cannot handle the power requirements of three pumps on maximum.*

### **AWTF Flows: > 55 MGD**

- No additional change necessary. (Ensure all prior changes have been made.)

## Hot Spot Listing, Inspection Frequency, and Delisting Procedure

*After resolving a sanitary sewer overflow or unauthorized discharge the following procedures shall be employed.*

- Based on the type of blockage that generated the overflow or discharge the Field Operations Supervisor shall select one of the following re-inspection frequencies for the location.
  - Quarterly
  - Monthly
  - Weekly
- Within Cityworks create a hot spot work order at the specified frequency.
- If the inspections identify repetitive issues that require routine cleaning, the location should be added to a cleaning preventative maintenance work order in Cityworks.
  - Once a preventative maintenance work order is developed, remove the location from the hot spot list.
- If the inspections do not identify repetitive issues, decrease the frequency of inspection as required based on the inspection results.
  - If weekly inspections are performed for a 1-month period without identifying issues, the hot spot inspection frequency shall be decrease to monthly.
  - If monthly inspections are performed for a 3-month period without identifying issues, the hot spot inspection frequency shall be decrease to quarterly.
- If quarterly inspections are performed for a 12-month period without identifying issues, the hot spot shall be delisted.

## Line Blockage Procedural Checklist

*Upon receipt of a service request for a basement back-up or possible line blockage employ the following practices:*

- Document all pertinent information received from the service request.
- Consult Cityworks and CRW sewer maps.
- Establish expected flow direction. Identify location of upstream and downstream manholes.
- Following all safety guidelines, secure the work area around the manholes.
- Pull respective manhole lids and examine flow conditions.
- If the downstream manhole has little or no flow present, and the upstream manhole is surcharged, this indicates that there is likely a blockage in the line.
  - Removal of these blockages requires the use of a flushing unit and necessary personnel.
  - Attempt to dislodge the blockage from the downstream manhole.
  - Vactor and remove grease and debris as blockage is dislodged.
- Next working day or as soon as practical, CCTV assessment should be performed if the issue was determined to be attributable to the CRW main.
  - Line may need to be reflashed to remove any additional debris, grease, deposits and buildups in order for the line to be examined for structural integrity and defects.
- The homeowner should be informed of the results of the investigation as soon as possible.

## Inlet and Catch Basin Inspection and Cleaning Activities Checklist

Complete the following items during inlet and catch basin inspections. Inspections are completed prior to reactive or preventative maintenance. Inspections can be conducted either by the two-person Vector truck crew or an individual in a pickup truck. Complete the following items when cleaning inlets and catch basins. The approximate time for the two person Vector truck crew to clean an inlet (without reconstruction) is two to six (2 to 6) man-hours.

**NOTE: WHENEVER AN ENTRY IS REQUIRED, BE SURE TO FOLLOW ALL CONFINED SPACE ENTRY GUIDELINES.**

- Protect crew members from oncoming pedestrian and vehicular traffic by setting up traffic cones, using the vehicle as a physical barrier, and turning on the flashing lights.
  - If necessary, provide for any additional traffic control measures necessary to accommodate a safe working area, including lane closures.
- Clear any leaves, twigs, or any other debris within the vicinity of the stormwater inlet.
- Remove the inlet grate and determine how a confined space entry protocol would apply. Catch basins are confined spaces, but would not generally require a permit unless a potential hazard would be present.
  - If necessary, follow all confined space entry procedures. Bad air could potentially exit the combined sewer system to the work space and crew members should always be on the alert.
- Determine the degree to which the stormwater inlet is blocked with debris or sediment. Assign a rating from 1 to 5 with 5 having the highest blockage and most structural deterioration.
- Determine what maintenance items are required, including cleaning and rebuilding
  - If the inlet is blocked, try to determine whether removing the blockage would structurally compromise the inlet. (Use your best judgment, you may not know the extent of structural deterioration until inlet is partially cleaned. By then, it may just need to be rebuilt immediately).

*NOTE: Cleaning of catch basins should be completed when there is a significant sediment buildup (even if there is no blockage).*

- Clear the catch basin box of large floatables and debris.

- Using the Vactor truck, clean the catch basin box and pipe by removing sediment buildup.

*NOTE: Be particularly careful if the blockage appears to be providing structural support.*

- If removing the blockage results in a collapse, remove the collapsed materials from the area.
- Properly dispose of waste collected during cleaning.
- If the GIS database does not include dimensions for a stormwater inlet, measure and record the dimensions and inverts of the catch basin box and pipe.
- Assign a condition score to the stormwater inlet based on structural integrity. This will be used to prioritize maintenance activities.
- Provide information on the type of inlet (open back) and whether it includes a hood.
- Check for evidence of illicit discharges, including oil and grease. Indications of illicit discharges may include sheen on the water surface, discolored water, or unusual odors.

*NOTE: Be particularly careful if the blockage appears to be providing structural support.*

- Document the maintenance activity on the ***Collection System Work Order in Cityworks***.
- Check the vicinity of the location to see if there are nearby stormwater inlets requiring maintenance.
- If time permits, and maintenance can be easily completed (such as those only requiring cleaning), perform maintenance on those nearby stormwater inlets following the same procedure.



## Inlets and Catch Basins (Reconstruction) Checklist

Complete the following items when reconstructing inlets and catch basins. The approximate time for the two person Vector truck crew to reconstruct an inlet is 16 man-hours.

Depending on the maintenance priority, cleaning and/or reconstruction may or may not be completed immediately following a general inspection.

- Following all safety guidelines, secure the work area around the stormwater inlet.
- If necessary, refer to the *Inlets and Catch Basins Inspection Activities Checklist* for general inspection procedures.
- If cleaning is required prior to reconstruction, refer to the *Inlets and Catch Basins (Cleaning) Checklist* for general cleaning procedures.
- If removing the blockage results in a collapse, remove the collapsed materials from the area.
- Reconstruct the stormwater inlet to a fully operational condition. Specific procedures regarding stormwater inlet reconstruction depend on the configuration and the extent of repairs needed.
- Document the maintenance activity on the ***Collection System Work Order in Cityworks***.
- Check the vicinity of the location to see if there are nearby stormwater inlets requiring maintenance.
  - If time permits, and maintenance can be easily completed (such as those only requiring cleaning), perform maintenance on those nearby stormwater inlets following the same procedure.

### MS4 Outfall Inspection Checklist

- Conduct the inspection during dry weather conditions.
- Document any flow that is present at the outfall.
- Check for standing water at the outfall.
- Observe the condition of the outfall pipe and related structures, such as an end wall. Document any defects.
- Observe the area downstream of the outfall and note any erosion or sedimentation that may be attributed to the outfall.
- Check for overgrown vegetation that may be impeding the outfall.
- Check for debris accumulation. If present, remove any significant debris present in the immediate vicinity of the MS4 outfall.
- Check for any signs of illicit discharge, such as residue with a sheen. If an illicit discharge is suspected, notify the Environmental Compliance Inspector immediately.
- Note high water levels that have the potential to prevent stormwater discharge.
- Take photos or provide sketches of the outfall and/or surrounding area for noteworthy items.
- Document the outfall inspection in Cityworks.

## 4.13 Emergency Sinkhole or Line Collapse Inspections and Repairs

### 4.13.1 Sinkhole / Line Collapse Remediation Procedures

#### Sinkhole / Line Collapse Remediation Procedural Checklist

*Once a potential sinkhole or line collapse is identified via customer complaints or other means related to the combined/sanitary sewer system, the following investigation and remediation procedures are utilized:*

- Consult Cityworks and CRW sewer maps.
- Establish expected flow direction. Identify location of upstream and downstream manholes.
- Following all safety guidelines, secure the work area around the manholes.
- Pull respective manhole lids and examine flow conditions.
- Employ listening devices to check for an indication of water flow.
- Perform a visual inspection for sewage or water.
- Conduct a CCTV inspection of the sanitary sewer lateral and gravity sewer mains in the vicinity of the sinkhole.
- Utilize a pole camera to conduct further investigations below the ground surface.
- Consult with the geotechnical consultant for sinkholes.
- Repair sinkholes or line deficiencies with CRW equipment if the depth is shallow enough for or employ an outside contractor to perform the repair.

### 4.13.2 Sinkhole Documentation

Each sinkhole investigation and repair is documented in Cityworks. With determination the sinkhole involves CRW infrastructure failure or compromise, CRW will have the sinkhole added to the GIS sinkhole layer, assigning a unique identifier to each sinkhole for perpetuity. **Appendix D** contains the master list of sinkholes that are incorporated in CRW's GIS.



# Appendix F



CAPITAL REGION™

WATER

FEBRUARY 2023

CAPITAL REGION WATER

**GREEN STORMWATER INFRASTRUCTURE  
OPERATIONS &  
MAINTENANCE MANUAL**



# TABLE OF CONTENTS

<b>1.</b>	<b>INTRODUCTION</b>	<b>1</b>
	GSI in the City of Harrisburg	2
	Overview of GSI O&M Program	3
	How to Use This Manual	4
<b>2.</b>	<b>OVERVIEW OF STORMWATER CONTROL MEASURES</b>	<b>5</b>
	Stormwater Planter	6
	Stormwater Bumpout	8
	Stormwater Tree	10
	Stormwater Tree Trench	12
	Permeable Pavement	14
	Storage/ Infiltration Trench	16
	Rain Garden	18
	Stormwater Wetland	20
	Stormwater Basin	22
<b>3.</b>	<b>INSPECTION AND MAINTENANCE PROCEDURES</b>	<b>25</b>
	Inspection and Maintenance Overview	26
	Routine Maintenance Event Procedures	30
	Maintenance Tasks by SCM Type	33
<b>4.</b>	<b>DATA COLLECTION PROCEDURES</b>	<b>71</b>
	Work Order Forms	72
	Equipment and Technology	72
	Photo Points	73
	Data Transfer	73
<b>5.</b>	<b>PUBLIC ENGAGEMENT</b>	<b>75</b>
	Green Stormwater Infrastructure Talking Points	76
	Frequently Asked Questions	77





## **APPENDICES**

<b>A.</b>	<b>Green Stormwater Infrastructure Maintenance Specifications</b>	<b>A-1</b>
<b>B.</b>	<b>Inspection Work Order Forms</b>	<b>B-1</b>
	▪ Subsurface CCTV Premaintenance Inspection Work Order	B-2
	▪ Subsurface CCTV Postmaintenance Inspection Work Order	B-3
	▪ Surface Inspection Work Order	B-4
	▪ Hydraulic Testing Work Order	B-6
<b>C.</b>	<b>Maintenance Work Order Forms</b>	<b>C-1</b>
	▪ Corrective Maintenance Work Order	C-2
	▪ Permeable Pavement—Maintenance Work Order	C-3
	▪ Surface—Maintenance Work Order	C-4
	▪ Subsurface—Maintenance Work Order	C-6
	▪ Watering Work Order	C-8
<b>D.</b>	<b>Contact List</b>	<b>D-1</b>
<b>E.</b>	<b>Weed &amp; Invasive Species Guide</b>	<b>E-1</b>
<b>F.</b>	<b>Examples of Common Pipe Defects</b>	<b>F-1</b>
<b>G.</b>	<b>Glossary</b>	<b>G-1</b>



# LIST OF TABLES

Table 2.1 – Stormwater Planter Components	7
Table 2.2 – Stormwater Bumpout Components	9
Table 2.3 – Stormwater Tree Components	11
Table 2.4 – Stormwater tree trench Components	13
Table 2.5 – Permeable Pavement Components	15
Table 2.6 – Storage/ Infiltration Trench Components	17
Table 2.7 – Rain Garden Components	19
Table 2.8 - Stormwater Wetland Components	21
Table 2.9 – Stormwater Basin Components	23
Table 3.1 – Determining Routine Maintenance Needs	29
Table 3.2 – Determining Corrective Maintenance Needs	29
Table 3.3 – Routine Maintenance Event Procedures	30
Table 3.4 – Surface and Permeable Pavement Inspection Preparedness Checklist	31
Table 3.5 – Subsurface Inspection Preparedness Checklist	31
Table 3.6 – Surface Maintenance Preparedness Checklist	32
Table 3.7 – Subsurface Maintenance Preparedness Checklist	33
Table 3.8 – Permeable Pavement Preparedness Checklist	33
Table 3.9 – Watering Preparedness Checklist	33
Table 3.10 – Stormwater Planter Routine Maintenance Tasks	35
Table 3.11 – Stormwater Bumpout Routine Maintenance Tasks	39
Table 3.12 – Stormwater Tree Routine Maintenance Tasks	43
Table 3.13 – Stormwater Tree Trench Routine Maintenance Tasks	47
Table 3.14 – Permeable Pavement Routine Maintenance Tasks	51
Table 3.15 – Storage/ Infiltration Trench Routine Maintenance Tasks	55
Table 3.16 – Rain Garden Routine Maintenance Tasks	59
Table 3.17 – Stormwater Wetland Routine Maintenance Tasks	63
Table 3.18 – Stormwater Basin Routine Maintenance Tasks	67

# LIST OF FIGURES

Figure 2.1 – Stormwater Planter Inflow and Outflow Plan	6
Figure 2.2 – Stormwater Planter Components	7
Figure 2.3 – Stormwater Bumpout Inflow and Outflow Plan	8
Figure 2.4 – Stormwater Bumpout Components	9
Figure 2.5 – Stormwater Tree Inflow and Outflow Plan	10
Figure 2.6 – Stormwater Tree Components	11
Figure 2.7 – Stormwater Tree Trench Inflow and Outflow Plan	12
Figure 2.8 – Stormwater Tree Trench Components	13
Figure 2.9 – Permeable Pavement Inflow and Outflow Plan	14
Figure 2.10 – Permeable Pavement Components	15
Figure 2.11 – Storage/ Infiltration Trench Inflow and Outflow Plan	16
Figure 2.12 – Storage/ Infiltration Trench Components	17
Figure 2.13 – Rain Garden Inflow and Outflow Plan	18
Figure 2.14 – Rain Garden Components	19
Figure 2.15 – Stormwater Wetland Inflow and Outflow Plan	20
Figure 2.16 – Stormwater Wetland Components	21
Figure 2.17 – Stormwater Basin Inflow and Outflow Plan	22
Figure 2.18 – Stormwater Basin Components	23
Figure 3.1 – Stormwater Planter Maintenance Zones	34
Figure 3.2 – Stormwater Bumpout Maintenance Zones	38
Figure 3.3 – Stormwater Tree Maintenance Zones	42
Figure 3.4 – Stormwater Tree Trench Maintenance Zones	46
Figure 3.5 – Permeable Pavement Maintenance Zones	50
Figure 3.6 – Storage/ Infiltration Trench Maintenance Zones	54
Figure 3.7 – Rain Garden Maintenance Zones	58
Figure 3.8 – Stormwater Wetland Maintenance Zones	62
Figure 3.9 – Stormwater Basin Maintenance Zones	66
Figure 4.1 – Overall GSI Program Data Management Work Flow	72

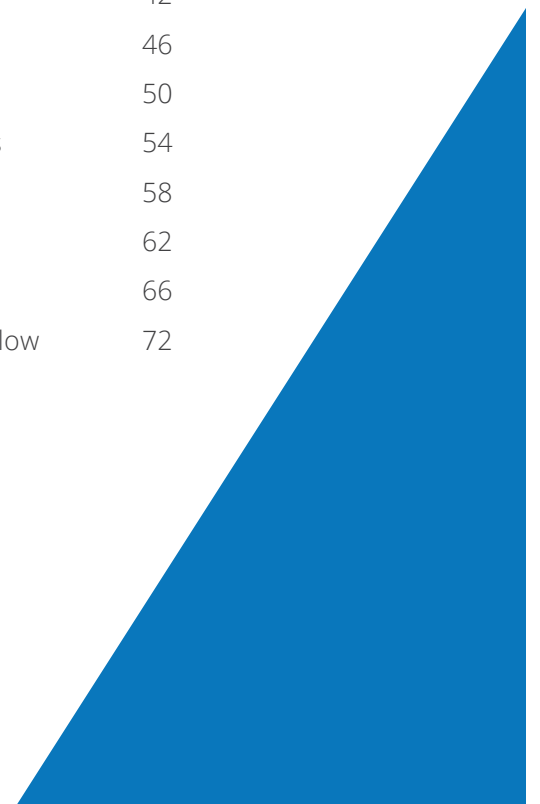



1

# INTRODUCTION

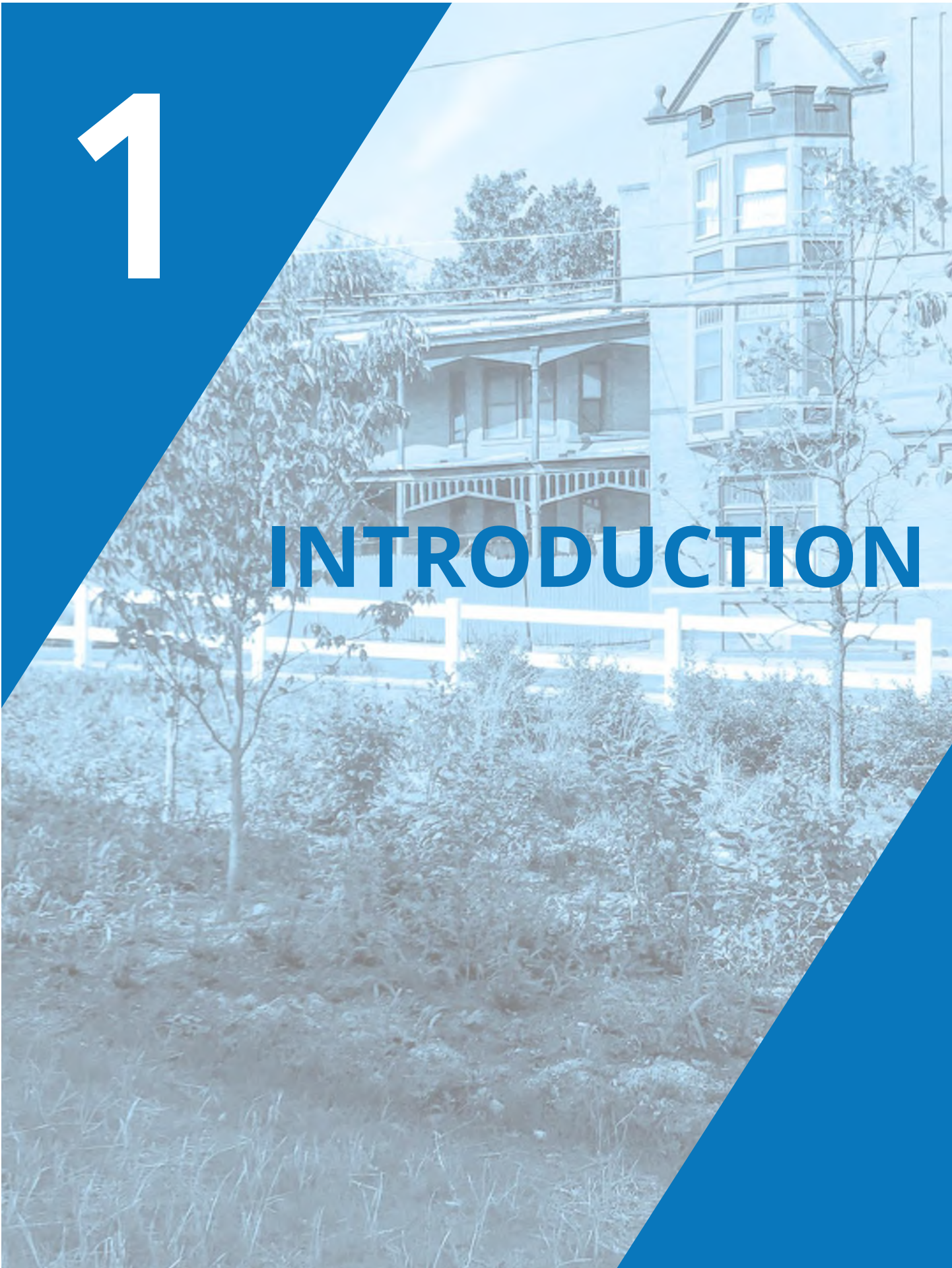

Capital Region Water (CRW) uses a combination of traditional infrastructure and Green Stormwater Infrastructure (GSI) to manage stormwater and minimize pollution to the City of Harrisburg's streams, rivers, and waterways. CRW's GSI consists of distributed Stormwater Control Measures (SCMs) such as stormwater planters and permeable pavement areas that are used to add storage capacity to the existing sewer system while creating additional green space benefits for the City. SCMs can be individual systems or connected hydraulically in series to create a larger system. Stormwater runoff collected by GSI is returned to the water cycle through natural processes such as infiltration and evapotranspiration or slowly released back to the sewer system.

Like traditional infrastructure, GSI requires regular operations and maintenance (O&M) activities to function properly. Regular cleaning of GSI storage areas and conveyance components is needed to prevent the build-up of debris and sediment within the systems in order to maintain the intended stormwater management functions. Because most GSI also incorporates landscaping, there are a number of seasonal tasks that are necessary to keep up the appearance and health of the plants. As plantings establish over time, the maintenance needs of the system will change. Other routine needs for GSI maintenance include: vacuum sweeping of permeable pavements and inspecting and cleaning underdrain systems, inlets and pipes.

## GSI IN THE CITY OF HARRISBURG

CRW captures and conveys stormwater in the City of Harrisburg through the use of a combined sewer system (CSS) as well as a municipal separate storm sewer system (MS4). Within the CSS, stormwater flows to the Advanced Wastewater Treatment Facility (AWTF) for treatment. During heavy storm events, however, flow volumes can exceed the CSS and/or the AWTF's capacity, resulting in combined sewer overflow (CSO) discharges into Paxton Creek, the Susquehanna River, and ultimately the Chesapeake Bay. Under the requirements of the Consent Decree issued by the Pennsylvania Department of Environmental Protection, CRW is obligated to reduce CSO discharges.

In sections of the City outside the CSS area, the MS4 captures and conveys stormwater runoff directly to the City's waterways. These MS4 areas also can become inundated during heavy storm events, resulting in system surcharges, localized drainage issues and increased pollutant transport and bank erosion to area streams, rivers and waterways. As an MS4 permit holder, CRW is working to reduce pollution associated with MS4 discharges. Stormwater management by GSI will contribute to CRW's pollution reduction strategies for both the CSS and MS4.



The City of Harrisburg's waterfront.

Image credit: Capital Region Water



Image credit: Flickr // Center for Neighborhood Technology

A rain garden designed to take stormwater runoff from the road through the use of a green inlet and splash pad.

GSI implementation in the City of Harrisburg is guided by the *City Beautiful H<sub>2</sub>O Program Plan*, which proposes that up to 100 acres of impervious surface can be managed by GSI over a 20-year period to reduce the impacts of stormwater runoff on the Harrisburg community, the Susquehanna River and Paxton Creek.

CRW uses various types of SCMs to manage stormwater in the City. SCMs utilized by CRW include:

- Stormwater Planter
- Stormwater Bumpout
- Stormwater Tree
- Stormwater Tree Trench
- Permeable Pavement
- Storage/ Infiltration Trench
- Rain Garden
- Stormwater Wetland
- Stormwater Basin

## OVERVIEW OF GSI O&M PROGRAM

In order to function properly, GSI must be able to collect and store stormwater runoff, infiltrate and/or detain it, and pass overflow back into the drainage network during large storms. Planted areas must be able to support a healthy plant community to take up stormwater. Soils must remain permeable to allow infiltration while the

pores in permeable pavement must be kept clean and free of debris. When maintaining GSI, it is important to keep these key priorities in mind.

GSI works best when SCMs are well maintained. In order to keep SCMs working properly, maintenance crews carry out several maintenance tasks on a regular basis (for example, trash and sediment removal). Other tasks are carried out only during certain seasons (like weeding and watering during the growing season). Crews check for clogging, dead plants, broken structures, vandalism, or anything else that could affect how the system works or its appearance during every site visit.

There are some types of issues that cannot be repaired during a routine maintenance visit. These might include repairing concrete curbs and tree guards, solving soil drainage issues, repairing sinkholes, cutting down or replacing large trees, digging up and replacing underground parts—or anything else that requires special equipment, materials, or testing.

The CRW GSI O&M Program (the Program) details necessary inspection and maintenance field services, and essential data collection and reporting functions for all GSI assets owned and operated by CRW.

The Program's inspection and maintenance field services are organized around three major functional areas:

- **Inspections**, conducted periodically to guide maintenance activities.
- **Routine Maintenance**, performed frequently to ensure that SCMs perform as designed.
- **Corrective Maintenance**, performed with assistance from an expert to address problems that cannot be correct routine maintenance.

These activities are discussed in detail in [Section 3—Inspection and Maintenance Procedures](#).

# HOW TO USE THIS MANUAL

This manual is organized into the following sections:

## **SECTION 2. OVERVIEW OF STORMWATER CONTROL MEASURES**

Provides a summary with photos and diagrams of the different types of SCMs used by CRW.

## **SECTION 3. INSPECTION AND MAINTENANCE PROCEDURES**

Provides an overview of CRW's inspection and routine maintenance program, and guidance for dealing with corrective maintenance. This section also includes specific maintenance guidance for each different type of SCM.

## **SECTION 4. DATA COLLECTION PROCEDURES**

Provides instructions for completing work orders and managing the flow of information using CRW's Cityworks Asset Management software system.

## **SECTION 5. PUBLIC ENGAGEMENT**

Includes talking points and suggested best practices for interacting with the public during maintenance activities.

## **APPENDICES**

### *A. GSI Maintenance Specifications*

Provides detailed, step-by-step specifications (with standard equipment, materials, and personnel lists) for completing routine maintenance.

### *B. Inspection Work Order Forms*

Includes sample work order forms used for GSI inspections.

### *C. Maintenance Work Order Forms*

Includes sample work order forms used for GSI maintenance.

### *D. Contacts List*

Provides a list of who to call to report problems observed during inspection or maintenance.

### *E. Weed & Invasive Species Guide*

Defines which plants are considered weeds by the Program.

### *F. Examples of Common Pipe Defects*

Provides visual examples of common pipe defects found in GSI pipes.

### *G. Glossary*

Defines terms used throughout the manual.



A field crew performing surface inspection and maintenance in a rain garden.

Image credit: AKRF, Inc.



# 2

## OVERVIEW OF STORMWATER CONTROL MEASURES

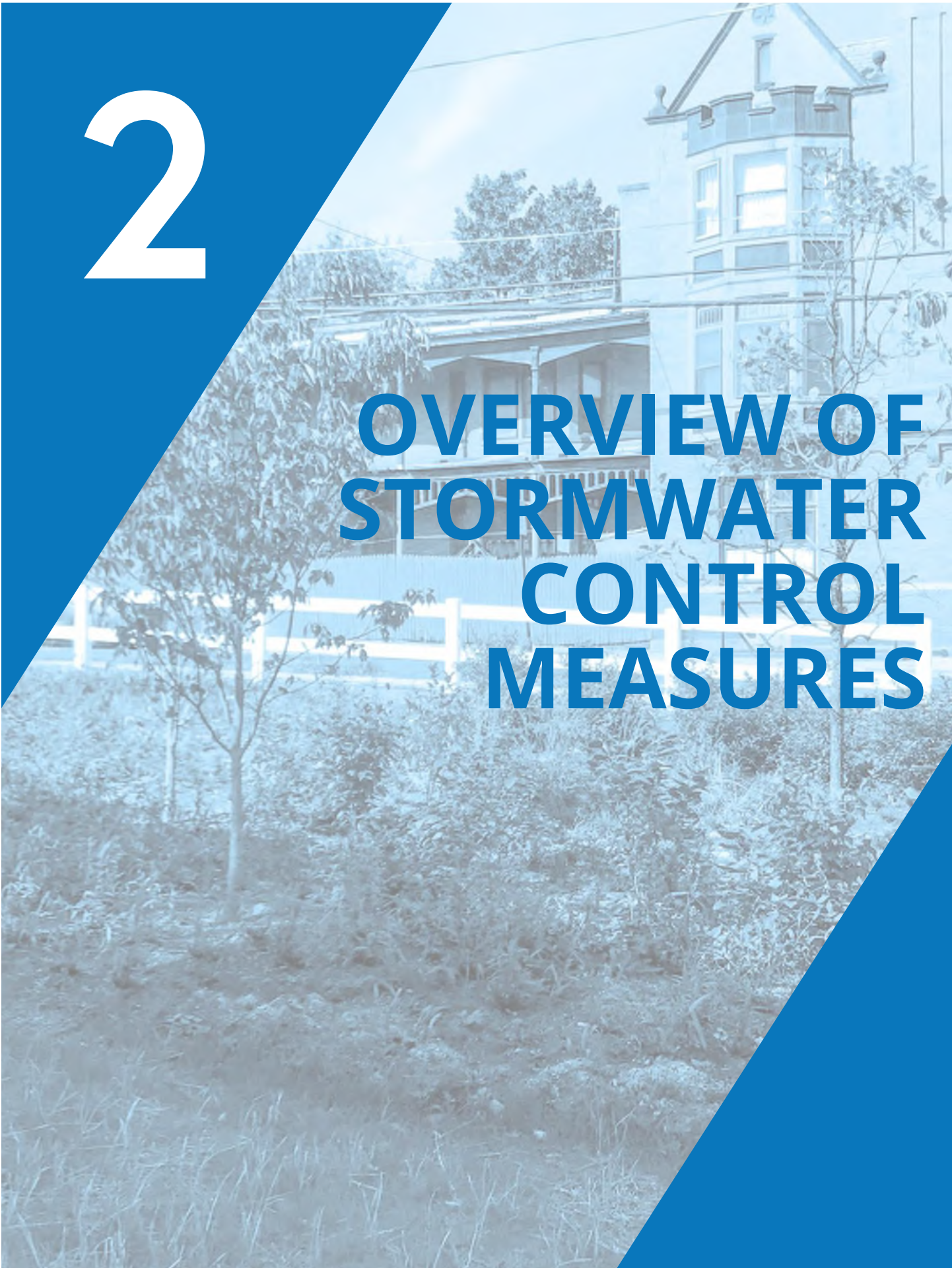

# STORMWATER PLANTER

A stormwater planter—planted with native grasses, flowering perennials and shrubs—is typically located inside the sidewalk area in more dense urban areas where limited space is available. Planters typically divert runoff from the adjacent roadway via a curb cut with a concrete apron or with a trench drain that carries water underneath the parking step-out zone and into the planter. Additional runoff from the sidewalk may be conveyed via sheet flow or through small openings in the planter box wall. Water infiltrates through the planting soil into a stone storage layer. A domed riser and underdrain pipe convey overflows out of the planter.

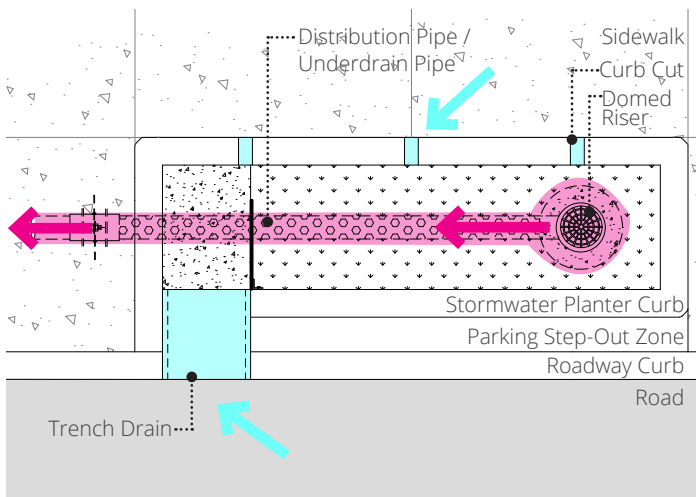

**FIGURE 2.1 – STORMWATER PLANTER INFLOW AND OUTFLOW PLAN**



Image credit: NYC Department of Environmental Protection



Image credit: greywateraction.org

**TABLE 2.1 – STORMWATER PLANTER COMPONENTS**

COMPONENT	DESCRIPTION
Cleanout	<ul style="list-style-type: none"> <li>Allows access to the distribution pipe and underdrain pipe from the surface.</li> </ul>
Concrete Apron	<ul style="list-style-type: none"> <li>A sloped concrete panel that collects water from the gutter and directs it into a curb cut or inlet.</li> </ul>
Curb Cut	<ul style="list-style-type: none"> <li>An opening in the curb that directs water into the SCM.</li> </ul>
Curb Cut with Trench Drain	<ul style="list-style-type: none"> <li>An opening in the curb that directs water through a linear drain underneath a walkway or other paved area into the SCM.</li> </ul>
Distribution Pipe	<ul style="list-style-type: none"> <li>Perforated and/or solid pipes that deliver stormwater runoff to an SCM. A cleanout pipe allows access to the distribution pipe from the surface.</li> </ul>
Domed Riser	<ul style="list-style-type: none"> <li>Controls the overflow of stormwater from the system.</li> </ul>
Geotextile	<ul style="list-style-type: none"> <li>Heavy-duty fabric made of synthetic fibers that is often used as a barrier between different types of drainage materials (such as stone and stormwater soil). Some systems also have an impermeable geomembrane liner if infiltration into underlying soils is not intended.</li> </ul>
Grasses, Perennials, and/or Shrubs	<ul style="list-style-type: none"> <li>Provides water filtration and volume reduction through biological processes.</li> </ul>
Observation Well	<ul style="list-style-type: none"> <li>Allows measurement from the surface of the water level in the system.</li> </ul>
Planter Wall	<ul style="list-style-type: none"> <li>A perimeter wall, often made of concrete, that separates the planter bed from the surrounding area.</li> </ul>
Stormwater Soil	<ul style="list-style-type: none"> <li>Engineered soil mix that provides growth media for plants and soil microorganisms and supports filtration and infiltration of runoff.</li> </ul>
Splash Pad	<ul style="list-style-type: none"> <li>A panel of stone or concrete that dissipates the energy of fast-moving water.</li> </ul>
Stone Storage	<ul style="list-style-type: none"> <li>Gravel layer made of clean-washed, open-graded stone to provide subsurface storage of water. An observation well allows measurement from the surface of the water level in the system.</li> </ul>
Underdrain Pipe	<ul style="list-style-type: none"> <li>Subsurface perforated pipe that collects and conveys runoff from the SCM back to the sewer system. The pipe usually has an end cap or orifice to control the rate at which water is released from the system.</li> </ul>

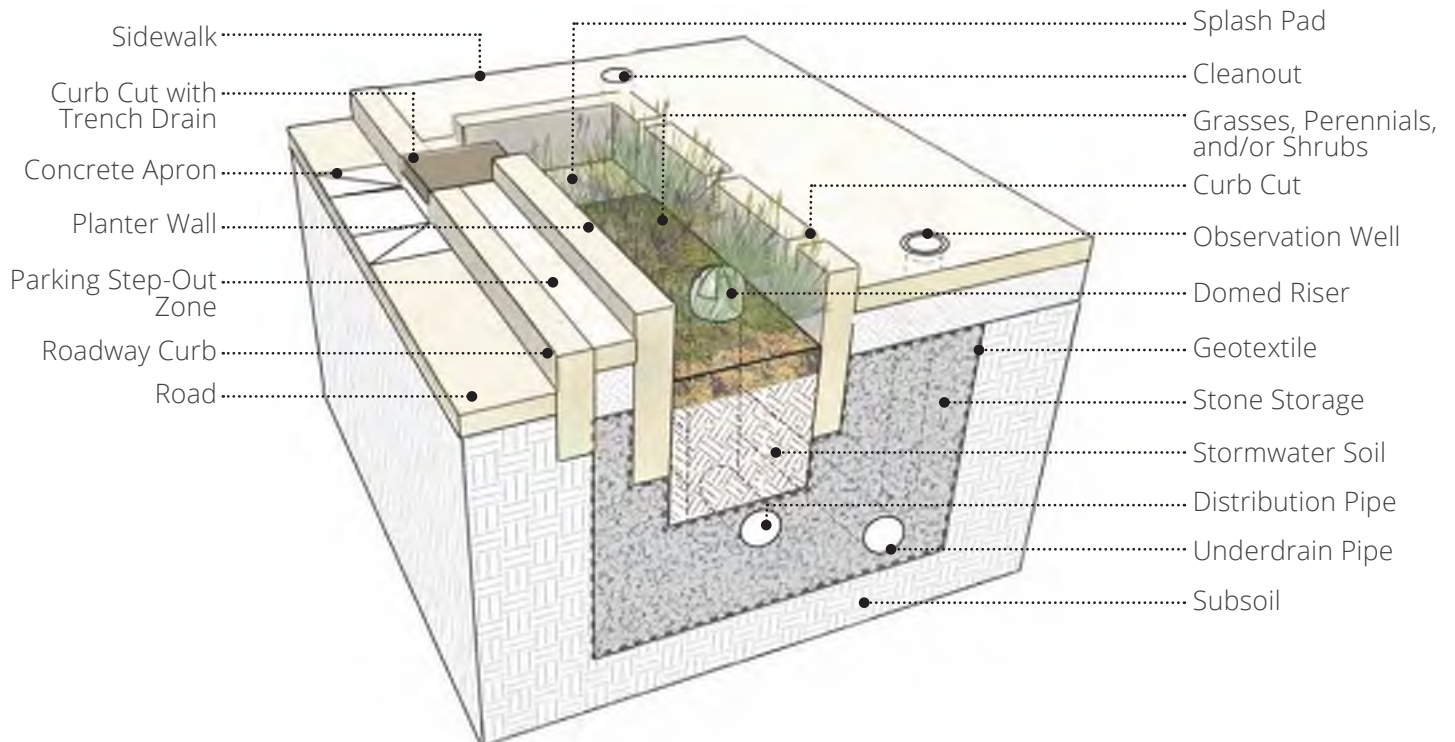

**FIGURE 2.2 – STORMWATER PLANTER COMPONENTS**

*Components diagrammed above are typical for this SCM but may be configured differently for individual systems.*

# STORMWATER BUMPOUT

A stormwater bumpout is a vegetated curb extension of the pedestrian zone into the roadway that intercepts gutterflow via inlets or curbcuts. Stormwater bumpouts are located mid-block, at intersections, or at the downslope end of the block where they capture the most drainage area. The system is composed of a stone bed layer topped with engineered soil media and plants designed to store, infiltrate, or evapotranspire stormwater runoff. Stormwater bumpouts are commonly planted with a variety of grasses and flowering perennials placed to maintain adequate sight lines. A domed riser is typically installed within a bumpout and provides an overflow to the subsurface stone bed layer during intense rainfall events. The subsurface stone storage bed may extend under the sidewalk and/or farther upslope to provide additional storage. Excess stormwater runoff is slowly released back to the existing sewer system via perforated underdrain pipe conveyance.

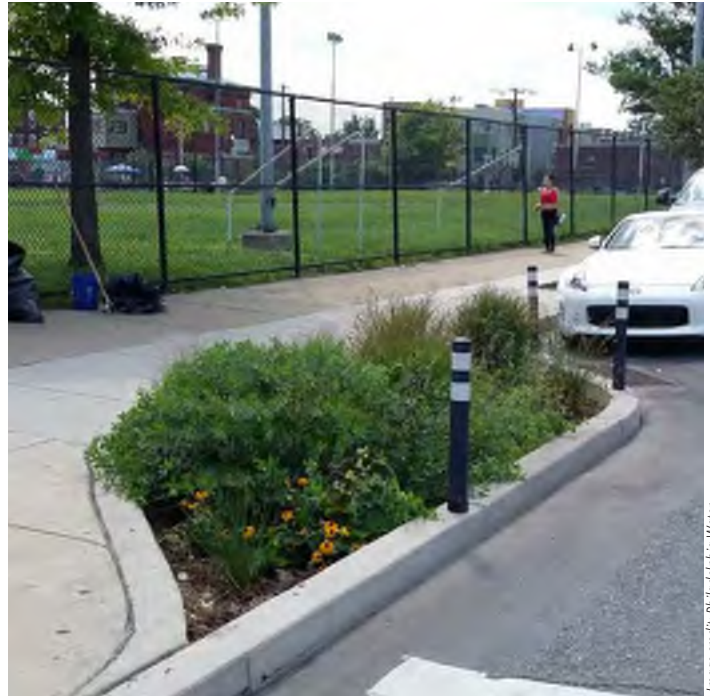
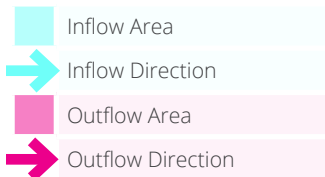
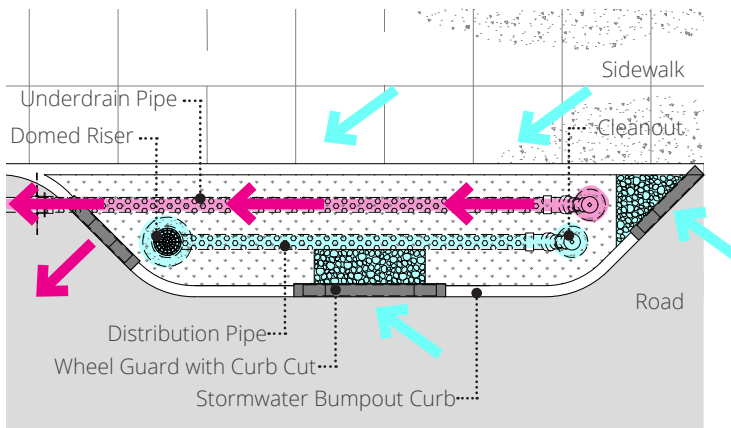

Image credit: Philadelphia Water



**FIGURE 2.3 – STORMWATER BUMPOUT INFLOW AND OUTFLOW PLAN**



Image credit: Arthur Smid // Life in Common

**TABLE 2.2 – STORMWATER BUMPOUT COMPONENTS**

COMPONENT	DESCRIPTION
Cleanout	▪ Allows access to the distribution pipe and underdrain pipe from the surface.
Curb Cut	▪ An opening in the curb that directs water into the SCM.
Domed Riser	▪ Controls the overflow of stormwater from the system.
Distribution Pipe	▪ Perforated and/or solid pipes that deliver stormwater runoff to an SCM. A cleanout pipe allows access to the distribution pipe from the surface.
Geotextile	▪ Heavy-duty fabric made of synthetic fibers that is often used as a barrier between different types of drainage materials (such as stone and stormwater soil). Some systems also have an impermeable geomembrane liner if infiltration into underlying soils is not intended.
Grasses, Perennials, and/or Shrubs	▪ Provides water quality and water quantity management through biological processes.
Observation Well	▪ Allows measurement from the surface of the water level in the system.
Planter Wall	▪ A perimeter wall, often made of concrete, that separates the planter bed from the surrounding area.
Stormwater Soil	▪ Engineered soil mix that provides growth media for plants and soil microorganisms and supports filtration and infiltration of runoff.
Splash Pad	▪ A panel of stone or concrete that dissipates the energy of fast-moving water.
Stone Storage	▪ Gravel layer made of clean-washed, open-graded stone to provide subsurface storage of water.
Underdrain Pipe	▪ Subsurface perforated pipe that collects and conveys runoff from the SCM back to the sewer system. The pipe usually has an end cap or orifice to control the rate at which water is released from the system.
Wheel Guard	▪ A plate placed across a curb cut to maintain a constant surface along the top of the curb and prevent cars from entering the opening.

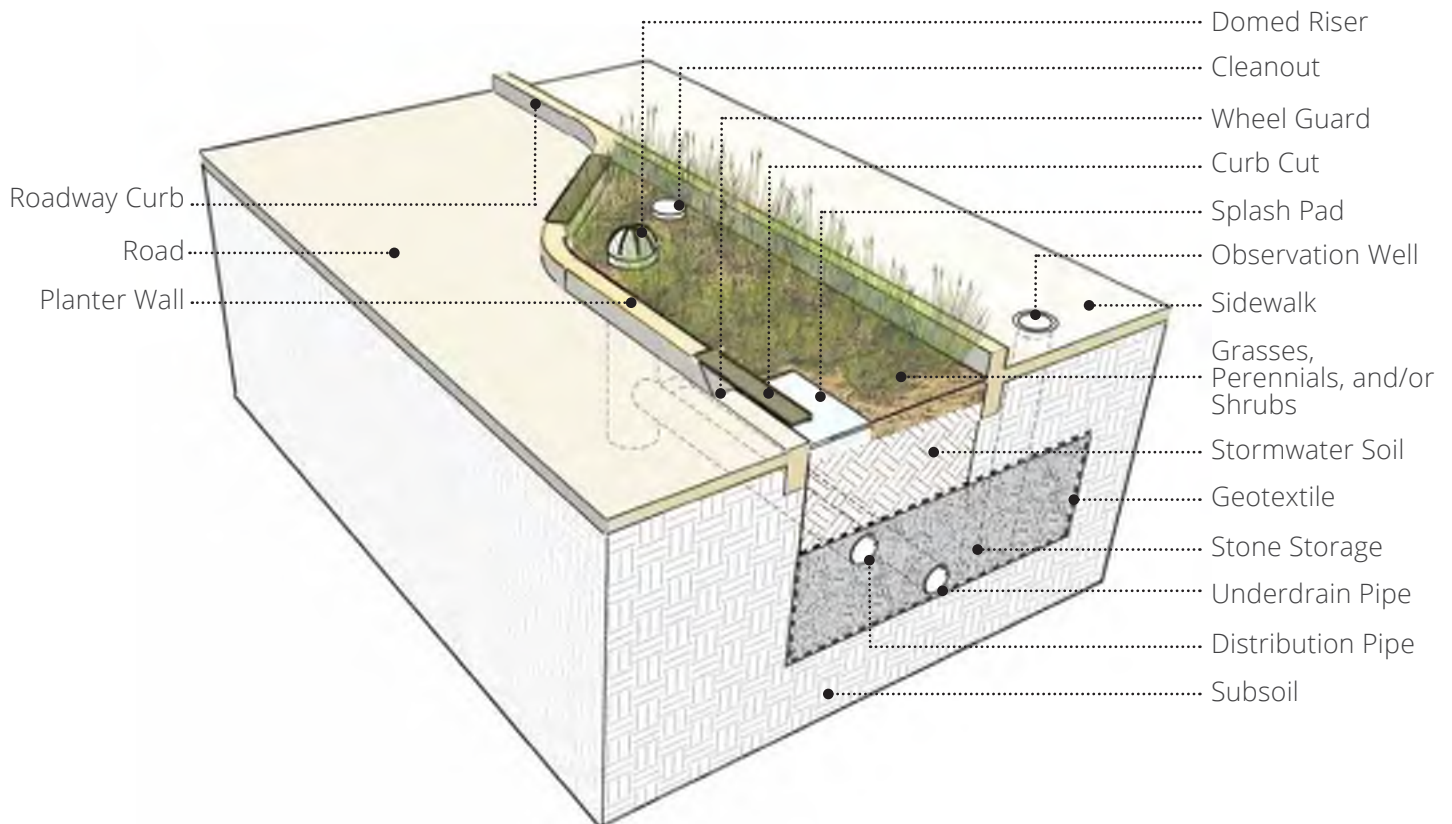
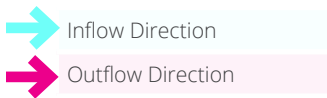
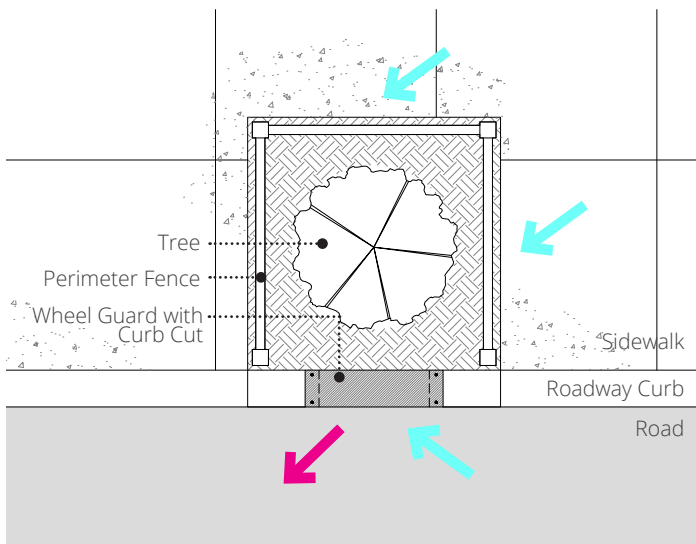

**FIGURE 2.4 – STORMWATER BUMPOUT COMPONENTS**

*Components diagrammed above are typical for this SCM but may be configured differently for individual systems.*

# STORMWATER TREE

A stormwater tree is a tree planted in a specialized tree pit installed in the sidewalk area. Stormwater runoff is conveyed into a stormwater tree pit through a curb opening or grate with a wheel guard. The soil media surface within the tree pit is graded slightly below street level to allow for ponding. Fencing is typically used as a protective barrier around the tree pit for pedestrian safety. Often, multiple tree pits are designed in series to maximize the potential for stormwater capture, treatment, and infiltration.



**FIGURE 2.5 – STORMWATER TREE INFLOW AND OUTFLOW PLAN**



Image credit: US Environmental Protection Agency



Image credit: National Association of City Transportation Officials

**TABLE 2.3 – STORMWATER TREE COMPONENTS**

COMPONENT	DESCRIPTION
Curb Cut	<ul style="list-style-type: none"> <li>An opening in the curb that directs water into the SCM.</li> </ul>
Perimeter Fence	<ul style="list-style-type: none"> <li>A low border to protect and delineate the system area.</li> </ul>
Stormwater Soil	<ul style="list-style-type: none"> <li>Engineered soil mix that provides growth media for plants and soil microorganisms and supports filtration and infiltration of runoff.</li> </ul>
Tree	<ul style="list-style-type: none"> <li>Provides water quality and water quantity management through biological processes.</li> </ul>
Wheel Guard	<ul style="list-style-type: none"> <li>A plate placed across a curb cut to maintain a constant surface along the top of the curb and prevent cars from entering the opening.</li> </ul>

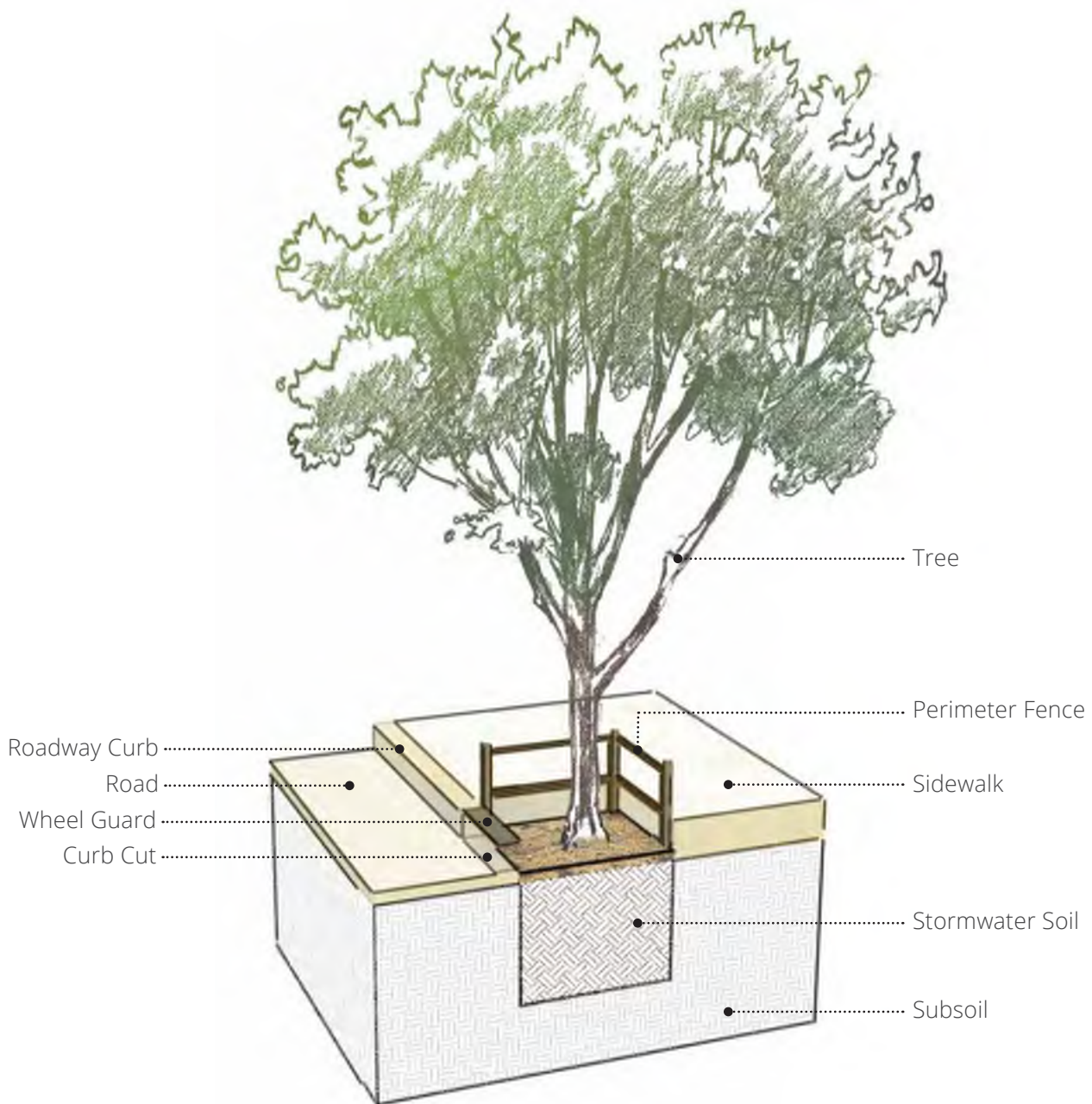
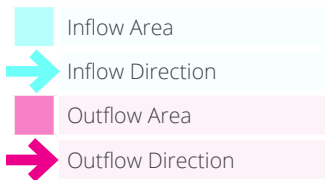
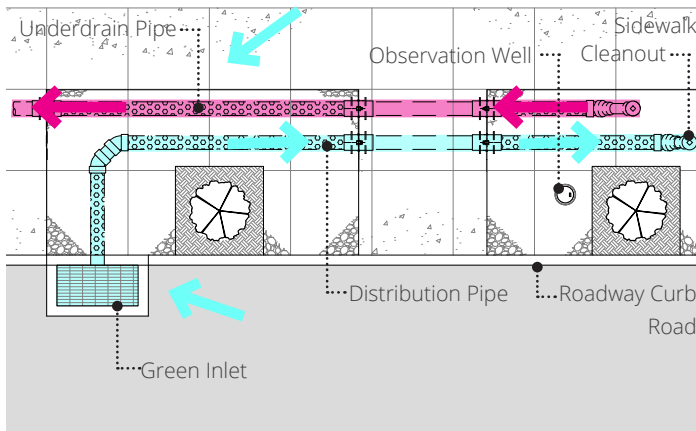

**FIGURE 2.6 – STORMWATER TREE COMPONENTS**

*Components diagrammed above are typical for this SCM but may be configured differently for individual systems.*

# STORMWATER TREE TRENCH

A stormwater tree trench is a subsurface infiltration/storage trench typically filled with stone, and planted throughout with one or more trees. Stormwater runoff is conveyed into the trench via green inlets and perforated distribution pipes. Stormwater inlets are typically fitted with pretreatment devices, such as an inlet filter bag, to prevent trash and debris from entering the system. Runoff is stored within the stone base where it infiltrates into underlying soil, provides water to tree roots and/or is slowly released back to the existing sewer system through the drainage pipe.



**FIGURE 2.7 – STORMWATER TREE TRENCH INFLOW AND OUTFLOW PLAN**



Image credit: ARRF, Inc.

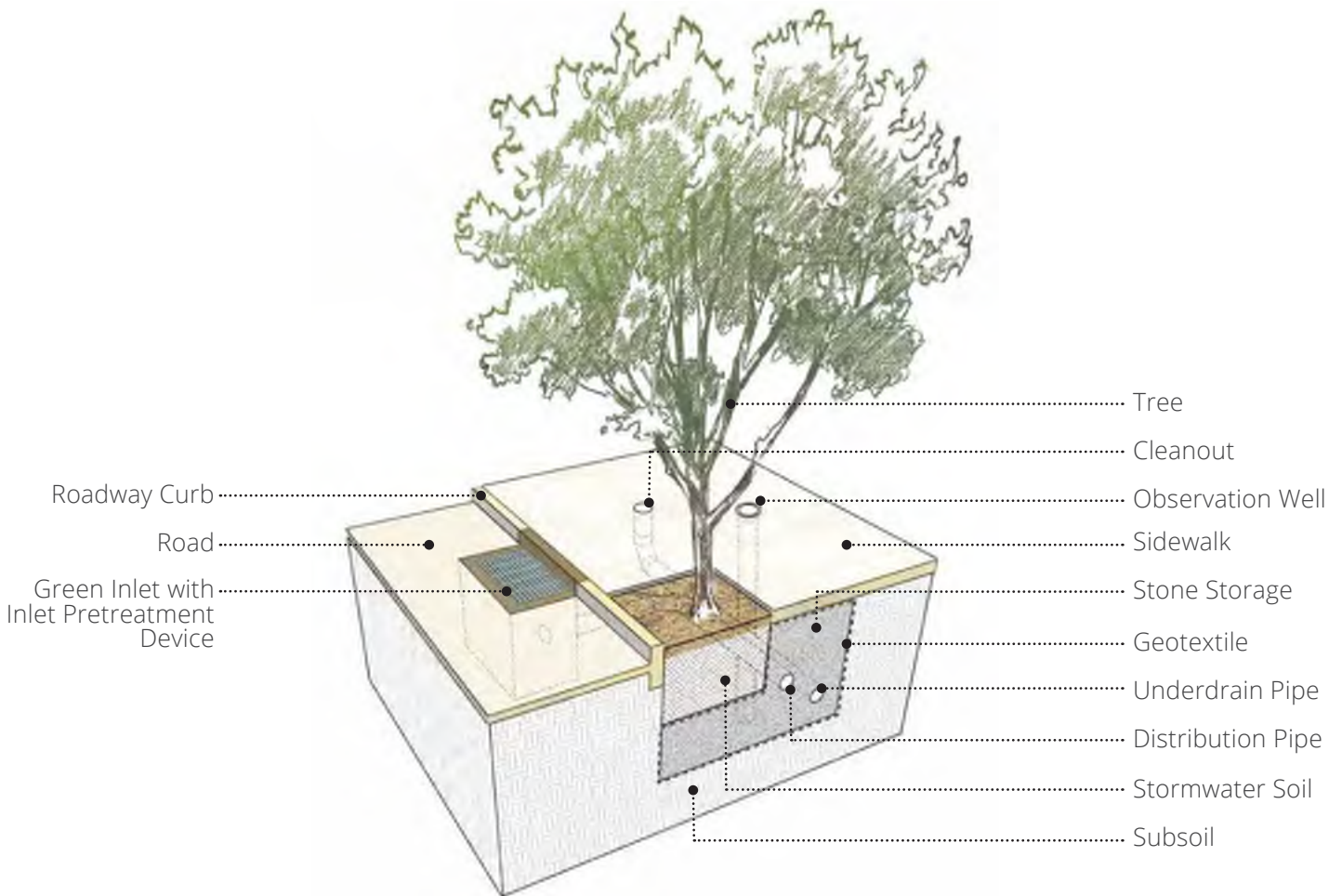

Image credit: USDA Forest Service



**TABLE 2.4 – STORMWATER TREE TRENCH COMPONENTS**

COMPONENT	DESCRIPTION
Cleanout	<ul style="list-style-type: none"> <li>Allows access to the distribution pipe and underdrain pipe from the surface.</li> </ul>
Distribution Pipe	<ul style="list-style-type: none"> <li>Perforated and/or solid pipes that deliver stormwater runoff to an SCM.</li> </ul>
Geotextile	<ul style="list-style-type: none"> <li>Heavy-duty fabric made of synthetic fibers that is often used as a barrier between different types of drainage materials (such as stone and stormwater soil). Some systems also have an impermeable geomembrane liner if infiltration into underlying soils is not intended.</li> </ul>
Green Inlet	<ul style="list-style-type: none"> <li>An inlet placed within an existing gutter or other surface flow path that diverts runoff from paved areas and redirects it into a green stormwater infrastructure system.</li> </ul>
Inlet Pretreatment Device	<ul style="list-style-type: none"> <li>Structure that captures trash, sediment, and/ or other pollutants from stormwater runoff before delivery to a surface detention area or media.</li> </ul>
Observation Well	<ul style="list-style-type: none"> <li>Allows measurement from the surface of the water level in the system.</li> </ul>
Stormwater Soil	<ul style="list-style-type: none"> <li>Engineered soil mix that provides growth media for plants and soil microorganisms and supports filtration and infiltration of runoff.</li> </ul>
Stone Storage	<ul style="list-style-type: none"> <li>Gravel layer made of clean-washed, open-graded stone to provide subsurface storage of water.</li> </ul>
Tree	<ul style="list-style-type: none"> <li>Provides water quality and water quantity management through biological processes.</li> </ul>
Underdrain Pipe	<ul style="list-style-type: none"> <li>Subsurface perforated pipe that collects and conveys runoff from the SCM back to the sewer system. The pipe usually has an end cap or orifice to control the rate at which water is released from the system.</li> </ul>



**FIGURE 2.8 – STORMWATER TREE TRENCH COMPONENTS**

*Components diagrammed above are typical for this SCM but may be configured differently for individual systems.*

# PERMEABLE PAVEMENT

Permeable pavements, used as an alternative to traditional pavements, allow stormwater to pass through the paved surface via void spaces and into an underlying layer of filter stone for storage, slow release, and infiltration. Permeable pavements may consist of porous asphalt, porous concrete, or interlocking concrete pavers with permeable joints. In systems where the subgrade soils do not infiltrate effectively, an underdrain pipe system can be used to release water back to the drainage network. Permeable pavements are typically used in low-traffic areas such as walkways, alleyways, basketball courts, or parking bays.



Image credit: USDA Forest Service

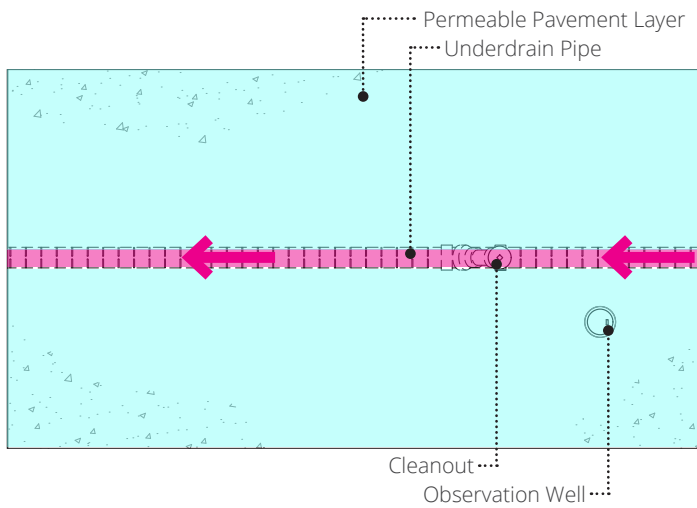

- Inflow Area
- Outflow Area
- Outflow Direction

**FIGURE 2.9 – PERMEABLE PAVEMENT INFLOW AND OUTFLOW PLAN**



Image credit: ARRF, Inc.



Image credit: USDA Forest Service

**TABLE 2.5 – PERMEABLE PAVEMENT COMPONENTS**

COMPONENT	DESCRIPTION
Cleanout	<ul style="list-style-type: none"> <li>Allows access to the underdrain pipe from the surface.</li> </ul>
Geotextile	<ul style="list-style-type: none"> <li>Heavy-duty fabric made of synthetic fibers that is often used as a barrier between different types of drainage materials (such as stone and stormwater soil). Some systems also have an impermeable geomembrane liner if infiltration into underlying soils is not intended.</li> </ul>
Observation Well	<ul style="list-style-type: none"> <li>Allows measurement from the surface of the water level in the system.</li> </ul>
Permeable Pavement Layer	<ul style="list-style-type: none"> <li>A hardscape surface that allows water to pass through the surface and into the ground below.</li> </ul>
Stone Storage	<ul style="list-style-type: none"> <li>Gravel layer made of clean-washed, open-graded stone to provide subsurface storage of water.</li> </ul>
Underdrain Pipe	<ul style="list-style-type: none"> <li>Subsurface perforated pipe that collects and conveys runoff from the SCM back to the sewer system. The pipe usually has an end cap or orifice to control the rate at which water is released from the system.</li> </ul>

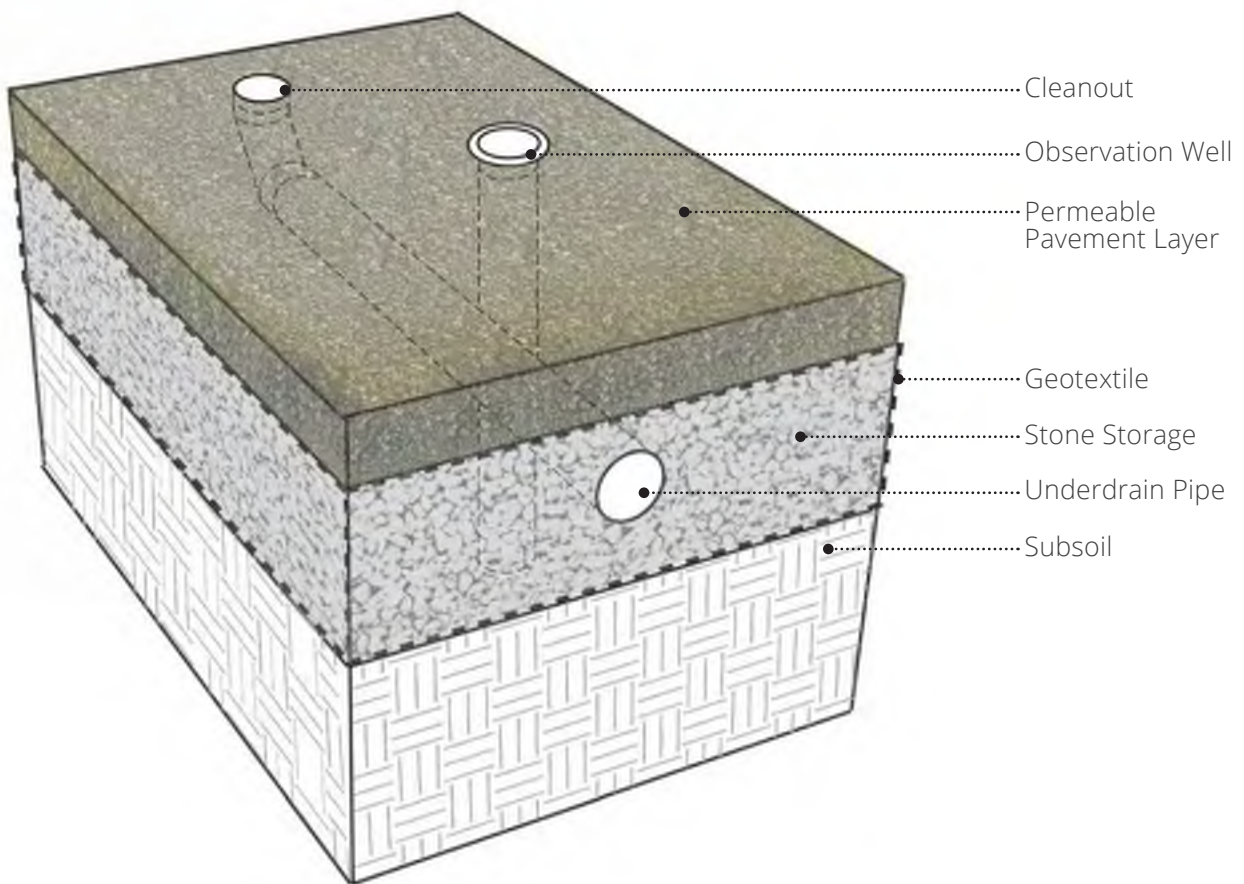

**FIGURE 2.10 – PERMEABLE PAVEMENT COMPONENTS**

*Components diagrammed above are typical for this SCM but may be configured differently for individual systems.*

# STORAGE/ INFILTRATION TRENCH

Subsurface infiltration/storage trenches may be located below sidewalks, streets, parking areas, or recreational areas. Runoff from adjacent paved areas is diverted via a green inlet, and conveyed via perforated distribution pipes into typically a subsurface stone bed where it is stored and/or infiltrated into the soil. Other subsurface storage alternatives include arches or half pipes, plastic crates, and concrete vaults. Excess stormwater is slowly released back to the existing sewer system via a perforated underdrain pipe. Inlets are typically fitted with pre-treatment devices, such as an inlet filter bag, to prevent trash and debris from entering the system.



Image credit: Contech Engineered Solutions

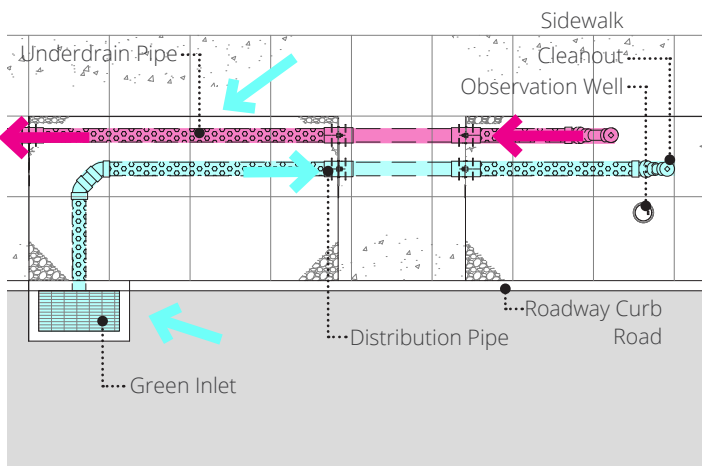

- Inflow Area
- Inflow Direction
- Outflow Area
- Outflow Direction

**FIGURE 2.11 – STORAGE/ INFILTRATION TRENCH INFLOW AND OUTFLOW PLAN**

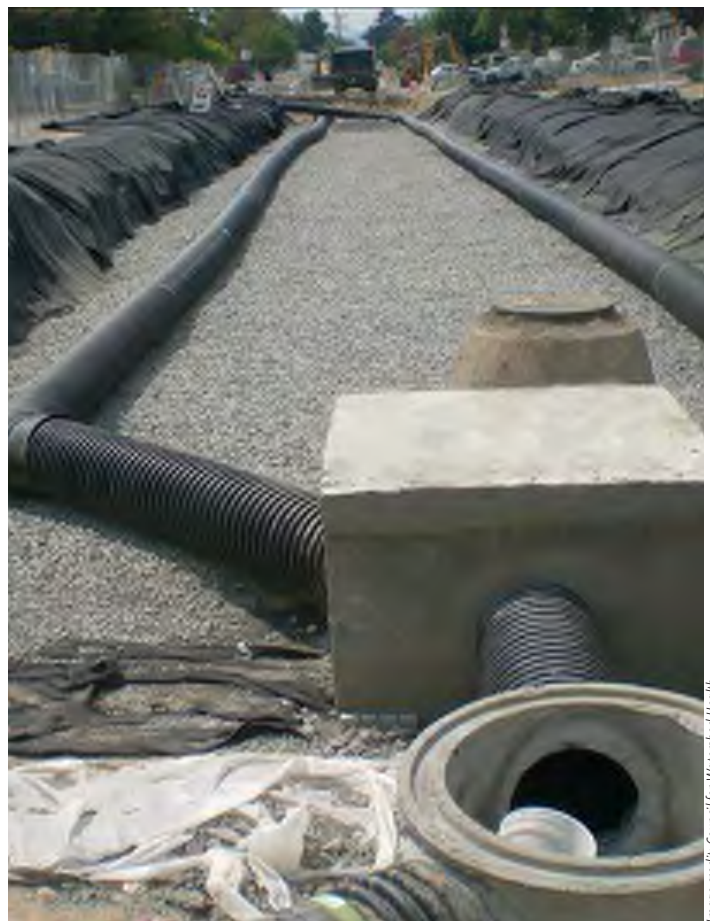
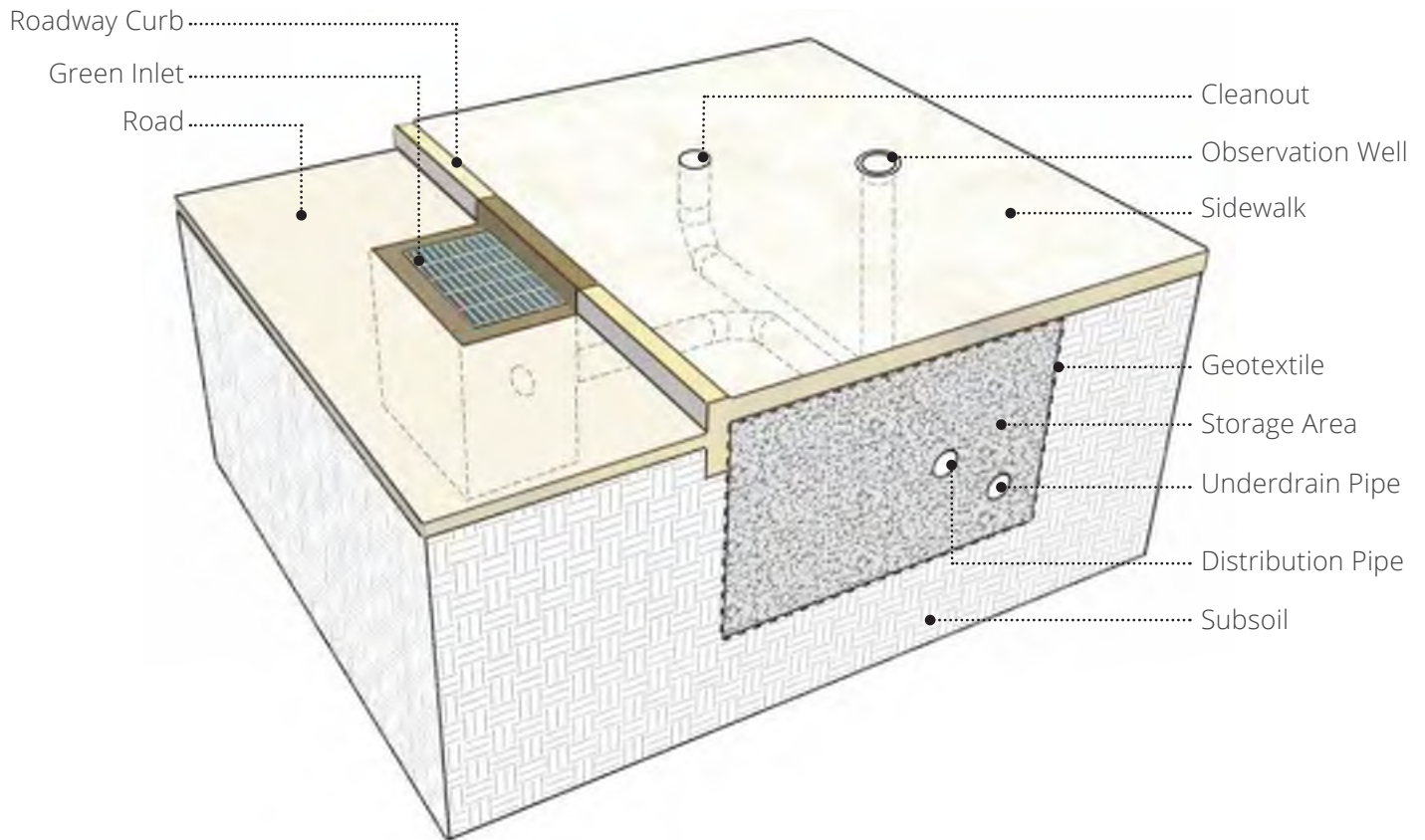

Image credit: Council for Watershed Health

**TABLE 2.6 – STORAGE/ INFILTRATION TRENCH COMPONENTS**

COMPONENT	DESCRIPTION
Cleanout	<ul style="list-style-type: none"> <li>Allows access to the distribution pipe and underdrain pipe from the surface.</li> </ul>
Distribution Pipe	<ul style="list-style-type: none"> <li>Perforated and/or solid pipes that deliver stormwater runoff to an SCM.</li> </ul>
Geotextile	<ul style="list-style-type: none"> <li>Heavy-duty fabric made of synthetic fibers that is often used as a barrier between different types of drainage materials (such as stone and stormwater soil). Some systems also have an impermeable geomembrane liner if infiltration into underlying soils is not intended.</li> </ul>
Green Inlet	<ul style="list-style-type: none"> <li>An inlet placed within an existing gutter or other surface flow path that diverts runoff from paved areas and redirects it into a green stormwater infrastructure system.</li> </ul>
Inlet Pretreatment Device	<ul style="list-style-type: none"> <li>Structure that captures trash, sediment, and/ or other pollutants from stormwater runoff before delivery to a surface detention area or media.</li> </ul>
Observation Well	<ul style="list-style-type: none"> <li>Allows measurement from the surface of the water level in the system.</li> </ul>
Storage Area	<ul style="list-style-type: none"> <li>Gravel layer made of clean-washed, open-graded stone to provide subsurface storage of water.</li> </ul>
Underdrain Pipe	<ul style="list-style-type: none"> <li>Subsurface perforated pipe that collects and conveys runoff from the SCM back to the sewer system. The pipe usually has an end cap or orifice to control the rate at which water is released from the system.</li> </ul>

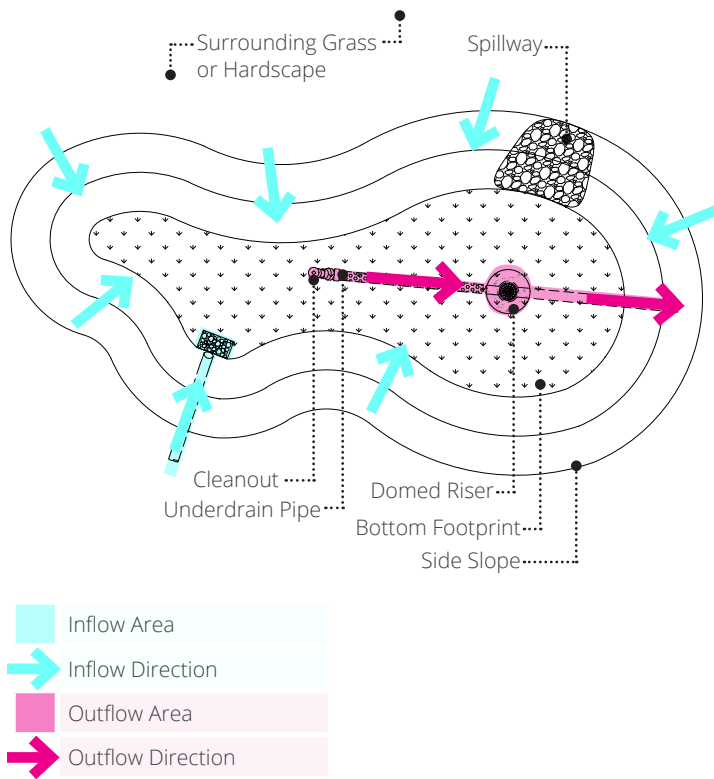

**FIGURE 2.12 – STORAGE/ INFILTRATION TRENCH COMPONENTS**

*Components diagrammed above are typical for this SCM but may be configured differently for individual systems.*

# RAIN GARDEN

A rain garden is a vegetated area designed to collect stormwater runoff from surrounding impervious surfaces such as roadways, roofs, walkways, playgrounds, and parking lots. Stormwater runoff is captured via trench drain, curb opening, or a stormwater inlet and conveyed to a shallow basin where it is filtered by a mix of native grasses, perennials, and/or shrubs, and is infiltrated through layers of stormwater soil and stone. Inlet pre-treatment devices, such as forebays and inlet filter bags, are sometimes used to catch sediment before it enters the planting bed. Captured water is slowly released back to the existing sewer system via a domed riser and perforated underdrain pipe. During large storms any excess water the system can not hold is safely conveyed over the spillway.



**FIGURE 2.13 – RAIN GARDEN INFLOW AND OUTFLOW PLAN**



Image credit: AKRF, Inc.



Image credit: Philadelphia Water

**TABLE 2.7 – RAIN GARDEN COMPONENTS**

COMPONENT	DESCRIPTION
Cleanout	<ul style="list-style-type: none"> <li>Allows access to the underdrain pipe from the surface.</li> </ul>
Domed Riser	<ul style="list-style-type: none"> <li>Controls the release of stormwater from the system.</li> </ul>
Geotextile	<ul style="list-style-type: none"> <li>Heavy-duty fabric made of synthetic fibers that is often used as a barrier between different types of drainage materials (such as stone and stormwater soil). Some systems also have an impermeable geomembrane liner if infiltration into underlying soils is not intended.</li> </ul>
Grasses, Perennials, and/or Shrubs	<ul style="list-style-type: none"> <li>Provides water quality and water quantity management through biological processes.</li> </ul>
Green Inlet	<ul style="list-style-type: none"> <li>An inlet placed within an existing gutter or other surface flow path that diverts runoff from paved areas and redirects it into a green stormwater infrastructure system.</li> </ul>
Inlet Pipe	<ul style="list-style-type: none"> <li>Conveys stormwater from a green inlet onto the SCM.</li> </ul>
Inlet Pretreatment Device	<ul style="list-style-type: none"> <li>Structure that captures trash, sediment, and/ or other pollutants from stormwater runoff before delivery to a surface detention area or media.</li> </ul>
Observation Well	<ul style="list-style-type: none"> <li>Allows measurement from the surface of the water level in the system.</li> </ul>
Outlet Pipe	<ul style="list-style-type: none"> <li>Conveys water from an outlet structure back to the municipal storm sewer system.</li> </ul>
Stormwater Soil	<ul style="list-style-type: none"> <li>Engineered soil mix that provides growth media for plants and soil microorganisms and supports filtration and infiltration of runoff.</li> </ul>
Sediment Forebay	<ul style="list-style-type: none"> <li>A pool or basin located at the stormwater runoff inflow point and designed to trap and settle sediment or other pollutants.</li> </ul>
Splash Pad	<ul style="list-style-type: none"> <li>A panel of stone or concrete that dissipates the energy of fast-moving water.</li> </ul>
Stone Storage	<ul style="list-style-type: none"> <li>Gravel layer made of clean-washed, open-graded stone to provide subsurface storage of water.</li> </ul>
Underdrain Pipe	<ul style="list-style-type: none"> <li>Subsurface perforated pipe that collects and conveys runoff from the SCM back to the sewer system. The pipe usually has an end cap or orifice to control the rate at which water is released from the system.</li> </ul>

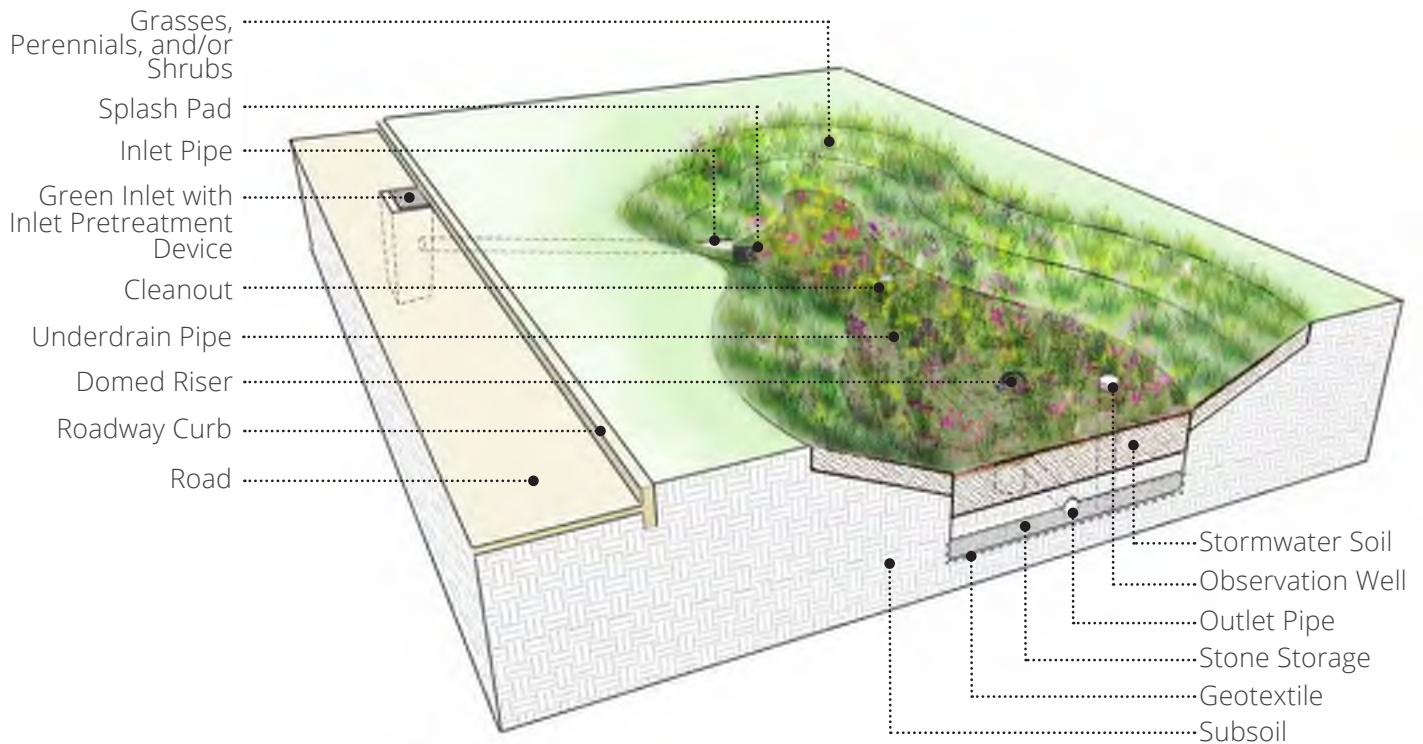

**FIGURE 2.14 – RAIN GARDEN COMPONENTS**

*Components diagrammed above are typical for this SCM but may be configured differently for individual systems.*

# STORMWATER WETLAND

Stormwater wetlands are shallow marsh systems planted with emergent vegetation that treat stormwater and are designed to imitate the functions of natural wetlands. Water is conveyed into the wetland via inlets and distribution piping, and release via an outlet control structure. Any additional water in the wetland can be released through a spillway. A standard constructed wetland contains a permanent pool of water for enhancing water quality and detaining stormwater runoff. Stormwater wetlands are an effective tool for removing pollutants by storing it in a permanent, shallow pool and allowing water to be treated through marshland vegetation and pollutants to settle to the bottom of the permanent pool. Wetland vegetation generally consists of a variety of open water, emergent, or low/high marsh uploading nutrients and pollutants for water quality improvement.



Image credit: Philadelphia Water

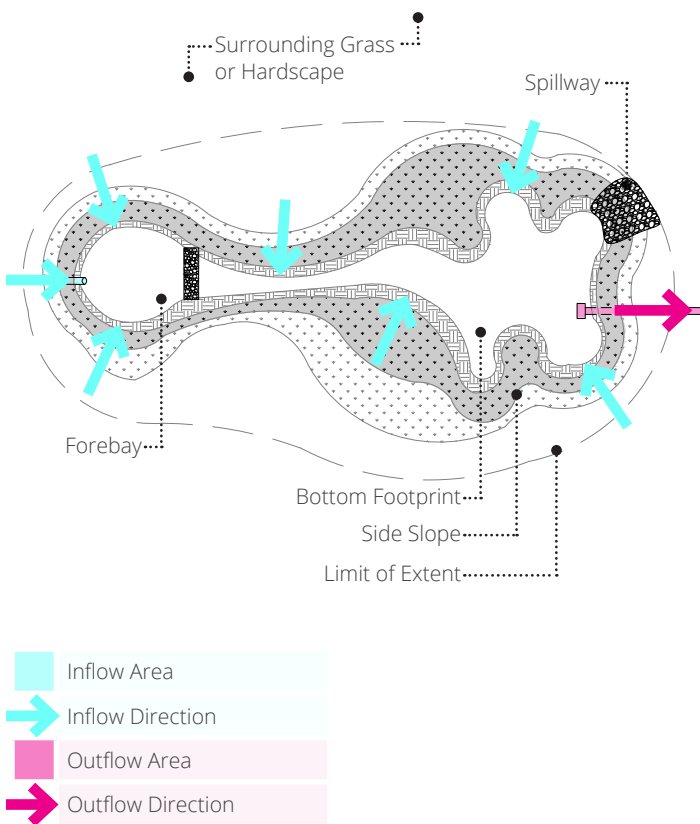

**FIGURE 2.15 – STORMWATER WETLAND INFLOW AND OUTFLOW PLAN**

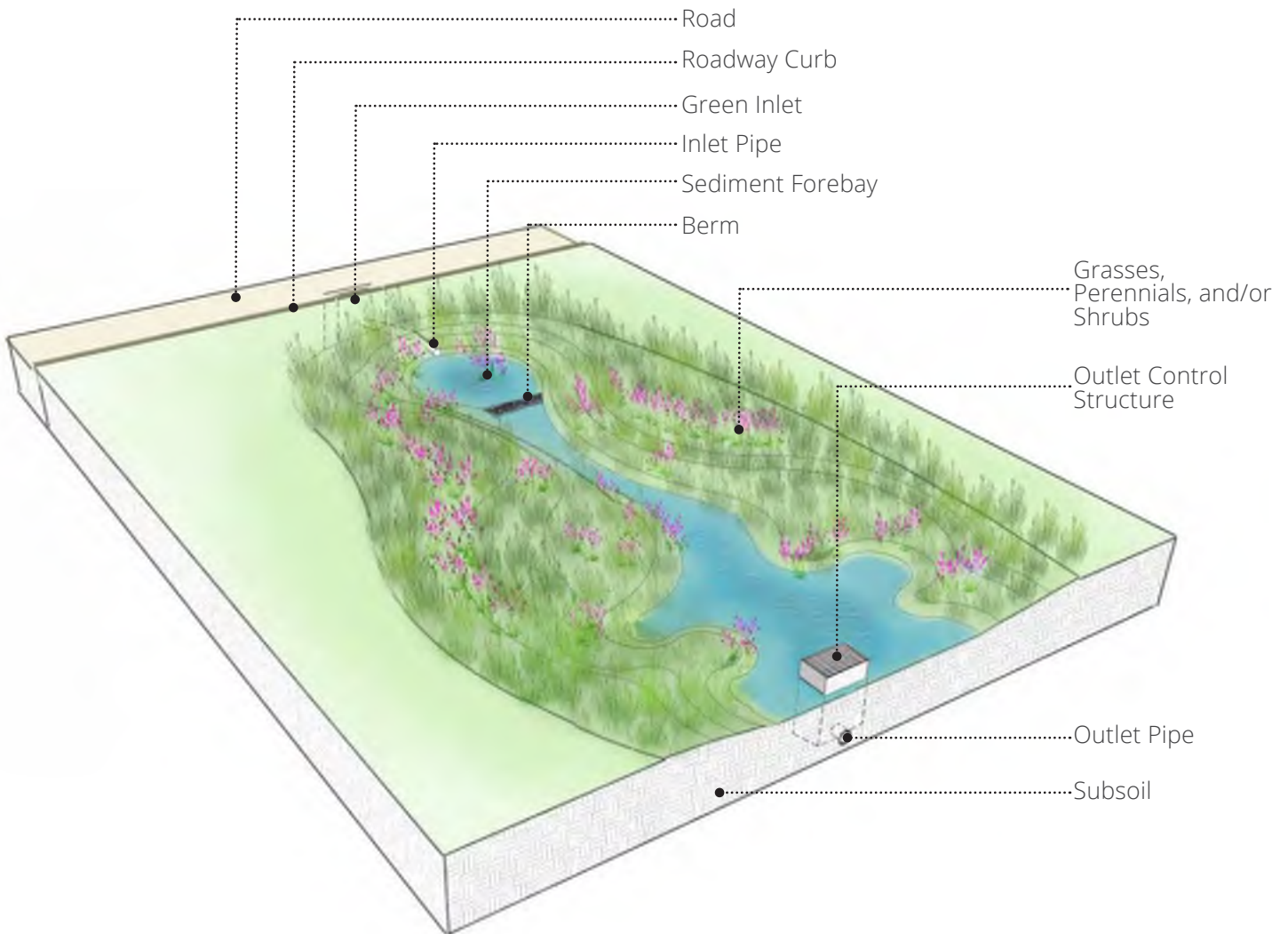

Image credit: AKRF, Inc.



**TABLE 2.8 - STORMWATER WETLAND COMPONENTS**

COMPONENT	DESCRIPTION
Berm	<ul style="list-style-type: none"> <li>▪ Raised barrier designed to keep stormwater inflow within the sediment forebay.</li> </ul>
Grasses, Perennials, and/or Shrubs	<ul style="list-style-type: none"> <li>▪ Provides water quality and water quantity management through biological processes.</li> </ul>
Green Inlet	<ul style="list-style-type: none"> <li>▪ An inlet placed within an existing gutter or other surface flow path that diverts runoff from paved areas and redirects it into a green stormwater infrastructure system.</li> </ul>
Inlet Pipe	<ul style="list-style-type: none"> <li>▪ Conveys stormwater from a green inlet onto the SCM.</li> </ul>
Outlet Control Structure	<ul style="list-style-type: none"> <li>▪ Controls the rate at which the stormwater flows out of the system. Stormwater wetlands also usually have an emergency spillway to release water safely from very large storms that exceed the capacity of the system.</li> </ul>
Outlet Pipe	<ul style="list-style-type: none"> <li>▪ Conveys water from an outlet structure back to the municipal storm sewer system.</li> </ul>
Sediment Forebay	<ul style="list-style-type: none"> <li>▪ A pool or basin located at the stormwater runoff inflow point and designed to trap and settle sediment or other pollutants.</li> </ul>



**FIGURE 2.16 – STORMWATER WETLAND COMPONENTS**

*Components diagrammed above are typical for this SCM but may be configured differently for individual systems.*

# STORMWATER BASIN

A stormwater basin is a surface ponding area that captures and temporarily stores stormwater runoff. Stormwater basins are normally dry during dry weather, but fill with water during and shortly after a storm. A forebay at the inflow point settles out sediment and debris and allows for easy maintenance. A vegetated low flow path conveys and infiltrated small volumes of water in between large storms. Plantings may consist of a diverse mix of native meadow grasses, herbaceous species, shrubs, and trees in some areas. A multi-stage outlet structure holds back smaller volumes of water during small storms while allowing for safe overflows during the largest storms. In some cases, a spillway will be incorporated into the design to ensure excess water can be discharged.



Image credit: Philadelphia Water



Image credit: Civic Design, Inc.

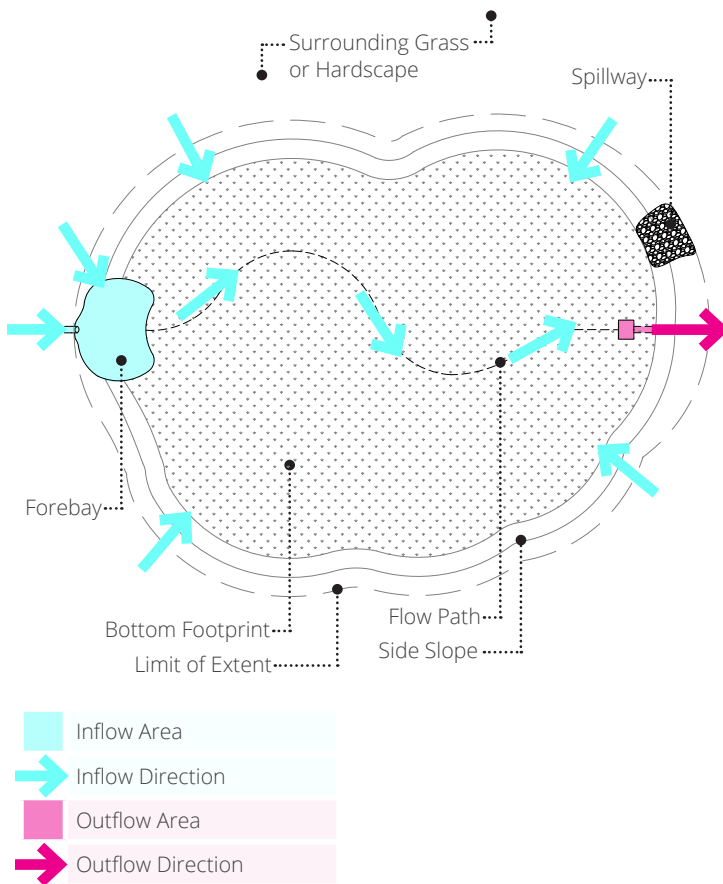

**FIGURE 2.17 – STORMWATER BASIN INFLOW AND OUTFLOW PLAN**

**TABLE 2.9 – STORMWATER BASIN COMPONENTS**

COMPONENT	DESCRIPTION
Grasses, Perennials, and/or Shrubs	<ul style="list-style-type: none"> <li>Provides water quality and water quantity management through biological processes.</li> </ul>
Green Inlet	<ul style="list-style-type: none"> <li>An inlet placed within an existing gutter or other surface flow path that diverts runoff from paved areas and redirects it into a green stormwater infrastructure system.</li> </ul>
Inlet Pipe	<ul style="list-style-type: none"> <li>Conveys stormwater from a green inlet onto the SCM.</li> </ul>
Multi-Stage Outlet Control Structure	<ul style="list-style-type: none"> <li>Controls rate at which the stormwater flows out of the system for different size storms. Stormwater basins usually also have an emergency spillway to release water safely from very large storms that exceed the capacity of the system.</li> </ul>
Outlet Pipe	<ul style="list-style-type: none"> <li>Conveys water from an outlet structure back to the municipal storm sewer system.</li> </ul>
Sediment Forebay	<ul style="list-style-type: none"> <li>A pool or basin located at the stormwater runoff inflow point and designed to trap and settle sediment or other pollutants.</li> </ul>

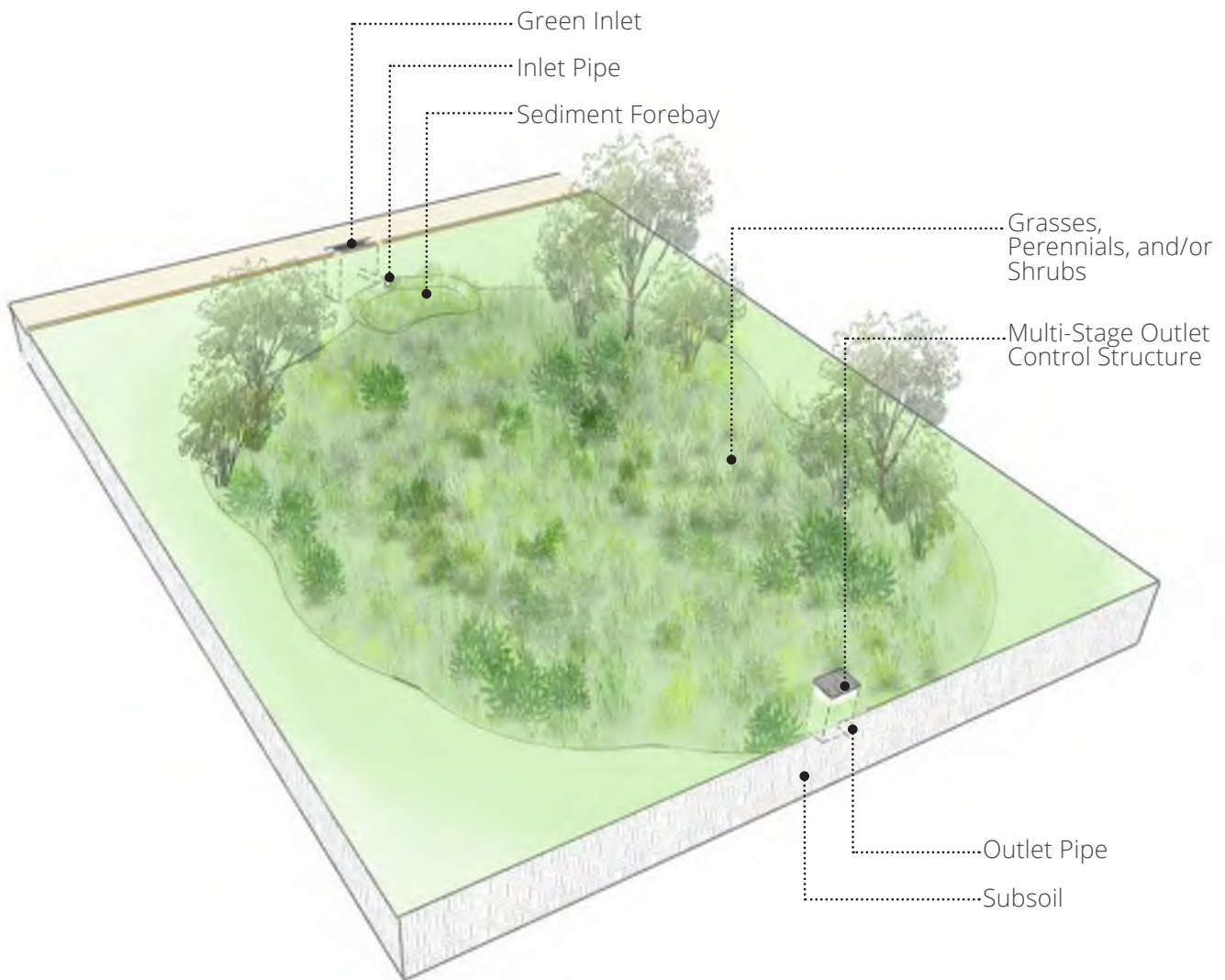

**FIGURE 2.18 – STORMWATER BASIN COMPONENTS**

*Components diagrammed above are typical for this SCM but may be configured differently for individual systems.*



# 3

## INSPECTION AND MAINTENANCE PROCEDURES

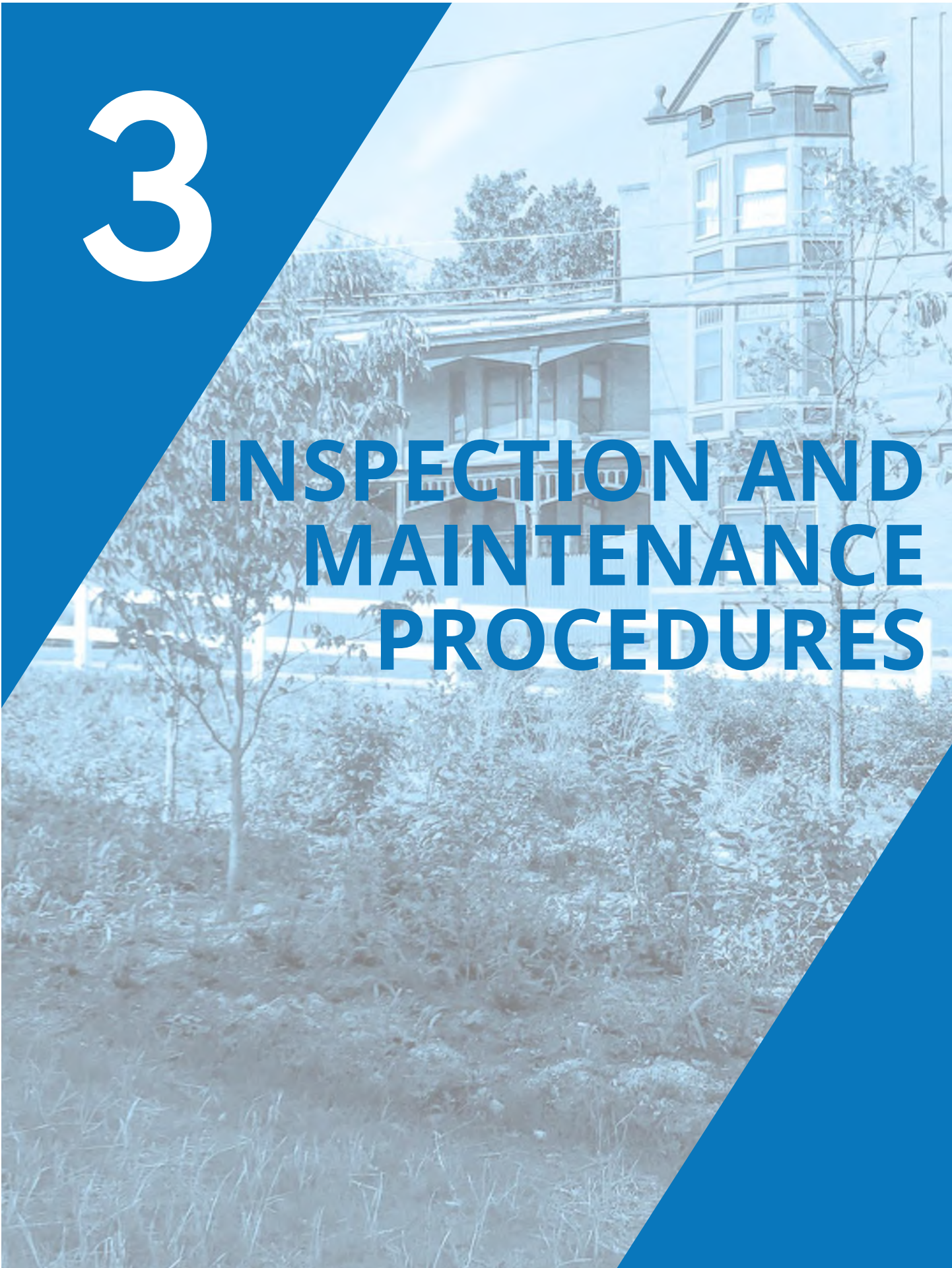

# INSPECTION AND MAINTENANCE OVERVIEW

CRW's maintenance team consists of in-house staff and contractors who fill a number of different GSI O&M Program roles that may grow and change over time. In general, roles can be categorized as follows:

- **Inspection:** includes the specially trained technical staff who are responsible for understanding and documenting the function of SCMs (including plants and structural components) and reporting back to Program Management.
- **Maintenance:** includes specially trained field staff responsible for conducting maintenance activities as directed by Program Management.

[Appendix A—GSI Maintenance Specifications](#) includes detailed requirements for inspection and maintenance personnel training and experience.

## INSPECTIONS

SCMs are periodically inspected prior to each maintenance visit, on different frequencies for surface, subsurface, and permeable pavement components. Inspections are meant to guide the work of maintenance crews and to help program managers understand how the SCMs are working. Inspections also help determine if the maintenance needed is something that can be performed independently by crews, or if additional corrective maintenance (which may require engineering, testing, or landscape re-design) is needed before the problem can be repaired. Refer to [Table 3.1](#) for guidance on determining maintenance needs.

### **SURFACE INSPECTIONS**

Surface inspections are performed year-round to ensure safety and function of SCMs. Surface inspections include all components that are visible at the surface of the SCM and are organized into the following categories:

- **Surface Visual Inspection:** Performed year-round by an inspector or maintenance crew foreman to check for safety hazards, evaluate condition of the SCMs, and determine maintenance needs.
- **Hydraulic Testing:** Performed as needed if an inspector or foreman observes clogging, poor drainage, or loss of storage volume.



Maintenance crew using a jet-vac to clean rain garden pipes.

During each type of inspection, the inspector or foreman completes an inspection work order (discussed further in [Section 4—Data Collection Procedures](#)). Inspection work order forms corresponding to each surface inspection type can be found in [Appendix B—Inspection Work Order Forms](#).

### **SUBSURFACE INSPECTIONS**

Subsurface inspections are typically performed annually or as needed to ensure that underground pipes and chambers remain clear and in good working order. Pipes and chambers are inspected using closed-circuit television (CCTV) cameras that are inserted into pipe cleanouts and access ports. Video collected by these underground cameras is reviewed by a trained technician to identify defects and clogs in the pipe and to determine if maintenance is needed. Inspections also occur postmaintenance (see subsurface maintenance).

## ROUTINE MAINTENANCE

Surface and subsurface maintenance are performed to ensure that SCMs remain effective at managing stormwater and continue to serve as a landscape amenity. All SCMs contain one or more types of surface, subsurface, or permeable pavement components.

### SURFACE MAINTENANCE

Surface maintenance consists of site cleanup, plant care, and minor repairs to structural components. It is typically performed by a crew of one to three laborers led by a single foreman with training in horticulture and GSI maintenance. Surface maintenance is done fairly frequently (typically, every 2–8 weeks) in order to keep sites looking tidy and free of trash and debris. In the first 1–2 years after installation, SCMs require more frequent surface maintenance (in particular, watering and weeding) to allow the young plants to grow and thrive. Refer to [Table 3.4](#) and [Table 3.6](#) for a preparedness checklist of required equipment and materials to perform surface inspection and maintenance. Refer to [Appendix A—GSI Maintenance Specifications](#) for detailed specifications for surface maintenance personnel, tasks and equipment.

### SUBSURFACE MAINTENANCE

Subsurface maintenance consists of pipe and inlet cleaning using hydraulic jets and a high-powered vacuum truck. Subsurface maintenance helps keep fine sediment and debris from passing through distribution pipes into underground storage areas (such as stone beds) that cannot be cleaned.



Maintenance crew foreman performing surface maintenance within a rain garden.



Inspector using a CCTV camera to observe pipes.

SCMs fed by sumped inlets (that is, inlets with a bottom deeper than the distribution pipe) tend to accumulate sediment in the sump and can be vacuumed easily using a high-powered vacuum truck. For this type of system, the distribution pipe and in some cases the underdrain should also be cleaned using a hydraulic jetter nozzle with rear-facing jets that projects high-pressure water into the line and forces debris backward into the inlet sump. Other types of chamber systems may require a different protocol.

Postmaintenance inspections are typically performed by the maintenance crew immediately following maintenance. Subsurface maintenance typically requires the use of a combination jet-vac truck operated by two or more trained technicians with Confined Space Entry certifications. During each postmaintenance inspection, structural defects are documented by a trained inspector according to standards outlined by the National Association of Sewer Service Companies (NASSCO). Inspection work order forms can be found in [Appendix B—Inspection Work Order Forms](#).

Refer to [Table 3.5](#) and [Table 3.7](#) for a preparedness checklist of required equipment and materials to perform subsurface inspection and maintenance. Refer to [Appendix A—GSI Maintenance Specifications](#) for detailed specifications for subsurface maintenance personnel, tasks and equipment.



Image credit: AKRF, Inc.

Crew performing hydraulic testing on a permeable pavement surface.

### PERMEABLE PAVEMENT MAINTENANCE

Permeable pavement maintenance consists of the sweeping and vacuuming necessary to keep permeable surfaces free of the fine sediment and debris that can cause clogging. Once clogged, permeable pavements can be very difficult to restore, therefore, frequent preventative maintenance is recommended for even the smallest accumulation of sediment and debris. Most types of permeable pavement (such as porous asphalt and concrete, and concrete interlocking pavers) can be cleaned by passing a vacuum over the entirety of the surface. As access permits, small to midsize sweeper trucks are preferred as they usually offer the best power and efficiency. For smaller, hard-to-access areas (such as sidewalks) a walk-behind vacuum unit may be needed. Permeable pavement maintenance can usually be completed by a crew of one to two people, including the vacuum operator. Refer to [Appendix A—GSI Maintenance Specifications](#) for detailed specifications for permeable

pavement maintenance tasks, equipment, and materials. Refer to [Table 3.4](#) and [Table 3.8](#) for a preparedness checklist of required equipment and materials to perform permeable pavement inspection and maintenance.

If snow needs to be removed from permeable pavements during the winter, additional care should be taken to prevent damage:

- Elevate plow blades 1–3 inches off the ground (unless using a rubber plowing edge).
- Avoid applying corrosive salts (such as sodium chloride) to concrete less than 2 years old.
- Never apply sand to permeable pavements.

### CORRECTIVE MAINTENANCE

Corrective maintenance is the term used for any maintenance that cannot or should not be addressed by maintenance crews alone and that requires the involvement of an expert. Problems that require corrective maintenance may be related to the engineering or landscape design of the system, or they may involve underground structures or other CRW infrastructure. Typically, after the problem has been identified by the inspector, or landscape foreman, some amount of further assessment will be conducted by an expert to determine the root cause. The root cause may be related to problems with design or construction, or it may be related to unforeseen events nearby, such as extreme weather or damage to infrastructure. [Table 3.2](#) outlines example problems that require corrective maintenance, and identifies the expert support needed to determine the appropriate cause of action. This table is not exhaustive.



Maintenance personnel reconstructing the domed riser within a bumpout based on the redesign from the engineer.



**TABLE 3.1 – DETERMINING ROUTINE MAINTENANCE NEEDS**

TYPE	CONDITIONS OBSERVED	TASK*
Surface Maintenance	<ul style="list-style-type: none"> <li>Sediment is present.</li> </ul>	Sediment Removal
	<ul style="list-style-type: none"> <li>Organic debris covers or obstructs the growth of plants.</li> </ul>	Organic Debris Removal
	<ul style="list-style-type: none"> <li>Trash is present.</li> </ul>	Trash Removal
	<ul style="list-style-type: none"> <li>Area of erosion (less than 20 square feet).</li> </ul>	Minor Erosion Repair
	<ul style="list-style-type: none"> <li>Loose stones, bricks or cracks are present in concrete or masonry structures.</li> </ul>	Minor Concrete/Masonry Repair
	<ul style="list-style-type: none"> <li>Settling/sinkhole up to 1 foot is present.</li> </ul>	Minor Settling/Sinkhole Repair
	<ul style="list-style-type: none"> <li>State-listed invasive plants or noxious weeds or any of the species listed in <a href="#">Appendix E—Weed and Invasive Species Guide</a> are present.</li> </ul>	Weeding
	<ul style="list-style-type: none"> <li>Dead plant material is present due to fall senescence (Oct.–Nov.) or dead materials are present when plants break dormancy in the spring.</li> </ul>	Cutting Back Vegetation
	<ul style="list-style-type: none"> <li>Debris is present on, or blocking flow to, an inlet or structure grate.</li> </ul>	Inlet and Structure Grate Cleaning
	<ul style="list-style-type: none"> <li>Plants appear wilted due to heat or drought stress.</li> </ul>	Watering
	<ul style="list-style-type: none"> <li>Large areas of bare soil are present that may have weed seeds produced by mature plants in the current growing season and/or seeds that overwintered from the previous growing season.</li> </ul>	Pre-emergent Herbicide Application
	<ul style="list-style-type: none"> <li>Total plant cover is less than 85% during the growing season after the establishment period is over.</li> </ul>	Planting Herbaceous Plants or Shrubs
	<ul style="list-style-type: none"> <li>Bare soil is present during the first 1–2 years of establishment in rain gardens, basins, and wetlands.</li> </ul>	Mulch Application
Subsurface Maintenance	<ul style="list-style-type: none"> <li>Media appears clogged or degraded with sediment, oil, or other pollutants.</li> </ul>	Stormwater Soil Replacement
	<ul style="list-style-type: none"> <li>More than 10% of pipe cross-sectional area is occluded by debris; storage loss is observed in subsurface chambers (refer to maintenance specifications/thresholds for any proprietary systems).</li> </ul>	Pipe Jetting and Inlet Cleaning
Permeable Pavement Maintenance	<ul style="list-style-type: none"> <li>Fine sediment, organic material, or other debris is present on porous surfaces.</li> </ul>	Regenerative Air Sweeping

\*Refer to Tables 3.10–3.18 for descriptions of maintenance tasks.

**TABLE 3.2 – DETERMINING CORRECTIVE MAINTENANCE NEEDS**

CONDITIONS OBSERVED	CORRECTIVE MAINTENANCE TASK	SUPPORTING EXPERT
<ul style="list-style-type: none"> <li>Recurring plant loss or poor health</li> </ul>	Varies based on investigation of root cause	Horticulturist or Professional Landscape Architect
<ul style="list-style-type: none"> <li>Ponding water for more than 72 hours</li> </ul>	Infiltration bed investigation & remediation	Professional Engineer
<ul style="list-style-type: none"> <li>Sinkhole(s) greater than 1 foot deep</li> </ul>	Sinkhole investigation & repair	Professional Engineer or Professional Geologist
<ul style="list-style-type: none"> <li>Erosion greater than 20 square foot in area</li> </ul>	Drainage area evaluation; additional stabilization of energy dissipator; wet weather inspection	Professional Engineer
<ul style="list-style-type: none"> <li>Structural failure of walls, footways, or other surfaces</li> </ul>	Concrete or Masonry Redesign or Repair	Professional Engineer or Professional Landscape Architect
<ul style="list-style-type: none"> <li>Pipe defect or collapse</li> </ul>	Pipe Repair	Professional Engineer
<ul style="list-style-type: none"> <li>Tree limbs that are damaged or unhealthy, contribute to poor overall form, or interfere with utilities and nearby structures</li> </ul>	Corrective Structural Pruning	Certified Arborist
<ul style="list-style-type: none"> <li>Infiltration bed failure and/or storage loss</li> </ul>	Storage Media Replacement	Professional Engineer and Professional Landscape Architect

# ROUTINE MAINTENANCE EVENT PROCEDURES

Preparation and documentation are key to ensuring the success of each inspection or maintenance visit. Before work begins, inspectors and crews must identify the personnel, equipment, and materials needed to complete the task. During and after work, they must follow the data collection and transmittal procedures outlined in [Section 4—Data Collection Procedures](#). Maintenance activities and equipment operation are to be performed in accordance with all applicable laws and regulations including, but not limited to, those of:

- United States of America;
- Commonwealth of Pennsylvania;
- City of Harrisburg;
- Occupational Safety and Health Administration (OSHA); and
- CRW's Health and Safety Plan (HASP).

In the event of a conflict between different health and safety regulations, maintenance personnel shall follow the most stringent/protective requirements. Personnel shall utilize personal protective equipment such as head, eye, and ear protection, as well as protective gloves, footwear, high-visibility clothing, and all other applicable protective equipment consistent with all OSHA

**TABLE 3.3 – ROUTINE MAINTENANCE EVENT PROCEDURES**

MAINTENANCE EVENT	PROCEDURES
Premaintenance Event	<ul style="list-style-type: none"> <li>▪ Acknowledge receipt of Maintenance Work Order as assigned by CRW within 24–48 hours. Receipt of Work Order shall acknowledge the scope of work detailed and provide a scheduled date of completion that is within the assigned work schedule period.</li> </ul>
	<ul style="list-style-type: none"> <li>▪ Review all site access restrictions, site characteristics, and maintenance maps to determine the most appropriate maintenance personnel, materials, and equipment.</li> </ul>
	<ul style="list-style-type: none"> <li>▪ Prepare digital or print copies of all applicable documents (work orders, reporting documents, etc.).</li> </ul>
	<ul style="list-style-type: none"> <li>▪ If there is a conflict between actual site conditions and the methods specified within this manual, coordinate with CRW to change methods or to facilitate more effective completion of the work. All modifications must be approved by CRW prior to the start of the work.</li> </ul>
	<ul style="list-style-type: none"> <li>▪ Contact CRW if the site is inaccessible.</li> </ul>
	<ul style="list-style-type: none"> <li>▪ Prepare the site for maintenance with all necessary warning devices, barricades, and personnel required to ensure the safety, protection, and warning of persons and vehicular traffic within the area.</li> </ul>
	<ul style="list-style-type: none"> <li>▪ Do not conduct work in saturated soil conditions unless specifically directed by CRW.</li> </ul>
During Maintenance Event	<ul style="list-style-type: none"> <li>▪ Perform all tasks per the requirements of this manual or as directed by CRW.</li> </ul>
	<ul style="list-style-type: none"> <li>▪ Minimize disturbance of soils and vegetation during execution of work:               <ol style="list-style-type: none"> <li>1. Select equipment that causes minimal disturbance.</li> <li>2. Practice careful foot placement when working in planted areas. Do not step on plants.</li> <li>3. Avoid compaction to rain garden areas by equipment and personnel.</li> </ol> </li> </ul>
	<ul style="list-style-type: none"> <li>▪ Minimize disruption to vehicular and pedestrian traffic.</li> </ul>
	<ul style="list-style-type: none"> <li>▪ Limit use and minimize leaking of water during freezing conditions.</li> </ul>
Postmaintenance Event	<ul style="list-style-type: none"> <li>▪ Complete all maintenance event documentation per Reporting Requirements of <a href="#">Section 4—Data Collection Procedures</a> of this manual including work order forms and photo points.</li> </ul>
	<ul style="list-style-type: none"> <li>▪ Remove any soil or organic debris from hardscape areas.</li> </ul>
	<ul style="list-style-type: none"> <li>▪ Clean the wheels of vehicles before leaving the site to avoid tracking soil onto roads or other hardscape areas.</li> </ul>
	<ul style="list-style-type: none"> <li>▪ Remove and dispose of all waste materials in accordance with <a href="#">Appendix A—GSI Maintenance Specifications</a>.</li> </ul>
	<ul style="list-style-type: none"> <li>▪ Electronically submit all required reporting documentation to CRW within 24 hours of completion.</li> <li>▪ All sites will be inspected by CRW.</li> </ul>

standards. Personnel are responsible for maintaining safe and healthy working conditions as part of their daily activities. Prior to maintenance events, maintenance personnel must assess sites for safety issues. If safety issues are identified, maintenance personnel must report them to CRW immediately. Personnel are responsible for temporarily securing the safety hazard using cones and safety tape.

**TABLE 3.4 – SURFACE AND PERMEABLE PAVEMENT INSPECTION PREPAREDNESS CHECKLIST**

<input type="checkbox"/>	Personal protective equipment
<input type="checkbox"/>	Inspection work order (paper or digital)
<input type="checkbox"/>	Maintenance map
<input type="checkbox"/>	Stormwater design and planting plans
<input type="checkbox"/>	Pencil, paper, and clipboard or tablet computer
<input type="checkbox"/>	Photography equipment that can show date
<input type="checkbox"/>	Manhole hook(s)
<input type="checkbox"/>	Measuring tape
<input type="checkbox"/>	Measuring wheels
<input type="checkbox"/>	Tree calipers
<input type="checkbox"/>	Traffic cones
<input type="checkbox"/>	Vehicle

**TABLE 3.5 – SUBSURFACE INSPECTION PREPAREDNESS CHECKLIST**

<input type="checkbox"/>	Personal protective equipment
<input type="checkbox"/>	Inspection work order (paper or digital)
<input type="checkbox"/>	Maintenance map
<input type="checkbox"/>	Stormwater design and planting plans
<input type="checkbox"/>	Rugged laptop computer equipped with video coding software
<input type="checkbox"/>	Pencil, paper, and clipboard
<input type="checkbox"/>	Photography equipment that can show date
<input type="checkbox"/>	Manhole hook(s)
<input type="checkbox"/>	Self-leveling CCTV push camera with 200-foot reel
<input type="checkbox"/>	CCTV push camera housing units (skids)
<input type="checkbox"/>	CCTV crawler camera (for pipes >12 inch diameter)
<input type="checkbox"/>	Measuring tape
<input type="checkbox"/>	Measuring wheel
<input type="checkbox"/>	Safety tape
<input type="checkbox"/>	Traffic cones
<input type="checkbox"/>	Flashlight
<input type="checkbox"/>	Vehicle



Image credit: AKRF, Inc.

Planning ahead and packing the truck with all the equipment and materials needed for the day's work can improve efficiency once crews arrive on site.

**TABLE 3.6 – SURFACE MAINTENANCE PREPAREDNESS CHECKLIST\***

EQUIPMENT	MATERIALS
<input type="checkbox"/> Personal protective equipment	<input type="checkbox"/> Contractor bags
<input type="checkbox"/> Maintenance map	<input type="checkbox"/> Erosion blanket (NAG C125BM or approved equal)
<input type="checkbox"/> Work order form	<input type="checkbox"/> Landscape fabric staples, 8 inches (box)
<input type="checkbox"/> Photography equipment that can show date	<input type="checkbox"/> Topsoil
<input type="checkbox"/> Pickup truck	<input type="checkbox"/> Grass seed
<input type="checkbox"/> Small rake, shovel and/or trowel	<input type="checkbox"/> Concrete and/or mortar mix
<input type="checkbox"/> Tarp	<input type="checkbox"/> Clean fill material
<input type="checkbox"/> Push broom	<input type="checkbox"/> Mulch
<input type="checkbox"/> Trash grabber, shovel, and/or broom and dust pan	<input type="checkbox"/> Nylon webbing or twine
<input type="checkbox"/> Leaf blower	<input type="checkbox"/> Herbicide
<input type="checkbox"/> Hoe	<input type="checkbox"/> Plant materials as requested in work order
<input type="checkbox"/> Seed spreader	<input type="checkbox"/> Stormwater soil
<input type="checkbox"/> Masonry chisel set and stone hammer	
<input type="checkbox"/> Concrete mixing tray	
<input type="checkbox"/> Masonry tools for mixing and finishing concrete and mortar	
<input type="checkbox"/> Masonry trowel	
<input type="checkbox"/> Hand shovel or hand spade	
<input type="checkbox"/> Hand tamper	
<input type="checkbox"/> Digging bar	
<input type="checkbox"/> Wheel barrow	
<input type="checkbox"/> Weeding fork	
<input type="checkbox"/> Garden shears	
<input type="checkbox"/> Soil knife	
<input type="checkbox"/> Oscillating “scuffle” hoe (Action hoe)	
<input type="checkbox"/> Grass clippers	
<input type="checkbox"/> Scissors	
<input type="checkbox"/> String trimmer	
<input type="checkbox"/> Hand saw	
<input type="checkbox"/> Loppers	
<input type="checkbox"/> Pruners	
<input type="checkbox"/> Herbicide spreader or sprayer	
<input type="checkbox"/> Disposal containers	
<input type="checkbox"/> Pitch fork	
<input type="checkbox"/> Rakes	
<input type="checkbox"/> Dust pan	
<input type="checkbox"/> 5-gallon buckets	
<input type="checkbox"/> Manhole hooks	

\*Not all equipment and materials listed here are needed for all seasons/ tasks. Refer to [Appendix A—GSI Maintenance Specifications](#) materials and equipment list specific for each task.

**TABLE 3.7 – SUBSURFACE MAINTENANCE PREPAREDNESS CHECKLIST**

EQUIPMENT	
<input type="checkbox"/>	Personal protective equipment
<input type="checkbox"/>	Maintenance map
<input type="checkbox"/>	Work order form
<input type="checkbox"/>	Photography equipment that can show date
<input type="checkbox"/>	Traffic cones
<input type="checkbox"/>	Safety and duct tape
<input type="checkbox"/>	Assorted screwdrivers, socket wrenches, and Allen wrenches
<input type="checkbox"/>	Chisel and mallet
<input type="checkbox"/>	Push broom
<input type="checkbox"/>	Hydrant key/wrench
<input type="checkbox"/>	Pliers, adjustable wrenches, vice grips
<input type="checkbox"/>	Confined space entry harness, tripod, and air monitor as per OSHA standard 29 CR 1910.146
<input type="checkbox"/>	Jet cleaning/vacuuming (jet/vac) truck with: <ul style="list-style-type: none"> <li>▪ Hose reel with up to 600 feet of 1 inch jetter hose capacity,</li> <li>▪ Water pump with flow of 80 gallons per minute (gpm) @ 2000 pounds per square inch (psi),</li> <li>▪ Vacuum flow of 2600 cubic feet per minute (cfm),</li> <li>▪ Vacuum lift of 22 inches of mercury (HG),</li> <li>▪ 8 cubic yards debris tank with strainer and decanting valve, and</li> <li>▪ 1,500 gallon integrated water tank</li> <li>▪ 200 feet of vacuum tubes ranging from 4–8 inches</li> <li>▪ 300 feet of 3/8 inch jetter hose</li> <li>▪ 300 feet of 5/8 inch jetter hose</li> <li>▪ 600 feet of 1 inch jetter hose</li> </ul>
<input type="checkbox"/>	Flushing, rotating, and penetrating nozzles
<input type="checkbox"/>	High-velocity water gun or air lance and associated hose
<input type="checkbox"/>	All purpose rags
<input type="checkbox"/>	Self-leveling CCTV push camera with 200 feet reel
<input type="checkbox"/>	CCTV push camera housing units (skids)
<input type="checkbox"/>	CCTV crawler camera (for pipes >12 inch diameter)
<input type="checkbox"/>	Rugged laptop computer equipped with video coding software
<input type="checkbox"/>	Measuring tape
<input type="checkbox"/>	Measuring wheel
<input type="checkbox"/>	Flashlight
<input type="checkbox"/>	Manhole hooks
<input type="checkbox"/>	5-gallon buckets
MATERIALS	
<input type="checkbox"/>	Contractor bags
<input type="checkbox"/>	Silt sock

**TABLE 3.8 – PERMEABLE PAVEMENT PREPAREDNESS CHECKLIST**

EQUIPMENT	
<input type="checkbox"/>	Personal protective equipment
<input type="checkbox"/>	Maintenance map
<input type="checkbox"/>	Work order form
<input type="checkbox"/>	Regenerative air sweeper with a minimum sweeping width of 78 inches, storage hopper capacity of 2 cubic yards, dust separator, system pressure of 3500 psi, and hydraulic system capacity of 5 gpm.
<input type="checkbox"/>	High-pressure walk-behind or drive-behind sweeper with debris tank with vacuum width of 36–48 inches
<input type="checkbox"/>	Shovel, spades and/or push broom to remove trash/ sediment/ debris
<input type="checkbox"/>	Water hose and spray nozzle
<input type="checkbox"/>	Manhole hooks
MATERIALS	
<input type="checkbox"/>	Contractor bags

**TABLE 3.9 – WATERING PREPAREDNESS CHECKLIST**

EQUIPMENT	
<input type="checkbox"/>	Personal protective equipment
<input type="checkbox"/>	Maintenance map
<input type="checkbox"/>	Work order form
<input type="checkbox"/>	Pickup truck of sufficient capacity to support tank
<input type="checkbox"/>	Water tank (250 gallon minimum)
<input type="checkbox"/>	Water hose with spray nozzle
<input type="checkbox"/>	Fire hydrant key/wrench
<input type="checkbox"/>	Backflow preventer and appurtenances
<input type="checkbox"/>	Traffic cones
<input type="checkbox"/>	Water meter
<input type="checkbox"/>	Tree watering bag
MATERIALS	
<input type="checkbox"/>	Water

## MAINTENANCE TASKS BY SCM TYPE

The pages that follow present maintenance task lists, diagrams, and guidance for identifying common problems, organized by SCM type. Additional detailed, step-by-step guidance for execution of each task can be found in [Appendix A—GSI Maintenance Specifications](#).

The SCM types are as follows:

- Stormwater Planter
- Stormwater Bumpout
- Stormwater Tree
- Stormwater Tree Trench
- Permeable Pavement
- Storage/ Infiltration Trench
- Rain Garden
- Stormwater Wetland
- Stormwater Basin

# STORMWATER PLANTER MAINTENANCE

## ROUTINE MAINTENANCE

Stormwater planters are maintained routinely to keep them neat, clean, safe, and functional, as outlined below. For problems beyond the scope of routine maintenance, additional analysis and planning may be needed to complete corrective maintenance repairs (refer to pages 36–37).

Routine maintenance typically consists of general cleanup and plant care, with minor repairs and replacements performed as needed. Refer to [Table 3.10](#) for a list of maintenance tasks with references to the appropriate detailed specifications ([Appendix A—GSI Maintenance Specifications](#)). Note that not all tasks will be needed every visit, and certain seasonal tasks (such as watering and replanting) should be done only at the specific request of CRW.

Common routine maintenance activities may include:

- Trash and sediment removal (year round);
- Weeding (during the growing season);
- Watering and mulching (during plant establishment);
- Planting, cutting back, and pruning plants (as seasonally appropriate); and
- Minor repairs and replacements as needed.



Image credit: Flickr // NYC DEP

A clean and clear curb cut allows stormwater runoff to easily flow into the stormwater planter.

### MAINTENANCE ZONE KEY

	Hardscape
	Inflow
	Vegetated Area
	Outflow

Refer to [SCM Overview](#) for component locations and descriptions.

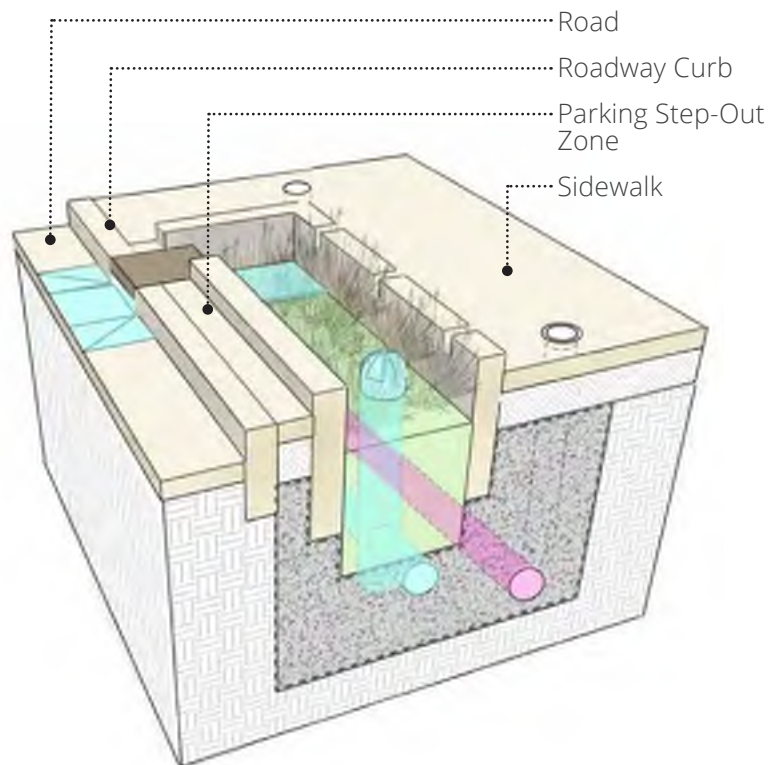

**FIGURE 3.1 – STORMWATER PLANTER MAINTENANCE ZONES**

**TABLE 3.10 – STORMWATER PLANTER ROUTINE MAINTENANCE TASKS**

SPECIFICATION REFERENCE	TASK	DESCRIPTION	ZONE
<b>Tasks to be Performed Every Routine Surface Maintenance Event or as Needed*</b>			
1.3.A	Sediment Removal	Removal of sediment from surface-accessible components.	
1.3.B	Organic Debris Removal	Removal of fallen leaves and branches or spent plant material from surface-accessible components.	
1.3.C	Trash Removal	Removal of trash from surface-accessible components.	
1.3.D	Minor Erosion Repair	Stabilization of nonrecurring eroded areas, rills or gullies less than 20 square feet in size caused by concentrated or channelized flow.	
1.3.E	Minor Concrete/ Masonry Repair	Repairs to small affected areas (such as resetting stones, filling cracks, etc.) that can be completed without the use of heavy equipment or concrete mixing.	
1.3.F	Minor Settling/ Sinkhole Repair	Filling and compacting of voids is done to minimize risk of structural failure and hazards to individuals.	
1.3.G	Weeding	Removal of all weeds.	
1.3.H	Cutting Back Vegetation	Pruning of unwanted, dead, or damaged plant parts to ensure a healthy and species-appropriate growth habit and shape.	
1.3.I	Inlet and Structure Grate Cleaning	Cleaning grate surfaces to ensure proper flow of water into and out of the system.	
1.3.P	Waste Disposal	Disposal of nonhazardous waste materials generated or collected during the performance of surface maintenance activities. The task includes proper containment, transport and disposal of waste material.	
<b>Task to be Performed as Requested by CRW During Routine Surface Maintenance Events</b>			
1.3.J	Watering**	Application of water (via hose or water bag) to establish and maintain healthy plant growth.	
1.3.K	Pre-emergent Herbicide Application	Application of pre-emergent herbicide by a licensed commercial pesticide applicator to prevent the growth of undesirable plants.	
1.3.L	Planting Herbaceous Vegetation	Installation of broadleaf, grassy, and ground cover perennial plant material, generally consistent with the planting plan, to replace failed plantings.	
1.3.M	Planting Shrubs	Installation of shrubs, generally consistent with the planting plan, to replace failed plantings.	
1.3.N	Mulch Application	Placement and spreading of mulch in planting beds.	
1.3.O	Stormwater Soil Replacement	Removal of existing stormwater soil, and replacement with new clean media.	
<b>Subsurface</b>	2.3.A	Inlet, Pipe and Chamber Cleaning	High-pressure hydraulic and vactor cleaning of structures and distribution and/or underdrain pipes.
	2.3.B	Postmaintenance Pipe Inspection	Inspection of distribution and/or underdrain pipes via CCTV video, and documentation of observed defects.
	2.3.C	Waste Disposal	Disposal of nonhazardous waste materials generated or collected during the performance of subsurface maintenance activities. The task includes proper containment, transport and disposal of waste material.

**CREW IS RESPONSIBLE FOR REPORTING ANY NONROUTINE MAINTENANCE SITE ISSUES TO CRW.**

\* Determined by the maintenance foreman on site.  
 \*\* Performed only when a Watering Work Order is assigned.

## CORRECTIVE MAINTENANCE

Corrective maintenance may be needed to address problems related to drainage; plant health or establishment; soil erosion or settling; or condition of masonry, concrete, or other structures. Examples of some of these problem conditions are shown on the following page. These examples are not exhaustive. If these conditions are observed during routine maintenance, they must be photographed and documented in the work order.

### CALL AN EXPERT

If the problems pose a direct safety hazard to the public or the maintenance crew, stop work, secure the site, and report the problem immediately (refer to [Appendix D—Contact List](#)).



The stormwater planter exemplifies a healthy, well-structured and functioning system.

Image credit: AKRF, Inc.



**RECURRING PLANT ESTABLISHMENT PROBLEMS**



Image credit: AKRF, Inc.

Poor plant establishment can be a problem if the plant species is not suitable for the location, or if there is repeated external stress (such as from large amounts of sediment).

**FENCE DAMAGE**



Image credit: AKRF, Inc.

Damage to fencing or structural components may be caused by a variety of factors and can create hazards for pedestrians and vehicles.

**PROLONGED STANDING WATER**



Image credit: AKRF, Inc.

Water should drain from properly-functioning SCMs within 3 days after a rainfall; if it does not, there may be a serious problem.

**MAJOR EROSION OR SETTLING**



Image credit: AKRF, Inc.

Eroded areas larger than 20 square feet in size, or settling more than 1 foot deep could be an indicator of potentially hazardous problems. Report major erosion or settling immediately.

# STORMWATER BUMPOUT MAINTENANCE

## ROUTINE MAINTENANCE

Stormwater bumpouts are maintained routinely to keep them neat, clean, safe, and functional, as outlined below. For problems beyond the scope of routine maintenance, additional analysis and planning may be needed to complete corrective maintenance repairs ([refer to pages 40–41](#)).

Routine maintenance typically consists of general cleanup and plant care, with minor repairs and replacements performed as needed. Refer to [Table 3.11](#) for a list of maintenance tasks with references to the appropriate detailed specifications ([Appendix A—GSI Maintenance Specifications](#)). Note that not all tasks will be needed every visit, and certain seasonal tasks (such as watering and replanting) should be done only at the specific request of CRW.

Common routine maintenance activities may include:

- Trash and sediment removal (year round);
- Weeding (during the growing season);
- Watering (during plant establishment);
- Planting, cutting back, and pruning plants (as seasonally appropriate); and
- Minor repairs and replacements as needed.



Image credit: NJ DEP

A stormwater bumpout with a clean and clear inflow point and thriving vegetation.

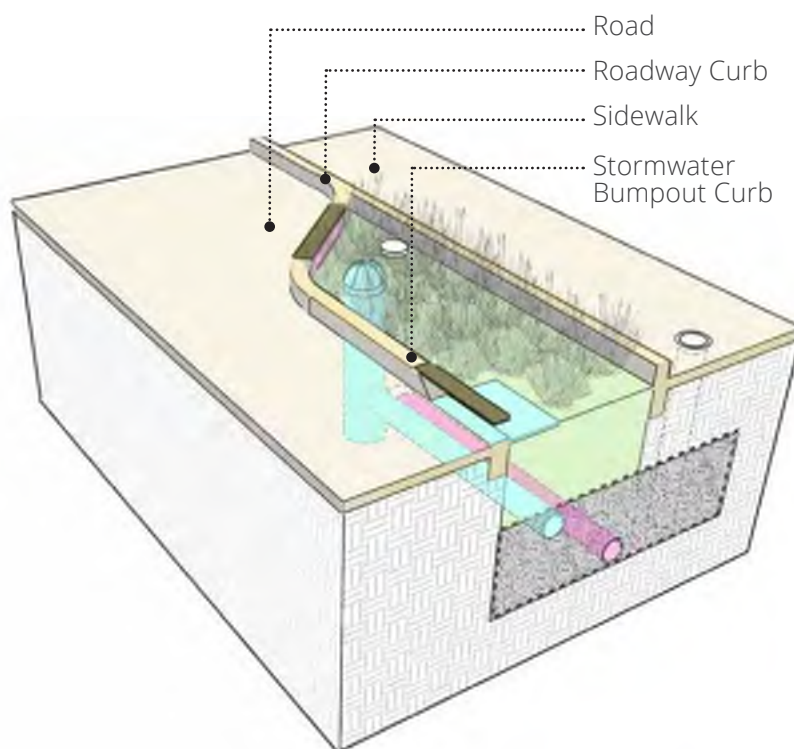

### MAINTENANCE ZONE KEY

	Hardscape
	Inflow
	Vegetated Area
	Outflow

Refer to *SCM Overview* for component locations and descriptions.

**FIGURE 3.2 – STORMWATER BUMPOUT MAINTENANCE ZONES**

**TABLE 3.11 – STORMWATER BUMPOUT ROUTINE MAINTENANCE TASKS**

SPECIFICATION REFERENCE	TASK	DESCRIPTION	ZONE	
<b>Tasks to be Performed Every Routine Surface Maintenance Event or as Needed*</b>				
Surface	1.3.A	Sediment Removal	Removal of sediment from surface-accessible components.	1, 2, 3, 4
	1.3.B	Organic Debris Removal	Removal of fallen leaves and branches or spent plant material from surface-accessible components.	1, 2, 3, 4
	1.3.C	Trash Removal	Removal of trash from surface-accessible components.	1, 2, 3, 4
	1.3.D	Minor Erosion Repair	Stabilization of nonrecurring eroded areas, rills or gullies less than 20 square feet in size caused by concentrated or channelized flow.	1, 2, 3, 4
	1.3.E	Minor Concrete/Masonry Repair	Repairs to small affected areas (such as resetting stones, filling cracks, etc.) that can be completed without the use of heavy equipment or concrete mixing.	1, 2, 3, 4
	1.3.F	Minor Settling/Sinkhole Repair	Filling and compacting of voids is done to minimize risk of structural failure and hazards to individuals.	1, 2, 3, 4
	1.3.G	Weeding	Removal of all weeds.	1, 2, 3, 4
	1.3.H	Cutting Back Vegetation	Pruning of unwanted, dead, or damaged plant parts to ensure a healthy and species-appropriate growth habit and shape.	1, 2, 3, 4
	1.3.I	Inlet and Structure Grate Cleaning	Clearing grate surfaces to ensure proper flow of water into and out of the system.	1, 2, 3, 4
	1.3.P	Waste Disposal	Disposal of nonhazardous waste materials generated or collected during the performance of surface maintenance activities. The task includes proper containment, transport and disposal of waste material.	1, 2, 3, 4
<b>Task to be Performed as Requested by CRW During Routine Surface Maintenance Events</b>				
Surface	1.3.J	Watering**	Application of water (via hose or water bag) to establish and maintain healthy plant growth.	1, 2, 3, 4
	1.3.K	Pre-emergent Herbicide Application	Application of pre-emergent herbicide by a licensed commercial pesticide applicator to prevent the growth of undesired plants.	1, 2, 3, 4
	1.3.L	Planting Herbaceous Vegetation	Installation of broadleaf, grassy, and ground cover perennial plant material, generally consistent with the planting plan, to replace failed plantings.	1, 2, 3, 4
	1.3.M	Planting Shrubs	Installation of shrubs, generally consistent with the planting plan, to replace failed plantings.	1, 2, 3, 4
	1.3.O	Stormwater Soil Replacement	Removal of existing stormwater soil, and replacement with new clean media.	1, 2, 3, 4
Subsurface	2.3.A	Inlet, Pipe and Chamber Cleaning	High-pressure hydraulic and vector cleaning of structures and distribution and/or underdrain pipes.	1, 2, 3, 4
	2.3.B	Postmaintenance Pipe Inspection	Inspection of distribution and/or underdrain pipes via CCTV video, and documentation of observed defects.	1, 2, 3, 4
	2.3.C	Waste Disposal	Disposal of nonhazardous waste materials generated or collected during the performance of subsurface maintenance activities. The task includes proper containment, transport and disposal of waste material.	1, 2, 3, 4

**CREW IS RESPONSIBLE FOR REPORTING ANY NONROUTINE MAINTENANCE SITE ISSUES TO CRW.**

\* Determined by the maintenance foreman on site.

\*\* Watering should only be performed when a Watering Work Order is assigned.

## CORRECTIVE MAINTENANCE

Corrective maintenance may be needed to address problems related to drainage; plant health or establishment; soil erosion or settling; or condition of masonry, concrete, or structures. Examples of some of these problem conditions are shown on the following page. These examples are not exhaustive. If these conditions are observed during routine maintenance, they should be be photographed and documented in the work order.

### CALL AN EXPERT

If the problems pose an direct safety hazard to the public or the maintenance crew, stop work, secure the site, and report the problem immediately (refer to [Appendix D—Contact List](#)).



This stormwater bumpout exemplifies a well-maintained and highly functional feature.

Image credit: AKGF, Inc.

**EXCESSIVE SEDIMENTATION**



If sediment accumulation seems excessive in the period between maintenance events, or if there is an unusual amount of grease or oil, it could be a sign of problems with the drainage area size, or activities upstream.

**REOCCURRING PLANT ESTABLISHMENT PROBLEMS**



Poor plant establishment can be a problem if the plant species is not suitable for the location, or if there is repeated external stress (such as from large amounts of sediment).

**PROLONGED STANDING WATER**



Water should drain from properly-functioning SCMs within three days after a rainfall; if it does not, there may be a serious problem.

**CRACKED OR BROKEN CURB**



Concrete curbs can become damaged beyond routine wear and tear due to collisions with vehicles.

# STORMWATER TREE MAINTENANCE

## ROUTINE MAINTENANCE

Stormwater trees are maintained routinely to keep them neat, clean, safe, and functional, as outlined below. For problems beyond the scope of routine maintenance, additional analysis and planning may be needed to complete corrective maintenance repairs ([refer to pages 44–45](#)).

Routine Maintenance typically consists of general cleanup and tree care, with minor repairs and replacements performed as needed. Refer to [Table 3.12](#) for a list of maintenance tasks with references to the appropriate detailed specifications ([Appendix A—GSI Maintenance Specifications](#)). Note that not all tasks will be needed every visit, and certain seasonal tasks (such as watering and replanting) should be done only at the specific request of CRW.

Common routine maintenance activities may include:

- Trash and sediment removal (year round);
- Weeding (during the growing season);
- Watering (during plant establishment); and
- Minor repairs and replacements as needed.

Note: all structural pruning should be done by a Certified Arborist and is not considered part of routine maintenance.

### MAINTENANCE ZONE KEY

Hardscape
Vegetated Area
Inflow and Outflow Area

*Refer to SCM Overview for component locations and descriptions.*



Image credit: Rosecote Runoff Reduction Project

A well-maintained stormwater tree.

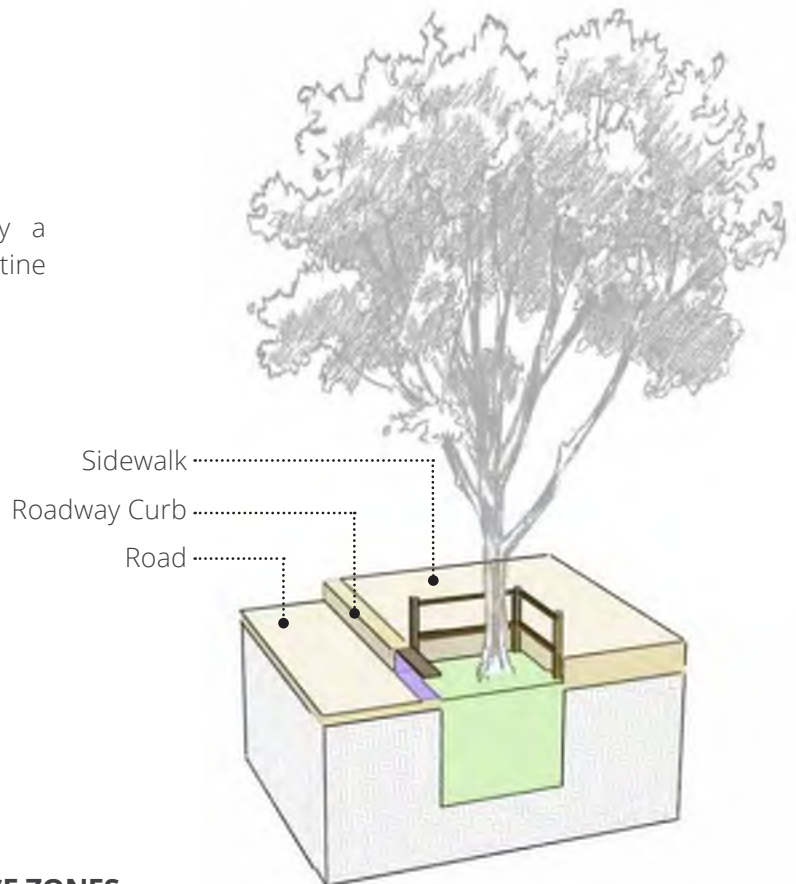

**FIGURE 3.3 – STORMWATER TREE MAINTENANCE ZONES**

**TABLE 3.12 – STORMWATER TREE ROUTINE MAINTENANCE TASKS**

SPECIFICATION REFERENCE	TASK	DESCRIPTION	ZONE	
<b>Tasks to be Performed Every Routine Surface Maintenance Event or as Needed*</b>				
<b>Surface</b>	1.3.A	Sediment Removal	Removal of sediment from surface-accessible components.	1 2 3
	1.3.B	Organic Debris Removal	Removal of fallen leaves and branches or spent plant material from surface-accessible components.	1 2 3
	1.3.C	Trash Removal	Removal of trash from surface-accessible components.	1 2 3
	1.3.D	Minor Erosion Repair	Stabilization of nonrecurring eroded areas, rills or gullies less than 20 square feet in size caused by concentrated or channelized flow.	2 3
	1.3.E	Minor Concrete/Masonry Repair	Repairs to small affected areas (such as resetting stones, filling cracks, etc.) that can be completed without the use of heavy equipment or concrete mixing.	1 3
	1.3.F	Minor Settling/Sinkhole Repair	Filling and compacting of voids is done to minimize risk of structural failure and hazards to individuals.	2 3
	1.3.G	Weeding	Removal of all weeds.	2 3
	1.3.H	Cutting Back Vegetation	Pruning of unwanted, dead, or damaged tree parts to ensure a healthy and species-appropriate growth habit and shape.	2 3
	1.3.P	Waste Disposal	Disposal of nonhazardous waste materials generated or collected during the performance of surface maintenance activities. The task includes proper containment, transport and disposal of waste material.	1 2 3
	<b>Task to be Performed as Requested by CRW During Routine Surface Maintenance Events</b>			
1.3.J	Watering**	Application of water (via hose or water bag) to establish and maintain healthy tree growth.	2 3	
1.3.K	Pre-emergent Herbicide Application	Application of pre-emergent herbicide by a licensed commercial pesticide applicator to prevent the growth of undesirable plants.	2 3	
1.3.O	Stormwater Soil Replacement	Removal of existing stormwater soil, and replacement with new clean media.	2 3	

**CREW IS RESPONSIBLE FOR REPORTING ANY NONROUTINE MAINTENANCE SITE ISSUES TO CRW.**

\* Determined by the maintenance foreman on site.

\*\* Watering should only be performed when a Watering Work Order is assigned.

## CORRECTIVE MAINTENANCE

Corrective maintenance may be needed to address problems related to drainage; tree health; pruning needs; soil erosion or settling; or condition of masonry, concrete, or structures. Examples of some of these problem conditions are shown on the following page. These examples are not exhaustive. If these conditions are observed during routine maintenance, they should be photographed and documented in the work order.

### CALL AN EXPERT

If the problems pose an direct safety hazard to the public or the maintenance crew, stop work, secure the site, and report the problem immediately (refer to [Appendix D—Contact List](#)).



This stormwater tree pit demonstrates a structurally and functionally sound stormwater feature.

Image credit: National Association of City Transportation Officials



**BROKEN BRANCHES**

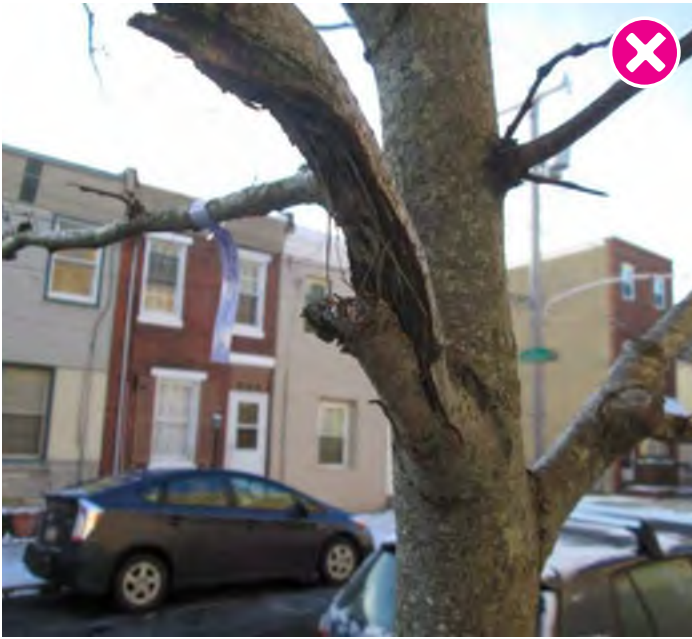

Image credit: AKRF, Inc.

Vandalism or vehicular collisions can damage the limbs or trunks of stormwater trees. A Certified Arborist should be notified immediately to examine the health of the tree.

**TREE HEIGHT**

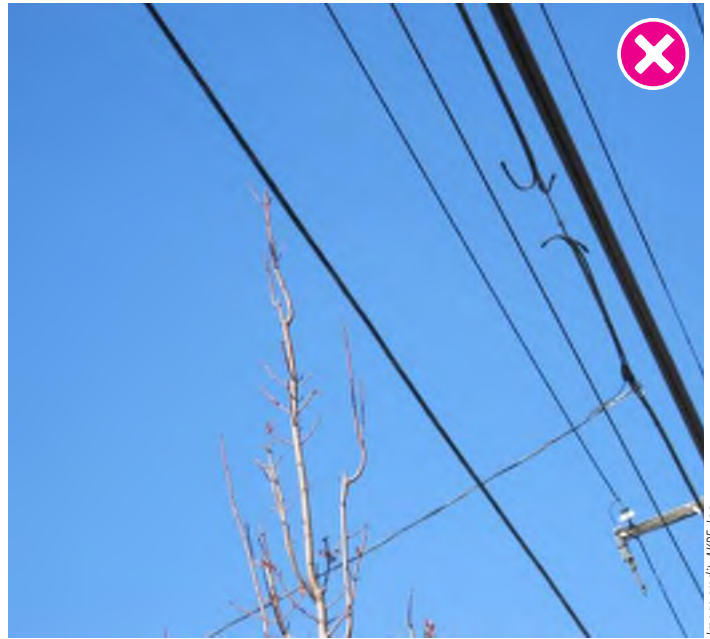

Image credit: AKRF, Inc.

Trees that are growing into overhead wires must be pruned by a Line Clearance Arborist.

**DEAD OR MISSING TREE**



Image credit: AKRF, Inc.

Dead stormwater trees can contribute to the public perception of a poorly maintained streetscape.

**ROOTS DISTURBING SIDEWALK**



Image credit: AKRF, Inc.

Trees that have been planted too deep or have sunk after construction may have a shortened life expectancy due to trunk damage or rot.

# STORMWATER TREE TRENCH MAINTENANCE

## ROUTINE MAINTENANCE

Stormwater tree trenches are maintained routinely to keep them neat, clean, safe, and functional, as outlined below. For problems beyond the scope of routine maintenance, additional analysis and planning may be needed to complete corrective maintenance repairs (refer to pages 48–49).

Routine maintenance typically consists of general cleanup and tree care, with minor repairs and replacements performed as needed. Refer to [Table 3.13](#) for a list of maintenance tasks with references to the appropriate detailed specifications ([Appendix A—GSI Maintenance Specifications](#)). Note that not all tasks will be needed every visit, and certain seasonal tasks (such as watering and replanting) should be done only at the specific request of CRW.

Common routine maintenance activities may include:

- Trash and sediment removal (year round);
- Weeding (during the growing season);
- Watering and mulching (during plant establishment); and
- Minor repairs and replacements as needed.

Note: all structural pruning should be done by a Certified Arborist and is not considered part of routine maintenance.

### MAINTENANCE ZONE KEY

	Hardscape
	Inflow
	Vegetated Area
	Outflow

Refer to *SCM Overview* for component locations and descriptions.



Image credit: GRIC Transit System

A stormwater tree trench in healthy and clean condition.

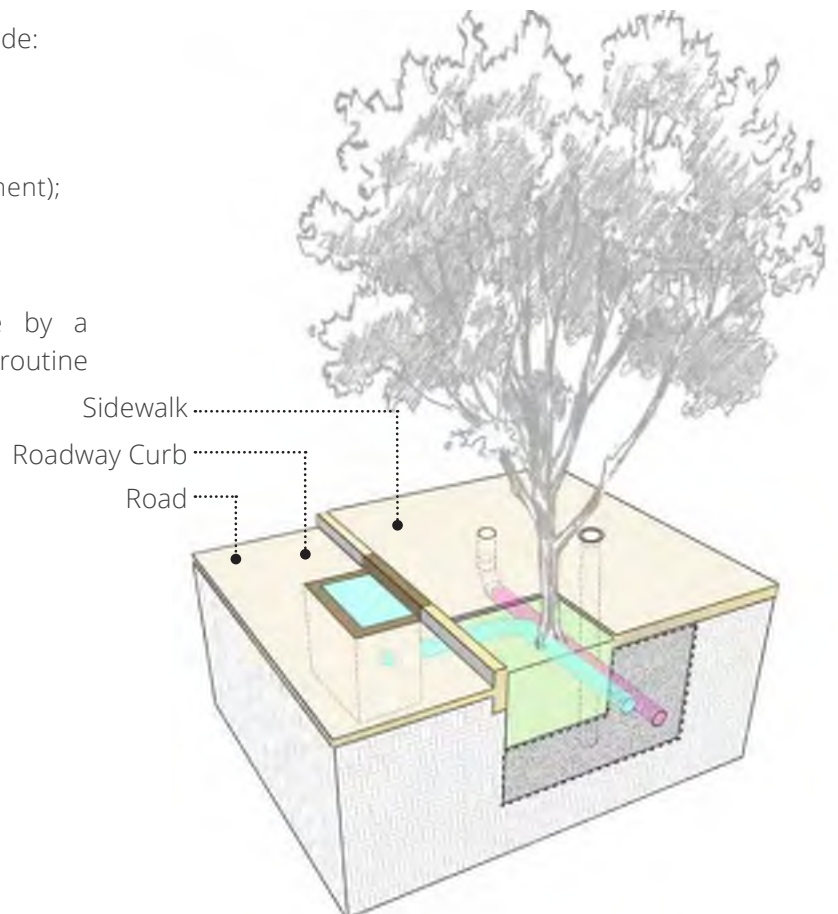

**FIGURE 3.4 – STORMWATER TREE TRENCH MAINTENANCE ZONES**

**TABLE 3.13 – STORMWATER TREE TRENCH ROUTINE MAINTENANCE TASKS**

SPECIFICATION REFERENCE	TASK	DESCRIPTION	ZONE	
<b>Tasks to be Performed Every Routine Surface Maintenance Event or as Needed*</b>				
Surface	1.3.A	Sediment Removal	Removal of sediment from surface-accessible components and inlet pretreatment devices.	1, 2, 3, 4
	1.3.B	Organic Debris Removal	Removal of fallen leaves and branches or spent plant material from surface-accessible components.	1, 2, 3, 4
	1.3.C	Trash Removal	Removal of trash from surface-accessible components.	1, 2, 3, 4
	1.3.D	Minor Erosion Repair	Stabilization of nonrecurring eroded areas, rills or gullies less than 20 square feet in size caused by concentrated or channelized flow.	1, 2, 3, 4
	1.3.E	Minor Concrete/ Masonry Repair	Repairs to small affected areas (such as resetting stones, filling cracks, etc.) that can be completed without the use of heavy equipment or concrete mixing.	1, 2, 3, 4
	1.3.F	Minor Settling/ Sinkhole Repair	Filling and compacting of voids is done to minimize risk of structural failure and hazards to individuals.	1, 2, 3, 4
	1.3.G	Weeding	Removal of all weeds.	1, 2, 3, 4
	1.3.H	Cutting Back Vegetation	Pruning of unwanted, dead, or damaged tree parts to ensure a healthy and species-appropriate growth habit and shape.	1, 2, 3, 4
	1.3.I	Inlet and Structure Grate Cleaning	Cleaning grate surfaces to ensure proper flow of water into and out of the system.	1, 2, 3, 4
	1.3.P	Waste Disposal	Disposal of nonhazardous waste materials generated or collected during the performance of surface maintenance activities. The task includes proper containment, transport and disposal of waste material.	1, 2, 3, 4
	<b>Task to be Performed as Requested by CRW During Routine Surface Maintenance Events</b>			
Surface	1.3.J	Watering**	Application of water (via hose or water bag) to establish and maintain healthy plant growth.	1, 2, 3, 4
	1.3.K	Pre-emergent Herbicide Application	Application of pre-emergent herbicide by a licensed commercial pesticide applicator to prevent the growth of undesired plants.	1, 2, 3, 4
	1.3.N	Mulch Application	Placement and spreading of mulch in tree pits.	1, 2, 3, 4
	1.3.O	Stormwater Soil Replacement	Removal of existing stormwater soil, and replacement with new clean media.	1, 2, 3, 4
	Subsurface	2.3.A	Inlet, Pipe and Chamber Cleaning	High-pressure hydraulic and vactor cleaning of structures and distribution and/or underdrain pipes.
2.3.B		Postmaintenance Pipe Inspection	Inspection of distribution and/or underdrain pipes via CCTV video, and documentation of observed defects.	1, 2, 3, 4
2.3.C		Waste Disposal	Disposal of nonhazardous waste materials generated or collected during the performance of subsurface maintenance activities. The task includes proper containment, transport and disposal of waste material.	1, 2, 3, 4

**CREW IS RESPONSIBLE FOR REPORTING ANY NONROUTINE MAINTENANCE SITE ISSUES TO CRW.**

\* Determined by the maintenance foreman on site.

\*\* Watering should only be performed when a Watering Work Order is assigned.

## CORRECTIVE MAINTENANCE

Corrective maintenance may be needed to address problems related to drainage; tree health; structural pruning; soil erosion or settling; or condition of masonry, concrete, or structures. Examples of some of these problem conditions are shown on the following page. These examples are not exhaustive. If these conditions are observed during routine maintenance, they should be photographed and documented in the work order.

### CALL AN EXPERT

If the problems pose an direct safety hazard to the public or the maintenance crew, stop work, secure the site, and report the problem immediately (refer to [Appendix D—Contact List](#)).



Healthy trees and sidewalks swept clean from trash and debris represent a well-maintained stormwater tree trench.

Image credit: ANRF, Inc.

**BROKEN BRANCHES**

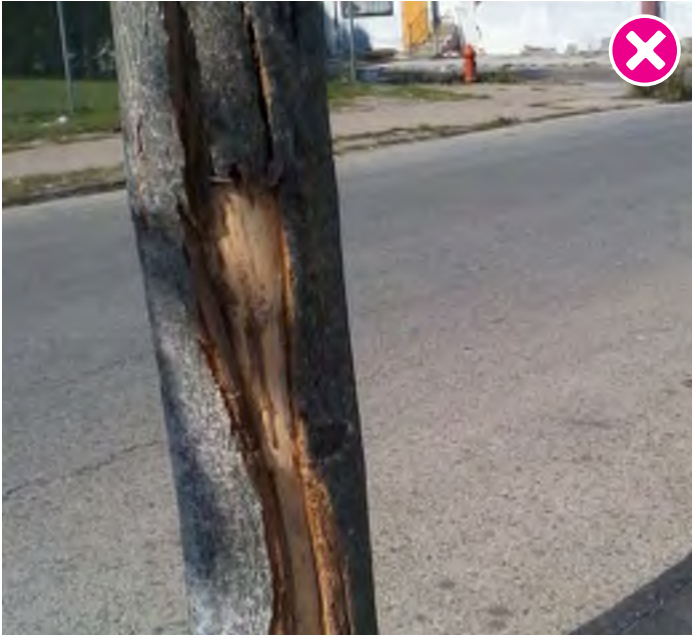

Intentional vandalism or vehicular collisions can damage the limbs or trunks of stormwater trees. Dead tree limbs, tears or stubs, particularly in young trees, where the damage affects a significant total canopy.

**BROKEN PIPE**



Pipes can be broken or damaged due to settling or nearby construction. Pipe repairs typically require significant excavation and engineering.

**DEAD OR MISSING TREE**



Dead stormwater trees can contribute to the public perception of a poorly maintained streetscape and be a safety hazard.

**TREE HEIGHT**

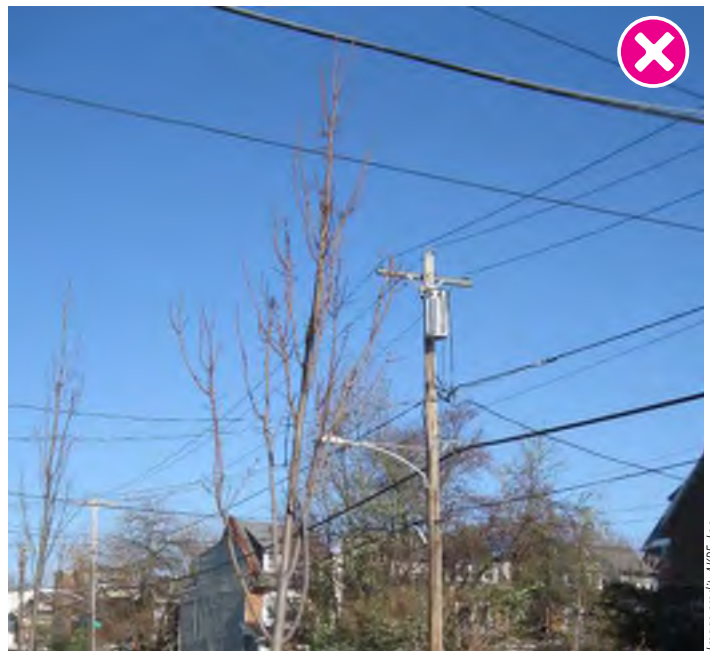

Trees that are growing into overhead wires must be pruned by a Line Clearance Arborist.

# PERMEABLE PAVEMENT MAINTENANCE

## ROUTINE MAINTENANCE

Permeable pavements are maintained routinely to keep them neat, clean, safe, and functional, as outlined below. For problems beyond the scope of routine maintenance, additional analysis and planning may be needed to complete corrective maintenance repairs ([refer to pages 52-53](#)).

Routine maintenance typically consists of general cleanup and regenerative air sweeping, with minor repairs and replacements performed as needed. Refer to [Table 3.14](#) for a list of maintenance tasks with references to the appropriate detailed specifications ([Appendix A—GSI Maintenance Specifications](#)).

Common routine maintenance activities may include:

- Trash and sediment removal (year round);
- Regenerative air sweeping (year round); and
- Minor repairs and replacements as needed.



Image credit: National Ready Mixed Concrete Association

A regenerative air sweeper cleaning permeable pavement.

### MAINTENANCE ZONE KEY

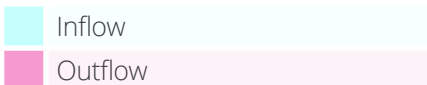

*Refer to SCM Overview for component locations and descriptions.*

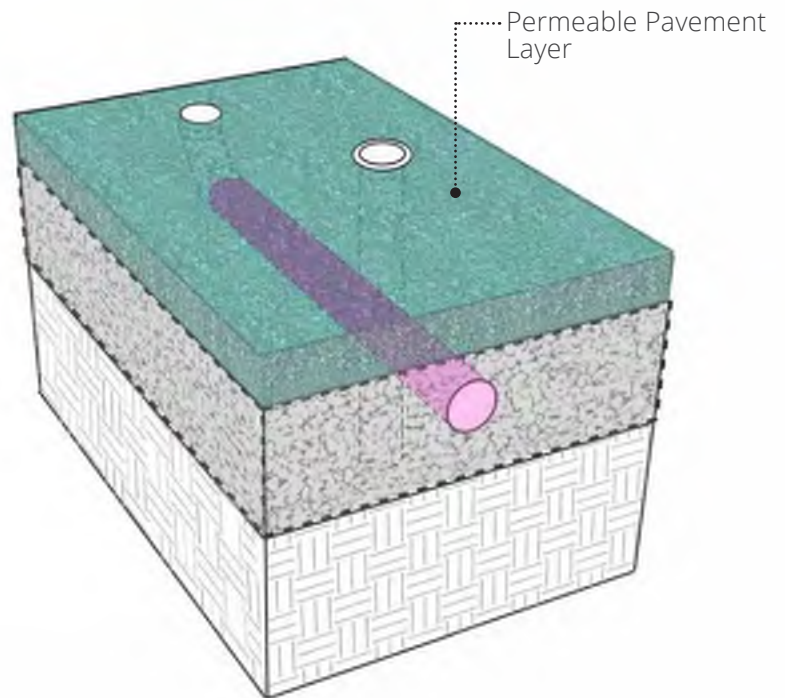

**FIGURE 3.5 – PERMEABLE PAVEMENT MAINTENANCE ZONES**

**TABLE 3.14 – PERMEABLE PAVEMENT ROUTINE MAINTENANCE TASKS**

SPECIFICATION REFERENCE	TASK	DESCRIPTION	ZONE		
<b>Tasks to be Performed Every Routine Surface Maintenance Event or as Needed*</b>					
<b>Surface</b>	1.3.A	Sediment Removal	Removal of sediment from surface-accessible components.		
	1.3.B	Organic Debris Removal	Removal of fallen leaves and branches or spent plant material from surface-accessible components.		
	1.3.C	Trash Removal	Removal of trash from surface-accessible components.		
	1.3.E	Minor Concrete/Masonry Repair	Repairs to small affected areas (such as resetting stones, filling cracks, etc.) that can be completed without the use of heavy equipment or concrete mixing.		
	1.3.I	Inlet and Structure Grate Cleaning	Clearing grate surfaces to ensure proper flow of water into and out of the system.		
	1.3.P	Waste Disposal	Disposal of nonhazardous waste materials generated or collected during the performance of surface maintenance activities. The task includes proper containment, transport and disposal of waste material.		
<b>Subsurface</b>	2.3.A	Inlet, Pipe and Chamber Cleaning	High-pressure hydraulic and vactor cleaning of structures and distribution and/or underdrain pipes.		
	2.3.B	Postmaintenance Pipe Inspection	Inspection of distribution and/or underdrain pipes via CCTV video, and documentation of observed defects.		
	2.3.C	Waste Disposal	Disposal of nonhazardous waste materials generated or collected during the performance of subsurface maintenance activities. The task includes proper containment, transport and disposal of waste material.		
<b>Permeable Pavement</b>	3.3.A	Vacuum Sweeping	Clears fine sediments, organic material, or other debris out of a permeable surface for better infiltration rates.		
	3.3.B	Waste Disposal	Disposal of nonhazardous waste materials generated or collected during the performance of permeable pavement maintenance activities. The task includes proper containment, transport and disposal of waste material.		

**CREW IS RESPONSIBLE FOR REPORTING ANY NONROUTINE MAINTENANCE SITE ISSUES TO CRW.**

\* Determined by the maintenance foreman on site.

## CORRECTIVE MAINTENANCE

Corrective maintenance may be needed to address problems related to drainage; settling; or condition of masonry, concrete, or structures. Examples of some of these problem conditions are shown on the following page. These examples are not exhaustive. If these conditions are observed during routine maintenance, they should be photographed and documented in the work order.

### CALL AN EXPERT

If the problems pose an direct safety hazard to the public or the maintenance crew, stop work, secure the site, and report the problem immediately (refer to [Appendix D—Contact List](#)).



Clear surface and joints contribute to well-draining and functioning interlocking pavers.

Image credit: National Ready Mixed Concrete Association



**SEDIMENT CLOGGING**



Image credit: Flickr // NIS Stormwater

Permeable grids or jointed systems may require adjustments to vacuum sweeper suction setting to prevent removal of loose joint fill material and to prevent the joint fill from clogging the equipment. In some cases clogged joint material may need to be replaced.

**SPILLED CONCRETE**



Image credit: AR&E, Inc.

Cement or mortar can clog porous concrete or asphalt. Removal and patching by a expert installer may be the only way to restore the affected area if the damage is extensive.

**OIL CLOG**



Image credit: New Dawn Permeable Pavement

Oil and fuel dripping can damage binder material in porous asphalt, hastening the decay of the paving materials.

**STRUCTURAL PROBLEM**



Image credit: New Dawn Permeable Pavement

Abrupt transitions in joint alignment, or bulging or collapsed areas of porous pavement may be signs that there are serious issues with the subsurface structure. To investigate subsurface issues, design or construction professionals may need to remove the pavers and their underlying stone components.

# STORAGE/ INFILTRATION TRENCH MAINTENANCE

## ROUTINE MAINTENANCE

Storage/ infiltration trenches are maintained routinely to keep them neat and functional, as outlined below. For problems beyond the scope of routine maintenance, additional analysis and planning may be needed to complete corrective maintenance repairs (refer to pages 56-57).

Routine maintenance typically consists of general cleanup and subsurface cleanup, with minor repairs and replacements performed as needed. Refer to [Table 3.15](#) for a list of maintenance tasks with references to the appropriate detailed specifications ([Appendix A—GSI Maintenance Specifications](#)).

Common routine maintenance activities may include:

- Trash and sediment removal (year round);
- Pipe Inspections (annually);
- Inlet/Pipe Cleaning (annually); and
- Minor repairs and replacements as needed.



Image credit: Council for Watershed Health

A storage/infiltration trench during construction, prior to backfill.

### MAINTENANCE ZONE KEY

	Hardscape
	Inflow
	Outflow

Refer to SCM Overview for component locations and descriptions.

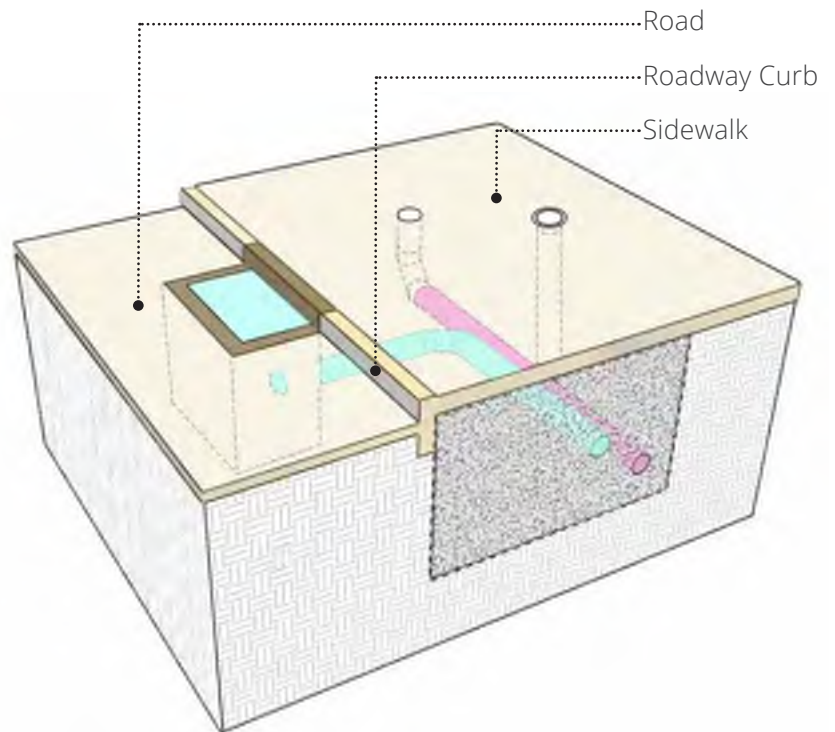

**FIGURE 3.6 – STORAGE/ INFILTRATION TRENCH MAINTENANCE ZONES**

**TABLE 3.15 – STORAGE/ INFILTRATION TRENCH ROUTINE MAINTENANCE TASKS**

SPECIFICATION REFERENCE	TASK	DESCRIPTION	ZONE	
<b>Tasks to be Performed Every Routine Surface Maintenance Event or as Needed*</b>				
<b>Surface</b>	1.3.A	Sediment Removal	Removal of sediment from surface-accessible components and inlet pretreatment devices.	Yellow, Cyan
	1.3.C	Trash Removal	Removal of trash from surface-accessible components.	Yellow, Cyan
	1.3.E	Minor Concrete/ Masonry Repair	Repairs to small affected areas (such as resetting stones, filling cracks, etc.) that can be completed without the use of heavy equipment or concrete mixing.	Yellow, Cyan
	1.3.I	Inlet and Structure Grate Cleaning	Clearing grate surfaces to ensure proper flow of water into and out of the system.	Yellow, Cyan
	1.3.P	Waste Disposal	Disposal of nonhazardous waste materials generated or collected during the performance of surface maintenance activities. The task includes proper containment, transport and disposal of waste material.	Yellow, Cyan
<b>Subsurface</b>	2.3.A	Inlet, Pipe and Chamber Cleaning	High-pressure hydraulic and vactor cleaning of structures and distribution and/or underdrain pipes.	Cyan, Pink
	2.3.B	Postmaintenance Pipe Inspection	Inspection of distribution and/or underdrain pipes via CCTV video, and documentation of observed defects.	Cyan, Pink
	2.3.C	Waste Disposal	Disposal of nonhazardous waste materials generated or collected during the performance of subsurface maintenance activities. The task includes proper containment, transport and disposal of waste material.	Cyan, Pink

**CREW IS RESPONSIBLE FOR REPORTING ANY NONROUTINE MAINTENANCE SITE ISSUES TO CRW.**

\* Determined by the maintenance foreman on site.

## CORRECTIVE MAINTENANCE

Corrective maintenance may be needed to address problems related to condition of masonry, concrete, or structures. Examples of some of these problem conditions are shown on the following page. These examples are not exhaustive. If these conditions are observed during routine maintenance, they should be photographed and documented in the work order.

### CALL AN EXPERT

If the problems pose an direct safety hazard to the public or the maintenance crew, stop work, secure the site, and report the problem immediately (refer to [Appendix D—Contact List](#)).



Good perimeter erosion and sediment controls are important during the construction of subsurface infiltration systems to prevent clogging of storage components.

Image credit: AKRF, Inc.

**SUNKEN CLEANOUT**



Deeply sunken or depressed features like the cleanout cover above that should otherwise be level with the surrounding pavement may be signs of subsurface defects, such as a collapsed pipe.

**CRACKED SIDEWALK**



VOIDS, broken pipes or structures can cause the overlying pavement to collapse or cause extensive cracking outside of control joints.

**COLLAPSED PIPE**



A CCTV-inspection photo of a broken pipe shows stone trench material that has fallen into a collapsed pipe. Repairing a pipe collapse can be complicated, involving excavation, replacement of piping and other stormwater components.

**CLOGGED PIPE**



Heavy construction debris, such as brick and concrete pieces, which typical flows cannot flush, can create dams where other debris can accumulate to form blockages.

# RAIN GARDEN MAINTENANCE

## ROUTINE MAINTENANCE

Rain gardens are maintained routinely to keep them neat, clean, safe, and functional, as outlined below. For problems beyond the scope of routine maintenance, additional analysis and planning may be needed to complete corrective maintenance repairs ([refer to pages 60–61](#)).

Routine maintenance typically consists of general cleanup and plant care, with minor repairs and replacements performed as needed. Refer to [Table 3.16](#) for a list of maintenance tasks with references to the appropriate detailed specifications ([Appendix A—GSI Maintenance Specifications](#)). Note that not all tasks will be needed every visit, and certain seasonal tasks (such as watering and replanting) should be done only at the specific request of CRW.

Common routine maintenance activities may include:

- Trash and sediment removal (year round);
- Weeding (during the growing season);
- Watering and mulching (during plant establishment);
- Planting, cutting back, and pruning plants (as seasonally appropriate);
- Pipe Inspections (annually); and
- Minor repairs and replacements as needed.

### MAINTENANCE ZONE KEY

	Hardscape
	Inflow
	Vegetated Area
	Outflow

*Refer to SCM Overview for component locations and descriptions.*



Image credit: Philadelphia Water

A well-maintained rain garden promotes appreciation among the surrounding community.

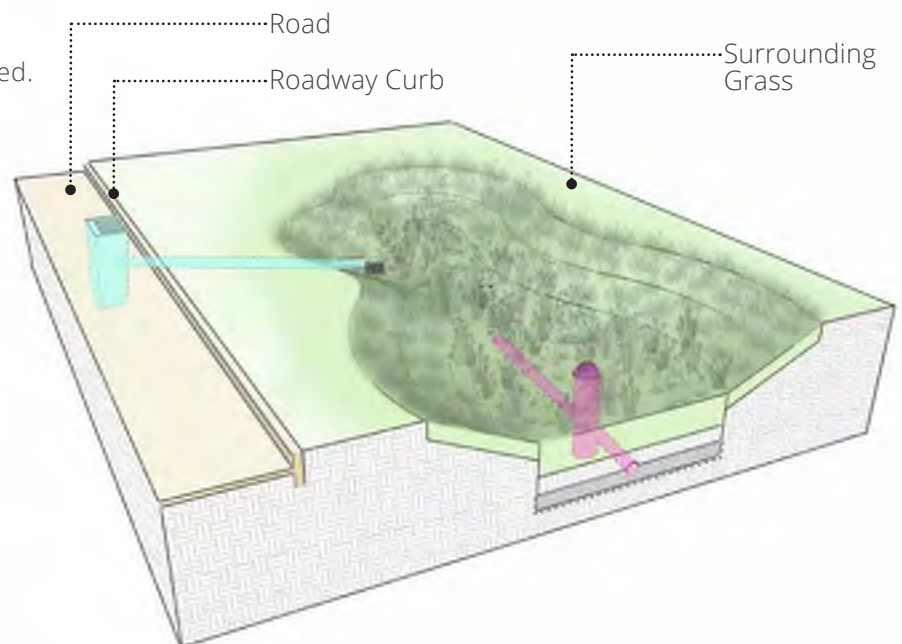

**FIGURE 3.7 – RAIN GARDEN MAINTENANCE ZONES**

**TABLE 3.16 – RAIN GARDEN ROUTINE MAINTENANCE TASKS**

SPECIFICATION REFERENCE	TASK	DESCRIPTION	ZONE
<b>Tasks to be Performed Every Routine Surface Maintenance Event or as Needed*</b>			
1.3.A	Sediment Removal	Removal of sediment from surface-accessible components and inlet pretreatment devices.	1, 2, 3, 4
1.3.B	Organic Debris Removal	Removal of fallen leaves and branches or spent plant material from surface-accessible components.	1, 2, 3, 4
1.3.C	Trash Removal	Removal of trash from surface-accessible components.	1, 2, 3, 4
1.3.D	Minor Erosion Repair	Stabilization of nonrecurring eroded areas, rills or gullies less than 20 square feet in size caused by concentrated or channelized flow.	1, 2, 3, 4
1.3.E	Minor Concrete/Masonry Repair	Repairs to small affected areas (such as resetting stones, filling cracks, etc.) that can be completed without the use of heavy equipment or concrete mixing.	1, 2, 3, 4
1.3.F	Minor Settling/Sinkhole Repair	Filling and compacting of voids is done to minimize risk of structural failure and hazards to individuals.	1, 2, 3, 4
1.3.G	Weeding	Removal of all weeds.	1, 2, 3, 4
1.3.H	Cutting Back Vegetation	Pruning of unwanted, dead, or damaged plant parts to ensure a healthy and species-appropriate growth habit and shape.	1, 2, 3, 4
1.3.I	Inlet and Structure Grate Cleaning	Clearing grate surfaces to ensure proper flow of water into and out of the system.	1, 2, 3, 4
1.3.P	Waste Disposal	Disposal of nonhazardous waste materials generated or collected during the performance of surface maintenance activities. The task includes proper containment, transport and disposal of waste material.	1, 2, 3, 4
<b>Task to be Performed as Requested by CRW During Routine Surface Maintenance Events</b>			
1.3.J	Watering**	Application of water (via hose or water bag) to establish and maintain healthy plant growth.	1, 2, 3, 4
1.3.K	Pre-emergent Herbicide Application	Application of pre-emergent herbicide by a licensed commercial pesticide applicator to prevent the growth of undesired plants.	1, 2, 3, 4
1.3.L	Planting Herbaceous Vegetation	Installation of broadleaf, grassy, and ground cover perennial plant material, generally consistent with the planting plan, to replace failed plantings.	1, 2, 3, 4
1.3.M	Planting Shrubs	Installation of shrubs, generally consistent with the planting plan, to replace failed plantings.	1, 2, 3, 4
1.3.N	Mulch Application	Placement and spreading of mulch in planting beds.	1, 2, 3, 4
1.3.O	Stormwater Soil Replacement	Removal of existing stormwater soil, and replacement with new clean media.	1, 2, 3, 4
<b>Subsurface</b>	2.3.A	Inlet, Pipe and Chamber Cleaning	High-pressure hydraulic and vector cleaning of structures and distribution and/or underdrain pipes.
	2.3.B	Postmaintenance Pipe Inspection	Inspection of distribution and/or underdrain pipes via CCTV video, and documentation of observed defects.
	2.3.C	Waste Disposal	Disposal of nonhazardous waste materials generated or collected during the performance of subsurface maintenance activities. The task includes proper containment, transport and disposal of waste material.

**CREW IS RESPONSIBLE FOR REPORTING ANY NONROUTINE MAINTENANCE SITE ISSUES TO CRW.**

\* Determined by the maintenance foreman on site.

\*\* Watering should only be performed when a Watering Work Order is assigned.

## CORRECTIVE MAINTENANCE

Corrective maintenance may be needed to address problems related to drainage; plant health or establishment; soil erosion or settling; or condition of masonry, concrete, or structures. Examples of some of these problem conditions are shown on the following page. These examples are not exhaustive. If these conditions are observed during routine maintenance, they should be photographed and documented in the work order.

### CALL AN EXPERT

If the problems pose an direct safety hazard to the public or the maintenance crew, stop work, secure the site, and report the problem immediately (refer to [Appendix D—Contact List](#)).



This newly planted rain garden built in at a playground manages runoff from the site and surrounding roadways.

Image credit: AKRF, Inc.



**BROKEN PIPE**



Pipes can be broken or damaged due to settling. Pipe repairs may require significant excavation and engineering.

**REOCCURRING PLANT ESTABLISHMENT PROBLEMS**



Poor plant establishment can be a problem if the plant species is not suitable for the location, or if there is repeated external stress (such as from large amounts of sediment).

**PROLONGED STANDING WATER**



Water should drain from properly-functioning SCMs within 3 days after a rainfall; if it does not, there may be a serious problem.

**MAJOR EROSION OR SETTLING**



Eroded areas larger than 20 square feet in size, or settling more than 1 foot deep could be a potential indicator of significant problems.

# STORMWATER WETLAND MAINTENANCE

## ROUTINE MAINTENANCE

Stormwater wetlands are maintained routinely to keep them clean, safe, and functional, as outlined below. For problems beyond the scope of routine maintenance, additional analysis and planning may be needed to complete corrective maintenance repairs ([refer to pages 64–65](#)).

Routine maintenance typically consists of general cleanup and plant care, with minor repairs and replacements performed as needed. Refer to [Table 3.17](#) for a list of maintenance tasks with references to the appropriate detailed specifications ([Appendix A—GSI Maintenance Specifications](#)). Note that not all tasks will be needed every visit, and certain seasonal tasks (such as watering and replanting) should be done only at the specific request of CRW.

Common routine maintenance activities may include:

- Trash and sediment removal (year round);
- Weeding (during the growing season);
- Watering a (during establishment of upland plants);
- Planting, cutting back, and pruning plants (as seasonally appropriate);
- Pipe Inspections (annually); and
- Minor repairs and replacements as needed.

### MAINTENANCE ZONE KEY

	Hardscape
	Inflow
	Vegetated Area
	Outflow

*Refer to SCM Overview for component locations and descriptions.*



Image credit: AKRF, Inc.

A functioning and aesthetically pleasing stormwater wetland due to the upkeep in maintenance.

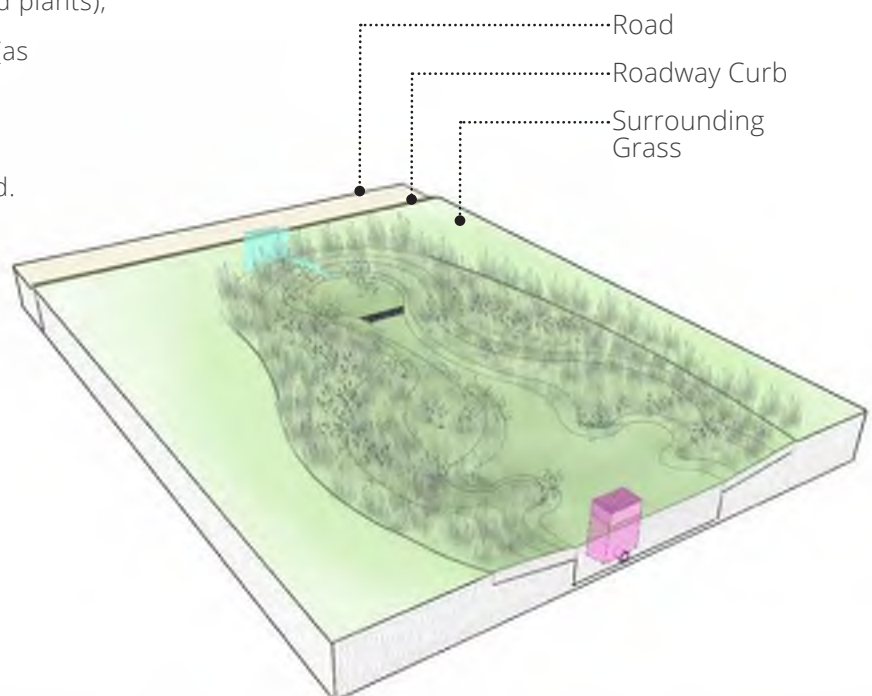

**FIGURE 3.8 – STORMWATER WETLAND MAINTENANCE ZONES**

**TABLE 3.17 – STORMWATER WETLAND ROUTINE MAINTENANCE TASKS**

SPECIFICATION REFERENCE	TASK	DESCRIPTION	ZONE	
<b>Tasks to be Performed Every Routine Surface Maintenance Event or as Needed*</b>				
Surface	1.3.A	Sediment Removal	Removal of sediment from surface-accessible components and inlet pretreatment devices.	1, 2, 3, 4
	1.3.B	Organic Debris Removal	Removal of fallen leaves and branches or spent plant material from surface-accessible components.	1, 2, 3, 4
	1.3.C	Trash Removal	Removal of trash from surface-accessible components.	1, 2, 3, 4
	1.3.D	Minor Erosion Repair	Stabilization of nonrecurring eroded areas, rills or gullies less than 20 square feet in size caused by concentrated or channelized flow.	2, 3, 4
	1.3.E	Minor Concrete/ Masonry Repair	Repairs to small affected areas (such as resetting stones, filling cracks, etc.) that can be completed without the use of heavy equipment or concrete mixing.	1, 2, 3, 4
	1.3.F	Minor Settling/ Sinkhole Repair	Filling and compacting of voids is done to minimize risk of structural failure and hazards to individuals.	2, 3, 4
	1.3.G	Weeding	Removal of all weeds.	2, 3, 4
	1.3.H	Cutting Back Vegetation	Pruning of unwanted, dead, or damaged plant parts to ensure a healthy and species-appropriate growth habit and shape.	2, 3, 4
	1.3.I	Inlet and Structure Grate Cleaning	Clearing grate surfaces to ensure proper flow of water into and out of the system.	1, 2, 3, 4
	1.3.P	Waste Disposal	Disposal of nonhazardous waste materials generated or collected during the performance of surface maintenance activities. The task includes proper containment, transport and disposal of waste material.	1, 2, 3, 4
	<b>Task to be Performed as Requested by CRW During Routine Surface Maintenance Events</b>			
Surface	1.3.J	Watering**	Application of water (via hose or water bag) to establish and maintain healthy plant growth.	2, 3, 4
	1.3.L	Planting Herbaceous Vegetation	Installation of broadleaf, grassy, and ground cover perennial plant material, generally consistent with the planting plan, to replace failed plantings.	2, 3, 4
	1.3.M	Planting Shrubs	Installation of shrubs, generally consistent with the planting plan, to replace failed plantings.	2, 3, 4
Subsurface	2.3.A	Inlet, Pipe and Chamber Cleaning	High-pressure hydraulic and vector cleaning of structures.	1, 2, 3, 4
	2.3.C	Waste Disposal	Disposal of nonhazardous waste materials generated or collected during the performance of subsurface maintenance activities. The task includes proper containment, transport and disposal of waste material.	1, 2, 3, 4

**CREW IS RESPONSIBLE FOR REPORTING ANY NONROUTINE MAINTENANCE SITE ISSUES TO CRW.**

\* Determined by the maintenance foreman on site.

\*\* Watering should only be performed when a Watering Work Order is assigned.

## CORRECTIVE MAINTENANCE

Corrective maintenance may be needed to address problems related to drainage; plant health or establishment; soil erosion or settling; or condition of masonry, concrete, or structures. Examples of some of these problem conditions are shown on the following page. These examples are not exhaustive. If these conditions are observed during routine maintenance, they should be photographed and documented in the work order.

### CALL AN EXPERT

If the problems pose an direct safety hazard to the public or the maintenance crew, stop work, secure the site, and report the problem immediately (refer to [Appendix D—Contact List](#)).



Constructed wetlands can help restore natural wetlands lost to urban development.

Image credit: Waterfront Alliance

**REOCCURRING ALGAE**

Image credit: NC State University

Excess nitrogen pollution can cause algae blooms that can degrade water quality. Expert input may be necessary to pinpoint the cause and control of algae blooms.

**STRUCTURAL PROBLEMS**

Image credit: Clemson University

A broken outfall structure creates a hazard for animals and people who may accidentally step through it. When a structural defect has the potential to cause harm, secure the area immediately and report to the appropriate authority.

**ANIMAL OR PEST INFESTATION**

Image credit: EPA

Small mammals such as muskrats can burrow into the wetland embankment, forming voids that can compromise the safety of the system. A pest removal service may be required to trap these nuisance creatures in a safe and humane way.

**UNCONTROLLABLE WEEDS**

Image credit: Backyard Pond Kits

Non-native invasive species like *Phragmites spp.* can takeover wetlands due to their lack of natural predators. If invasives are a problem, an integrated weed management plan may be necessary.

# STORMWATER BASIN MAINTENANCE

## ROUTINE MAINTENANCE

Stormwater basins are maintained routinely to keep them neat, clean, safe, and functional, as outlined below. For problems beyond the scope of routine maintenance, additional analysis and planning may be needed to complete corrective maintenance repairs ([refer to pages 68–69](#)).

Routine maintenance typically consists of general cleanup and plant care, with minor repairs and replacements performed as needed. Refer to [Table 3.18](#) for a list of maintenance tasks with references to the appropriate detailed specifications ([Appendix A—GSI Maintenance Specifications](#)). Note that not all tasks will be needed every visit, and certain seasonal tasks (such as watering and replanting) should be done only at the specific request of CRW.

Common routine maintenance activities may include:

- Trash and sediment removal (year round);
- Weeding (during the growing season);
- Watering (during plant establishment);
- Planting, cutting back, and pruning plants (as seasonally appropriate);
- Pipe Inspections (annually); and
- Minor repairs and replacements as needed.

### MAINTENANCE ZONE KEY

	Hardscape
	Inflow
	Vegetated Area
	Outflow

*Refer to SCM Overview for component locations and descriptions.*



A well-kept stormwater basin.

Image credit: Philadelphia Water

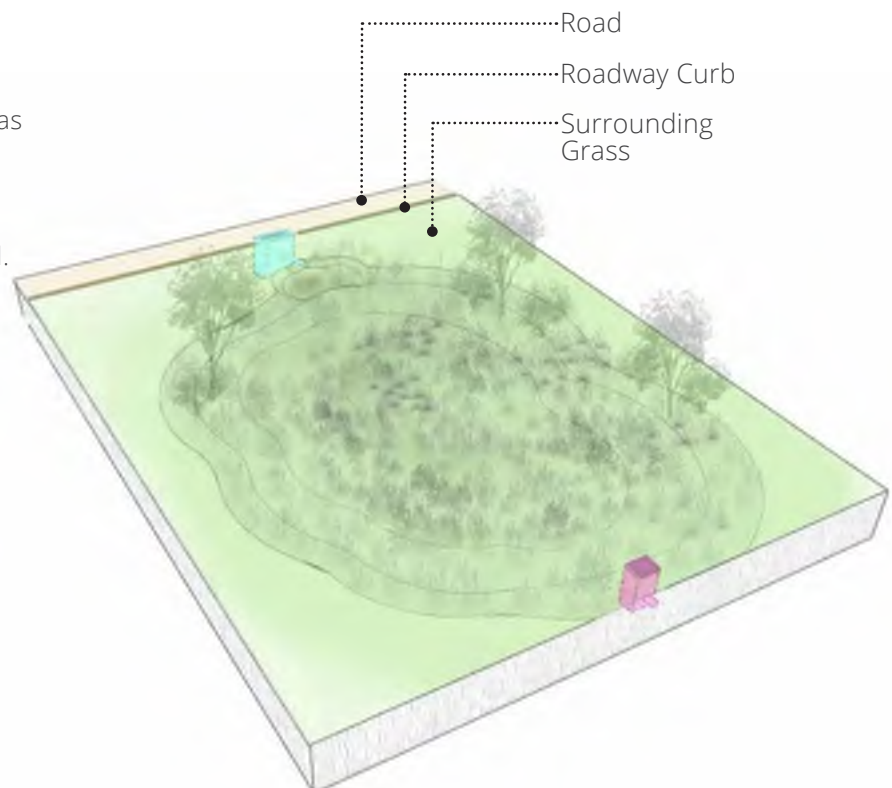

**FIGURE 3.9 – STORMWATER BASIN MAINTENANCE ZONES**

**TABLE 3.18 – STORMWATER BASIN ROUTINE MAINTENANCE TASKS**

SPECIFICATION REFERENCE	TASK	DESCRIPTION	ZONE	
<b>Tasks to be Performed Every Routine Surface Maintenance Event or as Needed*</b>				
Surface	1.3.A	Sediment Removal	Removal of sediment from surface-accessible components and inlet pretreatment devices.	1, 2, 3, 4
	1.3.B	Organic Debris Removal	Removal of fallen leaves and branches or spent plant material from surface-accessible components.	1, 2, 3, 4
	1.3.C	Trash Removal	Removal of trash from surface-accessible components.	1, 2, 3, 4
	1.3.D	Minor Erosion Repair	Stabilization of nonrecurring eroded areas, rills or gullies less than 20 square feet in size caused by concentrated or channelized flow.	2, 3, 4
	1.3.E	Minor Concrete/Masonry Repair	Repairs to small affected areas (such as resetting stones, filling cracks, etc.) that can be completed without the use of heavy equipment or concrete mixing.	1, 2, 3, 4
	1.3.F	Minor Settling/Sinkhole Repair	Filling and compacting of voids is done to minimize risk of structural failure and hazards to individuals.	2, 3, 4
	1.3.G	Weeding	Removal of all weeds.	3, 4
	1.3.H	Cutting Back Vegetation	Pruning of unwanted, dead, or damaged plant parts to ensure a healthy and species-appropriate growth habit and shape.	3, 4
	1.3.I	Inlet and Structure Grate Cleaning	Clearing grate surfaces to ensure proper flow of water into and out of the system.	2, 3, 4
	1.3.P	Waste Disposal	Disposal of nonhazardous waste materials generated or collected during the performance of surface maintenance activities. The task includes proper containment, transport and disposal of waste material.	1, 2, 3, 4
	<b>Task to be Performed as Requested by CRW During Routine Surface Maintenance Events</b>			
Surface	1.3.J	Watering**	Application of water (via hose or water bag) to establish and maintain healthy plant growth.	3, 4
	1.3.L	Planting Herbaceous Vegetation	Installation of broadleaf, grassy, and ground cover perennial plant material, generally consistent with the planting plan, to replace failed plantings.	3, 4
	1.3.M	Planting Shrubs	Installation of shrubs, generally consistent with the planting plan, to replace failed plantings.	3, 4
	1.3.N	Mulch Application	Placement and spreading of mulch in planting beds.	3, 4
Subsurface	2.3.A	Inlet, Pipe and Chamber Cleaning	High-pressure hydraulic and vector cleaning of structures.	2, 3, 4
	2.3.C	Waste Disposal	Disposal of nonhazardous waste materials generated or collected during the performance of subsurface maintenance activities. The task includes proper containment, transport and disposal of waste material.	2, 3, 4

**CREW IS RESPONSIBLE FOR REPORTING ANY NONROUTINE MAINTENANCE SITE ISSUES TO CRW.**

\* Determined by the maintenance foreman on site.

\*\* Watering should only be performed when a Watering Work Order is assigned.

## CORRECTIVE MAINTENANCE

Corrective maintenance may be needed to address problems related to drainage; plant health or establishment; soil erosion or settling; or condition of masonry, concrete, or structures. Examples of some of these problem conditions are shown on the following page. These examples are not exhaustive. If these conditions are observed during routine maintenance, they should be photographed and documented in the work order.

### CALL AN EXPERT

If the problems pose an direct safety hazard to the public or the maintenance crew, stop work, secure the site, and report the problem immediately (refer to [Appendix D—Contact List](#)).



A stormwater basin planted with native trees, shrubs, and perennials throughout the entire extents can mimic a naturally occurring pond.

Image credit: Perkiomen Watershed Conservancy



**MAJOR EROSION**

Image credit: AKRF, Inc.

Heavy erosion around the system's inlet could indicate poor design of the inflow and pretreatment systems.

**STRUCTURAL PROBLEMS**

Image credit: john88.wordpress.com

Broken conveyance pipes can prevent proper filling or drain-down of stormwater basins. Depending on their locations, these types of defects may not be visually detectable from the surface.

**UNCONTROLLABLE WEEDS**

Image credit: Invasive Plant Atlas

Non-native invasive species like Japanese hops can takeover basins due to their lack of natural predators. If invasives are a problem, an integrated weed management plan may be necessary.

**REOCCURRING PLANT ESTABLISHMENT PROBLEMS**

Image credit: AKRF, Inc.

Poor plant establishment can be a problem if the plant species is not suitable for the location, or if there is repeated external stress (such as from large amounts of sediment).



# 4

## DATA COLLECTION PROCEDURES

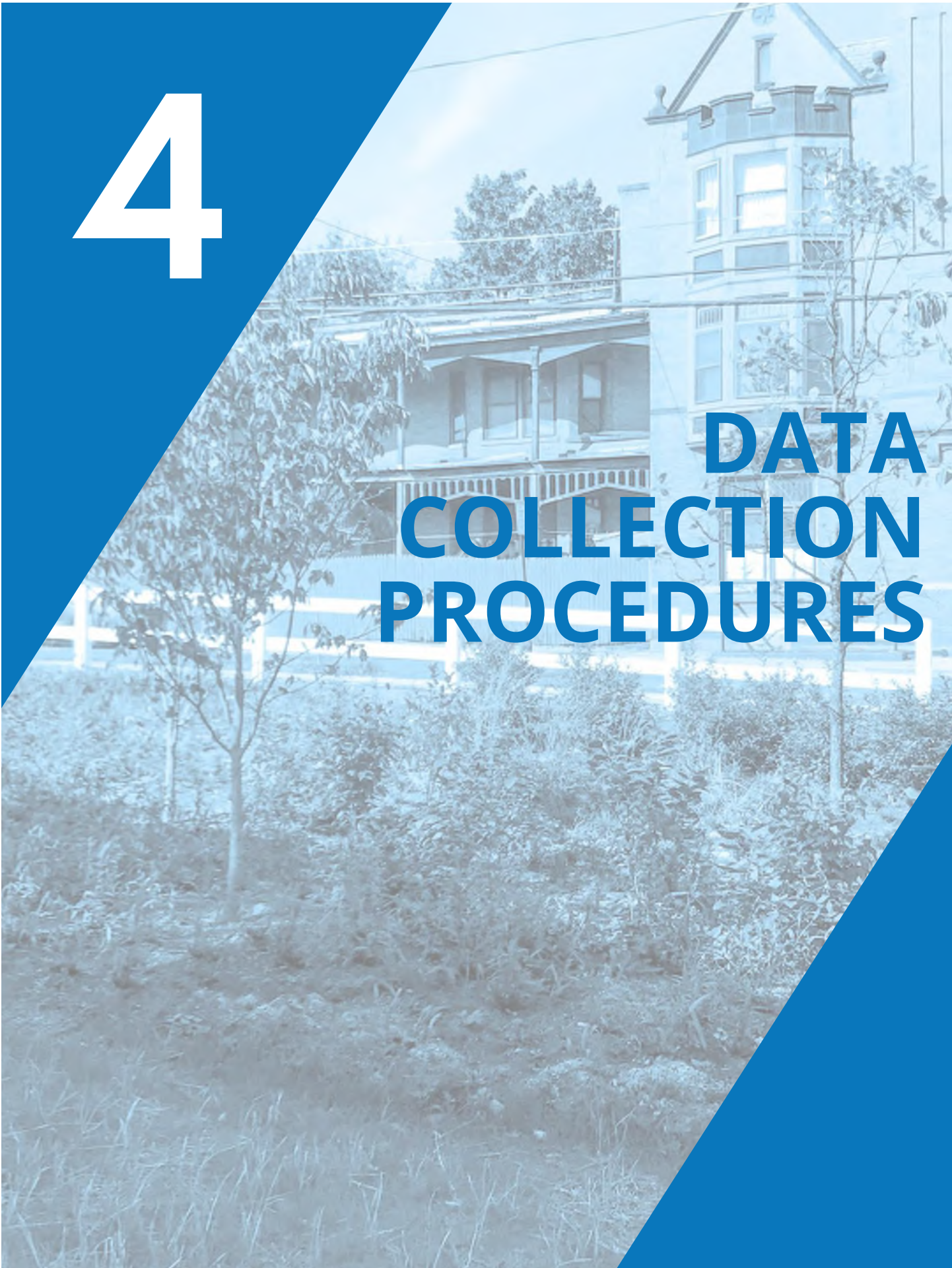

CRW uses a Cityworks asset management system to capture and store data about the Program. Maintenance data allows program managers to understand where and how frequently SCMs are being maintained, the type of work being done, the level of staff effort required, and what types of issues keep coming up. Figure 4.1 below provides an overview of the flow of data in the asset management system. By understanding the level of effort required to keep GSI in good condition, managers can allocate and deploy appropriate resources as needed.

## WORK ORDER FORMS

Inspectors and maintenance crews are responsible for collecting maintenance and inspection data during routine site visits using standard work order (WO) forms (refer to [Appendix B—Inspection Work Order Forms](#) and [Appendix C—Maintenance Work Order Forms](#)). Work orders are

requested prior to inspection and maintenance, and completed inspection and maintenance personnel during or immediately after maintenance. These forms must be completed and reviewed at the end of each work day. If forms are returned with incomplete data, inspectors and crews may be sent back to the site to collect missing information.

Data will then be used to generate regular reports that are reviewed by CRW (see Figure 4.1 below). This information is used for informal and external reporting.

## EQUIPMENT AND TECHNOLOGY

To ensure accuracy and completeness, maintenance data must be collected by crews during the course of routine maintenance, rather than in the office after maintenance

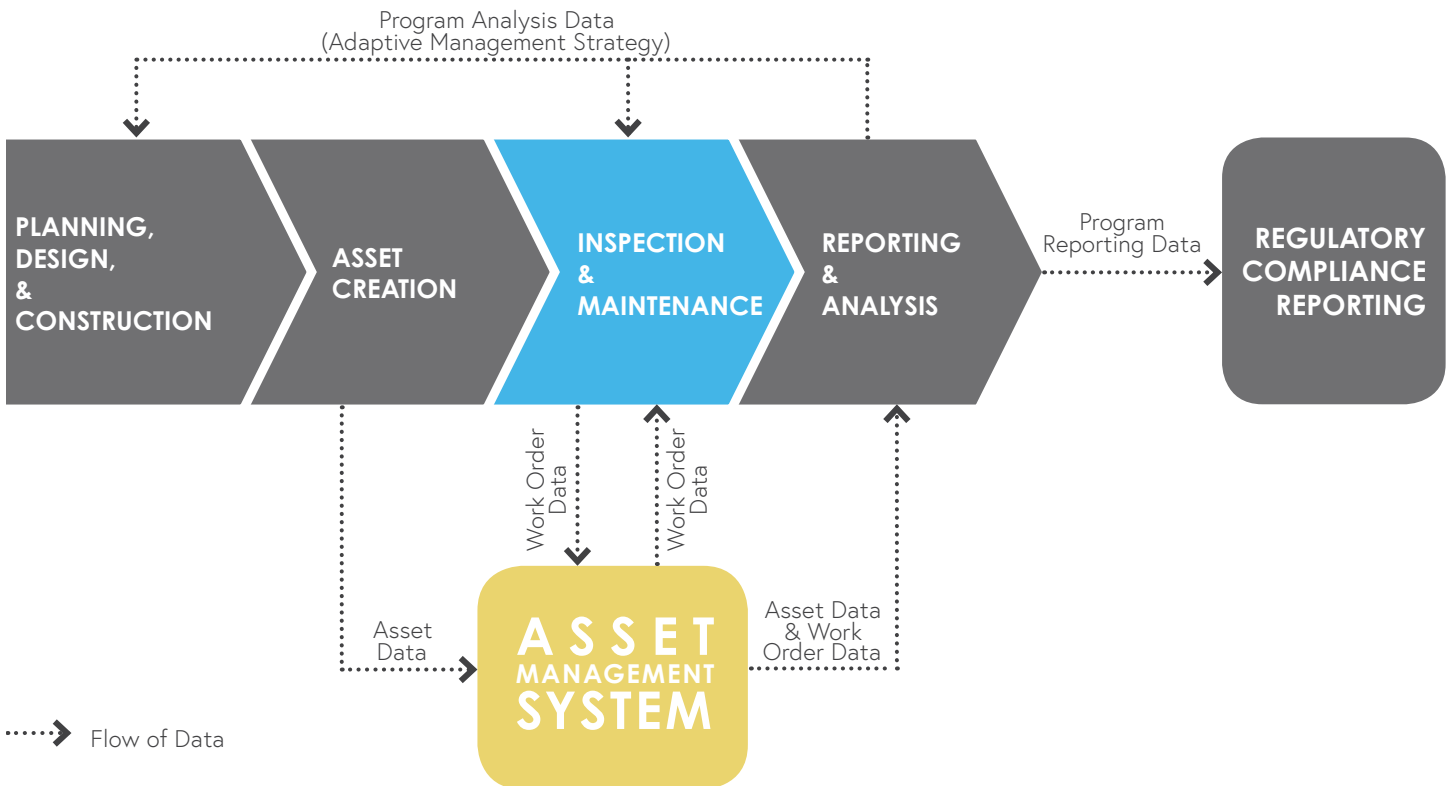

**FIGURE 4.1 – OVERALL GSI PROGRAM DATA MANAGEMENT WORK FLOW**

is complete. Either paper forms or Cityworks mobile software may be used as directed by CRW. If mobile software is used, crews must use tablet computers with the following minimum specifications:

- iOS, Android, and/or HTML5 operating system
- Cellular data connection
- 8 inch screen
- 500mpx camera with ability to collect date stamp
- 8 GB flash memory
- Rugged rubber case

## PHOTO POINTS

All types of WOs include the capture of photos and/or videos to document pre- and postmaintenance conditions. A map identifying the photo points where photos must be taken is included in each WO. If paper forms are used, photos must be collected and labeled separately such that each WO references uniquely numbered photos. If mobile electronic WOs are used, photos can be captured automatically within the WO fields. This can significantly



An example of a photo point taken at a rain garden looking downstream.

reduce time spent labeling and cross-referencing photos. Videos cannot be captured within an electronic WO and must be saved, labeled, and transferred separately.

## DATA TRANSFER

All inspection and maintenance data must be completed and delivered in full within two work days of completing field activities. CCTV video files must be named and organized to indicate the date, system ID, photo point and whether the photo is for surface, subsurface, or permeable pavement inspection or maintenance.

### **PREMAINTENANCE INSPECTION FILE NAMING:**

[4-digit year][2-digit month][2-digit-day]\_[System ID]\_Premaintenance

*Example:*

20190615\_1505\_Premaintenance

### **POSTMAINTENANCE INSPECTION FILE NAMING:**

[4-digit year][2-digit month][2-digit-day]\_[System ID]\_Postmaintenance

*Example:*

20190615\_1505\_Postmaintenance

If paper WOs were used, photo points files must be collected, named, and organized as follows:

### **PHOTO POINT FILE NAMING:**

[4-digit year][2-digit month][2-digit-day]\_[SCM ID]\_PhotoPoint#

*Example:*

20190615\_1505-1\_Photopoint1

### **FILE NAMING FOR PHOTOS OF PROBLEMS OBSERVED:**

[4-digit year][2-digit month][2-digit-day]\_[SCM ID]\_Problem[Unique Number beginning at 1]

*Example:*

20190615\_1505-1\_Problem1

All files must be delivered digitally (including paper WOs, which must be scanned) using standard file transfer software as requested by the Program Manager.



5

**PUBLIC  
ENGAGEMENT**

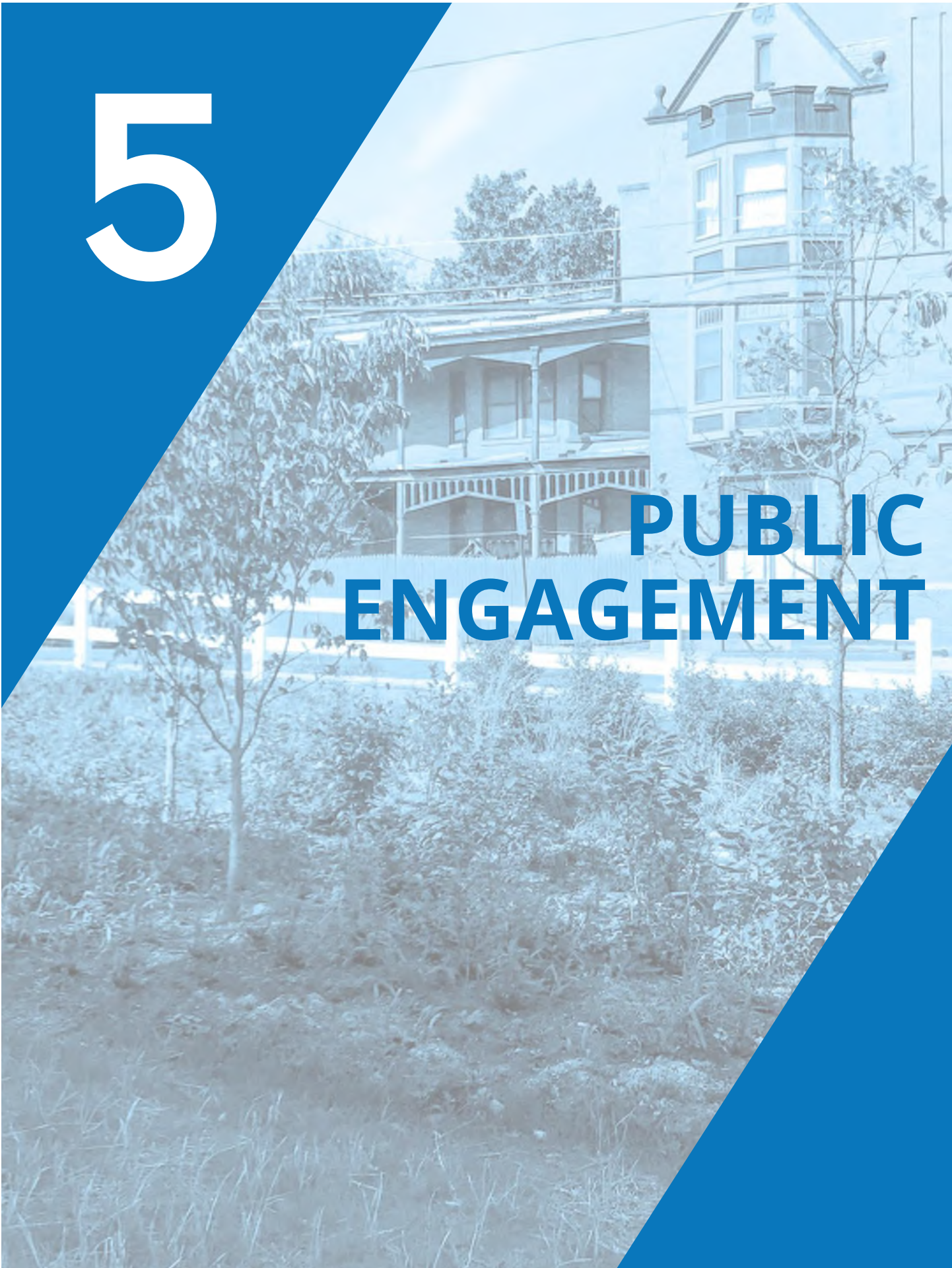

Many people are not familiar with GSI. Working in public spaces means members of the community who are curious about the work being done, or who may have an opinion they want to share, are likely to approach. When interacting with the public, it is essential to always be courteous and professional.

GSI maintenance personnel are in many ways the public face of CRW's GSI program, so it is important to make a good impression! These interactions are opportunities to promote the benefits of GSI while also educating citizens about how it works and why it has been installed.

If the community member appears upset, keep calm and avoid engaging in any kind of argument. Thank the individual for his or her input and stress that CRW is always interested in hearing from the community.

Keep in mind a few key pointers when engaging with members of the community:

- Introduce yourself and explain the work being done and that it is being completed for CRW.
- Use simple, non-technical terms whenever possible.
- Explain the goals of GSI maintenance—to keep the systems working properly and looking tidy.
- Acknowledge any concerns or feedback the community member offers. Write it down and report it back to a field supervisor. Document the community member's name, address and contact information that they are willing to share. Encourage them to call CRW at 888-510-0606 or contact CRW on-line at <https://capitalregionwater.com/report-problems/>

- Offer printed public information materials about green infrastructure and the GSI program. Always carry a supply of these materials.

## GREEN STORMWATER INFRASTRUCTURE TALKING POINTS

When talking to community members about SCMs, it is important to keep explanations brief and simple. For example, below are some talking points that can help explain what SCMs are and what they do.

- SCMs are designed to collect, infiltrate and absorb stormwater that runs off the streets and sidewalks when it rains.
- CRW is building rain gardens, tree trenches and other types of SCMs to manage stormwater and improve water quality in local waterways.
- Green stormwater infrastructure is a cost-effective way to help create a sustainable, beautiful Harrisburg. It can help to
  - i. Beautify neighborhoods.
  - ii. Reduce temperature during hot weather.
  - iii. Improve street drainage.
  - iv. Reduce puddles and ponds.
- CRW is responsible for maintenance of GSI. Maintenance crews will remove litter, sediment, and weeds from each installation on a regular basis.



Boards with visuals of GSI helped show the new systems being built in the community.

Image credit: ARRF, Inc.



## FREQUENTLY ASKED QUESTIONS

### **WILL THE RAIN GARDEN ATTRACT MOSQUITOES?**

Mosquitoes require a minimum of 72 hours in standing water for larvae development. SCMs are designed to drain down within 72 hours of the end of any rainfall event. If a system does not appear to be draining properly, community members can call 888-510-0606 or report it on-line at <https://capitalregionwater.com/report-problems/>

### **WILL TREE ROOTS CRACK THE SIDEWALK OR INTERFERE WITH UTILITY LINES?**

During design and construction, CRW and utility companies work together to ensure that SCMs will not directly interfere with existing underground and aboveground utility service lines. Older tree roots can break sidewalks because the tree pit is not large enough for the tree roots; however, CRW's standard designs gives tree roots plenty of space to grow.

### **CONTRACTORS HAVE BEEN BUILDING GSI IN MY NEIGHBORHOOD BUT THERE ARE NO PLANTS. WHY ARE THESE SITES STILL UNFINISHED?**

Construction may begin at different times throughout the year; however, planting must occur during the spring or fall when weather conditions are optimal. Construction may have begun earlier in order to be ready for the next appropriate planting season.

### **CAN I EXCHANGE PLANTS THAT WERE PLANTED IN AN SCM WITH PLANTS THAT I'VE SELECTED?**

GSI plants are specially selected because of their ability to survive the difficult conditions and changing water levels in these systems. Please do not replace them—other plants may not work as well in this setting.

### **DON'T RAIN GARDENS LOOK WEEDY AND OVERGROWN?**

Rain gardens can be planted to look naturalistic, like a meadow, or they can be maintained with a more formal garden appearance. Like any garden, regular maintenance will ensure that it does not become weedy and overgrown.

### **HOW WELL DOES PERMEABLE PAVEMENT WORK? IS IT DURABLE?**

The key difference between conventional concrete and asphalt pavements and permeable pavements is that the smallest stone particles, or fines, are left out of the permeable pavement mixture. This leaves small voids that allow water to infiltrate through the pavement, however, these pore spaces do slightly reduce the durability of the pavement in comparison with conventional pavements. With proper design, construction and maintenance, permeable pavement works well for many years, including in winter weather. Black ice does not form on permeable asphalt, as any thawed water infiltrates.

### **WON'T ROAD SALT KILL THE PLANTS IN THE SCMS?**

SCMs, especially those located next to streets or sidewalks, are designed with plants that are salt tolerant. They are also designed with well-drained soil that helps flush salt through the soil more rapidly and reduce high concentrations that negatively affect plants. Thus, road salt rarely kills the plants, although it can cause stress and damage if used in large quantities. To reduce the potential for any damage, you can choose eco-friendly salt such as calcium chloride, which is safe for plants and pets, or you can reduce the amount of salt spread.



An expert pointing out the components within the rain garden.

Image credit: ARRF, Inc.



APPENDIX

A

**GREEN  
STORMWATER  
INFRASTRUCTURE  
MAINTENANCE  
SPECIFICATIONS**

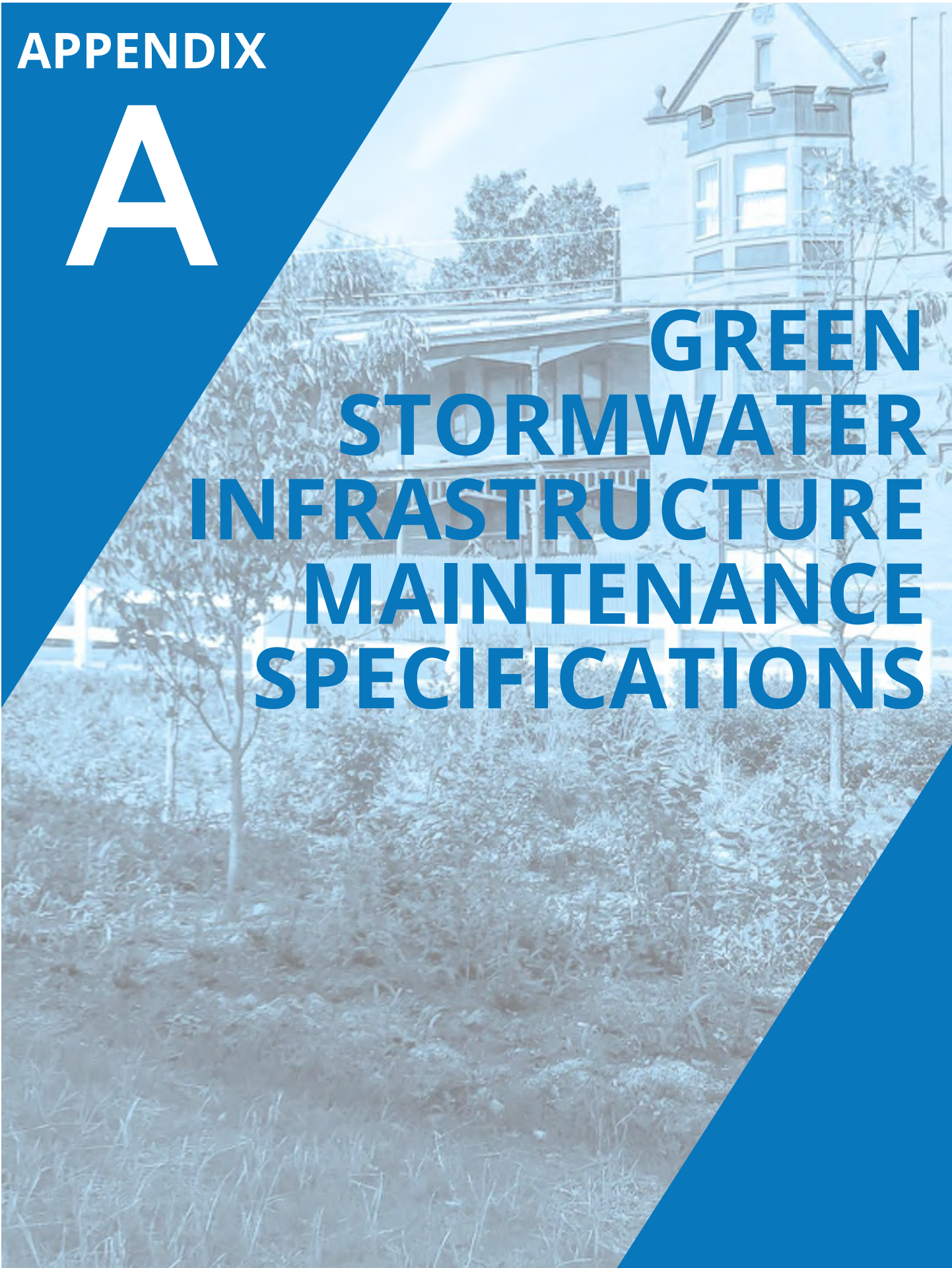

**PART 1: SURFACE MAINTENANCE****1.1 Personnel**

- A. All surface maintenance tasks require the following minimum personnel (refer to Part 4—Personnel Classification for descriptions of each personnel classification):
  - i. Functional Unit – Landscape Maintenance Contractor
    - 1. Green Stormwater Infrastructure Maintenance Foreman (1)
    - 2. Green Stormwater Infrastructure Maintenance Laborer (1)
- B. Personnel performing chemical weed control should include at a minimum,
  - i. A Pennsylvania Certified Pesticide Applicator or Registered Technician who is under the supervision of a Pennsylvania Certified Pesticide
  - ii. A Noncertified Applicator under the direct supervision of a Pennsylvania Certified Pesticide Applicator who is physically present and within sight of the application.

**1.2 Materials & Equipment**

- A. All surface maintenance tasks require the following minimum equipment:
  - i. Pickup truck
  - ii. Personal protective equipment
  - iii. Small rake, shovel and/or trowel
  - iv. Contractor trash bags
  - v. Tarp
- B. Sediment removal and organic debris removal requires the following minimum equipment:
  - i. Push broom
- C. Trash removal requires the following minimum equipment:
  - i. Trash grabber, broom, and/or dust pan
  - ii. Leaf blower
- D. Minor erosion repair requires the following minimum equipment and material:
  - i. Hoe
  - ii. Erosion blanket (NAG C125BN or approved equal)
  - iii. Landscape fabric staples, 8 inches (box)
  - iv. Topsoil
  - v. Seed spreader
  - vi. Grass seed
- E. Minor concrete/masonry repair requires the following minimum equipment and material:
  - i. Masonry chisel set and stone hammer
  - ii. Concrete mixing tray
  - iii. Masonry tools for mixing and finishing concrete and mortar
  - iv. Masonry trowel
  - v. Concrete or mortar mix
  - vi. Water
- F. Minor settling/sinkhole repair requires the following minimum equipment and materials:
  - i. Hand shovel or hand spade to clear settled area to uncover depression/void space
  - ii. Clean fill material
  - iii. Replacement stormwater soil and mulch
  - iv. Hand tamper
  - v. Digging bar
  - vi. Wheel barrow
- G. Weeding requires the following minimum equipment:
  - i. Weeding fork
  - ii. Garden shears
  - iii. Soil knife

- iv. Oscillating “scuffle” hoe
- H. Cutting back vegetation requires the following minimum equipment and materials:
  - i. Garden shears
  - ii. Grass clippers
  - iii. Scissors
  - iv. Arbor Tie™ or twine
  - v. String trimmer
  - vi. Loppers
  - vii. Pruners
  - viii. Hand saw
- I. Inlet and structure grate cleaning requires the following minimum equipment:
  - i. A push broom
  - ii. Trash grabber, broom, and/or dust pan
- J. Watering requires the following minimum equipment:
  - i. Fire hydrant wrench, backflow preventer and appurtenances (if watering off hydrant)
  - ii. Fire hydrant center compression lock
  - iii. Water tank (250 gallon minimum) and truck of sufficient capacity to support tank
  - iv. Water hose and spray nozzles
- K. Pre-emergent herbicide application requires the following minimum materials and equipment:
  - i. Herbicide
  - ii. Applicator personal protective gear as instructed by manufacturer’s specification.
  - iii. Herbicide spreader or sprayer
- L. Planting requires the following minimum materials and equipment:
  - i. Plant materials as referenced on site-specific planting plan and as requested and/or approved by CRW.
  - ii. Planting Accessories
    - 1. Stormwater soil
    - 2. Mulch
    - 3. Water
  - iii. Shovel
  - iv. Spade
  - v. Trowel
  - vi. Watering equipment
  - vii. Scissors
  - viii. Pruners
  - ix. Disposal containers
- M. Mulching requires the following minimum equipment and materials:
  - i. Mulch– Double-shredded hardwood mulch, aged 6 months to 1 year. For rain gardens, bark mulch is preferred to prevent floating. Mulch shall be maximum 2 inches in size in any dimension and be composed of no more than 30 percent fine materials. Mulch shall be free of wood chips, stones or other deleterious materials. It shall be natural in color, and dyes and postconsumer materials are not permitted.
  - ii. Pitch fork
  - iii. Push broom
  - iv. Dust pan
  - v. Rakes

### 1.3 Execution

- A. Sediment removal consists of the following tasks:
  - i. Remove accumulated sediment near stormwater inflow structures and from filter media surfaces.
  - ii. If sediment is present on plant media surfaces, separate the sediment by scraping the top 1–3 inches, being careful to not damage plants or remove the filter media.
  - iii. Collect and remove sediment using shovels, trash bags, and disposal containers as appropriate.
  - iv. Document the quantity of sediment removed using the assigned work order (sediment, organic debris, and trash quantities may be mixed and reported together).
- B. Organic debris removal consists of the following tasks:
  - i. Collect and remove organic debris within 4–5 feet within inflow structures and from filter media surfaces.
  - ii. Document the quantity of organic debris removed using the assigned work order (sediment, organic debris, and trash quantities may be mixed and reported together).
- C. Trash removal consists of the following tasks:
  - i. Collect and remove trash within 4–5 feet from stormwater inflow structures and from filter media surfaces.
  - ii. Document the quantity of trash removed using the assigned work orders (sediment, organic debris, and trash quantities may be mixed and reported together).
- D. Minor erosion repair consists of the following tasks:
  - i. Fill eroded area with material matching that of the surrounding media profile.
  - ii. Re-seed bare areas where applicable. Gently apply water immediately after installation of seed mix to wet the soil to at least 2 inch depth.
  - iii. Repair rills or gullies by filling with top soil and grading to match the surrounding surface. Stabilize with erosion control matting and then seed or sod. Gently apply water immediately after installation of seed mix to wet the soil to at least 2 inch depth.
  - iv. Install erosion control measures with manufacturer's specifications.
  - v. Document completion using the assigned work order.
- E. Minor concrete/ masonry repair consists of the following tasks:
  - i. Repair loose, or compromised concrete
    - 1. Remove loose debris or material from the repair area.
    - 2. To repair hairline crack, apply a concrete crack repair product, per the manufacturer's recommendation. To repair large/structural crack in concrete, clean out loose debris and fill the cracked area.
    - 3. Mix mortar to fill repair area and smooth joints.
  - ii. Replace or reset missing masonry parts
    - 1. Mix mortar or prepare masonry adhesive and plan placement of selected stones/bricks prior to installation.
    - 2. Place stone or brick material to match existing surface.
    - 3. Remove excess mortar or adhesive.
  - iii. Document completion using the assigned work order.
- F. Minor settling/ sinkhole repair consists of the following tasks:
  - i. Repair any sinkholes <24 inches in depth by filling with clean topsoil and compacting, stabilized with erosion control matting, and seed or sod, as necessary.
  - ii. Gently apply water immediately after installation of seed mix to wet the soil to at least 2 inch depth.
  - iii. Document completion using the assigned work order.
- G. Weeding consists of the following tasks:
  - i. Identify weeds for removal. Consult with CRW if there is uncertainty.
  - ii. If necessary, use a soil knife, shovel or spade to loosen the soil surrounding plant root mass.

- iii. Hand pull weeds when plants are big enough to grasp firmly but small enough that they are not established and/or when the soil is moist. Hand pull mature annual and tap-rooted herbaceous plants and tree seedlings.
  - iv. Remove the entire weed by gripping and pulling directly upward, ensuring the root is dislocated.
  - v. Remove the entire weed including root mass to prevent re-sprouting.
  - vi. Refill the remaining hole, regrading soil by hand or with a hand tool as needed to smooth surface.
  - vii. Document completion using the assigned work order.
- H. Cutting back vegetation consists of the following tasks:
- i. Cut back dead or diseased vegetation if present on site.
  - ii. Cut back dead flowers and seed heads to promote new flowering stalks during the growing season.
  - iii. Remove dead leaves:
    1. Cut back dead, damaged or diseased leaves to next healthy stem during the growing season.
    2. Cut back entire leaf if plant does not have stem structure.
  - iv. Pinch back plant as appropriate to encourage desired growth habit:
    1. Cut back a portion of the plant 2/3rds to 3/4ths of its full height to produce compact growth.
    2. Make all cuts above a branching point.
    3. In the Fall season, cut dead plant stems back to primary branching point to remove the majority of leaf bearing stems.
  - v. Perform renovation cutting as appropriate to encourage desired growth habit:
    1. Cut old and/or weak stems to base to promote vigorous growth on remaining stems during the growing season.
    2. Cut stalks with spent blossoms to lateral flowering branches to promote new blossoms.
    3. Cut back to base any stems having diseased leaves.
    4. Cut back grasses to maintain sight lines or to a prevent tripping hazard, cut seed heads back to the base and cut leaves to the base only as necessary, cutting no more than 1/3rd to 1/4th of the total plant.
  - vi. Cut any broken or diseased tree branches back to the nearest branching point, taking care to avoid damage to the branch collar.
    1. Never cut more than 10% of branches or the terminal leader.
  - vii. Document completion using the assigned work order.
- I. Inlet and structure grate cleaning consists of the following tasks:
- i. Hand-remove, sweep, or vacuum any debris at all grates for catch basins, domed risers, and control structures.
  - ii. For all catch basins located in the right-of-way, sweep or vacuum the surrounding area, collecting trash, sediment and/or organic debris at least 4 feet from all sides.
  - iii. Document completion using the assigned work order.
- J. Watering consists of the following tasks:
- i. Water during the watering season of April through October.
  - ii. Water plants during the first (1st) year of establishment.
  - iii. Water if there has been a period of four or more days without rain or rain less than 0.3 inches measured at the Harrisburg Capital City Airport (KCCY) as monitored by the National Weather Service (NOAA). NOAA forecast can be addressed at the following link: <https://www.weather.gov/>
  - iv. When watering, keep hoses neat to prevent tripping hazards to pedestrians.
  - v. Watering shall be a gentle spray to prevent runoff.

- vi. Water plants at a rate of 5 gallons for every 10 square foot area.
- vii. To the extent practicable, water the soil rather than the leaves to minimize water borne diseases and to conserve water.
- viii. Document completion using the assigned work order.
- K. Pre-emergent herbicide application consists of the following tasks:
  - i. Prepare and apply herbicide solution as per manufacturer's specifications, following manufacturer and safety specifications.
    - 1. Do not perform chemical vegetation control during periods of dry weather (not within 24 hours or a prior of expected rain event)
    - 2. Chemical vegetation control should be performed in weather conditions with little or no wind to prevent damage to adjacent desired plants.
  - ii. Apply during early spring before mulch installation, late summer or early fall; or immediately following cultivation
  - iii. Apply in granular form using a small handheld spreader. Water the granules after spreading. Apply liquid form using a hand-held or backpack sprayer.
  - iv. Apply evenly to bare soil, avoiding any areas seeded with non-weed species.
  - v. Document completion using the assigned work order.
- L. Planting herbaceous species consists of the following tasks:
  - i. Ensure new plant material meets the requirements of the original contract specifications, including size, root condition, health, form and appearance. Substandard, injured or undersized plant materials are not acceptable.
  - ii. Temporarily store herbaceous vegetation in a shaded area during replanting. Keep the roots moist and do not let them dry out.
  - iii. Plant herbaceous plants within the appropriate planting season.
    - 1. Spring (April 15th to May 30th)
    - 2. Late summer/ early fall (September 15th to October 31st)
  - iv. Ensure that adjacent vegetation is not damaged by planting operations. If adjacent vegetation is damaged, prune or remove any portion of existing vegetation that may have been damaged.
  - v. Ensure that all plant materials are planted with the basal branching point or crown of plant material set level with the prevailing grade.
  - vi. Compact the planting soil firmly around the rootballs to create good soil contact, free of voids and large air pockets.
  - vii. Apply or supplement mulch to maintain 2 inch total depth around replanted vegetation.
  - viii. Water plants thoroughly after installation, per specifications– Watering.
  - ix. Document completion using the assigned work order.
- M. Planting shrubs consists of the following tasks:
  - i. Ensure new plant material meets the requirements of the original contract specifications, including size, root condition, health, form and appearance. Substandard, injured or undersized plant materials are not acceptable.
  - ii. Temporarily store herbaceous vegetation in a shaded area during replanting. Keep the roots moist and do not let them dry out.
  - iii. Planting Seasons – Plant shrubs within the appropriate planting season.
    - 1. Deciduous Shrubs
      - a. Spring (March 15th to May 30th)
      - b. Late summer/ early fall (September 15th to October 31th)
    - 2. Evergreen Shrubs
      - a. Spring (April 15th to May 30th)
      - b. Fall (September 15th to October 31st)
  - iv. Ensure that adjacent vegetation is not damaged by planting operations. Prune or remove any portion of existing vegetation that may have been damaged.



- v. Dig a planting hole that is two times wider than the diameter of the root balls. Rough up the side of the planting holes if the surfaces are slick and compacted.
  - vi. Ensure the shrubs planted with the trunk or basal branching point of the shrubs are set level with the prevailing grade.
  - vii. Compact the planting soil firmly around the rootballs to create good soil contact, free from voids and large air pockets.
  - viii. Apply 2 inches of mulch around the planted shrub according to mulching detail in 'Mulch' specification, ensuring that mulch material is kept 2 inches away from the base of vegetation.
  - ix. Water the shrubs thoroughly after installation.
  - x. Document completion using the assigned work order.
- N. Mulch application consists of the following tasks:
- i. Mulch replacement will typically be timed to coincide with dormancy period of installed plants, and before the emergence of cool season weeds, preferably early spring from mid-March to mid-April. Seek approval for replacement mulching outside of the mulching timeframe.
    - 1. To remove existing layer of mulch, use rakes and shovels, and dispose of the waste material at an approved location.
    - 2. Do not damage existing vegetation when mulching.
  - ii. Mulch contiguous planted areas:
    - 1. Lay down at a uniform mulch depth of 2 inches over the planted area.
    - 2. Do not mulch at or over the base of shrubs, trees, and crowns of perennials and grasses. Maintain 2 inches of clearance at the base of trees and shrubs, and crown of plants.
  - iii. Mulch trees and shrubs in turf areas:
    - 1. Apply mulch ring of 2 inches uniform thickness, with a 3-foot radius around trunks or stems. Do not place mulch within 2 inches of trunks or stems.
  - iv. Document completion using the assigned work order.
- O. Stormwater soil replacement consists of the following tasks:
- i. Remove any residual waste material at the location designed for stormwater soil replacement as directed by CRW. Personnel may be required to temporarily salvage and stockpile existing vegetation that may be affected by the soil replacement operations. Coordinate with CRW for planting restoration. If utilities are in the area of soil replacement, exercise caution, performing excavation, placement and grading activities manually.
  - ii. Replacement soil must meet the product requirements of the original contract specifications, or the most current specifications approved by CRW.
    - 1. Place soil in horizontal lifts not exceeding 12 inches per lift until the specified soil depth is achieved. Install the lifts for the entire area footprint of the planting or stormwater area.
    - 2. Scarify the surface area of each lift by raking immediately prior to placing the next lift.
    - 3. Overfill by 10–15%, or as needed to allow for settlement of the soil.
  - iii. To encourage settling of stormwater and planting soil, saturate the entire footprint of the GSI area after each lift of soil is placed. The required degree of saturation of each lift shall be field verified by the Engineer prior to moving to the next lift. Grade the final soil surface with hand tools.
    - 1. Do not mechanically compact stormwater soil. Apply water for saturation by spraying or sprinkling through an energy dispersion device. Notify CRW when lifts will be saturated. Treat any sediment-laden water discharged from the system with an appropriate sediment-control device.

- iv. Scarify the top of each lift prior to adding more stormwater soil. Provide adequate equipment to achieve consistent and uniform compaction of the soil. Use the smallest equipment that can reasonably perform the task of spreading and compaction.
- v. Do not over-compact the placed stormwater soil. Limit motorized equipment access over placed soil. CRW shall approve placed and compacted stormwater soil before fine grading.
- vi. Fine grade:
  - 1. CRW shall approve all rough grading prior to fine grading.
  - 2. Utilize hand equipment to grade the finish surface of all planted areas to meet the grades shown on the Drawings and to provide positive drainage.
- vii. Document completion using the assigned work order.

P. Waste disposal consists of the following tasks:

- i. Debris removed from the site will be disposed of at City waste facilities. Collect the material removed during the maintenance operation in applicable waste storage container (e.g., traps, bins).
- ii. Dispose of the waste material as directed by disposal site.

Q. Reporting of non-maintenance site issues consists of the following tasks:

- i. Immediately secure the site when safety hazards (e.g. large sinkholes, widespread sealing) are observed and contact the appropriate expert or individual listed in Appendix D—Contacts.

## PART 2: SUBSURFACE MAINTENANCE

### 2.1 Personnel

- A. All subsurface maintenance tasks require the following minimum personnel (refer to Part 4—Personnel Classification for descriptions of each personnel classification):
  - i. Functional Unit: GSI O&M Inspector – Subsurface
    - 1. CCTV Inspector (1)
  - ii. Functional Unit: Pipe and Inlet Cleaning Crew
    - 1. Jetter Vacuum Operator (1)
    - 2. Jetter Vacuum Technician (1)

### 2.2 Materials & Equipment

- A. All subsurface maintenance requires the following minimum equipment:
  - i. Traffic cones (4)
  - ii. Safety and duct tape
  - iii. Assorted screwdrivers, socket wrenches, and Allen wrenches
  - iv. Manhole hooks
  - v. Contractor bags
  - vi. Chisel and mallet
  - vii. Push broom
  - viii. Hydrant key/wrench
  - ix. Pliers, adjustable wrenches, vice grips
  - x. Personal protective equipment
  - xi. Confined space entry harness, tripod, and air monitor as per OSHA standard 29 CR 1910.146
  - xii. Flashlight
- B. Inlet, pipe, and chamber cleaning requires the following minimum equipment:
  - i. Jet cleaning/vacuuming (jet/vac) truck with hose reel with up to 600 feet of 1 inch jetter hose capacity, Water pump with flow of 80 gallons per minute (gpm) at 2,000 pounds per square inch (psi), vacuum flow of 2,600 cubic feet per minute (cfm), vacuum lift of 22 inches of mercury (HG), 8 cubic yard debris tank with strainer and decanting valve, and 1,500 gallon integrated water tank
  - ii. 200 feet of vacuum tubes ranging from 4–8 inches.
  - iii. 300 feet of 3/8 inch jetter hose
  - iv. 300 feet of 5/8 inch jetter hose
  - v. 600 feet of 1 inch jetter hose
  - vi. Flexible hose guard
  - vii. Flushing, rotating, and penetrating nozzles
  - viii. High-velocity water gun or air lance and associated hose
  - ix. Silt sock
  - x. All purpose rags
- C. Postmaintenance pipe inspection requires the following minimum equipment:
  - i. Self-leveling CCTV push camera with 200 foot reel
  - ii. CCTV push camera housing units (skids)
  - iii. CCTV crawler camera (for pipes >12 inch diameter)
  - iv. Rugged laptop computer equipped with video coding software
  - v. Digital camera
  - vi. Measuring tape
  - vii. Measuring wheel

### 2.3 Execution

- A. Inlet, pipe and chamber cleaning for the combined sewer region consists of the tasks. [For locations in the MS4 region, additional precautions (such as dechlorination of jetting water) may be required as indicated by CRW]:
- i. For pre-treatment device(s):
    1. Remove trash, sediment, and organic debris from the pretreatment device(s).
      - a. If not permanently attached to the structure, remove the pretreatment device.
      - b. If removing by hand, remove enough material from the device to achieve a liftable weight (based on subsurface maintenance personnel judgment). Once re-moved, invert and shake or gently tap the device and pressure-wash device with water or hand-clean using wire brush or stiff nylon brush until clean.
      - c. If performed prior to vacuum cleaning structure, trash, sediment and/or organic debris from the pretreatment device may be emptied or washed back into the structure.
      - d. Loosen compacted sediment on structure with high- velocity water gun or air lance while vacuuming, removing all trash, sediment and/or organic debris down to the sump.
  - ii. For systems with distribution and/or underdrain piping:
    1. Select one of the following types of jetter nozzles:
      - a. Rotating nozzle– can have forward- and/ or rear-facing jets. A component of these nozzles rotates, providing lateral cleaning. These nozzles are effective at removing roots as well as debris from pipe walls.
      - b. Penetrating nozzle– has both forward and rear-facing jets. The forward-facing jets helps loosen large blockages.
      - c. Flushing nozzle– has rear-facing jets and is used to clean lines that do not have large blockages.
    2. If material to be cleaned is known, select appropriate nozzle; if not, initially use a penetrating type nozzle until material is determined.
    3. Before installing nozzle, always run water through the hose for a short period of time until the water runs clear.
  - iii. Jet clean pipe(s) through selected access structure:
    1. Insert vacuum tube into the structure from which pipe will be accessed, and vacuum waste material throughout jet- cleaning procedure.
      - a. Insert jetter hose into the pipe through the flexible hose guard.
      - b. Insert flexible hose guard in the pipe to guide the jetter hose and prevent wear from friction.
    2. Start high-pressure pump after ensuring the nozzle is fully inserted into the pipe.
    3. Jet clean pipe by moving trash, sediment and/or organic debris toward the access point for vacuuming. Perform as many passes as necessary to clean the pipe.
      - a. During jet cleaning, keep the nozzle moving and the water pump operating to prevent damage to pipe.
      - b. Stop maintenance immediately if indications of structural damage or failure are observed (e.g., infiltration bed stone, soil, or pieces of pipe are removed during jet cleaning) Report observation to owner/operator immediately.
      - c. Jet clean conveyance pipe until flowback water runs clear.
      - d. If pipe cannot be cleaned successfully using initial equipment and techniques, attempt cleaning with different equipment (e.g., other

- combinations of jetter hose diameter, nozzles, and/or pressure) or from alternative access points.
- e. If water remains in the pipe, obstructing the post- maintenance inspection, refer to “Troubleshooting” section below.
  - f. After cleaning, for structures that connect to the combined sewer, fill inlet with water up to the top of the trap opening.
  - g. Inspect structure to ensure all traps are closed and pretreatment devices/screens are latched and/or correctly installed prior to closing access points.
- iv. Troubleshooting:
1. If the jetter hose gets stuck or cannot maneuver pipe bends:
    - a. Decrease pressure and/or reduce jetter hose diameter to maneuver jetter through sharp bends or bends in close proximity (i.e., less than 5 feet apart).
    - b. If the nozzle becomes trapped in the pipe, shut off water supply and attempt to pull it back with the hose reel. If this does not work, turn on the water supply, send the nozzle to the upstream manhole for removal, and then pull back the jetter hose with the hose reel.
    - c. If pipes cannot be accessed via larger structures, cleanouts may be used to access pipes. The following steps and considerations may be necessary:
      - i. Attempt to jet the pipe through the cleanout.
      - ii. Insert a flexible vacuum hose, with a diameter only slightly smaller than access structure, into cleanout, sealing the area around the hose to maximize suction power.
      - iii. Cut a small window into the side of the vacuum hose and insert the jetter hose into the opening.
      - iv. Jet and vacuum the pipe.
  2. If jet cleaning through the cleanout does not successfully clean the pipe, flush the pipe.
    - i. Flush conveyance pipe using a jetter hose and no nozzle to loosen and push deposits and large debris to the downstream access point.
  3. Large quantities of debris:
    - i. If pipe has large quantities of debris, is longer than 200 feet, and/or must be jet cleaned from an upstream access point, perform multiple short passes that remove trash, sediment and/or organic debris in sections starting closest to the access point.
  4. Significant point blockages:
    - i. Select an appropriate penetrating nozzle.
    - ii. If nozzle will not move forward, pull back a few feet and let go to sling-shot against the blockage. This pulsating action on nozzle must be used only for extremely heavy blockages.
    - iii. Once the blockage has been removed, shut down the pressure, wait until flow subsides, and then make a couple of passes to ensure the pipe is free of blockages.
    - iv. Change the nozzle as needed, and re-clean the pipe where blockage was first identified.
- v. Roots:
1. If significant roots are present within the pipe, utilize a rotating nozzle.
  2. Exercise caution to avoid entangling the nozzle in roots. When removing the nozzle, pull slowly and gently on the hose. Do not yank or jerk the hose if nozzle does become entangled, as this could compromise the structural integrity of the pipe.

3. Attempt to move the nozzle slowly and carefully through the section of pipe that has roots.
  - vi. If a significant amount of water remains in the pipe after maintenance:
    1. Insert the vacuum hose at the most downstream access point, if possible.
    2. Seal other access points to maximize suction.
    3. Vacuum conveyance pipe until it is dewatered.
  - vii. Maintenance of proprietary subsurface storage chambers with maintenance port(s):
    1. Subsurface storage chambers with maintenance port(s) may also include distribution and underdrain piping, inlets, control structures, weirs, sumps, and similar components, which must be maintained.
      - a. Plug the outlet control structure to contain waste water within storage chamber.
      - b. Insert vacuum tube into the outlet control structure, if applicable, or the most downstream access point.
      - c. Open maintenance port.
      - d. To suspend any sediment or debris, pump water (at a high flow rate using a fire hydrant or jetter hose) through maintenance port until water level in the system is at least 1 inch, or as specified by manufacturer's guidelines.
      - e. Close maintenance port.
      - f. Repeat for all available maintenance ports.
      - g. Remove plug from outlet control structure.
      - h. Vacuum all waste water from outlet control structure or most downstream maintenance port.
      - i. Inspect the area to verify that subsurface storage unit is free of trash, sediment and/or organic debris.
      - j. If subsurface storage unit is not free of trash, sediment and/or organic debris, then repeat flushing procedures.
  - viii. Document completion using the assigned work order.
- B. Postmaintenance pipe inspection consists of the following tasks:
- i. For GSI systems with a stone bed and distribution and/or underdrain piping:
  - ii. If pretreatment device(s) is present:
    1. Perform a visual condition inspection and report tears, clogged fabric or missing components to the owner/operator.
  - iii. Complete a postmaintenance inspection of pipes.
    1. The type of closed-circuit television (CCTV) camera required will depend on pipe size, length, and presence of bends in the pipe network.
      - a. Position CCTV camera in center of pipe at access point. If possible, attempt access through a cleanout or riser before attempting access through other structures such as an inlet, control structure, or manhole.
      - b. Ensure the lighting is adequate to illuminate the pipe. Avoid excessive lighting as it can result in the flaring of the image or misrepresent defects.
      - c. Ensure color and video display correctly reflects the true colors of the pipe. Camera settings must follow manufacturer's recommendations to ensure proper identification and documentation.
      - d. Move camera at a steady pace not to exceed 30 feet per minute from entry point to the intended end point by pushing manually or re-motely steering.
      - e. Stop the camera if structural or construction defects are observed. Re-position camera to better view the defect(s) and capture still shots if possible.

- f. At the completion of the inspection, retract the camera to the entry point, recording the CCTV data.
  - g. Remove the camera from the pipe.
  - h. Close and secure any access points that were used for pre-maintenance inspection that will not be used for jetting. Clean and grease the bolts.
  - i. Code defects observed in CCTV camera inspections using the National Association of Sewer Service Companies (NASSCO) Pipeline Assessment Certification Program Manual (PACP) (Version 7.0 or later) and PACP partner software.
- iv. Document completion using the assigned work order.
- C. Waste disposal consists of the following tasks:
- i. Debris removed from the site will be disposed of at City waste facilities. Collect the material removed during the maintenance operation in applicable waste storage container (e.g., traps, bins, vacuum/jetter truck storage).
  - ii. Dispose of the waste material as directed by disposal site.
- D. Reporting of non-maintenance site issues consists of the following tasks:
- i. Immediately secure the site when safety hazards (e.g. large sinkholes, widespread sealing) are observed and contact the appropriate expert or individual listed in Appendix D—Contacts.

## PART 3: PERMEABLE PAVEMENT MAINTENANCE

### 3.1 Personnel

- A. All permeable pavement maintenance tasks require the following minimum personnel (refer to Part 4— Personnel Classification for descriptions of each personnel classification):
  - i. Functional Unit: Permeable Pavement Cleaning Crew
    - 1. Street Sweeping Operator (1)
    - 2. Street Sweeping Technician (1)

### 3.2 Materials & Equipment

- A. Vacuum sweeping requires the following minimum materials and equipment:
  - i. For parking areas, recreational courts, and roadways: Regenerative air sweeper with a minimum sweeping width of 78 inches, storage hopper capacity of 2 cubic yards, dust separator, system pressure of 3500 psi, and hydraulic system capacity of 5 gpm.
  - ii. Personal protective equipment
  - iii. Contractor bags
  - iv. Shovel, spades and/or push broom to remove trash, sediment and/or debris
  - v. Water hose and spray nozzle
  - vi. Traffic Cones
  - vii. Water meter

### 3.3 Execution

- A. Vacuum sweeping consists of the following tasks:
  - i. Manually remove large trash, sediment and/or organic debris.
  - ii. Clean pervious pavement using approved regenerative air sweeper.
  - iii. Sweep the entire surface of the permeable pavement moving at a controlled speed. Use water as needed for dust control.
    - 1. For permeable pavement with loose joint fill material: The level of suction delivered to the sweeper head can be regulated to minimize the amount of joint material removed from between pavers with controls on the vacuum sweeper. The blower velocity can be regulated with the sweeper engine throttle. Lower RPMs will generate less suction at the sweeper head. Adjusting the bleeder door opening will also create less suction at the paver surface at higher engine speeds while allowing increased air flow to move lighter materials such as leaves to be pulled into the collection hopper.
  - iv. Re-sweep the surface until all visible material is removed from the surface of the pervious pavement.
    - 1. For permeable pavement with loose joint fill material: Supplement/ replace joint fill material as needed.
  - v. Use a vacuum attachment as needed for any corners or difficult to access sections.
  - vi. Refer to Inlet/ Pipe Waste Disposal to remove sediment, trash and/or organic debris.
  - vii. Document completion using the assigned work order.
- B. Waste disposal consists of the following tasks:
  - i. Debris removed from the site will be disposed of at City waste facilities. Collect the material removed during the maintenance operation in applicable waste storage container (e.g., traps, bins, truck tank storage).
  - ii. Dispose of the waste material as directed by disposal site.
- C. Reporting of non-maintenance site issues consists of the following tasks:
  - i. Immediately secure the site when safety hazards (e.g. large sinkholes, widespread sealing) are observed and contact the appropriate expert or individual listed in Appendix D— Contacts.



**PART 4: PERSONNEL CLASSIFICATION**

- A. Functional Unit: GSI O&M Inspector – Landscape
  - i. Green Stormwater Infrastructure Inspector
    1. Conducts visual assessments of vegetative and structural components during routine inspections.
    2. Experienced with vegetation identification and health assessment, and GI maintenance requirements.
- B. Functional Unit: Landscape Maintenance Contractor
  - i. Green Stormwater Infrastructure Maintenance Foreman
    1. Manages GSI maintenance laborers and assures that they perform routine landscape maintenance of GSI effectively.
    2. Understands the functionality of different types of GSI ensures and the role they play in a combined sewer system.
    3. Understands how to use Cityworks to find work order requests and fulfill work orders while performing maintenance.
    4. Is familiar with vegetation identification and health assessment, experienced in landscape care, and is able to provide GSI maintenance services to ensure the system performs as intended.
    5. Is working under the oversight of a PA commercial certified pesticide applicator.
  - ii. Green Stormwater Infrastructure Maintenance Laborer
    1. Understands the functionality of different types of GSI assets and the role they play in a combined sewer system.
    2. Understands the fundamentals of landscape care and provides GSI maintenance services to ensure the system performs as intended.
- C. Functional Unit: GSI O&M Inspector – Subsurface
  - i. CCTV Inspector
    1. Experienced with the inspection and maintenance of storm sewer systems, operation of CCTV equipment, and is certified under the NASSCO pipeline assessment certification program (PACP).
    2. Conducts remote assessments of subsurface infrastructure such as pipes, inlets, and riser structures and codes any identified defects according to the NASSCO guidelines.
    3. Familiar with traffic control and certified in OSHA confined space entry.
- D. Functional Unit: Pipe and Inlet Cleaning Crew
  - i. Jetter Vacuum Operator
  - ii. Jetter Vacuum Technician
- E. Functional Unit: Permeable Pavement Cleaning Crew
  - i. Street Sweeping Operator
    1. Experienced with the operation of regenerative air sweepers and maintenance requirements for various types for porous pavement and permeable pavers.
  - ii. Street Sweeping Technician
    1. Is familiar with the use of regenerative air sweepers and maintenance requirements for various types for porous pavement and permeable pavers.
- F. Functional Unit: Pipe and Inlet Cleaning Crew
  - i. Jetter Vacuum Operator
    1. Experienced with the maintenance of storm sewer systems and the operation of vacuuming and jetting equipment.
    2. Understands the functionality of different types of GSI assets and the role they play in a combined sewer system.
    3. Is familiar with traffic control and OSHA confined space entry.
  - ii. Jetter Vacuum Technician
    1. Is able to perform the maintenance of storm sewer systems and GSI assets using vacuuming and jetting equipment.
    2. Is familiar with traffic control and OSHA confined space entry.



APPENDIX

B

**INSPECTION WORK  
ORDER FORMS**

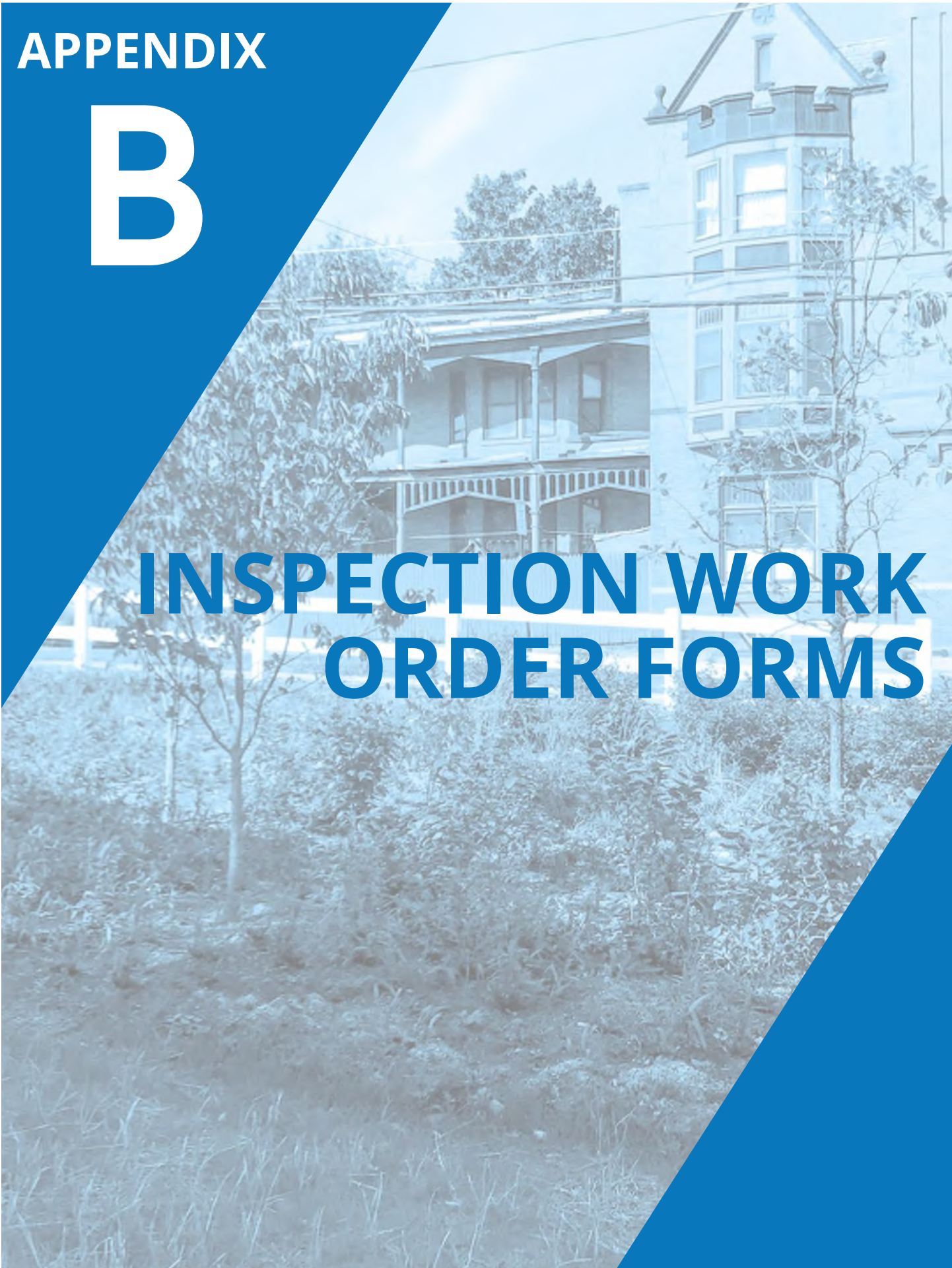

The following Inspection Work Order Forms can be found within Appendix B:

- Subsurface CCTV Premaintenance Inspection Work Order
- Subsurface CCTV Postmaintenance Inspection Work Order
- Surface Inspection Work Order
- Hydraulic Testing Work Order

## SUBSURFACE CCTV PREMAINTENANCE INSPECTION WORK ORDER

**General**

GSI Pipe Run ID: \_\_\_\_\_

Date/Time: \_\_\_\_\_

Inspector: \_\_\_\_\_

Maximum % Occlusion of  
Cross-sectional Pipe Area: \_\_\_\_\_

Sediment Depth in Chamber: \_\_\_\_\_

Camera Equipment Used:                      Push Camera              Crawler Camera              Not Used

Other \_\_\_\_\_

**Tasks (check all that apply)**

**Maintenance Needs**

Pipe Maintenance Needed                     

Inlet Maintenance Needed                     

Chamber Maintenance Needed                     

Corrective Maintenance Needed                     

Comments:

## SUBSURFACE CCTV POSTMAINTENANCE INSPECTION WORK ORDER

General

GSI Pipe Run ID:

\_\_\_\_\_

Date/Time:

\_\_\_\_\_

Inspector:

\_\_\_\_\_

Maximum % Occlusion of Cross-sectional Pipe Area:

\_\_\_\_\_

Sediment Depth in Chamber:

\_\_\_\_\_

Camera Equipment Used:

Push Camera

Crawler Camera

Not Used

Other

\_\_\_\_\_

Defect Log Reference Number

\_\_\_\_\_

Number of Structural Defects Observed

\_\_\_\_\_

Corrective Maintenance Needed

Yes

No

Comments:

## SURFACE INSPECTION WORK ORDER

(Page 1 of 2)

	Surface Inspection Type:	<i>Safety</i>	<i>Limited Functional</i>	<i>Extended Functional</i>
<b>General</b>	GSI SCM ID:	_____		
	Inspection Date/Time:	_____		
	Inspector:	_____		
	Photo points taken	<input type="checkbox"/> Yes	<input type="checkbox"/> No	

Safety Issues Present	<input type="checkbox"/> Yes	<input type="checkbox"/> No
Description of Safety Problem: _____		

<b>Safety</b>	Steps Taken to Address Safety Problem:			
	<i>Placed cones</i>	<i>Placed caution tape</i>	<i>Corrected problem (explain)</i>	
	<i>Other (explain)</i> _____			
	Corrective Action Mobilization Timeframe:			
	<i>Immediate</i>	<i>24-72 hours</i>	<i>As feasible</i>	<i>None needed</i>

<b>Condition Assessment</b>	Overall Aesthetic Condition Score <sup>1</sup>	1	2	3	
	Overall Functional Condition Score <sup>1</sup>	1	2	3	
	Overall Vegetation Condition Score <sup>1</sup>	1	2	3	4
	Vegetation Total Cover (%) _____	Invasive Vegetation Total Cover (%) _____			
	Invasive Vegetation Species Observed: _____				

<sup>1</sup> See Scoring Rubric on Page 2

<b><u>Tasks (check all that apply)</u></b>				
<b>Maintenance Needs</b>	Sediment Removal	<input type="checkbox"/>	Weeding	<input type="checkbox"/>
	Organic Debris Removal	<input type="checkbox"/>	Pre-emergent Herbicide Application	<input type="checkbox"/>
	Trash Removal	<input type="checkbox"/>	Cutting Back Vegetation	<input type="checkbox"/>
	Inlet and Structure Grate Cleaning	<input type="checkbox"/>	Planting Herbaceous Vegetation	<input type="checkbox"/>
	Minor Erosion Repair	<input type="checkbox"/>	Planting Shrubs	<input type="checkbox"/>
	Minor Concrete/Masonry Repair	<input type="checkbox"/>	Mulch Application	<input type="checkbox"/>
	Minor Settling/Sinkhole Repair	<input type="checkbox"/>	Stormwater Soil Replacement	<input type="checkbox"/>
	Corrective Maintenance	<input type="checkbox"/>	Watering	<input type="checkbox"/>

<b>Comments</b>	_____
	_____
	_____

## SURFACE INSPECTION WORK ORDER

(Page 2 of 2)

## Scoring Rubrics

<b>Rubric</b>	<b>Score</b>	<b>Condition</b>
<b>Functional Score</b>	1	System function appears to be consistent with design intent. No erosion, settling and/or areas of standing water more than 72 hours after a rainfall event (indicating possible loss of infiltration or storage volume) are observed.
	2	System function appears overall to be consistent with design intent. Limited erosion (<20 sf), settling, and/or areas of standing water more than 72 hours after a rainfall event (indicating possible loss of infiltration or storage volume) are observed.
	3	System function appears to not be consistent with design intent. Significant erosion, settling, and/or areas of standing water more than 72 hours after a rainfall event (indicating possible loss of infiltration or storage volume) are observed.
<b>Vegetation Condition Score</b>	1	Most plants (85% or more) are healthy: they have normal development (shape, form, color, etc.) for their species, season and time since installation and no diseases or pest damage are observed.
	2	Many plants (50 to 85%) are healthy: they have normal development (shape, form, color, etc.) for their species, season and time since installation, and/or only a few plants have diseases or pest damage. <i>Note: diseases or pest species that spread rapidly must be treated before a serious outbreak occurs.</i>
	3	A significant number (30 - 50%) of plants are unhealthy: they do not have normal development (shape, form, color, etc.) for their species, season and time since installation, and/or many have diseases or pest damage.
	4	The majority of plants (more than 85%) are dying, dead or missing.
<b>Aesthetic Score</b>	1	The appearance of the system is excellent. It is neat and clean, and no damage is observed. Plants, if any, have a vegetation condition score of 1.
	2	The appearance of the system is good. It is generally clean with minimal trash, debris, or damage. Plants, if any, have a vegetation condition score of 2 or better.
	3	The appearance of the system is unacceptable. There is a significant amount of trash, debris, and/or damage. Plants, if any, have a vegetation condition score of 3 or worse.



## HYDRAULIC TESTING WORK ORDER

GSI SCM ID: \_\_\_\_\_

Inspector: \_\_\_\_\_

Infiltration Test Date/Time: \_\_\_\_\_

Infiltration Test Type (circle):

Hydrant Test

Modified Borehole Percolation

Double Ring Infiltrometer

Borehole Infiltration Direct Push Casing

Borehole Infiltration Bentonite Casing

Infiltration Boring Depth (ft): \_\_\_\_\_

Measured Infiltration Rate (in/hr): \_\_\_\_\_

Draw Down Time: \_\_\_\_\_

Comments:



APPENDIX

C

**MAINTENANCE  
WORK ORDER  
FORMS**

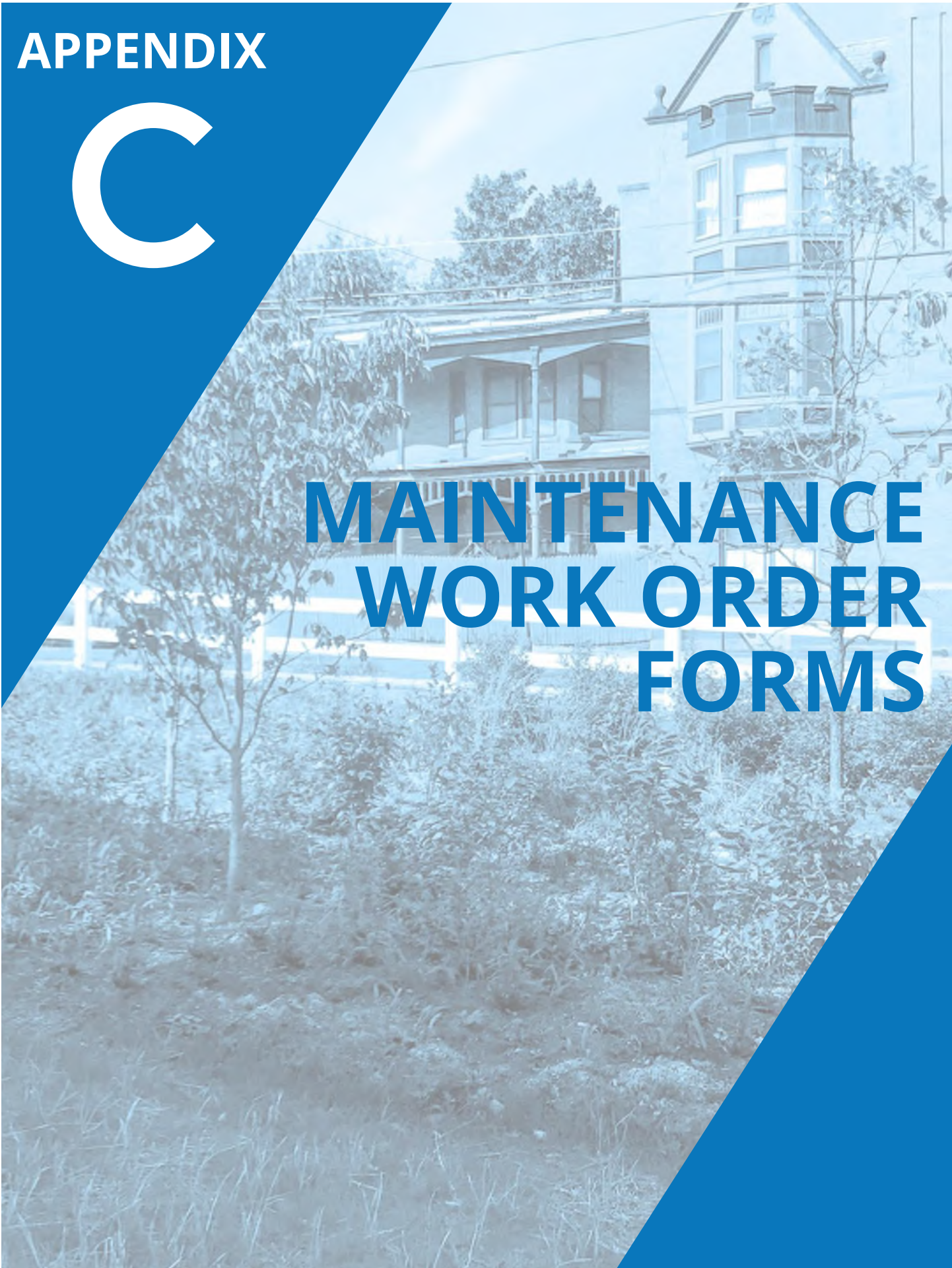

The following Maintenance Work Order Forms can be found within Appendix C:

- Corrective Maintenance Work Order
- Permeable Pavement—Maintenance Work Order
- Surface—Maintenance Work Order
- Subsurface—Maintenance Work Order
- Watering Work Order



## PERMEABLE PAVEMENT—MAINTENANCE WORK ORDER

Associated Inspection Work Order ID: \_\_\_\_\_

Inspection Comments: \_\_\_\_\_

**General**

GSI SCM ID: \_\_\_\_\_

Crew ID: \_\_\_\_\_

Start Date: \_\_\_\_\_ End Date: \_\_\_\_\_

Start Time: \_\_\_\_\_ End Time: \_\_\_\_\_

**Tasks (circle all that apply)**

**Maintenance Completed**

Surface Vacuuming	Yes	No	NA
Sediment Removal (Manual)	Yes	No	NA
<i>Quantity of Sediment Removed (cf)</i> _____			
Organic Debris Removal (Manual)	Yes	No	NA
<i>Quantity of Organic Debris Removed (cf)</i> _____			
Trash Removal (Manual)	Yes	No	NA
<i>Quantity of Trash Removed (cf)</i> _____			
Minor Concrete/Masonry Repair	Yes	No	NA
Minor Settling/Sinkhole Repair	Yes	No	NA
Inlet and Grate Cleaning	Yes	No	NA
Maintenance Complete?	Yes	No	

**Items (check all that apply)**

**Equipment**

Regenerative Air Vacuum Sweeper Truck	<input type="checkbox"/>	
Traditional Sweeper Truck	<input type="checkbox"/>	
Jet/Vac Truck with Attachments	<input type="checkbox"/>	
Other (Describe)	<input type="checkbox"/>	_____

**Materials**

<b><u>Items</u></b>	<b><u>Unit</u></b>	<b><u>Type/Quantity</u></b>
Contractor Bags	ea	

**Comments**

\_\_\_\_\_

\_\_\_\_\_

\_\_\_\_\_

\_\_\_\_\_

*CREW IS RESPONSIBLE FOR REPORTING ANY NONROUTINE MAINTENANCE SITE ISSUES TO CRW*

## SURFACE—MAINTENANCE WORK ORDER

(Page 1 of 2)

Associated Inspection Work Order ID: \_\_\_\_\_

Inspection Comments: \_\_\_\_\_

GSI SCM ID: \_\_\_\_\_

Crew ID: \_\_\_\_\_

Start Date: \_\_\_\_\_ End Date: \_\_\_\_\_

Start Time: \_\_\_\_\_ End Time: \_\_\_\_\_

Photo points taken  Yes  No

### Tasks (circle all that apply)

**Maintenance Checklist**

Sediment Removal	Yes	No	NA
<i>Quantity of sediment removed (cf)</i>	_____		
Organic Debris Removal	Yes	No	NA
<i>Quantity of organic debris removed (cf)</i>	_____		
Trash Removal	Yes	No	NA
<i>Quantity of trash removed (cf)</i>	_____		
Minor Erosion Repair	Yes	No	NA
Minor Concrete/Masonry Repair	Yes	No	NA
Minor Settling/Sinkhole Repair	Yes	No	NA
Weeding	Yes	No	NA
Cutting Back Vegetation	Yes	No	NA
Inlet and Structure Grate Cleaning	Yes	No	NA
Pre-emergent Herbicide Application	Yes	No	NA
Planting Herbaceous Vegetation	Yes	No	NA
Planting Shrubs	Yes	No	NA
Mulch Application	Yes	No	NA

*CREW IS RESPONSIBLE FOR REPORTING ANY NONROUTINE MAINTENANCE SITE ISSUES TO CRW*

## SURFACE—MAINTENANCE WORK ORDER

(Page 2 of 2)

	<u>Items</u>	<u>Unit</u>	<u>Quantity</u>
Materials	Contractor trash bags	ea	_____
	Erosion blanket (NAG C125BN or approved equal)	sf	_____
	Landscape fabric staples 8" (box)	ea	_____
	Topsoil	cy	_____
	Grass seed	lb	_____
	Concrete or mortar mix	qt	_____
	Water	gal	_____
	Clean fill material	ton	_____
	Mulch	cy	_____
	Arbor Tie™ or twine	lf	_____
	Herbicide (Granular)	lb	_____
	Herbicide (Liquid)	gal	_____
	Herbaceous plant materials		
	Plug	ea	_____
	1-2 quart container	ea	_____
	1 gallon container	ea	_____
	Shrub plant materials		
	1 gallon container	ea	_____
	2 gallon container	ea	_____
	3 gallon container	ea	_____
5 gallon container	ea	_____	
Stormwater soil	cy	_____	

**General Comments:**

---



---



---



---

*CREW IS RESPONSIBLE FOR REPORTING ANY NONROUTINE MAINTENANCE SITE ISSUES TO CRW*



## SUBSURFACE—MAINTENANCE WORK ORDER

(Page 1 of 2)

**General**

Associated Inspection Work Order ID: \_\_\_\_\_

Inspection Comments: \_\_\_\_\_

\_\_\_\_\_

\_\_\_\_\_

GSI Pipe Run ID: \_\_\_\_\_

Crew ID: \_\_\_\_\_

Start Date: \_\_\_\_\_ End Date: \_\_\_\_\_

Start Time: \_\_\_\_\_ End Time: \_\_\_\_\_

### Tasks (circle/check all that apply)

**Maintenance Checklist**

Cleaned Pipe(s) Yes No NA

Cleaned Inlet(s) Yes No NA

Cleaned GSI Structure ID 1  Cleaned Gray Inlet Asset ID 1

Cleaned GSI Structure ID 2  Cleaned Gray Inlet Asset ID 2

Cleaned GSI Structure ID 3  Cleaned Gray Inlet Asset ID 3

Cleaned GSI Structure ID 4  Cleaned Gray Inlet Asset ID 4

Clean Chamber(s) Yes No NA

Camera Equipment Used: Push Camera Crawler Camera Not Used

Other: \_\_\_\_\_

Comments: \_\_\_\_\_

\_\_\_\_\_

\_\_\_\_\_

*CREW IS RESPONSIBLE FOR REPORTING ANY NONROUTINE MAINTENANCE SITE ISSUES TO CRW*

## SUBSURFACE—MAINTENANCE WORK ORDER

(Page 2 of 2)

**Items (check all that apply)**

<b>Equipment</b>	CCTV Push Camera	<input type="checkbox"/>
	CCTV Crawler Camera	<input type="checkbox"/>
	Jet/Vac Truck	<input type="checkbox"/>
	Other (Describe)	<input type="checkbox"/>

	<b><u>Items</u></b>	<b><u>Unit</u></b>	<b><u>Type/Quantity</u></b>
<b>Materials</b>	Contractor Bags	ea	
	Silt Sock	ea	

**Notes/Comments**

<b>Postmaintenance Inspection</b>	Maximum % Occlusion of Cross-sectional Pipe Area:	_____
	Sediment Depth in Chamber:	_____
	Inspection Equipment Used:	_____
	Defect Log Reference Number:	_____
	Number of Structural Defects Observed:	_____
	Corrective Maintenance Needed:	_____
	Comments:	_____ _____ _____

*CREW IS RESPONSIBLE FOR REPORTING ANY NONROUTINE MAINTENANCE SITE ISSUES TO CRW*

## WATERING WORK ORDER

Associated Inspection Work Order ID: \_\_\_\_\_

Inspection Comments: \_\_\_\_\_

\_\_\_\_\_

\_\_\_\_\_

GSI SCM ID: \_\_\_\_\_

Crew ID: \_\_\_\_\_

Start Date: \_\_\_\_\_

End Date: \_\_\_\_\_

Start Watering Time: \_\_\_\_\_

End Watering Time: \_\_\_\_\_

Hydrant Opened:                      Yes                      No                      N/A

Hydrant Intersection Location: \_\_\_\_\_

Hydrant ID: \_\_\_\_\_

Hydrant Open Time: \_\_\_\_\_

Hydrant Close Time: \_\_\_\_\_

*CREW IS RESPONSIBLE FOR REPORTING ANY NONROUTINE MAINTENANCE SITE ISSUES TO CRW*



APPENDIX

D

CONTACT LIST



CONTACT	PHONE NUMBER
Capital Region Water	888-510-0606
Emergency Police and Fire Services	911
Police (nonemergency)	717-558-6900
Dauphin County Conservation District	717-921-8100
Harrisburg Public Works Department	3-1-1 or 717-255-3040
Pennsylvania 811 / PA One Call	811
Harrisburg Bureau of Parks and Recreation	311 or 717-255-3040
Pennsylvania State Animal Response Team	717-651-2736



APPENDIX

E

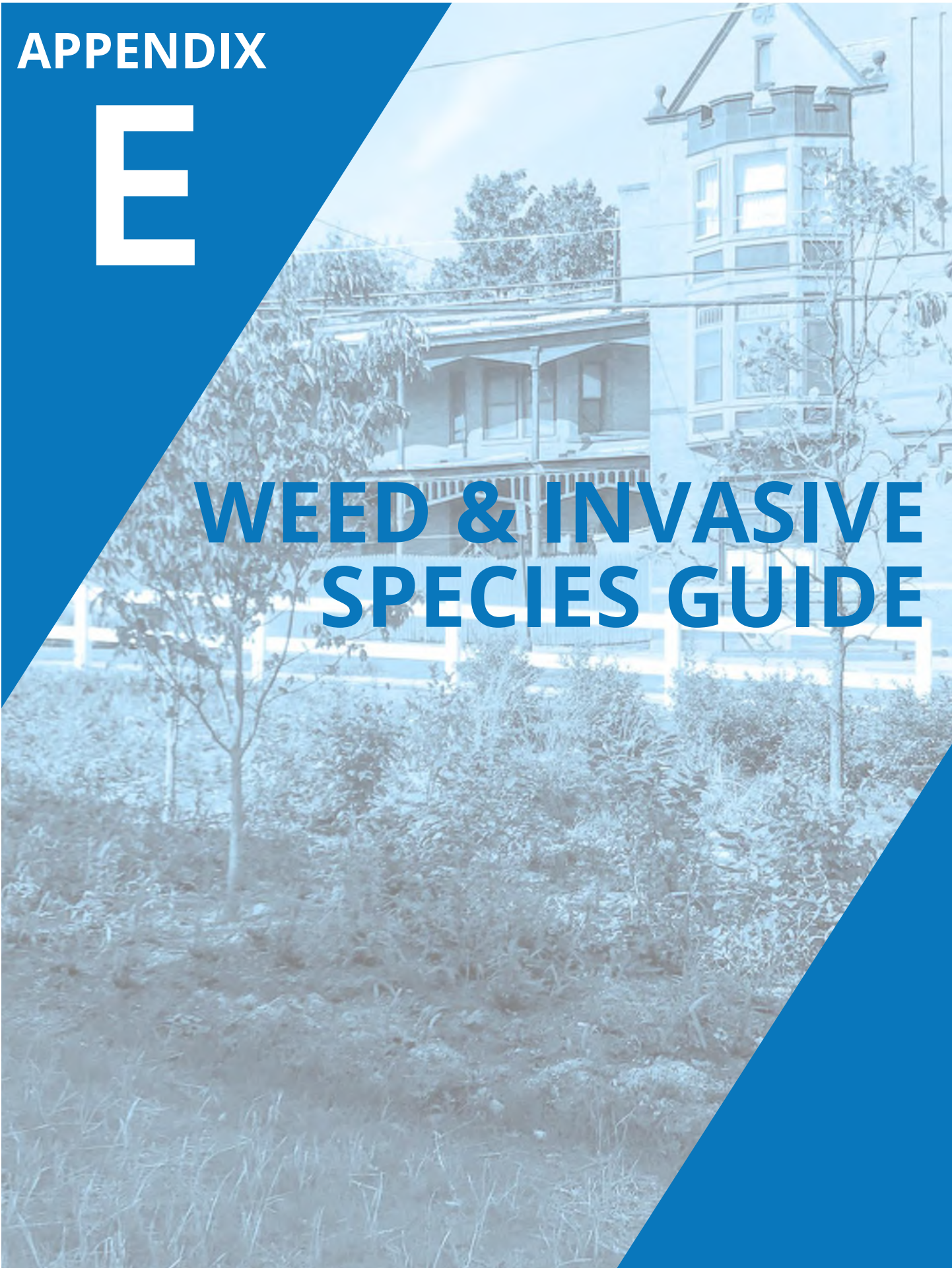

**WEED & INVASIVE  
SPECIES GUIDE**





The weeds and invasive species presented in Appendix E typically occur in vegetated SCMs in urban areas of Pennsylvania. The list is by no means exhaustive; other weeds and invasive species can also be present. Refer to Additional Resources provided at the end of Appendix E for more detailed information.



PLANT	CHARACTERISTICS	LIFE CYCLE/ ECOLOGY	RECOMMENDED MANAGEMENT
<b>Trees</b>			
<i>Acer platanoides</i> (Norway Maple)			
	<ul style="list-style-type: none"> <li>▪ Medium to large deciduous tree</li> <li>▪ Opposite palmate leaves</li> <li>▪ Leaf stalk produces white, milky sap when squeezed</li> <li>▪ Yellow to yellow-green flower clusters</li> </ul>	<ul style="list-style-type: none"> <li>▪ Invasive, non-native species; PA DCNR Rank 2 Significant Threat</li> <li>▪ Flowering period: early spring</li> <li>▪ Seeds produced in abundance and are spread by wind</li> <li>▪ Plants can dominate woodlands with mesic soils, displacing native trees</li> </ul>	<ul style="list-style-type: none"> <li>▪ Hand pulling of seedlings</li> <li>▪ Girdling of trunk for larger specimen</li> <li>▪ Herbicide application for larger populations and more developed or mature plants: see Additional References &amp; Resources at end of Appendix E.</li> </ul>
<i>Acer pseudoplatanus</i> (Sycamore Maple)			
	<ul style="list-style-type: none"> <li>▪ Medium to large deciduous tree with a broad canopy</li> <li>▪ Opposite, palmate leaves with five lobes</li> <li>▪ Fragrant, insect pollinated flowers</li> <li>▪ 1 to 1-1/2 inch long winged fruit</li> <li>▪ Smooth gray bark becomes fissured with age</li> </ul>	<ul style="list-style-type: none"> <li>▪ Invasive, non-native species</li> <li>▪ Flowering period: early spring</li> <li>▪ Abundant seeds are spread by wind</li> <li>▪ Grows well on disturbed sites</li> <li>▪ Monoecious (male and female flowers on the same plant)</li> </ul>	<ul style="list-style-type: none"> <li>▪ Hand pulling of seedlings</li> <li>▪ Girdling of trunk for larger specimen</li> <li>▪ Herbicide application for larger populations and more developed or mature plants: see Additional References &amp; Resources at end of Appendix E.</li> </ul>
<i>Ailanthus altissima</i> (Tree-of-Heaven)			
	<ul style="list-style-type: none"> <li>▪ Large deciduous tree</li> <li>▪ Pinnately compound leaves</li> <li>▪ Glandular leaf base gives off a pungent smell when crushed</li> <li>▪ Hollow stem pith gives off a peanut butter-like smell</li> <li>▪ Trunks develop cantaloupe textured bark at maturity</li> <li>▪ May be confused with staghorn sumac, a native species</li> </ul>	<ul style="list-style-type: none"> <li>▪ Invasive, non-native species; PA DCNR Rank 1 Severe Threat</li> <li>▪ Dioecious (male and female flowers on separate plants)</li> <li>▪ Female trees produce many seeds that are dispersed by wind</li> <li>▪ Can produce chemicals that prevent growth of other plants</li> </ul>	<ul style="list-style-type: none"> <li>▪ Hand pulling of seedlings</li> <li>▪ Girdling of trunk for larger specimen</li> <li>▪ Herbicide application for larger populations and more developed or mature plants: see Additional References &amp; Resources at end of Appendix E.</li> </ul>









PLANT	CHARACTERISTICS	LIFE CYCLE/ ECOLOGY	RECOMMENDED MANAGEMENT
<b>Trees</b>			
<i>Broussonetia papyrifera</i> (Paper Mulberry)			
	<ul style="list-style-type: none"> <li>▪ Small deciduous tree</li> <li>▪ Alternate, opposite or whorled leaves with wide, lobed margins</li> <li>▪ Female flowers formed in round, hanging cluster; male flowers form in drooping clusters</li> <li>▪ Orange, clustered fruits</li> </ul>	<ul style="list-style-type: none"> <li>▪ Invasive, non-native species; PA DCNR Rank 3 Lesser Threat</li> <li>▪ Dioecious (male and female flowers on separate plants)</li> <li>▪ Reproduces by seed dispersal and vegetative growth (sprouting/ suckering)</li> </ul>	<ul style="list-style-type: none"> <li>▪ Hand pulling of seedlings</li> <li>▪ Repeated cutting or mowing of smaller plants</li> <li>▪ Herbicide application for larger populations and more developed or mature plants: see Additional References &amp; Resources at end of Appendix E.</li> </ul>
<i>Ulmus pumila</i> (Siberian Elm)			
	<ul style="list-style-type: none"> <li>▪ Large deciduous tree with an open and rounded crown with slender, spreading branches</li> <li>▪ Irregular, furrowed light-gray bark</li> <li>▪ Serrated leaves with an oblique leaf base</li> <li>▪ Green, inconspicuous flowers without petals</li> <li>▪ Flat, circular fruit has a single seed</li> </ul>	<ul style="list-style-type: none"> <li>▪ Invasive, non-native species</li> <li>▪ Flowering period: mid spring</li> <li>▪ Abundant seeds are spread by wind and can germinate quickly</li> <li>▪ Adapted to drought, cold, poor soil, high wind and low moisture conditions</li> </ul>	<ul style="list-style-type: none"> <li>▪ Hand pulling of seedlings</li> <li>▪ Girdling of trunk during mid to late summer</li> <li>▪ In riparian areas, control should start up stream and progress down stream</li> <li>▪ Herbicide application for larger populations and more developed or mature plants: see Additional References &amp; Resources at end of Appendix E.</li> </ul>
<b>Woody Vines and Shrubs</b>			
<i>Ampelopsis glandulosa brevipedunculata</i> (Porcelainberry)			
	<ul style="list-style-type: none"> <li>▪ Large deciduous vine</li> <li>▪ Slightly lobed to deeply dissected leaves, alternately arranged</li> <li>▪ Greenish white inconspicuous flowers</li> <li>▪ White to light yellow berries mature to purple to blue in color</li> </ul>	<ul style="list-style-type: none"> <li>▪ Invasive, non-native species; PA DCNR Rank 1 Severe Threat</li> <li>▪ Slow to leaf out; most vegetative growth occurs in summer</li> <li>▪ Blooming period: midsummer</li> <li>▪ Fruits develop in late summer and mature in fall</li> <li>▪ Dispersed by birds and small mammals</li> </ul>	<ul style="list-style-type: none"> <li>▪ Hand pulling of young plants</li> <li>▪ Herbicide application for larger populations and more developed or mature plants: see Additional References &amp; Resources at end of Appendix E.</li> </ul>





PLANT	CHARACTERISTICS	LIFE CYCLE/ ECOLOGY	RECOMMENDED MANAGEMENT
<b>Woody Vines and Shrubs</b>			
<i>Berberis thunbergii</i> (Japanese Barberry)			
	<ul style="list-style-type: none"> <li>▪ Small to medium deciduous shrub</li> <li>▪ Small ovate leaves oppositely arranged</li> <li>▪ Pale yellow flowers in umbrella-shaped cluster</li> <li>▪ Bright red ovoid fruits on pendulous stalk</li> </ul>	<ul style="list-style-type: none"> <li>▪ Invasive, non-native species; PA DCNR Rank 1 Severe Threat</li> <li>▪ Flowering period: midspring</li> <li>▪ Fruits mature in late summer and fall</li> <li>▪ High shade and drought tolerance</li> <li>▪ Spreads primarily by seeds predation by birds</li> </ul>	<ul style="list-style-type: none"> <li>▪ Hand pulling or digging plants in early spring using heavy gloves, a hoe, or leverage tool</li> <li>▪ Cutting without herbicide treatment will result in resprouting</li> <li>▪ Herbicide application for larger populations and more developed or mature plants: see Additional References &amp; Resources at end of Appendix E.</li> </ul>
<i>Euonymus alatus</i> (Winged Burning Bush)			
	<ul style="list-style-type: none"> <li>▪ Medium deciduous shrub, wider than tall in growth</li> <li>▪ Simple, oppositely arranged leaves along stem</li> <li>▪ Inconspicuous greenish flowers</li> <li>▪ Small red-purple fruits</li> </ul>	<ul style="list-style-type: none"> <li>▪ Invasive, non-native species; PA DCNR Rank 2 Significant Threat</li> <li>▪ Flowering period: late spring</li> <li>▪ Fruits mature in mid to late summer</li> <li>▪ Spreads primarily by dispersal by birds and to lesser extent by small mammals</li> <li>▪ Large quantities of seedlings can appear at below parent plant</li> </ul>	<ul style="list-style-type: none"> <li>▪ Manual removal by pulling when young</li> <li>▪ Mechanical removal by digging out the roots when plants are mature</li> <li>▪ Herbicide application for larger populations and more developed or mature plants: see Additional References &amp; Resources at end of Appendix E.</li> </ul>
<i>Euonymus fortunei</i> (Wintercreeper)			
	<ul style="list-style-type: none"> <li>▪ Climbing or prostrate evergreen vine</li> <li>▪ Simple, oppositely arranged leaves</li> <li>▪ Older stems covered by gray corky bark</li> <li>▪ Small, greenish, inconspicuous five-petaled flowers</li> <li>▪ Round pink fruits have exposed orange seeds</li> </ul>	<ul style="list-style-type: none"> <li>▪ Invasive, non-native species; PA DCNR Rank 2 Significant Threat</li> <li>▪ Flowering period: late spring to early summer</li> <li>▪ Fruits ripen in late fall</li> <li>▪ Plants spread vegetatively or seeds disperse by wildlife</li> </ul>	<ul style="list-style-type: none"> <li>▪ Hand pull young plants</li> <li>▪ Mechanical removal by digging out the roots when plant are mature</li> <li>▪ Herbicide application for larger populations and more developed or mature plants: see Additional References &amp; Resources at end of Appendix E.</li> </ul>



PLANT	CHARACTERISTICS	LIFE CYCLE/ ECOLOGY	RECOMMENDED MANAGEMENT
<b>Woody Vines and Shrubs</b>			
<i>Hedera helix</i> (English Ivy)			
	<ul style="list-style-type: none"> <li>▪ Woody vine</li> <li>▪ Alternate, dark green, shiny leaves with waxy or leathery coating and 3 to 5-lobed leaf margins</li> <li>▪ Inconspicuous, greenish-yellow flowers in globular starbursts</li> <li>▪ Black fleshy fruits</li> </ul>	<ul style="list-style-type: none"> <li>▪ Invasive, non-native species; PA DCNR Rank 3 Lesser Threat</li> <li>▪ Bloom period: late summer to early fall</li> <li>▪ Fruits mature in late fall</li> <li>▪ Spreads through seed dispersal by birds and vegetatively</li> <li>▪ Aggressive spreader on forest floor and edges</li> </ul>	<ul style="list-style-type: none"> <li>▪ Hand pulling of young plants</li> <li>▪ Mechanical removal by digging out the roots when plants are mature</li> <li>▪ Herbicide application for larger populations and more developed or mature plants: see Additional References &amp; Resources at end of Appendix E.</li> </ul>
<i>Ligustrum vulgare</i> (European Privet)			
	<ul style="list-style-type: none"> <li>▪ Medium to large semi-deciduous shrub, historically planted for hedges</li> <li>▪ Simple, glossy, dark green, oppositely arranged leaves</li> <li>▪ Slightly fragrant tubular flowers arranged in clusters</li> <li>▪ Black berries persist through winter</li> </ul>	<ul style="list-style-type: none"> <li>▪ Invasive, non-native species; PA DCNR Rank 2 Significant Threat</li> <li>▪ Bloom period: late spring to early summer</li> <li>▪ Fruits mature in late summer or early fall</li> <li>▪ Spreads primarily through seed dispersal by birds, but can also spread vegetatively</li> </ul>	<ul style="list-style-type: none"> <li>▪ Hand pulling of young plants</li> <li>▪ Mechanical removal by digging out the roots when plants are mature</li> <li>▪ Herbicide application for larger populations and more developed or mature plants: see Additional References &amp; Resources at end of Appendix E.</li> </ul>
<i>Lonicera maackii</i> (Bush Honeysuckle)			
	<ul style="list-style-type: none"> <li>▪ Medium to large deciduous shrub</li> <li>▪ 1 to 2-1/2 inches long, simple, oppositely arranged leaves</li> <li>▪ Fragrant, tubular flowers arranged in pairs at leaf axil</li> <li>▪ Fruits ripen to black at maturity</li> </ul>	<ul style="list-style-type: none"> <li>▪ Invasive, non-native species; PA DCNR Rank 1 Severe Threat</li> <li>▪ Bloom period: early to late spring</li> <li>▪ Reddish berries ripen in mid to late summer</li> <li>▪ Seeds spread through dispersal by wildlife</li> </ul>	<ul style="list-style-type: none"> <li>▪ Hand pulling of young plants</li> <li>▪ Mechanical removal by digging out the roots when plants are mature</li> <li>▪ Herbicide application for larger populations and more developed or mature plants: see Additional References &amp; Resources at end of Appendix E.</li> </ul>

PLANT	CHARACTERISTICS	LIFE CYCLE/ ECOLOGY	RECOMMENDED MANAGEMENT
<b>Woody Vines and Shrubs</b>			
<i>Lonicera japonica</i> (Japanese Honeysuckle)			
	<ul style="list-style-type: none"> <li>▪ Woody vine to 80 feet in length</li> <li>▪ Opposite, pubescent, oval-shaped leaves from 1 to 2-1/2 inches long</li> <li>▪ Fragrant, tubular, white flowers at leaf axil</li> <li>▪ Fruits ripen to black at maturity</li> </ul>	<ul style="list-style-type: none"> <li>▪ Invasive, non-native species; PA DCNR Rank 1 Severe Threat</li> <li>▪ Bloom period: April to July</li> <li>▪ Black berries ripens in mid to late summer</li> <li>▪ Seeds spread through dispersal by wildlife</li> </ul>	<ul style="list-style-type: none"> <li>▪ Hand pulling of young plants</li> <li>▪ Mechanical removal by digging out the roots when plants are mature</li> <li>▪ Herbicide application for larger populations and more developed or mature plants: see Additional References &amp; Resources at end of Appendix E.</li> </ul>
<i>Rosa multiflora</i> (Multiflora Rose)			
	<ul style="list-style-type: none"> <li>▪ Medium to large deciduous shrub</li> <li>▪ Alternately arranged leaves</li> <li>▪ Leaves divided into 5-11 leaflets</li> <li>▪ White, simple flowers in clusters</li> <li>▪ Leathery red fruits develop in fall</li> </ul>	<ul style="list-style-type: none"> <li>▪ Invasive, non-native species; PA DCNR Rank 1 Severe Threat</li> <li>▪ Bloom period: late spring to early summer</li> <li>▪ Fruits ripens in late summer and can persist through winter</li> <li>▪ Reproduces by seed dispersed by wildlife and vegetatively (sprouting/suckering)</li> </ul>	<ul style="list-style-type: none"> <li>▪ Hand pull young plants</li> <li>▪ Mechanical removal by digging out the roots and runners when plants are matures</li> <li>▪ Herbicide application for larger populations and more developed or mature plants: see Additional References &amp; Resources at end of Appendix E.</li> </ul>
<i>Rhamnus carthartica</i> (Common Buckthorn)			
	<ul style="list-style-type: none"> <li>▪ Large deciduous shrub or small tree</li> <li>▪ Dull, green, ovate leaves arranged alternately or oppositely</li> <li>▪ Can be identified by a sharp thorn at the tip of the stem</li> <li>▪ Dark, purple or black drupes (fruits with a hard seed)</li> </ul>	<ul style="list-style-type: none"> <li>▪ Invasive, non-native species; PA DCNR Rank 1 Severe Threat</li> <li>▪ Bloom period: late spring</li> <li>▪ Berries ripen during late summer or early fall and persist during winter</li> <li>▪ Spreads by seed dispersal from wildlife</li> <li>▪ Buckthorn leaf litter can increase soil nitrogen in forests, negatively altering soil chemistry</li> </ul>	<ul style="list-style-type: none"> <li>▪ Hand pull young plants</li> <li>▪ Mechanical removal by digging out the roots when plants are matures</li> <li>▪ Repeated cutting and mowing of developed plants</li> <li>▪ Herbicide application for larger populations and more developed or mature plants: see Additional References &amp; Resources at end of Appendix E.</li> </ul>

PLANT	CHARACTERISTICS	LIFE CYCLE/ ECOLOGY	RECOMMENDED MANAGEMENT
<b>Woody Vines and Shrubs</b>			
<i>Rhodotypos scandans</i> (Jetbead)			
	<ul style="list-style-type: none"> <li>▪ Medium, shade-tolerant deciduous shrub</li> <li>▪ Deeply ribbed, simple, oppositely arranged leaves</li> <li>▪ Small, four-petaled, simple white flowers</li> <li>▪ Red berries ripens to black with age</li> </ul>	<ul style="list-style-type: none"> <li>▪ Invasive, non-native species; PA DCNR Rank 1 Severe Threat</li> <li>▪ Bloom period: late spring</li> <li>▪ Fruits ripen shortly after flowering</li> <li>▪ Spreads vegetatively and by seeds</li> </ul>	<ul style="list-style-type: none"> <li>▪ Hand pull young plants</li> <li>▪ Mechanical removal by digging out the roots when plants are mature</li> <li>▪ Herbicide application for larger populations and more developed or mature plants: see Additional References &amp; Resources at end of Appendix E.</li> </ul>
<b>Broadleaf Herbaceous Flowering Plants and Vines</b>			
<i>Actium minus</i> (Common Burdock)			
	<ul style="list-style-type: none"> <li>▪ Broadleaf herb to 6 feet in height</li> <li>▪ First year leaves are arranged in large rosettes</li> <li>▪ Second year heart-shaped leaves have coarse hairs underneath</li> <li>▪ Flower stalks are composed of florets enclosed in prickly burs</li> <li>▪ Robust tap root</li> </ul>	<ul style="list-style-type: none"> <li>▪ Non-native weed; potentially invasive</li> <li>▪ Biennial; first year rosette is followed by flower stalks in the second year</li> <li>▪ Bloom period: midsummer to mid fall</li> <li>▪ Seed produced in abundance in fall (up to 15,000 per plant)</li> <li>▪ Acts as a secondary host to other pathogens</li> </ul>	<ul style="list-style-type: none"> <li>▪ Manual removal of entire plant including taproot.</li> <li>▪ Herbicide application for larger populations and more developed or mature plants: see Additional References &amp; Resources at end of Appendix E.</li> </ul>
<i>Ambrosia artemisiifolia</i> (Common Ragweed)			
	<ul style="list-style-type: none"> <li>▪ Broadleaf herb</li> <li>▪ Deeply divided leaves with bottom sides covered by dense hairs</li> <li>▪ Inconspicuous, yellowish-white flowers in terminal spikelets</li> <li>▪ Yellowish to reddish-brown woody fruit capsules</li> </ul>	<ul style="list-style-type: none"> <li>▪ Native annual</li> <li>▪ Bloom period: midsummer to early fall</li> <li>▪ Seeds can persist in the soil for 5 years</li> <li>▪ Highly competitive plants of waste areas</li> </ul>	<ul style="list-style-type: none"> <li>▪ Hand pull entire plant before seed set in late summer.</li> </ul>

PLANT	CHARACTERISTICS	LIFE CYCLE/ ECOLOGY	RECOMMENDED MANAGEMENT
<b>Broadleaf Herbaceous Flowering Plants and Vines</b>			
<i>Artemisia vulgaris</i> (Mugwort)			
	<ul style="list-style-type: none"> <li>▪ Broadleaf herb</li> <li>▪ Lobed, pinnate or bi-pinnate leaves; serrated leaf margins</li> <li>▪ Whitish buds turn to yellowish gray at maturity</li> <li>▪ Stems are highly branched and purplish in color</li> <li>▪ Ascending stems covered in short hairs</li> <li>▪ Rhizomatous roots</li> </ul>	<ul style="list-style-type: none"> <li>▪ Invasive, non-native species; PA DCNR Rank 3 Lesser Threat</li> <li>▪ Perennial</li> <li>▪ Fruits develop during late summer to early fall</li> </ul>	<ul style="list-style-type: none"> <li>▪ Hand pull entire plant before seed set in late summer.</li> <li>▪ Herbicide application for larger populations and more developed or mature plants: see Additional References &amp; Resources at end of Appendix E.</li> </ul>
<i>Cirsium arvense</i> (Canada Thistle)			
	<ul style="list-style-type: none"> <li>▪ Broadleaf herb to 3 feet in height</li> <li>▪ Deeply serrated leaves</li> <li>▪ Lavender pom-pom like flowers</li> <li>▪ Tap-rooted</li> </ul>	<ul style="list-style-type: none"> <li>▪ Invasive, non-native species; PA DCNR Rank 2 Significant Threat</li> <li>▪ Annual or biennial</li> <li>▪ Bloom period: Late summer to early fall</li> <li>▪ Seeds dispersed by wind</li> <li>▪ Forms dense colonies</li> </ul>	<ul style="list-style-type: none"> <li>▪ Repeated mowing or tilling monthly for up to 4 years; entire rhizomatous root system must be removed</li> <li>▪ Herbicide application for larger populations and more developed or mature plants: see Additional References &amp; Resources at end of Appendix E.</li> </ul>
<i>Cirsium vulgare</i> (Bull Thistle)			
	<ul style="list-style-type: none"> <li>▪ Large broadleaf herb</li> <li>▪ Deeply serrated leaves end in a sharp lanced shaped tip</li> <li>▪ Stems covered by dense prickles</li> <li>▪ Lavender, pom-pom like solitary flower</li> <li>▪ Tap-rooted</li> </ul>	<ul style="list-style-type: none"> <li>▪ Invasive, non-native species; PA DCNR Rank 2 Significant Threat</li> <li>▪ Annual or biennial</li> <li>▪ Bloom period: Early summer through fall</li> <li>▪ Seeds dispersed by wind</li> <li>▪ Forms dense colonies</li> </ul>	<ul style="list-style-type: none"> <li>▪ Hand pull or mechanically remove by digging entire plant including rhizome</li> <li>▪ Herbicide application for larger populations and more developed or mature plants: see Additional References &amp; Resources at end of Appendix E.</li> </ul>



PLANT	CHARACTERISTICS	LIFE CYCLE/ ECOLOGY	RECOMMENDED MANAGEMENT
<b>Broadleaf Herbaceous Flowering Plants and Vines</b>			
<i>Chamaesyce maculata</i> (Spotted Spurge)			
	<ul style="list-style-type: none"> <li>▪ Highly branched, broadleaf herb forming a dense prostrate mat</li> <li>▪ Small, oblong, oppositely arranged leaves are attached obliquely to the stem</li> <li>▪ Small inconspicuous cup-shaped flowers</li> <li>▪ Slender tap root</li> </ul>	<ul style="list-style-type: none"> <li>▪ Annual</li> <li>▪ Bloom period: midsummer through late fall</li> <li>▪ Seeds can adhere to wet surfaces</li> <li>▪ Extensive re-seeder</li> <li>▪ Colonizer of poor, compacted soils</li> </ul>	<ul style="list-style-type: none"> <li>▪ Hand pull entire plant before seed set in late summer and early fall</li> </ul>
<i>Chenopodium album</i> (Lamb's Quarters)			
	<ul style="list-style-type: none"> <li>▪ Broadleaf herb to 18 inches in height</li> <li>▪ Pubescent (covered with fine hair) lanced or goose-foot shaped leaves alternately arranged</li> <li>▪ Mature plants are highly branched and pyramidal</li> <li>▪ Inconspicuous green flowers</li> <li>▪ Striated, purple or red-tinged stems</li> <li>▪ Notched, round seeds</li> </ul>	<ul style="list-style-type: none"> <li>▪ Annual</li> <li>▪ Bloom period: Late summer to early fall</li> <li>▪ Seeds produced in abundance (10,000 per plant)</li> <li>▪ Aggressive weed of disturbed soils</li> </ul>	<ul style="list-style-type: none"> <li>▪ Hand pull young plants</li> </ul>
<i>Erigeron canadensis</i> syn. <i>Conyza canadensis</i> (Horseweed, Mare's Tail)			
	<ul style="list-style-type: none"> <li>▪ Broadleaf herb to 7 feet in height</li> <li>▪ Elliptical, lanceolate or oblanceolate alternate leaves arranged along pubescent stem in a whorled pattern</li> <li>▪ Inconspicuous flowers in loose panicles</li> <li>▪ The seed is an achene (dry fruit)</li> </ul>	<ul style="list-style-type: none"> <li>▪ Native Annual</li> <li>▪ Seeds produced in abundance (700,000 per a plant)</li> <li>▪ Seeds dispersed by wind</li> <li>▪ Weed of moist, disturbed sites</li> </ul>	<ul style="list-style-type: none"> <li>▪ Hand pull young plants including tap root and secondary fibrous roots</li> </ul>
<i>Galinsoga quadriradiata</i> (Hairy Galinsoga, Shaggy Soldier)			
	<ul style="list-style-type: none"> <li>▪ Broadleaf herb with erect habit</li> <li>▪ Pubescent, oppositely arranged leaves with serrated margins</li> <li>▪ Small, white, three-toothed petaled flowers</li> </ul>	<ul style="list-style-type: none"> <li>▪ Annual</li> <li>▪ Bloom period: late summer to early fall</li> </ul>	<ul style="list-style-type: none"> <li>▪ Hand pull young plants</li> </ul>



PLANT	CHARACTERISTICS	LIFE CYCLE/ ECOLOGY	RECOMMENDED MANAGEMENT
<b>Broadleaf Herbaceous Flowering Plants and Vines</b>			
<i>Mollugo verticillata</i> (Carpetweed)			
	<ul style="list-style-type: none"> <li>▪ Small prostrate broadleaf herb with stems arranged in a circular mat</li> <li>▪ Spatulate leaves arranged in whorls at stem nodes</li> <li>▪ Small white flowers</li> </ul>	<ul style="list-style-type: none"> <li>▪ Annual</li> <li>▪ Bloom period: midspring to early fall</li> </ul>	<ul style="list-style-type: none"> <li>▪ Hand pull entire plant including small, branched taproot</li> </ul>
<i>Persicaria longiseta</i> (Oriental Lady's Thumb, Asiatic Smartweed, Bristled Knotweed)			
	<ul style="list-style-type: none"> <li>▪ Erect or sprawling broadleaf herb</li> <li>▪ Elongate, narrow opposite leaves</li> <li>▪ Stems have swollen nodes with papery sheaths</li> <li>▪ Pink flowers in clustered spikelets at the apex of the stems</li> <li>▪ Smooth, dark-colored seeds</li> <li>▪ Shallow taproot</li> </ul>	<ul style="list-style-type: none"> <li>▪ Annual</li> <li>▪ Bloom period: midsummer to fall</li> <li>▪ Reproduces by seeds and vegetatively from fibrous roots</li> <li>▪ Aggressive colonizer of moist, disturbed sites</li> </ul>	<ul style="list-style-type: none"> <li>▪ Hand pulling or mechanical removal of entire plant</li> </ul>
<i>Persicaria perfoliata</i> (Mile-a-Minute, Asiatic Tearthumb)			
	<ul style="list-style-type: none"> <li>▪ Trailing vine with arrow-shaped leaves and stems with small spines</li> <li>▪ Purple fruits from mid July to frost</li> </ul>	<ul style="list-style-type: none"> <li>▪ Invasive, non-native species; PA DCNR Rank 1 Severe Threat</li> <li>▪ Annual</li> </ul>	<ul style="list-style-type: none"> <li>▪ Hand pull entire vine before fruiting</li> <li>▪ Note: Wear gloves as thorns can irritate skin</li> <li>▪ Herbicide application for larger populations and more developed or mature plants: see Additional References &amp; Resources at end of Appendix E.</li> </ul>



PLANT	CHARACTERISTICS	LIFE CYCLE/ ECOLOGY	RECOMMENDED MANAGEMENT
<b>Broadleaf Herbaceous Flowering Plants and Vines</b>			
<i>Plantago major</i> (Common Plantain)			
	<ul style="list-style-type: none"> <li>▪ Prostrate broadleaf herb</li> <li>▪ Ribbed, ovoid leaves arranged in a basal rosette</li> <li>▪ Inconspicuous flowers in spikes</li> </ul>	<ul style="list-style-type: none"> <li>▪ Perennial</li> <li>▪ Bloom period: Spring through fall</li> <li>▪ Reproduces from seeds</li> </ul>	<ul style="list-style-type: none"> <li>▪ Hand pulling of entire plant including fibrous tap roots</li> </ul>
<i>Polygonum cuspidatum</i> (Japanese Knotweed)			
	<ul style="list-style-type: none"> <li>▪ Large broadleaf herb</li> <li>▪ 4 to 6 inch long, rounded leaves with a sharp tip are alternately arranged on a stem with zig-zap arrangement</li> <li>▪ Hollow stems</li> <li>▪ Small white flowers on clustered spikes</li> </ul>	<ul style="list-style-type: none"> <li>▪ Invasive, non-native species; PA DCNR Rank 1 Severe Threat</li> <li>▪ Perennial</li> <li>▪ Bloom period: late summer</li> <li>▪ Seeds set shortly after flowering</li> <li>▪ Reproduces vegetatively and by seeds</li> </ul>	<ul style="list-style-type: none"> <li>▪ Hand pulling or mechanical removal of immature plants including all roots and stems</li> <li>▪ Herbicide application for larger populations and more developed or mature plants: see Additional References &amp; Resources at end of Appendix E.</li> </ul>
<i>Phytolacca americana L.</i> (American Pokeweed)			
	<ul style="list-style-type: none"> <li>▪ Large broadleaf herb from 6 to 10 feet typical</li> <li>▪ Multiple stems from tuber-like taproot</li> <li>▪ Pinkish-red hollow stem</li> <li>▪ Alternate leaves, green on top and lighter below</li> <li>▪ Flowers borne on pinkish racemes</li> <li>▪ Black-purple berries from 1/4 to 3/8 inches in diameter</li> </ul>	<ul style="list-style-type: none"> <li>▪ Perennial</li> <li>▪ Bloom period: Mid-summer to fall</li> <li>▪ Reproduces from seed dispersal by birds and small mammals</li> <li>▪ Roots, fruits and mature leaves are poisonous</li> </ul>	<ul style="list-style-type: none"> <li>▪ Hand pulling or mechanical removal of entire plant including taproot; large plants may require several season of treatment for removal.</li> <li>▪ Herbicide application for larger populations and more developed or mature plants: see Additional References &amp; Resources at end of Appendix E.</li> </ul>

PLANT	CHARACTERISTICS	LIFE CYCLE/ ECOLOGY	RECOMMENDED MANAGEMENT
<b>Broadleaf Herbaceous Flowering Plants and Vines</b>			
<i>Rumex obtusifolius</i> (Curly Dock)			
	<ul style="list-style-type: none"> <li>▪ Broadleaf herb</li> <li>▪ Basal rosette with stalks that bolt during late spring</li> <li>▪ Leaves with wavy margins that undulate up and down</li> <li>▪ Tap root</li> </ul>	<ul style="list-style-type: none"> <li>▪ Perennial</li> <li>▪ Bloom period: midsummer to early fall</li> <li>▪ Seeds can persist for 50 years in the soil</li> </ul>	<ul style="list-style-type: none"> <li>▪ Hand pulling or mechanical removal of entire plant including taproot</li> </ul>
<i>Sonchus oleraceus</i> (Annual Sowthistle, Milk Thistle)			
	<ul style="list-style-type: none"> <li>▪ Broadleaf herb to 18 inches in height</li> <li>▪ Serrated whorled leaves clasping stem</li> <li>▪ Basal rosette like dandelion, but flowers are held on long stalks</li> </ul>	<ul style="list-style-type: none"> <li>▪ Non-native weed, potentially invasive</li> <li>▪ Annual</li> <li>▪ Bloom period: midsummer to early fall</li> </ul>	<ul style="list-style-type: none"> <li>▪ Hand pulling or mechanical removal of entire plant including taproot</li> </ul>
<i>Taraxacum officinale</i> (Dandelion)			
	<ul style="list-style-type: none"> <li>▪ Broadleaf herb with deeply toothed leaves forming a basal rosette</li> <li>▪ Yellow flowers</li> </ul>	<ul style="list-style-type: none"> <li>▪ Perennial</li> <li>▪ Bloom period: spring to summer</li> </ul>	<ul style="list-style-type: none"> <li>▪ Hand pulling or mechanical removal of entire plant including taproot</li> </ul>
<b>Grasses and Grasslike Herbaceous Plants</b>			
<i>Bromus tectorum</i> (Smooth Brome)			
	<ul style="list-style-type: none"> <li>▪ Leaves have a wrinkle resembling a "W" midway through the leaf blade</li> <li>▪ Seed produced in semi-compact 5 inch long seedheads</li> </ul>	<ul style="list-style-type: none"> <li>▪ Invasive, non-native species; PA DCNR Rank 3 Lesser Threat</li> <li>▪ Perennial cool season grass</li> <li>▪ Seeds can germinate in fall or spring</li> <li>▪ Fall germinated seedlings can have root systems that expand during the winter</li> </ul>	<ul style="list-style-type: none"> <li>▪ Hand pull or mechanical removal of entire plant including rhizomes</li> <li>▪ Herbicide application for larger populations and more developed or mature plants: see Additional References &amp; Resources at end of Appendix E.</li> </ul>

PLANT	CHARACTERISTICS	LIFE CYCLE/ ECOLOGY	RECOMMENDED MANAGEMENT
<b>Grasses and Grasslike Herbaceous Plants</b>			
<i>Cyperus esculentus</i> (Yellow Nutsedge)			
	<ul style="list-style-type: none"> <li>▪ Clump-forming sedge</li> <li>▪ Triangular-shaped stem</li> <li>▪ Bristly, yellow seedheads</li> </ul>	<ul style="list-style-type: none"> <li>▪ Native perennial</li> <li>▪ Can form dense stands in disturbed wetlands</li> </ul>	<ul style="list-style-type: none"> <li>▪ Hand pulling of entire plant including rhizomes before seed set in spring</li> </ul>
<i>Echinochloa crus-galli</i> (Barnyard Grass)			
	<ul style="list-style-type: none"> <li>▪ Clumping grass to 5 feet in height</li> <li>▪ Thick stems with reddish joints</li> <li>▪ Leaves rolled into shoots</li> <li>▪ Coarse reddish seedheads</li> <li>▪ Flowers are attached to branches rather than to the main axis</li> </ul>	<ul style="list-style-type: none"> <li>▪ Annual cool season grass</li> </ul>	<ul style="list-style-type: none"> <li>▪ Hand pulling of entire plant including rhizomes</li> <li>▪ Herbicide application for larger populations and more developed or mature plants: see Additional References &amp; Resources at end of Appendix E.</li> </ul>
<i>Microstegium vimineum</i> (Japanese Stiltgrass)			
	<ul style="list-style-type: none"> <li>▪ 2-3½ foot sprawling habit</li> <li>▪ Pale, green, lanced-shaped leaves with shiny midribs</li> </ul>	<ul style="list-style-type: none"> <li>▪ Invasive, non-native species; PA DCNR Rank 1 Severe Threat</li> <li>▪ Annual cool season grass</li> <li>▪ Germinates in spring</li> <li>▪ Bloom period: August–October</li> <li>▪ Fruits follow flowering</li> </ul>	<ul style="list-style-type: none"> <li>▪ Hand pulling of entire plant and tillers (running roots)</li> <li>▪ Brush cut large populations</li> <li>▪ Herbicide application for larger populations and more developed or mature plants: see Additional References &amp; Resources at end of Appendix E.</li> </ul>

PLANT	CHARACTERISTICS	LIFE CYCLE/ ECOLOGY	RECOMMENDED MANAGEMENT
<b>Grasses and Grasslike Herbaceous Plants</b>			
<i>Miscanthus sinensis</i> (Chinese Silvergrass)			
	<ul style="list-style-type: none"> <li>▪ Tall, clump-forming habit</li> <li>▪ Long-slender, and upright-to-arching leaves with sharp tips and rough margins</li> <li>▪ Fan-shaped terminal panicle flowers</li> </ul>	<ul style="list-style-type: none"> <li>▪ Invasive, non-native species; PA DCNR Rank 3 Lesser Threat</li> <li>▪ Perennial grass</li> <li>▪ Reproduces vegetatively and by seeds</li> <li>▪ Dead leaf litter is extremely flammable</li> </ul>	<ul style="list-style-type: none"> <li>▪ Hand pull or mechanical removal of entire plant including rhizomes</li> <li>▪ Herbicide application for larger populations and more developed or mature plants: see Additional References &amp; Resources at end of Appendix E.</li> </ul>
<i>Setaria faberi</i> (Giant Foxtail)			
	<ul style="list-style-type: none"> <li>▪ 3 to 4 foot high clump-forming grass</li> <li>▪ Rolled leaves in bud during seedling stage</li> <li>▪ Hairless leaf sheath</li> <li>▪ Round stem</li> <li>▪ Fibrous roots</li> <li>▪ Nodding seed head</li> </ul>	<ul style="list-style-type: none"> <li>▪ Annual cool season grass</li> </ul>	<ul style="list-style-type: none"> <li>▪ Hand pulling of entire plant including rhizomes</li> </ul>
<i>Sorghum halepense</i> (Johnson Grass)			
	<ul style="list-style-type: none"> <li>▪ Clump-forming grass to 6 foot height</li> <li>▪ Rolled leaves</li> <li>▪ Hairless leaf blades</li> <li>▪ Round stems</li> <li>▪ Thick fibrous roots</li> </ul>	<ul style="list-style-type: none"> <li>▪ Invasive, non-native species; PA DCNR Rank 3 Lesser Threat</li> <li>▪ Perennial cool season grass</li> <li>▪ Spreads by rhizomes and seeds</li> </ul>	<ul style="list-style-type: none"> <li>▪ Hand pull entire plant including rhizomes</li> <li>▪ Herbicide application for larger populations and more developed or mature plants: see Additional References &amp; Resources at end of Appendix E.</li> </ul>

**ADDITIONAL REFERENCES AND RESOURCES**

Refer to [Appendix A—GSI Maintenance Specifications](#) and the resources listed below for more detailed information about management techniques.

***Pennsylvania Department of Conservation and Natural Resources (PA DCNR) Invasive Species***

<https://www.dcnr.pa.gov/Conservation/WildPlants/InvasivePlants/Pages/default.aspx>

[PA DCNR Threat Rankings](#)

Rank 1, Severe Threat - Exotic plant species that possess characteristics of invasive species and spread easily into native plant communities and displace native vegetation. Includes species that are or could become widespread in Pennsylvania.

Rank 2, Significant Threat - Exotic plant species that possess characteristics of invasive species but are not presently considered to spread as easily and aggressively into native plant communities as those species listed as Rank 1.

Rank 3, Lesser Threat - Exotic plant species that spread in or near disturbed areas and are not presently considered a major threat to undisturbed native plant communities.

***Pennsylvania Department of Agriculture—Noxious, Invasive and Poisonous Plant Program***

[https://www.agriculture.pa.gov/Plants\\_Land\\_Water/PlantIndustry/NIPPP/Pages/default.aspx](https://www.agriculture.pa.gov/Plants_Land_Water/PlantIndustry/NIPPP/Pages/default.aspx)

***The Pennsylvania Flora Project of the Morris Arboretum—Invasive Plants***

<http://paflora.org/original/invasive.php>

***PennState College of Agriculture Sciences—Invasive Species QuickSheets***

<https://plantscience.psu.edu/research/labs/weed-ecology/research/wildland-weed-management/publications/invasive-species-quick-sheets>

***Center for Invasive Species and Ecosystem Health***

<https://www.invasive.org/index.cfm>



APPENDIX

F

**EXAMPLES OF  
COMMON PIPE  
DEFECTS**

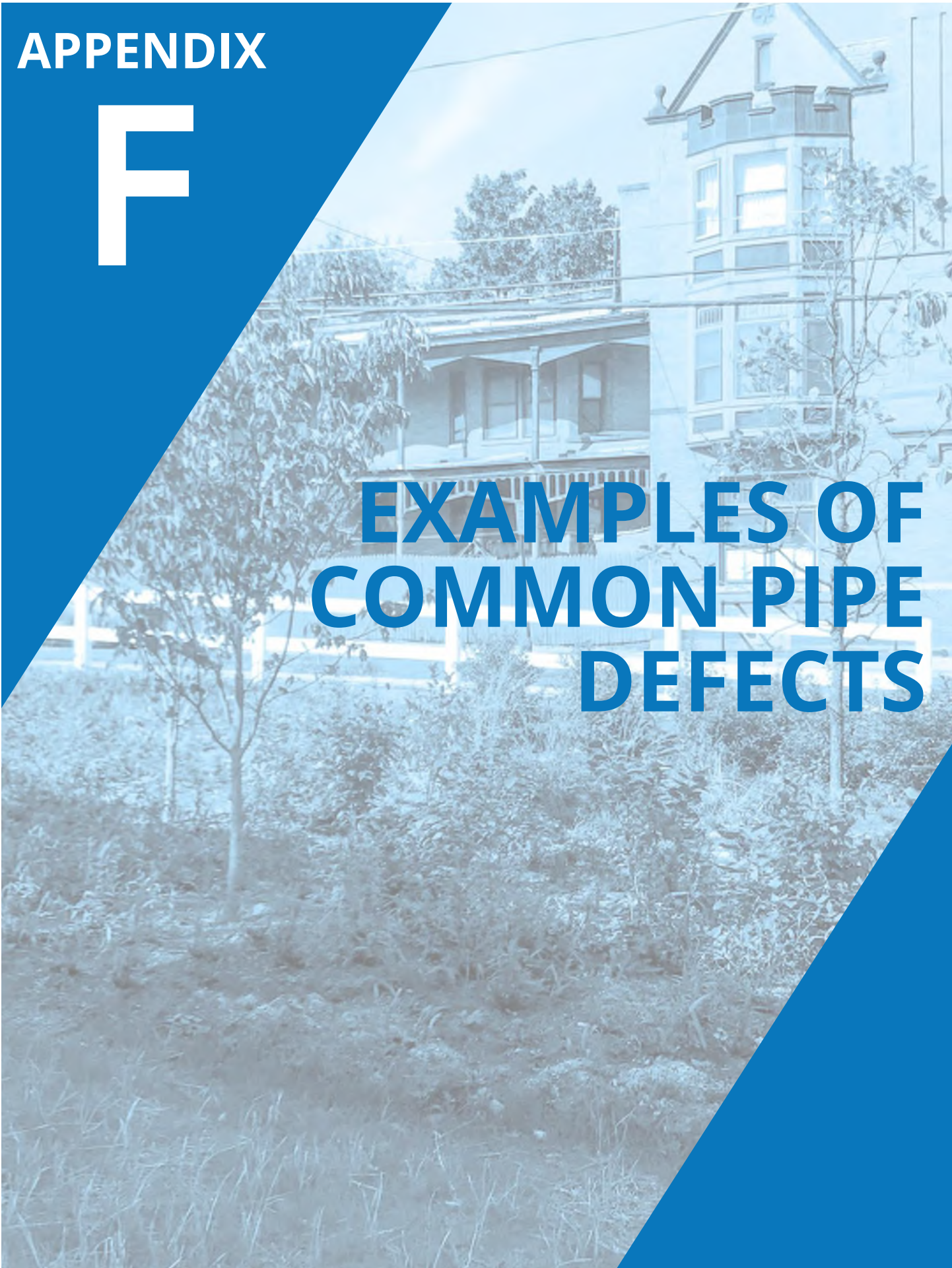

**STRUCTURAL DEFECTS**



**Crack**

- A break line that is visible on the surface but is not visibly open.



**Broken**

- A defect where pieces are noticeably displaced and have moved from original position at least one-half the thickness of the pipe.



**Fracture**

- A break line that is visibly open and a gap can be seen. The sections of pipe wall are still in place and cannot move.



**Hole**

- A defect where pipe material is completely dislodged from pipe wall and the surrounding media is exposed.



## STRUCTURAL DEFECTS

**Deformation**

- Pipe damage where the original cross-section or geometry of the pipe has noticeably changed.

**Joint Offset/Joint Separated**

- A defective displacement of at least one pipe thickness at a joint.

**Collapse**

- Deformation so great that there has been a complete loss of the structural integrity of the pipe with more than 40% of cross-sectional area lost.

**OPERATIONAL AND MAINTENANCE DEFECTS**



**Deposits Settled**

- Deposited material in the invert of the pipe.



**Roots - Fine**

- Small quantities of small-diameter roots that are insufficient to cause a quantifiable reduction of pipe cross-sectional area (<5% loss).



**Roots - Tap**

- Individual roots that are greater than one-half inch thick.



**Roots - Medium**

- Roots that have formed a mass and restrict the flow of water. Cross-sectional area lost is 5% up to 50%.

## OPERATIONAL AND MAINTENANCE DEFECTS

**Roots - Ball**

- Roots that have formed a mass, typically in the form of a ball, and have the potential to severely restrict the flow. The cross-sectional area lost is greater than 50%.

**Construction Debris**

- Material left in pipe during construction activities.

## MISCELLANEOUS FEATURES

**Water Level and Water Level Sag**

- The depth of water at the observed point in the pipe (includes flowing and stagnant water). Water level sag occurs when the grade of the pipe is insufficient.



APPENDIX

G

GLOSSARY

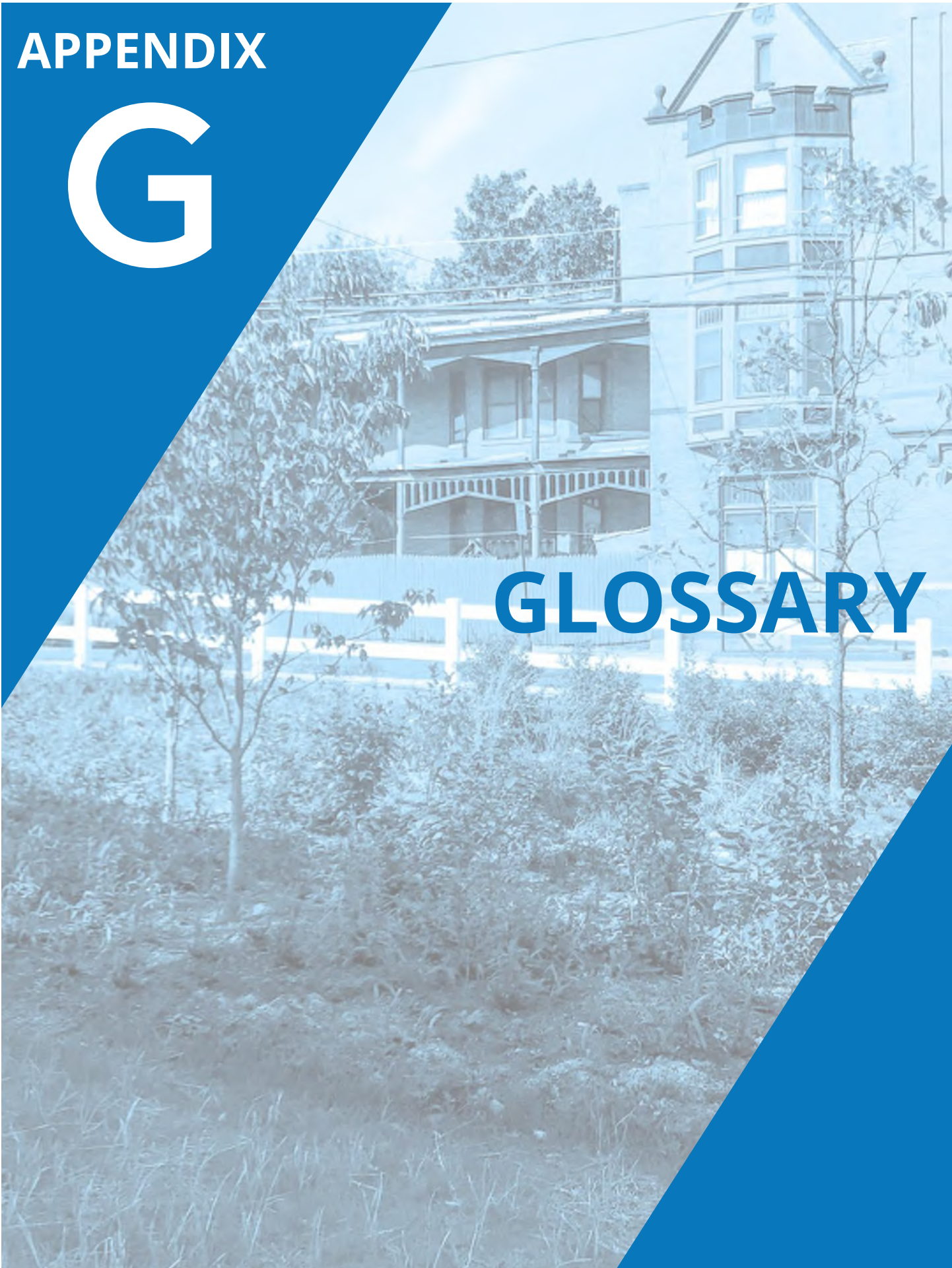

<b>Arborist</b>	An individual engaged in the profession of arboriculture who, through experience, education, and related training, possesses the competence to provide for or supervise the management of trees and other woody plants.
<b>Asset management</b>	Consists of the activities and practices to track maintenance work and effectively using those assets to gain value.
<b>Branch collar</b>	The raised ring or swelling at the base of the branch where it attaches to its parent branch or the tree trunk.
<b>Closed-circuit television (CCTV)</b>	The use of one or more video cameras to transmit a wired or wireless video signal to one or more monitors and/or to video recording equipment. In the context of this protocol, CCTV refers to the use of a remotely controlled camera to view and record the condition of subsurface structures.
<b>Cleanout</b>	A solid vertical pipe capped at the surface that provides access to subsurface pipes for pipe jetting, flushing, vacuum cleaning, and inspection.
<b>Conveyance pipes</b>	Pipes that carry stormwater runoff to, from, or within an SCM.
<b>Distribution pipes</b>	Pipes, including perforated and solid pipes, that deliver stormwater runoff to an SCM. Distribution pipes are typically located below ground within soil media or drainage gravel, but can also be located at the ground surface.
<b>Establishment</b>	The point after planting when a tree's root system has grown sufficiently into the surrounding soil to support shoot growth and anchor the tree.
<b>Establishment watering</b>	A series of watering events that aid in long-term survivorship of newly installed plants.
<b>Flow control structure</b>	Structural components of a stormwater drainage system that detain stormwater and allow its controlled release, for example, weirs, weir walls, orifices, spillways.
<b>Forebay (or sediment forebay)</b>	A pool or basin located immediately down-gradient of a stormwater runoff inflow point. Forebays are storage areas designed to trap and settle sediment or other pollutants. Forebays can either be dry (inundated with water during storm events) or wet (inundated with water continuously).
<b>Geotextile</b>	Soil separator fabric to prevent migration of small particles into void spaces.
<b>Green inlet</b>	An inlet placed within an existing gutter or other surface flow path that diverts runoff from paved areas and redirects it into a green stormwater infrastructure system.
<b>Green Stormwater Infrastructure (GSI)</b>	Refers collectively to engineered systems that use the natural hydrologic processes of infiltration and evaporation to manage stormwater runoff and provide environmental and community benefits. GSI consists of one or more hydraulically connected Stormwater Control Measures (see definition below), defined by a shared hydraulic outlet point.
<b>Hardscape</b>	Pavement composed of traditional or permeable asphalt, concrete or unit masonry.
<b>Hazardous waste</b>	Waste that is dangerous or potentially harmful to health or the environment.
<b>Herbaceous container</b>	A herbaceous plant (annual or perennial flower, grass, sedge or rush) that is available from nurseries in quart, #1, #3, and #5 sized containers.

<b>Herbaceous plug</b>	A young herbaceous plant (annual or perennial flower, grass, sedge or rush) that is grown in soil within a cylindrical container cell of a tray.
<b>High-pressure vacuum washing</b>	A method that uses water at a high pressure to dislodge soil particles/sediment, contaminants and debris from the pores of permeable paving. A vacuum must be used in conjunction with the washer to remove the debris.
<b>Infiltration</b>	A hydrologic process by which water drains downward through soil media and subbase to groundwater.
<b>Inlet</b>	A point of entry into the stormwater drainage system (storm sewer). Common types of inlets include grate inlets, curb opening inlets and combination grate and curb opening inlets. Inlets may be constructed with pretreatment structures such as inlet inserts, sumps, inlet traps, and screens. Inlets are connected to SCMs and/or storm sewer networks by lateral pipes.
<b>Inlet sump</b>	The area within an inlet or catch basin that is below the deepest conveyance pipe outlet of the structure and which provides capacity for sediment accumulation. Sumps within combined sewer inlets are designed to remain filled with water at all times to prevent the release of sewer gas. Sumps within inlets that are not connected to a combined sewer typically drain through weep holes (a series of small diameter drill holes) located in the bottom of the structure.
<b>Inlet trap</b>	A structure installed within an inlet over the connection of an inlet lateral or distribution pipe to provide protection from floatable trash and debris. In inlets directly connected to a combined sewer system, inlet traps define the standing water level of the inlet sump to prevent the escape of sewer gas from the system. Inlet hoods are typically installed in inlets not connected to a combined sewer.
<b>Invasive species</b>	A non-native plant species that has been introduced by humans, either accidentally or intentionally, into a region or location outside of its naturally occurring extent. Invasive species grow vigorously and rapidly, outcompeting or overwhelming desirable plant species. Because they do not have natural controls such as insect herbivores, invasive species pose a threat to native plant communities. For the purposes of this manual, invasive plants are those species listed as such by the Pennsylvania Department of Conservation and Natural Resources: ( <a href="http://www.dcnr.state.pa.us/cs/groups/public/documents/document/dcnr_20026634.pdf">www.dcnr.state.pa.us/cs/groups/public/documents/document/dcnr_20026634.pdf</a> )
<b>Jet cleaning</b>	The process of cleaning stormwater drainage systems using a truck- or trailer-mounted cleaning system that pumps high-pressure water through nozzles placed inside the drainage system. The high-pressure water jet cleaning device operates on the principle of high-volume, high-speed water movement to wash away accumulated soil particles/sediment, dirt, contaminants or debris, dissolve blockages, and clean interior surfaces. The nozzles are connected to the water supply by up to 500 feet of hose coiled on a reel. The thrust generated by the jets of water propels the nozzle assembly through the structure. The process is also referred to as high-velocity jet cleaning, hydrocleaning, hydraulic cleaning, or high pressure cleaning.
<b>Lateral pipes</b>	Pipes that connect inlets to SCMs and/or storm sewer networks.

<b>Maintenance zone</b>	Area or location associated with an SCM or SCM components that correlate to maintenance tasks. Maintenance zones identified in this manual consist of: hardscape, inflow, vegetated area, and outflow.
<b>Manhole</b>	A concrete chamber within a sewer network or connected to inlets that provides surface access, via cast iron manhole lids, to subsurface pipe networks for inspection, pipe jetting, pipe flushing, vacuum cleaning, and entry of trained personnel.
<b>Municipal Separate Storm Sewer System (MS4)</b>	A municipal storm sewer system that is not combined with the sanitary sewer system; MS4s usually discharge stormwater directly to surface water bodies.
<b>Organic debris</b>	Unwanted living, dead, or decomposing plant or animal matter including leaf litter, branches, fruit, flowers, bark, feces, and animal carcasses.
<b>Photo point</b>	Photo and/or video taken at a specific location for each SCM to document pre- and postmaintenance conditions.
<b>Plant transpiration</b>	A biological process in which plants absorb water through their roots and ultimately evaporate this water to the atmosphere through their leaves or stems.
<b>Pretreatment device</b>	Structure that captures trash, sediment, and/or other pollutants from stormwater runoff before delivery to a surface detention area or media.
<b>Regenerative air sweeping</b>	A method used to remove fine soil and sediment from permeable paving. Air at a high pressure and at an angle is used to dislodge soil particles/sediment, contaminants and debris from the surface of permeable paving. The air moves along the width of the sweeping head, and the vacuum tube transports the material into the storage hopper. With all the material removed, the clean air is reused.
<b>Risers and outlet control structures</b>	Structures that establish a high water level and regulate the overflow of stormwater SCMs. These structures typically consist of catch basins or vertical pipes set within a detention area.
<b>Sediment</b>	Nonorganic debris that includes fines, sand, gravel, or soil. The latter may contain some organic components but is still considered sediment.
<b>Settling</b>	A reduction in ground surface elevation due to compaction or soil voids.
<b>Stormwater Control Measure (SCM)</b>	Individual systems or a series of systems connected hydraulically to create a larger system (rain garden, tree trench, etc.)
<b>Stormwater Control Measure (SCM) component</b>	An individual or related group of SCM elements (an underdrain composed of individual pipe sections, fittings, collars, etc.) associated with a specific SCM.
<b>Structure</b>	When used to describe a component of a SCM, the term “structure” refers to a structural component, commonly a flow control structure such as an inlet, riser, or trench drain, but it also may refer to a wall, weir, or other constructed or hardscaped area.
<b>Subsoil</b>	The soil layer beneath an engineered soil or designed surface.
<b>Subsurface chamber storage</b>	Subsurface chambers, typically made of a modular framework of multiple crate-like or arch-like structures used to store and sometimes infiltrate stormwater.



<b>Subsurface maintenance</b>	Any maintenance events and associated tasks that apply to SCM elements that are located below ground and can only be maintained with specialized equipment.
<b>Surface maintenance</b>	Any maintenance events and associated tasks that apply to SCM elements that are located above ground and can be maintained from the surface.
<b>Terminal leader</b>	The vertical stem at the top of the tree trunk.
<b>Trench drain</b>	Narrow trench with a solid or grated cover used to convey stormwater runoff under areas of pedestrian traffic such as sidewalks and typically constructed of concrete or plastic with cast iron or plastic covers.
<b>Underdrain pipe</b>	Perforated pipe that collects water, often from an infiltration bed, and deliver it to a flow control structure. Underdrain pipes are always located beneath the ground surface and are typically plastic (for example, HDPE, PVC, etc.).
<b>Vacuum cleaning</b>	The use of a truck-mounted stormwater drainage system cleaning device. The cleaning device operates on the principle of large volume, high-speed air movement to lift water, soil particles/sediment, contaminants and debris. A large tube conveys the collected materials into a tank mounted on the truck. The cleaning device also includes a freshwater supply and high-pressure pump system to flush and clean pipes and structures. Collected material is transported in the truck to approved disposal sites. This process is sometimes called vactoring.
<b>Weed</b>	A plant that is not desired or intended in a specific SCM or other landscaped area (i.e., a plant out of place). Weeds may be native or non-native species. Weeds may alter the aesthetic appearance of a designed planting area or have other undesirable characteristics, e.g., a tree seedling that will eventually become too large for a system designed only for shrubs or herbaceous plants.



**CAPITAL REGION.**

**WATER**