



H BUMPER

All Makes Catalog
Popular Part Numbers

H HENDRICKSON
The World Rides On Us®

Welcome

TO THE HENDRICKSON ALL MAKES BUMPER PROGRAM

Hendrickson is the leading tier one OEM supplier of heavy duty truck bumpers for the North American commercial vehicle industry. Our commitment to quality and product innovation drives this industry leadership position, thus promoting the development of products that enhance vehicle styling and durability. Key capabilities, which include proprietary bumper forming technology and advanced metal and plastic materials, enable Hendrickson to manufacture aerodynamically contoured bumper designs that are durable yet lightweight. Hendrickson supplies over 1,000 different part numbers from chrome plated steel, prime painted bumpers to many proprietary products.

Hendrickson has an extensive field sales, parts and service organization to support our customers around the globe — truck owners, dealers, fleets and OEMs. Our investment in new technologies will continue as we strive to deliver value to our customers. At Hendrickson, innovation never rests.

Table of Contents

Bumper Materials and Technology	1
Understanding the Hendrickson All Makes Bumper Program	2
Ford	3
Freightliner	4
International	12
Kenworth	18
Mack	24
Peterbilt	28
Volvo	32
Western Star	35

Bumper

PRODUCTS AND TECHNOLOGY



AERO CLAD® Stainless Steel Clad Aluminum

- Durable, bright mirrored finish
- Finish 10 times thicker than chrome
- Resists corrosion
- Resists cracking, pitting, peeling and fading
- Lightweight for better fuel economy
- Minor abrasions can be buffed
- Full five-year limited warranty*



AERO GUARD® Bumper Technology

- Improved cold impact durability
- Lightweight aerodynamic design
- Molded-in-black textured finish
- Increased ground clearance
- Improved cooling air flow capacity



Steel Chrome

- One-year limited warranty*
- Available in 7-gauge or 10-gauge steel
- Bright mirrored finish
- Many shapes available
- Customize your bumper with cutouts and road lights
- Also available in corrosion resistant E-coat finish, ready for top coat



Solid Stainless Steel

- Full five-year limited warranty*
- Bright mirrored finish
- Resists corrosion
- Resists cracks, peeling rust and fading
- As durable as a steel bumper
- Minor abrasions can be buffed

* Visit our website at www.hendricksonbumper.com or call 800.356.6737 for complete warranty terms, conditions and limitations.



Understanding

HENDRICKSON ALL MAKES BUMPER PROGRAM

PART NUMBERING SYSTEM

Part Type:

100 - 199 Ford
200 - 299 Freightliner
400 - 499 International
500 - 599 Kenworth
600 - 699 Mack
700 - 799 Blank
800 - 899 Peterbilt
900 - 903 Volvo
904 - 911 Western Star

Material Thickness:

0 = Ten Gauge Steel
7 = Seven Gauge Steel

Material Abbreviations:

SQ = Texas Square
SSC = Stainless Steel Clad Aluminum
SSCSQ = Stainless Steel Clad Aluminum
Texas Square
STQ = Solid Stainless Steel Texas Square
AG = AERO GUARD®
BRT = HENDRICKSON AERO BRIGHT®

Example: Part #0100SQ

0 = Ten gauge steel
100 = Ford
SQ = Texas Square

Exclusive: Available only through OEM Truck Dealer

ORDER / REORDER REQUIREMENTS

Direct Questions to Hendrickson
Customer Service at **1-800-356-6737**,
or OEM Customer Service Division.

FREIGHT POLICY

Direct Questions to Hendrickson
Customer Service at **1-800-356-6737**,
or OEM Customer Service Division.

INQUIRIES

Questions regarding literature, order status and product
information may be directed to Hendrickson Customer
Service at **1-800-356-6737**, or OEM Customer Service
Division.

WARRANTY AND RETURN POLICY

AERO CLAD®: 5 years from date of sale. Direct
questions to your OEM claims administrator.

Steel Chrome: 1 year from date of sale for materials
and workmanship. Direct questions to your OEM claims
administrator.

Solid Stainless Steel: 5 years from date of sale.
Direct questions to your OEM claims administrator.

AERO GUARD®: 2 years from service date for parts and
labor. Direct questions to your OEM claims administrator.

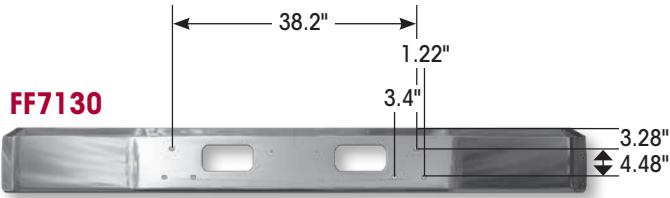

Ford OEM 8000 and 9000 Batwing Aero
FF7131 has bolt holes for air dam.

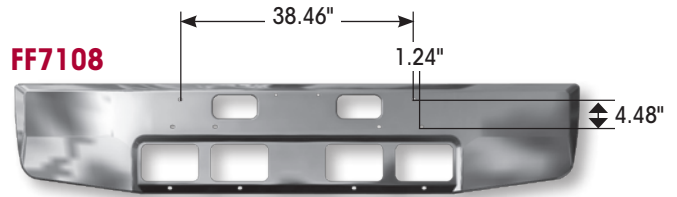

Ford OEM LTL 9000

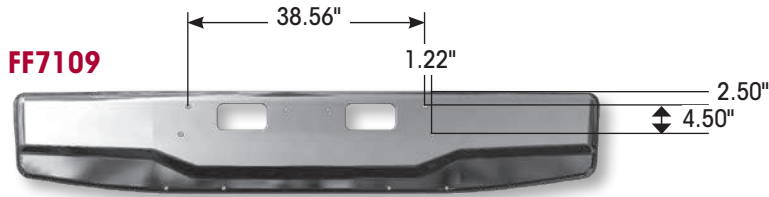

Ford OEM L-Series 8000 and 9000

PART NO.	MATERIAL / FINISH	GAUGE / THICKNESS	STYLE	LIGHT	CENTER STEP	VENT	TOW	RADAR	EXCLUSIVE	YEAR	MOUNT / BRACKET
FF7130	Chrome	7Ga	10.5" Setback Batwing	N	N	N	Y	N	Y	'88 - '96	N
FF7131	Chrome	7Ga	10.5" Setback Batwing	N	N	N	Y	N	Y	'88 - '96	N

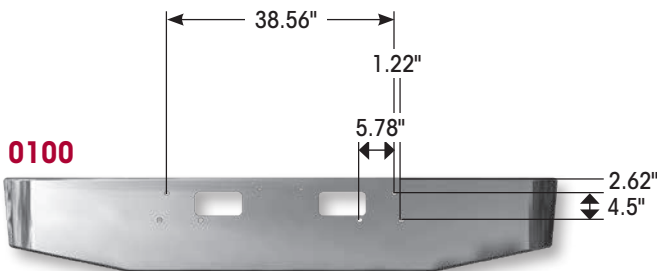

Ford L-Series conventional fits LN-LT-LTN 800, 900, 8000 and 9000
(Tow holes only). Fits trucks with 6V92 Detroit engine or 300
Cummins engine 1988 or newer (Axle forward only).

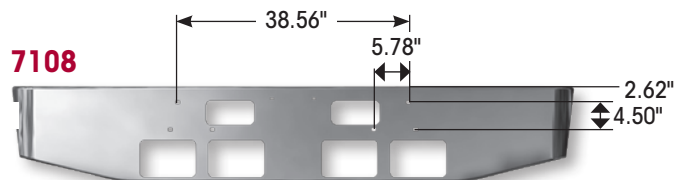

Ford Conventional LTL 9000 —
Step holes and four square light holes.

PART NO.	MATERIAL / FINISH	GAUGE / THICKNESS	STYLE	LIGHT	CENTER STEP	VENT	TOW	RADAR	EXCLUSIVE	YEAR	MOUNT / BRACKET
0100	Chrome	10Ga	16" Taper	N	N	N	Y	N	N	'88 - '96	N
0101	Chrome	10Ga	16" Taper	2 Round	N	N	Y	N	N	'88 - '96	N
7100	Chrome	7Ga	16" Taper	N	N	N	Y	N	N	'88 - '96	N
7108	Chrome	7Ga	16" Taper	4 Square	N	N	Y	N	N	'88 - '96	N
FF7109	Chrome	7Ga	Corporate Face	N	N	N	Y	N	Y	'88 - '96	N

FREIGHTLINER

FLC

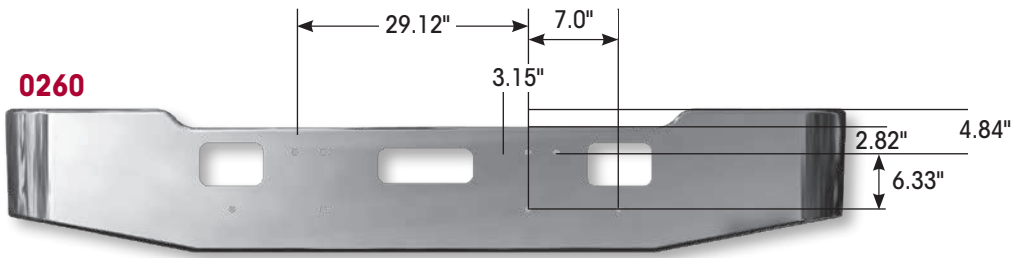

Freightliner FLC-112

PART NO.	MATERIAL / FINISH	GAUGE / THICKNESS	STYLE	LIGHT	CENTER STEP	VENT	TOW	RADAR	EXCLUSIVE	YEAR	MOUNT / BRACKET
0260	Chrome	10Ga	16" Gullwing	N	Y	N	Y	N	N	'86 & newer	N
0261	Chrome	10Ga	16" Gullwing	2 Square	Y	N	Y	N	N	'86 & newer	N

FLD

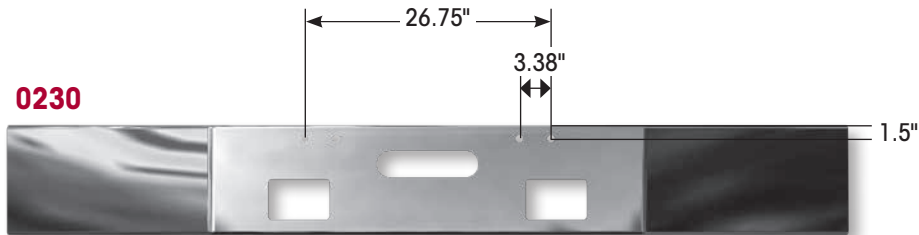

Fits FLD 120 — Severe Duty Construction

PART NO.	MATERIAL / FINISH	GAUGE / THICKNESS	STYLE	LIGHT	CENTER STEP	VENT	TOW	RADAR	EXCLUSIVE	YEAR	MOUNT / BRACKET
0230	Chrome	10Ga	12" Set Back	2 Square	Y	N	N	N	N	'89 - '04	N
7230	Chrome	7Ga	12" Set Back	2 Square	Y	N	N	N	N	'89 - '04	N
7240	Chrome	7Ga	12" Set Forward	2 Square	Y	N	N	N	N	'89 - '04	N

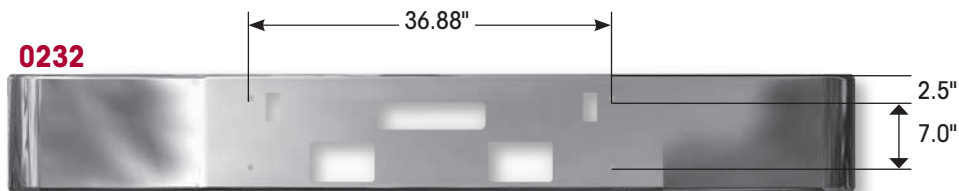

Freightliner FLD 112

PART NO.	MATERIAL / FINISH	GAUGE / THICKNESS	STYLE	LIGHT	CENTER STEP	VENT	TOW	RADAR	EXCLUSIVE	YEAR	MOUNT / BRACKET
0232	Chrome	10Ga	12" Set Back	2 Square	Y	N	Y	N	N	'89 - '04	N
7233	Chrome	7Ga	12" Set Forward	2 Square	Y	N	Y	N	N	'89 - '04	N

FREIGHTLINER

FLD cont.

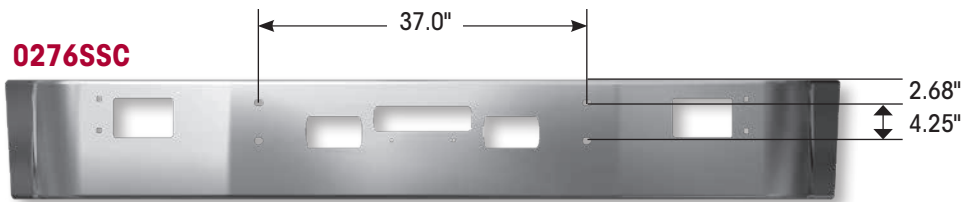

Freightliner FLD 120

PART NO.	MATERIAL / FINISH	GAUGE / THICKNESS	STYLE	LIGHT	CENTER STEP	VENT	TOW	RADAR	EXCLUSIVE	YEAR	MOUNT / BRACKET
0275BX	Steel Primed	10Ga	13.5" Set Back	2 Square	Y	N	N	N	N	'89 - '04	N
0275SSC*	AERO CLAD®	0.125	13.5" Set Back	2 Square	Y	N	N	N	N	'89 - '04	N
0276BX	Steel Primed	10Ga	13.5" Set Back	4 Square	Y	N	N	N	N	'89 - '04	N
0276SSC*	AERO CLAD	0.125	13.5" Set Back	4 Square	Y	N	N	N	N	'89 - '04	N

Braces and Spacers included with bumper.

For models fitted with Perlex drive lights, use Freightliner back-up bar P/N A21-20133-003.

For models fitted with Marchel drive lights, use Freightliner back-up bar P/N A21-20133-000.

***NOTE:** The SSC FLD Bumper requires the Freightliner back-up bar for assembly. The back-up bar is standard with all plastic bumper applications. The back-up bar is not standard with metal bumper applications.

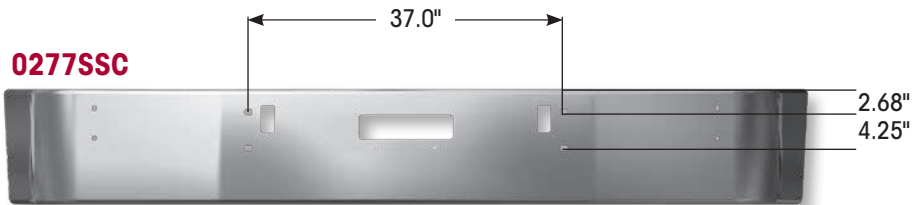

Freightliner FLD 112 with step and tow holes

PART NO.	MATERIAL / FINISH	GAUGE / THICKNESS	STYLE	LIGHT	CENTER STEP	VENT	TOW	RADAR	EXCLUSIVE	YEAR	MOUNT / BRACKET
0277SSC	AERO CLAD	0.125	13.5" Set Back	N	Y	N	Y	N	N	'89 - '04	N
0278SSC	AERO CLAD	0.125	13.5" Set Back	2 Square	Y	N	Y	N	N	'89 - '04	N
0279BX	Steel Primed	10Ga	13.5" Set Back	N	Y	N	N	N	N	'89 - '04	N
0279SSC	AERO CLAD	0.125	13.5" Set Back	N	Y	N	N	N	N	'89 - '04	N
0280SSC	AERO CLAD	0.125	13.5" Set Back	N	N	N	Y	N	N	'89 - '04	N
0280BX	Steel Primed	10Ga	13.5" Set Back	N	N	N	Y	N	N	'89 - '04	N

Braces and Spacers included with bumper.

IH Dealers use AM0277BX.



FREIGHTLINER

BUSINESS CLASS



PART NO.	MODEL	LEG	DIMENSION
0296SSC	FL50, 60, 70, 80, 106	A	14.2"
0295SSC	FL50, 60, 70, 80, 106	B	21.3"



Freightliner stainless steel clad aluminum fits Business Class — Includes brackets (Installed)

PART NO.	MATERIAL / FINISH	GAUGE / THICKNESS	STYLE	LIGHT	CENTER STEP	VENT	TOW	RADAR	EXCLUSIVE	YEAR	MOUNT / BRACKET
0295SSC	AERO CLAD®	0.125	11.3" Set Back	2 Square	Y	N	N	N	N	'97 - '02	N
0296SSC	AERO CLAD	0.125	11.3" Set Back	2 Square	Y	N	N	N	N	'97 - '02	N

CENTURY CLASS



Freightliner Century Class stainless steel clad aluminum — Includes brackets (Installed)

PART NO.	MATERIAL / FINISH	GAUGE / THICKNESS	STYLE	LIGHT	CENTER STEP	VENT	TOW	RADAR	EXCLUSIVE	YEAR	MOUNT / BRACKET
0290SSC	AERO CLAD	0.125	12" Set Back	N	Y	N	Y	N	N	'96 - '03	Y
0291SSC	AERO CLAD	0.125	12" Set Back	N	Y	N	Y	N	N	'04 - '07	Y

Required hardware to install bumper:

Mounting Bracket (P/N: A21-25693-000 LH & A21-25693-001 RH) and Spacer (2 required, P/N: 23-11427-038) available from your Freightliner dealer. Drill 14mm hole in top mounting bracket for pre-1997 Century Class.

FREIGHTLINER

FLD-CLASSIC

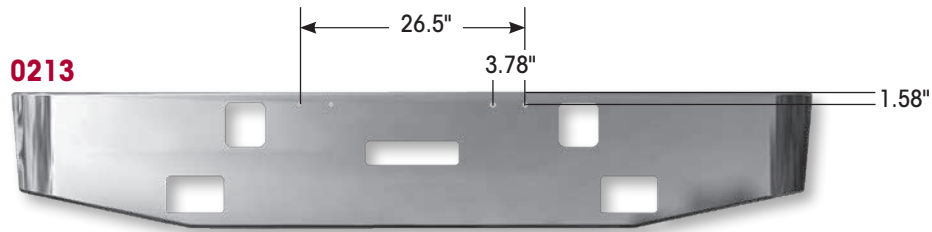

PART NO.	MATERIAL / FINISH	GAUGE / THICKNESS	STYLE	LIGHT	CENTER STEP	VENT	TOW	RADAR	EXCLUSIVE	YEAR	MOUNT / BRACKET
0207	Chrome	10Ga	16" Taper	2 Square	Y	N	N	N	N	—	N
0207SQ	Chrome	0.125	18" Texas Square	2 Square	Y	N	N	N	N	—	N
0209	Chrome	10Ga	16" Taper	2 Square	Y	N	N	N	N	'84 - '99	N
0209NLSQ	Chrome	0.125	18" Texas Square	N	Y	N	N	N	N	'84 - '99	N
0211SQ	Chrome	0.125	18" Texas Square	4 Square	Y	N	N	N	N	'84 - '99	N
0213	Chrome	10Ga	16" Taper	2 Square	Y	N	Y	N	N	'00 - '02	N
0213SQ	Chrome	0.125	18" Texas Square	2 Square	Y	N	Y	N	N	'00 - '02	N
0213SSCSQ	AERO CLAD®	0.125	18" Texas Square	2 Square	Y	N	Y	N	N	'00 - '02	N
0216	Chrome	10Ga	16" Taper	N	Y	N	Y	N	N	'00 - '02	N
0216SSCSQ	AERO CLAD	0.125	18" Texas Square	N	Y	N	Y	N	N	'00 - '02	N
0223SQ	Chrome	0.125	18" Texas Square	N	N	N	N	N	N	'84 - '99	N
0267SQ12	Chrome	10Ga	12" Texas Square	N	Y	N	N	N	N	'84 - '99	N
0283SQ18	Chrome	0.125	18" Box	N	Y	N	N	N	N	'84 - '99	N
7209NLSQ	Chrome	8Ga	18" Texas Square	N	Y	N	N	N	N	'84 - '99	N
7209	Chrome	8Ga	16" Taper	2 Square	Y	N	N	N	N	'84 - '99	N
7213SQ12	Chrome	8Ga	12" Texas Square	2 Square	Y	N	Y	N	N	'00 - '02	N
7213SQ	Chrome	8Ga	18" Texas Square	2 Square	Y	N	Y	N	N	'00 - '02	N
7213SSC	AERO CLAD	0.160	16" Taper	2 Square	Y	N	Y	N	N	'00 - '02	N
7216	Chrome	8Ga	16" Taper	N	Y	N	Y	N	N	'00 - '02	N
7216SQ	Chrome	8Ga	18" Texas Square	N	Y	N	Y	N	N	'00 - '02	N
7216SSC	AERO CLAD	0.160	16" Taper	N	Y	N	Y	N	N	'00 - '02	N

FREIGHTLINER

FLD-CLASSIC cont.

PART NO.	MATERIAL / FINISH	GAUGE / THICKNESS	STYLE	LIGHT	CENTER STEP	VENT	TOW	RADAR	EXCLUSIVE	YEAR	MOUNT / BRACKET
7250SSC	AERO CLAD®	0.16	16" Taper	2 Square	Y	N	N	N	N	'84 - '99	N
7251SSC	AERO CLAD	7Ga	16" Taper	N	N	N	Y	N	N	'84 - '99	N
0283SQ12	Chrome	0.125	12" Box	N	Y	N	N	N	N	'84 - '99	N
0283SQ20	Chrome	0.125	20" Box	N	Y	N	N	N	N	'84 - '99	N
0284SQ	Chrome	0.125	18" Texas Square	15 Round	Y	N	Y	N	N	'00 - '02	N
0289SQ18	Chrome	7Ga	18" Texas Square	15 Round	Y	N	N	N	N	'84 - '99	N
7209NL	Chrome	7Ga	16" Taper	N	N	N	Y	N	N	'84 - '99	N

122SD

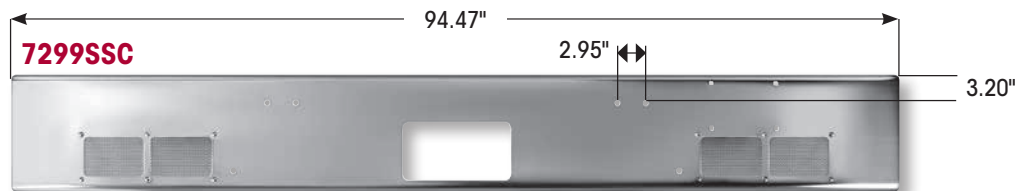

PART NO.	MATERIAL / FINISH	GAUGE / THICKNESS	STYLE	LIGHT	CENTER STEP	VENT	TOW	RADAR	EXCLUSIVE	YEAR	MOUNT / BRACKET
7299SSC	AERO CLAD	0.125	12.375" Set Forward	Y	N	N	Y	N	Y	All	N
7299NLSSC	AERO CLAD	0.125	12.375" Set Forward	N	N	N	Y	N	Y	All	N

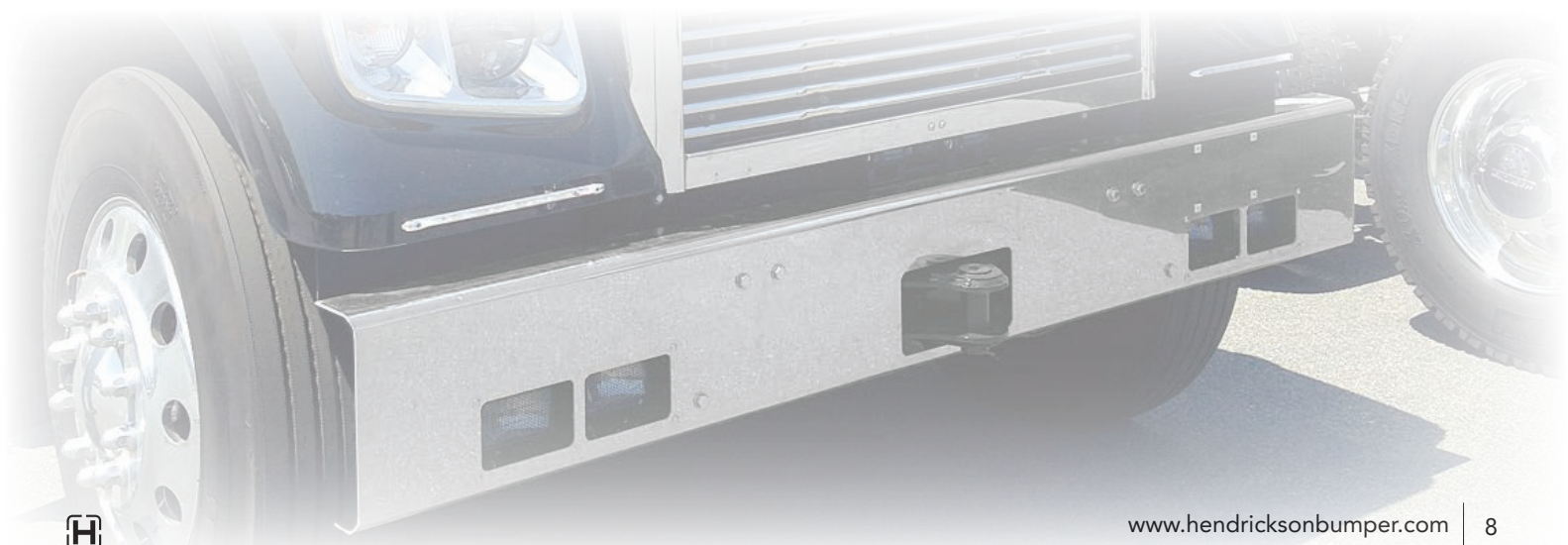

FREIGHTLINER

COLUMBIA

Introducing the industry's first three-piece bumper combining **HENDRICKSON AERO BRIGHT®** and steel-chrome technology.



0293BRTR



0293BRTL



HENDRICKSON AERO BRIGHT®

Features and Benefits

- Brilliant "chrome-like" mirror finish
- OEM styling and serviceability
- Easy installation to factory mounts
- High-impact TPO resin end caps

Columbia three-piece bumper now available with a ready-to-paint e-coat finish.



0292R

FF0292C

0292L



Features and Benefits

- Easy installation to factory mounts
- Ready for top coat
- High-impact TPO resin end caps
- Sturdy, robust
- E-coat finish
- One-year limited warranty*



FREIGHTLINER

COLUMBIA cont.

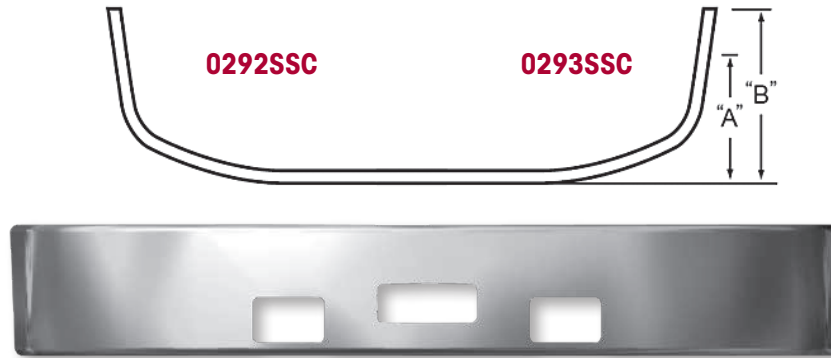

Freightliner Columbia stainless steel clad aluminum

PART NO.	LEG	DIMENSION
0292SSC*	A	25.15"
0293SSC**	B	28.34"

*When replacing factory bumper you must refer to Freightliner Bill of Material T80133.

**When replacing factory bumper you must refer to Freightliner Bill of Material T80132.

PART NO.	MATERIAL / FINISH	GAUGE / THICKNESS	STYLE	LIGHT	CENTER STEP	VENT	TOW	RADAR	EXCLUSIVE	YEAR	MOUNT / BRACKET
0288SSC	AERO CLAD®	0.125	14.5" Set Back	N	Y	N	N	N	N	Prior to '04	N
0292BRT	MIXED*	N/A	3 Piece Plastic/ Metal Combo	2 Round	N	Y	N	N	Y	'04-'07	N
0292L	BLACK	N/A	PLASTIC END CAP	N/A	N/A	N/A	N/A	N/A	N	Prior to '08	N/A
0292	Chrome	0.09	Metal Center Section	2 Round	N	Y	N	N	Y	Prior to '08	N/A
0292R	BLACK	N/A	PLASTIC END CAP	N/A	N/A	N/A	N/A	N/A	N	Prior to '08	N/A
0292SSC	AERO CLAD	0.125	14.5" Set Back	N	Y	N	Y	N	N	'04-'07	N
0293SSC	AERO CLAD	0.125	14.5" Set Back	N	Y	N	Y	N	N	Prior to '04	N
0293BRTR	AERO BRIGHT®	N/A	END CAP	N/A	N/A	N/A	N/A	N/A	N	Use with 0292	N
0293BRTL	AERO BRIGHT®	N/A	END CAP	N/A	N/A	N/A	N/A	N/A	N	Use with 0292	N
FF0292CX**	Steel Primed	0.09	Metal Center Section	2 Round	N	Y	N	N	Y	'04-'07	N

*Steel Chrome and AERO BRIGHT

**Steel Primed and TPO

FREIGHTLINER

CASCADIA

H AERO CLAD® Stainless Steel Clad Aluminum Bumper

Features and Benefits

- Durable, bright mirrored finish
- Finish 10 times thicker than chrome
- Resists corrosion
- Resists cracking, pitting, peeling and fading
- Increased ground clearance
- Lightweight for better fuel economy
- Minor abrasions can be buffed
- Full five-year limited warranty*



PART NO.	MATERIAL / FINISH	GAUGE / THICKNESS	STYLE	LIGHT	CENTER STEP	VENT	TOW	RADAR	EXCLUSIVE	YEAR	MOUNT / BRACKET
0256NLSSC**	AERO CLAD®	0.125	14.5" Set Back	N	Y	Y	Y	N	N	'08 - present	Y
0256SSC**	AERO CLAD	0.125	14.5" Set Back	2 Oval	Y	Y	Y	N	N	'08 - present	Y
0257NLSSC***	AERO CLAD	0.125	14.5" Set Back	N	Y	Y	Y	N	N	'08 - present	Y
0257SSC***	AERO CLAD	0.125	14.5" Set Back	2 Oval	Y	Y	Y	N	N	'08 - present	Y
0256TFLK	TPO	—	Top Fillers	—	—	—	—	—	N	'08 - present	—
0256TFRK	TPO	—	Top Fillers	—	—	—	—	—	N	'08 - present	—

** Kit includes hardware needed to replace OEM plastic bumper and includes top fillers.

*** Assembly when replacing existing AERO CLAD bumper. Top fillers sold separately.

CASCADIA AIR DAM KIT

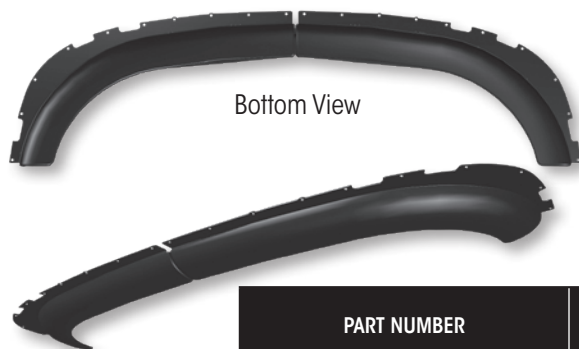

Bottom View

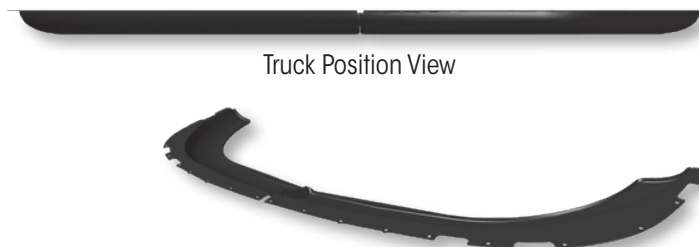

Truck Position View

PART NUMBER	DESCRIPTION
0256AD	Full air dam with hardware
0256ADL	Left side with hardware
0256ADR	Right side with hardware

NOTE: Images shown above are for Air Dam Kit 0256AD. Air Dams sold separately. Not included with bumper purchase.



INTERNATIONAL

VISION 98



PART NO.	MATERIAL / FINISH	GAUGE / THICKNESS	STYLE	LIGHT	CENTER STEP	VENT	TOW	RADAR	EXCLUSIVE	YEAR	MOUNT / BRACKET
AM0420SSC	AERO CLAD®	0.125	24" Set Back	N	N	Y	Y	N	N	'96 - newer	Face
AM0420X	Aluminum Primed	0.179	24" Set Back	N	N	Y	Y	N	N	'96 - newer	Face

4000

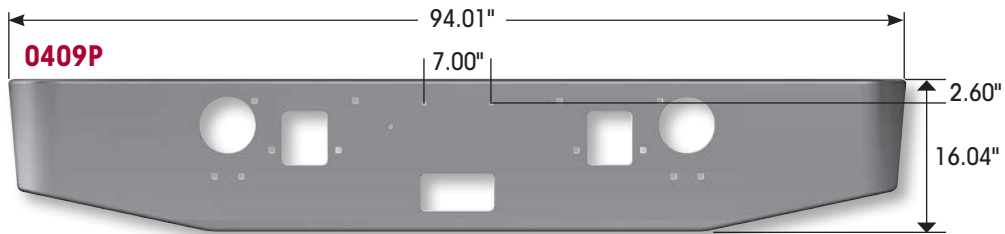

PART NO.	MATERIAL / FINISH	GAUGE / THICKNESS	STYLE	LIGHT	CENTER STEP	VENT	TOW	RADAR	EXCLUSIVE	YEAR	MOUNT / BRACKET
0409	Chrome	10Ga	16" Taper	Y	Y	Y	Y	N	N	—	Face
7422	Chrome	0.179	10" Wrap around	N	N	N	Y	N	N	'89 - '97	Face
7423	Chrome	0.179	10" Wrap around	Y	N	N	Y	N	N	—	Face

5000

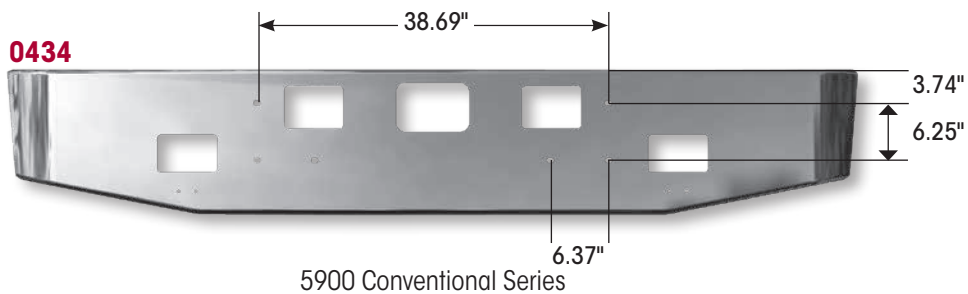

PART NO.	MATERIAL / FINISH	GAUGE / THICKNESS	STYLE	LIGHT	CENTER STEP	VENT	TOW	RADAR	EXCLUSIVE	YEAR	MOUNT / BRACKET
0434	Chrome	10Ga	16" Taper	2 Square	Y	Y	Y	N	N	—	Face
0434SQ	Chrome	0.1225	18" Texas Square	2 Square	Y	Y	Y	N	N	—	Face

INTERNATIONAL

7000

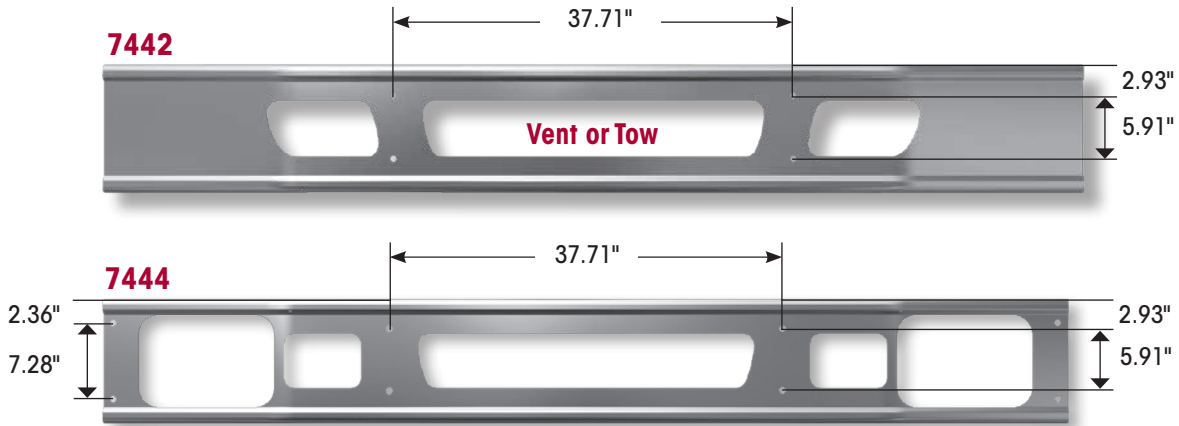

PART NO.	MATERIAL / FINISH	GAUGE / THICKNESS	STYLE	LIGHT	CENTER STEP	VENT	TOW	RADAR	EXCLUSIVE	YEAR	MOUNT / BRACKET
7442BX	Steel Primed	7Ga	12" Set Forward	Y	N	Y	Y	N	N	A	Face
7442	Chrome	7Ga	12" Set Forward	Y	N	Y	Y	N	N	A	Face
7442SSC	AERO CLAD®	0.16	12" Set Forward	Y	N	Y	Y	N	N	A	Face
7444BX	Steel Primed	7Ga	12" Set Forward	Y	N	Y	Y	N	N	A	Face
7444	Chrome	7Ga	12" Set Forward	Y	N	Y	Y	N	N	A	Face
7444SSC	AERO CLAD	0.16	12" Set Forward	Y	N	Y	Y	N	N	A	Face
7445BX	Steel Primed	7Ga	12" Set Back	Y	N	Y	Y	N	N	A	Face
7445	Chrome	7Ga	12" Set Back	Y	N	Y	Y	N	N	A	Face
7445SSC	AERO CLAD	0.16	12" Set Back	Y	N	Y	Y	N	N	A	Face
7467BX	Steel Primed	7Ga	12" Set Forward	Y	N	Y	Y	N	Y	A	Face
7467	Chrome	7Ga	12" Set Forward	Y	N	Y	Y	N	Y	A	Face
7468BX	Steel Primed	7Ga	12" Set Back	Y	N	Y	Y	N	Y	B	Face
7468	Chrome	7Ga	12" Set Back	Y	N	Y	Y	N	Y	B	Face
7469SSC	AERO CLAD	0.16	12" Set Back	Y	N	Y	Y	N	Y	C	Face

APPLICATION GUIDELINES		
A	B	C
7300 – Oct. 2001 and newer	7300 – Oct. 2001 and newer	7400 – July 2001 and newer
7400 – July 2001 and newer	7400 – July 2001 and newer	7500 – July 2001 and newer
7500 – July 2001 and newer	7500 – July 2001 and newer	7600 – April 2002 and newer
7600 – April 2002 and newer	7600 – April 2002 and newer	
	7700 – Dec. 2003 and newer	



INTERNATIONAL

9000

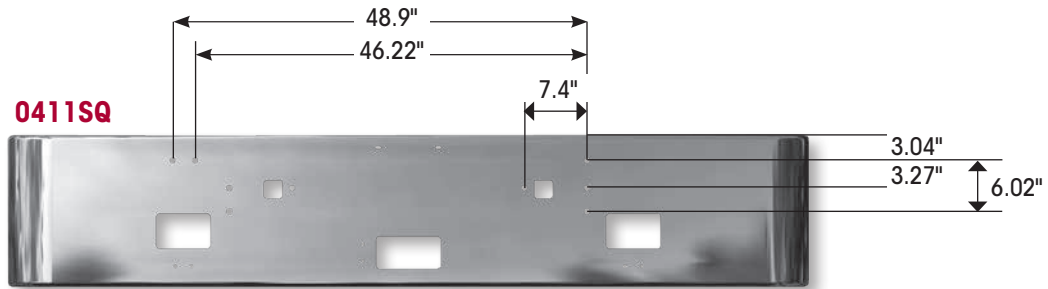

9370 Conventional Series

PART NO.	MATERIAL / FINISH	GAUGE / THICKNESS	STYLE	LIGHT	CENTER STEP	VENT	TOW	RADAR	EXCLUSIVE	YEAR	MOUNT / BRACKET
0408	Chrome	10Ga	16" Taper	N	Y	N	Y	N	N	—	Face
0410	Chrome	10Ga	16" Taper	N	Y	N	Y	N	N	—	Face
0410SQ	Chrome	10Ga	18" Texas Square	N	Y	N	Y	N	N	—	Face
0411	Chrome	10Ga	16" Taper	Y	Y	N	Y	N	N	—	Face
0411SQ	Chrome	0.125	18" Texas Square	Y	Y	N	Y	N	N	—	Face
0415SSCSQ	AERO CLAD®	0.125	18" Texas Square	Y	Y	N	Y	N	N	'96 - Newer	Face
0415STQ	Stainless	11Ga	18" Texas Square	2 Square	Y	N	Y	N	N	'96 - Newer	Face
0416SQ	Chrome	0.121	18" Texas Square	N	N	N	Y	N	N	—	Face
0417SQ	Chrome	0.121	18" Texas Square	9 Oval	N	N	Y	N	N	—	Face
0425SQ	Chrome	0.121	18" Texas Square	N	N	N	Y	N	N	'96 - Newer	Face
0425SSC	AERO CLAD	0.125	12" Set Back	2 Square	Y	N	Y	N	N	'96 - Newer	Flange
7410P	Chrome	0.158	16" Taper	N	Y	N	Y	N	N	—	Face
AM0413SSC	AERO CLAD	0.125	12" Set Back	Y	N	N	Y	N	Y	'96 - Newer	Face
AM0414SSC	AERO CLAD	0.125	12" Set Back	Y	N	N	Y	N	Y	'96 - Newer	Face
AM0415SSC	AERO CLAD	0.16	12" Set Back	Y	Y	N	Y	N	Y	—	Face
AM0442SSC	AERO CLAD	0.125	12" Set Back	N	N	Y	Y	Y	Y	—	Face

9370

PART NO.	MATERIAL / FINISH	GAUGE / THICKNESS	STYLE	LIGHT	CENTER STEP	VENT	TOW	RADAR	EXCLUSIVE	YEAR	MOUNT / BRACKET
7430	Chrome	8Ga	14" Set Forward	Y	Y	N	Y	N	N	'96 - Prior	Face

INTERNATIONAL

PROSTAR

H AERO CLAD® Stainless Steel Clad Aluminum Bumper

Features and Benefits

- Durable, bright mirrored finish
- Finish 10 times thicker than chrome
- Resists corrosion
- Resists cracking, pitting, peeling and fading
- High ground clearance
- Lightweight for better fuel economy
- Minor abrasions can be buffed
- Full five-year limited warranty*

0450SSC



OPTIONAL AIR DAM 0449AD



PART NO.	MATERIAL / FINISH	GAUGE / THICKNESS	STYLE	LIGHT	CENTER STEP	VENT	TOW	RADAR	EXCLUSIVE	YEAR	MOUNT / BRACKET
AM0449X	Primed Aluminum	0.16	—	Y	N	Y	Y	N	Y	Pre 2010	Tilt Mount to OEM brackets
AM0449SSC	AERO CLAD®	0.125	—	Y	N	Y	Y	N	Y	Pre 2010	Tilt Mount to OEM brackets
AM0450X	Primed Aluminum	0.16	—	Y	N	Y	Y	N	Y	2010 + Newer	Fixed Mount
AM0450SSC	AERO CLAD	0.125	—	Y	N	Y	Y	N	Y	2010 + Newer	Fixed Mount
AM0451SSC	AERO CLAD	0.125	—	Y	N	Y	Y	N	Y	All	Tilt Mount to OEM brackets
AM0449TFL	TPO	—	Top Fillers	—	—	—	—	—	Y	All	—
AM0449TFR	TPO	—	Top Fillers	—	—	—	—	—	Y	All	—

PROSTAR AIR DAM

PART NUMBER	DESCRIPTION
0449AD*	Full air dam with hardware
0449ADL*	Left side with hardware
0449ADR*	Right side with hardware

* Sold separately



INTERNATIONAL

PROSTAR cont.

H AERO GUARD®
Injection Molded Resin Bumper



Features and Benefits

- Cold impact durability to minus 30° F
- Lightweight design — molded structural design with fewer brackets and components
- Up to 3.75 inches of increased ground clearance over OEM bumper
- Molded in dark shadow gray — can be painted to color of choice
- Improved cooling air flow capacity
- Simple, two-piece design for serviceability
- AERO GUARD® bumper assembly is tilt mount compatible
- 100 percent recyclable TPO



PART NO.	MATERIAL / FINISH	GAUGE / THICKNESS	STYLE	LIGHT	CENTER STEP	VENT	TOW	RADAR	EXCLUSIVE	YEAR	MOUNT / BRACKET
0449AGK	AERO GUARD®	0.4	—	Y	N	Y	Y	N	Y	Pre 2010	Tilt Mount to OEM brackets
0449AGLAK	AERO GUARD	0.4	—	Y	N	Y	Y	N	Y	Pre 2010	Tilt Mount to OEM brackets
0449AGRAK	AERO GUARD	0.4	—	Y	N	Y	Y	N	Y	Pre 2010	Tilt Mount to OEM brackets
0449AGVK	AERO GUARD	0.4	—	Y	N	Y	Y	Y	Y	Pre 2010	Tilt Mount to OEM brackets
0450AGK	AERO GUARD	0.4	—	Y	N	Y	Y	N	Y	Any	Tilt Mount to OEM brackets
0450AGLK	AERO GUARD	0.4	—	Y	N	Y	Y	N	Y	Any	Tilt Mount to OEM brackets
0450AGRK	AERO GUARD	0.4	—	Y	N	Y	Y	N	Y	Any	Tilt Mount to OEM brackets
0450AGVK	AERO GUARD	0.4	—	Y	N	Y	Y	Y	Y	Any	Tilt Mount to OEM brackets
0450AGVLK	AERO GUARD	0.4	—	Y	N	Y	Y	Y	Y	Any	Tilt Mount to OEM brackets
0450AGVRK	AERO GUARD	0.4	—	Y	N	Y	Y	Y	Y	Any	Tilt Mount to OEM brackets

INTERNATIONAL

9900

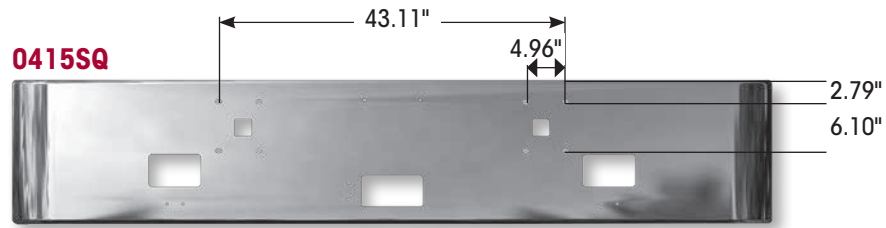

PART NO.	MATERIAL / FINISH	GAUGE / THICKNESS	STYLE	LIGHT	CENTER STEP	VENT	TOW	RADAR	EXCLUSIVE	YEAR	MOUNT / BRACKET
0415NL	Chrome	10Ga	16" Taper	N	Y	N	Y	N	N	—	Face
0415NLSQ	Chrome	10Ga	18" Texas Square	N	Y	N	Y	N	N	—	Face
0415	Chrome	10Ga	16" Taper	2 Square	Y	N	Y	N	N	—	Face
0415SQ	Chrome	10Ga	18" Texas Square	2 Square	Y	N	Y	N	N	—	Face
0424SQ	Chrome	10Ga	18" Texas Square	N	N	N	N	N	N	—	Face
0437SQ14	Chrome	10Ga	14" Texas Square	N	Y	N	Y	N	N	—	Face
0475SQ	Chrome	10Ga	18" Texas Square	9 Ovals	N	N	Y	N	N	—	Face
0485SQ	Chrome	10Ga	18" Texas Square	15 circles	N	N	Y	N	N	—	Face

NOTE: AERO CLAD® Texas Square requires separate purchase of stiffener brackets P/N 3523291C1 LH and 3523292C1 RH.

*Fits 1996 year and newer.

CONVENTIONAL

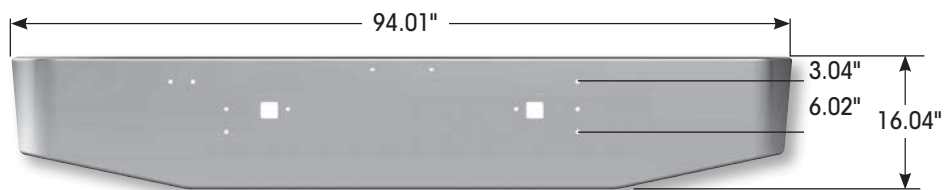

PART NO.	MATERIAL / FINISH	GAUGE / THICKNESS	STYLE	LIGHT	CENTER STEP	VENT	TOW	RADAR	EXCLUSIVE	YEAR	MOUNT / BRACKET
0416	Steel	10Ga	16" Taper	N	N	N	Y	N	N	—	N



KENWORTH

T300

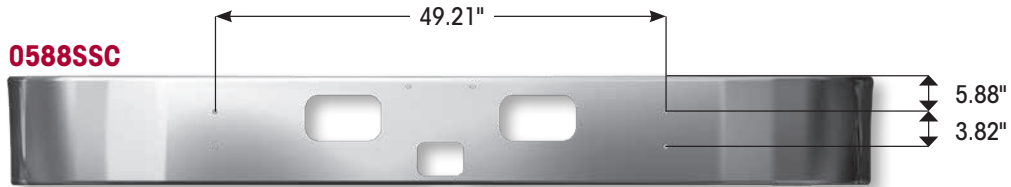

PART NO.	MATERIAL / FINISH	GAUGE / THICKNESS	STYLE	LIGHT	CENTER STEP	VENT	TOW	RADAR	EXCLUSIVE	YEAR	MOUNT / BRACKET
0588SSC	AERO CLAD®	0.125	12" Set Forward	N	Y	N	Y	N	N	All	N
0589SSC	AERO CLAD	0.125	12" Set Forward	N	N	N	Y	N	N	All	N
7588BX	Steel Primed	7Ga	12" Set Forward	N	Y	N	Y	N	N	All	N
7589BX	Steel Primed	7Ga	12" Set Forward	N	N	N	Y	N	N	All	N

T600



CONVENTIONAL: 1989 AND NEWER

PART NO.	MATERIAL / FINISH	GAUGE / THICKNESS	STYLE	LIGHT	CENTER STEP	VENT	TOW	RADAR	EXCLUSIVE	YEAR	MOUNT / BRACKET
0561BX	Steel Primed	10Ga	14" Set Back	N	Y	Y	Y	Y	N	'85 - '07	N
0562SSC	AERO CLAD	0.125	14" Set Back	N	Y	Y	Y	Y	N	'85 - '07	N



KENWORTH

T800

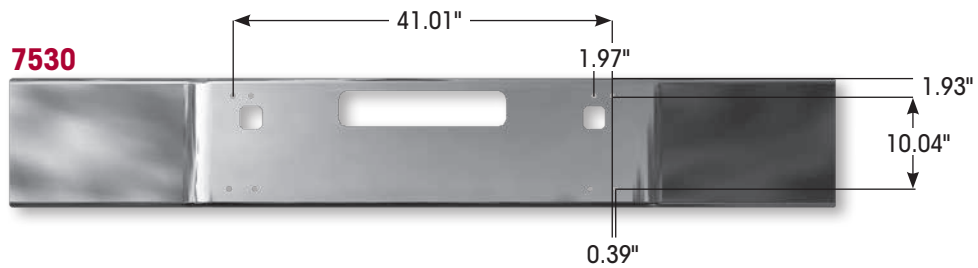

CONVENTIONAL WITH 7-INCH BREAK-BACK

PART NO.	MATERIAL / FINISH	GAUGE / THICKNESS	STYLE	LIGHT	CENTER STEP	VENT	TOW	RADAR	EXCLUSIVE	YEAR	MOUNT / BRACKET
0530	Chrome	10Ga	14" Open End	N	N	Y	Y	N	N	'86 - '04	N
0530SSC	AERO CLAD®	0.125	14" Open End	N	N	Y	Y	N	N	'86 - '04	N
0531	Chrome	10Ga	14" Open End	2 Square	N	Y	Y	N	N	'86 - '04	N
0531SSC	AERO CLAD	0.125	14" Open End	2 Square	N	Y	Y	N	N	'86 - '04	N
0534	Chrome	10Ga	14" Open End	N	N	Y	Y	N	N	'86 - '04	N
0539	Chrome	10Ga	14" Open End	N	N	N	Y	N	N	'86 - '04	N
0544	Chrome	10Ga	14" Taper	2 Square	N	Y	Y	N	N	'86 - '04	N
7530	Chrome	7Ga	14" Open End	N	N	Y	Y	N	N	'86 - '04	N
7530BX	Steel Primed	7Ga	14" Open End	N	N	Y	Y	N	N	'86 - '04	N
7531	Chrome	7Ga	14" Open End	2 Square	N	Y	Y	N	N	'86 - '04	N
7533	Chrome	7Ga	14" Open End	2 Square	N	Y	Y	N	N	'86 - '04	N
7534	Chrome	7Ga	14" Open End	N	N	Y	Y	N	N	'86 - '04	N
7540	Chrome	7Ga	14" Taper	N	N	Y	Y	N	N	'86 - '04	N
7542	Chrome	7Ga	14" Taper	N	N	Y	Y	N	N	'86 - '04	N
7543	Chrome	7Ga	14" Taper	2 Square	N	Y	Y	N	N	'86 - '04	N

KENWORTH

T800 cont.

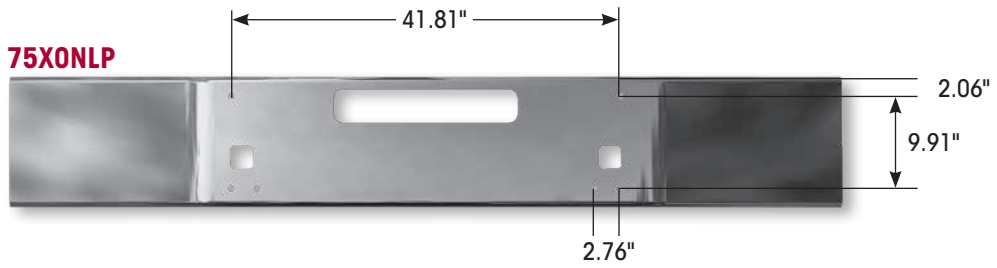

PART NO.	MATERIAL / FINISH	GAUGE / THICKNESS	STYLE	LIGHT	CENTER STEP	VENT	TOW	RADAR	EXCLUSIVE	YEAR	MOUNT / BRACKET
75X0	Chrome	7Ga	14" Open End	2 Square	N	Y	Y	N	Y	'05 - present	N
75X0NL	Chrome	7Ga	14" Open End	N	N	Y	Y	N	Y	'05 - present	N
75X2NLPOL	Polished Aluminum	0.25	14" Taper	N	N	Y	Y	N	N	'05 - present	N
75X2POL	Polished Aluminum	0.25	14" Taper	2 Square	N	Y	Y	N	N	'05 - present	N
75X2	Chrome	7Ga	14" Taper	2 Square	N	Y	Y	N	Y	'05 - present	N
75X2NL	Chrome	7Ga	14" Taper	N	N	Y	Y	N	Y	'05 - present	N
05X0NLSSC	AERO CLAD®	0.125	14" Open End	N	N	Y	Y	N	N	'04 - present	N
05X0SSC	AERO CLAD	0.125	14" Open End	2 Square	N	Y	Y	N	N	'04 - present	N



KENWORTH

W900

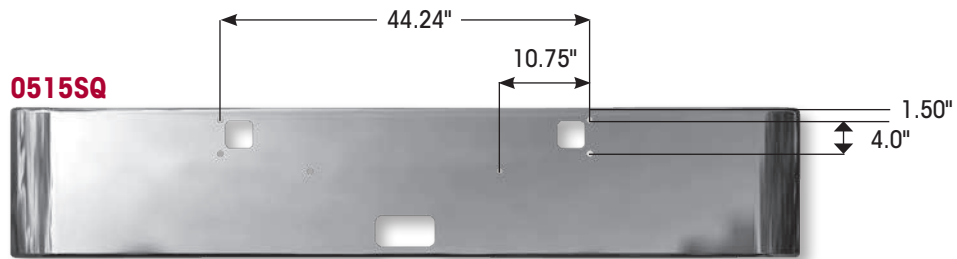

PART NO.	MATERIAL / FINISH	GAUGE / THICKNESS	STYLE	LIGHT	CENTER STEP	VENT	TOW	RADAR	EXCLUSIVE	YEAR	MOUNT / BRACKET
0502	Chrome	10Ga	16" Gullwing	N	Y	N	Y	N	N	'82 - '10	N
0502SQ	Chrome	0.125	18" Texas Square	N	Y	N	Y	N	N	'82 - '10	N
0503	Chrome	10Ga	16" Gullwing	2 Square	Y	N	Y	N	N	'82 - '10	N
0503SQ	Chrome	0.125	18" Texas Square	2 Square	Y	N	Y	N	N	'82 - '10	N
0515SQ16	Chrome	0.125	16" Texas Square	N	Y	N	Y	N	N	'82 - '10	N
0515IN18	Chrome	0.125	18" Taper	N	Y	N	Y	N	N	'82 - '10	N
7503	Chrome	7Ga	16" Gullwing	2 Square	Y	N	Y	N	N	'82 - '10	N
7512SQ	Chrome	7Ga	18" Texas Square	N	N	N	Y	N	N	'82 - '10	N
7525	Chrome	7Ga	16" Taper	N	Y	N	Y	N	N	'82 - '10	N
0514SQ	Chrome	0.125	18" Texas Square	2 Square	Y	N	Y	N	N	'82 - '10	N
0514SQ16	Chrome	0.125	16" Texas Square	2 Square	Y	N	Y	N	N	'82 - '10	N
0515SQ	Chrome	10Ga	18" Texas Square	N	Y	N	Y	N	N	'82 - '10	N

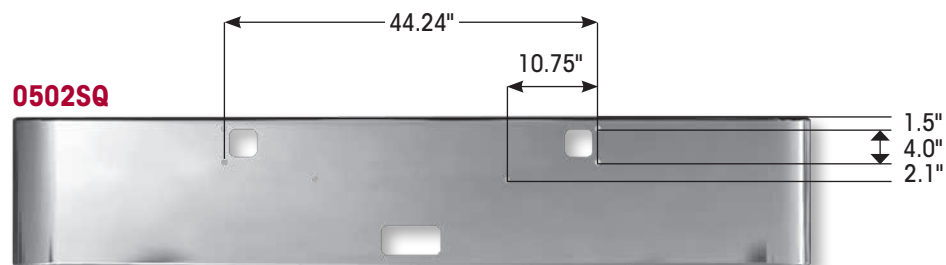

KENWORTH

W900 cont.

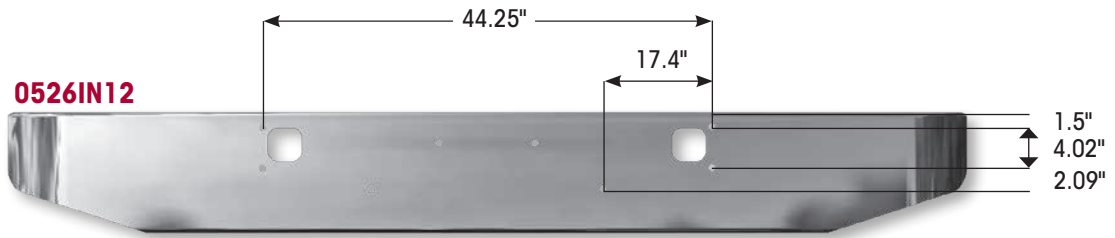

PART NO.	MATERIAL / FINISH	GAUGE / THICKNESS	STYLE	LIGHT	CENTER STEP	VENT	TOW	RADAR	EXCLUSIVE	YEAR	MOUNT / BRACKET
0521SQ	Chrome	0.125	20" Box	N	N	N	Y	N	N	'82 - '10	N
0522SQ	Chrome	0.125	18" Texas Square	N	N	N	Y	N	N	'82 - '10	N
0574SQ	Chrome	0.125	18" Texas Square	9 Oval	N	N	Y	N	N	'82 - '10	N
7514	Chrome	7Ga	16" Taper	2 Square	Y	N	Y	N	N	'82 - '10	N
7514SQ	Chrome	7Ga	18" Texas Square	2 Square	Y	N	Y	N	N	'82 - '10	N
7515	Chrome	8Ga	16" Taper	N	Y	N	Y	N	N	'82 - '10	N
7515SQ	Chrome	7Ga	18" Texas Square	N	Y	N	Y	N	N	'82 - '10	N

W900A

PART NO.	MATERIAL / FINISH	GAUGE / THICKNESS	STYLE	LIGHT	CENTER STEP	VENT	TOW	RADAR	EXCLUSIVE	YEAR	MOUNT / BRACKET
7510	Chrome	7Ga	16" Gullwing	N	N	N	Y	N	N	'67 - '81	N



KENWORTH

T660

H AERO CLAD® Stainless Steel Clad Aluminum Bumper



AERO CLAD® Features and Benefits

- Durable, bright mirrored finish
- Finish 10 times thicker than chrome
- Resists corrosion
- Resists cracking, pitting, peeling and fading
- Lightweight for better fuel economy
- High ground clearance
- Environmentally green alternative to chrome plating
- Minor abrasions can be buffed
- Full five-year limited warranty*



PART NO.	MATERIAL / FINISH	GAUGE / THICKNESS	STYLE	LIGHT	CENTER STEP	VENT	TOW	RADAR	EXCLUSIVE	YEAR	MOUNT / BRACKET
05R1NLSSC	AERO CLAD®	0.125	13.5" Set Back	N	N	Y	Y	N	N	'08 - present	Y
05R1NLVSSC	AERO CLAD	0.125	13.5" Set Back	N	N	Y	Y	Y	N	'08 - present	Y
05R1SSC	AERO CLAD	0.125	13.5" Set Back	Y	N	Y	Y	N	N	'08 - present	Y
05R1VSSC	AERO CLAD	0.125	13.5" Set Back	Y	N	Y	Y	Y	N	'08 - present	Y
05R1NLBAX	Steel Primed	10Ga	13.5" Set Back	N	N	Y	Y	N	N	'08 - present	Y
05R1NLVBAX	Steel Primed	10Ga	13.5" Set Back	N	N	Y	Y	Y	N	'08 - present	Y
05R1VBAX	Steel Primed	10Ga	13.5" Set Back	Y	N	Y	Y	Y	N	'08 - present	Y

T660 AIR DAM KIT

PART NUMBER	MATERIAL / FINISH
05R1AD	Full air dam with hardware
05R1ADL	Left side with hardware
05R1ADR	Right side with hardware

Air dam assembly: N33-6030 (Driver side), N33-6030R (Passenger side)



H HENDRICKSON AERO BRIGHT® Non-metal Bumper

Features and Benefits

- Brilliant "chrome-like" mirror finish
- OEM styling and serviceability
- Easy installation to factory mounts
- High-impact TPO resin end caps

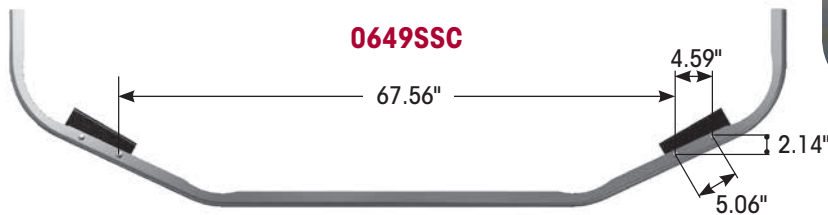

PART NO.	MATERIAL / FINISH	GAUGE / THICKNESS	STYLE	LIGHT	CENTER STEP	VENT	TOW	RADAR	EXCLUSIVE	YEAR	MOUNT / BRACKET
0636BSX	Steel Primed	10Ga	Set Forward	N	Y	N	Y	N	Y	'96 - Newer	N
0636SSC	AERO CLAD®	0.125	Set Forward	N	Y	N	Y	N	Y	'96 - Newer	N
0637BSX	Steel Primed	10Ga	Set Forward	Y	Y	N	Y	N	Y	'96 - Newer	N
0637SSC	AERO CLAD	0.125	Set Forward	Y	Y	N	Y	N	Y	'96 - Newer	Y
0648BSX	Steel Primed	10Ga	Set Back	N	Y	N	Y	N	Y	'96 - Newer	Y
0648SSC	AERO CLAD	0.125	Set Back	N	Y	N	Y	N	Y	'96 - Newer	Y
0649BLK	Black Paintable (ABS)	0.090	Set Back	Y	Y	Y	Y	N	Y	2004 - 2007	Y
0649BRT	AERO BRIGHT® (ABS)	0.090	Set Back	Y	Y	Y	Y	N	N	2004 - 2007	Y
0649BSX	Steel Primed	10Ga	Set Back	Y	Y	Y	Y	N	Y	—	Y
0649SSC	AERO CLAD	0.125	Set Back	Y	Y	N	Y	N	Y	'96 - Newer	Y
0653BX	Steel Primed	10Ga	Set Back	N	Y	N	Y	N	N	'96 - Newer	Y
0653SSC	AERO CLAD	0.125	Set Back	N	Y	N	Y	N	N	'96 - Newer	Y
0654BX	Steel Primed	10Ga	Set Back	Y	Y	N	Y	N	N	'96 - Newer	Y
0654SSC	AERO CLAD	0.125	Set Back	Y	Y	N	Y	N	N	'96 - Newer	Y
0655SSC	AERO CLAD	0.125	Set Forward	N	Y	N	Y	N	N	'96 - Newer	Y
0656SSC	AERO CLAD	0.125	Set Forward	Y	Y	N	Y	N	N	'96 - Newer	Y

MACK

CL

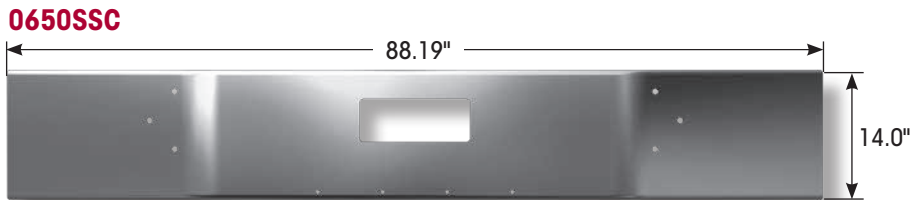

PART NO.	MATERIAL / FINISH	GAUGE / THICKNESS	STYLE	LIGHT	CENTER STEP	VENT	TOW	RADAR	EXCLUSIVE	YEAR	MOUNT / BRACKET
0650SSC	AERO CLAD®	0.125	Set Back	N	Y	N	N	N	N	—	N
0651SSC	AERO CLAD	0.125	Set Back	N	N	Y	Y	N	N	—	N

CORP

PART NO.	MATERIAL / FINISH	GAUGE / THICKNESS	STYLE	LIGHT	CENTER STEP	VENT	TOW	RADAR	EXCLUSIVE	YEAR	MOUNT / BRACKET
MM0611	Steel Primed	10Ga	Set Forward	Y	N	Y	Y	N	Y	All	N

DM

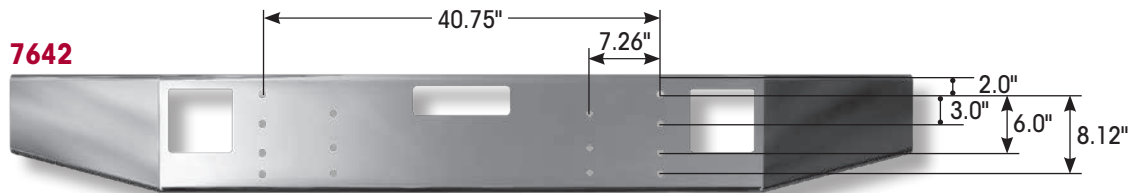

PART NO.	MATERIAL / FINISH	GAUGE / THICKNESS	STYLE	LIGHT	CENTER STEP	VENT	TOW	RADAR	EXCLUSIVE	YEAR	MOUNT / BRACKET
7642	Steel Chrome	8Ga	Set Back 10" Open End	N	N	Y	Y	N	N	'86 - '97	N

GRANITE



PART NO.	MATERIAL / FINISH	GAUGE / THICKNESS	STYLE	LIGHT	CENTER STEP	VENT	TOW	RADAR	EXCLUSIVE	YEAR	MOUNT / BRACKET
7645SSC	AERO CLAD	0.16	Set Forward 16" Taper	N	Y	N	Y	N	N	All	N
0658SSC	AERO CLAD	0.125	Set Back	N	N	N	Y	N	N	All	N

MACK

R



PART NO.	MATERIAL / FINISH	GAUGE / THICKNESS	STYLE	LIGHT	CENTER STEP	VENT	TOW	RADAR	EXCLUSIVE	YEAR	MOUNT / BRACKET
0609SQ	Steel Chrome	10Ga	R Model	N	N	Y	N	N	N	All	N
MM0603	Steel Chrome	10Ga	R Model	N	N	Y	Y	N	Y	All	N
MM0605	Steel Chrome	10Ga	R Model	Y	N	Y	Y	N	Y	All	N
MM0609	Steel Chrome	10Ga	R Model	N	N	Y	N	N	Y	All	N

RD

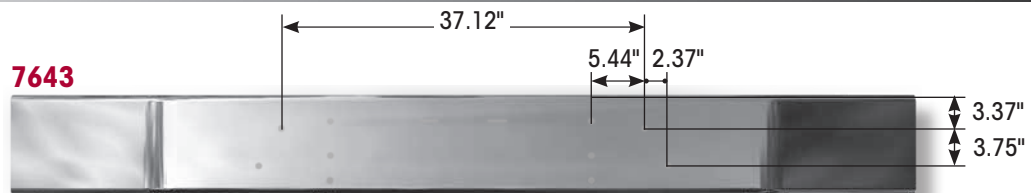

PART NO.	MATERIAL / FINISH	GAUGE / THICKNESS	STYLE	LIGHT	CENTER STEP	VENT	TOW	RADAR	EXCLUSIVE	YEAR	MOUNT / BRACKET
0643SSC	AERO CLAD®	0.125	Set Back	N	N	N	N	N	N	—	N
7643	Steel Chrome	8Ga	Set Back	N	N	N	N	N	N	'89 - '98	N
7644	Steel Chrome	8Ga	Set Back	N	N	N	Y	N	Y	—	N

*With cow catcher holes

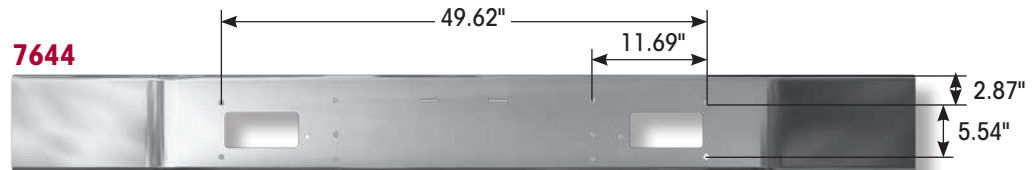

SET BACK AXLE WITH TOW HOLES AND COW CATCHER HOLES

SUPERLINER II

PART NO.	MATERIAL / FINISH	GAUGE / THICKNESS	STYLE	LIGHT	CENTER STEP	VENT	TOW	RADAR	EXCLUSIVE	YEAR	MOUNT / BRACKET
MM0613	Steel Chrome	10Ga	15" Taper	N	N	N	Y	N	Y	—	N

U

PART NO.	MATERIAL / FINISH	GAUGE / THICKNESS	STYLE	LIGHT	CENTER STEP	VENT	TOW	RADAR	EXCLUSIVE	YEAR	MOUNT / BRACKET
0603	Steel Chrome	10Ga	16" Taper	N	Y	N	Y	N	N	—	N
MM0605NL	Steel Chrome	10Ga	16" Taper	N	N	Y	Y	N	Y	—	N

Pinnacle CXU / Vision CX

AERO CLAD®
Stainless Steel Clad
Aluminum Bumper



MM0619SSC

AERO CLAD® Features and Benefits

- Durable, bright mirrored finish
- Finish 10 times thicker than chrome
- Resists corrosion
- Resists cracking, pitting, peeling and fading
- Lightweight for better fuel economy
- Minor abrasions can be buffed
- Full five-year limited warranty*



PART NO.	MATERIAL / FINISH	GAUGE / THICKNESS	STYLE	LIGHT	CENTER STEP	VENT	TOW	RADAR	EXCLUSIVE	YEAR	MOUNT / BRACKET
7658SSC	AERO CLAD®	0.160	Set Back	N	Y	N	Y	N	Y	'02 - Newer CX Vision	N
7659SSC	AERO CLAD	0.160	Set Back	Y	Y	N	Y	N	Y	'02 - Newer CX Vision	N
MM0619NLSSC	AERO CLAD	0.160	Set Back	N	Y	Y	Y	N	Y	'06 - Newer CX Pinnacle	N
MM0619SSC	AERO CLAD	0.160	Set Back	Y	Y	Y	Y	N	Y	'06 - Newer CX Pinnacle	N



PETERBILT

330

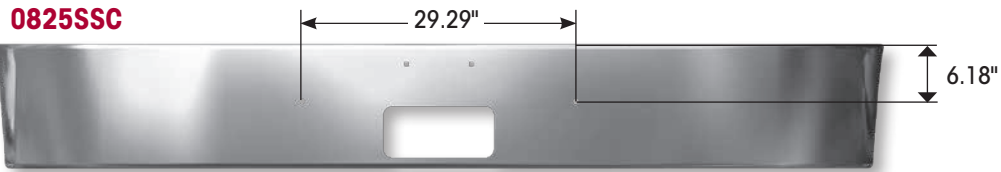

PART NO.	MATERIAL / FINISH	GAUGE / THICKNESS	STYLE	LIGHT	CENTER STEP	VENT	TOW	RADAR	EXCLUSIVE	YEAR	MOUNT / BRACKET
0825SSC	AERO CLAD®	0.125	13.5" Set Forward	N	N	N	X	N	Y	'97 & newer	N
0826SSC	AERO CLAD	0.125	16" Set Forward	N	Y	N	N	N	Y	'97 & newer	N

352 / 359

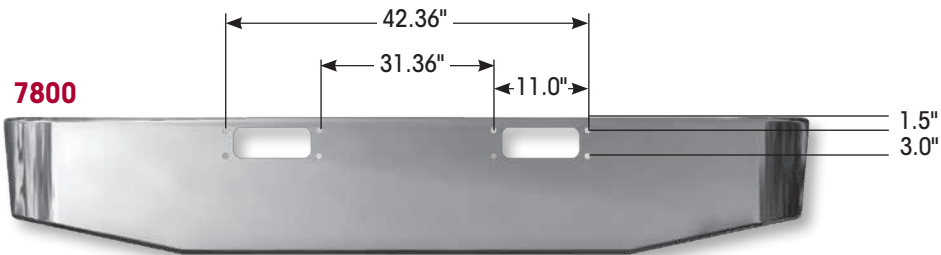

PART NO.	MATERIAL / FINISH	GAUGE / THICKNESS	STYLE	LIGHT	CENTER STEP	VENT	TOW	RADAR	EXCLUSIVE	YEAR	MOUNT / BRACKET
0800SQ	Chrome	0.10	18" TSQ	2 Square	N	N	N	N	N	'67 - '86	N
7800	AERO CLAD	0.7	16" Taper	2 Square	N	N	N	N	N	'67 - '86	N

367

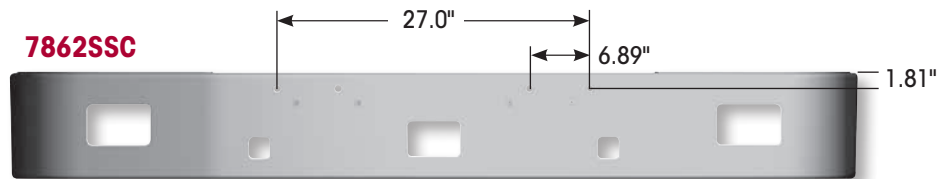

PART NO.	MATERIAL / FINISH	GAUGE / THICKNESS	STYLE	LIGHT	CENTER STEP	VENT	TOW	RADAR	EXCLUSIVE	YEAR	MOUNT / BRACKET
7862SSC	AERO CLAD	0.16	12" Set Back	Y	Y	N	Y	N	Y	'07 & Newer	Y
7862NLSSC	AERO CLAD	0.16	12" Set Back	N	Y	N	Y	N	Y	'07 & Newer	Y

PETERBILT

357 / 378 / 379 / 388

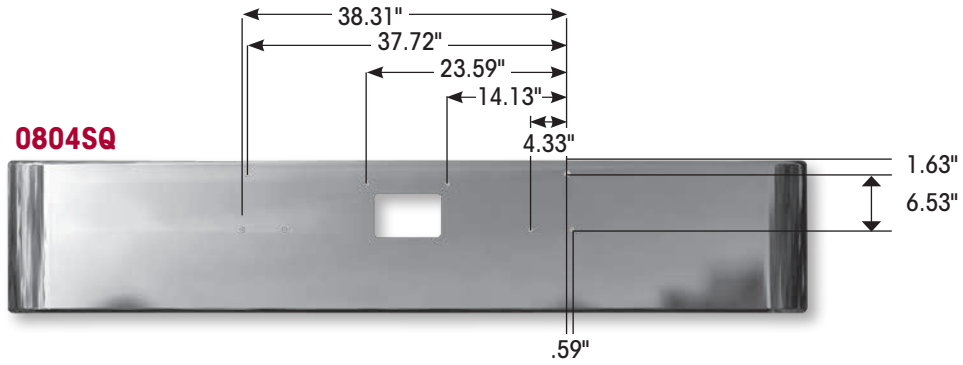

PART NO.	MATERIAL / FINISH	GAUGE / THICKNESS	STYLE	LIGHT	CENTER STEP	VENT	TOW	RADAR	EXCLUSIVE	YEAR	MOUNT / BRACKET
0804IN12	Chrome	10Ga	12" Taper	N	N	N	Y	N	N	'87 - '06	N
0804NTSQ	Chrome	0.125	18" Texas Square	N	N	N	N	N	N	'87 - '06	N
0804	Chrome	10Ga	16" Taper	N	N	N	Y	N	N	'87 - '06	N
0804SQ	Chrome	10Ga	18" Texas Square	N	N	N	Y	N	N	'87 - '06	N
0804SSC	AERO CLAD®	0.16	16" Taper	N	N	N	Y	N	N	'87 - '06	N
0804STQ	Stainless	11Ga	18" Texas Square	N	N	N	Y	N	N	'87 - '06	N
0805	Chrome	10Ga	16" Taper	2 Square	N	N	Y	N	N	'87 - '06	N
0805SQ	Chrome	0.125	18" Texas Square	2 Square	N	N	Y	N	N	'87 - '06	N
0807SQ	Chrome	0.125	18" Box	N	N	N	Y	N	N	'87 - '06	N
0813	Chrome	10Ga	16" Taper	N	N	N	Y	N	N	'87 - '06	N
0844SQ	Chrome	0.125	18" Texas Square	4 Oval	N	N	Y	N	N	'87 - '06	N
0864SQ	Chrome	0.125	18" Texas Square	6 Oval	N	N	Y	N	N	'87 - '06	N
0874SQ	Chrome	10Ga	18" Texas Square	9 Oval	N	N	Y	N	N	'87 - '06	N
0884SQ	Chrome	10Ga	18" Texas Square	15 Round	N	N	Y	N	N	'87 - '06	N
7805SQ	Chrome	7Ga	18" Texas Square	2 Square	N	N	Y	N	N	'87 - '06	N



PETERBILT

385

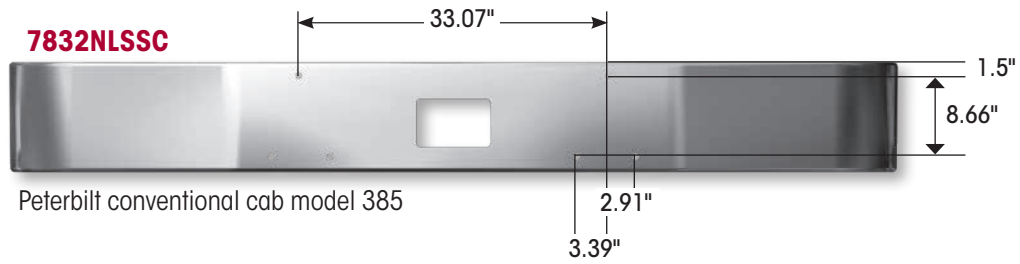

PART NO.	MATERIAL / FINISH	GAUGE / THICKNESS	STYLE	LIGHT	CENTER STEP	VENT	TOW	RADAR	EXCLUSIVE	YEAR	MOUNT / BRACKET
7832NLSSC	AERO CLAD®	0.16	12" Set Back	N	N	N	Y	N	N	'96 - '07	N
7832SSC	AERO CLAD	0.16	12" Set Back	2 Square	N	N	Y	N	N	'96 - '07	N

387

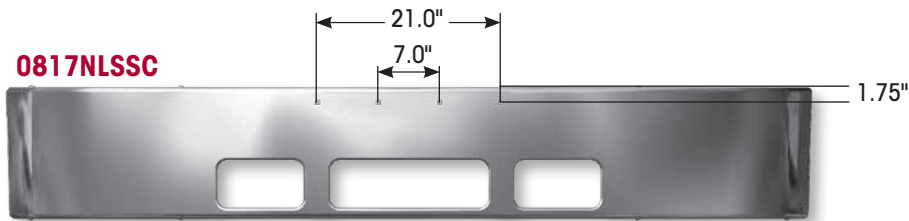

PART NO.	MATERIAL / FINISH	GAUGE / THICKNESS	STYLE	LIGHT	CENTER STEP	VENT	TOW	RADAR	EXCLUSIVE	YEAR	MOUNT / BRACKET
0817NLSSC	AERO CLAD	0.125	15" Set Back	N	Y	N	Y	N	Y	'02 - '10	Y
0817SSC	AERO CLAD	0.125	15" Set Back	2 Square	Y	N	Y	N	Y	'02 - '10	Y
0818NLSSC	AERO CLAD	0.125	15" Set Back	N	Y	N	Y	Y	Y	'02 - '10	Y
0818SSC	AERO CLAD	0.125	15" Set Back	2 Square	Y	N	Y	Y	Y	'02 - '10	Y

PETERBILT

384 / 386

H AERO CLAD® Stainless Steel Clad Aluminum Bumper



Features and Benefits

- Durable, bright mirrored finish
- Finish 10 times thicker than chrome
- Resists corrosion
- Resists cracking, pitting, peeling and fading
- Lightweight for better fuel economy
- Minor abrasions can be buffed
- Full five-year limited warranty*



PART NO.	MATERIAL / FINISH	GAUGE / THICKNESS	STYLE	LIGHT	CENTER STEP	VENT	TOW	RADAR	EXCLUSIVE	YEAR	MOUNT / BRACKET
0889NLSSC	AERO CLAD®	0.125	13.5" Set Back	N	Y	N	Y	N	Y	'06 - present	Y
0889SSC	AERO CLAD	0.125	13.5" Set Back	2 Square	Y	N	Y	N	Y	'06 - present	Y

587



PART NO.	MATERIAL / FINISH	GAUGE / THICKNESS	STYLE	LIGHT	CENTER STEP	VENT	TOW	RADAR	EXCLUSIVE	YEAR	MOUNT / BRACKET
08E0NLSSC	AERO CLAD	0.0125	13.5" Set Back	N	Y	N	Y	N	Y	ALL	Y



VOLVO

VNM

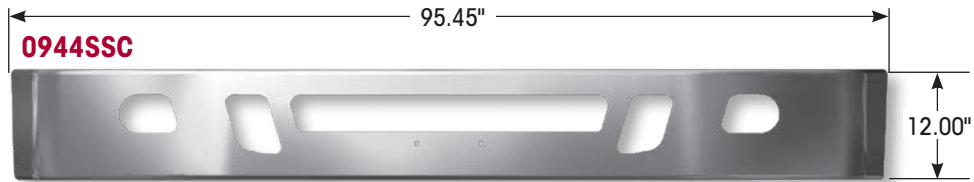

PART NO.	MATERIAL / FINISH	GAUGE / THICKNESS	STYLE	LIGHT	CENTER STEP	VENT	TOW	RADAR	EXCLUSIVE	YEAR	MOUNT / BRACKET
0944SSC	AERO CLAD®	0.125	Set Back	Y	N	Y	Y	N	N	—	Bracket

WG

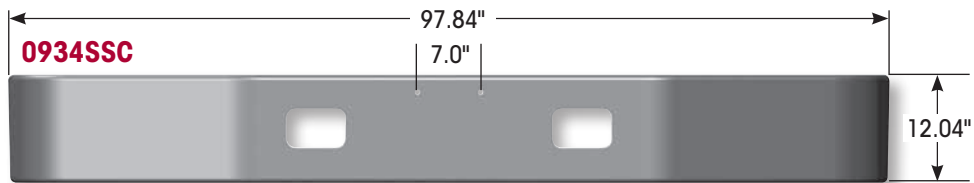

PART NO.	MATERIAL / FINISH	GAUGE / THICKNESS	STYLE	LIGHT	CENTER STEP	VENT	TOW	RADAR	EXCLUSIVE	YEAR	MOUNT / BRACKET
0934B	Steel Prime	10Ga	Set Back	Y	N	N	N	N	Y	—	Bracket
0934SSC	AERO CLAD	0.125	Set Back	Y	N	N	N	N	Y	—	Bracket

WIA



PART NO.	MATERIAL / FINISH	GAUGE / THICKNESS	STYLE	LIGHT	CENTER STEP	VENT	TOW	RADAR	EXCLUSIVE	YEAR	MOUNT / BRACKET
0932B	Steel Prime	10Ga	Set Back	N	N	N	Y	N	Y	—	Bracket
0932SSC	AERO CLAD	0.125	Set Back	N	N	N	Y	N	Y	—	Bracket

AERO CLAD® Stainless Steel Clad Aluminum Bumper

AERO CLAD® Features and Benefits

- Tested fuel efficient design
- Easy installation to factory mounts
- Mounting brackets included
- Durable, bright mirrored finish
- Finish 10 times thicker than chrome
- Resists corrosion
- Lightweight
- Resists cracking, pitting, peeling and fading
- Minor abrasions can be buffed
- Full five-year limited warranty*



MM0960SSC
(0961ADA-Optional)



STEEL 10-GAUGE **BUMPER**

Features and Benefits

- Easy installation to factory mounts
- Mounting brackets included
- Corrosion resistant E-coat finish, ready for top coat
- Manufactured with high-impact corrosion resistant steel
- Optional air dam that bolts up to factory installed belly pan can be attached to this bumper
- One-year limited warranty*



MM0961BAX

VOLVO

VNL



PART NO.	MATERIAL / FINISH	GAUGE / THICKNESS	STYLE	LIGHT	CENTER STEP	VENT	TOW	RADAR	EXCLUSIVE	YEAR	MOUNT / BRACKET
0935SSC	AERO CLAD®	0.125	—	N	N	Y	Y	N	Y	Prior '02	Bracket
0940SSC	AERO CLAD	0.125	—	N	N	Y	Y	N	N	Prior '02	Bracket
MM0960NLSSC**	AERO CLAD	0.125	—	N	N	Y	Y	N	Y	'03 - Newer	Bracket
MM0960SSC**	AERO CLAD	0.125	—	Y	N	Y	Y	N	Y	'03 - Newer	Bracket
MM0961BAX	Steel Prime	10Ga	—	Y	N	Y	Y	N	Y	'03 - Newer	Bracket
MM0961NLBAX	Steel Prime	10Ga	—	N	N	Y	Y	N	Y	'03 - Newer	Bracket
MM0961NLSSC*	AERO CLAD	0.125	—	N	N	Y	Y	N	Y	'03 - Newer	Bracket
MM0961SSC*	AERO CLAD	0.125	—	Y	N	Y	Y	N	Y	'03 - Newer	Bracket
MM0963BAX	Steel Prime	10Ga	—	Y	N	Y	Y	Y	Y	'03 - Newer	Bracket
MM0963NLBAX	Steel Prime	10Ga	—	N	N	Y	Y	Y	Y	'03 - Newer	Bracket
0961ADA	ABS	0.187	VNL AIR DAM KIT	—	—	—	—	—	—	—	—

* Extended - to be used with large wheel trim 24.5" diameter tire.

** Basic - to be used with small wheel trim 22.5" diameter tire.



WESTERN STAR

CONVENTIONAL

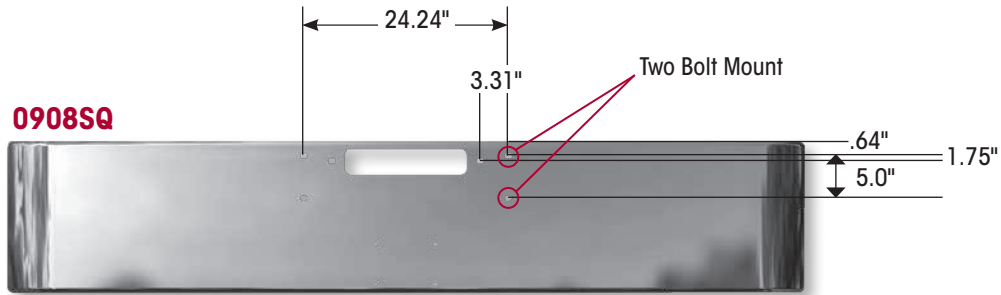

PART NO.	MATERIAL / FINISH	GAUGE / THICKNESS	STYLE	LIGHT	CENTER STEP	VENT	TOW	RADAR	EXCLUSIVE	YEAR	MOUNT / BRACKET
0904	Chrome	10Ga	16" Taper	N	N	N	N	N	N	'85 - '88	N
0904SQ	Chrome	0.125	18" Texas Square	N	N	N	N	N	N	'85 - '88	N
0906SQ	Chrome	0.125	18" Texas Square	2 Square	N	N	N	N	N	'85 - '88	N

CONVENTIONAL, 4964 CONSTELLATION AND HERITAGE

PART NO.	MATERIAL / FINISH	GAUGE / THICKNESS	STYLE	LIGHT	CENTER STEP	VENT	TOW	RADAR	EXCLUSIVE	YEAR	MOUNT / BRACKET
0907	Chrome	10Ga	16" Taper	2 Square	N	N	Y	N	N	'89 - '07 (All)	N
0907SQ	Chrome	10Ga	18" Texas Square	2 Square	N	N	Y	N	N	'89 - '07 (All)	N
0908	Chrome	10Ga	16" Taper	N	N	N	Y	N	N	'89 - '07 (All)	N
0908SQ	Chrome	0.125	18" Texas Square	N	N	N	Y	N	N	'89 - '07 (All)	N
0909SQ	Chrome	0.125	18" Texas Square	N	N	N	N	N	N	'89 - '07 (All)	N
0910	Chrome	10Ga	16" Taper	N	N	N	N	N	N	'89 - '07 (All)	N
0910SQ	Chrome	10Ga	18" Texas Square	N	N	N	N	N	N	'89 - '07 (All)	N
0911	Chrome	10Ga	16" Taper	2 Square	N	N	N	N	N	'89 - '07 (All)	N
0911SQ	Chrome	10Ga	18" Texas Square	2 Square	N	N	N	N	N	'89 - '07 (All)	N
0912SQ	Chrome	0.125	18" Texas Square	8 Oval	N	N	N	N	N	'89 - '07 (All)	N
0913SQ	Chrome	0.125	18" Texas Square	8 Oval	N	N	Y	N	N	'89 - '07 (All)	N
7907	Chrome	7Ga	16" Taper	2 Square	N	N	Y	N	N	'89 - '07 (All)	N
7908	Chrome	7Ga	16" Taper	N	N	N	Y	N	N	'89 - '07 (All)	N

Finding the right bumper is as easy as 1-2-3.



Step 1.

Download the Hendrickson Bumper App to your Apple or Android mobile devices.

Step 2.

Configure your bumper using easy to navigate menu of options or utilize the OEM part number to obtain the Hendrickson ALL Makes part.



Step 3.

Let the Hendrickson App find a dealer near you.



Additional product listings are only a click away!

Check out our Selection and Cross Reference Tools and browse our current literature. Visit us at www.hendrickson-intl.com/bumper.

If you can't find what you need, please call Customer Service at 800.356.6737.



Call Hendrickson at **800.356.6737** for additional information.



SPECIALTY PRODUCTS - BUMPER AND TRIM

501 Caton Farm Road
Crest Hill, IL 60441 USA
800.356.6737

815.727.4031 • Fax 815.727.9697

www.hendrickson-intl.com