



# Lenovo ThinkSystem ST650 V2 Server

## Product Guide

The Lenovo ThinkSystem ST650 V2 is an ideal 2-socket 4U tower server for small businesses up to large enterprises that need industry-leading reliability, management, and security, as well as maximizing performance and flexibility for future growth. The ST650 V2 is based on the new 3rd generation Intel Xeon Scalable processor family and the new Intel Optane Persistent Memory 200 Series.

The ST650 V2 is designed to handle a wide range of workloads, such as databases, virtualization and cloud computing, virtual desktop infrastructure (VDI), infrastructure security, systems management, enterprise applications, collaboration/email, streaming media, web, and HPC.



Figure 1. Lenovo ThinkSystem ST650 V2

### Did you know?

The ThinkSystem ST650 V2 is an enterprise-grade tower server with support for hot-swap power supplies, fans, and drives. It also offers full support of Lenovo XClarity Administrator for comprehensive systems management and includes the UEFI-based Lenovo XClarity Provisioning Manager for system setup and diagnosis, and the Lenovo XClarity Controller management processor for ongoing systems management and alerting. These tools make the ST650 V2 easy to deploy, integrate, service, and manage.

The ST650 V2 is a very storage-rich tower offering, supporting up to 32x 2.5-inch drives or up to 16x 3.5-inch drives. The tower server can also be converted to a 4U rack server if needed.

## Key features

The ThinkSystem ST650 V2 is a high-performance dual-socket tower server based on the third-generation Intel Xeon Scalable processors, supporting a wide range of processors to suit a wide range of budgets and application requirements.

### Scalability and performance

The ST650 V2 offers numerous features to boost performance, improve scalability and reduce costs:

- Supports one or two third-generation Intel Xeon Processor Scalable processors
  - Up to 36 cores and 72 threads
  - Core speeds of up to 3.6 GHz
  - TDP ratings of up to 250W
- Support for up to 32 TruDDR4 memory DIMMs operating at up to 3200 MHz means you have the fastest available memory subsystem.
- Supports configurations of 2 DIMMs per channel to operate at the 3200 MHz rated speed of the memory DIMMs.
- Using 128GB 3DS RDIMMs, the server supports up to 4TB of system memory.
- Supports the new Intel Optane Persistent Memory 200 Series for advanced in-memory database applications, dense-virtualization; up to 16 PMem Modules can be installed in conjunction with regular system memory.
- Supports up to eight single-width GPUs or four double-wide GPUs, for substantial processing power in a tower system.
- Supports a variety of front-accessible drive bays:
  - Up to 32x 2.5-inch hot-swap drive bays with two 5.25-inch media bays
  - Up to 12x 3.5-inch hot-swap drive bays with two 5.25-inch media bays
  - Up to 16x 3.5-inch hot-swap drive bays without the media bays
  - Up to 12x 3.5-inch simple-swap drive bays with two 5.25-inch media bays
- Supports up to 16x NVMe drives to maximize drive I/O performance, in terms of throughput, bandwidth, and latency.
- Supports up to 12x SATA drives using the onboard SATA controller (no additional adapter needed), enabling lower cost, high capacity storage solution.
- Supports high-speed RAID controllers from Broadcom providing 12 Gb SAS connectivity to the drive backplanes. A variety of PCIe 3.0 and PCIe 4.0 RAID adapters are available, including compact form factor adapters that are cabled and don't occupy a PCIe slot.
- Supports M.2 drives for convenient operating system boot functions or data storage. Available M.2 adapters support either one M.2 drive or two M.2 drives in a RAID 1 configuration for performance and reliability.
- The server has two integrated 10 GbE 10GBASE-T ports with support for additional networking using adapter cards.
- The server offers PCI Express 4.0 I/O expansion capabilities that doubles the theoretical maximum bandwidth of PCIe 3.0 (16GT/s in each direction for PCIe 4.0, compared to 8 GT/s with PCIe 3.0). A PCIe 4.0 x16 slot provides 64 GB/s bandwidth, enough to support a 200GbE network connection.
- Up to nine PCIe slots, eight of which are PCIe 4.0 and are standard.

## Availability and serviceability

The ST650 V2 provides many features to simplify serviceability and increase system uptime:

- The server offers Single Device Data Correction (SDDC, also known as Chipkill), Adaptive Double-Device Data Correction (ADDDC, also known as Redundant Bit Steering or RBS), and memory mirroring for redundancy in the event of a non-correctable memory failure.
- The server offers hot-swap drives, supporting RAID redundancy for data protection and greater system uptime.
- Available M.2 RAID Boot Adapters support RAID-1 which can enable two SATA or two NVMe M.2 drives to be configured as a redundant pair.
- The server has up to two hot-swap redundant power supplies and up to four large hot-swap redundant fans to provide availability for business-critical applications.
- The power-source-independent light path diagnostics uses LEDs to lead the technician to failed (or failing) components, which simplifies servicing, speeds up problem resolution, and helps improve system availability.
- Solid-state drives (SSDs) offer more reliability than traditional mechanical HDDs for greater uptime.
- Proactive Platform Alerts (including PFA and SMART alerts): Processors, voltage regulators, memory, internal storage (SAS/SATA HDDs and SSDs, NVMe SSDs, M.2 storage, flash storage adapters), fans, power supplies, RAID controllers, server ambient and subcomponent temperatures. Alerts can be surfaced through the XClarity Controller to managers such as Lenovo XClarity Administrator, VMware vCenter, and Microsoft System Center. These proactive alerts let you take appropriate actions in advance of possible failure, thereby increasing server uptime and application availability.
- The built-in XClarity Controller continuously monitors system parameters, triggers alerts, and performs recovery actions in case of failures to minimize downtime.
- Built-in diagnostics in UEFI, using Lenovo XClarity Provisioning Manager, speed up troubleshooting tasks to reduce service time.
- Lenovo XClarity Provisioning Manager supports diagnostics and can save service data to a USB key drive or remote CIFS share folder for troubleshooting and reduce service time.
- Auto restart in the event of a momentary loss of AC power (based on power policy setting in the XClarity Controller service processor)
- Offers a diagnostics port located at the rear of the server to allow you to attach an external diagnostics handset for enhanced systems management capabilities.
- Support for the XClarity Administrator Mobile app running on a supported smartphone and connected to the server through the service-enabled USB port, enables additional local systems management functions.
- Three-year or one-year customer-replaceable unit and onsite limited warranty, 9 x 5 next business day. Optional service upgrades are available.

## Manageability and security

Systems management features simplify local and remote management of the ST650 V2:

- Toolless cover removal provides easy access to upgrades and serviceable parts, such as CPU, memory, and adapter cards.
- The server includes an XClarity Controller (XCC) to monitor server availability. Optional upgrade to XCC Advanced to provide remote control (keyboard video mouse) functions. Optional upgrade to XCC Enterprise enables the additional support for the mounting of remote media files (ISO and IMG image files), boot capture, and power capping.
- Lenovo XClarity Administrator offers comprehensive hardware management tools that help to increase uptime, reduce costs and improve productivity through advanced server management capabilities.

- UEFI-based Lenovo XClarity Provisioning Manager, accessible from F1 during boot, provides system inventory information, graphical UEFI Setup, platform update function, RAID Setup wizard, operating system installation function, and diagnostic functions.
- Support for Lenovo XClarity Energy Manager, which captures real-time power and temperature data from the server and provides automated controls to lower energy costs.
- An integrated industry-standard Unified Extensible Firmware Interface (UEFI) enables improved setup, configuration, and updates, and simplifies error handling.
- Support for industry standard management protocols, IPMI 2.0, SNMP 3.0, Redfish REST API, serial console via IPMI
- Available physical security features include a lockable front door and a chassis intrusion switch to help prevent unauthorized access and notify administrators when the server cover has been removed.
- An integrated hardware Trusted Platform Module (TPM) supporting TPM 2.0 enables advanced cryptographic functionality, such as digital signatures and remote attestation.
- Administrator and power-on passwords help protect from unauthorized access to the server.
- Supports Secure Boot to ensure only a digitally signed operating system can be used. Supported with HDDs and SSDs, as well as M.2 drives.
- Industry-standard Advanced Encryption Standard (AES) NI support for faster, stronger encryption.
- Intel Execute Disable Bit functionality can prevent certain classes of malicious buffer overflow attacks when combined with a supported operating system.
- Intel Trusted Execution Technology provides enhanced security through hardware-based resistance to malicious software attacks, allowing an application to run in its own isolated space, protected from all other software running on a system.

### Energy efficiency

The ST650 V2 offers the following energy-efficiency features to save energy, reduce operational costs, and increase energy availability:

- Energy-efficient planar components help lower operational costs.
- High-efficiency power supplies with 80 PLUS Platinum and Titanium certifications
- Solid-state drives (SSDs) consume as much as 80% less power than traditional spinning 2.5-inch HDDs.
- The server uses hexagonal ventilation holes, which can be grouped more densely than round holes, providing more efficient airflow through the system and thus keeping your system cooler.
- Optional Lenovo XClarity Energy Manager provides advanced data center power notification, analysis, and policy-based management to help achieve lower heat output and reduced cooling needs.

### Comparing the ST650 V2 to the ST550

The ThinkSystem ST650 V2 is the new mainstream 2S tower server that is positioned above ST550, the value 2S tower. ST650 V2 with the industry’s latest technologies supports higher TDP CPUs, a larger memory footprint, more storage capabilities, a larger number of I/O slots, and supports more GPU adapters. Details are summarized in following table.

Table 1. Comparing the ThinkSystem ST650 V2 to the previous generation ST550

Feature	ST550	ST650 V2	Benefits
Form Factor	<ul style="list-style-type: none"> <li>• 4U Tower with rack convertible</li> </ul>	<ul style="list-style-type: none"> <li>• 4U Tower with rack convertible</li> </ul>	<ul style="list-style-type: none"> <li>• More features and capacities with same chassis</li> </ul>

Feature	ST550	ST650 V2	Benefits
Processor	<ul style="list-style-type: none"> <li>2x 2nd Gen Intel Xeon Scalable Processor</li> <li>up to 22 cores &amp; 125W per CPU</li> </ul>	<ul style="list-style-type: none"> <li>2x 3rd Gen Intel Xeon Scalable Processor</li> <li>up to 36 cores &amp; 250W per CPU</li> </ul>	<ul style="list-style-type: none"> <li>The latest high-performance processors from Intel</li> <li>Greater computing performance with top bin CPUs</li> </ul>
Memory	<ul style="list-style-type: none"> <li>6 channels per CPU</li> <li>12x TruDDR4 (R/LR/3DS) 2933MHz DIMMs</li> <li>Up to 2933MHz, Max 768GB</li> </ul>	<ul style="list-style-type: none"> <li>8 channels per CPU</li> <li>32x TruDDR4 (R/3DS) 3200MHz DIMMs</li> <li>Up to 1DPC &amp; 2DPC @ 3200MHz, Max 4TB</li> <li>2nd Gen Intel Optane Persistent Memory</li> </ul>	<ul style="list-style-type: none"> <li>5X increase in memory capacity</li> <li>Faster memory</li> <li>Support for PMem for even greater memory capacity and application performance</li> </ul>
Disk	<ul style="list-style-type: none"> <li>Internal M.2 with optional RAID 0/1</li> <li>Up to 8x 3.5" SS or HS SAS/SATA</li> <li>Up to 20x 2.5" HS SAS/SATA (optional 4x NVMe SSDs)</li> <li>Hybrid support for 8x 3.5" and 4x 2.5" HS SAS/SATA</li> <li>Optional 2x 5.25" drive bays for optical/backup drives</li> </ul>	<ul style="list-style-type: none"> <li>Internal M.2 with optional RAID 0/1</li> <li>Up to 16x 3.5" HS SAS/SATA (up to 8x optional NVMe SSDs)</li> <li>Up to 32x 2.5" HS SAS/SATA (up to 16x optional NVMe SSDs)</li> <li>Optional 2x 5.25" drive bays for optical/backup drives</li> </ul>	<ul style="list-style-type: none"> <li>Double the number of 3.5" drive bays</li> <li>1.6X more 2.5" drive bays.</li> <li>4X the number of NVMe SSDs supported</li> </ul>
RAID	<ul style="list-style-type: none"> <li>12Gb SAS/SATA/RAID support</li> <li>PCIe 3.0 adapters</li> <li>Onboard SATA support with RAID</li> <li>Range of 8-, 16- and 24-port RAID adapters</li> <li>8- and 16-port HBAs</li> <li>NVMe Switch for 4x NVMe</li> </ul>	<ul style="list-style-type: none"> <li>12Gb SAS/SATA/RAID support</li> <li>PCIe 3.0 and PCIe 4.0 adapters</li> <li>Onboard SATA support with RAID</li> <li>Onboard VROC NVMe support with RAID</li> <li>Wider range of 8-, 16- and 32-port RAID adapters</li> <li>8- and 16-port HBAs</li> <li>NVMe Retimer adapters for 16x NVMe</li> </ul>	<ul style="list-style-type: none"> <li>New with Intel VROC for onboard SATA RAID and NVMe RAID</li> <li>Featuring industry's latest PCIe Gen4 based RAID adapters</li> <li>NVMe Retimers lower the cost of NVMe support</li> </ul>
Networking	<ul style="list-style-type: none"> <li>2x 1GbE embedded</li> <li>1GbE dedicated Management port</li> </ul>	<ul style="list-style-type: none"> <li>2x 10GbE embedded</li> <li>1GbE dedicated Management port</li> </ul>	<ul style="list-style-type: none"> <li>Moved from embedded 1GbE to 10GbE for faster data transfer</li> </ul>
PCIe	<ul style="list-style-type: none"> <li>6 slots total</li> <li>3x PCIe 3.0 x16 slots</li> <li>2x PCIe 3.0 x8 slots</li> <li>1x PCIe 3.0 x4 slot</li> <li>Separate M.2 adapter support</li> </ul>	<ul style="list-style-type: none"> <li>Up to 9 slots total (1 is optional)</li> <li>4x PCIe 4.0 x16 slots</li> <li>Up to 4x PCIe x8 (3x Gen4, 1x Gen3)</li> <li>1x PCIe 4.0 x4 slot</li> <li>Separate M.2 adapter support</li> </ul>	<ul style="list-style-type: none"> <li>New PCIe 4.0 support</li> <li>Additional slots to support more I/O</li> <li>Extra x16 slot for high-performance networking</li> </ul>

Feature	ST550	ST650 V2	Benefits
GPU	<ul style="list-style-type: none"> <li>Up to 2x DW/SW GPU adapters</li> </ul>	<ul style="list-style-type: none"> <li>Up to 4x active DW or 8x SW GPU adapters</li> </ul>	<ul style="list-style-type: none"> <li>2X more the double-width GPU support and 4X more the single-width GPU support</li> </ul>
Management and Security	<ul style="list-style-type: none"> <li>XClarity Controller with upgrades</li> <li>Full XClarity software suite including XClarity Administrator</li> <li>Optional intrusion switch and lockable door</li> </ul>	<ul style="list-style-type: none"> <li>XClarity Controller with upgrades</li> <li>Full XClarity software suite including XClarity Administrator</li> <li>Optional intrusion switch and lockable door</li> <li>Support for External Diagnostics Handset</li> <li>Platform Firmware Resiliency (PFR) hardware Root of Trust</li> </ul>	<ul style="list-style-type: none"> <li>Common management tools with prior generation</li> <li>External Diagnostics Handset with LCD panel offers quick access to system status, firmware, network, and health information</li> <li>Platform Firmware Resiliency is an advanced security solution with a silicon-based to guard against corruption and unauthorized firmware updates</li> </ul>
Power Supply	<ul style="list-style-type: none"> <li>1x 450W Fixed PSU, Gold</li> <li>2x Hot-swap PSUs up to 1100W, Platinum</li> <li>750W Hot-swap Titanium PSU</li> </ul>	<ul style="list-style-type: none"> <li>2x Hot-swap PSUs up to 2400W, Platinum</li> <li>750W Hot-swap Titanium PSU</li> <li>1100W -48V DC PSU (planned)</li> </ul>	<ul style="list-style-type: none"> <li>Expanded power supply portfolio for exact configuration required and sharing with rest of the 2-socket/4-socket ThinkSystem V2 servers</li> </ul>

## Components and connectors

The following figure shows the front of the server.

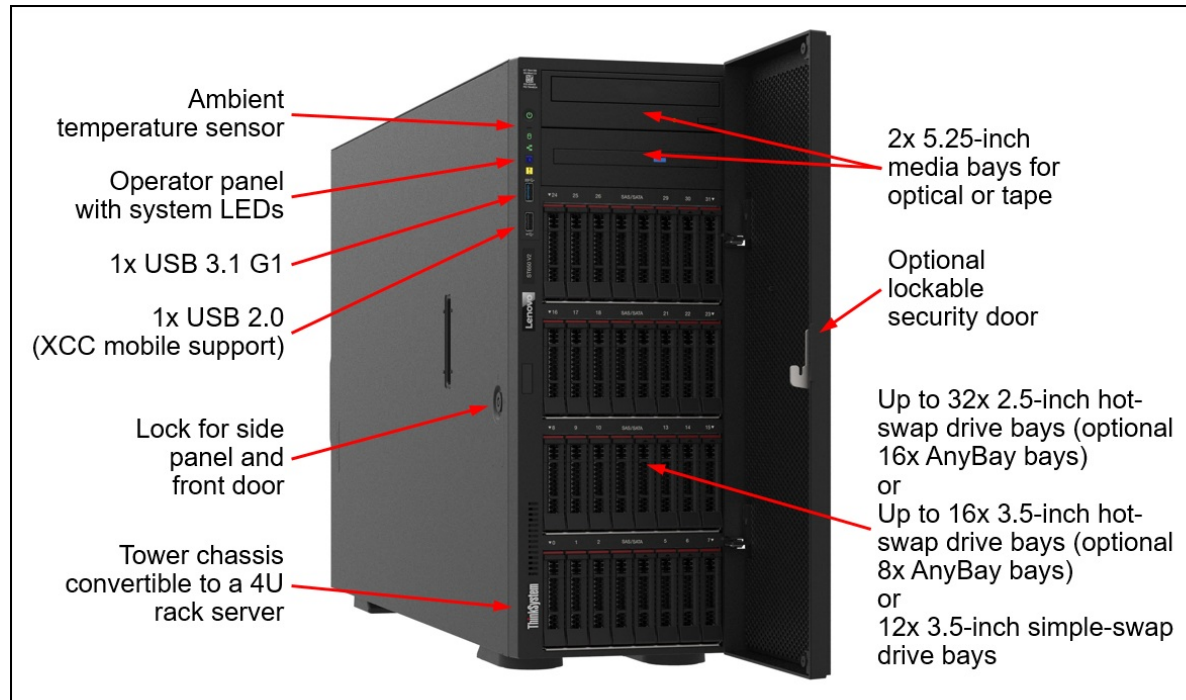

Figure 2. Front view of the ThinkSystem ST650 V2

The following figure shows the four drive bay combinations that the server supports.

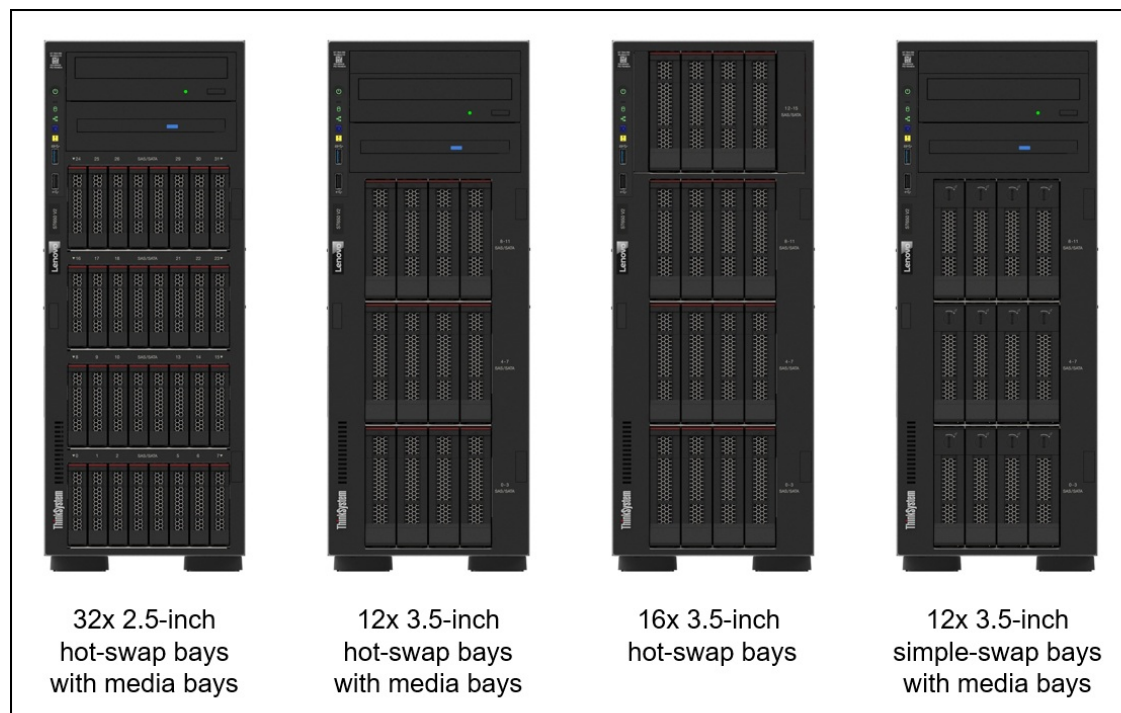

Figure 3. Drive bay combinations of the ThinkSystem ST650 V2

The following figure shows the components visible from the rear of the server.

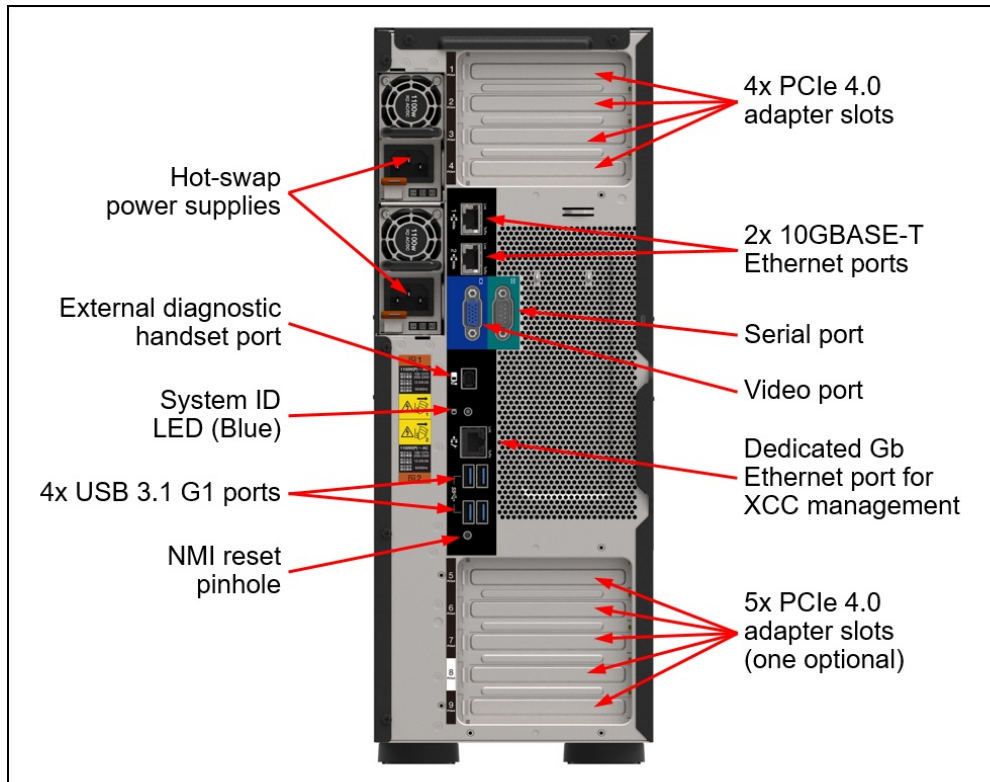

Figure 4. Rear view of the ThinkSystem ST650 V2



The following figure shows the locations of key components inside the server.

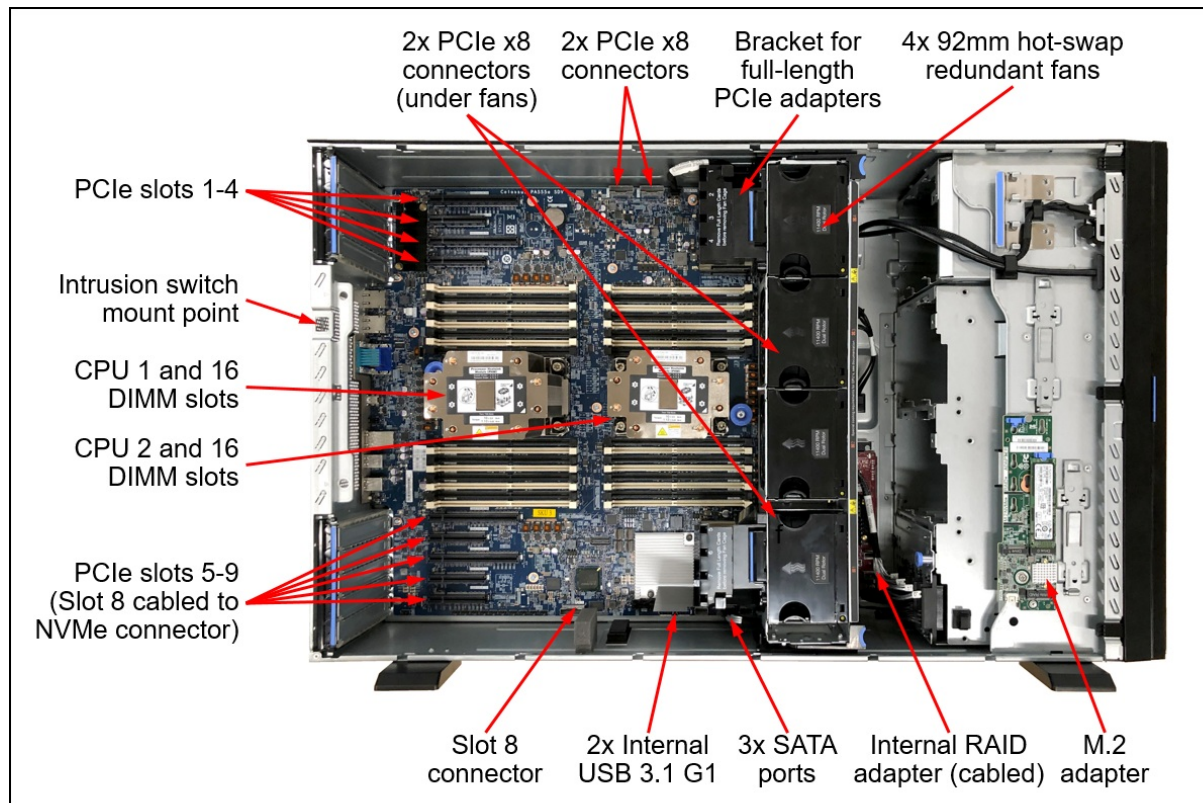

Figure 5. Internal view of the ThinkSystem ST650 V2

## System architecture

The following figure shows the architectural block diagram of the ST650 V2, showing the major components and their connections.

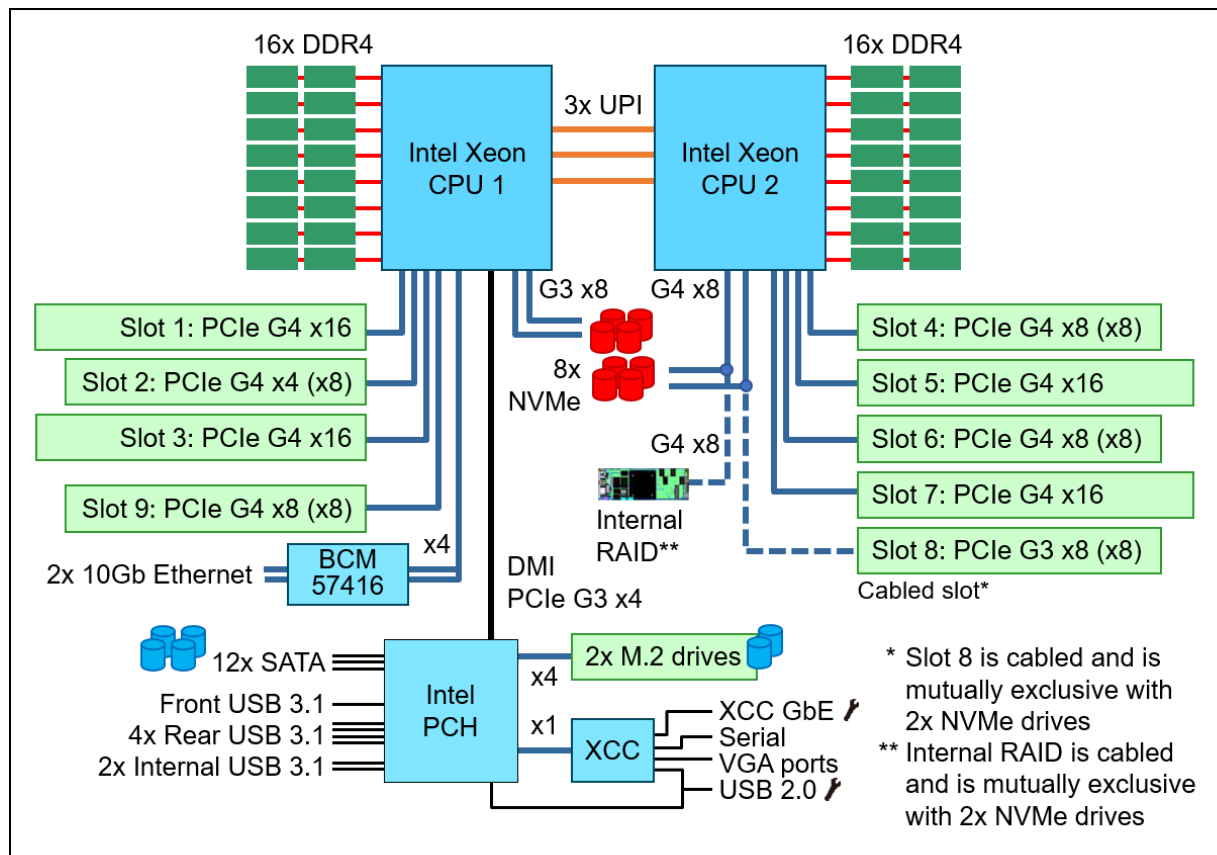

Figure 6. ST650 V2 system architectural block diagram

## Standard specifications

The following table lists the standard specifications.

Table 2. Standard specifications

Components	Specification
Machine types	7Z75 - 1 year warranty 7Z74 - 3 year warranty
Form factor	Tower or 4U Rack
Processor	One or two third-generation Intel Xeon Scalable processor (formerly codenamed "Ice Lake"). Supports processors up to 36 cores, core speeds of up to 3.6 GHz, and TDP ratings of up to 250W.
Chipset	Intel C621A "Lewisburg" chipset, part of the platform codenamed "Whitley"
Memory	32 DIMM slots with two processors (16 DIMM slots per processor). Each processor has 8 memory channels, with 2 DIMMs per channel (DPC). Lenovo TruDDR4 RDIMMs and 3DS RDIMMs are supported. DIMM slots are shared between standard system memory and persistent memory. DIMMs operate at up to 3200 MHz at 2 DPC.

Components	Specification
Persistent memory	Supports up to 16x Intel Optane Persistent Memory 200 Series modules (8 per processor) installed in the DIMM slots. Persistent memory (Pmem) is installed in combination with system memory DIMMs.
Memory maximum	With RDIMMs: Up to 4TB by using 32x 128GB 3DS RDIMMs With Persistent Memory: Up to 5TB by using 16x 64GB 3DS RDIMMs and 16x 256GB Pmem modules (2.5TB per processor)
Memory protection	ECC, SDDC (for x4-based memory DIMMs), ADDDC (for x4-based memory DIMMs, requires Platinum or Gold processors), and memory mirroring.
Disk drive bays	2.5-inch drive bays: <ul style="list-style-type: none"> <li>Up to 32x 2.5-inch hot-swap bays (16x NVMe) plus 2x 5.25-inch media bays</li> </ul> 3.5-inch drive bays: <ul style="list-style-type: none"> <li>Up to 16x 3.5-inch hot-swap bays (8x NVMe) (no media bays)</li> <li>Up to 12x 3.5-inch hot-swap bays (8x NVMe) plus 2x 5.25-inch media bays</li> <li>Up to 12x 3.5-inch simple-swap bays plus 2x 5.25-inch media bays</li> </ul> Internal drives for OS boot or drive storage: <ul style="list-style-type: none"> <li>Internal M.2 module supporting up to two M.2 drives</li> </ul>
Maximum internal storage	<ul style="list-style-type: none"> <li>2.5-inch drives: <ul style="list-style-type: none"> <li>491.52TB using 32x 15.36TB 2.5-inch SAS/SATA SSDs</li> <li>61.44TB using 16x 3.84TB 2.5-inch NVMe SSDs</li> <li>76.8TB using 32x 2.4TB 2.5-inch HDDs</li> </ul> </li> <li>3.5-inch drives: <ul style="list-style-type: none"> <li>288TB using 16x 18TB 3.5-inch HDDs</li> <li>122.88TB using 16x 7.68TB 3.5-inch SAS/SATA SSDs</li> <li>30.72TB using 8x 3.84TB 3.5-inch NVMe SSDs</li> </ul> </li> </ul>
Storage controller	<ul style="list-style-type: none"> <li>12x onboard SATA ports (Intel VROC SATA RAID, formerly known as Intel RSTe RAID)</li> <li>Up to 8x onboard NVMe ports (includes Intel VROC NVMe RAID, with optional license for non-Intel NVMe SSDs)</li> <li>NVMe Retimer Adapter (supports Intel VROC NVMe RAID)</li> <li>12 Gb SAS/SATA RAID adapters: <ul style="list-style-type: none"> <li>RAID 530i-8i (cacheless) supports RAID 0, 1, 10, 5, 50</li> <li>RAID 530i-16i (cacheless) supports RAID 0, 1, 10</li> <li>RAID 930-8i with 2GB flash-backed cache supports RAID 0, 1, 10, 5, 50, 6, 60</li> <li>RAID 930-16i with 4GB flash-backed cache supports RAID 0, 1, 10, 5, 50, 6, 60</li> <li>RAID 940-8i with 4GB or 8GB flash-backed cache supports RAID 0, 1, 10, 5, 50, 6, 60</li> <li>RAID 940-16i with 8GB flash-backed cache supports RAID 0, 1, 10, 5, 50, 6, 60</li> <li>RAID 940-32i with 8GB flash-backed cache supports RAID 0, 1, 10, 5, 50, 6, 60</li> </ul> </li> <li>12 Gb SAS/SATA non-RAID: 430-8i, 430-16i and 440-16i HBAs</li> </ul>
Optical drive and tape drive bays	Two half-height 5.25-inch media bays, available in most configurations. Supports two of LTO tape drive, RDX drive, or slim DVD-RW optical drive.
Network interfaces	Two onboard 10GBASE-T Ethernet RJ45 ports based on a Broadcom BCM57416 controller. Additional dedicated Gigabit port for remote management via the XClarity Controller (XCC) management processor.

Components	Specification
PCI Expansion slots	<p>Up to 9x PCIe slots - 8x PCIe 4.0 slots standard, 1x PCIe 3.0 slot optional (slot 8) All slots are full height, full length (FHFL) with rear access. Slots 4-8 require CPU 2 installed.</p> <ul style="list-style-type: none"> <li>• Slot 1: PCIe 4.0 x16 (CPU 1)</li> <li>• Slot 2: PCIe 4.0 x4 (x8 physical slot) (CPU 1)</li> <li>• Slot 3: PCIe 4.0 x16 (CPU 1)</li> <li>• Slot 4: PCIe 4.0 x8 (x8 physical slot) (CPU 2)</li> <li>• Slot 5: PCIe 4.0 x16 (CPU 2)</li> <li>• Slot 6: PCIe 4.0 x8 (x8 physical slot) (CPU 2)</li> <li>• Slot 7: PCIe 4.0 x16 (CPU 2)</li> <li>• Slot 8: PCIe 3.0 x8 (x8 physical slot) (CPU 2) (optional, cabled to PCIe connector)</li> <li>• Slot 9: PCIe 4.0 x8 (x8 physical slot) (CPU 1)</li> </ul> <p>The server also supports the installation of a RAID adapter or HBA in a dedicated area that does not consume any of the PCIe slots. See the location of the Internal RAID adapter (cabled) in the <a href="#">Internal view</a> of the server.</p> <p>All nine slots are mounted on the system board. The optional slot, Slot 8, is enabled through a cable, routed from one of the PCIe NVMe onboard connectors. See the <a href="#">I/O expansion</a> section for details.</p>
GPU support	Supports up to 8x single-wide GPUs or up to 4x double-wide GPUs
Ports	<p>Front: 1x USB 3.1 G1 (5 Gb/s) port, 1x USB 2.0 port (also for XCC local management)</p> <p>Rear: 2x 10GBASE-T RJ45 Ethernet ports, 4x USB 3.1 G1 (5 Gb/s) ports, 1x VGA video port, 1x DB-9 COM serial port, 1x 1GbE RJ-45 systems management port for XCC remote management, External diagnostics port</p> <p>Internal: 1x USB 3.1 G1 connector for operating system or license key purposes</p>
Cooling	Up to 4x single-rotor or dual-rotor hot swap 92 mm fans, configuration dependent. Fans are N+1 redundant. One additional fan integrated in each power supply.
Power supply	Up to two hot-swap redundant AC power supplies, 80 PLUS Platinum or 80 PLUS Titanium certification. 750 W, 1100 W, 1800 W and 2400 W AC options, supporting 220 V AC. 750 W and 1100 W options also support 110V input supply. In China only, all power supply options support 240 V DC.
Video	G200 graphics with 16 MB memory with 2D hardware accelerator, integrated into the XClarity Controller. Maximum resolution is 1920x1200 32bpp at 60Hz.
Hot-swap parts	Drives, power supplies, and fans.
Systems management	Operator panel with status LEDs. Optional External Diagnostics Handset with LCD display. XClarity Controller (XCC) embedded management, XClarity Administrator centralized infrastructure delivery, XClarity Integrator plugins, and XClarity Energy Manager centralized server power management. Optional XClarity Controller Advanced and Enterprise to enable remote control functions.
Security features	Power-on password, administrator's password, Trusted Platform Module (TPM), supporting TPM 2.0. In China only, optional Nationz TPM 2.0. Optional lockable front security door and optional chassis intrusion switch.
Operating systems supported	Microsoft Windows Server, Red Hat Enterprise Linux, SUSE Linux Enterprise Server, VMware ESXi. See the <a href="#">Operating system support</a> section for specifics.
Limited warranty	Three-year or one-year (model dependent) customer-replaceable unit and onsite limited warranty with 9x5 next business day (NBD).
Service and support	Optional service upgrades are available through Lenovo Services: 4-hour or 2-hour response time, 6-hour fix time, 1-year or 2-year warranty extension, software support for Lenovo hardware and some third-party applications.

Components	Specification
Dimensions	Width: 175 mm (6.9 in.), height: 462 mm (18.2 in.), depth: 734 mm (28.9 in.). See <a href="#">Physical and electrical specifications</a> for details.
Weight	2.5-inch configuration: 39.28 kg (86.60 lb) maximum 3.5-inch configuration: 46.23 kg (101.92 lb) maximum

## Models

ThinkSystem ST650 V2 models can be configured by using the [Lenovo Data Center Solution Configurator \(DCSC\)](#).

Configure-to-order (CTO) models are used to create models with factory-integrated server customizations. For CTO models, two base CTO models are available for the ST650 V2 as listed in the following table, CTO1WW and CTOLWW:

- The CTO1WW base CTO model is for general business and is selectable by choosing **General Purpose** mode in DCSC.
- The CTOLWW base model is intended for High Performance Computing (HPC) and Artificial Intelligence (AI) configurations and solutions, including configurations for Lenovo Scalable Infrastructure (LeSI), and is enabled using either the **HPC & AI LeSI Solutions** mode or **HPC & AI ThinkSystem Hardware** mode in DCSC. CTOLWW configurations can also be built using [System x and Cluster Solutions Configurator \(x-config\)](#).

Preconfigured server models may also be available for the ST650 V2, however these are region-specific; that is, each region may define their own server models, and not all server models are available in every region.

The following table lists the base CTO models of the ThinkSystem ST650 V2 server.

Table 3. Base CTO models

Description	Machine Type/Model General purpose	Machine Type/Model for HPC and AI
ThinkSystem ST650 V2 - 3 year Warranty	7Z74CTO1WW	7Z74CTOLWW
ThinkSystem ST650 V2 - 1 year Warranty	7Z75CTO1WW	7Z75CTOLWW

Models of the ST650 V2 are defined based on whether the server has 2.5-inch drive bays at the front (called the 2.5-inch chassis) or whether it has 3.5-inch drive bays at the front (called the 3.5-inch chassis). For models, the feature codes for these chassis bases are as listed in the following table.

Table 4. Chassis base feature codes

Feature code	Description
BA64	ThinkSystem ST650 V2 32x2.5" Chassis
BA63	ThinkSystem ST650 V2 16x3.5" Chassis

The following tables list the available models, grouped by region.

- [Models for Asia Pacific region](#)
- [Models for Australia and New Zealand](#)
- [Models for Brazil](#)
- [Models for EMEA region](#)
- [Models for India](#)
- [Models for Japan](#)
- [Models for Latin American countries \(except Brazil\)](#)
- [Models for USA and Canada](#)

Refer to the Specifications section for information about standard features of the server.

Common to all models:

- All models indicated as having the 750W power supply are using the Platinum power supply.

### Models for Asia Pacific region

The following table lists the models for the Asia Pacific region: Australia, Bangladesh, Brunei, Hong Kong, India, Japan, Korea, Sri Lanka, Malaysia, New Zealand, Philippines, Singapore, Thailand, Taiwan, Vietnam

Table 5. Models for Asia Pacific markets

Model	Intel Xeon Scalable processor†	Memory	RAID	Drive bays	Top bay	XCC	Intru. sw.	Fans	Power supplies	Power cords
Standard models with a 3-year warranty (machine type 7Z74)										
7Z74A00TAP	1x Silver 4309Y 8C 105W 2.8G	1x 16GB	930-8i	8x 2.5" SAS Open bay	2x Media; Open bay	Std	No	3x Perf	1x 750W	No
7Z74A01BAP	1x Silver 4310 12C 120W 2.1G	1x 16GB	930-8i	8x 2.5" SAS Open bay	2x Media; Open bay	Std	No	3x Perf	1x 750W	No
7Z74A01KAP	1x Silver 4314 16C 135W 2.4G	1x 16GB	930-8i	8x 2.5" SAS Open bay	2x Media; Open bay	Std	No	3x Perf	1x 750W	No
7Z74A01CAP	1x Silver 4316 20C 150W 2.3G	1x 16GB	930-8i	8x 2.5" SAS Open bay	2x Media; Open bay	Std	No	3x Perf	1x 750W	No

† Processor description: Processor model, number of cores, thermal design power (TDP), core frequency

### Models for Australia and New Zealand

**AP models:** Customers in Australia and New Zealand also have access to the [Asia Pacific region](#) models.

Table 6. Models for Australia and New Zealand

Model	Intel Xeon Scalable processor†	Memory	RAID	Drive bays	Top bay	XCC	Intru. sw.	Fans	Power supplies	Power cords
TopSeller models with a 3-year warranty (machine type 7Z74)										
7Z74A00UJU	1x Silver 4309Y 8C 105W 2.8G	1x 16GB	Onboard SATA	8x 2.5" SAS Open bay	2x Media; Open bay	Ent	No	4x Std	1x 750W	Yes
7Z74A01HAU	1x Silver 4310 12C 120W 2.1G	1x 32GB 2Rx8	Onboard SATA	8x 2.5" SAS Open bay	2x Media; Open bay	Ent	No	4x Std	1x 750W	Yes
7Z74A00QAU	1x Silver 4314 16C 135W 2.4G	1x 32GB 2Rx8	Onboard SATA	8x 2.5" SAS Open bay	2x Media; Open bay	Ent	No	4x Std	1x 750W	Yes
7Z74A00LAU	1x Silver 4316 20C 150W 2.3G	1x 32GB 2Rx8	Onboard SATA	8x 2.5" SAS Open bay	2x Media; Open bay	Ent	No	4x Std	1x 750W	Yes
7Z74A00MAU	1x Gold 5318Y 24C 165W 2.1G	1x 32GB 2Rx8	Onboard SATA	8x 2.5" SAS Open bay	2x Media; Open bay	Ent	No	4x Std	1x 750W	Yes

† Processor description: Processor model, number of cores, thermal design power (TDP), core frequency

## Models for Brazil

Table 7. Models for Brazil

Model	Intel Xeon Scalable processor†	Memory	RAID	Drive bays	Top bay	XCC	Intru. sw.	Fans	Power supplies	Power cords
Standard models with a 3-year warranty (machine type 7Z74)										
7Z74A027BR	1x Silver 4310 12C 120W 2.1G	1x 16GB	930-16i 4GB	16x 2.5" SAS Open bay	2x Media; Open bay	Std	Yes	4x Std	1x 750W	Yes
7Z74A025BR	1x Silver 4314 16C 135W 2.4G	1x 32GB 2Rx4	930-16i 4GB	16x 2.5" SAS Open bay	2x Media; Open bay	Std	Yes	4x Std	1x 750W	Yes
7Z74A028BR	1x Silver 4316 20C 150W 2.3G	1x 32GB 2Rx4	930-16i 4GB	16x 2.5" SAS Open bay	2x Media; Open bay	Std	Yes	4x Std	1x 750W	Yes

† Processor description: Processor model, number of cores, thermal design power (TDP), core frequency

## Models for EMEA region

Table 8. Models for EMEA region

Model	Intel Xeon Scalable processor†	Memory	RAID	Drive bays	Top bay	XCC	Intru. sw.	Fans	Power supplies	Power cords
Standard models with a 3-year warranty (machine type 7Z74)										
7Z74A00REA	1x Silver 4309Y 8C 105W 2.8G	1x 32GB 2Rx8	Onboard SATA	8x 3.5" SAS Open bay	2x Media; Open bay	Ent	Yes	3x Std	1x 750W	Yes
7Z74A00VEA	1x Silver 4309Y 8C 105W 2.8G	1x 32GB 2Rx8	Onboard SATA	8x 2.5" SAS Open bay	2x Media; Open bay	Ent	Yes	3x Std	1x 750W	Yes
7Z74A011EA	1x Silver 4309Y 8C 105W 2.8G	1x 32GB 2Rx8	930-8i	8x 2.5" SAS Open bay	2x Media; Open bay	Ent	Yes	3x Std	1x 750W	Yes
7Z74A020EA	1x Silver 4309Y 8C 105W 2.8G	1x 32GB 2Rx8	940-8i 4GB	8x 2.5" SAS Open bay	2x Media; Open bay	Ent	Yes	3x Std	1x 750W	Yes
7Z74A02TEA	1x Silver 4309Y 8C 105W 2.8G	1x 32GB 2Rx4	940-8i 4GB	8x 2.5" SAS Open bay	2x Media; Open bay	Ent	Yes	3x Std	1x 750W	Yes
7Z74A00HEA	1x Silver 4310 12C 120W 2.1G	1x 32GB 2Rx8	Onboard SATA	8x 2.5" SAS Open bay	2x Media; Open bay	Ent	Yes	3x Std	1x 750W	Yes
7Z74A00PEA	1x Silver 4310 12C 120W 2.1G	1x 32GB 2Rx8	930-8i	8x 3.5" SAS Open bay	2x Media; Open bay	Ent	Yes	3x Std	1x 750W	Yes
7Z74A00SEA	1x Silver 4310 12C 120W 2.1G	1x 32GB 2Rx8	Onboard SATA	8x 3.5" SAS Open bay	2x Media; Open bay	Ent	Yes	3x Std	1x 750W	Yes
7Z74A010EA	1x Silver 4310 12C 120W 2.1G	1x 32GB 2Rx8	930-8i	8x 2.5" SAS Open bay	2x Media; Open bay	Ent	Yes	3x Std	1x 750W	Yes
7Z74A018EA	1x Silver 4310 12C 120W 2.1G	1x 32GB 2Rx8	940-16i	16x 3.5" SAS Open bay	4x 3.5"; No media	Ent	Yes	4x Perf	1x 1100W	Yes
7Z74A01LEA	1x Silver 4310 12C 120W 2.1G	1x 32GB 2Rx8	940-8i 4GB	8x 2.5" SAS Open bay	2x Media; Open bay	Ent	Yes	3x Std	1x 750W	Yes
7Z74A02SEA	1x Silver 4310 12C 120W 2.1G	1x 32GB 2Rx4	940-8i 4GB	8x 2.5" SAS Open bay	2x Media; Open bay	Ent	Yes	3x Std	1x 750W	Yes
7Z74A00GEA	1x Silver 4314 16C 135W 2.4G	1x 32GB 2Rx8	Onboard SATA	8x 2.5" SAS Open bay	2x Media; Open bay	Ent	Yes	3x Std	1x 750W	Yes
7Z74A00JEA	1x Silver 4314 16C 135W 2.4G	1x 32GB 2Rx8	940-16i	16x 2.5" SAS Open bay	2x Media; Open bay	Ent	Yes	4x Perf	1x 1100W	Yes
7Z74A00XEA	1x Silver 4314 16C 135W 2.4G	1x 32GB 2Rx8	930-8i	8x 2.5" SAS Open bay	2x Media; Open bay	Ent	Yes	3x Std	1x 750W	Yes

Model	Intel Xeon Scalable processor†	Memory	RAID	Drive bays	Top bay	XCC	Intru. sw.	Fans	Power supplies	Power cords
7Z74A014EA	1x Silver 4314 16C 135W 2.4G	1x 32GB 2Rx8	940-8i 4GB	8x 2.5" SAS Open bay	2x Media; Open bay	Ent	Yes	3x Std	1x 750W	Yes
7Z74A016EA	1x Silver 4314 16C 135W 2.4G	1x 32GB 2Rx8	Onboard SATA	8x 3.5" SAS Open bay	2x Media; Open bay	Ent	Yes	3x Std	1x 750W	Yes
7Z74A01AEA	1x Silver 4314 16C 135W 2.4G	1x 32GB 2Rx8	940-16i	16x 3.5" SAS Open bay	4x 3.5"; No media	Ent	Yes	4x Perf	1x 1100W	Yes
7Z74A01JEA	1x Silver 4314 16C 135W 2.4G	1x 32GB 2Rx8	930-8i	8x 3.5" SAS Open bay	2x Media; Open bay	Ent	Yes	3x Std	1x 750W	Yes
7Z74A00ZEA	1x Gold 5315Y 8C 140W 3.2G	1x 32GB 2Rx8	930-8i	8x 2.5" SAS Open bay	2x Media; Open bay	Ent	Yes	3x Std	1x 750W	Yes
7Z74A022EA	1x Gold 5315Y 8C 140W 3.2G	1x 32GB 2Rx8	940-8i 4GB	8x 2.5" SAS Open bay	2x Media; Open bay	Ent	Yes	3x Std	1x 750W	Yes
7Z74A02REA	1x Gold 5315Y 8C 140W 3.2G	1x 32GB 2Rx4	940-8i 4GB	8x 2.5" SAS Open bay	2x Media; Open bay	Ent	Yes	3x Std	1x 750W	Yes
7Z74A00FEA	1x Gold 5317 12C 150W 3.0G	1x 32GB 2Rx8	930-8i	8x 2.5" SAS Open bay	2x Media; Open bay	Ent	Yes	3x Std	1x 750W	Yes
7Z74A021EA	1x Gold 5317 12C 150W 3.0G	1x 32GB 2Rx8	940-8i 4GB	8x 2.5" SAS Open bay	2x Media; Open bay	Ent	Yes	3x Std	1x 750W	Yes
7Z74A00NEA	1x Gold 5318Y 24C 165W 2.1G	1x 32GB 2Rx8	940-8i 4GB	8x 2.5" SAS Open bay	2x Media; Open bay	Ent	Yes	3x Std	1x 750W	Yes
7Z74A00WEA	1x Gold 5318Y 24C 165W 2.1G	1x 32GB 2Rx8	940-16i	16x 2.5" SAS Open bay	2x Media; Open bay	Ent	Yes	4x Perf	1x 1100W	Yes
7Z74A01FEA	1x Gold 5318Y 24C 165W 2.1G	1x 32GB 2Rx8	Onboard SATA	8x 3.5" SAS Open bay	2x Media; Open bay	Ent	Yes	3x Std	1x 750W	Yes
7Z74A00KEA	1x Gold 6326 16C 185W 2.9G	1x 32GB 2Rx8	940-8i 4GB	8x 2.5" SAS Open bay	2x Media; Open bay	Ent	Yes	3x Std	1x 750W	Yes
7Z74A00YEA	1x Gold 6326 16C 185W 2.9G	1x 32GB 2Rx8	940-16i	16x 2.5" SAS Open bay	2x Media; Open bay	Ent	Yes	4x Perf	1x 1100W	Yes
7Z74A019EA	1x Gold 6326 16C 185W 2.9G	1x 32GB 2Rx8	940-16i	16x 3.5" SAS Open bay	4x 3.5"; No media	Ent	Yes	4x Perf	1x 1100W	Yes
7Z74A01DEA	1x Gold 6326 16C 185W 2.9G	1x 32GB 2Rx8	930-8i	8x 3.5" SAS Open bay	2x Media; Open bay	Ent	Yes	3x Std	1x 750W	Yes
7Z74A01EEA	1x Gold 6326 16C 185W 2.9G	1x 32GB 2Rx8	Onboard SATA	8x 3.5" SAS Open bay	2x Media; Open bay	Ent	Yes	3x Std	1x 750W	Yes
7Z74A02QEA	1x Gold 6326 16C 185W 2.9G	1x 32GB 2Rx4	940-8i 4GB	8x 2.5" SAS Open bay	2x Media; Open bay	Ent	Yes	3x Std	1x 750W	Yes
7Z74A012EA	1x Gold 6342 24C 230W 2.8G	1x 32GB 2Rx8	940-16i	16x 2.5" SAS Open bay	2x Media; Open bay	Ent	Yes	4x Perf	1x 1100W	Yes
7Z74A017EA	1x Gold 6342 24C 230W 2.8G	1x 32GB 2Rx8	940-16i	16x 3.5" SAS Open bay	4x 3.5"; No media	Ent	Yes	4x Perf	1x 1100W	Yes
7Z74A01GEA	1x Gold 6342 24C 230W 2.8G	1x 32GB 2Rx8	940-8i 4GB	8x 2.5" SAS Open bay	2x Media; Open bay	Ent	Yes	4x Perf	1x 750W	Yes
7Z74A013EA	1x Gold 6346 16C 205W 3.1G	1x 32GB 2Rx8	940-16i	16x 2.5" SAS Open bay	2x Media; Open bay	Ent	Yes	4x Perf	1x 1100W	Yes
7Z74A015EA	1x Gold 6346 16C 205W 3.1G	1x 32GB 2Rx8	940-8i 4GB	8x 2.5" SAS Open bay	2x Media; Open bay	Ent	Yes	4x Perf	1x 750W	Yes
7Z74A02PEA	1x Gold 6346 16C 205W 3.1G	1x 32GB 2Rx4	940-8i 4GB	8x 2.5" SAS Open bay	2x Media; Open bay	Ent	Yes	3x Perf	1x 750W	Yes

† Processor description: Processor model, number of cores, thermal design power (TDP), core frequency



## Models for India

Table 9. Models for India

Model	Intel Xeon Scalable processor†	Memory	RAID	Drive bays	Top bay	XCC	Intru. sw.	Fans	Power supplies	Power cords
TopSeller models with a 3-year warranty (machine type 7Z74)										
7Z74A02ESG	1x Silver 4309Y 8C 105W 2.8G	1x 16GB	530-8i	8x 3.5" SAS Open bay	4x 3.5"; No media	Ent	No	3x Perf	1x 750W	Yes
7Z74A02FSG	1x Silver 4309Y 8C 105W 2.8G	1x 16GB	530-8i	8x 2.5" SAS Open bay	2x Media; Open bay	Ent	No	3x Perf	1x 750W	Yes
7Z74A02BSG	1x Silver 4310 12C 120W 2.1G	2x 16GB	930-8i	8x 2.5" SAS Open bay	2x Media; Open bay	Ent	No	3x Perf	1x 750W	Yes
7Z74A02DSG	1x Silver 4310 12C 120W 2.1G	2x 16GB	530-8i	8x 3.5" SAS Open bay	4x 3.5"; No media	Ent	No	3x Perf	1x 750W	Yes
7Z74A02ASG	1x Silver 4310T 10C 105W 2.3G	1x 16GB	530-8i	8x 3.5" SAS Open bay	4x 3.5"; No media	Ent	No	3x Perf	1x 750W	Yes
7Z74A02CSG	1x Silver 4310T 10C 105W 2.3G	1x 16GB	530-8i	8x 2.5" SAS Open bay	2x Media; Open bay	Ent	No	3x Perf	1x 750W	Yes

† Processor description: Processor model, number of cores, thermal design power (TDP), core frequency

## Models for Japan

**AP models:** Customers in Japan also have access to the [Asia Pacific region](#) models.

All models for Japan have the following features:

- Japanese keyboard
- Optical Wheel Mouse
- Security Door

Table 10. Models for Japan

Model	Intel Xeon Scalable processor†	Memory	RAID	Drive bays	Top bay	XCC	Intru. sw.	Fans	Power supplies	Power cords
Standard models with a 3-year warranty (machine type 7Z74)										
7Z741001JP	1x Silver 4309Y 8C 105W 2.8G	1x 16GB	940-8i 4GB	8x 2.5" SAS Open bay	2x Media; Open bay	Adv	No	3x Perf	1x 750W	Yes
7Z741002JP	1x Silver 4310 12C 120W 2.1G	1x 16GB	940-8i 4GB	8x 2.5" SAS Open bay	2x Media; Open bay	Adv	No	3x Perf	1x 750W	Yes
7Z741003JP	1x Silver 4310T 10C 105W 2.3G	1x 16GB	940-8i 4GB	8x 2.5" SAS Open bay	2x Media; Open bay	Adv	No	3x Perf	1x 750W	Yes

† Processor description: Processor model, number of cores, thermal design power (TDP), core frequency

## Models for Latin American countries (except Brazil)

Table 11. Models with a 3-year warranty for Latin American countries (except Brazil)

Model	Intel Xeon Scalable processor†	Memory	RAID	Drive bays	Top bay	XCC	Intru. sw.	Fans	Power supplies	Power cords
Standard models with a 3-year warranty (machine type 7Z74)										
7Z74A026LA	1x Silver 4310 12C 120W 2.1G	1x 16GB	930-16i 4GB	16x 2.5" SAS Open bay	2x Media; Open bay	Std	Yes	4x Std	1x 750W	Yes
7Z74A023LA	1x Silver 4314 16C 135W 2.4G	1x 32GB 2Rx4	930-16i 4GB	16x 2.5" SAS Open bay	2x Media; Open bay	Std	Yes	4x Std	1x 750W	Yes
7Z74A024LA	1x Silver 4316 20C 150W 2.3G	1x 32GB 2Rx4	930-16i 4GB	16x 2.5" SAS Open bay	2x Media; Open bay	Std	Yes	4x Std	1x 750W	Yes
Standard models with a 1-year warranty (machine type 7Z75)										
7Z751000LA	1x Silver 4310 12C 120W 2.1G	1x 16GB	540-8i	8x 2.5" SAS Open bay	2x Media; Open bay	Ent	No	4x Std	1x 750W	Yes

† Processor description: Processor model, number of cores, thermal design power (TDP), core frequency

## Models for USA and Canada

Table 12. Models for USA and Canada

Model	Intel Xeon Scalable processor†	Memory	RAID	Drive bays	Top bay	XCC	Intru. sw.	Fans	Power supplies	Power cords
Standard models with a 3-year warranty (machine type 7Z74)										
7Z74A01QNA	1x Silver 4309Y 8C 105W 2.8G	1x 32GB 2Rx8	Onboard SATA	8x 2.5" SAS Open bay	2x Media; Open bay	Ent	No	3x Perf	1x 750W	Yes
7Z74A01UNA	1x Silver 4309Y 8C 105W 2.8G	1x 32GB 2Rx8	Onboard SATA	8x 3.5" SAS Open bay	2x Media; Open bay	Ent	No	3x Perf	1x 750W	Yes
7Z74A02GNA	1x Silver 4309Y 8C 105W 2.8G	1x 32GB 2Rx8	Onboard SATA	8x 2.5" SAS Open bay	2x Media; Open bay	Ent	No	3x Perf	1x 750W	Yes
7Z74A02HNA	1x Silver 4309Y 8C 105W 2.8G	1x 32GB 2Rx8	Onboard SATA	8x 3.5" SAS Open bay	2x Media; Open bay	Ent	No	3x Perf	1x 750W	Yes
7Z74A01VNA	1x Silver 4310 12C 120W 2.1G	1x 32GB 2Rx8	Onboard SATA	8x 3.5" SAS Open bay	2x Media; Open bay	Ent	No	3x Perf	1x 750W	Yes
7Z74A01YNA	1x Silver 4310 12C 120W 2.1G	1x 32GB 2Rx8	Onboard SATA	8x 2.5" SAS Open bay	2x Media; Open bay	Ent	No	3x Perf	1x 750W	Yes
7Z74A02JNA	1x Silver 4310 12C 120W 2.1G	1x 32GB 2Rx8	Onboard SATA	8x 3.5" SAS Open bay	2x Media; Open bay	Ent	No	3x Perf	1x 750W	Yes
7Z74A02MNA	1x Silver 4310 12C 120W 2.1G	1x 32GB 2Rx8	Onboard SATA	8x 2.5" SAS Open bay	2x Media; Open bay	Ent	No	3x Perf	1x 750W	Yes
7Z74A01SNA	1x Silver 4314 16C 135W 2.4G	1x 32GB 2Rx8	Onboard SATA	8x 2.5" SAS Open bay	2x Media; Open bay	Ent	No	3x Perf	1x 750W	Yes
7Z74A01WNA	1x Silver 4314 16C 135W 2.4G	1x 32GB 2Rx8	Onboard SATA	8x 3.5" SAS Open bay	2x Media; Open bay	Ent	No	3x Perf	1x 750W	Yes
7Z74A02LNA	1x Silver 4314 16C 135W 2.4G	1x 32GB 2Rx8	Onboard SATA	8x 2.5" SAS Open bay	2x Media; Open bay	Ent	No	3x Perf	1x 750W	Yes
7Z74A02NNA	1x Silver 4314 16C 135W 2.4G	1x 32GB 2Rx8	Onboard SATA	8x 3.5" SAS Open bay	2x Media; Open bay	Ent	No	3x Perf	1x 750W	Yes

† Processor description: Processor model, number of cores, thermal design power (TDP), core frequency

## Processor options

The ST650 V2 supports processors in the third-generation Intel Xeon Scalable Processor family. The server supports one or two processors.

Topics in this section:

- [Processor options](#)
- [Processor features](#)
- [One-processor configurations](#)
- [Thermal restrictions based on processor](#)

## Processor options

The table below lists the processors that are supported.

Some processors include a suffix letter in the processor model number:

- M: Media Processing optimized
- N: NFV optimized
- P: High frequency-optimized for IaaS virtualization customers
- Q: Optimized for liquid cooling
- S: Large (512GB) SGX Enclave size
- T: High Tcase
- U: Single socket
- V: High density/low power-optimized for SaaS virtualization customers
- Y: Speed Select

**Memory tiers:** All processors support up to 6TB of memory. There are no L or M suffix processors.

**Options part numbers only for second processor:** The option part numbers listed in the table are only for use when adding a second processor. It is not supported to upgrade any processors already installed.

Table 13. Processor options

Part number	Feature code	Description	Maximum quantity†
4XG7A72930	BB2N	ST650 V2 Intel Xeon Silver 4309Y 8C 105W 2.8GHz Option Kit w/o Fan	2
4XG7A72949	BB3C	ST650 V2 Intel Xeon Silver 4310 12C 120W 2.1GHz Option Kit w/o Fan	2
4XG7A72943	BB34	ST650 V2 Intel Xeon Silver 4310T 10C 105W 2.3GHz Option Kit w/o Fan	2
4XG7A72939	BB2Z	ST650 V2 Intel Xeon Silver 4314 16C 135W 2.4GHz Option Kit w/o Fan	2
4XG7A72946	BB39	ST650 V2 Intel Xeon Silver 4316 20C 150W 2.3GHz Option Kit w/o Fan	2
4XG7A72954	BB3M	ST650 V2 Intel Xeon Gold 5315Y 8C 140W 3.2GHz Option Kit w/o Fan	2
4XG7A72940	BB30	ST650 V2 Intel Xeon Gold 5317 12C 150W 3.0GHz Option Kit w/o Fan	2
4XG7A72951	BB3E	ST650 V2 Intel Xeon Gold 5318N 24C 150W 2.1GHz Option Kit w/o Fan	2
4XG7A72929	BB2M	ST650 V2 Intel Xeon Gold 5318S 24C 165W 2.1GHz Option Kit w/o Fan	2
4XG7A72944	BB35	ST650 V2 Intel Xeon Gold 5318Y 24C 165W 2.1GHz Option Kit w/o Fan	2
4XG7A72933	BB2R	ST650 V2 Intel Xeon Gold 5320 26C 185W 2.2GHz Option Kit w/o Fan	2
4XG7A72938	BB2Y	ST650 V2 Intel Xeon Gold 5320T 20C 150W 2.3GHz Option Kit w/o Fan	2
4XG7A72927	BB2K	Intel Xeon Gold 6312U 24C 185W 2.4GHz Processor	1*
4XG7A72945	BB38	Intel Xeon Gold 6314U 32C 205W 2.3GHz Processor	1*
4XG7A72932	BB4E	ST650 V2 Intel Xeon Gold 6326 16C 185W 2.9GHz Option Kit w/o Fan	2

Part number	Feature code	Description	Maximum quantity†
4XG7A72952	BB3H	ST650 V2 Intel Xeon Gold 6330 28C 205W 2.0GHz Option Kit w/o Fan	2
4XG7A72955	BB3N	ST650 V2 Intel Xeon Gold 6330N 28C 165W 2.2GHz Option Kit w/o Fan	2
4XG7A72950	BB3D	ST650 V2 Intel Xeon Gold 6334 8C 165W 3.6GHz Option Kit w/o Fan	2
4XG7A72959	BB3S	ST650 V2 Intel Xeon Gold 6336Y 24C 185W 2.4GHz Option Kit w/o Fan	2
4XG7A72956	BB3P	ST650 V2 Intel Xeon Gold 6338 32C 205W 2.0GHz Option Kit w/o Fan	2
4XG7A72941	BB31	ST650 V2 Intel Xeon Gold 6338N 32C 185W 2.2GHz Option Kit w/o Fan	2
4XG7A72942	BB33	ST650 V2 Intel Xeon Gold 6338T 24C 165W 2.1GHz Option Kit w/o Fan	2
4XG7A72948	BB3B	ST650 V2 Intel Xeon Gold 6342 24C 230W 2.8GHz Option Kit w/o Fan	2
4XG7A72937	BB2W	ST650 V2 Intel Xeon Gold 6346 16C 205W 3.1GHz Option Kit w/o Fan	2
4XG7A72928	BB2L	ST650 V2 Intel Xeon Gold 6348 28C 235W 2.6GHz Option Kit w/o Fan	2
4XG7A72935	BB2U	ST650 V2 Intel Xeon Gold 6354 18C 205W 3.0GHz Option Kit w/o Fan	2
CTO only	BB3J	Intel Xeon Platinum 8351N 36C 225W 2.4GHz Processor	1*
4XG7A63659	BKDB	ST650 V2 Intel Xeon Platinum 8352M 32C 185W 2.3GHz Option Kit w/o Fan	2
4XG7A72957	BB3Q	ST650 V2 Intel Xeon Platinum 8352S 32C 205W 2.2GHz Option Kit w/o Fan	2
4XG7A72934	BB2S	ST650 V2 Intel Xeon Platinum 8352V 36C 195W 2.1G/3.5GHz Option Kit w/o Fan	2
4XG7A72936	BB2V	ST650 V2 Intel Xeon Platinum 8352Y 32C 205W 2.2GHz Option Kit w/o Fan	2
4XG7A72958	BB3R	ST650 V2 Intel Xeon Platinum 8358 32C 250W 2.6GHz Option Kit w/o Fan	2
4XG7A72947	BB3A	ST650 V2 Intel Xeon Platinum 8358P 32C 240W 2.6GHz Option Kit w/o Fan	2
4XG7A72931	BB2P	ST650 V2 Intel Xeon Platinum 8360Y 36C 250W 2.4GHz Option Kit w/o Fan	2

\* Processors with a U suffix and the 8351N processor are only supported one processor per server; as a result, there is no option part number for a second processor.

† The server supports two processors. In the configurator, you can select 1 or 2 processor feature codes. However for option part numbers, only 1 is supported per server. The option part numbers are only for use when adding a second processor. It is not supported to use the option part numbers to upgrade any processors already installed.

## Processor features

Supported processors have the following features:

- Third-generation Intel Xeon Scalable processors (formerly codenamed "Ice Lake")
- 10 nm process technology
- 8x DDR4 memory channels
- 64x PCIe 4.0 I/O lanes available for PCIe and NVMe devices
- 1.25 MB L2 cache per core
- 1.5 MB or more L3 cache per core
- Intel Deep Learning Boost, which provides built-in Artificial Intelligence (AI) acceleration with the Vector Neural Network Instruction set (VNNI). DL Boost and VNNI are designed to deliver significant, more efficient Deep Learning (Inference) acceleration for high-performance AI workloads.
- Intel Hyper-Threading Technology, which boosts performance for multithreaded applications by enabling simultaneous multithreading within each processor core, up to two threads per core.
- Intel Turbo Boost Technology 2.0, which allows processor cores to run at maximum speeds during peak workloads by temporarily going beyond processor TDP.
- Intel Virtualization Technology (includes VT-x and VT-d), which integrates hardware-level virtualization hooks that allow operating system vendors to better use the hardware for virtualization workloads.
- Intel Speed Select Technology, supported on some processor models, enables increased core Turbo Boost frequency on specific individual cores to maximize application performance.
- Intel Advanced Vector Extensions 512 (AVX-512), to enable acceleration of enterprise-class workloads, including databases and enterprise resource planning (ERP).
- Up to two Intel AVX-512 Fused-Multiply Add (FMA) units
- Intel SGX (Software Guard Extensions) and Intel TME (Total Memory Encryption) security features
- Two or three Intel Ultra Path Interconnect (UPI) links at up to 11.2 GT/s, to maximize inter-processor communication

The following table compares the features of the supported third-generation Intel Xeon processors.

### Abbreviations used in the table:

- TB: Turbo Boost 2.0
- UPI: Ultra Path Interconnect
- TDP: Thermal Design Power
- SGX: Software Guard Extensions
- PMem: Persistent Memory support

Table 14. Processor features

CPU model	Cores/ threads	Core speed (Base / TB max)	L3 cache*	Max memory speed	UPI links & speed	TDP	SGX Enclave Size	Pmem
4309Y	8 / 16	2.8 GHz / 3.6 GHz	12 MB	2667 MHz	2 / 10.4 GT/s	105W	8 GB	No
4310	12 / 24	2.1 GHz / 3.3 GHz	18 MB	2667 MHz	2 / 10.4 GT/s	120W	8 GB	No
4310T	10 / 20	2.3 GHz / 3.4 GHz	15 MB	2667 MHz	2 / 10.4 GT/s	105W	8 GB	No
4314	16 / 32	2.4 GHz / 3.4 GHz	24 MB	2667 MHz	2 / 10.4 GT/s	135W	8 GB	Yes
4316	20 / 40	2.3 GHz / 3.4 GHz	30 MB	2667 MHz	2 / 10.4 GT/s	150W	8 GB	No
5315Y	8 / 16	3.2 GHz / 3.6 GHz	12 MB	2933 MHz	3 / 11.2 GT/s	140W	64 GB	Yes
5317	12 / 24	3.0 GHz / 3.6 GHz	18 MB	2933 MHz	3 / 11.2 GT/s	150W	64 GB	Yes

CPU model	Cores/ threads	Core speed (Base / TB max)	L3 cache*	Max memory speed	UPI links & speed	TDP	SGX Enclave Size	Pmem
5318N	24 / 48	2.1 GHz / 3.4 GHz	36 MB	2667 MHz	3 / 11.2 GT/s	150W	64 GB	Yes
5318S	24 / 48	2.1 GHz / 3.4 GHz	36 MB	2933 MHz	3 / 11.2 GT/s	165W	512 GB	Yes
5318Y	24 / 48	2.1 GHz / 3.4 GHz	36 MB	2933 MHz	3 / 11.2 GT/s	165W	64 GB	Yes
5320	26 / 52	2.2 GHz / 3.4 GHz	39 MB	2933 MHz	3 / 11.2 GT/s	185W	64 GB	Yes
5320T	20 / 40	2.3 GHz / 3.5 GHz	30 MB	2933 MHz	3 / 11.2 GT/s	150W	64 GB	Yes
6312U	24 / 48	2.4 GHz / 3.6 GHz	36 MB	3200 MHz	None	185W	64 GB	Yes
6314U	32 / 64	2.3 GHz / 3.4 GHz	48 MB	3200 MHz	None	205W	64 GB	Yes
6326	16 / 32	2.9 GHz / 3.5 GHz	24 MB	3200 MHz	3 / 11.2 GT/s	185W	64 GB	Yes
6330	28 / 56	2.0 GHz / 3.1 GHz	42 MB	2933 MHz	3 / 11.2 GT/s	205W	64 GB	Yes
6330N	28 / 56	2.2 GHz / 3.4 GHz	42 MB	2667 MHz	3 / 11.2 GT/s	165W	64 GB	Yes
6334	8 / 16	3.6 GHz / 3.7 GHz	18 MB*	3200 MHz	3 / 11.2 GT/s	165W	64 GB	Yes
6336Y	24 / 48	2.4 GHz / 3.6 GHz	36 MB	3200 MHz	3 / 11.2 GT/s	185W	64 GB	Yes
6338	32 / 64	2.0 GHz / 3.2 GHz	48 MB	3200 MHz	3 / 11.2 GT/s	205W	64 GB	Yes
6338N	32 / 64	2.2 GHz / 3.5 GHz	48 MB	2667 MHz	3 / 11.2 GT/s	185W	64 GB	Yes
6338T	24 / 48	2.1 GHz / 3.4 GHz	36 MB	3200 MHz	3 / 11.2 GT/s	165W	64 GB	Yes
6342	24 / 48	2.8 GHz / 3.5 GHz	36 MB	3200 MHz	3 / 11.2 GT/s	230W	64 GB	Yes
6346	16 / 32	3.1 GHz / 3.6 GHz	36 MB*	3200 MHz	3 / 11.2 GT/s	205W	64 GB	Yes
6348	28 / 56	2.6 GHz / 3.5 GHz	42 MB	3200 MHz	3 / 11.2 GT/s	235W	64 GB	Yes
6354	18 / 36	3.0 GHz / 3.6 GHz	39 MB*	3200 MHz	3 / 11.2 GT/s	205W	64 GB	Yes
8351N	36 / 72	2.4 GHz / 3.5 GHz	54 MB	2933 MHz	None	225W	64 GB	Yes
8352M	32 / 64	2.3 GHz / 3.5 GHz	48 MB	3200 MHz	3 / 11.2 GT/s	185W	64 GB	Yes
8352S	32 / 64	2.2 GHz / 3.4 GHz	48 MB	3200 MHz	3 / 11.2 GT/s	205W	512 GB	Yes
8352V	36 / 72	2.1 GHz / 3.5 GHz	54 MB	2933 MHz	3 / 11.2 GT/s	195W	8 GB	Yes
8352Y	32 / 64	2.2 GHz / 3.4 GHz	48 MB	3200 MHz	3 / 11.2 GT/s	205W	64 GB	Yes
8358	32 / 64	2.6 GHz / 3.4 GHz	48 MB	3200 MHz	3 / 11.2 GT/s	250W	64 GB	Yes
8358P	32 / 64	2.6 GHz / 3.4 GHz	48 MB	3200 MHz	3 / 11.2 GT/s	240W	8 GB	Yes
8360Y	36 / 72	2.4 GHz / 3.5 GHz	54 MB	3200 MHz	3 / 11.2 GT/s	250W	64 GB	Yes

\* L3 cache is 1.5 MB per core or larger. Processors with a larger L3 cache per core are marked with an \*

## One-processor configurations

The ST650 V2 can be used with only one processor installed. Most core functions of the server (including the XClarity Controller) are connected to processor 1 as shown in the [System architecture](#) section.

With only one processor, the server has the following capabilities:

- 16 memory DIMMs for a 2TB maximum
- Slots 1-3 and slot 9 are available; Slot 4-8 are not available

Drive support is as follows:

- SAS/SATA drives are supported - 8, 16, 24 drives (2.5-inch) or 8, 12 drives (3.5-inch)
- NVMe drives are supported, up to 4 drives (3.5-inch only)
- M.2 drives are supported

Controller support is as follows:

- 8x onboard SATA
- 4x onboard NVMe
- RAID adapters/HBAs installed in slots 1-3
- Internal RAID controller and HBA are *not* supported

### Thermal restrictions by processor

Processors with a high TDP value require a lower ambient temperature. See the [Operating environment](#) section for details.

### Memory options

The ST650 V2 uses Lenovo TruDDR4 memory and supports 16 DIMMs per processor or 32 DIMMs with two processors installed. Each processor has eight memory channels with two DIMMs per channel. With 128 GB 3DS RDIMMs installed, the ST650 V2 supports a total of 4 TB of system memory.

The ST650 V2 also supports Intel Optane Persistent Memory 200 Series, as described in the [Persistent Memory](#) section.

Memory operates at up to 3200 MHz at two DIMMs per channel, depending on the memory DIMMs and processor model selected. If the processor selected has a lower memory bus speed, then all DIMMs will operate at that lower speed.

The following table lists the memory options that are available for the server.

Lenovo TruDDR4 memory uses the highest quality components that are sourced from Tier 1 DRAM suppliers and only memory that meets the strict requirements of Lenovo is selected. It is compatibility tested and tuned to maximize performance and reliability. From a service and support standpoint, Lenovo TruDDR4 memory automatically assumes the system warranty, and Lenovo provides service and support worldwide.

Table 15. Memory options

Part number	Feature code	Description	Maximum supported
RDIMMs			
4X77A08632	B963	ThinkSystem 16GB TruDDR4 3200MHz (2Rx8 1.2V) RDIMM	32 (16 per processor)
4X77A08633	B964	ThinkSystem 32GB TruDDR4 3200MHz (2Rx4 1.2V) RDIMM	32 (16 per processor)
4X77A08634	B965	ThinkSystem 32GB TruDDR4 3200MHz (2Rx8 1.2V) RDIMM	32 (16 per processor)
4X77A08635	B966	ThinkSystem 64GB TruDDR4 3200MHz (2Rx4 1.2V) RDIMM	32 (16 per processor)
3DS RDIMMs			
4X77A08636	BA62	ThinkSystem 128GB TruDDR4 3200 MHz (2S2Rx4 1.2V) 3DS RDIMM	32 (16 per processor)

The following rules apply when selecting the memory configuration:

- The following DIMM quantities are supported per processor: 1, 2, 4, 6, 8, 12, and 16. Other quantities per processor are not supported.
- The server supports RDIMMs and 3DS RDIMMs; UDIMMs and LRDIMMs are not supported
- Mixing RDIMMs and 3DS RDIMMs is not supported
- Mixing x4 and x8 DIMMs is supported

For best performance, consider the following:

- Populate memory DIMMs in quantities of 8 or 16 per processor, so that all memory channels are used

- Populate memory channels so they all have the same total memory capacity.
- Ensure all memory controllers on a processor socket have the same DIMM configuration.
- All processor sockets on the same physical server should have the same DIMM configuration.

The following memory protection technologies are supported:

- ECC
- SDDC (for x4-based memory DIMMs; look for "x4" in the DIMM description)
- ADDDC (for x4-based memory DIMMs)
- Memory mirroring

**Note:** Memory sparing is not supported

If memory channel mirroring is used, then DIMMs must be installed in pairs or sets of three (minimum of one pair or set of three per processor), and all DIMMs in the pair or set of three must be identical in type and size. 50% of the installed capacity is available to the operating system. Memory rank sparing is not supported.



## Persistent memory

The ST650 V2 server supports Intel Optane Persistent Memory 200 Series, a new class of memory and storage technology explicitly architected for data center usage. Persistent memory is an innovative technology that delivers a unique combination of affordable large memory capacity and persistence (non-volatility). It offers significantly lower latency than fetching data from SSDs, even NVMe SSDs, and offers higher capacities than system memory.

Persistent memory technology can help boost the performance of data-intensive applications such as in-memory analytics, databases, content delivery networks, and high performance computing (HPC), as well as deliver consistent service levels at scale with higher virtual machine and container density. When data is stored closer to the processor on nonvolatile media, applications can see significant overall improvement in performance.

The following table lists the ordering information for the supported persistent memory modules.

Table 16. Persistent memory module part numbers

Part number	Feature code	Description	Maximum supported
4ZC7A08732	B98B	ThinkSystem 128GB TruDDR4 3200MHz (1.2V) Intel Optane Persistent Memory	16 (8 per processor)
4ZC7A08734	B98A	ThinkSystem 256GB TruDDR4 3200MHz (1.2V) Intel Optane Persistent Memory	16 (8 per processor)

The following are the requirements when installing persistent memory (PMem) modules when installed in a two-socket server with third-generation Intel Xeon Scalable processors ("Ice Lake" processors):

- App Direct Mode and Memory Mode are supported. Mixed Mode is not supported.
- All PMem modules operate at 3200 MHz when the installed processor runs the memory bus at 3200 MHz.
- All installed PMem modules must be the same size. Mixing PMem modules of different capacities is not supported.
- Maximum 8 PMem modules per processor (install 1 in each memory channel).
- For each memory channel with both a PMem module and a memory DIMM installed, the PMem module is installed in channel slot 1 (DIMM1, closer to the processor) and the DIMM is installed in channel slot 0 (DIMM0).
- To maximize performance, balance all memory channels
- Both interleaved and non-interleaved modes are supported.
- Memory mirroring is not supported with PMem modules installed

For details, including App Direct Mode and Memory Mode configuration requirements, see the Intel Optane Persistent Memory 200 Series product guide, <https://lenovopress.com/LP1380>

## Internal storage

The ST650 V2 supports 2.5-inch hot-swap, 3.5-inch hot-swap, and 3.5-inch simple-swap drives at the front of the server in a variety of drive bay configurations. Some drive bay configurations are supported with two 5.25-inch media bays for tape, RDX or optical drives.

The server also supports one or two M.2 drives, installed in an M.2 adapter internal to the server.

In this section:

- [Drive bays](#)
- [Backplanes](#)
- [NVMe drive support](#)
- [Supported drive bay combinations](#)
- [Controller selections](#)
- [Field upgrades](#)
- [M.2 drives](#)

### Drive bays

The ST650 V2 supports four main drive bay configurations as shown in the following figure.

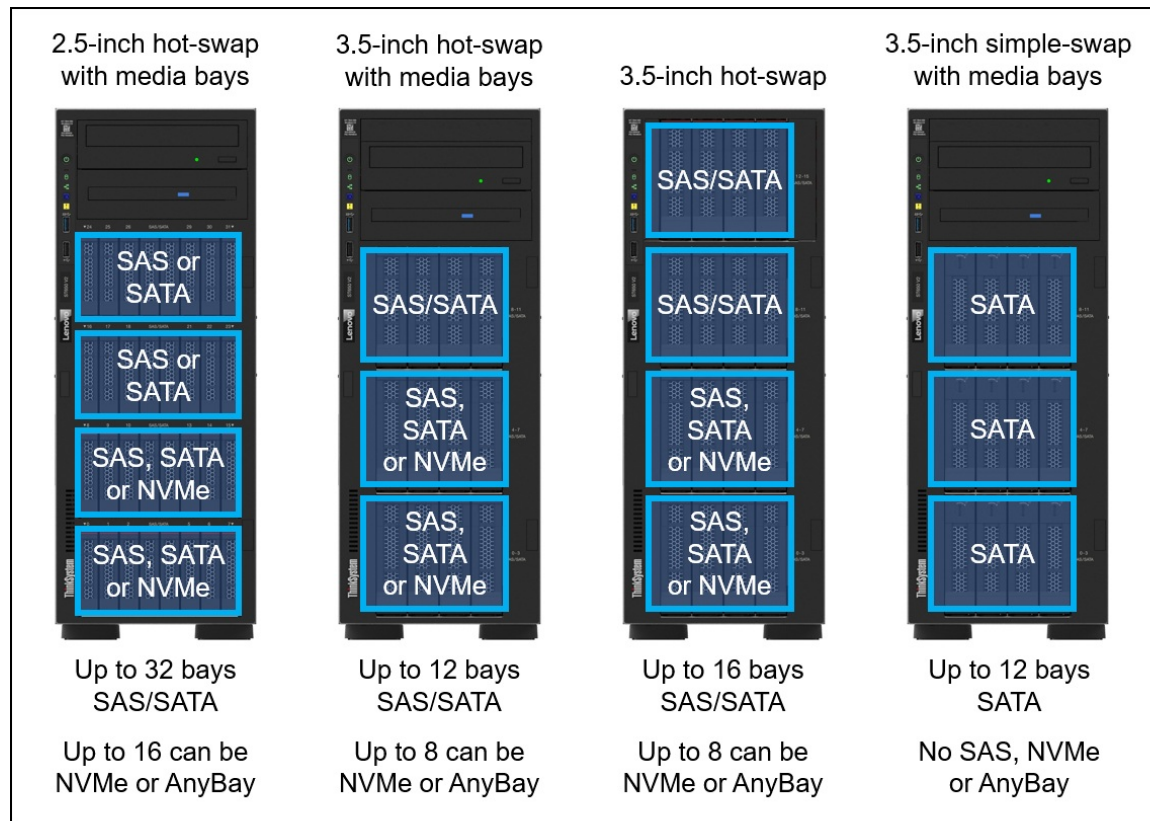

Figure 7. ST650 V2 drive bays

The four configurations are as follows:

- 2.5-inch hot-swap drive bays
  - Up to 32 drive bays, 8 drives per backplane
  - All 32 drives can be SAS or SATA
  - 16 drives can be AnyBay drive bays or NVMe drive bays
  - Optional support for 2 media bays

- 12x 3.5-inch hot-swap drive bays
  - Up to 12 drive bays, 4 drives per backplane
  - All 12 drives can be SAS or SATA
  - 8 drives can can be AnyBay drive bays or NVMe drive bays
  - Optional support for 2 media bays
  - Can be upgraded to 16x 3.5-inch drive bays by removing the media bays and installing 4XF7A79787.
- 16x 3.5-inch hot-swap drive bays
  - Up to 16 drive bays, 4 drives per backplane
  - All 16 drives can be SAS or SATA
  - 8 drives can can be AnyBay drive bays or NVMe drive bays
  - No support for 2 media bays
- 12x 3.5-inch simple-swap drive bays
  - Up to 12 drive bays supporting SATA drives, 4 drives per backplate
  - No support for SAS, AnyBay or NVMe drives
  - Optional support for 2 media bays

It is also possible to configure a server without any drives or backplanes. Drives and backplanes can be added in the field as described in the [field upgrades](#) section.

## Backplanes

The backplanes used to provide the drive bays are listed in the following table.

The table also lists the ordering information for the media bay that provides two 5.25-inch drive bays at the top of the server for a tape drive or optical drive. The media bays are not available when 16x 3.5-inch drive bays are configured.

**Field upgrades:** All backplanes are available as part numbers for field upgrades complete with the necessary cables, as listed in the table and described in the [Field upgrades](#) section below.

Table 17. Backplanes for drive bays

Part number*	Feature code	Description	Maximum supported
<b>2.5-inch hot-swap</b>			
4B27A60845	B8LU	ThinkSystem ST650 V2 2.5" SAS/SATA 8-Bay Backplane Kit	4
4B27A60846	BH8B	ThinkSystem ST650 V2 2.5" AnyBay 8-Bay Backplane Kit	2
4B27A09322	BH8D	ThinkSystem ST650 V2 2.5" NVMe 8-Bay Backplane Kit	2
<b>3.5-inch hot-swap</b>			
4B27A60843	BA5Q	ThinkSystem ST650 V2 3.5" SAS/SATA 4-Bay Backplane Kit	4
4B27A60844	BA5R	ThinkSystem ST650 V2 3.5" AnyBay 4-Bay Backplane Kit	2
4B27A09320	BCQS	ThinkSystem ST650 V2 3.5" NVMe 4-Bay Backplane Kit	2
<b>3.5-inch simple-swap</b>			
4M17A11753	BA5Y	ThinkSystem ST650 V2/V3 3.5" Simple-Swap SATA 4-Bay Backplate Kit	3
<b>Media bay</b>			
4M27A60829	BA5W	ThinkSystem ST650 V2 3.5" Chassis Media Bay Enablement Kit	1

\* Part numbers include cables and other components as described in the [Field upgrades](#) section.

**Common backplanes:** Two of the 2.5-inch backplanes listed in the above table use the same physical circuit board. Feature codes BH8B and BH8D use a backplane with eight bays where each bay has both a SAS/SATA connection and an NVMe connection. The difference is which connectors on the backplane are cabled: NVMe and SAS/SATA or just NVMe. Both feature codes use backplane SBB7A29600. Similarly 3.5-inch backplanes BA5R (AnyBay) and BCQS (NVMe) share a common backplane, SBB7A17369.

## NVMe drive support

The ST650 V2 supports NVMe drives to maximize storage performance.

Depending on the configuration, NVMe drives are connected either to onboard NVMe ports or to retimer adapters installed in PCIe slots.

- 2.5-inch drive configurations:
  - Up to 16 NVMe drives without oversubscription (that is, each x4 drive has a full x4 (4 lanes) connection to the processor)
  - Up to 8 drives can be connected to onboard NVMe ports
  - Other drives in the configuration are connected via retimer adapters
- 3.5-inch hot-swap drive configurations:
  - Up to 8 NVMe drives without oversubscription (that is, each x4 drive has a full x4 (4 lanes) connection to the processor)
  - All 8 drives can be connected to onboard NVMe ports
  - Alternatively, drives can be configured using retimer adapters

**PCIe 4.0 NVMe support:** The onboard NVMe ports connected to CPU 1 (NVMe ports 1 & 2) operate at PCIe 3.0 speeds in the ST650 V2 as shown in the following figure. That means any PCIe 4.0 drives installed in backplanes connected to those ports will operate at PCIe 3.0 speeds. NVMe drives connected to the NVMe ports connected to CPU 2 (NVMe ports 3 & 4) or connected to retimer adapters operate at PCIe 4.0 (Gen 4) speeds if the drives themselves support that speed. See the *ST650 V2 Backplane/Backplate Cable Routing Guide* for details about what connections are used in each configuration, <http://thinksystem.lenovofiles.com/help/index.jsp>.

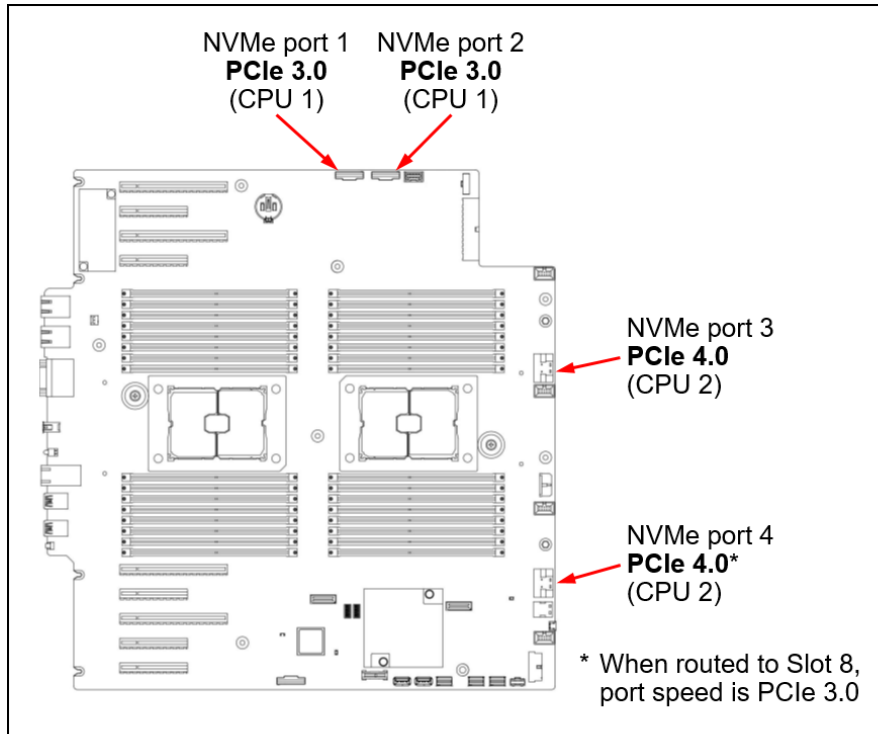

Figure 8. Onboard NVMe port speeds

The specifics of the drive bay configurations are covered in the [Supported drive bay combinations](#) and [Controller selections](#) sections.

The tables in those sections indicate the number of NVMe drives in each configuration plus the subscription ratio. The subscription ratio is the number of PCIe lanes from the processor compared to the number of lanes to the drives. A ratio of 1:1 means all drives get the full number of lanes they need to maximize drive performance (currently 4 lanes per drive). A ratio of 1:2 means each drive only gets the half the bandwidth from the processor.

### Supported drive bay combinations

This section describes the various combinations of 3.5-inch and 2.5-inch drives that the server supports. The combinations are based on whether the drives are 3.5-inch or 2.5-inch. The drives are connected using backplanes (hot-swap drives) or backplates (simple-swap drives). Up to four backplanes/backplates are installed, numbered 1-4 from the bottom as shown in the following figure.

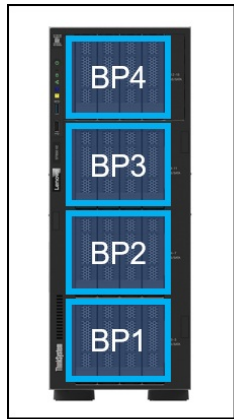

Figure 9. Backplane numbering

### 3.5-inch drive bay chassis

The following table shows the supported combinations when the server is configured with 3.5-inch drives. The choice of storage controller for each configuration is listed in the [Controller selections](#) section.

Table 18. Drive bay and backplane combinations with 3.5-inch chassis (Blue cells = SAS/SATA, Purple cells = AnyBay, Red cells = NVMe) (SS = Simple swap)

Config	Total drives	NVMe drives§	BP1	BP2	BP3	BP4	Slot 8 support
1	4	0	4x SS SATA	Open	Open	Open*	Yes
2	8	0	4x SS SATA	4x SS SATA	Open	Open*	Yes
3	12	0	4x SS SATA	4x SS SATA	4x SS SATA	Open*	Yes
4	4	0	4x SAS/SATA	Open	Open	Open	Yes
5	4	0	4x SAS/SATA	Open	Open	Open	Yes
6	8	0	4x SAS/SATA	4x SAS/SATA	Open	Open	Yes
7	8	0	4x SAS/SATA	4x SAS/SATA	Open	Open	Yes
8	8	4 (1:1)	4x NVMe	4x SAS/SATA	Open	Open	Yes
9	8	4 (1:1)	4x AnyBay	4x SAS/SATA	Open	Open	Yes
10	12	0	4x SAS/SATA	4x SAS/SATA	4x SAS/SATA	Open	Yes
11	12	8 (1:1)	4x NVMe	4x NVMe	4x SAS/SATA	Open	Yes**
12	12	4 (1:1)	4x NVMe	4x SAS/SATA	4x SAS/SATA	Open	Yes
13	12	8 (1:1)	4x AnyBay	4x AnyBay	4x SAS/SATA	Open	Yes**
14	12	4 (1:1)	4x AnyBay	4x SAS/SATA	4x SAS/SATA	Open	Yes
15	16	0	4x SAS/SATA	4x SAS/SATA	4x SAS/SATA	4x SAS/SATA	Yes
16	16	8 (1:1)	4x AnyBay	4x AnyBay	4x SAS/SATA	4x SAS/SATA	Yes**
17	16	8 (1:1)	4x NVMe	4x NVMe	4x SAS/SATA	4x SAS/SATA	Yes**

§ The text in parenthesis refers to the subscription ratio. See the [NVMe support](#) section for details.

\* In configurations with simple-swap drives, the BP4 zone can only be occupied by media bays (optical/tape drives)

\*\* Depending on the controllers used in this configuration, Slot 8 may not be available. See Controller selections section for details.

## 2.5-inch drive bay chassis

The following table shows the supported combinations when the server is configured with a 2.5-inch chassis (where the front drive bays are 2.5-inch). The table lists the front, middle and rear backplanes required for each drive bay combination. The choice of storage controller for each configuration is listed in the [Controller selections](#) section.

Table 19. Drive bay and backplane combinations with 2.5-inch chassis (Blue cells = SAS/SATA, Purple cells = AnyBay, Red cells = NVMe) (SS = Simple swap)

Config	Total drives	NVMe drives§	BP1	BP2	BP3	BP4	Slot 8 support
18	8	0	8x SAS/SATA	Open	Open	Open	Yes
19	8	0	8x SAS/SATA	Open	Open	Open	Yes
20	16	0	8x SAS/SATA	8x SAS/SATA	Open	Open	Yes
21	16	8 (1:1)	8x AnyBay	8x SAS/SATA	Open	Open	Yes**
22	16	8 (1:1)	8x NVMe	8x SAS/SATA	Open	Open	Yes**
23	24	0	8x SAS/SATA	8x SAS/SATA	8x SAS/SATA	Open	Yes
24	24	16 (1:1)	8x AnyBay	8x AnyBay	8x SAS/SATA	Open	Yes**
25	24	8 (1:1)	8x AnyBay	8x SAS/SATA	8x SAS/SATA	Open	Yes**
26	24	16 (1:1)	8x NVMe	8x NVMe	8x SAS/SATA	Open	Yes**
27	24	8 (1:1)	8x NVMe	8x SAS/SATA	8x SAS/SATA	Open	Yes**
28	32	0	8x SAS/SATA	8x SAS/SATA	8x SAS/SATA	8x SAS/SATA	Yes
29	32	16 (1:1)	8x AnyBay	8x AnyBay	8x SAS/SATA	8x SAS/SATA	Yes**
30	32	16 (1:1)	8x NVMe	8x NVMe	8x SAS/SATA	8x SAS/SATA	Yes**

§ The text in parenthesis refers to the subscription ratio. See the [NVMe support](#) section for details.

\*\* Depending on the controllers used in this configuration, Slot 8 may not be available. See [Controller selections](#) section for details.

## Controller selections

The ST650 V2 has the following requirements regarding the selection of storage controllers:

- The use of 8x Onboard NVMe requires 2 processors
- The use of a RAID/HBA 16i Internal (CFF) adapter requires 2 processors since the adapter is cabled to CPU 2
- The use of 5 or more adapter slots requires 2 processors
- The use of 3 or 4 Retimer adapters requires 2 processors (these adapters require PCIe x16 slots)
- The use of RAID/HBA 16i Internal and 8x Onboard NVMe ports are mutually exclusive
- The use of PCIe Slot 8 and 8x Onboard NVMe ports are mutually exclusive
- It is supported to use PCIe Slot 8 or RAID/HBA 16i Internal or both with only 4x Onboard NVMe ports
- NVMe drives connected to Onboard NVMe ports 1 & 2 will operate only at PCIe Gen3 speed. NVMe Onboard ports 3 & 4 will operate at Gen4 speed if the attached drives are PCIe Gen4 capable. See the [NVMe drive support](#) section for details.

This section helps you determine with storage adapter are supported for your desired drive bay configuration.

For additional information, consult the ThinkSystem ST650 V2 Backplane/Backplate Cable Routing Guide, available from:

<http://thinksystem.lenovofiles.com/help/index.jsp>

In the tables, the controllers are grouped as follows:

- RAID/HBA 8i corresponds to any of the following:
  - ThinkSystem RAID 530-8i PCIe 12Gb Adapter, 7Y37A01082

- ThinkSystem RAID 540-8i PCIe Gen4 12Gb Adapter, 4Y37A78834
- ThinkSystem RAID 930-8i 2GB Flash PCIe 12Gb Adapter, 7Y37A01084
- ThinkSystem RAID 940-8i 4GB Flash PCIe Gen4 12Gb Adapter, 4Y37A09728
- ThinkSystem RAID 940-8i 8GB Flash PCIe Gen4 12Gb Adapter, 4Y37A09729
- ThinkSystem 430-8i SAS/SATA 12Gb HBA, 7Y37A01088
- ThinkSystem 440-8i SAS/SATA PCIe Gen4 12Gb HBA, 4Y37A78601
- RAID/HBA 16i corresponds to any of the following:
  - ThinkSystem RAID 530-16i PCIe 12Gb Adapter, 4Y37A09727
  - ThinkSystem RAID 540-16i PCIe Gen4 12Gb Adapter, 4Y37A78835
  - ThinkSystem RAID 930-16i 4GB Flash PCIe 12Gb Adapter, 7Y37A01085
  - ThinkSystem RAID 940-16i 4GB Flash PCIe Gen4 12Gb Adapter, 4Y37A78600
  - ThinkSystem RAID 940-16i 8GB Flash PCIe Gen4 12Gb Adapter, 4Y37A09730
  - ThinkSystem 430-16i SAS/SATA 12Gb HBA, 7Y37A01089
  - ThinkSystem 440-16i SAS/SATA PCIe Gen4 12Gb HBA, 4Y37A78602
- RAID/HBA 16i Int (also referred to as RAID 16i CFF, compact form factor) corresponds to the following:
  - ThinkSystem RAID 940-16i 8GB Flash PCIe Gen4 12Gb Internal Adapter, 4Y37A09735
  - ThinkSystem 440-16i SAS/SATA PCIe Gen4 12Gb Internal HBA, 4Y37A09725
- RAID 32i corresponds to the following:
  - ThinkSystem RAID 940-32i 8GB Flash PCIe Gen4 12Gb Adapter, 4Y37A09733
- OB SATA (onboard SATA) corresponds to the following in CTO orders:
  - On Board SATA Software RAID Mode, feature AVV0
- OB NVMe (onboard NVMe) corresponds to the following in CTO orders:
  - Non RAID NVMe, feature BC4V
  - Intel VROC (VMD NVMe RAID) Intel SSD Only, feature B9X7
  - Intel VROC (VMD NVMe RAID) Premium, feature B96G

Many of the configurations also support the installation of the optional cable to enable PCIe Slot 8 as indicated in the table.

### 3.5-inch chassis configurations

The following table lists the supported drive bay combinations for configurations with 3.5-inch front drive bays, plus the list of supported controller combinations supported by each of those drive bay combinations. Information about the controllers can be found in the [Controllers for internal storage](#) section.

Table 20. Drive bay combinations with 3.5-inch chassis (Dark blue cells = SATA, Blue = SAS/SATA, Purple = AnyBay, Red cells = NVMe)

Cfg	BP1	BP2	BP3	BP4	CPUs	Slot 8 support	Controller combinations (drive count) (OB = Onboard)
1	SS SATA	Open	Open	Open*	1 or 2	Yes	OB SATA (4)
2	SS SATA	SS SATA	Open	Open*	1 or 2	Yes	OB SATA (8)
3	SS SATA	SS SATA	SS SATA	Open*	1 or 2	Yes	OB SATA (12)**
4	SAS	Open	Open	Open	1 or 2	Yes	OB SATA (4)
5	SAS	Open	Open	Open	1 or 2	Yes	1x RAID/HBA 8i (4)
					1 or 2	Yes	1x RAID/HBA 16i (4)
					2	Yes	1x RAID/HBA 16i Int (4)
6	SAS	SAS	Open	Open	1 or 2	Yes	OB SATA (8)
7	SAS	SAS	Open	Open	1 or 2	Yes	1x RAID/HBA 8i (8)
					1 or 2	Yes	1x RAID/HBA 16i (8)
					2	Yes	1x RAID/HBA 16i Int (8)



Cfg	BP1	BP2	BP3	BP4	CPUs	Slot 8 support	Controller combinations (drive count) (OB = Onboard)
8	NVMe	SAS	Open	Open	1 or 2	Yes	1x RAID/HBA 8i (4) + OB NVMe (4)
					1 or 2	Yes	1x RAID/HBA 16i (4) + OB NVMe (4)
					2	Yes	1x RAID/HBA 16i Int (4) + OB NVMe (4)
9	AnyBay	SAS	Open	Open	1 or 2	Yes	1x RAID/HBA 8i (8) + OB NVMe (4)
					1 or 2	Yes	1x RAID/HBA 16i (8) + OB NVMe (4)
					2	Yes	1x RAID/HBA 16i Int (8) + OB NVMe (4)
10	SAS	SAS	SAS	Open	1 or 2	Yes	2x RAID/HBA 8i (8+4)
					1 or 2	Yes	1x RAID/HBA 16i (12)
					2	Yes	1x RAID/HBA 16i Int (12)
11	NVMe	NVMe	SAS	Open	2	No	OB SATA (4) + OB NVMe (8)
					2	No	1x RAID/HBA 8i (4) + OB NVMe (8)
					2	No	1x RAID/HBA 16i (4) + OB NVMe (8)
					2	Yes	1x RAID/HBA 16i Int (4) + OB NVMe (4) + 1x Retimer (4)
12	NVMe	SAS	SAS	Open	1 or 2	Yes	OB SATA (8) + OB NVMe (4)
					1 or 2	Yes	1x RAID/HBA 8i (8) + OB NVMe (4)
					1 or 2	Yes	1x RAID/HBA 16i (8) + OB NVMe (4)
					2	Yes	1x RAID/HBA 16i Int (8) + OB NVMe (4)
13	AnyBay	AnyBay	SAS	Open	2	No	OB SATA (8) + 1x RAID/HBA 8i (4) + OB NVMe (8)
					2	No	2x RAID/HBA 8i (8+4) + OB NVMe (8)
					2	No	1x RAID/HBA 16i (12) + OB NVMe (8)
					2	Yes	1x RAID/HBA 16i Int (12) + OB NVMe (4) + 1x Retimer (4)
14	AnyBay	SAS	SAS	Open	1 or 2	Yes	OB SATA (8) + 1x RAID/HBA 8i (4) + OB NVMe (4)
					1 or 2	Yes	2x RAID/HBA 8i (8+4) + OB NVMe (4)
					1 or 2	Yes	1x RAID/HBA 16i (12) + OB NVMe (4)
					2	Yes	1x RAID/HBA 16i Int (12) + OB NVMe (4)
15	SAS	SAS	SAS	SAS	1 or 2	Yes	2x RAID/HBA 8i (8+8)
					1 or 2	Yes	1x RAID/HBA 16i (16)
					2	Yes	1x RAID/HBA 16i Int (16)
16	AnyBay	AnyBay	SAS	SAS	2	No	OB SATA (8) + 1x RAID/HBA 8i (8) + OB NVMe (8)
					2	No	2x RAID/HBA 8i (8+8) + OB NVMe (8)
					2	No	1x RAID/HBA 16i (16) + OB NVMe (8)
					2	Yes	OB SATA (8) + 1x RAID/HBA 8i (8) + OB NVMe (4) + 1x Retimer (4)
					2	Yes	2x RAID/HBA 8i (8+8) + OB NVMe (4) + 1x Retimer (4)
					2	Yes	1x RAID/HBA 16i (16) + OB NVMe (4) + 1x Retimer (4)
					2	Yes	1x RAID/HBA 16i Int (16) + OB NVMe (4) + 1x Retimer (4)
					2	Yes	OB SATA (8) + 1x RAID/HBA 8i (8) + 2x Retimer (4+4)
					2	Yes	2x RAID/HBA 8i (8+8) + 2x Retimer (4+4)
					2	Yes	1x RAID/HBA 16i (16) + 2x Retimer (4+4)
2	Yes	1x RAID/HBA 16i Int (16) + 2x Retimer (4+4)					
17	NVMe	NVMe	SAS	SAS	2	No	1x RAID/HBA 8i (8) + OB NVMe (8)
					2	No	1x RAID/HBA 16i (8) + OB NVMe (8)
					2	Yes	1x RAID/HBA 8i (8) + OB NVMe (4) + 1x Retimer (4)
					2	Yes	1x RAID/HBA 16i (8) + OB NVMe (4) + 1x Retimer (4)
					2	Yes	1x RAID/HBA 16i Int (8) + OB NVMe (4) + 1x Retimer (4)

Cfg	BP1	BP2	BP3	BP4	CPUs	Slot 8 support	Controller combinations (drive count) (OB = Onboard)
					2	Yes	1x RAID/HBA 8i (8) + 2x Retimer (4+4)
					2	Yes	1x RAID/HBA 16i (8) + 2x Retimer (4+4)
					2	Yes	1x RAID/HBA 16i Int (8) + 2x Retimer (4+4)

\* In configurations with simple-swap drives, the BP4 zone can only be occupied by media bays (optical/tape drives)

\*\* The OB SATA controller supports up to 12 SATA drives, however only the first 8 drives can be configured using RAID. The remaining drives are JBOD only.

## 2.5-inch chassis configurations

The following table lists the supported drive bay combinations for configurations with 2.5-inch front drive bays, plus the list of supported controller combinations supported by each of those drive bay combinations. Information about the controllers can be found in the [Controllers for internal storage](#) section.

Table 21. Drive bay combinations with 2.5-inch chassis (Blue = SAS/SATA, Purple = AnyBay, Red = NVMe)

Cfg	BP1	BP2	BP3	BP4	CPUs	Slot 8 support	Controller combinations (drive count) (OB = Onboard)
18	SAS	Open	Open	Open	1 or 2	Yes	OB SATA (8)
19	SAS	Open	Open	Open	1 or 2	Yes	1x RAID/HBA 8i (8)
					1 or 2	Yes	1x RAID/HBA 16i (8)
					2	Yes	1x RAID/HBA 16i Int (8)
					1 or 2	Yes	1x RAID 32i (8)
20	SAS	SAS	Open	Open	1 or 2	Yes	2x RAID/HBA 8i (8+8)
					1 or 2	Yes	1x RAID/HBA 16i (16)
					2	Yes	1x RAID/HBA 16i Int (16)
					1 or 2	Yes	1x RAID 32i (16)
21	AnyBay	SAS	Open	Open	2	No	2x RAID/HBA 8i (8+8) + OB NVMe (8)
					2	No	1x RAID/HBA 16i (16) + OB NVMe (8)
					2	No	1x RAID 32i (16) + OB NVMe (8)
					2	Yes	1x RAID/HBA 16i Int (16) + 2x Retimer (4+4)
22	NVMe	SAS	Open	Open	2	No	1x RAID/HBA 8i (8) + OB NVMe (8)
					2	No	1x RAID/HBA 16i (8) + OB NVMe (8)
					2	No	1x RAID 32i (8) + OB NVMe (8)
					2	Yes	1x RAID/HBA 16i Int (8) + 2x Retimer (4+4)
23	SAS	SAS	SAS	Open	2	Yes	OB SATA (8) + 1x RAID/HBA 16i Int (16)
					1 or 2	Yes	3x RAID/HBA 8i (8+8+8)
					1 or 2	Yes	1x RAID/HBA 8i (8) + 1x RAID/HBA 16i (16)
					1 or 2	Yes	1x RAID 32i (24)
24	AnyBay	AnyBay	SAS	Open	2	No	OB SATA (8) + 2x RAID/HBA 8i (8+8) + OB NVMe (8) + 2x Retimer (4+4)
					2	No	OB SATA (8) + 1x RAID/HBA 16i (16) + OB NVMe (8) + 2x Retimer (4+4)
					2	No	1x RAID/HBA 8i (8) + 1x RAID/HBA 16i (16) + OB NVMe (8) + 2x Retimer (4+4)
					2	No	3x RAID/HBA 8i (8+8+8) + OB NVMe (8) + 2x Retimer (4+4)
					2	No	1x RAID 32i (24) + OB NVMe (8) + 2x Retimer (4+4)
					2	Yes	OB SATA (8) + 2x RAID/HBA 8i (8+8) + 4x Retimer (4+4+4+4)

Cfg	BP1	BP2	BP3	BP4	CPUs	Slot 8 support	Controller combinations (drive count) (OB = Onboard)
					2	Yes	OB SATA (8) + 1x RAID/HBA 16i (16) + 4x Retimer (4+4+4+4)
					2	Yes	OB SATA (8) + 1x RAID/HBA Int 16i (16) + 4x Retimer (4+4+4+4)
					2	Yes	1x RAID/HBA 8i (8) + 1x RAID/HBA 16i (16) + 4x Retimer (4+4+4+4)
					2	Yes	3x RAID/HBA 8i (8+8+8) + 4x Retimer (4+4+4+4)
					2	Yes	1x RAID 32i (24) + 4x Retimer (4+4+4+4)
25	AnyBay	SAS	SAS	Open	2	No	OB SATA (8) + 2x RAID/HBA 8i (8+8) + OB NVMe (8)
					2	No	OB SATA (8) + 1x RAID/HBA 16i (16) + OB NVMe (8)
					2	No	1x RAID/HBA 8i (8) + 1x RAID/HBA 16i (16) + OB NVMe (8)
					2	No	3x RAID/HBA 8i (8+8+8) + OB NVMe (8)
					2	No	1x RAID 32i (24) + OB NVMe (8)
					2	Yes	OB SATA (8) + 2x RAID/HBA 8i (8+8) + 2x Retimer (4+4)
					2	Yes	OB SATA (8) + 1x RAID/HBA 16i (16) + 2x Retimer (4+4)
					2	Yes	OB SATA (8) + 1x RAID/HBA Int 16i (16) + 2x Retimer (4+4)
					2	Yes	1x RAID/HBA 8i (8) + 1x RAID/HBA 16i (16) + 2x Retimer (4+4)
					2	Yes	3x RAID/HBA 8i (8+8+8) + 2x Retimer (4+4)
					2	Yes	1x RAID 32i (24) + 2x Retimer (4+4)
26	NVMe	NVMe	SAS	Open	2	No	OB SATA (8) + OB NVMe (8) + 2x Retimer (4+4)
					2	No	1x RAID/HBA 8i (8) + OB NVMe (8) + 2x Retimer (4+4)
					2	No	1x RAID/HBA 16i (8) + OB NVMe (8) + 2x Retimer (4+4)
					2	No	1x RAID 32i (8) + OB NVMe (8) + 2x Retimer (4+4)
					2	Yes	OB SATA (8) + 4x Retimer (4+4+4+4)
					2	Yes	1x RAID/HBA 8i (8) + 4x Retimer (4+4+4+4)
					2	Yes	1x RAID/HBA 16i (8) + 4x Retimer (4+4+4+4)
					2	Yes	1x RAID/HBA 16i Int (8) + 4x Retimer (4+4+4+4)
					2	Yes	1x RAID 32i (8) + 4x Retimer (4+4+4+4)
27	NVMe	SAS	SAS	Open	2	No	2x RAID/HBA 8i (8+8) + OB NVMe (8)
					2	No	1x RAID/HBA 16i (16) + OB NVMe (8)
					2	No	1x RAID 32i (16) + OB NVMe (8)
					2	Yes	2x RAID/HBA 8i (8+8) + 2x Retimer (4+4)
					2	Yes	1x RAID/HBA 16i (16) + 2x Retimer (4+4)
					2	Yes	1x RAID/HBA 16i Int (16) + 2x Retimer (4+4)
					2	Yes	1x RAID 32i (16) + 2x Retimer (4+4)
28	SAS	SAS	SAS	SAS	1 or 2	Yes	4x RAID/HBA 8i (8+8+8+8)
					1 or 2	Yes	2x RAID/HBA 8i (8+8) + 1x RAID/HBA 16i (16)
					1 or 2	Yes	2x RAID/HBA 16i (16+16)
					1 or 2	Yes	1x RAID 32i (24)
29	AnyBay	AnyBay	SAS	SAS	2	No	OB SATA (8) + 3x RAID/HBA 8i (8+8+8) + OB NVMe (8) + 2x Retimer (4+4)
					2	No	OB SATA (8) + 1x RAID/HBA 8i (8) + 1x RAID/HBA 16i (16) + OB NVMe (8) + 2x Retimer (4+4)
					2	No	4x RAID/HBA 8i (8+8+8+8) + OB NVMe (8) + 2x Retimer (4+4)
					2	No	2x RAID/HBA 8i (8+8) + 1x RAID/HBA 16i (16) + OB NVMe (8) + 2x Retimer (4+4)
					2	No	1x RAID 32i (24) + OB NVMe (8) + 2x Retimer (4+4)
					2	Yes	OB SATA (8) + 3x RAID/HBA 8i (8+8+8) + 4x Retimer (4+4+4+4)
					2	Yes	OB SATA (8) + 1x RAID/HBA 8i (8) + 1x RAID/HBA 16i (16) + 4x Retimer (4+4+4+4)

Cfg	BP1	BP2	BP3	BP4	CPUs	Slot 8 support	Controller combinations (drive count) (OB = Onboard)
30	NVMe	NVMe	SAS	SAS	2	Yes	4x RAID/HBA 8i (8+8+8+8) + 4x Retimer (4+4+4+4)
					2	Yes	2x RAID/HBA 8i (8+8) + 1x RAID/HBA 16i (16) + 4x Retimer (4+4+4+4)
					2	Yes	1x RAID 32i (24) + 4x Retimer (4+4+4+4)
					2	No	OB SATA (8) + 1x RAID/HBA 8i (8) + OB NVMe (8) + 2x Retimer (4+4)
					2	No	2x RAID/HBA 8i (8+8) + OB NVMe (8) + 2x Retimer (4+4)
					2	No	1x RAID/HBA 16i (16) + OB NVMe (8) + 2x Retimer (4+4)
					2	No	1x RAID 32i (16) + OB NVMe (8) + 2x Retimer (4+4)
					2	Yes	OB SATA (8) + 1x RAID/HBA 8i (8) + 4x Retimer (4+4+4+4)
					2	Yes	2x RAID/HBA 8i (8+8) + 4x Retimer (4+4+4+4)
30	SAS	SAS	SAS	SAS	2	Yes	1x RAID/HBA 16i (16) + 4x Retimer (4+4+4+4)
					2	Yes	1x RAID/HBA 16i Int (16) + 4x Retimer (4+4+4+4)
					2	Yes	1x RAID 32i (16) + 4x Retimer (4+4+4+4)

## Field upgrades

The ST650 V2 is orderable without drive bays, allowing you to add a backplane, cabling and controllers as field upgrades. The server also supports upgrading some configurations by adding additional drive bay backplanes (for example, upgrading from 8 to 16x 2.5-inch drive bays).

**Upgrade path:** The key criteria for upgrade support is to ensure that the target configuration is one of the supported drive bay configurations as listed in the [Supported drive bay combinations](#) section.

To add drive bays you will need to order the appropriate backplane kit(s). ST650 V2 backplane kits include the necessary cables.

The following table lists the part numbers for drive backplanes and the media bay cage. For the use of these cables to add drives, see the ThinkSystem ST650 V2 Backplane/Backplate Cable Routing Guide, available from: <http://thinksystem.lenovofiles.com/help/index.jsp>

Table 22. Field upgrades for drives bay backplanes

Part number	Description and contents
2.5-inch hot-swap	
4B27A60845	ThinkSystem ST650 V2 2.5" SAS/SATA 8-Bay Backplane Kit <ul style="list-style-type: none"> <li>• 1x SBB7A06905 - SAS/SATA 8-Bay Backplane</li> <li>• 1x SBB7A15200 - SAS/SATA cable (miniSASx4*2 to BP Slimline x8, 470mm)</li> <li>• 1x SBB7A15217 - SAS/SATA cable (Slimline x4*2 to 2.5" BP Slimline x8), 700mm</li> <li>• 1x SBB7A15221 - SAS/SATA cable (RAID adapter Slimline x8 to BP Slimline x8), 415mm</li> <li>• 1x SBB7A15222 - SAS/SATA cable (RAID adapter Slimline x8 to BP Slimline x8), 535mm</li> <li>• 1x SBB7A15189 - Power cable PDB to 2.5" BP, 355mm</li> <li>• 1x SBB7A15188 - Power cable PDB to 2.5" BP, 455mm</li> <li>• 1x SBB7A20450 - SAS/SATA Label</li> </ul>

Part number	Description and contents
4B27A60846	<p>ThinkSystem ST650 V2 2.5" AnyBay 8-Bay Backplane Kit</p> <ul style="list-style-type: none"> <li>● 1x SBB7A29600 - Anybay 8-Bay Backplane</li> <li>● 1x SBB7A15200 - SAS/SATA cable (MiniSASx4*2 to BP Slimline x8),470mm</li> <li>● 1x SBB7A15217 - SAS/SATA cable (Slimline x4*2 to 2.5" BP Slimline x8), 700mm</li> <li>● 1x SBB7A15221 - SAS/SATA cable (RAID adapter Slimline x8 to BP Slimline x8), 415mm</li> <li>● 1x SBB7A15222 - SAS/SATA cable (RAID adapter Slimline x8 to BP Slimline x8), 535mm</li> <li>● 1x SBB7A34213 - NVMe cable (MB Slimline x8 to BP Slimline x8 for NVMe), pair of cables, 325 &amp; 240mm</li> <li>● 1x SBB7A34214 - NVMe cable (MB Slimline x8 to BP Slimline x8 for NVMe), pair of cables 820 &amp; 780mm</li> <li>● 1x SBB7A15188 - Power cable PDB to 2.5" BP, 455mm</li> <li>● 1x SBB7A20451 - AnyBay Label</li> </ul>
4B27A09322	<p>ThinkSystem ST650 V2 2.5" NVMe 8-Bay Backplane Kit</p> <ul style="list-style-type: none"> <li>● 1x SBB7A29600 - AnyBay 8-Bay Backplane</li> <li>● 1x SBB7A15217 - NVMe cable (Slimline x4*2 to 2.5" BP Slimline x8), 700mm</li> <li>● 1x SBB7A34213 - NVMe cable (MB Slimline x8 to BP Slimline x8 for NVMe), pair of cables, 325 &amp; 240mm</li> <li>● 1x SBB7A34214 - NVMe cable (MB Slimline x8 to BP Slimline x8 for NVMe), pair of cables 820 &amp; 780mm</li> <li>● 1x SBB7A15188 - Power cable PDB to 2.5" BP power, 455mm</li> <li>● 1x SBB7A28752 - NVMe Label</li> </ul>
<b>3.5-inch hot-swap</b>	
4B27A60843	<p>ThinkSystem ST650 V2 3.5" SAS/SATA 4-Bay Backplane Kit</p> <ul style="list-style-type: none"> <li>● 1x SBB7A17368 - 3.5" SAS/SATA 4-Bay Backplane</li> <li>● 1x SBB7A15198 - SAS/SATA cable (RAID card mini-SAS x4*2 C0/C1 to BP slimline x4*2 cable), 627mm</li> <li>● 1x SBB7A15199 - SAS/SATA cable (RAID card mini-SAS x4*2 C2/C3 to BP slimline x4*2 cable), 627mm</li> <li>● 1x SBB7A15219 - SAS/SATA cable (RAID card slimline x8 to BP Slimline x4*2), 240mm</li> <li>● 1x SBB7A15220 - SAS/SATA cable (RAID card slimline x8 to BP Slimline x4*2), 325mm</li> <li>● 1x SBB7A20290 - SATA cable (Slim SAS x4 TO Slim SAS x4 (BP1) 3.5"), 500mm</li> <li>● 1x SBB7A15225 - Power cable, PDB to 3.5" BP power, 455mm</li> <li>● 1x SBB7A20450 - SAS/SATA Label</li> </ul>
4B27A60844	<p>ThinkSystem ST650 V2 3.5" AnyBay 4-Bay Backplane Kit</p> <ul style="list-style-type: none"> <li>● 1x SBB7A17369 - 3.5" AnyBay 4-Bay Backplane</li> <li>● 1x SBB7A15198 - SAS/SATA cable (RAID card mini-SAS x4*2 C0/C1 to BP slimline x4*2 cable), 627mm</li> <li>● 1x SBB7A15199 - SAS/SATA cable (RAID card mini-SAS x4*2 C2/C3 to BP slimline x4*2 cable), 627mm</li> <li>● 1x SBB7A15202 - NVMe cable (MB Slimline x8 to BP MCIOx8), 240mm</li> <li>● 1x SBB7A15207 - NVMe cable (MB Slimline x8 to BP MCIOx8), 415mm</li> <li>● 1x SBB7A15219 - SAS/SATA cable (RAID card slimline x8 to BP Slimline x4*2), 240mm</li> <li>● 1x SBB7A15220 - SAS/SATA cable (RAID card slimline x8 to BP Slimline x4*2), 325mm</li> <li>● 1x SBB7A20290 - SATA cable (Slim SAS x4 TO Slim SAS x4 (BP1) 3.5"), 500mm</li> <li>● 1x SBB7A15225 - Power cable, PDB to 3.5" BP power, 455mm</li> <li>● 1x SBB7A20451 - Anybay Label</li> </ul>

Part number	Description and contents
4B27A09320	ThinkSystem ST650 V2 3.5" NVMe 4-Bay Backplane Kit <ul style="list-style-type: none"> <li>• 1x SBB7A17369 - 3.5" Anybay 4-Bay Backplane</li> <li>• 1x SBB7A15202 - NVMe cable (MB Slimline x8 to BP MCIOx8) pair of cables, 240mm</li> <li>• 1x SBB7A15207 - NVMe cable (MB Slimline x8 to BP MCIOx8) pair of cables, 415mm</li> <li>• 1x SBB7A20290 - Cable (Slim SAS x4 TO Slim SAS x4 (BP1) 3.5"), 500mm</li> <li>• 1x SBB7A15225 - Power cable, PDB to 3.5" BP power, 455mm</li> <li>• 1x SBB7A28752 - NVMe Label</li> </ul>
4Z57A16098	ThinkSystem ST650 V2/V3 Retimer Cable Kit for 3.5" HDD
3.5-inch simple-swap	
4M17A11753	ThinkSystem ST650 V2/V3 3.5" Simple-Swap SATA 4-Bay Backplate Kit <ul style="list-style-type: none"> <li>• 1x SBB7A17402 - ST650 v2 4x3.5" HDD backplate with SATA and power cables attached</li> </ul>
Replace media bay with 4x 3.5-inch drive bays	
4XF7A79787	ThinkSystem ST650 V2 3.5" SAS/SATA 4-Bay Drive Bay 4 Cage Kit <ul style="list-style-type: none"> <li>• 1x Cage for 4x 3.5-inch drive bays</li> <li>• 4x 3.5-inch drive bay fillers</li> </ul>

When adding drive bays, you will also need to add the appropriate storage controller(s). Consult the tables in the [Controller selections](#) section to determine what controller sections are supported and what additional controllers you will need. Controllers are described in the [Controllers for internal storage](#) section.

Some field upgrades require additional cable kits, as described in the following table.

Table 23. Cable kits for field upgrades related to drive bays

Part number	Description	Purpose
4Z57A60818	ThinkSystem ST650 V2 Internal HBA/RAID Adapter Cable Kit <ul style="list-style-type: none"> <li>• 2x SBB7A15212 - Slim SAS x4 to Slim SAS x4 BP3/4</li> <li>• 2x SBB7A15214 - Slim SAS x4 to Slim SAS x4 BP1/2</li> <li>• 2x SBB7A15216 - Slimline x4*2 C0/C1 to 2.5" BP Slimline x8, 700mm</li> <li>• 1x SBB7A15217 - Slimline x4*2 C2/C3 to 2.5" BP Slimline x8, 700mm</li> <li>• 1x SBB7A15218 - MB Slimline x8 to Slimline x8, 930mm</li> <li>• 1x SBB7A15196 - CFF RAID Power Cable</li> </ul>	Your existing configuration has an HBA or RAID adapter in one of the rear PCIe slots, and you wish to upgrade to one of the internal storage adapters (RAID 940-16i 8Gb Flash PCIe Gen4 12Gb Internal Adapter or 440-16i SAS/SATA PCIe Gen4 12Gb Internal HBA)
4Z57A16098	ThinkSystem ST650 V2/V3 Retimer Cable Kit for 3.5" HDD <ul style="list-style-type: none"> <li>• 1x SBB7A15223 - Slimline x8 to BP MCIO x8, 990mm</li> </ul>	NVMe cable required when you add a 3.5-inch AnyBay or NVMe backplane and want to connect it to an NVMe retimer adapter.
4Z57A16104*	ThinkSystem ST650 V2/V3 Retimer Cable Kit for 2.5" HDD <ul style="list-style-type: none"> <li>• 1x SBB7A34215 - Slimline x8 cable to BP Slimline x8</li> </ul>	NVMe cable required when you add a 2.5-inch AnyBay or NVMe backplane and want to connect it to an NVMe retimer adapter.
4Z57A16102	ThinkSystem ST650 V2 HW RAID/HBA Adapter Cable Kit <ul style="list-style-type: none"> <li>• 1x SBB7A15198 - Mini-SASx4*2 C0/C1 to BP Slimline x4*2 cable, 627mm</li> <li>• 1x SBB7A15199 - Mini-SASx4*2 C2/C3 to BP Slimline x4*2 cable, 627mm</li> <li>• 1x SBB7A15200 - Mini-SASx4*2 C0/C1 to BP Slimline x8 cable, 470mm</li> <li>• 1x SBB7A15219 - Slimline x8 to BP Slimline x4*2, 240mm</li> <li>• 1x SBB7A15220 - Slimline x8 to BP Slimline x4*2, 325mm</li> <li>• 1x SBB7A15221 - Slimline x8 to BP Slimline x8, 415mm</li> <li>• 1x SBB7A15222 - Slimline x8 to BP Slimline x8, 535mm</li> </ul>	Your existing configuration uses the onboard SATA ports and you wish to upgrade to a RAID adapter or HBA installed in one of the rear PCIe slots.

\* Also available as part number 4Z57A16106. The two part numbers have the same physical cable just different labeling.

## M.2 drives

The ST650 V2 supports one or two M.2 form-factor SATA or NVMe drives for use as an operating system boot solution or as additional storage. The M.2 drives install into an M.2 module which is mounted on the side of the drive bays.

There are three different M.2 modules supported, as listed in the following table.

Table 24. M.2 modules

Part number	Feature code	Description	SATA drives	NVMe drives	RAID	Maximum supported
4Y37A09739	B5XH	ThinkSystem M.2 SATA 2-Bay RAID Enablement Kit	Yes	No	Yes	1
4Y37A09750	B8P9	ThinkSystem M.2 NVMe 2-Bay RAID Enablement Kit	No	Yes	Yes	1
4Y37A09738	B5XJ	ThinkSystem M.2 SATA/NVMe 2-Bay Enablement Kit	Yes	Yes	No	1

Supported drives are listed in the [Internal drive options](#) section.

The M.2 SATA 2-Bay RAID Enablement Kit has the following features:

- Supports one or two SATA M.2 drives
- Support 42mm, 60mm, 80mm and 110mm drive form factors (2242, 2260, 2280 and 22110)
- RAID support via an onboard Marvell 88SE9230 SATA RAID Controller
- Support JBOD, RAID-0 and RAID-1 (RAID support requires two M.2 drives)
- PCIe 2.0 x2 host interface; 6Gbps SATA connection to the drives
- Management and configuration support via UEFI and OS-based tools
- Supports monitoring and reporting of events and temperature through I2C
- Firmware update via Lenovo firmware update tools

The M.2 NVMe 2-Bay RAID Enablement Kit has the following features:

- Supports one or two NVMe M.2 drives
- Support 42mm, 60mm, 80mm and 110mm drive form factors (2242, 2260, 2280 and 22110)
- RAID support via an onboard Marvell 88NR2241 NVMe RAID Controller
- With 1 drive, supports single-drive RAID-0
- With 2 drives, supports 2-drive RAID-0, 2-drive RAID-1, or two single-drive RAID-0 arrays
- PCIe 3.0 x2 host interface; PCIe 3.0 x1 connection to each drive
- Management and configuration support via UEFI and OS-based tools
- Supports monitoring and reporting of events and temperature through I2C
- Firmware update via Lenovo firmware update tools

The M.2 SATA/NVMe 2-Bay Enablement Kit has the following features:

- Supports one or two M.2 drives, either SATA or NVMe
- When two drives installed, they must be either both SATA or both NVMe
- Support 42mm, 60mm, 80mm and 110mm drive form factors (2242, 2260, 2280 and 22110)
- JBOD native support; no built-in RAID support (RAID can be enabled via Intel VROC)
- Either 6Gbps SATA or PCIe 3.0 x1 interface to the drives depending on the drives installed
- Supports monitoring and reporting of events and temperature through I2C
- Firmware update via Lenovo firmware update tools

For field upgrades, the ST650 V2 also requires an additional M.2 cable kit. Ordering information is listed in the following table.

Table 25. M.2 Cable for field upgrades

Part number	Description
4Z57A16099	ThinkSystem ST650 V2 M.2 Cable Kit <ul style="list-style-type: none"><li>• M.2 Signal &amp; Power Cable, 280mm</li></ul>

For further details about M.2 components, see the *ThinkSystem M.2 Drives and M.2 Adapters* product guide <https://lenovopress.com/lp0769-thinksystem-m2-drives-adapters>

## Controllers for internal storage

The ST650 V2 offers a variety of controller options for internal drives:

- For 2.5-inch and 3.5-inch drives:
  - Onboard SATA ports with software RAID support (Intel VROC SATA RAID, formerly known as Intel RSTe)
  - Onboard NVMe ports with software RAID support (Intel VROC NVMe RAID)
  - RAID adapters and HBAs for SAS/SATA drives (PCIe slot-based)
  - RAID adapters and HBAs for SAS/SATA drives (cabled in a dedicated space)



- For M.2 drives internal to the server (see [M.2 drives](#) section)
  - SATA controller integrated on the M.2 SATA 2-Bay RAID Enablement Kit

The following table lists the adapters used for the internal storage of the server.

As well as supporting RAID adapters and HBAs that install in a PCIe slot, the ST650 V2 supports a custom adapter (also known as CFF or compact form factor adapter) that is mounted in the server and cabled to one of the onboard NVMe ports.

- ThinkSystem 440-16i SAS/SATA PCIe Gen4 12Gb Internal HBA
- ThinkSystem RAID 940-16i 8GB Flash PCIe Gen4 12Gb Internal Adapter

The adapter is mounted adjacent to the drive bays and in front of the fans, and does not occupy a standard PCIe slot. See the [Internal view](#) for the location.

Table 26. Internal Storage adapter support

Part number	Feature code	Description	Power module (supercap)	Maximum supported	Slots supported
Onboard SATA - up to 14 drives - Intel VROC SATA RAID (Intel RSTe)					
None	AVV0	On Board SATA Software RAID Mode	No	1	Not applicable
Onboard NVMe - up to 12 drives - Intel VROC NVMe RAID					
None	B9X7	Intel VROC (VMD NVMe RAID) Intel SSD Only (Standard)	No	1	Not applicable
4L47A39164	B96G	Intel VROC (VMD NVMe RAID) Premium (license upgrade - to enable RAID support for non-Intel NVMe SSDs)	No	1	Not applicable
SAS/SATA RAID - PCIe 3.0					
7Y37A01082	AUNG	ThinkSystem RAID 530-8i PCIe 12Gb Adapter	No	4	Any slot
4Y37A09727	BFY5	ThinkSystem RAID 530-16i PCIe 12Gb Adapter	No	2	Any slot
7Y37A01084	AUNJ	ThinkSystem RAID 930-8i 2GB Flash PCIe 12Gb Adapter	Included	4	Any slot
7Y37A01085	AUNK	ThinkSystem RAID 930-16i 4GB Flash PCIe 12Gb Adapter	Included	2	Any slot
SAS/SATA RAID - PCIe 4.0					
4Y37A78834	BMFT	ThinkSystem RAID 540-8i PCIe Gen4 12Gb Adapter	No	4	Any slot
4Y37A78835	BNAX	ThinkSystem RAID 540-16i PCIe Gen4 12Gb Adapter	No	2	Any slot
4Y37A09728	B8NY	ThinkSystem RAID 940-8i 4GB Flash PCIe Gen4 12Gb Adapter	Included	4	Any slot
4Y37A09729	B8NW	ThinkSystem RAID 940-8i 8GB Flash PCIe Gen4 12Gb Adapter	Included	4	Any slot
4Y37A09730	B8NZ	ThinkSystem RAID 940-16i 8GB Flash PCIe Gen4 12Gb Adapter	Included	2	Any slot
4Y37A78600	BM35	ThinkSystem RAID 940-16i 4GB Flash PCIe Gen4 12Gb Adapter	Included	2	Any slot
4Y37A09735	B8P0	ThinkSystem RAID 940-16i 8GB Flash PCIe Gen4 12Gb Internal Adapter	Included	1	Internal
4Y37A09733	B8P8	ThinkSystem RAID 940-32i 8GB Flash PCIe Gen4 12Gb Adapter	Included	1	5,6,7,8,9

Part number	Feature code	Description	Power module (supercap)	Maximum supported	Slots supported
SAS/SATA HBA - PCIe 3.0					
7Y37A01088	AUNL	ThinkSystem 430-8i SAS/SATA 12Gb HBA	No	5	Any slot
7Y37A01089	AUNM	ThinkSystem 430-16i SAS/SATA 12Gb HBA	No	2	Any slot
SAS/SATA HBA - PCIe 4.0					
4Y37A78601	BM51	ThinkSystem 440-8i SAS/SATA PCIe Gen4 12Gb HBA	No	5	Any slot
4Y37A78602	BM50	ThinkSystem 440-16i SAS/SATA PCIe Gen4 12Gb HBA	No	2	Any slot
4Y37A09725	B8P1	ThinkSystem 440-16i SAS/SATA PCIe Gen4 12Gb Internal HBA	No	1	Internal
NVMe adapters					
4C57A65446	B98C	ThinkSystem 4-Port PCIe Gen4 NVMe Retimer Adapter	No	4	1,3,5,7

The onboard SATA controller has the following features:

- Controller integrated into the Intel PCH
- Supports up to 12 SATA drives
- 6 Gbps SATA host interface
- Supports RAID-0, 1, 5, 10 only on 8 drives (Intel VROC SATA RAID, previously known as RSTe)
- Supports JBOD
- Supports HDDs and SSDs; can be mixed

**RAID support limited to 8 drives:** With three 3.5-inch simple-swap backplates, the ST650 V2 supports 12 SATA drives connected to the onboard SATA controller, however only the first 8 drives can be configured in RAID arrays. The remaining 4 drives can only be configured as JBOD.

The onboard NVMe support has the following features:

- Controller integrated into the Intel processor
- Supports up to 16 NVMe drives
- Each drive has PCIe 3.0 x4 host interface
- Supports JBOD - Intel and non-Intel NVMe SSDs - no license required
- Supports RAID-0, 1, 5, 10 (Intel VROC NVMe RAID) - Intel NVMe SSDs only unless VROC Premium license is installed
- VROC Premium also extends to any drives connected via an NVMe Adapter (switch or retimer)

### Intel VROC onboard SATA and NVMe RAID

Intel VROC (Virtual RAID on CPU) is a feature of the Intel processor that enables RAID support. There are two separate functions of VROC:

- Intel VROC SATA RAID, formerly known as Intel RSTe
- Intel VROC NVMe RAID

VROC SATA RAID (RSTe) is available and supported with all SATA drives, both SATA SSDs and SATA HDDs. It offers a 6 Gb/s connection to each drive and on the ST650 V2 implements RAID levels 0, 1, 5, and 10. Hot-spare functionality is also supported.

VROC NVMe RAID offers RAID support for any NVMe drives directly connected to the ports on the server's system board or via adapters such as NVMe retimers or NVMe switch adapters. On the ST650 V2, it implements RAID levels 0, 1, 5, and 10. Hot-spare functionality is also supported.

**Performance tip:** For best performance with VROC NVMe RAID, the drives in an array should all be connected to the same processor. Spanning processors is possible however performance will be unpredictable and should be evaluated based on your workload.

By default, VROC NVMe RAID support is limited to use with only Intel-branded NVMe drives (feature B9X7). If you wish to enable RAID support for non-Intel NVMe SSDs, select the VROC Premium license using the ordering information in the following table. VROC Premium is fulfilled as a Feature on Demand (FoD) license and is activated via the XCC management processor user interface.

Table 27. VROC upgrade

Part number	Feature code	Description
4L47A39164	B96G	Intel VROC (VMD NVMe RAID) Premium

VROC Premium is only needed for non-Intel NVMe drives in a RAID configuration. You do not need the VROC Premium license upgrade under any of the following conditions:

- If you have SATA drives connected to the onboard SATA ports, you do not need VROC Premium
- If you have Intel NVMe drives connected to the onboard NVMe ports, you do not need VROC Premium
- If you have non-Intel NVMe drives connected to the onboard NVMe ports, but you don't want RAID support, you do not need VROC Premium

**Virtualization support:** Virtualization support for Intel VROC is as follows:

- **VROC SATA RAID (RSTe):** VROC SATA RAID is not supported by virtualization hypervisors such as ESXi, KVM, Xen, and Hyper-V. Virtualization is only supported on the onboard SATA ports in AHCI (non-RAID) mode.
- **VROC (VMD) NVMe RAID:** VROC (VMD) NVMe RAID is supported by ESXi, KVM, Xen, and Hyper-V. ESXi support is limited to RAID 1 only; other RAID levels are not supported. Windows and Linux OSes support VROC RAID NVMe, both for host boot functions and for guest OS function, and RAID-0, 1, 5, and 10 are supported.

For specifications about the RAID adapters and HBAs supported by the ST650 V2, see the ThinkSystem RAID Adapter and HBA Comparison, available from:

<https://lenovopress.com/lp1288-lenovo-thinksystem-raid-adapter-and-hba-reference#st650-v2-support=ST650%2520V2>

For details about these adapters, see the relevant product guide:

- SAS HBAs: <https://lenovopress.com/servers/options/hba>
- RAID adapters: <https://lenovopress.com/servers/options/raid>

## Internal drive options

The following tables list the drive options for internal storage of the server.

2.5-inch hot-swap drives:

- [2.5-inch hot-swap 12 Gb SAS HDDs](#)
- [2.5-inch hot-swap 6 Gb SATA HDDs](#)
- [2.5-inch hot-swap 12 Gb SAS SSDs](#)
- [2.5-inch hot-swap 6 Gb SATA SSDs](#)
- [2.5-inch hot-swap PCIe 4.0 NVMe SSDs](#)
- [2.5-inch hot-swap PCIe 3.0 NVMe SSDs](#)

3.5-inch hot-swap drives:

- [3.5-inch hot-swap 12 Gb SAS HDDs](#)
- [3.5-inch hot-swap 6 Gb SATA HDDs](#)
- [3.5-inch hot-swap 12 Gb SAS SSDs](#)
- [3.5-inch hot-swap 6 Gb SATA SSDs](#)
- [3.5-inch hot-swap PCIe 4.0 NVMe SSDs](#)
- [3.5-inch hot-swap PCIe 3.0 NVMe SSDs](#)

Simple-swap drives:

- [3.5-inch simple-swap 6 Gb SATA HDDs](#)

M.2 drives:

- [M.2 SATA drives](#)
- [M.2 NVMe drives](#)

**M.2 drive support:** The use of M.2 drives requires an additional adapter as described in the [M.2 drives](#) subsection.

**PCIe 4.0 NVMe drive support:** When installed in the ST650 V2 server and connected to onboard NVMe ports 1 or 2, PCIe 4.0 NVMe drives will operate at PCIe 3.0 speeds.

Table 28. 2.5-inch hot-swap 12 Gb SAS HDDs

Part number	Feature	Description	Maximum supported
2.5-inch hot-swap HDDs - 12 Gb SAS 10K			
7XB7A00024	AULY	ThinkSystem 2.5" 300GB 10K SAS 12Gb Hot Swap 512n HDD	32
7XB7A00025	AULZ	ThinkSystem 2.5" 600GB 10K SAS 12Gb Hot Swap 512n HDD	32
7XB7A00027	AUM1	ThinkSystem 2.5" 1.2TB 10K SAS 12Gb Hot Swap 512n HDD	32
7XB7A00028	AUM2	ThinkSystem 2.5" 1.8TB 10K SAS 12Gb Hot Swap 512e HDD	32
7XB7A00069	B0YS	ThinkSystem 2.5" 2.4TB 10K SAS 12Gb Hot Swap 512e HDD	32
2.5-inch hot-swap HDDs - 12 Gb SAS 15K			
7XB7A00021	AULV	ThinkSystem 2.5" 300GB 15K SAS 12Gb Hot Swap 512n HDD	32
7XB7A00022	AULW	ThinkSystem 2.5" 600GB 15K SAS 12Gb Hot Swap 512n HDD	32
7XB7A00023	AULX	ThinkSystem 2.5" 900GB 15K SAS 12Gb Hot Swap 512e HDD	32
2.5-inch hot-swap HDDs - 12 Gb NL SAS			
7XB7A00034	AUM6	ThinkSystem 2.5" 1TB 7.2K SAS 12Gb Hot Swap 512n HDD	32
7XB7A00035	AUM7	ThinkSystem 2.5" 2TB 7.2K SAS 12Gb Hot Swap 512n HDD	32
2.5-inch hot-swap SED HDDs - 12 Gb SAS 10K			
7XB7A00031	AUM5	ThinkSystem 2.5" 600GB 10K SAS 12Gb Hot Swap 512n HDD SED	32
7XB7A00033	B0YX	ThinkSystem 2.5" 1.2TB 10K SAS 12Gb Hot Swap 512n HDD SED	32
7XB7A00070	B0YV	ThinkSystem 2.5" 2.4TB 10K SAS 12Gb Hot Swap 512e HDD FIPS	32

Table 29. 2.5-inch hot-swap 6 Gb SATA HDDs

Part number	Feature	Description	Maximum supported
2.5-inch hot-swap HDDs - 6 Gb NL SATA			
7XB7A00036	AUUE	ThinkSystem 2.5" 1TB 7.2K SATA 6Gb Hot Swap 512n HDD	32
7XB7A00037	AUUJ	ThinkSystem 2.5" 2TB 7.2K SATA 6Gb Hot Swap 512e HDD	32

Table 30. 2.5-inch hot-swap 12 Gb SAS SSDs

Part number	Feature	Description	Maximum supported
2.5-inch hot-swap SSDs - 12 Gb SAS - Mixed Use/Mainstream (3-5 DWPD)			
4XB7A17062	B8HU	ThinkSystem 2.5" PM1645a 800GB Mainstream SAS 12Gb Hot Swap SSD	32
4XB7A17063	B8J4	ThinkSystem 2.5" PM1645a 1.6TB Mainstream SAS 12Gb Hot Swap SSD	32
4XB7A17064	B8JD	ThinkSystem 2.5" PM1645a 3.2TB Mainstream SAS 12Gb Hot Swap SSD	32
4XB7A17065	B8JA	ThinkSystem 2.5" PM1645a 6.4TB Mainstream SAS 12Gb Hot Swap SSD	32
2.5-inch hot-swap SSDs - 12 Gb SAS - Read Intensive/Entry/Capacity (<3 DWPD)			
4XB7A38175	B91A	ThinkSystem 2.5" PM1643a 960GB Entry SAS 12Gb Hot Swap SSD	32
4XB7A38176	B91B	ThinkSystem 2.5" PM1643a 1.92TB Entry SAS 12Gb Hot Swap SSD	32
4XB7A17054	B91C	ThinkSystem 2.5" PM1643a 3.84TB Entry SAS 12Gb Hot Swap SSD	32
4XB7A17055	B91D	ThinkSystem 2.5" PM1643a 7.68TB Entry SAS 12Gb Hot Swap SSD	32
4XB7A17056	BC4R	ThinkSystem 2.5" PM1643a 15.36TB Entry SAS 12Gb Hot Swap SSD	32

Table 31. 2.5-inch hot-swap 6 Gb SATA SSDs

Part number	Feature	Description	Maximum supported
2.5-inch hot-swap SSDs - 6 Gb SATA - Mixed Use/Mainstream (3-5 DWPD)			
4XB7A17125	BA7Q	ThinkSystem 2.5" S4620 480GB Mixed Use SATA 6Gb HS SSD	32
4XB7A17126	BA4T	ThinkSystem 2.5" S4620 960GB Mixed Use SATA 6Gb HS SSD	32
4XB7A17127	BA4U	ThinkSystem 2.5" S4620 1.92TB Mixed Use SATA 6Gb HS SSD	32
4XB7A17128	BK7L	ThinkSystem 2.5" S4620 3.84TB Mixed Use SATA 6Gb HS SSD	32
4XB7A17087	B8J1	ThinkSystem 2.5" 5300 240GB Mainstream SATA 6Gb Hot Swap SSD	32
4XB7A17088	B8HY	ThinkSystem 2.5" 5300 480GB Mainstream SATA 6Gb Hot Swap SSD	32
4XB7A17089	B8J6	ThinkSystem 2.5" 5300 960GB Mainstream SATA 6Gb Hot Swap SSD	32
4XB7A17090	B8JE	ThinkSystem 2.5" 5300 1.92TB Mainstream SATA 6Gb Hot Swap SSD	32
4XB7A17091	B8J7	ThinkSystem 2.5" 5300 3.84TB Mainstream SATA 6Gb Hot Swap SSD	32
4XB7A13633	B49L	ThinkSystem 2.5" S4610 240GB Mixed Use SATA 6Gb HS SSD	32
4XB7A13634	B49M	ThinkSystem 2.5" S4610 480GB Mixed Use SATA 6Gb HS SSD	32
4XB7A13635	B49N	ThinkSystem 2.5" S4610 960GB Mixed Use SATA 6Gb HS SSD	32
4XB7A13636	B49P	ThinkSystem 2.5" S4610 1.92TB Mixed Use SATA 6Gb HS SSD	32
2.5-inch hot-swap SSDs - 6 Gb SATA - Read Intensive/Entry (<3 DWPD)			
4XB7A72438	BM8B	ThinkSystem 2.5" PM893 480GB Read Intensive SATA 6Gb HS SSD	32
4XB7A72439	BM8A	ThinkSystem 2.5" PM893 960GB Read Intensive SATA 6Gb HS SSD	32

Part number	Feature	Description	Maximum supported
4XB7A72440	BM89	ThinkSystem 2.5" PM893 1.92TB Read Intensive SATA 6Gb HS SSD	32
4XB7A72441	BM88	ThinkSystem 2.5" PM893 3.84TB Read Intensive SATA 6Gb HS SSD	32
4XB7A72442	BM87	ThinkSystem 2.5" PM893 7.68TB Read Intensive SATA 6Gb HS SSD	32
4XB7A17072	B99D	ThinkSystem 2.5" S4520 240GB Read Intensive SATA 6Gb HS SSD	32
4XB7A17101	BA7G	ThinkSystem 2.5" S4520 480GB Read Intensive SATA 6Gb HS SSD	32
4XB7A17102	BA7H	ThinkSystem 2.5" S4520 960GB Read Intensive SATA 6Gb HS SSD	32
4XB7A17103	BA7J	ThinkSystem 2.5" S4520 1.92TB Read Intensive SATA 6Gb HS SSD	32
4XB7A17104	BK77	ThinkSystem 2.5" S4520 3.84TB Read Intensive SATA 6Gb HS SSD	32
4XB7A17105	BK78	ThinkSystem 2.5" S4520 7.68TB Read Intensive SATA 6Gb HS SSD	32
4XB7A38271	BCTC	ThinkSystem 2.5" Multi Vendor 240GB Entry SATA 6Gb Hot Swap SSD	32
4XB7A38272	BCTD	ThinkSystem 2.5" Multi Vendor 480GB Entry SATA 6Gb Hot Swap SSD	32
4XB7A38273	BCTE	ThinkSystem 2.5" Multi Vendor 960GB Entry SATA 6Gb Hot Swap SSD	32
4XB7A38274	BCTF	ThinkSystem 2.5" Multi Vendor 1.92TB Entry SATA 6Gb Hot Swap SSD	32
4XB7A38275	BCTG	ThinkSystem 2.5" Multi Vendor 3.84TB Entry SATA 6Gb Hot Swap SSD	32
4XB7A17075	B8HV	ThinkSystem 2.5" 5300 240GB Entry SATA 6Gb Hot Swap SSD	32
4XB7A17076	B8JM	ThinkSystem 2.5" 5300 480GB Entry SATA 6Gb Hot Swap SSD	32
4XB7A17077	B8HP	ThinkSystem 2.5" 5300 960GB Entry SATA 6Gb Hot Swap SSD	32
4XB7A17078	B8J5	ThinkSystem 2.5" 5300 1.92TB Entry SATA 6Gb Hot Swap SSD	32
4XB7A17079	B8JP	ThinkSystem 2.5" 5300 3.84TB Entry SATA 6Gb Hot Swap SSD	32
4XB7A17080	B8J2	ThinkSystem 2.5" 5300 7.68TB Entry SATA 6Gb Hot Swap SSD	32
4XB7A10247	B498	ThinkSystem 2.5" S4510 240GB Read Intensive SATA 6Gb HS SSD	32
4XB7A10248	B499	ThinkSystem 2.5" S4510 480GB Read Intensive SATA 6Gb HS SSD	32
4XB7A10249	B49A	ThinkSystem 2.5" S4510 960GB Read Intensive SATA 6Gb HS SSD	32
4XB7A13622	B49B	ThinkSystem 2.5" S4510 1.92TB Read Intensive SATA 6Gb HS SSD	32

Table 32. 2.5-inch hot-swap PCIe 4.0 NVMe SSDs (operate at PCIe 3.0 speeds when connected to NVMe ports 1 or 2 in this server)

Part number	Feature	Description	Maximum supported
2.5-inch SSDs - U.2 PCIe 4.0 NVMe - Mixed Use/Mainstream (3-5 DWPD)			
4XB7A17152	BCFV	ThinkSystem 2.5" U.2 P5600 1.6TB Mixed Use NVMe PCIe 4.0 x4 HS SSD	16
4XB7A17153	BCFR	ThinkSystem 2.5" U.2 P5600 3.2TB Mixed Use NVMe PCIe 4.0 x4 HS SSD	16
2.5-inch SSDs - U.2 PCIe 4.0 NVMe - Read Intensive/Entry (<3 DWPD)			
4XB7A17145	BCFT	ThinkSystem 2.5" U.2 P5500 1.92TB Read Intensive NVMe PCIe 4.0 x4 HS SSD	16
4XB7A17146	BCFW	ThinkSystem 2.5" U.2 P5500 3.84TB Read Intensive NVMe PCIe 4.0 x4 HS SSD	16

Table 33. 2.5-inch hot-swap PCIe 3.0 NVMe SSDs

Part number	Feature	Description	Maximum supported
2.5-inch SSDs - U.2 PCIe 3.0 NVMe - Read Intensive/Entry (<3 DWPD)			
4XB7A10175	B34N	ThinkSystem U.2 PM983 1.92TB Entry NVMe PCIe 3.0 x4 Hot Swap SSD	16
4XB7A10176	B34P	ThinkSystem U.2 PM983 3.84TB Entry NVMe PCIe 3.0 x4 Hot Swap SSD	16

**Note:** NVMe PCIe SSDs support surprise hot removal and hot insertion, provided the operating system supports PCIe SSD hot-swap.

Table 34. 3.5-inch hot-swap 12 Gb SAS HDDs

Part number	Feature	Description	Maximum supported
3.5-inch hot-swap HDDs - 12 Gb SAS 15K			
7XB7A00038	AUU2	ThinkSystem 3.5" 300GB 15K SAS 12Gb Hot Swap 512n HDD	16
7XB7A00039	AUU3	ThinkSystem 3.5" 600GB 15K SAS 12Gb Hot Swap 512n HDD	16
7XB7A00040	AUUC	ThinkSystem 3.5" 900GB 15K SAS 12Gb Hot Swap 512e HDD	16
3.5-inch hot-swap HDDs - 12 Gb NL SAS			
7XB7A00042	AUU5	ThinkSystem 3.5" 2TB 7.2K SAS 12Gb Hot Swap 512n HDD	16
7XB7A00043	AUU6	ThinkSystem 3.5" 4TB 7.2K SAS 12Gb Hot Swap 512n HDD	16
7XB7A00044	AUU7	ThinkSystem 3.5" 6TB 7.2K SAS 12Gb Hot Swap 512e HDD	16
7XB7A00045	B0YR	ThinkSystem 3.5" 8TB 7.2K SAS 12Gb Hot Swap 512e HDD	16
7XB7A00046	AUUG	ThinkSystem 3.5" 10TB 7.2K SAS 12Gb Hot Swap 512e HDD	16
4XB7A13906	B496	ThinkSystem 3.5" 14TB 7.2K SAS 12Gb Hot Swap 512e HDD	16
4XB7A13911	B7EZ	ThinkSystem 3.5" 16TB 7.2K SAS 12Gb Hot Swap 512e HDD	16
4XB7A38266	BCFP	ThinkSystem 3.5" 18TB 7.2K SAS 12Gb Hot Swap 512e HDD	16
3.5-inch hot-swap SED HDDs - 12 Gb NL SAS			
7XB7A00066	B0YQ	ThinkSystem 3.5" 8TB 7.2K SAS 12Gb Hot Swap 512e HDD FIPS	16

Table 35. 3.5-inch hot-swap 6 Gb SATA HDDs

Part number	Feature	Description	Maximum supported
3.5-inch hot-swap HDDs - 6 Gb NL SATA			
7XB7A00049	AUUF	ThinkSystem 3.5" 1TB 7.2K SATA 6Gb Hot Swap 512n HDD	16
7XB7A00050	AUUD	ThinkSystem 3.5" 2TB 7.2K SATA 6Gb Hot Swap 512n HDD	16
7XB7A00051	AUU8	ThinkSystem 3.5" 4TB 7.2K SATA 6Gb Hot Swap 512n HDD	16
7XB7A00052	AUUA	ThinkSystem 3.5" 6TB 7.2K SATA 6Gb Hot Swap 512e HDD	16
7XB7A00053	AUU9	ThinkSystem 3.5" 8TB 7.2K SATA 6Gb Hot Swap 512e HDD	16
7XB7A00054	AUUB	ThinkSystem 3.5" 10TB 7.2K SATA 6Gb Hot Swap 512e HDD	16
7XB7A00068	B118	ThinkSystem 3.5" 12TB 7.2K SATA 6Gb Hot Swap 512e HDD	16
4XB7A13907	B497	ThinkSystem 3.5" 14TB 7.2K SATA 6Gb Hot Swap 512e HDD	16
4XB7A13914	B7F0	ThinkSystem 3.5" 16TB 7.2K SATA 6Gb Hot Swap 512e HDD	16
4XB7A38130	BCFH	ThinkSystem 3.5" 18TB 7.2K SATA 6Gb Hot Swap 512e HDD	16

Table 36. 3.5-inch hot-swap 12 Gb SAS SSDs

Part number	Feature	Description	Maximum supported
3.5-inch hot-swap SSDs - 12 Gb SAS - Mixed Use/Mainstream (3-5 DWPD)			
4XB7A17066	B8HT	ThinkSystem 3.5" PM1645a 800GB Mainstream SAS 12Gb Hot Swap SSD	16
4XB7A17043	B8JN	ThinkSystem 3.5" PM1645a 1.6TB Mainstream SAS 12Gb Hot Swap SSD	16
4XB7A17067	B8JK	ThinkSystem 3.5" PM1645a 3.2TB Mainstream SAS 12Gb Hot Swap SSD	16
4XB7A17068	B8JG	ThinkSystem 3.5" PM1645a 6.4TB Mainstream SAS 12Gb Hot Swap SSD	16
3.5-inch hot-swap SSDs - 12 Gb SAS - Read Intensive/Entry/Capacity (<3 DWPD)			
4XB7A17058	B91E	ThinkSystem 3.5" PM1643a 3.84TB Entry SAS 12Gb Hot Swap SSD	16
4XB7A17059	BEVK	ThinkSystem 3.5" PM1643a 7.68TB Entry SAS 12Gb Hot Swap SSD	16



Table 37. 3.5-inch hot-swap 6 Gb SATA SSDs

Part number	Feature	Description	Maximum supported
<b>3.5-inch hot-swap SSDs - 6 Gb SATA - Mixed Use/Mainstream (3-5 DWPD)</b>			
4XB7A17137	BA4W	ThinkSystem 3.5" S4620 480GB Mixed Use SATA 6Gb HS SSD	16
4XB7A17138	BA4X	ThinkSystem 3.5" S4620 960GB Mixed Use SATA 6Gb HS SSD	16
4XB7A17139	BA4Y	ThinkSystem 3.5" S4620 1.92TB Mixed Use SATA 6Gb HS SSD	16
4XB7A17140	BK7P	ThinkSystem 3.5" S4620 3.84TB Mixed Use SATA 6Gb HS SSD	16
4XB7A13639	B49R	ThinkSystem 3.5" S4610 240GB Mixed Use SATA 6Gb HS SSD	16
4XB7A13640	B49S	ThinkSystem 3.5" S4610 480GB Mixed Use SATA 6Gb HS SSD	16
4XB7A13641	B49T	ThinkSystem 3.5" S4610 960GB Mixed Use SATA 6Gb HS SSD	16
4XB7A13642	B49U	ThinkSystem 3.5" S4610 1.92TB Mixed Use SATA 6Gb HS SSD	16
<b>3.5-inch hot-swap SSDs - 6 Gb SATA - Read Intensive/Entry (&lt;3 DWPD)</b>			
4XB7A17118	BA7K	ThinkSystem 3.5" S4520 240GB Read Intensive SATA 6Gb HS SSD	16
4XB7A17119	BA7L	ThinkSystem 3.5" S4520 480GB Read Intensive SATA 6Gb HS SSD	16
4XB7A17120	BA7M	ThinkSystem 3.5" S4520 960GB Read Intensive SATA 6Gb HS SSD	16
4XB7A17121	BA7N	ThinkSystem 3.5" S4520 1.92TB Read Intensive SATA 6Gb HS SSD	16
4XB7A17122	BK7F	ThinkSystem 3.5" S4520 3.84TB Read Intensive SATA 6Gb HS SSD	16
4XB7A17123	BK7G	ThinkSystem 3.5" S4520 7.68TB Read Intensive SATA 6Gb HS SSD	16
4XB7A38276	BCTH	ThinkSystem 3.5" Multi Vendor 240GB Entry SATA 6Gb Hot Swap SSD	16
4XB7A38277	BCTJ	ThinkSystem 3.5" Multi Vendor 480GB Entry SATA 6Gb Hot Swap SSD	16
4XB7A38278	BCTK	ThinkSystem 3.5" Multi Vendor 960GB Entry SATA 6Gb Hot Swap SSD	16
4XB7A38279	BCTL	ThinkSystem 3.5" Multi Vendor 1.92TB Entry SATA 6Gb Hot Swap SSD	16
4XB7A38281	BCTM	ThinkSystem 3.5" Multi Vendor 3.84TB Entry SATA 6Gb Hot Swap SSD	16
4XB7A13625	B49D	ThinkSystem 3.5" S4510 240GB Read Intensive SATA 6Gb HS SSD	16
4XB7A13626	B49E	ThinkSystem 3.5" S4510 480GB Read Intensive SATA 6Gb HS SSD	16
4XB7A13627	B49F	ThinkSystem 3.5" S4510 960GB Read Intensive SATA 6Gb HS SSD	16
4XB7A13628	B49G	ThinkSystem 3.5" S4510 1.92TB Read Intensive SATA 6Gb HS SSD	16

Table 38. 3.5-inch hot-swap PCIe 4.0 NVMe SSDs (operate at PCIe 3.0 speeds when connected to NVMe ports 1 or 2 in this server)

Part number	Feature	Description	Maximum supported
<b>3.5-inch SSDs - U.2 PCIe 4.0 NVMe - Mixed Use/Mainstream (3-5 DWPD)</b>			
4XB7A17155	BCFM	ThinkSystem 3.5" U.2 P5600 1.6TB Mixed Use NVMe PCIe 4.0 x4 HS SSD	8
4XB7A17156	BCFJ	ThinkSystem 3.5" U.2 P5600 3.2TB Mixed Use NVMe PCIe 4.0 x4 HS SSD	8
<b>3.5-inch SSDs - U.2 PCIe 4.0 NVMe - Read Intensive/Entry (&lt;3 DWPD)</b>			
4XB7A17149	BCFN	ThinkSystem 3.5" U.2 P5500 1.92TB Read Intensive NVMe PCIe 4.0 x4 HS SSD	8
4XB7A17150	BCFL	ThinkSystem 3.5" U.2 P5500 3.84TB Read Intensive NVMe PCIe 4.0 x4 HS SSD	8

**Note:** NVMe PCIe SSDs support surprise hot removal and hot insertion, provided the operating system supports PCIe SSD hot-swap.

Table 39. 3.5-inch hot-swap PCIe 3.0 NVMe SSDs

Part number	Feature	Description	Maximum supported
3.5-inch SSDs - U.2 PCIe 3.0 NVMe - Read Intensive/Entry (<3 DWPD)			
4XB7A10178	B34Q	ThinkSystem 3.5" PM983 1.92TB Entry NVMe PCIe 3.0 x4 Hot Swap SSD	8
4XB7A10179	B34R	ThinkSystem 3.5" PM983 3.84TB Entry NVMe PCIe 3.0 x4 Hot Swap SSD	8

**Note:** NVMe PCIe SSDs support surprise hot removal and hot insertion, provided the operating system supports PCIe SSD hot-swap.

Table 40. 3.5-inch simple-swap 6 Gb SATA HDDs

Part number	Feature	Description	Maximum supported
3.5-inch simple-swap HDDs - 6 Gb NL SATA			
7XB7A00055	AUZS	ThinkSystem 1TB 7.2K 6Gbps SATA 3.5" Simple Swap 512n HDD	12
7XB7A00056	AUZT	ThinkSystem 2TB 7.2K 6Gbps SATA 3.5" Simple Swap 512n HDD	12
7XB7A00057	AUZU	ThinkSystem 4TB 7.2K 6Gbps SATA 3.5" Simple Swap 512n HDD	12
7XB7A00058	AXC7	ThinkSystem 6TB 7.2K 6Gbps SATA 3.5" Simple Swap 512e HDD	12
7XB7A00059	AXC6	ThinkSystem 8TB 7.2K 6Gbps SATA 3.5" Simple Swap 512e HDD	12
7XB7A00060	AXC8	ThinkSystem 3.5" 10TB 7.2K SATA 6Gb Simple Swap 512e HDD	12
4XB7A08584	BA7D	ThinkSystem 3.5" 12TB 7.2K SATA 6Gb Simple Swap 512e HDD	12

Table 41. M.2 SATA drives

Part number	Feature	Description	Maximum supported
M.2 SSDs - 6 Gb SATA - Read Intensive/Entry (<3 DWPD)			
7N47A00129	AUUL	ThinkSystem M.2 32GB SATA 6Gbps Non-Hot Swap SSD	2
7N47A00130	AUUV	ThinkSystem M.2 128GB SATA 6Gbps Non-Hot Swap SSD	2
4XB7A17071	B8HS	ThinkSystem M.2 5300 240GB SATA 6Gbps Non-Hot Swap SSD	2
4XB7A17073	B919	ThinkSystem M.2 5300 480GB SATA 6Gbps Non-Hot Swap SSD	2
4XB7A17074	B8JJ	ThinkSystem M.2 5300 960GB SATA 6Gbps Non-Hot Swap SSD	2

Table 42. M.2 NVMe drives

Part number	Feature	Description	Maximum supported
M.2 SSDs - NVMe - Read Intensive/Entry (<3 DWPD)			
4XB7A38177	B8JR	ThinkSystem M.2 PM983 960GB NVMe PCIe 3.0 x4 Non-Hot Swap SSD	2

## USB memory key

For general portable storage needs, the server also supports the USB memory key option that is listed in the following table.

Table 43. USB memory key

Part number	Feature	Description
4X77A08621	B8NV	ThinkSystem 32GB USB Flash Drive

## Optical drives and backup units

For most configurations, the ST650 V2 has two 5.25-inch half-height drive bays for internal optical drives or backup units. The only configuration that does not support these media bays is the configuration with 4x 2.5-inch backplanes as described in the [Internal storage](#) section.

The drives and media supported by the server are listed in the following table.

**LTO tape drive in a rack conversion kit :** The ST650 V2 is supported installed on its side in a rack mount kit, however the use of an LTO tape drive in this configuration is supported but not recommended.

Table 44. Internal optical drives and backup units

Part number	Feature code	Description	Maximum supported
Optical drives			
4XA7A81755	BPHM	ThinkSystem 9.5mm Ultra-Slim USB DVD-RW v2	1
4XA7A08377	B36S	ThinkSystem 9.5mm Ultra-Slim USB DVD-RW	1
LTO tape drives			
4T27A80487	BN84	ThinkSystem Internal Half High LTO Gen8 SAS Tape Drive v2	1
4T27A10727	B4BM	ThinkSystem Internal Half High LTO Gen8 SAS Tape Drive	1
7T27A01503	AVF5	Internal LTO7 SAS Tape Drive	1
LTO media			
4TP7A09619	B4BN	ThinkSystem LTO Gen8 12TB Tape	Not applicable
7TP7A01606	AVF7	ThinkSystem LTO G7 6TB Tape	Not applicable
RDX drive and cartridges			
4T27A80485	BN5M	ThinkSystem Internal RDX USB 3.0 Dock v2	1
7T27A01501	AVF6	ThinkSystem Internal RDX USB 3.0 Dock	1
7TP7A01601	AVF8	ThinkSystem RDX 500GB Cartridge	Not applicable
7TP7A01602	AVF1	ThinkSystem RDX 1TB Cartridge	Not applicable
7TP7A04318	AXD1	ThinkSystem RDX 4TB Cartridge	Not applicable
7TP7A01603	AVF0	ThinkSystem RDX 2TB Cartridge	Not applicable

For field upgrades, the kits listed in the following table are available.

Table 45. Internal optical drives and backup units

Part number	Description	Purpose
4M27A60829	ThinkSystem ST650 V2 3.5" Chassis Media Bay Enablement Kit <ul style="list-style-type: none"> <li>• 2-bay 5.25" ODD/Tape Cage</li> <li>• Cage for 1x Slim ODD</li> <li>• ODD filler/bezel</li> <li>• Tape filler/bezel</li> </ul>	Provides the cage necessary to house two 5.25-inch drives, plus an inner cage for the slim optical drive. Also include blank bezels when a bay is not in use. Order tape drives and cables separately.
4Z57A16101	ThinkSystem ST650 V2 Optical Disk Drive Cable Kit <ul style="list-style-type: none"> <li>• Slim ODD Bezel</li> <li>• USB Cable for Slim ODD</li> </ul>	Provides the USB cable needed to connect the optical drive
4Z57A80565	ThinkSystem ST650 V2 Tape Drive Cable Kit v2	Provides the power cable and SAS cable to connect the tape drive. Order the SAS HBA separately.
4Z57A16100	ThinkSystem ST650 V2 Tape Drive Cable Kit <ul style="list-style-type: none"> <li>• ODD/Tape Power Cable</li> <li>• Tape SAS Cable</li> </ul>	Provides the power cable and SAS cable to connect the tape drive. Order the SAS HBA separately.

The ST650 V2 also supports external drives. External tape and RDX drives are described in the [External backup units](#) section.

The server supports the external USB optical drive listed in the following table.

Table 46. External optical drive

Part number	Feature code	Description
7XA7A05926	AVV8	ThinkSystem External USB DVD RW Optical Disk Drive

The drive is based on the Lenovo Slim DVD Burner DB65 drive and supports the following formats: DVD-RAM, DVD-RW, DVD+RW, DVD+R, DVD-R, DVD-ROM, DVD-R DL, CD-RW, CD-R, CD-ROM.

## I/O expansion

The ST650 V2 supports a total of up to 9 PCIe slots, all full-height and all with rear access. Slots 1-7 and 9 are PCIe 4.0 slots and Slot 8 is optional and is a PCIe 3.0 slot. Slots 4-8 require CPU 2 installed.

- Slot 1: PCIe 4.0 x16 (CPU 1)
- Slot 2: PCIe 4.0 x4 (x8 physical slot) (CPU 1)
- Slot 3: PCIe 4.0 x16 (CPU 1)
- Slot 4: PCIe 4.0 x8 (x8 physical slot) (CPU 2)
- Slot 5: PCIe 4.0 x16 (CPU 2)
- Slot 6: PCIe 4.0 x8 (x8 physical slot) (CPU 2)
- Slot 7: PCIe 4.0 x16 (CPU 2)
- Slot 8: PCIe 3.0 x8 (x8 physical slot) (CPU 2) (optional, cabled to PCIe connector)
- Slot 9: PCIe 4.0 x8 (x8 physical slot) (CPU 1)

The slots are shown in the following figure.

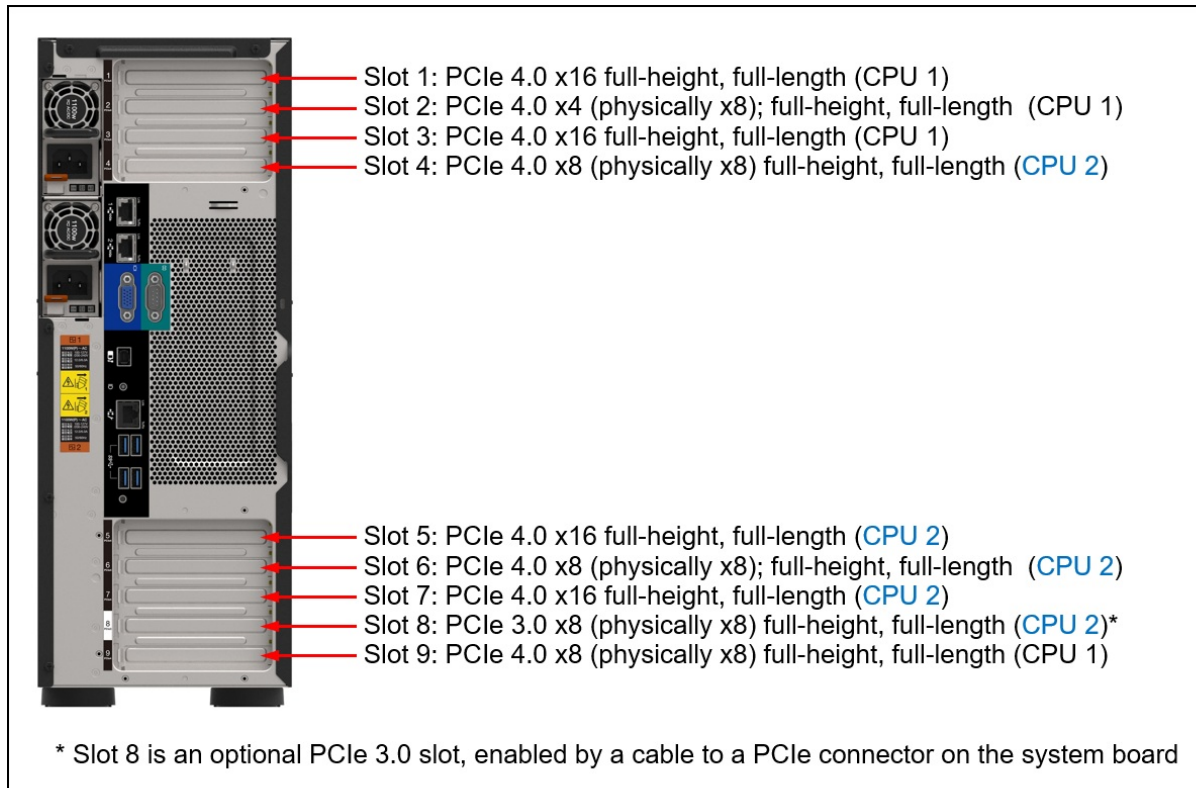

Figure 10. ST650 V2 PCIe slots

Slot 8 is optional and is enabled through the use of the cable listed in the following table. As shown in the [System architecture](#) section, Slot 8 is connected to CPU 2 and is mutually exclusive with four onboard NVMe ports. This means that to use Slot 8, only configurations with 4x 3.5-inch NVMe drives can be connected to the onboard NVMe controller. For any other NVMe configurations, retimer adapters will be required.

Table 47. Slot 8 cable kit

Part number	Feature code	Description	Purpose
4Z57A60819	BA6Q	ThinkSystem ST650 V2 PCIe Slot 8 Enablement Kit <ul style="list-style-type: none"> <li>SBB7A15218 - MB Slimline x8 to Slimline x8 to enable slot8, 930mm</li> </ul>	Enables Slot 8

For GPUs, additional components may be required. See the [GPU adapters](#) section for details.

## Network adapters

The ST650 V2 has two integrated 10GBASE-T ports for 1/10Gb Ethernet connectivity, based on the Broadcom BCM57416 controller.

The controller has the following features:

- General features
  - PCIe 3.0 x4 host interface
  - Supports 10GbE and 1GbE
    - 10GBASE-T IEEE 802.3an support
    - 1000BASE-T IEEE 802.3ab support
  - Supports IPv4 and IPv6
  - Broadcom TruFlow flow processing engine
- Virtualization features
  - SR-IOV support with up to 128 VFs
  - VXLAN, NVGRE, Geneve, GRE encapsulation and decapsulation
  - vSwitch acceleration
  - Multiqueue, NetQueue, and VMQ
  - Tunnel-aware stateless offloads
  - Message Signal Interrupts (MSI-X) support
- Ethernet features:
  - IPv4 and IPv6 offloads
  - TCP, UDP, and IP checksum offloads
  - Large Send Offload (LSO)
  - Large Receive Offload (LRO)
  - TCP Segmentation Offload (TSO)
  - Receive-side Scaling (RSS)
  - Transmit-side Scaling (TSS)
  - VLAN insertion/removal
  - Interrupt coalescing
  - Jumbo frames up to 9 KB
  - Network boot-PXE, UEFI
  - iSCSI boot
  - Data Plane Development Kit (DPDK) support
- Remote Direct Memory Access (RDMA):
  - Supports RDMA over converged Ethernet (RoCE) specifications
- Data Center Bridging / Converged Enhanced Ethernet (DCB/CEE):
  - Hardware Offloads of Ethernet TCP/IP
  - 802.1Qbb Priority Flow Control (PFC)
  - 802.1 Qaz Enhanced Transmission Selection (ETS)
  - 802.1 Qaz Data Center Bridging Exchange (DCBX)
- Management:
  - SMBus 2.0
  - MCTP over SMBus
  - NC-SI support

The ST650 V2 also supports network adapters that can be installed in the regular PCIe slots.

Table 48. Supported PCIe Network Adapters

Part number	Feature code	Description	Maximum supported	Slots supported
<b>Gigabit Ethernet</b>				
7ZT7A00484	AUZV	ThinkSystem Broadcom 5719 1GbE RJ45 4-Port PCIe Ethernet Adapter	9	All slots
7ZT7A00482	AUZX	ThinkSystem Broadcom 5720 1GbE RJ45 2-Port PCIe Ethernet Adapter	9	All slots
7ZT7A00533	AUZZ	ThinkSystem I350-F1 PCIe 1Gb 1-Port SFP Ethernet Adapter	9	All slots
7ZT7A00534	AUZY	ThinkSystem I350-T2 PCIe 1Gb 2-Port RJ45 Ethernet Adapter	9	All slots
7ZT7A00535	AUZW	ThinkSystem I350-T4 PCIe 1Gb 4-Port RJ45 Ethernet Adapter	9	All slots
<b>10GBASE-T Ethernet</b>				
7ZT7A00496	AUKP	ThinkSystem Broadcom 57416 10GBASE-T 2-Port PCIe Ethernet Adapter	9	All slots
4XC7A08245	B5SU	ThinkSystem Broadcom 57454 10GBASE-T 4-port PCIe Ethernet Adapter	9	All slots
<b>10 Gb Ethernet SFP+</b>				
7ZT7A00537	AUKX	ThinkSystem Intel X710-DA2 PCIe 10Gb 2-Port SFP+ Ethernet Adapter	9	All slots
<b>25 Gb Ethernet</b>				
4XC7A08238	B5T0	ThinkSystem Broadcom 57414 10/25GbE SFP28 2-port PCIe Ethernet Adapter	9	All slots
4XC7A08241	B5T3	ThinkSystem Broadcom 57454 10/25GbE SFP28 4-port PCIe Ethernet Adapter	9	All slots
4XC7A08295	BCD6	ThinkSystem Intel E810-DA2 10/25GbE SFP28 2-Port PCIe Ethernet Adapter	9	All slots
4XC7A08270	B652	ThinkSystem Marvell QL41232 10/25GbE SFP28 2-Port PCIe Ethernet Adapter	9	All slots
4XC7A62580	BE4U	ThinkSystem Mellanox ConnectX-6 Lx 10/25GbE SFP28 2-Port PCIe Ethernet Adapter	9	All slots
<b>100 Gb Ethernet</b>				
4XC7A08248	B8PP	ThinkSystem Mellanox ConnectX-6 Dx 100GbE QSFP56 2-port PCIe Ethernet Adapter	9	All slots

For more information, including the transceivers and cables that each adapter supports, see the list of Lenovo Press Product Guides in the Networking adapters category: <https://lenovopress.com/servers/options/ethernet>

## Fibre Channel host bus adapters

The following table lists the Fibre Channel HBAs supported by the ST650 V2.

Table 49. Fibre Channel HBAs

Part number	Feature code	Description	Maximum supported	Slots supported
<b>32 Gb Fibre Channel HBAs</b>				
4XC7A76498	BJ3G	ThinkSystem Emulex LPe35000 32Gb 1-port PCIe Fibre Channel Adapter V2	9	All slots
4XC7A76525	BJ3H	ThinkSystem Emulex LPe35002 32Gb 2-port PCIe Fibre Channel Adapter V2	9	All slots
4XC7A08279	BA1G	ThinkSystem QLogic QLE2770 32Gb 1-Port PCIe Fibre Channel Adapter	9	All slots
4XC7A08276	BA1F	ThinkSystem QLogic QLE2772 32Gb 2-Port PCIe Fibre Channel Adapter	9	All slots
<b>16 Gb Fibre Channel HBAs</b>				
01CV830	ATZU	Emulex 16Gb Gen6 FC Single-port HBA	9	All slots
01CV840	ATZV	Emulex 16Gb Gen6 FC Dual-port HBA	9	All slots
01CV750	ATZB	QLogic 16Gb Enhanced Gen5 FC Single-port HBA	9	All slots
01CV760	ATZC	QLogic 16Gb Enhanced Gen5 FC Dual-port HBA	9	All slots

For more information, see the list of Lenovo Press Product Guides in the Host bus adapters category:  
<https://lenovopress.com/servers/options/hba>

## SAS adapters for external storage

The following table lists SAS HBAs and RAID adapters supported by ST650 V2 server for use with external storage.

Table 50. Adapters for external storage

Part number	Feature code	Description	Maximum supported	Slots supported
<b>SAS HBAs</b>				
7Y37A01090	AUNR	ThinkSystem 430-8e SAS/SATA 12Gb HBA	9	All slots
7Y37A01091	AUNN	ThinkSystem 430-16e SAS/SATA 12Gb HBA	9	All slots
4Y37A09724	B8P7	ThinkSystem 440-16e SAS/SATA PCIe Gen4 12Gb HBA	9	All slots
<b>External RAID adapters</b>				
7Y37A01087	AUNQ	ThinkSystem RAID 930-8e 4GB Flash PCIe 12Gb Adapter	4*	Any 4 slots

\* See below regarding supercap requirements

**RAID 930-8e adapter:** The RAID 930-8e is not supported installed with any X40 internal RAID adapters.

The RAID 930-8e uses a flash power module (supercap), which can be installed in one of four locations on the air baffle in the server. The number of 930-8e RAID adapters supported is based on how many supercaps can be installed in the server. If an internal 930i or 940i RAID adapter with flash power modules is installed, the maximum number of 930-8e adapters supported is reduced by 1.

For more information, see the list of Lenovo Press Product Guides in the Host bus adapters and RAID adapters categories:

<https://lenovopress.com/servers/options/hba>  
<https://lenovopress.com/servers/options/raid>



The following table compares the specifications of the external SAS HBAs and RAID adapters.

Table 51. Comparison of external storage adapters

Feature	430-8e	430-16e	440-16e	930-8e
Adapter type	HBA	HBA	HBA	External RAID
Part number	7Y37A01090	7Y37A01091	4Y37A09724	7Y37A01087
Controller chip	LSI SAS3408	LSI SAS3416	Broadcom SAS3816	LSI SAS3516
Broadcom equivalent	HBA 9400-8e	HBA 9400-16e	HBA 9500-16e	MegaRAID 9480-8e
Host interface	PCIe 3.0x8	PCIe 3.0x8	PCIe 4.0 x8	PCIe 3.0x8
Port interface	12 Gb SAS	12 Gb SAS	12 Gb SAS	12 Gb SAS
Number of ports	8	16	16	8
Port connectors	2x Mini-SAS HD SFF8644	4x Mini-SAS HD SFF8644	4x Mini-SAS HD SFF8644	2x Mini-SAS HD SFF8644
Drive interface	SAS/SATA	SAS/SATA	SAS/SATA	SAS,SATA
Drive type	HDD/SSD/SED*	HDD/SSD/SED*	HDD/SSD/SED*	HDD, SED, SSD
Hot-swap drives	Yes	Yes	Yes	Yes
Max devices	1024	1024	1024	216
RAID levels	None	None	None	0, 1, 10, 5, 50, 6, 60
JBOD mode	Yes	Yes	Yes	Yes
Cache	None	None	None	4GB (Standard)
CacheVault cache protection	None	None	None	Yes (Flash)
Performance Accelerator (FastPath)	No	No	No	Yes
SSD Caching (CacheCade Pro 2.0)	No	No	No	No
SED support	Yes*	Yes*	Yes*	Yes (Safestore)

\* SAS HBAs support SEDs (self-encrypting drives) by using software on the server and simply passing SED commands through the HBA to the drives. SED support by RAID controllers is provided using the built-in MegaRAID SafeStore functionality of the adapter.

## Flash storage adapters

The ST650 V2 currently does not support flash storage adapters.

## GPU adapters

The ST650 V2 supports the following graphics processing units (GPUs).

Table 52. Supported GPUs

Part number	Feature code	Description	TDP	Maximum supported	Slots supported
Double-wide GPUs					
4X67A71310	BFT0	ThinkSystem NVIDIA Quadro RTX A6000 48GB PCIe Active GPU	300W	4	1,3,5,7*
NVLink bridge connector					
4X67A71309	BG3F	ThinkSystem NVIDIA Quadro RTX A6000 NVLink HB Bridge	-	2	Not applicable
Single-wide GPUs					
4X67A14934	B6CG	ThinkSystem NVIDIA Quadro RTX 4000 8GB PCIe Active GPU	160W	8	1-8
4X67A14926	B4YB	ThinkSystem NVIDIA T4 16GB PCIe Passive GPU	70W	8	1-8
4X67A11584	B31D	ThinkSystem NVIDIA Quadro P620 2GB PCIe Active GPU	40W	8	1-8

\* When a double-wide GPU is installed in slot 1, 3, 5 or 7, the adjacent slot 2, 4, 6 or 8 respectively is not available

For information about these GPUs, see the ThinkSystem GPU Summary, available at: <https://lenovopress.com/lp0768-thinksystem-thinkagile-gpu-summary>

The following table lists the field upgrades for GPUs.

**Zones:** PCIe slots in the server are grouped into zones:

- Zone 1 = slots 1, 2, 3, 4 (upper slots)
- Zone 2 = slots 5, 6, 7, 8, 9 (lower slots)

Table 53. GPU field upgrades

Part number	Feature code	Description	Purpose
4M27A60836	BA7B	ThinkSystem ST650 V2 Full Length PCIe Holder Kit <ul style="list-style-type: none"> <li>• 2x adapter brackets</li> <li>• 1x GPU filler</li> </ul>	<p>1 kit needed per server.</p> <p>The two brackets mount on the fan cage to secure the ends of full-length adapters that are installed. The left bracket is for slots in zone 1 and the right bracket is for zone 2.</p> <p>The GPU filler is needed for proper airflow if you have 1x double-wide GPU in slot 1, or 3x double-wide GPU adapters in slots 1, 3, and 7. Not needed for any combinations.</p>
4M27A11843	BF58	ThinkSystem ST650 V2 T4 GPU Thermal Kit <ul style="list-style-type: none"> <li>• 1x T4 filler sponge</li> </ul>	<p>1 kit needed for each zone, if a T4 is installed in that zone.</p> <p>The kit contains a sponge that is mounted to the underside of the server cover and is needed for proper cooling when T4 GPUs are installed.</p> <p><b>Note:</b> Once a sponge is installed in a zone, only low profile adapters can be installed in that zone. Full-height adapters are not supported.</p>
4Z57A60815	BB41	ThinkSystem ST650 V2 RTX 4000 GPU Power Cable Kit <ul style="list-style-type: none"> <li>• 320mm power cable for slots 1-4</li> <li>• 660 mm power cable for slots 5-8</li> </ul>	<p>Auxiliary power cable for NVIDIA RTX 4000. Use the cable that matches the slot where the GPU is installed.</p>
4Z57A60816	BB42	ThinkSystem ST650 V2 RTX A6000 GPU Power Cable Kit <ul style="list-style-type: none"> <li>• 320mm power cable for slots 1-4</li> <li>• 660 mm power cable for slots 5-8</li> </ul>	<p>Auxiliary power cable for NVIDIA RTX A6000. Use the cable that matches the slot where the GPU is installed.</p>

### Configuration rules

The following configuration requirements must be met when installing GPUs:

- All GPUs installed in a zone must be identical
- Dual-rotor cooling fans are required
- For the RTX A6000 and RTX 4000 GPUs, when the GPU is installed in a zone, a RAID card or HBA cannot also be installed in that zone
- When any GPUs are installed, only two backplanes are supported and no optical drive or tape drive can be installed.

### Cooling

The ST650 V2 server has up to 4x hot-swap 92 mm fans, either Performance or Standard fans, depending on the configuration. Performance fans are dual-rotor counter-rotating units that have two separate spinning fan rotors, one in front of the other, which rotate in opposite directions. Standard fans are single-rotor units.

Performance fans are N+1 rotor redundant and in the event of a rotor failure, the system will continue with no loss of performance provided the ambient temperature is 27 °C or lower. If the ambient temperature is above 27 °C, performance may be degraded. Standard fans are not redundant, and in the event of a fan failure, the server will continue however performance will be degraded.

The server also has one or two additional fans integrated in each of the two power supplies.

Depending on the configuration, Standard fans will be sufficient to provide the necessary air flow, however for CTO orders it will be possible in the DCSC configurator to override the default selection and select Performance fans. Fan types cannot be mixed. Ordering information is listed in the following table.

Table 54. Cooling fan options

Part number	Feature code	Description	Quantity required	
			1 CPU	2 CPUs
4M27A60831	BA5S	ThinkSystem ST650 V2/V3 Standard Fan Kit (single-rotor fans)	3 or 4	4
4M27A60832	BA5T	ThinkSystem ST650 V2/V3 Performance Fan Kit (dual-rotor fans)	3 or 4	4

The use of 4x dual-rotor fans supports all configurations, however the use of 3x fans or the use of single-rotor fans is supported under the following conditions:

- 3x single-rotor fans can be used in the following conditions
  - Processor: 1x CPU, TDP < 205W
  - No Persistent Memory installed
  - No GPUs installed
  - Drives: only 2 backplanes installed (8x 3.5-inch or 16x 2.5-inch)
  - PCIe slots: No restriction
  - Ambient temperature: 35 °C
- 3x double-rotor fans can be used in the following conditions (all must apply):
  - Processor: 1x CPU (no TDP restriction)
  - Persistent memory: No restriction
  - GPUs: up to 2 double-wide or 3 single-wide
  - Drives: only 2 backplanes installed (8x 3.5-inch or 16x 2.5-inch)
  - PCIe slots: No restriction
  - Ambient temperature: 30 °C
- 4x single-rotor fans can be used in the following conditions (all must apply):
  - Processor: TDP < 205W
  - Persistent memory: No support
  - GPUs: No support
  - Drives: No restriction
  - PCIe slots: No restriction
  - Ambient temperature: 35 °C

## Power supplies

The ST650 V2 supports up to two redundant hot-swap power supplies.

The power supply choices are listed in the following table. Both power supplies used in server must be identical.

**Tip:** When configuring a server in the DCSC configurator, power consumption is calculated precisely by interfacing with Lenovo Capacity Planner. You can therefore select the appropriate power supply for your configuration. However, do consider future upgrades that may require additional power needs.

Table 37. Power supply options

Part number	Feature	Description	Connector	Max supported	110V AC	220V AC	240V DC China only
4P57A75972	BHTU	ThinkSystem V2 750W(230V/115V) Platinum Hot-Swap Power Supply v2	C13	2	Yes	Yes	Yes
4P57A75973	BHS8	ThinkSystem 750W (230V) v2 Titanium Hot-Swap Power Supply	C13	2	No	Yes	Yes
4P57A75974	BHS9	ThinkSystem 1100W (230V/115V) v2 Platinum Hot-Swap Power Supply	C13	2	Yes	Yes	Yes
4P57A78362	BMUF	ThinkSystem V2 1800W (230V) Platinum Hot-Swap Power Supply v2	C13	2	No	Yes	Yes
4P57A26294	B8QB	ThinkSystem V2 1800W (230V) Platinum Hot-Swap Power Supply	C13	2	No	Yes	Yes
4P57A26295	B962	ThinkSystem V2 2400W (230V) Platinum Hot-Swap Power Supply	C19	2	No	Yes	Yes

Dual-voltage power supplies are auto-sensing and support both 110V AC (100-127V 50/60 Hz) and 220V AC (200-240V 50/60 Hz) power. For China customers, all power supplies support 240V DC.

Power supply options do not include a line cord. For server configurations, the inclusion of a power cord is model dependent. Configure-to-order models can be configured without power cords if desired. Note that the 2400W power supply has a [C19 connector](#).

## Power cords

Line cords and rack power cables with C13 connectors can be ordered as listed in the following table.

**110V customers:** If you plan to use the ThinkSystem 1100W power supply with a 110V power source, select a power cable that is rated above 10A. Power cables that are rated at 10A or below are not supported with 110V power.

Table 55. Power cords

Part number	Feature code	Description
Rack cables		
00Y3043	A4VP	1.0m, 10A/100-250V, C13 to C14 Jumper Cord
39Y7937	6201	1.5m, 10A/100-250V, C13 to C14 Jumper Cord
4L67A08369	6570	2.0m, 13A/100-250V, C13 to C14 Jumper Cord
4L67A08366	6311	2.8m, 10A/100-250V, C13 to C14 Jumper Cord
4L67A08370	6400	2.8m, 13A/100-250V, C13 to C14 Jumper Cord
39Y7932	6263	4.3m, 10A/100-250V, C13 to C14 Jumper Cord
4L67A08371	6583	4.3m, 13A/100-250V, C13 to C14 Jumper Cord
Line cords		

Part number	Feature code	Description
39Y7930	6222	2.8m, 10A/250V, C13 to IRAM 2073 (Argentina) Line Cord
81Y2384	6492	4.3m, 10A/250V, C13 to IRAM 2073 (Argentina) Line Cord
39Y7924	6211	2.8m, 10A/250V, C13 to AS/NZS 3112 (Australia/NZ) Line Cord
81Y2383	6574	4.3m, 10A/250V, C13 to AS/NZS 3112 (Australia/NZ) Line Cord
69Y1988	6532	2.8m, 10A/250V, C13 to NBR 14136 (Brazil) Line Cord
81Y2387	6404	4.3m, 10A/250V, C13 to NBR 14136 (Brazil) Line Cord
39Y7928	6210	2.8m, 10A/220V, C13 to GB 2099.1 (China) Line Cord
81Y2378	6580	4.3m, 10A/250V, C13 to GB 2099.1 (China) Line Cord
39Y7918	6213	2.8m, 10A/250V, C13 to DK2-5a (Denmark) Line Cord
81Y2382	6575	4.3m, 10A/250V, C13 to DK2-5a (Denmark) Line Cord
39Y7917	6212	2.8m, 10A/250V, C13 to CEE 7/7 (Europe) Line Cord
81Y2376	6572	4.3m, 10A/250V, C13 to CEE 7/7 (Europe) Line Cord
39Y7927	6269	2.8m, 10A/250V, C13 to IS 6538 (India) Line Cord
81Y2386	6567	4.3m, 10A/250V, C13 to IS 6538 (India) Line Cord
39Y7920	6218	2.8m, 10A/250V, C13 to SI 32 (Israel) Line Cord
81Y2381	6579	4.3m, 10A/250V, C13 to SI 32 (Israel) Line Cord
39Y7921	6217	2.8m, 10A/250V, C13 to CEI 23-16 (Italy) Line Cord
81Y2380	6493	4.3m, 10A/250V, C13 to CEI 23-16 (Italy) Line Cord
4L67A08362	6495	4.3m, 12A/200V, C13 to JIS C-8303 (Japan) Line Cord
39Y7922	6214	2.8m, 10A/250V, C13 to SABS 164-1 (South Africa) Line Cord
81Y2379	6576	4.3m, 10A/250V, C13 to SANS 164-1 (South Africa) Line Cord
39Y7926	6335	4.3m, 12A/100V, C13 to JIS C-8303 (Japan) Line Cord
39Y7925	6219	2.8m, 12A/220V, C13 to KSC 8305 (S. Korea) Line Cord
81Y2385	6494	4.3m, 12A/250V, C13 to KSC 8305 (S. Korea) Line Cord
39Y7919	6216	2.8m, 10A/250V, C13 to SEV 1011-S24507 (Swiss) Line Cord
81Y2390	6578	4.3m, 10A/250V, C13 to SEV 1011-S24507 (Swiss) Line Cord
23R7158	6386	2.8m, 10A/125V, C13 to CNS 10917 (Taiwan) Line Cord
81Y2375	6317	2.8m, 10A/250V, C13 to CNS 10917 (Taiwan) Line Cord
81Y2374	6402	2.8m, 13A/125V, C13 to CNS 10917 (Taiwan) Line Cord
4L67A08363	AX8B	4.3m, 10A/125V, C13 to CNS 10917 (Taiwan) Line Cord
81Y2389	6531	4.3m, 10A/250V, C13 to CNS 10917 (Taiwan) Line Cord
81Y2388	6530	4.3m, 13A/125V, C13 to CNS 10917 (Taiwan) Line Cord
39Y7923	6215	2.8m, 10A/250V, C13 to BS 1363/A (UK) Line Cord
81Y2377	6577	4.3m, 10A/250V, C13 to BS 1363/A (UK) Line Cord
90Y3016	6313	2.8M, 10A/125V, C13 to NEMA 5-15P (US) Line Cord
46M2592	A1RF	2.8m, 10A/250V, C13 to NEMA 6-15P (US) Line Cord
00WH545	6401	2.8M, 13A/125V, C13 to NEMA 5-15P (US) Line Cord
4L67A08359	6370	4.3m, 10A/125V, C13 to NEMA 5-15P (US) Line Cord
4L67A08361	6373	4.3m, 10A/250V, C13 to NEMA 6-15P (US) Line Cord
4L67A08360	AX8A	4.3m, 13A/125V, C13 to NEMA 5-15P (US) Line Cord

## Power cords (C19 connectors)

Line cords and rack power cables with C19 connectors can be ordered as listed in the following table.

Table 56. Power cords (C19 connectors)

Part number	Feature code	Description
Rack cables		
39Y7916	6252	2.5m, 16A/100-240V, C19 to IEC 320-C20 Rack Power Cable
Line cords		
40K9777	6276	4.3m, 220-240V, C19 to IRAM 2073 (Argentina) Line cord
40K9773	6284	4.3m, 220-240V, C19 to AS/NZS 3112 (Aus/NZ) Line cord
40K9775	6277	4.3m, 250V, C19 to NBR 14136 (Brazil) Line Cord
40K9774	6288	4.3m, 220-240V, C19 to GB2099.1 (China) Line cord
40K9769	6283	4.3m, 16A/230V, C19 to IEC 309-P+N+G (Den/Sws) Line Cord
40K9766	6279	4.3m, 220-240V, C19 to CEE7-VII (European) Line cord
40K9776	6285	4.3m, 220-240V, C19 to IS6538 (India) Line cord
40K9771	6282	4.3m, 220-240V, C19 to SI 32 (Israel) Line cord
40K9768	6281	4.3m, 220-240V, C19 to CEI 23-16 (Italy) Line cord
40K9770	6280	4.3m, 220-240V, C19 to SABS 164 (South Africa) Line cord
41Y9231	6289	4.3m, 15A/250V, C19 to KSC 8305 (S. Korea) Line Cord
81Y2391	6549	4.3m, 16A/230V, C19 to SEV 1011 (Sws) Line Cord
41Y9230	6287	4.3m, 16A/250V, C19 to CNS 10917-3 (Taiwan) Line Cord
40K9767	6278	4.3m, 220-240V, C19 to BS 1363/A w/13A fuse (UK) Line Cord
40K9772	6275	4.3m, 16A/208V, C19 to NEMA L6-20P (US) Line Cord
00D7197	A1NV	4.3m, 15A/250V, C19 to NEMA 6-15P (US) Line Cord

## Systems management

The server contains an integrated service processor, XClarity Controller (XCC), which provides advanced control, monitoring, and alerting functions. The XCC is based on the Pilot4 XE401 baseboard management controller (BMC) using a dual-core ARM Cortex A9 service processor.

Topics in this section:

- [Local management](#)
- [System status with XClarity Mobile](#)
- [Remote management](#)
- [Lenovo XClarity Provisioning Manager](#)
- [Lenovo XClarity Administrator](#)
- [Lenovo XClarity Essentials](#)
- [Lenovo XClarity Energy Manager](#)
- [Lenovo Capacity Planner](#)

## Local management

The ST650 V2 offers a front operator panel with key LED status indicators, as shown in the following figure.

**Tip:** The Network LED only shows network activity of the two 10GBASE-T ports. The Drive LED is only for the simple-swap drive bay configuration, not for hot-swap drives.

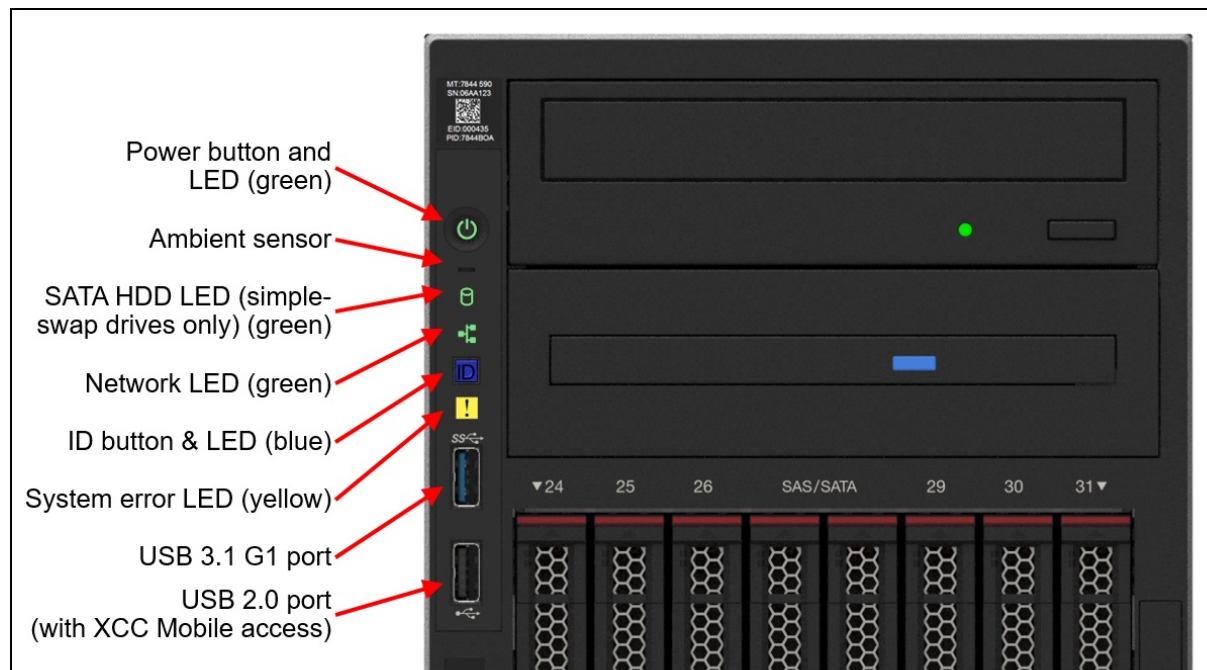

Figure 11. ST650 V2 front operator panel

When you press the ID button on the front panel, the blue system ID LEDs on both the front and rear of the server are lit to help you locate the server among other servers. You also can turn on the system ID LEDs using a remote management program for server presence detection.

## External Diagnostics Handset

The ST650 V2 also has a port at the rear of the server to connect an External Diagnostics Handset as shown in the following figure.



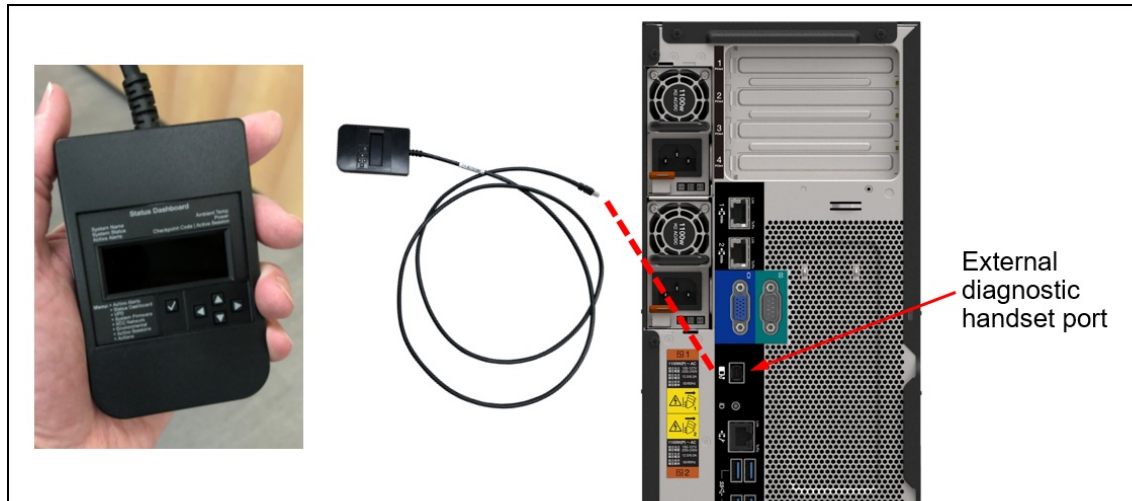

Figure 12. ST650 V2 External Diagnostics Handset

The External Diagnostics Handset allows quick access to system status, firmware, network, and health information. The LCD display on the panel and the function buttons give you access to the following information:

- Active alerts
- Status Dashboard
- System VPD: machine type & mode, serial number, UUID string
- System firmware levels: UEFI and XCC firmware
- XCC network information: hostname, MAC address, IP address, DNS addresses
- Environmental data: Ambient temperature, CPU temperature, AC input voltage, estimated power consumption
- Active XCC sessions
- System reset action

The handset has a magnet on the back of it to allow you to easily mount it on a convenient place on any rack cabinet. Many other ThinkSystem servers including the SR650 V2 and SR630 V2 also support the External Diagnostics Handset allowing you to share a handset amongst multiple systems.

Ordering information for the External Diagnostics Handset with is listed in the following table.

Table 57. External Diagnostics Handset ordering information

Part number	Feature code	Description
4TA7A64874	BEUX	External Diagnostics Handset

### System status with XClarity Mobile

The XClarity Mobile app includes a tethering function where you can connect your Android or iOS device to the server via USB to see the status of the server.

The steps to connect the mobile device are as follows:

1. Enable USB Management on the server, by holding down the ID button for 3 seconds (or pressing the dedicated USB management button if one is present)
2. Connect the mobile device via a USB cable to the server's USB port with the management symbol 
3. In iOS or Android settings, enable Personal Hotspot or USB Tethering
4. Launch the Lenovo XClarity Mobile app

Once connected you can see the following information:

- Server status including error logs (read only, no login required)
- Server management functions (XClarity login credentials required)

## Remote management

The server offers a dedicated RJ45 port at the rear of the server for remote management via the XClarity Controller management processor. The port supports 10/100/1000 Mbps speeds.

Remote server management is provided through industry-standard interfaces:

- Intelligent Platform Management Interface (IPMI) Version 2.0
- Simple Network Management Protocol (SNMP) Version 3 (no SET commands; no SNMP v1)
- Common Information Model (CIM-XML)
- Representational State Transfer (REST) support
- Redfish support (DMTF compliant)
- Web browser - HTML 5-based browser interface (Java and ActiveX not required) using a responsive design (content optimized for device being used - laptop, tablet, phone) with NLS support

IPMI via the Ethernet port (IPMI over LAN) is supported, however it is disabled by default. For CTO orders you can specify whether you want the feature enabled or disabled in the factory, using the feature codes listed in the following table.

Table 58. IPMI-over-LAN settings

Feature code	Description
B7XZ	Disable IPMI-over-LAN (default)
B7Y0	Enable IPMI-over-LAN

There are two XClarity Controller upgrades available for the server, Advanced and Enterprise.

XCC Advanced Upgrade adds the following functions:

- Remotely viewing video with graphics resolutions up to 1600x1200 at 75 Hz with up to 23 bits per pixel, regardless of the system state
- Remotely accessing the server using the keyboard and mouse from a remote client
- International keyboard mapping support
- Syslog alerting
- Redirecting serial console via SSH
- Component replacement log (Maintenance History log)
- Access restriction (IP address blocking)
- Lenovo SED security key management
- Displaying graphics for real-time and historical power usage data and temperature

XCC Enterprise Upgrade enables the following additional features:

- Boot video capture and crash video capture
- Virtual console collaboration - Ability for up to 6 remote users to be log into the remote session simultaneously
- Remote console Java client
- Mapping the ISO and image files located on the local client as virtual drives for use by the server
- Mounting the remote ISO and image files via HTTPS, SFTP, CIFS, and NFS
- Power capping
- System utilization data and graphic view
- Single sign on with Lenovo XClarity Administrator

- Update firmware from a repository
- License for XClarity Energy Manager

For configure-to-order (CTO), you can enable the required XCC functionality by selecting the appropriate XCC feature codes listed in the following table:

- XCC Standard - select neither feature listed in the table
- XCC Advanced - select feature AVUT
- XCC Enterprise - select feature AUPW

Table 59. XClarity Controller upgrades for configure-to-order

Feature code	Description
AVUT	ThinkSystem XClarity Controller Standard to Advanced Upgrade
AUPW	ThinkSystem XClarity Controller Standard to Enterprise Upgrade

For systems with XCC Standard or XCC Advanced installed, field upgrades are available as listed in the following table.

Table 60. XClarity Controller field upgrades

Part number	Description
4L47A09132	ThinkSystem XClarity Controller Standard to Advanced Upgrade (for servers that have XCC Standard)
4L47A09133	ThinkSystem XClarity Controller Advanced to Enterprise Upgrade (for servers that have XCC Advanced)

## Lenovo XClarity Provisioning Manager

Lenovo XClarity Provisioning Manager (LXPM) is a UEFI-based application embedded in ThinkSystem servers and accessible via the F1 key during system boot.

LXPM provides the following functions:

- Graphical UEFI Setup
- System inventory information and VPD update
- System firmware updates (UEFI and XCC)
- RAID setup wizard
- OS installation wizard (including unattended OS installation)
- Diagnostics functions

## Lenovo XClarity Administrator

Lenovo XClarity Administrator is a centralized resource management solution designed to reduce complexity, speed response, and enhance the availability of Lenovo systems and solutions.

Lenovo XClarity Administrator provides agent-free hardware management for ThinkSystem servers, in addition to ThinkServer, System x, and Flex System servers. The administration dashboard is based on HTML 5 and allows fast location of resources so tasks can be run quickly.

Because Lenovo XClarity Administrator does not require any agent software to be installed on the managed endpoints, there are no CPU cycles spent on agent execution, and no memory is used, which means that up to 1GB of RAM and 1 - 2% CPU usage is saved, compared to a typical managed system where an agent is required.

Lenovo XClarity Administrator provides full management function to ThinkSystem servers, including the following:

- Discovery
- Inventory
- Monitoring and alerting
- Call home
- Centralized user management
- Cryptography modes, server certificates, and encapsulation
- Configuration patterns
- Operating system deployment
- Firmware updates

For more information about Lenovo XClarity Administrator, including ordering part numbers, see the Lenovo XClarity Administrator Product Guide: <https://lenovopress.com/tips1200-lenovo-xclarity-administrator>

### **Lenovo XClarity Integrators**

Lenovo also offers software plug-in modules, Lenovo XClarity Integrators, to manage physical infrastructure from leading external virtualization management software tools including those from Microsoft and VMware.

These integrators are offered at no charge, however if software support is required, a Lenovo XClarity Pro software subscription license should be ordered.

Lenovo XClarity Integrators offer the following additional features:

- Ability to discover, manage, and monitor Lenovo server hardware from VMware vCenter or Microsoft System Center
- Deployment of firmware updates and configuration patterns to Lenovo x86 rack servers and Flex System from the virtualization management tool
- Non-disruptive server maintenance in clustered environments that reduces workload downtime by dynamically migrating workloads from affected hosts during rolling server updates or reboots
- Greater service level uptime and assurance in clustered environments during unplanned hardware events by dynamically triggering workload migration from impacted hosts when impending hardware failures are predicted

For more information about all the available Lenovo XClarity Integrators, see the Lenovo XClarity Administrator Product Guide: <https://lenovopress.com/tips1200-lenovo-xclarity-administrator>

## Lenovo XClarity Essentials

Lenovo offers the following XClarity Essentials software tools that can help you set up, use, and maintain the server at no additional cost:

- **Lenovo Essentials OneCLI**  
OneCLI is a collection of server management tools that uses a command line interface program to manage firmware, hardware, and operating systems. It provides functions to collect full system health information (including health status), configure system settings, and update system firmware and drivers.
- **Lenovo Essentials UpdateXpress**  
The UpdateXpress tool is a standalone GUI application for firmware and device driver updates that enables you to maintain your server firmware and device drivers up-to-date and help you avoid unnecessary server outages. The tool acquires and deploys individual updates and UpdateXpress System Packs (UXSPs) which are integration-tested bundles.
- **Lenovo Essentials Bootable Media Creator**  
The Bootable Media Creator (BOMC) tool is used to create bootable media for offline firmware update.

For more information and downloads, visit the Lenovo XClarity Essentials web page:

<http://support.lenovo.com/us/en/documents/LNVO-center>

## Lenovo XClarity Energy Manager

Lenovo XClarity Energy Manager is a power and temperature management solution for data centers. It is an agent-free, web-based console that enables you to monitor and manage power consumption and temperature in your data center through the management console. It enables server density and data center capacity to be increased through the use of power capping.

Lenovo XClarity Energy Manager is a licensed product. A single-node XClarity Energy Manager license is included with the XClarity Controller Enterprise (XCC Enterprise) upgrade as described in the [Remote Management](#) section. If your server does not have the XCC Enterprise upgrade, Energy Manager licenses can be ordered as shown in the following table.

Table 61. Lenovo XClarity Energy Manager

Description	Part number
4L40E51621	Lenovo XClarity Energy Manager Node License (1 license needed per server)

For more information about XClarity Energy Manager, see the following resources:

- **Lenovo Support page:**  
<https://datacentersupport.lenovo.com/us/en/solutions/Invo-lxem>
- **Lenovo Information Center:**  
[https://sysmgmt.lenovofiles.com/help/topic/LXEM/lxem\\_overview.html?cp=4](https://sysmgmt.lenovofiles.com/help/topic/LXEM/lxem_overview.html?cp=4)

## Lenovo Capacity Planner

Lenovo Capacity Planner is a power consumption evaluation tool that enhances data center planning by enabling IT administrators and pre-sales professionals to understand various power characteristics of racks, servers, and other devices. Capacity Planner can dynamically calculate the power consumption, current, British Thermal Unit (BTU), and volt-ampere (VA) rating at the rack level, improving the planning efficiency for large scale deployments.

For more information, refer to the Capacity Planner web page:

<http://datacentersupport.lenovo.com/us/en/solutions/Invo-lcp>

## Security

The ST650 V2 offers the following electronic security features:

- Administrator and power-on password
- Trusted Platform Module (TPM) supporting TPM 2.0 (no support for TPM 1.2)
- Optional Nationz TPM 2.0, available only in China (CTO only)
- Self-encrypting drives with support for IBM Security Key Lifecycle Manager

The ST650 V2 offers the following mechanical security features:

- Lockable side cover to help prevent access to internal components
- Optional chassis intrusion switch
- Optional lockable front security door (not supported with the tower is converted to a 4U rack server)

The server is NIST SP 800-147B compliant.

The following table lists the security options for the ST650 V2.

Table 62. Security features

Part number	Feature code	Description
4M27A60834	BA5U	ThinkSystem ST650 V2 Security Door
4Z57A60817	BB4F	ThinkSystem ST650 V2 Chassis Intrusion Cable Kit
CTO only*	B8LE	ThinkSystem Nationz Trusted Platform Module v2.0 (China customers only)

\* Not available as a field upgrade. The component is CTO or on pre-configured models only.

### Lenovo ThinkShield - Platform Firmware Resiliency

Lenovo's ThinkShield Security is a transparent and comprehensive approach to security that extends to all dimensions of our data center products: from development, to supply chain, and through the entire product lifecycle.

The ThinkSystem ST650 V2 offers Platform Firmware Resiliency (PFR) hardware Root of Trust (RoT) which is NIST SP800-193 compliant. This offering further enhances key platform subsystem protections against unauthorized firmware updates and corruption, to restore firmware to an integral state, and to closely monitor firmware for possible compromise from cyber attacks.

PFR operates upon the following server components:

- UEFI image – the low level server firmware that connects the operating system to the server hardware
- XCC image – the management “engine” software that controls and reports on the server status separate from the server operating system
- FPGA image – the code that runs the server's lowest level hardware controller on the motherboard

The Lenovo Platform Root of Trust Hardware performs the following three main functions:

- Detection – Measures the firmware and updates for authenticity
- Recovery – Recovers a corrupted image to a known-safe image
- Protection – Monitors the system to ensure the known-good firmware is not maliciously written

These enhanced protection capabilities are implemented using a dedicated, discrete security processor whose implementation has been rigorously validated by leading third-party security firms. Security evaluation results and design details are available for customer review – providing unprecedented transparency and assurance.

## Intel Transparent Supply Chain

Add a layer of protection in your data center and have peace of mind that the server hardware you bring into it is safe authentic and with documented, testable, and provable origin.

Lenovo has one of the world's best supply chains, as ranked by Gartner Group, backed by extensive and mature supply chain security programs that exceed industry norms and US Government standards. Now we are the first Tier 1 manufacturer to offer Intel® Transparent Supply Chain in partnership with Intel, offering you an unprecedented degree of supply chain transparency and assurance.

To enable Intel Transparent Supply Chain for the Intel-based servers in your order, add the following feature code in the [DCSC configurator](#), under the Security tab.

Table 63. Intel Transparent Supply Chain ordering information

Feature code	Description
BB0P	Intel Transparent Supply Chain

For more information on this offering, see the paper *Introduction to Intel Transparent Supply Chain on Lenovo ThinkSystem Servers*, available from <https://lenovopress.com/lp1434-introduction-to-intel-transparent-supply-chain-on-thinksystem-servers>.

## Security standards

The ST650 V2 supports the following security standards and capabilities:

- **Industry Standard Security Capabilities**
  - Intel CPU Enablement
    - AES-NI (Advanced Encryption Standard New Instructions)
    - CBnT (Converged Boot Guard and Trusted Execution Technology)
    - CET (Control flow Enforcement Technology)
    - Hardware-based side channel attack resilience enhancements
    - MKTME/TME (Multi-Key Total Memory Encryption)
    - SGX (Software Guard eXtensions)
    - SGX-TEM (Trusted Environment Mode)
    - TDX (Trust Domain Extensions)
    - TXT (Trusted eXecution Technology)
    - VT (Virtualization Technology)
    - XD (eXecute Disable)
  - Microsoft Windows Security Enablement
    - Credential Guard
    - Device Guard
    - Host Guardian Service
  - TCG (Trusted Computing Group) TPM (Trusted Platform Module) 2.0
  - UEFI (Unified Extensible Firmware Interface) Forum Secure Boot
- **Hardware Root of Trust and Security**
  - Independent security subsystem providing platform-wide NIST SP800-193 compliant Platform Firmware Resilience (PFR)
  - Host domain RoT supplemented by AMD Platform Secure Boot (PSB)
  - Management domain RoT supplemented by System x-derived Immutable Boot Block
- **Platform Security**
  - Boot and run-time firmware integrity monitoring with rollback to known-good firmware (e.g., “self-healing”)
  - Non-volatile storage bus security monitoring and filtering

- Resilient firmware implementation, such as to detect and defeat unauthorized flash writes or SMM (System Management Mode) memory incursions
- Patent-pending IPMI KCS channel privileged access authorization
- Host and management domain authorization, including integration with CyberArk for enterprise password management
- KMIP (Key Management Interoperability Protocol) compliant, including support for IBM SKLM and Thales KeySecure
- Reduced “out of box” attack surface
- Configurable network services

For more information on platform security, see the paper “How to Harden the Security of your ThinkSystem Server and Management Applications” available from <https://lenovopress.com/lp1260-how-to-harden-the-security-of-your-thinksystem-server>.

- **Standards Compliance and/or Support**

- NIST SP800-131A rev 2 “Transitioning the Use of Cryptographic Algorithms and Key Lengths”
- NIST SP800-147B “BIOS Protection Guidelines for Servers”
- NIST SP800-193 “Platform Firmware Resiliency Guidelines”
- ISO/IEC 11889 “Trusted Platform Module Library”
- Common Criteria TCG Protection Profile for “PC Client Specific TPM 2.0”
- European Union Commission Regulation 2019/424 (“ErP Lot 9”) “Ecodesign Requirements for Servers and Data Storage Products” Secure Data Deletion
- Optional FIPS 140-2 validated Self-Encrypting Disks (SEDs) with external KMIP-based key management

- **Product and Supply Chain Security**

- Suppliers validated through Lenovo’s Trusted Supplier Program
- Developed in accordance with Lenovo’s Secure Development Lifecycle (LSDL)
- Continuous firmware security validation through automated testing, including static code analysis, dynamic network and web vulnerability testing, software composition analysis, and subsystem-specific testing, such as UEFI security configuration validation
- Ongoing security reviews by US-based security experts, with attestation letters available from our third-party security partners
- Digitally signed firmware, stored and built on US-based infrastructure and signed on US-based Hardware Security Modules (HSMs)
- Manufacturing transparency via Intel Transparent Supply Chain (for details, see <https://lenovopress.com/lp1434-introduction-to-intel-transparent-supply-chain-on-lenovo-thinksystem-servers>)
- TAA (Trade Agreements Act) compliant manufacturing, by default in Mexico for North American markets with additional US and EU manufacturing options
- US 2019 NDAA (National Defense Authorization Act) Section 889 compliant

## Keyboards and Mice

The following table lists the supported full-sized USB keyboards and mice available for Lenovo ThinkSystem servers.

The keyboards have the following features:

- Full-sized 104-key keyboard with 3 special Windows keys
- 3 LEDs for caps lock, scroll lock and num lock



- Wired USB connection with 1.8m cable
- Adjustable feet at the rear of the keyboard

**Tip:** For keyboards that fit in the rack-mounted console kit, see the [KVM console options](#) section, or the [1U 18.5-inch Standard Media Console](#) product guide.

Table 64. Lenovo Preferred Pro USB Full-sized keyboards - ThinkSystem

Part number	Feature code	Description
Mice		
7M57A04698	B0LN	ThinkSystem Optical Wheel Mouse - USB
Keyboards		
7ZB7A05521	AXTM	ThinkSystem Pref. Pro Keyboard USB - Arabic 253 RoHS v2
7ZB7A05520	AXTN	ThinkSystem Pref. Pro Keyboard USB - Arabic French 462 RoHS v2
7ZB7A05519	AXTP	ThinkSystem Pref. Pro Keyboard USB - Belgium/French 120 RoHS v2
7ZB7A05518	AXTQ	ThinkSystem Pref. Pro Keyboard USB - Belgium/UK 120 RoHS v2
7ZB7A05517	AXTR	ThinkSystem Pref. Pro Keyboard USB - Brazil/Portuguese 275 RoHS v2
7ZB7A05515	AXTS	ThinkSystem Pref. Pro Keyboard USB - Bulgarian 442 RoHS v2
7ZB7A05511	AXTU	ThinkSystem Pref. Pro Keyboard USB - Czech RoHS v2
7ZB7A05509	AXTV	ThinkSystem Pref. Pro Keyboard USB - Danish 159 RoHS v2
7ZB7A05508	AXTW	ThinkSystem Pref. Pro Keyboard USB - Dutch 143 RoHS v2
7ZB7A05506	AXTX	ThinkSystem Pref. Pro Keyboard USB - French 189 roHS v2
7ZB7A05496	AXTZ	ThinkSystem Pref. Pro Keyboard USB - French Canadian 058 French RoHS v2
7ZB7A05504	AXTY	ThinkSystem Pref. Pro Keyboard USB - French Canadian 445 Multilingual RoHS v2
7ZB7A05495	AXU0	ThinkSystem Pref. Pro Keyboard USB - German 129 RoHS v2
7ZB7A05494	AXU1	ThinkSystem Pref. Pro Keyboard USB - Greek 319 RoHS v2
7ZB7A05493	AXU2	ThinkSystem Pref. Pro Keyboard USB - Hebrew RoHS v2
7ZB7A05492	AXU3	ThinkSystem Pref. Pro Keyboard USB - Hungarian 208 RoHS v2
7ZB7A05491	AXU4	ThinkSystem Pref. Pro Keyboard USB - Iceland 197 RoHS v2
7ZB7A05490	AXU5	ThinkSystem Pref. Pro Keyboard USB - Italy 141 RoHS v2
7ZB7A05489	AXU6	ThinkSystem Pref. Pro Keyboard USB - Japanese 194 RoHS
7ZB7A05488	AXU7	ThinkSystem Pref. Pro Keyboard USB - Korean 413 RoHS v2
7ZB7A05487	AXU8	ThinkSystem Pref. Pro Keyboard USB - LA Spanish 171 RoHS v2
7ZB7A05486	AXU9	ThinkSystem Pref. Pro Keyboard USB - Norwegian 155 RoHS v2
7ZB7A05485	AXUA	ThinkSystem Pref. Pro Keyboard USB - Polish RoHS v2
7ZB7A05484	AXUB	ThinkSystem Pref. Pro Keyboard USB - Portuguese 163 RoHS v2
7ZB7A05483	AXUC	ThinkSystem Pref. Pro Keyboard USB - Romanian RoHS v2
7ZB7A05482	AXUD	ThinkSystem Pref. Pro Keyboard USB - Russian/Cyrillic 441 RoHS v2
7ZB7A05481	AXUE	ThinkSystem Pref. Pro Keyboard USB - Serbian/Cyrillic RoHS v2
7ZB7A05480	AXUF	ThinkSystem Pref. Pro Keyboard USB - Slovak 245 RoHS v2
7ZB7A05471	AXUQ	ThinkSystem Pref. Pro Keyboard USB - Slovenian 234 RoHS v2
7ZB7A05479	AXUG	ThinkSystem Pref. Pro Keyboard USB - Spanish 172 RoHS v2
7ZB7A05478	AXUH	ThinkSystem Pref. Pro Keyboard USB - Swedish/Finn 153 RoHS v2
7ZB7A05477	AXUJ	ThinkSystem Pref. Pro Keyboard USB - Swiss F/G 150 RoHS v2

Part number	Feature code	Description
7ZB7A05476	AXUK	ThinkSystem Pref. Pro Keyboard USB - Thailand 191 RoHS v2
7ZB7A05513	AXTT	ThinkSystem Pref. Pro Keyboard USB - Trad Chinese/US 467 RoHS v2
7ZB7A05474	AXUM	ThinkSystem Pref. Pro Keyboard USB - Turkish 179 RoHS v2
7ZB7A05475	AXUL	ThinkSystem Pref. Pro Keyboard USB - Turkish 440 RoHS v2
7ZB7A05473	AXUN	ThinkSystem Pref. Pro Keyboard USB - UK English 166 RoHS v2
7ZB7A05522	AXTL	ThinkSystem Pref. Pro Keyboard USB - US English 103P RoHS v2
7ZB7A05472	AXUP	ThinkSystem Pref. Pro Keyboard USB - US Euro 103P RoHS v2

## Rack installation

The ST650 V2 can also be installed in the rack with the Rack Enablement Kit. The resulting server is a 4U rack-mountable server, as shown in the following figure.

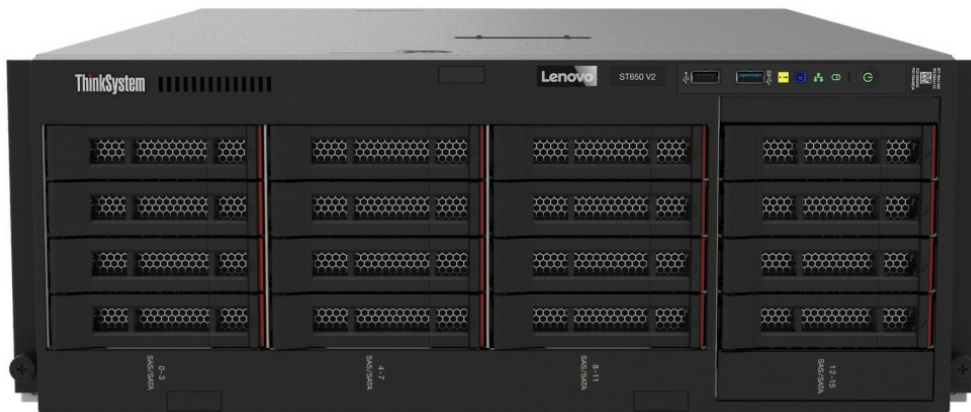

Figure 13. ThinkSystem ST650 V2 with Rack Conversion Kit installed

The part numbers are summarized in the following table.

**No CMA support:** The ST650 V2 does not support the use of a cable management arm.

Table 65. Rack installation options

Part number	Feature code	Description and contents
4M27A60835	BA5Z	ThinkSystem ST650 V2 Tower to Rack Conversion Kit <ul style="list-style-type: none"> <li>• ST650 V2 Tower to Rack Conversion Kit (EIA brackets, labels)</li> <li>• ST650 V2 Static Rail</li> <li>• ST650 V2 Rail Mylar (affix to rails to reduce friction)</li> </ul>

The rail kit has the specifications listed in the following table.

Table 66. Rail kit specifications

Feature	ThinkSystem ST650 V2 Static Rail
Part number	Part of 4M27A60835 (Feature code BA5V)
Rail type	Static (fixed, no slide)
Toolless installation	Yes
Cable Management Arm (CMA) support	No support
In-rack server maintenance	No
1U PDU support	Yes
0U PDU support	Limited*
Rack type	Lenovo and IBM 4-post, IEC standard-compliant
Mounting holes	Square or round
Mounting flange thickness	2 mm - 3.3 mm (0.08 - 0.13 in.)
Supported rack range	559 mm - 914 mm (22 - 36 in.)
Rail length***	600 mm (23.6 in.)

\* For 0U PDU support, the rack must be at least 1100 mm (43.31 in.) deep.

\*\*\* Measured when mounted on the rack, from the front surface of the front mounting flange to the rearmost point of the rail.

Supported rack cabinets are listed in the [Rack cabinets](#) section.

If you configured your server as a rack server, but later wish to convert it to a tower, use the kit in the following table to add the recommended stabilization feet.

Table 67. Stabilization feet for ST650 V2

Part number	Description
4M27A60833	ThinkSystem ST650 V2 Rack to Tower Conversion Kit <ul style="list-style-type: none"> <li>● Contains 4 stabilization feet</li> </ul>

## Operating system support

The server supports the following operating systems:

- Microsoft Windows Server 2016
- Microsoft Windows Server 2019
- Microsoft Windows Server 2022
- Red Hat Enterprise Linux 7.9
- Red Hat Enterprise Linux 8.2
- Red Hat Enterprise Linux 8.3
- Red Hat Enterprise Linux 8.4
- Red Hat Enterprise Linux 8.5
- SUSE Linux Enterprise Server 12 SP5
- SUSE Linux Enterprise Server 12 Xen SP5
- SUSE Linux Enterprise Server 15 SP2
- SUSE Linux Enterprise Server 15 SP3
- SUSE Linux Enterprise Server 15 Xen SP2
- SUSE Linux Enterprise Server 15 Xen SP3
- VMware ESXi 6.7 U3
- VMware ESXi 7.0 U2
- VMware ESXi 7.0 U3

For a complete list of supported, certified and tested operating systems, plus additional details and links to relevant web sites, see the Operating System Interoperability Guide:

<https://lenovopress.com/osig#servers=st650-v2-7z75-7z74>

For configure-to-order configurations, the server can be preloaded with VMware ESXi installed on M.2 cards. Ordering information is listed in the following table.

Table 68. VMware ESXi preload

Part number	Feature code	Description
CTO only	B88T	VMware ESXi 6.7 U3 (factory installed)
CTO only	BHSR	VMware ESXi 7.0 U2 (Factory Installed)

You can download supported VMware vSphere hypervisor images from the following web page and load it on the M.2 drives drives using the instructions provided:

[https://vmware.lenovo.com/content/custom\\_iso/](https://vmware.lenovo.com/content/custom_iso/)

## Physical and electrical specifications

The ST650 V2 has the following overall physical dimensions, including tower feet, excluding components that extend outside the standard chassis, such as power supply handles:

- Width: 175 mm (6.9 inches)
- Height: 462 mm (18.2 inches)
- Depth: 734 mm (28.9 inches)

The following table lists the detailed dimensions. See the figure below for the definition of each dimension.

Table 69. Detailed dimensions

Dimension	Description
175 mm	$X_a$ = Width, using widest features (not including feet)
248 mm	$X_b$ = Width, with chassis feet extended
462 mm	$Y_a$ = Height, from bottom of feet to top of chassis body
448 mm	$Y_b$ = Height, from bottom of chassis body to top of chassis body
713 mm	$Z_a$ = Depth, from front door to most rearward I/O port surface
734 mm	$Z_b$ = Depth, from front door to deepest feature of the chassis body feature
758 mm	$Z_c$ = Depth, from front door to deepest feature such as power supply handle
23 mm	$Z_e$ = Depth, front door to front plate of chassis body

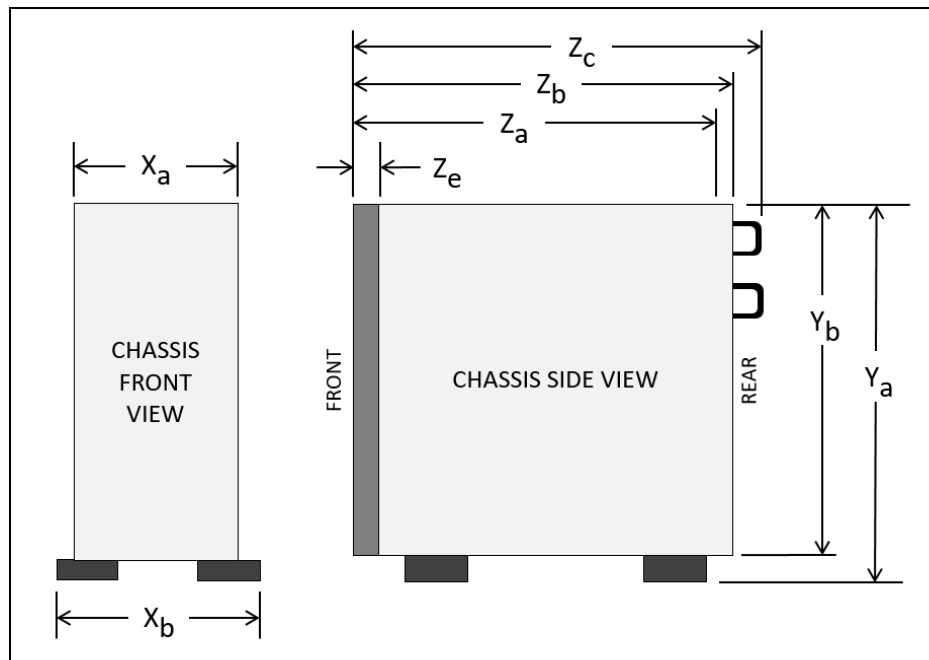

Figure 14. Server dimension

The shipping dimensions (cardboard packaging) of the ST650 V2 are as follows:

- Width: 597 mm (23.5 inches)
- Height: 374 mm (14.7 inches)
- Depth: 996 mm (39.2 inches)

The server has the following weight:

- Maximum weight:
  - 2.5-inch configuration: 39.28 kg (86.60 lb) maximum
  - 3.5-inch configuration: 46.23 kg (101.92 lb) maximum

Electrical specifications for AC input power supplies:

- Input voltage:
  - 100 to 127 (nominal) Vac, 50 Hz or 60 Hz
  - 200 to 240 (nominal) Vac, 50 Hz or 60 Hz
  - 180 to 300 Vdc (China only)
- Inlet current:

- 100-127 V:
  - 750W Platinum power supply: 8.4 A
  - 750W Titanium power supply: Not supported
  - 1100W power supply: 12 A\*
  - 1800W power supply: Not supported
  - 2400W power supply: Not supported
- 200-240 V:
  - 750W Platinum power supply: 4.1 A
  - 750W Titanium power supply: 4 A
  - 1100W power supply: 6 A
  - 1800W power supply: 10 A
  - 2400W power supply: 14 A

\* In China, this power supply cannot exceed 10 A current.

## Operating environment

The ST650 V2 server complies with ASHRAE Class A2 specifications with most configurations, and depending on the hardware configuration, also complies with ASHRAE Class A3 and Class A4 specifications.

The server is supported in the following environment:

- Air temperature:
  - Operating:
    - ASHRAE Class A2: 10°C to 35°C (50°F to 95°F); the maximum ambient temperature decreases by 1°C for every 300 m (984 ft) increase in altitude above 900 m (2,953 ft).
    - ASHRAE Class A3: 5°C to 40°C (41°F to 104°F); the maximum ambient temperature decreases by 1°C for every 175 m (574 ft) increase in altitude above 900 m (2,953 ft).
    - ASHRAE Class A4: 5°C to 45°C (41°F to 113°F); the maximum ambient temperature decreases by 1°C for every 125 m (410 ft) increase in altitude above 900 m (2,953 ft).
  - Server off: 5°C to 45°C (41°F to 113°F)
  - Shipment/storage: -40°C to 60°C (-40°F to 140°F)
- Maximum altitude: 3,050 m (10,000 ft)
- Relative Humidity (non-condensing):
  - Operating
    - ASHRAE Class A2: 8% to 80%; maximum dew point: 21°C (70°F)
    - ASHRAE Class A3: 8% to 85%; maximum dew point: 24°C (75°F)
    - ASHRAE Class A4: 8% to 90%; maximum dew point: 24°C (75°F)
  - Shipment/storage: 8% to 90%

The following table lists ambient temperature requirements by component type.

Table 70. Ambient temperature requirements

	Ambient temperature of 30 °C or lower	Ambient temperature of 35 °C or lower	Ambient temperature of 40 °C or lower	Ambient temperature of 45 °C or lower
<b>Processor</b>	Processors with 205 to 250W TDP	Processors with 165 to 195W TDP	Processors with 135 to 150W TDP	Processors with 120W TDP or lower
<b>System Memory</b>	32x DIMMs, each 64 GB or less	32x DIMMs, each 64 GB or less	32x DIMMs, each 32 GB or less	32x DIMMs, each 32 GB or less
<b>Persistent Memory</b>	Supported	Supported	No Persistent Memory support	No Persistent Memory support
<b>Drive backplanes</b>	All supported	All supported	Maximum of 2x backplanes/backplates	Maximum of 2x backplanes/backplates
<b>GPUs</b>	Supported	No GPU support	No GPU support	No GPU support
<b>NVMe Retimer adapters</b>	Supported	Supported	No NVMe retimer support	No NVMe retimer support
<b>ConnectX-6 adapters</b>	Supported	Supported	No ConnectX-6 adapters	No ConnectX-6 adapters
<b>Fibre Channel adapters</b>	Supported	Supported	No Fibre Channel adapter support	No Fibre Channel adapter support
<b>NVMe drives</b>	Supported	Supported	No NVMe drive support (includes M.2)	No NVMe drive support (includes M.2)
<b>RAID/SAS HBA adapters</b>	Supported	Supported	Supported	Supported
<b>Ethernet adapters</b>	Supported	Supported	Supported	Supported

### Acoustic noise emissions

The server has the following acoustic noise emissions declaration:

- Sound power level ( $L_{WAd}$ ):
  - Idling: 5.0 Bel (Minimum), 5.6 Bel (Typical), 7.2 Bel (GPU)
  - Operating: 5.6 Bel (Minimum), 5.6 Bel (Typical), 8.5 Bel (GPU)
- Sound pressure level ( $L_{pAm}$ ):
  - Idling: 37 dBA (Minimum), 41 dBA (Typical), 57 dBA (GPU)
  - Operating: 41 dBA (Minimum), 41 dBA (Typical), 69 dBA (GPU)

Notes:

- These sound levels were measured in controlled acoustical environments according to procedures specified by ISO7779 and are reported in accordance with ISO 9296.
- The declared acoustic sound levels are based on the specified configurations, which may change slightly depending on configuration/conditions.

- Min configuration: 1x 105W processor, 4x 16 GB DIMMs, 2x 480 GB SSD drives, 2-port onboard 10Gb Ethernet, 1x 750W power supply
- Typical configuration: 2x 125W processors, 16x 32 GB DIMMs, 8x SAS hard disk drives, 1x 530-8i RAID Adapter, 2-port onboard 10Gb Ethernet, 2x 750W power supplies
- GPU configuration: 2x 165W processors, 32x 64 GB DIMMs, 8x SAS hard disk drives, 1x 930-8i RAID adapter, 2-port onboard 10Gb Ethernet, 8x NVIDIA Tesla T4 GPU adapters, 2x 1800W power supplies
- The declared acoustic noise levels may increase greatly, if high-power components are installed such as high-power NICs, high-power processors and GPUs.
- Government regulations (such as those prescribed by OSHA or European Community Directives) may govern noise level exposure in the workplace and may apply to you and your server installation. The actual sound pressure levels in your installation depend upon a variety of factors, including the number of racks in the installation; the size, materials, and configuration of the room; the noise levels from other equipment; the room ambient temperature, and employee's location in relation to the equipment. Further, compliance with such government regulations depends on a variety of additional factors, including the duration of employees' exposure and whether employees wear hearing protection. Lenovo recommends that you consult with qualified experts in this field to determine whether you are in compliance with the applicable regulations.

### Shock and vibration

The server has the following vibration and shock limits:

- Vibration:
  - Operating: 0.21 G rms at 5 Hz to 500 Hz for 15 minutes across 3 axes
  - Non-operating: 1.04 G rms at 2 Hz to 200 Hz for 15 minutes across 6 surfaces
- Shock:
  - Operating: 15 G for 3 milliseconds in each direction (positive and negative X, Y, and Z axes)
  - Non-operating:
    - Server weight 12 kg - 22 kg: 50 G for 152 in./sec velocity change across 6 surfaces
    - Server weight 23 kg - 31 kg: 35 G for 152 in./sec velocity change across 6 surfaces
    - Server weight 32 kg - 68 kg: 35 G for 136 in./sec velocity change across 6 surfaces

### Particulate contamination

Airborne particulates (including metal flakes or particles) and reactive gases acting alone or in combination with other environmental factors such as humidity or temperature might damage the system that might cause the system to malfunction or stop working altogether.

The following specifications indicate the limits of particulates that the system can tolerate:

- Reactive gases:
  - The reactivity rate of copper coupons shall be less than 200 Angstroms per month (Å/month)
  - The reactivity rate of silver coupons shall be less than 200 Å/month
- Airborne particulates:
  - The room air should be continuously filtered with MERV 8 filters.
  - Air entering a data center should be filtered with MERV 11 or preferably MERV 13 filters.
  - The deliquescent relative humidity of the particulate contamination should be more than 60% RH
  - Data centers must be free of zinc whiskers

For additional information, see the Specifications section of the Setup Guide for the server, available from the Lenovo ThinkSystem Information Center, <https://thinksystem.lenovofiles.com/help/index.jsp>

### Warranty and Support

The ST650 V2 has a 1-year or 3-year warranty based on the machine type of the system:



- 7Z75 - 1 year warranty
- 7Z74 - 3 year warranty

The standard warranty terms are customer-replaceable unit (CRU) and onsite (for field-replaceable units FRUs only) with standard call center support during normal business hours and 9x5 Next Business Day Parts Delivered.

Lenovo's additional support services provide a sophisticated, unified support structure for your data center, with an experience consistently ranked number one in customer satisfaction worldwide. Available offerings include:

- **Premier Support**

Premier Support provides a Lenovo-owned customer experience and delivers direct access to technicians skilled in hardware, software, and advanced troubleshooting, in addition to the following:

- Direct technician-to-technician access through a dedicated phone line
- 24x7x365 remote support
- Single point of contact service
- End to end case management
- Third-party collaborative software support
- Online case tools and live chat support
- On-demand remote system analysis

- **Warranty Upgrade (Preconfigured Support)**

Services are available to meet the on-site response time targets that match the criticality of your systems.

- 3, 4, or 5 years of service coverage
- 1-year or 2-year post-warranty extensions
- **Foundation Service:** 9x5 service coverage with next business day onsite response. YourDrive YourData is an optional extra (see below).
- **Essential Service:** 24x7 service coverage with 4-hour onsite response or 24-hour committed repair (available only in select markets). Bundled with YourDrive YourData.
- **Advanced Service:** 24x7 service coverage with 2-hour onsite response or 6-hour committed repair (available only in select markets). Bundled with YourDrive YourData.

- **Managed Services**

Lenovo Managed Services provides continuous 24x7 remote monitoring (plus 24x7 call center availability) and proactive management of your data center using state-of-the-art tools, systems, and practices by a team of highly skilled and experienced Lenovo services professionals.

Quarterly reviews check error logs, verify firmware & OS device driver levels, and software as needed. We'll also maintain records of latest patches, critical updates, and firmware levels, to ensure you systems are providing business value through optimized performance.

- **Technical Account Management (TAM)**

A Lenovo Technical Account Manager helps you optimize the operation of your data center based on a deep understanding of your business. You gain direct access to your Lenovo TAM, who serves as your single point of contact to expedite service requests, provide status updates, and furnish reports to track incidents over time. In addition, your TAM will help proactively make service recommendations and manage your service relationship with Lenovo to make certain your needs are met.

- **Enterprise Server Software Support**

Enterprise Software Support is an additional support service providing customers with software support on Microsoft, Red Hat, SUSE, and VMware applications and systems. Around the clock availability for critical problems plus unlimited calls and incidents helps customers address challenges fast, without incremental costs. Support staff can answer troubleshooting and diagnostic questions, address product comparability and interoperability issues, isolate causes of problems, report defects to software vendors, and more.

- **YourDrive YourData**

Lenovo's YourDrive YourData is a multi-drive retention offering that ensures your data is always under your control, regardless of the number of drives that are installed in your Lenovo server. In the unlikely event of a drive failure, you retain possession of your drive while Lenovo replaces the failed drive part. Your data stays safely on your premises, in your hands. The YourDrive YourData service can be purchased in convenient bundles and is optional with Foundation Service. It is bundled with Essential Service and Advanced Service.

- **Health Check**

Having a trusted partner who can perform regular and detailed health checks is central to maintaining efficiency and ensuring that your systems and business are always running at their best. Health Check supports Lenovo-branded server, storage, and networking devices, as well as select Lenovo-supported products from other vendors that are sold by Lenovo or a Lenovo-Authorized Reseller.

Examples of region-specific warranty terms are second or longer business day parts delivery or parts-only base warranty.

If warranty terms and conditions include onsite labor for repair or replacement of parts, Lenovo will dispatch a service technician to the customer site to perform the replacement. Onsite labor under base warranty is limited to labor for replacement of parts that have been determined to be field-replaceable units (FRUs). Parts that are determined to be customer-replaceable units (CRUs) do not include onsite labor under base warranty.

If warranty terms include parts-only base warranty, Lenovo is responsible for delivering only replacement parts that are under base warranty (including FRUs) that will be sent to a requested location for self-service. Parts-only service does not include a service technician being dispatched onsite. Parts must be changed at customer's own cost and labor and defective parts must be returned following the instructions supplied with the spare parts.

Lenovo Service offerings are region-specific. Not all preconfigured support and upgrade options are available in every region. For information about Lenovo service upgrade offerings that are available in your region, refer to the following resources:

- Service part numbers in Lenovo Data Center Solution Configurator (DCSC):  
<http://dcsc.lenovo.com/#!/services>
- Lenovo Services Availability Locator  
<http://lenovolocator.com/>

For service definitions, region-specific details, and service limitations, please refer to the following documents:

- Lenovo Statement of Limited Warranty for Infrastructure Solutions Group (ISG) Servers and System Storage  
<http://pcsupport.lenovo.com/us/en/solutions/ht503310>
- Lenovo Data Center Services Agreement  
<http://support.lenovo.com/us/en/solutions/ht116628>

## Services

Lenovo Services is a dedicated partner to your success. Our goal is to reduce your capital outlays, mitigate your IT risks, and accelerate your time to productivity.

**Note:** Some service options may not be available in all countries. For more information, go to <https://www.lenovo.com/services>. For information about Lenovo service upgrade offerings that are available in your region, contact your local Lenovo sales representative or business partner.

Here's a more in-depth look at what we can do for you:

- **Asset Recovery Services**

Asset Recovery Services (ARS) helps customers recover the maximum value from their end-of-life equipment in a cost-effective and secure way. On top of simplifying the transition from old to new equipment, ARS mitigates environmental and data security risks associated with data center equipment disposal. Lenovo ARS is a cash-back solution for equipment based on its remaining market value, yielding maximum value from aging assets and lowering total cost of ownership for your customers. For more information, see the ARS page, <https://lenovopress.com/lp1266-reduce-e-waste-and-grow-your-bottom-line-with-lenovo-ars>.

- **Assessment Services**

An Assessment helps solve your IT challenges through an onsite, multi-day session with a Lenovo technology expert. We perform a tools-based assessment which provides a comprehensive and thorough review of a company's environment and technology systems. In addition to the technology based functional requirements, the consultant also discusses and records the non-functional business requirements, challenges, and constraints. Assessments help organizations like yours, no matter how large or small, get a better return on your IT investment and overcome challenges in the ever-changing technology landscape.

- **Design Services**

Professional Services consultants perform infrastructure design and implementation planning to support your strategy. The high-level architectures provided by the assessment service are turned into low level designs and wiring diagrams, which are reviewed and approved prior to implementation. The implementation plan will demonstrate an outcome-based proposal to provide business capabilities through infrastructure with a risk-mitigated project plan.

- **Basic Hardware Installation**

Lenovo experts can seamlessly manage the physical installation of your server, storage, or networking hardware. Working at a time convenient for you (business hours or off shift), the technician will unpack and inspect the systems on your site, install options, mount in a rack cabinet, connect to power and network, check and update firmware to the latest levels, verify operation, and dispose of the packaging, allowing your team to focus on other priorities.

- **Deployment Services**

When investing in new IT infrastructures, you need to ensure your business will see quick time to value with little to no disruption. Lenovo deployments are designed by development and engineering teams who know our Products & Solutions better than anyone else, and our technicians own the process from delivery to completion. Lenovo will conduct remote preparation and planning, configure & integrate systems, validate systems, verify and update appliance firmware, train on administrative tasks, and provide post-deployment documentation. Customer's IT teams leverage our skills to enable IT staff to transform with higher level roles and tasks.

- **Integration, Migration, and Expansion Services**

Move existing physical & virtual workloads easily, or determine technical requirements to support increased workloads while maximizing performance. Includes tuning, validation, and documenting ongoing run processes. Leverage migration assessment planning documents to perform necessary migrations.

## Regulatory compliance

The ST650 V2 conforms to the following standards:

- ANSI/UL 62368-1
- IEC 62368-1 (CB Certificate and CB Test Report)
- FCC - Verified to comply with Part 15 of the FCC Rules, Class A
- Canada ICES-003, issue 7, Class A
- CSA C22.2 No. 62368-1
- CISPR 32, Class A, CISPR 35
- Japan VCCI, Class A
- Taiwan BSMI CNS13438, Class A; CNS14336-1; Section 5 of CNS15663
- CE, UKCA Mark (EN55032 Class A, EN62368-1, EN55024, EN55035, EN61000-3-2, EN61000-3-3, (EU) 2019/424, and EN50581-1 (RoHS))
- Korea KN32, Class A, KN35
- Russia, Belorussia and Kazakhstan, TP EAC 037/2016 (for RoHS)
- Russia, Belorussia and Kazakhstan, EAC: TP TC 004/2011 (for Safety); TP TC 020/2011 (for EMC)
- Australia/New Zealand AS/NZS CISPR 32, Class A; AS/NZS 62368.1
- UL Green Guard, UL2819
- Energy Star 3.0
- EPEAT (NSF/ ANSI 426) Bronze
- China CCC certificate, GB17625.1; GB4943.1; GB/T9254
- China CECP certificate, CQC3135
- China CELP certificate, HJ 2507-2011
- Japanese Energy-Saving Act
- Mexico NOM-019
- TUV-GS (EN62368-1, and EK1-ITB2000)
- India BIS 13252 (Part 1)
- Germany GS
- Brazil INMETRO
- South Africa NRCS LOA
- Ukraine UkrCEPRO
- Morocco CMIM Certification (CM)
- EU2019/424 Energy Related Product (ErP Lot9)

## External drive enclosures

The server supports attachment to external drive enclosures using a RAID controller with external ports or a SAS host bus adapter. Adapters supported by the server are listed in the [SAS adapters for external storage](#) section.

**Note:** Information provided in this section is for ordering reference purposes only. For the operating system and adapter support details, refer to the interoperability matrix for a particular storage enclosure that can be found on the Lenovo Data Center Support web site:

<http://datacentersupport.lenovo.com>

Table 71. External drive enclosures

Description	Part number		
	Worldwide	Japan	PRC
Lenovo Storage D1212 LFF Disk Expansion with Dual SAS IO Modules	4587A11	4587A1J	4587A1C
Lenovo Storage D1224 SFF Disk Expansion with Dual SAS IO Modules	4587A31	4587A3J	4587A3C
Lenovo Storage D3284 4TB x 84 HD Expansion Enclosure	641311F		
Lenovo Storage D3284 6TB x 84 HD Expansion Enclosure	641312F		
Lenovo Storage D3284 8TB x 84 HD Expansion Enclosure	641313F		
Lenovo Storage D3284 10TB x 84 HD Expansion Enclosure	641314F		

For details about supported drives, adapters, and cables, see the following Lenovo Press Product Guides:

- Lenovo Storage D1212 and D1224  
<http://lenovopress.com/lp0512>
- Lenovo Storage D3284  
<http://lenovopress.com/lp0513>

## External storage systems

Lenovo offers the ThinkSystem DE Series and ThinkSystem DM Series external storage systems for high-performance storage. See the DE Series and DM Series product guides for specific controller models, expansion enclosures and configuration options:

- ThinkSystem DE Series Storage  
<https://lenovopress.com/storage/thinksystem/de-series#rt=product-guide>
- ThinkSystem DM Series Storage  
<https://lenovopress.com/storage/thinksystem/dm-series#rt=product-guide>

## External backup units

The server supports both USB-attached RDX backup units and SAS-attached tape drives.

The following table lists the available external SAS tape backup options.

**Tip:** Verify the end-to-end support of an IBM tape backup solution through the IBM System Storage Interoperation Center (SSIC): <http://www.ibm.com/systems/support/storage/ssic>

Table 72. External SAS backup options

Part number	Description
External SAS tape backup drives	
6160S6E	IBM TS2260 Tape Drive Model H6S
6160S7E	IBM TS2270 Tape Drive Model H7S
6160S8E	IBM TS2280 Tape Drive Model H8S
6160S9E	IBM TS2290 Tape Drive Model H8S
External SAS tape backup autoloaders	
6171S6R	IBM TS2900 Tape Autoloader w/LTO6 HH SAS
6171S7R	IBM TS2900 Tape Autoloader w/LTO7 HH SAS
6171S8R	IBM TS2900 Tape Autoloader w/LTO8 HH SAS
6171S9R	IBM TS2900 Tape Autoloader w/LTO9 HH SAS
External tape backup libraries	
6741A1F	IBM TS4300 3U Tape Library-Base Unit
SAS backup drives for TS4300 Tape Library	
01KP934	LTO 6 HH SAS Drive
01KP937	LTO 7 HH SAS Drive
01KP953	LTO 8 HH SAS Drive
02JH836	LTO 9 HH SAS Drive

For more information, see the list of Product Guides in the Backup units category:  
<https://lenovopress.com/servers/options/backup>

The following table lists the external RDX backup options available.

Table 73. External RDX dock and cartridges

Part number	Feature code	Description
External RDX docks		
4T27A10725	B32R	ThinkSystem RDX External USB 3.0 Dock (No cartridge included with the drive)
Cartridges		
7TP7A01601	AVF8	ThinkSystem RDX 500GB Cartridge
7TP7A01602	AVF1	ThinkSystem RDX 1TB Cartridge
7TP7A01603	AVF0	ThinkSystem RDX 2TB Cartridge
7TP7A04318	AXD1	ThinkSystem RDX 4TB Cartridge

For more information, see the Lenovo RDX USB 3.0 Disk Backup Solution product guide:  
<https://lenovopress.com/tips0894-rdx-usb-30>

## Fibre Channel SAN switches

Lenovo offers the ThinkSystem DB Series of Fibre Channel SAN switches for high-performance storage expansion. See the DB Series product guides for models and configuration options:

- ThinkSystem DB Series SAN Switches:  
<https://lenovopress.com/storage/switches/rack#rt=product-guide>

## Uninterruptible power supply units

The following table lists the uninterruptible power supply (UPS) units that are offered by Lenovo.

Table 74. Uninterruptible power supply units

Part number	Description
Tower UPS units	
55951AX	T1kVA Tower UPS (100-125VAC)
55951KX	T1kVA Tower UPS (200-240VAC)
55952AX	T1.5kVA Tower UPS (100-125VAC)
55952KX	T1.5kVA Tower UPS (200-240VAC)
Rack-mounted or tower UPS units	
55941AX	RT1.5kVA 2U Rack or Tower UPS (100-125VAC)
55941KX	RT1.5kVA 2U Rack or Tower UPS (200-240VAC)
55942AX	RT2.2kVA 2U Rack or Tower UPS (100-125VAC)
55942KX	RT2.2kVA 2U Rack or Tower UPS (200-240VAC)
55943AX	RT3kVA 2U Rack or Tower UPS (100-125VAC)
55943KX	RT3kVA 2U Rack or Tower UPS (200-240VAC)
55945KX	RT5kVA 3U Rack or Tower UPS (200-240VAC)
55946KX	RT6kVA 3U Rack or Tower UPS (200-240VAC)
55948KX	RT8kVA 6U Rack or Tower UPS (200-240VAC)
55949KX	RT11kVA 6U Rack or Tower UPS (200-240VAC)
55948PX	RT8kVA 6U 3:1 Phase Rack or Tower UPS (380-415VAC)
55949PX	RT11kVA 6U 3:1 Phase Rack or Tower UPS (380-415VAC)
Rack-mounted UPS units	
55943KT†	ThinkSystem RT3kVA 2U Standard UPS (200-230VAC) (2x C13 10A, 2x GB 10A, 1x C19 16A outlets)
55943LT†	ThinkSystem RT3kVA 2U Long Backup UPS (200-230VAC) (2x C13 10A, 2x GB 10A, 1x C19 16A outlets)
55946KT†	ThinkSystem RT6kVA 5U UPS (200-230VAC) (2x C13 10A outlets, 1x Terminal Block output)
5594XKT†	ThinkSystem RT10kVA 5U UPS (200-230VAC) (2x C13 10A outlets, 1x Terminal Block output)

† Only available in China and countries in the Asia Pacific region.

For more information, see the list of Product Guides in the UPS category:

<https://lenovopress.com/servers/options/ups>



## Power distribution units

The following table lists the power distribution units (PDUs) that are offered by Lenovo.

Table 75. Power distribution units

Part number	Feature code	Description	ANZ	ASEAN	Brazil	EET	MEA	RUCIS	WE	HTK	INDIA	JAPAN	LA	NA	PRC
<b>0U Basic PDUs</b>															
00YJ776	ATZY	0U 36 C13/6 C19 24A 1 Phase PDU	N	Y	Y	N	N	N	N	N	N	Y	Y	Y	N
00YJ779	ATZX	0U 21 C13/12 C19 48A 3 Phase PDU	N	N	Y	N	N	N	Y	N	N	Y	Y	Y	N
00YJ777	ATZZ	0U 36 C13/6 C19 32A 1 Phase PDU	Y	Y	N	Y	Y	Y	Y	Y	Y	N	N	Y	Y
00YJ778	AU00	0U 21 C13/12 C19 32A 3 Phase PDU	Y	Y	N	Y	Y	Y	Y	Y	Y	N	N	Y	Y
<b>0U Switched and Monitored PDUs</b>															
00YJ783	AU04	0U 12 C13/12 C19 Switched and Monitored 48A 3 Phase PDU	N	N	Y	N	N	N	Y	N	N	Y	Y	Y	N
00YJ781	AU03	0U 20 C13/4 C19 Switched and Monitored 24A 1 Phase PDU	N	N	Y	N	Y	N	Y	N	N	Y	Y	Y	N
00YJ782	AU02	0U 18 C13/6 C19 Switched and Monitored 32A 3 Phase PDU	Y	Y	Y	Y	Y	Y	Y	Y	Y	N	Y	N	Y
00YJ780	AU01	0U 20 C13/4 C19 Switched and Monitored 32A 1 Phase PDU	Y	Y	Y	Y	Y	Y	Y	Y	Y	N	Y	N	Y
<b>1U Switched and Monitored PDUs</b>															
4PU7A81117	BNDV	1U 18 C19/C13 switched and monitored 48A 3P WYE PDU - ETL	N	N	N	N	N	N	N	N	N	N	N	Y	N
4PU7A77467	BLC4	1U 18 C19/C13 Switched and Monitored 80A 3P Delta PDU	N	N	N	N	N	N	N	N	N	Y	N	Y	N
<b>1U Ultra Density Enterprise PDUs (9x IEC 320 C13 + 3x IEC 320 C19 outlets)</b>															
71763NU	6051	Ultra Density Enterprise C19/C13 PDU 60A/208V/3PH	N	N	Y	N	N	N	N	N	N	Y	Y	Y	N
71762NX	6091	Ultra Density Enterprise C19/C13 PDU Module	Y	Y	Y	Y	Y	Y	Y	Y	Y	Y	Y	Y	Y
<b>1U C13 Enterprise PDUs (12x IEC 320 C13 outlets)</b>															
39M2816	6030	DPI C13 Enterprise PDU Plus Module (WW)	Y	Y	Y	Y	Y	Y	Y	Y	Y	Y	Y	Y	Y
39Y8941	6010	DPI C13 Enterprise PDU Module (WW)	Y	Y	Y	Y	Y	Y	Y	Y	Y	Y	Y	Y	Y
<b>1U C19 Enterprise PDUs (6x IEC 320 C19 outlets)</b>															
39Y8948	6060	DPI C19 Enterprise PDU Module (WW)	Y	Y	Y	Y	Y	Y	Y	Y	Y	Y	Y	Y	Y
39Y8923	6061	DPI Three-phase 60A/208V C19 Enterprise PDU (US)	N	N	Y	N	N	N	Y	N	N	N	Y	Y	N
<b>1U Front-end PDUs (3x IEC 320 C19 outlets)</b>															
39Y8938	6002	DPI Single-phase 30A/120V Front-end PDU (US)	Y	Y	Y	Y	Y	Y	Y	Y	Y	Y	Y	Y	Y
39Y8939	6003	DPI Single-phase 30A/208V Front-end PDU (US)	Y	Y	Y	Y	Y	Y	Y	Y	Y	Y	Y	Y	Y
39Y8934	6005	DPI Single-phase 32A/230V Front-end PDU (International)	Y	Y	Y	Y	Y	Y	Y	Y	Y	Y	Y	Y	Y
39Y8940	6004	DPI Single-phase 60A/208V Front-end PDU (US)	Y	N	Y	Y	Y	Y	Y	N	N	Y	Y	Y	N

Part number	Feature code	Description	ANZ	ASEAN	Brazil	EET	MEA	RUCIS	WE	HTK	INDIA	JAPAN	LA	NA	PRC
39Y8935	6006	DPI Single-phase 63A/230V Front-end PDU (International)	Y	Y	Y	Y	Y	Y	Y	Y	Y	Y	Y	Y	Y
<b>1U NEMA PDUs (6x NEMA 5-15R outlets)</b>															
39Y8905	5900	DPI 100-127V NEMA PDU	Y	Y	Y	Y	Y	Y	Y	Y	Y	Y	Y	Y	Y
<b>Line cords for 1U PDUs that ship without a line cord</b>															
40K9611	6504	4.3m, 32A/380-415V, EPDU/IEC 309 3P+N+G 3ph wye (non-US) Line Cord	Y	Y	Y	Y	Y	Y	Y	Y	Y	Y	Y	Y	Y
40K9612	6502	4.3m, 32A/230V, EPDU to IEC 309 P+N+G (non-US) Line Cord	Y	Y	Y	Y	Y	Y	Y	Y	Y	Y	Y	Y	Y
40K9613	6503	4.3m, 63A/230V, EPDU to IEC 309 P+N+G (non-US) Line Cord	Y	Y	Y	Y	Y	Y	Y	Y	Y	Y	Y	Y	Y
40K9614	6500	4.3m, 30A/208V, EPDU to NEMA L6-30P (US) Line Cord	Y	Y	Y	Y	Y	Y	Y	Y	Y	Y	Y	Y	Y
40K9615	6501	4.3m, 60A/208V, EPDU to IEC 309 2P+G (US) Line Cord	N	N	Y	N	N	N	Y	N	N	Y	Y	Y	N
40K9617	6505	4.3m, 32A/230V, Souriau UTG Female to AS/NZ 3112 (Aus/NZ) Line Cord	Y	Y	Y	Y	Y	Y	Y	Y	Y	Y	Y	Y	Y
40K9618	6506	4.3m, 32A/250V, Souriau UTG Female to KSC 8305 (S. Korea) Line Cord	Y	Y	Y	Y	Y	Y	Y	Y	Y	Y	Y	Y	Y

For more information, see the Lenovo Press documents in the PDU category:  
<https://lenovopress.com/servers/options/pdu>

## Rack cabinets

The following table lists the supported rack cabinets.

Table 76. Rack cabinets

Part number	Description
93072RX	25U Standard Rack
93072PX	25U Static S2 Standard Rack
93634PX	42U 1100mm Dynamic Rack
93634EX	42U 1100mm Dynamic Expansion Rack
93604PX	42U 1200mm Deep Dynamic Rack
93614PX	42U 1200mm Deep Static Rack
93084EX	42U Enterprise Expansion Rack
93084PX	42U Enterprise Rack
93074RX	42U Standard Rack

For specifications about these racks, see the Lenovo Rack Cabinet Reference, available from:  
<https://lenovopress.com/lp1287-lenovo-rack-cabinet-reference>

For more information, see the list of Product Guides in the Rack cabinets category:  
<https://lenovopress.com/servers/options/racks>

## KVM console options

The following table lists the supported KVM consoles.

Table 77. KVM console

Part number	Description
4XF7A73009	ThinkSystem 18.5" LCD Console (with English keyboard)

The following table lists the available KVM switches and the options that are supported with them.

Table 79. KVM switches and options

Part number	Description
KVM Console switches	
1754D1T	ThinkSystem Digital 2x1x16 KVM Switch (DVI video output port)
1754A1T	ThinkSystem Analog 1x8 KVM Switch (DVI video output port)
1754D2X	Global 4x2x32 Console Manager (GCM32)
1754D1X	Global 2x2x16 Console Manager (GCM16)
1754A2X	Local 2x16 Console Manager (LCM16)
1754A1X	Local 1x8 Console Manager (LCM8)
Cables for ThinkSystem Digital and Analog KVM Console switches	
4X97A11108	ThinkSystem VGA to DVI Conversion Cable
4X97A11109	ThinkSystem Single-USB Conversion Cable for Digital KVM
4X97A11107	ThinkSystem Dual-USB Conversion Cable for Digital KVM
4X97A11106	ThinkSystem USB Conversion Cable for Analog KVM
Cables for GCM and LCM Console switches	
46M5383	Virtual Media Conversion Option Gen2 (VCO2)
46M5382	Serial Conversion Option (SCO)

For more information, see the list of Product Guides in the KVM Switches and Consoles category:  
<http://lenovopress.com/servers/options/kvm>

## Lenovo Financial Services

Lenovo Financial Services reinforces Lenovo's commitment to deliver pioneering products and services that are recognized for their quality, excellence, and trustworthiness. Lenovo Financial Services offers financing solutions and services that complement your technology solution anywhere in the world.

We are dedicated to delivering a positive finance experience for customers like you who want to maximize your purchase power by obtaining the technology you need today, protect against technology obsolescence, and preserve your capital for other uses.

We work with businesses, non-profit organizations, governments and educational institutions to finance their entire technology solution. We focus on making it easy to do business with us. Our highly experienced team of finance professionals operates in a work culture that emphasizes the importance of providing outstanding customer service. Our systems, processes and flexible policies support our goal of providing customers with a positive experience.

We finance your entire solution. Unlike others, we allow you to bundle everything you need from hardware and software to service contracts, installation costs, training fees, and sales tax. If you decide weeks or months later to add to your solution, we can consolidate everything into a single invoice.

Our Premier Client services provide large accounts with special handling services to ensure these complex transactions are serviced properly. As a premier client, you have a dedicated finance specialist who manages your account through its life, from first invoice through asset return or purchase. This specialist develops an in-depth understanding of your invoice and payment requirements. For you, this dedication provides a high-quality, easy, and positive financing experience.

For your region-specific offers, please ask your Lenovo sales representative or your technology provider about the use of Lenovo Financial Services. For more information, see the following Lenovo website:

<https://www.lenovo.com/us/en/landingpage/lenovo-financial-services/>

## Related publications and links

For more information, see these resources:

- ThinkSystem ST650 V2 product page:  
<https://www.lenovo.com/us/en/p/data-center/servers/towers/thinksystem-st650-v2/len21ts0001>
- ThinkSystem ST650 V2 datasheet  
<https://lenovopress.com/DS0127>
- Interactive 3D Tour of the ThinkSystem ST650 V2:  
<https://lenovopress.com/lp1422>
- Lenovo Press video walk-through of the ThinkSystem ST650 V2:  
<https://lenovopress.com/lp1401>
- ThinkSystem ST650 V2 drivers and support  
<http://datacentersupport.lenovo.com/products/servers/thinksystem/sr650v2/7z75/downloads>
- Lenovo Hardware Installation & Removal Videos on the ST650 V2:
  - YouTube: <https://www.youtube.com/playlist?list=PLYV5R7hVcs-AzfPHlrxNI8euajJKKXqy>
  - Youku: [http://list.youku.com/albumlist/show/id\\_59636523.html](http://list.youku.com/albumlist/show/id_59636523.html)
- Lenovo ThinkSystem ST650 V2 product publications:  
<http://thinksystem.lenovofiles.com/help/index.jsp>
  - Quick Start
  - Rack Installation Guide
  - Setup Guide
  - Maintenance Manual
  - Backplane/Backplate Cable Routing Guide
  - Messages and Codes Reference
  - Memory Population Reference
- ServerProven hardware compatibility:  
<http://www.lenovo.com/us/en/serverproven>

## Related product families

Product families related to this document are the following:

- [2-Socket Tower Servers](#)
- [ThinkSystem ST650 V2 server](#)

## Notices

Lenovo may not offer the products, services, or features discussed in this document in all countries. Consult your local Lenovo representative for information on the products and services currently available in your area. Any reference to a Lenovo product, program, or service is not intended to state or imply that only that Lenovo product, program, or service may be used. Any functionally equivalent product, program, or service that does not infringe any Lenovo intellectual property right may be used instead. However, it is the user's responsibility to evaluate and verify the operation of any other product, program, or service. Lenovo may have patents or pending patent applications covering subject matter described in this document. The furnishing of this document does not give you any license to these patents. You can send license inquiries, in writing, to:

Lenovo (United States), Inc.  
8001 Development Drive  
Morrisville, NC 27560  
U.S.A.  
Attention: Lenovo Director of Licensing

LENOVO PROVIDES THIS PUBLICATION "AS IS" WITHOUT WARRANTY OF ANY KIND, EITHER EXPRESS OR IMPLIED, INCLUDING, BUT NOT LIMITED TO, THE IMPLIED WARRANTIES OF NON-INFRINGEMENT, MERCHANTABILITY OR FITNESS FOR A PARTICULAR PURPOSE. Some jurisdictions do not allow disclaimer of express or implied warranties in certain transactions, therefore, this statement may not apply to you.

This information could include technical inaccuracies or typographical errors. Changes are periodically made to the information herein; these changes will be incorporated in new editions of the publication. Lenovo may make improvements and/or changes in the product(s) and/or the program(s) described in this publication at any time without notice.

The products described in this document are not intended for use in implantation or other life support applications where malfunction may result in injury or death to persons. The information contained in this document does not affect or change Lenovo product specifications or warranties. Nothing in this document shall operate as an express or implied license or indemnity under the intellectual property rights of Lenovo or third parties. All information contained in this document was obtained in specific environments and is presented as an illustration. The result obtained in other operating environments may vary. Lenovo may use or distribute any of the information you supply in any way it believes appropriate without incurring any obligation to you.

Any references in this publication to non-Lenovo Web sites are provided for convenience only and do not in any manner serve as an endorsement of those Web sites. The materials at those Web sites are not part of the materials for this Lenovo product, and use of those Web sites is at your own risk. Any performance data contained herein was determined in a controlled environment. Therefore, the result obtained in other operating environments may vary significantly. Some measurements may have been made on development-level systems and there is no guarantee that these measurements will be the same on generally available systems. Furthermore, some measurements may have been estimated through extrapolation. Actual results may vary. Users of this document should verify the applicable data for their specific environment.

© Copyright Lenovo 2022. All rights reserved.

This document, LP1390, was created or updated on April 4, 2022.

Send us your comments in one of the following ways:

- Use the online Contact us review form found at:  
<https://lenovopress.com/LP1390>
- Send your comments in an e-mail to:  
[comments@lenovopress.com](mailto:comments@lenovopress.com)

This document is available online at <https://lenovopress.com/LP1390>.

## Trademarks

Lenovo and the Lenovo logo are trademarks or registered trademarks of Lenovo in the United States, other countries, or both. A current list of Lenovo trademarks is available on the Web at <https://www.lenovo.com/us/en/legal/copytrade/>.

The following terms are trademarks of Lenovo in the United States, other countries, or both:

Lenovo®  
AnyBay®  
Bootable Media Creator  
Flex System  
Lenovo Services  
ServerProven®  
System x®  
ThinkServer®  
ThinkSystem  
TopSeller  
TruDDR4  
UpdateXpress System Packs  
XClarity®

The following terms are trademarks of other companies:

Intel®, Intel Optane™, and Xeon® are trademarks of Intel Corporation or its subsidiaries.

Linux® is the trademark of Linus Torvalds in the U.S. and other countries.

ActiveX®, Hyper-V®, Microsoft®, Windows Server®, and Windows® are trademarks of Microsoft Corporation in the United States, other countries, or both.

Other company, product, or service names may be trademarks or service marks of others.