

SIEMENS



Motion Control Drives

SINAMICS Converters for Single-Axis Drives

SINAMICS G120XA infrastructure converters
for standard pumps/fans

Catalog
D 31.6

Edition
November
2019

[siemens.com.cn/sinamics-g120xa](https://www.siemens.com.cn/sinamics-g120xa)

Related catalogs

<p>Motion Control Drives D 31.1 SINAMICS Inverters for Single-Axis Drives Built-In Units</p> <p>E86060-K5531-A111-A1-7600</p>		<p>Industrial Controls IC 10 SIRIUS</p> <p>PDF (E86060-K1010-A101-A9-7600)</p>	
<p>Motion Control Drives D 31.2 SINAMICS Inverters for Single-Axis Drives Distributed Inverters</p> <p>E86060-K5531-A121-A1-7600</p>		<p>Industrial Controls IC 10 AO SIRIUS Classic</p> <p>PDF (E86060-K1010-A191-A5-7600)</p>	
<p>SINAMICS S120 D 21.3 Chassis Format Converter Units Cabinet Modules</p> <p>SINAMICS S150 Converter Cabinet Units E86060-K5521-A131-A6-7600</p>		<p>Low-Voltage Power Distribution and Electrical Installation Technology LV 10 SENTRON • SIVACON • ALPHA Protection, Switching, Measuring and Monitoring Devices, Switchboards and Distribution Systems PDF (E86060-K8280-A101-A9-7600) Print (E86060-K8280-A101-A6-7600)</p>	
<p>Motion Control Drives D 21.4 SINAMICS S120 and SIMOTICS</p> <p>E86060-K5521-A141-A1-7600</p>		<p>SIMATIC ST 70 Products for Totally Integrated Automation</p> <p>E86060-K4670-A101-B7-7600</p>	
<p>SIMOTICS S-1FG1 D 41 Servo geared motors Helical, Parallel shaft, Bevel and Helical worm geared motors</p> <p>PDF (E86060-K5541-A101-A4-7600)</p>		<p>SIMATIC ST 70 N Products for Totally Integrated Automation</p> <p>E86060-K4670-A151-A9-7600</p>	
<p>SIMOTICS GP, SD, XP, DP D 81.1 Low-Voltage Motors Type series 1FP1, 1LE1, 1LE5, 1MB1, 1MB5, 1PC1 Frame sizes 63 to 450 Power range 0.09 to 1000 kW PDF (E86060-K5581-A111-B3-7600)</p>		<p>SIMATIC HMI / PC-based Automation ST 80/ST PC Human Machine Interface Systems PC-based Automation</p> <p>PDF (E86060-K4680-A101-C7-7600)</p>	
<p>FLENDER Couplings MD 10.1 Standard Couplings</p> <p>E86060-K5710-A111-A5-7600</p>		<p>Industrial Communication IK PI SIMATIC NET</p> <p>E86060-K6710-A101-B8-7600</p>	
<p>SIMOGEAR MD 50.1 Geared Motors Helical, parallel shaft, bevel, helical worm and worm geared motors</p> <p>E86060-K5250-A111-A5-7600</p>		<p>Products for Automation and Drives CA 01 Interactive Catalog Download</p> <p>www.siemens.com/automation/ca01</p>	
<p>Motion Control System PM 21 SIMOTION Equipment for Production Machines</p> <p>E86060-K4921-A101-A4-7600</p>		<p>Industry Mall Information and Ordering Platform on the Internet:</p> <p>www.siemens.com/industrymall</p>	



SINAMICS Converters for Single-Axis Drives

SINAMICS G120XA infrastructure converters
for standard pumps/fans

Catalog D 31.6 · November 2019

Dear Customer,

We are happy to present you with the new PDF version of the Catalog D 31.6 · November 2019.

The catalog provides a comprehensive overview of the new SINAMICS G120XA infrastructure converter system for standard pump and fan applications. With an available power range from 0.75 kW to 560 kW, the new series masters every challenge here.

The products listed in this Catalog are also included in the Industry Mall.
Please contact your local Siemens office for additional information.

Up-to-date information about SINAMICS G120XA is available online at
www.siemens.com.cn/sinamics-g120xa

You can access our Interactive Catalog and our Industry Mall on the Internet at:
www.siemens.com/industrymall

Your personal contact will be glad to receive your suggestions and recommendations for improvement. You can find your representative in our personal contacts database at
www.siemens.com/automation-contact

We hope that you will often enjoy using Catalog D 31.6 as a selection and ordering reference document and wish you every success with our products and solutions.

With kind regards,



Achim Peltz
Vice President
General Motion Control
Siemens AG, Digital Industries, Motion Control

SINAMICS Converters for Single-Axis Drives

SINAMICS G120XA infrastructure converters for standard pumps/fans

Motion Control Drives



Catalog D 31.6 · November 2019

Supersedes:

Catalog D 31.6 · January 2019

Order overview D 31.6 · January 2019

Refer to the Industry Mall for current updates of this catalog:

www.siemens.com/industrymall

Please contact your local Siemens branch.

© Siemens 2019

System overview

1

SINAMICS G120XA infrastructure converters for standard pumps/fans

2

Engineering tools

3

Services and documentation

4

Appendix

5



The products and systems described in this catalog are manufactured/distributed under application of a certified quality management system in accordance with EN ISO 9001. The certificate is recognized by all IQNet countries.

Digital Enterprise

The building blocks that ensure everything works together perfectly in the digital enterprise

Digitalization is already changing all areas of life and existing business models. It is placing greater pressure on industry while at the same time creating new business opportunities. Today, thanks to scalable solutions from Siemens, companies can already become a digital enterprise and ensure their competitiveness.



Industry faces tremendous challenges



Reduce time-to-market

Today manufacturers have to bring products to market at an ever-increasing pace despite the growing complexity of these products. In the past, a major manufacturer would push aside a small one, but now it is a fast manufacturer that overtakes a slow one.



Boost flexibility

Consumers want customized products, but at a price they would pay for a mass-produced item. That only works if production is more flexible than ever before.



Improve quality

To ensure a high level of quality while meeting legal requirements, companies have to establish closed quality loops and enable the traceability of products.

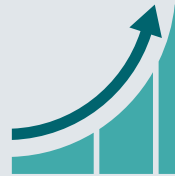

Boost efficiency

Today the product itself needs to be sustainable and environmentally friendly, while energy efficiency in production has become a competitive advantage.



Increase security

Increasing networking escalates the threat to production facilities of cyberattacks. Today more than ever, companies need suitable security measures.

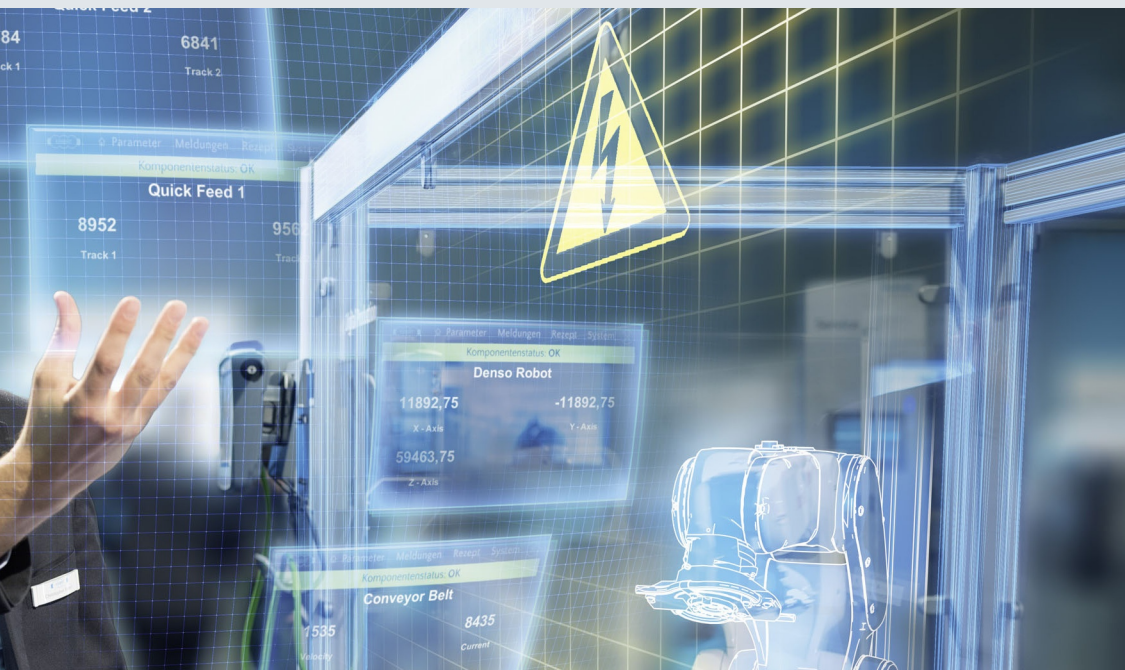

The digital enterprise has already become a reality

To fully benefit from all the advantages of digitalization, companies first have to achieve complete consistency of their data. Fully digitally integrated business processes, including those of suppliers, can help to create a digital representation of the entire value chain. This requires

- the integration of industrial software and automation,
- expansion of the communication networks,
- security in automation,
- and the use of business-specific industrial services.

MindSphere

The cloud-based open IoT operating system from Siemens

With MindSphere, Siemens offers a cost-effective and scalable cloud platform as a service (PaaS) for the development of applications. The platform, designed as an open operating system for the Internet of Things, makes it possible to improve the efficiency of plants by collecting and analyzing large volumes of production data.

Totally Integrated Automation (TIA) Where digitalization becomes reality

Totally Integrated Automation (TIA) ensures the seamless transition from the virtual to the real world. It already encompasses all the necessary conditions for transforming the benefits of digitalization into true added value. The data that will form the digital twin for actual production is generated from a common base.

Digital Plant

Learn more about the digital enterprise for the process industry
www.siemens.com/digitalplant

Digital Enterprise Suite

Learn more about the digital enterprise for the discrete industry
www.siemens.com/digital-enterprise-suite

Integrated Drive Systems

Faster on the market and in the black with Integrated Drive Systems

Integrated Drive Systems are Siemens' trendsetting answer to the high degree of complexity that characterizes drive and automation technology today. The world's only true one-stop solution for entire drive systems is characterized in particular by its threefold integration: Horizontal, vertical, and lifecycle integration ensure that every drive system component fits seamlessly into the whole system, into any automation environment, and even into the entire lifecycle of a plant.

The outcome is an optimal workflow – from engineering all the way to service that entails more productivity, increased efficiency, and better availability. That's how Integrated Drive Systems reduce time to market and time to profit.

Horizontal integration

Integrated drive portfolio: The core elements of a fully integrated drive portfolio are frequency converters, motors, couplings, and gear units. At Siemens, they're all available from a single source. Perfectly integrated, perfectly interacting. For all power and performance classes. As standard solutions or fully customized. No other player in the market can offer a comparable portfolio. Moreover, all Siemens drive components are perfectly matched, so they are optimally interacting.

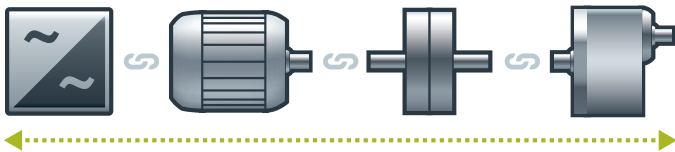

You can boost the availability of your application or plant to up to

99%*
*e.g., conveyor application

Vertical integration

Thanks to **vertical integration**, the complete drive train is seamlessly integrated in the entire automation environment – an important prerequisite for production with maximum value added. Integrated Drive Systems are part of Totally Integrated Automation (TIA), which means that they are perfectly embedded into the system architecture of the entire industrial production process. This enables optimal processes through maximum communication and control.

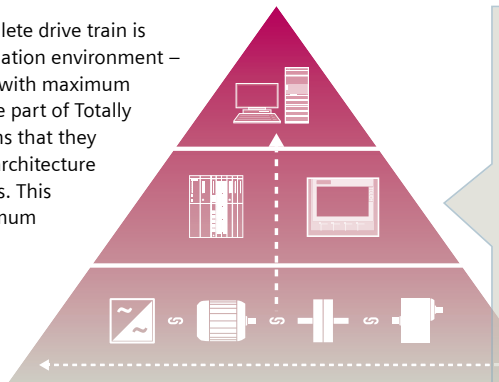

With TIA Portal you can cut your engineering time by up to

30%

Lifecycle integration

Lifecycle integration adds the factor of time: Software and service are available for the entire lifecycle of an Integrated Drive System. That way, important optimization potential for maximum productivity, increased efficiency, and highest availability can be leveraged throughout the system's lifecycle – from planning, design, and engineering to operation, maintenance, and all the way even to modernization.

With Integrated Drive Systems, assets become important success factors. They ensure shorter time to market, maximum productivity and efficiency in operation, and shorter time to profit.

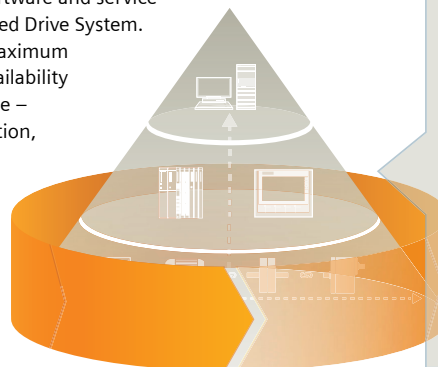

With Integrated Drive Systems you can reduce your maintenance costs by up to

15%

System overview



1/2	The SINAMICS converter family
1/6	Drive selection
1/7	SIMOTICS motors
1/8	SIMOTICS low-voltage motors for line and converter operation
1/9	Energy efficiency classes in accordance with EN 50598
1/12	SINAMICS G120XA infrastructure converters for standard pumps/fans
1/14	SINAMICS G120XA Starter Kit

Further information about SINAMICS and SIMOTICS can be found on the Internet at www.siemens.com/sinamics and www.siemens.com/simotics

System overview

The SINAMICS converter family

Overview

Integration in automation

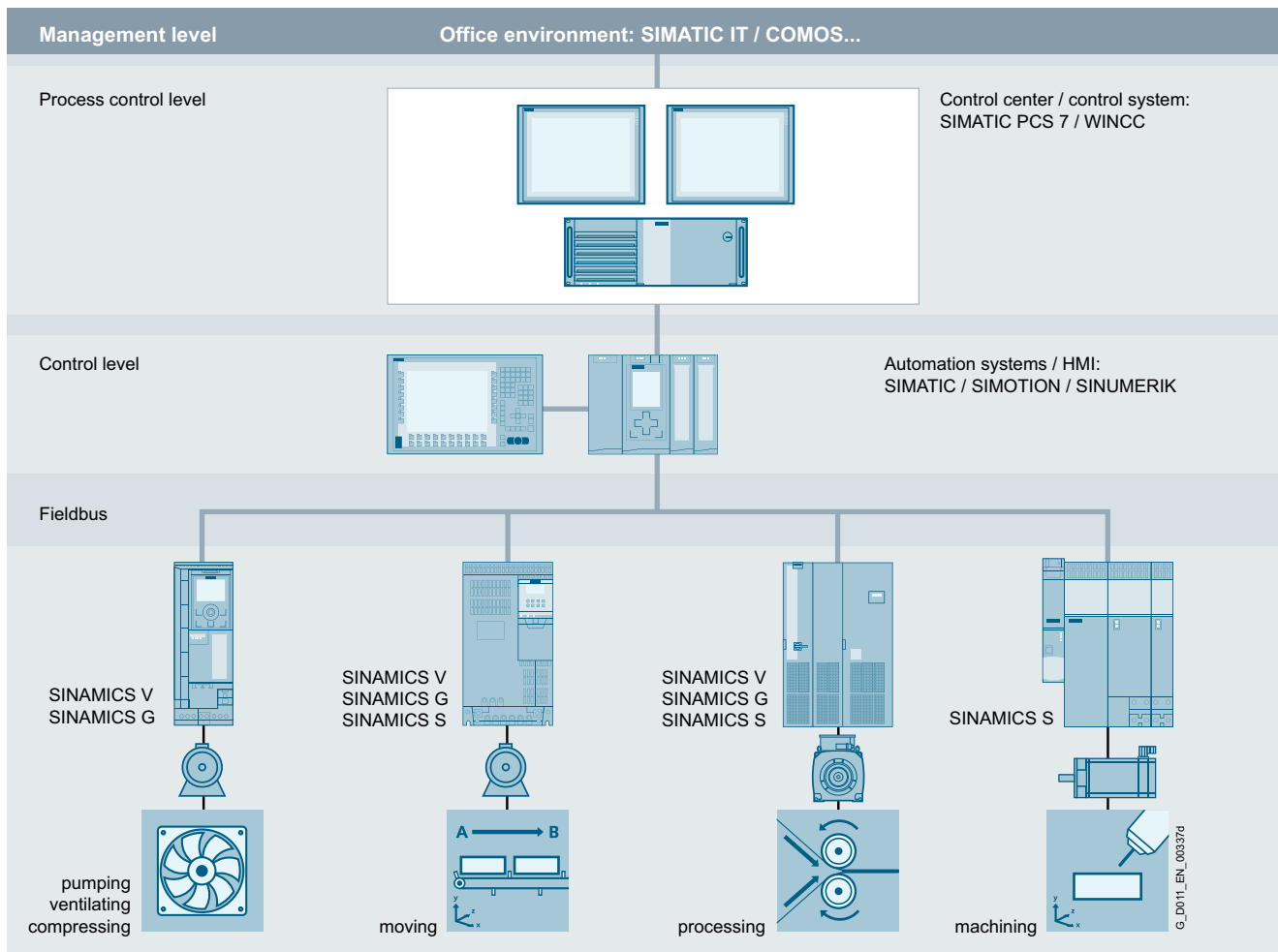

Totally Integrated Automation and communication

SINAMICS is an integral component of the Siemens "Totally Integrated Automation" concept. Integrated SINAMICS systems covering configuration, data storage, and communication at automation level ensure low-maintenance solutions with the SIMATIC, SIMOTION and SINUMERIK control systems.

Depending on the application, the appropriate variable frequency drives can be selected and incorporated in the automation concept. With this in mind, the drives are clearly subdivided into their different applications. A wide range of communication options (depending on the drive type) are available for establishing a communication link to the automation system:

- PROFINET
- PROFIBUS
- EtherNet/IP
- Modbus TCP
- Modbus RTU
- AS-Interface
- BACnet MS/TP

Applications

SINAMICS is the comprehensive converter family from Siemens designed for machine and plant engineering applications. SINAMICS offers solutions for all drive tasks:

- Simple pump and fan applications in the process industry
- Demanding single drives in centrifuges, presses, extruders, elevators, as well as conveyor and transport systems
- Drive line-ups in textile, plastic film, and paper machines as well as in rolling mill plants
- Highly dynamic servo drives for machine tools, as well as packaging and printing machines

Overview

SINAMICS as part of the Siemens modular automation system



Innovative, energy-efficient and reliable drive systems and applications as well as services for the entire drive train

The solutions for drive technology place great emphasis on the highest productivity, energy efficiency and reliability for all torque ranges, performance and voltage classes.

Siemens offers not only the right innovative variable frequency drive for every drive application, but also a wide range of energy-efficient low-voltage motors, geared motors, explosion-protected motors and high-voltage motors for combination with SINAMICS.

Furthermore, Siemens supports its customers with global pre-sales and after-sales services, with over 295 service points in 130 countries – and with special services e.g. application consulting or motion control solutions.

Energy efficiency

Energy management process

Efficient energy management consultancy identifies the energy flows, determines the potential for making savings and implements them with focused activities.

Almost two thirds of the industrial power requirement is from electric motors. This makes it all the more important to use drive technology permitting energy consumption to be reduced effectively even in the configuration phase, and consequently to optimize plant availability and process stability. With SINAMICS, Siemens offers powerful energy efficient solutions which, depending on the application, enable a significant reduction in electricity costs.

System overview

The SINAMICS converter family

Overview

Up to 70 % potential for savings using variable-speed operation

SINAMICS enables great potential for savings to be realized by controlling the motor speed. In particular, huge potential savings can be recovered from pumps, fans and compressors which are operated with mechanical throttle and valves. Here, changing to variable-speed drives brings enormous economic advantages. In contrast to mechanical control systems, the power consumption at partial load operation is always immediately adjusted to the demand at that time. So energy is no longer wasted, permitting savings of up to 60 % – in exceptional cases even up to 70 %. Variable-speed drives also offer clear advantages over mechanical control systems when it comes to maintenance and repair. Current spikes when starting up the motor and strong torque surges become things of the past – and the same goes for pressure waves in pipelines, cavitation or vibrations which cause sustainable damage to the plant. Smooth starting and ramp-down relieve the load on the mechanical system, ensuring a significantly longer service life of the entire drive train.

Regenerative feedback of braking energy

In conventional drive systems, the energy produced during braking is converted to heat using braking resistors. Energy produced during braking is efficiently recovered to the supply system by versions of SINAMICS G and SINAMICS S drives with regenerative feedback capability and these devices do not therefore need a braking resistor. This permits up to 60 % of the energy requirement to be saved, e.g. in lifting applications. Energy which can be reused at other locations on a machine. Furthermore, this reduced power loss simplifies the cooling of the system, enabling a more compact design.

Energy transparency in all configuration phases

Early on, in the configuration phase, the SIZER for Siemens Drives engineering tool provides information on the specific energy requirement. The energy consumption across the entire drive train is visualized and compared with different plant concepts.

SINAMICS in combination with energy-saving motors

Engineering integration stretches beyond the SINAMICS converter family to higher-level automation systems, and to a broad spectrum of energy-efficient motors with a wide range of performance classes, which, compared to previous motors, are able to demonstrate up to 10 % greater efficiency.

Variants

Depending on the application, the SINAMICS converter family offers the ideal variant for any drive task.

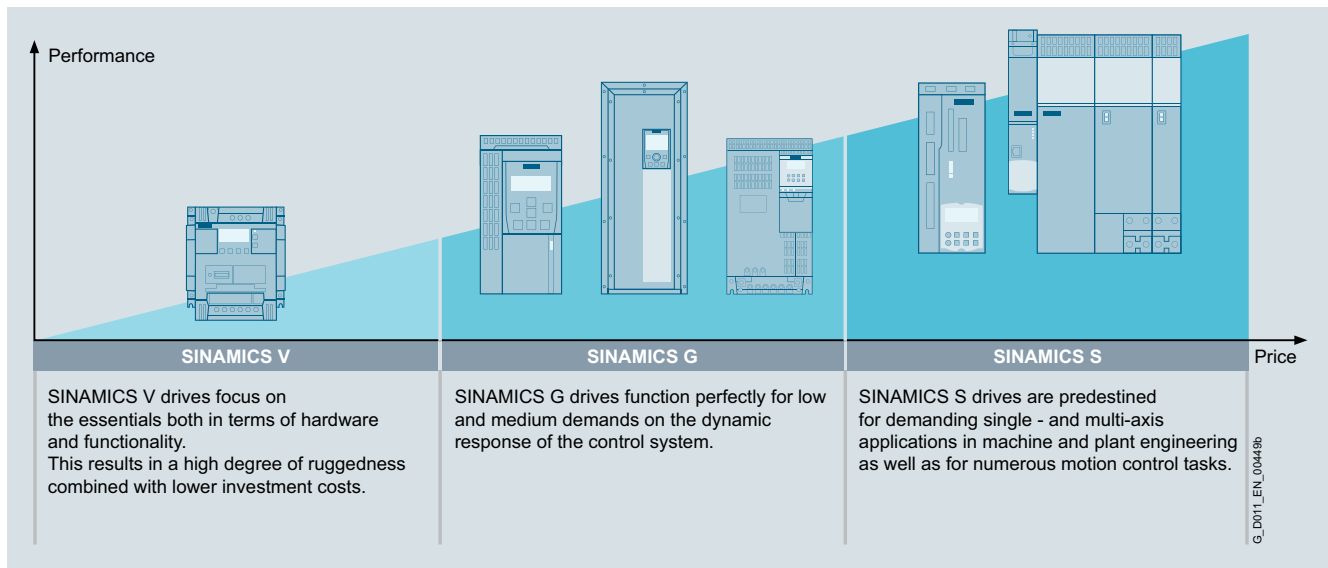

Overview

Platform concept

All SINAMICS variants are based on a platform concept. Joint hardware and software components, as well as standardized tools for dimensioning, configuration, and commissioning tasks ensure high-level integration across all components. SINAMICS handles a wide variety of drive tasks with no system gaps. The different SINAMICS variants can be easily combined with each other.







Quality management according to EN ISO 9001

SINAMICS conforms to the most exacting quality requirements. Comprehensive quality assurance measures in all development and production processes ensure a consistently high level of quality.

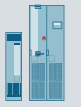
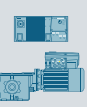
Of course, our quality management system is certified by an independent authority in accordance with EN ISO 9001.

IDS – Integration at its very best

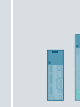
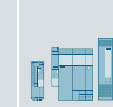
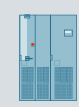
The Siemens Integrated Drive Systems (IDS) solution offers perfectly matched drive components with which you can meet your requirements. The drive components reveal their true strengths as an Integrated Drive System over the full range from engineering and commissioning through to operation: Integrated system configuration is performed using the Drive Technology Configurator: Just select a motor and a converter and design them with the SIZER for Siemens Drives engineering tool. The STARTER and SINAMICS Startdrive commissioning tools integrate the motor data and at the same time simplify efficient commissioning. Integrated Drive Systems are incorporated in the TIA Portal – this simplifies engineering, commissioning and diagnostics.

Low voltage										Direct voltage	Medium voltage
Standard performance frequency converters		Distributed frequency converters	Industry-specific frequency converters		Servo drives			High performance frequency converters		DC converters	Converters for applications with high outputs
											
SINAMICS V20 G120C G120	SINAMICS G130 G150	SINAMICS G110D G120D G110M SIMATIC ET 200pro FC-2	SINAMICS G120X G120XA	SINAMICS G180	SINAMICS V90	SINAMICS S110	SINAMICS S210	SINAMICS S120 S120M	SINAMICS S150	SINAMICS DCM DCP *	SINAMICS GH150 GH180 GM150 SM150 GL150 SL150 SM120CM
0.12 kW to 250 kW	75 kW to 2700 kW	0.37 kW to 7.5 kW	0.75 kW to 630 kW	2.2 kW to 6600 kW	0.05 kW to 7 kW	0.55 kW to 132 kW	0.05 kW to 7 kW	0.55 kW to 5700 kW	75 kW to 1200 kW	6 kW to 30 MW	0.15 MW to 85 MW
Pumps, fans, compressors, conveyor belts, mixers, mills, spinning machines, textile machines, refrigerated display counters, fitness equipment, ventilation systems, single-axis positioning applications in machine and plant engineering	Pumps, fans, compressors, conveyor belts, mixers, mills, extruders	Conveyor technology, single-axis positioning applications (G120D)	Pumps, fans, compressors, building management systems, process industry, HVAC, water/waste water industries	Pumps, fans, compressors, conveyor belts, extruders, mixers, mills, kneaders, centrifuges, separators	Handling machines, packaging machines, automatic assembly machines, metal forming machines, printing machines, winding and unwinding units	Single-axis positioning applications in machine and plant engineering	Packaging machines, handling equipment, feed and withdrawal devices, stacking units, automatic assembly machines, laboratory automation, wood, glass and ceramics industry, digital printing machines	Production machines (packaging, textile and printing machines, paper machines, plastic processing machines), machine tools, plants, process lines and rolling mills, marine drives, test bays	Test bays, cross cutters, centrifuges	Rolling mill drives, wire-drawing machines, extruders and kneaders, cableways and lifts, test bay drives * DC/DC controllers	Pumps, fans, compressors, mixers, extruders, mills, crushers, rolling mills, conveyor technology, excavators, test bays, blast furnace fans, retrofit
Catalog D 31.1	Catalog D 11	Catalog D 31.2	Catalog D 31.5, D 31.6	Catalog D 18.1	Catalog D 33	Catalog D 31.1	Catalog D 32	Catalogs D 21.3, D 21.4 NC 62	Catalog D 21.3	Catalog D 23.1 * Industry Mall	Catalogs D 15.1, D 12

Engineering tools (e.g. Drive Technology Configurator, SIZER for Siemens Drives, STARTER and SINAMICS Startdrive)

G_D011_EN_004500

System overview

Drive selection

1

Overview

SINAMICS selection guide – typical applications

Use	Requirements for torque accuracy/speed accuracy/position accuracy/coordination of axes/functionality					
	Continuous motion			Non-continuous motion		
	Basic	Medium	High	Basic	Medium	High
Pumping, ventilating, compressing 	Centrifugal pumps Radial / axial fans Compressors V20 G120C G120X, G120XA	Centrifugal pumps Radial / axial fans Compressors G120X, G120XA G130/G150 G180 ¹⁾	Eccentric screw pumps S120	Hydraulic pumps Metering pumps G120	Hydraulic pumps Metering pumps S110	Descaling pumps Hydraulic pumps S120
Moving 	Conveyor belts Roller conveyors Chain conveyors V20 G110D G110M G120C ET 200pro FC-2 ²⁾	Conveyor belts Roller conveyors Chain conveyors Lifting/ lowering devices Elevators Escalators/ moving walkways Indoor cranes Marine drives Cable railways G120 G120D G130/G150 G180 ¹⁾	Elevators Container cranes Mining hoists Excavators for open-cast mining Test bays S120 S150 DCM	Acceleration conveyors Storage and retrieval machines V90 G120 G120D	Acceleration conveyors Storage and retrieval machines Cross cutters Reel changers S110 S210 DCM	Storage and retrieval machines Robotics Pick & place Rotary indexing tables Cross cutters Roll feeds Engagers/ disengagers S120 S210 DCM
Processing 	Mills Mixers Kneaders Crushers Agitators Centrifuges V20 G120C	Mills Mixers Kneaders Crushers Agitators Centrifuges Extruders Rotary furnaces G120 G130/G150 G180 ¹⁾	Extruders Winders/unwinders Lead/follower drives Calenders Main press drives Printing machines S120 S150 DCM	Tubular bagging machines Single-axis motion control such as • Position profiles • Path profiles V90 G120	Tubular bagging machines Single-axis motion control such as • Position profiles • Path profiles S110 S210	Servo presses Rolling mill drives Multi-axis motion control such as • Multi-axis positioning • Cams • Interpolations S120 S210 DCM
Machining 	Main drives for • Turning • Milling • Drilling S110	Main drives for • Drilling • Sawing S110 S120	Main drives for • Turning • Milling • Drilling • Gear cutting • Grinding S120	Axis drives for • Turning • Milling • Drilling S110	Axis drives for • Drilling • Sawing S110 S120	Axis drives for • Turning • Milling • Drilling • Lasering • Gear cutting • Grinding • Nibbling and punching S120

Using the SINAMICS selection guide

The varying range of demands on modern variable frequency drives requires a large number of different types. Selecting the optimum drive has become a significantly more complex process. The application matrix shown simplifies this selection process considerably, by suggesting the ideal SINAMICS drive for examples of typical applications and requirements.

- The application type is selected from the vertical column
 - Pumping, ventilating, compressing
 - Moving
 - Processing
 - Machining
- The quality of the motion type is selected from the horizontal row
 - Basic
 - Medium
 - High

More information







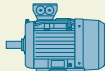

Further information about SINAMICS is available on the Internet at www.siemens.com/sinamics

Practical application examples and descriptions are available on the Internet at www.siemens.com/sinamics-applications

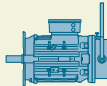
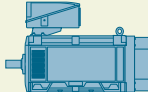
¹⁾ Industry-specific converters.

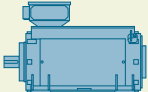
²⁾ Information on the SIMATIC ET 200pro FC-2 frequency converter is available in Catalog D 31.2 and at www.siemens.com/et200pro-fc

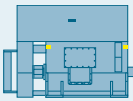
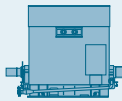
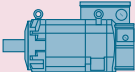
Overview

SIMOTICS						
Low-voltage motors for line and converter operation						
General Purpose SIMOTICS GP	Severe Duty SIMOTICS SD	Explosion-proof SIMOTICS XP	Definite Purpose SIMOTICS DP	Flexible Duty SIMOTICS FD	Transnom SIMOTICS TN	High Torque SIMOTICS HT
						
DC motors		High-voltage motors				
Direct Current SIMOTICS DC		High Voltage SIMOTICS HV				
						
Motors for motion control						
SIMOTICS S servomotors		SIMOTICS M main motors		SIMOTICS L linear motors		SIMOTICS T torque motors
Servomotors	Servo geared motors					

G_D011_EN_09491

SIMOTICS stands for

- 150 years of experience in building electric motors
- The most comprehensive range of motors worldwide
- Optimum solutions in all industries, regions and power/performance classes
- Innovative motor technologies of the highest quality and reliability
- Highest dynamic performance, precision and efficiency together with the optimum degree of compactness
- Our motors can be integrated into the drive train as part of the overall system
- A global network of skill sets and worldwide service around the clock

A clearly structured portfolio

The entire SIMOTICS product portfolio is transparently organized according to application-specific criteria in order to help users select the optimum motor for their application.

The product range extends from standard motors for pumps, fans and compressors to highly dynamic, precise motion control motors for positioning tasks and motion control in handling applications, as well as production machinery and machine tools, to DC motors and powerful high-voltage motors. Whatever it is that you want to move – we can supply the right motor for the task.

www.siemens.com/simotics

An outstanding performance for any job

A key characteristic of all SIMOTICS motors is their quality. They are robust, reliable, dynamic and precise to assure the requisite performance level for any process and deliver exactly the capabilities demanded by the application in hand. Thanks to their compact design, they can be integrated as space-saving units into installations. Furthermore, their impressive energy efficiency makes them effective as a means of reducing operating costs and protecting the environment.

A dense network of skill sets and servicing expertise around the world

SIMOTICS offers not only a wealth of sound experience gleaned from a development history which stretches back over around 150 years, but also the know-how of hundreds of engineers. This knowledge and our worldwide presence form the basis for a unique proximity to industries which feeds through in tangible terms to the specific motor configuration which is tailored to suit your application.

Our specialists are available to answer all your queries regarding any aspect of motor technology. At any time – wherever you are in the world. When you choose SIMOTICS, therefore, you reap the benefits of a global service network which is continuously accessible, thereby helping to optimize response times and minimize downtimes.

Perfection of the complete drive train







SIMOTICS is perfectly coordinated with other Siemens product families. In combination with the SINAMICS integrated converter family and the SIRIUS complete portfolio of industrial controls, SIMOTICS fits seamlessly as part of the complete drive train into automation solutions which are based on the SIMATIC, SIMOTION and SINUMERIK control systems.

System overview

1

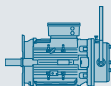
SIMOTICS low-voltage motors for line and converter operation

Overview

Low-voltage motors for line and converter operation						
General Purpose SIMOTICS GP	Severe Duty SIMOTICS SD	Explosion Proof SIMOTICS XP	Definite Purpose SIMOTICS DP	Transnom SIMOTICS TN	Flexible Duty SIMOTICS FD	High Torque SIMOTICS HT
						
IEC: 0.09 ... 45 kW Reluctance: 0.55 ... 52 kW NEMA: 1 ... 200 hp	IEC: 0.09 ... 200 kW Reluctance: 0.55 ... 78 kW NEMA: 1 ... 400 hp	IEC: 0.09 ... 460 kW NEMA: 1 ... 300 hp	IEC: 0.37 ... 200 kW NEMA: 1 ... 200 hp	200 ... 3500 kW	200 ... 1800 kW	150 ... 2100 kW
IEC: 0.6 ... 294 Nm Reluctance: 3.4 ... 191 Nm NEMA: 1.5 ... 883 lb-ft	IEC: 1 ... 1202 Nm Reluctance: 2.3 ... 286 Nm NEMA: 1.5 ... 1483 lb-ft	IEC: 1.2 ... 4043 Nm NEMA: 1.5 ... 1187 lb-ft	IEC: 2.5 ... 1546 Nm NEMA: 1.5 ... 1104 lb-ft	642 ... 20864 Nm	610 ... 14600 Nm	6000 ... 42000 Nm
IEC: 750 ... 3000 rpm (at 50 Hz) Reluctance: 1500/1800/2610 rpm NEMA: 900 ... 3600 rpm (at 60 Hz)	IEC: 750 ... 3000 rpm (at 50 Hz) Reluctance: 1500/1800/2610/ 3000/3600 rpm NEMA: 900 ... 3600 rpm (at 60 Hz)	IEC: 750 ... 3000 rpm (at 50 Hz) NEMA: 900 ... 3600 rpm (at 60 Hz)	IEC: 750 ... 3000 rpm (at 50 Hz) NEMA: 900 ... 3600 rpm (at 60 Hz)	IEC: 750 ... 3000 rpm (at 50 Hz)	IEC: 750 ... 3000 rpm (at 50 Hz)	IEC: 200 ... 800 rpm (at 50 Hz)
Pumps, fans and compressors with especially low weight requirements	Pumps, fans, compressors, mixers, mills, extruders and rollers with special demands in terms of ruggedness, particularly in the chemical and petrochemical industries	General industrial applications with special requirements regarding explosion protection for use in Zones 1, 2, 21, and 22 such as in the process industry	Ships, work and transport roller tables, tunnels, multi-story car parks, shopping malls, dockside cranes, container terminals as well as motors customized for special applications	Pumps, fans, compressors, conveyor belts, mixers, extruders in the chem. and petrochem. industry, paper-making machines, mining, cement, steel industry, and marine applications including propulsion	Pumps, fans, compressors, conveyor belts, centrifuges, extruders, winders, hoisting gear in cranes, presses, paper machines, rolling mills, marine applications including propulsion	High-torque gearless motors for paper-making machines, low-speed pumps, mills, steel shears, bow thrusters, winches or main drives on ships
IEC: D 81.1 NEMA: D 81.2	IEC: D 81.1 NEMA: D 81.2	IEC: D 81.1, D 83.1 NEMA: D 81.2	IEC: D 81.1 NEMA: D 81.2	D 81.1, D 84.1	D 81.8	D 86.2

G_D011_EN_00565a

SIMOTICS GP and SIMOTICS SD

SIMOTICS GP General Purpose motors with an aluminum housing are suitable for a wide range of standard drive tasks in industrial environments. SIMOTICS SD Severe Duty motors with a cast-iron housing are extremely rugged and are therefore the first choice for applications in harsh environmental conditions.

SIMOTICS GP and SIMOTICS SD are fundamentally optimized for line operation. In addition, two converter-optimized motor lines are available for variable-speed converter-fed operation.

- **Induction technology (VSD10 line)**

The VSD10 line converter motors are designed exclusively for use on converters and are specially optimized for SINAMICS frequency converters. In terms of economy, efficiency and reliability, they are perfectly matched to SINAMICS G120 standard converters over the complete life cycle.

- **Synchronous reluctance technology (VSD4000 line)**

VSD4000 line reluctance motors are designed exclusively for use on converters and are specially optimized for SINAMICS G120. Compared to systems with induction motors, synchronous reluctance technology is characterized by particularly high efficiency levels, especially in the partial load range, and by high dynamics. The vector control of the frequency converter ensures optimal operating characteristics. More information on the reluctance drive system is available at

www.siemens.com/reluctance-drive-system

Overview

Step by step to more efficiency

One of the core objectives of the European Union is a sustainable power industry. In industrial plants today, around 70 % of the power demand is from electrically driven systems. This high percentage contains huge potential for saving energy in electrical drives. For that reason, the European Union introduced minimum requirements for the energy efficiency of electric motors in the form of a statutory motor regulation as early as 2011.

However, measures aimed solely at the motor are not enough to achieve the mandatory energy-saving targets. The European legislation fills this gap with the standard series EN 50598 and extends the focus from individual drive components to entire drive systems, even enabling consideration of specific use cases.

The European standard series EN 50598 defines the ecodesign requirements for drive systems in the low-voltage range with an electrically driven machine. It consists of definitions for energy efficiency (parts 1 and 2) and an ecobalance calculation (part 3).

To take account of the different use cases, consideration of eight application-relevant operating points has been introduced as mandatory for the first time. Determination of loss values at these eight points and definition of efficiency classes are laid down by the standard in a uniform way. This enables data relevant to operation, such as application-specific load profiles, to now be taken into account more easily in the energy efficiency analysis.

The standard is especially important for variable-speed drives of the following types:

- for AC/AC converters without energy recovery functionality
- for motors with integrated converters
- for supply voltages of 100 V to 1000 V
- for power ratings of 0.12 kW to 1000 kW

To cover all applications of driven machines, the new standard defines operating points in full-load and partial-load operation, at which the losses of the motor and drive systems have to be determined. Based on the loss data at the operating points in partial-load operation, variable-speed drives can be explicitly considered in more detail. This makes their advantages especially clear.

Centrifugal pumps, fans

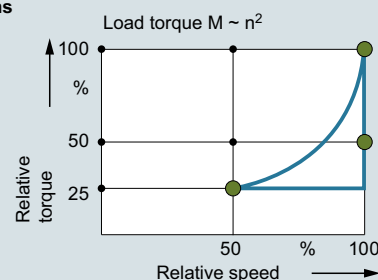

Hoisting gear, extruders, conveyor belts

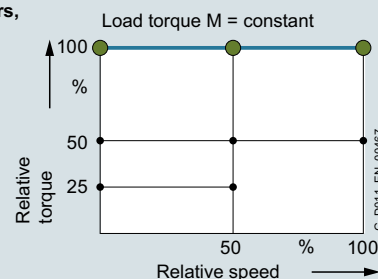
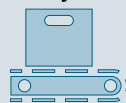

Winders, coilers

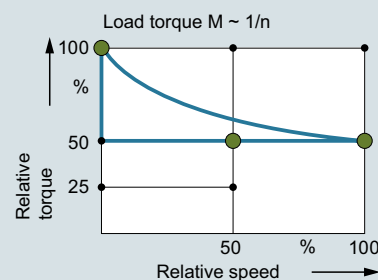

Duty cycles for different driven machines

Moreover, frequency converters and motor systems are classified in efficiency classes, which permit an initial rough estimate of the potential saving. Definition of reference systems is a key aspect of this because they provide standard reference values. The positioning of these reference systems defines the efficiency class. The relative distance from the reference system can be used as an absolute measure of the efficiency at the operating point in question.

System overview

1

Energy efficiency classes in accordance with EN 50598

Overview

Advantages of the detailed loss consideration of EN 50598 over the previous consideration of efficiencies and maximum loss values

For motors, the efficiency consideration was previously only defined for operation without a converter at 50/60 Hz. It provides a good way of comparing the energy efficiency of motors from different manufacturers for this use case.

The more detailed loss analysis of EN 50598, on the other hand, is aimed at speed-controlled operation and therefore now also includes motors especially designed for converter operation in the energy analysis. These were previously not covered by the applicable standards.

Moreover, a loss analysis over the entire setting and load range of the motor is possible. This is done in accordance with the standard EN 50598 with typical values.

For holistic consideration, it is essential to include all the relevant components of a drive system. The EN 50598 standard defines this in detail. The standardized expression of power loss data as a percentage makes comparison considerably easier and more transparent.

The method also makes it possible to consider a motor that produces a holding torque at speed zero, for example. In this case, the efficiency is zero, but a power loss from current producing magnetization and holding torque does occur. In summary, the key advantage of standard EN 50598 is the ability to perform the energy analysis of an electrical drive system based on standardized load profiles in all operating ranges due to uniform general conditions. This provides the user with complete transparency irrespective of the manufacturer.

Establishing efficiency classes of frequency converters (Complete Drive Modules CDM)

To avoid overmodulation and to ensure comparability between makes, which cannot be achieved otherwise, the efficiency classes of CDMs refer to the 90/100 operating point (90 % motor stator frequency, 100 % torque current).

Standard EN 50598-2 defines the relative losses of a CDM in efficiency classes IE0 to IE2. With reference to the value of a CDM of efficiency class IE1 (reference converter), a CDM of efficiency class IE2 has 25 % lower losses and a CDM of efficiency class IE0 has 25 % higher losses.

Operating points for CDMs

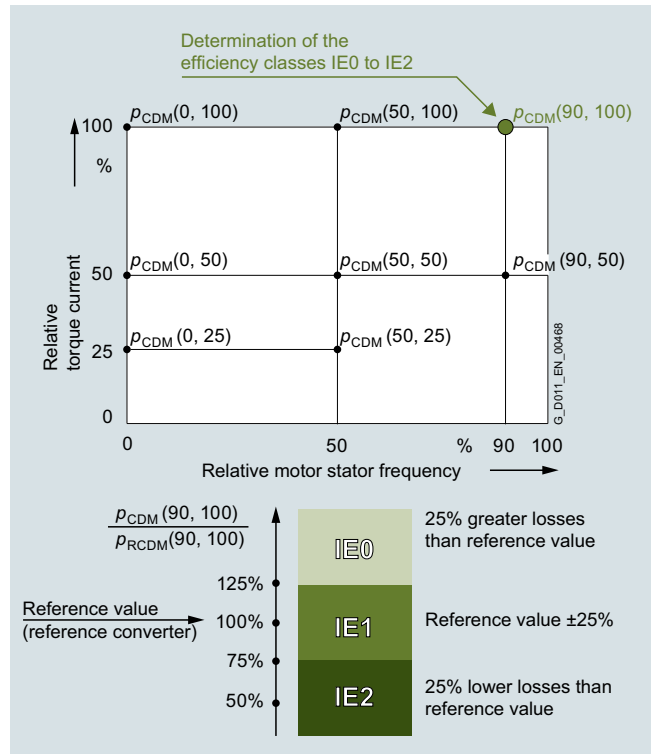

Complete Drive Module (CDM) – determining the efficiency class

Establishing the efficiency classes of drive systems (Power Drive Systems PDS)

What is possible for the individual systems, of course, also applies to the entire electrical PDS (frequency converter plus motor). Detailed comparisons are now possible at this level, too. The reference values for the reference system provide clear indications of the energy performance of the PDS.

Because targeted matching of the motor and CDM provides additional potential for optimization in electrical drive systems, it is especially important for the user to consider the entire drive system.

For the efficiency class of a PDS, too, a specific load point is defined. In this case, the reference point used is the 100/100 operating point (100 % motor stator frequency, 100 % torque).

Standard EN 50598-2 defines the relative losses of a PDS in efficiency classes IES0 to IES2. With reference to the value of a PDS of efficiency class IES1 (reference drive), a PDS of efficiency class IES2 has 20 % lower losses and a PDS of efficiency class IES0 has 20 % higher losses.

Energy efficiency classes in accordance with EN 50598

Overview

Operating points for PDS

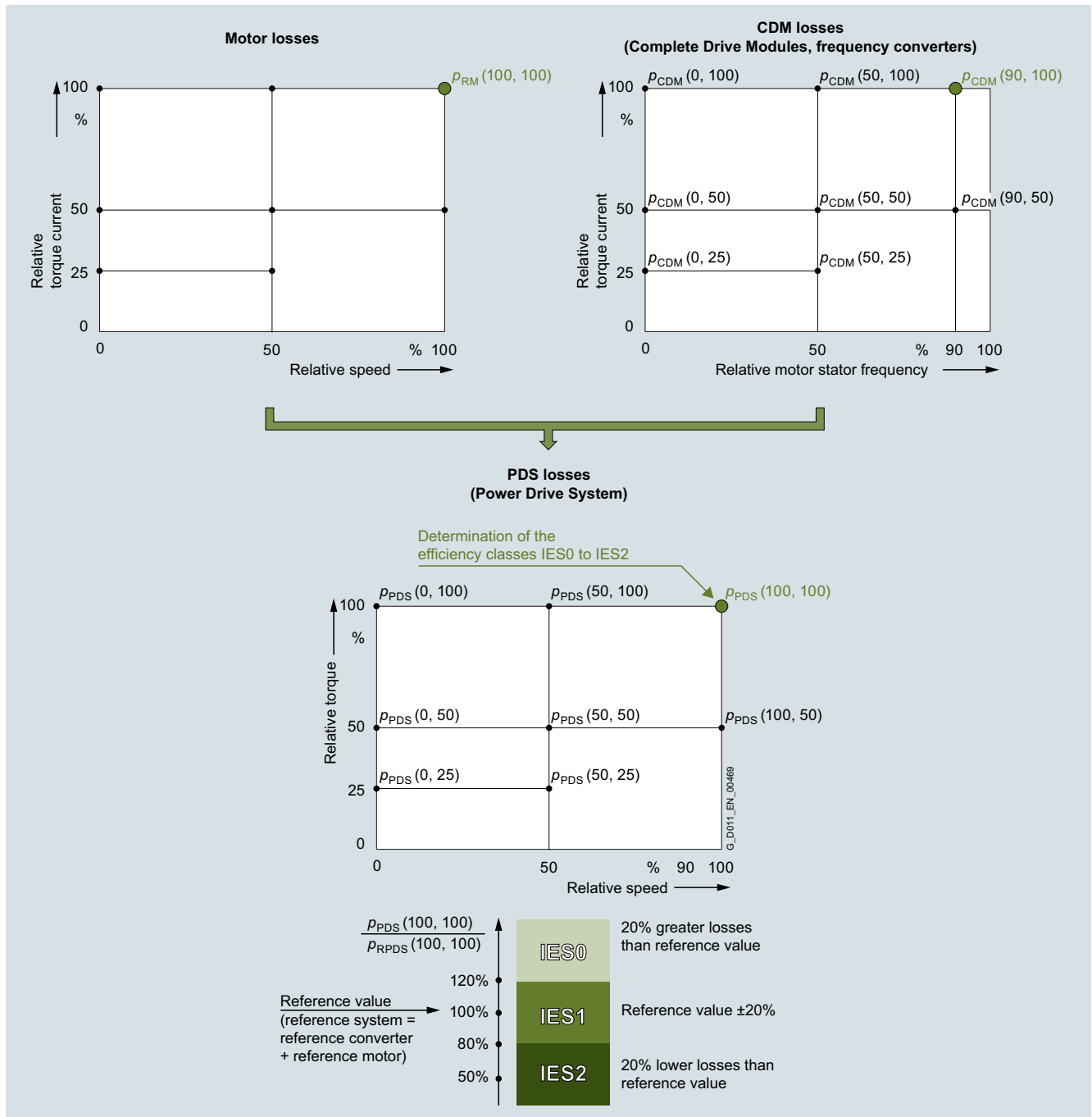

Power Drive System (PDS) – determining the efficiency class

More information

An example of a highly efficient drive system with efficiency class IES2 is the new synchronous inductance drive system with SIMOTICS reluctance motors and SINAMICS drives. More information is available on the Internet at www.siemens.com/drivesystem-reluctance, www.siemens.com/simotics-gp, www.siemens.com/simotics-sd

Power loss data of SINAMICS converters for single-axis drives are available on the Internet at <https://support.industry.siemens.com/cs/document/94059311>. More information on current laws and standards, new standards, and mandatory guidelines is available on the Internet at www.siemens.com/legislation-and-standards

System overview

SINAMICS G120XA infrastructure converters for standard pumps/fans

1

Overview



SINAMICS G120XA, frame sizes FSA to FSJ, with IOP-2 Intelligent Operator Panel

Easy handling, utmost reliability, superior efficiency and advanced digitalization – Siemens offers an answer to these trends with the SINAMICS G120XA converter series. SINAMICS G120XA is an innovative and user-friendly converter series that has been specifically developed for applications performed in infrastructure environments such as water/wastewater, but also for tasks in building automation. In this context, the converter supports, for example, pump, fan and compressor applications through numerous integrated functionalities and combines these in one device for the target sectors.

The SINAMICS G120XA converter is an integrated and efficient drive solution for a wide range of tasks. The system allows convenient handling through optimized user interfaces: IOP-2 Intelligent Operator Panel with graphic color display and the optional web server module SINAMICS G120 Smart Access – a Wi-Fi-based web server solution. Thus, the SINAMICS G120XA fulfils the request for an easy and fast setup of the devices during the commissioning phase. Further, experienced users can use the full flexibility of a SINAMICS converter and adjust the relevant application to their requirements.

Totally integrated operation - this approach is also supported from ordering through to delivery. For example, all the major features of the converter are configured and displayed in the article number. The delivery includes the complete device - as configured - that means, the converter and the selected operator panel.

In addition, SINAMICS G120XA has an extremely rugged and reliable construction and an integrated DC link reactor with a maximum output of 250 kW.

The converter system is fit for digitalization. Thanks to its full integration in the SINAMICS CONNECT 300 system, data from up to eight converters can be acquired and transferred to the MindSphere cloud solution. The MindSphere application "Analyze MyDrives" facilitates the evaluation of data – tailored to individual customer needs. This simplifies the acquisition and evaluation of converter conditions.

Further, the SINAMICS G120XA converter series provides innovative hardware and software functions, e.g. for controlling synchronous reluctance drive systems with SIMOTICS reluctance motors. In this way, the SINAMICS G120XA converter series makes a substantial contribution towards saving energy and makes more careful use of our natural resources.

User-friendliness

A high degree of user-friendliness is one of the main characteristics of the SINAMICS G120XA:

- Operator panel with color display and extensive diagnostics functions (IOP-2 Intelligent Operator Panel)
- Two different setup options are available: Standard and quick start with graphical user guidance
- Optimized setups for pumps and fans in the web server module SINAMICS G120 Smart Access
- SINAMICS SD card for storing parameter settings, cloning and local commissioning

Integrated functionalities for the start/operating/stop phases of the application

SINAMICS G120XA is always preset, depending on the selected converter performance. Further, the following functions can be easily selected and parameterized:

Start phase

During the start phase, the following functions are supported by default:

- Deragging mode for pumps for cleaning the pump system, improving efficiency and reducing wear
- Pipe filling mode for preventing pressure shocks in pipeline systems
- Two acceleration ramps for shorter start/stop times
- Flying restart of the running motor for fast hot restart
- Automatic restart function after power failure during short downtimes

Operating phase

During the operating phase, the following functions are supported by default:

- Continued run mode with autonomous reduction of output and pulse frequency
- PID controller for autonomous closed-loop control mode, operated according to analog input values
- Up to 16 variable-speed setpoints as fixed frequencies
- Speed monitoring via sensor (pulse input)
- Multi-pump control of up to four pumps
- Protection against blocking, leakage, dry running and cavitation
- Fire response mode for extended operation in case of emergency
- Skip frequencies for skipping critical frequencies and avoiding vibration
- Real time clock for switching over setpoints or controlling releases

Stop phase

During the stop phase, the following functions are supported by default:

- ON/OFF2 for an optimized braking ramp
- Condensation protection for the motor
- Frost protection function for the pump

A detailed description of the functions and connection diagrams are included in the device documentation.

Overview

Commissioning of complex applications

Sample applications, which include the description and device setting, are provided for SINAMICS G120XA.

The following application descriptions are available:

- Fan for exhaust air with closed-loop control of pressure and air quality
- Fan for cooling tower with closed-loop control of the cooling water temperature
- Fan for tunnel/parking garage with closed-loop control of air quality and essential service mode
- Fan for supply air with closed-loop control of pressure, temperature, air quality and flowrate
- Pumps with closed-loop control of the pressure
- Pumps with closed-loop control of the filling level
- Pumps for cooling circuits with closed-loop control of the temperature
- Compressor with closed-loop control of the pressure
- Vacuum pump with closed-loop control of the pressure

Practical application examples and descriptions are available on the Internet at

www.siemens.com/sinamics-applications

System overview

SINAMICS G120XA Starter Kit

Overview

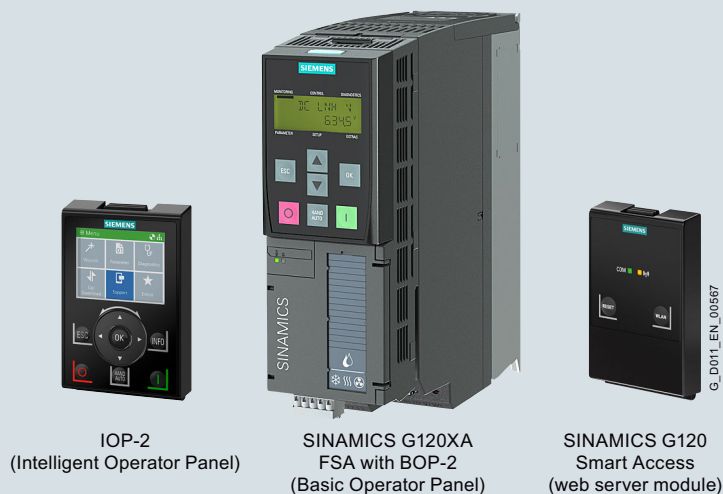

IOP-2
(Intelligent Operator Panel)

SINAMICS G120XA
FSA with BOP-2
(Basic Operator Panel)

SINAMICS G120
Smart Access
(web server module)

SINAMICS G120XA Starter Kit

The SINAMICS G120XA Starter Kit comprises a SINAMICS G120XA converter (380 ... 440 V 3 AC, USS, Modbus RTU, BACnet MS/TP, FSA, 0.75 kW) with a BOP-2 Basic Operator Panel, an IOP-2 Intelligent Operator Panel and a SINAMICS G120 Smart Access web server module.

The delivery quantity is limited to three per customer.

The SINAMICS G120XA Starter Kits can be perfectly combined with the SIMATIC Starter Kits. In this way simple drive tasks up to motion control applications can be quickly implemented.

Further information on SIMATIC Starter Kits can be found at:
www.siemens.com/s7-1200-starterkits
www.siemens.com/s7-1500-starterkits

Selection and ordering data

Description	Article No.
SINAMICS G120XA Starter Kit (available soon) <ul style="list-style-type: none"> • 380 ... 440 V 3 AC converter, USS, Modbus RTU, BACnet MS/TP, FSA, 0.75 kW • BOP-2 • IOP-2 • SINAMICS G120 Smart Access 	6SL3200-0AE71-0AA0

SINAMICS G120XA infrastructure converters for standard pumps/fans

0.75 kW to 560 kW

2



2/2	SINAMICS G120XA infrastructure converters for standard pumps/fans	2/26	Supplementary system components
2/2	Overview	2/26	Operator Panels
2/3	Benefits	2/27	IOP-2 Intelligent Operator Panel
2/4	Application	2/30	BOP-2 Basic Operator Panel
2/4	Design	2/31	Memory cards
2/5	Function	2/32	SINAMICS G120 Smart Access
2/6	Integration	2/33	Shield connection kits for Power Module
2/8	Selection and ordering data	2/34	Spare parts
2/8	• SINAMICS G120XA converters · Degree of protection IP20, IP00 for frame size FSJ · 380 ... 440 V 3 AC	2/34	FPI board for frame sizes FSH and FSJ
2/9	- Configuration with line-side and load-side components	2/34	PSB board for frame sizes FSH and FSJ
2/10	• Supplementary system components and spare parts for SINAMICS G120XA converters	2/34	Current transformers for frame sizes FSH and FSJ
2/11	Technical specifications	2/34	Spare parts kit for Control Unit
2/22	Configuration	2/34	Shield connection kit for Control Unit
2/23	Characteristic curves	2/35	Shield connection kits for Power Module
2/25	Dimensional drawings	2/35	Mounting set for frame sizes FSD to FSG
2/25	More information	2/35	Terminal cover kits for frame sizes FSD to FSG
		2/36	Fan units
		2/36	Control Unit

Further information about SINAMICS G120XA can be found on the Internet at www.siemens.com.cn/sinamics-g120xa

SINAMICS G120XA infrastructure converters for standard pumps/fans

0.75 kW to 560 kW

SINAMICS G120XA infrastructure converters for standard pumps/fans

Overview



SINAMICS G120XA, frame sizes FSA to FSJ, with IOP-2 Intelligent Operator Panel

Easy handling, utmost reliability, superior efficiency and advanced digitalization – Siemens offers an answer to these trends with the SINAMICS G120XA converter series. SINAMICS G120XA is an innovative and user-friendly converter series that has been specifically developed for applications performed in infrastructure environments such as water/wastewater, but also for tasks in building automation. In this context, the converter supports, for example, pump, fan and compressor applications through numerous integrated functionalities and combines these in one device for the target sectors.

The SINAMICS G120XA converter is an integrated and efficient drive solution for a wide range of tasks. The system allows convenient handling through optimized user interfaces: IOP-2 Intelligent Operator Panel with graphic color display and the optional web server module SINAMICS G120 Smart Access – a Wi-Fi-based web server solution. Thus, the SINAMICS G120XA fulfils the request for an easy and fast setup of the devices during the commissioning phase. Further, experienced users can use the full flexibility of a SINAMICS converter and adjust the relevant application to their requirements.

Totally integrated operation - this approach is also supported from ordering through to delivery. For example, all the major features of the converter are configured and displayed in the article number. The delivery includes the complete device - as configured - that means, the converter and the selected operator panel.

In addition, SINAMICS G120XA has an extremely rugged and reliable construction and an integrated DC link reactor with a maximum output of 250 kW.

The converter system is fit for digitalization. Thanks to its full integration in the SINAMICS CONNECT 300 system, data from up to eight converters can be acquired and transferred to the MindSphere cloud solution. The MindSphere application "Analyze MyDrives" facilitates the evaluation of data – tailored to individual customer needs. This simplifies the acquisition and evaluation of converter conditions.

Further, the SINAMICS G120XA converter series provides innovative hardware and software functions, e.g. for controlling synchronous reluctance drive systems with SIMOTICS reluctance motors. In this way, the SINAMICS G120XA converter series makes a substantial contribution towards saving energy and makes more careful use of our natural resources.

User-friendliness

A high degree of user-friendliness is one of the main characteristics of the SINAMICS G120XA:

- Operator panel with color display and extensive diagnostics functions (IOP-2 Intelligent Operator Panel)
- Two different setup options are available: Standard and quick start with graphical user guidance
- Optimized setups for pumps and fans in the web server module SINAMICS G120 Smart Access
- SINAMICS SD card for storing parameter settings, cloning and local commissioning

Integrated functionalities for the start/operating/stop phases of the application

SINAMICS G120XA is always preset, depending on the selected converter performance. Further, the following functions can be easily selected and parameterized:

Start phase

During the start phase, the following functions are supported by default:

- Deragging mode for pumps for cleaning the pump system, improving efficiency and reducing wear
- Pipe filling mode for preventing pressure shocks in pipeline systems
- Two acceleration ramps for shorter start/stop times
- Flying restart of the running motor for fast hot restart
- Automatic restart function after power failure during short downtimes

Operating phase

During the operating phase, the following functions are supported by default:

- Continued run mode with autonomous reduction of output and pulse frequency
- PID controller for autonomous closed-loop control mode, operated according to analog input values
- Up to 16 variable-speed setpoints as fixed frequencies
- Speed monitoring via sensor (pulse input)
- Multi-pump control of up to four pumps
- Protection against blocking, leakage, dry running and cavitation
- Fire response mode for extended operation in case of emergency
- Skip frequencies for skipping critical frequencies and avoiding vibration
- Real time clock for switching over setpoints or controlling releases

Stop phase

During the stop phase, the following functions are supported by default:

- ON/OFF2 for an optimized braking ramp
- Condensation protection for the motor
- Frost protection function for the pump

A detailed description of the functions and connection diagrams are included in the device documentation.

SINAMICS G120XA infrastructure converters for standard pumps/fans

0.75 kW to 560 kW

SINAMICS G120XA infrastructure converters for standard pumps/fans

Overview

Commissioning of complex applications

Sample applications, which include the description and device setting, are provided for SINAMICS G120XA.

The following application descriptions are available:

- Fan for exhaust air with closed-loop control of pressure and air quality
- Fan for cooling tower with closed-loop control of the cooling water temperature
- Fan for tunnel/parking garage with closed-loop control of air quality and essential service mode
- Fan for supply air with closed-loop control of pressure, temperature, air quality and flowrate
- Pumps with closed-loop control of the pressure
- Pumps with closed-loop control of the filling level
- Pumps for cooling circuits with closed-loop control of the temperature
- Compressor with closed-loop control of the pressure
- Vacuum pump with closed-loop control of the pressure

Practical application examples and descriptions are available on the Internet at

www.siemens.com/sinamics-applications

Benefits

Energy efficiency

SINAMICS G120XA increases the efficiency and minimizes energy consumption in the complete process chain. The converter has integrated hardware as well as software functions as standard. The main features are:

- Power units with DC link reactor for extremely high active power component thanks to efficient converter topology – for the same drive power, the converter requires a lower line current than comparable converters
- Flux reduction through automatic adaptation of the motor current to the prevailing load conditions with closed-loop control modes V/f (ECO) and vector without sensor (SLVC) and savings of up to 5 % under partial load conditions
- Hibernation mode dependent on setpoints in the process
- High efficiency up to $\eta = 98\%$

Application-specific commissioning and operation using operator panel

- Local commissioning without specialized knowledge of converters thanks to default settings and graphical user interface
- Unique: SINAMICS SD memory card for pre-parameterization and cloning of converter data sets
- Data backup for easy replacement
- Commissioning/diagnostics and controlling of converters

Flexible deployment of integrated functions

- Four integrated PID controllers
Distributed closed-loop control for motor-independent process control without higher-level controller (PLC)
- Three freely programmable digital timer switches
Control for freely selectable daily and weekly programs

Flexible deployment across a wide range of applications

- Isolated digital inputs with separate potential group
- Isolated analog inputs
 - Potential transfer avoided
 - EMC-compliant design without the need for additional components in line with process industry requirements
- Direct connection of recommended, optional temperature sensors PTC, KTY and Pt1000
- Connection and evaluation of a recommended, optional Pt100 temperature sensor by using a free analog input and output
- 230 V AC relay
 - Direct control for auxiliary equipment, e.g. reactor or valve actuators
- X9 terminal strip for devices in frame sizes FSH and FSJ (315 kW to 560 kW)
 - Input for external 24 V DC supply
 - Input for external alarm/fault
 - Input for EMERGENCY OFF/EMERGENCY STOP
 - Output for 24 V DC
 - Control of the main contactor
 - Feedback message "DC link charged"
- Use at ambient temperatures of
 - -20 °C to +60 °C: frame sizes FSA to FSG
 - 0 °C to +50 °C: frame sizes FSH and FSJ
- Removable operator panel
 - Protection against unauthorized access
 - Color-coded signaling of operating states
- Version for harsh environmental conditions
 - PCB coating for environmental class/harmful chemical substances Class 3C2 acc. to EN 60721-3-3

Extended warranty

Siemens offers for SINAMICS G120XA an extended warranty up to 7½ years:

- 24 months of standard warranty
- Optional extension via **Drive Service Extended Exchange**
 - 6 months free of charge after product registration at: <https://myregistration.siemens.com>
 - chargeable for additional 3 or 5 years

More information at:

<https://support.industry.siemens.com/cs/ww/en/sc/4842>

SINAMICS G120XA infrastructure converters for standard pumps/fans

0.75 kW to 560 kW

SINAMICS G120XA infrastructure converters for standard pumps/fans

Application

The specialist for pump, fan and compressor applications

SINAMICS G120XA is ideally suited to pump applications (centrifugal pumps, oscillating and rotating pumps), fan applications (axial and radial fans) and compressor applications (cooling compressors, air and gas compressors). They are deployed in the water/wastewater industries, in industrial environments, and in building automation.

SINAMICS G120XA is ideally suited for the following applications:

- Circulating pumps for heating and cooling systems
- Pumps for pressure boosting stations
- Level control
- Fans in cooling towers
- Fans for air intake and discharge
- Fans for tunnels and multi-story car parks
- Fans for stairwells
- Compressors for cooling units

Reliable operation in harsh environments

SINAMICS G120XA is suitable for use under harsh environmental conditions:

- Degree of protection IP20 for use in the control cabinet
- Use at ambient temperatures of
 - -20 °C to +60 °C: frame sizes FSA to FSG
 - 0 °C to +50 °C: frame sizes FSH and FSJ
- Coated modules for increased resistance to humidity and dust (Class 3C2)

Design

SINAMICS G120XA is a converter system that comprises a power output module and a control module with or without an operator panel.

The converter is configured on the basis of the power requirement and the application. State-of-the-art IGBT technology with pulse-width modulation is used for reliable and flexible motor operation. Comprehensive protection functions provide a high degree of protection for the converter and motor.

The SINAMICS G120XA converters are intended for installation in a control cabinet.

- Selection of the line filter for line voltage 380 V to 440 V 3 AC
 - Without integrated line filter 0.75 kW to 132 kW
 - With integrated line filter Category C3, 0.75 kW to 560 kW
- Environmental class/harmful chemical substances acc. to EN 60721-3-3
 - Class 3C2
- Selection of communication
 - USS
 - Modbus RTU
 - BACnet MS/TP
- Selection of the operator panel
 - The operator panels support user-friendly local commissioning, control and diagnostics and enable complete converter data sets to be pre-parameterized and cloned.
 - Without operator panel
 - BOP-2 Basic Operator Panel
 - The menu prompting and the 2-line display allow for simple commissioning of the converter. Simultaneous display of the parameter and parameter value, as well as parameter filtering, means that basic commissioning of a drive can also be performed without a printed parameter list.
 - IOP-2 Intelligent Operator Panel
 - Supports entry-level personnel as well as drive experts. Thanks to the color display, a user-friendly menu structure and wizards, it is much easier to commission, diagnose and locally control standard drives.

Line-side power components

The following line-side power components are available for the SINAMICS G120XA converters:

- Line filters for category C3 for frame sizes FSA to FSF
 - With an additional line filter, the converter without integrated line filter complies with a higher radio interference class.
- Line reactors for devices from 315 kW and for frame sizes FSH and FSJ
 - Line reactors smooth the current drawn by the converter and thus reduce harmonic components in the line current. Through the reduction of the current harmonics, the thermal load on the power components in the rectifier and in the DC link capacitors is reduced as well as the harmonic effects on the supply. The use of a line reactor increases the service life of the converter.
 - SINAMICS G120XA frame sizes FSA to FSG feature an integrated DC link reactor as standard. The use of an additional line reactor is not necessary for this.

Recommended line-side overcurrent protection devices and power components

This section contains recommendations for additional line-side components, such as Siemens fuses and circuit breakers (line-side components must be dimensioned in accordance with IEC standards).

Additional information about the listed fuses and circuit breakers is available in the Catalogs LV 10, IC 10 and IC 10 AO as well as in the Industry Mall.

SINAMICS G120XA infrastructure converters for standard pumps/fans

0.75 kW to 560 kW

SINAMICS G120XA infrastructure converters for standard pumps/fans

Design

Load-side power components

Various load-side power components are available for the SINAMICS G120XA converters. These allow the use of longer shielded motor cables and increase the motor service life:

- Output reactors for frame sizes FSD to FSJ
Output reactors reduce the rate of voltage rise (dv/dt) and the height of the current peaks, and can allow longer motor cables to be connected.
- Sine-wave filters for frame sizes FSD to FSG
Sine-wave filters limit the rate of voltage rise (dv/dt) and the peak voltages on the motor winding. Similar to an output reactor, they enable the connection of longer motor cables.
- dv/dt filters plus VPL for frame sizes FSH and FSJ
dv/dt filters plus VPL (Voltage Peak Limiter) limit the voltage rate-of-rise dv/dt to values of <math><500\text{ V}/\mu\text{s}</math> and the typical voltage peaks to values according to the limit value curve according to IEC/TS 60034-17: 2006.
Standard motors with standard insulation and without insulated bearings can be used for converter operation if a dv/dt filter plus VPL is used.

Optional accessories

- SINAMICS memory card (SD card)
- SINAMICS G120 Smart Access for simple setup via Wi-Fi
- SINAMICS CONNECT 300 for connecting up to eight converters to the MindSphere cloud (available soon)

Note:

Shield connection kits for frame sizes FSA to FSC are an integral component of the delivery. The shield connection kits for the Power Module are not included in the scope of delivery for the SINAMICS G120XA converters, frame sizes FSD to FSG, but they can be ordered as an option.

Spare parts

- FPI (freely programmable interface) board for frame sizes FSH and FSJ
- PSB (power supply board) board for frame sizes FSH and FSJ
- Current transformers for frame sizes FSH and FSJ
- Spare parts kit for Control Unit for frame sizes FSA to FSJ
- Shield connection kit for Control Unit for frame sizes FSD to FSG
- Shield connection kits for Power Module for frame sizes FSA to FSC
- Mounting set for frame sizes FSD to FSG
- Terminal cover kits for covering the connecting terminals for frame sizes FSD to FSG
- Fan units
 - External for frame sizes FSA to FSJ
 - Internal for frame sizes FSH and FSJ
- SITOP power supply for frame sizes FSH and FSJ
- Fuse for the external fan unit for frame sizes FSH and FSJ
- Control Unit for frame sizes FSA to FSJ

Function

Technology function

Functions specific to pumps, fans and compressors are already integrated, e.g.:

- Specific firmware functions such as deragging or pipe fill mode
- Automatic restart
Application restart after a power failure or fault occurrence
- Flying restart
Connection of the converter when the motor is running
- Flux reduction
Automatic adaptation of the motor current to the prevailing load conditions in V/f control mode (ECO mode) as well as in sensorless vector control mode
- Cascade connection
Load-dependent connection and disconnection of a maximum of three additional motors by the converter in order to provide a largely constant output power (implemented by means of an additional external circuit)
- Hibernation mode
Startup or shutdown of the drive when the relevant value drops below an external setpoint or the internal PID controller setpoint
- Real-time clock
For time-dependent process controls, e.g. to reduce the temperature of a heating control at night and with automatic daylight saving/standard time switchover

Functions especially for building technology as well as heating/air conditioning/ventilation applications

- Four integrated PID controllers
One PID controller for controlling the drive speed as a function of pressure, temperature, flowrate, fill level, air quality and other process variables; a further three PID controllers with freely configurable outputs, e.g. for controlling valves (heating, cooling) or flaps
- Emergency mode
Special converter operating mode that enhances the availability of the drive system in the event of a fire
- Bypass mode
When the setpoint is reached or a fault occurs, the system changes over to line operation (implemented by means of an additional external circuit)
- Programmable time switches

SINAMICS G120XA infrastructure converters for standard pumps/fans

0.75 kW to 560 kW

SINAMICS G120XA infrastructure converters for standard pumps/fans

Integration

2

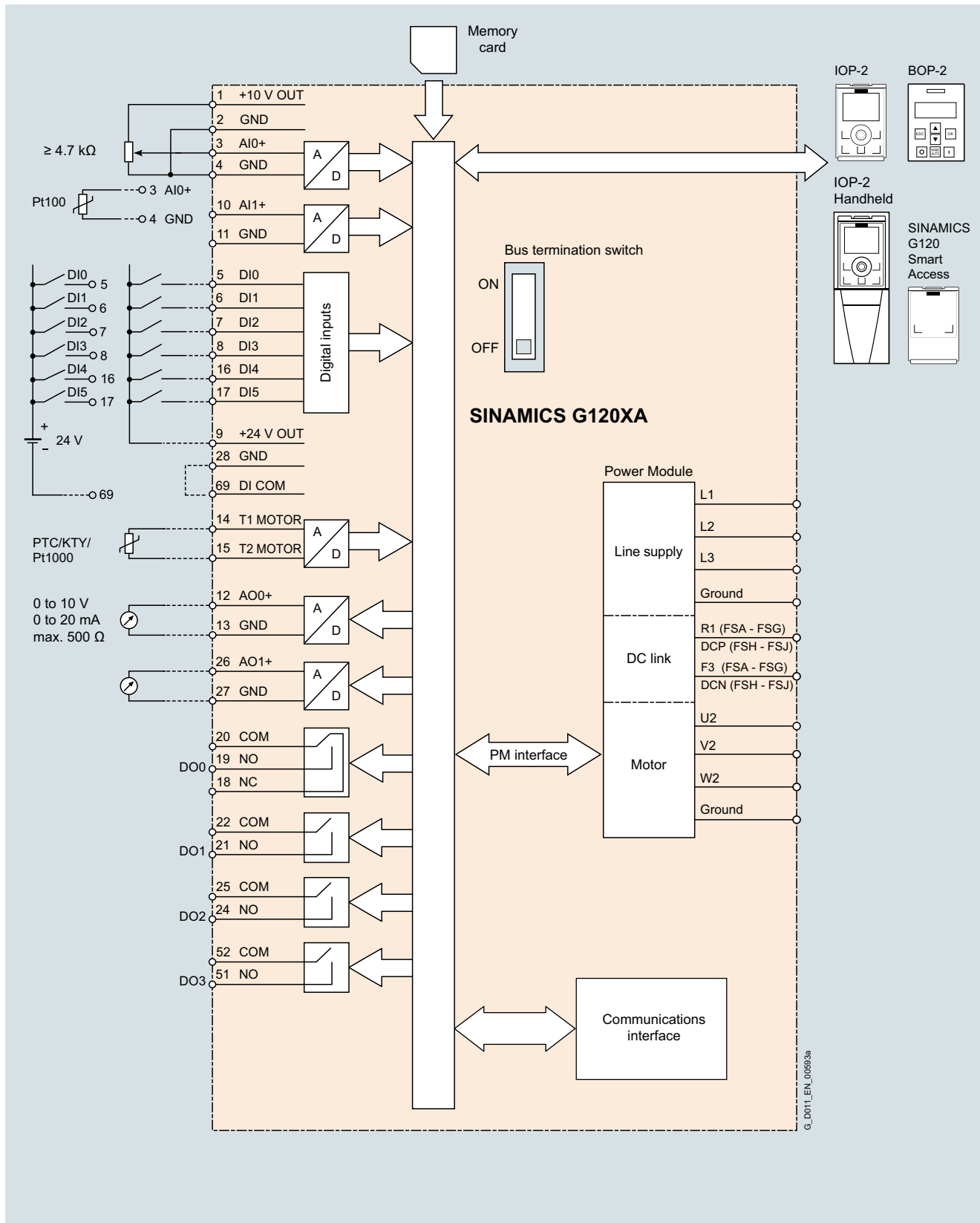

SINAMICS G120XA connection diagram

SINAMICS G120XA infrastructure converters for standard pumps/fans

0.75 kW to 560 kW

SINAMICS G120XA infrastructure converters for standard pumps/fans

Integration

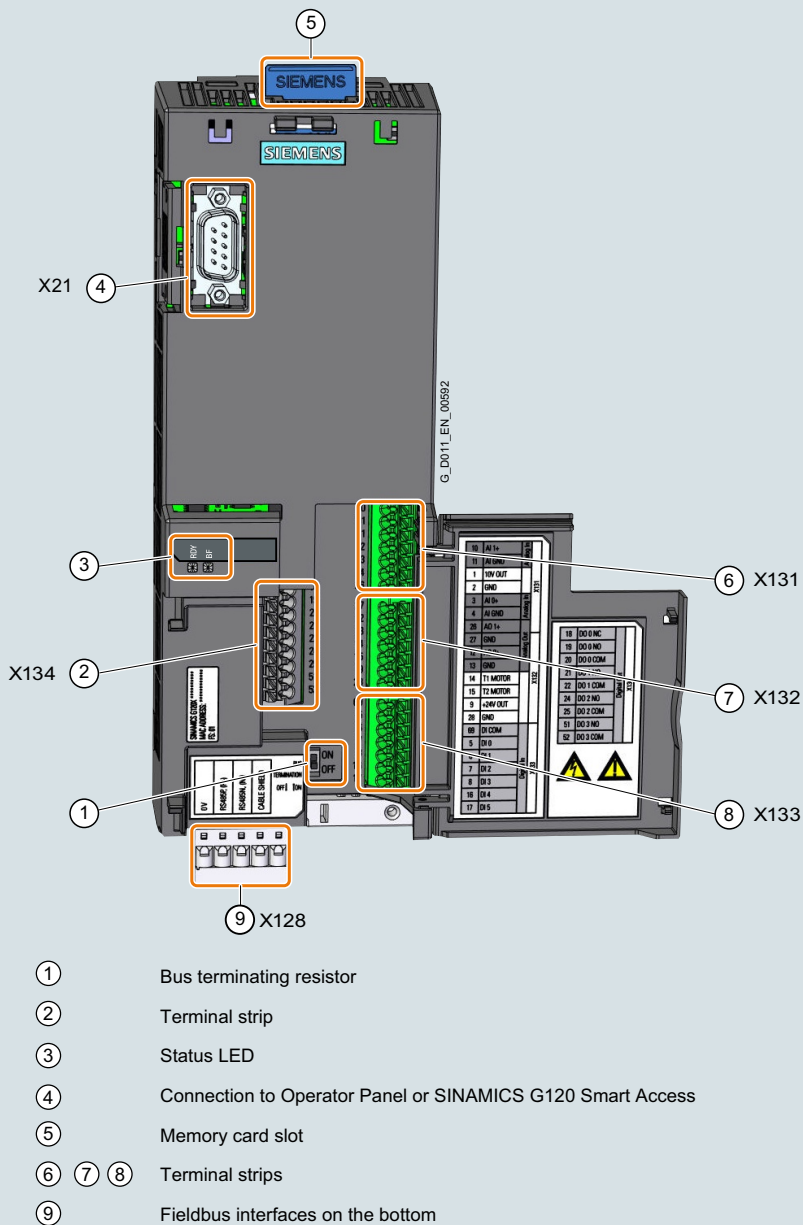

SINAMICS G120XA interface overview

SINAMICS G120XA infrastructure converters for standard pumps/fans

0.75 kW to 560 kW

SINAMICS G120XA infrastructure converters for standard pumps/fans

Selection and ordering data

SINAMICS G120XA converters · Degree of protection IP20, IP00 for frame size FSJ → Configuration with line-side and load-side components (see right page)

Rated power ¹⁾ kW	Rated output current I_{rated} ²⁾		Rated input current ³⁾ A	Max. output current A	Frame size	SINAMICS G120XA	SINAMICS G120XA
	400 V A	380 V A				Degree of protection IP20, IP00 for frame size FSJ without integrated line filter	Degree of protection IP20, IP00 for frame size FSJ with integrated line filter
						Article No.	Article No.
380 ... 440 V 3 AC · Rated pulse frequency 4 kHz ≤ 90 kW and 2 kHz ≥ 110 kW · Input frequency 47 ... 63 Hz							
0.75	2.2	2.2	2.1	2.2	FSA	6SL32 2 0- ■ YD10- 0 U B 0	6SL32 2 0- ■ YD10- 0 C B 0
1.1	3.1	3.1	2.8	3.1	FSA	6SL32 2 0- ■ YD12- 0 U B 0	6SL32 2 0- ■ YD12- 0 C B 0
1.5	4.1	4.1	3.6	4.1	FSA	6SL32 2 0- ■ YD14- 0 U B 0	6SL32 2 0- ■ YD14- 0 C B 0
2.2	5.6	5.6	5.3	5.6	FSA	6SL32 2 0- ■ YD16- 0 U B 0	6SL32 2 0- ■ YD16- 0 C B 0
3	7.3	7.3	6.6	7.3	FSA	6SL32 2 0- ■ YD18- 0 U B 0	6SL32 2 0- ■ YD18- 0 C B 0
4	8.8	9.3	8.5	9.7	FSB	6SL32 2 0- ■ YD20- 0 U B 0	6SL32 2 0- ■ YD20- 0 C B 0
5.5	12.5	12.5	11.5	13.8	FSB	6SL32 2 0- ■ YD22- 0 U B 0	6SL32 2 0- ■ YD22- 0 C B 0
7.5	16.5	16.5	15.8	18.2	FSB	6SL32 2 0- ■ YD24- 0 U B 0	6SL32 2 0- ■ YD24- 0 C B 0
11	25	25	25.8	27.5	FSC	6SL32 2 0- ■ YD26- 0 U B 0	6SL32 2 0- ■ YD26- 0 C B 0
15	31	31	28.5	34.1	FSC	6SL32 2 0- ■ YD28- 0 U B 0	6SL32 2 0- ■ YD28- 0 C B 0
18.5	37	37.5	41	41	FSD	6SL32 2 0- ■ YD30- 0 U B 0	6SL32 2 0- ■ YD30- 0 C B 0
22	43	45	46	48	FSD	6SL32 2 0- ■ YD32- 0 U B 0	6SL32 2 0- ■ YD32- 0 C B 0
30	58	59	56	64	FSD	6SL32 2 0- ■ YD34- 0 U B 0	6SL32 2 0- ■ YD34- 0 C B 0
37	68	73.5	73	75	FSD	6SL32 2 0- ■ YD36- 0 U B 0	6SL32 2 0- ■ YD36- 0 C B 0
45	82.5	85	84	91	FSD	6SL32 2 0- ■ YD38- 0 U B 0	6SL32 2 0- ■ YD38- 0 C B 0
55	103	108	106	113	FSE	6SL32 2 0- ■ YD40- 0 U B 0	6SL32 2 0- ■ YD40- 0 C B 0
75	136	144	143	150	FSF	6SL32 2 0- ■ YD42- 0 U B 0	6SL32 2 0- ■ YD42- 0 C B 0
90	164	174	164	181	FSF	6SL32 2 0- ■ YD44- 0 U B 0	6SL32 2 0- ■ YD44- 0 C B 0
110	201	205	200	222	FSF	6SL32 2 0- ■ YD46- 0 U B 0	6SL32 2 0- ■ YD46- 0 C B 0
132	237	245	234	261	FSF	6SL32 2 0- ■ YD48- 0 U B 0	6SL32 2 0- ■ YD48- 0 C B 0
160	289	292	278	318	FSG	–	6SL32 2 0- ■ YD50- 0 C B 0
200	364	370	348	401	FSG	–	6SL32 2 0- ■ YD52- 0 C B 0
250	436	468	417	480	FSG	–	6SL32 2 0- ■ YD54- 0 C B 0
315	583	605	617	770	FSH	–	6SL32 2 0- ■ YD56- 0 C B 0
355	644	670	684	870	FSH	–	6SL32 2 0- ■ YD58- 0 C B 0
400	722	750	760	972	FSH	–	6SL32 2 0- ■ YD60- 0 C B 0
450	803	840	870	1107	FSJ	–	6SL32 2 5- ■ YD62- 0 C B 0
500	882	925	959	1225	FSJ	–	6SL32 2 5- ■ YD64- 0 C B 0
560	992	1035	1060	1370	FSJ	–	6SL32 2 5- ■ YD66- 0 C B 0

Article No. supplements

Environmental class/harmful chemical substances acc. to EN 60721-3-3

Class 3C2

Operator Panel

Without Operator Panel

With BOP-2 Basic Operator Panel (numeric 2-line display)

With IOP-2 Intelligent Operator Panel (graphic color display)

Line filter

Without integrated line filter

With integrated line filter Category C3

Communication

USS, Modbus RTU, BACnet MS/TP

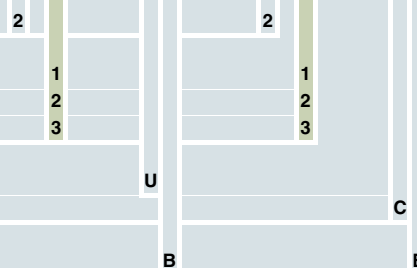

¹⁾ Rated power based on the rated output current I_{rated} . The rated output current I_{rated} is based on the duty cycle for low overload (LO).
²⁾ The rated output current I_{rated} is based on the duty cycle for low overload (LO). These current values are valid for 400 V and are specified on the rating plate of the converter.

³⁾ The input current depends on the motor load and line impedance. The input currents apply for a load at rated power (based on I_{rated}) for a line impedance corresponding to $u_k = 1\%$. The current values are specified on the rating plate of the converter.

SINAMICS G120XA infrastructure converters for standard pumps/fans

0.75 kW to 560 kW

SINAMICS G120XA infrastructure converters for standard pumps/fans

Line-side components				Load-side power components		
Line filters	Line reactors	Recommended line-side overcurrent protection devices		Output reactors	Sine-wave filters	dv/dt filters plus VPL
Category C3 Mandatory for converter without integrated line filter		Fuses IEC-compliant Further information at https://support.industry.siemens.com/cs/cn/en/view/109762896				
Article No.	Article No.	Current A	Article No.	Article No.	Article No.	Article No.
6SL3203-0BE17-7BA0	A DC link reactor is integrated for frame sizes FSA to FSG – therefore no line reactor is required.	16	3NA3805	–	–	–
		16	3NA3805	–	–	–
		16	3NA3805	–	–	–
		16	3NA3805	–	–	–
		16	3NA3805	–	–	–
6SL3203-0BE21-8BA0		32	3NA3812	–	–	–
		32	3NA3812	–	–	–
		32	3NA3812	–	–	–
6SL3203-0BE23-8BA0		50	3NA3820	–	–	–
		50	3NA3820	–	–	–
		63	3NA3822	6SL3202-0AE23-8CA0	6SL3202-0AE24-6SA0	–
		80	3NA3824	6SE6400-3TC07-5ED0	–	–
6SL3203-0BE27-5BA0		100	3NA3830	–	6SL3202-0AE26-2SA0	–
		100	3NA3830	–	6SL3202-0AE28-8SA0	–
6SL3203-0BE31-1BA0		125	3NA3832	6SE6400-3TC14-5FD0	–	–
		160	3NA3836	–	6SL3202-0AE31-5SA0	–
6SL3203-0BE31-8BA0		200	3NA3140	–	–	–
		224	3NA3142	–	6SL3202-0AE31-8SA0	–
		300	3NA3250	6SL3000-2BE32-1AA0	6SL3000-2CE32-3AA0	–
		315	3NA3252	6SL3000-2BE32-6AA0	–	–
		355	3NA3254	6SL3000-2BE33-2AA0	6SL3000-2CE32-8AA0 ¹⁾	–
–	–	400	3NA3260	6SL3000-2BE33-8AA0	6SL3000-2CE33-3AA0 ¹⁾	–
–	–	630	3NA3372	6SL3000-2BE35-0AA0	6SL3000-2CE34-1AA0 ¹⁾	–
–	6SL3000-0CE36-3AA0	710	3NE1437-2	6SL3000-2AE36-1AA0	–	6SL3000-2DE38-4AA0
–	6SL3000-0CE37-7AA0	800	3NE1438-2	6SL3000-2AE38-4AA0	–	–
–	–	850	3NE1448-2	–	–	–
–	6SL3000-0CE38-7AA0	2 × 500	3NE1334-2 2 fuses	6SL3000-2AE41-0AA0	–	6SL3000-2DE41-4AA0
–	6SL3000-0CE41-0AA0	2 × 560	3NE1435-2 2 fuses	–	–	–
–	–	2 × 630	3NE1436-2 2 fuses	6SL3000-2AE41-4AA0	–	–

Ordering examples

Basic selection	Example 1	Example 2
SINAMICS G120XA converters · degree of protection IP20 · 380 ... 440 V 3 AC, 15 kW · with integrated line filter	6SL32 2 0- YD28- 0 C B 0	6SL32 2 0- YD28- 0 C B 0
Article No. supplements		
Environmental class/harmful chemical substances acc. to EN 60721-3-3		
Class 3C2	2	2
Operator Panel		
With BOP-2 Basic Operator Panel (numeric 2-line display)	2	
With IOP-2 Intelligent Operator Panel (graphic color display)		3
Line filter		
With integrated line filter Category C3		C
Communication		
USS, Modbus RTU, BACnet MS/TP		B
Complete Article No.	6SL32 2 0- 2 YD28- 0 C B 0	6SL32 2 0- 3 YD28- 0 C B 0

¹⁾ For 160 kW, 200 kW and 250 kW, only operation in Vector Control is permitted. V/f must not be used.



SINAMICS G120XA infrastructure converters for standard pumps/fans

0.75 kW to 560 kW

SINAMICS G120XA infrastructure converters for standard pumps/fans

Selection and ordering data

Supplementary system components for SINAMICS G120XA

Description	Article No.
IOP-2 Intelligent Operator Panel Operating languages: English, German, French, Italian, Spanish, Portuguese, Dutch, Swedish, Finnish, Russian, Czech, Polish, Turkish, Chinese Simplified	6SL3255-0AA00-4JA2
IOP-2 Handheld	6SL3255-0AA00-4HA1
BOP-2 Basic Operator Panel	6SL3255-0AA00-4CA1
Door mounting kit for IOP-2/BOP-2	6SL3256-0AP00-0JA0
SINAMICS SD card 512 MB, empty	6SL3054-4AG00-2AA0
SINAMICS G120 Smart Access for wireless commissioning, operation and diagnostics of the following converters using a smartphone, tablet or laptop	6SL3255-0AA00-5AA0
Shield connection kits for Power Module for SINAMICS G120XA • Frame sizes FSA to FSC • Frame size FSD • Frame size FSE • Frame size FSF • Frame size FSG • Frame sizes FSH to FSJ	Included in the scope of delivery of the converters, can be ordered as spare part NEW 6SL3262-1AD02-0DA0 NEW 6SL3262-1AE02-0DA0 NEW 6SL3262-1AF02-0DA0 NEW 6SL3262-1AG02-0DA0 Please observe the notes included in the operating instructions
SINAMICS G120XA Starter Kit (available soon) • Converter 380 ... 440 V 3 AC, USS/Modbus RTU, BACnet MS/TP, FSA, 0.75 kW • BOP-2 • IOP-2 • SINAMICS G120 Smart Access	6SL3200-0AE71-0AA0
SINAMICS G120XA training case	6AG1067-2AA00-0AC2

Compact Installation Instructions are supplied in hard copy form in English and Chinese with every SINAMICS G120XA.

Further technical specifications and documentation are available on the Internet at:

www.siemens.com/sinamics-g120xa/documentation

and via the Drive Technology Configurator (DT Configurator) in the Siemens Industry Mall:

www.siemens.com.cn/dt-configurator

Spare parts for SINAMICS G120XA

Description	Article No.
FPI board (freely-programmable interface board) for SINAMICS G120X and SINAMICS G120XA • Frame sizes FSH and FSJ	NEW 6SL3200-OSP05-0AA0
PSB board (power supply board) for SINAMICS G120X and SINAMICS G120XA • Frame sizes FSH and FSJ	NEW 6SL3200-OSP06-0AA0
Current transformers for SINAMICS G120X and SINAMICS G120XA • 2000 A for frame size FSJ • 1000 A for frame sizes FSH and FSJ	NEW 6SL3200-0SE01-0AA0 NEW 6SL3200-0SE02-0AA0
Spare parts kit for Control Unit for SINAMICS G120X and SINAMICS G120XA • Frame sizes FSA to FSJ	NEW 6SL3200-OSK10-0AA0
Shield connection kit for Control Unit for SINAMICS G120X and SINAMICS G120XA • Frame sizes FSD to FSG	NEW 6SL3264-1EA00-0YA0
Shield connection kits for Power Module for SINAMICS G120XA • Frame size FSA • Frame size FSB • Frame size FSC	NEW 6SL3262-1AA01-0DA0 NEW 6SL3262-1AB01-0DA0 NEW 6SL3262-1AC01-0DA0
Mounting set for SINAMICS G120X and SINAMICS G120XA • Frame sizes FSD to FSG	6SL3200-OSK08-0AA0
Terminal cover kits for SINAMICS G120X and SINAMICS G120XA • Frame size FSD • Frame size FSE • Frame size FSF • Frame size FSG	6SL3200-OSM13-0AA0 6SL3200-OSM14-0AA0 6SL3200-OSM15-0AA0 6SL3200-OSM16-0AA0
External fan units for SINAMICS G120XA • Frame size FSA • Frame size FSB • Frame size FSC • Frame size FSD • Frame size FSE • Frame size FSF • Frame size FSG • Frame size FSH • Frame size FSJ	NEW 6SL3200-OSF52-0AA0 NEW 6SL3200-OSF53-0AA0 NEW 6SL3200-OSF54-0AA0 6SL3200-OSF15-0AA0 6SL3200-OSF16-0AA0 6SL3200-OSF17-0AA0 6SL3200-OSF18-0AA0 NEW 6SL3200-OSF55-0AA0 NEW 6SL3200-OSF56-0AA0
Internal fan unit for SINAMICS G120XA • Frame sizes FSH and FSJ	NEW 6SL3200-OSF51-0AA0
SITOP power supply for the external fan unit for SINAMICS G120XA • Frame sizes FSH and FSJ	6EP3446-8SB00-0AY0
Fuse for the external fan unit for SINAMICS G120XA • Frame sizes FSH and FSJ	6SY7000-0AC46
Control Unit for SINAMICS G120XA USS, Modbus RTU, BACnet MS/TP • Frame sizes FSA to FSJ	NEW 6SL3200-0SC00-0BA0

SINAMICS G120XA infrastructure converters for standard pumps/fans

0.75 kW to 560 kW

SINAMICS G120XA infrastructure converters for standard pumps/fans

Technical specifications

Unless explicitly specified otherwise, the following technical specifications are valid for all SINAMICS G120XA converters.

General technical specifications	
Mechanical specifications	
Shock and vibration load	
<ul style="list-style-type: none"> Frame sizes FSA to FSG <ul style="list-style-type: none"> Transport in transport packaging acc. to EN 61800-5-1 and EN 60068-2-6 Vibration during operation acc. to EN 60721-3-3: 1995 Frame sizes FSH and FSJ <ul style="list-style-type: none"> Vibration during operation: Test Fc acc. to EN 60068-2-6 Shock during operation: Test acc. to EN 60068-2-27 Vibration in product packaging: Test Fc acc. to EN 60068-2-64 Shock in product packaging: Test Fc acc. to EN 60068-2-27 	Class 2M3 Class 3M1 0.075 mm at 10 ... 58 Hz 9.81 m/s ² (1 × g) at > 58 ... 200 Hz 100 m/s ² (10 × g)/11 ms 30 min/axis, 3 axes 10 ... 200 Hz ASD 1.0 (m ² /s ³) 10 × g/11 ms
Degree of protection	
<ul style="list-style-type: none"> Frame sizes FSA to FSH Frame size FSJ 	IP20/ UL Open Type IP00/ UL Open Type
Permissible mounting position	Vertical wall mounting
Ambient conditions	
Protection class acc. to EN 61800-5-1	Class III (PELV1) for Power Module Class II (PELV1) for Control Unit
Touch protection acc. to EN 61800-5-1	Class I (with protective conductor system)
Humidity, max.	<95 %, condensation not permissible
Ambient temperature	
<ul style="list-style-type: none"> Storage acc. to EN 60068-2-1 <ul style="list-style-type: none"> Frame sizes FSA to FSG Frame sizes FSH and FSJ Transport acc. to EN 60068-2-1 Operation acc. to EN 60068-2-2 <ul style="list-style-type: none"> Frame sizes FSA to FSG Frame sizes FSH and FSJ All frame sizes with operator panel 	-40 ... +70 °C (-40 ... +158 °F) -25 ... +55 °C (-13 ... +131 °F) -40 ... +70 °C (-40 ... +158 °F) -20 °C ... +60 °C (-4 ... +140 °F) with a side clearance of 5 cm or -20 °C ... +55 °C (-4 ... +131 °F) for side-by-side mounting, >40 °C (104 °F) with derating 0 ... 50 °C (32 ... 122 °F), >40 °C (104 °F) with derating 0 ... 50 °C (32 ... 122 °F) <i>see also derating characteristics</i>
Environmental class in operation	
<ul style="list-style-type: none"> Harmful chemical substances Organic/biological pollutants Degree of pollution 	Class 3C2 acc. to EN 60721-3-3 Class 3B1 acc. to EN 60721-3-3 2 acc. to EN 61800
Standards	
Compliance with standards ¹⁾	CE, RCM, RoHS II, EAC
CE marking acc. to	EMC Directive 2014/30/EU Low Voltage Directive 2014/35/EU
EMC Directive ¹⁾ acc. to EN 61800-3	
<ul style="list-style-type: none"> Interference immunity Interference emissions <ul style="list-style-type: none"> Frame sizes FSA to FSF without integrated line filter Frame sizes FSA to FSJ with integrated line filter Category C3 Frame sizes FSA to FSF without integrated line filter, with optional line filter Category C3 	The SINAMICS G120XA converters are tested according to the interference immunity requirements for environments according to Category C3. 2) Observance of the limit values according to Category C3 Observance of the limit values according to Category C3
Note: The EMC product standard EN 61800-3 does not apply directly to a frequency converter but to a PDS (Power Drive System), which comprises the complete circuitry, motor and cables in addition to the converter. The frequency converters on their own do not generally require identification according to the EMC Directive.	

¹⁾ Additional information is available in the operating instructions on the Internet at: www.siemens.com/sinamics-g120xa/documentation

²⁾ Non-filtered devices are designed for operation in IT systems or in conjunction with an RCD. The customer must provide suitable RI suppression equipment to ensure that these devices comply with the limits defined for Category C3.

SINAMICS G120XA infrastructure converters for standard pumps/fans

0.75 kW to 560 kW

SINAMICS G120XA infrastructure converters for standard pumps/fans

Technical specifications

SINAMICS G120XA converters

Integrated bus interface

Fieldbus protocols

- USS
- Modbus RTU
- BACnet MS/TP

Hardware

RS485 connected at a terminal, isolated,
 USS: max. 187.5 kBaud
 Modbus RTU: 19.2 kBaud,
 BACnet MS/TP: max. 187.5 kBaud,
 bus terminating resistor can be switched in

I/O interfaces

Signal cable cross-section

0.15 ... 1.5 mm² (28 ... 16 AWG)

Digital inputs

6 isolated inputs
 Optically isolated;
 Free reference potential (own potential group)
 NPN/PNP logic can be selected using the wiring

- Switching level: 0 → 1
- Switching level: 1 → 0

11 V
 5 V

Digital outputs

1 relay changeover contact
 250 V AC, 1 A (inductive load),
 30 V DC, 1 A (ohmic load)
 3 relay NO contacts
 250 V AC, 1 A (inductive load),
 30 V DC, 1 A (ohmic load)

Analog inputs

2 analog inputs
 Non-isolated input
 Switchable between voltage (-10 ... +10 V) and current (0/4 ... 20 mA) using a parameter
 12-bit resolution
 Can be used as additional digital input

- Switching threshold: 0 → 1
- Switching threshold: 1 → 0

4 V
 1.6 V

Analog outputs

2 analog outputs
 Non-isolated output
 Switchable between voltage (0 ... 10 V) and current (0/4 ... 20 mA) using a parameter
 Voltage mode: 10 V, min. burden 10 kΩ
 Current mode: 20 mA, max. burden 500 Ω
 The analog outputs have short-circuit protection

PTC/KTY/Pt1000 interface

1 motor temperature sensor input
 Connectable sensors PTC, Pt1000, KTY and bimetal,
 accuracy ±5 °C
Note:
 Connection and evaluation of a recommended, optional Pt100 temperature sensor possible by using a free analog input and output

Voltage supply for the integrated Control Unit

24 V DC via the Power Module

Tool interfaces

Memory card

Optional
SINAMICS SD card

Operator panels

Optional
BOP-2 Basic Operator Panel or IOP-2 Intelligent Operator Panel or SINAMICS G120 Smart Access

2

SINAMICS G120XA infrastructure converters for standard pumps/fans

0.75 kW to 560 kW

SINAMICS G120XA infrastructure converters for standard pumps/fans

Technical specifications

SINAMICS G120XA converters

Open-loop/closed-loop control techniques

V/f linear/quadratic/parameterizable ✓

V/f with flux current control (FCC) ✓

V/f ECO linear/quadratic ✓

Vector control, sensorless ✓

Software functions

Setpoint input, can be parameterized ✓

Fixed frequencies 16, parameterizable

JOG ✓

Digital motorized potentiometer (MOP) ✓

Ramp smoothing ✓

Extended ramp-function generator (with ramp smoothing OFF3) ✓

Slip compensation ✓

Switchable drive data sets (DDS) ✓ (4)

Switchable command data sets (CDS) ✓ (2)

Flying restart ✓

Automatic restart after line supply failure or operating fault (AR) ✓

Technology controller (internal PID) ✓

Energy saving display ✓

3 additional, free PID controllers ✓

Hibernation mode with internal/external PID controller ✓

Belt monitoring with and without sensor (load torque monitoring) ✓

Dry-running/overload protection monitoring (load torque monitoring) ✓

Deragging ✓

Thermal motor protection ✓ (R^2t , sensor: PTC, Pt100, Pt1000, KTY and bimetal)

Thermal converter protection ✓

Motor identification ✓

Auto-ramping (V_{dc_max} controller) ✓Kinetic buffering (V_{dc_min} controller) ✓

Braking functions

• DC braking ✓

• Compound braking ✓

SINAMICS G120XA infrastructure converters for standard pumps/fans

0.75 kW to 560 kW

SINAMICS G120XA infrastructure converters for standard pumps/fans

Technical specifications

General technical specifications of the power electronics	
System operating voltage	
• Frame sizes FSA to FSG	380 ... 440 V 3 AC +10 % -20 %
• Frame sizes FSH and FSJ	380 ... 440 V 3 AC +10 % -15 %
Line supply requirements	
Line impedance u_k	
• Frame sizes FSA to FSG	2 %
• Frame sizes FSD to FSG	No restriction
• Frame sizes FSH and FSJ	A line reactor ($u_k = 2 %$) must be connected in series, if the short-circuit power ratio $R_{SC} > 33$ (315 ... 500 kW) or $R_{SC} > 20$ (560 kW)
Input frequency	47 ... 63 Hz
Output frequency	
• Frame sizes FSA to FSG	Control mode V/f: 0 ... 550 Hz Control mode Vector: 0 ... 240 Hz
• Frame sizes FSH and FSJ	Control mode V/f: 0 ... 100 Hz Control mode Vector: 0 ... 100 Hz
Pulse frequency	
• Frame sizes FSA to FSG	4 kHz for converters with a rated power ≤ 90 kW 2 kHz for converters with a rated power ≥ 110 kW Higher pulse frequencies up to 16 kHz see derating data
• Frame sizes FSH and FSJ	2 kHz Self-adjusting up to 4 kHz see derating data
Power factor λ	
• Frame sizes FSA to FSG	0.75 ... 0.93
• Frame sizes FSH and FSJ	0.75 ... 0.93 (with line reactor $u_k = 2 %$)
Offset factor $\cos \varphi$	0.99
Output voltage, max. as % of line voltage	97 %
Overload capability	
• Low overload LO	1.1 × base-load current I_L (i. e. 110 % overload) for 60 s within a cycle time of 600 s
Cooling	Air cooling using an integrated fan
Installation altitude	Up to 1000 m (3281 ft) above sea level without derating, >1000 m (3281 ft) see derating characteristics
Short Circuit Current Rating (SCCR), max.	100 kA see Recommended line-side overcurrent protection devices – the value depends on the fuses and circuit breakers used For more information, see: https://support.industry.siemens.com/cs/cn/en/view/109762896
Protection functions	<ul style="list-style-type: none"> • Undervoltage • Overvoltage • Overcurrent/overload • Ground fault • Short-circuit <ul style="list-style-type: none"> • Stall protection • Motor blocking protection • Motor overtemperature • Converter overtemperature • Parameter locking

Maximum permissible motor cable lengths SINAMICS G120XA

The values specified in the table below apply with low-capacitance CY cables and with pulse frequencies set in the factory.

	Maximum permissible motor cable lengths (shielded/unshielded) in m (ft)			
	FSA to FSC	FSD and FSE	FSF and FSG	FSH and FSJ
Without compliance to the EMC category				
Converters without optional power components	150/300 (492/984)	200/300 (656/984)	300/450 (984/1476)	150/200 (492/656)
Converters with optional output reactor	–	200/300 (656/984) ¹⁾	300/450 (984/1476) ¹⁾	300/450 (984/1476)
Converters with optional dv/dt filter plus VPL	–	–	–	300/450 (984/1476)
With compliance to the EMC category				
Converters with integrated line filter Category C3 to comply with radio interference emissions according to EN 61800-3 EMC Category C3	50/– (164/–)	100/– (328/–)	150/– (492/–)	100/– (328/–)
Converters without integrated line filter with external line filter Category C3 to comply with radio interference emissions according to EN 61800-3 EMC Category C3	50/– (164/–)	50/– (164/–)	FSF: 50/– (164/–) FSG: –	–

¹⁾ For frame sizes FSD to FSG the maximum permissible cable lengths are not increased with an output reactor. By means of the output reactor, the loading of the motor windings is reduced by lower rates of voltage rise (dv/dt). By means of two output reactors connected in series, the maximum permis-

sible cable lengths for frame sizes FSD and FSE are increased to 350 m (1148 ft) (shielded) and 525 m (1723 ft) (unshielded), and for frame sizes FSF and FSG to 525 m (1723 ft) (shielded) and 800 m (2625 ft) (unshielded).

SINAMICS G120XA infrastructure converters for standard pumps/fans

0.75 kW to 560 kW

SINAMICS G120XA infrastructure converters for standard pumps/fans

Technical specifications

SINAMICS G120XA converters · Degree of protection IP20, IP00 for frame size FSJ · 380 ... 440 V 3 AC

		6SL3220-.YD10-0CB0 6SL3220-.YD10-0UB0	6SL3220-.YD12-0CB0 6SL3220-.YD12-0UB0	6SL3220-.YD14-0CB0 6SL3220-.YD14-0UB0	6SL3220-.YD16-0CB0 6SL3220-.YD16-0UB0
Type of voltage		3 AC	3 AC	3 AC	3 AC
Line voltage	V	380 ... 440	380 ... 440	380 ... 440	380 ... 440
Output current					
• rated value at 400 V	A	2.2	3.1	4.1	5.6
• rated value at 380 V	A	2.2	3.1	4.1	5.6
• maximum	A	2.2	3.1	4.1	5.6
Supplied active power at rated value of output voltage with low overload	kW	0.75	1.1	1.5	2.2
Pulse frequency	kHz	4	4	4	4
Efficiency		0.96	0.96	0.96	0.96
Power loss maximum ¹⁾	kW	0.043	0.055	0.072	0.088
Cooling air flow	m ³ /s (ft ³ /h)	0.005 (635.66406)	0.005 (635.66406)	0.005 (635.66406)	0.005 (635.66406)
1 m measuring surface sound pressure level maximum	dB	55	55	55	55
Input current with low overload rated value	A	2.1	2.8	3.6	5.3
for mains supply line					
• Type of electrical connection		Screw-type terminals	Screw-type terminals	Screw-type terminals	Screw-type terminals
• Number of connections		1	1	1	1
• Connectable conductor cross-section	mm ²	1.5 ... 2.5	1.5 ... 2.5	1.5 ... 2.5	1.5 ... 2.5
• Connectable conductor cross-section (AWG)		18 ... 14	18 ... 14	18 ... 14	18 ... 14
for motor supply line					
• Type of electrical connection		Screw-type terminals	Screw-type terminals	Screw-type terminals	Screw-type terminals
• Number of connections		1	1	1	1
• Connectable conductor cross-section	mm ²	1.5 ... 2.5	1.5 ... 2.5	1.5 ... 2.5	1.5 ... 2.5
• Connectable conductor cross-section (AWG)		18 ... 14	18 ... 14	18 ... 14	18 ... 14
Type of electrical connection for PE conductor		On housing with M4 screw	On housing with M4 screw	On housing with M4 screw	On housing with M4 screw
Cable length for motor					
• shielded maximum	m (ft)	150 (492.12598)	150 (492.12598)	150 (492.12598)	150 (492.12598)
• unshielded maximum	m (ft)	300 (984.25197)	300 (984.25197)	300 (984.25197)	300 (984.25197)
Dimensions					
• Width	mm (in)	73 (2.87402)	73 (2.87402)	73 (2.87402)	73 (2.87402)
• Height	mm (in)	232 (9.13386)	232 (9.13386)	232 (9.13386)	232 (9.13386)
• Depth	mm (in)	209 (8.22835)	209 (8.22835)	209 (8.22835)	209 (8.22835)
Frame size		FSA	FSA	FSA	FSA
Weight, approx.	kg (lb)	3.4 (7.49572)	3.4 (7.49572)	3.4 (7.49572)	3.4 (7.49572)

¹⁾ Typical values. More information can be found on the Internet at <https://support.industry.siemens.com/cs/document/94059311>

SINAMICS G120XA infrastructure converters for standard pumps/fans

0.75 kW to 560 kW

SINAMICS G120XA infrastructure converters for standard pumps/fans

Technical specifications

		6SL3220-.YD18-0CB0 6SL3220-.YD18-0UB0	6SL3220-.YD20-0CB0 6SL3220-.YD20-0UB0	6SL3220-.YD22-0CB0 6SL3220-.YD22-0UB0	6SL3220-.YD24-0CB0 6SL3220-.YD24-0UB0
Type of voltage		3 AC	3 AC	3 AC	3 AC
Line voltage	V	380 ... 440	380 ... 440	380 ... 440	380 ... 440
Output current					
• rated value at 400 V	A	7.3	8.8	12.5	16.5
• rated value at 380 V	A	7.3	9.3	12.5	16.5
• maximum	A	7.3	9.7	13.8	18.2
Supplied active power at rated value of output voltage with low overload	kW	3	4	5.5	7.5
Pulse frequency	kHz	4	4	4	4
Efficiency		0.96	0.97	0.97	0.97
Power loss maximum ¹⁾	kW	0.119	0.119	0.175	0.231
Cooling air flow	m ³ /s (ft ³ /h)	0.005 (635.66406)	0.005 (635.66406)	0.0092 (1169.62187)	0.0092 (1169.62187)
1 m measuring surface sound pressure level maximum	dB	55	63	63	63
Input current with low overload rated value	A	6.6	8.5	11.5	15.8
for mains supply line					
• Type of electrical connection		Screw-type terminals	Screw-type terminals	Screw-type terminals	Screw-type terminals
• Number of connections		1	1	1	1
• Connectable conductor cross-section	mm ²	1.5 ... 2.5	6 ... 16	6 ... 16	6 ... 16
• Connectable conductor cross-section (AWG)		18 ... 14	10 ... 6	10 ... 6	10 ... 6
for motor supply line					
• Type of electrical connection		Screw-type terminals	Screw-type terminals	Screw-type terminals	Screw-type terminals
• Number of connections		1	1	1	1
• Connectable conductor cross-section	mm ²	1.5 ... 2.5	6 ... 16	6 ... 16	6 ... 16
• Connectable conductor cross-section (AWG)		18 ... 14	10 ... 6	10 ... 6	10 ... 6
Type of electrical connection for PE conductor		On housing with M4 screw	On housing with M4 screw	On housing with M4 screw	On housing with M4 screw
Cable length for motor					
• shielded maximum	m (ft)	150 (492.12598)	150 (492.12598)	150 (492.12598)	150 (492.12598)
• unshielded maximum	m (ft)	300 (984.25197)	300 (984.25197)	300 (984.25197)	300 (984.25197)
Dimensions					
• Width	mm (in)	73 (2.87402)	100 (3.93701)	100 (3.93701)	100 (3.93701)
• Height	mm (in)	232 (9.13386)	275 (10.82677)	275 (10.82677)	275 (10.82677)
• Depth	mm (in)	209 (8.22835)	209 (8.22835)	209 (8.22835)	209 (8.22835)
Frame size		FSA	FSB	FSB	FSB
Weight, approx.	kg (lb)	3.4 (7.49572)	6 (13.22774)	6 (13.22774)	6 (13.22774)

¹⁾ Typical values. More information can be found on the Internet at <https://support.industry.siemens.com/cs/document/94059311>

SINAMICS G120XA infrastructure converters for standard pumps/fans

0.75 kW to 560 kW

SINAMICS G120XA infrastructure converters for standard pumps/fans

Technical specifications

		6SL3220-.YD26-0CB0 6SL3220-.YD26-0UB0	6SL3220-.YD28-0CB0 6SL3220-.YD28-0UB0	6SL3220-.YD30-0UC0 6SL3220-.YD30-0UB0	6SL3220-.YD32-0CB0 6SL3220-.YD32-0UB0
Type of voltage		3 AC	3 AC	3 AC	3 AC
Line voltage	V	380 ... 440	380 ... 440	380 ... 440	380 ... 440
Output current					
• rated value at 400 V	A	25	31	37	43
• rated value at 380 V	A	25	31	37.5	45
• maximum	A	27.5	34.1	41	48
Supplied active power at rated value of output voltage with low overload	kW	11	15	18.5	22
Pulse frequency	kHz	4	4	4	4
Efficiency		0.97	0.97	0.98	0.98
Power loss maximum ¹⁾	kW	0.31	0.402	0.541	0.641
Cooling air flow	m ³ /s (ft ³ /h)	0.0185 (2351.95680)	0.0185 (2351.95680)	0.055 (6992.30465)	0.055 (6992.30465)
1 m measuring surface sound pressure level maximum	dB	67	67	62.2	62.2
Input current with low overload rated value	A	25.8	28.5	41	46
for mains supply line					
• Type of electrical connection		Screw-type terminals	Screw-type terminals	Screw-type terminals	Screw-type terminals
• Number of connections		1	1	1	1
• Connectable conductor cross-section	mm ²	6 ... 16	6 ... 16	10 ... 35	10 ... 35
• Connectable conductor cross-section (AWG)		10 ... 6	10 ... 6	8 ... 2	8 ... 2
for motor supply line					
• Type of electrical connection		Screw-type terminals	Screw-type terminals	Screw-type terminals	Screw-type terminals
• Number of connections		1	1	1	1
• Connectable conductor cross-section	mm ²	6 ... 16	6 ... 16	10 ... 35	10 ... 35
• Connectable conductor cross-section (AWG)		10 ... 6	10 ... 6	8 ... 2	8 ... 2
Type of electrical connection for PE conductor		On housing with M4 screw	On housing with M4 screw	Screw-type terminals	Screw-type terminals
Cable length for motor					
• shielded maximum	m (ft)	150 (492.12598)	150 (492.12598)	200 (656.16798)	200 (656.16798)
• unshielded maximum	m (ft)	300 (984.25197)	300 (984.25197)	300 (984.25197)	300 (984.25197)
Dimensions					
• Width	mm (in)	140 (5.51181)	140 (5.51181)	200 (7.87402)	200 (7.87402)
• Height	mm (in)	295 (11.61417)	295 (11.61417)	472 (18.58268)	472 (18.58268)
• Depth	mm (in)	209 (8.22835)	209 (8.22835)	239 (9.40945)	239 (9.40945)
Frame size		FSC	FSC	FSD	FSD
Weight, approx.	kg (lb)	7.5 (16.53467)	7.5 (16.53467)	17.9 (39.46274)	17.9 (39.46274)

¹⁾ Typical values. More information can be found on the Internet at <https://support.industry.siemens.com/cs/document/94059311>

SINAMICS G120XA infrastructure converters for standard pumps/fans

0.75 kW to 560 kW

SINAMICS G120XA infrastructure converters for standard pumps/fans

Technical specifications

		6SL3220-.YD34-0CB0 6SL3220-.YD34-0UB0	6SL3220-.YD36-0UC0 6SL3220-.YD36-0UB0	6SL3220-.YD38-0CB0 6SL3220-.YD38-0UB0	6SL3220-.YD40-0CB0 6SL3220-.YD40-0UB0
Type of voltage		3 AC	3 AC	3 AC	3 AC
Line voltage	V	380 ... 440	380 ... 440	380 ... 440	380 ... 440
Output current					
• rated value at 400 V	A	58	68	82.5	103
• rated value at 380 V	A	59	73.5	85	108
• maximum	A	64	75	91	113
Supplied active power at rated value of output voltage with low overload	kW	30	37	45	55
Pulse frequency	kHz	4	4	4	4
Efficiency		0.98	0.98	0.98	0.98
Power loss maximum ¹⁾	kW	0.929	0.977	1.269	1.567
Cooling air flow	m ³ /s (ft ³ /h)	0.055 (6992.30465)	0.055 (6992.30465)	0.083 (10552.02338)	0.083 (10552.02338)
1 m measuring surface sound pressure level maximum	dB	62.2	62.2	62.2	66.5
Input current with low overload rated value	A	56	73	84	106
for mains supply line					
• Type of electrical connection		Screw-type terminals	Screw-type terminals	Screw-type terminals	Screw-type terminals
• Number of connections		1	1	1	1
• Connectable conductor cross-section	mm ²	10 ... 35	10 ... 35	10 ... 35	25 ... 95
• Connectable conductor cross-section (AWG)		8 ... 2	8 ... 2	8 ... 2	4 ... -1
for motor supply line					
• Type of electrical connection		Screw-type terminals	Screw-type terminals	Screw-type terminals	Screw-type terminals
• Number of connections		1	1	1	1
• Connectable conductor cross-section	mm ²	10 ... 35	10 ... 35	10 ... 35	25 ... 95
• Connectable conductor cross-section (AWG)		8 ... 2	8 ... 2	8 ... 2	4 ... -1
Type of electrical connection for PE conductor		Screw-type terminals	Screw-type terminals	Screw-type terminals	Screw-type terminals
Cable length for motor					
• shielded maximum	m (ft)	200 (656.16798)	200 (656.16798)	200 (656.16798)	200 (656.16798)
• unshielded maximum	m (ft)	300 (984.25197)	300 (984.25197)	300 (984.25197)	300 (984.25197)
Dimensions					
• Width	mm (in)	200 (7.87402)	200 (7.87402)	200 (7.87402)	275 (10.82677)
• Height	mm (in)	472 (18.58268)	472 (18.58268)	472 (18.58268)	551 (21.69291)
• Depth	mm (in)	239 (9.40945)	239 (9.40945)	239 (9.40945)	239 (9.40945)
Frame size		FSD	FSD	FSD	FSE
Weight, approx.	kg (lb)	17.9 (39.46274)	19.1 (42.10829)	18.3 (40.34459)	27 (59.52481)

¹⁾ Typical values. More information can be found on the Internet at <https://support.industry.siemens.com/cs/document/94059311>

SINAMICS G120XA infrastructure converters for standard pumps/fans

0.75 kW to 560 kW

SINAMICS G120XA infrastructure converters for standard pumps/fans

Technical specifications

		6SL3220-.YD42-0CB0 6SL3220-.YD42-0UB0	6SL3220-.YD44-0CB0 6SL3220-.YD44-0UB0	6SL3220-.YD46-0CB0 6SL3220-.YD46-0UB0	6SL3220-.YD48-0CB0 6SL3220-.YD48-0UB0
Type of voltage		3 AC	3 AC	3 AC	3 AC
Line voltage	V	380 ... 440	380 ... 440	380 ... 440	380 ... 440
Output current					
• rated value at 400 V	A	136	164	201	237
• rated value at 380 V	A	144	174	205	245
• maximum	A	150	181	222	261
Supplied active power at rated value of output voltage with low overload	kW	75	90	110	132
Pulse frequency	kHz	4	4	2	2
Efficiency		0.98	0.98	0.98	0.98
Power loss maximum ¹⁾	kW	1.737	2.183	2.293	2.89
Cooling air flow	m ³ /s (ft ³ /h)	0.153 (19451.32021)	0.153 (19451.32021)	0.153 (19451.32021)	0.153 (19451.32021)
1 m measuring surface sound pressure level maximum	dB	73.1	73.1	73.1	73.1
Input current with low overload rated value	A	143	164	200	234
for mains supply line					
• Type of electrical connection		M10 screw	M10 screw	M10 screw	M10 screw
• Number of connections		2	2	2	2
• Connectable conductor cross-section	mm ²	35 ... 120	35 ... 120	35 ... 120	35 ... 120
• Connectable conductor cross-section (AWG)		2 ... -3	2 ... -3	2 ... -3	2 ... -3
for motor supply line					
• Type of electrical connection		M10 screw	M10 screw	M10 screw	M10 screw
• Number of connections		2	2	2	2
• Connectable conductor cross-section	mm ²	35 ... 120	35 ... 120	35 ... 120	35 ... 120
• Connectable conductor cross-section (AWG)		2 ... -3	2 ... -3	2 ... -3	2 ... -3
Type of electrical connection for PE conductor		M10 screw	M10 screw	M10 screw	M10 screw
Cable length for motor					
• shielded maximum	m (ft)	300 (984.25197)	300 (984.25197)	300 (984.25197)	300 (984.25197)
• unshielded maximum	m (ft)	450 (1476.37795)	450 (1476.37795)	450 (1476.37795)	450 (1476.37795)
Dimensions					
• Width	mm (in)	305 (12.00787)	305 (12.00787)	305 (12.00787)	305 (12.00787)
• Height	mm (in)	709 (27.91339)	709 (27.91339)	709 (27.91339)	709 (27.91339)
• Depth	mm (in)	360 (14.17323)	360 (14.17323)	360 (14.17323)	360 (14.17323)
Frame size		FSF	FSF	FSF	FSF
Weight, approx.	kg (lb)	66.8 (147.26878)	66.8 (147.26878)	68.3 (150.57572)	68.3 (150.57572)

¹⁾ Typical values. More information can be found on the Internet at <https://support.industry.siemens.com/cs/document/94059311>

SINAMICS G120XA infrastructure converters for standard pumps/fans

0.75 kW to 560 kW

SINAMICS G120XA infrastructure converters for standard pumps/fans**Technical specifications**

		6SL3220-.YD50-0CB0	6SL3220-.YD52-0CB0	6SL3220-.YD54-0CB0	6SL3220-.YD56-0CB0
Type of voltage		3 AC	3 AC	3 AC	3 AC
Line voltage	V	380 ... 440	380 ... 440	380 ... 440	380 ... 440
Output current					
• rated value at 400 V	A	289	364	436	583
• rated value at 380 V	A	292	370	468	605
• maximum	A	318	401	480	770
Supplied active power at rated value of output voltage with low overload	kW	160	200	250	315
Pulse frequency	kHz	2	2	2	2
Efficiency		0.98	0.98	0.98	0.98
Power loss maximum ¹⁾	kW	3.448	4.509	5.437	6.395
Cooling air flow	m ³ /s (ft ³ /h)	0.21 (26697.89049)	0.21 (26697.89049)	0.21 (26697.89049)	0.345 (43860.82008)
1 m measuring surface sound pressure level maximum	dB	74.9	74.9	74.9	72.9
Input current with low overload rated value	A	278	348	417	617
for mains supply line					
• Type of electrical connection		M10 screw	M10 screw	M10 screw	M12 screw
• Number of connections		2	2	2	4
• Connectable conductor cross-section	mm ²	35 ... 185	35 ... 185	35 ... 185	35 ... 240
• Connectable conductor cross-section (AWG)		2 ... -3	2 ... -3	2 ... -3	2 ... -3
for motor supply line					
• Type of electrical connection		M10 screw	M10 screw	M10 screw	M12 screw
• Number of connections		2	2	2	4
• Connectable conductor cross-section	mm ²	35 ... 185	35 ... 185	35 ... 185	35 ... 240
• Connectable conductor cross-section (AWG)		2 ... -3	2 ... -3	2 ... -3	2 ... -3
Type of electrical connection for PE conductor		M10 screw	M10 screw	M10 screw	M12 screw
Cable length for motor					
• shielded maximum	m (ft)	300 (984.25197)	300 (984.25197)	300 (984.25197)	150 (492.12598)
• unshielded maximum	m (ft)	450 (1476.37795)	450 (1476.37795)	450 (1476.37795)	200 (656.16798)
Dimensions					
• Width	mm (in)	305 (12.00787)	305 (12.00787)	305 (12.00787)	548 (21.5748)
• Height	mm (in)	999 (39.33071)	999 (39.33071)	999 (39.33071)	1695 (66.73228)
• Depth	mm (in)	360 (14.17323)	360 (14.17323)	360 (14.17323)	393 (15.47244)
Frame size		FSG	FSG	FSG	FSH
Weight, approx.	kg (lb)	105 (231.48536)	113 (249.12234)	120 (264.5547)	132 (291.01017)

¹⁾ Typical values. More information can be found on the Internet at <https://support.industry.siemens.com/cs/document/94059311>

SINAMICS G120XA infrastructure converters for standard pumps/fans

0.75 kW to 560 kW

SINAMICS G120XA infrastructure converters for standard pumps/fans

Technical specifications

		6SL3220-YD58-0CB0	6SL3220-YD60-0CB0	6SL3225-YD62-0CB0	6SL3225-YD64-0CB0	6SL3225-YD66-0CB0
Type of voltage		3 AC	3 AC	3 AC	3 AC	3 AC
Line voltage	V	380 ... 440	380 ... 440	380 ... 440	380 ... 440	380 ... 440
Output current						
• rated value at 400 V	A	644	722	803	882	992
• rated value at 380 V	A	670	750	840	925	1035
• maximum	A	870	972	1107	1225	1370
Supplied active power at rated value of output voltage with low overload	kW	355	400	450	500	560
Pulse frequency	kHz	2	2	2	2	2
Efficiency		0.98	0.98	0.98	0.98	0.98
Power loss maximum ¹⁾	kW	7.291	7.989	9	10	11.2
Cooling air flow	m ³ /s (ft ³ /h)	0.345 (43860.82008)	0.345 (43860.82008)	0.345 (43860.82008)	0.345 (43860.82008)	0.345 (43860.82008)
1 m measuring surface sound pressure level maximum	dB	72.9	72.9	75.4	75.4	75.4
Input current with low overload rated value	A	684	760	870	959	1060
for mains supply line						
• Type of electrical connection		M12 screw	M12 screw	M12 screw	M12 screw	M12 screw
• Number of connections		4	4	6	6	6
• Connectable conductor cross-section	mm ²	35 ... 240	35 ... 240	35 ... 240	35 ... 240	35 ... 240
• Connectable conductor cross-section (AWG)		2 ... -3	2 ... -3	2 ... -3	2 ... -3	2 ... -3
for motor supply line						
• Type of electrical connection		M12 screw	M12 screw	M12 screw	M12 screw	M12 screw
• Number of connections		4	4	6	6	6
• Connectable conductor cross-section	mm ²	35 ... 240	35 ... 240	35 ... 240	35 ... 240	35 ... 240
• Connectable conductor cross-section (AWG)		2 ... -3	2 ... -3	2 ... -3	2 ... -3	2 ... -3
Type of electrical connection for PE conductor		M12 screw	M12 screw	M12 screw	M12 screw	M12 screw
Cable length for motor						
• shielded maximum	m (ft)	150 (492.12598)	150 (492.12598)	150 (492.12598)	150 (492.12598)	150 (492.12598)
• unshielded maximum	m (ft)	200 (656.16798)	200 (656.16798)	200 (656.16798)	200 (656.16798)	200 (656.16798)
Dimensions						
• Width	mm (in)	548 (21.5748)	548 (21.5748)	801 (31.53543)	801 (31.53543)	801 (31.53543)
• Height	mm (in)	1695 (66.73228)	1695 (66.73228)	1621 (63.8189)	1621 (63.8189)	1621 (63.8189)
• Depth	mm (in)	393 (15.47244)	393 (15.47244)	393 (15.47244)	393 (15.47244)	393 (15.47244)
Frame size		FSH	FSH	FSJ	FSJ	FSJ
Weight, approx.	kg (lb)	134 (295.41941)	137 (302.03328)	204 (449.74299)	210 (462.97072)	218 (480.6077)

¹⁾ Typical values. More information can be found on the Internet at <https://support.industry.siemens.com/cs/document/94059311>

SINAMICS G120XA infrastructure converters for standard pumps/fans

0.75 kW to 560 kW

SINAMICS G120XA infrastructure converters for standard pumps/fans

Configuration

The following electronic configuring aids and engineering tools are available for the SINAMICS G120XA:

Drive Technology Configurator (DT Configurator)

Drive Technology Configurator (DT Configurator) within the CA 01

The Interactive Catalog CA 01 - the offline Industry Mall of Siemens - contains over 100000 products with approximately 5 million possible drive system product variants. The Drive Technology Configurator (DT Configurator) has been developed to facilitate selection of the correct motor and/or converter from the wide spectrum of drives. It is integrated as a selection tool in Catalog CA 01.

Online DT Configurator

In addition, the DT Configurator can be used on the Internet without requiring any installation. The DT Configurator can be found in the Siemens Industry Mall at the following address:

www.siemens.com.cn/dt-configurator

You can find further information on the Drive Technology Configurator (DT Configurator) in the section Engineering tools.

SINAMICS web server for SINAMICS G120XA via SINAMICS G120 Smart Access

Web server for efficient commissioning, diagnostics and maintenance

Thanks to the optionally available SINAMICS G120 Smart Access, the SINAMICS G120XA drive system offers a web server for efficient commissioning, diagnostics and maintenance options. The web server provides access to a multi-faceted range of new options for parameter assignment and drive diagnostics for laptops, tablets and smartphones.

You can find further information on the SINAMICS web server for SINAMICS G120XA via SINAMICS G120 Smart Access in the section Engineering tools.

SINAMICS G120XA infrastructure converters for standard pumps/fans

0.75 kW to 560 kW

SINAMICS G120XA infrastructure converters for standard pumps/fans

Characteristic curves

Derating data

Pulse frequency

Frame size	Rated power ¹⁾ at 50 Hz 400 V 3 AC kW	Rated output current in A (at an ambient temperature of 40 °C (104 °F)) for a pulse frequency of															
		2 kHz		4 kHz		6 kHz		8 kHz		10 kHz		12 kHz		14 kHz		16 kHz	
		400 V	380 V	400 V	380 V	400 V	380 V	400 V	380 V	400 V	380 V	400 V	380 V	400 V	380 V	400 V	380 V
FSA	0.75	2.2	2.2	2.2	2.2	1.87	1.87	1.54	1.54	1.32	1.32	1.1	1.1	0.99	0.99	0.88	0.88
	1.1	3.1	3.1	3.1	3.1	2.64	2.64	2.17	2.17	1.86	1.86	1.55	1.55	1.4	1.4	1.24	1.24
	1.5	4.1	4.1	4.1	4.1	3.49	3.49	2.87	2.87	2.46	2.46	2.05	2.05	1.85	1.85	1.64	1.64
	2.2	5.6	5.6	5.6	5.6	4.76	4.76	3.92	3.92	3.36	3.36	2.8	2.8	2.52	2.52	2.24	2.24
	3	7.3	7.3	7.3	7.3	6.21	6.21	5.11	5.11	4.38	4.38	3.65	3.65	3.29	3.29	2.92	2.92
FSB	4	8.8	9.3	8.8	9.3	7.48	7.91	6.16	6.51	5.28	5.58	4.4	4.65	3.96	4.19	3.52	3.72
	5.5	12.5	12.5	12.5	12.5	14.03	14.03	8.75	8.75	7.5	7.5	6.25	6.25	5.63	5.63	5	5
	7.5	16.5	16.5	16.5	16.5	15.3	15.3	11.48	11.48	9.9	9.9	8.25	8.25	7.43	7.43	6.6	6.6
FSC	11	25	25	25	25	21.25	21.25	17.5	17.5	15	15	12.5	12.5	11.25	11.25	10	10
	15	31	31	31	31	26.35	26.35	21.7	21.7	18.6	18.6	15.5	15.5	13.95	13.95	12.4	12.4
FSD	18.5	37	37.5	37	37.5	31.4	31.8	25.9	26.25	22.2	22.5	18.5	18.8	16.6	16.82	14.8	15
	22	43	45	43	45	36.5	38.2	30.1	31.5	25.8	27	21.5	22.5	19.3	20.2	17.2	18
	30	58	59	58	59	49.3	50.2	40.6	41.3	34.8	35.4	29	29.5	26.1	26.6	23.2	23.6
	37	68	73.5	68	73.5	57.8	62.5	47.6	51.45	40.8	44.1	34	36.8	30.6	33.1	27.2	29.4
	45	82.5	85	82.5	85	70.1	72.2	57.7	59.45	49.4	50.9	41.2	42.4	37.1	38.2	33	34
FSE	55	103	108	103	108	87.5	91.7	72.1	75.6	61.8	64.8	51.5	54	46.3	48.5	41.2	43.2
FSF	75	136	144	136	144	115.6	122.4	95.2	100.8	81.6	86.4	68	72	61.2	64.8	54.4	57.6
	90	164	174	164	174	139.4	147.9	114.8	121.8	98.4	104.4	82	87	73.8	78.3	65.6	69.6
	110	201	205	141	143.8	101	103	80.4	82	–	–	–	–	–	–	–	–
	132	237	245	166	171.6	119	123	94.8	98	–	–	–	–	–	–	–	–
FSG	160	289	292	194	196	139	140.4	111	112.2	–	–	–	–	–	–	–	–
	200	364	370	244	248	174	176.9	139	141.3	–	–	–	–	–	–	–	–
	250	436	468	305	327.4	218	234	174	186.8	–	–	–	–	–	–	–	–
FSH ²⁾	315	583	605	466	483.6	–	–	–	–	–	–	–	–	–	–	–	–
	355	644	670	515	535.8	–	–	–	–	–	–	–	–	–	–	–	–
	400	722	750	578	600.4	–	–	–	–	–	–	–	–	–	–	–	–
FSJ ²⁾	450	803	840	642	671.6	–	–	–	–	–	–	–	–	–	–	–	–
	500	882	925	705	739.4	–	–	–	–	–	–	–	–	–	–	–	–
	560	992	1035	793	827.4	–	–	–	–	–	–	–	–	–	–	–	–

The rated output currents in **bold** apply for the standard pulse frequency.

¹⁾ Rated power based on the rated output current I_{rated} . The rated output current I_{rated} is based on the duty cycle for low overload (LO).

²⁾ With the factory setting these converters start at a pulse frequency of 4 kHz and automatically reduce the pulse frequency under load to the corresponding required frequencies. The pulse frequency increases automatically up to 4 kHz with decreasing load. The rated current values refer to a pulse frequency of 2 kHz and are reached at any time by automatic adaptation of the output pulse frequency.

SINAMICS G120XA infrastructure converters for standard pumps/fans

0.75 kW to 560 kW

SINAMICS G120XA infrastructure converters for standard pumps/fans

Characteristic curves

Ambient temperature

Frame sizes FSA to FSG:

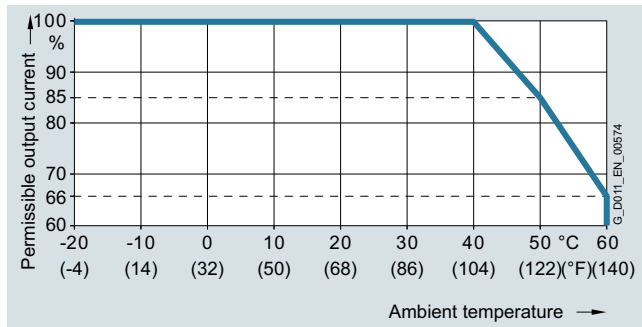

Permissible output current as a function of the ambient temperature for SINAMICS G120XA, frame sizes FSA to FSG, for low overload (LO)

Frame sizes FSH and FSJ:

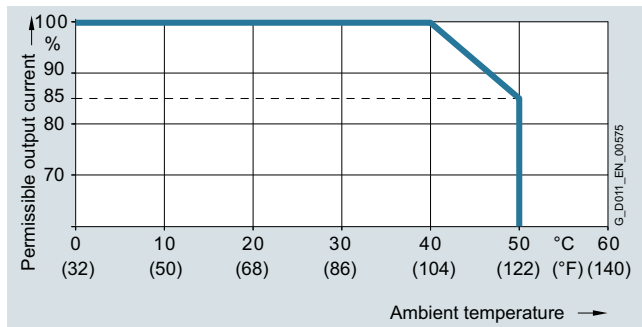

Permissible output current as a function of the ambient temperature for SINAMICS G120XA, frame sizes FSH and FSJ, for low overload (LO)

The operating temperature ranges of the operator panels should be taken into account.

Installation altitude

Frame sizes FSA to FSJ:

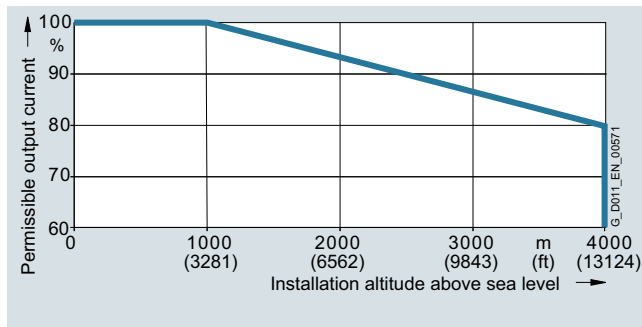

Permissible output current as a function of the installation altitude for SINAMICS G120XA for low overload (LO)

The connected motors, power elements and components must be considered separately.

Permissible line supplies as a function of the installation altitude

- Installation altitude up to 2000 m (6562 ft) above sea level
 - Connection to every supply system permitted for the converter

- Installation altitudes between 2000 m (6562 ft) and 4000 m (13124 ft) above sea level
 - Connection only to a TN system with grounded neutral point
 - TN systems with grounded line conductor are not permitted
 - The TN system with grounded neutral point can also be supplied using an isolation transformer
 - The phase-to-phase voltage does not have to be reduced

System operating voltage

Frame sizes FSA to FSG:

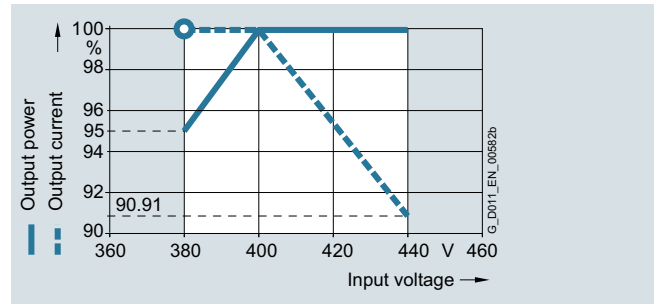

Permissible output current and output power as a function of the input voltage for SINAMICS G120XA, frame sizes FSA to FSG, for low overload (LO)

Note:

The values for the output current at 380 V are shown in the selection and ordering data on page 2/8.

Frame sizes FSH and FSJ:

Frame size	Rated power ¹⁾ kW	Rated output current A	Base-load current ²⁾ A	Rated output current in % at a line voltage of			
				380 V	400 V	415 V	440 V
FSH	315	605	590	100 %	96.3 %	93.5 %	88.8 %
	355	670	645	100 %	96.1 %	93.2 %	88.3 %
	400	750	725	100 %	96.3 %	93.6 %	89 %
FSJ	450	840	820	100 %	95.6 %	92.3 %	86.8 %
	500	925	895	100 %	95.3 %	91.7 %	85.8 %
	560	1035	1015	100 %	95.8 %	92.7 %	87.5 %

¹⁾ Rated power based on the rated output current I_{rated} . The rated output current I_{rated} is based on the duty cycle for low overload (LO).

²⁾ The base-load current is based on the duty cycle for low overload (LO).

SINAMICS G120XA infrastructure converters for standard pumps/fans

0.75 kW to 560 kW

SINAMICS G120XA infrastructure converters for standard pumps/fans

Dimensional drawings

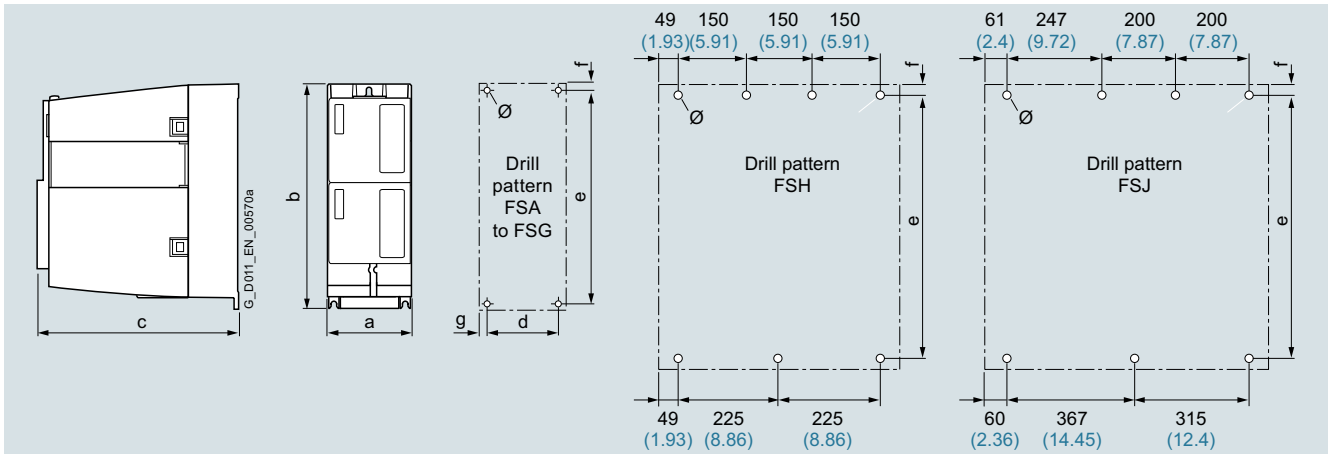

Principle dimension drawing and drill pattern for SINAMICS G120XA

Frame size	Dimensions in mm (inches)			Drilling dimensions in mm (inches)					Mounting With screws (plus washers and nuts)	Cooling clearance ²⁾ in mm (inches)		
	a (width)	b (height)	c (depth) ¹⁾	d	e	f	g	Ø		top	bottom	front
FSA	73 (2.87)	232 (9.13)	209 (8.23)	55 (2.17)	221.5 (8.72)	5.5 (0.22)	9 (0.35)	5 (0.2)	4 × M4	80 (3.15)	100 (3.94)	0 (0)
FSB	100 (3.94)	275 (10.83)	209 (8.23)	80 (3.15)	265 (10.43)	7 (0.28)	10 (0.39)	5 (0.2)	4 × M4	80 (3.15)	100 (3.94)	0 (0)
FSC	140 (5.51)	295 (11.61)	209 (8.23)	118 (4.65)	283 (11.14)	7 (0.28)	11 (0.43)	5.5 (0.22)	4 × M5	80 (3.15)	100 (3.94)	0 (0)
FSD	200 (7.87)	472 (18.58)	239 (9.41)	170 (6.69)	430 (16.93)	15 (0.59)	15 (0.59)	6 (0.24)	4 × M5	300 (11.81)	350 (13.78)	0 (0)
FSE	275 (10.83)	551 (21.69)	239 (9.41)	230 (9.06)	509 (20.04)	11 (0.43)	22.5 (0.89)	6.5 (0.26)	4 × M6	300 (11.81)	350 (13.78)	0 (0)
FSF	305 (12.01)	709 (27.91)	360 (14.17)	270 (10.63)	680 (26.77)	16.6 (0.65)	17.5 (0.69)	8.5 (0.33)	4 × M8	300 (11.81)	350 (13.78)	0 (0)
FSG	305 (12.01)	999 (39.33)	360 (14.17)	265 (10.43)	970.5 (38.21)	18.5 (0.73)	20 (0.79)	12 (0.47)	4 × M10	300 (11.81)	350 (13.78)	0 (0)
FSH	548 (21.57)	1487 (58.54)	410 (16.14)	see above	1444 (56.85)	22 (0.87)	see above	20 (0.79)	7 × M8	200 (7.87)	200 (7.87)	100 (3.94)
FSJ	801 (31.54)	1438 (56.61)	410 (16.14)	see above	1399 (55.08)	18 (0.71)	see above	20 (0.79)	7 × M8	200 (7.87)	200 (7.87)	100 (3.94)

More information

Compact Installation Instructions are supplied in hard copy form in English and Chinese with every SINAMICS G120XA. Further documentation, such as the operating instructions, is available free on the Internet at:

www.siemens.com/sinamics-g120xa/documentation

Detailed information on the SINAMICS G120XA infrastructure converters for standard pumps/fans, including the latest technical documentation (brochures, tutorials, dimensional drawings, certificates and operating instructions), is available on the Internet at:

www.siemens.com.cn/sinamics-g120xa

and is also available via the Drive Technology Configurator (DT Configurator) on the Internet.

The DT Configurator can be found in the Siemens Industry Mall at the following address:

www.siemens.com.cn/dt-configurator

¹⁾ Increased depth for frame sizes FSA to FSG:

- When the operator panel is plugged on, the depth increases by 9 mm (0.35 in)
- When the SINAMICS G120 Smart Access is plugged on, the depth increases by 7 mm (0.28 in)

²⁾ The converters with frame sizes FSA to FSG can be mounted side by side. A side clearance of 1 mm (0.04 in) is recommended for tolerance-related reasons. For frame sizes FSH and FSJ, a side clearance of 30 mm (1.18 in) between the converters is required.

SINAMICS G120XA infrastructure converters for standard pumps/fans

0.75 kW to 560 kW

Supplementary system components > Operator panels

Overview

Operator panel	IOP-2 and IOP-2 Handheld Intelligent Operator Panel	BOP-2 Basic Operator Panel
Description		
	<p>Thanks to the high-contrast color display, menu-based operation and the wizards, commissioning of the standard drives is easy. Application wizards guide the user through the commissioning of important applications such as pumps, fans, compressors, or conveyor systems.</p>	<p>Commissioning of standard drives is easy with the menu-prompted dialog on a 2-line display. Simultaneous display of the parameter and parameter value, as well as parameter filtering, means that basic commissioning of a drive can be performed easily and, in most cases, without a printed parameter list.</p>
Possible applications	<ul style="list-style-type: none"> • Can be mounted directly on the converter • Can be mounted in a control cabinet door using a door mounting kit (achievable degree of protection is IP55/UL Type 12 enclosure) • Available as handheld version • The following languages are integrated in the IOP-2: English, German, French, Italian, Spanish, Portuguese, Dutch, Swedish, Finnish, Russian, Czech, Polish, Turkish, Chinese Simplified 	<ul style="list-style-type: none"> • Can be mounted directly on the converter • Can be mounted in the control cabinet door using a door mounting kit (achievable degree of protection is IP55/UL Type 12)
Quick commissioning without expert knowledge	<ul style="list-style-type: none"> • Standard commissioning using the clone function • For quicker access, the parameter block names can be directly entered respectively changed on the IOP-2 using the virtual keyboard. • User-defined parameter list with a reduced number of self-selected parameters • Simple commissioning of standard applications using Quick Startup and Advanced Startup; it is not necessary to know the parameter structure • Simple local commissioning using the handheld version • Commissioning is possible largely without documentation 	<ul style="list-style-type: none"> • Standard commissioning using the clone function
High degree of operator friendliness and intuitive operation	<ul style="list-style-type: none"> • Intuitive navigation by operating with a sensor control field • Graphic color display to show status values such as pressure or flow rate in the form of scalar values, bar-type diagrams, or trend displays • Status display with freely selectable units to specify physical values • Direct manual operation of the drive – you can simply toggle between the automatic and manual modes • Simple cloning of specific settings of the IOP-2 user interface. 	<ul style="list-style-type: none"> • 2-line display for showing up to 2 process values with text • Status display of predefined units • Direct manual operation of the drive – you can simply toggle between the automatic and manual modes
Minimization of maintenance times	<ul style="list-style-type: none"> • Diagnostics using plain text display, can be used locally on-site without documentation • The support function is used to determine the drive data for the Power Module, Control Unit and IOP-2 and makes this available as a two-dimensional code (data matrix/QR code) • Easily upgradable to new functional status via USB interface 	<ul style="list-style-type: none"> • Diagnostics with menu prompting with 7-segment display

SINAMICS G120XA infrastructure converters for standard pumps/fans

0.75 kW to 560 kW

Supplementary system components > IOP-2 Intelligent Operator Panel

Overview**IOP-2 Intelligent Operator Panel**

IOP-2 Intelligent Operator Panel

The Intelligent Operator Panel IOP-2 is a very user-friendly and powerful operator panel for the SINAMICS G120, SINAMICS G120C, SINAMICS G120P, SINAMICS G120X, SINAMICS G120XA, SINAMICS G110D, SINAMICS G120D, SINAMICS G110M and SIMATIC ET 200pro FC-2.

The IOP-2 supports both newcomers and drive experts. Thanks to the membrane keyboard with a central sensor control field, high-contrast color displays, menu-based operation and simple setup processes, which do not require special drive know-how, it is easy to commission drives. The updated IOP-2 (from V2.3) offers a new concept, which allows faster and easier commissioning of the drive.

The Quick Startup provides with an overview of the basic parameters required to commission and operate the drive in a few minutes.

Advanced Startup supports easier commissioning of more complex applications and provides the parameters on one screen, thus eliminating the need to switch between different areas within the IOP-2.

Advanced Setup provides with a list of categories that needs to be checked and that guides the user by highlighting the status icons of categories, which have been altered by the user. Furthermore, a drive can be essentially commissioned without having to use a printed parameter list – as the parameters are displayed in plain text, and explanatory help texts and the parameter filtering functions are provided.

The status screen allows the graphical visualization of two process values and the numerical visualization of four process values. Process values can also be displayed in technological units.

The IOP-2 supports standard commissioning of identical drives. For this purpose, a parameter list can be copied from a converter into the IOP-2 and downloaded into other drive units of the same type as required.

The IOP-2 can be installed in control cabinet doors using the optionally available door mounting kit.

Updating the IOP-2

The IOP-2 can be updated and expanded using the integrated USB interface.

Data to support future drive systems can be transferred from the PC to the IOP-2. Further, the USB interface allows user languages and simple setup processes that will become available in the future to be subsequently downloaded and the firmware to be updated for the IOP-2¹⁾.

¹⁾ Information on updates for the IOP-2 is available at <https://support.industry.siemens.com/cs/document/67273266>

The IOP-2 is supplied with power via the USB interface during an update.

IOP-2 Handheld

IOP-2 Handheld

A handheld version of the IOP-2 can be ordered for mobile use. In addition to the IOP-2, it includes a housing with rechargeable batteries, a charging unit, an RS232 connecting cable, and a USB cable. The charging unit is supplied with connector adapters for Europe, the US and UK. When the batteries are fully charged, the operating time is up to 10 hours.

To connect the IOP-2 Handheld to SINAMICS G110D, SINAMICS G120D, SINAMICS G110M and SIMATIC ET 200pro FC-2, the RS232 connecting cable with optical interface is required in addition.

SINAMICS G120XA infrastructure converters for standard pumps/fans

0.75 kW to 560 kW

Supplementary system components > IOP-2 Intelligent Operator Panel

Selection and ordering data

Description	Article No.
<p>IOP-2 Intelligent Operator Panel For use with SINAMICS G120 SINAMICS G120C SINAMICS G120P SINAMICS G120X SINAMICS G120XA SINAMICS G110D SINAMICS G120D SINAMICS G110M SIMATIC ET 200pro FC-2</p> <p>Operating languages: English, German, French, Italian, Spanish, Portuguese, Dutch, Swedish, Finnish, Russian, Czech, Polish, Turkish, Chinese Simplified</p>	6SL3255-0AA00-4JA2
<p>IOP-2 Handheld For use with SINAMICS G120 SINAMICS G120C SINAMICS G120P SINAMICS G120X SINAMICS G120XA SINAMICS G110D SINAMICS G120D SINAMICS G110M SIMATIC ET 200pro FC-2</p> <p>Included in the scope of delivery:</p> <ul style="list-style-type: none"> • IOP-2 • Handheld housing • Rechargeable batteries (4 × AA) • Charging unit (international) • RS232 connecting cable ¹⁾ 3 m (9.84 ft) long, can be used in combination with SINAMICS G120 SINAMICS G120C SINAMICS G120P SINAMICS G120X SINAMICS G120XA • USB cable 1 m (3.28 ft) long 	6SL3255-0AA00-4HA1
Accessories	
<p>Door mounting kit For mounting an operator panel in control cabinet doors with sheet steel thicknesses of 1 ... 3 mm (0.04 in ... 0.12 in) Degree of protection IP55 Included in the scope of delivery:</p> <ul style="list-style-type: none"> • Seal • Mounting material • Connecting cable 5 m (16.4 ft) long, also supplies voltage to the IOP-2 directly via the converter 	6SL3256-0AP00-0JA0
<p>RS232 connecting cable 2.5 m (8.20 ft) long, with optical interface for connecting the IOP-2 Handheld to SINAMICS G110D SINAMICS G120D SINAMICS G110M SIMATIC ET 200pro FC-2</p>	3RK1922-2BP00

Benefits

- New device design
 - Intuitive user interface – membrane keyboard with central sensor control field
 - High-contrast color display with a range of display options
 - IOP-2 device design open for future functional expansions (e.g. device functions, commissioning setups, languages)
 - Easily upgradable to new functional status via USB interface
- Commissioning
 - Simple commissioning via Quick Startup and Advanced Startup
 - Quick Startup allows easy and fast access to all basic parameters required for the commissioning of simple applications
 - Advanced Startup provides the parameters necessary for the commissioning of more complex applications and eliminates the need to switch between different areas of the IOP-2
 - I/O Setup supports quick and easy configuration of the digital and analog inputs and outputs
 - Fieldbus Setup allows easy configuration of the Ethernet/IP and PROFINET interface protocols
 - Fast standard commissioning of converters thanks to the cloning function
 - For quicker access, the parameter data set names can be directly entered respectively changed on the IOP-2 using the virtual keyboard. Extended help functions support the user during commissioning.
 - Simple local commissioning on-site using the handheld version
- Operator control and monitoring
 - Simple, individual local drive control (start/stop, setpoint value specification, change in direction of rotation)
 - Application-specific scenarios such as operator concepts with additional external operating elements can be implemented easily
 - Simple cloning of specific settings of the IOP-2 user interface, such as status screen, language settings, lighting duration, date/time settings, parameter backup mode and “My Parameters” – settings made once can such be easily transferred to many further IOP-2 Intelligent Operator Panels
- Diagnostics
 - Rapid diagnostics thanks to on-site plain text display
 - Integrated plain text help function for local display and resolution of fault messages
- Support function
 - Used to determine the drive data for the Power Module, Control Unit and IOP-2 (article number, serial number, firmware version, error statuses) and makes this available as a two-dimensional code (data matrix/QR code)
 - Allows easy contact with Customer Support via a data matrix/QR code generated on the IOP-2
 - Quick access via mobile devices (e.g. smartphones, tablets) to product information, documentation, FAQs, contact persons via a two-dimensional code generated on the IOP-2 (data matrix/QR code)
 - Scanning and evaluating of the two-dimensional data matrix code using the Industry Online Support app (<https://support.industry.siemens.com/cs/ww/en/sc/2067>), see also: <https://support.industry.siemens.com/cs/document/109748340>

¹⁾ For use in conjunction with SINAMICS G110D, SINAMICS G120D, SINAMICS G110M and SIMATIC ET 200pro FC-2, the RS232 connecting cable with optical interface is required (Article No.: **3RK1922-2BP00**). The cable must be ordered separately.

SINAMICS G120XA infrastructure converters for standard pumps/fans

0.75 kW to 560 kW

Supplementary system components > IOP-2 Intelligent Operator Panel

Integration

Using the IOP-2 with the converters

	<ul style="list-style-type: none"> • SINAMICS G120 with CU230P-2, CU240E-2 or CU250S-2 • SINAMICS G120C • SINAMICS G120P with CU230P-2 • SINAMICS G120X and SINAMICS G120XA 	<ul style="list-style-type: none"> • SINAMICS G110D • SINAMICS G120D • SINAMICS G110M • SIMATIC ET 200pro FC-2
Plugging the IOP-2 onto the converter (Voltage supply via converter)	✓	–
Door mounting of the IOP-2 with the door mounting kit (Voltage supply via converter. For this purpose, the IOP-2 must be connected up by means of the connecting cable supplied with the door mounting kit.)	✓	–
Mobile use of the IOP-2 Handheld (supplied from rechargeable batteries)	✓	✓ (RS232 connecting cable with optical interface required, article number 3RK1922-2BP00)

Door mounting

Using the optionally available door mounting kit, an operator panel can be simply mounted in a control cabinet door with just a few manual operations. In the case of door mounting, the IOP-2 Operator Panel achieves degree of protection IP55/UL Type 12 enclosure.

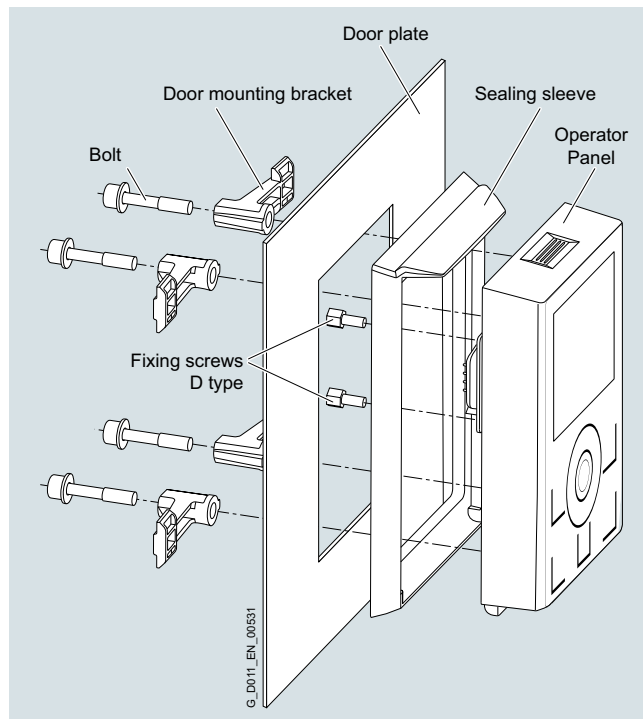

Door mounting kit with plugged-on IOP-2

Technical specifications

	IOP-2 6SL3255-0AA00-4JA2	IOP-2 Handheld 6SL3255-0AA00-4HA1
Display	High-contrast color display, a variety of display options	
• Resolution	320 × 240 pixels	
Operator panel	Membrane keyboard with central sensor control field	
Operating languages	English, German, French, Italian, Spanish, Portuguese, Dutch, Swedish, Finnish, Russian, Czech, Polish, Turkish, Chinese Simplified	
Ambient temperature		
• During transport and storage	-40 ... +70 °C (-40 ... +158 °F)	-20 ... +55 °C (-4 ... +131 °F)
• During operation	For direct mounting on the converter: 0 ... 50 °C (32 ... 122 °F) For installation with door mounting kit: 0 ... 55 °C (32 ... 131 °F)	0 ... 40 °C (32 ... 104 °F)
Humidity	Relative humidity < 95 %, non-condensing	
Degree of protection	For direct mounting on the converter: IP20 For installation with door mounting kit: IP55, UL Type 12 enclosure	IP20
Dimensions (H × W × D)	106.86 × 70 × 19.65 mm (4.21 × 2.76 × 0.77 in)	195.04 × 70 × 37.58 mm (7.68 × 2.76 × 1.48 in)
Weight, approx.	0.134 kg (0.3 lb)	0.724 kg (1.6 lb)
Compliance with standards	CE, RCM, cULus, EAC, KC-REM-S49-SINAMICS	

SINAMICS G120XA infrastructure converters for standard pumps/fans

0.75 kW to 560 kW

Supplementary system components > BOP-2 Basic Operator Panel

Overview



BOP-2 Basic Operator Panel

The Basic Operator Panel BOP-2 can be used to commission drives, monitor drives in operation and input individual parameter settings.

Commissioning of standard drives is easy with the menu-prompted dialog on a 2-line display. Simultaneous display of the parameter and parameter value, as well as parameter filtering, means that basic commissioning of a drive can be performed easily and, in most cases, without a printed parameter list.

The drives are easily controlled manually using directly assigned navigation buttons. The BOP-2 has a dedicated switchover button to switch from automatic to manual mode.

Diagnostics can easily be performed on the connected converter by following the menus.

Up to two process values can be numerically visualized simultaneously.

BOP-2 supports standard commissioning of identical drives. For this purpose, a parameter list can be copied from a converter into the BOP-2 and when required, downloaded into other drive units of the same type.

The operating temperature of the BOP-2 is 0 °C ... 50 °C (32 °F ... 122 °F).

Selection and ordering data

Description	Article No.
BOP-2 Basic Operator Panel	6SL3255-0AA00-4CA1
Accessories	
Door mounting kit For mounting an operator panel in control cabinet doors with sheet steel thicknesses of 1 ... 3 mm (0.04 ... 0.12 in) Degree of protection IP55 Included in the scope of delivery:	6SL3256-0AP00-0JA0
<ul style="list-style-type: none"> • Seal • Mounting material • Connecting cable 5 m/16.4 ft long, also supplies voltage to the operator panel directly via the converter 	

Benefits

- Shorten commissioning times – Easy commissioning of standard drives using basic commissioning wizards (setup)
- Minimize standstill times – Fast detection and rectification of faults (Diagnostics)
- Greater transparency in the process – The status display of the BOP-2 makes process variable monitoring easy (Monitoring)
- Direct mounting on the converter
- User-friendly user interface:
 - Easy navigation using clear menu structure and clearly assigned control keys
 - Two-line display

SINAMICS G120XA infrastructure converters for standard pumps/fans

0.75 kW to 560 kW

Supplementary system components > Memory cards

Overview



SINAMICS SD memory card

The parameter settings for a converter can be stored on the SINAMICS SD memory card. When service is required, e.g. after the converter has been replaced and the data have been downloaded from the memory card, the drive system is immediately ready for use again.

- Parameter settings can be written from the memory card to the converter or saved from the converter to the memory card.
- Up to 100 parameter sets can be stored.
- The memory card supports standard commissioning without the use of an operator panel such as the IOP-2 or BOP-2.
- If firmware is stored on the memory card, the firmware can be upgraded/downgraded during power-up.

Note:

The memory card is not required for operation and does not have to remain inserted.

Selection and ordering data

Description	Article No.
SINAMICS SD card 512 MB, empty	6SL3054-4AG00-2AA0

SINAMICS G120XA infrastructure converters for standard pumps/fans

0.75 kW to 560 kW

Supplementary system components > SINAMICS G120 Smart Access

Overview



SINAMICS G120 Smart Access

It is also easy and convenient to commission and operate the SINAMICS G120, SINAMICS G120C, SINAMICS G120X and SINAMICS G120XA converters of firmware V4.7 SP6 and higher using the web server module SINAMICS G120 Smart Access and a connected smartphone, tablet or laptop.

Benefits

- Wireless commissioning, operation and diagnostics via mobile device or laptop thanks to the optional SINAMICS G120 Smart Access
- Easy access to the converter in difficult-to-access areas
- Intuitive user interface and commissioning wizard
- Free choice of terminal devices as the web server works with all common web browsers, such as iOS, Android, Windows, Linux and Mac OS

Function

- Commissioning using commissioning wizard
- Setting and saving parameters
- Testing motor in JOG mode
- Monitoring of converter data
- Quick diagnostics
- Saving the settings and restoring to factory settings

Selection and ordering data

Description	Article No.
SINAMICS G120 Smart Access For wireless commissioning, operation and diagnostics of the following converters using a smartphone, tablet or laptop <ul style="list-style-type: none"> • SINAMICS G120C • SINAMICS G120 together with the CU230P-2 and CU240E-2 Control Units (without fail-safe versions) • SINAMICS G120X and SINAMICS G120XA 	6SL3255-0AA00-5AA0

Technical specifications

	SINAMICS G120 Smart Access 6SL3255-0AA00-5AA0
Operating system	iOS, Android, Windows, Linux, Mac OS
Languages	Support of six languages: English, French, German, Italian, Spanish, Chinese
Ambient temperature	<ul style="list-style-type: none"> • During storage and transport: -40 ... +70 °C (-40 ... +158 °F) • During operation: 0 ... 50 °C (32 ... 122 °F) if the Smart Access is plugged directly into the converter
Humidity	< 95 %, non-condensing
Degree of protection	Depending on the degree of protection of the converter, max. IP55/UL Type 12 enclosure
Dimensions	<ul style="list-style-type: none"> • Width: 70 mm (2.76 in) • Height: 108.9 mm (4.29 in) • Depth: 17.3 mm (0.68 in)
Weight, approx.	0.08 kg (0.18 lb)
Compliance with standards	CE, FCC, SRRG, WPC, ANATEL, BTK

Integration



SINAMICS G120XA frame size FSD with plugged-on SINAMICS G120 Smart Access

The optional SINAMICS G120 Smart Access is simply plugged onto the converter and is available for the following converters of firmware V4.7 SP6 and higher.

- SINAMICS G120C
- SINAMICS G120 together with the CU230P-2 and CU240E-2 Control Units (without fail-safe versions)
- SINAMICS G120X and SINAMICS G120XA

SINAMICS G120XA infrastructure converters for standard pumps/fans

0.75 kW to 560 kW

Supplementary system components > Shield connection kits for Power Module**Overview**

A shield connection kit is supplied with the SINAMICS G120XA converters, frame sizes FSA to FSC. It is advisable to install the supplied shield connection kit for EMC-compliant configuration of the converter.

The shield connection kits for the Power Module are not included in the scope of delivery for the SINAMICS G120XA converters, frame sizes FSD to FSG, but they can be ordered as an option.

Please observe the notes included in the operating instructions for the SINAMICS G120XA converters, frame sizes FSH and FSJ.

www.siemens.com/sinamics-g120xa/documentation

Selection and ordering data

Description	Article No.
Shield connection kits for Power Module for SINAMICS G120XA	
• Frame sizes FSA to FSC	Included in the scope of delivery of the converters, can be ordered as spare part
• Frame size FSD	NEW 6SL3262-1AD02-0DA0
• Frame size FSE	NEW 6SL3262-1AE02-0DA0
• Frame size FSF	NEW 6SL3262-1AF02-0DA0
• Frame size FSG	NEW 6SL3262-1AG02-0DA0

SINAMICS G120XA infrastructure converters for standard pumps/fans

0.75 kW to 560 kW

Spare parts > FPI board for frame sizes FSH and FSJ

Overview

The FPI board (freely-programmable interface board) is available as a spare part for the SINAMICS G120X and SINAMICS G120XA converters, frame sizes FSH and FSJ. This is an interface board between Control Unit and Power Module with additional customer terminals (X9, X41).

Selection and ordering data

Description	Article No.
FPI board for SINAMICS G120X and SINAMICS G120XA frame sizes FSH and FSJ	NEW 6SL3200-0SP05-0AA0

Spare parts > PSB board for frame sizes FSH and FSJ

Overview

The PSB board (power supply board) is available as a spare part for the SINAMICS G120X and SINAMICS G120XA converters, frame sizes FSH and FSJ. This is an internal power supply with ± 24 V for the electronics and 56 V for a power unit fan.

Selection and ordering data

Description	Article No.
PSB board for SINAMICS G120X and SINAMICS G120XA frame sizes FSH and FSJ	NEW 6SL3200-0SP06-0AA0

Spare parts > Current transformers for frame sizes FSH and FSJ

Overview

Current transformers are available as spare parts for the SINAMICS G120X and SINAMICS G120XA converters, frame sizes FSH and FSJ. These are 2000 A or 1000 A current transformers for measuring the motor current at the device output. The current transformers are used for motor control and converter protection.

Selection and ordering data

Description	Article No.
Current transformers for SINAMICS G120X and SINAMICS G120XA	
• 2000 A for frame size FSJ	NEW 6SL3200-0SE01-0AA0
• 1000 A for frame sizes FSH and FSJ	NEW 6SL3200-0SE02-0AA0

Spare parts > Spare parts kit for Control Unit

Overview

The spare parts kit contains small parts for the SINAMICS G120X and SINAMICS G120XA Control Unit:

Included in the scope of delivery:

- 1x STO connecting plug for frame sizes FSA to FSC
- 3x replacement doors for the Control Unit
- 4x I/O terminals
- 1x screw for RS485 terminal
- 1x blanking cover
- Label set

Selection and ordering data

Description	Article No.
Spare parts kit for Control Unit for SINAMICS G120X and SINAMICS G120XA	NEW 6SL3200-0SK10-0AA0

Spare parts > Shield connection kit for Control Unit

Overview

A shield connection kit for the Control Unit is supplied with the SINAMICS G120X and SINAMICS G120XA converters, frame sizes FSD to FSG. It is advisable to install the supplied shield connection kit for EMC-compliant configuration of the converter. This shield connection kit can be ordered as a spare part.

The shield connection kit offers optimum shield connection and strain relief for all signal and communication cables.

The kit contains the following:

- a matching shield connection plate
- all of the necessary connecting and retaining elements for mounting

Selection and ordering data

Description	Article No.
Shield connection kit for Control Unit for SINAMICS G120X and SINAMICS G120XA frame sizes FSD to FSG	NEW 6SL3264-1EA00-0YA0

SINAMICS G120XA infrastructure converters for standard pumps/fans

0.75 kW to 560 kW

Spare parts > Shield connection kits for Power Module

Overview

A shield connection kit is supplied with the SINAMICS G120XA converters, frame sizes FSA to FSC. It is advisable to install the supplied shield connection kit for EMC-compliant configuration of the converter. This shield connection kit can also be ordered as spare part.

The shield connection kits for the Power Module are not included in the scope of delivery for the SINAMICS G120XA converters, frame sizes FSD to FSG, but they can be ordered as an option.

Please observe the notes included in the operating instructions for the SINAMICS G120XA converters, frame sizes FSH and FSJ.

www.siemens.com/sinamics-g120xa/documentation

Selection and ordering data

Description	Article No.
Shield connection kits for Power Module for SINAMICS G120XA	
• Frame size FSA	NEW 6SL3262-1AA01-0DA0
• Frame size FSB	NEW 6SL3262-1AB01-0DA0
• Frame size FSC	NEW 6SL3262-1AC01-0DA0

2

Spare parts > Mounting set for frame sizes FSD to FSG

Overview

A **mounting set** can be ordered for SINAMICS G120 PM240-2 Power Modules, SINAMICS G120C, SINAMICS G120X and SINAMICS G120XA. It contains the following parts:

- 1 SUB-D connector with mounting material
- 1 motor connector and 1 power supply connector
- 2 serrated strips including mounting material for connecting the shield
- 3 sleeves for inserting in the cutouts for the signal cables of the cable bonding plate
- Ferrite cores (only necessary for devices with integrated line filter class B)
- Screws for fixing the cable bonding plate and the cover

Selection and ordering data

Description	Article No.
Mounting set for SINAMICS G120 PM240-2 Power Modules, SINAMICS G120C, SINAMICS G120X and SINAMICS G120XA in frame sizes FSD to FSG	6SL3200-OSK08-0AA0

Spare parts > Terminal cover kits for frame sizes FSD to FSG

Overview

The terminal cover kit includes a replacement cover for the connecting terminals.

Terminal cover kits, which are suitable for the following converters in frame sizes FSD to FSG, are available:

- SINAMICS G120 PM240-2 Power Modules
- SINAMICS G120 PM250 Power Modules
- SINAMICS G120C
- SINAMICS G120X and SINAMICS G120XA

Selection and ordering data

Description	Article No.
Terminal cover kits for SINAMICS G120 PM240-2 Power Modules	
• for frame size FSD	6SL3200-OSM13-0AA0
• for frame size FSE	6SL3200-OSM14-0AA0
• for frame size FSF	6SL3200-OSM15-0AA0
• for frame size FSG	6SL3200-OSM16-0AA0
Terminal cover kits for SINAMICS G120 PM250 Power Modules	
• for frame sizes FSD and FSE	6SL3200-OSM11-0AA0
• for frame size FSF	6SL3200-OSM12-0AA0
Terminal cover kits for SINAMICS G120C	
• for frame size FSD	6SL3200-OSM13-0AA0
• for frame size FSE	6SL3200-OSM14-0AA0
• for frame size FSF	6SL3200-OSM15-0AA0
Terminal cover kits for SINAMICS G120X and SINAMICS G120XA	
• for frame size FSD	6SL3200-OSM13-0AA0
• for frame size FSE	6SL3200-OSM14-0AA0
• for frame size FSF	6SL3200-OSM15-0AA0
• for frame size FSG	6SL3200-OSM16-0AA0

SINAMICS G120XA infrastructure converters for standard pumps/fans

0.75 kW to 560 kW

Spare parts > Fan units

Overview

The fans of the SINAMICS G120XA converters are designed for extra long service life. For special requirements, replacement fans are available that can be exchanged quickly and easily.

Selection and ordering data

Description	Article No.
External fan units for SINAMICS G120XA	
• Frame size FSA	NEW 6SL3200-0SF52-0AA0
• Frame size FSB	NEW 6SL3200-0SF53-0AA0
• Frame size FSC	NEW 6SL3200-0SF54-0AA0
• Frame size FSD	6SL3200-0SF15-0AA0
• Frame size FSE	6SL3200-0SF16-0AA0
• Frame size FSF	6SL3200-0SF17-0AA0
• Frame size FSG	6SL3200-0SF18-0AA0
• Frame size FSH	NEW 6SL3200-0SF55-0AA0
• Frame size FSJ	NEW 6SL3200-0SF56-0AA0
Internal fan unit for SINAMICS G120XA	
• Frame sizes FSH and FSJ	NEW 6SL3200-0SF51-0AA0
Accessories	
SITOP power supply for the external fan unit for SINAMICS G120XA, frame sizes FSH and FSJ	6EP3446-8SB00-0AY0
Fuse for the external fan unit for SINAMICS G120XA, frame sizes FSH and FSJ	6SY7000-0AC46

Spare parts > Control Unit

Overview

To replace the Control Unit of the SINAMICS G120XA, the Control Unit is available for the frame sizes FSA to FSJ as a spare part.

Selection and ordering data

Description	Article No.
Control Unit for SINAMICS G120XA frame sizes FSA to FSJ USS, Modbus RTU, BACnet MS/TP	NEW 6SL3200-0SC00-0BA0

3/2 Drive Technology Configurator
**3/3 SINAMICS web server for
SINAMICS G120XA via
SINAMICS G120 Smart Access**
Security information

Siemens provides products and solutions with industrial security functions that support the secure operation of plants, systems, machines and networks.

In order to protect plants, systems, machines and networks against cyber threats, it is necessary to implement – and continuously maintain – a holistic, state-of-the-art industrial security concept. Siemens' products and solutions constitute one element of such a concept.

Customers are responsible for preventing unauthorized access to their plants, systems, machines and networks. Such systems, machines and components should only be connected to an enterprise network or the internet if and to the extent such a connection is necessary and only when appropriate security measures (e.g. firewalls and/or network segmentation) are in place.

For additional information on industrial security measures that may be implemented, please visit

<https://www.siemens.com/industrialsecurity>

Siemens' products and solutions undergo continuous development to make them more secure. Siemens strongly recommends that product updates are applied as soon as they are available and that the latest product versions are used. Use of product versions that are no longer supported, and failure to apply the latest updates may increase customer's exposure to cyber threats.

To stay informed about product updates, subscribe to the Siemens Industrial Security RSS Feed under

<https://www.siemens.com/industrialsecurity>

Engineering tools

Drive Technology Configurator

Overview

The Drive Technology Configurator (DT Configurator) helps you to configure the optimum drive technology products for your application – starting with gear units, motors, converters as well as the associated options and components and ending with controllers, software licenses and connection systems. Whether with little or detailed knowledge of products: preselected product groups, deliberate navigation through selection menus and direct product selection through entry of the article number support quick, efficient and convenient configuration.

In addition, comprehensive documentation comprising technical data sheets, 2D dimensional drawings/3D CAD models, operating instructions, certificates, etc. can be selected in the DT Configurator. Immediate ordering is possible by simply transferring a parts list to the shopping cart of the Industry Mall.

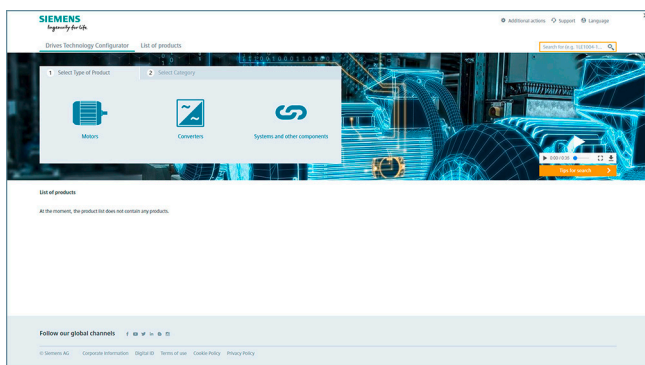

Drive Technology Configurator for efficient drive configuration with the following functions

- Quick and easy configuration of drive products and associated components – gear units, motors, converters, controllers, connection systems
- Configuration of drive systems for pumps, fans and compressor applications from 1 kW to 2.6 MW
- Retrievable documentation for configured products and components, such as
 - Data sheets in up to 9 languages in PDF or RTF format
 - 2D dimensional drawings/3D CAD models in various formats
 - Terminal box drawing and terminal connection diagram
 - Operating instructions
 - Certificates
 - Start-up calculation for SIMOTICS motors
 - EPLAN macros
- Support with retrofitting in conjunction with Spares On Web (www.siemens.com/sow)
- Ability to order products directly through the Siemens Industry Mall

Access to the Drive Technology Configurator

The Drive Technology Configurator can be called up without registration and without a login:
www.siemens.com.cn/dt-configurator

More information

Online access to the Drive Technology Configurator

More information about the Drive Technology Configurator is available on the Internet at
www.siemens.com/dtconfigurator

Offline access to the Drive Technology Configurator in the Interactive Catalog CA 01

In addition, the Drive Technology Configurator is also included in the Interactive Catalog CA 01 – the offline version of the Siemens Industry Mall.

The Interactive Catalog CA 01 in German, English, French and Spanish is available for downloading from the Internet:
www.siemens.com/automation/CA01

SINAMICS web server for SINAMICS G120XA via SINAMICS G120 Smart Access

Overview

Web server for efficient commissioning, diagnostics and maintenance

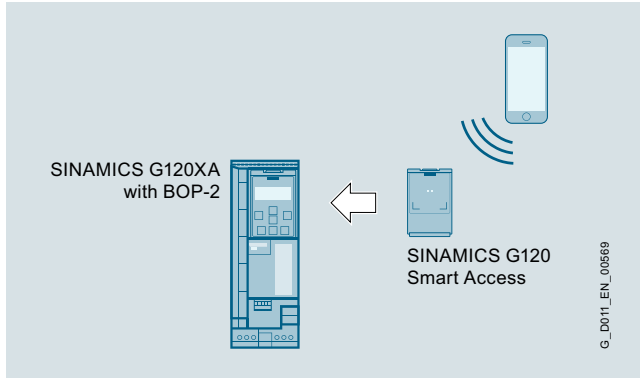

SINAMICS G120XA with BOP-2 and SINAMICS G120 Smart Access

Thanks to the optionally available SINAMICS G120 Smart Access, the SINAMICS G120XA drive system offers a web server for efficient commissioning, diagnostics and maintenance options. The web server provides access to a multi-faceted range of new options for parameter assignment and drive diagnostics for laptops, tablets and smartphones, including:

- Simple and fast commissioning
- Drive traversing via the control panel
- Downloading/uploading a configuration
- Providing a status overview of the drive
- Evaluating warnings and fault messages
- Monitoring and adapting parameter settings

Benefits*Simple and fast commissioning*

- No installation of additional commissioning software
- Standard pages for limit values and settings
- Comprehensive fault diagnosis

Direct language selection

- English, German, French, Italian, Spanish, Chinese

Accessibility

- Free choice of terminal devices as the web server works with all common web browsers, such as iOS, Android, Windows, Linux and Mac OS

Diagnostic functions

- Quick overview of the current configuration and the state of the drive
- Understandable diagnostic information and messages, including the causes of issues and possible remedies, are displayed in plain text in multiple languages

Freely configurable parameter lists

- Monitoring parameters for diagnostic purposes, for example for operating personnel
- Adjustment of the parameter lists using filters, parameter groups and the configuration of personal lists

Access security

- Protection against unauthorized access to the drive information

Application

Easy commissioning, diagnostics and maintenance are possible locally, provided appropriate security measures are applied.

Engineering tools

Notes

3

Services and documentation



4/2	Partner
4/3	Industry Services
4/4	Industry Services – Portfolio overview
4/5	Online Support
4/6	Training
4/6	SITRAIN – Digital Industry Academy
4/7	Training courses for SINAMICS low-voltage converters
4/8	SINAMICS G120XA training case
4/9	Applications
4/10	Product Partner – Drives Options
4/11	mySupport documentation
4/12	Documentation
4/12	General documentation
4/13	SINAMICS G120XA documentation

Services and documentation

Partner

Partner at Siemens

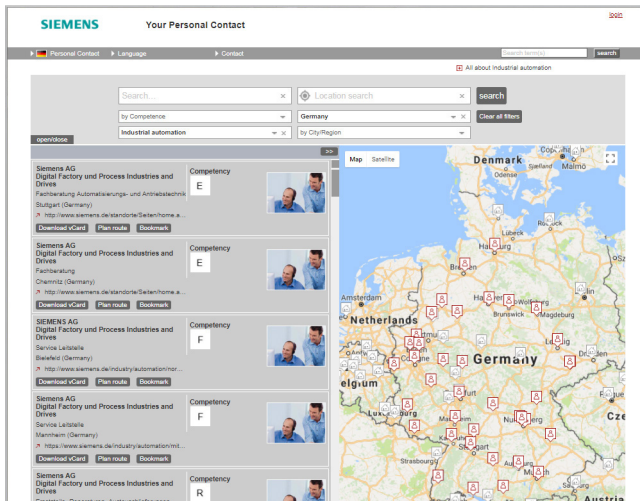

At your service locally, around the globe for consulting, sales, training, service, support, spare parts on the entire portfolio of Digital Industries.

Your partner can be found in our Personal Contacts Database at: www.siemens.com/automation-contact

You start by selecting

- the required competence,
- products and branches,
- a country and a city

or by a

location search or free text search.

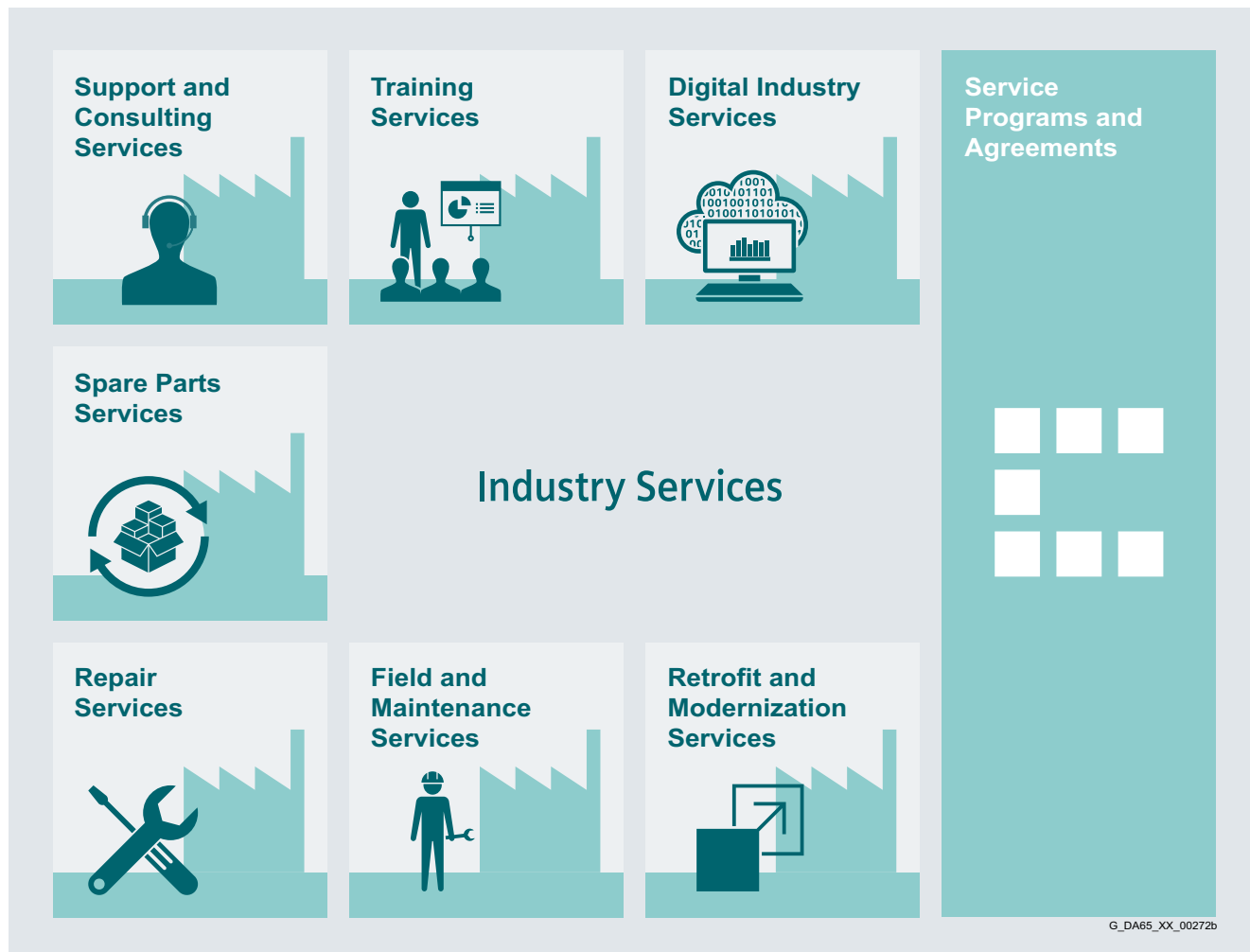
Overview

Keep your business running and shaping your digital future – with Industry Services

Optimizing the productivity of your equipment and operations can be a challenge, especially with constantly changing market conditions. Working with our service experts makes it easier. We understand your industry's unique processes and provide the services needed so that you can better achieve your business goals.

You can count on us to maximize your uptime and minimize your downtime, increasing your operations' productivity and reliability. When your operations have to be changed quickly to meet a new demand or business opportunity, our services give you the flexibility to adapt. Of course, we take care that your production is protected against cyber threats. We assist in keeping your operations as energy and resource efficient as possible and reducing your total cost of ownership. As a trendsetter, we ensure that you can capitalize on the opportunities of digitalization and by applying data analytics to enhance decision making: You can be sure that your plant reaches its full potential and retains this over the longer lifespan.

You can rely on our highly dedicated team of engineers, technicians and specialists to deliver the services you need – safely, professionally and in compliance with all regulations. We are there for you, where you need us, when you need us.

www.siemens.com/industrieservices

Services and documentation

Industry Services

Industry Services – Portfolio overview

Overview



Digital Industry Services

Digital Industry Services make your industrial processes transparent to gain improvements in productivity, asset availability, and energy efficiency.

Production data is generated, filtered and translated with intelligent analytics to enhance decision-making.

This is done whilst taking data security into consideration and with continuous protection against cyber-attack threats.

www.siemens.com/global/en/products/services/industry/digital-industry-services.html

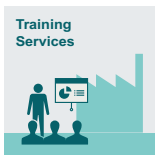

Training Services

From the basics and advanced to specialist skills, SITRAIN courses provide expertise right from the manufacturer – and encompass the entire spectrum of Siemens products and systems for the industry.

Worldwide, SITRAIN courses are available wherever you need a training course in more than 170 locations in over 60 countries.

<https://support.industry.siemens.com/cs/ww/en/sc/2226>

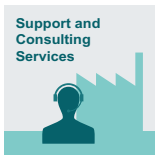

Support and Consulting Services

Industry Online Support site for comprehensive information, application examples, FAQs and support requests.

Technical and Engineering Support for advice and answers for all inquiries about functionality, handling, and fault clearance. The Service Card as prepaid support for value added services such as Priority Call Back or Extended Support offers the clear advantage of quick and easy purchasing.

Information & Consulting Services, e.g. SIMATIC System Audit; clarity about the state and service capability of your automation system or Lifecycle Information Services; transparency on the lifecycle of the products in your plants.

<https://support.industry.siemens.com/cs/ww/en/sc/2235>



Spare Parts

Spare Parts Services are available worldwide for smooth and fast supply of spare parts – and thus optimal plant availability. Genuine spare parts are available for up to ten years. Logistic experts take care of procurement, transport, custom clearance, storage and order manage-

ment. Reliable logistics processes ensure that components reach their destination as needed.

Since not all spare parts can be kept in stock at all times, Siemens offers a preventive measure for spare parts provisioning on the customer's premises with optimized **Spare Parts Packages** for individual products, custom-assembled drive components and entire integrated drive trains – including risk consulting.

Asset Optimization Services help you design a strategy for parts supply where your investment and carrying costs are reduced and the risk of obsolescence is avoided.

<https://support.industry.siemens.com/cs/ww/en/sc/2110>



Repair Services

Repair Services are offered on-site and in regional repair centers for fast restoration of faulty devices' functionality.

Also available are extended repair services, which include additional diagnostic and repair measures, as well as emergency services.

<https://support.industry.siemens.com/cs/ww/en/sc/2154>



Field and Maintenance Services

Siemens specialists are available globally to provide expert field and maintenance services, including commissioning, functional testing, preventive maintenance and fault clearance.

All services can be included in customized service agreements with defined reaction times or fixed maintenance intervals.

<https://support.industry.siemens.com/cs/ww/en/sc/2265>



Retrofit and Modernization Services

Provide a cost-effective solution for the expansion of entire plants, optimization of systems or upgrading existing products to the latest technology and software, e.g. migration services for automation systems.

Service experts support projects from planning through commissioning and, if desired over the entire extended lifespan, e.g. Retrofit for Integrated Drive Systems for an extended lifetime of your machines and plants.

<https://support.industry.siemens.com/cs/ww/en/sc/2286>



Service Programs and Agreements

A technical Service Program or Agreement enables you to easily bundle a wide range of services into a single annual or multi-year agreement.

You pick the services you need to match your unique requirements or fill gaps in your organization's maintenance capabilities.

Programs and agreements can be customized as KPI-based and/or performance-based contracts.

<https://support.industry.siemens.com/cs/ww/en/sc/2275>

Overview

Online Support – fast, intuitive, whenever you want, wherever you need

Web

support.industry.siemens.com

App

SIEMENS

Scan the QR code for information on our Online Support app.

- FAQ / Application examples**
Information about industrial products, programming and configuration as well as application examples
- Technical information**
Videos, documentation, manuals, updates, product notes, compatibility tool, certificates, planning data such as dimensional drawings, product data, 3D models
- Forum**
Exchange information and experience with other users and experts

Online Support for Siemens Industry Products

4

Siemens Industry and Online Support with some 1.7 million visitors per month is one of the most popular web services provided by Siemens. It is the central access point for comprehensive technical know-how about products, systems and services for automation and drives applications as well as for process industries.

In connection with the challenges and opportunities related to digitalization you can look forward to continued support with innovative offerings.

Services and documentation

Training

SITRAIN – Digital Industry Academy



Time for learning

Today's demands on our knowledge are every bit as diverse and dynamic as our profession itself. We keep learning more and longer – for our work, for our career and for ourselves. Advancing digitalization entails new topics and is also changing the way we absorb and process knowledge. SITRAIN – Digital Industry Academy offers the right source of knowledge here, which we can use anytime in just the way we need it. The time for learning is now.

4

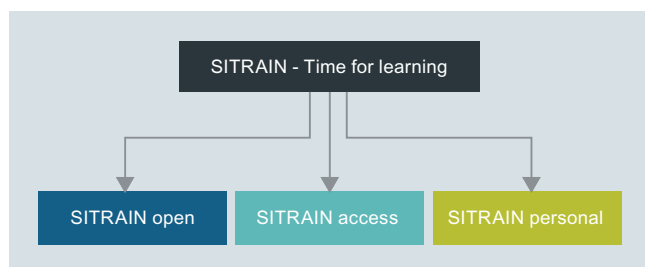

Knowledge for every need

With its three areas – SITRAIN open, SITRAIN access and SITRAIN personal – SITRAIN offers you an all-encompassing range of options for an ongoing expansion of your knowledge and skills, suited for every type of learner. And SITRAIN uses advancing digitalization to continuously expand content and offer new training methods.

Find
your local
offer here



SITRAIN – Digital Industry Academy Customer Support Germany

Tel.: +49 911 895-7575

E-Mail: sitrain.digital.industry.academy.de@siemens.com

Knowledge you can always find

SITRAIN open bundles useful information, worthwhile data and up-to-date expert knowledge about Siemens products for industry. Search it anytime, find anything – and always the right stuff.

Knowledge that gets you ahead

SITRAIN access is learning in the digital age. It offers you individualized ways to build your knowledge and access to exclusive digital training courses. Take advantage of sustainable learning success with a wide range of learning methods. Improve your skills – whether working in groups with others, or by yourself. Whenever, wherever and however you need to.

Knowledge you can experience

We all want to learn from the best. And SITRAIN personal's training courses let you benefit from our well-practiced trainers' expert knowledge, along with direct access to our training equipment. That's the best way to convey knowledge – whether at your company or in our training classrooms.

SITRAIN – Digital Industry Academy

www.siemens.com/sitrain

- SITRAIN open:
www.siemens.com/sitrain-open
- SITRAIN access:
www.siemens.com/sitrain-access
- SITRAIN personal:
www.siemens.com/sitrain-personal

Overview

Training courses for SINAMICS drive system

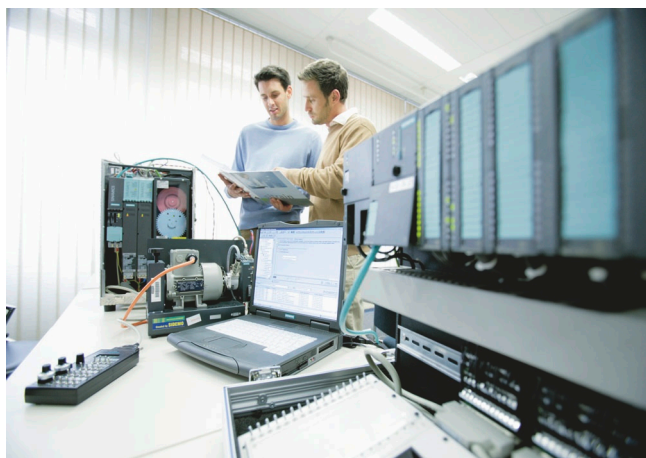

This provides an overview of the training courses available for the SINAMICS drive system.

The courses are modular in design and are directed at a variety of target groups as well as individual customer requirements.

The system overview will acquaint decision-makers and sales personnel with the system very quickly.

The engineering course provides all the information you need to configure the drive system.

The courses dedicated to diagnostics and servicing, parameterization and commissioning, communication as well as extended functions such as Safety Integrated are sure to provide all the technical knowledge service engineers will need.

All courses contain as many practical exercises as possible to enable intensive and direct training on the drive system and with the tools in small groups.

Please also take note of the training options available for SIMOTICS motors. You will find more information about course contents and dates in Catalog ITC and on the Internet.

Title (all courses are available in English and German)	Target group			Duration	Order code
	Planners, decision-makers, sales personnel	Commissioning engineers, configuring engineers	Service personnel, maintenance technicians		
Courses Fundamentals and overview					
SINAMICS and SIMOTICS – Basics of drive technology	✓	✓	✓	5 days	DR-GAT
SINAMICS and SIMOTICS – System overview	✓	–	–	3 days	DR-SYS
SINAMICS System Overview	✓	–	–	2 days	DR-SN-UEB
Courses SINAMICS S120					
Planning and engineering	✓	–	–	5 days	DR-S12-PL
Parameterizing and commissioning	–	✓	–	5 days	DR-S12-PM
Parameterization Advanced Course	–	✓	–	5 days	DR-S12-PA
Parameterizing and optimizing	–	✓	–	3 days	DR-S12-OPT
Parameterizing Safety Integrated	–	✓	–	4 days	DR-S12-SAF
Diagnostics and service	–	–	✓	5 days	DR-S12-DG
Diagnostics at chassis and cabinet units	–	✓	✓	3 days	DR-S12-CHA
Diagnostics PROFINET and PROFIBUS	–	✓	✓	3 days	DR-S12-NET
Courses SINAMICS G120					
Planning and engineering	✓	–	–	2 days	DR-G12-PL
Parameterizing and commissioning	–	✓	–	2 days	DR-G12-PM
Parameterization Advanced Course	–	✓	–	3 days	DR-G12-PA
Parameterizing Safety Integrated	–	✓	–	2 days	DR-G12-SAF
Courses SINAMICS G120X					
Parameterizing and commissioning	–	✓	✓	1 day	DR-G12X-PM
Courses SINAMICS G130/G150/G180/S150					
DYNAVERT – commissioning and diagnostics	–	✓	✓	2 days	DR-DYNA
SINAMICS G150/G130/S150 – diagnostics and service	–	✓	✓	5 days	DR-G15-DG
SINAMICS G180 – diagnostics and service	–	–	✓	2.5 days	DR-G18-DG

Services and documentation

Training

SINAMICS G120XA training case

Overview



SINAMICS G120XA training case

The SINAMICS G120XA training case is a convincing demonstration system thanks to its compact design. It is suitable for direct customer presentations as well as for tests in technical departments. It enables the functions of SINAMICS G120XA to be demonstrated and tested quickly and easily.

It contains the following components:

- SINAMICS G120XA frequency converter, USS, Modbus RTU, BACnet MS/TP, 0.75 kW
- Operator panels IOP-2 and BOP-2
- SINAMICS G120 Smart Access
- SIMOTICS GP asynchronous (induction) motor

The SINAMICS G120XA training case is supplied as a trolley with a hood.

Technical specifications

SINAMICS G120XA training case	
	6AG1067-2AA00-0AC2
Supply voltage	230 V 1 AC
Dimensions	
• Width	290 mm (11.42 in)
• Height	470 mm (18.50 in)
• Depth	300 mm (11.81 in)
Weight, approx.	16.9 kg (37.26 lb)

Selection and ordering data

Description	Article No.
SINAMICS G120XA training case	6AG1067-2AA00-0AC2

Overview



Our understanding of an application is the customer-specific solution of an automation task based on standard hardware and software components. In this respect, industry knowledge and technological expertise are just as important as expert knowledge about how our products and systems work. We are setting ourselves this challenge with more than 280 application engineers in 20 countries.

Application centers

We currently have application centers in:

- Germany: Head Office in Erlangen and in other German regions, e.g. in Munich, Nuremberg, Stuttgart, Mannheim, Frankfurt, Chemnitz, Cologne, Bielefeld, Bremen, Hanover, Hamburg
- Belgium: Brussels
- Brazil: Sao Paulo
- China: Beijing and 12 regions
- Denmark: Ballerup
- France: Paris
- Great Britain: Manchester
- India: Mumbai
- Italy: Bologna, Milan
- Japan: Tokyo, Osaka
- The Netherlands: The Hague
- Austria: Vienna
- Poland: Warsaw
- Sweden: Göteborg
- Switzerland: Zurich, Lausanne
- Spain: Madrid
- South Korea: Seoul
- Taiwan: Taipei
- Turkey: Istanbul
- USA: Atlanta

These application centers specialize in the use of SIMATIC/SIMOTION/SINAMICS. You therefore can rely on automation and drive specialists for implementing successful applications. By involving your personnel at an early stage in the process, we can provide a solid basis for rapid knowledge transfer, maintenance and further development of your automation solution.

Advice on applications and implementation

We offer a variety of consultation services to help you find the optimum solution for the SIMATIC/SIMOTION/SINAMICS application you want to implement:

The quotation phase includes

- clarification of technical questions,
- discussion of machine concepts and customer-specific solutions,
- selection of suitable technology and
- suggestions for implementation.

A technical feasibility study is also performed at the outset. In this way, difficult points of the application can be identified and solved early on. We can also configure and implement your application as a complete solution from a single source.

A large number of proven standard applications are available for use during the implementation phase. This saves engineering costs.

The system can be commissioned by experienced, competent personnel, if required. This saves time and trouble.

If servicing is required, we can support you on site or remotely. For further information about servicing, please see the section "Industry Services".

On-site application training

Training for the implemented applications can also be organized and carried out on site. This training for machine manufacturers and their customers does not deal with individual products, but the entire hardware and software system (for example, automation, drives and visualization).

From an initial concept to successful installation and commissioning: We provide complete support for SIMATIC/SIMOTION/SINAMICS! Contact your Siemens representative.

You can find further information at www.siemens.com/machinebuilding

Services and documentation

Product Partner – Drives Options

Overview

Siemens Product Partners for Drives Options

Individual options for our drives

In order to meet as many customer requirements as possible in the field of drive technology, in addition to its own products, Siemens also relies on the individual and complementary services of selected partners.

We are increasingly focusing on the standard drive options, and our Siemens Product Partners for Drives Options supplement our drives with individual drive options.

This gives Siemens a unique flexibility to meet all application requirements. Naturally, we support our Siemens Product Partners for Drives Options in tailoring their options perfectly to our drives.

For you as our customer, there are multiple benefits:

- The Siemens Product Partners for Drives Options meet the same high standards of quality and performance that we place on our own products
- Drive options can be adapted to individual requirements/ designs
- The Siemens Product Partners for Drives Options know our Siemens converter portfolio and can advise you individually and quickly

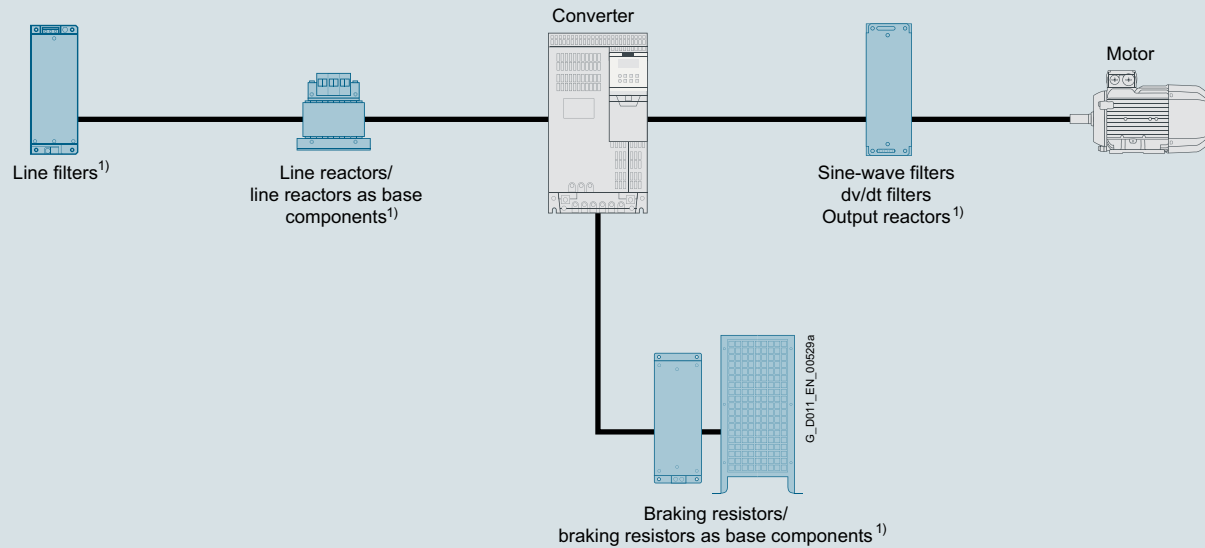

¹⁾ Options that can be supplied from Siemens as well as from Product Partners for Drives Options.

Schematic circuit diagram

More information

You can find more information on the Internet at www.siemens.com/drives-options-partner

Overview

mySupport documentation – Compiling personal documents

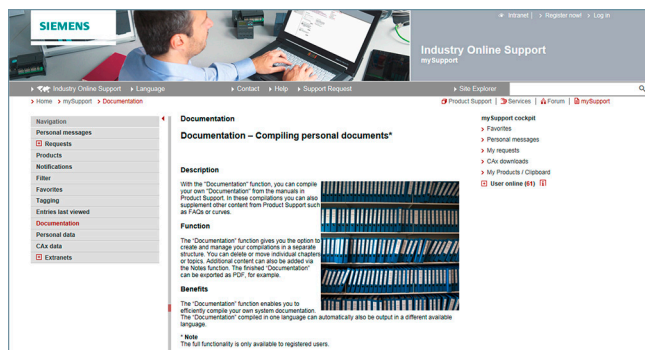

mySupport documentation is a web-based system for generating personalized documentation based on standard documents and is part of the Siemens Industry Online Support portal.

In mySupport, a personal document library can be created in the "Documentation" category. This library can be accessed online in mySupport or also be generated in various formats for offline use.

Previously, this functionality was available in the My Documentation Manager for configurable manuals. Due to the integration in mySupport, all entries of the Industry Online Support can now be imported into the personal document library, including FAQs or product notifications.

If you have already worked with the My Documentation Manager, all of the previously created libraries will continue to be available without restrictions in mySupport.

In addition, the personal library in mySupport can be shared with other mySupport users. In this way, a collection of relevant documents can be created very effectively and used together with other mySupport users all over the world.

You must register/log in for configuring and generating/managing.

Benefits

- Display
View, print or download standard documents or personalized documents
- Configure
Transfer standard documents or parts of them to personalized documents
- Generate/Manage
Generate and manage personalized documents in the formats PDF, RTF or XML in all available languages

Function

Opening mySupport documentation in the Industry Online Support portal

- About the product support, entry type "Manual":
<https://support.industry.siemens.com/cs/ww/en/ps/manual>
By clicking on the required version of the manual and then "Show and configure", the manual opens in a modular view, where you can navigate from topic to topic. Here the direct link to a topic can be used and made available to other users. The selected document can be added to the personal library via "mySupport Cockpit" > "Add to mySupport documentation".
- Via the direct link
<https://support.industry.siemens.com/my/ww/en/documentation/advanced>
After logon/registration, the online help is displayed as the current document.

More information

You can find additional information on the Internet at

- <https://support.industry.siemens.com/my/ww/en/documentation>
- https://support.industry.siemens.com/cs/helpcenter/en/index.htm?#persoenliche_bibliothek_aufbauen.htm

Services and documentation

Documentation

General documentation

Overview

A high-quality programmable control or drive system can be used to maximum effect only if the user is aware of the performance of the products used as a result of intensive training and good technical documentation.

This is becoming more important due to the shorter innovation cycles of modern automation products and the convergence of electronics and mechanical engineering.

A comprehensive range of documentation is available which includes a Getting Started guide, operating instructions, installation manuals and a list manual.

The documents are available in hardcopy form or as a PDF file for downloading from the Internet.

Information and documentation relating to SINUMERIK, SINAMICS, SIMOTION and SIMOTICS are available on the Internet at <https://support.industry.siemens.com/cs/document/109476679>

Application

Explanations of the manuals:

- **Operating Instructions**
contain all the information needed to install the device and make electrical connections, information about commissioning and a description of the converter functions.
Phases of use: Control cabinet construction, commissioning, operation, maintenance and servicing.
- **Hardware Installation Manual**
contains all relevant information about the intended use of the components of a system (technical specifications, interfaces, dimensional drawings, characteristics, or possible applications), information about installation and electrical connections and information about maintenance and servicing.
Phases of use: Control cabinet configuration/construction, maintenance and servicing.
- **Operating and Installation Instructions** (for converter and accessories)
contain all relevant information about the intended use of the components, such as technical specifications, interfaces, dimensional drawings, characteristics, or possible applications.
Phases of use: Control cabinet configuration/construction.
- **Manual/Configuration Manual**
contains all necessary information about the intended use of the components of a system, e.g. technical specifications, interfaces, dimensional drawings, characteristics, or possible applications.
Phases of use: Cabinet configuration/setup, circuit diagram configuration/drawing.
- **Commissioning Manual**
contains all information relevant to commissioning after installation and wiring. It also contains all safety and warning notices relevant to commissioning in addition to overview drawings.
Phases of use: Commissioning of components that have already been connected, configuration of system functions.
- **List Manual**
contains all parameters, function diagrams, and faults/alarms for the product/system as well as their meanings and setting options. It contains parameter data and fault/alarm descriptions with functional correlations.
Phases of use: Commissioning of components that have already been connected, configuration of system functions, fault cause/diagnosis.
- **Getting Started**
provides information about getting started for the first-time user as well as references to additional information. It contains information about the basic steps to be taken during commissioning. The information in the other documentation should be carefully observed for all of the other work required.
Phases of use: Commissioning of components that have already been connected.
- **Function Manual Drive Functions**
contains all the relevant information about individual drive functions: Description, commissioning and integration in the drive system.
Phases of use: Commissioning of components that have already been connected, configuration of system functions.

Selection and ordering data

Description	Article No.
Configuration Manual EMC Installation Guideline SIMOCRANE, SIMOTICS, SIMOTION, SINAMICS, SINUMERIK <ul style="list-style-type: none"> • German • English • Italian • French • Spanish • Chinese Simplified 	6FC5297-0AD30-0AP3 6FC5297-0AD30-0BP3 6FC5297-0AD30-0CP3 6FC5297-0AD30-0DP3 6FC5297-0AD30-0EP3 6FC5297-0AD30-0RP3

SINAMICS G120XA documentation**Overview**

Compact Installation Instructions are supplied in hard copy form in German and English with every SINAMICS G120XA. Further documentation, such as the operating instructions, is available free on the Internet at:
www.siemens.com/sinamics-g120xa/documentation

Detailed information on the SINAMICS G120XA infrastructure converters for standard pumps/fans, including the latest technical documentation (brochures, tutorials, dimensional drawings, certificates and operating instructions), is available on the Internet at:

www.siemens.com.cn/sinamics-g120xa

and is also available via the Drive Technology Configurator (DT Configurator) on the Internet.

The DT Configurator can be found in the Siemens Industry Mall at the following address:

www.siemens.com.cn/dt-configurator

Services and documentation

Documentation

Notes

4

Appendix



5/2

Conditions of sale and delivery

Appendix

Conditions of sale and delivery

1. General Provisions

By using this catalog you can purchase products (hardware, software and services) described therein from Siemens Aktiengesellschaft subject to the following Terms and Conditions of Sale and Delivery (hereinafter referred to as "T&C"). Please note that the scope, the quality and the conditions for supplies and services, including software products, by any Siemens entity having a registered office outside Germany, shall be subject exclusively to the General Terms and Conditions of the respective Siemens entity. The following T&C apply exclusively for orders placed with Siemens Aktiengesellschaft, Germany.

1.1 For customers with a seat or registered office in Germany

For customers with a seat or registered office in Germany, the following terms and conditions apply subordinate to T&C:

- for products, which include specific terms and conditions in the description text, these specific terms and conditions shall apply and subordinate thereto,
- for installation work the "General Conditions for Erection Works – Germany"¹⁾ ("Allgemeine Montagebedingungen – Deutschland" (currently only available in German)) and/or
- for stand-alone software products and software products forming a part of a product or project, the "General License Conditions for Software Products for Automation and Drives for Customers with a Seat or registered Office in Germany"¹⁾ and/or
- for consulting services the "General Terms and Conditions for Consulting Services of the Division DF – Germany"¹⁾ and/or
- for other supplies and/or services the "General Conditions for the Supply of Products and Services of the Electrical and Electronics Industry"¹⁾.

In case such supplies and/or services should contain Open Source Software, the conditions of which shall prevail over the "General Conditions for the Supply of Products and Services of the Electrical and Electronics Industry"¹⁾, a notice will be contained in the scope of delivery in which the applicable conditions for Open Source Software are specified. This shall apply mutatis mutandis for notices referring to other third party software components.

1.2 For customers with a seat or registered office outside Germany

For customers with a seat or registered office outside Germany, the following terms and conditions apply subordinate to T&C:

- for products, which include specific terms and conditions in the description text, these specific terms and conditions shall apply and subordinate thereto,
- for services the "International Terms & Conditions for Services"¹⁾ supplemented by "Software Licensing Conditions"¹⁾ and/or
- for consulting services the "General Terms and Conditions for Consulting Services of the Division DF – Germany"¹⁾ and/or
- for other supplies of hard- and software the "International Terms & Conditions for Products"¹⁾ supplemented by "Software Licensing Conditions"¹⁾

1.3 For customers with master or framework agreement

To the extent our supplies and/or services offered are covered by an existing master or framework agreement, the terms and conditions of that agreement shall apply instead of T&C.

2. Prices

The prices are in € (Euro) ex point of delivery, exclusive of packaging.

The sales tax (value added tax) is not included in the prices. It shall be charged separately at the respective rate according to the applicable statutory legal regulations.

Prices are subject to change without prior notice. We will charge the prices valid at the time of delivery.

To compensate for variations in the price of raw materials (e.g. silver, copper, aluminum, lead, gold, dysprosium and neodym), surcharges are calculated on a daily basis using the so-called metal factor for products containing these raw materials. A surcharge for the respective raw material is calculated as a supplement to the price of a product if the basic official price of the raw material in question is exceeded.

The metal factor of a product indicates the basic official price (for those raw materials concerned) as of which the surcharges on the price of the product are applied, and with what method of calculation.

An exact explanation of the metal factor can be downloaded at:

www.siemens.com/automation/salesmaterial-as/catalog/en/terms_of_trade_en.pdf

To calculate the surcharge (except in the cases of dysprosium and neodym), the official price from the day prior to that on which the order was received or the release order was effected is used.

To calculate the surcharge applicable to dysprosium and neodym ("rare earths"), the corresponding three-month basic average price in the quarter prior to that in which the order was received or the release order was effected is used with a one-month buffer (details on the calculation can be found in the explanation of the metal factor).

3. Additional Terms and Conditions

The dimensions are in mm. In Germany, according to the German law on units in measuring technology, data in inches apply only to devices for export.

Illustrations are not binding.

Insofar as there are no remarks on the individual pages of this catalog – especially with regard to data, dimensions and weights given – these are subject to change without prior notice.

¹⁾ The text of the Terms and Conditions of Siemens AG can be downloaded at www.siemens.com/automation/salesmaterial-as/catalog/en/terms_of_trade_en.pdf

4. Export Regulations

We shall not be obligated to fulfill any agreement if such fulfillment is prevented by any impediments arising out of national or international foreign trade or customs requirements or any embargoes and/or other sanctions.

Export may be subject to license. We shall indicate in the delivery details whether licenses are required under German, European and US export lists.

Our products are controlled by the U.S. Government (when labeled with "ECCN" unequal "N") and authorized for export only to the country of ultimate destination for use by the ultimate consignee or end-user(s) herein identified. They may not be resold, transferred, or otherwise disposed of, to any other country or to any person other than the authorized ultimate consignee or end-user(s), either in their original form or after being incorporated into other items, without first obtaining approval from the U.S. Government or as otherwise authorized by U.S. law and regulations.

The export indications can be viewed in advance in the description of the respective goods on the Industry Mall, our online catalog system. Only the export labels "AL" and "ECCN" indicated on order confirmations, delivery notes and invoices are authoritative.

Products labeled with "AL" unequal "N" are subject to European / national export authorization. Products without label, with label "AL:N" / "ECCN:N", or label "AL:9X9999" / "ECCN: 9X9999" may require authorization from responsible authorities depending on the final end-use, or the destination.

If you transfer goods (hardware and/or software and/or technology as well as corresponding documentation, regardless of the mode of provision) delivered by us or works and services (including all kinds of technical support) performed by us to a third party worldwide, you must comply with all applicable national and international (re-)export control regulations.

If required for the purpose of conducting export control checks, you (upon request by us) shall promptly provide us with all information pertaining to the particular end customer, final disposition and intended use of goods delivered by us respectively works and services provided by us, as well as to any export control restrictions existing in this relation.

The products listed in this catalog may be subject to European/German and/or US export regulations. Any export requiring approval is therefore subject to authorization by the relevant authorities.

Errors excepted and subject to change without prior notice.

Appendix

Notes

Selection and ordering at Siemens Industry Mall, Catalog CA 01, downloading and ordering catalogs

Easy product selection and ordering: Industry Mall and Interactive Catalog CA 01

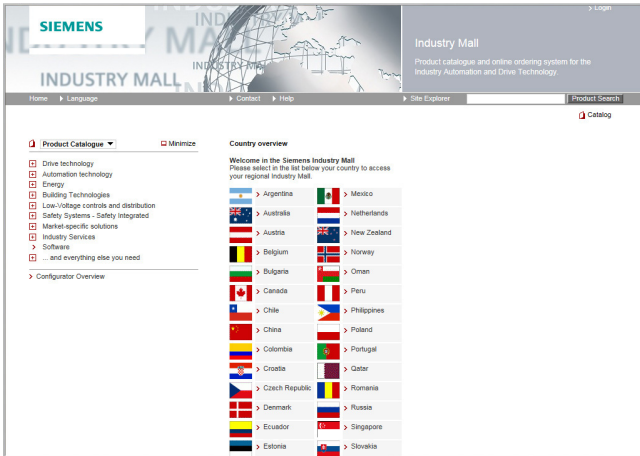

Industry Mall

The Industry Mall is a Siemens AG Internet ordering platform. It provides you with online access to a comprehensive product spectrum that is presented in an informative, well-organized way.

Powerful search functions help you select the required products, while configurators enable you to configure complex product and system components quickly and easily. CAx data are also available for you to use.

Data transfer allows the entire procedure, from selection through ordering to tracking and tracing, to be carried out online. Availability checks, individual customer discounting, and quotation preparation are also possible.

www.siemens.com/industrymall



Interactive Catalog CA 01 – Products for automation and drives

The Interactive Catalog CA 01 combined with the Siemens Industry Mall unites the benefits of offline and online media in one application – the performance of an offline catalog with the availability of a wide range of up-to-date information on the Internet.

Select products and assemble orders using the CA 01, determine the availability of the selected products, and track and trace them via the Industry Mall.

Information and download:

www.siemens.com/automation/ca01

Downloading catalogs

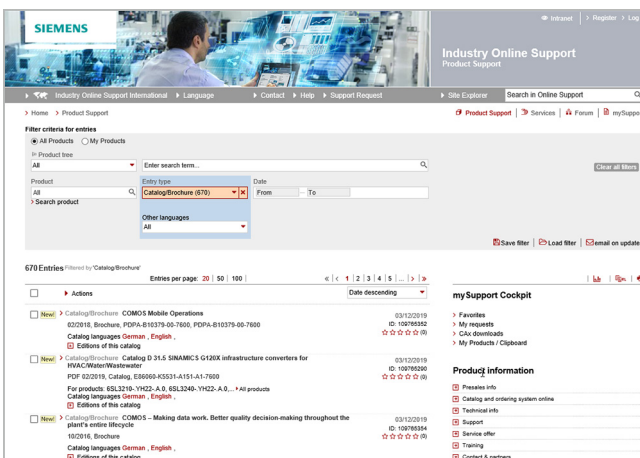

Siemens Industry Online Support

You can download catalogs and brochures in PDF format from Siemens Industry Online Support without having to register.

The filter box makes it possible to perform targeted searches.

www.siemens.com/industry-catalogs

Ordering printed catalogs



Please contact your local Siemens branch if you are interested in ordering printed catalogs.

Addresses can be found at

www.siemens.com/automation-contact

Get more information

SINAMICS G120XA infrastructure converters
for standard pumps/fans:

www.siemens.com.cn/sinamics-g120xa

SIMOTICS electric motors:

www.siemens.com/simotics

Motion Control Systems and Solutions for production
machine and machine tool equipment:

www.siemens.com/motioncontrol

Local partners worldwide:

www.siemens.com/automation-contact

Published by
Siemens AG

Digital Industries
Motion Control
Postfach 31 80
91050 Erlangen, Germany

(Article No. E86060-K5531-A161-A2-7600)

V6.MKKATA.GMC.108

KG 1119 76 En

Produced in Germany

© Siemens 2019

Subject to changes and errors. The information given in this document only contains general descriptions and/or performance features which may not always specifically reflect those described, or which may undergo modification in the course of further development of the products. The requested performance features are binding only when they are expressly agreed upon in the concluded contract.

All product designations may be trademarks or product names of Siemens AG or other companies whose use by third parties for their own purposes could violate the rights of the owners.

Security information

Siemens provides products and solutions with industrial security functions that support the secure operation of plants, systems, machines and networks.

In order to protect plants, systems, machines and networks against cyber threats, it is necessary to implement – and continuously maintain – a holistic, state-of-the-art industrial security concept. Siemens' products and solutions constitute one element of such a concept.

Customers are responsible for preventing unauthorized access to their plants, systems, machines and networks. Such systems, machines and components should only be connected to an enterprise network or the internet if and to the extent such a connection is necessary and only when appropriate security measures (e.g. firewalls and/or network segmentation) are in place.

For additional information on industrial security measures that may be implemented, please visit

<https://www.siemens.com/industrialsecurity>

Siemens' products and solutions undergo continuous development to make them more secure. Siemens strongly recommends that product updates are applied as soon as they are available and that the latest product versions are used. Use of product versions that are no longer supported, and failure to apply the latest updates may increase customer's exposure to cyber threats.

To stay informed about product updates, subscribe to the Siemens Industrial Security RSS Feed under

<https://www.siemens.com/industrialsecurity>