

SHARP®

PN-R556

PN-R496

PN-R426

Professional LCD Monitors

Find the Right Angle for Your Message



AWARD WINNER
BEST SHOW
InfoComm 2016

With award-winning Sharp PN-R556/R496/R426 professional LCD monitors, you have more flexibility than ever to set up your digital signage in the most eye-catching way possible. Not only can these monitors be suspended from a ceiling, they can also be installed face up, face down, or at a tilted angle. The 55" Class (54.6" diagonal) PN-R556 display, 49" Class (48.5" diagonal) PN-R496 display and the 42" Class (41.9" diagonal) PN-R426 display offers such a wide variety of installation options, you'll be sure to find the ideal setup to match your location and signage needs. DisplayPort™ 1.2 connectivity comes standard, and the interface can be expanded with an optional HDBaseT™ 2.0 receiver board. The system is designed for increased convenience and versatility as the PN-R556/R496/R426 monitors stylishly make your key message even more visible to your intended target.

Flexible Installation

Excellent Image Quality

Thanks to their 1,920 (H) x 1,080 (V)-pixel resolution, PN-R556/R496/R426 monitors express all of the detail and visual impact of your selected full-HD content. Everything from fine text to intricate graphics is rendered crisply and clearly. Brightness of 700 cd/m² further enhances their performance in professional digital signage applications.

Adaptable to Various Settings

Whether in a landscape or portrait orientation, PN-R556/R496/R426 monitors can be installed face up, face down, or tilted forward or backward at an angle of up to 90 degrees. Such flexibility helps you to incorporate these monitors into a wider-than-ever variety of settings.

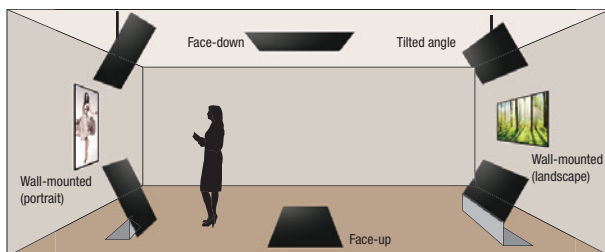

Note: Please consult with your local authorized Sharp dealer or representative regarding tilttable angles and other installation conditions.

Slim Body Suits Any Location

A slim design with a bezel of only 7.8 mm on all four sides helps onscreen images stand out and catch the viewer's eye. Onscreen images beautifully fill the screen, reaching almost to the edges of the monitor. The subtle design of the monitors makes them a stylish fit for virtually any location.

Other Key Features

24/7 Operation

Built solid, PN-R556/R496/R426 monitors are ideal for use in demanding professional applications that require around-the-clock operation, seven days a week.

Power on Delay

This feature lets you delay the startup of each monitor in a multi-monitor installation. This reduces the load placed on the power supply when multiple monitors are turned on at the same time.

Fanless Architecture

Airflow is maintained and heat is dissipated without the use of noisy, dust-creating mechanical air-ventilation fans. The fanless design also facilitates maintenance of the monitor.

Hanging Installation

The design of PN-R556/R496/R426 monitors is robust enough that they can be suspended from the four corners of the rear housing. Each monitor is bundled with mounting brackets that allow you to suspend it easily using wires.

Note: Please consult with your local authorized Sharp dealer or representative for installation advice.



Functional Remote Control

The PN-R556/R496/R426's newly designed remote control offers enhanced operability. For example, the remote control and monitors can be assigned an identity number (from 0 to 9) for mutual recognition, which enables the remote to send commands to the targeted monitor only. The remote also lets you perform basic operations on connected HDMI®-CEC compatible devices, including power on/off. And it has three designated function buttons—HDMI, DisplayPort, and Option—to simplify input switching.



Built-in Temperature Sensor

If the temperature inside a monitor rises, a built-in sensor detects it and the monitor automatically lowers the brightness level of its backlight system.

Enlarge (Zoom) Display Mode

This feature enables multiple monitors to be grouped together to display a single enlarged image. The framing of the image is corrected to eliminate misalignment between monitors.

DisplayPort Daisy Chain

Multiple PN-R556/R496/R426 monitors can be set up in a daisy chain configuration, so you can display the same content simultaneously on all screens. No matter which terminal receives the input signal, it can be output via DisplayPort.

Expandable Interface

To enhance their functionality in professional signage applications, PN-R556/R496/R426 monitors come standard, equipped with a range of interface terminals such as HDMI inputs and Display Port 1.2 input/output terminals. What's more, these LCD monitors feature an Intel® Mini OPS-compatible expansion slot that supports the addition of an optional expansion board. You can add either an HDBaseT 2.0-compliant receiver board that supports various types of media and control signals or a wireless board that brings convenient functionality to office environments.

Support for HDBaseT 2.0 (Option)

Installing an optional HDBaseT Receiver Board (PN-ZB03H) allows the monitor to receive HDMI video, audio signals, and control signals sent up to 328 feet via a single LAN cable*1. This brings convenient connectivity with HDMI devices such as PCs and BD players. Compatibility with the HDBaseT 2.0 standard allows you to remotely operate a PC from a USB device connected to the optional board*2. With HDBaseT 2.0 support, you can use fewer cables and reduce the time and cost of installation.

PN-ZB03H HDBaseT Receiver Board	
Supported standard	HDBaseT 2.0
Maximum resolution	4,096 x 2,160 (30 Hz)
Copy protection	HDCP pass-through
Transmission distance	Up to 328 feet / 100m
Input/output terminals	HDBaseT x 1, LAN x 1 (10Base-T/100Base-TX), USB x 1 (USB 2.0)
Power supply	From the monitor

*1 Category 6 or higher shielded cable (available commercially)

*2 Requires an HDBaseT 2.0-compatible transmitter (available commercially). Not all USB devices are supported.

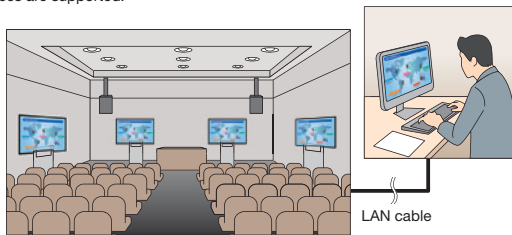

A single LAN cable supports long-distance signal transmission up to 328 ft.

Wireless Connectivity (Option)

The optional Wireless Board (PN-ZB03W) allows up to 10 devices—including Mac® or Windows® computers, smartphones and tablets—to connect to the PN-R556/R496/R426 simultaneously without any cable hassles. You can display the content of one device on the whole screen, or you can display the content from up to four devices in a 2 x 2 split screen. This wireless collaboration is a great way to enhance productivity in the workplace.

PN-ZB03W Wireless Board	
Maximum resolution	1,920 x 1,080 (30 Hz)
Wireless communication method	2.4GHz, IEEE802.11b/g/n 5GHz, IEEE802.11a/n
Input/output terminals	LAN x 1 (10Base-T/100Base-TX), USB x 1 (USB 2.0), Wireless adapter x 1 (USB 2.0)
Power supply	From the monitor



Standard

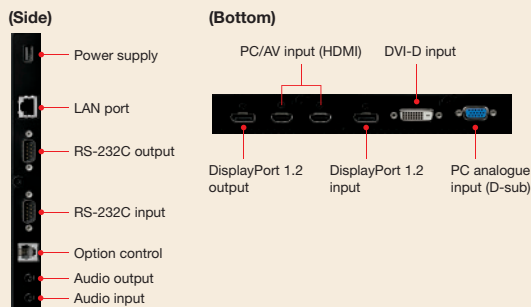

Option

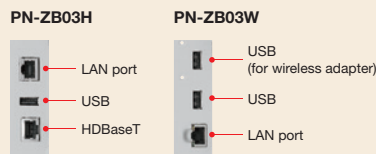

An optional board can slide into the slot on the back of the monitor.

ID Setting

Thanks to an RS-232C interface, multiple PN-R556/R496/R426 monitors* can be easily controlled and monitored from a central location via a PC. Each monitor can be assigned an individual ID code to use when remotely turning that monitor on or off, changing its input, or making various screen adjustments and settings.

* PN-R556/R496/R426 monitors can be connected together in a daisy chain configuration.

Built-In Speakers

Built-in 10W + 10W rear speakers eliminate the need for external speakers and ensure a stylishly streamlined profile.

Crestron Connected™

These monitors are compatible with Crestron Connected software, which means that you can remotely control and manage each monitor via a LAN network.



Specifications

Model Name	PN-R556	PN-R496	PN-R426
Installation	Landscape / Portrait / Face-up / Face-down		
LCD Panel	55" Class (54.6" diagonal) TFT LCD	49" Class (48.5" diagonal) TFT LCD	42" Class (41.9" diagonal) TFT LCD
Max. Resolution	1,920 x 1,080 pixels		
Max. Display Colors (approx.)	1.07 billion colors		
Pixel Pitch (H x V)	0.630 x 0.630 mm	0.559 x 0.559 mm	0.483 x 0.483 mm
Brightness*1	700 cd/m ²		
Contrast Ratio	1,300 : 1		
Viewing Angle (H/V)	178°/178° (CR ≥ 10)		
Active Screen Area (W x H)	47 5/8" x 26 13/16"	42 1/4" x 23 3/4"	36 9/16" x 20 9/16"
Response Time	8ms (grey to grey, avg.)		
Backlight	LED, edge lit		
Computer Input	Video: Analog RGB (0.7 Vp-p) [75Ω], Digital (DVI 1.0 standard-compliant), DisplayPort 1.2, HDMI Synchronization: Horizontal/vertical separation (TTL: positive/negative), Sync on green*2, Composite sync (TTL: positive/negative)*2 Plug & Play: VESA DDC2B Power Management: VESA DPMS, DVI DMPM		
Input Terminals*3	DisplayPort x 1, DVI-D 24-pin (HDCP compatible) x 1, Mini D-sub 15-pin x 1, HDMI (PC/AV signal compatible) x 2, RS-232C x 1, 3.5 mm-diameter mini stereo jack x 1		
Output Terminals*3	DisplayPort x 1, 3.5 mm-diameter mini stereo jack x 1, RS-232C x 1		
Input/Output Terminals*3	LAN: 10Base-T/100Base-TX x 1		
Power Supply Terminal	5 V, 2 A (5V, 500 mA when the expansion slot is used) (USB type-A connector)		
Expansion Slot	12V, 2.4 A (power supplied when expanding the functions with an optional part)		
Built-in Speakers	10W + 10W		
Mounting	VESA (4 points), 400 mm (15 3/4") pitch, M6 screw	VESA (4 points), 7 7/8" (200 mm) pitch, M6 screw	
Power Supply	100V – 240V AC, 50/60 Hz		
Power Consumption	175W	155W	135W
Environmental Conditions	Operating Temperature*4: 0°C to 40°C Operating Humidity: 20% to 80% RH (no condensation)		
Dimensions (W x D x H) (approx.; display only)	48 7/16" x 2 1/4" x 27 5/8"	43 1/8" x 2 1/4" x 24 5/8"	37 3/16" x 2 1/4" x 21 3/8"
Weight (approx.)	55.1 lbs	43 lbs	34.2 lbs
Main Accessories	AC power cord, remote control unit, battery (AAA size x 2), CD-ROM, set-up manual, cable clamp x 2, ceiling mounting bracket x 4, ceiling mounting bracket fixing screw x 4, logo sticker		

*1 Brightness depends on input mode and other picture settings. Brightness level will decrease slightly over the lifetime of the product. Due to the physical limitations of the equipment, it is not possible to maintain a precisely constant level of brightness.
*2 D-sub input terminal only. *3 Use a commercially available connection cable for PC and other video connections. *4 When using the monitor laying flat on a surface (when the monitor is tilted 20 degrees or more upward or downward from the perpendicular in relation to a level surface) the ambient temperature must be within the range of 0°C to 30°C. Temperature condition may change when using the monitor together with the optional equipment recommended by Sharp. In such cases, please check the temperature condition specified by the optional equipments.

Dimensions

(PN-R556)

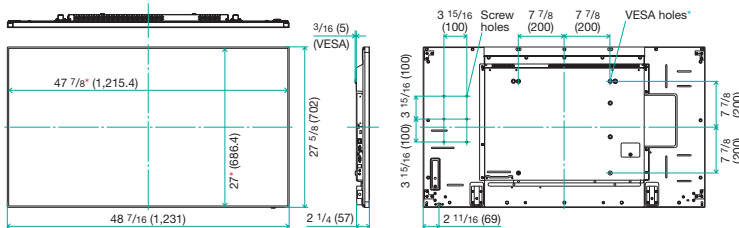

(PN-R496)

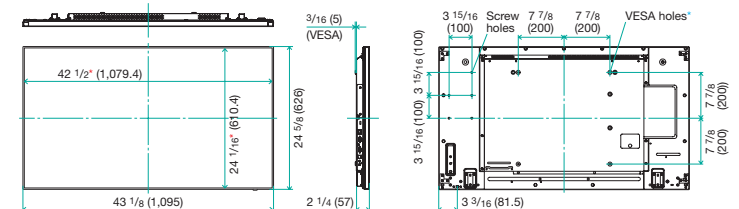

(PN-R426)

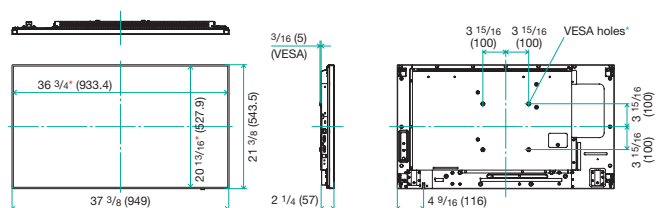

Units: inch (mm)
* Screen dimensions
* To use the VESA-standard mounting bracket, use M6 screws that are 8 to 10 mm plus the thickness of the bracket.

Options

- PN-ZB03H : HDBaseT Receiver Board
- PN-ZB03W : Wireless Board



SHARP ELECTRONICS CORPORATION
100 Paragon Drive, Montvale, NJ 07645
1-800-BE-SHARP • www.sharppusa.com

Sharp and all related trademarks are trademarks or registered trademarks of Sharp Corporation and/or its affiliated companies. Windows is a registered trademark of Microsoft Corporation in the United States and other countries. Mac is a trademark of Apple Inc., registered in the US and other countries. Android is a trademark of Google Inc. iOS is a trademark or registered trademark of Cisco in the US and other countries and is used under license. HDBaseT and the HDBaseT Alliance logo are trademarks of the HDBaseT Alliance. DisplayPort and the DisplayPort Compliance Logo are trademarks owned by the Video Electronics Standards Association in the United States and other countries. The terms HDMI, High-Definition Multimedia Interface and the HDMI logo are trademarks or registered trademarks of HDMI Licensing Administrator, Inc. Intel is a trademark of Intel Corporation in the U.S. and/or other countries. Crestron Connected is a trademark of Crestron Electronics, Inc. All other brand names and product names may be trademarks or registered trademarks of their respective owners. All screen images appearing in this brochure are simulated. Design and specifications are subject to change without prior notice.