

SECTION 7

SYSTEMS DESCRIPTION AND OPERATION

TABLE OF CONTENTS

PARAGRAPH	PAGE
7.1 AIRCRAFT	7-1
7.2 AIRFRAME	7-1
7.3 POWERPLANT	7-3
7.4 ENGINE CONTROLS	7-5
7.5 FLIGHT CONTROLS	7-6
7.6 LANDING GEAR	7-7
7.7 BRAKE SYSTEM	7-8
7.8 FUEL SYSTEM	7-9
7.9 ELECTRICAL SYSTEM	7-12
7.9.1 MASTER SWITCH PANEL	7-13
7.9.2 BREAKER PANEL	7-14
7.9.3 SWITCH PANEL	7-16
7.10 CUT-OFF	7-17
7.11 EXTERNAL POWER	7-18
7.12 EMERGENCY LOCATOR TRANSMITTER	7-19
7.13 INSTRUMENT PANEL AND PEDESTAL LAYOUT	7-20

SECTION 7

SYSTEMS DESCRIPTION AND OPERATION

TABLE OF CONTENTS

PARAGRAPH		PAGE
7.14	ANNUNCIATOR PANEL	7-24
7.15	STALL WARNING SYSTEM	7-25
7.16	ENVIRONMENTAL SYSTEM	7-26
7.16.1	CABIN AIR HEATING / WINDSHIELD DEFROSTING SYSTEM	7-26
7.16.2	FRESH AIR SYSTEM	7-27
7.17	PITOT AND STATIC SYSTEM	7-28
7.18	DIGITAL COCKPIT	7-29
7.18.1	GARMIN G500 AVIONIC SYSTEM AND GARMIN LRUs OVERVIEW	7-29
7.18.2	GARMIN G500 AVIONIC SYSTEM AND GARMIN LRUs COMPONENTS	7-32
7.18.3	GARMIN G500 AVIONIC SYSTEM AND GARMIN LRUs CONTROLS	7-38
7.18.4	MD302 STANDBY ATTITUDE MODULE	7-44
7.18.5	EDM-930 ENGINE DATA MANAGEMENT SYSTEM	7-45
7.18.6	ENGINE INDICATION SYSTEM (EIS)	7-47
7.18.7	GARMIN TERRAIN-SVT FEATURE	7-48
7.18.8	GARMIN ADS-B IN TRAFFIC FEATURE	7-50

SECTION 7

SYSTEMS DESCRIPTION AND OPERATION

TABLE OF CONTENTS

PARAGRAPH		PAGE
7.18.9	SOFTWARE RELEASE NOTIFICATION	7-52
7.19	PLACARDS	7-54

- THIS PAGE INTENTIONALLY LEFT BLANK -

SECTION 7

SYSTEMS DESCRIPTION AND OPERATION

7.1 AIRCRAFT

Vulcanair V1.0 is a four seats, single piston engine, high wing monoplane aircraft, equipped with a fixed tricycle landing gear and digital cockpit.

7.2 AIRFRAME

The airframe for Vulcanair V1.0 aircraft is mainly of all-metal construction, with dorsal fin, fairings and wing tips made of composite material.

The fuselage is made of all metal structure. It consists of two main parts assembled (fwd/rear sections), fireproof bulkhead, floor, metal fittings and other aluminum parts that allow the connection of main landing gear, wing, strut, engine mount, seats and instrument panel. Several hard points are incorporated in the fuselage to support the main aircraft components.

The forward side of the fuselage is a truss that includes the attaching point for the wing-halves, the engine mount and the landing gear, while the rear side of the fuselage is a metal semi-monocoque structure that consists of bulkheads, stringers and stiffeners, to which all of outer skin is riveted.

The cabin may be accessed through three doors (composite material) provided with a proper interlocking system: two crew doors located at the forward LH side (pilot door) and RH side (co-pilot door) of the fuselage and a cabin entrance door for passenger (passenger door) located at the RH side of the fuselage. An access door to the baggage compartment is located just aft the passenger door. An internal sliding door installed behind the rear bench permits another access to the baggage compartment.

Windows include a windshield, an upper windshield, a rear window and a LH side window.

Rev. 14

DATE: 03 October 2018

7-1

The empennages are made of all metal stressed-skin, full cantilever, consisting of a vertical tail (fin and rudder) and a horizontal tail (stabilator). Only the stabilator is provided with trim tab and also it incorporates one torque tube that is hinged to the aft bulkhead assembly of the fuselage.

The rudder (statically balanced) is connected to the vertical fin through two hinges on the rear spar of the fin (bellcrank connected to lower hinge for movement transmission) and it is cable controlled.

The stabilator unit is an all movable tail plane (statically balanced) and it consists of two symmetrical metal semi-monocoque halves coupled with a hinge torque tube assembled to the rear bulkhead of the fuselage; it is push-pull rods controlled. The stabilator is provided with one trim tab in two rigidly jointed halves, one for each half-stabilator.

The wing is composed of two halves-wing. Each one is connected to the fuselage by means of two bolt attachments and a single strut brace per side.

Each wing is made of all metal stressed-skin, full cantilever consisting of a torsion box with removable aluminum leading edge and carbon fiber tip.

A rigid metal removable fuel tank is located in each half-wing in an opportune wing box compartment between the wing spars and appropriately supported by the wing structure.

An aileron and flap (all metal construction) are attached to each half-wing.

Static wicks are installed on the wing and tail plane trailing edges to clear the aircraft of surface static electricity.

The fixed tricycle landing gear with a steerable nose gear (nose wheel is steerable through the rudder pedals).

A tapered leg, positioned crossways to the fuselage and attached to the fuselage structure (under the seats in truss central section) by means of a mounting bracket and bolt, supports each main wheel.

The metal nose gear-leg is made with welded brackets and it is pivotally attached to the engine mount; the nose fork attaches and pivots at the lower end of the nose gear. Shock absorption for the steerable nose wheel is provided by a spring strut cylinder (oil and metallic spring) installed between nose gear strut and nose wheel fork.

Brakes are hydraulically actuated through the rudder pedal tips.

7.3 POWERPLANT

(Refer to Figure 7-1)

Vulcanair V1.0 aircraft is powered by one engine Lycoming model IO-360-M1A, fuel injected, direct drive, four cylinders, horizontally opposed (361 cu-in displacement), air cooled with down exhaust outlets. This engine is supplied with a starter and an RSA-5AD1 type fuel injection system.

Lycoming IO-360-M1A engine has a rated maximum continuous power of 180 HP at 2700 RPM at standard sea level conditions and a compression ratio of 8.5:1.

The engine is enclosed by cowlings consisting of eight panels; two LH/RH hinged upper side cowlings permit an easy access to the engine internal area.

Lycoming IO-360-M1A engine is securely installed to the aircraft fuselage truss through its tubular mount; this one is secured to the fuselage truss by means of four attachment points easily identifiable on the fireproof bulkhead.

The fireproof bulkhead separates the engine compartment from the rest of the fuselage and supports various aircraft components on both fwd and aft sides.

A total of four engine shock mounts are installed between the engine and the related four mounting pads to isolate the airframe from the engine vibrations.

Lycoming IO-360-M1A engine is coupled with Hartzell propeller model HC-C2YR-1BFP/F7497, two-blade, constant speed, non-counterweighted, single-acting, hydraulically actuated, controlled by an engine speed sensing device (governor) to maintain a constant engine/propeller RPM by changing the blade angle; no feathering capability is added.

The propeller is an aluminum blade model with a swept tip and a diameter of 74 in (1.88 m).

Both aviation fuel (AVGAS) and automotive fuel (MOGAS) types are approved for use in Lycoming IO-360-M1A engine (as per Lycoming Service Instruction No.1070).

The engine lubrication system consists of a wet sump, engine driven oil pump, an oil filter, and an oil cooler.

One electric start boost system “SlickSTART™” manufactured by Champion Aerospace is installed on the aircraft in order to improve the ignition system.

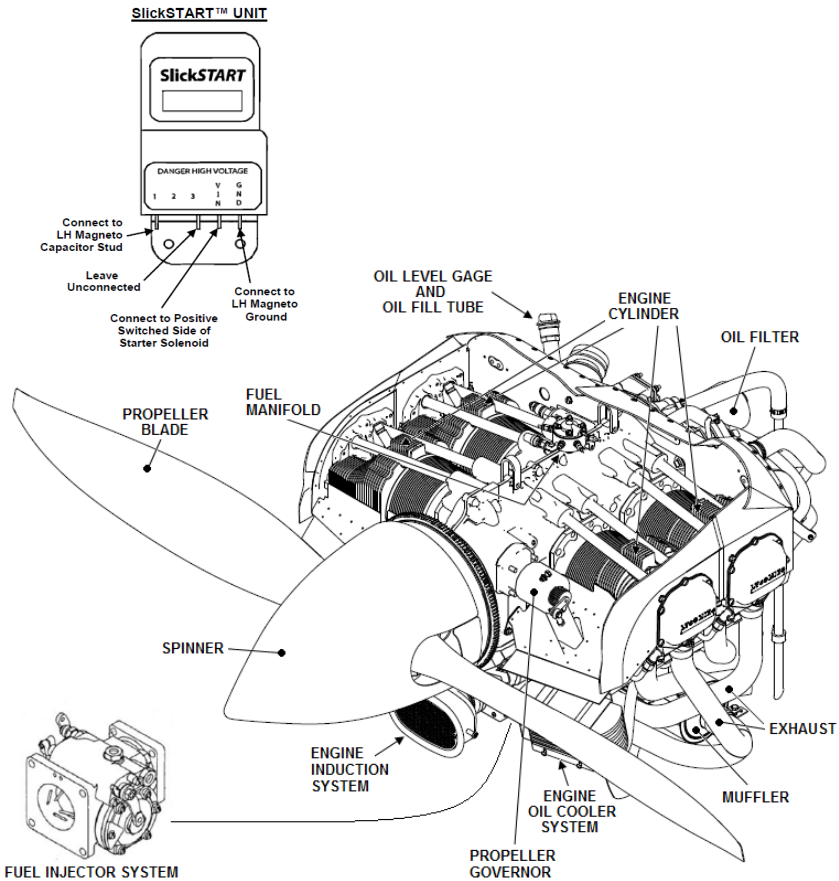

Figure 7-1 Powerplant system overview

7.4 ENGINE CONTROLS

(Refer to Figure 7-2)

The engine and propeller are operated by three sets of control levers mounted on the control pedestal below and at the center of the instrument panel.

The controls are (from LH to RH): power lever, propeller speed lever and mixture control lever.

Pedestal control lever friction is adjusted by a friction wheel located on the RH side of the control pedestal. Friction should be set for a smooth, but not loose movement of the control levers. To increase friction, rotate the wheel clockwise, to decrease friction rotate the wheel counterclockwise.

The alternate air door, as well as the air stoppage to the engine, can be controlled through the alternate air control handle. This last one is located on the central pedestal, just below the engine and propeller control levers.

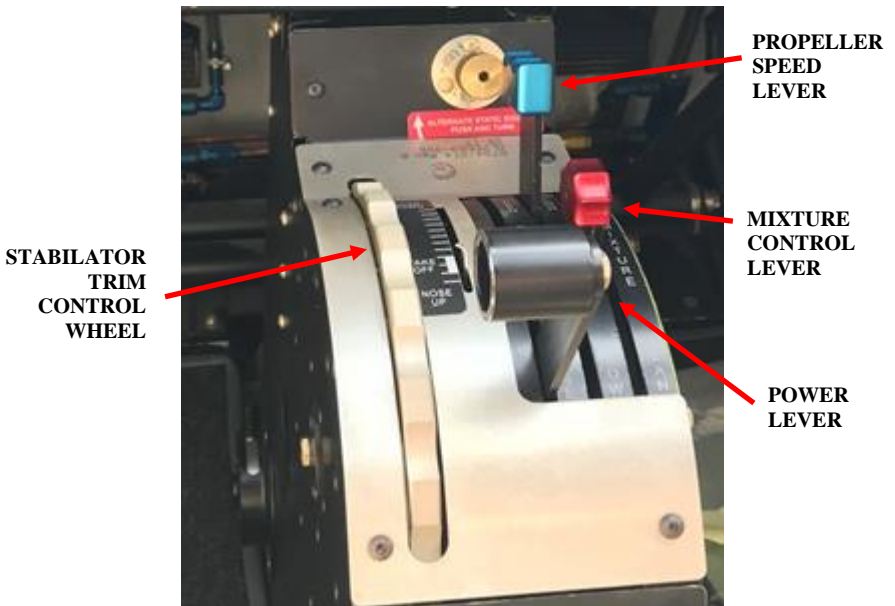

Figure 7-2 Control pedestal overview

7.5 FLIGHT CONTROLS

(Refer to Figures 7-2 and 7-3)

Primary flight controls are conventional equipment, consisting of a control wheel which operates the ailerons and stabilator, and pedals which operate the rudder. Duplicate controls are provided for the co-pilot.

The two ailerons (statically balanced) are controlled through cables and push-pull rods.

The stabilator (statically balanced) is controlled through push-pull rods.

The rudder (statically balanced) is controlled through cables.

Secondary controls are provided by the stabilator trim tab.

Stabilator trim is operated by a wheel, located on the LH side of the control pedestal, which turns a chain sprocket.

To show tab position, an indicator is mounted close to the trim control wheel.

The trailing edge single slot wing flaps, one on each wing, are electrically operated by an actuator, installed in correspondence of the RH wing root, and activated by a control switch located on the instrument panel. This actuator is connected to a lever which operates the RH wing flap through a push-pull rod and the LH wing lever through a torque tube assembled to the fuselage truss.

The LH wing flap is connected to the lever by a push-pull rod.

Electrical up and down limit switches are provided to safeguard against over-travel.

The flap position is mechanically/electrically transmitted to the indicator located next to the related control switch.

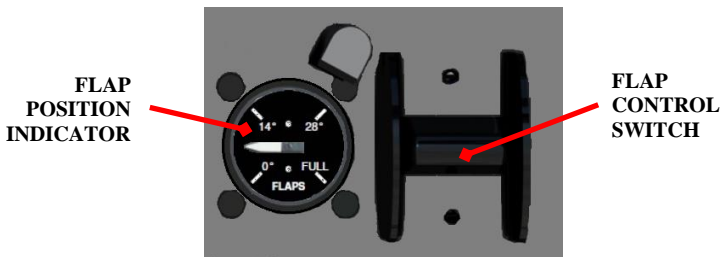

Figure 7-3 Flap position indicator and related control switch

7.6 LANDING GEAR

Vulcanair V1.0 aircraft is equipped with a fixed tricycle landing gear with a steerable nose gear.

The main landing gear consists of two cantilever legs, two wheels with brakes and two main wheel fairings (optional equipment).

The tapered leaf-springs are positioned crossways to the fuselage and attached to the fuselage structure (under the seats in truss central section) by means of two mounting brackets and bolts.

A wheel axle is attached to the lower end of each landing gear strut with four bolts.

The two main wheels are equipped with 6.00-6, 6-ply tires and with single disc hydraulic brake assemblies, installed on the inboard side of each wheel, which are actuated by individual toe brake cylinders mounted on the rudder pedals.

The nose gear consists of one welded tubular strut pivotally attached to the engine mount and linked to the rudder pedals to provide ground control, one shock absorber fitted directly on the nose landing gear structure and one nose wheel fairing (optional equipment).

The nose gear-leg is made with welded brackets. The nose fork attaches and pivots at the lower end. An axle bolt and nut fasten the axle, spacer, wheel and tire assembly to the nose fork.

The forward bottom end of the nose gear strut has a horizontal pivot for the nose wheel fork. The nose wheel fork with the nose gear wheel can thus only move up and down.

Shock absorption for the steerable nose wheel is provided by a spring strut cylinder (oil and metallic spring) installed between nose gear strut and nose wheel fork.

Nose wheel steering is accomplished through use of the rudder pedals. The nose wheel is equipped with 5.00-5, 6-ply tire.

7.7 BRAKE SYSTEM

(Refer to Figure 7-4)

The brakes are hydraulically operated by individual hydraulic brake cylinders mounted on the rudder pedals. To operate the brakes, apply toe pressure against the top of the rudder pedals.

The parking brake consists of one manually operated knob assembly, installed on the control pedestal, and connected to the parking brake valve.

When pressure is applied to the brake system and the parking brake knob is rotated to “LOCK”, the valve holds the pressure on the brake assemblies until released. Rotate to “UNLOCK” the knob to release the parking brake.

Hydraulic fluid for the brake cylinders is contained in a remote reservoir installed on the LH hand side in front of the fireproof bulkhead.

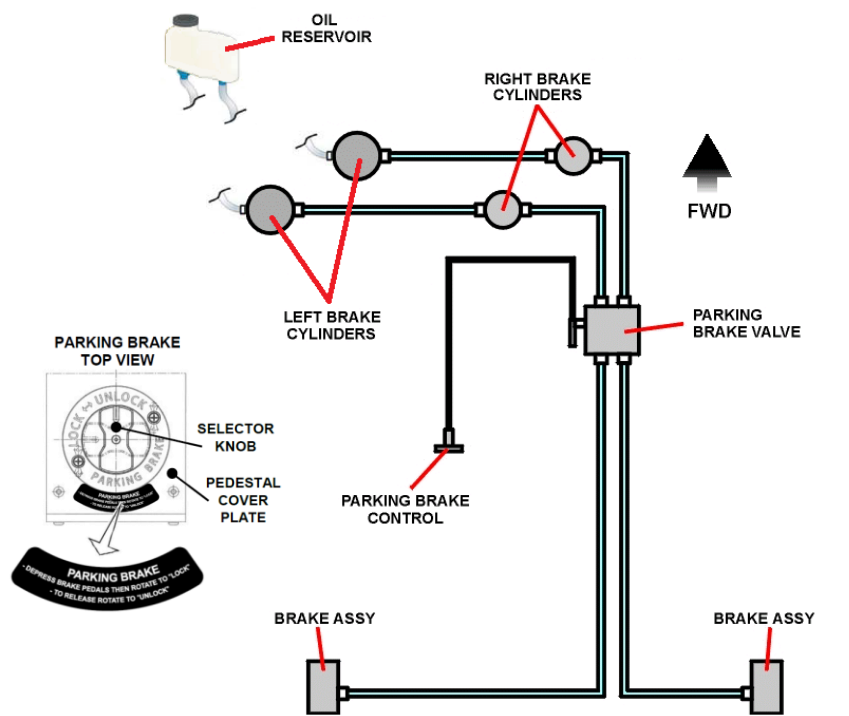

Figure 7-4 Brake system block architecture

7.8 FUEL SYSTEM

(Refer to Figure 7-5)

The main components of the fuel system are: Fuel Tanks, Fuel Selector Valve, Low Pressure Fuel Filter and Auxiliary Fuel Pump (electrically operated).

Fuel is stored in two wing tanks (one per wing). Each fuel tank is provided with sump (with flush drain valve) and finger strainer.

The total fuel capacity for each tank is 100 liters (26.4 USG), of which 95 liters (25.1 USG) are usable. Fuel exchange between fuel tanks is not possible.

Although only one fuel tanks configuration can be installed on the aircraft, two fuel types are approved for use in Lycoming IO-360-M1A engines:

- a) Aviation Fuels (AVGAS)
- b) Automotive Fuels (MOGAS)

Due to the higher volatility of MOGAS as compared to AVGAS, to reduce the vapour lock issue, an additional fuel line has been installed; its purpose is to increase the fuel circulating through the fuel hoses in engine compartment, thus reducing vapour formation potential. As per above, the fuel system consists of two separate fuel lines:

1. Fuel supply line (main), that carries the fuel from the fuel tanks to the injector.
2. Fuel return line, that carries back the fuel from the injector to the fuel tanks.

Fuel is gravity fed, through the main fuel line (tube 3/8"), from the wing tanks to the fuel selector valve in the cabin at the control pedestal plate.

From the selector valve, the fuel flows through the fireproof bulkhead and reaches the low pressure fuel filter installed fwd the fireproof bulkhead. The filtered fuel flows to the auxiliary fuel pump and then to the Lycoming engine pump installed on the engine's accessory housing. The engine driven fuel pump provides the fuel to the injector; excess of fuel return back to the fuel tank through the fuel return line (tube 1/4").

The aircraft is equipped with a three-positions fuel selector valve. The positions for the fuel control system operations are: "OFF", "RIGHT" and "LEFT". The pointer of the fuel selector control knob indicates the position of the fuel selector valve. The fuel selector control knob allows the pilot to select the LH or RH wing fuel tank to supply the engine. The pilot shuts off the engine selecting the "OFF" position. To select the "OFF" position, it is required to raise the red button on handle and then rotate the concerned handle.

Rev. 14

DATE: 03 October 2018

7-9

When the pilot changes from LH to RH tank and viceversa, it is not possible to pass over the “OFF” position.

The electrically operated auxiliary fuel pump provides the fuel pressure for priming during engine starting, and supplies fuel to the engine, during the take-off and landing operating phase, in case of mechanical pump malfunction or failure. The auxiliary fuel pump must be used also for switching from one tank to the other.

A control switch labelled “FUEL PUMP” is provided on the master switch panel. Function of auxiliary fuel pump is indicated by means of an advisory light on the annunciator panel, installed on the top of the instrument panel. A green advisory light labelled “FUEL PUMP ON” (when lighted) informs the pilot that the auxiliary fuel pump is switched ON.

The fuel system can be monitored by means of the JPI EDM-930 display that interfaces directly with the engine, the electrical sensors and the fuel senders, and uses its own LCD to display all the data (fuel pressure, fuel flow and RH/LH tank fuel quantity information) to the pilot.

The block architecture of the fuel system can be generally schematized in Figure 7-5 below.

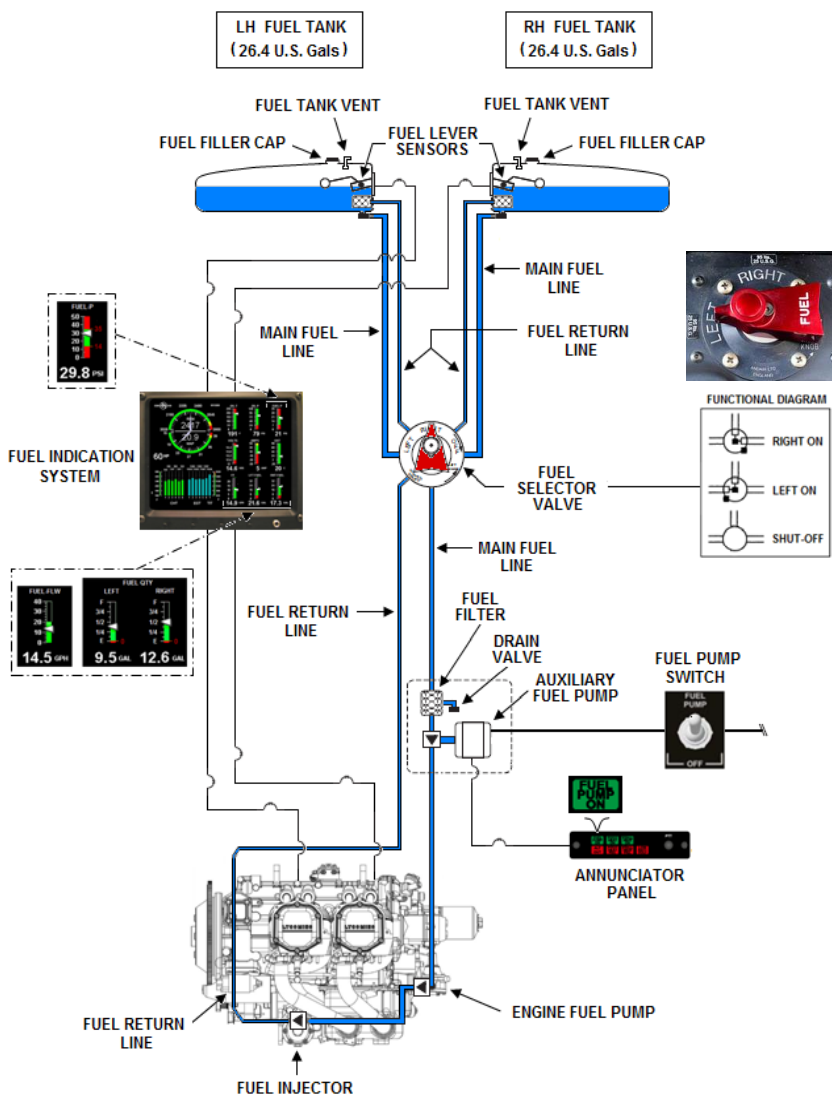

Figure 7-5 Fuel system block architecture

7.9 ELECTRICAL SYSTEM

(Refer to Figures 7-6 through 7-9)

Electrical power is supplied by 28 Volt, direct current, negative ground electrical system.

The power generation is realized through the following basic elements:

- ALTERNATOR
- MAIN BATTERY

The alternator is able to provide up to 70A current output.

Alternator output voltage regulation is performed using a voltage regulator which senses alternator unregulated voltage and modulates alternator field current in order to stabilize its voltage.

The installed voltage regulator Plane Power p/n R1224B (Vulcanair p/n NV7.003-130A) is a solid-state voltage regulator with over-voltage protection, field short (over-current) protection and reverse battery protection, and also supports precision load sharing for twin applications, and an alternator inoperative lamp.

The Main Battery is lead-acid battery Concorde p/n RG24-12 (Vulcanair p/n NV7.003-149B) with characteristics 24Vdc@11Ah. It provides for engine starting and as a reserve power source in case of alternator power loss.

The voltage generated by the power generation system is made available immediately on Main Bus Bar and, after activation of associated switch, to the other two bus bars, Avionic Bus Bar and Secondary Cut-Off Bus Bar.

The Avionic Bus is activated through a dedicated switch located on the instrument panel and operated by the pilot, while the Secondary Cut-Off Bus is derived from the Main Bus through a switch that is automatically opened by a status signal coming from the voltage regulator in case of an alternator failure. In this way all the loads connected on this bar will be instantly powered off, avoiding a current draw from battery during the emergency phase.

The three power bus bars composing the power distribution system provide the energy to all the electrical loads. Each of them has a dedicated breaker for over current protection.

The block architecture of the electrical power and distribution system can be generally schematized as shown in Figure 7-6 below.

The COM1 switch is provided to have the COM1 power supplied by the battery in case of complete bus bar failure.

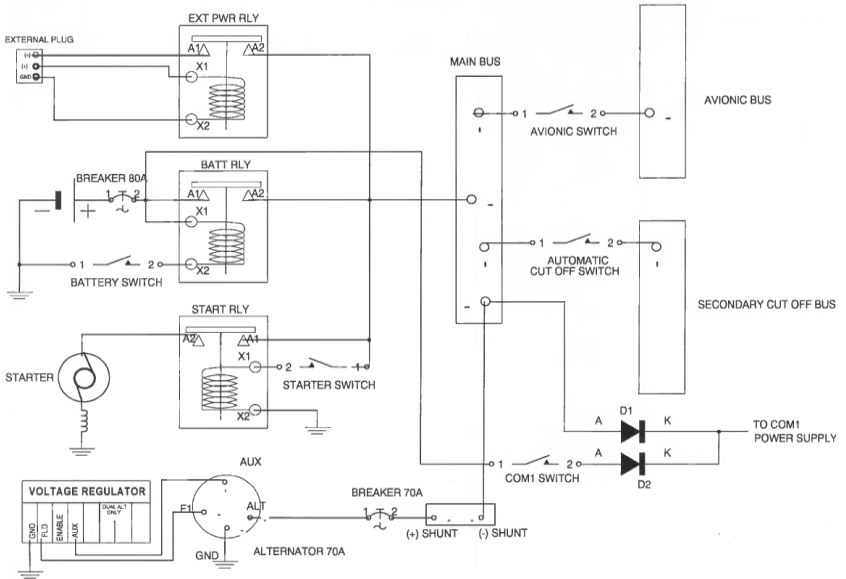

Figure 7-6 Electrical system block architecture

The management of the electrical generation and distribution is done by means of:

- Master Switch Panel
- Breaker Panel
- Switch Panel

7.9.1 MASTER SWITCH PANEL

The master switch panel is located on the LH side of the pilot wheel.



Figure 7-7 Master switch panel

7.9.2 BREAKER PANEL

The breaker panel is located under the pilot wheel and divided in the following areas:

- MAIN BUS BREAKERS
- AVIONIC BUS BREAKERS
- SECONDARY BUS BREAKERS

Only for aircraft s/n 1001 and 1002

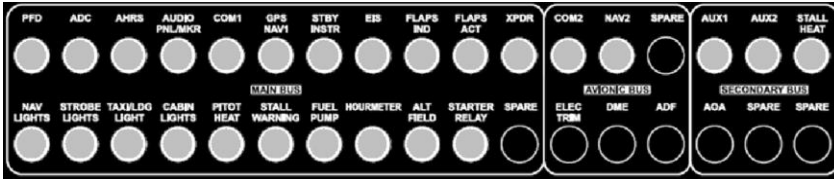

For aircraft from s/n 1003 onwards

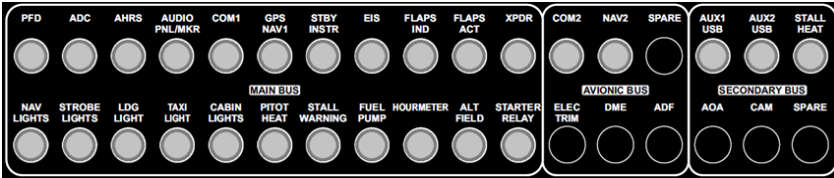

Figure 7-8 Breaker panel

In the following table have been described the effects in terms of losing function(s) when every single breaker is pulled out:

BREAKERS	LOST FUNCTIONS
PFD	<ul style="list-style-type: none"> • PRIMARY FLIGHT DISPLAY
ADC	<ul style="list-style-type: none"> • AIR DATA COMPUTER
AHRS	<ul style="list-style-type: none"> • AHRS
AUDIO PNL/MKR Note: In case of failure of Audio Panel, the pilot is automatically connected to COM1	<ul style="list-style-type: none"> • COM2/NAV2 AUDIO • NAV1 AUDIO • MARKER BEACON
COM1	<ul style="list-style-type: none"> • COM1
GPS/NAV1	<ul style="list-style-type: none"> • GPS/NAV1

STBY INSTR	<ul style="list-style-type: none"> • MD302 STANDBY MODULE
EIS	<ul style="list-style-type: none"> • ENGINE INDICATION SYSTEM
FLAPS IND	<ul style="list-style-type: none"> • FLAPS INDICATION
FLAP ACT	<ul style="list-style-type: none"> • FLAP ACTUATOR
XPDR	<ul style="list-style-type: none"> • TRANSPONDER
NAV LIGHTS	<ul style="list-style-type: none"> • NAVIGATION LIGHTS
STROBE LIGHTS	<ul style="list-style-type: none"> • STROBE LIGHTS
<u>Only for aircraft s/n 1001 and 1002</u>	
TAXI/LDG LIGHT	<ul style="list-style-type: none"> • TAXI/LANDING LIGHT
<u>For aircraft from s/n 1003 onwards</u>	
LDG LIGHT	<ul style="list-style-type: none"> • LANDING LIGHT
TAXI LIGHT	<ul style="list-style-type: none"> • TAXI LIGHT
<u>For all aircraft</u>	
CABIN LIGHTS	<ul style="list-style-type: none"> • CABIN LIGHTS
PITOT HEAT	<ul style="list-style-type: none"> • PITOT HEATING SYSTEM
STALL WARNING	<ul style="list-style-type: none"> • STALL WARNING AUDIO SIGNAL
FUEL PUMP	<ul style="list-style-type: none"> • FUEL PUMP
HOURMETER	<ul style="list-style-type: none"> • HOURMETER
ALT FIELD	<ul style="list-style-type: none"> • ALTERNATOR
STARTER RELAY	<ul style="list-style-type: none"> • STARTER RELAY
COM2	<ul style="list-style-type: none"> • COM2
NAV2	<ul style="list-style-type: none"> • NAV2
ELEC TRIM	<ul style="list-style-type: none"> • <i>not used</i>
DME	<ul style="list-style-type: none"> • DME (if installed)
ADF	<ul style="list-style-type: none"> • ADF (if installed)
<u>Only for aircraft s/n 1001 and 1002</u>	
AUX1	<ul style="list-style-type: none"> • AUXILIARY SOCKET 1
AUX2	<ul style="list-style-type: none"> • AUXILIARY SOCKET 2
<u>For aircraft from s/n 1003 onwards</u>	
AUX1 USB	<ul style="list-style-type: none"> • AUXILIARY SOCKET 1 + USB SOCKET

AUX2 USB	<ul style="list-style-type: none"> AUXILIARY SOCKET 2 + USB SOCKET
<u>For all aircraft</u>	
STALL HEAT	<ul style="list-style-type: none"> STALL DETECTOR HEATING
AOA	<ul style="list-style-type: none"> ANGLE-OF-ATTACK INDIC. (if installed)
<u>For aircraft from s/n 1003 onwards</u>	
CAM	NOT USED

Table 7-1 Breakers vs. lost functions

7.9.3 SWITCH PANEL

The switch panel is located under the pilot wheel on the RH side of breaker panel and is divided in the following areas:

- SWITCHES
- DIMMER POTS

(Applicable only to aircraft s/n 1001 and 1002)

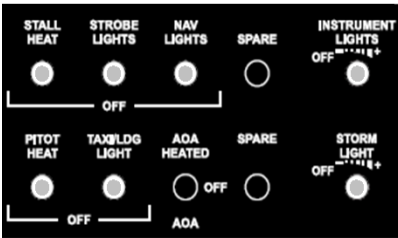

(Applicable to aircraft from s/n 1003 onwards)

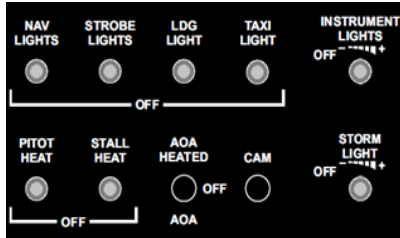

Figure 7-9 Switch panel

The dimmer pots modulate the brightness of the storm (flood) light on the cockpit and of the instrument light for magnetic compass, respectively.

7.10 CUT-OFF

Below are listed all the equipment and systems that are automatically cut off in case of alternator failure:

- a) Stall heat 28Vdc @ 3A

Only for aircraft s/n 1001 and 1002

- b₁) Aux 1 power socket 28Vdc @ 5A
c₁) Aux 2 power socket 28Vdc @ 5A

For aircraft from s/n 1003 onwards

- b₂) Aux 1 power socket 28Vdc @ 5A + USB socket charger
c₂) Aux 2 power socket 28Vdc @ 5A + USB socket charger

7.11 EXTERNAL POWER

(Refer to Figure 7-10)

An external power receptacle, installed in a suitable bay of the LH fuselage nose section and protected by a spring-loaded door, allows an external auxiliary power source to be connected.

The receptacle is provided with a standard type socket suitable for the connection to the plug of an external 28Vdc power source. The socket is connected to the aircraft electrical system by means of a suitable relay.

NOTE

Set “MASTER BATTERY” switch to OFF position when ground power is engaged.

NOTE

Plugging and turning ON, the external power results in a battery charge process. Be aware of battery state of charge since it is not monitored.

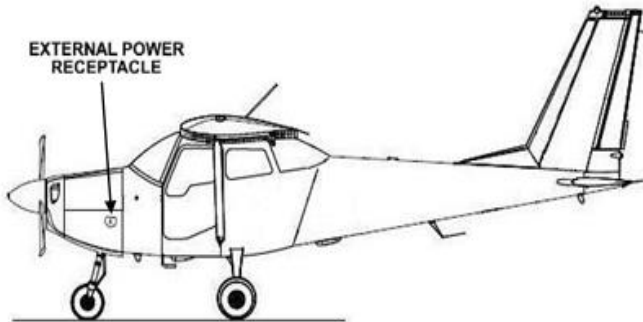

Figure 7-10 External power receptacle

7.12 EMERGENCY LOCATOR TRANSMITTER

An automatically activated Emergency Locator Transmitter (ELT) can be installed optionally onboard the aircraft.

The transmitter unit is installed in the central fuselage, under the floor in proximity of the 2nd seat row, and the antenna is mounted on the upper skin of the fuselage tail cone.

A remote switch with a warning light is installed on the instrument panel RH side.

Although the ELT is designed to activate automatically in the event of a crash, the transmitter may also be manually activated by either the header switch on the transmitter body, or via the remote switch on the instrument panel.

WARNING

Pilot must ensure that the ELT remote switch is set to “ARM” position, unless during ELT functional testing.

WARNING

The ELT is for aviation emergency use only, unauthorized use is prohibited. It must be used in accordance with the National and Local Regulations.

CAUTION

Take precautions to avoid inadvertent transmitter activation and consequent triggering of a false alarm. Refer to “inadvertent ELT activation” procedure in the applicable documentation issued by the manufacturer.

For detailed technical and operating information, as well as for ELT functional testing, refer to the relevant applicable manufacturer’s documentation.

7.13 INSTRUMENT PANEL AND PEDESTAL LAYOUT

(Refer to Figures 7-11 through 7-14)

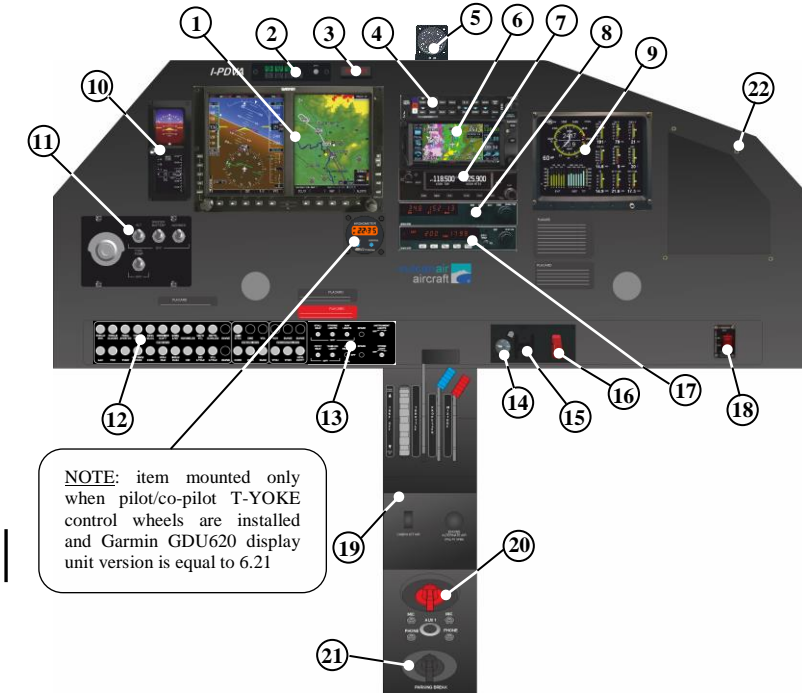

NOTE: item mounted only when pilot/co-pilot T-YOKE control wheels are installed and Garmin GDU620 display unit version is equal to 6.21

- | | |
|----------------------------------|--------------------------------|
| 1. GDU620 (PFD/MFD) | 12. Breaker panel |
| 2. Annunciator panel | 13. Switch panel |
| 3. RAD | 14. Flap indicator |
| 4. GMA350 (Audio panel) | 15. Flap motor actuator switch |
| 5. Magnetic compass | 16. VHF COM1 emergency switch |
| 6. GTN650 (NAV/COM/GPS unit) | 17. KR87 (ADF) |
| 7. GNC255B (NAV/COM unit) | 18. ELT remote switch |
| 8. KN62A (DME) | 19. Central pedestal |
| 9. EDM-930 (EIS) | 20. Fuel selector |
| 10. MD302 (STBY attitude module) | 21. Parking brake |
| 11. Master switch panel | 22. Instrument panel |

Figure 7-11 Instrument panel and pedestal
(Applicable only to aircraft s/n 1002)

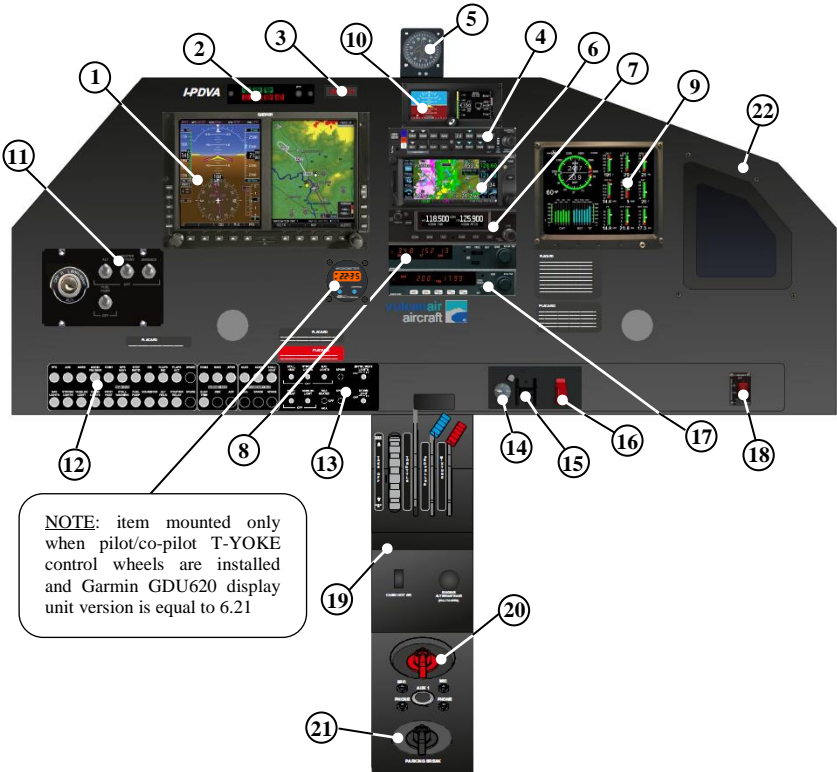

- | | |
|----------------------------------|--------------------------------|
| 1. GDU620 (PFD/MFD) | 12. Breaker panel |
| 2. Annunciator panel | 13. Switch panel |
| 3. RAD | 14. Flap indicator |
| 4. GMA350 (Audio panel) | 15. Flap motor actuator switch |
| 5. Magnetic compass | 16. VHF COM1 emergency switch |
| 6. GTN650 (NAV/COM/GPS unit) | 17. KR87 (ADF) |
| 7. GNC255B (NAV/COM unit) | 18. ELT remote switch |
| 8. KN62A (DME) | 19. Central pedestal |
| 9. EDM-930 (EIS) | 20. Fuel selector |
| 10. MD302 (STBY attitude module) | 21. Parking brake |
| 11. Master switch panel | 22. Instrument panel |

Figure 7-12 Instrument panel and pedestal
(Applicable to aircraft from s/n 1001 up to s/n 1008, except s/n 1002)

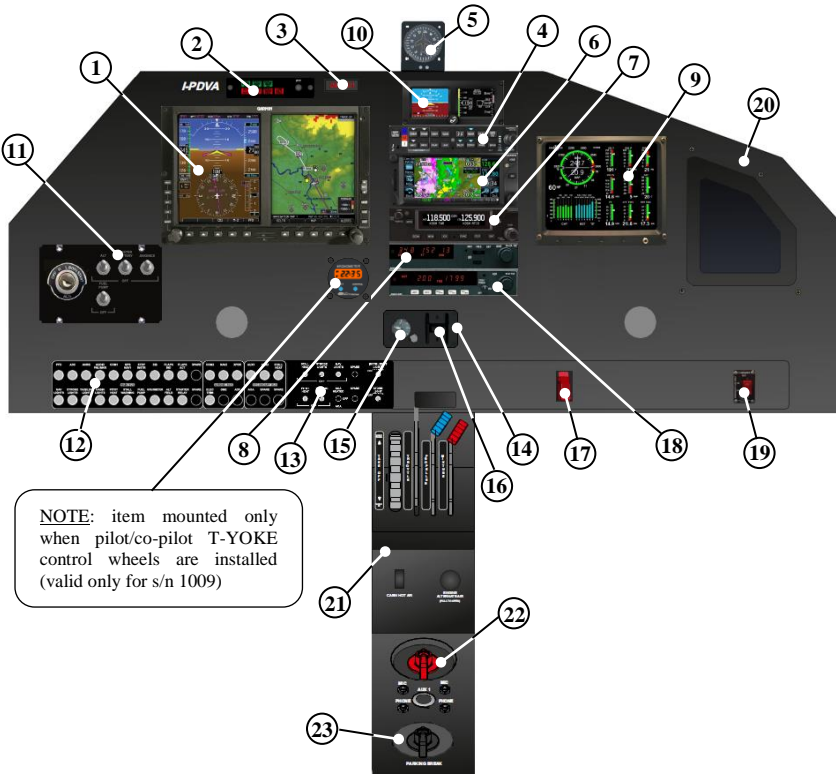

NOTE: item mounted only when pilot/co-pilot T-YOKE control wheels are installed (valid only for s/n 1009)

- | | |
|----------------------------------|--------------------------------|
| 1. GDU620 (PFD/MFD) | 13. Switch panel |
| 2. Annunciator panel | 14. Flap control panel |
| 3. RAD | 15. Flap indicator |
| 4. GMA350 (Audio panel) | 16. Flap motor actuator switch |
| 5. Magnetic compass | 17. VHF COM1 emergency switch |
| 6. GTN650 (NAV/COM/GPS unit) | 18. KR87 (ADF) |
| 7. GNC255B (NAV/COM unit) | 19. ELT remote switch |
| 8. KN62A (DME) | 20. Instrument panel |
| 9. EDM-930 (EIS) | 21. Central pedestal |
| 10. MD302 (STBY attitude module) | 22. Fuel selector |
| 11. Master switch panel | 23. Parking brake |
| 12. Breaker panel | |

Figure 7-13 Instrument panel
(Applicable to aircraft from s/n 1009 onwards)

GDU620 (MFD/PFD) unit



**Figure 7-14 Instrument panel with optional GDU620 (MFD/PFD) unit
(Optional configuration applicable to all aircraft)**

7.14 ANNUNCIATOR PANEL

(Refer to Figure 7-15)

The annunciator panel is an advisory lights system that provides information to the pilot regarding the status of some electrical systems as alternator, Pitot and stall heat.

This led type unit is installed on the instrument panel (on the top of the GDU620 dual display) and it includes fuel pump green light, alternator red light, Pitot heat green/red lights, stall heat green/red lights and low battery voltage red light and its own push to test (“PPT”) switch as shown in the Figure 7-15.



Figure 7-15 Annunciator panel

The list of the available advisories to the pilot is reported in the following table:

TEXT	COLOR	REMARKS
FUEL PUMP ON	GREEN	Green when Fuel Pump is ON.
ALT OUT	RED	Red when the alternator fails.
PITOT HEAT ON	GREEN	Green when Pitot heating is engaged.
PITOT HEAT FAIL	RED	Red when Pitot heating is engaged but failed.
STALL HEAT ON	GREEN	Green when stall warning shield heating is engaged.
STALL HEAT FAIL	RED	Red when stall warning shield heating is engaged but failed.
LOW BATT VOLT	RED	Red light turns ON when voltage battery goes under defined threshold.

Table 7-2 Advisories list of annunciator panel

7.15 STALL WARNING SYSTEM

(Refer to Figure 7-16)

The stall warning system consists of a heated stall detector (high incidence sensor) composed of a metal vane and microswitch assembly, installed on the outboard leading edge of the LH wing between ribs #4 and #5, and a horn located on the LH side of the control pedestal.

The vane is exposed to the airstream during flight, and it is forced upwards by the airflow if the aircraft approaches stall incidence.

The upward movement of the vane closes the internal microswitch, causing a cabin-mounted warning horn to sound.

The stall detector is fitted with an integrally mounted electrical heating element to avoid ice formation.

Both the stall warning circuit and the stall heating circuit are protected by appropriate circuit breakers.

The stall warning circuit is powered through Main Bus Bar.

The stall heat is powered through Secondary Cut-Off Bar.

The system can be checked on the ground by switching the battery ON and moving the wing sensor vane upwards.

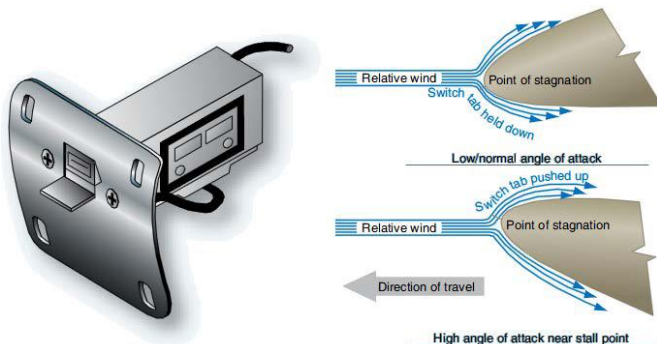

Figure 7-16 Stall warning system

7.16 ENVIRONMENTAL SYSTEM

(Refer to Figures 7-17 and 7-18)

The Environmental System consists of the following separated sub-systems:

- Cabin Air Heating / Windshield Defrosting System
- Fresh Air System

7.16.1 CABIN AIR HEATING / WINDSHIELD DEFROSTING SYSTEM

Hot air in the cabin is provided by four air outlet vents: two for windshield defrost installed on the instrument panel cover and two adjustable air outlet vents installed on the lower LH/RH side of the control pedestal.

Dynamic air coming from the air inlet is mixed with the one coming from the heat exchanger through a heater valve, installed on the RH lower FWD side of the fuselage firewall, in order to obtain the desired temperature.

The crew can manually change the temperature of the air flow through the regulation of the heater valve opening/closing by means of a push/pull control knob installed on the central pedestal. With the control knob full pushed, the heater valve is closed.

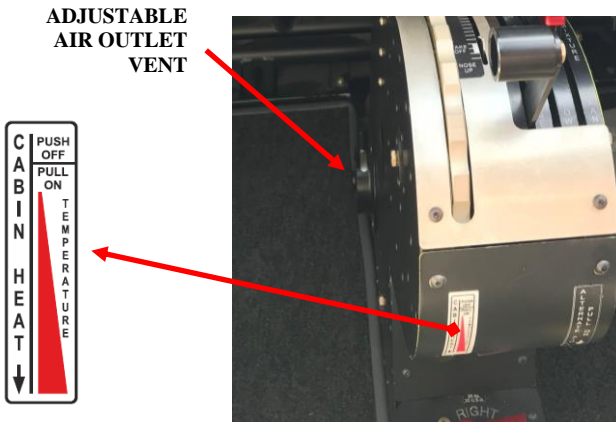

Figure 7-17 Cabin hot air controls overview

7.16.2 FRESH AIR SYSTEM

Fresh air in the cabin is provided by two dynamic air inlets installed on the wing leading edge linked to four adjustable air outlet vents (two for each side) with shut-off provision installed inside the cabin.

The crew and/or passengers can manually change the air flow through the regulation of the air outlet vents opening/closing.

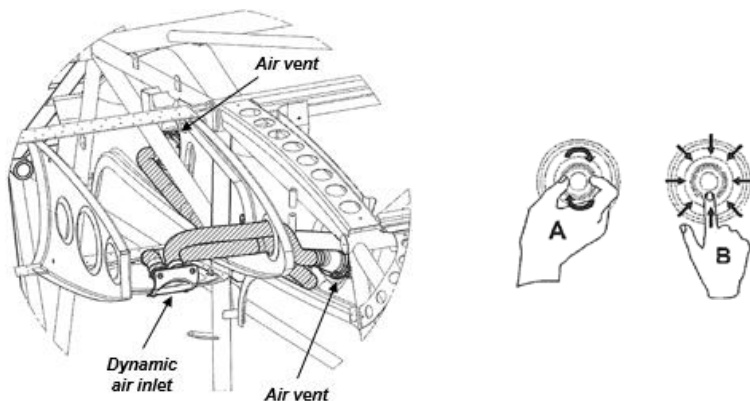

Figure 7-18 Cabin fresh air controls overview

7.17 PITOT AND STATIC SYSTEM

(Refer to Figure 7-19)

The Pitot-static system supplies dynamic and static air pressure for the operation of the airspeed indicator.

The airspeed indicator receives ram air pressure through lines connected to the Pitot tube mounted under the LH wing leading edge.

The Pitot tube is equipped with an internal electrical heating element to avoid ice build-up that could obstruct the tube opening during severe weather conditions.

Atmospheric pressure is provided by two static pressure ports mounted forward the pilot/co-pilot doors on opposite sides of the fuselage.

Dedicated lines connect these ports to the Air Data Computer (ADC) and Stand-by instrument (MD302 Standby Attitude Module).

In an emergency situation, cabin air pressure is substituted for atmospheric pressure by means of the alternate static source which is located on the top side of the engine control pedestal.

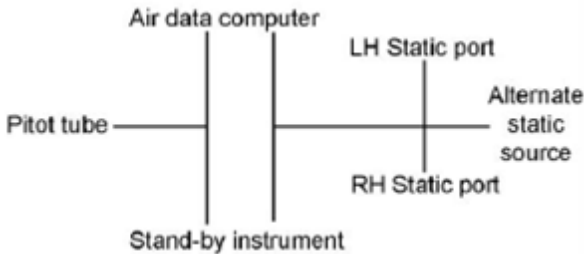

Figure 7-19 Pitot and static system connections scheme

7.18 DIGITAL COCKPIT

(Refer to Figures 7-20 through 7-49)

WARNING

The detailed description, operation and functionalities of equipment manufactured by Garmin, JPI and MidContinent are provided on the documents listed in the NOTE below, which are to be considered as attached to this AFM and kept onboard the aircraft.

NOTE

For detailed description and operation of Garmin G500 avionic system and Garmin LRUs, JPI EDM-930 unit and MD302 Stand-by Attitude module refer to the following documents (latest revision):

- *“Garmin G500 Pilot’s Guide” p/n 190-01102-02 (for a/c installing GDU620 up to SW version 6.21)*
- *“Garmin G500 Pilot’s Guide” p/n 190-00601-02 (for a/c installing GDU620 from SW version 7.30 onwards)*
- *“Garmin GTN650 Pilot’s Guide” p/n 190-01004-03*
- *“Garmin GNC255 Pilot’s Guide” p/n 190-01182-01*
- *“Garmin GMA350 Pilot’s Guide” p/n 190-01134-12*
- *“MD302 Stand-by Attitude Module Pilot’s Guide” p/n 9017846*
- *“JPI Engine Data Management EDM-930 Primary TSO Pilot’s Guide” p/n 1012*

7.18.1 GARMIN G500 AVIONIC SYSTEM AND GARMIN LRUS OVERVIEW

The Garmin G500 avionic system is an integrated display system that presents primary flight instrumentation, navigation, and a moving map to the pilot through a dual VGA 6.5 in. LCD display.

In normal operating mode, the Primary Flight Display (PFD) presents graphical flight instrumentation (attitude, heading, airspeed, altitude, vertical speed), while the Multi-Function Display (MFD) normally displays a full-color moving map with navigation information.

All the components of the Garmin G500 are Line-replaceable Units (LRUs).

This modular approach allows to the various components to be mounted either behind each of the displays or in remote locations in the aircraft, based upon the needs of the aircraft manufacturer.

In addition to the Garmin G500, the aircraft configuration includes other Garmin LRUs, interfacing with the Garmin G500, and giving to the aircraft further functionalities as VHF communication, VOR/LOC/GS, GPS, transponder and audio selector features.

Garmin G500 Configuration

- GDU620 (PFD/MFD)
- GDC74A (Air Data System)
- GRS77 and GMU44 (AHRS and Magnetometer)

Additional Garmin LRUs

- GMA350 (Audio Panel)
- GTX33 w/ES (Transponder ADS-B Out)
- GTN650 (NAV/COM/GPS Unit)
- GNC255B (NAV/COM Unit)

Concerning the third party's equipment, the aircraft configuration includes:

Standby

- Digital MD302 Standby Attitude Module

Optional Equipment

- GTX345R (Transponder ADS-B In & Out)
- ADF Bendix/King KR87
- DME Bendix/King KN62A

The power plant and electrical systems are monitored by the JPI EDM-930 (Primary Engine Data Management System) that interfaces directly with the engines and the electrical sensors and displays the data to the pilot through its own LCD. It also provides a fuel level indication interfacing directly with the fuel transmitters located in the aircraft wings.

The Figure 7-20 illustrates the block architecture of the Garmin G500 suite and third party's equipment for a typical aircraft configuration.

The Figure 7-21 illustrates the block architecture of the Garmin G500 avionic system when the optional GTX345R Transponder is installed.

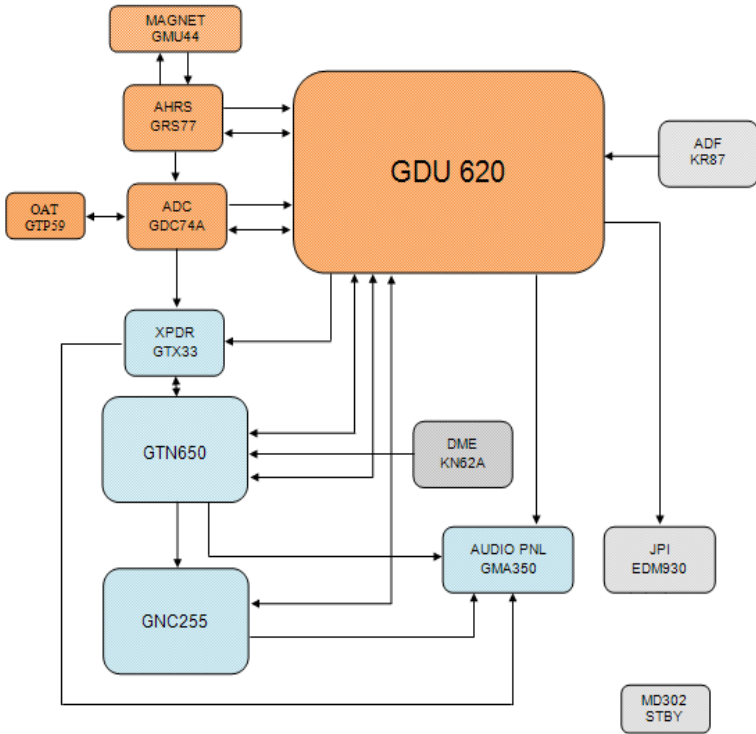

Figure 7-20 Garmin G500 avionic system block architecture

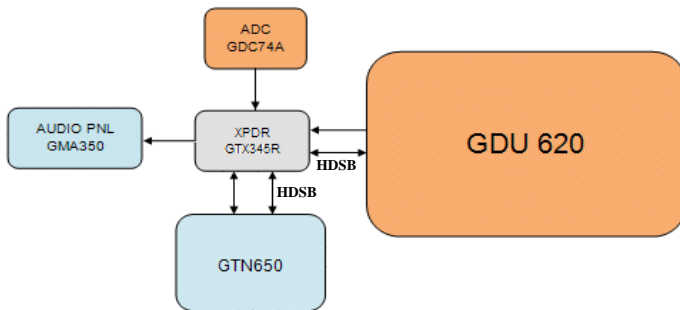

Figure 7-21 Garmin G500 avionic system with optional GTX345R

7.18.2 GARMIN G500 AVIONIC SYSTEM AND GARMIN LRUS COMPONENTS

A description of the main components of the Garmin G500 Avionic Display System and Garmin LRUs is reported hereunder.

GDU620 Display unit PFD/MFD

GDU620 has a dual VGA (640 x 480 pixels) 6.5 inch LCD display.

The Primary Flight Display (PFD) is located on the RH side of the GDU620 while the Multifunction Display (MFD) on the LH side (with the optional GDU unit, the PFD is located on the RH side, while the MFD is located on the LH side).

The PFD shows primary flight information, while the MFD shows navigation and flight plan information (traffic, weather and terrain).

GDU620 uses an external configuration module, so in case of replacement, no reconfiguration is needed.



Figure 7-22 GDU620 Display unit PFD/MFD

GDC74A Air Data Computer and GTP 59 OAT probe

GDC74A Air Data Computer is a remote mounted device that provides air data (pressure altitude, airspeed, vertical speed) for flight instrumentation.

It receives the standard Pitot and static system inputs as well as the GTP59 outside air temperature (OAT) sensor input.

This allows the system to automatically perform calculations such as true airspeed (TAS) and density altitude.



Figure 7-23 GDC74A Air Data Computer - GTP59 OAT probe

GRS77 Attitude Heading and Reference System and GMU44 Magnetometer

GRS77 AHRS is a remote mounted device that provides flight attitude and heading data for flight instrumentation. It provides valid attitude, angular rate and acceleration information to the PFD and interfaces with the GMU44 magnetometer.

GMU44 is a tri-axial magnetometer which allows the system to measure both the horizontal and vertical components of the earth's magnetic field.

Both GRS77 and GMU44 are solid-state components that require very little initialization time (less than one minute).



Figure 7-24 GRS77 AHRS - GMU44 Magnetometer

GMA350 Audio Panel

GMA350 is a horizontally oriented panel-mounted audio controller and marker beacon system that collects, processes and distributes audio signals between avionics, crew and passengers.

GMA350 provides a speaker output that may be used as a cockpit speaker or for a PA system to address passengers. GMA350 also includes a digital recording and playback feature.



Figure 7-25 GMA350 Audio Panel

GTX33 w/ES Transponder

GTX33 Mode-S transponder is a radio transmitter and receiver with ADS-B Out capability, that that operates on radar frequencies (receives ground radar or TCAS interrogations and transmits a coded response of pulses to ground-based radar).

The GTX33 Mode-S transponder is solid-state units and require no warm-up time. This is designed to minimize pilot workload when at the threshold of the runway. GTX33 is equipped with IDENT capability that activates the Special Position Identification (SPI) pulse for 18 seconds.

GTX33 replies to Mode-A, Mode-C and Mode-S interrogation.



Figure 7-26 GTX33 w/ES Transponder

GTN650 NAV/COM/GPS unit

GTN650 unit is a horizontal panel-mount GPS/SBAS navigator with a touch-screen interface and color moving map.

GTN650 unit can give simultaneously, in relation to the aircraft position, approach information and weather and traffic data.

GTN650 unit is certified for primary navigation, including operations en route or terminal, incorrect approaches and approaches with vertical guidance.

In addition, it includes, an airborne VHF communications transceiver and airborne VOR/Localizer (LOC) and Glideslope (G/S) receivers.



Figure 7-27 GTN650 NAV/COM/GPS unit

GNC255B NAV/COM unit

GNC255B is a horizontally oriented panel-mounted that features a number of advanced features to save time and effort, in addition to the traditional NAV & COMM functions.

It does not feature a GPS function, but it can interface a compatible GPS source as GTN650.

When connected to a GPS source, the GNC255B is able to find the nearest airport to the present position and easily access its weather, center and FSS frequencies.



Figure 7-28 GNC255B NAV/COM unit

OPTIONAL EQUIPMENT:

ADF Bendix/King KR87 unit

Bendix King KR87 Automatic Direction Finder (ADF) system is a digitally tuned solid state receiver which provides bearing information to stations in the 200 KHz to 1799 KHz frequency band and which also provides audio reception to enable the pilot to identify stations and listen to transcribed weather broadcasts or commercial radio stations in the AM broadcast band.

The unit features a gas discharge display that displays the active ADF frequency in the LH window. The RH window will display either the standby frequency (which can be transferred to the active window) or a flight timer or programmable elapsed timer.



Figure 7-29 KR87 ADF system

DME Bendix/King KN62A unit

Bendix King KN62A DME system is a panel mounted, 200 channel DME employing the latest state of the art solid state transmitter and large scale integrated circuit (LSI) technology. All tuning is done electronically using a single crystal, digital, frequency synthesizer.

The unit features a gas discharge display that simultaneously indicates range, speed and time to station or range and frequency.



Figure 7-30 KN62A DME system

GTX 345R Transponder

GTX345R transponder can be installed optionally onboard the aircraft as alternative to the transponder GTX33 w/ES.

GTX345R is a combined mode S/ES transponder and ADS-B transceiver that adds the ADS-B In functionality, other than ADS-B Out one, allowing the displaying of the ADS-B traffic to the pilot on the Garmin GDU620 display unit (MFD) and on GTN650 unit.

GTX345R requires two Ethernet connections, one for GDU620 display unit and another one for the GTN650 unit (the ADS-B Out squitters sent by the nearby aircraft are detected by the GTX345R transponder and forwarded to the GDU620 display unit and GTN650 unit through the Ethernet link).

NOTE

To support the GTX345R transponder, GDU620 display unit and GTN650 unit require the following software version (minimum):

- GDU620 display unit: version 7.12

- GTN650 unit: version 6.11

NOTE

The software versions are displayed on each unit. Use the version Information key to view more detailed information about the software version installed on relative unit.



Figure 7-31 GTX 345R Transponder

7.18.3 GARMIN G500 AVIONIC SYSTEM AND GARMIN LRUs CONTROLS

Controls are located on the GDU620 display unit (PFD/MFD), GMA350 audio panel, GTN650 NAV/COM/GPS unit and GNC255B NAV/COM unit.

GDU620 display unit (PFD/MFD) controls

Functions on the PFD are accessed by using the bezel keys on the side of the PFD and the softkeys below the PFD.

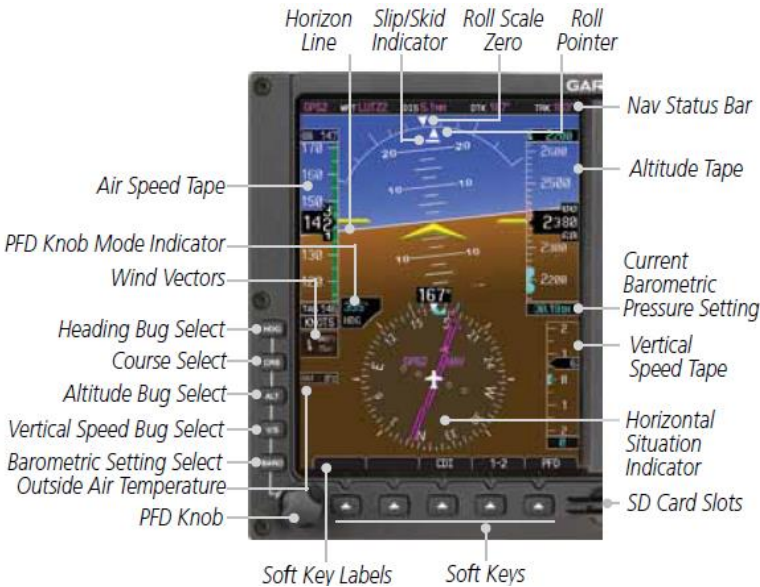

Figure 7-32 PFD description (Ground Pointer Mode)

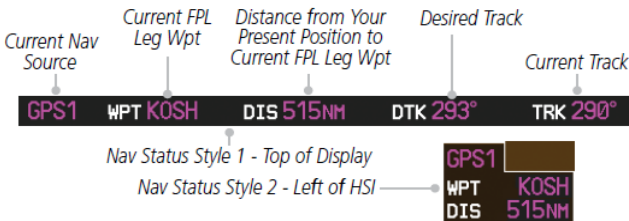

Figure 7-33 PFD Nav Status Bar description

Functions on the MFD are accessed by using the bezel keys on the side of the MFD and the softkeys below the MFD.

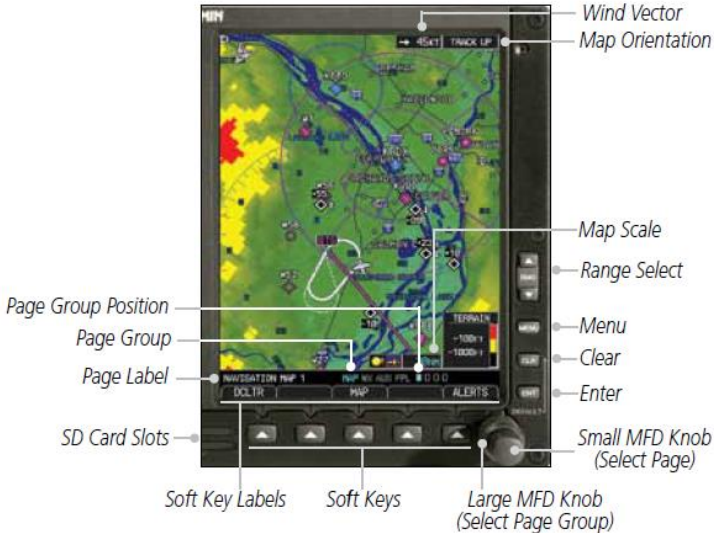

Figure 7-34 MFD description

PFD AND MFD SOFTKEYS FUNCTION

The softkeys are located along the bottoms of the displays. The softkeys labels shown depend on the softkey level or page being displayed.

The bezel keys below the softkeys can be used to select the appropriate softkey. When a softkey is selected, its color changes to black text on gray background and remains this way until it is turned off, at which time it reverts to white text on black background. When a softkey function is disabled, the softkey label is subdued (dimmed). Softkeys revert to the previous level after 45 seconds of inactivity. Each softkey sublevel has a BACK softkey which can be pressed to return to the previous level.



Figure 7-35 PFD softkeys layout

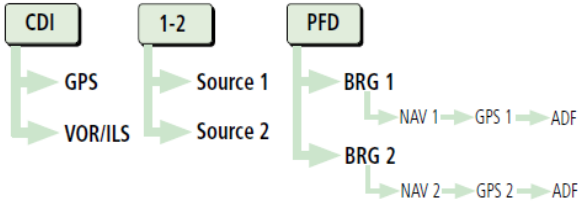

Figure 7-36 PFD softkeys diagram

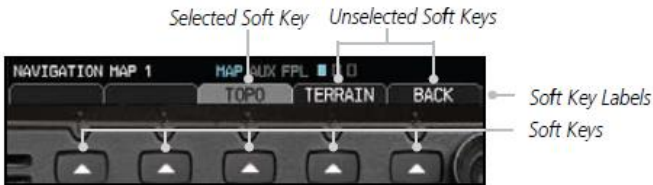

Figure 7-37 MFD softkeys layout

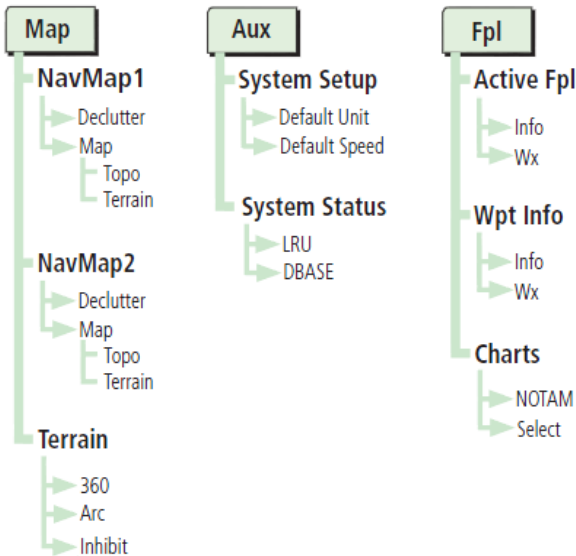
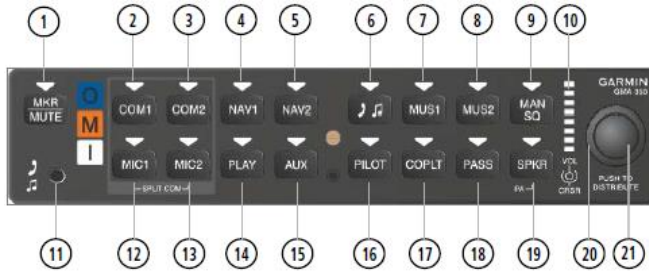

Figure 7-38 MFD softkeys diagram

GMA350 audio panel controls

GMA350 audio panel controls are shown in the Figure 7-39 below.



- ① **MKR/MUTE** – Selects marker beacon receiver audio. Mutes the currently received marker beacon receiver audio. Deactivates automatically and marker beacon audio is heard when the next marker beacon signal is received. Also, stops play of recorded COM audio.
- ② **COM1** – When selected, audio from the #1 COM receiver can be heard. Press and hold to enable/disable monitored COM muting during primary COM reception.
- ③ **COM2** – When selected, audio from the #2 COM receiver can be heard. Press and hold to enable/disable monitored COM muting during primary COM reception.
- ④ **NAV1** – When selected, audio from the #1 NAV receiver can be heard.
- ⑤ **NAV2** – When selected, audio from the #2 NAV receiver can be heard.
- ⑥ **Telephone/Entertainment** – Selects and deselects audio from a telephone or entertainment device connected to the Front Panel Jack. Audio from a telephone connected to the rear of the audio panel is used if a device is not connected to the Front Panel Jack. Press and hold to enable/disable muting during reception.
- ⑦ **MUS1** – Selects and deselects music entertainment audio. Press and hold to enable/disable **MUS1** muting during reception.
- ⑧ **MUS2** – Selects and deselects music entertainment audio. Press and hold to enable/disable **MUS2** muting during reception.
- ⑨ **MAN SQ** – Manual Squelch annunciator. When lit, squelch is controlled manually.
- ⑩ **Volume Indicator** – Indicates volume/squelch setting relative to full scale.
- ⑪ **Front Panel Jack** – Used for an entertainment or telephone input.
- ⑫ **MIC1** – Selects the #1 transmitter for transmitting. COM1 receive is simultaneously selected when this key is pressed allowing received audio from the #1 COM receiver to be heard. COM2 receive can be added by pressing the **COM2** Key. Selection of a second MIC button initiates Split-COM mode. When in Split-COM mode, the pilot is using COM1, the copilot is using the COM2.
- ⑬ **MIC2** – Selects the #2 transmitter for transmitting. COM2 receive is simultaneously selected when this key is pressed allowing received audio from the #2 COM receiver to be heard. COM1 receive can be added by pressing the **COM1** Key. Selection of a second MIC button initiates Split-COM mode. When in Split-COM mode, the pilot is using COM1, the copilot is using the COM2.
- ⑭ **PLAY** – Press once to play the latest recorded memory block. Press while audio is playing begins playing the previously recorded memory block. Each subsequent press thereafter plays the previous block of memory.
- ⑮ **AUX** – When selected, audio from the AUX inputs can be heard.
- ⑯ **PILOT** – Controls the pilot intercom system. Press and hold to toggle 3D Audio on/off for all headset positions.
- ⑰ **COPLT** – Controls the copilot intercom system. Press and hold to toggle copilot configuration between crew and passenger.
- ⑱ **PASS** – Controls the passenger intercom system. Press and hold to enable/disable passenger muting during reception.
- ⑲ **SPKR** – Selects and deselects the cabin speaker. COM, NAV, AUX, and MKR receiver audio can be heard on the speaker. Press and hold for 2 seconds for Passenger Address (PA). The **SPKR** key flashes during PA.
- ⑳ **Cursor (CRSR) Control Knob** – Turn to move the cursor (flashing white or blue annunciator) to the desired source.
- ㉑ **Volume (VOL) Control Knob** – Turn the smaller knob to control volume or squelch of the selected source (indicated by the flashing white or blue annunciator). When the volume control cursor is not active press to switch to Blue-Select mode. If the volume control cursor is active, press twice (once to cancel the cursor, twice to activate Blue-Select mode).

Figure 7-39 Audio panel controls

GTN650 NAV/COM/GPS unit controls

GTN650 NAV/COM/GPS unit controls are designed to simplify operation of the system and minimize workload and the time required to access sophisticated functionality.

Controls are located on the bezel and on the touchscreen display.

Controls are comprised of dual concentric knobs, volume/squelch knob, bezel keys, and active touch areas on the display.

Touchscreen keys are placed around the display. The keys vary depending on the page selected. Touch the key to perform the function or access the described information.



Figure 7-40 GTN650 NAV/COM/GPS unit description

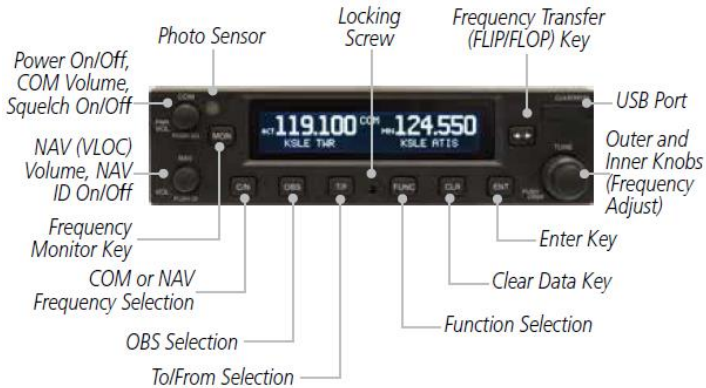



Figure 7-41 GTN650 touchscreen key controls (Home page)

GNC255B NAV/COM unit controls

GNC255B NAV/COM unit controls are designed to simplify systems operation, minimize workload, and reduce time required to access functionality.

Controls are comprised of dual concentric knobs for frequency tuning, COM volume/squelch knob, NAV volume/ID knob, and bezel keys.





-  To switch between the active (left-most) and standby (right-most) frequency press and release the **FLIP/FLOP** key. Switching between COM frequencies is disabled when transmitting.

-  To select the COM or NAV (VLOC) radio mode press the **C/N** key.

-  To see the current OBS setting and graphic CDI press the **OBS** key. The **OBS** page will be disabled if the unit is installed with an external converter.

-  To toggle between the bearing TO or radial FROM the active VOR press the **T/F** key. The T/F page also shows Distance/Speed/Time information. The **T/F** key does not operate for Localizer frequencies.

-  To erase information, cancel entries, or reset timers press the **CLR** key.

-  To save selected values, to confirm a prompt, and to save the standby frequency press the **ENT** key.

-  The **FUNC** (Function) key accesses function categories for the COM Radio, NAV Radio, ICS Configuration, System Configuration, and Timer. Pressing the **FUNC** key once displays the Function mode. Pressing the **FUNC** key a second time exits the Function mode.

-  The **MON** (Monitor) key engages the monitor function. The standby frequency can be monitored while still listening to the active frequency.

Figure 7-42 GNC255B NAV/COM unit description and controls

7.18.4 MD302 STANDBY ATTITUDE MODULE

MD302 Standby Attitude Module is a self-contained situational awareness instrument that provides aircraft attitude, altitude, airspeed and slip indication during normal operation or in case of primary instrument failure.

This instrument is installed horizontally in the top central area of the instrument panel (for all aircraft except s/n 1002) or vertically on the LH side of the Garmin GDU620 dual display (only for aircraft s/n 1002).

WARNING

All MD302 Standby Attitude Module settings, set up during the aircraft delivery or after a maintenance activity, must not be modified.

WARNING

Heading function of the MD302 Standby Attitude Module must not be enabled.



FLIGHT MODE
VERTICAL ORIENTATION



FLIGHT MODE
HORIZONTAL ORIENTATION

Figure 7-43 MD302 Standby Attitude Module

7.18.5 EDM-930 ENGINE DATA MANAGEMENT SYSTEM

EDM-930 is a combined electronic indicating system that interfaces directly with the engine and the electrical sensors and displays simultaneously to the pilot, through its own LCD, the power plant and the aircraft systems operating parameters.

EDM-930 includes a Remote Alarm Display (RAD) that is a 0.2” high, 8 characters independent display, located on the top of GDU620 display unit; the RAD displays digital cautions and limit exceedances when some parameters have reached its pre-set trigger point.

An alarm is activated as soon one parameter exceeds its operating range.



Figure 7-44 EDM-930 System - RAD unit

EDM-930 Engine Data Management System controls

Functions on EDM-930 system are accessed by using the four operating buttons on the lower side of the EDM (these buttons could change labels depending on the current operating mode of the EDM).

The EDM-930 Engine Data Management System controls are shown in the following Figure 7-45.

The term “*tap*” is used to denote pressing a button momentarily, while the term “*hold*” is used to denote pressing and holding a button for five or more seconds.

Rev. 14

DATE: 03 October 2018

7-45

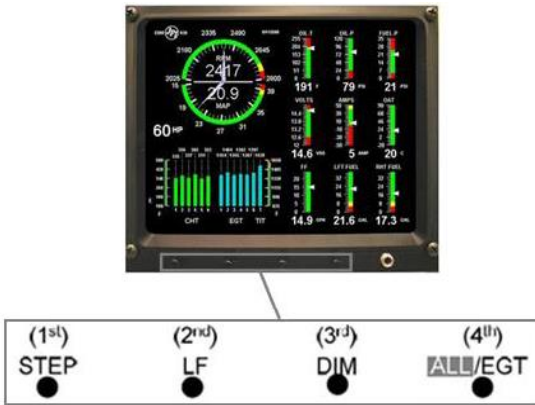

1st Button

- In the Automatic mode, *tapping* the STEP button stops Scanner auto-sequencing and changes to Manual mode. Each *tap* of the STEP button then displays the next measurement in the sequence. Holding the STEP button sequences in reverse order.
- In the Lean Find mode tapping the EXIT button will terminate the Lean Find mode and change to the Automatic mode.
- In the Program mode tapping the NEXT button will advance to the next item.

2nd Button

- In Automatic or Manual modes, tapping the LF button will activate the Lean Find mode.
- In the LF mode holding the LF button after peak EGT is found will display the peak EGT.
- In Automatic or Manual modes holding the LF button for three seconds will toggle between Standard and Normalize (NRM) views.
- In the programming mode, tapping the PLUS or MINUS button will allow you to edit a parameter value.
- Holding LF during power up will display the primary alarm limits after the self-test is complete.

1st and 2nd Buttons

- Holding both the STEP and LF buttons simultaneously for five seconds will enter the pilot programming mode.
- Just after entering Lean Find Mode (but before any EGT has risen), holding both First and Second buttons for five seconds will toggle between LOP or ROP leaning modes.
- Tapping both the STEP and LF buttons simultaneously in Manual mode toggles to 'include' or 'exclude' the displayed non-primary measurement from the Automatic mode. Note: Measurements are never excluded from the Manual mode.

3rd Button

- Tapping DIM (brightness decreases) or holding DIM (brightness increases) allows decrease or increase brightness respectively.

2nd and 3rd Buttons

- Holding both the LF and DIM buttons simultaneously will display the Hobbs readings. Tap button labeled NEXT to see additional information screens.

4th Button

- Select what is shown during Scanner auto-sequence. Choices are ALL, TEMP or FUEL. Highlighted one is what is active.

Figure 7-45 EDM-930 system controls

7.18.6 ENGINE INDICATION SYSTEM (EIS)

The engine parameters and their ranges for the Vulcanair V1.0 aircraft are reported in the following table:

<i>Parameter</i>	<i>Units</i>	<i>Range</i>	<i>Low Red</i>	<i>Low Yellow</i>	<i>Green</i>	<i>Upper Yellow</i>	<i>High Red</i>
			<i>Warning</i>	<i>Caution</i>	<i>Normal</i>	<i>Caution</i>	<i>Warning</i>
<i>Tachometer</i>	<i>RPM</i>	<i>550 ÷ 2800</i>			<i>550 ÷ 2700</i>		<i>2700</i>
<i>Man. Pres.</i>	<i>In Hg A</i>	<i>10 ÷ 40</i>			<i>10 ÷ 32</i>		
<i>Oil Pres.</i>	<i>PSIG</i>	<i>0 ÷ 100</i>	<i>25</i>	<i>25 ÷ 55</i>	<i>55 ÷ 95</i>		<i>95</i>
<i>Oil Temp.</i>	<i>°F</i>	<i>32 ÷ 260</i>			<i>75 ÷ 224</i>	<i>225 ÷ 245</i>	<i>245</i>
<i>Fuel Flow</i>	<i>Gal/hr</i>	<i>0.6 ÷ 40</i>			<i>0 ÷ 20</i>		
<i>Fuel Pres.</i>	<i>PSIG</i>	<i>0 ÷ 50</i>	<i>14</i>		<i>14 ÷ 35</i>		<i>35</i>
<i>EGT</i>	<i>°F</i>	<i>32 ÷ 1800</i>			<i>1180 ÷ 1380</i>		
<i>CHT</i>	<i>°F</i>	<i>32 ÷ 600</i>			<i>200 ÷ 475</i>	<i>475 ÷ 500</i>	<i>500</i>

Table 7-3 Engine parameters

7.18.7 GARMIN TERRAIN-SVT FEATURE (OPTIONAL)

NOTE

For detailed description and operation of the Garmin Terrain-SVT feature refer to the document “Garmin G500 Pilot’s Guide”.

The optional Garmin Synthetic Vision Technology (SVT) is a visual enhancement to the Garmin G500; SVT is displayed as a forward-looking display of the topography immediately in front of the aircraft.

When the SVT is enabled on the Garmin G500, it is possible to have a terrain alerting feature called “Standard Terrain-SVT”.

The Terrain-SVT feature is integrated within SVT to provide visual and audible alerts to indicate the presence of terrain threats relative to the projected flight path.

Terrain-SVT page is displayed on the MFD and it is possible to setup it in 360° view or arc view (120°) as shown in Figure 7-46 below.

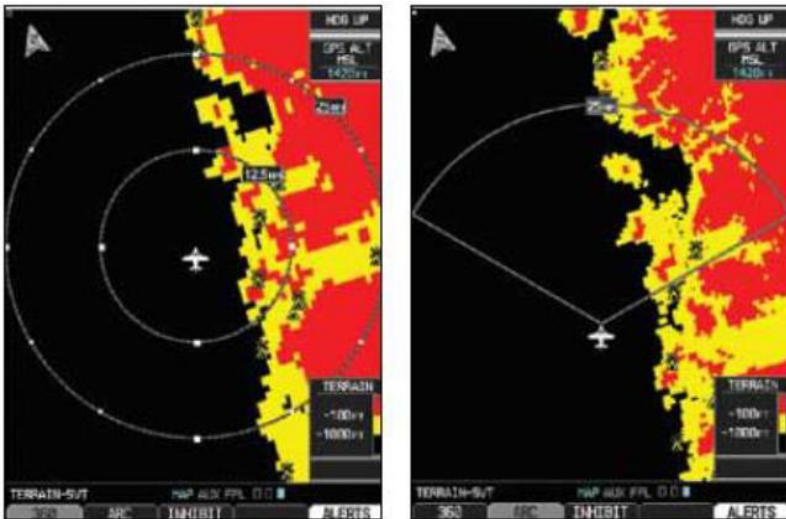

Figure 7-46 Terrain-SVT page 360° view and arc view (120°)

WARNING

Do not use Terrain-SVT information for primary terrain avoidance. Terrain-SVT is intended only to enhance situational awareness.

NOTE

Terrain data is not displayed when the aircraft is outside of the terrain database coverage area.

NOTE

Terrain-SVT is provided with the Garmin Synthetic Vision Technology (SVT) functionality and not marketed separately.

Terrain-SVT alerts typically employ a CAUTION or a WARNING alert severity level, or both. When an alert is issued, visual annunciations are displayed on the PFD and MFD (Terrain- SVT page only) and aural alerts are simultaneously issued.

The Terrain Alert Annunciation is shown to the upper LH side of the Altimeter on the PFD and below the Terrain Legend on the MFD. If the Terrain- SVT page is not displayed at the time, a pop-up alert appears on the MFD.

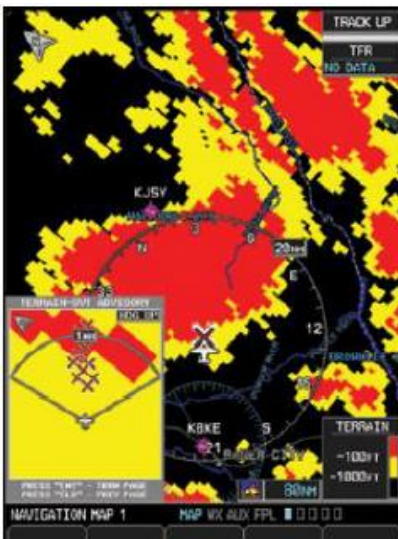

TERRAIN-SVT ALERTS SUMMARY

PFD/MFD Alert Annunciation	Aural Message
TERRAIN	"Caution, Terrain, Terrain"
TERRAIN	"Warning, Terrain, Terrain"
OBSTACLE	"Caution, Obstacle, Obstacle"
OBSTACLE	"Warning, Obstacle, Obstacle"

Figure 7-47 Terrain-SVT advisory pop-up on the MFD

7.18.8 TRANSPONDER ADS-B IN TRAFFIC FEATURE (OPTIONAL)

NOTE

For detailed description and operation of the Garmin ADS-B IN Traffic feature refer to documents “Garmin G500 Pilot’s Guide” p/n 190-00601-02 and “Garmin GTN650 Pilot’s Guide” p/n 190-01004-03” latest revision.

NOTE

To support the transponder ADS-B IN capability, GTX345R transponder must be installed onboard the aircraft, and GDU620 display unit and GTN650 unit require the following software version (minimum):

- GDU620 display unit: version 7.12
- GTN650 unit: version 6.11

The optional Garmin ADS-B IN Traffic feature allows a properly-equipped aircraft to receive TIS-B (Traffic Information Service - Broadcast) and FIS-B (Flight Information Services - Broadcast) weather from ground stations and other aircraft equipped with ADS-B OUT capability.

ADS-B IN Traffic targets can be displayed both in air and on ground.

On the GTN650 unit the ADS-B IN Traffic is displayed on the dedicate traffic page selected by touching the traffic icon on the display (“Traffic Menu” page will appear). Touching ADS-B display icon toggles the display of ADS-B Traffic and ADS-B Traffic alerting.

Traffic targets displayed on the dedicated traffic page may be selected in order to obtain additional information about a traffic target or to view all targets in a grouped target. When a grouped target is selected, the Next key on the dedicated traffic page will cycle through all targets located in close proximity to where the screen has been touched.

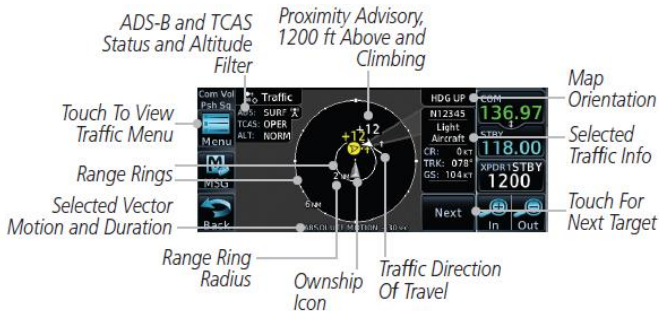

Figure 7-48 ADS-B Traffic page on GTN650 unit

On GDU620 display unit the ADS-B IN traffic can be display in the traffic page of the MFD. This page will be entered rotating the large knob to select the “MAP PAGE GROUP” and then selecting, through the softkey or turning the inner knob, the ADS-B Traffic Map Page.

The Traffic Map Page shows surrounding TIS traffic data in relation to the aircraft’s current position and altitude. The Traffic option is designed to assist in detection and avoidance of other aircraft.

Traffic targets displayed on the dedicated traffic page may be selected in order to obtain additional information about a traffic target.

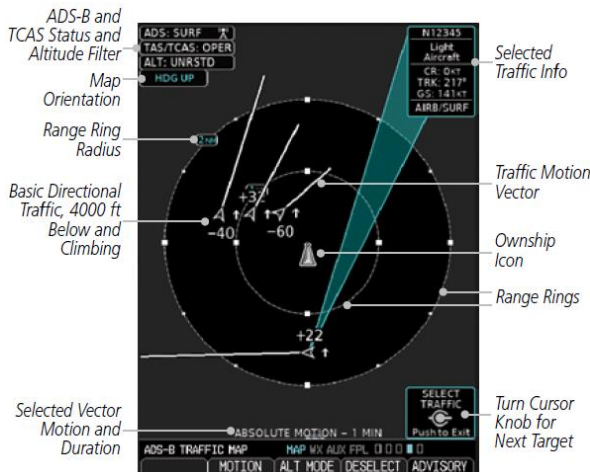

Figure 7-49 ADS-B Traffic Map page on GDU 620 display unit

7.18.9 SOFTWARE RELEASE NOTIFICATION

In the following table is reported the current list of the software version number of each avionic system.

SYSTEM INFORMATION	SOFTWARE RELEASE	
<u>GARMIN G500 suite</u>		
GDU620 (Display unit PFD/MFD)	version 6.21 ⁽¹⁾	
	version 7.30 ⁽²⁾	
GDC74A (Air Data Computer)	version 3.09 ⁽¹⁾	
	version 3.11 ⁽²⁾	
GRS77 (AHRS)	version 3.04 ⁽¹⁾	
	version 3.06 ⁽²⁾	
GMU44 (Magnetometer)	version 2.01	
GMA350 (Audio panel)	version 3.05	
GTX33 w/ES (Transponder)	version 8.02	
GTX345R (Optional transponder)	version 2.12	
GTN650 (NAV/COM/GPS Unit)	MAIN	v. 6.21
	GPS/WAAS	v. 5.2
	COM	v. 2.20
	NAV	v. 6.02
GNC255B (NAV/COM Unit)	DISPLAY	v. 2.02 ⁽³⁾
		v. 2.20 ⁽⁴⁾
	COM	v. 2.12 ⁽³⁾
		v. 2.30 ⁽⁴⁾
	NAV	v. 6.02 ⁽³⁾
		v. 6.03 ⁽⁴⁾

<u>Standby instrument</u>	
MD302	version 1.0.5 ⁽⁵⁾
	version 1.1.0 ⁽⁶⁾
	version 1.1.1 ⁽²⁾
<u>Engine Data Management</u>	
EDM-930	version 1.20.489

(1) Valid for V1.0 aircraft from s/n 1001 up to s/n 1008.

(2) Valid for V1.0 aircraft from s/n 1009 onwards.

(3) Valid for V1.0 aircraft s/n 1001 and 1002.

(4) Valid for V1.0 aircraft from s/n 1003 onwards.

(5) Valid for V1.0 aircraft from s/n 1002 up to s/n 1008.

(6) Valid for V1.0 aircraft s/n 1001.

Table 7-4 Software release notification

WARNING

In case of replacement of one of the previous avionic units, verify proper software load and confirm that its software version number is in compliance with that one showed in table above, before installing it.

NOTE

*The software versions are displayed on each unit.
Use the version Information key to view more detailed information about the software version installed on relative unit.
This information is useful when contacting Customer Support.*

7.19 PLACARDS

A list of placards not inserted in Section 2 of this Aircraft Flight Manual are reported below.

On the top side of the MLG wheel fairings:



On the LH/RH sides of the fuselage nose, near static ports:



Outside LH crew door, near door handle:



Outside RH crew door and passenger door, near door handle:



Inside LH crew door, near door handle:



Inside RH crew door and passenger door, near door handle:



Inside LH crew door, near door interlock mechanism:

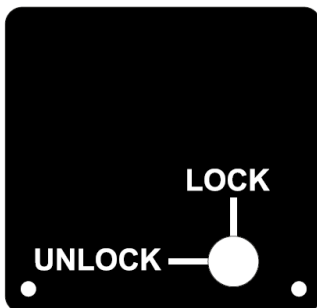

Inside RH crew door and passenger door, near door interlock mechanism:

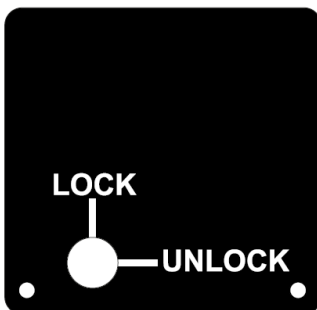

Inside the cabin, passenger area LH side

Only for aircraft s/n 1002



For aircraft from s/n 1003 onwards, plus s/n 1001

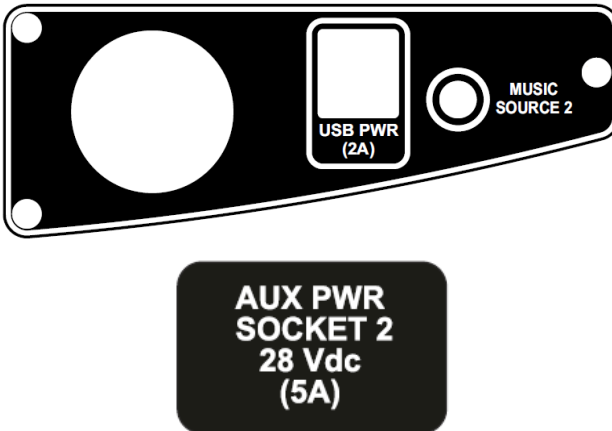

Inside the cabin, passenger area overhead panel:

For aircraft from s/n 1003 onwards, plus s/n 1001



Inside the cabin, on the central pedestal (central area):

Only for aircraft s/n 1002



For aircraft from s/n 1003 onwards, plus s/n 1001

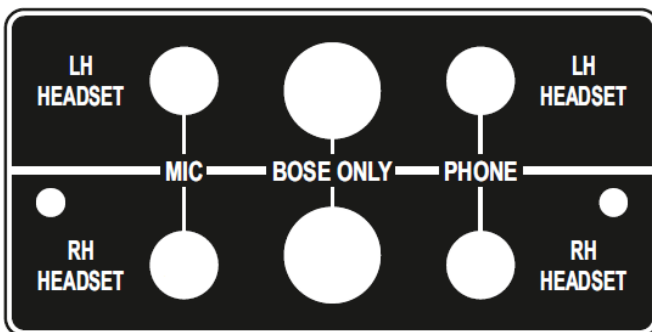

Inside the cabin, on the central pedestal (lower area):

Only for aircraft s/n 1001

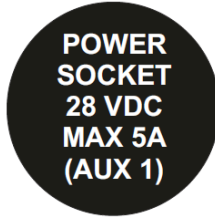

For aircraft from s/n 1002 onwards



For aircraft from s/n 1003 onwards, plus s/n 1001

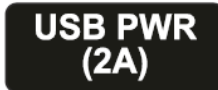

Inside the cabin, on the instrument panel LH side (glove compartment):

For aircraft from s/n 1003 onwards, plus s/n 1001



On the first aid box:

FIRST AID

Inside the first aid box:

**THIS FIRST AID KIT CONTAINS
THE FOLLOWING EQUIPMENT:**

- 1 FIRST AID MANUAL
- 1 DISINFECTANT FOR CUTS/ABRASIONS
- 2 RUBBER GLOVES
- 1 NATRIUMCHLORIDE DRIPS
- 1 STERILE GAUZE (18cm x 40cm)
- 3 STERILE GAUZE (10cm x 10 cm)
- 1 MEDICAL TWEEZERS
- 1 COTTON WOOL
- 1 BOX OF ADHESIVE PLASTERS (VARIOUS)
- 1 ADHESIVE DRESSING (5m x 2,5cm)
- 1 BANDAGE
- 1 MULTIPURPOSE SCISSORS
- 1 TORNIQUET
- 1 DRY ICE
- 1 BAG FOR MEDICAL REFUSE
- 1 EYE WASH
- 3 TUBES OF OINTMENT FOR BURNS (FOILLE)
- 2 TRIANGULAR SLING DRESSINGS

I.A.W. RAI/ENAC CIRCULAR No. 5A/1994

Inside the first aid box (small type):

**THIS FIRST AID KIT CONTAINS
THE FOLLOWING EQUIPMENT:**

- 1 FIRST AID MANUAL**
- 5 DISINFECTANT FOR CUTS/ABRASIONS**
- 2 RUBBER GLOVES**
- 2 STERILE GAUZE (18cm x 40cm)**
- 1 STERILE GAUZE (8cm x 10cm)**
- 1 MEDICAL TWEEZERS**
- 1 COTTON WOOL**
- 1 BOX OF ADHESIVE PLASTERS (VARIOUS)**
- 1 ADHESIVE DRESSING (5m x 1.25cm)**
- 1 BANDAGE**
- 1 MULTIPURPOSE SCISSORS**
- 1 ADHESIVE DRESSING (10cm x 6cm)**