

IF IT DOESN'T SAY
BUSH HOG®
IT JUST WON'T CUT IT™

[GO TO IMPORTANT NOTICE](#)

MACHINE PRICE LIST & SPECIFICATIONS

[GO TO TABLE OF CONTENTS](#)

PRICES F.O.B. FACTORY AND SUBJECT
TO CHANGE WITHOUT NOTICE

Prices Effective April 1, 2023

Revised March 31, 2023

NOTEWORTHY UPDATES:

	PG. #
• 2107 Multi-Spindle Model	22 MS1
• 2120 20' Flex-Wing Model	42 FW5
• 4110 10' Flex-Wing Model	59 FW14
• 4115 15' Flex-Wing Model	61 FW16

GET DETAILS ABOUT
SPECIAL DISCOUNTS
AND FINANCING

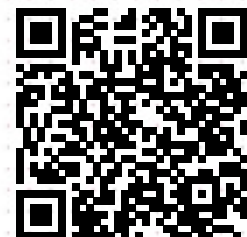



IMPORTANT NOTICE

Prices shown in this book are list prices and do not include freight, setup, or handling unless specifically noted. Shipping weights listed in this book are approximate and include crating or skids where applicable. All prices are F.O.B. factory; freight shipments arranged by Bush Hog® will be per the published rate chart and subject to change. Bush Hog® reserves the right to ship items via motor freight collect at its discretion. Dealers should reference their whole good invoices and billing statements for freight amount and due dates.

Prices, terms, and discounts are subject to change without notice. Orders placed will be accepted based on the price in effect at the time of shipment unless otherwise specified. Prices shown in this book do not include any applicable federal, provincial, state, or local taxes, or levies.

Machines included in this price book conform to safety standards applicable to the products at the time of manufacture and may include safety devices such as shields, guards, or operator protective devices. Under no circumstances should machines be operated without the safety devices in place.

This document is confidential and is for use by authorized Bush Hog® dealership personnel only. It is not to be distributed for any purpose other than selling Bush Hog® branded products.

Bush Hog® reserves the right to make changes and/or improvements in design and construction of parts or machines shown herein without notice or obligation.

ROTARY CUTTER OR FLAIL MOWER THROWN OBJECT PROTECTION

Bush Hog offers three types of shielding to protect the operator, passersby, livestock, and property from mower thrown objects: deflectors, single chain guards, and double chain guards. Shielding should be selected based on the intended use of the mower. Double chain guards or deflectors should be used for highway, right-of-way, parks, or greenbelt mowing or other mowing where human dwellings, vehicles, or livestock could be within 300 feet of the mower. Chain guards are more durable, provide longer service life, and require less maintenance than deflectors. Single chain guards should be sufficient for agricultural and other mowing where passersby or property are not within 300 feet of the mower during operation.

No shielding is completely effective in preventing thrown objects. The possibility of injury or property damage from this hazard can be substantially reduced by selecting proper shielding, maintaining the mower and shielding in good operating condition, inspecting the area for foreign debris before mowing, operating the mower at a minimum cutting height of 4", and keeping people at least 300 feet from the mower at all times during operation.

BUSH HOG® GUARANTEES EACH PIECE OF EQUIPMENT AGAINST DEFECTIVE MATERIALS AND WORKMANSHIP FOR A PERIOD OF ONE YEAR FROM DATE OF DELIVERY UNLESS OTHERWISE NOTED.

FINISHING MOWERS

HDTH Series Rear Discharge Mowers	FM1	4
TDC Series Tri-Deck Mowers	FM3	6

SINGLE-SPINDLE ROTARY CUTTERS

BH110 Series Single-Spindles	SS1	10
BH210-2 Series Single Spindles	SS3	12
BH310-2 Series Single-Spindles.....	SS6	15
BH410 Series Single Spindles	SS9	18
BH510 Series Single-Spindles.....	SS11	20

MULTI-SPINDLE ROTARY CUTTERS

2107 7' Multi-Spindle.....	MS1	22
2208 8' Multi-Spindle	MS3	24
2310 10' Multi-Spindle	MS5	26
3308-2 8' Multi-Spindle	MS7	28
3308-2 8' Swing-Hitch Multi-Spindle.....	MS9	30
3510 10' Multi-Spindle	MS11	32
3514 14' Multi-Spindle.....	MS13	34
14215 15' Multi-Spindle.....	MS15	36

FLEX-WING ROTARY CUTTERS

1812 12' Flex-Wing	FW1	38
1815 15' Flex-Wing	FW3	40
2120 20' Flex-Wing.....	FW5	42
2215 15' Flex-Wing	FW7	44
*2810 10' Single Flex-Wing.....	FW9	46
2814 14' Single Flex-Wing	FW11	48
*2815 15' Flex-Wing	FW13	50
2820 20' Flex-Wing	FW15	52
*3810 10' Flex-Wing	FW18	55
*3815 15' Flex-Wing	FW20	57
4110 10' Flex-Wing	FW22	59
4115 15' Flex-Wing	FW24	61
4815 15' Flex-Wing	FW26	63

CROP FLAIL SHREDDERS

BRC Series Crop Flails.....	FS1	66
-----------------------------	-----	----

BOOM MOWERS

PT5 & RMB Series Rear-Mounted Boom Mowers	BM1	74
Forward-Reach Rear-Mounted Boom Mowers.....	BM4	77

SKID STEER BRUSH CUTTERS

BCSS Series Closed-Front Brush Cutters	BC1	82
BCSS Series Open-Front Brush Cutters.....	BC3	84

CONSTRUCTION IMPLEMENTS

DSP Series Pull Dirt Scrapers	CS1	88
PHD Series Post Hole Diggers	CS3	90
PHDHF Farm-Ranch Series Post Hole Diggers.....	CS5	92
PHDHC Contractor Series Post Hole Diggers	CS7	94
XD Series Backhoes	CS11	98
AGR Series Ag Grapples.....	CS13	100
BGR Series Bucket Grapples.....	CS14	101
BRGR Series Brush Grapples	CS14	101
PF Series Pallet Forks.....	CS15	102

LANDSCAPE IMPLEMENTS

CRB Series Compact Rear Blades.....	LS1	104
CBX Series Compact Box Blades	LS1	104
CLR Series Compact Landscape Rakes	LS2	105
CRG Series Compact Road Graders.....	LS2	105
CPG & CAR Series Compact Pluggers & Aerators	LS3	106
35 Series Rear Mount Medium Blades.....	LS4	107
50 Series Rear Mount Medium Blades.....	LS5	108
70 Series Medium Duty Blades.....	LS6	109
91 Series Medium Duty Blades.....	LS7	110
100 Series Heavy Duty Blades.....	LS8	111
141 Series Heavy Duty Blades	LS9	112
160 Series Heavy Duty Blades.....	LS10	113
181 Series Heavy Duty Blades.....	LS12	114
225 & 300 Series Heavy Duty Blades.....	LS13	115
LLR Series Economy Landscape Rakes.....	LS13	116
MLR Series Medium Duty Landscape Rakes.....	LS13	116
BBX Series Box Blades	LS14	117
SBX Series Box Blades	LS15	118
MBX Series Box Blades	LS16	119
RBX Series Retractable Shank Box Blades.....	LS17	120
RO Series Roll-Over Box Blades	LS17	120
RG Series Road Graders	LS18	121
HDRG Series Road Graders	LS19	122
PVB & PVS Series Pulverizers.....	LS20	123
PG & MPG Series Pluggers & Core-Type Aerators	LS21	124
FSP Series Fertilizer & Seed Spreaders.....	LS22	125
MS Series Manure Spreaders.....	LS23	126
CP Series Cultipackers.....	LS24	127
BHQA Series Quick Hitches.....	LS25	128

TILLAGE IMPLEMENTS

RTC Series Compact Tillers.....	TL1	130
RTG Series Tillers	TL2	131
RTX Series Heavy-Duty Tillers.....	TL4	133
1D, 2D, & 3D Series Lift Disc Harrows.....	TL5	134
DHP Series Pull Disc Harrows.....	TL11	140
APP Series All-Purpose Plows.....	TL13	142
HDSS Series Heavy-Duty Subsoilers.....	TL14	143
SS Series Subsoilers.....	TL15	144
LP Series Layoff Plows.....	TL15	144
RCV Series Cultivator	TL15	144
PA Series Pasture Aerators	TL16	145

HAY TOOLS

DHM Series Hay Mowers	HT1	148
HT Series Hay Tedders	HT2	149
XLRR-I Series Pull-Type V-Rakes.....	HT3	150
EWR Series Pull Type V-Rakes	HT4	151
3PB Series Bale Implements.....	HT5	152
BS Series Tractor-Mounted Bale Spears.....	HT6	153

SNOW REMOVAL EQUIPMENT

SBSA Series Single Auger Snow Blowers	SB1	156
SBDA Series Dual Auger Snow Blowers	SB3	158
SBPT Series Pull Type Snow Blowers.....	SB4	159
SBSS Series Skid Steer Snow Blowers.....	SB6	161
SBLM Series Loader Mount Snow Blowers	SB8	163

WHEEL & TIRE SELECTION GUIDE

294, 50050727, 50072403, 50074504	TIRE1	166
50074505, 50075401, 50083457, 500BH.....	TIRE2	167

*Available only through current dealer stock

Blue Text Denotes New Products

SERIES: HDTH | TDC



FINISHING MOWERS



FINISHING MOWERS

[RETURN TO TABLE OF CONTENTS](#)



HDTH SERIES FINISHING MOWER

MODEL	HDTH5	HDTH6	HDTH7	HDTH8
Cutting Width	60"	72"	84"	99"
Cutting Height (1/2" incr.)	1/2" - 6 1/2"			
Minimum Tractor PTO HP	15	20	30	35
Hitch	Cat 1 Std & QH		Cat 1, 2, Std & QH	
Blade Size	1/4" x 2 1/2" x 21"	1/4" x 2 1/2" x 25"	5/16" x 2 1/2" x 29"	1/4" x 2 1/2" x 21"
Number of Blades	3			5
Blade Tip Speed	18,266 FPM			
Blade Overlap	1 1/2"			
Blade Uplift	Parallel			
Driveline	ASAE Category 3			
Front Roller (optional)	3" x 5"			3" x 13"
Discharge	Rear			
Deck Thickness	7 Gauge Steel Plate			
Tire Size (solid)	3 1/4 x 10		4 x 10	5 x 13
Belts	(1) B Size Aramid Cord			(2) B Size Aramid Cord
Belt Adjustment	Spring-Loaded Idler			
Gearbox	45 HP		55 HP	
Approx. Weight	672 lb.	730 lb.	954 lb.	1,190 lb.
1-Year Machine Limited Warranty 5-Year Gearbox Limited Warranty				

*Gearbox rating based on field performance.

HOW TO ORDER:

The Base Unit Selection for the HDTH Finish Mowers comes as a complete unit.

Freight NOT included in list price



[RETURN TO TABLE OF CONTENTS](#)

All models are available in the colors below:

Model Color Indicator	Unit Color
R	Bush Hog Red
G	John Deere Green
O	Kubota Orange
B	New Holland Blue

HDTH SERIES FINISHING MOWER

BASE UNIT SELECTION

Model Number	Description	Approx. Wt.	List Price (\$US)
HDTH5R	HDTH Finishing Mower, Bush Hog Red, 5'	672 lb.	\$4,875
HDTH5G	HDTH Finishing Mower, John Deere Green, 5'	672 lb.	\$4,875
HDTH5O	HDTH Finishing Mower, Kubota Orange, 5'	672 lb.	\$4,875
HDTH5B	HDTH Finishing Mower, New Holland Blue, 5'	672 lb.	\$4,875
HDTH6R	HDTH Finishing Mower, Bush Hog Red, 6'	730 lb.	\$5,594
HDTH6G	HDTH Finishing Mower, John Deere Green, 6'	730 lb.	\$5,594
HDTH6O	HDTH Finishing Mower, Kubota Orange, 6'	730 lb.	\$5,594
HDTH6B	HDTH Finishing Mower, New Holland Blue, 6'	730 lb.	\$5,594
HDTH7R	HDTH Finishing Mower, Bush Hog Red, 7'	954 lb.	\$6,990
HDTH7G	HDTH Finishing Mower, John Deere Green, 7'	954 lb.	\$6,990
HDTH7O	HDTH Finishing Mower, Kubota Orange, 7'	954 lb.	\$6,990
HDTH7B	HDTH Finishing Mower, New Holland Blue, 7'	954 lb.	\$6,990
HDTH8R	HDTH Finishing Mower, Bush Hog Red, 8'	1,190 lb.	\$9,565
HDTH8G	HDTH Finishing Mower, John Deere Green, 8'	1,190 lb.	\$9,565
HDTH8O	HDTH Finishing Mower, Kubota Orange, 8'	1,190 lb.	\$9,565
HDTH8B	HDTH Finishing Mower, New Holland Blue, 8'	1,190 lb.	\$9,565

OPTIONS

Model Number	Description	List Price (\$US)
50059787	Front Roller Kit (HDTH5 & HDTH6)	\$101
50078559	Front Roller Kit (HDTH7 & HDTH8)	\$144

[RETURN TO TABLE OF CONTENTS](#)

TDC SERIES FINISHING MOWER

MODEL	TDC-1200	TDC-1500	TDC-1700
Cutting Width	12'	15'	17'
Cutting Height (1/4" incr.)	1" - 5"		
Minimum Tractor PTO HP	25	30	35
Tractor PTO Speed	540		
Hitch	Cat 1 & 2, Drawbar		
Number of Blades Per Deck (Total)	3 (9)		
Blade Tip Speed	15,747 FPM	16,863 FPM	16,732 FPM
Center Deck Cutting Width (ft.)	5'	6'	
Wing Deck Cutting Width (ft.)	4'	5'	6'
Deck Overlap Adjustment (in.)	6"		
Degree of Cutting Attitude (Flex)	30° Up / 15° Down		
Deck Thickness	8-Gauge Steel Plate		
Splitter Gearbox HP	80 HP		
Mower Deck Gearbox HP	50 HP		
Deck Lift Cylinders (in.)	2½" x 10" Single Acting		
Main Driveline	Cat 6 Constant Velocity with Slip Clutch		
Hydraulics	3 - Single Action		
Transport Width (ft.)	7.6'	8.1'	8.3'
Transport Length (ft.)	11.9'	12.2'	12.2'
Transport Height (ft.)	6.2'	7.7'	8.7'
Overall Width (ft.)	12.2'	15.2'	17.2'
Max. Overall Length (ft.)	12.7'	13'	13'
Deflector Type	Rear Safety Chains Std		
Transport Tires (2) / Deck Tires (12)	20½ x 8 - 10 Highway Rated / 11 x 4.00 - 5NHS		
1-Year Machine Limited Warranty			

HOW TO ORDER:

The Base Unit Selection for the TDC Finish Mowers comes as a complete unit.

Freight NOT included in list price



[RETURN TO TABLE OF CONTENTS](#)

TDC SERIES FINISHING MOWER

BASE UNIT SELECTION

Model Number	Description	Approx. Wt.	List Price (\$US)
TDC-1200	TDC Series Finishing Mower, 12'	2,742 lb.	\$34,000
TDC-1500	TDC Series Finishing Mower, 15'	2,874 lb.	\$37,100
TDC-1700	TDC Series Finishing Mower, 17'	2,995 lb.	\$38,450

OPTIONS / SHIPPED SEPARATELY

Model Number	Description	List Price (\$US)
50082150	Mulching Kit TDC-1200, (Complete, 3 Units - Blades & Baffles)	\$1,758
50082151	Mulching Kit TDC-1500, (Complete, 3 Units - Blades & Baffles)	\$1,925
50082152	Mulching Kit TDC-1700, (Complete, 3 Units - Blades & Baffles)	\$2,100

SERIES: BH110 | BH210-2 | BH310-2 | BH410 | BH510



SINGLE-SPINDLE

ROTARY CUTTERS

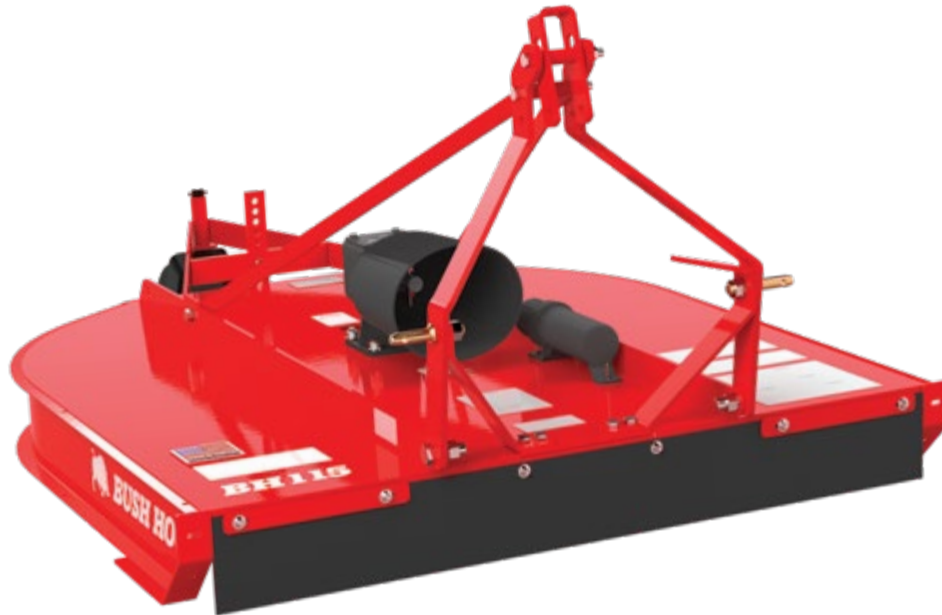

SINGLE-SPINDLE ROTARY CUTTERS

[RETURN TO TABLE OF CONTENTS](#)

BH110 SERIES SINGLE-SPINDLE ROTARY CUTTERS

MODEL	BH114	BH115	BH116
Cutting Width	44"	56"	68"
Cutting Height	1 ½" - 11"		
Cutting Capacity	1" Diameter		
Hitch	Cat. 1 Std; Quick Hitch Optional		
Deck Thickness	12 Gauge		
Side Bands	"C" Channel, 10 Gauge x 8"		
Gearbox Rating (HP)	60*		
Driveline	ASAE Category 3		
Driveline Protection	Slip Clutch or Shearpin		
Blade Holder	Formed Pan		
Blades	1/2" x 3" Corner Uplift		
Blade Tip Speed	15,904 fpm	15,472 fpm	14,307 fpm
Wheels	14 ½" Laminated		
Minimum Tractor PTO HP	15	20	25
Safety Shielding	Front Rubber Belt and Rear Metal Band Standard; Front Chains Optional		
10-Year Gearbox Limited Warranty 1-Year Machine Limited Warranty			

*Gearbox rating based on field performance.

WARNING:

A deflector kit or chain shielding must be used for all non-agricultural purposes or in areas where thrown objects could be hazardous to people, animals, or property.

HOW TO ORDER:

The BH110 Series Rotary Cutters are priced as a base unit including front belting and rear metal band. To receive a complete cutter, you must choose your base unit selection, including your choice of model color from the chart at the top of the next page, and indicate your choice of driveline from Group 2 Driveline Selection. **All units are sold in pairs. Each pair must be the same model and color.**

Freight NOT included in list price



[RETURN TO TABLE OF CONTENTS](#)

All models are available in the colors below:

Model Color Indicator	Unit Color
1R	Bush Hog Red
1G	John Deere Green
1O	Kubota Orange
1B	New Holland Blue

BH110 SINGLE-SPINDLE ROTARY CUTTER

BASE UNIT SELECTION

Model Number	Description	Approx. Wt.	List Price (\$US)
BH114-1x	BH114 Rotary Cutter, 540 PTO, Lift Hitch, 4'	393 lb.	\$2,240
BH115-1x	BH115 Rotary Cutter, 540 PTO, Lift Hitch, 5'	491 lb.	\$2,527
BH116-1x	BH116 Rotary Cutter, 540 PTO, Lift Hitch, 6'	577 lb.	\$2,792

GROUP 2 DRIVELINE SELECTION

Model Number	Description	Approx. Wt.	List Price (\$US)
50075901	Driveline, ASAE Category 3, with Shearpin (BH114 Model Only)	25 lb.	\$191
50075919	Driveline, ASAE Category 3, with Shearpin (BH115 and BH116 Models Only)	25 lb.	\$227
50075900	Driveline, ASAE Category 3, with Slip-Clutch (BH114 and BH115 Models Only)	25 lb.	\$458
50076537	Driveline, ASAE Category 3, with Slip-Clutch (BH116 Model Only)	25 lb.	\$458

OPTIONS

Model Number	Description	Approx. Wt.	List Price (\$US)
50081169	Front Chain Bundle, BH114	35 lb.	\$164
50081170	Front Chain Bundle, BH115	40 lb.	\$176
50081433	Front Chain Bundle, BH116	45 lb.	\$188
50081027	Quick Hitch Kit	5 lb.	\$62



[RETURN TO TABLE OF CONTENTS](#)



BH210-2 SERIES SINGLE-SPINDLE ROTARY CUTTERS

MODEL	BH215-2	BH216-2	BH217-2
Cutting Width	60"	72"	84"
Cutting Height	1 ½" - 12"		
Cutting Capacity	2" Diameter		
Hitch	Cat. 1 Std & QH Compatible; Cat. 2 Std Only with Optional Bushings		Cat. 1 or 2 Std and Quick Hitch
Deck Thickness	11 Gauge	10 Gauge	
Side Bands	11 ½" x 11 Gauge	11 ½" x 10 Gauge	11 ¾" x 10 Gauge
Driveline	ASAE Category 3		
Driveline Protection	Slip Clutch or Shearbolt		Slip Clutch Standard
Gearbox Rating (HP)	65*		130*
Tractor PTO Speed	540		
Minimum Tractor PTO HP	25	30	50
Blade Holder	Oval Pan		
Blades	1/2" x 4" Uplift		
Blade Tip Speed	14,335 fpm	14,963 fpm	
Wheels	15 ½" Laminated		
Safety Shielding	Front: Rubber Belt or Single Row Chains Rear: Metal Band or Single Row Chains		
Approximate Weight	650 lb.	750 lb.	1,035 lb.
10-Year Gearbox Limited Warranty 1-Year Machine Limited Warranty			

*Gearbox rating based on field performance.

NOTICE:	PTO adapter must not be used in any application.
WARNING:	A deflector kit or chain shielding must be used for all non-agricultural purposes or in areas where thrown objects could be hazardous to people, animals, or property.
HOW TO ORDER:	To receive a complete cutter, you must order from each group listed for the model you have selected.

Freight NOT included in list price



[RETURN TO TABLE OF CONTENTS](#)

All models are available in the colors below:

Model Color Indicator	Unit Color
2R	Bush Hog Red
2G	John Deere Green
2O	Kubota Orange
2B	New Holland Blue

BH215-2 SINGLE-SPINDLE ROTARY CUTTER

BASE UNIT SELECTION			
Model Number	Description	Approx. Wt.	List Price (\$US)
BH215-2R	BH215 Rotary Cutter, 5', Bush Hog Red	650 lb.	\$3,049
BH215-2G	BH215 Rotary Cutter, 5', John Deere Green	650 lb.	\$3,049
BH215-2O	BH215 Rotary Cutter, 5', Kubota Orange	650 lb.	\$3,049
BH215-2B	BH215 Rotary Cutter, 5', New Holland Blue	650 lb.	\$3,049
GROUP 2 PTO SELECTION			
50053123	ASAE Category 3 Shearbolt Driveline	31 lb.	\$425
50053126	ASAE Category 3 Slip-Clutch Driveline	40 lb.	\$660
GROUP 3 ENCLOSURE SELECTION			
50071036	Front Rubber Belt	9 lb.	\$112
50074734	Front Single Row Chains	46 lb.	\$215
50080236	Rear Metal Band	18 lb.	\$92
50080237	Rear Single Row Chains	58 lb.	\$386
GROUP 4 OPTIONS			
50080070	Cat. 2 Hitch Bushings	1 lb.	Order Thru Service Parts

BH216-2 SINGLE-SPINDLE ROTARY CUTTER

BASE UNIT SELECTION			
Model Number	Description	Approx. Wt.	List Price (\$US)
BH216-2R	BH216 Rotary Cutter, 6', Bush Hog Red	750 lb.	\$3,582
BH216-2G	BH216 Rotary Cutter, 6', John Deere Green	750 lb.	\$3,582
BH216-2O	BH216 Rotary Cutter, 6', Kubota Orange	750 lb.	\$3,582
BH216-2B	BH216 Rotary Cutter, 6', New Holland Blue	750 lb.	\$3,582
GROUP 2 PTO SELECTION			
50053131	ASAE Category 3 Shearbolt Driveline	32 lb.	\$425
50053127	ASAE Category 3 Slip-Clutch Driveline	40 lb.	\$660
GROUP 3 ENCLOSURE SELECTION			
50070831	Front Rubber Belt	10 lb.	\$125
50074732	Front Single Row Chains	54 lb.	\$287
50080241	Rear Metal Band	28 lb.	\$111
50080242	Rear Single Row Chains	67 lb.	\$487
GROUP 4 OPTIONS			
50080070	Cat. 2 Hitch Bushings	1 lb.	Order Thru Service Parts

NOTE: Safety shieldings are non-returnable items for all models.

[RETURN TO TABLE OF CONTENTS](#)



BH217-2 SINGLE-SPINDLE ROTARY CUTTER

BASE UNIT SELECTION

Model Number	Description	Approx. Wt.	List Price (\$US)
BH217-2R	BH217 Rotary Cutter, 7', Bush Hog Red	1,035 lb.	\$6,405
BH217-2G	BH217 Rotary Cutter, 7', John Deere Green	1,035 lb.	\$6,405
BH217-2O	BH217 Rotary Cutter, 7', Kubota Orange	1,035 lb.	\$6,405
BH217-2B	BH217 Rotary Cutter, 7', New Holland Blue	1,035 lb.	\$6,405

GROUP 2 ENCLOSURE SELECTION

Model Number	Description	Approx. Wt.	List Price (\$US)
50070944	Front Rubber Belt	37 lb.	\$162
50074733	Front Single Row Chains	62 lb.	\$400
50080245	Rear Metal Band	36 lb.	\$161
50080246	Rear Single Row Chains	75 lb.	\$598

NOTE: Safety shieldings are non-returnable items for all models.

[RETURN TO TABLE OF CONTENTS](#)



BH310-2 SERIES SINGLE-SPINDLE ROTARY CUTTERS

MODEL	BH315-2	BH316-2	BH317-2
Cutting Width	60"	72"	84"
Cutting Height	1 ½" - 12"		
Cutting Capacity	3"		
Hitch	Cat. 1 or 2 Std & Quick Hitch		Cat. 2 or 3 Std & Quick Hitch
Deck Thickness (GA)	10		
Side Bands	11 ½" x 1/4"		11 ¾" x 1/4"
Driveline	ASAE Category 4		
Driveline Protection	Slip Clutch		
Gearbox Rating (HP)	130*		
Tractor PTO Speed	540		
Minimum Tractor PTO HP	35	45	55
Blade Holder	Round Pan		
Blades	1/2" x 4" Uplift		
Blade Tip Speed	14,600 fpm	15,000 fpm	14,450 fpm
Wheels	15 ½" Laminated		Single or Dual 15 ½" Laminated
Safety Shielding	Front: Rubber Belt or Single or Double Row Chains Rear: Metal Band or Single or Double Row Chains		
Approximate Weight	890 lb.	1,050 lb.	1,250 lb.
10-Year Gearbox Limited Warranty 1-Year Machine Limited Warranty			

*Gearbox rating based on field performance.

NOTICE:	PTO adapter must not be used in any application.
WARNING:	A deflector kit or chain shielding must be used for all non-agricultural purposes or in areas where thrown objects could be hazardous to people, animals, or property.
HOW TO ORDER:	To receive a complete cutter, you must order from each group listed for the model you have selected.

Freight NOT included in list price



[RETURN TO TABLE OF CONTENTS](#)

BH315-2 SINGLE-SPINDLE ROTARY CUTTER

BASE UNIT SELECTION

Model Number	Description	Approx. Wt.	List Price (\$US)
BH315-2R	BH315 Rotary Cutter, 5', Bush Hog Red	890 lb.	\$4,900
BH315-2G	BH315 Rotary Cutter, 5', John Deere Green	890 lb.	\$4,900
BH315-2O	BH315 Rotary Cutter, 5', Kubota Orange	890 lb.	\$4,900
BH315-2B	BH315 Rotary Cutter, 5', New Holland Blue	890 lb.	\$4,900

GROUP 2 FRONT ENCLOSURE SELECTION

Model Number	Description	Approx. Wt.	List Price (\$US)
50080400	Front Rubber Belt	17 lb.	\$112
50074734	Front Single Row Chains	46 lb.	\$215
50080485	Front Double Row Chains	70 lb.	\$514

GROUP 3 REAR ENCLOSURE SELECTION

Model Number	Description	Approx. Wt.	List Price (\$US)
50080236	Rear Metal Band	18 lb.	\$92
50080237	Rear Single Row Chains	58 lb.	\$386
50080384	Rear Double Row Chains	74 lb.	\$503

BH316-2 SINGLE-SPINDLE ROTARY CUTTER

BASE UNIT SELECTION

Model Number	Description	Approx. Wt.	List Price (\$US)
BH316-2R	BH316 Rotary Cutter, 6', Bush Hog Red	1,050 lb.	\$5,893
BH316-2G	BH316 Rotary Cutter, 6', John Deere Green	1,050 lb.	\$5,893
BH316-2O	BH316 Rotary Cutter, 6', Kubota Orange	1,050 lb.	\$5,893
BH316-2B	BH316 Rotary Cutter, 6', New Holland Blue	1,050 lb.	\$5,893

GROUP 2 FRONT ENCLOSURE SELECTION

Model Number	Description	Approx. Wt.	List Price (\$US)
50080401	Front Rubber Belt	28 lb.	\$125
50074732	Front Single Row Chains	54 lb.	\$287
50080486	Front Double Row Chains	80 lb.	\$551

GROUP 3 REAR ENCLOSURE SELECTION

Model Number	Description	Approx. Wt.	List Price (\$US)
50080241	Rear Metal Band	28 lb.	\$111
50080242	Rear Single Row Chains	67 lb.	\$487
50080385	Rear Double Row Chains	88 lb.	\$608

NOTE: Safety shieldings are non-returnable items for all models.



[RETURN TO TABLE OF CONTENTS](#)



BH317-2 SINGLE-SPINDLE ROTARY CUTTER

BASE UNIT SELECTION

Model Number	Description	Approx. Wt.	List Price (\$US)
BH317-2R	BH317 Rotary Cutter, 7', Bush Hog Red	1,250 lb.	\$7,366
BH317-2G	BH317 Rotary Cutter, 7', John Deere Green	1,250 lb.	\$7,366
BH317-2O	BH317 Rotary Cutter, 7', Kubota Orange	1,250 lb.	\$7,366
BH317-2B	BH317 Rotary Cutter, 7', New Holland Blue	1,250 lb.	\$7,366

GROUP 2 TAILWHEEL SELECTION

Model Number	Description	Approx. Wt.	List Price (\$US)
50080397	Single Tailwheel Assembly	65 lb.	\$405
50080395	Dual Tailwheel Assembly	130 lb.	\$1,137

GROUP 3 FRONT ENCLOSURE SELECTION

Model Number	Description	Approx. Wt.	List Price (\$US)
50070944	Front Rubber Belt	37 lb.	\$162
50074733	Front Single Row Chains	62 lb.	\$400
50080487	Front Double Row Chains	90 lb.	\$625

GROUP 4 REAR ENCLOSURE SELECTION

Model Number	Description	Approx. Wt.	List Price (\$US)
50080245	Rear Metal Band	36 lb.	\$161
50080246	Rear Single Row Chains	75 lb.	\$598
50080386	Rear Double Row Chains	105 lb.	\$686

NOTE: Safety shieldings are non-returnable items for all models.

[RETURN TO TABLE OF CONTENTS](#)



BH410 SERIES SINGLE-SPINDLE ROTARY CUTTERS

MODEL	BH416	BH417
Cutting Width	72"	84"
Cutting Height	1 1/2" - 12"	
Cutting Capacity	4"	
Hitch	Cat. 2 or 3 Std & QH	
Deck Thickness	7 Gauge	
Side Bands	13" x 1/4"	
Driveline	ASAE Category 5	ASAE Category 6
Driveline Protection	Slip Clutch	
Gearbox Rating (HP)	210*	
Tractor PTO Speed	540	
Minimum Tractor PTO HP	60	70
Blade Holder	Round Pan	
Blades	1/2" x 4" Uplift	
Blade Tip Speed (FPM)	13,997	14,488
Wheels	Single 21" Laminated	Dual 21" Laminated
Safety Shielding	Front: Single or Double Row Chains Rear: Single or Double Row Chains	
Approximate Weight	1,300 lb.	2,000 lb.
10-Year Gearbox Limited Warranty 1-Year Machine Limited Warranty 10-Year Deck Rust-Thru Limited Warranty on Galvanized Decks		

*Gearbox rating based on field performance.

WARNING:

A deflector kit or chain shielding must be used for all non-agricultural purposes or in areas where thrown objects could be hazardous to people, animals, or property.

HOW TO ORDER:

To receive a complete cutter, you must order from each group listed for the model you have selected.

Freight NOT included in list price

[RETURN TO TABLE OF CONTENTS](#)

BH416 SINGLE-SPINDLE ROTARY CUTTER

BASE UNIT SELECTION			
Model Number	Description	Approx. Wt.	List Price (\$US)
BH416-1R	BH416 Rotary Cutter, 6'	1,114 lb.	\$8,901
BH416-1Z	BH416 Rotary Cutter, 6', Galvanized	1,114 lb.	\$9,857
GROUP 2 FRONT ENCLOSURE SELECTION			
50080837	Front Single Row Chains	68 lb.	\$361
50080836	Front Double Row Chains	102 lb.	\$551
GROUP 3 REAR ENCLOSURE SELECTION			
50080834	Rear Single Row Chains	86 lb.	\$509
50080833	Rear Double Row Chains	103 lb.	\$728
OPTIONS			
50080466	1/2" x 5" x 22-1/4" Corner Uplift Blades	Order Through Service Parts	
BH416 Spec	Special Paint Colors	Call for Quote	

BH417 SINGLE-SPINDLE ROTARY CUTTER

BASE UNIT SELECTION			
Model Number	Description	Approx. Wt.	List Price (\$US)
BH417-1R	BH417 Rotary Cutter, 7'	1,817 lb.	\$12,012
BH417-1Z	BH417 Rotary Cutter, 7', Galvanized	1,817 lb.	\$13,511
GROUP 2 HEIGHT ADJUSTMENT SELECTION			
1817	Manual Ratchet Bundle	15 lb.	\$249
64830	Hydraulic Cylinder Bundle	30 lb.	\$531
GROUP 3 FRONT ENCLOSURE SELECTION			
50080845	Front Single Row Chains	78 lb.	\$404
50080844	Front Double Row Chains	117 lb.	\$625
GROUP 4 REAR ENCLOSURE SELECTION			
50080842	Rear Single Row Chains	94 lb.	\$625
50080841	Rear Double Row Chains	112 lb.	\$802
OPTIONS			
BH417 Spec	Special Paint Colors	Call for Quote	

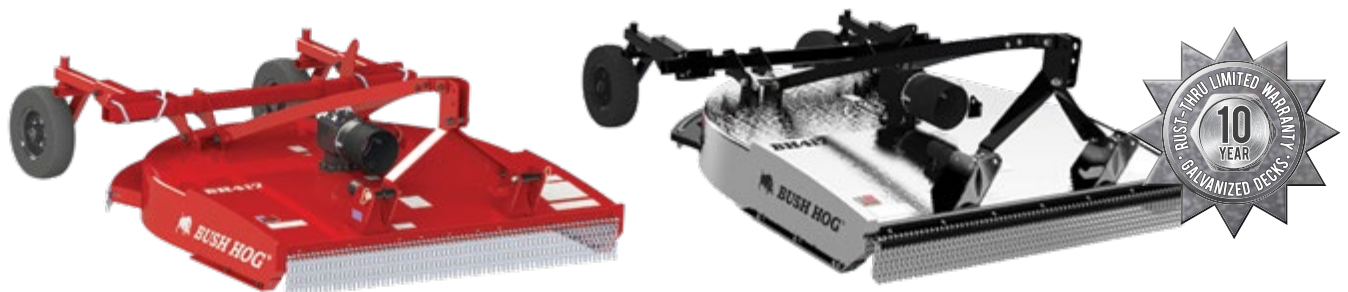

[RETURN TO TABLE OF CONTENTS](#)



BH516 SINGLE-SPINDLE ROTARY CUTTER

MODEL	BH516
Cutting Width	72"
Cutting Height	1 ½" - 12"
Cutting Capacity	5"
Hitch	Cat. 2 or 3 Std & QH
Deck Thickness	7 Gauge
Side Bands	13" x 1/4"
Driveline	ASAE Category 6
Driveline Protection	Slip Clutch
Gearbox Rating (HP)	225*
Tractor PTO Speed	540
Minimum Tractor PTO HP	70
Blade Holder	Reinforced Round Pan
Blades	1/2" x 5" Uplift
Blade Tip Speed (FPM)	13,346
Wheels	Single 21" Laminated
Safety Shielding	Double Row Chains Standard
Approximate Weight	1,775 lb.

10-Year Gearbox Limited Warranty | 1-Year Machine Limited Warranty | 10-Year Deck Rust-Thru Limited Warranty on Galvanized Decks

*Gearbox rating based on field performance.

WARNING:

A deflector kit or chain shielding must be used for all non-agricultural purposes or in areas where thrown objects could be hazardous to people, animals, or property.

HOW TO ORDER:

To receive a complete cutter, you must order from each group listed for the model you have selected. The BH516 comes equipped with lift-type hitch, driveline, and double row chains standard.

Freight NOT included in list price

BH516 SINGLE-SPINDLE ROTARY CUTTER

BASE UNIT SELECTION

Model Number	Description	Approx. Wt.	List Price (\$US)
BH516-1R	BH516 Rotary Cutter, 6'	1,775 lb.	\$11,403
BH516-1Z	BH516 Rotary Cutter, 6', Galvanized	1,775 lb.	\$12,515

OPTIONS

BH516 Spec

Special Paint Colors

Call for Quote

NOTE: Safety shieldings are non-returnable items for all models.

SERIES: 2000 | 3000 | 4200



MULTI-SPINDLE ROTARY CUTTERS



MULTI-SPINDLE ROTARY CUTTERS

NEW
 for Winter
 2022

RETURN TO TABLE OF CONTENTS



2107 MULTI-SPINDLE ROTARY CUTTER

MODEL	2107
Cutting Width	7' 2"
Transport Width	7' 6"
Overall Length	7' 4"
Cutting Height	1 1/2" - 11"
Cutting Capacity	2" Diameter
Hitch	Cat 1 & 2 Std & QH
Deck Thickness	10 gauge
Side Bands	7 gauge x 11 3/4"
Gearbox HP	140HP (Transfer) 65HP (Cutting)
Driveline	ASAE Category 3
Driveline Protection	2-Plate Slip-Clutch
Blade Holders	Oval Pan
Blades	1/2" x 4" Uplift
Blade Overlap	4"
Blade Tip Speed	Approx. 16,000 FPM
Wheel	15 1/2" Laminated
Minimum Tractor PTO HP	30 (w/ Adequate Front Ballasts)
Tractor PTO Speed	540 RPM
Height Adjustment	Manual Tailwheel Height Adjustment
Safety Shielding	Single Chains (Front) Metal Band or Single Chains (Rear)
10-Year Gearbox Limited Warranty 1-Year Machine Limited Warranty	

*Gearbox rating based on field performance.

NOTICE:	PTO adapter must not be used in any application.
WARNING:	A deflector kit or chain shielding must be used for all non-agricultural purposes or in areas where thrown objects could be hazardous to people, animals, or property.
HOW TO ORDER:	To receive a complete cutter, you must order from each group listed for the model you have selected.

Freight NOT included in list price



[RETURN TO TABLE OF CONTENTS](#)

2107 MULTI-SPINDLE ROTARY CUTTER

BASIC UNIT SELECTION

Model Number	Description	Approx. Wt.	List Price (\$US)
2107R	2107 Rotary Cutter including Lift Hitch Bundle, 540 PTO Cat 3 Slip-Clutch Driveline	1.050 lb.	\$7,608

GROUP 2 TAILWHEEL SELECTION

Model Number	Description	Approx. Wt.	List Price (\$US)
50083924	Single Tailwheel w/15.5" Laminated Tailwheel	65 lb.	\$405
50083925	Dual Tailwheel w/15.5" Laminated Tailwheels	130 lb.	\$905

GROUP 3 FRONT ENCLOSURE SELECTION

Model Number	Description	Approx. Wt.	List Price (\$US)
50082483	Front Single Row Chains	70 lb.	\$356
50082484	Front Double Row Chains	120 lb.	\$485

GROUP 4 REAR ENCLOSURE SELECTION

Model Number	Description	Approx. Wt.	List Price (\$US)
50082489	Rear Metal Band	40 lb.	\$156
50082486	Rear Single Row Chains	60 lb.	\$297
50082487	Rear Double Row Chains	100 lb.	\$434

NOTE: Safety shieldings are non-returnable items for all models.



[RETURN TO TABLE OF CONTENTS](#)



2208 MULTI-SPINDLE ROTARY CUTTER

MODEL	2208
Cutting Width	8' 3"
Transport Width	8' 10"
Overall Length	13' 4" (Pull) 8' 6" (Lift & Semi) 13' 4" (Pull)
Cutting Height	1 ½" - 13"
Tongue Weight	880 lb. (Pull)
Cutting Capacity	2" Diameter
Hitch	Cat. 1 or 2 Std & Quick Hitch Self-Leveling Pull-Type
Deck Thickness	10 Gauge
Side Bands	11 ¾" x 7 Gauge
Gearbox Rating (HP)	140* (Transfer) 65* (Cutting)
Driveline	ASAE Category 4
Driveline Protection	2-Plate Slip-Clutch
Blade Holders	10ga Oval Pans
Blades	1/2" x 4" Uplift
Blade Overlap	4 ¾"
Blade Tip Speed	16,173 fpm
Wheels	15 ½" Laminated
Minimum Tractor PTO HP	35 (Pull) 45 (Lift)
Safety Shielding	Chains (Front) Metal Band or Chains (Rear)
Safety Tow Chain	Standard (Pull)
10-Year Gearbox Limited Warranty 1-Year Machine Limited Warranty	

*Gearbox rating based on field performance.

NOTICE:	PTO adapter must not be used in any application.
WARNING:	A deflector kit or chain shielding must be used for all non-agricultural purposes or in areas where thrown objects could be hazardous to people, animals, or property.
HOW TO ORDER:	To receive a complete cutter, you must order from each group listed for the model you have selected.

Freight NOT included in list price



2208 MULTI-SPINDLE ROTARY CUTTER

BASE UNIT SELECTION

Model Number	Description	Approx. Wt.	List Price (\$US)
2208R	2208 Base Unit, 540 PTO	1,240 lb.	\$7,833

GROUP 2 HITCH SELECTION

Model Number	Description	Approx. Wt.	List Price (\$US)
50081054	Lift Bundle with Cat. 4 Driveline, Twin Beam Axles, and 15 ½" Laminated Tires	250 lb.	\$2,039
50076024	Semi-Mount Bundle with Cat. 4 Driveline, Twin Beam Axles, and 15 ½" Laminated Tires	175 lb.	\$1,676
50081053	Pull Bundle with Cat. 4 Driveline, Cushioned Axles, and 21" Laminated Tires	500 lb.	\$3,428

GROUP 3 HEIGHT ADJUSTMENT SELECTION (Pull Model Only)

Model Number	Description	Approx. Wt.	List Price (\$US)
1817	Manual Ratchet Bundle	15 lb.	\$249
89045	Hydraulic Cylinder Bundle	45 lb.	\$625

GROUP 4 FRONT ENCLOSURE SELECTION

Model Number	Description	Approx. Wt.	List Price (\$US)
50075423	Front Single Row Chains	83 lb.	\$434
50075424	Front Double Row Chains	110 lb.	\$716

GROUP 5 REAR ENCLOSURE SELECTION

Model Number	Description	Approx. Wt.	List Price (\$US)
50075503	Rear Metal Band	30 lb.	\$165
50075425	Rear Single Row Chains	72 lb.	\$352
50075426	Rear Double Row Chains	95 lb.	\$524

NOTE: Safety shieldings are non-returnable items for all models.

[RETURN TO TABLE OF CONTENTS](#)

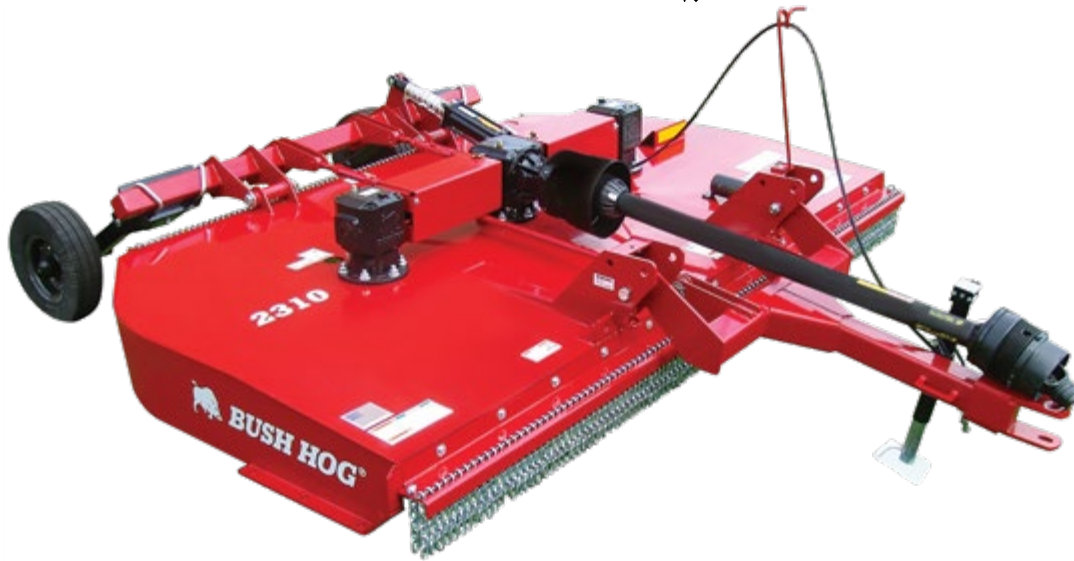

2310 MULTI-SPINDLE ROTARY CUTTER

MODEL	2310
Cutting Width	9' 9"
Transport Width	10' 3"
Overall Length	12' 7" (Pull)
Cutting Height	1 ½" - 12"
Cutting Capacity	2" Diameter
Hitch	Cat. 2 or 3 Std & Quick Hitch Self-Leveling Pull-Type
Deck Thickness	10 Gauge
Side Bands	11 ¾" x 7 Gauge
Driveline	ASAE Category 4
Driveline Protection	Slip Clutch
Gearbox Rating (HP)	140* (Transfer) 130* (Cutting)
Tractor PTO Speed	540
Minimum Tractor PTO HP	50 (Pull), 70 (Lift)
Blade Holders	10ga Round Pans
Blades	1/2" x 4" Uplift
Blade Tip Speed	15,828 fpm
Tires	Dual Laminated, Foam-Filled, or Pneumatic Aircraft
Safety Shielding	Front Single or Double Row Chains Rear Metal Band or Single or Double Row Chains
Approximate Weight	2,280 lb
10-Year Gearbox Limited Warranty 1-Year Machine Limited Warranty	

*Gearbox rating based on field performance.

NOTICE:	PTO adapter must not be used in any application.
WARNING:	A deflector kit or chain shielding must be used for all non-agricultural purposes or in areas where thrown objects could be hazardous to people, animals, or property.
HOW TO ORDER:	To receive a complete cutter, you must order from each group listed for the model you have selected. Group 4 Wheel Selection for Pull-Type Units Only.

Freight NOT included in list price



2310 MULTI-SPINDLE ROTARY CUTTER

BASE UNIT SELECTION

Model Number	Description	Approx. Wt.	List Price (\$US)
2310R	2310 Base Unit, 540 PTO	1,650 lb.	\$11,998

GROUP 2 HITCH SELECTION

Model Number	Description	Approx. Wt.	List Price (\$US)
50080720	Pull Bundle with CV Driveline	325 lb.	\$3,582
50080721	Lift Bundle with Driveline and 21" Laminated Tires	275 lb.	\$2,387
50080722	Semi-Mount Bundle with Driveline and 21" Laminated Tires	170 lb.	\$1,988

GROUP 3 HEIGHT ADJUSTMENT SELECTION

Model Number	Description	Approx. Wt.	List Price (\$US)
1817	Manual Ratchet Bundle	15 lb.	\$249
89045	Hydraulic Cylinder Bundle	45 lb.	\$625

GROUP 4 WHEEL SELECTION (Pull Models Only)

Model Number	Description	Approx. Wt.	List Price (\$US)
294	21" Laminated Tire	70 lb.	each \$345
50050727	Used Aircraft Tire, Pneumatic, 29" x 9" x 15"	75 lb.	each \$390
50083457	New Foam-Filled Tire, 25.5" x 8" x 14"	100 lb.	each \$661

GROUP 5 FRONT ENCLOSURE SELECTION

Model Number	Description	Approx. Wt.	List Price (\$US)
50080716	Front Single Row Chains	80 lb.	\$469
50080717	Front Double Row Chains	140 lb.	\$646

GROUP 6 REAR ENCLOSURE SELECTION

Model Number	Description	Approx. Wt.	List Price (\$US)
50081033	Rear Metal Band	50 lb.	\$264
50081043	Rear Single Row Chains	70 lb.	\$421
50081044	Rear Double Row Chains	120 lb.	\$579

NOTE: Safety shieldings are non-returnable items for all models.

[RETURN TO TABLE OF CONTENTS](#)



3308-2 MULTI-SPINDLE ROTARY CUTTER

MODEL	3308-2
Cutting Width	8' 3"
Transport Width	8' 10"
Overall Length	8' 9" (Lift)
Axle Suspension	Heavy-Duty Axle with Rubber Cushions (Pull)
Cutting Height	1 ½" - 13"
Cutting Capacity	3" Diameter
Hitch	Cat. 1 or 2 Std and Quick Hitch Self-Leveling Pull-Type
Deck Thickness	10 Gauge
Side Bands	11 ¾" x 1/4"
Gearbox Rating (HP)	140HP (Transfer) 130HP (Cutting)
Driveline	ASAE Category 4
Driveline Protection	4-Plate Slip Clutch
Blade Holders	7ga Round Pans
Blades	1/2" x 4" Uplift
Blade Overlap	5"
Blade Tip Speed	16,121 fpm
Wheels	See Wheel Selection
Minimum Tractor PTO HP	40 (Pull & Semi-Mount), 50 (Lift)
Safety Shielding	Front Single or Double Row Chains Rear Metal Band or Single or Double Row Chains
Safety Tow Chain	Standard (Pull)
Approximate Weight	2050 lb.

10-Year Gearbox Limited Warranty | 1-Year Machine Limited Warranty

*Gearbox rating based on field performance.

NOTICE:	PTO adapter must not be used in any application.
WARNING:	A deflector kit or chain shielding must be used for all non-agricultural purposes or in areas where thrown objects could be hazardous to people, animals, or property.
HOW TO ORDER:	To receive a complete cutter, you must order from each group listed for the model you have selected.

Freight NOT included in list price



[RETURN TO TABLE OF CONTENTS](#)

3308-2 MULTI-SPINDLE ROTARY CUTTER

BASE UNIT SELECTION

Model Number	Description	Approx. Wt.	List Price (\$US)
3308R-2	3308-2 Base Unit, 540 PTO	1,309 lb.	\$9,262

GROUP 2 HITCH SELECTION

Model Number	Description	Approx. Wt.	List Price (\$US)
50081004	Lift Bundle*	125 lb.	\$1,353
50081005	Semi-Mount Bundle*	87 lb.	\$957
50081006	Pull Bundle*	470 lb.	\$4,824

* Lift and Semi-Mount Bundles include Driveline with Slip-Clutch.
 ** Pull Bundle includes CV Driveline with Slip-Clutch and Heavy-Duty Axle.

GROUP 3 AXLE SELECTION (Lift and Semi-Mount Models Only)

Model Number	Description	Approx. Wt.	List Price (\$US)
50075427	Twin Beam Axle with 15 ½" Laminated Tires	177 lb.	\$1,009
50081013	Lift and Semi-Mount HD Axle Arms (pair) with 21" Laminated Tires	250 lb.	\$2,279

GROUP 4 HEIGHT ADJUSTMENT SELECTION

Model Number	Description	Approx. Wt.	List Price (\$US)
1817	Manual Ratchet Bundle	15 lb.	\$249
89045	Hydraulic Cylinder Bundle	45 lb.	\$625

Note: Selection is for pull model and heavy duty axle on lift and semi-mount models

GROUP 5 WHEEL SELECTION (**Pull Models Only, 2 Tires Required)

Model Number	Description	Approx. Wt.	List Price (\$US)
294	21" Laminated Tire	70 lb.	each \$345
50050727	Used Aircraft Tire, Pneumatic, 29" x 9" x 15"	75 lb.	each \$390
50083457	New Foam-Filled Tire, 25.5" x 8" x 14"	100 lb.	each \$661

GROUP 6 FRONT ENCLOSURE SELECTION

Model Number	Description	Approx. Wt.	List Price (\$US)
50075423	Front Single Row Chains	83 lb.	\$434
50075424	Front Double Row Chains	110 lb.	\$716

GROUP 7 REAR ENCLOSURE SELECTION

Model Number	Description	Approx. Wt.	List Price (\$US)
50075503	Rear Metal Band	30 lb.	\$165
50075425	Rear Single Row Chains	72 lb.	\$352
50075426	Rear Double Row Chains	95 lb.	\$524

NOTE: Safety shieldings are non-returnable items for all models.

[RETURN TO TABLE OF CONTENTS](#)

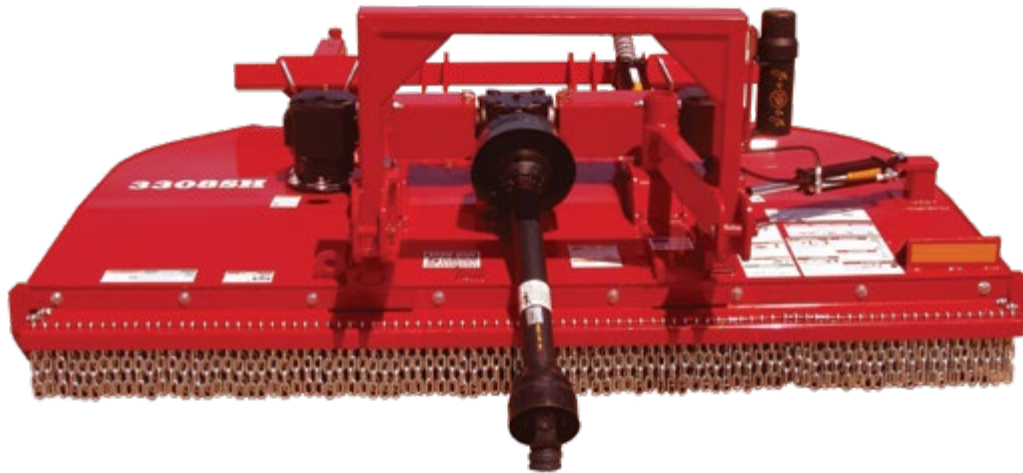

3308SH-2 MULTI-SPINDLE ROTARY CUTTER

MODEL	3308SH-2
Cutting Width	8' 3"
Transport Width	8' 10"
Overall Length	9' 7" (Semi-Mount)
Axle Suspension	Heavy Duty Axle with Rubber Suspension
Cutting Height	1 ½" - 13"
Cutting Capacity	3" Diameter
Hitch	Cat. 1 or 2 (Semi-Mount Only With Variable Offset up to 13" to the Right of Tractor Center Line)
Deck Thickness	10 Gauge
Side Bands	11 ¾" x 1/4"
Gearbox Rating (HP)	140* (Transfer) 130* (Cutting)
Driveline	ASAE Category 4
Driveline Protection	4-Plate Slip Clutch
Blade Holders	7ga Round Pans
Blades	1/2" x 3 ½" Uplift
Blade Overlap	5"
Blade Tip Speed	16,121 fpm
Wheels	21" Laminated Tires
Minimum Tractor PTO HP	40
Safety Shielding	Front Single or Double Row Chains Rear Metal Band or Single or Double Row Chains
10-Year Gearbox Limited Warranty 1-Year Machine Limited Warranty	

*Gearbox rating based on field performance.

NOTICE:	PTO adapter must not be used in any application.
WARNING:	A deflector kit or chain shielding must be used for all non-agricultural purposes or in areas where thrown objects could be hazardous to people, animals, or property.
HOW TO ORDER:	To receive a cutter, you must choose a Selection from Groups 1-4. The Base 3308SH-2 comes equipped with Swing Hitch Bundle including Driveline and HD Axle.

Freight NOT included in list price



3308SH-2 MULTI-SPINDLE ROTARY CUTTER

BASE UNIT SELECTION

Model Number	Description	Approx. Wt.	List Price (\$US)
3308SH-2	3308SH-2 Base Unit, 540 PTO, Cat 4 Driveline, HD Axle, and 21" Laminated Tires	1,750 lb.	\$13,655

GROUP 2 HEIGHT ADJUSTMENT SELECTION

Model Number	Description	Approx. Wt.	List Price (\$US)
1817	Manual Ratchet Bundle	15 lb.	\$249
89045	Hydraulic Cylinder Bundle	45 lb.	\$625

GROUP 3 FRONT ENCLOSURE SELECTION

Model Number	Description	Approx. Wt.	List Price (\$US)
50075423	Front Single Row Chains	83 lb.	\$434
50075424	Front Double Row Chains	110 lb.	\$716

GROUP 4 REAR ENCLOSURE SELECTION

Model Number	Description	Approx. Wt.	List Price (\$US)
50075503	Rear Metal Band	30 lb.	\$165
50075425	Rear Single Row Chains	72 lb.	\$352
50075426	Rear Double Row Chains	95 lb.	\$524

[RETURN TO TABLE OF CONTENTS](#)



3510 MULTI-SPINDLE ROTARY CUTTER

MODEL	3510
Cutting Width	10' 6"
Cutting Height	1 ½" - 13"
Cutting Capacity	3 ½" Diameter
Hitch	Cat. 2 or 3 Std and Quick Hitch Self-Leveling Pull-Type
Deck Thickness	10 Gauge
Side Bands	1/4" x 10"
Driveline	ASAE Category 5
Driveline Protection	4-Plate Slip Clutch
Gearbox Rating (HP)	210* (Transfer) 210* (Cutting)
Tractor PTO Speed	540
Minimum Tractor PTO HP	60 (Pull), 75 (Lift)
Blade Holders	7ga Round Pans
Blades	1/2" x 4" Uplift
Blade Tip Speed	16,881 fpm
Wheels	See Wheel Selection
Safety Shielding	Front Single or Double Row Chains Rear Metal Band or Single or Double Row Chains
Approximate Weight	2,900 lb.
10-Year Gearbox Limited Warranty 1-Year Machine Limited Warranty	

*Gearbox rating based on field performance.

NOTICE:	PTO adapter must not be used in any application.
WARNING:	A deflector kit or chain shielding must be used for all non-agricultural purposes or in areas where thrown objects could be hazardous to people, animals, or property.
HOW TO ORDER:	To receive a complete cutter, you must order from each group listed for the model you have selected.

Freight NOT included in list price

[RETURN TO TABLE OF CONTENTS](#)

3510 MULTI-SPINDLE ROTARY CUTTER

BASE UNIT SELECTION

Model Number	Description	Approx. Wt.	List Price (\$US)
3510R	3510 Base Unit, 540 PTO	2,054 lb.	\$11,583

GROUP 2 HITCH SELECTION

Model Number	Description	Approx. Wt.	List Price (\$US)
50076949	Lift Hitch Bundle	225 lb.	\$2,116
50068324	Semi-Mount Bundle	8 lb.	\$356
50036646	Pull Bundle (540 PTO only)	260 lb.	\$2,466

GROUP 3 DRIVELINE SELECTION

Model Number	Description	Approx. Wt.	List Price (\$US)
76729	Lift and Semi-Mount Driveline, 1-3/8-6, 540 PTO	65 lb.	\$1,188
76625	Pull, CV Driveline, 1-3/8-6, 540 PTO	70 lb.	\$1,777

GROUP 4 AXLE SELECTION (For All Models)

Model Number	Description	Approx. Wt.	List Price (\$US)
50068235	Pull, Single Wheel Axle Arms (pair)	162 lb.	\$1,466
50068236	Pull, Dual Wheel Axle Arms (pair)	194 lb.	\$1,876
50082188	Lift and Semi-Mount HD Axle Arms (pair) with 20.5" Pneumatic Aircraft Tires	200 lb.	\$2,328
50081078	Lift and Semi-Mount HD Axle Arms (pair) with 21" Laminated Tires	250 lb.	\$2,458

GROUP 5 HEIGHT ADJUSTMENT SELECTION (For All Models)

Model Number	Description	Approx. Wt.	List Price (\$US)
1817	Manual Ratchet Bundle	15 lb.	\$249
90492	Hydraulic Cylinder Bundle	45 lb.	\$665

GROUP 6 WHEEL SELECTION (Pull Models Only)

Model Number	Description	Approx. Wt.	List Price (\$US)
294	21" Laminated Tire	70 lb.	each \$345
50075401	25" Laminated Tire	85 lb.	each \$420
50050727	Used Aircraft Tire, Pneumatic, 29" x 9" x 15"	75 lb.	each \$390
50083457	New Foam-Filled Tire, 25.5" x 8" x 14"	100 lb.	each \$661

GROUP 7 FRONT ENCLOSURE SELECTION

Model Number	Description	Approx. Wt.	List Price (\$US)
50076736	Front Single Row Chains	140 lb.	\$684
50076927	Front Double Row Chains	165 lb.	\$1,132

GROUP 8 REAR ENCLOSURE SELECTION

Model Number	Description	Approx. Wt.	List Price (\$US)
50076729	Rear Metal Band	40 lb.	\$180
50076939	Rear Single Row Chains	155 lb.	\$807
50076947	Rear Double Row Chains	180 lb.	\$1,242

NOTE: Safety shieldings are non-returnable items for all models.

[RETURN TO TABLE OF CONTENTS](#)

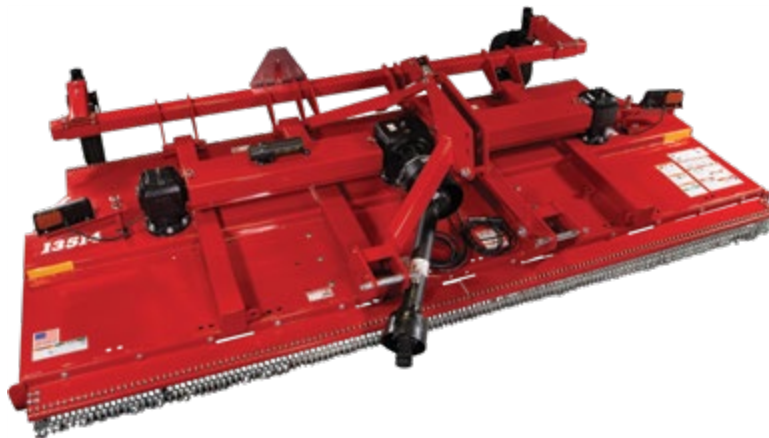

3514 MULTI-SPINDLE ROTARY CUTTER

MODEL	3514
Cutting Width	14'
Transport Width	14' 8"
Overall Length	14' 7" (Pull)
Axle Suspension	Heavy-Duty Axle with Rubber Cushions
Cutting Height	1 ½" - 13"
Cutting Capacity	3 ½" Diameter
Hitch	Cat 2 and 3 Std and Quick Hitch & Self-Leveling Pull-Type
Deck Thickness	10 Gauge
Side Bands	1/4" x 10"
Gearbox Rating (HP)	210* (Transfer) 210* (Cutting)
Driveline	ASAE Category 5 (540 PTO), ASAE Category 4 (1000 PTO Pull)
Cross Shafts	ASAE Category 5 Rubber Element with Category 4 Shearpin
Driveline Protection	4-Plate Slip Clutch
Blade Holders	7ga Round Pans (540) 7ga Round Pans or Blade Bar (1000)
Blades	1/2" x 4" Uplift
Blade Overlap	3"
Blade Tip Speed	15,242 fpm (540/1000 rpm)
Wheels	See Wheel Selection
Minimum Tractor PTO HP	75 (Pull), 90 (Lift)
Safety Shielding	Front Rubber Belt or Single Row Chains Rear Rubber Belt Metal Band or Single Row Chains
Highway Light Kit	Standard
10-Year Gearbox Limited Warranty 1-Year Machine Limited Warranty	

*Gearbox rating based on field performance.

NOTICE:	PTO adapter must not be used in any application.
WARNING:	A deflector kit or chain shielding must be used for all non-agricultural purposes or in areas where thrown objects could be hazardous to people, animals, or property.
HOW TO ORDER:	To receive a complete cutter, you must order a basic unit and then select one item from each of Groups 1 - 8 in the ordering section. Additional equipment may be added to your order by making your selection from the options list.

Freight NOT included in list price



[RETURN TO TABLE OF CONTENTS](#)

3514 MULTI-SPINDLE ROTARY CUTTER

BASE UNIT SELECTION

Model Number	Description	Approx. Wt.	List Price (\$US)
3514RS	3514 Base Unit, 540 PTO, Shear Bolt Cross-Shafts	2,590 lb.	\$13,993
13514RS	13514 Base Unit, 1,000 PTO, Shear Bolt Cross-Shafts	2,590 lb.	\$13,993
13514SS	13514 Base Unit, 1,000 PTO, Blade Bar for Shredder Kit, Shear Bolt Cross-Shafts	2,559 lb.	\$13,993

GROUP 2 HITCH SELECTION

50076724	Lift Bundle with 21" Laminated Tires	530 lb.	\$5,879
50035727	Pull Bundle	281 lb.	\$4,352

GROUP 3 DRIVELINE SELECTION

76729	Lift and Semi-Mount Driveline, 1-3/8-6, 540 PTO	65 lb.	\$1,188
76730	Lift and Semi-Mount Driveline, 1-3/8-21, 1000 PTO	65 lb.	\$1,172
76731	Lift and Semi-Mount Driveline, 1-3/4-20, 1000 PTO	65 lb.	\$1,188
76625	Pull, CV Driveline, 1-3/8-6, 540 PTO	70 lb.	\$1,777
76624	Pull, CV Driveline, 1-3/8-21, 1000 PTO	70 lb.	\$1,662

GROUP 4 AXLE SELECTION (Pull Models Only)

50068369	Pull, Single Wheel Axle Arms (pair)*	162 lb.	\$1,490
50068370	Pull, Dual Wheel Axle Arms (pair)**	194 lb.	\$1,856

*If #50068369 axle is selected, you must select #294 tire from Group 6 Wheel Selection.

**If #50068370 is selected, you may select either tire from Group 6 Wheel Selection.

GROUP 5 HEIGHT ADJUSTMENT SELECTION (For All Models)

1817	Manual Ratchet Bundle	15 lb.	\$249
90492	Hydraulic Cylinder Bundle	45 lb.	\$665

GROUP 6 WHEEL SELECTION (Pull Models Only)

294	21" Laminated Tire	70 lb.	each \$345
50083457	New Foam-Filled Tire, 25.5" x 8" x 14"	100 lb.	each \$661

GROUP 7 FRONT ENCLOSURE SELECTION

50076813	Front Single Row Chains	160 lb.	\$832
50076807	Front Rubber Belting	65 lb.	\$648

GROUP 8 REAR ENCLOSURE SELECTION

50076817	Rear Metal Band	55 lb.	\$307
50076819	Rear Single Row Chains	170 lb.	\$908
50076818	Rear Rubber Belting	65 lb.	\$693

OPTIONS

90604	Shredder Kit for 38" and 40" Rows		\$791
90607	Shredder Kit for 30" Rows		\$791
50050192	Lift, Single Tailwheel Bundle with 21" Tire		\$1,182
50068369	Pull, Single Wheel Axle Arms (pair)* *Must be used with #294 tire only.	162 lb.	\$1,490

NOTE: Safety shieldings are non-returnable items for all models.



[RETURN TO TABLE OF CONTENTS](#)



14215 MULTI-SPINDLE ROTARY CUTTER

MODEL	14215	MODEL	14215
Cutting Width	15'	Outboard Driveline	ASAE Category 5
Transport Width	15' 7"	Driveline Protection (Outboard)	Multi-Plate Slip-Clutch
Cutting Height	1 1/2" - 16"	Blade Holders	7ga Round Pans
Cutting Capacity	3 1/2" Diameter	Blades	1/4" x 4" Uplift
Minimum Tractor PTO HP	125	Blade Overlap	3"
Tractor PTO Speed	1,000 RPM	Blade Tip Speed	17,280 fpm (Center); 15,708 fpm (Outboard)
Hitch	Cat. 2 or 3 Std & QH	Axle Suspension	Spring-Loaded
Deck Thickness	7 Gauge	Wheels	21" Laminated
Side Bands	1/4" x 10"	Approximate Weight	3,700 lb.
Gearbox Rating (HP)	210* (Transfer) 210* (Cutting)	Safety Shielding	Front Rubber Belt; Rear Metal Band
Main Driveline	ASAE Category 5	Highway Light Kit	Standard

10-Year Gearbox Limited Warranty | 1-Year Machine Limited Warranty | 10-Year Deck Rust-Thru Limited Warranty on Galvanized Decks

*Gearbox rating based on field performance.

NOTICE:	PTO adapter must not be used in any application.
WARNING:	A deflector kit or chain shielding must be used for all non-agricultural purposes or in areas where thrown objects could be hazardous to people, animals, or property.
HOW TO ORDER:	To receive a complete cutter, you must order a Basic Unit and a Group 2 Height Adjustment Selection. The 14215R-2 comes equipped with Lift-Type Hitch, Round Blade Pans, ASAE Cat 5 Drivelines with Slip-Clutches, Front Belting and Rear Metal Band.

Freight NOT included in list price

14215 MULTI-SPINDLE ROTARY CUTTER

BASE UNIT SELECTION

Model Number	Description	Approx. Wt.	List Price (\$US)
14215R-2	14215 Base Unit, 1,000 PTO, Slip-Clutch Cross-Shafts	3,700 lb.	\$32,690

GROUP 2 HEIGHT ADJUSTMENT SELECTION

1817	Manual Ratchet Bundle	15 lb.	\$249
90492	Hydraulic Cylinder Bundle	45 lb.	\$665

SERIES: 1800 | 2100 | 2200 | 2800 | 4100 | 4800



FLEX-WING

ROTARY CUTTERS



FLEX-WING ROTARY CUTTERS

[RETURN TO TABLE OF CONTENTS](#)



1812 FLEX-WING ROTARY CUTTER

MODEL	1812	MODEL	1812
Transport Height*	5' 8"	Blade Holders	7ga Oval Pans
Transport Width**	6' 8"	Blades	1/2" x 3" Parallel Uplift
Overall Width	12' 8"	Blade Overlap	6"
Cutting Width	12'	Blade Tip Speed	14,464 fpm Center (540 rpm); 13,930 fpm Wings (540 rpm)
Length***	13' 3"	Wing Cutting Angles	22° Down to 45° Up
Axle Suspension	Cushioned Rubber Bumper on Each Center Axle Arm	Center Hydraulic Lift	Standard
Cutting Height	1 1/2" - 14"	Wing Hydraulic Lift	Standard
Cutting Capacity	1 1/2" Diameter	Axle Tube Pivots	Greaseable Bushings
Hitch	Cast Swivel Clevis	Wing Adjustment	Greaseable Turnbuckles
Approx. Tongue Weight	1,100 lb.	Wheels	See Wheel Selection
Deck Thickness	10 Gauge	Minimum Tractor PTO HP	50
Side Bands	1/4" x 11 1/2"	Jack Stand	Standard
Gearbox Rating (HP)	160† (Transfer) 65† (Cutting)	Safety Tow Chain	Standard
Driveline	ASAE Category 4 (540 PTO)	Safety Shielding	Single or Double Row Chains
Driveline Protection	(3) Multi-Plate Slip Clutch		

10-Year Gearbox Limited Warranty | 1-Year Machine Limited Warranty

NOT FOR COMMERCIAL APPLICATION

*Measured at maximum transport height.

**Measured at outside of wing skids, folded.

***Measured from hitch pin to axle spindle at transport height.

†Gearbox rating based on field performance.

WARNING:

A deflector kit or chain shielding must be used for all non-agricultural purposes or in areas where thrown objects could be hazardous to people, animals, or property.

HOW TO ORDER:

To receive a complete cutter, you must order a basic unit and then select one item from each of Groups 2 - 5 in the ordering section. Additional equipment may be added to your order by making your selection from the options list.

Freight NOT included in list price



[RETURN TO TABLE OF CONTENTS](#)

1812 FLEX-WING ROTARY CUTTER

BASE UNIT SELECTION

Model Number	Description	Approx. Wt.	List Price (\$US)
1812R1	1812 12' Flex-Wing, Oval Blade Holder, 540 PTO, No Deck Rings	2,555 lb.	\$19,483

Model Includes Center and Wing Hydraulic Cylinders and Hoses, Cast Swivel Hitch, Tow Chain, Wing Drivelines, and CV, ASAE Category 4 Driveline.
Assembly Included in List Price.

GROUP 2 CENTER AXLE SELECTION

Model Number	Description	Approx. Wt.	List Price (\$US)
50074514	Dual Axle Arms (4 Tires)	125 lb.	\$1,034
50074515	Single Axle Arms (2 Tires)	90 lb.	\$762

GROUP 3 WING AXLE SELECTION

Model Number	Description	Approx. Wt.	List Price (\$US)
50072771	Dual Axle Arms (4 Tires)	80 lb.	\$555
50072772	Single Axle Arms (2 Tires)	40 lb.	\$263

GROUP 4 WHEEL SELECTION

Model Number	Description	Approx. Wt.	List Price (\$US)
294	21" Laminated Tire	70 lb.	each \$345
		4 Tires 280 lb.	\$1,380
		6 Tires 420 lb.	\$2,070
		8 Tires 560 lb.	\$2,760
50074504	Used Aircraft Tire, Pneumatic, 20.5" x 6.75" x 10"	43 lb.	each \$259
		4 Tires 172 lb.	\$1,036
		6 Tires 258 lb.	\$1,554
		8 Tires 344 lb.	\$2,072
50074505	Used Aircraft Tire, Foam-Filled, 20.5" x 6.75" x 10"	60 lb.	each \$424
		4 Tires 240 lb.	\$1,696
		6 Tires 360 lb.	\$2,544
		8 Tires 480 lb.	\$3,392

GROUP 5 ENCLOSURE SELECTION

Model Number	Description	Approx. Wt.	List Price (\$US)
50074511	Single Row Chains, Front and Rear	200 lb.	\$917
50074512	Double Row Chains, Front and Rear	315 lb.	\$1,372

OPTIONS

Model Number	Description	List Price (\$US)
50074762	Hydraulic Hose Kit to Raise Wings Independent of Center Section (Requires Two Sets of Tractor Outlets)	\$57
1812 Spec	Special Paint Colors	Call for Quote
50072725	Field Conversion Kit, Center Single to Dual Axle. Order (2) Kits + Tires of Choice	Order Through Service Parts
50073432	Field Conversion Kit, Wing Single Axle to Dual Axle. Order (1) Kit Per Wing + Tires of Choice.	Order Through Service Parts

NOTE: Safety shieldings are non-returnable items for all models.

[RETURN TO TABLE OF CONTENTS](#)



1815 FLEX-WING ROTARY CUTTER

MODEL	1815	MODEL	1815
Transport Height*	7'	Blades	1/2" x 4" Parallel Uplift
Transport Width**	7' 7"	Blade Overlap	6"
Cutting Width	15'	Blade Tip Speed	15,000 fpm (540 rpm); 15,600 fpm (1,000 rpm)
Length***	15' 2"	Wing Cutting Angles	22° Down to 45° Up
Axle Suspension	Cushioned Rubber on Center Axle	Center Hydraulic Lift	Standard
Cutting Height	1 1/2" - 14"	Wing Hydraulic Lift	Standard
Cutting Capacity	2 1/2" Diameter	Axle Tube Pivots	Greaseable Bushings
Hitch	See Hitch Selection	Wing Adjustment	Greaseable Turnbuckles
Approx. Tongue Weight	1,700 lb.	Wheels	See Wheel Selection
Deck Thickness	10 Gauge	Minimum Tractor PTO HP	60
Side Bands	1/4" x 12"	Grass Baffles	Optional
Gearbox Rating (HP)	160 hp† (Transfer) 130 hp† (Cutting)	Jack Stand	Standard
Drivelines	Main: See Driveline Selection Wings: ASAE Category 4	Safety Tow Chain	Standard
Driveline Protection	(3) Multi-Plate Slip Clutch	Safety Shielding	Single or Double Row Chains
Blade Holders	7ga Round Pans		

10-Year Gearbox Limited Warranty | 1-Year Machine Limited Warranty

NOT FOR COMMERCIAL APPLICATION

*Measured at maximum transport height.

**Measured at outside of wing skids, folded.

***Measured from hitch pin to axle spindle at transport height.

†Gearbox rating based on field performance.

WARNING:

A deflector kit or chain shielding must be used for all non-agricultural purposes or in areas where thrown objects could be hazardous to people, animals, or property.

HOW TO ORDER:

To receive a complete cutter, you must order a basic unit and then select one item from each of Groups 2 - 6 in the ordering section. Additional equipment may be added to your order by making your selection from the options list.

Freight NOT included in list price



[RETURN TO TABLE OF CONTENTS](#)

1815 FLEX-WING ROTARY CUTTER

BASE UNIT SELECTION			
Model Number	Description	Approx. Wt.	List Price (\$US)
1815R1	1815 15' Flex-Wing, Round Blade Holder, 540 PTO, No Deck Rings	3,420 lb.	\$21,860
1815RR1	1815 15' Flex-Wing, Round Blade Holder, 540 PTO, With Deck Rings	3,630 lb.	\$22,623
11815R1	1815 15' Flex-Wing, Round Blade Holder, 1,000 PTO, No Deck Rings	3,420 lb.	\$21,860
11815RR1	1815 15' Flex-Wing, Round Blade Holder, 1,000 PTO, With Deck Rings	3,630 lb.	\$22,623
Model Includes Center and Wing Hydraulic Cylinders and Hoses, Tow Chain, and Wing Drivelines. Assembly Included in List Price.			
GROUP 2 HITCH SELECTION			
Model Number	Description	Approx. Wt.	List Price (\$US)
50054505	Perma-Level® Hitch	55 lb.	\$556
GROUP 3 DRIVELINE SELECTION			
Model Number	Description	Approx. Wt.	List Price (\$US)
50069764	CV Driveline, 540 PTO, 1-3/8-6, ASAE Category 6	80 lb.	\$1,850
50069765	CV Driveline, 1000 PTO, 1-3/8-21, ASAE Category 5	80 lb.	\$1,799
GROUP 4 WING AXLE SELECTION			
Model Number	Description	Approx. Wt.	List Price (\$US)
50072772	Single Axle Arms (2 Tires)	40 lb.	\$263
50072771	Dual Axle Arms (4 Tires)	80 lb.	\$555
GROUP 5 FRONT WHEEL SELECTION			
Model Number	Description	Approx. Wt.	List Price (\$US)
294	21" Laminated Tire	70 lb.	each \$345
		4 Tires 280 lb.	\$1,380
		6 Tires 420 lb.	\$2,070
		8 Tires 560 lb.	\$2,760
50074504	Used Aircraft Tire, Pneumatic, 20.5" x 6.75" x 10"	43 lb.	each \$259
		4 Tires 172 lb.	\$1,036
		6 Tires 258 lb.	\$1,554
		8 Tires 344 lb.	\$2,072
50074505	Used Aircraft Tire, Foam-Filled, 20.5" x 6.75" x 10"	60 lb.	each \$424
		4 Tires 240 lb.	\$1,696
		6 Tires 360 lb.	\$2,544
		8 Tires 480 lb.	\$3,392
GROUP 6 ENCLOSURE SELECTION			
Model Number	Description	Approx. Wt.	List Price (\$US)
50072776	Single Row Chains, Front and Rear	270 lb.	\$1,745
50073433	Double Row Chains, Front and Rear	430 lb.	\$2,215
GROUP 7 HYDRAULIC HOSE SELECTION			
Model Number	Description	Approx. Wt.	List Price (\$US)
50082034	3 Hoses (1 to Adjust Cutter Height & 2 to Raise or Lower Wings Independently)	5 lb.	\$100
50082035	2 Hoses With "T" (1 to Adjust Cutter Height & 1 to Raise or Lower Wings at the Same Time)	5 lb.	\$100
OPTIONS			
Model Number	Description	Approx. Wt.	List Price (\$US)
50073353	Grass Distribution Kit	75 lb.	\$482
50077430	EZ-Mount Driveline Holder (Please Contact Service Parts to Place Order)	5 lb.	\$149
1815 Spec	Special Paint Colors		Call for Quote
50073432	Field Conversion Kit, Wing Single Axle to Dual Axle. Order (1) Kit Per Wing + Tires of Choice.		Order Through Service Parts

NOTE: Safety shieldings are non-returnable items for all models.

NEW
 for Summer
 2022

RETURN TO TABLE OF CONTENTS



2120 FLEX-WING ROTARY CUTTER

MODEL	2120	MODEL	2120
Transport Height*	9'	Wing Drivelines	ASAE Category 4
Transport Width**	10' 9"	Blades	1/2" x 4" Parallel Uplift
Cutting Width	20'	Blade Holders	7ga Round Pans
Overall Width	21'	Blade Overlap	6"
Overall Length	18' 3"	Blade Tip Speed	Approx. 16,000 FPM
Axle Suspension	Cushioned Springs at Each Axle Arm	Wing Cutting Angles	22° Down to 45° Up
Cutting Height	1 1/2" - 14"	Center Hydraulic Lift	Standard
Cutting Capacity	2" Diameter	Wing Hydraulic Lift	Standard
Hitch	Perma-Level Standard	Axle Tube Pivots	Greaseable Bushings
Approx. Weight	6,100 lb.	Axle Arm Pivots	Greaseable
Approx. Tongue Weight	2,100 lb.	Wing Adjustment	Greaseable Turnbuckles
Deck Thickness	10 Gauge	Wheels	See Wheel Selection
Minimum Tractor PTO HP	70	Grass Distribution Baffles	Standard
Side Bands	1/4" x 12"	Jack Stand	Standard
Gearbox Rating (HP)	160 hp† (Transfer) 130 hp† (Cutting)	Safety Tow Chain	Standard
Input Driveline	ASAE Cat 6 (540) or Cat 5 (1,000)	Safety Shielding	Single Row Chains Standard

10-Year Gearbox Limited Warranty | 1-Year Machine Limited Warranty

*Measured at maximum transport height.

**Measured at outside of wing skirts.

†Gearbox rating based on field performance.

WARNING:

A deflector kit or chain shielding must be used for all non-agricultural purposes or in areas where thrown objects could be hazardous to people, animals, or property.

HOW TO ORDER:

To receive a complete cutter, you must order a basic unit and then select one item from each of Groups 2 - 6 in the ordering section. Additional equipment may be added to your order by making your selection from the options list.

Freight NOT included in list price



[RETURN TO TABLE OF CONTENTS](#)

2120 FLEX-WING ROTARY CUTTER

BASE UNIT SELECTION

Model Number	Description	Approx. Wt.	List Price (\$US)
2120R1	2120 Flex-Wing Rotary Cutter -540 PTO, Pan Blade Carriers	5,000 lb.	\$26,605
12120R1	2120 Flex-Wing Rotary Cutter -1000 PTO, Pan Blade Carriers	5,000 lb.	\$26,605

GROUP 2 HITCH SELECTION

Model Number	Description	Approx. Wt.	List Price (\$US)
50072803	Ball Hitch with 2 5/16" Ball	70 lb.	\$556
50054505	Perma-Level® Hitch	55 lb.	\$556

GROUP 3 DRIVELINE SELECTION

Model Number	Description	Approx. Wt.	List Price (\$US)
50069764	CV Driveline, 540 PTO, 1-3/8-6, ASAE Category 6	80 lb.	\$1,850
50074699	CV Driveline, 1,000 PTO, 1-3/4-20, ASAE Category 6	80 lb.	\$1,850
50081633	CV Driveline, 1,000PTO, 1-3/8-21, ASAE Category 5	80 lb.	\$1,799

GROUP 4 CENTER AXLE SELECTION

Model Number	Description	Approx. Wt.	List Price (\$US)
50074158	Dual Axle Arms (4 Tires), Half Spindles	135 lb.	\$1,931
50076586	Tandem Walking Axle Arms (4 Tires)	290 lb.	\$2,885

GROUP 5 WING AXLE SELECTION

Model Number	Description	Approx. Wt.	List Price (\$US)
50074159	Single Axle Arms (2 Tires), Half Spindles	100 lb.	\$1,540
50074158	Dual Axle Arms (4 Tires), Half Spindles	135 lb.	\$1,931
50076586	Tandem Walking Axle Arms (4 Tires)	290 lb.	\$2,885

GROUP 6 WHEEL SELECTION

Model Number	Description	Approx. Wt.	List Price (\$US)
294	21" Laminated Tire	70 lb.	each \$345
		6 Tires 420 lb.	\$2,070
		8 Tires 560 lb.	\$2,760
50075401	25" Laminated Tire	85 lb.	each \$420
		6 Tires 510 lb.	\$2,520
		8 Tires 680 lb.	\$3,360
50050727	Used Aircraft Tire, Pneumatic, 29" x 9" x 15"	75 lb.	each \$390
		6 Tires 450 lb.	\$2,340
		8 Tires 600 lb.	\$3,120
50072403	Used Aircraft Tire, Pneumatic, 27.75" x 8.75" x 14.5", 24-Ply	80 lb.	each \$425
		6 Tires 480 lb.	\$2,550
		8 Tires 640 lb.	\$3,400
50083457	New Foam-Filled Tire, 25.5" x 8" x 14"	100 lb.	each \$661
		6 Tires 600 lb.	\$3,966
		8 Tires 800 lb.	\$5,288

GROUP 7 ENCLOSURE SELECTION

Model Number	Description	Approx. Wt.	List Price (\$US)
50083671	Single Row Chains, Front and Rear	240 lb.	\$2,394
50083672	Double Row Chains, Front and Rear	395 lb.	\$3,261

OPTIONS

Model Number	Description	Approx. Wt.	List Price (\$US)
50077430	EZ-Mount Driveline Holder (Please Contact Service Parts to Place Order)	5 lb.	\$149

NOTE: Safety shieldings are non-returnable items for all models.

[RETURN TO TABLE OF CONTENTS](#)



2215 FLEX-WING ROTARY CUTTER

MODEL	2215	MODEL	2215
Transport Height*	7' 3"	Blade Overlap	6"
Transport Width**	8' 2"	Blade Tip Speed	16,286 fpm (540 rpm); 16,000 fpm (1000 rpm)
Cutting Width	15'	Wing Cutting Angles	22° Down to 45° Up
Axle Suspension	Cushioned Springs at Each Wheel	Center Hydraulic Lift	Standard
Cutting Height	1 ½" - 14"	Wing Hydraulic Lift	Standard
Cutting Capacity	3 ½" Diameter	Axle Tube Pivots	Greaseable Bushings
Hitch	See Hitch Selection	Axle Arm Pivots	Greaseable
Approx. Tongue Weight	1,800 lb.	Wing Adjustment	Greaseable Turnbuckles
Deck Thickness	10 Gauge	Wheels	See Wheel Selection
Side Bands	1/4" x 13 ½"	Minimum Tractor PTO HP	60
Gearbox Rating (HP)	250 hp† (Transfer) 210 hp† (Cutting)	Grass Baffles	Optional
Drivelines	Main: See Driveline Selection Wings: ASAE Category 4	Jack Stand	Standard
Driveline Protection	(3) Multi-Plate Slip Clutch	Safety Tow Chain	Standard
Blade Holders	7ga Round Pans	Safety Shielding	Single or Double Row Chains
Blades	1/2" x 4" Parallel Uplift		

10-Year Gearbox Limited Warranty | 1-Year Machine Limited Warranty

*Measured at maximum transport height.

**Measured at outside of wing skids.

†Gearbox rating based on field performance.

WARNING:

A deflector kit or chain shielding must be used for all non-agricultural purposes or in areas where thrown objects could be hazardous to people, animals, or property.

HOW TO ORDER:

To receive a complete cutter, you must order a basic unit and then select one item from each of Groups 2 - 6 in the ordering section. Additional equipment may be added to your order by making your selection from the options list.

Freight NOT included in list price



[RETURN TO TABLE OF CONTENTS](#)

2215 FLEX-WING ROTARY CUTTER

BASE UNIT SELECTION

Model Number	Description	Approx. Wt.	List Price (\$US)
2215R1	2215 15' Flex-Wing, Round Blade Holder, 540 PTO, No Deck Rings	3,565 lb.	\$23,063
2215RR1	2215 15' Flex-Wing, Round Blade Holder, 540 PTO, With Deck Rings	3,775 lb.	\$23,823
12215R1	2215 15' Flex-Wing, Round Blade Holder, 1,000 PTO, No Deck Rings	3,565 lb.	\$23,063
12215RR1	2215 15' Flex-Wing, Round Blade Holder, 1,000 PTO, With Deck Rings	3,775 lb.	\$23,823

Model Includes Perma-Level Hitch and Tow Chain. Assembly Included in List Price.

GROUP 2 DRIVELINE SELECTION

50069764	CV Driveline, 540 PTO, 1-3/8-6, ASAE Category 6	80 lb.	\$1,850
50069765	CV Driveline, 1,000 PTO, 1-3/8-21, ASAE Category 5	80 lb.	\$1,799
50074699	CV Driveline, 1,000 PTO, 1-3/4-20, ASAE Category 6	80 lb.	\$1,850

GROUP 3 CENTER AXLE SELECTION

50070267	Dual Axle Arms (4 Tires)	125 lb.	\$1,842
50076588	Tandem Walking Axle Arms (4 Tires)	210 lb.	\$2,622

GROUP 4 WING AXLE SELECTION

50068188	Single Axle Arms (2 Tires)	100 lb.	\$1,476
50070267	Dual Axle Arms (4 Tires)	125 lb.	\$1,842
50076588	Tandem Walking Axle Arms (4 Tires)	210 lb.	\$2,622

GROUP 5 WHEEL SELECTION

294	21" Laminated Tire	70 lb.	each \$345
		6 Tires 420 lb.	\$2,070
		8 Tires 560 lb.	\$2,760
50075401	25" Laminated Tire	85 lb.	each \$420
		6 Tires 510 lb.	\$2,520
		8 Tires 680 lb.	\$3,360
50050727	Used Aircraft Tire, Pneumatic, 29" x 9" x 15"	75 lb.	each \$390
		6 Tires 450 lb.	\$2,340
		8 Tires 600 lb.	\$3,120
50072403	Used Aircraft Tire, Pneumatic, 27.75" x 8.75" x 14.5", 24-Ply	80 lb.	each \$425
		6 Tires 480 lb.	\$2,550
		8 Tires 640 lb.	\$3,400
50083457	New Foam-Filled Tire, 25.5" x 8" x 14"	100 lb.	each \$661
		6 Tires 600 lb.	\$3,966
		8 Tires 800 lb.	\$5,288

GROUP 6 ENCLOSURE SELECTION

50076835	Single Row Chains, Front and Rear	275 lb.	\$1,713
50076836	Double Row Chains, Front and Rear	440 lb.	\$2,172

GROUP 7 HYDRAULIC HOSE SELECTION

50082034	3 Hoses (1 to Adjust Cutter Height & 2 to Raise or Lower Wings Independently)	5 lb.	\$100
50082035	2 Hoses With "T" (1 to Adjust Cutter Height & 1 to Raise or Lower Wings at the Same Time)	5 lb.	\$100

OPTIONS

50076825	Grass and Crop Baffles	75 lb.	\$605
50077430	EZ-Mount Driveline Holder (Please Contact Service Parts to Place Order)	5 lb.	\$149
50073131	Field Conversion Kit, Wing Single Axle to Dual Axle. Order (1) Kit Per Wing + Tires of Choice.	Order Through Service Parts	
2215 Spec	Special Paint Colors	Call for Quote	

NOTE: Safety shieldings are non-returnable items for all models.

RETURN TO TABLE OF CONTENTS



2810 FLEX-WING ROTARY CUTTER

MODEL	2810	MODEL	2810
Transport Height*	7' 3"	Blade Holders	7ga Round Pans
Transport Width**	8' 2"	Blades	1/2" x 4" Parallel Uplift
Total Length	15' 3"	Blade Overlap	6"
Total Width	12'	Blade Tip Speed	16,286 fpm (540 rpm); 15,906 fpm (1000 rpm)
Cutting Width	10' 6"	Wing Cutting Angles	22° Down to 45° Up
Axle Suspension	Cushioned Springs at Each Wheel	Center Hydraulic Lift	Standard
Cutting Height	1 1/2" - 14"	Wing Hydraulic Lift	Standard
Cutting Capacity	4" Diameter	Axle Tube Pivots	Greaseable Bushings
Hitch	Self-Leveling Perma-Level®	Wing Adjustment	Greaseable Turnbuckles
Approx. Tongue Weight	1,900 lb.	Wheels	See Wheel Selection
Deck Thickness	11 Gauge (Center Top) 7 Gauge (Center Bottom) 7 Gauge (Wings)	Minimum Tractor PTO HP	60
Side Bands	1/4" x 13 1/2"	Grass Baffles	Optional
Gearbox Rating (HP)	250 hp† (Transfer) 225 hp† (Cutting)	Jack Stand	Standard
Drivelines	Main: See Driveline Selection Wings: ASAE Category 4	Safety Tow Chain	Standard
Driveline Protection	(2) Multi-Plate Slip Clutch	Safety Shielding	Double Row Chains
10-Year Gearbox Limited Warranty 6-Month Machine Limited Warranty (Contractors) 1-Year Machine Limited Warranty (Consumers)			

*Measured at maximum transport height.

**Measured at outside of wing skids.

†Gearbox rating based on field performance.

WARNING:

A deflector kit or chain shielding must be used for all non-agricultural purposes or in areas where thrown objects could be hazardous to people, animals, or property.

HOW TO ORDER:

To receive a complete cutter, you must order a basic unit and then select one item from each of Groups 2 - 6 in the ordering section. Additional equipment may be added to your order by making your selection from the options list.

Freight NOT included in list price



[RETURN TO TABLE OF CONTENTS](#)

2810 FLEX-WING ROTARY CUTTER

RIGHT WING ONLY BASE UNIT SELECTION

Model Number	Description	Approx. Wt.	List Price (\$US)
2810R4	2810 10' Single Flex-Wing, Round Blade Holder, 540 PTO, No Deck Rings	4,325 lb.	\$24,902
2810RR4	2810 10' Single Flex-Wing, Round Blade Holder, 540 PTO, With Deck Rings	4,535 lb.	\$25,514
12810R4	2810 10' Single Flex-Wing, Round Blade Holder, 1,000 PTO, No Deck Rings	4,325 lb.	\$24,902
12810RR4	2810 10' Single Flex-Wing, Round Blade Holder, 1,000 PTO, With Deck Rings	4,535 lb.	\$25,514

Model Includes Center and Wing Hydraulic Cylinders and Hoses, Perma-Level Hitch, Tow Chain, and Wing Drivelines.
Assembly Included in List Price.

GROUP 2 DRIVELINE SELECTION

50069764	CV Driveline, 540 PTO, 1-3/8-6, ASAE Category 6	80 lb.	\$1,850
50082326	CV Driveline, 1,000 PTO, 1-3/8-21, ASAE Category 6	80 lb.	\$1,850
50074699	CV Driveline, 1,000 PTO, 1-3/4-20, ASAE Category 6	80 lb.	\$1,850

GROUP 3 CENTER AXLE SELECTION

50074158	Dual Axle Arms (4 Tires), Half Spindles	135 lb.	\$1,931
50076586	Tandem Walking Axle Arms (4 Tires)	290 lb.	\$2,885

GROUP 4 WING AXLE SELECTION

50070526	Single Axle Arm (1 Tire)	50 lb.	\$758
50070527	Dual Axle Arm (2 Tires)	65 lb.	\$937
50076589	Tandem Walking Axle (4 Tires)	105 lb.	\$1,389

GROUP 5 FRONT WHEEL SELECTION

294	21" Laminated Tire	70 lb.	each \$345
		5 Tires 350 lb.	\$1,725
		6 Tires 420 lb.	\$2,070
50075401	25" Laminated Tire	85 lb.	each \$420
		5 Tires 425 lb.	\$2,100
		6 Tires 510 lb.	\$2,520
50050727	Used Aircraft Tire, Pneumatic, 29" x 9" x 15"	75 lb.	each \$390
		5 Tires 375 lb.	\$1,950
		6 Tires 450 lb.	\$2,340
50072403	Used Aircraft Tire, Pneumatic, 27.75" x 8.75" x 14.5", 24-Ply	80 lb.	each \$425
		5 Tires 400 lb.	\$2,125
		6 Tires 480 lb.	\$2,550
50083457	New Foam-Filled Tire, 25.5" x 8" x 14"	100 lb.	each \$661
		5 Tires 500 lb.	\$3,305
		6 Tires 600 lb.	\$3,966

GROUP 6 ENCLOSURE SELECTION

50070419	Double Row Chains, Front and Rear	310 lb.	\$1,170
----------	-----------------------------------	---------	---------

OPTIONS

50070395	Grass and Crop Distribution Baffles	60 lb.	\$524
50077430	EZ-Mount Driveline Holder (Please Contact Service Parts to Place Order)	5 lb.	\$149
50073131	Field Conversion Kit, Wing Single Axle to Dual Axle. Order (1) Kit Per Wing + Tires of Choice.	Order Through Service Parts	
2810 Spec	Special Paint Colors	Call for Quote	

NOTE: Safety shieldings are non-returnable items for all models.

[RETURN TO TABLE OF CONTENTS](#)



2814 FLEX-WING ROTARY CUTTER

MODEL	2814
Transport Height*	9'
Transport Width**	9'
Cutting Width	14'
Overall Width	14' 6"
Overall Length	17' 2"
Axle Suspension	Cushioned Springs at Each Axle Arm
Cutting Height	1 ½" - 14"
Cutting Capacity	3" Diameter
Hitch	See Hitch Selection
Approx. Tongue Weight	2,600 lb.
Deck Thickness	11 Gauge (Center Top) 10 Gauge (Center Bottom) 10 Gauge (Wings)
Side Bands	1/4" x 13 ½"
Gearbox Rating (HP)	250 hp† (Transfer) 225 hp† (Cutting)
Drivelines	Main: See Driveline Selection Wings: ASAE Category 5
Blade Holders	7ga Round Pans

MODEL	2814
Blades	1/2" x 4" Parallel Uplift
Blade Overlap	6"
Blade Tip Speed	15,625 fpm (Center); 15,936 fpm (Wing)
Wing Cutting Angles	22° Down to 45° Up
Center Hydraulic Lift	Standard
Wing Hydraulic Lift	Standard
Axle Tube Pivots	Greaseable Bushings
Axle Arm Pivots	Greaseable
Wing Adjustment	Greaseable Turnbuckles
Wheels	See Wheel Selection
Minimum Tractor PTO HP	90
Jack Stand	Standard
Safety Tow Chain	Standard
Safety Shielding	Double Row Chains

10-Year Gearbox Limited Warranty | 1-Year Machine Limited Warranty

*Measured at maximum transport height.

**Measured at outside of wing skids.

†Gearbox rating based on field performance.

WARNING:

A deflector kit or chain shielding must be used for all non-agricultural purposes or in areas where thrown objects could be hazardous to people, animals, or property.

HOW TO ORDER:

To receive a complete cutter, you must order a basic unit and then select one item from each of Groups 2 - 7 in the ordering section. Additional equipment may be added to your order by making your selection from the options list.

Freight NOT included in list price



[RETURN TO TABLE OF CONTENTS](#)

2814 FLEX-WING ROTARY CUTTER

BASE UNIT SELECTION			
Model Number	Description	Approx. Wt.	List Price (\$US)
2814RR1	2814 14' Single Flex-Wing, Pan Blade Carrier, 540 PTO, With Deck Rings and Double Row Chains	5,100 lb.	\$31,112
12814RR1	2814 14' Single Flex-Wing, Pan Blade Carrier, 1000 PTO, With Deck Rings and Double Row Chains	5,100 lb.	\$31,112
GROUP 2 HITCH SELECTION			
50072803	Ball Hitch with 2 5/8" Ball	45 lb.	\$556
50054505	Perma-Level® Hitch	55 lb.	\$556
GROUP 3 DRIVELINE SELECTION			
50069764	CV Driveline, 540 PTO, 1-3/8-6, ASAE Category 6	80 lb.	\$1,850
50082326	CV Driveline, 1,000 PTO, 1-3/8-21, ASAE Category 6	80 lb.	\$1,850
50074699	CV Driveline, 1,000 PTO, 1-3/4-20, ASAE Category 6	80 lb.	\$1,850
GROUP 4 CENTER AXLE SELECTION			
50074158	Dual Axle Arms (4 Tires), Half Spindles	135 lb.	\$1,931
GROUP 5 WING AXLE SELECTION			
50075164	Single Axle Arms (1 Tire), Half Spindles	95 lb.	\$826
50075163	Dual Axle Arms (2 Tires), Half Spindles	130 lb.	\$978
GROUP 6 WHEEL SELECTION			
294	21" Laminated Tire		70 lb. each \$345
		5 Tires	350 lb. \$1,725
		6 Tires	420 lb. \$2,070
50075401	25" Laminated Tire		85 lb. each \$420
		5 Tires	425 lb. \$2,100
		6 Tires	510 lb. \$2,520
50050727	Used Aircraft Tire, Pneumatic, 29" x 9" x 15"		75 lb. each \$390
		5 Tires	375 lb. \$1,950
		6 Tires	450 lb. \$2,340
50072403	Used Aircraft Tire, Pneumatic, 27.75" x 8.75" x 14.5", 24-Ply		80 lb. each \$425
		5 Tires	400 lb. \$2,125
		6 Tires	480 lb. \$2,550
50083457	New Foam-Filled Tire, 25.5" x 8" x 14"		100 lb. each \$661
		5 Tires	500 lb. \$3,305
		6 Tires	600 lb. \$3,966
OPTIONS			
50077430	EZ-Mount Driveline Holder (Please Contact Service Parts to Place Order)	5 lb.	\$149
50073131	Field Conversion Kit, Wing Single Axle to Dual Axle. Order (1) Kit Per Wing + Tires of Choice.	Order Through Service Parts	

[RETURN TO TABLE OF CONTENTS](#)



2815 FLEX-WING ROTARY CUTTER

MODEL	2815	MODEL	2815
Transport Height*	7' 3"	Blade Overlap	6"
Transport Width**	8' 2"	Blade Tip Speed	16,286 fpm (540 rpm); 16,391 fpm (1000 rpm)
Cutting Width	15'	Wing Cutting Angles	22° Down to 45° Up
Axle Suspension	Cushioned Springs at Each Wheel	Center Hydraulic Lift	Standard
Cutting Height	1 ½" - 14"	Wing Hydraulic Lift	Standard
Cutting Capacity	4" Diameter	Axle Tube Pivots	Greaseable Bushings
Hitch	Self-Leveling Perma-Level®	Axle Arm Pivots	Greaseable
Approx. Tongue Weight	1,900 lb.	Wing Adjustment	Greaseable Turnbuckles
Deck Thickness	11 Gauge (Center Top) 7 Gauge (Center Bottom) 7 Gauge (Wings)	Wheels	See Wheel Selection
Side Bands	1/4" x 13 ½"	Minimum Tractor PTO HP	60
Gearbox Rating (HP)	250 hp† (Transfer) 225 hp† (Cutting)	Grass Baffles	Optional
Drivelines	Main: See Driveline Selection Wings: ASAE Category 4	Jack Stand	Standard
Driveline Protection	(3) Multi-Plate Slip Clutch	Safety Tow Chain	Standard
Blade Holders	7ga Round Pans	Safety Shielding	Double Row Chains
Blades	1/2" x 4" Parallel Uplift		

10-Year Gearbox Limited Warranty | 6-Month Machine Limited Warranty (Contractors) | 1-Year Machine Limited Warranty (Consumers)

*Measured at maximum transport height.

**Measured at outside of wing skids.

†Gearbox rating based on field performance.

WARNING:

A deflector kit or chain shielding must be used for all non-agricultural purposes or in areas where thrown objects could be hazardous to people, animals, or property.

HOW TO ORDER:

To receive a complete cutter, you must order a basic unit and then select one item from each of Groups 2 - 6 in the ordering section. Additional equipment may be added to your order by making your selection from the options list.

Freight NOT included in list price



[RETURN TO TABLE OF CONTENTS](#)

2815 FLEX-WING ROTARY CUTTER

BASE UNIT SELECTION

Model Number	Description	Approx. Wt.	List Price (\$US)
2815R4	2815 15' Flex-Wing, Round Blade Holder, 540 PTO, No Deck Rings	4,325 lb.	\$28,313
2815RR4	2815 15' Flex-Wing, Round Blade Holder, 540 PTO, With Deck Rings	4,535 lb.	\$29,233
12815R4	2815 15' Flex-Wing, Round Blade Holder, 1,000 PTO, No Deck Rings	4,325 lb.	\$28,313
12815RR4	2815 15' Flex-Wing, Round Blade Holder, 1,000 PTO, With Deck Rings	4,535 lb.	\$29,233

Model Includes Center and Wing Hydraulic Cylinders and Hoses, Perma-Level Hitch, Tow Chain, and Wing Drivelines. Assembly Included in List Price.

GROUP 2 DRIVELINE SELECTION

50069764	CV Driveline, 540 PTO, 1-3/8-6, ASAE Category 6	80 lb.	\$1,850
50082326	CV Driveline, 1,000 PTO, 1-3/8-21, ASAE Category 6	80 lb.	\$1,850
50074699	CV Driveline, 1,000 PTO, 1-3/4-20, ASAE Category 6	80 lb.	\$1,850

GROUP 3 CENTER AXLE SELECTION

50074158	Dual Axle Arms (4 Tires)	135 lb.	\$1,931
50076586	Tandem Walking Axle Arms (4 Tires)	290 lb.	\$2,885

GROUP 4 WING AXLE SELECTION

50068188	Single Axle Arms (2 Tires)	100 lb.	\$1,476
50070267	Dual Axle Arms (4 Tires)	125 lb.	\$1,842
50076588	Tandem Walking Axle Arms (4 Tires)	210 lb.	\$2,622

GROUP 5 WHEEL SELECTION

294	21" Laminated Tire		70 lb.	each \$345
		6 Tires	420 lb.	\$2,070
		8 Tires	560 lb.	\$2,760
50075401	25" Laminated Tire		85 lb.	each \$420
		6 Tires	510 lb.	\$2,520
		8 Tires	680 lb.	\$3,360
50050727	Used Aircraft Tire, Pneumatic, 29" x 9" x 15"		75 lb.	each \$390
		6 Tires	450 lb.	\$2,340
		8 Tires	600 lb.	\$3,120
50072403	Used Aircraft Tire, Pneumatic, 27.75" x 8.75" x 14.5", 24-Ply		80 lb.	each \$425
		6 Tires	480 lb.	\$2,550
		8 Tires	640 lb.	\$3,400
50083457	New Foam-Filled Tire, 25.5" x 8" x 14"		100 lb.	each \$661
		6 Tires	600 lb.	\$3,966
		8 Tires	800 lb.	\$5,288

GROUP 6 ENCLOSURE SELECTION

50069458	Double Row Chains, Front and Rear	475 lb.	\$1,908
----------	-----------------------------------	---------	---------

GROUP 7 HYDRAULIC HOSE SELECTION

50082034	3 Hoses (1 to Adjust Cutter Height & 2 to Raise or Lower Wings Independently)	5 lb.	\$100
50082035	2 Hoses With "T" (1 to Adjust Cutter Height & 1 to Raise or Lower Wings at the Same Time)	5 lb.	\$100

OPTIONS

50069451	Grass and Crop Distribution Baffles	75 lb.	\$692
50077430	EZ-Mount Driveline Holder (Please Contact Service Parts to Place Order)	5 lb.	\$149
50073131	Field Conversion Kit, Wing Single Axle to Dual Axle. Order (1) Kit Per Wing + Tires of Choice.	Order Through Service Parts	
2815 Spec	Special Paint Colors	Call for Quote	

NOTE: Safety shieldings are non-returnable items for all models.

[RETURN TO TABLE OF CONTENTS](#)



2820 FLEX-WING ROTARY CUTTER

MODEL	2820	MODEL	2820
Transport Height*	9'	Blades	1/2" x 4" Parallel Uplift
Transport Width**	9'	Blade Overlap	6"
Cutting Width	20'	Blade Tip Speed	15,625 fpm (Center); 15,936 fpm (Wing)
Overall Width	21'	Wing Cutting Angles	22° Down to 45° Up
Overall Length	17' 2"	Center Hydraulic Lift	Standard
Axle Suspension	Cushioned Springs at Each Axle Arm	Wing Hydraulic Lift	Standard
Cutting Height	1 1/2" - 14"	Axle Tube Pivots	Greaseable Bushings
Cutting Capacity	3" Diameter	Axle Arm Pivots	Greaseable
Hitch	See Hitch Selection	Wing Adjustment	Greaseable Turnbuckles
Approx. Tongue Weight	2,600 lb.	Wheels	See Wheel Selection
Deck Thickness	11 Gauge (Center Top) 10 Gauge (Center Bottom) 10 Gauge (Wings)	Minimum Tractor PTO HP	90
Side Bands	1/4" x 13 1/2"	Grass Baffles	Optional
Gearbox Rating (HP)	250 hp† (Transfer) 225 hp† (Cutting)	Jack Stand	Standard
Drivelines	Main: See Driveline Selection Wings: ASAE Category 5	Safety Tow Chain	Standard
Blade Holders	7ga Round Pans or Shredder Bar	Safety Shielding	Single or Double Row Chains

10-Year Gearbox Limited Warranty | 1-Year Machine Limited Warranty

*Measured at maximum transport height.

**Measured at outside of wing skids.

†Gearbox rating based on field performance.

WARNING:

A deflector kit or chain shielding must be used for all non-agricultural purposes or in areas where thrown objects could be hazardous to people, animals, or property.

HOW TO ORDER:

To receive a complete cutter, you must order a basic unit and then select one item from each of Groups 2 - 7 in the ordering section. Additional equipment may be added to your order by making your selection from the options list.

Freight NOT included in list price



[RETURN TO TABLE OF CONTENTS](#)

2820 FLEX-WING ROTARY CUTTER

BASE UNIT SELECTION

Model Number	Description	Approx. Wt.	List Price (\$US)
2820RR1	2820 20' Flex-Wing, Pan Blade Carrier, 540 PTO, With Deck Rings	5,850 lb.	\$36,531
12820RR1	2820 20' Flex-Wing, Pan Blade Carrier, 1,000 PTO, With Deck Rings	5,850 lb.	\$36,531
12820SR1	2820 20' Flex-Wing, Bar Blade Carrier, 1,000 PTO, With Deck Rings	5,850 lb.	\$36,820

Model Includes Center and Wing Hydraulic Cylinders and Hoses, Tow Chain, and Wing Drivelines. Assembly Included in List Price.

GROUP 2 HITCH SELECTION

50072803	Ball Hitch with 2 5/16" Ball	45 lb.	\$556
50054505	Perma-Level® Hitch	55 lb.	\$556

GROUP 3 DRIVELINE SELECTION

50069764	CV Driveline, 540 PTO, 1-3/8-6, ASAE Category 6	80 lb.	\$1,850
50082326	CV Driveline, 1,000 PTO, 1-3/8-21, ASAE Category 6	80 lb.	\$1,850
50074699	CV Driveline, 1,000 PTO, 1-3/4-20, ASAE Category 6	80 lb.	\$1,850

GROUP 4 CENTER AXLE SELECTION

50074158	Dual Axle Arms (4 Tires), Half Spindles	135 lb.	\$1,931
50076586	Tandem Walking Axle Arms (4 Tires)	290 lb.	\$2,885

GROUP 5 WING AXLE SELECTION

50074159	Single Axle Arms (2 Tires), Half Spindles	100 lb.	\$1,540
50074158	Dual Axle Arms (4 Tires), Half Spindles	135 lb.	\$1,931
50076586	Tandem Walking Axle Arms (4 Tires)	290 lb.	\$2,885

GROUP 6 WHEEL SELECTION

294	21" Laminated Tire	70 lb.	each \$345
		6 Tires	420 lb. \$2,070
		8 Tires	560 lb. \$2,760
50075401	25" Laminated Tire	85 lb.	each \$420
		6 Tires	510 lb. \$2,520
		8 Tires	680 lb. \$3,360
50050727	Used Aircraft Tire, Pneumatic, 29" x 9" x 15"	75 lb.	each \$390
		6 Tires	450 lb. \$2,340
		8 Tires	600 lb. \$3,120
50072403	Used Aircraft Tire, Pneumatic, 27.75" x 8.75" x 14.5", 24-Ply	80 lb.	each \$425
		6 Tires	480 lb. \$2,550
		8 Tires	640 lb. \$3,400
50083457	New Foam-Filled Tire, 25.5" x 8" x 14"	100 lb.	each \$661
		6 Tires	600 lb. \$3,966
		8 Tires	800 lb. \$5,288

2820 Series Flex-Wing Rotary Cutter Continued on Next Page



[RETURN TO TABLE OF CONTENTS](#)

2820 FLEX-WING ROTARY CUTTER *Continued*

GROUP 7 ENCLOSURE SELECTION			
Model Number	Description	Approx. Wt.	List Price (\$US)
50074153	Single Row Chains, Front and Rear	240 lb.	\$2,394
50074152	Double Row Chains, Front and Rear	395 lb.	\$3,261
OPTIONS			
50074156	Grass Distribution Baffles	170 lb.	\$568
50077430	EZ-Mount Driveline Holder (Please Contact Service Parts to Place Order)	5 lb.	\$149
50074155	Shredder Kit for 2820 Flex-Wing Series Rotary Cutter, Model SR1 Adds second blade bar and (2) uplift blades to each cutting circle of SR1 model for finer shredding.	290 lb.	\$1,882
NOTE: SR1 base unit includes a straight blade bar with (2) uplift blades and (2) flat blades per cutting circle.			
50074199	38" Row Crop Spacing Wheel Spindle Kit for Duals Kit places both center-section inside tires 3 inches toward the center of cutter to move tire off-center of row. Location is best with #294 laminated tire. (Please Contact Service Parts to Place Order)		LIMITED AVAILABILITY Order Through Service Parts
50073131	Field Conversion Kit, Wing Single Axle to Dual Axle. Order (1) Kit Per Wing + Tires of Choice.		Order Through Service Parts
2820 Spec	Special Paint Colors		Call for Quote

NOTE: Safety shieldings are non-returnable items for all models.

[RETURN TO TABLE OF CONTENTS](#)



3810 FLEX-WING ROTARY CUTTER

MODEL	3810	MODEL	3810
Transport Height*	7' 3"	Blades	1/2" x 4" Parallel Uplift
Transport Width**	8' 2"	Blade Overlap	6"
Cutting Width	10' 6"	Blade Tip Speed	16,286 fpm (540 rpm); 16,391 fpm (1000 rpm)
Axle Suspension	Cushioned Springs at Each Wheel	Wing Cutting Angles	22° Down to 45° Up
Cutting Height	1 1/2" - 14"	Center Hydraulic Lift	Standard
Cutting Capacity	4 1/2" Diameter	Wing Hydraulic Lift	Standard
Hitch	See Hitch Selection	Axle Tube Pivots	Greaseable Bushings
Approx. Tongue Weight	2,200 lb.	Axle Arm Pivots	Greaseable
Deck Thickness	11 Gauge (Center Top) 7 Gauge (Center Bottom) 7 Gauge (Wings)	Wing Adjustment	Greaseable Turnbuckles
Side Bands	1/4" x 13 1/2"	Wheels	See Wheel Selection
Gearbox Rating (HP)	250 hp† (Transfer) 225 hp† (Cutting)	Minimum Tractor PTO HP	60
Drivelines	Main: See Driveline Selection Wings: ASAE Category 5	Grass Baffles	Optional
Driveline Protection	(2) Multi-Plate Slip Clutch	Jack Stand	Standard
Blade Holders	7ga Reinforced Round Pans	Safety Tow Chain	Standard
Blade Bolts	Hex Shaped	Safety Shielding	Double Row Chains

10-Year Gearbox Limited Warranty | 1-Year Machine Limited Warranty (Contractors) | 1-Year Machine Limited Warranty (Consumers)

*Measured at maximum transport height.

**Measured at outside of wing skids.

†Gearbox rating based on field performance.

WARNING:

A deflector kit or chain shielding must be used for all non-agricultural purposes or in areas where thrown objects could be hazardous to people, animals, or property.

HOW TO ORDER:

To receive a complete cutter, you must order a basic unit and then select one item from each of Groups 2 - 7 in the ordering section. Additional equipment may be added to your order by making your selection from the options list.

Freight NOT included in list price



RETURN TO TABLE OF CONTENTS

3810 FLEX-WING ROTARY CUTTER

BASE UNIT SELECTION

Model Number	Description	Approx. Wt.	List Price (\$US)
3810RR3	3810 10' Single Flex-Wing, Round Blade Holder, 540 PTO, With Deck Rings	4,710 lb.	\$27,772
13810RR3	3810 10' Single Flex-Wing, Round Blade Holder, 1,000 PTO, With Deck Rings Model Includes Center and Wing Hydraulic Cylinders and Hoses, Tow Chain, and Wing Drivelines. Assembly Included in List Price.	4,710 lb.	\$27,772

GROUP 2 HITCH SELECTION

50072803	Ball Hitch with 2 5/16" Ball	45 lb.	\$556
50054505	Perma-Level® Hitch	55 lb.	\$556

GROUP 3 DRIVELINE SELECTION

50069764	CV Driveline, 540 PTO, 1-3/8-6, ASAE Category 6	80 lb.	\$1,850
50082326	CV Driveline, 1,000 PTO, 1-3/8-21, ASAE Category 6	80 lb.	\$1,850
50074699	CV Driveline, 1,000 PTO, 1-3/4-20, ASAE Category 6	80 lb.	\$1,850

GROUP 4 CENTER AXLE SELECTION

50074158	Dual Axle Arms (4 Tires), Half Spindles	135 lb.	\$1,931
50076586	Tandem Walking Axle Arms (4 Tires)	290 lb.	\$2,885

GROUP 5 WING AXLE SELECTION

50075164	Single Axle Arms (1 Tire), Half Spindles	95 lb.	\$826
50075163	Dual Axle Arms (2 Tires), Half Spindles	130 lb.	\$978
50076587	Tandem Walking Axle Arms (2 Tires)	110 lb.	\$1,474

GROUP 6 WHEEL SELECTION

294	21" Laminated Tire		70 lb.	each \$345
		5 Tires	350 lb.	\$1,725
		6 Tires	420 lb.	\$2,070
50075401	25" Laminated Tire		85 lb.	each \$420
		5 Tires	425 lb.	\$2,100
		6 Tires	510 lb.	\$2,520
50050727	Used Aircraft Tire, Pneumatic, 29" x 9" x 15"		75 lb.	each \$390
		5 Tires	375 lb.	\$1,950
		6 Tires	450 lb.	\$2,340
50072403	Used Aircraft Tire, Pneumatic, 27.75" x 8.75" x 14.5", 24-Ply		80 lb.	each \$425
		5 Tires	400 lb.	\$2,125
		6 Tires	480 lb.	\$2,550
50083457	New Foam-Filled Tire, 25.5" x 8" x 14"		100 lb.	each \$661
		5 Tires	500 lb.	\$3,305
		6 Tires	600 lb.	\$3,966

GROUP 7 ENCLOSURE SELECTION

50070419	Double Row Chains, Front and Rear	310 lb.	\$1,170
----------	-----------------------------------	---------	---------

OPTIONS

50070395	Grass and Crop Distribution Baffles	60 lb.	\$524
50077430	EZ-Mount Driveline Holder (Please Contact Service Parts to Place Order)	5 lb.	\$149
50073131	Field Conversion Kit, Wing Single Axle to Dual Axle. Order (1) Kit Per Wing + Tires of Choice.	Order Through Service Parts	

NOTE: Safety shieldings are non-returnable items for all models.

[RETURN TO TABLE OF CONTENTS](#)



3815 FLEX-WING ROTARY CUTTER

MODEL	3815	MODEL	3815
Transport Height*	7' 3"	Blades	1/2" x 4" Parallel Uplift
Transport Width**	8' 2"	Blade Overlap	6"
Cutting Width	15'	Blade Tip Speed	16,286 fpm (540 rpm); 16,391 fpm (1000 rpm)
Axle Suspension	Cushioned Springs at Each Wheel	Wing Cutting Angles	22° Down to 45° Up
Cutting Height	1 1/2" - 14"	Center Hydraulic Lift	Standard
Cutting Capacity	4 1/2" Diameter	Wing Hydraulic Lift	Standard
Hitch	See Hitch Selection	Axle Tube Pivots	Greaseable Bushings
Approx. Tongue Weight	2,200 lb.	Axle Arm Pivots	Greaseable
Deck Thickness	11 Gauge (Center Top) 7 Gauge (Center Bottom) 7 Gauge (Wings)	Wing Adjustment	Greaseable Turnbuckles
Side Bands	1/4" x 13 1/2"	Wheels	See Wheel Selection
Gearbox Rating (HP)	250 hp† (Transfer) 225 hp† (Cutting)	Minimum Tractor PTO HP	60
Drivelines	Main: See Driveline Selection Wings: ASAE Category 5	Grass Baffles	Optional
Driveline Protection	(3) Multi-Plate Slip Clutch	Jack Stand	Standard
Blade Holders	7ga Reinforced Round Pans	Safety Tow Chain	Standard
Blade Bolts	Hex Shaped	Safety Shielding	Double Row Chains
10-Year Gearbox Limited Warranty 1-Year Machine Limited Warranty (Contractors) 1-Year Machine Limited Warranty (Consumers)			

*Measured at maximum transport height.

**Measured at outside of wing skids.

†Gearbox rating based on field performance.

WARNING:

A deflector kit or chain shielding must be used for all non-agricultural purposes or in areas where thrown objects could be hazardous to people, animals, or property.

HOW TO ORDER:

To receive a complete cutter, you must order a basic unit and then select one item from each of Groups 2 - 7 in the ordering section. Additional equipment may be added to your order by making your selection from the options list.

Freight NOT included in list price



[RETURN TO TABLE OF CONTENTS](#)

3815 FLEX-WING ROTARY CUTTER

BASE UNIT SELECTION			
Model Number	Description	Approx. Wt.	List Price (\$US)
3815RR3	3815 15' Flex-Wing, Round Blade Holder, 540 PTO, With Deck Rings	4,710 lb.	\$32,058
13815RR3	3815 15' Flex-Wing, Round Blade Holder, 1,000 PTO, With Deck Rings <small>Model Includes Center and Wing Hydraulic Cylinders and Hoses, Tow Chain, and Wing Drivelines. Assembly Included in List Price.</small>	4,710 lb.	\$32,058
GROUP 2 HITCH SELECTION			
50072803	Ball Hitch with 2 5/8" Ball	45 lb.	\$556
50054505	Perma-Level® Hitch	55 lb.	\$556
GROUP 3 DRIVELINE SELECTION			
50069764	CV Driveline, 540 PTO, 1-3/8-6, ASAE Category 6	80 lb.	\$1,850
50082326	CV Driveline, 1,000 PTO, 1-3/8-21, ASAE Category 6	80 lb.	\$1,850
50074699	CV Driveline, 1,000 PTO, 1-3/4-20, ASAE Category 6	80 lb.	\$1,850
GROUP 4 CENTER AXLE SELECTION			
50074158	Dual Axle Arms (4 Tires), Half Spindles	135 lb.	\$1,931
50076586	Tandem Walking Axle Arms (4 Tires)	290 lb.	\$2,885
GROUP 5 WING AXLE SELECTION			
50074159	Single Axle Arms (2 Tires), Half Spindles	100 lb.	\$1,540
50074158	Dual Axle Arms (4 Tires), Half Spindles	135 lb.	\$1,931
50076586	Tandem Walking Axle Arms (4 Tires)	290 lb.	\$2,885
GROUP 6 WHEEL SELECTION			
294	21" Laminated Tire	70 lb.	each \$345
		6 Tires 420 lb.	\$2,070
		8 Tires 560 lb.	\$2,760
50075401	25" Laminated Tire	85 lb.	each \$420
		6 Tires 510 lb.	\$2,520
		8 Tires 680 lb.	\$3,360
50050727	Used Aircraft Tire, Pneumatic, 29" x 9" x 15"	75 lb.	each \$390
		6 Tires 450 lb.	\$2,340
		8 Tires 600 lb.	\$3,120
50072403	Used Aircraft Tire, Pneumatic, 27.75" x 8.75" x 14.5", 24-Ply	80 lb.	each \$425
		6 Tires 480 lb.	\$2,550
		8 Tires 640 lb.	\$3,400
50083457	New Foam-Filled Tire, 25.5" x 8" x 14"	100 lb.	each \$661
		6 Tires 600 lb.	\$3,966
		8 Tires 800 lb.	\$5,288
GROUP 7 ENCLOSURE SELECTION			
50069458	Double Row Chains, Front and Rear	475 lb.	\$1,908
GROUP 8 HYDRAULIC HOSE SELECTION			
50082034	3 Hoses (1 to Adjust Cutter Height & 2 to Raise or Lower Wings Independently)	5 lb.	\$100
50082035	2 Hoses With "T" (1 to Adjust Cutter Height & 1 to Raise or Lower Wings at the Same Time)	5 lb.	\$100
OPTIONS			
50069451	Grass and Crop Distribution Baffles	75 lb.	\$692
50077430	EZ-Mount Driveline Holder (Please Contact Service Parts to Place Order)	5 lb.	\$149
50073131	Field Conversion Kit, Wing Single Axle to Dual Axle. Order (1) Kit Per Wing + Tires of Choice.	Order Through Service Parts	
3815 Spec	Special Paint Colors	Call for Quote	

NOTE: Safety shieldings are non-returnable items for all models.

[RETURN TO TABLE OF CONTENTS](#)

NEW
 for
 2023



4110 FLEX-WING ROTARY CUTTER

MODEL	4110	MODEL	4110
Transport Height*	7' 3"	Blade Holders	7GA Round Pans With Hardened Hex Head Blade Bolts and Bushings
Transport Width**	8' 2"	Blades	1/2" x 4" Parallel Uplift
Total Length	15' 3"	Blade Overlap	6"
Total Width	12'	Blade Tip Speed	16,286 fpm (540 rpm); 16,391 fpm (1000 rpm)
Cutting Width	10' 6"	Wing Cutting Angles	22° Down to 45° Up
Axle Suspension	Center Isolator Bank & Isolators at Each Wheel	Center Hydraulic Lift	Standard
Cutting Height	1 1/2" - 16"	Wing Hydraulic Lift	Standard
Cutting Capacity	4" Diameter	Axle Tube Pivots	Greaseable Bushings
Hitch	Self-Leveling Perma-Level® + or 2 5/16" Ball	Wing Adjustment	Greaseable Turnbuckles
Approx. Tongue Weight	1,900 lb.	Wheels	See Wheel Selection
Deck Thickness	11 Gauge (Center Top) 7 Gauge (Center Bottom) 7 Gauge (Wings)	Minimum Tractor PTO HP	60
Side Bands	1/4" x 13 1/2"	Grass Baffles	Optional
Gearbox Rating (HP)	250 hp† (Transfer) 225 hp† (Cutting)	Jack Stand	Standard
Drivelines	Main: See Driveline Selection Wings: ASAE Category 4	Safety Tow Chain	Standard
Driveline Protection	Multi-Plate Slip-Clutch	Safety Shielding	Double Row Chains

10-Year Gearbox Limited Warranty | 6-Month Machine Limited Warranty (Contractors) | 1-Year Machine Limited Warranty (Consumers)

*Measured at maximum transport height.

**Measured at outside of wing skids.

†Gearbox rating based on field performance.

WARNING: A deflector kit or chain shielding must be used for all non-agricultural purposes or in areas where thrown objects could be hazardous to people, animals, or property.

HOW TO ORDER: To receive a complete cutter, you must order a basic unit and then select one item from each of Groups 2 - 6 in the ordering section. Additional equipment may be added to your order by making your selection from the options list.

Freight NOT included in list price

[RETURN TO TABLE OF CONTENTS](#)

4110 FLEX-WING ROTARY CUTTER

RIGHT WING ONLY BASIC UNIT SELECTION

Model Number	Description	Approx. Wt.	List Price (\$US)
4110RR1	4110 Single-Wing Flex-Wing Rotary Cutter, 540 PTO, Deck Rings, Double Row Chains	5,530 lb.	\$28,374
14110RR1	4110 Single-Wing Flex-Wing Rotary Cutter, 1000 PTO, Deck Rings, Double Row Chains	5,530 lb.	\$28,374

GROUP 2 HITCH SELECTION

50083676	Perma-Level® Hitch +	60 lb.	\$556
50083959	2 3/8" Ball Hitch	30 lb.	\$556

GROUP 3 DRIVELINE SELECTION

50081632	CV Driveline, 540 PTO, 1-3/8-6, ASAE Category 6	80 lb.	\$1,850
50083778	CV Driveline, 1,000 PTO, 1-3/8-21, ASAE Category 6	80 lb.	\$1,850
50074699	CV Driveline, 1,000 PTO, 1-3/4-20, ASAE Category 6	80 lb.	\$1,850

GROUP 4 CENTER AXLE SELECTION

50083448	Dual Axle Arms (4 Tires), Half Spindles	140 lb.	\$1,931
50083449	Walking Tandem Axle Arms (4 Tires), Half Spindles	330 lb.	\$2,885

GROUP 5 WING AXLE SELECTION

50083770	Single Axle Arms (1 Tire), Half Spindles	90 lb.	\$758
50083769	Dual Axle Arms (2 Tires), Half Spindles	110 lb.	\$966
50083768	Walking Tandem Axle Arms (2 Tires), Half Spindles	165 lb.	\$1,483

GROUP 6 WHEEL SELECTION

294	21" Laminated Tire		70 lb.	each \$345
		5 Tires	350 lb.	\$1,725
		6 Tires	420 lb.	\$2,070
50075401	25" Laminated Tire		85 lb.	each \$420
		5 Tires	425 lb.	\$2,100
		6 Tires	510 lb.	\$2,520
50050727	Used Aircraft Tire, 29x9x15		75 lb.	each \$390
		5 Tires	375 lb.	\$1,950
		6 Tires	450 lb.	\$2,340
50072403	Used Aircraft Tire, 27.75 x 8.75"-24PR		80 lb.	each \$425
		5 Tires	400 lb.	\$2,125
		6 Tires	480 lb.	\$2,550
50083457	New Foam-Filled Tire, 25.5 x 8" x 14"		100 lb.	each \$661
		5 Tires	500 lb.	\$3,305
		6 Tires	600 lb.	\$3,966

OPTIONS

50083454	Grass Distribution Baffle Kit	80 lb.	\$525
----------	-------------------------------	--------	-------

NOTE: Safety shieldings are non-returnable items for all models.

[RETURN TO TABLE OF CONTENTS](#)

NEW
 for
 2023



4115 FLEX-WING ROTARY CUTTER

MODEL	4115
Transport Height*	7' 3"
Transport Width**	8' 2"
Cutting Width	15'
Axle Suspension	Center Isolator Bank & Isolators at Each Wheel
Cutting Height	1 ½" - 16"
Cutting Capacity	4" Diameter
Hitch	Self-Leveling Perma-Level®+ or 2 ½" Ball
Approx. Tongue Weight	2,000 lb.
Deck Thickness	7 Gauge
Side Bands	1/4" x 13 ½"
Gearbox Rating (HP)	250 hp† (Transfer) 225 hp† (Cutting)
Drivelines	Main: See Driveline Selection Wings: ASAE Category 4
Driveline Protection	Multi-Plate Slip-Clutch
Blade Holders	7GA Round Pans With Hardened Hex Head Blade Bolts and Bushings
Blades	1/2" x 4" Parallel Uplift

MODEL	4115
Blade Overlap	6"
Blade Tip Speed	16,286 fpm (540 rpm); 16,391 fpm (1000 rpm)
Wing Cutting Angles	22° Down to 45° Up
Center Hydraulic Lift	Standard
Wing Hydraulic Lift	Standard
Axle Tube Pivots	Greaseable Bushings
Axle Arm Pivots	Greaseable
Wing Adjustment	Greaseable Turnbuckles
Wheels	See Wheel Selection
Minimum Tractor PTO HP	60
Grass Baffles	Optional
Jack Stand	Standard
Safety Tow Chain	Standard
Safety Shielding	Single or Double Row Chains

10-Year Gearbox Limited Warranty | 6-Month Machine Limited Warranty (Contractors) | 1-Year Machine Limited Warranty (Consumers)

*Measured at maximum transport height.

**Measured at outside of wing skids.

†Gearbox rating based on field performance.

WARNING: A deflector kit or chain shielding must be used for all non-agricultural purposes or in areas where thrown objects could be hazardous to people, animals, or property.

HOW TO ORDER: To receive a complete cutter, you must order a basic unit and then select one item from each of Groups 2 - 6 in the ordering section. Additional equipment may be added to your order by making your selection from the options list.

Freight NOT included in list price



RETURN TO TABLE OF CONTENTS

4115 FLEX-WING ROTARY CUTTER

BASIC UNIT SELECTION			
Model Number	Description	Approx. Wt.	List Price (\$US)
4115R1	4115 Flex-Wing Rotary Cutter, 540 PTO, Pan Blade Carriers	4,765 lb.	\$28,233
4115RR1	4115 Flex-Wing Rotary Cutter, 540 PTO, Pan Blade Carriers, Deck Rings	5,065 lb.	\$29,233
14115R1	4115 Flex-Wing Rotary Cutter, 1000 PTO, Pan Blade Carriers	4,765 lb.	\$28,233
14115RR1	4115 Flex-Wing Rotary Cutter, 1000 PTO, Pan Blade Carriers, Deck Rings	5,065 lb.	\$29,233
GROUP 2 HITCH SELECTION			
50083676	Perma-Level® Hitch +	60 lb.	\$556
50083959	2 5/8" Ball Hitch	30 lb.	\$556
GROUP 3 DRIVELINE SELECTION			
50081632	CV Driveline, 540 PTO, 1-3/8-6, ASAE Category 6	80 lb.	\$1,850
50083778	CV Driveline, 1,000 PTO, 1-3/8-21, ASAE Category 6	80 lb.	\$1,850
50074699	CV Driveline, 1,000 PTO, 1-3/4-20, ASAE Category 6	80 lb.	\$1,850
GROUP 4 CENTER AXLE SELECTION			
50083448	Dual Axle Arms (4 Tires), Half Spindles	140 lb.	\$1,931
50083449	Walking Tandem Axle Arms (4 Tires), Half Spindles	330 lb.	\$2,885
GROUP 5 WING AXLE SELECTION			
50083447	Single Axle Arms (2 Tires), Half Spindles	100 lb.	\$1,476
50083448	Dual Axle Arms (4 Tires), Half Spindles	140 lb.	\$1,931
50083449	Walking Tandem Axle Arms (4 Tires), Half Spindles	330 lb.	\$2,885
GROUP 6 WHEEL SELECTION			
294	21" Laminated Tire	70 lb.	each \$345
		6 Tires	420 lb. \$2,070
		8 Tires	560 lb. \$2,760
50075401	25" Laminated Tire	85 lb.	each \$420
		6 Tires	510 lb. \$2,520
		8 Tires	680 lb. \$3,360
50050727	Used Aircraft Tire, 29x9x15	75 lb.	each \$390
		6 Tires	450 lb. \$2,340
		8 Tires	600 lb. \$3,120
50072403	Used Aircraft Tire, 27.75 x 8.75"-24PR	80 lb.	each \$425
		6 Tires	480 lb. \$2,550
		8 Tires	640 lb. \$3,400
50083457	New Foam-Filled Tire, 25.5 x 8" x 14"	100 lb.	each \$661
		6 Tires	600 lb. \$3,966
		8 Tires	800 lb. \$5,288
GROUP 7 ENCLOSURE SELECTION			
50083455	Single Row Chains, Front and Rear	205 lb.	\$1,431
50083456	Double Row Chains, Front and Rear	285 lb.	\$1,908
GROUP 8 HYDRAULIC HOSE SELECTION			
50083451	3 Hoses (1 to Adjust Cutter Height & 2 to Raise or Lower Wings Independently)	5 lb.	\$100
50083452	2 Hoses With "T" (1 to Adjust Cutter Height & 1 to Raise or Lower Wings at the Same Time)	5 lb.	\$100
OPTIONS			
50083453	Grass Distribution Baffle Kit	100 lb.	\$650

NOTE: Safety shieldings are non-returnable items for all models.

[RETURN TO TABLE OF CONTENTS](#)



4815 FLEX-WING ROTARY CUTTER

MODEL	4815	MODEL	4815
Transport Height*	7' 3"	Blades	1/2" x 4" Parallel Uplift
Transport Width**	8' 2"	Blade Overlap	6"
Cutting Width	15'	Blade Tip Speed	16,286 fpm (540 rpm); 16,391 fpm (1000 rpm)
Axle Suspension	Cushioned Springs at Each Wheel	Wing Cutting Angles	22° Down to 45° Up
Cutting Height	1 1/2" - 14"	Center Hydraulic Lift	Standard
Cutting Capacity	4 1/2" Diameter	Wing Hydraulic Lift	Standard
Hitch	See Hitch Selection	Axle Tube Pivots	Greaseable Bushings
Approx. Tongue Weight	2,200 lb.	Axle Arm Pivots	Greaseable
Deck Thickness	11 Gauge (Center Top) 7 Gauge (Center Bottom) 7 Gauge (Wings)	Wing Adjustment	Greaseable Turnbuckles
Side Bands	1/4" x 13 1/2"	Wheels	See Wheel Selection
Gearbox Rating (HP)	250 hp† (Transfer) 225 hp† (Cutting)	Minimum Tractor PTO HP	70
Drivelines	Main: See Driveline Selection Wings: ASAE Category 5	Grass Baffles	Optional
Driveline Protection	(3) Multi-Plate Slip Clutch	Jack Stand	Standard
Blade Holders	3/4" Uplift	Safety Tow Chain	Standard
Blade Bolts	Hex Shaped	Safety Shielding	Double Row Chains

10-Year Gearbox Limited Warranty | 1 1/2-Year Machine Limited Warranty (Contractors) | 1 1/2-Year Machine Limited Warranty (Consumers)

*Measured at maximum transport height.

**Measured at outside of wing skids.

†Gearbox rating based on field performance.

WARNING:

A deflector kit or chain shielding must be used for all non-agricultural purposes or in areas where thrown objects could be hazardous to people, animals, or property.

HOW TO ORDER:

To receive a complete cutter, you must order a basic unit and then select one item from each of Groups 2 - 7 in the ordering section. Additional equipment may be added to your order by making your selection from the options list.

Freight NOT included in list price

[RETURN TO TABLE OF CONTENTS](#)

4815 FLEX-WING ROTARY CUTTER

BASE UNIT SELECTION

Model Number	Description	Approx. Wt.	List Price (\$US)
4815RR1	4815 15' Flex-Wing, Extreme-Duty Blade Holder, 540 PTO, With Deck Rings	4,775 lb.	\$34,098
14815RR1	4815 15' Flex-Wing, Extreme-Duty Blade Holder, 1,000 PTO, With Deck Rings	4,775 lb.	\$34,098

Model Includes Center and Wing Hydraulic Cylinders and Hoses, Tow Chain, and Wing Drivelines.
Assembly Included in List Price.

GROUP 2 HITCH SELECTION

50072803	Ball Hitch with 2 5/16" Ball	45 lb.	\$556
50054505	Perma-Level® Hitch	55 lb.	\$556

GROUP 3 DRIVELINE SELECTION

50069764	CV Driveline, 540 PTO, 1-3/8-6, ASAE Category 6	80 lb.	\$1,850
50082326	CV Driveline, 1,000 PTO, 1-3/8-21, ASAE Category 6	80 lb.	\$1,850
50074699	CV Driveline, 1,000 PTO, 1-3/4-20, ASAE Category 6	80 lb.	\$1,850

GROUP 4 CENTER AXLE SELECTION

50074158	Dual Axle Arms (4 Tires), Half Spindles	135 lb.	\$1,931
50076586	Tandem Walking Axle Arms (4 Tires)	290 lb.	\$2,885

GROUP 5 WING AXLE SELECTION

50074159	Single Axle Arms (2 Tires), Half Spindles	100 lb.	\$1,540
50074158	Dual Axle Arms (4 Tires), Half Spindles	135 lb.	\$1,931
50076586	Tandem Walking Axle Arms (4 Tires)	290 lb.	\$2,885

GROUP 6 WHEEL SELECTION

294	21" Laminated Tire	70 lb.	each \$345
		6 Tires 420 lb.	\$2,070
		8 Tires 560 lb.	\$2,760
50075401	25" Laminated Tire	85 lb.	each \$420
		6 Tires 510 lb.	\$2,520
		8 Tires 680 lb.	\$3,360
50050727	Used Aircraft Tire, Pneumatic, 29" x 9" x 15"	75 lb.	each \$390
		6 Tires 450 lb.	\$2,340
		8 Tires 600 lb.	\$3,120
50072403	Used Aircraft Tire, Pneumatic, 27.75" x 8.75" x 14.5", 24-Ply	80 lb.	each \$425
		6 Tires 480 lb.	\$2,550
		8 Tires 640 lb.	\$3,400
50083457	New Foam-Filled Tire, 25.5" x 8" x 14"	100 lb.	each \$661
		6 Tires 600 lb.	\$3,966
		8 Tires 800 lb.	\$5,288

GROUP 7 ENCLOSURE SELECTION

50076494	Double Row Chains, Front and Rear	480 lb.	\$2,315
----------	-----------------------------------	---------	---------

GROUP 8 HYDRAULIC HOSE SELECTION

50082034	3 Hoses (1 to Adjust Cutter Height & 2 to Raise or Lower Wings Independently)	5 lb.	\$100
50082035	2 Hoses With "T" (1 to Adjust Cutter Height & 1 to Raise or Lower Wings at the Same Time)	5 lb.	\$100

OPTIONS

50069451	Grass and Crop Distribution Baffles	75 lb.	\$692
50077430	EZ-Mount Driveline Holder (Please Contact Service Parts to Place Order)	5 lb.	\$149
50073131	Field Conversion Kit, Wing Single Axle to Dual Axle. Order (1) Kit Per Wing + Tires of Choice.	Order Through Service Parts	
4815 Spec	Special Paint Colors	Call for Quote	

NOTE: Safety shieldings are non-returnable items for all models.

SERIES: **BRC**



CROP FLAIL SHREDDERS

CROP FLAIL SHREDDERS



[RETURN TO TABLE OF CONTENTS](#)

BRC115/BRC118 ROW CROP FLAIL SHREDDERS

MODEL	BRC115	BRC118
Cutting Width	180"	216"
Overall Width	204"	240"
Cutting Height	1" - 18"	
Hitch	Cat 2 & 3 Quick Hitch Lift, Semi-Mount or Pull Type*	
Cutter Shaft	10 3/4" Diameter	
Minimum Tractor PTO HP	120 (Lift), 100 (Semi-Mount), 100 (Pull)	130 (Lift), 110 (Semi-Mount), 110 (Pull)
Blades	Hard-Surfaced with Tungsten Carbide	
Tires	(4) 6.70x15	
Wheel Hubs	5-Bolt	
Gearbox Rating (1,000 rpm)	207 hp	
Knife Tip Speed	12,620 fpm	
Number of Blades	168	200
Driveline Size	Category 5 or 6	
Driveline Protection	5 x 5 V, Banded Belt	
Rotor Bearing Protection	Anti-Wrap Seal Protector	
Cutter Shaft Bearings	2 3/16" Triple Sealed	
Hood Thickness	3/16" With 3/16" Wear Liner	
End Plate Thickness	1/4"	
Safety Deflector - Lights	Standard	
Five-Year Limited Gearbox Warranty		

*Tractor Quick Hitch must be used for Lift-Type and Semi-Mount units.

HOW TO ORDER:

To receive a complete machine, select the desired basic unit and order one item each from Groups 1 - 4. Red is the standard paint color for all units. If desired, special paint may be selected from Group 5.

Freight NOT included in list price



[RETURN TO TABLE OF CONTENTS](#)

BRC115/BRC118 ROW CROP FLAIL SHREDDERS

BASE UNIT SELECTION

Model Number	Description	Approx. Wt.	List Price (\$US)
BRC115	BRC Series Row Crop Flail Shredder, 15' Base Unit	4,425 lb.	\$42,926
BRC118	BRC Series Row Crop Flail Shredder, 18' Base Unit	4,785 lb.	\$46,721

GROUP 2 HITCH SELECTION

Model Number	Description	Approx. Wt.	List Price (\$US)
00727125	Lift-Type Hitch Bundle w/4 Fixed Axles*		\$7,225
00727126	Pull-Type Hitch Bundle w/4 Fixed Axles	210 lb.	\$10,464
00727127	Semi-Mount or Lift Type Hitch w/4 Swivel Axles*		\$11,490

*Lift-Type and Semi-Mount units must be used on tractors equipped with Quick Hitches

GROUP 3 DRIVELINE SELECTION

Model Number	Description	Approx. Wt.	List Price (\$US)
00726673A	Driveline, Lift or Semi-Mount, Category 6 with 1 3/8" PTO Yoke	175 lb.	\$1,576
00726672A	Driveline, Lift or Semi-Mount, Category 6 with 1 1/4" PTO Yoke	185 lb.	\$1,902
00786844	Driveline, Pull Type, Category 5 CV with 1 3/8" PTO Yoke	210 lb.	\$2,020
00786845	Driveline, Pull Type, Category 5 CV with 1 3/4" PTO Yoke	240 lb.	\$2,020

GROUP 4 LIFT SELECTION

Model Number	Description	Approx. Wt.	List Price (\$US)
00554600P	Ratchet Jack Manual Lift Kit	12 lb.	\$302
00725933	Hydraulic Cylinder Lift Kit	<i>Included in Base</i>	\$686

GROUP 5 SPECIAL PAINT COLOR SELECTION

Model Number	Description	List Price (\$US)
00787653	Custom Paint, John Deere Green	\$400
00787654	Custom Paint, Kubota Orange	\$400
00787655	Custom Paint, Case/IH Red	\$400
00787656	Custom Paint, Massey Ferguson Red	\$400
00787657	Custom Paint, New Holland Blue	\$400

CONTAINER FEES - International Shipments

Model Number	Description	List Price (\$US)
00888891	Container Processing Fee <i>(Each Unit is Processed to Accommodate Loading)</i>	net \$550
00888892	Special Paint Colors	net \$400

[RETURN TO TABLE OF CONTENTS](#)

BRC120 ROW CROP FLAIL SHREDDER

MODEL	BRC120
Cutting Width	240"
Overall Width	264"
Cutting Height	1" - 18"
Hitch	Cat 2 & 3 Quick Hitch Lift, Semi-Mount or Pull Type*
Cutter Shaft	10 3/4" Diameter
Minimum Tractor PTO HP	130 (Lift), 120 (Semi-Mount), 120 (Pull)
Blades	Hard-Surfaced with Tungsten Carbide
Tires	(4) 9.5L - 15"
Wheel Hubs	6-Bolt
Gearbox Rating (1,000 rpm)	207 hp
Knife Tip Speed	12,620 fpm, Reverse Rotation
Number of Blades	216
Driveline Size	Category 5 or 6
Driveline Protection	5 x 5 V, Banded Belt
Rotor Bearing Protection	Anti-Wrap Seal Protector
Cutter Shaft Bearings	2 5/16" Triple Sealed
Hood Thickness	3/16" With 3/16" Wear Liner
End Plate Thickness	1/4"
Safety Deflector - Lights	Standard
Five-Year Limited Gearbox Warranty	

*Tractor Quick Hitch must be used for Lift-Type and Semi-Mount units.

HOW TO ORDER:

To receive a complete machine, select the desired basic unit and order one item each from Groups 1 - 4. Red is the standard paint color for all units. If desired, special paint may be selected from Group 5. Extra equipment (dealer installed) may be selected from the Options listed in the ordering section.

Freight NOT included in list price



[RETURN TO TABLE OF CONTENTS](#)

BRC120 ROW CROP FLAIL SHREDDER

BASE UNIT SELECTION			
Model Number	Description	Approx. Wt.	List Price (\$US)
BRC120	BRC 120 Series Row Crop Flail Shredder, 20' Base Unit	4,950 lb.	\$52,595

GROUP 2 HITCH SELECTION			
Model Number	Description	Approx. Wt.	List Price (\$US)
00727128	Lift-Type Hitch Bundle w/4 Fixed Axles*	Included in Base	\$7,353
00727129	Lift-Type Hitch w/End Tow & w/4 Fixed Axles*	660 lb.	\$13,350
00727130	Pull-Type Hitch w/4 Fixed Axles	210 lb.	\$6,869
00727131	Pull-Type Hitch w/End Tow & w/4 Fixed Axles	870 lb.	\$11,522
00727132	Semi-Mount or Lift Type Hitch w/4 Swivel Axles*	100 lb.	\$11,499
00727133	Semi-Mount or Lift Type Hitch w/End Tow & w/4 Swivel Axles*	870 lb.	\$15,529

*Lift-Type and Semi-Mount units must be used on tractors equipped with Quick Hitches

GROUP 3 DRIVELINE SELECTION			
Model Number	Description	Approx. Wt.	List Price (\$US)
00726673A	Driveline, Lift or Semi-Mount, Category 6 with 1 3/8" PTO Yoke	175 lb.	\$1,576
00726672A	Driveline, Lift or Semi-Mount, Category 6 with 1 3/4" PTO Yoke	185 lb.	\$1,902
00786844	Driveline, Pull Type, Category 5 CV with 1 3/8" PTO Yoke	210 lb.	\$2,020
00786845	Driveline, Pull Type, Category 5 CV with 1 3/4" PTO Yoke	240 lb.	\$2,020

GROUP 4 LIFT SELECTION			
Model Number	Description	Approx. Wt.	List Price (\$US)
00554600P	Ratchet Jack Manual Lift Kit	12 lb.	\$302
00725933	Hydraulic Cylinder Lift Kit	Included in Base	\$686

GROUP 5 SPECIAL PAINT COLOR SELECTION		
Model Number	Description	List Price (\$US)
00787653	Custom Paint, John Deere Green	\$400
00787654	Custom Paint, Kubota Orange	\$400
00787655	Custom Paint, Case/IH Red	\$400
00787656	Custom Paint, Massey Ferguson Red	\$400
00787657	Custom Paint, New Holland Blue	\$400

OPTIONS – Dealer Installed (Must Order Separately)			
Model Number	Description	Approx. Wt.	List Price (\$US)
00727009	End Tow Kit for BRC120, Pull Type (Field Installation)	660 lb.	\$11,095
00727010	End Tow Kit for BRC120, Semi-Mount or Lift Type (Field Installation)	500 lb.	\$11,099

CONTAINER FEES – International Shipments		
Model Number	Description	List Price (\$US)
00888891	Container Processing Fee (Each Unit is Processed to Accommodate Loading)	net \$550
00888892	Container Loading Fee (Single Charge Per Container Load)	net \$400

[RETURN TO TABLE OF CONTENTS](#)



BRC125 ROW CROP FLAIL SHREDDER

MODEL	BRC125
Cutting Width	300"
Overall Width	324"
Cutting Height	1" - 18"
Hitch	Lift, Semi-Mount or Pull Type*
Cutter Shaft	10 3/4" Diameter
Minimum Tractor PTO HP	160 (Lift), 150 (Semi-Mount), 140 (Pull)
Blades	Hard-Surfaced with Tungsten Carbide
Tires	(4) 9.5L - 15"
Wheel Hubs	6-Bolt
Gearbox Rating (1,000 rpm)	207 hp
Knife Tip Speed	12,620 FPM, Reverse Rotation
Number of Blades	272
Driveline Size	Category 5 or 6
Driveline Protection	5 x 5 V, Banded Belt
Rotor Bearing Protection	Anti-Wrap Seal Protector
Cutter Shaft Bearings	2 5/16" Triple Sealed
Hood Thickness	3/16" With 3/16" Internal Wear Liner
End Plate Thickness	1/4"
Safety Deflector - Lights	Standard
Five-Year Limited Gearbox Warranty	

*Tractor Quick Hitch must be used for Lift-Type and Semi-Mount units.

HOW TO ORDER:

To receive a complete machine, select the desired basic unit and order one item each from Groups 1 - 4. Red is the standard paint color for all units. If desired, special paint may be selected from Group 5. Extra equipment (dealer installed) may be selected from the Options listed in the ordering section.

Freight NOT included in list price



[RETURN TO TABLE OF CONTENTS](#)

BRC125 ROW CROP FLAIL SHREDDER

BASE UNIT SELECTION			
Model Number	Description	Approx. Wt.	List Price (\$US)
BRC125	BRC 125 Series Row Crop Flail Shredder, 25' Base Unit	6,300 lb.	\$66,421

GROUP 2 HITCH SELECTION			
Model Number	Description	Approx. Wt.	List Price (\$US)
00727128	Lift-Type Hitch Bundle w/4 Fixed Axles*	<i>Included in Base</i>	\$7,353
00727134	Lift-Type Hitch w/End Tow & w/4 Fixed Axles*	450 lb.	\$13,373
00727130	Pull-Type Hitch w/4 Fixed Axles	210 lb.	\$6,869
00727135	Pull-Type Hitch w/End Tow & w/4 Fixed Axles	780 lb.	\$11,531
00727132	Semi-Mount or Lift Type Hitch w/4 Swivel Axles*	100 lb.	\$11,499
00727136	Semi-Mount or Lift Type Hitch w/End Tow & w/4 Swivel Axles*	450 lb.	\$15,539

*Lift-Type and Semi-Mount units must be used on tractors equipped with Quick Hitches

GROUP 3 DRIVELINE SELECTION			
Model Number	Description	Approx. Wt.	List Price (\$US)
00726673A	Driveline, Lift or Semi-Mount, Category 6 with 1 3/8" PTO Yoke	175 lb.	\$1,576
00726672A	Driveline, Lift or Semi-Mount, Category 6 with 1 3/4" PTO Yoke	185 lb.	\$1,902
00786844	Driveline, Pull Type, Category 5 CV with 1 3/8" PTO Yoke	210 lb.	\$2,020
00786845	Driveline, Pull Type, Category 5 CV with 1 3/4" PTO Yoke	240 lb.	\$2,020

GROUP 4 LIFT SELECTION			
Model Number	Description	Approx. Wt.	List Price (\$US)
00725933	Hydraulic Cylinder Lift Kit	<i>Included in Base</i>	\$686

GROUP 5 SPECIAL PAINT COLOR SELECTION			
Model Number	Description		List Price (\$US)
00787653	Custom Paint, John Deere Green		\$400
00787654	Custom Paint, Kubota Orange		\$400
00787655	Custom Paint, Case/IH Red		\$400
00787656	Custom Paint, Massey Ferguson Red		\$400
00787657	Custom Paint, New Holland Blue		\$400

OPTIONS – Dealer Installed (Must Order Separately)			
Model Number	Description	Approx. Wt.	List Price (\$US)
00727042	Pair of Axle Arms, Pull & Lift Type with Tires & Wheels <i>(May Not Fit All Row Spacings, Not Recommended with End Tow Kit)</i>	199 lb.	\$3,105
00727141	Pair of Axle Arms, Semi-Mount Type with Tires & Wheels <i>(May Not Fit All Row Spacings, Not Recommended with End Tow Kit)</i>	229 lb.	\$4,364
00726952	End Tow Kit, Pull Type <i>(For Field Installation, Order Separately from Machine)</i>	580 lb.	\$10,988
00726953	End Tow Kit, Semi-Mount or Lift Type <i>(For Field Installation, Order Separately from Machine)</i>	420 lb.	\$10,988

CONTAINER FEES – International Shipments			
Model Number	Description		List Price (\$US)
00888891	Container Processing Fee (Each Unit is Processed to Accommodate Loading)		net \$550
00888892	Container Loading Fee (Single Charge Per Container Load)		net \$400

SERIES: PT5 | RMB



REAR-MOUNTED BOOM MOWERS



BOOM MOWERS



[RETURN TO TABLE OF CONTENTS](#)



REAR-MOUNTED BOOM MOWER SERIES

MODEL	RMB1445-1	RMB1660-1	RMB1865-1	PT5-2 POWERTRIM
Minimum Tractor PTO HP/Weight	See Head Selection Chart Next Page -Varies Based on Head Choice			
Tractor PTO	540 RPM			N/A
Machine Weight with Flail*	1,220 lb.	2,403 lb.	2,470 lb.	415 lb.
Hydraulic System	Totally Independent (Self-Contained Hyd. System, Pump Powered by Tractor PTO)			Open Center Hyd. System (Closed Center Kit Avail.), Tractor Remote Outlet, 3.7-5.6 GPM, Flow Control Valve Kit Std
Hydraulic Remotes Required	None Required			One Set
Hydraulic Oil Required	21.75 gal.	47.5 gal.		N/A
Attachment Method	Cat 1/2, 3-Point Mount			
Controls	Cable-Controlled Quick Detach (QD) Standard		Cable-Controlled Quick Detach (QD)/ Electronic Controls (XTC) Standard	Cable-Controlled Hydraulic Remotes Standard
Maximum Reach, Horizontal (A)	14' 1"	16' 5"	18' 1"	11' 5"
Maximum Height, Horizontal (B)	13' 2"	14' 6"	16' 1"	7' 2"
Maximum Height, Horizontal (C)	13' 5"	15' 9"	17' 5"	5' 7"
Maximum Height, Vertical (D)	13' 9"	20' 8"	22' 4"	10' 2"
Maximum Depth (E), 45°	5' 4"	7' 3"	8' 2"	4' 6"
Lightbar Kit	Standard			

*Machine Weight with Flail of RMB1445-1, RMB1660-1 and RMB1865-1 includes the weight of the Oil.

NOTICE: RMB Series mowers are to be used only on tractors equipped with cabs. For rotary mower heads, protective screen material must be installed.

HOW TO ORDER: To receive a complete cutter, for RMB models you must include a basic unit and the appropriate head option(s) from Group 2, 3 or 4 in the ordering section. For the PT5 model, make your base unit selection, which comes standard with a sickle bar head. No head selection is necessary. Additional equipment may be added to your order by making your selection from the Options list.

Freight NOT included in list price

[RETURN TO TABLE OF CONTENTS](#)

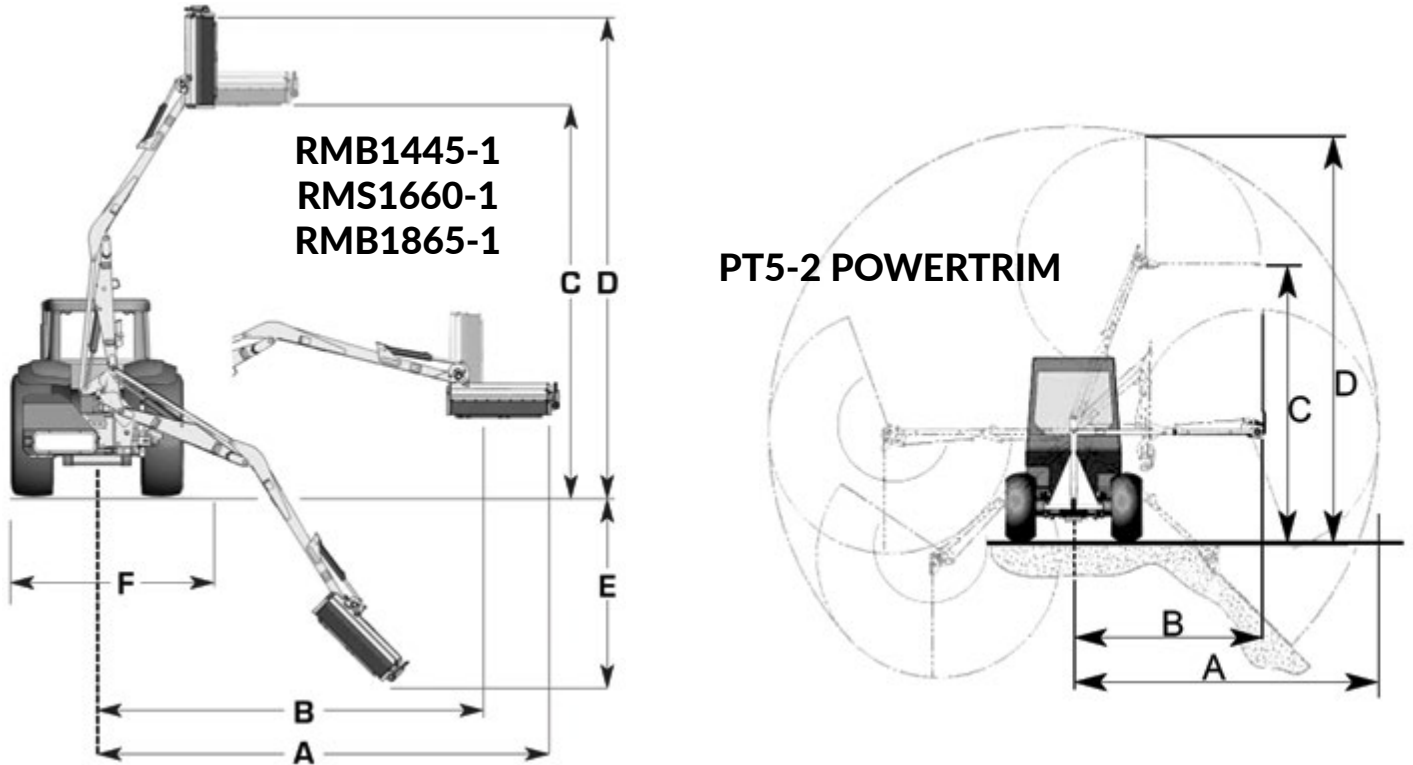

HEAD SELECTION CHART

FLAIL HEAD	RMB1445-1	RMB1660-1	RMB1865-1	PT5-2 POWERTRIM
Minimum Tractor PTO HP/Weight	45 HP / 4,410 lb.	60 HP / 6,614 lb.	85 HP / 9,920 lb.	<i>Not Available For Use On This Model</i>
Rotor/Knife	Super Cut/Universal	Super Cut/F91 Competition or Multi-Cut Competition		N/A
Typical Application	Grass, Light Brush	Hedge Cutting, Grass		N/A
Cutting Capacity	1" Diameter	1 ½" Diameter	2" Diameter	N/A
Cutting Width	39"	47"		N/A
ROTARY HEAD	RMB1445-1	RMB1660-1	RMB1865-1	PT5-2 POWERTRIM
Minimum Tractor PTO HP/Weight	<i>Not Available For Use On This Model</i>	85 HP / 7,614 lb.	85 HP / 9,920 lb.	<i>Not Available For Use On This Model</i>
Typical Application	N/A	Grass/Brush		N/A
Cutting Capacity	N/A	4" Diameter		N/A
Cutting Width	N/A	60"		N/A
CUTTER BAR	RMB1445 (Only)	RMB1660	RMB1865-1/1865E-1	PT5-2 POWERTRIM <i>(Sickle Bar Standard)</i>
Minimum Tractor PTO HP/Weight	45 HP / 4,410 lb.	60 HP / 6,614 lb.	85 HP / 9,920 lb.	15 HP / 1,212 lb.
Cutter Type	Sickle Bar			
Cutting Capacity	1 ¼" Diameter			¾" Diameter
Cutting Width	59"			

NOTE: ALL UNITS ARE SHIPPED WITH NO OIL INSTALLED.
Prices F.O.B. Selma, Alabama and Subject to Change Without Notice



RETURN TO TABLE OF CONTENTS

REAR-MOUNTED BOOM MOWER SERIES

BASE UNIT SELECTION

Model Number	Description	Approx. Wt. <i>Includes Flail Head</i>	List Price (\$US)
RMB1445-1	RMB 1445 Rear-Mounted Boom with Quick Detach Cable Controls and Light Kit	1,220 lb.	\$26,350
RMB1660-1	RMB 1660 Rear-Mounted Boom with Quick Detach Cable Controls and Light Kit	2,403 lb.	\$31,750
RMB1865-1	RMB 1865 Rear-Mounted Boom with Quick Detach Cable Controls and Light Kit	2,470 lb.	\$35,250
RMB1865E-1	RMB 1865E (Electronic Controls) Rear-Mounted Boom with Quick Detach Cable Controls and Light Kit	2,470 lb.	\$40,150
PT5-2	Powertrim Rear-Mounted Boom Series with Flow Control Valve Kit, Sickle Bar Head and One Set of Hydraulic Remotes	415 lb.	\$21,800

GROUP 2 ROTARY HEAD SELECTION

Model Number	Description	Approx. Wt.	List Price (\$US)
<u>RMB1660-1, RMB1865-1, RMB1865E-1</u>			
50071277	Rotary Head, 5/8" x 6" Blades, 60" Wide Cut, 4" Capacity <i>(Includes Buzzer Kit)</i>	915 lb.	\$17,350
<i>For rotary head, protective screen materials supplied must be installed.</i>			

GROUP 3 FLAIL HEAD SELECTION

Model Number	Description	Approx. Wt.	List Price (\$US)
<u>RMB1445-1</u>			
50071904	Supercut Compact Flailhead, Universal Knives, 39" Wide Cut, 1" Capacity	309 lb.	\$9,600
<u>RMB1660-1, RMB1865-1, RMB1865E-1</u>			
50068497	Supercut Flailhead, Competition Knives, 47" Wide Cut, 1.5" Capacity	520 lb.	\$13,000
50068498	Multicut Flailhead, Competition Knives, 47" Wide Cut, 2" Capacity	712 lb.	\$16,300

GROUP 4 CUTTER BAR SELECTION

Model Number	Description	Approx. Wt.	List Price (\$US)
<u>RMB1445-1</u>			
50068394	Sheartrim Cutter Bar, 59" Wide Cut, 1.25" Capacity	143 lb.	\$11,200
<u>RMB1660-1, RMB1865-1, RMB1865E-1</u>			
50068397	Sheartrim Cutter Bar, 59" Wide Cut, 1.25" Capacity	143 lb.	\$12,100

OPTIONS

Model Number	Description	List Price (\$US)
<u>PT5-2</u>		
8130059	Closed Center Conversion Kit	<i>Order Through Service Parts</i>
<u>RMB1445-1</u>		
50081252	Lift Float Kit	\$1,050
<u>RMB1660-1, RMB1865-1, RMB1865E-1</u>		
50068500	Lift Float Kit	\$1,325
50068502	Skid Kit <i>(Supercut Flailhead)</i>	\$1,025
50068503	Skid Kit <i>(Multicut Flailhead)</i>	\$760
21604.02	Side Wheel Kit <i>(For use with Rotary Head Only)</i>	\$563
8402928	Buzzer Kit <i>(For use with Rotary Head only; Serial Number M175799 and lower)</i>	<i>Order Through Service Parts</i>

[RETURN TO TABLE OF CONTENTS](#)



FORWARD REACH REAR-MOUNTED BOOM MOWER

MODEL	RMB1880F	RMB2080F
Minimum Tractor PTO HP	80 HP	
Tractor Minimum Weight (lb.)	9,920 lb.	11,500 lb.
Tractor PTO	540	
Machine Weight (lb.)*	2,469 lb.	2,540 lb.
Hydraulic System	Totally Independent (Self-Contained Hyd. System, Pump Powered by Tractor PTO)	
Hydraulic Remotes Required	One Set If Using Rotary Cutter Head Only (To Power Hyd. Hood)	
Hydraulic Oil Required	47.5 gal.	
Attachment Method	Cat 2 & 3, 3-Point Mount	
Controls	Evolution Controls (Joystick, Keypad combination)	
Maximum Reach, Horizontal (A)	18' 1"	19' 8"
Maximum Height, Horizontal (B)	16' 1"	17' 9"
Maximum Height, Horizontal (C)	17' 5"	18' 8"
Maximum Height, Vertical (D)	22' 0"	23' 4"
Maximum Depth (E), 45°	7' 10"	9' 2"
Lightbar Kit	Standard	

*Excluding attachment and oil

NOTICE: RMB Series mowers are to be used only on tractors equipped with cabs. For rotary mower heads, protective screen material must be installed.

HOW TO ORDER: To receive a complete cutter, for RMB models you must include a basic unit above and the appropriate head option in the ordering section.

Freight NOT included in list price

NOTE: ALL UNITS ARE SHIPPED WITH NO OIL INSTALLED.
Prices F.O.B. Selma, Alabama and Subject to Change Without Notice

RETURN TO TABLE OF CONTENTS 

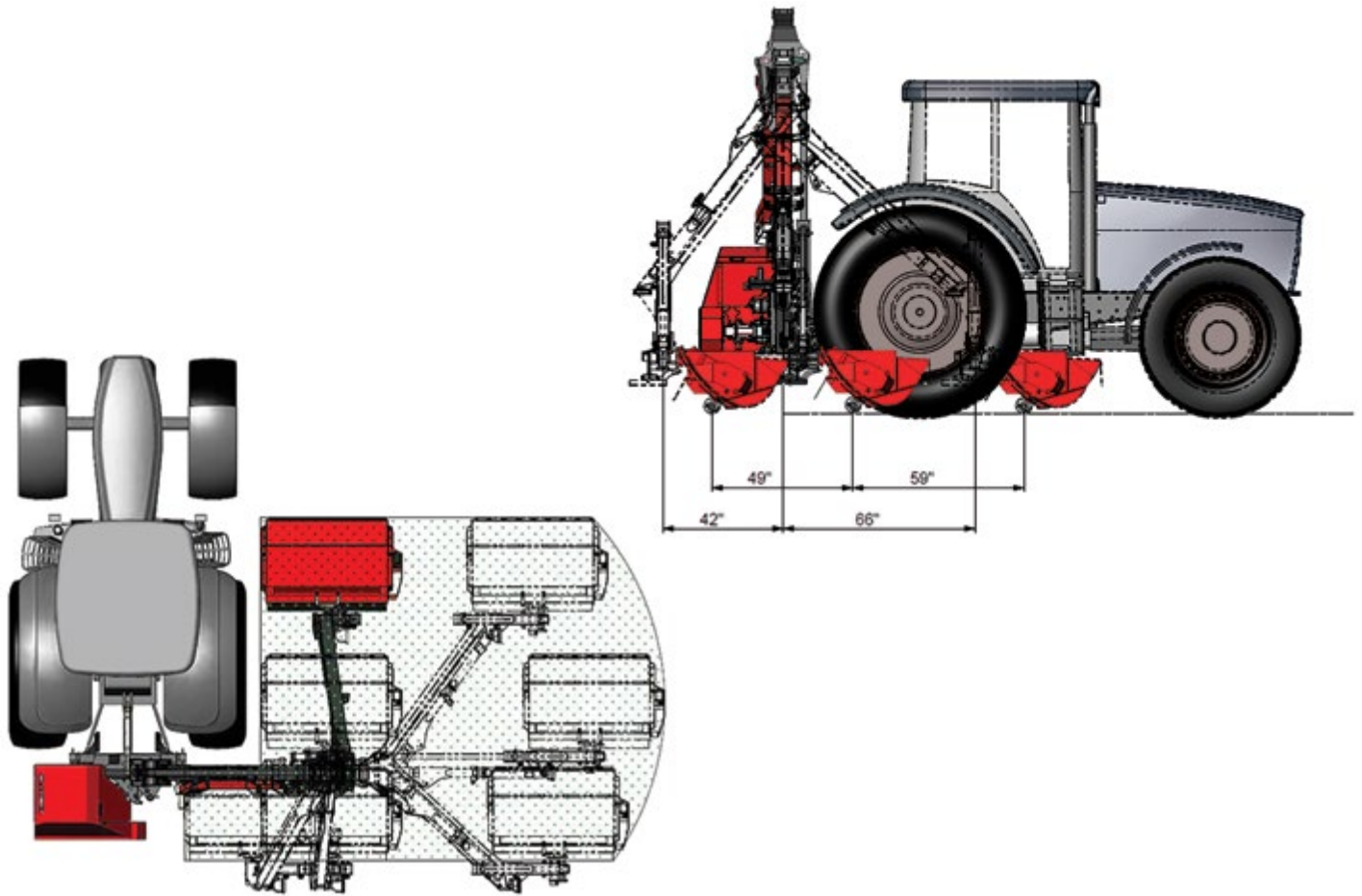

HEAD SELECTION CHART

FLAIL HEAD	50081485	50081486	50081487
Min. Tractor PTO HP/Weight - RMB1880F	80 HP / 9,920 lb.		
Min. Tractor PTO HP/Weight - RMB2080F	80 HP / 11,500 lb.		
Rotor / Knife	Uni-Boot Flail	Omega Flail	Uni-Boot Flail
Typical Application	Hedge Cutting, Grass		
Cutting Capacity	1" Diameter	1 ½" Diameter	1" Diameter
Cutting Width	47"	45"	59"

ROTARY HEAD	50081488
Min. Tractor PTO HP/Weight - RMB1880F	80 HP / 9,920 lb.
Min. Tractor PTO HP/Weight - RMB2080F	80 HP / 11,500 lb.
Typical Application	Grass / Brush
Cutting Capacity	4" Diameter
Cutting Width	47"

Freight NOT included in list price

NOTE: ALL UNITS ARE SHIPPED WITH NO OIL INSTALLED.
Prices F.O.B. Selma, Alabama and Subject to Change Without Notice



[RETURN TO TABLE OF CONTENTS](#)

FORWARD REACH REAR-MOUNTED BOOM MOWER

BASE UNIT SELECTION

Model Number	Description	Approx. Wt.	List Price (\$US)
RMB1880F	RMB 1880F Rear Mounted Boom Series Mower with Two-Way Rotor Engagement - Electric Control and Light Kit	2,469 lb.	\$61,671
RMB2080F	RMB 2080F Rear Mounted Boom Series Mower with Two-Way Rotor Engagement - Electric Control and Light Kit	2,540 lb.	\$66,213

*Base Unit weight excluding Cutting Head and Oil

GROUP 2 FLAIL HEAD SELECTION

Model Number	Description	Approx. Wt.	List Price (\$US)
50081485	120 Flail Head UNI-Boot Flail	702 lb.	\$12,423
50081486	120 Head OMEGA Flail	783 lb.	\$13,645
50081487	150 Head UNI-Boot Flail	778 lb.	\$14,144

GROUP 3 ROTARY HEAD SELECTION

Model Number	Description	Approx. Wt.	List Price (\$US)
50081488	1.2 M HD Rotary Head Tri-Blade	573 lb.	\$15,880

OPTION

Model Number	Description	List Price (\$US)
22073.23	Evolution Control Remote Mounting Kit (Alt. When Armrest Mounting Not Possible)	\$348

SERIES: BCSS



SKID STEER BRUSH CUTTERS

SKID STEER BRUSH CUTTERS

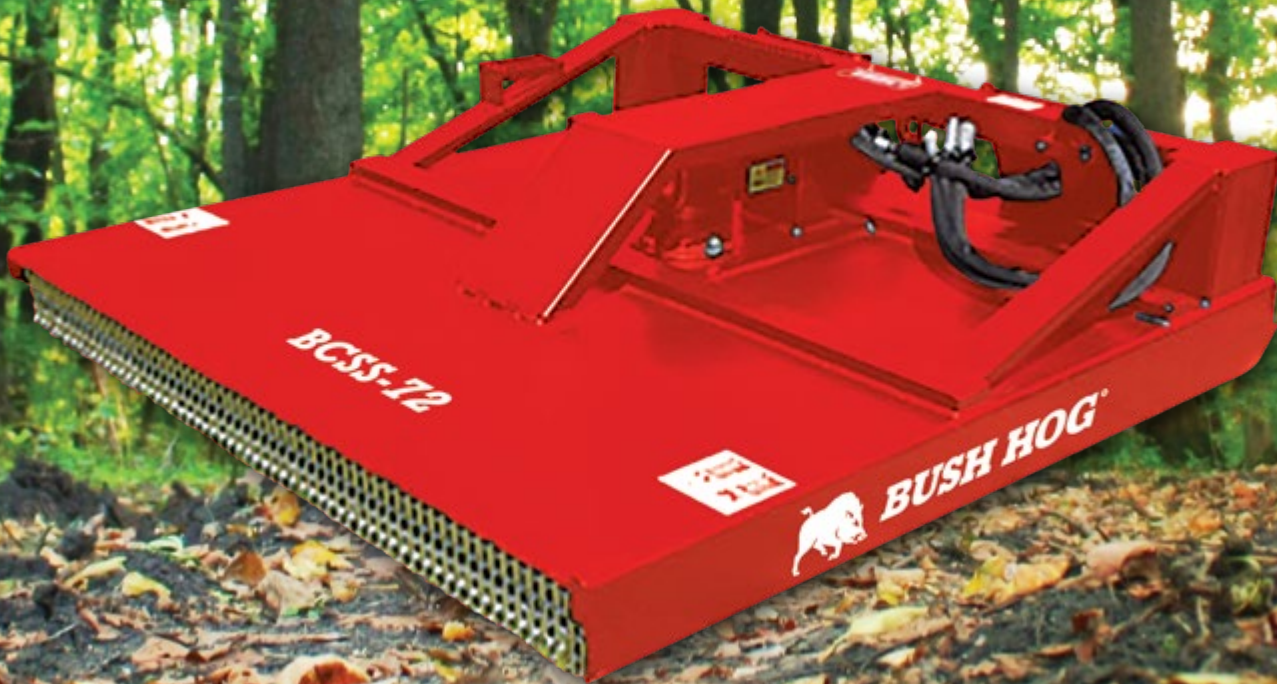

[RETURN TO TABLE OF CONTENTS](#)



BCSS-72 Single Spindle



BCSS-90, Offset Multi-Spindle

BCSS SERIES BRUSH CUTTER – CLOSED FRONT

MODEL	BCSS-60LF	BCSS-60	BCSS-72LF	BCSS-72	BCSS-72HF	BCSS-90	BCSS-90HF
Duty Type	Heavy Duty						
Cutting Width	60"		72"			90"	
Overall Width	61.750"		73.750"			93.250"	
Overall Length	72.250"		84.250"			78.375"	
Weight	950 lb.	970 lb.	1,168 lb.		1,224 lb.	1,790 lb.	1,840 lb.
GPM Flow	10 – 15 GPM	16 – 25 GPM	15 – 20 GPM	21 – 25 GPM	26 – 40 GPM	20 – 25 GPM	26 – 40 GPM
Cutting Capacity	3"	4"	3"	4"	5"	4"	5"
Operating PSI Cont./Int.	3,000 / 3,500 PSI				3,000 / 4,100 PSI	3,000 / 3,500 PSI	3,000 / 4,100 PSI
Spindle Config.	Single Spindle					Offset Multi-Spindle	
Blades	(2) .500"x 4.0" High Strength Updraft					(4) .500" x 4.0" High Strength Updraft	
Blade Rotation	Counter Clockwise						
Deck Thickness	1/4" Steel						
Motor Protection	Pressure Reliefs						
Drive Protection	GRD-2 Bolt (Shear Bolt)						
Motor/Gearbox Coupler	Machined Steel						

3-Year Structural Steel, 18-Month Hydraulic Motor, and 1-Year Gearbox and Bearing Housing Limited Warranty

HOW TO ORDER:

Choose a model from the Base Unit Selection to order a complete unit. Each unit comes standard with hoses, couplers and gearbox guard.

Freight NOT included in list price



[RETURN TO TABLE OF CONTENTS](#)

BCSS SERIES BRUSH CUTTER - CLOSED FRONT

BASE UNIT SELECTION

Model Number	Description	Approx. Wt.	List Price (\$US)
BCSS-60LF	Closed Front Brush Cutter, 60" Low Flow	950 lb.	\$10,250
BCSS-60	Closed Front Brush Cutter, 60"	970 lb.	\$10,337
BCSS-72LF	Closed Front Brush Cutter, 72" Low Flow	1,168 lb.	\$11,849
BCSS-72	Closed Front Brush Cutter, 72"	1,168 lb.	\$12,101
BCSS-72HF	Closed Front Brush Cutter, 72" High Flow	1,224 lb.	\$13,641
BCSS-90	Closed Front Brush Cutter, 90"	1,790 lb.	\$17,747
BCSS-90HF	Closed Front Brush Cutter, 90" High Flow	1,840 lb.	\$20,268

BRUSH CUTTER					HD WOODEN CRATE				TOTAL SHIPPING WEIGHT
BUSH HOG MODELS	OVERALL WIDTH	OVERALL LENGTH	HEIGHT	WEIGHT	WIDTH	LENGTH	HEIGHT	HEIGHT	
BCSS-60LF	61.75"	72.25"	21"	950 lb.	67"	78"	30"	1,188 lb.	1,188 lb.
BCSS-60	61.75"	72.25"	21"	970 lb.	67"	78"	30"	1,188 lb.	1,188 lb.
BCSS-72LF	73.75"	84.25"	21"	1,168 lb.	79.5"	91"	30"	1,435 lb.	1,435 lb.
BCSS-72	73.75"	84.25"	21"	1,168 lb.	79.5"	91"	30"	1,435 lb.	1,435 lb.
BCSS-72HF	73.75"	84.25"	22"	1,224 lb.	79.5"	91"	30"	1,485 lb.	1,485 lb.
BCSS-90	78.38"	93.25"	22"	1,790 lb.	85"	98.5"	30"	2,105 lb.	2,105 lb.
BCSS-90HF	78.38"	93.25"	22"	1,840 lb.	85"	98.5"	30"	2,155 lb.	2,155 lb.

Shipped Fully Assembled; HD Wooden Crate - Heat Treated, Stamped

[RETURN TO TABLE OF CONTENTS](#)



BCSS-S721 Standard Single Spindle



BCSS-721 HD Single Spindle

BCSS SERIES BRUSH CUTTER - OPEN FRONT

MODEL	BCSS-S601LF	BCSS-S601	BCSS-S721LF	BCSS-S721	BCSS-721LF	BCSS-721	BCSS-721HF
Duty Type	Standard Duty				Heavy Duty		
Cutting Width	60"		72"				
Overall Width	61.750"		73.750"				
Overall Length	72.250"		84.250"				
Weight	840 lb.		1,000 lb.		1,186 lb.	1,220 lb.	1,270 lb.
GPM Flow	10 - 15 GPM	16 - 25 GPM	15 - 20 GPM	21 - 25 GPM	15 - 20 GPM	21 - 25 GPM	26 - 40 GPM
Cutting Capacity	3"	4"	3"	4"	3"	4"	5"
Operating PSI Cont./Int.	3,000 / 3,500 PSI						
Spindle Config.	Single Spindle						
Blades	(2) .500"x 4.0" High Strength						
Blade Rotation	Counter Clockwise						
Deck Thickness	1/4" Steel						
Motor Protection	Pressure Reliefs						
Drive Protection	GRD-2 Bolt (Shear Bolt)						
Motor/Gearbox Coupler	Machined Steel						

3-Year Structural Steel, 18-Month Hydraulic Motor, and 1-Year Gearbox and Bearing Housing Limited Warranty

HOW TO ORDER:

Choose a model from the Base Unit Selection to order a complete unit. Each unit comes standard with hoses, couplers and gearbox guard.

Freight NOT included in list price



[RETURN TO TABLE OF CONTENTS](#)

BCSS SERIES BRUSH CUTTER - OPEN FRONT

BASE UNIT SELECTION

Model Number	Description	Approx. Wt.	List Price (\$US)
BCSS-S601LF	Open Front Brush Cutter, Standard Duty 60" Low Flow	840 lb.	\$9,390
BCSS-S601	Open Front Brush Cutter, Standard Duty 60"	840 lb.	\$9,488
BCSS-S721LF	Open Front Brush Cutter, Standard Duty 72" Low Flow	1,000 lb.	\$10,186
BCSS-S721	Open Front Brush Cutter, Standard Duty 72"	1,000 lb.	\$10,249
BCSS-721LF	Open Front Brush Cutter, HD 72" Low Flow	1,186 lb.	\$11,649
BCSS-721	Open Front Brush Cutter, HD 72"	1,220 lb.	\$11,973
BCSS-721HF	Open Front Brush Cutter, HD 72" High Flow	1,270 lb.	\$13,582

BRUSH CUTTER					HD WOODEN CRATE				TOTAL SHIPPING WEIGHT
BUSH HOG MODELS	OVERALL WIDTH	OVERALL LENGTH	HEIGHT	WEIGHT	WIDTH	LENGTH	HEIGHT	HEIGHT	
BCSS-S601LF	61.75"	73.38"	20"	840 lb.	64"	77"	30"	1,078 lb.	1,188 lb.
BCSS-S601	61.75"	73.38"	20"	840 lb.	64"	77"	30"	1,078 lb.	1,188 lb.
BCSS-S721LF	73.75"	85.38"	20"	1,000 lb.	80"	91"	30"	1,267 lb.	1,435 lb.
BCSS-S721	73.75"	85.38"	20"	1,000 lb.	80"	91"	30"	1,267 lb.	1,435 lb.
BCSS-721LF	73.75"	84.25"	21"	1,186 lb.	80"	91"	30"	1,428 lb.	1,485 lb.
BCSS-721	73.75"	84.25"	21"	1,220 lb.	80"	91"	30"	1,474 lb.	2,105 lb.
BCSS-721HF	73.75"	84.25"	21"	1,270 lb.	80"	91"	30"	1,540 lb.	2,155 lb.

Shipped Fully Assembled; HD Wooden Crate - Heat Treated, Stamped

PULL DIRT SCRAPERS | POST HOLE DIGGERS | BACKHOES | GRAPPLES | PALLET FORKS



CONSTRUCTION IMPLEMENTS



CONSTRUCTION IMPLEMENTS



[RETURN TO TABLE OF CONTENTS](#)



DSP SERIES PULL DIRT SCRAPER

MODEL	DSP8	DSP10	DSP12
Horsepower Rating	70 - 125 HP		
Transport Width	97"	121"	145"
Working Width	96 3/16"	120 3/16"	144 3/16"
Capacity	1 3/4 cu. yds..	2 1/4 cu. yds..	2 3/4 cu. yds.
Weight with Weight Box (Without Material in Weight Box)	1,525 lb. (Tilt Axle) 1,405 lb. (No Tilt Axle)	1,645 lb. (Tilt Axle) 1,525 lb. (No Tilt Axle)	1,700 lb. (Tilt Axle) 1,580 lb. (No Tilt Axle)
Maximum Weight of Material in Weight Box	760 lb.		
Depth of Box	39"		
Dump Clearance	5" Below Grade		
Maximum Tilt Depth to the Right	7"	7 5/8"	8 1/4"
Maximum Tilt Angle	3 1/2°		
Tongue Construction	4" x 4" x 1/4" Tubing		
Side Plate Construction	3/8" x 24 5/16" High x 39 3/4" Deep		
Moldboard Construction	1/4" x 24 1/4" High When Formed		
Cutting Edge	1/2" x 6" Reversible and Replaceable		
Cutting Edge Reinforcement	3" x 3" x 5/16" Angle Plus a 1/4" Moldboard = 9/16" at the Cutting Edge		
Tires	New 9.5L x 15 8-Ply Rib TL on 5-Bolt Rim with 5.5" Bolt Center		
Maximum Transport Speed	20 mph		
Lift Cylinder	3 1/2" x 8" ASAE		
Tilt Cylinder	3 1/2" x 8" ASAE		

HOW TO ORDER:

The DSP Series Dirt Scraper is available as a pull-type implement only. To receive a complete unit, you must indicate your choice of basic unit, including your choice of model color from the chart above, and make a selection from Group 2 Tilt Preference Selection. Additional equipment may be selected from the Options Section at the bottom of the next page. Each unit selected from this ordering page is shipped in one crate with the tongue, tailwheels and options to be assembled by the dealer.

Freight NOT included in list price



DSP SERIES PULL DIRT SCRAPER

BASE UNIT SELECTION

Model Number	Description	List Price (\$US)
DSP8-01	DSP Series Pull Dirt Scraper, Bush Hog Red, 8'	\$5,259
DSP8-03	DSP Series Pull Dirt Scraper, John Deere Green, 8'	\$5,259
DSP8-05	DSP Series Pull Dirt Scraper, Kubota Orange, 8'	\$5,259
DSP8-14	DSP Series Pull Dirt Scraper, New Holland Blue, 8'	\$5,259
DSP8-16	DSP Series Pull Dirt Scraper, Caterpillar Yellow, 8'	\$5,259
DSP10-01	DSP Series Pull Dirt Scraper, Bush Hog Red, 10'	\$5,899
DSP10-03	DSP Series Pull Dirt Scraper, John Deere Green, 10'	\$5,899
DSP10-05	DSP Series Pull Dirt Scraper, Kubota Orange, 10'	\$5,899
DSP10-14	DSP Series Pull Dirt Scraper, New Holland Blue, 10'	\$5,899
DSP10-16	DSP Series Pull Dirt Scraper, Caterpillar Yellow, 10'	\$5,899
DSP12-01	DSP Series Pull Dirt Scraper, Bush Hog Red, 12'	\$6,549
DSP12-03	DSP Series Pull Dirt Scraper, John Deere Green, 12'	\$6,549
DSP12-05	DSP Series Pull Dirt Scraper, Kubota Orange, 12'	\$6,549
DSP12-14	DSP Series Pull Dirt Scraper, New Holland Blue, 12'	\$6,549
DSP12-16	DSP Series Pull Dirt Scraper, Caterpillar Yellow, 12'	\$6,549

GROUP 2 TILT PREFERENCE SELECTION (Must Choose One)

Model Number	Description	List Price (\$US)
50082247	Tilt Axle Bundle (Fits All)	\$3,718
50082248	Fixed Axle Bundle (Fits All)	\$2,748

OPTIONS

Model Number	Description	List Price (\$US)
50082249	Weight Box, No Weights Included (Fits All)	\$675



[RETURN TO TABLE OF CONTENTS](#)



PHD SERIES POST HOLE DIGGER

MODEL	PHD2401	PHD2402	PHD2403
Usage Type	Utility	Agricultural	Industrial
Input RPM	540		
Auger RPM	180	170	135
Gear Ratio	3.00:1	3.18:1	4.00:1
Maximum Digging Depth	42" Standard, 48" HD		
Hitch	ASAE Cat 1	ASAE Cat 1 & 2	
Component Protection	Shear Bolt		
Output Shaft	2" Diameter		
Driveshaft	ASAE Category 1	ASAE Category 3	
Yoke	27/8" Tubing		3" Tubing
Boom	27/8" Tubing	31/2" Tubing	31/2" Tubing With Reinforcing Hitch Rib
Maximum PTO HP	45	65	95
Five-Year Limited Gearbox Warranty			

NOTICE:

Category 2 conversion bushings are not supplied with PHD2402 and PHD2403 models.

HOW TO ORDER:

To receive a complete unit, select a model from the Base Unit section and an auger from Group 2 of the ordering section on the next page. Price of a complete unit is the list price for the base unit plus the list price for the auger selected. Optional desired equipment for these units may be selected from the Options list in the ordering section.

Freight NOT included in list price



[RETURN TO TABLE OF CONTENTS](#)

PHD2401, PHD2402, PHD2403 POST HOLE DIGGER

BASE UNIT SELECTION

Model Number	Description	Approx. Wt.	List Price (\$US)
PHD2401	PHD Series Utility Post Hole Digger	160 lb.	\$1,733
PHD2402	PHD Series Agricultural Post Hole Digger	206 lb.	\$2,329
PHD2403	PHD Series Industrial Post Hole Digger	210 lb.	\$2,996

GROUP 2 AUGER SELECTION

Model Number	Description	Approx. Wt.	List Price (\$US)
Standard Duty Augers - Fish Tail Point (Replaceable)			
50072104	6" Semi-Double Flight Auger, Standard Duty, Fish Tail Point (Replaceable), With 42" Maximum Digging Depth	22 lb.	\$394
50072105	9" Double Flight Auger, Standard Duty, Fish Tail Point (Replaceable), With 42" Maximum Digging Depth	37 lb.	\$478
50072106	12" Double Flight Auger, Standard Duty, Fish Tail Point (Replaceable), With 42" Maximum Digging Depth	46 lb.	\$499

Heavy Duty Augers - Aggressor Point (Replaceable)

00780367	6" Semi-Double Flight Auger, Heavy Duty, Aggressor Point (Replaceable), With 48" Maximum Digging Depth	42 lb.	\$442
00780368	9" Double Flight Auger, Heavy Duty, Aggressor Point (Replaceable), With 48" Maximum Digging Depth	57 lb.	\$525
00780369	12" Double Flight Auger, Heavy Duty, Aggressor Point (Replaceable), With 48" Maximum Digging Depth	64 lb.	\$554
00780371	18" Double Flight Auger, Heavy Duty, Aggressor Point (Replaceable), With 48" Maximum Digging Depth (May Not Be Used on PHD2401)	82 lb.	\$781
00780372	24" Double Flight Auger, Heavy Duty, Aggressor Point (Replaceable), With 48" Maximum Digging Depth (May Not Be Used on PHD2401)	109 lb.	\$914

OPTIONS

Model Number	Description	Approx. Wt.	List Price (\$US)
50072108	Parking Stand Kit for PHD 2401,PHD2402	12 lb.	\$254
50072111	Parking Stand Kit for PHD2403	13 lb.	\$280
50072109	Hydraulic Down Force Kit for PHD2401	39 lb.	\$1,015
50072110	Hydraulic Down Force Kit for PHD2402	40 lb.	\$1,015
50072112	Hydraulic Down Force Kit for PHD2403	42 lb.	\$992
50068115	Bear Claw Auger Point Assembly, For Use on Standard Duty Augers Only		\$172
50072107	12" Auger Extension, For Use on Standard Duty Augers Only	16 lb.	\$379
01A01030	7" Auger Extension, For Use on Heavy Duty Augers Only	4 lb.	\$362
01A01040	14" Auger Extension, For Use on Heavy Duty Augers Only	7 lb.	\$458

[RETURN TO TABLE OF CONTENTS](#)



PHDHF FARM/RANCH SERIES POST HOLE DIGGER

MODEL	PHDHF15-2	PHDHF20-2	PHDHF30-2	PHDHF35
Drive Type	Planetary with Reversible Motor			
Shaft Output Size	2" Hex			
Maximum Output Torque*	1,512 ft. / lb.	1,747 ft. / lb.	2,511 ft. / lb.	3,529 ft. / lb.
Recommended Hydraulic Flow	6 - 15 gpm	10 - 20 gpm	15 - 30 gpm	20 - 35 gpm
Maximum System Pressure	3,000 psi			3,500 psi
Drive Protection	Hydraulic Relief Valve			
Hydraulic Hoses	1/2" x 8' with 10 MB Ends			
Type of Mounts	Loader Bucket, Skid Steer Universal, Euro Style Quick Attach			
Maximum Auger Diameter (Rock)	18"	24"	36"	
Maximum Auger Diameter (Dirt)	18"	30"	36"	
Standard Digging Depth	48"			
Two-Year Limited Warranty				

**All values are theoretical. Specifications and models are subject to change without notice.*

NOTICE:

PHDHF Series diggers are "Farm/Ranch" type, designed for use with tractor front end loaders or small skid steer loaders. Mounting brackets with frames offset to the right are designed for use on a tractor front end loader to provide visibility of the auger.

HOW TO ORDER:

The PHDHF Series digger is priced as a basic unit with a choice of mounting kit bundle, auger, and options. In order to receive a complete unit, you must specify the basic unit, your selection of mounting kit from Group 2, and selection of auger from Group 3. Hydraulic hose is included. Additional equipment may be added to your order by making your selection from the Options list.

Freight NOT included in list price



[RETURN TO TABLE OF CONTENTS](#)

PHDHF FARM/RANCH SERIES POST HOLE DIGGER

BASE UNIT SELECTION

Model Number	Description	Approx. Wt.	List Price (\$US)
PHDHF15-2	Planetary Drive Post Hole Digger for Systems Delivering 6 - 15 GPM Hydraulic Flow, 1,419 ft/lb Torque at Maximum System Pressure (3,000 psi)	130 lb.	\$3,208
PHDHF20-2	Planetary Drive Post Hole Digger for Systems Delivering 10 - 20 GPM Hydraulic Flow, 1,777 ft/lb Torque at Maximum System Pressure (3,000 psi)	135 lb.	\$3,236
PHDHF30-2	Planetary Drive Post Hole Digger for Systems Delivering 15 - 30 GPM Hydraulic Flow, 2,623 ft/lb Torque at Maximum System Pressure (3,000 psi)	140 lb.	\$3,517
PHDHF35	Planetary Drive Post Hole Digger for Systems Delivering 20 - 30 GPM Hydraulic Flow, 3,500 ft/lb Torque at Maximum System Pressure (3,500 psi)	145 lb.	\$3,650

GROUP 2 MOUNTING KIT SELECTION

Model Number	Description	Approx. Wt.	List Price (\$US)
50077005	Skid Steer Mount, Quick Attach, Center Hitch	117 lb.	\$805
50077004	Loader Bucket Mount*	57 lb.	\$569
50077006	Skid Steer Mount, Quick Attach, Right Offset (Offset to Right 15")**	128 lb.	\$805
50077007	Euro Quick Attach, Right Offset (Offset to Right 15")**	140 lb.	\$900

* Requires drilling two holes in bucket. (Hoses not included.)

** Mounting brackets with frames offset to the right are designed for use on a tractor front end loader to provide visibility of the auger.

GROUP 3 AUGER SELECTION

Model Number	Description	Approx. Wt.	List Price (\$US)
HSDA Augers (Soil, Clay, Loose Rock), 48" Long			
00789048	6" Auger	68 lb.	\$473
00789049	9" Auger	69 lb.	\$671
00789050	12" Auger	108 lb.	\$761
00789051	18" Auger	159 lb.	\$1,129
00789052	24" Auger (PHDHF30 Only)	245 lb.	\$1,424
00789053	30" Auger (PHDHF30 Only)	303 lb.	\$1,859
00789054	36" Auger (PHDHF30 Only)	333 lb.	\$2,286
00789055	9" x 18" Tree Auger	136 lb.	\$1,226
00789056	12" x 24" Tree Auger	287 lb.	\$1,321
00789057	18" x 36" Tree Auger (PHDHF30 Only)	322 lb.	\$2,242

Note: Augers 18" and greater will incur a separate freight charge of \$52.

T-Post Puff Auger (Soil, Clay, Compacted Soil)

00776653	2" Auger	25 lb.	\$686
----------	----------	--------	-------

OPTIONS

Model Number	Description	Approx. Wt.	List Price (\$US)
00776654	24" Variable Length Auger Extension	33 lb.	\$442
00776655	48" Variable Length Auger Extension	57 lb.	\$738
00785968	Auger Adapter, 2" Hex (Female) to 2" Round (Male) (Bush Hog)	15 lb.	\$370
00786085	Auger Adapter, 2" Round (Female) to 2" Hex (Male) (3/4" Hole)	14 lb.	\$370
00768105	Hydraulic Hose Kit for Bolt-on Bucket Mount Kit (Hoses are 25' Long) (Dealer Installed)	25 lb.	\$626



[RETURN TO TABLE OF CONTENTS](#)



PHDHC CONSTRUCTION/CONTRACTOR SERIES POST HOLE DIGGER

MODEL	PHDHC20	PHDHC30	PHDHC35
Drive Type	Planetary with Reversible Motor		
Shaft Output Size	2" Hex		
Maximum Output Torque*	2,008 ft. / lb.	2,937 ft. / lb.	3,582 ft. / lb.
Recommended Hydraulic Flow	10 – 20 gpm	15 – 30 gpm	20 – 35 gpm
Maximum System Pressure	3,000 psi		
Drive Protection	Hydraulic Relief Valve		
Hydraulic Hoses	1/2" x 8' with 10 MB Ends		
Type of Mounts	Loader Bucket, Skid Steer Universal, Euro Style Quick Attach, Backhoe		
Maximum Auger Diameter (Rock)	24"	36"	
Maximum Auger Diameter (Dirt)	30"	36"	
Standard Digging Depth	48"		
Five-Year Limited Warranty			

*All values are theoretical. Specifications and models are subject to change without notice.

NOTICE:	PHDHC Series diggers are "Construction/Contractor" type, designed for use with skid steer loaders, tractor loader backhoes, and mini-excavators.
HOW TO ORDER:	The PHDHC Series digger is priced as a basic unit with a choice of mounting kit bundle, auger, and options. In order to receive a complete unit, you must specify the basic unit, your selection of mounting kit from Group 2, and selection of auger from Group 3. Additional equipment may be added to your order by making your selection from the Options list.

Freight NOT included in list price



[RETURN TO TABLE OF CONTENTS](#)

PHDHC CONSTRUCTION/CONTRACTOR SERIES POST HOLE DIGGER

BASE UNIT SELECTION

Model Number	Description	Approx. Wt.	List Price (\$US)
PHDHC20	Planetary Drive Post Hole Digger for Systems Delivering 10 - 20 GPM Hydraulic Flow, 2,008 ft/lb Torque at Maximum System Pressure (3,000 psi)	211 lb.	\$4,246
PHDHC30	Planetary Drive Post Hole Digger for Systems Delivering 15 - 30 GPM Hydraulic Flow, 2,937 ft/lb Torque at Maximum System Pressure (3,000 psi)	211 lb.	\$4,476
PHDHC35	Planetary Drive Post Hole Digger for Systems Delivering 20 - 35 GPM Hydraulic Flow, 3,582 ft/lb Torque at Maximum System Pressure (3,000 psi)	211 lb.	\$4,843

GROUP 2 MOUNTING KIT SELECTION

Model Number	Description	Approx. Wt.	List Price (\$US)
Skid Steer / Loader			
50077005	Skid Steer Mount, Quick Attach, Center Hitch	117 lb.	\$805
50077004	Loader Bucket Mount*	57 lb.	\$569
50077006	Skid Steer Mount, Quick Attach, Right Offset (Offset to Right 15")**	128 lb.	\$805
50077007	Euro Quick Attach, Right Offset (Offset to Right 15")**	140 lb.	\$900
* Requires drilling two holes in bucket. (Hoses not included.)			
** Mounting brackets with frames offset to the right are designed for use on a tractor front end loader to provide visibility of the auger.			
Backhoe and Mini-Excavator (See instructions at end of Ordering Section)			
00776624	Mounting Kit for Case 580, 580E, 580SE	32 lb.	\$562
00776625	Mounting Kit for Case 780	32 lb.	\$562
00776626	Mounting Kit for Ford CL55, 555 Series; Deere 12, B, C; 410A, B, C, D; 9300, 9305, 210C, 300B, D; 310A, B, C, D, E; 500C, 510B, 510C	32 lb.	\$562
00776627	Mounting Kit for JCB 1400B, 1500, 215, 217, 214	32 lb.	\$562
00776628	Mounting Kit for Deere 510; 710B, C, D	32 lb.	\$562
00776629	Mounting Kit for Deere 9450, 9550, 401C	32 lb.	\$562
00776630	Mounting Kit for Deere 310SE, 410E	32 lb.	\$562
00776631	Mounting Kit for Cat 410, 416, 426	32 lb.	\$562
00788379	Mounting Kit for Kubota KX91	32 lb.	\$562

*Mounting brackets with frames offset to the right are designed for use on a tractor front end loader to provide visibility of the auger.

Case, Ford, JCB, John Deere, and CAT are trade names and/or registered trademarks which are the intellectual property of the entity listed or of the entity's successor(s). These names are used only to clarify the identification of skid steer loaders.

If mounting to a tractor front end loader, use mounting kits shown in PHDHF Series price sheets. Mounting kits for most backhoe and excavator models are available. See instructions at the end of this ordering section for backhoe or excavator models not listed above.

PHDHC Series Post Hole Diggers Continued on Next Page

[RETURN TO TABLE OF CONTENTS](#)

PHDHC SERIES POST HOLE DIGGER *Continued*

GROUP 3 AUGER SELECTION

Model Number	Description	Approx. Wt.	List Price (\$US)
T-Post Puff Auger (Solid Rock)			
00776653	2" Auger	25 lb.	\$686
HSDA AUGERS (Soil, Clay, Loose Rock)			
00789048	6" Auger	68 lb.	\$473
00789049	9" Auger	69 lb.	\$671
00789050	12" Auger	108 lb.	\$761
00789051	18" Auger	159 lb.	\$1,129
00789052	24" Auger	245 lb.	\$1,424
00789053	30" Auger	303 lb.	\$1,859
00789054	36" Auger	333 lb.	\$2,286
00789055	9" x 18" Tree Auger	136 lb.	\$1,226
00789056	12" x 24" Tree Auger	287 lb.	\$1,321
00789057	18" x 36" Tree Auger	322 lb.	\$2,242
HSRA AUGERS (Loose Rock, Solid Rock, Concrete)			
00776632	4-½" Auger	60 lb.	\$1,290
00776633	6" Auger	53 lb.	\$1,799
HRAD AUGERS (Soil, Hard Clay, Loose or Solid Rock, Concrete)			
00776644	9" Auger	102 lb.	\$2,092
00776645	12" Auger	107 lb.	\$2,677
00776646	18" Auger	201 lb.	\$3,435
00776647	24" Auger	291 lb.	\$3,944
00776648	30" Auger	340 lb.	\$4,533
00776649	36" Auger	395 lb.	\$5,582

OPTIONS (DEALER INSTALLED)

Model Number	Description	Approx. Wt.	List Price (\$US)
00776654	24" Variable Length Auger Extension	33 lb.	\$442
00776655	48" Variable Length Auger Extension	57 lb.	\$738
00776656	72" Variable Length Auger Extension	80 lb.	\$870

BACKHOE & EXCAVATOR MOUNTING BRACKET INFORMATION

(See Group 2 Mounting Kit Selection for Weight and Price)

STEP 1	Choose PHDHC Series digger that matches the hydraulic flow and pressure of the backhoe or excavator.
STEP 2	Measure the width of the backhoe or excavator dipper (outer boom section) at the connection point.
STEP 3	Measure the pin diameter required to connect the digger to the backhoe or excavator.
STEP 4	If the dipper width and pin diameter are the same as those listed in the chart below, order the part number that corresponds. If part number is not shown for the size you need, contact Bush Hog Customer Service Department with your dipper width and pin diameter information so they can determine availability.

PHDHC Series Post Hole Diggers Continued on Next Page



[RETURN TO TABLE OF CONTENTS](#)

PHDHC SERIES POST HOLE DIGGER *Continued*

DIPPER WIDTH & PIN DIAMETERS FOR MOUNT KITS LISTED IN GROUP 2 MOUNTING KIT SELECTION			
Part Number	Dipper Width	Pin Diameter	Typical Application
00776624	10"	1¼"	Case 580, 580E, 580SE
00776625	8"	2½"	Case 780
00776626	8"	1¾"	Ford CL55, 555 Series; Deere 12, B, C; 410A, B, C, D; 9300, 9305
00776627	6¾"	1¾"	JCB 1400B, 1500, 215, 217, 214
00776628	6½"	1¾"	Deere 510, 710B, C, D
00776629	8"	1½"	Deere 9450, 9550, 401C
00776630	8"	2¾"	Deere 310SE, 410E
00776631	10"	2"	CAT 410, 416, 426
00788379	5½"	1⅞"	Kubota KX91

AUGER SIZING CHART FOR PHDHF AND PHDHC SERIES POST HOLE DIGGERS

	Approx. Wt.	Farm and Ranch						Construction					
		PHDHF15		PHDHF20		PHDHF30		PHDHC20		PHDHC30		PHDHC35	
		Dirt	Rock	Dirt	Rock	Dirt	Rock	Dirt	Rock	Dirt	Rock	Dirt	Rock
T-POST PUFF AUGER (Solid Rock)													
2" Auger	25 lb.	X		X	X	X	X	X	X	X	X	X	X
HSDA AUGERS (Soil, Clay, Loose Rock)													
6" Auger	68 lb.	X		X	X	X	X	X	X	X	X	X	X
9" Auger	69 lb.	X		X	X	X	X	X	X	X	X	X	X
12" Auger	108 lb.	X		X		X	X	X	X	X	X	X	X
18" Auger	159 lb.	X		X		X		X	X	X	X	X	X
24" Auger	245 lb.			X		X		X	X	X	X	X	X
30" Auger	303 lb.			X		X		X		X	X	X	X
36" Auger	333 lb.					X				X	X	X	X
9" x 18" Tree Auger	136 lb.			X		X		X		X			
12" x 24" Tree Auger	287 lb.			X		X		X		X			
18" x 36" Tree Auger	322 lb.					X				X			
HSRA AUGERS (Loose Rock, Solid Rock, Concrete)													
4½" Auger	60 lb.							X	X	X	X	X	X
6" Auger	53 lb.							X	X	X	X	X	X
HRAD AUGERS (Soil, Hard Clay, Loose or Solid Rock, Concrete)													
9" Auger	102 lb.							X	X	X	X	X	X
12" Auger	107 lb.							X	X	X	X	X	X
18" Auger	201 lb.							X	X	X	X	X	X
24" Auger	291 lb.							X	X	X	X	X	X
30" Auger	340 lb.							X		X	X	X	X
36" Auger	395 lb.									X	X	X	X



RETURN TO TABLE OF CONTENTS

All models are available in the colors below:

Model Color Indicator	Unit Color
01	Bush Hog Red
02	Bush Hog Black
03	John Deere Green
05	Kubota Orange
14	New Holland Blue



*** THIS PRODUCT IS PRICED AT LIST LESS 25% ***

XD SERIES BACKHOE

BASE UNITS

** BASE UNITS OPERATE ON OPEN CENTRE VALVES - SEE MISC ACCESSORIES **

Model Number	Description	Approx. Wt.	List Price (\$US)
	<small>** Please use Model Color Indicator behind product model number (ex. XD65C-02) **Please See P/N BFC501 under Hydraulic Accessories when ordering XD65C and XD65 model Backhoes**</small>		
XD65C	6' 4" Backhoe Base Unit	500 lb.	\$9,668
XD65	6' 4" Backhoe Base Unit	575 lb.	\$11,447
XD75	7' 8" Backhoe Base Unit	800 lb.	\$13,203
XD95	9' 4" Backhoe Base Unit (5-7 GPM flow required for all XD models)	850 lb.	\$15,599
XD95EL	11' 4" Backhoe Base Unit, extended reach Hydraulically retracted foot pedal control	1,000 lb.	\$18,700
XD600S	6' Skid digger- std quick attach skidsteer mount Includes flat-faced couplers	375 lb.	\$4,643

GROUP 1 TRACTOR MOUNTINGS

** VISIT WEBSITE FOR CURRENT SUBFRAME AND SKIDSTEER MOUNTING LISTS **

Model Number	Description	List Price (\$US)
PT302BH	3 Point Hitch Mount - Category 1 (Fits all models & includes turn buckle tie down except XD600S)	\$1,306
PT322	3 Point Hitch Mount - Category 2 (Fits XD75, and XD95 includes tie down)	\$1,254
SF100	Subframe Mounting Kit (See bushhog.com for current subframe list in backhoe section)	\$2,376

NOTE: Some tractors may require wheel spacers after subframe installation.

Skidsteer Mountings

SQ400	Universal Skidsteer Quick Attach Mount 35" Wide, Includes Flat Faced Couplers (Requires tie back kit)	\$1,487
SQ500	Universal Skidsteer Quick Attach Mount 44" Wide, Includes Flat Faced Couplers (Requires tie back)	\$2,183
TB100	Tie Back Kit FOR SQ400 and 500 Quick Attach (See www.bushhog.com for current mounting list)	\$777

HOW TO ORDER:

To order a complete unit you must select a base unit from the first section, select a subframe mount from Group 1, and a bucket from Group 2. Add color code to the end of selected model number.

Freight NOT included in list price



[RETURN TO TABLE OF CONTENTS](#)

XD SERIES BACKHOE

GROUP 2 BUCKETS

Model Number	Description	List Price (\$US)
XD65 & XD65C		
BK2609	9" Bucket - XD65 - 3 teeth / Bucket Volume = .5115 cubic ft or 884 cubic in.	\$736
BK2612	12" Bucket - XD65 - 3 teeth / Bucket Volume = .6934 cubic ft or 1200 cubic in.	\$817
BK2615	15" Bucket - XD65 - 4 teeth / Bucket Volume = .8749 cubic ft or 1512 cubic in.	\$866
BK2618	18" Bucket - XD65 - 4 teeth / Bucket Volume = 1.0567 cubic ft or 1826 cubic in.	\$893
XD75 & XD95, XD600S		
BK2900	9" Bucket - XD65 - 3 teeth / Bucket Volume = .5115 cubic ft or 884 cubic in.	\$1,035
BK2120	12" Bucket- XD75 & XD95, XD600S - 3 teeth / Bucket Volume = 1.1694 cubic ft or 2020 cubic in.	\$1,061
BK2150	15" Bucket- XD75 & XD95, XD600S - 4 teeth / Bucket Volume = 1.4806 cubic ft or 2558 cubic in.	\$1,155
BK2180	18" Bucket- XD75 & XD95, XD600S - 4 teeth / Bucket Volume = 1.7912 cubic ft or 3095 cubic in.	\$1,212
BK2240	24" Bucket- XD75 & XD95, XD600S - 5 teeth / Bucket Volume = 2.413 cubic ft or 4169 cubic in.	\$1,399
BK2240D	24" Ditching Bucket (No Teeth) - XD75 & XD95, XD600S / Bucket Volume = same as above BK2240	\$1,287

OPTIONS

Model Number	Description	List Price (\$US)
Backhoe Thumbs		
BT5280	Clamp-on Mechanical Thumb for XD65 Backhoe	\$803
BT5290	Clamp-on Mechanical Thumb for XD75/XD95 Backhoe	\$956
BT5300	Hydraulic Thumb Kit - XD75 & XD95 - Factory installed option - foot pedal control	\$2,430
BT5310	Clamp-on Mechanical Thumb for XD600S	\$956
BT5330	Clamp-on Mechanical Thumb for XD95EL	\$956
Miscellaneous Accessories		
BT7240	Vertical Stabilizer Kit XD75, XD95 & XD95EL	\$1,834
BT7250	Operators Seat for XD65C Backhoe	\$791
BP220	Street Pad Kit for XD65C Backhoe	\$466
BT7220	Quick Change Bucket Adapter (XD75 & XD95) **may need to order pins for multiple buckets**	\$773
BT7230	Ripper Tool (XD75 & XD95)	\$736
BP210	Rubber Street Pad Kit (XD65) (Set of two)	\$347
BP230	Rubber Street Pad Kit (XD75 & XD95) (Set of two)	\$347
Z51920	Male Flat Face Coupler	\$170
Z51919	Male Flat Face Coupler	\$110
PTO Pump Kits		
PTO605	PTO Hydraulic Pump Kit - 7GPM (XD65C)	\$2,108
PTO62	PTO Hydraulic Pump Kit - 7 GPM (XD65)	\$2,183
PTO72	PTO72 PTO Hydraulic Pump Kit - 7 GPM (XD75 & XD95)	\$2,183
Hydraulic Accessories		
BFC501	Flow Divider Kit for use on XD65C and XD65 models only when tractor hydraulics are above 8GPM	\$923
BT7270	Closed Center Plug	\$142
Z51920	Male Flat Face Coupler	\$170
Z51919	Male Flat Face Coupler	\$110
Z56918	Power Beyond Sleeve (Used to power an accessory downstream of a control valve)	\$66

NOTE: Backhoes ship from factory with male pioneer ends installed unless specified otherwise.

[RETURN TO TABLE OF CONTENTS](#)



All models are available in the colors below:

Model Color Indicator	Unit Color
01	Bush Hog Red
02	Bush Hog Black
03	John Deere Green
05	Kubota Orange
14	New Holland Blue
16	Caterpillar Yellow

AGR SERIES AG GRAPPLE

MODEL	AGR60	AGR72
Overall Depth	25" / Closed	
Overall Height	37 3/4"	
Overall Width	5'	6'
Useable Depth	N/A	
Useable Open Height	31"	
Useable Width (inside end plates)	5'	6'
Roll Back Angle	N/A	
Weight	372 lb.	409 lb.
Number of Teeth	5	
Attachment Method	Universal Skid Steer Quick Attach, Euro or John Deere	
Maximum Tractor HP	40	
Hoses (included)	Two (2) – 96" Hoses	
Paint Color	See Paint Color Chart Above	

NOTICE: All units, with the exception of the AGR60JD and the AGR72JD, are available in the colors in the chart above.

HOW TO ORDER: The AGR Series Grapple is priced as a complete unit. Select your desired model from the Base Unit Selection offered. Indicate your choice of model color from the chart above. **Note: The AGR60JD and the AGR72JD models are available in green only. Do not make a color selection if you are ordering either of these two models.**

Freight NOT included in list price. Freight discount available for multiple unit orders. Please contact Customer Service for details.

BASE UNIT SELECTION

Model Number	Description	Approx. Wt.	List Price (\$US)
AGR60SS-xx	Ag Grapple, Skid Steer, 60"	372 lb.	\$2,909
AGR60E-xx	Ag Grapple, Euro, 60"	409 lb.	\$3,043
AGR60JD	Ag Grapple, John Deere, 60"	372 lb.	\$2,912
AGR72SS-xx	Ag Grapple, Skid Steer, 72"	409 lb.	\$3,245
AGR72E-xx	Ag Grapple, Euro, 72"	409 lb.	\$3,372
AGR72JD	Ag Grapple, John Deere, 72"	409 lb.	\$3,299

[RETURN TO TABLE OF CONTENTS](#)

BGR SERIES



BRGR SERIES



BGR SERIES BUCKET GRAPPLE AND BRGR SERIES BRUSH GRAPPLE

MODEL	BGR72T	BGR84T	BGR72	BGR84	BRGR72	BRGR84
	WITH TEETH		WITHOUT TEETH			
Overall Depth	39 ¼"				37 ½"	
Overall Height	24"				25 ½"	
Overall Width	6'	7'	6'	7'	6'	7'
Useable Depth	33¾"				28"	
Useable Open Height	45½"				46½"	
Useable Width (inside end plates)	71"	83"	71"	83"	71"	83"
Roll Back Angle	20°				13°	
Weight	907 lb.	993 lb.	827 lb.	903 lb.	702 lb.	787 lb.
Number of Teeth	8	9			8	10
Attachment Method	Universal Skid Steer Quick Attach					
Hoses (included)	Two (2) - 96" Hoses					
Paint Color	Black					

HOW TO ORDER:

The BGR and BRGR Series Grapples are priced as complete units. Select the desired model number from the Base Unit Selection below.

Freight NOT included in list price. Freight discount available for multiple unit orders. Please contact Customer Service for details.

BGR SERIES BUCKET GRAPPLE BASE UNIT SELECTION

Model Number	Description	Approx. Wt.	List Price (\$US)
BGR72	Bucket Grapple, 72"	827 lb.	\$6,539
BGR72T	Bucket Grapple, with Teeth, 72"	907 lb.	\$7,146
BGR84	Bucket Grapple, 84"	903 lb.	\$6,939
BGR84T	Bucket Grapple, with Teeth, 84"	993 lb.	\$7,584

BRGR SERIES BRUSH GRAPPLE BASE UNIT SELECTION

Model Number	Description	Approx. Wt.	List Price (\$US)
BRGR72	Brush Grapple, 72"	702 lb.	\$5,949
BRGR84	Brush Grapple, 84"	787 lb.	\$6,371

[RETURN TO TABLE OF CONTENTS](#)



PF48 SERIES PALLET FORK

MODEL	PF48SS, PF48E, PF48JD
Over Height	41 ³ / ₈ "
Overall Width	45 ⁵ / ₁₆ "
Overall Depth	60 ³ / ₈ "
Fork Size	1 ¹ / ₂ " x 4"
Fork Length	48"
Fork Adjustable Width	Up to 44 ³ / ₈ " in Increments of 4"
Weight	387 lb.
Max. Capacity	4,400 lb.
Attachment Method	Universal Skid Steer Quick Attach, Euro or John Deere
Color	Black

HOW TO ORDER:

The PF48 Series Pallet Fork is priced as a complete unit. Select your desired model from the Base Unit Selection offered.

Freight NOT included in list price. Freight discount available for multiple unit orders. Please contact Customer Service for details.

BASE UNIT SELECTION

Model Number	Description	Approx. Wt.	List Price (\$US)
PF48SS	Pallet Fork, Skid Steer, 48"	387 lb.	\$1,916
PF48E	Pallet Fork, Euro, 48"	387 lb.	\$1,979
PF48JD	Pallet Fork, John Deere, 48"	387 lb.	\$1,964



LANDSCAPE IMPLEMENTS



LANDSCAPE IMPLEMENTS



[RETURN TO TABLE OF CONTENTS](#)



COMPACT SERIES BOX BLADE

COMPACT SERIES REAR BLADE



All models are available in the colors below:	
Model Color Indicator	Unit Color
01	Bush Hog Red
03	John Deere Green
05	Kubota Orange
14	New Holland Blue
16	Caterpillar Yellow

CRB SERIES COMPACT REAR BLADES

MODEL	CRB48	CRB60	CRB72
Maximum Tractor HP	24		
Hitch	ASAE Cat 1 Std & Quick Hitch		
Moldboard Width	48"	60"	72"
Moldboard Height	12"x 1/4"		
Adjustment Angles	15° & 30° Forward and Reverse		

HOW TO ORDER:

The Compact Series Rear Blade is available as a lift-type implement only. It is priced as a complete unit and is shipped fully assembled. Indicate your choice of model color from the chart above.

Freight NOT included in list price. Freight discount available for multiple unit orders. Please contact Customer Service for details.

BASE UNIT SELECTION

Model Number	Description	Approx. Wt.	List Price (\$US)
CRB48-xx	Compact Series Rear Blade, 4'	136 lb.	\$798
CRB60-xx	Compact Series Rear Blade, 5'	150 lb.	\$853
CRB72-xx	Compact Series Rear Blade, 6'	164 lb.	\$935

CBX SERIES COMPACT BOX BLADES

MODEL	CBX48	CBX60
Maximum Tractor HP	24	
Hitch	ASAE Cat 1 Std & Quick Hitch	
Moldboard Width	48"	60"
Box Depth	12"	
Number of Scarifier Teeth	4	5
Number of Blades	(2) Blades, Bolt-On Reversible Cutting Edge	

HOW TO ORDER:

The Compact Series Box Blade is available as a lift-type implement only. It is priced as a complete unit and is shipped fully assembled.

Freight NOT included in list price. Freight discount available for multiple unit orders. Please contact Customer Service for details.

BASE UNIT SELECTION

Model Number	Description	Approx. Wt.	List Price (\$US)
CBX48-xx	Compact Series Box Blade, 4'	248 lb.	\$1,321
CBX60-xx	Compact Series Box Blade, 5'	258 lb.	\$1,499

[RETURN TO TABLE OF CONTENTS](#)



**COMPACT SERIES
LANDSCAPE RAKE**



**COMPACT SERIES
ROAD GRADER**

All models are available in the colors below:	
Model Color Indicator	Unit Color
01	Bush Hog Red
03	John Deere Green
05	Kubota Orange
14	New Holland Blue
16	Caterpillar Yellow

CLR SERIES COMPACT LANDSCAPE RAKES

MODEL	CLR48	CLR60
Maximum Tractor HP	24	
Hitch	ASAE Cat 1 Std & Quick Hitch	
Rake Pivot	18° & 36°	
Tine Spacing	1"	

HOW TO ORDER:

The Compact Series Landscape Rake is available as a lift-type implement only. It is priced as a complete unit and is shipped fully assembled. Indicate your choice of model color from the chart above.

Freight NOT included in list price. Freight discount available for multiple unit orders. Please contact Customer Service for details.

BASE UNIT SELECTION

Model Number	Description	Approx. Wt.	List Price (\$US)
CLR48-xx	Compact Series Landscape Rake, 4'	126 lb.	\$1,030
CLR60-xx	Compact Series Landscape Rake, 5'	143 lb.	\$1,119

CRG SERIES COMPACT ROAD GRADERS

MODEL	CRG48	CRG60
Maximum Tractor HP	24	
Hitch	ASAE Cat 1 Std & Quick Hitch	
Side Panel Thickness	3/16"	
Front Main Beam	3" x 3" x 3/16"	
Rear Main Beam	2" x 2" x 0.1196"	
Number of Blades	(2) Blades, Bolt-On Reversible Cutting Edge	

HOW TO ORDER:

The Compact Series Road Grader is available as a lift-type implement only. It is priced as a complete unit and is shipped fully assembled. Indicate your choice of model color from the chart above.

Freight NOT included in list price. Freight discount available for multiple unit orders. Please contact Customer Service for details.

BASE UNIT SELECTION

Model Number	Description	Approx. Wt.	List Price (\$US)
CRG48-xx	Compact Series Road Grader, 4'	238 lb.	\$1,581
CRG60-xx	Compact Series Road Grader, 5'	297 lb.	\$1,708

[RETURN TO TABLE OF CONTENTS](#)

All models are available in the colors below:

Model Color Indicator	Unit Color
01	Bush Hog Red
03	John Deere Green
05	Kubota Orange
14	New Holland Blue
16	Caterpillar Yellow

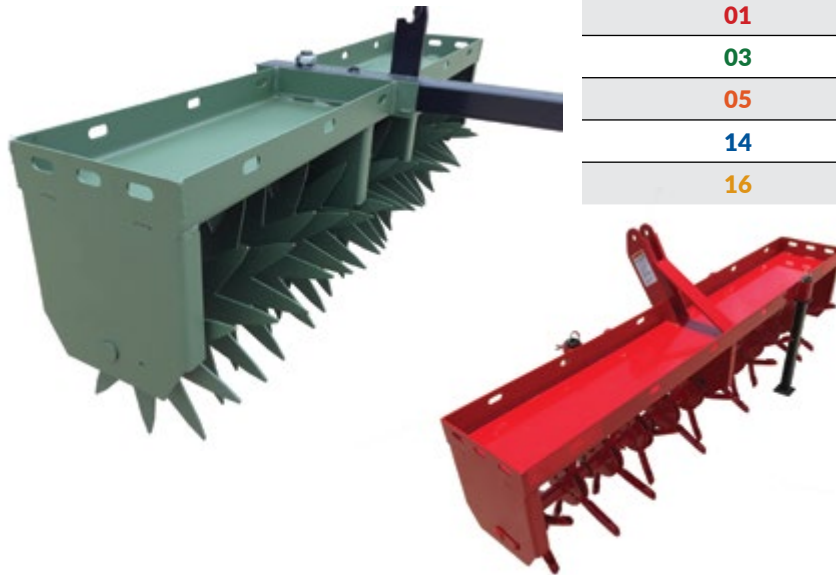

COMPACT SERIES PLUGGER & AERATORS

MODEL	CPG48	CPG60	CPG72	CAR48	CAR60	CAR72
Overall Width	49 7/8"	62 1/4"	74"	49 7/8"	62 1/4"	74"
Working Width	43 11/16"	56 1/4"	67 7/8"	44 15/16"	57 3/8"	69"
Overall Depth	20 5/8"			20 5/8"		
Weight	166 lb.	199 lb.	219 lb.	166 lb.	199 lb.	219 lb.
Number of Spoons/knives	32	40	48	120	150	180
Number of Hubs	4	5	6	4	5	6
Spoon/Knife Spacing	6"			3 15/16"		
Axle	1 1/4"			1 1/4"		
Hitch	Cat 1 & Quick Hitch			Cat 1 & Quick Hitch		

HOW TO ORDER:

To receive a complete order for a Compact Plugger or Aerator, enter the correct model number and paint color code.

Freight NOT included in list price. Freight discount available for multiple unit orders. Please contact Customer Service for details.

COMPACT PLUGGER

Model Number	Description	Approx. Wt.	List Price (\$US)
CPG48-xx	Compact Plugger, Lift Type, 48"	166 lb.	\$1,340
CPG60-xx	Compact Plugger, Lift Type, 60"	199 lb.	\$1,660
CPG72-xx	Compact Plugger, Lift Type, 72"	219 lb.	\$1,971

COMPACT AERATOR

Model Number	Description	Approx. Wt.	List Price (\$US)
CAR48-xx	Compact Aerator, Lift Type, 48"	166 lb.	\$1,340
CAR60-xx	Compact Aerator, Lift Type, 60"	199 lb.	\$1,661
CAR72-xx	Compact Aerator, Lift Type, 72"	219 lb.	\$1,971

[RETURN TO TABLE OF CONTENTS](#)

All models are available in the colors below:	
Model Color Indicator	Unit Color
01	Bush Hog Red
03	John Deere Green
05	Kubota Orange
14	New Holland Blue
16	Caterpillar Yellow



35 SERIES REAR MOUNT MEDIUM BLADES

MODEL	3505	3506	3507
Maximum Tractor HP	35 (2 WD), 30 (4 WD)		
Hitch	3-Point ASAE Cat 1 & Quick Hitch		
Moldboard Width	5'	6'	7'
Moldboard Height	14½" x 1/4"		
Cutting Edge	1/2" x 6" Reversible		
King Pin Diameter	1¼" Grade 8		
Tilt Adjustment	15° Up or Down		
Angle Adjustment	5 Forward Positions up to 30°, 3 Reverse Positions up to 15°		

HOW TO ORDER:

The 35 Series Rear Mounted Blade is available as a lift-type implement only. It is priced as a complete unit and is shipped fully assembled. Indicate your choice of model color from the chart above. Additional equipment for this model is listed in the Options section below.

Freight NOT included in list price. Freight discount available for multiple unit orders. Please contact Customer Service for details.

BASE UNIT SELECTION

Model Number	Description	Approx. Wt.	List Price (\$US)
3505-xx	35 Series Utility Blade, 5'	280 lb.	\$1,385
3506-xx	35 Series Utility Blade, 6'	290 lb.	\$1,445
3507-xx	35 Series Utility Blade, 7'	325 lb.	\$1,555

[RETURN TO TABLE OF CONTENTS](#)



All models are available in the colors below:	
Model Color Indicator	Unit Color
01	Bush Hog Red
03	John Deere Green
05	Kubota Orange
14	New Holland Blue
16	Caterpillar Yellow

50 SERIES REAR MOUNT MEDIUM BLADES

MODEL	5006	5007
Maximum Tractor HP	50 (2 WD), 40 (4 WD)	
Hitch	3-Point ASAE Cat 1 & Quick Hitch	
Moldboard Width	6'	7'
Moldboard Height	16" x 5/16"	
Cutting Edge	1/2" x 6" Reversible	
King Pin Diameter	1 1/4" Grade 8	
Tilt Adjustment	15° Up or Down	
Offset Adjustment	23" Left or Right	
Angle Adjustment	5 Forward Positions up to 30°, 3 Reverse Positions up to 15°	
Parking Stand	Standard	

HOW TO ORDER:

The 50 Series Rear Mounted Blade is available as a lift-type implement only. It is priced as a complete unit and is shipped fully assembled. Indicate your choice of model color from the chart above. Additional equipment for this model is listed in the Options section below.

Freight NOT included in list price. Freight discount available for multiple unit orders. Please contact Customer Service for details.

BASE UNIT SELECTION

Model Number	Description	Approx. Wt.	List Price (\$US)
5006-xx	50 Series Medium Blade, 6'	390 lb.	\$1,935
5007-xx	50 Series Medium Blade, 7'	455 lb.	\$2,045

OPTIONS

Model Number	Description	List Price (\$US)
50072391	Skid Shoe Kit, 35/50/70 Series Blades	\$427

[RETURN TO TABLE OF CONTENTS](#)



All models are available in the colors below:	
Model Color Indicator	Unit Color
01	Bush Hog Red
03	John Deere Green
05	Kubota Orange
14	New Holland Blue
16	Caterpillar Yellow

70 SERIES MEDIUM DUTY BLADES

MODEL	7006	7007	7008
Maximum Tractor HP	70 (2 WD), 55 (4 WD)		
Hitch	3-Point ASAE Cat 1 & 2 & Quick Hitch		
Moldboard Width	6'	7'	8'
Moldboard Height	18" x 5/16"		
Cutting Edge	1/2" x 6" Reversible		
King Pin Diameter	1 1/4" Grade 8		
Tilt Adjustment	5 Positions up to 30°		
Offset Adjustment	18" Left or Right		
Angle Adjustment	360° Rotation, 5 Forward Positions up to 45°, 5 Reverse Positions up to 30°		
Parking Stand	Standard		

HOW TO ORDER:

The 70 Series Rear Mounted Blade is available as a lift-type implement only. It is priced as a complete unit and is shipped fully assembled. Indicate your choice of model color from the chart above. Additional equipment for this model is listed in the Options section below.

Freight NOT included in list price. Freight discount available for multiple unit orders. Please contact Customer Service for details.

BASE UNIT SELECTION

Model Number	Description	Approx. Wt.	List Price (\$US)
7006-xx	70 Series Medium Duty Blade, 6'	510 lb.	\$2,625
7007-xx	70 Series Medium Duty Blade, 7'	538 lb.	\$2,800
7008-xx	70 Series Medium Duty Blade, 6'	572 lb.	\$2,950

OPTIONS

Model Number	Description	Approx. Wt.	List Price (\$US)
50072391	Skid Shoe Kit, 35/50/70 Series Blades		\$427
1817	Manual Ratchet Bundle (For Offset Function Only)	15 lb.	\$249
50070543	End Plate Kit, 70/91 Series Blades		\$716



[RETURN TO TABLE OF CONTENTS](#)



All models are available in the colors below:	
Model Color Indicator	Unit Color
01	Bush Hog Red
03	John Deere Green
05	Kubota Orange
14	New Holland Blue
16	Caterpillar Yellow

91 SERIES MEDIUM DUTY BLADES

MODEL	9107	9108
Maximum Tractor HP	90 (2 WD), 70 (4 WD)	
Hitch	3-Point ASAE Cat 1 & 2 & Cat 2 Quick Hitch	
Moldboard Width	7'	8'
Moldboard Height	16" x 3/8"	
Cutting Edge	1/2" x 6" Reversible	
King Pin Diameter	3"	
Tilt Adjustment	15° Maximum Left or Right	
Offset Adjustment	20" Maximum Left or Right	
Angle Adjustment	50° Maximum Left or Right, Forward or Reverse	
Parking Stand	Standard	

HOW TO ORDER:

The 91 Series Rear Mounted Blade is available as a lift-type implement only. Your order must specify model number (including model color indicator from the chart above), three (3) blade adjustment selections*, and any desired additional equipment from the Options section below.

Freight NOT included in list price. Freight discount available for multiple unit orders. Please contact Customer Service for details.

BASE UNIT SELECTION

Model Number	Description	Approx. Wt.	List Price (\$US)
9107-xx	91 Series Medium Duty Blade, 7'	807 lb.	\$4,425
9108-xx	91 Series Medium Duty Blade, 8'	827 lb.	\$4,515

BLADE ADJUSTMENT SELECTION*

Model Number	Description	Approx. Wt.	List Price (\$US)
95839	8" Hydraulic Cylinder Kit	52 lb.	\$739
95838	16" Hydraulic Cylinder Kit	67 lb.	\$842
89295	8" Pin Jack Assembly	15 lb.	\$260
89294	16" Pin Jack Assembly	37 lb.	\$319
95841	Hose Holder Bundle		\$124

*NOTE: The tilt function requires (1) 8" selection. The angle function requires (1) 16" selection, and the offset function requires (1) 16" selection. Only (1) hose holder bundle is required, regardless of the number of hydraulic functions ordered.

OPTIONS

Model Number	Description	Approx. Wt.	List Price (\$US)
89290	Skid Shoes	60 lb.	\$500
50070543	End Plate Kit, 70/91 Series Blades		\$716



[RETURN TO TABLE OF CONTENTS](#)



100 SERIES HEAVY DUTY BLADES

MODEL	100-08	100-09
Maximum Tractor HP	125 (2 WD), 80 (4 WD)	
Hitch	3-Point ASAE Cat 1 & 2 & Quick Hitch	
Moldboard Width	8'	9'
Moldboard Height	17" x 3/8"	
Cutting Edge	1/2" x 6"	
King Pin Diameter	3"	
Tilt Adjustment	15° Maximum Left or Right	
Offset Adjustment	20" Maximum Left or Right	
Angle Adjustment	50° Maximum Left or Right, Forward or Reverse	
Parking Stand	Standard	
Hose Holder	Standard	

HOW TO ORDER:

The 100 Series Rear Mounted Blade is available as a lift-type implement only. Your order must specify model number, three (3) blade adjustment selections*, and any desired additional equipment from the Options section below.

Freight NOT included in list price. Freight discount available for multiple unit orders. Please contact Customer Service for details.

BASE UNIT SELECTION

Model Number	Description	Approx. Wt.	List Price (\$US)
100-08	100 Series Heavy Duty Blade, 8', Bush Hog Red	836 lb.	\$5,832
100-09	100 Series Heavy Duty Blade, 9', Bush Hog Red	876 lb.	\$6,035

BLADE ADJUSTMENT SELECTION*

Model Number	Description	Approx. Wt.	List Price (\$US)
OFFSET	9150040400 Hydraulic Offset/Angle Blade Adjustment	63 lb.	\$1,325
	00768250 Manual Offset/Angle Blade Adjustment	38 lb.	\$806
ANGLE	9150040400 Hydraulic Offset/Angle Blade Adjustment	63 lb.	\$1,325
	00768250 Manual Offset/Angle Blade Adjustment	38 lb.	\$806
TILT	9150040004 Hydraulic Tilt Blade Adjustment	33 lb.	\$898
	00768270 Manual Tilt Blade Adjustment	22 lb.	\$806

*NOTE: Select either manual or hydraulic adjustment for each of the three functions (offset, angle and tilt).

OPTIONS

Model Number	Description	Approx. Wt.	List Price (\$US)
0591240000	End Plates	65 lb.	\$470
0691700000	Open Center 3-Spool Valve		Order Through Service Parts
00759684	Valve Mounting Kit (Hose Fittings)		Order Through Service Parts
0781300000	Selector Valve (Valve Only)		Order Through Service Parts
00768242	Skid Shoes for 100/160/225/300 Series Blades	30 lb.	\$607
00768321	Gauge Wheel, Hydraulic Adjustment	112 lb.	\$1,592
00768493	Gauge Wheel, Ratchet Adjustment	143 lb.	\$1,212



[RETURN TO TABLE OF CONTENTS](#)



All models are available in the colors below:	
Model Color Indicator	Unit Color
01	Bush Hog Red
03	John Deere Green
05	Kubota Orange
14	New Holland Blue
16	Caterpillar Yellow

141 SERIES HEAVY DUTY BLADES

MODEL	14108	14109
Maximum Tractor HP	141 (2 WD), 110 (4 WD)	
Hitch	3-Point ASAE Cat 2 & 3 & Quick Hitch	
Moldboard Width	8'	9'
Moldboard Height	19"	
Cutting Edge	1/2" x 6"	
King Pin Diameter	4"	
Tilt Adjustment	15° Up or Down	
Offset Adjustment	35" Left or Right	
Angle Adjustment	45° Left or Right	
Parking Stand	Standard	
Hose Holder (Front)	Standard	

HOW TO ORDER: The 141 Series Rear Mounted Blade is available as a lift-type implement only. Your order must specify model number, three (3) blade adjustment selections*, and any desired additional equipment from the Options section below.

Freight NOT included in list price. Freight discount available for multiple unit orders. Please contact Customer Service for details.

BASE UNIT SELECTION

Model Number	Description	Approx. Wt.	List Price (\$US)
14108-xx	141 Series Heavy Duty Blade, 8', Bush Hog Red	1,146 lb.	\$6,686
14109-xx	141 Series Heavy Duty Blade, 9', Bush Hog Red	1,170 lb.	\$6,941

BLADE ADJUSTMENT SELECTION*

Model Number	Description	Approx. Wt.	List Price (\$US)
95839	8" Hydraulic Cylinder Kit	52 lb.	\$739
95838	16" Hydraulic Cylinder Kit	67 lb.	\$842
89295	8" Pin Jack Assembly	15 lb.	\$260
89294	16" Pin Jack Assembly	37 lb.	\$319

*NOTE: The tilt function requires (1) 8" selection. The angle function requires (1) 16" selection, and the offset function requires (1) 16" selection. Only (1) hose holder bundle is required, regardless of the number of hydraulic functions ordered.

OPTIONS

Model Number	Description	Approx. Wt.	List Price (\$US)
89290	Skid Shoes	60 lb.	\$500
95899	End Plate Kit for 141/181 Series Blades		\$772
95841	Hose Holder Bundle		\$124



[RETURN TO TABLE OF CONTENTS](#)



160 SERIES HEAVY DUTY BLADES

MODEL	160-08	160-09	160-10
Maximum Tractor HP	190 (2 WD), 160 (4 WD)	175 (2 WD), 150 (4 WD)	160 (2 WD), 135 (4 WD)
Hitch	3-Point ASAE Cat 2 & 3 & Quick Hitch		
Moldboard Width	8'	9'	10'
Moldboard Height	18" x 1/2"		
Cutting Edge	1/2" x 6"		
King Pin Diameter	4"		
Tilt Adjustment	15° Up or Down		
Offset Adjustment	37" Left or Right		
Angle Adjustment	45° Left or Right		
Parking Stand	Standard		
Hose Holder	Standard		

HOW TO ORDER:

The 160 Series Rear Mounted Blade is available as a lift-type implement only. Your order must specify model number, three (3) blade adjustment selections*, and any desired additional equipment from the Options section below.

Freight NOT included in list price. Freight discount available for multiple unit orders. Please contact Customer Service for details.

BASE UNIT SELECTION

Model Number	Description	Approx. Wt.	List Price (\$US)
160-08	160 Series Heavy Duty Blade, 8', Bush Hog Red	1,339 lb.	\$8,446
160-09BH	160 Series Heavy Duty Blade, 9', Bush Hog Red	1,449 lb.	\$8,647
160-10	160 Series Heavy Duty Blade, 10', Bush Hog Red	1,459 lb.	\$8,843

BLADE ADJUSTMENT SELECTION*

OFFSET	9150040400	Hydraulic Offset/Angle Blade Adjustment	63 lb.	\$1,325
	B69115A	Manual Offset/Angle Blade Adjustment	45 lb.	\$848
ANGLE	9150040400	Hydraulic Offset/Angle Blade Adjustment	63 lb.	\$1,325
	B69115A	Manual Offset/Angle Blade Adjustment	45 lb.	\$848
TILT	9150040004	Hydraulic Tilt Blade Adjustment	33 lb.	\$898
	B69116B	Manual Tilt Blade Adjustment	28 lb.	\$848

*NOTE: Select either manual or hydraulic adjustment for each of the three functions (offset, angle and tilt).

OPTIONS

9150052411	Dual Gauge Wheel, Hydraulic Adjustment	354 lb.	\$2,805
0691700000	Open Center 3-Spool Valve	Order Through Service Parts	
00759684	Valve Mounting Kit (Hose Fittings)	Order Through Service Parts	
0781300000	Selector Valve (Valve Only)	Order Through Service Parts	
00768242	Skid Shoes for 100/160/225/300 Series Blades	30 lb.	\$607
0691360000	End Plates for 160/225/300 Series Blades	58 lb.	\$575



[RETURN TO TABLE OF CONTENTS](#)



All models are available in the colors below:	
Model Color Indicator	Unit Color
01	Bush Hog Red
03	John Deere Green
05	Kubota Orange
14	New Holland Blue
16	Caterpillar Yellow

181 SERIES HEAVY DUTY BLADES

MODEL	18109	18110
Maximum Tractor HP	180 (2 WD), 140 (4 WD)	
Hitch	3-Point ASAE Cat 2 & 3 & Quick Hitch	
Moldboard Width	9'	10'
Moldboard Height	18" x 1/2"	
Cutting Edge	1/2" x 6"	
King Pin Diameter	5"	
Tilt Adjustment	15° Up or Down	
Offset Adjustment	37" Left or Right	
Angle Adjustment	45° Left or Right	
Parking Stand	Standard	
Hose Holder (Front)	Standard	

HOW TO ORDER:

The 181 Series Rear Mounted Blade is available as a lift-type implement only. Your order must specify model number, three (3) blade adjustment selections, and any desired additional equipment from the Options section below.

Freight NOT included in list price. Freight discount available for multiple unit orders. Please contact Customer Service for details.

BASE UNIT SELECTION

Model Number	Description	Approx. Wt.	List Price (\$US)
18109-xx	181 Series Heavy Duty Blade, 9', Bush Hog Red	1,589 lb.	\$10,615
18110-xx	181 Series Heavy Duty Blade, 10', Bush Hog Red	1,613 lb.	\$10,733

BLADE ADJUSTMENT SELECTION*

Model Number	Description	Approx. Wt.	List Price (\$US)
95839	8" Hydraulic Cylinder Kit	52 lb.	\$739
95838	16" Hydraulic Cylinder Kit	67 lb.	\$842
89295	8" Pin Jack Assembly	15 lb.	\$260
89294	16" Pin Jack Assembly	37 lb.	\$319

OPTIONS

Model Number	Description	Approx. Wt.	List Price (\$US)
89290	Skid Shoes	60 lb.	\$500
95899	End Plate Kit for 141/181 Series Blades		\$772
95841	Hose Holder Bundle		\$124



[RETURN TO TABLE OF CONTENTS](#)



225 & 300 SERIES HEAVY DUTY BLADES

MODEL	225-08	225-10	225-12	300-12	300-14
Max. Tractor Draw Bar HP (2WD/4WD)	250/225	225/200	175/160	NA/300	NA/250
Hitch	3-Point Cat 2 & 3 & Quick Hitch			3-Point Cat 3 & 4 & Quick Hitch	
Moldboard Width	8'	10'	12'		14'
Moldboard Height	20" x 1/2"				
Cutting Edge	1/2" x 6"				
King Pin Diameter	4 1/2"			5"	
Tilt Adjustment (Hydraulic Only)	15° Up or Down				
Offset Adjustment (Hydraulic Only)	46" Left or Right			50" Left or Right	
Angle Adjustment (Hydraulic Only)	45° Left or Right				
Parking Stand	Standard				
Hose Holder	Standard				

HOW TO ORDER:

The 225 and 300 Series Rear Mounted Blades are available as a lift-type implement only. Each model is priced as a complete unit with all hydraulics included. Your order must specify model number. Any desired additional equipment may be ordered from the Options section below.

Freight NOT included in list price. Freight discount available for multiple unit orders. Please contact Customer Service for details.

BASE UNIT SELECTION

Model Number	Description	Approx. Wt.	List Price (\$US)
225-08	225 Series Heavy Duty Blade, 8', Complete, with All Hydraulics Included, Bush Hog Red	2,120 lb.	\$16,902
225-10	225 Series Heavy Duty Blade, 10', Complete, with All Hydraulics Included, Bush Hog Red	2,260 lb.	\$17,362
225-12	225 Series Heavy Duty Blade, 12', Complete, with All Hydraulics Included, Bush Hog Red	2,400 lb.	\$18,042
300-12	300 Series Heavy Duty Blade, 12', Complete, with All Hydraulics Included, Bush Hog Red	3,463 lb.	\$27,449
300-14	300 Series Heavy Duty Blade, 14', Complete, with All Hydraulics Included, Bush Hog Red	3,603 lb.	\$28,130

OPTIONS

00761806	Dual Gauge Wheel, Hydraulic Adjustment	421 lb.	\$3,296
0691700000	Open Center 3-Spool Valve	Order Through Service Parts	
00759684	Valve Mounting Kit (Hose Fittings)	Order Through Service Parts	
0781300000	Selector Valve (Valve Only)	Order Through Service Parts	
00768242	Skid Shoes for 100/160/225/300 Series Blades	30 lb.	\$607
0691360000	End Plates for 160/225/300 Series Blades	58 lb.	\$575



[RETURN TO TABLE OF CONTENTS](#)



All models are available in the colors below:	
Model Color Indicator	Unit Color
01	Bush Hog Red
03	John Deere Green
05	Kubota Orange
14	New Holland Blue
16	Caterpillar Yellow

LLR SERIES ECONOMY LANDSCAPE RAKES

MODEL	LLR60	LLR72	LLR84
Rake Width	60"	72"	84"
Rake Height	15"		
Hitch	ASAE Cat 1 & Quick Hitch		
Tractor HP	35 Maximum		
Rake Pivot	5 Forward Positions, Up to 30°; 3 Reverse Positions, Up to 15°		
Pivot King Pin	1 1/4"		
Tine Spacing	1"		
Tine Material	High Carbon Spring Steel		
Tine Size	5/16" x 1"		

HOW TO ORDER:

The LLR Series Landscape Rake is available as a lift-type implement only. It is priced as a complete unit and is shipped fully assembled. Indicate your choice of model color from the chart above. If desired, an optional Gauge Wheel Kit may be selected from the Options section below.

Freight NOT included in list price. Freight discount available for multiple unit orders. Please contact Customer Service for details.

BASE UNIT SELECTION

Model Number	Description	Approx. Wt.	Color	List Price (\$US)
LLR60-xx	LLR Economy Landscape Rake, 60"	205 lb.	See Table Above	\$1,344
LLR72-xx	LLR Economy Landscape Rake, 72"	225 lb.	See Table Above	\$1,460
LLR84-xx	LLR Economy Landscape Rake, 84"	245 lb.	See Table Above	\$1,665

MLR SERIES MEDIUM DUTY LANDSCAPE RAKES

MODEL	MLR72	MLR84	MLR96
Rake Width	70"	84"	96"
Rake Height	15"		
Hitch	ASAE Cat 1 & Quick Hitch		
Tractor HP	50 Maximum		
Rake Pivot	5 Forward Positions, Up to 30°; 3 Reverse Positions, Up to 15°		
Pivot King Pin	1 1/4"		
Tine Spacing	1"		
Tine Material	High Carbon Spring Steel		
Tine Size	5/16" x 1"		

HOW TO ORDER:

The MLR Series Landscape Rake is available as a lift-type implement only. It is priced as a complete unit and is shipped fully assembled. Indicate your choice of model color from the chart above. If desired, an optional Gauge Wheel Kit may be selected from the Options section below.

Freight NOT included in list price. Freight discount available for multiple unit orders. Please contact Customer Service for details.

BASE UNIT SELECTION

Model Number	Description	Approx. Wt.	Color	List Price (\$US)
MLR72-xx	MLR Medium Duty Landscape Rake, 72"	325 lb.	See Table Above	\$1,935
MLR84-xx	MLR Medium Duty Landscape Rake, 84"	345 lb.	See Table Above	\$2,065
MLR96-xx	MLR Medium Duty Landscape Rake, 96"	365 lb.	See Table Above	\$2,355

OPTIONS

50047898	Gauge Wheel Kit	20 lb.	See Table Above	\$430
----------	-----------------	--------	-----------------	--------------

[RETURN TO TABLE OF CONTENTS](#)



All models are available in the colors below:

Model Color Indicator	Unit Color
01	Bush Hog Red
03	John Deere Green
05	Kubota Orange
14	New Holland Blue
16	Caterpillar Yellow

BBX SERIES BOX BLADES

MODEL	BBX48	BBX60	BBX65	BBX72
Working Width	48"	60"	65"	72"
Moldboard Height	15 ⁵ / ₈ "			
Box Depth	22"			
Overall Depth	27"			
Overall Height	33"			
Overall Width	49"	61"	66"	73"
Side Sheet Thickness	1/4"			
Scarifier Size	5/8" x 2 ¹ / ₂ "			
Number of Scarifier Teeth	4		5	
Hitch	ASAE Cat 1 & Quick Hitch			
Lower Hitch	Single Lug			
Cutting Edge	1/2" x 6" (Reversible)			
Number of Blades	2			
Maximum HP Requirement	40 (2WD), 30 (4WD)			
A-Frame	Bolt-On			

HOW TO ORDER:

The BBX Series Box Blade is available as a lift-type implement only. It is priced as a complete unit and is shipped fully assembled. Indicate your choice of model color from the chart above.

Freight NOT included in list price. Freight discount available for multiple unit orders. Please contact Customer Service for details.

BASE UNIT SELECTION

Model Number	Description	Approx. Wt.	Color	List Price (\$US)
BBX48-xx	BBX Series Box Blade, 4 Scarifiers, 48"	260 lb.	See Table Above	\$1,384
BBX60-xx	BBX Series Box Blade, 4 Scarifiers, 60"	325 lb.	See Table Above	\$1,582
BBX65-xx	BBX Series Box Blade, 5 Scarifiers, 65"	375 lb.	See Table Above	\$1,639
BBX72-xx	BBX Series Box Blade, 5 Scarifiers, 72"	390 lb.	See Table Above	\$1,703



[RETURN TO TABLE OF CONTENTS](#)



All models are available in the colors below:	
Model Color Indicator	Unit Color
01	Bush Hog Red
03	John Deere Green
05	Kubota Orange
14	New Holland Blue
16	Caterpillar Yellow

SBX SERIES BOX BLADES

MODEL	SBX48	SBX60	SBX65	SBX72	SBX78	SBX84
Working Width	48"	60"	65"	72"	78"	84"
Moldboard Height	18"					
Box Depth	24"					
Overall Depth	29"					
Overall Height	35¼"					
Overall Width	49"	61"	66"	73"	78"	85"
Side Sheet Thickness	3/8"					
Scarifier Size	3/4" x 2½"					
Number of Scarifier Teeth	4	5			6	
Hitch	ASAE Cat 1 & Quick Hitch					
Lower Hitch	Double Lug					
Cutting Edge	1/2" x 6" (Reversible)					
Number of Blades	2					
Maximum HP Requirement	50 (2WD), 45 (4WD)					

HOW TO ORDER:

The SBX Series Box Blade is available as a lift-type implement only. It is priced as a complete unit and is shipped fully assembled. Indicate your choice of model color from the chart above.

Freight NOT included in list price. Freight discount available for multiple unit orders. Please contact Customer Service for details.

BASE UNIT SELECTION

Model Number	Description	Approx. Wt.	Color	List Price (\$US)
SBX48-xx	SBX Series Box Blade, 4 Scarifiers, 48"	430 lb.	See Table Above	\$1,849
SBX60-xx	SBX Series Box Blade, 5 Scarifiers, 60"	490 lb.	See Table Above	\$2,108
SBX65-xx	SBX Series Box Blade, 5 Scarifiers, 65"	510 lb.	See Table Above	\$2,199
SBX72-xx	SBX Series Box Blade, 6 Scarifiers, 72"	550 lb.	See Table Above	\$2,349
SBX78-xx	SBX Series Box Blade, 6 Scarifiers, 78"	580 lb.	See Table Above	\$2,489
SBX84-xx	SBX Series Box Blade, 6 Scarifiers, 84"	610 lb.	See Table Above	\$2,639

[RETURN TO TABLE OF CONTENTS](#)



All models are available in the colors below:

Model Color Indicator	Unit Color
01	Bush Hog Red
03	John Deere Green
05	Kubota Orange
14	New Holland Blue
16	Caterpillar Yellow

MBX SERIES BOX BLADES

MODEL	MBX60	MBX72	MBX84	MBX96
Working Width	60"	72"	84"	96"
Moldboard Height	18"			
Box Depth	24"			
Overall Depth	29"			
Overall Height	35 ¼"			
Overall Width	61"	73"	85"	97"
Swinging Tailgate	Yes			
Side Sheet Thickness	3/8"			
Scarifier Size	3/4" x 2 ½"			
Number of Scarifier Teeth	5	6		
Hitch	ASAE Cat 1 & 2 & Quick Hitch			
Lower Hitch	Triple Lug			
Cutting Edge	1/2" x 6" (Reversible)			
Number of Blades	2			
Maximum HP Requirement	65 (2WD), 55 (4WD)			

HOW TO ORDER:

The MBX Series Box Blade is available as a lift-type implement only. It is priced as a complete unit and is shipped fully assembled. Indicate your choice of model color from the chart above.

Freight NOT included in list price. Freight discount available for multiple unit orders. Please contact Customer Service for details.

BASE UNIT SELECTION

Model Number	Description	Approx. Wt.	Color	List Price (\$US)
MBX60-xx	MBX Series Box Blade, 5 Scarifiers, 60"	580 lb.	See Table Above	\$2,459
MBX72-xx	MBX Series Box Blade, 6 Scarifiers, 72"	640 lb.	See Table Above	\$2,800
MBX84-xx	MBX Series Box Blade, 6 Scarifiers, 84"	710 lb.	See Table Above	\$3,229
MBX96-xx	MBX Series Box Blade, 6 Scarifiers, 96"	790 lb.	See Table Above	\$3,625

[RETURN TO TABLE OF CONTENTS](#)



RBX SERIES



RO SERIES

RBX SERIES RETRACTABLE SHANK BOX BLADES

MODEL	RBX720	RBX780	RBX840
Working Width	72"	65"	84"
Number of Scarifiers	6	5	
Cutting Edge	Reversible 1/2" x 6", Heat Treated		
Points & Shanks	Replaceable		
Hitch	ASAE Cat 1 & 2, Quick Hitch		
Maximum HP Requirement	65 (2WD), 55 (4WD)		

HOW TO ORDER:

The RBX Series Box Blade is available as a lift-type implement only. It is priced as a complete unit and is shipped fully assembled. Indicate your choice of model from the Base Unit Selection below.

Freight NOT included in list price. Freight discount available for multiple unit orders. Please contact Customer Service for details.

BASE UNIT SELECTION

Model Number	Description	Approx. Wt.	Color	List Price (\$US)
RBX720	RBX Series Retractable Shank Box Blade, 72"	829 lb.	Caterpillar Yellow	\$5,101
RBX780	RBX Series Retractable Shank Box Blade, 78"	890 lb.	Caterpillar Yellow	\$5,495
RBX840	RBX Series Retractable Shank Box Blade, 84"	957 lb.	Caterpillar Yellow	\$5,882

RO SERIES ROLL-OVER BOX BLADES

MODEL	RO-600	RO-650	RO-720	RO-840
Working Width	60"	65"	72"	84"
Number of Scarifiers	5		6	
Cutting Edge	Reversible 1/2" x 6", Heat Treated			
Points & Shanks	Replaceable			
Hitch	ASAE Cat 1 & Quick Hitch			
Maximum HP Requirement	60 (2WD), 55 (4WD)			

HOW TO ORDER:

The RO Series Box Blade is available as a lift-type implement only. It is priced as a complete unit and is shipped fully assembled, with the exception of the handle. Indicate your choice of model from the Base Unit Selection below.

Freight NOT included in list price. Freight discount available for multiple unit orders. Please contact Customer Service for details.

BASE UNIT SELECTION

Model Number	Description	Approx. Wt.	Color	List Price (\$US)
RO-600	RO Series Roll-Over Box Blade, 60"	630 lb.	Caterpillar Yellow	\$3,597
RO-650	RO Series Roll-Over Box Blade, 65"	680 lb.	Caterpillar Yellow	\$3,904
RO-720	RO Series Roll-Over Box Blade, 72"	710 lb.	Caterpillar Yellow	\$4,160
RO-840	RO Series Roll-Over Box Blade, 84"	780 lb.	Caterpillar Yellow	\$4,732



[RETURN TO TABLE OF CONTENTS](#)

All models are available in the colors below:

Model Color Indicator	Unit Color
01	Bush Hog Red
03	John Deere Green
05	Kubota Orange
14	New Holland Blue
16	Caterpillar Yellow



RG SERIES ROAD GRADERS

MODEL	RG60	RG72	RG84
Hitch	Cat 1 Std & Quick Hitch		
Recommended HP	50 (2WD), 40 (FWA)		
Working Width	60"	72"	84"
Side Panel Thickness	3/16"	3/16"	3/16"
Front Main Beam Construction	4" x 4" x 5/16" Wall		
Rear Beam Construction	2½" x 2½" x 3/16" Wall		
Skid Shoe Construction	3/8" x 2½" x 3/16" Long		
Scarifier Shanks	Three-Position Shanks with Dimpled-On Hardened Tips		
Number of Scarifier Shanks	4	6	8
Cutting Edges	(Two) 1/2" x 6" Bolt-On, Replaceable and Reversible Heat-Treated Blades		

HOW TO ORDER: The RG Series Road Grader is available as a lift-type implement only. It is priced as a complete unit and is shipped fully assembled. Indicate your choice of model color from the chart above.

Freight NOT included in list price. Freight discount available for multiple unit orders. Please contact Customer Service for details.

BASE UNIT SELECTION

Model Number	Description	Approx. Wt.	Color	List Price (\$US)
RG60-xx	RG Series Road Grader, 60"	500 lb.	See Table Above	\$2,554
RG72-xx	RG Series Road Grader, 72"	571 lb.	See Table Above	\$2,806
RG84-xx	RG Series Road Grader, 84"	642 lb.	See Table Above	\$3,050

OPTIONS

Model Number	Description	List Price (\$US)
DEDUCT4SHANK	Deduct (4) Shanks, RG 60 Models	-\$94
DEDUCT6SHANK	Deduct (6) Shanks, RG72 and RG84 Models	-\$137



[RETURN TO TABLE OF CONTENTS](#)

All models are available in the colors below:	
Model Color Indicator	Unit Color
01	Bush Hog Red
03	John Deere Green
05	Kubota Orange
14	New Holland Blue
16	Caterpillar Yellow



HDRG SERIES HEAVY DUTY ROAD GRADERS

MODEL	HDRG84	HDRG96
Hitch	3-Point Cat 1 & 2	
Maximum Recommended HP	90 (2WD), 70 (4WD)	90 (2WD), 70 (4WD)
Working Width	84"	96"
Side Panel Thickness	3/16"	3/16"
Front Main Beam Construction	4" x 4" x 3/8"	
Rear Beam Construction	4" x 4" x 1/4"	
Skid Shoe Construction	1/2" x 2 1/2"	
Scarifier Shanks	Four Position Shanks with Hardened Tips	
Number of Scarifier Shanks	6	8
Cutting Edges	1/2" x 6" Bolt on Replaceable & Reversible Heat Treated Blades	

HOW TO ORDER:

The HDRG Series Road Grader is available as a lift-type implement only. It is priced as a complete unit and is shipped fully assembled. Indicate your choice of model color from the chart above.

Freight NOT included in list price. Freight discount available for multiple unit orders. Please contact Customer Service for details.

BASE UNIT SELECTION

Model Number	Description	Approx. Wt.	Color	List Price (\$US)
HDRG84-xx	Heavy Duty Road Grader, 84"	750 lb.	See Table Above	\$3,695
HDRG96-xx	Heavy Duty Road Grader, 96"	828 lb.	See Table Above	\$4,236

[RETURN TO TABLE OF CONTENTS](#)



SINGLE ROLL



DOUBLE ROLL

PVB & PVS SERIES PULVERIZERS

MODEL	PVB (Bar Shank) Series	PVS (Spike Shank) Series
A-Frame	Heavy Duty Solid	
Hitch	ASAE Cat 1 Heavy Duty Double Strap	
Shank	Bar, Reversible	Spike, Non-Reversible
Working Width	60" - 84"	
Roller Bearing	1"	
Rear Roller	Hinged	
Number of Rollers	(1) Single Roll, (2) Double Roll	
Independent Spring Tension	Yes	
Spikes on Roller	No	1¼"
Maximum Tractor HP	60 PTO	
One-Year Limited Warranty		

HOW TO ORDER: The PV Series Pulverizer is available as a lift-type implement only. It is priced as a complete unit and is shipped fully assembled. Select the desired model from the ordering section below.

Freight NOT included in list price. Freight discount available for multiple unit orders. Please contact Customer Service for details.

SINGLE ROLL PULVERIZER – BASE UNIT SELECTION

Model Number	Description	Approx. Wt.	List Price (\$US)
PVB-600	PVB Series Single Roller Pulverizer, Bar Shank, 60", Caterpillar Yellow	530 lb.	\$2,840
PVB-660	PVB Series Single Roller Pulverizer, Bar Shank, 66", Caterpillar Yellow	560 lb.	\$3,088
PVB-720	PVB Series Single Roller Pulverizer, Bar Shank, 72", Caterpillar Yellow	590 lb.	\$3,358
PVB-840	PVB Series Single Roller Pulverizer, Bar Shank, 84", Caterpillar Yellow	650 lb.	\$3,957
PVS-600	PVS Series Single Roller Pulverizer, Spike Shank, 60", Caterpillar Yellow	530 lb.	\$2,824
PVS-660	PVS Series Single Roller Pulverizer, Spike Shank, 66", Caterpillar Yellow	560 lb.	\$3,072
PVS-720	PVS Series Single Roller Pulverizer, Spike Shank, 72", Caterpillar Yellow	590 lb.	\$3,342
PVS-840	PVS Series Single Roller Pulverizer, Spike Shank, 84", Caterpillar Yellow	650 lb.	\$3,941

DOUBLE ROLL PULVERIZER – BASE UNIT SELECTION

Model Number	Description	Approx. Wt.	List Price (\$US)
PVB-602	PVB Series Double Roller Pulverizer, Bar Shank, 60", Caterpillar Yellow	640 lb.	\$3,560
PVB-662	PVB Series Double Roller Pulverizer, Bar Shank, 66", Caterpillar Yellow	680 lb.	\$3,829
PVB-722	PVB Series Double Roller Pulverizer, Bar Shank, 72", Caterpillar Yellow	720 lb.	\$4,292
PVB-842	PVB Series Double Roller Pulverizer, Bar Shank, 84", Caterpillar Yellow	790 lb.	\$4,983
PVS-602	PVS Series Double Roller Pulverizer, Spike Shank, 60", Caterpillar Yellow	640 lb.	\$3,542
PVS-662	PVS Series Double Roller Pulverizer, Spike Shank, 66", Caterpillar Yellow	680 lb.	\$3,811
PVS-722	PVS Series Double Roller Pulverizer, Spike Shank, 72", Caterpillar Yellow	720 lb.	\$4,274
PVS-842	PVS Series Double Roller Pulverizer, Spike Shank, 84", Caterpillar Yellow	790 lb.	\$4,966

[RETURN TO TABLE OF CONTENTS](#)



PG & MPG SERIES PLUGGERS | CORE-TYPE & SLICING AERATORS

MODEL	PG-600	PG-720	MPG-600	MPG-720
Working Width	60"	72"	60"	72"
Shaft	1¼"			
Sleeves	Greaseable			
Spoons	3/4" Hard Spoons With Closed Design			
Number of Hubs	8	10		12
Number of Spoons	64	80		96
Number of Slicing Knives	32	40		48
Weight Box	Heavy Duty Steel Weight Rack			
Hitch	(Lift) ASAE Cat 1 Std & Quick Hitch			
Maximum Tractor HP	60 (PTO)			
One-Year Limited Warranty				

HOW TO ORDER:

The Plugger Series Core Type Aerator is available as a lift-type implement only. It is priced as a complete unit and is shipped fully assembled. Select the desired model from the ordering section below. Optional Slicing Knife, available for all models, may be selected from the Options list.

Freight NOT included in list price. Freight discount available for multiple unit orders. Please contact Customer Service for details.

PG SERIES PLUGGER – BASE UNIT SELECTION

Model Number	Description	Approx. Wt.	List Price (\$US)
PG-600	PG Series Plugger, 8 Hubs, 64 Spoons, 60", Caterpillar Yellow	350 lb.	\$4,670
PG-720	PG Series Plugger, 10 Hubs, 80 Spoons, 72", Caterpillar Yellow	390 lb.	\$5,294

MPG SERIES PLUGGER – BASE UNIT SELECTION

Model Number	Description	Approx. Wt.	List Price (\$US)
MPG-600	MPG Series Plugger, 10 Hubs, 80 Spoons, 60", Caterpillar Yellow	460 lb.	\$4,882
MPG-720	MPG Series Plugger, 12 Hubs, 96 Spoons, 72", Caterpillar Yellow	500 lb.	\$5,578

OPTIONS

Model Number	Description	List Price (\$US)
95159	Slicing Knives (To receive a complete unit with Slicing Knives instead of Spoons, add Part Number 95159 to your order)	\$35



[RETURN TO TABLE OF CONTENTS](#)



FSP SERIES FERTILIZER & SEED SPREADERS

MODEL	FSP-500	FSP-800
Hitch	3-Pt ASAE Cat 1 (Not QH)	
Hopper	Polyethylene	
Hopper Capacity	500 lb.	800 lb.
Distribution Fins	Electroplated	
Distribution	Spin	
Frame	Heavy Tube, Powder Coat Paint	
PTO Speed	540	
Spread Swath	Approx. 49'	

HOW TO ORDER:

The FSP Series Fertilizer Spreader is priced as a complete unit. These units are available in multiples of two (2) only.

Freight NOT included in list price. Freight discount available for multiple unit orders. Please contact Customer Service for details.

BASE UNIT SELECTION

Model Number	Description	Approx. Wt.	List Price (\$US)
FSP-500	FSP Series Fertilizer Spreader, 3-Pt Hitch, 500 lb. Hopper Capacity	123 lb.	each \$1,395
FSP-800	FSP Series Fertilizer Spreader, 3-Pt Hitch, 800 lb. Hopper Capacity	128 lb.	each \$1,488

NOTE: Must be ordered in multiples of two (Models can be mixed).



[RETURN TO TABLE OF CONTENTS](#)



All models are available in the colors below:	
Model Color Indicator	Unit Color
01	Bush Hog Red
03	John Deere Green
05	Kubota Orange
14	New Holland Blue
34	Grey

***** THIS PRODUCT IS PRICED AT LIST LESS 25% *****
MS SERIES MANURE SPREADERS

HOW TO ORDER: Select a model number and be sure to add a color code to the end.

Freight NOT included in list price. Freight discount available for multiple unit orders. Please contact Customer Service for details.

BASE UNIT SELECTION

** Please use Model Color Indicator behind product model number (ex. MS500G-03)

Model Number	Description	List Price (\$US)
GROUND DRIVE MANURE SPREADERS		
MS250G	25 Bushel capacity, ground drive, 3 speed apron drive, poly floor, full length frame, no jack	\$6,536
MS500G	50 bushel capacity, ground drive, 3 speed apron drive, poly floor, full length frame, with jack stand	\$9,271
MS800G	80 bushel capacity, ground drive, 3 speed apron drive, poly floor, full length frame, with jack stand	\$10,123
PTO DRIVE MANURE SPREADERS		
MS500P	50 bushel capacity, PTO drive, 3 speed apron drive, poly floor, full length frame, with jack stand	\$9,271
MS800P	80 bushel capacity, PTO drive, 3 speed apron drive, poly floor, full length frame, with jack stand	\$10,123
MS1300P	130 bushel capacity, PTO drive, 2 speed apron drive, plus clean out speed, Tires-11L-15 SL/6	\$21,766

OPTIONS

JACK STANDS		
Z91513	Flat bottom jack, optional on MS250G, std on all other models	\$158
TOP BEATER FOR MS1300P MODEL ONLY		
M7640	Top Beater Option	\$1,757
FINES PANS		
M7550	Fines pan for MS250G	\$546
M7610	Fines Pan: Fits MS500G, MS500P	\$629
M7620	Fines Pan: Fits MS1300P	\$2,055
END GATES		
M7570	End Gate: Fits MS500G, MS500P	\$972
M7580	End Gate: Fits MS800G, MS800P	\$1,035
M7630	End Gate: Fits MS1300P; Hydraulic operated	\$2,635

[RETURN TO TABLE OF CONTENTS](#)



Image represents original design, Cat. 1 & Quick Hitch compatible. Updated design (image coming soon) is Cat. 1 & 2 Std., & Quick Hitch compatible.

All models are available in the colors below:	
Model Color Indicator	Unit Color
01	Bush Hog Red
03	John Deere Green
05	Kubota Orange
14	New Holland Blue
16	Caterpillar Yellow

CP SERIES CULTIPACKERS

MODEL	CP960	CP972	CP984	CP996	CP1560	CP1572	CP1584	CP1596	CP1660	CP1672	CP1684	CP1696
Hitch	Cat. 1 & 2 Std., & Quick Hitch											
Overall Width	67.19"	80.38"	91.78"	103.19"	67.72"	80.91"	92.31"	103.72"	67.72"	80.91"	92.31"	103.72"
Working Width	60"	72"	84"	96"	60"	72"	84"	96"	60"	72"	84"	96"
Overall Length	16.79"				20.47"				21.12"			
Overall Height	33.11"				37.53"				38.18"			
Roller Diameter	9.6"				15"				16.3"			
Roller Material	Notched Gray Iron				Smooth Gray Iron				Notched Ductile Iron			
Unit Weight (lb)	427	501	564	625	712	835	954	1,073	901	1,083	1,235	1,387
Minimum Tractor HP	35											

HOW TO ORDER: Select a model number and color code indicator to receive a complete unit.

Freight NOT included in list price. Freight discount available for multiple unit orders. Please contact Customer Service for details.

BASE UNIT SELECTION

Model Number	Description	Approx. Wt.	List Price (\$US)
CP960-xx	3-Pt 60" Cultipacker, 9.5" Gray Iron Notched - 1.75" Axle	427 lb.	\$2,704
CP972-xx	3-Pt 72" Cultipacker, 9.5" Gray Iron Notched - 1.75" Axle	501 lb.	\$2,992
CP984-xx	3-Pt 84" Cultipacker, 9.5" Gray Iron Notched - 1.75" Axle	564 lb.	\$3,276
CP996-xx	3-Pt 96" Cultipacker, 9.5" Gray Iron Notched - 1.75" Axle	625 lb.	\$3,686
CP1560-xx	3-Pt 60" Cultipacker, 15" Gray Iron Smooth - 2" Axle	712 lb.	\$3,500
CP1572-xx	3-Pt 72" Cultipacker, 15" Gray Iron Smooth - 2" Axle	835 lb.	\$4,179
CP1584-xx	3-Pt 84" Cultipacker, 15" Gray Iron Smooth - 2" Axle	954 lb.	\$4,800
CP1596-xx	3-Pt 96" Cultipacker, 15" Gray Iron Smooth - 2" Axle	1,073 lb.	\$4,939
CP1660-xx	3-Pt 60" Cultipacker, 16.3" Ductile Iron Notched - 2" Axle	901 lb.	\$3,999
CP1672-xx	3-Pt 72" Cultipacker, 16.3" Ductile Iron Notched - 2" Axle	1,083 lb.	\$4,800
CP1684-xx	3-Pt 84" Cultipacker, 16.3" Ductile Iron Notched - 2" Axle	1,235 lb.	\$5,549
CP1696-xx	3-Pt 96" Cultipacker, 16.3" Ductile Iron Notched - 2" Axle	1,387 lb.	\$6,299



[RETURN TO TABLE OF CONTENTS](#)



BUSH HOG QUICK HITCHES

MODEL	BHQA1	BHQA2
Width	32 3/4"	39 1/16"
Maximum Recommended HP	50 HP	100 HP
Weight Capacity	2,000 lb.	3,600 lb.
ISO CERTIFIED		

HOW TO ORDER:

The BH Series Quick Attachment is priced as a complete unit. Indicate your choice of model from the Base Unit Selection below. Note: Bush Hog Quick Hitches are sold in packs of 2 units.

Freight NOT included in list price. Freight discount available for multiple unit orders. Please contact Customer Service for details.

BASE UNIT SELECTION

Model Number	Description	Approx. Wt.	List Price (\$US)
BHQA1	Quick Hitch for Category 1 Tractors	75 lb.	\$542
BHQA2	Quick Hitch for Category 2 Tractors	108 lb.	\$848

**** BHQA1 & BHQA2 Quick Hitches are sold in packs of two same size units ****

TILLERS | HARROWS | PLOWS | SUBSOILERS | CULTIVATORS | PASTURE AERATORS



TILLAGE IMPLEMENTS



TILLAGE IMPLEMENTS

[RETURN TO TABLE OF CONTENTS](#)



RTC SERIES COMPACT ROTARY TILLERS

MODEL	RTC
Tractor HP Range	15 - 25 HP
Hitch	ASAE Cat 1 Quick Hitch
Offset	Center Mount
Tillage Width	48"
Number of Flanges (Rotor)	5
Number of Blades	30
Rotor Speed (540 PTO)	253 rpm
Blades	C Type
Power to Rotor	Gear
Transmission Depth of Cut*	6"
Slip Clutch	Standard

Five-Year Limited Gearbox Warranty One-Year Limited Machine Warranty

*May require additional passes, depending on soil type.

HOW TO ORDER: The RTC Series Rotary Tiller is priced as a complete unit and is shipped fully assembled except for the hitch.

Freight NOT included in list price. Freight discount available for multiple unit orders. Please contact Customer Service for details.

BASE UNIT SELECTION

Model Number	Description	Approx. Wt.	Approx. Ship Wt.	List Price (\$US)
RTC50G-03	RTC Series Rotary Tiller, JD Green, 48" Tillage Width, 15 LH Blades, 15 RH Blades, Slip Clutch Standard	374 lb.	395 lb.	each \$3,233
RTC50G-05	RTC Series Rotary Tiller, Kubota Orange, 48" Tillage Width, 15 LH Blades, 15 RH Blades, Slip Clutch Standard	374 lb.	395 lb.	each \$3,233
RTC50G-14	RTC Series Rotary Tiller, New Holland Blue, 48" Tillage Width, 15 LH Blades, 15 RH Blades, Slip Clutch Standard	374 lb.	395 lb.	each \$3,233
RTC50G-21	RTC Series Rotary Tiller, Bush Hog Red, 48" Tillage Width, 15 LH Blades, 15 RH Blades, Slip Clutch Standard	374 lb.	395 lb.	each \$3,233

RTC Series tillers are sold in packs of two, same size and same color.



[RETURN TO TABLE OF CONTENTS](#)



RTG SERIES ROTARY TILLERS

MODEL	RT48G	RT60G	RT60GR	RT72G	RT72GR	RT84G	RT84GR
Rotation	Standard		Reverse	Standard	Reverse	Standard	Reverse
Drivetrain	Gear						
Hitch	ASAE Cat 1, Std and Quick Hitch				ASAE Cat 1 & 2, Std and Quick Hitch		
Working Width	47"	59"		70.5"		82.5"	
Total Width	54"	66"		78"		90"	
Number of Flanges	5	7		9		10	
Blades per Flange	6						
Rotor/Blade Rotation Diameter	17"						
Rotor Shaft Diameter	3"						
Rotor RPM	211						
Weight	550 lb.	673 lb.	683 lb.	747 lb.	759 lb.	817 lb.	831 lb.
PTO Driveline with Slip Clutch	ASAE Category 3	ASAE Category 4					
Tilling Depth*	6"	7.5"					
Minimum/Maximum Tractor HP (PTO)	15/35	25/45		35/55		45/65	
Five-Year Limited Gearbox Warranty One-Year Limited Machine Warranty							

*Requires multiple passes.

HOW TO ORDER:

The RTG Series Rotary Tiller is priced as a complete unit and is shipped fully assembled. To receive a complete unit, indicate your model choice and desired color from the Base Unit Selection of the ordering section on the following page.

Freight NOT included in list price. Freight discount available for multiple unit orders. Please contact Customer Service for details.



RETURN TO TABLE OF CONTENTS

All models are available in the colors below:

Model Color Indicator	Unit Color
R	Bush Hog Red
G	John Deere Green
O	Kubota Orange
B	New Holland Blue

RTG SERIES ROTARY TILLERS

BASE UNIT SELECTION

Model Number	Description	Approx. Wt.	List Price (\$US)
RT48G-1x	RTG Series Rotary Tiller, Standard Rotation, 47" Working Width, All Gear Drive and Driveline with Slip Clutch	550 lb.	\$3,400
RT60G-1x	RTG Series Rotary Tiller, Standard Rotation, 59" Working Width, All Gear Drive and Driveline with Slip Clutch	673 lb.	\$4,180
RT60GR-1x	RTG Series Rotary Tiller, Reverse Rotation, 59" Working Width, All Gear Drive and Driveline with Slip Clutch	683 lb.	\$4,575
RT72G-1x	RTG Series Rotary Tiller, Standard Rotation, 70.5" Working Width, All Gear Drive and Driveline with Slip Clutch	747 lb.	\$4,814
RT72GR-1x	RTG Series Rotary Tiller, Reverse Rotation, 70.5" Working Width, All Gear Drive and Driveline with Slip Clutch	759 lb.	\$4,969
RT84G-1x	RTG Series Rotary Tiller, Standard Rotation, 82.5" Working Width, All Gear Drive and Driveline with Slip Clutch	817 lb.	\$5,446
RT84GR-1x	RTG Series Rotary Tiller, Reverse Rotation, 82.5" Working Width, All Gear Drive and Driveline with Slip Clutch	831 lb.	\$5,602

OPTIONS

Model Number	Description	Approx. Wt.	List Price (\$US)
50081431	Tiller Hitch Extension Kit (<i>fits RT60, RT72 models; not compatible with RT84</i>)	15 lb.	\$228
50083082	Front Deflector Kit, 4' Tiller	10 lb.	\$28
50076433	Front Deflector Kit, 5' Tiller	10 lb.	\$34
50076434	Front Deflector Kit, 6' Tiller	10 lb.	\$41
50076435	Front Deflector Kit, 7' Tiller	10 lb.	\$49

(For use on tractors with shorter lower lift arms. Not compatible with Quick Hitch)

[RETURN TO TABLE OF CONTENTS](#)



RTX SERIES HEAVY-DUTY ROTARY TILLERS

MODEL	RTX85G	RTX92G
Rotation	Standard	
Drivetrain	Gear	
Hitch	ASAE Cat. 1 Std. & QH, Cat. 2 Std.	
Working Width	85"	92"
Total Width	91"	99"
Hood thickness	10 ga.	
End Plates Thickness	.375"	
Number of Flanges	9	10
Blades per Flange	6	
Rotor Shaft Diameter	3.5"	
Rotor Shaft Wall Thickness	.25"	
Rotor RPM	235	
Weight	1,094 lb	1,149 lb.
PTO Driveline with Slip Clutch	ASAE Category 4	
Tilling Depth*	10"	
Min / Max Tractor HP (PTO)	60 / 90	
Colors	Red	

Five-Year Limited Gearbox Warranty One-Year Limited Machine Warranty

HOW TO ORDER:

The RTX Series Rotary Tiller is priced as a complete unit and is shipped fully assembled except for the hitch.

Freight NOT included in list price. Freight discount available for multiple unit orders. Please contact Customer Service for details.

COMPLETE UNIT SELECTION

Model Number	Description	Approx. Wt.	List Price (\$US)
RTX85G	RTX Series Rotary Tiller, 85" Working Width, All Gear Drive WITH Slip Clutch	1,094 lb.	\$8,668
RTX92G	RTX Series Rotary Tiller, 92" Working Width, All Gear Drive WITH Slip Clutch	1,149 lb.	\$8,938

[RETURN TO TABLE OF CONTENTS](#)



1D SERIES LIFT DISC HARROWS

MODEL	1D60-xx	1D78-xx
Hitch	Cat. 1 Std. & Quick Hitch	
Recommended HP	35 HP	
Bearing Hanger	3/8" x 6", Dual 1/2" U-Bolts	
Bearing Type - 2/Gang	Self-Aligning, Sealed Ball Bearings	
Angling Capabilities	0, 7, 14, 21 Degrees (Front & Rear Gangs)	
Frame Tubes	2" Square	
Gang Tubes	3" x 1 1/2"	
Gang Axles	1" Square, High Carbon Steel	
Options	Disc Scrapers	

GANG INFO - 1D60-XX

Disc Blade Spacing	Disc Blade Size	Cutting Width	Overall Width	No. Disc Blades	Gang Weight	Frame Weight	Total Weight	Axle Length
9" Front & Rear	16"	51.4"	58.2"	12	308 lb.	135 lb.	443 lb.	21.5"
7.5" Front & Rear	16"	61"	67.8"	16	348 lb.	135 lb.	483 lb.	26"
9" Front, 7.5" Rear	16"	61"	67.8"	14	312 lb.	135 lb.	447 lb.	21.5" (F) / 26" (R)
9" Front & Rear	18"	51.4"	58.2"	12	344 lb.	135 lb.	479 lb.	21.5"
7.5" Front & Rear	18"	61"	67.8"	16	395 lb.	135 lb.	530 lb.	26"
9" Front, 7.5" Rear	18"	61"	67.8"	14	339 lb.	135 lb.	474 lb.	21.5" (F) / 26" (R)

GANG INFO - 1D78-XX

Disc Blade Spacing	Disc Blade Size	Cutting Width	Overall Width	No. Disc Blades	Gang Weight	Frame Weight	Total Weight	Axle Length
9" Front & Rear	16"	69"	75.8"	16	372 lb.	135 lb.	507 lb.	31"
7.5" Front & Rear	16"	76.5"	83.3"	20	312 lb.	135 lb.	447 lb.	34"
9" Front, 7.5" Rear	16"	76.5"	83.3"	18	395 lb.	135 lb.	530 lb.	31" (F) / 34" (R)
9" Front & Rear	18"	69"	75.8"	16	420 lb.	135 lb.	555 lb.	31"
7.5" Front & Rear	18"	76.5"	83.3"	20	468 lb.	135 lb.	603 lb.	34"
9" Front, 7.5" Rear	18"	76.5"	83.3"	18	339 lb.	135 lb.	474 lb.	31" (F) / 34" (R)



[RETURN TO TABLE OF CONTENTS](#)

All models are available in the colors below:

Model Color Indicator	Unit Color
01	Bush Hog Red
03	John Deere Green
05	Kubota Orange
14	New Holland Blue
16	Caterpillar Yellow

1D SERIES LIFT DISC HARROWS

BASE UNIT SELECTION

Model Number	Description	List Price (\$US)
1D60-xx	1D Series Lift Disc Harrow 60"	\$697
1D78-xx	1D Series Lift Disc Harrow 78"	\$697

GANG ASSEMBLY SELECTION

Model Number	Description	List Price (\$US)
50072592	1D60 Gang Assembly, 16" Scallop Disc, 7.5" Front & Rear Spacing	\$2,058
50072593	1D60 Gang Assembly, 16" Scallop Disc, 9" Front & Rear Spacing	\$1,905
50072594	1D60 Gang Assembly, 16" Scallop Disc, 9" Front, 7.5" Rear Spacing	\$1,982
50072595	1D60 Gang Assembly, 18" Scallop Disc, 7.5" Front & Rear Spacing	\$2,185
50072596	1D60 Gang Assembly, 18" Scallop Disc, 9" Front & Rear Spacing	\$1,998
50072597	1D60 Gang Assembly, 18" Scallop Disc, 9" Front, 7.5" Rear Spacing	\$2,076
50072598	1D78 Gang Assembly, 16" Scallop Disc, 7.5" Front & Rear Spacing	\$2,185
50072599	1D78 Gang Assembly, 16" Scallop Disc, 9" Front & Rear Spacing	\$2,140
50072600	1D78 Gang Assembly, 16" Scallop Disc, 9" Front, 7.5" Rear Spacing	\$2,207
50072601	1D78 Gang Assembly, 18" Scallop Disc, 7.5" Front & Rear Spacing	\$2,436
50072602	1D78 Gang Assembly, 18" Scallop Disc, 9" Front & Rear Spacing	\$2,280
50072603	1D78 Gang Assembly, 18" Scallop Disc, 9" Front, 7.5" Rear Spacing	\$2,268

OPTIONS (1D SERIES ONLY)

Model Number	Description	List Price (\$US)
50073441	1D60 Scrapper Kit, 16/18 Discs, 7.5" Front & Rear Spacing	\$719
50073442	1D60 Scrapper Kit, 16/18 Discs, 9" Front & Rear Spacing	\$569
50069898	1D60 Scrapper Kit, 16/18 Discs, 9" Front, 7.5" Rear Spacing	\$662
50073443	1D78 Scrapper Kit, 16/18 Discs, 7.5" Front & Rear Spacing	\$870
50073444	1D78 Scrapper Kit, 16/18 Discs, 9" Front & Rear Spacing	\$804
50070558	1D78 Scrapper Kit, 16/18 Discs, 9" Front, 7.5" Rear Spacing	\$797



[RETURN TO TABLE OF CONTENTS](#)



2D SERIES LIFT DISC HARROWS

MODEL	2D78-xx	2D96-xx
Hitch	Cat. 1 Std. & Quick Hitch	
Recommended HP	65 HP	
Bearing Hanger	3/8" x 6", Dual 5/8" U-Bolts	
Bearing Type - 2/Gang	Self-Aligning, Sealed Ball Bearings	
Angling Capabilities	0, 7, 14, 21 Degrees (Front & Rear Gangs)	
Frame Tubes	2 1/2" Square	
Gang Tubes	3" x 2"	
Gang Axles	1" Square, High Carbon Steel	
Options	Disc Scrapers	

GANG INFO - 2D78-XX								
Disc Blade Spacing	Disc Blade Size	Cutting Width	Overall Width	No. Disc Blades	Gang Weight	Frame Weight	Total Weight	Axle Length
9" Front & Rear	18"	70.8"	77.6"	16	452 lb.	223 lb.	675 lb.	31"
7.5" Front & Rear	18"	78.13"	84.9"	20	477 lb.	223 lb.	700 lb.	34"
9" Front, 7.5" Rear	18"	78.13"	84.9"	18	472 lb.	223 lb.	695 lb.	31" (F) / 34" (R)
9" Front & Rear	20"	70.8"	77.6"	16	504 lb.	223 lb.	727 lb.	31"
7.5" Front & Rear	20"	78.13"	84.9"	20	547 lb.	223 lb.	770 lb.	34"
9" Front, 7.5" Rear	20"	78.13"	84.9"	18	543 lb.	223 lb.	766 lb.	31" (F) / 34" (R)

GANG INFO - 2D96-XX								
Disc Blade Spacing	Disc Blade Size	Cutting Width	Overall Width	No. Disc Blades	Gang Weight	Frame Weight	Total Weight	Axle Length
9" Front & Rear	18"	88.9"	95.7"	20	517 lb.	223 lb.	740 lb.	39.5"
7.5" Front & Rear	18"	91.3"	98.2"	24	580 lb.	223 lb.	803 lb.	41"
9" Front, 7.5" Rear	18"	91.3"	98.2"	22	635 lb.	223 lb.	858 lb.	39.5" (F) / 41" (R)
9" Front & Rear	20"	88.9"	95.7"	20	592 lb.	223 lb.	815 lb.	39.5"
7.5" Front & Rear	20"	91.3"	98.2"	24	648 lb.	223 lb.	871 lb.	41"
9" Front, 7.5" Rear	20"	91.3"	98.2"	22	679 lb.	223 lb.	902 lb.	39.5" (F) / 41" (R)



[RETURN TO TABLE OF CONTENTS](#)

All models are available in the colors below:

Model Color Indicator	Unit Color
01	Bush Hog Red
03	John Deere Green
05	Kubota Orange
14	New Holland Blue
16	Caterpillar Yellow

2D SERIES LIFT DISC HARROWS

BASE UNIT SELECTION

Model Number	Description	List Price (\$US)
2D78-xx	2D Series Lift Disc Harrow 78"	\$1,136
2D96-xx	2D Series Lift Disc Harrow 96"	\$1,136

GANG ASSEMBLY SELECTION

Model Number	Description	List Price (\$US)
50072738	2D78 Gang Assembly, 18" Scallop Disc, 7.5" Front & Rear Spacing	\$2,680
50072739	2D78 Gang Assembly, 18" Scallop Disc, 9" Front & Rear Spacing	\$2,482
50072740	2D78 Gang Assembly, 18" Scallop Disc, 9" Front, 7.5" Rear Spacing	\$2,516
50072741	2D78 Gang Assembly, 20" Scallop Disc, 7.5" Front & Rear Spacing	\$3,045
50072742	2D78 Gang Assembly, 20" Scallop Disc, 9" Front & Rear Spacing	\$2,791
50072743	2D78 Gang Assembly, 20" Scallop Disc, 9" Front, 7.5" Rear Spacing	\$2,803
50072744	2D96 Gang Assembly, 18" Scallop Disc, 7.5" Front & Rear Spacing	\$3,223
50072745	2D96 Gang Assembly, 18" Scallop Disc, 9" Front & Rear Spacing	\$3,028
50072746	2D96 Gang Assembly, 18" Scallop Disc, 9" Front, 7.5" Rear Spacing	\$3,165
50072747	2D96 Gang Assembly, 20" Scallop Disc, 7.5" Front & Rear Spacing	\$3,778
50072748	2D96 Gang Assembly, 20" Scallop Disc, 9" Front & Rear Spacing	\$3,446
50072749	2D96 Gang Assembly, 20" Scallop Disc, 9" Front, 7.5" Rear Spacing	\$3,533

OPTIONS (2D SERIES ONLY)

Model Number	Description	List Price (\$US)
50073445	2D78 Scraper Kit, 18/20 Discs, 7.5" Front & Rear Spacing	\$930
50073446	2D78 Scraper Kit, 18/20 Discs, 9" Front & Rear Spacing	\$823
50069897	2D78 Scraper Kit, 18/20 Discs, 9" Front, 7.5" Rear Spacing	\$890
50073447	2D96/3D96 Scraper Kit, (18/20, 20/22 Discs), 7.5" Front & Rear Spacing	\$1,050
50073448	2D96/3D96 Scraper Kit, (18/20, 20/22 Discs), 9" Front & Rear Spacing	\$953
50070559	2D96/3D96 Scraper Kit, (18/20, 20/22 Discs), 9" Front, 7.5" Rear Spacing	\$1,018

[RETURN TO TABLE OF CONTENTS](#)



3D SERIES

3D SERIES LIFT DISC HARROWS

MODEL	3D96-xx	3D118-xx
Hitch	Cat. 1 & 2 Std. & Quick Hitch	
Recommended HP	95 HP	
Bearing Hanger	1/2" x 7", Dual 5/8" U-Bolts	
Bearing Type - 2/Gang	Self-Aligning, Sealed Ball Bearings	
Angling Capabilities	0, 7, 14, 21 Degrees (Front Gangs); 7, 14, 21 Degrees (Rear Gangs)	
Frame Tubes	3" Square	
Gang Tubes	4" x 3"	
Gang Axles	1 1/8" Square, High Carbon Steel	
Options	Disc Scrapers	

GANG INFO - 3D96-XX								
Disc Blade Spacing	Disc Blade Size	Cutting Width	Overall Width	No. Disc Blades	Gang Weight	Frame Weight	Total Weight	Axle Length
9" Front & Rear	20"	88.8"	95.7"	20	773 lb.	379 lb.	1,152 lb.	40.25"
7.5" Front & Rear	20"	93.4"	100.3"	24	807 lb.	379 lb.	1,186 lb.	42"
9" Front, 7.5" Rear	20"	93.4"	100.3"	22	794 lb.	379 lb.	1,173 lb.	40.25" (F) / 42" (R)
9" Front & Rear	22"	88.8"	95.7"	20	896 lb.	379 lb.	1,275 lb.	40.25"
7.5" Front & Rear	22"	93.4"	100.3"	24	932 lb.	379 lb.	1,311 lb.	42"
9" Front, 7.5" Rear	22"	93.4"	100.3"	22	920 lb.	379 lb.	1,299 lb.	40.25" (F) / 42" (R)

GANG INFO - 3D118-XX								
Disc Blade Spacing	Disc Blade Size	Cutting Width	Overall Width	No. Disc Blades	Gang Weight	Frame Weight	Total Weight	Axle Length
9" Front & Rear	20"	107"	113.9"	24	867 lb.	379 lb.	1,246 lb.	49.5"
7.5" Front & Rear	20"	106.8"	113.7"	28	1,052 lb.	379 lb.	1,431 lb.	49.5"
9" Front, 7.5" Rear	20"	106.8"	113.7"	26	976 lb.	379 lb.	1,355 lb.	49.5"
9" Front & Rear	22"	107"	113.9"	24	1,002 lb.	379 lb.	1,381 lb.	49.5"
7.5" Front & Rear	22"	106.8"	113.7"	28	1,100 lb.	379 lb.	1,479 lb.	49.5"
9" Front, 7.5" Rear	22"	106.8"	113.7"	26	1,106 lb.	379 lb.	1,485 lb.	49.5"

HOW TO ORDER:

These disc harrows are available as lift type implements only. For total price, select a model, gang assembly, and any desired option. Units are shipped fully assembled.

Freight NOT included in list price. **Freight discount available for multiple unit orders. Please contact Customer Service for details.**



[RETURN TO TABLE OF CONTENTS](#)

All models are available in the colors below:

Model Color Indicator	Unit Color
01	Bush Hog Red
03	John Deere Green
05	Kubota Orange
14	New Holland Blue
16	Caterpillar Yellow

3D SERIES LIFT DISC HARROWS

BASE UNIT SELECTION

Model Number	Description	List Price (\$US)
3D96-xx	3D Series Lift Disc Harrow 96"	\$2,075
3D118-xx	3D Series Lift Disc Harrow 118"	\$2,075

GANG ASSEMBLY SELECTION

Model Number	Description	List Price (\$US)
50072750	3D96 Gang Assembly, 20" Scallop Disc, 7.5" Front & Rear Spacing	\$5,061
50072751	3D96 Gang Assembly, 20" Scallop Disc, 9" Front & Rear Spacing	\$4,970
50072752	3D96 Gang Assembly, 20" Scallop Disc, 9" Front, 7.5" Rear Spacing	\$4,911
50072753	3D96 Gang Assembly, 22" Scallop Disc, 7.5" Front & Rear Spacing	\$5,646
50072754	3D96 Gang Assembly, 22" Scallop Disc, 9" Front & Rear Spacing	\$5,302
50072755	3D96 Gang Assembly, 22" Scallop Disc, 9" Front, 7.5" Rear Spacing	\$5,444
50072756	3D118 Gang Assembly, 20" Scallop Disc, 7.5" Front & Rear Spacing	\$5,956
50072757	3D118 Gang Assembly, 20" Scallop Disc, 9" Front & Rear Spacing	\$5,551
50072758	3D118 Gang Assembly, 20" Scallop Disc, 9" Front, 7.5" Rear Spacing	\$5,729
50072759	3D118 Gang Assembly, 22" Scallop Disc, 7.5" Front & Rear Spacing	\$6,528
50072760	3D118 Gang Assembly, 22" Scallop Disc, 9" Front & Rear Spacing	\$6,181
50072761	3D118 Gang Assembly, 22" Scallop Disc, 9" Front, 7.5" Rear Spacing	\$6,363

OPTIONS (3D SERIES ONLY)

Model Number	Description	List Price (\$US)
50073447	2D96/3D96 Scraper Kit, (18/20, 20/22 Discs), 7.5" Front & Rear Spacing	\$1,050
50073448	2D96/3D96 Scraper Kit, (18/20, 20/22 Discs), 9" Front & Rear Spacing	\$953
50070559	2D96/3D96 Scraper Kit, (18/20, 20/22 Discs), 9" Front, 7.5" Rear Spacing	\$1,018
50073449	3D118 Scraper Kit, 20/22 Discs, 7.5" Front & Rear Spacing	\$1,155
50073450	3D118 Scraper Kit, 20/22 Discs, 9" Front & Rear Spacing	\$1,036
50069896	3D118 Scraper Kit, 20/22 Discs, 9" Front, 7.5" Rear Spacing	\$1,096



[RETURN TO TABLE OF CONTENTS](#)



DHP SERIES PULL DISC HARROW

MODEL	DHP8	DHP10	DHP12
Drawbar Required HP	40 – 65 HP	45 – 100 HP	55 – 100 HP
Hitch	Pull-Type with Clevis & Hole for 1 ¼" Pin		
Approx. Weight Load on Each Blade	95 – 114 lb.	84 – 98 lb.	78 – 90 lb.
Number of Bearings	8	12	
Disc Bearing Type	Triple Lip Sealed Ball Bearings		
Angling Capabilities	15, 16.5, 18, 19.5, 21 Degrees (Front Gangs); 12, 13.5, 15, 16.5, 18 Degrees (Rear Gangs)		
Frame Tubes	3" Square		
Construction - Tubing	Slide Mainframe, Mainframe Middle, and Gang Arm - 4" x 3" x 1/4"; Mainframe Front and Rear - 5" x 3" x 1/4"; Hitch Frame - 4" x 4" x 1/4"		
Gang Axles	1 ½" Square, High Carbon Steel		
Front to Rear Leveling System	Manual Crank Adjustment		
Depth Control	Cylinder Stroke Control Spacers		
Hydraulic Cylinder	3 ½" x 8" ASAE Hydraulic Cylinder		
Transport Tires and Wheels	(Two) 9.5Lx15 Tires on 15" x 6" – 5 Bolt Wheels		
Park Jack	Standard		
Options	Disc Scrapers, Dual Wheel Transport Kit		

GANG INFO - DHP8

Disc Blade Spacing	Notched Disc Blade Size	Cutting Width	Apprx. Transport Width	No. Disc Blades	Gang Weight	Frame Weight	Total Weight	Axle Length
9" Front & Rear	20"	90.25"	8' 10"	20	792 lb.	1,423 lb.	2,215 lb.	40.25"
7.5" Front & Rear	20"	92.5"	8' 10"	24	864 lb.	1,423 lb.	2,287 lb.	42"
9" Front, 7.5" Rear	20"	92.5"	8' 10"	22	828 lb.	1,423 lb.	2,251 lb.	40.25" (F) / 42" (R)
9" Front & Rear	22"	90.25"	8' 10"	20	856 lb.	1,423 lb.	2,279 lb.	40.25"
7.5" Front & Rear	22"	92.5"	8' 10"	24	976 lb.	1,423 lb.	2,399 lb.	42"
9" Front, 7.5" Rear	22"	92.5"	8' 10"	22	916 lb.	1,423 lb.	2,339 lb.	40.25" (F) / 42" (R)

GANG INFO - DHP10

Disc Blade Spacing	Notched Disc Blade Size	Cutting Width	Apprx. Transport Width	No. Disc Blades	Gang Weight	Frame Weight	Total Weight	Axle Length
9" Front & Rear	20"	125"	10' 10"	28	1,124 lb.	1,510 lb.	2,634 lb.	58.5"
7.5" Front & Rear	20"	123.25"	10' 10"	32	1,118 lb.	1,510 lb.	2,698 lb.	57.5"
9" Front, 7.5" Rear	20"	123.25"	10' 10"	30	1,156 lb.	1,510 lb.	2,666 lb.	58.5" (F) / 57.5" (R)
9" Front & Rear	22"	125"	10' 10"	28	1,236 lb.	1,510 lb.	2,746 lb.	58.5"
7.5" Front & Rear	22"	123.25"	10' 10"	32	1,272 lb.	1,510 lb.	2,782 lb.	57.5"
9" Front, 7.5" Rear	22"	123.25"	10' 10"	30	1,254 lb.	1,510 lb.	2,764 lb.	58.5" (F) / 57.5" (R)

GANG INFO - DHP12

Disc Blade Spacing	Notched Disc Blade Size	Cutting Width	Apprx. Transport Width	No. Disc Blades	Gang Weight	Frame Weight	Total Weight	Axle Length
9" Front & Rear	20"	143.25"	12' 4"	32	1,240 lb.	1,510 lb.	2,750 lb.	67.5"
7.5" Front & Rear	20"	140.5"	12' 4"	36	1,300 lb.	1,510 lb.	2,810 lb.	65"
9" Front, 7.5" Rear	20"	140.5"	12' 4"	34	1,270 lb.	1,510 lb.	2,780 lb.	67.5" (F) / 65" (R)
9" Front & Rear	22"	143.25"	12' 4"	32	1,356 lb.	1,510 lb.	2,866 lb.	67.5"
7.5" Front & Rear	22"	140.5"	12' 4"	36	1,468 lb.	1,510 lb.	2,978 lb.	65"
9" Front, 7.5" Rear	22"	140.5"	12' 4"	34	1,412 lb.	1,510 lb.	2,922 lb.	67.5" (F) / 65" (R)

HOW TO ORDER:

These disc harrows are available as pull type implements only. For the total price, select a model, gang assembly, and desired option(s). Each unit is shipped in three crates for dealer assembly.

Freight NOT included in list price. **Freight discount available for multiple unit orders. Please contact Customer Service for details.**



[RETURN TO TABLE OF CONTENTS](#)

All models are available in the colors below:

Model Color Indicator	Unit Color
01	Bush Hog Red
03	John Deere Green
05	Kubota Orange
14	New Holland Blue
16	Caterpillar Yellow

DHP SERIES PULL DISC HARROW

BASE UNIT SELECTION		
Model Number	Description	List Price (\$US)
DHP8-xx	DHP Series Pull Disc Harrow, 8', Single Axle	\$8,629
DHP10-xx	DHP Series Pull Disc Harrow, 10', Single Axle	\$8,809
DHP12-xx	DHP Series Pull Disc Harrow, 12', Single Axle	\$8,809
DHP8 SERIES GANG ASSEMBLY SELECTION		
50072135	DHP8 Gang Assembly, 20" Scallop Disc, 7.5" Front & Rear Spacing	\$6,222
50072136	DHP8 Gang Assembly, 20" Scallop Disc, 9" Front & Rear Spacing	\$5,923
50072137	DHP8 Gang Assembly, 20" Scallop Disc, 9" Front, 7.5" Rear Spacing	\$6,032
50072138	DHP8 Gang Assembly, 22" Scallop Disc, 7.5" Front & Rear Spacing	\$6,629
50072139	DHP8 Gang Assembly, 22" Scallop Disc, 9" Front & Rear Spacing	\$6,291
50072140	DHP8 Gang Assembly, 22" Scallop Disc, 9" Front, 7.5" Rear Spacing	\$6,454
DHP10 SERIES GANG ASSEMBLY SELECTION		
50072141	DHP10 Gang Assembly, 20" Scallop Disc, 7.5" Front & Rear Spacing	\$7,594
50072142	DHP10 Gang Assembly, 20" Scallop Disc, 9" Front & Rear Spacing	\$7,871
50072143	DHP10 Gang Assembly, 20" Scallop Disc, 9" Front, 7.5" Rear Spacing	\$7,470
50072144	DHP10 Gang Assembly, 22" Scallop Disc, 7.5" Front & Rear Spacing	\$8,068
50072145	DHP10 Gang Assembly, 22" Scallop Disc, 9" Front & Rear Spacing	\$7,270
50072146	DHP10 Gang Assembly, 22" Scallop Disc, 9" Front, 7.5" Rear Spacing	\$7,894
DHP12 SERIES GANG ASSEMBLY SELECTION		
50072147	DHP12 Gang Assembly, 20" Scallop Disc, 7.5" Front & Rear Spacing	\$10,007
50072148	DHP12 Gang Assembly, 20" Scallop Disc, 9" Front & Rear Spacing	\$9,640
50072149	DHP12 Gang Assembly, 20" Scallop Disc, 9" Front, 7.5" Rear Spacing	\$9,828
50072230	DHP12 Gang Assembly, 22" Scallop Disc, 7.5" Front & Rear Spacing	\$10,706
50072231	DHP12 Gang Assembly, 22" Scallop Disc, 9" Front & Rear Spacing	\$10,327
50072232	DHP12 Gang Assembly, 22" Scallop Disc, 9" Front, 7.5" Rear Spacing	\$10,498
OPTIONS		
DHP8 SERIES ONLY		
50072310	DHP8 Scraper Kit, 20/22 Discs, 7.5" Front & Rear Spacing	\$1,555
50072311	DHP8 Scraper Kit, 20/22 Discs, 9" Front & Rear Spacing	\$1,299
50072312	DHP8 Scraper Kit, 20/22 Discs, 9" Front, 7.5" Rear Spacing	\$1,384
DHP10 SERIES ONLY		
50072313	DHP10 Scraper Kit, 20/22 Discs, 7.5" Front & Rear Spacing	\$1,950
50072314	DHP10 Scraper Kit, 20/22 Discs, 9" Front & Rear Spacing	\$1,879
50072315	DHP10 Scraper Kit, 20/22 Discs, 9" Front, 7.5" Rear Spacing	\$1,810
DHP12 SERIES ONLY		
50072316	DHP12 Scraper Kit, 20/22 Discs, 7.5" Front & Rear Spacing	\$2,158
50072317	DHP12 Scraper Kit, 20/22 Discs, 9" Front & Rear Spacing	\$2,051
50072318	DHP12 Scraper Kit, 20/22 Discs, 9" Front, 7.5" Rear Spacing	\$2,087
50072233	DHP Dual Wheel Transport Kit, Available for all DHP models	\$1,210

[RETURN TO TABLE OF CONTENTS](#)



APP SERIES ALL-PURPOSE PLOWS

MODEL	APP48-3	APP60-5	APP66-5	APP66-7	APP85-7	APP85-9
Overall Width	49 ⁵ / ₈ "	61 ⁵ / ₈ "	67 ⁵ / ₈ "		85 ⁵ / ₈ "	
Maximum Working Width	44"	56"	62"		80"	
Overall Depth	39 ³ / ₄ "					
Overall Height	40 ³ / ₈ "					
Weight (lb.)	206	228	284	367	386	455
Number of Shanks	3	5		7		9
Angle Iron Size	2 ¹ / ₂ " Width x 2 ¹ / ₂ " Height x 3/8" Thickness					
Hole Spacing	1"					
Hitch	Cat 1 Std & Quick Hitch					
Teeth	5/16" x 2" x 10 ¹ / ₈ " 1080 High Carbon 38-44 Rockwell C Reversible					
Suggested Min. PTO HP	24	35		49		63

HOW TO ORDER:

The All Purpose Plow is available as a lift-type implement only. It is priced as a complete unit and is shipped fully assembled.

Freight NOT included in list price. Freight discount available for multiple unit orders. Please contact Customer Service for details.

BASE UNIT SELECTION

Model Number	Description	List Price (\$US)
APP48-3	All Purpose Plow, 48", 3 Shanks, Bush Hog Red	\$1,135
APP60-5	All Purpose Plow, 60", 5 Shanks, Bush Hog Red	\$1,649
APP66-5	All Purpose Plow, 66", 5 Shanks, Bush Hog Red	\$1,812
APP66-7	All Purpose Plow, 66", 7 Shanks, Bush Hog Red	\$2,160
APP85-7	All Purpose Plow, 85", 7 Shanks, Bush Hog Red	\$2,325
APP85-9	All Purpose Plow, 85", 9 Shanks, Bush Hog Red	\$2,649

[RETURN TO TABLE OF CONTENTS](#)

All models are available in the colors below:

Model Color Indicator	Unit Color
01	Bush Hog Red
03	John Deere Green
05	Kubota Orange
14	New Holland Blue
16	Caterpillar Yellow



HDSS SERIES HEAVY-DUTY SUBSOILERS

MODEL	HDSS1S	HDSS1L	HDSS2S	HDSS2L
Hitch	Cat 1 & 2 Quick Hitch			
Overall Width	41"		49"	
Overall Height	39½"	43½"	39½"	43½"
Horsepower	Approximately 35 HP per shank up to 85 HP			
Shank Size	11/4" x 97/16" x 26¼" (Long), 11/4" x 97/16" x 22¼" (Short)			
Number of Shanks	1		2	
Cutting Point	1" x 2½" x 9¾"			
Maximum Cutting Depth	19¼"	23¼"	19¼"	23¼"

HOW TO ORDER:

The Heavy Duty Series Subsoiler is available as a 3-Point type implement only. It is priced as a complete unit and is shipped fully assembled. Indicate your choice of model color from the chart above.

Freight NOT included in list price. Freight discount available for multiple unit orders. Please contact Customer Service for details.

BASE UNIT SELECTION

Model Number	Description	Approx. Wt.	List Price (\$US)
HDSS1S-xx	Subsoiler, Heavy Duty, 1 Shank, Short	261 lb.	\$1,808
HDSS1L-xx	Subsoiler, Heavy Duty, 1 Shank, Long	276 lb.	\$2,029
HDSS2S-xx	Subsoiler, Heavy Duty, 2 Shank, Short	420 lb.	\$3,401
HDSS2L-xx	Subsoiler, Heavy Duty, 2 Shank, Long	450 lb.	\$3,466

[RETURN TO TABLE OF CONTENTS](#)



SS1 SUBSOILER



LP LAYOFF PLOW

All models are available in the colors below:	
Model Color Indicator	Unit Color
01	Bush Hog Red
03	John Deere Green
05	Kubota Orange
14	New Holland Blue
16	Caterpillar Yellow



1RCV CULTIVATOR

SS1 SERIES SUBSOILERS, LP SERIES LAYOFF PLOWS, 1RCV SERIES CULTIVATOR

MODEL	SS1 SUBSOILER	LP LAYOFF PLOW	1RCV CULTIVATOR
Hitch	Cat 1 Std & Quick Hitch		
Overall Width	32 3/8"		57 7/8"
Overall Height	50"	38"	41 3/16"
Horsepower	25 - 45		
Shank Size	3/4" x 6"	3/4" x 4"	3/8" x 1 3/4"
Number of Shanks	1		6
Cutting Point	1/2" x 2 1/2" x 12"	16" x 4.75 mm	1/4" x 2 1/2" x 11"
Maximum Cutting Depth	25 5/8"		

HOW TO ORDER:

The Ground Engaging Implements are available as a 3-Point type implement only. Each model is priced as a complete unit and is shipped fully assembled. Indicate your choice of model color from the chart above.

Freight NOT included in list price. Freight discount available for multiple unit orders. Please contact Customer Service for details.

BASE UNIT SELECTION

Model Number	Description	Approx. Wt.	List Price (\$US)
SS1-xx	Subsoiler, Standard Duty	113 lb.	\$640
LP-xx	Layoff Plow, Light Duty	75 lb.	\$380
1RCV-xx	Cultivator, Light Duty	171 lb.	\$865

OPTIONS (1RCV MODEL ONLY)

Model Number	Description	Approx. Wt.	List Price (\$US)
50072481	Middle Tine Kit for 1RCV Series Cultivator	113 lb.	\$147

[RETURN TO TABLE OF CONTENTS](#)



All models are available in the colors below:

Model Color Indicator	Unit Color
01	Bush Hog Red
03	John Deere Green
05	Kubota Orange
14	New Holland Blue
16	Caterpillar Yellow

PA SERIES PASTURE AERATOR

MODEL	PA8	PA10
Tractor HP Requirements	40 - 90 HP	
Working Width	86"	116"
Overall Width	97.38"	127.63"
Overall Length	136" in Transportation Position	
Overall Height	44.25" (With Tines on the Ground)	
Weight Box	Standard	
Maximum Ballast in Weight Box (Ballast Not Included with Unit)	2,200 lb.	2,900 lb.
Number of Tines	24 (LH), 24 (RH)	32 (LH), 32 (RH)
Tine Material	Forged and Heat Treated Through Steel	
Tine Hub Spacing	7.5"	
Tine Penetration	Up to 8.125", Depending on Ground Condition	
Frame Construction	4" Square Tubing, All Welded Construction	
Main Tongue Beam	4" Square	
Rotor/Tine Support Hangers	1" x 7" Heavy Duty Hangers	
Rotor Bearings	Heavy Duty Greaseable	
Rotor Bearing Protection	.38" x 3.5" Metal Housing	
Rotor Angle Adjustment	2.5°, 5°, 7.5°	
Tires and Wheels	9.5L x 15 Tires on 15" - 5 Bolt Wheels	
Tine Depth Control	Add Cylinder Donuts to Cylinder Rod (Included)	
Hydraulic Cylinder	3.5" x 8"	
Transportation Lock	Manual Cylinder Lock	
Rear Axle Pivot	Greaseable	
Safety Tow Chain	Included	

One-Year Limited Warranty

HOW TO ORDER:

The PA Series Pasture Aerator is available as a pull-type implement only. It is priced as a complete unit, and each unit is shipped in one crate with the tongue and tailwheels to be assembled by the dealer. Indicate your choice of model color from the chart above.

Freight NOT included in list price. Freight discount available for multiple unit orders. Please contact Customer Service for details.

BASE UNIT SELECTION

Model Number	Description	Approx. Wt.	List Price (\$US)
PA8-xx	PA Series Pasture Aerator, 8'	1,950 lb.	\$17,157
PA10-xx	PA Series Pasture Aerator, 10'	2,500 lb.	\$20,722



HAY TOOLS



[RETURN TO TABLE OF CONTENTS](#)

DHM SERIES HAY MOWERS

MODEL	DHM7	DHM8	DHM9	DHM10
Working Width	6' 9"	8'	9' 3"	10' 6"
Number of Oval Discs	5	6	7	8
Blades Per Disc	2			
Driveline Size	Cat. 4			
Minimum PTO HP	40	46	52	56
Hitch	Cat. 2			
PTO Speed	540			
Safety Curtain	Standard			
Weight	906 lb.	1,235 lb.	1,300 lb.	1,400 lb.

NOTICE:

Bush Hog Disc Mowers are intended for agricultural use. Do not operate mowers near structures that may be vulnerable to damage from thrown objects. Operating tractor should be equipped with a cab.

HOW TO ORDER:

The DHM Series Hay Mower is priced as a complete unit. Select the desired model number from the Base Unit Selection below.

Freight NOT included in list price. Freight discount available for multiple unit orders. Please contact Customer Service for details.

BASE UNIT SELECTION

Model Number	Description	Approx. Wt.	List Price (\$US)
DHM7	DHM Series Hay Mower, 5 Discs, 2 Blades, 6' 7" Mowing Width, Complete	906 lb.	\$13,408
DHM8	DHM Series Hay Mower, 6 Discs, 2 Blades, 8' Mowing Width, Complete	1,235 lb.	\$18,122
DHM9	DHM Series Hay Mower, 7 Discs, 2 Blades, 9' 3" Mowing Width, Complete	1,300 lb.	\$19,580
DHM10	DHM Series Hay Mower, 8 Discs, 2 Blades, 10' 6" Mowing Width, Complete	1,400 lb.	\$23,594



[RETURN TO TABLE OF CONTENTS](#)



HT SERIES HAY TEDDERS

MODEL	HT210	HT417	HT417H	HT419H	HT625H
Number of Rotors	2	4			6
Working Width (Approx.)	10'	17' 1"		19'	25' 7"
Number of Tines	12	24			36
Transport Width	10'			11'	9' 6"
Working Speed	5 - 10 mph				
Minimum Tractor HP	15 HP	22 HP		25 HP	50 HP
PTO Speed	540				
Folding	N/A	Manual	Hydraulic		
Tire Size	16 x 6.50-8				

HOW TO ORDER:

The HT Series Hay Tedder is priced as a complete unit. Indicate your choice of model number from the Base Unit Selection in the order section below.

Freight NOT included in list price. Freight discount available for multiple unit orders. Please contact Customer Service for details.

BASE UNIT SELECTION

Model Number	Description	Approx. Wt.	List Price (\$US)
HT210	Hay Tedder, Pull Type, 10' ***HT210 MUST BE ORDERED IN MULTIPLES OF 2***	385 lb.	\$4,183
HT417	Hay Tedder, Pull Type, 17', Spring-Assist Fold	830 lb.	\$9,269
HT417H	Hay Tedder, 17', Hydraulic Fold	850 lb.	\$10,715
HT419H	Hay Tedder, 19', Hydraulic Fold	1,225 lb.	\$11,978
HT625H	Hay Tedder, 26', Hydraulic Fold	2,470 lb.	\$28,630

OPTIONS

Model Number	Description	Approx. Wt.	List Price (\$US)
3670402	Hydraulic Tilt Kits (fits HT417H, HT419H models)	17 lb.	\$1,170



[RETURN TO TABLE OF CONTENTS](#)



XLRR-I SERIES PULL-TYPE V-RAKES

MODEL	XLRR819	XLRR1022	XLRR1226
Number of Finger Wheels	8	10	12
Finger Wheel Diameter	55"		
Tine Diameter	7mm		
Minimum Windrow Width*	3'		
Maximum Windrow Width*	6' 7"		
Minimum Working Width*	16' 4"	19'	21' 8"
Maximum Working Width*	18'	21'	24' 6"
Transport Width	8' 5"		
Minimum HP Requirement	30 HP		50 HP
Tire Size	205/75/15		

**Depending on Crop Conditions*

HOW TO ORDER:

The XLRR-I Series Pull-Type V-Rake is priced as a complete unit. Indicate your choice of model number from the Base Unit Selection in the order section below. Add any additional equipment from the Options section.

Freight NOT included in list price. Freight discount available for multiple unit orders. Please contact Customer Service for details.

BASE UNIT SELECTION

Model Number	Description	Approx. Wt.	List Price (\$US)
XLRR819-1	8 Wheel V-Type Hay Rake, 19'	1,675 lb.	\$10,492
XLRR1022-1	10 Wheel V-Type Hay Rake, 22'	1,875 lb.	\$11,661
XLRR1226-1	12 Wheel V-Type Hay Rake, 26'	2,115 lb.	\$12,988

OPTIONS

Model Number	Description	List Price (\$US)
3690405	Center "Kicker" Wheel Kit	\$1,164
3690416	Tandem Wheel Kit	\$2,164
3690414	Hydraulic Windrow Adjustment for XLRR819 & XLRR1022	\$1,428
3690415	Hydraulic Windrow Adjustment for XLRR1226	\$1,459
3666777	Solid Cover for 55" Center Rake Wheel (Price Per Wheel)	\$61

[RETURN TO TABLE OF CONTENTS](#)



EWR SERIES PULL TYPE WHEEL V-RAKES

MODEL	EWR820	EWR1023
Number of Finger Wheels	8	10
Windrow Width, Adjustable	3' - 5'	
Working Width (Approx.)	20'	23'
Transport Width	10'	
Minimum HP Requirement	30 HP	
Tire Size	195-70R/15	
Operating Speed	Up to 14 MPH	

HOW TO ORDER:

The RR Series Rotary Rake is priced as a complete unit. Indicate your choice of model number from the Base Unit Selection in the order section below.

Freight NOT included in list price. Freight discount available for multiple unit orders. Please contact Customer Service for details.

BASE UNIT SELECTION

Model Number	Description	Approx. Wt.	List Price (\$US)
EWR820	EWR Series Economy Pull Type Wheel V-Rake, 20', 8 Wheels	1,200 lb.	\$7,490
EWR1023	EWR Series Economy Pull Type Wheel V-Rake, 23', 10 Wheels	1,355 lb.	\$8,272

OPTIONS

Model Number	Description	List Price (\$US)
3660408	Center Wheel (Kicker) Kit for EWR Series Pull Type Wheel V-Rake	each \$754
3666777	Solid Cover for 55" Center Rake Wheel (Price Per Wheel)	each \$61

(Order one per wheel)

[RETURN TO TABLE OF CONTENTS](#)



3PBS2 SERIES



3PBS1 SERIES



3PBU SERIES

All models are available in the colors below:

Model Color Indicator	Unit Color
01	Bush Hog Red
03	John Deere Green
05	Kubota Orange
14	New Holland Blue
16	Caterpillar Yellow

3PB SERIES 3-PT HAY IMPLEMENTS

MODEL	3PBS1	3PBS2	3PBU
Hitch (3-PT)	Cat. 1 Std., Quick Hitch	Cat. 1 & 2, Std., Quick Hitch	Cat. 1 & 2, Std., Quick Hitch
Tractor HP (Min.)	35 HP	35 HP	35 HP
Overall Width	31 7/8"	39"	69 1/2"
Overall Depth	51"	52"	67"
Overall Height	25 3/8"	25 3/8"	25 1/16"
Spear Size (Diameter)	1.78"	1.78"	N/A
Usable Spear Length	42 1/2"	42 1/2"	N/A
Maximum Load Capacity	2,800 lb.	2,800 lb.	2,000 lb.

HOW TO ORDER:

The 3PB Series Hay Implement is available as a 3-PT type implement only. It is priced as a complete unit and is shipped fully assembled. To receive a complete Single Probe Bale Spear, you must indicate your choice of basic unit in the order section below. To receive a complete Bale Unroller, you must indicate base unit selection, including your choice of model color from the chart above.

Freight NOT included in list price. Freight discount available for multiple unit orders. Please contact Customer Service for details.

BASE UNIT SELECTION

Model Number	Description	Color	Approx. Wt.	List Price (\$US)
3PBS1	Single Probe Bale Spear, 3-Pt, Category 1 Only	Black Only	80 lb.	\$595
3PBS2	Single Probe Bale Spear, 3-Pt, Category 1 & 2	Black Only	97 lb.	\$664
3PBU-xx	3PBU Series Bale Unroller, 3-Pt	See Table Above	326 lb.	\$2,244

[RETURN TO TABLE OF CONTENTS](#)

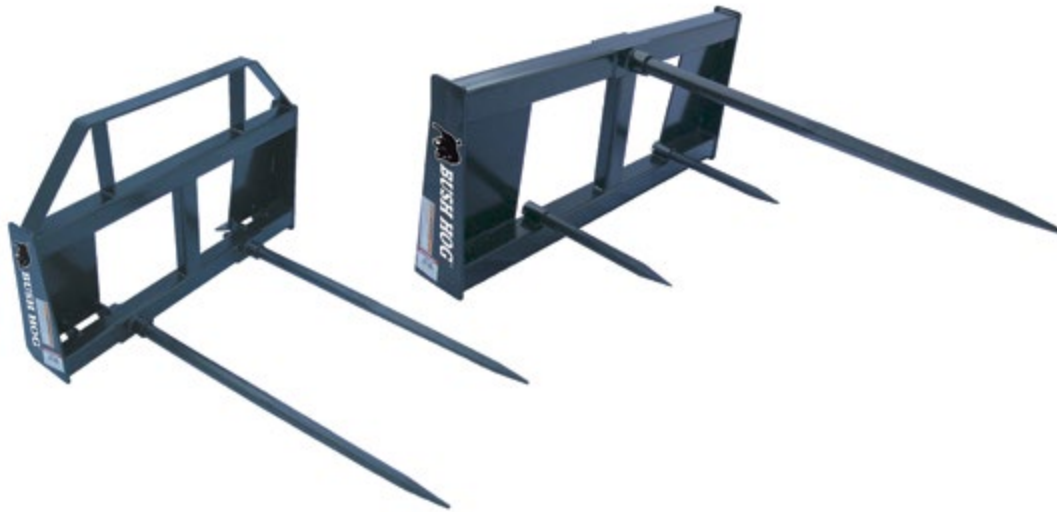

BS SERIES TRACTOR-MOUNTED BALE SPEARS

MODEL	BS1	BS2
Overall Height	21 ³ / ₁₆ "	30"
Overall Width	45 ⁵ / ₁₆ "	
Overall Depth	51"	
Spear Size	1.78"	
Useable Spear Length	42 ¹ / ₂ "	
Weight	144 lb.	200 lb.
Max. Spear Capacity	3,500 lb. @ 23 ¹ / ₂ "	
Attachment Method	Universal Skid Steer, EURO, or JD 300, 400, 500 Quick Attach	
Color	Black	

HOW TO ORDER:

The BS Series Bale Spear is priced as a complete unit. Select your desired model from the Base Unit Selection offered.

Freight NOT included in list price. Freight discount available for multiple unit orders. Please contact Customer Service for details.

BS1 SERIES BASE UNIT SELECTION

Model Number	Description	Approx. Wt.	List Price (\$US)
BS1SS	Bale Spear, Single, Skid Steer	144 lb.	\$1,040
BS1E	Bale Spear, Single, Euro	144 lb.	\$1,155
BS1JD	Bale Spear, Single, John Deere	144 lb.	\$1,126

BS2 SERIES BASE UNIT SELECTION

Model Number	Description	Approx. Wt.	List Price (\$US)
BS2SS	Bale Spear, Double, Skid Steer	200 lb.	\$1,230
BS2E	Bale Spear, Double, Euro	200 lb.	\$1,320
BS2JD	Bale Spear, Double, John Deere	200 lb.	\$1,304

SERIES: SBSA | SBDA | SBPT | SBSS | SBLM



SNOW BLOWERS



SNOW REMOVAL EQUIPMENT

[RETURN TO TABLE OF CONTENTS](#)



***** THIS PRODUCT IS PRICED AT LIST LESS 25% *****

54"-60" SINGLE AUGER SNOW BLOWERS

MODEL	SBSA54	SBSA60
HP (Rec)	15 HP	20 HP
Cutting Width	54"	60"
Cutting Edge	3/8 x 1	
Auger Diameter	14"	
Fan Diameter	21"	
Chute Diameter	8"	
Chute Rotation	Std/Opt	
Chute Deflector	Std/Opt	
Main Body Height	25"	
3PH Mount	Cat 1 Std & Quick Hitch	
Weight	366 lb.	396 lb.

Five-Year Limited Gearbox Warranty Two-Year Limited Machine Warranty

HOW TO ORDER:

Choose a model from the Base Unit Selection to order a complete unit. The 54" and 60" models come standard with a manual chute rotator.

Freight NOT included in list price.

BASE UNIT SELECTION

Model Number	Description	Approx. Wt.	List Price (\$US)
SBSA54	Single Auger 54" Snow Blower	366 lb.	\$3,859
SBSA60	Single Auger 60" Snow Blower	396 lb.	\$4,033

OPTIONS

Model Number	Description	List Price (\$US)
50078918	Hydraulic Chute Rotator (fits all models)	\$904
50078919	Hydraulic Deflector Kit (fits SBSA54-72 models)	\$558



[RETURN TO TABLE OF CONTENTS](#)



*** THIS PRODUCT IS PRICED AT LIST LESS 25% ***

72"-97" SINGLE AUGER SNOW BLOWERS

MODEL	SBSA72	SBSA78	SBSA87	SBSA97
HP (Rec)	35 HP	50 HP	60 HP	75 HP
Cutting Width	72"	78"	87"	97"
Cutting Edge	3/8 x 1	1/2 x 1½	1/2 x 2	1/2 x 2
Auger Diameter	14"	15"	19"	
Fan Diameter	21"	23"	27"	
Chute Diameter	10"		12"	
Chute Rotation	Opt/Opt			
Chute Deflector	Std/Opt			
Main Body Height	29"		36"	
3PH Mount	Cat 1 Std & Quick Hitch	Cat 1 & 2 Std & Quick Hitch	Cat 2 Std & Quick Hitch	
Weight	540 lb.	748 lb.	1,034 lb.	1,106 lb.

Five-Year Limited Gearbox Warranty Two-Year Limited Machine Warranty

HOW TO ORDER:

Choose a model from the Base Unit Selection to order a complete unit. The 54" and 60" models come standard with a manual chute rotator.

Freight NOT included in list price.

BASE UNIT SELECTION

Model Number	Description	Approx. Wt.	List Price (\$US)
SBSA72	Single Auger 72" Snow Blower	540 lb.	\$4,514
SBSA78	Single Auger 78" Snow Blower	748 lb.	\$5,727
SBSA87	Single Auger 87" Snow Blower	1,034 lb.	\$6,548
SBSA97	Single Auger 97" Snow Blower	1,106 lb.	\$6,907

GROUP 2 CHUTE ROTATOR SELECTION

Model Number	Description	List Price (\$US)
50078913	Manual Chute Rotator (fits SBSA72 model)	\$189
50078914	Manual Chute Rotator (fits SBSA78 models)	\$189
50078915	Manual Chute Rotator (fits SBSA87 and SBSA97 models)	\$189
50078918	Hydraulic Chute Rotator (fits all models)	\$904

OPTIONS

Model Number	Description	List Price (\$US)
50078919	Hydraulic Deflector Kit (fits SBSA54-72, and SBPT60-68 models)	\$558
50078920	Hydraulic Deflector Kit (fits SBSA78-97, SBPT78-97, and SBDA models)	\$566
50078922	Multi-Hinged Deflector (fits SBSA78 and SBPT78 models)	\$659
50078923	Multi-Hinged Deflector (fits SBSA87, SBSA97, and SBPT87 models)	\$677



[RETURN TO TABLE OF CONTENTS](#)



*** THIS PRODUCT IS PRICED AT LIST LESS 25% ***

DUAL AUGER SNOW BLOWERS

MODEL	SBDA108	SBDA1108A	SBDA1108B
HP (Rec)	Up to 175 HP		
RPM	540	1,000	
Driveline	1 ³ / ₈ 6 Tractor End	1 ³ / ₈ 21 Tractor End	1 ³ / ₄ 20 Tractor End
Cutting Width	108"		
Cutting Edge	1/2 x 6		
Auger Diameter	19" (x1) 15" (x1)		
Fan Diameter	32"		
Chute Diameter	13"		
Chute Rotation	Hydraulic		
Chute Deflector (Man/Hyd)	Std/Opt		
Main Body Height	43"		
3PH Mount	Cat 2 and 3 Std & Quick Hitch		
Weight	1,980 lb.		

Five-Year Limited Gearbox Warranty Two-Year Limited Machine Warranty

HOW TO ORDER:

Choose a model from the Base Unit Selection to order a complete unit.

Freight NOT included in list price.

BASE UNIT SELECTION

Model Number	Description	Approx. Wt.	List Price (\$US)
SBDA108	Double Auger 108" Snow Blower 540 1-3/8 6 PTO	1,980 lb.	\$12,227
SBDA1108A	Double Auger 108" Snow Blower 1,000 1-3/8 21 PTO	1,980 lb.	\$16,352
SBDA1108B	Double Auger 108" Snow Blower 1,000 1-3/4 20 PTO	1,980 lb.	\$16,461

OPTIONS

Model Number	Description	List Price (\$US)
50078920	Hydraulic Deflector Kit (fits SBSA78-97, SBPT78-97, and SBDA models)	\$566
50078924	Multi-Hinged Deflector (fits SBDA models)	\$696

[RETURN TO TABLE OF CONTENTS](#)



***** THIS PRODUCT IS PRICED AT LIST LESS 25% *****

PULL TYPE SNOW BLOWERS

MODEL	SBPT60	SBPT68	SBPT78	SBPT87	SBPT97
HP (Rec)	25 HP	35 HP	50 HP	60 HP	
Cutting Width	60"	68"	78"	87"	97"
Cutting Edge	Bolt On, 1/2"x 4"				
Auger Diameter	14"		15"	19"	19"
Fan Diameter	18"	21"	23"	27"	27"
Chute Diameter	8"	10"		12"	
Chute Rotation (Man/Hyd)	Std./Opt.		Opt./Opt.		
Chute Deflector (Man/Hyd)	Std./Opt. 6" Cyl.		Std./Opt. 8" Cyl.		
Main Body Height	25"		28"	32 1/2"	
3PH Mount	Cat. 1		Cat. 1 & 2		Cat. 2
Weight	495 lb.	671 lb.	900 lb.	1,175 lb.	1,225 lb.

Five-Year Limited Gearbox Warranty Two-Year Limited Machine Warranty

HOW TO ORDER:

To order a complete unit, choose a base unit then either a manual or hydraulic chute rotator from Group 2 below. Note only the SBPT60 comes equipped with a manual chute rotator standard.

Freight NOT included in list price.

BASE UNIT SELECTION

Model Number	Description	Approx. Wt.	List Price (\$US)
SBPT60	Pull Type 60" Snow Blower	495 lb.	\$5,783
SBPT68	Pull Type 68" Snow Blower	671 lb.	\$6,398
SBPT78	Pull Type 78" Snow Blower	900 lb.	\$7,585
SBPT87	Pull Type 87" Snow Blower	1,175 lb.	\$9,831
SBPT97	Pull Type 97" Snow Blower	1,225 lb.	\$10,323

GROUP 2 SELECTION

Model Number	Description	List Price (\$US)
50081957	Manual Chute Rotator (fits SBPT68 model)	\$189
50078916	Manual Chute Rotator (fits SBPT78 model)	\$189
50078917	Manual Chute Rotator (fits SBPT87 and SBPT97 models)	\$189
50078918	Hydraulic Chute Rotator (fits all models)	\$904



RETURN TO TABLE OF CONTENTS

OPTIONS

Model Number	Description	List Price (\$US)
50078919	Hydraulic Deflector Kit (fits SBSA54-72, and SBPT60-68 models)	\$558
50078920	Hydraulic Deflector Kit (fits SBSA78-97, SBPT78-97, and SBDA models)	\$566
50081958	Rear Mounted Blade (fits SBPT60 model)	\$984
50081959	Rear Mounted Blade (fits SBPT68 model)	\$1,151
50078925	Rear Mounted Blade (fits SBPT78 model)	\$1,366
50078926	Rear Mounted Blade (fits SBPT87 model)	\$1,483
50081960	Rear Mounted Blade (fits SBPT97 model)	\$1,522
50081964	60" Back Drag Kit	\$620
50081961	60" Tivar Scraper Blade and Skid Shoe Kit	\$630
50081965	68" Back Drag Kit	\$575
50081962	68" Tivar Scraper Blade and Skid Shoe Kit	\$707
50079573	78" Back Drag Kit	\$717
50079575	78" Tivar Scraper Blade and Skid Shoe Kit	\$815
50079574	87" Back Drag Kit	\$746
50079576	87" Tivar Scraper Blade and Skid Shoe Kit	\$827
50081966	97" Back Drag Kit	\$805
50081963	97" Tivar Scraper Blade and Skid Shoe Kit	\$867
50079132	Optional Hydraulic Lift Kit	\$1,013

Rear Mounted Blade – An optional steel back drag blade for pulling snow away from structures. Manually operated by chain.

Back Drag Kit – An optional Tivar back drag blade for pulling snow away from structures. Tivar material less abrasive on textured road surfaces such as cobblestone or brick. Manually operated by chain.

Tivar Scraper Blade and Skid Shoe Kit – Kit includes a Tivar scraper blade plus Tivar skid shoes that are less abrasive than steel on textured surfaces. Must remove the stock steel scraper blade that ships with snow blower and replace with the Tivar scraper blade.

Hydraulic Lift Kit – Both of the optional back drag blades, either the steel rear mounted blade or the Tivar blade, are manually operated unless the hydraulic lift kit option is desired.

[RETURN TO TABLE OF CONTENTS](#)



***** THIS PRODUCT IS PRICED AT LIST LESS 25% *****

SKIDSTEER SNOW BLOWERS

MODEL	SBS760 SERIES
Cutting Width	76"
Cutting Edge	1/2 x 3
Auger	19"
Tube	3" Square
Flighting	5/16 x 2¼
Auger Diameter	19"
GPM (Min)	14
Mounting	Universal Skidsteer Attach
Chute Rotation	Hydraulic
Chute Diameter	11"
Chute Deflector (Man/Hyd)	Std/Opt
Main Body Height	31"
Fan Diameter	32"
Fan Shaft	2" Diameter
Weight	950 lb.

HOW TO ORDER:

Choose a model from the Base Unit Selection to order a complete unit.

Freight NOT included in list price.

BASE UNIT SELECTION

Model Number	Description	Approx. Wt.	List Price (\$US)
SBSS760	Skidsteer 76" Snow Blower 14-17 GPM	950 lb.	\$12,614
SBSS761	Skidsteer 76" Snow Blower 18-20 GPM	950 lb.	\$12,614
SBSS762	Skidsteer 76" Snow Blower 20-22 GPM	950 lb.	\$12,614
SBSS763	Skidsteer 76" Snow Blower 23-26 GPM	950 lb.	\$15,093
SBSS764	Skidsteer 76" Snow Blower 27-33 GPM	950 lb.	\$15,093
SBSS765	Skidsteer 76" Snow Blower 33-40 GPM	950 lb.	\$16,231



[RETURN TO TABLE OF CONTENTS](#)

OPTIONS

Model Number	Description	List Price (\$US)
50078921	Hydraulic Deflector Kit (fits SBSS models)	\$530
50078927	7 Pin Wire Kit - Bobcat	\$2,480
50078928	8 Pin Wire Kit - Cat	\$501
50078929	8 Pin Wire Kit - Terrex	\$501
50078930	14 Pin Wire Kit - Gehl/Case/NH/JCB/Volvo	\$501
50078931	14 Pin Wire Kit - JD	\$501
50083029	14 Pin Wire Kit - Kubota	\$501
50083773	14 Pin Wire Kit - Wacker	\$501



[RETURN TO TABLE OF CONTENTS](#)



***** THIS PRODUCT IS PRICED AT LIST LESS 25% *****

LOADER MOUNT SNOW BLOWERS

MODEL	SBLM66	SBLM66HD	SBLM76	SBLM76HD	SBLM86	SBLM86HD
Cutting Width	66"		76"		86"	
HP (Rec)	40 - 60 HP					
Cutting Edge	3/8" x 3"					
Skid Shoes	3/8" x 1 1/2"					
Auger Diameter	19"					
Auger Flighting	5/16" x 2 1/4"					
Auger Tube	3 1/2" OD					
Fan Diameter	26"					
Chute Diameter	12"					
Chute Rotation	Hydraulic					
Chute Deflector	Hydraulic					
Main Body Height	31"					
Loader Mount - Hitch	Universal Skid Steer, EURO (ALO), or JD 440/540 Quick Attach					

Five-Year Limited Gearbox Warranty Two-Year Limited Machine Warranty

HOW TO ORDER:

To order a complete unit, choose a base unit with desired powerpak, and one of the no charge mounting kits from the selections below. Approximate weights shown are for loader mounted snow blowers and rear mounted PowerPaks. Additional mounting kits available for purchase in the options below.

Freight NOT included in list price.

BASE UNIT SELECTION

Model Number	Description	"Approx. Weight Blower / Pak"	List Price (\$US)
SBLM66	Loader Mount 66" Snow Blower, w/2-HR Duty PowerPak	970 lb. / 535 lb.	\$23,332
SBLM66HD	Loader Mount 66" Snow Blower, w/Full Duty PowerPak	970 lb. / 575 lb.	\$27,680
SBLM76	Loader Mount 76" Snow Blower, w/2-HR Duty PowerPak	1,015 lb. / 535 lb.	\$24,090
SBLM76HD	Loader Mount 76" Snow Blower, w/Full Duty PowerPak	1,015 lb. / 575 lb.	\$28,656
SBLM86	Loader Mount 86" Snow Blower, w/2-HR Duty PowerPak	1,065 lb. / 535 lb.	\$24,332
SBLM86HD	Loader Mount 86" Snow Blower, w/Full Duty PowerPak	1,065 lb. / 575 lb.	\$28,776

GROUP 2 SELECTION - MOUNTING KIT (Choose One at No Charge - Included in Base Unit Pricing)

Model Number	Description	List Price (\$US)
50081967NC	Quick Attach Mounting Kit, Universal Skid Steer	No Charge
50081968NC	Quick Attach Mounting Kit, EURO (ALO)	No Charge
50081969NC	Quick Attach Mounting Kit, JD 440/540	No Charge

OPTIONS (Additional Mounting Kits Available to Purchase)

Model Number	Description	List Price (\$US)
50081967	Quick Attach Mounting Kit, Universal Skid Steer	\$731
50081968	Quick Attach Mounting Kit, EURO (ALO)	\$935
50081969	Quick Attach Mounting Kit, JD 440/540	\$1,017



WHEEL & TIRE

SELECTION GUIDE

WHEEL & TIRE SELECTION GUIDE





[RETURN TO TABLE OF CONTENTS](#)

WHEEL & TIRE SELECTION GUIDE

WHEEL / TIRE MODEL NUMBER	PROFILE	TREAD														
294																
DESCRIPTION																
21" Laminated Tire																
AVAILABLE ON THESE MODELS																
<table style="width: 100%; border-collapse: collapse;"> <tr> <td style="width: 25%;">BH416</td> <td style="width: 25%;">2310</td> <td style="width: 25%;">1812</td> <td style="width: 25%;">2820</td> </tr> <tr> <td>BH417</td> <td>3308-2</td> <td>1815</td> <td>4110</td> </tr> <tr> <td>BH516</td> <td>3510</td> <td>2120</td> <td>4115</td> </tr> <tr> <td>2308</td> <td>3514</td> <td>2215</td> <td>4815</td> </tr> </table>	BH416	2310	1812	2820	BH417	3308-2	1815	4110	BH516	3510	2120	4115	2308	3514	2215	4815
BH416	2310	1812	2820													
BH417	3308-2	1815	4110													
BH516	3510	2120	4115													
2308	3514	2215	4815													
WHEEL / TIRE MODEL NUMBER	PROFILE	TREAD														
50050727																
DESCRIPTION																
Used Aircraft Tire, Pneumatic, 29" x 9" x 15"																
AVAILABLE ON THESE MODELS																
<table style="width: 100%; border-collapse: collapse;"> <tr> <td style="width: 33%;">2310</td> <td style="width: 33%;">2120</td> <td style="width: 33%;">4110</td> </tr> <tr> <td>3308-2</td> <td>2215</td> <td>4115</td> </tr> <tr> <td>3510</td> <td>2820</td> <td>4815</td> </tr> </table>	2310	2120	4110	3308-2	2215	4115	3510	2820	4815							
2310	2120	4110														
3308-2	2215	4115														
3510	2820	4815														
WHEEL / TIRE MODEL NUMBER	PROFILE	TREAD														
50072403																
DESCRIPTION																
Used Aircraft Tire, Pneumatic, 27.75" x 8.75" x 14.5", 24-Ply																
AVAILABLE ON THESE MODELS																
<table style="width: 100%; border-collapse: collapse;"> <tr> <td style="width: 33%;">2120</td> <td style="width: 33%;">2820</td> <td style="width: 33%;">4115</td> </tr> <tr> <td>2215</td> <td>4110</td> <td>4815</td> </tr> </table>	2120	2820	4115	2215	4110	4815										
2120	2820	4115														
2215	4110	4815														
WHEEL / TIRE MODEL NUMBER	PROFILE	TREAD														
50074504																
DESCRIPTION																
Used Aircraft Tire, Pneumatic, 20.5" x 6.75" x 10"																
AVAILABLE ON THESE MODELS																
<table style="width: 100%; border-collapse: collapse;"> <tr> <td style="width: 50%;">3510</td> <td style="width: 50%;">1812</td> </tr> </table>	3510	1812														
3510	1812															

[RETURN TO TABLE OF CONTENTS](#)

WHEEL & TIRE SELECTION GUIDE

WHEEL / TIRE MODEL NUMBER	PROFILE	TREAD												
50074505														
DESCRIPTION														
Used Aircraft Tire, Foam-Filled, 20.5" x 6.75" x 10"														
AVAILABLE ON THESE MODELS														
1812														
WHEEL / TIRE MODEL NUMBER	PROFILE	TREAD												
50075401														
DESCRIPTION														
25" Laminated Tire														
AVAILABLE ON THESE MODELS														
<table border="0" style="width: 100%; border-collapse: collapse;"> <tr> <td style="width: 25%;">3510</td> <td style="width: 25%;">2120</td> <td style="width: 25%;">2820</td> <td style="width: 25%;">4115</td> </tr> <tr> <td>1815</td> <td>2215</td> <td>4110</td> <td>4815</td> </tr> </table>	3510	2120	2820	4115	1815	2215	4110	4815						
3510	2120	2820	4115											
1815	2215	4110	4815											
WHEEL / TIRE MODEL NUMBER	PROFILE	TREAD												
50083457														
DESCRIPTION														
New Foam-Filled Tire, 25.5" x 8" x 14"														
AVAILABLE ON THESE MODELS														
<table border="0" style="width: 100%; border-collapse: collapse;"> <tr> <td style="width: 25%;">3308-2</td> <td style="width: 25%;">1815</td> <td style="width: 25%;">2215</td> <td style="width: 25%;">4115</td> </tr> <tr> <td>3510</td> <td>2120</td> <td>2820</td> <td>4815</td> </tr> <tr> <td>3514</td> <td>2820</td> <td>4110</td> <td></td> </tr> </table>	3308-2	1815	2215	4115	3510	2120	2820	4815	3514	2820	4110			
3308-2	1815	2215	4115											
3510	2120	2820	4815											
3514	2820	4110												
WHEEL / TIRE MODEL NUMBER	PROFILE	TREAD												
500BH														
DESCRIPTION														
15.5" Laminated Tire														
AVAILABLE ON THESE MODELS														
<table border="0" style="width: 100%; border-collapse: collapse;"> <tr> <td style="width: 12.5%;">BH215</td> <td style="width: 12.5%;">BH217</td> <td style="width: 12.5%;">BH316</td> <td style="width: 12.5%;">SQ84T</td> <td style="width: 12.5%;">3308-2</td> </tr> <tr> <td>BH216</td> <td>BH315</td> <td>BH317</td> <td>2308</td> <td>3308SH</td> </tr> </table>	BH215	BH217	BH316	SQ84T	3308-2	BH216	BH315	BH317	2308	3308SH				
BH215	BH217	BH316	SQ84T	3308-2										
BH216	BH315	BH317	2308	3308SH										



IF IT DOESN'T SAY
BUSH HOG®
IT JUST WON'T CUT IT™

The products, information, and images in this literature have been compiled for worldwide distribution. Some illustrations and text may include product options, accessories, and financing not available in all regions. Please visit Bush Hog®'s website or contact your local dealer for complete details. Bush Hog® reserves the right to improve our products and make changes to specifications, designs, pricing, and standard equipment without notice.

Always operate machines in accordance with supplied operators manuals. Visit bushhog.com/safety for safety information and materials.

Copyright ©2023 Bush Hog LLC. All rights reserved. Bush Hog®, the Bush Hog® logo, and the hog symbol are registered trademarks of Alamo Group Inc. All other trademarks, trade names, or service marks appearing in this brochure are the property of their respective companies or mark holders.

Revised 31 MARCH 2023

