



IF IT DOESN'T SAY  
**BUSH HOG**®  
IT JUST WON'T CUT IT™

## MACHINE PRICE LIST & SPECIFICATIONS

PRICES F.O.B. FACTORY AND SUBJECT TO CHANGE WITHOUT NOTICE

Prices Effective January 1, 2021

STATE OF MN CONTRACT T-632(5)  
AFTERMARKET ATTACHMENTS: TRACTORS,  
COMPACT / SKID LOADERS, & WHEEL LOADERS

### NOTEWORTHY UPDATES

**NEW**

Page 20 | SS3  
BH210-2 SERIES  
SINGLE SPINDLES

**NEW**

Page 24 | SS7  
BH310-2 SERIES  
SINGLE SPINDLES

**NEW**

Page 27 | SS10  
BH416-1Z | BH417-1Z  
GALVANIZED SINGLE SPINDLES

**NEW**

Page 29 | SS12  
BH516-1Z GALVANIZED  
SINGLE SPINDLES

**NEW**

Page 34 | MS3  
2208 SERIES  
ROTARY CUTTER

**NEW**

Page 43 | MS12  
3510 LIFT AND SEMI-  
MOUNT HD AXLE ARMS  
(PAIR) WITH 20.5"  
PNEUMATIC AIRCRAFT TIRES

**NEW**

HYDRAULIC HOSE SELECTION  
ON 15' FLEX-WINGS

**NEW**

Page 157 | SB4  
SBPT/PULL TYPE SERIES  
NEW SNOW BLOWER MODELS

**NEW**

Page 161 | SB8  
SBLM/LOADER MOUNTED  
NEW SNOW BLOWER SERIES

[GO TO IMPORTANT NOTICE](#)

[GO TO INDEX](#)





[RETURN TO INDEX](#)

# IMPORTANT NOTICE

Prices shown in this book are list prices and do not include freight, setup, or handling unless specifically noted. Shipping weights listed in this book are approximate and include crating or skids where applicable. All prices are F.O.B. factory; freight shipments arranged by Bush Hog® will be per the published rate chart and subject to change. Bush Hog® reserves the right to ship items via motor freight collect at its discretion. Dealers should reference their whole good invoices and billing statements for freight amount and due dates.

Prices, terms, and discounts are subject to change without notice. Orders placed will be accepted based on the price in effect at the time of shipment unless otherwise specified. Prices shown in this book do not include any applicable federal, provincial, state, or local taxes, or levies.

Machines included in this price book conform to safety standards applicable to the products at the time of manufacture and may include safety devices such as shields, guards, or operator protective devices. Under no circumstances should machines be operated without the safety devices in place.

This document is confidential and is for use by authorized Bush Hog® dealership personnel only. It is not to be distributed for any purpose other than selling Bush Hog® branded products.

Bush Hog® reserves the right to make changes and/or improvements in design and construction of parts or machines shown herein without notice or obligation.

## ROTARY CUTTER OR FLAIL MOWER THROWN OBJECT PROTECTION

*Bush Hog offers three types of shielding to protect the operator, passersby, livestock, and property from mower thrown objects: deflectors, single chain guards, and double chain guards. Shielding should be selected based on the intended use of the mower. Double chain guards or deflectors should be used for highway, right-of-way, parks, or greenbelt mowing or other mowing where human dwellings, vehicles, or livestock could be within 300 feet of the mower. Chain guards are more durable, provide longer service life, and require less maintenance than deflectors. Single chain guards should be sufficient for agricultural and other mowing where passersby or property are not within 300 feet of the mower during operation.*

*No shielding is completely effective in preventing thrown objects. The possibility of injury or property damage from this hazard can be substantially reduced by selecting proper shielding, maintaining the mower and shielding in good operating condition, inspecting the area for foreign debris before mowing, operating the mower at a minimum cutting height of 4", and keeping people at least 300 feet from the mower at all times during operation.*

**BUSH HOG® GUARANTEES EACH PIECE OF EQUIPMENT AGAINST DEFECTIVE MATERIALS AND WORKMANSHIP FOR A PERIOD OF ONE YEAR FROM DATE OF DELIVERY UNLESS OTHERWISE NOTED.**

# INDEX OF PRODUCTS

## FINISHING MOWERS

HDTH Series Rear Discharge Finishing Mower .....	FM1	4
<b>TDC Series Tri-Deck Finish Mower .....</b>	<b>FM3</b>	<b>6</b>

SEE TURF MANAGEMENT CONTRACT T-775(5)  
FOR ZERO TURN PRICING

## SINGLE-SPINDLE ROTARY CUTTERS

BH100 Series Rotary Cutter .....	SS1	18
<b>BH215-2 Series Rotary Cutter .....</b>	<b>SS3</b>	<b>20</b>
<b>BH216-2 Series Rotary Cutter .....</b>	<b>SS3</b>	<b>20</b>
<b>BH217-2 Series Rotary Cutter.....</b>	<b>SS5</b>	<b>22</b>
<b>BH315-2 Series Rotary Cutter .....</b>	<b>SS7</b>	<b>24</b>
<b>BH316-2 Series Rotary Cutter .....</b>	<b>SS7</b>	<b>24</b>
<b>BH317-2 Series Rotary Cutter.....</b>	<b>SS7</b>	<b>24</b>
<b>BH416 Series Rotary Cutter.....</b>	<b>SS10</b>	<b>27</b>
<b>BH417 Series Rotary Cutter.....</b>	<b>SS10</b>	<b>27</b>
<b>BH516 Series Rotary Cutter .....</b>	<b>SS12</b>	<b>29</b>

## MULTI-SPINDLE RIGID DECK ROTARY CUTTERS

SQ84T Squealer Series Twin Spindle Rotary Cutter.....	MS1	32
<b>2208 Series Rotary Cutter .....</b>	<b>MS3</b>	<b>34</b>
2310 Series Rotary Cutter .....	MS5	36
3308-2 Series Rotary Cutter.....	MS7	38
3308SH-2 Series Rotary Cutter .....	MS9	40
3510 Series Rotary Cutter .....	MS11	42
3514 Series Rotary Cutter .....	MS13	44
14215 Series Rotary Cutter.....	MS15	46

## FLEX-WING ROTARY CUTTERS

1812 Series Flex-Wing Rotary Cutter.....	FW1	48
1815 Series Flex-Wing Rotary Cutter.....	FW3	50
2215 Series Flex-Wing Rotary Cutter .....	FW5	52
2810CD Contractor Series Flex-Wing Rotary Cutter .....	FW7	54
2815 Contractor Series Flex-Wing Rotary Cutter.....	FW9	56
3810HD Contractor Series Flex-Wing Rotary Cutter.....	FW11	58
3815 Contractor Series Flex-Wing Rotary Cutter .....	FW13	60
4815 Contractor Series Flex-Wing Rotary Cutter .....	FW15	62
2814 Series Flex-Wing Rotary Cutter.....	FW17	64
2820 Series Flex-Wing Rotary Cutter .....	FW19	66

## FLAIL SHREDDERS

BRC115 Series Row Crop Flail Shredder .....	FS1	70
BRC118 Series Row Crop Flail Shredder .....	FS1	70
BRC120 Series Row Crop Flail Shredder .....	FS3	72
BRC125 Series Row Crop Flail Shredder .....	FS5	74

## BOOM MOWERS

Rear-Mounted Boom Mower Series .....	BM1	78
<b>Forward Reach Rear-Mounted Boom Mower Series.....</b>	<b>BM4</b>	<b>81</b>

## CONSTRUCTION

DSP Series Pull Dirt Scraper .....	CS1	86
PHD Series Post Hole Digger .....	CS3	88
PHDHF Farm-Ranch Series Post Hole Digger .....	CS5	90
PHDHC Construction-Contractor Series Post Hole Digger .....	CS7	92
XD Series Backhoe .....	CS11	96
AGR Series Ag Grapple.....	CS13	98
BGR Series Bucket Grapple.....	CS14	99
BRGR Series Brush Grapple .....	CS14	99
PF48 Series Pallet Fork .....	CS15	100

## LANDSCAPE

CRB Series Compact Rear Blade.....	LS1	102
CBX Series Compact Box Blade.....	LS1	102
CLR Series Compact Landscape Rake .....	LS2	103
CRG Series Compact Road Grader.....	LS2	103
CPG CPA Series Compact Plugger and Aerator .....	LS3	104
35 Series Rear Mount Medium Blade.....	LS4	105
50 Series Rear Mount Medium Blade.....	LS5	106
70 Series Medium Duty Blade.....	LS6	107
91 Series Medium Duty Blade.....	LS7	108
100 Series Heavy Duty Blade.....	LS8	109
141 Series Heavy Duty Blade.....	LS9	110
160 Series Heavy Duty Blade.....	LS10	111
181 Series Heavy Duty Blade.....	LS11	112
225/300 Series Heavy Duty Blade .....	LS12	113
LLR Series Economy Landscape Rake.....	LS13	114
MLR Series Medium Duty Landscape Rake .....	LS13	114
BBX Series Box Blade .....	LS14	115
SBX Series Box Blade.....	LS15	116
MBX Series Box Blade .....	LS16	117
RBX Series Retractable Shank Box Blade.....	LS17	118
RO Series Roll-Over Box Blade .....	LS17	118
RG Series Road Grader .....	LS18	119
HDRG Series Heavy Duty Road Grader .....	LS19	120
PV Series Pulverizer .....	LS20	121
PG & MPG Series Plugger Core Type Aerator.....	LS21	122
FSP Series Fertilizer Spreader .....	LS22	123
MS Manure Spreader.....	LS23	124
CP Series Cultipacker.....	LS24	125
Quick Hitches.....	LS25	126

## TILLAGE

RTC Series Rotary Tiller .....	TL1	128
RTG Series Rotary Tiller .....	TL2	129
RTX Heavy Duty Rotary Tiller.....	TL4	131
Lift Disc Harrow Series.....	TL5	132
DHP Series Pull Disc Harrow.....	TL11	138
APP Series All Purpose Plow.....	TL13	140
HDS5 Series Heavy Duty Subsoiler .....	TL14	141
SS1 Series Subsoiler, LP Series Layoff Plow, IRCV Series Cultivator.....	TL15	142
PA Series Pasture Aerator .....	TL16	143

## HAY TOOLS

DHM Hay Mower.....	HT1	146
HT Hay Tedder.....	HT2	147
XLRR-I Series Pull-Type V-Rake .....	HT3	148
EWR Series Pull Type Wheel V-Rake.....	HT4	149
3PB Series 3-PT Hay Spears .....	HT5	150
3PB Series 3-PT Bale Unroller.....	HT5	150
BS Series Tractor-Mounted Bale Spear.....	HT6	151

## SNOW BLOWERS

SBSA Series 54"-60" Single Auger Snow Blower.....	SB1	154
SBSA Series 72"-97" Single Auger Snow Blower.....	SB2	155
SBDA Series Double Auger Snow Blower .....	SB3	156
<b>SBPT Series Pull Type Snow Blower .....</b>	<b>SB4</b>	<b>157</b>
SBSS Series Skid Steer Snow Blower.....	SB6	159
<b>SBL Series Loader Mount Snow Blower.....</b>	<b>SB8</b>	<b>161</b>

## WHEEL & TIRE SELECTION GUIDE

294, 97708, 50050727, 50068834 .....	<b>TIRE1</b>	<b>162</b>
50072403, 50074504, 50074505, 50075401.....	<b>TIRE2</b>	<b>163</b>
50078502, 500BH.....	<b>TIRE3</b>	<b>164</b>

\*Limited Availability

Blue Text Denotes New Products



[RETURN TO INDEX](#)

# FINISHING MOWERS

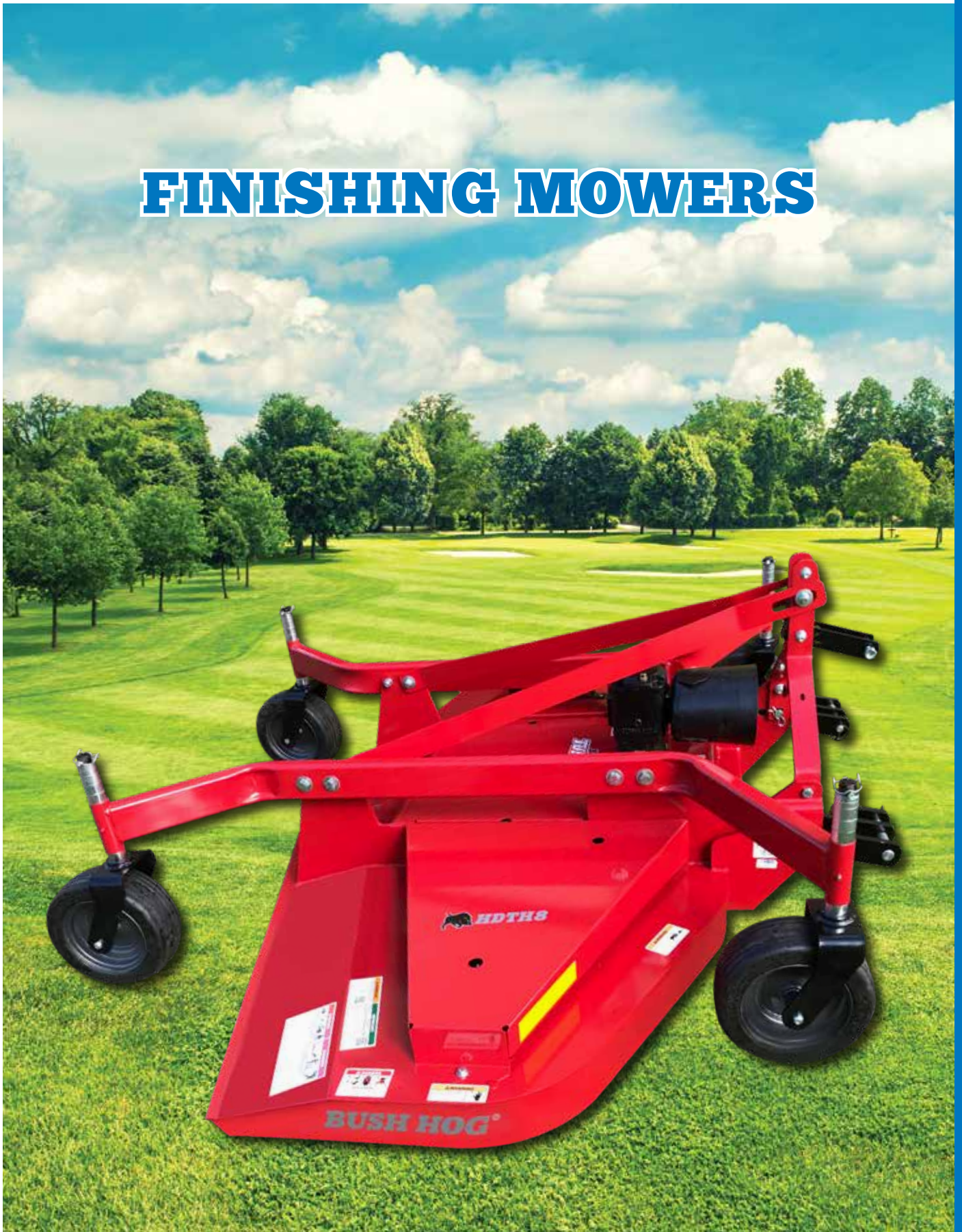

FINISHING MOWERS

**RETURN TO INDEX**



## HDTH SERIES FINISHING MOWER

MODEL	HDTH5	HDTH6	HDTH7	HDTH8
Cutting Width	60"	72"	84"	99"
Cutting Height (1/2" incr.)	1/2" - 6½"	1½" - 6½"		
Minimum Tractor PTO HP	15	20	30	35
Hitch	Cat 1 Std & QH		Cat 1, 2, Std & QH	
Blade Size	1/4" x 2½" x 21"	1/4" x 2½" x 25"	5/16" x 2½" x 29"	1/4" x 2½" x 21"
Number of Blades	3			5
Blade Tip Speed	18,231 FPM	18,272 FPM	18,266 FPM	18,266 FPM
Blade Overlap	1½"			
Blade Uplift	Parallel			
Driveline	ASAE Category 3			
Front Roller (optional)	3" x 5"			3" x 13"
Discharge	Rear			
Deck Thickness	7 Gauge			
Tire Size (solid)	3¼ x 10		4 x 10	5 x 13
Belts	(1) B Size Aramid Cord			(2) B Size Aramid Cord
Belt Adjustment	Spring-Loaded Idler			
Gearbox	45 HP		55 HP	
Approx. Weight	672 lb.	730 lb.	954 lb.	1,190 lb.
<b>Five-Year Limited Gearbox Warranty.</b>				

\*Gearbox rating based on field performance.

**HOW TO ORDER:**

The Base Unit Selection for the HDTH Finish Mowers comes as a complete unit.

Freight NOT included in list price



**RETURN TO INDEX**

All models are available in the colors below:	
Model Color Indicator	Unit Color
R	Bush Hog Red
G	John Deere Green
O	Kubota Orange
B	New Holland Blue

## HDTH SERIES FINISHING MOWER

### BASE UNIT SELECTION

Model Number	Description	Approx. Wt.	List Price (\$US)
HDTH5R	HDTH Finishing Mower, Bush Hog Red, 5'	672 lb.	\$3,408
HDTH5G	HDTH Finishing Mower, John Deere Green, 5'	672 lb.	\$3,408
HDTH5O	HDTH Finishing Mower, Kubota Orange, 5'	672 lb.	\$3,408
HDTH5B	HDTH Finishing Mower, New Holland Blue, 5'	672 lb.	\$3,408
HDTH6R	HDTH Finishing Mower, Bush Hog Red, 6'	730 lb.	\$3,911
HDTH6G	HDTH Finishing Mower, John Deere Green, 6'	730 lb.	\$3,911
HDTH6O	HDTH Finishing Mower, Kubota Orange, 6'	730 lb.	\$3,911
HDTH6B	HDTH Finishing Mower, New Holland Blue, 6'	730 lb.	\$3,911
HDTH7R	HDTH Finishing Mower, Bush Hog Red, 7'	954 lb.	\$4,887
HDTH7G	HDTH Finishing Mower, John Deere Green, 7'	954 lb.	\$4,887
HDTH7O	HDTH Finishing Mower, Kubota Orange, 7'	954 lb.	\$4,887
HDTH7B	HDTH Finishing Mower, New Holland Blue, 7'	954 lb.	\$4,887
HDTH8R	HDTH Finishing Mower, Bush Hog Red, 8'	1,190 lb.	\$6,687
HDTH8G	HDTH Finishing Mower, John Deere Green, 8'	1,190 lb.	\$6,687
HDTH8O	HDTH Finishing Mower, Kubota Orange, 8'	1,190 lb.	\$6,687
HDTH8B	HDTH Finishing Mower, New Holland Blue, 8'	1,190 lb.	\$6,687

### OPTIONS

Model Number	Description	List Price (\$US)
50059787	Front Roller Kit (HDTH5 & HDTH6)	\$73
50078559	Front Roller Kit (HDTH7 & HDTH8)	\$104

**RETURN TO INDEX**

**NEW**  
*for*  
**Summer  
2020**



**TDC SERIES FINISHING MOWER**

MODEL	TDC-1200	TDC-1500	TDC-1700
Cutting Width	12'	15'	17'
Cutting Height (1/4" incr.)	1" - 5"		
Minimum Tractor PTO HP	25	30	35
Tractor PTO Speed	540		
Hitch	Cat 1 & 2, Drawbar		
Number of Blades Per Deck (Total)	3 (9)		
Blade Tip Speed	15,747 FPM	16,863 FPM	16,732 FPM
Center Deck Cutting Width (ft.)	5'	6'	
Wing Deck Cutting Width (ft.)	4'	5'	6'
Deck Overlap Adjustment (in.)	6"		
Degree of Cutting Attitude (Flex)	30° Up / 15° Down		
Deck Thickness	8-Gauge Steel Plate		
Splitter Gearbox HP	80 HP		
Mower Deck Gearbox HP	50 HP		
Deck Lift Cylinders (in.)	2½" x 10" Single Acting		
Main Driveline	Cat 6 Constant Velocity with Slip Clutch		
Hydraulics	3 - Single Action		
Transport Width (ft.)	7.6'	8.1'	8.3'
Transport Length (ft.)	11.9'	12.2'	12.2'
Transport Height (ft.)	6.2'	7.7'	8.7'
Overall Width (ft.)	12.2'	15.2'	17.2'
Max. Overall Length (ft.)	12.7'	13'	13'
Deflector Type	Rear Safety Chains Std		
Transport Tires (2) / Deck Tires (12)	20½ x 8 - 10 Highway Rated / 11 x 4.00 - 5NHS		

**One-Year Limited Warranty.**

**HOW TO ORDER:** The Base Unit Selection for the TDC Finish Mowers comes as a complete unit.

Freight NOT included in list price





**RETURN TO INDEX**

## TDC SERIES FINISHING MOWER

### BASE UNIT SELECTION

Model Number	Description	Approx. Wt.	List Price (\$US)
TDC-1200	TDC Series Rotary Cutter, 12'	2,742 lb.	<b>\$23,090</b>
TDC-1500	TDC Series Rotary Cutter, 15'	2,874 lb.	<b>\$23,805</b>
TDC-1700	TDC Series Rotary Cutter, 17'	2,995 lb.	<b>\$24,881</b>

### OPTIONS / SHIPPED SEPARATELY

Model Number	Description	List Price (\$US)
50082150	Mulching Kit TDC-1200, (Complete, 3 Units - Blades & Baffles)	<b>\$1,239</b>
50082151	Mulching Kit TDC-1500, (Complete, 3 Units - Blades & Baffles)	<b>\$1,357</b>
50082152	Mulching Kit TDC-1700, (Complete, 3 Units - Blades & Baffles)	<b>\$1,478</b>



**RETURN TO INDEX**



[RETURN TO INDEX](#)

# SINGLE-SPINDLE ROTARY CUTTERS



SINGLE-SPINDLE ROTARY CUTTERS

**RETURN TO INDEX**



## BH100 SERIES ROTARY CUTTER

MODEL	BH114	BH115	BH116
Cutting Width	4'	5'	6'
Cutting Height	2" - 11"		
Cutting Capacity	1" Diameter		
Hitch	Cat. 1 Std; Quick Hitch Optional		
Deck Thickness	12 Gauge		
Side Bands	"C" Channel, 10 Gauge x 8"		
Gearbox Rating (HP)	60*		
Driveline	ASAE Category 3		
Driveline Protection	Slip Clutch or Shearpin		
Blade Holder	Formed Pan		
Blades	1/2" x 3" Corner Uplift		
Blade Tip Speed	15,904 fpm	15,472 fpm	14,307 fpm
Wheels	14 1/2" Laminated		
Minimum Tractor PTO HP	15	20	25
Safety Shielding	Front Rubber Belt and Rear Metal Band Standard; Front Chains Optional		
<b>10-Year Gearbox Limited Warranty and 1-Year Machine Limited Warranty</b>			

\*Gearbox rating based on field performance.

**WARNING:**

A deflector kit or chain shielding must be used for all non-agricultural purposes or in areas where thrown objects could be hazardous to people, animals, or property.

**HOW TO ORDER:**

The BH100 Series Rotary Cutters are priced as a base unit including front belting and rear metal band. To receive a complete cutter, you must choose your base unit selection, including your choice of model color from the chart at the top of the next page, and indicate your choice of driveline from Group 2 Driveline Selection. **All units are sold in pairs. Each pair must be the same model and color.**

Freight NOT included in list price



**RETURN TO INDEX**

All models are available in the colors below:	
Model Color Indicator	Unit Color
<b>1R</b>	<b>Bush Hog Red</b>
<b>1G</b>	<b>John Deere Green</b>
<b>1O</b>	<b>Kubota Orange</b>
<b>1B</b>	<b>New Holland Blue</b>

## BH100 SERIES ROTARY CUTTER

### BASE UNIT SELECTION

Model Number	Description	Approx. Wt.	List Price (\$US)
BH114-1x	BH100 Series Rotary Cutter, 540 PTO, Lift Hitch, 4'	393 lb.	<b>\$1,384</b>
BH115-1x	BH100 Series Rotary Cutter, 540 PTO, Lift Hitch, 5'	491 lb.	<b>\$1,512</b>
BH116-1x	BH100 Series Rotary Cutter, 540 PTO, Lift Hitch, 6'	577 lb.	<b>\$1,779</b>

### GROUP 2 DRIVELINE SELECTION

Model Number	Description	Approx. Wt.	List Price (\$US)
50075901	Driveline, ASAE Category 3, with Shearpin (BH114 Model Only)	25 lb.	<b>\$125</b>
50075919	Driveline, ASAE Category 3, with Shearpin (BH115 and BH116 Models Only)	25 lb.	<b>\$144</b>
50075900	Driveline, ASAE Category 3, with Slip-Clutch (BH114 and BH115 Models Only)	25 lb.	<b>\$301</b>
50076537	Driveline, ASAE Category 3, with Slip-Clutch (BH116 Model Only)	25 lb.	<b>\$301</b>

### OPTIONS

Model Number	Description	Approx. Wt.	List Price (\$US)
50081169	Front Chain Bundle, BH114	35 lb.	<b>\$109</b>
50081170	Front Chain Bundle, BH115	40 lb.	<b>\$117</b>
50081433	Front Chain Bundle, BH116	45 lb.	<b>\$125</b>
50081027	Quick Hitch Kit	5 lb.	<b>\$40</b>

**RETURN TO INDEX**



## BH215-2/BH216-2 SERIES ROTARY CUTTER

MODEL	BH215-2	BH216-2
Cutting Width	60"	72"
Cutting Height	2" - 12"	
Cutting Capacity	2" Diameter	
Hitch	Cat. 1 Std & Quick Hitch; Cat. 2 Compatible with Optional Bushings	
Deck Thickness	11 Gauge	10 Gauge
Side Bands	11½" x 11 Gauge	11½" x 10 Gauge
Driveline	ASAE Category 3	
Driveline Protection	Slip Clutch or Shearbolt	
Gearbox Rating (HP)	65*	
Tractor PTO Speed	540	
Minimum Tractor PTO HP	25	
Blade Holder	Oval Pan	
Blades	1/2" x 4" Uplift	
Blade Tip Speed	14,335 fpm	14,963 fpm
Wheels	15 ½" Laminated	
Safety Shielding	Front Rubber Belt or Single Row Chains   Rear Metal Band Front and Rear Chains	
Approximate Weight	650 lb.	750 lb.
<b>10-Year Gearbox Limited Warranty and 1-Year Machine Limited Warranty</b>		

\*Gearbox rating based on field performance.

<b>NOTICE:</b>	PTO adapter must not be used in any application.
<b>WARNING:</b>	A deflector kit or chain shielding must be used for all non-agricultural purposes or in areas where thrown objects could be hazardous to people, animals, or property.
<b>HOW TO ORDER:</b>	To receive a complete cutter, you must order from each group listed for the model you have selected.

Freight NOT included in list price



**RETURN TO INDEX**

All models are available in the colors below:	
Model Color Indicator	Unit Color
2R	Bush Hog Red
2G	John Deere Green
2O	Kubota Orange
2B	New Holland Blue

## BH215-2 SERIES ROTARY CUTTER

### BASE UNIT SELECTION

Model Number	Description	Approx. Wt.	List Price (\$US)
BH215-2R	BH215 Series Rotary Cutter, 5', Bush Hog Red	650 lb.	\$1,917
BH215-2G	BH215 Series Rotary Cutter, 5', John Deere Green	650 lb.	\$1,917
BH215-2O	BH215 Series Rotary Cutter, 5', Kubota Orange	650 lb.	\$1,917
BH215-2B	BH215 Series Rotary Cutter, 5', New Holland Blue	650 lb.	\$1,917

### GROUP 2 PTO SELECTION

50053123	ASAE Category 3 Shearbolt Driveline	31 lb.	\$289
50053126	ASAE Category 3 Slip-Clutch Driveline	40 lb.	\$450

### GROUP 3 ENCLOSURE SELECTION

50071036	Front Deflector	9 lb.	\$80
50080236	Rear Band	18 lb.	\$63
50074734	Front Chains	46 lb.	\$146
50080237	Rear Chains	58 lb.	\$277

### GROUP 4 OPTIONS

50080070	Cat. 2 Hitch Bushings	1 lb.	Order Thru Service Parts
----------	-----------------------	-------	--------------------------

## BH216-2 SERIES ROTARY CUTTER

### BASE UNIT SELECTION

Model Number	Description	Approx. Wt.	List Price (\$US)
BH216-2R	BH216 Series Rotary Cutter, 6', Bush Hog Red	750 lb.	\$2,466
BH216-2G	BH216 Series Rotary Cutter, 6', John Deere Green	750 lb.	\$2,466
BH216-2O	BH216 Series Rotary Cutter, 6', Kubota Orange	750 lb.	\$2,466
BH216-2B	BH216 Series Rotary Cutter, 6', New Holland Blue	750 lb.	\$2,466

### GROUP 2 PTO SELECTION

50053131	ASAE Category 3 Shearbolt Driveline	32 lb.	\$289
50053125	ASAE Category 3 Slip-Clutch Driveline	40 lb.	\$450

### GROUP 3 ENCLOSURE SELECTION

50070831	Front Deflector	10 lb.	\$89
50080241	Rear Band	28 lb.	\$76
50074732	Front Chains	54 lb.	\$185
50080242	Rear Chains	67 lb.	\$337

### GROUP 4 OPTIONS

50080070	Cat. 2 Hitch Bushings	1 lb.	Order Thru Service Parts
----------	-----------------------	-------	--------------------------

NOTE: Safety shieldings are non-returnable items for all models.

**RETURN TO INDEX**



## BH217-2 SERIES ROTARY CUTTER

MODEL	BH217-2
Cutting Width	84"
Cutting Height	2" - 12"
Cutting Capacity	2" Diameter
Hitch	Cat. 1 or 2 Std and Quick Hitch
Deck Thickness	10 Gauge
Side Bands	11 <sup>3</sup> / <sub>4</sub> " x 10 Gauge
Driveline	ASAE Category 3
Driveline Protection	Slip Clutch Standard
Gearbox Rating (HP)	130*
Tractor PTO Speed	540
Minimum Tractor PTO HP	50
Blade Holder	Oval Pan
Blades	1/2" x 4" Uplift
Blade Tip Speed	14,963 fpm
Wheels	15 1/2" Laminated
Safety Shielding	Front Rubber Belt   Rear Metal Band   Front and Rear Chains
Approximate Weight	1,035 lb.
<b>10-Year Gearbox Limited Warranty and 1-Year Machine Limited Warranty</b>	

\*Gearbox rating based on field performance.

**NOTICE:**

PTO adapter must not be used in any application.

**WARNING:**

A deflector kit or chain shielding must be used for all non-agricultural purposes or in areas where thrown objects could be hazardous to people, animals, or property.

**HOW TO ORDER:**

To receive a complete cutter, you must order Base Unit, and Front and Rear Safety Enclosures.

Freight NOT included in list price





**RETURN TO INDEX**

All models are available in the colors below:	
Model Color Indicator	Unit Color
<b>2R</b>	<b>Bush Hog Red</b>
<b>2G</b>	<b>John Deere Green</b>
<b>2O</b>	<b>Kubota Orange</b>
<b>2B</b>	<b>New Holland Blue</b>

## BH217-2 SERIES ROTARY CUTTER

### BASE UNIT SELECTION

Model Number	Description	Approx. Wt.	List Price (\$US)
<b>BH217-2R</b>	<b>BH217 Series Rotary Cutter, 7', Bush Hog Red</b>	1,035 lb.	<b>\$4,411</b>
<b>BH217-2G</b>	<b>BH217 Series Rotary Cutter, 7', John Deere Green</b>	1,035 lb.	<b>\$4,411</b>
<b>BH217-2O</b>	<b>BH217 Series Rotary Cutter, 7', Kubota Orange</b>	1,035 lb.	<b>\$4,411</b>
<b>BH217-2B</b>	<b>BH217 Series Rotary Cutter, 7', New Holland Blue</b>	1,035 lb.	<b>\$4,411</b>

### GROUP 2 ENCLOSURE SELECTION

Model Number	Description	Approx. Wt.	List Price (\$US)
<b>50070944</b>	<b>Front Deflector</b>	37 lb.	<b>\$116</b>
<b>50080245</b>	<b>Rear Band</b>	36 lb.	<b>\$111</b>
<b>50074733</b>	<b>Front Chains</b>	62 lb.	<b>\$259</b>
<b>50080246</b>	<b>Rear Chains</b>	75 lb.	<b>\$415</b>

NOTE: Safety shieldings are non-returnable items for all models.

**RETURN TO INDEX**



## BH310-2 SERIES ROTARY CUTTERS

MODEL	BH315-2	BH316-2	BH317-2
Cutting Width	60"	72"	84"
Cutting Height	2" - 12"		
Cutting Capacity	3"		
Hitch	Cat. 1 or 2 Std & Quick Hitch		Cat. 2 or 3 Std & Quick Hitch
Deck Thickness (GA)	10		
Side Bands	11 1/2" x 1/4"		11 3/4" x 1/4"
Driveline	ASAE Category 4		
Driveline Protection	Slip Clutch		
Gearbox Rating (HP)	130*		
Tractor PTO Speed	540		
Minimum Tractor PTO HP	35	45	55
Blade Holder	Round Pan		
Blades	1/2" x 4" Uplift		
Blade Tip Speed	14,600 fpm	15,000 fpm	14,450 fpm
Wheels	15 1/2" Laminated		Single or Dual 15 1/2" Laminated
Safety Shielding	Front Rubber Belt   Rear Metal Band   Front and Rear Single or Double Row Chains		
Approximate Weight	890 lb.	1,050 lb.	1,250 lb.
<b>10-Year Gearbox Limited Warranty and 1-Year Machine Limited Warranty</b>			

\*Gearbox rating based on field performance.

<b>NOTICE:</b>	PTO adapter must not be used in any application.
<b>WARNING:</b>	A deflector kit or chain shielding must be used for all non-agricultural purposes or in areas where thrown objects could be hazardous to people, animals, or property.
<b>HOW TO ORDER:</b>	To receive a complete cutter, you must order from each group listed for the model you have selected.

Freight NOT included in list price



**RETURN TO INDEX**

## BH315-2 SERIES ROTARY CUTTER

BASE UNIT SELECTION			
Model Number	Description	Approx. Wt.	List Price (\$US)
<b>BH315-2R</b>	<b>BH315 Series Rotary Cutter, 5', Bush Hog Red</b>	890 lb.	<b>\$3,607</b>
<b>BH315-2G</b>	<b>BH315 Series Rotary Cutter, 5', John Deere Green</b>	890 lb.	<b>\$3,607</b>
<b>BH315-2O</b>	<b>BH315 Series Rotary Cutter, 5', Kubota Orange</b>	890 lb.	<b>\$3,607</b>
<b>BH315-2B</b>	<b>BH315 Series Rotary Cutter, 5', New Holland Blue</b>	890 lb.	<b>\$3,607</b>

GROUP 2 FRONT ENCLOSURE SELECTION			
Model Number	Description	Approx. Wt.	List Price (\$US)
50080400	Front Deflector	17 lb.	<b>\$68</b>
50074734	Front Chains	46 lb.	<b>\$146</b>
50080485	Double Row Front Chains	70 lb.	<b>\$369</b>

GROUP 3 REAR ENCLOSURE SELECTION			
Model Number	Description	Approx. Wt.	List Price (\$US)
50080236	Rear Band	18 lb.	<b>\$63</b>
50080237	Rear Chains	58 lb.	<b>\$277</b>
50080384	Double Row Rear Chains	74 lb.	<b>\$361</b>

## BH316-2 SERIES ROTARY CUTTER

BASE UNIT SELECTION			
Model Number	Description	Approx. Wt.	List Price (\$US)
<b>BH316-2R</b>	<b>BH316 Series Rotary Cutter, 6', Bush Hog Red</b>	1,050 lb.	<b>\$4,166</b>
<b>BH316-2G</b>	<b>BH316 Series Rotary Cutter, 6', John Deere Green</b>	1,050 lb.	<b>\$4,166</b>
<b>BH316-2O</b>	<b>BH316 Series Rotary Cutter, 6', Kubota Orange</b>	1,050 lb.	<b>\$4,166</b>
<b>BH316-2B</b>	<b>BH316 Series Rotary Cutter, 6', New Holland Blue</b>	1,050 lb.	<b>\$4,166</b>

GROUP 2 FRONT ENCLOSURE SELECTION			
Model Number	Description	Approx. Wt.	List Price (\$US)
50080401	Front Deflector	28 lb.	<b>\$75</b>
50074732	Front Chains	54 lb.	<b>\$185</b>
50080486	Double Row Front Chains	80 lb.	<b>\$426</b>

GROUP 3 REAR ENCLOSURE SELECTION			
Model Number	Description	Approx. Wt.	List Price (\$US)
50080241	Rear Band	28 lb.	<b>\$76</b>
50080242	Rear Chains	67 lb.	<b>\$337</b>
50080385	Double Row Rear Chains	88 lb.	<b>\$425</b>

**NOTE: Safety shieldings are non-returnable items for all models.**



RETURN TO INDEX

## BH317-2 SERIES ROTARY CUTTER

### BASE UNIT SELECTION

Model Number	Description	Approx. Wt.	List Price (\$US)
<b>BH317-2R</b>	<b>BH317 Series Rotary Cutter, 7', Bush Hog Red</b>	1,250 lb.	<b>\$5,207</b>
<b>BH317-2G</b>	<b>BH317 Series Rotary Cutter, 7', John Deere Green</b>	1,250 lb.	<b>\$5,207</b>
<b>BH317-2O</b>	<b>BH317 Series Rotary Cutter, 7', Kubota Orange</b>	1,250 lb.	<b>\$5,207</b>
<b>BH317-2B</b>	<b>BH317 Series Rotary Cutter, 7', New Holland Blue</b>	1,250 lb.	<b>\$5,207</b>

### GROUP 2 TAILWHEEL SELECTION

Model Number	Description	Approx. Wt.	List Price (\$US)
50080397	Single Tailwheel Assembly	63 lb.	<b>\$283</b>
50080395	Dual Tailwheel Assembly	130 lb.	<b>\$796</b>

### GROUP 3 FRONT ENCLOSURE SELECTION

Model Number	Description	Approx. Wt.	List Price (\$US)
50070944	Front Deflector	37 lb.	<b>\$116</b>
50074733	Front Chains	62 lb.	<b>\$259</b>
50080487	Double Row Front Chains	90 lb.	<b>\$526</b>

### GROUP 4 REAR ENCLOSURE SELECTION

Model Number	Description	Approx. Wt.	List Price (\$US)
50080245	Rear Band	36 lb.	<b>\$111</b>
50080246	Rear Chains	75 lb.	<b>\$415</b>
50080386	Double Row Rear Chains	105 lb.	<b>\$480</b>

**NOTE: Safety shieldings are non-returnable items for all models.**

**RETURN TO INDEX**

**GALVANIZED MODEL AVAILABLE  
FEBRUARY 2021**



## BH400 SERIES ROTARY CUTTER

MODEL	BH416	BH417
Cutting Width	72"	84"
Cutting Height	2" - 12"	
Cutting Capacity	4"	
Hitch	Cat. 2 or 3 Std & QH	
Deck Thickness	7 Gauge	
Side Bands	13" x 1/4"	
Driveline	ASAE Category 5	ASAE Category 6
Driveline Protection	Slip Clutch	
Gearbox Rating (HP)	210*	
Tractor PTO Speed	540	
Minimum Tractor PTO HP	60	70
Blade Holder	Round Pan	
Blades	1/2" x 4" Uplift	
Blade Tip Speed (FPM)	13,997	14,488
Wheels	Single 21" Laminated	Dual 21" Laminated
Safety Shielding	Single or Double Row Chains	
Approximate Weight	1,300 lb.	2,000 lb.

**10-Year Gearbox Limited Warranty and 1-Year Machine Limited Warranty | 10-Year Deck Rust-Thru Limited Warranty on Galvanized Decks**

\*Gearbox rating based on field performance.

**WARNING:**

A deflector kit or chain shielding must be used for all non-agricultural purposes or in areas where thrown objects could be hazardous to people, animals, or property.

**HOW TO ORDER:**

To receive a complete cutter, you must order from each group listed for the model you have selected.

Freight NOT included in list price

**RETURN TO INDEX**

## BH416 ROTARY CUTTER

### BASE UNIT SELECTION

Model Number	Description	Approx. Wt.	List Price (\$US)
BH416-1R	BH416 Series Rotary Cutter, 6'	1,114 lb.	\$6,464
BH416-1Z	BH416 Series Rotary Cutter, 6', Galvanized <i>(available February 2021)</i>	1,114 lb.	\$7,159

### GROUP 2 FRONT ENCLOSURE SELECTION

50080837	Single Row Front Chains	68 lb.	\$259
50080836	Double Row Front Chains	102 lb.	\$396

### GROUP 3 REAR ENCLOSURE SELECTION

50080834	Single Row Rear Chains	86 lb.	\$366
50080833	Double Row Rear Chains	103 lb.	\$523

### OPTIONS

50080466	1/2" x 5" x 22-1/4" Parallel Uplift Blades	Order Through Service Parts	
BH416 Spec	Special Paint Colors	Call for Quote	

## BH417 ROTARY CUTTER

### BASE UNIT SELECTION

Model Number	Description	Approx. Wt.	List Price (\$US)
BH417-1R	BH417 Series Rotary Cutter, 7'	1,817 lb.	\$8,724
BH417-1Z	BH417 Series Rotary Cutter, 7', Galvanized <i>(available February 2021)</i>	1,817 lb.	\$9,813

### GROUP 2 HEIGHT ADJUSTMENT SELECTION

1817	Manual Ratchet Bundle	15 lb.	\$164
64830	Hydraulic Cylinder Bundle	30 lb.	\$362

### GROUP 3 FRONT ENCLOSURE SELECTION

50080845	Single Row Front Chains	78 lb.	\$290
50080844	Double Row Front Chains	117 lb.	\$440

### GROUP 4 REAR ENCLOSURE SELECTION

50080842	Single Row Rear Chains	94 lb.	\$449
50080841	Double Row Rear Chains	112 lb.	\$576

### OPTIONS

BH417 Spec	Special Paint Colors	Call for Quote	
------------	----------------------	----------------	--



**GALVANIZED MODEL AVAILABLE  
FEBRUARY 2021**

**RETURN TO INDEX**



**GALVANIZED MODEL AVAILABLE  
FEBRUARY 2021**



## BH500 SERIES ROTARY CUTTER

MODEL	BH516
Cutting Width	72"
Cutting Height	2" - 12"
Cutting Capacity	5"
Hitch	Cat. 2 or 3 Std & QH
Deck Thickness	7 Gauge
Side Bands	13" x 1/4"
Driveline	ASAE Category 6
Driveline Protection	Slip Clutch
Gearbox Rating (HP)	225*
Tractor PTO Speed	540
Minimum Tractor PTO HP	70
Blade Holder	Reinforced Round Pan
Blades	1/2" x 5" Uplift
Blade Tip Speed (FPM)	13,346
Wheels	Single 21" Laminated
Safety Shielding	Double Row Chains Standard
Approximate Weight	1,775 lb.

**10-Year Gearbox Limited Warranty and 1-Year Machine Limited Warranty | 10-Year Deck Rust-Thru Limited Warranty on Galvanized Decks**

\*Gearbox rating based on field performance.

**WARNING:**

A deflector kit or chain shielding must be used for all non-agricultural purposes or in areas where thrown objects could be hazardous to people, animals, or property.

**HOW TO ORDER:**

To receive a complete cutter, you must order from each group listed for the model you have selected. The BH516 comes equipped with lift-type hitch, driveline, and double row chains standard.

Freight NOT included in list price

## BH516 ROTARY CUTTER

### BASE UNIT SELECTION

Model Number	Description	Approx. Wt.	List Price (\$US)
BH516-1R	BH516 Series Rotary Cutter, 6'	1,775 lb.	<b>\$8,281</b>
BH516-1Z	BH516 Series Rotary Cutter, 6', Galvanized (available February 2021)	1,775 lb.	<b>\$9,089</b>

### OPTIONS

BH516 Spec

Special Paint Colors

Call for Quote

NOTE: Safety shieldings are non-returnable items for all models.



[RETURN TO INDEX](#)





[RETURN TO INDEX](#)

# MULTI-SPINDLE RIGID DECK ROTARY CUTTERS

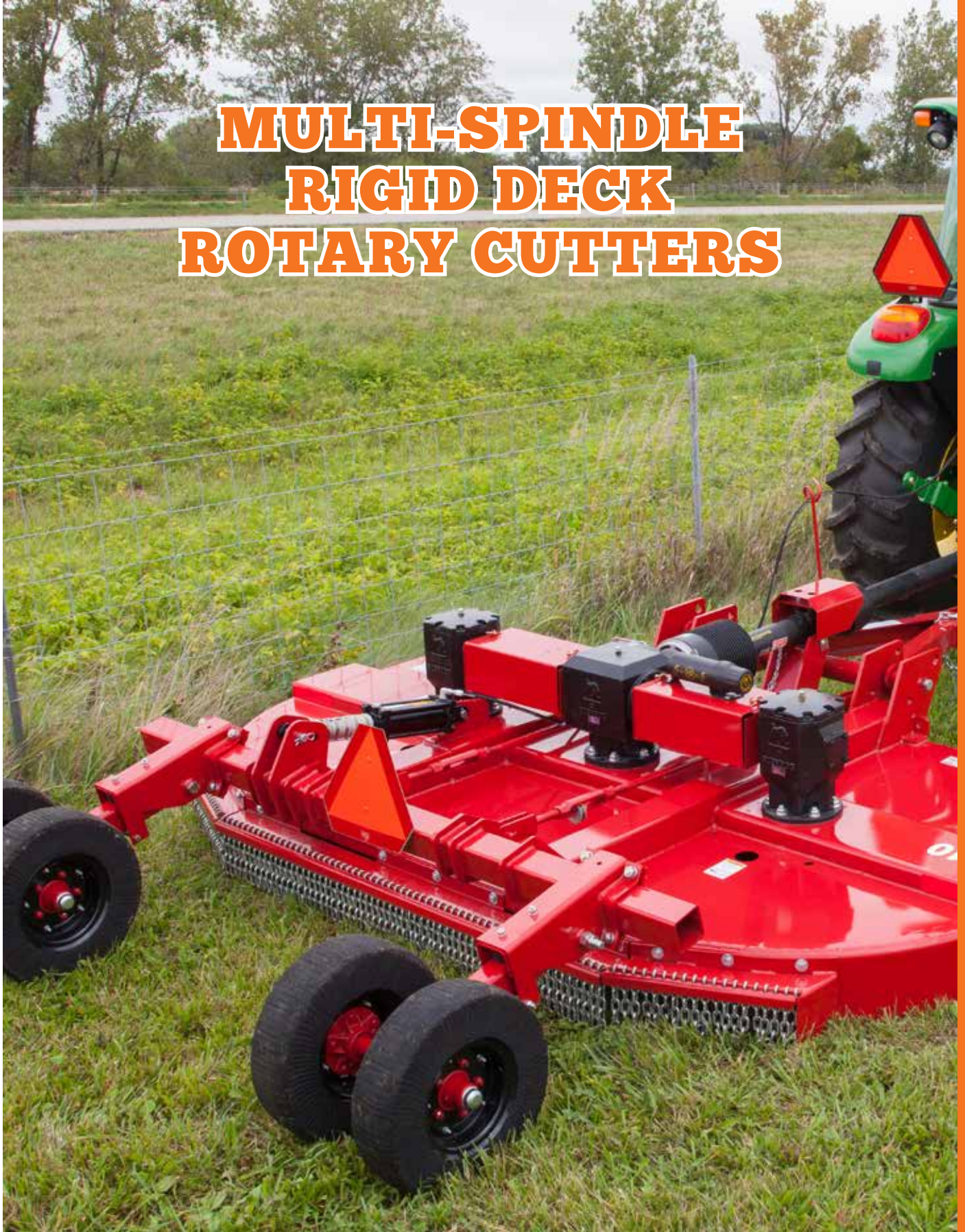

MULTI-SPINDLE RIGID DECK ROTARY CUTTERS

**RETURN TO INDEX**



## SQ84T SQUEALER SERIES TWIN-SPINDLE 7' ROTARY CUTTER

MODEL	SQ84T
Cutting Width	7' 1"
Overall Width	7' 3"
Overall Length	6' 3"
Cutting Height	2" - 12"
Cutting Capacity	1 ½" Diameter
Hitch	Cat 1 with 9" Offset
Deck Thickness	11 Gauge
Side Bands	7/8" x 11 Gauge
Driveline	ASAE Category 3
Driveline Protection	Slip Clutch
Blade Holder	Oval Pans
Blades	1/2" x 4" Uplift
Blade Tip Speed	11,500 fpm
Wheels	15 ½" Laminated
Minimum Tractor PTO HP	35
Safety Shielding	Front Rubber and Rear Metal Band Standard
Gearbox Rating (HP)	(1 ea.) 65* Center/Cutting and (1 ea.) 45* Cutting (540 rpm)

All models are available in the colors below:	
Model Color Indicator	Unit Color
2R	Bush Hog Red
2G	John Deere Green
2O	Kubota Orange
2B	New Holland Blue

**10-Year Gearbox Limited Warranty and 1-Year Machine Limited Warranty**

\*Gearbox rating based on field performance.

<b>NOTICE:</b>	PTO adapter must not be used in any application.
<b>WARNING:</b>	A deflector kit or chain shielding must be used for all non-agricultural purposes or in areas where thrown objects could be hazardous to people, animals, or property.
<b>HOW TO ORDER:</b>	To receive a complete cutter, you must order from each group listed for the model you have selected.

Freight NOT included in list price



**RETURN TO INDEX**

## SQ84T SQUEALER SERIES TWIN-SPINDLE 7' ROTARY CUTTER

### BASE UNIT SELECTION

Model Number	Description	Approx. Wt.	List Price (\$US)
<b>SQ84TRR</b>	<b>SQ84T Series Rotary Cutter, 7', Bush Hog Red</b>	720 lb.	<b>\$5,569</b>
<b>SQ84TRG</b>	<b>SQ84T Series Rotary Cutter, 7', John Deere Green</b>	720 lb.	<b>\$5,569</b>
<b>SQ84TRO</b>	<b>SQ84T Series Rotary Cutter, 7', Kubota Orange</b>	720 lb.	<b>\$5,569</b>
<b>SQ84TRB</b>	<b>SQ84T Series Rotary Cutter, 7', New Holland Blue</b>	720 lb.	<b>\$5,569</b>

Driveline and front and rear safety deflectors are included in above price.

### GROUP 2 TIRE SELECTION

<b>78868</b>	<b>15 1/2" Laminated Tires</b>	<b>\$395</b>
--------------	--------------------------------	--------------

NOTE: Safety shieldings are non-returnable items for all models.

RETURN TO INDEX



## 2208 SERIES ROTARY CUTTER

MODEL	2208
Cutting Width	8' 3"
Transport Width	8' 10"
Overall Length	13' 4" (Pull)
Length	8' 6" (Lift & Semi)   13' 4" (Pull)
Cutting Height	2" - 13"
Tongue Weight	880 lb. (Pull)
Cutting Capacity	2" Diameter
Hitch	Cat. 1 or 2 Std & Quick Hitch   Self-Leveling Pull-Type
Deck Thickness	10 Gauge
Side Bands	11 3/4" x 7 Gauge
Gearbox Rating (HP)	140* (Transfer)   65* (Cutting)
Driveline	ASAE Category 4
Driveline Protection	2-Plate Slip-Clutch
Blade Holder	Oval Pans
Blades	1/2" x 4" Uplift
Blade Overlap	4 3/4"
Blade Tip Speed	16,173 fpm
Wheels	15 1/2" Laminated
Minimum Tractor PTO HP	35 (Pull)   45 (Lift)
Safety Shielding	Chains (Front)   Metal Band or Chains (Rear)
Safety Tow Chain	Standard (Pull)
<b>10-Year Gearbox Limited Warranty and 1-Year Machine Limited Warranty</b>	

\*Gearbox rating based on field performance.

**NOTICE:**

PTO adapter must not be used in any application.

**WARNING:**

A deflector kit or chain shielding must be used for all non-agricultural purposes or in areas where thrown objects could be hazardous to people, animals, or property.

**HOW TO ORDER:**

To receive a complete cutter, you must order from each group listed for the model you have selected.

Freight NOT included in list price



**RETURN TO INDEX**

## 2208 SERIES ROTARY CUTTER

### BASE UNIT SELECTION

Model Number	Description	Approx. Wt.	List Price (\$US)
2208R	Base Unit	1,240 lb.	\$5,259

### GROUP 2 HITCH SELECTION

Model Number	Description	Approx. Wt.	List Price (\$US)
50081054	Lift Bundle with Cat. 4 Driveline, Twin Beam Axles, and 15 ½" Laminated Tires	250 lb.	\$1,355
50076024	Semi-Mount Bundle with Cat. 4 Driveline, Twin Beam Axles, and 15 ½" Laminated Tires	175 lb.	\$1,114
50081053	Pull Bundle with Cat. 4 Driveline, Cushioned Axles, and 21" Laminated Tires	500 lb.	\$2,279

### GROUP 3 HEIGHT ADJUSTMENT SELECTION (Pull Model Only)

Model Number	Description	Approx. Wt.	List Price (\$US)
1817	Manual Ratchet Bundle	15 lb.	\$164
89045	Hydraulic Cylinder Bundle	45 lb.	\$380

### GROUP 4 FRONT ENCLOSURE SELECTION

Model Number	Description	Approx. Wt.	List Price (\$US)
50075423	Front Single Row Chains	83 lb.	\$285
50075424	Front Double Row Chains	110 lb.	\$471

### GROUP 5 REAR ENCLOSURE SELECTION

Model Number	Description	Approx. Wt.	List Price (\$US)
50075503	Rear Metal Band	30 lb.	\$108
50075425	Rear Single Row Chains	72 lb.	\$232
50075426	Rear Double Row Chains	95 lb.	\$345

NOTE: Safety shieldings are non-returnable items for all models.

**RETURN TO INDEX**

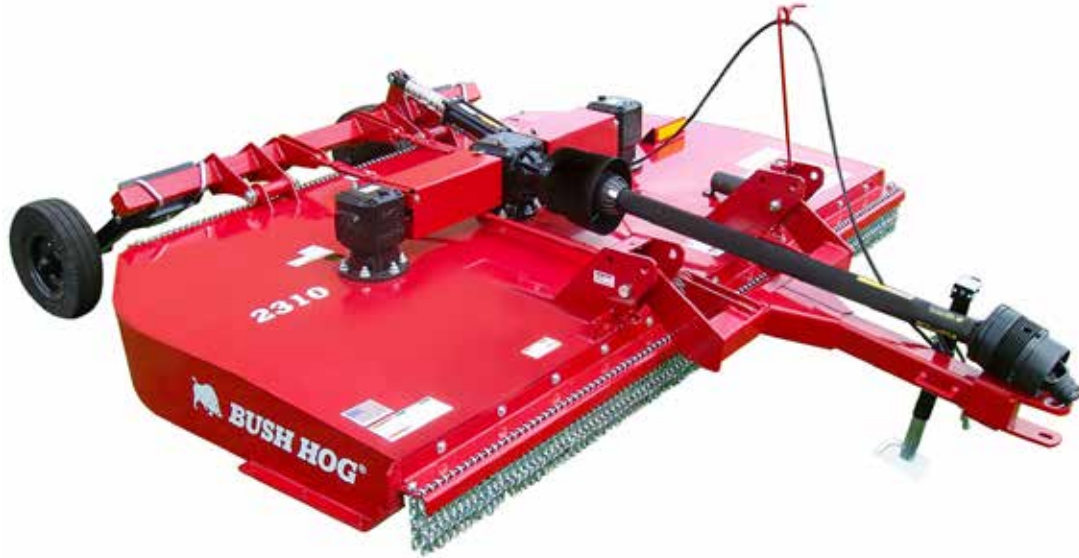

## 2310 SERIES ROTARY CUTTER

MODEL	2310
Cutting Width	9' 9"
Transport Width	10' 3"
Overall Length	12' 7" (Pull)
Cutting Height	2" - 12"
Cutting Capacity	2" Diameter
Hitch	Cat. 2 or 3 Std & Quick Hitch   Self-Leveling Pull-Type
Deck Thickness	10 Gauge
Side Bands	10" x 7 Gauge
Driveline	ASAE Category 4
Driveline Protection	Slip Clutch
Gearbox Rating (HP)	140* (Transfer); 130* (Cutting)
Tractor PTO Speed	540
Minimum Tractor PTO HP	50 (Pull), 70 (Lift)
Blade Holder	Round Pans
Blades	1/2" x 4" Uplift
Blade Tip Speed	15,828 fpm
Tires	Dual Laminated, Foam-Filled, or Pneumatic Aircraft
Safety Shielding	Front Single or Double Row Chains   Rear Metal Band or Single or Double Row Chains
Approximate Weight	2,280 lb
<b>10-Year Gearbox Limited Warranty and 1-Year Machine Limited Warranty</b>	

\*Gearbox rating based on field performance.

<b>NOTICE:</b>	PTO adapter must not be used in any application.
<b>WARNING:</b>	A deflector kit or chain shielding must be used for all non-agricultural purposes or in areas where thrown objects could be hazardous to people, animals, or property.
<b>HOW TO ORDER:</b>	To receive a complete cutter, you must order from each group listed for the model you have selected. Group 4 Wheel Selection for Pull-Type Units Only.

Freight NOT included in list price



**RETURN TO INDEX**

## 2310 SERIES ROTARY CUTTER

### BASE UNIT SELECTION

Model Number	Description	Approx. Wt.	List Price (\$US)
2310R	2310 Series Rotary Cutter, Round Blade Pan, 540 PTO	1,650 lb.	<b>\$7,857</b>

### GROUP 2 HITCH SELECTION

Model Number	Description	Approx. Wt.	List Price (\$US)
50080720	Pull Bundle with CV Driveline	325 lb.	<b>\$2,323</b>
50080721	Lift Bundle with Driveline and 21" Laminated Tires	275 lb.	<b>\$1,548</b>
50080722	Semi-Mount Bundle with Driveline and 21" Laminated Tires	170 lb.	<b>\$1,289</b>

### GROUP 3 HEIGHT ADJUSTMENT SELECTION

Model Number	Description	Approx. Wt.	List Price (\$US)
1817	Manual Ratchet Bundle	15 lb.	<b>\$164</b>
89045	Hydraulic Cylinder Bundle	45 lb.	<b>\$380</b>

### GROUP 4 WHEEL SELECTION (Pull Models Only)

Model Number	Description	Approx. Wt.	List Price (\$US)
294	20" Laminated Tire	72 lb.	each <b>\$223</b>
50050727	Used Aircraft Tire, 29x9x15	75 lb.	each <b>\$280</b>

### GROUP 5 FRONT ENCLOSURE SELECTION

Model Number	Description	Approx. Wt.	List Price (\$US)
50080716	Front Single Row Chains	80 lb.	<b>\$303</b>
50080717	Front Double Row Chains	140 lb.	<b>\$418</b>

### GROUP 6 REAR ENCLOSURE SELECTION

Model Number	Description	Approx. Wt.	List Price (\$US)
50081033	Rear Metal Band	50 lb.	<b>\$170</b>
50081043	Rear Single Row Chains	70 lb.	<b>\$272</b>
50081044	Rear Double Row Chains	120 lb.	<b>\$375</b>

NOTE: Safety shieldings are non-returnable items for all models.

**RETURN TO INDEX**



## 3308-2 SERIES ROTARY CUTTER

MODEL	3308-2
Cutting Width	8' 3"
Transport Width	8' 10"
Overall Length	8' 9" (Lift)
Axle Suspension	Heavy-Duty Axle with Rubber Cushions (Pull)
Cutting Height	2" - 13"
Cutting Capacity	3" Diameter
Hitch	Cat. 1 or 2 Std and Quick Hitch   Self-Leveling Pull-Type
Deck Thickness	10 Gauge
Side Bands	1/4" x 12"
Gearbox Rating (HP)	140* (Transfer); 130* (Cutting) Remove (540 rpm)
Driveline	ASAE Category 4
Driveline Protection	4-Plate Slip Clutch
Blade Holder	Round Pans
Blades	1/2" x 4" Uplift
Blade Overlap	5"
Blade Tip Speed	16,121 fpm
Wheels	See Wheel Selection
Minimum Tractor PTO HP	40 (Pull & Semi-Mount), 50 (Lift)
Safety Shielding	Front Single or Double Row Chains   Rear Metal Band or Single or Double Row Chains
Safety Tow Chain	Standard (Pull)
Approximate Weight	2050 lb.
<b>10-Year Gearbox Limited Warranty and 1-Year Machine Limited Warranty</b>	

\*Gearbox rating based on field performance.

<b>NOTICE:</b>	PTO adapter must not be used in any application.
<b>WARNING:</b>	A deflector kit or chain shielding must be used for all non-agricultural purposes or in areas where thrown objects could be hazardous to people, animals, or property.
<b>HOW TO ORDER:</b>	To receive a complete cutter, you must order from each group listed for the model you have selected.

Freight NOT included in list price





**RETURN TO INDEX**

## 3308-2 SERIES ROTARY CUTTER

### BASE UNIT SELECTION

Model Number	Description	Approx. Wt.	List Price (\$US)
3308R-2	3308-2 Series Rotary Cutter, Round Pan, 540 PTO	1,309 lb.	\$6,115

### GROUP 2 HITCH SELECTION

Model Number	Description	Approx. Wt.	List Price (\$US)
50081004	Lift Bundle*	125 lb.	\$884
50081005	Semi-Mount Bundle*	87 lb.	\$625
50081006	Pull Bundle*	470 lb.	\$3,154

\* Lift and Semi-Mount Bundles include Driveline with Slip-Clutch.  
 \*\* Pull Bundle includes CV Driveline with Slip-Clutch and Heavy-Duty Axle.

### GROUP 3 AXLE SELECTION (Lift and Semi-Mount Models Only)

Model Number	Description	Approx. Wt.	List Price (\$US)
50075427	Twin Beam Axle with 15 1/2" Laminated Tires	177 lb.	\$665
50081013	Lift and Semi-Mount HD Axle Arms (pair) with 21" Laminated Tires	250 lb.	\$1,490

### GROUP 4 HEIGHT ADJUSTMENT SELECTION

Model Number	Description	Approx. Wt.	List Price (\$US)
1817	Manual Ratchet Bundle	15 lb.	\$164
89045	Hydraulic Cylinder Bundle	45 lb.	\$380

Note: Selection is for pull model and heavy duty axle on lift and semi-mount models

### GROUP 5 WHEEL SELECTION (\*\*Pull Models Only, 2 Tires Required)

Model Number	Description	Approx. Wt.	List Price (\$US)
294	20" Laminated Tire	72 lb.	each \$223
50050727	Used Aircraft Tire, 29x9x15	75 lb.	each \$280
50078502	Foam-Filled Tire, 27 x 8-18	100 lb.	each \$475

### GROUP 6 FRONT ENCLOSURE SELECTION

Model Number	Description	Approx. Wt.	List Price (\$US)
50075423	Front Single Row Chains	83 lb.	\$285
50075424	Front Double Row Chains	110 lb.	\$471

### GROUP 7 REAR ENCLOSURE SELECTION

Model Number	Description	Approx. Wt.	List Price (\$US)
50075503	Rear Metal Band	30 lb.	\$108
50075425	Rear Single Row Chains	72 lb.	\$232
50075426	Rear Double Row Chains	95 lb.	\$345

NOTE: Safety shieldings are non-returnable items for all models.

**RETURN TO INDEX**

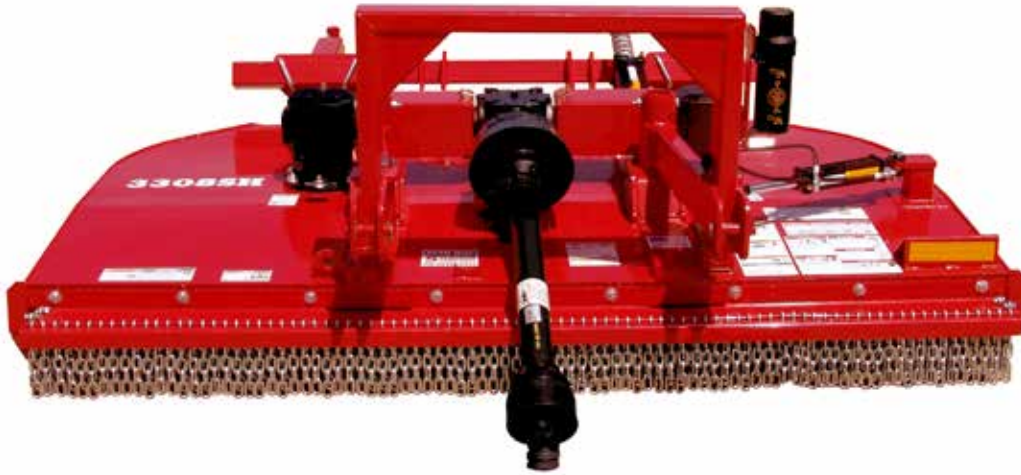

## 3308SH-2 SERIES MULTI-SPINDLE ROTARY CUTTER

MODEL	3308SH-2
Cutting Width	8' 3"
Transport Width	8' 10"
Overall Length	9' 7" (Semi-Mount)
Axle Suspension	Heavy Duty Axle with Rubber Suspension
Cutting Height	2" - 13"
Cutting Capacity	3" Diameter
Hitch	Cat. 1 or 2 (Semi-Mount Only With Variable Offset up to 13" to the Right of Tractor Center Line)
Deck Thickness	10 Gauge
Side Bands	1/4" x 12"
Gearbox Rating (HP)	140* (Transfer); 130* (Cutting)
Driveline	ASAE Category 4
Driveline Protection	4-Plate Slip Clutch
Blade Holder	Round Pans
Blades	1/2" x 3 1/2" Uplift
Blade Overlap	5"
Blade Tip Speed	16,121 fpm
Wheels	21" Laminated Tires
Minimum Tractor PTO HP	40
Safety Shielding	Front Single or Double Row Chains   Rear Metal Band or Single or Double Row Chains
<b>10-Year Gearbox Limited Warranty and 1-Year Machine Limited Warranty</b>	

\*Gearbox rating based on field performance.

<b>NOTICE:</b>	PTO adapter must not be used in any application.
<b>WARNING:</b>	A deflector kit or chain shielding must be used for all non-agricultural purposes or in areas where thrown objects could be hazardous to people, animals, or property.
<b>HOW TO ORDER:</b>	To receive a cutter, you must choose a Selection from Groups 1-4. The Base 3308SH-2 comes equipped with Swing Hitch Bundle including Driveline and HD Axle.

Freight NOT included in list price



**RETURN TO INDEX**

## 3308SH-2 SERIES MULTI-SPINDLE ROTARY CUTTER

### BASE UNIT SELECTION

Model Number	Description	Approx. Wt.	List Price (\$US)
3308SH-2	3308SH-2 Series Multi-Spindle Rotary Cutter, Round Pan Blade Carrier, 540 PTO, Swing Hitch Bundle Includes Driveline, HD Axle with 21" Laminated Tires	1,750 lb.	\$9,324

### GROUP 2 HEIGHT ADJUSTMENT SELECTION

Model Number	Description	Approx. Wt.	List Price (\$US)
1817	Manual Ratchet Bundle	15 lb.	\$164
89045	Hydraulic Cylinder Bundle	45 lb.	\$380

### GROUP 3 FRONT ENCLOSURE SELECTION

Model Number	Description	Approx. Wt.	List Price (\$US)
50075423	Front Single Row Chains	83 lb.	\$285
50075424	Front Double Row Chains	110 lb.	\$471

### GROUP 4 REAR ENCLOSURE SELECTION

Model Number	Description	Approx. Wt.	List Price (\$US)
50075503	Rear Metal Band	30 lb.	\$108
50075425	Rear Single Row Chains	72 lb.	\$232
50075426	Rear Double Row Chains	95 lb.	\$345

RETURN TO INDEX



## 3510 SERIES ROTARY CUTTER

MODEL	3510
Cutting Width	10' 6"
Cutting Height	2" - 13"
Cutting Capacity	3½" Diameter
Hitch	Cat. 2 or 3 Std and Quick Hitch   Self-Leveling Pull-Type
Deck Thickness	10 Gauge
Side Bands	1/4" x 10"
Driveline	ASAE Category 5
Driveline Protection	4-Plate Slip Clutch
Gearbox Rating (HP)	210* (Transfer); 210* (Cutting)
Tractor PTO Speed	540
Minimum Tractor PTO HP	50 (Pull), 75 (Lift)
Blade Holder	Round Pans
Blades	1/2" x 4" Uplift
Blade Tip Speed	16,881 fpm
Wheels	<i>See Wheel Selection</i>
Safety Shielding	Front Single or Double Row Chains   Rear Metal Band or Single or Double Row Chains
Approximate Weight	2,900 lb.
<b>10-Year Gearbox Limited Warranty and 1-Year Machine Limited Warranty</b>	

\*Gearbox rating based on field performance.

**NOTICE:**

PTO adapter must not be used in any application.

**WARNING:**

A deflector kit or chain shielding must be used for all non-agricultural purposes or in areas where thrown objects could be hazardous to people, animals, or property.

**HOW TO ORDER:**

To receive a complete cutter, you must order from each group listed for the model you have selected.

Freight NOT included in list price



**RETURN TO INDEX**

## 3510 SERIES ROTARY CUTTER

### BASE UNIT SELECTION

Model Number	Description	Approx. Wt.	List Price (\$US)
3510R	3510 Series Rotary Cutter, Round Blade Holder, 540 PTO	2,054 lb.	\$7,909

### GROUP 2 HITCH SELECTION

Model Number	Description	Approx. Wt.	List Price (\$US)
50076949	Lift Hitch Bundle	225 lb.	\$1,443
50068324	Semi-Mount Bundle	8 lb.	\$242
50036646	Pull Bundle (540 PTO only)	260 lb.	\$1,667

### GROUP 3 DRIVELINE SELECTION

Model Number	Description	Approx. Wt.	List Price (\$US)
76729	Lift and Semi-Mount Driveline, 1-3/8-6, 540 PTO	69 lb.	\$854
76625	Pull, CV Driveline, 1-3/8-6, 540 PTO	73 lb.	\$1,201

### GROUP 4 AXLE SELECTION (For All Models)

Model Number	Description	Approx. Wt.	List Price (\$US)
50068235	Pull, Single Wheel Axle Arms (pair)	162 lb.	\$1,000
50068236	Pull, Dual Wheel Axle Arms (pair)	194 lb.	\$1,268
50081078	Lift and Semi-Mount HD Axle Arms (pair) with 20.5" Pneumatic Aircraft Tires	200 lb.	\$1,662

### GROUP 5 HEIGHT ADJUSTMENT SELECTION (For All Models)

Model Number	Description	Approx. Wt.	List Price (\$US)
1817	Manual Ratchet Bundle	15 lb.	\$164
90492	Hydraulic Cylinder Bundle	45 lb.	\$420

### GROUP 6 WHEEL SELECTION (Pull Models Only)

Model Number	Description	Approx. Wt.	List Price (\$US)
294	20" Laminated Tire	72 lb.	each \$223
50075401	25" Laminated Tire	85 lb.	each \$301
50050727	Used Aircraft Tire, 29x9x15	75 lb.	each \$280
50078502	Foam-Filled Tire, 27 x 8-18	100 lb.	each \$475

### GROUP 7 FRONT ENCLOSURE SELECTION

Model Number	Description	Approx. Wt.	List Price (\$US)
50076736	Front Single Row Chains	140 lb.	\$462
50076927	Front Double Row Chains	165 lb.	\$771

### GROUP 8 REAR ENCLOSURE SELECTION

Model Number	Description	Approx. Wt.	List Price (\$US)
50076729	Rear Metal Band	40 lb.	\$122
50076939	Rear Single Row Chains	155 lb.	\$545
50076947	Rear Double Row Chains	180 lb.	\$847

NOTE: Safety shieldings are non-returnable items for all models.

RETURN TO INDEX



## 3514 SERIES ROTARY CUTTER

MODEL	3514
Cutting Width	14'
Transport Width	14' 8"
Overall Length	14' 7" (Pull)
Axle Suspension	Heavy-Duty Axle with Rubber Cushions
Cutting Height	2½" - 13"
Cutting Capacity	3½" Diameter
Hitch	Cat 2 and 3 Std and Quick Hitch & Self-Leveling Pull-Type
Deck Thickness	10 Gauge
Side Bands	1/4" x 10"
Gearbox Rating (HP)	(1 ea.) 210* Center and (2 ea.) 210* Cutting (540 rpm)
Driveline	ASAE Category 5 (540 PTO), ASAE Category 4 (1000 PTO Pull)
Cross Shafts	ASAE Category 5 Rubber Element with Category 4 Shearpin
Driveline Protection	4-Plate Slip Clutch
Blade Holder	Round (540 PTO), Round or Bar (1000 PTO)
Blades	1/2" x 4" Uplift
Blade Overlap	3"
Blade Tip Speed	15,242 fpm (540/1000 rpm)
Wheels	<i>See Wheel Selection</i>
Minimum Tractor PTO HP	75 (Pull), 90 (Lift)
Safety Shielding	Front Rubber Belt or Single Row Chains   Rear Rubber Belt   Metal Band or Single Row Chains
Highway Light Kit	Standard
<b>10-Year Gearbox Limited Warranty and 1-Year Machine Limited Warranty</b>	

\*Gearbox rating based on field performance.

**NOTICE:**

PTO adapter must not be used in any application.

**WARNING:**

A deflector kit or chain shielding must be used for all non-agricultural purposes or in areas where thrown objects could be hazardous to people, animals, or property.

**HOW TO ORDER:**

To receive a complete cutter, you must order a basic unit and then select one item from each of Groups 1 - 8 in the ordering section. Additional equipment may be added to your order by making your selection from the options list.

Freight NOT included in list price



**RETURN TO INDEX**

## 3514 SERIES ROTARY CUTTER

### BASE UNIT SELECTION

Model Number	Description	Approx. Wt.	List Price (\$US)
3514RS	3514 Series Rotary Cutter, Round Blade Holder, 540 PTO with Shear Bolt Cross Shafts	2,590 lb.	\$9,616
13514RS	13514 Series Rotary Cutter, Round Blade Holder, 1000 PTO with Shear Bolt Cross Shafts	2,590 lb.	\$10,206
13514SS	13514 Series Rotary Cutter, Blade Bar, 1000 PTO with Shear Bolt Cross Shafts	2,559 lb.	\$10,206

### GROUP 2 HITCH SELECTION

50076724	Lift Bundle with 21" Laminated Tires	530 lb.	\$4,287
50035727	Pull Bundle	281 lb.	\$3,020

### GROUP 3 DRIVELINE SELECTION

76729	Lift and Semi-Mount Driveline, 1-3/8-6, 540 PTO	69 lb.	\$854
76730	Lift and Semi-Mount Driveline, 1-3/8-21, 1000 PTO	69 lb.	\$854
76731	Lift and Semi-Mount Driveline, 1-3/4-20, 1000 PTO	70 lb.	\$854
76625	Pull, CV Driveline, 1-3/8-6, 540 PTO	73 lb.	\$1,201
76624	Pull, CV Driveline, 1-3/8-21, 1000 PTO	70 lb.	\$1,195

### GROUP 4 AXLE SELECTION (Pull Models Only)

50068369	Pull, Single Wheel Axle Arms (pair)*	162 lb.	\$1,071
50068370	Pull, Dual Wheel Axle Arms (pair)**	194 lb.	\$1,334

\*If #50068369 axle is selected, you must select #294 tire from Group 6 Wheel Selection.

\*\*If #50068370 is selected, you may select either tire from Group 6 Wheel Selection.

### GROUP 5 HEIGHT ADJUSTMENT SELECTION (For All Models)

1817	Manual Ratchet Bundle	15 lb.	\$164
90492	Hydraulic Cylinder Bundle	45 lb.	\$420

### GROUP 6 WHEEL SELECTION (Pull Models Only)

294	20" Laminated Tire	72 lb.	each \$223
50078502	Foam-Filled Tire, 27 x 8-18	100 lb.	each \$475

### GROUP 7 FRONT ENCLOSURE SELECTION

50076813	Front Single Row Chains	160 lb.	\$606
50076807	Front Rubber Belting	65 lb.	\$466

### GROUP 8 REAR ENCLOSURE SELECTION

50076817	Rear Metal Band	55 lb.	\$222
50076819	Rear Single Row Chains	170 lb.	\$652
50076818	Rear Rubber Belting	65 lb.	\$498

### OPTIONS

90604	Shredder Kit for 38" and 40"		\$481
90607	Shredder Kit for 30" Rows		\$481
50050192	Lift, Single Tailwheel Bundle with 21" Tire		\$850
50068369	Pull, Single Wheel Axle Arms (pair)* *Must be used with #294 tire only.	162 lb.	\$1,071

NOTE: Safety shieldings are non-returnable items for all models.

**RETURN TO INDEX**



## 14215 ROTARY CUTTER

MODEL	14215	MODEL	14215
Cutting Width	15'	Outboard Driveline	ASAE Category 5
Transport Width	15' 7"	Driveline Protection (Outboard)	Multi-Plate Slip-Clutch
Cutting Height	2" - 16"	Blade Holder	Round Pans
Cutting Capacity	3 1/2" Diameter	Blades	1/4" x 4" Uplift
Minimum Tractor PTO HP	125	Blade Overlap	3"
Tractor PTO Speed	1,000 RPM	Blade Tip Speed	17,280 fpm (Center); 15,708 fpm (Outboard)
Hitch	Cat. 1 or 2 Std and Quick Hitch	Axle Suspension	Spring-Loaded
Deck Thickness	7 Gauge	Wheels	21" Laminated
Side Bands	1/4" x 10"	Approximate Weight	3,700 lb.
Gearbox Rating (HP)	210* (Transfer); 210* (Cutting)	Safety Shielding	Front and Rear Rubber Belt Standard
Main Driveline	ASAE Category 5	Highway Light Kit	Standard

**10-Year Gearbox Limited Warranty and 1-Year Machine Limited Warranty | 10-Year Deck Rust-Thru Limited Warranty on Galvanized Decks**

\*Gearbox rating based on field performance.

<b>NOTICE:</b>	PTO adapter must not be used in any application.
<b>WARNING:</b>	A deflector kit or chain shielding must be used for all non-agricultural purposes or in areas where thrown objects could be hazardous to people, animals, or property.
<b>HOW TO ORDER:</b>	To receive a complete cutter, you must order a Basic Unit and a Group 2 Height Adjustment Selection. The 14215R-2 comes equipped with Lift-Type Hitch, Round Blade Pans, ASAE Cat 5 Drivelines with Slip-Clutches, Front Belting and Rear Metal Band.

Freight NOT included in list price

## 14215 ROTARY CUTTER

### BASE UNIT SELECTION

Model Number	Description	Approx. Wt.	List Price (\$US)
14215R-2	14215 Series Rotary Cutter, Round Blade Holder, 1000 PTO with Slip-Clutch Cross-Shafts	3,700 lb.	<b>\$24,072</b>

### GROUP 2 HEIGHT ADJUSTMENT SELECTION

1817	Manual Ratchet Bundle	15 lb.	<b>\$164</b>
90492	Hydraulic Cylinder Bundle	45 lb.	<b>\$420</b>





[RETURN TO INDEX](#)

# FLEX-WING ROTARY CUTTERS



FLEX-WING ROTARY CUTTERS

**RETURN TO INDEX**



## 1812 SERIES FLEX-WING ROTARY CUTTER

MODEL	1812	MODEL	1812
Transport Height*	5' 8"	Blade Holder	Oval
Transport Width**	6' 8"	Blades	1/2" x 3" Parallel Uplift
Overall Width	12' 8"	Blade Overlap	6"
Cutting Width	12'	Blade Tip Speed	14,464 fpm Center (540 rpm); 13,930 fpm Wings (540 rpm)
Length***	13' 3"	Wing Cutting Angles	22° Down to 45° Up
Axle Suspension	Cushioned Rubber Bumper on Each Center Axle Arm	Center Hydraulic Lift	Standard
Cutting Height	2" - 14"	Wing Hydraulic Lift	Standard
Cutting Capacity	1 1/2" Diameter	Axle Tube Pivots	Greaseable Bushings
Hitch	Cast Swivel Clevis	Wing Adjustment	Greaseable Turnbuckles
Approx. Tongue Weight	1,100 lb.	Wheels	See Wheel Selection
Deck Thickness	10 Gauge	Minimum Tractor PTO HP	50
Side Bands	1/4" x 11 1/2"	Jack Stand	Standard
Gearbox Rating (HP)	160† Transfer Gearbox, 65† Cutting Gearboxes	Safety Tow Chain	Standard
Driveline	ASAE Category 4 (540 PTO)	Safety Shielding	Single or Double Row Chains
Driveline Protection	(3) Multi-Plate Slip Clutch		

**10-Year Gearbox Limited Warranty and 1-Year Machine Limited Warranty**

**NOT FOR COMMERCIAL APPLICATION**

\*Measured at maximum transport height.

\*\*Measured at outside of wing skirts, folded.

\*\*\*Measured from hitch pin to axle spindle at transport height.

†Gearbox rating based on field performance.

**WARNING:**

A deflector kit or chain shielding must be used for all non-agricultural purposes or in areas where thrown objects could be hazardous to people, animals, or property.

**HOW TO ORDER:**

To receive a complete cutter, you must order a basic unit and then select one item from each of Groups 2 - 5 in the ordering section. Additional equipment may be added to your order by making your selection from the options list.

Freight NOT included in list price



**RETURN TO INDEX**

## 1812 SERIES FLEX-WING ROTARY CUTTER

### BASE UNIT SELECTION

Model Number	Description	Approx. Wt.	List Price (\$US)
1812R1	1812 Series Flex-Wing Rotary Cutter, Oval Blade Holder, 540 PTO, No Deck Rings	2,554 lb.	\$13,898

Model Includes Center and Wing Hydraulic Cylinders and Hoses, Cast Swivel Hitch, Tow Chain, Wing Drivelines, and CV, ASAE Category 4 Driveline. Assembly Included in List Price.

### GROUP 2 CENTER AXLE SELECTION

Model Number	Description	Approx. Wt.	List Price (\$US)
50074514	Dual Axle Arms (4 Tires)	88 lb.	\$736
50074515	Single Axle Arms (2 Tires)	69 lb.	\$548

### GROUP 3 WING AXLE SELECTION

Model Number	Description	Approx. Wt.	List Price (\$US)
50072771	Dual Axle Arms (4 Tires)	38 lb.	\$378
50072772	Single Axle Arms (2 Tires)	19 lb.	\$191

### GROUP 4 WHEEL SELECTION

Model Number	Description	Approx. Wt.	List Price (\$US)
294	20" Laminated Tire	72 lb.	each \$223
		4 Tires 288 lb.	\$892
		6 Tires 432 lb.	\$1,338
		8 Tires 576 lb.	\$1,784
50074504	Used Aircraft Tire, 20.5x6.75-10	43 lb.	each \$185
		4 Tires 172 lb.	\$740
		6 Tires 258 lb.	\$1,110
		8 Tires 344 lb.	\$1,480
50074505	Used Aircraft Tire, Foam Filled, 20.5x6.75-10	60 lb.	each \$304
		4 Tires 240 lb.	\$1,216
		6 Tires 360 lb.	\$1,824
		8 Tires 480 lb.	\$2,432

### GROUP 5 ENCLOSURE SELECTION

Model Number	Description	Approx. Wt.	List Price (\$US)
50074511	Single Row Chains, Front and Rear	197 lb.	\$653
50074512	Double Row Chains, Front and Rear	315 lb.	\$986

### OPTIONS

Model Number	Description	List Price (\$US)
50074762	Hydraulic Hose Kit to Raise Wings Independent of Center Section (Requires Two Sets of Tractor Outlets)	\$40
1812 Spec	Special Paint Colors	Call for Quote
50072725	Field Conversion Kit, Center Single to Dual Axle. Order (2) Kits + Tires of Choice	Order Through Service Parts
50073432	Field Conversion Kit, Wing Single Axle to Dual Axle. Order (1) Kit Per Wing + Tires of Choice.	Order Through Service Parts

NOTE: Safety shieldings are non-returnable items for all models.

**RETURN TO INDEX**



## 1815 SERIES FLEX-WING ROTARY CUTTER

MODEL	1815	MODEL	1815
Transport Height*	7'	Blades	1/2" x 4" Parallel Uplift
Transport Width**	7' 7"	Blade Overlap	6"
Cutting Width	15'	Blade Tip Speed	15,000 fpm (540 rpm); 15,600 fpm (1,000 rpm)
Length***	15' 2"	Wing Cutting Angles	22° Down to 45° Up
Axle Suspension	Cushioned Rubber on Center Axle	Center Hydraulic Lift	Standard
Cutting Height	2" - 14"	Wing Hydraulic Lift	Standard
Cutting Capacity	2½" Diameter	Axle Tube Pivots	Greaseable Bushings
Hitch	See Hitch Selection	Wing Adjustment	Greaseable Turnbuckles
Approx. Tongue Weight	1,700 lb.	Wheels	See Wheel Selection
Deck Thickness	10 Gauge	Minimum Tractor PTO HP	60
Side Bands	1/4" x 12"	Grass Baffles	Optional
Gearbox Rating (HP)	160 hp† Transfer Gearbox, 130 hp† Cutting Gearboxes	Jack Stand	Standard
Driveline	Main: See Driveline Selection Wings: ASAE Category 4	Safety Tow Chain	Standard
Driveline Protection	(3) Multi-Plate Slip Clutch	Safety Shielding	Single or Double Row Chains
Blade Holder	Round		

**10-Year Gearbox Limited Warranty and 1-Year Machine Limited Warranty**

**NOT FOR COMMERCIAL APPLICATION**

\*Measured at maximum transport height.

\*\*Measured at outside of wing skirts, folded.

\*\*\*Measured from hitch pin to axle spindle at transport height.

†Gearbox rating based on field performance.

**WARNING:**

A deflector kit or chain shielding must be used for all non-agricultural purposes or in areas where thrown objects could be hazardous to people, animals, or property.

**HOW TO ORDER:**

To receive a complete cutter, you must order a basic unit and then select one item from each of Groups 2 - 6 in the ordering section. Additional equipment may be added to your order by making your selection from the options list.

Freight NOT included in list price



**RETURN TO INDEX**

## 1815 SERIES FLEX-WING ROTARY CUTTER

### BASE UNIT SELECTION

Model Number	Description	Approx. Wt.	List Price (\$US)
1815R1	1815 Flex-Wing Series Rotary Cutter, Round Blade Holder, 540 PTO, No Deck Rings	3,421 lb.	<b>\$16,097</b>
1815RR1	1815 Flex-Wing Series Rotary Cutter, Round Blade Holder, 540 PTO, With Deck Rings	3,630 lb.	<b>\$16,659</b>
11815R1	1815 Flex-Wing Series Rotary Cutter, Round Blade Holder, 1,000 PTO, No Deck Rings	3,421 lb.	<b>\$16,097</b>
11815RR1	1815 Flex-Wing Series Rotary Cutter, Round Blade Holder, 1,000 PTO, With Deck Rings	3,630 lb.	<b>\$16,659</b>

Model Includes Center and Wing Hydraulic Cylinders and Hoses, Tow Chain, and Wing Drivelines.  
Assembly Included in List Price.

### GROUP 2 HITCH SELECTION

50054505	Perma-Level® Hitch	53 lb.	<b>\$392</b>
----------	--------------------	--------	--------------

### GROUP 3 DRIVELINE SELECTION

50069764	CV Driveline, 540 PTO, 1-3/8-6, ASAE Category 6	90 lb.	<b>\$1,295</b>
50069765	CV Driveline, 1000 PTO, 1-3/8-21, ASAE Category 5	90 lb.	<b>\$1,340</b>

### GROUP 4 WING AXLE SELECTION

50072772	Single Axle Arms (2 Tires)	19 lb.	<b>\$191</b>
50072771	Dual Axle Arms (4 Tires)	38 lb.	<b>\$378</b>

### GROUP 5 FRONT WHEEL SELECTION

294	20" Laminated Tire	72 lb.	each <b>\$223</b>
		<b>6 Tires</b>	432 lb. <b>\$1,338</b>
		<b>8 Tires</b>	576 lb. <b>\$1,784</b>
50075401	25" Laminated Tire	85 lb.	each <b>\$301</b>
		<b>6 Tires</b>	510 lb. <b>\$1,806</b>
		<b>8 Tires</b>	680 lb. <b>\$2,408</b>
97708	Pneumatic Aircraft Tire, 24x7.7x10	75 lb.	each <b>\$236</b>
		<b>6 Tires</b>	450 lb. <b>\$1,416</b>
		<b>8 Tires</b>	600 lb. <b>\$1,888</b>

### GROUP 6 ENCLOSURE SELECTION

50072776	Single Row Chains, Front and Rear	269 lb.	<b>\$1,272</b>
50073433	Double Row Chains, Front and Rear	431 lb.	<b>\$1,593</b>

### GROUP 7 HYDRAULIC HOSE SELECTION

50082034	Independent Wing Control (3-Hoses)	5 lb.	<b>\$0</b>
50082035	Single Wing Control (2-Hoses)	5 lb.	<b>\$0</b>

### OPTIONS

50073353	Grass Distribution Kit	74 lb.	<b>\$346</b>
50077430	EZ-Mount Driveline Holder (Please Contact Service Parts to Place Order)	8 lb.	<b>\$106</b>
1815 Spec	Special Paint Colors		Call for Quote
50073432	Field Conversion Kit, Wing Single Axle to Dual Axle. Order (1) Kit Per Wing + Tires of Choice.		Order Through Service Parts

NOTE: Safety shieldings are non-returnable items for all models.

**RETURN TO INDEX**

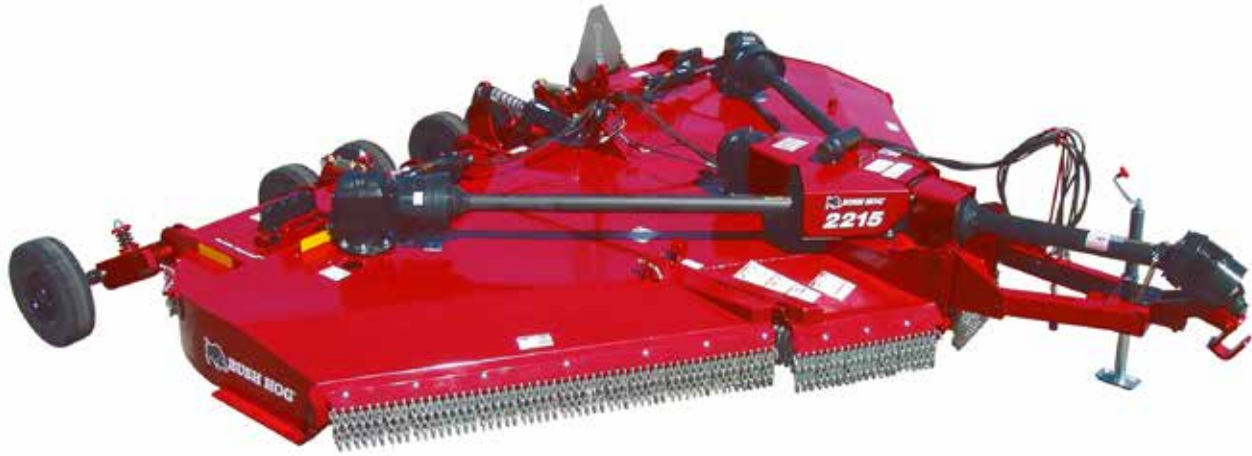

## 2215 SERIES FLEX-WING ROTARY CUTTER

MODEL	2215	MODEL	2215
Transport Height*	7' 3"	Blade Overlap	6"
Transport Width**	8' 2"	Blade Tip Speed	16,286 fpm (540 rpm); 16,000 fpm (1000 rpm)
Cutting Width	15'	Wing Cutting Angles	22° Down to 45° Up
Axle Suspension	Cushioned Springs at Each Wheel	Center Hydraulic Lift	Standard
Cutting Height	2" - 14"	Wing Hydraulic Lift	Standard
Cutting Capacity	3½" Diameter	Axle Tube Pivots	Greaseable Bushings
Hitch	See Hitch Selection	Axle Arm Pivots	Greaseable
Approx. Tongue Weight	1,800 lb.	Wing Adjustment	Greaseable Turnbuckles
Deck Thickness	10 Gauge	Wheels	See Wheel Selection
Side Bands	1/4" x 13 ½"	Minimum Tractor PTO HP	60
Gearbox Rating (HP)	250 hp† Transfer Gearbox, 210 hp† Cutting Gearboxes	Grass Baffles	Optional
Driveline	Main: See Driveline Selection Wings: ASAE Category 4	Jack Stand	Standard
Driveline Protection	(3) Multi-Plate Slip Clutch	Safety Tow Chain	Standard
Blade Holder	Round	Safety Shielding	Single or Double Row Chains
Blades	1/2" x 4" Parallel Uplift		

**10-Year Gearbox Limited Warranty and 1-Year Machine Limited Warranty**

\*Measured at maximum transport height.

\*\*Measured at outside of wing skids.

†Gearbox rating based on field performance.

**WARNING:**

A deflector kit or chain shielding must be used for all non-agricultural purposes or in areas where thrown objects could be hazardous to people, animals, or property.

**HOW TO ORDER:**

To receive a complete cutter, you must order a basic unit and then select one item from each of Groups 2 - 6 in the ordering section. Additional equipment may be added to your order by making your selection from the options list.

Freight NOT included in list price



**RETURN TO INDEX**

## 2215 SERIES FLEX-WING ROTARY CUTTER

### BASE UNIT SELECTION

Model Number	Description	Approx. Wt.	List Price (\$US)
2215R1	2215 Flex-Wing Series Rotary Cutter, Round Blade Holder, 540 PTO, No Deck Rings	3,565 lb.	\$16,982
2215RR1	2215 Flex-Wing Series Rotary Cutter, Round Blade Holder, 540 PTO, With Deck Rings	3,774 lb.	\$17,542
12215R1	2215 Flex-Wing Series Rotary Cutter, Round Blade Holder, 1,000 PTO, No Deck Rings	3,565 lb.	\$16,982
12215RR1	2215 Flex-Wing Series Rotary Cutter, Round Blade Holder, 1,000 PTO, With Deck Rings	3,774 lb.	\$17,542

Model Includes Perma-Level Hitch and Tow Chain. Assembly Included in List Price.

### GROUP 2 DRIVELINE SELECTION

50069764	CV Driveline, 540 PTO, 1-3/8-6, ASAE Category 6	90 lb.	\$1,295
50069765	CV Driveline, 1,000 PTO, 1-3/8-21, ASAE Category 5	90 lb.	\$1,340
50074699	CV Driveline, 1,000 PTO, 1-3/4-20, ASAE Category 6	90 lb.	\$1,340

### GROUP 3 CENTER AXLE SELECTION

50070267	Dual Axle Arms (4 Tires)	126 lb.	\$1,343
50076588	Tandem Walking Axle Arms (4 Tires)	209 lb.	\$1,885

### GROUP 4 WING AXLE SELECTION

50068188	Single Axle Arms (2 Tires)	98 lb.	\$1,042
50070267	Dual Axle Arms (4 Tires)	126 lb.	\$1,343
50076588	Tandem Walking Axle Arms (4 Tires)	209 lb.	\$1,885

### GROUP 5 WHEEL SELECTION

294	20" Laminated Tire		72 lb.	each \$223
		6 Tires	432 lb.	\$1,338
		8 Tires	576 lb.	\$1,784
50075401	25" Laminated Tire		85 lb.	each \$301
		6 Tires	510 lb.	\$1,806
		8 Tires	680 lb.	\$2,408
50050727	Used Aircraft Tire, 29x9x15		75 lb.	each \$280
		6 Tires	450 lb.	\$1,680
		8 Tires	600 lb.	\$2,240
50072403	Used Aircraft Tire, 27.75x8.75-24PR		80 lb.	each \$305
		6 Tires	480 lb.	\$1,830
		8 Tires	640 lb.	\$2,440
50078502	Foam-Filled Tire, 27 x 8-18		100 lb.	each \$475
		6 Tires	600 lb.	\$2,850
		8 Tires	800 lb.	\$3,800
50068834	Foam Filled Aircraft Tire, 26x6.6x14		90 lb.	each \$465
		6 Tires	540 lb.	\$2,790
		8 Tires	720 lb.	\$3,720

### GROUP 6 ENCLOSURE SELECTION

50076835	Single Row Chains, Front and Rear	273 lb.	\$1,249
50076836	Double Row Chains, Front and Rear	439 lb.	\$1,562

### GROUP 7 HYDRAULIC HOSE SELECTION

50082034	Independent Wing Control (3-Hoses)	5 lb.	\$0
50082035	Single Wing Control (2-Hoses)	5 lb.	\$0

### OPTIONS

50076825	Grass and Crop Baffles	76 lb.	\$434
50077430	EZ-Mount Driveline Holder (Please Contact Service Parts to Place Order)	8 lb.	\$106
50073131	Field Conversion Kit, Wing Single Axle to Dual Axle. Order (1) Kit Per Wing + Tires of Choice.	Order Through Service Parts	
2215 Spec	Special Paint Colors	Call for Quote	

NOTE: Safety shieldings are non-returnable items for all models.

**RETURN TO INDEX**



SEE WARRANTY SPECIFICATIONS BELOW



## 2810 SERIES FLEX-WING ROTARY CUTTER

MODEL	2810
Transport Height*	7' 3"
Transport Width**	8' 2"
Total Length	15' 3"
Total Width	12'
Cutting Width	10' 6"
Axle Suspension	Cushioned Springs at Each Wheel
Cutting Height	2" - 14"
Cutting Capacity	4" Diameter
Hitch	Self-Leveling Perma-Level®
Approx. Tongue Weight	1,900 lb.
Deck Thickness	11 Gauge (Center Top) 7 Gauge (Center Bottom) 7 Gauge (Wings)
Side Bands	1/4" x 13½"
Gearbox Rating (HP)	250 hp† Transfer Gearbox, 225 hp† Cutting Gearboxes
Driveline	Main: See Driveline Selection Wings: ASAE Category 4
Driveline Protection	(2) Multi-Plate Slip Clutch

MODEL	2810
Blade Holder	Round
Blades	1/2" x 4" Parallel Uplift
Blade Overlap	6"
Blade Tip Speed	16,286 fpm (540 rpm); 15,906 fpm (1000 rpm)
Wing Cutting Angles	22° Down to 45° Up
Center Hydraulic Lift	Standard
Wing Hydraulic Lift	Standard
Axle Tube Pivots	Greaseable Bushings
Wing Adjustment	Greaseable Turnbuckles
Wheels	See Wheel Selection
Minimum Tractor PTO HP	60
Grass Baffles	Optional
Jack Stand	Standard
Safety Tow Chain	Standard
Safety Shielding	Double Row Chains"

**10-Year Gearbox Limited Warranty | 6-Month Machine Limited Warranty (Contractors) | 1-Year Machine Limited Warranty (Consumers)**

\*Measured at maximum transport height.

\*\*Measured at outside of wing skirts.

†Gearbox rating based on field performance.

**WARNING:**

A deflector kit or chain shielding must be used for all non-agricultural purposes or in areas where thrown objects could be hazardous to people, animals, or property.

**HOW TO ORDER:**

To receive a complete cutter, you must order a basic unit and then select one item from each of Groups 2 - 6 in the ordering section. Additional equipment may be added to your order by making your selection from the options list.

Freight NOT included in list price





**RETURN TO INDEX**

## 2810 SERIES FLEX-WING ROTARY CUTTER

### RIGHT WING ONLY BASE UNIT SELECTION

Model Number	Description	Approx. Wt.	List Price (\$US)
2810R4	2810 Flex-Wing Series Rotary Cutter, Round Blade Holder, 540 PTO, No Deck Rings	4,324 lb.	<b>\$18,337</b>
2810RR4	2810 Flex-Wing Series Rotary Cutter, Round Blade Holder, 540 PTO, With Deck Rings	4,533 lb.	<b>\$18,787</b>
12810R4	2810 Flex-Wing Series Rotary Cutter, Round Blade Holder, 1,000 PTO, No Deck Rings	4,324 lb.	<b>\$18,337</b>
12810RR4	2810 Flex-Wing Series Rotary Cutter, Round Blade Holder, 1,000 PTO, With Deck Rings	4,533 lb.	<b>\$18,787</b>

Model Includes Center and Wing Hydraulic Cylinders and Hoses, Perma-Level Hitch, Tow Chain, and Wing Drivelines. Assembly Included in List Price.

### GROUP 2 DRIVELINE SELECTION

50069764	CV Driveline, 540 PTO, 1-3/8-6, ASAE Category 6	90 lb.	<b>\$1,295</b>
50069765	CV Driveline, 1,000 PTO, 1-3/8-21, ASAE Category 5	90 lb.	<b>\$1,340</b>
50074699	CV Driveline, 1,000 PTO, 1-3/4-20, ASAE Category 6	90 lb.	<b>\$1,340</b>

### GROUP 3 CENTER AXLE SELECTION

50074158	Dual Axle Arms (4 Tires), Half Spindles	171 lb.	<b>\$1,376</b>
50076586	Tandem Walking Axle Arms (4 Tires)	392 lb.	<b>\$2,075</b>

### GROUP 4 WING AXLE SELECTION

50070526	Single Axle Arm (1 Tire)	49 lb.	<b>\$552</b>
50070627	Dual Axle Arm (2 Tires)	63 lb.	<b>\$659</b>
50076589	Tandem Walking Axle (4 Tires)	104 lb.	<b>\$999</b>

### GROUP 5 FRONT WHEEL SELECTION

294	20" Laminated Tire		72 lb.	each <b>\$223</b>
		5 Tires	360 lb.	<b>\$1,115</b>
		6 Tires	432 lb.	<b>\$1,338</b>
50075401	25" Laminated Tire		85 lb.	each <b>\$301</b>
		5 Tires	425 lb.	<b>\$1,505</b>
		6 Tires	510 lb.	<b>\$1,806</b>
50050727	Used Aircraft Tire, 29x9x15		75 lb.	each <b>\$280</b>
		5 Tires	375 lb.	<b>\$1,400</b>
		6 Tires	450 lb.	<b>\$1,680</b>
50072403	Used Aircraft Tire, 27.75x8.75-24PR		80 lb.	each <b>\$305</b>
		5 Tires	400 lb.	<b>\$1,525</b>
		6 Tires	480 lb.	<b>\$1,830</b>
50078502	Foam-Filled Tire, 27 x 8-18		100 lb.	each <b>\$475</b>
		5 Tires	500 lb.	<b>\$2,375</b>
		6 Tires	600 lb.	<b>\$2,850</b>
50068834	Foam Filled Aircraft Tire, 26x6.6x14		90 lb.	each <b>\$465</b>
		5 Tires	540 lb.	<b>\$2,325</b>
		6 Tires	720 lb.	<b>\$2,790</b>

### GROUP 6 ENCLOSURE SELECTION

50070419	Double Row Chains, Front and Rear	310 lb.	<b>\$852</b>
----------	-----------------------------------	---------	--------------

### OPTIONS

50070395	Grass and Crop Distribution Baffles	59 lb.	<b>\$318</b>
50077430	EZ-Mount Driveline Holder (Please Contact Service Parts to Place Order)	8 lb.	<b>\$106</b>
50073131	Field Conversion Kit, Wing Single Axle to Dual Axle. Order (1) Kit Per Wing + Tires of Choice.	Order Through Service Parts	
2810 Spec	Special Paint Colors	Call for Quote	

NOTE: Safety shieldings are non-returnable items for all models.

**RETURN TO INDEX**



SEE WARRANTY SPECIFICATIONS BELOW



## 2815 SERIES FLEX-WING ROTARY CUTTER

MODEL	2815
Transport Height*	7' 3"
Transport Width**	8' 2"
Cutting Width	15'
Axle Suspension	Cushioned Springs at Each Wheel
Cutting Height	2" - 14"
Cutting Capacity	4" Diameter
Hitch	Self-Leveling Perma-Level®
Approx. Tongue Weight	1,900 lb.
Deck Thickness	11 Gauge (Center Top) 7 Gauge (Center Bottom) 7 Gauge (Wings)
Side Bands	1/4" x 13½"
Gearbox Rating (HP)	250 hp† Splitter Gearbox, 225 hp† Cutting Gearboxes
Driveline	Main: See Driveline Selection Wings: ASAE Category 4
Driveline Protection	(3) Multi-Plate Slip Clutch
Blade Holder	Round
Blades	1/2" x 4" Parallel Uplift

MODEL	2815
Blade Overlap	6"
Blade Tip Speed	16,286 fpm (540 rpm); 16,391 fpm (1000 rpm)
Wing Cutting Angles	22° Down to 45° Up
Center Hydraulic Lift	Standard
Wing Hydraulic Lift	Standard
Axle Tube Pivots	Greaseable Bushings
Axle Arm Pivots	Greaseable
Wing Adjustment	Greaseable Turnbuckles
Wheels	See Wheel Selection
Minimum Tractor PTO HP	60
Grass Baffles	Optional
Jack Stand	Standard
Safety Tow Chain	Standard
Safety Shielding	Double Row Chains

**10-Year Gearbox Limited Warranty | 6-Month Machine Limited Warranty (Contractors) | 1-Year Machine Limited Warranty (Consumers)**

\*Measured at maximum transport height.

\*\*Measured at outside of wing skids.

†Gearbox rating based on field performance.

**WARNING:**

**A deflector kit or chain shielding must be used for all non-agricultural purposes or in areas where thrown objects could be hazardous to people, animals, or property.**

**HOW TO ORDER:**

To receive a complete cutter, you must order a basic unit and then select one item from each of Groups 2 - 6 in the ordering section. Additional equipment may be added to your order by making your selection from the options list.

Freight NOT included in list price



**RETURN TO INDEX**

## 2815 SERIES FLEX-WING ROTARY CUTTER

### BASE UNIT SELECTION

Model Number	Description	Approx. Wt.	List Price (\$US)
2815R4	2815 Flex-Wing Series Rotary Cutter, Round Blade Holder, 540 PTO, No Deck Rings	4,324 lb.	\$20,848
2815RR4	2815 Flex-Wing Series Rotary Cutter, Round Blade Holder, 540 PTO, With Deck Rings	4,533 lb.	\$21,526
12815R4	2815 Flex-Wing Series Rotary Cutter, Round Blade Holder, 1,000 PTO, No Deck Rings	4,324 lb.	\$20,848
12815RR4	2815 Flex-Wing Series Rotary Cutter, Round Blade Holder, 1,000 PTO, With Deck Rings	4,533 lb.	\$21,526

Model Includes Center and Wing Hydraulic Cylinders and Hoses, Perma-Level Hitch, Tow Chain, and Wing Drivelines. Assembly Included in List Price.

### GROUP 2 DRIVELINE SELECTION

50069764	CV Driveline, 540 PTO, 1-3/8-6, ASAE Category 6	90 lb.	\$1,295
50069765	CV Driveline, 1,000 PTO, 1-3/8-21, ASAE Category 5	90 lb.	\$1,340
50074699	CV Driveline, 1,000 PTO, 1-3/4-20, ASAE Category 6	90 lb.	\$1,340

### GROUP 3 CENTER AXLE SELECTION

50074158	Dual Axle Arms (4 Tires)	126 lb.	\$1,376
50076586	Tandem Walking Axle Arms (4 Tires)	392 lb.	\$2,075

### GROUP 4 WING AXLE SELECTION

50068188	Single Axle Arms (2 Tires)	98 lb.	\$1,042
50070267	Dual Axle Arms (4 Tires)	126 lb.	\$1,343
50076588	Tandem Walking Axle Arms (4 Tires)	209 lb.	\$1,885

### GROUP 5 WHEEL SELECTION

294	20" Laminated Tire		72 lb.	each \$223
		6 Tires	432 lb.	\$1,338
		8 Tires	576 lb.	\$1,784
50075401	25" Laminated Tire		85 lb.	each \$301
		6 Tires	510 lb.	\$1,806
		8 Tires	680 lb.	\$2,408
50050727	Used Aircraft Tire, 29x9x15		75 lb.	each \$280
		6 Tires	450 lb.	\$1,680
		8 Tires	600 lb.	\$2,240
50072403	Used Aircraft Tire, 27.75x8.75-24PR		80 lb.	each \$305
		6 Tires	480 lb.	\$1,830
		8 Tires	640 lb.	\$2,440
50078502	Foam-Filled Tire, 27 x 8-18		100 lb.	each \$475
		6 Tires	600 lb.	\$2,850
		8 Tires	800 lb.	\$3,800
50068834	Foam Filled Aircraft Tire, 26x6.6x14		90 lb.	each \$465
		6 Tires	540 lb.	\$2,790
		8 Tires	720 lb.	\$3,720

### GROUP 6 ENCLOSURE SELECTION

50069458	Double Row Chains, Front and Rear	477 lb.	\$1,372
----------	-----------------------------------	---------	---------

### GROUP 7 HYDRAULIC HOSE SELECTION

50082034	Independent Wing Control (3-Hoses)	5 lb.	\$0
50082035	Single Wing Control (2-Hoses)	5 lb.	\$0

### OPTIONS

50069451	Grass and Crop Distribution Baffles	76 lb.	\$420
50077430	EZ-Mount Driveline Holder (Please Contact Service Parts to Place Order)	8 lb.	\$106
50073131	Field Conversion Kit, Wing Single Axle to Dual Axle. Order (1) Kit Per Wing + Tires of Choice.		Order Through Service Parts
2815 Spec	Special Paint Colors		Call for Quote

NOTE: Safety shieldings are non-returnable items for all models.

**RETURN TO INDEX**



SEE WARRANTY SPECIFICATIONS BELOW



## 3810 SERIES FLEX-WING ROTARY CUTTER

MODEL	3810	MODEL	3810
Transport Height*	7' 3"	Blades	1/2" x 4" Parallel Uplift
Transport Width**	8' 2"	Blade Overlap	6"
Cutting Width	10' 6"	Blade Tip Speed	16,286 fpm (540 rpm); 16,391 fpm (1000 rpm)
Axle Suspension	Cushioned Springs at Each Wheel	Wing Cutting Angles	22° Down to 45° Up
Cutting Height	2" to 14"	Center Hydraulic Lift	Standard
Cutting Capacity	4 1/2" Diameter	Wing Hydraulic Lift	Standard
Hitch	See Hitch Selection	Axle Tube Pivots	Greaseable Bushings
Approx. Tongue Weight	2,200 lb.	Axle Arm Pivots	Greaseable
Deck Thickness	11 Gauge (Center Top) 7 Gauge (Center Bottom) 7 Gauge (Wings)	Wing Adjustment	Greaseable Turnbuckles
Side Bands	1/4" x 13 1/2"	Wheels	See Wheel Selection
Gearbox Rating (HP)	250 hp† Splitter Gearbox, 225 hp† Cutting Gearbox	Minimum Tractor PTO HP	60
Driveline	Main: See Driveline Selection Wings: ASAE Category 5	Grass Baffles	Optional
Driveline Protection	(2) Multi-Plate Slip Clutch	Jack Stand	Standard
Blade Holder	Round	Safety Tow Chain	Standard
Blade Bolts	Hex Shaped	Safety Shielding	Double Row Chains

**10-Year Gearbox Limited Warranty | 1-Year Machine Limited Warranty (Contractors) | 1-Year Machine Limited Warranty (Consumers)**

\*Measured at maximum transport height.

\*\*Measured at outside of wing skirts.

†Gearbox rating based on field performance.

**WARNING:**

A deflector kit or chain shielding must be used for all non-agricultural purposes or in areas where thrown objects could be hazardous to people, animals, or property.

**HOW TO ORDER:**

To receive a complete cutter, you must order a basic unit and then select one item from each of Groups 2 - 7 in the ordering section. Additional equipment may be added to your order by making your selection from the options list.

Freight NOT included in list price



**RETURN TO INDEX**

## 3810 SERIES FLEX-WING ROTARY CUTTER

### BASE UNIT SELECTION

Model Number	Description	Approx. Wt.	List Price (\$US)
3810RR3	3810 Flex-Wing Series Rotary Cutter, Round Blade Holder, 540 PTO, With Deck Rings	4,708 lb.	\$20,450
13810RR3	3810 Flex-Wing Series Rotary Cutter, Round Blade Holder, 1,000 PTO, With Deck Rings	4,708 lb.	\$20,450

Model Includes Center and Wing Hydraulic Cylinders and Hoses, Tow Chain, and Wing Drivelines. Assembly Included in List Price.

### GROUP 2 HITCH SELECTION

50072803	Ball Hitch with 2 <sup>5</sup> / <sub>16</sub> " Ball	45 lb.	\$357
50054505	Perma-Level® Hitch	53 lb.	\$392

### GROUP 3 DRIVELINE SELECTION

50069764	CV Driveline, 540 PTO, 1-3/8-6, ASAE Category 6	90 lb.	\$1,295
50069765	CV Driveline, 1,000 PTO, 1-3/8-21, ASAE Category 5	90 lb.	\$1,340
50074699	CV Driveline, 1,000 PTO, 1-3/4-20, ASAE Category 6	90 lb.	\$1,340

### GROUP 4 CENTER AXLE SELECTION

50074158	Dual Axle Arms (4 Tires), Half Spindles	171 lb.	\$1,376
50076586	Tandem Walking Axle Arms (4 Tires)	392 lb.	\$2,075

### GROUP 5 WING AXLE SELECTION

50075164	Single Axle Arms (1 Tire), Half Spindles	98 lb.	\$563
50075163	Dual Axle Arms (2 Tires), Half Spindles	126 lb.	\$697
50076587	Tandem Walking Axle Arms (2 Tires)	209 lb.	\$1,060

### GROUP 6 WHEEL SELECTION

294	20" Laminated Tire		72 lb.	each \$223
		5 Tires	360 lb.	\$1,115
		6 Tires	432 lb.	\$1,338
50075401	25" Laminated Tire		85 lb.	each \$301
		5 Tires	425 lb.	\$1,505
		6 Tires	510 lb.	\$1,806
50050727	Used Aircraft Tire, 29x9x15		75 lb.	each \$280
		5 Tires	375 lb.	\$1,400
		6 Tires	450 lb.	\$1,680
50072403	Used Aircraft Tire, 27.75x8.75-24PR		80 lb.	each \$305
		5 Tires	400 lb.	\$1,525
		6 Tires	480 lb.	\$1,830
50078502	Foam-Filled Tire, 27 x 8-18		100 lb.	each \$475
		5 Tires	500 lb.	\$2,375
		6 Tires	600 lb.	\$2,850
50068834	Foam Filled Aircraft Tire, 26x6.6x14		90 lb.	each \$465
		5 Tires	540 lb.	\$2,325
		6 Tires	720 lb.	\$2,790

### GROUP 7 ENCLOSURE SELECTION

50070419	Double Row Chains, Front and Rear	310 lb.	\$852
----------	-----------------------------------	---------	-------

### OPTIONS

50070395	Grass and Crop Distribution Baffles	59 lb.	\$318
50077430	EZ-Mount Driveline Holder (Please Contact Service Parts to Place Order)	8 lb.	\$106
50073131	Field Conversion Kit, Wing Single Axle to Dual Axle. Order (1) Kit Per Wing + Tires of Choice.		Order Through Service Parts

NOTE: Safety shieldings are non-returnable items for all models.

**RETURN TO INDEX**



SEE WARRANTY SPECIFICATIONS BELOW



## 3815 SERIES FLEX-WING ROTARY CUTTER

MODEL	3815
Transport Height*	7' 3"
Transport Width**	8' 2"
Cutting Width	15'
Axle Suspension	Cushioned Springs at Each Wheel
Cutting Height	2" - 14"
Cutting Capacity	4½" Diameter
Hitch	See Hitch Selection
Approx. Tongue Weight	2,200 lb.
Deck Thickness	11 Gauge (Center Top) 7 Gauge (Center Bottom) 7 Gauge (Wings)
Side Bands	1/4" x 13½"
Gearbox Rating (HP)	250 hp† Splitter Gearbox, 225 hp† Cutting Gearbox
Driveline	Main: See Driveline Selection Wings: ASAE Category 5
Driveline Protection	(3) Multi-Plate Slip Clutch
Blade Holder	Round
Blade Bolts	Hex Shaped

MODEL	3815
Blades	1/2" x 4" Parallel Uplift
Blade Overlap	6"
Blade Tip Speed	16,286 fpm (540 rpm); 16,391 fpm (1000 rpm)
Wing Cutting Angles	22° Down to 45° Up
Center Hydraulic Lift	Standard
Wing Hydraulic Lift	Standard
Axle Tube Pivots	Greaseable Bushings
Axle Arm Pivots	Greaseable
Wing Adjustment	Greaseable Turnbuckles
Wheels	See Wheel Selection
Minimum Tractor PTO HP	60
Grass Baffles	Optional
Jack Stand	Standard
Safety Tow Chain	Standard
Safety Shielding	Double Row Chains

**10-Year Gearbox Limited Warranty | 1-Year Machine Limited Warranty (Contractors) | 1-Year Machine Limited Warranty (Consumers)**

\*Measured at maximum transport height.

\*\*Measured at outside of wing skirts.

†Gearbox rating based on field performance.

**WARNING:**

A deflector kit or chain shielding must be used for all non-agricultural purposes or in areas where thrown objects could be hazardous to people, animals, or property.

**HOW TO ORDER:**

To receive a complete cutter, you must order a basic unit and then select one item from each of Groups 2 - 7 in the ordering section. Additional equipment may be added to your order by making your selection from the options list.

Freight NOT included in list price



**RETURN TO INDEX**

## 3815 SERIES FLEX-WING ROTARY CUTTER

### BASE UNIT SELECTION

Model Number	Description	Approx. Wt.	List Price (\$US)
3815RR3	3815 Flex-Wing Series Rotary Cutter, Round Blade Holder, 540 PTO, With Deck Rings	4,675 lb.	\$23,498
13815RR3	3815 Flex-Wing Series Rotary Cutter, Round Blade Holder, 1,000 PTO, With Deck Rings <small>Model Includes Center and Wing Hydraulic Cylinders and Hoses, Tow Chain, and Wing Drivelines. Assembly Included in List Price.</small>	4,675 lb.	\$23,498

### GROUP 2 HITCH SELECTION

50072803	Ball Hitch with 2 <sup>5</sup> / <sub>16</sub> " Ball	45 lb.	\$357
50054505	Perma-Level® Hitch	53 lb.	\$392

### GROUP 3 DRIVELINE SELECTION

50069764	CV Driveline, 540 PTO, 1-3/8-6, ASAE Category 6	90 lb.	\$1,295
50069765	CV Driveline, 1,000 PTO, 1-3/8-21, ASAE Category 5	90 lb.	\$1,340
50074699	CV Driveline, 1,000 PTO, 1-3/4-20, ASAE Category 6	90 lb.	\$1,340

### GROUP 4 CENTER AXLE SELECTION

50074158	Dual Axle Arms (4 Tires), Half Spindles	171 lb.	\$1,376
50076586	Tandem Walking Axle Arms (4 Tires)	392 lb.	\$2,075

### GROUP 5 WING AXLE SELECTION

50074159	Single Axle Arms (2 Tires), Half Spindles	138 lb.	\$1,107
50074158	Dual Axle Arms (4 Tires), Half Spindles	171 lb.	\$1,376
50076586	Tandem Walking Axle Arms (4 Tires)	392 lb.	\$2,075

### GROUP 6 WHEEL SELECTION

294	20" Laminated Tire		72 lb.	each \$223
		6 Tires	432 lb.	\$1,338
		8 Tires	576 lb.	\$1,784
50075401	25" Laminated Tire		85 lb.	each \$301
		6 Tires	510 lb.	\$1,806
		8 Tires	680 lb.	\$2,408
50050727	Used Aircraft Tire, 29x9x15		75 lb.	each \$280
		6 Tires	450 lb.	\$1,680
		8 Tires	600 lb.	\$2,240
50072403	Used Aircraft Tire, 27.75x8.75-24PR		80 lb.	each \$305
		6 Tires	480 lb.	\$1,830
		8 Tires	640 lb.	\$2,440
50078502	Foam-Filled Tire, 27 x 8-18		100 lb.	each \$475
		6 Tires	600 lb.	\$2,850
		8 Tires	800 lb.	\$3,800
50068834	Foam Filled Aircraft Tire, 26x6.6x14		90 lb.	each \$465
		6 Tires	540 lb.	\$2,790
		8 Tires	720 lb.	\$3,720

### GROUP 7 ENCLOSURE SELECTION

50069458	Double Row Chains, Front and Rear	477 lb.	\$1,372
----------	-----------------------------------	---------	---------

### GROUP 8 HYDRAULIC HOSE SELECTION

50082034	Independent Wing Control (3-Hoses)	5 lb.	\$0
50082035	Single Wing Control (2-Hoses)	5 lb.	\$0

### OPTIONS

50069451	Grass and Crop Distribution Baffles	76 lb.	\$420
50077430	EZ-Mount Driveline Holder (Please Contact Service Parts to Place Order)	8 lb.	\$106
50073131	Field Conversion Kit, Wing Single Axle to Dual Axle. Order (1) Kit Per Wing + Tires of Choice.	Order Through Service Parts	
3815 Spec	Special Paint Colors	Call for Quote	

NOTE: Safety shieldings are non-returnable items for all models.

[RETURN TO INDEX](#)

SEE WARRANTY SPECIFICATIONS BELOW



## 4815 SERIES FLEX-WING ROTARY CUTTER

MODEL	4815	MODEL	4815
Transport Height*	7' 3"	Blades	1/2" x 4" Parallel Uplift
Transport Width**	8' 2"	Blade Overlap	6"
Cutting Width	15'	Blade Tip Speed	16,286 fpm (540 rpm); 16,391 fpm (1000 rpm)
Axle Suspension	Cushioned Springs at Each Wheel	Wing Cutting Angles	22° Down to 45° Up
Cutting Height	2" - 14"	Center Hydraulic Lift	Standard
Cutting Capacity	4 1/2" Diameter	Wing Hydraulic Lift	Standard
Hitch	See Hitch Selection	Axle Tube Pivots	Greaseable Bushings
Approx. Tongue Weight	2,200 lb.	Axle Arm Pivots	Greaseable
Deck Thickness	11 Gauge (Center Top) 7 Gauge (Center Bottom) 7 Gauge (Wings)	Wing Adjustment	Greaseable Turnbuckles
Side Bands	1/4" x 13 1/2"	Wheels	See Wheel Selection
Gearbox Rating (HP)	250 hp <sup>†</sup> Splitter Gearbox, 225 hp <sup>†</sup> Cutting Gearboxes	Minimum Tractor PTO HP	70
Driveline	Main: See Driveline Selection Wings: ASAE Category 5	Grass Baffles	Optional
Driveline Protection	(3) Multi-Plate Slip Clutch	Jack Stand	Standard
Blade Holder	Round	Safety Tow Chain	Standard
Blade Bolts	Hex Shaped	Safety Shielding	Double Row Chains

10-Year Gearbox Limited Warranty | 1 1/2-Year Machine Limited Warranty (Contractors) | 1 1/2-Year Machine Limited Warranty (Consumers)

\*Measured at maximum transport height.

\*\*Measured at outside of wing skirts.

†Gearbox rating based on field performance.

### WARNING:

A deflector kit or chain shielding must be used for all non-agricultural purposes or in areas where thrown objects could be hazardous to people, animals, or property.

### HOW TO ORDER:

To receive a complete cutter, you must order a basic unit and then select one item from each of Groups 2 - 7 in the ordering section. Additional equipment may be added to your order by making your selection from the options list.

Freight NOT included in list price





**RETURN TO INDEX**

## 4815 SERIES FLEX-WING ROTARY CUTTER

### BASE UNIT SELECTION

Model Number	Description	Approx. Wt.	List Price (\$US)
4815RR1	4815 Flex-Wing Series Rotary Cutter, Round Blade Holder, 540 PTO, With Deck Rings	4,774 lb.	\$24,766
14815RR1	4815 Flex-Wing Series Rotary Cutter, Round Blade Holder, 1,000 PTO, With Deck Rings <small>Model Includes Center and Wing Hydraulic Cylinders and Hoses, Tow Chain, and Wing Drivelines. Assembly Included in List Price.</small>	4,774 lb.	\$24,766

### GROUP 2 HITCH SELECTION

50072803	Ball Hitch with 2 <sup>5/16</sup> " Ball	45 lb.	\$357
50054505	Perma-Level® Hitch	53 lb.	\$392

### GROUP 3 DRIVELINE SELECTION

50069764	CV Driveline, 540 PTO, 1-3/8-6, ASAE Category 6	90 lb.	\$1,295
50069765	CV Driveline, 1,000 PTO, 1-3/8-21, ASAE Category 5	90 lb.	\$1,340
50074699	CV Driveline, 1,000 PTO, 1-3/4-20, ASAE Category 6	90 lb.	\$1,340

### GROUP 4 CENTER AXLE SELECTION

50074158	Dual Axle Arms (4 Tires), Half Spindles	171 lb.	\$1,376
50076586	Tandem Walking Axle Arms (4 Tires)	392 lb.	\$2,075

### GROUP 5 WING AXLE SELECTION

50074159	Single Axle Arms (2 Tires), Half Spindles	138 lb.	\$1,107
50074158	Dual Axle Arms (4 Tires), Half Spindles	171 lb.	\$1,376
50076586	Tandem Walking Axle Arms (4 Tires)	392 lb.	\$2,075

### GROUP 6 WHEEL SELECTION

294	20" Laminated Tire		72 lb.	each \$223
		6 Tires	432 lb.	\$1,338
		8 Tires	576 lb.	\$1,784
50075401	25" Laminated Tire		85 lb.	each \$301
		6 Tires	510 lb.	\$1,806
		8 Tires	680 lb.	\$2,408
50050727	Used Aircraft Tire, 29x9x15		75 lb.	each \$280
		6 Tires	450 lb.	\$1,680
		8 Tires	600 lb.	\$2,240
50072403	Used Aircraft Tire, 27.75x8.75-24PR		80 lb.	each \$305
		6 Tires	480 lb.	\$1,830
		8 Tires	640 lb.	\$2,440
50078502	Foam-Filled Tire, 27 x 8-18		100 lb.	each \$475
		6 Tires	600 lb.	\$2,850
		8 Tires	800 lb.	\$3,800
50068834	Foam Filled Aircraft Tire, 26x6.6x14		90 lb.	each \$465
		6 Tires	540 lb.	\$2,790
		8 Tires	720 lb.	\$3,720

### GROUP 7 ENCLOSURE SELECTION

50076494	Double Row Chains, Front and Rear	477 lb.	\$1,665
----------	-----------------------------------	---------	---------

### GROUP 8 HYDRAULIC HOSE SELECTION

50082034	Independent Wing Control (3-Hoses)	5 lb.	\$0
50082035	Single Wing Control (2-Hoses)	5 lb.	\$0

### OPTIONS

50069451	Grass and Crop Distribution Baffles	76 lb.	\$420
50077430	EZ-Mount Driveline Holder (Please Contact Service Parts to Place Order)	8 lb.	\$106
50073131	Field Conversion Kit, Wing Single Axle to Dual Axle. Order (1) Kit Per Wing + Tires of Choice.	Order Through Service Parts	
4815 Spec	Special Paint Colors	Call for Quote	

NOTE: Safety shieldings are non-returnable items for all models.

[RETURN TO INDEX](#)

**NEW**  
*for*  
**Summer  
2020**



## 2814 SERIES FLEX-WING ROTARY CUTTER

MODEL	2814	MODEL	2814
Transport Height*	9'	Blades	1/2" x 4" Parallel Uplift
Transport Width**	9'	Blade Overlap	6"
Cutting Width	14'	Blade Tip Speed	15,625 fpm (Center); 15,936 fpm (Wing)
Overall Width	14' 6"	Wing Cutting Angles	22° Down to 45° Up
Overall Length	17' 2"	Center Hydraulic Lift	Standard
Axle Suspension	Cushioned Springs at Each Axle Arm	Wing Hydraulic Lift	Standard
Cutting Height	2" - 14"	Axle Tube Pivots	Greaseable Bushings
Cutting Capacity	3" Diameter	Axle Arm Pivots	Greaseable
Hitch	See Hitch Selection	Wing Adjustment	Greaseable Turnbuckles
Approx. Tongue Weight	2,600 lb.	Wheels	See Wheel Selection
Deck Thickness	11 Gauge (Center Top) 7 Gauge (Center Bottom) 7 Gauge (Wings)	Minimum Tractor PTO HP	90
Side Bands	1/4" x 13 1/2"	Jack Stand	Standard
Gearbox Rating (HP)	250 hp† Splitter Gearbox, 225 hp† Cutting Gearboxes	Safety Tow Chain	Standard
Driveline	Main: See Driveline Selection Wings: ASAE Category 5	Safety Shielding	Double Row Chains
Blade Holder	Round		

**10-Year Gearbox Limited Warranty and 1-Year Machine Limited Warranty**

\*Measured at maximum transport height.

\*\*Measured at outside of wing skirts.

†Gearbox rating based on field performance.

### WARNING:

A deflector kit or chain shielding must be used for all non-agricultural purposes or in areas where thrown objects could be hazardous to people, animals, or property.

### HOW TO ORDER:

To receive a complete cutter, you must order a basic unit and then select one item from each of Groups 2 - 7 in the ordering section. Additional equipment may be added to your order by making your selection from the options list.

Freight NOT included in list price



**RETURN TO INDEX**

## 2814 SERIES FLEX-WING ROTARY CUTTER

### BASE UNIT SELECTION

Model Number	Description	Approx. Wt.	List Price (\$US)
2814RR1	2814 Flex-Wing Series Rotary Cutter, Pan Blade Carrier, 540 PTO, With Deck Rings and Double Row Chains	5,100 lb.	\$22,394
12814RR1	12814 Flex-Wing Series Rotary Cutter, Pan Blade Carrier, 1000 PTO, With Deck Rings and Double Row Chains	5,100 lb.	\$22,394

### GROUP 2 HITCH SELECTION

50072803	Ball Hitch with 2 <sup>5</sup> / <sub>16</sub> " Ball	45 lb.	\$357
50054505	Perma-Level® Hitch	53 lb.	\$392

### GROUP 3 DRIVELINE SELECTION

50069764	CV Driveline, 540 PTO, 1-3/8-6, ASAE Category 6	90 lb.	\$1,295
50069765	CV Driveline, 1,000 PTO, 1-3/8-21, ASAE Category 5	90 lb.	\$1,340
50074699	CV Driveline, 1,000 PTO, 1-3/4-20, ASAE Category 6	90 lb.	\$1,340

### GROUP 4 CENTER AXLE SELECTION

50074158	Dual Axle Arms (4 Tires), Half Spindles	171 lb.	\$1,376
----------	---	---------	---------

### GROUP 5 WING AXLE SELECTION

50075164	Single Axle Arms (1 Tires), Half Spindles	98 lb.	\$563
50075163	Dual Axle Arms (2 Tires), Half Spindles	126 lb.	\$697

### GROUP 6 WHEEL SELECTION

294	20" Laminated Tire		72 lb.	each \$223
		5 Tires	360 lb.	\$1,115
		6 Tires	432 lb.	\$1,338
50075401	25" Laminated Tire		85 lb.	each \$301
		5 Tires	425 lb.	\$1,505
		6 Tires	510 lb.	\$1,806
50050727	Used Aircraft Tire, 29x9x15		75 lb.	each \$280
		5 Tires	375 lb.	\$1,400
		6 Tires	450 lb.	\$1,680
50072403	Used Aircraft Tire, 27.75x8.75-24PR		80 lb.	each \$305
		5 Tires	400 lb.	\$1,525
		6 Tires	480 lb.	\$1,830
50078502	Foam-Filled Tire, 27 x 8-18		100 lb.	each \$475
		5 Tires	500 lb.	\$2,375
		6 Tires	600 lb.	\$2,850
50068834	Foam Filled Aircraft Tire, 26x6.6x14		90 lb.	each \$465
		5 Tires	450 lb.	\$2,325
		6 Tires	540 lb.	\$2,790

### OPTIONS

50077430	EZ-Mount Driveline Holder (Please Contact Service Parts to Place Order)	8 lb.	\$106
50073131	Field Conversion Kit, Wing Single Axle to Dual Axle. Order (1) Kit Per Wing + Tires of Choice.	Order Through Service Parts	

RETURN TO INDEX



## 2820 SERIES FLEX-WING ROTARY CUTTER

MODEL	2820	MODEL	2820
Transport Height*	9'	Blades	1/2" x 4" Parallel Uplift
Transport Width**	11'	Blade Overlap	6"
Cutting Width	20'	Blade Tip Speed	15,625 fpm (Center); 15,936 fpm (Wing)
Overall Width	21'	Wing Cutting Angles	22° Down to 45° Up
Overall Length	17' 2"	Center Hydraulic Lift	Standard
Axle Suspension	Cushioned Springs at Each Axle Arm	Wing Hydraulic Lift	Standard
Cutting Height	2" - 14"	Axle Tube Pivots	Greaseable Bushings
Cutting Capacity	3" Diameter	Axle Arm Pivots	Greaseable
Hitch	See Hitch Selection	Wing Adjustment	Greaseable Turnbuckles
Approx. Tongue Weight	2,600 lb.	Wheels	See Wheel Selection
Deck Thickness	11 Gauge (Center Top) 7 Gauge (Center Bottom) 7 Gauge (Wings)	Minimum Tractor PTO HP	90
Side Bands	1/4" x 13½"	Grass Baffles	Optional
Gearbox Rating (HP)	250 hp† Splitter Gearbox, 225 hp† Cutting Gearboxes	Jack Stand	Standard
Driveline	Main: See Driveline Selection Wings: ASAE Category 5	Safety Tow Chain	Standard
Blade Holder	Round or Shredder Bar	Safety Shielding	Single or Double Row Chains

**10-Year Gearbox Limited Warranty and 1-Year Machine Limited Warranty**

\*Measured at maximum transport height.

\*\*Measured at outside of wing skirts.

†Gearbox rating based on field performance.

### WARNING:

**A deflector kit or chain shielding must be used for all non-agricultural purposes or in areas where thrown objects could be hazardous to people, animals, or property.**

### HOW TO ORDER:

To receive a complete cutter, you must order a basic unit and then select one item from each of Groups 2 - 7 in the ordering section. Additional equipment may be added to your order by making your selection from the options list.

Freight NOT included in list price



**RETURN TO INDEX**

## 2820 SERIES FLEX-WING ROTARY CUTTER

### BASE UNIT SELECTION

Model Number	Description	Approx. Wt.	List Price (\$US)
2820RR1	2820 Flex-Wing Series Rotary Cutter, Pan Blade Carrier, 540 PTO, With Deck Rings	5,851 lb.	\$26,294
12820RR1	2820 Flex-Wing Series Rotary Cutter, Pan Blade Carrier, 1,000 PTO, With Deck Rings	5,851 lb.	\$26,294
12820SR1	2820 Flex-Wing Series Rotary Cutter, Bar Blade Carrier, 1,000 PTO, With Deck Rings	5,851 lb.	\$26,502

Model Includes Center and Wing Hydraulic Cylinders and Hoses, Tow Chain, and Wing Drivelines.  
Assembly Included in List Price.

### GROUP 2 HITCH SELECTION

50072803	Ball Hitch with 2 <sup>5</sup> / <sub>16</sub> " Ball	45 lb.	\$357
50054505	Perma-Level® Hitch	53 lb.	\$392

### GROUP 3 DRIVELINE SELECTION

50069764	CV Driveline, 540 PTO, 1-3/8-6, ASAE Category 6	90 lb.	\$1,295
50069765	CV Driveline, 1,000 PTO, 1-3/8-21, ASAE Category 5	90 lb.	\$1,340
50054513	CV Driveline, 1,000 PTO, 1-3/8-21, ASAE Category 6	90 lb.	\$1,601
50074699	CV Driveline, 1,000 PTO, 1-3/4-20, ASAE Category 6	90 lb.	\$1,340

### GROUP 4 CENTER AXLE SELECTION

50074158	Dual Axle Arms (4 Tires), Half Spindles	171 lb.	\$1,376
50076586	Tandem Walking Axle Arms (4 Tires)	392 lb.	\$2,075

### GROUP 5 WING AXLE SELECTION

50074159	Single Axle Arms (2 Tires), Half Spindles	138 lb.	\$1,107
50074158	Dual Axle Arms (4 Tires), Half Spindles	171 lb.	\$1,376
50076586	Tandem Walking Axle Arms (4 Tires)	392 lb.	\$2,075

### GROUP 6 WHEEL SELECTION

294	20" Laminated Tire		72 lb.	each \$223
		6 Tires	432 lb.	\$1,338
		8 Tires	576 lb.	\$1,784
50075401	25" Laminated Tire		85 lb.	each \$301
		6 Tires	510 lb.	\$1,806
		8 Tires	680 lb.	\$2,408
50050727	Used Aircraft Tire, 29x9x15		75 lb.	each \$280
		6 Tires	450 lb.	\$1,680
		8 Tires	600 lb.	\$2,240
50072403	Used Aircraft Tire, 27.75x8.75-24PR		80 lb.	each \$305
		6 Tires	480 lb.	\$1,830
		8 Tires	640 lb.	\$2,440
50078502	Foam-Filled Tire, 27 x 8-18		100 lb.	each \$475
		6 Tires	600 lb.	\$2,850
		8 Tires	800 lb.	\$3,800
50068834	Foam Filled Aircraft Tire, 26x6.6x14		90 lb.	each \$465
		6 Tires	540 lb.	\$2,790
		8 Tires	720 lb.	\$3,720

2820 Series Flex-Wing Rotary Cutter Continued on Next Page



RETURN TO INDEX

## 2820 SERIES FLEX-WING ROTARY CUTTER *Continued*

## GROUP 7 ENCLOSURE SELECTION

Model Number	Description	Approx. Wt.	List Price (\$US)
50074153	Single Row Chains, Front and Rear	239 lb.	<b>\$1,706</b>
50074152	Double Row Chains, Front and Rear	395 lb.	<b>\$2,346</b>
OPTIONS			
50074156	Grass Distribution Baffles	170 lb.	<b>\$408</b>
50077430	EZ-Mount Driveline Holder (Please Contact Service Parts to Place Order)	8 lb.	<b>\$106</b>
50074155	<b>Shredder Kit for 2820 Flex-Wing Series Rotary Cutter, Model SR1</b> Adds second blade bar and (2) uplift blades to each cutting circle of SR1 model for finer shredding.	288 lb.	<b>\$1,353</b>
NOTE: SR1 base unit includes a straight blade bar with (2) uplift blades and (2) flat blades per cutting circle.			
50074199	<b>38" Row Crop Spacing Wheel Spindle Kit for Duals</b> Kit places both center-section inside tires 3 inches toward the center of cutter to move tire off-center of row. Location is best with #294 laminated tire. (Please Contact Service Parts to Place Order)		<b style="color: red; text-decoration: underline;">LIMITED AVAILABILITY</b> <b>Order Through Service Parts</b>
50073131	<b>Field Conversion Kit, Wing Single Axle to Dual Axle.</b> <b>Order (1) Kit Per Wing + Tires of Choice.</b>		<b>Order Through Service Parts</b>
2820 Spec	Special Paint Colors		<b>Call for Quote</b>

NOTE: Safety shieldings are non-returnable items for all models.



[RETURN TO INDEX](#)

# FLAIL SHREDDERS

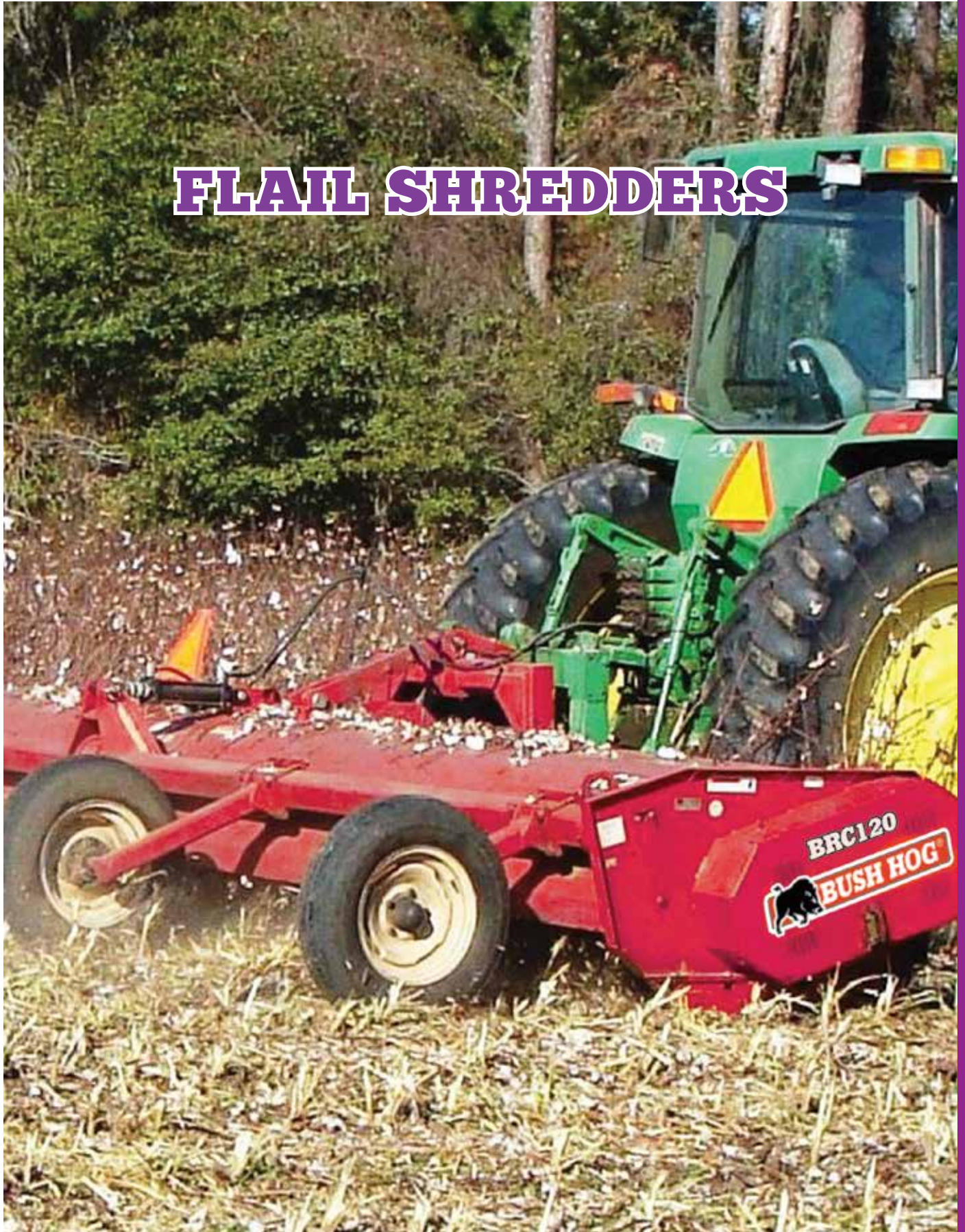

FLAIL SHREDDERS

[RETURN TO INDEX](#)

## BRC115/BRC118 SERIES ROW CROP FLAIL SHREDDER

MODEL	BRC115	BRC118
Cutting Width	180"	216"
Overall Width	204"	240"
Cutting Height	1" - 18"	
Hitch	Cat 2 & 3 Quick Hitch Lift, Semi-Mount or Pull Type*	
Cutter Shaft	10 3/4" Diameter	
Minimum Tractor PTO HP	120 (Lift), 100 (Semi-Mount), 100 (Pull)	130 (Lift), 110 (Semi-Mount), 110 (Pull)
Blades	Hard-Surfaced	
Tires	(4) 6.70x15	
Wheel Hubs	5-Bolt	
Gearbox Rating (1,000 rpm)	207 hp	
Knife Tip Speed	12,620 fpm	
Number of Blades	168	200
Driveline Size	Category 5 or 6	
Driveline Protection	5 x 5 V, Banded Belt	
Rotor Bearing Protection	Anti-Wrap Seal Protector	
Cutter Shaft Bearings	2 9/16" Triple Sealed	
Hood Thickness	3/16", With Wear Liner	
End Plate Thickness	1/4"	
Safety Deflector - Lights	Standard	
<b>Five-Year Limited Gearbox Warranty.</b>		

\*Tractor Quick Hitch must be used for Lift-Type and Semi-Mount units.

### HOW TO ORDER:

To receive a complete machine, select the desired basic unit and order one item each from Groups 1 - 4. Red is the standard paint color for all units. If desired, special paint may be selected from Group 5.

Freight NOT included in list price





**RETURN TO INDEX**

## BRC115/BRC118 SERIES ROW CROP FLAIL SHREDDER

### BASE UNIT SELECTION

Model Number	Description	Approx. Wt.	List Price (\$US)
BRC115	BRC Series Row Crop Flail Shredder, 15' Base Unit	4,425 lb.	<b>\$25,319</b>
BRC118	BRC Series Row Crop Flail Shredder, 18' Base Unit	4,785 lb.	<b>\$27,558</b>

### GROUP 2 HITCH SELECTION

Model Number	Description	Approx. Wt.	List Price (\$US)
00727125	Hitch Bundle for BRC115, BRC118, Lift Type*		<b>\$4,766</b>
00727126	Hitch Bundle for BRC115, BRC118, Pull Type	210 lb.	<b>\$6,903</b>
00727127	Hitch Bundle for BRC115, BRC118, Semi-Mount Type*		<b>\$7,580</b>

\*Lift-Type and Semi-Mount units must be used on tractors equipped with Quick Hitches.

### GROUP 3 DRIVELINE SELECTION

Model Number	Description	Approx. Wt.	List Price (\$US)
00726673A	Driveline, Lift or Semi-Mount, Category 6 with 1 <sup>3</sup> / <sub>8</sub> " PTO Yoke	175 lb.	<b>\$1,040</b>
00726672A	Driveline, Lift or Semi-Mount, Category 6 with 1 <sup>3</sup> / <sub>4</sub> " PTO Yoke	185 lb.	<b>\$1,254</b>
00786844	Driveline, Pull Type, Category 5 CV with 1 <sup>3</sup> / <sub>8</sub> " PTO Yoke	210 lb.	<b>\$1,333</b>
00786845	Driveline, Pull Type, Category 5 CV with 1 <sup>3</sup> / <sub>4</sub> " PTO Yoke	240 lb.	<b>\$1,333</b>

### GROUP 4 LIFT SELECTION

Model Number	Description	Approx. Wt.	List Price (\$US)
00554600P	Ratchet Jack Manual Lift Kit	12 lb.	<b>\$144</b>
00725933	Hydraulic Cylinder Lift Kit	Included in Base	<b>\$453</b>

### GROUP 5 SPECIAL PAINT COLOR SELECTION

Model Number	Description	List Price (\$US)
00787653	Custom Paint, John Deere Green	<b>\$161</b>
00787654	Custom Paint, Kubota Orange	<b>\$161</b>
00787655	Custom Paint, Case/IH Red	<b>\$161</b>
00787656	Custom Paint, Massey Ferguson Red	<b>\$161</b>
00787657	Custom Paint, New Holland Blue	<b>\$161</b>

### CONTAINER FEES - International Shipments

Model Number	Description	List Price (\$US)
00888891	Container Processing Fee (Each Unit is Processed to Accommodate Loading)	net <b>\$300</b>
00888892	Special Paint Colors	net <b>\$300</b>

[RETURN TO INDEX](#)

## BRC120 SERIES ROW CROP FLAIL SHREDDER

MODEL	BRC120
Cutting Width	240"
Overall Width	264"
Cutting Height	1" - 18"
Hitch	Cat 2 & 3 Quick Hitch Lift, Semi-Mount or Pull Type*
Cutter Shaft	10 <sup>3</sup> / <sub>4</sub> " Diameter
Minimum Tractor PTO HP	130 (Lift), 120 (Semi-Mount), 120 (Pull)
Blades	Hard-Surfaced with Tungsten Carbide
Tires	9.5L - 15"
Wheel Hubs	6-Bolt
Gearbox Rating (1,000 rpm)	207 hp
Knife Tip Speed	12,620 fpm, Reverse Rotation
Number of Blades	216
Driveline Size	Category 5 or 6
Driveline Protection	5 x 5 V, Banded Belt
Rotor Bearing Protection	Anti-Wrap Seal Protector
Cutter Shaft Bearings	2 <sup>9</sup> / <sub>16</sub> "
Hood Thickness	3/16", With 3/16" Wear Liner
End Plate Thickness	1/4"
Safety Deflector - Lights	Standard
<b>Five-Year Limited Gearbox Warranty.</b>	

\*Tractor Quick Hitch must be used for Lift-Type and Semi-Mount units.

### HOW TO ORDER:

To receive a complete machine, select the desired basic unit and order one item each from Groups 1 - 4. Red is the standard paint color for all units. If desired, special paint may be selected from Group 5. Extra equipment (dealer installed) may be selected from the Options listed in the ordering section.

Freight NOT included in list price



**RETURN TO INDEX**

## BRC120 SERIES ROW CROP FLAIL SHREDDER

### BASE UNIT SELECTION

Model Number	Description	Approx. Wt.	List Price (\$US)
BRC120	BRC 120 Series Row Crop Flail Shredder, 20' Base Unit	4,950 lb.	<b>\$31,023</b>

### GROUP 2 HITCH SELECTION

Model Number	Description	Approx. Wt.	List Price (\$US)
00727128	Hitch Bundle for BRC120, BRC125, Lift Type*	Included in Base	<b>\$4,851</b>
00727129	Hitch Bundle for BRC120, Lift Type with End Tow*	660 lb.	<b>\$8,807</b>
00727130	Hitch Bundle for BRC120, BRC125, Pull Type	210 lb.	<b>\$4,531</b>
00727131	Hitch Bundle for BRC120, Pull Type with End Tow	870 lb.	<b>\$7,601</b>
00727132	Hitch Bundle for BRC120, BRC125, Semi-Mount Type*	100 lb.	<b>\$7,814</b>
00727133	Hitch Bundle for BRC120, Semi-Mount Type with End Tow*	870 lb.	<b>\$10,245</b>

\*Lift-Type and Semi-Mount units must be used on tractors equipped with Quick Hitches.

### GROUP 3 DRIVELINE SELECTION

Model Number	Description	Approx. Wt.	List Price (\$US)
00726673A	Driveline, Lift or Semi-Mount, Category 6 with 1 <sup>3</sup> / <sub>8</sub> " PTO Yoke	175 lb.	<b>\$1,040</b>
00726672A	Driveline, Lift or Semi-Mount, Category 6 with 1 <sup>3</sup> / <sub>4</sub> " PTO Yoke	185 lb.	<b>\$1,254</b>
00786844	Driveline, Pull Type, Category 5 CV with 1 <sup>3</sup> / <sub>8</sub> " PTO Yoke	210 lb.	<b>\$1,333</b>
00786845	Driveline, Pull Type, Category 5 CV with 1 <sup>3</sup> / <sub>4</sub> " PTO Yoke	240 lb.	<b>\$1,333</b>

### GROUP 4 LIFT SELECTION

Model Number	Description	Approx. Wt.	List Price (\$US)
00554600P	Ratchet Jack Manual Lift Kit	12 lb.	<b>\$144</b>
00725933	Hydraulic Cylinder Lift Kit	Included in Base	<b>\$453</b>

### GROUP 5 SPECIAL PAINT COLOR SELECTION

Model Number	Description	List Price (\$US)
00787653	Custom Paint, John Deere Green	<b>\$161</b>
00787654	Custom Paint, Kubota Orange	<b>\$161</b>
00787655	Custom Paint, Case/IH Red	<b>\$161</b>
00787656	Custom Paint, Massey Ferguson Red	<b>\$161</b>
00787657	Custom Paint, New Holland Blue	<b>\$161</b>

### OPTIONS – Dealer Installed (Must Order Separately)

Model Number	Description	Approx. Wt.	List Price (\$US)
00727009	End Tow Kit for BRC120, Pull Type (Field Installation)	660 lb.	<b>\$7,319</b>
00727010	End Tow Kit for BRC120, Semi-Mount or Lift Type (Field Installation)	500 lb.	<b>\$7,322</b>

### CONTAINER FEES – International Shipments

Model Number	Description	List Price (\$US)
00888891	Container Processing Fee (Each Unit is Processed to Accommodate Loading)	net <b>\$300</b>
00888892	Container Loading Fee (Single Charge Per Container Load)	net <b>\$300</b>

[RETURN TO INDEX](#)

## BRC125 SERIES ROW CROP FLAIL SHREDDER

MODEL	BRC125
Cutting Width	300"
Overall Width	324"
Cutting Height	1" - 18"
Hitch	Lift, Semi-Mount or Pull Type*
Cutter Shaft	10 <sup>3</sup> / <sub>4</sub> " Diameter
Minimum Tractor PTO HP	160 (Lift), 150 (Semi-Mount), 140 (Pull)
Blades	Hard-Surfaced
Tires	9.5L - 15"
Wheel Hubs	6-Bolt
Gearbox Rating (1,000 rpm)	207 hp
Knife Tip Speed	12,000 fpm, Reverse Rotation
Number of Blades	272
Driveline Size	Category 5 or 6
Driveline Protection	5 x 5 V, Banded Belt
Rotor Bearing Protection	Anti-Wrap Seal Protector
Cutter Shaft Bearings	2 <sup>9</sup> / <sub>16</sub> "
Hood Thickness	3/16", With 3/16" Internal Wear Liner
End Plate Thickness	1/4"
Safety Deflector - Lights	Standard
<b>Five-Year Limited Gearbox Warranty.</b>	

\*Tractor Quick Hitch must be used for Lift-Type and Semi-Mount units.

### HOW TO ORDER:

To receive a complete machine, select the desired basic unit and order one item each from Groups 1 - 4. Red is the standard paint color for all units. If desired, special paint may be selected from Group 5. Extra equipment (dealer installed) may be selected from the Options listed in the ordering section.

Freight NOT included in list price



**RETURN TO INDEX**

## BRC125 SERIES ROW CROP FLAIL SHREDDER

### BASE UNIT SELECTION

Model Number	Description	Approx. Wt.	List Price (\$US)
BRC125	BRC 125 Series Row Crop Flail Shredder, 25' Base Unit	6,300 lb.	\$39,178

### GROUP 2 HITCH SELECTION

Model Number	Description	Approx. Wt.	List Price (\$US)
00727128	Hitch Bundle for BRC120, BRC125, Lift Type*	Included in Base	\$4,851
00727134	Hitch Bundle for BRC125, Lift Type with End Tow*	450 lb.	\$8,822
00727130	Hitch Bundle for BRC120, BRC125, Pull Type	210 lb.	\$4,531
00727135	Hitch Bundle for BRC125, Pull Type with End Tow	780 lb.	\$7,607
00727132	Hitch Bundle for BRC120, BRC125, Semi-Mount Type*	100 lb.	\$7,814
00727136	Hitch Bundle for BRC125, Semi-Mount Type with End Tow*	450 lb.	\$10,251

\*Lift-Type and Semi-Mount units must be used on tractors equipped with Quick Hitches.

### GROUP 3 DRIVELINE SELECTION

Model Number	Description	Approx. Wt.	List Price (\$US)
00726673A	Driveline, Lift or Semi-Mount, Category 6 with 1 <sup>3</sup> / <sub>8</sub> " PTO Yoke	175 lb.	\$1,040
00726672A	Driveline, Lift or Semi-Mount, Category 6 with 1 <sup>3</sup> / <sub>4</sub> " PTO Yoke	185 lb.	\$1,254
00786844	Driveline, Pull Type, Category 5 CV with 1 <sup>3</sup> / <sub>8</sub> " PTO Yoke	210 lb.	\$1,333
00786845	Driveline, Pull Type, Category 5 CV with 1 <sup>3</sup> / <sub>4</sub> " PTO Yoke	240 lb.	\$1,333

### GROUP 4 LIFT SELECTION

Model Number	Description	Approx. Wt.	List Price (\$US)
00725933	Hydraulic Cylinder Lift Kit	Included in Base	\$453

### GROUP 5 SPECIAL PAINT COLOR SELECTION

Model Number	Description	List Price (\$US)
00787653	Custom Paint, John Deere Green	\$161
00787654	Custom Paint, Kubota Orange	\$161
00787655	Custom Paint, Case/IH Red	\$161
00787656	Custom Paint, Massey Ferguson Red	\$161
00787657	Custom Paint, New Holland Blue	\$161

### OPTIONS – Dealer Installed (Must Order Separately)

Model Number	Description	Approx. Wt.	List Price (\$US)
00727042	Pair of Axle Arms, Pull & Lift Type with Tires & Wheels (May Not Fit All Row Spacings, Not Recommended with End Tow Kit)	199 lb.	\$2,048
00727141	Pair of Axle Arms, Semi-Mount Type with Tires & Wheels (May Not Fit All Row Spacings, Not Recommended with End Tow Kit)	229 lb.	\$2,879
00726952	End Tow Kit, Pull Type (For Field Installation, Order Separately from Machine)	580 lb.	\$7,249
00726953	End Tow Kit, Semi-Mount or Lift Type (For Field Installation, Order Separately from Machine)	420 lb.	\$7,249

### CONTAINER FEES – International Shipments

Model Number	Description	List Price (\$US)
00888891	Container Processing Fee (Each Unit is Processed to Accommodate Loading)	net \$300
00888892	Container Loading Fee (Single Charge Per Container Load)	net \$300



[RETURN TO INDEX](#)



[RETURN TO INDEX](#)

# BOOM MOWERS

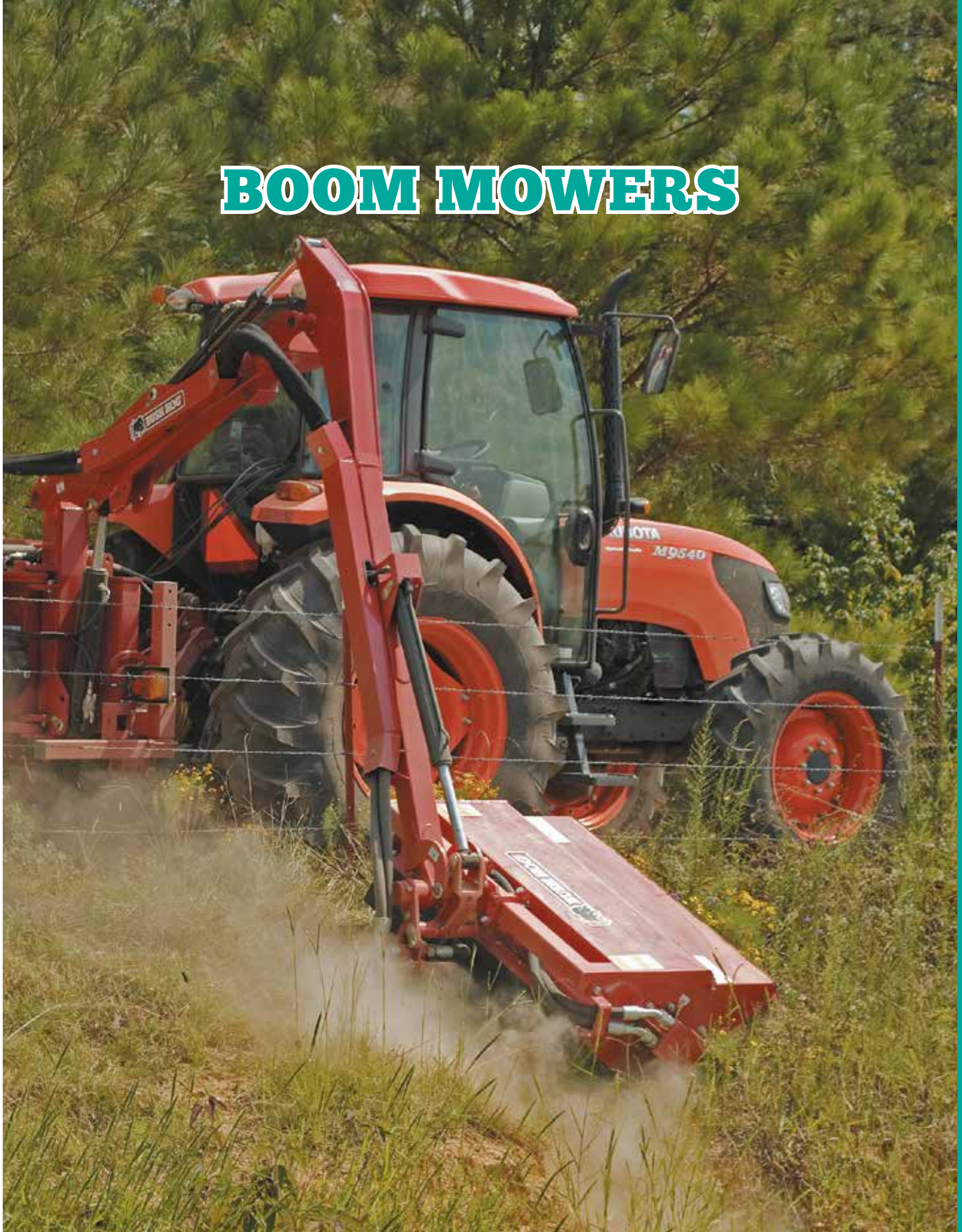

BOOM MOWERS

**RETURN TO INDEX**



## REAR-MOUNTED BOOM MOWER SERIES

MODEL	RMB1445-1	RMB1660-1	RMB1865-1	PT5-2 POWERTRIM
<b>Minimum Tractor PTO HP/Weight</b>	See Head Selection Chart Next Page – Varies Based on Head Choice			
<b>Tractor PTO</b>	540	540	540	N/A
<b>Machine Weight with Flail</b>	1,220 lb.	2,403 lb.	2,470 lb.	415 lb.
<b>Hydraulic System</b>	Totally Independent			Open Center Hyd. System (Closed Center Kit Avail.), Tractor Remote Outlet, 3.7-5.6 GPM, Flow Control Valve Kit Std
<b>Attachment Method</b>	Cat 1/2, 3-Point Mount			Cat 1/2, 3-Point Mount
<b>Controls</b>	Cable-Controlled Quick Detach (QD) Standard		Cable-Controlled Quick Detach (QD)/ Electronic Controls (XTC) Standard	Cable-Controlled Hydraulic Remotes Standard
<b>Maximum Reach, Horizontal (A)</b>	14' 1"	16' 5"	18' 1"	11' 5"
<b>Maximum Height, Horizontal (B)</b>	13' 2"	14' 6"	16' 1"	7' 2"
<b>Maximum Height, Horizontal (C)</b>	13' 5"	15' 9"	17' 5"	5' 7"
<b>Maximum Height, Vertical (D)</b>	13' 9"	20' 8"	22' 4"	10' 2"
<b>Maximum Depth, 45°</b>	5' 4"	7' 3"	8' 2"	4' 6"
<b>Lightbar Kit</b>	Standard			

**NOTICE:**

RMB Series mowers are to be used only on tractors equipped with cabs. For rotary mower heads, protective screen material must be installed.

**HOW TO ORDER:**

To receive a complete cutter, for RMB models you must include a basic unit and the appropriate head option(s) from Group 2, 3 or 4 in the ordering section. For the PT5 model, make your base unit selection, which comes standard with a sickle bar head. No head selection is necessary. Additional equipment may be added to your order by making your selection from the Options list.

Freight NOT included in list price



[RETURN TO INDEX](#)

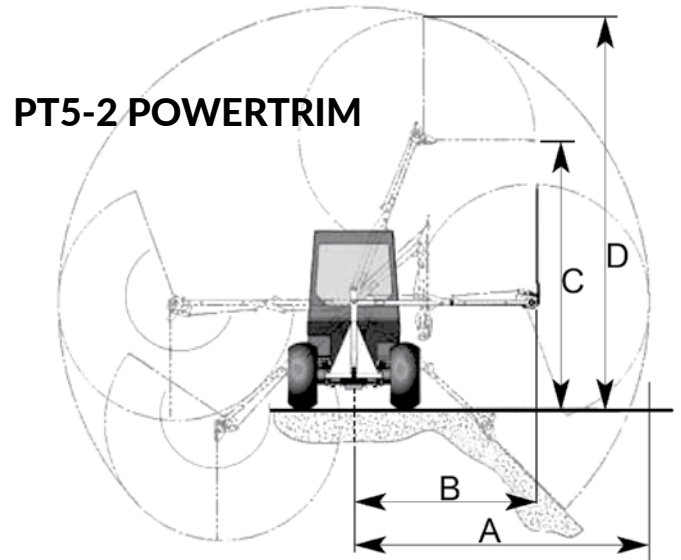
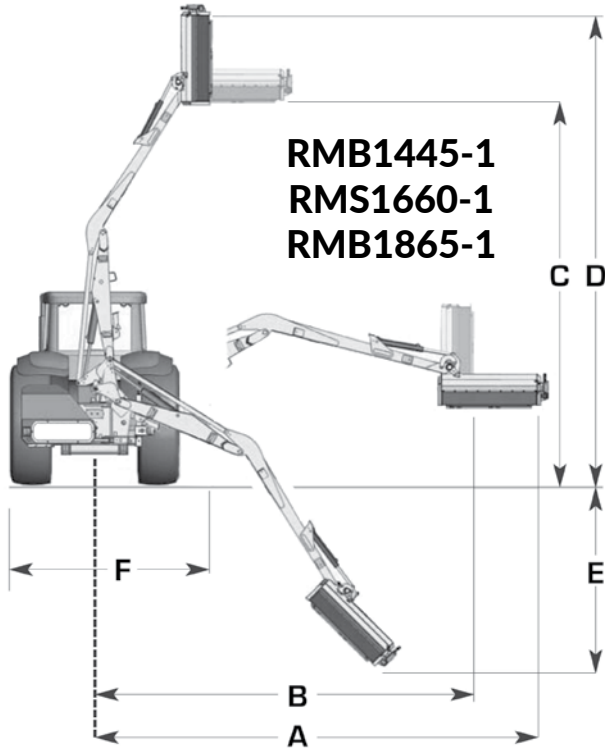

## HEAD SELECTION CHART

FLAIL HEAD	RMB1445-1	RMB1660-1	RMB1865-1	PT5-2 POWERTRIM
Minimum Tractor PTO HP/Weight	45 / 4,410 lb.	60 / 6,614 lb.	65 / 7,716 lb.	Not Available For Use On This Model
Rotor/Knife	Super Cut/Universal	Super Cut/F91 Competition or Multi-Cut Competition		NA
Typical Application	Grass, Light Brush	Hedge Cutting, Grass		NA
Cutting Capacity	1" Diameter	1½" Diameter	2" Diameter	NA
Cutting Width	39"	47"		NA
ROTARY HEAD	RMB1445-1	RMB1660-1	RMB1865-1	PT5-2 POWERTRIM
Minimum Tractor PTO HP/Weight	Not Available For Use On This Model	85 / 7,614 lb.	85 / 8,716 lb.	Not Available For Use On This Model
Typical Application	NA	Grass/Brush		NA
Cutting Capacity	NA	4" Diameter		NA
Cutting Width	NA	60"		NA
CUTTER BAR	RMB1445 (Only)	RMB1660	RMB1865-1/1865E-1	PT5-2 POWERTRIM (Sickle Bar Standard)
Minimum Tractor PTO HP/Weight	45 / 4,410 lb.	60 / 6,614 lb.	65 / 7,716 lb.	15 / 1,212 lb.
Cutter Type	Sickle Bar			
Cutting Capacity	1¼" Diameter			¾" Diameter
Cutting Width	59"			



RETURN TO INDEX

## REAR-MOUNTED BOOM MOWER SERIES

### BASE UNIT SELECTION

Model Number	Description	Approx. Wt. Includes Flail Head	List Price (\$US)
RMB1445-1	RMB 1445 Rear-Mounted Boom with Quick Detach Cable Controls and Light Kit	1,220 lb.	\$17,102
RMB1660-1	RMB 1660 Rear-Mounted Boom with Quick Detach Cable Controls and Light Kit	2,403 lb.	\$20,756
RMB1865-1	RMB 1865 Rear-Mounted Boom with Quick Detach Cable Controls and Light Kit	2,470 lb.	\$22,617
RMB1865E-1	RMB 1865E (Electronic Controls) Rear-Mounted Boom with Quick Detach Cable Controls and Light Kit	2,470 lb.	\$26,343
PT5-2	Powertrim Rear-Mounted Boom Series with Flow Control Valve Kit, Sickle Bar Head and One Set of Hydraulic Remotes	415 lb.	\$11,877

### GROUP 2 ROTARY HEAD SELECTION

Model Number	Description	Approx. Wt.	List Price (\$US)
<u>RMB1660-1, RMB1865-1, RMB1865E-1</u>			
50071277	Rotary Head, 5/8" x 6" Blades, 60" Wide Cut, 4" Capacity (Includes Buzzer Kit)	915 lb.	\$10,664
For rotary head, protective screen materials supplied must be installed.			

### GROUP 3 FLAIL HEAD SELECTION

Model Number	Description	Approx. Wt.	List Price (\$US)
<u>RMB1445-1</u>			
50071904	Supercut Compact Flailhead, Universal Knives, 39" Wide Cut, 1" Capacity	309 lb.	\$5,667
<u>RMB1660-1, RMB1865-1, RMB1865E-1</u>			
50068497	Supercut Flailhead, Competition Knives, 47" Wide Cut, 1.5" Capacity	520 lb.	\$7,377
50068498	Multicut Flailhead, Competition Knives, 47" Wide Cut, 2" Capacity	712 lb.	\$8,812

### GROUP 4 CUTTER BAR SELECTION

Model Number	Description	Approx. Wt.	List Price (\$US)
<u>RMB1445-1</u>			
50068394	Sheartrim Cutter Bar, 59" Wide Cut, 1.25" Capacity	143 lb.	\$6,591
<u>RMB1660-1, RMB1865-1, RMB1865E-1</u>			
50068397	Sheartrim Cutter Bar, 59" Wide Cut, 1.25" Capacity	143 lb.	\$6,990

### OPTIONS

Model Number	Description	List Price (\$US)
<u>PT5-2</u>		
8130059	Closed Center Conversion Kit	Order Through Service Parts
<u>RMB1445-1</u>		
50081252	Lift Float Kit	\$597
<u>RMB1660-1, RMB1865-1, RMB1865E-1</u>		
50068500	Lift Float Kit	\$621
50068502	Skid Kit (Supercut Flailhead)	\$572
50068503	Skid Kit (Multicut Flailhead)	\$470
21604.02	Side Wheel Kit (For use with Rotary Head Only)	\$435
8402928	Buzzer Kit (For use with Rotary Head only; Serial Number M175799 and lower)	Order Through Service Parts

**RETURN TO INDEX**



## FORWARD REACH REAR-MOUNTED BOOM MOWER

MODEL	RMB1880F	RMB2080F
Minimum Tractor PTO HP	80	
Tractor Minimum Weight (lb.)	8,818	
Tractor PTO	540	
Machine Weight (lb.)*	2,469	2,540
Hydraulic System	Totally Independent	
Attachment Method	Cat 2 & 3, 3-Point Mount	
Controls	Two-Way Rotor Engagement - Electric Control (ERC)	
Maximum Reach, Horizontal (A)	18' 1"	19' 8"
Maximum Height, Horizontal (B)	16' 1"	17' 9"
Maximum Height, Horizontal (C)	17' 5"	18' 8"
Maximum Height, Vertical (D)	22' 0"	23' 4"
Maximum Depth, 45°	7' 10"	9' 2"
Lightbar Kit	Standard	
<i>* Excluding attachment and oil</i>		

**NOTICE:**

RMB Series mowers are to be used only on tractors equipped with cabs. For rotary mower heads, protective screen material must be installed.

**HOW TO ORDER:**

To receive a complete cutter, for RMB models you must include a basic unit above and the appropriate head option in the ordering section.

Freight NOT included in list price

**RETURN TO INDEX**

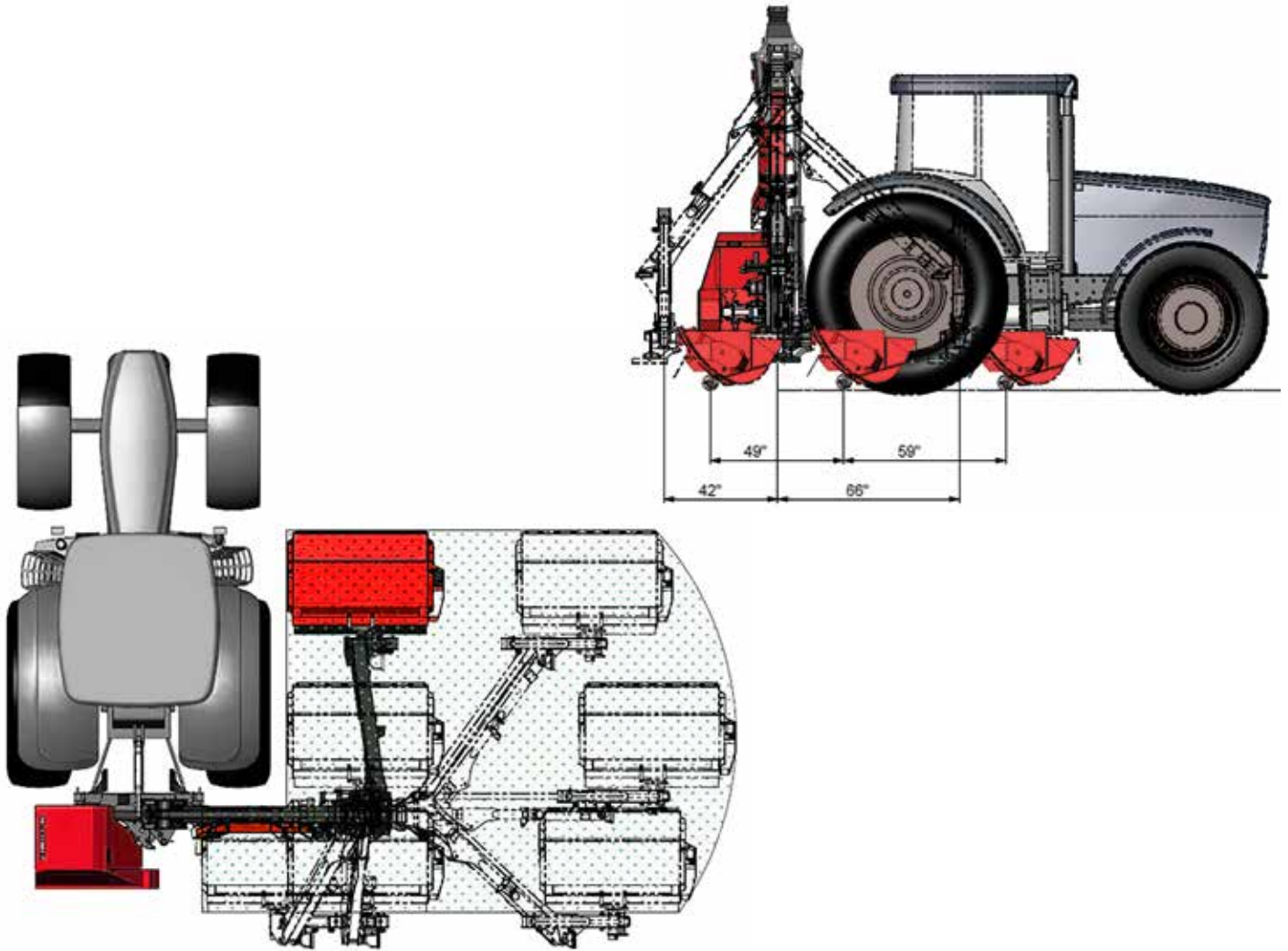

### HEAD SELECTION CHART

FLAIL HEAD	50081485	50081486	50081487
Minimum Tractor PTO HP / Weight	80 / 8,818 lb.		
Rotor / Knife	Uni-Boot Flail	Omega Flail	Uni-Boot Flail
Typical Application	Hedge Cutting, Grass		
Cutting Capacity	1" Diameter	1½" Diameter	1" Diameter
Cutting Width	47"	45"	59"

ROTARY HEAD	50081488
Minimum Tractor PTO HP / Weight	80 / 8,818 lb.
Typical Application	Grass / Brush
Cutting Capacity	4" Diameter
Cutting Width	47"

Freight NOT included in list price



**RETURN TO INDEX**

## FORWARD REACH REAR-MOUNTED BOOM MOWER

### BASE UNIT SELECTION

Model Number	Description	Approx. Wt.	List Price (\$US)
RMB1880F	RMB 1880F Rear Mounted Boom Series Mower with Two-Way Rotor Engagement - Electric Control and Light Kit	2,469 lb.	<b>\$35,797</b>
RMB2080F	RMB 2080F Rear Mounted Boom Series Mower with Two-Way Rotor Engagement - Electric Control and Light Kit	2,540 lb.	<b>\$37,930</b>

\*Base Unit weight excluding Cutting Head and Oil

### GROUP 2 FLAIL HEAD SELECTION

Model Number	Description	Approx. Wt.	List Price (\$US)
50081485	120 Flail Head UNI-Boot Flail	702 lb.	<b>\$7,150</b>
50081486	120 Head OMEGA Flail	783 lb.	<b>\$7,853</b>
50081487	150 Head UNI-Boot Flail	778 lb.	<b>\$8,140</b>

### GROUP 3 ROTARY HEAD SELECTION

Model Number	Description	Approx. Wt.	List Price (\$US)
50081488	1.2 M HD Rotary Head Tri-Blade	573 lb.	<b>\$9,139</b>



**RETURN TO INDEX**

[RETURN TO INDEX](#)

# CONSTRUCTION



RETURN TO INDEX



## DSP SERIES PULL DIRT SCRAPER

MODEL	DSP8	DSP10	DSP12
<b>Horsepower Rating</b>	70 - 125 HP		
<b>Transport Width</b>	97"	121"	145"
<b>Working Width</b>	96 <sup>3</sup> / <sub>16</sub> "	120 <sup>3</sup> / <sub>16</sub> "	144 <sup>3</sup> / <sub>16</sub> "
<b>Capacity</b>	1 <sup>3</sup> / <sub>4</sub> Cu. Yds.	2 <sup>1</sup> / <sub>4</sub> Cu. Yds.	2 <sup>3</sup> / <sub>4</sub> Cu. Yds.
<b>Weight with Weight Box (Without Material in Weight Box)</b>	1,525 lb. (Tilt Axle) 1,405 lb. (No Tilt Axle)	1,645 lb. (Tilt Axle) 1,525 lb. (No Tilt Axle)	1,700 lb. (Tilt Axle) 1,580 lb. (No Tilt Axle)
<b>Maximum Weight of Material in Weight Box</b>	760 lb.		
<b>Depth of Box</b>	39"		
<b>Dump Clearance</b>	5" Below Grade		
<b>Maximum Tilt Depth to the Right</b>	7"	7 <sup>5</sup> / <sub>8</sub> "	8 <sup>1</sup> / <sub>4</sub> "
<b>Maximum Tilt Angle</b>	3 <sup>1</sup> / <sub>2</sub> °		
<b>Tongue Construction</b>	4" x 4" x 1/4" Tubing		
<b>Side Plate Construction</b>	3/8" x 24 <sup>5</sup> / <sub>16</sub> " High x 39 <sup>3</sup> / <sub>4</sub> " Deep		
<b>Moldboard Construction</b>	1/4" x 24 <sup>3</sup> / <sub>4</sub> " High When Formed		
<b>Cutting Edge</b>	1/2" x 6" Reversible and Replaceable		
<b>Cutting Edge Reinforcement</b>	3" x 3" x 5/16" Angle Plus a 1/4" Moldboard = 9/16" at the Cutting Edge		
<b>Tires</b>	New 9.5L x 15 8-Ply Rib TL on 5-Bolt Rim with 5.5" Bolt Center		
<b>Maximum Transport Speed</b>	20 mph		
<b>Lift Cylinder</b>	3 <sup>1</sup> / <sub>2</sub> " x 8" ASAE		
<b>Tilt Cylinder</b>	3 <sup>1</sup> / <sub>2</sub> " x 8" ASAE		

### HOW TO ORDER:

The DSP Series Dirt Scraper is available as a pull-type implement only. To receive a complete unit, you must indicate your choice of basic unit, including your choice of model color from the chart above, and make a selection from Group 2 Tilt Preference Selection. Additional equipment may be selected from the Options Section at the bottom of the next page. Each unit selected from this ordering page is shipped in one crate with the tongue, tailwheels and options to be assembled by the dealer.

Freight NOT included in list price





**RETURN TO INDEX**

All models are available in the colors below:	
Model Color Indicator	Unit Color
01	Bush Hog Red
03	John Deere Green
05	Kubota Orange
14	New Holland Blue
16	Caterpillar Yellow

## DSP SERIES PULL DIRT SCRAPER

### BASE UNIT SELECTION

Model Number	Description	List Price (\$US)
DSP8-01	DSP Series Pull Dirt Scraper, Bush Hog Red, 8'	\$3,217
DSP8-03	DSP Series Pull Dirt Scraper, John Deere Green, 8'	\$3,217
DSP8-05	DSP Series Pull Dirt Scraper, Kubota Orange, 8'	\$3,217
DSP8-14	DSP Series Pull Dirt Scraper, New Holland Blue, 8'	\$3,217
DSP8-16	DSP Series Pull Dirt Scraper, Caterpillar Yellow, 8'	\$3,217
DSP10-01	DSP Series Pull Dirt Scraper, Bush Hog Red, 10'	\$3,738
DSP10-03	DSP Series Pull Dirt Scraper, John Deere Green, 10'	\$3,738
DSP10-05	DSP Series Pull Dirt Scraper, Kubota Orange, 10'	\$3,738
DSP10-14	DSP Series Pull Dirt Scraper, New Holland Blue, 10'	\$3,738
DSP10-16	DSP Series Pull Dirt Scraper, Caterpillar Yellow, 10'	\$3,738
DSP12-01	DSP Series Pull Dirt Scraper, Bush Hog Red, 12'	\$4,310
DSP12-03	DSP Series Pull Dirt Scraper, John Deere Green, 12'	\$4,310
DSP12-05	DSP Series Pull Dirt Scraper, Kubota Orange, 12'	\$4,310
DSP12-14	DSP Series Pull Dirt Scraper, New Holland Blue, 12'	\$4,310
DSP12-16	DSP Series Pull Dirt Scraper, Caterpillar Yellow, 12'	\$4,310

### GROUP 2 TILT PREFERENCE SELECTION (Must Choose One)

Model Number	Description	List Price (\$US)
50072337	Fixed Gauge Wheel Bundle	\$1,964
50074713	Hydraulic Tilt Bundle (DSP8 Series Only)	\$2,645
50072336	Hydraulic Tilt Bundle (DSP10 Series, DSP12 Series)	\$2,425

### OPTIONS

Model Number	Description	List Price (\$US)
50074757	Weight Box, No Weights Included (DSP8 Series Only)	\$339
50072350	Weight Box, No Weights Included (DSP10 Series, DSP12 Series)	\$440

**RETURN TO INDEX**



## PHD SERIES POST HOLE DIGGER

MODEL	PHD2401	PHD2402	PHD2403
Usage Type	Utility	Agricultural	Industrial
Input RPM	540		
Auger RPM	180	170	135
Gear Ratio	3.00:1	3.18:1	4.00:1
Maximum Digging Depth	42" Standard, 48" HD		
Hitch	ASAE Cat 1	ASAE Cat 1 & 2	
Component Protection	Shear Bolt		
Output Shaft	2" Diameter		
Driveshaft	ASAE Category 1	ASAE Category 3	
Yoke	27/8" Tubing		3" Tubing
Boom	27/8" Tubing	3½" Tubing	3½" Tubing With Reinforcing Hitch Rib
Maximum PTO HP	45	65	95
<b>Five-Year Limited Gearbox Warranty.</b>			

**NOTICE:**

Category 2 conversion bushings are not supplied with PHD2402 and PHD2403 models.

**HOW TO ORDER:**

To receive a complete unit, select a model from the Base Unit section and an auger from Group 2 of the ordering section on the next page. Price of a complete unit is the list price for the base unit plus the list price for the auger selected. Optional desired equipment for these units may be selected from the Options list in the ordering section.

Freight NOT included in list price



**RETURN TO INDEX**

## PHD2401, PHD2402, PHD2403 POST HOLE DIGGER

### BASE UNIT SELECTION

Model Number	Description	Approx. Wt.	List Price (\$US)
PHD2401	PHD Series Utility Post Hole Digger	160 lb.	\$1,192
PHD2402	PHD Series Agricultural Post Hole Digger	206 lb.	\$1,602
PHD2403	PHD Series Industrial Post Hole Digger	210 lb.	\$2,060

### GROUP 2 AUGER SELECTION

Model Number	Description	Approx. Wt.	List Price (\$US)
<b>Standard Duty Augers – Fish Tail Point (Replaceable)</b>			
50072104	6" Semi-Double Flight Auger, Standard Duty, Fish Tail Point (Replaceable), With 42" Maximum Digging Depth	22 lb.	\$272
50072105	9" Double Flight Auger, Standard Duty, Fish Tail Point (Replaceable), With 42" Maximum Digging Depth	37 lb.	\$327
50072106	12" Double Flight Auger, Standard Duty, Fish Tail Point (Replaceable), With 42" Maximum Digging Depth	46 lb.	\$340

#### Heavy Duty Augers – Aggressor Point (Replaceable)

00780367	6" Semi-Double Flight Auger, Heavy Duty, Aggressor Point (Replaceable), With 48" Maximum Digging Depth	42 lb.	\$320
00780368	9" Double Flight Auger, Heavy Duty, Aggressor Point (Replaceable), With 48" Maximum Digging Depth	57 lb.	\$379
00780369	12" Double Flight Auger, Heavy Duty, Aggressor Point (Replaceable), With 48" Maximum Digging Depth	64 lb.	\$401
00780371	18" Double Flight Auger, Heavy Duty, Aggressor Point (Replaceable), With 48" Maximum Digging Depth (May Not Be Used on PHD2401)	82 lb.	\$565
00780372	24" Double Flight Auger, Heavy Duty, Aggressor Point (Replaceable), With 48" Maximum Digging Depth (May Not Be Used on PHD2401)	109 lb.	\$661

### OPTIONS

Model Number	Description	Approx. Wt.	List Price (\$US)
50072108	Parking Stand Kit for PHD 2401,PHD2402	12 lb.	\$175
50072111	Parking Stand Kit for PHD2403	13 lb.	\$193
50072109	Hydraulic Down Force Kit for PHD2401	39 lb.	\$700
50072110	Hydraulic Down Force Kit for PHD2402	40 lb.	\$700
50072112	Hydraulic Down Force Kit for PHD2403	42 lb.	\$684
50068115	Bear Claw Auger Point Assembly, For Use on Standard Duty Augers Only		\$137
50072107	12" Auger Extension, For Use on Standard Duty Augers Only	16 lb.	\$259
01A01030	7" Auger Extension, For Use on Heavy Duty Augers Only	4 lb.	\$262
01A01040	14" Auger Extension, For Use on Heavy Duty Augers Only	7 lb.	\$331

**RETURN TO INDEX**



## PHDHF FARM/RANCH SERIES POST HOLE DIGGER

MODEL	PHDHF15-2	PHDHF20-2	PHDHF30-2	PHDHF35
Drive Type	Planetary with Reversible Motor			
Shaft Output Size	2" Hex			
Maximum Output Torque*	1,512 ft. / lb.	1,747 ft. / lb.	2,511 ft. / lb.	3,529 ft. / lb.
Recommended Hydraulic Flow	6 - 15 gpm	10 - 20 gpm	15 - 30 gpm	20 - 35 gpm
Maximum System Pressure	3,000 psi			3,500 psi
Drive Protection	Hydraulic Relief Valve			
Hydraulic Hoses	1/2" x 8' with 10 MB Ends			
Type of Mounts	Loader Bucket, Skid Steer Universal, Euro Style Quick Attach			
Maximum Auger Diameter (Rock)	18"	24"	36"	
Maximum Auger Diameter (Dirt)	18"	30"	36"	
Standard Digging Depth	48"			
<b>Two-Year Limited Warranty.</b>				

\*All values are theoretical. Specifications and models are subject to change without notice.

<b>NOTICE:</b>	PHDHF Series diggers are "Farm/Ranch" type, designed for use with tractor front end loaders or small skid steer loaders. Mounting brackets with frames offset to the right are designed for use on a tractor front end loader to provide visibility of the auger.
----------------	---

<b>HOW TO ORDER:</b>	The PHDHF Series digger is priced as a basic unit with a choice of mounting kit bundle, auger, and options. In order to receive a complete unit, you must specify the basic unit, your selection of mounting kit from Group 2, and selection of auger from Group 3. Hydraulic hose is included. Additional equipment may be added to your order by making your selection from the Options list.
----------------------	---

Freight NOT included in list price



**RETURN TO INDEX**

## PHDHF FARM/RANCH SERIES POST HOLE DIGGER

### BASE UNIT SELECTION

Model Number	Description	Approx. Wt.	List Price (\$US)
PHDHF15-2	Planetary Drive Post Hole Digger for Systems Delivering 6 - 15 GPM Hydraulic Flow, 1,419 ft/lb Torque at Maximum System Pressure (3,000 psi)	130 lb.	\$2,320
PHDHF20-2	Planetary Drive Post Hole Digger for Systems Delivering 10 - 20 GPM Hydraulic Flow, 1,777 ft/lb Torque at Maximum System Pressure (3,000 psi)	135 lb.	\$2,431
PHDHF30-2	Planetary Drive Post Hole Digger for Systems Delivering 15 - 30 GPM Hydraulic Flow, 2,623 ft/lb Torque at Maximum System Pressure (3,000 psi)	140 lb.	\$2,543
PHDHF35	Planetary Drive Post Hole Digger for Systems Delivering 20 - 30 GPM Hydraulic Flow, 3,500 ft/lb Torque at Maximum System Pressure (3,500 psi)	145 lb.	\$2,656

### GROUP 2 MOUNTING KIT SELECTION

Model Number	Description	Approx. Wt.	List Price (\$US)
50077005	Skid Steer Mount, Quick Attach, Center Hitch	117 lb.	\$565
50077004	Loader Bucket Mount*	57 lb.	\$399
50077006	Skid Steer Mount, Quick Attach, Right Offset (Offset to Right 15")**	128 lb.	\$565
50077007	Skid Steer Mount, Euro Quick Attach, Right Offset (Offset to Right 15")**	140 lb.	\$632

\* Requires drilling two holes in bucket. (Hoses not included.)

\*\* Mounting brackets with frames offset to the right are designed for use on a tractor front end loader to provide visibility of the auger.

### GROUP 3 AUGER SELECTION

Model Number	Description	Approx. Wt.	List Price (\$US)
<b>HSDA Augers (Soil, Clay, Loose Rock), 48" Long</b>			
00789048	6" Auger	68 lb.	\$342
00789049	9" Auger	69 lb.	\$485
00789050	12" Auger	108 lb.	\$552
00789051	18" Auger	159 lb.	\$816
00789052	24" Auger (PHDHF30 Only)	245 lb.	\$1,029
00789053	30" Auger (PHDHF30 Only)	303 lb.	\$1,344
00789054	36" Auger (PHDHF30 Only)	333 lb.	\$1,653
00789055	9" x 18" Tree Auger	136 lb.	\$886
00789056	12" x 24" Tree Auger	287 lb.	\$955
00789057	18" x 36" Tree Auger (PHDHF30 Only)	322 lb.	\$1,621

Note: Augers 18" and greater will incur a separate freight charge of \$52.

#### T-Post Puff Auger (Soil, Clay, Compacted Soil)

00776653	2" Auger	25 lb.	\$496
----------	----------	--------	-------

### OPTIONS

Model Number	Description	Approx. Wt.	List Price (\$US)
00776654	24" Variable Length Auger Extension	33 lb.	\$320
00776655	48" Variable Length Auger Extension	57 lb.	\$534
00785968	Auger Adapter, 2" Hex (Female) to 2" Round (Male) (Bush Hog)	15 lb.	\$267
00786085	Auger Adapter, 2" Round (Female) to 2" Hex (Male) (3/4" Hole)	14 lb.	\$267
00768105	Hydraulic Hose Kit for Bolt-on Bucket Mount Kit (Hoses are 25' Long) (Dealer Installed)	25 lb.	\$453

**RETURN TO INDEX**



## PHDHC CONSTRUCTION/CONTRACTOR SERIES POST HOLE DIGGER

MODEL	PHDHC20	PHDHC30	PHDHC35
Drive Type	Planetary with Reversible Motor		
Shaft Output Size	2" Hex		
Maximum Output Torque*	2,008 ft. / lb.	2,937 ft. / lb.	3,582 ft. / lb.
Recommended Hydraulic Flow	10 - 20 gpm	15 - 30 gpm	20 - 35 gpm
Maximum System Pressure	3,000 psi		
Drive Protection	Hydraulic Relief Valve		
Hydraulic Hoses	1/2" x 8' with 10 MB Ends		
Type of Mounts	Loader Bucket, Skid Steer Universal, Euro Style Quick Attach, Backhoe		
Maximum Auger Diameter (Rock)	24"	36"	
Maximum Auger Diameter (Dirt)	30"	36"	
Standard Digging Depth	48"		
<b>Five-Year Limited Warranty.</b>			

*\*All values are theoretical. Specifications and models are subject to change without notice.*

NOTICE:	PHDHC Series diggers are "Construction/Contractor" type, designed for use with skid steer loaders, tractor loader backhoes, and mini-excavators.
HOW TO ORDER:	The PHDHC Series digger is priced as a basic unit with a choice of mounting kit bundle, auger, and options. In order to receive a complete unit, you must specify the basic unit, your selection of mounting kit from Group 2, and selection of auger from Group 3. Additional equipment may be added to your order by making your selection from the Options list.

Freight NOT included in list price



**RETURN TO INDEX**

## PHDHC CONSTRUCTION/CONTRACTOR SERIES POST HOLE DIGGER

### BASE UNIT SELECTION

Model Number	Description	Approx. Wt.	List Price (\$US)
PHDHC20	Planetary Drive Post Hole Digger for Systems Delivering 10 - 20 GPM Hydraulic Flow, 2,008 ft/lb Torque at Maximum System Pressure (3,000 psi)	211 lb.	\$3,070
PHDHC30	Planetary Drive Post Hole Digger for Systems Delivering 15 - 30 GPM Hydraulic Flow, 2,937 ft/lb Torque at Maximum System Pressure (3,000 psi)	211 lb.	\$3,236
PHDHC35	Planetary Drive Post Hole Digger for Systems Delivering 20 - 35 GPM Hydraulic Flow, 3,582 ft/lb Torque at Maximum System Pressure (3,000 psi)	211 lb.	\$3,502

### GROUP 2 MOUNTING KIT SELECTION

Model Number	Description	Approx. Wt.	List Price (\$US)
<b>Skid Steer</b>			
50074571	Universal Skid Steer Quick Attach Frame with Centered Hitch	146 lb.	\$582
50074572	Universal Skid Steer Quick Attach Frame (Offset to Right 15")	146 lb.	\$582
<b>Backhoe and Mini-Excavator (See instructions at end of Ordering Section)</b>			
00776624	Mounting Kit for Case 580, 580E, 580SE	32 lb.	\$406
00776625	Mounting Kit for Case 780	32 lb.	\$406
00776626	Mounting Kit for Ford CL55, 555 Series; Deere 12, B, C; 410A, B, C, D; 9300, 9305, 210C, 300B, D; 310A, B, C, D, E; 500C, 510B, 510C	32 lb.	\$406
00776627	Mounting Kit for JCB 1400B, 1500, 215, 217, 214	32 lb.	\$406
00776628	Mounting Kit for Deere 510; 710B, C, D	32 lb.	\$406
00776629	Mounting Kit for Deere 9450, 9550, 401C	32 lb.	\$406
00776630	Mounting Kit for Deere 310SE, 410E	32 lb.	\$406
00776631	Mounting Kit for Cat 410, 416, 426	32 lb.	\$406
00788379	Mounting Kit for Kubota KX91	32 lb.	\$406

\*Mounting brackets with frames offset to the right are designed for use on a tractor front end loader to provide visibility of the auger.

Case, Ford, JCB, John Deere, and CAT are trade names and/or registered trademarks which are the intellectual property of the entity listed or of the entity's successor(s). These names are used only to clarify the identification of skid steer loaders.

If mounting to a tractor front end loader, use mounting kits shown in PHDHF Series price sheets. Mounting kits for most backhoe and excavator models are available. See instructions at the end of this ordering section for backhoe or excavator models not listed above.

*PHDHC Series Post Hole Diggers Continued on Next Page*



RETURN TO INDEX

## PHDHC SERIES POST HOLE DIGGER *Continued*

### GROUP 3 AUGER SELECTION

Model Number	Description	Approx. Wt.	List Price (\$US)
<b>T-Post Puff Auger (Solid Rock)</b>			
00776653	2" Auger	25 lb.	<b>\$496</b>
<b>HSDA AUGERS (Soil, Clay, Loose Rock)</b>			
00789048	6" Auger	68 lb.	<b>\$342</b>
00789049	9" Auger	69 lb.	<b>\$485</b>
00789050	12" Auger	108 lb.	<b>\$552</b>
00789051	18" Auger	159 lb.	<b>\$816</b>
00789052	24" Auger	245 lb.	<b>\$1,029</b>
00789053	30" Auger	303 lb.	<b>\$1,344</b>
00789054	36" Auger	333 lb.	<b>\$1,653</b>
00789055	9" x 18" Tree Auger	136 lb.	<b>\$886</b>
00789056	12" x 24" Tree Auger	287 lb.	<b>\$955</b>
00789057	18" x 36" Tree Auger	322 lb.	<b>\$1,621</b>
<b>HSRA AUGERS (Loose Rock, Solid Rock, Concrete)</b>			
00776632	4-½" Auger	60 lb.	<b>\$933</b>
00776633	6" Auger	53 lb.	<b>\$1,301</b>
<b>HRAD AUGERS (Soil, Hard Clay, Loose or Solid Rock, Concrete)</b>			
00776644	9" Auger	102 lb.	<b>\$1,541</b>
00776645	12" Auger	107 lb.	<b>\$1,935</b>
00776646	18" Auger	201 lb.	<b>\$2,484</b>
00776647	24" Auger	291 lb.	<b>\$2,852</b>
00776648	30" Auger	340 lb.	<b>\$3,278</b>
00776649	36" Auger	395 lb.	<b>\$4,036</b>

### OPTIONS (DEALER INSTALLED)

Model Number	Description	Approx. Wt.	List Price (\$US)
00776654	24" Variable Length Auger Extension	33 lb.	<b>\$320</b>
00776655	48" Variable Length Auger Extension	57 lb.	<b>\$534</b>
00776656	72" Variable Length Auger Extension	80 lb.	<b>\$629</b>

### BACKHOE & EXCAVATOR MOUNTING BRACKET INFORMATION

(See Group 2 Mounting Kit Selection for Weight and Price)

<b>STEP 1</b>	Choose PHDHC Series digger that matches the hydraulic flow and pressure of the backhoe or excavator.
<b>STEP 2</b>	Measure the width of the backhoe or excavator dipper (outer boom section) at the connection point.
<b>STEP 3</b>	Measure the pin diameter required to connect the digger to the backhoe or excavator.
<b>STEP 4</b>	If the dipper width and pin diameter are the same as those listed in the chart below, order the part number that corresponds. If part number is not shown for the size you need, contact Bush Hog Customer Service Department with your dipper width and pin diameter information so they can determine availability.

*PHDHC Series Post Hole Diggers Continued on Next Page*





**RETURN TO INDEX**

## PHDHC SERIES POST HOLE DIGGER *Continued*

DIPPER WIDTH & PIN DIAMETERS FOR MOUNT KITS LISTED IN GROUP 2 MOUNTING KIT SELECTION			
Part Number	Dipper Width	Pin Diameter	Typical Application
00776624	10"	1¾"	Case 580, 580E, 580SE
00776625	8"	2½"	Case 780
00776626	8"	1¾"	Ford CL55, 555 Series; Deere 12, B, C; 410A, B, C, D; 9300, 9305
00776627	6¾"	1¾"	JCB 1400B, 1500, 215, 217, 214
00776628	6½"	1¾"	Deere 510, 710B, C, D
00776629	8"	1½"	Deere 9450, 9550, 401C
00776630	8"	2¾"	Deere 310SE, 410E
00776631	10"	2"	CAT 410, 416, 426
00788379	5½"	1¾"	Kubota KX91

### AUGER SIZING CHART FOR PHDHF AND PHDHC SERIES POST HOLE DIGGERS

		Farm and Ranch						Construction					
		PHDHF15		PHDHF20		PHDHF30		PHDHC20		PHDHC30		PHDHC35	
		Dirt	Rock	Dirt	Rock	Dirt	Rock	Dirt	Rock	Dirt	Rock	Dirt	Rock
	Approx. Wt.												
<b>T-POST PUFF AUGER (Solid Rock)</b>													
2" Auger	25 lb.	X		X	X	X	X	X	X	X	X	X	X
<b>HSDA AUGERS (Soil, Clay, Loose Rock)</b>													
6" Auger	68 lb.	X		X	X	X	X	X	X	X	X	X	X
9" Auger	69 lb.	X		X	X	X	X	X	X	X	X	X	X
12" Auger	108 lb.	X		X		X	X	X	X	X	X	X	X
18" Auger	159 lb.	X		X		X		X	X	X	X	X	X
24" Auger	245 lb.			X		X		X	X	X	X	X	X
30" Auger	303 lb.			X		X		X		X	X	X	X
36" Auger	333 lb.					X				X	X	X	X
9" x 18" Tree Auger	136 lb.			X		X		X		X			
12" x 24" Tree Auger	287 lb.			X		X		X		X			
18" x 36" Tree Auger	322 lb.					X				X			
<b>HSRA AUGERS (Loose Rock, Solid Rock, Concrete)</b>													
4½" Auger	60 lb.							X	X	X	X	X	X
6" Auger	53 lb.							X	X	X	X	X	X
<b>HRAD AUGERS (Soil, Hard Clay, Loose or Solid Rock, Concrete)</b>													
9" Auger	102 lb.							X	X	X	X	X	X
12" Auger	107 lb.							X	X	X	X	X	X
18" Auger	201 lb.							X	X	X	X	X	X
24" Auger	291 lb.							X	X	X	X	X	X
30" Auger	340 lb.							X		X	X	X	X
36" Auger	395 lb.									X	X	X	X



**RETURN TO INDEX**

All models are available in the colors below:	
Model Color Indicator	Unit Color
01	Bush Hog Red
02	Bush Hog Black
03	John Deere Green
05	Kubota Orange
14	New Holland Blue



**\*\*\* THIS PRODUCT IS PRICED AT LIST LESS 25% \*\*\***

## XD SERIES BACKHOE

### BASE UNITS

\*\* BASE UNITS OPERATE ON OPEN CENTRE VALVES - SEE MISC ACCESSORIES \*\*

Model Number	Description	Approx. Wt.	List Price (\$US)
<small>** Please use Model Color Indicator behind product model number (ex. XD65C-02) **Please See P/N BFC501 under Hydraulic Accessories when ordering XD65C and XD65 model Backhoes**</small>			
XD65C	6' 4" Backhoe Base Unit	500 lb.	<b>\$6,797</b>
XD65	6' 4" Backhoe Base Unit	575 lb.	<b>\$8,052</b>
XD75	7' 8" Backhoe Base Unit	800 lb.	<b>\$9,297</b>
XD95	9' 4" Backhoe Base Unit (5-7 GPM flow required for all XD models)	850 lb.	<b>\$10,978</b>
XD95EL	11' 4" Backhoe Base Unit, extended reach Hydraulically retracted foot pedal control	1,000 lb.	<b>\$13,163</b>
XD600S	6' Skid digger- std quick attach skidsteer mount Includes flat-faced couplers	375 lb.	<b>\$2,387</b>

### GROUP 1 TRACTOR MOUNTINGS

\*\* VISIT WEBSITE FOR CURRENT SUBFRAME AND SKIDSTEER MOUNTING LISTS \*\*

Model Number	Description	List Price (\$US)
PT300	3 Point Hitch Mount - Category 1 (Fits all models & includes turn buckle tie down except XD600S)	<b>\$789</b>
PT322	3 Point Hitch Mount - Category 2 (Fits XD75, and XD95 includes tie down)	<b>\$869</b>
SF100	Subframe Mounting Kit (See <a href="http://www.bushhog.com">www.bushhog.com</a> for current subframe list in backhoe section)	<b>\$1,476</b>

NOTE: Some tractors may require wheel spacers after subframe installation.

#### Skidsteer Mountings

SQ400	Universal Skidsteer Quick Attach Mount 35" Wide, Includes Flat Faced Couplers (Requires tie back kit)	<b>\$1,035</b>
SQ500	Universal Skidsteer Quick Attach Mount 44" Wide, Includes Flat Faced Couplers (Requires tie back)	<b>\$1,274</b>
TB100	Tie Back Kit FOR SQ400 and 500 Quick Attach (See <a href="http://www.bushhog.com">www.bushhog.com</a> for current mounting list)	<b>\$474</b>

#### HOW TO ORDER:

To order a complete unit you must select a base unit from the first section, select a subframe mount from Group 1, and a bucket from Group 2. Add color code to the end of selected model number.

Freight NOT included in list price

RETURN TO INDEX

## XD SERIES BACKHOE

## GROUP 2 BUCKETS

Model Number	Description	List Price (\$US)
<b>XD65 &amp; XD65C</b>		
BK2609	9" Bucket - XD65 - 3 teeth / Bucket Volume = .5115 cubic ft or 884 cubic in.	<b>\$508</b>
BK2612	12" Bucket - XD65 - 3 teeth / Bucket Volume = .6934 cubic ft or 1200 cubic in.	<b>\$575</b>
BK2615	15" Bucket - XD65 - 4 teeth / Bucket Volume = .8749 cubic ft or 1512 cubic in.	<b>\$602</b>
BK2618	18" Bucket - XD65 - 4 teeth / Bucket Volume = 1.0567 cubic ft or 1826 cubic in.	<b>\$624</b>
<b>XD75 &amp; XD95, XD600S</b>		
BK2900	9" Bucket - XD65 - 3 teeth / Bucket Volume = .5115 cubic ft or 884 cubic in.	<b>\$727</b>
BK2120	12" Bucket- XD75 & XD95, XD600S - 3 teeth / Bucket Volume = 1.1694 cubic ft or 2020 cubic in.	<b>\$745</b>
BK2150	15" Bucket- XD75 & XD95, XD600S - 4 teeth / Bucket Volume = 1.4806 cubic ft or 2558 cubic in.	<b>\$808</b>
BK2180	18" Bucket- XD75 & XD95, XD600S - 4 teeth / Bucket Volume = 1.7912 cubic ft or 3095 cubic in.	<b>\$842</b>
BK2240	24" Bucket- XD75 & XD95, XD600S - 5 teeth / Bucket Volume = 2.413 cubic ft or 4169 cubic in.	<b>\$974</b>
BK2240D	24" Ditching Bucket (No Teeth) - XD75 & XD95, XD600S / Bucket Volume = same as above BK2240	<b>\$900</b>

## OPTIONS

Model Number	Description	List Price (\$US)
<b>Backhoe Thumbs</b>		
BT5280	Clamp-on Mechanical Thumb for XD65 Backhoe	<b>\$561</b>
BT5290	Clamp-on Mechanical Thumb for XD75/XD95 Backhoe	<b>\$665</b>
BT5300	Hydraulic Thumb Kit - XD75 & XD95 - Factory installed option - foot pedal control	<b>\$1,702</b>
BT5310	Clamp-on Mechanical Thumb for XD600S	<b>\$665</b>
BT5330	Clamp-on Mechanical Thumb for XD95EL	<b>\$685</b>
<b>Miscellaneous Accessories</b>		
BT7240	Vertical Stabilizer Kit XD75, XD95 & XD95EL	<b>\$1,028</b>
BT7250	Operators Seat for XD65C Backhoe	<b>\$552</b>
BP220	Street Pad Kit for XD65C Backhoe	<b>\$328</b>
BT7220	Quick Change Bucket Adapter (XD75 & XD95) **may need to order pins for multiple buckets**	<b>\$534</b>
BT7230	Ripper Tool (XD75 & XD95)	<b>\$522</b>
BP210	Rubber Street Pad Kit (XD65) (Set of two)	<b>\$232</b>
BP230	Rubber Street Pad Kit (XD75 & XD95) (Set of two)	<b>\$232</b>
Z56916	Female Flat Face Coupler	<b>\$42</b>
Z51920	Male Flat Face Coupler	<b>\$122</b>
Z51919	Male Flat Face Coupler	<b>\$74</b>
<b>PTO Pump Kits</b>		
PTO605	PTO Hydraulic Pump Kit - 7GPM (XD65C)	<b>\$1,476</b>
PTO62	PTO Hydraulic Pump Kit - 7 GPM (XD65)	<b>\$1,523</b>
PTO72	PTO72 PTO Hydraulic Pump Kit - 7 GPM (XD75 & XD95)	<b>\$1,523</b>
<b>Hydraulic Accessories</b>		
BFC501	Flow Divider Kit for use on XD65C and XD65 models only when tractor hydraulics are above 8GPM	<b>\$640</b>
BT5360	XD65-95 Backhoe Closed Centre Kit	<b>\$873</b>
Z51920	Male Flat Face Coupler	<b>\$122</b>
Z51919	Male Flat Face Coupler	<b>\$74</b>
Z56918	Power Beyond Sleeve (Used to power an accessory downstream of a control valve)	<b>\$42</b>

NOTE: Backhoes ship from factory with male pioneer ends installed unless specified otherwise.

**RETURN TO INDEX**



All models are available in the colors below:	
Model Color Indicator	Unit Color
01	Bush Hog Red
02	Bush Hog Black
03	John Deere Green
05	Kubota Orange
14	New Holland Blue
16	Caterpillar Yellow

## AGR SERIES AG GRAPPLE

MODEL	AGR60	AGR72
Overall Depth	25" / Closed	
Overall Height	37¾"	
Overall Width	5'	6'
Useable Depth	N/A	
Useable Open Height	31"	
Useable Width (inside end plates)	5'	6'
Roll Back Angle	N/A	
Weight	372 lb.	409 lb.
Number of Teeth	5	
Attachment Method	Universal Skid Steer Quick Attach, Euro or John Deere	
Maximum Tractor HP	40	
Paint Color	See Paint Color Chart Above	

**NOTICE:** All units, with the exception of the AGR60JD and the AGR72JD, are available in the colors in the chart above.

**HOW TO ORDER:** The AGR Series Grapple is priced as a complete unit. Select your desired model from the Base Unit Selection offered. Indicate your choice of model color from the chart above. **Note: The AGR60JD and the AGR72JD models are available in green only. Do not make a color selection if you are ordering either of these two models.**

Freight NOT included in list price. Freight discount available for multiple unit orders. Please contact Customer Service for details.

### BASE UNIT SELECTION

Model Number	Description	Approx. Wt.	List Price (\$US)
AGR60SS-xx	Ag Grapple, Skid Steer, 60"	372 lb.	\$2,187
AGR60E-xx	Ag Grapple, Euro, 60"	409 lb.	\$2,299
AGR60JD	Ag Grapple, John Deere, 60"	372 lb.	\$2,257
AGR72SS-xx	Ag Grapple, Skid Steer, 72"	409 lb.	\$2,444
AGR72E-xx	Ag Grapple, Euro, 72"	409 lb.	\$2,551
AGR72JD	Ag Grapple, John Deere, 72"	409 lb.	\$2,509

[RETURN TO INDEX](#)

**BGR SERIES**



**BRGR SERIES**



## BGR SERIES BUCKET GRAPPLE AND BRGR SERIES BRUSH GRAPPLE

MODEL	BGR72T	BGR84T	BGR72	BGR84	BRGR72	BRGR84
	WITH TEETH		WITHOUT TEETH			
Overall Depth	39¼"				37½"	
Overall Height	24"				25½"	
Overall Width	6'	7'	6'	7'	6'	7'
Useable Depth	33¾"				28"	
Useable Open Height	45½"				46½"	
Useable Width (inside end plates)	71"	83"	71"	83"	71"	83"
Roll Back Angle	20°				13°	
Weight	907 lb.	993 lb.	827 lb.	903 lb.	702 lb.	787 lb.
Number of Teeth	8	9			8	10
Attachment Method	Universal Skid Steer Quick Attach					
Paint Color	Black					

**HOW TO ORDER:** The BGR and BRGR Series Grapples are priced as complete units. Select the desired model number from the Base Unit Selection below.

Freight NOT included in list price. Freight discount available for multiple unit orders. Please contact Customer Service for details.

### BGR SERIES BUCKET GRAPPLE BASE UNIT SELECTION

Model Number	Description	Approx. Wt.	List Price (\$US)
BGR72	Bucket Grapple, 72"	827 lb.	<b>\$4,923</b>
BGR72T	Bucket Grapple, with Teeth, 72"	907 lb.	<b>\$5,354</b>
BGR84	Bucket Grapple, 84"	903 lb.	<b>\$5,207</b>
BGR84T	Bucket Grapple, with Teeth, 84"	993 lb.	<b>\$5,687</b>

### BRGR SERIES BRUSH GRAPPLE BASE UNIT SELECTION

Model Number	Description	Approx. Wt.	List Price (\$US)
BRGR72	Brush Grapple, 72"	702 lb.	<b>\$4,464</b>
BRGR84	Brush Grapple, 84"	787 lb.	<b>\$4,776</b>

**RETURN TO INDEX**



## PF48 SERIES PALLET FORK

MODEL	PF48SS, PF48E, PF48JD
Over Height	41 <sup>3</sup> / <sub>8</sub> "
Overall Width	45 <sup>5</sup> / <sub>16</sub> "
Overall Depth	60 <sup>3</sup> / <sub>8</sub> "
Fork Size	1 <sup>1</sup> / <sub>2</sub> " x 4"
Fork Length	48"
Fork Adjustable Width	Up to 44 <sup>3</sup> / <sub>8</sub> " in Increments of 4"
Weight	387 lb.
Max. Capacity	4,400 lb.
Attachment Method	Universal Skid Steer Quick Attach, Euro or John Deere
Color	Black

### HOW TO ORDER:

The PF48 Series Pallet Fork is priced as a complete unit. Select your desired model from the Base Unit Selection offered.

Freight NOT included in list price. Freight discount available for multiple unit orders. Please contact Customer Service for details.

### BASE UNIT SELECTION

Model Number	Description	Approx. Wt.	List Price (\$US)
PF48SS	Pallet Fork, Skid Steer, 48"	387 lb.	<b>\$1,329</b>
PF48E	Pallet Fork, Euro, 48"	387 lb.	<b>\$1,388</b>
PF48JD	Pallet Fork, John Deere, 48"	387 lb.	<b>\$1,373</b>



[RETURN TO INDEX](#)

# LANDSCAPE

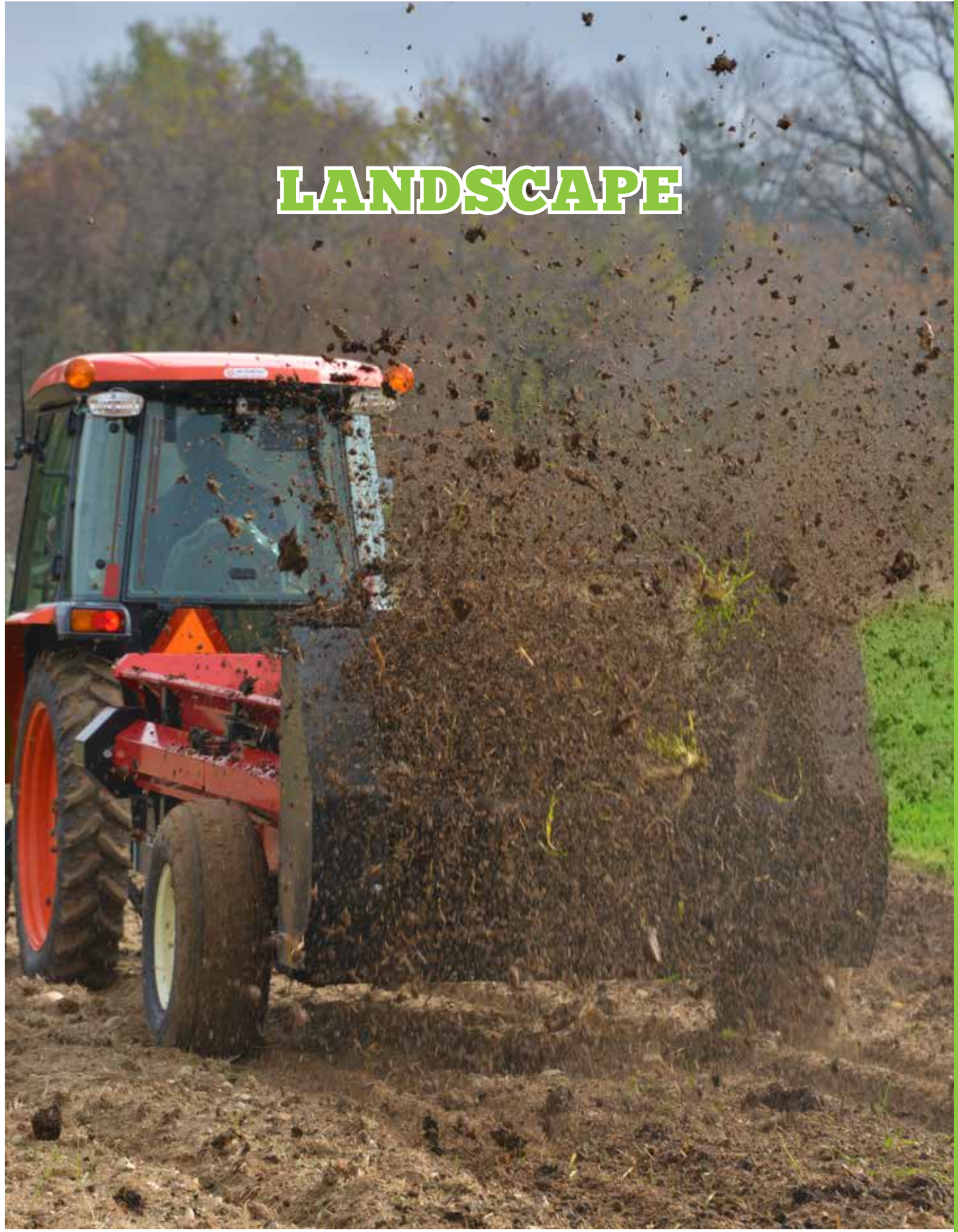

LANDSCAPE

**RETURN TO INDEX**



All models are available in the colors below:	
Model Color Indicator	Unit Color
01	Bush Hog Red
03	John Deere Green
05	Kubota Orange
14	New Holland Blue
16	Caterpillar Yellow

## CRB SERIES COMPACT REAR BLADE

MODEL	CRB48	CRB60	CRB72
Maximum Tractor HP	24		
Hitch	ASAE Cat 1 Std & Quick Hitch		
Moldboard Width	48"	60"	72"
Moldboard Height	12"x 1/4"		
Adjustment Angles	15° & 30° Forward and Reverse		

**HOW TO ORDER:**

The Compact Series Rear Blade is available as a lift-type implement only. It is priced as a complete unit and is shipped fully assembled. Indicate your choice of model color from the chart above.

Freight NOT included in list price. Freight discount available for multiple unit orders. Please contact Customer Service for details.

**BASE UNIT SELECTION**

Model Number	Description	Approx. Wt.	List Price (\$US)
CRB48-xx	Compact Series Rear Blade, 4'	136 lb.	<b>\$576</b>
CRB60-xx	Compact Series Rear Blade, 5'	150 lb.	<b>\$614</b>
CRB72-xx	Compact Series Rear Blade, 6'	164 lb.	<b>\$673</b>

## CBX SERIES COMPACT BOX BLADE

MODEL	CBX48	CBX60
Maximum Tractor HP	24	
Hitch	ASAE Cat 1 Std & Quick Hitch	
Moldboard Width	48"	60"
Box Depth	12"	
Number of Scarifier Teeth	4	5
Number of Blades	(2) Blades, Bolt-On Reversible Cutting Edge	

**HOW TO ORDER:**

The Compact Series Box Blade is available as a lift-type implement only. It is priced as a complete unit and is shipped fully assembled.

Freight NOT included in list price. Freight discount available for multiple unit orders. Please contact Customer Service for details.

**BASE UNIT SELECTION**

Model Number	Description	Approx. Wt.	List Price (\$US)
CBX48-xx	Compact Series Box Blade, 4'	248 lb.	<b>\$921</b>
CBX60-xx	Compact Series Box Blade, 5'	258 lb.	<b>\$1,030</b>



**RETURN TO INDEX**



**COMPACT SERIES  
LANDSCAPE RAKE**



**COMPACT SERIES  
ROAD GRADER**

All models are available in the colors below:	
Model Color Indicator	Unit Color
01	Bush Hog Red
03	John Deere Green
05	Kubota Orange
14	New Holland Blue
16	Caterpillar Yellow

## CLR SERIES COMPACT LANDSCAPE RAKE

MODEL	CLR48	CLR60
Maximum Tractor HP	24	
Hitch	ASAE Cat 1 Std & Quick Hitch	
Rake Pivot	18° & 36°	
Tine Spacing	1"	

**HOW TO ORDER:**

The Compact Series Landscape Rake is available as a lift-type implement only. It is priced as a complete unit and is shipped fully assembled. Indicate your choice of model color from the chart above.

Freight NOT included in list price. Freight discount available for multiple unit orders. Please contact Customer Service for details.

**BASE UNIT SELECTION**

Model Number	Description	Approx. Wt.	List Price (\$US)
CLR48-xx	Compact Series Landscape Rake, 4'	126 lb.	<b>\$778</b>
CLR60-xx	Compact Series Landscape Rake, 5'	143 lb.	<b>\$840</b>

## CRG SERIES COMPACT ROAD GRADER

MODEL	CRG48	CRG60
Maximum Tractor HP	24	
Hitch	ASAE Cat 1 Std & Quick Hitch	
Side Panel Thickness	3/16"	
Front Main Beam	3" x 3" x 3/16"	
Rear Main Beam	2" x 2" x 0.1196"	
Number of Blades	(2) Blades, Bolt-On Reversible Cutting Edge	

**HOW TO ORDER:**

The Compact Series Road Grader is available as a lift-type implement only. It is priced as a complete unit and is shipped fully assembled. Indicate your choice of model color from the chart above.

Freight NOT included in list price. Freight discount available for multiple unit orders. Please contact Customer Service for details.

**BASE UNIT SELECTION**

Model Number	Description	Approx. Wt.	List Price (\$US)
CRG48-xx	Compact Series Road Grader, 4'	238 lb.	<b>\$1,168</b>
CRG60-xx	Compact Series Road Grader, 5'	297 lb.	<b>\$1233</b>

**RETURN TO INDEX**

All models are available in the colors below:	
Model Color Indicator	Unit Color
01	Bush Hog Red
03	John Deere Green
05	Kubota Orange
14	New Holland Blue
16	Caterpillar Yellow

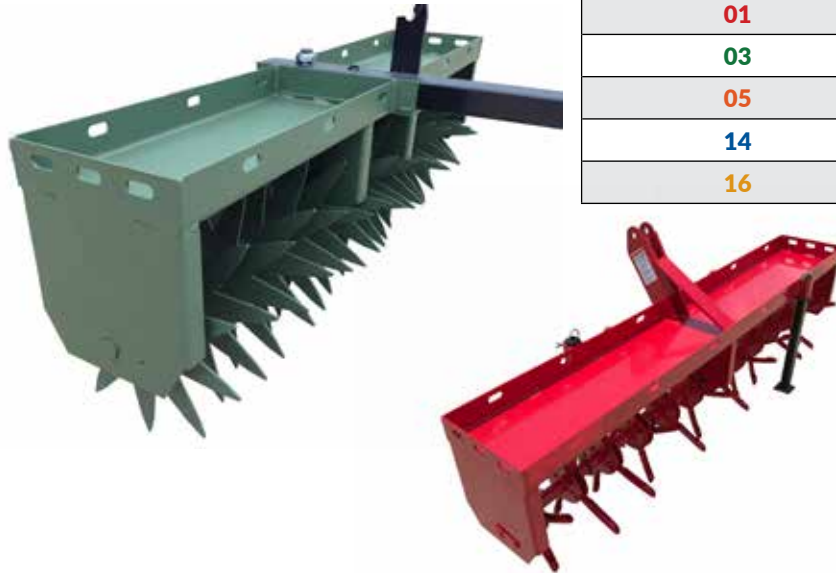

## COMPACT SERIES PLUGGER & AERATOR

MODEL	CPG48	CPG60	CAR48	CAR60
Overall Width	49 <sup>7</sup> / <sub>8</sub> "	62 <sup>1</sup> / <sub>4</sub> "	49 <sup>7</sup> / <sub>8</sub> "	62 1/4"
Working Width	43 <sup>11</sup> / <sub>16</sub> "	56 <sup>1</sup> / <sub>4</sub> "	44 <sup>15</sup> / <sub>16</sub> "	57 3/8"
Overall Depth	20 <sup>5</sup> / <sub>8</sub> "	20 <sup>5</sup> / <sub>8</sub> "	20 5/8"	20 5/8"
Weight	166 lb.	199 lb.	166 lb.	199 lb.
Number of Spoons/knives	32	40	120	150
Number of Hubs	4	5	4	5
Spoon/Knife Spacing	6"		3 <sup>15</sup> / <sub>16</sub> "	
Axle	1 <sup>1</sup> / <sub>4</sub> "		1 <sup>1</sup> / <sub>4</sub> "	
Hitch	Cat 1 & Quick Hitch		Cat 1 & Quick Hitch	

**HOW TO ORDER:**

To receive a complete order for a Compact Plugger or Aerator, enter the correct model number and paint color code.

Freight NOT included in list price. Freight discount available for multiple unit orders. Please contact Customer Service for details.

### COMPACT PLUGGER

Model Number	Description	Approx. Wt.	List Price (\$US)
CPG48-xx	Compact Plugger, Lift Type, 48"	166 lb.	<b>\$1,011</b>
CPG60-xx	Compact Plugger, Lift Type, 60"	199 lb.	<b>\$1,257</b>
CPG72-xx	Compact Plugger, Lift Type, 72"	219 lb.	<b>\$1,505</b>

### COMPACT AERATOR

Model Number	Description	Approx. Wt.	List Price (\$US)
CAR48-xx	Compact Aerator, Lift Type, 48"	166 lb.	<b>\$1,011</b>
CAR60-xx	Compact Aerator, Lift Type, 60"	199 lb.	<b>\$1,257</b>
CAR72-xx	Compact Aerator, Lift Type, 72"	219 lb.	<b>\$1,505</b>

**RETURN TO INDEX**

All models are available in the colors below:	
Model Color Indicator	Unit Color
01	Bush Hog Red
03	John Deere Green
05	Kubota Orange
14	New Holland Blue
16	Caterpillar Yellow

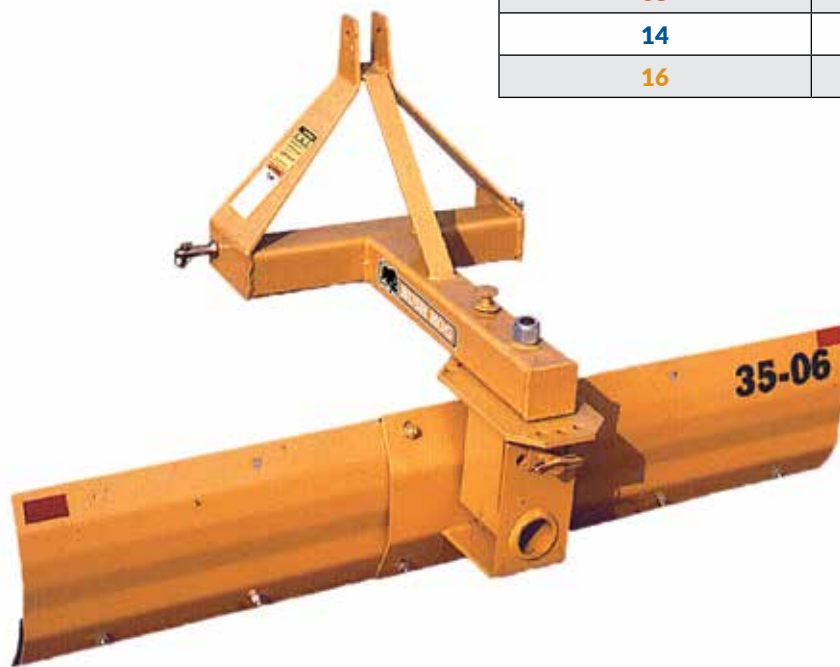

## 35 SERIES REAR MOUNT MEDIUM BLADE

MODEL	3505	3506	3507
Maximum Tractor HP	35 (2 WD), 30 (4 WD)		
Hitch	3-Point ASAE Cat 1 & Quick Hitch		
Moldboard Width	5'	6'	7'
Moldboard Height	14½" x 1/4"		
Cutting Edge	1/2" x 6" Reversible		
King Pin Diameter	1¼" Grade 8		
Tilt Adjustment	15° Up or Down		
Angle Adjustment	5 Forward Positions up to 30°, 3 Reverse Positions up to 15°		

**HOW TO ORDER:**

The 35 Series Rear Mounted Blade is available as a lift-type implement only. It is priced as a complete unit and is shipped fully assembled. Indicate your choice of model color from the chart above. Additional equipment for this model is listed in the Options section below.

Freight NOT included in list price. Freight discount available for multiple unit orders. Please contact Customer Service for details.

**BASE UNIT SELECTION**

Model Number	Description	Approx. Wt.	List Price (\$US)
3505-xx	35 Series Utility Blade, 5'	280 lb.	\$928
3506-xx	35 Series Utility Blade, 6'	290 lb.	\$979
3507-xx	35 Series Utility Blade, 7'	325 lb.	\$1,024

**RETURN TO INDEX**



All models are available in the colors below:	
Model Color Indicator	Unit Color
01	Bush Hog Red
03	John Deere Green
05	Kubota Orange
14	New Holland Blue
16	Caterpillar Yellow

## 50 SERIES REAR MOUNT MEDIUM BLADE

MODEL	5006	5007
Maximum Tractor HP	50 (2 WD), 40 (4 WD)	
Hitch	3-Point ASAE Cat 1 & Quick Hitch	
Moldboard Width	6'	7'
Moldboard Height	16" x 5/16"	
Cutting Edge	1/2" x 6" Reversible	
King Pin Diameter	1 1/4" Grade 8	
Tilt Adjustment	15° Up or Down	
Offset Adjustment	23" Left or Right	
Angle Adjustment	5 Forward Positions up to 30°, 3 Reverse Positions up to 15°	
Parking Stand	Standard	

### HOW TO ORDER:

The 50 Series Rear Mounted Blade is available as a lift-type implement only. It is priced as a complete unit and is shipped fully assembled. Indicate your choice of model color from the chart above. Additional equipment for this model is listed in the Options section below.

Freight NOT included in list price. Freight discount available for multiple unit orders. Please contact Customer Service for details.

### BASE UNIT SELECTION

Model Number	Description	Approx. Wt.	List Price (\$US)
5006-xx	50 Series Medium Blade, 6'	390 lb.	\$1,248
5007-xx	50 Series Medium Blade, 7'	455 lb.	\$1,304

### OPTIONS

Model Number	Description	List Price (\$US)
50072391	Skid Shoe Kit, 35/50/70 Series Blades	\$352

**RETURN TO INDEX**



All models are available in the colors below:	
Model Color Indicator	Unit Color
01	Bush Hog Red
03	John Deere Green
05	Kubota Orange
14	New Holland Blue
16	Caterpillar Yellow

## 70 SERIES MEDIUM DUTY BLADE

MODEL	7006	7007	7008
Maximum Tractor HP	70 (2 WD), 55 (4 WD)		
Hitch	3-Point ASAE Cat 1 & 2 & Quick Hitch		
Moldboard Width	6'	7'	8'
Moldboard Height	18" x 5/16"		
Cutting Edge	1/2" x 6" Reversible		
King Pin Diameter	1 1/4" Grade 8		
Tilt Adjustment	5 Positions up to 30°		
Offset Adjustment	18" Left or Right		
Angle Adjustment	360° Rotation, 5 Forward Positions up to 45°, 5 Reverse Positions up to 30°		
Parking Stand	Standard		

### HOW TO ORDER:

The 70 Series Rear Mounted Blade is available as a lift-type implement only. It is priced as a complete unit and is shipped fully assembled. Indicate your choice of model color from the chart above. Additional equipment for this model is listed in the Options section below.

Freight NOT included in list price. Freight discount available for multiple unit orders. Please contact Customer Service for details.

### BASE UNIT SELECTION

Model Number	Description	Approx. Wt.	List Price (\$US)
7006-xx	70 Series Medium Duty Blade, 6'	510 lb.	\$1,809
7007-xx	70 Series Medium Duty Blade, 7'	538 lb.	\$1,910
7008-xx	70 Series Medium Duty Blade, 6'	572 lb.	\$2,031

### OPTIONS

Model Number	Description	Approx. Wt.	List Price (\$US)
50072391	Skid Shoe Kit, 35/50/70 Series Blades		\$352
1817	Manual Ratchet Bundle (For Offset Function Only)	15 lb.	\$164
50070543	End Plate Kit, 70/91 Series Blades		\$385

**RETURN TO INDEX**



All models are available in the colors below:	
Model Color Indicator	Unit Color
01	Bush Hog Red
03	John Deere Green
05	Kubota Orange
14	New Holland Blue
16	Caterpillar Yellow

## 91 SERIES MEDIUM DUTY BLADE

MODEL	9107	9108
Maximum Tractor HP	90 (2 WD), 70 (4 WD)	
Hitch	3-Point ASAE Cat 1 & 2 & Cat 2 Quick Hitch	
Moldboard Width	7'	8'
Moldboard Height	16" x 3/8"	
Cutting Edge	1/2" x 6" Reversible	
King Pin Diameter	3"	
Tilt Adjustment	15° Maximum Left or Right	
Offset Adjustment	20" Maximum Left or Right	
Angle Adjustment	50° Maximum Left or Right, Forward or Reverse	
Parking Stand	Standard	

### HOW TO ORDER:

The 91 Series Rear Mounted Blade is available as a lift-type implement only. Your order must specify model number (including model color indicator from the chart above), three (3) blade adjustment selections\*, and any desired additional equipment from the Options section below.

Freight NOT included in list price. Freight discount available for multiple unit orders. Please contact Customer Service for details.

### BASE UNIT SELECTION

Model Number	Description	Approx. Wt.	List Price (\$US)
9107-xx	91 Series Medium Duty Blade, 7'	807 lb.	\$3,062
9108-xx	91 Series Medium Duty Blade, 8'	827 lb.	\$3,128

### BLADE ADJUSTMENT SELECTION\*

Model Number	Description	Approx. Wt.	List Price (\$US)
95839	8" Hydraulic Cylinder Kit	52 lb.	\$565
95838	16" Hydraulic Cylinder Kit	67 lb.	\$644
89295	8" Pin Jack Assembly	15 lb.	\$199
89294	16" Pin Jack Assembly	37 lb.	\$240
95841	Hose Holder Bundle		\$95

\*NOTE: The tilt function requires (1) 8" selection. The angle function requires (1) 16" selection, and the offset function requires (1) 16" selection. Only (1) hose holder bundle is required, regardless of the number of hydraulic functions ordered.

### OPTIONS

Model Number	Description	Approx. Wt.	List Price (\$US)
89290	Skid Shoes	60 lb.	\$380
50070543	End Plate Kit, 70/91 Series Blades		\$385

**RETURN TO INDEX**



## 100 SERIES HEAVY DUTY BLADE

MODEL	100-08	100-09
Maximum Tractor HP	125 (2 WD), 80 (4 WD)	
Hitch	3-Point ASAE Cat 1 & 2 & Quick Hitch	
Moldboard Width	8'	9'
Moldboard Height	17" x 3/8"	
Cutting Edge	1/2" x 6"	
King Pin Diameter	3"	
Tilt Adjustment	15° Maximum Left or Right	
Offset Adjustment	20" Maximum Left or Right	
Angle Adjustment	50° Maximum Left or Right, Forward or Reverse	
Parking Stand	Standard	
Hose Holder	Standard	

**HOW TO ORDER:**

The 100 Series Rear Mounted Blade is available as a lift-type implement only. Your order must specify model number, three (3) blade adjustment selections\*, and any desired additional equipment from the Options section below.

Freight NOT included in list price. Freight discount available for multiple unit orders. Please contact Customer Service for details.

**BASE UNIT SELECTION**

Model Number	Description	Approx. Wt.	List Price (\$US)
100-08	100 Series Heavy Duty Blade, 8', Bush Hog Red	836 lb.	\$3,663
100-09	100 Series Heavy Duty Blade, 9', Bush Hog Red	876 lb.	\$3,790

**BLADE ADJUSTMENT SELECTION\***

Model Number	Description	Approx. Wt.	List Price (\$US)
OFFSET 9150040400	Hydraulic Offset/Angle Blade Adjustment	63 lb.	\$874
	Manual Offset/Angle Blade Adjustment	38 lb.	\$325
ANGLE 9150040400	Hydraulic Offset/Angle Blade Adjustment	63 lb.	\$874
	Manual Offset/Angle Blade Adjustment	38 lb.	\$325
TILT 9150040004	Hydraulic Tilt Blade Adjustment	33 lb.	\$592
	Manual Tilt Blade Adjustment	22 lb.	\$283

\*NOTE: Select either manual or hydraulic adjustment for each of the three functions (offset, angle and tilt).

**OPTIONS**

Model Number	Description	Approx. Wt.	List Price (\$US)
0591240000	End Plates	65 lb.	\$310
0691700000	Open Center 3-Spool Valve		Order Through Service Parts
00759684	Valve Mounting Kit (Hose Fittings)		Order Through Service Parts
0781300000	Selector Valve (Valve Only)		Order Through Service Parts
00768242	Skid Shoes for 100/160/225/300 Series Blades	30 lb.	\$401
00768321	Gauge Wheel, Hydraulic Adjustment	112 lb.	\$1,051
00768493	Gauge Wheel, Ratchet Adjustment	143 lb.	\$800

**RETURN TO INDEX**



All models are available in the colors below:	
Model Color Indicator	Unit Color
01	Bush Hog Red
03	John Deere Green
05	Kubota Orange
14	New Holland Blue
16	Caterpillar Yellow

## 141 SERIES HEAVY DUTY BLADE

MODEL	141-08	141-09
Maximum Tractor HP	141 (2 WD), 110 (4 WD)	
Hitch	3-Point ASAE Cat 2 & 3 & Quick Hitch	
Moldboard Width	8'	9'
Moldboard Height	19"	
Cutting Edge	1/2" x 6"	
King Pin Diameter	4"	
Tilt Adjustment	15° Up or Down	
Offset Adjustment	35" Left or Right	
Angle Adjustment	45° Left or Right	
Parking Stand	Standard	
Hose Holder (Front)	Standard	

### HOW TO ORDER:

The 141 Series Rear Mounted Blade is available as a lift-type implement only. Your order must specify model number, three (3) blade adjustment selections\*, and any desired additional equipment from the Options section below.

Freight NOT included in list price. Freight discount available for multiple unit orders. Please contact Customer Service for details.

### BASE UNIT SELECTION

Model Number	Description	Approx. Wt.	List Price (\$US)
14108-xx	141 Series Heavy Duty Blade, 8', Bush Hog Red	1,146 lb.	\$4,804
14109-xx	141 Series Heavy Duty Blade, 9', Bush Hog Red	1,170 lb.	\$5,012

### BLADE ADJUSTMENT SELECTION\*

Model Number	Description	Approx. Wt.	List Price (\$US)
95839	8" Hydraulic Cylinder Kit	52 lb.	\$565
95838	16" Hydraulic Cylinder Kit	67 lb.	\$644
89295	8" Pin Jack Assembly	15 lb.	\$199
89294	16" Pin Jack Assembly	37 lb.	\$240

\*NOTE: The tilt function requires (1) 8" selection. The angle function requires (1) 16" selection, and the offset function requires (1) 16" selection. Only (1) hose holder bundle is required, regardless of the number of hydraulic functions ordered.

### OPTIONS

Model Number	Description	Approx. Wt.	List Price (\$US)
89290	Skid Shoes	60 lb.	\$380
95899	End Plate Kit for 141/181 Series Blades		\$571
95841	Hose Holder Bundle		\$95





**RETURN TO INDEX**



## 160 SERIES HEAVY DUTY BLADE

MODEL	160-08	160-09	160-10
Maximum Tractor HP	190 (2 WD), 160 (4 WD)	175 (2 WD), 150 (4 WD)	160 (2 WD), 135 (4 WD)
Hitch	3-Point ASAE Cat 2 & 3 & Quick Hitch		
Moldboard Width	8'	9'	10'
Moldboard Height	18" x 1/2"		
Cutting Edge	1/2" x 6"		
King Pin Diameter	4"		
Tilt Adjustment	15° Up or Down		
Offset Adjustment	37" Left or Right		
Angle Adjustment	45° Left or Right		
Parking Stand	Standard		
Hose Holder	Standard		

**HOW TO ORDER:**

The 160 Series Rear Mounted Blade is available as a lift-type implement only. Your order must specify model number, three (3) blade adjustment selections\*, and any desired additional equipment from the Options section below.

Freight NOT included in list price. Freight discount available for multiple unit orders. Please contact Customer Service for details.

**BASE UNIT SELECTION**

Model Number	Description	Approx. Wt.	List Price (\$US)
160-08	160 Series Heavy Duty Blade, 8', Bush Hog Red	1,339 lb.	\$5,305
160-09BH	160 Series Heavy Duty Blade, 9', Bush Hog Red	1,449 lb.	\$5,432
160-10	160 Series Heavy Duty Blade, 10', Bush Hog Red	1,459 lb.	\$5,555

**BLADE ADJUSTMENT SELECTION\***

OFFSET	9150040400	Hydraulic Offset/Angle Blade Adjustment	63 lb.	\$874
	B69115A	Manual Offset/Angle Blade Adjustment	45 lb.	\$342
ANGLE	9150040400	Hydraulic Offset/Angle Blade Adjustment	63 lb.	\$874
	B69115A	Manual Offset/Angle Blade Adjustment	45 lb.	\$342
TILT	9150040004	Hydraulic Tilt Blade Adjustment	33 lb.	\$592
	B69116B	Manual Tilt Blade Adjustment	28 lb.	\$342

\*NOTE: Select either manual or hydraulic adjustment for each of the three functions (offset, angle and tilt).

**OPTIONS**

9150052411	Dual Gauge Wheel, Hydraulic Adjustment	354 lb.	\$1,850
0691700000	Open Center 3-Spool Valve	Order Through Service Parts	
00759684	Valve Mounting Kit (Hose Fittings)	Order Through Service Parts	
0781300000	Selector Valve (Valve Only)	Order Through Service Parts	
00768242	Skid Shoes for 100/160/225/300 Series Blades	30 lb.	\$401
0691360000	End Plates for 160/225/300 Series Blades	58 lb.	\$379

**RETURN TO INDEX**



All models are available in the colors below:	
Model Color Indicator	Unit Color
01	Bush Hog Red
03	John Deere Green
05	Kubota Orange
14	New Holland Blue
16	Caterpillar Yellow

## 181 SERIES HEAVY DUTY BLADE

MODEL	181-09	181-10
Maximum Tractor HP	180 (2 WD), 140 (4 WD)	
Hitch	3-Point ASAE Cat 2 & 3 & Quick Hitch	
Moldboard Width	9'	10'
Moldboard Height	18" x 1/2"	
Cutting Edge	1/2" x 6"	
King Pin Diameter	5"	
Tilt Adjustment	15° Up or Down	
Offset Adjustment	37" Left or Right	
Angle Adjustment	45° Left or Right	
Parking Stand	Standard	
Hose Holder (Front)	Standard	

### HOW TO ORDER:

The 181 Series Rear Mounted Blade is available as a lift-type implement only. Your order must specify model number, three (3) blade adjustment selections, and any desired additional equipment from the Options section below.

Freight NOT included in list price. Freight discount available for multiple unit orders. Please contact Customer Service for details.

### BASE UNIT SELECTION

Model Number	Description	Approx. Wt.	List Price (\$US)
18109-xx	181 Series Heavy Duty Blade, 9', Bush Hog Red	1,589 lb.	\$7,829
18110-xx	181 Series Heavy Duty Blade, 10', Bush Hog Red	1,613 lb.	\$7,910

### BLADE ADJUSTMENT SELECTION\*

Model Number	Description	Approx. Wt.	List Price (\$US)
95839	8" Hydraulic Cylinder Kit	52 lb.	\$565
95838	16" Hydraulic Cylinder Kit	67 lb.	\$644
89295	8" Pin Jack Assembly	15 lb.	\$199
89294	16" Pin Jack Assembly	37 lb.	\$240

### OPTIONS

Model Number	Description	Approx. Wt.	List Price (\$US)
89290	Skid Shoes	60 lb.	\$380
95899	End Plate Kit for 141/181 Series Blades		\$571
95841	Hose Holder Bundle		\$95

**RETURN TO INDEX**



## 225/300 SERIES HEAVY DUTY BLADE

MODEL	225-08	225-10	225-12	300-12	300-14
Max. Tractor Draw Bar HP (2WD/4WD)	250/225	225/200	175/160	NA/300	NA/250
Hitch	3-Point Cat 2 & 3 & Quick Hitch			3-Point Cat 3 & 4 & Quick Hitch	
Moldboard Width	8'	10'	12'	12'	14'
Moldboard Height	20" x 1/2"				
Cutting Edge	1/2" x 6"				
King Pin Diameter	4 1/2"			5"	
Tilt Adjustment (Hydraulic Only)	15° Up or Down				
Offset Adjustment (Hydraulic Only)	46" Left or Right			50' Left or Right	
Angle Adjustment (Hydraulic Only)	45° Left or Right				
Parking Stand	Standard				
Hose Holder	Standard				

### HOW TO ORDER:

The 225 and 300 Series Rear Mounted Blades are available as a lift-type implement only. Each model is priced as a complete unit with all hydraulics included. Your order must specify model number. Any desired additional equipment may be ordered from the Options section below.

Freight NOT included in list price. Freight discount available for multiple unit orders. Please contact Customer Service for details.

### BASE UNIT SELECTION

Model Number	Description	Approx. Wt.	List Price (\$US)
225-08	225 Series Heavy Duty Blade, 8', Complete, with All Hydraulics Included, Bush Hog Red	2,120 lb.	<b>\$10,618</b>
225-10	225 Series Heavy Duty Blade, 10', Complete, with All Hydraulics Included, Bush Hog Red	2,260 lb.	<b>\$10,907</b>
225-12	225 Series Heavy Duty Blade, 12', Complete, with All Hydraulics Included, Bush Hog Red	2,400 lb.	<b>\$11,333</b>
300-12	300 Series Heavy Duty Blade, 12', Complete, with All Hydraulics Included, Bush Hog Red	3,463 lb.	<b>\$17,244</b>
300-14	300 Series Heavy Duty Blade, 14', Complete, with All Hydraulics Included, Bush Hog Red	3,603 lb.	<b>\$17,671</b>

### OPTIONS

00761806	Dual Gauge Wheel, Hydraulic Adjustment	421 lb.	<b>\$2,239</b>
0691700000	Open Center 3-Spool Valve		Order Through Service Parts
00759684	Valve Mounting Kit (Hose Fittings)		Order Through Service Parts
0781300000	Selector Valve (Valve Only)		Order Through Service Parts
00768242	Skid Shoes for 100/160/225/300 Series Blades	30 lb.	<b>\$401</b>
0691360000	End Plates for 160/225/300 Series Blades	58 lb.	<b>\$379</b>



**RETURN TO INDEX**

All models are available in the colors below:	
Model Color Indicator	Unit Color
01	Bush Hog Red
03	John Deere Green
05	Kubota Orange
14	New Holland Blue
16	Caterpillar Yellow

## LLR SERIES ECONOMY LANDSCAPE RAKE

MODEL	LLR60	LLR72	LLR84
Rake Width	60"	72"	84"
Rake Height	15"		
Hitch	ASAE Cat 1 & Quick Hitch		
Tractor HP	35 Maximum		
Rake Pivot	5 Forward Positions, Up to 30°; 3 Reverse Positions, Up to 15°		
Pivot King Pin	1¼"		
Tine Spacing	1"		
Tine Material	High Carbon Spring Steel		
Tine Size	5/16" x 1"		

**HOW TO ORDER:**

The LLR Series Landscape Rake is available as a lift-type implement only. It is priced as a complete unit and is shipped fully assembled. Indicate your choice of model color from the chart above. If desired, an optional Gauge Wheel Kit may be selected from the Options section below.

Freight NOT included in list price. Freight discount available for multiple unit orders. Please contact Customer Service for details.

**BASE UNIT SELECTION**

Model Number	Description	Approx. Wt.	Color	List Price (\$US)
LLR60-xx	LLR Economy Landscape Rake, 60"	205 lb.	See Table Above	<b>\$1,003</b>
LLR72-xx	LLR Economy Landscape Rake, 72"	225 lb.	See Table Above	<b>\$1,083</b>
LLR84-xx	LLR Economy Landscape Rake, 84"	245 lb.	See Table Above	<b>\$1,243</b>

## MLR SERIES MEDIUM DUTY LANDSCAPE RAKE

MODEL	MLR72	MLR84	MLR96
Rake Width	70"	84"	96"
Rake Height	15"		
Hitch	ASAE Cat 1 & Quick Hitch		
Tractor HP	50 Maximum		
Rake Pivot	5 Forward Positions, Up to 30°; 3 Reverse Positions, Up to 15°		
Pivot King Pin	1¼"		
Tine Spacing	1"		
Tine Material	High Carbon Spring Steel		
Tine Size	5/16" x 1"		

**HOW TO ORDER:**

The MLR Series Landscape Rake is available as a lift-type implement only. It is priced as a complete unit and is shipped fully assembled. Indicate your choice of model color from the chart above. If desired, an optional Gauge Wheel Kit may be selected from the Options section below.

Freight NOT included in list price. Freight discount available for multiple unit orders. Please contact Customer Service for details.

**BASE UNIT SELECTION**

Model Number	Description	Approx. Wt.	Color	List Price (\$US)
MLR72-xx	MLR Medium Duty Landscape Rake, 72"	325 lb.	See Table Above	<b>\$1,441</b>
MLR84-xx	MLR Medium Duty Landscape Rake, 84"	345 lb.	See Table Above	<b>\$1,535</b>
MLR96-xx	MLR Medium Duty Landscape Rake, 96"	365 lb.	See Table Above	<b>\$1,762</b>

**OPTIONS**

50047898	Gauge Wheel Kit	20 lb.	See Table Above	<b>\$354</b>
----------	-----------------	--------	-----------------	--------------

[RETURN TO INDEX](#)



All models are available in the colors below:	
Model Color Indicator	Unit Color
01	Bush Hog Red
03	John Deere Green
05	Kubota Orange
14	New Holland Blue
16	Caterpillar Yellow

## BBX SERIES BOX BLADE

MODEL	BBX48	BBX60	BBX65	BBX72
Working Width	48"	60"	65"	72"
Moldboard Height	15 <sup>5</sup> / <sub>8</sub> "			
Box Depth	22"			
Overall Depth	27"			
Overall Height	33"			
Overall Width	49"	61"	66"	73"
Side Sheet Thickness	1/4"			
Scarifier Size	5/8" x 2 <sup>1</sup> / <sub>2</sub> "			
Number of Scarifier Teeth	4		5	
Hitch	ASAE Cat 1 & Quick Hitch			
Lower Hitch	Single Lug			
Cutting Edge	1/2" x 6" (Reversible)			
Number of Blades	2			
Maximum HP Requirement	40 (2WD), 30 (4WD)			
A-Frame	Bolt-On			

### HOW TO ORDER:

The BBX Series Box Blade is available as a lift-type implement only. It is priced as a complete unit and is shipped fully assembled. Indicate your choice of model color from the chart above.

Freight NOT included in list price. Freight discount available for multiple unit orders. Please contact Customer Service for details.

### BASE UNIT SELECTION

Model Number	Description	Approx. Wt.	Color	List Price (\$US)
BBX48-xx	BBX Series Box Blade, 4 Scarifiers, 48"	260 lb.	See Table Above	<b>\$989</b>
BBX60-xx	BBX Series Box Blade, 4 Scarifiers, 60"	325 lb.	See Table Above	<b>\$1,082</b>
BBX65-xx	BBX Series Box Blade, 5 Scarifiers, 65"	375 lb.	See Table Above	<b>\$1,101</b>
BBX72-xx	BBX Series Box Blade, 5 Scarifiers, 72"	390 lb.	See Table Above	<b>\$1,122</b>

**RETURN TO INDEX**



All models are available in the colors below:	
Model Color Indicator	Unit Color
01	Bush Hog Red
03	John Deere Green
05	Kubota Orange
14	New Holland Blue
16	Caterpillar Yellow

## SBX SERIES BOX BLADE

MODEL	SBX48	SBX60	SBX65	SBX72	SBX78	SBX84
Working Width	48"	60"	65"	72"	78"	84"
Moldboard Height	18"					
Box Depth	24"					
Overall Depth	29"					
Overall Height	35¼"					
Overall Width	49"	61"	66"	73"	78"	85"
Side Sheet Thickness	3/8"					
Scarifier Size	3/4" x 2½"					
Number of Scarifier Teeth	4	5		6		
Hitch	ASAE Cat 1 & Quick Hitch					
Lower Hitch	Double Lug					
Cutting Edge	1/2" x 6" (Reversible)					
Number of Blades	2					
Maximum HP Requirement	50 (2WD), 45 (4WD)					

### HOW TO ORDER:

The SBX Series Box Blade is available as a lift-type implement only. It is priced as a complete unit and is shipped fully assembled. Indicate your choice of model color from the chart above.

Freight NOT included in list price. Freight discount available for multiple unit orders. Please contact Customer Service for details.

### BASE UNIT SELECTION

Model Number	Description	Approx. Wt.	Color	List Price (\$US)
SBX48-xx	SBX Series Box Blade, 4 Scarifiers, 48"	430 lb.	See Table Above	<b>\$1,108</b>
SBX60-xx	SBX Series Box Blade, 5 Scarifiers, 60"	490 lb.	See Table Above	<b>\$1,249</b>
SBX65-xx	SBX Series Box Blade, 5 Scarifiers, 65"	510 lb.	See Table Above	<b>\$1,324</b>
SBX72-xx	SBX Series Box Blade, 6 Scarifiers, 72"	550 lb.	See Table Above	<b>\$1,385</b>
SBX78-xx	SBX Series Box Blade, 6 Scarifiers, 78"	580 lb.	See Table Above	<b>\$1,478</b>
SBX84-xx	SBX Series Box Blade, 6 Scarifiers, 84"	610 lb.	See Table Above	<b>\$1,592</b>

[RETURN TO INDEX](#)



All models are available in the colors below:	
Model Color Indicator	Unit Color
01	Bush Hog Red
03	John Deere Green
05	Kubota Orange
14	New Holland Blue
16	Caterpillar Yellow

## MBX SERIES BOX BLADE

MODEL	MBX60	MBX72	MBX84	MBX96
Working Width	60"	72"	84"	96"
Moldboard Height	18"			
Box Depth	24"			
Overall Depth	29"			
Overall Height	35 ¼"			
Overall Width	61"	73"	85"	97"
Swinging Tailgate	Yes			
Side Sheet Thickness	3/8"			
Scarifier Size	3/4" x 2 ½"			
Number of Scarifier Teeth	5	6		
Hitch	ASAE Cat 1 & 2 & Quick Hitch			
Lower Hitch	Triple Lug			
Cutting Edge	1/2" x 6" (Reversible)			
Number of Blades	2			
Maximum HP Requirement	65 (2WD), 55 (4WD)			

### HOW TO ORDER:

The MBX Series Box Blade is available as a lift-type implement only. It is priced as a complete unit and is shipped fully assembled. Indicate your choice of model color from the chart above.

Freight NOT included in list price. Freight discount available for multiple unit orders. Please contact Customer Service for details.

### BASE UNIT SELECTION

Model Number	Description	Approx. Wt.	Color	List Price (\$US)
MBX60-xx	MBX Series Box Blade, 5 Scarifiers, 60"	580 lb.	See Table Above	<b>\$1,493</b>
MBX72-xx	MBX Series Box Blade, 6 Scarifiers, 72"	640 lb.	See Table Above	<b>\$1,767</b>
MBX84-xx	MBX Series Box Blade, 6 Scarifiers, 84"	710 lb.	See Table Above	<b>\$2,071</b>
MBX96-xx	MBX Series Box Blade, 6 Scarifiers, 96"	790 lb.	See Table Above	<b>\$2,327</b>

**RETURN TO INDEX**



**RBX SERIES**



**RO SERIES**

## RBX SERIES RETRACTABLE SHANK BOX BLADE

MODEL	RBX720	RBX780	RBX840
Working Width	72"	65"	84"
Number of Scarifiers	6	5	
Cutting Edge	Reversible 1/2" x 6", Heat Treated		
Points & Shanks	Replaceable		
Hitch	ASAE Cat 1 & 2, Quick Hitch		
Maximum HP Requirement	65 (2WD), 55 (4WD)		

**HOW TO ORDER:**

The RBX Series Box Blade is available as a lift-type implement only. It is priced as a complete unit and is shipped fully assembled. Indicate your choice of model from the Base Unit Selection below.

Freight NOT included in list price. Freight discount available for multiple unit orders. Please contact Customer Service for details.

**BASE UNIT SELECTION**

Model Number	Description	Approx. Wt.	Color	List Price (\$US)
RBX720	RBX Series Retractable Shank Box Blade, 72"	829 lb.	Caterpillar Yellow	<b>\$3,716</b>
RBX780	RBX Series Retractable Shank Box Blade, 78"	890 lb.	Caterpillar Yellow	<b>\$4,006</b>
RBX840	RBX Series Retractable Shank Box Blade, 84"	957 lb.	Caterpillar Yellow	<b>\$4,286</b>

## RO SERIES ROLL-OVER BOX BLADE

MODEL	RO-600	RO-650	RO-720	RO-840
Working Width	60"	65"	72"	84"
Number of Scarifiers	5		6	
Cutting Edge	Reversible 1/2" x 6", Heat Treated			
Points & Shanks	Replaceable			
Hitch	ASAE Cat 1 & Quick Hitch			
Maximum HP Requirement	60 (2WD), 55 (4WD)			

**HOW TO ORDER:**

The RO Series Box Blade is available as a lift-type implement only. It is priced as a complete unit and is shipped fully assembled, with the exception of the handle. Indicate your choice of model from the Base Unit Selection below.

Freight NOT included in list price. Freight discount available for multiple unit orders. Please contact Customer Service for details.

**BASE UNIT SELECTION**

Model Number	Description	Approx. Wt.	Color	List Price (\$US)
RO-600	RO Series Roll-Over Box Blade, 60"	630 lb.	Caterpillar Yellow	<b>\$2,590</b>
RO-650	RO Series Roll-Over Box Blade, 65"	680 lb.	Caterpillar Yellow	<b>\$2,814</b>
RO-720	RO Series Roll-Over Box Blade, 72"	710 lb.	Caterpillar Yellow	<b>\$3,008</b>
RO-840	RO Series Roll-Over Box Blade, 84"	780 lb.	Caterpillar Yellow	<b>\$3,441</b>



**RETURN TO INDEX**

All models are available in the colors below:	
Model Color Indicator	Unit Color
01	Bush Hog Red
03	John Deere Green
05	Kubota Orange
14	New Holland Blue
16	Caterpillar Yellow



## RG SERIES ROAD GRADER

MODEL	RG60	RG72	RG84
Hitch	Cat 1 Std & Quick Hitch		
Recommended HP	50 (2WD), 40 (FWA)		
Working Width	60"	72"	84"
Side Panel Thickness	3/16"	3/16"	3/16"
Front Main Beam Construction	4" x 4" x 5/16" Wall		
Rear Beam Construction	2½" x 2½" x 3/16" Wall		
Skid Shoe Construction	3/8" x 2½" x 3/16" Long		
Scarifier Shanks	Three-Position Shanks with Dimpled-On Hardened Tips		
Number of Scarifier Shanks	4	6	8
Cutting Edges	(Two) 1/2" x 6" Bolt-On, Replaceable and Reversible Heat-Treated Blades		

### HOW TO ORDER:

The RG Series Road Grader is available as a lift-type implement only. It is priced as a complete unit and is shipped fully assembled. Indicate your choice of model color from the chart above.

Freight NOT included in list price. Freight discount available for multiple unit orders. Please contact Customer Service for details.

### BASE UNIT SELECTION

Model Number	Description	Approx. Wt.	Color	List Price (\$US)
RG60-xx	RG Series Road Grader, 60"	500 lb.	See Table Above	<b>\$1,776</b>
RG72-xx	RG Series Road Grader, 72"	571 lb.	See Table Above	<b>\$1,925</b>
RG84-xx	RG Series Road Grader, 84"	642 lb.	See Table Above	<b>\$2,069</b>

### OPTIONS

Model Number	Description	List Price (\$US)
DEDUCT4SHANK	Deduct (4) Shanks, RG 60 Models	<b>-\$94</b>
DEDUCT6SHANK	Deduct (6) Shanks, RG72 and RG84 Models	<b>-\$137</b>

**RETURN TO INDEX**

All models are available in the colors below:	
Model Color Indicator	Unit Color
01	Bush Hog Red
03	John Deere Green
05	Kubota Orange
14	New Holland Blue
16	Caterpillar Yellow



## HDRG SERIES HEAVY DUTY ROAD GRADER

MODEL	HDRG84	HDRG96
Hitch	3-Point Cat 1 & 2	
Maximum Recommended HP	90 (2WD), 70 (4WD)	90 (2WD), 70 (4WD)
Working Width	84"	96"
Side Panel Thickness	3/16"	3/16"
Front Main Beam Construction	4" x 4" x 3/8"	
Rear Beam Construction	4" x 4" x 1/4"	
Skid Shoe Construction	1/2" x 2 1/2"	
Scarifier Shanks	Four Position Shanks with Hardened Tips	
Number of Scarifier Shanks	6	8
Cutting Edges	1/2" x 6" Bolt on Replaceable & Reversible Heat Treated Blades	

**HOW TO ORDER:**

The HDRG Series Road Grader is available as a lift-type implement only. It is priced as a complete unit and is shipped fully assembled. Indicate your choice of model color from the chart above.

Freight NOT included in list price. Freight discount available for multiple unit orders. Please contact Customer Service for details.

**BASE UNIT SELECTION**

Model Number	Description	Approx. Wt.	Color	List Price (\$US)
HDRG84-xx	Heavy Duty Road Grader, 84"	750 lb.	See Table Above	<b>\$2,574</b>
HDRG96-xx	Heavy Duty Road Grader, 96"	828 lb.	See Table Above	<b>\$2,989</b>

**RETURN TO INDEX**



**SINGLE ROLL**



**DOUBLE ROLL**

**PV SERIES PULVERIZER**

MODEL	PVB (Bar Shank) Series	PVS (Spike Shank) Series
<b>A-Frame</b>	Heavy Duty Solid	
<b>Hitch</b>	ASAE Cat 1 Heavy Duty Double Strap	
<b>Shank</b>	Bar, Reversible	Spike, Non-Reversible
<b>Working Width</b>	60" - 84"	
<b>Roller Bearing</b>	1"	
<b>Rear Roller</b>	Hinged	
<b>Number of Rollers</b>	(1) Single Roll, (2) Double Roll	
<b>Independent Spring Tension</b>	Yes	
<b>Spikes on Roller</b>	No	1¼"
<b>Maximum Tractor HP</b>	60 PTO	
<b>One-Year Limited Warranty.</b>		

**HOW TO ORDER:** The PV Series Pulverizer is available as a lift-type implement only. It is priced as a complete unit and is shipped fully assembled. Select the desired model from the ordering section below.

Freight NOT included in list price. Freight discount available for multiple unit orders. Please contact Customer Service for details.

**SINGLE ROLL PULVERIZER – BASE UNIT SELECTION**

Model Number	Description	Approx. Wt.	List Price (\$US)
PVB-600	PVB Series Single Roller Pulverizer, Bar Shank, 60", Caterpillar Yellow	530 lb.	\$2,010
PVB-660	PVB Series Single Roller Pulverizer, Bar Shank, 66", Caterpillar Yellow	560 lb.	\$2,197
PVB-720	PVB Series Single Roller Pulverizer, Bar Shank, 72", Caterpillar Yellow	590 lb.	\$2,403
PVB-840	PVB Series Single Roller Pulverizer, Bar Shank, 84", Caterpillar Yellow	650 lb.	\$2,865
PVS-600	PVS Series Single Roller Pulverizer, Spike Shank, 60", Caterpillar Yellow	530 lb.	\$2,010
PVS-660	PVS Series Single Roller Pulverizer, Spike Shank, 66", Caterpillar Yellow	560 lb.	\$2,197
PVS-720	PVS Series Single Roller Pulverizer, Spike Shank, 72", Caterpillar Yellow	590 lb.	\$2,404
PVS-840	PVS Series Single Roller Pulverizer, Spike Shank, 84", Caterpillar Yellow	650 lb.	\$2,866

**DOUBLE ROLL PULVERIZER – BASE UNIT SELECTION**

Model Number	Description	Approx. Wt.	List Price (\$US)
PVB-602	PVB Series Double Roller Pulverizer, Bar Shank, 60", Caterpillar Yellow	640 lb.	\$2,538
PVB-662	PVB Series Double Roller Pulverizer, Bar Shank, 66", Caterpillar Yellow	680 lb.	\$2,738
PVB-722	PVB Series Double Roller Pulverizer, Bar Shank, 72", Caterpillar Yellow	720 lb.	\$3,099
PVB-842	PVB Series Double Roller Pulverizer, Bar Shank, 84", Caterpillar Yellow	790 lb.	\$3,630
PVS-602	PVS Series Double Roller Pulverizer, Spike Shank, 60", Caterpillar Yellow	640 lb.	\$2,538
PVS-662	PVS Series Double Roller Pulverizer, Spike Shank, 66", Caterpillar Yellow	680 lb.	\$2,736
PVS-722	PVS Series Double Roller Pulverizer, Spike Shank, 72", Caterpillar Yellow	720 lb.	\$3,097
PVS-842	PVS Series Double Roller Pulverizer, Spike Shank, 84", Caterpillar Yellow	790 lb.	\$3,630

**RETURN TO INDEX**



**PG SERIES**



**MPG SERIES**

## PG & MPG SERIES PLUGGERS | CORE-TYPE & SLICING AERATORS

MODEL	PG-600	PG-720	MPG-600	MPG-720
Working Width	60"	72"	60"	72"
Shaft	1 1/4"			
Sleeves	Greaseable			
Spoons	3/4" Hard Spoons With Closed Design			
Number of Hubs	8	10	12	
Number of Spoons	64	80	96	
Number of Slicing Knives	32	40	48	
Weight Box	Heavy Duty Steel Weight Rack			
Hitch	(Lift) ASAE Cat 1 Std & Quick Hitch			
Maximum Tractor HP	60 (PTO)			
<b>One-Year Limited Warranty.</b>				

**HOW TO ORDER:**

The Plugger Series Core Type Aerator is available as a lift-type implement only. It is priced as a complete unit and is shipped fully assembled. Select the desired model from the ordering section below. Optional Slicing Knife, available for all models, may be selected from the Options list.

Freight NOT included in list price. Freight discount available for multiple unit orders. Please contact Customer Service for details.

**PG SERIES PLUGGER – BASE UNIT SELECTION**

Model Number	Description	Approx. Wt.	List Price (\$US)
PG-600	PG Series Plugger, 8 Hubs, 64 Spoons, 60", Caterpillar Yellow	350 lb.	\$3,571
PG-720	PG Series Plugger, 10 Hubs, 80 Spoons, 72", Caterpillar Yellow	390 lb.	\$4,048

**MPG SERIES PLUGGER – BASE UNIT SELECTION**

Model Number	Description	Approx. Wt.	List Price (\$US)
MPG-600	MPG Series Plugger, 10 Hubs, 80 Spoons, 60", Caterpillar Yellow	460 lb.	\$3,733
MPG-720	MPG Series Plugger, 12 Hubs, 96 Spoons, 72", Caterpillar Yellow	500 lb.	\$4,265

**OPTIONS**

Model Number	Description	List Price (\$US)
95159	Slicing Knives (To receive a complete unit with Slicing Knives instead of Spoons, add Part Number 95159 to your order)	\$29



**RETURN TO INDEX**



## FSP SERIES FERTILIZER SPREADER

MODEL	FSP-500	FSP-800
Hitch	3-Pt ASAE Cat 1 (Not QH)	
Hopper	Polyethylene	
Hopper Capacity	500 lb.	800 lb.
Distribution Fins	Electroplated	
Distribution	Spin	
Frame	Heavy Tube, Powder Coat Paint	
PTO Speed	540	
Spread Swath	Approx. 49'	

**HOW TO ORDER:**

The FSP Series Fertilizer Spreader is priced as a complete unit. These units are available in multiples of two (2) only.

Freight NOT included in list price. Freight discount available for multiple unit orders. Please contact Customer Service for details.

### BASE UNIT SELECTION

Model Number	Description	Approx. Wt.	List Price (\$US)
FSP-500	FSP Series Fertilizer Spreader, 3-Pt Hitch, 500 lb. Hopper Capacity	123 lb.	each <b>\$853</b>
FSP-800	FSP Series Fertilizer Spreader, 3-Pt Hitch, 800 lb. Hopper Capacity	128 lb.	each <b>\$914</b>

NOTE: Must be ordered in multiples of two (Models can be mixed).



**RETURN TO INDEX**



All models are available in the colors below:	
Model Color Indicator	Unit Color
01	Bush Hog Red
03	John Deere Green
05	Kubota Orange
14	New Holland Blue
34	Grey

**\*\*\* THIS PRODUCT IS PRICED AT LIST LESS 25% \*\*\***

## MANURE SPREADER

### HOW TO ORDER:

Select a model number and be sure to add a color code to the end.

Freight NOT included in list price. Freight discount available for multiple unit orders. Please contact Customer Service for details.

### BASE UNIT SELECTION

\*\* Please use Model Color Indicator behind product model number (ex. MS500G-03)

Model Number	Description	List Price (\$US)
<b>GROUND DRIVE MANURE SPREADERS</b>		
MS250G	25 Bushel capacity, ground drive, 3 speed apron drive, poly floor, full length frame, no jack	\$4,347
MS500G	50 bushel capacity, ground drive, 3 speed apron drive, poly floor, full length frame, with jack stand	\$6,286
MS800G	80 bushel capacity, ground drive, 3 speed apron drive, poly floor, full length frame, with jack stand	\$6,892
<b>PTO DRIVE MANURE SPREADERS</b>		
MS500P	50 bushel capacity, PTO drive, 3 speed apron drive, poly floor, full length frame, with jack stand	\$6,286
MS800P	80 bushel capacity, PTO drive, 3 speed apron drive, poly floor, full length frame, with jack stand	\$6,892
MS1300P	130 bushel capacity, PTO drive, 2 speed apron drive, plus clean out speed, Tires-11L-15 SL/6	\$15,386
MS1300X	130 bushel capacity, PTO drive, 2 speed apron drive, plus clean out speed, T model c/w re- tread - Re-tread tire size 11R22-5/8	\$15,386

### OPTIONS

#### JACK STANDS

Z91513	Flat bottom jack, optional on MS250G, std on all other models	\$121
--------	---	-------

#### TOP BEATER FOR MS1300 & 1300X MODEL ONLY

M7640	Top Beater Option	\$1,227
-------	-------------------	---------

#### FINES PANS

M7550	Fines pan for MS250G	\$383
M7610	Fines pan: Fits MX50P (all serial numbers); MX50G SN# B07920001 and up	\$439
M7620	Fines pan: Fits MX130 & MX130T models only	\$1,438

#### END GATES

M7570	End Gate: Fits MX50P (all serial numbers); MX50G SN# B07920001 and up	\$674
M7580	End Gate: Fits MX80G SN# A0596023 and up; MX80P SN# A0597011 and up	\$653
M7630	End Gate: Fits MX130 & MX130T models only. Hydraulic operated	\$1,893

[RETURN TO INDEX](#)



All models are available in the colors below:	
Model Color Indicator	Unit Color
01	Bush Hog Red
03	John Deere Green
05	Kubota Orange
14	New Holland Blue
16	Caterpillar Yellow

## CULTIPACKER

MODEL	CP960	CP972	CP984	CP996	CP1560	CP1572	CP1584	CP1596	CP1660	CP1672	CP1684	CP1696
Hitch	Cat 1 & Quick Hitch											
Overall Width	67.19"	80.38"	91.78"	103.19"	67.72"	80.91"	92.31"	103.72"	67.72"	80.91"	92.31"	103.72"
Working Width	60"	72"	84"	96"	60"	72"	84"	96"	60"	72"	84"	96"
Overall Length	16.79"				20.47"				21.12"			
Overall Height	33.11"				37.53"				38.18"			
Roller Diameter	9.6"				15"				16.3"			
Roller Material	Notched Gray Iron				Smooth Gray Iron				Notched Ductile Iron			
Unit Weight (lb)	427	501	564	625	614	717	816	917	712	835	954	1073
Minimum Tractor HP	35											

**HOW TO ORDER:** Select a model number and color code indicator to receive a complete unit.

Freight NOT included in list price. Freight discount available for multiple unit orders. Please contact Customer Service for details.

### BASE UNIT SELECTION

Model Number	Description	Approx. Wt.	List Price (\$US)
CP960-xx	3-Pt 60" Cultipacker, 9.5" Gray Iron Notched - 1.75" Axle	427 lb.	\$1,978
CP972-xx	3-Pt 72" Cultipacker, 9.5" Gray Iron Notched - 1.75" Axle	501 lb.	\$2,170
CP984-xx	3-Pt 84" Cultipacker, 9.5" Gray Iron Notched - 1.75" Axle	564 lb.	\$2,366
CP996-xx	3-Pt 96" Cultipacker, 9.5" Gray Iron Notched - 1.75" Axle	625 lb.	\$2,668
CP1560-xx	3-Pt 60" Cultipacker, 15" Gray Iron Smooth - 2" Axle	614 lb.	\$2,387
CP1572-xx	3-Pt 72" Cultipacker, 15" Gray Iron Smooth - 2" Axle	717 lb.	\$2,859
CP1584-xx	3-Pt 84" Cultipacker, 15" Gray Iron Smooth - 2" Axle	816 lb.	\$3,332
CP1596-xx	3-Pt 96" Cultipacker, 15" Gray Iron Smooth - 2" Axle	917 lb.	\$3,819
CP1660-xx	3-Pt 60" Cultipacker, 16.3" Ductile Iron Notched - 2" Axle	712 lb.	\$2,603
CP1672-xx	3-Pt 72" Cultipacker, 16.3" Ductile Iron Notched - 2" Axle	835 lb.	\$3,124
CP1684-xx	3-Pt 84" Cultipacker, 16.3" Ductile Iron Notched - 2" Axle	954 lb.	\$3,640
CP1696-xx	3-Pt 96" Cultipacker, 16.3" Ductile Iron Notched - 2" Axle	1,073 lb.	\$4,146

**RETURN TO INDEX**



## BUSH HOG QUICK HITCH

MODEL	BHQA1	BHQA2
Width	32 <sup>3</sup> / <sub>4</sub> "	39 <sup>1</sup> / <sub>4</sub> "
Maximum Recommended HP	50 HP	100 HP
<b>ISO CERTIFIED</b>		

**HOW TO ORDER:**

The BH Series Quick Attachment is priced as a complete unit. Indicate your choice of model from the Base Unit Selection below. Note: Bush Hog Quick Hitches are sold in packs of 2 units.

Freight NOT included in list price. Freight discount available for multiple unit orders. Please contact Customer Service for details.

### BASE UNIT SELECTION

Model Number	Description	Approx. Wt.	List Price (\$US)
BHQA1	Quick Hitch for Category 1 Tractors	75 lb.	<b>\$295</b>
BHQA2	Quick Hitch for Category 2 Tractors	108 lb.	<b>\$480</b>

\*\* BHQA1 & BHQA2 Quick Hitches are sold in packs of two same size units \*\*





[RETURN TO INDEX](#)

**TILLAGE**

# TILLAGE

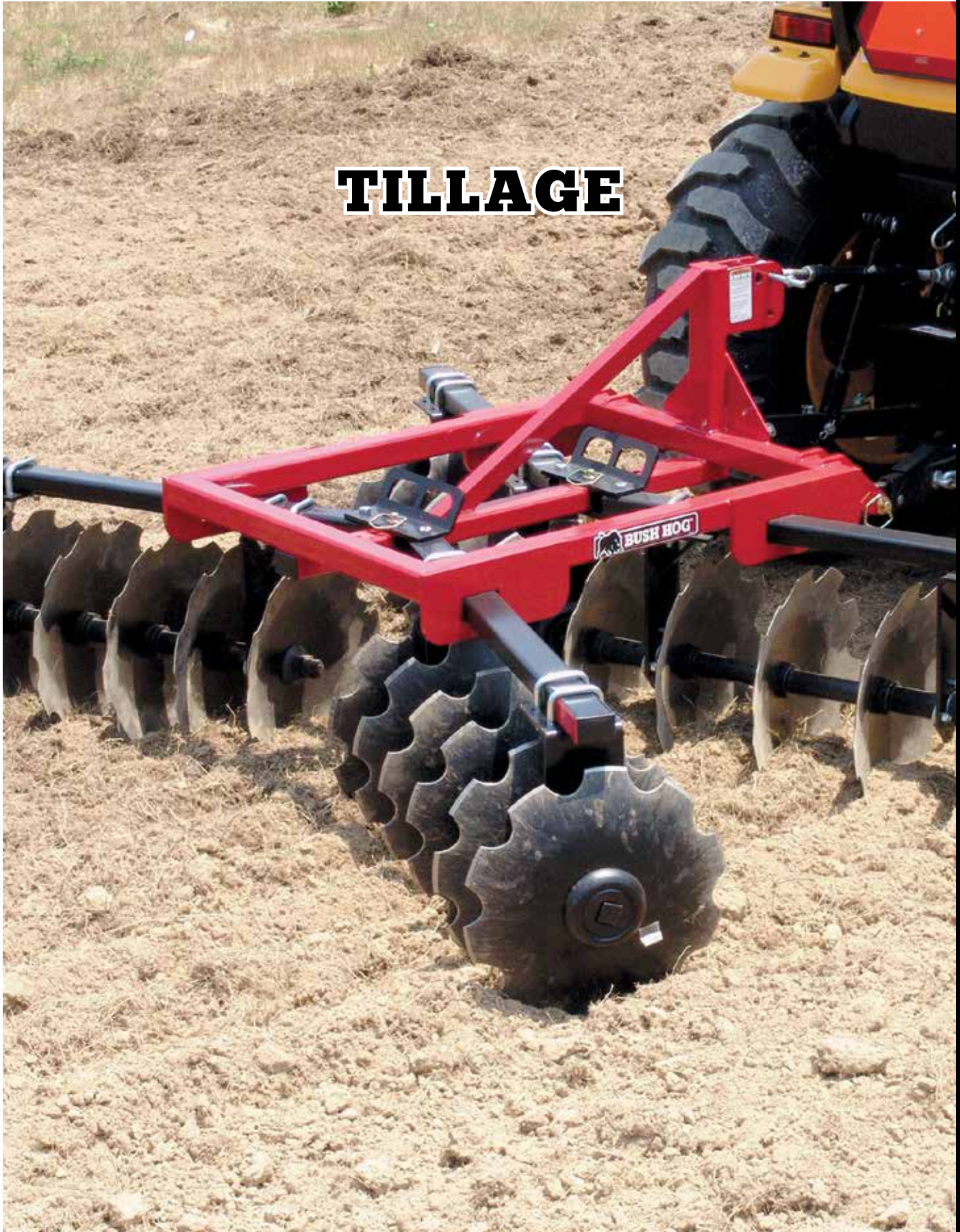

**RETURN TO INDEX**



## RTC SERIES ROTARY TILLER

MODEL	RTC
Tractor HP Range	15 PTO
Hitch	ASAE Cat 1 Quick Hitch
Offset	Center Mount
Tillage Width	48"
Number of Flanges (Rotor)	5
Number of Blades	30
Rotor Speed (540 PTO)	253 rpm
Blades	C Type
Power to Rotor	Gear
Transmission Depth of Cut*	6"
Slip Clutch	Standard

**Five-Year Limited Gearbox Warranty. One-Year Limited Machine Warranty.**

\*May require additional passes, depending on soil type.

### HOW TO ORDER:

The RTC Series Rotary Tiller is priced as a complete unit and is shipped fully assembled except for the hitch.

Freight NOT included in list price. Freight discount available for multiple unit orders. Please contact Customer Service for details.

### BASE UNIT SELECTION

Model Number	Description	Approx. Wt.	Approx. Ship Wt.	List Price (\$US)
RTC50G-03	RTC Series Rotary Tiller, JD Green, 48" Tillage Width, 15 LH Blades, 15 RH Blades, Slip Clutch Standard	374 lb.	395 lb.	each <b>\$2,280</b>
RTC50G-05	RTC Series Rotary Tiller, Kubota Orange, 48" Tillage Width, 15 LH Blades, 15 RH Blades, Slip Clutch Standard	374 lb.	395 lb.	each <b>\$2,280</b>
RTC50G-14	RTC Series Rotary Tiller, New Holland Blue, 48" Tillage Width, 15 LH Blades, 15 RH Blades, Slip Clutch Standard	374 lb.	395 lb.	each <b>\$2,280</b>
RTC50G-21	RTC Series Rotary Tiller, Bush Hog Red, 48" Tillage Width, 15 LH Blades, 15 RH Blades, Slip Clutch Standard	374 lb.	395 lb.	each <b>\$2,280</b>

RTC Series tillers are sold in packs of two, same size and same color.

**RETURN TO INDEX**



## RTG SERIES ROTARY TILLER

MODEL	RT60G	RT60GR	RT72G	RT72GR	RT84G	RT84GR
<b>Rotation</b>	Standard	Reverse	Standard	Reverse	Standard	Reverse
<b>Drivetrain</b>	Gear					
<b>Hitch</b>	ASAE Cat 1, Std and Quick Hitch			ASAE Cat 1 & 2, Std and Quick Hitch		
<b>Working Width</b>	59"		70.5"		82.5"	
<b>Total Width</b>	66"		78"		90"	
<b>Number of Flanges</b>	7		9		11	
<b>Blades per Flange</b>	6					
<b>Rotor/Blade Rotation Diameter</b>	17"					
<b>Rotor Shaft Diameter</b>	3"					
<b>Rotor RPM</b>	211					
<b>Weight</b>	673 lb.	683 lb.	747 lb.	759 lb.	817 lb.	831 lb.
<b>PTO Driveline with Slip Clutch</b>	ASAE Category 4					
<b>Tilling Depth*</b>	7.5"					
<b>Minimum/Maximum Tractor H.P. (PTO)</b>	25/45		35/55		45/65	

**Five-Year Limited Gearbox Warranty. One-Year Limited Machine Warranty.**

\*Requires multiple passes.

### HOW TO ORDER:

The RTG Series Rotary Tiller is priced as a complete unit and is shipped fully assembled. To receive a complete unit, indicate your model choice and desired color from the Base Unit Selection of the ordering section on the following page.

Freight NOT included in list price. **Freight discount available for multiple unit orders. Please contact Customer Service for details.**



RETURN TO INDEX

All models are available in the colors below:	
Model Color Indicator	Unit Color
<b>R</b>	<b>Bush Hog Red</b>
<b>G</b>	<b>John Deere Green</b>
<b>O</b>	<b>Kubota Orange</b>
<b>B</b>	<b>New Holland Blue</b>

## RTG SERIES ROTARY TILLER

### BASE UNIT SELECTION

Model Number	Description	Approx. Wt.	Approx. Ship Wt.	List Price (\$US)
RT60G-1x	RTG Series Rotary Tiller, Standard Rotation, 59" Working Width, All Gear Drive and Driveline with Slip Clutch	673 lb.	798 lb.	<b>\$2,804</b>
RT60GR-1x	RTG Series Rotary Tiller, Reverse Rotation, 59" Working Width, All Gear Drive and Driveline with Slip Clutch	683 lb.	808 lb.	<b>\$3,002</b>
RT72G-1x	RTG Series Rotary Tiller, Standard Rotation, 70.5" Working Width, All Gear Drive and Driveline with Slip Clutch	747 lb.	877 lb.	<b>\$3,220</b>
RT72GR-1x	RTG Series Rotary Tiller, Reverse Rotation, 70.5" Working Width, All Gear Drive and Driveline with Slip Clutch	759 lb.	889 lb.	<b>\$3,417</b>
RT84G-1x	RTG Series Rotary Tiller, Standard Rotation, 82.5" Working Width, All Gear Drive and Driveline with Slip Clutch	817 lb.	952 lb.	<b>\$3,779</b>
RT84GR-1x	RTG Series Rotary Tiller, Reverse Rotation, 82.5" Working Width, All Gear Drive and Driveline with Slip Clutch	831 lb.	966 lb.	<b>\$3,975</b>

### OPTIONS

Model Number	Description	Approx. Wt.	List Price (\$US)
50081431	Tiller Hitch Extension Kit <i>(fits RT60, RT72 models; not compatible with RT84)</i>	15 lb.	<b>\$153</b>
50076433	Front Deflector Kit, 5' Tiller	10 lb.	<b>\$22</b>
50076534	Front Deflector Kit, 6' Tiller	10 lb.	<b>\$26</b>
50076435	Front Deflector Kit, 7' Tiller	10 lb.	<b>\$32</b>

*(For use on tractors with shorter lower lift arms. Not compatible with Quick Hitch)*

**RETURN TO INDEX**



## RTX HEAVY DUTY SERIES ROTARY TILLER

MODEL	RTX85G	RTX92G
Rotation	Standard	
Drivetrain	Gear	
Hitch	ASAE Cat. 1 Std. & QH, Cat. 2 Std.	
Working Width	85"	92"
Total Width	91"	99"
Hood thickness	10 ga.	
End Plates Thickness	.375"	
Number of Flanges	9	10
Blades per Flange	6	
Rotor Shaft Diameter	3.5"	
Rotor Shaft Wall Thickness	.25"	
Rotor RPM	235	
Weight	1,094 lb	1,149 lb.
PTO Driveline with Slip Clutch	ASAE Category 4	
Tilling Depth*	10"	
Min / Max Tractor HP (PTO)	60 / 90	
Colors	Red	

**Five-Year Limited Gearbox Warranty. One-Year Limited Machine Warranty.**

### HOW TO ORDER:

The RTX Series Rotary Tiller is priced as a complete unit and is shipped fully assembled except for the hitch.

Freight NOT included in list price. Freight discount available for multiple unit orders. Please contact Customer Service for details.

### COMPLETE UNIT SELECTION

Model Number	Description	Approx. Wt.	List Price (\$US)
RTX85G	RTX Series Rotary Tiller, 85" Working Width, All Gear Drive WITH Slip Clutch	1,094 lb.	\$6,268
RTX92G	RTX Series Rotary Tiller, 92" Working Width, All Gear Drive WITH Slip Clutch	1,149 lb.	\$6,460

**RETURN TO INDEX**



## 1D SERIES LIFT DISC HARROW

MODEL	1D60-xx	1D78-xx
Hitch	Cat. 1 Std. & Quick Hitch	
Recommended HP	35 HP	
Bearing Hanger	3/8" x 6", Dual 1/2" U-Bolts	
Bearing Type - 2/Gang	Self-Aligning, Sealed Ball Bearings	
Angling Capabilities	0, 7, 14, 21 Degrees (Front & Rear Gangs)	
Frame Tubes	2" Square	
Gang Tubes	3" x 1 1/2"	
Gang Axles	1" Square, High Carbon Steel	
Options	Disc Scrapers	

### GANG INFO - 1D60-XX

Disc Blade Spacing	Disc Blade Size	Cutting Width	Overall Width	No. Disc Blades	Gang Weight	Frame Weight	Total Weight	Axle Length
9" Front & Rear	16"	51.4"	58.2"	12	308 lb.	135 lb.	443 lb.	21.5"
7.5" Front & Rear	16"	61"	67.8"	16	348 lb.	135 lb.	483 lb.	26"
9" Front, 7.5" Rear	16"	61"	67.8"	14	312 lb.	135 lb.	447 lb.	21.5" (F) / 26" (R)
9" Front & Rear	18"	51.4"	58.2"	12	344 lb.	135 lb.	479 lb.	21.5"
7.5" Front & Rear	18"	61"	67.8"	16	395 lb.	135 lb.	530 lb.	26"
9" Front, 7.5" Rear	18"	61"	67.8"	14	339 lb.	135 lb.	474 lb.	21.5" (F) / 26" (R)

### GANG INFO - 1D78-XX

Disc Blade Spacing	Disc Blade Size	Cutting Width	Overall Width	No. Disc Blades	Gang Weight	Frame Weight	Total Weight	Axle Length
9" Front & Rear	16"	69"	75.8"	16	372 lb.	135 lb.	507 lb.	31"
7.5" Front & Rear	16"	76.5"	83.3"	20	312 lb.	135 lb.	447 lb.	34"
9" Front, 7.5" Rear	16"	76.5"	83.3"	18	395 lb.	135 lb.	530 lb.	31" (F) / 34" (R)
9" Front & Rear	18"	69"	75.8"	16	420 lb.	135 lb.	555 lb.	31"
7.5" Front & Rear	18"	76.5"	83.3"	20	468 lb.	135 lb.	603 lb.	34"
9" Front, 7.5" Rear	18"	76.5"	83.3"	18	339 lb.	135 lb.	474 lb.	31" (F) / 34" (R)



**RETURN TO INDEX**

All models are available in the colors below:	
Model Color Indicator	Unit Color
01	Bush Hog Red
03	John Deere Green
05	Kubota Orange
14	New Holland Blue
16	Caterpillar Yellow

## 1D SERIES LIFT DISC HARROW

### BASE UNIT SELECTION

Model Number	Description	List Price (\$US)
1D60-xx	1D Series Lift Disc Harrow 60"	\$462
1D78-xx	1D Series Lift Disc Harrow 78"	\$462

### GANG ASSEMBLY SELECTION

Model Number	Description	List Price (\$US)
50072592	1D60 Gang Assembly, 16" Scallop Disc, 7.5" Front & Rear Spacing	\$1,490
50072593	1D60 Gang Assembly, 16" Scallop Disc, 9" Front & Rear Spacing	\$1,388
50072594	1D60 Gang Assembly, 16" Scallop Disc, 9" Front, 7.5" Rear Spacing	\$1,450
50072595	1D60 Gang Assembly, 18" Scallop Disc, 7.5" Front & Rear Spacing	\$1,565
50072596	1D60 Gang Assembly, 18" Scallop Disc, 9" Front & Rear Spacing	\$1,442
50072597	1D60 Gang Assembly, 18" Scallop Disc, 9" Front, 7.5" Rear Spacing	\$1,511
50072598	1D78 Gang Assembly, 16" Scallop Disc, 7.5" Front & Rear Spacing	\$1,620
50072599	1D78 Gang Assembly, 16" Scallop Disc, 9" Front & Rear Spacing	\$1,542
50072600	1D78 Gang Assembly, 16" Scallop Disc, 9" Front, 7.5" Rear Spacing	\$1,584
50072601	1D78 Gang Assembly, 18" Scallop Disc, 7.5" Front & Rear Spacing	\$1,726
50072602	1D78 Gang Assembly, 18" Scallop Disc, 9" Front & Rear Spacing	\$1,627
50072603	1D78 Gang Assembly, 18" Scallop Disc, 9" Front, 7.5" Rear Spacing	\$1,672

### OPTIONS (1D SERIES ONLY)

Model Number	Description	List Price (\$US)
50073441	1D60 Scraper Kit, 16/18 Discs, 7.5" Front & Rear Spacing	\$546
50073442	1D60 Scraper Kit, 16/18 Discs, 9" Front & Rear Spacing	\$430
50069898	1D60 Scraper Kit, 16/18 Discs, 9" Front, 7.5" Rear Spacing	\$514
50073443	1D78 Scraper Kit, 16/18 Discs, 7.5" Front & Rear Spacing	\$661
50073444	1D78 Scraper Kit, 16/18 Discs, 9" Front & Rear Spacing	\$613
50070558	1D78 Scraper Kit, 16/18 Discs, 9" Front, 7.5" Rear Spacing	\$618

**RETURN TO INDEX**



**2D SERIES**

## 2D SERIES LIFT DISC HARROW

MODEL	2D78-xx	2D96-xx
<b>Hitch</b>	Cat. 1 Std. & Quick Hitch	
<b>Recommended HP</b>	65 HP	
<b>Bearing Hanger</b>	3/8" x 6", Dual 5/8" U-Bolts	
<b>Bearing Type - 2/Gang</b>	Self-Aligning, Sealed Ball Bearings	
<b>Angling Capabilities</b>	0, 7, 14, 21 Degrees (Front & Rear Gangs)	
<b>Frame Tubes</b>	2½" Square	
<b>Gang Tubes</b>	3" x 2"	
<b>Gang Axles</b>	1" Square, High Carbon Steel	
<b>Options</b>	Disc Scrapers	

### GANG INFO - 2D78-XX

Disc Blade Spacing	Disc Blade Size	Cutting Width	Overall Width	No. Disc Blades	Gang Weight	Frame Weight	Total Weight	Axle Length
9" Front & Rear	18"	70.8"	77.6"	16	452 lb.	223 lb.	675 lb.	31"
7.5" Front & Rear	18"	78.13"	84.9"	20	477 lb.	223 lb.	700 lb.	34"
9" Front, 7.5" Rear	18"	78.13"	84.9"	18	472 lb.	223 lb.	695 lb.	31" (F) / 34" (R)
9" Front & Rear	20"	70.8"	77.6"	16	504 lb.	223 lb.	727 lb.	31"
7.5" Front & Rear	20"	78.13"	84.9"	20	547 lb.	223 lb.	770 lb.	34"
9" Front, 7.5" Rear	20"	78.13"	84.9"	18	543 lb.	223 lb.	766 lb.	31" (F) / 34" (R)

### GANG INFO - 2D96-XX

Disc Blade Spacing	Disc Blade Size	Cutting Width	Overall Width	No. Disc Blades	Gang Weight	Frame Weight	Total Weight	Axle Length
9" Front & Rear	18"	88.9"	95.7"	20	517 lb.	223 lb.	740 lb.	39.5"
7.5" Front & Rear	18"	91.3"	98.2"	24	580 lb.	223 lb.	803 lb.	41"
9" Front, 7.5" Rear	18"	91.3"	98.2"	22	635 lb.	223 lb.	858 lb.	39.5" (F) / 41" (R)
9" Front & Rear	20"	88.9"	95.7"	20	592 lb.	223 lb.	815 lb.	39.5"
7.5" Front & Rear	20"	91.3"	98.2"	24	648 lb.	223 lb.	871 lb.	41"
9" Front, 7.5" Rear	20"	91.3"	98.2"	22	679 lb.	223 lb.	902 lb.	39.5" (F) / 41" (R)





**RETURN TO INDEX**

All models are available in the colors below:	
Model Color Indicator	Unit Color
01	Bush Hog Red
03	John Deere Green
05	Kubota Orange
14	New Holland Blue
16	Caterpillar Yellow

## 2D SERIES LIFT DISC HARROW

### BASE UNIT SELECTION

Model Number	Description	List Price (\$US)
2D78-xx	2D Series Lift Disc Harrow 78"	\$767
2D96-xx	2D Series Lift Disc Harrow 96"	\$767

### GANG ASSEMBLY SELECTION

Model Number	Description	List Price (\$US)
50072738	2D78 Gang Assembly, 18" Scallop Disc, 7.5" Front & Rear Spacing	\$1,924
50072739	2D78 Gang Assembly, 18" Scallop Disc, 9" Front & Rear Spacing	\$1,776
50072740	2D78 Gang Assembly, 18" Scallop Disc, 9" Front, 7.5" Rear Spacing	\$1,790
50072741	2D78 Gang Assembly, 20" Scallop Disc, 7.5" Front & Rear Spacing	\$2,184
50072742	2D78 Gang Assembly, 20" Scallop Disc, 9" Front & Rear Spacing	\$2,000
50072743	2D78 Gang Assembly, 20" Scallop Disc, 9" Front, 7.5" Rear Spacing	\$2,027
50072744	2D96 Gang Assembly, 18" Scallop Disc, 7.5" Front & Rear Spacing	\$2,310
50072745	2D96 Gang Assembly, 18" Scallop Disc, 9" Front & Rear Spacing	\$2,189
50072746	2D96 Gang Assembly, 18" Scallop Disc, 9" Front, 7.5" Rear Spacing	\$2,225
50072747	2D96 Gang Assembly, 20" Scallop Disc, 7.5" Front & Rear Spacing	\$2,729
50072748	2D96 Gang Assembly, 20" Scallop Disc, 9" Front & Rear Spacing	\$2,489
50072749	2D96 Gang Assembly, 20" Scallop Disc, 9" Front, 7.5" Rear Spacing	\$2,503

### OPTIONS (2D SERIES ONLY)

Model Number	Description	List Price (\$US)
50073445	2D78 Scraper Kit, 18/20 Discs, 7.5" Front & Rear Spacing	\$691
50073446	2D78 Scraper Kit, 18/20 Discs, 9" Front & Rear Spacing	\$624
50069897	2D78 Scraper Kit, 18/20 Discs, 9" Front, 7.5" Rear Spacing	\$678
50073447	2D96/3D96 Scraper Kit, (18/20, 20/22 Discs), 7.5" Front & Rear Spacing	\$795
50073448	2D96/3D96 Scraper Kit, (18/20, 20/22 Discs), 9" Front & Rear Spacing	\$720
50070559	2D96/3D96 Scraper Kit, (18/20, 20/22 Discs), 9" Front, 7.5" Rear Spacing	\$780

**RETURN TO INDEX**



**3D SERIES**

## 3D SERIES LIFT DISC HARROW

MODEL	3D96-xx	3D118-xx
<b>Hitch</b>	Cat. 1 & 2 Std. & Quick Hitch	
<b>Recommended HP</b>	95 HP	
<b>Bearing Hanger</b>	1/2" x 7", Dual 5/8" U-Bolts	
<b>Bearing Type - 2/Gang</b>	Self-Aligning, Sealed Ball Bearings	
<b>Angling Capabilities</b>	0, 7, 14, 21 Degrees (Front Gangs); 7, 14, 21 Degrees (Rear Gangs)	
<b>Frame Tubes</b>	3" Square	
<b>Gang Tubes</b>	4" x 3"	
<b>Gang Axles</b>	1 1/8" Square, High Carbon Steel	
<b>Options</b>	Disc Scrapers	

### GANG INFO - 3D96-XX

Disc Blade Spacing	Disc Blade Size	Cutting Width	Overall Width	No. Disc Blades	Gang Weight	Frame Weight	Total Weight	Axle Length
9" Front & Rear	20"	88.8"	95.7"	20	773 lb.	379 lb.	1,152 lb.	40.25"
7.5" Front & Rear	20"	93.4"	100.3"	24	807 lb.	379 lb.	1,186 lb.	42"
9" Front, 7.5" Rear	20"	93.4"	100.3"	22	794 lb.	379 lb.	1,173 lb.	40.25" (F) / 42" (R)
9" Front & Rear	22"	88.8"	95.7"	20	896 lb.	379 lb.	1,275 lb.	40.25"
7.5" Front & Rear	22"	93.4"	100.3"	24	932 lb.	379 lb.	1,311 lb.	42"
9" Front, 7.5" Rear	22"	93.4"	100.3"	22	920 lb.	379 lb.	1,299 lb.	40.25" (F) / 42" (R)

### GANG INFO - 3D118-XX

Disc Blade Spacing	Disc Blade Size	Cutting Width	Overall Width	No. Disc Blades	Gang Weight	Frame Weight	Total Weight	Axle Length
9" Front & Rear	20"	107"	113.9"	24	867 lb.	379 lb.	1,246 lb.	49.5"
7.5" Front & Rear	20"	106.8"	113.7"	28	1,052 lb.	379 lb.	1,431 lb.	49.5"
9" Front, 7.5" Rear	20"	106.8"	113.7"	26	976 lb.	379 lb.	1,355 lb.	49.5"
9" Front & Rear	22"	107"	113.9"	24	1,002 lb.	379 lb.	1,381 lb.	49.5"
7.5" Front & Rear	22"	106.8"	113.7"	28	1,100 lb.	379 lb.	1,479 lb.	49.5"
9" Front, 7.5" Rear	22"	106.8"	113.7"	26	1,106 lb.	379 lb.	1,485 lb.	49.5"

#### HOW TO ORDER:

These disc harrows are available as lift type implements only. For total price, select a model, gang assembly, and any desired option. Units are shipped fully assembled.

Freight NOT included in list price. **Freight discount available for multiple unit orders. Please contact Customer Service for details.**



**RETURN TO INDEX**

All models are available in the colors below:	
Model Color Indicator	Unit Color
01	Bush Hog Red
03	John Deere Green
05	Kubota Orange
14	New Holland Blue
16	Caterpillar Yellow

## 3D SERIES LIFT DISC HARROW

### BASE UNIT SELECTION

Model Number	Description	List Price (\$US)
3D96-xx	3D Series Lift Disc Harrow 96"	\$1,380
3D118-xx	3D Series Lift Disc Harrow 118"	\$1,380

### GANG ASSEMBLY SELECTION

Model Number	Description	List Price (\$US)
50072750	3D96 Gang Assembly, 20" Scallop Disc, 7.5" Front & Rear Spacing	\$3,699
50072751	3D96 Gang Assembly, 20" Scallop Disc, 9" Front & Rear Spacing	\$3,645
50072752	3D96 Gang Assembly, 20" Scallop Disc, 9" Front, 7.5" Rear Spacing	\$3,581
50072753	3D96 Gang Assembly, 22" Scallop Disc, 7.5" Front & Rear Spacing	\$4,104
50072754	3D96 Gang Assembly, 22" Scallop Disc, 9" Front & Rear Spacing	\$3,840
50072755	3D96 Gang Assembly, 22" Scallop Disc, 9" Front, 7.5" Rear Spacing	\$3,943
50072756	3D118 Gang Assembly, 20" Scallop Disc, 7.5" Front & Rear Spacing	\$4,254
50072757	3D118 Gang Assembly, 20" Scallop Disc, 9" Front & Rear Spacing	\$4,068
50072758	3D118 Gang Assembly, 20" Scallop Disc, 9" Front, 7.5" Rear Spacing	\$4,145
50072759	3D118 Gang Assembly, 22" Scallop Disc, 7.5" Front & Rear Spacing	\$4,731
50072760	3D118 Gang Assembly, 22" Scallop Disc, 9" Front & Rear Spacing	\$4,506
50072761	3D118 Gang Assembly, 22" Scallop Disc, 9" Front, 7.5" Rear Spacing	\$4,588

### OPTIONS (3D SERIES ONLY)

Model Number	Description	List Price (\$US)
50073447	2D96/3D96 Scraper Kit, (18/20, 20/22 Discs), 7.5" Front & Rear Spacing	\$795
50073448	2D96/3D96 Scraper Kit, (18/20, 20/22 Discs), 9" Front & Rear Spacing	\$720
50070559	2D96/3D96 Scraper Kit, (18/20, 20/22 Discs), 9" Front, 7.5" Rear Spacing	\$780
50073449	3D118 Scraper Kit, 20/22 Discs, 7.5" Front & Rear Spacing	\$878
50073450	3D118 Scraper Kit, 20/22 Discs, 9" Front & Rear Spacing	\$777
50069896	3D118 Scraper Kit, 20/22 Discs, 9" Front, 7.5" Rear Spacing	\$833

**RETURN TO INDEX**



## DHP SERIES PULL DISC HARROW

MODEL	DHP8	DHP10	DHP12
<b>Drawbar Required HP</b>	40 - 65 HP	45 - 100 HP	55 - 100 HP
<b>Hitch</b>	Pull-Type with Clevis & Hole for 1 1/4" Pin		
<b>Approx. Weight Load on Each Blade</b>	95 - 114 lb.	84 - 98 lb.	78 - 90 lb.
<b>Number of Bearings</b>	8	12	
<b>Disc Bearing Type</b>	Triple Lip Sealed Ball Bearings		
<b>Angling Capabilities</b>	15, 16.5, 18, 19.5, 21 Degrees (Front Gangs); 12, 13.5, 15, 16.5, 18 Degrees (Rear Gangs)		
<b>Frame Tubes</b>	3" Square		
<b>Construction - Tubing</b>	Slide Mainframe, Mainframe Middle, and Gang Arm - 4" x 3" x 1/4"; Mainframe Front and Rear - 5" x 3" x 1/4"; Hitch Frame - 4" x 4" x 1/4"		
<b>Gang Axles</b>	1 1/8" Square, High Carbon Steel		
<b>Front to Rear Leveling System</b>	Manual Crank Adjustment		
<b>Depth Control</b>	Cylinder Stroke Control Spacers		
<b>Hydraulic Cylinder</b>	3 1/2" x 8" ASAE Hydraulic Cylinder		
<b>Transport Tires and Wheels</b>	(Two) 9.5Lx15 Tires on 15" x 6" - 5 Bolt Wheels		
<b>Park Jack</b>	Standard		
<b>Options</b>	Disc Scrapers, Dual Wheel Transport Kit		

### GANG INFO - DHP8

Disc Blade Spacing	Notched Disc Blade Size	Cutting Width	Apprx. Transport Width	No. Disc Blades	Gang Weight	Frame Weight	Total Weight	Axle Length
9" Front & Rear	20"	90.25"	8' 10"	20	792 lb.	1,423 lb.	2,215 lb.	40.25"
7.5" Front & Rear	20"	92.5"	8' 10"	24	864 lb.	1,423 lb.	2,287 lb.	42"
9" Front, 7.5" Rear	20"	92.5"	8' 10"	22	828 lb.	1,423 lb.	2,251 lb.	40.25" (F) / 42" (R)
9" Front & Rear	22"	90.25"	8' 10"	20	856 lb.	1,423 lb.	2,279 lb.	40.25"
7.5" Front & Rear	22"	92.5"	8' 10"	24	976 lb.	1,423 lb.	2,399 lb.	42"
9" Front, 7.5" Rear	22"	92.5"	8' 10"	22	916 lb.	1,423 lb.	2,339 lb.	40.25" (F) / 42" (R)

### GANG INFO - DHP10

Disc Blade Spacing	Notched Disc Blade Size	Cutting Width	Apprx. Transport Width	No. Disc Blades	Gang Weight	Frame Weight	Total Weight	Axle Length
9" Front & Rear	20"	125"	10' 10"	28	1,124 lb.	1,510 lb.	2,634 lb.	58.5"
7.5" Front & Rear	20"	123.25"	10' 10"	32	1,118 lb.	1,510 lb.	2,698 lb.	57.5"
9" Front, 7.5" Rear	20"	123.25"	10' 10"	30	1,156 lb.	1,510 lb.	2,666 lb.	58.5" (F) / 57.5" (R)
9" Front & Rear	22"	125"	10' 10"	28	1,236 lb.	1,510 lb.	2,746 lb.	58.5"
7.5" Front & Rear	22"	123.25"	10' 10"	32	1,272 lb.	1,510 lb.	2,782 lb.	57.5"
9" Front, 7.5" Rear	22"	123.25"	10' 10"	30	1,254 lb.	1,510 lb.	2,764 lb.	58.5" (F) / 57.5" (R)

### GANG INFO - DHP12

Disc Blade Spacing	Notched Disc Blade Size	Cutting Width	Apprx. Transport Width	No. Disc Blades	Gang Weight	Frame Weight	Total Weight	Axle Length
9" Front & Rear	20"	143.25"	12' 4"	32	1,240 lb.	1,510 lb.	2,750 lb.	67.5"
7.5" Front & Rear	20"	140.5"	12' 4"	36	1,300 lb.	1,510 lb.	2,810 lb.	65"
9" Front, 7.5" Rear	20"	140.5"	12' 4"	34	1,270 lb.	1,510 lb.	2,780 lb.	67.5" (F) / 65" (R)
9" Front & Rear	22"	143.25"	12' 4"	32	1,356 lb.	1,510 lb.	2,866 lb.	67.5"
7.5" Front & Rear	22"	140.5"	12' 4"	36	1,468 lb.	1,510 lb.	2,978 lb.	65"
9" Front, 7.5" Rear	22"	140.5"	12' 4"	34	1,412 lb.	1,510 lb.	2,922 lb.	67.5" (F) / 65" (R)

#### HOW TO ORDER:

These disc harrows are available as pull type implements only. For the total price, select a model, gang assembly, and desired option(s). Each unit is shipped in three crates for dealer assembly.

Freight NOT included in list price. **Freight discount available for multiple unit orders. Please contact Customer Service for details.**



**RETURN TO INDEX**

All models are available in the colors below:	
Model Color Indicator	Unit Color
01	Bush Hog Red
03	John Deere Green
05	Kubota Orange
14	New Holland Blue
16	Caterpillar Yellow

## DHP SERIES PULL DISC HARROW

BASE UNIT SELECTION		
Model Number	Description	List Price (\$US)
DHP8-xx	DHP Series Pull Disc Harrow, 8', Single Axle	\$6,372
DHP10-xx	DHP Series Pull Disc Harrow, 10', Single Axle	\$6,440
DHP12-xx	DHP Series Pull Disc Harrow, 12', Single Axle	\$6,440
DHP8 SERIES GANG ASSEMBLY SELECTION		
50072135	DHP8 Gang Assembly, 20" Scallop Disc, 7.5" Front & Rear Spacing	\$4,633
50072136	DHP8 Gang Assembly, 20" Scallop Disc, 9" Front & Rear Spacing	\$4,431
50072137	DHP8 Gang Assembly, 20" Scallop Disc, 9" Front, 7.5" Rear Spacing	\$4,498
50072138	DHP8 Gang Assembly, 22" Scallop Disc, 7.5" Front & Rear Spacing	\$4,899
50072139	DHP8 Gang Assembly, 22" Scallop Disc, 9" Front & Rear Spacing	\$4,696
50072140	DHP8 Gang Assembly, 22" Scallop Disc, 9" Front, 7.5" Rear Spacing	\$4,793
DHP10 SERIES GANG ASSEMBLY SELECTION		
50072141	DHP10 Gang Assembly, 20" Scallop Disc, 7.5" Front & Rear Spacing	\$5,586
50072142	DHP10 Gang Assembly, 20" Scallop Disc, 9" Front & Rear Spacing	\$5,844
50072143	DHP10 Gang Assembly, 20" Scallop Disc, 9" Front, 7.5" Rear Spacing	\$5,503
50072144	DHP10 Gang Assembly, 22" Scallop Disc, 7.5" Front & Rear Spacing	\$5,905
50072145	DHP10 Gang Assembly, 22" Scallop Disc, 9" Front & Rear Spacing	\$5,637
50072146	DHP10 Gang Assembly, 22" Scallop Disc, 9" Front, 7.5" Rear Spacing	\$5,772
DHP12 SERIES GANG ASSEMBLY SELECTION		
50072147	DHP12 Gang Assembly, 20" Scallop Disc, 7.5" Front & Rear Spacing	\$7,513
50072148	DHP12 Gang Assembly, 20" Scallop Disc, 9" Front & Rear Spacing	\$7,245
50072149	DHP12 Gang Assembly, 20" Scallop Disc, 9" Front, 7.5" Rear Spacing	\$7,382
50072230	DHP12 Gang Assembly, 22" Scallop Disc, 7.5" Front & Rear Spacing	\$7,985
50072231	DHP12 Gang Assembly, 22" Scallop Disc, 9" Front & Rear Spacing	\$7,742
50072232	DHP12 Gang Assembly, 22" Scallop Disc, 9" Front, 7.5" Rear Spacing	\$7,847
OPTIONS		
DHP8 SERIES ONLY		
50072310	DHP8 Scraper Kit, 20/22 Discs, 7.5" Front & Rear Spacing	\$1,189
50072311	DHP8 Scraper Kit, 20/22 Discs, 9" Front & Rear Spacing	\$993
50072312	DHP8 Scraper Kit, 20/22 Discs, 9" Front, 7.5" Rear Spacing	\$1,058
DHP10 SERIES ONLY		
50072313	DHP10 Scraper Kit, 20/22 Discs, 7.5" Front & Rear Spacing	\$1,491
50072314	DHP10 Scraper Kit, 20/22 Discs, 9" Front & Rear Spacing	\$1,437
50072315	DHP10 Scraper Kit, 20/22 Discs, 9" Front, 7.5" Rear Spacing	\$1,384
DHP12 SERIES ONLY		
50072316	DHP12 Scraper Kit, 20/22 Discs, 7.5" Front & Rear Spacing	\$1,650
50072317	DHP12 Scraper Kit, 20/22 Discs, 9" Front & Rear Spacing	\$1,568
50072318	DHP12 Scraper Kit, 20/22 Discs, 9" Front, 7.5" Rear Spacing	\$1,596
50072233	DHP Dual Wheel Transport Kit, Available for all DHP models	\$915

**RETURN TO INDEX**



## APP SERIES ALL PURPOSE PLOW

MODEL	APP48-3	APP60-5	APP66-5	APP66-7	APP85-7	APP85-9
Overall Width	49 <sup>5</sup> / <sub>8</sub> "	61 <sup>5</sup> / <sub>8</sub> "	67 <sup>5</sup> / <sub>8</sub> "		85 <sup>5</sup> / <sub>8</sub> "	
Maximum Working Width	44"	56"	62"		80"	
Overall Depth	39 <sup>3</sup> / <sub>4</sub> "					
Overall Height	40 <sup>3</sup> / <sub>8</sub> "					
Weight (lb.)	206	228	284	367	386	455
Number of Shanks	3	5		7		9
Angle Iron Size	2 <sup>1</sup> / <sub>2</sub> " Width x 2 <sup>1</sup> / <sub>2</sub> " Height x 3/8" Thickness					
Hole Spacing	1"					
Hitch	Cat 1 Std & Quick Hitch					
Teeth	5/16" x 2" x 10 <sup>1</sup> / <sub>8</sub> " 1080 High Carbon 38-44 Rockwell C Reversible					
Suggested Min. PTO HP	24	35		49		63

**HOW TO ORDER:**

The All Purpose Plow is available as a lift-type implement only. It is priced as a complete unit and is shipped fully assembled.

Freight NOT included in list price. Freight discount available for multiple unit orders. Please contact Customer Service for details.

**BASE UNIT SELECTION**

Model Number	Description	List Price (\$US)
APP48-3	All Purpose Plow, 48", 3 Shanks, Bush Hog Red	<b>\$856</b>
APP60-5	All Purpose Plow, 60", 5 Shanks, Bush Hog Red	<b>\$1,220</b>
APP66-5	All Purpose Plow, 66", 5 Shanks, Bush Hog Red	<b>\$1,344</b>
APP66-7	All Purpose Plow, 66", 7 Shanks, Bush Hog Red	<b>\$1,575</b>
APP85-7	All Purpose Plow, 85", 7 Shanks, Bush Hog Red	<b>\$1,631</b>
APP85-9	All Purpose Plow, 85", 9 Shanks, Bush Hog Red	<b>\$1,875</b>

**RETURN TO INDEX**

All models are available in the colors below:	
Model Color Indicator	Unit Color
01	Bush Hog Red
03	John Deere Green
05	Kubota Orange
14	New Holland Blue
16	Caterpillar Yellow



## HDSS SERIES HEAVY DUTY SUBSOILER

MODEL	HDSS1S	HDSS1L	HDSS2S	HDSS2L
Hitch	Cat 1 & 2 Quick Hitch			
Overall Width	41"		49"	
Overall Height	39½"	43½"	39½"	43½"
Horsepower	Approximately 35 HP per shank up to 85 HP			
Shank Size	11/4" x 97/16" x 26¼" (Long), 11/4" x 97/16" x 22¼" (Short)			
Number of Shanks	1		2	
Cutting Point	1" x 2½" x 9¾"			
Maximum Cutting Depth	19¼"	23¼"	19¼"	23¼"

**HOW TO ORDER:**

The Heavy Duty Series Subsoiler is available as a 3-Point type implement only. It is priced as a complete unit and is shipped fully assembled. Indicate your choice of model color from the chart above.

Freight NOT included in list price. Freight discount available for multiple unit orders. Please contact Customer Service for details.

**BASE UNIT SELECTION**

Model Number	Description	Approx. Wt.	List Price (\$US)
HDSS1S-xx	Subsoiler, Heavy Duty, 1 Shank, Short	261 lb.	<b>\$1,339</b>
HDSS1L-xx	Subsoiler, Heavy Duty, 1 Shank, Long	276 lb.	<b>\$1,367</b>
HDSS2S-xx	Subsoiler, Heavy Duty, 2 Shank, Short	420 lb.	<b>\$2,548</b>
HDSS2L-xx	Subsoiler, Heavy Duty, 2 Shank, Long	450 lb.	<b>\$2,575</b>

**RETURN TO INDEX**



**SS1 SUBSOILER**



**LP LAYOFF PLOW**

All models are available in the colors below:	
Model Color Indicator	Unit Color
01	Bush Hog Red
03	John Deere Green
05	Kubota Orange
14	New Holland Blue
16	Caterpillar Yellow



**1RCV CULTIVATOR**

**SS1 SERIES SUBSOILER, LP SERIES LAYOFF PLOW,  
1RCV SERIES CULTIVATOR**

MODEL	SS1 SUBSOILER	LP LAYOFF PLOW	1RCV CULTIVATOR
Hitch	Cat 1 Std & Quick Hitch		
Overall Width	32 <sup>3</sup> / <sub>8</sub> "		57 <sup>7</sup> / <sub>8</sub> "
Overall Height	50"	38"	41 <sup>3</sup> / <sub>16</sub> "
Horsepower	25 - 45		
Shank Size	3/4" x 6"	3/4" x 4"	3/8" x 1 <sup>1</sup> / <sub>4</sub> "
Number of Shanks	1		6
Cutting Point	1/2" x 2 <sup>1</sup> / <sub>2</sub> " x 12"	16" x 4.75 mm	1/4" x 2 <sup>1</sup> / <sub>2</sub> " x 11"
Maximum Cutting Depth	25 <sup>5</sup> / <sub>8</sub> "		

**HOW TO ORDER:**

The Ground Engaging Implements are available as a 3-Point type implement only. Each model is priced as a complete unit and is shipped fully assembled. Indicate your choice of model color from the chart above.

Freight NOT included in list price. Freight discount available for multiple unit orders. Please contact Customer Service for details.

**BASE UNIT SELECTION**

Model Number	Description	Approx. Wt.	List Price (\$US)
SS1-xx	Subsoiler, Standard Duty	113 lb.	<b>\$454</b>
LP-xx	Layoff Plow, Light Duty	75 lb.	<b>\$264</b>
1RCV-xx	Cultivator, Light Duty	171 lb.	<b>\$605</b>

**OPTIONS (1RCV MODEL ONLY)**

Model Number	Description	Approx. Wt.	List Price (\$US)
50072481	Middle Tine Kit for 1RCV Series Cultivator	113 lb.	<b>\$117</b>



**RETURN TO INDEX**



All models are available in the colors below:	
Model Color Indicator	Unit Color
01	Bush Hog Red
03	John Deere Green
05	Kubota Orange
14	New Holland Blue
16	Caterpillar Yellow

## PA SERIES PASTURE AERATOR

MODEL	PA8	PA10
Tractor HP Requirements	40 - 90 HP	
Working Width	86"	116"
Overall Width	97.38"	127.63"
Overall Length	136" in Transportation Position	
Overall Height	44.25" (With Tines on the Ground)	
Weight Box	Standard	
Maximum Ballast in Weight Box (Ballast Not Included with Unit)	2,200 lb.	2,900 lb.
Number of Tines	24 (LH), 24 (RH)	32 (LH), 32 (RH)
Tine Material	Forged and Heat Treated Through Steel	
Tine Hub Spacing	7.5"	
Tine Penetration	Up to 8.125", Depending on Ground Condition	
Frame Construction	4" Square Tubing, All Welded Construction	
Main Tongue Beam	4" Square	
Rotor/Tine Support Hangers	1" x 7" Heavy Duty Hangers	
Rotor Bearings	Heavy Duty Greaseable	
Rotor Bearing Protection	.38" x 3.5" Metal Housing	
Rotor Angle Adjustment	2.5°, 5°, 7.5°	
Tires and Wheels	9.5L x 15 Tires on 15" - 5 Bolt Wheels	
Tine Depth Control	Add Cylinder Donuts to Cylinder Rod (Included)	
Hydraulic Cylinder	3.5" x 8"	
Transportation Lock	Manual Cylinder Lock	
Rear Axle Pivot	Greaseable	
Safety Tow Chain	Included	
<b>One-Year Limited Warranty.</b>		

### HOW TO ORDER:

The PA Series Pasture Aerator is available as a pull-type implement only. It is priced as a complete unit, and each unit is shipped in one crate with the tongue and tailwheels to be assembled by the dealer. Indicate your choice of model color from the chart above.

Freight NOT included in list price. Freight discount available for multiple unit orders. Please contact Customer Service for details.

### BASE UNIT SELECTION

Model Number	Description	Approx. Wt.	List Price (\$US)
PA8-xx	PA Series Pasture Aerator, 8'	1,950 lb.	<b>\$13,068</b>
PA10-xx	PA Series Pasture Aerator, 10'	2,500 lb.	<b>\$15,686</b>



[RETURN TO INDEX](#)



[RETURN TO INDEX](#)

# HAY TOOLS



<b>RETURN TO INDEX</b>
------------------------



## DHM SERIES HAY MOWER

MODEL	DHM7	DHM8	DHM9	DHM10
Working Width	6' 9"	8'	9' 3"	10' 6"
Number of Oval Discs	5	6	7	8
Blades Per Disc	2			
Driveline Size	Cat. 4			
Minimum PTO HP	40	46	52	56
Hitch	Cat. 2			
PTO Speed	540			
Safety Curtain	Standard			
Weight	906 lb.	1,235 lb.	1,300 lb.	1,400 lb.

**NOTICE:**

Bush Hog Disc Mowers are intended for agricultural use. Do not operate mowers near structures that may be vulnerable to damage from thrown objects. Operating tractor should be equipped with a cab.

**HOW TO ORDER:**

The DHM Series Hay Mower is priced as a complete unit. Select the desired model number from the Base Unit Selection below.

Freight NOT included in list price. Freight discount available for multiple unit orders. Please contact Customer Service for details.

### BASE UNIT SELECTION

Model Number	Description	Approx. Wt.	List Price (\$US)
DHM7	DHM Series Hay Mower, 5 Discs, 2 Blades, 6' 7" Mowing Width, Complete	906 lb.	<b>\$9,180</b>
DHM8	DHM Series Hay Mower, 6 Discs, 2 Blades, 8' Mowing Width, Complete	1,235 lb.	<b>\$12,782</b>
DHM9	DHM Series Hay Mower, 7 Discs, 2 Blades, 9' 3" Mowing Width, Complete	1,300 lb.	<b>\$13,405</b>
DHM10	DHM Series Hay Mower, 8 Discs, 2 Blades, 10' 6" Mowing Width, Complete	1,400 lb.	<b>\$16,640</b>

**RETURN TO INDEX**



## HT SERIES HAY TEDDER

MODEL	HT210	HT417	HT417H	HT419H
Number of Rotors	2	4		
Working Width (Approx.)	10'	17' 1"		19'
Number of Tines	12	24		
Transport Width	10'			11'
Working Speed	5 - 10 mph			
Minimum Tractor HP	15 HP	22 HP		25 HP
PTO Speed	540			
Folding	N/A	Manual	Hydraulic	
Tire Size	16 x 6.50-8			

### HOW TO ORDER:

The HT Series Hay Tedder is priced as a complete unit. Indicate your choice of model number from the Base Unit Selection in the order section below.

Freight NOT included in list price. Freight discount available for multiple unit orders. Please contact Customer Service for details.

### BASE UNIT SELECTION

Model Number	Description	Approx. Wt.	List Price (\$US)
HT210	Hay Tedder, Pull Type, 10' ***HT210 MUST BE ORDERED IN MULTIPLES OF 2***	385 lb.	\$3,104
HT417	Hay Tedder, Pull Type, 17', Spring-Assist Fold	830 lb.	\$6,880
HT417H	Hay Tedder, 17', Hydraulic Fold	850 lb.	\$7,953
HT419H	Hay Tedder, 19', Hydraulic Fold	1,225 lb.	\$8,890

### OPTIONS

Model Number	Description	Approx. Wt.	List Price (\$US)
3670402	Hydraulic Tilt Kits (fits HT417H, HT419H models)	17 lb.	\$868

**RETURN TO INDEX**



## XLRR-I SERIES PULL-TYPE V-RAKE

MODEL	XLRR819	XLRR1022	XLRR1226
Number of Finger Wheels	8	10	12
Finger Wheel Diameter	55"		
Tine Diameter	7mm		
Minimum Windrow Width*	3'		
Maximum Windrow Width*	6' 7"		
Minimum Working Width*	16' 4"	19'	21' 8"
Maximum Working Width*	18'	21'	24' 6"
Transport Width	8' 5"		
Minimum HP Requirement	30 HP		50 HP
Tire Size	205/75/15		

\*Depending on Crop Conditions

### HOW TO ORDER:

The XLRR-I Series Pull-Type V-Rake is priced as a complete unit. Indicate your choice of model number from the Base Unit Selection in the order section below. Add any additional equipment from the Options section.

Freight NOT included in list price. Freight discount available for multiple unit orders. Please contact Customer Service for details.

### BASE UNIT SELECTION

Model Number	Description	Approx. Wt.	List Price (\$US)
XLRR819-1	8 Wheel V-Type Hay Rake, 19'	1,675 lb.	\$7,788
XLRR1022-1	10 Wheel V-Type Hay Rake, 22'	1,875 lb.	\$8,655
XLRR1226-1	12 Wheel V-Type Hay Rake, 26'	2,115 lb.	\$9,640

### OPTIONS

Model Number	Description	List Price (\$US)
3690405	Center "Kicker" Wheel Kit	\$864
3690416	Tandem Wheel Kit	\$1,606
3690414	Hydraulic Windrow Adjustment for XLRR819 & XLRR1022	\$1,060
3690415	Hydraulic Windrow Adjustment for XLRR1226	\$1,083
3666777	Solid Cover for 55" Center Rake Wheel (Price Per Wheel)	\$46

**RETURN TO INDEX**



## EWR SERIES PULL TYPE WHEEL V-RAKE

MODEL	EWR820	EWR1023
Number of Finger Wheels	8	10
Windrow Width, Adjustable	3' - 5'	
Working Width (Approx.)	20'	23'
Transport Width	10'	
Minimum HP Requirement	30 HP	
Tire Size	195-70R/15	
Operating Speed	Up to 14 MPH	

**HOW TO ORDER:**

The RR Series Rotary Rake is priced as a complete unit. Indicate your choice of model number from the Base Unit Selection in the order section below.

Freight NOT included in list price. Freight discount available for multiple unit orders. Please contact Customer Service for details.

**BASE UNIT SELECTION**

Model Number	Description	Approx. Wt.	List Price (\$US)
EWR820	EWR Series Economy Pull Type Wheel V-Rake, 20', 8 Wheels	1,200 lb.	\$5,726
EWR1023	EWR Series Economy Pull Type Wheel V-Rake, 23', 10 Wheels	1,355 lb.	\$6,324

**OPTIONS**

Model Number	Description	List Price (\$US)
3660408	Center Wheel (Kicker) Kit for EWR Series Pull Type Wheel V-Rake	each \$576
3666777	Solid Cover for 55" Center Rake Wheel (Price Per Wheel) (Order one per wheel)	each \$46

**RETURN TO INDEX**



**3PBS2 SERIES**



**3PBS1 SERIES**



**3PBU SERIES**

All models are available in the colors below:	
Model Color Indicator	Unit Color
01	Bush Hog Red
03	John Deere Green
05	Kubota Orange
14	New Holland Blue
16	Caterpillar Yellow

## 3PB SERIES 3-PT HAY IMPLEMENTS

MODEL	3PBS1	3PBS2	3PBU
Hitch (3-PT)	Cat. 1 Std., Quick Hitch	Cat. 1 & 2, Std., Quick Hitch	Cat. 1 & 2, Std., Quick Hitch
Tractor HP (Min.)	35 HP	35 HP	35 HP
Overall Width	31 7/8"	39"	69 1/2"
Overall Depth	51"	52"	67"
Overall Height	25 3/8"	25 3/8"	25 5/16"
Spear Size (Diameter)	1.78"	1.78"	N/A
Usable Spear Length	42 1/2"	42 1/2"	N/A
Maximum Load Capacity	2,800 lb.	2,800 lb.	2,000 lb.

### HOW TO ORDER:

The 3PB Series Hay Implement is available as a 3-PT type implement only. It is priced as a complete unit and is shipped fully assembled. To receive a complete Single Probe Bale Spear, you must indicate your choice of basic unit in the order section below. To receive a complete Bale Unroller, you must indicate base unit selection, including your choice of model color from the chart above.

Freight NOT included in list price. Freight discount available for multiple unit orders. Please contact Customer Service for details.

### BASE UNIT SELECTION

Model Number	Description	Color	Approx. Wt.	List Price (\$US)
3PBS1	Single Probe Bale Spear, 3-Pt, Category 1 Only	Black Only	80 lb.	<b>\$419</b>
3PBS2	Single Probe Bale Spear, 3-Pt, Category 1 & 2	Black Only	97 lb.	<b>\$466</b>
3PBU-xx	3PBU Series Bale Unroller, 3-Pt	See Table Above	326 lb.	<b>\$1,661</b>



**RETURN TO INDEX**

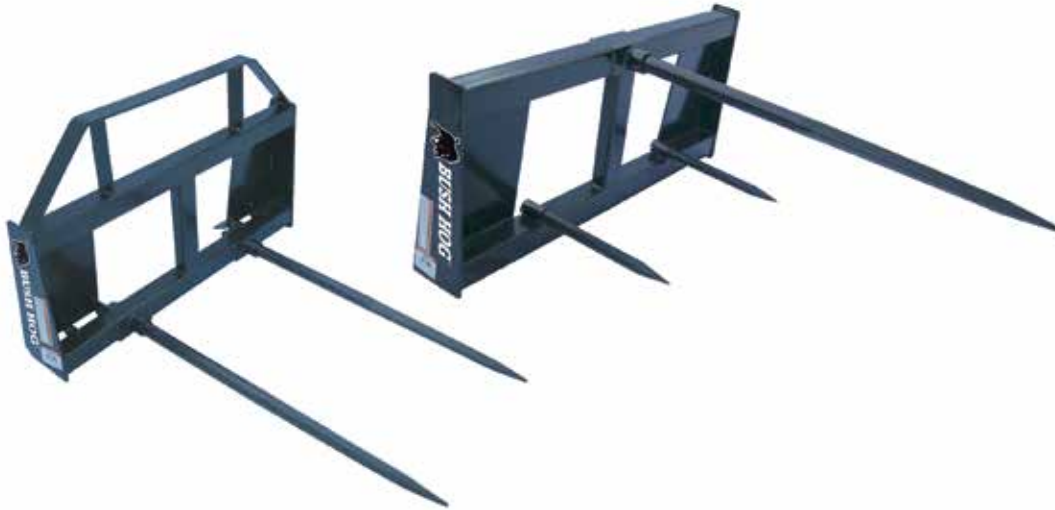

## BS SERIES BALE SPEAR

MODEL	BS1	BS2
Overall Height	21 <sup>3</sup> / <sub>16</sub> "	30"
Overall Width	45 <sup>5</sup> / <sub>16</sub> "	
Overall Depth	51"	
Spear Size	1.78"	
Useable Spear Length	42 <sup>1</sup> / <sub>2</sub> "	
Weight	144 lb.	200 lb.
Max. Spear Capacity	3,500 lb. @ 23 <sup>1</sup> / <sub>2</sub> "	
Attachment Method	Universal Skid Steer, EURO, or JD 300, 400, 500 Quick Attach	
Color	Black	

**HOW TO ORDER:**

The BS Series Bale Spear is priced as a complete unit. Select your desired model from the Base Unit Selection offered.

Freight NOT included in list price. Freight discount available for multiple unit orders. Please contact Customer Service for details.

### BS1 SERIES BASE UNIT SELECTION

Model Number	Description	Approx. Wt.	List Price (\$US)
BS1SS	Bale Spear, Single, Skid Steer	144 lb.	<b>\$766</b>
BS1E	Bale Spear, Single, Euro	144 lb.	<b>\$862</b>
BS1JD	Bale Spear, Single, John Deere	144 lb.	<b>\$838</b>

### BS2 SERIES BASE UNIT SELECTION

Model Number	Description	Approx. Wt.	List Price (\$US)
BS2SS	Bale Spear, Double, Skid Steer	200 lb.	<b>\$896</b>
BS2E	Bale Spear, Double, Euro	200 lb.	<b>\$972</b>
BS2JD	Bale Spear, Double, John Deere	200 lb.	<b>\$958</b>



[RETURN TO INDEX](#)



[RETURN TO INDEX](#)

# SNOW BLOWERS



SNOW BLOWERS

**RETURN TO INDEX**



**\*\*\* THIS PRODUCT IS PRICED AT LIST LESS 25% \*\*\***

## SINGLE AUGER SNOW BLOWER

MODEL	SBSA54	SBSA60
HP (Rec)	15 HP	20 HP
Cutting Width	54"	60"
Cutting Edge	3/8 x 1	
Auger Diameter	14"	
Fan Diameter	21"	
Chute Diameter	8"	
Chute Rotation	Std/Opt	
Chute Deflector	Std/Opt	
Main Body Height	25"	
3PH Mount	Cat 1 Std & Quick Hitch	
Weight	366 lb.	396 lb.

**Five-Year Limited Gearbox Warranty. Two-Year Limited Machine Warranty.**

### HOW TO ORDER:

Choose a model from the Base Unit Selection to order a complete unit. The 54" and 60" models come standard with a manual chute rotator.

Freight NOT included in list price.

### BASE UNIT SELECTION

Model Number	Description	Approx. Wt.	List Price (\$US)
SBSA54	Single Auger 54" Snow Blower	366 lb.	<b>\$2,840</b>
SBSA60	Single Auger 60" Snow Blower	396 lb.	<b>\$2,922</b>

### OPTIONS

Model Number	Description	List Price (\$US)
50078918	Hydraulic Chute Rotator (fits all models)	<b>\$670</b>
50078919	Hydraulic Deflector Kit (fits SBSA54-72 models)	<b>\$409</b>

**RETURN TO INDEX**



**\*\*\* THIS PRODUCT IS PRICED AT LIST LESS 25% \*\*\***

## SINGLE AUGER SNOW BLOWER

MODEL	SBSA72	SBSA78	SBSA87	SBSA97
HP (Rec)	35 HP	50 HP	60 HP	75 HP
Cutting Width	72"	78"	87"	97"
Cutting Edge	3/8 x 1	1/2 x 1½	1/2 x 2	1/2 x 2
Auger Diameter	14"	15"	19"	
Fan Diameter	21"	23"	27"	
Chute Diameter	10"		12"	
Chute Rotation	Opt/Opt			
Chute Deflector	Std/Opt			
Main Body Height	29"		36"	
3PH Mount	Cat 1 Std & Quick Hitch	Cat 1 & 2 Std & Quick Hitch	Cat 2 Std & Quick Hitch	
Weight	540 lb.	748 lb.	1,034 lb.	1,106 lb.

**Five-Year Limited Gearbox Warranty. Two-Year Limited Machine Warranty.**

### HOW TO ORDER:

Choose a model from the Base Unit Selection to order a complete unit. The 54" and 60" models come standard with a manual chute rotator.

Freight NOT included in list price.

### BASE UNIT SELECTION

Model Number	Description	Approx. Wt.	List Price (\$US)
SBSA72	Single Auger 72" Snow Blower	540 lb.	<b>\$3,324</b>
SBSA78	Single Auger 78" Snow Blower	748 lb.	<b>\$4,118</b>
SBSA87	Single Auger 87" Snow Blower	1,034 lb.	<b>\$4,631</b>
SBSA97	Single Auger 97" Snow Blower	1,106 lb.	<b>\$4,845</b>

### GROUP 2 CHUTE ROTATOR SELECTION

Model Number	Description	List Price (\$US)
50078913	Manual Chute Rotator (fits SBSA72 model)	<b>\$128</b>
50078914	Manual Chute Rotator (fits SBSA78 models)	<b>\$128</b>
50078915	Manual Chute Rotator (fits SBSA87 and SBSA97 models)	<b>\$128</b>
50078918	Hydraulic Chute Rotator (fits all models)	<b>\$670</b>

### OPTIONS

Model Number	Description	List Price (\$US)
50078919	Hydraulic Deflector Kit (fits SBSA54-72, and SBPT60-68 models)	<b>\$409</b>
50078920	Hydraulic Deflector Kit (fits SBSA78-97, SBPT78-97, and SBDA models)	<b>\$409</b>
50078922	Multi-Hinged Deflector (fits SBSA78 and SBPT78 models)	<b>\$468</b>
50078923	Multi-Hinged Deflector (fits SBSA87, SBSA97, and SBPT87 models)	<b>\$479</b>

**RETURN TO INDEX**



**\*\*\* THIS PRODUCT IS PRICED AT LIST LESS 25% \*\*\***  
**DOUBLE AUGER SNOW BLOWER**

MODEL	SBDA108	SBDA1108A	SBDA1108B
HP (Rec)	Up to 175 HP		
RPM	540	1,000	
Driveline	1 <sup>3</sup> / <sub>8</sub> 6 Tractor End	1 <sup>3</sup> / <sub>8</sub> 21 Tractor End	1 <sup>3</sup> / <sub>4</sub> 20 Tractor End
Cutting Width	108"		
Cutting Edge	1/2 x 6		
Auger Diameter	19" (x1) 15" (x1)		
Fan Diameter	32"		
Chute Diameter	13"		
Chute Rotation	Hydraulic		
Chute Deflector (Man/Hyd)	Std/Opt		
Main Body Height	43"		
3PH Mount	Cat 2 and 3 Std & Quick Hitch		
Weight	1,980 lb.		

**Five-Year Limited Gearbox Warranty. Two-Year Limited Machine Warranty.**

**HOW TO ORDER:**

Choose a model from the Base Unit Selection to order a complete unit.

Freight NOT included in list price.

**BASE UNIT SELECTION**

Model Number	Description	Approx. Wt.	List Price (\$US)
SBDA108	Double Auger 108" Snow Blower 540 1-3/8 6 PTO	1,980 lb.	<b>\$8,968</b>
SBDA1108A	Double Auger 108" Snow Blower 1,000 1-3/8 21 PTO	1,980 lb.	<b>\$11,651</b>
SBDA1108B	Double Auger 108" Snow Blower 1,000 1-3/4 20 PTO	1,980 lb.	<b>\$11,771</b>

**OPTIONS**

Model Number	Description	List Price (\$US)
50078920	Hydraulic Deflector Kit (fits SBSA78-97, SBPT78-97, and SBDA models)	<b>\$409</b>
50078924	Multi-Hinged Deflector (fits SBDA models)	<b>\$502</b>

**RETURN TO INDEX**

**NEW**  
*Models for  
Winter  
2020*



**\*\*\* THIS PRODUCT IS PRICED AT LIST LESS 25% \*\*\***

## PULL TYPE SNOW BLOWER

MODEL	SBPT60	SBPT68	SBPT78	SBPT87	SBPT97
HP (Rec)	25 HP	35 HP	50 HP	60 HP	
Cutting Width	60"	68"	78"	87"	97"
Cutting Edge	Bolt On, 1/2"x 4"				
Auger Diameter	14"		15"	19"	19"
Fan Diameter	18"	21"	23"	27"	27"
Chute Diameter	8"	10"		12"	
Chute Rotation (Man/Hyd)	Std./Opt.	Opt./Opt.			
Chute Deflector (Man/Hyd)	Std./Opt. 6" Cyl.		Std./Opt. 8" Cyl.		
Main Body Height	25"		28"	32 1/2"	
3PH Mount	Cat. 1		Cat. 1 & 2		Cat. 2
Weight	495 lb.	671 lb.	900 lb.	1,175 lb.	1,225 lb.

**Five-Year Limited Gearbox Warranty. Two-Year Limited Machine Warranty.**

**HOW TO ORDER:**

To order a complete unit, choose a base unit then either a manual or hydraulic chute rotator from Group 2 below. Note only the SBPT60 comes equipped with a manual chute rotator standard.

Freight NOT included in list price.

**BASE UNIT SELECTION**

Model Number	Description	Approx. Wt.	List Price (\$US)
SBPT60	Pull Type 60" Snow Blower	495 lb.	<b>\$4,090</b>
SBPT68	Pull Type 68" Snow Blower	671 lb.	<b>\$4,525</b>
SBPT78	Pull Type 78" Snow Blower	900 lb.	<b>\$5,345</b>
SBPT87	Pull Type 87" Snow Blower	1,175 lb.	<b>\$6,952</b>
SBPT97	Pull Type 97" Snow Blower	1,225 lb.	<b>\$7,295</b>

**GROUP 2 SELECTION**

Model Number	Description	List Price (\$US)
50081957	Manual Chute Rotator (fits SBPT68 model)	<b>\$128</b>
50078916	Manual Chute Rotator (fits SBPT78 model)	<b>\$128</b>
50078917	Manual Chute Rotator (fits SBPT87 and SBPT97 models)	<b>\$128</b>
50078918	Hydraulic Chute Rotator (fits all models)	<b>\$670</b>



RETURN TO INDEX

### OPTIONS

Model Number	Description	List Price (\$US)
50078919	Hydraulic Deflector Kit (fits SBSA54-72, and SBPT60-68 models)	\$409
50078920	Hydraulic Deflector Kit (fits SBSA78-97, SBPT78-97, and SBDA models)	\$409
50081958	Rear Mounted Blade (fits SBPT60 model)	\$695
50081959	Rear Mounted Blade (fits SBPT68 model)	\$812
50078925	Rear Mounted Blade (fits SBPT78 model)	\$917
50078926	Rear Mounted Blade (fits SBPT87 model)	\$1,049
50081960	Rear Mounted Blade (fits SBPT97 model)	\$1,078
50081964	60" Back Drag Kit	\$378
50081961	60" Tivar Scraper Blade and Skid Shoe Kit	\$447
50081965	68" Back Drag Kit	\$392
50081962	68" Tivar Scraper Blade and Skid Shoe Kit	\$506
50079573	78" Back Drag Kit	\$514
50079575	78" Tivar Scraper Blade and Skid Shoe Kit	\$409
50079574	87" Back Drag Kit	\$548
50079576	87" Tivar Scraper Blade and Skid Shoe Kit	\$445
50081966	97" Back Drag Kit	\$518
50081963	97" Tivar Scraper Blade and Skid Shoe Kit	\$630
50079132	Optional Hydraulic Lift Kit	\$733



**RETURN TO INDEX**



**\*\*\* THIS PRODUCT IS PRICED AT LIST LESS 25% \*\*\***

## SKIDSTEER SNOW BLOWER

MODEL	SBSS760 SERIES
Cutting Width	76"
Cutting Edge	1/2 x 3
Auger	19"
Tube	3" Square
Flighting	5/16 x 2¼
Auger Diameter	19"
GPM (Min)	14
Mounting	Universal Skidsteer Attach
Chute Rotation	Hydraulic
Chute Diameter	11"
Chute Deflector (Man/Hyd)	Std/Opt
Main Body Height	31"
Fan Diameter	32"
Fan Shaft	2" Diameter
Weight	950 lb.

**HOW TO ORDER:**

Choose a model from the Base Unit Selection to order a complete unit.

Freight NOT included in list price.

**BASE UNIT SELECTION**

Model Number	Description	Approx. Wt.	List Price (\$US)
SBSS760	Skidsteer 76" Snow Blower 14-17 GPM	950 lb.	<b>\$8,461</b>
SBSS761	Skidsteer 76" Snow Blower 18-20 GPM	950 lb.	<b>\$8,461</b>
SBSS762	Skidsteer 76" Snow Blower 20-22 GPM	950 lb.	<b>\$8,461</b>
SBSS763	Skidsteer 76" Snow Blower 23-26 GPM	950 lb.	<b>\$10,580</b>
SBSS764	Skidsteer 76" Snow Blower 27-33 GPM	950 lb.	<b>\$10,580</b>
SBSS765	Skidsteer 76" Snow Blower 33-40 GPM	950 lb.	<b>\$10,655</b>



**RETURN TO INDEX**

<b>OPTIONS</b>		
<b>Model Number</b>	<b>Description</b>	<b>List Price (\$US)</b>
50078921	Hydraulic Deflector Kit (fits SBSS models)	\$370
50078927	7 Pin Wire Kit - Bobcat	\$2,010
50078928	8 Pin Wire Kit - Cat	\$382
50078929	8 Pin Wire Kit - Terrex	\$382
50078930	14 Pin Wire Kit - Gehl/Case/NH/JCB/Volvo	\$382
50078931	14 Pin Wire Kit - JD	\$382

**RETURN TO INDEX**

**NEW**  
*for*  
**Winter  
2020**



**\*\*\* THIS PRODUCT IS PRICED AT LIST LESS 25% \*\*\***  
**LOADER MOUNT SNOW BLOWER**

MODEL	SBLM66	SBLM66HD	SBLM76	SBLM76HD	SBLM86	SBLM86HD
Cutting Width	66"		76"		86"	
HP (Rec)	40 - 60 HP					
Cutting Edge	3/8" x 3"					
Skid Shoes	3/8" x 1 1/2"					
Auger Diameter	19"					
Auger Flighting	5/16" x 2 1/4"					
Auger Tube	3 1/2" OD					
Fan Diameter	26"					
Chute Diameter	12"					
Chute Rotation	Hydraulic					
Chute Deflector	Hydraulic					
Main Body Height	31"					
Loader Mount - Hitch	Universal Skid Steer, EURO (ALO), or JD 440/540 Quick Attach					

**Five-Year Limited Gearbox Warranty. Two-Year Limited Machine Warranty.**

**HOW TO ORDER:** To order a complete unit, choose a base unit with desired powerpak, and one of the no charge mounting kits from the selections below. Approximate weights shown are for loader mounted snow blowers and rear mounted PowerPaks. Additional mounting kits available for purchase in the options below.

Freight NOT included in list price.

**BASE UNIT SELECTION**

Model Number	Description	"Approx. Weight Blower / Pak"	List Price (\$US)
SBLM66	Loader Mount 66" Snow Blower, w/2-HR Duty PowerPak	970 lb. / 535 lb.	\$16,415
SBLM66HD	Loader Mount 66" Snow Blower, w/Full Duty PowerPak	970 lb. / 575 lb.	\$19,450
SBLM76	Loader Mount 76" Snow Blower, w/2-HR Duty PowerPak	1,015 lb. / 535 lb.	\$16,805
SBLM76HD	Loader Mount 76" Snow Blower, w/Full Duty PowerPak	1,015 lb. / 575 lb.	\$19,876
SBLM86	Loader Mount 86" Snow Blower, w/2-HR Duty PowerPak	1,065 lb. / 535 lb.	\$17,025
SBLM86HD	Loader Mount 86" Snow Blower, w/Full Duty PowerPak	1,065 lb. / 575 lb.	\$20,138

**GROUP 2 SELECTION - MOUNTING KIT (Choose One at No Charge - Included in Base Unit Pricing)**



Model Number	Description	List Price (\$US)
50081967NC	Quick Attach Mounting Kit, Universal Skid Steer	No Charge
50081968NC	Quick Attach Mounting Kit, EURO (ALO)	No Charge
50081969NC	Quick Attach Mounting Kit, JD 440/540	No Charge



**OPTIONS (Additional Mounting Kits Available to Purchase)**



Model Number	Description	List Price (\$US)
50081967	Quick Attach Mounting Kit, Universal Skid Steer	\$515
50081968	Quick Attach Mounting Kit, EURO (ALO)	\$662
50081969	Quick Attach Mounting Kit, JD 440/540	\$712



**RETURN TO INDEX**

## WHEEL & TIRE SELECTION GUIDE

WHEEL / TIRE MODEL NUMBER						PROFILE	TREAD
<b>294</b>							
<b>DESCRIPTION</b>							
20" Laminated Tire							
<b>AVAILABLE ON THESE MODELS</b>							
<b>BH416</b>	<b>2308</b>	<b>3510</b>	<b>1815</b>	<b>2815</b>	<b>4815</b>		
<b>BH417</b>	<b>2310</b>	<b>3514</b>	<b>2215</b>	<b>3810</b>	<b>2820</b>		
<b>BH516</b>	<b>3308-2</b>	<b>1812</b>	<b>2810</b>	<b>3815</b>			



WHEEL / TIRE MODEL NUMBER						PROFILE	TREAD
<b>97708</b>							
<b>DESCRIPTION</b>							
Pneumatic Aircraft Tire, 24 x 7.7 x 10							
<b>AVAILABLE ON THESE MODELS</b>							
<b>1815</b>							



WHEEL / TIRE MODEL NUMBER						PROFILE	TREAD
<b>50050727</b>							
<b>DESCRIPTION</b>							
Used Aircraft Tire, 29 x 9 x 15							
<b>AVAILABLE ON THESE MODELS</b>							
<b>2310</b>	<b>3510</b>	<b>2810</b>	<b>3810</b>	<b>4815</b>			
<b>3308-2</b>	<b>2215</b>	<b>2815</b>	<b>3815</b>	<b>2820</b>			



WHEEL / TIRE MODEL NUMBER						PROFILE	TREAD
<b>50068834</b>							
<b>DESCRIPTION</b>							
Foam Filled Aircraft Tire, 26 x 6.6 x 14							
<b>AVAILABLE ON THESE MODELS</b>							
<b>2215</b>	<b>2815</b>	<b>3815</b>	<b>2820</b>				
<b>2810</b>	<b>3810</b>	<b>4815</b>					



[RETURN TO INDEX](#)

## WHEEL & TIRE SELECTION GUIDE

WHEEL / TIRE MODEL NUMBER	PROFILE	TREAD
<b>50072403</b>		
<b>DESCRIPTION</b>		
Used Aircraft Tire, 27.75 x 8.75-24PR		
<b>AVAILABLE ON THESE MODELS</b>		
<b>2215    2810    2815    3810    3815    4815    2820</b>		



WHEEL / TIRE MODEL NUMBER	PROFILE	TREAD
<b>50074504</b>		
<b>DESCRIPTION</b>		
Used Aircraft Tire, 20.5 x 6.75-10		
<b>AVAILABLE ON THESE MODELS</b>		
<b>1812</b>		

WHEEL / TIRE MODEL NUMBER	PROFILE	TREAD
<b>50074505</b>		
<b>DESCRIPTION</b>		
Used Aircraft Tire, Foam Filled, 20.5 x 6.75-10		
<b>AVAILABLE ON THESE MODELS</b>		
<b>1812</b>		

WHEEL / TIRE MODEL NUMBER	PROFILE	TREAD
<b>50075401</b>		
<b>DESCRIPTION</b>		
25" Laminated Tire		
<b>AVAILABLE ON THESE MODELS</b>		
<b>3510    2810    3810    4815 2215    2815    3815    2820</b>		

**RETURN TO INDEX**

## WHEEL & TIRE SELECTION GUIDE

WHEEL / TIRE MODEL NUMBER	PROFILE	TREAD												
<b>50078502</b>														
<b>DESCRIPTION</b>														
Foam-Filled Tire, 27 x 8-18														
<b>AVAILABLE ON THESE MODELS</b>														
<table border="0"> <tr> <td><b>3308-2</b></td> <td><b>1815</b></td> <td><b>2815</b></td> <td><b>4815</b></td> </tr> <tr> <td><b>3510</b></td> <td><b>2215</b></td> <td><b>3810</b></td> <td><b>2820</b></td> </tr> <tr> <td><b>3514</b></td> <td><b>2810</b></td> <td><b>3815</b></td> <td></td> </tr> </table>	<b>3308-2</b>	<b>1815</b>	<b>2815</b>	<b>4815</b>	<b>3510</b>	<b>2215</b>	<b>3810</b>	<b>2820</b>	<b>3514</b>	<b>2810</b>	<b>3815</b>			
<b>3308-2</b>	<b>1815</b>	<b>2815</b>	<b>4815</b>											
<b>3510</b>	<b>2215</b>	<b>3810</b>	<b>2820</b>											
<b>3514</b>	<b>2810</b>	<b>3815</b>												

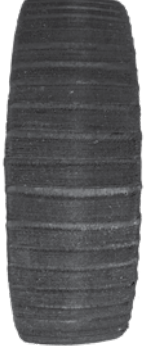
WHEEL / TIRE MODEL NUMBER	PROFILE	TREAD										
<b>500BH</b>												
<b>DESCRIPTION</b>												
15 1/2" Solid Laminated Tire												
<b>AVAILABLE ON THESE MODELS</b>												
<table border="0"> <tr> <td><b>BH215</b></td> <td><b>BH217</b></td> <td><b>BH316</b></td> <td><b>SQ84T</b></td> <td><b>3308-2</b></td> </tr> <tr> <td><b>BH216</b></td> <td><b>BH315</b></td> <td><b>BH317</b></td> <td><b>2308</b></td> <td><b>3308SH</b></td> </tr> </table>	<b>BH215</b>	<b>BH217</b>	<b>BH316</b>	<b>SQ84T</b>	<b>3308-2</b>	<b>BH216</b>	<b>BH315</b>	<b>BH317</b>	<b>2308</b>	<b>3308SH</b>		
<b>BH215</b>	<b>BH217</b>	<b>BH316</b>	<b>SQ84T</b>	<b>3308-2</b>								
<b>BH216</b>	<b>BH315</b>	<b>BH317</b>	<b>2308</b>	<b>3308SH</b>								

# • NOTES •

---



---



---



---



---



---



---



---



---



---



---





IF IT DOESN'T SAY  
**BUSH HOG**®  
IT JUST WON'T CUT IT™

2501 Griffin Avenue, Selma, Alabama 36703

Tel: 800-363-6096 | Fax: 334-874-2701



**BushHog.com**



**CONTENT DISCLAIMER:**

The products and information contained in this literature are subject to change without notice. Bush Hog® reserves the right to improve our products and make changes to specifications, designs, and standard equipment without notice. For additional product information, please visit Bush Hog®'s website or see your dealer for complete details.