

T775E,F,G Remote Temperature Controller

The T775 family of Electronic Remote Temperature Controllers provides electronic Series 90, 4 to 20 mA, or 0 to 18 Vdc proportional plus integral (P+I) modulating control for hot water, steam, or chilled water valves, dampers and other applications where electronic accuracy, in addition to remote sensing, is desired.

In addition, certain models of the T775 family of controllers provide on-off temperature control of heating, cooling, and ventilating systems in agricultural confinement buildings, storage areas and heavy industrial applications.



T775E,F



T775G

- T775E models provide P+I modulating control with one temperature input and either 4 to 20 mA, 0 to 18 Vdc, or Electronic Series 90^a modulating output and zero to three relay output stages.
- T775F models provide P+I modulating control with two temperature inputs and either 4 to 20 mA, 0 to 18 Vdc, or Electronic Series 90^a modulating output and zero to three relay output stages.
- T775G models provide P+I modulating control with one temperature input and either 4 to 20 mA, 0 to 18 Vdc, or Electronic Series 90^a modulating output and zero to three relay output stages.
- T775G meets National Electric Code (Article 547) requirements for animal confinement buildings.
- T775G Typical applications include barns, brooder houses, poultry houses, hog houses, pump houses, and crop storage houses.
- NEMA 4X enclosure resists oil, water, dust and corrosion.
- Setpoint temperature range is -40°F to +220°F (-40°C to +104°C).
- Ambient temperature range is -30°F to +140°F (-22°C to +60°C) for T775E models and -30°F to +125°F (-22°C to +52°C) for T775F and T775G models.
- Linear platinum temperature sensor with T775E,F.
- Adjustable temperature range and differential.

- LCD indication for mode and output status.
- Keypad provides ease of programming and operation.
- Accuracy is within +/- 1°F/C at nominal input voltage, nominal sensor ambient temperature (77°F [25°C] operating ambient). Accuracy may vary as parameters deviate from nominal.
- Stage(s) independently programmed for heating or cooling.
- 24/120/240 Vac input voltage.
- Spdt relay outputs.

^a The Electronic Series 90 output provided with certain T775 models cannot drive electromechanical slidewire devices.

IMPORTANT: The T775 is an operating control, not a limit or safety control. When used in applications requiring safety or limit controls, use a separate safety or limit control device in conjunction with the T775.

CONTENTS

Specifications	2
Ordering Information	2
Installation	5
Description/Operation	17
Checkout	19



Specifications

IMPORTANT: *The specifications given in this publication do not include normal manufacturing tolerances. Therefore, an individual unit may not exactly match the listed specifications. Also, this product is tested and calibrated under closely controlled conditions and some minor difference in performance can be expected if those conditions are changed.*

MODELS: The T775E,F,G family of Electronic Temperature Controllers provides 4 to 20 mA, 0 to 18 Vdc, or Electronic Series 90^a Proportional plus Integral (P+I) modulating control for hot water, steam, or chilled water valves, dampers, and other applications where electronic accuracy, in addition to remote sensing, is desired.

Model Number	Number of Inputs	Output Modulation Type	Number of Relay Outputs
T775E1015	1	Electronic Series 90	1
T775E1056	1	4 to 20 mA	1
T775E1064	1	4 to 20 mA	2
T775E1072	1	4 to 20 mA	3
T775E1098	1	0 to 18 Vdc	1
T775E1114	1	0 to 18 Vdc	3
T775F1022	2	Electronic Series 90	3
T775F1055	2	4 to 20 mA	3
T775F1089	2	0 to 18 Vdc	3
T775G1005	1	Electronic Series 90	3
T775G013	1	4-20 mA	3
T775G1021	1	0 to 18 Vdc	3

T775E: P+I modulating control with one temperature input and either 4 to 20 mA, 0 to 18 Vdc, or Electronic Series 90^a modulating output and zero to three relay output stages.

T775F: P+I modulating control with two temperature inputs and either 4 to 20 mA, 0 to 18 Vdc, or Electronic Series 90^a modulating output and zero to three relay output stages.

T775G: P+I modulating control with one temperature input and either 4 to 20 mA, 0 to 18 Vdc, or Electronic Series 90^a modulating output and zero to three relay output stages.

^a The Electronic Series 90 output provided with certain T775 models can not drive electromechanical slidewire devices.

ELECTRICAL RATINGS:

Voltage Input: 24/120/240 Vac, 50/60 Hz.

Power Consumption:

For one and two stage units:

8 VA maximum at 60 Hz.

10 VA maximum at 50 Hz.

For three and four stage units:

13 VA maximum at 60 Hz.

20 VA maximum at 50 Hz.

CONTACT RATINGS:

1/2 hp; 9.8 FLA, 58.8 LRA at 120 Vac.

1/2 hp; 4.9 FLA, 29.4 LRA at 240 Vac.

125 VA pilot duty at 120/240 Vac.

10A at 24 Vac (resistive).

SENSOR: Positive coefficient platinum type, 4.8 ohms/^o/F, 1000 ft maximum distance between sensor and solid state controller (requires calibration over 400 ft). Sensor Range: -40°F to +220°F (-40°C to +104°C). To maintain NEMA 4X rating, use environmental proof cable and 203401B Waterproof Sensor.

Ordering Information

When ordering replacement and modernization products from your wholesaler or distributor, refer to the price sheets for complete ordering number.

If you have additional questions, need further information, or would like to comment on our products or services, please write or phone:

1. Your local Honeywell Home and Building Control Sales Office (check the white pages of your phone directory).

2. Home and Building Control Customer Logistics

Honeywell Inc., 1885 Douglas Drive North

Minneapolis, Minnesota 55422-4386

In Canada—Honeywell Limited/Honeywell Limitée, 740 Ellesmere Road, Scarborough, Ontario M1P 2V9. International Sales and Service offices in all principal cities of the world.

TEMPERATURE ACCURACY:

+/-1°F (at nominal input voltage, 77°F [25°C] operating ambient, nominal sensor ambient).

Accuracy may vary based on deviation from nominal values of input voltage, operating ambient and sensor ambient.

DISPLAY RESOLUTION: Sensed temperature and other operating parameters are displayed via a liquid crystal display (LCD) with a resolution of 1°F or 1°C.

SETPOINT ADJUSTMENT RANGE: -40°F to 220°F (-40°C to 104°C).

DIFFERENTIAL: Adjustable from 1 to 35 degrees (F or C).

OPERATING AMBIENT TEMPERATURE:

One and Two Stage Units: -30°F to 140°F (-35°C to +60°C).

Three and Four Stage Units: -30°F to 125°F (-35°C to +52°C).

OPERATING HUMIDITY: 5% to 95% relative humidity (RH) noncondensing.

APPROVALS:

Underwriters Laboratories Inc. Listed: File No. E4436.

Canadian Standards Association Certified: File No. LR47125.

DIMENSIONS: See Fig. 1 and 2.

MOUNTING: Mounts on any suitable horizontal or vertical surface (see Fig. 3 and 4 for mounting hole locations).

MAIN FEATURES: See Fig. 3 and 4.

Fig. 1—Approximate dimensions of T775E,F in in. (mm).

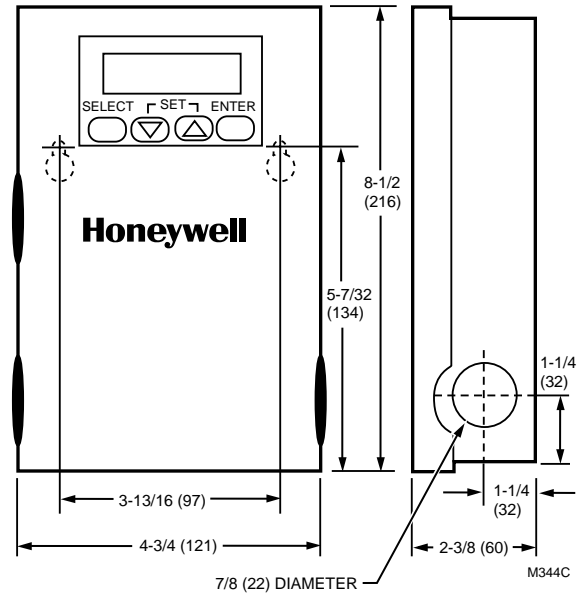

Fig. 2—Approximate dimensions of T775G in in. (mm).

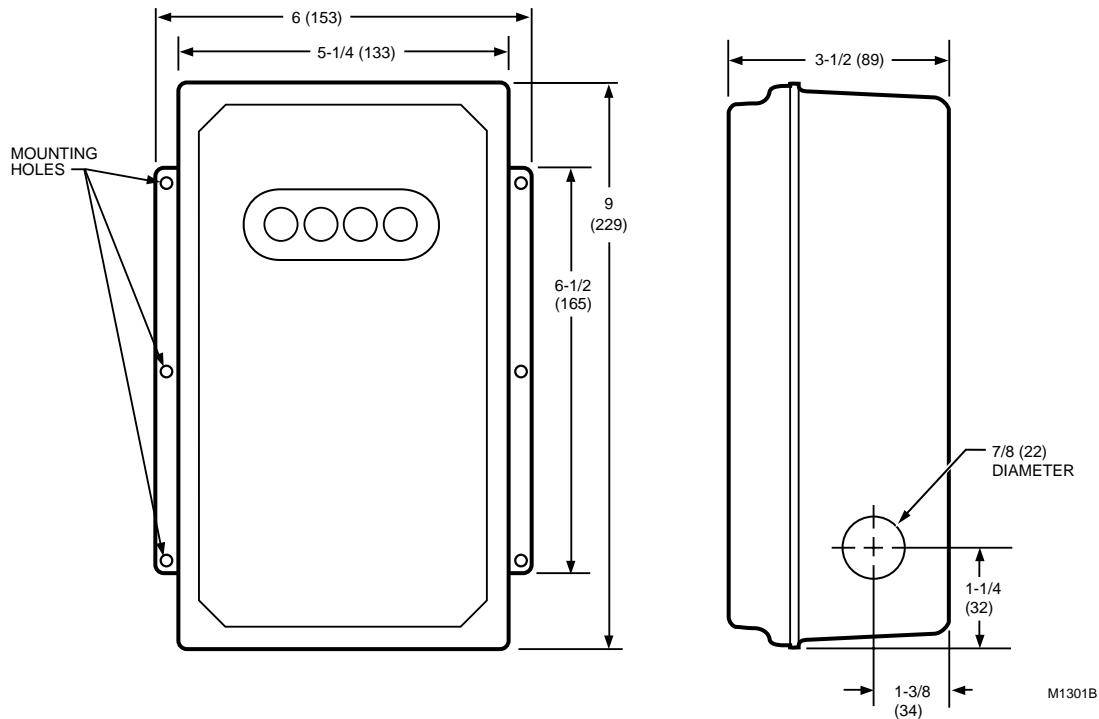

Fig. 3—Feature locations, T775E,F.

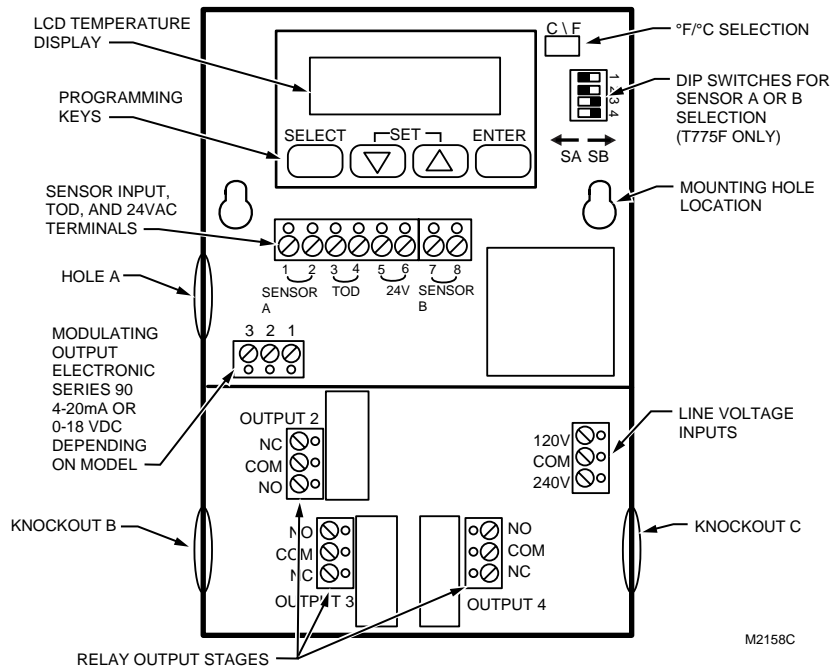
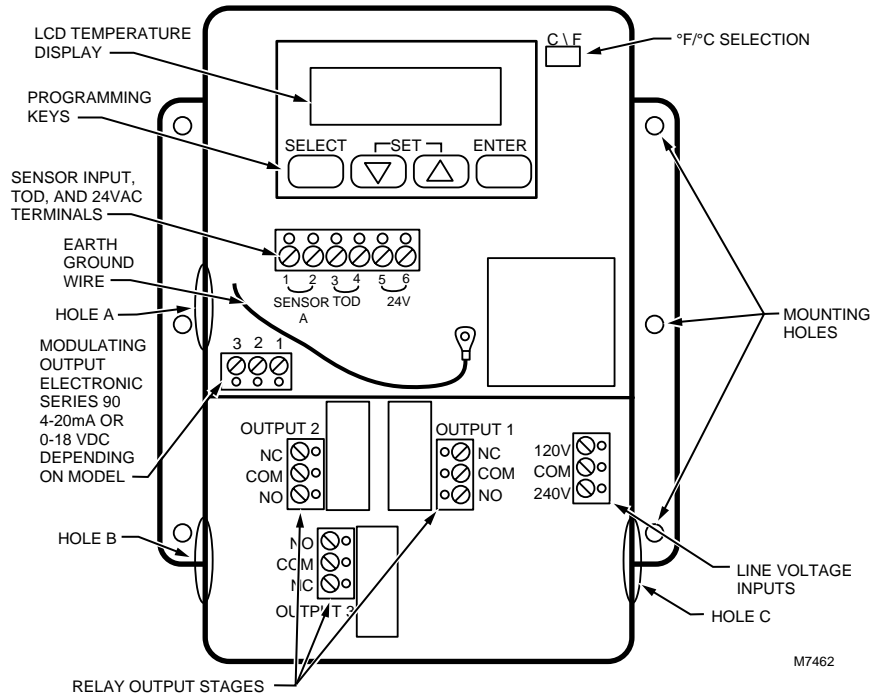

Fig. 4—Feature locations, T775G.



ACCESSORIES:

- T775E,F:
 C7100C1003 Duct Mount Averaging Sensor^a.
 T7047C1090 Wall Mounted Sensor Case.
 107324A Bulb Holder, duct insertion.
 121371A Copper Immersion Well.
 121371E Stainless Steel Well.
 107048 Heat Conduction Compound, 4 ounce.
 C7043A1098 Case and Immersion Well for running conduit to sensor.
 203531A Panel Mount Kit

T775G:

- 121371A Copper Immersion Well.
 121371E Stainless Steel Well.
 107408 Heat Conduction Compound, 4 ounce.
 203401B Waterproof Sensor
 A775A1003 Sensor Simulator
 202026D NEMA 4 Replacement Cover Kit (T775G only).

^a Accuracy decreases to +/-2°F.

Installation

WHEN INSTALLING THIS PRODUCT...

1. Read these instructions carefully. Failure to follow them could damage the product or cause a hazardous condition.
2. Check the ratings given in the instructions and on the product to make sure the product is suitable for your application.
3. Installer must be a trained, experienced service technician.
4. After installation is complete, check out the product operation as provided in these instructions.



WARNING

Disconnect power before installation to prevent electrical shock or equipment damage.

LOCATION AND MOUNTING

Mount the T775E,F Controller on any convenient interior location using the two mounting holes provided in the back of the metal enclosure (mounting screws are not provided and must be obtained separately). Mount the T775G Controller on any convenient interior location using the six mounting holes provided along the sides of the NEMA 4X enclosure (mounting screws are not included). Use controller dimensions in Fig. 1 (T775E,F) or Fig. 2 (T775G) as a guide.

SENSOR LOCATION

Locate the 193987GA Sensor up to 1000 feet (304 meters) from the T775 using standard AWG 18/2 unshielded wire. For cable runs longer than 25 feet shielded cable is recommended. See Fig. 5. It may be located on pipes, in an immersion well, in a wall mount case or on a bulb holder. See Fig. 6 for nomenclature. The 193987GA is not a water tight or water resistant sensor. For wet applications, see the Accessories list in the Specifications section.

Multiple sensors can be parallel-series wired to sense average temperatures in large spaces.

To maintain control accuracy, the number of parallel-series wired sensors must be of the n² power (4, 9, 16, etc). See Fig. 7.

Fig. 5—Using shielded cable for cable runs longer than 25 feet.

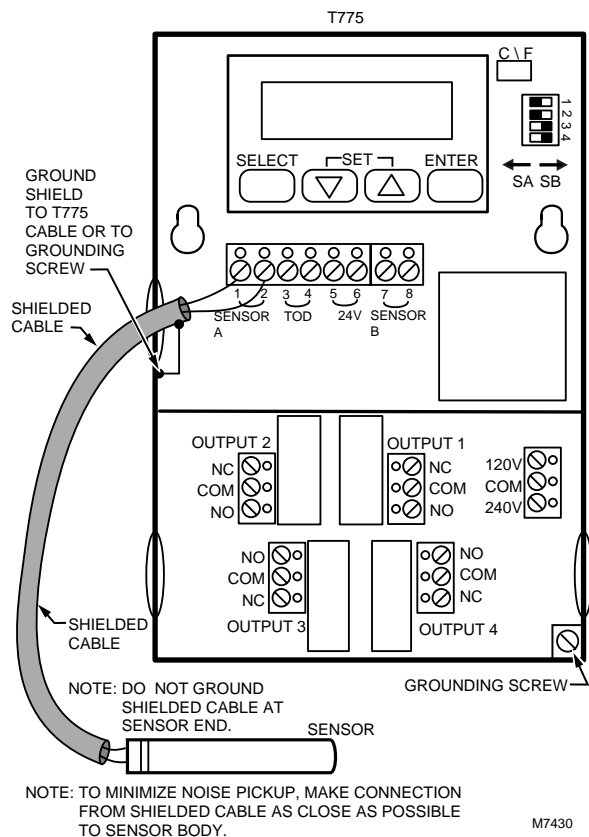

SENSOR MOUNTING

Sensors can be mounted on a wall or panel for sensing space temperature (Fig. 6), strapped to a pipe or inserted in a well (Fig. 8) for hot/cold water sensing, or taped to a standard cap or bulb holder for duct air sensing. To prevent moisture or condensation entering the sensor through the leadwire holes, mount the sensor with the leadwires exiting the bottom of the sensor.

NOTE: Use heat conductive compound in immersion wells. See Optional Accessories in the Specifications section.

Fig. 6—Sensor mounted on wall.

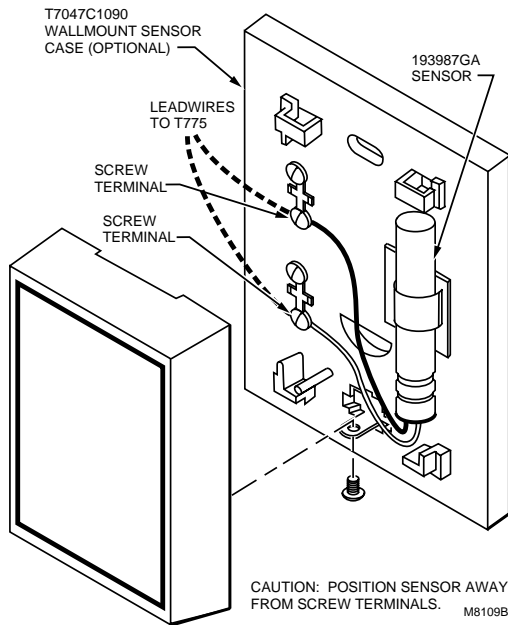

Fig. 7—Parallel-series wiring of sensors.

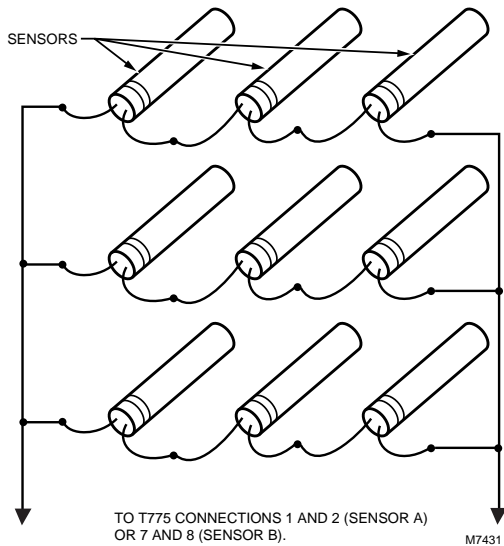
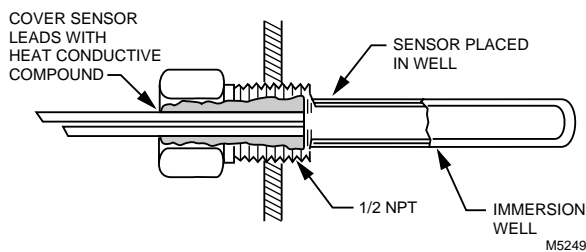

Fig. 8—Sensor inserted in immersion well.



WIRING



Disconnect power before installation to prevent electrical shock or equipment damage.

Disconnect external power before wiring to prevent electrical shock or equipment damage. All wiring must comply with applicable codes and ordinances.

IMPORTANT: The T775 is an operating control, not a limit or safety control. When used in applications requiring safety or limit controls, use a separate safety or limit control device in conjunction with the T775.



Do not use 24 Vac power at terminals 5 and 6 to power any external loads when 120 Vac or 240 Vac is used to power the T775.

Refer to Fig. 3 or 4 for locating the appropriate power inputs, remote sensor input, relay and modulating output terminals, contact closure input and sensor selection switch. Gain access to the terminals through standard conduit knockouts (A-C) located around the perimeter of the enclosure.

NOTE: Use hole A only for sensor, low-voltage and contact closure wiring and access to modulating output.

When wiring the input power, apply only one source of power to the T775 (24 Vac or 120 Vac or 240 Vac). Use knockouts B and C to gain access to 120 Vac or 240 Vac input terminals and the load relay output terminals.

To improve static protection for the T775G, connect earth ground to the center ground screw. See Fig. 4.

Use the T775 to control damper and valve actuators that accept Electronic Series 90, 4 to 20 mA, or 0 to 18 Vdc modulating inputs as well as controlling up to three On/Off loads. Depending on the application and the motor or actuator being used, the T775 can control up to three Modutrol Motors by using resistor kits that are available as accessory parts for existing motors. Using specified resistor kits can also allow the user to control an Electronic Series 90 Motor with a 4 to 20 mA controller. Information regarding these kits can be found in the TRADELINE® Catalog, motor specification, or from your local distributor. See Fig. 9 through 18 for typical T775 wiring applications.

Fig. 9—Wiring T775 for 24 Vac input and up to 24 Vac loads.

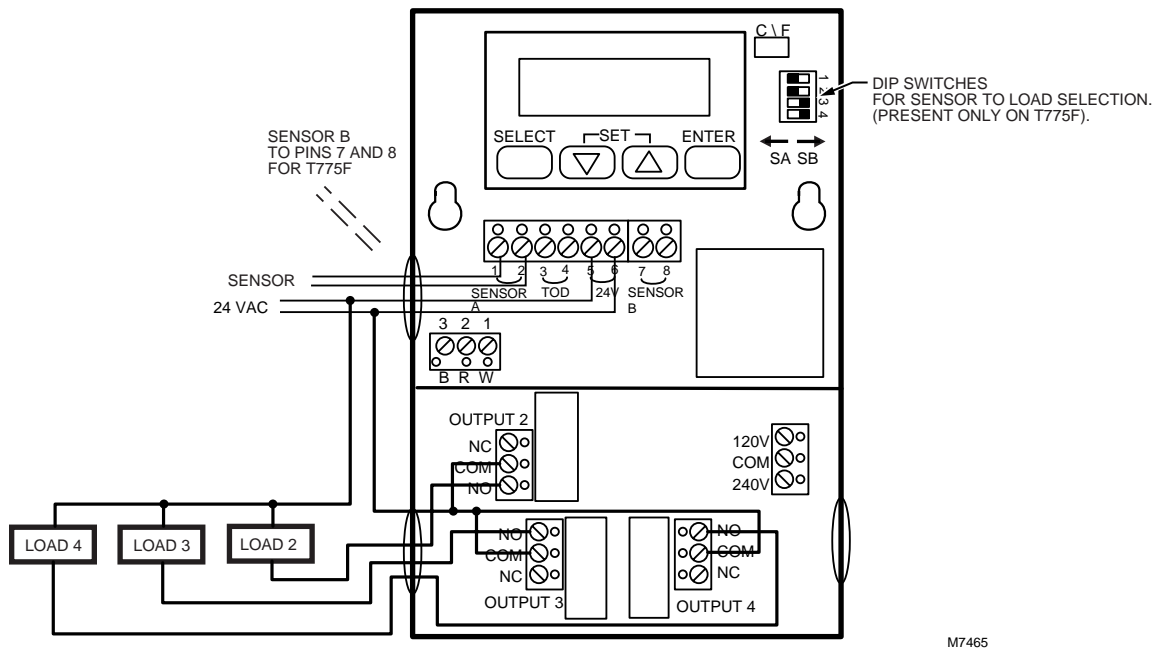

Fig. 10—Wiring T775 for 120 Vac input and up to three 120 Vac loads.

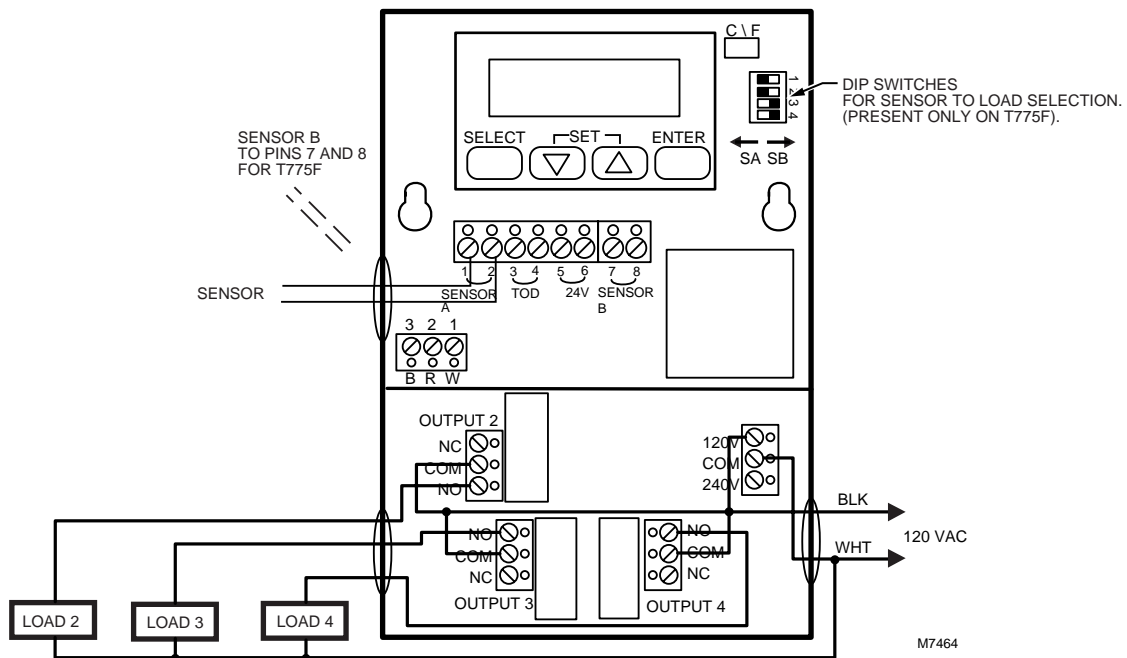

Fig. 11—Wiring T775 for 240 Vac and up to three 240 Vac loads.

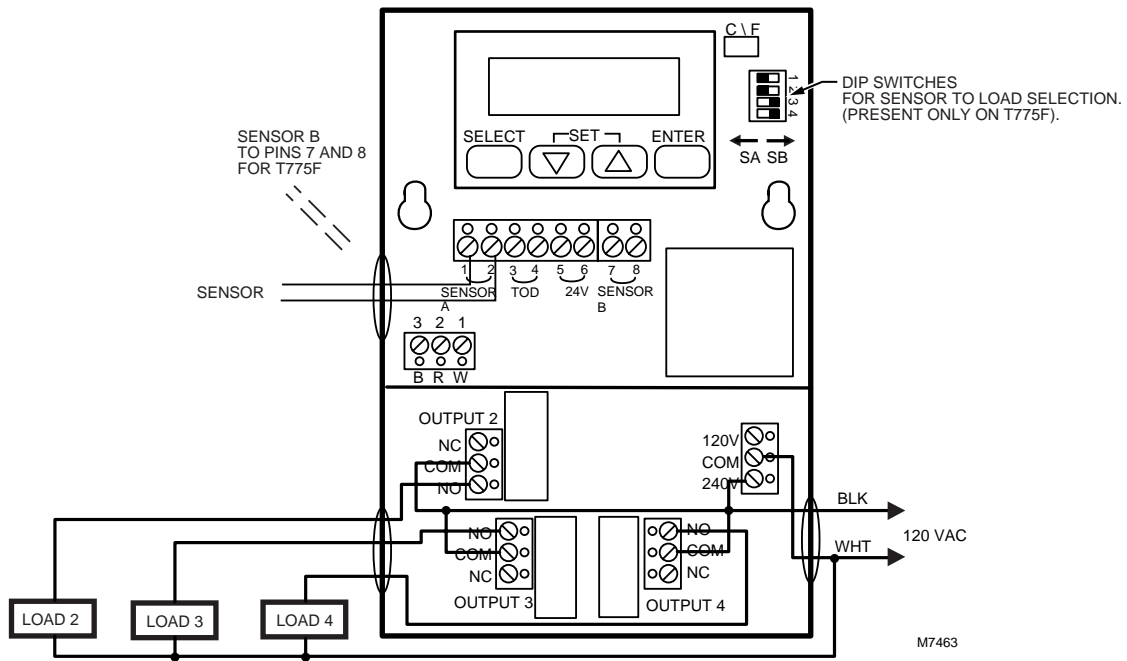

Fig. 12—Wiring T775 to electronic Series 90 Modutrol Motor control.

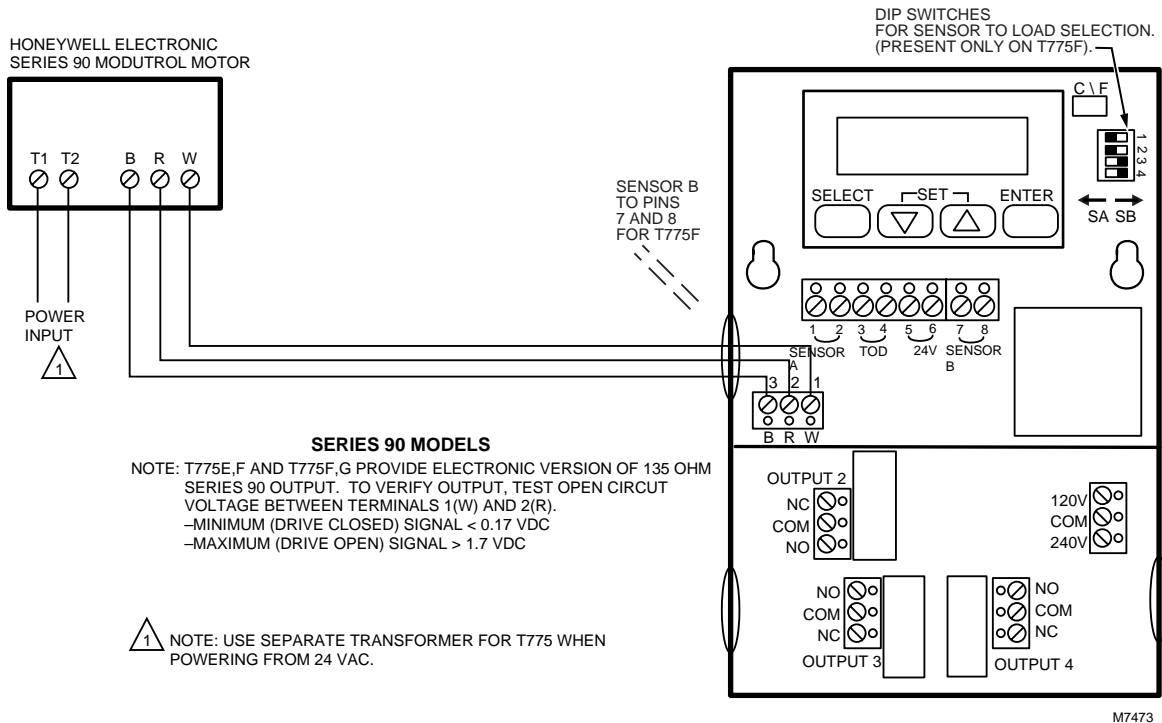

Fig. 13—Changeover relay and minimum position potentiometer used with Series 90 Modutrol Motors.

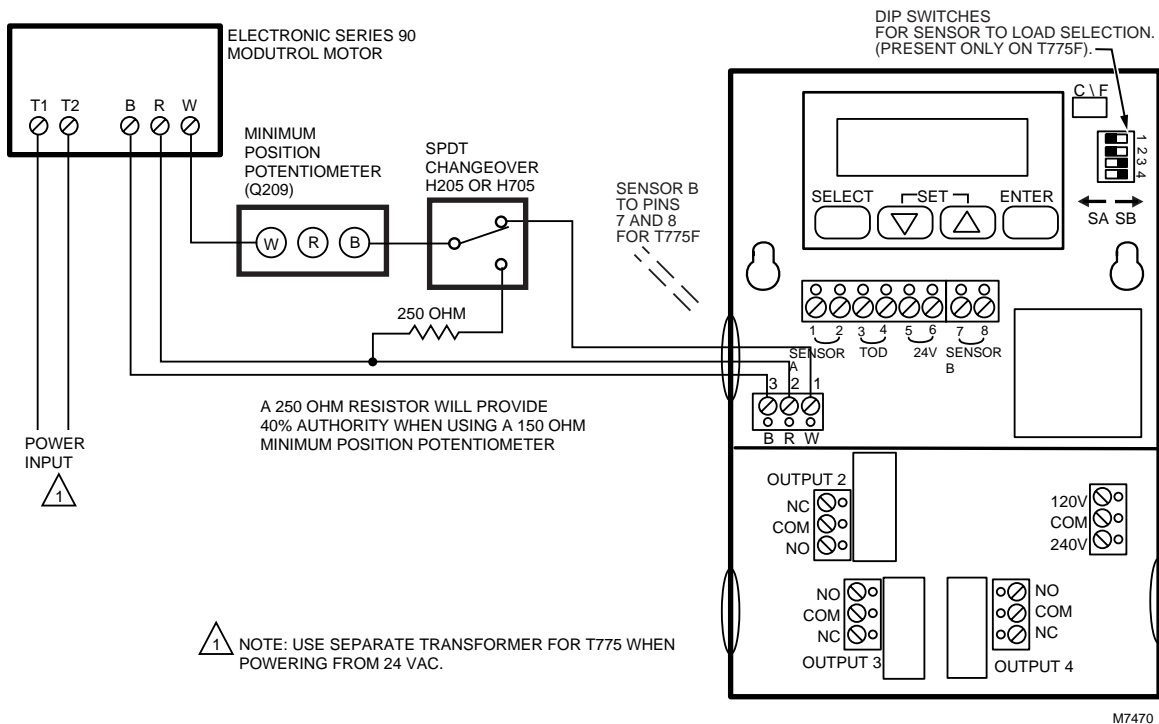

Fig. 14—T991 used with Series 90 Modutrol Motor and T775 to provide modulating low limit.

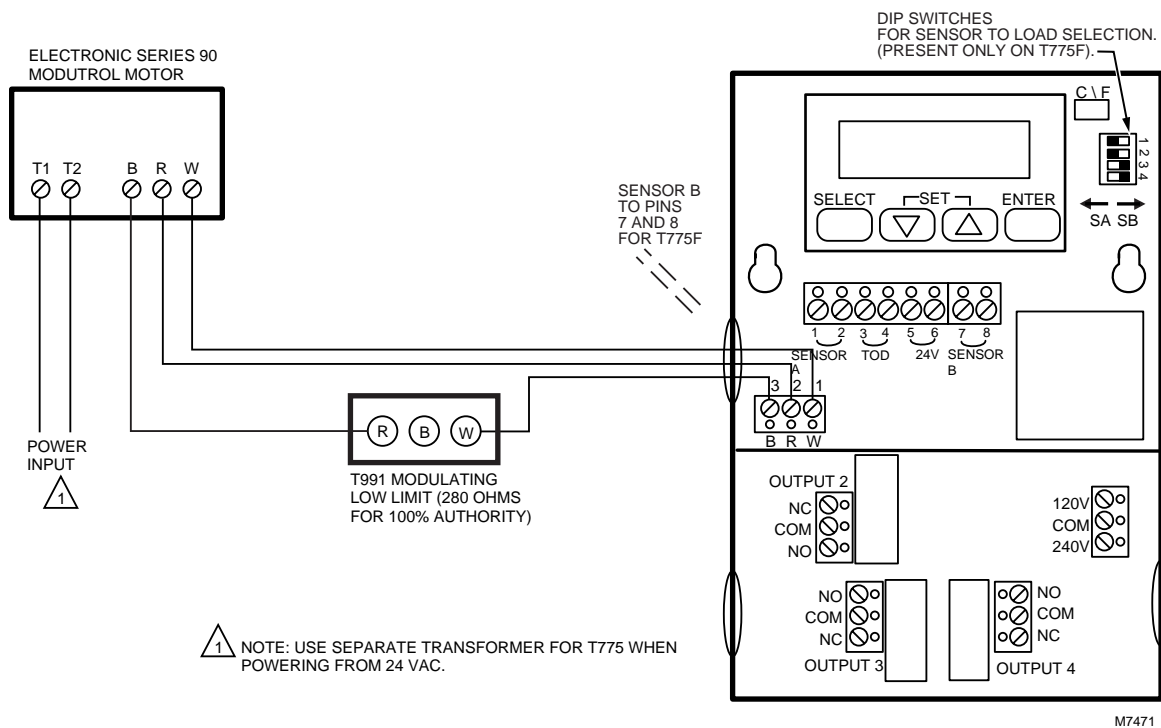

Fig. 15—Wiring T775 to ML984 Valve Actuator.

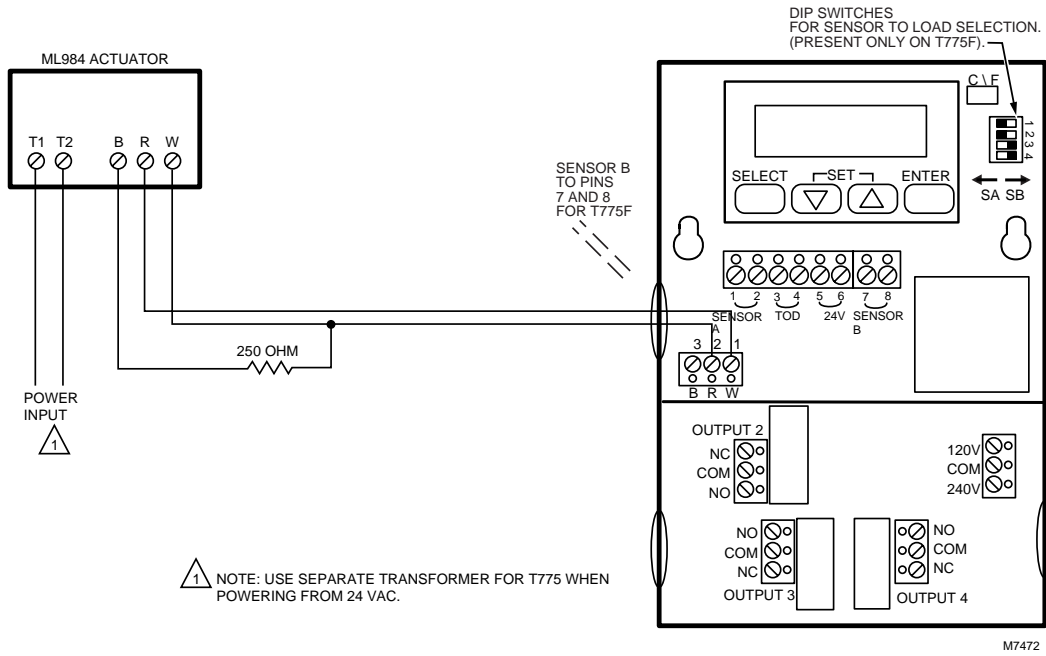

Fig. 16—Wiring T775 with up to 3 Series 90 Modutrol Motors.

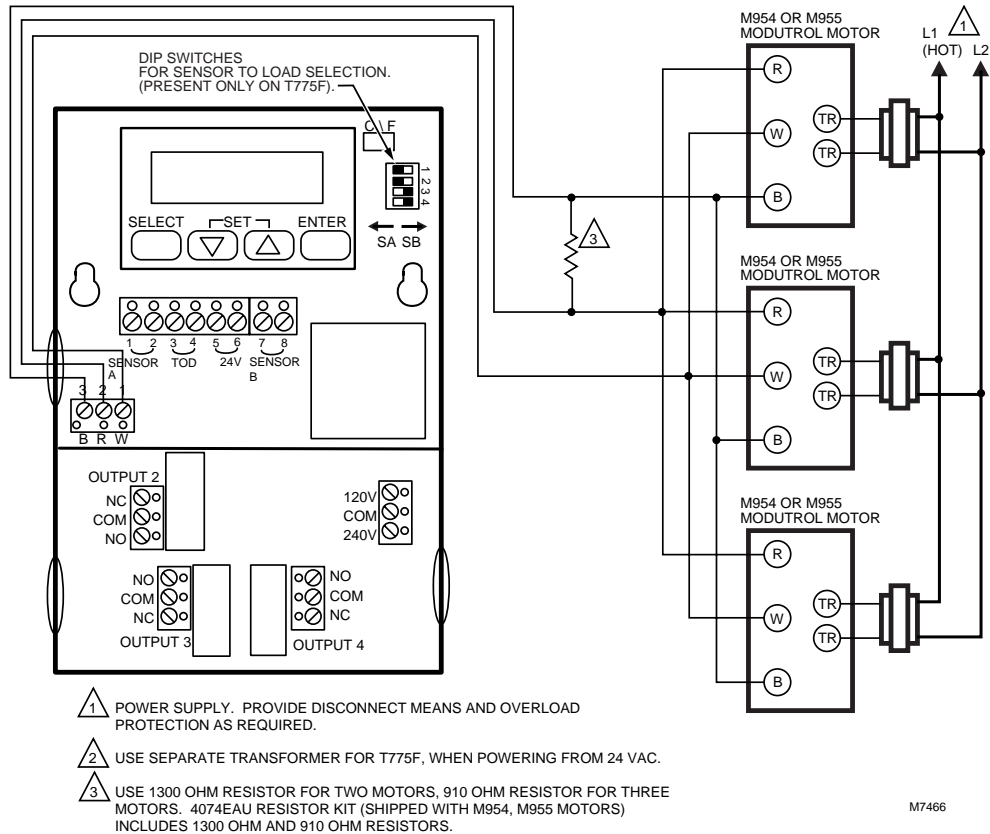

Fig. 17—Wiring T775 to 4 to 20 mA actuator.

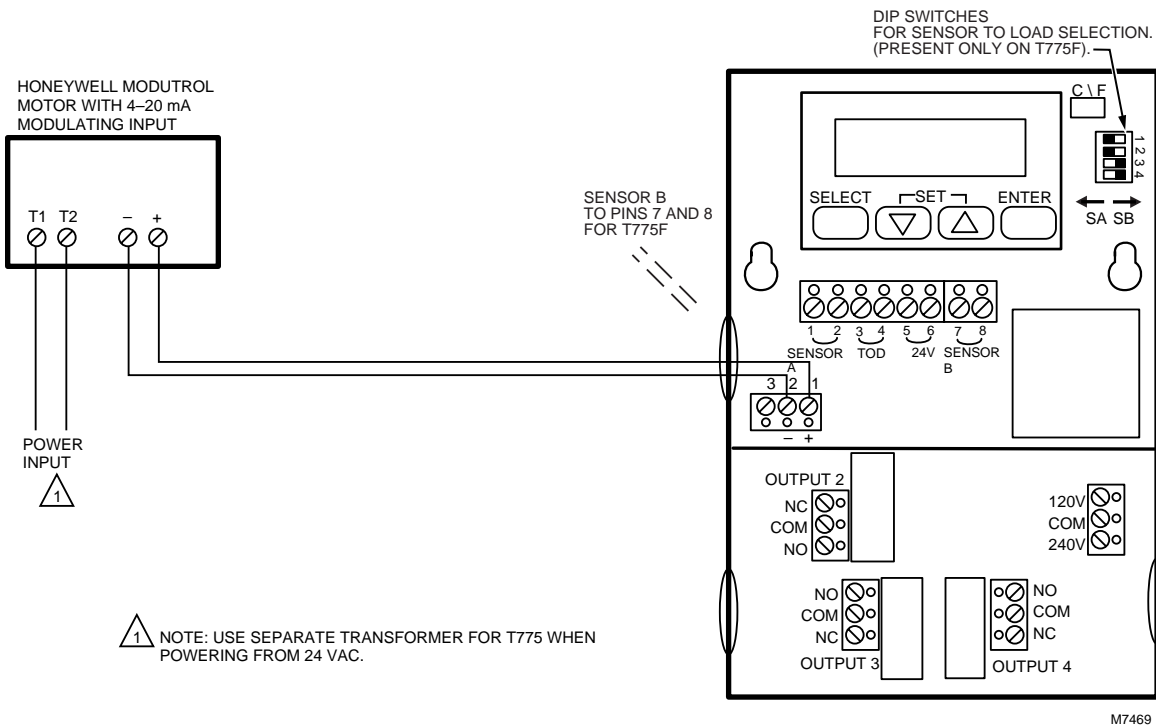

Fig. 18—Wiring T775 with modulating actuator with voltage control input.

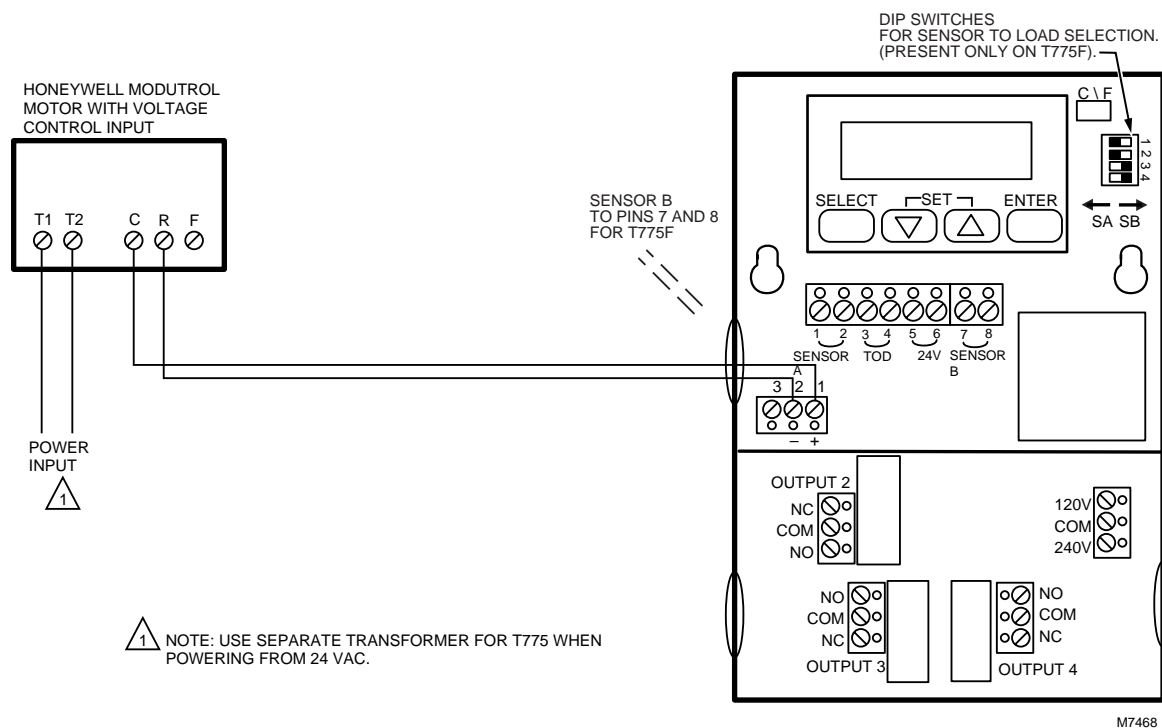
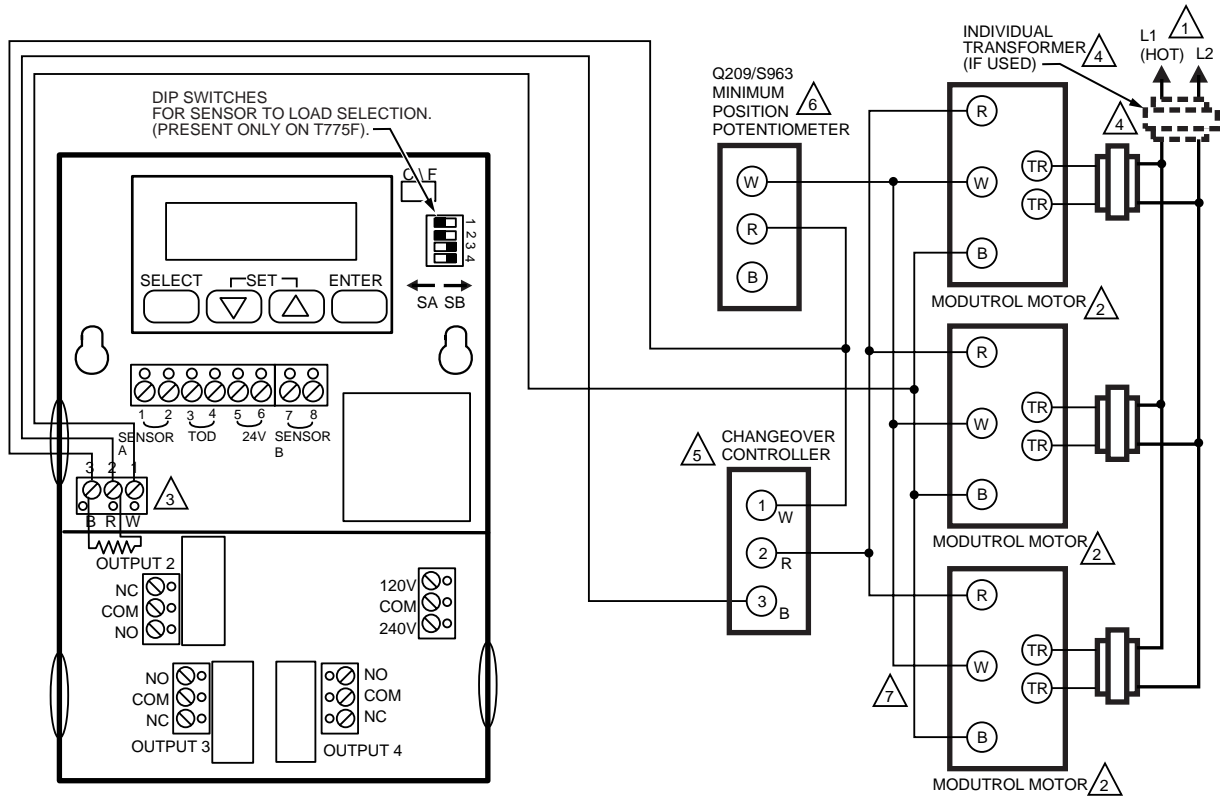

Fig. 19—Unison control of M9185 Modutrol IV Motor using one minimum position potentiometer for all motors. System is shown connected for cooling; for heating, reverse the W and B leads at the controller.



1 POWER SUPPLY. PROVIDE DISCONNECT MEANS AND OVERLOAD PROTECTION AS REQUIRED.

2 UP TO 6 SIMILAR MOTORS CAN BE CONNECTED IN UNISON.

3 USE RESISTOR BETWEEN R AND B ON T775E, F, AND G:
 A. 1300 OHMS FOR TWO MOTORS.
 B. 910 OHMS FOR THREE MOTORS (4074EAU KIT).

4 IF COMMON TRANSFORMER IS USED, ALL MOTORS MUST BE IN PHASE. CONNECT SAME TRANSFORMER LEAD TO T1 ON EACH MOTOR, CONNECT OTHER TRANSFORMER LEAD TO T2 ON EACH MOTOR.

5 USE TEMPERATURE CONTROLLER, SUCH AS H205, H705, OR T675A FOR CHANGEOVER CONTROL.

6 AUTHORITY OF MINIMUM POSITION POTENTIOMETER, IF USED, INCREASES WITH NUMBER OF MOTORS PARALLELED. WITH 1 MOTOR, 50 PERCENT STROKE; WITH TWO MOTORS, 100 PERCENT STROKE; WITH 3 MOTORS, 100 PERCENT STROKE WITH 1/3 OF FULL POTENTIOMETER ROTATION.

7 REVERSING B AND W TERMINALS ON ONE OR MORE MOTORS WILL NOT AFFECT CONTROL PERFORMANCE ON OTHER MOTORS. SYSTEM CAN BE CONFIGURED TO HAVE SOME MOTORS REVERSE ACTING AND OTHER MOTORS DIRECT ACTING.

8 USE SEPARATE TRANSFORMER FOR T775, WHEN POWERING FROM 24 VAC.

M7467

Fig. 20—Explanation of calibration setpoints for heating and cooling modes.

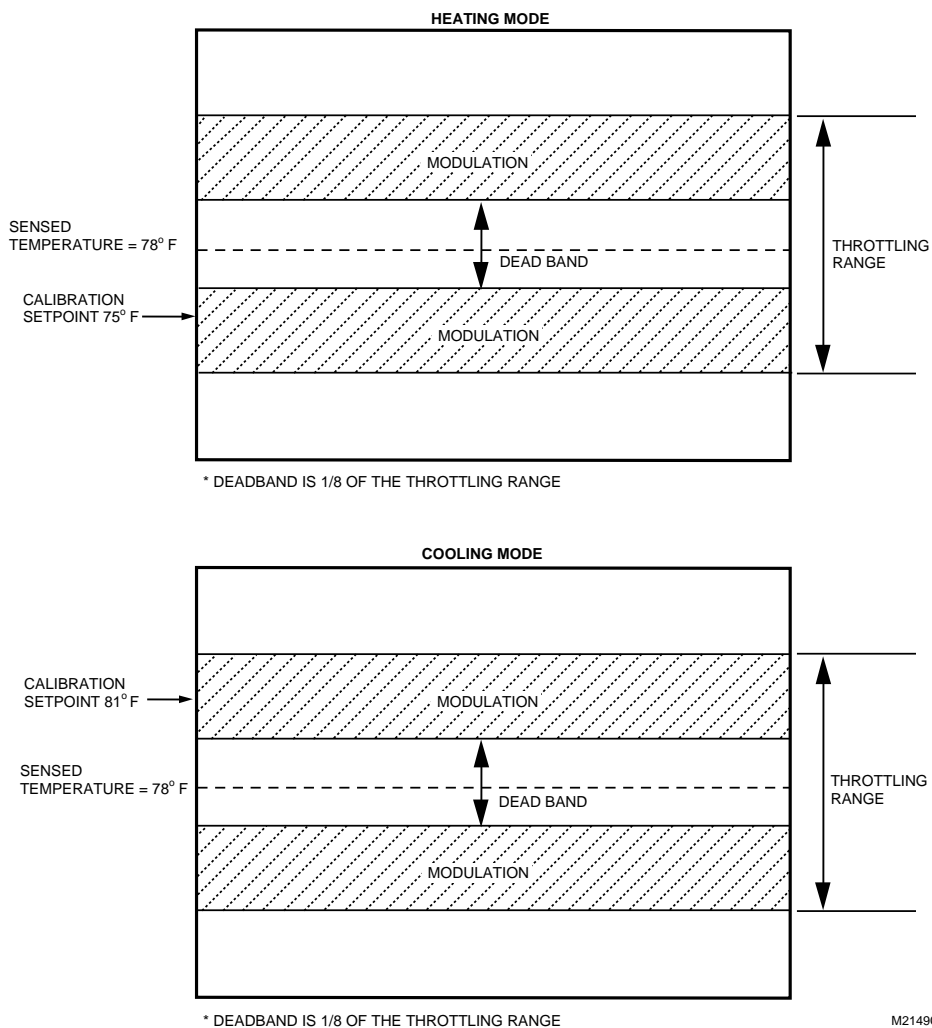

See Fig. 20 for definitions of modulating setpoint temperatures and temperature/load diagrams.

IMPORTANT: To assure proper operation, avoid poor wiring practices listed below that can cause erratic temperature readings from the 193987GA or 203401B Sensor.

- a. Do not route temperature sensor wiring with building power wiring.
- b. Do not locate temperature sensor wiring next to control contactors.
- c. Do not locate temperature sensor wiring near electrical motors.
- d. Do not locate temperature sensor wiring near welding equipment.
- e. Make sure good mechanical connections are made to both the sensor and the controller.
- f. Do not mount the sensor with the leadwire end (wire end) pointing up in an area where condensation can occur.

If any of the above conditions cannot be avoided, use shielded cable. See Fig. 5.

DEVICE SETUP

1. Determine the loads to be controlled and the operating mode (heat or cool) and enter in the Device Programming Worksheet.

For example: Load 2: Compressor 1 (cool)
 Setpt 1 _____ On at _____
 Diff 1 _____ Off at _____

2. For two sensor models (T775F) determine which loads are controlled from sensor A or sensor B and enter on the worksheet.

For example: Load 2: Compressor 1 (cool)—Sensor A
 Setpt 1 _____ On at _____
 Diff 1 _____ Off at _____

3. Determine the setpoint (Setpt) and the throttling range for Load 1 and the switching differential (Diff) for each On/Off load and enter on the worksheet.

For example: Load 2: Compressor 1 (cool)—Sensor A
 Setpt 1 78°F On at _____
 Diff 1 4°F Off at _____

4. Refer to the Control Algorithm section to calculate the load on and off temperatures and enter on the worksheet. Remember that the On/Off outputs are off at setpoint in both the heating and cooling operating modes. When in cooling mode, the load turns off at setpoint plus the differential. When in heating mode, the load turns on at setpoint minus the differential.

For example: Load 1: Compressor 1 (cool)—Sensor A
 Setpt 1 78°F On at 82°F
 Diff 1 4°F Off at 78°F

 **CAUTION**

The T775 will not allow the user to program for both heating and cooling loads to be energized at the same time.

If this situation results, cooling loads will be energized and heating loads will be prevented from also energizing. The number (1,2,3,4) of these nonenergized loads flashes along with the word HEAT to indicate a call for both heating and cooling loads controlled by one sensor has occurred and to alert the user to reprogram the affected control values.

5. Remove the T775 cover and enter the values listed on the worksheet and the date in the first column on the label inside the T775 cover.

Device Programming Worksheet	
Load 1: SetPt 1 _____ Throttling Range _____	On at _____ Off at _____
Load 2: Setpt 2 _____ Diff 2 _____	On at _____ Off at _____
Load 3: Setpt 3 _____ Diff 3 _____	On at _____ Off at _____
Load 4: Setpt 4 _____ Diff 4 _____	On at _____ Off at _____

DEVICE PROGRAMMING

Factory Default Values

When power is initially applied to the T775 the control points are at their default value set at the factory. Default values are:

	Setpoint (°F)	Differential (°F)	Operating Mode
Stage 1	72	2	Heat
Stage 2	70	2	Heat
Stage 3	68	2	Heat
Stage 4	66	2	Heat

1. For the T775F, assign the loads to the appropriate sensor by setting the DIP switch in the upper right corner of the T775 (See DIP Switch Selection, Fig. 23).
2. Before programming the T775, verify that the °F/°C selection jumper is properly installed. The T775 is shipped from the factory with the jumper installed in the °F position. When °C is desired, remove the jumper.
3. Apply power to the device. The device begins counting down from 210. This countdown sequence lasts for approximately 3-1/2 minutes.
4. To override this time delay, press Select.
5. Press Select and Enter keys simultaneously to begin programming the load operating mode (Heat or Cool).
6. Press the Set (down arrow) to change to cooling. The Set (up arrow) changes back to heating.
7. Press Enter to program the displayed mode into memory.
8. Press Select to go to the next stage.
9. Repeat steps 6 through 8 for additional stages.
10. Pressing Select after the last stage is set up returns to the display of the sensed temperature.

PROGRAMMING STAGE CONTROL VALUES

IMPORTANT: If you have a 0 to 18 Vdc output T775, go to the Calibration Procedure for 0 to 18 Vdc Output T775 section before continuing to program the stage control values. The Electronic Series 90 and 4 to 20 mA output devices require no calibration; proceed to step 1.

IMPORTANT: When programming all stages, the first stage designated on the LCD is always the modulating output.

1. Press Select to display the current stage setpoint.
2. Press Set (up arrow) to increase or Set (down arrow) to decrease to the desired setpoint.
3. Press Enter to enter the displayed value into memory.
4. Press Select to display the current stage throttling range or switching differential.
5. Press Set (up arrow) to increase or Set (down arrow) to decrease to the desired throttling range or switching differential.
6. Press Enter to enter the displayed value into memory.
7. Repeat steps 1 through 6 to program each additional stage.
8. For the T775E, press Select/Select (two times) to return to stage 1 parameters. For the T775F, press Select/Select/Select/Select (four times) to return to stage 1 parameters. For the T775G, press Select to return to stage 1 parameters. Scroll through the programming loop a second time to confirm that the appropriate values were entered into memory by pressing Select.

NOTE: The T775F has three options for displaying the sensed temperature:

1. Sensor A only.
2. Sensor B only.
3. Alternating between Sensors A and B.

For the T775F only:

9. Press Select after viewing the switching differential for the final stage to display Sensor A temperature only.
10. Press Select again to display Sensor B temperature only.
11. Press Select again to alternate the display between Sensor A and Sensor B temperatures at approximately five-second intervals.
12. Before replacing the cover on the T775, check to verify that the control values are recorded on the label on the backside of the cover.

IMPORTANT: For the T775E and T775G only: After initial programming, altering the setpoints for stage 1 up or down will result in a change in setpoints 2, 3, and 4 by the same number of degrees and in the same direction. When increasing or decreasing the setpoint for stage 1 results in exceeding the control limits (-40°F to +220°F [-40°C to +104°C]) for subsequent stages, the control will not allow the user to enter a value for stage 1 higher or lower than this limit. This will allow for easy sequential output staging to be modified, while keeping the margin intact between setpoints.

NOTE: The control values programmed into memory will not be lost in event of a power failure.

CALIBRATION PROCEDURE FOR 0 TO 18 Vdc OUTPUT T775

NOTE: The 0 to 18 Vdc output T775 models have field selectable starting voltages and spans and will require calibration. The 135-ohm, Series 90 and 4 to 20 mA output T775 models require no calibration.

1. Disconnect power to the device.
2. Remove the device cover and disconnect the load from the plus and minus outputs. Connect a dc voltmeter to the plus and minus modulating outputs of the T775 (see Fig. 21).
3. Loosen the screw in the upper right corner of the T775 approximately six turns with a screwdriver (see Fig. 22).

Fig. 21—Modulating output terminal.

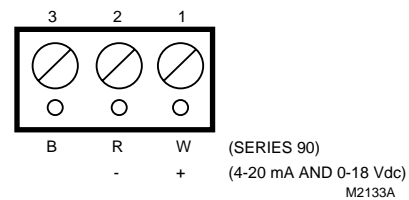
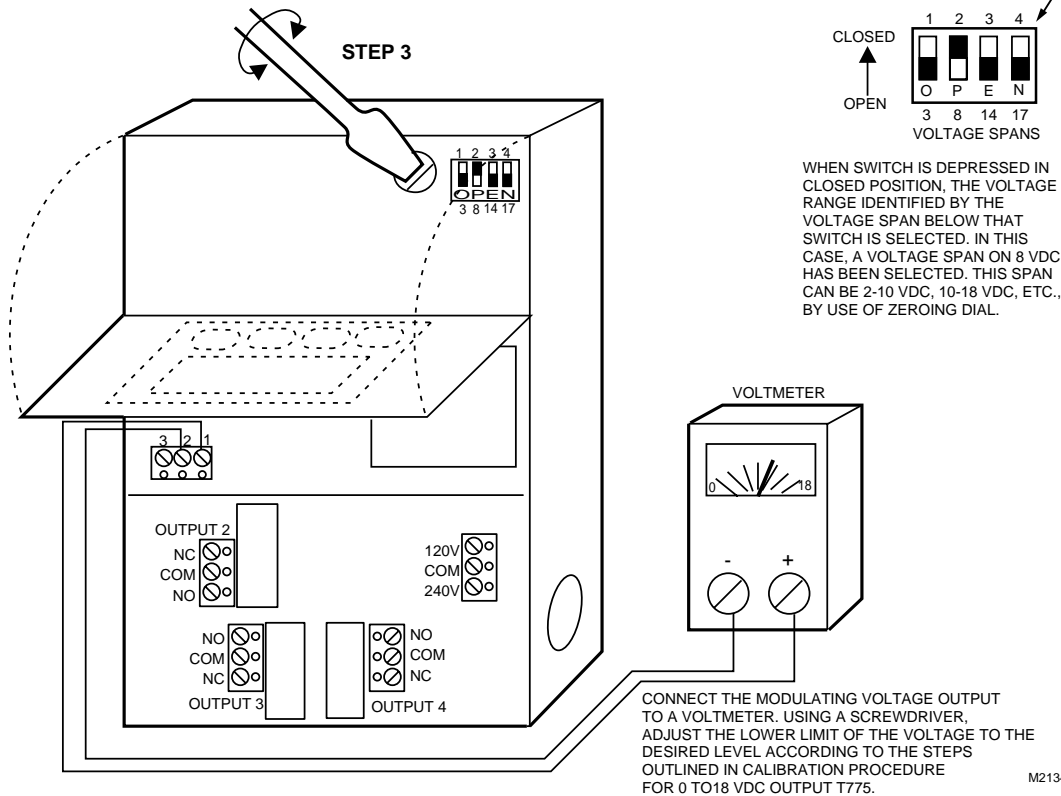
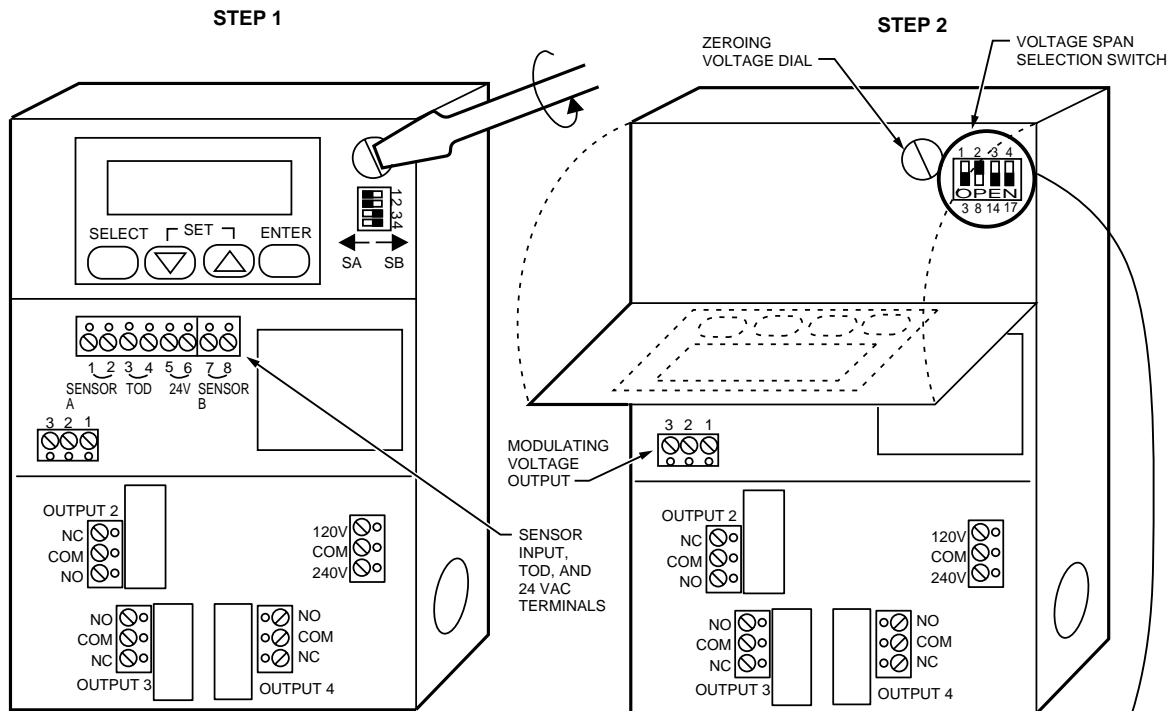

Fig. 22—Output voltage span selection.



M2134D

Description/Operation

CONTROL ALGORITHM

Proportional plus Integral Modulating Control

Proportional + Integral (P+I) control provides fast, responsive operation of the controlled devices in reacting to temperature changes by providing an output signal proportional to the deviation between setpoint and actual temperature. An integral proportion also provides a time dependent output signal that is dependent on the length of time the deviation existed between actual setpoint and sensed temperature.

The P+I algorithm places the control setpoint in the middle of the throttling range. A deadband exists around setpoint and is proportional to the throttling range. For the T775, this deadband is one-eighth of the throttling range.

Modulating Control

There are three modulation options available for the T775. These options are:

- Electronic Series 90: This output provides an electronic signal equivalent to an electronic 135-ohm potentiometer. It is intended to drive Electronic Series 90 Modutrol® Motors for control of dampers and valves. This electronic signal does *not* drive electro-mechanical slidewire devices.
- 4 to 20 mA: This is a general purpose current mode output which can drive a 600-ohm maximum load without output current degradation. This modulation output can be used with Honeywell Modutrol® Motors that accept an input signal of 4 to 20 mA (M744S,T,Y and the M745S,T, and Y) or other Honeywell motors with the use of resistor kits.
- 0 to 18 Vdc (has series 100-ohm output resistor): This output module is intended as a general purpose voltage output and can drive a 2000-ohm load minimum. The span of voltage output is user selectable via a dual inline package (DIP) switch. (See Fig. 23) The spans offered are 3, 8, 14, and 17 volts. A zero adjustment dial is provided allowing the user to select starting voltage for common ranges such as 4 to 7 Vdc, 6 to 9 Vdc, 2 to 10 Vdc, 10.5 to 13.5 Vdc, 14.5 to 17.5 Vdc, 1 to 15 Vdc, and 1 to 18 Vdc. This modulation output can be used with Honeywell Modutrol® Motors that accept a voltage span comparable to any of the above. The device is factory set at the 2 to 10 Vdc range. The 0 to 18 Vdc output has an output rating to 20K ohms at rated voltages and to 2K ohms with a -5% voltage shift.

The T775E and G operate with one temperature input supplied by the remote sensor, while the T775F has two temperature inputs. The T775E and G are capable of providing up to four outputs, the first one of which is modulating. Each stage of the T775E and G has its own independent setpoint, which can be configured to operate in the cooling or heating mode. The mode of operation for each stage is user determined by the programming keys.

Fig. 23—DIP switch settings for sensor selection.

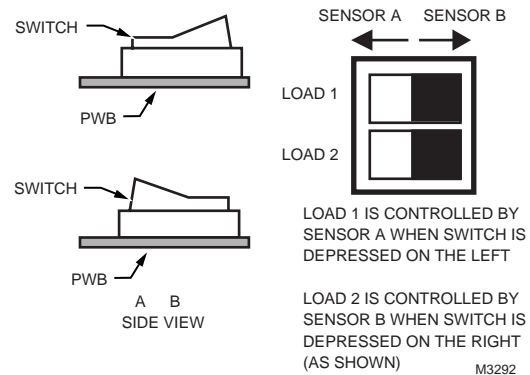

CONTROLLER DESCRIPTION OPERATION

- The throttling range is the range around which the T775 attempts to control the setpoint.

Heating Mode Operation

- The throttling range is centered around the setpoint.
- Modulating outputs are at their minimum or closed position at setpoint plus one-half of the throttling range.
- Modulating outputs are at their maximum or open position at setpoint minus one-half of the throttling range.
- Relay outputs are energized at setpoint minus differential and are de-energized at setpoint.

Cooling Mode Operation

- The throttling range is centered around the setpoint.
- Modulating outputs are at their minimum or closed position at setpoint minus one-half of the throttling range.
- Modulating outputs are at their maximum or open position at setpoint plus one-half of the throttling range.
- Relay outputs are energized at setpoint plus differential and de-energized at setpoint.
- Relay outputs are de-energized at temperature setpoint value.

The T775F has dual sensor inputs and allows two separate controllers to exist within one enclosure. Selection of the stage parameters (operation mode, setpoints, throttling range, and differentials) is the same as that for a single sensor device once each stage has been assigned to its operating sensor. This assignment is hardware driven via a set of four DIP switches. An explanation of the DIP switch assignments is shown in Fig. 23.

Contact Closure Override Input

A two-terminal input is provided to allow the user to override a relay energized condition on all outputs. When used with modulating devices, a contact closure override input causes the output to return to its minimum position. This function is generated by using a contact closure between terminal pins 3 and 4 of the terminal block for sensor input shown in Fig. 3 and 4. This can be achieved manually or by using an Energy Management System (EMS) controller or time clock with normally open contacts (W7505 or S7005, for example).

When this override is active, the display shows the numbers of the stages that would have been energized and the words STAGE ENERGIZED flash on the display.

°F/°C Selection

A single jumper plug controls °F/°C indication of the displayed temperature value. The location of this jumper is shown in Fig. 3 and 4. The unit is shipped with the jumper installed in the °F mode. To operate the device in the °C mode, remove the jumper.

DIP Switch Selections

On the T775F, the DIP switches are provided for assignment of each relay output stage to its operating sensor. When an individual switch is depressed toward its corresponding load number (1-4 on DIP switch) or to the right, Sensor B is the controlling sensor for that output stage. When an individual switch is depressed to the left, Sensor A is the controlling sensor for the output stage. An example of the switches and their corresponding positioning is shown in Fig. 23.

A second set of DIP switches is present for voltage range selection on 0 to 18 Vdc modulating devices. On the printed wiring board below each switch is the span corresponding to each switch. Fig. 22 shows the location of this switch, zeroing dial and how to set the voltage span.

KEYPAD PROGRAMMING AND DISPLAY

The T775 uses a Liquid Crystal Display (LCD) for interactive prompting during programming and display of sensed and assigned setpoint and differential values. User programming of the T775 is accomplished using the four programming keys.

Programming Keys

The four programming keys are the Select, Up arrow, Down arrow and Enter keys.

- Select key sequentially prompts the user for what parameter is being displayed: setpoint, differential, stage energized, heat or cool (operation mode), 1,2,3,4 (indicating assigned stage). Once the last parameter value is viewed, pressing the Select key displays the control values again from the beginning of the display loop.
- Up and Down arrow keys allow the displayed parameter to be increased or decreased. After pressing the

Select key, a control value can be changed using the arrow keys. Control values are increased or decreased by 1°F or 1°C each time the arrow key is depressed.

- Enter key places the new value into the memory of the microprocessor.

IMPORTANT: *A control value or operation is not entered into the memory of the microprocessor until the Enter key is pressed.*

Control values and operation selection remain in the device memory even after the power is removed.

- Press the Select and Enter keys at the same time to change the control algorithm from heating to cooling or from cooling to heating. The heating and cooling parameters are not displayed during the normal Select key sequences. The only parameters displayed after pressing the Select and Enter keys at the same time are the stage indication and the word heat or cool. To change the operation from heating to cooling or vice versa for a desired output stage, use the arrow keys. Once the mode is changed, pressing the Enter key is necessary to enter this change into the microprocessor memory. The next stage of heat or cool assignment appears after the Select key is pressed. When all stages are programmed, the display reverts back to sensed temperature and load energized status.

Display

Once power is applied or restored to the device, the display counts down from 210 until the display reads zero, during which time any previously energized outputs are de-energized. This is intended to protect compressors in the event of a power outage.

To avoid viewing this entire countdown, press the Select key. The LCD display now shows what it normally reads: load (sensed) temperature, stages energized, and which sensor (Sensor A or Sensor B) is being read for two sensor devices. At any time during the programming procedure, 60 seconds after the last key closure, the display reverts back to showing the sensed temperature and stage status indication.

For two sensor applications, the user has three options for what is displayed. The display can be configured to alternatively indicate Sensor A and Sensor B sensed temperature at a five second rate or lock on to Sensor A or Sensor B sensed temperature continuously.

This selection is accomplished by stopping at Sensor A or Sensor B sensed temperature points in the Select screen scrolling loop. To lock on to either sensor, the user must scroll the Select key through the loop to the sensed temperature prompt of interest. The display sticks to that parameter until the Select key is activated to advance the loop. When the loop is stopped at any other prompt, the display alternatively indicates Sensors A and B sensed temperature after 60 seconds from the last key closure or immediately after the Select key has been pressed at the end of the programming sequence.

Error Messages

There are seven error messages that can be displayed in response to software or hardware problems with the T775. The error Codes that can be seen flashing on the display are:

SF—Sensor Failure

If the display shows a flashing SF, this indicates an out of range or defective sensor. Make sure that the sensors are connected properly. For the T775E and G, all loads will be de-energized when this message is flashing.

For the T775F, the loads controlled by the out-of-range sensor will be de-energized. The display flashes SF to indicate which sensor is defective or in error. In the event that only one sensor is defective, the remaining sensor and its load(s) operate normally. Only the load(s) controlled by the defective or unconnected sensor will be de-energized.

IMPORTANT: *A sensor value of less than -40°F or greater than 220°F is out of range and will display SF and de-energize the loads assigned to this sensor when this condition occurs.*

EF—EEPROM Failure

The values read back from the EEPROM are not the same as what was written into the EEPROM. This error cannot be field repaired. Replace the device. The EEPROM is not intended to be field repaired.

CF—Calibration Failure

A calibration resistor reading was not within the range of the Analog to Digital converter. This error cannot be field repaired. Replace the device.

OF—Stray Interrupt Failure

An unused interrupt occurred. This error cannot be field repaired. Replace the device.

CE—Configuration Error

The device hardware was configured to a nonexistent device. This error cannot be field repaired. Replace the device.

OE—ROM Error

The internal Read Only Memory (ROM) of the microprocessor is defective. This error cannot be field repaired. Replace the device.

AE—RAM Error

The internal Random Access Memory (RAM) of the microprocessor is defective. This error cannot be field repaired. Replace the device.

Setpoint Calibration

To maintain temperature accuracy, sensor wires should be 18 AWG two-conductor. If the length of the sensor wire exceeds 400 feet, recalibration will be necessary to maintain accuracy. Table 1 shows the corresponding temperature calibration offset that should be used for different sensor wire lengths. Add this offset to the desired temperature setpoint for these applications. Refer to programming instructions for entering temperature setpoints in the Device Programming section.

TABLE 1—CALIBRATION OFFSET FOR SENSOR WIRE LENGTH.

Sensor Wire Length	Temperature Calibration Offset
0-399 ft	none required
400-599 ft	1 degree
600-799 ft	2 degrees
800-1000 ft	3 degrees

Checkout

After the controller is installed and wired, apply power. Make desired initial adjustments and settings.

1. As illustrated in the example in Fig. 24, record the sensed temperatures for both Sensors A and B as displayed on the device. Use the Select key to advance through the programming loop to determine and then write on the Checkout Table (in Fig. 24) the loads that are controlled by each sensor.

2. Write the operating mode (heat or cool) for each stage in the Checkout Table.

3. Write the sensed temperature for each load on the Sensed Temperature line.

4. Plot the on and off (open/closed) values at which the device energizes and de-energizes each output load by referring to the Device Programming Worksheet.

5. Verify which loads are energized by using the Checkout Table. As shown in the example, the display indicates, in the lower right corner, which stages are energized. If no stages are energized, the words “stage energized” will not appear.

NOTE: If the sensed temperature is between the on and off temperatures, the load may be either energized or de-energized. Refer to the Control Algorithm section for further explanation.

6. If an error message flashes, refer to the Error Messages section. If SF flashes, check the sensor connections; if properly connected and SF continues to flash, check the sensor location to make sure it is located in an ambient condition within the sensor capability (-40°F to +220°F).

Fig. 24—Checkout Table and checkout example with Sensor A = 68°F and Sensor B = 73°F.

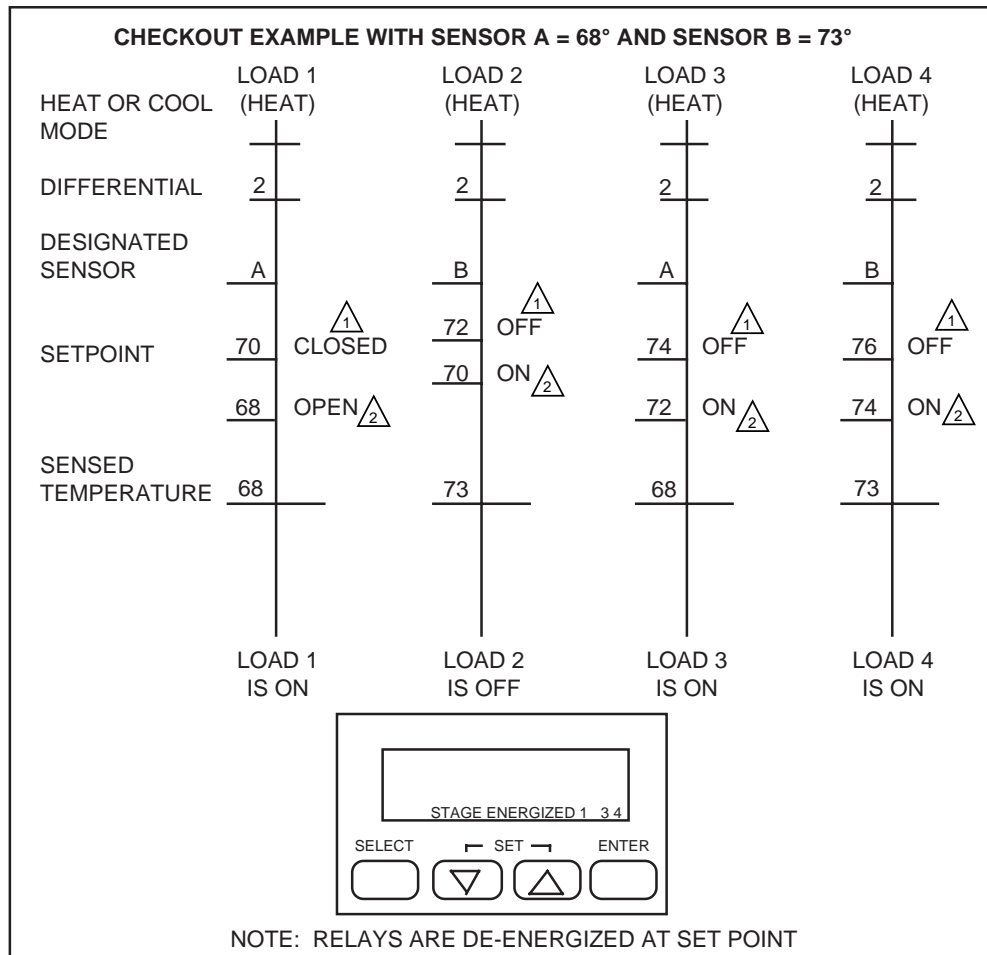

CHECKOUT TABLE

	LOAD 1	LOAD 2	LOAD 3	LOAD 4
HEAT OR COOL MODE				
DIFFERENTIAL				
DESIGNATED SENSOR				
SETPOINT				
SENSED TEMPERATURE				

¹ INDICATES LOAD STATUS WHEN SENSED TEMPERATURE REACHES SETPOINT.

² INDICATES LOAD STATUS WHEN SENSED TEMPERATURE REACHES SETPOINT MINUS DIFFERENTIAL (HEAT MODE).

M7426A

Fig. 25—Two-stage control, 120 or 240 Vac input; 120 or 240 Vac load.

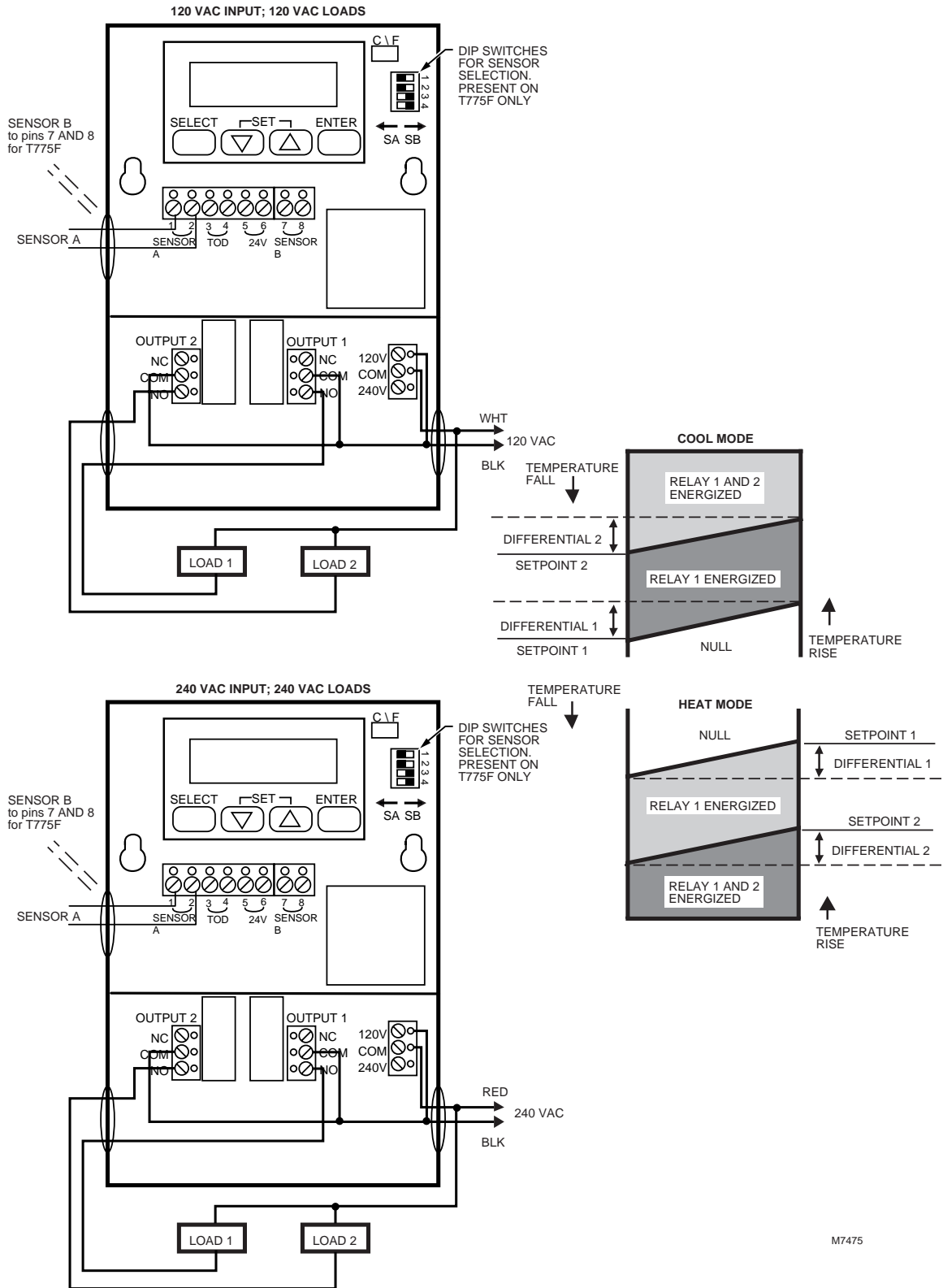

M7475

Fig. 26—Two-stage control, 24 Vac input, 24 Vac load.

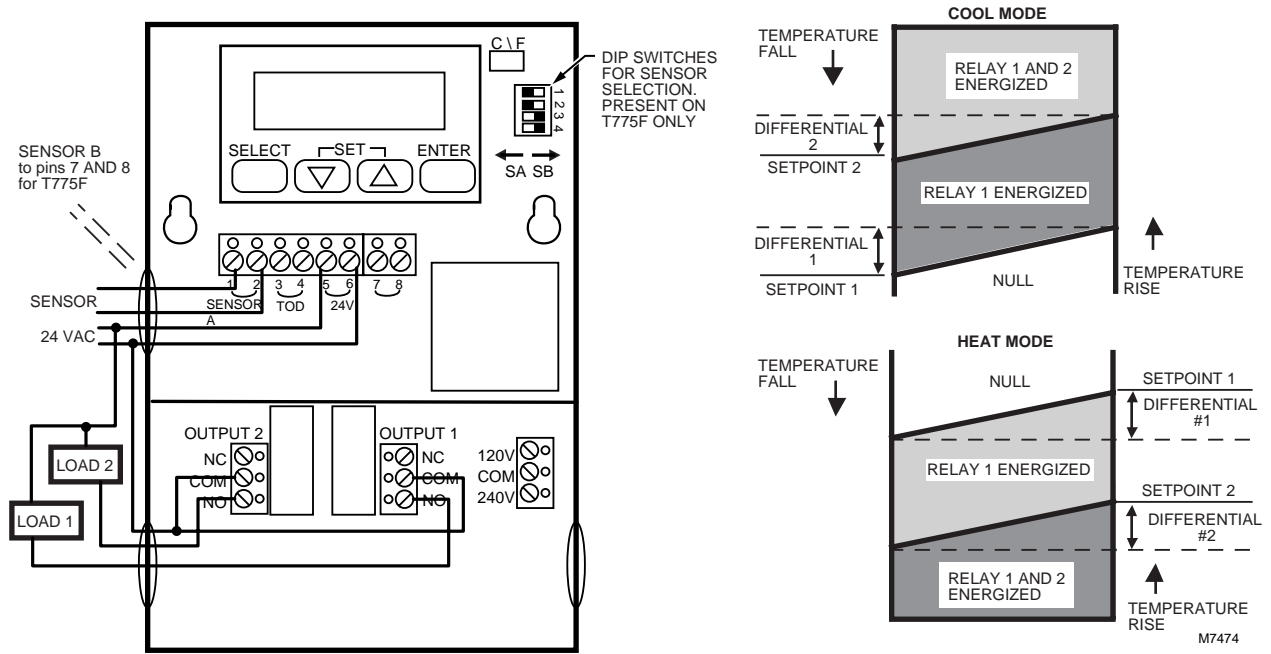

Fig. 27—Four stage control, 120 or 240 Vac input, 120 or 240 Vac load.

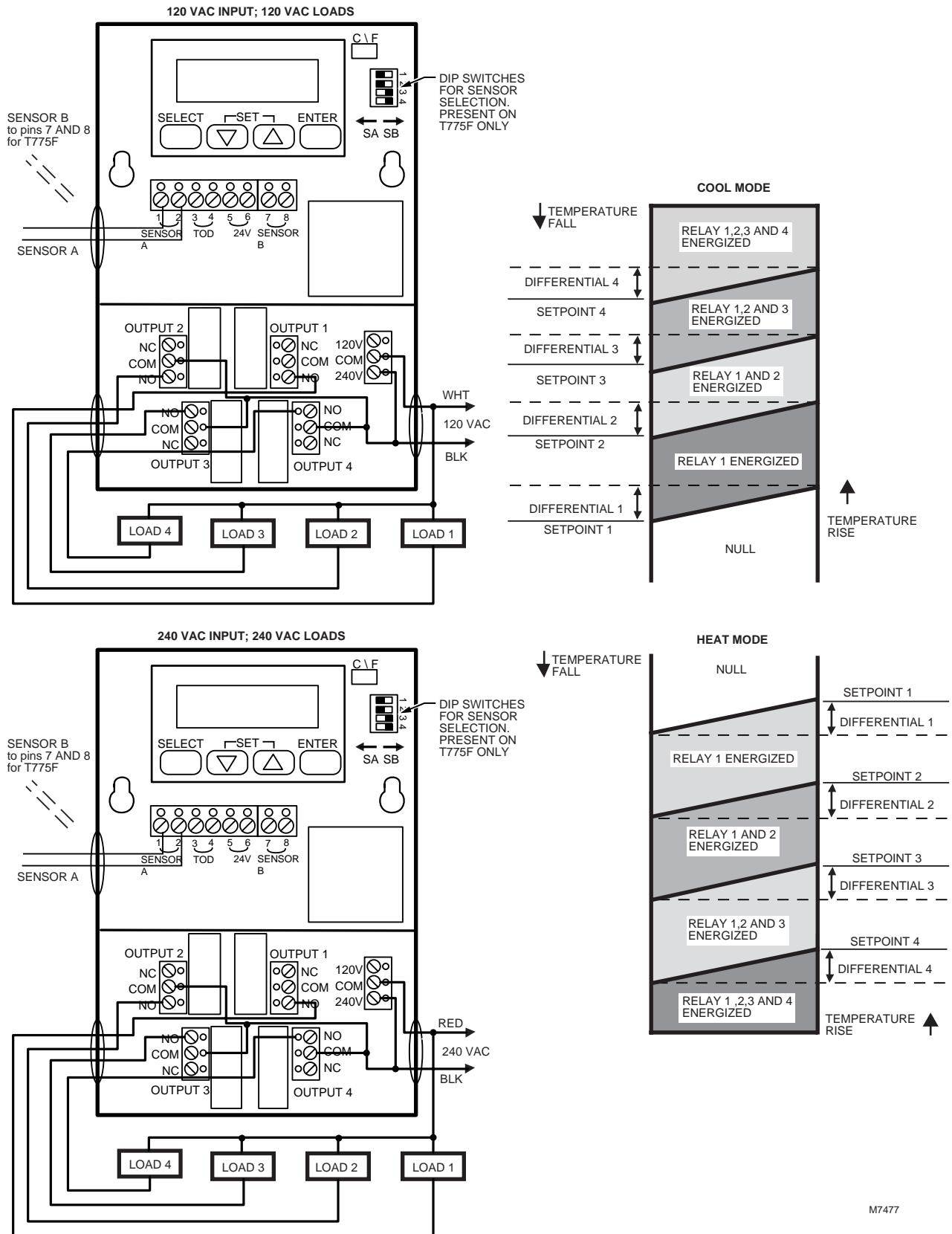
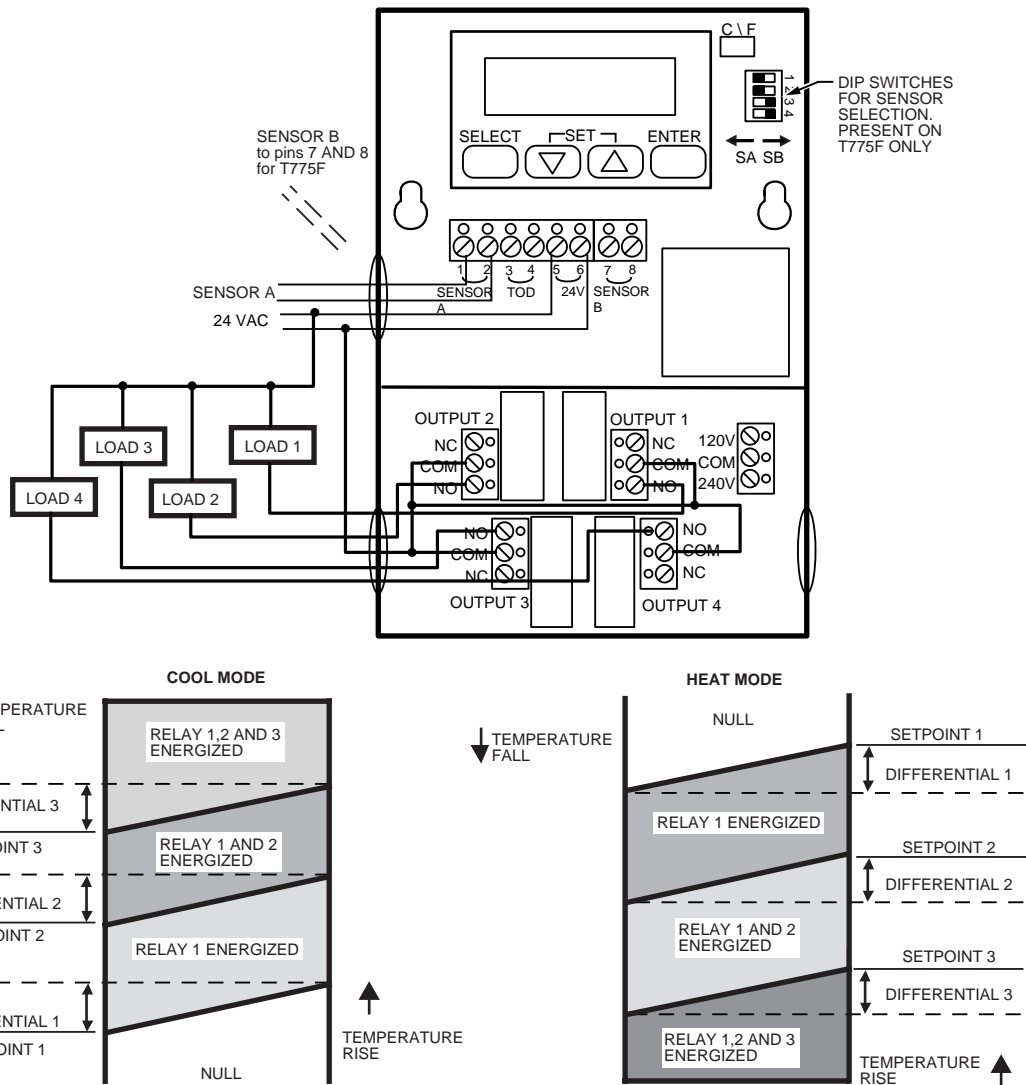

Fig. 28—Four-stage control, 24 Vac input; 24 Vac load.



NOTE: FOR THERMOSTAT APPLICATIONS, CONNECT NO CONTACT OF COOLING STAGE TO Y1 (AND SECOND STAGE TO Y2)
CONNECT NO CONTACT OF HEATING STAGE TO W1 (AND SECOND STAGE TO W2).

M7476

Honeywell

Home and Building Control
Honeywell Inc.
1985 Douglas Drive North
Golden Valley, MN 55422

Home and Building Control
Honeywell Limited—Honeywell Limitée
740 Ellesmere Road
Scarborough, Ontario
M1P 2V9

Helping You Control Your World

