

HARLINGEN®



2023



BORN IN ITALY

EUROPEAN SERVICE CENTER - MAINTENANCE - WAREHOUSE

***HARLINGEN GLOBAL
NETWORK***





BORN IN ITALY

ABOUT HARLINGEN

Decades ago, HARLINGEN aspired to supply various metal cutting tools and toolholding parts with reliable quality to the industrial fields when it was established in Lodi Italy in the early 1980s.

Up to now, HARLINGEN has been active in more than 40 countries and regions, supplying directly to major automotive and aircraft manufacturing industry as well as distributing through an array of industrial supply channels. Thanks to additional fulfillment facility strategically located in Los Angeles (for Pan America) and Shanghai (For Asia area), HARLINGEN is currently serving customers globally.

MANUFACTURING

Starting from a forged steel blanks up to the finished polygon shank holders with super high accuracy, HARLINGEN makes ALL procedures in its 35000m² workshops certified by ISO 9001:2008. Every single process is strictly processed and controlled in-house by ourselves, utilizing the most advanced facilities like MAZAK, HAAS, STUDER, HARDINGE. HAIMER, ZOLLER, ZEISS ... are applied to ensure warranty for each HARLINGEN product. Based on extremely strict quality control, HARLINGEN PSC, Hydraulic Expansions Chucks, Shrink Fit Chucks and HSK tooling systems etc. are among the leading level of the world. There are more than 60 professional technicians in HARLINGEN R&D team to make innovation and supply customized products and turnkey projects. No matter you are turning a rod in some places in Asia, or you are going to make profile milling in North America, THINK CUTTING, THINK HARLINGEN. We deliver you with confidence and trust ... when it comes to precision machining, HARLINGEN always hold and shape your dream.



New MFG. and R&D center located in Shuangliu (350,000sqf, under construction)

RELIABLE QUALITY ASSURANCE

Not only due to using the world class inspection device from Haimer, Zoller, Kelch..for Our quality control system. More important. As a stalwart in this industry for many year. It is our concept that we are committed to being the customer's preferred source of these tools by meeting and surpassing their expectations for reliable quality.



VISION

Our statement of core value as well as our long cultivated common culture at HARLINGEN is:

- Quality
- Responsibility
- Customer focus
- Commitment

Facing with the keen competition and continuing requirement of customers, we quite understand that even we have gained all these achievements, the decline is always in the offing. We must keep improving.

If you have any suggestions, or comments, please feel free to advise us. We value that as the most pivotal impulse for our pace forward. We, at HARLINGEN, look forward to working with you in this heady, fascinating industrial times!



Yours truly
The Harlingen Team



1 CNC TOOLING SYSTEM

HSK ISO12164(DIN 69893)TOOL HOLDERS

5



SK DIN 69871(DIN ISO 7388-1)TOOL HOLDERS

21



JIS B 6339(MAS 403 BT)TOOL HOLDERS

37



SHRINK FIT POWER CLAMP MACHINE

55



ACCESSORIES FOR TOOL HOLDERS

57



2 CNC CUTTING TOOLS

INDEXABLE TURNING TOOLS & ISO CARBIDE INSERTS

65



INDEXABLE MILLING CUTTERS & CARBIDE INSERTS

126



SOLID CARBIDE END MILLS

148



INDEXABLE DRILLING CUTTERS & CARBIDE INSERTS

156

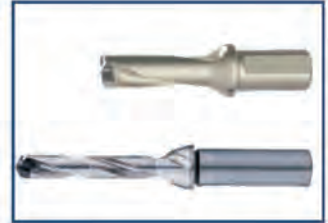

SOLID CARBIDE TWIST DRILLS

170



INDEXABLE THREADING CUTTERS & CARBIDE INSERTS

173



HSS-E MACHINE TAPS

186



INDEXABLE GROOVING TOOLS & CARBIDE INSERTS

188



BORING CUTTER AND ABS TOOLING SYSTEM

196



HSK ISO12164 (DIN 69893) TOOL HOLDERS

HYDRAULIC EXPANSIONS CHUCK	8
SHRINK FIT CHUCK	11
ER COLLET CHUCK	13
POWER MILLING CHUCK	14
MICRO-COMPENSATION TAPPING CHUCK	15
SIDE LOCK HOLDER	16
2° SIDE LOCK HOLDER	16
MORSE TAPER HOLDER WITH TANG	17
SHELL END MILL ARBOR	17
COMBINATION FACE MILL ADAPTER	18
FACE MILLING CUTTER HOLDER	19
SLOTING CUTTER HOLDER	19
HSK TEST BARS	20



FEATURES:

- Fixed axial positioning due to flat face
- High repetition accuracy while changing tools
- Suitable for high speed cutting
- No pull studs required

Taper hollow shanks with tool gripper groove for automatic tool change

ISO 12164-1(DIN69893-1) form A

- Used for machining centers, milling machines, special machines with automatic tool change.
- Pipe for central axial coolant feed.
- Torque transmission by 2 driving slots at the end of the taper
- 2 flange grooves for tool magazine, position notch.

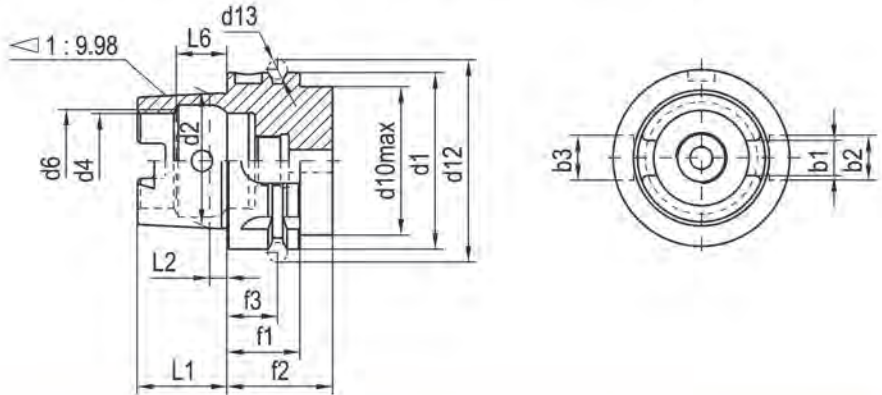

Shank	Size(mm)															
	b1	b2	b3	d1	d2	d4	d6	d10	d12	d13	f1	f2	f3	L1	L2	L6
HSK-A32	7.05	7	9	32	24.007	17	19	26	37	4	20	35	16	16	3.2	8.92
HSK-A40	8.05	9	11	40	30.007	21	23	34	45	4	20	35	16	20	4	11.42
HSK-A50	10.54	12	14	50	38.009	26	29	42	59.3	7	26	42	18	25	5	14.13
HSK-A63	12.54	16	18	63	48.010	34	37	53	72.3	7	26	42	18	32	6.3	18.13
HSK-A100	20.02	20	22	100	75.013	53	58	88	109.75	7	29	45	20	50	10	28.56

ISO12164-3 form T

- The standard for the HSK-T (T = Turning) was developed especially for using stationary tools on lathes.
- In comparison with the other HSK variants the driving element play is limited and the effect on the position of the cutting edge minimised.
- In addition it is possible to also mount powered tools on the HSK-T station without modifications to the revolver
- Pipe for central axial coolant feed.
- Torque transmission by 2 driving slots which tolerance is narrowed.
- 2 flange grooves for tool magazine, position notch.

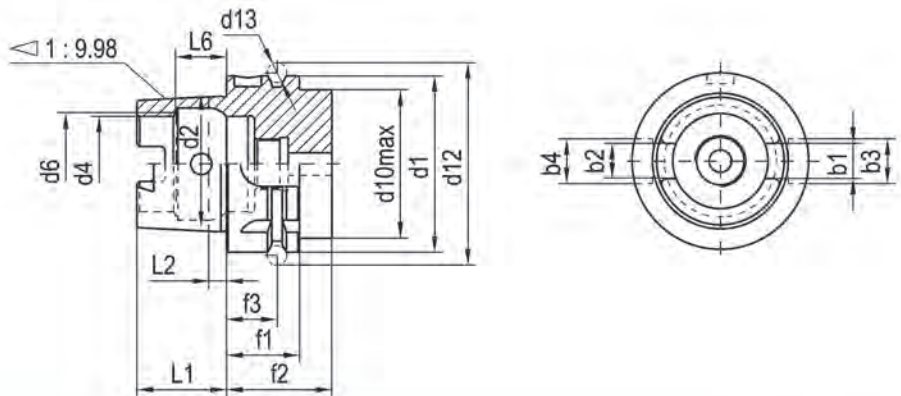

Shank	Size(mm)																
	b1	b2	b3	b4	d1	d2	d4	d6	d10	d12	d13	f1	f2	f3	L1	L2	L6
HSK-T32	7.05	6.932	7	9	32	24.007	17	19	31	37	4	20	23	16	16	3.2	8.92
HSK-T40	8.05	7.932	9	11	40	30.007	21	23	39	45	4	20	23	16	20	4	11.42
HSK-T50	10.54	10.425	12	14	50	38.009	26	29	49	59.3	7	26	30	18	25	5	14.13
HSK-T63	12.54	12.425	16	18	63	48.010	34	37	62	72.3	7	26	30	18	32	6.3	18.13
HSK-T100	20.02	19.091	20	22	100	75.013	53	58	99	109.75	7	29	34	20	50	10	28.56

Taper hollow shanks for manual tool change

ISO 12164-1 (DIN69893-1) form C

- Preferred for use on spindles in transfer lines and special machines without automatic tool change or stub drill spindles and tool extensions / reducers.
- Central axial coolant feed.
- Torque transmission by 2 driving slots at the end of the taper.

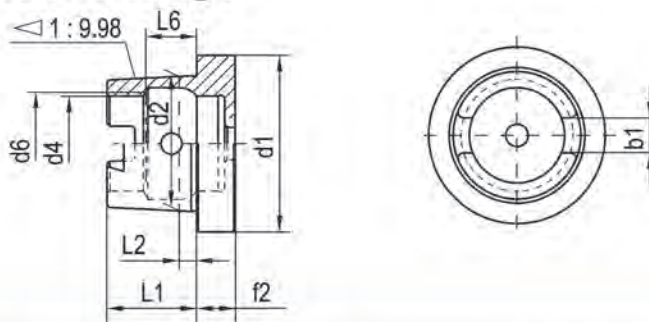

Shank	Size(mm)								
	b1	d1	d2	d4	d6	f2	L1	L2	L6
HSK-C32	7.05	32	24.007	17	19	10	16	3.2	8.92
HSK-C40	8.05	40	30.007	21	23	10	20	4	11.42
HSK-C50	10.54	50	38.009	26	29	12.5	25	5	14.13
HSK-C63	12.54	63	48.010	34	37	12.5	32	6.3	18.13
HSK-C100	20.02	100	75.013	53	58	16	50	10	28.56

Taper hollow shanks with tool gripper groove for high speed cutting

DIN69893-5 form E

- Used for high frequency spindles, woodworking machines.
- Rotationally symmetrical, without any driving slot.
- Torque transmission by friction
- Pipe for central axial coolant feed.

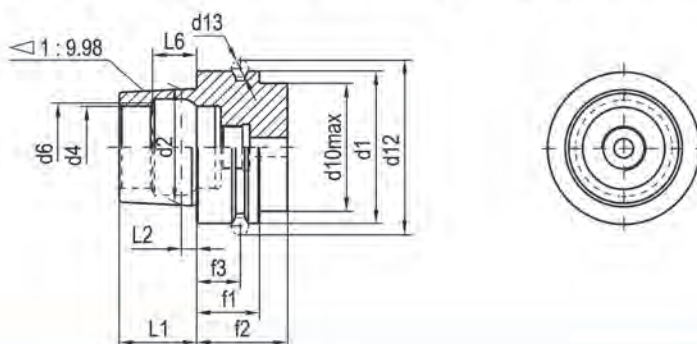

Shank	Size(mm)												
	d1	d2	d4	d6	d10	d12	d13	f1	f2	f3	L1	L2	L6
HSK-E32	32	24.007	17	19	26	37	4	20	35	16	16	3.2	8.92
HSK-E40	40	30.007	21	23	34	45	4	20	35	16	20	4	11.42
HSK-E50	50	38.009	26	29	42	59.3	7	26	42	18	25	5	14.13
HSK-E63	63	48.010	34	37	53	72.3	7	26	42	18	32	6.3	18.13

DIN69893-6 form F

- with enlarged collar.
- Central coolant feed facility.

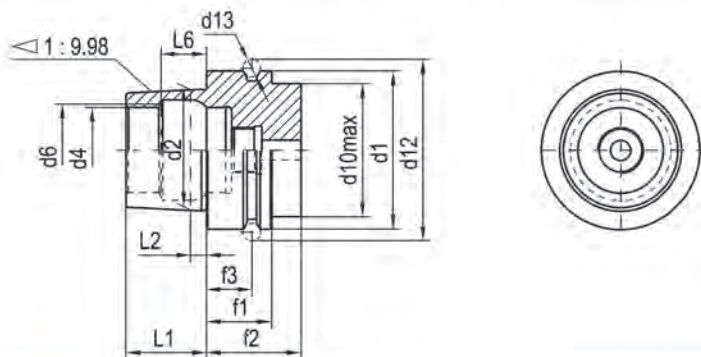

Shank	Size(mm)												
	d1	d2	d4	d6	d10	d12	d13	f1	f2	f3	L1	L2	L6
HSK-F50	50	30.007	21	23	42	59.3	7	26	42	18	20	4	11.42
HSK-F63	63	38.009	26	29	53	72.3	7	26	42	18	25	5	14.13
HSK-F80	80	48.010	34	37	67	88.8	7	26	42	18	32	6.3	18.13

HYDRAULIC EXPANSIONS CHUCK

- Super transmitted torque for high clamping reliability.
- Radial run-out less than 3µ (system accuracy at 4xd)
- For clamping cutting tools with cylindric shank tolerance h6
- Flexible clamping range due to use of reducing sleeve for Various shank.
- Axial length adjustment available and max. adjustment travel 10mm.
- Ideal damping characteristics, resulting in optimum surface finish, increase cutter life time and spindle protection.
- Reducing sleeve, Coolant pipe and coolant pipe Wrench optional.

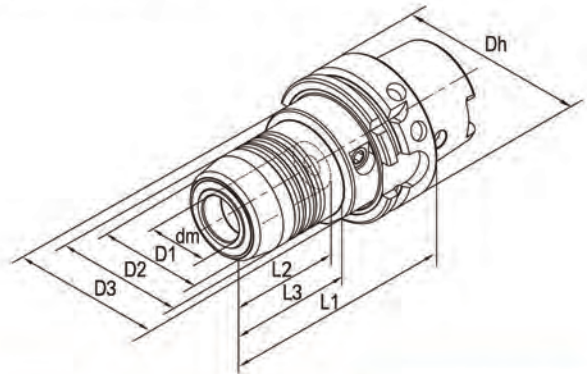
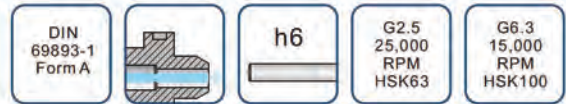

Order No.	Model	Shank	Size(mm)									Screw type	Screw Wrench	for Collets
			Dh	dm	D1	D2	D3	L1	L2	L3				
111-01-401	HSK63A-HCM06-70	HSK-A63	63	6	22	26	50	70	37	24	HCS005014C	TS5	-	
111-01-402	HSK63A-HCM08-70	HSK-A63	63	8	24	28	50	70	37	25	HCS006014C	TS5	-	
111-01-403	HSK63A-HCM10-80	HSK-A63	63	10	26	30	50	80	41	35	HCS008014C	TS5	-	
111-01-404	HSK63A-HCM12-85	HSK-A63	63	12	28	32	50	85	46	40	HCS008014C	TS5	HC12	
111-01-405	HSK63A-HCM16-90	HSK-A63	63	16	34	38	50	90	49	46	HCS008014C	TS5	-	
111-01-406	HSK63A-HCM20-90	HSK-A63	63	20	38	42	50	90	51	48	HCS008014C	TS5	HC20	
111-01-407	HSK63A-HCM25-120	HSK-A63	63	25	53	57	63	120	57	59	HCS012014C	TS6	-	
111-01-408	HSK63A-HCM32-125	HSK-A63	63	32	60	64	75	125	61	63	HCS012014C	TS6	HC32	
111-01-409	HSK63A-HCM14-85	HSK-A63	63	14	30	34	50	85	46	40	HCS008014C	TS5	-	
111-01-410	HSK63A-HCM18-90	HSK-A63	63	18	36	40	50	90	49	47	HCS008014C	TS5	-	
111-01-411	HSK63A-HCM06-150	HSK-A63	63	6	22	26	50	150	37	103	HCS005014C	TS5	-	
111-01-412	HSK63A-HCM08-150	HSK-A63	63	8	24	28	50	150	37	104	HCS006014C	TS5	-	
111-01-413	HSK63A-HCM10-150	HSK-A63	63	10	26	30	50	150	41	104	HCS008014C	TS5	-	
111-01-414	HSK63A-HCM12-150	HSK-A63	63	12	28	32	50	150	46	105	HCS008014C	TS5	HC12	
111-01-415	HSK63A-HCM14-150	HSK-A63	63	14	30	34	50	150	46	105	HCS008014C	TS5	-	
111-01-416	HSK63A-HCM16-150	HSK-A63	63	16	34	38	50	150	49	106	HCS008014C	TS5	-	
111-01-417	HSK63A-HCM18-150	HSK-A63	63	18	36	40	50	150	49	107	HCS008014C	TS5	-	
111-01-418	HSK63A-HCM20-150	HSK-A63	63	20	38	42	50	150	51	108	HCS008014C	TS5	HC20	
111-01-419	HSK63A-HCM06-200	HSK-A63	63	6	22	26	50	200	37	153	HCS005014C	TS5	-	
111-01-420	HSK63A-HCM08-200	HSK-A63	63	8	24	28	50	200	37	154	HCS006014C	TS5	-	
111-01-421	HSK63A-HCM10-200	HSK-A63	63	10	26	30	50	200	41	154	HCS008014C	TS5	-	
111-01-422	HSK63A-HCM12-200	HSK-A63	63	12	28	32	50	200	46	155	HCS008014C	TS5	HC12	
111-01-423	HSK63A-HCM14-200	HSK-A63	63	14	30	34	50	200	46	155	HCS008014C	TS5	-	
111-01-424	HSK63A-HCM16-200	HSK-A63	63	16	34	38	50	200	49	156	HCS008014C	TS5	-	
111-01-425	HSK63A-HCM18-200	HSK-A63	63	18	36	40	50	200	49	157	HCS008014C	TS5	-	
111-01-426	HSK63A-HCM20-200	HSK-A63	63	20	38	42	50	200	51	158	HCS008014C	TS5	HC20	
111-01-601	HSK100A-HCM06-75	HSK-A100	100	6	22	26	50	75	37	26	HCS005014C	TS5	-	
111-01-602	HSK100A-HCM08-75	HSK-A100	100	8	24	28	50	75	37	26	HCS006014C	TS5	-	
111-01-603	HSK100A-HCM10-90	HSK-A100	100	10	26	30	50	90	41	42	HCS008014C	TS5	-	
111-01-604	HSK100A-HCM12-95	HSK-A100	100	12	28	32	50	95	46	47	HCS008014C	TS5	HC12	
111-01-605	HSK100A-HCM16-100	HSK-A100	100	16	34	38	50	100	49	53	HCS008014C	TS5	-	
111-01-606	HSK100A-HCM20-105	HSK-A100	100	20	38	42	50	105	51	51	HCS008014C	TS5	HC20	
111-01-607	HSK100A-HCM25-110	HSK-A100	100	25	53	57	63	110	57	62	HCS012014C	TS6	-	
111-01-608	HSK100A-HCM32-110	HSK-A100	100	32	60	64	75	110	61	62	HCS012014C	TS6	HC32	
111-01-609	HSK100A-HCM12-150	HSK-A100	100	12	28	32	50	150	46	102	HCS008014C	TS5	HC12	
111-01-610	HSK100A-HCM20-150	HSK-A100	100	20	38	42	50	150	51	104	HCS008014C	TS5	HC20	

Optional accessories:

	Dh=63	Dh=100
Coolant tubes		
Model	TU-HSK63	TU-HSK100
Order No.	100-00-001	100-00-002

	Dh=63	Dh=100
Coolant tube Wrench		
Model	W-HSK63	W-HSK100
Order No.	100-00-003	100-00-004

REDUCING SLEEVE FOR HYDRAULIC EXPANSIONS CHUCK

- Radial run-out less than 5μ .
- For clamping cutting tools with cylindric shank tolerance h6.

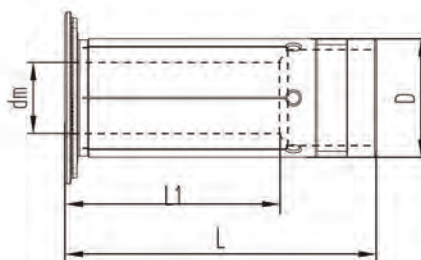

Order No.	Model	Size (mm)			
		dm	D	L1	L
100-01-001	HC12-3	3	12	16.5	47.5
100-01-002	HC12-4	4	12	16.5	47.5
100-01-003	HC12-5	5	12	16.5	47.5
100-01-004	HC12-6	6	12	24	47.5
100-01-005	HC12-8	8	12	25.5	47.5
100-01-006	HC20-3	3	20	17.5	52.5
100-01-007	HC20-4	4	20	17.5	52.5
100-01-008	HC20-5	5	20	17.5	52.5
100-01-009	HC20-6	6	20	25.5	52.5
100-01-010	HC20-7	7	20	28	52.5
100-01-011	HC20-8	8	20	28	52.5
100-01-012	HC20-9	9	20	32.5	52.5
100-01-013	HC20-10	10	20	32.5	52.5
100-01-014	HC20-11	11	20	36	52.5
100-01-015	HC20-12	12	20	36	52.5
100-01-016	HC20-13	13	20	36.5	52.5
100-01-017	HC20-14	14	20	37	52.5
100-01-018	HC20-15	15	20	37	52.5
100-01-019	HC20-16	16	20	37.5	52.5
100-01-020	HC32-6	6	32	25.5	63.5
100-01-021	HC32-8	8	32	27.5	63.5
100-01-022	HC32-10	10	32	30.5	63.5
100-01-023	HC32-12	12	32	30.5	63.5
100-01-024	HC32-14	14	32	32.5	63.5
100-01-025	HC32-16	16	32	40.5	63.5
100-01-026	HC32-18	18	32	40.5	63.5
100-01-027	HC32-20	20	32	40.5	63.5
100-01-028	HC32-25	25	32	48.5	63.5

HYDRAULIC EXPANSIONS CHUCK SET

- Each set including 1pc each of HSK63A-HCM20-90 hydraulic expansion chuck, HC20-6, HC20-8, HC20-10, HC20-12, HC20-16 (internal dia: 6, 8, 10, 12, 16mm) reducing sleeves and screw wrench.
- pack in strong aluminium box.



ORDER NO.111-01-S04

PRECISION HYDRAULIC EXPANSIONS CHUCK

- Used on CNC tool grinding machine for grinding/sharpening of drill, reamer, end mill etc.
- High precision and Radial Run-out not more than 2μ at 4d checking point.
- Super transmitted torque for high clamping reliability.
- For clamping cylindrical shank tolerance h6
- Can be operated frequently long time and keep good repeatability.
- Coolant pipe and coolant pipe Wrench optional.

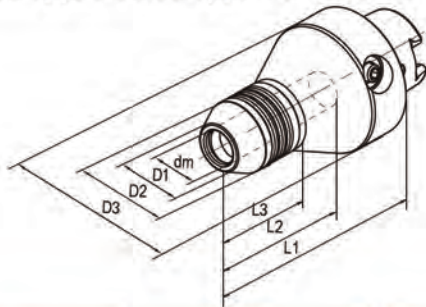

Order No.	Model	Shank	Size(mm)							Wrench	for Collets
			dm	D1	D2	D3	L1	L2	L3		
111-01-001	HSK63C-HCM12-110M	HSK-C63	12	21.5	36.5	75	110	83	47	TS5	HC12..M
111-01-002	HSK63C-HCM20-110M	HSK-C63	20	28	42	75	110	83	47	TS5	HC20..M
111-01-003	HSK63C-HCM32-110M	HSK-C63	32	40	54	80	110	83	62.5	TS5	HC32..M

Optional accessories:

Coolant tubes	Dh=63	Dh=100
Model	TU-HSK63	TU-HSK100
Order No.	100-00-001	100-00-002

Coolant tube Wrench	Dh=63	Dh=100
Model	W-HSK63	W-HSK100
Order No.	100-00-003	100-00-004

PRECISION REDUCING SLEEVE FOR HYDRAULIC CHUCK

- Radial run-out less than 3μ .
- Used for grinding/sharpening of drill, reamer, end mill etc.
- For clamping cutting tools with cylindrical shank tolerance h6

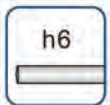

Order No.	Model	Size (mm)			
		dm	D	L1	L
100-01-101	HC12-3M	3	12	16.5	47.5
100-01-102	HC12-4M	4	12	16.5	47.5
100-01-103	HC12-5M	5	12	16.5	47.5
100-01-104	HC12-6M	6	12	24	47.5
100-01-105	HC12-8M	8	12	25.5	47.5
100-01-106	HC20-3M	3	20	17.5	52.5
100-01-107	HC20-4M	4	20	17.5	52.5
100-01-108	HC20-5M	5	20	17.5	52.5
100-01-109	HC20-6M	6	20	25.5	52.5
100-01-110	HC20-7M	7	20	28	52.5
100-01-111	HC20-8M	8	20	28	52.5
100-01-112	HC20-9M	9	20	32.5	52.5
100-01-113	HC20-10M	10	20	32.5	52.5
100-01-114	HC20-11M	11	20	36	52.5
100-01-115	HC20-12M	12	20	36	52.5
100-01-116	HC20-13M	13	20	36.5	52.5
100-01-117	HC20-14M	14	20	37	52.5
100-01-118	HC20-15M	15	20	37	52.5
100-01-119	HC20-16M	16	20	37.5	52.5
100-01-120	HC32-6M	6	32	25.5	63.5
100-01-121	HC32-8M	8	32	27.5	63.5
100-01-122	HC32-10M	10	32	30.5	63.5
100-01-123	HC32-12M	12	32	30.5	63.5
100-01-124	HC32-14M	14	32	32.5	63.5
100-01-125	HC32-16M	16	32	40.5	63.5
100-01-126	HC32-18M	18	32	40.5	63.5
100-01-127	HC32-20M	20	32	40.5	63.5
100-01-128	HC32-25M	25	32	48.5	63.5

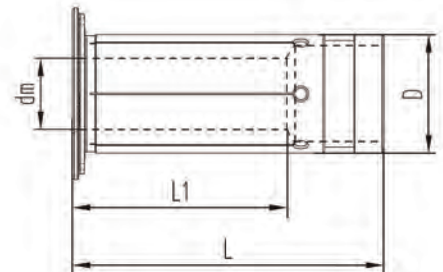

SHRINK FIT CHUCK

- Made of high-temperature steel and fit for High frequency heating machine.
- For clamping cutting tools with cylinderic shank tolerance h6
- High tool-gripping strength and machining accuracy
- 360 degree concentric clamping without set screws, collets.
- Engineered to produce the high degree of balance available
- With indicating line for shank depth of cutter.
- Coolant pipe and coolant pipe Wrench optional.

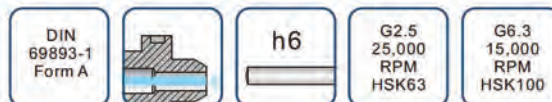

Order No.	Model	Shank	Size(mm)						Screw
			Dh	dm	D1	D2	L	H	
111-02-401	HSK63A-SFX03-80	HSK-A63	63	3	10	-	80	10	-
111-02-402	HSK63A-SFX04-80	HSK-A63	63	4	10	-	80	12	-
111-02-403	HSK63A-SFX05-80	HSK-A63	63	5	10	-	80	15	-
111-02-404	HSK63A-SFX06-80	HSK-A63	63	6	21	27	80	36	S005014C
111-02-405	HSK63A-SFX06-120	HSK-A63	63	6	21	27	120	36	S005014C
111-02-406	HSK63A-SFX06-160	HSK-A63	63	6	21	32	160	36	S005014C
111-02-407	HSK63A-SF08-80	HSK-A63	63	8	21	27	80	36	S006014C
111-02-408	HSK63A-SF08-120	HSK-A63	63	8	21	27	120	36	S006014C
111-02-409	HSK63A-SF08-160	HSK-A63	63	8	21	32	160	36	S006014C
111-02-410	HSK63A-SF10-85	HSK-A63	63	10	24	32	85	42	S008014C
111-02-411	HSK63A-SF10-120	HSK-A63	63	10	24	32	120	42	S008014C
111-02-412	HSK63A-SF10-160	HSK-A63	63	10	24	34	160	42	S008014C
111-02-413	HSK63A-SF12-90	HSK-A63	63	12	24	32	90	47	S008014C
111-02-414	HSK63A-SF12-120	HSK-A63	63	12	24	32	120	47	S008014C
111-02-415	HSK63A-SF12-160	HSK-A63	63	12	24	34	160	47	S008014C
111-02-416	HSK63A-SF14-90	HSK-A63	63	14	27	34	90	47	S008014C
111-02-417	HSK63A-SF14-120	HSK-A63	63	14	27	34	120	47	S008014C
111-02-418	HSK63A-SF14-160	HSK-A63	63	14	27	42	160	47	S008014C
111-02-419	HSK63A-SF16-95	HSK-A63	63	16	27	34	95	50	S012014C
111-02-420	HSK63A-SF16-120	HSK-A63	63	16	27	34	120	50	S012014C
111-02-421	HSK63A-SF16-160	HSK-A63	63	16	27	42	160	50	S012014C
111-02-422	HSK63A-SF18-95	HSK-A63	63	18	33	42	95	50	S012014C
111-02-423	HSK63A-SF18-120	HSK-A63	63	18	33	42	120	50	S012014C
111-02-424	HSK63A-SF18-160	HSK-A63	63	18	33	51	160	50	S012014C
111-02-425	HSK63A-SF20-100	HSK-A63	63	20	33	42	100	52	S016016C
111-02-426	HSK63A-SF20-120	HSK-A63	63	20	33	42	120	52	S016016C
111-02-427	HSK63A-SF20-160	HSK-A63	63	20	33	51	160	52	S016016C
111-02-428	HSK63A-SF25-115	HSK-A63	63	25	44	53	115	58	S016016C
111-02-429	HSK63A-SF25-160	HSK-A63	63	25	44	60	160	58	S016016C
111-02-601	HSK100A-SFX06-85	HSK-A100	100	6	21	27	85	36	S005014C
111-02-602	HSK100A-SFX06-120	HSK-A100	100	6	21	27	120	36	S005014C
111-02-603	HSK100A-SFX06-160	HSK-A100	100	6	21	32	160	36	S005014C
111-02-604	HSK100A-SF08-85	HSK-A100	100	8	21	27	85	36	S006014C
111-02-605	HSK100A-SF08-120	HSK-A100	100	8	21	27	120	36	S006014C
111-02-606	HSK100A-SF-160	HSK-A100	100	8	21	32	160	36	S006014C
111-02-607	HSK100A-SF10-90	HSK-A100	100	10	24	32	90	42	S008014C
111-02-608	HSK100A-SF10-120	HSK-A100	100	10	24	32	120	42	S008014C
111-02-609	HSK100A-SF10-160	HSK-A100	100	10	24	34	160	42	S008014C
111-02-610	HSK100A-SF12-95	HSK-A100	100	12	24	32	95	47	S008014C
111-02-611	HSK100A-SF12-120	HSK-A100	100	12	24	32	120	47	S008014C
111-02-612	HSK100A-SF12-160	HSK-A100	100	12	24	34	160	47	S008014C
111-02-613	HSK100A-SF14-95	HSK-A100	100	14	27	34	95	47	S008014C
111-02-614	HSK100A-SF14-120	HSK-A100	100	14	27	34	120	47	S008014C
111-02-615	HSK100A-SF14-160	HSK-A100	100	14	27	42	160	47	S008014C
111-02-616	HSK100A-SF16-100	HSK-A100	100	16	27	34	100	50	S012014C
111-02-617	HSK100A-SF16-120	HSK-A100	100	16	27	34	120	50	S012014C
111-02-618	HSK100A-SF16-160	HSK-A100	100	16	27	42	160	50	S012014C
111-02-619	HSK100A-SF18-100	HSK-A100	100	18	33	42	100	50	S012014C
111-02-620	HSK100A-SF18-120	HSK-A100	100	18	33	42	120	50	S012014C
111-02-621	HSK100A-SF18-160	HSK-A100	100	18	33	51	160	50	S012014C
111-02-622	HSK100A-SF20-105	HSK-A100	100	20	33	42	105	52	S016016C
111-02-623	HSK100A-SF20-120	HSK-A100	100	20	33	42	120	52	S016016C
111-02-624	HSK100A-SF20-160	HSK-A100	100	20	33	51	160	52	S016016C
111-02-625	HSK100A-SF25-115	HSK-A100	100	25	44	53	115	58	S016016C
111-02-626	HSK100A-SF25-160	HSK-A100	100	25	44	60	160	58	S016016C
111-02-627	HSK100A-SF32-120	HSK-A100	100	32	44	53	120	58	S016016C
111-02-628	HSK100A-SF32-160	HSK-A100	100	32	44	60	160	58	S016016C

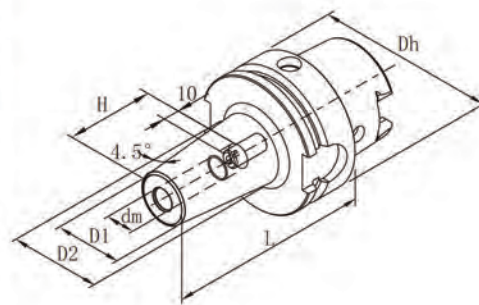

Optional accessories:

	Coolant tubes		Coolant tube Wrench	
	Dh=63	Dh=100	Dh=63	Dh=100
Model	TU-HSK63	TU-HSK100	W-HSK63	W-HSK100
Order No.	100-00-001	100-00-002	100-00-003	100-00-004

SHRINK FIT CHUCK

- Used for high speed spindles.
- For clamping cutting tools with cylindric shank tolerance h6
- High tool-gripping strength and machining accuracy
- With indicating line for shank depth of cutter.
- Coolant pipe and coolant pipe Wrench optional.

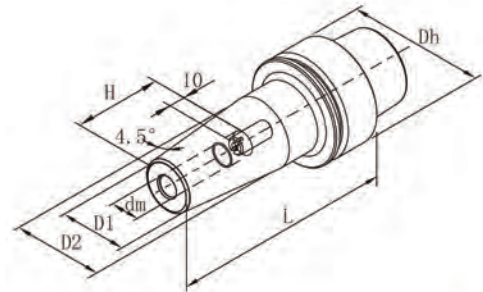

Order No.	Model	Shank	Size(mm)						Screw
			Dh	dm	D1	D2	L	H	
113-02-201	HSK40E-SFX03-60	HSK-E40	40	3	10	-	60	-	-
113-02-202	HSK40E-SFX04-60	HSK-E40	40	4	10	-	60	-	-
113-02-203	HSK40E-SFX05-60	HSK-E40	40	5	10	-	60	-	-
113-02-204	HSK40E-SFX06-80	HSK-E40	40	6	21	27	80	36	S005014C
113-02-205	HSK40E-SF08-80	HSK-E40	40	8	21	27	80	36	S006014C
113-02-206	HSK40E-SF10-80	HSK-E40	40	10	24	32	80	42	S008014C
113-02-207	HSK40E-SF12-90	HSK-E40	40	12	24	32	90	47	S008014C
113-02-208	HSK40E-SF14-90	HSK-E40	40	14	27	34	90	47	S008014C
113-02-209	HSK40E-SF16-90	HSK-E40	40	16	27	34	90	50	S012014C

Optional accessories:

Coolant tubes	Dh=63	Dh=100
Model	TU-HSK63	TU-HSK100
Order No.	100-00-001	100-00-002

Coolant tube Wrench	Dh=63	Dh=100
Model	W-HSK63	W-HSK100
Order No.	100-00-003	100-00-004

ER COLLET CHUCK

- Radial run-out less than 0.01mm.
- Constructed of alloy steel for long, durable service life.
- For clamping tools with plain shank in collets to DIN6499.
- Supplied with high performance clamping nut.
- Coolant pipe and coolant pipe Wrench optional.

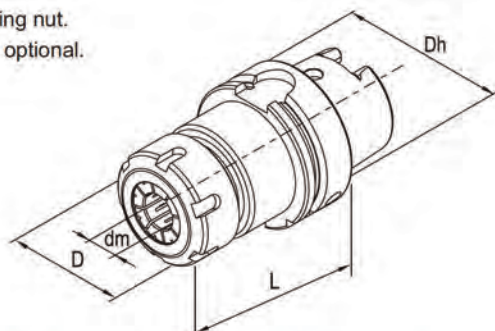
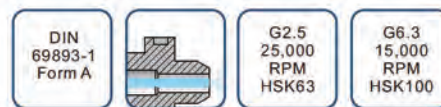

Order No.	Model	Shank	for Collets	Size(mm)				Nuts	Screw	Wrench
				Dh	dm	D	L			
111-04-401	HSK63A-ER11-75	HSK-A63	ER11	63	0.5-7	19	75	CN11HS	SER11C	W17D
111-04-402	HSK63A-ER16-80	HSK-A63	ER16	63	0.5-10	28	80	CN16HS	SER16C	W25D
111-04-403	HSK63A-ER16-100	HSK-A63	ER16	63	0.5-10	28	100	CN16HS	SER16C	W25D
111-04-404	HSK63A-ER16-120	HSK-A63	ER16	63	0.5-10	28	120	CN16HS	SER16C	W25D
111-04-405	HSK63A-ER20-80	HSK-A63	ER20	63	1.0-13	34	80	CN20HS	SER20C	W30D
111-04-406	HSK63A-ER20-100	HSK-A63	ER20	63	1.0-13	34	100	CN20HS	SER20C	W30D
111-04-407	HSK63A-ER20-120	HSK-A63	ER20	63	1.0-13	34	120	CN20HS	SER20C	W30D
111-04-408	HSK63A-ER25-80	HSK-A63	ER25	63	1.0-16	42	80	CN25B	S008014C	YER25B
111-04-409	HSK63A-ER25-100	HSK-A63	ER25	63	1.0-16	42	100	CN25B	SER25C	YER25B
111-04-410	HSK63A-ER25-120	HSK-A63	ER25	63	1.0-16	42	120	CN25B	SER25C	YER25B
111-04-411	HSK63A-ER32-80	HSK-A63	ER32	63	2.0-20	50	80	CN32B	S008014C	YER32B
111-04-412	HSK63A-ER32-100	HSK-A63	ER32	63	2.0-20	50	100	CN32B	SER32C	YER32B
111-04-413	HSK63A-ER32-120	HSK-A63	ER32	63	2.0-20	50	120	CN32B	SER32C	YER32B
111-04-414	HSK63A-ER40-80	HSK-A63	ER40	63	3.0-26	63	80	CN40B	-	YER40B
111-04-415	HSK63A-ER40-100	HSK-A63	ER40	63	3.0-26	63	100	CN40B	SER40C	YER40B
111-04-416	HSK63A-ER40-120	HSK-A63	ER40	63	3.0-26	63	120	CN40B	SER40C	YER40B
111-04-601	HSK100A-ER16-100	HSK-A100	ER16	100	0.5-10	28	100	CN16HS	SER16C	W25D
111-04-602	HSK100A-ER16-160	HSK-A100	ER16	100	0.5-10	28	160	CN16HS	SER16C	W25D
111-04-603	HSK100A-ER20-100	HSK-A100	ER20	100	1.0-13	34	100	CN20HS	SER20C	W30D
111-04-604	HSK100A-ER20-160	HSK-A100	ER20	100	1.0-13	34	160	CN20HS	SER20C	W30D
111-04-605	HSK100A-ER25-100	HSK-A100	ER25	100	1.0-16	42	100	CN25B	SER25C	YER25B
111-04-606	HSK100A-ER25-160	HSK-A100	ER25	100	1.0-16	42	160	CN25B	SER25C	YER25B
111-04-607	HSK100A-ER32-100	HSK-A100	ER32	100	2.0-20	50	100	CN32B	SER32C	YER32B
111-04-608	HSK100A-ER32-160	HSK-A100	ER40	100	3.0-26	63	160	CN32B	SER40C	YER40B
111-04-609	HSK100A-ER40-100	HSK-A100	ER40	100	3.0-26	63	100	CN40B	SER40C	YER40B
111-04-610	HSK100A-ER40-120	HSK-A100	ER40	100	3.0-26	63	120	CN40B	SER40C	YER40B
111-04-611	HSK100A-ER40-160	HSK-A100	ER40	100	3.0-26	63	160	CN40B	SER40C	YER40B

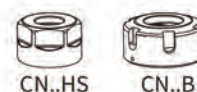

Optional accessories:

	Coolant tubes	Dh=63	Dh=100
Model		TU-HSK63	TU-HSK100
Order No.		100-00-001	100-00-002

	Coolant tube Wrench	Dh=63	Dh=100
Model		W-HSK63	W-HSK100
Order No.		100-00-003	100-00-004

ER COLLET CHUCK & COLLETS KIT SET

- Each set including 1pc of HSK63A ER collet chuck and 9pc of ER collets,
- Equipped with ER collet nut wrench and pack in strong aluminium box.
- Long working life time due to system radial run-out less than 0.01mm.

Order No.	Shank Model	Collet	Wrench
111-04-S41	HSK63A-ER16-100	ER16: dia.2-3-4-5-6-7-8-9-10mm	W25D
111-04-S42	HSK63A-ER25-100	ER25: dia.3-4-5-6-8-10-12-14-16mm	YER25B
111-04-S43	HSK63A-ER32-100	ER32: dia.4-6-8-10-12-14-16-18-20mm	YER32B



POWER MILLING CHUCK

- Very high clamping force and High stability improving surface quality and tool life time.
- Optimised design resulting in Ideal damping characteristics and low vibration.
- Radial run-out less than 0.01mm.
- For clamping cutting tools with cylindric shank tolerance h6
- Flexible clamping range by using reducing sleeve for various tool shank.
- Reducing sleeve ,Coolant pipe and coolant pipe wrench optional.

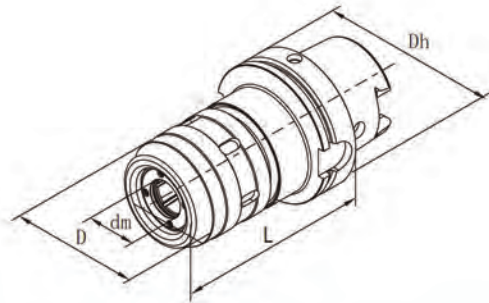

POWER MILLING CHUCK SET

Each set including 1pc each of HSK63A-C32-115 power milling chuck, C32-8,C32-10,C32-12,C32-16, C32-20,C32-25 (internal dia:8,10,12,16,20,25mm) reducing sleeve and wrench,pack in strong alu. box.



ORDER NO.111-03-S04

Order No.	Model	Shank	for Collets	Size(mm)			
				Dh	dm	D	L
111-03-401	HSK63A-C20-105	HSK-A63	C20	63	20	52	105
111-03-402	HSK63A-C25-110	HSK-A63	C25	63	25	62	110
111-03-403	HSK63A-C32-115	HSK-A63	C32	63	32	72	115
111-03-601	HSK100A-C20-110	HSK-A100	C20	100	20	52	110
111-03-602	HSK100A-C25-115	HSK-A100	C25	100	25	62	115
111-03-603	HSK100A-C32-120	HSK-A100	C32	100	32	72	120
111-03-604	HSK100A-C42-120	HSK-A100	C42	100	42	87	120

Optional accessories:

Coolant tubes	Dh=63		Dh=100	
	Model		Model	
	Order No.		Order No.	
	TU-HSK63	TU-HSK100		
	100-00-001	100-00-002		

Coolant tube Wrench	Dh=63		Dh=100	
	Model		Model	
	Order No.		Order No.	
	W-HSK63	W-HSK100		
	100-00-003	100-00-004		

REDUCING SLEEVE FOR POWER MILLING CHUCK

- For drill,milling,reaming. • Radial run-out less than 0.01mm
- For clamping cutting tools with cylindric shank tolerance h6

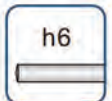

Order No.	Model	Size (mm)			Order No.	Model	Size (mm)		
		dm	D	L			dm	D	L
100-03-001	C20-3	3	20	55	100-03-020	C32-6	6	32	65
100-03-002	C20-4	4	20	55	100-03-021	C32-8	8	32	65
100-03-003	C20-5	5	20	55	100-03-022	C32-10	10	32	65
100-03-004	C20-6	6	20	55	100-03-023	C32-12	12	32	65
100-03-005	C20-8	8	20	55	100-03-024	C32-14	14	32	65
100-03-006	C20-10	10	20	55	100-03-025	C32-16	16	32	65
100-03-007	C20-12	12	20	55	100-03-026	C32-18	18	32	65
100-03-008	C20-14	14	20	55	100-03-027	C32-20	20	32	65
100-03-009	C20-16	16	20	55	100-03-028	C32-25	25	32	65
100-03-010	C25-4	4	25	60	100-03-029	C42-6	6	42	70
100-03-011	C25-5	5	25	60	100-03-030	C42-8	8	42	70
100-03-012	C25-6	6	25	60	100-03-031	C42-10	10	42	70
100-03-013	C25-8	8	25	60	100-03-032	C42-12	12	42	70
100-03-014	C25-10	10	25	60	100-03-033	C42-14	14	42	70
100-03-015	C25-12	12	25	60	100-03-034	C42-16	16	42	70
100-03-016	C25-14	14	25	60	100-03-035	C42-18	18	42	70
100-03-017	C25-16	16	25	60	100-03-036	C42-20	20	42	70
100-03-018	C25-18	18	25	60	100-03-037	C42-25	25	42	70
100-03-019	C25-20	20	25	60	100-03-038	C42-32	32	42	70

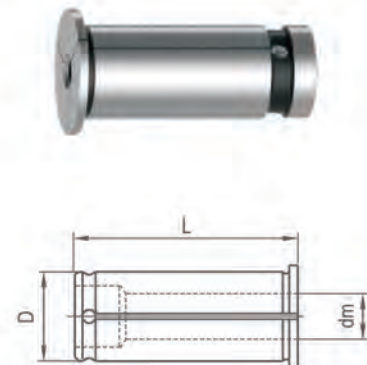

AUTOMATIC MICRO-COMPENSATION TAPPING CHUCK

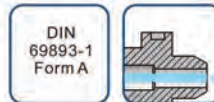

- Compensation capacity $\pm 0.5\text{mm}$.
- Precision producing true thread with quality surface.
- Increase the tool life of taps/thread formers.
- On machine centers with synchronised spindles.
- For right hand and left hand thread.

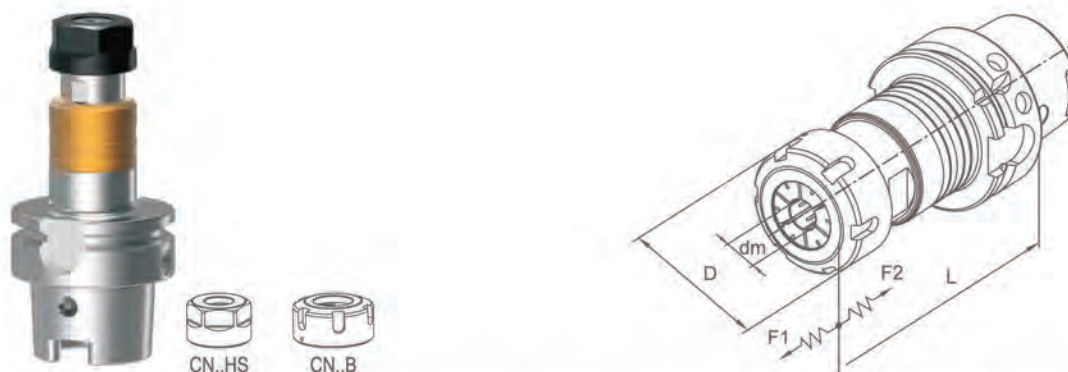

Order No.	Model	SHANK	capacity	Size(mm)					Nuts	for Collets
				D	dm	L	F1	F2		
111-13-401	HSK63A-V20-100	HSK-A63	M4-M12(No.8-7/16")	34	3-10	100	0.5	0.5	CN20HS	ER20
111-13-601	HSK100A-V20-110	HSK-A100	M4-M12(No.8-7/16")	34	3-10	110	0.5	0.5	CN20HS	ER20
111-13-402	HSK63A-V32-120	HSK-A63	M4-M20(No.8-3/4")	50	3-16	120	0.5	0.5	CN32B	ER32
111-13-602	HSK100A-V32-130	HSK-A100	M4-M20(No.8-3/4")	50	3-16	130	0.5	0.5	CN32B	ER32

Optional accessories:	V20	V32
oolant Nuts	CN20C	CN32C
Sealing Disk	DER20C	DER32C
Wrench for Nut	W30D	YER32B
Wrench for fixing	W24D	W36D

Optional accessories:	Dh=63	Dh=100
Coolant tubes	TU-HSK63	TU-HSK100
Coolant tube Wrench	W-HSK63	W-HSK100

ER TAP COLLET

- Special design with internal square drive for machine taps.

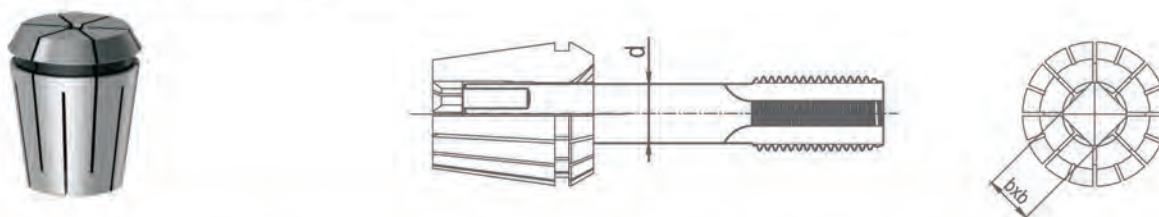

Order No.	Model	For taps				
		Shank d(mm)	Square b(mm)	ISO529/ISO2283	DIN374/DIN376	JISB4430
100-13-201	ER20-6.3B5	6.3	5	M8	M8	M6/M8
100-13-202	ER20-7B5.5	7	5.5	-	M10	M10
100-13-203	ER20-8B6.3	8	6.3	M10	-	-
100-13-204	ER20-8.5B6.5	8.5	6.5	-	-	M12
100-13-205	ER20-9B7.1	9	7.1	M12	M12	-
100-13-301	ER32-6.3B5	6.3	5	M8	M8	M6/M8
100-13-302	ER32-7B5.5	7	5.5	-	M10	M10
100-13-303	ER32-8B6.3	8	6.3	M10	-	-
100-13-304	ER32-8.5B6.5	8.5	6.5	-	-	M12
100-13-305	ER32-9B7.1	9	7.1	M12	M12	-
100-13-306	ER32-12B9	12	9	-	M16	-
100-13-307	ER32-12.5B10	12.5	10	M16	-	M16
100-13-308	ER32-14B11.2	14	11.2	M18/M20	M18	M18
100-13-309	ER32-15B12	15	12	-	-	M20
100-13-310	ER32-16B12	16	12	-	M20	-

SIDE LOCK HOLDER

- For clamping tools with weldon shank to DIN1835 form B and DIN6535 form HB.
- Coolant pipe and coolant pipe Wrench optional.

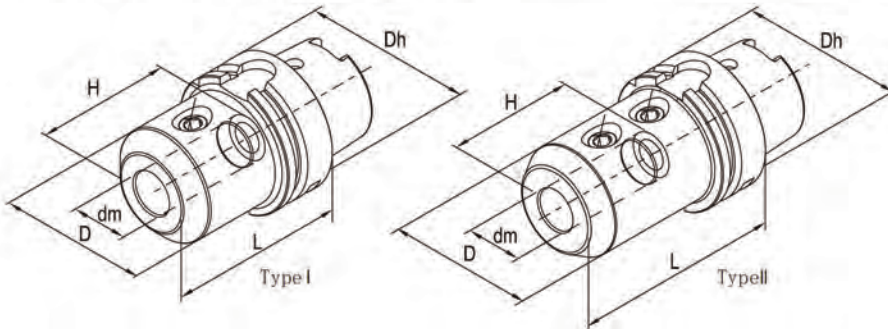
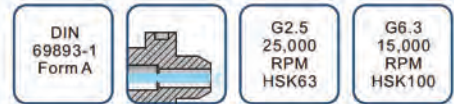

Order No.	Model	Shank	Size(mm)					Screw type	Type
			Dh	dm	D	L	H		
111-05-401	HSK63A-XP16-80	HSK-A63	63	16	48	80	52	SXP16	I
111-05-402	HSK63A-XP20-80	HSK-A63	63	20	50	80	54	SXP20	I
111-05-403	HSK63A-XP25-110	HSK-A63	63	25	60	110	66	SXP25	II
111-05-404	HSK63A-XP32-110	HSK-A63	63	32	68	110	70	SXP32	II
111-05-601	HSK100A-XP16-100	HSK-A100	100	16	48	100	52	SXP16	I
111-05-602	HSK100A-XP20-100	HSK-A100	100	20	50	100	54	SXP20	I
111-05-603	HSK100A-XP25-100	HSK-A100	100	25	60	100	66	SXP25	II
111-05-604	HSK100A-XP32-100	HSK-A100	100	32	68	100	66	SXP32	II
111-05-605	HSK100A-XP40-120	HSK-A100	100	40	84	120	80	SXP32	II
111-05-606	HSK100A-XP40-160	HSK-A100	100	40	84	160	80	SXP32	II

2° SIDE LOCK HOLDER

- For clamping tools with parallel shank and inclined clamping flat(2°) DIN1835 form E and DIN6535 form HE.
- Coolant pipe and coolant pipe Wrench optional.

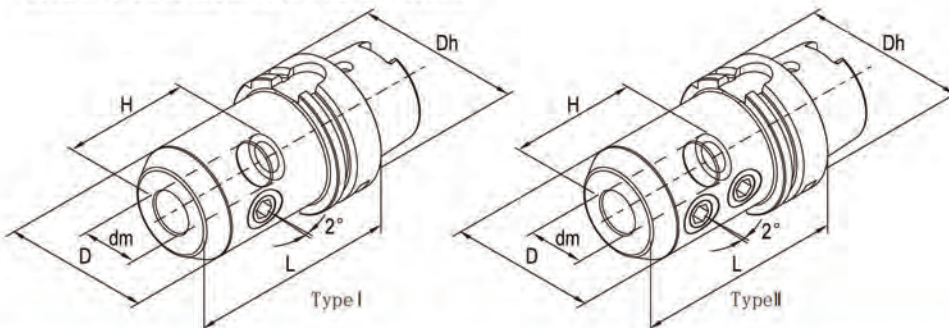

Order No.	Model	Shank	Size(mm)					Screw type	Screw type	Type
			Dh	dm	D	L	H			
111-05-405	HSK63A-XP16-100	HSK-A63	63	16	48	100	52	SXP16	S012014C	I
111-05-406	HSK63A-XP20-100	HSK-A63	63	20	52	100	54	SXP20	S020018C	I
111-05-407	HSK63A-XP25-110	HSK-A63	63	25	65	110	59	SXP25	S020016C	II
111-05-408	HSK63A-XP32-110	HSK-A63	63	32	72	110	63	SXP32	S020016C	II
111-05-607	HSK100A-XP16-100	HSK-A100	100	16	48	100	52	SXP16	S012014C	I
111-05-608	HSK100A-XP20-110	HSK-A100	100	20	52	110	54	SXP20	S020016C	I
111-05-609	HSK100A-XP25-120	HSK-A100	100	25	65	120	59	SXP25	S020016C	II
111-05-610	HSK100A-XP32-120	HSK-A100	100	32	72	120	63	SXP32	S020016C	II

Optional accessories:

Coolant tubes	Dh=63		Dh=100		Coolant tube Wrench	Dh=63		Dh=100	
	Model	TU-HSK63	TU-HSK100	Model		W-HSK63	W-HSK100		
Order No.	100-00-001	100-00-002	Order No.	100-00-003	100-00-004				

MORSE TAPER HOLDER WITH TANG

- For clamping tools with MT taper shank with tang.

DIN 69893-1 Form A
Standard G6.3 8,000 RPM

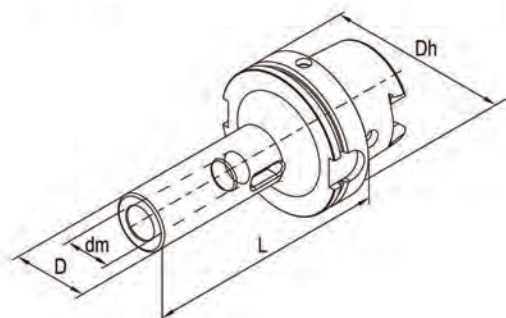

Order No.	Model	Shank	Morse taper	Capacity(φ mm)	Size(mm)			
					Dh	D	dm	L
111-06-401	HSK63A-M1-100	HSK-A63	MT1	3-14	63	25	12.065	100
111-06-402	HSK63A-M2-120	HSK-A63	MT2	14.25-23.0	63	32	17.780	120
111-06-403	HSK63A-M3-140	HSK-A63	MT3	23.25-31.75	63	40	23.825	140
111-06-404	HSK63A-M4-160	HSK-A63	MT4	32.0-50.5	63	48	31.267	160
111-06-601	HSK100A-M1-110	HSK-A100	MT1	3-14	100	25	12.065	110
111-06-602	HSK100A-M2-120	HSK-A100	MT2	14.25-23.0	100	32	17.780	120
111-06-603	HSK100A-M3-150	HSK-A100	MT3	23.25-31.75	100	40	23.825	150
111-06-604	HSK100A-M4-170	HSK-A100	MT4	32.0-50.5	100	48	31.267	170
111-06-605	HSK100A-M5-200	HSK-A100	MT5	51-76	100	63	44.399	200

SHELL END MILL ARBOR

- For clamping shell end mill and milling cutter.

DIN 69893-1 Form A
Standard G6.3 15,000 RPM

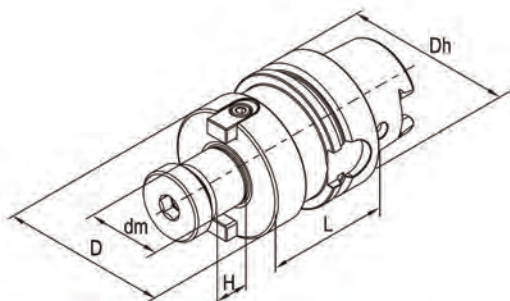

Order No.	Model	Shank	Size(mm)					Screw	Key	Screw
			Dh	dm	D	L	H			
111-07-401	HSK63A-XMB16-50	HSK-A63	63	16	34	50	17	MS08030	JC08017	MS03008
111-07-402	HSK63A-XMB16-100	HSK-A63	63	16	34	100	17	MS08030	JC08017	MS03008
111-07-403	HSK63A-XMB22-50	HSK-A63	63	22	42	50	19	MS10030	JC10021	MS04010
111-07-404	HSK63A-XMB22-100	HSK-A63	63	22	42	100	19	MS10030	JC10021	MS04010
111-07-405	HSK63A-XMB27-60	HSK-A63	63	27	60	60	21	SXM27	JC12023	MS05016
111-07-406	HSK63A-XMB27-100	HSK-A63	63	27	60	100	21	SXM27	JC12023	MS05016
111-07-407	HSK63A-XMB32-60	HSK-A63	63	32	78	60	24	SXM32	JC14020	MS06020
111-07-408	HSK63A-XMB32-100	HSK-A63	63	32	78	100	24	SXM32	JC14020	MS06020
111-07-409	HSK63A-XMB40-60	HSK-A63	63	40	89	60	27	SXM40	JC16030	MS08020
111-07-601	HSK100A-XMB22-50	HSK-A100	100	22	42	50	19	MS10030	JC10021	MS04010
111-07-602	HSK100A-XMB22-100	HSK-A100	100	22	42	100	19	MS10030	JC10021	MS04010
111-07-603	HSK100A-XMB27-50	HSK-A100	100	27	60	50	21	SXM27	JC12023	MS05016
111-07-604	HSK100A-XMB27-100	HSK-A100	100	27	60	100	21	SXM27	JC12023	MS05016
111-07-605	HSK100A-XMB32-50	HSK-A100	100	32	78	50	24	SXM32	JC14020	MS06020
111-07-606	HSK100A-XMB32-100	HSK-A100	100	32	78	100	24	SXM32	JC14020	MS06020
111-07-607	HSK100A-XMB40-60	HSK-A100	100	40	89	60	27	SXM40	KXM40	MS08020
111-07-608	HSK100A-XMB40-100	HSK-A100	100	40	89	100	27	SXM40	KXM40	MS08020

COMBINATION FACE MILL ADAPTER

• For clamping shell end mills and milling cutter heads with longitudinal or transverse groove.

DIN 69893-1 Form A	Standard G6.3 15,000 RPM
--------------------------	-----------------------------------

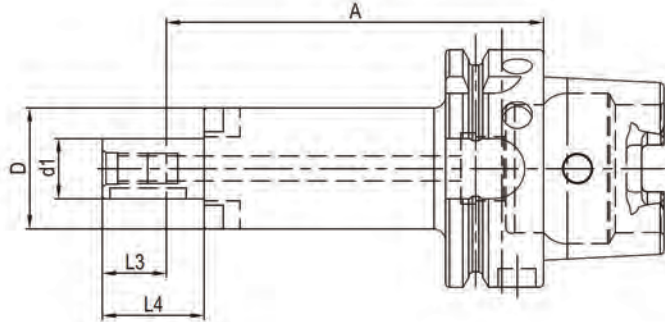

Order No.	Model	SHANK	Size(mm)				
			A	D	d1	L3	L4
111-16-401	HSK63A-XSL16-100	HSK63A	100	φ 32	φ 16	17	27
111-16-402	HSK63A-XSL22-100	HSK63A	100	φ 40	φ 22	19	31
111-16-403	HSK63A-XSL27-100	HSK63A	100	φ 48	φ 27	21	33
111-16-404	HSK63A-XSL32-100	HSK63A	100	φ 58	φ 32	24	38
111-16-601	HSK100A-XSL16-100	HSK100A	100	φ 32	φ 16	17	27
111-16-602	HSK100A-XSL22-100	HSK100A	100	φ 40	φ 22	19	31
111-16-603	HSK100A-XSL27-100	HSK100A	100	φ 48	φ 27	21	33
111-16-604	HSK100A-XSL32-100	HSK100A	100	φ 58	φ 32	24	38
111-16-605	HSK100A-XSL40-100	HSK100A	100	φ 70	φ 40	27	41

FACE MILLING CUTTER HOLDER

- For clamping face milling cutter with 4 holes.
- Increased collar contact surface.
- Suppled with lock screws.

DIN
69893-1
Form A

Standard
G6.3
8,000
RPM

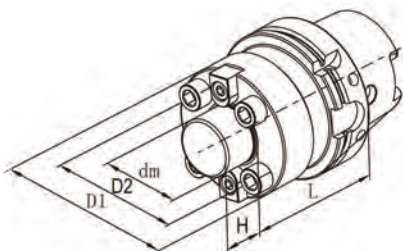

Order No.	Model	Shank	Size(mm)					Screw	Key	Screw
			dm	D1	D2	L	H			
111-09-601	HSK100A-XMC40-75	HSK-A100	40	89	66.7	75	27	MS12045(4)	KXM40	MS08020
111-09-602	HSK100A-XMC60-75	HSK-A100	60	129	101.6	75	38	MS16045(4)	KXMC60	MS10025

SLOTING CUTTER HOLDER

- For clamping saws and side milling cutter.
- Furnished complete with assorted spacers, nut and key.

DIN
69893-1
Form A

Standard
G6.3
8,000
RPM

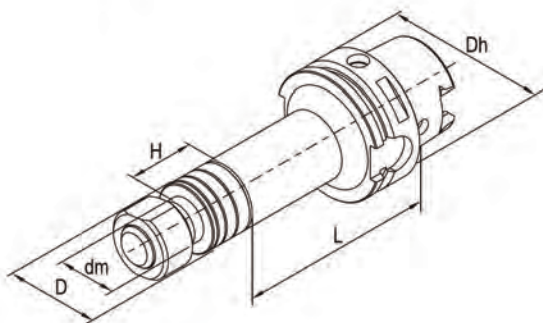

Order No.	Model	Shank	Size(mm)					Nuts	Washer	Key
			Dh	dm	D	L	H			
111-10-401	HSK63A-XS13-75	HSK-A63	63	13	20	75	30	MXS13	SD13	-
111-10-402	HSK63A-XS16-90	HSK-A63	63	16	26	90	30	MXS16	SD16	JA04020
111-10-403	HSK63A-XS16-120	HSK-A63	63	16	26	120	30	MXS16	SD16	JA04020
111-10-404	HSK63A-XS22-90	HSK-A63	63	22	34	90	30	MXS22	SD22	JA06020
111-10-405	HSK63A-XS22-135	HSK-A63	63	22	34	135	30	MXS22	SD22	JA06020
111-10-406	HSK63A-XS27-90	HSK-A63	63	27	40	90	30	MXS27	SD27	JA07022
111-10-407	HSK63A-XS27-135	HSK-A63	63	27	40	135	30	MXS27	SD27	JA07022
111-10-408	HSK63A-XS32-90	HSK-A63	63	32	46	90	30	MXS32	SD32	JA08022
111-10-409	HSK63A-XS32-135	HSK-A63	63	32	46	135	30	MXS32	SD32	JA08022
111-10-601	HSK100A-XS13-75	HSK-A100	100	13	20	75	30	MXS13	SD13	-
111-10-602	HSK100A-XS16-90	HSK-A100	100	16	26	90	30	MXS16	SD16	JA04020
111-10-603	HSK100A-XS16-120	HSK-A100	100	16	26	120	30	MXS16	SD16	JA04020
111-10-604	HSK100A-XS22-90	HSK-A100	100	22	34	90	30	MXS22	SD22	JA06020
111-10-605	HSK100A-XS22-135	HSK-A100	100	22	34	135	30	MXS22	SD22	JA06020
111-10-606	HSK100A-XS27-90	HSK-A100	100	27	40	90	30	MXS27	SD27	JA07022
111-10-607	HSK100A-XS27-135	HSK-A100	100	27	40	135	30	MXS27	SD27	JA07022
111-10-608	HSK100A-XS32-90	HSK-A100	100	32	46	90	30	MXS32	SD32	JA08022
111-10-609	HSK100A-XS32-135	HSK-A100	100	32	46	135	30	MXS32	SD32	JA08022
111-10-610	HSK100A-XS40-90	HSK-A100	100	40	55	90	30	MXS40	SD40	JA010025
111-10-611	HSK100A-XS40-135	HSK-A100	100	40	55	135	30	MXS40	SD40	JA010025

HSK TEST BARS



Order No.	Model	Shank	Size(mm)			
			D	d	L	L1
161-15-005	HSK63A-TB40-300	HSK-A63	63	40	300	260
161-15-010	HSK100X-TB50-350	HSK-A100	100	50	350	300

SK DIN 69871 (ISO 7388-1) TOOL HOLDERS

HYDRAULIC EXPANSIONS CHUCK	23
SHRINK FIT CHUCK	26
ER COLLET CHUCK	27
POWER MILLING CHUCK	28
MICRO-COMPENSATION TAPPING CHUCK	29
PRECISION FLOATING TAPPING HOLDER	30
SIDE LOCK HOLDER	31
2° SIDE LOCK HOLDER	31
MORSE TAPER HOLDERS WITHOUT TANG	32
INTEGRAL DRILL CHUCK HOLDER	33
SHELL END MILL ARBOR	33
COMBINATION FACE MILL ADAPTER	34
FACE MILLING CUTTER HOLDER	35
SLOTING CUTTER HOLDER	35
7:24 TEST BARS	36



TAPER SHANK INTERFACE SK DIN 69871(ISO 7388-1)-FORMS AND FEATURES

FEATURES:

- Used for NC machines and machining center.
- Extremely high tool quality protects the machine spindle and extends the life time of the tools.

Form A: without through hole.

Form AD: with through hole for central coolant feed.

Form AD/B: for lateral coolant feed via the tool collar.

SK40 DIN 69871(ISO 7388-1)

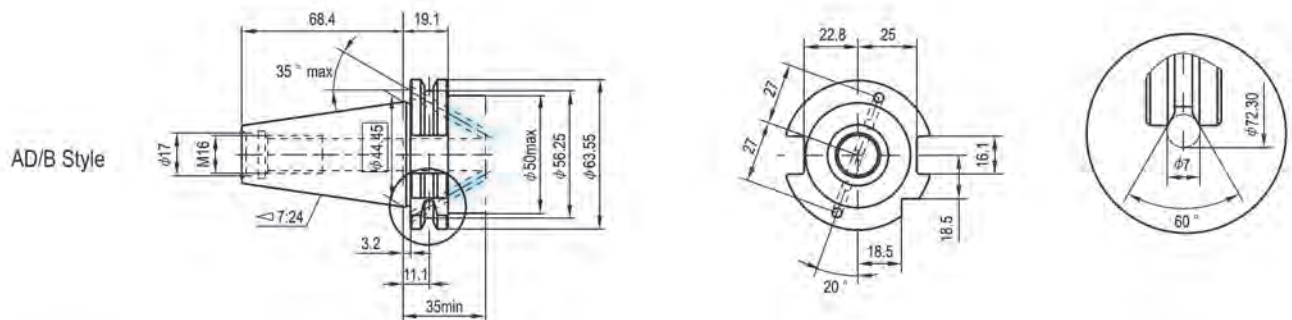
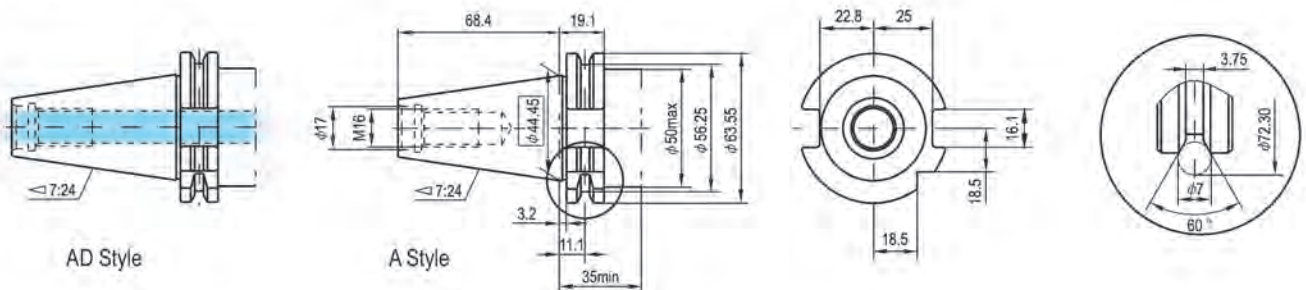

SK50 DIN 69871(ISO 7388-1)

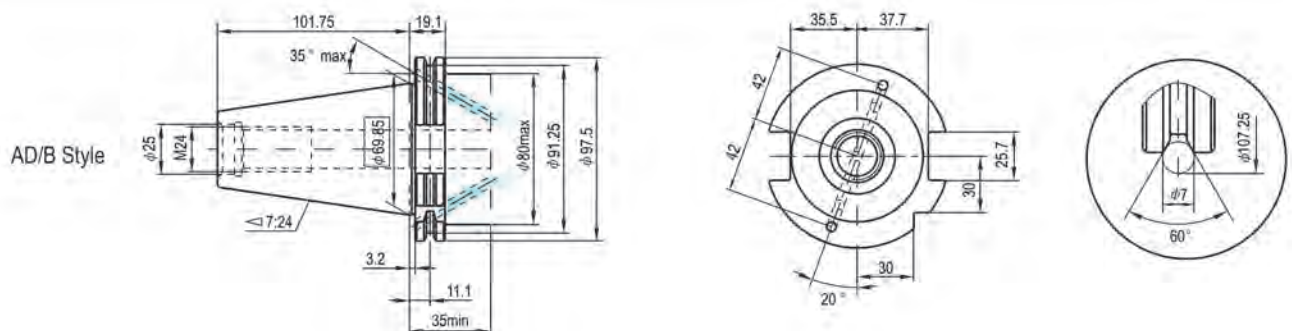
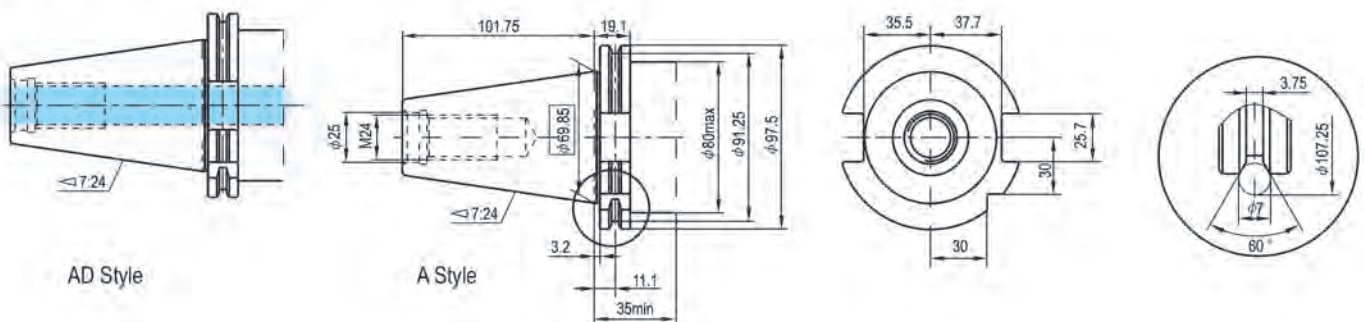

HYDRAULIC EXPANSIONS CHUCK

- Super transmitted torque for high clamping reliability.
- Radial run-out less than 3μ (system accuracy at 4xd)
- For clamping cutting tools with cylindric shank tolerance h6
- Flexible clamping range due to use of reducing sleeve for Various shank.
- Axial length adjustment available and max. adjustment travel 10mm.
- Ideal damping characteristics, resulting in optimum surface finish, increase cutter life time and spindle protection.

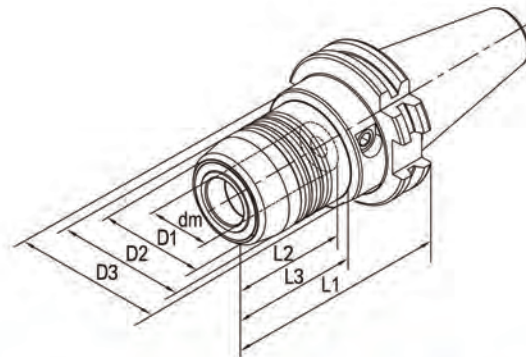
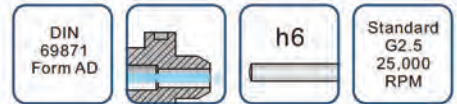

Order No.	Model	Shank	Size(mm)							Screw	Screw wrench	for Collets
			dm	D1	D2	D3	L1	L2	L3			
132-01-401	JT40-HCM06-80.5	SK40-AD	6	22	26	50	80.5	37	29.5	HCS005014C	TS5	-
132-01-402	JT40-HCM08-80.5	SK40-AD	8	24	28	50	80.5	37	30	HCS006014C	TS5	-
132-01-403	JT40-HCM10-80.5	SK40-AD	10	26	30	50	80.5	41	31	HCS008014C	TS5	-
132-01-404	JT40-HCM12-80.5	SK40-AD	12	28	32	50	80.5	46	31.5	HCS008014C	TS5	HC12
132-01-405	JT40-HCM16-80.5	SK40-AD	16	34	38	50	80.5	49	33	HCS008014C	TS5	-
132-01-406	JT40-HCM20-80.5	SK40-AD	20	38	42	50	80.5	51	34	HCS008014C	TS5	HC20
132-01-407	JT40-HCM25-80.5	SK40-AD	25	53	55	66	80.5	57	22	HCS012014C	TS6	-
132-01-408	JT40-HCM32-80.5	SK40-AD	32	60	63	80	80.5	61	25.5	HCS012014C	TS6	HC32
132-01-501	JT50-HCM06-80.5	SK50-AD	6	22	26	50	80.5	37	29.5	HCS005014C	TS5	-
132-01-502	JT50-HCM08-80.5	SK50-AD	8	24	28	50	80.5	37	30	HCS006014C	TS5	-
132-01-503	JT50-HCM10-80.5	SK50-AD	10	26	30	50	80.5	41	31	HCS008014C	TS5	-
132-01-504	JT50-HCM12-80.5	SK50-AD	12	28	32	50	80.5	46	31.5	HCS008014C	TS5	HC12
132-01-505	JT50-HCM16-80.5	SK50-AD	16	34	38	50	80.5	49	34	HCS008014C	TS5	-
132-01-506	JT50-HCM20-80.5	SK50-AD	20	38	42	50	80.5	51	34	HCS008014C	TS5	HC20
132-01-507	JT50-HCM25-80.5	SK50-AD	25	53	57	66	80.5	57	34	HCS012014C	TS6	-
132-01-508	JT50-HCM32-80.5	SK50-AD	32	60	64	72	80.5	61	34	HCS012014C	TS6	HC32

REDUCING SLEEVE FOR HYDRAULIC EXPANSIONS CHUCK

- Radial run-out less than 5 μ .
- For clamping cutting tools with cylindric shank tolerance h6.

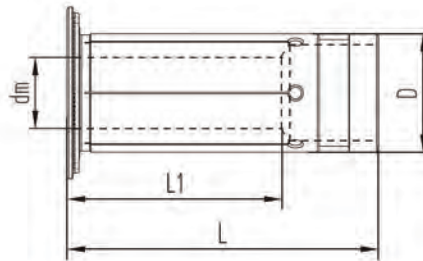

Order No.	Model	Size (mm)			
		dm	D	L1	L
100-01-001	HC12-3	3	12	16.5	47.5
100-01-002	HC12-4	4	12	16.5	47.5
100-01-003	HC12-5	5	12	16.5	47.5
100-01-004	HC12-6	6	12	24	47.5
100-01-005	HC12-8	8	12	25.5	47.5
100-01-006	HC20-3	3	20	17.5	52.5
100-01-007	HC20-4	4	20	17.5	52.5
100-01-008	HC20-5	5	20	17.5	52.5
100-01-009	HC20-6	6	20	25.5	52.5
100-01-010	HC20-7	7	20	28	52.5
100-01-011	HC20-8	8	20	28	52.5
100-01-012	HC20-9	9	20	32.5	52.5
100-01-013	HC20-10	10	20	32.5	52.5
100-01-014	HC20-11	11	20	36	52.5
100-01-015	HC20-12	12	20	36	52.5
100-01-016	HC20-13	13	20	36.5	52.5
100-01-017	HC20-14	14	20	37	52.5
100-01-018	HC20-15	15	20	37	52.5
100-01-019	HC20-16	16	20	37.5	52.5
100-01-020	HC32-6	6	32	25.5	63.5
100-01-021	HC32-8	8	32	27.5	63.5
100-01-022	HC32-10	10	32	30.5	63.5
100-01-023	HC32-12	12	32	30.5	63.5
100-01-024	HC32-14	14	32	32.5	63.5
100-01-025	HC32-16	16	32	40.5	63.5
100-01-026	HC32-18	18	32	40.5	63.5
100-01-027	HC32-20	20	32	40.5	63.5
100-01-028	HC32-25	25	32	48.5	63.5

HYDRAULIC EXPANSIONS CHUCK SET

- each set including 1pc each of SK40-AD hydraulic expansion chuck,HC20-6,HC20-8,HC20-10,HC20-12,HC20-16 (internal dia:6,8,10,12,16mm) reducing sleeve and screw wrench,pack in strong aluminium box.



ORDER NO.132-01-S04

PRECISION HYDRAULIC EXPANSIONS CHUCK

- Used on CNC tool grinding machine for grinding/sharpening of drill, reamer, end mill etc.
- High precision and Radial Run-out not more than 2μ at 4d checking point.
- Super transmitted torque for high clamping reliability.
- For clamping cylinderic shank tolerance h6.
- Axial length adjustment available and max. adjustment travel 10mm.
- Can be operated frequently long time and keep good repeatability.

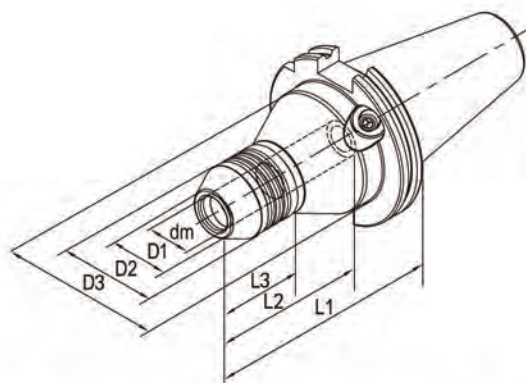
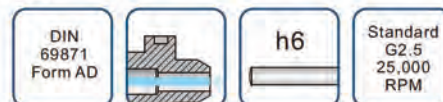

Order No.	Model	Shank	Size(mm)							Wrench	for Collets
			dm	D1	D2	D3	L1	L2	L3		
132-01-001	JT50-HCM12-110M	SK50-AD	12	21.5	36.5	60	110	50	55	TS5	HC12..M
132-01-002	JT50-HCM20-110M	SK50-AD	20	28	42	70	110	95	47	TS5	HC20..M
132-01-003	JT50-HCM32-110M	SK50-AD	32	40	54	70	110	95	62.5	TS5	HC32..M

PRECISION REDUCING SLEEVE FOR HYDRAULIC CHUCK

- Radial run-out less than 3μ .
- Used for grinding/sharpening of drill, reamer, end mill etc.
- For clamping cutting tools with cylinderic shank tolerance h6

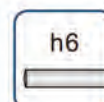

Order No.	Model	Size (mm)			
		dm	D	L1	L
100-01-101	HC12-3M	3	12	16.5	47.5
100-01-102	HC12-4M	4	12	16.5	47.5
100-01-103	HC12-5M	5	12	16.5	47.5
100-01-104	HC12-6M	6	12	24	47.5
100-01-105	HC12-8M	8	12	25.5	47.5
100-01-106	HC20-3M	3	20	17.5	52.5
100-01-107	HC20-4M	4	20	17.5	52.5
100-01-108	HC20-5M	5	20	17.5	52.5
100-01-109	HC20-6M	6	20	25.5	52.5
100-01-110	HC20-7M	7	20	28	52.5
100-01-111	HC20-8M	8	20	28	52.5
100-01-112	HC20-9M	9	20	32.5	52.5
100-01-113	HC20-10M	10	20	32.5	52.5
100-01-114	HC20-11M	11	20	36	52.5
100-01-115	HC20-12M	12	20	36	52.5
100-01-116	HC20-13M	13	20	36.5	52.5
100-01-117	HC20-14M	14	20	37	52.5
100-01-118	HC20-15M	15	20	37	52.5
100-01-119	HC20-16M	16	20	37.5	52.5
100-01-120	HC32-6M	6	32	25.5	63.5
100-01-121	HC32-8M	8	32	27.5	63.5
100-01-122	HC32-10M	10	32	30.5	63.5
100-01-123	HC32-12M	12	32	30.5	63.5
100-01-124	HC32-14M	14	32	32.5	63.5
100-01-125	HC32-16M	16	32	40.5	63.5
100-01-126	HC32-18M	18	32	40.5	63.5
100-01-127	HC32-20M	20	32	40.5	63.5
100-01-128	HC32-25M	25	32	48.5	63.5

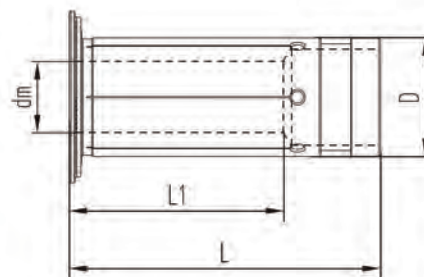

SHRINK FIT CHUCK

- Made of high-temperature steel and fit for High frequency heating machine.
- For clamping cutting tools with cylinderic shank tolerance h6
- High tool-gripping strength and machining accuracy
- 360 degree concentric clamping without set screws, collets.
- Engineered to produce the high degree of balance available
- With indicating line for shank depth of cutter.

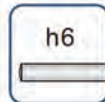

Order No.	Model	Shank	Size(mm)					Screw
			dm	D1	D2	L	H	
132-02-401	JT40-SFX03-80	SK40-AD	3	10	-	80	10	-
132-02-402	JT40-SFX04-80	SK40-AD	4	10	-	80	12	-
132-02-403	JT40-SFX05-80	SK40-AD	5	10	-	80	15	-
132-02-404	JT40-SFX06-80	SK40-AD	6	21	27	80	36	S005014C
132-02-405	JT40-SFX06-120	SK40-AD	6	21	27	120	36	S005014C
132-02-406	JT40-SFX06-160	SK40-AD	6	21	32	160	36	S005014C
132-02-407	JT40-SF08-80	SK40-AD	8	21	27	80	36	S006014C
132-02-408	JT40-SF08-120	SK40-AD	8	21	27	120	36	S006014C
132-02-409	JT40-SF08-160	SK40-AD	8	21	32	160	36	S006014C
132-02-410	JT40-SF10-80	SK40-AD	10	24	32	80	42	S008014C
132-02-411	JT40-SF10-120	SK40-AD	10	24	32	120	42	S008014C
132-02-412	JT40-SF10-160	SK40-AD	10	24	34	160	42	S008014C
132-02-413	JT40-SF12-80	SK40-AD	12	24	32	80	47	S008014C
132-02-414	JT40-SF12-120	SK40-AD	12	24	32	120	47	S008014C
132-02-415	JT40-SF12-160	SK40-AD	12	24	34	160	47	S008014C
132-02-416	JT40-SF14-80	SK40-AD	14	27	34	80	47	S008014C
132-02-417	JT40-SF14-120	SK40-AD	14	27	34	120	47	S008014C
132-02-418	JT40-SF14-160	SK40-AD	14	27	42	160	47	S008014C
132-02-419	JT40-SF16-80	SK40-AD	16	27	34	80	50	S012014C
132-02-420	JT40-SF16-120	SK40-AD	16	27	34	120	50	S012014C
132-02-421	JT40-SF16-160	SK40-AD	16	27	42	160	50	S012014C
132-02-422	JT40-SF18-80	SK40-AD	18	33	42	80	50	S012014C
132-02-423	JT40-SF18-120	SK40-AD	18	33	42	120	50	S012014C
132-02-424	JT40-SF18-160	SK40-AD	18	33	50	160	50	S012014C
132-02-425	JT40-SF20-80	SK40-AD	20	33	42	80	52	S016016C
132-02-426	JT40-SF20-120	SK40-AD	20	33	42	120	52	S016016C
132-02-427	JT40-SF20-160	SK40-AD	20	33	50	160	52	S016016C
132-02-428	JT40-SF25-100	SK40-AD	25	44	50	100	58	S016016C
132-02-429	JT40-SF25-120	SK40-AD	25	44	50	120	58	S016016C
132-02-430	JT40-SF25-160	SK40-AD	25	44	50	160	58	S016016C
132-02-501	JT50-SFX06-80	SK50-AD	6	21	27	80	36	S005014C
132-02-502	JT50-SFX06-120	SK50-AD	6	21	27	120	36	S005014C
132-02-503	JT50-SFX06-160	SK50-AD	6	21	32	160	36	S005014C
132-02-504	JT50-SF08-80	SK50-AD	8	21	27	80	36	S006014C
132-02-505	JT50-SF08-120	SK50-AD	8	21	27	120	36	S006014C
132-02-506	JT50-SF08-160	SK50-AD	8	21	32	160	36	S006014C
132-02-507	JT50-SF10-80	SK50-AD	10	24	32	80	42	S008014C
132-02-508	JT50-SF10-120	SK50-AD	10	24	32	120	42	S008014C
132-02-509	JT50-SF10-160	SK50-AD	10	24	34	160	42	S008014C
132-02-510	JT50-SF12-80	SK50-AD	12	24	32	80	47	S008014C
132-02-511	JT50-SF12-120	SK50-AD	12	24	32	120	47	S008014C
132-02-512	JT50-SF12-160	SK50-AD	12	24	34	160	47	S008014C
132-02-513	JT50-SF14-80	SK50-AD	14	27	34	80	47	S008014C
132-02-514	JT50-SF14-120	SK50-AD	14	27	34	120	47	S008014C
132-02-515	JT50-SF14-160	SK50-AD	14	27	42	160	47	S008014C
132-02-516	JT50-SF16-80	SK50-AD	16	27	34	80	50	S012014C
132-02-517	JT50-SF16-120	SK50-AD	16	27	34	120	50	S012014C
132-02-518	JT50-SF16-160	SK50-AD	16	27	42	160	50	S012014C
132-02-519	JT50-SF18-80	SK50-AD	18	33	42	80	50	S012014C
132-02-520	JT50-SF18-120	SK50-AD	18	33	42	120	50	S012014C
132-02-521	JT50-SF18-160	SK50-AD	18	33	51	160	50	S012014C
132-02-522	JT50-SF20-80	SK50-AD	20	33	42	80	52	S016016C
132-02-523	JT50-SF20-120	SK50-AD	20	33	42	120	52	S016016C
132-02-524	JT50-SF20-160	SK50-AD	20	33	51	160	52	S016016C
132-02-525	JT50-SF25-100	SK50-AD	25	44	53	100	58	S016016C
132-02-526	JT50-SF25-120	SK50-AD	25	44	53	120	58	S016016C
132-02-527	JT50-SF25-160	SK50-AD	25	44	60	160	58	S016016C
132-02-528	JT50-SF32-100	SK50-AD	32	44	53	100	58	S016016C
132-02-529	JT50-SF32-120	SK50-AD	32	44	53	120	58	S016016C
132-02-530	JT50-SF32-160	SK50-AD	32	44	60	160	58	S016016C

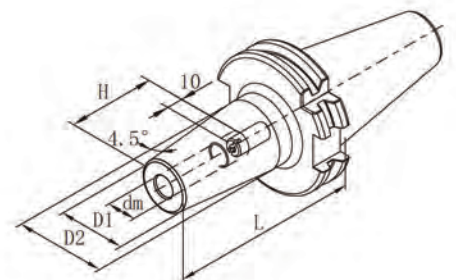

ER COLLET CHUCK

- Radial run-out less than 0.01mm.
- Constructed of alloy steel for long, durable service life.
- For clamping tools with plain shank in collets to DIN6499.
- Supplied with high performance clamping nut.

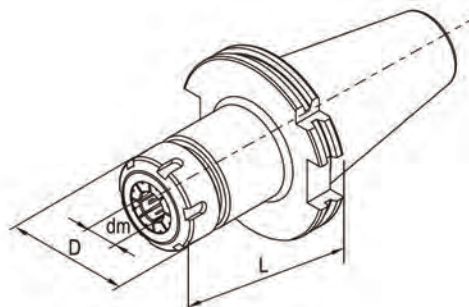

Order No.	Model	Shank	Size(mm)			Nuts	Screw	For Collets	Wrench
			dm	D	L				
132-04-401	JT40-ER11-70	SK40-AD	0.5-7	19	70	CN11HS	SER11C	ER11	W17D
132-04-402	JT40-ER11-120	SK40-AD	0.5-7	19	120	CN11HS	SER11C	ER11	W17D
132-04-403	JT40-ER16-70	SK40-AD	0.5-10	28	70	CN16HS	SER16C	ER16	W25D
132-04-404	JT40-ER16-120	SK40-AD	0.5-10	28	120	CN16HS	SER16C	ER16	W25D
132-04-405	JT40-ER20-80	SK40-AD	1.0-13	34	80	CN20HS	SER20C	ER20	W30D
132-04-406	JT40-ER20-120	SK40-AD	1.0-13	34	120	CN20HS	SER20C	ER20	W30D
132-04-407	JT40-ER25-80	SK40-AD	1.0-16	42	80	CN25B	SER25C	ER25	YER25B
132-04-408	JT40-ER25-120	SK40-AD	1.0-16	42	120	CN25B	SER25C	ER25	YER25B
132-04-409	JT40-ER32-60	SK40-AD	2.0-20	50	60	CN32B	SER32C	ER32	YER32B
132-04-410	JT40-ER32-120	SK40-AD	2.0-20	50	120	CN32B	SER32C	ER32	YER32B
132-04-411	JT40-ER40-80	SK40-AD	3.0-26	63	80	CN40B	SER40C	ER40	YER40B
132-04-501	JT50-ER16-60	SK50-AD	0.5-10	28	60	CN16HS	SER16C	ER16	W25D
132-04-502	JT50-ER16-120	SK50-AD	0.5-10	28	120	CN16HS	SER16C	ER16	W25D
132-04-503	JT50-ER20-70	SK50-AD	1.0-13	34	70	CN20HS	SER20C	ER20	W30D
132-04-504	JT50-ER20-120	SK50-AD	1.0-13	34	120	CN20HS	SER20C	ER20	W30D
132-04-505	JT50-ER25-70	SK50-AD	1.0-16	42	70	CN25B	SER25C	ER25	YER25B
132-04-506	JT50-ER25-120	SK50-AD	1.0-16	42	120	CN25B	SER25C	ER25	YER25B
132-04-507	JT50-ER32-90	SK50-AD	2.0-20	50	90	CN32B	SER32C	ER32	YER32B
132-04-508	JT50-ER32-120	SK50-AD	2.0-20	50	120	CN32B	SER32C	ER32	YER32B
132-04-509	JT50-ER40-100	SK50-AD	3.0-26	50	100	CN40B	SER40C	ER40	YER40B



ER COLLET CHUCK & COLLET SET

- Each set including 1pc of SK40-AD ER collet chuck and 9pc of ER collets,
- Equipped with ER collet nut wrench and pack in strong aluminium box.
- Long working life time due to system radial run-out less than 0.01mm.

Order No.	Shank Model	Collet	Wrench
132-04-S41	JT40-ER16-70	ER16: dia.2-3-4-5-6-7-8-9-10mm	W25D
132-04-S42	JT40-ER25-80	ER25: dia.3-4-5-6-8-10-12-14-16mm	YER25B
132-04-S43	JT40-ER32-60	ER32: dia.4-6-8-10-12-14-16-18-20mm	YER32B

POWER MILLING CHUCK

- Very high clamping force and High stability improving surface quality and tool life time.
- Optimised design resulting in Ideal damping characteristics and low vibration.
- Radial run-out less than 0.01mm.
- For clamping cutting tools with cylindric shank tolerance h6
- Flexible clamping range by using reducing sleeve for various tool shank.

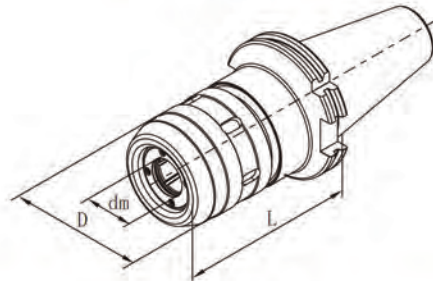

Order No.	Model	Shank	Size(mm)			For Collets	Wrench
			dm	D	L		
132-03-401	JT40-C20-95	SK40-AD	20	55	95	C20	WC20
132-03-402	JT40-C25-100	SK40-AD	25	62	100	C25	WC25
132-03-403	JT40-C32-105	SK40-AD	32	72	105	C32	WC32
132-03-501	JT50-C20-105	SK50-AD	20	55	105	C20	WC20
132-03-502	JT50-C25-110	SK50-AD	25	62	110	C25	WC25
132-03-503	JT50-C32-110	SK50-AD	32	72	110	C32	WC32
132-03-504	JT50-C42-110	SK50-AD	42	87	110	C42	WC42

POWER MILLING CHUCK SET

- Each set including 1pc of SK40-AD power milling chuck and reducing sleeves, equipped with wrench and packed in strong aluminium box.
- Long tool life due to system radial run-out less than 0.01mm.



Order No.	content		
	1pc chuck	1pc each size of reducing sleeve	1pc wrench
132-03-S04	JT40-C32-105	C32-6, C32-8, C32-10, C32-12, C32-16, C32-20, C32-25 (internal dia: 6, 8, 10, 12, 16, 20, 25mm)	WC32
132-03-S05	JT50-C32-110	C32-6, C32-8, C32-10, C32-12, C32-16, C32-20, C32-25 (internal dia: 6, 8, 10, 12, 16, 20, 25mm)	WC32

REDUCING SLEEVE FOR POWER MILLING CHUCK

- For drill, milling, reaming.
- Radial run-out less than 0.01mm
- For clamping cutting tools with cylindric shank tolerance h6

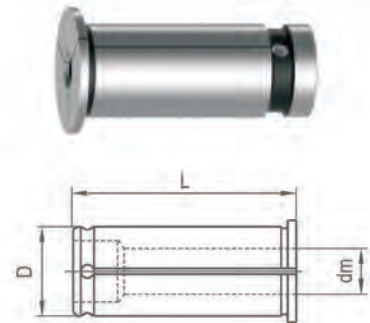
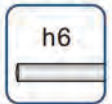

Order No.	Modle	Size (mm)		
		dm	D	L
100-03-001	C20-3	3	20	55
100-03-002	C20-4	4	20	55
100-03-003	C20-5	5	20	55
100-03-004	C20-6	6	20	55
100-03-005	C20-8	8	20	55
100-03-006	C20-10	10	20	55
100-03-007	C20-12	12	20	55
100-03-008	C20-14	14	20	55
100-03-009	C20-16	16	20	55
100-03-010	C25-4	4	25	60
100-03-011	C25-5	5	25	60
100-03-012	C25-6	6	25	60
100-03-013	C25-8	8	25	60
100-03-014	C25-10	10	25	60
100-03-015	C25-12	12	25	60
100-03-016	C25-14	14	25	60
100-03-017	C25-16	16	25	60
100-03-018	C25-18	18	25	60
100-03-019	C25-20	20	25	60

Order No.	Modle	Size (mm)		
		dm	D	L
100-03-020	C32-6	6	32	65
100-03-021	C32-8	8	32	65
100-03-022	C32-10	10	32	65
100-03-023	C32-12	12	32	65
100-03-024	C32-14	14	32	65
100-03-025	C32-16	16	32	65
100-03-026	C32-18	18	32	65
100-03-027	C32-20	20	32	65
100-03-028	C32-25	25	32	65
100-03-029	C42-6	6	42	70
100-03-030	C42-8	8	42	70
100-03-031	C42-10	10	42	70
100-03-032	C42-12	12	42	70
100-03-033	C42-14	14	42	70
100-03-034	C42-16	16	42	70
100-03-035	C42-18	18	42	70
100-03-036	C42-20	20	42	70
100-03-037	C42-25	25	42	70
100-03-038	C42-32	32	42	70

AUTOMATIC MICRO-COMPENSATION TAPPING CHUCK

- Compensation capacity $\pm 0.5\text{mm}$.
- Precision producing true thread with quality surface.
- Increase the tool life of taps/thread formers.
- On machine centers with synchronised spindles.
- For right hand and left hand thread.

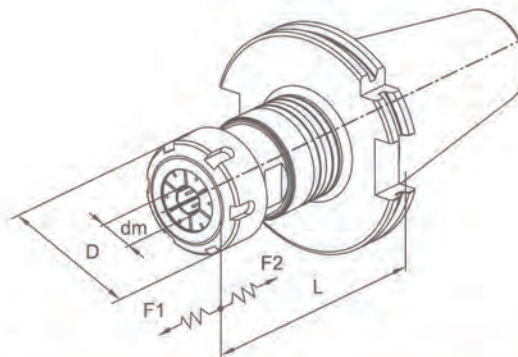
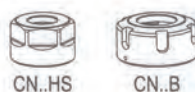

Order No.	Model	SHANK	capacity	Size(mm)					Nuts	for Collets
				D	dm	L	F1	F2		
132-13-401	JT40-V20-80	SK40-AD	M4-M12(No.8-7/16)	34	3-10	80	0.5	0.5	CN20HS	ER20
132-13-501	JT50-V20-80	SK50-AD	M4-M12(No.8-7/16)	34	3-10	80	0.5	0.5	CN20HS	ER20
132-13-402	JT40-V32-95	SK40-AD	M4-M20(No.8-3/4)	50	3-16	95	0.5	0.5	CN32B	ER32
132-13-502	JT50-V32-95	SK50-AD	M4-M20(No.8-3/4)	50	3-16	95	0.5	0.5	CN32B	ER32

Optional accessories:	V20	V32
Coolant Nuts	CN20C	CN32C
Sealing Disk	DER20C	DER32C
Wrench for Nut	W30D	YER32B
Wrench for fixing	W24D	W36D

ER TAP COLLET

- Special design with internal square drive for machine taps.

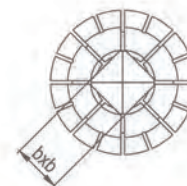
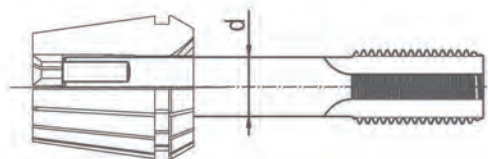

Order No.	Model	For taps				
		Shank d(mm)	Square b(mm)	ISO529/ISO2283	DIN374/DIN376	JISB4430
100-13-201	ER20-6.3B5	6.3	5	M8	M8	M6/M8
100-13-202	ER20-7B5.5	7	5.5	-	M10	M10
100-13-203	ER20-8B6.3	8	6.3	M10	-	-
100-13-204	ER20-8.5B6.5	8.5	6.5	-	-	M12
100-13-205	ER20-9B7.1	9	7.1	M12	M12	-
100-13-301	ER32-6.3B5	6.3	5	M8	M8	M6/M8
100-13-302	ER32-7B5.5	7	5.5	-	M10	M10
100-13-303	ER32-8B6.3	8	6.3	M10	-	-
100-13-304	ER32-8.5B6.5	8.5	6.5	-	-	M12
100-13-305	ER32-9B7.1	9	7.1	M12	M12	-
100-13-306	ER32-12B9	12	9	-	M16	-
100-13-307	ER32-12.5B10	12.5	10	M16	-	M16
100-13-308	ER32-14B11.2	14	11.2	M18/M20	M18	M18
100-13-309	ER32-15B12	15	12	-	-	M20
100-13-310	ER32-16B12	16	12	-	M20	-

PRECISION FLOATING TAPPING HOLDER

- For compensating the pitch tolerances of taps.
- Increases the tool life of taps/thread formers.

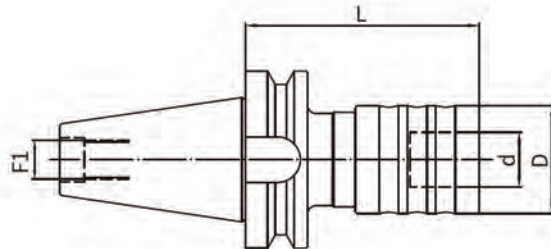

Order No.	Model	Capacity	For Collects	Size(mm)			
				D	dm	L	F1
132-13-451	JT40-HP3-58	M3-M12	HP3-D19	43	19	58	M16
132-13-452	JT40-HP12-138	M6-M30	HP12-D31	61	31	138	M16
121-13-551	JT50-HP3-58	M3-M12	HP3-D19	43	19	58	M24
121-13-552	JT50-HP12-89	M6-M30	HP12-D31	61	31	89	M24
121-13-553	JT50-HP24-150	M24-M48	HP24-D48	82	48	150	M24

TAPPING COLLET (DIN371/376)

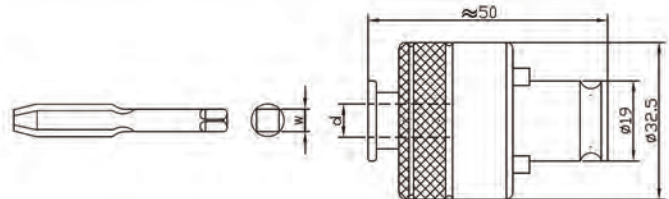

Order No.	Model	Specification		Φ d	Φ w
		DIN371	DIN376		
100-13-701	HP3	M2		2.8	2.1
100-13-702	HP3	M3		3.5	2.7
100-13-703	HP3	M4		4.5	3.4
100-13-704	HP3	M5		6.0	4.9
100-13-705	HP3	M6		6.0	4.9
100-13-706	HP3	M8		8.0	6.2
100-13-707	HP3	M10		10.0	8.0
100-13-708	HP3		M12	9.0	7.0
100-13-709	HP3		M14	11.0	9.0
100-13-710	HP3		M16	12.0	9.0

DIN376

Order No.	Model	Specification	Φ d	Φ w	Φ D
100-13-711	HP12	M6	4.5	3.4	31
100-13-712	HP12	M8	6.0	4.9	31
100-13-713	HP12	M10	7.0	5.5	31
100-13-714	HP12	M12	9.0	7.0	31
100-13-715	HP12	M14	11.0	9.0	31
100-13-716	HP12	M16	12.0	9.0	31
100-13-717	HP12	M18	14.0	11.0	31
100-13-718	HP12	M20	16.0	12.0	31
100-13-719	HP12	M22	18.0	14.5	31
100-13-720	HP12	M24	18.0	14.5	31
100-13-721	HP12	M27	20.0	16.0	31
100-13-722	HP12	M30	22.0	18.0	31
100-13-723	HP24	M24	18.0	14.5	48
100-13-724	HP24	M27	20.0	16.0	48
100-13-725	HP24	M30	22.0	18.0	48
100-13-726	HP24	M33	25.0	20.0	48
100-13-727	HP24	M36	28.0	22.0	48
100-13-728	HP24	M39/M42	32.0	24.0	48
100-13-729	HP24	M45/M48	36.0	29.0	48

SIDE LOCK HOLDER

• For clamping tools with weldon shank to DIN1835 form B and DIN6535 form HB.

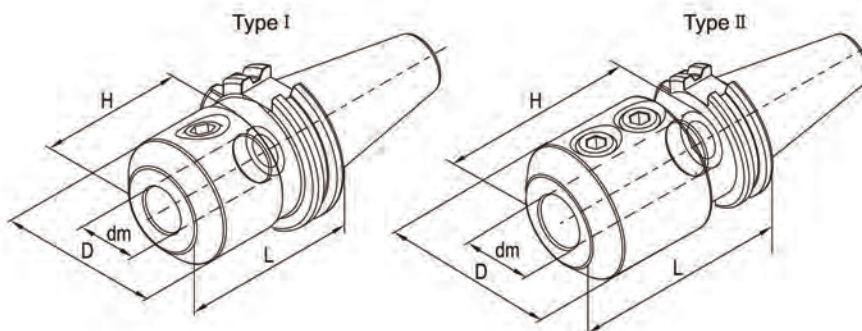

Order No.	Model	Shank	Size(mm)				Screw	Type
			dm	D	L	H		
132-05-401	JT40-XP16-63	SK40-AD	16	48	63	52	SXP16	I
132-05-402	JT40-XP20-70	SK40-AD	20	50	70	54	SXP20	I
132-05-403	JT40-XP25-100	SK40-AD	25	60	100	66	SXP25	II
132-05-404	JT40-XP32-100	SK40-AD	32	68	100	70	SXP32	II
132-05-501	JT50-XP16-63	SK50-AD	16	48	63	52	SXP16	I
132-05-502	JT50-XP20-63	SK50-AD	20	50	63	54	SXP20	I
132-05-503	JT50-XP25-80	SK50-AD	25	60	80	66	SXP25	II
132-05-504	JT50-XP32-100	SK50-AD	32	68	100	70	SXP32	II
132-05-505	JT50-XP40-110	SK50-AD	40	84	110	80	SXP32	II

2° SIDE LOCK HOLDER

• For clamping tools with parallel shank and inclined clamping flat(2°)
DIN1835 form E and DIN6535 form HE.

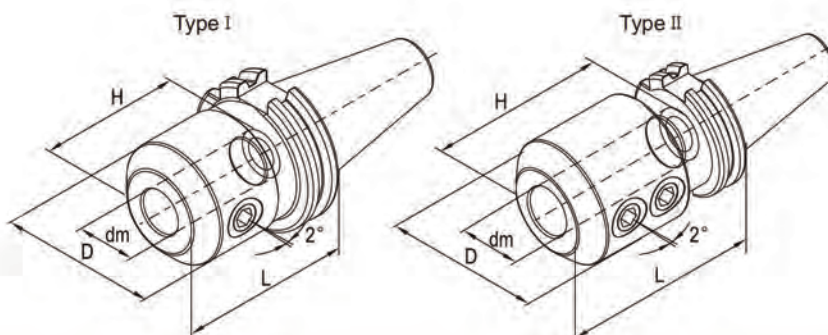

Order No.	Model	Shank	Size(mm)				Screw	Screw	Type
			dm	D	L	H			
132-05-405	JT40-XPD16-63	SK40-AD	16	48	63	52	SXP16	S012014C	I
132-05-406	JT40-XPD20-70	SK40-AD	20	52	70	54	SXP20	S016016C	I
132-05-407	JT40-XPD25-100	SK40-AD	25	65	100	59	SXP25	S020016C	II
132-05-408	JT40-XPD32-100	SK40-AD	32	72	100	63	SXP32	S020016C	II
132-05-506	JT50-XPD16-63	SK50-AD	16	48	63	52	SXP16	S012014C	I
132-05-507	JT50-XPD20-63	SK50-AD	20	52	63	54	SXP20	S016016C	I
132-05-508	JT50-XPD25-80	SK50-AD	25	65	80	59	SXP25	S020016C	II
132-05-509	JT50-XPD32-100	SK50-AD	32	72	100	63	SXP32	S020016C	II

MORSE TAPER HOLDERS WITHOUT TANG

• For clamping tools with MT taper shank without tang.

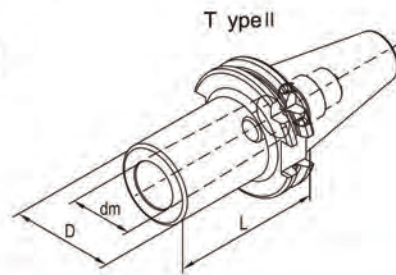
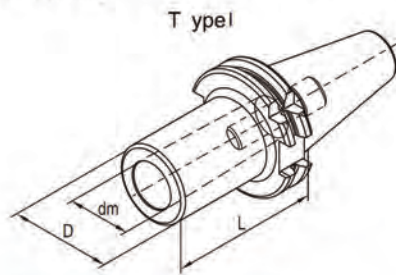

Order No.	Model	SHANK	Morse Taper	Capacity (φ mm)	Size(mm)			Screw	Type
					dm	D	L		
131-06-451	JT40-MW1-45	JT40	MT1	6-12	12.065	27	45	MS06025	I
131-06-452	JT40-MW2-50	JT40	MT2	14-20	17.780	32	50	MS10030-A	I
131-06-453	JT40-MW3-75	JT40	MT3	22-36	23.825	40	75	MS12035-A	II
131-06-454	JT40-MW4-95	JT40	MT4	32-56	31.267	50	95	MS16040-A	II
131-06-551	JT50-MW1-45	JT50	MT1	6-12	12.065	27	45	MS06025	I
131-06-552	JT50-MW2-60	JT50	MT2	14-20	17.780	32	60	MS10030	I
131-06-553	JT50-MW3-65	JT50	MT3	22-36	23.825	40	65	MS12035	I
131-06-554	JT50-MW4-75	JT50	MT4	32-56	31.267	50	75	MS16040-B	I
131-06-555	JT50-MW5-105	JT50	MT5	40-63	44.399	78	105	MS20048-A	II

MORSE TAPER HOLDERS WITH TANG

• For clamping tools with MT taper shank with tang.

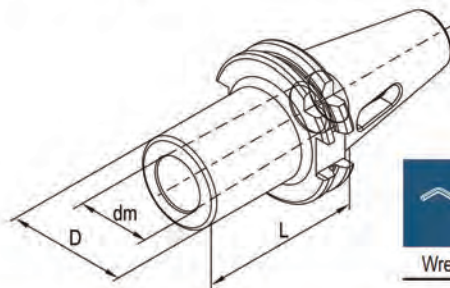

Wrench	MT1	MT2	MT3	MT4(I)	MT4(II)	MT5
S5	S8	S10	S14	S12	S17	

Order No.	Model	SHANK	Morse Taper	Capacity (φ mm)	Size(mm)		
					dm	D	L
131-06-401	JT40-M1-45	JT40	MT1	3-14	12.065	25	45
131-06-402	JT40-M1-120	JT40	MT1	3-14	12.065	25	120
131-06-403	JT40-M2-60	JT40	MT2	14.25-23	17.780	32	60
131-06-404	JT40-M2-120	JT40	MT2	14.25-23	17.780	32	120
131-06-405	JT40-M3-75	JT40	MT3	23.25-31.75	23.825	40	75
131-06-406	JT40-M3-135	JT40	MT3	23.25-31.75	23.825	40	135
131-06-407	JT40-M4-95	JT40	MT4	32-50.5	31.267	48	95
131-06-408	JT40-M4-165	JT40	MT4	32-50.5	31.267	48	165
131-06-501	JT50-M1-45	JT50	MT1	3-14	12.065	25	45
131-06-502	JT50-M1-120	JT50	MT2	3-14	12.065	25	120
131-06-503	JT50-M1-180	JT50	MT3	3-14	12.065	25	180
131-06-504	JT50-M2-45	JT50	MT2	14.25-23	17.780	32	45
131-06-505	JT50-M2-135	JT50	MT2	14.25-23	17.780	32	135
131-06-506	JT50-M2-180	JT50	MT2	14.25-23	17.780	32	180
131-06-507	JT50-M3-75	JT50	MT3	23.25-31.75	23.825	40	75
131-06-508	JT50-M3-150	JT50	MT3	23.25-31.75	23.825	40	150
131-06-509	JT50-M3-180	JT50	MT3	23.25-31.75	23.825	40	180
131-06-510	JT50-M4-75	JT50	MT4	32-50.5	31.267	48	75
131-06-511	JT50-M4-180	JT50	MT4	32-50.5	31.267	48	180
131-06-512	JT50-M5-105	JT50	MT5	51-76	44.399	63	105

INTEGRAL DRILL CHUCK HOLDER

- Radial run-out less than 0.05mm.
- Wrench-Lock chucks incorporate wrench groove for additional tightening force.
- Integral shank design provides for greater accuracy and safety.
- Wrench included.

DIN
69871
Form A

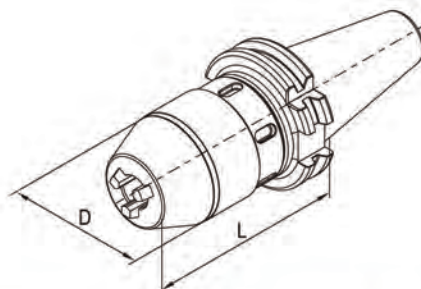

Order No.	Model	Shank	Capacity (mm)	Size(mm)		Wrench
				D	L	
132-12-401	JT40-KPU08-80	SK40-A	0.5-8	37.5	80	WCN20
132-12-402	JT40-KPU13-90	SK40-A	1.0-13	50.5	90	WCN32
132-12-403	JT40-KPU16-105	SK40-A	3-16	57	105	WCN32
132-12-501	JT50-KPU08-80	SK50-A	0.5-8	37.5	80	WCN20
132-12-502	JT50-KPU13-100	SK50-A	1.0-13	50.5	100	WCN32
132-12-503	JT50-KPU16-105	SK50-A	3-16	57	105	WCN32

SHELL END MILL ARBOR

- For clamping shell end mill and milling cutter.

DIN
69871
Form A

Standard
G6.3
15,000
RPM

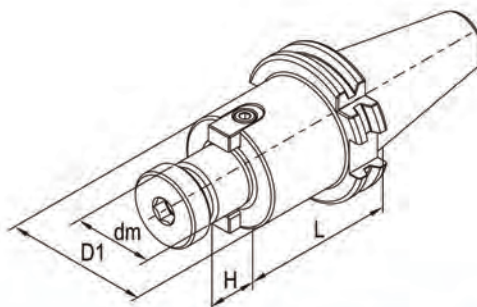

Order No.	Model	Shank	Size(mm)				Screw	Key	Screw
			dm	D1	L	H			
131-07-401	JT40-XMB16-60	SK40-A	16	34	60	17	MS08030	JC08017	MS03008
131-07-402	JT40-XMB16-120	SK40-A	16	34	120	17	MS08030	JC08017	MS03008
131-07-403	JT40-XMB22-60	SK40-A	22	42	60	19	MS10030	JC10021	MS04010
131-07-404	JT40-XMB22-120	SK40-A	22	42	120	19	MS10030	JC10021	MS04010
131-07-405	JT40-XMB27-60	SK40-A	27	60	60	21	SXM27	JC12023	MS05016
131-07-406	JT40-XMB27-120	SK40-A	27	60	120	21	SXM27	JC12023	MS05016
131-07-407	JT40-XMB32-60	SK40-A	32	78	60	24	SXM32	JC14020	MS06020
131-07-408	JT40-XMB40-60	SK40-A	40	89	60	27	SXM40	KXM40	MS08020
131-07-501	JT50-XMB16-60	SK50-A	16	34	60	17	MS08030	JC08017	MS03008
131-07-502	JT50-XMB16-120	SK50-A	16	34	120	17	MS08030	JC08017	MS03008
131-07-503	JT50-XMB22-60	SK50-A	22	42	60	19	MS10030	JC10021	MS04010
131-07-504	JT50-XMB22-120	SK50-A	22	42	120	19	MS10030	JC10021	MS04010
131-07-505	JT50-XMB27-60	SK50-A	27	60	60	21	SXM27	JC12023	MS05016
131-07-506	JT50-XMB27-90	SK50-A	27	60	90	21	SXM27	JC12023	MS05016
131-07-507	JT50-XMB27-120	SK50-A	27	60	120	21	SXM27	JC12023	MS05016
131-07-508	JT50-XMB32-75	SK50-A	32	78	75	24	SXM32	JC14020	MS06020
131-07-509	JT50-XMB40-75	SK50-A	40	89	75	27	SXM40	KXM40	MS08020

COMBINATION FACE MILL ADAPTER

- For clamping shell end mills and milling cutter heads with longitudinal or transverse groove.

DIN 69891 Form A	Standard G6.3 15,000 RPM
------------------------	-----------------------------------

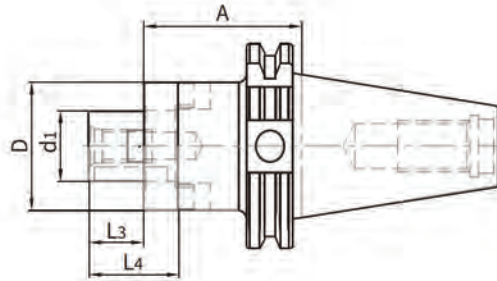

Order No.	Model	SHANK	Size(mm)				
			A	D	d1	L3	L4
131-16-401	JT40-XSL16-45	JT40	55	φ 32	φ 16	17	27
131-16-402	JT40-XSL22-43	JT40	55	φ 40	φ 22	19	31
131-16-403	JT40-XSL27-43	JT40	55	φ 48	φ 27	21	33
131-16-404	JT40-XSL32-46	JT40	60	φ 48.5	φ 32	24	38
131-16-405	JT40-XSL40-46	JT40	60	φ 48.5	φ 40	27	41
131-16-406	JT40-XSL16-90	JT40	100	φ 32	φ 16	17	27
131-16-407	JT40-XSL22-88	JT40	100	φ 40	φ 22	19	31
131-16-408	JT40-XSL27-88	JT40	100	φ 48	φ 27	21	33
131-16-409	JT40-XSL32-86	JT40	100	φ 58	φ 32	24	38
131-16-410	JT40-XSL40-86	JT40	100	φ 70	φ 40	27	41
131-16-501	JT50-XSL16-90	JT50	100	φ 32	φ 16	17	27
131-16-502	JT50-XSL22-88	JT50	100	φ 40	φ 22	19	31
131-16-503	JT50-XSL27-88	JT50	100	φ 48	φ 27	21	33
131-16-504	JT50-XSL32-86	JT50	100	φ 58	φ 32	24	38
131-16-505	JT50-XSL40-86	JT50	100	φ 70	φ 40	27	41

FACE MILLING CUTTER HOLDER

- For clamping face milling cutter with 4 holes .
- Increased collar contact surface.
- Suppled with lock screws.

DIN 69871 Form A	Standard G6.3 8,000 RPM
------------------------	----------------------------------

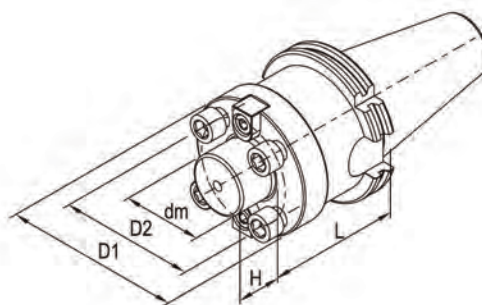

Order No.	Model	Shank	Size(mm)					Screw (4pcs)	Key	Screw
			dm	D1	D2	L	H			
131-09-401	JT40-XMC40-60	SK40-A	40	89	66.7	60	27	MS12045	KXM40	MS08020
131-09-501	JT50-XMC40-75	SK50-A	40	89	66.7	75	27	MS12045	KXM40	MS08020
131-09-502	JT50-XMC60-75	SK50-A	60	129	101.6	75	38	MS16045	KXMC60	MS10025

SLOTING CUTTER HOLDER

- For clamping saws and side milling cutter.
- Furnished complete with assorted spacers,nut and key.

DIN 69871 Form A	Standard G6.3 8,000 RPM
------------------------	----------------------------------

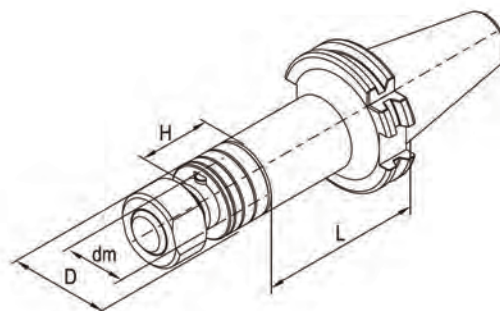

Order No.	Model	Shank	Size(mm)				Nuts	Spacer	Key
			dm	D	L	H			
131-10-401	JT40-XS22-75	SK40-A	22	34	75	30	MXS22	SD22	JA06020
131-10-402	JT40-XS22-120	SK40-A	22	34	120	30	MXS22	SD22	JA06020
131-10-403	JT40-XS27-75	SK40-A	27	40	75	30	MXS27	SD27	JA07022
131-10-404	JT40-XS27-120	SK40-A	27	40	120	30	MXS27	SD27	JA07022
131-10-405	JT40-XS32-90	SK40-A	32	46	90	30	MXS32	SD32	JA08022
131-10-501	JT50-XS22-90	SK50-A	22	34	90	30	MXS22	SD22	JA06020
131-10-502	JT50-XS27-90	SK50-A	27	40	90	30	MXS27	SD27	JA07022
131-10-503	JT50-XS27-135	SK50-A	27	40	135	30	MXS27	SD27	JA07022
131-10-504	JT50-XS32-90	SK50-A	32	46	90	30	MXS32	SD32	JA08022
131-10-505	JT50-XS32-135	SK50-A	32	46	135	30	MXS32	SD32	JA08022
131-10-506	JT50-XS40-90	SK50-A	40	55	90	30	MXS40	SD40	JA10025
131-10-507	JT50-XS40-135	SK50-A	40	55	135	30	MXS40	SD40	JA10025
131-10-508	JT50-XS50-90	SK50-A	50	69	90	30	MXS50	SD50	JA12025

7:24 TEST BARS

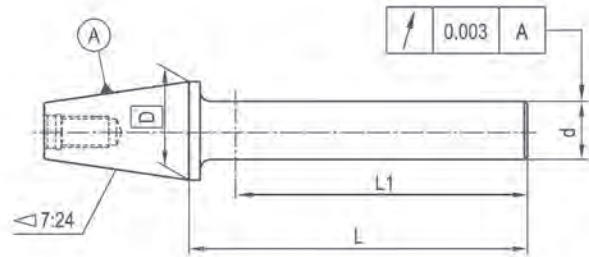

Order No.	Model	Shank	Size(mm)			
			D	d	L	L1
163-15-005	JT40-TB40-300	40	44.45	40	300	265
163-15-010	JT50-TB50-350	50	69.85	50	350	300

JIS B 6339 (MAS 403 BT) Tool holder

HYDRAULIC EXPANSIONS CHUCK	39
SHRINK FIT CHUCK	42
ER COLLET CHUCK	44
ER SLIM COLLET CHUCK	46
INTEGRAL DRILL CHUCK HOLDER	46
POWER MILLING CHUCK	47
MICRO-COMPENSATION TAPPING CHUCK	48
HP HIGH PRECISE TAPPING HOLDER	49
SIDE LOCK HOLDER	50
2° SIDE LOCK HOLDER	50
SHELL END MILL ARBOR	52
FACE MILLING CUTTER HOLDER	53
SLOTING CUTTER HOLDER	53
7:24 TEST BARS	54



TAPER SHANK INTERFACE JIS B6339 (MAS 403 BT) -FORMS AND FEATURES

FEATURES:

- Used for NC machines and machining center.
- Extremely high tool quality protects the machine spindle and extends the life time of the tools.
- Material : Special alloy steel for high stressed components,
- Surface hardness:58~62HRC
- Tensile strength in the core at least 950 N/mm 2
- Accuracy : Cone angle according norm
- Surface roughness of cone max. Ra 0,3

Form A: without through hole.

Form AD:with through hole for central coolant feed.

Form AD/B:for lateral coolant feed via the tool collar.

BT30 JIS B 6339 (MAS 403 BT)

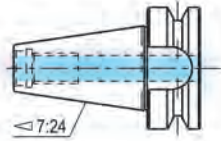

AD Style

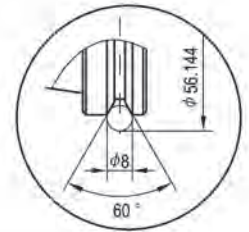
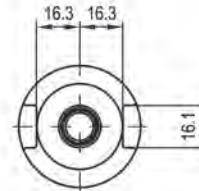
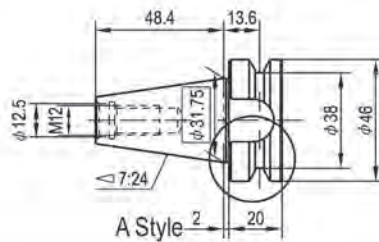

BT40 JIS B 6339 (MAS 403 BT)

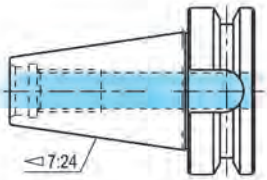

AD Style

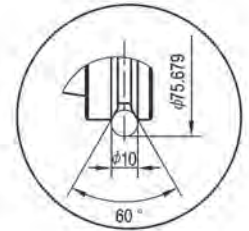
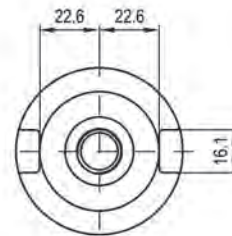
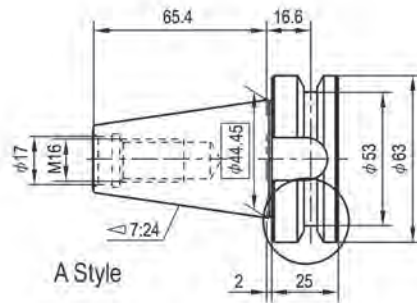

BT50 JIS B 6339 (MAS 403 BT)

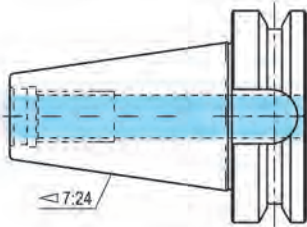

AD Style

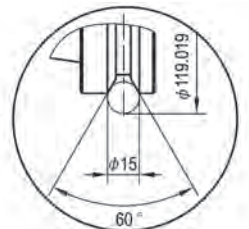
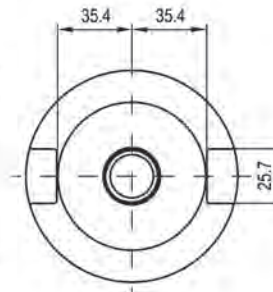
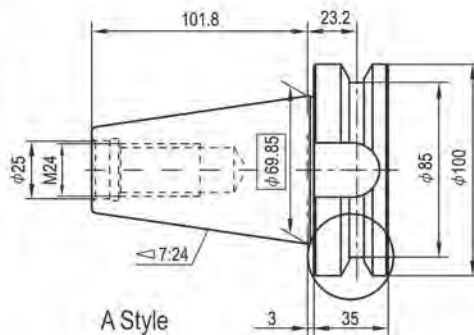

AD/B Style

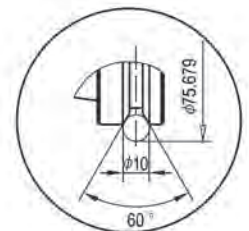
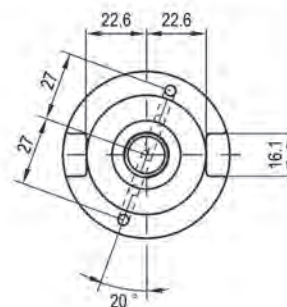
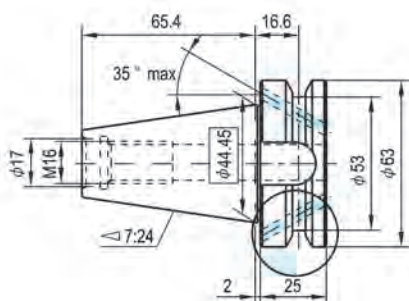

HYDRAULIC EXPANSIONS CHUCK

- Super transmitted torque for high clamping reliability.
- Radial run-out less than 3μ (system accuracy at 4x)
- For clamping cutting tools with cylindric shank tolerance h6
- Flexible clamping range due to use of reducing sleeve for Various shank.
- Axial length adjustment available and max. adjustment travel 10mm.
- Ideal damping characteristics, resulting in optimum surface finish, increase cutter life time and spindle protection.

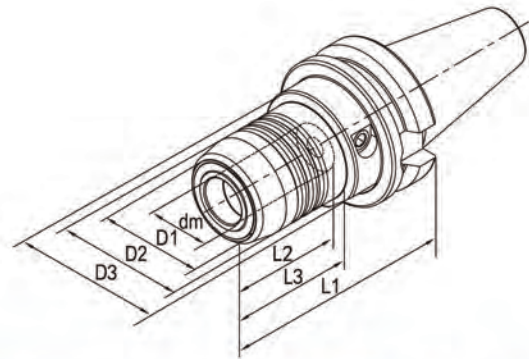
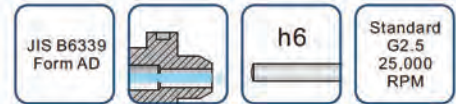

Order No.	Model	Shank	Size(mm)							Screw	Screw wrench	for Collets
			dm	D1	D2	D3	L1	L2	L3			
122-01-301	BT30-HCM06-50.8	BT30-AD	6	23	26	46	50.8	37	18	HCS005014C	TS5	-
122-01-302	BT30-HCM08-50.8	BT30-AD	8	25	28	46	50.8	37	18.5	HCS006014C	TS5	-
122-01-303	BT30-HCM10-50.8	BT30-AD	10	27	30	46	50.8	41	19	HCS008014C	TS5	-
122-01-304	BT30-HCM12-50.8	BT30-AD	12	29	32	46	50.8	46	19.5	HCS008014C	TS5	HC12
122-01-305	BT30-HCM16-90	BT30-AD	16	35	38	45	90	49	50	HCS008014C	TS5	-
122-01-306	BT30-HCM20-90	BT30-AD	20	37.5	42	45	90	51	50	HCS008014C	TS5	HC20
122-01-401	BT40-HCM06-90	BT40-AD	6	22	26	50	90	37	43	HCS005014C	TS5	-
122-01-402	BT40-HCM08-90	BT40-AD	8	24	28	50	90	37	44.5	HCS006014C	TS5	-
122-01-403	BT40-HCM10-90	BT40-AD	10	26	30	50	90	41	44.5	HCS008014C	TS5	-
122-01-404	BT40-HCM12-90	BT40-AD	12	28	32	50	90	46	44.5	HCS008014C	TS5	HC12
122-01-405	BT40-HCM16-90	BT40-AD	16	34	38	50	90	49	47.5	HCS008014C	TS5	-
122-01-406	BT40-HCM20-90	BT40-AD	20	38	42	50	90	51	47.5	HCS008014C	TS5	HC20
122-01-407	BT40-HCM25-83	BT40-AD	25	53	57	72	83	57	25.5	HCS012014C	TS6	-
122-01-408	BT40-HCM32-83	BT40-AD	32	60	63	80	83	61	25.5	HCS012014C	TS6	HC32
122-01-409	BT40-HCM14-90	BT40-AD	14	30	34	50	90	46	44.5	HCS008014C	TS5	-
122-01-410	BT40-HCM18-90	BT40-AD	18	36	40	50	90	49	47.5	HCS008014C	TS5	-
122-01-411	BT40-HCM06-150	BT40-AD	6	22	26	50	150	37	103	HCS005014C	TS5	-
122-01-412	BT40-HCM08-150	BT40-AD	8	24	28	50	150	37	104	HCS006014C	TS5	-
122-01-413	BT40-HCM10-150	BT40-AD	10	26	30	50	150	41	104	HCS008014C	TS5	-
122-01-414	BT40-HCM12-150	BT40-AD	12	28	32	50	150	46	105	HCS008014C	TS5	HC12
122-01-415	BT40-HCM14-150	BT40-AD	14	30	34	50	150	46	105	HCS008014C	TS5	-
122-01-416	BT40-HCM16-150	BT40-AD	16	34	38	50	150	49	106	HCS008014C	TS5	-
122-01-417	BT40-HCM18-150	BT40-AD	18	36	40	50	150	49	107	HCS008014C	TS5	-
122-01-418	BT40-HCM20-150	BT40-AD	20	38	42	50	150	51	107	HCS008014C	TS5	HC20
122-01-419	BT40-HCM06-200	BT40-AD	6	22	26	50	200	37	153	HCS005014C	TS5	-
122-01-420	BT40-HCM08-200	BT40-AD	8	24	28	50	200	37	154	HCS006014C	TS5	-
122-01-421	BT40-HCM10-200	BT40-AD	10	26	30	50	200	41	154	HCS008014C	TS5	-
122-01-422	BT40-HCM12-200	BT40-AD	12	28	32	50	200	46	155	HCS008014C	TS5	HC12
122-01-423	BT40-HCM14-200	BT40-AD	14	30	34	50	200	46	155	HCS008014C	TS5	-
122-01-424	BT40-HCM16-200	BT40-AD	16	34	38	50	200	49	156	HCS008014C	TS5	-
122-01-425	BT40-HCM18-200	BT40-AD	18	36	40	50	200	49	157	HCS008014C	TS5	-
122-01-426	BT40-HCM20-200	BT40-AD	20	38	42	50	200	51	157	HCS008014C	TS5	HC20
122-01-501	BT50-HCM06-90	BT50-AD	6	22	26	44.5	90	37	29.5	HCS005014C	TS5	-
122-01-502	BT50-HCM08-90	BT50-AD	8	24	28	44.5	90	37	30	HCS006014C	TS5	-
122-01-503	BT50-HCM10-90	BT50-AD	10	26	30	44.5	90	41	31	HCS008014C	TS5	-
122-01-504	BT50-HCM12-90	BT50-AD	12	28	32	44.5	90	46	34	HCS008014C	TS5	HC12
122-01-505	BT50-HCM16-90	BT50-AD	16	34	38	44.5	90	49	34	HCS008014C	TS5	-
122-01-506	BT50-HCM20-90	BT50-AD	20	38	42	44.5	90	51	34	HCS008014C	TS5	HC20
122-01-507	BT50-HCM25-90	BT50-AD	25	53	57	66	90	57	34	HCS012014C	TS6	-
122-01-508	BT50-HCM32-90	BT50-AD	32	60	64	72	90	61	34	HCS012014C	TS6	HC32
122-01-509	BT50-HCM12-150	BT50-AD	12	28	32	50	150	46	95	HCS008014C	TS5	HC12
122-01-510	BT50-HCM20-150	BT50-AD	20	38	42	50	150	51	95	HCS008014C	TS5	HC20

REDUCING SLEEVE FOR HYDRAULIC EXPANSIONS CHUCK

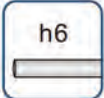

- Radial run-out less than 5 μ .
- For clamping cutting tools with cylindric shank tolerance h6.

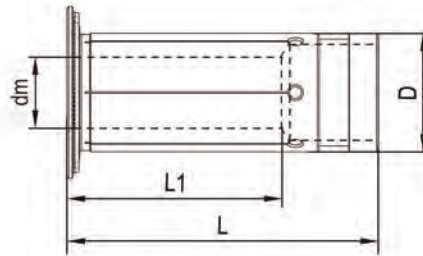

Order No.	Model	Size (mm)			
		dm	D	L1	L
100-01-001	HC12-3	3	12	16.5	47.5
100-01-002	HC12-4	4	12	16.5	47.5
100-01-003	HC12-5	5	12	16.5	47.5
100-01-004	HC12-6	6	12	24	47.5
100-01-005	HC12-8	8	12	25.5	47.5
100-01-006	HC20-3	3	20	17.5	52.5
100-01-007	HC20-4	4	20	17.5	52.5
100-01-008	HC20-5	5	20	17.5	52.5
100-01-009	HC20-6	6	20	25.5	52.5
100-01-010	HC20-7	7	20	28	52.5
100-01-011	HC20-8	8	20	28	52.5
100-01-012	HC20-9	9	20	32.5	52.5
100-01-013	HC20-10	10	20	32.5	52.5
100-01-014	HC20-11	11	20	36	52.5
100-01-015	HC20-12	12	20	36	52.5
100-01-016	HC20-13	13	20	36.5	52.5
100-01-017	HC20-14	14	20	37	52.5
100-01-018	HC20-15	15	20	37	52.5
100-01-019	HC20-16	16	20	37.5	52.5
100-01-020	HC32-6	6	32	25.5	63.5
100-01-021	HC32-8	8	32	27.5	63.5
100-01-022	HC32-10	10	32	30.5	63.5
100-01-023	HC32-12	12	32	30.5	63.5
100-01-024	HC32-14	14	32	32.5	63.5
100-01-025	HC32-16	16	32	40.5	63.5
100-01-026	HC32-18	18	32	40.5	63.5
100-01-027	HC32-20	20	32	40.5	63.5
100-01-028	HC32-25	25	32	48.5	63.5

HYDRAULIC EXPANSIONS CHUCK SET

- each set including 1pc each of BT40-HCM20-90 hydraulic expansion chuck, HC20-6, HC20-8, HC20-10, HC20-12, HC20-16 (internal dia: 6, 8, 10, 12, 16mm) reducing sleeve and screw wrench, pack in strong aluminium box.



ORDER NO.122-01-S04

PRECISION HYDRAULIC EXPANSIONS CHUCK

- Used on CNC tool grinding machine for grinding/sharpening of drill, reamer, end mill etc.
- High precision and Radial Run-out not more than 2μ at 4d checking point.
- Super transmitted torque for high clamping reliability.
- For clamping cylinderic shank tolerance h6
- Can be operated frequently long time and keep good repeatability.

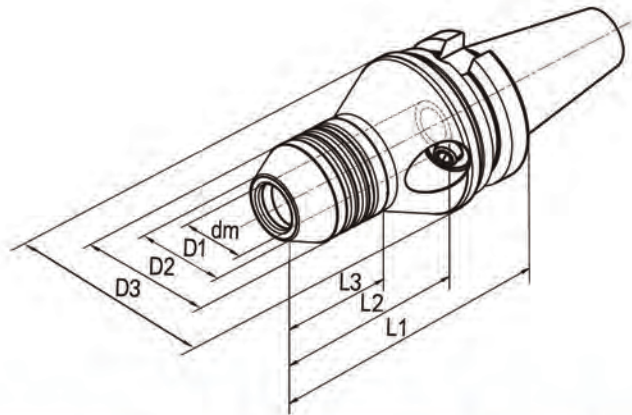

Order No.	Model	Shank	Size(mm)							Wrench	for Collets
			dm	D1	D2	D3	L1	L2	L3		
122-01-001	BT40-HCM12-110M	BT40-AD	12	21.5	36.5	60	110	80	47	TS5	HC12..M
122-01-002	BT40-HCM20-110M	BT40-AD	20	28	42	67	110	85	47	TS5	HC20..M

PRECISION REDUCING SLEEVE FOR HYDRAULIC CHUCK

- Radial run-out less than 3μ .
- Used for grinding/sharpening of drill, reamer, end mill etc.
- For clamping cutting tools with cylinderic shank tolerance h6

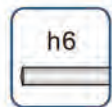

Order No.	Model	Size (mm)			
		dm	D	L1	L
100-01-101	HC12-3M	3	12	16.5	47.5
100-01-102	HC12-4M	4	12	16.5	47.5
100-01-103	HC12-5M	5	12	16.5	47.5
100-01-104	HC12-6M	6	12	24	47.5
100-01-105	HC12-8M	8	12	25.5	47.5
100-01-106	HC20-3M	3	20	17.5	52.5
100-01-107	HC20-4M	4	20	17.5	52.5
100-01-108	HC20-5M	5	20	17.5	52.5
100-01-109	HC20-6M	6	20	25.5	52.5
100-01-110	HC20-7M	7	20	28	52.5
100-01-111	HC20-8M	8	20	28	52.5
100-01-112	HC20-9M	9	20	32.5	52.5
100-01-113	HC20-10M	10	20	32.5	52.5
100-01-114	HC20-11M	11	20	36	52.5
100-01-115	HC20-12M	12	20	36	52.5
100-01-116	HC20-13M	13	20	36.5	52.5
100-01-117	HC20-14M	14	20	37	52.5
100-01-118	HC20-15M	15	20	37	52.5
100-01-119	HC20-16M	16	20	37.5	52.5
100-01-120	HC32-6M	6	32	25.5	63.5
100-01-121	HC32-8M	8	32	27.5	63.5
100-01-122	HC32-10M	10	32	30.5	63.5
100-01-123	HC32-12M	12	32	30.5	63.5
100-01-124	HC32-14M	14	32	32.5	63.5
100-01-125	HC32-16M	16	32	40.5	63.5
100-01-126	HC32-18M	18	32	40.5	63.5
100-01-127	HC32-20M	20	32	40.5	63.5
100-01-128	HC32-25M	25	32	48.5	63.5

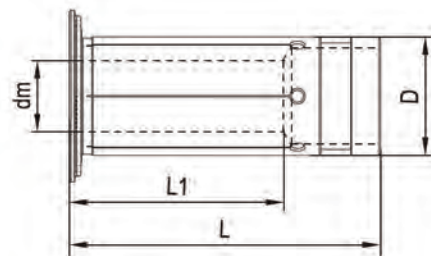

SHRINK FIT CHUCK

- Made of high-temperature steel and fit for High frequency heating machine.
- For clamping cutting tools with cylinderic shank tolerance h6
- High tool-gripping strength and machining accuracy
- 360 degree concentric clamping without set screws, collets.
- Engineered to produce the high degree of balance available
- With indicating line for shank depth of cutter.

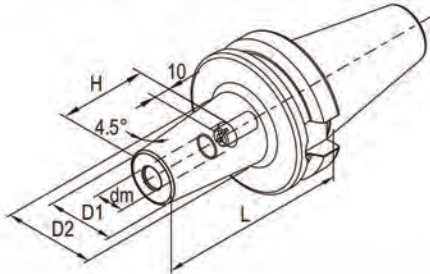

Order No.	Model	Shank	Size(mm)					Screw
			dm	D1	D2	L	H	
122-02-301	BT30-SFX03-60	BT30-AD	3	10	-	60	10	-
122-02-302	BT30-SFX04-60	BT30-AD	4	10	-	60	12	-
122-02-303	BT30-SFX05-60	BT30-AD	5	10	-	60	15	-
122-02-304	BT30-SFX06-80	BT30-AD	6	21	27	80	36	S005014C
122-02-305	BT30-SFX06-105	BT30-AD	6	21	27	105	36	S005014C
122-02-306	BT30-SFX06-120	BT30-AD	6	21	27	120	36	S005014C
122-02-307	BT30-SF08-80	BT30-AD	8	21	27	80	36	S006014C
122-02-308	BT30-SF08-105	BT30-AD	8	21	27	105	36	S006014C
122-02-309	BT30-SF08-120	BT30-AD	8	21	32	120	36	S006014C
122-02-310	BT30-SF10-80	BT30-AD	10	24	32	80	42	S008014C
122-02-311	BT30-SF10-105	BT30-AD	10	24	32	105	42	S008014C
122-02-312	BT30-SF10-120	BT30-AD	10	24	32	120	42	S008014C
122-02-313	BT30-SF12-80	BT30-AD	12	24	32	80	47	S008014C
122-02-314	BT30-SF12-105	BT30-AD	12	24	32	105	47	S008014C
122-02-315	BT30-SF12-120	BT30-AD	12	24	34	120	47	S008014C
122-02-316	BT30-SF14-80	BT30-AD	14	27	34	80	47	S008014C
122-02-317	BT30-SF14-105	BT30-AD	14	27	34	105	47	S008014C
122-02-318	BT30-SF14-120	BT30-AD	14	27	34	120	47	S008014C
122-02-319	BT30-SF16-80	BT30-AD	16	27	34	80	50	S012014C
122-02-320	BT30-SF16-105	BT30-AD	16	27	34	105	50	S012014C
122-02-321	BT30-SF16-120	BT30-AD	16	27	34	120	50	S012014C
122-02-401	BT40-SFX03-80	BT40-AD	3	10	-	80	10	-
122-02-402	BT40-SFX04-80	BT40-AD	4	10	-	80	12	-
122-02-403	BT40-SFX05-80	BT40-AD	5	10	-	80	15	-
122-02-404	BT40-SFX06-90	BT40-AD	6	21	27	90	36	S005014C
122-02-405	BT40-SFX06-120	BT40-AD	6	21	27	120	36	S005014C
122-02-406	BT40-SFX06-160	BT40-AD	6	21	32	160	36	S005014C
122-02-407	BT40-SF08-90	BT40-AD	8	21	27	90	36	S006014C
122-02-408	BT40-SF08-120	BT40-AD	8	21	27	120	36	S006014C
122-02-409	BT40-SF08-160	BT40-AD	8	21	32	160	36	S006014C
122-02-410	BT40-SF10-90	BT40-AD	10	24	32	90	42	S008014C
122-02-411	BT40-SF10-120	BT40-AD	10	24	32	120	42	S008014C
122-02-412	BT40-SF10-160	BT40-AD	10	24	34	160	42	S008014C
122-02-413	BT40-SF12-90	BT40-AD	12	24	32	90	47	S008014C
122-02-414	BT40-SF12-120	BT40-AD	12	24	32	120	47	S008014C
122-02-415	BT40-SF12-160	BT40-AD	12	24	34	160	47	S008014C
122-02-416	BT40-SF14-90	BT40-AD	14	27	34	90	47	S008014C
122-02-417	BT40-SF14-120	BT40-AD	14	27	34	120	47	S008014C
122-02-418	BT40-SF14-160	BT40-AD	14	27	42	160	47	S008014C
122-02-419	BT40-SF16-90	BT40-AD	16	27	34	90	50	S012014C
122-02-420	BT40-SF16-120	BT40-AD	16	27	34	120	50	S012014C
122-02-421	BT40-SF16-160	BT40-AD	16	27	42	160	50	S012014C
122-02-422	BT40-SF18-90	BT40-AD	18	33	42	90	50	S012014C
122-02-423	BT40-SF18-120	BT40-AD	18	33	42	120	50	S012014C
122-02-424	BT40-SF18-160	BT40-AD	18	33	51	160	50	S012014C
122-02-425	BT40-SF20-90	BT40-AD	20	33	42	90	52	S016016C
122-02-426	BT40-SF20-120	BT40-AD	20	33	42	120	52	S016016C
122-02-427	BT40-SF20-160	BT40-AD	20	33	51	160	52	S016016C
122-02-428	BT40-SF25-100	BT40-AD	25	44	53	100	58	S016016C
122-02-429	BT40-SF25-120	BT40-AD	25	44	53	120	58	S016016C
122-02-430	BT40-SF25-160	BT40-AD	25	44	60	160	58	S016016C

SHRINK FIT CHUCK

- Made of high-temperature steel and fit for High frequency heating machine.
- For clamping cutting tools with cylinderic shank tolerance h6
- High tool-gripping strength and machining accuracy
- 360 degree concentric clamping without set screws, collets.
- Engineered to produce the high degree of balance available
- With indicating line for shank depth of cutter.

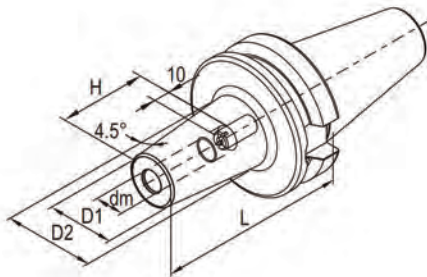

Order No.	Model	Shank	Size(mm)					Screw
			dm	D1	D2	L	H	
122-02-501	BT50-SFX06-100	BT50-AD	6	21	27	100	36	S005014C
122-02-502	BT50-SFX06-120	BT50-AD	6	21	27	120	36	S005014C
122-02-503	BT50-SFX06-160	BT50-AD	6	21	32	160	36	S005014C
122-02-504	BT50-SF08-100	BT50-AD	8	21	27	100	36	S006014C
122-02-505	BT50-SF08-120	BT50-AD	8	21	27	120	36	S006014C
122-02-506	BT50-SF08-160	BT50-AD	8	21	32	160	36	S006014C
122-02-507	BT50-SF10-100	BT50-AD	10	24	32	100	42	S008014C
122-02-508	BT50-SF10-120	BT50-AD	10	24	32	120	42	S008014C
122-02-509	BT50-SF10-160	BT50-AD	10	24	34	160	42	S008014C
122-02-510	BT50-SF12-100	BT50-AD	12	24	32	100	47	S008014C
122-02-511	BT50-SF12-120	BT50-AD	12	24	32	120	47	S008014C
122-02-512	BT50-SF12-160	BT50-AD	12	24	34	160	47	S008014C
122-02-513	BT50-SF14-100	BT50-AD	14	27	34	100	47	S008014C
122-02-514	BT50-SF14-120	BT50-AD	14	27	34	120	47	S008014C
122-02-515	BT50-SF14-160	BT50-AD	14	27	42	160	47	S008014C
122-02-516	BT50-SF16-100	BT50-AD	16	27	34	100	50	S012014C
122-02-517	BT50-SF16-120	BT50-AD	16	27	34	120	50	S012014C
122-02-518	BT50-SF16-160	BT50-AD	16	27	42	160	50	S012014C
122-02-519	BT50-SF18-100	BT50-AD	18	33	42	100	50	S012014C
122-02-520	BT50-SF18-120	BT50-AD	18	33	42	120	50	S012014C
122-02-521	BT50-SF18-160	BT50-AD	18	33	51	160	50	S012014C
122-02-522	BT50-SF20-100	BT50-AD	20	33	42	100	52	S016016C
122-02-523	BT50-SF20-120	BT50-AD	20	33	42	120	52	S016016C
122-02-524	BT50-SF20-160	BT50-AD	20	33	51	160	52	S016016C
122-02-525	BT50-SF25-110	BT50-AD	25	44	53	110	58	S016016C
122-02-526	BT50-SF25-135	BT50-AD	25	44	60	135	58	S016016C
122-02-527	BT50-SF25-160	BT50-AD	25	44	60	160	58	S016016C
122-02-528	BT50-SF32-110	BT50-AD	32	44	53	110	58	S016016C
122-02-529	BT50-SF32-135	BT50-AD	32	44	60	135	58	S016016C
122-02-530	BT50-SF32-160	BT50-AD	32	44	60	160	58	S016016C

ER COLLET CHUCK

- Radial run-out less than 0.01mm.
- Constructed of alloy steel for long, durable service life.
- For clamping tools with plain shank in collets to DIN6499.
- Supplied with high performance clamping nut.

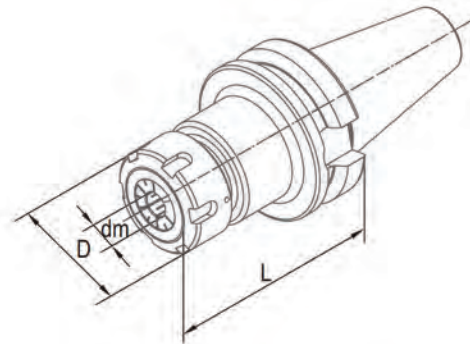
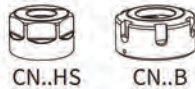

Order No.	Model	Shank	Size(mm)			Nuts	Screw	For Collets	Wrench
			dm	D	L				
122-04-301	BT30-ER11-60	BT30-AD	0.5-7	19	60	CN11HS	SER11C	ER11	W17D
122-04-302	BT30-ER11-90	BT30-AD	0.5-7	19	90	CN11HS	SER11C	ER11	W17D
122-04-303	BT30-ER16-60	BT30-AD	0.5-10	28	60	CN16HS	SER16C	ER16	W25D
122-04-304	BT30-ER16-90	BT30-AD	0.5-10	28	90	CN16HS	SER16C	ER16	W25D
122-04-305	BT30-ER16-120	BT30-AD	0.5-10	28	120	CN16HS	SER16C	ER16	W25D
122-04-306	BT30-ER20-60	BT30-AD	1.0-13	34	60	CN20HS	SER20C	ER20	W30D
122-04-307	BT30-ER20-90	BT30-AD	1.0-13	34	90	CN20HS	SER20C	ER20	W30D
122-04-308	BT30-ER20-120	BT30-AD	1.0-13	34	120	CN20HS	SER20C	ER20	W30D
122-04-309	BT30-ER25-60	BT30-AD	1.0-16	42	60	CN25B	SER25C	ER25	YER25B
122-04-310	BT30-ER25-90	BT30-AD	1.0-16	42	90	CN25B	SER25C	ER25	YER25B
122-04-311	BT30-ER25-120	BT30-AD	1.0-16	42	120	CN25B	SER25C	ER25	YER25B
122-04-312	BT30-ER32-60	BT30-AD	2.0-20	50	60	CN32B	SER32C	ER32	YER32B
122-04-313	BT30-ER32-90	BT30-AD	2.0-20	50	90	CN32B	SER32C	ER32	YER32B
122-04-401	BT40-ER11-70	BT40-AD	0.5-7	19	70	CN11HS	SER11C	ER11	W17D
122-04-402	BT40-ER11-120	BT40-AD	0.5-7	19	120	CN11HS	SER11C	ER11	W17D
122-04-403	BT40-ER16-70	BT40-AD	0.5-10	28	70	CN16HS	SER16C	ER16	W25D
122-04-404	BT40-ER16-100	BT40-AD	0.5-10	28	100	CN16HS	SER16C	ER16	W25D
122-04-405	BT40-ER16-120	BT40-AD	0.5-10	28	120	CN16HS	SER16C	ER16	W25D
122-04-406	BT40-ER16-150	BT40-AD	0.5-10	28	150	CN16HS	SER16C	ER16	W25D
122-04-407	BT40-ER20-80	BT40-AD	1.0-13	34	80	CN20HS	SER20C	ER20	W30D
122-04-408	BT40-ER20-100	BT40-AD	1.0-13	34	100	CN20HS	SER20C	ER20	W30D
122-04-409	BT40-ER20-120	BT40-AD	1.0-13	34	120	CN20HS	SER20C	ER20	W30D
122-04-410	BT40-ER20-150	BT40-AD	1.0-13	34	150	CN20HS	SER20C	ER20	W30D
122-04-411	BT40-ER25-80	BT40-AD	1.0-16	42	80	CN25B	SER25C	ER25	YER25B
122-04-412	BT40-ER25-100	BT40-AD	1.0-16	42	100	CN25B	SER25C	ER25	YER25B
122-04-413	BT40-ER25-120	BT40-AD	1.0-16	42	120	CN25B	SER25C	ER25	YER25B
122-04-414	BT40-ER25-150	BT40-AD	1.0-16	42	150	CN25B	SER25C	ER25	YER25B
122-04-415	BT40-ER32-60	BT40-AD	2.0-20	50	60	CN32B	SER32C	ER32	YER32B
122-04-416	BT40-ER32-80	BT40-AD	2.0-20	50	80	CN32B	SER32C	ER32	YER32B
122-04-417	BT40-ER32-100	BT40-AD	2.0-20	50	100	CN32B	SER32C	ER32	YER32B
122-04-418	BT40-ER32-120	BT40-AD	2.0-20	50	120	CN32B	SER32C	ER32	YER32B
122-04-419	BT40-ER32-150	BT40-AD	2.0-20	50	150	CN32B	SER32C	ER32	YER32B
122-04-420	BT40-ER40-80	BT40-AD	3.0-26	63	80	CN40B	SER40C	ER40	YER40B
122-04-421	BT40-ER40-100	BT40-AD	3.0-26	63	100	CN40B	SER40C	ER40	YER40B
122-04-422	BT40-ER40-120	BT40-AD	3.0-26	63	120	CN40B	SER40C	ER40	YER40B
122-04-423	BT40-ER40-150	BT40-AD	3.0-26	63	150	CN40B	SER40C	ER40	YER40B

ER COLLET CHUCK

- Radial run-out less than 0.01mm.
- Constructed of alloy steel for long, durable service life.
- For clamping tools with plain shank in collets to DIN6499.
- Supplied with high performance clamping nut.

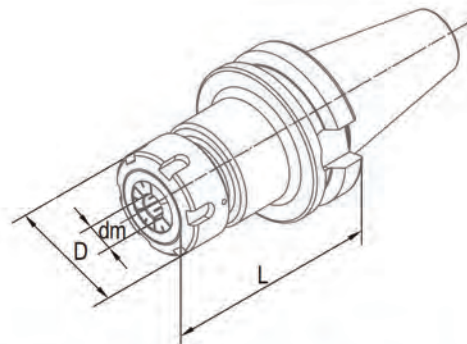
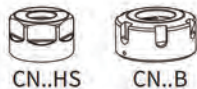

Order No.	Model	Shank	Size(mm)			Nuts	Screw	For Collets	Wrench
			dm	D	L				
122-04-501	BT50-ER16-80	BT50-AD	0.5-10	28	80	CN16HS	SER16C	ER16	W25D
122-04-502	BT50-ER16-100	BT50-AD	0.5-10	28	100	CN16HS	SER16C	ER16	W25D
122-04-503	BT50-ER16-120	BT50-AD	0.5-10	28	120	CN16HS	SER16C	ER16	W25D
122-04-504	BT50-ER16-165	BT50-AD	0.5-10	28	165	CN16HS	SER16C	ER16	W25D
122-04-505	BT50-ER20-80	BT50-AD	1.0-13	34	80	CN20HS	SER20C	ER20	W30D
122-04-506	BT50-ER20-100	BT50-AD	1.0-13	34	100	CN20HS	SER20C	ER20	W30D
122-04-507	BT50-ER20-120	BT50-AD	1.0-13	34	120	CN20HS	SER20C	ER20	W30D
122-04-508	BT50-ER20-135	BT50-AD	1.0-13	34	135	CN20HS	SER20C	ER20	W30D
122-04-509	BT50-ER20-165	BT50-AD	1.0-13	34	165	CN20HS	SER20C	ER20	W30D
122-04-510	BT50-ER25-80	BT50-AD	1.0-16	42	80	CN25B	SER25C	ER25	YER25B
122-04-511	BT50-ER25-100	BT50-AD	1.0-16	42	100	CN25B	SER25C	ER25	YER25B
122-04-512	BT50-ER25-120	BT50-AD	1.0-16	42	120	CN25B	SER25C	ER25	YER25B
122-04-513	BT50-ER25-165	BT50-AD	1.0-16	42	165	CN25B	SER25C	ER25	YER25B
122-04-514	BT50-ER32-90	BT50-AD	2.0-20	50	90	CN32B	SER32C	ER32	YER32B
122-04-515	BT50-ER32-100	BT50-AD	2.0-20	50	100	CN32B	SER32C	ER32	YER32B
122-04-516	BT50-ER32-120	BT50-AD	2.0-20	50	120	CN32B	SER32C	ER32	YER32B
122-04-517	BT50-ER32-165	BT50-AD	2.0-20	50	165	CN32B	SER32C	ER32	YER32B
122-04-518	BT50-ER32-200	BT50-AD	2.0-20	50	200	CN32B	SER32C	ER32	YER32B
122-04-519	BT50-ER32-250	BT50-AD	2.0-20	50	250	CN32B	SER32C	ER32	YER32B
122-04-520	BT50-ER40-100	BT50-AD	3.0-26	63	100	CN40B	SER40C	ER40	YER40B
122-04-521	BT50-ER40-120	BT50-AD	3.0-26	63	120	CN40B	SER40C	ER40	YER40B
122-04-522	BT50-ER40-165	BT50-AD	3.0-26	63	165	CN40B	SER40C	ER40	YER40B
122-04-523	BT50-ER40-200	BT50-AD	3.0-26	63	200	CN40B	SER40C	ER40	YER40B

ER COLLET CHUCK & COLLET SET

- Each set including 1pc of BT40-AD ER collet chuck and 9pc of ER collets,
- Equipped with ER collet nut wrench and pack in strong aluminium box.
- Long working life time due to system radial run-out less than 0.01mm.

Order No.	Shank Model	Collet	Wrench
122-04-S41	BT40-ER16-70	ER16: dia.2-3-4-5-6-7-8-9-10mm	W25D
122-04-S42	BT40-ER25-80	ER25: dia.3-4-5-6-8-10-12-14-16mm	YER25B
122-04-S43	BT40-ER32-60	ER32: dia.4-6-8-10-12-14-16-18-20mm	YER32B



ER SLIM COLLET CHUCK

- For clamping tools with plain shank in collets to DIN6499.
- Supplied with fine balanced mini clamping nut for high speed.

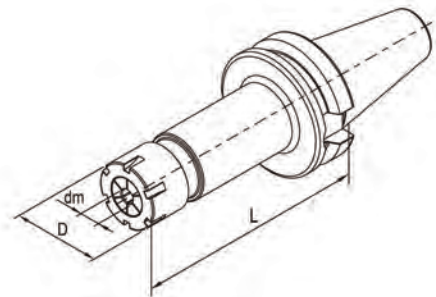

Order No.	Model	Shank	Size(mm)			Nuts	Screw	For Collets	Wrench
			dm	D	L				
122-04-314	BT30-ER11-60(M)	BT30-AD	0.5-7	16	60	CNM11	SER11C	ER11	WM11
122-04-315	BT30-ER11-90(M)	BT30-AD	0.5-7	16	90	CNM11	SER11C	ER11	WM11
122-04-316	BT30-ER11-120(M)	BT30-AD	0.5-7	16	120	CNM11	SER11C	ER11	WM11
122-04-317	BT30-ER16-60(M)	BT30-AD	0.5-10	23	60	CNM16	SER16C	ER16	WM16
122-04-318	BT30-ER16-90(M)	BT30-AD	0.5-10	23	90	CNM16	SER16C	ER16	WM16
122-04-319	BT30-ER16-120(M)	BT30-AD	0.5-10	23	120	CNM16	SER16C	ER16	WM16
122-04-320	BT30-ER20-60(M)	BT30-AD	1.0-13	28	60	CNM20	SER20C	ER20	WM20
122-04-321	BT30-ER20-90(M)	BT30-AD	1.0-13	28	90	CNM20	SER20C	ER20	WM20
122-04-322	BT30-ER20-120(M)	BT30-AD	1.0-13	28	120	CNM20	SER20C	ER20	WM20
122-04-424	BT40-ER11-90(M)	BT40-AD	0.5-7	16	90	CNM11	SER11C	ER11	WM11
122-04-425	BT40-ER11-120(M)	BT40-AD	0.5-7	16	120	CNM11	SER11C	ER11	WM11
122-04-426	BT40-ER11-150(M)	BT40-AD	0.5-7	16	150	CNM11	SER11C	ER11	WM11
122-04-427	BT40-ER16-90(M)	BT40-AD	0.5-10	23	90	CNM16	SER16C	ER16	WM16
122-04-428	BT40-ER16-120(M)	BT40-AD	0.5-10	23	120	CNM16	SER16C	ER16	WM16
122-04-429	BT40-ER16-150(M)	BT40-AD	0.5-10	23	150	CNM16	SER16C	ER16	WM16
122-04-430	BT40-ER20-95(M)	BT40-AD	1.0-13	28	95	CNM20	SER20C	ER20	WM20
122-04-431	BT40-ER20-120(M)	BT40-AD	1.0-13	28	120	CNM20	SER20C	ER20	WM20
122-04-432	BT40-ER20-150(M)	BT40-AD	1.0-13	28	150	CNM20	SER20C	ER20	WM20
122-04-524	BT50-ER16-105(M)	BT50-AD	0.5-10	23	105	CNM16	SER16C	ER16	WM16
122-04-525	BT50-ER16-135(M)	BT50-AD	0.5-10	23	135	CNM16	SER16C	ER16	WM16
122-04-526	BT50-ER16-165(M)	BT50-AD	0.5-10	23	165	CNM16	SER16C	ER16	WM16
122-04-527	BT50-ER20-105(M)	BT50-AD	1.0-13	28	105	CNM20	SER20C	ER20	WM20
122-04-528	BT50-ER20-135(M)	BT50-AD	1.0-13	28	135	CNM20	SER20C	ER20	WM20
122-04-529	BT50-ER20-165(M)	BT50-AD	1.0-13	28	165	CNM20	SER20C	ER20	WM20

INTEGRAL DRILL CHUCK HOLDER

- Radial run-out less than 0.05mm.
- Wrench-Lock chucks incorporate wrench groove for additional tightening force.
- Integral shank design provides for greater accuracy and safety.
- Wrench included.

DIN69871
Form A

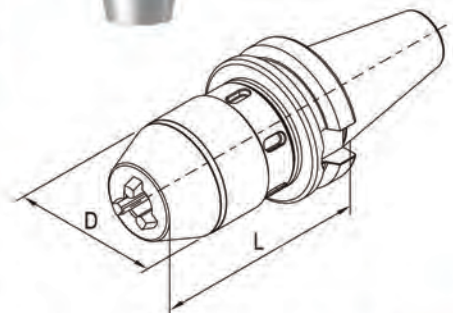

Order No.	Model	Shank	Capacity	Size(mm)		Wrench
				D	L	
122-12-301	BT30-KPU08-80	BT30-A	0.5-8	37.5	80	WCN20
122-12-302	BT30-KPU13-110	BT30-A	1.0-13	50.5	110	WCN32
122-12-401	BT40-KPU08-80	BT40-A	0.5-8	37.5	80	WCN20
122-12-402	BT40-KPU13-95	BT40-A	1.0-13	50.5	95	WCN32
122-12-403	BT40-KPU16-100	BT40-A	3-16	57	100	WCN32
122-12-501	BT50-KPU13-105	BT50-A	1.0-13	50.5	105	WCN32
122-12-502	BT50-KPU16-110	BT50-A	3-16	57	110	WCN32

POWER MILLING CHUCK

- Very high clamping force and High stability improving surface quality and tool life time.
- Optimised design resulting in Ideal damping characteristics and low vibration.
- Radial run-out less than 0.01mm.
- For clamping cutting tools with cylindric shank tolerance h6
- Flexible clamping range by using reducing sleeve for various tool shank.

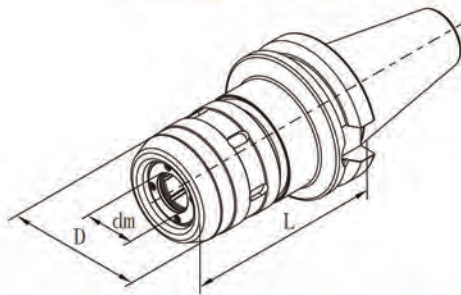

Order No.	Model	Shank	Size(mm)			For Collets	Wrench
			dm	D	L		
122-03-301	BT30-C20-95	BT30-AD	20	55	95	C20	WC20
122-03-401	BT40-C20-95	BT40-AD	20	55	95	C20	WC20
122-03-402	BT40-C20-120	BT40-AD	20	55	120	C20	WC20
122-03-403	BT40-C25-100	BT40-AD	25	62	100	C25	WC25
122-03-404	BT40-C25-120	BT40-AD	25	62	120	C25	WC25
122-03-405	BT40-C32-105	BT40-AD	32	72	105	C32	WC32
122-03-501	BT50-C20-105	BT50AD	20	55	105	C20	WC20
122-03-502	BT50-C20-135	BT50AD	20	55	135	C20	WC20
122-03-503	BT50-C25-110	BT50AD	25	62	110	C25	WC25
122-03-504	BT50-C25-135	BT50AD	25	62	135	C25	WC25
122-03-505	BT50-C32-110	BT50AD	32	72	110	C32	WC32
122-03-506	BT50-C32-135	BT50AD	32	72	135	C32	WC32
122-03-507	BT50-C42-110	BT50AD	42	87	110	C42	WC42

POWER MILLING CHUCK SET

- Each set including 1pc of SK40-AD power milling chuck and reducing sleeves, equipped with wrench and packed in strong aluminium box.
- Long tool life due to system radial run-out less than 0.01mm.



REDUCING SLEEVE FOR POWER MILLING CHUCK

- For drill, milling, reaming.
- Radial run-out less than 0.01mm.
- For clamping cutting tools with cylindric shank tolerance h6.

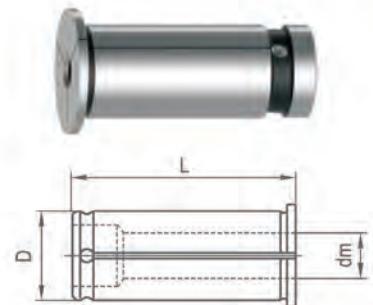
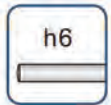

Order No.	Modle	Size (mm)		
		dm	D	L
100-03-001	C20-3	3	20	55
100-03-002	C20-4	4	20	55
100-03-003	C20-5	5	20	55
100-03-004	C20-6	6	20	55
100-03-005	C20-8	8	20	55
100-03-006	C20-10	10	20	55
100-03-007	C20-12	12	20	55
100-03-008	C20-14	14	20	55
100-03-009	C20-16	16	20	55
100-03-010	C25-4	4	25	60
100-03-011	C25-5	5	25	60
100-03-012	C25-6	6	25	60
100-03-013	C25-8	8	25	60
100-03-014	C25-10	10	25	60
100-03-015	C25-12	12	25	60
100-03-016	C25-14	14	25	60
100-03-017	C25-16	16	25	60
100-03-018	C25-18	18	25	60
100-03-019	C25-20	20	25	60

Order No.	Modle	Size (mm)		
		dm	D	L
100-03-020	C32-6	6	32	65
100-03-021	C32-8	8	32	65
100-03-022	C32-10	10	32	65
100-03-023	C32-12	12	32	65
100-03-024	C32-14	14	32	65
100-03-025	C32-16	16	32	65
100-03-026	C32-18	18	32	65
100-03-027	C32-20	20	32	65
100-03-028	C32-25	25	32	65
100-03-029	C42-6	6	42	70
100-03-030	C42-8	8	42	70
100-03-031	C42-10	10	42	70
100-03-032	C42-12	12	42	70
100-03-033	C42-14	14	42	70
100-03-034	C42-16	16	42	70
100-03-035	C42-18	18	42	70
100-03-036	C42-20	20	42	70
100-03-037	C42-25	25	42	70
100-03-038	C42-32	32	42	70

Order No.	content		
	1pc chuck	1pc each size of reducing sleeve	1pc wrench
122-03-S10	BT40-C20-95	C20-6, C20-8, C20-10, C20-12, C20-16 (internal dia: 6, 8, 10, 12, 16mm)	WC20
122-03-S04A	BT40-C32-105	C32-6, C32-8, C32-10, C32-12, C32-16, C32-20, C32-25 (internal dia: 6, 8, 10, 12, 16, 20, 25mm)	WC32
122-03-S05	BT50-C32-110	C32-6, C32-8, C32-10, C32-12, C32-16, C32-20, C32-25 (internal dia: 6, 8, 10, 12, 16, 20, 25mm)	WC32

AUTOMATIC MICRO-COMPENSATION TAPPING CHUCK

- Compensation capacity $\pm 0.5\text{mm}$.
- Precision producing true thread with quality surface.
- Increase the tool life of taps/thread formers.
- On machine centers with synchronised spindles.
- For right hand and left hand thread.

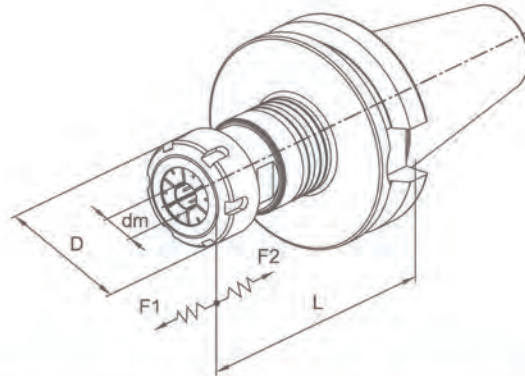
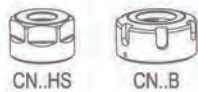

Order No.	Model	SHANK	capacity	Size(mm)					Nuts	for Collets
				D	dm	L	F1	F2		
122-13-301	BT30-V20-80	BT30-AD	M4-M12(No.8-7/16)	34	3-10	80	0.5	0.5	CN20HS	ER20..
122-13-401	BT40-V20-85	BT40-AD	M4-M12(No.8-7/16)	34	3-10	85	0.5	0.5	CN20HS	ER20..
122-13-501	BT50-V20-100	BT50-AD	M4-M12(No.8-7/16)	34	3-10	100	0.5	0.5	CN20HS	ER20..
122-13-402	BT40-V32-100	BT40-AD	M4-M20(No.8-3/4)	50	3-16	100	0.5	0.5	CN32B	ER32..
122-13-502	BT50-V32-115	BT50-AD	M4-M20(No.8-3/4)	50	3-16	115	0.5	0.5	CN32B	ER32..

Optional accessories:	V20	V32
Coolant Nuts	CN20C	CN32C
Sealing Disk	DER20C	DER32C
Wrench for Nut	W30D	YER32B
Wrench for fixing	W24D	W36D

ER TAP COLLET

- Special design with internal square drive for machine taps.

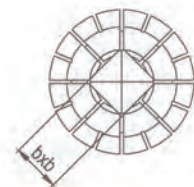
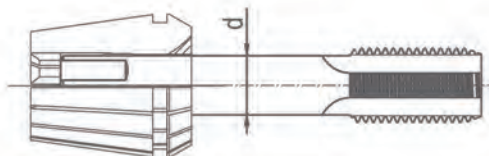

Order No.	Model	For taps				
		Shank d(mm)	Square b(mm)	ISO529/ISO2283	DIN374/DIN376	JISB4430
100-13-201	ER20-6.3B5	6.3	5	M8	M8	M6/M8
100-13-202	ER20-7B5.5	7	5.5	-	M10	M10
100-13-203	ER20-8B6.3	8	6.3	M10	-	-
100-13-204	ER20-8.5B6.5	8.5	6.5	-	-	M12
100-13-205	ER20-9B7.1	9	7.1	M12	M12	-
100-13-301	ER32-6.3B5	6.3	5	M8	M8	M6/M8
100-13-302	ER32-7B5.5	7	5.5	-	M10	M10
100-13-303	ER32-8B6.3	8	6.3	M10	-	-
100-13-304	ER32-8.5B6.5	8.5	6.5	-	-	M12
100-13-305	ER32-9B7.1	9	7.1	M12	M12	-
100-13-306	ER32-12B9	12	9	-	M16	-
100-13-307	ER32-12.5B10	12.5	10	M16	-	M16
100-13-308	ER32-14B11.2	14	11.2	M18/M20	M18	M18
100-13-309	ER32-15B12	15	12	-	-	M20
100-13-310	ER32-16B12	16	12	-	M20	-

HP HIGH PRECISE TAPPING HOLDER

- Be used on CNC for tapping.
- High precise, low running out.
- Have the function of floating, tension and compression, thread tolerance compensation.
- Can increase the life of the screw, improve the quality of the thread.

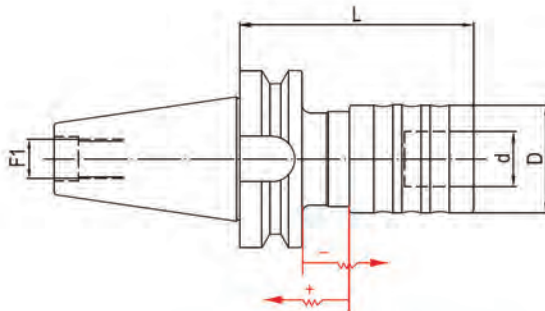

Order No.	Model	Capacity	For Collects	Size(mm)			
				D	dm	L	F1
121-13-451	BT40-HP3-85	M3-M12	HP3-D19	43	19	85	M16
121-13-452	BT40-HP12-122	M6-M30	HP12-D31	61	31	122	M16
121-13-551	BT50-HP3-95	M3-M12	HP3-D19	43	19	95	M24
121-13-552	BT50-HP12-89	M6-M30	HP24-D48	61	31	132	M16
121-13-553	BT50-HP24-150	M24-M48	HP24-D48	82	48	150	M24

TAPPING COLLET (DIN371/376)

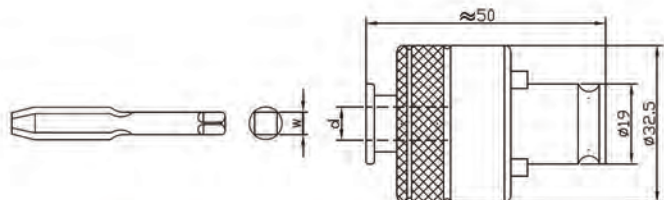

Order No.	Model	Specification		Φ d	Φ w
		DIN371	DIN376		
100-13-701	HP3	M2		2.8	2.1
100-13-702	HP3	M3		3.5	2.7
100-13-703	HP3	M4		4.5	3.4
100-13-704	HP3	M5		6.0	4.9
100-13-705	HP3	M6		6.0	4.9
100-13-706	HP3	M8		8.0	6.2
100-13-707	HP3	M10		10.0	8.0
100-13-708	HP3		M12	9.0	7.0
100-13-709	HP3		M14	11.0	9.0
100-13-710	HP3		M16	12.0	9.0

DIN376

Order No.	Model	Specification	Φ d	Φ w	Φ D
100-13-711	HP12	M6	4.5	3.4	31
100-13-712	HP12	M8	6.0	4.9	31
100-13-713	HP12	M10	7.0	5.5	31
100-13-714	HP12	M12	9.0	7.0	31
100-13-715	HP12	M14	11.0	9.0	31
100-13-716	HP12	M16	12.0	9.0	31
100-13-717	HP12	M18	14.0	11.0	31
100-13-718	HP12	M20	16.0	12.0	31
100-13-719	HP12	M22	18.0	14.5	31
100-13-720	HP12	M24	18.0	14.5	31
100-13-721	HP12	M27	20.0	16.0	31
100-13-722	HP12	M30	22.0	18.0	31
100-13-723	HP24	M24	18.0	14.5	48
100-13-724	HP24	M27	20.0	16.0	48
100-13-725	HP24	M30	22.0	18.0	48
100-13-726	HP24	M33	25.0	20.0	48
100-13-727	HP24	M36	28.0	22.0	48
100-13-728	HP24	M39/M42	32.0	24.0	48
100-13-729	HP24	M45/M48	36.0	29.0	48

SIDE LOCK HOLDER

• For clamping tools with weldon shank to DIN1835 form B and DIN6535 form HB.

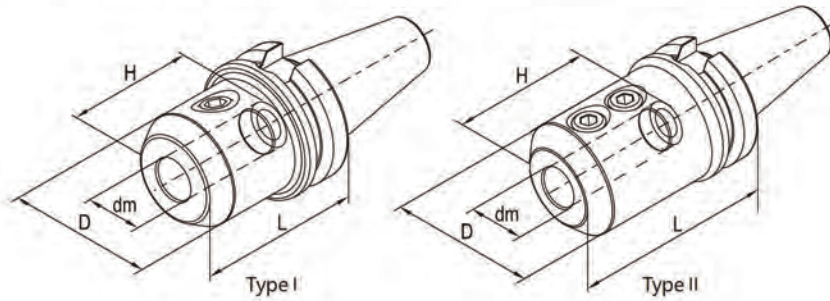

Order No.	Model	Shank	Size(mm)				Screw	Type
			dm	D	L	H		
122-05-301	BT30-XP16-63	BT30-AD	16	48	63	52	SXP16	I
122-05-302	BT30-XP20-70	BT30-AD	20	50	70	54	SXP20	I
122-05-401	BT40-XP16-63	BT40-AD	16	48	63	52	SXP16	I
122-05-402	BT40-XP20-70	BT40-AD	20	50	70	54	SXP20	I
122-05-403	BT40-XP25-90	BT40-AD	25	60	90	66	SXP25	II
122-05-404	BT40-XP32-100	BT40-AD	32	68	100	70	SXP32	II
122-05-501	BT50-XP16-80	BT50-AD	16	48	80	52	SXP16	I
122-05-502	BT50-XP20-80	BT50-AD	20	50	80	54	SXP20	I
122-05-503	BT50-XP25-100	BT50-AD	25	60	100	66	SXP25	II
122-05-504	BT50-XP32-105	BT50-AD	32	68	105	70	SXP32	II
122-05-505	BT50-XP40-120	BT50-AD	40	84	120	80	SXP32	II

2° SIDE LOCK HOLDER

• For clamping tools with parallel shank and inclined clamping flat(2°)
DIN1835 form E and DIN6535 form HE.

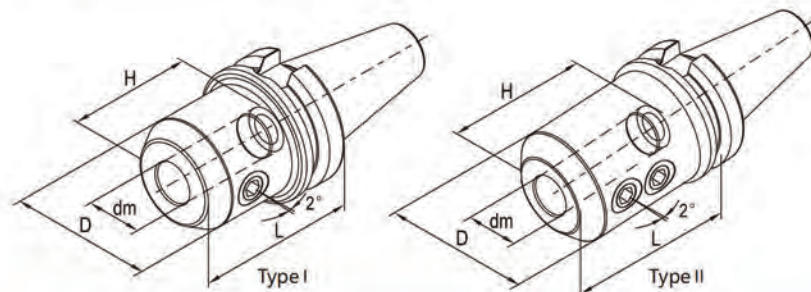

Order No.	Model	Shank	Size(mm)				Screw	Screw	Type
			dm	D	L	H			
122-05-303	BT30-XPD16-63	BT30-AD	16	45	63	52	SXP16	S012014C	I
122-05-304	BT30-XPD20-75	BT30-AD	20	52	75	54	SXP20	S016016C	I
122-05-305	BT30-XPD25-85	BT30-AD	25	65	85	59	SXP25	S020016C	II
122-05-405	BT40-XPD16-75	BT40-AD	16	48	75	52	SXP16	S012014C	I
122-05-406	BT40-XPD20-75	BT40-AD	20	52	75	54	SXP20	S016016C	I
122-05-407	BT40-XPD25-90	BT40-AD	25	65	90	59	SXP25	S020016C	II
122-05-408	BT40-XPD25-165	BT40-AD	25	65	165	59	SXP25	S020016C	II
122-05-409	BT40-XPD32-105	BT40-AD	32	72	105	63	SXP32	S020016C	II
122-05-410	BT40-XPD32-165	BT40-AD	32	72	165	63	SXP32	S020016C	II
122-05-506	BT50-XPD16-80	BT50-AD	16	48	80	52	SXP16	S012014C	I
122-05-507	BT50-XPD20-80	BT50-AD	20	52	80	54	SXP20	S016016C	I
122-05-508	BT50-XPD25-100	BT50-AD	25	65	100	59	SXP25	S020016C	II
122-05-509	BT50-XPD25-165	BT50-AD	25	65	165	59	SXP25	S020016C	II
122-05-510	BT50-XPD32-105	BT50-AD	32	72	105	63	SXP32	S020016C	II
122-05-511	BT50-XPD32-165	BT50-AD	32	72	165	63	SXP32	S020016C	II

MORSE TAPER HOLDERS WITHOUT TANG

• For clamping tools with MT taper shank without tang.

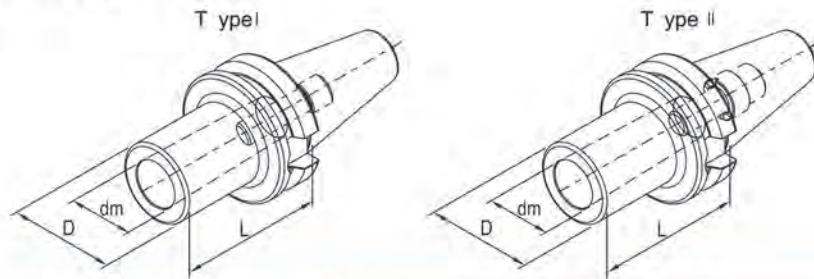

Order No.	Model	SHANK	Morse Taper	Capacity (ϕ mm)	Size(mm)			Screw	Type
					dm	D	L		
121-06-451	BT40-MW1-50	BT40	MT1	6-12	12.065	27	50	MS06025	I
121-06-452	BT40-MW2-64	BT40	MT2	14-20	17.780	32	64	MS10030-A	I
121-06-453	BT40-MW3-76	BT40	MT3	22-36	23.825	40	76	MS12035-A	II
121-06-454	BT40-MW4-103	BT40	MT4	32-56	31.267	50	103	MS16040-A	II
121-06-551	BT50-MW1-45	BT50	MT1	6-12	12.065	27	50	MS06025	I
121-06-552	BT50-MW2-60	BT50	MT2	14-20	17.780	32	60	MS10030	I
121-06-553	BT50-MW3-65	BT50	MT3	22-36	23.825	40	65	MS12035	I
121-06-554	BT50-MW4-75	BT50	MT4	32-56	31.267	50	75	MS16040-B	I
121-06-555	BT50-MW5-105	BT50	MT5	40-63	44.399	78	105	MS20048-A	II

MORSE TAPER HOLDERS WITH TANG

• For clamping tools with MT taper shank without tang.

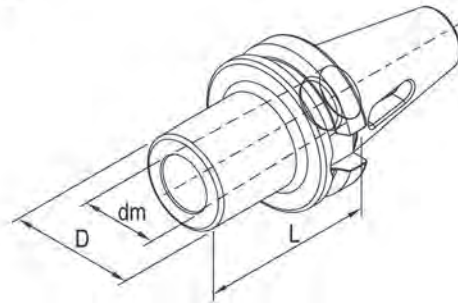

Order No.	Model	SHANK	Morse Taper	Capacity (ϕ mm)	Size(mm)		
					dm	D	L
121-06-401	BT30-M1-50	BT30	MT1	3-14	12.065	25	50
121-06-402	BT30-M2-60	BT30	MT2	14.25-23	17.780	32	60
121-06-403	BT40-M1-45	BT40	MT1	3-14	12.065	25	45
121-06-404	BT40-M1-120	BT40	MT1	3-14	12.065	25	120
121-06-405	BT40-M2-60	BT40	MT2	14.25-23	17.780	32	60
121-06-406	BT40-M2-120	BT40	MT2	14.25-23	17.780	32	120
121-06-407	BT40-M3-75	BT40	MT3	23.25-31.75	23.825	40	75
121-06-408	BT40-M3-135	BT40	MT3	23.25-31.75	23.825	40	135
121-06-409	BT40-M4-95	BT40	MT4	32-50.5	31.267	48	95
121-06-410	BT40-M4-165	BT40	MT4	32-50.5	31.267	48	165
121-06-501	BT50-M1-45	BT50	MT1	3-14	12.065	25	45
121-06-502	BT50-M1-120	BT50	MT1	3-14	12.065	25	120
121-06-503	BT50-M1-180	BT50	MT1	3-14	12.065	25	180
121-06-504	BT50-M2-45	BT50	MT2	14.25-23	17.780	32	45
121-06-505	BT50-M2-135	BT50	MT2	14.25-23	17.780	32	135
121-06-506	BT50-M2-180	BT50	MT2	14.25-23	17.780	32	180
121-06-507	BT50-M3-75	BT50	MT3	23.25-31.75	23.825	40	75
121-06-508	BT50-M3-150	BT50	MT3	23.25-31.75	23.825	40	150
121-06-509	BT50-M3-180	BT50	MT3	23.25-31.75	23.825	40	180
121-06-510	BT50-M4-75	BT50	MT4	32-50.5	31.267	48	75
121-06-511	BT50-M4-180	BT50	MT4	32-50.5	31.267	48	180
121-06-512	BT50-M5-107	BT50	MT5	51-76	44.399	63	107
121-06-513	BT50-M5-210	BT50	MT5	51-76	44.399	63	210

SHELL END MILL ARBOR

• For clamping shell end mill and milling cutter.

JIS B6339
Form A

Standard
G6.3
15,000
RPM

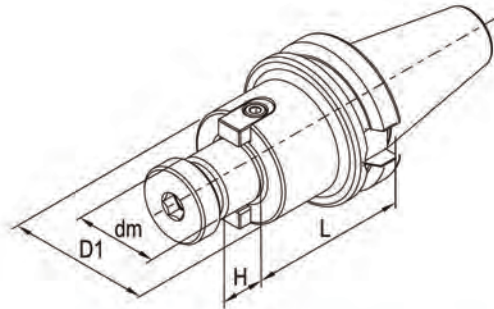

Order No.	Model	Shank	Size(mm)				Screw	Key	Screw
			dm	D1	L	H			
121-07-301	BT30-XMB16-60	BT30-A	16	34	60	17	MS08030	JC08017	MS03008
121-07-302	BT30-XMB22-45	BT30-A	22	42	45	19	MS10030	JC10021	MS04010
121-07-303	BT30-XMB27-45	BT30-A	27	60	45	21	SXM27	JC12023	MS05016
121-07-401	BT40-XMB16-60	BT40-A	16	34	60	17	MS08030	JC08017	MS03008
121-07-402	BT40-XMB16-90	BT40-A	16	34	90	17	MS08030	JC08017	MS03008
121-07-403	BT40-XMB16-120	BT40-A	16	34	120	17	MS08030	JC08017	MS03008
121-07-404	BT40-XMB22-60	BT40-A	22	42	60	19	MS10030	JC10021	MS04010
121-07-405	BT40-XMB22-90	BT40-A	22	42	90	19	MS10030	JC10021	MS04010
121-07-406	BT40-XMB22-120	BT40-A	22	42	120	19	MS10030	JC10021	MS04010
121-07-407	BT40-XMB27-60	BT40-A	27	60	60	21	SXM27	JC12023	MS05016
121-07-408	BT40-XMB27-90	BT40-A	27	60	90	21	SXM27	JC12023	MS05016
121-07-409	BT40-XMB27-120	BT40-A	27	60	120	21	SXM27	JC12023	MS05016
121-07-410	BT40-XMB32-60	BT40-A	32	78	60	24	SXM32	JC14020	MS06020
121-07-411	BT40-XMB40-60	BT40-A	40	89	60	27	SXM40	KXM40	MS08020

Order No.	Model	Shank	Size(mm)					Screw	Key	Screw
			dm	D1	D2	L	H			
121-07-501	BT50-XMB16-60	BT50-A	16	34	-	60	17	MS08030	JC08017	MS03008
121-07-502	BT50-XMB16-90	BT50-A	16	34	-	90	17	MS08030	JC08017	MS03008
121-07-503	BT50-XMB16-120	BT50-A	16	34	-	120	17	MS08030	JC08017	MS03008
121-07-504	BT50-XMB22-60	BT50-A	22	42	-	60	19	MS10030	JC10021	MS04010
121-07-505	BT50-XMB22-90	BT50-A	22	42	-	90	19	MS10030	JC10021	MS04010
121-07-506	BT50-XMB22-120	BT50-A	22	42	-	120	19	MS10030	JC10021	MS04010
121-07-507	BT50-XMB22-150	BT50-A	22	42	60	150	19	MS10030	JC10021	MS04010
121-07-508	BT50-XMB22-200	BT50-A	22	42	60	22	19	MS10030	JC10021	MS04010
121-07-509	BT50-XMB22-250	BT50-A	22	42	60	250	19	MS10030	JC10021	MS04010
121-07-510	BT50-XMB27-60	BT50-A	27	60	-	60	21	SXM27	JC12023	MS05016
121-07-511	BT50-XMB27-90	BT50-A	27	60	-	90	21	SXM27	JC12023	MS05016
121-07-512	BT50-XMB27-120	BT50-A	27	60	-	120	21	SXM27	JC12023	MS05016
121-07-513	BT50-XMB27-150	BT50-A	27	60	75	150	21	SXM27	JC12023	MS05016
121-07-514	BT50-XMB27-200	BT50-A	27	60	75	200	21	SXM27	JC12023	MS05016
121-07-515	BT50-XMB27-250	BT50-A	27	60	75	250	21	SXM27	JC12023	MS05016
121-07-516	BT50-XMB27-300	BT50-A	27	60	75	300	21	SXM27	JC12023	MS05016
121-07-517	BT50-XMB32-60	BT50-A	32	78	-	60	24	SXM32	JC14020	MS06020
121-07-518	BT50-XMB32-90	BT50-A	32	78	-	90	24	SXM32	JC14020	MS06020
121-07-519	BT50-XMB32-120	BT50-A	32	78	-	120	24	SXM32	JC14020	MS06020
121-07-520	BT50-XMB32-150	BT50-A	32	78	-	150	24	SXM32	JC14020	MS06020
121-07-521	BT50-XMB32-200	BT50-A	32	78	-	200	24	SXM32	JC14020	MS06020
121-07-522	BT50-XMB40-60	BT50-A	40	89	-	60	27	SXM40	KXM40	MS08020
121-07-523	BT50-XMB40-90	BT50-A	40	89	-	90	27	SXM40	KXM40	MS08020
121-07-524	BT50-XMB40-120	BT50-A	40	89	-	120	27	SXM40	KXM40	MS08020
121-07-525	BT50-XMB40-150	BT50-A	40	89	-	150	27	SXM40	KXM40	MS08020

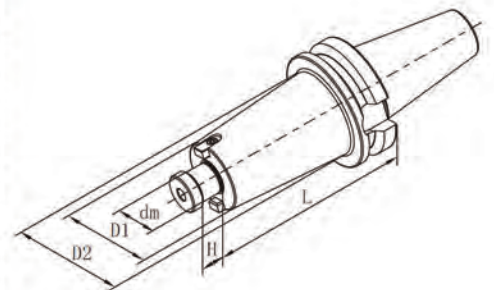

FACE MILLING CUTTER HOLDER

- For clamping face milling cutter with 4 holes.
- Increased collar contact surface.
- Suppled with lock screws.

JIS B6339
Form A

Standard
G6.3
8,000
RPM

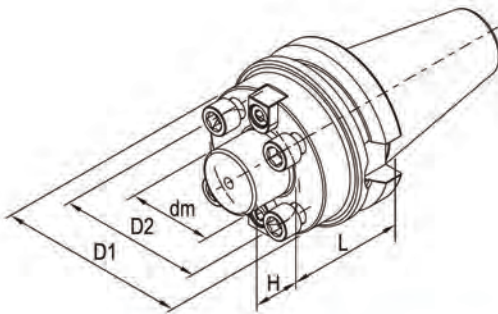

Order No.	Model	Shank	Size(mm)					Screw	Key	Screw
			dm	D1	D2	L	H			
121-09-401	BT40-XMC40-60	BT40-A	40	89	66.7	60	27	MS12045(4)	KXM40	MS08020
121-09-501	BT50-XMC40-75	BT50-A	40	89	66.7	75	27	MS12045(4)	KXM40	MS08020
121-09-502	BT50-XMC60-75	BT50-A	60	129	101.6	75	38	MS16045(4)	KXMC60	MS10025

SLOTING CUTTER HOLDER

- For clamping saws and side milling cutter.
- Furnished complete with assorted spacers, nut and key.

JIS B6339
Form A

Standard
G6.3
8,000
RPM

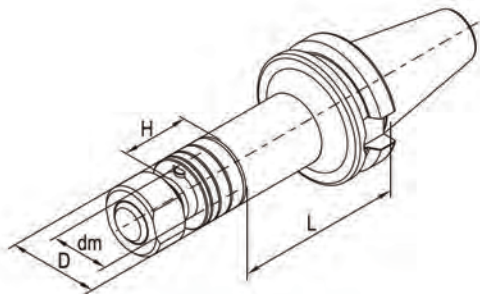

Order No.	Model	Shank	Size(mm)				Nuts	Spacer	Key
			dm	D	L	H			
121-10-401	BT40-XS22-75	BT40-A	22	34	75	30	MXS22	SD22	JA06020
121-10-402	BT40-XS22-120	BT40-A	22	34	120	30	MXS22	SD22	JA06020
121-10-403	BT40-XS27-75	BT40-A	27	40	75	30	MXS27	SD27	JA07022
121-10-404	BT40-XS27-120	BT40-A	27	40	120	30	MXS27	SD27	JA07022
121-10-405	BT40-XS32-90	BT40-A	32	46	90	30	MXS32	SD32	JA08022
121-10-501	BT50-XS22-90	BT50-A	22	34	90	30	MXS22	SD22	JA06020
121-10-502	BT50-XS22-135	BT50-A	22	34	135	30	MXS22	SD22	JA06020
121-10-503	BT50-XS27-90	BT50-A	27	40	90	30	MXS27	SD27	JA07022
121-10-504	BT50-XS27-135	BT50-A	27	40	135	30	MXS27	SD27	JA07022
121-10-505	BT50-XS32-90	BT50-A	32	46	90	30	MXS32	SD32	JA08022
121-10-506	BT50-XS32-135	BT50-A	32	46	135	30	MXS32	SD32	JA08022
121-10-507	BT50-XS40-90	BT50-A	40	55	90	30	MXS40	SD40	JA10025
121-10-508	BT50-XS40-135	BT50-A	40	55	135	30	MXS40	SD40	JA10025
121-10-509	BT50-XS50-90	BT50-A	50	69	90	30	MXS50	SD50	JA12025
121-10-510	BT50-XS50-135	BT50-A	50	69	135	30	MXS50	SD50	JA12025

7:24 TEST BARS

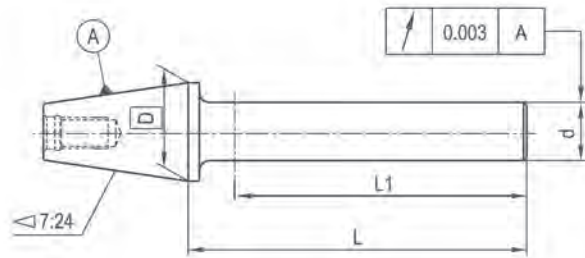

Order No.	Model	Shank	Size(mm)			
			D	d	L	L1
162-15-005	BT30-TB30-300	30	31.75	30	300	265
162-15-010	BT40-TB40-300	40	44.45	40	300	265
162-15-015	BT50-TB50-350	50	69.85	50	350	300

SHRINK FIT POWER CLAMP MACHINE

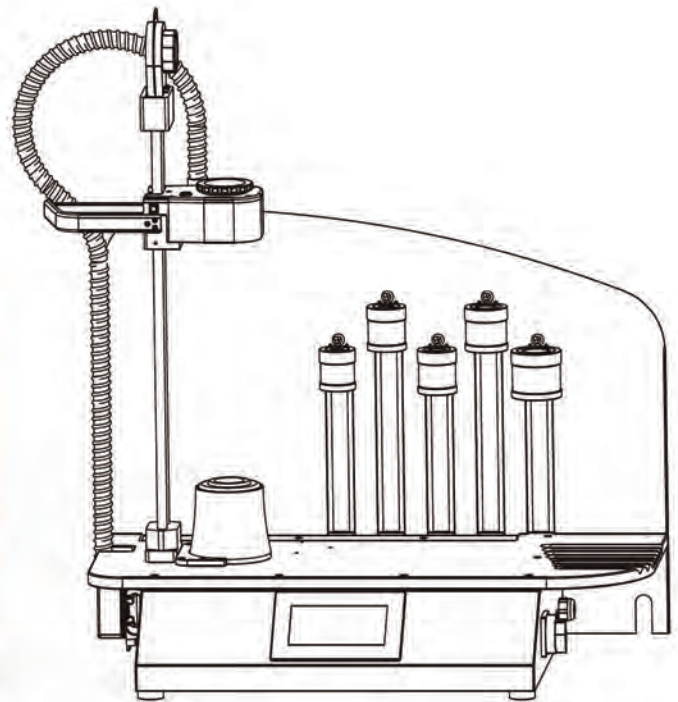

Order No. 100-02-001

Standard accessories

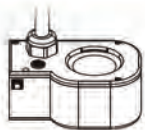

1x Inductor



5x Stop disc



1x Chuck support
for tool holders

Technical details

Mains voltage:	3x360-440V,25A
Power:	13KW
Tools:	Solid carbide and HSS
Tools diameter:	Φ3-32 (h6)mm
Maximum length of shrink fit chuck with tool:	≤500mm
Cooling:	Contact cooling
Dimensions (WxDxH):	960x550x1050
Weight :	35kg

Optional accessories



Support plate

For taper size	ISO30	ISO40	ISO50	HSK40	
Order No.	CHS-ISO30	CHS-ISO40	CHS-ISO50		
For taper size	CHS-HSK40	HSK50	HSK63	HSK80	HSK100
Order No.	CHS-HSK50	CHS-HSK63	CHS-HSK80	CHS-HSK100	

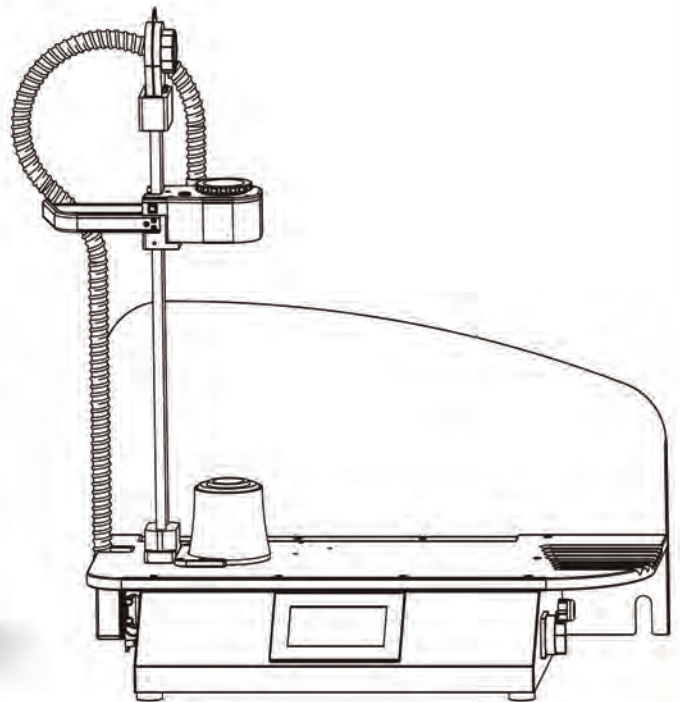

Order No. 100-02-002

Standard accessories

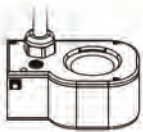

1x Inductor



5x Stop disc



1x Chuck support
for tool holders

Technical details

Mains voltage: 3x360-440V,25A

Power: 13KW

Tools: Solid carbide and HSS

Tools diameter: $\Phi 3-32$ (h6)mm

Maximum length of shrink fit chuck with tool: ≤ 500 mm

Cooling: Without cooling

Dimensions (WxDxH): 960x550x1050

Weight: 35kg

Optional accessories



Support plate

For taper size	ISO30	ISO40	ISO50	HSK40	
Order No.	CHS-ISO30	CHS-ISO40	CHS-ISO50		
For taper size	CHS-HSK40	HSK50	HSK63	HSK80	HSK100
Order No.	CHS-HSK50	CHS-HSK63	CHS-HSK80	CHS-HSK100	

HSK COOLANT TUBES

Order No.	Model	shank	Size(mm)			
			M	d	L1	L2
100-00-001	TU-HSK63	HSK63	M18x1	12	11.5	36.6
100-00-002	TU-HSK100	HSK100	M24x1.5	16	15.5	44.2

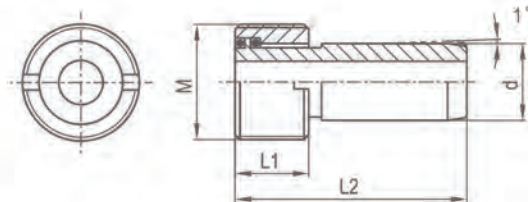

HSK COOLANT TUBE WRENCH

Order No.	Model	shank
100-00-003	W-HSK63	HSK63
100-00-004	W-HSK100	HSK100

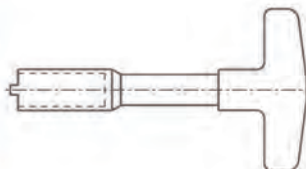

SHRINK FIT CHUCK EXTENSION

- Used in shrink fit chuck, hydraulic chuck and power milling chuck.
- For clamping cutting tools with cylindrical shank tolerance h6.
- Fit for high frequency heating machining.
- Avoid vibrations in the clamping system, resulting in increasing surface quality and tool life time.

Order No.	Model	Size(mm)			
		dm	D	D1	L
100-00-005	C12-SFX03-160	3	12	8	160
100-00-006	C12-SFX04-160	4	12	8	160
100-00-007	C16-SFX03-160	3	16	10	160
100-00-008	C16-SFX04-160	4	16	10	160
100-00-009	C16-SFX05-160	5	16	10	160
100-00-010	C20-SFX05-160	5	20	14	160
100-00-011	C16-SFX06-160	6	16	10	160
100-00-012	C20-SFX06-160	6	20	14	160
100-00-013	C20-SF08-160	8	20	14	160
100-00-014	C25-SF08-160	8	25	19	160
100-00-015	C25-SF10-160	10	25	20	160
100-00-016	C25-SF12-160	12	25	20	160
100-00-017	C25-SF14-160	14	25	20	160
100-00-018	C25-SF16-160	16	25	22	160
100-00-019	C32-SF10-160	10	32	24	160
100-00-020	C32-SF12-160	12	32	24	160
100-00-021	C32-SF14-160	14	32	27	160
100-00-022	C32-SF16-160	16	32	27	160
100-00-023	C32-SF18-160	18	32	27	160
100-00-024	C32-SF20-160	20	32	27	160

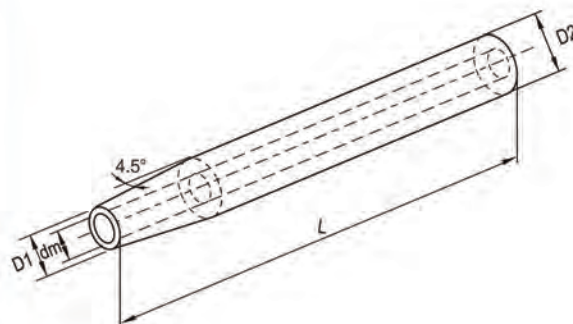

ER COLLET CHUCK EXTENTION

- Used in ER collet chuck, power milling chuck.
- For clamping cutting tools with cylindrical shank.

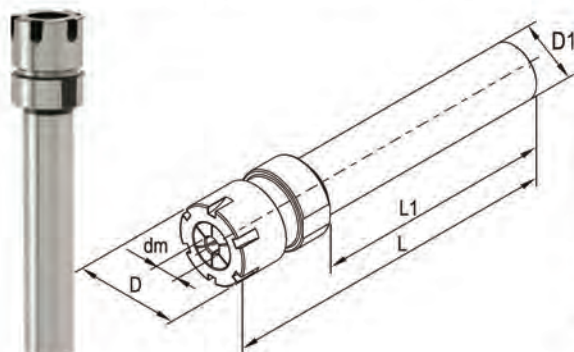

Order No.	Model	Size(mm)					Nuts	Screw	for Collets	Wrench
		dm	D	D1	L1	L				
100-00-025	C16-ER11-50(M)	0.5-7	16	16	50	77	CNM11	S006014C	ER11	WM11
100-00-026	C16-ER11-100(M)	0.5-7	16	16	100	127	CNM11	S006014C	ER11	WM11
100-00-027	C20-ER16-50(M)	0.5-10	23	20	50	85	CNM16	S006014C	ER16	WM16
100-00-028	C20-ER16-100(M)	0.5-10	23	20	100	135	CNM16	S006014C	ER16	WM16
100-00-029	C20-ER16-150(M)	0.5-10	23	20	150	185	CNM16	S006014C	ER16	WM16
100-00-030	C20-ER20-50(M)	1.0-13	28	20	50	88	CNM20	S008014C	ER20	WM20
100-00-031	C20-ER20-100(M)	1.0-13	28	20	100	138	CNM20	S008014C	ER20	WM20
100-00-032	C20-ER20-150(M)	1.0-13	28	20	150	188	CNM20	S008014C	ER20	WM20
100-00-033	C25-ER20-50(M)	1.0-13	28	25	50	88	CNM20	S008014C	ER20	WM20
100-00-034	C25-ER20-100(M)	1.0-13	28	25	100	138	CNM20	S008014C	ER20	WM20
100-00-035	C25-ER20-150(M)	1.0-13	28	25	150	188	CNM20	S008014C	ER20	WM20

ER COLLET

- Exactly according to DIN 6499.
- Wide holding range of 1mm each collet (ER 11 is 0.5mm)
- True double angle for extreme concentricity.

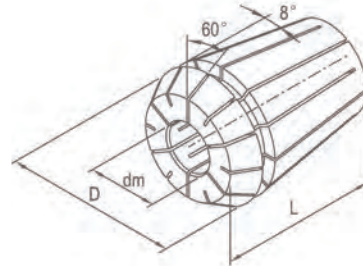

ER11 L/D: 18.5mm/11.5mm

Order No.	Capacity dm(mm)
100-04-001	2.5-2.0
100-04-002	3.0-2.5
100-04-003	3.5-3.0
100-04-004	4.0-3.5
100-04-005	4.5-4.0
100-04-006	5.0-4.5
100-04-007	5.5-5.0
100-04-008	6.0-5.5
100-04-009	6.5-6.0
100-04-010	7.0-6.5

ER16 L/D: 27.5mm/17mm

Order No.	Capacity dm(mm)
100-04-011	3.0-2.0
100-04-012	4.0-3.0
100-04-013	5.0-4.0
100-04-014	6.0-5.0
100-04-015	7.0-6.0
100-04-016	8.0-7.0
100-04-017	9.0-8.0
100-04-018	10.0-9.0

ER20 L/D: 31.5mm/21.0mm

Order No.	Capacity dm(mm)
100-04-019	3.0-2.0
100-04-020	4.0-3.0
100-04-021	5.0-4.0
100-04-022	6.0-5.0
100-04-023	7.0-6.0
100-04-024	8.0-7.0
100-04-025	9.0-8.0
100-04-026	10.0-9.0
100-04-027	11.0-10.0
100-04-028	12.0-11.0
100-04-029	13.0-12.0

ER25 L/D: 34.0mm/26.0mm

Order No.	Capacity dm(mm)
100-04-030	3.0-2.0
100-04-031	4.0-3.0
100-04-032	5.0-4.0
100-04-033	6.0-5.0
100-04-034	7.0-6.0
100-04-035	8.0-7.0
100-04-036	9.0-8.0
100-04-037	10.0-9.0
100-04-038	11.0-10.0
100-04-039	12.0-11.0
100-04-040	13.0-12.0
100-04-041	14.0-13.0
100-04-042	15.0-14.0
100-04-043	16.0-15.0

ER32 L/D: 40.0mm/33.0mm

Order No.	Capacity dm(mm)
100-04-044	3.0-2.0
100-04-045	4.0-3.0
100-04-046	5.0-4.0
100-04-047	6.0-5.0
100-04-048	7.0-6.0
100-04-049	8.0-7.0
100-04-050	9.0-8.0
100-04-051	10.0-9.0
100-04-052	11.0-10.0
100-04-053	12.0-11.0
100-04-054	13.0-12.0
100-04-055	14.0-13.0
100-04-056	15.0-14.0
100-04-057	16.0-15.0
100-04-058	17.0-16.0
100-04-059	18.0-17.0
100-04-060	19.0-18.0
100-04-061	20.0-19.0

ER40 L/D: 46.0mm/41.0mm

Order No.	Capacity dm(mm)
100-04-062	4.0-3.0
100-04-063	5.0-4.0
100-04-064	6.0-5.0
100-04-065	7.0-6.0
100-04-066	8.0-7.0
100-04-067	9.0-8.0
100-04-068	10.0-9.0
100-04-069	11.0-10.0
100-04-070	12.0-11.0
100-04-071	13.0-12.0
100-04-072	14.0-13.0
100-04-073	15.0-14.0
100-04-074	16.0-15.0
100-04-075	17.0-16.0
100-04-076	18.0-17.0
100-04-077	19.0-18.0
100-04-078	20.0-19.0
100-04-079	21.0-20.0
100-04-080	22.0-21.0
100-04-081	23.0-22.0
100-04-082	24.0-23.0
100-04-083	25.0-24.0
100-04-084	26.0-25.0

PRECISION ER COLLET

- Precision 0.005mm.
- Wide holding range of 1mm each collet (ER 11 is 0.5mm).
- True double angle for extreme concentricity.

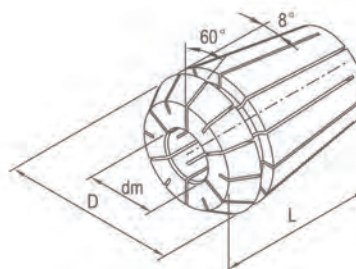

ER11 L/D: 18.5mm/11.5mm

Order No.	Capacity dm(mm)
100-04-P01	2.5-2.0
100-04-P02	3.0-2.5
100-04-P03	3.5-3.0
100-04-P04	4.0-3.5
100-04-P05	4.5-4.0
100-04-P06	5.0-4.5
100-04-P07	5.5-5.0
100-04-P08	6.0-5.5
100-04-P09	6.5-6.0
100-04-P10	7.0-6.5

ER16 L/D: 27.5mm/17mm

Order No.	Capacity dm(mm)
100-04-P11	3.0-2.0
100-04-P12	4.0-3.0
100-04-P13	5.0-4.0
100-04-P14	6.0-5.0
100-04-P15	7.0-6.0
100-04-P16	8.0-7.0
100-04-P17	9.0-8.0
100-04-P18	10.0-9.0

ER20 L/D: 31.5mm/21.0mm

Order No.	Capacity dm(mm)
100-04-P19	3.0-2.0
100-04-P20	4.0-3.0
100-04-P21	5.0-4.0
100-04-P22	6.0-5.0
100-04-P23	7.0-6.0
100-04-P24	8.0-7.0
100-04-P25	9.0-8.0
100-04-P26	10.0-9.0
100-04-P27	11.0-10.0
100-04-P28	12.0-11.0
100-04-P29	13.0-12.0

ER25 L/D: 34.0mm/26.0mm

Order No.	Capacity dm(mm)
100-04-P30	3.0-2.0
100-04-P31	4.0-3.0
100-04-P32	5.0-4.0
100-04-P33	6.0-5.0
100-04-P34	7.0-6.0
100-04-P35	8.0-7.0
100-04-P36	9.0-8.0
100-04-P37	10.0-9.0
100-04-P38	11.0-10.0
100-04-P39	12.0-11.0
100-04-P40	13.0-12.0
100-04-P41	14.0-13.0
100-04-P42	15.0-14.0
100-04-P43	16.0-15.0

ER32 L/D: 40.0mm/33.0mm

Order No.	Capacity dm(mm)
100-04-P44	3.0-2.0
100-04-P45	4.0-3.0
100-04-P46	5.0-4.0
100-04-P47	6.0-5.0
100-04-P48	7.0-6.0
100-04-P49	8.0-7.0
100-04-P50	9.0-8.0
100-04-P51	10.0-9.0
100-04-P52	11.0-10.0
100-04-P53	12.0-11.0
100-04-P54	13.0-12.0
100-04-P55	14.0-13.0
100-04-P56	15.0-14.0
100-04-P57	16.0-15.0
100-04-P58	17.0-16.0
100-04-P59	18.0-17.0
100-04-P60	19.0-18.0
100-04-P61	20.0-19.0

ER40 L/D: 46.0mm/41.0mm

Order No.	Capacity dm(mm)
100-04-P62	4.0-3.0
100-04-P63	5.0-4.0
100-04-P64	6.0-5.0
100-04-P65	7.0-6.0
100-04-P66	8.0-7.0
100-04-P67	9.0-8.0
100-04-P68	10.0-9.0
100-04-P69	11.0-10.0
100-04-P70	12.0-11.0
100-04-P71	13.0-12.0
100-04-P72	14.0-13.0
100-04-P73	15.0-14.0
100-04-P74	16.0-15.0
100-04-P75	17.0-16.0
100-04-P76	18.0-17.0
100-04-P77	19.0-18.0
100-04-P78	20.0-19.0
100-04-P79	21.0-20.0
100-04-P80	22.0-21.0
100-04-P81	23.0-22.0
100-04-P82	24.0-23.0
100-04-P83	25.0-24.0
100-04-P84	26.0-25.0

ER NUT

Style B

Order No.	Model	Size(mm)			Wrench	For Collet
		D	M	H		
100-04-085	CN25B	42	M32x1.5	20	YER25B	ER25
100-04-086	CN32B	50	M40x1.5	23	YER32B	ER32
100-04-087	CN40B	60	M50x1.5	26	YER40B	ER40

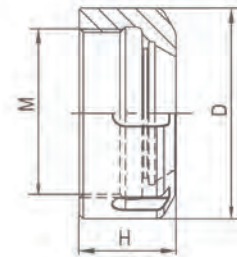

Style HS

Order No.	Model	Size(mm)				Wrench	For Collet
		D	M	H	W		
100-04-088	CN11HS	19	M14x0.75	11.3	17	W17D	ER11
100-04-089	CN16HS	28	M22x1.5	17.5	25	W25D	ER16
100-04-090	CN20HS	34	M25x1.5	19	30	W30D	ER20

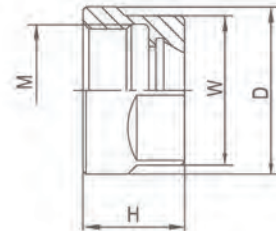

Style M

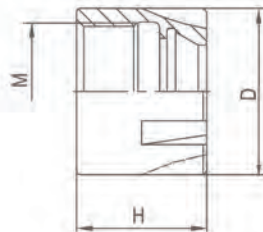

Order No.	Model	Size(mm)			Wrench	For Collet
		D	M	H		
100-04-091	CNM11	16	M13x0.75	12	WM11	ER11
100-04-092	CNM16	23	M19x1.0	18	WM16	ER16
100-04-093	CNM20	28	M24x1.0	19	WM20	ER20

Style Coolant

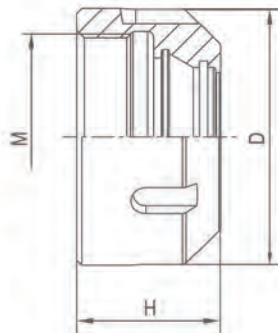

Order No.	Model	Size(mm)			Wrench	For Collet
		D	M	H		
100-04-094	CN20C	34	M25x1.5	24	W30D	ER20
100-04-095	CN32C	50	M40x1.5	28	YER32B	ER32

SEALING DISK

• Used together with ER collet or ER tap collet.

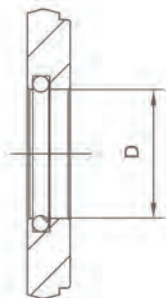

Order No.	Model	D	For Collet
100-04-096	DER20C-6	6	ER20
100-04-097	DER20C-6.5	6.5	ER20
100-04-098	DER20C-7	7	ER20
100-04-099	DER20C-8	8	ER20
100-04-100	DER20C-8.5	8.5	ER20
100-04-101	DER20C-9	9	ER20
100-04-102	DER20C-10	10	ER20
100-04-103	DER32C-6	6	ER32
100-04-104	DER32C-6.5	6.5	ER32
100-04-105	DER32C-7	7	ER32
100-04-106	DER32C-8	8	ER32
100-04-107	DER32C-8.5	8.5	ER32
100-04-108	DER32C-9	9	ER32
100-04-109	DER32C-10	10	ER32
100-04-110	DER32C-12	12	ER32
100-04-111	DER32C-12.5	12.5	ER32
100-04-112	DER32C-14	14	ER32
100-04-113	DER32C-15	15	ER32
100-04-114	DER32C-16	16	ER32

ACCESSORIES FOR TOOLHOLDERS

PULL STUDS

According to DIN69872

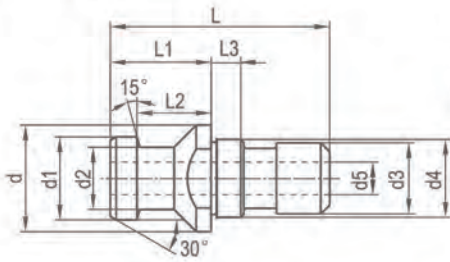

Order No.		For Taper Shank	Model	Size(mm)										
without hole	with hole			L	L1	L2	L3	d	d1	d2	d3	d4	d5	
100-00-036	-	SK30	D30	44	24	19	5	17	13	9	M12	13	-	
100-00-038	100-00-037	SK40	D40	54	26	20	7	23	19	14	M16	17	7	
100-00-040	100-00-039	SK50	D50	74	34	25	10	36	28	21	M24	25	11.5	

According to ISO7388/2 A

Order No.		For Taper Shank	Model	Size(mm)										
without hole	with hole			L	L1	L2	L3	d	d1	d2	d3	d4	d5	
100-00-056	-	ISO/SK30	LDA30	44	24	19	5	17	12	8	M12	13	-	
100-00-058	100-00-059	ISO/SK40	LDA40	54	26	20	7	23	19	14	M16	17	7	
100-00-060	100-00-061	ISO/SK50	LDA50	74	34	25	10	36	28	21	M24	25	11.5	

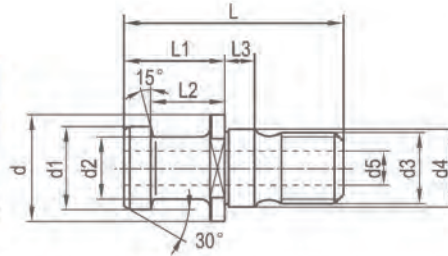

According to ISO7388/2 B

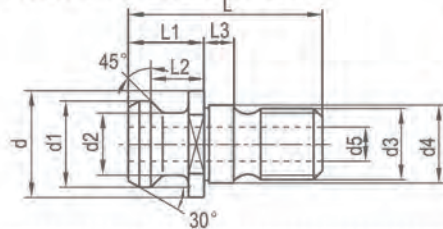

Order No.		For Taper Shank	Model	Size(mm)										
without hole	with hole			L	L1	L2	L3	d	d1	d2	d3	d4	d5	
100-00-062	-	ISO/SK30	LDB30	31.8	11.8	8.1	5	16.5	13.3	9.3	M12	13	-	
100-00-064	100-00-065	ISO/SK40	LDB40	44.5	16.4	11.2	7	22.5	19	13	M16	17	7	
100-00-066	100-00-067	ISO/SK50	LDB50	66.5	25.6	18	10	36	29.1	19.6	M24	25	11.5	

According to MAS403

Order No.		For Taper Shank	Model	Size(mm)										
without hole	with hole			L	L1	L2	L3	d	d1	d2	d3	d4	α	d5
100-00-042	-	BT30	P30T-I	43	23	18	4.5	16.5	11	7	M12	12.5	45°	-
100-00-044	-	BT30	P30T-II	43	23	18	4.5	16.5	11	7	M12	12.5	30°	-
100-00-046	100-00-041	BT40	P40T-I	60	35	28	6	23	15	10	M16	17	45°	4
100-00-048	100-00-043	BT40	P40T-II	60	35	28	6	23	15	10	M16	17	30°	4
100-00-050	100-00-045	BT50	P50T-I	85	45	35	10	38	23	17	M24	25	45°	7
100-00-052	100-00-047	BT50	P50T-II	85	45	35	10	38	23	17	M24	25	30°	7

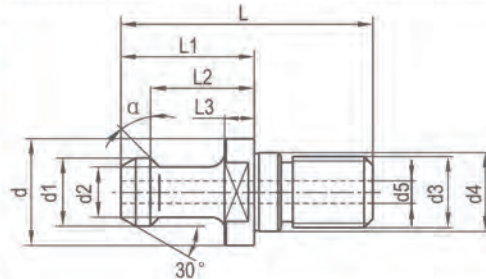

MAZAK/BT style

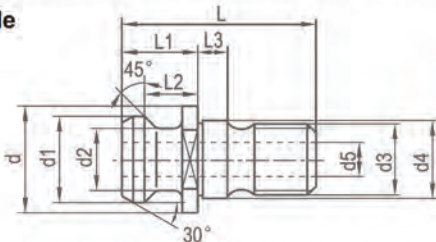

Order No.		For Taper Shank	Model	Size(mm)										
without hole	with hole			L	L1	L2	L3	d	d1	d2	d3	d4	d5	
100-00-068	100-00-069	BT40	MAZAK/BT40	44.1	19.1	14	5	22	18.8	12.5	M16	17	7	
100-00-070	100-00-071	BT50	MAZAK/BT50	65.2	25.2	17.6	8	37	29	20.8	M24	25	10	

PULL STUDS WRENCH



Order No.	For Taper Shank	Model	Size(mm)					Torque (N.m)	Weight(Kg)
			L	H	h	W1	W2		
100-00-053	BT30	PW-8T30	210	16	5	13	7	<80	0.31
100-00-054	BT40	PW-8T40	230	25	6	19	10	<150	0.43
100-00-055	BT50	PW-8T50	250	33	10	30	17	<280	0.54

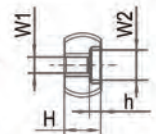
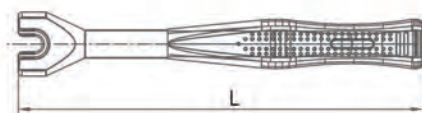

WASHERS FOR SLOTTING CUTTER HOLDER

Order No.	Model	h(mm)	Description
100-10-S01	SD13	3,5,7,8,10,12	suitable for XS13 series holder
100-10-S02	SD16	3,5,7,8,10,12	suitable for XS16 series holder
100-10-S03	SD22	3,5,7,8,10,12	suitable for XS22 series holder
100-10-S04	SD27	3,5,7,8,10,12	suitable for XS27 series holder
100-10-S05	SD32	3,5,7,8,10,12	suitable for XS32 series holder
100-10-S06	SD40	3,5,7,8,10,12	suitable for XS40 series holder
100-10-S07	SD50	3,5,7,8,10,12	suitable for XS50 series holder

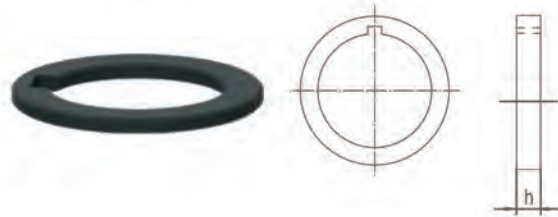

ER NUT WRENCH

For B style nut



Order No.	Model	Size(mm)			For Collet
		L	W	B	
100-04-115	PW-ER25B	250	35	5	ER25
100-04-116	PW-ER32B	270	45	5	ER32
100-04-117	PW-ER40B	300	57	5	ER40

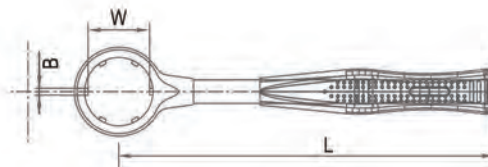

For HS style nut



Order No.	Model	Size(mm)		For Collet
		L	W	
100-04-118	PW-ER16HS	225	25	ER16
100-04-119	PW-ER20HS	240	30	ER20

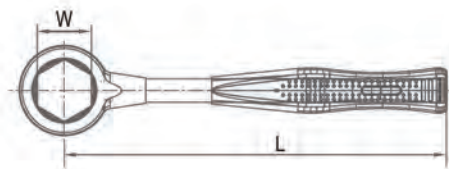

Order No.	Model	Size(mm)				
		L	L1	D	b	s
100-04-120	W17D	176.8	150	40	17	5
100-04-121	W25D	194.2	160	52	25	5
100-04-122	W30D	215	180	55	30	5

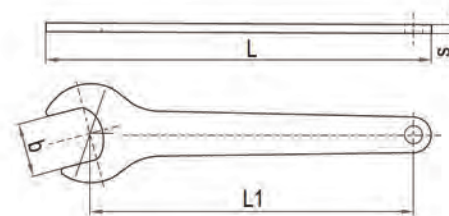

Order No.	Model	Size(mm)				
		L	L1	D	b	s
100-04-123	YER25B	210	38	43	63	5
100-04-124	YER32B	250	45	51	75	5
100-04-125	YER40B	290	58	64	90	5

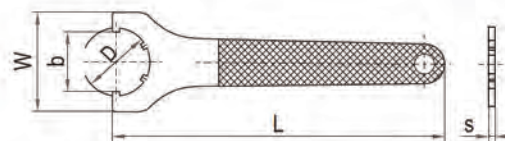

DIGITAL ZERO SETTING DEVICE

- Special hardened steel, No damage to cutting edge of tool during setting; No feeler gauge or edge finder necessary

Technical Data:

- Height of body-reference face: 49mm;
- Indicator display: 0.01mm;
- Spring-mounted contact face: 52.5mm;

Order No.	Height	Graduation
1801-1005	50mm	0.01mm/0.0005"







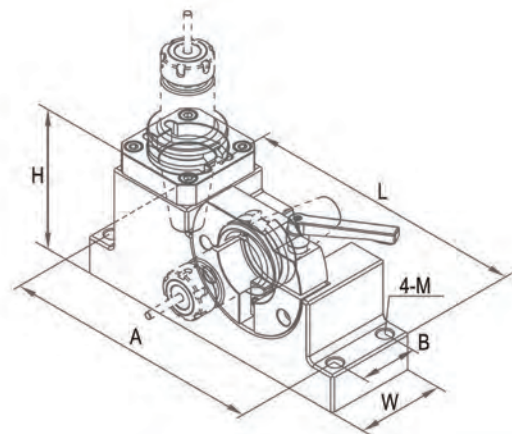

















TOOLING SETUP FIXTURE



- Made of quality aluminium alloy steel.



Order No.	Model	For Taper Shank	Size(mm)						
			L	H	W	A	B	M	
100-00-072	T-M/BT30	#30	200	96	64	184	40	M8	
100-00-073	T-M/BT40	#40	272	133	85	248	55	M12	
100-00-074	T-M/BT50	#50	364	168	125	338	85	M12	
100-00-075	T-M/HSK63	HSK63	272	135	85	248	55	M12	
100-00-076	T-M/HSK100	HSK100	364	170	125	338	85	M12	

ISO NAMENCLATURE FOR EXTERNAL TOOLHOLDER

<p>C  Top Clamping</p> <p>M  Top and hole clamping</p> <p>P  Hole clamping</p> <p>S  Screw on</p>	<p>C </p> <p>D </p> <p>K </p> <p>L </p> <p>R </p> <p>S </p> <p>T </p> <p>V </p> <p>W </p>	<p>90° A</p> <p>75° B</p> <p>90° C</p> <p>45° D</p> <p>60° E</p> <p>90° F</p> <p>90° G</p> <p>107.5° H</p> <p>93° J</p> <p>75° K</p> <p>95° L</p> <p>50° M</p> <p>63° N</p> <p>75° R</p> <p>45° S</p> <p>60° T</p> <p>93° U</p> <p>72.5° V</p> <p>60° W</p> <p>85° Y</p>	<p>B 5° </p> <p>C 7° </p> <p>D 15° </p> <p>E 20° </p> <p>F 25° </p> <p>N 0° </p> <p>P 11° </p>	<p>R </p> <p>N </p> <p>L </p>
<p>S</p>	<p>C</p>	<p>L</p>	<p>C</p>	<p>R</p>
<p>Clamping Method</p>	<p>Insert shape</p>	<p>Style & lead angle</p>	<p>Clearance angle</p>	<p>Cutting Direction</p>

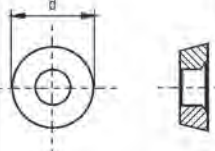
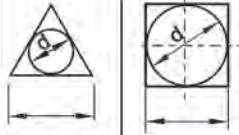
 <p>height of cutting edge "h" in mm</p>	 <p>Width of shank "b" in mm</p>	 <p>L1 in mm</p> <p>A = 32 B = 40 C = 50 D = 60 E = 70 F = 80 G = 90 H = 100 J = 110 K = 125 L = 140 M = 150 N = 160 P = 170 Q = 180 R = 200 S = 250 T = 300 U = 350 V = 400 W = 450 Y = 500</p>	 <table border="1" data-bbox="1029 506 1109 808"> <thead> <tr> <th>d (mm)</th> </tr> </thead> <tbody> <tr><td>06</td></tr> <tr><td>08</td></tr> <tr><td>10</td></tr> <tr><td>12</td></tr> <tr><td>16</td></tr> <tr><td>20</td></tr> <tr><td>25</td></tr> <tr><td>32</td></tr> </tbody> </table>  <table border="1" data-bbox="949 996 1189 1476"> <thead> <tr> <th colspan="4">d</th> </tr> <tr> <th>(mm)</th> <th>(inch)</th> <th>(mm)</th> <th>(mm)</th> </tr> </thead> <tbody> <tr><td>06</td><td>5/32</td><td>3.96</td><td>03</td></tr> <tr><td>09</td><td>7/32</td><td>5.55</td><td>05</td></tr> <tr><td>11</td><td>1/4</td><td>6.35</td><td>06</td></tr> <tr><td>16</td><td>3/8</td><td>9.52</td><td>09</td></tr> <tr><td>22</td><td>1/2</td><td>12.7</td><td>12</td></tr> <tr><td>27</td><td>5/8</td><td>15.8</td><td>15</td></tr> <tr><td>33</td><td>3/4</td><td>19.0</td><td>19</td></tr> <tr><td>44</td><td>1</td><td>25.4</td><td>25</td></tr> </tbody> </table>	d (mm)	06	08	10	12	16	20	25	32	d				(mm)	(inch)	(mm)	(mm)	06	5/32	3.96	03	09	7/32	5.55	05	11	1/4	6.35	06	16	3/8	9.52	09	22	1/2	12.7	12	27	5/8	15.8	15	33	3/4	19.0	19	44	1	25.4	25	<p>F: straight style S: single positioning D: with shim and positive rake angle</p>
d (mm)																																																					
06																																																					
08																																																					
10																																																					
12																																																					
16																																																					
20																																																					
25																																																					
32																																																					
d																																																					
(mm)	(inch)	(mm)	(mm)																																																		
06	5/32	3.96	03																																																		
09	7/32	5.55	05																																																		
11	1/4	6.35	06																																																		
16	3/8	9.52	09																																																		
22	1/2	12.7	12																																																		
27	5/8	15.8	15																																																		
33	3/4	19.0	19																																																		
44	1	25.4	25																																																		
<p>25</p>	<p>25</p>	<p>M</p>	<p>16</p>	<p>F</p>																																																	
<p>Nose height</p>	<p>Width of shank</p>	<p>Length of toolholder</p>	<p>Length of cutting edge</p>	<p>Defined by the manufacturer</p>																																																	

INDEXABLE TURNING TOOLS & ISO CARBIDE INSERT

TOOLHOLDERS WITH NEGATIVE RAKE ANGEL

68



TOOLHOLDERS WITH POSITIVE RAKE ANGEL

78

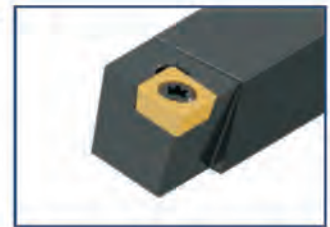

BORING BAR WITH NEGATIVE RAKE ANGEL

89



BORING WITH POSITIVE RAKE ANGEL

94



ISO CARBIDE INSERTS

107



TOOLHOLDERS WITH NEGATIVE RAKE ANGEL

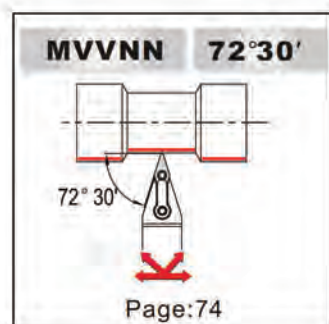
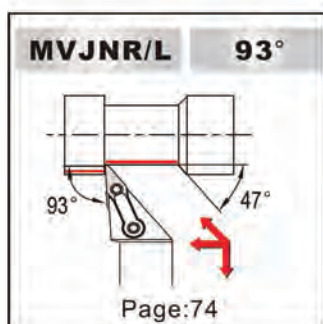
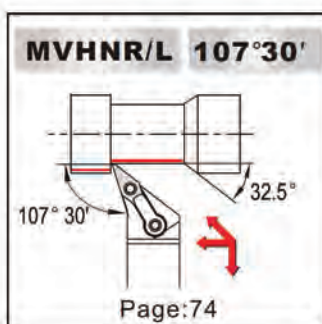
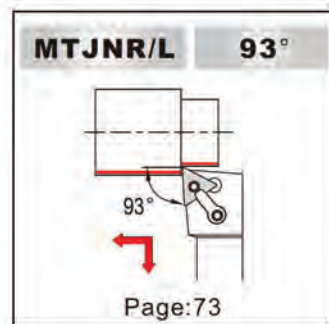
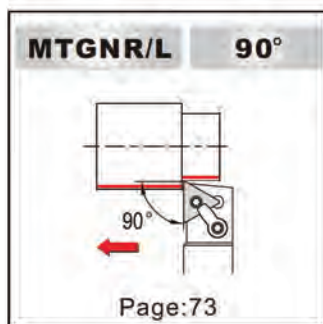
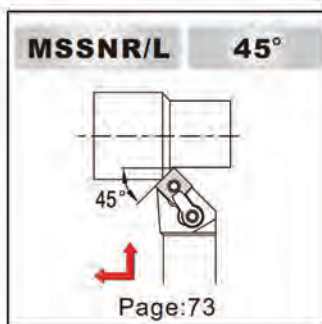
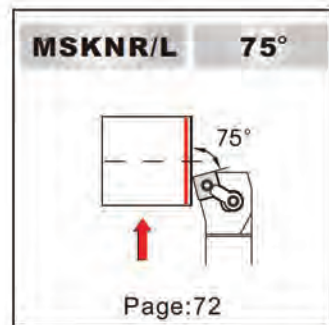
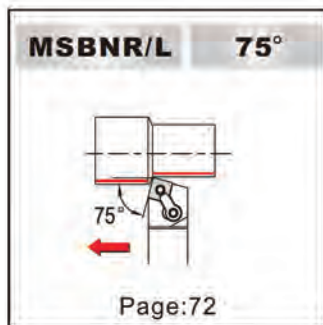
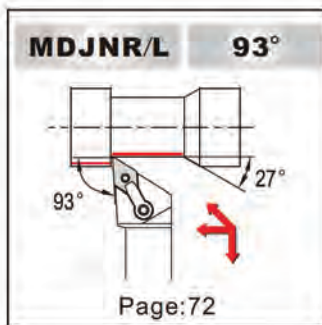
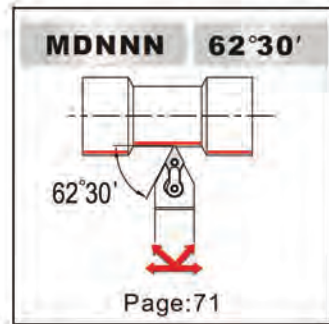
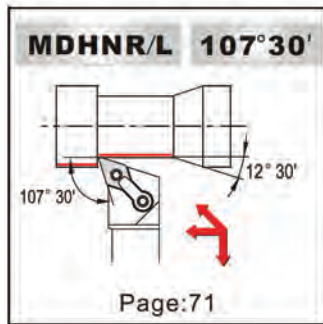
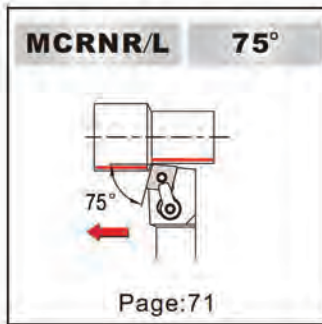
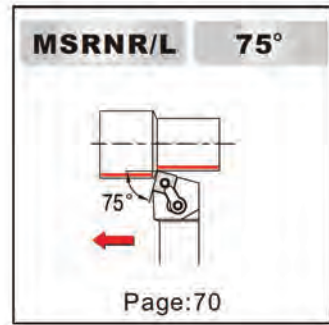
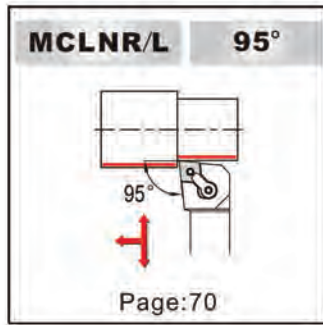
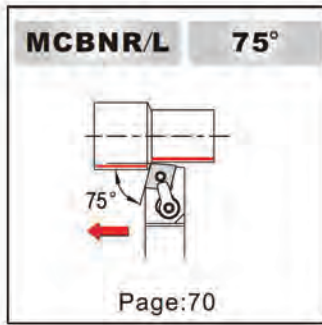

TOOLHOLDERS WITH NEGATIVE RAKE ANGEL

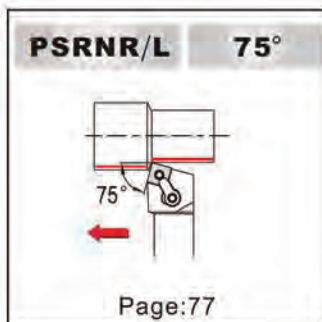
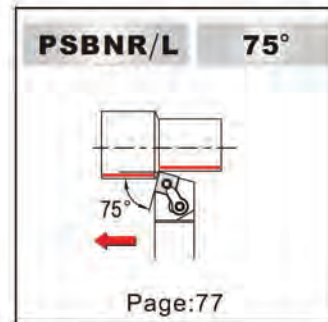
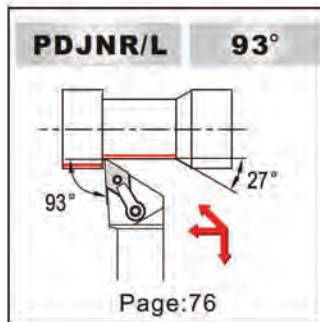
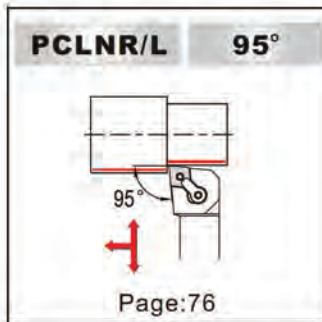
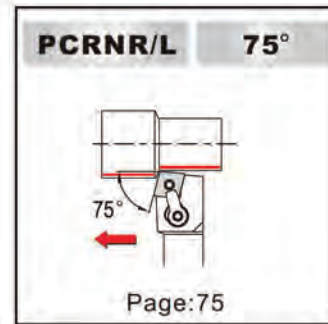
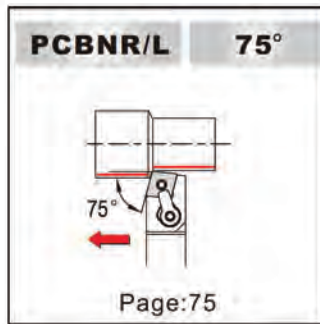
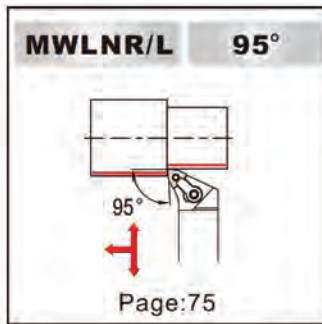

TOOLHOLDERS WITH NEGATIVE RAKE ANGEL

MCBNR/L

75°

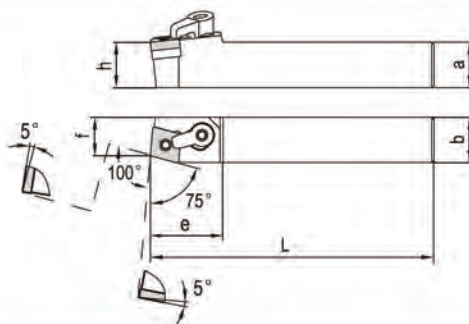

Order No.		ISO Code	Size(mm)					Insert	Shim	Lock pin	Clamp	Clamp screw	
Right hand	Left hand		a	b	L	h	f						e
211-01-001	211-01-002	MCBNR/L2020K12	20	20	125	20	17	32	CN..1204..	ICSN-433	NL-46	CL-9	XNS-59
211-01-003	211-01-004	MCBNR/L2525M12	25	25	150	25	22	32	CN..1204..	ICSN-433	NL-46	CL-9	XNS-59
211-01-005	211-01-006	MCBNR/L3232P12	32	32	170	32	27	32	CN..1204..	ICSN-433	NL-46	CL-9	XNS-59
211-01-007	211-01-008	MCBNR/L2525M16	25	25	150	25	22	40	CN..1606..	ICSN-533	NL-58	CL-9	XNS-510
211-01-009	211-01-010	MCBNR/L3232P16	32	32	170	32	27	40	CN..1606..	ICSN-533	NL-58	CL-9	XNS-510
211-01-011	211-01-012	MCBNR/L4040R19	40	40	200	40	35	40	CN..1906..	ICSN-633	NL-68	CL-12	XNS-510

MCLNR/L

95°

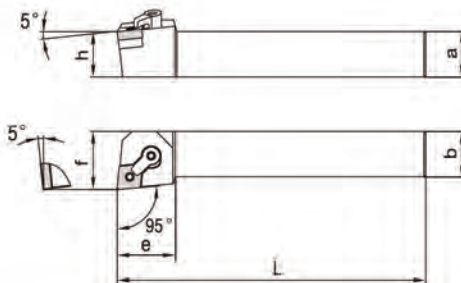
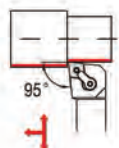

Order No.		ISO Code	Size(mm)					Insert	Shim	Lock pin	Clamp	Clamp screw	
Right hand	Left hand		a	b	L	h	f						e
211-01-013	211-01-014	MCLNR/L1616H12	16	16	100	16	20	32	CN..1204..	ICSN-433	NL-46	CL-20	XNS-48
211-01-015	211-01-016	MCLNR/L2020K12	20	20	125	20	25	32	CN..1204..	ICSN-433	NL-46	CL-20	XNS-48
211-01-017	211-01-018	MCLNR/L2525M12	25	25	150	25	32	32	CN..1204..	ICSN-433	NL-46	CL-20	XNS-48
211-01-019	211-01-020	MCLNR/L3232P12	32	32	170	32	40	32	CN..1204..	ICSN-433	NL-46	CL-20	XNS-48
211-01-021	211-01-022	MCLNR/L2525M16	25	25	150	25	32	38	CN..1606..	ICSN-533	NL-58	CL-12	XNS-510
211-01-023	211-01-024	MCLNR/L3232P16	32	32	170	32	40	38	CN..1606..	ICSN-533	NL-58	CL-12	XNS-510
211-01-025	211-01-026	MCLNR/L4040R16	40	40	200	40	50	38	CN..1606..	ICSN-533	NL-58	CL-12	XNS-510
211-01-027	211-01-028	MCLNR/L2525M19	25	25	150	25	32	38	CN..1906..	ICSN-633	NL-68	CL-12	XNS-510
211-01-029	211-01-030	MCLNR/L3232P19	32	32	170	32	40	38	CN..1906..	ICSN-633	NL-68	CL-12	XNS-510
211-01-031	211-01-032	MCLNR/L4040R19	40	40	200	40	50	38	CN..1906..	ICSN-633	NL-68	CL-12	XNS-510
211-01-033	211-01-034	MCLNR/L4040R25	40	40	200	40	50	45	CN..2509..	ICSN-846	NL-810	CL-24	XNS-610

MSRNR/L

75°

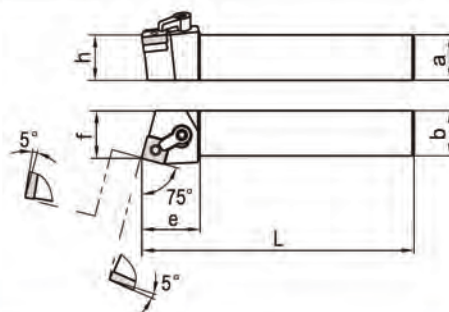
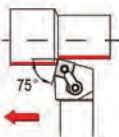

Order No.		ISO Code toolholder	Size(mm)					For insert	Shim	Lock pin	Clamp	Clamp screw	
Right hand	Left hand		a	b	L	h	f						e
211-03-019	211-03-020	MSRNR/L2525M12	25	25	150	25	27	32	SN..1204..	ISSN-433	NL-46	CL-9	XNS-59
211-03-021	211-03-022	MSRNR/L2525M15	25	25	150	25	27	38	SN..1506..	ISSN-533	NL-58	CL-12	XNS-510

TOOLHOLDERS WITH NEGATIVE RAKE ANGEL

MCRNR/L

75°

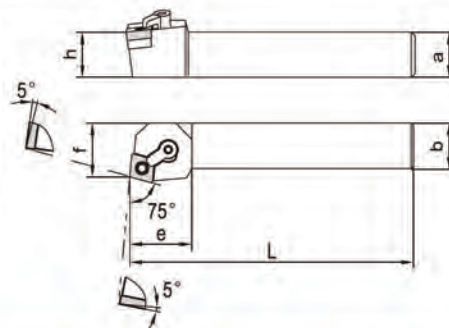
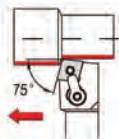

Order No.		ISO Code	Size(mm)						Insert	Shim	Lock pin	Clamp	Clamp screw
Right hand	Left hand		a	b	L	h	f	e					
211-01-035	211-01-036	MCRNR/L2020K12	20	20	125	20	22	32	CN..1204..	ICSN-433	NL-46	CL-20	XNS-48
211-01-037	211-01-038	MCRNR/L2525M12	25	25	150	25	35	32	CN..1204..	ICSN-433	NL-46	CL-20	XNS-48
211-01-039	211-01-040	MCRNR/L3232P12	32	32	170	32	35	38	CN..1606..	ICSN-533	NL-58	CL-12	XNS-510
211-01-041	211-01-042	MCRNR/L2525M16	25	25	150	25	43	38	CN..1606..	ICSN-533	NL-58	CL-12	XNS-510
211-01-043	211-01-044	MCRNR/L3232P16	32	32	170	32	35	38	CN..1906..	ICSN-633	NL-68	CL-12	XNS-510
211-01-045	211-01-046	MCRNR/L4040R19	40	40	200	40	43	38	CN..1906..	ICSN-633	NL-68	CL-12	XNS-510
211-01-047	211-01-048	MCRNR/L4040R25	40	40	200	40	43	45	CN..2509..	ICSN-846	NL-810	CL-24	XNS-610

MDHNR/L

107°30'

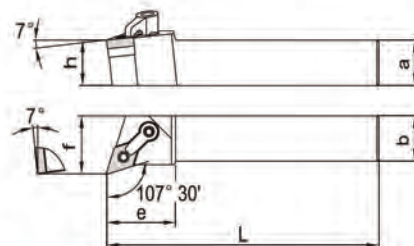
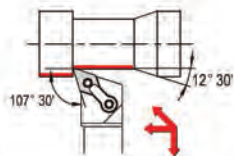

Order No.		ISO Code	Size(mm)						Insert	Shim	Lock pin	Clamp	Clamp screw
Right hand	Left hand		a	b	L	h	f	e					
211-02-001	211-02-002	MDHNR/L2020K11	20	20	125	20	25	30	DN..1104..	IDSN-322	NL-34L	CL-20	XNS-48
211-02-003	211-02-004	MDHNR/L2525M11	25	25	150	25	32	30	DN..1104..	IDSN-322	NL-34L	CL-20	XNS-48
211-02-005	211-02-006	MDHNR/L2020K15	20	20	125	20	25	35	DN..1506..	IDSN-433	NI-46L	CL-12	XNS-510
211-02-007	211-02-008	MDHNR/L2525M15	25	25	150	25	32	35	DN..1506..	IDSN-433	NI-46L	CL-12	XNS-510
211-02-009	211-02-010	MDHNR/L3232P15	32	32	170	32	40	35	DN..1506..	IDSN-433	NI-46L	CL-12	XNS-510

MDNNN

62°30'

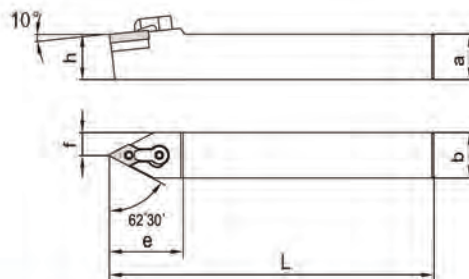
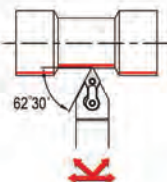

Order No.	ISO Code toolholder	Size(mm)						Insert	Shim	Lock pin	Clamp	Clamp screw
		a	b	L	h	f	e					
211-02-027	MDNNN1616H11	16	16	100	16	8	35	DN..1104..	IDSN-322	NL-34L	CL-20	XNS-48
211-02-029	MDNNN2020K11	20	20	125	20	10	35	DN..1104..	IDSN-322	NL-34L	CL-20	XNS-48
211-02-031	MDNNN2525M11	25	25	150	25	12.5	35	DN..1104..	IDSN-322	NL-34L	CL-20	XNS-48
211-02-033	MDNNN3232P11	32	32	170	32	16	35	DN..1104..	IDSN-322	NL-34L	CL-20	XNS-48
211-02-035	MDNNN2525M15	25	25	150	25	12.5	42	DN..1506..	IDSN-433	NL-46L	CL-12	XNS-510
211-02-037	MDNNN3232P15	32	32	170	32	16	42	DN..1506..	IDSN-433	NL-46L	CL-12	XNS-510

TOOLHOLDERS WITH NEGATIVE RAKE ANGEL

MDJNR/L

93°

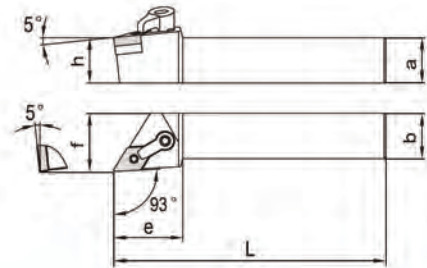
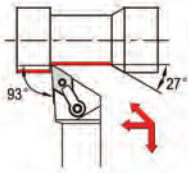

Order No.		ISO Code toolholder	Size(mm)						For Insert	Shim	Lock pin	Clamp	Clamp screw
Right hand	Left hand		a	b	L	h	f	e					
211-02-011	211-02-012	MDJNR/L1616H11	16	16	100	16	20	32	DN..1104..	IDSN-322	NL-34L	CL-20	XNS-48
211-02-013	211-02-014	MDJNR/L2020K11	20	20	125	20	25	32	DN..1104..	IDSN-322	NL-34L	CL-20	XNS-48
211-02-015	211-02-016	MDJNR/L2525M11	25	25	150	25	32	32	DN..1104..	IDSN-322	NL-34L	CL-20	XNS-48
211-02-017	211-02-018	MDJNR/L3232P11	32	32	170	32	40	32	DN..1104..	IDSN-322	NL-34L	CL-20	XNS-48
211-02-019	211-02-020	MDJNR/L2020K15	20	20	125	20	25	38	DN..1506..	IDSN-433	NL-46L	CL-12	XNS-510
211-02-021	211-02-022	MDJNR/L2525M15	25	25	150	25	32	38	DN..1506..	IDSN-433	NL-46L	CL-12	XNS-510
211-02-023	211-02-024	MDJNR/L3232P15	32	32	170	32	40	38	DN..1506..	IDSN-433	NL-46L	CL-12	XNS-510
211-02-025	211-02-026	MDJNR/L4040R15	40	40	200	40	50	38	DN..1506..	IDSN-433	NL-46L	CL-12	XNS-510

MSBNR/L

75°

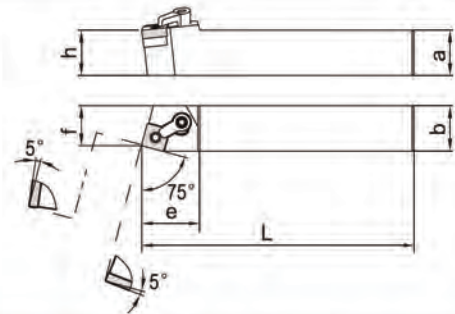
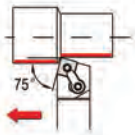

Order No.		ISO Code toolholder	Size(mm)						For insert	Shim	Lock pin	Clamp	Clamp screw
Right hand	Left hand		a	b	L	h	f	e					
211-03-001	211-03-002	MSBNR/L2020K12	20	20	125	20	17	32	SN..1204..	ISSN-433	NL-46	CL-9	XNS-59
211-03-003	211-03-004	MSBNR/L3232P15	32	32	170	32	27	38	SN..1506..	ISSN-533	NL-58	CL-12	XNS-510
211-03-005	211-03-006	MSBNR/L3232P19	32	32	170	32	27	42	SN..1906..	ISSN-633	NL-68	CL-12	XNS-510

MSKNR/L

75°

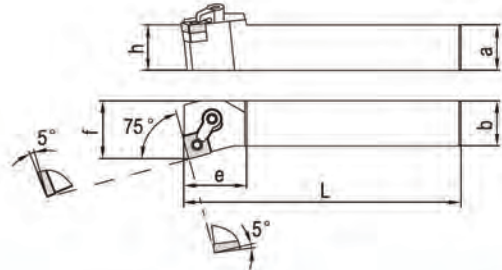
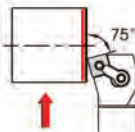

Order No.		ISO Code toolholder	Size(mm)						For insert	Shim	Lock pin	Clamp	Clamp screw
Right hand	Left hand		a	b	L	h	f	e					
211-03-007	211-03-008	MSKNR/L2020K12	20	20	125	20	25	32	SN..1204..	ISSN-433	NL-46	CL-9	XNS-59
211-03-009	211-03-010	MSKNR/L2525M12	25	25	150	25	32	32	SN..1204..	ISSN-433	NL-46	CL-9	XNS-59
211-03-011	211-03-012	MSKNR/L3232P12	32	32	170	32	40	32	SN..1204..	ISSN-433	NL-46	CL-9	XNS-59
211-03-013	211-03-014	MSKNR/L2525M15	25	25	150	25	32	38	SN..1506..	ISSN-533	NL-58	CL-12	XNS-510
211-03-015	211-03-016	MSKNR/L3232P15	32	32	170	32	40	38	SN..1506..	ISSN-533	NL-58	CL-12	XNS-510
211-03-017	211-03-018	MSKNR/L3232P19	32	32	170	32	40	38	SN..1906..	ISSN-633	NL-68	CL-12	XNS-510

TOOLHOLDERS WITH NEGATIVE RAKE ANGEL

MSSNR/L

45°

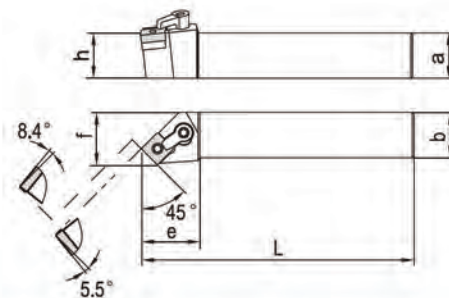

Order No.		ISO Code toolholder	Size(mm)						For insert	Shim	Lock pin	Clamp	Clamp screw
Right hand	Left hand		a	b	L	h	f	e					
211-03-023	211-03-024	MSSNR/L2020K12	20	20	125	20	25	32	SN..1204..	ISSN-433	NL-46	CL-9	XNS-59
211-03-025	211-03-026	MSSNR/L2525M12	25	25	150	25	32	32	SN..1204..	ISSN-433	NL-46	CL-9	XNS-59
211-03-027	211-03-028	MSSNR/L3232P12	32	32	170	32	40	32	SN..1204..	ISSN-433	NL-46	CL-9	XNS-59
211-03-029	211-03-030	MSSNR/L3232P15	32	32	170	32	40	38	SN..1506..	ISSN-533	NL-58	CL-9	XNS-510
211-03-031	211-03-032	MSSNR/L4040R15	40	40	200	40	50	38	SN..1506..	ISSN-533	NL-58	CL-9	XNS-510
211-03-033	211-03-034	MSSNR/L4040R19	40	40	200	40	50	45	SN..1906..	ISSN-633	NL-68	CL-12	XNS-510

MTGNR/L

90°

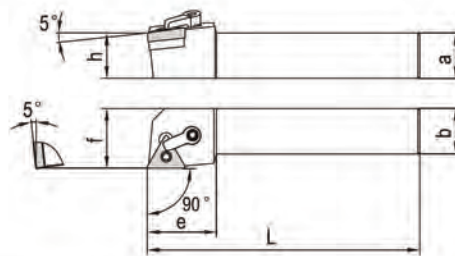
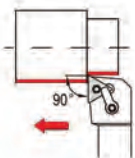

Order No.		ISO Code toolholder	Size(mm)						For insert	Shim	Lock pin	Clamp	Clamp screw
Right hand	Left hand		a	b	L	h	f	e					
211-04-001	211-04-002	MTGNR/L1616H16	16	16	100	16	20	29	TN..1604..	ITSN-323	NL-34L	CL-6	XNS-36
211-04-003	211-04-004	MTGNR/L2020K16	20	20	125	20	25	29	TN..1604..	ITSN-323	NL-34L	CL-6	XNS-36
211-04-005	211-04-006	MTGNR/L2525M16	25	25	150	25	32	29	TN..1604..	ITSN-323	NL-34L	CL-6	XNS-36
211-04-007	211-04-008	MTGNR/L3232P16	32	32	170	32	40	29	TN..1604..	ITSN-323	NL-34L	CL-6	XNS-36
211-04-009	211-04-010	MTGNR/L2020K22	20	20	125	20	25	35	TN..2204..	ITSN-433	NL-46	CL-9	XNS-510
211-04-011	211-04-012	MTGNR/L2525M22	25	25	150	25	32	35	TN..2204..	ITSN-433	NL-46	CL-9	XNS-510
211-04-013	211-04-014	MTGNR/L3232P22	32	32	170	32	40	35	TN..2204..	ITSN-433	NL-46	CL-9	XNS-510

MTJNR/L

93°

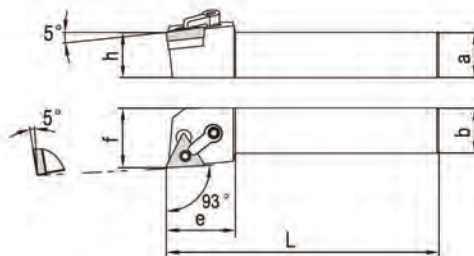
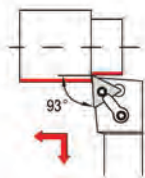

Order No.		ISO Code toolholder	Size(mm)						For insert	Shim	Lock pin	Clamp	Clamp screw
Right hand	Left hand		a	b	L	h	f	e					
211-04-015	211-04-016	MTJNR/L1616H16	16	16	100	16	20	29	TN..1604..	ITSN-323	NL-34L	CL-6	XNS-36
211-04-017	211-04-018	MTJNR/L2020K16	20	20	125	20	25	29	TN..1604..	ITSN-323	NL-34L	CL-6	XNS-36
211-04-019	211-04-020	MTJNR/L2525M16	25	25	150	25	32	29	TN..1604..	ITSN-323	NL-34L	CL-6	XNS-36
211-04-021	211-04-022	MTJNR/L3232P16	32	32	170	32	40	29	TN..1604..	ITSN-323	NL-34L	CL-6	XNS-36
211-04-023	211-04-024	MTJNR/L2525M22	25	25	150	25	32	35	TN..2204..	ITSN-433	NL-46	CL-9	XNS-510
211-04-025	211-04-026	MTJNR/L3232P22	32	32	170	32	40	35	TN..2204..	ITSN-433	NL-46	CL-9	XNS-510

TOOLHOLDERS WITH NEGATIVE RAKE ANGEL

MVHNR/L 107°30'

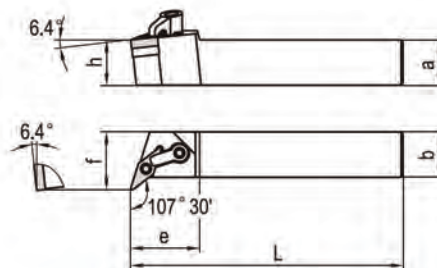
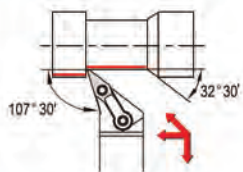

Order No.		ISO Code toolholder	Size(mm)						For insert	Shim	Lock pin	Clamp	Clamp screw
Right hand	Left hand		a	b	L	h	f	e					
211-05-001	211-05-002	MVHNR/L2525M16	25	25	150	25	32	38	VN..1604..	IVSN-322	NL-34L	CL-30	XNS-510
211-05-003	211-05-004	MVHNR/L3232P16	32	32	170	32	40	38	VN..1604..	IVSN-322	NL-34L	CL-30	XNS-510

MVJNR/L 93°

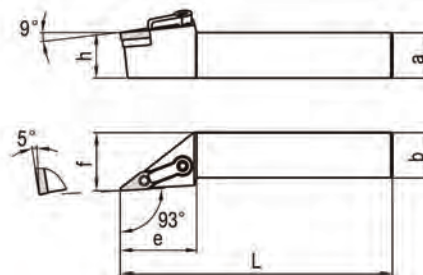
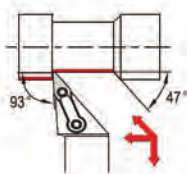

Order No.		ISO Code toolholder	Size(mm)						For insert	Shim	Lock pin	Clamp	Clamp screw
Right hand	Left hand		a	b	L	h	f	e					
211-05-005	211-05-006	MVJNR/L1616H16	16	16	100	16	20	42	VN..1604..	IVSN-322	NL-34L	CL-30	XNS-59
211-05-007	211-05-008	MVJNR/L2020K16	20	20	125	20	25	42	VN..1604..	IVSN-322	NL-34L	CL-30	XNS-510
211-05-009	211-05-010	MVJNR/L2525M16	25	25	150	25	32	42	VN..1604..	IVSN-322	NL-34L	CL-30	XNS-510
211-05-011	211-05-012	MVJNR/L3232P16	32	32	170	32	40	42	VN..1604..	IVSN-322	NL-34L	CL-30	XNS-510

MVVNN 72°30'

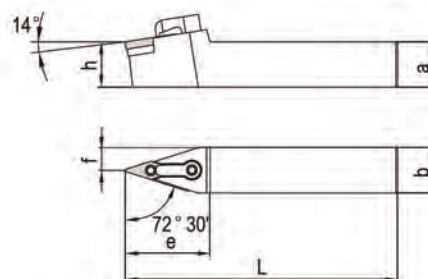
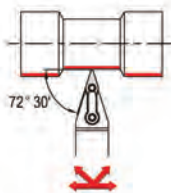

Order No.	ISO Code toolholder	Size(mm)						For insert	Shim	Lock pin	Clamp	Clamp screw
		a	b	L	h	f	e					
211-05-013	MVVNN2020K16	20	20	125	20	10	45	VN..1604..	IVSN-322	NL-34L	CL-30	XNS-510
211-05-015	MVVNN2525M16	25	25	150	25	12.5	45	VN..1604..	IVSN-322	NL-34L	CL-30	XNS-510
211-05-017	MVVNN3232P16	32	32	170	32	16	45	VN..1604..	IVSN-322	NL-34L	CL-30	XNS-510

TOOLHOLDERS WITH NEGATIVE RAKE ANGEL

MWLNRL

95°

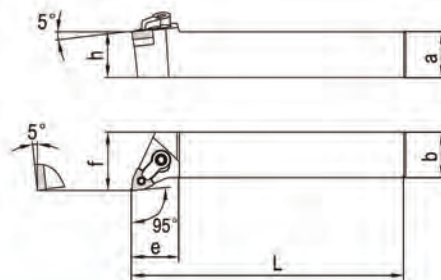
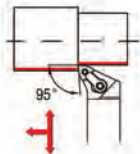

Order No.		ISO Code toolholder	Size(mm)						For insert	Shim	Lock pin	Clamp	Clamp screw
Right hand	Left hand		a	b	L	h	f	e					
211-06-001	211-06-002	MWLNRL2020K06	20	20	125	20	25	30	WN..0604..	IWSN-322	NL-34L	CL-6	XNS-36
211-06-003	211-06-004	MWLNRL2525M06	25	25	150	25	32	30	WN..0604..	IWSN-322	NL-34L	CL-6	XNS-36
211-06-005	211-06-006	MWLNRL3232P06	32	32	170	32	40	30	WN..0604..	IWSN-322	NL-34L	CL-6	XNS-36
211-06-007	211-06-008	MWLNRL2020K08	20	20	125	20	25	32	WN..0804..	IWSN-433	NL-46	CL-20	XNS-48
211-06-009	211-06-010	MWLNRL2525M08	25	25	150	25	32	32	WN..0804..	IWSN-433	NL-46	CL-20	XNS-48
211-06-011	211-06-012	MWLNRL3232P08	32	32	170	32	40	32	WN..0804..	IWSN-433	NL-46	CL-20	XNS-48
211-06-013	211-06-014	MWLNRL4040R08	40	40	200	40	50	32	WN..0804..	IWSN-433	NL-46	CL-20	XNS-48

PCBNRL

75°

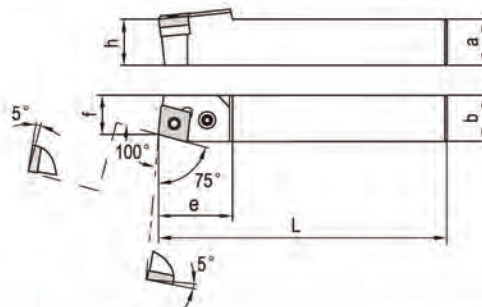
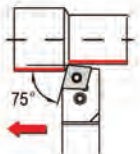

Order No.		ISO Code toolholder	Size(mm)						Insert	Shim	Lever	Screw	Tubular rivet
Right hand	Left hand		a	b	L	h	f	e					
211-07-001	211-07-002	PCBNRL3232P16	32	32	170	32	27	40	CN..1606..	PC1604	PL-5	PS0820A	SP08
211-07-003	211-07-004	PCBNRL4040R16	40	40	200	40	35	40	CN..1606..	PC1604	PL-5	PS0820A	SP08
211-07-005	211-07-006	PCBNRL4040R19	40	40	200	40	35	40	CN..1906..	PC1904	PL-6	PS1027	SP10
211-07-007	211-07-008	PCBNRL5050S19	50	50	250	50	45	40	CN..1906..	PC1904	PL-6	PS1027	SP10
211-07-009	211-07-010	PCBNRL4040R25	40	40	200	40	35	50	CN..2509..	PC2506	PL-8	PS1236	SP13
211-07-011	211-07-012	PCBNRL5050S25	50	50	250	50	45	50	CN..2509..	PC2506	PL-8	PS1236	SP13

PCRNRL

75°

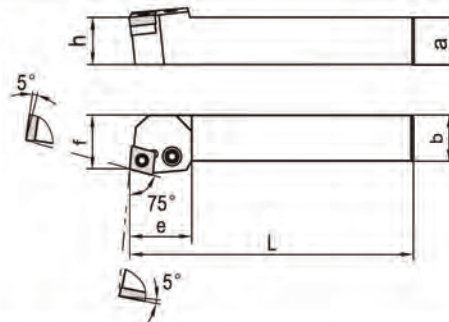
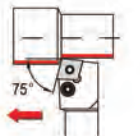

Order No.		ISO Code toolholder	Size(mm)						Insert	Shim	Lever	Screw	Tubular rivet
Right hand	Left hand		a	b	L	h	f	e					
211-07-013	211-07-014	PCRNRL3232P16	32	32	170	32	35	40	CN..1606..	PC1604	PL-5	PS0820A	SP08
211-07-015	211-07-016	PCRNRL4040R16	40	40	200	40	43	40	CN..1606..	PC1604	PL-5	PS0820A	SP08
211-07-017	211-07-018	PCRNRL4040R19	40	40	200	40	43	40	CN..1906..	PC1904	PL-6	PS1027	SP10
211-07-019	211-07-020	PCRNRL5050S19	50	50	250	50	53	40	CN..1906..	PC1904	PL-6	PS1027	SP10
211-07-021	211-07-022	PCRNRL4040R25	40	40	200	40	43	50	CN..2509..	PC2506	PL-8	PS1236	SP13
211-07-023	211-07-024	PCRNRL5050S25	50	50	250	50	53	50	CN..2509..	PC2506	PL-8	PS1236	SP13

TOOLHOLDERS WITH NEGATIVE RAKE ANGEL

PCLNR/L

95°

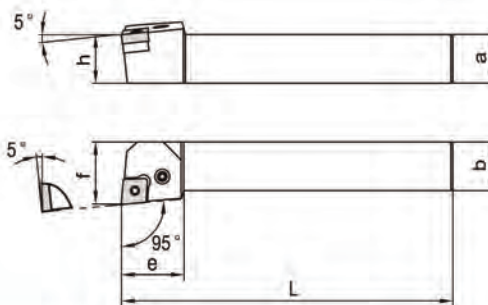
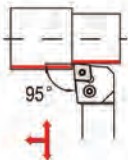

Order No.		ISO Code toolholder	Size(mm)							Insert	Shim	Lever	Screw	Tubular rivet
Right hand	Left hand		a	b	L	h	f	e						
211-07-025	211-07-026	PCLNR/L3232P16	32	32	170	32	40	38	CN..1606..	PC1604	PL-5	PS0820A	SP08	
211-07-027	211-07-028	PCLNR/L4040R16	40	40	200	40	50	38	CN..1606..	PC1604	PL-5	PS0820A	SP08	
211-07-029	211-07-030	PCLNR/L4040R19	40	40	200	40	50	38	CN..1906..	PC1904	PL-6	PS1027	SP10	
211-07-031	211-07-032	PCLNR/L5050S19	50	50	250	50	60	38	CN..1906..	PC1904	PL-6	PS1027	SP10	
211-07-033	211-07-034	PCLNR/L4040R25	40	40	200	40	50	50	CN..2509..	PC2506	PL-8	PS1236	SP13	
211-07-035	211-07-036	PCLNR/L5050S25	50	50	250	50	60	50	CN..2509..	PC2506	PL-8	PS1236	SP13	

PDJNR/L

93°

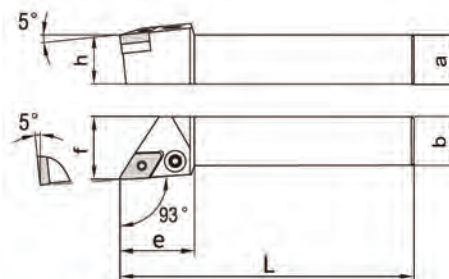
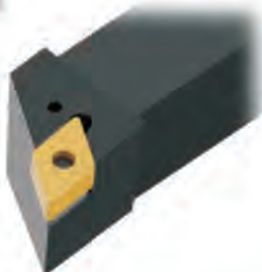
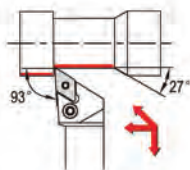

Order No.		ISO Code toolholder	Size(mm)							Insert	Shim	Lever	Screw	Tubular rivet
Right hand	Left hand		a	b	L	h	f	e						
211-08-001	211-08-002	PDJNR/L3232P15	32	32	170	32	40	38	DN..1506..	PD1503	PL-5M	PS0821	SP06	
211-08-003	211-08-004	PDJNR/L4040R15	40	40	200	40	50	38	DN..1506..	PD1503	PL-5M	PS0821	SP06	
211-08-005	211-08-006	PDJNR/L5050S15	50	50	250	50	60	38	DN..1506..	PD1503	PL-5M	PS0821	SP06	

TOOLHOLDERS WITH NEGATIVE RAKE ANGEL

PSBNR/L

75°

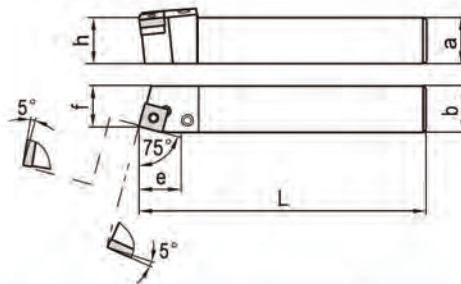

Order No.		ISO Code toolholder	Size(mm)							Insert	Shim	Lever	Screw	Tubular rivet
Right hand	Left hand		a	b	L	h	f	e						
211-09-001	211-09-002	PSBNR/L3232P15	32	32	170	32	27	38	SN..1506..	PS1504	PL-5	PS0820A	SP08	
211-09-003	211-09-004	PSBNR/L4040R15	40	40	200	40	35	38	SN..1506..	PS1504	PL-5	PS0820A	SP08	
211-09-005	211-09-006	PSBNR/L4040R19	40	40	200	40	35	42	SN..1906..	PS1904	PL-6	PS1027	SP10	
211-09-007	211-09-008	PSBNR/L5050S19	50	50	250	50	45	42	SN..1906..	PS1904	PL-6	PS1027	SP10	
211-09-009	211-09-010	PSBNR/L4040R25	40	40	200	40	35	50	SN..2509..	PS2506	PL-8	PS1236	SP13	
211-09-011	211-09-012	PSBNR/L5050S25	50	50	250	50	45	50	SN..2509..	PS2506	PL-8	PS1236	SP13	

PSRNR/L

75°

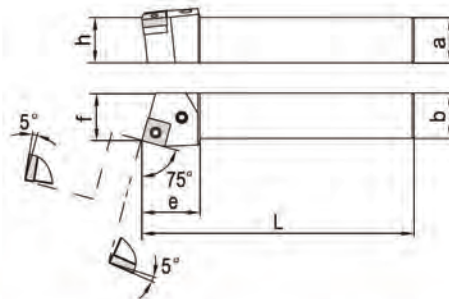

Order No.		ISO Code toolholder	Size(mm)							Insert	Shim	Lever	Screw	Tubular rivet
Right hand	Left hand		a	b	L	h	f	e						
211-09-013	211-09-014	PSRNR/L3232P15	32	32	170	32	35	38	SN..1506..	PS1504	PL-5	PS0820A	SP08	
211-09-015	211-09-016	PSRNR/L4040R15	40	40	200	40	43	38	SN..1506..	PS1504	PL-5	PS0820A	SP08	
211-09-017	211-09-018	PSRNR/L4040R19	40	40	200	40	43	38	SN..1906..	PS1904	PL-6	PS1027	SP10	
211-09-019	211-09-020	PSRNR/L5050S19	50	50	250	50	53	38	SN..1906..	PS1904	PL-6	PS1027	SP10	
211-09-021	211-09-022	PSRNR/L4040R25	40	40	200	40	43	50	SN..2509..	PS2506	PL-8	PS1236	SP13	
211-09-023	211-09-024	PSRNR/L5050S25	50	50	250	50	53	50	SN..2509..	PS2506	PL-8	PS1236	SP13	

TOOLHOLDERS WITH POSITIVE RAKE ANGEL

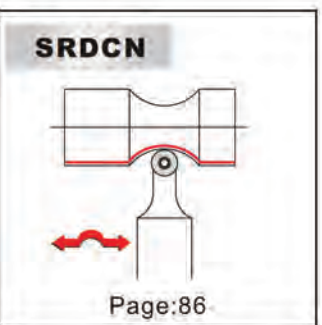
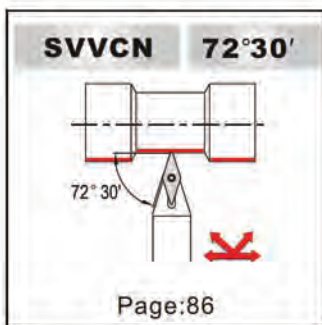
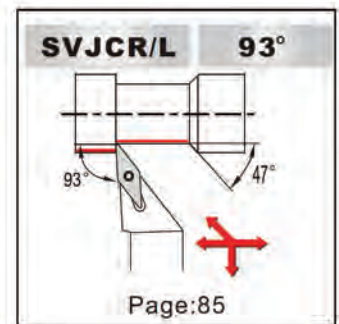
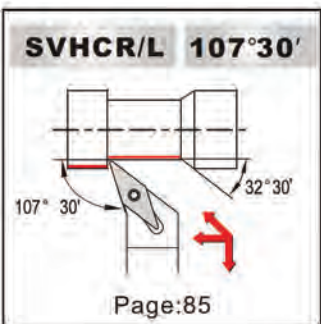
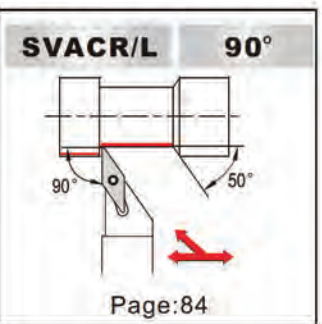
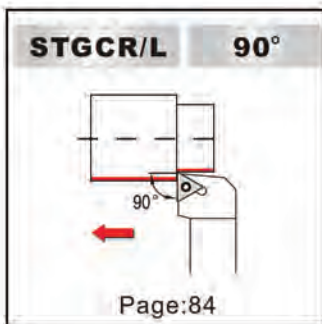
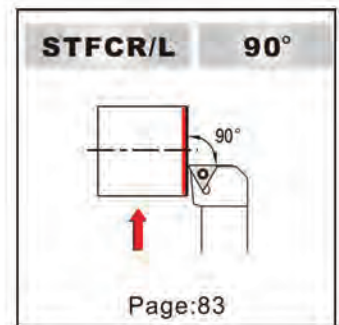
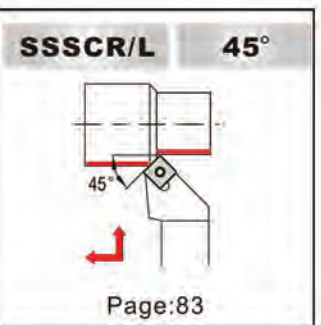
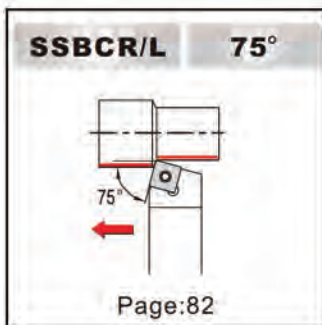
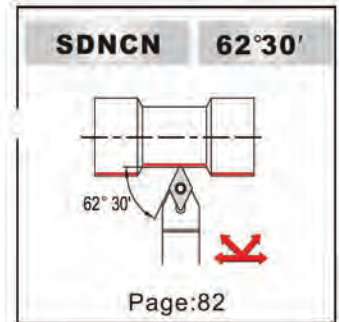
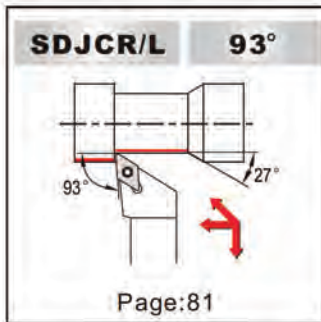
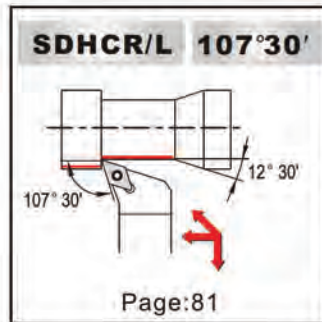
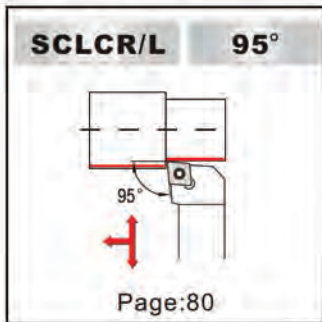
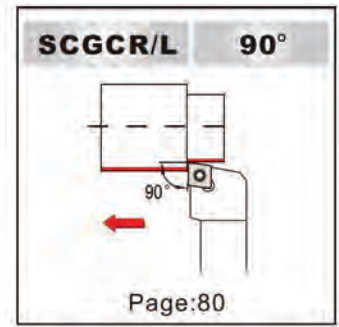
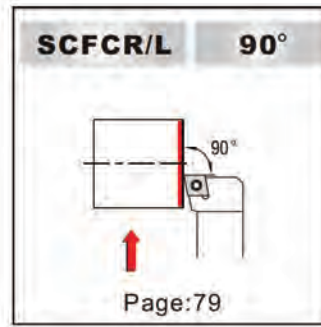
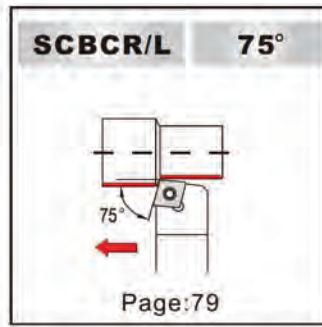
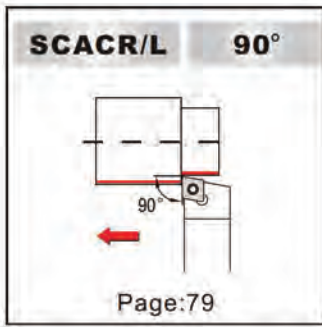

TOOLHOLDERS WITH POSITIVE RAKE ANGLE

SCACR/L

90°

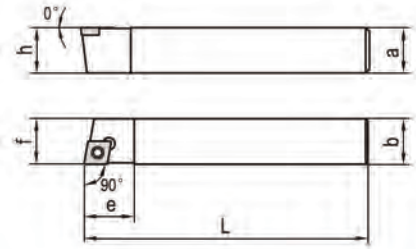
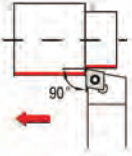

Order No.		ISO Code toolholder	Size(mm)						For insert	Screw	Torx wrench
Right hand	Left hand		a	b	L	h	f	e			
211-10-001	211-10-002	SCACR/L1616H09	16	16	100	16	16	16	CC..09T3..	L60 M3.5x8.8	T15
211-10-003	211-10-004	SCACR/L1616M09	16	16	125	16	16	16	CC..09T3..	L60 M3.5x8.8	T15
211-10-005	211-10-006	SCACR/L2020H12	20	20	100	20	20	25	CC..1204..	L60 M5x10.8	T20
211-10-007	211-10-008	SCACR/L2020M12	20	20	125	20	20	25	CC..1204..	L60 M5x10.8	T20

SCBCR/L

75°

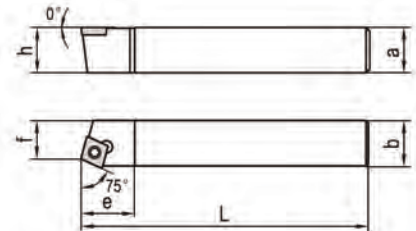
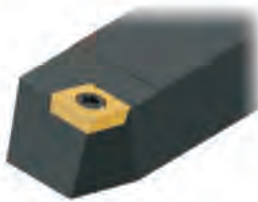
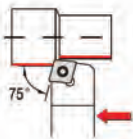

Order No.		ISO Code toolholder	Size(mm)						For insert	Screw	Torx wrench
Right hand	Left hand		a	b	L	h	f	e			
211-10-009	211-10-010	SCBCR/L2525M12	25	25	150	25	22	25	CC..1204..	L60 M5x10.8	T20

SCFCR/L

90°

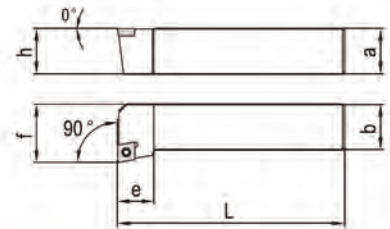
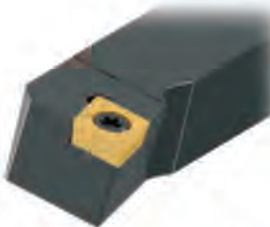
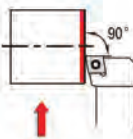

Order No.		ISO Code toolholder	Size(mm)						For insert	Screw	Torx wrench
Right hand	Left hand		a	b	L	h	f	e			
211-10-011	211-10-012	SCFCR/L1616H09	16	16	100	16	20	16	CC..09T3..	L60 M3.5x8.8	T15
211-10-013	211-10-014	SCFCR/L2020K09	20	20	125	20	25	16	CC..09T3..	L60 M3.5x8.8	T15
211-10-015	211-10-016	SCFCR/L2525M12	25	25	150	25	32	25	CC..1204..	L60 M5x10.8	T20

TOOLHOLDERS WITH POSITIVE RAKE ANGEL

SCGCR/L

90°

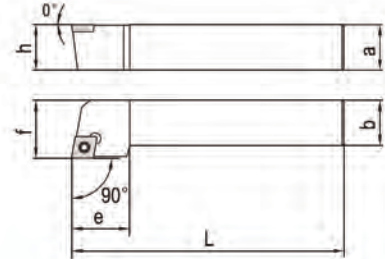
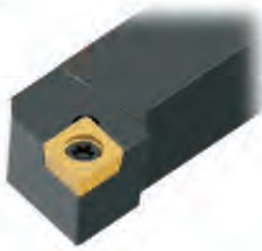
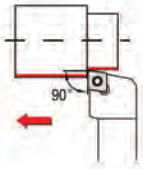

Order No.		ISO Code toolholder	Size(mm)						For insert	Screw	Torx wrench
Right hand	Left hand		a	b	L	h	f	e			
211-10-017	211-10-018	SCGCR/L1616H09	16	16	100	16	20	16	CC..09T3..	L60 M3.5x8.8	T15
211-10-019	211-10-020	SCGCR/L2020K09	20	20	125	20	25	16	CC..09T3..	L60 M3.5x8.8	T15
211-10-021	211-10-022	SCGCR/L2525M12	25	25	150	25	32	25	CC..1204..	L60 M5x10.8	T20

SCLCR/L

95°

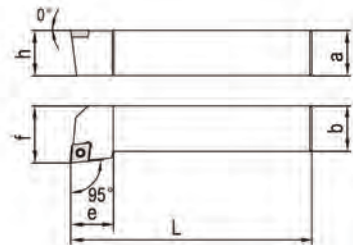
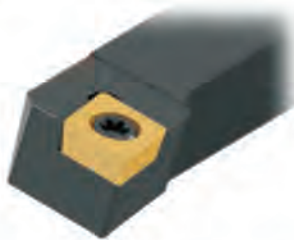
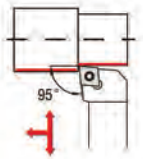

Order No.		ISO Code toolholder	Size(mm)						For insert	Screw	Torx wrench
Right hand	Left hand		a	b	L	h	f	e			
211-10-023	211-10-024	SCLCR/L1616H09	16	16	100	16	20	16	CC..09T3..	L60 M3.5x8.8	T15
211-10-025	211-10-026	SCLCR/L2020K09	20	20	125	20	25	25	CC..09T3..	L60 M3.5x8.8	T15
211-10-027	211-10-028	SCLCR/L2020K12	20	20	125	20	25	25	CC..1204..	L60 M5x10.8	T20
211-10-029	211-10-030	SCLCR/L2525M12	25	25	150	25	32	25	CC..1204..	L60 M5x10.8	T20

SCLCR/L...D

95°

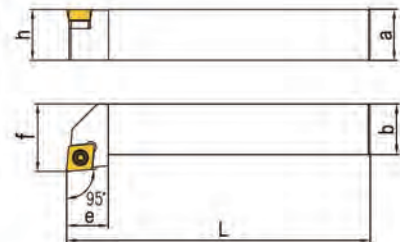
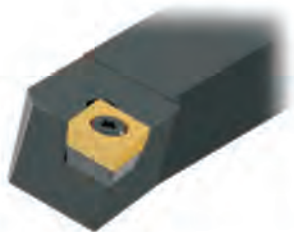
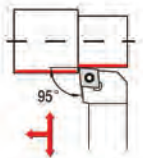

Order No.		ISO Code toolholder	Size(mm)						Insert	Shim	Shim screw	Screw	Torx wrench
Right hand	Left hand		a	b	L	h	f	e					
211-10-031	211-10-032	SCLCR/L1616H09D	16	16	100	16	20	16	CC..09T3..	SKCP-343	SRS-3	MS-1156	T15
211-10-033	211-10-034	SCLCR/L2020K09D	20	20	125	20	25	25	CC..09T3..	SKCP-343	SRS-3	MS-1156	T15
211-10-035	211-10-036	SCLCR/L2020K12D	20	20	125	20	25	25	CC..1204..	SKCP-453	SRS-4	MS-1158	T20
211-10-037	211-10-038	SCLCR/L2525M12D	25	25	150	25	32	25	CC..1204..	SKCP-453	SRS-4	MS-1158	T20

TOOLHOLDERS WITH POSITIVE RAKE ANGEL

SDHCR/L 107°30'

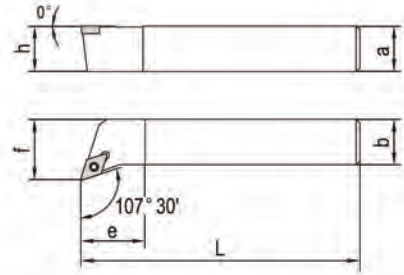
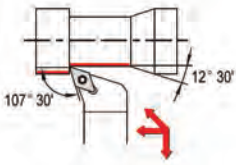

Order No.		ISO Code toolholder	Size(mm)						For insert	Screw	Torx wrench
Right hand	Left hand		a	b	L	h	f	e			
211-11-001	211-11-002	SDHCR/L1616H07	16	16	100	16	20	16	DC..0702..	L60 M2.5x5.2	T8
211-11-003	211-11-004	SDHCR/L2020K07	20	20	125	20	25	16	DC..0702..	L60 M2.5x5.2	T8
211-11-005	211-11-006	SDHCR/L2525M07	25	25	150	25	32	18	DC..0702..	L60 M2.5x5.2	T8
211-11-007	211-11-008	SDHCR/L1616H11	16	16	100	16	20	18	DC..11T3..	L60 M3.5x8.8	T15
211-11-009	211-11-010	SDHCR/L2020K11	20	20	125	20	25	18	DC..11T3..	L60 M3.5x8.8	T15
211-11-011	211-11-012	SDHCR/L2525M11	25	25	150	25	32	25	DC..11T3..	L60 M3.5x8.8	T15

SDJCR/L 93°

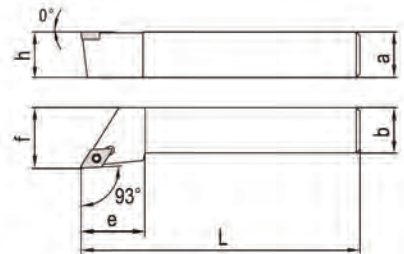
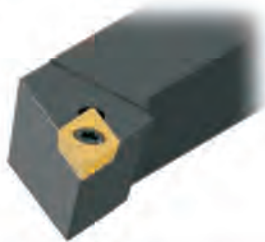
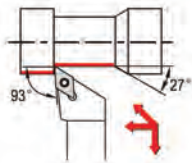

Order No.		ISO Code toolholder	Size(mm)						For insert	Screw	Torx wrench
Right hand	Left hand		a	b	L	h	f	e			
211-11-013	211-11-014	SDJCR/L1212F07	12	12	80	12	16	16	DC..0702..	L60 M2.5x5.2	T8
211-11-015	211-11-016	SDJCR/L1616H07	16	16	100	16	20	16	DC..0702..	L60 M2.5x5.2	T8
211-11-017	211-11-018	SDJCR/L2020K07	20	20	125	20	25	16	DC..0702..	L60 M2.5x5.2	T8
211-11-019	211-11-020	SDJCR/L1616H11	16	16	100	16	20	22	DC..11T3..	L60 M3.5x8.8	T15
211-11-021	211-11-022	SDJCR/L2020K11	20	20	125	20	25	22	DC..11T3..	L60 M3.5x8.8	T15
211-11-023	211-11-024	SDJCR/L2525M11	25	25	150	25	32	22	DC..11T3..	L60 M3.5x8.8	T15

SDJCR/L...D 93°

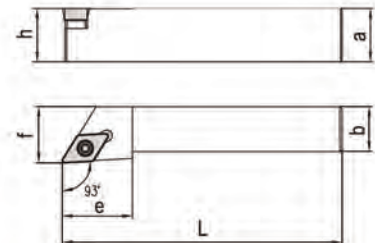
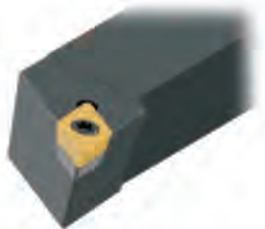
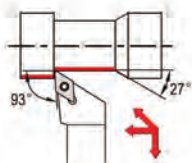

Order No.		ISO Code toolholder	Size(mm)						Insert	Shim	Shim screw	Screw	Torx wrench
Right hand	Left hand		a	b	L	h	f	e					
211-11-025	211-11-026	SDJCR/L1616H11D	16	16	100	16	20	22	DC..11T3..	SKDP-343	SRS-3	MS-1156	T15
211-11-027	211-11-028	SDJCR/L2020K11D	20	20	125	20	25	22	DC..11T3..	SKDP-343	SRS-3	MS-1156	T15
211-11-029	211-11-030	SDJCR/L2525M11D	25	25	150	25	32	22	DC..11T3..	SKDP-343	SRS-3	MS-1156	T15

TOOLHOLDERS WITH POSITIVE RAKE ANGEL

SDNCN 62°30'

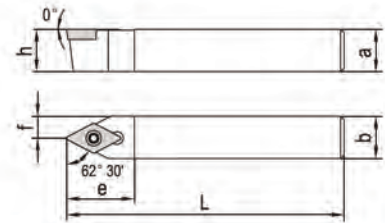
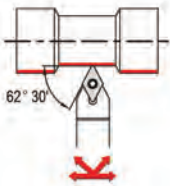

Order No.	ISO Code toolholder	Size(mm)						For insert	Screw	Torx wrench
		a	b	L	h	f	e			
211-11-031	SDNCN1616H07	16	16	100	16	8	16	DC..0702..	L60 M2.5x5.2	T8
211-11-033	SDNCN1616M07	16	16	150	16	8	16	DC..0702..	L60 M2.5x5.2	T8
211-11-035	SDNCN2020H07	20	20	100	20	10	16	DC..0702..	L60 M2.5x5.2	T8
211-11-037	SDNCN2020M07	20	20	150	20	10	16	DC..0702..	L60 M2.5x5.2	T8
211-11-039	SDNCN1616H11	16	16	100	16	8	22	DC..11T3..	L60 M3.5x8.8	T15
211-11-041	SDNCN1616M11	16	16	150	16	8	22	DC..11T3..	L60 M3.5x8.8	T15
211-11-043	SDNCN2020H11	20	20	100	20	10	22	DC..11T3..	L60 M3.5x8.8	T15
211-11-045	SDNCN2020M11	20	20	150	20	10	22	DC..11T3..	L60 M3.5x8.8	T15

SSBCR/L 75°

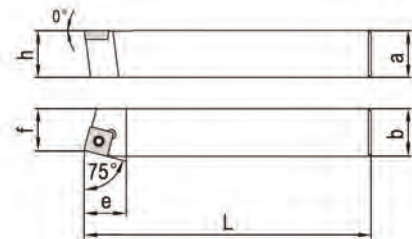
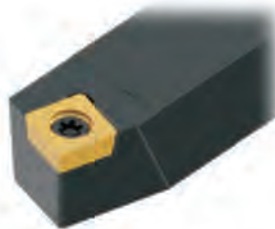
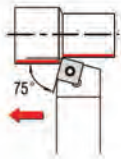

Order No.		ISO Code toolholder	Size(mm)						For insert	Screw	Torx wrench
Right hand	Left hand		a	b	L	h	f	e			
211-12-001	211-12-002	SSBCR/L1616H09	16	16	100	16	13	16	SC..09T3..	L60 M3.5x8.8	T15

SSBCR/L...D 75°

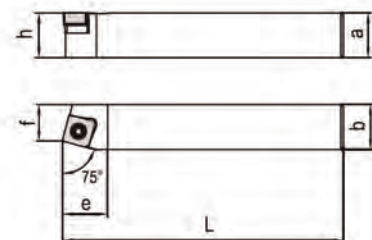
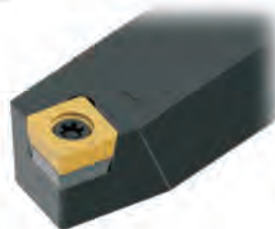
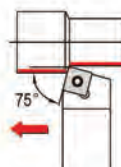

Order No.		ISO Code toolholder	Size(mm)						Insert	Shim	Shim screw	Screw	Torx wrench
Right hand	Left hand		a	b	L	h	f	e					
211-12-003	211-12-004	SSBCR/L1616H09D	16	16	100	16	20	16	SC..09T3	SKSP-343	SRS-3	MS-1156	T15
211-12-005	211-12-006	SSBCR/L2020K09D	20	20	125	20	25	25	SC..09T3	SKSP-343	SRS-3	MS-1156	T15
211-12-007	211-12-008	SSBCR/L2020K12D	20	20	125	20	25	25	SC..1204	SKSP-453	SRS-4	MS-1158	T20
211-12-009	211-12-010	SSBCR/L2525M12D	25	25	150	25	22	25	SC..1204	SKSP-453	SRS-4	MS-1158	T20

TOOLHOLDERS WITH POSITIVE RAKE ANGEL

SSKCR/L

75°

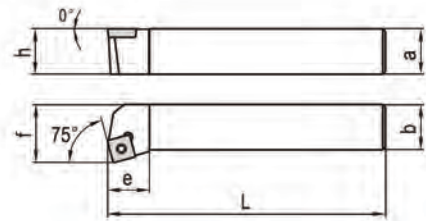
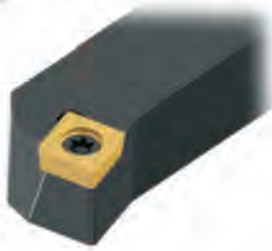
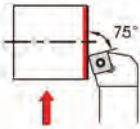

Order No.		ISO Code toolholder	Size(mm)						For insert	Screw	Torx wrench
Right hand	Left hand		a	b	L	h	f	e			
211-12-011	211-12-012	SSKCR/L1616H09	16	16	100	16	20	20	SC..09T3	L60 M3.5x8.8	T15
211-12-013	211-12-014	SSKCR/L2020K09	20	20	125	20	25	20	SC..09T3	L60 M3.5x8.8	T15
211-12-015	211-12-016	SSKCR/L2020K12	20	20	125	20	25	28	SC..1204	L60 M5x10.8	T20
211-12-017	211-12-018	SSKCR/L2525M12	25	25	150	25	32	28	SC..1204	L60 M5x10.8	T20

SSSCR/L

45°

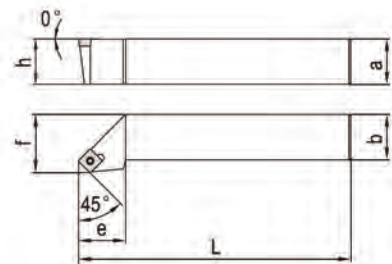
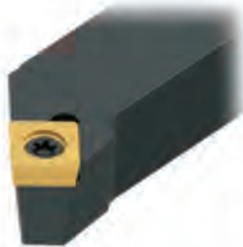
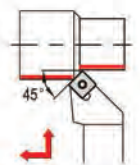

Order No.		ISO Code toolholder	Size(mm)						For insert	Screw	Torx wrench
Right hand	Left hand		a	b	L	h	f	e			
211-12-019	211-12-020	SSSCR/L1616H09	16	16	100	16	20	16	SC..09T3..	L60 M3.5x8.8	T15
211-12-021	211-12-022	SSSCR/L2020K09	20	20	125	20	25	25	SC..09T3..	L60 M3.5x8.8	T15
211-12-023	211-12-024	SSSCR/L2020K12	20	20	125	20	25	25	SC..1204..	L60 M5x10.8	T20

STFCR/L

90°

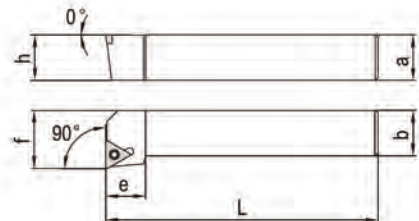
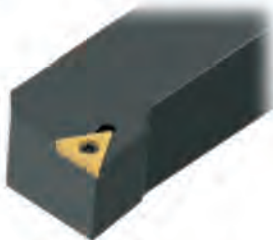
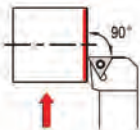

Order No.		ISO Code toolholder	Size(mm)						For insert	Screw	Torx wrench
Right hand	Left hand		a	b	L	h	f	e			
211-13-001	211-13-002	STFCR/L2020K11	20	20	125	20	25	16	TC..1102..	L60 M2.5x5.2	T8
211-13-003	211-13-004	STFCR/L2020K16	20	20	125	20	25	20	TC..16T3..	L60 M3.5x8.8	T15
211-13-005	211-13-006	STFCR/L2525M16	25	25	150	25	32	20	TC..16T3..	L60 M3.5x8.8	T15

STGCR/L

90°

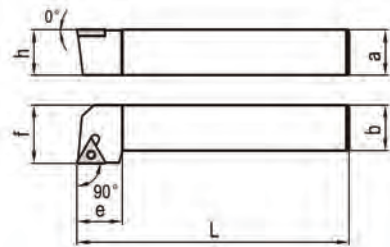
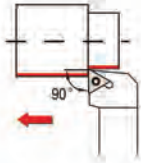

Order No.		ISO Code toolholder	Size(mm)						For insert	Screw	Torx wrench
Right hand	Left hand		a	b	L	h	f	e			
211-13-007	211-13-008	STGCR/L1616H11	16	16	100	16	20	16	TC..1102..	L60 M2.5x5.2	T8
211-13-009	211-13-010	STGCR/L2020K11	20	20	125	20	25	18	TC..1102..	L60 M2.5x5.2	T8
211-13-011	211-13-012	STGCR/L1616H16	16	16	100	16	20	20	TC..16T3..	L60 M3.5x8.8	T15
211-13-013	211-13-014	STGCR/L2020K16	20	20	125	20	25	20	TC..16T3..	L60 M3.5x8.8	T15
211-13-015	211-13-016	STGCR/L2525M16	25	25	150	25	32	20	TC..16T3..	L60 M3.5x8.8	T15

STGCR/L...D

90°

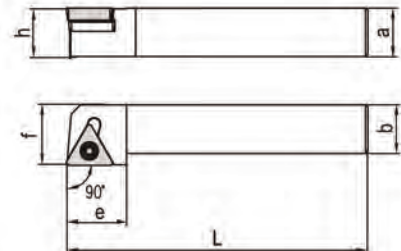
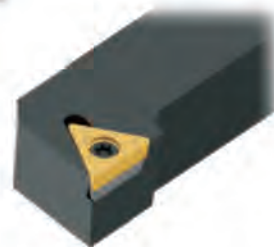

Order No.		ISO Code toolholder	Size(mm)						Insert	Shim	Shim screw	Screw	Torx wrench
Right hand	Left hand		a	b	L	h	f	e					
211-13-017	211-13-018	STGCR/L1616H16D	16	16	100	16	20	20	TC..16T3..	SKTP-343	SRS-3	MS-1156	T15
211-13-019	211-13-020	STGCR/L2020K16D	20	20	125	20	25	20	TC..16T3..	SKTP-343	SRS-3	MS-1156	T15
211-13-021	211-13-022	STGCR/L2525M16D	25	25	150	25	32	20	TC..16T3..	SKTP-343	SRS-3	MS-1156	T15

SVACR/L

90°

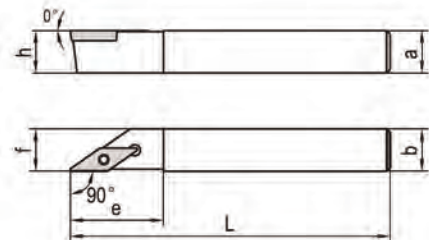
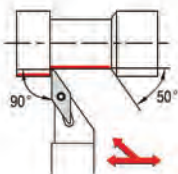

Order No.		ISO Code toolholder	Size(mm)						For insert	Screw	Torx wrench
Right hand	Left hand		a	b	L	h	f	e			
211-14-001	211-14-002	SVACR/L1616M11	16	16	150	16	16	22	VC..1103..	L60 M2.5x5.2	T8
211-14-003	211-14-004	SVACR/L1616M16	16	16	150	16	16	30	VC..1604..	L60 M3.5x8.8	T15

TOOLHOLDERS WITH POSITIVE RAKE ANGEL

SVHCR/L 107°30'

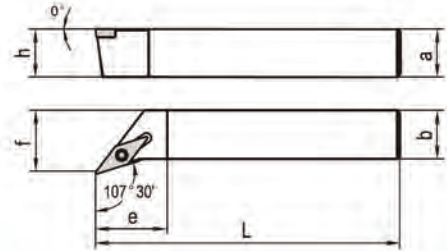
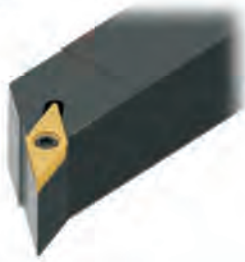
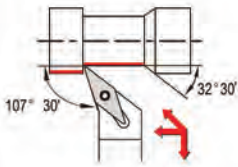

Order No.		ISO Code toolholder	Size(mm)						For insert	Screw	Torx wrench
Right hand	Left hand		a	b	L	h	f	e			
211-14-005	211-14-006	SVHCR/L1616H11	16	16	100	16	20	27	VC..1103..	L60 M2.5x5.2	T8
211-14-007	211-14-008	SVHCR/L2020K11	20	20	125	20	25	27	VC..1103..	L60 M2.5x5.2	T8
211-14-009	211-14-010	SVHCR/L2525M11	25	25	150	25	32	27	VC..1103..	L60 M2.5x5.2	T8
211-14-011	211-14-012	SVHCR/L2020K16	20	20	125	20	25	32	VC..1604..	L60 M3.5x8.8	T15
211-14-013	211-14-014	SVHCR/L2525M16	25	25	150	25	32	32	VC..1604..	L60 M3.5x8.8	T15

SVJCR/L 93°

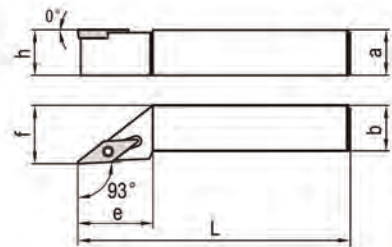
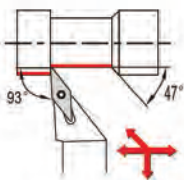

Order No.		ISO Code toolholder	Size(mm)						For insert	Screw	Torx wrench
Right hand	Left hand		a	b	L	h	f	e			
211-14-015	211-14-016	SVJCR/L1616H11	16	16	100	16	20	22	VC..1103..	L60 M2.5x5.2	T8
211-14-017	211-14-018	SVJCR/L2020K11	20	20	125	20	25	25	VC..1103..	L60 M2.5x5.2	T8
211-14-019	211-14-020	SVJCR/L2525M11	25	25	150	25	32	35	VC..1103..	L60 M2.5x5.2	T8
211-14-021	211-14-022	SVJCR/L2020K16	20	20	125	20	25	35	VC..1604..	L60 M3.5x8.8	T15
211-14-023	211-14-024	SVJCR/L2525M16	25	25	150	25	32	35	VC..1604..	L60 M3.5x8.8	T15

SVJBR/L...D 93°

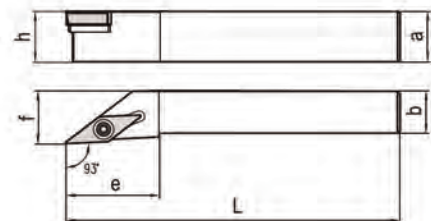
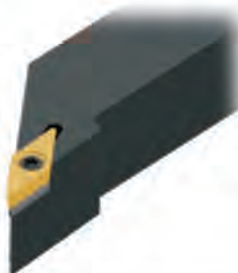
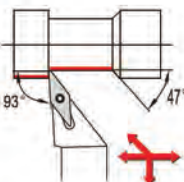

Order No.		ISO Code toolholder	Size(mm)						Insert	Shim	Shim screw	Screw	Torx wrench
Right hand	Left hand		a	b	L	h	f	e					
211-14-025	211-14-026	SVJBR/L2020K16D	20	20	125	20	25	25	VB..1604..	SKVN-343	SRS-3	MS-1156	T15
211-14-027	211-14-028	SVJBR/L2525M16D	25	25	150	25	32	35	VB..1604..	SKVN-343	SRS-3	MS-1156	T15

TOOLHOLDERS WITH POSITIVE RAKE ANGEL

SVVCN 72°30'

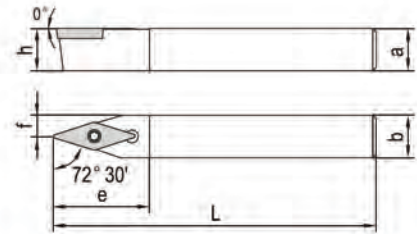
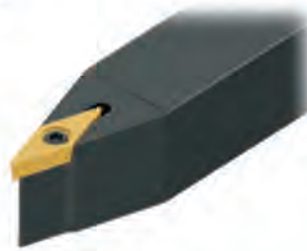
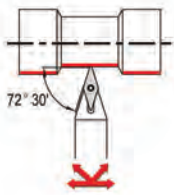

Order No.	ISO Code toolholder	Size(mm)						For insert	Screw	Torx wrench
		a	b	L	h	f	e			
211-14-029	SVVCN1616H11	16	16	100	16	8	25	VC..1103..	L60 M2.5x5.2	T8
211-14-031	SVVCN2020K11	20	20	125	20	10	25	VC..1103..	L60 M2.5x5.2	T8
211-14-033	SVVCN2525M11	25	25	150	25	12.5	25	VC..1103..	L60 M2.5x5.2	T8
211-14-035	SVVCN2020K16	20	20	125	20	10	35	VC..1604..	L60 M3.5x8.8	T15
211-14-037	SVVCN2525M16	25	25	150	25	12.5	35	VC..1604..	L60 M3.5x8.8	T15

SRDCN

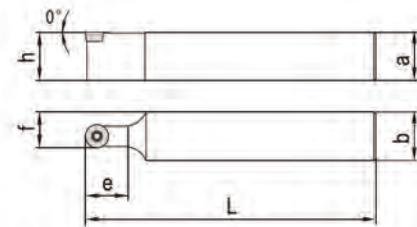
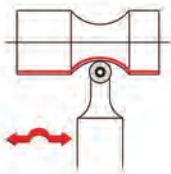





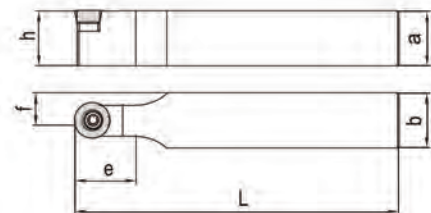
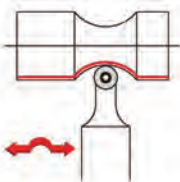





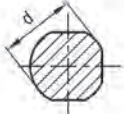
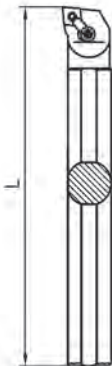



Order No.	ISO Code toolholder	Size(mm)						For insert	Screw	Hex wrench
		a	b	L	h	f	e			
211-15-001	SRDCN2020K08	20	20	125	20	10	35	RC..0803..	L60 M3x6	T10
211-15-002	SRDCN2525M08	25	25	150	25	12.5	35	RC..0803..	L60 M3x6	T10
211-15-003	SRDCN2020K10	20	20	125	20	10	35	RC..1003..	L60 M3.5x8.8	T15
211-15-004	SRDCN2525M10	25	25	150	25	12.5	35	RC..1003..	L60 M3.5x8.8	T15
211-15-005	SRDCN2020K12	20	20	125	20	10	35	RC..1204..	L60 M3.5x14	T15
211-15-006	SRDCN2525M12	25	25	150	25	12.5	35	RC..1204..	L60 M3.5x14	T15
211-15-007	SRDCN3232P12	32	32	170	32	16	40	RC..1204..	L60 M3.5x14	T15
211-15-008	SRDCN2525M16	25	25	170	25	12.5	35	RC..1606..	L60 M4x15	T15
211-15-009	SRDCN3232P16	32	32	170	32	16	40	RC..1606..	L60 M4x15	T15



SRDCN...D



Order No.	ISO Code toolholder	Size(mm)						Insert	Shim	Shim screw	Screw	Torx wrench
		a	b	L	h	f	e					
211-15-010	SRDCN2020K09D	20	20	125	20	10	10	RC..09T3..	SR-3	-	MS-1156	T15
211-15-011	SRDCN2525M09D	25	25	150	25	12.5	12.5	RC..09T3..	SR-3	-	MS-1156	T15

ISO NAMENCLATURE FOR BORING BAR

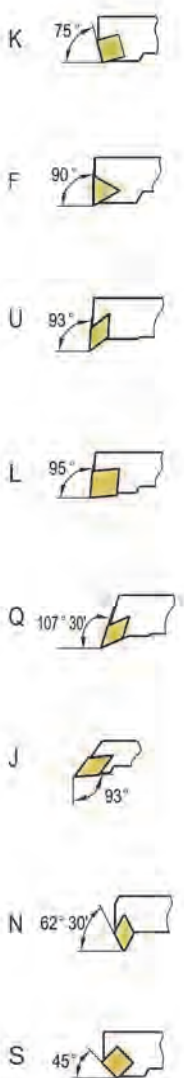
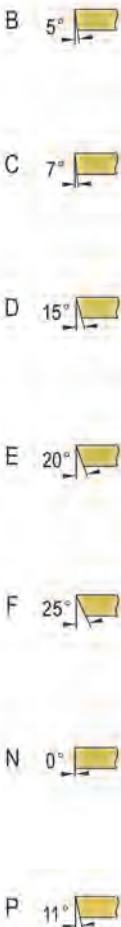
<p>S: Steel Bar</p> <p>A: Steel Bar with inner coolant</p> <p>C: Carbide shank Bar</p> <p>E: Carbide shank Bar with inner coolant</p>	 <p>toleranze: g7</p>	 <p>A = 32 B = 40 C = 50 D = 60 E = 70 F = 80 G = 90 H = 100 J = 110 K = 125 L = 140 M = 150 N = 160 P = 170 Q = 180 R = 200 S = 250 T = 300 U = 350 V = 400 W = 450 Y = 500</p>	<p>C</p>  <p>Top Clamping</p> <p>M</p>  <p>Top and hole clamping</p> <p>P</p>  <p>Hole clamping</p> <p>S</p>  <p>Screw on</p>	<p>C </p> <p>D </p> <p>K </p> <p>L </p> <p>R </p> <p>S </p> <p>T </p> <p>V </p> <p>W </p>
S	25	U	S	T
Type of Bar	Shank diameter	Total Length	Clamping Method	Insert Shape

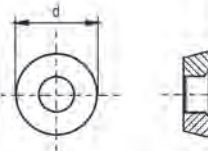
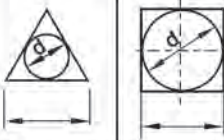
 <p>K 75°</p> <p>F 90°</p> <p>U 93°</p> <p>L 95°</p> <p>Q 107° 30'</p> <p>J 93°</p> <p>N 62° 30'</p> <p>S 45°</p>	 <p>B 5°</p> <p>C 7°</p> <p>D 15°</p> <p>E 20°</p> <p>F 25°</p> <p>N 0°</p> <p>P 11°</p>	 <p>R</p> <p>N</p> <p>L</p>	 <p>d</p> <table border="1" data-bbox="1029 506 1109 808"> <thead> <tr> <th>d (mm)</th> </tr> </thead> <tbody> <tr><td>06</td></tr> <tr><td>08</td></tr> <tr><td>10</td></tr> <tr><td>12</td></tr> <tr><td>16</td></tr> <tr><td>20</td></tr> <tr><td>25</td></tr> <tr><td>32</td></tr> </tbody> </table>  <table border="1" data-bbox="949 991 1189 1476"> <thead> <tr> <th rowspan="2"></th> <th colspan="4">d</th> </tr> <tr> <th>(mm)</th> <th>(inch)</th> <th>(mm)</th> <th>(mm)</th> </tr> </thead> <tbody> <tr><td>06</td><td>5/32</td><td>3.96</td><td>03</td></tr> <tr><td>09</td><td>7/32</td><td>5.55</td><td>05</td></tr> <tr><td>11</td><td>1/4</td><td>6.35</td><td>06</td></tr> <tr><td>16</td><td>3/8</td><td>9.52</td><td>09</td></tr> <tr><td>22</td><td>1/2</td><td>12.7</td><td>12</td></tr> <tr><td>27</td><td>5/8</td><td>15.8</td><td>15</td></tr> <tr><td>33</td><td>3/4</td><td>19.0</td><td>19</td></tr> <tr><td>44</td><td>1</td><td>25.4</td><td>25</td></tr> </tbody> </table>	d (mm)	06	08	10	12	16	20	25	32		d				(mm)	(inch)	(mm)	(mm)	06	5/32	3.96	03	09	7/32	5.55	05	11	1/4	6.35	06	16	3/8	9.52	09	22	1/2	12.7	12	27	5/8	15.8	15	33	3/4	19.0	19	44	1	25.4	25	<p>D: Increase offset by 1.0mm</p> <p>E: Increase offset by 2.0mm</p> <p>X: Reverse boring</p>
d (mm)																																																						
06																																																						
08																																																						
10																																																						
12																																																						
16																																																						
20																																																						
25																																																						
32																																																						
	d																																																					
	(mm)	(inch)	(mm)	(mm)																																																		
06	5/32	3.96	03																																																			
09	7/32	5.55	05																																																			
11	1/4	6.35	06																																																			
16	3/8	9.52	09																																																			
22	1/2	12.7	12																																																			
27	5/8	15.8	15																																																			
33	3/4	19.0	19																																																			
44	1	25.4	25																																																			

F	C	R	16	D
---	---	---	----	---

Style & lead angle	Clearance angle	Hand of Bar	Length of cutting edge	Defined by the manufacturer
--------------------	-----------------	-------------	------------------------	-----------------------------

BORING BAR WITH NEGATIVE RAKE ANGEL

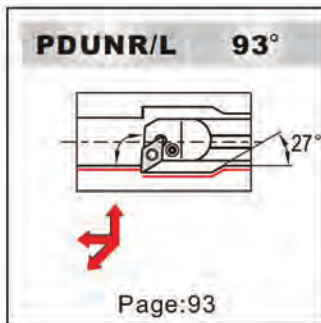
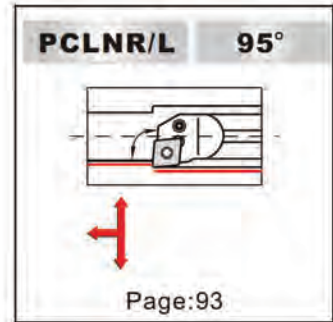
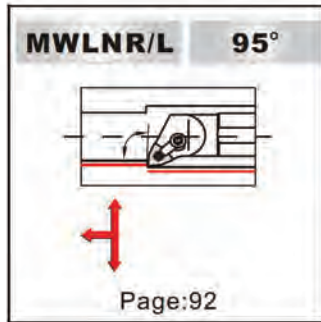
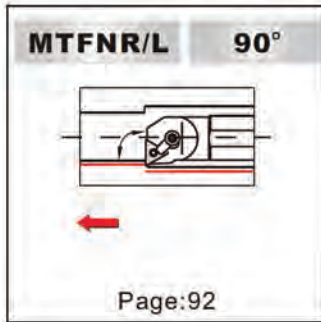
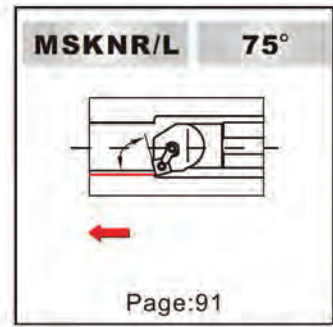
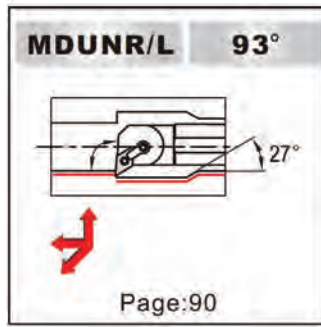
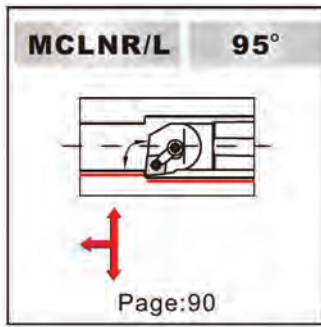

BORING BAR WITH NEGATIVE RAKE ANGEL

S..MCLNR/L 95°

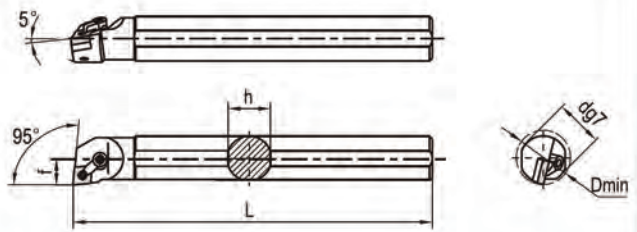
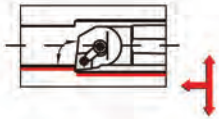

Order No.		ISO Code toolholder	Size(mm)					For Insert	Shim	Lock pin	Clamp	Clamp screw
Right hand	Left hand		d	f	L	h	Dmin					
221-01-001	221-01-002	S25R-MCLNR/L12	25	17	200	23	32	CN..1204..	-	NL-44	CL-12	XNS-47
221-01-003	221-01-004	S32S-MCLNR/L12	32	22	250	30	40	CN..1204..	ICSN-433	NL-46	CL-12	XNS-48
221-01-005	221-01-006	S40T-MCLNR/L12	40	27	300	37	50	CN..1204..	ICSN-433	NL-46	CL-12	XNS-48
221-01-007	221-01-008	S50W-MCLNR/L12	50	35	450	47	63	CN..1204..	ICSN-433	NL-46	CL-12	XNS-48
221-01-009	221-01-010	S40T-MCLNR/L16	40	27	300	37	50	CN..1606..	ICSN-533	NL-58	CL-12	XNS-59
221-01-011	221-01-012	S50W-MCLNR/L16	50	35	450	47	63	CN..1606..	ICSN-533	NL-58	CL-12	XNS-59

A..MCLNR/L 95°

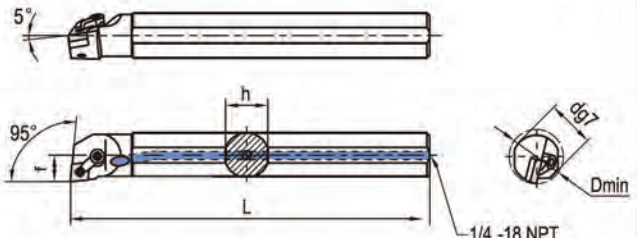

Order No.		ISO Code toolholder	Size(mm)					For Insert	Shim	Lock pin	Clamp	Clamp screw
Right hand	Left hand		d	f	L	h	Dmin					
225-01-001	225-01-002	A25R-MCLNR/L12	25	17	200	23	32	CN..1204..	-	NL-44	CL-20	XNS-47
225-01-003	225-01-004	A32S-MCLNR/L12	32	22	250	30	40	CN..1204..	ICSN-433	NL-46	CL-20	XNS-48
225-01-005	225-01-006	A40T-MCLNR/L12	40	27	300	37	50	CN..1204..	ICSN-433	NL-46	CL-20	XNS-48
225-01-007	225-01-008	A50W-MCLNR/L12	50	35	450	46	63	CN..1204..	ICSN-433	NL-46	CL-20	XNS-48
225-01-009	225-01-010	A40T-MCLNR/L16	40	27	300	37	50	CN..1606..	ICSN-533	NL-58	CL-12	XNS-59
225-01-011	225-01-012	A50W-MCLNR/L16	50	35	450	47	63	CN..1606..	ICSN-533	NL-58	CL-12	XNS-59

S..MDUNR/L 93°

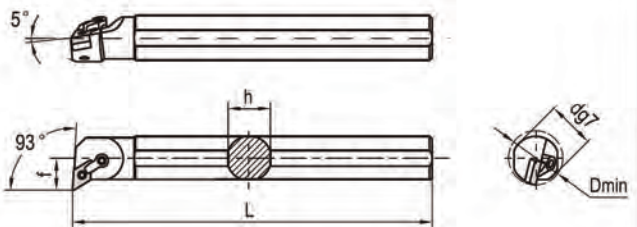
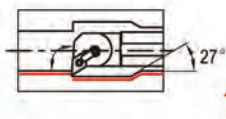

Order No.		ISO Code toolholder	Size(mm)					For Insert	Shim	Lock pin	Clamp	Clamp screw
Right hand	Left hand		d	f	L	h	Dmin					
221-02-001	221-02-002	S25R-MDUNR/L11	25	17	200	23	32	DN..1104..	-	NL-33L	CL-20	XNS-48
221-02-003	221-02-004	S32S-MDUNR/L11	32	22	250	30	40	DN..1104..	IDSN-322	NL-34L	CL-20	XNS-48
221-02-005	221-02-006	S32S-MDUNR/L15	32	22	250	30	40	DN..1506..	IDSN-433	NL-46L	CL-12	XNS-59
221-02-007	221-02-008	S40T-MDUNR/L15	40	27	300	37	50	DN..1506..	IDSN-433	NL-46L	CL-12	XNS-59
221-02-009	221-02-010	S50W-MDUNR/L15	50	35	450	47	63	DN..1506..	IDSN-433	NL-46L	CL-12	XNS-59

BORING BAR WITH NEGATIVE RAKE ANGEL

A..MDUNR/L 93°

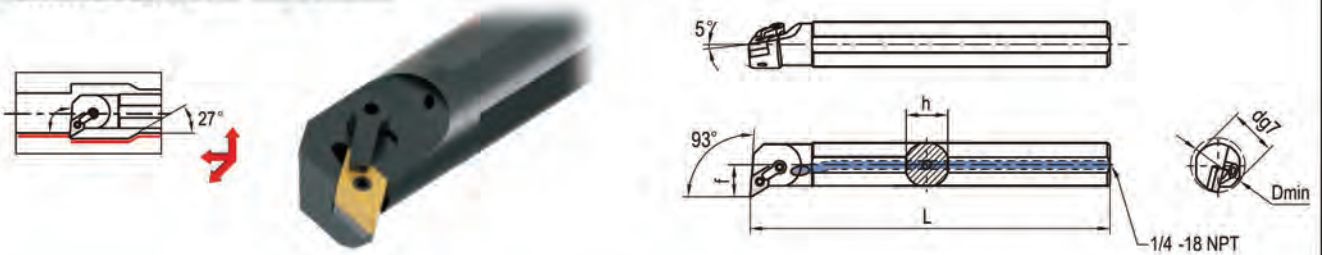

Order No.		ISO Code toolholder	Size(mm)					For Insert	Shim	Lock pin	Clamp	Clamp screw
Right hand	Left hand		d	f	L	h	Dmin					
225-02-001	225-02-002	A25R-MDUNR/L11	25	17	200	23	32	DN..1104..	-	NL-33L	CL-20	XNS-48
225-02-003	225-02-004	A32S-MDUNR/L11	32	22	250	30	40	DN..1104..	IDSN-322	NL-34L	CL-20	XNS-48
225-02-005	225-02-006	A32S-MDUNR/L15	32	22	250	30	40	DN..1506..	IDSN-433	NL-46L	CL-12	XNS-59
225-02-007	225-02-008	A40T-MDUNR/L15	40	27	300	37	50	DN..1506..	IDSN-433	NL-46L	CL-12	XNS-59
225-02-009	225-02-010	A50W-MDUNR/L15	50	35	450	47	63	DN..1506..	IDSN-433	NL-46L	CL-12	XNS-59

S..MSKNR/L 75°

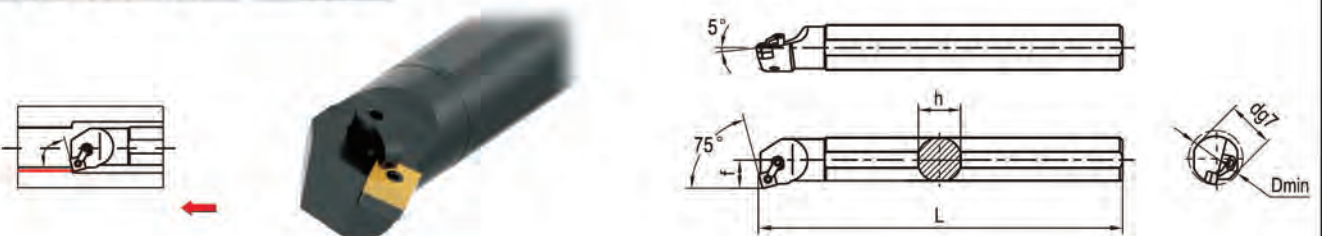

Order No.		ISO Code toolholder	Size(mm)					For Insert	Shim	Lock pin	Clamp	Clamp screw
Right hand	Left hand		d	f	L	h	Dmin					
221-03-001	221-03-002	S32S-MSKNR/L12	32	22	250	30	40	SN..1204..	ISSN-433	NL-46	CL-9	XNS-59
221-03-003	221-03-004	S40T-MSKNR/L12	40	27	300	37	50	SN..1204..	ISSN-433	NL-46	CL-9	XNS-59
221-03-005	221-03-006	S50W-MSKNR/L12	50	35	450	46	63	SN..1204..	ISSN-433	NL-46	CL-9	XNS-59
221-03-007	221-03-008	S40T-MSKNR/L15	40	27	300	37	50	SN..1506..	ISSN-533	NL-58	CL-12	XNS-59
221-03-009	221-03-010	S50W-MSKNR/L15	50	35	450	47	63	SN..1506..	ISSN-533	NL-58	CL-12	XNS-59

A..MSKNR/L 75°

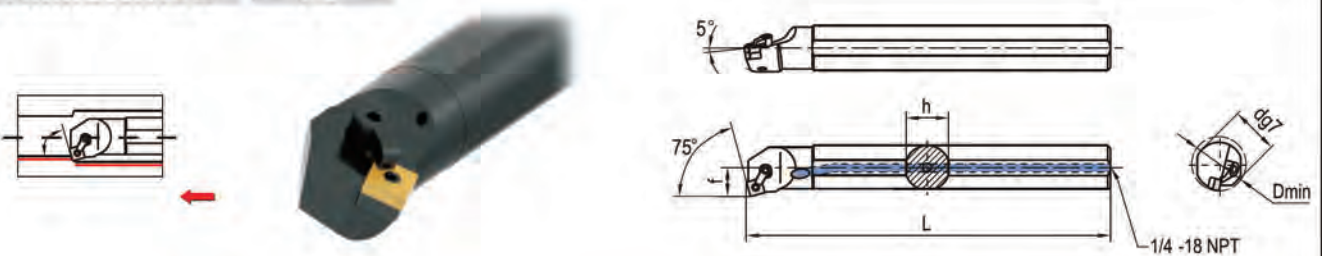

Order No.		ISO Code toolholder	Size(mm)					For Insert	Shim	Lock pin	Clamp	Clamp screw
Right hand	Left hand		d	f	L	h	Dmin					
225-03-001	225-03-002	A32S-MSKNR/L12	32	22	250	30	40	SN..1204..	ISSN-433	NL-46	CL-9	XNS-59
225-03-003	225-03-004	A40T-MSKNR/L12	40	27	300	37	50	SN..1204..	ISSN-433	NL-46	CL-9	XNS-59
225-03-005	225-03-006	A40T-MSKNR/L15	40	27	300	37	50	SN..1506..	ISSN-533	NL-58	CL-12	XNS-59

BORING BAR WITH NEGATIVE RAKE ANGEL

S..MTFNR/L 90°

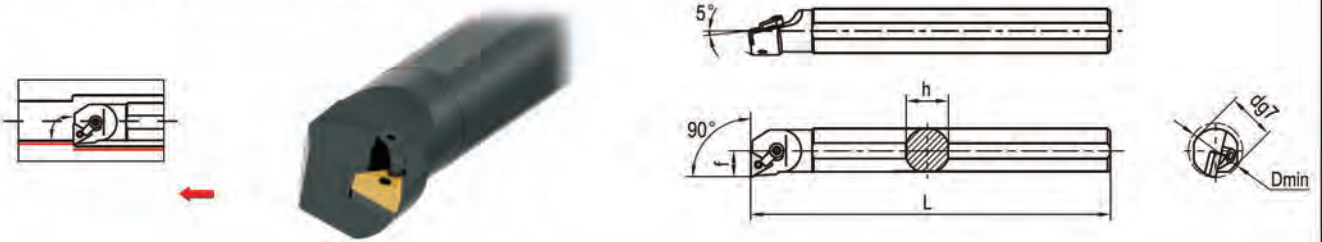

Order No.		ISO Code toolholder	Size(mm)					For Insert	Shim	Lock pin	Clamp	Clamp screw
Right hand	Left hand		d	f	L	h	Dmin					
221-04-001	221-04-002	S25R-MTFNR/L16	25	17	200	23	32	TN..1604..	-	NL-33L	CL-6	XNS-36
221-04-003	221-04-004	S32S-MTFNR/L16	32	22	250	30	40	TN..1604..	ITSN-323	NL-34L	CL-6	XNS-36
221-04-005	221-04-006	S40T-MTFNR/L16	40	27	300	37	50	TN..1604..	ITSN-323	NL-34L	CL-6	XNS-36
221-04-007	221-04-008	S50W-MTFNR/L16	50	35	450	47	63	TN..1604..	ITSN-323	NL-34L	CL-6	XNS-36
221-04-009	221-04-010	S40T-MTFNR/L22	40	27	300	37	50	TN..2204..	ITSN-433	NL46	CL-9	XNS-59
221-04-011	221-04-012	S50W-MTFNR/L22	50	35	450	47	63	TN..2204..	ITSN-433	NL46	CL-9	XNS-59

A..MTFNR/L 90°

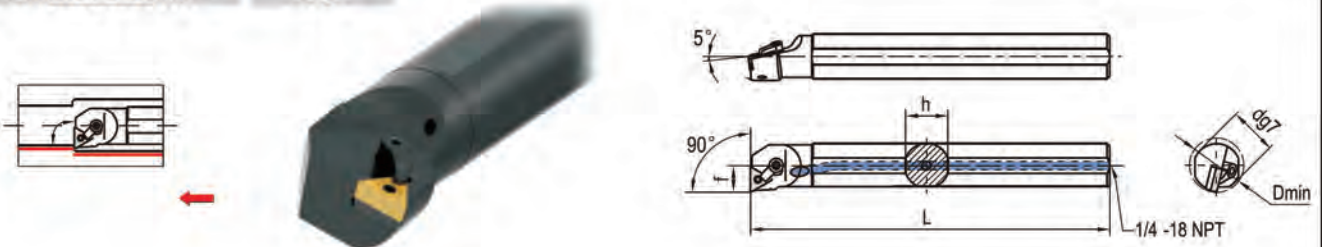

Order No.		ISO Code toolholder	Size(mm)					For Insert	Shim	Lock pin	Clamp	Clamp screw
Right hand	Left hand		d	f	L	h	Dmin					
225-04-001	225-04-002	A25R-MTFNR/L16	25	17	200	23	32	TN..1604..	-	NL-33L	CL-6	XNS-36
225-04-003	225-04-004	A32S-MTFNR/L16	32	22	250	30	40	TN..1604..	ITSN-323	NL-34L	CL-6	XNS-36
225-04-005	225-04-006	A40T-MTFNR/L16	40	27	300	37	50	TN..1604..	ITSN-323	NL-34L	CL-6	XNS-36
225-04-007	225-04-008	A50W-MTFNR/L16	50	35	450	46	63	TN..1604..	ITSN-323	NL-34L	CL-6	XNS-36
225-04-009	225-04-010	A40T-MTFNR/L22	40	27	300	37	50	TN..2204..	ITSN-433	NL-46	CL-9	XNS-59
225-04-011	225-04-012	A50W-MTFNR/L22	50	35	450	47	63	TN..2204..	ITSN-433	NL-46	CL-9	XNS-59

S..MWLNR/L 95°

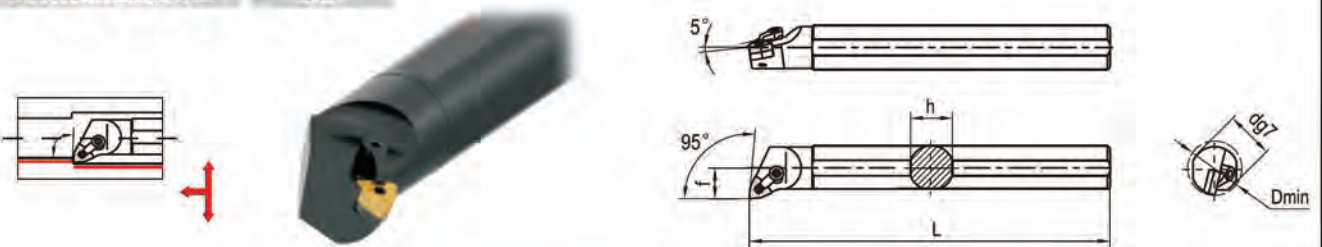

Order No.		ISO Code toolholder	Size(mm)					For Insert	Shim	Lock pin	Clamp	Clamp screw
Right hand	Left hand		d	f	L	h	Dmin					
221-06-001	221-06-002	S25R-MWLNR/L06	25	17	200	23	32	WN..0604..	-	NL-33L	CL-6	XNS-36
221-06-003	221-06-004	S32S-MWLNR/L06	32	22	250	30	40	WN..0604..	IWSN-322	NL-34L	CL-6	XNS-36
221-06-005	221-06-006	S25R-MWLNR/L08	25	17	200	23	32	WN..0804..	-	NL-44	CL-20	XNS-47
221-06-007	221-06-008	S32S-MWLNR/L08	32	22	250	30	40	WN..0804..	IWSN-433	NL-46	CL-20	XNS-48
221-06-009	221-06-010	S40T-MWLNR/L08	40	27	300	37	50	WN..0804..	IWSN-433	NL-46	CL-20	XNS-48
221-06-011	221-06-012	S50W-MWLNR/L08	50	35	450	47	63	WN..0804..	IWSN-433	NL-46	CL-20	XNS-48

BORING BAR WITH NEGATIVE RAKE ANGEL

A..MWLNR/L 95°

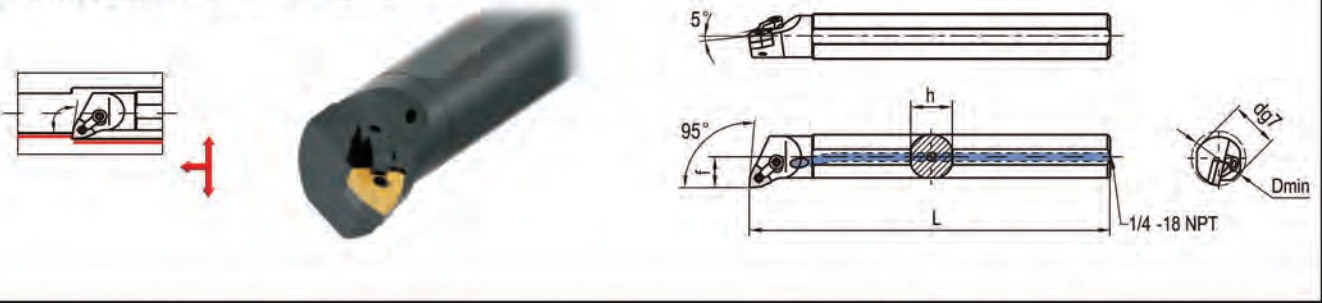

Order No.		ISO Code toolholder	Size(mm)					For Insert	Shim	Lock pin	Clamp	Clamp screw
Right hand	Left hand		d	f	L	h	Dmin					
225-06-001	225-06-002	A25R-MWLNR/L06	25	17	200	23	32	WN..0604..	-	NL-33L	CL-6	XNS-36
225-06-003	225-06-004	A32S-MWLNR/L06	32	22	250	30	40	WN..0604..	IWSN-322	NL-34L	CL-6	XNS-36
225-06-005	225-06-006	A25R-MWLNR/L08	25	17	200	23	32	WN..0804..	-	NL-44	CL-20	XNS-47
225-06-007	225-06-008	A32S-MWLNR/L08	32	22	250	30	40	WN..0804..	IWSN-433	NL-46	CL-20	XNS-48
225-06-009	225-06-010	A40T-MWLNR/L08	40	27	300	37	50	WN..0804..	IWSN-433	NL-46	CL-20	XNS-48

S..PCLNR/L 95°

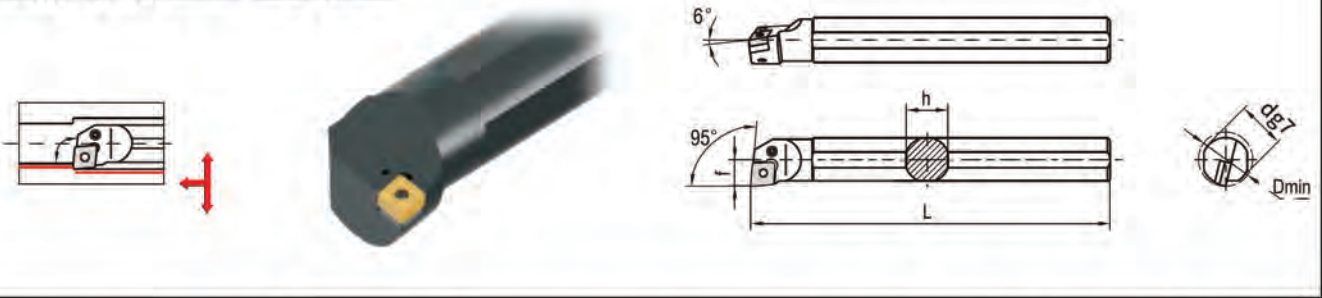

Order No.		ISO Code toolholder	Size(mm)					For Insert	Shim	Lever	Screw	Tubular rivet
Right hand	Left hand		d	f	L	h	Dmin					
221-07-001	221-07-002	S32U-PCLNR/L12	32	22	350	30	40	CN..1204..	PC1203	PL-4	PS0820B	SP06
221-07-003	221-07-004	S40V-PCLNR/L12	40	27	400	37	50	CN..1204..	PC1203	PL-4	PS0820B	SP06
221-07-005	221-07-006	S50WPCLNR/L12	50	35	450	47	63	CN..1204..	PC1203	PL-4	PS0820B	SP06
221-07-007	221-07-008	S40V-PCLNR/L16	40	27	400	37	50	CN..1606..	PC1604	PL-5	PS0825	SP08
221-07-009	221-07-010	S50WPCLNR/L16	50	35	450	47	63	CN..1606..	PC1604	PL-5	PS0825	SP08

S..PDUNR/L 93°

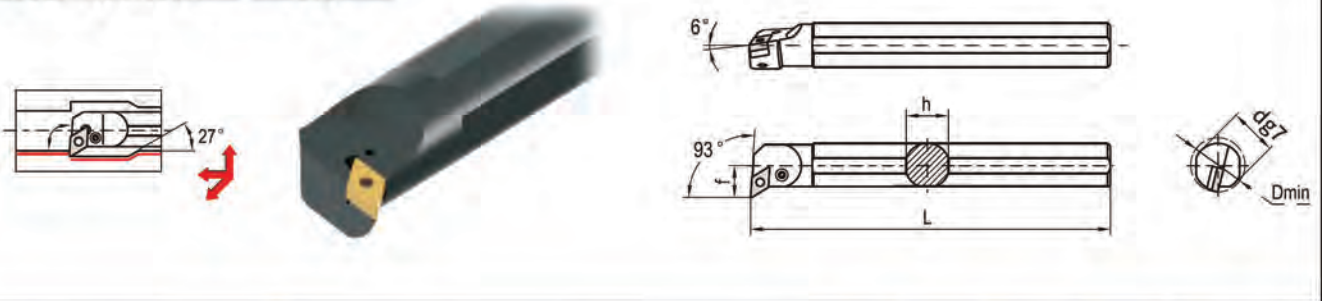

Order No.		ISO Code toolholder	Size(mm)					For Insert	Shim	Lever	Screw	Tubular rivet
Right hand	Left hand		d	f	L	h	Dmin					
221-08-001	221-08-002	S32U-PDUNR/L11	32	22	350	30	40	DN..1104..	PD1103	PL-3	PS0617	SP05
221-08-003	221-08-004	S40V-PDUNR/L11	40	27	400	37	50	DN..1104..	PD1103	PL-3	PS0617	SP05
221-08-005	221-08-006	S50WPDUNR/L11	50	35	450	47	63	DN..1104..	PD1103	PL-3	PS0617	SP05
221-08-007	221-08-008	S40V-PDUNR/L15	40	27	400	37	50	DN..1506..	PD1503	PL-4	PS0820B	SP06
221-08-009	221-08-010	S50WPDUNR/L15	50	35	450	47	63	DN..1506..	PD1503	PL-4	PS0820B	SP06

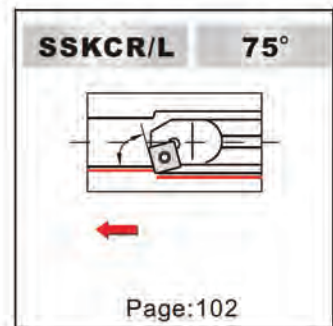
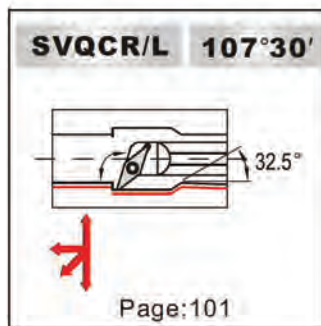
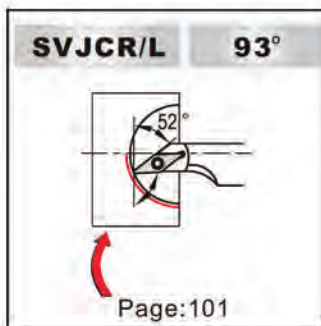
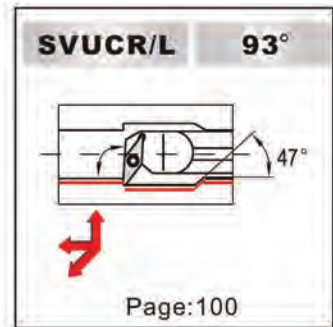
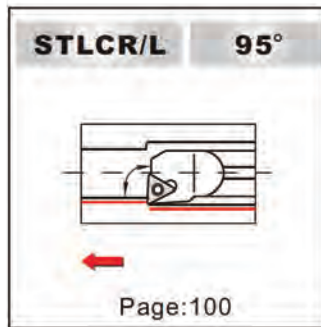
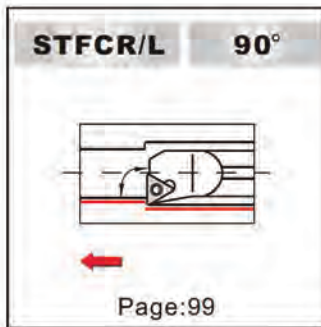
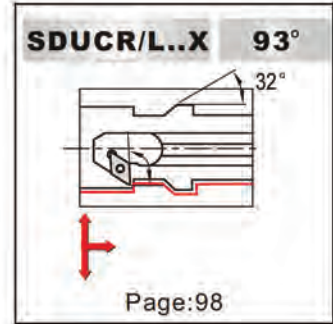
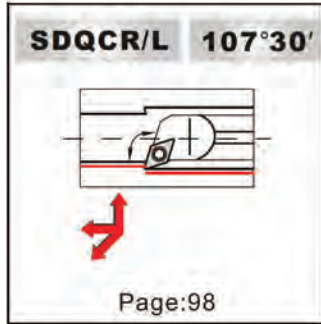
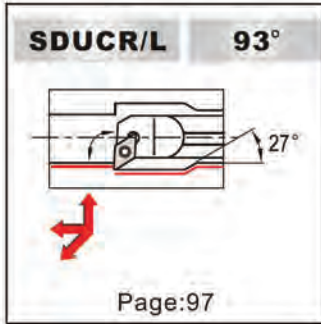
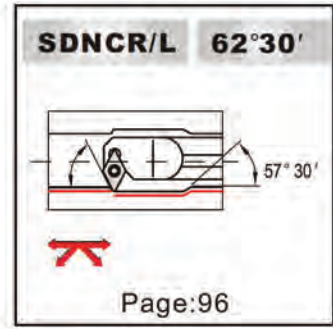
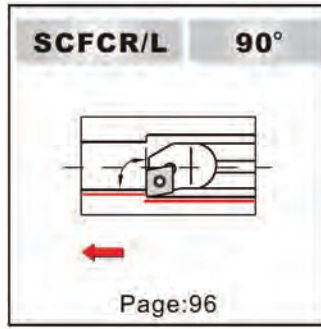
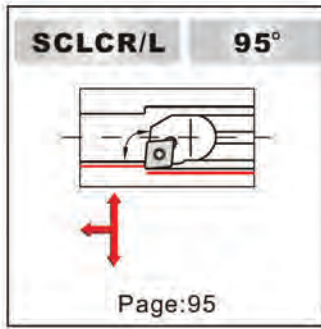

BORING BAR WITH POSITIVE RAKE ANGEL

S..SCLCR/L 95°

Order No.		ISO Code toolholder	Size(mm)					For Insert	Screw	Torx wrench
Right hand	Left hand		d	f	L	h	Dmin			
221-10-001	221-10-002	S08H-SCLCR/L06	8	6	100	7	11	CC..0602..	L60 M2.5x5.2	T8
221-10-003	221-10-004	S10K-SCLCR/L06	10	7	125	9	13	CC..0602..	L60 M2.5x5.2	T8
221-10-005	221-10-006	S12M-SCLCR/L06	12	9	150	11	16	CC..0602..	L60 M2.5x5.2	T8
221-10-007	221-10-008	S16R-SCLCR/L09	16	11	200	15	20	CC..09T3..	L60 M3.5x8.8	T15
221-10-009	221-10-010	S20S-SCLCR/L09	20	13	250	18	25	CC..09T3..	L60 M3.5x8.8	T15
221-10-011	221-10-012	S25T-SCLCR/L12	25	17	300	23	32	CC..1204..	L60 M5x10.8	T20
221-10-013	221-10-014	S32U-SCLCR/L12	32	22	350	30	40	CC..1204..	L60 M5x10.8	T20

A..SCLCR/L 95°

Order No.		ISO Code toolholder	Size(mm)					A	For Insert	Screw	Torx wrench
Right hand	Left hand		d	f	L	h	Dmin				
225-10-001	225-10-002	A16R-SCLCR/L06	16	11	200	15	20	1/8"-27NPT	CC..0602..	L60 M2.5x5.2	T8
225-10-003	225-10-004	A16R-SCLCR/L09	16	11	200	15	20	1/8"-27NPT	CC..09T3..	L60 M3.5x8.8	T15
225-10-005	225-10-006	A20S-SCLCR/L09	20	13	250	18	25	1/8"-27NPT	CC..09T3..	L60 M3.5x8.8	T15
225-10-007	225-10-008	A25T-SCLCR/L09	25	17	300	23	32	1/4"-18NPT	CC..09T3..	L60 M3.5x8.8	T15

E..SCLCR/L 95°

Order No.		ISO Code toolholder	Size(mm)				For Insert	Screw	Torx wrench
Right hand	Left hand		d	f	Dmin	L			
224-10-001	224-10-002	E20S-SCLCR/L09	20	13	25	250	CC..09T3..	L60 M3.5x8.8	T15

BORING BAR WITH POSITIVE RAKE ANGEL

S..SCFCR/L 90°

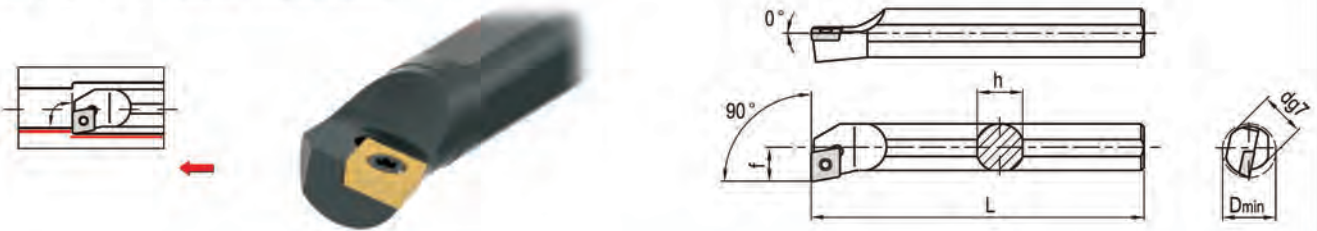

Order No.		ISO Code toolholder	Size(mm)					For Insert	Screw	Torx wrench
Right hand	Left hand		d	f	L	h	Dmin			
221-10-015	221-10-016	S08H-SCFCR/L06	8	6	100	7	11	CC..0602..	L60 M2.5x5.2	T8
221-10-017	221-10-018	S10K-SCFCR/L06	10	7	125	9	13	CC..0602..	L60 M2.5x5.2	T8
221-10-019	221-10-020	S12M-SCFCR/L06	12	9	150	11	16	CC..0602..	L60 M2.5x5.2	T8
221-10-021	221-10-022	S16R-SCFCR/L09	16	11	200	15	20	CC..09T3..	L60 M3.5x8.8	T15
221-10-023	221-10-024	S20S-SCFCR/L09	20	13	250	18	25	CC..09T3..	L60 M3.5x8.8	T15
221-10-025	221-10-026	S25T-SCFCR/L12	25	17	300	23	32	CC..1204..	L60 M5x10.8	T20
221-10-027	221-10-028	S32U-SCFCR/L12	32	22	350	30	40	CC..1204..	L60 M5x10.8	T20

A..SCFCR/L 90°

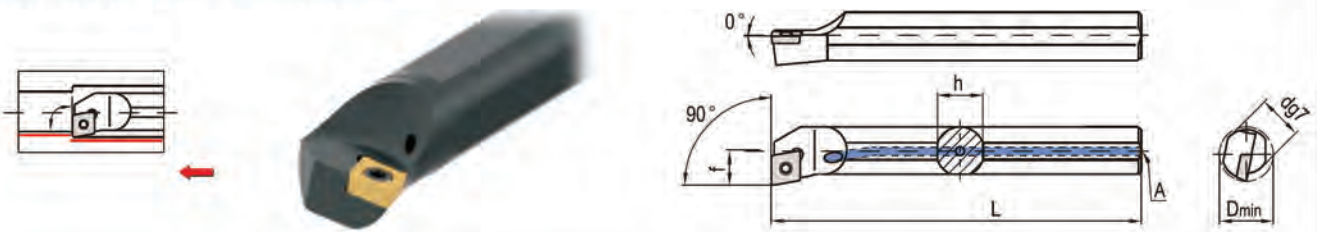

Order No.		ISO Code toolholder	Size(mm)					A	For Insert	Screw	Torx wrench
Right hand	Left hand		d	f	L	h	Dmin				
225-10-009	225-10-010	A20S-SCFCR09	20	13	250	18	25	1/8"-27NPT	CC..09T3..	L60 M3.5x8.8	T15
225-10-011	225-10-012	A25T-SCFCR09	25	17	300	23	32	1/4"-18NPT	CC..09T3..	L60 M3.5x8.8	T15

S..SDNCR/L 62°30'

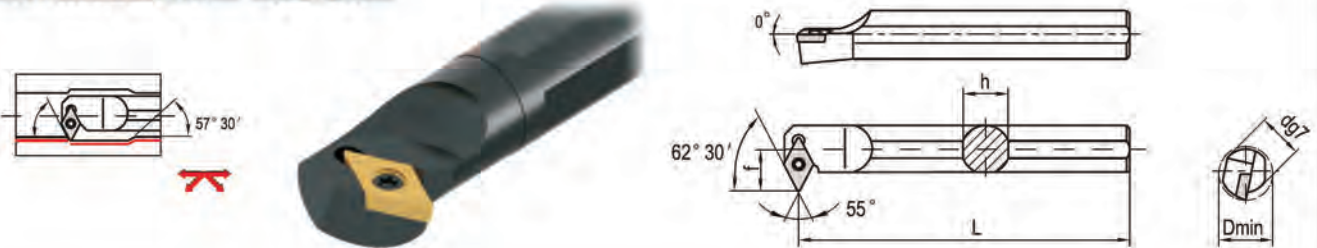

Order No.		ISO Code toolholder	Size(mm)					For Insert	Screw	Torx wrench
Right hand	Left hand		d	f	L	h	Dmin			
221-11-001	221-11-002	S12M-SDNCR/L07	12	9	150	11	16	DC..0702..	L60 M2.5x5.2	T8
221-11-003	221-11-004	S20S-SDNCR/L11	20	13	250	18	25	DC..11T3..	L60 M3.5x8.8	T15
221-11-005	221-11-006	S25T-SDNCR/L11	25	17	300	23	32	DC..11T3..	L60 M3.5x8.8	T15

BORING BAR WITH POSITIVE RAKE ANGEL

S..SDUCR/L 93°

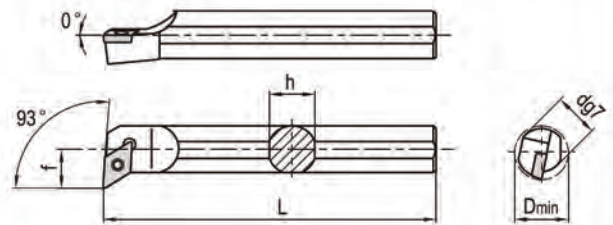
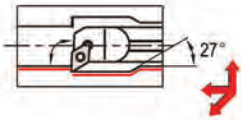

Order No.		ISO Code toolholder	Size(mm)					For Insert	Screw	Torx wrench
Right hand	Left hand		d	f	L	h	Dmin			
221-11-019	221-11-020	S10K-SDUCR/L07	10	7	125	9	13	DC..0702..	L60 M2.5x5.2	T8
221-11-021	221-11-022	S12M-SDUCR/L07	12	9	150	11	16	DC..0702..	L60 M2.5x5.2	T8
221-11-023	221-11-024	S16R-SDUCR/L07	16	11	200	15	20	DC..0702..	L60 M2.5x5.2	T8
221-11-025	221-11-026	S20S-SDUCR/L11	20	13	250	18	25	DC..11T3..	L60 M3.5x8.8	T15
221-11-027	221-11-028	S25T-SDUCR/L11	25	17	300	23	32	DC..11T3..	L60 M3.5x8.8	T15
221-11-029	221-11-030	S32U-SDUCR/L11	32	22	350	30	40	DC..11T3..	L60 M3.5x8.8	T15

A..SDUCR/L 93°

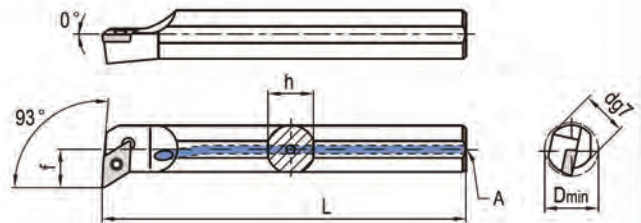
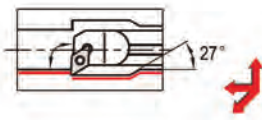

Order No.		ISO Code toolholder	Size(mm)					A	For Insert	Screw	Torx wrench
Right hand	Left hand		d	f	L	h	Dmin				
225-11-001	225-11-002	A10K-SDUCR/L07	10	7	125	9	13	dia.3.3	DC..0702..	L60 M2.5x5.2	T8
225-11-003	225-11-004	A12M-SDUCR/L07	12	9	150	11	16	1/16"-27NPT	DC..0702..	L60 M2.5x5.2	T8
225-11-005	225-11-006	A16R-SDUCR/L07	16	11	200	15	20	1/8"-27NPT	DC..0702..	L60 M2.5x5.2	T8
225-11-007	225-11-008	A20S-SDUCR/L11	20	13	250	18	25	1/8"-27NPT	DC..11T3..	L60 M3.5x8.8	T15
225-11-009	225-11-010	A25T-SDUCR/L11	25	17	300	23	32	1/4"-18NPT	DC..11T3..	L60 M3.5x8.8	T15

E..SDUCR/L 93°

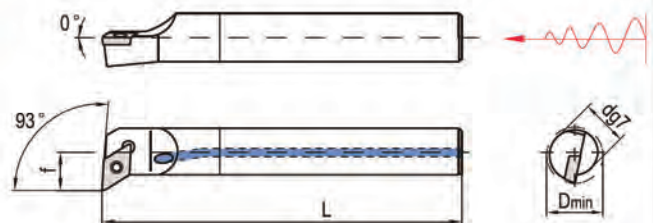
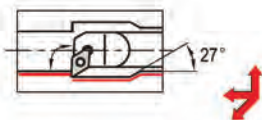

Order No.		ISO Code toolholder	Size(mm)				For Insert	Screw	Torx wrench
Right hand	Left hand		d	f	Dmin	L			
224-11-001	224-11-002	E10M-SDUCR/L07	10	7	13	150	DC..0702..	L60 M2.5x5.2	T8
224-11-003	224-11-004	E12Q-SDUCR/L07	12	9	16	180	DC..0702..	L60 M2.5x5.2	T8
224-11-005	224-11-006	E16R-SDUCR/L07	16	11	20	200	DC..0702..	L60 M2.5x5.2	T8
224-11-007	224-11-008	E20S-SDUCR/L11	20	13	25	250	DC..11T3..	L60 M3.5x8.8	T15
224-11-009	224-11-010	E25T-SDUCR/L11	25	17	32	300	DC..11T3..	L60 M3.5x8.8	T15

BORING BAR WITH POSITIVE RAKE ANGEL

S..SDQCR/L 107°30'

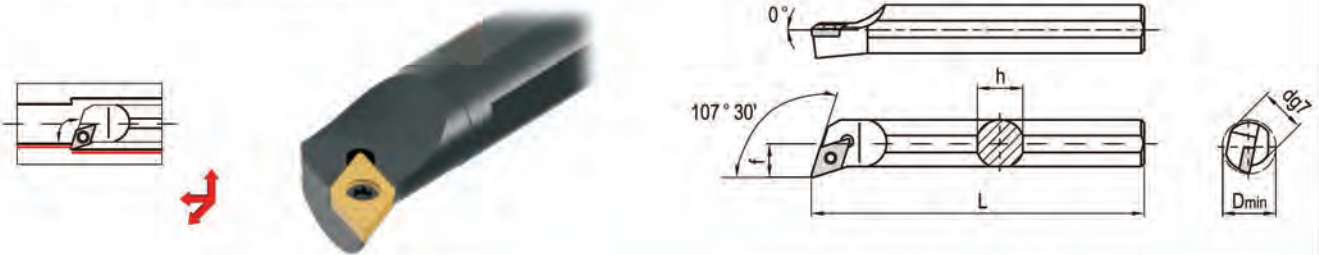

Order No.		ISO Code toolholder	Size(mm)						For Insert	Screw	Torx wrench
Right hand	Left hand		d	f	L	h	Dmin				
221-11-007	221-11-008	S10K-SDQCR/L07	10	7	125	9	13	DC..0702..	L60 M2.5x5.2	T8	
221-11-009	221-11-010	S12M-SDQCR/L07	12	9	150	11	16	DC..0702..	L60 M2.5x5.2	T8	
221-11-011	221-11-012	S16R-SDQCR/L07	16	11	200	15	20	DC..0702..	L60 M2.5x5.2	T8	
221-11-013	221-11-014	S20S-SDQCR/L11	20	13	250	18	25	DC..11T3..	L60 M3.5x8.8	T15	
221-11-015	221-11-016	S25T-SDQCR/L11	25	17	300	23	32	DC..11T3..	L60 M3.5x8.8	T15	
221-11-017	221-11-018	S32U-SDQCR/L11	32	22	350	30	40	DC..11T3..	L60 M3.5x8.8	T15	

S..SDUCR/L-X 93°

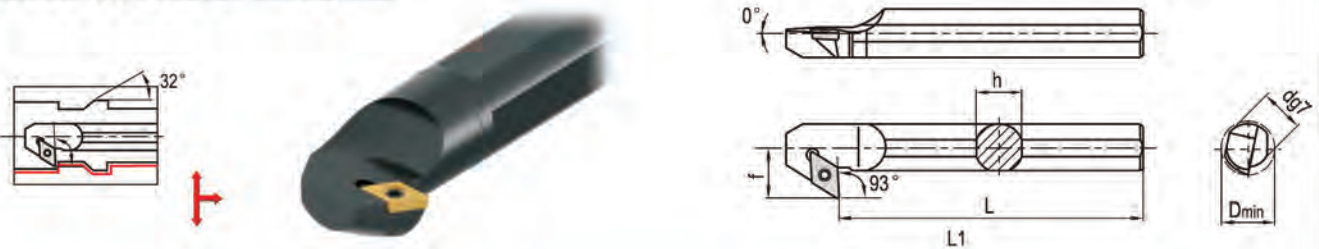

Order No.		ISO Code toolholder	Size(mm)						For Insert	Screw	Torx wrench
Right hand	Left hand		d	f	L	L1	h	Dmin			
221-11-031	221-11-032	S16R-SDUCR/L07-EX	16	13	200	212	15	22	DC..0702..	L60 M2.5x5.2	T8
221-11-033	221-11-034	S20S-SDUCR/L07-EX	20	15	250	262	18	27	DC..0702..	L60 M2.5x5.2	T8
221-11-035	221-11-036	S25T-SDUCR/L07-DX	25	18	300	312	23	33	DC..0702..	L60 M2.5x5.2	T8
221-11-037	221-11-038	S32U-SDUCR/L11-X	32	22	350	366	30	40	DC..11T3..	L60 M3.5x8.8	T15

A..SDUCR/L-X 93°

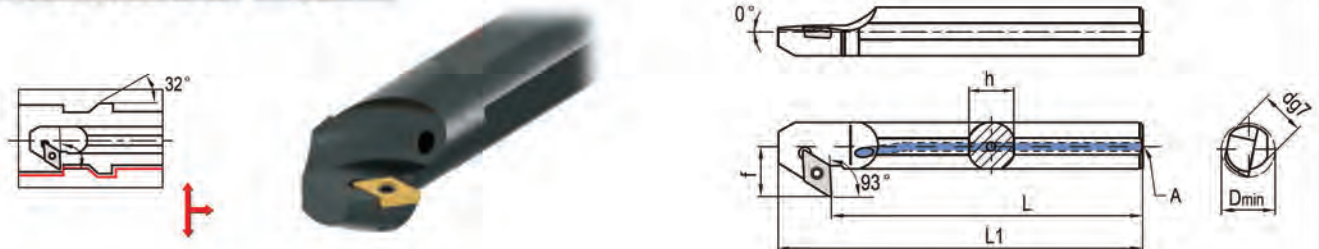

Order No.		ISO Code toolholder	Size(mm)						A	For Insert	Screw	Torx wrench
Right hand	Left hand		d	f	L	L1	h	Dmin				
225-11-011	225-11-012	A16R-SDUCR/L07-EX	16	13	200	212	15	22	1/8"-27NPT	DC..0702..	L60 M2.5x5.2	T8
225-11-013	225-11-014	A20S-SDUCR/L07-EX	20	15	250	262	18	27	1/8"-27NPT	DC..0702..	L60 M2.5x5.2	T8
225-11-015	225-11-016	A25T-SDUCR/L07-DX	25	18	300	312	23	33	1/4"-18NPT	DC..0702..	L60 M2.5x5.2	T8

BORING BAR WITH POSITIVE RAKE ANGEL

S..STFCR/L 90°

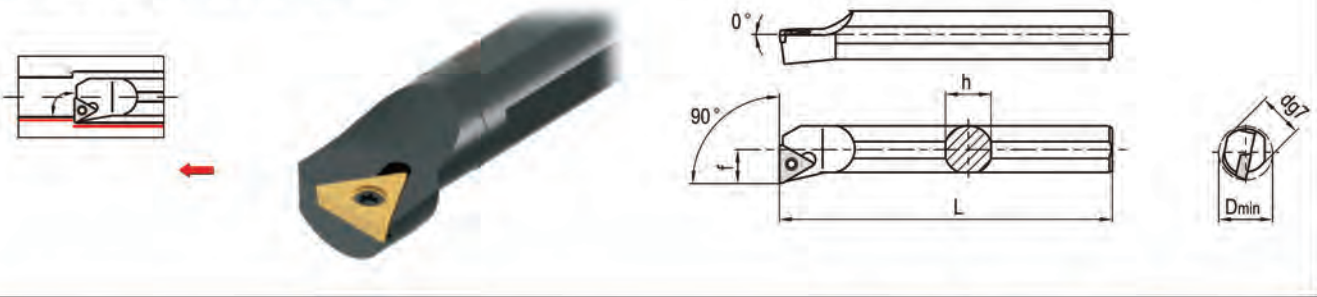

Order No.		ISO Code toolholder	Size(mm)					For Insert	Screw	Torx wrench
Right hand	Left hand		d	f	L	h	Dmin			
221-13-001	221-13-002	S10K-STFCR/L11	10	7	125	9	13	TC..1102..	L60 M2.5x5.2	T8
221-13-003	221-13-004	S12M-STFCR/L11	12	9	150	11	16	TC..1102..	L60 M2.5x5.2	T8
221-13-005	221-13-006	S16R-STFCR/L11	16	11	200	15	20	TC..1102..	L60 M2.5x5.2	T8
221-13-007	221-13-008	S20S-STFCR/L16	20	13	250	18	25	TC..16T3..	L60 M3.5x8.8	T15
221-13-009	221-13-010	S25T-STFCR/L16	25	17	300	23	32	TC..16T3..	L60 M3.5x8.8	T15
221-13-011	221-13-012	S32U-STFCR/L16	32	22	350	30	40	TC..16T3..	L60 M3.5x8.8	T15

A..STFCR/L 90°

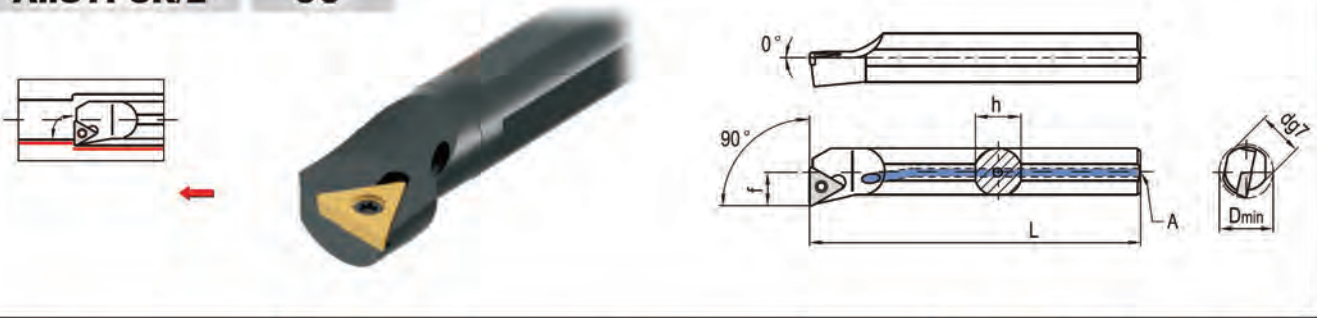

Order No.		ISO Code toolholder	Size(mm)					A	For Insert	Screw	Torx wrench
Right hand	Left hand		d	f	L	h	Dmin				
225-13-001	225-13-002	A10K-STFCR/L11	10	7	125	9	13	φ 3.3	TC..1102..	L60 M2.5x5.2	T8
225-13-003	225-13-004	A12M-STFCR/L11	12	9	150	11	16	1/16"-27NPT	TC..1102..	L60 M2.5x5.2	T8
225-13-005	225-13-006	A16R-STFCR/L11	16	11	200	15	20	1/8"-27NPT	TC..1102..	L60 M2.5x5.2	T8
225-13-007	225-13-008	A20S-STFCR/L16	20	13	250	18	25	1/8"-27NPT	TC..16T3..	L60 M3.5x8.8	T15
225-13-009	225-13-010	A25T-STFCR/L16	25	17	300	23	32	1/4"-18NPT	TC..16T3..	L60 M3.5x8.8	T15

E..STFCR/L 90°

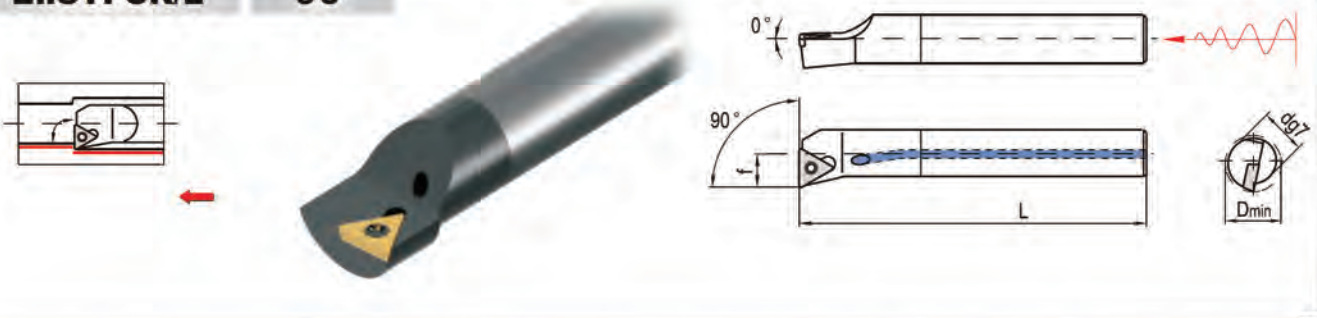

Order No.		ISO Code toolholder	Size(mm)				For Insert	Screw	Torx wrench
Right hand	Left hand		d	f	Dmin	L			
224-13-001	224-13-002	E10M-STFPR/L11	10	7	13	150	TP..1103..	L60 M3x6	T9
224-13-003	224-13-004	E12Q-STFPR/L11	12	9	16	180	TP..1103..	L60 M3x6	T9
224-13-005	224-13-006	E16R-STFPR/L11	16	11	20	200	TP..1103..	L60 M3x6	T9

BORING BAR WITH POSITIVE RAKE ANGEL

A..STLCR/L

95°

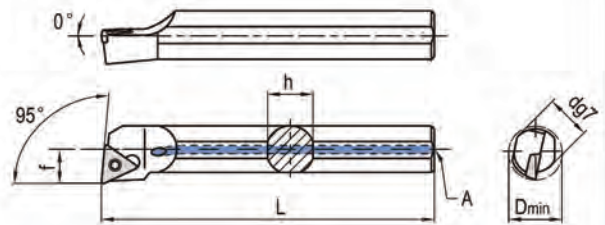
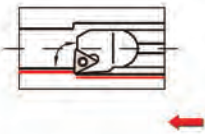

Order No.		ISO Code toolholder	Size(mm)					A	For Insert	Screw	Torx wrench
Right hand	Left hand		d	f	L	h	Dmin				
225-13-011	225-13-012	A10K-STLCR/L11	10	7	125	9	13	φ 3.3	TC..1102..	L60 M2.5x5.2	T8
225-13-013	225-13-014	A12M-STLCR/L11	12	9	150	11	16	1/16"-27NPT	TC..1102..	L60 M2.5x5.2	T8
225-13-015	225-13-016	A16R-STLCR/L11	16	11	200	15	20	1/8"-27NPT	TC..1102..	L60 M2.5x5.2	T8

S..SVUCR/L

93°

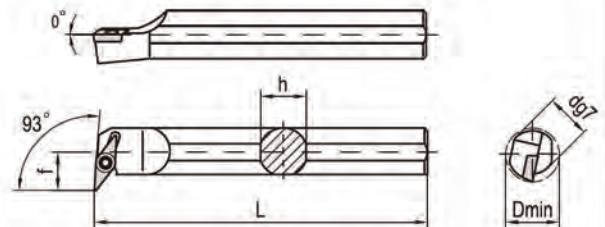
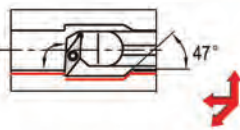

Order No.		ISO Code toolholder	Size(mm)					For Insert	Screw	Torx wrench
Right hand	Left hand		d	f	L	h	Dmin			
221-14-001	221-14-002	S16R-SVUCR/L11	16	11	200	15	20	VC..1103..	L60 M2.5x5.2	T8
221-14-003	221-14-004	S20S-SVUCR/L11	20	13	250	18	25	VC..1103..	L60 M2.5x5.2	T8
221-14-005	221-14-006	S25T-SVUCR/L16	25	17	300	23	32	VC..1604..	L60 M3.5x8.8	T15

A..SVUCR/L

93°

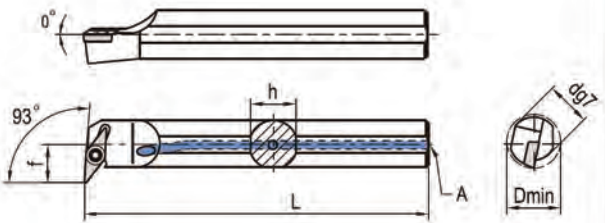

Order No.		ISO Code toolholder	Size(mm)					A	For Insert	Screw	Torx wrench
Right hand	Left hand		d	f	L	h	Dmin				
225-14-001	225-14-002	A20S-SVUCR/L11	20	13	250	18	25	1/8"-27NPT	VC..1103..	L60 M2.5x5.2	T8
225-14-003	225-14-004	A25T-SVUCR/L16	25	17	300	23	32	1/4"-18NPT	VC..1604..	L60 M3.5x8.8	T15

BORING BAR WITH POSITIVE RAKE ANGEL

S..SVJCR/L 93°

Order No.		ISO Code toolholder	Size(mm)						For Insert	Screw	Torx wrench
Right hand	Left hand		d	f	L1	L2	h	Dmin			
221-14-007	221-14-008	S20S-SVJCR/L11	20	2	250	37.5	18	25	VC..1103..	L60 M2.5x5.2	T8
221-14-009	221-14-010	S25T-SVJCR/L11	25	3.5	300	45	23	30	VC..1103..	L60 M2.5x5.2	T8

A..SVJCR/L 93°

Order No.		ISO Code toolholder	Size(mm)						A	For Insert	Screw	Torx wrench
Right hand	Left hand		d	f	L1	L2	h	Dmin				
225-14-005	225-14-006	A20S-SVJCR/L11	20	2	250	37.5	18	25	1/8"-27NPT	VC..1103..	L60 M2.5x5.2	T8
225-14-007	225-14-008	A25T-SVJCR/L11	25	3.5	300	45	23	30	1/4"-18NPT	VC..1103..	L60 M2.5x5.2	T8

S..SVQCR/L 107°30'

Order No.		ISO Code toolholder	Size(mm)					For Insert	Screw	Torx wrench
Right hand	Left hand		d	f	L	h	Dmin			
221-14-011	221-14-012	S16R-SVQCR/L11	16	11	200	15	20	VC..1103..	L60 M2.5x5.2	T8
221-14-013	221-14-014	S20S-SVQCR/L11	20	13	250	18	25	VC..1103..	L60 M2.5x5.2	T8
221-14-015	221-14-016	S25T-SVQCR/L16	25	17	300	23	32	VC..1604..	L60 M3.5x8.8	T15

BORING BAR WITH POSITIVE RAKE ANGEL

A..SVQCR/L 10730'

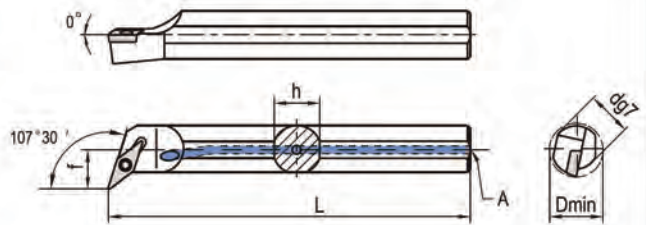
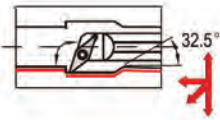

Order No.		ISO Code toolholder	Size(mm)					A	For Insert	Screw	Torx wrench
Right hand	Left hand		d	f	L	h	Dmin				
225-14-009	225-14-010	A16R-SVQCR/L11	16	11	200	15	20	1/8"-27NPT	VC..1103..	L60 M2.5x5.2	T8
225-14-011	225-14-012	A20S-SVQCR/L11	20	13	250	18	25	1/8"-27NPT	VC..1103..	L60 M2.5x5.2	T8
225-14-013	225-14-014	A25T-SVQCR/L16	25	17	300	23	32	1/4"-18NPT	VC..1604..	L60 M3.5x8.8	T15

S..SSKCR/L 75°

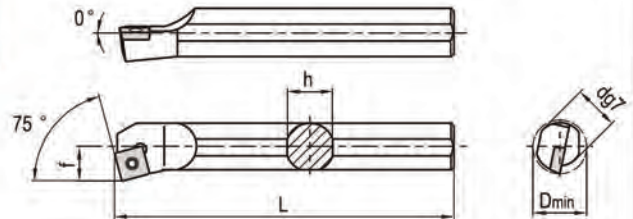
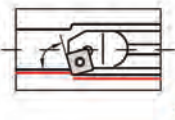

Order No.		ISO Code toolholder	Size(mm)					For Insert	Screw	Torx wrench
Right hand	Left hand		d	f	L	h	Dmin			
221-12-001	221-12-002	S20S-SSKCR/L09	20	13	250	18	25	SC..09T3..	L60 M3.5x8.8	T15
221-12-003	221-12-004	S25T-SSKCR/L12	25	17	300	23	32	SC..1204..	L60 M5x10.8	T20

ER COLLET CHUCK WITH CYLINDER SHANK

this extension can be used on NC lathe for clamping boring bar.

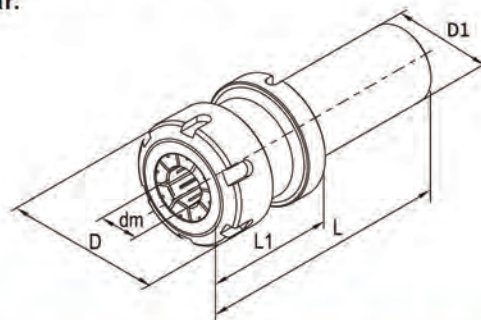

Order No.	Model	Shank diameter (mm)	for Collets	Size(mm)					Nuts	Screw	Wrench
				dm	D	D1	L1	L			
172-04-005	C32-ER25-105	32	ER25	1.0~16	42	32	35	105	CN25B	SER25C	YER25B
172-04-010	C32-ER32-120	32	ER32	2.0~20	50	32	50	120	CN32B	SER32C	YER32B
172-04-015	C32-ER40-130	32	ER40	3.0~26	63	32	60	130	CN40B	SER32C	YER40B
172-04-020	C40-ER25-105	40	ER25	1.0~16	42	40	35	105	CN25B	SER25C	YER25B
172-04-025	C40-ER32-105	40	ER32	2.0~20	50	40	35	105	CN32B	SER32C	YER32B
172-04-030	C40-ER40-130	40	ER40	3.0~26	63	40	60	130	CN40B	SER40C	YER40B

FACING TOOLHOLDERS

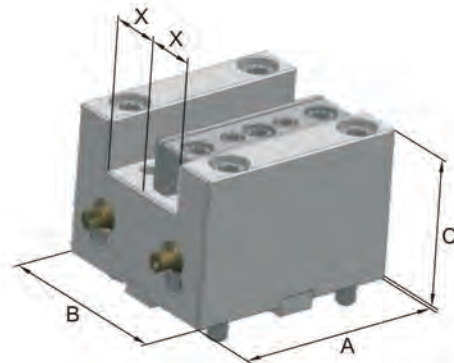

Order No.	Model	Size(mm)				Suitable Machines
		X	A	B	C	
741-11-001	BMT45-B20x60	20	85	75	60	DOOSAN, Hardinge, Spinner, Samsung, Victor, Jyoti
741-11-002	BMT45-B20x90	20	85	75	90	DOOSAN, Hardinge, Spinner, Samsung, Victor, Jyoti
741-12-001	BMT55-B25x60	25	95	90	60	DOOSAN, Goodway, Victor, Hwacheon, Hardinge, Jyoti, Samsung, Hyundai WIA
741-12-002	BMT55-B25x95	25	105	90	95	DOOSAN, Goodway, Victor, Hwacheon, Hardinge, Jyoti, Samsung, Hyundai WIA
741-13-001	BMT65-B25x95	25	115	95	95	DOOSAN, Goodway, Victor, Hwacheon, Hardinge, Haas, Samsung, Hyundai WIA
741-14-001	BMT75-B25x70	25	135	112	70	DOOSAN, Hwacheon, Victor, Samsung, Hyundai WIA
741-14-002	BMT75-B32x122	32	135	112	122	DOOSAN, Hwacheon, Victor, Samsung, Hyundai WIA
741-15-001	BMT85-B32x107	32	169	130	107	DOOSAN, Hwacheon, Victor, Samsung, Hyundai WIA

For external cooling

TURNING TOOLHOLDERS

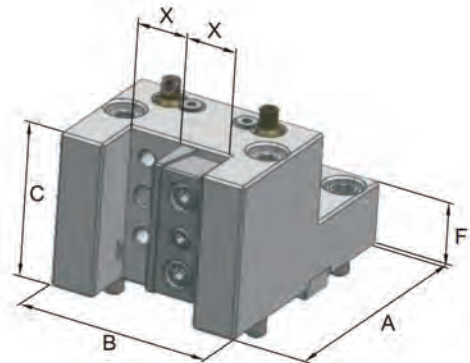

Order No.	Model	Size(mm)					Suitable Machines
		X	A	B	C	F	
741-21-001	BMT45-C20x60	20	105	75	60	25	DOOSAN, Hardinge, Spinner, Samsung, Victor, Jyoti
741-22-001	BMT55-C20x60	20	115	90	60	28	DOOSAN, Goodway, Victor, Hwacheon, Hardinge, Jyoti, Samsung, Hyundai WIA
741-22-002	BMT55-C25x65	25	111	85	65	28	DOOSAN, Goodway, Victor, Hwacheon, Hardinge, Jyoti, Samsung, Hyundai WIA
741-23-001	BMT65-C25x90	25	131	95	90	35	DOOSAN, Goodway, Victor, Hwacheon, Hardinge, Haas, Samsung, Hyundai WIA
741-24-001	BMT75-C25x85	25	140	112	85	45	DOOSAN, Hwacheon, Victor, Samsung, Hyundai WIA
741-24-002	BMT75-C32x85	32	150	112	85	35	DOOSAN, Hwacheon, Victor, Samsung, Hyundai WIA
741-25-001	BMT85-C32x120	32	173	130	95	50	DOOSAN, Hwacheon, Victor, Samsung, Hyundai WIA

For external cooling



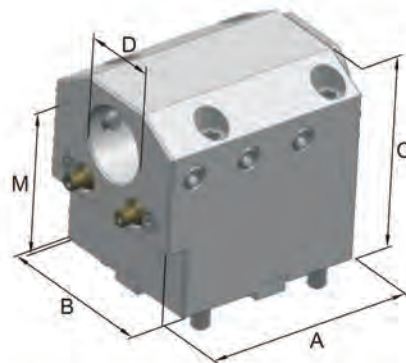

BORING BAR





Order No.	Model	Size(mm)					Suitable Machines
		D	A	B	C	M	
741-31-001	BMT45-E25x65	25	95	75	88	65	DOOSAN, Hardinge, Samsung, Spinner, Victor
741-31-002	BMT45-E32x65	32	95	75	95	65	DOOSAN, Hardinge, Samsung, Spinner, Victor
741-31-003	BMT45-E40x90	40	100	75	118	90	DOOSAN, Hardinge, Samsung, Spinner, Victor
741-32-001	BMT55-E32x60	32	105	90	90	60	DOOSAN, Goodway, Hardinge, Hwacheon, Hyundai WIA, Jyoti, Samsung
741-32-002	BMT55-E40x70	40	105	90	102	70	DOOSAN, Goodway, Hardinge, Hwacheon, Hyundai WIA, Jyoti, Samsung
741-33-001	BMT65-E40x72	40	95	95	106	72	DOOSAN, Victor, Goodway, Haas, Hwacheon, Hyundai WIA, Hardinge, Samsung
741-33-002	BMT65-E40x90	40	115	95	118	90	DOOSAN, Victor, Goodway, Haas, Hwacheon, Hyundai WIA, Hardinge, Samsung
741-33-003	BMT65-E50x100	50	115	95	135	100	DOOSAN, Victor, Goodway, Haas, Hwacheon, Hyundai WIA, Hardinge, Samsung
741-34-001	BMT75-E50x90	50	120	112	130	90	DOOSAN, Victor, Hyundai WIA, Hwacheon, Samsung
741-35-001	BMT85-E50x110	50	162	130	157	110	DOOSAN, Victor, Hwacheon, Hyundai Wia, Samsung

For internal and external cooling

Insert Failure Mode Guide

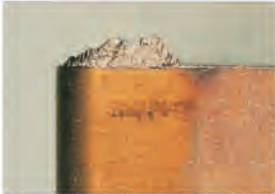

Problem/Failure Mode	Cause	Control Action/Remedy
<p>Rapid Flank Wear</p> 	<ul style="list-style-type: none"> • Excessive cutting speed. • Work material microstructure contains carbides. 	<ul style="list-style-type: none"> • Reduce cutting speed. • Use harder grade. • Select more positive rake chipbreaker. • Flood cutting zone with coolant.
<p>Edge Chipping</p> 	<ul style="list-style-type: none"> • Excessive feed rate. • Interrupted cut. • Vibration 	<ul style="list-style-type: none"> • Reduce feed rate. • Select tougher grade. • Select stronger chipbreaker. • Increase lead angle. • Increase system rigidity.
<p>Crater</p> 	<ul style="list-style-type: none"> • Excessive cutting speed. • Ineffective use of coolant. 	<ul style="list-style-type: none"> • Reduce cutting speed & feed. • Select harder grade with oxide coating. • Select more positive rake chipbreaker. • Flood cutting zone with coolant.
<p>Built-up Edge, Torn Finish, Chip Welding</p> 	<ul style="list-style-type: none"> • High work hardening material. 	<ul style="list-style-type: none"> • Increase lead angle. • Select tougher grade. • Select stronger chipbreaker. • Vary depth-of-cut if possible.

Insert Failure Mode Guide

Problem/Failure Mode	Cause	Control Action/Remedy
<p>Built-up Edge, Torn Finish, Chip Welding</p> 	<ul style="list-style-type: none"> • Low cutting speed. • Low feed rate. • Poor shearing action. 	<ul style="list-style-type: none"> • Increase cutting speed and feed rate. • Select more positive rake chipbreaker. • Select tougher grade (use PVD coated insert). • Flood cutting zone with coolant.
<p>Fracture</p> 	<ul style="list-style-type: none"> • Improper selection of grade/ chipbreaker and /or cutting conditions. 	<ul style="list-style-type: none"> • Reduce feed rate. • Select tougher grade. • Select stronger chipbreaker. • make sure set-up is as rigid as possible.
<p>Thermal Cracking</p> 	<ul style="list-style-type: none"> • Extreme variation in cutting temperatures. • Interrupted cut. 	<ul style="list-style-type: none"> • Reduce feed rate. • Increase cutting speed. • Select stronger chipbreaker.

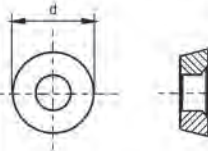
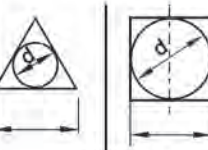
ISO NAMENCLATURE FOR INDEXABLE CARBIDE INSERTS

<table border="1"> <tr><td>A 85°</td><td></td></tr> <tr><td>B 82°</td><td></td></tr> <tr><td>K 55°</td><td></td></tr> <tr><td>H</td><td></td></tr> <tr><td>L 90°</td><td></td></tr> <tr><td>O</td><td></td></tr> <tr><td>P</td><td></td></tr> <tr><td>C 80°</td><td></td></tr> <tr><td>D 55°</td><td></td></tr> <tr><td>E 75°</td><td></td></tr> <tr><td>M 86°</td><td></td></tr> <tr><td>V 35°</td><td></td></tr> <tr><td>R -</td><td></td></tr> <tr><td>S 90°</td><td></td></tr> <tr><td>T 60°</td><td></td></tr> <tr><td>W 80°</td><td></td></tr> </table>	A 85°		B 82°		K 55°		H		L 90°		O		P		C 80°		D 55°		E 75°		M 86°		V 35°		R -		S 90°		T 60°		W 80°		 <table border="1"> <thead> <tr><th></th><th>a</th></tr> </thead> <tbody> <tr><td>A</td><td>3°</td></tr> <tr><td>B</td><td>5°</td></tr> <tr><td>C</td><td>7°</td></tr> <tr><td>D</td><td>15°</td></tr> <tr><td>E</td><td>20°</td></tr> <tr><td>F</td><td>25°</td></tr> <tr><td>G</td><td>30°</td></tr> <tr><td>N</td><td>0°</td></tr> <tr><td>P</td><td>11°</td></tr> <tr><td>O</td><td>Others</td></tr> </tbody> </table>		a	A	3°	B	5°	C	7°	D	15°	E	20°	F	25°	G	30°	N	0°	P	11°	O	Others	<table border="1"> <thead> <tr> <th></th> <th>(± mm)</th> <th>(± mm)</th> <th>(± mm)</th> </tr> </thead> <tbody> <tr><td>A</td><td>0,025</td><td>0,005</td><td>0,025</td></tr> <tr><td>C</td><td>0,025</td><td>0,013</td><td>0,025</td></tr> <tr><td>E</td><td>0,025</td><td>0,025</td><td>0,025</td></tr> <tr><td>F</td><td>0,013</td><td>0,005</td><td>0,025</td></tr> <tr><td>G</td><td>0,025</td><td>0,025</td><td>0,130</td></tr> <tr><td>H</td><td>0,013</td><td>0,013</td><td>0,025</td></tr> <tr><td>J</td><td>0,050</td><td>0,05</td><td>0,025</td></tr> <tr><td></td><td>0,080</td><td>0,05</td><td>0,025</td></tr> <tr><td></td><td>0,100</td><td>0,05</td><td>0,025</td></tr> <tr><td>K</td><td>0,050</td><td>0,013</td><td>0,025</td></tr> <tr><td></td><td>0,080</td><td>0,013</td><td>0,025</td></tr> <tr><td></td><td>0,100</td><td>0,013</td><td>0,025</td></tr> <tr><td>M</td><td>0,05</td><td>0,08</td><td>0,13</td></tr> <tr><td></td><td>0,08</td><td>0,13</td><td>0,13</td></tr> <tr><td></td><td>0,10</td><td>0,15</td><td>0,13</td></tr> <tr><td>N</td><td>0,05</td><td>0,08</td><td>0,025</td></tr> <tr><td></td><td>0,08</td><td>0,13</td><td>0,025</td></tr> <tr><td></td><td>0,10</td><td>0,15</td><td>0,025</td></tr> <tr><td>U</td><td>0,08</td><td>0,13</td><td>0,13</td></tr> <tr><td></td><td>0,13</td><td>0,20</td><td>0,13</td></tr> <tr><td></td><td>0,18</td><td>0,27</td><td>0,13</td></tr> </tbody> </table>		(± mm)	(± mm)	(± mm)	A	0,025	0,005	0,025	C	0,025	0,013	0,025	E	0,025	0,025	0,025	F	0,013	0,005	0,025	G	0,025	0,025	0,130	H	0,013	0,013	0,025	J	0,050	0,05	0,025		0,080	0,05	0,025		0,100	0,05	0,025	K	0,050	0,013	0,025		0,080	0,013	0,025		0,100	0,013	0,025	M	0,05	0,08	0,13		0,08	0,13	0,13		0,10	0,15	0,13	N	0,05	0,08	0,025		0,08	0,13	0,025		0,10	0,15	0,025	U	0,08	0,13	0,13		0,13	0,20	0,13		0,18	0,27	0,13	<table border="1"> <tr><td>A</td><td></td><td></td></tr> <tr><td>C</td><td></td><td></td></tr> <tr><td>F</td><td></td><td></td></tr> <tr><td>G</td><td></td><td></td></tr> <tr><td>H</td><td></td><td></td></tr> <tr><td>J</td><td></td><td></td></tr> <tr><td>M</td><td></td><td></td></tr> <tr><td>N</td><td></td><td></td></tr> <tr><td>Q</td><td></td><td></td></tr> <tr><td>R</td><td></td><td></td></tr> <tr><td>T</td><td></td><td></td></tr> <tr><td>U</td><td></td><td></td></tr> <tr><td>W</td><td></td><td></td></tr> <tr><td>X</td><td colspan="2">special design</td></tr> </table>	A			C			F			G			H			J			M			N			Q			R			T			U			W			X	special design		 <table border="1"> <thead> <tr><th>d (mm)</th></tr> </thead> <tbody> <tr><td>06</td></tr> <tr><td>08</td></tr> <tr><td>10</td></tr> <tr><td>12</td></tr> <tr><td>16</td></tr> <tr><td>20</td></tr> <tr><td>25</td></tr> <tr><td>32</td></tr> </tbody> </table>  <table border="1"> <thead> <tr> <th rowspan="2">(mm)</th> <th colspan="3">d</th> </tr> <tr> <th>(inch)</th> <th>(mm)</th> <th>(mm)</th> </tr> </thead> <tbody> <tr><td>06</td><td>5/32</td><td>3.96</td><td>03</td></tr> <tr><td>09</td><td>7/32</td><td>5.55</td><td>05</td></tr> <tr><td>11</td><td>1/4</td><td>6.35</td><td>06</td></tr> <tr><td>16</td><td>3/8</td><td>9.52</td><td>09</td></tr> <tr><td>22</td><td>1/2</td><td>12.7</td><td>12</td></tr> <tr><td>27</td><td>5/8</td><td>15.8</td><td>15</td></tr> <tr><td>33</td><td>3/4</td><td>19.0</td><td>19</td></tr> <tr><td>44</td><td>1</td><td>25.4</td><td>25</td></tr> </tbody> </table>	d (mm)	06	08	10	12	16	20	25	32	(mm)	d			(inch)	(mm)	(mm)	06	5/32	3.96	03	09	7/32	5.55	05	11	1/4	6.35	06	16	3/8	9.52	09	22	1/2	12.7	12	27	5/8	15.8	15	33	3/4	19.0	19	44	1	25.4	25
A 85°																																																																																																																																																																																																																																												
B 82°																																																																																																																																																																																																																																												
K 55°																																																																																																																																																																																																																																												
H																																																																																																																																																																																																																																												
L 90°																																																																																																																																																																																																																																												
O																																																																																																																																																																																																																																												
P																																																																																																																																																																																																																																												
C 80°																																																																																																																																																																																																																																												
D 55°																																																																																																																																																																																																																																												
E 75°																																																																																																																																																																																																																																												
M 86°																																																																																																																																																																																																																																												
V 35°																																																																																																																																																																																																																																												
R -																																																																																																																																																																																																																																												
S 90°																																																																																																																																																																																																																																												
T 60°																																																																																																																																																																																																																																												
W 80°																																																																																																																																																																																																																																												
	a																																																																																																																																																																																																																																											
A	3°																																																																																																																																																																																																																																											
B	5°																																																																																																																																																																																																																																											
C	7°																																																																																																																																																																																																																																											
D	15°																																																																																																																																																																																																																																											
E	20°																																																																																																																																																																																																																																											
F	25°																																																																																																																																																																																																																																											
G	30°																																																																																																																																																																																																																																											
N	0°																																																																																																																																																																																																																																											
P	11°																																																																																																																																																																																																																																											
O	Others																																																																																																																																																																																																																																											
	(± mm)	(± mm)	(± mm)																																																																																																																																																																																																																																									
A	0,025	0,005	0,025																																																																																																																																																																																																																																									
C	0,025	0,013	0,025																																																																																																																																																																																																																																									
E	0,025	0,025	0,025																																																																																																																																																																																																																																									
F	0,013	0,005	0,025																																																																																																																																																																																																																																									
G	0,025	0,025	0,130																																																																																																																																																																																																																																									
H	0,013	0,013	0,025																																																																																																																																																																																																																																									
J	0,050	0,05	0,025																																																																																																																																																																																																																																									
	0,080	0,05	0,025																																																																																																																																																																																																																																									
	0,100	0,05	0,025																																																																																																																																																																																																																																									
K	0,050	0,013	0,025																																																																																																																																																																																																																																									
	0,080	0,013	0,025																																																																																																																																																																																																																																									
	0,100	0,013	0,025																																																																																																																																																																																																																																									
M	0,05	0,08	0,13																																																																																																																																																																																																																																									
	0,08	0,13	0,13																																																																																																																																																																																																																																									
	0,10	0,15	0,13																																																																																																																																																																																																																																									
N	0,05	0,08	0,025																																																																																																																																																																																																																																									
	0,08	0,13	0,025																																																																																																																																																																																																																																									
	0,10	0,15	0,025																																																																																																																																																																																																																																									
U	0,08	0,13	0,13																																																																																																																																																																																																																																									
	0,13	0,20	0,13																																																																																																																																																																																																																																									
	0,18	0,27	0,13																																																																																																																																																																																																																																									
A																																																																																																																																																																																																																																												
C																																																																																																																																																																																																																																												
F																																																																																																																																																																																																																																												
G																																																																																																																																																																																																																																												
H																																																																																																																																																																																																																																												
J																																																																																																																																																																																																																																												
M																																																																																																																																																																																																																																												
N																																																																																																																																																																																																																																												
Q																																																																																																																																																																																																																																												
R																																																																																																																																																																																																																																												
T																																																																																																																																																																																																																																												
U																																																																																																																																																																																																																																												
W																																																																																																																																																																																																																																												
X	special design																																																																																																																																																																																																																																											
d (mm)																																																																																																																																																																																																																																												
06																																																																																																																																																																																																																																												
08																																																																																																																																																																																																																																												
10																																																																																																																																																																																																																																												
12																																																																																																																																																																																																																																												
16																																																																																																																																																																																																																																												
20																																																																																																																																																																																																																																												
25																																																																																																																																																																																																																																												
32																																																																																																																																																																																																																																												
(mm)	d																																																																																																																																																																																																																																											
	(inch)	(mm)	(mm)																																																																																																																																																																																																																																									
06	5/32	3.96	03																																																																																																																																																																																																																																									
09	7/32	5.55	05																																																																																																																																																																																																																																									
11	1/4	6.35	06																																																																																																																																																																																																																																									
16	3/8	9.52	09																																																																																																																																																																																																																																									
22	1/2	12.7	12																																																																																																																																																																																																																																									
27	5/8	15.8	15																																																																																																																																																																																																																																									
33	3/4	19.0	19																																																																																																																																																																																																																																									
44	1	25.4	25																																																																																																																																																																																																																																									
C	N	M	G	12																																																																																																																																																																																																																																								
Shape	Clearance angle	Tolerance	Type of inserts	Length of cutting edge																																																																																																																																																																																																																																								

 <p>01 S=1,59 T1 S=1,98 02 S=2,38 03 S=3,18 T3 S=3,97 04 S=4,76 05 S=5,56 06 S=6,35 07 S=7,94 09 S=9,52</p>	 <table border="1" data-bbox="462 765 566 1110"> <thead> <tr> <th></th> <th>R (mm)</th> </tr> </thead> <tbody> <tr><td>02</td><td>0,2</td></tr> <tr><td>04</td><td>0,4</td></tr> <tr><td>05</td><td>0,5</td></tr> <tr><td>08</td><td>0,8</td></tr> <tr><td>12</td><td>1,2</td></tr> <tr><td>16</td><td>1,6</td></tr> <tr><td>20</td><td>2,0</td></tr> <tr><td>24</td><td>2,4</td></tr> <tr><td>32</td><td>3,2</td></tr> </tbody> </table> <p>MO: round insert</p>		R (mm)	02	0,2	04	0,4	05	0,5	08	0,8	12	1,2	16	1,6	20	2,0	24	2,4	32	3,2	<p>F Sharp</p> <p>E Rounded</p> <p>T Chamfered</p> <p>S Chamfered and Rounded</p>	<p>Right</p> <p>Left</p> <p>Right and Left</p>	<p>Chipbreaker</p> <p>NPF NPM NPR MSF NMF NMM NTM NTR</p>
	R (mm)																							
02	0,2																							
04	0,4																							
05	0,5																							
08	0,8																							
12	1,2																							
16	1,6																							
20	2,0																							
24	2,4																							
32	3,2																							
<p>04</p>	<p>04</p>	<p>E</p>	<p>N</p>	<p>NPF</p>																				
<p>Height of cutting edge</p>	<p>Corner radius</p>	<p>Cutting edge preparation</p>	<p>Hand of tool</p>	<p>Defined by the manufacturer</p>																				

INSERT TECHNICAL INFORMATION

Insert selection guide

Step 1: Choose workpiece material (ISO P/steel, ISO M/stainless steel, ISO K/cast iron, ISO N/aluminum alloys, ISO S/heat resistant alloys, ISO H/hardened steel)

Step 2: Choose type of application (turning, parting&grooving, milling , drilling).

Step 3: Choose a grade based on machining conditions(good, average or difficult conditions).

Step 4: Chosse a geometry based on operation(finishing/light, medium, roughing/heavy).

Description of Harlingen Carbide Grades

ISO	P					M				K				
	High		Medium		Low	High	Medium	Low	High	Medium		Low		
Cutting speeds	P01	P10	P20	P30	P40	M10	M20	M30	M40	K01	K10	K20	K30	K40
Turning insert with coating			HC2115									HC3215		
				HC2125			HP1215							
				HC2025										

P steel:

HC2025 Toughness and wear resistance. It is wide range applicative and suitable for semi-finishing and finishing ISO P material.

HC2115 Adopted with thick TiCN and thick Al₂O₃ coating, HC2115 is the best option for semi-finishing and finishing ISO P material, and optimized for impact resistance and wear resistance.

Contracting with prime grade, the cutting speed can be increased over 25% and the flank wear can be decreased 30% in same cutting speed.

HC2125 Adopted with thick TiCN and thick Al₂O₃ coating, HC2125 is optimized for blade intensity and resisting plastic deformation. It is the preferred option in roughing/medium finishing ISO P material.

HC2125 can be worked stably in high removal rate cutting parameters and serious work conditions. Besides, it's qualified in cutting without cutting fluid. In addition, the cutting speed can be increased over 25% in same cutting condition meanwhile tool life can be extended 50% in the same cutting speed.











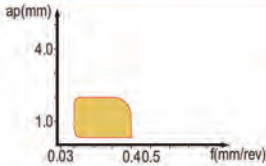

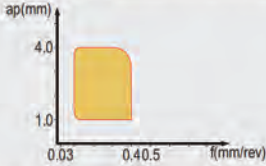

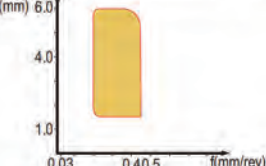

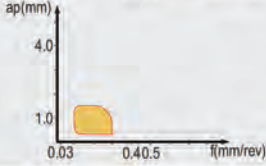
M stainless steel

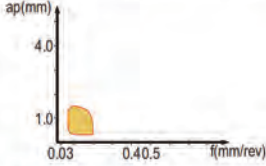
HP1215 The highly hard substrate combines both favorable shock resistance and blade security. Used PVD coating with excellent versatility, it is preferred in interrupted turning and milling stainless steel.

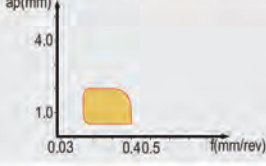
K cast iron

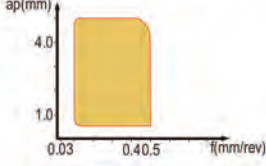
HC3215 The medium-coarse substrate has high strength and toughness, columnar textured MT-TiCN and α -Al₂O₃ CVD coating has excellent adhesion between the coating and substrate. After coating treatment, optimized extremely smooth coating surface, reduce the surface stress and cutting resistance. Suitable for continue and slight interrupt cast iron cutting at medium to high velocity due to perfect universality.

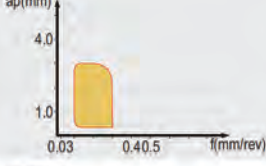
Chipbreaker for turning

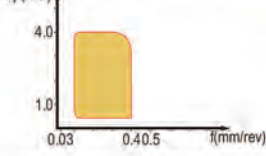
Chip breaker	Application range	High lights
 <p>NPF</p>		<p>For finish machining of steel. Cutting depth = 0.3mm-2.0mm, Feed = 0.2mm/r(0.1-0.4)</p>
 <p>NPM</p>		<p>For semi-finish machining of steel. Cutting depth = 1.0mm-4.0mm, Feed = 0.2mm/r(0.1-0.4)</p>
 <p>NPR</p>		<p>For rough machining of steel. Cutting depth = 1.5mm-6mm, Feed = 0.3mm/r(0.2-0.45)</p>
 <p>MSF</p>		<p>For finish machining of stainless steel. Cutting depth = 0.2mm-1.5mm, Feed = 0.15mm/r(0.1-0.3)</p>
 <p>NMF</p>		<p>For finish machining of stainless steel. Cutting depth = 0.2mm-1.5mm, Feed = 0.1mm/r(0.05-0.2)</p>
 <p>NMM</p>		<p>For semi-finish machining of stainless steel. Cutting depth = 0.5mm-2.0mm, Feed = 0.2mm/r(0.15-0.4)</p>
 <p>PLAIN</p>		<p>For semi-finishing to roughing of cast iron. Cutting depth = 0.5mm-5.0mm, Feed = 0.3mm/r(0.1-0.5)</p>
 <p>NTM</p>		<p>Semi-finishing for stainless steel, steel and cast iron. Cutting depth = 0.3mm-3.0mm, Feed = 0.15mm/r(0.1-0.3)</p>
 <p>NTR</p>		<p>Roughing for steel and cast iron. Cutting depth = 0.5mm-4.0mm, Feed = 0.2mm/r(0.1-0.4)</p>

Cutting Data recommendations for turning

Workpiece material	Alloy treatment and status		Hardness (HB)	Cutting speed Vc(m/min)						
				HC2115	HC2125	HC2025	HP1215	HC3215	HK434	
P	Mild steel	annealed	<=0.15%C	125						
		annealed	0.15%-0.45%C	150-250		330m/min (200-400)				
		tempered	>=0.45%	300						
	Lower alloy steel	annealed		180						
		annealed		250-300	380m/min (220-480)					
		tempered		350						
	Higher alloy steel	annealed		200			310m/min (190-390)			
tempered			350							
M	Stainless steel	annealed	ferritic/martensitic	200						
		quenching	austenitic	180				180m/min (140-260)		
		quenching	duplex	230-260						
		quenching	austenitic/austenitic	330						
K	Grey cast iron		pearlitic/ferritic	180					450m/min (300-500)	
			pearlitic/ferritic	260						
	Nodular cast iron		ferritic	160					260m/min (200-420)	
			pearlitic	250						
	Malleable cast iron		ferritic	130					260m/min (200-420)	
			pearlitic	230						
N	Alu. forging alloy	no hardened		60						
		hardened		100						
	Alu. casting alloy	no hardened	<12%Si	80						
		hardened	<12%Si	90						
		no hardened	>12%Si	130						600m/min (400-1200)
	Copper and copper alloy	brass		-						
		bronze		90						
	Non metallic material	thermoset		100						
		fiber reinforced plastic		-						
ebonite			-							

CNMG

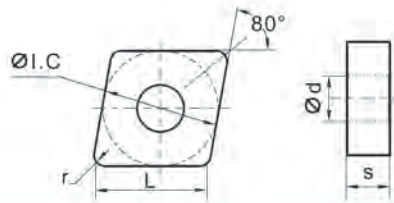

Order No.	Application	Model	Chip Breaker	Grade	Dimensions(mm)					Photos
					L	I.C	S	d	r	
311-01-001	finishing of steel.	CNMG120404	NPF	HC2115	12.9	12.7	4.76	5.16	0.4	
311-01-002	finishing of steel.	CNMG120408	NPF	HC2115	12.9	12.7	4.76	5.16	0.8	
312-01-001	semi-finishing of steel	CNMG120404	NPM	HC2115	12.9	12.7	4.76	5.16	0.4	
312-01-002	semi-finishing of steel	CNMG120408	NPM	HC2115	12.9	12.7	4.76	5.16	0.8	
312-01-003	semi-finishing of steel	CNMG120412	NPM	HC2115	12.9	12.7	4.76	5.16	1.2	
312-01-004	semi-finishing of steel	CNMG160608	NPM	HC2115	16.1	15.875	6.35	6.35	0.8	
312-01-005	semi-finishing of steel	CNMG160612	NPM	HC2115	16.1	15.875	6.35	6.35	1.2	
312-01-006	semi-finishing of steel	CNMG160616	NPM	HC2115	16.1	15.875	6.35	6.35	1.6	
312-01-007	semi-finishing of steel	CNMG190608	NPM	HC2115	19.3	19.05	6.35	7.94	0.8	
312-01-008	semi-finishing of steel	CNMG190612	NPM	HC2115	19.3	19.05	6.35	7.94	1.2	
312-01-009	semi-finishing of steel	CNMG190616	NPM	HC2115	19.3	19.05	6.35	7.94	1.6	
313-01-001	roughing of steel	CNMG120408	NPR	HC2025	12.9	12.7	4.76	5.16	0.8	
313-01-002	roughing of steel	CNMG120412	NPR	HC2025	12.9	12.7	4.76	5.16	1.2	
313-01-003	roughing of steel	CNMG120416	NPR	HC2025	12.9	12.7	4.76	5.16	1.6	
313-01-004	roughing of steel	CNMG160608	NPR	HC2025	16.1	15.875	6.35	6.35	0.8	
313-01-005	roughing of steel	CNMG160612	NPR	HC2025	16.1	15.875	6.35	6.35	1.2	
313-01-006	roughing of steel	CNMG160616	NPR	HC2025	16.1	15.875	6.35	6.35	1.6	
313-01-007	roughing of steel	CNMG190608	NPR	HC2025	19.3	19.05	6.35	7.94	0.8	
313-01-008	roughing of steel	CNMG190612	NPR	HC2025	19.3	19.05	6.35	7.94	1.2	
313-01-009	roughing of steel	CNMG190616	NPR	HC2025	19.3	19.05	6.35	7.94	1.6	
321-01-001	finishing of stainless steel.	CNMG090304	MSF	HP1215	9.7	9.525	3.18	3.81	0.4	
321-01-002	finishing of stainless steel.	CNMG120404	MSF	HP1215	12.9	12.7	4.76	5.16	0.4	
321-01-003	finishing of stainless steel.	CNMG120404	NMF	HP1215	12.9	12.7	4.76	5.16	0.4	
321-01-004	finishing of stainless steel.	CNMG120408	NMF	HP1215	12.9	12.7	4.76	5.16	0.8	
322-01-001	semi-finishing of stainless steel	CNMG120404	NMM	HP1215	12.9	12.7	4.76	5.16	0.4	
322-01-002	semi-finishing of stainless steel	CNMG120408	NMM	HP1215	12.9	12.7	4.76	5.16	0.8	
322-01-003	semi-finishing of stainless steel	CNMG160608	NMM	HP1215	16.1	15.875	6.35	6.35	0.8	
335-01-001	semi-finishing to roughing of cast iron	CNMG120404	-	HC3215	12.9	12.7	4.76	5.16	0.4	
335-01-002	semi-finishing to roughing of cast iron	CNMG120408	-	HC3215	12.9	12.7	4.76	5.16	0.8	
335-01-003	semi-finishing to roughing of cast iron	CNMG120412	-	HC3215	12.9	12.7	4.76	5.16	1.2	
335-01-004	semi-finishing to roughing of cast iron	CNMG160608	-	HC3215	16.1	15.875	6.35	6.35	0.8	
335-01-005	semi-finishing to roughing of cast iron	CNMG160612	-	HC3215	16.1	15.875	6.35	6.35	1.2	
335-01-006	semi-finishing to roughing of cast iron	CNMG160616	-	HC3215	16.1	15.875	6.35	6.35	1.6	
335-01-007	semi-finishing to roughing of cast iron	CNMG190608	-	HC3215	19.3	19.05	6.35	7.94	0.8	
335-01-008	semi-finishing to roughing of cast iron	CNMG190612	-	HC3215	19.3	19.05	6.35	7.94	1.2	
335-01-009	semi-finishing to roughing of cast iron	CNMG190616	-	HC3215	19.3	19.05	6.35	7.94	1.6	

DNMG

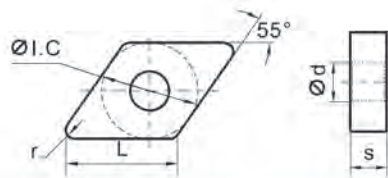

Order No.	Application	Model	Chip Breaker	Grade	Dimensions(mm)					Photos
					L	I.C.	S	d	r	
311-02-001	finishing of steel.	DNMG150404	NPF	HC2115	15.5	12.7	4.76	5.16	0.4	
311-02-002	finishing of steel.	DNMG150408	NPF	HC2115	15.5	12.7	4.76	5.16	0.8	
311-02-003	finishing of steel.	DNMG150604	NPF	HC2115	15.5	12.7	6.35	5.16	0.4	
311-02-004	finishing of steel.	DNMG150608	NPF	HC2115	15.5	12.7	6.35	5.16	0.8	
312-02-001	semi-finishing of steel	DNMG110404	NPM	HC2115	11.6	9.525	4.76	3.81	0.4	
312-02-002	semi-finishing of steel	DNMG110408	NPM	HC2115	11.6	9.525	4.76	3.81	0.8	
312-02-003	semi-finishing of steel	DNMG110412	NPM	HC2115	11.6	9.525	4.76	3.81	1.2	
312-02-004	semi-finishing of steel	DNMG150404	NPM	HC2115	15.5	12.7	4.76	5.16	0.4	
312-02-005	semi-finishing of steel	DNMG150408	NPM	HC2115	15.5	12.7	4.76	5.16	0.8	
312-02-006	semi-finishing of steel	DNMG150412	NPM	HC2115	15.5	12.7	4.76	5.16	1.2	
312-02-007	semi-finishing of steel	DNMG150604	NPM	HC2115	15.5	12.7	6.35	5.16	0.4	
312-02-008	semi-finishing of steel	DNMG150608	NPM	HC2115	15.5	12.7	6.35	5.16	0.8	
312-02-009	semi-finishing of steel	DNMG150612	NPM	HC2115	15.5	12.7	6.35	5.16	1.2	
313-02-001	roughing of steel	DNMG150412	NPR	HC2025	15.5	12.7	4.76	5.16	1.2	
313-02-002	roughing of steel	DNMG150608	NPR	HC2025	15.5	12.7	6.35	5.16	0.8	
313-02-003	roughing of steel	DNMG150612	NPR	HC2025	15.5	12.7	6.35	5.16	1.2	
313-02-004	roughing of steel	DNMG150616	NPR	HC2025	15.5	12.7	6.35	5.16	1.6	
321-02-001	finishing of stainless steel.	DNMG110404	MSF	HP1215	11.6	9.525	4.76	3.81	0.4	
321-02-002	finishing of stainless steel.	DNMG150404	MSF	HP1215	15.5	12.7	4.76	5.16	0.4	
321-02-003	finishing of stainless steel.	DNMG150604	NMF	HP1215	15.5	12.7	6.35	5.16	0.4	
321-02-004	finishing of stainless steel.	DNMG150608	NMF	HP1215	15.5	12.7	6.35	5.16	0.8	
322-02-001	semi-finishing of stainless steel	DNMG110404	NMM	HP1215	11.6	9.525	4.76	3.81	0.4	
322-02-002	semi-finishing of stainless steel	DNMG110408	NMM	HP1215	11.6	9.525	4.76	3.81	0.8	
322-02-003	semi-finishing of stainless steel	DNMG150604	NMM	HP1215	15.5	12.7	6.35	5.16	0.4	
322-02-004	semi-finishing of stainless steel	DNMG150608	NMM	HP1215	15.5	12.7	6.35	5.16	0.8	
322-02-005	semi-finishing of stainless steel	DNMG150612	NMM	HP1215	15.5	12.7	6.35	5.16	1.2	
335-02-001	semi-finishing to roughing of cast iron	DNMG110408	-	HC3215	11.6	9.525	4.76	3.81	0.8	
335-02-002	semi-finishing to roughing of cast iron	DNMG150404	-	HC3215	15.5	12.7	4.76	5.16	0.4	
335-02-003	semi-finishing to roughing of cast iron	DNMG150408	NPM	HC3215	15.5	12.7	4.76	5.16	0.8	
335-02-004	semi-finishing to roughing of cast iron	DNMG150608	-	HC3215	15.5	12.7	6.35	5.16	0.8	
335-02-005	semi-finishing to roughing of cast iron	DNMG150612	-	HC3215	15.5	12.7	6.35	5.16	1.2	

SNMG

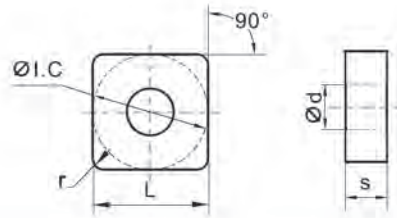

Order No.	Application	Model	Chip Breaker	Grade	Dimensions(mm)					Photos
					L	I.C	S	d	r	
311-03-001	finishing of steel.	SNMG 120404	NPF	HC2115	12.7	12.7	4.76	5.16	0.4	
311-03-002	finishing of steel.	SNMG 120408	NPF	HC2115	12.7	12.7	4.76	5.16	0.8	
312-03-001	semi-finishing of steel	SNMG 120404	NPM	HC2115	12.7	12.7	4.76	5.16	0.4	
312-03-002	semi-finishing of steel	SNMG 120408	NPM	HC2115	12.7	12.7	4.76	5.16	0.8	
312-03-003	semi-finishing of steel	SNMG 120412	NPM	HC2115	12.7	12.7	4.76	5.16	1.2	
312-03-004	semi-finishing of steel	SNMG 150608	NPM	HC2115	15.9	15.9	6.35	6.35	0.8	
312-03-005	semi-finishing of steel	SNMG 150612	NPM	HC2115	15.9	15.9	6.35	6.35	1.2	
312-03-006	semi-finishing of steel	SNMG 190612	NPM	HC2115	19.1	19.1	6.35	7.94	1.2	
313-03-001	roughing of steel	SNMG 120408	NPR	HC2025	12.7	12.7	4.76	5.16	0.4	
313-03-002	roughing of steel	SNMG 120412	NPR	HC2025	12.7	12.7	4.76	5.16	0.8	
313-03-003	roughing of steel	SNMG 150612	NPR	HC2025	15.9	15.9	6.35	6.35	1.2	
313-03-004	roughing of steel	SNMG 150616	NPR	HC2025	15.9	15.9	6.35	6.35	1.6	
313-03-005	roughing of steel	SNMG 190612	NPR	HC2025	19.1	19.1	6.35	7.94	1.2	
313-03-006	roughing of steel	SNMG 190616	NPR	HC2025	19.1	19.1	6.35	7.94	1.6	
321-03-001	finishing of stainless steel.	SNMG 120408	NMF	HP1215	12.7	12.7	4.76	5.16	0.8	
322-03-001	semi-finishing of stainless steel	SNMG 120404	NMM	HP1215	12.7	12.7	4.76	5.16	0.4	
322-03-002	semi-finishing of stainless steel	SNMG 120408	NMM	HP1215	12.7	12.7	4.76	5.16	0.8	
322-03-003	semi-finishing of stainless steel	SNMG 120412	NMM	HP1215	12.7	12.7	4.76	5.16	1.2	
322-03-004	semi-finishing of stainless steel	SNMG 150608	NMM	HP1215	15.9	15.9	6.35	6.35	0.8	
335-03-001	semi-finishing to roughing of cast iron	SNMG090304	-	HC3215	9.525	9.525	3.18	3.81	0.4	
335-03-002	semi-finishing to roughing of cast iron	SNMG090308	-	HC3215	9.525	9.525	3.18	3.81	0.8	
335-03-003	semi-finishing to roughing of cast iron	SNMG 120404	-	HC3215	12.7	12.7	4.76	5.16	0.4	
335-03-004	semi-finishing to roughing of cast iron	SNMG 120408	-	HC3215	12.7	12.7	4.76	5.16	0.8	
335-03-005	semi-finishing to roughing of cast iron	SNMG 120412	-	HC3215	12.7	12.7	4.76	5.16	1.2	
335-03-006	semi-finishing to roughing of cast iron	SNMG 150608	-	HC3215	15.9	15.9	6.35	6.35	0.8	
335-03-007	semi-finishing to roughing of cast iron	SNMG 150612	-	HC3215	15.9	15.9	6.35	6.35	1.2	
335-03-008	semi-finishing to roughing of cast iron	SNMG190612	-	HC3215	19.1	19.1	6.35	7.94	1.2	
335-03-009	semi-finishing to roughing of cast iron	SNMG190616	-	HC3215	19.1	19.1	6.35	7.94	1.6	
335-03-010	semi-finishing to roughing of cast iron	SNMG250724	-	HC3215	25.4	25.4	7.94	9.12	2.4	
335-03-011	semi-finishing to roughing of cast iron	SNMG250924	-	HC3215	25.4	25.4	9.525	9.12	2.4	

TNMG

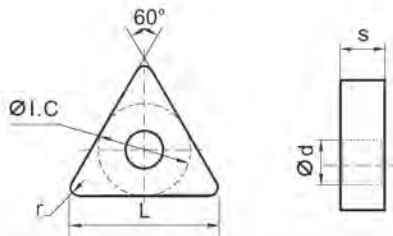

Order No.	Application	Model	Chip Breaker	Grade	Dimensions(mm)					Photos
					L	I.C	S	d	r	
311-04-001	finishing of steel.	TNMG 160404	NPF	HC2115	16.5	9.525	4.76	3.81	0.4	
311-04-002	finishing of steel.	TNMG 160408	NPF	HC2115	16.5	9.525	4.76	3.81	0.8	
312-04-001	semi-finishing of steel	TNMG 160404	NPM	HC2115	16.5	9.525	4.76	3.81	0.4	
312-04-002	semi-finishing of steel	TNMG 160408	NPM	HC2115	16.5	9.525	4.76	3.81	0.8	
312-04-003	semi-finishing of steel	TNMG 160412	NPM	HC2115	16.5	9.525	4.76	3.81	1.2	
312-04-004	semi-finishing of steel	TNMG 220404	NPM	HC2115	22	12.7	4.76	5.16	0.4	
312-04-005	semi-finishing of steel	TNMG 220408	NPM	HC2115	22	12.7	4.76	5.16	0.8	
312-04-006	semi-finishing of steel	TNMG 220412	NPM	HC2115	22	12.7	4.76	5.16	1.2	
		TNMG 220416	NPM	HC2115	22	12.7	4.76	5.16	1.6	
313-04-001	roughing of steel	TNMG 160404	NPR	HC2025	16.5	9.525	4.76	3.81	0.4	
313-04-002	roughing of steel	TNMG 160408	NPR	HC2025	16.5	9.525	4.76	3.81	0.8	
313-04-003	roughing of steel	TNMG 160412	NPR	HC2025	16.5	9.525	4.76	3.81	1.2	
313-04-004	roughing of steel	TNMG 220412	NPR	HC2025	22	12.7	4.76	5.16	1.2	
313-04-005	roughing of steel	TNMG 220416	NPR	HC2025	22	12.7	4.76	5.16	1.6	
313-04-006	roughing of steel	TNMG 270612	NPR	HC2025	27.5	15.9	6.35	6.35	1.2	
321-04-001	finishing of stainless steel.	TNMG 160404	MSF	HP1215	16.5	9.525	4.76	3.81	0.4	
321-04-002	finishing of stainless steel.	TNMG 160404	NMF	HP1215	16.5	9.525	4.76	3.81	0.4	
321-04-003	finishing of stainless steel.	TNMG 160408	NMF	HP1215	16.5	9.525	4.76	3.81	0.8	
322-04-001	semi-finishing of stainless steel	TNMG 160404	NMM	HP1215	16.5	9.525	4.76	3.81	0.4	
322-04-002	semi-finishing of stainless steel	TNMG 160408	NMM	HP1215	16.5	9.525	4.76	3.81	0.8	
322-04-003	semi-finishing of stainless steel	TNMG 220404	NMM	HP1215	22	12.7	4.76	5.16	0.4	
322-04-004	semi-finishing of stainless steel	TNMG 220408	NMM	HP1215	22	12.7	4.76	5.16	0.8	
322-04-005	semi-finishing of stainless steel	TNMG 220412	NMM	HP1215	22	12.7	4.76	5.16	1.2	
335-04-001	semi-finishing to roughing of cast iron	TNMG 160404	-	HC3215	16.5	9.525	4.76	3.81	0.4	
335-04-002	semi-finishing to roughing of cast iron	TNMG 160408	-	HC3215	16.5	9.525	4.76	3.81	0.8	
335-04-003	semi-finishing to roughing of cast iron	TNMG 160412	-	HC3215	16.5	9.525	4.76	3.81	1.2	
335-04-004	semi-finishing to roughing of cast iron	TNMG 220408	-	HC3215	22	12.7	4.76	5.16	0.8	
335-04-005	semi-finishing to roughing of cast iron	TNMG 220412	-	HC3215	22	12.7	4.76	5.16	1.2	
335-04-006	semi-finishing to roughing of cast iron	TNMG 220416	-	HC3215	22	12.7	4.76	5.16	1.6	

VNMG

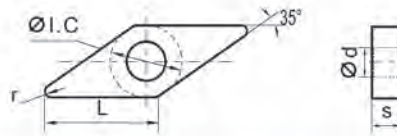

Order No.	Application	Model	Chip Breaker	Grade	Dimensions(mm)					Photos
					L	I.C	S	d	r	
311-05-001	finishing of steel.	VNMG160404	NPF	HC2115	16.6	9.525	4.76	3.81	0.4	
311-05-002	finishing of steel.	VNMG160408	NPF	HC2115	16.6	9.525	4.76	3.81	0.8	
312-05-001	semi-finishing of steel	VNMG160404	NPM	HC2115	16.6	9.525	4.76	3.81	0.4	
312-05-002	semi-finishing of steel	VNMG160408	NPM	HC2115	16.6	9.525	4.76	3.81	0.8	
312-05-003	semi-finishing of steel	VNMG160412	NPM	HC2115	16.6	9.525	4.76	3.81	1.2	
313-05-001	roughing of steel	VNMG160412	NPR	HC2125	16.6	9.525	4.76	3.81	1.2	
321-05-001	finishing of stainless steel.	VNMG160404	MSF	HP1215	16.6	9.525	4.76	3.81	0.4	
322-05-001	semi-finishing of stainless steel	VNMG160404	NMM	HP1215	16.6	9.525	4.76	3.81	0.4	
322-05-002	semi-finishing of stainless steel	VNMG160408	NMM	HP1215	16.6	9.525	4.76	3.81	0.8	
335-05-001	semi-finishing to roughing of cast iron	VNMG160404	-	HC3215	16.6	9.525	4.76	3.81	0.4	
335-05-002	semi-finishing to roughing of cast iron	VNMG160408	-	HC3215	16.6	9.525	4.76	3.81	0.8	

WNMG

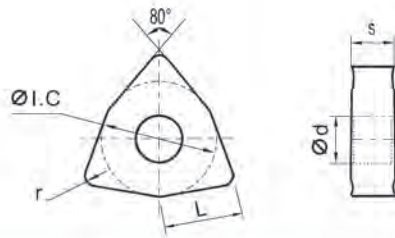

Order No.	Application	Model	Chip Breaker	Grade	Dimensions(mm)					Photos
					L	I.C	S	d	r	
311-06-001	finishing of steel.	WNMG060404	NPF	HC2115	6.5	9.525	4.76	3.81	0.4	
311-06-002	finishing of steel.	WNMG060408	NPF	HC2115	6.5	9.525	4.76	3.81	0.8	
311-06-003	finishing of steel.	WNMG080404	NPF	HC2115	8.7	12.7	4.76	5.16	0.4	
311-06-004	finishing of steel.	WNMG080408	NPF	HC2115	8.7	12.7	4.76	5.16	0.5	
312-06-001	semi-finishing of steel	WNMG060408	NPM	HC2115	6.5	9.525	4.76	3.81	0.8	
312-06-002	semi-finishing of steel	WNMG080404	NPM	HC2115	8.7	12.7	4.76	5.16	0.4	
312-06-003	semi-finishing of steel	WNMG080408	NPM	HC2115	8.7	12.7	4.76	5.16	0.5	
312-06-004	semi-finishing of steel	WNMG080412	NPM	HC2115	8.7	12.7	4.76	5.16	1.2	
313-06-001	roughing of steel	WNMG080408	NPR	HC2025	8.7	12.7	4.76	5.16	0.5	
313-06-002	roughing of steel	WNMG080412	NPR	HC2025	8.7	12.7	4.76	5.16	1.2	
321-06-001	finishing of stainless steel.	WNMG060404	MSF	HP1215	6.5	9.525	4.76	3.81	0.4	
321-06-002	finishing of stainless steel.	WNMG080404	MSF	HP1215	8.7	12.7	4.76	5.16	0.4	
321-06-003	finishing of stainless steel.	WNMG060408	NMF	HP1215	6.5	9.525	4.76	3.81	0.8	
321-06-004	finishing of stainless steel.	WNMG080404	NMF	HP1215	8.7	12.7	4.76	5.16	0.4	
321-06-005	finishing of stainless steel.	WNMG080408	NMF	HP1215	8.7	12.7	4.76	5.16	0.5	
322-06-001	semi-finishing of stainless steel	WNMG060408	NMM	HP1215	6.5	9.525	4.76	3.81	0.8	
322-06-002	semi-finishing of stainless steel	WNMG060412	NMM	HP1215	6.5	9.525	4.76	3.81	1.2	
322-06-003	semi-finishing of stainless steel	WNMG080404	NMM	HP1215	8.7	12.7	4.76	5.16	0.4	
322-06-004	semi-finishing of stainless steel	WNMG080408	NMM	HP1215	8.7	12.7	4.76	5.16	0.5	
335-06-001	semi-finishing to roughing of cast iron	WNMG080404	-	HC3215	8.7	12.7	4.76	5.16	0.4	
335-06-002	semi-finishing to roughing of cast iron	WNMG080408	-	HC3215	8.7	12.7	4.76	5.16	0.5	
335-06-003	semi-finishing to roughing of cast iron	WNMG080412	-	HC3215	8.7	12.7	4.76	5.16	1.2	

CCMT

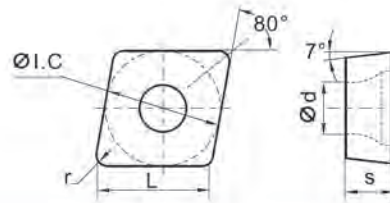

Order No.	Application	Model	Chip Breaker	Grade	Dimensions(mm)					Photos
					L	I.C	S	d	r	
311-07-001	finishing of steel.	CCMT060202	NTF	HC2115	6.4	6.35	2.38	2.8	0.2	
311-07-002	finishing of steel.	CCMT060204	NTF	HC2115	6.4	6.35	2.38	2.8	0.4	
311-07-003	finishing of steel.	CCMT09T304	NTF	HC2115	9.7	9.525	3.97	4.4	0.4	
311-07-004	finishing of steel.	CCMT09T308	NTF	HC2115	9.7	9.525	3.97	4.4	0.8	
311-07-005	finishing of steel.	CCMT120404	NTF	HC2115	12.9	12.7	4.76	5.56	0.4	
311-07-006	finishing of steel.	CCMT120408	NTF	HC2115	12.9	12.7	4.76	5.56	0.8	
312-07-001	semi-finishing of steel	CCMT060204	NTM	HC2115	6.4	6.35	2.38	2.8	0.4	
312-07-002	semi-finishing of steel	CCMT060208	NTM	HC2115	6.4	6.35	2.38	2.8	0.8	
312-07-003	semi-finishing of steel	CCMT09T304	NTM	HC2115	9.7	9.525	3.97	4.4	0.4	
312-07-004	semi-finishing of steel	CCMT09T308	NTM	HC2115	9.7	9.525	3.97	4.4	0.8	
312-07-005	semi-finishing of steel	CCMT120404	NTM	HC2115	12.9	12.7	4.76	5.56	0.4	
312-07-006	semi-finishing of steel	CCMT120408	NTM	HC2115	12.9	12.7	4.76	5.56	0.8	
313-07-001	roughing of steel	CCMT060208	NTR	HC2125	6.4	6.35	2.38	2.8	0.8	
313-07-002	roughing of steel	CCMT09T304	NTR	HC2125	9.7	9.525	3.97	4.4	0.4	
313-07-003	roughing of steel	CCMT09T308	NTR	HC2125	9.7	9.525	3.97	4.4	0.8	
313-07-004	roughing of steel	CCMT120408	NTR	HC2125	12.9	12.7	4.76	5.56	0.8	
313-07-005	roughing of steel	CCMT120412	NTR	HC2125	12.9	12.7	4.76	5.56	1.2	
321-07-001	finishing of stainless steel.	CCMT060202	NTF	HP1215	6.4	6.35	2.38	2.8	0.2	
321-07-002	finishing of stainless steel.	CCMT060204	NTF	HP1215	6.4	6.35	2.38	2.8	0.4	
321-07-003	finishing of stainless steel.	CCMT09T304	NTF	HP1215	9.7	9.525	3.97	4.4	0.4	
321-07-004	finishing of stainless steel.	CCMT09T308	NTF	HP1215	9.7	9.525	3.97	4.4	0.8	
321-07-005	finishing of stainless steel.	CCMT120404	NTF	HP1215	12.9	12.7	4.76	5.56	0.4	
321-07-006	finishing of stainless steel.	CCMT120408	NTF	HP1215	12.9	12.7	4.76	5.56	0.8	
322-07-001	semi-finishing of stainless steel	CCMT060204	NTM	HP1215	6.4	6.35	2.38	2.8	0.4	
322-07-002	semi-finishing of stainless steel	CCMT060208	NTM	HP1215	6.4	6.35	2.38	2.8	0.8	
322-07-003	semi-finishing of stainless steel	CCMT09T304	NTM	HP1215	9.7	9.525	3.97	4.4	0.4	
322-07-004	semi-finishing of stainless steel	CCMT09T308	NTM	HP1215	9.7	9.525	3.97	4.4	0.8	
322-07-005	semi-finishing of stainless steel	CCMT120404	NTM	HP1215	12.9	12.7	4.76	5.56	0.4	
322-07-006	semi-finishing of stainless steel	CCMT120408	NTM	HP1215	12.9	12.7	4.76	5.56	0.8	
335-07-001	semi-finishing to roughing of cast iron	CCMT060208	NTR	HC3215	6.4	6.35	2.38	2.8	0.8	
335-07-002	semi-finishing to roughing of cast iron	CCMT09T304	NTR	HC3215	9.7	9.525	3.97	4.4	0.4	
335-07-003	semi-finishing to roughing of cast iron	CCMT09T308	NTR	HC3215	9.7	9.525	3.97	4.4	0.8	
335-07-004	semi-finishing to roughing of cast iron	CCMT120408	NTR	HC3215	12.9	12.7	4.76	5.56	0.8	
335-07-005	semi-finishing to roughing of cast iron	CCMT120412	NTR	HC3215	12.9	12.7	4.76	5.56	1.2	

DCMT

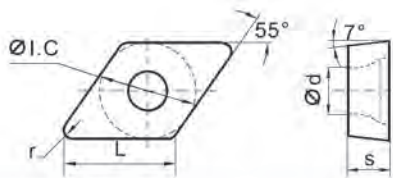

Order No.	Application	Model	Chip Breaker	Grade	Dimensions(mm)					Photos
					L	I.C	S	d	r	
311-08-001	finishing of steel.	DCMT070204	NTF	HC2115	7.8	6.35	2.38	2.8	0.4	
311-08-002	finishing of steel.	DCMT11T302	NTF	HC2115	11.6	9.525	3.97	4.4	0.2	
311-08-003	finishing of steel.	DCMT11T304	NTF	HC2115	11.6	9.525	3.97	4.4	0.4	
312-08-001	semi-finishing of steel	DCMT070204	NTM	HC2115	7.8	6.35	2.38	2.8	0.4	
312-08-002	semi-finishing of steel	DCMT070208	NTM	HC2115	7.8	6.35	2.38	2.8	0.8	
312-08-003	semi-finishing of steel	DCMT11T304	NTM	HC2115	11.6	9.525	3.97	4.4	0.4	
312-08-004	semi-finishing of steel	DCMT11T308	NTM	HC2115	11.6	9.525	3.97	4.4	0.8	
313-08-001	roughing of steel	DCMT11T304	NTR	HC2125	11.6	9.525	3.97	4.4	0.4	
313-08-002	roughing of steel	DCMT11T308	NTR	HC2125	11.6	9.525	3.97	4.4	0.8	
321-08-001	finishing of stainless steel.	DCMT070204	NTF	HP1215	7.8	6.35	2.38	2.8	0.4	
321-08-002	finishing of stainless steel.	DCMT11T302	NTF	HP1215	11.6	9.525	3.97	4.4	0.2	
321-08-003	finishing of stainless steel.	DCMT11T304	NTF	HP1215	11.6	9.525	3.97	4.4	0.4	
322-08-001	semi-finishing of stainless steel	DCMT070204	NTM	HP1215	7.8	6.35	2.38	2.8	0.4	
322-08-002	semi-finishing of stainless steel	DCMT070208	NTM	HP1215	7.8	6.35	2.38	2.8	0.8	
322-08-003	semi-finishing of stainless steel	DCMT11T304	NTM	HP1215	11.6	9.525	3.97	4.4	0.4	
322-08-004	semi-finishing of stainless steel	DCMT11T308	NTM	HP1215	11.6	9.525	3.97	4.4	0.8	
335-08-001	semi-finishing to roughing of cast iron	DCMT11T304	NTR	HC3215	11.6	9.525	3.97	4.4	0.4	
335-08-002	semi-finishing to roughing of cast iron	DCMT11T308	NTR	HC3215	11.6	9.525	3.97	4.4	0.8	

SCMT

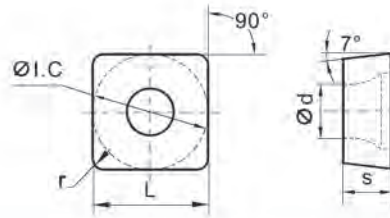

Order No.	Application	Model	Chip Breaker	Grade	Dimensions(mm)					Photos
					L	I.C	S	d	r	
311-09-001	finishing of steel.	SCMT09T304	NTF	HC2115	9.525	9.525	3.97	4.4	0.4	
311-09-002	finishing of steel.	SCMT09T308	NTF	HC2115	9.525	9.525	3.97	4.4	0.8	
311-09-003	finishing of steel.	SCMT120404	NTF	HC2115	12.7	12.7	4.76	5.56	0.4	
312-09-001	semi-finishing of steel	SCMT09T304	NTM	HC2115	9.525	9.525	3.97	4.4	0.4	
312-09-002	semi-finishing of steel	SCMT09T308	NTM	HC2115	9.525	9.525	3.97	4.4	0.8	
312-09-003	semi-finishing of steel	SCMT120404	NTM	HC2115	12.7	12.7	4.76	5.56	0.4	
312-09-004	semi-finishing of steel	SCMT120408	NTM	HC2115	12.7	12.7	4.76	5.56	0.8	
312-09-005	semi-finishing of steel	SCMT120412	NTM	HC2115	12.7	12.7	4.76	5.56	1.2	
313-09-001	roughing of steel	SCMT09T304	NTR	HC2125	9.525	9.525	3.97	4.4	0.4	
313-09-002	roughing of steel	SCMT09T308	NTR	HC2125	9.525	9.525	3.97	4.4	0.8	
313-09-003	roughing of steel	SCMT120404	NTR	HC2125	12.7	12.7	4.76	5.56	0.4	
313-09-004	roughing of steel	SCMT120408	NTR	HC2125	12.7	12.7	4.76	5.56	0.8	
313-09-005	roughing of steel	SCMT120412	NTR	HC2125	12.7	12.7	4.76	5.56	1.2	
321-09-001	semi-finishing to roughing of steel	SCMT09T304	-	HC2115	9.525	9.525	3.97	4.4	0.4	
321-09-002	semi-finishing to roughing of steel	SCMT120404	-	HC2115	12.7	12.7	4.76	5.56	0.4	
321-09-003	finishing of stainless steel.	SCMT09T304	NTF	HP1215	9.525	9.525	3.97	4.4	0.4	
321-09-004	finishing of stainless steel.	SCMT09T308	NTF	HP1215	9.525	9.525	3.97	4.4	0.8	
321-09-005	finishing of stainless steel.	SCMT120404	NTF	HP1215	12.7	12.7	4.76	5.56	0.4	
322-09-001	semi-finishing of stainless steel	SCMT09T304	NTM	HP1215	9.525	9.525	3.97	4.4	0.4	
322-09-002	semi-finishing of stainless steel	SCMT09T308	NTM	HP1215	9.525	9.525	3.97	4.4	0.8	
322-09-003	semi-finishing of stainless steel	SCMT120404	NTM	HP1215	12.7	12.7	4.76	5.56	0.4	
322-09-004	semi-finishing of stainless steel	SCMT120408	NTM	HP1215	12.7	12.7	4.76	5.56	0.8	
322-09-005	semi-finishing of stainless steel	SCMT120412	NTM	HP1215	12.7	12.7	4.76	5.56	1.2	
335-09-001	semi-finishing to roughing of cast iron	SCMT09T304	NTR	HC3215	9.525	9.525	3.97	4.4	0.4	
335-09-002	semi-finishing to roughing of cast iron	SCMT09T308	NTR	HC3215	9.525	9.525	3.97	4.4	0.8	
335-09-003	semi-finishing to roughing of cast iron	SCMT120404	NTR	HC3215	12.7	12.7	4.76	5.56	0.4	
335-09-004	semi-finishing to roughing of cast iron	SCMT120408	NTR	HC3215	12.7	12.7	4.76	5.56	0.8	
335-09-005	semi-finishing to roughing of cast iron	SCMT120412	NTR	HC3215	12.7	12.7	4.76	5.56	1.2	



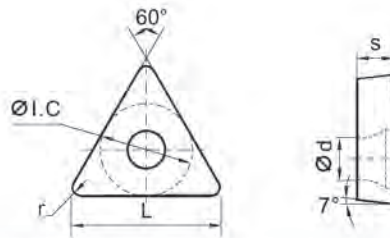



TCMT

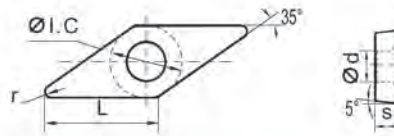

Order No.	Application	Model	Chip Breaker	Grade	Dimensions(mm)					Photos
					L	I.C	S	d	r	
311-10-001	finishing of steel.	TCMT110202	NTF	HC2115	11	6.35	2.38	2.8	0.2	
311-10-002	finishing of steel.	TCMT110204	NTF	HC2115	11	6.35	2.38	2.8	0.4	
311-10-003	finishing of steel.	TCMT16T304	NTF	HC2115	16.5	9.525	3.97	4.4	0.4	
311-10-004	finishing of steel.	TCMT16T308	NTF	HC2115	16.5	9.525	3.97	4.4	0.8	
312-10-001	semi-finishing of steel	TCMT090204	NTM	HC2115	9.6	5.56	2.38	2.5	0.4	
312-10-002	semi-finishing of steel	TCMT090208	NTM	HC2115	9.6	5.56	2.38	2.5	0.8	
312-10-003	semi-finishing of steel	TCMT110204	NTM	HC2115	11	6.35	2.38	2.8	0.4	
312-10-004	semi-finishing of steel	TCMT110208	NTM	HC2115	11	6.35	2.38	2.8	0.8	
312-10-005	semi-finishing of steel	TCMT16T304	NTM	HC2115	16.5	9.525	3.97	4.4	0.4	
312-10-006	semi-finishing of steel	TCMT16T308	NTM	HC2115	16.5	9.525	3.97	4.4	0.8	
312-10-007	semi-finishing of steel	TCMT16T312	NTM	HC2115	16.5	9.525	3.97	4.4	1.2	
313-10-001	roughing of steel	TCMT16T308	NTR	HC2125	16.5	9.525	3.97	4.4	0.8	
313-10-002	roughing of steel	TCMT220408	NTR	HC2125	22	12.7	4.76	5.5	0.8	
321-10-001	finishing of stainless steel.	TCMT110202	NTF	HP1215	11	6.35	2.38	2.8	0.2	
321-10-002	finishing of stainless steel.	TCMT110204	NTF	HP1215	11	6.35	2.38	2.8	0.4	
321-10-003	finishing of stainless steel.	TCMT16T304	NTF	HP1215	16.5	9.525	3.97	4.4	0.4	
321-10-004	finishing of stainless steel.	TCMT16T308	NTF	HP1215	16.5	9.525	3.97	4.4	0.8	
322-10-001	semi-finishing of stainless steel	TCMT090204	NTM	HP1215	9.6	5.56	2.38	2.5	0.4	
322-10-002	semi-finishing of stainless steel	TCMT090208	NTM	HP1215	9.6	5.56	2.38	2.5	0.8	
322-10-003	semi-finishing of stainless steel	TCMT110204	NTM	HP1215	11	6.35	2.38	2.8	0.4	
322-10-004	semi-finishing of stainless steel	TCMT110208	NTM	HP1215	11	6.35	2.38	2.8	0.8	
322-10-005	semi-finishing of stainless steel	TCMT16T304	NTM	HP1215	16.5	9.525	3.97	4.4	0.4	
322-10-006	semi-finishing of stainless steel	TCMT16T308	NTM	HP1215	16.5	9.525	3.97	4.4	0.8	
322-10-007	semi-finishing of stainless steel	TCMT16T312	NTM	HP1215	16.5	9.525	3.97	4.4	1.2	
335-10-001	semi-finishing to roughing of cast iron	TCMT16T308	NTR	HC3215	16.5	9.525	3.97	4.4	0.8	
335-10-002	semi-finishing to roughing of cast iron	TCMT220408	NTR	HC3215	22	12.7	4.76	5.5	0.8	

VBMT



Order No.	Application	Model	Chip Breaker	Grade	Dimensions(mm)					Photos
					L	I.C.	S	d	r	
311-11-001	finishing of steel.	VBMT 160404	NTF	HC2115	16.5	9.525	4.76	4.4	0.4	
311-11-002	finishing of steel.	VBMT 160408	NTF	HC2115	16.5	9.525	4.76	4.4	0.8	
312-11-001	semi-finishing of steel	VBMT 110304	NTM	HC2115	11	6.35	3.18	2.8	0.4	
312-11-002	semi-finishing of steel	VBMT 160404	NTM	HC2115	16.5	9.525	4.76	4.4	0.4	
312-11-003	semi-finishing of steel	VBMT 160408	NTM	HC2115	16.5	9.525	4.76	4.4	0.8	
312-11-004	semi-finishing of steel	VBMT 160412	NTM	HC2115	16.5	9.525	4.76	4.4	1.2	
313-11-001	roughing of steel	VBMT 160404	NTR	HC2125	16.5	9.525	4.76	4.4	0.4	
313-11-002	roughing of steel	VBMT 160408	NTR	HC2125	16.5	9.525	4.76	4.4	0.8	
321-11-001	finishing of stainless steel.	VBMT 160404	NTF	OP1215	16.5	9.525	4.76	4.4	0.4	
321-11-002	finishing of stainless steel.	VBMT 160408	NTF	OP1215	16.5	9.525	4.76	4.4	0.8	
322-11-001	semi-finishing of stainless steel	VBMT 110304	NTM	OP1215	11	6.35	3.18	2.8	0.4	
322-11-002	semi-finishing of stainless steel	VBMT 160404	NTM	OP1215	16.5	9.525	4.76	4.4	0.4	
322-11-003	semi-finishing of stainless steel	VBMT 160408	NTM	OP1215	16.5	9.525	4.76	4.4	0.8	
322-11-004	semi-finishing of stainless steel	VBMT 160412	NTM	OP1215	16.5	9.525	4.76	4.4	1.2	
335-11-001	semi-finishing to roughing of cast iron	VBMT 160404	NTR	HC3215	16.5	9.525	4.76	4.4	0.4	
335-11-002	semi-finishing to roughing of cast iron	VBMT 160408	NTR	HC3215	16.5	9.525	4.76	4.4	0.8	

VCMT

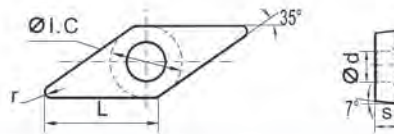

Order No.	Application	Model	Chip Breaker	Grade	Dimensions(mm)					Photos
					L	I.C	S	d	r	
311-12-001	finishing of steel.	VCMT110302	NTF	HC2115	11	6.35	3.18	2.8	0.2	
311-12-002	finishing of steel.	VCMT110304	NTF	HC2115	11	6.35	3.18	2.8	0.4	
311-12-003	finishing of steel.	VCMT160404	NTF	HC2115	16.6	9.525	4.76	3.81	0.4	
312-12-001	semi-finishing of steel	VCMT160404	NTM	HC2115	16.6	9.525	4.76	3.81	0.4	
312-12-002	semi-finishing of steel	VCMT160408	NTM	HC2115	16.6	9.525	4.76	3.81	0.8	
313-12-001	roughing of steel	VCMT160404	NTR	HC2125	16.6	9.525	4.76	3.81	0.4	
321-12-001	finishing of stainless steel.	VCMT110302	NTF	OP1215	11	6.35	3.18	2.8	0.2	
321-12-002	finishing of stainless steel.	VCMT110304	NTF	OP1215	11	6.35	3.18	2.8	0.4	
321-12-003	finishing of stainless steel.	VCMT160404	NTF	OP1215	16.6	9.525	4.76	3.81	0.4	

RCMT

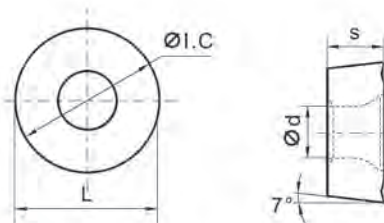

Order No.	Application	Model	Chip Breaker	Grade	Dimensions(mm)					Photos
					L	I.C	S	d	r	
315-13-001	semi-finishing to roughing of steel	RCMX0803MO	-	HC2125	8	8	3.18	3.36		
315-13-002	semi-finishing to roughing of steel	RCMX1003MO	-	HC2125						
315-13-003	semi-finishing to roughing of steel	RCMX1204MO	-	HC2125						
315-13-004	semi-finishing to roughing of steel	RCMT1606MO	-	HC2125	16	16	6.35	5.5		
325-13-001	semi-finishing to roughing of cast iron	RCMT0803MO	-	HC3215	8	8	3.18	3.36		
325-13-002	semi-finishing to roughing of cast iron	RCMX1003MO	-	HC3215						
325-13-003	semi-finishing to roughing of cast iron	RCMX1204MO	-	HC3215						
325-13-004	semi-finishing to roughing of cast iron	RCMT1606MO	-	HC3215	16	16	6.35	5.5		

Feature:

- Grade HK434 without coating: combined with extra micrograin tungsten carbide and cobalt powder, achieved fully density in internal organization by low pressure sintering. High hardness, high strength and good thermal conductivity fit for finishing to semi-finishing of non-ferrous and cast iron.
- Chipbreaker NL : suitable for aluminum and aluminum alloy material.

CCGX

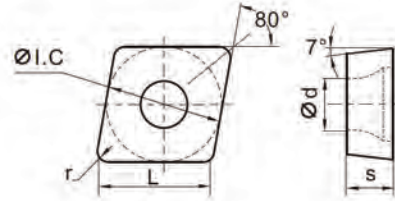

Order No.	Model	Chip Breaker	Grade	Dimensions(mm)				
				L	I.C	S	d	r
344-14-001	CCGX060202	NL	HK434	6.4	6.35	2.38	2.8	0.2
344-14-002	CCGX060204	NL	HK434	6.4	6.35	2.38	2.8	0.4
344-14-003	CCGX09T302	NL	HK434	9.7	9.525	3.97	4.4	0.2
344-14-004	CCGX09T304	NL	HK434	9.7	9.525	3.97	4.4	0.4
344-14-005	CCGX09T308	NL	HK434	9.7	9.525	3.97	4.4	0.8
344-14-006	CCGX120404	NL	HK434	12.9	12.7	4.76	5.56	0.4
344-14-007	CCGX120408	NL	HK434	12.9	12.7	4.76	5.56	0.8

DCGX

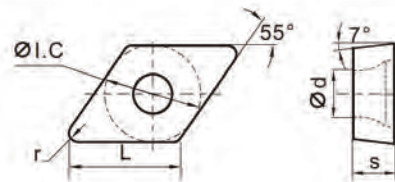

Order No.	Model	Chip Breaker	Grade	Dimensions(mm)				
				L	I.C	S	d	r
344-15-001	DCGX070202	NL	HK434	7.8	6.35	2.38	2.8	0.2
344-15-002	DCGX070204	NL	HK434	7.8	6.35	2.38	2.8	0.4
344-15-003	DCGX11T302	NL	HK434	11.6	9.525	3.97	4.4	0.2
344-15-004	DCGX11T304	NL	HK434	11.6	9.525	3.97	4.4	0.4
344-15-005	DCGX11T308	NL	HK434	11.6	9.525	3.97	4.4	0.8

SCGX

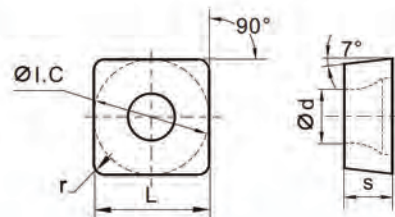
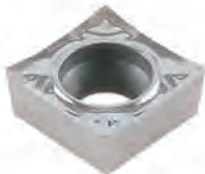

Order No.	Model	Chip Breaker	Grade	Dimensions(mm)				
				L	I.C	S	d	r
344-16-001	SCGX09T304	NL	HK434	9.525	9.525	3.97	4.4	0.2
344-16-002	SCGX09T308	NL	HK434	9.525	9.525	3.97	4.4	0.8
344-16-003	SCGX120408	NL	HK434	12.7	12.7	4.76	5.56	0.8

TURING POSITIVE INSERTS FOR ALUMINIUM

Feature:

- Grade HK434 without coating: combined with extra micrograin tungsten carbide and cobalt powder, achieved fully density in internal organization by low pressure sintering. High hardness, high strength and good thermal conductivity fit for finishing to semi-finishing of non-ferrous and cast iron.
- Chipbreaker NL : suitable for aluminum and aluminum alloy material.

TCGX

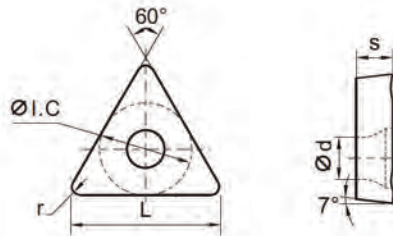

Order No.	Model	Chip Breaker	Grade	Dimensions(mm)				
				L	I.C	S	d	r
344-18-001	TCGX090204	NL	HK434	9.6	5.56	2.38	2.5	0.2
344-18-002	TCGX110202	NL	HK434	11	6.35	2.38	2.8	0.2
344-18-003	TCGX110204	NL	HK434	11	6.35	2.38	2.8	0.4
344-18-004	TCGX16T308	NL	HK434	16.5	9.525	3.97	4.4	0.8

VCGX

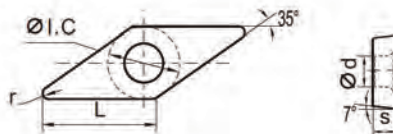

Order No.	Model	Chip Breaker	Grade	Dimensions(mm)				
				L	I.C	S	d	r
344-19-001	VCGX110302	NL	HK434	11	6.35	3.18	2.8	0.2
344-19-002	VCGX110304	NL	HK434	11	6.35	3.18	2.8	0.4
344-19-003	VCGX110308	NL	HK434	11	6.35	3.18	2.8	0.8
344-19-004	VCGX160402	NL	HK434	16.6	9.525	4.76	4.4	0.2
344-19-005	VCGX160404	NL	HK434	16.6	9.525	4.76	4.4	0.4
344-19-006	VCGX160408	NL	HK434	16.6	9.525	4.76	4.4	0.8
344-19-007	VCGX160412	NL	HK434	16.6	9.525	4.76	4.4	1.2
344-19-008	VCGX220530	NL	HK434	22	12.7	5.56	5.5	3

MILLING CUTTER

INDEXABLE FACE MILLS & CARBIDE INSERTS

127

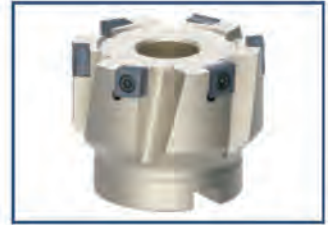

INDEXABLE END MILLS & CARBIDE INSERTS

138



INDEXABLE SIDE MILLING CUTTERS & CARBIDE INSERTS

142



INDEXABLE HELICAL MILLING CUTTER & CARBIDE INSERTS

147



SOLID CARBIDE END MILLS

148



HSS-Co8 SINGLE END MILLS

154



SQUARE SHOULDER INDEXABLE FACE MILLS FOR CNCQ INSERTS

Features:

- 90° major cutting angle.
- Radial and Axial run-out less than 0.02mm.
- Inserts to be hold by swiss SFS high strength screws.
- Made of quality alloy steel and hardness HRC45-HRC48.
- Big chip space for moving chip quickly and smoothly.
- Easy cutting due to big positive rake angel.
- Suitable for light to medium square shoulder milling.

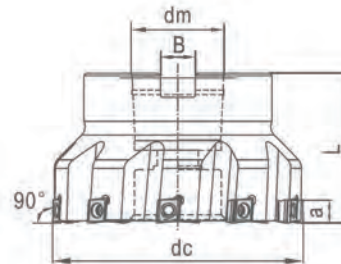
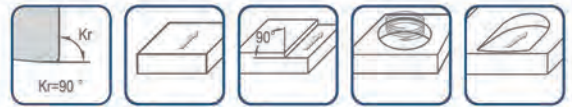

Order No.	Model	Size (mm)					No.of teeth	Insert	Forcing Screw	Screw	Torx wrench
		dc	dm	a	B	L					
231-54-001	FM90-50CN09.XDZ24	50	24	9	10	50	5	CNCQ090508	MS10035	C040A11S	WT15
231-54-002	FM90-63CN09.XDZ24	63	24	9	10	50	6	CNCQ090508	MS10035	C040A11S	WT15
231-54-003	FM90-80CN09.XDZ30	80	30	9	12	55	8	CNCQ090508	MS12045	C040A11S	WT15
231-54-004	FM90-100CN09.XDZ38	100	38	9	14	63	10	CNCQ090508	SXDZ38	C040A11S	WT15
231-54-005	FM90-125CN09.XDZ48	125	48	9	16	63	12	CNCQ090508	SXDZ48	C040A11S	WT15
231-54-006	FM90-80CN12.XDZ30	80	30	12	12	55	7	CNCQ120508	MS12045	C050A12S	WT20
231-54-007	FM90-100CN12.XDZ38	100	38	12	14	63	9	CNCQ120508	SXDZ38	C050A12S	WT20
231-54-008	FM90-125CN12.XDZ48	125	48	12	16	63	11	CNCQ120508	SXDZ48	C050A12S	WT20
231-54-009	FM90-160CN12.XDZ48	160	48	12	16	63	14	CNCQ120508	SXDZ48	C050A12S	WT20

Insert not included

Recommended cutting data:

Application	Finish cutting			Medium cutting			Rough cutting		
	Surface speed Vc(m/min)	Feed per tooth fz(mm)	Cutting depth ap(mm)	Surface speed Vc(m/min)	Feed per tooth fz(mm)	Cutting depth ap(mm)	Surface speed Vc(m/min)	Feed per tooth fz(mm)	Cutting depth ap(mm)
Steel	-	-	-	200-100	0.05-0.12	< α	120-60	0.15-0.2	< α
Stainless Steel	-	-	-	-	-	-	-	-	-
Cast iron	-	-	-	180-80	0.05-0.15	< α	150-80	0.15-0.2	< α
Non ferrous metal	-	-	-	< 2000	0.1-0.15	< α	< 2000	0.15-0.2	< α
High temperature alloy	-	-	-	-	-	-	-	-	-

SOLID CARBIDE INSERT CNCQ



Order No.	Model	Application	Grade	Size (mm)			
				d	s	d1	r
230-54-101	CNCQ090508NF	Steel	EP2220	9.525	5.56	4.4	0.8
230-54-102	CNCQ120508NF	Steel	EP2220	12.7	5.56	5.5	0.8
230-54-103	CNCQ090508NF	Cast iron	EP3215	9.525	5.56	4.4	0.8
230-54-104	CNCQ120508NF	Cast iron	EP3215	12.7	5.56	5.5	0.8

90° INDEXABLE FACE MILLS FOR APKT INSERTS

Features:

- 90° major cutting angle.
- Radial and Axial run-out less than 0.02mm.
- Inserts to be hold by swiss SFS high strength screws.
- Made of quality alloy steel and hardness HRC45-HRC48.
- High precision and high metal removal rate.
- Suitable for light to medium square shoulder milling.

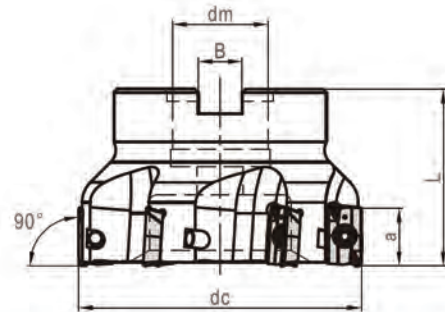
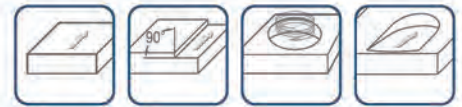

Order No.	Model	Size(mm)					No. of Teeth	Insert	Screw	Wrench	Weight (Kg)
		dc	dm	a	B	L					
231-59-001	FM90-50AP16M	50	22	14	10.4	40	4	APMT1604	C040A09S	WT15	0.4
231-59-002	FM90-63AP16M	63	22	14	10.4	45	5	APMT1604	C040A09S	WT15	0.6
231-59-003	FM90-80AP16M	80	27	14	12.4	50	6	APMT1604	C040A09S	WT15	1.1
231-59-004	FM90-100AP16M	100	32	14	14.4	50	7	APMT1604	C040A09S	WT15	1.9
231-59-005	FM90-125AP16M	125	40	14	16.4	63	8	APMT1604	C040A09S	WT15	3.9
231-59-006	FM90-160AP16M	160	40	14	16.4	63	10	APMT1604	C040A09S	WT15	4.9

Insert not included

SOLID CARBIDE INSERT APKT

Insert with highly positive geometry and helical cutting edges.

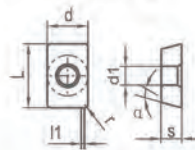

Order No.	Model	Size(mm)							Grade	Application
		d	L	S	a	d1	l1	r		
230-59-107	APMT1604PDTR_EY1220	9.525	16	4.76	11°	4.4	1.2	0.8	EY1220	Steel, Stainless Steel, Cast Iron

90° INDEXABLE FACE MILLS FOR APKT INSERTS

Features:

- 90° major cutting angle.
- Radial and Axial run-out less than 0.02mm.
- Inserts to be hold by swiss SFS high strength screws.
- Made of quality alloy steel and hardness HRC45-HRC48.
- High precision and high metal removal rate.
- Suitable for light to medium square shoulder milling.

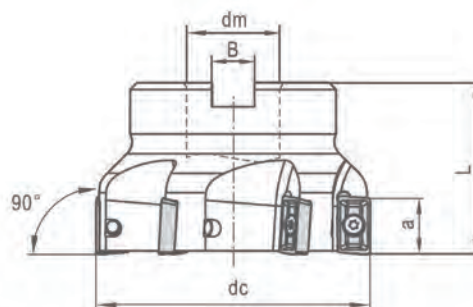
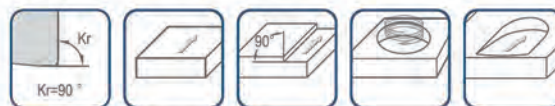

Order No.	Model	Size (mm)					No. of teeth	Insert	Screw	Torx wrench	Weight (Kg)
		dc	dm	a	B	L					
231-51-001	FM90-40AP16N	40	16	14	8.4	40	4	APKT1604	C040A09S	WT15	0.3
231-51-002	FM90-50AP16N	50	22	14	10.4	40	4	APKT1604	C040A09S	WT15	0.4
231-51-003	FM90-63AP16N	63	22	14	10.4	45	5	APKT1604	C040A09S	WT15	0.6
231-51-004	FM90-80AP16N	80	27	14	12.4	50	6	APKT1604	C040A09S	WT15	1.1
231-51-005	FM90-100AP16N	100	32	14	14.4	50	7	APKT1604	C040A09S	WT15	1.9
231-51-006	FM90-125AP16N	125	40	14	16.4	63	8	APKT1604	C040A09S	WT15	3.9
231-51-007	FM90-160AP16N	160	40	14	16.4	63	10	APKT1604	C040A09S	WT15	4.9

Insert not included

Recommended cutting data:

Application	Finish cutting			Medium cutting			Rough cutting		
	Surface speed Vc(m/min)	Feed per tooth fz(mm)	Cutting depth ap(mm)	Surface speed Vc(m/min)	Feed per tooth fz(mm)	Cutting depth ap(mm)	Surface speed Vc(m/min)	Feed per tooth fz(mm)	Cutting depth ap(mm)
Steel	300-100	0.05-0.10	0.1-2.0	250-120	0.1-0.25	2-8	160-100	0.15-0.30	8-15
Stainless Steel	230-120	0.05-0.10	0.1-2.0	120-60	0.1-0.25	2-8	100-60	0.15-0.30	4-12
Cast iron	300-110	0.05-0.10	0.1-2.0	250-110	0.1-0.25	2-8	140-100	0.15-0.30	4-15
Non ferrous metal	< 2000	0.05-0.10	0.1-2.0	< 2000	0.1-0.25	2-8	< 2000	0.15-0.30	4-15
High temperature alloy	-	-	-	20-60	0.06-0.20	2-4	-	-	-

SOLID CARBIDE INSERT APKT

Insert with highly positive geometry and helical cutting edges.

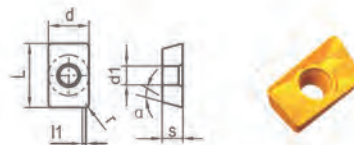

Order No.	Model	Application	Grade	Size (mm)						
				d	L	s	α	d1	l1	r
230-51-101	APKT1604 08-ZM	Steel, Stainless steel and Cast iron	EP1315	9.51	17.56	5.735	11°	4.4	1.395	0.8
230-51-102	APKT1604 08-ZM	Stainless steel	EP1215	9.51	17.56	5.735	11°	4.4	1.395	0.8
230-51-103	APKT1604 08-ZM	Steel and Cast iron	EP2202	9.51	17.56	5.735	11°	4.4	1.395	0.8

HIGH FEED INDEXABLE FACE MILLS FOR SDMT INSERTS

Features:

- Radial and Axial run-out less than 0.02mm
- Insert to be hold by swiss SFS high strength screws.
- Made of quality alloy steel and hardness HRC50-HRC52.
- Suitable for medium cutting of steel, stainless steel and cast iron at high feed rate.

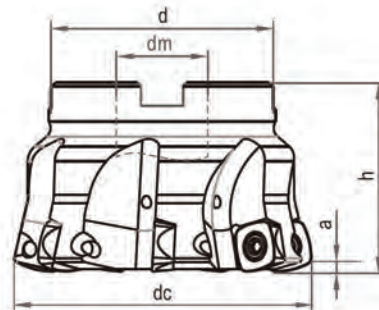
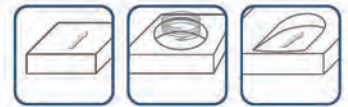

Order No.	Size (mm)					No.of teeth	Insert	Screw	Torx wrench
	dc	h	d	dm	a				
231-67-005	32	40	38	16	1	3	SDMT09T307	C030A07S	WT15
231-67-010	40	40	38	16	1	4	SDMT09T307	C030A07S	WT15
231-67-015	50	40	43	22	1	5	SDMT09T307	C030A07S	WT15
231-67-020	63	40	48	22	1	6	SDMT09T307	C030A07S	WT15
231-67-030	40	40	38	16	2	3	SDMT120412	L60-M4x8.4	WT15
231-67-035	50	40	43	22	2	4	SDMT120412	L60-M4x8.4	WT15
231-67-040	63	40	48	22	2	5	SDMT120412	L60-M4x8.4	WT15
231-67-045	80	50	58	27	2	7	SDMT120412	L60-M4x8.4	WT15

Insert not included

SOLID CARBIDE INSERT SDMT

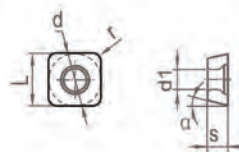

SM



NPM

Order No.	Model	Application	Grade	Size(mm)					
				d	L	s	α	d1	r
230-67-101	SDMT09T307-SM	Stainless steel	EP1215	9	9	3.5	16°	3.5	0.7
230-67-102	SDMT09T307-SM	Steel & Cast iron	EP2202	9	9	3.5	16°	3.5	0.7
230-67-103	SDMT09T307-SM	Universal	EP1315	9	9	3.5	16°	3.5	0.7
230-67-104	SDMT120412-NPM	Stainless steel	EP1215	12.7	12.7	4.76	15°	4.4	2
230-67-105	SDMT120412-NPM	Steel & Cast iron	EP2202	12.7	12.7	4.76	15°	4.4	2
230-67-106	SDMT120412-NPM	Universal	EP1315	12.7	12.7	4.76	15°	4.4	2

90° INDEXABLE FACE MILLS FOR LDFT INSERTS

Features:

- 90° major cutting angle.
- Radial and Axial run-out less than 0.02mm.
- Inserts to be hold by swiss SFS high strength screws.
- Made of quality alloy steel and hardness HRC45-HRC48.
- High precision and high metal removal rate.
- Suitable for light to medium square shoulder milling.

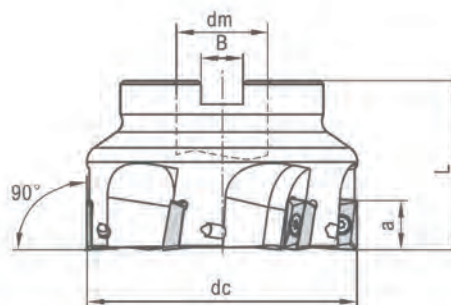
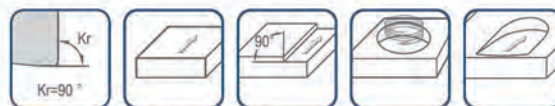

Order No.	Model	Size (mm)					No. of teeth	Insert	Screw	Torx wrench	Weight (Kg)
		dc	dm	a	B	L					
231-52-001	FMA90-40LD15	40	16	15	8.4	40	4	LDMT1504..	C035A08S	WT15	0.3
231-52-002	FMA90-50LD15	50	22	15	10.4	40	5	LDMT1504..	C035A08S	WT15	0.4
231-52-003	FMA90-63LD15	63	22	15	10.4	40	6	LDMT1504..	C035A08S	WT15	0.6
231-52-004	FMA90-80LD15	80	27	15	12.4	50	7	LDMT1504..	C035A08S	WT15	1.1
231-52-005	FMA90-100LD15	100	32	15	14.4	50	8	LDMT1504..	C035A08S	WT15	1.9
231-52-006	FMA90-125LD15	125	40	15	16.4	63	10	LDMT1504..	C035A08S	WT15	3.9
231-52-007	FMA90-160LD15	160	40	15	16.4	63	12	LDMT1504..	C035A08S	WT15	4.9
231-52-008	FMB90-100LD15	100	32	15	14.4	50	6	LDMT1504..	C035A08S	WT15	1.9
231-52-009	FMB90-125LD15	125	40	15	16.4	63	7	LDMT1504..	C035A08S	WT15	3.9
231-52-010	FMB90-160LD15	160	40	15	16.4	63	8	LDMT1504..	C035A08S	WT15	4.9

Insert not included

Recommended cutting data:

Application	Finish cutting			Medium cutting			Rough cutting		
	Surface speed Vc(m/min)	Feed per tooth fz(mm)	Cutting depth ap(mm)	Surface speed Vc(m/min)	Feed per tooth fz(mm)	Cutting depth ap(mm)	Surface speed Vc(m/min)	Feed per tooth fz(mm)	Cutting depth ap(mm)
Steel	350-120	0.05-0.10	0.1-2.0	240-100	0.10-0.25	2-4	150-80	0.20-0.35	< 14
Stainless Steel	250-100	0.05-0.10	0.1-2.0	200-100	0.10-0.25	2-4	140-80	0.20-0.35	< 14
Cast iron	300-120	0.05-0.10	0.1-2.0	280-90	0.10-0.25	2-4	220-80	0.20-0.35	< 14
Non ferrous metal	< 2000	0.05-0.10	0.1-2.0	< 2000	0.10-0.25	2-4	< 2000	0.20-0.35	< 14
High temperature alloy	-	-	-	75-25	0.10-0.25	2-4	-	-	-

SOLID CARBIDE INSERT LDMT

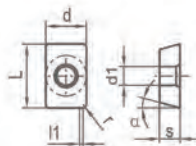

Order No.	Model	Application	Grade	Size (mm)						
				d	L	s	α	d1	l1	r
230-52-101	LDMT1504PDSR-EM	Steel	EP2220	9.525	15	4.76	15°	4.4	-	0.8
230-52-102	LDMT1504PDSR-EM	Cast iron	EP3215	9.525	15	4.76	15°	4.4	-	0.8
230-52-103	LDKT150408FR-AL	Non ferrous metal	EW5220	9.525	15	4.76	15°	4.4	-	0.8

90° INDEXABLE FACE MILLS FOR ANKX INSERTS

Features:

- 90° major cutting angle.
- Radial and Axial run-out less than 0.02mm.
- Inserts to be hold by swiss SFS high strength screws.
- Made of quality alloy steel and hardness HRC45-HRC48.
- Suitable for medium to heavy cutting.

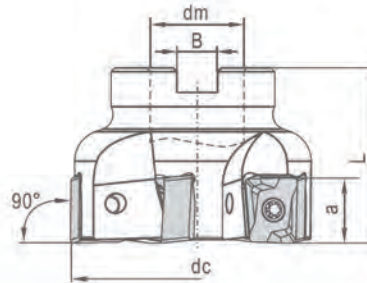
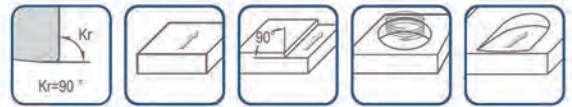

Order No.	Model	Size (mm)					No.of teeth	Insert	Screw	Torx wrench	Weight (Kg)
		dc	dm	a	B	L					
232-53-001	FM90-50AN16	50	22	15	10.4	40	4	ANKX1607	C050A12S	WT20	0.5
232-53-002	FM90-63AN16	63	22	15	10.4	40	5	ANKX1607	C050A12S	WT20	0.7
232-53-003	FM90-80AN16	80	27	15	12.4	50	6	ANKX1607	C050A12S	WT20	1.2
232-53-004	FM90-100AN16	100	32	15	14.4	50	8	ANKX1607	C050A12S	WT20	2.1

Insert not included

SOLID CARBIDE INSERT ANKX

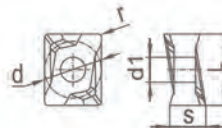

Order No.	Model	Application	Grade	Size(mm)				
				L	d	d1	S	r
230-53-101	ANKX160708R-EM	Steel,Stainless steel	EP1230	16	11.21	5.5	10.7	0.8
230-53-102	ANKX160708R-EH	Steel,Stainless steel	EP1230	16	11.21	5.5	10.7	0.8
230-53-103	ANKX160716R-EM	Steel,Stainless steel	EP1230	16	11.21	5.5	10.7	1.6
230-53-104	ANKX160716R-EH	Steel,Stainless steel	EP1230	16	11.21	5.5	10.7	1.6
230-53-105	ANKX160708R-EM	Cast iron	EC3125	16	11.21	5.5	10.7	0.8
230-53-106	ANKX160716R-EM	Cast iron	EC3125	16	11.21	5.5	10.7	1.6

45° INDEXABLE FACE MILLS FOR SNEU INSERTS

Features:

- Radial and Axial run-out less than 0.02mm.
- Inserts to be hold by swiss SFS high strength screws.
- Cost efficient due to 2-side insert with 8 cutting edge.
- Made of quality alloy steel and hardness HRC45-HRC48.
- Suitable for medium to heavy cutting of steel and cast iron.

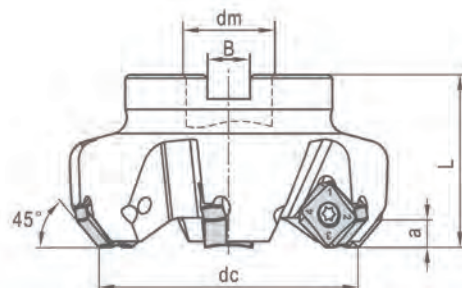

Order No.	Model	Size (mm)					No.of teeth	Insert	Screw	Torx wrench	Weight (Kg)
		dc	dm	a	B	L					
232-55-001	FM45-50SN12	50	22	5	10.4	40	4	SNEU1206...	C050A12S	WT20	0.5
232-55-002	FM45-63SN12	63	22	5	10.4	40	5	SNEU1206...	C050A12S	WT20	0.6
232-55-003	FM45-80SN12	80	27	5	12.4	50	7	SNEU1206...	C050A12S	WT20	1.1
232-55-004	FM45-100SN12	100	32	5	14.4	50	8	SNEU1206...	C050A12S	WT20	1.8
232-55-005	FM45-125SN12	125	40	5	16.4	63	10	SNEU1206...	C050A12S	WT20	3.7
232-55-006	FM45-160SN12	160	40	5	16.4	63	12	SNEU1206...	C050A12S	WT20	4.5
232-55-007	FM45-200SN12	200	60	5	25.7	63	14	SNEU1206...	C050A12S	WT20	6.5
232-55-008	FM45-250SN12	250	60	5	25.7	63	16	SNEU1206...	C050A12S	WT20	14.2
232-55-009	FM45-315SN12	315	60	5	25.7	63	20	SNEU1206...	C050A12S	WT20	26

Insert not included

SOLID CARBIDE INSERT SNEU



Order No.	Model	Application	Grade	Size(mm)				
				d	s	d1	l1	r
230-55-101	SNEU1206ANEN-EM	Steel	EP2230	12.7	6.35	6	2.2	0.8
230-55-102	SNEU1206ANSN-EH	Steel	EP2230	12.7	6.35	6	2.2	0.8
230-55-103	SNEU1206ANEN-EM	Cast iron	EC3215	12.7	6.35	6	2.2	0.8
230-55-104	SNEU1206ANSN-EH	Cast iron	EC3215	12.7	6.35	6	2.2	0.8

45° INDEXABLE FACE MILLS FOR SEMT INSERTS

Features:

- Radial and Axial run-out less than 0.02mm.
- Inserts to be hold by swiss SFS high strength screws.
- Made of quality alloy steel and hardness HRC45-HRC48.
- High precision and high metal removal rate.
- Suitable for light to medium cutting of steel and cast iron.

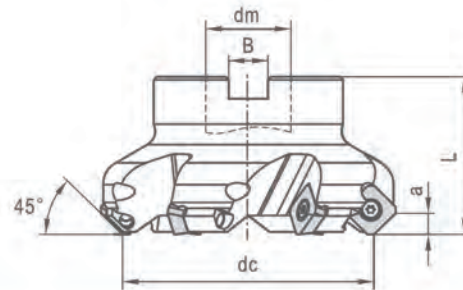
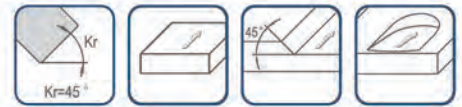

Order No.	Model	Size (mm)					No. of teeth	Insert	Screw	Torx wrench	Weight (Kg)
		dc	dm	a	B	L					
231-56-001	FM45-50SE12	50	22	6.5	10.4	45	4	SEMT..1204..	C050A12S	WT20	0.5
231-56-002	FM45-63SE12	63	22	6.5	10.4	45	5	SEMT..1204..	C050A12S	WT20	0.6
231-56-003	FM45-80SE12	80	27	6.5	12.4	50	6	SEMT..1204..	C050A12S	WT20	1.1
231-56-004	FM45-100SE12	100	32	6.5	14.4	50	7	SEMT..1204..	C050A12S	WT20	1.8
231-56-005	FM45-125SE12	125	40	6.5	16.4	63	8	SEMT..1204..	C050A12S	WT20	3.7
231-56-006	FM45-160SE12	160	40	6.5	16.4	63	10	SEMT..1204..	C050A12S	WT20	4.3

Insert not included

Recommended cutting data:

Application	Finish cutting			Medium cutting			Rough cutting		
	Surface speed Vc(m/min)	Feed per tooth fz(mm)	Cutting depth ap(mm)	Surface speed Vc(m/min)	Feed per tooth fz(mm)	Cutting depth ap(mm)	Surface speed Vc(m/min)	Feed per tooth fz(mm)	Cutting depth ap(mm)
Steel	350-120	0.05-0.10	0.1-2.0	240-100	0.10-0.25	2-4	150-80	0.20-0.35	< 12
Stainless Steel	250-100	0.05-0.15	0.1-2.0	200-100	0.10-0.25	1-4	180-90	0.15-0.40	< 12
Cast iron	280-150	0.05-0.15	0.1-2.0	280-90	0.10-0.25	1-4	250-80	0.15-0.40	< 12
Non ferrous metal	-	-	-	75-25	0.10-0.25	1-4	-	-	-
High temperature alloy	-	-	-	-	-	-	-	-	-

SOLID CARBIDE INSERT SEMT



Order No.	Model	Application	Grade	Size(mm)						
				d	L	s	α	d1	l1	r
230-56-101	SEMT1204AFN-EM	Stainless steel	EP4215	12.7	12.7	4.76	20°	5.4	2.1	0.2
230-56-102	SEMT1204AFN-EM	Steel	EP2220	12.7	12.7	4.76	20°	5.4	2.1	0.2
230-56-103	SEMT1204AFN-EM	Cast iron	EP3215	12.7	12.7	4.76	20°	5.4	2.1	0.2
230-56-105	SEGT1204AFN-AL	Non ferrous metal	EW5220	12.7	12.7	4.76	20°	5.4	2.1	0.2

INDEXABLE COPY FACE MILLING CUTTER

Features:

- Radial and Axial run-out less than 0.02mm.
- Inserts to be hold by swiss SFS high strength screws.
- Made of quality alloy steel and hardness HRC45-HRC48.
- High precision and high metal removal rate.
- Suitable for light to medium milling.

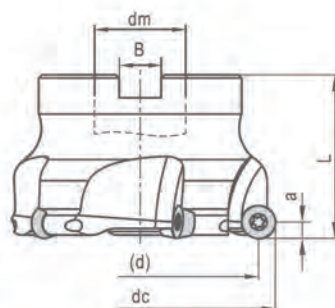

Order No.	Model	Size (mm)						No.of teeth	Insert	Screw	Torx wrench	Weight (Kg)
		dc	dm	(d)	a	B	L					
231-57-001	FMR-50RD12-Z3	50	22	38	6	10.4	45	3	RDKW..1204..	C040A09S	WT15	0.4
231-57-002	FMR-50RD12-Z4	50	22	38	6	10.4	45	4	RDKW..1204..	C040A09S	WT15	0.4
231-57-003	FMR-63RD12-Z3	63	22	51	6	10.4	45	3	RDKW..1204..	C040A09S	WT15	0.6
231-57-004	FMR-63RD12-Z4	63	22	51	6	10.4	45	4	RDKW..1204..	C040A09S	WT15	0.6
231-57-005	FMR-63RD12-Z5	63	22	51	6	10.4	45	5	RDKW..1204..	C040A09S	WT15	0.6
231-57-006	FMR-80RD12-Z5	80	27	68	6	12.4	50	5	RDKW..1204..	C040A09S	WT15	1.1
231-57-007	FMR-100RD12-Z6	100	32	88	6	14.4	50	6	RDKW..1204..	C040A09S	WT15	1.8
231-57-008	FMR-125RD12-Z7	125	40	113	6	16.4	63	7	RDKW..1204..	C040A09S	WT15	3.7
231-57-009	FMR-160RD12-Z8	160	40	148	6	16.4	63	8	RDKW..1204..	C040A09S	WT15	4.9
231-57-010	FMR-80RD16	80	27	64	8	12.4	45	5	RDKW..1606	C050A12S	WT20	1.1
231-57-011	FMR-100RD16	100	32	84	8	14.4	50	6	RDKW..1606	C050A12S	WT20	1.8
231-57-012	FMR-125RD16	125	40	109	8	16.4	63	7	RDKW..1606	C050A12S	WT20	3.7
231-57-013	FMR-160RD16	160	40	144	8	16.4	63	8	RDKW..1606	C050A12S	WT20	4.9
231-57-014	FMR-100RD20	100	32	80	10	14.4	50	5	RDKW..1606	L60M6x18	WT25	1.8
231-57-015	FMR-125RD20	125	40	105	10	16.4	63	5	RDKW..1606	L60M6x18	WT25	3.7
231-57-016	FMR-160RD20	160	40	140	10	16.4	63	6	RDKW..1606	L60M6x18	WT25	4.9

Insert not included

SOLID CARBIDE INSERT RDKW



Order No.	Model	Application	Grade	Size(mm)			
				d	s	α	d1
230-57-103	RDKW1204MO-EM	Steel	EP2220	12	4.76	15°	4.4
230-57-104	RDKW1606MO-EM	Steel	EP2220	16	6.35	15°	5.56
230-57-105	RDKW2006MO-EM	Steel	EP2220	20	6.35	15°	6.55

45° INDEXABLE FACE MILLS WITH ALUMINUM ALLOY BODY

Features:

- Suitable for cutting both non-ferrous material and cast iron.
- Radial and Axial run-out less than 0.02mm.
- Inserts to be hold by swiss SFS high strength screws.
- 45° or 90° Lead angle can be exchanged by using different cartridges and inserts.
- Cutter made of high alu. alloy and hardened for high speed cutting meanwhile keeping good rigidity and deformation resistance.

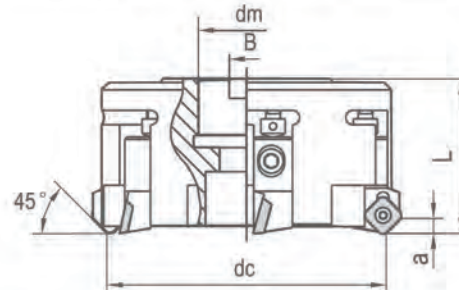

Order No.	Model	Size (mm)					No. of teeth	Cartridge	Insert	Max. speed RPM	Weight (Kg)
		dc	dm	a	B	L					
232-56-007	FMM-80AL-45	80	27	6.5	12.4	63	4	SSSER16CA-12AL	SE..1204..	6000	0.9
232-56-008	FMM-100AL-45	100	32	6.5	14.4	63	5	SSSER16CA-12AL	SE..1204..	4800	1
232-56-009	FMM-125AL-45	125	40	6.5	16.4	63	6	SSSER16CA-12AL	SE..1204..	3800	1.9
232-56-010	FMM-160AL-45	160	40	6.5	16.4	63	8	SSSER16CA-12AL	SE..1204..	3000	2.7
232-56-011	FMM-200AL-45	200	60	6.5	25.7	63	10	SSSER16CA-12AL	SE..1204..	2400	4.6
232-56-012	FMM-250AL-45	250	60	6.5	25.7	63	12	SSSER16CA-12AL	SE..1204..	2000	7.2
232-56-013	FMM-315AL-45	315	60	6.5	25.7	63	14	SSSER16CA-12AL	SE..1204..	1500	10.2

Insert not included

Recommended cutting data:

Application	Finish cutting			Medium cutting		
	Surface speed Vc(m/min)	Feed per tooth fz(mm)	Cutting depth ap(mm)	Surface speed Vc(m/min)	Feed per tooth fz(mm)	Cutting depth ap(mm)
Steel	280-150	0.05-0.15	0.1-0.5	-	-	-
Stainless Steel	< 2000	0.05-0.15	0.1-0.5	< 2000	0.15-0.25	0.1-2.0
Cast iron	< 1200	0.05-0.15	0.1-0.5	< 1200	0.05-0.25	0.1-1.0
Non ferrous metal	< 2000	0.05-0.10	0.1-0.5	< 2000	0.05-0.25	0.1-0.5
High temperature alloy	-	-	-	-	-	-

Spare part

Cartridge	Screw	Hex wrench	Screw	Screw	Torx wrench
SSSER16CA-12AL	MS06025	S5	AS06019	C050A12S	WT20

SOLID CARBIDE INSERT SE...



Order No.	Model	Application	Grade	Size (mm)						
				d	L	s	α	d1	l1	r
230-56-104	SEMT1204AFN-EM	Cast iron	EP3215	12.7	12.7	4.76	20°	5.4	2.1	0.2
230-56-105	SEGT1204AFN-AL	Non ferrous metal	EW5220	12.7	12.7	4.76	20°	5.4	2.1	0.2
230-56-106	SEGW1204AFN-PCD	Non ferrous metal	PCD	12.7	12.7	4.76	20°	5.4	2.1	0.2

90° INDEXABLE FACE MILLS WITH ALUMINUM ALLOY BODY

Features:

- Suitable for cutting both non-ferrous material and cast iron.
- Radial and Axial run-out less than 0.02mm.
- Inserts to be hold by swiss SFS high strength screws.
- 45° or 90° Lead angle can be exchanged by using different cartridges and inserts.
- Cutter made of ligh alu. alloy and hardened for high speed cutting meanwhile keeping good rigidity and deformation resistance.

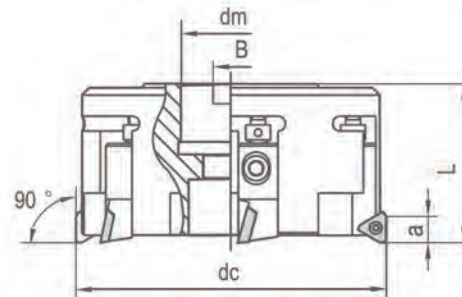
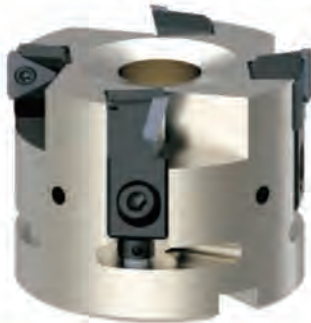

Order No.	Model	Size (mm)					No.of teeth	Cartridge	Insert	Max.speed RPM	Weight (Kg)
		dc	dm	a	B	L					
232-58-001	FMM-80AL-90	80	27	12	12.4	63	4	STGER16CA-16AL	TEHW16T3PER	4000	0.9
232-58-002	FMM-100AL-90	100	32	12	14.4	63	5	STGER16CA-16AL	TEHW16T3PER	3200	1.0
232-58-003	FMM-125AL-90	125	40	12	16.4	63	6	STGER16CA-16AL	TEHW16T3PER	2500	1.9
232-58-004	FMM-160AL-90	160	40	12	16.4	63	8	STGER16CA-16AL	TEHW16T3PER	2000	2.7
232-58-005	FMM-200AL-90	200	60	12	25.7	63	10	STGER16CA-16AL	TEHW16T3PER	1600	4.6
232-58-006	FMM-250AL-90	250	60	12	25.7	63	12	STGER16CA-16AL	TEHW16T3PER	1300	7.2
232-58-007	FMM-315AL-90	315	60	12	25.7	63	14	STGER16CA-16AL	TEHW16T3PER	1000	10.2

Insert not included

Recommended cutting data:

Application	Finish cutting			Medium cutting		
	Surface speed Vc(m/min)	Feed per tooth fz(mm)	Cutting depth ap(mm)	Surface speed Vc(m/min)	Feed per tooth fz(mm)	Cutting depth ap(mm)
Steel	280-150	0.05-0.15	0.1-0.5	-	-	-
Stainless Steel	< 2000	0.05-0.15	0.1-0.5	< 2000	0.15-0.25	0.1-2.0
Cast iron	< 1200	0.05-0.15	0.1-0.5	< 1200	0.05-0.25	0.1-1.0
Non ferrous metal	< 2000	0.05-0.10	0.1-0.5	< 2000	0.05-0.25	0.1-0.5
High temperature alloy	-	-	-	-	-	-

Spare part

Cartridge	Screw	Hex wrench	Screw	Screw	Torx wrench
STGER16CA-16AL	MS06025	S5	AS06019	C035A08S	WT15

SOLID CARBIDE INSERT TEHW

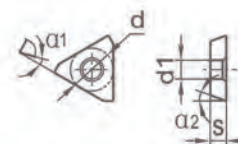

Order No.	Model	Application	Grade	Size (mm)				
				d	s	α1	α2	d1
230-58-101	TEHW16T3PER	Non ferrous metal and Cast iron	EW5215	9.525	3.97	20°	20°	4.4
230-58-102	TEHW16T3PER-PCD	Non ferrous metal	PCD	9.525	3.97	20°	20°	4.4

90° INDEXABLE END MILLS FOR APMT1135 INSERT

Features:

- Radial and Axial run-out less than 0.02mm.
- Inserts to be hold by swiss SFS high strength screws.
- Made of quality alloy steel and hardness HRC45-HRC48.
- For face milling to large depths, as well as slotting.

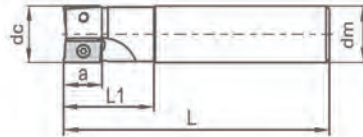

with Cylinder Shank

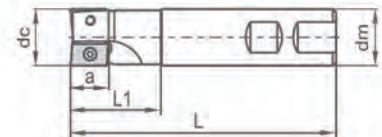

with Weldon Shank

Order No.		Model		Size(mm)					No. of teeth	Insert	Screw	Torx wrench	Weight (Kg)
Weldon	Cylindrical	Weldon	Cylindrical	dc	dm	a	L1	L					
241-59-001	241-59-002	EM90-12AP11	EM90-12AP11.C	12	12	11	20	70	1	APMT1135..	C025A07S	FT7	0.1
241-59-003	241-59-004	EM90-14AP11	EM90-14AP11.C	14	16	11	25	80	1	APMT1135..	C025A07S	FT7	0.1
241-59-005	241-59-006	EM90-16AP11	EM90-16AP11.C	16	16	11	30	80	2	APMT1135..	C025A07S	FT7	0.1
241-59-007	241-59-008	EM90-20AP11	EM90-20AP11.C	20	20	11	30	90	2	APMT1135..	C025A07S	FT7	0.4
241-59-009	241-59-010	EM90-25AP11	EM90-25AP11.C	25	25	11	30	100	3	APMT1135..	C025A07S	FT7	0.5
241-59-011	241-59-012	EM90-30AP11	EM90-30AP11.C	30	25	11	30	100	3	APMT1135..	C025A07S	FT7	0.5
241-59-013	241-59-014	EM90-32AP11	EM90-32AP11.C	32	32	11	30	110	4	APMT1135..	C025A07S	FT7	0.7
241-59-015	241-59-016	EM90-40AP11	EM90-40AP11.C	40	32	11	30	110	5	APMT1135..	C025A07S	FT7	0.8
241-59-017	241-59-018	EM90-16AP11L150	EM90-16AP11L150.C	16	16	11	30	150	2	APMT1135..	C025A07S	FT7	0.2
241-59-019	241-59-020	EM90-20AP11L150	EM90-20AP11L150.C	20	20	11	30	150	2	APMT1135..	C025A07S	FT7	0.4
241-59-021	241-59-022	EM90-25AP11L165	EM90-25AP11L165.C	25	25	11	30	165	3	APMT1135..	C025A07S	FT7	0.6
241-59-023	241-59-024	EM90-25AP11L200	EM90-25AP11L200.C	25	25	11	30	200	3	APMT1135..	C025A07S	FT7	0.8
241-59-025	241-59-026	EM90-30AP11L200	EM90-30AP11L200.C	30	25	11	30	200	3	APMT1135..	C025A07S	FT7	0.9
241-59-027	241-59-028	EM90-32AP11L200	EM90-32AP11L200.C	32	32	11	30	200	4	APMT1135..	C025A07S	FT7	1.3
241-59-029	241-59-030	EM90-32AP11L250	EM90-32AP11L250.C	32	32	11	30	250	4	APMT1135..	C025A07S	FT7	1.6
241-59-031	241-59-032	EM90-32AP11L300	EM90-32AP11L300.C	32	32	11	30	300	4	APMT1135..	C025A07S	FT7	1.9
241-59-033	241-59-034	EM90-40AP11L200	EM90-40AP11L200.C	40	32	11	35	200	5	APMT1135..	C025A07S	FT7	1.4

Insert not included

Recommended cutting data:

Application	Finish cutting			Medium cutting			Rough cutting		
	Surface speed Vc(m/min)	Feed per tooth fz(mm)	Cutting depth ap(mm)	Surface speed Vc(m/min)	Feed per tooth fz(mm)	Cutting depth ap(mm)	Surface speed Vc(m/min)	Feed per tooth fz(mm)	Cutting depth ap(mm)
Steel	300-100	0.05-0.10	0.1-2.0	250-120	0.1-0.25	2-4	160-100	0.15-0.30	4-8
Stainless Steel	230-120	0.05-0.10	0.1-2.0	120-60	0.1-0.25	2-4	100-60	0.15-0.30	4-8
Cast iron	300-110	0.05-0.10	0.1-2.0	250-110	0.1-0.25	2-4	140-100	0.15-0.30	4-8
Non ferrous metal	-	-	-	-	-	-	-	-	-
High temperature alloy	-	-	-	-	-	-	-	-	-

SOLID CARBIDE INSERT APMT1135

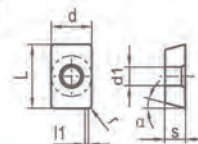

Order No.	Model	Application	Grade	Size(mm)						
				d	L	s	α	d1	l1	r
230-59-101	APMT1135PDER-EM	Steel	EP2220	6.16	11	3.5	11°	2.8	1.3	0.8
230-59-102	APMT1135PDER-EM	Cast iron	EP3215	6.16	11	3.5	11°	2.8	1.3	0.8



90° INDEXABLE END MILLS FOR APMT1604 INSERT

Features:

- Radial and Axial run-out less than 0.02mm.
- Inserts to be hold by swiss SFS high strength screws.
- Made of quality alloy steel and hardness HRC45-HRC48.
- Special strength design for rough cutting.

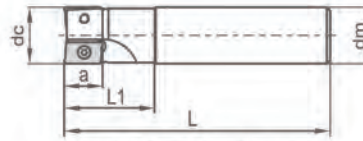

with Cylinder Shank

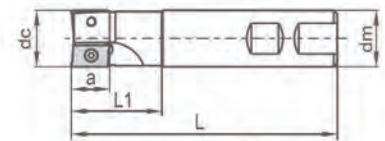

with Weldon Shank

Standard Size

Order No.		Model		Size(mm)					No. of teeth	Insert	Screw	Torx wrench	Weight (Kg)
Weldon	Cylindrical	Weldon	Cylindrical	dc	dm	a	L1	L					
241-59-035	241-59-036	EM90-16AP16M	EM90-16AP16M.C	16	16	14	30	90	1	APMT1604..	C040A09S	T15	0.1
241-59-037	241-59-038	EM90-20AP16M	EM90-20AP16M.C	20	20	14	30	90	1	APMT1604..	C040A09S	T15	0.2
241-59-039	241-59-040	EM90-25AP16M	EM90-25AP16M.C	25	25	14	30	100	2	APMT1604..	C040A09S	T15	0.4
241-59-041	241-59-042	EM90-32AP16M	EM90-32AP16M.C	32	32	14	40	110	3	APMT1604..	C040A09S	T15	0.7
241-59-043	241-59-044	EM90-40AP16M	EM90-40AP16M.C	40	32	14	40	110	4	APMT1604..	C040A09S	T15	0.8

Long length size

Order No.		Model		Size(mm)					No. of teeth	Insert	Screw	Torx wrench	Weight (Kg)
Weldon	Cylindrical	Weldon	Cylindrical	dc	dm	a	L1	L					
241-59-045	241-59-046	EM90-25AP16ML165	EM90-25AP16ML165.C	25	25	14	40	165	2	APMT1604.	C040A09S	T15	0.6
241-59-047	241-59-048	EM90-25AP16ML200	EM90-25AP16ML200.C	25	25	14	40	200	2	APMT1604.	C040A09S	T15	0.8
241-59-049	241-59-050	EM90-30AP16ML200	EM90-30AP16ML200.C	30	25	14	40	200	2	APMT1604.	C040A09S	T15	0.9
241-59-051	241-59-052	EM90-32AP16ML200	EM90-32AP16ML200.C	32	32	14	40	200	3	APMT1604.	C040A09S	T15	1.3
241-59-053	241-59-054	EM90-32AP16ML250	EM90-32AP16ML250.C	32	32	14	40	250	3	APMT1604.	C040A09S	T15	1.6
241-59-055	241-59-056	EM90-32AP16ML300	EM90-32AP16ML300.C	32	32	14	40	300	3	APMT1604.	C040A09S	T15	1.9
241-59-057	241-59-058	EM90-35AP16ML200	EM90-35AP16ML200.C	35	32	14	40	200	3	APMT1604.	C040A09S	T15	1.3
241-59-059	241-59-060	EM90-35AP16ML250	EM90-35AP16ML250.C	35	32	14	40	250	3	APMT1604.	C040A09S	T15	1.6
241-59-061	241-59-062	EM90-35AP16ML300	EM90-35AP16ML300.C	35	32	14	40	300	3	APMT1604.	C040A09S	T15	1.9
241-59-063	241-59-064	EM90-40AP16ML200	EM90-40AP16ML200.C	40	32	14	40	200	4	APMT1604.	C040A09S	T15	1.4

Insert not included

Recommended cutting data:

Application	Finish cutting			Medium cutting			Rough cutting		
	Surface speed Vc(m/min)	Feed per tooth fz(mm)	Cutting depth ap(mm)	Surface speed Vc(m/min)	Feed per tooth fz(mm)	Cutting depth ap(mm)	Surface speed Vc(m/min)	Feed per tooth fz(mm)	Cutting depth ap(mm)
Steel	300-100	0.05-0.10	0.1-2.0	250-120	0.1-0.25	2-8	160-100	0.15-0.30	8-15
Stainless Steel	230-120	0.05-0.10	0.1-2.0	120-60	0.1-0.25	2-8	100-60	0.15-0.30	4-12
Cast iron	300-110	0.05-0.10	0.1-2.0	250-110	0.1-0.25	2-8	140-100	0.15-0.30	4-15
Non ferrous metal	-	-	-	-	-	-	-	-	-
High temperature alloy	-	-	-	-	-	-	-	-	-

SOLID CARBIDE INSERT APMT1604

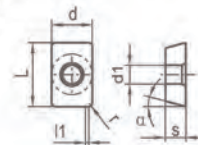

Order No.	Model	Application	Grade	Size(mm)						
				d	L	s	α	d1	l1	r
230-59-103	APMT1604 PDER-EM	Steel	EP2220	9.525	16	4.76	11°	4.4	0.9	0.8
230-59-104	APMT1604 PDER-EM	Cast iron	EP3215	9.525	16	4.76	11°	4.4	0.9	0.8

45° INDEXABLE END MILLS FOR SPMT0903 INSERT

Features:

- Radial and Axial run-out less than 0.02mm.
- Inserts to be hold by swiss SFS high strength screws.
- Made of quality alloy steel and hardness HRC45-HRC48.
- Used for both of milling and countersinking.

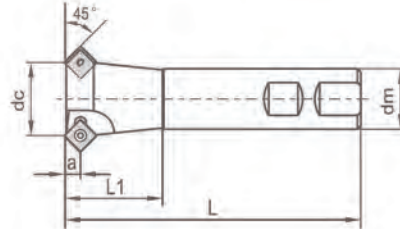

Order No.	Model	Size(mm)					No.of teeth	Insert	Screw	Torx wrench	Weight (Kg)
		dc	dm	a	L1	L					
241-60-001	EM45-10SP09	10	16	5	40	92	1	SPMT0903..	C030A07S	T9	0.1
241-60-002	EM45-12SP09	12	20	5	40	104	1	SPMT0903..	C030A07S	T9	0.2
241-60-003	EM45-16SP09	16	20	5	40	121	1	SPMT0903..	C030A07S	T9	0.3
241-60-004	EM45-20SP09	20	25	5	40	133	2	SPMT0903..	C030A07S	T9	0.5
241-60-005	EM45-25SP09	25	32	5	40	152	2	SPMT0903..	C030A07S	T9	0.9
241-60-006	EM45-32SP09	32	32	5	40	165	3	SPMT0903..	C030A07S	T9	1.0

Insert not included

Recommended cutting data:

Application	Finish cutting			Medium cutting			Rough cutting		
	Surface speed Vc(m/min)	Feed per tooth fz(mm)	Cutting depth ap(mm)	Surface speed Vc(m/min)	Feed per tooth fz(mm)	Cutting depth ap(mm)	Surface speed Vc(m/min)	Feed per tooth fz(mm)	Cutting depth ap(mm)
Steel	250-80	0.05-0.10	0.1-1.0	200-70	0.10-0.25	10-2.5	150-55	0.20-0.35	< 4
Stainless Steel	190-70	0.05-0.10	0.1-1.0	150-40	0.10-0.25	1.0-2.5	-	-	-
Cast iron	-	-	-	-	-	-	-	-	-
Non ferrous metal	-	-	-	-	-	-	-	-	-
High temperature alloy	-	-	-	-	-	-	-	-	-

SOLID CARBIDE INSERT SPMT0903

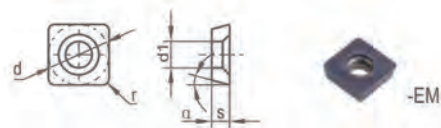

Order No.	Model	Application	Grade	Size (mm)				
				d	s	α	d1	r
230-60-101	SPMT090308EN-EM	Steel	EP2220	9.525	3.18	11°	3.4	0.8

INDEXABLE END MILLS FOR ROUND INSERT RDKW

Features:

- Radial and Axial run-out less than 0.02mm.
- Inserts to be hold by swiss SFS high strength screws.
- Made of quality alloy steel and hardness HRC45-HRC48.
- Especial suitable for cutting of Circular and Curved surface.

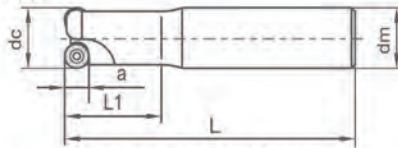
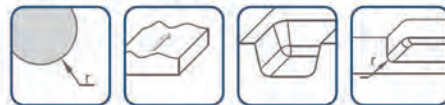

with Cylinder Shank

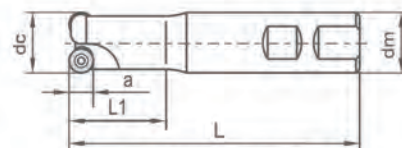

with Weldon Shank

Order No.		Model		Size(mm)					No.of teeth	Insert	Screw	Torx wrench	Weight (Kg)
Weldon	Cylindrical	Weldon	Cylindrical	dc	dm	a	L1	L					
241-57-001	241-57-002	EMR-12RD08	EMR-12RD08.C	12	16	8	30	90	1	RDKW0803.. C030A07S	T9	0.1	
241-57-003	241-57-004	EMR-14RD08	EMR-14RD08.C	14	16	8	30	100	1	RDKW0803.. C030A08S	T10	0.1	
241-57-005	241-57-006	EMR-16RD08	EMR-16RD08.C	16	16	8	30	100	2	RDKW0803.. C030A09S	T11	0.2	
241-57-007	241-57-008	EMR-20RD08	EMR-20RD08.C	20	20	8	30	120	2	RDKW0803.. C030A10S	T12	0.2	
241-57-009	241-57-010	EMR-25RD10	EMR-25RD10.C	25	25	10	40	120	2	RDKW10T3.. C030A08S	T15	0.5	
241-57-011	241-57-012	EMR-30RD10	EMR-30RD10.C	30	25	10	40	133	2	RDKW10T3.. C030A09S	T16	0.7	
241-57-013	241-57-014	EMR-32RD10	EMR-32RD10.C	32	32	10	40	133	2	RDKW10T3.. C030A10S	T17	0.8	
241-57-015	241-57-016	EMR-40RD10	EMR-40RD10.C	40	32	10	40	152	3	RDKW10T3.. C030A11S	T18	1.0	
241-57-017	241-57-018	EMR-50RD10	EMR-50RD10.C	50	32	10	40	165	3	RDKW10T3.. C030A12S	T19	1.1	
241-57-019	241-57-020	EMR-32RD12	EMR-32RD12.C	32	32	12	40	133	2	RDKW1204.. C040A09S	T15	0.9	
241-57-021	241-57-022	EMR40RD12	EMR40RD12.C	40	32	12	40	152	3	RDKW1204.. C040A09S	T15	1.0	
241-57-023	241-57-024	EMR-16RD08L150	EMR-16RD08L150.C	16	16	8	30	150	2	RDKW0803.. C030A07S	T9	0.3	
241-57-025	241-57-026	EMR-20RD08L160	EMR-20RD08L160.C	20	20	8	30	160	2	RDKW0803.. C030A07S	T9	0.4	
241-57-027	241-57-028	EMR-25RD10L200	EMR-25RD10L200.C	25	25	10	40	200	2	RDKW10T3.. C035A08S	T15	0.8	
241-57-029	241-57-030	EMR-25RD10L250	EMR-25RD10L250.C	25	25	10	40	250	2	RDKW10T3.. C035A08S	T15	1.0	
241-57-031	241-57-032	EMR-30RD10L200	EMR-30RD10L200.C	30	25	10	40	200	2	RDKW10T3.. C035A08S	T15	0.9	
241-57-033	241-57-034	EMR-30RD10L250	EMR-30RD10L250.C	30	25	10	40	250	2	RDKW10T3.. C035A08S	T15	1.4	
241-57-035	241-57-036	EMR-32RD10L250	EMR-32RD10L250.C	32	32	10	40	250	2	RDKW10T3.. C035A08S	T15	1.5	
241-57-037	241-57-038	EMR-32RD10L300	EMR-32RD10L300.C	32	32	10	40	300	2	RDKW10T3.. C035A08S	T15	1.9	
241-57-039	241-57-040	EMR-35RD10L200	EMR-35RD10L200.C	35	32	10	40	200	3	RDKW10T3.. C035A08S	T15	1.3	
241-57-041	241-57-042	EMR-35RD10L250	EMR-35RD10L250.C	35	32	10	40	250	3	RDKW10T3.. C035A08S	T15	1.6	
241-57-043	241-57-044	EMR-40RD10L250	EMR-40RD10L250.C	40	32	10	40	250	3	RDKW10T3.. C035A08S	T15	1.7	
241-57-045	241-57-046	EMR40RD10L300	EMR40RD10L300.C	40	32	10	40	300	3	RDKW10T3.. C035A08S	T15	2.0	

Insert not included

Recommended cutting data:

Application	Finish cutting			Medium cutting			Rough cutting		
	Surface speed Vc(m/min)	Feed per tooth fz(mm)	Cutting depth ap(mm)	Surface speed Vc(m/min)	Feed per tooth fz(mm)	Cutting depth ap(mm)	Surface speed Vc(m/min)	Feed per tooth fz(mm)	Cutting depth ap(mm)
Steel	150-80	0.05-0.10	1.5-2.0	120-80	0.15-0.35	2.5-3.0	100-60	0.1-0.2	< d/2
Stainless Steel	100-90	0.05-0.10	1.5-2.0	80-70	0.15-0.35	2.5-3.0	80-60	0.1-0.2	< d/2
Cast iron	150-100	0.05-0.10	1.5-2.0	120-90	0.15-0.35	2.5-3.0	90-60	0.1-0.2	< d/2
Non ferrous metal	-	-	-	-	-	-	-	-	-
High temperature alloy	-	-	-	-	-	-	-	-	-

SOLID CARBIDE INSERT RDKW



Order No.	Model	Application	Grade	Size (mm)			
				d	s	α	d1
230-57-101	RDKW0803MO-EM	Steel	EP2220	8	3.18	15°	3.4
230-57-102	RDKW10T3MO-EM	Steel	EP2220	10	3.97	15°	4.4
230-57-103	RDKW1204MO-EM	Steel	EP2220	12.0	4.76	15°	4.4

INDEXABLE SIDE MILLING CUTTERS FOR SNCQ INSERT

Features:

- Radial and Axial run-out less than 0.02mm.
- Inserts to be hold by swiss SFS high strength screws.
- Made of quality alloy steel and hardness HRC45-HRC48.
- High precision for quality surface.

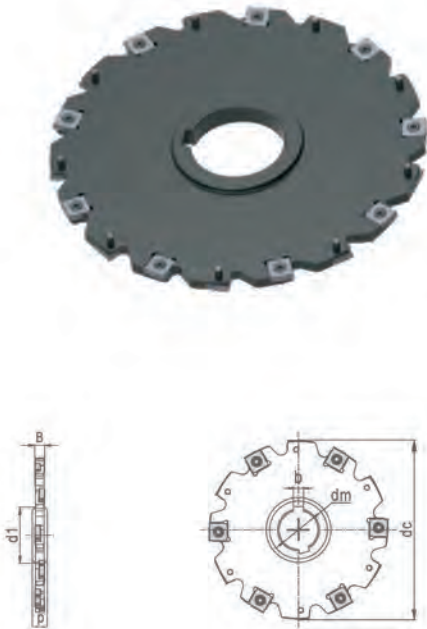

Order No.	Size(mm)						No.of teeth	Insert	Screw	Torx wrench
	dc	d1	dm	P	B	b				
251-61-001	80	38	22	12	6	6	4*2	SNCQ123503N	ST4073-91F	WT15
251-61-003	100	45	27	12	6	7	5*2	SNCQ123503N	ST4073-91F	WT15
251-61-005	125	55	40	12	6	10	6*2	SNCQ123503N	ST4073-91F	WT15
251-61-007	160	55	40	12	6	10	8*2	SNCQ123503N	ST4073-91F	WT15
251-61-009	200	69	50	12	6	12	9*2	SNCQ123503N	ST4073-91F	WT15
251-61-011	250	69	50	12	6	12	12*2	SNCQ123503N	ST4073-91F	WT15
251-61-013	80	38	22	12	7	6	4*2	SNCQ120403N	ST409-91F	WT15
251-61-015	100	45	27	12	7	7	5*2	SNCQ120403N	ST409-91F	WT15
251-61-017	125	55	40	12	7	10	6*2	SNCQ120403N	ST409-91F	WT15
251-61-019	160	55	40	12	7	10	8*2	SNCQ120403N	ST409-91F	WT15
251-61-021	200	69	50	12	7	12	9*2	SNCQ120403N	ST409-91F	WT15
251-61-023	250	69	50	12	7	12	12*2	SNCQ120403N	ST409-91F	WT15
251-61-025	80	38	22	12	8	6	4*2	SNCQ124503N	ST409-91F	WT15
251-61-027	100	45	27	12	8	7	5*2	SNCQ124503N	ST409-91F	WT15
251-61-029	125	55	40	12	8	10	6*2	SNCQ124503N	ST409-91F	WT15
251-61-031	160	55	40	12	8	10	8*2	SNCQ124503N	ST409-91F	WT15
251-61-033	200	69	50	12	8	12	9*2	SNCQ124503N	ST409-91F	WT15
251-61-035	250	69	50	12	8	12	12*2	SNCQ124503N	ST409-91F	WT15
251-61-037	100	45	27	12	9	7	5*2	SNCQ120503N	ST409-91F	WT15
251-61-039	125	55	40	12	9	10	6*2	SNCQ120503N	ST409-91F	WT15
251-61-041	160	55	40	12	9	10	8*2	SNCQ120503N	ST409-91F	WT15
251-61-043	200	69	50	12	9	12	9*2	SNCQ120503N	ST409-91F	WT15
251-61-045	250	69	50	12	9	12	12*2	SNCQ120503N	ST409-91F	WT15

Insert not included

Recommended cutting data:

Application	Medium cutting			Rough cutting		
	Surface speed Vc(m/min)	Feed per tooth fz(mm)	Cutting depth ap(mm)	Surface speed Vc(m/min)	Feed per tooth fz(mm)	Cutting depth ap(mm)
Steel	200-100	0.05-0.12	< α	120-60	0.15-0.2	< α
Stainless Steel	-	-	-	-	-	-
Cast iron	180-80	0.05-0.15	< α	150-80	0.15-0.2	< α
Non ferrous metal	< 2000	0.1-0.15	< α	< 2000	0.15-0.2	< α
High temperature alloy	-	-	-	-	-	-

SOLID CARBIDE INSERT SNCQ

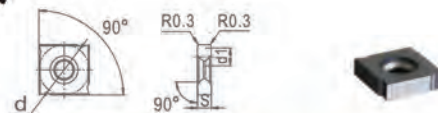

Order No.	Model	For cutting width	Application	Grade	Size(mm)		
					s	d	d1
230-61-101	SNCQ123503N	6-7mm	Steel	EP2220	3.5	12.7	4.5
230-61-102	SNCQ120403N	7-8mm	Steel	EP2220	4	12.7	4.5
230-61-103	SNCQ124503N	8-9mm	Steel	EP2220	4.5	12.7	4.5
230-61-104	SNCQ120503N	9-10mm	Steel	EP2220	5	12.7	4.5
230-61-105	SNCQ123503N	6-7mm	Cast iron	EP3215	3.5	12.7	4.5
230-61-106	SNCQ120403N	7-8mm	Cast iron	EP3215	4	12.7	4.5
230-61-107	SNCQ124503N	8-9mm	Cast iron	EP3215	4.5	12.7	4.5
230-61-108	SNCQ120503N	9-10mm	Cast iron	EP3215	5	12.7	4.5

INDEXABLE SIDE MILLING CUTTERS FOR SNCQ INSERT

Features:

- Radial and Axial run-out less than 0.02mm.
- Inserts to be hold by swiss SFS high strength screws.
- Made of quality alloy steel and hardness HRC45-HRC48.
- High precision for quality surface.

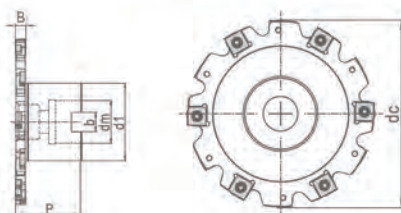

Order No.	Size(mm)						No. of teeth	Insert	Screw	Torx wrench
	dc	d1	dm	P	B	b				
251-61-002	63	42	22	50	6	10.4	3*2	SNCQ123503N	ST4073-91F	WT15
251-61-004	80	42	22	50	6	10.4	4*2	SNCQ123503N	ST4073-91F	WT15
251-61-006	100	60	27	50	6	12.4	5*2	SNCQ123503N	ST4073-91F	WT15
251-61-008	125	78	32	50	6	14.4	6*2	SNCQ123503N	ST4073-91F	WT15
251-61-010	160	89	40	50	6	16.4	8*2	SNCQ123503N	ST4073-91F	WT15
251-61-012	63	42	22	50	7	10.4	3*2	SNCQ120403N	ST409-91F	WT15
251-61-014	80	42	22	50	7	10.4	4*2	SNCQ120403N	ST409-91F	WT15
251-61-016	100	60	27	50	7	12.4	5*2	SNCQ120403N	ST409-91F	WT15
251-61-018	125	78	32	50	7	14.4	6*2	SNCQ120403N	ST409-91F	WT15
251-61-020	160	89	40	50	7	16.4	8*2	SNCQ120403N	ST409-91F	WT15
251-61-022	63	42	22	50	8	10.4	3*2	SNCQ124503N	ST409-91F	WT15
251-61-024	80	42	22	50	8	10.4	4*2	SNCQ124503N	ST409-91F	WT15
251-61-026	100	60	27	50	8	12.4	5*2	SNCQ124503N	ST409-91F	WT15
251-61-028	125	78	32	50	8	14.4	6*2	SNCQ124503N	ST409-91F	WT15
251-61-030	160	89	40	50	8	16.4	8*2	SNCQ124503N	ST409-91F	WT15
251-61-032	100	60	27	50	8	12.4	5*2	SNCQ120503N	ST409-91F	WT15
251-61-034	125	78	40	50	8	14.4	6*2	SNCQ120503N	ST409-91F	WT15
251-61-036	160	89	40	50	8	16.4	8*2	SNCQ120503N	ST409-91F	WT15

Insert not included

Recommended cutting data:

Application	Medium cutting			Rough cutting		
	Surface speed Vc(m/min)	Feed per tooth fz(mm)	Cutting depth ap(mm)	Surface speed Vc(m/min)	Feed per tooth fz(mm)	Cutting depth ap(mm)
Steel	200-100	0.05-0.12	< α	120-60	0.15-0.2	< α
Stainless Steel	-	-	-	-	-	-
Cast iron	180-80	0.05-0.15	< α	150-80	0.15-0.2	< α
Non ferrous metal	< 2000	0.1-0.15	< α	< 2000	0.15-0.2	< α
High temperature alloy	-	-	-	-	-	-

SOLID CARBIDE INSERT SNCQ

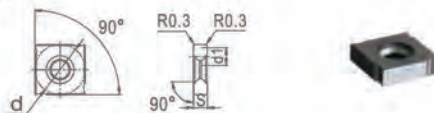

Order No.	Model	For cutting width	Application	Grade	Size(mm)		
					s	d	d1
230-61-101	SNCQ123503N	6-7mm	Steel	EP2220	3.5	12.7	4.5
230-61-102	SNCQ120403N	7-8mm	Steel	EP2220	4	12.7	4.5
230-61-103	SNCQ124503N	8-9mm	Steel	EP2220	4.5	12.7	4.5
230-61-104	SNCQ120503N	9-10mm	Steel	EP2220	5	12.7	4.5
230-61-105	SNCQ123503N	6-7mm	Cast iron	EP3215	3.5	12.7	4.5
230-61-106	SNCQ120403N	7-8mm	Cast iron	EP3215	4	12.7	4.5
230-61-107	SNCQ124503N	8-9mm	Cast iron	EP3215	4.5	12.7	4.5
230-61-108	SNCQ120503N	9-10mm	Cast iron	EP3215	5	12.7	4.5

INDEXABLE SIDE MILLING CUTTERS FOR LNCT INSERT

Features:

- Radial and Axial run-out less than 0.02mm.
- Made of quality alloy steel and hardness HRC45-HRC48.
- Inserts to be hold by swiss SFS high strength screws.
- High precision for quality surface.

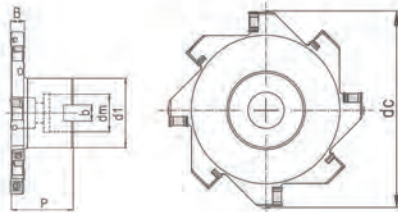
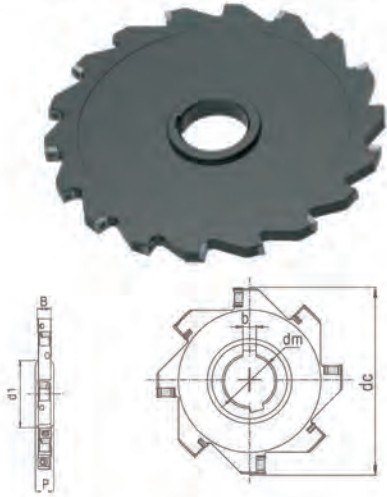

Order No.	Size(mm)						No.of teeth	Insert	Screw	Torx wrench
	dc	d1	dm	P	B	b				
251-62-001	100	46	32	16	10	8	4*2	LNCT070408N	C030A07S	WT9
251-62-003	125	55	40	16	10	10	5*2	LNCT070408N	C030A08S	WT9
251-62-005	160	55	40	16	10	10	6*2	LNCT070408N	C030A09S	WT9
251-62-007	200	69	50	16	10	12	7*2	LNCT070408N	C030A10S	WT9
251-62-009	100	46	32	18	12	8	4*2	LNCT090408N	C035A08S	WT15
251-62-011	125	55	40	18	12	10	5*2	LNCT090408N	C035A08S	WT15
251-62-013	160	55	40	18	12	10	6*2	LNCT090408N	C035A08S	WT15
251-62-015	200	69	50	18	12	12	7*2	LNCT090408N	C035A08S	WT15
251-62-017	250	69	50	18	12	12	8*2	LNCT090408N	C035A08S	WT15
251-62-019	125	55	40	24	16	10	5*2	LNCT120508N	C035A09S	WT15
251-62-021	160	55	40	24	16	10	6*2	LNCT120508N	C035A09S	WT15
251-62-023	200	69	50	24	16	12	7*2	LNCT120508N	C035A09S	WT15
251-62-025	250	69	50	24	12	12	8*2	LNCT120508N	C035A09S	WT15

Order No.	Size(mm)						No.of teeth	Insert	Screw	Torx wrench
	dc	d1	dm	P	B	b				
251-62-002	80	42	22	50	10	10.4	4*2	LNCT070408N	C030A07S	WT9
251-62-004	100	60	27	50	10	12.4	5*2	LNCT070408N	C030A07S	WT9
251-62-006	125	78	32	50	10	14.4	6*2	LNCT070408N	C030A07S	WT9
251-62-008	160	89	40	50	10	16.4	7*2	LNCT070408N	C030A07S	WT9
251-62-010	100	60	27	50	12	12.4	5*2	LNCT090408N	C035A08S	WT15
251-62-012	125	78	32	50	12	14.4	6*2	LNCT090408N	C035A08S	WT15
251-62-014	160	89	40	50	12	16.4	7*2	LNCT090408N	C035A08S	WT15
251-62-016	200	89	40	50	12	16.4	8*2	LNCT090408N	C035A08S	WT15
251-62-018	125	78	32	50	16	14.4	5*2	LNCT120508N	C040A09S	WT15
251-62-020	160	89	40	50	16	16.4	6*2	LNCT120508N	C040A09S	WT15
251-62-022	200	89	40	50	16	16.4	7*2	LNCT120508N	C040A09S	WT15
251-62-024	250	129	60	50	16	25.7	8*2	LNCT120508N	C040A09S	WT15

Insert not included

Recommended cutting data:

Application	Medium cutting			Rough cutting		
	Surface speed Vc(m/min)	Feed per tooth fz(mm)	Cutting depth ap(mm)	Surface speed Vc(m/min)	Feed per tooth fz(mm)	Cutting depth ap(mm)
Steel	200-100	0.05-0.12	< α	120-60	0.15-0.2	< α
Stainless Steel	-	-	-	-	-	-
Cast iron	180-80	0.05-0.15	< α	150-80	0.15-0.2	< α
Non ferrous metal	< 2000	0.1-0.15	< α	< 2000	0.15-0.2	< α
High temperature alloy	-	-	-	-	-	-

SOLID CARBIDE INSERT LNCT

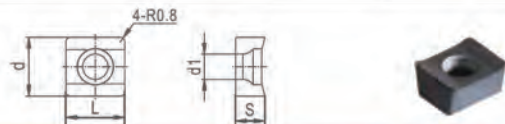

Order No.	Model	For cutting width	Application	Grade	Size(mm)			
					s	L	d	d1
230-62-101	LNCT070408N	9-13.5	Steel	EP2220	4.76	7.94	9.525	4.7
230-62-102	LNCT090408N	11-16	Steel	EP2220	4.76	9.525	9.525	5.8
230-62-103	LNCT120508N	15-22	Steel	EP2220	5.56	12.7	11.5	6
230-62-104	LNCT070408N	9-13.5	Cast iron	EP3215	4.76	7.94	9.525	4.7
230-62-105	LNCT090408N	11-16	Cast iron	EP3215	4.76	9.525	9.525	5.8
230-62-106	LNCT120508N	15-22	Cast iron	EP3215	5.56	12.7	11.5	6

INDEXABLE SIDE MILLING CUTTERS FOR CNCQ INSERT

Features:

- Radial and Axial run-out less than 0.02mm.
- Inserts to be hold by swiss SFS high strength screws.
- Made of quality alloy steel and hardness HRC45-HRC48.
- High precision for quality surface.

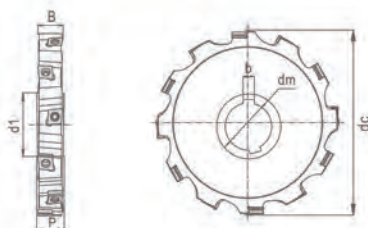

Order No.	Size(mm)						No. of teeth	Insert	Screw	Torx wrench
	dc	d1	dm	P	B	b				
251-54-001	100	46	32	16	14	8	4*2	CNCQ0905..L CNCQ0905..R	C040A09S	WT15
251-54-003	125	55	40	16	14	10	4*2	CNCQ0905..L CNCQ0905..R	C040A09S	WT15
251-54-005	160	55	40	16	14	10	6*2	CNCQ0905..L CNCQ0905..R	C040A09S	WT15
251-54-007	200	69	50	16	14	12	7*2	CNCQ0905..L CNCQ0905..R	C040A09S	WT15
251-54-009	250	69	50	16	14	12	9*2	CNCQ0905..L CNCQ0905..R	C040A09S	WT15
251-54-011	100	46	32	22	20	8	4*2	CNCQ1205..L CNCQ1205..R	C050A12S	WT20
251-54-013	125	55	40	22	20	10	4*2	CNCQ1205..L CNCQ1205..R	C050A12S	WT20
251-54-015	160	55	40	22	20	10	6*2	CNCQ1205..L CNCQ1205..R	C050A12S	WT20
251-54-017	200	69	50	22	20	12	7*2	CNCQ1205..L CNCQ1205..R	C050A12S	WT20
251-54-019	250	69	50	21	20	12	9*2	CNCQ1205..L CNCQ1205..R	C050A12S	WT20
251-54-021	125	55	40	27	24	10	4*2	CNCQ1505..L CNCQ1505..R	C050A12S	WT20
251-54-023	160	55	40	27	24	10	6*2	CNCQ1505..L CNCQ1505..R	C050A12S	WT20
251-54-025	200	69	50	27	24	12	7*2	CNCQ1505..L CNCQ1505..R	C050A12S	WT20
251-54-027	250	69	50	27	24	12	9*2	CNCQ1505..L CNCQ1505..R	C050A12S	WT20

Insert not included

Recommended cutting data:

Application	Medium cutting			Rough cutting		
	Surface speed Vc(m/min)	Feed per tooth fz(mm)	Cutting depth ap(mm)	Surface speed Vc(m/min)	Feed per tooth fz(mm)	Cutting depth ap(mm)
Steel	200-100	0.05-0.12	< α	120-60	0.15-0.2	< α
Stainless Steel	-	-	-	-	-	-
Cast iron	180-80	0.05-0.15	< α	150-80	0.15-0.2	< α
Non ferrous metal	< 2000	0.1-0.15	< α	< 2000	0.15-0.2	< α
High temperature alloy	-	-	-	-	-	-

SOLID CARBIDE INSERT CNCQ

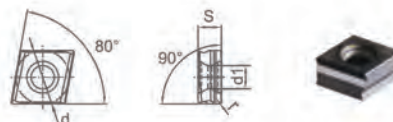

Order No.	Model	For cutting width	Application	Grade	Size(mm)			
					s	d	d1	r
230-54-105	CNCQ090504L/R	13.5-18.5mm	Steel	EP2220	5.56	9.525	4.4	0.4
230-54-106	CNCQ090508L/R	13.5-18.5mm	Steel	EP2220	5.56	9.525	4.4	0.8
230-54-107	CNCQ120504L/R	18.5-24mm	Steel	EP2220	5.56	12.7	5.5	0.4
230-54-108	CNCQ120508L/R	18.5-24mm	Steel	EP2220	5.56	12.7	5.5	0.8
230-54-109	CNCQ150504L/R	24-30.5mm	Steel	EP2220	5.56	15.875	5.5	0.4
230-54-110	CNCQ090504L/R	13.5-18.5mm	Cast iron	EP3215	5.56	9.525	4.4	0.4
230-54-111	CNCQ090508L/R	13.5-18.5mm	Cast iron	EP3215	5.56	9.525	4.4	0.8
230-54-112	CNCQ120504L/R	18.5-24mm	Cast iron	EP3215	5.56	12.7	5.5	0.4
230-54-113	CNCQ120508L/R	18.5-24mm	Cast iron	EP3215	5.56	12.7	5.5	0.8
230-54-114	CNCQ150504L/R	24-30.5mm	Cast iron	EP3215	5.56	15.875	5.5	0.4

INDEXABLE SIDE MILLING CUTTERS FOR CNCQ INSERT

Features:

- Radial and Axial run-out less than 0.02mm.
- Inserts to be hold by swiss SFS high strength screws.
- Made of quality alloy steel and hardness HRC45-HRC48.
- High precision for quality surface.

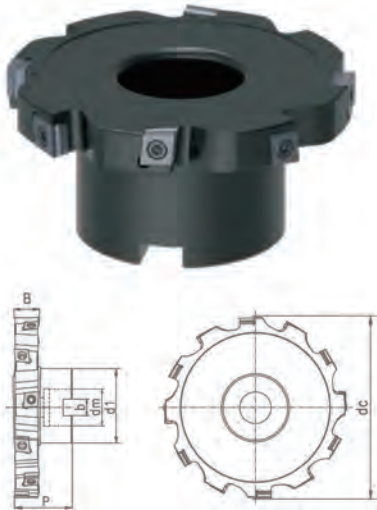

Order No.	Size(mm)						Insert	Screw	Torx wrench	
	dc	d1	dm	P	B	b				
251-54-002	80	42	22	50	14	10.4	3*2	CNCQ0905..L CNCQ0905..R	C040A09S	WT15
251-54-004	100	60	27	50	14	12.4	4*2	CNCQ0905..L CNCQ0905..R	C040A09S	WT15
251-54-006	125	78	32	50	14	14.4	4*2	CNCQ0905..L CNCQ0905..R	C040A09S	WT15
251-54-008	160	89	40	50	14	16.4	6*2	CNCQ0905..L CNCQ0905..R	C040A09S	WT15
251-54-010	100	60	27	50	20	12.4	4*2	CNCQ1205..L CNCQ1205..R	C050A12S	WT20
251-54-012	125	78	32	50	20	14.4	4*2	CNCQ1205..L CNCQ1205..R	C050A12S	WT20
251-54-014	160	89	40	50	20	16.4	6*2	CNCQ1205..L CNCQ1205..R	C050A12S	WT20
251-54-016	200	89	40	50	20	16.4	8*2	CNCQ1205..L CNCQ1205..R	C050A12S	WT20
251-54-018	125	78	32	50	24	14.4	4*2	CNCQ1505..L CNCQ1505..R	C050A12S	WT20
251-54-020	160	89	40	50	24	16.4	6*2	CNCQ1505..L CNCQ1505..R	C050A12S	WT20
251-54-022	200	89	40	50	24	16.4	7*2	CNCQ1505..L CNCQ1505..R	C050A12S	WT20
251-54-024	250	129	60	50	24	25.7	9*2	CNCQ1505..L CNCQ1505..R	C050A12S	WT20

Insert not included

Recommended cutting data:

Application	Medium cutting			Rough cutting		
	Surface speed Vc(m/min)	Feed per tooth fz(mm)	Cutting depth ap(mm)	Surface speed Vc(m/min)	Feed per tooth fz(mm)	Cutting depth ap(mm)
Steel	200-100	0.05-0.12	< α	120-60	0.15-0.2	< α
Stainless Steel	-	-	-	-	-	-
Cast iron	180-80	0.05-0.15	< α	150-80	0.15-0.2	< α
Non ferrous metal	< 2000	0.1-0.15	< α	< 2000	0.15-0.2	< α
High temperature alloy	-	-	-	-	-	-

SOLID CARBIDE INSERT CNCQ

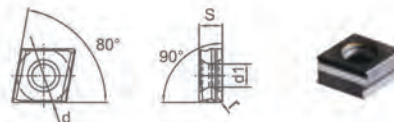

Order No.	Model	For cutting width	Application	Grade	Size(mm)			
					s	d	d1	r
230-54-105	CNCQ090504L/R	13.5-18.5mm	Steel	EP2220	5.56	9.525	4.4	0.4
230-54-106	CNCQ090508L/R	13.5-18.5mm	Steel	EP2220	5.56	9.525	4.4	0.8
230-54-107	CNCQ120504L/R	18.5-24mm	Steel	EP2220	5.56	12.7	5.5	0.4
230-54-108	CNCQ120508L/R	18.5-24mm	Steel	EP2220	5.56	12.7	5.5	0.8
230-54-109	CNCQ150504L/R	24-30.5mm	Steel	EP2220	5.56	15.875	5.5	0.4
230-54-110	CNCQ090504L/R	13.5-18.5mm	Cast iron	EP3215	5.56	9.525	4.4	0.4
230-54-111	CNCQ090508L/R	13.5-18.5mm	Cast iron	EP3215	5.56	9.525	4.4	0.8
230-54-112	CNCQ120504L/R	18.5-24mm	Cast iron	EP3215	5.56	12.7	5.5	0.4
230-54-113	CNCQ120508L/R	18.5-24mm	Cast iron	EP3215	5.56	12.7	5.5	0.8
230-54-114	CNCQ150504L/R	24-30.5mm	Cast iron	EP3215	5.56	15.875	5.5	0.4

INDEXABLE HELICAL MILLING CUTTERS FOR INSERT CNCQ

Features:

- Radial and Axial run-out less than 0.02mm.
- Cost efficient due to 2-side insert with 4 cutting edge.
- Insert to be hold by Swiss SFS high strength screws.
- Made of quality alloy steel and hardness HRC45-HRC48.
- Precision ground insert for better surface.
- Suitable for roughing to finishing cutting.

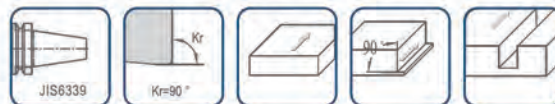

Order No.	Shank	Size(mm)			No. of Insert	No. of teeth	Insert	Screw	Torx wrench
		dc	a	L					
231-54-010	BT40-A	50	51	100	18	3	CNCQ090508NF	C040A11S	WT15
231-54-011	BT40-A	63	58	100	28	4	CNCQ090508NF	C040A11S	WT15
231-54-012	BT50-A	50	51	125	18	3	CNCQ090508NF	C040A11S	WT15
231-54-013	BT50-A	50	58	140	28	4	CNCQ090508NF	C040A11S	WT15
231-54-014	BT50-A	80	80	150	35	5	CNCQ120508NF	C050A12S	WT20

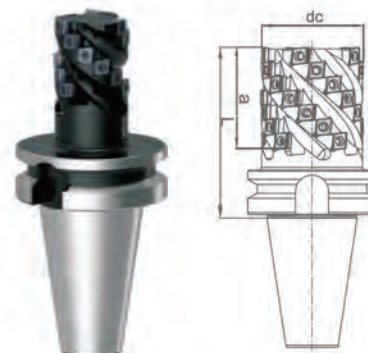

Insert not included

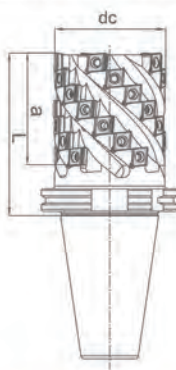

Order No.	Shank	Size(mm)			No. of Insert	No. of teeth	Insert	Screw	Torx wrench
		dc	a	L					
231-54-015	SK40-A	50	51	95	18	3	CNCQ090508NF	C040A11S	WT15
231-54-016	SK40-A	63	58	110	28	4	CNCQ090508NF	C040A11S	WT15
231-54-017	SK50-A	50	51	110	18	3	CNCQ090508NF	C040A11S	WT15
231-54-018	SK50-A	50	58	125	28	4	CNCQ090508NF	C040A11S	WT15
231-54-019	SK50-A	80	80	135	35	5	CNCQ120508NF	C050A12S	WT20

Insert not included

Order No.	Shank	Size(mm)			No. of Insert	No. of teeth	Insert	Screw	Torx wrench
		dc	a	L					
231-54-020	HSK63-A	50	51	95	18	3	CNCQ090508NF	C040A11S	WT15
231-54-021	HSK63-A	63	58	110	28	4	CNCQ090508NF	C040A11S	WT15
231-54-022	HSK100-A	50	51	110	18	3	CNCQ090508NF	C040A11S	WT15
231-54-023	HSK100-A	50	58	125	28	4	CNCQ090508NF	C040A11S	WT15
231-54-024	HSK100-A	80	80	135	35	5	CNCQ120508NF	C050A12S	WT20

Insert not included

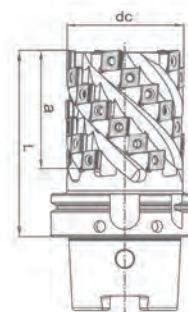

Recommended cutting data:

Application	Finish cutting			Medium cutting			Rough cutting		
	Surface speed Vc(m/min)	Feed per tooth fz(mm)	Cutting depth ap(mm)	Surface speed Vc(m/min)	Feed per tooth fz(mm)	Cutting depth ap(mm)	Surface speed Vc(m/min)	Feed per tooth fz(mm)	Cutting depth ap(mm)
Steel	-	-	-	200-100	0.05-0.12	< α	120-60	0.15-0.2	< α
Stainless Steel	-	-	-	-	-	-	-	-	-
Cast iron	-	-	-	180-80	0.05-0.15	< α	150-80	0.15-0.2	< α
Non ferrous metal	-	-	-	< 2000	0.1-0.15	< α	< 2000	0.15-0.2	< α
High temperature alloy	-	-	-	-	-	-	-	-	-

SOLID CARBIDE INSERT CNCQ

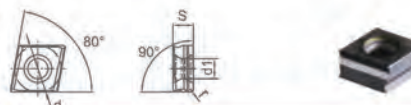

Order No.	Model	Application	Grade	Size(mm)			
				s	d	d1	r
230-54-101	CNCQ090508NF	Steel	EP2220	5.56	9.525	4.4	0.8
230-54-102	CNCQ120508NF	Steel	EP2220	5.56	12.7	5.5	0.8
230-54-103	CNCQ090508NF	Cast iron	EP3215	5.56	9.525	4.4	0.8
230-54-104	CNCQ120508NF	Cast iron	EP3215	5.56	12.7	5.5	0.8

HIGH PERFORMANCE DOUBLE CORE END MILLS

- Special Stepped-core design ensure both stable edge and chip evacuation for high efficient cutting.
- Made of micrograin solid carbide and with coating AlCrN.
- Primary application ISO material group P, M and K.
- Four flute with center cutting and size similar to DIN6527L

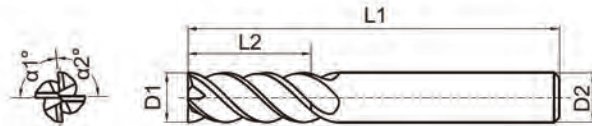

Order No.	e8 Size D1(mm)	h6 Shank Dia.D2(mm)	Length of Flute L2(mm)	Overall Length L1(mm)	Flute No.
423-03-001	4.0	4	10	50	4
423-03-002	5.0	5	11	50	4
423-03-003	6.0	6	13	57	4
423-03-004	8.0	8	19	63	4
423-03-005	10.0	10	22	72	4
423-03-006	12.0	12	26	83	4
423-03-007	16.0	16	32	92	4
423-03-008	20.0	20	38	104	4

Recommended cutting data for side milling:

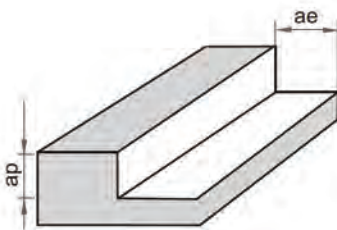

Workpiece material end mill dia.	Mild steel		Alloy steel		Hardened steel (HRC30-HRC43)		Stainless steel	
	speed (r/min)	feed (mm/min)	speed (r/min)	feed (mm/min)	speed (r/min)	feed (mm/min)	speed (r/min)	feed (mm/min)
4 mm	9800	1170	7850	950	5550	550	4750	280
5 mm	7900	1100	6300	850	4450	530	3820	300
6 mm	6550	1050	5250	840	3700	520	3180	320
8 mm	4900	980	3950	790	2780	500	2390	280
10 mm	3950	950	3150	750	2230	450	1910	270
12 mm	3300	850	2620	680	1850	400	1590	250
16 mm	2450	630	1950	500	1390	330	1190	210
20 mm	2000	560	1550	430	1110	290	950	190
cutting width and depth	ap=1.5D ae=0.4D	ap=1.5D ae=0.4D	ap=1.5D ae=0.4D	ap=1.5D ae=0.4D	ap=1.5D ae=0.2D	ap=1.5D ae=0.2D	ap=1.5D ae=0.2D	ap=1.5D ae=0.2D

Recommended cutting data for slotting

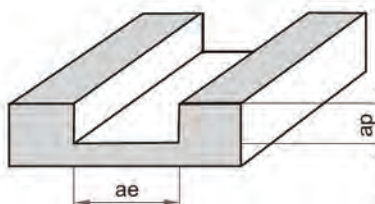

Workpiece material end mill dia.	Mild steel		Alloy steel		Hardened steel (HRC30-HRC43)		Stainless steel	
	speed (r/min)	feed (mm/min)	speed (r/min)	feed (mm/min)	speed (r/min)	feed (mm/min)	speed (r/min)	feed (mm/min)
4 mm	9000	900	7160	710	4780	380	3980	230
5 mm	7200	860	5730	690	3820	380	3180	250
6 mm	6000	840	4780	670	3180	380	2650	260
8 mm	4500	810	3580	640	2340	380	1990	200
10 mm	3600	790	2860	630	1910	340	1590	190
12 mm	3000	720	2390	570	1590	320	1320	180
16 mm	2250	560	1790	450	1190	260	990	160
20 mm	1800	470	1430	370	960	230	790	140
cutting depth	ap=1.0D	ap=1.0D	ap=1.0D	ap=1.0D	ap=0.5D	ap=0.5D	ap=0.5D	ap=0.5D

HIGH PERFORMANCE END MILLS FOR STAINLESS STEEL

- Special geometry design for stainless steel.
- With mini corner radius ($R=0.3-1.0\text{mm}$)
- Made of micrograin solid carbide and with coating TiAlN.
- Group P, M and S.
- Four flute with center cutting and shank according to DIN6535A

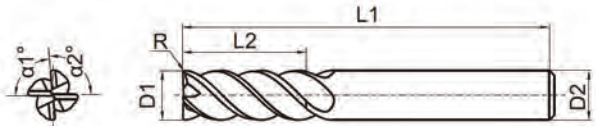

Order No.	e8 Size D1(mm)	h6 Shank Dia.D2(mm)	Length of Flute L2(mm)	Overall Length L1(mm)	Corner radius R(mm)	Flute No.
423-22-001	4.0	6	8	50	0.3	4
423-22-002	5.0	6	10	50	0.3	4
423-22-003	6.0	6	12	50	0.3	4
423-22-004	8.0	8	16	60	0.3	4
423-22-005	10.0	10	20	75	0.4	4
423-22-006	12.0	12	25	75	0.5	4
423-22-007	16.0	16	40	100	0.7	4
423-22-008	20.0	20	40	100	1	4

Recommended cutting data for side milling:

Workpiece material end mill dia.	Mild steel		Alloy steel		Hardened steel (HRC30-HRC43)		Stainless steel	
	speed (r/min)	feed (mm/min)	speed (r/min)	feed (mm/min)	speed (r/min)	feed (mm/min)	speed (r/min)	feed (mm/min)
4 mm	9200	600	8700	1390	5025	300	5400	400
5 mm	7500	610	6960	1390	100	300	4400	400
6 mm	6250	620	5800	1400	3350	300	3680	400
8 mm	4680	630	4400	1300	2550	285	2760	360
10 mm	3715	650	3500	1200	2150	285	2200	320
12 mm	3150	570	3000	1100	1750	265	1850	280
16 mm	2350	430	2250	810	1300	190	1380	230
20 mm	1900	350	1750	630	1050	170	1050	190
cutting width and depth	ap=1.0D ae=0.45D	ap=1.0D ae=0.45D	ap=1.0D ae=0.2D	ap=1.0D ae=0.2D	ap=0.5D ae=0.2D	ap=0.5D ae=0.2D	ap=0.5D ae=0.2D	ap=0.5D ae=0.2D

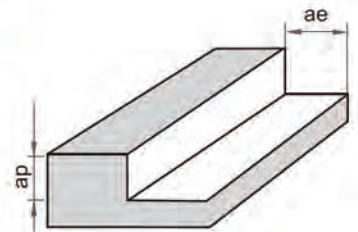

Recommended cutting data for slotting

Workpiece material end mill dia.	Mild steel		Alloy steel		Hardened steel (HRC30-HRC43)		Stainless steel	
	speed (r/min)	feed (mm/min)	speed (r/min)	feed (mm/min)	speed (r/min)	feed (mm/min)	speed (r/min)	feed (mm/min)
4 mm	9000	1000	6000	560	3900	400	4000	450
5 mm	7200	1000	4800	620	3120	380	3250	420
6 mm	6000	1000	4000	640	2600	370	2700	400
8 mm	4600	1000	3000	580	1900	360	2030	330
10 mm	3600	1000	2400	550	1400	300	1600	300
12 mm	2860	830	2000	450	1150	270	1300	280
16 mm	2100	530	1500	360	880	180	1000	210
20 mm	1680	450	1200	310	715	160	800	160
cutting depth	ap=1.0D	ap=1.0D	ap=1.0D	ap=1.0D	ap=0.5D	ap=0.5D	ap=0.5D	ap=0.5D

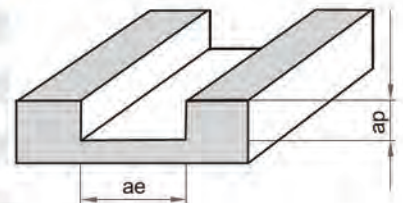

HIGH PERFORMANCE END MILLS FOR ALUMINIUM

Features:

- Special geometry design for aluminium or Alu. alloy.
- Variable pitch edge and different helix flute prevent vibration for long tool life time and better surface.
- Made of micrograin solid carbide and without coating.
- Three flute with center cutting and shank according to DIN6535A
- Neck reduced.

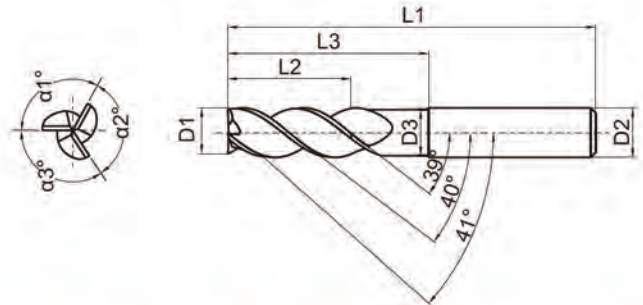
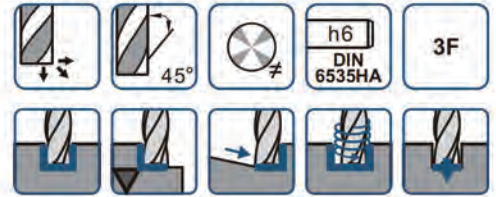

Order No.	e8 Size D1(mm)	Flute Helix	h6 Shank Dia .D2(mm)	Length of Flute L2(mm)	Overall Length L1(mm)	Neck dia. D3(mm)	Neck length L3(mm)	Flute No.
422-00-001	4.0	39°/40°/41°	6	8	50	3.5	14	3
422-00-002	5.0	39°/40°/41°	6	10	50	4.5	16	3
422-00-003	6.0	39°/40°/41°	6	13	50	5.5	20	3
422-00-004	8.0	39°/40°/41°	8	18	60	7.5	25	3
422-00-005	10.0	39°/40°/41°	10	22	75	9.3	32	3
422-00-006	12.0	39°/40°/41°	12	25	75	11	35	3
422-00-007	16.0	39°/40°/41°	16	35	100	15	50	3
422-00-008	20.0	39°/40°/41°	20	40	100	19	50	3

Recommended cutting data for side milling:

Workpiece material	Aluminium alloy	
end mill dia.	speed (r/min)	feed (mm/min)
4 mm	21450	3200
5 mm	17160	3000
6 mm	14300	3000
8 mm	10700	3000
10 mm	8600	3000
12 mm	7200	3000
16 mm	5380	2500
20 mm	4300	2200
cutting width and depth	ap=1.5D ae=0.4D	ap=1.5D ae=0.4D

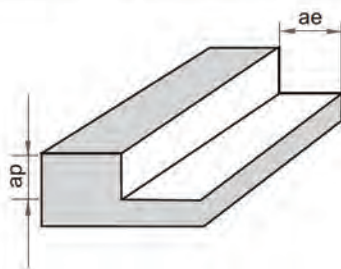

Recommended cutting data for slotting

Workpiece material	Aluminium alloy	
end mill dia.	speed (r/min)	feed (mm/min)
4 mm	25000	5800
5 mm	20000	5600
6 mm	14300	5500
8 mm	10700	4800
10 mm	8600	4800
12 mm	7200	5000
16 mm	5380	4000
20 mm	4300	3500
cutting depth	ap=0.6D	ap=0.6D

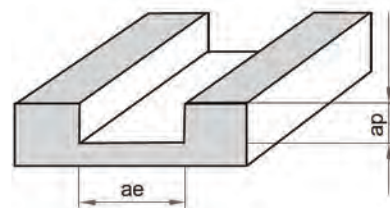

STANDARD SOLID CARBID SLOT DRILL

- Made of micrograin solid carbide and with coating TiAIN
- Improved coating for general-purpose applications in steel and case iron.
- Two flute with center cutting and size similar to DIN6527

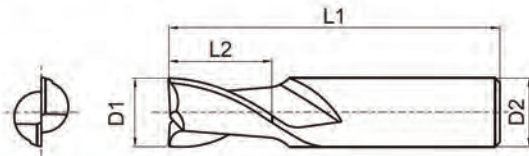
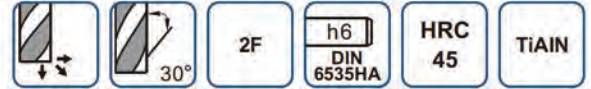

Standard Length

Order No.	e8 Size D1(mm)	h6 Shank Dia .D2(mm)	Length of Flute L2(mm)	Overall Length L1(mm)	Flute No.
421-01-001	1.0	3	3	38	2
421-01-002	1.5	3	5	38	2
421-01-003	2.0	3	6	38	2
421-01-004	2.5	3	7	38	2
421-01-005	3.0	3	7	38	2
421-01-006	3.5	4	10	50	2
421-01-007	4.0	4	10	50	2
421-01-008	4.5	5	11	50	2
421-01-009	5.0	5	11	50	2
421-01-010	5.5	6	13	57	2
421-01-011	6.0	6	13	57	2
421-01-012	7.0	8	16	63	2
421-01-013	8.0	8	19	63	2
421-01-014	9.0	10	16	72	2
421-01-015	10.0	10	22	72	2
421-01-016	12.0	12	26	83	2
421-01-017	14.0	14	26	83	2
421-01-018	16.0	16	32	92	2
421-01-019	18.0	18	32	92	2
421-01-020	20.0	20	38	104	2
421-01-021	25.0	25	38	104	2

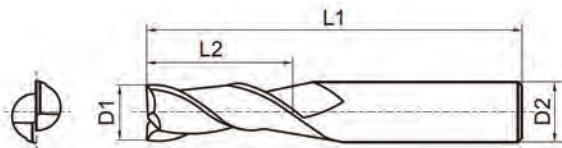

Long Length

Order No.	e8 Size D1(mm)	h6 Shank Dia .D2(mm)	Length of Flute L2(mm)	Overall Length L1(mm)	Flute No.
421-01-022	3.0	3	15	57	2
421-01-023	3.5	4	19	57	2
421-01-024	4.0	4	19	57	2
421-01-025	4.5	5	25	63	2
421-01-026	5.0	5	25	63	2
421-01-027	5.5	6	25	75	2
421-01-028	6.0	6	25	75	2
421-01-029	8.0	8	30	75	2
421-01-030	10.0	10	35	90	2
421-01-031	12.0	12	45	100	2
421-01-032	14.0	14	45	100	2
421-01-033	16.0	16	50	100	2
421-01-034	18.0	18	50	100	2
421-01-035	20.0	20	60	120	2
421-01-036	25.0	25	60	120	2

STANDARD SOLID CARBIDE END MILL

- Made of micrograin solid carbide and with coating TiAIN
- Improved coating for general-purpose applications in steel and case iron.
- Four flute with center cutting and size similar to DIN6527

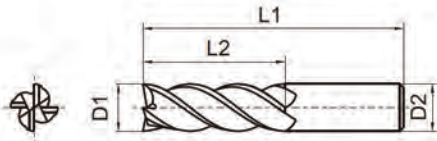
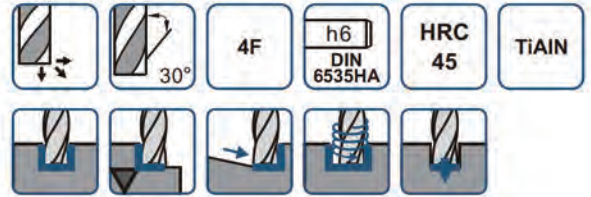

Standard Length

Order No.	e8 Size D1(mm)	h6 Shank Dia .D2(mm)	Length of Flute L2(mm)	Overall Length L1(mm)	Flute No.
423-01-001	1.0	3	3	38	4
423-01-002	1.5	3	5	38	4
423-01-003	2.0	3	6	38	4
423-01-004	2.5	3	7	38	4
423-01-005	3.0	3	7	38	4
423-01-006	3.5	4	10	50	4
423-01-007	4.0	4	10	50	4
423-01-008	4.5	5	11	50	4
423-01-009	5.0	5	11	50	4
423-01-010	5.5	6	13	57	4
423-01-011	6.0	6	13	57	4
423-01-012	7.0	8	16	63	4
423-01-013	8.0	8	19	63	4
423-01-014	9.0	10	16	72	4
423-01-015	10.0	10	22	72	4
423-01-016	12.0	12	26	83	4
423-01-017	14.0	14	26	83	4
423-01-018	16.0	16	32	92	4
423-01-019	18.0	18	32	92	4
423-01-020	20.0	20	38	104	4
423-01-021	25.0	25	38	104	4

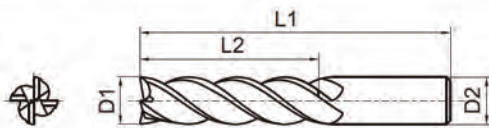

Long Length

Order No.	e8 Size D1(mm)	h6 Shank Dia .D2(mm)	Length of Flute L2(mm)	Overall Length L1(mm)	Flute No.
423-01-022	3.0	3	15	57	4
423-01-023	3.5	4	19	57	4
423-01-024	4.0	4	19	57	4
423-01-025	4.5	5	25	63	4
423-01-026	5.0	5	25	63	4
423-01-027	5.5	6	25	75	4
423-01-028	6.0	6	25	75	4
423-01-029	8.0	8	30	75	4
423-01-030	10.0	10	35	90	4
423-01-031	12.0	12	45	100	4
423-01-032	14.0	14	45	100	4
423-01-033	16.0	16	50	100	4
423-01-034	18.0	18	50	100	4
423-01-035	20.0	20	60	120	4
423-01-036	25.0	25	60	120	4

SOLID CARBID BALL NOSE SLOT DRILL

- Made of micrograin solid carbide and with coating TiAIN
- Improved coating for general-purpose applications in steel and case iron.
- Two flute with center cutting and size similar to DIN6527

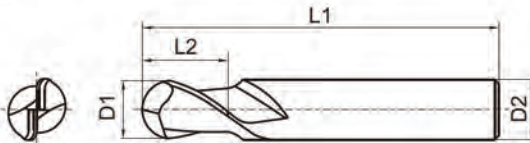

Order No.	e8 Size D1(mm)	h6 Shank Dia .D2(mm)	Length of Flute L2(mm)	Overall Length L1(mm)	Flute No.
421-11-001	1.0	3	3	38	2
421-11-002	1.5	3	5	38	2
421-11-003	2.0	3	6	38	2
421-11-004	2.5	3	7	38	2
421-11-005	3.0	3	7	38	2
421-11-006	3.5	4	10	50	2
421-11-007	4.0	4	10	50	2
421-11-008	5.0	5	11	50	2
421-11-009	6.0	6	13	57	2
421-11-010	7.0	8	13	63	2
421-11-011	8.0	8	16	63	2
421-11-012	9.0	10	16	72	2
421-11-013	10.0	10	19	72	2
421-11-014	12.0	12	22	83	2
421-11-015	14.0	14	22	83	2
421-11-016	16.0	16	26	92	2
421-11-017	18.0	18	26	92	2
421-11-018	20.0	20	32	104	2

SOLID CARBID BALL NOSE END MILL

- Made of micrograin solid carbide and with coating TiAIN
- Improved coating for general-purpose applications in steel and case iron.
- Two flute with center cutting and size similar to DIN6527

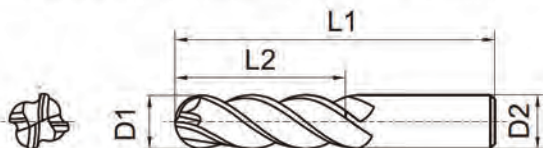

Order No.	e8 Size D1(mm)	h6 Shank Dia .D2(mm)	Length of Flute L2(mm)	Overall Length L1(mm)	Flute No.
423-11-001	3.0	3	7	38	4
423-11-002	3.5	4	10	50	4
423-11-003	4.0	4	10	50	4
423-11-004	5.0	5	11	50	4
423-11-005	6.0	6	13	57	4
423-11-006	7.0	8	13	63	4
423-11-007	8.0	8	16	63	4
423-11-008	9.0	10	16	72	4
423-11-009	10.0	10	19	72	4
423-11-010	12.0	12	22	83	4
423-11-011	14.0	14	22	83	4
423-11-012	16.0	16	26	92	4
423-11-013	18.0	18	26	92	4
423-11-014	20.0	20	32	104	4

HSS-Co8 SINGLE END MILLS

- Each piece is ground by CBN grinding wheel on WALTER machine.
- Run out control is more strict than DIN844.2 standard.
- Effective for machining high strength, heat resistant and other difficult to machine materials.
- Better appearance quality and longer tool life

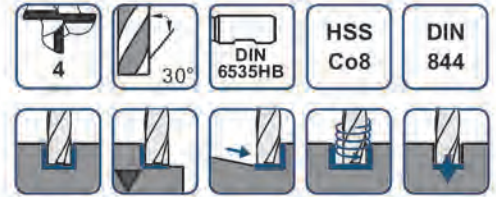
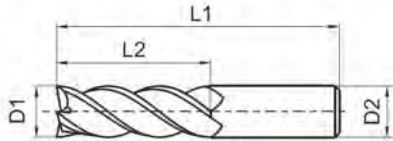

Order No.	e8 Size	h6 Shank Dia.	Length of Flute	Overall Length
522-41-303	3	6	8	52
522-41-304	4	6	11	55
522-41-305	5	6	13	57
522-41-306	6	6	13	57
522-41-308	8	10	19	69
522-41-309	9	10	19	69
522-41-310	10	10	22	72
522-41-312	12	12	26	83
522-41-314	14	12	26	83
522-41-316	16	16	32	92
522-41-318	18	16	32	92
522-41-320	20	20	38	104
522-41-322	22	20	38	104
522-41-325	25	25	45	121
522-41-328	28.0 (6F)	25	45	121
522-41-330	30.0 (6F)	25	45	121
522-41-332	32.0 (6F)	32	53	133

HSS-Co8 SINGLE END MILLS LONG LENGTH

- Each piece is ground by CBN grinding wheel on WALTER machine.
- Run out control is more strict than DIN844.2 standard.
- Effective for machining high strength, heat resistant and other difficult to machine materials.
- Better appearance quality and longer tool life

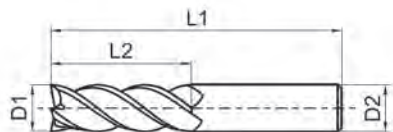

Order No.	e8 Size	h6 Shank Dia.	Length of Flute	Overall Length
523-41-303	3	6	12	56
523-41-304	4	6	19	63
523-41-305	5	6	24	68
523-41-306	6	6	24	68
523-41-308	8	10	38	88
523-41-310	10	10	45	95
523-41-312	12	12	53	110
523-41-314	14	12	53	110
523-41-316	16	16	63	123
523-41-318	18	16	63	123
523-41-320	20	20	75	141
523-41-325	25	25	90	166

HSS-Co8 SINGLE END MILLS

- Each piece is ground by CBN grinding wheel on WALTER machine.
- Run out control is more strict than DIN844.2 standard.
- Effective for machining high strength, heat resistant and other difficult to machine materials.
- Better appearance quality and longer tool life

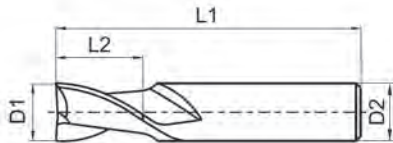

Order No.	e8 Size	h6 Shank Dia.	Length of Flute	Overall Length
522-21-303	3	6	5	49
522-21-304	4	6	7	51
522-21-305	5	6	8	52
522-21-306	6	6	8	52
522-21-308	8	10	11	61
522-21-309	9	10	11	61
522-21-310	10	10	13	63
522-21-312	12	12	16	73
522-21-314	14	12	16	73
522-21-316	16	16	19	79
522-21-318	18	16	19	79
522-21-320	20	20	22	88
522-21-325	25	25	26	102

HSS-Co8 SINGLE END MILLS LONG LENGTH

- Each piece is ground by CBN grinding wheel on WALTER machine.
- Run out control is more strict than DIN844.2 standard.
- Effective for machining high strength, heat resistant and other difficult to machine materials.
- Better appearance quality and longer tool life

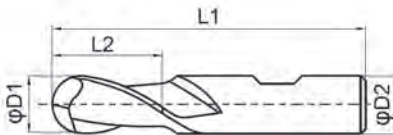

Order No.	e8 Size	h6 Shank Dia.	Length of Flute	Overall Length
522-23-303	3	6	8	52
522-23-304	4	6	11	55
522-23-305	5	6	13	57
522-23-306	6	6	13	57
522-23-308	8	10	19	69
522-23-310	10	10	22	72
522-23-312	12	12	26	83
522-23-316	16	16	32	92
522-23-320	20	20	38	104

DRILLING TOOL

INDEXABLE DRILLING CUTTERS

160,164



SOLID CARBIDE INSERT FOR DRILL

157,168



SOLID CARBIDE TWIST DRILLS

170



SPEEDY DRILL WITH QUICK RELEASE CARBIDE CUTTING HEAD

High performance.

High productivity.

High precision

Features:

- Optimised geometries carbide cutting head for quality surface by drilling of mild steel, alloy steel and cast iron.
- Self-lock setting system without screws make cutting head can be changed directly from toolholder and no need to take toolholder out from machine.
- Internal coolant for cooling and efficient chip evacuation, result in high speed and smooth cutting as well as extending insert lifetime.
- Right hand cutting



SOLID CARBIDE CUTTING HEAD

- Made of solid carbide with modern coating and precision ground point for maximum performance and very high feed rates.
- Can be changed very easily even while mounted in the machine due to easy-to-handle quick change coupling.
- High efficient chip evacuation properly for various material due to optimised chip flute..Special surface treatment lead to very high performance and long lifetime..Standard style with 140° point angle.

STYLE HAGN

- Universal use for cutting steel and cast iron.
- better for cutting depth not more than 5D.

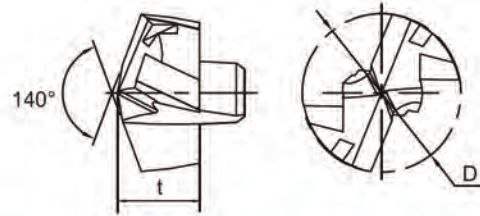

Order No.	Size D (mm)	t (mm)
HAGN-120	12	7
HAGN-121	12.1	7
HAGN-122	12.2	7
HAGN-123	12.3	7
HAGN-124	12.4	7
HAGN-125	12.5	7
HAGN-126	12.6	7
HAGN-127	12.7	7
HAGN-128	12.8	7
HAGN-129	12.9	7
HAGN-130	13	7.6
HAGN-131	13.1	7.6
HAGN-132	13.2	7.6
HAGN-133	13.3	7.6
HAGN-134	13.4	7.6
HAGN-135	13.5	7.6
HAGN-136	13.6	7.6
HAGN-137	13.7	7.6
HAGN-138	13.8	7.6
HAGN-139	13.9	7.6

Order No.	Size D (mm)	t (mm)
HAGN-140	14	8.1
HAGN-141	14.1	8.1
HAGN-142	14.2	8.1
HAGN-143	14.3	8.1
HAGN-144	14.4	8.1
HAGN-145	14.5	8.1
HAGN-146	14.6	8.1
HAGN-147	14.7	8.1
HAGN-148	14.8	8.1
HAGN-149	14.9	8.1
HAGN-150	15	8.7
HAGN-151	15.1	8.7
HAGN-152	15.2	8.7
HAGN-153	15.3	8.7
HAGN-154	15.4	8.7
HAGN-155	15.5	8.7
HAGN-156	15.6	8.7
HAGN-157	15.7	8.7
HAGN-158	15.8	8.7
HAGN-159	15.9	8.7

Order No.	Size D (mm)	t (mm)
HAGN-160	16	9.3
HAGN-161	16.1	9.3
HAGN-162	16.2	9.3
HAGN-163	16.3	9.3
HAGN-164	16.4	9.3
HAGN-165	16.5	9.3
HAGN-166	16.6	9.3
HAGN-167	16.7	9.3
HAGN-168	16.8	9.3
HAGN-169	16.9	9.3
HAGN-170	17	9.9
HAGN-171	17.1	9.9
HAGN-172	17.2	9.9
HAGN-173	17.3	9.9
HAGN-174	17.4	9.9
HAGN-175	17.5	9.9
HAGN-176	17.6	9.9
HAGN-177	17.7	9.9
HAGN-178	17.8	9.9
HAGN-179	17.9	9.9

Order No.	Size D (mm)	t (mm)
HAGN-180	18	10.5
HAGN-181	18.1	10.5
HAGN-182	18.2	10.5
HAGN-183	18.3	10.5
HAGN-184	18.4	10.5
HAGN-185	18.5	10.5
HAGN-186	18.6	10.5
HAGN-187	18.7	10.5
HAGN-188	18.8	10.5
HAGN-189	18.9	10.5
HAGN-190	19	11
HAGN-191	19.1	11
HAGN-192	19.2	11
HAGN-193	19.3	11
HAGN-194	19.4	11
HAGN-195	19.5	11
HAGN-196	19.6	11
HAGN-197	19.7	11
HAGN-198	19.8	11
HAGN-199	19.9	11

Order No.	Size D (mm)	t (mm)
HAGN-200	20	11.6
HAGN-201	20.1	11.6
HAGN-202	20.2	11.6
HAGN-203	20.3	11.6
HAGN-204	20.4	11.6
HAGN-205	20.5	11.6
HAGN-206	20.6	11.6
HAGN-207	20.7	11.6
HAGN-208	20.8	11.6
HAGN-209	20.9	11.6
HAGN-210	21	12.1
HAGN-211	21.1	12.1
HAGN-212	21.2	12.1
HAGN-213	21.3	12.1
HAGN-214	21.4	12.1
HAGN-215	21.5	12.1
HAGN-216	21.6	12.1
HAGN-217	21.7	12.1
HAGN-218	21.8	12.1
HAGN-219	21.9	12.1

Order No.	Size D (mm)	t (mm)
HAGN-220	22	12.7
HAGN-221	22.1	12.7
HAGN-222	22.2	12.7
HAGN-223	22.3	12.7
HAGN-224	22.4	12.7
HAGN-225	22.5	12.7
HAGN-226	22.6	12.7
HAGN-227	22.7	12.7
HAGN-228	22.8	12.7
HAGN-229	22.9	12.7
HAGN-230	23	13.3
HAGN-231	23.1	13.3
HAGN-232	23.2	13.3
HAGN-233	23.3	13.3
HAGN-234	23.4	13.3
HAGN-235	23.5	13.3
HAGN-236	23.6	13.3
HAGN-237	23.7	13.3
HAGN-238	23.8	13.3
HAGN-239	23.9	13.3

Order No.	Size D (mm)	t (mm)
HAGN-240	24	13.9
HAGN-241	24.1	13.9
HAGN-242	24.2	13.9
HAGN-243	24.3	13.9
HAGN-244	24.4	13.9
HAGN-245	24.5	13.9
HAGN-246	24.6	13.9
HAGN-247	24.7	13.9
HAGN-248	24.8	13.9
HAGN-249	24.9	13.9
HAGN-250	25	14.5
HAGN-251	25.1	14.5
HAGN-252	25.2	14.5
HAGN-253	25.3	14.5
HAGN-254	25.4	14.5
HAGN-255	25.5	14.5
HAGN-256	25.6	14.5
HAGN-257	25.7	14.5
HAGN-258	25.8	14.5
HAGN-259	25.9	14.5

SOLID CARBIDE CUTTING HEAD

- Made of solid carbide with modern coating and precision ground point for maximum performance and very high feed rates.
- Can be changed very easily even while mounted in the machine due to easy-to-handle quick change coupling.
- High efficient chip evacuation properly for various material due to optimised chip flute..Special surface treatment lead to very high performance and long lifetime..Standard style with 140° point angle.

STYLE HAGC

- Special design for cutting cast iron.
- better for cutting depth not more than 5D

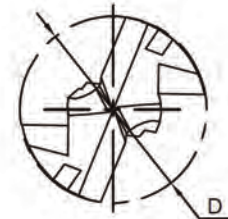
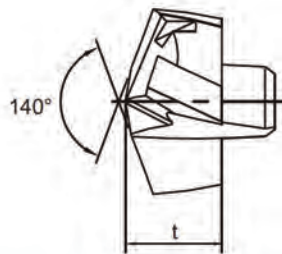
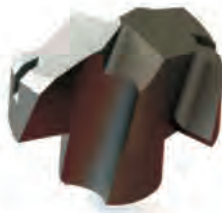

Order No.	Size D (mm)	t (mm)
HAGC-120	12	7
HAGC-121	12.1	7
HAGC-122	12.2	7
HAGC-123	12.3	7
HAGC-124	12.4	7
HAGC-125	12.5	7
HAGC-126	12.6	7
HAGC-127	12.7	7
HAGC-128	12.8	7
HAGC-129	12.9	7
HAGC-130	13	7.6
HAGC-131	13.1	7.6
HAGC-132	13.2	7.6
HAGC-133	13.3	7.6
HAGC-134	13.4	7.6
HAGC-135	13.5	7.6
HAGC-136	13.6	7.6
HAGC-137	13.7	7.6
HAGC-138	13.8	7.6
HAGC-139	13.9	7.6

Order No.	Size D (mm)	t (mm)
HAGC-140	14	8.1
HAGC-141	14.1	8.1
HAGC-142	14.2	8.1
HAGC-143	14.3	8.1
HAGC-144	14.4	8.1
HAGC-145	14.5	8.1
HAGC-146	14.6	8.1
HAGC-147	14.7	8.1
HAGC-148	14.8	8.1
HAGC-149	14.9	8.1
HAGC-150	15	8.7
HAGC-151	15.1	8.7
HAGC-152	15.2	8.7
HAGC-153	15.3	8.7
HAGC-154	15.4	8.7
HAGC-155	15.5	8.7
HAGC-156	15.6	8.7
HAGC-157	15.7	8.7
HAGC-158	15.8	8.7
HAGC-159	15.9	8.7

Order No.	Size D (mm)	t (mm)
HAGC-160	16	9.3
HAGC-161	16.1	9.3
HAGC-162	16.2	9.3
HAGC-163	16.3	9.3
HAGC-164	16.4	9.3
HAGC-165	16.5	9.3
HAGC-166	16.6	9.3
HAGC-167	16.7	9.3
HAGC-168	16.8	9.3
HAGC-169	16.9	9.3
HAGC-170	17	9.9
HAGC-171	17.1	9.9
HAGC-172	17.2	9.9
HAGC-173	17.3	9.9
HAGC-174	17.4	9.9
HAGC-175	17.5	9.9
HAGC-176	17.6	9.9
HAGC-177	17.7	9.9
HAGC-178	17.8	9.9
HAGC-179	17.9	9.9

Order No.	Size D (mm)	t (mm)
HAGC-180	18	10.5
HAGC-181	18.1	10.5
HAGC-182	18.2	10.5
HAGC-183	18.3	10.5
HAGC-184	18.4	10.5
HAGC-185	18.5	10.5
HAGC-186	18.6	10.5
HAGC-187	18.7	10.5
HAGC-188	18.8	10.5
HAGC-189	18.9	10.5
HAGC-190	19	11
HAGC-191	19.1	11
HAGC-192	19.2	11
HAGC-193	19.3	11
HAGC-194	19.4	11
HAGC-195	19.5	11
HAGC-196	19.6	11
HAGC-197	19.7	11
HAGC-198	19.8	11
HAGC-199	19.9	11

Order No.	Size D (mm)	t (mm)
HAGC-200	20	11.6
HAGC-201	20.1	11.6
HAGC-202	20.2	11.6
HAGC-203	20.3	11.6
HAGC-204	20.4	11.6
HAGC-205	20.5	11.6
HAGC-206	20.6	11.6
HAGC-207	20.7	11.6
HAGC-208	20.8	11.6
HAGC-209	20.9	11.6
HAGC-210	21	12.1
HAGC-211	21.1	12.1
HAGC-212	21.2	12.1
HAGC-213	21.3	12.1
HAGC-214	21.4	12.1
HAGC-215	21.5	12.1
HAGC-216	21.6	12.1
HAGC-217	21.7	12.1
HAGC-218	21.8	12.1
HAGC-219	21.9	12.1

Order No.	Size D (mm)	t (mm)
HAGC-220	22	12.7
HAGC-221	22.1	12.7
HAGC-222	22.2	12.7
HAGC-223	22.3	12.7
HAGC-224	22.4	12.7
HAGC-225	22.5	12.7
HAGC-226	22.6	12.7
HAGC-227	22.7	12.7
HAGC-228	22.8	12.7
HAGC-229	22.9	12.7
HAGC-230	23	13.3
HAGC-231	23.1	13.3
HAGC-232	23.2	13.3
HAGC-233	23.3	13.3
HAGC-234	23.4	13.3
HAGC-235	23.5	13.3
HAGC-236	23.6	13.3
HAGC-237	23.7	13.3
HAGC-238	23.8	13.3
HAGC-239	23.9	13.3

Order No.	Size D (mm)	t (mm)
HAGC-240	24	13.9
HAGC-241	24.1	13.9
HAGC-242	24.2	13.9
HAGC-243	24.3	13.9
HAGC-244	24.4	13.9
HAGC-245	24.5	13.9
HAGC-246	24.6	13.9
HAGC-247	24.7	13.9
HAGC-248	24.8	13.9
HAGC-249	24.9	13.9
HAGC-250	25	14.5
HAGC-251	25.1	14.5
HAGC-252	25.2	14.5
HAGC-253	25.3	14.5
HAGC-254	25.4	14.5
HAGC-255	25.5	14.5
HAGC-256	25.6	14.5
HAGC-257	25.7	14.5
HAGC-258	25.8	14.5
HAGC-259	25.9	14.5

SOLID CARBIDE CUTTING HEAD

- Made of solid carbide with modern coating and precision ground point for maximum performance and very high feed rates.
- Can be changed very easily even while mounted in the machine due to easy-to-handle quick change coupling.
- High efficient chip evacuation properly for various material due to optimised chip flute..Special surface treatment lead to very high performance and long lifetime..Standard style with 140° point angle.

STYLE HAGP

- Special desing cutting milled steel and alloy steel.
- Suitable for cutting depth more than 5D due to better Self-centering point.

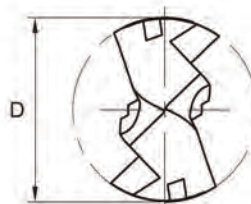
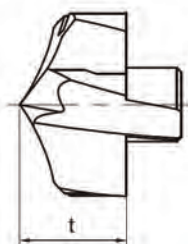

Order No.	Size D (mm)	t (mm)
HAGP-120	12	7
HAGP-121	12.1	7
HAGP-122	12.2	7
HAGP-123	12.3	7
HAGP-124	12.4	7
HAGP-125	12.5	7
HAGP-126	12.6	7
HAGP-127	12.7	7
HAGP-128	12.8	7
HAGP-129	12.9	7
HAGP-130	13	7.6
HAGP-131	13.1	7.6
HAGP-132	13.2	7.6
HAGP-133	13.3	7.6
HAGP-134	13.4	7.6
HAGP-135	13.5	7.6
HAGP-136	13.6	7.6
HAGP-137	13.7	7.6
HAGP-138	13.8	7.6
HAGP-139	13.9	7.6

Order No.	Size D (mm)	t (mm)
HAGP-140	14	8.1
HAGP-141	14.1	8.1
HAGP-142	14.2	8.1
HAGP-143	14.3	8.1
HAGP-144	14.4	8.1
HAGP-145	14.5	8.1
HAGP-146	14.6	8.1
HAGP-147	14.7	8.1
HAGP-148	14.8	8.1
HAGP-149	14.9	8.1
HAGP-150	15	8.7
HAGP-151	15.1	8.7
HAGP-152	15.2	8.7
HAGP-153	15.3	8.7
HAGP-154	15.4	8.7
HAGP-155	15.5	8.7
HAGP-156	15.6	8.7
HAGP-157	15.7	8.7
HAGP-158	15.8	8.7
HAGP-159	15.9	8.7

Order No.	Size D (mm)	t (mm)
HAGP-160	16	9.3
HAGP-161	16.1	9.3
HAGP-162	16.2	9.3
HAGP-163	16.3	9.3
HAGP-164	16.4	9.3
HAGP-165	16.5	9.3
HAGP-166	16.6	9.3
HAGP-167	16.7	9.3
HAGP-168	16.8	9.3
HAGP-169	16.9	9.3
HAGP-170	17	9.9
HAGP-171	17.1	9.9
HAGP-172	17.2	9.9
HAGP-173	17.3	9.9
HAGP-174	17.4	9.9
HAGP-175	17.5	9.9
HAGP-176	17.6	9.9
HAGP-177	17.7	9.9
HAGP-178	17.8	9.9
HAGP-179	17.9	9.9

Order No.	Size D (mm)	t (mm)
HAGP-180	18	10.5
HAGP-181	18.1	10.5
HAGP-182	18.2	10.5
HAGP-183	18.3	10.5
HAGP-184	18.4	10.5
HAGP-185	18.5	10.5
HAGP-186	18.6	10.5
HAGP-187	18.7	10.5
HAGP-188	18.8	10.5
HAGP-189	18.9	10.5
HAGP-190	19	11
HAGP-191	19.1	11
HAGP-192	19.2	11
HAGP-193	19.3	11
HAGP-194	19.4	11
HAGP-195	19.5	11
HAGP-196	19.6	11
HAGP-197	19.7	11
HAGP-198	19.8	11
HAGP-199	19.9	11

Order No.	Size D (mm)	t (mm)
HAGP-200	20	11.6
HAGP-201	20.1	11.6
HAGP-202	20.2	11.6
HAGP-203	20.3	11.6
HAGP-204	20.4	11.6
HAGP-205	20.5	11.6
HAGP-206	20.6	11.6
HAGP-207	20.7	11.6
HAGP-208	20.8	11.6
HAGP-209	20.9	11.6
HAGP-210	21	12.1
HAGP-211	21.1	12.1
HAGP-212	21.2	12.1
HAGP-213	21.3	12.1
HAGP-214	21.4	12.1
HAGP-215	21.5	12.1
HAGP-216	21.6	12.1
HAGP-217	21.7	12.1
HAGP-218	21.8	12.1
HAGP-219	21.9	12.1

Order No.	Size D (mm)	t (mm)
HAGP-220	22	12.7
HAGP-221	22.1	12.7
HAGP-222	22.2	12.7
HAGP-223	22.3	12.7
HAGP-224	22.4	12.7
HAGP-225	22.5	12.7
HAGP-226	22.6	12.7
HAGP-227	22.7	12.7
HAGP-228	22.8	12.7
HAGP-229	22.9	12.7
HAGP-230	23	13.3
HAGP-231	23.1	13.3
HAGP-232	23.2	13.3
HAGP-233	23.3	13.3
HAGP-234	23.4	13.3
HAGP-235	23.5	13.3
HAGP-236	23.6	13.3
HAGP-237	23.7	13.3
HAGP-238	23.8	13.3
HAGP-239	23.9	13.3

Order No.	Size D (mm)	t (mm)
HAGP-240	24	13.9
HAGP-241	24.1	13.9
HAGP-242	24.2	13.9
HAGP-243	24.3	13.9
HAGP-244	24.4	13.9
HAGP-245	24.5	13.9
HAGP-246	24.6	13.9
HAGP-247	24.7	13.9
HAGP-248	24.8	13.9
HAGP-249	24.9	13.9
HAGP-250	25	14.5
HAGP-251	25.1	14.5
HAGP-252	25.2	14.5
HAGP-253	25.3	14.5
HAGP-254	25.4	14.5
HAGP-255	25.5	14.5
HAGP-256	25.6	14.5
HAGP-257	25.7	14.5
HAGP-258	25.8	14.5
HAGP-259	25.9	14.5

DRILLING TOOLHOLDER

- Made of high quality alloy steel
- Round shank with flat according to ISO9766
- With coolant hole design for high speed and smooth cutting.
- Quality polished flute for chip moving quickly.
- Supplied with assembly key and without carbide cutting head.

Drilling depth : Dx3

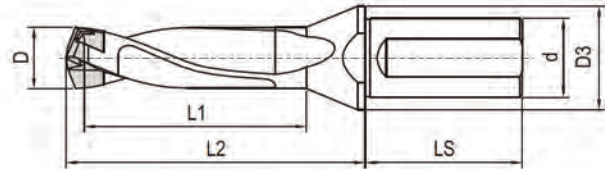

Order No.	For Cutting Dia.(mm)	Size(mm)						Key
		d	D3	L1	L2	LS	D	
103D-025	12.0-12.9	16	20	37	54.5	48	12	#2
103D-030	13.0-13.9	16	20	41	58.1	48	13	#2
103D-035	14.0-14.9	16	20	44	63.6	48	14	#2
103D-040	15.0-15.9	20	25	45	68.7	50	15	#2
103D-045	16.0-16.9	20	25	48	73.3	50	16	#2
103D-050	17.0-17.9	20	25	51	77.9	50	17	#3
103D-055	18.0-18.9	25	32	54	82.5	56	18	#3
103D-060	19.0-19.9	25	32	57	87	56	19	#3
103D-065	20.0-20.9	25	32	60	91.6	56	20	#3
103D-070	21.0-21.9	25	32	63	96.2	56	21	#4
103D-075	22.0-22.9	25	32	66	100.8	56	22	#4
103D-080	23.0-23.9	32	42	69	105.4	60	23	#4
103D-085	24.0-24.9	32	42	72	109.9	60	24	#4
103D-090	25.0-26.0	32	42	75	114.5	60	25	#4

Drilling depth : Dx5

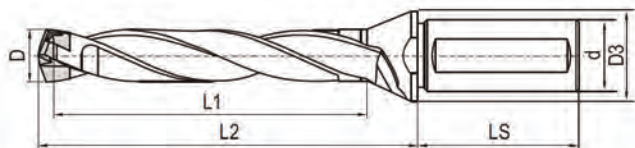

Order No.	For Cutting Dia.(mm)	Size(mm)						Key
		d	D3	L1	L2	LS	D	
105D-025	12.0-12.9	16	20	62	79.5	48	12	#2
105D-030	13.0-13.9	16	20	68	85.1	48	13	#2
105D-035	14.0-14.9	16	20	73	92.7	48	14	#2
105D-040	15.0-15.9	20	25	75	98.7	50	15	#2
105D-045	16.0-16.9	20	25	80	105.3	50	16	#2
105D-050	17.0-17.9	20	25	85	111.9	50	17	#3
105D-055	18.0-18.9	25	32	90	118.5	56	18	#3
105D-060	19.0-19.9	25	32	95	125	56	19	#3
105D-065	20.0-20.9	25	32	100	131.6	56	20	#3
105D-070	21.0-21.9	25	32	105	138.2	56	21	#4
105D-075	22.0-22.9	25	32	110	144.8	56	22	#4
105D-080	23.0-23.9	32	42	115	151.4	60	23	#4
105D-085	24.0-24.9	32	42	120	158	60	24	#4
105D-090	25.0-26.0	32	42	125	164.5	60	25	#4

DRILLING TOOLHOLDER

- Made of high quality alloy steel
- Round shank with flat according to ISO9766
- With coolant hole design for high speed and smooth cutting.
- Quality polished flute for chip moving quickly.
- Supplied with assembly key and without carbide cutting head.

Drilling depth : Dx8

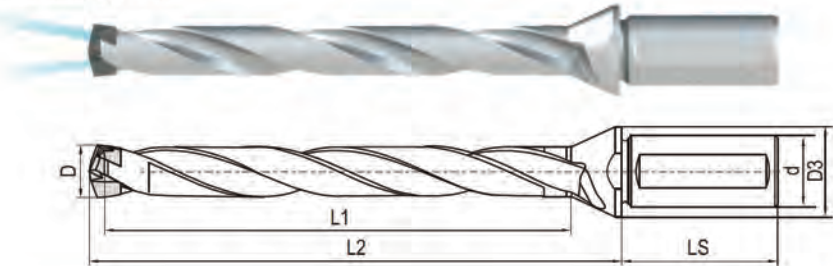

Order No.	For Cutting Dia.(mm)	Size(mm)						Key
		d	D3	L1	L2	LS	D	
108D-025	12.0-12.9	16	20	100	117	48	12	#2
108D-030	13.0-13.9	16	20	108	125.5	48	13	#2
108D-035	14.0-14.9	16	20	116	136.2	48	14	#2
108D-040	15.0-15.9	20	25	120	143.7	50	15	#2
108D-045	16.0-16.9	20	25	128	153.3	50	16	#2
108D-050	17.0-17.9	20	25	136	162.9	50	17	#3
108D-055	18.0-18.9	25	32	144	172.5	56	18	#3
108D-060	19.0-19.9	25	32	152	182	56	19	#3
108D-065	20.0-20.9	25	32	160	191.6	56	20	#3
108D-070	21.0-21.9	25	32	168	201.2	56	21	#4
108D-075	22.0-22.9	25	32	176	210.8	56	22	#4
108D-080	23.0-23.9	32	42	184	220.4	60	23	#4
108D-085	24.0-24.9	32	42	192	230	60	24	#4
108D-090	25.0-26.0	32	42	200	239.5	60	25	#4

Drilling depth : Dx12

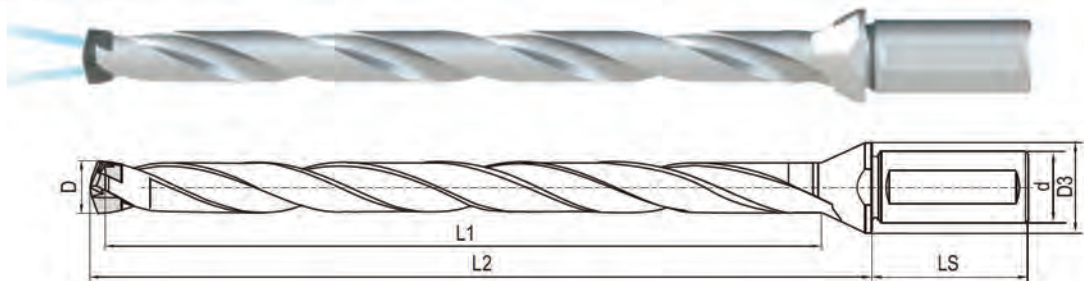

Order No.	For Cutting Dia.(mm)	Size(mm)						Key
		d	D3	L1	L2	LS	D	
112D-025	12.0-12.9	16	20	150	167	48	12	#2
112D-030	13.0-13.9	16	20	162	179	48	13	#2
112D-035	14.0-14.9	16	20	174	194	48	14	#2
112D-040	15.0-15.9	20	25	180	210	50	15	#2
112D-045	16.0-16.9	20	25	192	224	50	16	#2
112D-050	17.0-17.9	20	25	204	238	50	17	#3
112D-055	18.0-18.9	25	32	216	252	56	18	#3
112D-060	19.0-19.9	25	32	228	266	56	19	#3
112D-065	20.0-20.9	25	32	240	280	56	20	#3
112D-070	21.0-21.9	25	32	252	294	56	21	#4
112D-075	22.0-23.0	25	32	264	308	56	22	#4

INNOVATION SELF-LOCKED CLAMPING SYSTEM

- Centering by cylindrical fuses
- The cutting head can be self-locked with toolholder due to its seat elastic deformation.
- Axial drill force is transferred to toolholder by end faces.
- Drill torque is transferred to toolholder by stop faces.

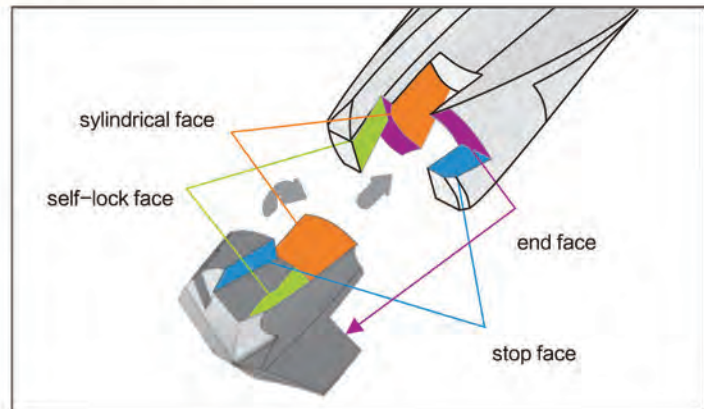
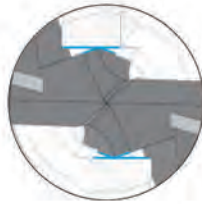

HOW TO ATTACH CUTTING HEADS



- Fix drill holder on adapter, for insert exchange, fix adapter on Tool tightening fixture.



- Clean the top groove of drill holder



- Put insert into drill holder



- Turn slightly in a clockwise direction.



- Set the wrench properly

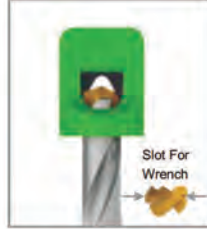

- Make sure the wrench fits with insert's slot.



- Turn the wrench in a clockwise direction slowly



- Complete

HOW TO DETACH CUTTING HEADS



- Remove the dust & chip from insert.



- Set the wrench properly.



- Make sure the wrench fits with insert's slot.



- Turn the wrench in a counterclockwise direction slowly.



- Once Self-Lock is released, the insert can be turned by finger easily.



- Remove insert from toolholder.

Coolant

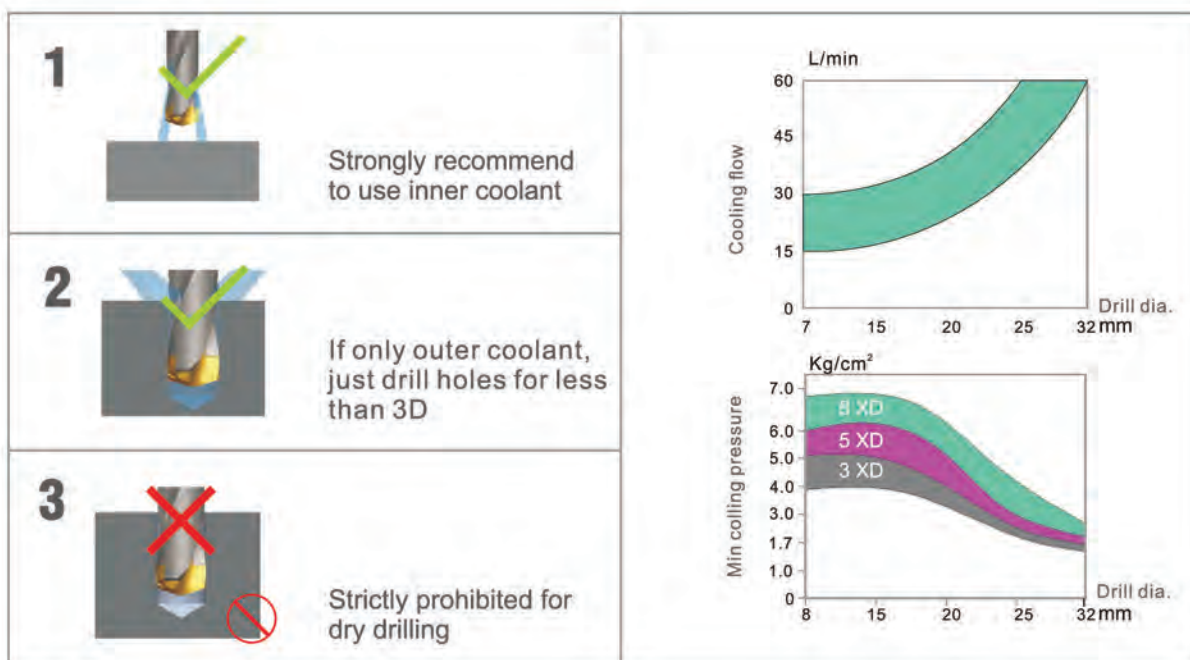

Recommended cutting data:

Workpiece material	Alloy treatment and status		Hardness (HB)	Cutting speed Vc(m/min)	Feed rate fz(mm/rev.)						
					D<10	10<=D<11.9	12<=D<13.9	14<=D<15.9	16<=D<19.9	20<=D<25.9	
P	Mild steel	annealed <0.25%C	125	80-140	0.12	0.15	0.18	0.20	0.25	0.25	
		tempered >=0.25%-0.55%C	190-250	80-120	0.17	0.21	0.24	0.27	0.35	0.35	
		tempered >=0.55%	220	70-110	0.22	0.28	0.30	0.35	0.45	0.45	
	Lower alloy steel	annealed		200	70-120						
		tempered		275	70-110	0.12	0.14	0.16	0.18	0.23	0.25
		tempered		300	50-90	0.18	0.21	0.24	0.26	0.31	0.35
		tempered		350	40-70	0.25	0.28	0.32	0.35	0.40	0.45
Higher alloy steel	annealed		200	50-90	0.12	0.12	0.15	0.18	0.20	0.22	
	tempered		325	40-80	0.16	0.17	0.20	0.23	0.25	0.27	
M	Stainless steel	annealed ferritic/martensitic	200	40-70	0.20	0.22	0.25	0.28	0.30	0.33	
		quenching martensitic	240	40-70	0.10	0.12	0.14	0.16	0.16	0.18	
		quenching austenitic	180	30-70	0.12	0.15	0.17	0.20	0.21	0.24	
K	Grey cast iron	ferritic	160	90-160							
		pearlitic	250	80-140							
	Nodular cast iron	ferritic	180	90-180	0.15	0.18	0.20	0.24	0.26	0.30	
		pearlitic	260	80-140	0.22	0.27	0.32	0.37	0.45	0.35	
					0.30	0.35	0.40	0.45	0.55	0.37	
	Malleable cast iron	ferritic	130	90-160							
pearlitic		230	80-140								

Lower cutting speed and feed rate should be used for tool holders of 8D or 12D

INDEXABLE DRILLING CUTTERS

- Variable helix improve chip evacuation.
- Internal coolant and High feed rates.
- Made of quality alloy steel.
- Straight shank with flat for driving
- Insert pockets precisely positioned to keep cutting forces low and evenly distributed.

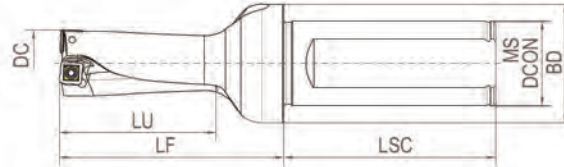

Order No.	Model	Size(mm)						Center Insert	Side Insert	Screw	Torx wrench
		Dc	Lu	DCON MS	BD	LF	LSC				
266-21-216	ISS16C-2D	16	37	20	28	53	50	SOCT050204X	SXMT050204	C020A05S	T6
266-21-217	ISS16.5C-2D	16.5	38	20	28	54	50	SOCT050204X	SXMT050204	C020A05S	T6
266-21-218	ISS17C-2D	17	39	20	28	55	50	SOCT050204X	SXMT050204	C020A05S	T6
266-21-219	ISS17.5C-2D	17.5	40	25	35	59	56	SOCT050204X	SXMT050204	C020A05S	T6
266-21-220	ISS18C-2D	18	41	25	35	60	56	SOCT050204X	SXMT050204	C020A05S	T6
266-21-221	ISS18.5C-2D	18.5	42	25	35	61	56	SOCT060306X	SXMT060306	C022A06S	FT7
266-21-222	ISS19C-2D	19	43	25	35	62	56	SOCT060306X	SXMT060306	C022A06S	FT7
266-21-223	ISS19.5C-2D	19.5	44	25	35	63	56	SOCT060306X	SXMT060306	C022A06S	FT7
266-21-224	ISS20C-2D	20	45	25	35	64	56	SOCT060306X	SXMT060306	C022A06S	FT7
266-21-225	ISS20.5C-2D	20.5	46	25	35	65	56	SOCT060306X	SXMT060306	C022A06S	FT7
266-21-226	ISS21C-2D	21	47	25	35	66	56	SOCT060306X	SXMT060306	C022A06S	FT7
266-21-227	ISS21.5C-2D	21.5	48	25	35	67	56	SOCT070306X	SXMT070306	C025A07S	FT7
266-21-228	ISS22C-2D	22	49	25	35	68	56	SOCT070306X	SXMT070306	C025A07S	FT7
266-21-229	ISS22.5C-2D	22.5	50	25	35	69	56	SOCT070306X	SXMT070306	C025A07S	FT7
266-21-230	ISS23C-2D	23	51	25	35	70	56	SOCT070306X	SXMT070306	C025A07S	FT7
266-21-231	ISS23.5C-2D	23.5	52	32	42	74	60	SOCT070306X	SXMT070306	C025A07S	FT7
266-21-232	ISS24C-2D	24	53	32	42	75	60	SOCT070306X	SXMT070306	C025A07S	FT7
266-21-233	ISS24.5C-2D	24.5	54	32	42	76	60	SOCT080408X	SXMT080408	C030A07S	T9
266-21-234	ISS25C-2D	25	55	32	42	77	60	SOCT080408X	SXMT080408	C030A07S	T9
266-21-235	ISS25.5C-2D	25.5	56	32	42	78	60	SOCT080408X	SXMT080408	C030A07S	T9
266-21-236	ISS26C-2D	26	57	32	42	79	60	SOCT080408X	SXMT080408	C030A07S	T9
266-21-237	ISS26.5C-2D	26.5	58	32	42	80	60	SOCT080408X	SXMT080408	C030A07S	T9
266-21-238	ISS27C-2D	27	59	32	42	81	60	SOCT080408X	SXMT080408	C030A07S	T9
266-21-239	ISS28C-2D	28	61	32	42	83	60	SOCT080408X	SXMT080408	C030A07S	T9
266-21-240	ISS29C-2D	29	63	32	42	86	60	SOCT080408X	SXMT080408	C030A07S	T9
266-21-241	ISS30C-2D	30	65	32	42	87	60	SOCT100408X	SXMT100408	C035A08S	T15
266-21-242	ISS31C-2D	31	67	32	42	89	60	SOCT100408X	SXMT100408	C035A08S	T15
266-21-243	ISS32C-2D	32	69	32	42	91	60	SOCT100408X	SXMT100408	C035A08S	T15
266-21-244	ISS33C-2D	33	71	32	42	93	60	SOCT100408X	SXMT100408	C035A08S	T15
266-21-245	ISS34C-2D	34	73	32	42	95	60	SOCT100408X	SXMT100408	C035A08S	T15
266-21-246	ISS35C-2D	35	75	32	42	97	60	SOCT120508X	SXMT120508	C045B12C	T20
266-21-247	ISS36C-2D	36	77	32	42	99	60	SOCT120508X	SXMT120508	C045B12C	T20
266-21-248	ISS37C-2D	37	79	40	50	104	68	SOCT120508X	SXMT120508	C045B12C	T20
266-21-249	ISS38C-2D	38	81	40	50	106	68	SOCT120508X	SXMT120508	C045B12C	T20
266-21-250	ISS39C-2D	39	83	40	50	108	68	SOCT120508X	SXMT120508	C045B12C	T20
266-21-251	ISS40C-2D	40	85	40	50	110	68	SOCT120508X	SXMT120508	C045B12C	T20
266-21-252	ISS41C-2D	41	87	40	50	112	68	SOCT120508X	SXMT120508	C045B12C	T20
266-21-253	ISS42C-2D	42	89	40	50	114	68	SOCT120508X	SXMT120508	C045B12C	T20

INDEXABLE DRILLING CUTTERS

- Variable helix improve chip evacuation.
- Internal coolant and High feed rates.
- Made of quality alloy steel.
- Straight shank with flat for driving
- Insert pockets precisely positioned to keep cutting forces low and evenly distributed.

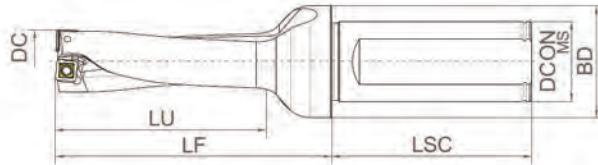

Order No.	Model	Size(mm)						Center Insert	Side Insert	Screw	Torx wrench
		Dc	Lu	DCON MS	BD	LF	LSC				
266-21-316	ISS16C-3D	16	53	20	28	69	50	SOCT050204X	SXMT050204	C020A05S	T6
266-21-317	ISS16.5C-3D	16.5	55	20	28	71	50	SOCT050204X	SXMT050204	C020A05S	T6
266-21-318	ISS17C-3D	17	56	20	28	72	50	SOCT050204X	SXMT050204	C020A05S	T6
266-21-319	ISS17.5C-3D	17.5	58	25	35	77	56	SOCT060306X	SXMT060306	C022A06S	FT7
266-21-320	ISS18C-3D	18	59	25	35	78	56	SOCT060306X	SXMT060306	C022A06S	FT7
266-21-321	ISS18.5C-3D	18.5	61	25	35	80	56	SOCT060306X	SXMT060306	C022A06S	FT7
266-21-322	ISS19C-3D	19	62	25	35	81	56	SOCT060306X	SXMT060306	C022A06S	FT7
266-21-323	ISS19.5C-3D	19.5	64	25	35	83	56	SOCT060306X	SXMT060306	C022A06S	FT7
266-21-324	ISS20C-3D	20	65	25	35	84	56	SOCT060306X	SXMT060306	C022A06S	FT7
266-21-325	ISS20.5C-3D	20.5	67	25	35	86	56	SOCT060306X	SXMT060306	C022A06S	FT7
266-21-326	ISS21C-3D	21	68	25	35	87	56	SOCT060306X	SXMT060306	C022A06S	FT7
266-21-327	ISS21.5C-3D	21.5	70	25	35	89	56	SOCT070306X	SXMT070306	C025A07S	FT7
266-21-328	ISS22C-3D	22	71	25	35	90	56	SOCT070306X	SXMT070306	C025A07S	FT7
266-21-329	ISS22.5C-3D	22.5	73	25	35	92	56	SOCT070306X	SXMT070306	C025A07S	FT7
266-21-330	ISS23C-3D	23	74	25	35	93	56	SOCT070306X	SXMT070306	C025A07S	FT7
266-21-331	ISS23.5C-3D	23.5	76	32	42	98	60	SOCT070306X	SXMT070306	C025A07S	FT7
266-21-332	ISS24C-3D	24	77	32	42	99	60	SOCT070306X	SXMT070306	C025A07S	FT7
266-21-333	ISS24.5C-3D	24.5	79	32	42	101	60	SOCT080408X	SXMT080408	C030A07S	T9
266-21-334	ISS25C-3D	25	80	32	42	102	60	SOCT080408X	SXMT080408	C030A07S	T9
266-21-335	ISS25.5C-3D	25.5	82	32	42	104	60	SOCT080408X	SXMT080408	C030A07S	T9
266-21-336	ISS26C-3D	26	83	32	42	105	60	SOCT080408X	SXMT080408	C030A07S	T9
266-21-337	ISS26.5C-3D	26.5	85	32	42	107	60	SOCT080408X	SXMT080408	C030A07S	T9
266-21-338	ISS27C-3D	27	86	32	42	108	60	SOCT080408X	SXMT080408	C030A07S	T9
266-21-339	ISS28C-3D	28	89	32	42	111	60	SOCT080408X	SXMT080408	C030A07S	T9
266-21-340	ISS29C-3D	29	92	32	42	114	60	SOCT080408X	SXMT080408	C030A07S	T9
266-21-341	ISS30C-3D	30	95	32	42	117	60	SOCT080408X	SXMT080408	C030A07S	T9
266-21-342	ISS31C-3D	31	98	32	42	120	60	SOCT100408X	SXMT100408	C035A08S	T15
266-21-343	ISS32C-3D	32	101	32	42	123	60	SOCT100408X	SXMT100408	C035A08S	T15
266-21-344	ISS33C-3D	33	104	32	42	126	60	SOCT100408X	SXMT100408	C035A08S	T15
266-21-345	ISS34C-3D	34	107	32	42	129	60	SOCT100408X	SXMT100408	C035A08S	T15
266-21-346	ISS35C-3D	35	110	32	42	132	60	SOCT120508X	SXMT120508	C045B12C	T20
266-21-347	ISS36C-3D	36	113	32	42	135	60	SOCT120508X	SXMT120508	C045B12C	T20
266-21-348	ISS37C-3D	37	116	40	50	141	68	SOCT120508X	SXMT120508	C045B12C	T20
266-21-349	ISS38C-3D	38	119	40	50	144	68	SOCT120508X	SXMT120508	C045B12C	T20
266-21-350	ISS39C-3D	39	122	40	50	147	68	SOCT120508X	SXMT120508	C045B12C	T20
266-21-351	ISS40C-3D	40	125	40	50	150	68	SOCT120508X	SXMT120508	C045B12C	T20
266-21-352	ISS41C-3D	41	128	40	50	153	68	SOCT120508X	SXMT120508	C045B12C	T20
266-21-353	ISS42C-3D	42	131	40	50	156	68	SOCT120508X	SXMT120508	C045B12C	T20

INDEXABLE DRILLING CUTTERS

- Variable helix improve chip evacuation.
- Internal coolant and High feed rates.
- Made of quality alloy steel.
- Straight shank with flat for driving
- Insert pockets precisely positioned to keep cutting forces low and evenly distributed.

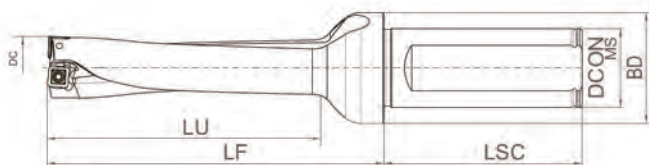

Order No.	Model	Size(mm)						Center Insert	Side Insert	Screw	Torx wrench
		Dc	Lu	DCON MS	BD	LF	LSC				
266-21-416	ISS16C-4D	16	69	20	28	85	50	SOCT050204X	SXMT050204	C020A05S	T6
266-21-417	ISS16.5C-D	16.5	71	20	28	87	50	SOCT050204X	SXMT050204	C020A05S	T6
266-21-418	ISS17C-4D	17	73	20	28	89	50	SOCT050204X	SXMT050204	C020A05S	T6
266-21-419	ISS17.5C-4D	17.5	75	25	35	94	56	SOCT050204X	SXMT050204	C020A05S	T6
266-21-420	ISS18C-4D	18	77	25	35	96	56	SOCT050204X	SXMT050204	C020A05S	T6
266-21-421	ISS18.5C-4D	18.5	79	25	35	98	56	SOCT060306X	SXMT060306	C022A06S	FT7
266-21-422	ISS19C-4D	19	81	25	35	100	56	SOCT060306X	SXMT060306	C022A06S	FT7
266-21-423	ISS19.5C-4D	19.5	83	25	35	102	56	SOCT060306X	SXMT060306	C022A06S	FT7
266-21-424	ISS20C-4D	20	85	25	35	104	56	SOCT060306X	SXMT060306	C022A06S	FT7
266-21-425	ISS20.5C-4D	20.5	87	25	35	106	56	SOCT060306X	SXMT060306	C022A06S	FT7
266-21-426	ISS21C-4D	21	89	25	35	108	56	SOCT060306X	SXMT060306	C022A06S	FT7
266-21-427	ISS21.5C-4D	21.5	91	25	35	110	56	SOCT070306X	SXMT070306	C025A07S	FT7
266-21-428	ISS22C-4D	22	93	25	35	112	56	SOCT070306X	SXMT070306	C025A07S	FT7
266-21-429	ISS22.5C-4D	22.5	95	25	35	114	56	SOCT070306X	SXMT070306	C025A07S	FT7
266-21-430	ISS23C-4D	23	97	25	35	116	56	SOCT070306X	SXMT070306	C025A07S	FT7
266-21-431	ISS23.5C-4D	23.5	99	25	35	121	56	SOCT070306X	SXMT070306	C025A07S	FT7
266-21-432	ISS24C-4D	24	101	32	42	123	60	SOCT070306X	SXMT070306	C025A07S	FT7
266-21-433	ISS24.5C-4D	24.5	103	32	42	125	60	SOCT080408X	SXMT080408.	C030A07S	T9
266-21-434	ISS25C-4D	25	105	32	42	127	60	SOCT080408X	SXMT080408.	C030A07S	T9
266-21-435	ISS25.5C-4D	25.5	107	32	42	129	60	SOCT080408X	SXMT080408.	C030A07S	T9
266-21-436	ISS26C-4D	26	109	32	42	131	60	SOCT080408X	SXMT080408.	C030A07S	T9
266-21-437	ISS26.5C-4D	26.5	111	32	42	133	60	SOCT080408X	SXMT080408.	C030A07S	T9
266-21-438	ISS27C-4D	27	113	32	42	135	60	SOCT080408X	SXMT080408.	C030A07S	T9
266-21-439	ISS28C-4D	28	117	32	42	139	60	SOCT080408X	SXMT080408.	C030A07S	T9
266-21-440	ISS29C-4D	29	121	32	42	143	60	SOCT080408X	SXMT080408.	C030A07S	T9
266-21-441	ISS30C-4D	30	125	32	42	147	60	SOCT100408X	SXMT100408	C035A08S	T15
266-21-442	ISS31C-4D	31	129	32	42	151	60	SOCT100408X	SXMT100408	C035A08S	T15
266-21-443	ISS32C-4D	32	133	32	42	155	60	SOCT100408X	SXMT100408	C035A08S	T15
266-21-444	ISS33C-4D	33	137	32	42	159	60	SOCT100408X	SXMT100408	C035A08S	T15
266-21-445	ISS34C-4D	34	141	32	42	163	60	SOCT100408X	SXMT100408	C035A08S	T15
266-21-446	ISS35C-4D	35	145	32	42	167	60	SOCT120508X	SXMT120508	C045B12C	T20
266-21-447	ISS36C-4D	36	149	32	42	171	60	SOCT120508X	SXMT120508	C045B12C	T20
266-21-448	ISS37C-4D	37	153	40	68	178	68	SOCT120508X	SXMT120508	C045B12C	T20
266-21-449	ISS38C-4D	38	157	40	68	182	68	SOCT120508X	SXMT120508	C045B12C	T20
266-21-450	ISS39C-4D	39	161	40	68	186	68	SOCT120508X	SXMT120508	C045B12C	T20
266-21-451	ISS40C-4D	40	165	40	68	190	68	SOCT120508X	SXMT120508	C045B12C	T20
266-21-452	ISS41C-4D	41	169	40	68	194	68	SOCT120508X	SXMT120508	C045B12C	T20
266-21-453	ISS42C-4D	42	173	40	68	198	68	SOCT120508X	SXMT120508	C045B12C	T20

INDEXABLE DRILLING CUTTERS

- Variable helix improve chip evacuation.
- Internal coolant and High feed rates.
- Made of quality alloy steel.
- Straight shank with flat for driving
- Insert pockets precisely positioned to keep cutting forces low and evenly distributed.

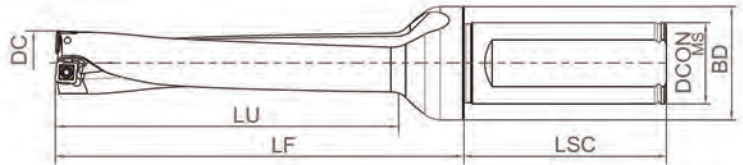

Order No.	Model	Size(mm)						Center Insert	Side Insert	Screw	Torx wrench
		Dc	Lu	DCON MS	BD	LF	LSC				
266-21-516	ISS16C-5D	16	85	20	28	101	50	SOCT050204X	SXMT050204	C020A05S	T6
266-21-517	ISS16.5C-5D	16.5	88	20	28	104	50	SOCT050204X	SXMT050204	C020A05S	T6
266-21-518	ISS17C-5D	17	90	20	28	106	50	SOCT050204X	SXMT050204	C020A05S	T6
266-21-519	ISS17.5C-5D	17.5	93	25	35	112	56	SOCT050204X	SXMT050204	C020A05S	T6
266-21-520	ISS18C-5D	18	95	25	35	114	56	SOCT050204X	SXMT050204	C020A05S	T6
266-21-521	ISS18.5C-5D	18.5	98	25	35	117	56	SOCT060306X	SXMT060306	C022A06S	FT7
266-21-522	ISS19C-5D	19	100	25	35	119	56	SOCT060306X	SXMT060306	C022A06S	FT7
266-21-523	ISS19.5C-5D	19.5	103	25	35	122	56	SOCT060306X	SXMT060306	C022A06S	FT7
266-21-524	ISS20C-5D	20	105	25	35	124	56	SOCT060306X	SXMT060306	C022A06S	FT7
266-21-525	ISS20.5C-5D	20.5	108	25	35	127	56	SOCT060306X	SXMT060306	C022A06S	FT7
266-21-526	ISS21C-5D	21	110	25	35	129	56	SOCT060306X	SXMT060306	C022A06S	FT7
266-21-527	ISS21.5C-5D	21.5	113	25	35	132	56	SOCT070306X	SXMT070306	C025A07S	FT7
266-21-528	ISS22C-5D	22	115	25	35	134	56	SOCT070306X	SXMT070306	C025A07S	FT7
266-21-529	ISS22.5C-5D	22.5	118	25	35	137	56	SOCT070306X	SXMT070306	C025A07S	FT7
266-21-530	ISS23C-5D	23	120	25	35	139	56	SOCT070306X	SXMT070306	C025A07S	FT7
266-21-531	ISS23.5C-5D	23.5	123	25	35	145	56	SOCT070306X	SXMT070306	C025A07S	FT7
266-21-532	ISS24C-5D	24	125	32	42	147	60	SOCT070306X	SXMT070306	C025A07S	FT7
266-21-533	ISS24.5C-5D	24.5	128	32	42	150	60	SOCT080408X	SXMT080408.	C030A07S	T9
266-21-534	ISS25C-5D	25	130	32	42	152	60	SOCT080408X	SXMT080408.	C030A07S	T9
266-21-535	ISS25.5C-5D	25.5	133	32	42	155	60	SOCT080408X	SXMT080408.	C030A07S	T9
266-21-536	ISS26C-5D	26	135	32	42	157	60	SOCT080408X	SXMT080408.	C030A07S	T9
266-21-537	ISS26.5C-5D	26.5	138	32	42	160	60	SOCT080408X	SXMT080408.	C030A07S	T9
266-21-538	ISS27C-5D	27	140	32	42	162	60	SOCT080408X	SXMT080408.	C030A07S	T9
266-21-539	ISS28C-5D	28	145	32	42	167	60	SOCT080408X	SXMT080408.	C030A07S	T9
266-21-540	ISS29C-5D	29	150	32	42	172	60	SOCT080408X	SXMT080408.	C030A07S	T9
266-21-541	ISS30C-5D	30	155	32	42	177	60	SOCT100408X	SXMT100408	C035A08S	T15
266-21-542	ISS31C-5D	31	160	32	42	182	60	SOCT100408X	SXMT100408	C035A08S	T15
266-21-543	ISS32C-5D	32	165	32	42	187	60	SOCT100408X	SXMT100408	C035A08S	T15
266-21-544	ISS33C-5D	33	170	32	42	192	60	SOCT100408X	SXMT100408	C035A08S	T15
266-21-545	ISS34C-5D	34	175	32	42	197	60	SOCT100408X	SXMT100408	C035A08S	T15
266-21-546	ISS35C-5D	35	180	32	42	202	60	SOCT120508X	SXMT120508	C045B12C	T20
266-21-547	ISS36C-5D	36	185	32	42	207	60	SOCT120508X	SXMT120508	C045B12C	T20
266-21-548	ISS37C-5D	37	190	40	50	215	68	SOCT120508X	SXMT120508	C045B12C	T20
266-21-549	ISS38C-5D	38	195	40	50	220	68	SOCT120508X	SXMT120508	C045B12C	T20
266-21-550	ISS39C-5D	39	200	40	50	225	68	SOCT120508X	SXMT120508	C045B12C	T20
266-21-551	ISS40C-5D	40	205	40	50	230	68	SOCT120508X	SXMT120508	C045B12C	T20
266-21-552	ISS41C-5D	41	210	40	50	235	68	SOCT120508X	SXMT120508	C045B12C	T20
266-21-553	ISS42C-5D	42	215	40	50	240	68	SOCT120508X	SXMT120508	C045B12C	T20

SOLID CARBIDE SIDE INSERT

- Variable helix improve chip evacuation.
- Internal coolant and High feed rates.
- Made of quality alloy steel.
- Straight shank with flat for driving
- Insert pockets precisely positioned to keep cutting forces low and evenly distributed.

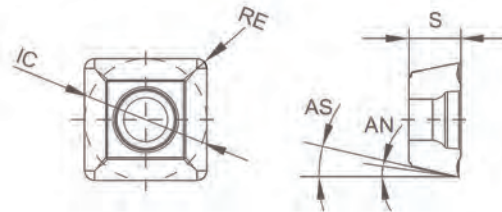

Order No.	Model	Grade	Application	Size (mm)			
				d	r	s	α
260-16-101	SXMT040204-EM	EC2640	Steel,cast iron	4.9	0.4	2.3	8°
260-16-102	SXMT050204-EM	EC2640	Steel,cast iron	5.5	0.4	2.5	8°
260-16-103	SXMT060306-EM	EC2640	Steel,cast iron	6.4	0.6	2.9	8°
260-16-104	SXMT070306-EM	EC2640	Steel,cast iron	7.5	0.6	3.3	8°
260-16-105	SXMT080408-EM	EC2640	Steel,cast iron	8.9	0.8	3.7	8°
260-16-106	SXMT100408-EM	EC2640	Steel,cast iron	10.3	0.8	4.3	8°
260-16-107	SXMT120508-EM	EC2640	Steel,cast iron	12.6	0.8	5.1	8°
260-16-101A	SXMT040204-EM	EC2615	Stainless steel	4.9	0.4	2.3	8°
260-16-102A	SXMT050204-EM	EC2615	Stainless steel	5.5	0.4	2.5	8°
260-16-103A	SXMT060306-EM	EC2615	Stainless steel	6.4	0.6	2.9	8°
260-16-104A	SXMT070306-EM	EC2615	Stainless steel	7.5	0.6	3.3	8°
260-16-105A	SXMT080408-EM	EC2615	Stainless steel	8.9	0.8	3.7	8°
260-16-106A	SXMT100408-EM	EC2615	Stainless steel	10.3	0.8	4.3	8°
260-16-107A	SXMT120508-EM	EC2615	Stainless steel	12.6	0.8	5.1	8°

SOLID CARBIDE CENTER INSERT

- Variable helix improve chip evacuation.
- Internal coolant and High feed rates.
- Made of quality alloy steel.
- Straight shank with flat for driving
- Insert pockets precisely positioned to keep cutting forces low and evenly distributed.

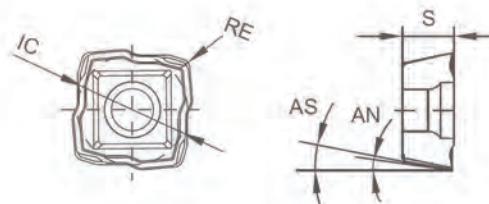

Order No.	Model	Size(mm)				
		IC	RE	S	AN	AS
260-21-001B	SOCT050204	5.06	0.4	2.5	8°	11°
260-21-002B	SOCT060306	6.4	0.6	2.9	8°	11°
260-21-003B	SOCT070306	7.5	0.6	3.3	8°	11°
260-21-004B	SOCT080408	8.9	0.8	3.7	8°	11°
260-21-005B	SOCT100408	10.3	0.8	4.3	8°	13°
260-21-006B	SOCT120508	12.5	0.8	5.1	8°	13°

RECOMMENDED CUTTING DATA

ISO Material	Hardness/Strength	SpeedVc (m / min)	Feed f (mm / rev)			
			Φ 14-20.5	Φ 21-28	Φ 29-34	Φ 34-42
P Mild steel	≤180HB	230 (150-260)	0.05 (0.03-0.1)	0.05 (0.03-0.1)	0.05 (0.03-0.1)	0.05 (0.03-0.1)
P Low alloy steel	≤280HB	140 (100-220)	0.09 (0.06-0.13)	0.12 (0.1-0.18)	0.15 (0.13-0.21)	0.22 (0.2-0.27)
P High alloy steel	≤280HB	140 (80-180)	0.08 (0.05-0.12)	0.12 (0.06-0.15)	0.14 (0.09-0.18)	0.15 (0.1-0.2)
M Stainless steel	≤250HB	150 (100-180)	0.08 (0.05-0.12)	0.1 (0.06-0.12)	0.15 (0.1-0.17)	0.18 (0.15-0.2)
K Cast iron	≤350 N/mm2	120 (100-180)	0.09 (0.06-0.13)	0.13 (0.1-0.18)	0.18 (0.13-0.21)	0.25 (0.2-0.27)
K Nodular cast iron	≤800 N/mm2	100 (80-150)	0.09 (0.06-0.13)	0.12 (0.08-0.16)	0.16 (0.1-0.2)	0.2 (0.15-0.25)
N Alu. Alloy	-	220 (100-800)	0.09 (0.06-0.20)	0.13 (0.1-0.25)	0.18 (0.13-0.3)	0.25 (0.2-0.35)
S Heat resistant alloy	-	30 (15-50)	0.04 (0.02-0.06)	0.06 (0.03-0.1)	0.08 (0.04-0.12)	0.1 (0.06-0.14)
S Titanium alloy	-	60 (30-100)	0.06 (0.04-0.08)	0.08 (0.06-0.12)	0.1 (0.08-0.15)	0.12 (0.1-0.15)

ECCENTRIC BUSHING

- With this bushing indexable drill can be micro adjusted by +/-0.2mm

Order No.	Model	Size(mm)			
		C	dm	D	L
260-16-001	C25-XP20	25	20	42	5
260-16-002	C32-XP25	32	25	50	8
260-16-003	C40-XP32	40	32	60	8
260-16-004	C50-XP40	50	40	66	8

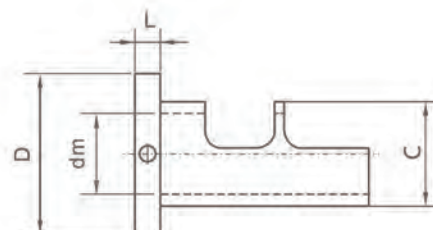



Operate guide:

- increase cutting diameter : rotate bushing till marking line on drill point to areo "+"
- decrease cutting diameter : rotate bushing till marking line on drill point to areo "-"

SOLID CARBIDE TWIST DRILLS

- Right hand cutting.
- Made of micrograin solid carbide and with HELICA coating.
- General purpose used for steel, stainless steel and cast iron.

DIN 6537		3xD	Type N	 140°
m7		HRC 45	HELICA coating	

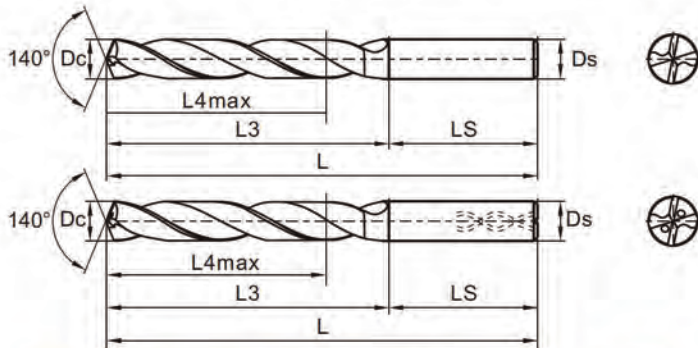

external coolant



internal coolant



Order No.		Dc. (mm)	Ds (mm)	L4max (mm)	L3 (mm)	L (mm)
external coolant	internal coolant					
411-37-005	412-37-005	3.00	4	14.00	20	62
411-37-010	412-37-010	3.17	4	14.00	20	62
411-37-015	412-37-015	3.30	4	14.00	20	62
411-37-020	412-37-020	3.50	4	15.00	20	62
411-37-025	412-37-025	4.00	4	17.00	24	66
411-37-030	412-37-030	4.20	4	17.00	24	66
411-37-035	412-37-035	4.50	6	18.00	24	66
411-37-040	412-37-040	5.00	6	20.00	28	66
411-37-045	412-37-045	5.16	6	20.00	28	66
411-37-050	412-37-050	5.50	6	21.00	28	66
411-37-055	412-37-055	6.00	6	21.00	28	66
411-37-060	412-37-060	6.50	8	23.00	34	79
411-37-065	412-37-065	6.80	8	25.00	34	79
411-37-070	412-37-070	7.00	8	25.00	34	79
411-37-075	412-37-075	7.10	8	25.00	34	79
411-37-080	412-37-080	7.50	8	25.00	34	79
411-37-085	412-37-085	7.80	8	27.00	34	79
411-37-090	412-37-090	8.00	8	27.00	41	79
411-37-095	412-37-095	8.50	10	27.00	47	89
411-37-100	412-37-100	8.80	10	29.00	47	89
411-37-105	412-37-105	9.00	10	29.00	47	89
411-37-110	412-37-110	9.13	10	29.00	47	89
411-37-115	412-37-115	9.50	10	29.00	47	89
411-37-120	412-37-120	10.00	10	31.00	47	89

Order No.		Dc. (mm)	Ds (mm)	L4max (mm)	L3 (mm)	L (mm)
external coolant	internal coolant					
411-37-125	412-37-125	10.20	12	31.00	55	102
411-37-130	412-37-130	10.50	12	31.00	55	102
411-37-135	412-37-135	10.70	12	33.00	55	102
411-37-140	412-37-140	11.00	12	33.00	55	102
411-37-145	412-37-145	11.50	12	33.00	55	102
411-37-150	412-37-150	12.00	12	36.00	55	102
411-37-155	412-37-155	12.50	14	36.00	60	107
411-37-160	412-37-160	12.70	14	36.00	60	107
411-37-165	412-37-165	13.00	14	36.00	60	107
411-37-170	412-37-170	13.50	14	37.00	60	107
411-37-175	412-37-175	14.00	14	37.00	60	107
411-37-180	412-37-180	14.50	16	38.00	65	115
411-37-185	412-37-185	15.00	16	38.00	65	115
411-37-190	412-37-190	15.50	16	39.00	65	115
411-37-195	412-37-195	16.00	16	39.00	65	115
411-37-200	412-37-200	16.50	18	40.00	73	123
411-37-205	412-37-205	17.00	18	40.00	73	123
411-37-210	412-37-210	17.50	18	41.00	73	123
411-37-215	412-37-215	18.00	18	41.00	73	123
411-37-220	412-37-220	18.50	20	49.00	79	131
411-37-225	412-37-225	19.00	20	49.00	79	131
411-37-230	412-37-230	19.50	20	49.00	79	131
411-37-235	412-37-235	20.00	20	49.00	79	131



Recommended cutting data for solid carbide twist drill

Material	Tensile strength(N/mm2)/ Hardness (HB)	Feed rate fz(mm/r)			Speed Vc(m/min)
		φ 4-8mm	φ 8-20	φ 20-25mm	
Structural steels	<500 N/mm2	0.08-0.15	0.15-0.3	0.3-0.35	80-130
Structural steels	500-700 N/mm2	0.06-0.12	0.12-0.25	0.25-0.35	65-100
Structural steels	>700 N/mm2	0.06-0.12	0.12-0.25	0.25-0.3	60-90
Tool steels	<1400 N/mm2	0.06-0.12	0.12-0.25	0.25-0.3	50-70
Tool steels	>1400 N/mm2	0.05-0.1	0.1-0.18	0.17-0.25	45-60
Stainless steel	<850 N/mm2	0.06-0.1	0.1-0.2	0.2-0.25	45-65
Cast iron	<200HB	0.1-0.15	0.14-0.18	0.18-0.22	95-100
Cast iron	>200HB	0.08-0.12	0.12-0.15	0.16-0.2	80-100
Al-alloys		0.12-0.2	0.2-0.35	0.35-0.4	80-180
Co-alloys		0.12-0.2	0.2-0.35	0.35-0.4	70-140
Ti-alloys		0.06-0.1	0.1-0.2	0.2-0.25	35-50

DRILLING CUTTER

SOLID CARBIDE TWIST DRILLS

- Right hand cutting.
- Made of micrograin solid carbide and with HELICA coating.
- General purpose used for steel, stainless steel and cast iron.

DIN 6537		5xD	Type N	 140°
m7		HRC 45	HELICA coating	

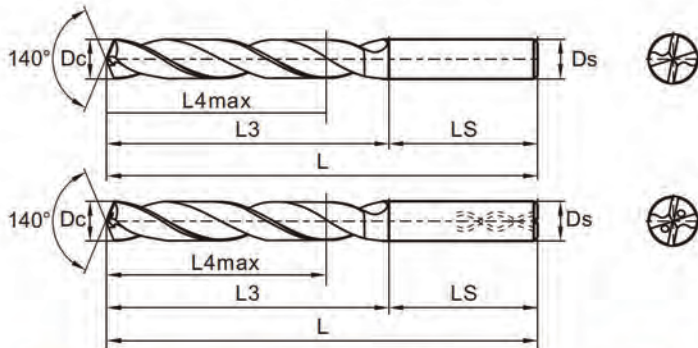

Order No.		Dc. (mm)	Ds (mm)	L4max (mm)	L3 (mm)	L (mm)
external coolant	internal coolant					
411-57-005	412-57-005	3.00	4	21	28	66
411-57-010	412-57-010	3.17	4	21	28	66
411-57-015	412-57-015	3.30	4	21	28	66
411-57-020	412-57-020	3.50	4	21	28	66
411-57-025	412-57-025	4.00	4	27	36	74
411-57-030	412-57-030	4.20	6	27	36	74
411-57-035	412-57-035	4.50	6	27	36	74
411-57-040	412-57-040	5.00	6	32	36	74
411-57-045	412-57-045	5.16	6	32	44	82
411-57-050	412-57-050	5.50	6	32	44	82
411-57-055	412-57-055	6.00	6	32	44	82
411-57-060	412-57-060	6.50	8	35	53	91
411-57-065	412-57-065	6.80	8	40	53	91
411-57-070	412-57-070	7.00	8	40	53	91
411-57-075	412-57-075	7.10	8	40	53	91
411-57-080	412-57-080	7.50	8	40	53	91
411-57-085	412-57-085	7.80	8	42	53	91
411-57-090	412-57-090	8.00	8	42	53	91
411-57-095	412-57-095	8.50	10	42	61	103
411-57-100	412-57-100	8.80	10	45	61	103
411-57-105	412-57-105	9.00	10	45	61	103
411-57-110	412-57-110	9.13	10	45	61	103
411-57-115	412-57-115	9.50	10	45	61	103
411-57-120	412-57-120	10.00	10	48	61	103

Order No.		Dc. (mm)	Ds (mm)	L4max (mm)	L3 (mm)	L (mm)
external coolant	internal coolant					
411-57-125	412-57-125	10.20	12	48	71	118
411-57-130	412-57-130	10.50	12	48	71	118
411-57-135	412-57-135	10.70	12	56	71	118
411-57-140	412-57-140	11.00	12	56	71	118
411-57-145	412-57-145	11.50	12	56	71	118
411-57-150	412-57-150	12.00	12	56	71	118
411-57-155	412-57-155	12.50	14	56	77	124
411-57-160	412-57-160	12.70	14	56	77	124
411-57-165	412-57-165	13.00	14	56	77	124
411-57-170	412-57-170	13.50	14	59	77	124
411-57-175	412-57-175	14.00	14	59	77	124
411-57-180	412-57-180	14.50	16	60	83	133
411-57-185	412-57-185	15.00	16	60	83	133
411-57-190	412-57-190	15.50	16	62	83	133
411-57-195	412-57-195	16.00	16	62	83	133
411-57-200	412-57-200	16.50	18	64	93	143
411-57-205	412-57-205	17.00	18	64	93	143
411-57-210	412-57-210	17.50	18	66	93	143
411-57-215	412-57-215	18.00	18	66	93	143
411-57-220	412-57-220	18.50	20	71	101	153
411-57-225	412-57-225	19.00	20	71	101	153
411-57-230	412-57-230	19.50	20	71	101	153
411-57-235	412-57-235	20.00	20	71	101	153

Recommended cutting data for solid carbide twist drill

Material	Tensile strength(N/mm2)/ Hardness (HB)	Feed rate fz(mm/r)			Speed Vc(m/min)
		φ 4-8mm	φ 8-20	φ 20-25mm	
Structural steels	<500 N/mm2	0.08-0.15	0.15-0.3	0.3-0.35	80-130
Structural steels	500-700 N/mm2	0.06-0.12	0.12-0.25	0.25-0.35	65-100
Structural steels	>700 N/mm2	0.06-0.12	0.12-0.25	0.25-0.3	60-90
Tool steels	<1400 N/mm2	0.06-0.12	0.12-0.25	0.25-0.3	50-70
Tool steels	>1400 N/mm2	0.05-0.1	0.1-0.18	0.17-0.25	45-60
Stainless steel	<850 N/mm2	0.06-0.1	0.1-0.2	0.2-0.25	45-65
Cast iron	<200HB	0.1-0.15	0.14-0.18	0.18-0.22	95-100
Cast iron	>200HB	0.08-0.12	0.12-0.15	0.16-0.2	80-100
Al-alloys		0.12-0.2	0.2-0.35	0.35-0.4	80-180
Co-alloys		0.12-0.2	0.2-0.35	0.35-0.4	70-140
Ti-alloys		0.06-0.1	0.1-0.2	0.2-0.25	35-50

SOLID CARBIDE TWIST DRILLS

- Right hand cutting.
- Made of micrograin solid carbide and with HELICA coating.
- General purpose used for steel, stainless steel and cast iron.

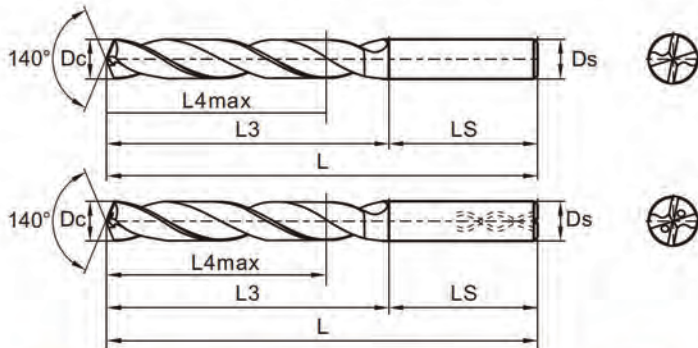

DIN 6537		7xD	Type N	140°
m7		HRC 45	HELICA coating	



Order No.		Dc. (mm)	Ds (mm)	L4max (mm)	L3 (mm)	L (mm)
external coolant	internal coolant					
411-77-005	412-77-005	4.50	6	45	56	94
411-77-010	412-77-010	5.00	6	45	56	94
411-77-015	412-77-015	5.16	6	45	56	94
411-77-020	412-77-020	5.50	6	45	56	94
411-77-025	412-77-025	6.00	6	45	56	94
411-77-030	412-77-030	6.50	8	57	67	110
411-77-035	412-77-035	6.80	8	57	67	110
411-77-040	412-77-040	7.00	8	57	67	110
411-77-045	412-77-045	7.10	8	57	67	110
411-77-050	412-77-050	7.50	8	57	67	110
411-77-055	412-77-055	7.80	8	57	67	110
411-77-060	412-77-060	8.00	8	57	67	110
411-77-065	412-77-065	8.50	10	62	80	122
411-77-070	412-77-070	8.80	10	62	80	122
411-77-075	412-77-075	9.00	10	62	80	122
411-77-080	412-77-080	9.13	10	62	80	122
411-77-085	412-77-085	9.50	10	62	80	122
411-77-090	412-77-090	10.00	10	62	80	122
411-77-095	412-77-095	10.20	12	72	94	141
411-77-100	412-77-100	10.50	12	72	94	141
411-77-105	412-77-105	10.70	12	72	94	141
411-77-110	412-77-110	11.00	12	72	94	141
411-77-115	412-77-115	11.50	12	72	94	141
411-77-120	412-77-120	12.00	12	72	94	141

Order No.		Dc. (mm)	Ds (mm)	L4max (mm)	L3 (mm)	L (mm)
external coolant	internal coolant					
411-77-125	412-77-125	12.50	14	83	108	155
411-77-130	412-77-130	12.70	14	83	108	155
411-77-135	412-77-135	13.00	14	83	108	155
411-77-140	412-77-140	13.50	14	83	108	155
411-77-145	412-77-145	14.00	14	83	108	155
411-77-150	412-77-150	14.50	16	92	121	171
411-77-155	412-77-155	15.00	16	92	121	171
411-77-160	412-77-160	15.50	16	92	121	171
411-77-165	412-77-165	16.00	16	92	121	171
411-77-170	412-77-170	16.50	18	103	135	185
411-77-175	412-77-175	17.00	18	103	135	185
411-77-180	412-77-180	17.50	18	103	135	185
411-77-185	412-77-185	18.00	18	103	135	185
411-77-190	412-77-190	18.50	20	112	148	200
411-77-195	412-77-195	19.00	20	112	148	200
411-77-200	412-77-200	19.50	20	112	148	200
411-77-205	412-77-205	20.00	20	112	148	200

Recommended cutting data for solid carbide twist drill

Material	Tensile strength(N/mm2)/ Hardness (HB)	Feed rate fz(mm/r)			Speed Vc(m/min)
		φ 4-8mm	φ 8-20	φ 20-25mm	
Structural steels	<500 N/mm2	0.08-0.15	0.15-0.3	0.3-0.35	80-130
Structural steels	500-700 N/mm2	0.06-0.12	0.12-0.25	0.25-0.35	65-100
Structural steels	>700 N/mm2	0.06-0.12	0.12-0.25	0.25-0.3	60-90
Tool steels	<1400 N/mm2	0.06-0.12	0.12-0.25	0.25-0.3	50-70
Tool steels	>1400 N/mm2	0.05-0.1	0.1-0.18	0.17-0.25	45-60
Stainless steel	<850 N/mm2	0.06-0.1	0.1-0.2	0.2-0.25	45-65
Cast iron	<200HB	0.1-0.15	0.14-0.18	0.18-0.22	95-100
Cast iron	>200HB	0.08-0.12	0.12-0.15	0.16-0.2	80-100
Al-alloys		0.12-0.2	0.2-0.35	0.35-0.4	80-180
Co-alloys		0.12-0.2	0.2-0.35	0.35-0.4	70-140
Ti-alloys		0.06-0.1	0.1-0.2	0.2-0.25	35-50



THREADING CUTTER

INDEXABLE THREADING TOOL & SOLID CARBIDE INSERT

174,175



INDEXABLE THREADING MILL & SOLID CARBIDE INSERT

182,183



HSS-COBALT MACHINE TAPS

186

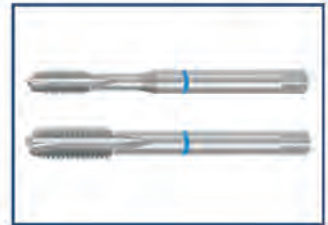

INDEXABLE THREAD TURNING TOOL

- Made of hardened alloy steel and HRC43-46.

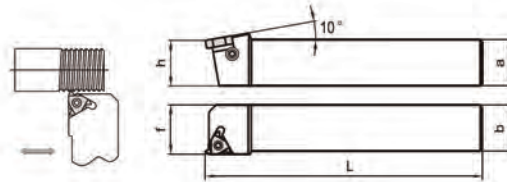

Order No.		Model		Size(mm)					Insert	Screw	Torx wrench	Shim	Shim scerw	Hex wrench
Right hand	Left hand	Right hand	Left hand	h	a	b	L	f						
211-17-001	211-17-002	SER1616H16T	SEL1616H16T	16	16	16	100	20	16ER/EL..	L60 M3.5x14.0	T15	LT16/0.5 LT16/1.75	SS04008	S2.5
211-17-003	211-17-004	SER2020K16T	SEL2020K16T	20	20	20	125	25	16ER/EL..	L60 M3.5x14.0	T15	LT16/0.5 LT16/1.75	SS04008	S2.5
211-17-005	211-17-006	SER2525M16T	SEL2525M16T	25	25	25	150	32	16ER/EL..	L60 M3.5x14.0	T15	LT16/0.5 LT16/1.75	SS04008	S2.5
211-17-007	211-17-008	SER3225P16T	SEL3225P16T	32	32	25	170	32	16ER/EL..	L60 M3.5x14.0	T15	LT16/0.5 LT16/1.75	SS04008	S2.5
211-17-009	211-17-010	SER3232P16T	SEL3232P16T	32	32	32	170	40	16ER/EL..	L60 M3.5x14.0	T15	LT16/0.5 LT16/1.75	SS04008	S2.5
211-17-011	211-17-012	SER2525M22T	SEL2525M22T	25	25	25	150	32	22ER/EL..	L60 M4x15.0	T15	LT22	SS04008	S2.5
211-17-013	211-17-014	SER3225P22T	SEL3225P22T	32	32	25	170	32	22ER/EL..	L60 M4x15.0	T15	LT22	SS04008	S2.5
211-17-015	211-17-016	SER3232P22T	SEL3232P22T	32	32	32	170	40	22ER/EL..	L60 M4x15.0	T15	LT22	SS04008	S2.5

Insert Not included.

INDEXABLE THREAD BORING BAR

- Made of hardened alloy steel and HRC43-46.

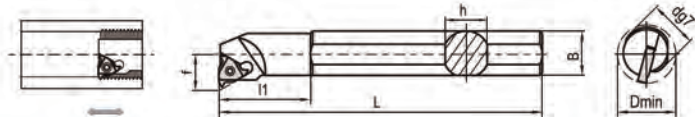

Order No.		Model		Size(mm)							Insert	Screw	Torx wrench	Shim	Shim scerw	Hex wrench
Right hand	Left hand	Right hand	Left hand	d	f	L	h	B	l1	Dmin						
221-17-001	221-17-002	SNR0010H11	SNL0010H11	10	7.2	100	9	9.5	25	12	11NR/L..	L60M2.5x5.2	T8	-	-	-
221-17-003	221-17-004	SNR0012K11	SNL0012K11	12	9	125	11	11.5	32	16	11NR/L..	L60M2.5x5.2	T8	-	-	-
221-17-005	221-17-006	SNR0016M16	SNL0016M16	16	12	150	15	15.5	32	20	16NR/L..	L60M3.5x8.8	T15	-	-	-
221-17-007	221-17-008	SNR0020Q16	SNL0020Q16	20	14	180	18	19	40	25	16NR/L..	L60M3.5x8.8	T15	-	-	-
221-17-009	221-17-010	SNR0025R16	SNL0025R16	25	17	200	23	24	45	30	16NR/L..	L60 M3.5x14.0	T15	LT16/0.5 LT16/1.75	SS04008	S2.5
221-17-011	221-17-012	SNR0032S16	SNL0032S16	32	22	250	30	31	60	38	16NR/L..	L60 M3.5x14.0	T15	LT16/0.5 LT16/1.75	SS04008	S2.5
221-17-013	221-17-014	SNR0040T16	SNL0040T16	40	27	300	37	38.5	75	50	16NR/L..	L60 M3.5x14.0	T15	LT16/0.5 LT16/1.75	SS04008	S2.5
221-17-015	221-17-016	SNR0050U16	SNL0050U16	50	35	350	47	48.5	90	63	16NR/L..	L60 M3.5x14.0	T15	LT16/0.5 LT16/1.75	SS04008	S2.5
221-17-017	221-17-018	SNR0025R22	SNL0025R22	25	17	200	23	24	45	30	22NR/L..	L60 M4x15.0	T15	LT22	SS04008	S2.5
221-17-019	221-17-020	SNR0032S22	SNL0032S22	32	22	250	30	31	60	38	22NR/L..	L60 M4x15.0	T15	LT22	SS04008	S2.5
221-17-021	221-17-022	SNR0040T22	SNL0040T22	40	27	300	37	38.5	75	50	22NR/L..	L60 M4x15.0	T15	LT22	SS04008	S2.5
221-17-023	221-17-024	SNR0050U22	SNL0050U22	50	35	350	47	48.5	75	63	22NR/L..	L60 M4x15.0	T15	LT22	SS04008	S2.5

Shim LT16/0.5 fit to insert of pitch 0.5~1.5mm, Shim LT16/1.75 fit to insert of pich 1.75~3.0mm.

Insert Not included.

SOLID CARBIDE THREADING INSERT

- Made of micrograin solid carbide and with TiAlN coating.
- General purpose used for steel, stainless steel and cast iron.

PRTIAL PROFILE 60°

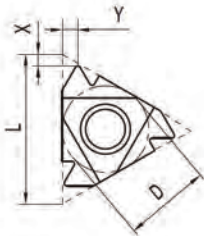
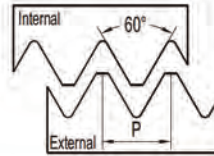

External

Order No.		Model		D (IC)	Lead&Pitch		Dimensions(mm)		
Right hand	Left hand	Right hand	Left hand		mm	TPI	X	Y	L
302-01-001	302-01-002	11ER A 60	11EL A 60	1/4"	0.5~1.5	48~16	0.8	0.9	11.0
302-01-003	302-01-004	16ER A 60	16EL A 60	3/8"	0.5~1.5	48~16	0.8	0.9	16.0
302-01-005	302-01-006	16ER AG 60	16EL AG 60	3/8"	0.5~3.0	48~8	1.2	1.7	16.0
302-01-007	302-01-008	16ER G 60	16EL G 60	3/8"	1.75~3.0	14~8	1.2	1.7	16.0
302-01-009	302-01-010	22ER N 60	22EL N 60	1/2"	3.5~5.0	7~5	1.7	2.5	22.0
302-01-011	302-01-012	27ER Q 60	27EL Q 60	5/8"	5.5~6.0	4.5~4	2.3	3.1	27.0

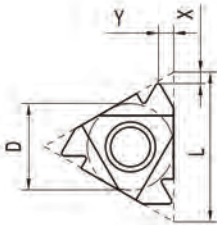

Internal

Order No.		Model		D (IC)	Lead&Pitch		Dimensions(mm)		
Right hand	Left hand	Right hand	Left hand		mm	TPI	X	Y	L
301-01-001	301-01-002	08IR A 60	08IL A 60	3/16"	0.5~1.5	48~16	0.8	0.6	8
301-01-003	301-01-004	11IR A 60	11IL A 60	1/4"	0.5~1.5	48~16	0.8	0.9	11
301-01-005	301-01-006	16IR A 60	16IL A 60	3/8"	0.5~1.5	48~16	0.8	0.9	16
301-01-007	301-01-008	16IR AG 60	16IL AG 60	3/8"	0.5~3.0	48~8	1.2	1.7	16
301-01-009	301-01-010	16IR G 60	16IL G 60	3/8"	1.75~3.0	14~8	1.2	1.7	16
301-01-011	301-01-012	22IR N 60	22IL N 60	1/2"	3.5~5.0	7~5	1.6	2.4	22
301-01-013	301-01-014	27IR Q 60	27IL Q 60	5/8"	5.5~6.0	4.5~4	2.3	3.1	27

PRTIAL PROFILE 55°

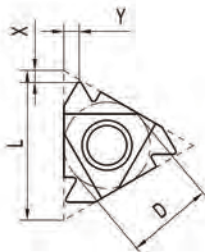
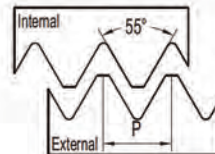

External

Order No.		Model		D (IC)	Lead&Pitch		Dimensions(mm)		
Right hand	Left hand	Right hand	Left hand		mm	TPI	X	Y	L
302-02-001	302-02-002	11ER A 55	11EL A 55	1/4"	0.5~1.5	48~16	0.8	0.9	11
302-02-003	302-02-004	16ER A 55	16EL A 55	3/8"	0.5~1.5	48~16	0.8	0.9	16
302-02-005	302-02-006	16ER AG 55	16EL AG 55	3/8"	0.5~3.0	48~8	1.2	1.7	16
302-02-007	302-02-008	16ER G 55	16EL G 55	3/8"	1.75~3.0	14~8	1.2	1.7	16
302-02-009	302-02-010	22ER N 55	22EL N 55	1/2"	3.5~5.0	7~5	1.7	2.5	22
302-02-011	302-02-012	27ER Q 55	27EL Q 55	5/8"	5.5~6.0	4.5~4	2	2.9	27

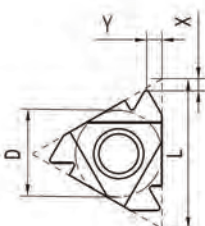

Internal

Order No.		Model		D (IC)	Lead&Pitch		Dimensions(mm)		
Right hand	Left hand	Right hand	Left hand		mm	TPI	X	Y	L
301-02-001	301-02-002	08IR A 55	08IL A 55	3/16"	0.5~1.5	48~16	0.6	0.7	8
301-02-003	301-02-004	11IR A 55	11IL A 55	1/4"	0.5~1.5	48~16	0.8	0.9	11
301-02-005	301-02-006	16IR A 55	16IL A 55	3/8"	0.5~1.5	48~16	0.8	0.9	16
301-02-007	301-02-008	16IR AG 55	16IL AG 55	3/8"	0.5~3.0	48~8	1.2	1.7	16
301-02-009	301-02-010	16IR G 55	16IL G 55	3/8"	1.75~3.0	14~8	1.2	1.7	16
301-02-011	301-02-012	22IR N 55	22IL N 55	1/2"	3.5~5.0	7~5	1.7	2.5	22
301-02-013	301-02-014	27IR Q 55	27IL Q 55	5/8"	5.5~6.0	4.5~4	2.0	2.9	27

ISO METRIC FULL PROFILE

• According to standard ISO965-1,DIN13

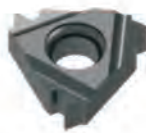
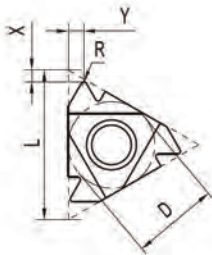
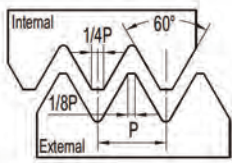

External

Order No.		Model		D (IC)	Pitch P(mm)	Dimensions(mm)		
Right hand	Left hand	Right hand	Left hand			X	Y	L
302-03-001	302-03-002	11ER 0.50ISO	11EL 0.50ISO	1/4"	0.5	0.6	0.4	11
302-03-003	302-03-004	11ER 0.75ISO	11EL 0.75ISO	1/4"	0.75	0.6	0.6	11
302-03-005	302-03-006	11ER 0.80ISO	11EL 0.80ISO	1/4"	0.8	0.6	0.6	11
302-03-007	302-03-008	11ER 1.00ISO	11EL 1.00ISO	1/4"	1.0	0.6	0.7	11
302-03-009	302-03-010	11ER 1.25ISO	11EL 1.25ISO	1/4"	1.25	0.6	0.9	11
302-03-011	302-03-012	11ER 1.50ISO	11EL 1.50ISO	1/4"	1.5	0.6	1.0	11
302-03-013	302-03-014	16ER 0.50ISO	16EL 0.50ISO	3/8"	0.5	0.6	0.6	16
302-03-015	302-03-016	16ER 0.75ISO	16EL 0.75ISO	3/8"	0.75	0.6	0.6	16
302-03-017	302-03-018	16ER 1.00ISO	16EL 1.00ISO	3/8"	1.0	0.7	0.7	16
302-03-019	302-03-020	16ER 1.25ISO	16EL 1.25ISO	3/8"	1.25	0.8	0.9	16
302-03-021	302-03-022	16ER 1.50ISO	16EL 1.50ISO	3/8"	1.50	0.8	1.0	16
302-03-023	302-03-024	16ER 1.75ISO	16EL 1.75ISO	3/8"	1.75	0.9	1.2	16
302-03-025	302-03-026	16ER 2.00ISO	16EL 2.00ISO	3/8"	2.0	1.0	1.3	16
302-03-027	302-03-028	16ER 2.50ISO	16EL 2.50ISO	3/8"	2.5	1.1	1.5	16
302-03-029	302-03-030	16ER 3.00ISO	16EL 3.00ISO	3/8"	3.0	1.2	1.6	16
302-03-031	302-03-032	22ER 3.50ISO	22EL 3.50ISO	1/2"	3.5	1.6	2.3	22
302-03-033	302-03-034	22ER 4.00ISO	22EL 4.00ISO	1/2"	4.0	1.6	2.3	22
302-03-035	302-03-036	22ER 4.50ISO	22EL 4.50ISO	1/2"	4.5	1.7	2.4	22
302-03-037	302-03-038	22ER 5.00ISO	22EL 5.00ISO	1/2"	5.0	1.7	2.5	22
302-03-039	302-03-040	27ER 5.50ISO	27EL 5.50ISO	5/8"	5.5	1.9	2.7	27
302-03-041	302-03-042	27ER 6.00ISO	27EL 6.00ISO	5/8"	6.0	2.0	2.9	27

Internal

Order No.		Model		D (IC)	Pitch P(mm)	Dimensions(mm)		
Right hand	Left hand	Right hand	Left hand			X	Y	L
301-03-001	301-03-002	11IR 0.50ISO	11IL 0.50ISO	1/4"	0.50	0.6	0.6	11
301-03-003	301-03-004	11IR 0.75ISO	11IL 0.75ISO	1/4"	0.75	0.6	0.6	11
301-03-005	301-03-006	11IR 1.00ISO	11IL 1.00ISO	1/4"	1.00	0.6	0.6	11
301-03-007	301-03-008	11IR 1.25ISO	11IL 1.25ISO	1/4"	1.25	0.7	0.7	11
301-03-009	301-03-010	11IR 1.50ISO	11IL 1.50ISO	1/4"	1.50	0.8	0.9	11
301-03-011	301-03-012	11IR 1.75ISO	11IL 1.75ISO	1/4"	1.75	0.8	1.0	11
301-03-013	301-03-014	11IR 2.00 ISO	11IL 2.00 ISO	1/4"	2.00	0.9	1.2	11
301-03-015	301-03-016	16IR 0.50ISO	16IL 0.50ISO	3/8"	0.50	1.0	1.3	16
301-03-017	301-03-018	16IR 0.75ISO	16IL 0.75ISO	3/8"	0.75	0.6	0.6	16
301-03-019	301-03-020	16IR 1.00ISO	16IL 1.00ISO	3/8"	1.00	0.7	0.7	16
301-03-021	301-03-022	16IR 1.25ISO	16IL 1.25ISO	3/8"	1.25	0.8	0.9	16
301-03-023	301-03-024	16IR 1.50ISO	16IL 1.50ISO	3/8"	1.50	0.8	1.0	16
301-03-025	301-03-026	16IR 1.75ISO	16IL 1.75ISO	3/8"	1.75	0.9	1.2	16
301-03-027	301-03-028	16IR 2.00ISO	16IL 2.00ISO	3/8"	2.00	1.0	1.3	16
301-03-029	301-03-030	16IR 2.50ISO	16IL 2.50ISO	3/8"	2.50	1.1	1.5	16
301-03-031	301-03-032	16IR 3.00ISO	16IL 3.00ISO	3/8"	3.00	1.1	1.5	16
301-03-033	301-03-034	22IR 3.50ISO	22IL 3.50ISO	1/2"	3.50	1.6	2.3	22
301-03-035	301-03-036	22IR 4.00ISO	22IL 4.00ISO	1/2"	4.00	1.6	2.3	22
301-03-037	301-03-038	22IR 4.50ISO	22IL 4.50ISO	1/2"	4.50	1.6	2.4	22
301-03-039	301-03-040	22IR 5.00ISO	22IL 5.00ISO	1/2"	5.00	1.6	2.5	22
301-03-041	301-03-042	27IR 5.50ISO	27IL 5.50ISO	5/8"	5.50	1.6	2.3	27
301-03-043	301-03-044	27IR 6.00ISO	27IL 6.00ISO	5/8"	6.00	1.8	2.5	27

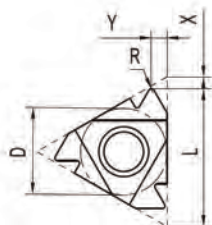

THREADING CUTTER

AMERICAN UN FULL PROFILE

• According to standard ANSI B1.1-1983

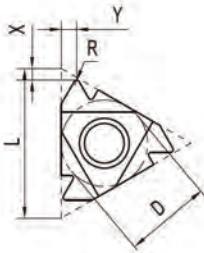
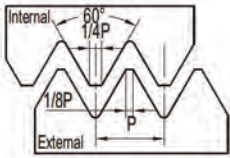

External

Order No.		Model		D (IC)	Pitch P(mm)	Dimensions(mm)		
Right hand	Left hand	Right hand	Left hand			X	Y	L
302-04-001	302-04-002	11ER 32UN	11EL 32UN	1/4"	32	0.6	0.6	11
302-04-003	302-04-004	11ER 28UN	11EL 28UN	1/4"	28	0.6	0.7	11
302-04-005	302-04-006	11ER 24UN	11EL 24UN	1/4"	24	0.7	0.8	11
302-04-007	302-04-008	11ER 20UN	11EL 20UN	1/4"	20	0.8	0.9	11
302-04-009	302-04-010	11ER 18UN	11EL 18UN	1/4"	18	0.8	1.0	11
302-04-011	302-04-012	11ER 16UN	11EL 16UN	1/4"	16	0.9	1.1	11
302-04-013	302-04-014	16ER 32UN	16EL 32UN	3/8"	32	0.6	0.6	16
302-04-015	302-04-016	16ER 28UN	16EL 28UN	3/8"	28	0.6	0.7	16
302-04-017	302-04-018	16ER 24UN	16EL 24UN	3/8"	24	0.7	0.8	16
302-04-019	302-04-020	16ER 20UN	16EL 20UN	3/8"	20	0.8	0.9	16
302-04-021	302-04-022	16ER 18UN	16EL 18UN	3/8"	18	0.8	1.0	16
302-04-023	302-04-024	16ER 16UN	16EL 16UN	3/8"	16	0.9	1.1	16
302-04-025	302-04-026	16ER 14UN	16EL 14UN	3/8"	14	1.0	1.2	16
302-04-027	302-04-028	16ER 12UN	16EL 12UN	3/8"	12	1.1	1.4	16
302-04-029	302-04-030	16ER 11UN	16EL 11UN	3/8"	11	1.1	1.5	16
302-04-031	302-04-032	16ER 10UN	16EL 10UN	3/8"	10	1.2	1.5	16
302-04-033	302-04-034	16ER 9UN	16EL 9UN	3/8"	9	1.2	1.7	16
302-04-035	302-04-036	16ER 8UN	16EL 8UN	3/8"	8	1.2	2.0	16
302-04-037	302-04-038	22ER 7UN	22EL 7UN	1/2"	7	1.6	2.3	22
302-04-039	302-04-040	22ER 6UN	22EL 6UN	1/2"	6	1.6	2.3	22
302-04-041	302-04-042	22ER 5UN	22EL 5UN	1/2"	5	1.7	2.5	22
302-04-043	302-04-044	27ER 4.5UN	27EL 4.5UN	5/8"	4.5	1.9	2.7	27
302-04-045	302-04-046	27ER 4UN	27EL 4UN	5/8"	4	2.1	3.0	27

Internal

Order No.		Model		D (IC)	Pitch P(mm)	Dimensions(mm)		
Right hand	Left hand	Right hand	Left hand			X	Y	L
301-04-001	301-04-002	08IR 32UN	08IL 32UN	3/16"	32	0.6	0.5	8
301-04-003	301-04-004	08IR 28UN	08IL 28UN	3/16"	28	0.6	0.6	8
301-04-005	301-04-006	08IR 24UN	08IL 24UN	3/16"	24	0.6	0.6	8
301-04-007	301-04-008	08IR 20UN	08IL 20UN	3/16"	20	0.6	0.7	8
301-04-009	301-04-010	08IR 18UN	08IL 18UN	3/16"	18	0.6	0.7	8
301-04-011	301-04-012	08IR 16UN	08IL 16UN	3/16"	16	0.6	0.7	8
301-04-013	301-04-014	11IR 32UN	11IL 32UN	1/4"	32	0.6	0.6	11
301-04-015	301-04-016	11IR 28UN	11IL 28UN	1/4"	28	0.6	0.7	11
301-04-017	301-04-018	11IR 24UN	11IL 24UN	1/4"	24	0.7	0.8	11
301-04-019	301-04-020	11IR 20UN	11IL 20UN	1/4"	20	0.8	0.9	11
301-04-021	301-04-022	11IR 18UN	11IL 18UN	1/4"	18	0.8	1.0	11
301-04-023	301-04-024	11IR 16UN	11IL 16UN	1/4"	16	0.9	1.1	11
301-04-025	301-04-026	16IR 32UN	16IL 32UN	3/8"	32	0.6	0.6	16
301-04-027	301-04-028	16IR 28UN	16IL 28UN	3/8"	28	0.6	0.7	16
301-04-029	301-04-030	16IR 24UN	16IL 24UN	3/8"	24	0.7	0.8	16
301-04-031	301-04-032	16IR 20UN	16IL 20UN	3/8"	20	0.8	0.9	16
301-04-033	301-04-034	16IR 18UN	16IL 18UN	3/8"	18	0.8	1.0	16
301-04-035	301-04-036	16IR 16UN	16IL 16UN	3/8"	16	0.9	1.1	16
301-04-037	301-04-038	16IR 14UN	16IL 14UN	3/8"	14	1.0	1.2	16
301-04-039	301-04-040	16IR 12UN	16IL 12UN	3/8"	12	1.1	1.4	16
301-04-041	301-04-042	16IR 11UN	16IL 11UN	3/8"	11	1.1	1.5	16
301-04-043	301-04-044	16IR 10UN	16IL 10UN	3/8"	10	1.1	1.5	16
301-04-045	301-04-046	16IR 9UN	16IL 9UN	3/8"	9	1.2	1.7	16
301-04-047	301-04-048	16IR 8UN	16IL 8UN	3/8"	8	1.2	1.5	16
301-04-049	301-04-050	22IR 7UN	22IL 7UN	1/2"	7	1.6	2.3	22
301-04-051	301-04-052	22IR 6UN	22IL 6UN	1/2"	6	1.6	2.3	22
301-04-053	301-04-054	22IR 5UN	22IL 5UN	1/2"	5	1.7	2.3	22
301-04-055	301-04-056	27IR 4.5UN	27IL 4.5UN	5/8"	4.5	1.9	2.4	27
301-04-057	301-04-058	27IR 4UN	27IL 4UN	5/8"	4	2.1	2.7	27

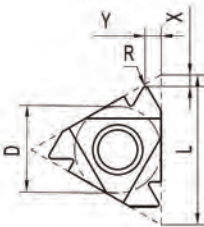

AMERICAN TAPER PIPE FULL PROFILE

• According to standard ANSI/ASME B 1.20.1-1983

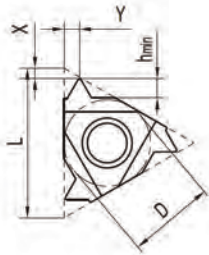
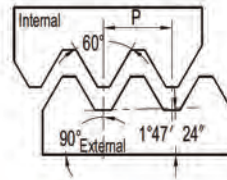

External

Order No.		Model		D (IC)	Pitch P(mm)	Dimensions(mm)		
Right hand	Left hand	Right hand	Left hand			X	Y	L
302-05-001	302-05-002	11ER 27NPT	11EL 27NPT	1/4"	27	0.7	0.8	11
302-05-003	302-05-004	11ER 18NPT	11EL 18NPT	1/4"	18	0.8	1.0	11
302-05-005	302-05-006	11ER 14NPT	11EL 14NPT	1/4"	14	0.8	1.0	11
302-05-007	302-05-008	16ER 27NPT	16EL 27NPT	3/8"	27	0.7	0.8	16
302-05-009	302-05-010	16ER 18NPT	16EL 18NPT	3/8"	18	0.8	1.0	16
302-05-011	302-05-012	16ER 14NPT	16EL 14NPT	3/8"	14	0.9	1.2	16
302-05-013	302-05-014	16ER 11.5NPT	16EL 11.5NPT	3/8"	11.5	1.1	1.5	16
302-05-015	302-05-016	16ER 8NPT	16EL 8NPT	3/8"	8	1.3	1.8	16

Internal

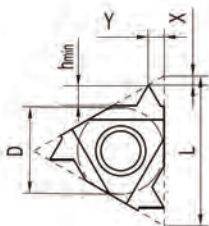

Order No.		Model		D (IC)	Pitch P(mm)	Dimensions(mm)		
Right hand	Left hand	Right hand	Left hand			X	Y	L
301-05-001	301-05-002	08IR 27NPT	08IL 27NPT	3/16"	27	0.6	0.6	8
301-05-003	301-05-004	08IR 18NPT	08IL 18NPT	3/16"	18	0.6	0.6	8
301-05-005	301-05-006	11IR 27NPT	11IL 27NPT	1/4"	27	0.7	0.8	11
301-05-007	301-05-008	11IR 18NPT	11IL 18NPT	1/4"	18	0.8	1.0	11
301-05-009	301-05-010	11IR 14NPT	11IL 14NPT	1/4"	14	0.8	1.0	11
301-05-011	301-05-012	16IR 27NPT	16IL 27NPT	3/8"	27	0.7	0.8	16
301-05-013	301-05-014	16IR 18NPT	16IL 18NPT	3/8"	18	0.8	1.0	16
301-05-015	301-05-016	16IR 14NPT	16IL 14NPT	3/8"	14	0.9	1.2	16
301-05-017	301-05-018	16IR 11.5NPT	16IL 11.5NPT	3/8"	11.5	1.1	1.5	16
301-05-019	301-05-020	16IR 8NPT	16IL 8NPT	3/8"	8	1.3	1.8	16

THREADING CUTTER

AMERICAN DRYSEAL TAPER PIPE FULL PROFILE

• According to standard ANSI B1.20.3-1976

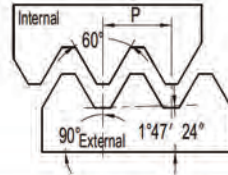

External

Order No.		Model		D (IC)	Pitch P(mm)	Dimensions(mm)		
Right hand	Left hand	Right hand	Left hand			X	Y	L
302-06-001	302-06-002	11ER 27NPTF	11EL 27NPTF	1/4"	27	0.7	0.7	11
302-06-003	302-06-004	11ER 18NPTF	11EL 18NPTF	1/4"	18	0.8	1.0	11
302-06-005	302-06-006	11ER 14NPTF	11EL 14NPTF	1/4"	14	0.8	1.0	11
302-06-007	302-06-008	16ER 27NPTF	16EL 27NPTF	3/8"	27	0.7	0.7	16
302-06-009	302-06-010	16ER 18NPTF	16EL 18NPTF	3/8"	18	0.8	1.0	16
302-06-011	302-06-012	16ER 14NPTF	16EL 14NPTF	3/8"	14	0.9	1.2	16
302-06-013	302-06-014	16ER 11.5NPTF	16EL 11.5NPTF	3/8"	11.5	1.1	1.5	16
302-06-015	302-06-016	16ER 8NPTF	16EL 8NPTF	3/8"	8	1.5	1.8	16

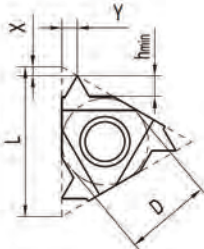

Internal

Order No.		Model		D (IC)	Pitch P(mm)	Dimensions(mm)		
Right hand	Left hand	Right hand	Left hand			X	Y	L
301-06-001	301-06-002	08IR 27NPTF	08IL 27NPTF	3/16"	27	0.7	0.7	8
301-06-003	301-06-004	08IR 18NPTF	08IL 18NPTF	3/16"	18	0.8	1.0	8
301-06-005	301-06-006	11IR 27NPTF	11IL 27NPTF	1/4"	27	0.7	0.7	11
301-06-007	301-06-008	11IR 18NPTF	11IL 18NPTF	1/4"	18	0.8	1.0	11
301-06-009	301-06-010	11IR 14NPTF	11IL 14NPTF	1/4"	14	0.8	1.0	11
301-06-011	301-06-012	16IR 27NPTF	16IL 27NPTF	3/8"	27	0.7	0.7	16
301-06-013	301-06-014	16IR 18NPTF	16IL 18NPTF	3/8"	18	0.8	1.0	16
301-06-015	301-06-016	16IR 14NPTF	16IL 14NPTF	3/8"	14	0.9	1.2	16
301-06-017	301-06-018	16IR 11.5NPTF	16IL 11.5NPTF	3/8"	11.5	1.1	1.5	16
301-06-019	301-06-020	16IR 8NPTF	16IL 8NPTF	3/8"	8	1.5	1.8	16

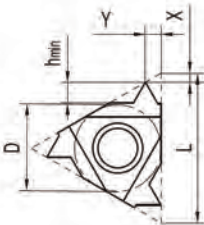

BRITISH STANDARD TAPER PIPE FULL PROFILE

• According to standard B.S.21:1985

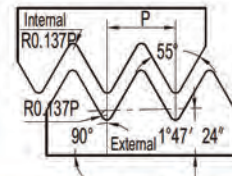

External

Order No.		Model		D (IC)	Pitch P(mm)	Dimensions(mm)		
Right hand	Left hand	Right hand	Left hand			X	Y	L
302-07-001	302-07-002	11ER 28BSPT	11EL 28BSPT	1/4"	28	0.6	0.6	11
302-07-003	302-07-004	11ER 19BSPT	11EL 19BSPT	1/4"	19	0.8	0.9	11
302-07-005	302-07-006	11ER 14BSPT	11EL 14BSPT	1/4"	14	0.9	1.0	11
302-07-007	302-07-008	16ER 28BSPT	16EL 28BSPT	3/8"	28	0.6	0.6	16
302-07-009	302-07-010	16ER 19BSPT	16EL 19BSPT	3/8"	19	0.8	0.9	16
302-07-011	302-07-012	16ER 14BSPT	16EL 14BSPT	3/8"	14	1.0	1.2	16
302-07-013	302-07-014	16ER 11BSPT	16EL 11BSPT	3/8"	11	1.1	1.5	16

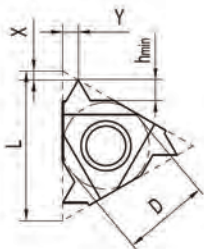

Internal

Order No.		Model		D (IC)	Pitch P(mm)	Dimensions(mm)		
Right hand	Left hand	Right hand	Left hand			X	Y	L
301-07-001	301-07-002	11IR 28BSPT	11IL 28BSPT	1/4"	28	0.6	0.6	11
301-07-003	301-07-004	11IR 19BSPT	11IL 19BSPT	1/4"	19	0.8	0.9	11
301-07-005	301-07-006	11IR 14BSPT	11IL 14BSPT	1/4"	14	0.9	1.0	11
301-07-007	301-07-008	16IR 28BSPT	16IL 28BSPT	3/8"	28	0.6	0.6	16
301-07-009	301-07-010	16IR 19BSPT	16IL 19BSPT	3/8"	19	0.8	0.9	16
301-07-011	301-07-012	16IR 14BSPT	16IL 14BSPT	3/8"	14	1.0	1.2	16
301-07-013	301-07-014	16IR 11BSPT	16IL 11BSPT	3/8"	11	1.1	1.5	16

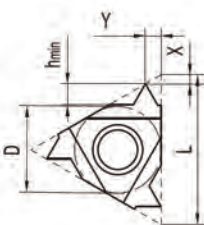

55° WHITWORTH FULL PROFILE

• According to standard B.S.84:1956,ISO228-1982

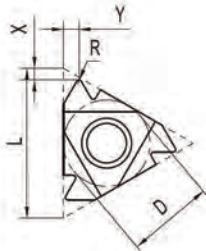
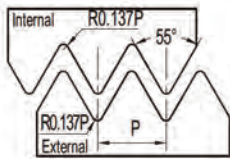

External

Order No.		Model		D (IC)	Pitch P(mm)	Dimensions(mm)		
Right hand	Left hand	Right hand	Left hand			X	Y	L
302-08-001	302-08-002	11ER 28W	11EL 28W	1/4"	28	0.6	0.6	11
302-08-003	302-08-004	11ER 26W	11EL 26W	1/4"	28	0.6	0.7	11
302-08-005	302-08-006	11ER 20W	11EL 20W	1/4"	24	0.7	0.8	11
302-08-007	302-08-008	11ER 19W	11EL 19W	1/4"	20	0.8	0.9	11
302-08-009	302-08-010	11ER 16W	11EL 16W	1/4"	16	0.9	1.1	11
302-08-011	302-08-012	11ER 14W	11EL 14W	1/4"	32	0.6	0.6	11
302-08-013	302-08-014	16ER 28W	16EL 28W	3/8"	28	0.6	0.7	16
302-08-015	302-08-016	16ER 26W	16EL 26W	3/8"	26	0.7	0.8	16
302-08-017	302-08-018	16ER 20W	16EL 20W	3/8"	20	0.8	0.9	16
302-08-019	302-08-020	16ER 19W	16EL 19W	3/8"	19	0.8	1.0	16
302-08-021	302-08-022	16ER 14W	16EL 14W	3/8"	14	1.0	1.2	16
302-08-023	302-08-024	16ER 12W	16EL 12W	3/8"	12	1.1	1.4	16
302-08-025	302-08-026	16ER 11W	16EL 11W	3/8"	11	1.1	1.5	16
302-08-027	302-08-028	16ER 10W	16EL 10W	3/8"	10	1.2	1.5	16
302-08-029	302-08-030	16ER 9W	16EL 9W	3/8"	9	1.2	1.7	16
302-08-031	302-08-032	16ER 8W	16EL 8W	3/8"	8	1.2	2.0	16
302-08-033	302-08-034	22ER 7W	22EL 7W	1/2"	7	1.6	2.3	22
302-08-035	302-08-036	22ER 6W	22EL 6W	1/2"	6	1.6	2.3	22
302-08-037	302-08-038	22ER 5W	22EL 5W	1/2"	5	1.7	2.5	22
302-08-039	302-08-040	27ER 4.5W	27EL 4.5W	5/8"	4.5	1.9	2.7	27
302-08-041	302-08-042	27ER 4W	27EL 4W	5/8"	4	2.1	3.0	27

Internal

Order No.		Model		D (IC)	Pitch P(mm)	Dimensions(mm)		
Right hand	Left hand	Right hand	Left hand			X	Y	L
301-08-001	301-08-002	08IR 28W	08IL 28W	3/16"	28	0.6	0.6	8
301-08-003	301-08-004	08IR 26W	08IL 26W	3/16"	26	0.6	0.6	8
301-08-005	301-08-006	08IR 24W	08IL 24W	3/16"	24	0.6	0.7	8
301-08-007	301-08-008	08IR 20W	08IL 20W	3/16"	20	0.6	0.7	8
301-08-009	301-08-010	08IR 19W	08IL 19W	3/16"	19	0.6	0.7	8
301-08-011	301-08-012	08IR 16W	08IL 16W	3/16"	16	0.6	0.7	8
301-08-013	301-08-014	11IR 28W	11IL 28W	1/4"	28	0.6	0.6	11
301-08-015	301-08-016	11IR 26W	11IL 26W	1/4"	28	0.6	0.7	11
301-08-017	301-08-018	11IR 20W	11IL 20W	1/4"	24	0.7	0.8	11
301-08-019	301-08-020	11IR 19W	11IL 19W	1/4"	20	0.8	0.9	11
301-08-021	301-08-022	11IR 16W	11IL 16W	1/4"	16	0.9	1.1	11
301-08-023	301-08-024	11IR 14W	11IL 14W	1/4"	32	0.6	0.6	11
301-08-025	301-08-026	16IR 28W	16IL 28W	3/8"	28	0.6	0.7	16
301-08-027	301-08-028	16IR 26W	16IL 26W	3/8"	26	0.7	0.8	16
301-08-029	301-08-030	16IR 20W	16IL 20W	3/8"	20	0.8	0.9	16
301-08-031	301-08-032	16IR 19W	16IL 19W	3/8"	19	0.8	1.0	16
301-08-033	301-08-034	16IR 14W	16IL 14W	3/8"	14	1.0	1.2	16
301-08-035	301-08-036	16IR 12W	16IL 12W	3/8"	12	1.1	1.4	16
301-08-037	301-08-038	16IR 11W	16IL 11W	3/8"	11	1.1	1.5	16
301-08-039	301-08-040	16IR 10W	16IL 10W	3/8"	10	1.2	1.5	16
301-08-041	301-08-042	16IR 9W	16IL 9W	3/8"	9	1.2	1.7	16
301-08-043	301-08-044	16IR 8W	16IL 8W	3/8"	8	1.2	2.0	16
301-08-045	301-08-046	22IR 7W	22IL 7W	1/2"	7	1.6	2.3	22
301-08-047	301-08-048	22IR 6W	22IL 6W	1/2"	6	1.6	2.3	22
301-08-049	301-08-050	22IR 5W	22IL 5W	1/2"	5	1.7	2.5	22
301-08-051	301-08-052	27IR 4.5W	27IL 4.5W	5/8"	4.5	1.9	2.7	27
301-08-053	301-08-054	27IR 4W	27IL 4W	5/8"	4	2.1	3.0	27

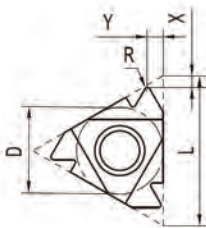

THREADING CUTTER

INCH SIZE TRAPEZE ACME

• According to standard ANSI/ASME 1.5-1988

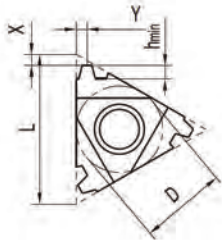
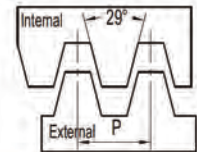

External

Order No.		Model		D (IC)	Pitch P(mm)	Dimensions(mm)		
Right hand	Left hand	Right hand	Left hand			X	Y	L
302-09-001	302-09-002	16ER 16ACME	16EL 16ACME	3/8"	16	1	1.1	16
302-09-003	302-09-004	16ER 14ACME	16EL 14ACME	3/8"	14	1.0	1.2	16
302-09-005	302-09-006	16ER 12ACME	16EL 12ACME	3/8"	12	1.1	1.2	16
302-09-007	302-09-008	16ER 10ACME	16EL 10ACME	3/8"	10	1.3	1.4	16
302-09-009	302-09-010	16ER 8ACME	16EL 8ACME	3/8"	8	1.4	1.5	16
302-09-011	302-09-012	22ER 6ACME	22EL 6ACME	1/2"	6	1.7	1.9	22
302-09-013	302-09-014	22ER 5ACME	22EL 5ACME	1/2"	5	1.8	2.1	22
302-09-015	302-09-016	27ER 4ACME	27EL 4ACME	5/8"	4	2.0	2.3	27

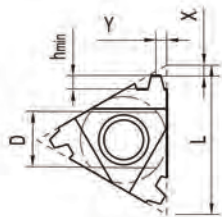

Internal

Order No.		Model		D (IC)	Pitch P(mm)	Dimensions(mm)		
Right hand	Left hand	Right hand	Left hand			X	Y	L
301-09-001	301-09-002	16IR 16ACME	16IL 16ACME	3/8"	16	1	1.1	16
301-09-003	301-09-004	16IR 14ACME	16IL 14ACME	3/8"	14	1.0	1.2	16
301-09-005	301-09-006	16IR 12ACME	16IL 12ACME	3/8"	12	1.1	1.2	16
301-09-007	301-09-008	16IR 10ACME	16IL 10ACME	3/8"	10	1.3	1.4	16
301-09-009	301-09-010	16IR 8ACME	16IL 8ACME	3/8"	8	1.4	1.5	16
301-09-011	301-09-012	22IR 6ACME	22IL 6ACME	1/2"	6	1.7	1.9	22
301-09-013	301-09-014	22IR 5ACME	22IL 5ACME	1/2"	5	1.8	2.1	22
301-09-015	301-09-016	27IR 4ACME	27IL 4ACME	5/8"	4	2.0	2.3	27

METRIC SIZE TRAPEZE TR

• According to standard DIN103-1977

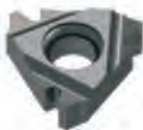
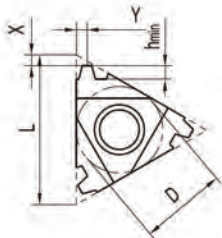
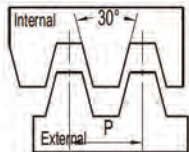

External

Order No.		Model		D (IC)	Pitch P(mm)	Dimensions(mm)		
Right hand	Left hand	Right hand	Left hand			X	Y	L
302-10-001	302-10-002	11ER 1.50TR	11EL 1.50TR	1/4"	1.5	0.8	0.9	11
302-10-003	302-10-004	16ER 1.50TR	16EL 1.50TR	3/8"	1.5	1.0	1.1	16
302-10-005	302-10-006	16ER 2.00TR	16EL 2.00TR	3/8"	2.0	1.1	1.3	16
302-10-007	302-10-008	16ER 2.50TR	16EL 2.50TR	3/8"	2.5	1.2	1.4	16
302-10-009	302-10-010	16ER 3.00TR	16EL 3.00TR	3/8"	3.0	1.3	1.5	16
302-10-011	302-10-012	22ER 4.00TR	22EL 4.00TR	1/2"	4.0	1.7	1.9	22
302-10-013	302-10-014	22ER 5.00TR	22EL 5.00TR	1/2"	5.0	2.1	2.5	22
302-10-015	302-10-016	22ER 6.00TR	22EL 6.00TR	1/2"	6.0	2.3	2.7	22
302-10-017	302-10-018	27ER 6.00TR	27EL 6.00TR	5/8"	6.0	2.3	2.7	27
302-10-019	302-10-020	27ER 7.00TR	27EL 7.00TR	5/8"	7.0	2.2	2.6	27

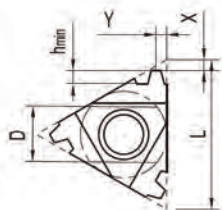

Internal

Order No.		Model		D (IC)	Pitch P(mm)	Dimensions(mm)		
Right hand	Left hand	Right hand	Left hand			X	Y	L
301-10-001	301-10-002	11IR 1.50TR	11IL 1.50TR	1/4"	1.5	0.8	0.9	11
301-10-003	301-10-004	16IR 1.50TR	16IL 1.50TR	3/8"	1.5	1.0	1.1	16
301-10-005	301-10-006	16IR 2.00TR	16IL 2.00TR	3/8"	2.0	1.1	1.3	16
301-10-007	301-10-008	16IR 2.50TR	16IL 2.50TR	3/8"	2.5	1.2	1.4	16
301-10-009	301-10-010	16IR 3.00TR	16IL 3.00TR	3/8"	3.0	1.3	1.5	16
301-10-011	301-10-012	22IR 4.00TR	22IL 4.00TR	1/2"	4.0	1.7	1.9	22
301-10-013	301-10-014	22IR 5.00TR	22IL 5.00TR	1/2"	5.0	2.1	2.5	22
301-10-015	301-10-016	22IR 6.00TR	22IL 6.00TR	1/2"	6.0	2.3	2.7	22
301-10-017	301-10-018	27IR 6.00TR	27IL 6.00TR	5/8"	6.0	2.3	2.7	27
301-10-019	301-10-020	27IR 7.00TR	27IL 7.00TR	5/8"	7.0	2.2	2.6	27

INDEXABLE THREADING MILLS

- Used for cutting both internal and external thread.
- Shank according to DIN1835B.

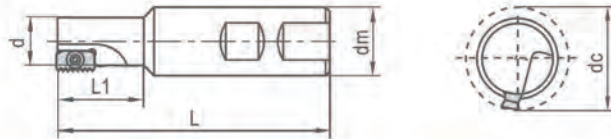

Order No.	Model	Size(mm)					No.of teeth	Insert	Screw	Torx wrench	Weight
		dc	dm	d	L1	L					
241-17-001	SMT-14.5-14	14.5	20	11	25	85	1	14...	C030A07S	T9	0.2
241-17-002	SMT-17-14	17	20	14	30	85	1	14...	C030A07S	T9	0.3
241-17-003	SMT-20-14	20	20	17	35	90	1	14...	C030A07S	T9	0.3
241-17-004	SMT-25-14	25	25	22	40	100	1	14...	C030A07S	T9	0.4
241-17-005	SMT-18-21	18	20	14	30	85	1	21...	C040A09S	T15	0.3
241-17-006	SMT-21-21	21	20	17	40	95	1	21...	C040A09S	T15	0.3
241-17-007	SMT-25-21	25	25	21	50	115	1	21...	C040A09S	T15	0.4
241-17-008	SMT-29-30	29	25	24	50	115	1	30...	C050A12S	T20	0.6
241-17-009	SMT-48-40	48	40	40	80	160	1	40...	C050A12S	T20	2.3

Inert not included

Recommend cutting data

Application	Finish cutting			Medium cutting			rough cutting		
	Surface speed Vc(m/min)	Feed per tooth fz(mm)	Cutting depth ap(mm)	Surface speed Vc(m/min)	Feed per tooth fz(mm)	Cutting depth ap(mm)	Surface speed Vc(m/min)	Feed per tooth fz(mm)	Cutting depth ap(mm)
Steel	-	-	-	140-80	0.05-0.12	-	-	-	-
Stainless Steel	-	-	-	100-60	0.04-0.10	-	-	-	-
Cast iron	-	-	-	100-60	0.05-0.15	-	-	-	-
Non ferrous metal	-	-	-	-	-	-	-	-	-
High temperature alloy	-	-	-	-	-	-	-	-	-

INDEXABLE THREADING CHASER

- used for cutting both internal and external thread.

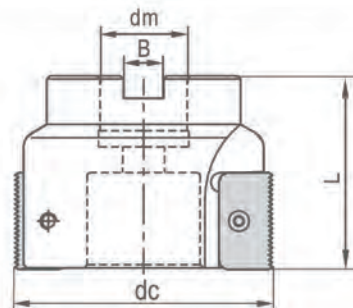

Order No.	Model	Size(mm)				No.of teeth	Insert	Screw	Torx wrench	Weight
		dc	dm	B	L					
231-17-001	SMF-50-14	50	22	10.4	40	5	14...	C030A07S	WT9	0.4
231-17-002	SMF-63-21	63	22	10.4	50	5	21...	C040A09S	WT15	0.6
231-17-003	SMF-80-21	80	27	12.4	50	6	21...	C040A09S	WT15	1.1
231-17-004	SMF-80-30	80	27	12.4	55	4	30...	C050A12S	WT20	1.1
231-17-005	SMF-100-30	100	32	14.4	60	4	30...	C050A12S	WT20	1.9
231-17-006	SMF-80-40	80	27	12.4	65	4	40...	C050A12S	WT20	1.1
231-17-007	SMF-100-40	100	32	14.4	70	4	40...	C050A12S	WT20	1.9

Inert not included

Recommend cutting data

Application	Finish cutting			Medium cutting			rough cutting		
	Surface speed Vc(m/min)	Feed per tooth fz(mm)	Cutting depth ap(mm)	Surface speed Vc(m/min)	Feed per tooth fz(mm)	Cutting depth ap(mm)	Surface speed Vc(m/min)	Feed per tooth fz(mm)	Cutting depth ap(mm)
Steel	-	-	-	140-80	0.05-0.12	-	-	-	-
Stainless Steel	-	-	-	100-60	0.04-0.10	-	-	-	-
Cast iron	-	-	-	100-60	0.08-0.15	-	-	-	-
Non ferrous metal	-	-	-	-	-	-	-	-	-
High temperature alloy	-	-	-	-	-	-	-	-	-

CARBIDE ISO METRIC THREAD MILLING INSERTS FOR STEEL

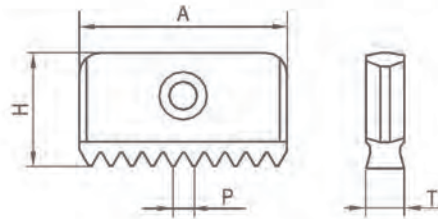

External

Order No.	Model	Pitch P(mm)	Insert size			Grade	Application
			A	H	T		
304-17-001	14E0.75 ISO	0.75	14	7.5	3.1	EP2220	Steel
304-17-002	14E1.00 ISO	1.00	14	7.5	3.1	EP2220	Steel
304-17-003	14E1.25 ISO	1.25	14	7.5	3.1	EP2220	Steel
304-17-004	14E1.50 ISO	1.50	14	7.5	3.1	EP2220	Steel
304-17-005	14E1.75 ISO	1.75	14	7.5	3.1	EP2220	Steel
304-17-006	14E2.00 ISO	2.00	14	7.5	3.1	EP2220	Steel
304-17-007	14E2.50 ISO	2.50	14	7.5	3.1	EP2220	Steel
304-17-008	21E1.00 ISO	1.00	21	12	4.7	EP2220	Steel
304-17-009	21E1.50 ISO	1.50	21	12	4.7	EP2220	Steel
304-17-010	21E2.00 ISO	2.00	21	12	4.7	EP2220	Steel
304-17-011	21E2.50 ISO	2.50	21	12	4.7	EP2220	Steel
304-17-012	21E3.00 ISO	3.00	21	12	4.7	EP2220	Steel
304-17-013	30E1.50 ISO	1.50	30	16	5.5	EP2220	Steel
304-17-014	30E2.00 ISO	2.00	30	16	5.5	EP2220	Steel
304-17-015	30E3.00 ISO	3.00	30	16	5.5	EP2220	Steel
304-17-016	30E3.50 ISO	3.50	30	16	5.5	EP2220	Steel
304-17-017	30E4.00 ISO	4.00	30	16	5.5	EP2220	Steel
304-17-018	40E1.50 ISO	1.50	40	20	6.3	EP2220	Steel
304-17-019	40E2.00 ISO	2.00	40	20	6.3	EP2220	Steel
304-17-020	40E3.00 ISO	3.00	40	20	6.3	EP2220	Steel
304-17-021	40E4.00 ISO	4.00	40	20	6.3	EP2220	Steel
304-17-022	40E5.00 ISO	5.00	40	20	6.3	EP2220	Steel
304-17-023	40E6.00 ISO	6.00	40	20	6.3	EP2220	Steel

Internal

Order No.	Model	Pitch P(mm)	Insert size			Grade	Application
			A	H	T		
303-17-001	1410.50 ISO	0.50	14	7.5	3.1	EP2220	Steel
303-17-002	1410.75 ISO	0.75	14	7.5	3.1	EP2220	Steel
303-17-003	1411.00 ISO	1.00	14	7.5	3.1	EP2220	Steel
303-17-004	1411.25 ISO	1.25	14	7.5	3.1	EP2220	Steel
303-17-005	1411.50 ISO	1.50	14	7.5	3.1	EP2220	Steel
303-17-006	1411.75 ISO	1.75	14	7.5	3.1	EP2220	Steel
303-17-007	1412.00 ISO	2.00	14	7.5	3.1	EP2220	Steel
303-17-008	1412.50 ISO	2.50	14	7.5	3.1	EP2220	Steel
303-17-009	2111.00 ISO	1.00	21	12	4.7	EP2220	Steel
303-17-010	2111.50 ISO	1.50	21	12	4.7	EP2220	Steel
303-17-011	2111.75 ISO	1.75	21	12	4.7	EP2220	Steel
303-17-012	2112.00 ISO	2.00	21	12	4.7	EP2220	Steel
303-17-013	2112.50 ISO	2.50	21	12	4.7	EP2220	Steel
303-17-014	2113.00 ISO	3.00	21	12	4.7	EP2220	Steel
303-17-015	2113.50 ISO	3.50	21	12	4.7	EP2220	Steel
303-17-016	3011.50 ISO	1.50	30	16	5.5	EP2220	Steel
303-17-017	3012.00 ISO	2.00	30	16	5.5	EP2220	Steel
303-17-018	3013.00 ISO	3.00	30	16	5.5	EP2220	Steel
303-17-019	3013.50 ISO	3.50	30	16	5.5	EP2220	Steel
303-17-020	3014.00 ISO	4.00	30	16	5.5	EP2220	Steel
303-17-021	3014.50 ISO	4.50	30	16	5.5	EP2220	Steel
303-17-022	4011.50 ISO	1.50	40	20	6.3	EP2220	Steel
303-17-023	4012.00 ISO	2.00	40	20	6.3	EP2220	Steel
303-17-024	4013.00 ISO	3.00	40	20	6.3	EP2220	Steel
303-17-025	4013.50 ISO	3.50	40	20	6.3	EP2220	Steel
303-17-026	4014.00 ISO	4.00	40	20	6.3	EP2220	Steel
303-17-027	4014.50 ISO	4.50	40	20	6.3	EP2220	Steel
303-17-028	4015.00 ISO	5.00	40	20	6.3	EP2220	Steel
303-17-029	4015.50 ISO	5.50	40	20	6.3	EP2220	Steel
303-17-030	4016.00 ISO	6.00	40	20	6.3	EP2220	Steel

CARBIDE ISO METRIC THREAD MILLING INSERTS FOR STAINLESS STEEL

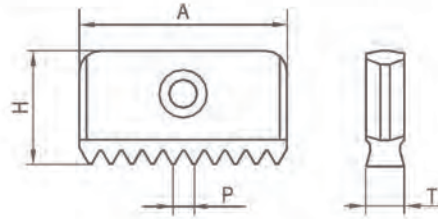

External

Order No.	Model	Pitch P(mm)	Insert size			Grade	Application
			A	H	T		
306-17-001	14E0.75 ISO	0.75	14	7.5	3.1	EP3220	INOX
306-17-002	14E1.00 ISO	1.00	14	7.5	3.1	EP3220	INOX
306-17-003	14E1.25 ISO	1.25	14	7.5	3.1	EP3220	INOX
306-17-004	14E1.50 ISO	1.50	14	7.5	3.1	EP3220	INOX
306-17-005	14E1.75 ISO	1.75	14	7.5	3.1	EP3220	INOX
306-17-006	14E2.00 ISO	2.00	14	7.5	3.1	EP3220	INOX
306-17-007	14E2.50 ISO	2.50	14	7.5	3.1	EP3220	INOX
306-17-008	21E1.00 ISO	1.00	21	12	4.7	EP3220	INOX
306-17-009	21E1.50 ISO	1.50	21	12	4.7	EP3220	INOX
306-17-010	21E2.00 ISO	2.00	21	12	4.7	EP3220	INOX
306-17-011	21E2.50 ISO	2.50	21	12	4.7	EP3220	INOX
306-17-012	21E3.00 ISO	3.00	21	12	4.7	EP3220	INOX
306-17-013	30E1.50 ISO	1.50	30	16	5.5	EP3220	INOX
306-17-014	30E2.00 ISO	2.00	30	16	5.5	EP3220	INOX
306-17-015	30E3.00 ISO	3.00	30	16	5.5	EP3220	INOX
306-17-016	30E3.50 ISO	3.50	30	16	5.5	EP3220	INOX
306-17-017	30E4.00 ISO	4.00	30	16	5.5	EP3220	INOX
306-17-018	40E1.50 ISO	1.50	40	20	6.3	EP3220	INOX
306-17-019	40E2.00 ISO	2.00	40	20	6.3	EP3220	INOX
306-17-020	40E3.00 ISO	3.00	40	20	6.3	EP3220	INOX
306-17-021	40E4.00 ISO	4.00	40	20	6.3	EP3220	INOX
306-17-022	40E5.00 ISO	5.00	40	20	6.3	EP3220	INOX
306-17-023	40E6.00 ISO	6.00	40	20	6.3	EP3220	INOX

Internal

Order No.	Model	Pitch P(mm)	Insert size			Grade	Application
			A	H	T		
305-17-001	1410.50 ISO	0.50	14	7.5	3.1	EP3220	INOX
305-17-002	1410.75 ISO	0.75	14	7.5	3.1	EP3220	INOX
305-17-003	1411.00 ISO	1.00	14	7.5	3.1	EP3220	INOX
305-17-004	1411.25 ISO	1.25	14	7.5	3.1	EP3220	INOX
305-17-005	1411.50 ISO	1.50	14	7.5	3.1	EP3220	INOX
305-17-006	1411.75 ISO	1.75	14	7.5	3.1	EP3220	INOX
305-17-007	1412.00 ISO	2.00	14	7.5	3.1	EP3220	INOX
305-17-008	1412.50 ISO	2.50	14	7.5	3.1	EP3220	INOX
305-17-009	2111.00 ISO	1.00	21	12	4.7	EP3220	INOX
305-17-010	2111.50 ISO	1.50	21	12	4.7	EP3220	INOX
305-17-011	2111.75 ISO	1.75	21	12	4.7	EP3220	INOX
305-17-012	2112.00 ISO	2.00	21	12	4.7	EP3220	INOX
305-17-013	2112.50 ISO	2.50	21	12	4.7	EP3220	INOX
305-17-014	2113.00 ISO	3.00	21	12	4.7	EP3220	INOX
305-17-015	2113.50 ISO	3.50	21	12	4.7	EP3220	INOX
305-17-016	3011.50 ISO	1.50	30	16	5.5	EP3220	INOX
305-17-017	3012.00 ISO	2.00	30	16	5.5	EP3220	INOX
305-17-018	3013.00 ISO	3.00	30	16	5.5	EP3220	INOX
305-17-019	3013.50 ISO	3.50	30	16	5.5	EP3220	INOX
305-17-020	3014.00 ISO	4.00	30	16	5.5	EP3220	INOX
305-17-021	3014.50 ISO	4.50	30	16	5.5	EP3220	INOX
305-17-022	4011.50 ISO	1.50	40	20	6.3	EP3220	INOX
305-17-023	4012.00 ISO	2.00	40	20	6.3	EP3220	INOX
305-17-024	4013.00 ISO	3.00	40	20	6.3	EP3220	INOX
305-17-025	4013.50 ISO	3.50	40	20	6.3	EP3220	INOX
305-17-026	4014.00 ISO	4.00	40	20	6.3	EP3220	INOX
305-17-027	4014.50 ISO	4.50	40	20	6.3	EP3220	INOX
305-17-028	4015.00 ISO	5.00	40	20	6.3	EP3220	INOX
305-17-029	4015.50 ISO	5.50	40	20	6.3	EP3220	INOX
305-17-030	4016.00 ISO	6.00	40	20	6.3	EP3220	INOX

CARBIDE ISO METRIC THREAD MILLING INSERTS FOR CAST IRON

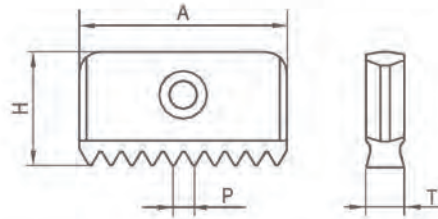
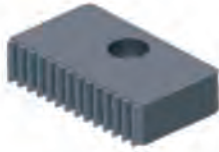

External

Order No.	Model	Pitch P(mm)	Insert size			Grade	Application
			A	H	T		
308-17-001	14E0.75 ISO	0.75	14	7.5	3.1	EP3220	Cast Iron
308-17-002	14E1.00 ISO	1.00	14	7.5	3.1	EP3220	Cast Iron
308-17-003	14E1.25 ISO	1.25	14	7.5	3.1	EP3220	Cast Iron
308-17-004	14E1.50 ISO	1.50	14	7.5	3.1	EP3220	Cast Iron
308-17-005	14E1.75 ISO	1.75	14	7.5	3.1	EP3220	Cast Iron
308-17-006	14E2.00 ISO	2.00	14	7.5	3.1	EP3220	Cast Iron
308-17-007	14E2.50 ISO	2.50	14	7.5	3.1	EP3220	Cast Iron
308-17-008	21E1.00 ISO	1.00	21	12	4.7	EP3220	Cast Iron
308-17-009	21E1.50 ISO	1.50	21	12	4.7	EP3220	Cast Iron
308-17-010	21E2.00 ISO	2.00	21	12	4.7	EP3220	Cast Iron
308-17-011	21E2.50 ISO	2.50	21	12	4.7	EP3220	Cast Iron
308-17-012	21E3.00 ISO	3.00	21	12	4.7	EP3220	Cast Iron
308-17-013	30E1.50 ISO	1.50	30	16	5.5	EP3220	Cast Iron
308-17-014	30E2.00 ISO	2.00	30	16	5.5	EP3220	Cast Iron
308-17-015	30E3.00 ISO	3.00	30	16	5.5	EP3220	Cast Iron
308-17-016	30E3.50 ISO	3.50	30	16	5.5	EP3220	Cast Iron
308-17-017	30E4.00 ISO	4.00	30	16	5.5	EP3220	Cast Iron
308-17-018	40E1.50 ISO	1.50	40	20	6.3	EP3220	Cast Iron
308-17-019	40E2.00 ISO	2.00	40	20	6.3	EP3220	Cast Iron
308-17-020	40E3.00 ISO	3.00	40	20	6.3	EP3220	Cast Iron
308-17-021	40E4.00 ISO	4.00	40	20	6.3	EP3220	Cast Iron
308-17-022	40E5.00 ISO	5.00	40	20	6.3	EP3220	Cast Iron
308-17-023	40E6.00 ISO	6.00	40	20	6.3	EP3220	Cast Iron

Internal

Order No.	Model	Pitch P(mm)	Insert size			Grade	Application
			A	H	T		
307-17-001	14I0.50 ISO	0.50	14	7.5	3.1	EP3220	Cast Iron
307-17-002	14I0.75 ISO	0.75	14	7.5	3.1	EP3220	Cast Iron
307-17-003	14I1.00 ISO	1.00	14	7.5	3.1	EP3220	Cast Iron
307-17-004	14I1.25 ISO	1.25	14	7.5	3.1	EP3220	Cast Iron
307-17-005	14I1.50 ISO	1.50	14	7.5	3.1	EP3220	Cast Iron
307-17-006	14I1.75 ISO	1.75	14	7.5	3.1	EP3220	Cast Iron
307-17-007	14I2.00 ISO	2.00	14	7.5	3.1	EP3220	Cast Iron
307-17-008	14I2.50 ISO	2.50	14	7.5	3.1	EP3220	Cast Iron
307-17-009	21I1.00 ISO	1.00	21	12	4.7	EP3220	Cast Iron
307-17-010	21I1.50 ISO	1.50	21	12	4.7	EP3220	Cast Iron
307-17-011	21I1.75 ISO	1.75	21	12	4.7	EP3220	Cast Iron
307-17-012	21I2.00 ISO	2.00	21	12	4.7	EP3220	Cast Iron
307-17-013	21I2.50 ISO	2.50	21	12	4.7	EP3220	Cast Iron
307-17-014	21I3.00 ISO	3.00	21	12	4.7	EP3220	Cast Iron
307-17-015	21I3.50 ISO	3.50	21	12	4.7	EP3220	Cast Iron
307-17-016	30I1.50 ISO	1.50	30	16	5.5	EP3220	Cast Iron
307-17-017	30I2.00 ISO	2.00	30	16	5.5	EP3220	Cast Iron
307-17-018	30I3.00 ISO	3.00	30	16	5.5	EP3220	Cast Iron
307-17-019	30I3.50 ISO	3.50	30	16	5.5	EP3220	Cast Iron
307-17-020	30I4.00 ISO	4.00	30	16	5.5	EP3220	Cast Iron
307-17-021	30I4.50 ISO	4.50	30	16	5.5	EP3220	Cast Iron
307-17-022	40I1.50 ISO	1.50	40	20	6.3	EP3220	Cast Iron
307-17-023	40I2.00 ISO	2.00	40	20	6.3	EP3220	Cast Iron
307-17-024	40I3.00 ISO	3.00	40	20	6.3	EP3220	Cast Iron
307-17-025	40I3.50 ISO	3.50	40	20	6.3	EP3220	Cast Iron
307-17-026	40I4.00 ISO	4.00	40	20	6.3	EP3220	Cast Iron
307-17-027	40I4.50 ISO	4.50	40	20	6.3	EP3220	Cast Iron
307-17-028	40I5.00 ISO	5.00	40	20	6.3	EP3220	Cast Iron
307-17-029	40I5.50 ISO	5.50	40	20	6.3	EP3220	Cast Iron
307-17-030	40I6.00 ISO	6.00	40	20	6.3	EP3220	Cast Iron

HSS-E ISO METRIC COARSE THREAD SPIRAL POINT MACHINE TAP

- Spiral point • Right hand cutting.
- Ground teeth and Chamfer :4-5 threads
- Hole of application: through hole and thread depth <3d1.

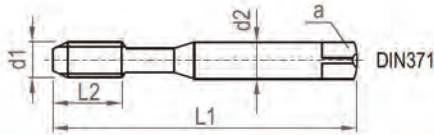

Order No.	Application	Size (d1)	thread length (L2)	Total Length (L1)	Shank Dia. (d2)	Square (a)
-----------	-------------	-----------	--------------------	-------------------	-----------------	------------

DIN371



442-12-001	Stainless steel	M3x0.5	11	56	3.5	2.7
442-12-002	Stainless steel	M4x0.7	13	63	4.5	3.4
442-12-003	Stainless steel	M5x0.8	16	70	6	4.9
442-12-004	Stainless steel	M6x1	19	80	6	4.9
442-12-005	Stainless steel	M8x1.25	22	90	8	6.2
442-12-006	Stainless steel	M10x1.5	24	100	10	8

DIN376



442-22-007	Stainless steel	M12x1.75	29	110	9	7
442-22-008	Stainless steel	M14x2	30	110	11	9
442-22-009	Stainless steel	M16x2	32	110	12	9
442-22-010	Stainless steel	M18x2.5	34	125	14	11
442-22-011	Stainless steel	M20x2.5	34	140	16	12
442-22-012	Stainless steel	M22x2.5	34	140	18	14.5
442-22-013	Stainless steel	M24x3	38	160	18	14.5

Order No.	Application	Size (d1)	thread length (L2)	Total Length (L1)	Shank Dia. (d2)	Square (a)
-----------	-------------	-----------	--------------------	-------------------	-----------------	------------

DIN371



442-13-001	Cast Iron	M3x0.5	11	56	3.5	2.7
442-13-002	Cast Iron	M4x0.7	13	63	4.5	3.4
442-13-003	Cast Iron	M5x0.8	16	70	6	4.9
442-13-004	Cast Iron	M6x1	19	80	6	4.9
442-13-005	Cast Iron	M8x1.25	22	90	8	6.2
442-13-006	Cast Iron	M10x1.5	24	100	10	8

DIN376



442-23-007	Cast Iron	M12x1.75	29	110	9	7
442-23-008	Cast Iron	M14x2	30	110	11	9
442-23-009	Cast Iron	M16x2	32	110	12	9
442-23-010	Cast Iron	M18x2.5	34	125	14	11
442-23-011	Cast Iron	M20x2.5	34	140	16	12
442-23-012	Cast Iron	M22x2.5	34	140	18	14.5
442-23-013	Cast Iron	M24x3	38	160	18	14.5

Order No.	Application	Size (d1)	thread length (L2)	Total Length (L1)	Shank Dia. (d2)	Square (a)
-----------	-------------	-----------	--------------------	-------------------	-----------------	------------

DIN371



442-14-001	Alloy Steel	M3x0.5	11	56	3.5	2.7
442-14-002	Alloy Steel	M4x0.7	13	63	4.5	3.4
442-14-003	Alloy Steel	M5x0.8	16	70	6	4.9
442-14-004	Alloy Steel	M6x1	19	80	6	4.9
442-14-005	Alloy Steel	M8x1.25	22	90	8	6.2
442-14-006	Alloy Steel	M10x1.5	24	100	10	8

DIN376



442-24-007	Alloy Steel	M12x1.75	29	110	9	7
442-24-008	Alloy Steel	M14x2	30	110	11	9
442-24-009	Alloy Steel	M16x2	32	110	12	9
442-24-010	Alloy Steel	M18x2.5	34	125	14	11
442-24-011	Alloy Steel	M20x2.5	34	140	16	12
442-24-012	Alloy Steel	M22x2.5	34	140	18	14.5
442-24-013	Alloy Steel	M24x3	38	160	18	14.5

Order No.	Application	Size (d1)	thread length (L2)	Total Length (L1)	Shank Dia. (d2)	Square (a)
-----------	-------------	-----------	--------------------	-------------------	-----------------	------------

DIN371



442-11-001	Universal	M3x0.5	11	56	3.5	2.7
442-11-002	Universal	M4x0.7	13	63	4.5	3.4
442-11-003	Universal	M5x0.8	16	70	6	4.9
442-11-004	Universal	M6x1	19	80	6	4.9
442-11-005	Universal	M8x1.25	22	90	8	6.2
442-11-006	Universal	M10x1.5	24	100	10	8

DIN376



442-21-007	Universal	M12x1.75	29	110	9	7
442-21-008	Universal	M14x2	30	110	11	9
442-21-009	Universal	M16x2	32	110	12	9
442-21-010	Universal	M18x2.5	34	125	14	11
442-21-011	Universal	M20x2.5	34	140	16	12
442-21-012	Universal	M22x2.5	34	140	18	14.5
442-21-013	Universal	M24x3	38	160	18	14.5



THREADING CUTTER

HSS-E ISO METRIC COARSE THREAD SPIRAL FLUTE MACHINE TAP

- Fast spiral Flute 35° .
- Ground teeth and Chamfer :2-3 threads
- Right hand cutting.
- Hole of application: Blind hole and thread depth $2.5d_1$.

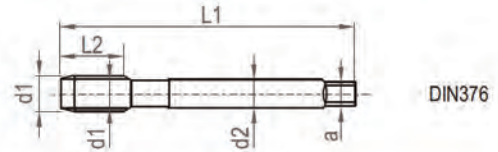
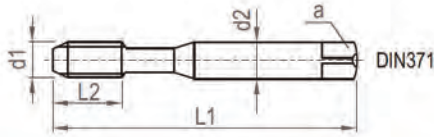

Order No.	Application	Size (d1)	thread length (L2)	Total Length (L1)	Shank Dia. (d2)	Square (a)
-----------	-------------	-----------	--------------------	-------------------	-----------------	------------

DIN371



443-12-001	Stainless steel	M3x0.5	11	56	3.5	2.7
443-12-002	Stainless steel	M4x0.7	13	63	4.5	3.4
443-12-003	Stainless steel	M5x0.8	16	70	6	4.9
443-12-004	Stainless steel	M6x1	19	80	6	4.9
443-12-005	Stainless steel	M8x1.25	22	90	8	6.2
443-12-006	Stainless steel	M10x1.5	24	100	10	8

DIN376



443-22-007	Stainless steel	M12x1.75	29	110	9	7
443-22-008	Stainless steel	M14x2	30	110	11	9
443-22-009	Stainless steel	M16x2	32	110	12	9
443-22-010	Stainless steel	M18x2.5	34	125	14	11
443-22-011	Stainless steel	M20x2.5	34	140	16	12
443-22-012	Stainless steel	M22x2.5	34	140	18	14.5
443-22-013	Stainless steel	M24x3	38	160	18	14.5

Order No.	Application	Size (d1)	thread length (L2)	Total Length (L1)	Shank Dia. (d2)	Square (a)
-----------	-------------	-----------	--------------------	-------------------	-----------------	------------

DIN371



443-13-001	Cast Iron	M3x0.5	11	56	3.5	2.7
443-13-002	Cast Iron	M4x0.7	13	63	4.5	3.4
443-13-003	Cast Iron	M5x0.8	16	70	6	4.9
443-13-004	Cast Iron	M6x1	19	80	6	4.9
443-13-005	Cast Iron	M8x1.25	22	90	8	6.2
443-13-006	Cast Iron	M10x1.5	24	100	10	8

DIN376



443-23-007	Cast Iron	M12x1.75	29	110	9	7
443-23-008	Cast Iron	M14x2	30	110	11	9
443-23-009	Cast Iron	M16x2	32	110	12	9
443-23-010	Cast Iron	M18x2.5	34	125	14	11
443-23-011	Cast Iron	M20x2.5	34	140	16	12
443-23-012	Cast Iron	M22x2.5	34	140	18	14.5
443-23-013	Cast Iron	M24x3	38	160	18	14.5

Order No.	Application	Size (d1)	thread length (L2)	Total Length (L1)	Shank Dia. (d2)	Square (a)
-----------	-------------	-----------	--------------------	-------------------	-----------------	------------

DIN371



443-14-001	Alloy Steel	M3x0.5	11	56	3.5	2.7
443-14-002	Alloy Steel	M4x0.7	13	63	4.5	3.4
443-14-003	Alloy Steel	M5x0.8	16	70	6	4.9
443-14-004	Alloy Steel	M6x1	19	80	6	4.9
443-14-005	Alloy Steel	M8x1.25	22	90	8	6.2
443-14-006	Alloy Steel	M10x1.5	24	100	10	8

DIN376



443-24-007	Alloy Steel	M12x1.75	29	110	9	7
443-24-008	Alloy Steel	M14x2	30	110	11	9
443-24-009	Alloy Steel	M16x2	32	110	12	9
443-24-010	Alloy Steel	M18x2.5	34	125	14	11
443-24-011	Alloy Steel	M20x2.5	34	140	16	12
443-24-012	Alloy Steel	M22x2.5	34	140	18	14.5
443-24-013	Alloy Steel	M24x3	38	160	18	14.5

Order No.	Application	Size (d1)	thread length (L2)	Total Length (L1)	Shank Dia. (d2)	Square (a)
-----------	-------------	-----------	--------------------	-------------------	-----------------	------------

DIN371



443-11-001	Universal	M3x0.5	11	56	3.5	2.7
443-11-002	Universal	M4x0.7	13	63	4.5	3.4
443-11-003	Universal	M5x0.8	16	70	6	4.9
443-11-004	Universal	M6x1	19	80	6	4.9
443-11-005	Universal	M8x1.25	22	90	8	6.2
443-11-006	Universal	M10x1.5	24	100	10	8

DIN376



443-21-007	Universal	M12x1.75	29	110	9	7
443-21-008	Universal	M14x2	30	110	11	9
443-21-009	Universal	M16x2	32	110	12	9
443-21-010	Universal	M18x2.5	34	125	14	11
443-21-011	Universal	M20x2.5	34	140	16	12
443-21-012	Universal	M22x2.5	34	140	18	14.5
443-21-013	Universal	M24x3	38	160	18	14.5

PARTING & GROOVING CUTTER

PARTING & GROOVING TOOLHOLDERS

189,192



SOLID CARBIDE PARTING & GROOVING INSERTS

191,194



INDEXABLE GROOVING MILLS AND INSERTS

193



EXTERNAL PARTING AND GROOVING TOOLHOLDERS FOR INSERT QE

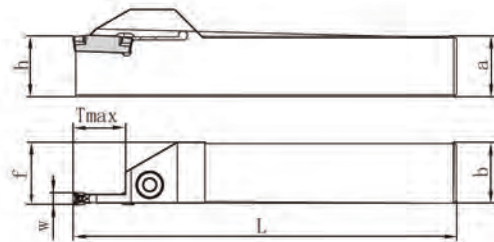
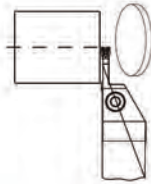

Order No.		Model		Size(mm)						Insert	Screw	Torx wrench
Right hand	Left hand	Right hand	Left hand	W	Tmax	a=h	b	f	L			
211-18-001	211-18-002	QE1616R02H08	QE1616L02H08	2	8	16	16	16.25	100	QE2.00	MS05016	S4
211-18-003	211-18-004	QE2020R02K08	QE2020L02K08	2	8	20	20	20.25	125	QE2.00	MS05016	S4
211-18-005	211-18-006	QE2525R02M08	QE2525L02M08	2	8	25	25	25.25	150	QE2.00	MS05016	S4
211-18-007	211-18-008	QE1616R03H16	QE1616L03H16	3	16	16	16	16.25	100	QE3.00	MS05016	S4
211-18-009	211-18-010	QE2020R03K16	QE2020L03K16	3	16	20	20	20.25	125	QE3.00	MS05016	S4
211-18-011	211-18-012	QE2525R03M16	QE2525L03M16	3	16	25	25	25.25	150	QE3.00	MS05016	S4
211-18-013	211-18-014	QE3225R03P16	QE3225L03P16	3	16	32	25	25.25	170	QE3.00	MS05016	S4
211-18-015	211-18-016	QE3232R03P16	QE3232L03P16	3	16	32	32	32.25	170	QE3.00	MS05016	S4
211-18-017	211-18-018	QE2020R04K16	QE2020L04K16	4	16	20	20	20.5	125	QE4.00	MS05016	S4
211-18-019	211-18-020	QE2525R04M16	QE2525L04M16	4	16	25	25	25.5	150	QE4.00	MS05016	S4
211-18-021	211-18-022	QE3225R04P16	QE3225L04P16	4	16	32	25	25.5	170	QE4.00	MS05016	S4
211-18-023	211-18-024	QE3232R04P16	QE3232L04P16	4	16	32	32	32.5	170	QE4.00	MS05016	S4
211-18-025	211-18-026	QE4040R04R16	QE4040L04R16	4	16	40	40	40.5	200	QE4.00	MS05016	S4
211-18-027	211-18-028	QE2525R05M20	QE2525L05M20	5	20	25	25	25.5	150	QE4.00	MS05016	S4
211-18-029	211-18-030	QE3225R05P20	QE3225L05P20	5	20	32	25	25.5	170	QE5.00	MS06020	S5
211-18-031	211-18-032	QE3232R05P20	QE3232L05P20	5	20	32	32	32.5	170	QE5.00	MS06020	S5
211-18-033	211-18-034	QE4040R05R20	QE4040L05R20	5	20	40	40	40.5	200	QE5.00	MS06020	S5

Insert not included

INTERNAL GROOVING TOOLHOLDERS FOR INSERT QE

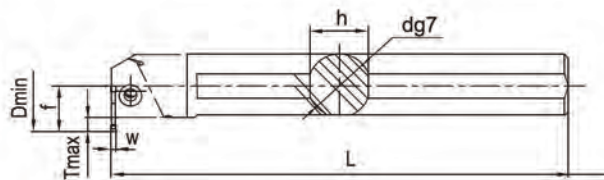
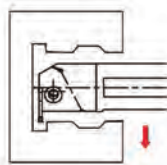

Order No.		Model		Size(mm)							Insert	Screw	Torx wrench
Right hand	Left hand	Right hand	Left hand	W	Tmax	d	h	f	Dmin	L			
221-18-001	221-18-002	S20Q-QER02-05	S20Q-QEL02-05	2	5	20	18	15	26	180	QE2.00	MS04012	S3
221-18-003	221-18-004	S25R-QER02-07	S25R-QEL02-07	2	7	25	23	19.5	33	200	QE2.00	MS05016	S4
221-18-005	221-18-006	S20Q-QER03-06	S20Q-QEL03-06	3	6	20	18	16	27	180	QE3.00	MS05016	S4
221-18-007	221-18-008	S25R-QER03-07	S25R-QEL03-07	3	7	25	23	19.5	33	200	QE3.00	MS05016	S4
221-18-009	221-18-010	S32S-QER03-09	S32S-QEL03-09	3	9	32	30	25	42	250	QE3.00	MS05016	S4
221-18-011	221-18-012	S25R-QER04-10	S25R-QEL04-10	4	10	25	23	22.5	36	200	QE4.00	MS05016	S4
221-18-013	221-18-014	S32S-QER04-11	S32S-QEL04-11	4	11	32	30	27	44	250	QE4.00	MS05016	S4
221-18-015	221-18-016	S40T-QER04-13	S40T-QEL04-13	4	13	40	37	33	54	300	QE4.00	MS05016	S4
221-18-017	221-18-018	S32S-QER05-11	S32S-QEL05-11	5	11	32	30	27	44	250	QE5.00	MS06020	S5
221-18-019	221-18-020	S40T-QER05-13	S40T-QEL05-13	5	13	40	37	33	54	300	QE5.00	MS06020	S5

Insert not included



FACE GROOVING TOOLHOLDERS FOR INSERT QE

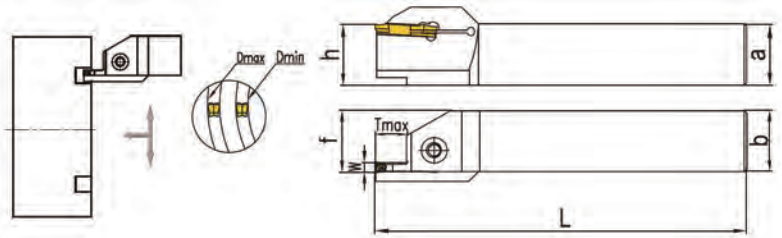

Order No.		Model		Size(mm)							Insert	Screw	Torx wrench
Right hand	Left hand	Right hand	Left hand	W	Tmax	D	a=h	b	f	L			
211-18-035	211-18-036	QE2020R02K08-M048060	QE2020L02K08-M048060	2	8	48-60	20	20	20.25	125	QE2.00	MS05016	S4
211-18-037	211-18-038	QE2020R02K08-H060075	QE2020L02K08-H060075	2	8	60-75	20	20	20.25	125	QE2.00	MS05016	S4
211-18-039	211-18-040	QE2020R02K08-H075100	QE2020L02K08-H075100	2	8	75-100	20	20	20.25	125	QE2.00	MS05016	S4
211-18-041	211-18-042	QE2525R02M08-M048060	QE2525L02M08-M048060	2	8	48-60	25	25	25.25	150	QE2.00	MS05016	S4
211-18-043	211-18-044	QE2525R02M08-H060075	QE2525L02M08-H060075	2	8	60-75	25	25	25.25	150	QE2.00	MS05016	S4
211-18-045	211-18-046	QE2525R02M08-H075100	QE2525L02M08-H075100	2	8	75-100	25	25	25.25	150	QE2.00	MS05016	S4
211-18-047	211-18-048	QE2020R03K16-H075100	QE2020L03K16-H075100	3	16	75-100	20	20	20.25	125	QE3.00	MS05016	S4
211-18-049	211-18-050	QE2525R03M16-H075100	QE2525L03M16-H075100	3	16	75-100	25	25	25.25	150	QE3.00	MS05016	S4
211-18-051	211-18-052	QE3232R03P16-H075100	QE3232L03P16-H075100	3	16	75-100	32	32	32.25	170	QE3.00	MS05016	S4
211-18-053	211-18-054	QE2020R04K16-M038048	QE2020L04K16-M038048	4	16	38-48	20	20	20.5	125	QE4.00	MS05016	S4
211-18-055	211-18-056	QE2020R04K16-M048060	QE2020L04K16-H048060	4	16	48-60	20	20	20.5	125	QE4.00	MS05016	S4
211-18-057	211-18-058	QE2020R04K16-H060075	QE2020L04K16-H060075	4	16	60-75	20	20	20.5	125	QE4.00	MS05016	S4
211-18-059	211-18-060	QE2020R04K16-H075100	QE2020L04K16-H075100	4	16	75-100	20	20	20.5	125	QE4.00	MS05016	S4
211-18-061	211-18-062	QE2020R04K16-H100140	QE2020L04K16-H100140	4	16	100-140	20	20	20.5	125	QE4.00	MS05016	S4
211-18-063	211-18-064	QE2020R04K16-H140240	QE2020L04K16-H140240	4	16	140-240	20	20	20.5	125	QE4.00	MS05016	S4
211-18-065	211-18-066	QE2020R04K16-M240480	QE2020L04K16-H240480	4	16	240-480	20	20	20.5	125	QE4.00	MS05016	S4
211-18-067	211-18-068	QE2525R04M16-H038048	QE2525L04M16-H038048	4	16	38-48	25	25	25.5	150	QE4.00	MS05016	S4
211-18-069	211-18-070	QE2525R04M16-H048060	QE2525L04M16-H048060	4	16	48-60	25	25	25.5	150	QE4.00	MS05016	S4
211-18-071	211-18-072	QE2525R04M16-H060075	QE2525L04M16-H060075	4	16	60-75	25	25	25.5	150	QE4.00	MS05016	S4
211-18-073	211-18-074	QE2525R04M16-H075100	QE2525L04M16-H075100	4	16	75-100	25	25	25.5	150	QE4.00	MS05016	S4
211-18-075	211-18-076	QE2525R04M16-H100140	QE2525L04M16-H100140	4	16	100-140	25	25	25.5	150	QE4.00	MS05016	S4
211-18-077	211-18-078	QE2525R04M16-H140240	QE2525L04M16-H140240	4	16	140-240	25	25	25.5	150	QE4.00	MS05016	S4
211-18-079	211-18-080	QE2525R04M16-H240480	QE2525L04M16-H240480	4	16	240-480	25	25	25.5	150	QE4.00	MS05016	S4
211-18-081	211-18-082	QE3232R04P16-H038048	QE3232L04P16-H038048	4	16	38-48	32	32	32.5	170	QE4.00	MS05016	S4
211-18-083	211-18-084	QE3232R04P16-H048060	QE3232L04P16-H048060	4	16	48-60	32	32	32.5	170	QE4.00	MS05016	S4
211-18-085	211-18-086	QE3232R04P16-H060075	QE3232L04P16-H060075	4	16	60-75	32	32	32.5	170	QE4.00	MS05016	S4
211-18-087	211-18-088	QE3232R04P16-H075100	QE3232L04P16-H075100	4	16	75-100	32	32	32.5	170	QE4.00	MS05016	S4
211-18-089	211-18-090	QE3232R04P16-H100140	QE3232L04P16-H100140	4	16	100-140	32	32	32.5	170	QE4.00	MS05016	S4
211-18-091	211-18-092	QE3232R04P16-H140240	QE3232L04P16-H140240	4	16	140-240	32	32	32.5	170	QE4.00	MS05016	S4
211-18-093	211-18-094	QE3232R04P16-H240480	QE3232L04P16-H240480	4	16	240-480	32	32	32.5	170	QE4.00	MS05016	S4
211-18-095	211-18-096	QE2525R05M20-H054070	QE2525L05M20-H054070	5	20	54-70	25	25	25.5	150	QE5.00	MS06020	S5
211-18-097	211-18-098	QE2525R05M20-H070095	QE2525L05M20-H070095	5	20	70-95	25	25	25.5	150	QE5.00	MS06020	S5
211-18-099	211-18-100	QE2525R05M20-H095130	QE2525L05M20-H095130	5	20	95-130	25	25	25.5	150	QE5.00	MS06020	S5
211-18-101	211-18-102	QE2525R05M20-H130180	QE2525L05M20-H130180	5	20	130-180	25	25	25.5	150	QE5.00	MS06020	S5
211-18-103	211-18-104	QE2525R05M20-H180000	QE2525L05M20-H180000	5	20	180-	25	25	25.5	150	QE5.00	MS06020	S5
211-18-105	211-18-106	QE3232R05P20-H054070	QE3232L05P20-H054070	5	20	54-70	32	32	32.5	170	QE5.00	MS06020	S5
211-18-107	211-18-108	QE3232R05P20-H070095	QE3232L05P20-H070095	5	20	70-95	32	32	32.5	170	QE5.00	MS06020	S5
211-18-109	211-18-110	QE3232R05P20-H095130	QE3232L05P20-H095130	5	20	95-130	32	32	32.5	170	QE5.00	MS06020	S5
211-18-111	211-18-112	QE3232R05P20-H130180	QE3232L05P20-H130180	5	20	130-180	32	32	32.5	170	QE5.00	MS06020	S5
211-18-113	211-18-114	QE3232R05P20-H180000	QE3232L05P20-H180000	5	20	180-	32	32	32.5	170	QE5.00	MS06020	S5

Insert not included



SOLID CARBIDE PARTING & GROOVING INSERTS QE

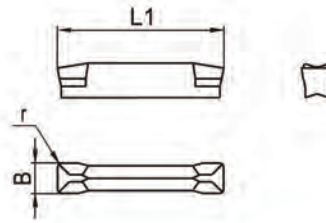

Order No.	Model	Grade	Application	Insert size (mm)		
				L1	B	r
311-20-001	QE2.00-EMF	EC2120	steel and cast iron	16	2	0.2
311-20-002	QE3.00-EMF	EC2120	steel and cast iron	20	3	0.3
311-20-003	QE4.00-EMF	EC2120	steel and cast iron	20	4	0.4
311-20-004	QE5.00-EMF	EC2120	steel and cast iron	26	5	0.4
321-20-001	QE2.00-EMF	EC4130	stainless steel	16	2	0.2
321-20-002	QE3.00-EMF	EC4130	stainless steel	20	3	0.3
321-20-003	QE4.00-EMF	EC4130	stainless steel	20	4	0.4
321-20-004	QE5.00-EMF	EC4130	stainless steel	26	5	0.4

GRE EXTERNAL GROOVING TOOLHOLDS FOR INSERT TN1635

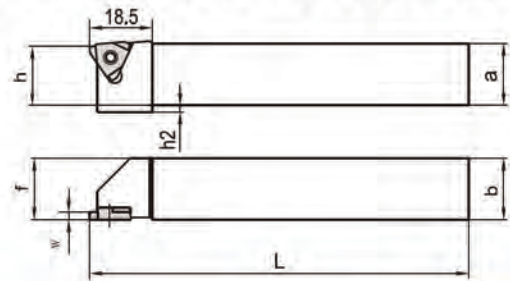

Order No.		Model		Size(mm)					Insert	Screw	Torx wrench
Right hand	Left hand	Right hand	Left hand	a=h	b	h2	f	L			
211-19-001	211-19-002	GRE.R 1616K TN16	GRE.L 1616K TN16	16	16	-	16	125	TN1635...	L60 M3.5x8.8	T15
211-19-003	211-19-004	GRE.R 2020K TN16	GRE.L 2020K TN16	20	20	-	20	125	TN1635...	L60 M3.5x8.8	T15

Insert not included.

GRI INTERNAL GROOVING TOOLHOLDS FOR INSERT TN1635

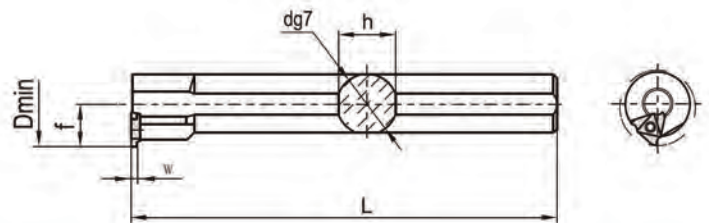

Order No.		Model		Size(mm)					Insert	Screw	Torx wrench
Right hand	Left hand	Right hand	Left hand	d	h	f	Dmin	L			
211-19-005	211-19-006	GRI.R S20M TN16	GRI.L S20M TN16	20	18	13	25	150	TN1635...	L60 M3.5x8.8	T15
211-19-007	211-19-008	GRI.R S25Q TN16	GRI.L S25Q TN16	25	23	17	32	180	TN1635...	L60 M3.5x8.8	T15

Insert not included.

GRV INTERNAL GROOVING TOOLHOLDS FOR INSERT TN1635

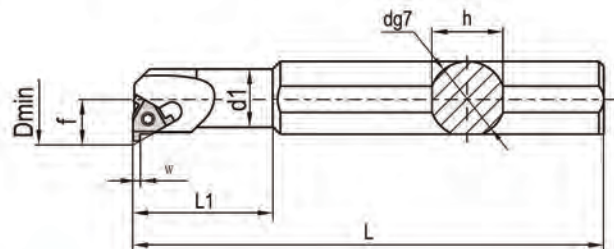

Order No.		Model		Size(mm)							Insert	Screw	Torx wrench
Right hand	Left hand	Right hand	Left hand	d	d1	h	f	Dmin	L1	L			
211-19-009	211-19-010	GRV.R S20Q.20 TN16	GRV.L S20Q.20 TN16	20	16	18	11.5	20	40	180	TN1635...V	L60 M3.5x8.8	T15

SHANK STYLE INDEXABLE GROOVING MILLS FOR INSERT TN1635

- Suitable for cutting both internal and external groove.
- Shank according to DIN1835B.
- Right hand cutting.

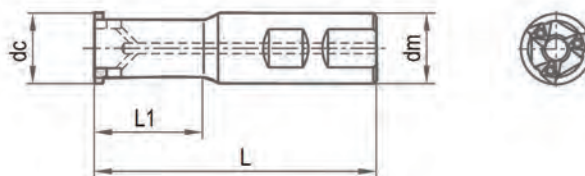
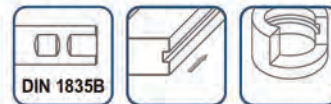

Order No.	Model	Size(mm)				No.of teeth	Insert	Screw	Torx wrench	Weight
		dc	dm	L1	L					
241-19-001	CMT-20TN16	20	20	30	90	1	TN1635R	L60-M3.5x8.8A	T15	0.2
241-19-002	CMT-25TN16	25	25	40	105	1	TN1635R	L60-M3.5x8.8A	T15	0.3
241-19-003	CMT-32TN16	32	32	55	125	3	TN1635R	L60-M3.5x8.8A	T15	0.5
241-19-004	CMT-40TN16	40	32	70	135	3	TN1635R	L60-M3.5x8.8A	T15	0.8

Insert not included

INDEXABLE GROOVING MILLS FOR INSERT TN1635

- Suitable for cutting both internal and external groove.
- Right hand cutting.

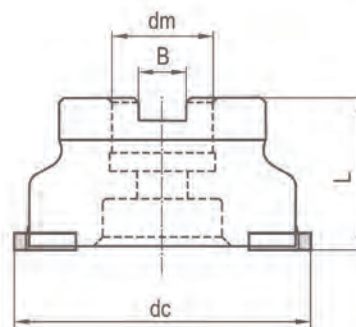
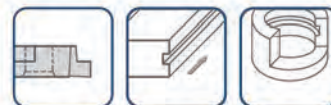

Order No.	Model	Size(mm)				No.of teeth	Insert	Screw	Torx wrench	Weight
		dc	dm	B	L					
231-19-001	FMT-51TN16	51	22	10.4	40	4	TN1635R..	L60-M3.5x8.8A	WT15	0.4
231-19-002	FMT-63TN16	63	22	10.4	40	6	TN1635R..	L60-M3.5x8.8A	WT15	0.6
231-19-003	FMT-80TN16	80	27	12.4	50	6	TN1635R..	L60-M3.5x8.8A	WT15	0.9

Insert not included

SOLID CARBIDE GROOVING INSERT TN1635

Note:

- For GRI internal groove cutting, left hand toolholder must choose left hand insert and right hand toolholder must choose right hand insert.

Note:

- For GRE External groove cutting, left hand toolholder must choose right hand insert and right hand toolholder must choose left hand insert.

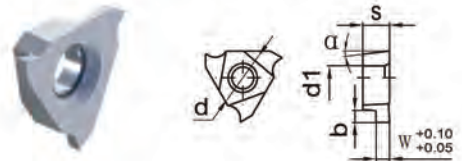
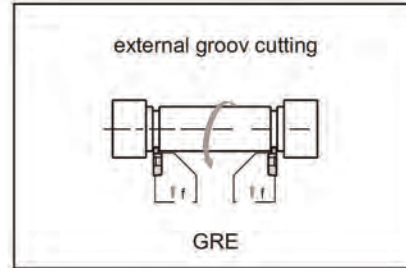
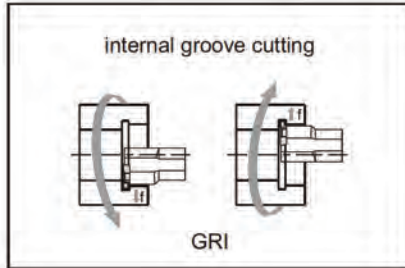

Right hand

Order No.	Model	Size(mm)						Grade	Application
		w	b	d	d1	s	α		
311-21-001	TN1635R110	1.1	0.9	9.525	3.8	3.5	0°	EP2125	steel and INOX
311-21-003	TN1635R130	1.3	1.3	9.525	3.8	3.5	0°	EP2125	steel and INOX
311-21-005	TN1635R160	1.6	1.4	9.525	3.8	3.5	0°	EP2125	steel and INOX
311-21-007	TN1635R185	1.85	1.7	9.525	3.8	3.5	0°	EP2125	steel and INOX
311-21-009	TN1635R215	2.15	2	9.525	3.8	3.5	0°	EP2125	steel and INOX
311-21-011	TN1635R265	2.65	2.2	9.525	3.8	3.5	0°	EP2125	steel and INOX
331-21-001	TN1635R110	1.1	0.9	9.525	3.8	3.5	0°	EP3125	cast iron
331-21-003	TN1635R130	1.3	1.3	9.525	3.8	3.5	0°	EP3125	cast iron
331-21-005	TN1635R160	1.6	1.4	9.525	3.8	3.5	0°	EP3125	cast iron
331-21-007	TN1635R185	1.85	1.7	9.525	3.8	3.5	0°	EP3125	cast iron
331-21-009	TN1635R215	2.15	2	9.525	3.8	3.5	0°	EP3125	cast iron
331-21-011	TN1635R265	2.65	2.2	9.525	3.8	3.5	0°	EP3125	cast iron
341-21-001	TN1635R110	1.1	0.9	9.525	3.8	3.5	0°	EW3125	Al-alloy
341-21-003	TN1635R130	1.3	1.3	9.525	3.8	3.5	0°	EP3125	Al-alloy
341-21-005	TN1635R160	1.6	1.4	9.525	3.8	3.5	0°	EP3125	Al-alloy
341-21-007	TN1635R185	1.85	1.7	9.525	3.8	3.5	0°	EP3125	Al-alloy
341-21-009	TN1635R215	2.15	2	9.525	3.8	3.5	0°	EP3125	Al-alloy
341-21-011	TN1635R265	2.65	2.2	9.525	3.8	3.5	0°	EP3125	Al-alloy

Left hand

Order No.	Model	Size(mm)						Grade	Application
		w	b	d	d1	s	α		
311-21-002	TN1635L110	1.1	0.9	9.525	3.8	3.5	0°	EP2125	steel and INOX
311-21-004	TN1635L130	1.3	1.3	9.525	3.8	3.5	0°	EP2125	steel and INOX
311-21-006	TN1635L160	1.6	1.4	9.525	3.8	3.5	0°	EP2125	steel and INOX
311-21-008	TN1635L185	1.85	1.7	9.525	3.8	3.5	0°	EP2125	steel and INOX
311-21-010	TN1635L215	2.15	2	9.525	3.8	3.5	0°	EP2125	steel and INOX
311-21-012	TN1635L265	2.65	2.2	9.525	3.8	3.5	0°	EP2125	steel and INOX
331-21-002	TN1635L110	1.1	0.9	9.525	3.8	3.5	0°	EP3125	cast iron
331-21-004	TN1635L130	1.3	1.3	9.525	3.8	3.5	0°	EP3125	cast iron
331-21-006	TN1635L160	1.6	1.4	9.525	3.8	3.5	0°	EP3125	cast iron
331-21-008	TN1635L185	1.85	1.7	9.525	3.8	3.5	0°	EP3125	cast iron
331-21-010	TN1635L215	2.15	2	9.525	3.8	3.5	0°	EP3125	cast iron
331-21-012	TN1635L265	2.65	2.2	9.525	3.8	3.5	0°	EP3125	cast iron
341-21-002	TN1635L110	1.1	0.9	9.525	3.8	3.5	0°	EW3125	Al-alloy
341-21-004	TN1635L130	1.3	1.3	9.525	3.8	3.5	0°	EP3125	Al-alloy
341-21-006	TN1635L160	1.6	1.4	9.525	3.8	3.5	0°	EP3125	Al-alloy
341-21-008	TN1635L185	1.85	1.7	9.525	3.8	3.5	0°	EP3125	Al-alloy
341-21-010	TN1635L215	2.15	2	9.525	3.8	3.5	0°	EP3125	Al-alloy
341-21-012	TN1635L265	2.65	2.2	9.525	3.8	3.5	0°	EP3125	Al-alloy

SOLID CARBIDE GROOVING INSERT TN1635...V

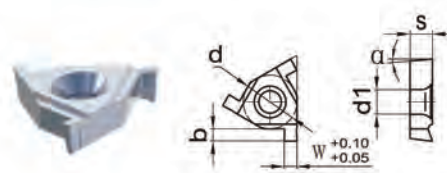
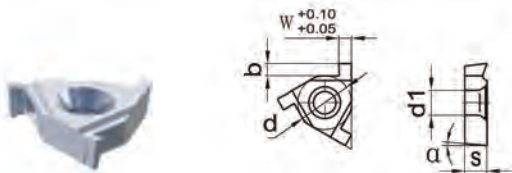
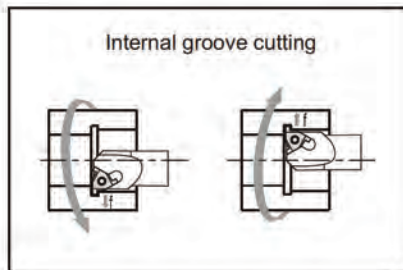

Right hand

Order No.	Model	Size(mm)						Grade	Application
		w	b	d	d1	s	α		
311-21-013	TN1635R110-V	1.1	1.3	9.525	3.8	3.5	0°	EP2125	steel and INOX
311-21-015	TN1635R130-V	1.3	1.6	9.525	3.8	3.5	0°	EP2125	steel and INOX
311-21-017	TN1635R160-V	1.6	1.85	9.525	3.8	3.5	0°	EP2125	steel and INOX
311-21-019	TN1635R185-V	1.85	1.85	9.525	3.8	3.5	0°	EP2125	steel and INOX
311-21-021	TN1635R215-V	2.15	1.85	9.525	3.8	3.5	0°	EP2125	steel and INOX
331-21-013	TN1635R110-V	1.1	0.9	9.525	3.8	3.5	0°	EP3125	cast iron
331-21-015	TN1635R130-V	1.3	1.3	9.525	3.8	3.5	0°	EP3125	cast iron
331-21-017	TN1635R160-V	1.6	1.4	9.525	3.8	3.5	0°	EP3125	cast iron
331-21-019	TN1635R185-V	1.85	1.7	9.525	3.8	3.5	0°	EP3125	cast iron
331-21-021	TN1635R215-V	2.15	2	9.525	3.8	3.5	0°	EP3125	cast iron
341-21-013	TN1635R110-V	1.1	0.9	9.525	3.8	3.5	0°	EW3125	Al-alloy
341-21-015	TN1635R130-V	1.3	1.3	9.525	3.8	3.5	0°	EP3125	Al-alloy
341-21-017	TN1635R160-V	1.6	1.4	9.525	3.8	3.5	0°	EP3125	Al-alloy
341-21-019	TN1635R185-V	1.85	1.7	9.525	3.8	3.5	0°	EP3125	Al-alloy
341-21-021	TN1635R215-V	2.15	2	9.525	3.8	3.5	0°	EP3125	Al-alloy

Left hand

Order No.	Model	Size(mm)						Grade	Application
		w	b	d	d1	s	α		
311-21-014	TN1635L110-V	1.1	0.9	9.525	3.8	3.5	0°	EP2125	steel and INOX
311-21-016	TN1635L130-V	1.3	1.3	9.525	3.8	3.5	0°	EP2125	steel and INOX
311-21-018	TN1635L160-V	1.6	1.4	9.525	3.8	3.5	0°	EP2125	steel and INOX
311-21-020	TN1635L185-V	1.85	1.7	9.525	3.8	3.5	0°	EP2125	steel and INOX
311-21-022	TN1635L215-V	2.15	2	9.525	3.8	3.5	0°	EP2125	steel and INOX
331-21-014	TN1635L110-V	1.1	0.9	9.525	3.8	3.5	0°	EP3125	cast iron
331-21-016	TN1635L130-V	1.3	1.3	9.525	3.8	3.5	0°	EP3125	cast iron
331-21-018	TN1635L160-V	1.6	1.4	9.525	3.8	3.5	0°	EP3125	cast iron
331-21-020	TN1635L185-V	1.85	1.7	9.525	3.8	3.5	0°	EP3125	cast iron
331-21-022	TN1635L215-V	2.15	2	9.525	3.8	3.5	0°	EP3125	cast iron
341-21-014	TN1635L110-V	1.1	0.9	9.525	3.8	3.5	0°	EW3125	Al-alloy
341-21-016	TN1635L130-V	1.3	1.3	9.525	3.8	3.5	0°	EP3125	Al-alloy
341-21-018	TN1635L160-V	1.6	1.4	9.525	3.8	3.5	0°	EP3125	Al-alloy
341-21-020	TN1635L185-V	1.85	1.7	9.525	3.8	3.5	0°	EP3125	Al-alloy
341-21-022	TN1635L215-V	2.15	2	9.525	3.8	3.5	0°	EP3125	Al-alloy

BORING CUTTER & ABS TOOLING SYSTEM

ADJUSTABLE DOUBLE-EDGE BORING CUTTERS WITH ABS SHANK

197



SMALL DIAM. BORING CUTTERS WITH FINE ADJ. & BORING BAR

198



MICRO-ADJUSTABLE BORING CUTTERS & CARTRIDGES

200



PRECISION MICRO-ADJUSTABLE CARTRIDGES

201



ABS TOOLING SYSTEM

202



ADJUSTABLE DOUBLE-EDGE BORING CUTTERS WITH ABS SHANK

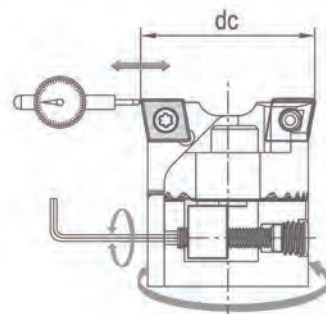
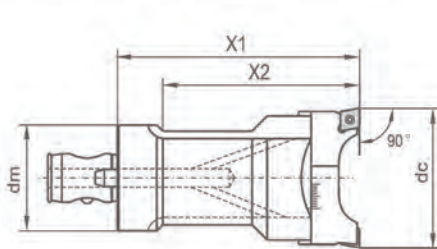

Order No.	Model	Shank	Capacity dc(mm)	Size (mm)			Insert	Screw	Torx wrench
				dm	X1	X2			
275-64-001	ABS25-TS9025-45	ABS25	25-32	25	45	35	CCMT060204	C025A07S	T7
275-64-002	ABS32-TS9025-70	ABS32	25-32	32	70	58	CCMT060204	C025A07S	T7
275-64-003	ABS25-TS9030-50	ABS25	30-38	25	50	-	CCMT060204	C025A07S	T7
275-64-004	ABS32-TS9030-85	ABS32	30-38	32	85	73	CCMT060204	C025A07S	T7
275-64-005	ABS32-TS9037-60	ABS32	37-47	32	60	-	CCMT060204	C025A07S	T7
275-64-006	ABS40-TS9046-60	ABS40	46-56	40	60	-	CCMT09T308	C035A08S	T15
275-64-007	ABS50-TS9046-120	ABS50	46-56	50	120	104	CCMT09T308	C035A08S	T15
275-64-008	ABS40-TS9055-60	ABS40	55-70	40	60	-	CCMT09T308	C035A08S	T15
275-64-009	ABS50-TS9055-135	ABS50	55-70	50	135	-	CCMT09T308	C035A08S	T15
275-64-010	ABS50-TS9069-70	ABS50	69-84	50	70	-	CCMT120408	C050A12S	T20
275-64-011	ABS63-TS9083-80	ABS63	83-101	63	80	-	CCMT120408	C050A12S	T20
275-64-012	ABS63-TS9099-80	ABS63	99-125	63	80	-	CCMT120408	C050A12S	T20
275-64-013	ABS80-TS90123-90	ABS80	123-150	80	90	-	CCMT120408	C050A12S	T20

Spare Parts

Model	Cartridge	Screw	Hex wrench	Washer	Screw	Hex wrench	Weight (Kg)
ABS25-TS9025-45	TS9025.CC06	MS04016	S3	DT04	RS03010	S1.5	0.15
ABS32-TS9025-70	TS9025.CC06	MS04016	S3	DT04	RS03010	S1.5	0.25
ABS25-TS9030-50	TS9030.CC06	MS04016	S3	DT04	RS03010	S1.5	0.20
ABS32-TS9030-85	TS9030.CC06	MS04016	S3	DT04	RS03010	S1.5	0.35
ABS32-TS9037-60	TS9037.CC06	MS04016	S3	DT04	RS03010	S1.5	0.75
ABS40-TS9046-60	TS9046.CC09	MS05016	S4	DT05	RS04012	S2.0	0.55
ABS50-TS9046-120	TS9046.CC09	MS05016	S4	DT05	RS04012	S2.0	1.35
ABS40-TS9055-60	TS9055.CC09	MS06025	S5	DT06	RS04012	S2.0	1.00
ABS50-TS9055-135	TS9055.CC09	MS06025	S5	DT06	RS04012	S2.0	2.50
ABS50-TS9069-70	TS9069.CC12	MS08030	S6	DT08	RS05016	S2.5	1.20
ABS63-TS9083-80	TS9083.CC12	MS01030	S8	DT10	RS05020	S2.5	1.90
ABS63-TS9099-80	TS9099.CC12	MS01030	S8	DT10	RS05020	S3.0	2.20
ABS80-TS90123-90	TS90123.CC12	MS01030	S8	DT10	RS05020	S3.0	3.60

MICRO-ADJUSTABLE BORING HEADS FOR SMALL DIAMETER

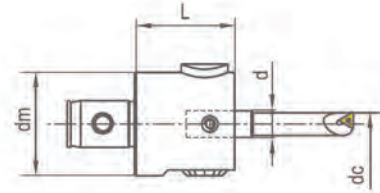

Order No.	Model	Shank	Capacity dc(mm)	Slide travel	Size(mm)			Weight (Kg)
					dm	L	d	
276-63-001	ABS40-SBZ-8	ABS40	3-11	2	40	35	8	0.35
276-63-002	ABS50-SBZ-12	ABS50	3-28	3	50	40	12	0.66
276-63-003	ABS63-SBZ-16	ABS63	3-50	5	63	60	16	1.53

Boring bar not included.

REDUCING SLEEVES

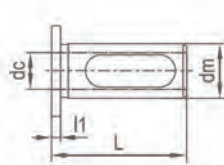

Type I

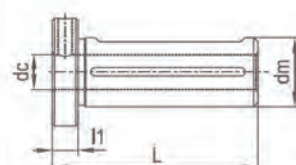

Type II



Order No.	Model	Size(mm)				Weight (Kg)	Type
		dc	dm	l1	L		
280-63-001	SBJ-12C8	8	12	2	30	0.05	A
280-63-002	SBJ-16C8	8	16	6	48	0.06	B

SOLID CARBIDE BORING BAR

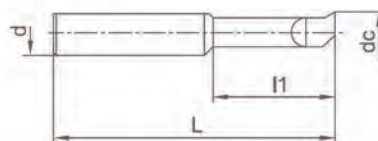

Order No.	Model	Capacity dc(mm)	Size(mm)		
			d	l1	L
471-63-001	YBJ-0803-9	3-5	8	9	38
471-63-002	YBJ-0805-15	5-7	8	15	43
471-63-003	YBJ-0807-21	7-9	8	21	49
471-63-004	YBJ-0809-27	9-11	8	27	54

INDEXABLE CARBIDE BORING BAR

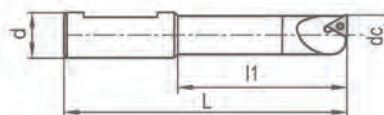

Order No.	Model	Capacity dc(mm)	Size(mm)			Insert	Screw	Torx wrench	Weight(Kg)
			d	l1	L				
224-63-001	YSBJ-160840	8-11	16	40	82	TBGT060102L	C020S05J	T6	0.06
224-63-002	YSBJ-1610-50	10-13	16	50	92	TBGT060102L	C020S05J	T6	0.07
224-63-003	YSBJ-1612-60	12-17	16	60	102	TPGH090204L	C025A07S	FT7	0.08
224-63-004	YSBJ-1616-80	16-21	16	80	122	TPGH090204L	C025A07S	FT7	0.12
224-63-005	YSBJ-1620-100	20-26	16	100	142	TPGH110304L	C030A07S	T9	0.16

Insert not included

INDEXABLE STEEL BORING BAR

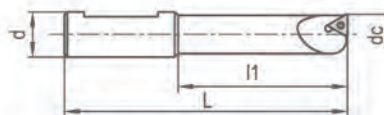

Order No.	Model	Capacity dc(mm)	Size(mm)			Insert	Screw	Torx wrench	Weight(Kg)
			d	l1	L				
221-63-001	SBJ-1208-30	8-10	12	32	60	TBGT060102L	C020S05J	T6	-
221-63-002	SBJ-1210-40	10-12	12	40	68	TBGT060102L	C020S05J	T6	-
221-63-003	SBJ-1212-48	12-14	12	48	76	TPGH090204L	C025A07S	FT7	-
221-63-004	SBJ-1214-56	14-16	12	56	84	TPGH090204L	C025A07S	FT7	-
221-63-005	SBJ-1216-60	16-18	12	60	88	TPGH090204L	C025A07S	FT7	-
221-63-006	SBJ-1218-60	18-20	12	60	88	TPGH110304L	C030A07S	T9	-
221-63-007	SBJ-1220-60	20-24	12	60	88	TPGH110304L	C030A07S	T9	-
221-63-008	SBJ-1224-60	24-28	12	60	88	TPGH110304L	C030A07S	T9	-
221-63-009	SBJ-1608-32	8-11	16	32	74	TBGT060102L	C020S05J	T6	0.06
221-63-010	SBJ-1610-40	10-13	16	40	82	TBGT060102L	C020S05J	T6	0.07
221-63-011	SBJ-1612-53	12-17	16	53	95	TPGH090204L	C025A07S	FT7	0.08
221-63-012	SBJ-1616-68	16-21	16	68	110	TPGH090204L	C025A07S	FT7	0.12
221-63-013	SBJ-1620-83	20-26	16	83	125	TPGH110304L	C030A07S	T9	0.16
221-63-014	SBJ-1625-90	25-32	16	90	132	TPGH110304L	C030A07S	T9	0.25
221-63-015	SBJ-1630-90	30-42	16	90	132	TPGH110304L	C030A07S	T9	0.3
221-63-016	SBJ-1640-90	40-50	16	90	132	TPGH110304L	C030A07S	T9	0.4

Insert not included

INDEXABLE STEEL STUB BORING BAR

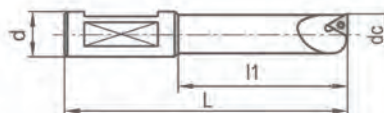

Order No.	Model	Capacity dc(mm)	Size(mm)			Insert	Screw	Torx wrench	Weight(Kg)
			d	l1	L				
221-63-017	SBJ-1608-16	8-11	16	16	58	TBGT060102L	C020S05J	T6	0.06
221-63-018	SBJ-1610-20	10-13	16	20	62	TBGT060102L	C020S05J	T6	0.07
221-63-019	SBJ-1612-24	12-17	16	24	66	TPGH090204L	C025A07S	FT7	0.08
221-63-020	SBJ-1616-32	16-21	16	32	74	TPGH090204L	C025A07S	FT7	0.12
221-63-021	SBJ-1620-32	20-26	16	32	74	TPGH110304L	C030A07S	T9	0.16
221-63-022	SBJ-1625-32	25-32	16	32	74	TPGH110304L	C030A07S	T9	0.25

Insert not included

PRECISION MICRO-ADJUSTABLE BORING HEADS

Adjusting accuracy:0.01mm

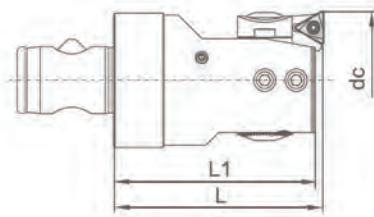

Forward boring

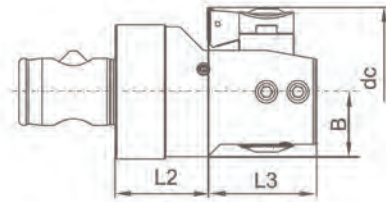

back boring

Order No.	Model	Shank	Capacity dc(mm)		Size (mm)					Cartridge	Screw	Weight (Kg)
			Forward boring	Back boring	L	L1	L2	L3	B			
276-65-001	ABS25-FBZ026008-45	ABS25	26-47	36-47	45	43	19	24	12.5	BZ02...	SS03005A	0.2
276-65-002	ABS32-FBZ033010-50	ABS32	33-60	44-60	50	48	22	26	16	BZ03...	SS04010A	0.3
276-65-003	ABS40-FBZ042013-60	ABS40	42-74	57-74	60	58	24	34	20	BZ04...	SS05010A	0.6
276-65-004	ABS50-FBZ053017-60	ABS50	53-95	68-95	60	58	20	38	25	BZ05...	SS06012A	0.9
276-65-005	ABS63-FBZ068032-80	ABS63	68-152	84-152	80	78	30	48	32.5	BZ06...	SS08012A	2
276-65-006	ABS80-FBZ098053-90	ABS80	98-203	98-203	90	88	40	48	45	BZ06...	SS08015A	4

Cartridge and insert not included

CARTRIDGE FOR MICRO-ADJUSTABLE BORING HEAD

Order No.	Model	Capacity dc(mm)		For boring cutter	Insert	Screw	Torx wrench
		Forward boring	Back boring				
280-65-001	BZ021.TP08	26-34	-	ABS25-FBZ026008-45	TP..0802..L	C020S05J	T6
280-65-002	BZ022.TP08	33-41	36-41	ABS25-FBZ026008-45	TP..0802..L	C020S05J	T6
280-65-003	BZ023.TP08	39-47	42-47	ABS25-FBZ026008-45	TP..0802..L	C020S05J	T6
					TP..0802..L	C020S05J	T6
280-65-004	BZ031.TP08	33-43	-	ABS32-FBZ033010-50	TP..0802..L	C020S05J	T6
280-65-005	BZ032.TP08	42-52	44-52	ABS32-FBZ033010-50	TP..0802..L	C020S05J	T6
280-65-006	BZ033.TP08	50-60	52-60	ABS32-FBZ033010-50	TP..0802..L	C020S05J	T6
280-65-007	BZ041.TP11	42-55	-	ABS40-FBZ042013-60	TP..1103..L	C030A07S	T9
280-65-008	BZ042.TP11	52-65	57-65	ABS40-FBZ042013-60	TP..1103..L	C030A07S	T9
280-65-009	BZ043.TP11	61-74	66-74	ABS40-FBZ042013-60	TP..1103..L	C030A07S	T9
					TP..1103..L	C030A07S	T9
280-65-010	BZ051.TP11	53-70	68-70	ABS50-FBZ053017-60	TP..1103..L	C030A07S	T9
280-65-011	BZ052.TP11	64-81	70-81	ABS50-FBZ053017-60	TP..1103..L	C030A07S	T9
280-65-012	BZ053.TP11	78-95	84-95	ABS50-FBZ053017-60	TP..1103..L	C030A07S	T9
					TP..1103..L	C030A07S	T9
280-65-013	BZ061.TP11	68-100	84-100	ABS63-FBZ068032-80	TP..1103..L	C030A07S	T9
280-65-014		98-151	98-151	ABS80-FBZ098053-90	TP..1103..L	C030A07S	T9
280-65-015	BZ062.TP11	95-127	107-127	ABS63-FBZ068032-80	TP..1103..L	C030A07S	T9
280-65-016		125-178	125-178	ABS80-FBZ098053-90	TP..1103..L	C030A07S	T9
280-65-017	BZ063.TP11	120-152	132-152	ABS63-FBZ068032-80	TP..1103..L	C030A07S	T9
280-65-018		150-203	150-203	ABS80-FBZ098053-90	TP..1103..L	C030A07S	T9
280-65-019	BZ021.CC06	26-34	-	ABS25-FBZ026008-45	CC..0602	C025A07S	FT7
280-65-020	BZ031.CC06	33-43	-	ABS32-FBZ033010-50	CC..0602	C025A07S	FT7
280-65-021	BZ041.TC11	42-55	-	ABS40-FBZ042013-60	TC..1102	C025A07S	FT7
280-65-022	BZ051.TC11	53-70	68-70	ABS50-FBZ053017-60	TC..1102	C025A07S	FT7
280-65-023	BZ061.TC11	68-100	84-100	ABS63-FBZ068032-80	TC..1102	C025A07S	FT7
280-65-024		98-151	98-151	ABS80-FBZ098053-90	TC..1102	C025A07S	FT7

Insert not included



PRECISION MICRO-ADJUSTABLE CARTRIDGES

- Adjusting accuracy:0.01mm
- Used on non-standard precision boring cutter for combination holes.

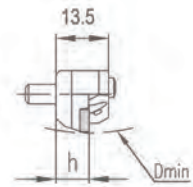
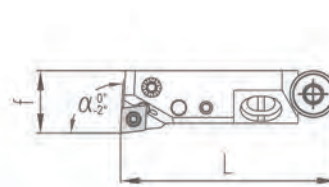

Order No.		Model		Size(mm)					Insert	Diagram
Right hand	Left hand	Right hand	Left hand	h	f	L	α	Dmin		
280-66-001	280-66-002	SWFCR08CM-03	SWFCL08CM-03	8.5	16	55.5	90°	36	WC..030204	
280-66-003	280-66-004	SCFCR08CM-06	SCFCL08CM-06	8.5	16	55.5	90°	36	CC..060204	
280-66-005	280-66-006	SCFPR08CM-06	SCFPL08CM-06	8.5	16	55.5	90°	36	CP..060204	
280-66-007	280-66-008	STFCR08CM-09	STFCL08CM-09	8.5	16	55.5	90°	36	TC..090204	
280-66-009	280-66-010	STFPR08CM-09	STFPL08CM-09	8.5	16	55.5	90°	36	TP..090204	
280-66-011	280-66-012	STFCR08CM-11	STFCL08CM-11	8.5	20	55.5	90°	44	TC..110204	
280-66-013	280-66-014	STFPR08CM-11	STFPL08CM-11	8.5	20	55.5	90°	44	TP..110204	
280-66-015	280-66-016	SCLCR08CM-06	SCLCL08CM-06	8.5	16	55.5	95°	36	CC..060204	
280-66-017	280-66-018	SCLPR08CM-06	SCLPL08CM-06	8.5	16	55.5	95°	36	CP..060204	
280-66-019	280-66-020	STLCR08CM-09	STLCL08CM-09	8.5	16	55.5	95°	36	TC..090204	
280-66-021	280-66-022	STLPR08CM-09	STLPL08CM-09	8.5	16	55.5	95°	36	TP..090204	
280-66-023	280-66-024	STLCR08CM-11	STLCL08CM-11	8.5	20	55.5	95°	44	TC..110204	
280-66-025	280-66-026	STLPR08CM-11	STLPL08CM-11	8.5	20	55.5	95°	44	TP..110204	
280-66-027	280-66-028	SDQCR08CM-07	SDQCL08CM-07	8.5	16	58.5	120°	36	DC..070204	

- Can be customized according to requirement.

DIN69893 HSK TAPER SHANK ABS TOOLHOLDER

- Used for holding boring cutter with ABS quick shank.

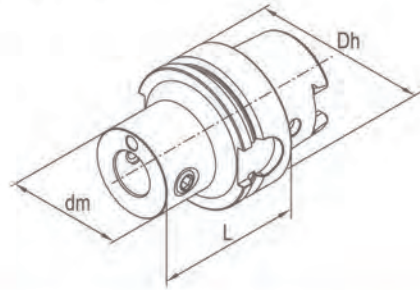

Order No.	Model	SHANK	Size (mm)			Thrust screw	Receiving screw
			Dh	dm	L		
111-11-401	HSK63A-ABS25-50	HSK-A63	63	25	50	21A.25-E1	21A.25-E2
111-11-402	HSK63A-ABS32-55	HSK-A63	63	32	55	21A.32-E1	21A.32-E2
111-11-403	HSK63A-ABS40-60	HSK-A63	63	40	60	21A.40-E1	21A.40-E2
111-11-404	HSK63A-ABS50-70	HSK-A53	63	50	70	21A.50-E1	21A.50-E2
111-11-405	HSK63A-ABS63-80	HSK-A63	63	63	80	21A.63-E1	21A.63-E2
111-11-406	HSK63A-ABS80-100	HSK-A63	63	100	100	21A.100-E1	21A.100-E2
111-11-601	HSK100A-ABS25-60	HSK-A100	100	25	60	21A.25-E1	21A.25-E2
111-11-602	HSK100A-ABS32-60	HSK-A100	100	32	60	21A.32-E1	21A.32-E2
111-11-603	HSK100A-ABS40-80	HSK-A100	100	40	80	21A.40-E1	21A.40-E2
111-11-604	HSK100A-ABS50-80	HSK-A100	100	50	80	21A.50-E1	21A.50-E2
111-11-605	HSK100A-ABS63-80	HSK-A100	100	63	80	21A.63-E1	21A.63-E2
111-11-606	HSK100A-ABS80-90	HSK-A100	100	80	90	21A.80-E1	21A.80-E2
111-11-607	HSK100A-ABS100-100	HSK-A100	100	100	100	21A.100-E1	21A.100-E2

DIN69871 SK TAPER SHANK ABS TOOLHOLDER

- Used for holding boring cutter with ABS quick shank.

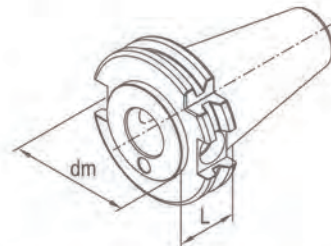

Order No.	Model	SHANK	Size(mm)		Thrust screw	Receiving screw
			dm	L		
132-11-401	JT40-ABS25-20	SK40-AD	25	20	21 A.25-E1	21A.25-E2
132-11-402	JT40-ABS32-22.5	SK40-AD	32	22.5	21A.32-E1	21A.32-E2
132-11-403	JT40-ABS40-22.5	SK40-AD	40	22.5	21A.40-E1	21A.40-E2
132-11-404	JT40-ABS50-45	SK40-AD	50	45	21A.50-E1	21A.50-E2
132-11-405	JT40-ABS63-65	SK40-AD	63	65	21A.63-E1	21A.63-E2
132-11-501	JT50-ABS25-20	SK50-AD	25	20	21 A.25-E1	21A.25-E2
132-11-502	JT50-ABS32-22.5	SK50-AD	32	22.5	21 A.32-E1	21A.32-E2
132-11-503	JT50-ABS40-22.5	SK50-AD	40	22.5	21A.40-E1	21A.40-E2
132-11-504	JT50-ABS50-45	SK50-AD	50	45	21A.50-E1	21A.50-E2
132-11-505	JT50-ABS63-50	SK50-AD	63	50	21A.63-E1	21A.63-E2
132-11-506	JT50-ABS80-60	SK50-AD	80	60	21A.80-E1	21A.80-E2
132-11-507	JT50-ABS100-80	SK50-AD	100	80	21A.100-E1	21A.100-E2

DIN69871 SK TAPER SHANK ABS TOOLHOLDER

• Used for holding boring cutter with ABS quick shank.

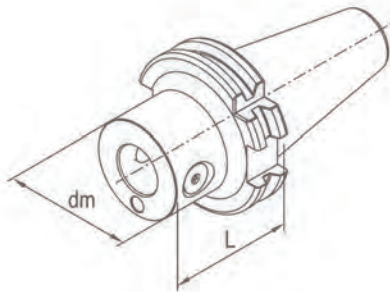

Order No.	Model	SHANK	Size(mm)		Thrust screw	Receiving screw
			dm	L		
132-11-406	JT40-ABS25-50	SK40-AD	25	50	21A.25-E1	21A.25-E2
132-11-407	JT40-ABS25-75	SK40-AD	25	75	21A.25-E1	21A.25-E2
132-11-408	JT40-ABS25-95	SK40-AD	25	95	21A.25-E1	21A.25-E2
132-11-409	JT40-ABS32-50	SK40-AD	32	50	21A.32-E1	21A.32-E2
132-11-410	JT40-ABS32-75	SK40-AD	32	75	21A.32-E1	21A.32-E2
132-11-411	JT40-ABS32-100	SK40-AD	32	100	21A.32-E1	21A.32-E2
132-11-412	JT40-ABS32-135	SK40-AD	32	135	21A.32-E1	21A.32-E2
132-11-413	JT40-ABS40-50	SK40-AD	40	50	21A.40-E1	21A.40-E2
132-11-414	JT40-ABS40-80	SK40-AD	40	80	21A.40-E1	21A.40-E2
132-11-415	JT40-ABS40-110	SK40-AD	40	110	21A.40-E1	21A.40-E2
132-11-416	JT40-ABS40-150	SK40-AD	40	150	21A.40-E1	21A.40-E2
132-11-417	JT40-ABS50-50	SK40-AD	50	50	21A.50-E1	21A.50-E2
132-11-418	JT40-ABS50-80	SK40-AD	50	80	21A.50-E1	21A.50-E2
132-11-419	JT40-ABS50-115	SK40-AD	50	115	21A.50-E1	21A.50-E2
132-11-420	JT40-ABS50-150	SK40-AD	50	150	21A.50-E1	21A.50-E2
132-11-421	JT40-ABS63-90	SK40-AD	63	90	21A.63-E1	21A.63-E2
132-11-422	JT40-ABS63-135	SK40-AD	63	135	21A.63-E1	21A.63-E2
132-11-423	JT40-ABS63-175	SK40-AD	63	175	21A.63-E1	21A.63-E2
132-11-508	JT50-ABS25-60	SK50-AD	25	60	21A.25-E1	21A.25-E2
132-11-509	JT50-ABS25-90	SK50-AD	25	90	21A.25-E1	21A.25-E2
132-11-510	JT50-ABS25-105	SK50-AD	25	105	21A.25-E1	21A.25-E2
132-11-511	JT50-ABS32-60	SK50-AD	32	60	21A.32-E1	21A.32-E2
132-11-512	JT50-ABS32-90	SK50-AD	32	90	21A.32-E1	21A.32-E2
132-11-513	JT50-ABS32-110	SK50-AD	32	110	21A.32-E1	21A.32-E2
132-11-514	JT50-ABS32-135	SK50-AD	32	135	21A.32-E1	21A.32-E2
132-11-515	JT50-ABS40-60	SK50-AD	40	60	21A.40-E1	21A.40-E2
132-11-516	JT50-ABS40-90	SK50-AD	40	90	21A.40-E1	21A.40-E2
132-11-517	JT50-ABS40-120	SK50-AD	40	120	21A.40-E1	21A.40-E2
132-11-518	JT50-ABS40-150	SK50-AD	40	150	21A.40-E1	21A.40-E2
132-11-519	JT50-ABS50-60	SK50-AD	50	60	21A.50-E1	21A.50-E2
132-11-520	JT50-ABS50-90	SK50-AD	50	90	21A.50-E1	21A.50-E2
132-11-521	JT50-ABS50-125	SK50-AD	50	125	21A.50-E1	21A.50-E2
132-11-522	JT50-ABS50-165	SK50-AD	50	165	21A.50-E1	21A.50-E2
132-11-523	JT50-ABS63-60	SK50-AD	63	60	21A.63-E1	21A.63-E2
132-11-524	JT50-ABS63-105	SK50-AD	63	105	21A.63-E1	21A.63-E2
132-11-525	JT50-ABS63-145	SK50-AD	63	145	21A.63-E1	21A.63-E2
132-11-526	JT50-ABS63-175	SK50-AD	63	175	21A.63-E1	21A.63-E2
132-11-527	JT50-ABS63-225	SK50-AD	63	225	21A.63-E1	21A.63-E2
132-11-528	JT50-ABS80-70	SK50-AD	80	70	21A.80-E1	21A.80-E2
132-11-529	JT50-ABS80-125	SK50-AD	80	125	21A.80-E1	21A.80-E2
132-11-530	JT50-ABS80-155	SK50-AD	80	155	21A.80-E1	21A.80-E2
132-11-531	JT50-ABS80-200	SK50-AD	80	200	21A.80-E1	21A.80-E2
132-11-532	JT50-ABS80-250	SK50-AD	80	250	21A.80-E1	21A.80-E2
132-11-533	JT50-ABS100-115	SK50-AD	100	115	21A.100-E1	21A.100-E2
132-11-534	JT50-ABS100-155	SK50-AD	100	155	21A.100-E1	21A.100-E2
132-11-535	JT50-ABS100-200	SK50-AD	100	200	21A.100-E1	21A.100-E2
132-11-536	JT50-ABS100-250	SK50-AD	100	250	21A.100-E1	21A.100-E2

JIS B6339 BT TAPER SHANK ABS TOOLHOLDER

- Used for holding boring cutter with ABS quick shank.

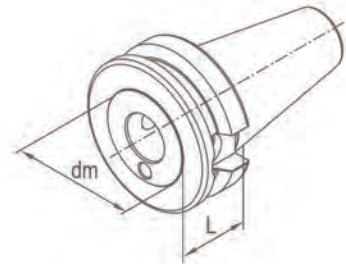

Order No.	Model	SHANK	Size(mm)		Thrust screw	Receiving screw
			dm	L		
122-11-401	BT40-ABS25-27	BT40-AD	25	27	21A.25-E1	21A.25-E2
122-11-402	BT40-ABS32-27.5	BT40-AD	32	27.5	21A.32-E1	21A.32-E2
122-11-403	BT40-ABS40-27.5	BT40-AD	40	27.5	21A.40-E1	21A.40-E2
122-11-404	BT40-ABS50-50-ABS5	BT40-AD	50	50.5	21A.50-E1	21A.50-E2
122-11-405	BT40-ABS63-55	BT40-AD	63	55	21A.63-E1	21A.63-E2
122-11-501	BT50-ABS32-38.5	BT50-AD	32	38.5	21A.32-E1	21A.32-E2
122-11-502	BT50-ABS40-38.5	BT50-AD	40	38.5	21A.40-E1	21A.40-E2
122-11-503	BT50-ABS50-38.5	BT50-AD	50	38.5	21A.50-E1	21A.50-E2
122-11-504	BT50-ABS63-38.5	BT50-AD	63	38.5	21A.63-E1	21A.63-E2
122-11-505	BT50-ABS80-75	BT50-AD	80	75	21A.80-E1	21A.80-E2
122-11-506	BT50-ABS100-90	BT50-AD	100	90	21A.100-E1	21A.100-E2

JIS B6339 BT TAPER SHANK ABS TOOLHOLDER

• Used for holding boring cutter with ABS quick shank.

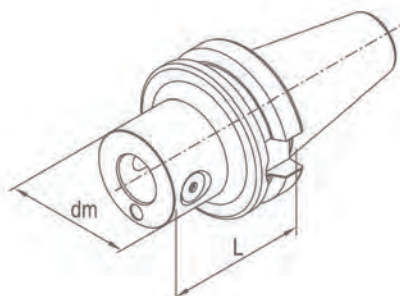

Order No.	Model	SHANK	Size(mm)		Thrust screw	Receiving screw
			dm	L		
122-11-301	BT30-ABS25-40	BT30-AD	25	40	21A.25-E1	21A.25-E2
122-11-302	BT30-ABS32-50	BT30-AD	32	50	21A.32-E1	21A.32-E2
122-11-303	BT30-ABS40-50	BT30-AD	40	50	21A.40-E1	21A.40-E2
122-11-406	BT40-ABS25-58	BT40-AD	25	58	21A.25-E1	21A.25-E2
122-11-407	BT40-ABS25-75	BT40-AD	25	75	21A.25-E1	21A.25-E2
122-11-408	BT40-ABS25-100	BT40-AD	25	100	21A.25-E1	21A.25-E2
122-11-409	BT40-ABS32-58	BT40-AD	32	58	21A.32-E1	21A.32-E2
122-11-410	BT40-ABS32-85	BT40-AD	32	85	21A.32-E1	21A.32-E2
122-11-411	BT40-ABS32-110	BT40-AD	32	110	21A.32-E1	21A.32-E2
122-11-412	BT40-ABS32-145	BT40-AD	32	145	21A.32-E1	21A.32-E2
122-11-413	BT40-ABS40-58	BT40-AD	40	58	21A.40-E1	21A.40-E2
122-11-414	BT40-ABS40-90	BT40-AD	40	90	21A.40-E1	21A.40-E2
122-11-415	BT40-ABS40-120	BT40-AD	40	120	21A.40-E1	21A.40-E2
122-11-416	BT40-ABS40-150	BT40-AD	40	150	21A.40-E1	21A.40-E2
122-11-417	BT40-ABS50-58	BT40-AD	50	58	21A.50-E1	21A.50-E2
122-11-418	BT40-ABS50-95	BT40-AD	50	95	21A.50-E1	21A.50-E2
122-11-419	BT40-ABS50-125	BT40-AD	50	125	21A.50-E1	21A.50-E2
122-11-420	BT40-ABS50-165	BT40-AD	50	165	21A.50-E1	21A.50-E2
122-11-421	BT40-ABS63-70	BT40-AD	63	70	21A.63-E1	21A.63-E2
122-11-422	BT40-ABS63-98	BT40-AD	63	98	21A.63-E1	21A.63-E2
122-11-423	BT40-ABS63-135	BT40-AD	63	135	21A.63-E1	21A.63-E2
122-11-424	BT40-ABS63-180	BT40-AD	63	180	21A.63-E1	21A.63-E2
122-11-507	BT50-ABS25-79	BT50-AD	25	79	21A.25-E1	21A.25-E2
122-11-508	BT50-ABS25-100	BT50-AD	25	100	21A.25-E1	21A.25-E2
122-11-509	BT50-ABS25-125	BT50-AD	25	125	21A.25-E1	21A.25-E2
122-11-510	BT50-ABS32-79	BT50-AD	32	79	21A.32-E1	21A.32-E2
122-11-511	BT50-ABS32-105	BT50-AD	32	105	21A.32-E1	21A.32-E2
122-11-512	BT50-ABS32-130	BT50-AD	32	130	21A.32-E1	21A.32-E2
122-11-513	BT50-ABS32-165	BT50-AD	32	165	21A.32-E1	21A.32-E2
122-11-514	BT50-ABS40-79	BT50-AD	40	79	21A.40-E1	21A.40-E2
122-11-515	BT50-ABS40-105	BT50-AD	40	105	21A.40-E1	21A.40-E2
122-11-516	BT50-ABS40-140	BT50-AD	40	140	21A.40-E1	21A.40-E2
122-11-517	BT50-ABS40-175	BT50-AD	40	175	21A.40-E1	21A.40-E2
122-11-518	BT50-ABS50-79	BT50-AD	50	79	21A.50-E1	21A.50-E2
122-11-519	BT50-ABS50-110	BT50-AD	50	110	21A.50-E1	21A.50-E2
122-11-520	BT50-ABS50-145	BT50-AD	50	145	21A.50-E1	21A.50-E2
122-11-521	BT50-ABS50-180	BT50-AD	50	180	21A.50-E1	21A.50-E2
122-11-522	BT50-ABS63-79	BT50-AD	63	79	21A.63-E1	21A.63-E2
122-11-523	BT50-ABS63-125	BT50-AD	63	125	21A.63-E1	21A.63-E2
122-11-524	BT50-ABS63-165	BT50-AD	63	165	21A.63-E1	21A.63-E2
122-11-525	BT50-ABS63-200	BT50-AD	63	200	21A.63-E1	21A.63-E2
122-11-526	BT50-ABS63-250	BT50-AD	63	250	21A.63-E1	21A.63-E2
122-11-527	BT50-ABS80-89	BT50-AD	80	89	21A.80-E1	21A.80-E2
122-11-528	BT50-ABS80-135	BT50-AD	80	135	21A.80-E1	21A.80-E2
122-11-529	BT50-ABS80-150	BT50-AD	80	150	21A.80-E1	21A.80-E2
122-11-530	BT50-ABS80-175	BT50-AD	80	175	21A.80-E1	21A.80-E2
122-11-531	BT50-ABS80-210	BT50-AD	80	210	21A.80-E1	21A.80-E2
122-11-532	BT50-ABS80-265	BT50-AD	80	265	21A.80-E1	21A.80-E2
122-11-533	BT50-ABS100-134	BT50-AD	100	134	21A.100-E1	21A.100-E2
122-11-534	BT50-ABS100-165	BT50-AD	100	165	21A.100-E1	21A.100-E2
122-11-535	BT50-ABS100-200	BT50-AD	100	200	21A.100-E1	21A.100-E2
122-11-536	BT50-ABS100-250	BT50-AD	100	250	21A.100-E1	21A.100-E2

ABS EXTENSION ADAPTER

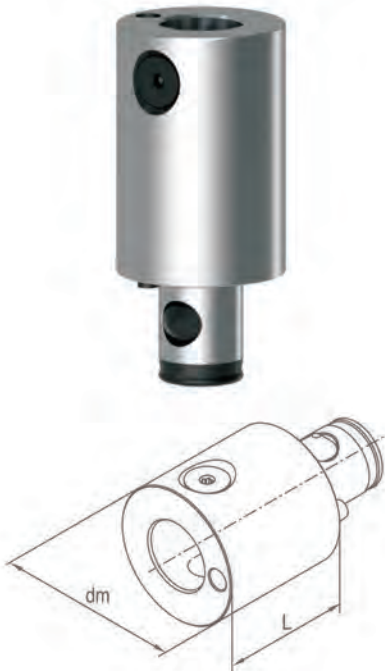

Order No.	Model	Size (mm)		Thrust screw	Receiving screw	Floating pin	Orientation pin
		dm	L				
141-11-001	ABS25/25-45	25	45	21A.25-E1	21A.25-E2	21A.25-E3	21A.25-E4
141-11-002	ABS25/25-60	25	60	21A.25-E1	21A.25-E2	21A.25-E3	21A.25-E4
141-11-003	ABS32/32-50	32	50	21A.32-E1	21A.32-E2	21A.32-E3	21A.32-E4
141-11-004	ABS32/32-70	32	70	21A.32-E1	21A.32-E2	21A.32-E3	21A.32-E4
141-11-005	ABS40/40-60	40	60	21A.40-E1	21A.40-E2	21A.40-E3	21A.40-E4
141-11-006	ABS40/40-90	40	90	21A.40-E1	21A.40-E2	21A.40-E3	21A.40-E4
141-11-007	ABS50/50-65	50	65	21A.50-E1	21A.50-E2	21A.50-E3	21A.50-E4
141-11-008	ABS50/50-100	50	100	21A.50-E1	21A.50-E2	21A.50-E3	21A.50-E4
141-11-009	ABS63/63-85	63	85	21A.63-E1	21A.63-E2	21A.63-E3	21A.63-E4
141-11-010	ABS63/63-125	63	125	21A.63-E1	21A.63-E2	21A.63-E3	21A.63-E4
141-11-011	ABS80/80-85	80	85	21A.80-E1	21A.80-E2	21A.80-E3	21A.80-E4
141-11-012	ABS80/80-125	80	125	21A.80-E1	21A.80-E2	21A.80-E3	21A.80-E4
141-11-013	ABS100/100-85	100	85	21A.100-E1	21A.80-E2	21A.100-E3	21A.100-E4
141-11-014	ABS100/100-125	100	125	21A.100-E1	21A.80-E2	21A.100-E3	21A.100-E4
141-11-015	ABS100/100-160	100	160	21A.100-E1	21A.80-E2	21A.100-E3	21A.100-E4

ABS REDUCING ADAPTER

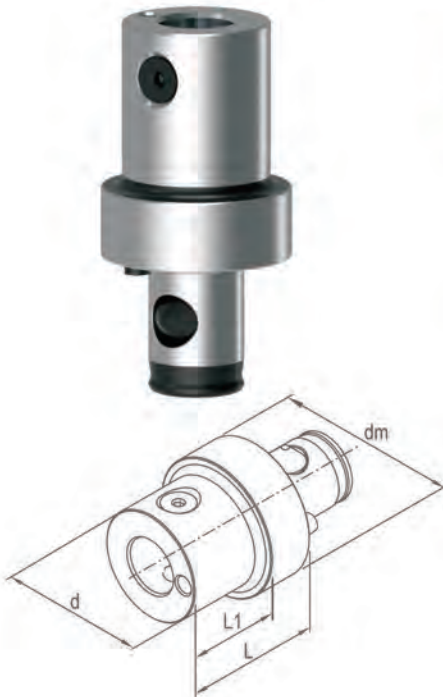

Order No.	Model	Size (mm)				Thrust screw	Receiving screw	Floating pin	Orientation pin
		dm	d	L	L1				
142-11-001	ABS32/25-40	32	25	40	28	21A.25-E1	21A.25-E2	21A.32-E3	21A.32-E4
142-11-002	ABS40/25-40	40	25	40	26	21A.25-E1	21A.25-E2	21A.40-E3	21A.40-E4
142-11-003	ABS40/32-40	40	32	40	26	21A.32-E1	21A.32-E2	21A.40-E3	21A.40-E4
142-11-004	ABS50/25-50	50	25	50	34	21A.25-E1	21A.25-E2	21A.50-E3	21A.50-E4
142-11-005	ABS50/32-50	50	32	50	34	21A.32-E1	21A.32-E2	21A.50-E3	21A.50-E4
142-11-006	ABS50/40-50	50	40	50	34	21A.40-E1	21A.40-E2	21A.50-E3	21A.50-E4
142-11-007	ABS63/25-60	63	25	60	40	21A.25-E1	21A.25-E2	21A.63-E3	21A.63-E4
142-11-008	ABS63/32-60	63	32	60	40	21A.32-E1	21A.32-E2	21A.63-E3	21A.63-E4
142-11-009	ABS63/40-60	63	40	60	40	21A.40-E1	21A.40-E2	21A.63-E3	21A.63-E4
142-11-010	ABS63/50-60	63	50	60	40	21A.50-E1	21A.50-E2	21A.63-E3	21A.63-E4
142-11-011	ABS80/32-60	80	32	60	36	21A.32-E1	21A.32-E2	21A.80-E3	21A.80-E4
142-11-012	ABS80/40-60	80	40	60	36	21A.40-E1	21A.40-E2	21A.80-E3	21A.80-E4
142-11-013	ABS80/50-60	80	50	60	36	21A.50-E1	21A.50-E2	21A.80-E3	21A.80-E4
142-11-014	ABS80/63-60	80	63	60	36	21A.63-E1	21A.63-E2	21A.80-E3	21A.80-E4
142-11-015	ABS100/40-80	100	40	80	52	21A.40-E1	21A.40-E2	21A.100-E3	21A.100-E4
142-11-016	ABS100/50-80	100	50	80	52	21A.50-E1	21A.50-E2	21A.100-E3	21A.100-E4
142-11-017	ABS100/63-80	100	63	80	52	21A.63-E1	21A.63-E2	21A.100-E3	21A.100-E4
142-11-018	ABS100/80-80	100	80	80	52	21A.80-E1	21A.80-E2	21A.100-E3	21A.100-E4

ACCESSORIES

SEAL RING

for ABS	dm=25	dm=32	dm=40	dm=50	dm=63	dm=80	dm=100	dm=125
Model	21A.25-E9	21A.32-E9	21A.40-E9	21A.50-E9	21A.63-E9	21A.80-E9	21A.100-E9	21A.125-E9
Order No.	140-00-001	140-00-002	140-00-003	140-00-004	140-00-005	140-00-006	140-00-007	140-00-008



Email: sales@harlingentools.com

Web: www.harlingentools.com

Add: Via Codognino No. 4, 26854 Cornegliano Laudense (LO), Italy

HARLINGEN®

