

CONNECTICUT STATE PRICING - 3/4/2019

These prices do not include freight or installation.

These are Not-To-Exceed prices and further discounts are available for qualifying orders.

MATRIX

Cardio

Treadmills

Manfucaturer Brand Name	Model Number/ Catalog Name	Product Description	MSRP	% Discount	With Discount
Matrix	T7XI-04	Treadmill-19" capacitive touchscreen	\$ 13,775.00	47%	\$ 7,300.75
Matrix	T7XI-04	Treadmill HDBTIP TV	\$ 13,775.00	47%	\$ 7,300.75
Matrix	T7X1-04	Treadmill - PROIP TV	\$ 13,775.00	47%	\$ 7,300.75
Matrix	T7XE-05	Treadmill - 16" touchscreen display w/ Fit Touch Tec	\$ 11,995.00	47%	\$ 6,357.35
Matrix	T7XE-06	Treadmill - HDBTIP TV w/VA	\$ 12,894.00	47%	\$ 6,833.82
Matrix	T7XE-06	Treadmill - PROIP TV w/VA	\$ 12,894.00	47%	\$ 6,883.82
Matrix	T5X-08	Treadmill - LED Console	\$ 8,995.00	47%	\$ 4,767.35
Matrix	T3XE-06	Treadmill - 16" touchscreen display w/ Fit Touch Tec	\$ 8,995.00	50%	\$ 4,767.35
Matrix	T3XH	Treadmill-16" touchscreen display - Simplified	\$ 8,995.00	47%	\$ 4,767.35
Matrix	T3X-04	Treadmill LED Console Display	\$ 6,995.00	50%	\$ 3,707.35
Matrix	T1XE-06	Treadmill - 16" touchscreen display w/ Fit Touch Tec	\$ 6,995.00	47%	\$ 3,707.35
Matrix	T1X-04	Treadmill - Large LED Display	\$ 4,994.90	47%	\$ 2,647.30

Performance Trainers

Matrix	T-DPT	Treadmill - S-Drive Performance Trainer- No Motor	\$ 3,895.00	30%	\$ 2,726.50
Matrix	SPT	S-Force Performance Trainer	\$ 4,895.00	30%	\$ 3,426.50

Ascents

Model Number/ Catalog Name	Product Description	MSRP	% Discount	With Discount
Matrix				

Matrix	A7XI-05	Ascent- 16" capacitive touchscreen w/FitTouch Tech.	\$	13,775.00	47%	\$	6,474.25
Matrix	A7XI-05	Ascent -HDBTIP TV	\$	13,775.00	47%	\$	6,474.25
Matrix	A7XI-05	Ascent - PROIPTV	\$	13,775.00	47%	\$	6,474.25
Matrix	A7XE-05	Ascent - 16" touchscreen display w/ FitTouch Tech.	\$	11,995.00	47%	\$	5,637.65
Matrix	A7XE-05	Ascent- HDBTIP; w/VA	\$	12,894.00	47%	\$	6,060.18
Matrix	A7XE-05	Ascent - PROIPTV	\$	12,894.00	47%	\$	6,060.18
Matrix	A5X-06	Ascent- LED Console	\$	8,995.00	47%	\$	4,227.65
Matrix	A3XE-04	Ascent - 10" Touchscreen w/FitTouch Technology	\$	8,995.00	47%	\$	4,227.65
Matrix	A3X-03	Ascent - LED Console	\$	7,995.00	47%	\$	3,757.65
Matrix	ALB7XI-04	Ascent Lower Body 16" capacitive w/Fit Touch Tech.	\$	13,775.00	47%	\$	6,474.25
Matrix	ALB7XI-05	Ascent Lower Body- HDBTIP TV	\$	13,775.00	47%	\$	6,474.25
Matrix	ALB7XI-04	Ascent Lower Body - PROIP TV	\$	13,775.00	47%	\$	6,474.25
Matrix	ALB7XE-04	Ascent Lower Body 16" touchscreen w/ Fit Touch Technology	\$	11,995.00	47%	\$	5,637.65
Matrix	ALB7XE-04	Ascent Lower Body - HDBTIP TV	\$	12,894.00	47%	\$	6,060.18
Matrix	ALB7XE-04	Ascent Lower Body - PROIP TV w/VA	\$	12,894.00	47%	\$	6,060.18
Matrix	ALB5X-06	Ascent Lower Body - LED Console	\$	8,995.00	47%	\$	4,227.65
Matrix	ALB3XE-02	Ascent Lower Body	\$	8,995.00	47%	\$	4,227.65
Matrix	ALB3X-02	Ascent Lower Body - LED Console	\$	7,995.00	47%	\$	3,757.65

MATRIX

Cardio

Climbmills

Model Number/ Catalog Name	Product Description	MSRP	% Discount	With Discount
Matrix C7XI-05	Climbmill- 16" capacitive touchscreen w/ FitTouch	\$ 13,775.00	47%	\$ 7,300.75
Matrix C7XI-05	Climbmill- HDBTIP TV	\$ 13,775.00	47%	\$ 7,300.75
Matrix C7XI-05	Climbmill - PROIP TV	\$ 13,775.00	47%	\$ 7,300.75
Matrix C7XE-05	Climbmill-16" touchscreen display w/FitTouch Tech.	\$ 11,995.00	47%	\$ 6,357.35

Matrix	C7XE-05	Climbmill - HDBTIP TV	\$	12,894.00	47%	\$	6,833.82
Matrix	C5X-06	Climbmill - LED Console	\$	8,995.00	47%	\$	4,767.35
Matrix	C3XE-04	Climbmill - 10" touchscreen display w/FitTouch Tech.	\$	8,995.00	47%	\$	4,767.35
Matrix	C3X-04	Climbmill - LED Console	\$	7,995.00	47%	\$	4,237.35

Ellipticals

Model Number/

Matrix	Catalog Name	Product Description	MSRP	% Discount	With Discount
Matrix	E7XI-04	Elliptical- 16" capacative touchscreen w/ FitTouch	\$ 11,650.00	40%	\$ 6,990.00
Matrix	E7XI-04	Elliptical - HDBTIP TV	\$ 11,650.00	40%	\$ 6,990.00
Matrix	E7XI-04	Elliptical PROIP TV	\$ 11,650.00	40%	\$ 6,990.00
Matrix	E7XE-04	Elliptical- 16" capacative touchscreen w/ FitTouch	\$ 9,995.00	40%	\$ 5,997.00
Matrix	E7XE-04	Elliptical - HDBTIP TV w/VA	\$ 10,894.00	40%	\$ 6,536.40
Matrix	E7XE-04	Elliptical - PROIP TV w/VA	\$ 10,894.00	40%	\$ 6,536.40
Matrix	E5X-06	Elliptical - LED Console	\$ 6,995.00	40%	\$ 4,197.00
Matrix	E3XE-04	Elliptical - 10" touchscreen w/ Fit Touch Technology	\$ 6,995.00	40%	\$ 4,197.00
Matrix	E3X-04	Elliptical - LED Console	\$ 5,995.00	40%	\$ 3,597.00
Matrix	E1XE	Elliptical - 10" touchscreen w/ Fit Touch Technology	\$ 6,295.00	40%	\$ 3,777.00
Matrix	E1X	Elliptical - LED Display	\$ 4,695.00	40%	\$ 2,817.00

Steppers

Model Number/

Matrix	Catalog Name	Product Description	MSRP	% Discount	With Discount
Matrix	S7XI-04	Stepper- 16" capacative touchscreen w/ FitTouch	\$ 8,995.00	40%	\$ 5,397.00
Matrix	S7XI-04	Stepper- HDBTIP TV	\$ 8,995.00	40%	\$ 5,397.00
Matrix	S7XI-04	Stepper- PROIP TV	\$ 8,995.00	40%	\$ 5,397.00
Matrix	S7XE-04	Stepper- 16" touchscreen display w/FitTouch Tech.	\$ 6,995.00	40%	\$ 4,197.00
Matrix	S7XE-04	Stepper- HDBTIP w/VA	\$ 7,894.00	40%	\$ 4,736.40
Matrix	S7XE-04	Stepper-PROIP TV w/VA	\$ 7,894.00	40%	\$ 4,736.40
Matrix	S5X-06	Stepper- LED Console	\$ 4,395.00	40%	\$ 2,637.00
Matrix	S3XE-04	Stepper- 10" touchscreen w/FitTouch Technology	\$ 5,295.00	40%	\$ 3,177.00
Matrix	S3X-04	Stepper - LED Console	\$ 3,895.00	40%	\$ 2,337.00

Matrix

Bikes

Matrix	Model Number/ Catalog Name	Product Description	MSRP	% Discount	With Discount
Matrix	H7XI-06	Hybrid - 16" capacative touchscreen w/FitTouch	\$ 8,475.00	40%	\$ 5,085.00
Matrix	H7XI-06	Hybrid - HDBTIP w/VA	\$ 8,475.00	40%	\$ 5,085.00
Matrix	H7XI-06	Hybrid - PROIP TV	\$ 8,475.00	40%	\$ 5,085.00
Matrix	H7XE-06	Hybrid - 16" capacative touchscreen w/FitTouch	\$ 6,995.00	40%	\$ 4,197.00
Matrix	H7XE-06	Hybrid - HDBTIP W/VA	\$ 7,894.00	40%	\$ 4,736.40
Matrix	H7XE-06	Hybrid - PROIP TV w/VA	\$ 7,894.00	40%	\$ 4,736.40
Matrix	H5X-06	Hybrid - LED Console	\$ 4,395.00	40%	\$ 2,637.00
Matrix	H3XE-06	Hybrid - 10" touchscreen w/FitTouch Technology	\$ 5,095.00	40%	\$ 3,057.00
Matrix	R7XI-06	Recumbent- 16" capacative w/FitTouch Tech.	\$ 8,150.00	40%	\$ 4,890.00
Matrix	R7XI-06	Recumbent- HDBTIP TV	\$ 8,150.00	40%	\$ 4,890.00
Matrix	R7XI-06	Recumbent- PROIP TV	\$ 8,150.00	40%	\$ 4,890.00
Matrix	R7XE-06	Recumbent- 16" touchscreen w/FitTouch Tech.	\$ 6,595.00	40%	\$ 3,957.00
Matrix	R7XE-06	Recumbent-HDBTIP w/VA	\$ 7,894.00	40%	\$ 4,736.40
Matrix	R7XE-06	Recumbent - PROIP TV w/VA	\$ 7,494.00	40%	\$ 4,496.40
Matrix	R5X-06	Recumbent- LED Console	\$ 3,995.00	40%	\$ 2,397.00
Matrix	R3XE-06	Recumbent - 10" touchscreen w/FitTouch Tech.	\$ 4,895.00	40%	\$ 2,937.00
Matrix	R3X-06	Recumbent - LED Console	\$ 3,595.00	40%	\$ 2,157.00
Matrix	ROM3	Recumbent w/ROM - LED Console	\$ 6,995.00	40%	\$ 4,197.00
Matrix	R1XE	Recumbent - 10" touchscreen w/FitTouch Tech.	\$ 4,395.00	40%	\$ 2,637.00
Matrix	R1X	Recumbent - LED Console	\$ 2,995.00	40%	\$ 1,797.00

MATRIX**Cardio****Bikes**

Model Number/ Catalog Name		Product Description	MSRP	% Discount	With Discount
Matrix	U7XI-06	Upright- 16" capacitive touchscreen w/ FitTouch	\$ 7,850.00	40%	\$ 4,710.00
Matrix	U7XI-06	Upright- HDBTIP TV	\$ 7,850.00	40%	\$ 4,710.00
Matrix	U7XI-06	Upright- PROIP TV	\$ 7,850.00	40%	\$ 4,710.00
Matrix	U7XE-06	Upright- 16" touchscreen w/ FitTouch Technology	\$ 6,295.00	40%	\$ 3,777.00
Matrix	U7XE-06	Upright - HDBTIP w/VA	\$ 7,194.00	40%	\$ 4,316.40
Matrix	U7XE-06	Upright - PROIP TV w/ VA	\$ 7,194.00	40%	\$ 4,316.40
Matrix	U5X-06	Upright - LED Console	\$ 3,695.00	40%	\$ 2,217.00
Matrix	U3X-06	Upright - LED Console	\$ 3,295.00	40%	\$ 1,977.00
Matrix	U3XE-06	Upright - 10"touchscreen w/ FitTouch Technology	\$ 4,595.00	40%	\$ 2,757.00
Matrix	U1XE	Upright - 10" touchscreen w/FitTouch Technology	\$ 3,895.00	40%	\$ 2,337.00
Matrix	U1X	Upright - LED Console	\$ 2,695.00	40%	\$ 1,617.00
Matrix					
Matrix					

Rower

Model Number/ Catalog Name		Product Description	MSRP	% Discount	With Discount
Matrix	Rower-02	Rower-X with Magnetic Resistance	\$ 1,895.00	30%	\$ 1,326.50

MATRIX

Cardio

Entertainment & Technology

Model Number/ Catalog Name		Product Description	MSRP	% Discount	With Discount
Matrix	VA-16GB	Virtual Active - 10 Pack	\$ 899.00	0%	\$ 899.00
Matrix	VACP	Virtual Active - Incremental Pack	\$ 399.00	0%	\$ 399.00

Matrix	RFID	RFID (USE rfid cardio kit #)	\$	400.00	0%	\$	400.00
Matrix	WAPPAM	Wireless Access Point Pkg Asset Mgmt	\$	3,195.00	0%	\$	3,195.00
Matrix	WAPAMI	Wireless Access Point Pkg Asset Mgmt Incremental	\$	2,295.00	0%	\$	2,295.00
Matrix	DATA	Asset Management Data Fee	\$	69.00	0%	\$	69.00
Matrix	ZMT4000027	Workout Tracking Mobile App - 1 Year	\$	2,388.00	35%	\$	1,552.20
Matrix	ZMT4000028	Workout Tracking Mobile App - 2 Years	\$	4,776.00	35%	\$	3,104.40
Matrix	ZMT4000029	Workout Tracking Mobile App - 3 Years	\$	7,164.00	35%	\$	4,656.60
Matrix	ZMT4000030	Workout Tracking Mobile App - 4 Years	\$	9,552.00	35%	\$	6,208.80
Matrix	ZMT4000031	Workout Tracking Mobile App - 5 Years	\$	11,990.00	35%	\$	7,793.50
Matrix	ZMT4000052	Personal Trainer Portal - 1 Year	\$	4,995.00	35%	\$	3,246.75
Matrix	MC3R-9LK	MYE Wireless Audio Receiver	\$	199.00	35%	\$	129.35
Matrix	MWTD-S9	MYE Wireless Audio Digital Transmitter	\$	399.00	35%	\$	259.35
Matrix	ZMD4006553	Matrix MYE 15.6" TV with HDMI Port	\$	1,495.00	35%	\$	971.75
Matrix	ZMD4006554	Matrix MYE 15.6" TV with PRO IDIOM	\$	1,595.00	35%	\$	1,036.75

MATRIX

Cardio

Entertainment & Technology

Model Number/

	Catalog Name	Product Description	MSRP	% Discount	With Discount	
Matrix	LHR-T1X	T1X-04 Long Handrail	\$	499.00	0% \$	499.00
Matrix	1000356737	TV Bracket for 5 Series HURSE	\$	195.00	0% \$	195.00
Matrix	1000348697	TV Bracket for 3 Series HURSEAC	\$	195.00	0% \$	195.00
Matrix	1000362098	TV Bracket for 1/3XE Series Tread	\$	195.00	0% \$	195.00
Matrix	1000362148	TV Bracket for 3X Series Tread	\$	195.00	0% \$	195.00
Matrix	1000356251	TV Bracket for 5X/7XE Series Tread	\$	195.00	0% \$	195.00
Matrix	1000356804	TV Bracket for 5/7/7XE Series Climbmill	\$	195.00	0% \$	195.00
Matrix	1000352847	TV Bracket for 3 Series Climbmill	\$	195.00	0% \$	195.00

Matrix 1000362998 TV Bracket for 1 Series URE \$ 195.00 0% \$ 195.00

MATRIX

GroupX

Cardio

Model Number/ Catalog Name	Product Description	MSRP	% Discount	With Discount
Matrix CXC	Indoor Cycling Bike - Optional LCD Console	\$ 1,995.00	30%	\$ 1,396.50
Matrix CXM	Indoor Cycling Bike - Backlit LCD Console	\$ 2,495.00	30%	\$ 1,746.50
Matrix CXP	Indoor Cycling Bike - Target Training Console	\$ 3,295.00	30%	\$ 2,306.50
Matrix KC-01	Krankcycle w/Seat	\$ 2,295.00	30%	\$ 1,606.50
Matrix KC-02	Krankcycle w/out Seat	\$ 2,195.00	30%	\$ 1,536.50
Matrix KC-TRAIN1	Krankcycle Start-Up Kit	\$ 129.00	30%	\$ 129.00
Matrix KC-COM	Wireless Computer + Bracket	\$ 199.00	30%	\$ 139.30
Matrix MX4SGI	MX4 Small Group 5 hr Training - Individual	\$ 129.00	30%	\$ 129.00
Matrix MX4SGM	MX4 Small Group 5 hr Training - Group - Max 12	\$ 2,250.00	30%	\$ 2,250.00
Matrix MX4MS	MX4 Annual Support (Yearly Subscription)	\$ 1,500.00	30%	\$ 1,500.00
Matrix S8IT	Sprint 8 2 Hr Instructor Training - 1 Person	\$ 199.00	30%	\$ 199.00
Matrix S8GT	Sprint 8 2 Hr Instructor Training - Team of 10+	\$ 1,750.00	30%	\$ 1,750.00
Matrix T-DPT	S-Drive Performance Trainer	\$ 3,895.00	30%	\$ 2,726.50
Matrix SPT	S-Force Performance Trainer	\$ 4,895.00	30%	\$ 3,426.50

MATRIX

Group X

Connexus

	Model Number/ Catalog Name	Product Description	MSRP	% Discount	With Discount
Matrix	GFTFS	Connexus Free (free standing config.)	\$ 5,800.00	30%	\$ 4,060.00
Matrix	GFTWM	Connexus Perimeter (wall unit)	\$ 4,150.00	30%	\$ 2,905.00
Matrix	GFTEXP	Connexus Perimeter Expansion Kit	\$ 3,350.00	30%	\$ 2,345.00
Matrix	ZMK4001073	MX4 Connexus Perimeter Kit	\$ 5,414.00	30%	\$ 3,519.10
Matrix	ZMK4001074	MX4 Connexus Expansion Kit	\$ 4,615.00	30%	\$ 2,999.75
Matrix	ZMK4001075	MX4 Connexus Free Kit	\$ 14,130.00	30%	\$ 9,184.50
Matrix	GFTMB	Connexus Med Ball Wall	\$ 575.00	30%	\$ 402.50
Matrix	GFTCB	Connexus Magnetic Chalkboard	\$ 330.00	30%	\$ 231.00
Matrix	GFTLM	Connexus Landmine Attachment	\$ 260.00	30%	\$ 182.00
Matrix	GFT3S	Connexus 3 Shelf Mobile Storage Cart	\$ 1,250.00	30%	\$ 875.00
Matrix	GFT2S	Connexus 2 Shelf Mobile Storage Cart	\$ 900.00	30%	\$ 630.00

Accessory Kits

	Model Number/ Catalog Name	Product Description	MSRP	% Discount	With Discount
Matrix	ZMK4000600	Connexus Free w/Boxing Kit	\$ 3,450.00	30%	\$ 2,415.00
Matrix	ZMK4000601	Connexus Free Standard Kit	\$ 3,390.00	30%	\$ 2,373.00
Matrix	ZMK4000602	Connexus Perimeter Wall w/ Boxing Kit	\$ 1,990.00	30%	\$ 1,393.00
Matrix	ZMK4000603	Connexus Perimeter Wall standard Kit	\$ 1,690.00	30%	\$ 1,183.00
Matrix	MAS0883-05	Connexus Vertical Extrusion w/handle (for Free Stand Only)	\$ 480.00	30%	\$ 336.00
Matrix	MAS0887-05	Connexus Heavy Bag Straps & Carabineer	\$ 55.00	30%	\$ 38.50
Matrix	MG-A67B	Matrix MG Weight Tree	\$ 510.00	30%	\$ 367.20
Matrix	MAS0939-05	Trainer Battle Attachment	\$ 75.00	0%	\$ 75.00
Matrix	MAS0940-05	Connexus Lower Wall Mount Bracket	\$ 65.00	0%	\$ 65.00

MATRIX

Ultra Selectorized

Chest

Model Number/ Catalog Name	Product Description	MSRP	% Discount	With Discount
Matrix G7S13	Converging Chest Press	\$ 4,350.00	35%	\$ 2,827.50
Matrix G7S12	Pectoral Fly	\$ 4,250.00	35%	\$ 2,762.50

Shoulder

Model Number/ Catalog Name	Product Description	MSRP	% Discount	With Discount
Matrix G7S23	Converging Shoulder	\$ 4,250.00	35%	\$ 2,762.50
Matrix G7S21	Lateral Raise	\$ 3,950.00	35%	\$ 2,567.50

Back

Model Number/ Catalog Name	Product Description	MSRP	% Discount	With Discount
Matrix G7S33	Diverging Lat Pull Down	\$ 4,250.00	35%	\$ 2,762.50
Matrix G7S34	Diverging Seated Row	\$ 4,350.00	35%	\$ 2,827.50

Arm

Model Number/ Catalog Name	Product Description	MSRP	% Discount	With Discount
Matrix G7S40	Independent Biceps Curl	\$ 3,950.00	35%	\$ 2,567.50
Matrix G7S42	Triceps Press	\$ 4,250.00	35%	\$ 2,762.50

Core

Model Number	Product Description	MSRP	% Discount	With Discount
Matrix G7S51	Abdominal Crunch	\$ 4,250.00	35%	\$ 2,762.50
Matrix G7S52	Back Extension	\$ 4,450.00	35%	\$ 2,892.50



Ultra Selectorized

Leg

Model Number/ Catalog Name		Product Description	MSRP	% Discount	With Discount
Matrix	G7S70	Leg Press	\$ 6,750.00	35%	\$ 4,387.50
Matrix	G7S71	Leg Extension	\$ 4,250.00	35%	\$ 2,762.50
Matrix	G7S72	Seated Leg Curl	\$ 4,350.00	35%	\$ 2,827.50
Matrix	G7S73	Prone Leg Curl	\$ 4,150.00	35%	\$ 2,697.50
Matrix	G7S74	Hip Adductor	\$ 4,350.00	35%	\$ 2,827.50
Matrix	G7S75	Hip Abductor	\$ 4,350.00	35%	\$ 2,827.50
Matrix	G7S77	Calf Extension	\$ 3,950.00	35%	\$ 2,567.50
Matrix	G7S78	Glute	\$ 3,950.00	35%	\$ 2,567.50

Aura Selectorized

Chest

Model Number/ Catalog Name		Product Description	MSRP	% Discount	With Discount
Matrix	G3S10	Chest Press	\$ 3,550.00	35%	\$ 2,307.50
Matrix	G3S13	Converging Chest Press	\$ 3,775.00	35%	\$ 2,453.75
Matrix	G3S12	Pec Fly	\$ 3,675.00	35%	\$ 2,388.75

Shoulder

Model Number/ Catalog Name		Product Description	MSRP	% Discount	With Discount
Matrix	G3S20	Shoulder Press	\$ 3,300.00	35%	\$ 2,145.00
Matrix	G3S23	Converging Shoulder	\$ 3,550.00	35%	\$ 2,307.50
Matrix	G3S21	Lateral Raise	\$ 3,300.00	35%	\$ 2,145.00
Matrix	G3S22	Rear Delt/Fly	\$ 3,875.00	35%	\$ 2,518.75

MATRIX

Aura Selectorized

Back

Model Number/

Catalog Name	Product Description	MSRP	% Discount	With Discount
Matrix G3S30	Lat Pull	\$ 2,900.00	35%	\$ 1,885.00
Matrix G3S33	Diverging Lat Pull	\$ 3,150.00	35%	\$ 2,047.50
Matrix G3S31	Seated Row	\$ 3,400.00	35%	\$ 2,210.00
Matrix G3S34	Diverging Seated Row	\$ 3,675.00	35%	\$ 2,388.75

Matrix

Arm

Model Number/

Catalog Name	Product Description	MSRP	% Discount	With Discount
Matrix G3S40	Arm Curl	\$ 3,150.00	35%	\$ 2,047.50
Matrix G3S42	Seated Dip	\$ 3,350.00	35%	\$ 2,177.50
Matrix G3S45	Triceps Extension	\$ 3,300.00	35%	\$ 2,145.00
Matrix G3S60	Dip/Chin Assist	\$ 3,675.00	35%	\$ 2,388.75

Matrix

Core

Model Number/

Catalog Name	Product Description	MSRP	% Discount	With Discount
Matrix G3S51	Abdominal Crunch	\$ 3,550.00	35%	\$ 2,307.50
Matrix G3S52	Back Extension	\$ 3,550.00	35%	\$ 2,307.50
Matrix G3S55	Rotary Torso	\$ 3,550.00	35%	\$ 2,307.50

MATRIX

Aura Selectorized

Leg

Model Number/ Catalog Name	Product Description	MSRP	% Discount	With Discount
Matrix G3S70	Leg Press	\$ 5,550.00	35%	\$ 3,607.50
Matrix G3S71	Leg Extension	\$ 3,400.00	35%	\$ 2,210.00
Matrix G3S72	Seated Leg Curl	\$ 3,400.00	35%	\$ 2,210.00
Matrix G3S73	Prone Leg Curl	\$ 3,300.00	35%	\$ 2,145.00
Matrix G3S74	Hip Adductor	\$ 3,550.00	35%	\$ 2,307.50
Matrix G3S75	Hip Abductor	\$ 3,550.00	35%	\$ 2,307.50
Matrix G3S76	Rotary Hip	\$ 3,875.00	35%	\$ 2,518.75
Matrix G3S77	Calf Press	\$ 3,775.00	35%	\$ 2,453.75

Aura Benches and Racks

Benches

Model Number/ Catalog Name	Product Description	MSRP	% Discount	With Discount
Matrix G3FW13	Olympic Flat Bench	\$ 1,095.00	28%	\$ 788.40
Matrix G3FW14	Olympic Incline Bench	\$ 1,195.00	28%	\$ 860.40
Matrix G3FW15	Olympic Decline Bench	\$ 1,195.00	28%	\$ 860.40
Matrix G3FW40	Preacher Curl	\$ 895.00	28%	\$ 644.40
Matrix G3FW52	Back Extension	\$ 895.00	28%	\$ 644.40
Matrix G3FW72	Squat Rack	\$ 1,495.00	28%	\$ 1,076.40
Matrix G3FW73	Power Station	\$ 1,995.00	28%	\$ 1,436.40
Matrix G3FW80	Multi Adjustable Bench	\$ 995.00	28%	\$ 716.40
Matrix G3FW82	Adjustable Bench	\$ 795.00	28%	\$ 572.40
Matrix G3FW81	Flat Bench	\$ 525.00	28%	\$ 378.00
Matrix G3FW83	Adjustable Decline Bench	\$ 795.00	28%	\$ 572.40
Matrix G3FW84	Utility Bench	\$ 595.00	28%	\$ 428.40

MATRIX

Aura Benches and Racks

Racks

Model Number/

Catalog Name	Product Description	MSRP	% Discount	With Discount
Matrix G3FW91	10 Pair Dumbbell Rack	\$ 1,095.00	28%	\$ 788.40
Matrix G3FW94	Olympic Weight Tree	\$ 595.00	28%	\$ 428.40
Matrix G3FW96	Barbell Rack	\$ 895.00	28%	\$ 644.40
Matrix G3FW97	Accessory Rack	\$ 695.00	28%	\$ 500.40

Aura Multi Stations

Model Number/

Catalog Name	Product Description	MSRP	% Discount	With Discount
Matrix G3-MS20	Matrix Aura Cable Cross	\$ 4,190.00	28%	\$ 3,016.80
Matrix G3-MS24	Matrix Aura Adjustable Pulley	\$ 1,975.00	28%	\$ 1,422.00
Matrix G3-MS51	Matrix Aura Lat Pulldown	\$ 2,025.00	28%	\$ 1,458.00
Matrix G3-MS52	Matrix Aura Triceps Pushdown	\$ 1,450.00	28%	\$ 1,044.00
Matrix G3-MS53	Matrix Seated Row	\$ 2,125.00	28%	\$ 1,530.00
Matrix G3-MS40CK	Matrix Aura Multi-station Connection Kit	\$ 295.00	28%	\$ 212.40
Matrix G3-MS50CK	Matrix Aura Multi-station Connection Kit	\$ 575.00	28%	\$ 414.00
Matrix G3-MS80CK	Matrix Aura Multi-station Connection Kit	\$ 335.00	28%	\$ 241.20
Matrix G3-MSFT300	Matrix Aura Functional Trainer 300lb	\$ 5,890.00	28%	\$ 4,240.80
Matrix G3-MSFT400	Matrix Aura Functional Trainer 400lbs	\$ 6,290.00	28%	\$ 4,528.80

MATRIX

Versa Selectorized

STD Stack

Model Number/

	Catalog Name	Product Description	MSRP	% Discount	With Discount
Matrix	VS-S13-USB1	Converging Chest Press	\$ 2,795.00	35%	\$ 1,816.75
Matrix	VS-S23-USB1	Converging Shoulder Press	\$ 2,995.00	35%	\$ 1,946.75
Matrix	VS-S72-USB1	Seated Leg Curl	\$ 2,695.00	35%	\$ 1,751.75
Matrix	VS-S71-USB1	Leg Extension	\$ 2,895.00	35%	\$ 1,881.75
Matrix	VS-S33-USB1	Diverging Lat Pulldown	\$ 2,995.00	35%	\$ 1,946.75
Matrix	VS-S42-USB1	Triceps Press	\$ 2,395.00	35%	\$ 1,556.75
Matrix	VS-S34-USB1	Diverging Seated Row	\$ 2,795.00	35%	\$ 1,816.75
Matrix	VS-S40-USB1	Bicep Curl	\$ 2,395.00	35%	\$ 1,556.75
Matrix	VS-S53-USB1	Abdominal	\$ 2,195.00	35%	\$ 1,426.75
Matrix	VS-S52-USB1	Back Extension	\$ 2,495.00	35%	\$ 1,621.75

Matrix

STD Stack Pl

Matrix	VS-S13-USB3	Converging Chest Press	\$ 3,190.00	35%	\$ 2,073.50
Matrix	VS-S23-USB3	Converging Shoulder Press	\$ 3,390.00	35%	\$ 2,203.50
Matrix	VS-S72-USB3	Seated Leg Curl	\$ 3,090.00	35%	\$ 2,008.50
Matrix	VS-S71-USB3	Leg Extension	\$ 3,290.00	35%	\$ 2,138.50
Matrix	VS-S33-USB3	Diverging Lat Pulldown	\$ 3,390.00	35%	\$ 2,203.50
Matrix	VS-S42-USB3	Triceps Press	\$ 2,790.00	35%	\$ 1,813.50
Matrix	VS-S34-USB3	Diverging Seated Row	\$ 3,190.00	35%	\$ 2,073.50
Matrix	VS-S40-USB3	Bicep Curl	\$ 2,790.00	35%	\$ 1,813.50
Matrix	VS-S53-USB3	Abdominal	\$ 2,590.00	35%	\$ 1,683.50
Matrix	VS-S52-USB3	Back Extension	\$ 2,890.00	35%	\$ 1,878.50

Matrix

Heavy Stack

Matrix	VS-S13-USB2	Converging Chest Press	\$ 2,970.00	35%	\$ 1,930.50
Matrix	VS-S23-USB2	Converging Shoulder Press	\$ 3,170.00	35%	\$ 2,060.50
Matrix	VS-S72-USB2	Seated Leg Curl	\$ 3,770.00	35%	\$ 2,450.50
Matrix	VS-S71-USB2	Leg Extension	\$ 2,870.00	35%	\$ 1,865.50

Matrix	VS-S33-USB2	Diverging Lat Pulldown	\$	3,170.00	35%	\$	2,060.50
Matrix	VS-S42-USB2	Triceps Press	\$	2,570.00	35%	\$	1,670.50
Matrix	VS-S34-USB2	Diverging Seated Row	\$	2,970.00	35%	\$	1,930.50
Matrix	VS-S40-USB2	Bicep Curl	\$	2,570.00	35%	\$	1,670.50
Matrix	VS-S53-USB2	Abdominal	\$	2,370.00	35%	\$	1,540.50
Matrix	VS-S52-USB2	Back Extension	\$	2,670.00	35%	\$	1,735.50
Matrix	VS-S78-USB2	Glute	\$	2,870.00	35%	\$	1,865.50
Matrix	Heavy Stack +						
Matrix	VS-S13-USB4	Converging Chest Press	\$	3,365.00	35%	\$	2,187.25
Matrix	VS-S23-USB4	Converging Shoulder Press	\$	3,565.00	35%	\$	2,317.25
Matrix	VS-S72-USB4	Seated Leg Curl	\$	4,165.00	35%	\$	2,707.25
Matrix	VS-S71-USB4	Leg Extension	\$	3,265.00	35%	\$	2,122.25
Matrix	VS-S33-USB4	Diverging Lat Pulldown	\$	3,465.00	35%	\$	2,552.25
Matrix	VS-S42-USB4	Triceps Press	\$	2,965.00	35%	\$	1,927.25
Matrix	VS-S34-USB4	Diverging Seated Row	\$	3,365.00	35%	\$	2,187.25
Matrix	VS-S40-USB4	Bicep Curl	\$	2,965.00	35%	\$	1,927.25
Matrix	VS-S53-USB4	Abdominal	\$	2,765.00	35%	\$	1,797.25
Matrix	VS-S52-USB4	Back Extension	\$	3,065.00	35%	\$	1,992.25
Matrix	VS-S78-USB4	Glute	\$	3,265.00	35%	\$	2,122.25

MATRIX

Versa Duals

STD Stack

Model Number/ Catalog Name	Product Description	MSRP	% Discount	With Discount
Matrix VS-S22-USB1	Pec Fly/Rear Delt	\$ 3,095.00	35%	\$ 2,011.75
Matrix VS-S74-USB1	Hip Adductor/Abductor	\$ 3,095.00	35%	\$ 2,011.75

Matrix	VS-S131-02B1	Multi-Press	\$	3,095.00	35%	\$	2,011.75
Matrix	VS-S331-02B1	Lat Row	\$	3,095.00	35%	\$	2,011.75
Matrix	VS-S401-02B1	Tri/Bicep	\$	2,995.00	35%	\$	1,946.75
Matrix	VS-S531-02B1	Low Back/AB	\$	2,995.00	35%	\$	1,946.75
Matrix	VS-S711-02B1	Leg Extension/Leg Curl	\$	3,095.00	35%	\$	2,011.75
Matrix	STD Stack Plus						
Matrix	VS-S22-USB3	Pec Fly/Rear Delt	\$	3,490.00	35%	\$	2,268.50
Matrix	VS-S74-USB3	Hip Adductor/Abductor	\$	3,490.00	35%	\$	2,268.50
Matrix	VS-S131-02B3	Multi-Press	\$	3,490.00	35%	\$	2,268.50
Matrix	VS-S331-02B3	Lat Row	\$	3,490.00	35%	\$	2,268.50
Matrix	VS-S401-02B3	Tri/Bicep	\$	3,390.00	35%	\$	2,203.50
Matrix	VS-S531-02B3	Low Back/AB	\$	3,390.00	35%	\$	2,203.50
Matrix	VS-S711-02B3	Leg Extension/Leg Curl	\$	3,490.00	35%	\$	2,268.50
Matrix	Hvy. Stack Basic						
Matrix	VS-S22-USB2	Pec Fly/Rear Delt	\$	3,270.00	35%	\$	2,125.50
Matrix	VS-S74-USB2	Hip Adductor/Abductor	\$	3,270.00	35%	\$	2,125.50
Matrix	VS-S131-02B2	Multi-Press	\$	3,270.00	35%	\$	2,125.50
Matrix	VS-S331-02B2	Lat Row	\$	3,270.00	35%	\$	2,125.50
Matrix	VS-S401-02B2	Tri/Bicep	\$	3,170.00	35%	\$	2,060.50
Matrix	VS-S531-02B2	Low Back/AB	\$	3,170.00	35%	\$	2,060.50
Matrix	VS-S601-0282	Chin/Dip	\$	4,170.00	35%	\$	2,710.50
Matrix	VS-S711-02B2	Leg Extension/Leg Curl	\$	3,270.00	35%	\$	2,125.50
Matrix	Heavy Stack +						
Matrix	VS-S22-USB4	Pec Fly/Rear Delt	\$	3,665.00	35%	\$	2,382.25
Matrix	VS-S74-USB4	Hip Adductor/Abductor	\$	3,665.00	35%	\$	2,382.25
Matrix	VS-S131-02B4	Multi-Press	\$	3,665.00	35%	\$	2,382.25
Matrix	VS-S331-02B4	Lat Row	\$	3,665.00	35%	\$	2,382.25
Matrix	VS-S401-02B4	Tri/Bicep	\$	3,565.00	35%	\$	2,317.25
Matrix	VS-S531-02B4	Low Back/AB	\$	3,565.00	35%	\$	2,317.25
Matrix	VS-S601-0284	Chin/Dip	\$	4,565.00	35%	\$	2,967.25
Matrix	VS-S711	Leg Extension/Leg Curl	\$	3,665.00	35%	\$	2,382.25
Matrix							

Matrix
 Matrix
 Matrix
 Matrix
 Matrix
 Matrix
 Matrix
 Matrix

MATRIX

Versa Functional Trainers

Model Number/

Matrix	Catalog Name	Product Description	MSRP	% Discount	With Discount
Matrix	VS-VFT LS+VS-FTS1	Functional Trainer STD Stack, 18" Storage	\$ 4,395.00	28%	\$ 2,856.75
Matrix	VS-VFT HS+VS-FTS	Functional Trainer Heavy Stack, 18" Storage	\$ 4,795.00	28%	\$ 3,116.75
Matrix	VS-VFT LS+VS-FTS3	Functional Trainer STD Stack, 30" Storage	\$ 4,595.00	28%	\$ 2,986.75
Matrix	VS-VFT HS+VS-FTS	Functional Trainer Heavy Stack, 18" Storage	\$ 4,995.00	28%	\$ 3,246.75

Matrix
 Matrix
 Matrix
 Matrix

Varsity

Bench & Rack

Model Number/

Matrix	Catalog Name	Product Description	MSRP	% Discount	With Discount
Matrix	G1FW153	Adjustable Incline Bench	\$ 525.00	28%	\$ 378.00
Matrix	G1FW161	Smith Machine	\$ 2,695.00	28%	\$ 1,940.40

Matrix

Multi Station

Model Number/

Matrix	Catalog Name	Product Description	MSRP	% Discount	With Discount
Matrix	G1MG30	3-Stack Multi-Gym	\$ 5,390.00	28%	\$ 3,880.80

Matrix

Matrix
 Matrix
 Matrix
 Matrix
 Matrix
 Matrix
 Matrix

MATRIX

Magnum

Configurable Multi-Stations

Model Number/ Catalog Name	Product Description	MSRP	% Discount	With Discount
Matrix MG-902	Prone Leg Curl	\$ 3,475.00	28%	\$ 2,258.75
Matrix MG-903	Leg Press	\$ 4,450.00	28%	\$ 2,892.50
Matrix MG-921	Lat Pulldown	\$ 2,850.00	28%	\$ 1,852.50
Matrix MG-DP921	Dual-pulley Lat Pulldown	\$ 3,275.00	28%	\$ 2,128.75
Matrix MG-926	Low Row	\$ 2,850.00	28%	\$ 1,852.50
Matrix MG-DP926	Dual-pulley Low Row	\$ 3,250.00	28%	\$ 2,112.50
Matrix MG-936	Rear Delt / Fly	\$ 3,650.00	28%	\$ 2,372.50
Matrix MG-937	Dip / Chin Assist	\$ 3,650.00	28%	\$ 2,372.50
Matrix MG-946	Lat Pulldown / Low Row	\$ 3,100.00	28%	\$ 2,015.00
Matrix MG-924	Adjustable Crossover	\$ 4,450.00	28%	\$ 2,892.50
Matrix MG-923	Adjustable Pulley	\$ 2,325.00	28%	\$ 1,511.25
Matrix MG-DP923	Dual Adjustable Pulley	\$ 2,375.00	28%	\$ 1,543.75
Matrix MG-942	Triceps Pushdown	\$ 2,350.00	28%	\$ 1,527.50
Matrix MG-947	Biceps / Triceps	\$ 2,600.00	28%	\$ 1,690.00
Matrix MG-ADA2220	Chest Press/Row (Wheelchair access.)	\$ 4,175.00	28%	\$ 2,713.75
Matrix MG-ADA1121	Biceps/Lat Pull (Wheelchair access.)	\$ 4,175.00	28%	\$ 2,713.75
Matrix MG-ADA18	Pec Deck (Wheelchair access.)	\$ 4,175.00	28%	\$ 2,713.75
Matrix MG-ADA23	Adj Pulley (Wheelchair access.)	\$ 3,625.00	28%	\$ 2,356.25

Free Standing Multi-Stations

Model Number/ Catalog Name	Product Description	MSRP	% Discount	With Discount
Matrix MG-FS902	Free-standing Prone Leg Curl	\$ 3,575.00	28%	\$ 2,323.75

Matrix	MG-FS903	Free-standing Leg Press	\$ 4,525.00	28%	\$ 2,941.25
Matrix	MG-FS921	Free-standing Lat Pulldown	\$ 2,950.00	28%	\$ 1,917.50
Matrix	MG-FSDP921	Free-standing Dual-pulley Lat Pulldown	\$ 3,375.00	28%	\$ 2,193.75
Matrix	MG-FS926	Free-standing Low Row	\$ 2,950.00	28%	\$ 1,917.50
Matrix	MG-FSDP926	Free-standing Dual-pulley Low Row	\$ 3,375.00	28%	\$ 2,193.75
Matrix	MG-FS936	Free-standing Rear Delt / Fly	\$ 3,750.00	28%	\$ 2,437.50
Matrix	MG-FS937	Free-standing Dip / Chin Assist	\$ 3,750.00	28%	\$ 2,437.50
Matrix	MG-FS946	Free-standing Lat Pulldown / Low Row	\$ 3,200.00	28%	\$ 2,080.00
Matrix	MG-FS924	Free-standing Adjustable Crossover	\$ 4,450.00	28%	\$ 2,892.50
Matrix	MG-FS923	Free-standing Adjustable Pulley	\$ 2,800.00	28%	\$ 1,820.00
Matrix	MG-FSDP923	Free-standing Dual Adjustable Pulley	\$ 2,900.00	28%	\$ 1,885.00
Matrix	MG-FS942	Free-standing Triceps Pushdown	\$ 2,600.00	28%	\$ 1,690.00
Matrix	MG-FS947	Free-standing Biceps / Triceps	\$ 2,825.00	28%	\$ 1,836.25

Station Options

Model Number/

	Catalog Name	Product Description	MSRP	% Discount	With Discount
Matrix	M99	Wheelchair Seat	\$ 355.00	0%	\$ 355.00
Matrix	COCB-02	Crossover Bar w/ Chin Handles	\$ 200.00	0%	\$ 200.00
Matrix	TAR-1	Free-Standing Accessory Rack (Ridge Black Color)	\$ 545.00	0%	\$ 545.00
Matrix	TAR-2	Bolt-On Accessory Rack (Ridge Black Color Only)	\$ 500.00	0%	\$ 500.00

MATRIX

Magnum

Plate Loaded

Model Number/

	Catalog Name	Product Description	MSRP	% Discount	With Discount
--	--------------	---------------------	------	------------	---------------

Matrix	MG-PL12	Vertical Bench Press	\$	2,325.00	28%	\$	1,674.00
Matrix	MG-PL13	Supine Bench Press	\$	1,800.00	28%	\$	1,296.00
Matrix	MG-PL14	Incline Bench Press	\$	2,325.00	28%	\$	1,674.00
Matrix	MG-PL15	Vertical Decline Bench Press	\$	2,550.00	28%	\$	1,836.00
Matrix	MG-PL23	Shoulder Press	\$	2,050.00	28%	\$	1,476.00
Matrix	MG-PL33	Lat Pulldown	\$	2,050.00	28%	\$	1,476.00
Matrix	MG-PL34	Seated Row	\$	2,050.00	28%	\$	1,476.00
Matrix	MG-PL50	Ab Crunch Bench	\$	1,390.00	28%	\$	1,000.80
Matrix	MG-PL62	Smith Machine	\$	3,990.00	28%	\$	2,872.80
Matrix	MG-PL70	Leg Press	\$	3,990.00	28%	\$	2,872.80
Matrix	MG-PL71	Hack Squat	\$	3,825.00	28%	\$	2,754.00
Matrix	MG-PL76	Standing Calf	\$	2,090.00	28%	\$	1,504.80
Matrix	MG-PL77	Seated Calf	\$	1,225.00	28%	\$	882.00
Matrix	MG-PL79	Squat Lunge	\$	1,390.00	28%	\$	1,000.80
Matrix	MG-404	4-Way Neck	\$	1,750.00	28%	\$	1,260.00
Matrix	MG-405	Reverse Back Extension	\$	2,230.00	28%	\$	1,605.60

MATRIX

Magnum

Free Weights (* stocked in ice silver frame, black pads)

	Model Number/ Catalog Name	Product Description		MSRP	% Discount		With Discount
Matrix	MG-A78N*	Olympic Flat Bench	\$	985.00	28%	\$	709.20
Matrix	MG-A78*	Olympic Flat Bench (integrated storage horns)	\$	1,315.00	28%	\$	946.80
Matrix	MG-A678N	Breaker Olympic Flat Bench	\$	1,250.00	28%	\$	900.00
Matrix	MG-A678	Breaker Olympic Flat Bench (integrated storage horns)	\$	1,585.00	28%	\$	1,141.20
Matrix	MG-A678BN	Breaker Olympic Flat Bench (blk bar)	\$	1,250.00	28%	\$	900.00
Matrix	MG-A678B	Breaker Olympic Flat Bench (integrated storage horns)(blk ba	\$	1,585.00	28%	\$	1,141.20
Matrix	MG-A79N*	Olympic Incline Bench	\$	1,160.00	28%	\$	835.20

Matrix	MG-A79*	Olympic Incline Bench (integrated storage horns)	\$ 1,500.00	28%	\$ 1,080.00
Matrix	MG-A679N*	Breaker Olympic Incline Bench	\$ 1,335.00	28%	\$ 961.20
Matrix	MG-A679*	Breaker Olympic Incline Bench (integrated storage horns)	\$ 1,670.00	28%	\$ 1,202.40
Matrix	MG-A679BN*	Breaker Olympic Incline Bench (blk bar)	\$ 1,335.00	28%	\$ 961.20
Matrix	MG-A679B*	Breaker Olympic Incline Bench(integrated storage horns)(blk	\$ 1,670.00	28%	\$ 1,202.40
Matrix	MG-A80N*	Olympic Decline Bench	\$ 1,050.00	28%	\$ 756.00
Matrix	MG-A80*	Olympic Decline Bench(integrated storage horns)	\$ 1,385.00	28%	\$ 997.20
Matrix	MG-A680N*	Breaker Olympic Decline Bench	\$ 1,385.00	28%	\$ 997.20
Matrix	MG-A680*	Breaker Olympic Decline Bench(integrated storage horns)	\$ 1,720.00	28%	\$ 1,238.40
Matrix	MG-A680BN*	Breaker Olympic Decline Bench(blk bar)	\$ 1,385.00	28%	\$ 997.20
Matrix	MG-A680B*	Breaker Olympic Decline Bench(integrated storage horns) (bl	\$ 1,720.00	28%	\$ 1,238.40
Matrix	MG-A45N*	Olympic Shoulder Bench	\$ 1,385.00	28%	\$ 997.20
Matrix	MG-A45*	Olympic Shoulder Bench(integrated storage horns)	\$ 1,720.00	28%	\$ 1,238.40
Matrix	MG-A645N*	Breaker Olympic Shoulder Bench	\$ 1,715.00	28%	\$ 1,234.80
Matrix	MG-A645*	Breaker Olympic Shoulder Bench(integrated storage horns)	\$ 2,050.00	28%	\$ 1,476.00
Matrix	MG-A645BN*	Breaker Olympic Shoulder Bench(blk bar)	\$ 1,715.00	28%	\$ 1,234.80
Matrix	MG-A645B*	Breaker Olympic Shoulder Bench(integrated storage horns)(b	\$ 2,050.00	28%	\$ 1,476.00
Matrix	MG-C895	3-Way Olympic Bench	\$ 2,250.00	28%	\$ 1,620.00
Matrix	MG-A82*	Multi-Adjustable Bench Low Profile	\$ 1,045.00	28%	\$ 752.40

MATRIX

Magnum

Free Weights (* stocked in ice silver frame, black pads)

Model Number/ Catalog Name	Product Description	MSRP	% Discount	With Discount
Matrix MG-A85*	Multi-adjustable Bench	\$ 1,050.00	28%	\$ 756.00
Matrix MG-A59*	Flat Bench	\$ 485.00	28%	\$ 349.20
Matrix MG-A71	Standing Arm Curl	\$ 1,000.00	28%	\$ 720.00
Matrix MG-A68*	Barbell Rack	\$ 815.00	28%	\$ 586.80

Matrix	MG-A63C*	Verticle Knee Raise w/Chin	\$	1,375.00	28%	\$	990.00
Matrix	MG-A62*	Preacher Curl	\$	875.00	28%	\$	630.00
Matrix	MG-A87*	Utility Bench	\$	600.00	28%	\$	432.00
Matrix	MG-A67*	Weight Tree	\$	490.00	28%	\$	352.80
Matrix	MG-A81*	Squat Rack	\$	1,575.00	28%	\$	1,134.00
Matrix	MG-A93*	Back Extension Bench	\$	875.00	28%	\$	630.00
Matrix	MG-A84*	2-tier Dumbbell Rack w/Saddles (10 pr.)	\$	915.00	28%	\$	658.80
Matrix	MG-A41*	3-tier Studio Dumbbell Rack w/Saddles (10 pr.)	\$	895.00	28%	\$	644.40
Matrix	MG-A42*	3-tier Dumbbell Rack w/Saddles (15 pr.)	\$	1,200.00	28%	\$	864.00
Matrix	MG-A86*	Multi-adjustable Bench w/Decline	\$	1,150.00	28%	\$	828.00
Matrix	MG-A44*	3-tier Beauty Bell Rack	\$	575.00	28%	\$	414.00
Matrix	MG-A61*	Adjustable Decline Bench	\$	875.00	28%	\$	630.00
Matrix	MG-A77*	Adjustable Ab Bench	\$	1,225.00	28%	\$	882.00
Matrix	MG-A96*	Glute Ham Bench	\$	1,655.00	28%	\$	1,191.60
Matrix	MG-A695	Flat-to-incline Bench w/Horizontal Adjustment	\$	1,250.00	28%	\$	900.00

MATRIX

Magnum

Free Weights (* stocked in ice silver frame, black pads)

Model Number/

	Catelog Name	Product Description		MSRP	% Discount		With Discount
Matrix	MG-A688*	3-tier Flat-tray Dumbbell Rack	\$	1,125.00	28%	\$	810.00
Matrix	MG-A689*	3-tier Flat-tray Dumbbell Rack 6'	\$	1,000.00	28%	\$	720.00
Matrix	MG-A696*	2-tier Flat-tray Dumbbell Rack	\$	825.00	28%	\$	594.00
Matrix	MG-A697*	2-tier Flat-tray Dumbbell Rack 6'	\$	765.00	28%	\$	550.80
Matrix	MG-A301	Horizontal Plate Rack (Ridge Black Color Only)	\$	540.00	28%	\$	388.80
Matrix	MG-A303	Attachment Storage Rack (Ridge Black Color Only)	\$	900.00	28%	\$	648.00
Matrix	MG-SUP	Step-up Platform w/ Handle	\$	435.00	28%	\$	313.20

Racks (spotter stands priced seperatley)

	Model Number/ Catalog Name	Product Description	MSRP	% Discount	With Discount
Matrix	MG-A694	Open Rack 8'	\$ 2,850.00	28%	\$ 2,052.00
Matrix	MG-A694-9	Open Rack 9'	\$ 2,995.00	28%	\$ 2,156.40
Matrix	MG-A690	Half Rack 8'	\$ 2,525.00	28%	\$ 1,818.00
Matrix	MG-A690-9	Half Rack 9'	\$ 2,665.00	28%	\$ 1,918.80
Matrix	MG-A47	Power Rack 8'	\$ 3,175.00	28%	\$ 2,286.00
Matrix	MG-A47-9	Power Rack 9'	\$ 3,225.00	28%	\$ 2,322.00
Matrix	MG-A691	Double Half Rack 8'	\$ 4,875.00	28%	\$ 3,510.00
Matrix	MG-A691S	Double Half Rack 8' - COMPACT	\$ 4,400.00	28%	\$ 3,168.00
Matrix	MG-A691-9	Double Half Rack 9'	\$ 5,180.00	28%	\$ 3,729.60
Matrix	MG-MR694	MEGA Open Rack 8'	\$ 4,050.00	28%	\$ 2,916.00
Matrix	MG-MR694-9	MEGA Open Rack 9' - no spotter stands	\$ 4,350.00	28%	\$ 3,132.00
Matrix	MG-MR690	MEGA Half Rack 8'	\$ 3,800.00	28%	\$ 2,736.00
Matrix	MG-MR690-9	MEGA Half Rack 9' - no spotter stands	\$ 4,000.00	28%	\$ 2,880.00
Matrix	MG-MR47	MEGA Power Rack 8' - no spotter stands	\$ 4,200.00	28%	\$ 3,024.00
Matrix	MG-MR47-9	MEGA FullPower Rack 9'- no spotter stands	\$ 4,600.00	28%	\$ 3,312.00
Matrix	MG-MR691	MEGA Double Half Rack 8'	\$ 6,600.00	28%	\$ 4,752.00
Matrix	MG-A47691	Combo Power / Half Rack	\$ 7,400.00	28%	\$ 5,328.00

MATRIX

Magnum

Rack Options

	Model Number/ Catalog Name	Product Description	MSRP	% Discount	With Discount
Matrix	MG-OPT1	MEGA/PRO J-Hooks (Pair)	\$ 365.00	0%	\$ 365.00
Matrix	MG-OPT1R	Reverse J-Hooks (Pair)	\$ 365.00	0%	\$ 365.00
Matrix	MG-OPT3	Dip Bars	\$ 365.00	0%	\$ 365.00
Matrix	MG-OPT3R	Reverse Dip Bars	\$ 365.00	0%	\$ 365.00

Matrix	MG-OPT4	3-peg Band Pegs	\$	365.00	0%	\$	365.00
Matrix	MG-OPT5	2-peg Band Pegs	\$	245.00	0%	\$	245.00
Matrix	MG-OPT6	Squat Handles (Pair)	\$	240.00	0%	\$	240.00
Matrix	MG-OPT7	Step-up Platform	\$	500.00	0%	\$	360.00
Matrix	MG-OPT7R	Reverse Step-up Platform	\$	500.00	0%	\$	360.00
Matrix	MG-OPT8	Technique Scoops	\$	795.00	0%	\$	795.00
Matrix	MG-OPT8R	Reverse Technique Scoops (Pair)	\$	795.00	0%	\$	795.00
Matrix	OPT10	Custom Platform Logo	\$	595.00	0%	\$	428.40
Matrix	OPT11	Platform Ramp	\$	200.00	0%	\$	144.00
Matrix	MG-MOPT11	Platform Ramp (for MEGA Power Racks)	\$	200.00	0%	\$	144.00
Matrix	MG-OPT13	Land Mine Attachement	\$	270.00	0%	\$	270.00
Matrix	MG-MOPT13	Land Mine Attachment (for Mega Power Racks)	\$	270.00	0%	\$	270.00
Matrix	OPT14U	Name Plate (Universal Mount)	\$	280.00	0%	\$	280.00
Matrix	OPT16	Core Handle	\$	120.00	0%	\$	120.00
Matrix	MG-OPT17	Jammin Arms (Pair)	\$	1,190.00	0%	\$	1,190.00
Matrix	MG-OPT17B	Jammin Arms w/ Band Attachment	\$	1,390.00	0%	\$	1,390.00
Matrix	MG-OPT17R	Reverse Jammin Arms (Pair) (for Power Racks only)	\$	1,190.00	0%	\$	1,190.00
Matrix	MG-OPT17RB	Reverse Jammin Arms w/ Band Attachment (Pair)	\$	1,390.00	0%	\$	1,390.00

MATRIX

Magnum

Rack Options

Model Number/ Catalog Name		Product Description	MSRP	% Discount	With Discount
Matrix	MG-OPT29	Docking Kit w/o Platform	\$	40.00	0% \$ 40.00
Matrix	MG-MOPT29	Docking Kit w/o Platform - Mega Rack	\$	40.00	0% \$ 40.00
Matrix	MG-OPT29P	Docking Kit with Platform	\$	40.00	0% \$ 40.00
Matrix	MG-MOPT29P	Docking Kit with Platform - Mega Rack	\$	40.00	0% \$ 40.00
Matrix	MG-OPT31	Battle Rope Attachment	\$	109.00	0% \$ 109.00

Matrix	MG-MOPT31	Battle Rope Attachment - Mega Rack	\$	109.00	0%	\$	109.00
Matrix	MG-OPT41	Dual Olympic Bar Storage	\$	40.00	0%	\$	40.00
Matrix	MG-MOPT41	Dual Olympic Bar Storage - Mega Rack	\$	40.00	0%	\$	40.00
Matrix	OPT42	Rotating Chin Handles	\$	450.00	0%	\$	450.00
Matrix	MG-MOPT42	Rotating Chin Handles - MR47	\$	480.00	0%	\$	480.00
Matrix	MG-OPT43	Side Mounted Pull-Up Bar	\$	330.00	0%	\$	330.00
Matrix	MG-MOPT43	Side Mounted Pull-Up Bar - Mega Rack	\$	330.00	0%	\$	330.00
Matrix	MG-OPT44	Bolt On Olympic Bar Holder (Pair)	\$	180.00	0%	\$	180.00
Matrix	MG-OPT45	Bolt On Spotters Stand MEGA and A Series	\$	420.00	0%	\$	420.00
Matrix	MG-OPT46	Removable Front Band Peg	\$	210.00	0%	\$	210.00
Matrix	MG-OPT21	Safety Arm Storage	\$	155.00	0%	\$	155.00
Matrix	MG-OPT22	Safety Arm Storage (for MR Series Racks) (Pair)	\$	205.00	0%	\$	205.00
Matrix	OPT23	Safety Arm Storage for D Series Rack	\$	59.00	0%	\$	59.00
Matrix	MG-OPT26	Fat Bar J-hooks	\$	390.00	0%	\$	390.00
Matrix	MG-OPT26R	Reverse Fat Bar J-hooks	\$	390.00	0%	\$	390.00

MATRIX

Magnum

Rack Connection Brackets

Model Number/ Catalog Name	Product Description	MSRP	% Discount	With Discount
Matrix OPT32-8	Straight Ladder - 8'	\$ 850.00		\$ 850.00
Matrix OPT32-10	Straight Ladder - 9'9"	\$ 950.00	0%	\$ 950.00
Matrix OPT33-8	Pyramid Ladder - 8'	\$ 950.00	0%	\$ 950.00
Matrix OPT33-10	Pyramid Ladder - 9'9"	\$ 1,050.00	0%	\$ 1,050.00
Matrix OPT35-6	Straight Chin Bar - 6'	\$ 470.00	0%	\$ 470.00
Matrix OPT35-8	Straight Chin Bar - 8'	\$ 510.00	0%	\$ 510.00
Matrix MG-MOPT35-6	Mega Straight Chin Bar - 6'	\$ 470.00	0%	\$ 470.00
Matrix MG-MOPT35-8	Mega Straight Chin Bar - 8'	\$ 510.00	0%	\$ 510.00

Matrix	OPT36-6	Dual Sided Fat/Straight Chin Bar - 6'	\$	690.00	0%	\$	690.00
Matrix	OPT36-8	Dual Sided Fat/Straight Chin Bar - 8'	\$	750.00	0%	\$	750.00
Matrix	MGOPT-46	Upper Band Pegs	\$	210.00	0%	\$	210.00
Matrix	MG-MOPT36-6	Mega Dual Sided Fat/Straight Chin Bar - 6'	\$	690.00	0%	\$	690.00
Matrix	MG-MOPT36-8	Mega Dual Sided Fat/Straight Chin Bar - 8'	\$	750.00	0%	\$	750.00
Matrix	MG-OPT47-02	Ropeflex	\$	1,795.00	0%	\$	1,795.00
Matrix	MG-OPT-C	Magnum Series Mounting Kit	\$	99.00	0%	\$	99.00
Matrix	MG-MOPT-C47	Mounting Kit - MR47	\$	49.00	0%	\$	49.00
Matrix	MG-MOPT-C9094	Mounting Kit - MR690 / MR694	\$	40.00	0%	\$	40.00
Matrix	MG-MOPT-C91	Mounting Kit - MR691	\$	40.00	0%	\$	40.00

MATRIX

Magnum Platforms

	Model Number/ Catalog Name	Product Description	MSRP	% Discount	With Discount
Matrix	MG-PS86	6' x 8' w/Hardwood Center (stand alone)	\$ 2,000.00	28%	\$ 1,440.00
Matrix	MG-PS88	8' x 8' w/Hardwood Center (stand alone)	\$ 2,600.00	28%	\$ 1,872.00
Matrix	MG-AOSP	MG A-series Optional Spotter Platform	\$ 365.00	28%	\$ 310.25
Matrix	MG-A691P	Hardwood Insert w/6' x 8' Platform (1 side for double half)	\$ 2,600.00	28%	\$ 1,872.00
Matrix	MG-A691SP	Hardwood Insert w/6' x 8' Platform (MG-A691S)	\$ 2,600.00	28%	\$ 1,872.00
Matrix	MG-A47P	Hardwood Insert w/6' x 8' Platform (MG-A47/ MG-A694)	\$ 2,750.00	28%	\$ 1,980.00
Matrix	MG-A690P	Hardwood Insert w/6' x 8' Platform (MG-A690)	\$ 2,600.00	28%	\$ 1,872.00
Matrix	MG-A694P	Hardwood Insert w/6' x 8' Platform (MG-A694)	\$ 2,850.00	28%	\$ 2,052.00
Matrix	MG-MR691P	MEGA Hardwood Insert Platform (double half)	\$ 2,850.00	28%	\$ 2,052.00
Matrix	MG-MR694P	MEGA Hardwood Insert Platform (open power)	\$ 3,050.00	28%	\$ 2,196.00
Matrix	MG-MR690P	MEGA Hardwood Insert w/6' x 8' Platform (1 side double half	\$ 2,850.00	28%	\$ 2,052.00
Matrix	MG-MR47P	MEGA Hardwood Insert w/6' x 8' Platform (MG-A47/ MG-A694)	\$ 3,050.00	28%	\$ 2,196.00
Matrix	MG-MRP9091	MEGA Solid Rubber Surface Power Platform 6' x 8' (1 side MEGA)	\$ 1,750.00	28%	\$ 1,260.00

Matrix	MG-MRP4794	MEGA Solid Rubber Surface Power Platform for MG-A47 / MG-A694	\$ 1,875.00	28%	\$ 1,350.00
Matrix	MG-RP9091	Solid Rubber Surface Power Platform (MG-A690 Half Rack)	\$ 1,600.00	28%	\$ 1,152.00
Matrix	MG-RP9091S	Solid Rubber Surface Power Platform (MG-A690S Half Rack)	\$ 1,600.00	28%	\$ 1,152.00
Matrix	MG-RP86	Solid Rubber Surface Power Platform 8' x 6' (stand alone)	\$ 1,190.00	28%	\$ 856.80
Matrix	MG-RP4794	Solid Rubber Surface Power Platform for MG-A47 / MG-A694	\$ 1,700.00	28%	\$ 1,224.00

MATRIX

Varsity

Selectorized / Single Station

Model Number/

	Catalog Name	Product Description	MSRP	% Discount	With Discount
Matrix	VY-2003M	Medical Leg Press	\$ 8,975.00	35%	\$ 5,833.75
Matrix	VY-2010	Multi-Hip	\$ 5,490.00	35%	\$ 3,568.50
Matrix	VY-2040	Medical Leg Extension / Seated Leg Curl Combo	\$ 5,200.00	35%	\$ 3,380.00
Matrix	VY-6240M	Medical Leg Extension / Seated Leg Curl Combo	\$ 4,795.00	35%	\$ 3,116.75

Selectorized / Duals

Model Number/

	Catalog Name	Product Description	MSRP	% Discount	With Discount
Matrix	VY-6036	Rear Delt / Fly	\$ 3,700.00	35%	\$ 2,405.00
Matrix	VY-6040	Leg Ext. / Prone Leg Curl	\$ 3,700.00	35%	\$ 2,405.00
Matrix	VY-6041	Ab / Low Back	\$ 3,700.00	35%	\$ 2,405.00
Matrix	VY-6042	Biceps / Triceps	\$ 3,300.00	35%	\$ 2,145.00
Matrix	VY-6045	3 Way Press	\$ 3,700.00	35%	\$ 2,405.00
Matrix	VY-6046	Lat Pulldown / Low Row	\$ 3,500.00	35%	\$ 2,275.00
Matrix	VY-6037	Dip / Chin Assist	\$ 3,700.00	35%	\$ 2,405.00
Matrix	VY-6043	Hip Adductor / Abductor	\$ 4,100.00	35%	\$ 2,665.00
Matrix	VY-6010	Multi Hip	\$ 4,350.00	35%	\$ 2,827.50
Matrix	VY-6003	Leg Press / Calf	\$ 4,825.00	35%	\$ 3,136.25

MATRIX

Varsity

Free Weights

Model Number/ Catalog Name	Product Description	MSRP	% Discount	With Discount
Matrix VY-D78	Olympic Flat Bench	\$ 690.00	28%	\$ 496.80
Matrix VY-D79	Olympic Incline Bench	\$ 915.00	28%	\$ 658.80
Matrix VY-D85A	Multi-adjustble Bench	\$ 700.00	28%	\$ 504.00
Matrix VY-D695	Flat-to-incline Bench w/Horizontal Adjustment	\$ 985.00	28%	\$ 709.20
Matrix VY-D96	Glute Ham Bench	\$ 1,100.00	28%	\$ 792.00
Matrix VY-D306	Horizontal Plate Rack (Ridge Black Color Only)	\$ 350.00	28%	\$ 252.00
Matrix VY-D59	Flat Bench	\$ 350.00	28%	\$ 252.00
Matrix VY-D61	Adjustable Decline	\$ 640.00	28%	\$ 460.80
Matrix VY-D62	Preacher Curl-Seated	\$ 465.00	28%	\$ 334.80
Matrix VY-D63C	Verticle Knee Raise w/Chin	\$ 960.00	28%	\$ 691.20
Matrix VY-D77	Adjustble Ab Bench	\$ 815.00	28%	\$ 586.80
Matrix VY-D86	Multi-adjustble Bench w/Decline	\$ 875.00	28%	\$ 630.00
Matrix VY-D87	Utility Bench	\$ 380.00	28%	\$ 273.60
Matrix VY-D93	Back Extension Bench	\$ 525.00	28%	\$ 378.00
Matrix VY-D67C	Weight Tree	\$ 285.00	28%	\$ 205.20
Matrix VY-D67H	Weight Tree w/ Olympic Bar Holders	\$ 335.00	28%	\$ 241.20
Matrix VY-D68	Barbell Rack	\$ 615.00	28%	\$ 442.80
Matrix VY-D70	10-pair Dumbbell Rack	\$ 665.00	28%	\$ 478.80
Matrix VY-D697	2-tier Hex Dumbbell Rack	\$ 585.00	28%	\$ 421.20

MATRIX

Varsity

Plate Loaded

Model Number/

Catalog Name	Product Description	MSRP	% Discount	With Discount
Matrix VY-M49	Angled Smith Machine	\$ 3,350.00	28%	\$ 2,412.00
Matrix VY-400	Perfect Squat	\$ 2,485.00	28%	\$ 1,789.20
Matrix VY-401	Leg Extension	\$ 2,175.00	28%	\$ 1,566.00
Matrix VY-402	Prone Leg Curl	\$ 2,175.00	28%	\$ 1,566.00
Matrix VY-431	Biceps Curl	\$ 2,100.00	28%	\$ 1,512.00
Matrix VY-432	Triceps Extension	\$ 2,100.00	28%	\$ 1,512.00

Functional Trainers / Multi Station

Model Number/

Catalog Name	Product Description	MSRP	% Discount	With Discount
Matrix VY-6044	Functional Trainer 2:1	\$ 3,850.00	28%	\$ 2,772.00
Matrix VY-6047	Functional Trainer 4:1	\$ 4,250.00	28%	\$ 3,060.00
Matrix VY-FTHP	Handle Package for Functional Trainer 6044 and 6047	\$ 550.00	28%	\$ 396.00
Matrix VY-6099	Total Body Trainer	\$ 3,800.00	28%	\$ 2,736.00
Matrix VY-6024	Adjustable Crossover (stand alone)	\$ 3,550.00	28%	\$ 2,556.00

Racks

Model Number/

Catalog Name	Product Description	MSRP	% Discount	With Discount
Matrix VY-D694	Open Rack 8'	\$ 2,290.00	28%	\$ 1,648.80
Matrix VY-D690	Half Rack 8'	\$ 2,190.00	28%	\$ 1,576.80
Matrix VY-D690-7	Half Rack 7'	\$ 2,000.00	28%	\$ 1,440.00
Matrix VY-D47	Power Rack 8'	\$ 2,600.00	28%	\$ 1,872.00
Matrix VY-D691	Double Half Rack 8'	\$ 3,450.00	28%	\$ 2,484.00

MATRIX

Varsity

Plate Loaded

Model Number/ Catalog Name		Product Description	MSRP	% Discount	With Discount
Matrix	VY-DOPT1	J-Hooks - (Pair)	\$ 370.00	0%	\$ 370.00
Matrix	VY-DOPT1R	Reverse J-hooks (Pair)	\$ 370.00	0%	\$ 370.00
Matrix	VY-DOPT3	Dip Bars	\$ 370.00	0%	\$ 370.00
Matrix	VY-DOPT3R	Reverse Dip Bars	\$ 370.00	0%	\$ 370.00
Matrix	VY-DOPT4	3-peg Band Pegs	\$ 370.00	0%	\$ 370.00
Matrix	VY-DOPT5	2-peg Band Pegs	\$ 250.00	0%	\$ 250.00
Matrix	VY-DOPT6	Squat Handles (Pair)	\$ 205.00	0%	\$ 205.00
Matrix	OPT10	Custom Platform Logo	\$ 595.00	0%	\$ 595.00
Matrix	OPT11	Platform Ramp	\$ 160.00	0%	\$ 160.00
Matrix	VY-DOPT13	Land Mine Attachment	\$ 260.00	0%	\$ 260.00
Matrix	OPT14U	Name Plate (Universal Mount)	\$ 280.00	0%	\$ 280.00
Matrix	OPT16	Core Handle	\$ 110.00	0%	\$ 110.00
Matrix	OPT23	Safety Arm Storage	\$ 155.00	0%	\$ 155.00
Matrix	OPT26R	Reverse Fat Bar J-hooks	\$ 390.00	0%	\$ 390.00
Matrix	VY-DOPT29	Docking Kit Varsity Rack w/o Platform	\$ 40.00	0%	\$ 40.00
Matrix	VY-DOPT29P	Docking Kit Varsity Rack with Platform	\$ 40.00	0%	\$ 40.00
Matrix	VY-DOPT31-02	Battle Rope Attachment - Varsity Racks	\$ 129.00	0%	\$ 129.00

MATRIX

Varsity

Rack Options

Model Number/

	Catalog Name	Product Description	MSRP	% Discount	With Discount
Matrix	OPT42	Rotating Chin Handles	\$ 450.00	0%	\$ 450.00
Matrix	VY-DOPT44	Bolt On Olympic Bar Holder (Pair)	\$ 180.00	0%	\$ 180.00
Matrix	OPT45	Bolt On Spotters Stand - A Series and MEGA	\$ 420.00	0%	\$ 420.00
Matrix	VY-DOPT45	Bolt On Spotters Stand - D Series	\$ 300.00	0%	\$ 300.00
Matrix	VY-DOPT45DH	Bolt On Spotters Stand - D Series Double Half Rack	\$ 470.00	0%	\$ 470.00

Rack Connection Brackets**Model Number/**

	Catalog Name	Product Description	MSRP	% Discount	With Discount
Matrix	OPT32-8	Straight Ladder - 8'	\$ 850.00	0%	\$ 850.00
Matrix	OPT32-10	Straight Ladder - 9'9"	\$ 950.00	0%	\$ 950.00
Matrix	OPT33-8	Pyramid Ladder - 8'	\$ 950.00	0%	\$ 950.00
Matrix	OPT33-10	Pyramid Ladder - 9'9"	\$ 1,050.00	0%	\$ 1,050.00
Matrix	OPT35-6	Straight Chin Bar - 6'	\$ 470.00	0%	\$ 470.00
Matrix	OPT35-8	Straight Chin Bar - 8'	\$ 510.00	0%	\$ 510.00
Matrix	OPT36-6	Dual Sided Fat/Straight Chin Bar - 6'	\$ 690.00	0%	\$ 690.00
Matrix	OPT36-8	Dual Sided Fat/Straight Chin Bar - 8'	\$ 750.00	0%	\$ 750.00

Model Number/

	Catalog Name	Product Description	MSRP	% Discount	With Discount
Matrix	VY-D47P	Hardwood Insert w/6' x 8' Platform (VY-D47/ VY-D694)	\$ 2,995.00	28%	\$ 2,156.40
Matrix	VY-D690P	Hardwood Insert w/6' x 8' Platform (VY-D690)	\$ 2,795.00	28%	\$ 2,012.40
Matrix	VY-D691P	Hardwood Insert w/6' x 8' Platform (VY-D691)	\$ 1,975.00	28%	\$ 1,422.00
Matrix	VY-D694P	Hardwood Insert w/ 6' x 8' Platform	\$ 2,750.00	28%	\$ 1,980.00
Matrix	VY-DRP4794	Solid Rubber Surface Power Platform (VY-D47 / VY-D694)	\$ 1,700.00	28%	\$ 1,224.00
Matrix	VY-DRP90	Solid Rubber Insert w/6' x 8' Platform (VY-D690)	\$ 1,600.00	28%	\$ 1,152.00
Matrix	VY-DRP91	Solid Rubber Insert w/6' x 8' Platform (VY-D691)	\$ 1,600.00	28%	\$ 1,152.00





MATRIX

CARDIO

2018 BROCHURE



CONTENTS

4 MATRIX FITNESS

TOTAL SOLUTIONS PARTNER
STRONG. SMART. BEAUTIFUL.™

8 MATRIX CONNECTED SOLUTIONS

20 TREADMILLS

32 ASCENTS & ELLIPTICALS

50 CLIMBMILLS & STEPPERS

62 CYCLES

80 GROUP TRAINING

TRAINING CYCLES

S-DRIVE™ PERFORMANCE TRAINER

S-FORCE™ PERFORMANCE TRAINER

ROWER

KRANKCYCLE®

GET MORE THAN THE WORLD'S FINEST FITNESS EQUIPMENT

When you choose Matrix, you're getting more than the world's finest fitness equipment. You're getting a partner that will be there, for your grand opening and every day after. Together, there's no detail of your business that we can't refine, reimagine or reinvent. And that includes your bottom line.

FACILITY PLANNING

Your space. Your goals. Your budget. We'll help bring your fitness center to life from your earliest ideas to the day you open your doors.

CERTIFIED INSTALLATION/SERVICE KIT

Maximize uptime. Optimize your investment. We provide all the tools you need to get up and running and stay that way.

INDUSTRY-LEADING WARRANTIES

Our promise of quality to you. We offer all of the protection you need to choose confidently, and know that you've chosen the products with the lowest cost of ownership in the industry.

TURNKEY PREVENTIVE MAINTENANCE PROGRAM

Protect your investment with our Preventive Maintenance Program — in addition to the regular tips we provide to extend equipment life, you'll get routine maintenance visits performed by expert technicians, all customized to your equipment and schedule.

* Availability of financing options varies by market.

FINANCING*

Whenever possible, we work with our customers to develop financial solutions that expand their options and maximize their investments.

UNMATCHED CUSTOMER SUPPORT

A 95% first-time fix rate. A 90% live answer rate in two minutes or less. A 48-hour service response window. 260 service providers with over 600 technicians to serve you. And with our amazing console technology, we can provide diagnostic services remotely or on site.

MATRIX LEARNING

Product training. Maintenance tips. Career building. On-demand educational videos. A whole new world of service and support. It's all at your fingertips with Matrix Learning (matrixlearningcenter.com).

TOTAL MARKETING SUPPORT KIT

You want to let clients know about the exciting programs and products that make your facility different, and we want to help. Ask us about customized promotional materials to help you reach and retain clients like never before.





STRONG. SMART. BEAUTIFUL.™

It's more than a tagline. It's our holistic promise to you that these three qualities will shine through every product that hits your floor and define our ongoing partnership.

STRONG

Our high-quality, ultra-durable products are just as strong as our commitment to be your partner, not just your supplier. This strength gives us a solid foundation for success, today and in the future, and has made us one of the world's fastest-growing commercial fitness brands.

SMART

We listen and create products with a purpose in mind — to address your needs and resolve them in ingenious ways. Forward-thinking options like Asset Management™ and Virtual Active™ enhance and redefine the exercise experience, for both you and your members.

BEAUTIFUL

Our products attract beginners and fitness enthusiasts alike. Every piece of equipment is approachable, unintimidating and a pleasure to use. We continue to set new industry standards through award-winning aesthetic distinction and incredible attention to detail.

MATRIX CONNECTED SOLUTIONS

GET CONNECTED TO A WORLD OF DIGITAL SOLUTIONS

You want to deliver an unmatched fitness experience, and Matrix Connected Solutions give you the flexible tools you need to do it your way, regardless of the size of your facility or budget.

With the power of our robust, open platform at your fingertips, service and maintenance become hassle-free. Your trainers can connect and engage with members in new ways for better results and more referrals. Everyone who comes through your doors can instantly connect to their favorite music, entertainment and social networks. It's easier than ever to expand your marketing efforts and make your brand the center of each member's fit lifestyle. And that's just a taste of what Matrix Connected Solutions can do.

Discover how our complete selection of hardware and software solutions can help bring your vision of fitness to life in bigger, bolder, brighter ways than ever before.



CONNECTED
SOLUTIONS

EMERGENCY
STOP

MATRIX CONNECTED SOLUTIONS

YOUR GOALS

You have a vision of fitness that's all your own. The flexibility of our complete digital ecosystem lets you choose how you enhance your business, streamline your administrative tasks, impress the people you serve and much more.

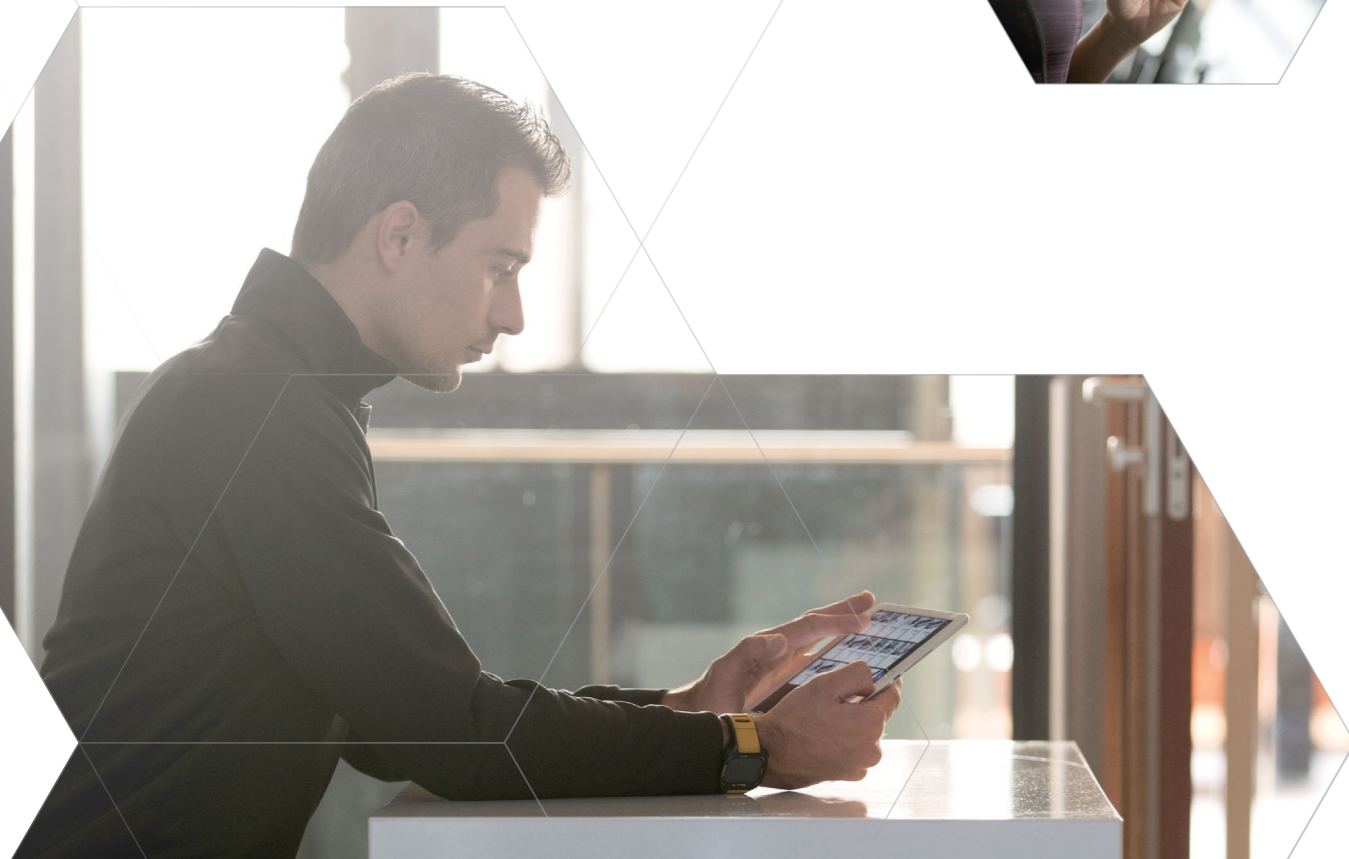

INCREASE RETENTION

Bringing members back again is essential to the success of your business. With our smart digital options, they won't just come back — they'll bring friends.

BUILD ENGAGEMENT

Keep your members enthused, excited and eager for more with powerful tools that keep the exercise experience fresh.

BOOST REVENUE

Find out how to tap forward-thinking revenue streams that can redefine your bottom line in powerful new ways.

MAXIMIZE ROI

Count on us for smart tools that streamline the way you run your business while maximizing your investment and the value of every membership.

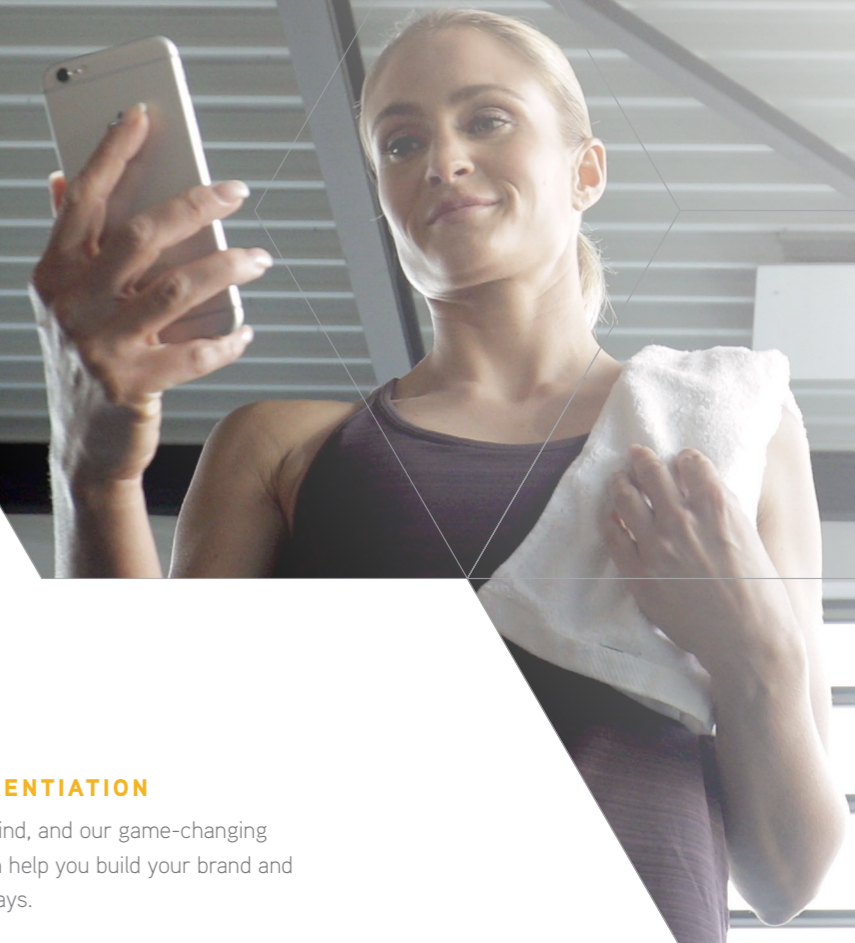

ENHANCE DIFFERENTIATION

Your facility is one of a kind, and our game-changing Connected Solutions can help you build your brand and stand out in impactful ways.

ENERGIZE ACQUISITION

You're always striving to bring in new members, and we can help extend your brand, reach untapped demographics and impress everyone who stops by.

MATRIX CONNECTED SOLUTIONS OUR SOLUTIONS

Our robust, open platform is more than a collection of hardware, software and connectivity options. It's a fully integrated digital ecosystem that enhances the way you manage machines, mentor and motivate members, and promote your unique brand.



PERSONAL TRAINER PORTAL

Create a truly personalized training experience with our flexible, customizable digital solution. Personal Trainer Portal helps trainers engage with a wide range of members, represents your unique brand and helps you tap unexplored revenue streams. Consider pairing Personal Trainer Portal with Workout Tracking Network and our 7xi console to build member loyalty that truly lasts.

CUSTOMIZE & CONNECT

Personal Trainer Portal is easily adaptable to the practices that have made your facility successful and works with third-party apps and wearables.

POWERFUL PROMOTIONS

Smart new promotional tools include special offer push notifications, incentivized referrals and “at-risk” notifications to help retain valuable members.

REDEFINE YOUR BOTTOM LINE

Offer training as an add-on to premium memberships, as an introductory special, on a session-by-session basis or through your own promotional combination.



WORKOUT TRACKING NETWORK

Our ingenious Workout Tracking Network lets your members capture data from all their favorite fitness apps and all the places they work out in one place using a single customizable interface that puts your facility at the center of their fit lifestyle.

MOTIVATING MEMBERS IN NEW WAYS

Our mobile app makes it easy for members to create personalized goals, chart progress, compete in challenges, take part in reward programs, applaud others through social feeds and more.

INTUITIVE USE & IMPORTANT INFORMATION

Our open platform streamlines the way you manage your facility and brings all of your members’ fitness data to your branded tracking platform no matter where or when they exercise.

PROMOTIONS & INCENTIVES

Innovative features like “find a class”, “request training” and incentivized referrals help you promote your business and tap new revenue streams in game-changing ways.

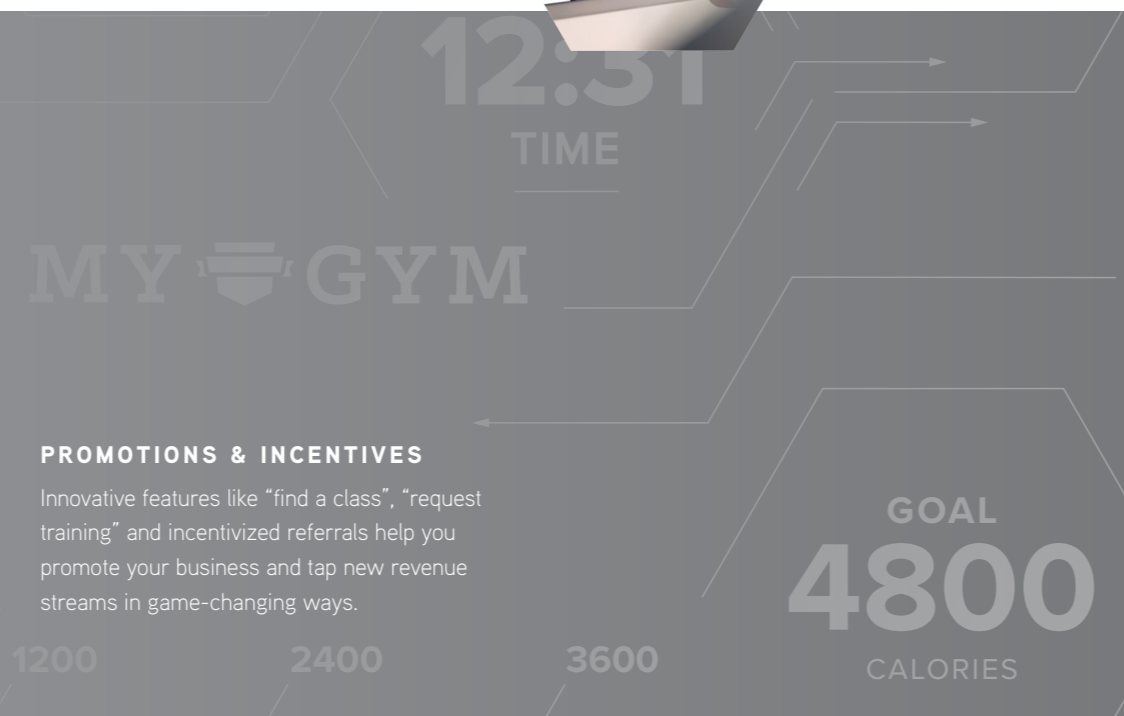

ASSET MANAGEMENT

Our industry-leading Asset Management™ platform offers a 360-degree view of your equipment status on virtually any internet-connected device, plus insightful reporting capabilities, streamlined service, marketing tools and much more. With Asset Management, it’s easier than ever to keep your equipment in top condition and your members happy.



SUPERIOR INVENTORY MANAGEMENT

Asset Management uses easy-to-read color-coding to tell you whether a product is functioning properly, detect errors and alert you if something is offline.

STREAMLINED WORKFLOW & REPORTING

The system monitors usage patterns to maximize product life, helps identify the optimum product mix, creates customized reports and can even manage data from multiple facilities.

SIMPLIFIED SERVICE

Asset Management provides automatic performance notifications and improves communication with Matrix and your service provider, all while reducing paperwork and hassle for you.

SMART MARKETING TOOLS

When used with 7xi or 7xe consoles, Asset Management provides integrated facility calendar alerts, automated messaging to promote specials and customized welcome screens.



7XI CONSOLE

Experience the 7xi console, and you'll be wowed by a brilliant display and a fitness-specific, easy-to-navigate app interface that's superior to anything in the industry. Connect your members to stunning entertainment, social media favorites, brand-building communication and more, all continually updated for free. To set your facility apart even further, consider pairing 7xi consoles with Personal Trainer Portal and start building the kind of engagement that leads to lasting loyalty.

PREMIUM ENTERTAINMENT

Members can enjoy must-see TV, cheer on friends through social media, race through mountain trails and access personal playlists via the brightest screen and sharpest picture available.

EVER-EXPANDING APP SELECTION

Our fitness-optimized apps include Netflix, Facebook, Twitter, YouTube, Weather and more, plus our exclusive Sprint 8[®] HIIT program, Virtual Active™ and other great workouts.

SINGLE-POINT USER LOGIN

An xID single-point user login lets members access their own fitness data, social media accounts and favorite apps, automatically loading their personal preferences when they log in.

CUSTOMIZE TO BUILD YOUR BRAND

When used in conjunction with Asset Management™, you can customize your 7xi home screen to deliver your message and promote classes, challenges, special events and more.



COMPLETE CONSOLE SELECTION

Our diverse collection of consoles gives you choices in what you put on your floor. Sophisticated, easy-to-operate designs give your members control of the data they collect, the content that keeps them engaged and the way they reach their goals.



7xi console



7xe console



5x console



3xe console



3x console



1xe console



1x console

ENHANCING THE EXERCISE EXPERIENCE

Make every workout a fresh, special experience by adding some of our uniquely interactive programs. Count on us to create distinctive exercise experiences that will set your facility apart from others, engage your members on a whole new level and keep them coming back for more.



SPRINT 8

Go beyond high-intensity interval training to give members results they can see in the mirror. Our scientifically validated Sprint 8® program is effective, quick and simple.



VIRTUAL ACTIVE

Transform ordinary workouts into breathtaking journeys through exotic locals with our speed- and terrain-interactive Virtual Active™ program.



VIRTUAL COACHING

Take Virtual Active workouts to the next level with an onscreen virtual coach that provides instruction and encouragement.



LANDMARKS

Our Landmarks program turns Stepper and ClimbMill workouts into engaging, exhilarating journeys to the top of natural and man-made wonders of the world.



DIGITAL TV

Keep users motivated and help them achieve their fitness goals with the industry's very best screen technology.



REMOTE AUDIO

Enhance the exercise experience by syncing remote audio to your facility's big screens.



RFID

Simple radio-frequency tags can give your members a seamless exercise experience from door to door, streamlining check-ins, workouts and purchasing from your vending centers.



IPTV

Ideal for hotels, IPTV lets guests sync their entertainment experience from the room to the fitness center to the hotel bar and back.



PRO:IDIOM

A must-have for hotels, Pro:Idiom protects content providers from piracy while offering guests a synced entertainment experience.

FACILITY-SPECIFIC SOLUTIONS

Depending on what kind of fitness center you operate, some of our facility-specific solutions might be right for your goals and members. Check out RFID to streamline the exercise experience, digital TV if you'd like to add a little extra entertainment, remote audio to coordinate with your mounted big screens or IPTV and Pro:Idiom if you do business in the hospitality channel.



TREADMILLS

THE BEST CHOICE IN THE LONG RUN

Striking the perfect balance between engineering and aesthetics, our treadmills attract more attention and require less maintenance than anything you put next to them.

TREADMILLS

- 1 ULTIMATE DECK™**
Our self-lubricating deck offers over 25,000 miles of maintenance-free performance.
- 2 DYNAMIC RESPONSE DRIVE SYSTEM™**
An AC motor and an intelligent control board fine-tune response based on the unique footfall pattern to help the user step confidently.
- 3 CAST ALUMINUM END CAPS**
Designed for lasting durability.
- 4 SPACIOUS RUNNING SURFACE**
Extra-wide deck offers an added sense of security and freedom.



*Shown in Matte Black





T7XI TREADMILL

- 48 cm / 19" capacitive touchscreen with FitTouch™ Technology offers intuitive operation
- WiFi connectivity accommodates integrated Matrix Asset Management™ system, plus optional Workout Tracking Network and Personal Trainer Portal
- Custom interface configuration through Matrix Asset Management facilitates personalized communication with users
- Advanced Sprint 8® High Intensity Interval Training program
- Integrated Virtual Active™ programming provides an immersive exercise experience
- Optimized app interface designed specifically for fitness offers easy access to social media and web content
- Crossbar speed and incline controls make adjustments quick and easy
- Ultimate Deck™ System for superior performance and durability
- Matrix 5.0 HP AC motor with Dynamic Response Drive System™ finetunes response based on footfall pattern for a smooth, consistent, natural workout



T7XE TREADMILL

- 41 cm / 16" touchscreen display with FitTouch™ Technology offers intuitive operation
- WiFi connectivity accommodates optional Matrix Asset Management™ system, Workout Tracking Network and Personal Trainer Portal
- Custom interface configuration facilitates personalized communication with users
- Advanced Sprint 8® High Intensity Interval Training program
- Compatible with Virtual Active™ programming to provide an immersive exercise experience
- Optimized app interface designed specifically for fitness
- Crossbar speed and incline controls make adjustments quick and easy
- Ultimate Deck™ System for superior performance and durability
- Matrix 5.0 HP AC motor with Dynamic Response Drive System™ finetunes response based on footfall pattern for a smooth, consistent, natural workout



T5X TREADMILL

- LED console display offers intuitive operation
- WiFi connectivity accommodates optional Matrix Asset Management™ system and Workout Tracking Network
- Sprint 8® High Intensity Interval Training program
- Crossbar speed and incline controls make adjustments quick and easy
- Ultimate Deck™ System for superior performance and durability
- Matrix 5.0 HP AC motor with Dynamic Response Drive System™ finetunes response based on footfall pattern for a smooth, consistent, natural workout



T3XE TREADMILL

- 41 cm / 16" touchscreen display with FitTouch Technology offers intuitive operation
- WiFi connectivity accommodates optional Matrix Asset Management system, Workout Tracking Network and Personal Trainer Portal
- Custom interface configuration facilitates personalized communication with users
- Compatible with Virtual Active™ programming to provide an immersive exercise experience
- Optimized app interface designed specifically for fitness
- Ultimate Deck System for superior performance and durability
- Matrix 4.2 HP AC motor with Dynamic Response Drive System finetunes response based on footfall pattern for a smooth, consistent, natural workout



T3XH TREADMILL

- 41 cm / 16" touchscreen display with Simplified Display Mode for therapeutic, rehabilitation and active-aging settings
- WiFi connectivity accommodates optional Matrix Asset Management™ system and Workout Tracking Network
- Custom interface configuration facilitates personalized communication with users
- Compatible with Virtual Active™ programming to provide an immersive exercise experience
- Optimized app interface designed specifically for fitness



- Extended handrails with neutral-position, angled grips ensure secure entry and exit
- Ultimate Deck™ System for superior performance and durability
- Low 0.16 km/h / 0.1 mph start speed in forward and reverse directions allows users with limited abilities to take part in functional movement exercises
- Matrix 4.2 HP AC Dynamic Response Drive System™ with .5mA current leakage fine tunes response based on footfall pattern for a smooth, consistent, natural workout
- Integrated IR sensor stops belt motion when triggered by an object or person



T3XM TREADMILL

- Intuitive LED console displays only the feedback essential to therapists and clinicians
- Med CE IIa certified to serve the needs of therapeutic, rehabilitation and active-aging settings
- WiFi connectivity accommodates optional Matrix Asset Management™ system
- Extended handrails with neutral-position, angled grips ensure secure entry and exit
- Ultimate Deck™ System for superior performance and durability
- Low 0.16 km/h / 0.1 mph start speed in forward and reverse directions allows users with limited abilities to take part in functional movement exercises
- Matrix 4.2 HP AC Dynamic Response Drive System™ with .1mA current leakage finetunes response based on footfall pattern for a smooth, consistent, natural workout
- Integrated IR sensor stops belt motion when triggered by an object or person



T3X TREADMILL

- LED console display with expanded feedback offers intuitive operation
- WiFi connectivity accommodates optional Matrix Asset Management system and Workout Tracking Network
- Ultimate Deck System for superior performance and durability
- Matrix 4.2 HP AC motor with Dynamic Response Drive System finetunes response based on footfall pattern for a smooth, consistent, natural workout



T1XE TREADMILL

- 41 cm / 16" touchscreen display with FitTouch™ Technology offers intuitive operation
- WiFi connectivity accommodates optional Matrix Asset Management™ system and Workout Tracking Network
- Custom interface configuration facilitates personalized communication with users
- Compatible with Virtual Active™ programming to provide an immersive exercise experience
- Optimized app interface designed specifically for fitness
- Ultimate Deck™ System for superior performance and durability
- Matrix 3.0 HP AC motor with Dynamic Response Drive System™ finetunes response based on footfall pattern for a smooth, consistent, natural workout
- Optional: Handrail Kit extends handrails for increased stability during entry and exit



T1X TREADMILL

- Large LED display provides easy viewing and easy-to-use controls
- WiFi connectivity accommodates optional Matrix Asset Management system and Workout Tracking Network
- Ultimate Deck System for superior performance and durability
- Matrix 3.0 HP AC motor with Dynamic Response Drive System finetunes response based on footfall pattern for a smooth, consistent, natural workout
- Optional: Handrail Kit extends handrails for increased stability during entry and exit

Images and specifications subject to change. Visit matrixfitness.com for latest warranty information.

FEATURES	T7xi Treadmill	T7xe Treadmill	T5x Treadmill	T3xe Treadmill
Deck Type	Ultimate hard-wax reversible 1" deck	Ultimate hard-wax reversible 1" deck	Ultimate hard-wax reversible 1" deck	Ultimate hard-wax reversible 1" deck
Belt Type	Habasit, 2-ply commercial grade	Habasit, 2-ply commercial grade	Habasit, 2-ply commercial grade	Habasit, 2-ply commercial grade
Running Area	152 x 56 cm / 60" x 22"	152 x 56 cm / 60" x 22"	152 x 56 cm / 60" x 22"	152 x 51 cm / 60" x 20"
Step-on Height	24 cm / 9.5"	24 cm / 9.5"	24 cm / 9.5"	19 cm / 7.5"
Cushion System	Ultimate Deck cushioning system	Ultimate Deck cushioning system	Ultimate Deck cushioning system	Ultimate Deck cushioning system
Incline Range	0-15% (590-kg / 1,300-lb. thrust elevation motor)	0-15% (590-kg / 1,300-lb. thrust elevation motor)	0-15% (590-kg / 1,300-lb. thrust elevation motor)	0-15% (590-kg / 1,300-lb. thrust elevation motor)
Speed Range	0.8 – 24.1 km/h / 0.5 – 15 mph*	0.8 – 24.1 km/h / 0.5 – 15 mph*	0.8 – 24.1 km/h / 0.5 – 15 mph*	0.8 – 20 km/h / 0.5 – 12 mph
Contact & Telemetric HR	Yes	Yes	Yes	Yes
Crossbar Controls	Go, stop, cool down, speed and incline	Go, stop, cool down, speed and incline	Go, stop, cool down, speed and incline	No
Tread Sense	Yes	Yes	Yes	Yes
CONSOLE				
Display Type	48 cm / 19" class projective capacitive touchscreen LCD	41 cm / 16" class touchscreen LCD	Dot-matrix LED with profile display	41 cm / 16" class touchscreen LCD
Display Feedback	Time of Day, Time Elapsed, Time Remaining, Total Program Time, Distance (Kilometers or Miles), Calories, Calories per Hour, Speed, Pace, Average Pace, Elevation Gained, Incline, Heart Rate, Peak Heart Rate, METs, Watts, Dynamic Profile Display	Time of Day, Time Elapsed, Time Remaining, Total Program Time, Distance (Kilometers or Miles), Calories, Calories per Hour, Speed, Average Pace, Elevation Gained, Incline, Heart Rate, Peak Heart Rate, METs, Watts, Dynamic Profile Display	Time of Day, Distance (Kilometers or Miles), Calories, Calories per Hour, Speed, Incline, Pace, Average Pace, Heart Rate, METs, Watts, Workout Profile	Time of Day, Time Elapsed, Time Remaining, Total Program Time, Distance (Kilometers or Miles), Calories, Calories per Hour, Speed, Average Pace, Elevation Gained, Incline, Heart Rate, Peak Heart Rate, METs, Watts, Dynamic Profile Display
Secondary Data Display	Yes	Yes	No	No
User-defined Multi-language Display	English, German, French, Italian, Spanish, Dutch, Portuguese, Chinese, Japanese, Korean, Swedish, Finnish, Russian, Arabic, Turkish, Polish, Welsh, Basque, Vietnamese, Somali, Danish	English, German, French, Italian, Spanish, Dutch, Portuguese, Chinese, Japanese, Korean, Swedish, Finnish, Russian, Arabic, Turkish, Polish, Welsh, Basque, Vietnamese, Somali, Danish	English, German, French, Italian, Spanish, Dutch, Portuguese, Japanese, Swedish, Finnish, Turkish, Polish, Russian, Danish	English, German, French, Italian, Spanish, Dutch, Portuguese, Chinese, Japanese, Korean, Swedish, Finnish, Russian, Arabic, Turkish, Polish, Welsh, Basque, Vietnamese, Somali, Danish
Workouts	Manual, Rolling Hills, Fat Burn, Sprint 8, Target HR (incline), Gerkin Protocol, Calorie Goal, Distance Goal, Time Goal, Army PFT, Navy PRT, Marine PFT, Air Force PRT, Physical Efficiency Battery (PEB), Virtual Active	Manual, Rolling Hills, Fat Burn, Sprint 8, Target HR (incline), Gerkin Protocol, Calorie Goal, Distance Goal, Time Goal, Army PFT, Navy PRT, Marine PFT, Air Force PRT, Physical Efficiency Battery (PEB)	Manual, Rolling Hills, Fat Burn, Sprint 8, 5k, Target HR, Gerkin Protocol, Army PFT, Navy PRT, Marine PFT, Air Force PRT, Physical Efficiency Battery (PEB), WiFi Protocol	Manual, Rolling Hills, Fat Burn, Target HR (incline), Gerkin Protocol, Calorie Goal, Distance Goal, Time Goal, Army PFT, Navy PRT, Marine PFT, Air Force PRT, Physical Efficiency Battery (PEB)
CSAFE Ready-FitLinux Certified	Yes	Yes	Yes	Yes
IPTV Compatible	Yes	Yes	No	Yes
Prodiom Compatible	Yes	Yes	Optional – add-on TV	No
FitTouch Technology	Yes	Yes	No	Yes
One-button Start	Yes	Yes	Yes	Yes
On-the-fly Program Change	Yes	Yes	Yes	Yes
Integrated Vista Clear Television Technology	Yes	Yes	No	Yes
FITCONNECTION Ready	No	No	Yes	No
Ethernet Compatible	Yes	Yes	No	Yes
WiFi Enabled	Yes	Yes	Optional	Optional
Bluetooth Enabled	Yes	Yes	No	Optional
Connects to Apple Watch	Yes	Yes	No	No
iPod / iPhone / iPad Compatible	Made for iPod, iPhone, iPad	Made for iPod, iPhone, iPad	Charging only	Charging only
Multimedia Playback	Compatible with most tablet and smart phone systems	Compatible with most tablet and smart phone systems	No	Compatible with most tablet and smartphone systems using Android OS
Personal Fan	Yes	Yes	Yes	No
Personal Trainer Portal Compatible	Yes	Yes	No	Yes
USB Port	Yes	Yes	Yes	Yes
Virtual Active Compatible	Included	Yes	No	Yes
Asset Management Compatible	Included	Yes	Yes	Yes
Workout Tracking Network Compatible	Yes	Yes	Yes	Yes
Web Connectivity	Custom app interface in addition to web browser	Optional	No	Optional
Facility Communication Portal/Calendar	Programmed through Asset Management	Optional	No	Optional
RFID Compatible	Yes	Yes	Yes	Yes
Pause Function	Yes	Yes	Yes	Yes
Reading Rack	No	No	No	No
DRIVE SYSTEM				
Drive System	Matrix 5.0 HP AC Dynamic Response Drive System	Matrix 5.0 HP AC Dynamic Response Drive System	Matrix 5.0 HP AC Dynamic Response Drive System	Matrix 4.2 HP AC Dynamic Response Drive System
TECH SPECS				
Power Requirements	216 – 250v, 50 Hz 20-amp dedicated circuit required, non-looped grounded	216 – 250v, 50 Hz 20-amp dedicated circuit required, non-looped grounded	216 – 250v, 50 Hz 20-amp dedicated circuit required, non-looped grounded	216 – 250v, 50 Hz 20-amp dedicated circuit required, non-looped grounded
Electrical Receptacle & Plug	NEMA 220v 6-20R	NEMA 220v 6-20R	NEMA 220v 6-20R	NEMA 220v 6-20R
Assembled Dimensions	214 x 93 x 160 cm / 84.4" x 36.5" x 62.9"	214 x 93 x 160 cm / 84.4" x 36.5" x 62.9"	214 x 93 x 146 cm / 84.4" x 36.5" x 57.4"	215 x 86 x 143 cm / 84.8" x 33.7" x 56.3"
Max User Weight	182 kg / 400 lbs.	182 kg / 400 lbs.	182 kg / 400 lbs.	182 kg / 400 lbs.
Assembled Weight	181 kg / 399 lbs.	181 kg / 399 lbs.	179 kg / 394 lbs.	173 kg / 380 lbs.
Shipping Weight	200 kg / 440 lbs.	200 kg / 440 lbs.	197 kg / 433 lbs.	186 kg / 409 lbs.
WARRANTY				
Frame	7 years	7 years	7 years	7 years
Drive System	Lifetime	Lifetime	Lifetime	7 years
Parts & Labor	3 years	3 years	3 years	3 years
Wear Items (iPod® Cable, USB Port, Headphone Jack, Battery)	90 days parts	90 days parts	90 days parts	90 days parts

* 24.1 km/h / 15 mph rating good for users up to 159 kg / 350 lbs.

Images and specifications subject to change. Visit matrixfitness.com for latest warranty information.

FEATURES	T3xh Treadmill	T3xm Treadmill	T3x Treadmill	T1xe Treadmill	T1x Treadmill
Deck Type	Ultimate hard-wax reversible 1" deck	Ultimate hard-wax reversible 1" deck	Ultimate hard-wax reversible 1" deck	Ultimate hard-wax reversible 1" deck	Ultimate hard-wax reversible 1" deck
Belt Type	Habasit, 2-ply commercial grade	Habasit, 2-ply commercial grade	Habasit, 2-ply commercial grade	Habasit, 2-ply commercial grade	Habasit, 2-ply commercial grade
Running Area	152 x 51 cm / 60" x 20"	152 x 51 cm / 60" x 20"	152 x 51 cm / 60" x 20"	152 x 51 cm / 60" x 20"	152 x 51 cm / 60" x 20"
Step-on Height	19 cm / 7.5"	19 cm / 7.5"	19 cm / 7.5"	19 cm / 7.5"	19 cm / 7.5"
Cushion System	Ultimate Deck cushioning system	Ultimate Deck cushioning system	Ultimate Deck cushioning system	Ultimate Deck cushioning system	Ultimate Deck cushioning system
Incline Range	0-15% (590-kg / 1,300-lb. thrust elevation motor)	0-15% (590-kg / 1,300-lb. thrust elevation motor)	0-15% (590-kg / 1,300-lb. thrust elevation motor)	0-15% (590-kg / 1,300-lb. thrust elevation motor)	0-15% (590-kg / 1,300-lb. thrust elevation motor)
Speed Range	0.16 – 19.3 km/h / 0.1 – 12 mph forward / 0.16 – 6.4 km/h 0.1 – 4 mph reverse	0.16 – 19.3 km/h / 0.1 – 12 mph forward / 0.16 – 6.4 km/h 0.1 – 4 mph reverse	0.8 – 20 km/h / 0.5 – 12 mph	0.8 – 20 km/h / 0.5 – 12 mph	0.8 – 20 km/h / 0.5 – 12 mph
Contact & Telemetric HR	Yes	Yes	Yes	Yes	Yes
Crossbar Controls	No	No	No	No	No
Tread Sense	Yes. Engages above 0.8 kph / 0.5 mph	Yes. Engages above 0.8 kph / 0.5 mph	Yes	Yes	Yes
CONSOLE					
Display Type	41 cm / 16" class touchscreen LCD	Dot-matrix LED with profile display	Dot-matrix LED with profile display	41 cm / 16" class touchscreen LCD	Alphanumeric LED
Display Feedback	Time of Day, Time Elapsed, Time Remaining, Total Program Time, Distance (Kilometers or Miles), Calories, Calories per Hour, Speed, Pace, Average Pace, Elevation Gained, Incline, Heart Rate, Peak Heart Rate, METs, Watts, Dynamic Profile Display, Static Profile Display, Simplified Display Mode	Time of Day, Time Elapsed, Time Remaining, Total Program Time, Distance (Kilometers or Miles), Calories, Calories per Hour, Speed, Incline, Pace, Average Pace, Heart Rate, METs, Watts, Workout Profile, Forward/Reverse	No	Time of Day, Time Elapsed, Time Remaining, Total Program Time, Distance (Kilometers or Miles), Calories, Calories per Hour, Speed, Average Pace, Elevation Gained, Incline, Heart Rate, Peak Heart Rate, METs, Watts, Dynamic Profile Display	Time Elapsed, Time Remaining, Distance, Calories, Speed, Incline, Pace, Heart Rate
Secondary Data Display	No	No	No	No	No
User-defined Multi-language Display	English, German, French, Italian, Spanish, Dutch, Portuguese, Chinese, Japanese, Korean, Swedish, Finnish, Russian, Arabic, Turkish, Polish, Welsh, Basque, Vietnamese, Somali, Danish	Accessible only through manager menu: English, German, French, Italian, Spanish, Dutch, Portuguese, Japanese, Swedish, Finnish, Turkish, Polish, Russian, Danish	Accessible only through manager menu: English, German, French, Italian, Spanish, Dutch, Portuguese, Japanese, Swedish, Finnish, Turkish, Polish	English, German, French, Italian, Spanish, Dutch, Portuguese, Chinese, Japanese, Korean, Swedish, Finnish, Russian, Arabic, Turkish, Polish, Welsh, Basque, Vietnamese, Somali, Danish	Accessible only through manager menu: English, German, French, Italian, Spanish, Dutch, Portuguese, Swedish, Finnish, Turkish, Polish
Workouts	Manual, Rolling Hills, Fat Burn, Target HR (incline), Gerkin Protocol, Calorie Goal, Distance Goal, Time Goal, Army PFT, Navy PRT, Marine PFT, Air Force PRT, Physical Efficiency Battery (PEB), WiFi Protocol	Manual, Rolling Hills, Fat Burn, 5k, 10k, Target HR, Gerkin Protocol, Army PFT, Navy PRT, Marine PFT, Air Force PRT, Physical Efficiency Battery (PEB)	Manual, Rolling Hills, Fat Burn, 5k, Target HR, Gerkin Protocol, Army PFT, Navy PRT, Marine PFT, Air Force PRT, Physical Efficiency Battery (PEB)	Manual, Rolling Hills, Fat Burn, Target HR (incline), Gerkin Protocol, Calorie Goal, Distance Goal, Time Goal, Army PFT, Navy PRT, Marine PFT, Air Force PRT, Physical Efficiency Battery (PEB)	Manual, Rolling Hills, Fat Burn, Target HR, Gerkin Protocol
CSAFE Ready-FitLinux Certified	Yes	No	Yes	Yes	No
IPTV Compatible	Yes	No	No	No	No
Prodiom Compatible	Yes	No	Optional – add-on TV	No	Optional – add-on TV
FitTouch Technology	Yes	No	No	Yes	No
One-button Start	Yes	Yes	Yes	Yes	Yes
On-the-fly Program Change	Yes	Yes	Yes	Yes	Yes
Integrated Vista Clear Television Technology	Yes	No	No	Yes	No
FITCONNECTION Ready	No	No	Yes	No	Yes
Ethernet Compatible	Yes	No	No	No	No
WiFi Enabled	Optional	Optional - Asset Management only	Optional	Optional	Optional
Bluetooth Enabled	Optional	No	No	Optional	No
Connects to Apple Watch	No	No	No	No	No
iPod / iPhone / iPad Compatible	Charging only	Charging only	Charging only	Charging only	Charging only
Multimedia Playback	Compatible with most tablet and smartphone systems using Android OS	No	No	Compatible with most tablet and smartphone systems using Android OS	No
Personal Fan	No	No	No	No	No
Personal Trainer Portal Compatible	Yes	No	No	No	No
USB Port	Yes	Yes	Yes	Yes	Yes
Virtual Active Compatible	Yes	No	No	Yes	No
Asset Management Compatible	Yes	Yes	Yes	Yes	Yes
Workout Tracking Network Compatible	Yes	No	Yes	Yes	Yes
Web Connectivity	Optional	No	No	Optional	No
Facility Communication Portal/Calendar	Optional	No	No	Optional	No
RFID Compatible	No	No	No	No	No
Pause Function	Yes	Yes	Yes	Yes	Yes
Reading Rack	No	No	No	No	No
DRIVE SYSTEM					
Drive System	Matrix 4.2 HP AC Dynamic Response Drive System with 5mA current leakage	Matrix 4.2 HP AC Dynamic Response Drive System with 1mA current leakage	Matrix 4.2 HP AC Dynamic Response Drive System	Matrix 3.0 HP AC Dynamic Response Drive System	Matrix 3.0 HP AC Dynamic Response Drive System
TECH SPECS					
Power Requirements	216 – 250v, 50 Hz 20-amp dedicated circuit required, non-looped grounded	216 – 250v, 50 Hz 20-amp dedicated circuit required, non-looped grounded	216 – 250v, 50 Hz 20-amp dedicated circuit required, non-looped grounded	216 – 250v, 50 Hz 20-amp dedicated circuit required, non-looped grounded	216 – 250v, 50 Hz 20-amp dedicated circuit required, non-looped grounded
Electrical Receptacle & Plug	NEMA 220v 6-20R	NEMA 220v 6-20R	NEMA 220v 6-20R	NEMA 220v 6-20R	NEMA 220v 6-20R
Assembled Dimensions	215 x 86 x 143 cm / 84.8" x 33.7" x 56.3"	215 x 86 x 143 cm / 84.8" x 33.7" x 56.3"	215 x 86 x 143 cm / 84.8" x 33.7" x 56.3"	214 x 86 x 143 cm / 84.3" x 33.7" x 56.3"	214 x 86 x 143 cm / 84.3" x 33.7" x 56.3"
Max User Weight	182 kg / 400 lbs.	182 kg / 400 lbs.	182 kg / 400 lbs.	158.8 kg / 350 lbs.	158.8 kg / 350 lbs.
Assembled Weight	173 kg / 380 lbs.	173 kg / 380 lbs.	172 kg / 378 lbs.	153.8 kg / 338 lbs.	152.8 kg / 336 lbs.
Shipping Weight	186 kg / 409 lbs.	186 kg / 409 lbs.	185 kg / 408 lbs.	172.3 kg / 379 lbs.	171.5 kg / 377 lbs.
WARRANTY					
Frame	7 years	7 years	7 years	7 years*	7 years*
Drive System	7 years	7 years	7 years	3 years*	3 years*
Parts & Labor	3 years	3 years	3 years	3 years*	3 years*
Wear Items (iPod® Cable, USB Port, Headphone Jack, Battery)	90 days parts	90 days parts	90 days parts	90 days parts*	90 days parts*

* Warranty limited to 6 hours of use or less per day. Full commercial warranty not available on T1 series.



ASCENTS & ELLIPTICALS

A HARMONY OF DESIGN AND NATURAL MOVEMENT

We listened. We watched. We designed. And we developed equipment that provides smooth, stable, natural movement that makes every workout comfortable and efficient.

ASCENTS & ELLIPTICALS



- 1 LOW STEP-ON HEIGHT**
Offers easy access for users of all kinds.
- 2 CONTRALATERAL MOTION**
Mimics the body's natural movements for a smooth exercise experience.
- 3 ERGO FORM™ GRIPS**
Sculpted grips enhance comfort, and integrated controls offer instant access to key functions.
- 4 REMOVABLE DISK**
For fast, easy service.
- 5 VARIABLE INCLINE**
Responsive incline adjustment and variable stride length add a dynamic element of challenge.

*Shown in Matte Black





A7XI ASCENT TRAINER®

- 41 cm / 16" capacitive touchscreen with FitTouch™ Technology offers intuitive operation
- WiFi connectivity accommodates integrated Matrix Asset Management™ system, plus optional Workout Tracking Network and Personal Trainer Portal
- Custom interface configuration through Matrix Asset Management facilitates personalized communication with users
- Advanced Sprint 8® High Intensity Interval Training program
- Integrated Virtual Active™ programming provides an immersive exercise experience
- Optimized app interface designed specifically for fitness offers easy access to social media and web content
- Adjustable incline and resistance for greater workout variety
- Constant Rate of Acceleration and our patented suspension design deliver a perpetually smooth motion free of wheels and tracks
- Contralateral action with tapered, dual-action handlebars mimics the body's true movement and proper fit



A7XE ASCENT TRAINER®

- 41 cm / 16" touchscreen display with FitTouch™ Technology offers intuitive operation
- WiFi connectivity accommodates optional Matrix Asset Management™ system, Workout Tracking Network and Personal Trainer Portal
- Custom interface configuration facilitates personalized communication with users
- Advanced Sprint 8® High Intensity Interval Training program
- Compatible with Virtual Active™ programming to provide an immersive exercise experience
- Optimized app interface designed specifically for fitness
- Adjustable incline and resistance for greater workout variety
- Constant Rate of Acceleration and our patented suspension design deliver a perpetually smooth motion free of wheels and tracks
- Contralateral action with tapered, dual-action handlebars mimics the body's true movement and proper fit



A5X ASCENT TRAINER

- LED console display offers intuitive operation
- WiFi connectivity accommodates optional Matrix Asset Management system and Workout Tracking Network
- Sprint 8 High Intensity Interval Training program
- Adjustable incline and resistance for greater workout variety
- Constant Rate of Acceleration and our patented suspension design deliver a perpetually smooth motion free of wheels and tracks
- Contralateral action with tapered, dual-action handlebars mimics the body's true movement and proper fit



A3XE ASCENT TRAINER®

- 25.6 cm / 10.1" touchscreen display with FitTouch™ Technology offers intuitive operation
- WiFi connectivity accommodates optional Matrix Asset Management™ system, Workout Tracking Network and Personal Trainer Portal
- Custom interface configuration facilitates personalized communication with users
- Compatible with Virtual Active™ programming to provide an immersive exercise experience
- Optimized app interface designed specifically for fitness
- Adjustable incline and resistance for greater workout variety
- Constant Rate of Acceleration and our patented suspension design deliver a perpetually smooth motion free of wheels and tracks
- Contralateral action with tapered, dual-action handlebars mimics the body's true movement and proper fit

A3X ASCENT TRAINER

- LED console display with expanded feedback offers intuitive operation
- WiFi connectivity accommodates optional Matrix Asset Management system and Workout Tracking Network
- Adjustable incline and resistance for greater workout variety
- Constant Rate of Acceleration and our patented suspension design deliver a perpetually smooth motion free of wheels and tracks
- Contralateral action with tapered, dual-action handlebars mimics the body's true movement and proper fit



ALB7XI LOWER BODY ASCENT TRAINER®

- 41 cm / 16" capacitive touchscreen with FitTouch™ Technology offers intuitive operation
- WiFi connectivity accommodates integrated Matrix Asset Management™ system, plus optional Workout Tracking Network and Personal Trainer Portal
- Custom interface configuration through Matrix Asset Management facilitates personalized communication with users
- Advanced Sprint 8® High Intensity Interval Training program
- Integrated Virtual Active™ programming provides an immersive exercise experience
- Optimized app interface designed specifically for fitness offers easy access to social media and web content
- Adjustable incline and resistance for greater workout variety
- Constant rate of acceleration and our patented suspension design delivers a perpetually smooth motion free of wheels and tracks



ALB7XE LOWER BODY ASCENT TRAINER®

- 41 cm / 16" touchscreen display with FitTouch™ Technology offers intuitive operation
- WiFi connectivity accommodates optional Matrix Asset Management™ system, Workout Tracking Network and Personal Trainer Portal
- Custom interface configuration facilitates personalized communication with users
- Advanced Sprint 8® High Intensity Interval Training program
- Compatible with Virtual Active™ programming to provide an immersive exercise experience
- Optimized app interface designed specifically for fitness
- Adjustable incline and resistance for greater workout variety
- Constant rate of acceleration and our patented suspension design delivers a perpetually smooth motion free of wheels and tracks



ALB5X LOWER BODY ASCENT TRAINER

- LED console display offers intuitive operation
- WiFi connectivity accommodates optional Matrix Asset Management system and Workout Tracking Network
- Sprint 8 High Intensity Interval Training program
- Adjustable incline and resistance for greater workout variety
- Constant rate of acceleration and our patented suspension design delivers a perpetually smooth motion free of wheels and tracks



ALB3XE LOWER BODY ASCENT TRAINER®

- 25.6 cm / 10.1" touchscreen display with FitTouch™ Technology offers intuitive operation
- WiFi connectivity accommodates optional Matrix Asset Management™ system and Workout Tracking Network
- Custom interface configuration facilitates personalized communication with users
- Compatible with Virtual Active™ programming to provide an immersive exercise experience
- Optimized app interface designed specifically for fitness
- Adjustable incline and resistance for greater workout variety
- Constant rate of acceleration and our patented suspension design delivers a perpetually smooth motion free of wheels and tracks



ALB3X LOWER BODY ASCENT TRAINER

- LED console display with expanded feedback offers intuitive operation
- WiFi connectivity accommodates optional Matrix Asset Management system and Workout Tracking Network
- Adjustable incline and resistance for greater workout variety
- Constant rate of acceleration and our patented suspension design delivers a perpetually smooth motion free of wheels and tracks



E7XI SUSPENSION ELLIPTICAL™

- 41 cm / 16" capacitive touchscreen with FitTouch™ Technology offers intuitive operation
- WiFi connectivity accommodates optional Matrix Asset Management™ system, Workout Tracking Network and Personal Trainer Portal
- Custom interface configuration facilitates personalized communication with users
- Advanced Sprint 8® High Intensity Interval Training program
- Compatible with Virtual Active™ programming to provide an immersive exercise experience

- Optimized app interface designed specifically for fitness
- Constant Rate of Acceleration and our patented suspension design deliver a perpetually smooth motion free of wheels and tracks
- Contralateral action with tapered, dual-action handlebars mimics the body's true movement and proper fit



E7XE SUSPENSION ELLIPTICAL™

- 41 cm / 16" touchscreen display with FitTouch™ Technology offers intuitive operation
- WiFi connectivity accommodates optional Matrix Asset Management™ system, Workout Tracking Network and Personal Trainer Portal
- Custom interface configuration facilitates personalized communication with users
- Advanced Sprint 8® High Intensity Interval Training program
- Compatible with Virtual Active™ programming to provide an immersive exercise experience

- Optimized app interface designed specifically for fitness
- Constant Rate of Acceleration and our patented suspension design deliver a perpetually smooth motion free of wheels and tracks
- Contralateral action with tapered, dual-action handlebars mimics the body's true movement and proper fit



E5X SUSPENSION ELLIPTICAL™

- LED console display offers intuitive operation
- WiFi connectivity accommodates optional Matrix Asset Management™ system and Workout Tracking Network
- Sprint 8® High Intensity Interval Training program
- Constant Rate of Acceleration and our patented suspension design deliver a perpetually smooth motion free of wheels and tracks
- Contralateral action with tapered, dual-action handlebars mimics the body's true movement and proper fit

E3XE SUSPENSION ELLIPTICAL

- 25.6 cm / 10.1" touchscreen display with FitTouch™ Technology offers intuitive operation
- WiFi connectivity accommodates optional Matrix Asset Management system, Workout Tracking Network and Personal Trainer Portal
- Custom interface configuration facilitates personalized communication with users
- Compatible with Virtual Active™ programming to provide an immersive exercise experience
- Optimized app interface designed specifically for fitness
- Constant Rate of Acceleration and our patented suspension design deliver a perpetually smooth motion free of wheels and tracks
- Contralateral action with tapered, dual-action handlebars mimics the body's true movement and proper fit

E3X SUSPENSION ELLIPTICAL™

- LED console display with expanded feedback offers intuitive operation
- WiFi connectivity accommodates optional Matrix Asset Management™ system and Workout Tracking Network
- Constant Rate of Acceleration and our patented suspension design deliver a perpetually smooth motion free of wheels and tracks
- Contralateral action with tapered, dual-action handlebars mimics the body's true movement and proper fit

E1XE SUSPENSION ELLIPTICAL

- 25.6 cm / 10.1" touchscreen display with FitTouch™ Technology offers intuitive operation
- WiFi connectivity accommodates optional Matrix Asset Management system and Workout Tracking Network
- Custom interface configuration facilitates personalized communication with users
- Compatible with Virtual Active™ programming to provide an immersive exercise experience
- Optimized app interface designed specifically for fitness
- Constant Rate of Acceleration, coupled with our suspension design, deliver a perpetually smooth motion
- Contralateral action with tapered, dual-action handlebars mimics the body's true movement and proper fit

E1X SUSPENSION ELLIPTICAL

- LED console display is easily navigated by users at all experience levels
- WiFi connectivity accommodates optional Matrix Asset Management system and Workout Tracking Network
- Constant Rate of Acceleration, coupled with our suspension design, deliver a perpetually smooth motion
- Contralateral action with tapered, dual-action handlebars mimics the body's true movement and proper fit

Images and specifications subject to change. Visit matrixfitness.com for latest warranty information.

FEATURES	A7xi Ascent Trainer	A7xe Ascent Trainer	A5x Ascent Trainer	A3xe Ascent Trainer	A3x Ascent Trainer
Stride Length	51 – 61 cm / 20 – 24"	51 – 61 cm / 20 – 24"	51 – 61 cm / 20 – 24"	51 – 61 cm / 20 – 24"	51 – 61 cm / 20 – 24"
Incline Range	24 – 54% (15° range)	24 – 54% (15° range)	24 – 54% (15° range)	24 – 54% (15° range)	24 – 54% (15° range)
Step-on Height	24 cm / 9.5"	24 cm / 9.5"	24 cm / 9.5"	24 cm / 9.5"	24 cm / 9.5"
Contact & Telemetric HR	Yes	Yes	Yes	Yes	Yes
Footpad Inset	Premium	Premium	Premium	None	None
Pedal Spacing	6.4 cm / 2.5"	6.4 cm / 2.5"	6.4 cm / 2.5"	6.4 cm / 2.5"	6.4 cm / 2.5"
Handlebar Design	Multi-position dual-action / premium ergo-bend stationary	Multi-position dual-action / premium ergo-bend stationary	Multi-position dual-action / premium ergo-bend stationary	Multi-position dual-action / custom ergo-bend stationary	Multi-position dual-action / custom ergo-bend stationary
Remote Buttons	Yes	Yes	Yes	Yes	Yes
CONSOLE					
Display Type	41 cm / 16" class projective capacitive touchscreen LCD	41 cm / 16" class touchscreen LCD	Dot-matrix LED with profile display	25.6 cm / 10.1" touchscreen LCD	Dot-matrix LED with profile display
Display Feedback	Time of Day, Time Elapsed, Time Remaining, Distance (Kilometers or Miles), Calories, Calories per Hour, Speed, Pace, Average Pace, Incline, RPM, Heart Rate, Peak Heart Rate, METs, Watts, Dynamic Profile Display, Static Profile Display	Time of Day, Time Elapsed, Time Remaining, Distance (Kilometers or Miles), Calories, Calories per Hour, Speed, Pace, Average Pace, Incline, RPM, Heart Rate, Peak Heart Rate, METs, Watts, Dynamic Profile Display, Static Profile Display	Time of Day, Time Elapsed, Time Remaining, Total Program Time, Distance (Kilometers or Miles), Calories, Speed, Level, Incline, RPM, Heart Rate, METs, Watts, Workout Profile	Time of Day, Time Elapsed, Time Remaining, Total Program Time, Distance (Kilometers or Miles), Calories, Calories per Hour, Level, Speed, Pace, Average Pace, Incline, RPM, Heart Rate, Peak Heart Rate, METs, Watts, Dynamic Profile Display, Static Profile Display	Time of Day, Time Elapsed, Time Remaining, Total Program Time, Distance (Kilometers or Miles), Calories, Calories per Hour, Level, Speed, RPM, Incline, Heart Rate, METs, Watts, Profile
Secondary Data Display	Yes	Yes	No	No	No
User-defined Multi-language Display	English, German, French, Italian, Spanish, Dutch, Portuguese, Chinese (s), Chinese (t), Japanese, Korean, Swedish, Finnish, Russian, Arabic, Turkish, Polish, Welsh, Basque, Vietnamese, Somali, Danish	English, German, French, Italian, Spanish, Dutch, Portuguese, Chinese (s), Chinese (t), Japanese, Korean, Swedish, Finnish, Russian, Arabic, Turkish, Polish, Welsh, Basque, Vietnamese, Somali, Danish	English, German, French, Italian, Spanish, Dutch, Portuguese, Japanese, Swedish, Finnish, Turkish, Polish, Russian, Danish	English, German, French, Italian, Spanish, Dutch, Portuguese, Chinese (s), Chinese (t), Japanese, Korean, Swedish, Finnish, Russian, Arabic, Turkish, Polish, Welsh, Basque, Vietnamese, Somali, Danish	Accessible only through Manager Menu: English, German, French, Italian, Spanish, Dutch, Portuguese, Japanese, Swedish, Finnish, Turkish, Polish
Resistance Range	1-25	1-25	1-25	1-25	1-25
Workouts	Manual, Rolling Hills, Target HR, Interval Training, Constant Watts, Fat Burn, Fitness Test, Glute Training, Calorie Goal, Distance Goal, Time Goal, Sprint 8, Virtual Active	Manual, Rolling Hills, Target HR, Interval Training, Constant Watts, Fat Burn, Fitness Test, Glute Training, Calorie Goal, Distance Goal, Time Goal, Sprint 8	Manual, Rolling Hills, Target HR, Interval Training, Constant Watts, Fat Burn, Fitness Test, Glute Training, Sprint 8	Manual, Rolling Hills, Target HR, Interval Training, Constant Watts, Fat Burn, Fitness Test, Glute, Random, Calorie Goal, Distance Goal, Time Goal	Manual, Target HR, Interval Training, Fat Burn, Fitness Test, Constant Watts
CSAFE Ready-FitLinux Certified	Yes	Yes	Yes	Yes	Yes
iPTV Compatible	Yes	Yes	No	Yes	No
Prodiom Compatible	Yes	Yes	Optional – add-on TV	Yes	Optional – add-on TV
FitTouch Technology	Yes	Yes	No	Yes	No
Instant On Technology	Yes	Yes	Yes	Yes	Yes
One-button Start	Yes	Yes	Yes	Yes	Yes
On-the-fly Program Change	Yes	Yes	Yes	Yes	Yes
Integrated Vista Clear Television Technology	Yes	Yes	No	Yes	No
FITCONNECTION Ready	No	No	Yes	No	Yes
Ethernet Compatible	Yes	Yes	No	Yes	No
WiFi Enabled	Yes	Yes	Optional	Optional	Optional
Bluetooth Enabled	Yes	Yes	No	Optional	No
Connects to Apple Watch	Yes	Yes	No	No	No
iPod / iPhone / iPad Compatible	Made for iPod, iPhone, iPad	Made for iPod, iPhone, iPad	Charging only	Charging only	Charging only
Multimedia Playback	Compatible with most tablets and smartphones	Compatible with most tablets and smartphones	No	Compatible with most tablet and smartphone systems using Android OS	No
Personal Fan	Yes	Yes	Yes	No	No
Personal Trainer Portal Compatible	Yes	Yes	No	Yes	No
USB Port	Yes	Yes	Yes	Yes	Yes
Virtual Active Compatible	Included	Yes	No	Yes	No
Asset Management Compatible	Included	Yes	Yes	Yes	Yes
Workout Tracking Network Compatible	Yes	Yes	Yes	Yes	Yes
Web Connectivity	Custom app interface in addition to web browser	Optional	No	Optional	No
Facility Communication Portal/Calendar	Programmed through Asset Management	Optional	No	Optional	No
RFID Compatible	Yes	Yes	Yes	Yes	No
Pause Function	Yes	Yes	Yes	Yes	Yes
Reading Rack	Yes	Yes	No	Yes	Yes
RESISTANCE SYSTEM					
Resistance System	Brushless generator	Brushless generator	Brushless generator	Brushless generator	Brushless generator
TECH SPECS					
Power Requirements	Self-powered / powered 100v-240v – 50/60Hz AC	Self-powered / powered 100v-240v – 50/60Hz AC	Self-powered / powered 100v-240v – 50/60Hz AC*	Self-powered / powered 100v-240v – 50/60Hz AC	Self-powered / powered 100v-240v – 50/60Hz AC*
Minimum Watts	4 powered / 57 self-powered	4 powered / 57 self-powered	24 powered / 24 self-powered	21 powered & self-powered	8 powered / 24 self-powered
Minimum RPM	10 powered / 25 self-powered	10 powered / 25 self-powered	25 powered / 24 self-powered	25 powered & self-powered	15 powered / 25 self-powered
Assembled Dimensions	179 x 74 x 176 cm / 70.4" x 29.1" x 69.4"	179 x 74 x 176 cm / 70.4" x 29.1" x 69.4"	179 x 74 x 176 cm / 70.4" x 29.1" x 69.4"	179 x 74 x 171 cm / 70.4" x 29.1" x 67.4"	179 x 74 x 171 cm / 70.4" x 29.1" x 67.4"
Max User Weight	182 kg / 400 lbs.	182 kg / 400 lbs.	182 kg / 400 lbs.	182 kg / 400 lbs.	182 kg / 400 lbs.
Assembled Weight	202.7 kg / 445 lbs.	202.7 kg / 445 lbs.	201 kg / 442 lbs.	202.7 kg / 445 lbs.	201 kg / 442 lbs.
Shipping Weight	216.5 kg / 476 lbs.	216.5 kg / 476 lbs.	214.6 kg / 472 lbs.	216.5 kg / 476 lbs.	214.6 kg / 472 lbs.
WARRANTY					
Frame	7 years	7 years	7 years	7 years	7 years
Generator	5 years	5 years	5 years	5 years	5 years
Parts & Labor	3 years	3 years	3 years	3 years	3 years
Wear Items (iPod® Cable, USB Port, Headphone Jack, Battery)	90 days parts	90 days parts	90 days parts	90 days parts	90 days parts

* Plug in equipment with xID workout tracking for best results.





CLIMBERMILLS & STEPPERS

STEP UP TO THE BEST

Give your members the truest stair-climbing workout on the market with a combination of high-design and low maintenance that can live virtually anywhere in your facility.

CLIMBMILLS & STEPPERS



*Shown in Matte Black

- 1 DELINEATED STEPS**
Extra-deep steps accommodate a wide range of users, and color variations cue proper foot placement.
- 2 STEP POSITIONING SOFTWARE**
Locks steps at lowest possible point for easy entry and exit.
- 3 ERGO FORM™ GRIPS**
Sculpted grips enhance comfort, and integrated controls offer instant access to key functions.
- 4 REMOVABLE ACCESS PANEL**
Access panel can be easily removed with a common coin, and an internal service light provides component visibility.
- 5 CONTROL DRIVE**
Stairs stop moving instantly if any object pushes against the direction of rotation, ensuring a safe, secure stair-climbing experience.

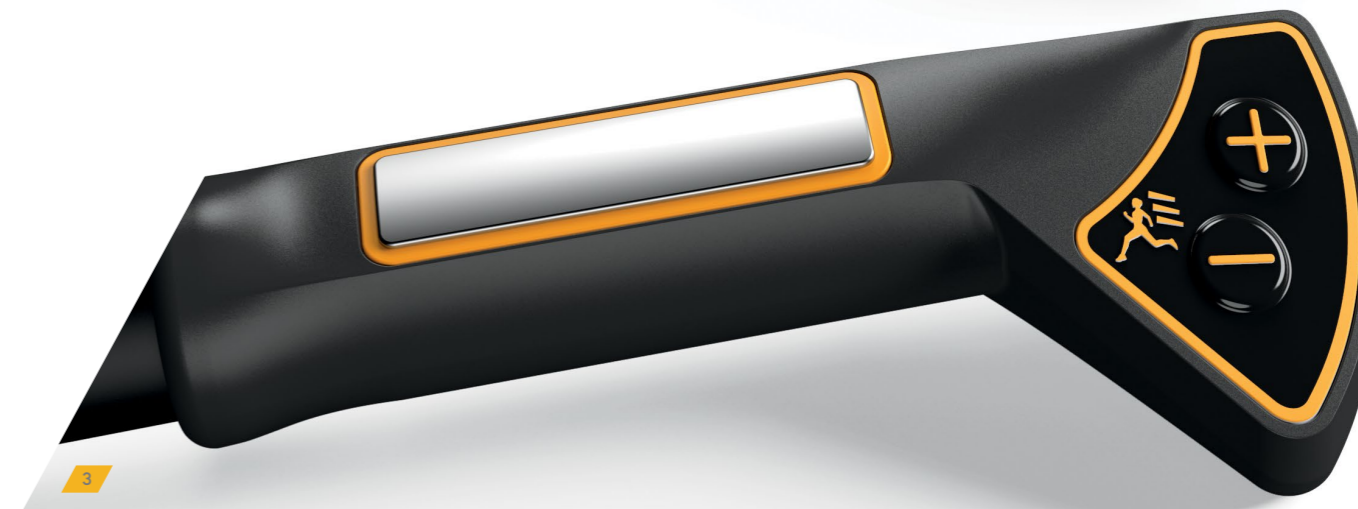



C7XI CLIMBMILL™

- 41 cm / 16" capacitive touchscreen with FitTouch™ Technology offers intuitive operation
- WiFi connectivity accommodates integrated Matrix Asset Management™ system, plus optional Workout Tracking Network and Personal Trainer Portal
- Custom interface configuration through Matrix Asset Management facilitates personalized communication with users
- Landmarks program enables users to scale some of the most famous buildings and monuments around the world
- Integrated Virtual Active™ programming provides an immersive exercise experience
- Optimized app interface designed specifically for fitness offers easy access to social media and web content
- Anti-rust design prevents corrosion, prolonging the life of the product
- Rear-locking and leveling casters allow easy placement within facility
- Oil-free ECB modular drive system for maintenance-free performance and quiet operation



C7XE CLIMBMILL™

- 41 cm / 16" touchscreen display with FitTouch™ Technology offers intuitive operation
- WiFi connectivity accommodates optional Matrix Asset Management™ system, Workout Tracking Network and Personal Trainer Portal
- Custom interface configuration facilitates personalized communication with users
- Landmarks program enables users to scale some of the most famous buildings and monuments around the world
- Compatible with Virtual Active™ programming to provide an immersive exercise experience
- Optimized app interface designed specifically for fitness
- Anti-rust design prevents corrosion, prolonging the life of the product
- Rear-locking and leveling casters allow easy placement within facility
- Oil-free ECB modular drive system for maintenance-free performance and quiet operation



C5X CLIMBMILL

- LED console display offers intuitive operation
- WiFi connectivity accommodates optional Matrix Asset Management system and Workout Tracking Network
- Landmarks program enables users to scale some of the most famous buildings and monuments around the world
- Anti-rust design prevents corrosion, prolonging the life of the product
- Rear-locking and leveling casters allow easy placement within facility
- Oil-free ECB modular drive system for maintenance-free performance and quiet operation



C3XE CLIMBMILL™

- 25.6 cm / 10.1" touchscreen display with FitTouch™ Technology offers intuitive operation
- WiFi connectivity accommodates optional Matrix Asset Management™ system, Workout Tracking Network and Personal Trainer Portal
- Custom interface configuration facilitates personalized communication with users
- Compatible with Virtual Active™ programming to provide an immersive exercise experience
- Optimized app interface designed specifically for fitness
- Anti-rust design prevents corrosion, prolonging the life of the product
- Rear-locking and leveling casters allow easy placement within facility
- Oil-free ECB modular drive system for maintenance-free performance and quiet operation

C3X CLIMBMILL

- LED console display with expanded feedback offers intuitive operation
- WiFi connectivity accommodates optional Matrix Asset Management system and Workout Tracking Network
- Anti-rust design prevents corrosion, prolonging the life of the product
- Rear-locking and leveling casters allow easy placement within facility
- Oil-free ECB modular drive system for maintenance-free performance and quiet operation



S7XI STEPPER

- 41 cm / 16" capacitive touchscreen with FitTouch™ Technology offers intuitive operation
- WiFi connectivity accommodates integrated Matrix Asset Management™ system, plus optional Workout Tracking Network and Personal Trainer Portal
- Custom interface configuration through Matrix Asset Management facilitates personalized communication with users
- Landmarks program enables users to scale some of the most famous buildings and monuments around the world
- Integrated Virtual Active™ programming provides an immersive exercise experience
- Optimized app interface designed specifically for fitness offers easy access to social media and web content
- Ultra non-slip large pedals for increased stability
- Angled independent stepping motion mimics real climbing feel
- Belt-drive design for smooth and quiet operation



S7XE STEPPER

- 41 cm / 16" touchscreen display with FitTouch™ Technology offers intuitive operation
- WiFi connectivity accommodates optional Matrix Asset Management™ system, Workout Tracking Network and Personal Trainer Portal
- Custom interface configuration facilitates personalized communication with users
- Landmarks program enables users to scale some of the most famous buildings and monuments around the world
- Compatible with Virtual Active™ programming to provide an immersive exercise experience
- Optimized app interface designed specifically for fitness
- Ultra non-slip large pedals for increased stability
- Angled independent stepping motion mimics real climbing feel
- Belt-drive design for smooth and quiet operation



S5X STEPPER

- LED console display offers intuitive operation
- WiFi connectivity accommodates optional Matrix Asset Management system and Workout Tracking Network
- Landmarks program enables users to scale some of the most famous buildings and monuments around the world
- Ultra non-slip large pedals for increased stability
- Angled independent stepping motion mimics real climbing feel
- Belt-drive design for smooth and quiet operation



S3XE STEPPER

- 25.6 cm / 10.1" touchscreen display with FitTouch™ Technology offers intuitive operation
- WiFi connectivity accommodates optional Matrix Asset Management™ system, Workout Tracking Network and Personal Trainer Portal
- Custom interface configuration facilitates personalized communication with users
- Compatible with Virtual Active™ programming to provide an immersive exercise experience
- Optimized app interface designed specifically for fitness
- Ultra non-slip large pedals for increased stability
- Angled independent stepping motion mimics real climbing feel
- Belt-drive design for smooth and quiet operation



S3X STEPPER

- LED console display with expanded feedback offers intuitive operation
- WiFi connectivity accommodates optional Matrix Asset Management system and Workout Tracking Network
- Ultra non-slip large pedals for increased stability
- Angled independent stepping motion mimics real climbing feel
- Belt-drive design for smooth and quiet operation

Images and specifications subject to change. Visit matrixfitness.com for latest warranty information.

FEATURES	C7xi ClimbiMill™	C7xe ClimbiMill	C5x ClimbiMill	C3xe ClimbiMill	C3x ClimbiMill
Step Depth	25.4 cm / 10"	25.4 cm / 10"	25.4 cm / 10"	25.4 cm / 10"	25.4 cm / 10"
Step Height	20.3 cm / 8"	20.3 cm / 8"	20.3 cm / 8"	20.3 cm / 8"	20.3 cm / 8"
Contact & Telemetric HR	Yes	Yes	Yes	Yes	Yes
Delimited Steps	Yes	Yes	Yes	Yes	Yes
Handlebar Design	Ergonomically designed handrails and ergo form grips	Ergonomically designed handrails and ergo form grips	Ergonomically designed handrails and ergo form grips	Ergonomically designed handrails and ergo form grips	Ergonomically designed handrails and ergo form grips
Remote Buttons	Yes	Yes	Yes	Yes	Yes
Control Zone	Yes	Yes	No	No	No
Auto-stop Function	Yes	Yes	Yes	Yes	Yes
CONSOLE					
Display Type	41 cm / 16" class projective capacitive touchscreen LCD	41 cm / 16" class touchscreen LCD	Dot-matrix LED with profile display	25.6 cm / 10.1" touchscreen LCD	Dot-matrix LED with profile display
Display Feedback	Time, Clock, Time Elapsed, Time Remaining, Total Steps, Floors Climbed, Calories, Calories per Hour, Level, Speed, SPM, Average SPM, Heart Rate, Peak Heart Rate, METs, Dynamic Profile Display, Static Profile Display	Time, Clock, Time Elapsed, Time Remaining, Total Steps, Floors Climbed, Calories, Calories per Hour, Level, Speed, SPM, Average SPM, Heart Rate, Peak Heart Rate, METs, Dynamic Profile Display, Static Profile Display	Time Elapsed, Time Remaining, Time of Day, Total Program Time, Total Steps, Floors Climbed, Calories, SPM, Average SPM, Heart Rate, METs, Watts, Level, Workout Profile	Time of Day, Time Elapsed, Time Remaining, Total Steps, Floors Climbed, Calories, Calories per Hour, Level, Speed, SPM, Average SPM, Heart Rate, Peak Heart Rate, METs, Watts, Dynamic Profile Display, Static Profile Display	Time Elapsed, Time Remaining, Time of Day, Total Program Time, Floors Climbed, SPM, Calories, Heart Rate, METs, Watts, Level
Secondary Data Display	Yes	Yes	No	No	No
User-defined Multi-language Display	English, German, French, Italian, Spanish, Dutch, Portuguese, Chinese (s), Chinese (t), Japanese, Korean, Swedish, Finnish, Russian, Arabic, Turkish, Polish, Welsh, Basque, Vietnamese, Somali, Danish	English, German, French, Italian, Spanish, Dutch, Portuguese, Chinese (s), Chinese (t), Japanese, Korean, Swedish, Finnish, Russian, Arabic, Turkish, Polish, Welsh, Basque, Vietnamese, Somali, Danish	English, German, French, Italian, Spanish, Dutch, Portuguese, Japanese, Swedish, Finnish, Turkish, Polish, Russian, Danish	English, German, French, Italian, Spanish, Dutch, Portuguese, Chinese (s), Chinese (t), Japanese, Korean, Swedish, Finnish, Russian, Arabic, Turkish, Polish, Welsh, Basque, Vietnamese, Somali, Danish	Accessible only through Manager Menu: English, German, French, Italian, Spanish, Dutch, Portuguese, Japanese, Swedish, Finnish, Polish, Turkish, Polish
Resistance Range	1-25	1-25	1-25	1-25	1-25
Workouts	Manual, Training Workouts (Rolling Hills, Interval Training, Calorie Training, Goal Training), Fat Burn, Target HR, Fitness Test (Sub-maximal Test, WFI Test, CPAT), Time Goal, Floor Goal, Calorie Goal, Landmarks, Virtual Active	Manual, Training Workouts (Rolling Hills, Interval Training, Calorie Training, Goal Training), Fat Burn, Target HR, Fitness Test (Sub-maximal Test, WFI Test, CPAT), Time Goal, Floor Goal, Calorie Goal, Landmarks	Manual, Training Workouts (Rolling Hills, Fat Burn, Interval Training), Goal Training (Time Goal, Floor Goal, Calorie Goal), Target HR, Fitness Test (Sub-maximal Test, WFI Test, CPAT), Landmarks	Manual, Rolling Hills, Target HR, Interval Training, Fat Burn, Fitness Test, Time Goal, Calorie Goal, Floor Goal	Manual, Interval Training, Fat Burn, Target HR, HR, Fitness Test (Sub-maximal Test, WFI Test, CPAT)
CSAFE Ready-FitLinux Certified	Yes	Yes	Yes	Yes	Yes
iPTV Compatible	Yes	Yes	No	Yes	No
Prodiom Compatible	Yes	Yes	Optional - add-on TV	Yes	Optional - add-on TV
FitTouch Technology	Yes	Yes	No	Yes	Optional - add-on TV
Instant On Technology	N/A: Powered	N/A: Powered	N/A: Powered	N/A: Powered	N/A: Powered
One-button Start	Yes	Yes	Yes	Yes	Yes
On-the-fly Program Change	Yes	Yes	Yes	Yes	Yes
Integrated Vista Clear Television Technology	Yes	Yes	No	Yes	No
FITCONNEXION Ready	No	No	Yes	No	Yes
Ethernet Compatible	Yes	Yes	No	Yes	No
WiFi Enabled	Yes	Yes	Optional	Optional	Optional
Bluetooth Enabled	Yes	Yes	No	Optional	No
Connects to Apple Watch	Yes	Yes	No	No	No
iPod / iPhone / iPad Compatible	Made for iPod, iPhone, iPad	Made for iPod, iPhone, iPad	Charging only	Charging only	Charging only
Multimedia Playback	Compatible with most tablets and smartphones	Compatible with most tablets and smartphones	No	Compatible with most tablet and smartphone systems using Android OS	No
Personal Fan	Yes	Yes	No	No	No
Personal Trainer Portal Compatible	Yes	Yes	No	Yes	No
USB Port	Yes	Yes	Yes	Yes	Yes
Virtual Active Compatible	Included	Yes	No	Yes	No
Asset Management Compatible	Included	Yes	Yes	Yes	Yes
Workout Tracking Network Compatible	Yes	Yes	Yes	Yes	Yes
Web Connectivity	Custom app interface in addition to web browser	Optional	No	Optional	No
Facility Communication Portal/Calendar	Programmed through Asset Management	Optional	No	Optional	No
RFID Compatible	Yes	Yes	Yes	Yes	No
Pause Function	Yes	Yes	Yes	Yes	Yes
Reading Rack	Yes	Yes	No	Yes	Yes
RESISTANCE SYSTEM					
Resistance Technology	ECB w/ flywheel	ECB w/ flywheel	ECB w/ flywheel	ECB w/ flywheel	ECB w/ flywheel
TECH SPECS					
Power Requirements	100v-240v - 50/60Hz AC	100v-240v - 50/60Hz AC	100v-240v - 50/60Hz AC	100v-240v - 50/60Hz AC	100v-240v - 50/60Hz AC
Assembled Dimensions	165 x 102 x 213 cm / 65" x 40.3" x 83.9"	165 x 102 x 213 cm / 65" x 40.3" x 83.9"	165 x 102 x 213 cm / 65" x 40.3" x 83.9"	144 x 102 x 213 cm / 56.7" x 40.3" x 83.9"	144 x 102 x 213 cm / 56.7" x 40.3" x 83.9"
Max User Weight	182 kg / 400 lbs.	182 kg / 400 lbs.	182 kg / 400 lbs.	182 kg / 400 lbs.	182 kg / 400 lbs.
Assembled Weight	171 kg / 377 lbs.	171 kg / 377 lbs.	168 kg / 370 lbs.	160 kg / 353 lbs.	160 kg / 353 lbs.
Shipping Weight	198.5 kg / 437 lbs.	198.5 kg / 437 lbs.	190 kg / 418 lbs.	188 kg / 414 lbs.	188 kg / 414 lbs.
WARRANTY					
Frame	7 years	7 years	7 years	7 years	7 years
Generator	5 years	5 years	5 years	5 years	5 years
Parts & Labor	3 years	3 years	3 years	3 years	3 years
Wear Items (iPod® Cable, USB Port, Headphone Jack, Battery)	90 days parts	90 days parts	90 days parts	90 days parts	90 days parts

Images and specifications subject to change. Visit matrixfitness.com for latest warranty information.

FEATURES	S7xi Stepper	S7xe Stepper	S5x Stepper	S3xe Stepper	S3x Stepper
Step Range	31 cm / 12.2"	31 cm / 12.2"	31 cm / 12.2"	31 cm / 12.2"	31 cm / 12.2"
Contact & Telemetric HR	Yes	Yes	Yes	Yes	Yes
Pedal Spacing	8.4 cm / 3.3"	8.4 cm / 3.3"	8.4 cm / 3.3"	8.4 cm / 3.3"	8.4 cm / 3.3"
Handlebar Design	Ergonomically designed handrails and ergo form grips	Ergonomically designed handrails and ergo form grips	Ergonomically designed handrails and ergo form grips	Ergonomically designed handrails and ergo form grips	Ergonomically designed handrails and ergo form grips
Remote Buttons	Yes	Yes	Yes	Yes	Yes
CONSOLE					
Display Type	41 cm / 16" class projective capacitive touchscreen LCD	41 cm / 16" class touchscreen LCD	Dot-matrix LED with profile display	25.6 cm / 10.1" touchscreen LCD	Dot-matrix LED with profile display
Display Feedback	Time of Day, Time Elapsed, Time Remaining, Total Program Time, Total Steps, Floors Climbed, Calories, Calories per Hour, Level, Speed, SPM, Average SPM, Heart Rate, Peak Heart Rate, METs, Watts, Dynamic Profile Display, Static Profile Display	Time of Day, Time Elapsed, Time Remaining, Total Program Time, Total Steps, Floors Climbed, Calories, Calories per Hour, Level, Speed, SPM, Average SPM, Heart Rate, Peak Heart Rate, METs, Watts, Dynamic Profile Display, Static Profile Display	Time of Day, Time Elapsed, Time Remaining, Total Steps, Floors Climbed, Calories, METs, Watts, Average SPM, SPM, Heart Rate, Level, Workout Profile	Time of Day, Time Elapsed, Time Remaining, Total Program Time, Total Steps, Floors Climbed, Calories, Calories per Hour, Level, Speed, SPM, Average SPM, Heart Rate, Peak Heart Rate, METs, Watts, Dynamic Profile Display, Static Profile Display	Time of Day, Time Elapsed, Time Remaining, Total Program Time, Speed, Floors Climbed, Calories, METs, Watts, SPM, Heart Rate, Level, Workout Profile
Secondary Data Display	Yes	Yes	No	No	No
User-defined Multi-language Display	English, German, French, Italian, Spanish, Dutch, Portuguese, Chinese (s), Chinese (t), Japanese, Korean, Swedish, Finnish, Russian, Arabic, Turkish, Polish, Welsh, Basque, Vietnamese, Somali, Danish	English, German, French, Italian, Spanish, Dutch, Portuguese, Chinese (s), Chinese (t), Japanese, Korean, Swedish, Finnish, Russian, Arabic, Turkish, Polish, Welsh, Basque, Vietnamese, Somali, Danish	English, German, French, Italian, Spanish, Dutch, Portuguese, Japanese, Swedish, Finnish, Turkish, Polish, Welsh, Basque, Vietnamese, Somali, Danish	English, German, French, Italian, Spanish, Dutch, Portuguese, Chinese (s), Chinese (t), Japanese, Korean, Swedish, Finnish, Russian, Arabic, Turkish, Polish, Welsh, Basque, Vietnamese, Somali, Danish	Accessible only through Manager Menu: English, German, French, Italian, Spanish, Dutch, Portuguese, Japanese, Swedish, Finnish, Turkish, Polish
Resistance Range	1-25	1-25	1-25	1-25	1-25
Workouts	Manual, Rolling Hills, Target HR, Interval Training, Fat Burn, Stepper Fitness Test, Time Goal, Calorie Goal, Floor Goal, Landmarks, Virtual Active	Manual, Rolling Hills, Target HR, Interval Training, Fat Burn, Stepper Fitness Test, Time Goal, Calorie Goal, Floor Goal, Landmarks	Manual, Rolling Hills, Target HR, Interval Training, Fat Burn, Stepper Fitness Test, Landmarks	Manual, Rolling Hills, Target HR, Interval Training, Fat Burn, Stepper Fitness Test, Time Goal, Calorie Goal, Floor Goal	Manual, Target HR, Interval Training, Constant Watts, Fat Burn, Fitness Test
CSAFE Ready-FitLinux Certified	Yes	Yes	Yes	Yes	Yes
iPTV Compatible	Yes	Yes	No	Yes	No
Prodiom Compatible	Yes	Yes	Optional - add-on TV	Yes	Optional - add-on TV
FitTouch Technology	Yes	Yes	No	Yes	No
Instant On Technology	N/A: Powered	N/A: Powered	Yes	Yes	Yes
One-button Start	Yes	Yes	Yes	Yes	Yes
On-the-fly Program Change	Yes	Yes	Yes	Yes	Yes
Integrated Vista Clear Television Technology	Yes	Yes	No	Yes	No
FITCONNEXION Ready	No	No	Yes	No	Yes
Ethernet Compatible	Yes	Yes	No	Yes	No
WiFi Enabled	Yes	Yes	Optional	Optional	Optional
Bluetooth Enabled	Yes	Yes	No	Optional	No
Connects to Apple Watch	Yes	Yes	No	No	No
iPod / iPhone / iPad Compatible	Made for iPod, iPhone, iPad	Made for iPod, iPhone, iPad	Charging only	Charging only	Charging only
Multimedia Playback	Compatible with most tablets and smartphones	Compatible with most tablets and smartphones	No	Compatible with most tablet and smartphone systems using Android OS	No
Personal Fan	Yes	Yes	Yes	No	No
Personal Trainer Portal Compatible	Yes	Yes	No	Yes	No
USB Port	Yes	Yes	Yes	Yes	Yes
Virtual Active Compatible	Included	Yes	No	Yes	No
Asset Management Compatible	Included	Yes	Yes	Yes	Yes
Workout Tracking Network Compatible	Yes	Yes	Yes	Yes	Yes
Web Connectivity	Custom app interface in addition to web browser	Optional	No	Optional	No
Facility Communication Portal/Calendar	Programmed through Asset Management	Optional	No	Optional	No
RFID Compatible	Yes	Yes	Yes	Yes	No
Pause Function	Yes	Yes	Yes	Yes	Yes
Reading Rack	Yes	Yes	No	Yes	Yes
RESISTANCE SYSTEM					
Resistance Technology	Hybrid generator	Hybrid generator	Hybrid generator	Hybrid generator	Hybrid generator
TECH SPECS					
Power Requirements	Powered 100v-240v - 50/60Hz AC	Powered 100v-240v - 50/60Hz AC	Self-powered / powered 100v-240v - 50/60Hz AC*	Powered 100v-240v - 50/60Hz AC	Self-powered / powered 100v-240v - 50/60Hz AC*
Minimum Watts	18 powered	18 powered	18 powered / 18 self-powered	18 powered	18 powered / 18 self-powered
Assembled Dimensions	115 x 83 x 178 cm / 45.1" x 32.7" x 70.2"	115 x 83 x 178 cm / 45.1" x 32.7" x 70.2"	115 x 83 x 176 cm / 45.1" x 32.7" x 69.4"	115 x 83 x 176 cm / 45.1" x 32.7" x 69.4"	115 x 83 x 176 cm / 45.1" x 32.7" x 69.4"
Max User Weight	182 kg / 400 lbs.	182 kg / 400 lbs.	182 kg / 400 lbs.	182 kg / 400 lbs.	182 kg / 400 lbs.
Assembled Weight	117.7 kg / 259 lbs.	117.7 kg / 259 lbs.	116.2 kg / 255 lbs.	117.7 kg / 259 lbs.	117.2 kg / 258 lbs.
Shipping Weight	125.5 kg / 276 lbs.	125.5 kg / 276 lbs.	123.6 kg / 272 lbs.	125.5 kg / 276 lbs.	124.5 kg / 274 lbs.
WARRANTY					
Frame	7 years	7 years	7 years	7 years	7 years
Generator	5 years	5 years	5 years	5 years	5 years
Parts & Labor	3 years	3 years	3 years	3 years	3 years
Wear Items (iPod® Cable, USB Port, Headphone Jack, Battery)	90 days parts	90 days parts	90 days parts	90 days parts	90 days parts

* Plug in equipment with xID workout tracking for best results.



CYCLES

A BETTER RIDE BY DESIGN

Performance, comfort and styling make our cycles a favorite for members, while easy use and streamlined maintenance make them a top choice for owners, trainers and service techs. And with self-powered options, you can place them anywhere in your facility.

CYCLES



*Shown in Matte Black

- 1 45° SEAT ANGLE**
Ergonomic angle enhances comfort and workout effectiveness. (Hybrid only)
- 2 STEP-THROUGH ENTRY**
Makes it easy for users to get on and get started. (Hybrid shown)
- 3 INTEGRATED TRANSPORT HANDLE AND TOP-DOWN LEVELERS**
Handle is easily accessible, and top-down adjustment simplifies leveling after installation, maintenance or use. (Recumbent shown)
- 4 ONE-HAND SEAT ADJUSTMENT**
Intuitive one-hand adjustment finetunes seat position for users of all sizes. (Upright shown)
- 5 RACE-INSPIRED HANDLES**
Comfortably contoured handles include elbow rests. (Upright only)





H7XI HYBRID CYCLE™

- 41 cm / 16" capacitive touchscreen with FitTouch™ Technology offers intuitive operation
- WiFi connectivity accommodates integrated Matrix Asset Management™ system, plus optional Workout Tracking Network and Personal Trainer Portal
- Custom interface configuration through Matrix Asset Management facilitates personalized communication with users
- Advanced Sprint 8® High Intensity Interval Training program
- Integrated Virtual Active™ programming provides an immersive exercise experience
- Optimized app interface designed specifically for fitness offers easy access to social media and web content
- Innovative command seating position ensures a convenient and comfortable workout
- Pivoting arm rest for maximum comfort



H7XE HYBRID CYCLE™

- 41 cm / 16" touchscreen display with FitTouch™ Technology offers intuitive operation
- WiFi connectivity accommodates optional Matrix Asset Management™ system, Workout Tracking Network and Personal Trainer Portal
- Custom interface configuration facilitates personalized communication with users
- Advanced Sprint 8® High Intensity Interval Training program
- Compatible with Virtual Active™ programming to provide an immersive exercise experience
- Optimized app interface designed specifically for fitness
- Innovative command seating position ensures a convenient and comfortable workout
- Pivoting arm rest for maximum comfort



H5X HYBRID CYCLE

- LED console display offers intuitive operation
- WiFi connectivity accommodates optional Matrix Asset Management system and Workout Tracking Network
- Sprint 8 High Intensity Interval Training program
- Innovative command seating position ensures a convenient and comfortable workout
- Pivoting arm rest for maximum comfort



H3XE HYBRID CYCLE™

- 25.6 cm / 10.1" touchscreen display with FitTouch™ Technology offers intuitive operation
- WiFi connectivity accommodates optional Matrix Asset Management™ system, Workout Tracking Network and Personal Trainer Portal
- Custom interface configuration facilitates personalized communication with users
- Compatible with Virtual Active™ programming to provide an immersive exercise experience
- Optimized app interface designed specifically for fitness
- Innovative command seating position ensures a convenient and comfortable workout
- Pivoting arm rest for maximum comfort

H3X HYBRID CYCLE

- LED console display with expanded feedback offers intuitive operation
- WiFi connectivity accommodates optional Matrix Asset Management system and Workout Tracking Network
- Innovative command seating position ensures a convenient and comfortable workout
- Pivoting arm rest for maximum comfort



R7XI RECUMBENT CYCLE

- 41 cm / 16" capacitive touchscreen with FitTouch™ Technology offers intuitive operation
- WiFi connectivity accommodates integrated Matrix Asset Management™ system, plus optional Workout Tracking Network and Personal Trainer Portal
- Custom interface configuration through Matrix Asset Management facilitates personalized communication with users
- Advanced Sprint 8® High Intensity Interval Training program
- Integrated Virtual Active™ programming provides an immersive exercise experience
- Optimized app interface designed specifically for fitness offers easy access to social media and web content



R7XE RECUMBENT CYCLE

- 41 cm / 16" touchscreen display with FitTouch™ Technology offers intuitive operation
- WiFi connectivity accommodates optional Matrix Asset Management™ system, Workout Tracking Network and Personal Trainer Portal
- Custom interface configuration facilitates personalized communication with users
- Advanced Sprint 8® High Intensity Interval Training program
- Compatible with Virtual Active™ programming to provide an immersive exercise experience
- Optimized app interface designed specifically for fitness



R5X RECUMBENT CYCLE

- LED console display offers intuitive operation
- WiFi connectivity accommodates optional Matrix Asset Management system and Workout Tracking Network
- Sprint 8 High Intensity Interval Training program



R3XE RECUMBENT CYCLE

- 25.6 cm / 10.1" touchscreen display with FitTouch™ Technology offers intuitive operation
- WiFi connectivity accommodates optional Matrix Asset Management™ system, Workout Tracking Network and Personal Trainer Portal
- Custom interface configuration facilitates personalized communication with users
- Compatible with Virtual Active™ programming to provide an immersive exercise experience
- Optimized app interface designed specifically for fitness



R3XM RECUMBENT CYCLE

- Intuitive, bright LED console displays only the feedback essential to therapists and clinicians
- Med CE IIa certified to serve the needs of therapeutic, rehabilitation and active-aging settings
- WiFi connectivity accommodates optional Matrix Asset Management system
- Pedal cranks independently adjust without tools from 3.8–17.8 cm / 1.5"–7" to allow rotational movement for users with limited range of motion
- Swivel seat with 160-degree motion locks at right, left and center to provide easy entry and exit
- Self-balancing pedals with heel cups and straps provide secure, stable foot placement



R3X RECUMBENT CYCLE

- LED console display with expanded feedback offers intuitive operation
- WiFi connectivity accommodates optional Matrix Asset Management™ system and Workout Tracking Network



R1XE RECUMBENT CYCLE

- 25.6 cm / 10.1" touchscreen display with FitTouch™ Technology offers intuitive operation
- WiFi connectivity accommodates optional Matrix Asset Management system and Workout Tracking Network
- Custom interface configuration facilitates personalized communication with users
- Compatible with Virtual Active™ programming to provide an immersive exercise experience
- Optimized app interface designed specifically for fitness



R1X RECUMBENT CYCLE

- LED console display is easily navigated by users at all experience levels
- WiFi connectivity accommodates optional Matrix Asset Management system and Workout Tracking Network



U7XI UPRIGHT CYCLE

- 41 cm / 16" capacitive touchscreen with FitTouch™ Technology offers intuitive operation
- WiFi connectivity accommodates integrated Matrix Asset Management™ system, plus optional Workout Tracking Network and Personal Trainer Portal
- Custom interface configuration through Matrix Asset Management facilitates personalized communication with users
- Advanced Sprint 8® High Intensity Interval Training program
- Integrated Virtual Active™ programming provides an immersive exercise experience
- Optimized app interface designed specifically for fitness offers easy access to social media and web content
- Low step-over height for easy access



U7XE UPRIGHT CYCLE

- 41 cm / 16" touchscreen display with FitTouch™ Technology offers intuitive operation
- WiFi connectivity accommodates optional Matrix Asset Management™ system, Workout Tracking Network and Personal Trainer Portal
- Custom interface configuration facilitates personalized communication with users
- Advanced Sprint 8® High Intensity Interval Training program
- Compatible with Virtual Active™ programming to provide an immersive exercise experience
- Optimized app interface designed specifically for fitness
- Low step-over height for easy access



U5X UPRIGHT CYCLE

- LED console display offers intuitive operation
- WiFi connectivity accommodates optional Matrix Asset Management system and Workout Tracking Network
- Sprint 8 High Intensity Interval Training program
- Low step-over height for easy access



U3XE UPRIGHT CYCLE

- 25.6 cm / 10.1" touchscreen display with FitTouch™ Technology offers intuitive operation
- WiFi connectivity accommodates optional Matrix Asset Management™ system, Workout Tracking Network and Personal Trainer Portal
- Custom interface configuration facilitates personalized communication with users
- Compatible with Virtual Active™ programming to provide an immersive exercise experience
- Optimized app interface designed specifically for fitness
- Low step-over height for easy access



U3X UPRIGHT CYCLE

- LED console display with expanded feedback offers intuitive operation
- WiFi connectivity accommodates optional Matrix Asset Management system and Workout Tracking Network
- Low step-over height for easy access



U1XE UPRIGHT CYCLE

- 25.6 cm / 10.1" touchscreen display with FitTouch™ Technology offers intuitive operation
- WiFi connectivity accommodates optional Matrix Asset Management™ system and Workout Tracking Network
- Custom interface configuration facilitates personalized communication with users
- Compatible with Virtual Active™ programming to provide an immersive exercise experience
- Optimized app interface designed specifically for fitness
- Low step-over height for easy access

U1X UPRIGHT CYCLE

- LED console display is easily navigated by users at all experience levels
- WiFi connectivity accommodates optional Matrix Asset Management system and Workout Tracking Network
- Low step-over height for easy access

Images and specifications subject to change. Visit matrixfitness.com for latest warranty information.

FEATURES	H7xi Hybrid Cycle™	H7xe Hybrid Cycle	H5x Hybrid Cycle	H3xe Hybrid Cycle	H3x Hybrid Cycle
Contact & Telemetric HR	Yes	Yes	Yes	Yes	Yes
Handlebar Design	Front vertical ergo bend	Front vertical ergo bend	Front vertical ergo bend	Front vertical ergo bend	Front vertical ergo bend
Integrated Arm Rests	Yes	Yes	Yes	Yes	Yes
Remote Buttons	Yes	Yes	Yes	Yes	Yes
Bottle Holder	Yes	Yes	Yes	Yes	Yes
CONSOLE					
Display Type	41 cm / 16" class projective capacitive touchscreen LCD	41 cm / 16" class touchscreen LCD	Dot-matrix LED with profile display	25.6 cm / 10.1" touchscreen LCD	Dot-matrix LED with profile display
Display Feedback	Time of Day, Time Elapsed, Time Remaining, Total Program Time, Distance (Kilometers or Miles), Calories, Calories per Hour, Level, Speed, Pace, Average Pace, RPM, Heart Rate, Peak Heart Rate, METs, Watts, Dynamic Profile Display, Static Profile Display	Time of Day, Time Elapsed, Time Remaining, Total Program Time, Distance (Kilometers or Miles), Calories, Calories per Hour, Level, Speed, Pace, Average Pace, RPM, Heart Rate, Peak Heart Rate, METs, Watts, Dynamic Profile Display, Static Profile Display	Time of Day, Time Elapsed, Time Remaining, Total Program Time, Distance (Kilometers or Miles), Calories, Speed, Level, RPM, Heart Rate, METs, Watts, Workout Profile	Time of Day, Time Elapsed, Time Remaining, Total Program Time, Distance (Kilometers or Miles), Calories, Calories per Hour, Level, Speed, Pace, Average Pace, RPM, Heart Rate, Peak Heart Rate, METs, Watts, Dynamic Profile Display, Static Profile Display	Time of Day, Time Elapsed, Time Remaining, Total Program Time, Distance (Kilometers or Miles), Calories, Calories per Hour, Speed, Level, RPM, Heart Rate, METs, Watts, Workout Profile
Secondary Data Display	Yes	Yes	No	No	No
User-defined Multi-language Display	English, German, French, Italian, Spanish, Dutch, Portuguese, Chinese (s), Chinese (t), Japanese, Korean, Swedish, Finnish, Russian, Arabic, Turkish, Polish, Welsh, Basque, Vietnamese, Somali, Danish	English, German, French, Italian, Spanish, Dutch, Portuguese, Chinese (s), Chinese (t), Japanese, Korean, Swedish, Finnish, Russian, Arabic, Turkish, Polish, Welsh, Basque, Vietnamese, Somali, Danish	English, German, French, Italian, Spanish, Dutch, Portuguese, Russian, Swedish, Finnish, Turkish, Polish, Russian, Danish	English, German, French, Italian, Spanish, Dutch, Portuguese, Chinese (s), Chinese (t), Japanese, Korean, Swedish, Finnish, Russian, Arabic, Turkish, Polish, Welsh, Basque, Vietnamese, Somali, Danish	Accessible only through Manager Menu: English, German, French, Italian, Spanish, Dutch, Portuguese, Japanese, Swedish, Finnish, Turkish, Polish
Resistance Range	1-30	1-30	1-30	1-30	1-30
Workouts	Manual, Rolling Hills, Target HR, Interval Training, Constant Watts, Fat Burn, Fitness Test, Time Goal, Calorie Goal, Distance Goal, Sprint 8, Virtual Active	Manual, Rolling Hills, Target HR, Interval Training, Constant Watts, Fat Burn, Fitness Test, Time Goal, Calorie Goal, Distance Goal, Sprint 8	Manual, Rolling Hills, Target HR, Interval Training, Constant Watts, Fat Burn, Fitness Test	Manual, Rolling Hills, Target HR, Interval Training, Constant Watts, Fat Burn, Fitness Test, Calorie Goal, Distance Goal, Time Goal	Manual, Interval Training, Fat Burn, Fitness Test, Target HR, Constant Watts
CSAFE Ready-FitLinxx Certified	Yes	Yes	Yes	Yes	Yes
IPTV Compatible	Yes	Yes	No	Yes	No
Pro-Idiom Compatible	Yes	Yes	Optional – add-on TV	Yes	Optional – add-on TV
FitTouch Technology	Yes	Yes	No	Yes	No
Instant On Technology	Yes	Yes	Yes	Yes	Yes
One-button Start	Yes	Yes	Yes	Yes	Yes
On-the-fly Program Change	Yes	Yes	Yes	Yes	Yes
Integrated Vista Clear Television Technology	Yes	Yes	No	Yes	No
FITCONNECTION Ready	No	No	Yes	No	Yes
Ethernet Compatible	Yes	Yes	No	Yes	No
WiFi Enabled	Yes	Yes	Optional	Optional	Optional
Bluetooth Enabled	Yes	Yes	No	Optional	No
Connects to Apple Watch	Yes	Yes	No	No	No
iPod / iPhone / iPad Compatible	Made for iPod, iPhone, iPad	Made for iPod, iPhone, iPad	Charging only	Charging only	Charging only
Multimedia Playback	Compatible with most tablets and smartphones	Compatible with most tablets and smartphones	No	Compatible with most tablet and smartphone systems using Android OS	No
Personal Fan	Yes	Yes	Yes	No	No
Personal Trainer Portal Compatible	Yes	Yes	No	Yes	No
USB Port	Yes	Yes	Yes	Yes	Yes
Virtual Active Compatible	Included	Yes	No	Yes	No
Asset Management Compatible	Included	Yes	Yes	Yes	Yes
Workout Tracking Network Compatible	Yes	Yes	Yes	Yes	Yes
Web Connectivity	Custom app interface in addition to web browser	Optional	No	Optional	No
Facility Communication Portal/ Calendar	Programmed through Asset Management	Optional	No	Optional	No
RFID Compatible	Yes	Yes	Yes	Yes	No
Pause Function	Yes	Yes	Yes	Yes	Yes
Reading Rack	Yes	Yes	No	Yes	Yes
RESISTANCE SYSTEM					
Resistance System	Brushless generator	Brushless generator	Brushless generator	Brushless generator	Brushless generator
TECH SPECS					
Crank Design	Three piece with integrated pullers	Three piece with integrated pullers	Three piece with integrated pullers	Three piece with integrated pullers	Three piece with integrated pullers
Power Requirements	Self-powered / powered 100v-240v – 50/60Hz AC	Self-powered / powered 100v-240v – 50/60Hz AC	Self-powered / powered 100v-240v – 50/60Hz AC*	Self-powered / powered 100v-240v – 50/60Hz AC	Self-powered / powered 100v-240v – 50/60Hz AC*
Minimum Watts	4 powered / 10 self-powered	4 powered / 10 self-powered	4 powered / 7 self-powered	4 powered / 10 self-powered	4 powered / 7 self-powered
Minimum RPM	25 powered / 25 self-powered	25 powered / 25 self-powered	25 powered / 25 self-powered	25 powered / 25 self-powered	25 powered / 25 self-powered
Assembled Dimensions	147 x 65 x 156 cm / 57.7" x 25.8" x 61.6"	147 x 65 x 156 cm / 57.7" x 25.8" x 61.6"	147 x 65 x 155 cm / 57.7" x 25.8" x 61"	147 x 65 x 155 / 57.7" x 25.8" x 60.9"	147 x 65 x 155 / 57.7" x 25.8" x 60.9"
Max User Weight	182 kg / 400 lbs.	182 kg / 400 lbs.	182 kg / 400 lbs.	182 kg / 400 lbs.	182 kg / 400 lbs.
Assembled Weight	100.5 kg / 221.5 lbs.	100 kg / 220 lbs.	97.1 kg / 214 lbs.	100 kg / 220 lbs.	96.2 kg / 212 lbs.
Shipping Weight	103 kg / 227 lbs.	102 kg / 224.9 lbs.	101 kg / 222 lbs.	102 kg / 224.9 lbs.	99.7 kg / 219 lbs.
WARRANTY					
Frame	7 years	7 years	7 years	7 years	7 years
Generator	5 years	5 years	5 years	5 years	5 years
Parts & Labor	3 years	3 years	3 years	3 years	3 years
Wear Items (iPod® Cable, USB Port, Headphone Jack, Battery)	90 days parts	90 days parts	90 days parts	90 days parts	90 days parts

* Plug in equipment with xID workout tracking for best results.



GROUP TRAINING

SHATTER LIMITS TOGETHER

Add our group training solutions to your cardio floor to give members the kind of heart-pumping variety they crave. Exclusive products and programs developed by industry experts will give your members the kind of signature exercise experience that keeps them coming back for more.

Visit matrixfitness.com or see our Group Training Brochure to learn more about how group training solutions can help you differentiate your facility and drive revenue growth by earning and retaining members.

TRAINING CYCLES

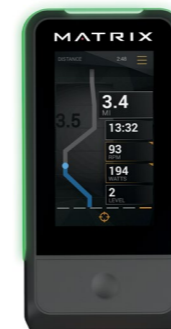

TARGET TRAINING DISPLAY

Our advanced CXP Target Training Cycle includes a unique display that makes it easy for anyone to achieve their goal. An integrated LED wrap lights with vibrant colors to help members maintain effort and hit their target whether they're tracking watts, calories, RPMs, heart rate or powering through a HIIT workout.



CXP TARGET TRAINING CYCLE

- Ideal for precision tracking during workouts that target watts, heart rate, RPMs, distance or calories, providing personalized intensity and progress metrics
- Intuitive touchscreen offers engaging graphics and an LED color wrap that helps instructors and riders gauge intensity (compatible with ANT+ and Bluetooth)
- Interval, pace, heart rate, goal-based and HIIT workouts provide variety
- Narrow Q-factor optimizes ergonomics for a real outdoor riding feel
- Low-maintenance, well-protected rear flywheel design includes magnetic resistance for smooth, consistent adjustments and watt measurement within 2% accuracy
- Contoured resistance lever provides tactile feedback for quick changes
- Intuitive adjustments customize the cycle to each user's body
- Ergonomically sculpted seat relieves pressure on touchpoints
- Multi-position handlebars include water bottle holders
- Forged steel pedal cranks include quick-adjust straps
- Quick-release service panel, removable pedal cranks and dial levelers streamline service and setup



CXM TRAINING CYCLE

- Ideal for metric-focused group cycling classes or for use by riders on your cardio floor
- Backlit LCD console clearly displays key metrics and offers intuitive operation when switching between watts, heart rate, RPMs or lap mode (compatible with ANT+ and Bluetooth)
- Narrow Q-factor optimizes ergonomics for a real outdoor riding feel
- Low-maintenance, well-protected rear flywheel design includes magnetic resistance for smooth, consistent adjustments and watt measurement within 10% accuracy
- Contoured resistance lever provides tactile feedback for quick changes
- Intuitive adjustments customize the cycle to each user's body
- Ergonomically sculpted seat relieves pressure on touchpoints
- Multi-position handlebars include water bottle holders
- Quick-release service panel and removable pedal cranks streamline service



CXC TRAINING CYCLE

- Ideal for group cycling classes or for use by riders on your cardio floor
- Narrow Q-factor optimizes ergonomics for a real outdoor riding feel
- Low-maintenance, well-protected rear flywheel design includes magnetic resistance for smooth, consistent adjustments
- Contoured resistance lever provides tactile feedback for quick changes
- Intuitive adjustments customize the cycle to each user's body
- Ergonomically sculpted seat relieves pressure on touchpoints
- Multi-position handlebars include water bottle holders
- Integrated device storage shelf keeps smartphones in view
- Optional wireless LCD console displays RPMs, calories, distance, time and heart rate when used with a heart rate strap
- Quick-release service panel and removable pedal cranks streamline service

S-DRIVE PERFORMANCE TRAINER



S-DRIVE™ PERFORMANCE TRAINER

- Sled brake with eight settings provides a true-to-life weighted sled pushing experience
- Parachute brake with 11 settings gives users the feel of real parachute resistance
- Sled and parachute brakes can be used individually or together to vary between cardio and strength-building workouts
- Adjustable harness allows for a complete upper-body range of movement
- Built-in bar simulates sled pushing and pulling without needing the space to use a traditional sled
- 7-degree incline maintains natural sprint mechanics while reducing starting effort
- Full perimeter handrails offer easy entry and exit and support during lateral movement
- Low-inertia design allows for sustained acceleration and quick deceleration, ideal for high-intensity interval training
- Heavy-duty deck stands up to the most intense workouts
- Self-powered design makes it easy to place the unit anywhere in your facility
- 19 cm / 7" step-on height offers easy access for users of all kinds

S-FORCE PERFORMANCE TRAINER



S-FORCE™ PERFORMANCE TRAINER

- Ideal for low-impact, high-intensity interval and athletic performance training as a part of circuit, group or stand-alone workouts
- Smooth, quiet magnetic resistance system and a specifically designed motion provide low-impact, high-intensity exercise
- With increased speed comes increased magnetic resistance, creating challenging progressive workouts
- Upright position targets the calves and hamstrings, while the acceleration position works the shins and quads
- User-defined path accommodates up to a 91 cm / 36" stride length
- Adjustable backlit console provides complete, easy-to-read feedback
- Clearly defined quick keys offer instant access to Sprint 8, interval training and goal-based training programs
- Contoured handlebars offer multiple grips facilitating the upright and acceleration user positions
- Foot platforms and ergonomically sculpted seat provide stability when entering and exiting
- Cord-free design and integrated wheels make it easy to place the unit anywhere in your facility

ROWER



ROWER

- Aluminum flywheel with 10 precise magnetic resistance settings offers challenge to first-time users and experienced rowers alike
- Adjustable, backlit console makes it easy to access training programs and see complete workout data
- Clearly defined quick keys provide instant access to sprinting, distance rowing and high-intensity interval training programs
- Self-powered design makes it easy to place the unit anywhere in your facility
- Ergo Form™ seat delivers a more comfortable exercise experience
- Seat lock offers enhanced stability when getting on or off the rower
- Long, reinforced handle includes a comfort-enhancing over-mold
- Can be lifted to stand vertically, minimizing footprint
- Transport wheels simplify movement within the facility
- Aluminum rail reinforced with stainless-steel strips adds lasting durability
- Low-maintenance cord and magnetic resistance system provide a smooth, quiet rowing experience

KRANKCYCLE

Johnny G Krankcycle by Matrix



KRANKCYCLE®

- Independent crank arms provide greater variety of movement to keep users engaged
- Ergonomically designed saddle allows easy transition between seated and standing exercise positions
- Adjustable crank-arm height encourages greater range of muscle activation
- Crank and flywheel assembly rotates to accommodate forward and reverse movements
- Shorter crank arms and narrow crank axis encourage speed and power training
- Wheelchair accessible when purchased without the seat
- Easily integrated into a functional circuit as an upper-body cardio station

Images and specifications subject to change. Visit matrixfitness.com for latest warranty information.

FEATURES	CXP Target Training Cycle	CXM Training Cycle	CXC Training Cycle
Power Measurement (Watt)	Direct (flywheel hub) via torque sensor (+/- 2% tolerance)	Calculated	No
Console	Target Training capacitive touchscreen	Backlit LCD	Optional LCD
Generator Powered	Yes	Yes	No
Training Intensity Guide	Yes	No	No
Telemetric HR	Yes	Yes	Yes
WiFi Enabled	Optional	No	No
ANT+/Bluetooth Enabled	Yes	Yes	No
Asset Management Compatible	Optional	No	No
Workout Tracking Compatible	Optional	No	No
Resistance System	Magnetic	Magnetic	Magnetic
Emergency Stop	Push	Push	Push
Flywheel	Rear, aluminum, evenly-weighted	Rear, aluminum, evenly-weighted	Rear, aluminum, evenly-weighted
Adjustment Type	Quick-touch levers	Quick-touch levers	Quick-touch levers
Posts & Sliders	Aluminum, pin-to-lock adjustment	Aluminum, pin-to-lock adjustment	Aluminum, pin-to-lock adjustment
Handlebar Adjustments	Vertical & horizontal	Vertical & horizontal	Vertical & horizontal
Saddle	Ergonomically sculpted seat	Ergonomically sculpted seat	Ergonomically sculpted seat
Handlebar	Ergo-formed, multi-position, soft PVC	Ergo-formed, multi-position, soft PVC	Ergo-formed, multi-position, soft PVC
Saddle Adjustments	Vertical & horizontal	Vertical & horizontal	Vertical & horizontal
Water Bottle Holder	Dual, integrated on handlebar	Dual, integrated on handlebar	Dual, integrated on handlebar
FRAME			
Frame Color	Matte black	Matte black	Matte black
Frame Material	Steel	Steel	Steel
Shrouds & Guards	Full frame	Full frame	Full frame
Frame Design	Off-set	Off-set	Off-set
Q Factor	155 mm / 6.1"	155 mm / 6.1"	155 mm / 6.1"
Crank Type	Forged steel 170 mm	Forged steel 170 mm	Forged steel 170 mm
Pedal Type	Dual-sided SPD & easy-fit strap	Dual-sided SPD & toe cage	Dual-sided SPD & toe cage
Frame Stabilizer Bars	Oversized, hidden bolts & fixings	Oversized, hidden bolts & fixings	Oversized, hidden bolts & fixings
Protection Plates	Yes with rear-access stretch plates	Yes	Yes
Leveling Feet	4, with 2 rear easy-access dial levelers	4	4
Transport Wheels	2	2	2
DRIVE SYSTEM			
Drivetrain	Flexonic belt	Flexonic belt	Flexonic belt
Drivetrain Gear Ratio	1:10	1:10	1:10
TECH SPECS			
Overall Dimensions (L x W x H)	122.4 x 56.4 x 102.8 cm / 48.2" x 22.2" x 40.5"	122.4 x 56.4 x 102.8 cm / 48.2" x 22.2" x 40.5"	122.4 x 56.4 x 102.8 cm / 48.2" x 22.2" x 40.5"
Product Weight	61 kg / 134.4 lbs.	57 kg / 125.6 lbs.	51 kg / 112.4 lbs.
Max User Weight	158.75 kg / 350 lbs.	158.75 kg / 350 lbs.	158.75 kg / 350 lbs.
WARRANTY			
Frame	10 years	10 years	10 years
Parts	3 years	3 years	3 years
Labor	1 year	1 year	1 year
Wear Items	1 year	1 year	1 year

Images and specifications subject to change. Visit matrixfitness.com for latest warranty information.

FEATURES	S-Drive™ Performance Trainer
Resistance Type	Independent sled and parachute brakes
User Harness	Adjustable, connection free harness
Deck Type	Reversible silicone 2.5 cm / 1" deck
Belt Type	Habasit, 2-ply commercial grade
Running Area	152 x 51 cm / 60" x 22"
Step-on Height	17.8 cm / 7"
Incline Range	7° fixed
Speed Range	User-defined
DRIVE SYSTEM	
Drive System	Self-propelled or Self-powered
TECH SPECS	
Power Requirements	Self-powered
Assembled Dimensions (L x W x H)	195 x 88.3 x 150 cm / 76.8" x 34.8" x 59"
Max User Weight	182 kg / 400 lbs.
Assembled Weight	122.5 kg / 270 lbs.
Shipping Weight	145.2 kg / 320 lbs.
WARRANTY	
Frame	7 years
Drive Motor	N/A
Parts	3 years
Labor	3 years
Wear Items (user harness)	90 days parts
FEATURES	S-Force™ Performance Trainer
Stride Length	91.4 cm / 36"
Resistance Levels	5
Handlebar Design	Multi-position handlebar
Pedals	Self-leveling with quick-release strap
Transport	3 wheel transport
CONSOLE	
Display Screen	Extra-large backlit LCD display
Display Feedback	Time, Distance, SPM (steps per minute), Steps, Heart Rate (with heart rate strap), Calories
Programs	Sprint 8, Goals, Interval, Challenge
Telemetric Receiver	Yes
TECH SPECS	
Resistance Technology	Magnetic resistance
Max User Weight	181.4 kg / 400 lbs.
Product Weight	132 kg / 290 lbs.
Shipping Weight	155 kg / 340 lbs.
Overall Dimensions (L x W x H)	182 x 69 x 166 cm / 72" x 27" x 66"
Power Requirements	3 D-cell batteries
WARRANTY	
Frame	7 years
Parts	3 years
Console	2 years
Labor	3 years
Wear Items (user harness)	6 months

Images and specifications subject to change. Visit matrixfitness.com for latest warranty information.

FEATURES	Rower
Handlebar Design	Extra-long ergo-grp handlebar
Foot Stretchers	Adjustable heel cups with easy-to-read settings
Monorail	Aluminum
CONSOLE	
Display Screen	Extra-large blue backlit LCD display
Display Readout	Time, Distance, SPM (strokes per minute), Stroke, Watts, Heart Rate, Calories, 500m Split
Programs	Manual, Interval, Challenge
Telemetric Receiver	Yes
TECH SPECS	
Resistance Technology	Magnetic resistance
Resistance Levels	10
Drive System	Coil spring poly-V belt
Max User Weight	160 kg / 350 lbs.
Product Weight	55 kg / 121 lbs.
Shipping Weight	65 kg / 144 lbs.
Overall Dimensions (L x W x H)	223 x 55 x 99 cm / 87.6" x 21.5" x 38.9"
Power Requirement	Generator powered LCD display with battery back-up
WARRANTY	
Frame	7 years
Labor	3 years
Parts	3 years
Wear Items	2 years (rope, seat, foot support) 1 year (other)
FEATURES	Krankcycle®
Drive System	Chain drive
Frame	Steel base frame with cast iron drive frame treated with zinc oxide and polyester powder coating
TECH SPECS	
Overall Dimensions L x W x H	144 x 68 x 105 cm / 56.5" x 26.8" x 41.5"
Weight	57 kg / 124.4 lbs.
Max User Weight	159 kg / 350 lbs.
WARRANTY	
Frame	5 years
Cranks, Brackets, Flywheel	2 years
Bearings, Tension Knob Assembly	1 year
Wear Items (brake pad, water bottle holder)	90 days parts
Labor	1 year

A TRULY GLOBAL COMPANY

Australia / New Zealand

Johnson Health Tech Australia Pty. Ltd.
p: 61-3-5136-3100
e: sales@jhata.com.au
w: au.matrixfitness.com

Brazil

Johnson Health Tech Brasil
p: 55-19-2107-5300
e: contato@johnsonhealthtech.com.br
w: br.matrixfitness.com

Canada

Johnson Health Tech Canada/STAK Fitness
p: 514-336-0006
e: info@stakfitness.com
w: ca.matrixfitness.com

China

Johnson Health Tech (Shanghai) Co., Ltd.
p: 86-21-32503800
e: danielhsu@johnsonfitness.com
w: cn.matrixfitness.com

Denmark

Johnson Health Tech Denmark
p: 31-30-2445-435
e: info@matrixfitness.nl
w: dk.matrixfitness.com

France

Johnson Health Tech France
p: 33-130-68280
e: denis.daon@jhtfrance.fr
w: fr.matrixfitness.com

Germany / Austria

Johnson Health Tech GmbH
p: +49 (0) 2234/ 9997-100
e: mail@johnsonfitness.eu
w: de.matrixfitness.com

Greece / Cyprus / Bulgaria

Johnson Health Tech Hellas SA
p: 30-211-4112797
e: g.papageorgiou@jht.gr
w: gr.matrixfitness.com

Hong Kong

Johnson Health Tech - Hong Kong
p: 852-2302-0596
e: lindatang@johnsonfitness.com
w: hk.matrixfitness.com

Italy

Johnson Health Tech Italia Spa
p: 39-073-62269
e: jht@jht.it
w: it.matrixfitness.com

Japan

Johnson Health Tech Japan
p: 81-3-5419-3560
e: info@johnsonjapan.com
w: jp.matrixfitness.com

Korea

Johnson Health Tech Co., Ltd. Korea
p: 82-2-6731-0175
e: sales@kr.johnsonfitness.com
w: kr.matrixfitness.com

Malaysia

Johnson Fitness (Malaysia) SDN. BHD.
p: 60-3-5632-8273
e: deanchu@johnsonfitness.com
w: my.matrixfitness.com

Mexico

Johnson Health Tech Mexico
p: 52-55-7012-7810
e: joseguillermo.maci@jhtmexico.mx
w: mx.matrixfitness.com

Netherlands / Belgium / Luxembourg

Johnson Health Tech Netherlands B.V.
p: 31-30-2445-435
e: info@matrixfitness.nl
w: nl.matrixfitness.com

Philippines

Johnson Health Tech Philippines Inc.
p: 63-2-631-5810
e: Katsuya.Ito@johnsonfitness.com
w: ph.matrixfitness.com

Poland

Johnson Health Tech Sp. Z O. O.
p: 48-222-809-430
e: kontakt@johnsonfitness.eu
w: pl.matrixfitness.com

Romania

Johnson Health Tech Romania
p: 44-771-581-246
e: ionut.vlad@jht.ro
w: ro.matrixfitness.com

Spain / Portugal

Johnson Health Tech Ibérica SL
p: 34-914-885525
e: info@jht.es
w: es.matrixfitness.com

Switzerland

Johnson Health Tech (Schweiz) GmbH
p: 41-44-843-30-30
e: office@johnsonfitness.eu
w: ch.matrixfitness.com

Taiwan

Johnson Health Tech-Taiwan
p: 886-4-25667100
e: harrysai@johnsonfitness.com
w: tw.matrixfitness.com

Thailand

Johnson Health Tech (Thailand) Co., Ltd.
p: 66-2-7519-360
e: daniellai@johnsonfitness.com
w: th.matrixfitness.com

United Arab Emirates / Jordan / Kuwait / Oman / Qatar

Johnson Health Tech United Arab Emirates
p: 971-44567939
e: sales@uae.johnsonfitness.com
w: ae.matrixfitness.com

United Kingdom

Johnson Health Tech UK Ltd
p: 44-1782-644900
e: sales@matrixfitness.co.uk
w: uk.matrixfitness.com

United States

Johnson Health Tech North America
p: 866-693-4863
e: info@matrixfitness.com
w: matrixfitness.com

Vietnam

Johnson Health Tech (Vietnam) Co. Ltd.
p: 84-8-38227011
e: sales.vn@johnsonfitness.com
w: vn.matrixfitness.com



MATRIX

About Matrix Fitness

Matrix is a brand of Johnson Health Tech (JHT). JHT has been producing premium fitness equipment since 1975 and is among the fastest-growing manufacturers of fitness equipment in the world. It has earned both ISO 9002 and 9001 certifications. A truly global company with 26 subsidiaries worldwide, JHT has the intellectual resources necessary to produce the most technologically advanced equipment on the market and the economies of scale needed to deliver the best value possible.

Matrix Fitness

1600 Landmark Drive
Cottage Grove, WI 53527 USA

matrixfitness.com

Toll-Free 866.693.4863

Facsimile 608.839.8687

 matrixfitnessusa  @matrixfitnessusa

MATRIX
Strong • Smart • Beautiful

© 2018 Matrix Fitness. All Rights Reserved.
Product specifications subject to change without notice.

AUTHORIZED MATRIX FITNESS DISTRIBUTOR

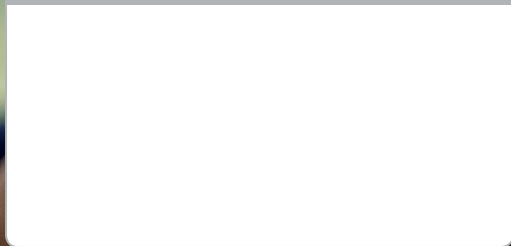



MATRIX

STRENGTH

2018 BROCHURE





CONTENTS

4 MATRIX FITNESS

TOTAL SOLUTIONS PARTNER
STRONG. SMART. BEAUTIFUL.™
STRENGTH OVERVIEW

12 MATRIX CONNECTED SOLUTIONS

18 ULTRA

THE ULTIMATE STRENGTH TRAINING EXPERIENCE

36 VERSA

THE POWER OF CHOICE IN STRENGTH TRAINING

56 AURA

THE STANDARD IN PERFORMANCE AND DESIGN

88 MAGNUM

A LEGACY OF PERFORMANCE AND PROVEN DURABILITY

144 VARSITY

DESIGNED FOR SUPERIOR VALUE AND TRAINING VARIETY

GET MORE THAN THE WORLD'S FINEST FITNESS EQUIPMENT

When you choose Matrix, you're getting more than the world's finest fitness equipment. You're getting a partner that will be there, for your grand opening and every day after. Together, there's no detail of your business that we can't refine, reimagine or reinvent. And that includes your bottom line.

FACILITY PLANNING

Your space. Your goals. Your budget. We'll help bring your fitness center to life from your earliest ideas to the day you open your doors.

CERTIFIED INSTALLATION/SERVICE KIT

Maximize uptime. Optimize your investment. We provide all the tools you need to get up and running and stay that way.

INDUSTRY-LEADING WARRANTIES

Our promise of quality to you. We offer all of the protection you need to choose confidently, and know that you've chosen the products with the lowest cost of ownership in the industry.

TURNKEY PREVENTIVE MAINTENANCE PROGRAM

Protect your investment with our Preventive Maintenance Program — in addition to the regular tips we provide to extend equipment life, you'll get routine maintenance visits performed by expert technicians, all customized to your equipment and schedule.

* Availability of financing options varies by market.

FINANCING*

Whenever possible, we work with our customers to develop financial solutions that expand their options and maximize their investments.

UNMATCHED CUSTOMER SUPPORT

A 95% first-time fix rate. A 90% live answer rate in two minutes or less. A 48-hour service response window. 260 service providers with over 600 technicians to serve you. And with our amazing console technology, we can provide diagnostic services remotely or on site.

MATRIX LEARNING

Product training. Maintenance tips. Career building. On-demand educational videos. A whole new world of service and support. It's all at your fingertips with Matrix Learning (matrixlearningcenter.com).

TOTAL MARKETING SUPPORT KIT

You want to let clients know about the exciting programs and products that make your facility different, and we want to help. Ask us about customized promotional materials to help you reach and retain clients like never before.



STRONG. SMART. BEAUTIFUL.™

It's more than a tagline. It's our holistic promise to you that these three qualities will shine through every product that hits your floor and define our ongoing partnership.

STRONG

Our high-quality, ultra-durable products are just as strong as our commitment to be your partner, not just your supplier. This strength gives us a solid foundation for success, today and in the future, and has made us one of the world's fastest-growing commercial fitness brands.

SMART

We listen and create products with a purpose in mind — to address your needs and resolve them in ingenious ways. Forward-thinking options like Asset Management™ and Virtual Active™ enhance and redefine the exercise experience, for both you and your members.

BEAUTIFUL

Our products attract beginners and fitness enthusiasts alike. Every piece of equipment is approachable, unimimidating and a pleasure to use. We continue to set new industry standards through award-winning aesthetic distinction and incredible attention to detail.

STRENGTH OVERVIEW

ULTRA SERIES

Powerful yet comfortable. Advanced functionality with intuitive operation. The industry's most durable components wrapped in breathtaking industrial design. The Ultra Series goes beyond your expectations of strength training equipment to earn and retain members like nothing else.



ULTRA SERIES

VERSA SERIES

Bring your vision of fitness to life — our most versatile series gives you the options to build a strength training area that fits your space and the needs of your members in a beautifully precise way. The Versa Series incorporates advanced biomechanics for a natural, smooth, efficient workout experience.



VERSA SERIES



AURA SERIES

AURA SERIES

Superior styling made the Aura Series an instant classic. Signature features made it one of the most-imitated product lines in the industry. Choose the Aura Series, and you'll discover that beginners and fitness enthusiasts alike will be drawn to something that the competition can't imitate — an unmistakable aura of greatness.

STRENGTH OVERVIEW

MAGNUM SERIES

Born from a long tradition of premium performance, there's no better choice for professional athletes than the unrivaled performance and durability of the Magnum Series. Advanced options like Breaker Benches and MEGA Racks help athletes reach their potential, and the impeccable designs stand up to the most demanding environments.

VARSITY SERIES

For a blend of performance and value perfect for heavy-use facilities, look no further than the Varsity Series. It offers the dynamic performance and superior ergonomics that the fitness world has come to expect from Matrix, plus the uncompromising durability you need to accommodate a steady stream of users.



MAGNUM SERIES



VARSITY SERIES

MATRIX CONNECTED SOLUTIONS

GET CONNECTED TO A WORLD OF DIGITAL SOLUTIONS

You want to deliver an unmatched fitness experience, and Matrix Connected Solutions give you the flexible tools you need to do it your way, regardless of the size of your facility or budget.

With the power of our robust, open platform at your fingertips, service and maintenance become hassle-free. Your trainers can connect and engage with members in new ways for better results and more referrals. Everyone who comes through your doors can instantly enjoy their favorite music, entertainment and social networks on connected cardio platforms. By adding our Intelligent Training Console to Ultra Series equipment you can offer the very best guided strength training experience. It's easier than ever to expand your marketing efforts and make your brand the center of each member's fit lifestyle. And that's just a taste of what Matrix Connected Solutions can do.

Discover how our complete selection of hardware and software solutions can help bring your vision of fitness to life in bigger, bolder, brighter ways than ever before.

DISCOVER MORE AT MATRIXCONNECTEDSOLUTIONS.COM



CONNECTED
SOLUTIONS

MATRIX CONNECTED SOLUTIONS

YOUR GOALS

You have a vision of fitness that's all your own. By adding our Intelligent Training Console to your Ultra Series strength equipment, you can take advantage of some of the most powerful tools in our Connected Solutions portfolio. You'll discover that our flexible digital ecosystem lets you choose how you enhance your business, streamline your administrative tasks, impress the people you serve and much more.

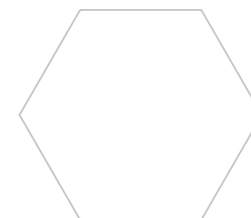
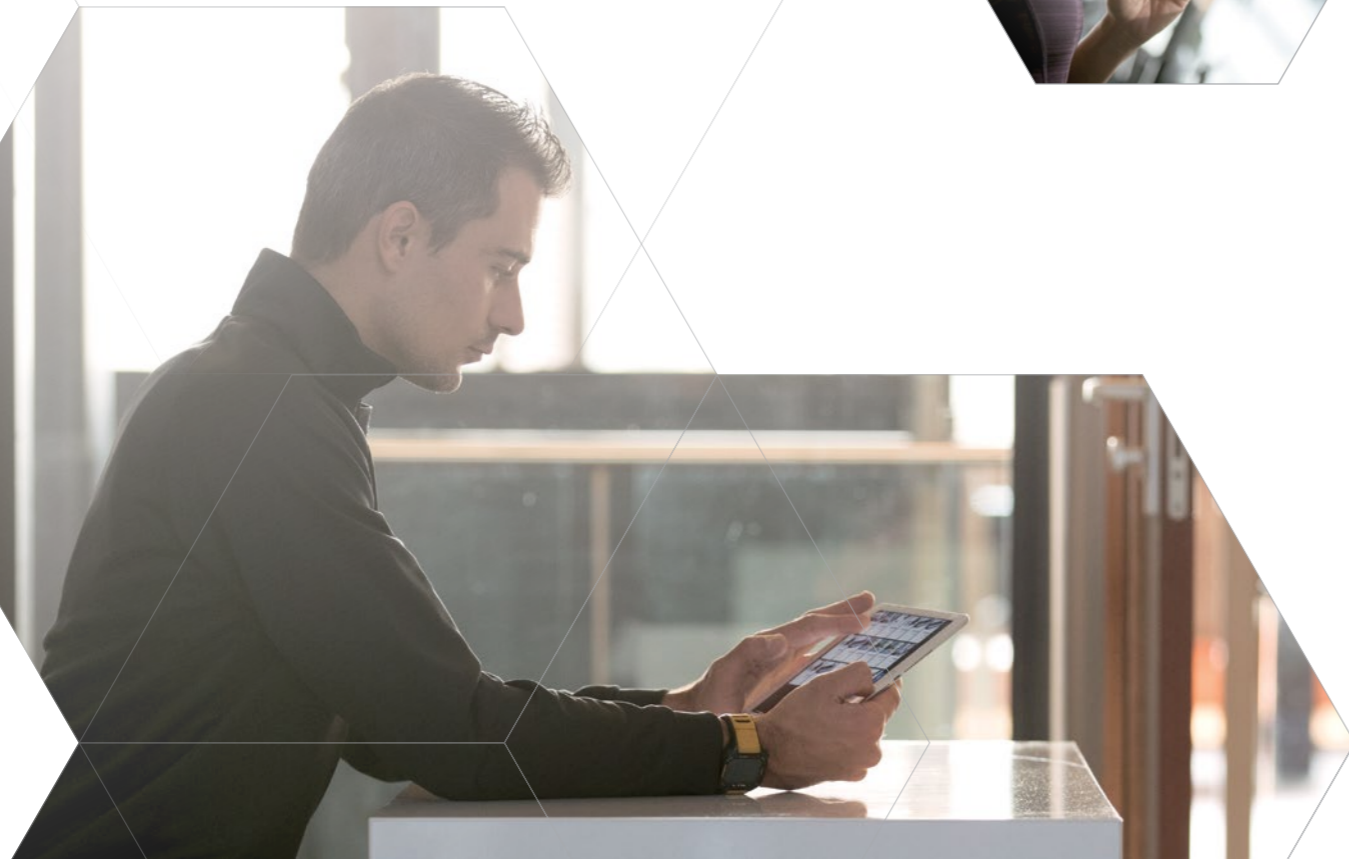

INCREASE RETENTION

Bringing members back again is essential to the success of your business. With our smart digital options, they won't just come back — they'll bring friends.

BUILD ENGAGEMENT

Keep your members enthused, excited and eager for more with powerful tools that keep the exercise experience fresh.

BOOST REVENUE

Find out how to tap forward-thinking revenue streams that can redefine your bottom line in powerful new ways.

MAXIMIZE ROI

Count on us for smart tools that streamline the way you run your business while maximizing your investment and the value of every membership.

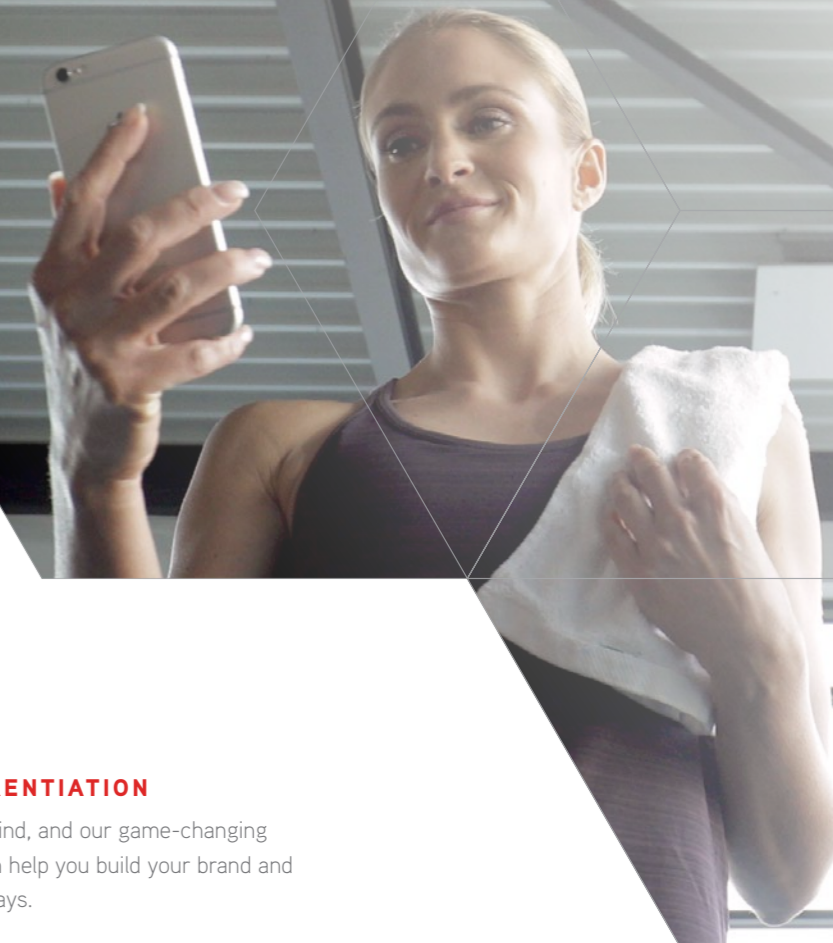

ENHANCE DIFFERENTIATION

Your facility is one of a kind, and our game-changing Connected Solutions can help you build your brand and stand out in impactful ways.

ENERGIZE ACQUISITION

You're always striving to bring in new members, and we can help extend your brand, reach untapped demographics and impress everyone who stops by.

MATRIX CONNECTED SOLUTIONS

INTELLIGENT TRAINING CONSOLE

Available exclusively on our new Ultra Series equipment, Intelligent Training Console sets your facility apart with a digitally connected, guided strength training experience that will attract both new and experienced strength training enthusiasts and keep them coming back for more.

Your members will discover an intuitive interface that makes it easy for anyone to get started, plus dual user sign-in that streamlines transitions between two alternating users and their specific strength training programs. Since our original progression-based programming was designed in collaboration with the National Strength and Conditioning Association (NSCA), your members can count on measurable results. You can even customize the interface to strongly represent your brand, providing a unified look and feel throughout your entire facility.

Best of all, when you choose our Intelligent Training Console, you can take advantage of some of our most powerful Connected Solutions. This means that while your members are busy transforming their physiques, you'll be transforming the way you do business.



PERSONAL TRAINER PORTAL

MAKE TRAINING MORE PERSONAL THAN EVER

Our flexible, customizable Personal Trainer Portal helps trainers engage with a wide range of clients, bringing personal training to a whole new demographic of members. Using virtually any tablet or personal computer, trainers can view member information, create signature strength programs, assign workouts and check progress, and members can provide instant feedback. Personal Trainer Portal works with a wide variety of popular third-party apps and wearables, and its customizable interface strongly represents your brand and your latest promotions.



WORKOUT TRACKING NETWORK

BRING IT ALL TOGETHER UNDER YOUR BRAND

Our ingenious Workout Tracking Network lets members capture data from all their favorite fitness apps and all the ways they work out in one place using a single customizable interface that puts your facility at the center of their fit lifestyle. Members can easily create personalized strength training goals, compete in challenges and applaud others through activity-based social feeds, and you can motivate members by offering reward points for check-ins, personal training, purchases and even personal bests.

ASSET MANAGEMENT

KEEPING AN EYE ON YOUR EQUIPMENT SO YOU DON'T HAVE TO

Our industry-leading Asset Management™ platform offers a 360-degree view of your strength training equipment on virtually any internet-connected device. Easy-to-read color-coding tells you whether a product is functioning properly, detects errors and alerts you if something is offline. Whether you manage one facility or many, the system can create customized reports to help maximize product life and identify the optimum product mix. It also improves communication with Matrix and your service provider, streamlining maintenance and repair while reducing paperwork and hassle. The customizable interface even provides an array of smart marketing tools to help you get more members into your facility.

RFID

STREAMLINE YOUR MEMBERS' EXERCISE EXPERIENCE

RFID is a smart way to streamline your members' strength training experience. Simple radio-frequency tags make check-in, program loading and workout tracking completely touch-free and virtually automatic. Members can even use RFID with your existing RFID-compatible vending machines, kiosks and in-facility sales centers for quick impulse buys of your branded merchandise, snacks, beverages and more.



ULTRA

THE ULTIMATE STRENGTH TRAINING EXPERIENCE

The powerful and comfortable Ultra Series gives you the most advanced functionality with an intuitive design that couldn't be easier to operate. All Ultra Series equipment is designed for smooth converging and diverging movements to encourage a natural path of motion and enhance user comfort. Ultra Series also includes Action Specific Grips™ to reduce stress on contact points and a uniformly low stack height (135 cm / 53") to improve the aesthetic of your fitness center. Both durable and beautiful, the Ultra Series will exceed your expectations when it comes to earning and retaining members.

ULTRA SERIES

- 1 USER AMENITIES**
All single-station units offer a convenient accessory pad, bottle holder and towel bar.
- 2 INCREMENTAL WEIGHTS**
Easy to access and reference from the seated position.
- 3 ELECTRONIC REP COUNTER**
Tracks reps, activity time and rest time for a streamlined workout experience.
- 4 INDEPENDENT CONVERGING/DIVERGING MOTION**
Encourages a natural path of motion to enhance comfort.
- 5 EXERCISE PLACARDS**
Easy-to-read reference cards highlight targeted muscle groups and proper machine use.
- 6 ACTION SPECIFIC GRIPS™**
Ergonomically designed to reduce stress on contact points while enhancing feel and form.



* Shown in Matte Black



2



4

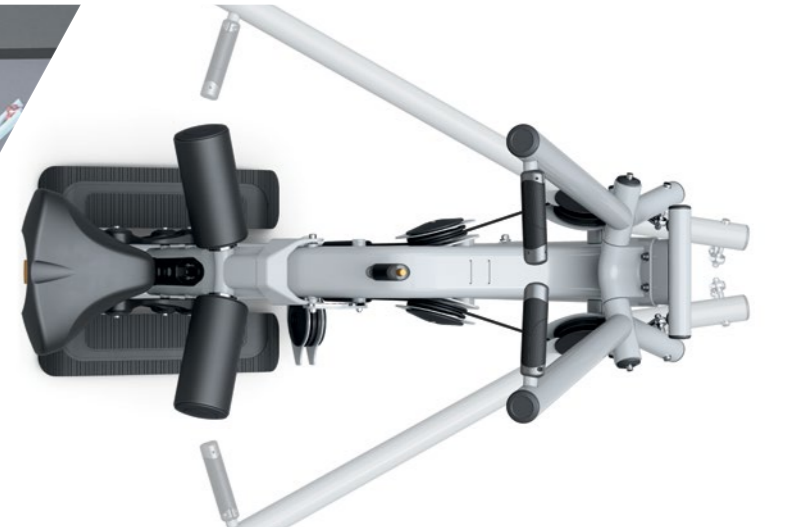

6



ULTRA SERIES WITH INTELLIGENT TRAINING CONSOLE

ULTRA: THE SMART CHOICE

Our powerful Ultra Series just got better and smarter with the addition of our new Intelligent Training Console. When you choose Ultra Series with Intelligent Training Console, you'll get a digitally connected, guided experience that will give those new to strength training a reason to sign up with your facility and those who already love it a reason to return. Members begin by defining their physical transformation target and receiving step-by-step equipment instruction. The intuitive interface makes it easy to identify their benchmark weight and start a personalized progression program. They'll also be able to review previous workouts to chart their development, helping them maximize their results and reach their individual goals more efficiently than ever.



A GUIDED TRAINING EXPERIENCE

Ideal for those new to strength training or experienced members who are struggling to progress, Intelligent Training Console features Endurance, Build and Strength programs to give members a guided training experience specific to their goals.

ORIGINAL PROGRESSIONS

Original progression-based programming designed in collaboration with the National Strength and Conditioning Association (NSCA) helps members find a benchmark weight and provides 8-12 weeks of workouts to maximize results.

EXPLOSIVE LIFTING

New explosive lifting program focuses on speed and power instead of just strength, helping members accelerate results while keeping the strength training experience fresh.

WORKOUT HISTORY

Workout history snapshot lets members quickly review past sessions and track overall progress.

DEMO VIDEOS

On-console demo videos provide guidance on maintaining proper form for each exercise.

INTUITIVE NAVIGATION

Intuitive touchscreen console navigation makes it easy for members of any ability or experience level to get started.

DUAL USER SIGN-IN

Dual user sign-in streamlines transitions between two alternating users and their specific strength training programs.

RECORDED SETTINGS

Stored seat settings make it easy for users to find the same ergonomically sound fit every time they work out.

TOUCH-FREE LOGIN

RFID compatibility gives users a quick, touch-free way to login, load their personal preferences and start their workout.

FULLY CONNECTED TECHNOLOGY

Internet connectivity via WiFi or Ethernet accommodates optional Personal Trainer Portal, Workout Tracking Network and Asset Management.

BRAND-BUILDING CUSTOMIZATION

Customizable interface strongly represents your brand to provide a unified look and feel throughout your entire facility.

INTELLIGENT TRAINING CONSOLE SPECIFICATIONS

CONSOLE	
Display Type	25.7 cm / 10.1" class touchscreen LCD
Display Feedback	Reps, Sets, Rest Time, Heart Rate, Total Weight
Workouts	Manual, Endurance, Build, Strength*, Explosive Lifts*
User-defined Multi-language Display	English, German, French, Italian, Spanish, Dutch, Portuguese, Chinese, Japanese, Korean, Swedish, Finnish, Russian, Arabic, Turkish, Polish, Welsh, Basque, Vietnamese, Somali, Danish
FitTouch Technology	Yes
Lift to Start	Yes
Ethernet Compatible	Yes
WiFi Enabled	Yes
Bluetooth Enabled	Heart rate only
Personal Trainer Portal Compatible	Yes
USB Port	Software updates only
Asset Management Compatible	Included
Workout Tracking Network Compatible	Yes
RFID Compatible	Yes
TECH SPECS	
Power Requirements	120v / 60Hz AC power
Assembled Dimensions	(As assembled on the Ultra weight stack) 153 cm / 60.2"
Shipping Dimensions	43.5 x 39.5 x 22 cm / 17.1" x 15.6" x 8.7"
Shipping Weight	7.8 kg / 17.2 lbs.

STRENGTH WARRANTY (NORTH AMERICA ONLY)

Parts & Labor	3 years
---------------	---------

* Workout program only available on certain modalities
Visit www.matrixfitness.com for latest warranty information.



CONVERGING CHEST PRESS G7-S13

- Independent converging arm movements provide a natural path of motion and increased exercise variety
- Adjustable back pad with gas assist facilitates easy range of motion changes
- Action Specific Grips™ provide greater comfort and minimal point pressure
- Integrated foot platform provides additional user stability and comfort during use
- Designed for easy entry and exit



LATERAL RAISE G7-S21

- Independent arms facilitate greater exercise variety
- Oversized arm pads enhance comfort and accommodate a variety of users
- Rotating handles provide natural motion



PEC FLY / REAR DELT G7-S22

- Rotating grips provide comfort and smooth movement during use
- Angled back pad and delt grips enhance user comfort and improve biomechanics
- Oversized handles reduce the need to adjust the seat position between rear deltoid and fly exercises
- Heavy weight stack accommodates advanced users



CONVERGING SHOULDER PRESS G7-S23

- Independent converging arm movements provide a natural path of motion and increased exercise variety
- Dual-position hand grips allow for greater training variety
- Action Specific Grips™ provide greater comfort and minimal point pressure
- Counterbalanced pressing arm provides optimal starting resistance
- Reclining seat position allows for better posture and back support



DIVERGING LAT PULLDOWN G7-S33

- Independent diverging arm movements provide a natural path of motion and increased exercise variety
- Angled seat encourages proper user position
- Thigh pads and seat easily adjust to provide stability, comfort and improved ergonomics
- Action Specific Grips provide greater comfort and improved grip strength



DIVERGING SEATED ROW G7-S34

- Independent diverging arm movements provide a natural path of motion and increased exercise variety
- Dual-position foot placement provide greater user comfort
- Action Specific Grips™ provide greater comfort and improved grip strength
- Adjustable chest pad with gas shock accommodates a variety of users



INDEPENDENT BICEPS CURL G7-S40

- Unique pivoting elbow pads and rotating handles improve function, comfort and feel during use
- Independent motion for greater exercise variety
- Action Specific Grips provide greater comfort and minimal point pressure
- Designed for easy entry and exit without chest compression from traditional machines
- Elbow pad wear covers improve upholstery performance in high contact areas



TRICEPS PRESS G7-S42

- Oversized rotating handles adapt to a wide variety of users and provide exercise variation
- Action Specific Grips™ provide greater comfort and minimal point pressure
- Angled back pad reduces stress, improves stabilization and enhances comfort



ABDOMINAL CRUNCH G7-S51

- Curved back pads for full muscular contraction and comfort
- Self-aligning handles adjust to accommodate a variety of users
- Dual-supported pivoting design fosters natural abdominal crunch motion
- Action Specific Grips provide greater comfort and minimal point pressure
- Elbow pad wear covers improve upholstery performance in high contact areas



BACK EXTENSION G7-S52

- Multi-position foot placement accommodates a variety of users
- Thumb-switch controls allow easy adjustments
- Contoured back pad enhances user comfort and provides additional support



ROTARY TORSO G7-S55

- Kneeling position minimizes low-back stress while stretching hip flexors
- Contoured knee pads with wear covers enhance comfort, stability and durability
- Oversized handlebars accommodate a variety of users without adjustment
- Knee pad wear cover improves upholstery performance in high contact areas
- Range of motion feature with 8 different start positions add greater versatility



LEG PRESS G7-S70

- Angled and adjustable seat carriage enhances comfort
- Ergonomic adjustment handle and gas shock enable simple changes in start position
- Oversized foot platform increases movement variety including calf exercises
- Integrated assistance handle enables easy exit and entry
- Guide rod and bearing-designed carriage improves long-term durability and smooth performance



LEG EXTENSION G7-S71

- Self-adjusting tibia pad for greater ease of use
- Soft contoured knee pad provides optimal comfort behind user's knee during use
- Thumb-switch controls and ergonomic adjustment handle allow easy user setup
- Angled seat and back pads encourage full quadriceps contraction
- Pivot location clearly marked to encourage correct knee alignment



SEATED LEG CURL G7-S72

- Back pad, tibia pad and range-of-motion adjustments are easily accessible from a seated position
- Angled seat and unique pivot location encourage full hamstring contraction
- Gas-assisted adjustable thigh pad and thumb switch control allow easy user setup
- Soft contoured thigh pad provides optimal comfort during use



PRONE LEG CURL G7-S73

- Contoured elbow pads enhance stabilization and comfort
- Divergent pad angle eliminates lower-back stress
- Integrated sweat guard protects frame from damage
- Thumb-switch controls allow easy adjustments



HIP ADDUCTOR G7-S74

- Ergonomic adjustment handle enables simple changes in start position
- Foot pegs and contoured knee pads provide user stabilization and support
- Adjustable reclining position offers customized lumbar comfort
- Integrated foot platform allows easy exit and entry



HIP ABDUCTOR G7-S75

- Ergonomic adjustment handle enables simple changes in start position
- Foot pegs and contoured knee pads provide user stabilization and support
- Adjustable reclining position offers customized lumbar comfort
- Integrated foot platform allows easy exit and entry



CALF EXTENSION G7-S77

- Angled seat position provides greater lumbar support
- Ergonomic adjustment handle enables simple changes in start position
- Range-of-motion adjustment accommodates a variety of users and start positions
- Guide rod and bearing-designed carriage improves long-term durability and smooth performance



GLUTE G7-S78

- Upright user position increases comfort and machine approachability
- Rotating foot pad provides stable and smooth contact throughout the full range of motion
- Oversized foot platform bolsters stability
- Adjustable chest pad accommodates a variety of users



ULTRA SINGLE-STATION	PRODUCT DIMENSIONS*						PRODUCT WEIGHT		WEIGHT STACK	
	METRIC (CM)			ENGLISH (INCHES)			METRIC	ENGLISH	METRIC	ENGLISH
	L	W	H	L	W	H	KG	LBS.	KG	LBS.
G7-S13 Converging Chest Press	168.5	141	135	66.3	55.4	53	348	768	108	240
G7-S21 Lateral Raise	105.5	150	135	41.5	59	53	281	620	90	200
G7-S22 Pec Fly / Rear Delt	143.5	193.5	197	56.4	76.1	77.6	329	726	135	300
G7-S23 Converging Shoulder Press	168	146.5	174	66.1	57.6	68.4	359	792	90	200
G7-S33 Diverging Lat Pulldown	152	161	195	59.6	63.1	76.7	382	842	108	240
G7-S34 Diverging Seated Row	158	138.5	140.5	62.2	54.5	55.3	343	757	108	240
G7-S40 Independent Biceps Curl	135	168	135	53	66.2	53	266	587	90	200
G7-S42 Triceps Press	124	121	135	48.8	47.7	53	305	673	120	265
G7-S51 Abdominal Crunch	139	121	147	54.6	47.5	57.9	290	640	108	240
G7-S52 Back Extension	145	120	135	57.2	47.3	53	319	704	108	240
G7-S55 Rotary Torso	117	123	141	45.8	48.2	55.2	232	512	90	200
G7-S70 Leg Press	206	113	152	80.9	44.3	59.9	436	962	180	400
G7-S71 Leg Extension	152.4	125.9	135	60	49.6	53	304	671	108	240
G7-S72 Seated Leg Curl	148.5	117	135	58.4	46	53	320	706	90	200
G7-S73 Prone Leg Curl	173	112	135	68	44	53	280	618	90	200
G7-S74 Hip Adductor	182	173	135	71.6	67.8	53	272	600	90	200
G7-S75 Hip Abductor	182	173	135	71.6	68	53	277	611	90	200
G7-S77 Calf Extension	169	120	150	66.5	47.2	59	291	642	180	400
G7-S78 Glute	200.5	90	156	79	35.3	61.5	239	527	63	140

STRENGTH WARRANTY (NORTH AMERICA ONLY)

Frame (Not Coatings)**	10 years
Weight Stacks	5 years
Pulleys	5 years
Pivot Bearings	5 years
Other Items Not Specified	3 years
Labor	3 years
Upholstery / Cables / Springs / Grips	1 year
Accessories	6 months

* Dimensions listed are maximum in-use dimensions
 ** Frame is defined as the welded-metal base of the unit and does not include removable parts.
 NOTE: All specifications are subject to change without notice. Actual products may differ from those pictured in this catalog.
 Visit www.matrixfitness.com for latest warranty information.

ULTRA STANDARD FRAME COLORS

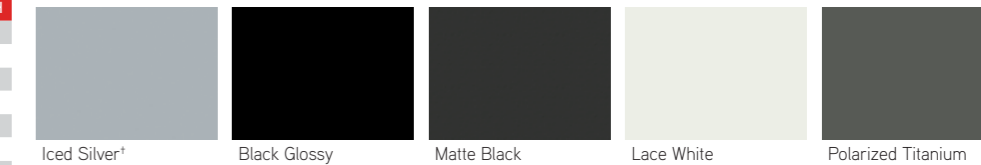

ULTRA UPHOLSTERY COLOR OPTIONS



Frame and upholstery colors applicable to North America.
 Product pricing is reflective of **standard** upholstery only. Other color options available at an additional charge.
 NOTE: Actual product colors may vary from what is shown here.
 † Iced Silver is stocked frame color. Additional lead times may apply for other frame colors.



VERSA

THE POWER OF CHOICE IN STRENGTH TRAINING

The Versa Series offers a wide range of options — like standard or heavy weight stacks and optional foot support kits — so you can assemble a collection just right for your space, members and budget. Count on the Versa Series for a mix of advanced biomechanics and smart options that will bring your vision of fitness to life.

VERSA SERIES

- 1 EXERCISE PLACARDS**
Easy-to-read reference cards highlight targeted muscle groups and proper machine use.
- 2 CONVERGING/DIVERGING MOTION**
Encourages a natural path of motion to enhance comfort.
- 3 INCREMENTAL WEIGHTS**
Easy to access and reference from the seated position.
- 4 ACTION SPECIFIC GRIPS™**
Ergonomically designed to reduce stress on contact points while enhancing feel and form (Versa+ package).
- 5 ELECTRONIC REP COUNTER**
Tracks reps, activity time and rest time for a streamlined workout experience (Versa+ package).
- 6 GAS-ASSISTED SEAT ADJUSTMENT**
Offers smooth, instant adjustment, with a 4-bar linkage for increased stability (Versa+ package).



* Shown in Matte Black

VERSA OPTIONS

Versa+ (shown throughout brochure)

- Comes with:
- Action Specific Grips™
 - Gas-assisted Seat Adjustment
 - Electronic Rep Counter/Timer
 - Decorative Top Wing
 - Ergonomic Adjustment Handles
 - Heavy Weight Stack
 - Incremental Weight

Weight Stack

- Choose between Standard and Heavy Weight Stack

Optional Foot Support Kit

- Available on:
- Converging Chest Press
 - Converging Shoulder Press
 - Biceps Curl
 - Back Extension





CONVERGING CHEST PRESS VS-S13

- Independent converging movement provides a natural path of motion
- Designed for easy entry and exit
- Adjustable start position facilitates increased range of motion



CONVERGING SHOULDER PRESS VS-S23

- Independent converging movement provides a natural path of motion
- Dual-position hand grips allow for greater training variety
- Counterbalanced pressing arms provide optimal starting resistance



DIVERGING LAT PULLDOWN VS-S33

- Independent diverging movement provides a natural path of motion
- Angled seat encourages proper user position
- Thigh pad easily adjusts for stability and comfort



DIVERGING SEATED ROW VS-S34

- Independent cable movement provides a user-defined path of motion and exercise variety
- Adjustable chest pad accommodates users of all sizes
- Rotating grips provide maximum comfort and ergonomic hand positioning throughout the range of motion
- Integrated foot pegs provide added support during heavy lifts



BICEPS CURL VS-S40

- Arm pad is angled for stability and limits unwanted shoulder movement during exercise
- Optimized pivot location creates biomechanically correct range of motion



TRICEPS PRESS VS-S42

- Rotating handles adapt to users of all sizes
- Angled back pad reduces stress, improves stabilization and enhances comfort



BACK EXTENSION VS-S52

- Multi-position foot placement accommodates a variety of users
- Contoured back pad enhances comfort



ABDOMINAL VS-S53

- 3-position design trains abdominals and obliques for added exercise variety and core rotation
- Ergonomic back pad improves range of motion and enhances comfort



LEG PRESS / CALF PRESS VS-S70

- One-handed start adjustment for ease of use
- Gas-assisted foot platform provides smoother adjustments
- Assistance handle and low step-over height offer easy access
- Foot plate identifies user foot position with unique visual indicators



LEG EXTENSION VS-S71

- Angled seat and back pads encourage full quadriceps contraction
- Self-adjusting tibia pad enhances comfort
- Pivot location is clearly marked to encourage correct alignment
- Back pad ratchets forward for easy adjustment from seated position



SEATED LEG CURL VS-S72

- Angled seat and unique pivot location encourage full hamstring contraction
- Tibia pad and range-of-motion adjustments are easily accessible from seated position
- Back pad ratchets forward for easy adjustment from seated position
- Adjustable thigh pad provides stabilization during exercise



GLUTE VS-S78

- Adjustable chest pad accommodates users of all sizes
- Low step-height stabilization platform allows for ease of use
- Upright user position, contoured elbow pads and large foot pad enhance comfort

VERSA DUALS

MORE FUNCTION, LESS SPACE

The expanded versatility of our dual stations makes it easy to create a weight-training collection just right for your space, your budget and the people you serve. By mixing and matching a range of our two-in-one stations, you can make the most of your floor space while providing a complete strength training experience. Intuitive adjustment, incremental weight control and clearly illustrated placards make it easy for users of all ability levels to smoothly transition from one exercise to the next, while ergonomic design adds comfort to every workout. Choose from eight dual-station units, customize with weight stack options or our premium Versa+ package, and complete your offering with more Versa single-station units.



* Shown in Matte Black



MULTI-PRESS VS-S131

- Designed for easy entry and exit
- Smoothly transition between exercises with one simple adjustment
- Dual-position hand grips allow for greater training variety
- Elevated foot rests provide stability and comfort during heavy lifts
- Reclined position offers greater lumbar support
- Clearly indicated adjustments for ease of use



REAR DELT / PEC FLY VS-S22

- Comfortable, oversized grips accommodate users of all sizes
- Always forward-facing user position enhances comfort and ease of use
- Wide motion for improved biomechanics and dual function



LAT PULLDOWN / SEATED ROW VS-S331

- Thigh pad easily adjusts to provide stability and comfort
- Elevated foot rests provide stability and comfort during heavy lifts
- Stainless-steel cable guides provide added protection for lasting durability
- Clearly indicated adjustments for ease of use



BICEPS / TRICEPS VS-S401

- Compact design minimizes floor space
- Stainless-steel cable guides provide added protection for lasting durability
- Large foot platform provides stability



AB / LOW BACK VS-S531

- Angled seat and lumbar pad enhance user comfort
- Multi-position foot placement accommodates a variety of users
- Low handle positions offer easy entry and exit and provide stability
- Clearly indicated adjustments for ease of use



CHIN / DIP ASSIST VS-S601

- Multi-position pull-up handles for greater exercise variety
- Ideally angled dip grips encourage proper wrist placement and muscle variation
- Gas-assisted knee platform folds up for unassisted bodyweight exercises and training variety
- Large, textured foot platforms provide easy entry and exit
- Knee platform features a protective top pad for added training security
- Integrated hard stop prevents knee pad disengagement
- Clearly indicated adjustments for ease of use



LEG EXTENSION / LEG CURL VS-S711

- Angled pads and ideal pivot location promote full muscle contraction and alignment for both exercises
- Dual-action CAM enables a smooth transition between exercises
- Adjustments are easily performed in the seated position
- Back pad ratchets forward for easy adjustment from the seated position
- Clearly indicated adjustments for ease of use



HIP ADDUCTOR / ABDUCTOR VS-S74

- Dual-function machine saves space and increases functionality
- Reclined position provides greater lumbar support
- Clearly indicated adjustments allow for ease of use

VERSA FUNCTIONAL TRAINER

SPACE-SAVING VERSATILITY

The smart design of our functional trainer provides a remarkable range of exercise options in a space-saving footprint. Incremental weight adjustment and a 1:2 pulley ratio make it easy to control exercise intensity and create progressions right for everyone from deconditioned users to elite athletes. Everything about our functional trainer — from the multi-grip pull-up bar to the color-coded adjustment points to the professionally illustrated exercise placards — offers intuitive operation for users and trainers alike. Optional storage makes it easy to organize and stow accessories for instant access, and the completely enclosed design protects the unit's moving parts while creating a solid, cohesive aesthetic on your floor.



ACCESSORY STORAGE

* Accessories not included.



* Shown in Matte Black

FUNCTIONAL TRAINER VS-VFT-S30

- Multi-position pull-up handles for greater exercise variety
- Fully enclosed weight stacks protect the machine's internal components
- Enhanced placards highlight targeted muscle groups and proper user positioning for a wide range of exercises
- One-handed pulley adjustment offers easy operation
- Frame guards protect against chips and scratches
- Clearly indicated adjustments for ease of use

* Accessories not included.



VS-VFT-S18

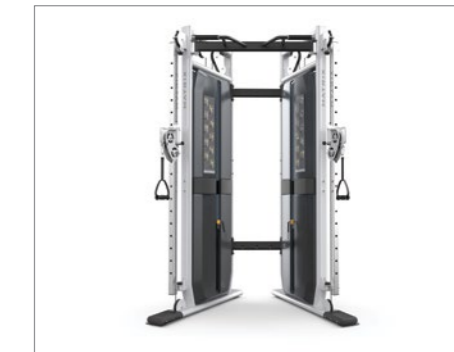

- Compact design accommodates placement in spaces with ceilings as low as 2.4 m / 8'
- 76 cm / 30" connection provides ample storage for functional training accessories
- 1:2 pulley ratio provides smooth operation
- Standard effective resistance 34 kg / 75 lbs. (per side)
- Also available: VS-VFT-S18 Functional Trainer with 46 cm / 18" connection to accommodate optional training handles

- Optional: VS-VFT60 heavy stack for added 13.6 kg / 30 lbs. of resistance per side for 47.6 kg / 105 lbs. effective resistance
- Optional accessory: VS-FTHP handle package includes four training handles (v-bar, curl bar, ropes, ankle strap)
- Optional: VS-FTIW 2.2 kg / 5 lb. increment weight



VERSA PLUS SINGLE-STATION	PRODUCT DIMENSIONS*						PRODUCT WEIGHT		WEIGHT STACK	
	METRIC (CM)			ENGLISH (INCHES)			METRIC	ENGLISH	METRIC	ENGLISH
	L	W	H	L	W	H	KG	LBS.	KG	LBS.
VS-S13P Converging Chest Press	139.3	134.7	167.1	54.9	53	65.8	265	584	104	230
VS-S23P Converging Shoulder Press	171	143.7	203.6	67.3	56.6	80.1	269	591	104	230
VS-S33P Diverging Lat Pulldown	155.4	150.1	187.9	61.2	59.1	74	272	599	104	230
VS-S34P Diverging Seated Row	137.8	99.4	167.1	54.2	39.1	65.8	231	509	104	230
VS-S40P Biceps Curl	121.8	127	167.1	48	50	65.8	256	564	91	200
VS-S42P Triceps Press	157.7	107.5	167.1	62.1	42.3	65.8	262	577	104	230
VS-S52P Back Extension	133.5	126.4	167.1	52.6	49.8	65.8	244	537	104	230
VS-S53P Abdominal	136.6	141.4	167.1	53.8	55.7	65.8	216	476	104	230
VS-S70P Leg Press	232.4	102.4	167.1	91.5	40.3	65.8	301	662	188	415
VS-S71P Leg Extension	183.5	128.9	167.1	72.3	50.7	65.8	236	520	104	230
VS-S72P Seated Leg Curl	176.9	113.3	167.1	69.7	44.6	65.8	264	581	91	200
VS-S78P Glute	177.8	99.9	167.1	70	39.3	65.8	188	414	68	150
VS-S131P Multi-Press	154.3	157.2	199.9	60.7	61.9	78.7	268	590	104	230
VS-S22P Pectoral Fly / Rear Delt	150.5	169	167.1	59.2	66.5	65.8	216	475	91	200
VS-S331P Lat Pulldown / Seated Row	180.5	157.9	226.3	71.1	62.2	89.1	278	613	104	230
VS-S401P Bicep / Tricep	166.6	124.7	226.2	65.6	49.1	89.1	237	522	91	200
VS-S531P Abdominal / Back Extension	132.2	131.5	167.1	52.1	51.8	65.8	263	579	104	230
VS-S601P Chin / Dip Assist	142.8	152.8	219.7	56.2	60.2	86.5	307	676	93	205
VS-S711P Leg Extension / Leg Curl	177.6	118.3	167.1	69.9	46.6	65.8	283	624	104	230
VS-S74P Hip Adductor / Abductor	169.6	159.1	167.1	66.8	62.6	63.3	242	533	104	230

VERSA HEAVY SINGLE-STATION	PRODUCT DIMENSIONS*						PRODUCT WEIGHT		WEIGHT STACK	
	METRIC (CM)			ENGLISH (INCHES)			METRIC	ENGLISH	METRIC	ENGLISH
	L	W	H	L	W	H	KG	LBS.	KG	LBS.
VS-S13H Converging Chest Press	139.3	134.7	160.8	54.9	53	63.3	262	578	104	230
VS-S23H Converging Shoulder Press	171	143.7	203.6	67.3	56.6	80.1	266	585	104	230
VS-S33H Diverging Lat Pulldown	155.4	150.1	187.9	61.2	59.1	74	269	593	104	230
VS-S34H Diverging Seated Row	137.8	99.4	160.8	54.2	39.1	63.3	228	503	104	230
VS-S40H Biceps Curl	121.8	127	160.8	48	50	63.3	253	558	91	200
VS-S42H Triceps Press	157.7	107.5	160.8	62.1	42.3	63.3	259	571	104	230
VS-S52H Back Extension	133.5	126.4	160.8	52.6	49.8	63.3	241	531	104	230
VS-S53H Abdominal	136.6	141.4	160.8	53.8	55.7	63.3	213	470	104	230
VS-S70 Leg Press	232.4	102.4	160.8	91.5	40.3	63.3	298	656	188**	415**
VS-S71H Leg Extension	183.5	128.9	160.8	72.3	50.7	63.3	233	514	104	230
VS-S72H Seated Leg Curl	176.9	113.3	160.8	69.7	44.6	63.3	261	575	91	200
VS-S78 Glute	177.8	99.9	160.8	70	39.3	63.3	185	409	68**	150**
VS-S131H Multi-Press	154.3	157.2	199.9	60.7	61.9	78.7	268	590	104	230
VS-S22H Pectoral Fly / Rear Delt	150.5	169	160.8	59.2	66.5	63.3	213	469	91	200
VS-S331H Lat Pulldown / Seated Row	180.5	157.9	226.3	71.1	62.2	89.1	275	607	104	230
VS-S401H Bicep / Tricep	166.6	124.7	226.2	65.6	49.1	89.1	234	516	91	200
VS-S531H Abdominal / Back Extension	132.2	131.5	160.8	52.1	51.8	63.3	260	573	104	230
VS-S601 Chin / Dip Assist	142.8	152.8	219.7	56.2	60.2	86.5	304	670	93**	205**
VS-S711H Leg Extension / Leg Curl	177.6	118.3	160.8	69.9	46.6	63.3	280	618	104	230
VS-S74H Hip Adductor / Abductor	169.6	159.1	160.8	66.8	62.6	63.3	239	527	104	230

VERSA STANDARD SINGLE-STATION	PRODUCT DIMENSIONS*						PRODUCT WEIGHT		WEIGHT STACK	
	METRIC (CM)			ENGLISH (INCHES)			METRIC	ENGLISH	METRIC	ENGLISH
	L	W	H	L	W	H	KG	LBS.	KG	LBS.
VS-S13 Converging Chest Press	139.3	134.7	160.8	54.9	53	63.3	231	509	72.6	160

VERSA STANDARD SINGLE-STATION cont.	PRODUCT DIMENSIONS*						PRODUCT WEIGHT		WEIGHT STACK	
	METRIC (CM)			ENGLISH (INCHES)			METRIC	ENGLISH	METRIC	ENGLISH
	L	W	H	L	W	H	KG	LBS.	KG	LBS.
VS-S23 Converging Shoulder Press	171	143.7	203.6	67.3	56.6	80.1	234	516	72.6	160
VS-S33 Diverging Lat Pulldown	155.4	150.1	187.9	61.2	59.1	74	238	524	72.6	160
VS-S34 Diverging Seated Row	137.8	99.4	160.8	54.2	39.1	63.3	197	433	72.6	160
VS-S40 Biceps Curl	121.8	127	160.8	48	50	63.3	222	489	68	150
VS-S42 Triceps Press	157.7	107.5	160.8	62.1	42.3	63.3	228	502	72.6	160
VS-S52 Back Extension	133.5	126.4	160.8	52.6	49.8	63.3	241	531	72.6	160
VS-S53 Abdominal	136.6	141.4	160.8	53.8	55.7	63.3	213	470	72.6	160
VS-S70 Leg Press	232.4	102.4	160.8	91.5	40.3	63.3	298	656	188	415
VS-S71 Leg Extension	183.5	128.9	160.8	72.3	50.7	63.3	202	444	72.6	160
VS-S72 Seated Leg Curl	176.9	113.3	160.8	69.7	44.6	63.3	239	526	68	150
VS-S78 Glute	177.8	99.9	160.8	70	39.3	63.3	185	408	68	150
VS-S131 Multi-Press	154.3	157.2	199.9	60.7	61.9	78.7	236	520	72.6	160
VS-S22 Pectoral Fly / Rear Delt	150.5	169	160.8	59.2	66.5	63.3	190	419	68	150
VS-S331 Lat Pulldown / Seated Row	180.5	157.9	226.3	71.1	62.2	89.1	243	537	72.6	160
VS-S401 Bicep / Tricep	166.6	124.7	226.2	65.6	49.1	89.1	211	466	68	150
VS-S531 Abdominal / Back Extension	132.2	131.5	160.8	52.1	51.8	63.3	228	503	72.6	160
VS-S601 Chin / Dip Assist	142.8	152.8	219.7	56.2	60.2	86.5	304	670	93	205
VS-S711 Leg Extension / Leg Curl	177.6	118.3	160.8	69.9	46.6	63.3	248	548	72.6	160
VS-S74 Hip Adductor / Abductor	169.6	159.1	160.8	66.8	62.6	63.3	208	458	72.6	160

VERSA MULTI-STATION	PRODUCT DIMENSIONS*						PRODUCT WEIGHT		WEIGHT STACK	
	METRIC (CM)			ENGLISH (INCHES)			METRIC	ENGLISH	METRIC	ENGLISH
	L	W	H	L	W	H	KG	LBS.	KG	LBS.
VS-VFT-S18 Functional Trainer	111.8	160	237.6	44	63	93.5	355	782	68	150
VS-VFT-S30 Functional Trainer	122.7	145.8	237.6	48.3	57.4	93.5	369	814	68	150

2:1 Pulley Ratio. Effective resistance of Versa Functional Trainer standard stack is (34 kg / 75lbs.)

VERSA HEAVY MULTI-STATION (VS-VFT60)	PRODUCT DIMENSIONS*						PRODUCT WEIGHT		WEIGHT STACK	
	METRIC (CM)			ENGLISH (INCHES)			METRIC	ENGLISH	METRIC	ENGLISH
	L	W	H	L	W	H	KG	LBS.	KG	LBS.
VS-VFT-S18 + VS-VFT60 Functional Trainer	111.8	160	237.6	44	63	93.5	409	902	95.5	210
VS-VFT-S30 + VS-VFT60 Functional Trainer	122.7	145.8	237.6	48.3	57.4	93.5	424	934	95.5	210

2:1 Pulley Ratio. Effective resistance of Versa Functional Trainer heavy stack is (47.6 kg / 105lbs.)

STRENGTH WARRANTY (NORTH AMERICA ONLY)	
Frame (Not Coatings)**	10 years
Weight Stacks	5 years
Pulleys	5 years
Pivot Bearings	5 years
Other Items Not Specified	3 years
Labor	3 years
Upholstery / Cables / Springs / Grips	1 year
Accessories	6 months

* Dimensions listed are maximum in-use dimensions
 ** There are two models with only one standard weight stack option: – Glute (68 kg / 150 lbs.), Leg Press (188 kg / 415 lbs.)
 *** Frame is defined as the welded-metal base of the unit and does not include removable parts.
 NOTE: All specifications are subject to change without notice. Actual products may differ from those pictured in this catalog. Visit www.matrixfitness.com for latest warranty information.

VERSA STANDARD FRAME COLORS

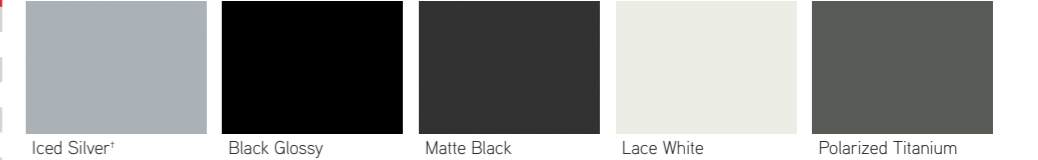

VERSA UPHOLSTERY COLOR OPTIONS



Frame and upholstery colors applicable to North America. Product pricing is reflective of **standard** upholstery only. Other color options available at an additional charge. NOTE: Actual product colors may vary from what is shown here. † Iced Silver is stocked frame color. Additional lead times may apply for other frame colors.



AURA

THE STANDARD IN PERFORMANCE AND DESIGN

A superior blend of features and sophistication, the Aura Series appeals to fitness enthusiasts of all kinds. Independent converging and diverging motions on select units provide a natural resistance movement that feels smooth and natural. Ergo Form™ cushions ensure proper body alignment and support while introducing an extra touch of style. In addition to offering a unique aesthetic distinction that attracts users, our round-tube construction with automotive-quality powder-coat finish provides lasting strength and durability.

AURA SERIES

- 1** **FRAME AND FINISH**
Attractive round-tube construction provides unmatched strength, and automotive-quality finish is highly resistant to chips and scratches.
- 2** **BOTTLE AND TOWEL HOLDER**
Conveniently positioned to prevent spills and clutter on your floor.
- 3** **EXERCISE PLACARDS**
Easy-to-read reference cards highlight targeted muscle groups and proper machine use.
- 4** **ERGO FORM™ CUSHIONS**
Uniquely attractive design ensures proper body alignment and support.
- 5** **INCREMENTAL WEIGHTS**
Easy to access and reference from the seated position.
- 6** **CONVERGING/DIVERGING MOTION**
Encourages a natural path of motion to enhance comfort.

* Weight plates, Olympic bars and dumbbells are not included.

* Shown in Matte Black





CHEST PRESS G3-S10

- Adjustable pressing arm allows users to determine their own range of motion
- Oversized, dual-position hand grips provide greater comfort and variety



PECTORAL FLY G3-S12

- Dual hand grips accommodate users of all sizes
- Independent arm action ensures more balanced exercise by not allowing the dominant side to control the exercise
- Adjustable starting position allows for greater range of motion



CONVERGING CHEST PRESS G3-S13

- Independent converging movement provides a natural path of motion
- Dual hand-grip positions provide greater training variety
- Designed for easy entry and exit



SHOULDER PRESS G3-S20

- Dual-position hand grips allow for greater training variety
- Oversized hand grips provide improved function and comfort
- Counterbalanced pressing arm provides optimal starting resistance



LATERAL RAISE G3-S21

- Full back pad enhances user position, comfort and support
- Independent arm action ensures balanced exercise
- Handles pivot to accommodate users of all sizes



REAR DELT / FLY G3-S22

- User arms pivot to accommodate individual forearm lengths and varying paths of motion
- Optimized handle positions reduce the need to adjust the seat position between rear deltoid and fly exercises



CONVERGING SHOULDER PRESS G3-S23

- Independent converging movement provides a natural path of motion
- Pressing arm includes both standard and neutral grips for user preference
- Oversized hand grips provide greater comfort and variety
- Counterbalanced pressing arm provides optimal starting resistance



LAT PULLDOWN G3-S30

- Thigh pads easily adjust to provide both stability and comfort
- Straight bar with angled ends ensures correct arm and wrist position throughout the entire range of motion



SEATED ROW G3-S31

- Dual-position hand grips allow for greater training variety
- Optimized pivot location creates a biomechanically correct arc of motion



DIVERGING LAT PULLDOWN G3-S33

- Independent diverging movement provides a natural path of motion
- Angled seat cues optimal user position
- Thigh pads easily adjust to provide both stability and comfort



DIVERGING SEATED ROW G3-S34

- Independent diverging movement provides a natural path of motion
- Dual-position hand grips provide greater training variety



ARM CURL G3-S40

- Arm pad is angled for stability and limits unwanted shoulder movement during exercise
- Optimized pivot location creates a biomechanically correct range of motion
- Angled hand grips ensure optimal wrist position



TRICEPS PRESS G3-S42

- Rotating handles adapt to users of all sizes
- Over-molded grips ensure a secure, non-slip feel
- Angled back pad reduces stress, improves stabilization and enhances comfort



TRICEPS EXTENSION G3-S45

- Seat and upper-arm pads are angled to enhance user stability during exercise
- Handle pivots adjust for varying forearm lengths
- Optimized pivot location creates a biomechanically correct range of motion



ABDOMINAL CRUNCH G3-S51

- Dual axis of rotation enhances user feel for a natural crunch movement and muscle contraction
- Seat and handle positions enhance user stability



BACK EXTENSION G3-S52

- Adjustable nonskid footrests provide secure and proper positioning
- Pivot position coordinates the function of hip and lower-back muscles
- Lower-back reference pad encourages proper user alignment



ROTARY TORSO G3-S55

- Unique design reinforces proper user positioning
- Range of motion is adjustable in 10-degree increments
- Foot bar helps users of all sizes achieve proper stabilization



DIP / CHIN ASSIST G3-S60

- Rotating dip handles adapt to users of all sizes
- Pull-up bar offers both standard and neutral grips for individual preference
- Steps allow easy entry and exit
- 2 sets of pull-up grips allow users of all heights a full range of motion



LEG PRESS G3-S70

- 4-bar linkage enhances alignment and provides variable resistance
- Large nonskid footplate accommodates users of all sizes



LEG EXTENSION G3-S71

- Angled seat and back pads encourage full quadriceps contraction
- Adjustable start position facilitates increased range of motion
- Self-adjusting tibia pad enhances comfort
- Pivot location is clearly marked to encourage correct alignment



SEATED LEG CURL G3-S72

- Seat, back and tibia pads adjust without affecting knee alignment or start-position angle
- Adjustable start position facilitates increased range of motion
- Pivot location is clearly marked to encourage correct alignment



PRONE LEG CURL G3-S73

- Divergent pad angle eliminates lower-back stress
- Standard range of motion adjusts for individual preference
- Pivot location is clearly marked to encourage correct alignment



HIP ADDUCTOR G3-S74

- Knee pads and dual footrests provide leg support and enhanced comfort
- Weight stack positioned in front of the user acts as a shield, providing enhanced privacy



HIP ABDUCTOR G3-S75

- Knee pads and dual footrests provide leg support to eliminate unwanted torque around the knee
- Weight stack positioned in front of the user acts as a shield, providing enhanced privacy



ROTARY HIP G3-S76

- Hip exercises performed from standing position enhance alignment and increase target muscle involvement
- Adjustable carriage allows users of varying heights to achieve optimal positioning
- Starting positions are incremental at 15-degree intervals through 270 degrees of rotation
- Low step-up height 13.2 cm / 5.2" for easy entry and exit



CALF PRESS G3-S77

- Force is transmitted through hips to eliminate spinal compression
- Footplates are curved for comfortable positioning and a full range of motion
- Fully enclosed linear bearings provide smooth, quiet motion



FUNCTIONAL TRAINER G3-MSFT300 / G3-MSFT400

- 1:4 pulley ratio offers low starting resistance and high-speed movements
- Available with 132-kg / 290-lb. or 177-kg / 390-lb. stacks
- Standard swiveling accessory station includes 10 attachments
- Multi-grip-position pull-up handles with unique rock-climbing attachment
- Integrated fold-away step offers easy access
- G3-MSFT300 effective resistance: 32.9-kg / 72.5-lbs. (per side)
- G3-MSFT400 effective resistance: 44.2-kg / 97.5-lbs. (per side)



Flanged pulley housing

ADJUSTABLE CABLE CROSSOVER G3-MS20

- Widely spaced, dual-adjustable pulleys offer exercise variety
- Pull-up bar with both lat and neutral grips provide hand placement options
- One-handed adjustment makes operation easy
- Flanged pulley housing minimizes cable wear and increases durability
- 1:2 pulley ratio provides smooth operation

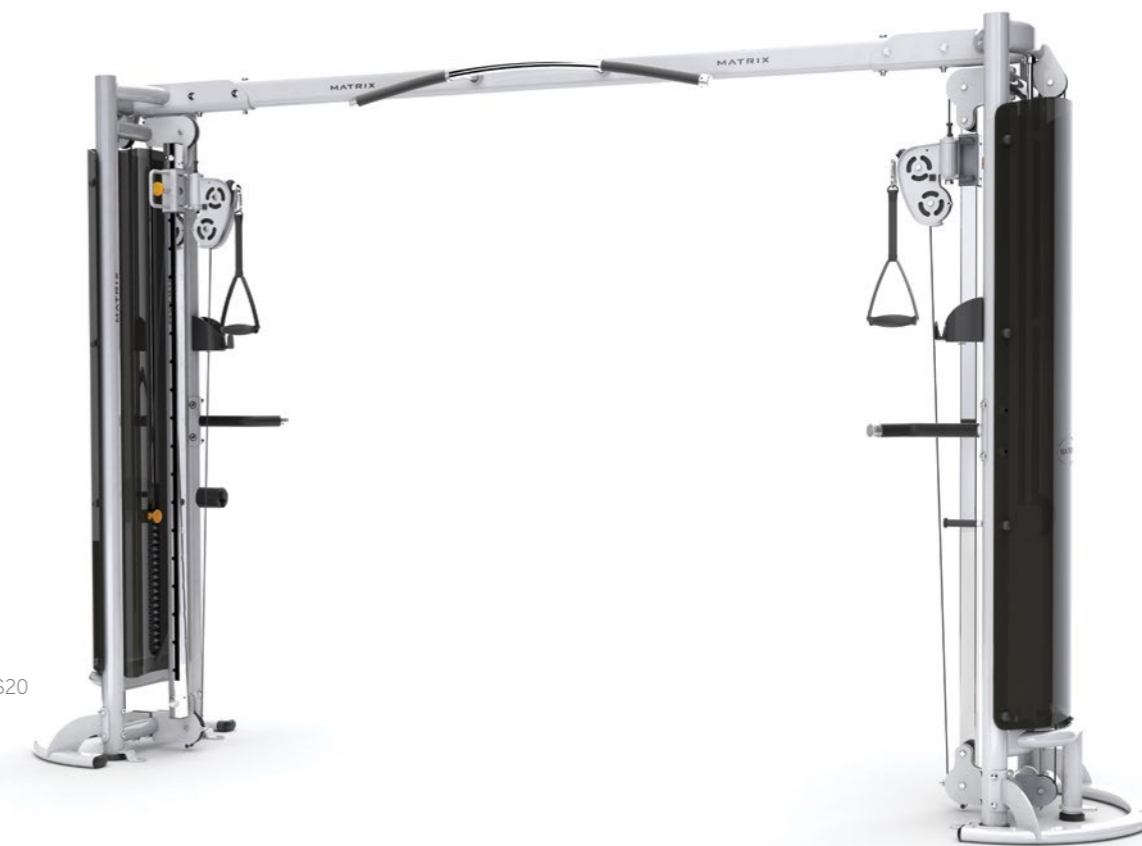



ADJUSTABLE PULLEY G3-MS24

- Single-handed height adjustment offers easy use
- 1:2 pulley ratio provides smooth movement and smaller incremental weight changes
- Balance bar adds support during exercise
- Includes water bottle holder and towel hook
- Modular design is easily customized to your space



LAT PULLDOWN G3-MS51

- Two independent cables add training variety
- Pivoting knee pad allows for quick and easy adjustments
- Includes water bottle holder and towel hook
- Modular design is easily customized to your space



TRICEPS PRESSDOWN G3-MS52

- Swiveling top pulley enhances durability
- 1:1 pulley ratio allows for heavy training
- Additional stability pad enhances comfort
- Includes water bottle holder and towel hook
- Modular design is easily customized to your space

LOW ROW G3-MS53

- Two independent cables offer training variety
- 1:1 pulley ratio allows for heavy training
- Two large foot platforms and oversized seat accommodate users of all sizes
- Includes water bottle holder and towel hook
- Modular design is easily customized to your space



SAMPLE CONFIGURATIONS UTILIZING THE FOUR COMPONENT STATIONS

4-stack Multi-station



5-stack Multi-station



8-stack Multi-station





SQUAT RACK G3-FW72

- 6 racking positions accommodate all users
- Takeoffs are positioned 15 cm / 6" apart to allow easy removal and re-racking of the bar
- Fixed side frames are positioned at a height of 84 cm / 33"
- 6 standard weight horns hold multiple weight-plate sizes



POWER STATION G3-FW73

- 8 racking positions accommodate users for any type of lift
- Adjustable bar stop allows positioning from 78 cm to 122 cm / 30.5" to 48"
- Fixed side frame is positioned at 51 cm / 20" for Olympic lifts
- Integrated pull-up bar increases functionality
- 6 standard weight horns hold multiple weight-plate sizes



OLYMPIC FLAT BENCH G3-FW13

- Multiple weight takeoff points are spread 15 cm / 6" apart accommodating users of all sizes
- Standard weight storage keeps weight plates in close proximity and spaced to accommodate large plates



OLYMPIC INCLINE BENCH G3-FW14

- Bench is angled 30 degrees to emphasize upper chest
- Adjustable seat allows fine-tuning of the exercise position
- Standard weight storage keeps weight plates in close proximity and spaced to accommodate large plates



OLYMPIC DECLINE BENCH G3-FW15

- Bench is angled at -15 degrees to emphasize lower chest
- 2 takeoff positions provide adaptability for users with varying arm lengths
- Tibia adjuster allows for near-infinite adjustment positions and is spaced to accommodate large plates



PREACHER CURL G3-FW40

- Elbow pad is angled 55 degrees to vary resistance and improve user comfort
- Seat pad is angled 10 degrees to enhance stability and comfort



BACK EXTENSION BENCH G3-FW52

- Bench is angled 45 degrees for easy entry and exit, making it ideal for lower-back exercise
- 9 positions provide 24 cm / 9.5" of adjustment for users of most heights
- Footrests incorporate lower-leg pads for stability and comfort during heavy lifts



FLAT BENCH G3-FW81

- Bench has 3-point contact for improved leveling
- Integrated foot supports enhance user stability
- Integrated wheels simplify movement around facility



ADJUSTABLE DECLINE BENCH G3-FW83

- Bench offers 8 positions of adjustment from 15 to 30 degrees
- Leg pads designed in fixed position allow for easy entry and exit
- Integrated wheels simplify movement around facility



UTILITY BENCH G3-FW84

- Back angle is 85 degrees, improving comfort and stability for overhead movements
- Integrated foot supports increase stability
- Integrated wheels simplify movement around facility



10-PAIR DUMBBELL RACK G3-FW91

- Offset angle prevents wrist strain when removing and replacing dumbbells
- Individual cradles improve racking of dumbbells
- Storage space for 10 pairs of dumbbells up to 45 kg / 100 lbs.
- Also available: 5-pair Dumbbell Rack, G3-FW90 (single tier, not shown)



OLYMPIC WEIGHT TREE G3-FW94

- 9 chrome-plated storage horns accommodate Olympic plates
- Rubber bumpers on horns protect frame finish
- Ergonomic design positions heavier plates further off the ground for easier removal and replacement



BARBELL RACK G3-FW96

- Upright design provides convenience for barbell accessories
- Rack holds 10 barbells, 5 per side
- Chromed pegs provide lasting commercial finish



ACCESSORY RACK G3-FW97

- Facilitates placement of all accessories in one spot for convenience and a clutter-free facility
- Top shelf holds additional accessories



AURA SINGLE-STATION	PRODUCT DIMENSIONS*						PRODUCT WEIGHT		WEIGHT STACK	
	METRIC (CM)			ENGLISH (INCHES)			METRIC	ENGLISH	METRIC	ENGLISH
	L	W	H	L	W	H	KG	LBS.	KG	LBS.
G3-S10 Chest Press	127	155.9	184.7	50	61.4	72.7	275	607	113	250
G3-S12 Pectoral Fly	113.3	156.8	150.6	44.6	61.7	59.3	246	542	91	200
G3-S13 Converging Chest Press	128.3	155.1	174.8	50.5	61.1	68.8	293	645	113	250
G3-S20 Shoulder Press	152	146.9	150.7	59.8	57.8	59.3	251	553	91	200
G3-S21 Lateral Raise	154.2	152.4	150.6	60.7	60	59.3	271	597	91	200
G3-S22 Rear Delt / Fly	136.8	191.6	204.3	53.9	75.4	80.4	294	648	134	295
G3-S23 Converging Shoulder Press	153.8	149.3	173.6	60.6	58.8	68.4	251	553	91	200
G3-S30 Lat Pulldown	146.4	119.6	221.7	57.6	47.1	87.3	250	551	134	295
G3-S31 Seated Row	151.4	92.1	210.6	59.6	36.3	82.9	273	601	113	250
G3-S33 Diverging Lat Pulldown	146.7	88.4	211.7	57.8	34.8	83.3	237	527	113	250
G3-S34 Diverging Seated Row	154.4	87.9	198.7	60.8	34.6	78.2	259	570	113	250
G3-S40 Arm Curl	122.2	108.6	150.6	48.1	42.8	59.3	228	502	91	200
G3-S42 Triceps Press	158.8	128	173.6	62.5	50.4	68.4	261	575	91	200
G3-S45 Triceps Extension	117.4	108.4	150.6	46.2	42.7	59.3	223	491	91	200
G3-S51 Abdominal Crunch	142.8	112.2	150.5	56.2	44.2	59.3	184	405	91	200
G3-S52 Back Extension	157.7	106.5	174.9	62.1	41.9	68.9	277	610	134	295
G3-S55 Rotary Torso	164.2	97	173.7	64.6	38.2	68.4	216	476	91	200
G3-S60 Dip / Chin Assist	117.6	121.8	230.7	46.3	47.9	90.8	229	505	91	200
G3-S70 Leg Press	210.1	124.6	184.6	82.7	49	72.7	417	920	175	385
G3-S71 Leg Extension	178.9	109.4	173.6	70.4	43.1	68.4	265	584	113	250
G3-S72 Seated Leg Curl	178.9	109.4	173.6	70.4	43.1	68.4	257	566	113	250
G3-S73 Prone Leg Curl	177.5	111.7	173.6	69.9	44	68.3	272	600	91	200
G3-S74 Hip Adductor	166.6	164.3	150.8	65.6	64.7	59.4	264	582	100	220
G3-S75 Hip Abductor	166.6	107.5	150.8	65.6	42.3	59.4	270	595	100	220
G3-S76 Rotary Hip	111.7	119.7	184.3	44	47.1	72.6	295	650	134	295
G3-S77 Calf Press	173	68.9	150.5	68.1	27.1	59.3	304	670	134	295

AURA MULTI-STATIONS	PRODUCT DIMENSIONS*						PRODUCT WEIGHT		WEIGHT STACK	
	METRIC (CM)			ENGLISH (INCHES)			METRIC	ENGLISH	METRIC	ENGLISH
	L	W	H	L	W	H	KG	LBS.	KG	LBS.
G3-MSFT300 Functional Trainer	169.2	130.2	234.4	66.6	51.2	92.3	601	1324	2 X 131	2 X 290
G3-MSFT400 Functional Trainer	169.2	130.2	234.4	66.6	51.2	92.3	697	1537	2 X 176	2 X 390
G3-MS20 Adjustable Cable Crossover	397.4	90	239.6	156.5	35.4	94.3	399	880	2 X 91	2 X 200
G3-MS24 Adjustable Pulley	68	70	240	27	28	94.5	90	198.5	91	200
G3-MS51 Lat Pulldown	140	120	252	55	47.5	99.5	118	261	134	295
G3-MS52 Triceps Pressdown	85	59	240	33.5	23.5	94.5	80.5	177.5	91	200
G3-MS53 Low Row	230	71	240	91	28	94.5	126	278	134	295
4-stack Multi-station Configuration**	167.8	369.8	252	66.1	145.6	99.2	998	2200	2 X 91, 2 X 134	2 X 200, 2 X 295
5-stack Multi-station Configuration**	481.5	369.8	251.7	189.6	145.6	99.1	1197	2640	3 X 91, 2 X 134	3 X 200, 2 X 295
8-stack Multi-station Configuration**	561.3	370.9	251.7	221	146	99.1	1996	4400	4 X 91, 4 X 134	4 X 200, 4 X 295

AURA FREE WEIGHTS	PRODUCT DIMENSIONS*						PRODUCT WEIGHT	
	METRIC (CM)			ENGLISH (INCHES)			METRIC	ENGLISH
	L	W	H	L	W	H	KG	LBS.
G3-FW72 Squat Rack	184.7	160.8	195.6	72.7	63.3	77	140	309
G3-FW73 Power Station	184.8	160.5	223.5	72.8	63.2	88	177	390
G3-FW13 Olympic Flat Bench	181	159	127	71	63	50	76	168
G3-FW14 Olympic Incline Bench	190	159	145	75	63	57	87	191
G3-FW15 Olympic Decline Bench	211	159	127	83	63	50	90	198
G3-FW40 Preacher Curl Bench	92.7	69.6	89.1	36.5	27.4	35.1	40	88
G3-FW52 Back Extension Bench	122.1	76.4	86.8	48.1	30.1	34.2	61	135
G3-FW81 Flat Bench	156.2	68.7	43	61.5	27	16.9	26	57
G3-FW83 Adjustable Decline Bench	161	60.9	85.1	63.4	24	33.5	38	84
G3-FW84 Utility Bench	118.9	75.9	96.2	46.8	29.9	37.9	27	60
G3-FW91 10-pair Dumbbell Rack	281.7	70.7	82.3	110.9	27.8	32.4	130	287
G3-FW90 5-pair Dumbbell Rack	284	71	81	112	28	32	82	181
G3-FW94 Olympic Weight Tree	87	56.9	107.7	34.2	22.4	42.4	45	100
G3-FW96 Barbell Rack	138.5	76.9	155.2	54.5	30.3	61.1	83	184
G3-FW97 Accessory Rack	110	68	111	43	27	44	54	120

STRENGTH WARRANTY (NORTH AMERICA ONLY)	
Frame (Not Coatings)**	10 years
Weight Stacks	5 years
Pulleys	5 years
Pivot Bearings	5 years
Other Items Not Specified	3 years
Labor	3 years
Upholstery / Cables / Springs / Grips	1 year
Accessories	6 months

* Dimensions listed are maximum in-use dimensions
 ** For the 4-, 5- & 8-stack, the exact product weight and dimensions will depend on configuration.
 *** Frame is defined as the welded-metal base of the unit and does not include removable parts.
 NOTE: All specifications are subject to change without notice. Actual products may differ from those pictured in this catalog.
 Olympic bars, dumbbells and weight plates are not included unless specified. Visit www.matrixfitness.com for latest warranty information.

AURA STANDARD FRAME COLORS

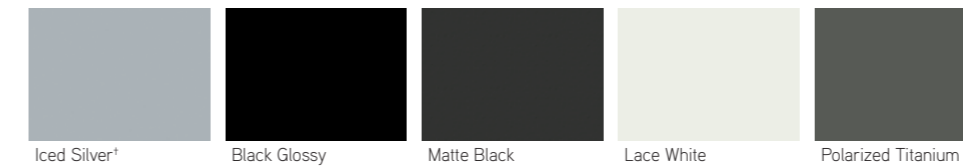

AURA UPHOLSTERY COLOR OPTIONS



Frame and upholstery colors applicable to North America.
 Product pricing is reflective of **standard** upholstery only. Other color options available at an additional charge.
 NOTE: Actual product colors may vary from what is shown here.
 † Iced Silver is stocked frame color. Additional lead times may apply for other frame colors.





MAGNUM

A LEGACY OF PERFORMANCE AND PROVEN DURABILITY

Ideal for helping professional athletes reach their ultimate potential, the Magnum Series provides an unparalleled blend of performance and durability. Simple, exclusive Breaker Benches allow users to get into the start position with less stress on their joints. Other products like Double MEGA Racks pack in the functionality to help you make the most of your floor space. Best of all, everything that carries the Magnum Series name will withstand the most intense training environments.

MAGNUM SERIES

- 1 DURABLE CONSTRUCTION**
Built to withstand the rigorous strength training of professional sports teams.
- 2 CONVERGING/DIVERGING MOTION**
Encourages a natural path of motion to enhance comfort.
- 3 ERGONOMICS AND BIOMECHANICS**
Designed for comfort while providing a natural, mechanically correct motion.
- 4 COLOR-CODED ADJUSTMENT POINTS**
Conveniently located and clearly marked for easy use.
- 5 FRAME FINISH**
Automotive-quality finish is highly resistant to chips and scratches.
- 6 VARIETY**
A robust selection meets the training needs of virtually any facility.

* Weight plates, Olympic bars and dumbbells are not included.

* Shown in Matte Black



TOWER STATIONS

MULTIPLE CONFIGURATIONS

The 17 different machines in the 900 series of tower stations provide the ultimate training variety for your customers. You can use them as stand-alone units, or you can link them to maximize your space and create the exact layout you want. Back-to-back or almost any other configuration is possible to fit your facility.





LEG PRESS MG-903

- Large foot platform for added stability
- Low step-over height provides easy entry and exit
- Available as a freestanding unit (MG-FS903)



LAT PULLDOWN MG-921

- Thigh pads easily adjust to provide stability and comfort
- Available as a freestanding unit (MG-FS921)



DUAL-PULLEY LAT PULLDOWN MG-DP921

- Thigh pads easily adjust to provide stability and comfort
- Dual rotational pulleys for added exercise variety and independent motion
- Available as a freestanding unit (MG-FSDP921)



ADJUSTABLE PULLEY MG-923

- Column adjusts to provide exercise variety with 17 positions
- Available as a freestanding unit (MG-FS923)



DUAL ADJUSTABLE PULLEY MG-DP923

- Column adjusts into 17 positions
- Dual rotational pulleys for added exercise variety and independent motion
- Available as a freestanding unit (MG-FSDP923)

ADJUSTABLE CROSSOVER MG-924

- 1:2 ratio enables smooth resistance and extended travel
- Large support handles provide extra stability
- Available as a freestanding unit (MG-FS924)



LOW ROW MG-926

- Large foot platform for added stability
- Available as a freestanding unit (MG-FS926)



DUAL-PULLEY LOW ROW MG-DP926

- Dual rotational pulleys for added exercise variety and independent motion
- Available as a freestanding unit (MG-FSDP926)





REAR DELT / FLY MG-936

- Dual grips for added variety and comfort
- Dual function with a space-saving design
- Available as a freestanding unit (MG-FS936)



DIP / CHIN ASSIST MG-937

- Dual grips for added exercise variety
- Dual function with a space-saving design
- Large knee pad for comfort and stability
- Available as a freestanding unit (MG-FS937)



TRICEPS PUSHDOWN MG-942

- Compact, space-saving design
- Large backpad for support
- Available as a freestanding unit (MG-FS942)



LAT PULLDOWN / LOW ROW MG-946

- Dual function with a space-saving design
- Thigh pads easily adjust to provide stability and comfort
- Available as a freestanding unit (MG-FS946)



BICEPS / TRICEPS MG-947

- Dual grips for added exercise variety
- Dual function with a space-saving design
- Available as a freestanding unit (MG-FS947)



ADJUSTABLE PULLEY MG-ADA23

- Unique lower handles support wheelchair users
- Cable column adjusts to provide exercise variety with 17 positions
- Wheelchair accessible



CHEST PRESS / ROW MG-ADA2220

- Direct roll-in wheelchair design
- Chest pad easily rotates to switch between exercises
- Dual function for added exercise variety
- Wheelchair accessible



BICEPS / LAT PULLDOWN MG-ADA1121

- Gas-assisted arm pad for ease of use
- Elbow pads help alleviate shoulder stress and provide greater stability and comfort
- Dual function for added exercise variety
- Wheelchair accessible



PEC DECK MG-ADA18

- Direct roll-in wheelchair design
- Oversized arm pads eliminate need for adjustments
- Wheelchair accessible



FREESTANDING ACCESSORY RACK TAR1

- Accommodates multiple accessories for organized storage



BOLT-ON ACCESSORY PACK TAR2

- Accommodates multiple accessories for organized storage
- Available option for 900 series towers

BREAKER BENCHES

EASIER TAKEOFFS

Incredibly beneficial for beginners and professional athletes alike, this exclusive system uses pivoting uprights to place the bar directly over the user. We call them Breaker Benches because they eliminate the need for assistance to break the bar, allowing users to get into the start position with less stress on their joints. Greater comfort, easier takeoffs and increased efficiency add up to a superior solution for all users in resistance training.

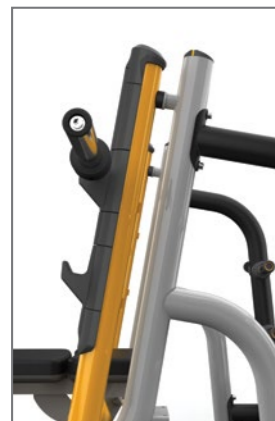

Uprights resting in the start position



Uprights pivoted to forward position



BREAKER OLYMPIC FLAT BENCH MG-A678

- Uprights pivot forward into ideal starting position, directly over the user for easy takeoff
- Molded urethane guards protect Olympic bars from damage, reduce noise and provide a hand rest for spotters
- Wide back pad stabilizes users during heavy lifts
- 10 weight-storage horns (20-kg / 45-lb. plates store at waist height)
- Designed to meet EN957 and ASTM safety standards
- Shown with optional spotter platform (MG-AOSP)



OLYMPIC FLAT BENCH MG-A78

- Molded urethane guards protect Olympic bars from damage, reduce noise and provide a hand rest for spotters
- Wide back pad stabilizes users during heavy lifts
- 10 weight-storage horns (20-kg / 45-lb. plates store at waist height)
- Designed to meet EN957 and ASTM safety standards
- Shown with optional spotter platform (MG-AOSP)



BREAKER OLYMPIC INCLINE BENCH MG-A679

- Uprights pivot forward into ideal starting position, directly over the user for easy takeoff
- Molded urethane guards protect Olympic bars from damage, reduce noise and provide a hand rest for spotters
- Wide back pad stabilizes users during heavy lifts
- Ratcheting seat design for ease of use and adjustment
- 10 weight-storage horns (20-kg / 45-lb. plates store at waist height)
- Comes standard with built-in spotter platform
- Designed to meet EN957 and ASTM safety standards



OLYMPIC INCLINE BENCH MG-A79

- Molded urethane guards protect Olympic bars from damage, reduce noise and provide a hand rest for spotters
- Wide back pad stabilizes users during heavy lifts
- Ratcheting seat design for ease of use and adjustment
- 10 weight-storage horns (20-kg / 45-lb. plates store at waist height)
- Comes standard with built-in spotter platform
- Designed to meet EN957 and ASTM safety standards



BREAKER OLYMPIC DECLINE BENCH MG-A680

- Uprights pivot forward into ideal starting position, directly over the user for easy takeoff
- Molded urethane guards protect Olympic bars from damage, reduce noise and provide a hand rest for spotters
- 10 weight-storage horns (20-kg / 45-lb. plates store at waist height)
- Wide back pad stabilizes users during heavy lifts
- Designed to meet EN957 and ASTM safety standards
- Knee and ankle pads easily pivot to accommodate all user sizes



OLYMPIC DECLINE BENCH MG-A80

- Molded urethane guards protect Olympic bars from damage, reduce noise and provide a hand rest for spotters
- 10 weight-storage horns (20-kg / 45-lb. plates store at waist height)
- Wide back pad stabilizes users during heavy lifts
- Designed to meet EN957 and ASTM safety standards
- Knee and ankle pads easily pivot to accommodate all user sizes



BREAKER OLYMPIC SHOULDER BENCH MG-A645

- Uprights pivot forward into ideal starting position, directly over the user for easy takeoff
- Molded urethane guards protect Olympic bars from damage, reduce noise and provide a hand rest for spotters
- Comes standard with built-in spotter platform
- 10 weight-storage horns (20-kg / 45-lb. plates store at waist height)
- Designed to meet EN957 and ASTM safety standards



OLYMPIC SHOULDER BENCH MG-A45

- Front and rear takeoffs connected with bottom stop bar
- Molded urethane guards protect Olympic bars from damage, reduce noise and provide a hand rest for spotters
- Comes standard with built-in spotter platform
- 10 weight-storage horns (20-kg / 45-lb. plates store at waist height)
- Designed to meet EN957 and ASTM safety standards



3-WAY OLYMPIC BENCH MG-C895

- Molded urethane guards protect Olympic bars from damage, reduce noise and provide a hand rest for spotters
- Flat bench press, incline press and shoulder press can all be performed with simple adjustments
- Easy-to-use seat automatically moves into proper position when back is adjusted
- 10 weight-storage horns hold over 454 kg / 1000 lbs. of Olympic plates
- Designed to meet EN957 and ASTM safety standards



MULTI-ADJUSTABLE BENCH LP MG-A82

- Seat automatically adjusts with the back pad for ease of use
- Adjustable back pad with 8 positions from 0 to 75 degrees
- Tapered wide back pad stabilizes users during heavy lifts
- Molded guards protect high wear / scuff areas
- Transport handle and integrated wheels simplify movement within facility
- Low 17.8" floor-to-pad height minimizes lower back stress and prevents arching



MULTI-ADJUSTABLE BENCH MG-A85

- Seat automatically adjusts with the back pad for ease of use
- Adjustable back pad with 5 positions from 0 to 80 degrees
- Wide back pad stabilizes users during heavy lifts
- Molded guards protect high wear / scuff areas
- Drop-away handle and integrated wheels simplify movement within facility



FLAT BENCH MG-A59

- Single cross leg provides more freedom for users
- Wide back pad stabilizes users during heavy lifts
- Molded guards protect high wear / scuff areas
- Integrated wheels simplify movement within facility



MULTI-ADJUSTABLE BENCH W/ DECLINE MG-A86

- Backrest adjusts into 7 positions — decline: -10 and 2.5 degrees; incline: 17.5, 32, 48, 64.5 and 87.5 degrees
- Wide back pad stabilizes users during heavy lifts
- Molded guards protect high wear / scuff areas
- Leg pads provide added stability
- Integrated wheels simplify movement within facility



UTILITY BENCH MG-A87

- Oversized foot supports provide maximum stability
- Molded guards protect high wear / scuff areas
- Oversized rubber foot platforms provide added stability
- Integrated wheels simplify movement within facility



STANDING ARM CURL MG-A71

- Arm pad height adjusts to accommodate users of all sizes
- Durable extruded guards protect frame and bar
- Utilizing both sides of the machine increases functionality and saves space



PREACHER CURL MG-A62

- Angled, ratcheting seat encourages proper body positioning
- Durable extruded guards protect frame and bar



VKR W/ CHIN MG-A63C

- Oversized round handles enhance comfort on dip
- Angled back support, elbow pads and handles provide added stability and comfort
- Multiple chin grips and rock-climbing grips add exercise variety



ADJUSTABLE DECLINE BENCH MG-A61

- 9 adjustments from 10 to 30 degrees
- Gas-assist for easy adjustment
- Wide back pad stabilizes users during heavy lifts
- Molded guards protect high wear / scuff areas
- Integrated wheels for easy transport



ADJUSTABLE AB BENCH MG-A77

- Adjustable leg pad accommodates all users
- Molded guards protect high wear / scuff areas
- Back support pivots into 6 different positions from 0 to 25 degrees
- Elevated knee position reduces low-back stress



SQUAT RACK MG-A81

- Fixed-bottom stops provide added security
- Molded urethane guards protect Olympic bars from damage and reduce noise
- 4 racking positions and 10 weight-storage horns are standard
- Bottom stops can also be used to hold bar for various exercises



GLUTE HAM BENCH MG-A96

- Step-through design
- Leg pads and oversized footplate can be adjusted while in exercise position
- Gas-assisted leg pad offers easy vertical adjustment
- Handles to perform reverse hyperextensions
- Hooks to attach bands for reverse hyperextensions



BACK EXTENSION BENCH MG-A93

- Large thigh pads and skid-resistant foot platform for enhanced stability
- Handles offer easy entry and exit
- Molded guards protect high wear / scuff areas
- Gas-assist for easy adjustment



BARBELL RACK MG-A68

- Durable extruded guards protect frame and bar
- Horizontal storage for 10 straight or E-Z Curl bars



WEIGHT TREE MG-A67

- 8 chromed weight horns, 3 of which accommodate 20-kg / 45-lb. plates
- Maximum capacity: over 454 kg / 1000 lbs. of Olympic plates
- Rubber bumpers on horns protect frame finish



WEIGHT TREE W/ BAR HOLDERS MG-A67B

- 6 chromed storage horns, 2 of which accommodate 20-kg / 45-lb. plates
- 2 vertical bar holders for Olympic or curl bar storage
- Rubber bumpers on horns protect frame finish



2-TIER DUMBBELL RACK W/ SADDLES

MG-A84

- Storage space for 10 pairs of pro-style dumbbells of any size
- Cradles hold dumbbells securely in place to prevent rolling pinch hazards
- Offset angle prevents wrist strain when removing and replacing dumbbells



3-TIER DUMBBELL RACK W/ SADDLES

MG-A42

- Storage space for 15 pairs of pro-style dumbbells of any size
- Cradles hold dumbbells securely in place to prevent rolling pinch hazards
- Offset angle prevents wrist strain when removing and replacing dumbbells



3-TIER STUDIO DUMBBELL RACK W/ SADDLES

MG-A41

- Storage space for 10 pairs of pro-style dumbbells from 2–20 kg / 5–50 lbs.
- Space-saving design minimizes footprint and utilizes 35% less space than a traditional 2-tier rack
- Cradles hold dumbbells securely in place to prevent rolling pinch hazards
- Offset angle prevents wrist strain when removing and replacing dumbbells
- Evenly spaced shelves provide consistent user interaction and reduce risk of user error



2-TIER FLAT-TRAY DUMBBELL RACK

MG-A696

- 2.4 m / 8' rack holds rubber hex dumbbells weighing a) 2–22.5 kg / 5–50 lbs. or b) 25–45 kg / 55–100 lbs.
- Also available: 1.8 m / 6', 2-tier flat-tray dumbbell rack (MG-A697)



3-TIER FLAT-TRAY DUMBBELL RACK

MG-A688

- 2.4 m / 8' rack holds rubber hex dumbbells weighing 2–45 kg / 3–100 lbs.
- Also available: 1.8 m / 6', 3-tier flat-tray dumbbell rack (MG-A689)



3-TIER BEAUTY BELL RACK

MG-A44

- Flat-tray beauty bell rack accommodates rubber or urethane dumbbells



STEP-UP PLATFORM W/ HANDLE MG-SUP

- 20 cm / 8" step-up height



SPOTTER PLATFORM MG-AOSP

- Wide-tapered rubber platform provides additional leverage for heavy lifting
- Available as an option on the MG-A78 and MG-A678 Olympic Flat Benches
- Comes standard on the Olympic Incline and Shoulder Press Benches





VERTICAL BENCH PRESS MG-PL12

- Independent converging movement provides a natural path of motion
- Back pad adjusts to alter range of motion and expand training options
- Dual-grip pressing positions offer greater training variety
- Ratcheting seat for easy adjustment
- 4 integrated weight-storage horns



SUPINE BENCH PRESS MG-PL13

- Converging independent arms provide a natural path of motion
- Dual-grip pressing positions offer greater training variety
- 2 integrated weight-storage horns



INCLINE BENCH PRESS MG-PL14

- Independent converging movement provides a natural path of motion
- Back pad adjusts to alter range of motion and expand training options
- Dual-grip pressing positions offer greater training variety
- Ratcheting seat for easy adjustment
- 4 integrated weight-storage horns



VERTICAL DECLINE BENCH PRESS MG-PL15

- Independent converging movement provides a natural path of motion
- Back pad adjusts to alter range of motion and expand training options
- Dual-grip pressing positions offer greater training variety
- Ratcheting seat for easy adjustment
- 4 integrated weight-storage horns



SHOULDER PRESS MG-PL23

- Independent converging movement provides a natural path of motion
- Slightly reclined position reduces lower back strain
- Dual-grip pressing positions offer greater training variety
- Ratcheting seat for easy adjustment
- 4 integrated weight-storage horns



LAT PULLDOWN MG-PL33

- Diverging independent arms provide a natural path of motion
- Easy-to-use thigh-pad adjustment for proper support
- Angled seat cues optimal user position
- 2 integrated weight-storage horns



SEATED ROW MG-PL34

- Diverging independent arms provide a natural path of motion
- Dual-grip positions offer greater training variety
- Two different foot positions accommodate a greater variety of user heights
- Ratcheting seat for easy adjustment
- Integrated weight-storage horn



AB CRUNCH BENCH MG-PL50

- Dual supported pivot for added strength and performance
- Lower step-through height for easy entry and exit
- Dual-action pivot for natural biomechanics
- Angled handles enhance shoulder comfort and feel
- Center tube supports heavier individuals
- Weight horn accommodates 12-kg / 25-lb. plates for advanced users



SMITH MACHINE MG-PL62

- Counter balanced 11.3-kg / 25-lb. bar takeoff for low starting resistance
- Features a 90-degree path of motion adapts to all exercises
- Linear bearings provide a smooth motion
- Non-removable bottom stops add training security
- 6 integrated weight-storage horns hold multiple weight-plate sizes



45-DEGREE LEG PRESS MG-PL70

- Easy-to-use and see racking mechanism
- Adjustable bottom stops provide long or short ranges of motion for all user heights
- Adjustable angle back pad enhances comfort, optimizes hip angles and accommodates a greater range of users
- Assistance handle on platform for easier entry and exit
- Linear bearings for smooth feel and function
- 6 integrated weight-storage horns hold multiple weight-plate sizes



HACK SQUAT MG-PL71

- Large footplate and back pad accommodate users of all sizes
- Spring-loaded take off handles for ease of use and engagement
- Adjustable bottom stops provide long or short ranges of motion for all user heights
- 4 integrated weight-storage horns



STANDING CALF MG-PL76

- Adjustable height shoulder pads accommodate users of all sizes
- Angled footplate provides superior grip and improves calf recruitment
- Angled support handles enhance comfort



SEATED CALF MG-PL77

- Seat moves with input arm to maintain alignment
- Curved and angled foot pad improves comfort and calf recruitment
- Quick-release bar catch simplifies operation
- Knee pads adjust for tibia length and range of motion



SQUAT / LUNGE MG-PL79

- Independent lifting arms for balanced exercise and exercise variation
- Multiple hand-grip positions offer greater training variety
- 3 integrated weight-storage horns keep weight plates in close proximity
- 4 user weight horns provide maximal loading for strong users



4-WAY NECK MG-404

- Counterbalanced arm for optimal starting resistance
- Counterweighted pivoting head pads enhance comfort
- Adjustable seat and 4 handles provide comfortable user positioning
- 2 weight-storage horns



REVERSE BACK EXTENSION MG-405

- Adjustable starting point to select desired range of motion
- Leg pad can be locked in forward position to use without resistance
- Dual hand grips provide added variety and comfort
- 2 weight-storage horns



DOUBLE MEGA RACK CONFIGURATION

It doesn't get any bigger than this. Matrix Double MEGA Racks take your training to the max. A combination of two racks and custom connecting elements, the Double MEGA Rack allows you to tailor your equipment to your facility. This flexibility enables you to define your own priorities and get the most out of your investment each and every training day. Plus, the Matrix 7-gauge steel uprights and heavy-duty frames mean the Double MEGA Rack can simultaneously handle your toughest athletes and your most rigorous workouts. Maximize your space and your athletes at the same time with the Double MEGA Rack.

**Shown with optional accessories.*



MEGA POWER RACK MG-MR47

- Fully enclosed style offers ideal spotting abilities
- Shown with adjustable safety bars, dual-grip chin bar, bar storage, band storage and weight storage
- J-hooks made of high-density polyethylene (HDPE) to protect Olympic bars from scratches
- Visual height indicator and colored locking pin make bar-level changes quick and easy
- 3 retractable lower-band pegs on each side (6 total)



MEGA HALF RACK MG-MR690

- Open-front design gives users freedom of movement
- Shown with adjustable safety bars, dual-grip chin bar, bar storage, band storage and weight storage
- J-hooks made of high-density polyethylene (HDPE) to protect Olympic bars from scratches
- Visual height indicator and colored locking pin make bar-level changes quick and easy
- 3 retractable lower-band pegs on each side (6 total)



MEGA OPEN RACK MG-MR694

- Designed for a variety of lifts — presses, squats, overhead lifts and more
- Shown with adjustable safety bars, dual-grip chin bars, bar storage, band storage and weight storage
- J-hooks made of high-density polyethylene (HDPE) to protect Olympic bars from scratches
- Visual height indicator and colored locking pin make bar-level changes quick and easy
- 3 retractable lower-band pegs on each side (6 total)



MEGA DOUBLE HALF RACK MG-MR691

- Designed for training efficiency
- Shown with 2 sets of adjustable safety bars, dual-grip chin bars, bar storage, band storage and weight storage
- J-hooks made of high-density polyethylene (HDPE) to protect Olympic bars from scratches
- Visual height indicator and colored locking pin make bar-level changes quick and easy
- 3 retractable lower-band pegs on each side per half rack (12 total)



POWER RACK MG-A47

- Fully enclosed style offers ideal spotting abilities
- Shown with adjustable safety bars, chin bars, bar storage, band storage and weight storage
- J-hooks made of high-density polyethylene (HDPE) to protect Olympic bars from scratches
- Visual height indicator and colored locking pin make bar-level changes quick and easy



HALF RACK MG-A690

- Open-front design gives users freedom of movement
- Shown with adjustable safety bars, chin bars, bar storage, band storage and weight storage
- J-hooks made of high-density polyethylene (HDPE) to protect Olympic bars from scratches
- Visual height indicator and colored locking pin make bar-level changes quick and easy



OPEN RACK MG-A694

- Designed for a variety of lifts — presses, squats, overhead lifts and more
- Shown with adjustable safety bars, chin bars, bar storage, band storage and weight storage
- J-hooks made of high-density polyethylene (HDPE) to protect Olympic bars from scratches
- Visual height indicator and colored locking pin make bar-level changes quick and easy



DOUBLE HALF RACK MG-A691

- Designed for training efficiency
- Shown with 2 sets of adjustable safety bars, chin bars, bar storage, band storage and weight storage
- J-hooks made of high-density polyethylene (HDPE) to protect Olympic bars from scratches
- Visual height indicator and colored locking pin make bar-level changes quick and easy



COMBO POWER HALF RACK MG-A47691

- Combined rack design allows for various open- and closed-training environments
- Shown with 2 sets of adjustable safety bars, chin bars, bar storage, band storage and weight storage
- J-hooks made of high-density polyethylene (HDPE) to protect Olympic bars from scratches
- Visual height indicator and colored locking pin make bar-level changes quick and easy



RUBBER PLATFORM W/ HARDWOOD INSERT

- Durable rubber training surface to absorb impact, dampen noise and protect flooring during Olympic lifts
- Hardwood center insert provides optimum foot grip and stability during explosive Olympic lifts
- Options available: MEGA Platform w/ Hardwood Insert (MR47P) for use with the MR47; MEGA Platform w/Hardwood Insert (MR690P) for use with the MR690; MEGA Platform w/ Hardwood Insert (MR691P) for use with the MR691; MEGA Platform w/ Hardwood Insert (MR694P) for use with the MR694; Platform w/ Hardwood Insert (A47P) for use with the A47 and A47691; Platform w/ Hardwood Insert (A690P) for use with the A690; Platform w/ Hardwood Insert (A691P) for use with the A691 and A47691; Platform w/ Hardwood Insert (A694P) for use with the A694



SOLID RUBBER SURFACE PLATFORM

- Durable rubber training surface to absorb impact, dampen noise and protect flooring during Olympic lifts
- Options available: MEGA Solid Rubber Surface Platform (MRP4794) for use with the MR47 and MR694; MEGA Solid Rubber Surface Platform (MRP9091) for use with the MR690 and MR691; Solid Rubber Surface Platform (RP4794) for use with the A47, A694, A47691; Solid Rubber Surface Platform (RP9091) for use with the A690, A691, A47691



STAND-ALONE RUBBER PLATFORM W/ HARDWOOD INSERT PS86

- 183 x 244 cm / 6' x 8' durable rubber training surface to absorb impact, dampen noise and protect flooring during explosive Olympic lifts
- Hardwood center insert provides optimum foot grip and stability during explosive Olympic lifts
- Also available: 244 x 244 cm / 8' x 8' Stand-alone Platform w/ Hardwood Insert (PS88)



STAND-ALONE SOLID RUBBER SURFACE PLATFORM RP86

- Durable rubber training surface to absorb impact, dampen noise and protect flooring during Olympic lifts



REVERSE J-HOOKS OPT1R

- Made of high-density polyethylene (HDPE) to protect bar knurling
- For use on the outside of the following Power or Open Racks: MR47, MR694, A47, A694, A47691
- Available in Ridge Black only

DIP BARS OPT3

- Attaches to rack uprights for body-weight dips
- For use on the following racks: MR690, MR691, A690, A691, A47691
- Also available: Reverse Dip Bars (OPT3R) for use on the following racks: MR47, MR694, A47, A694, A47691
- Available in Ridge Black only

3-PEG BAND PEGS OPT4

- Band pegs provide added training variety
- For use on the following racks: A47, A694, A47691
- Available in Ridge Black only



TECHNIQUE SCOOPS OPT8

- Large cradles accept bumper plates to assist with Olympic lifts and customized takeoff heights
- For use on the following racks: MR690, MR691, A690, A691, A47691
- Also available: Reverse Technique Scoops (OPT8R) for use on the following racks: MR47, MR694, A47, A694, A47691
- Available in Ridge Black only

CUSTOM PLATFORM LOGO OPT10

- Proudly display your facility logo on the platform

PLATFORM RAMP OPT11

- Ramp allows for gradual incline to rack platforms
- Replaces standard platform framework
- Also available: MEGA Platform Ramp (MOPT11) for use on MEGA rack platforms
- Available in Ridge Black only



2-PEG BAND PEGS OPT5

- Band pegs provide added training variety
- For use on the following racks: A690, A691, A47691
- Available in Ridge Black only

SQUAT HANDLES OPT6

- Squat handles can be set at any height on all rack uprights
- Available in Ridge Black only

STEP-UP PLATFORM OPT7

- Adjustable height platform provides additional body-weight exercises
- For use on the following racks: A690, A691, A47691
- Also available: Reverse Step-up Platform (OPT7R) for use on the following racks: MR47, A47, A694, A47691
- Available in Ridge Black only



LAND MINE ATTACHMENT OPT13

- Attaches to any rack for rotational training (bar not included)
- Also available: MEGA Land Mine Attachment (MOPT13) for use on all MEGA racks
- Available in Ridge Black only

NAMEPLATE OPT14U

- Proudly display your logo above your rack

CORE HANDLE OPT16

- Used with an Olympic bar and Land Mine Attachment for added training variety
- Available in Ridge Black only

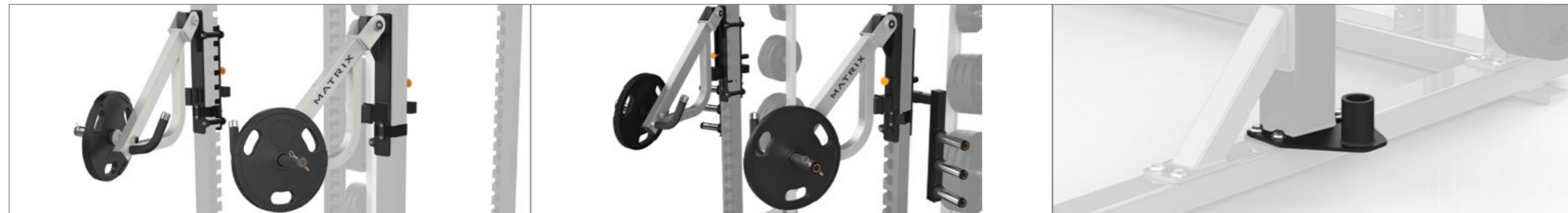

JAMMIN ARMS OPT17

- Angled pressing arms can be placed at 13 different heights for added training variety
- For use on the following racks: MR690, MR691, A690, A691, A47691
- Also available: Reverse Jammin Arms (OPT17R) for use on the following racks: MR47, MR694, A47, A694, A47691

JAMMIN ARMS W/ BAND ATTACHMENT OPT17B

- Angled pressing arms with band attachments for added training variety with speed and resistance
- For use on the following racks: MR690, MR691, A690, A691, A47691
- Also available: Reverse Jammin Arms w/ Band Attachment (OPT17RB) for use on the following racks: MR47, MR694, A47, A694, A47691

SAFETY ARM STORAGE OPT21

- Bolt-on storage for safety arms provides easy access to arms when not in use
- For use on the following racks: A690, A691, A47691
- Also available: MEGA Safety Arm Storage (Pair) (OPT22) for use on the following racks: MR690, MR691
- Available in Ridge Black only



BATTLE ROPE ATTACHMENT OPT31

- For rope training as an anchor point on any rack
- Also available: MEGA Battle Rope Attachment (MOPT31) for use on all MEGA racks
- Available in Chrome finish only

STRAIGHT LADDER OPT32

- Horizontal ladder connecting power racks together for bodyweight training
- For use on the following racks: MR47, A47, A47691
- Also available: Straight Ladder Connecting Bracket in both 244 cm / 8' (OPT32-8) and 297 cm / 9'9" (OPT32-10) lengths
- Available in Matte Black only

PYRAMID LADDER OPT33

- Elevated ladder connecting power racks together for bodyweight training
- For use on the following racks: MR47, A47, A47691
- Also available: Pyramid Ladder Connecting Bracket in 244 cm / 8' (OPT33-8) and 297 cm / 9'9" (OPT33-10) lengths
- Available in Matte Black only



FAT BAR J-HOOKS OPT26

- Made of high-density polyethylene (HDPE) to protect bar knurling
- Oversized hooks accommodate large-diameter Olympic bars
- Also available: Reverse Fat Bar J-hooks (OPT26R) for use on the following racks: MR47, MR694, A47, A694, A47691
- Available in Ridge Black only

DOCKING KIT W/ NO PLATFORM OPT29

- Connects MG-A695 Flat-to-incline Bench w/ Horizontal Adjustment directly to racks without a platform
- Also available: MEGA Docking Kit w/ No Platform (MOPT29) for use on all MEGA racks
- Available in Ridge Black only

DOCKING KIT W/ PLATFORM OPT29P

- Connects MG-A695 Flat-to-incline Bench w/ Horizontal Adjustment directly to racks when using a platform
- Also available: MEGA Docking Kit w/ Platform (MOPT29P) for use on all MEGA racks
- Available in Ridge Black only



STRAIGHT CHIN BAR OPT35

- Single-sided pull-up bar connects power racks together for added bodyweight training
- Also available: Straight Chin Bar Connecting Bracket in 183 cm / 6' (OPT35-6), 244 cm / 8' (OPT35-8), and 297 cm / 9'9" (OPT35-10) lengths
- Also available: MEGA Straight Chin Bar Connecting Bracket (MOPT35) for use on all MEGA racks
- Also available: MEGA Straight Chin Bar Connecting Bracket in 183 cm / 6' (MOPT35-6), 244 cm / 8' (MOPT35-8), and 297 cm / 9'9" (MOPT35-10) lengths

DUAL-SIDED FAT/STRAIGHT CHIN BAR OPT36

- Multiple grip pull-up bar connects power racks together for added bodyweight training
- Also available: Dual-sided Fat/Straight Chin Bar Connecting Bracket in 183 cm / 6' (OPT36-6), 244 cm / 8' (OPT36-8), and 297 cm / 9'9" (OPT36-10) lengths
- Also available: MEGA Dual-sided Fat/Straight Chin Bar Connecting Bracket (MOPT36) for use on all MEGA racks
- Also available: MEGA Dual-sided Fat/Straight Chin Bar Connecting Bracket in 183 cm / 6' (MOPT36-6), 244 cm / 8' (MOPT36-8), and 297 cm / 9'9" (MOPT36-10) lengths



DUAL OLYMPIC BAR STORAGE OPT41

- Vertical Olympic bar storage
- Also available: MEGA Dual Olympic Bar Storage (MOPT41) for use on all MEGA racks



ROTATING CHIN HANDLES OPT42

- Handles rotate into multiple positions for added exercise variety
- For use on the following racks: A47, A690, A691, A694, A47691
- Also available: MOPT42 for use on the MR47
- Available in Ridge Black only



SIDE-MOUNTED PULL-UP BAR OPT43

- Mounts upward or downward for bodyweight exercises or additional suspension-device exercises
- For use on the A47 and A47691 racks
- Also available: MEGA Side-mounted Pull-up Bar (MOPT43) for use on the MR47
- Available in Ridge Black only



OLYMPIC BAR HOLDERS OPT44

- Two bolt-on vertical Olympic bar holders
- For use on the following racks: A47, A690, A694, A47691
- Available in Ridge Black only



BOLT-ON SPOTTER STANDS OPT45

- Two bolt-on spotter stands
- Attaches to any rack
- Available in Ridge Black only



BOLT-ON FRONT BAND PEG OPT46

- Two bolt-on upper band pegs for added training variety
- For use on the following racks: MR47, A47, A690, A691, A694, A47691
- Available in Ridge Black only



HORIZONTAL PLATE RACK MG-A301

- Holds: (4) 45-lb. bumper plates, (2) 25-lb. bumper plates, (2) 10-lb. bumper plates, (4) 10-lb. rubber-coated Olympic plates, (4) 5-lb. rubber-coated Olympic plates, and (4) 2.5-lb. rubber-coated Olympic plates
- Includes 1 horn to hold collars
- Integrated wheels for easy transport
- Available in Ridge Black only



ATTACHMENT STORAGE RACK MG-A303

- Stores resistance chains and bands; also stores options for your Power Racks, such as dip bars, technique scoops, step-up platforms, etc.
- Accessories not included
- Available in Ridge Black only



FLAT-TO-INCLINE BENCH W/ HORIZONTAL ADJUSTMENT MG-A695

- Locking rods for attachment to power racks
- Lever allows user to adjust horizontal length of bench while seated
- Seat automatically adjusts to proper angle as the backrest is adjusted
- Drop-away handle and wheels provide easy movement

*Optional docking kit required to secure bench to racks



MAGNUM SERIES OPTIONS & COMPONENTS (P/N)

OPT1R	Reverse J-hooks	OPT13	Land Mine Attachment	MOPT29	Mega Rack Docking Kit w/ No Platform	OPT46	Bolt-On Front Band Peg
OPT3	Dip Bars	MOPT13	Mega Rack Land Mine Attachment	OPT29P	Docking Kit w/ Platform	A47P	Platform w/ Hardwood Insert
OPT3R	Reverse Dip Bars	OPT14U	Nameplate (Universal Mount)	MOPT29P	Mega Rack Docking Kit w/ Platform	A690P	Platform w/ Hardwood Insert
OPT4	3-peg Band Pegs	OPT16	Core Handle*	OPT31	Battle Rope Attachment	A691P	Platform w/ Hardwood Insert
OPT5	2-peg Band Pegs	OPT17	Jammin' Arms	MOPT31	Mega Rack Battle Rope Attachment	A694P	Platform w/ Hardwood Insert
OPT6	Squat Handles	OPT17B	Jammin' Arms w/ Band Attachment	OPT41	Dual Olympic Bar Storage	MR47P	Mega Platform w/ Hardwood Insert
OPT7	Step-up Platform	OPT17R	Reverse Jammin' Arms	MOPT41	Mega Rack Dual Olympic Bar Storage	MR690P	Mega Platform w/ Hardwood Insert
OPT7R	Reverse Step-up Platform	OPT17RB	Reverse Jammin' Arms w/ Band Attachment	OPT42	Rotating Chin Handles	MR691P	Mega Platform w/ Hardwood Insert
OPT8	Technique Scoops	OPT21	Safety Arm Storage	MOPT42	Mega Rack Rotating Chin Handles	MR694P	Mega Platform w/ Hardwood Insert
OPT8R	Reverse Technique Scoops	OPT22	Safety Arm Storage	OPT43	Side-mounted Pull-up Bar	RP4794	Solid Rubber Surface Platform
OPT10	Custom Platform Logo *	OPT26	Fat Bar J-hooks	MOPT43	Mega Rack Side-mounted Pull-up Bar	RP9091	Solid Rubber Surface Platform
OPT11	Platform Ramp	OPT26R	Reverse Fat Bar J-hooks	OPT44	Bolt-on Olympic Bar Holder (Pair)	MRP4794	Mega Solid Rubber Surface Platform
MOPT11	Mega Rack Platform Ramp	OPT29	Docking Kit w/ No Platform	OPT45	Bolt-On Spotter Stand (Pair)	MRP9091	Mega Solid Rubber Surface Platform

MR47	MR690	MR691	MR694	A47	A690	A691	A694	A47691									
OPT1R	OPT26	OPT3	OPT22	OPT3	OPT22	OPT1R	OPT17RB	OPT1R	OPT26	OPT3	OPT21	OPT3	OPT21	OPT1R	OPT26	OPT1R	OPT17RB
OPT3R	OPT26R	OPT6	OPT26	OPT6	OPT26	OPT3R	OPT26	OPT3R	OPT26R	OPT5	OPT26	OPT5	OPT26	OPT3R	OPT26R	OPT3	OPT21
OPT6	MOPT29	OPT8	MOPT29	OPT8	MOPT29	OPT6	OPT26R	OPT4	OPT29	OPT6	OPT29	OPT6	OPT29	OPT4	OPT29	OPT3R	OPT26
OPT7R	MOPT29P	OPT10	MOPT29P	OPT10	MOPT29P	OPT8R	MOPT29	OPT6	OPT29P	OPT7	OPT29P	OPT7	OPT29P	OPT6	OPT29P	OPT4	OPT26R
OPT8R	MOPT31	MOPT11	MOPT31	MOPT11	MOPT31	OPT10	MOPT29P	OPT7R	OPT31	OPT8	OPT31	OPT8	OPT31	OPT7R	OPT31	OPT5	OPT29
OPT10	MOPT41	MOPT13	MOPT41	MOPT13	MOPT41	MOPT11	MOPT31	OPT8R	OPT41	OPT10	OPT41	OPT10	OPT41	OPT8R	OPT41	OPT6	OPT29P
MOPT11	MOPT42	OPT14U	OPT45	OPT14U	OPT45	MOPT13	MOPT41	OPT10	OPT42	OPT11	OPT42	OPT11	OPT42	OPT10	OPT42	OPT7	OPT31
MOPT13	MOPT43	OPT16	MR690P	OPT16	MR691P	OPT14U	OPT45	OPT11	OPT43	OPT13	OPT44	OPT13	OPT45	OPT11	OPT44	OPT7R	OPT41
OPT14U	OPT45	OPT17	MRP9091	OPT17	MRP9091	OPT16	MR694P	OPT13	OPT44	OPT14U	OPT45	OPT14U	OPT46	OPT13	OPT45	OPT8	OPT42
OPT16	OPT46	OPT17B	OPT17B	OPT17B	MRP4794	OPT14U	OPT45	OPT16	OPT46	OPT16	A691P	OPT14U	OPT46	OPT8R	OPT8	OPT43	
OPT17R	MR47P					OPT16	OPT46	OPT17	A690P	OPT17	RP9091	OPT16	A694P	OPT10	OPT44		
OPT17RB	MRP4794					OPT17R	A47P	OPT17B	RP9091	OPT17B		OPT17R	RP4794	OPT11	OPT45		
						OPT17RB	RP4794					OPT17RB		OPT13	OPT46		
														OPT14U	A47P		
														OPT16	A691P		
														OPT17	RP4794		
														OPT17B	RP9091		
														OPT17R			

Only one chin up option available per rack. All 691 models accept two (one per side).

MAGNUM MULTI-STATION TOWERS	PRODUCT DIMENSIONS						PRODUCT WEIGHT		WEIGHT STACK	
	METRIC (CM)			ENGLISH (INCHES)			METRIC	ENGLISH	METRIC	ENGLISH
MG-903 Leg Press	234	86	234	92	34	92	318	700	178	392
MG-921 Lat Pulldown	127	69	234	50	27	92	231	510	151	332
MG-DP921 Dual-pulley Lat Pulldown	127	69	234	50	27	92	244	538	151	332
MG-923 Adjustable Pulley	107	117	234	42	46	92	155	342	105	232
MG-DP923 Dual Adjustable Pulley	107	117	234	42	46	92	163	360	105	232
MG-924 Adjustable Crossover	69	366	234	27	144	92	330	728	(2) 105	(2) 232
MG-926 Low Row	216	69	234	85	27	92	236	520	142	312
MG-DP926 Dual-pulley Low Row	216	69	234	85	27	92	243	535	142	312
MG-936 Rear Delt / Fly	135	81	229	53	32	90	194	428	104	228
MG-937 Dip / Chin Assist	170	97	234	67	38	92	181	400	105	232
MG-942 Triceps Pushdown	107	117	234	42	46	92	220	485	87	192
MG-946 Lat Pulldown / Low Row	198	69	234	78	27	92	215	475	151	332
MG-947 Biceps / Triceps	107	117	234	42	46	92	170	375	120	264
MG-ADA23 Adjustable Pulley	79	69	218	31	27	86	155	342	82	180
MG-ADA2220 Chest Press / Row	117	99	218	46	39	86	231	510	109	240
MG-ADA1121 Biceps / Lat Pulldown	132	74	218	52	29	86	242	534	114	252
MG-ADA18 Pec Deck	81	102	218	32	40	86	189	416	104	228
TAR-1 Freestanding Accessory Rack	67	64	72	27	25	29	15	33		
TAR-2 Bolt-on Accessory Rack	66	29	74	26	12	29	8	17		

MAGNUM FREE WEIGHTS	PRODUCT DIMENSIONS						PRODUCT WEIGHT	
	METRIC (CM)			ENGLISH (INCHES)			METRIC	ENGLISH
	L	W	H	L	W	H	KG	LBS.
MG-A678 Breaker Olympic Flat Bench	173	168	130	68	66	51	94	207
MG-A78 Olympic Flat Bench	163	168	130	64	66	51	73	160
MG-A679 Breaker Olympic Incline Bench	170	168	160	67	66	63	126	277
MG-A79 Olympic Incline Bench	170	168	160	67	66	63	107	235
MG-A680 Breaker Olympic Decline Bench	206	168	135	81	66	53	107	235
MG-A80 Olympic Decline Bench	201	168	137	79	66	54	82	180
MG-A645 Breaker Olympic Shoulder Bench	135	138	183	53	66	72	118	260
MG-A45 Olympic Shoulder Bench	127	138	165	50	66	65	137	303
MG-C895 3-way Olympic Bench	167	180	173	71	66	68	155	342
MG-A82 Multi-adjustable Bench LP	152	78	46	59.7	30.6	17.8	55	121.5
MG-A85 Multi-adjustable Bench	135	58	51	53	23	20	43	95
MG-A59 Flat Bench	142	58	46	56	23	18	25	55
MG-A86 Multi-adjustable Bench w/ Decline	163	61	51	64	24	20	54	120
MG-A87 Utility Bench	142	66	89	56	26	35	31	68
MG-A71 Standing Arm Curl	119	79	104	47	31	41	61	135
MG-A62 Preacher Curl	119	76	99	47	30	39	57	125
MG-A63C VKR w/ Chin	135	109	245	53	43	96	120	265
MG-A61 Adjustable Decline Bench	163	64	81	64	25	32	45	99
MG-A77 Adjustable Ab Bench	155	69	145	61	27	57	59	131
MG-A81 Squat Rack	206	138	196	81	66	77	120	265
MG-A96 Glute Ham Bench	157	91	130	62	36	51	136	300
MG-A93 Back Extension Bench	124	79	97	49	31	38	39	87
MG-A68 Barbell Rack	112	66	168	44	26	66	70	154
MG-A67 Weight Tree	69	58	91	27	23	36	23	50
MG-A67B Weight Tree w/Bar Holders	51	52	112	20	21	44	23	50
MG-A84 2-tier Dumbbell Rack w/ Saddles	46	239	81	18	94	32	91	200
MG-A42 3-tier Dumbbell Rack w/ Saddles	76	244	114	30	96	45	113	250
MG-A41 3-tier Studio Dumbbell Rack w/ Saddles	183	74	117	72	29	46	115	254
MG-A696 2-tier Flat-tray Dumbbell Rack	61	257	89	24	101	35	120	265
MG-A688 3-tier Flat-tray Dumbbell Rack	71	257	114	28	101	45	186	410
MG-A44 3-tier Beauty Belt Rack	72	105	111	28	41	44	72	158

MAGNUM FREE WEIGHTS cont.	PRODUCT DIMENSIONS						PRODUCT WEIGHT	
	METRIC (CM)			ENGLISH (INCHES)			METRIC	ENGLISH
	L	W	H	L	W	H	KG	LBS.
MG-SUP Step-up Platform w/ Handle	91	41	125	36	16	49	34	75
MG-AOSP Spotter Platform	66	84	29	26	33	12	28	61

MAGNUM PLATE-LOADED	PRODUCT DIMENSIONS						PRODUCT WEIGHT	
	METRIC (CM)			ENGLISH (INCHES)			METRIC	ENGLISH
	L	W	H	L	W	H	KG	LBS.
MG-PL12 Vertical Bench Press	146.5	168.5	199.5	58	66.5	78.5	196	432
MG-PL13 Supine Bench Press	185.4	128.3	91.4	73	50.5	36	98	216
MG-PL14 Incline Bench Press	208.2	143.2	129.6	82	56.5	51	147.5	325
MG-PL15 Vertical Decline Bench Press	148	168.5	195	58.5	66.5	77	195.5	431
MG-PL23 Shoulder Press	161.3	160	118.1	63.5	63	46.5	118	260
MG-PL33 Lat Pulldown	182.9	123.2	190.5	72	48.5	75	128	282
MG-PL34 Seated Row	152.4	139.7	106.7	60	55	42	118	260
MG-PL50 Ab Crunch Bench	162.6	88.9	100.3	64	35	39.5	60	132.5
MG-PL62 Smith Machine	153.7	231.1	245.1	60.5	91	96.5	230	507
MG-PL70 45-Degree Leg Press	228.6	151.1	133.4	90	59.5	52.5	298	657
MG-PL71 Hack Squat	228.2	150	144.6	90	59	57	270	595
MG-PL76 Standing Calf	138	89	184.5	54.5	35	73	124	273.5
MG-PL77 Seated Calf	141	80	96.5	55.5	31.5	38	65	143.5
MG-PL79 Squat / Lunge	148.6	170.2	86.4	58.5	67	34	120	264.5
MG-404 4-way Neck	84	147	165	33	58	65	79	175
MG-405 Reverse Back Extension	150	109	145	59	43	57	134	295

MAGNUM RACKS	PRODUCT DIMENSIONS						PRODUCT WEIGHT	
	METRIC (CM)			ENGLISH (INCHES)			METRIC	ENGLISH
	L	W	H	L	W	H	KG	LBS.
MG-MR47 MEGA Power Rack	206	207	246.5	81	81.5	97	347	765
MG-MR690 MEGA Half Rack	170.5	207	246.5	67	81.5	97	259	570
MG-MR694 MEGA Open Rack	206	207	246.5	81	81.5	97	250	550
MG-MR691 MEGA Double Half Rack	314	207	246.5	123.5	81.5	97	542	1195
MG-A47 Power Rack	204.5	187	256.5	80.5	73.5	101	268	590
MG-A690 Half Rack	166.5	187	256.5	65.5	73.5	101	195	430
MG-A694 Open Rack	204.5	187	256.5	80.5	73.5	101	234	515
MG-A691 Double Half Rack	306	204.5	256.5	120.5	80.5	101	420	925
MG-A47691 Combo Power Half Rack	345.5	204.5	256.5	136	80.5	101	499	1100

OPTIONS	PRODUCT DIMENSIONS						PRODUCT WEIGHT	
	METRIC (CM)			ENGLISH (INCHES)			METRIC	ENGLISH
	L	W	H	L	W	H	KG	LBS.
OPT1R Reverse J-hooks	36	13	25	14	5	10	14	30
OPT3 Dip Bars	86	69	26	34	27	10	16	35
OPT3R Reverse Dip Bars	86	69	26	34	27	10	11	24
OPT4 3-peg Band Pegs	20	102	8	8	40	3	12	26
OPT5 2-peg Band Pegs	39	44	7	15	17	2.5	7	14
OPT6 Squat Handles	23	23	13	9	9	5	8	16
OPT7 Step-up Platform	81	61	36	32	24	14	19	41
OPT7R Reverse Step-up Platform	82	61						

OPTIONS cont.	PRODUCT DIMENSIONS						PRODUCT WEIGHT	
	METRIC (CM)			ENGLISH (INCHES)			METRIC	ENGLISH
	L	W	H	L	W	H	KG	LBS.
OPT14U Nameplate	102	1	20	40	0.25	8	2	5
OPT16 Core Handle	48	79	5	19	31	2	5	10
OPT17 Jammin Arms	94	53	94	37	21	37	49	108
OPT17B Jammin Arms w/ Band Attachment	107	56	97	42	22	38	52	114
OPT17R Reverse Jammin Arms	94	56	94	37	22	37	50	110
OPT17RB Reverse Jammin Arms w/ Band Attachment	107	56	96	42	22	37.5	64	140
OPT21 Safety Arm Storage (Pair)	20	20	8	8	8	3	3	6
OPT22 Safety Arm Storage (Pair)	23	21	9	9	8	3.5	2	4
OPT26 Fat Bar J-hooks	47	18	34	19	7	13	16	35
OPT26R Reverse Fat Bar J-hooks	45	11	33	17.5	4	13	15	32
OPT29 Docking Kit w/ No Platform	23	3	12	9	1	4.5	3	5
MOPT29 MEGA Rack Docking Kit w/ No Platform	26	3	14	10	1	5.5	3	5
OPT29P Docking Kit w/ Platform	23	3	7	9	1	2.5	2	3
MOPT29P MEGA Rack Docking Kit w/ Platform	26	3	6	10	1	2	2	3
OPT31 Battle Rope Attachment	18	23	17	7	9	7	4	7
MOPT31 MEGA Rack Battle Rope Attachment	18	23	17	7	9	7	4	7
OPT32-8 Straight Ladder	243.9	81.2	7.7	96	32	3	42.5	93.6
OPT32-10 Straight Ladder	297.2	81.2	7.7	117	32	3	51.5	113.2
OPT33-8 Pyramid Ladder	243.9	68.6	51.5	96	27	20.3	44.5	98
OPT33-10 Pyramid Ladder	297.2	68.6	53.1	117	27	20.9	53.3	117.2
OPT35-6 Straight Chin Bar	182.9	25.7	17.8	72	10.1	7	17.3	38.1
OPT35-8 Straight Chin Bar	243.9	25.7	17.8	96	10.1	7	20.8	45.7
OPT35-10 Straight Chin Bar	297.2	25.7	17.8	117	10.1	7	33	72.6
MOPT35-6 MEGA Straight Chin Bar	182.9	30.4	7.7	72	12	3	16.8	37
MOPT35-8 MEGA Straight Chin Bar	243.9	30.4	7.7	96	12	3	20.3	44.6
MOPT35-10 MEGA Straight Chin Bar	297.2	30.4	7.7	117	12	3	32.5	71.5
OPT36-6 Dual-sided Fat/Straight Chin Bar	182.9	52.4	17.8	72	20.7	7	24.3	53.4
OPT36-8 Dual-sided Fat/Straight Chin Bar	243.9	52.4	17.8	96	20.7	7	27.7	61.1
OPT36-10 Dual-sided Fat/Straight Chin Bar	297.2	52.4	17.8	117	20.7	7	40	87.8
MOPT36-6 MEGA Dual-sided Fat/Straight Chin Bar	182.9	52.4	9.2	72	20.62	3.59	23.75	52.25
MOPT36-8 MEGA Dual-sided Fat/Straight Chin Bar	243.9	52.4	9.2	96	20.62	3.59	27.2	59.9
MOPT36-10 MEGA Dual-sided Fat/Straight Chin Bar	297.2	52.4	9.2	117	20.62	3.59	39.4	86.8
OPT41 Olympic Bar Storage	16	110	31	6	43	12	12.7	28
MOPT41 MEGA Rack Dual Olympic Bar Storage	18	110	33	7	43	13	21.8	48
OPT42 Rotating Chin Handles	16.5	110	33	6.5	43	13	11	23
MOPT42 Rotating Chin Handles	16.1	110	46.4	6.4	43	18.3	15	33
OPT43 Side-mounted Pull-up Bar	120	22	19	47.25	8.7	7.5	7.25	16
MOPT43 MEGA Side-mounted Pull-up Bar	131	28	17	51.6	11	6.7	9	20
OPT44 Bolt-on Olympic Bar Holders (Pair)	23.2	10.2	27	9.25	4	10.6	5.7	12.5
OPT45 Bolt-On Spotter Stand (Pair)	38	81.5	30	15	32	11.5	31	68
OPT46 Bolt-On Front Band Peg	28	16	27	11	6.25	10.5	4	9
A47P Platform w/ Hardwood Insert	366	254	7	144	100	2.5	177	390
MR47P MEGA Platform w/ Hardwood Insert	366	254	8	144	100	3	236	520
A690P Platform w/ Hardwood Insert	331	254	7	130	100	2.5	193	425
MR690P MEGA Platform w/ Hardwood Insert	331	254	8	130	100	3	248	545
A691P Platform w/ Hardwood Insert	331	254	7	130	100	2.5	193	425
MR691P MEGA Platform w/ Hardwood Insert	331	254	8	130	100	3	248	545
A694P Platform w/ Hardwood Insert	366	254	7	144	100	2.5	177	390
MR694P MEGA Platform w/ Hardwood Insert	366	254	8	144	100	3	236	520
RP4794 Solid Rubber Surface Platform	366	254	7	144	100	2.5	209	460
MRP4794 MEGA Solid Rubber Surface Platform	366	254	8	144	100	3	279	615

OPTIONS cont.	PRODUCT DIMENSIONS						PRODUCT WEIGHT	
	METRIC (CM)			ENGLISH (INCHES)			METRIC	ENGLISH
	L	W	H	L	W	H	KG	LBS.
RP9091 MEGA Solid Rubber Surface Platform	331	254	7	130	100	2.5	223	490
MRP9091 MEGA Solid Rubber Surface Platform	331	254	8	130	100	3	266	585
PS86 Stand-alone Rubber Platform w/ Hardwood Insert (183 x 244 cm / 6' x 8')	253	191	5	100	75	2	186	410
PS88 Stand-alone Rubber Platform w/ Hardwood Insert (244 x 244 cm / 8' x 8')	253	253	5	100	100	2	227	501
RP86 Stand-alone Solid Rubber Surface Platform (183 x 244 cm / 6' x 8')	253	191	5	100	75	2	177	390
MG-A301 Horizontal Plate Rack	183	33	46	72	13	18	34	75
MG-A303 Attachment Storage Rack	122	114	178	48	45	70	73	160
MG-A695 Flat-to-incline Bench w/ Horizontal Adjustment	137	76	51	54	30	20	64	140

STRENGTH WARRANTY (NORTH AMERICA ONLY)	
Frame (Not Coatings)**	10 years
Weight Stacks	5 years
Pulleys	5 years
Pivot Bearings	5 years
Other Items Not Specified	3 years
Labor	3 years
Upholstery / Cables / Springs / Grips	1 year
Accessories	6 months

* Dimensions listed are maximum in-use dimensions
 ** Frame is defined as the welded-metal base of the unit and does not include removable parts.
 NOTE: All specifications are subject to change without notice. Actual products may differ from those pictured in this catalog.
 Olympic bars, dumbbells and weight plates are not included unless specified. Visit www.matrixfitness.com for latest warranty information.

MAGNUM STANDARD FRAME COLORS

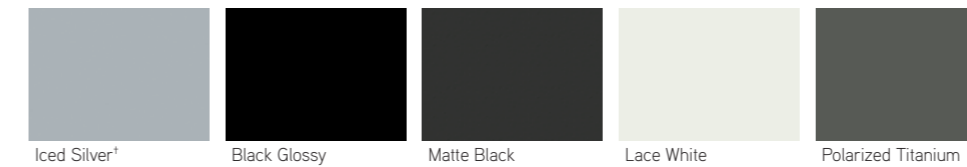

MAGNUM FRAME COLOR OPTIONS

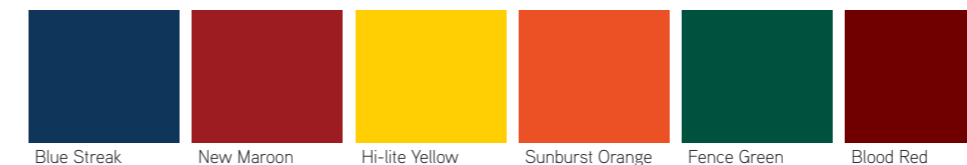

MAGNUM UPHOLSTERY COLOR OPTIONS



Frame and upholstery colors applicable to North America. Product pricing is reflective of **standard** upholstery only. Other color options available at an additional charge. NOTE: Actual product colors may vary from what is shown here. † Iced Silver is stocked frame color. Additional lead times may apply for other frame colors.





VARSITY

DESIGNED FOR SUPERIOR VALUE AND TRAINING VARIETY

The Varsity Series is the ideal choice for heavy-use facilities looking for a combination of performance and value. Smart design helps you make efficient use of your space and your budget, like our versatile functional trainers and plate-loaded equipment that provide conveniently contained personal training areas. If you're looking to accommodate a steady stream of users in a limited space, look no further than the Varsity Series.

VARSITY SERIES



1

DURABLE CONSTRUCTION

Built to withstand the rigorous strength training of professional sports teams.

2

COLOR-CODED ADJUSTMENT POINTS

Conveniently located and clearly marked for easy use.

3

VALUE

Designed to handle a steady stream of users for years to come.

* Weight plates, Olympic bars and dumbbells are not included.

* Shown in Matte Black

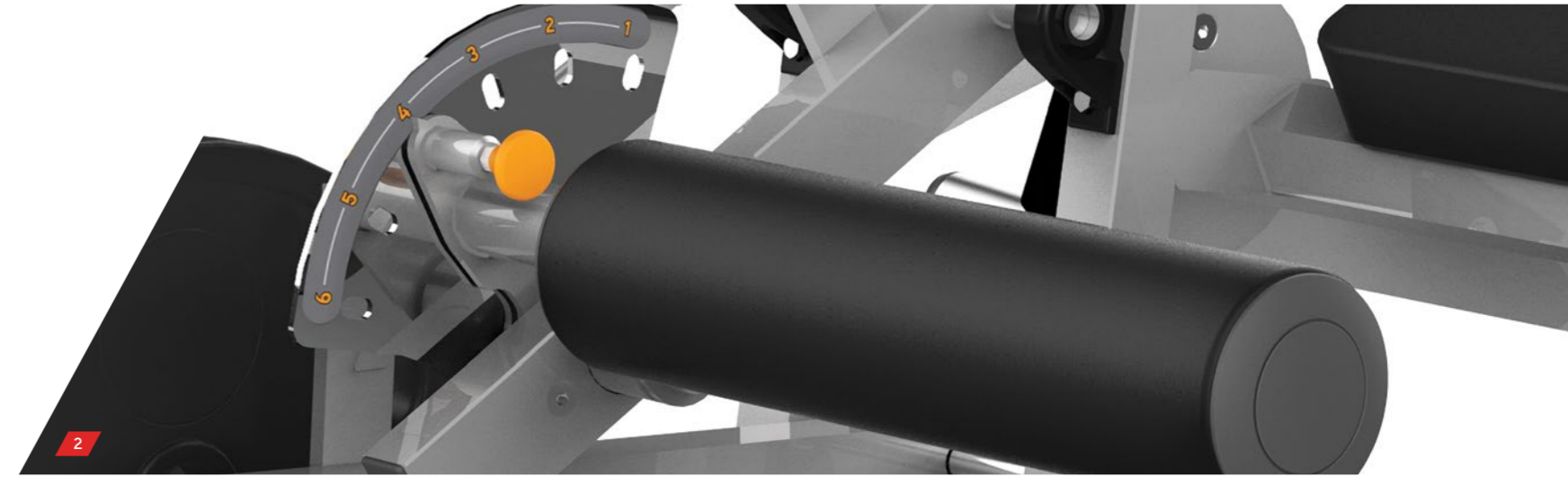

3



FUNCTIONAL TRAINER 1:2 VY-6044

- Compact design at only 208 cm / 80" tall fits comfortably in low ceiling facilities
- Fully enclosed, angled weight stacks create a space-efficient personal training area
- Pulleys adjust into 17 positions to allow users to perform high-speed, low-inertia exercises
- Dual-grip chin bar for greater exercise variety
- Ample storage for additional optional handles
- 1:2 pulley ratio provides low incremental weight changes and moderate speed work
- Effective resistance: 35 kg / 78 lbs. (per side)



FUNCTIONAL TRAINER 1:4 VY-6047

- Compact design at only 208 cm / 80" tall fits comfortably in low ceiling facilities
- Fully enclosed, angled weight stacks create a space-efficient personal training area
- Pulleys adjust into 17 positions to allow users to perform high-speed, low-inertia exercises
- Dual-grip chin bar for greater exercise variety
- Ample storage for additional optional handles
- 1:4 pulley ratio provides lower incremental weight changes, high speed work and increased cable travel
- Effective resistance: 26 kg / 57 lbs. (per side)



3-STACK MULTI-GYM G1-MG30

- 3 weight stacks allow multiple users to exercise simultaneously
- Stations include: multiple position chest / shoulder press, lat pulldown / low row, leg extension / prone leg curl



LEG PRESS VY-2003M

- Oversized double-angled foot platform offers foot-placement variety
- Low step-on height and oversized seat pad add comfort
- Multi-position back rest adds training variety and improves hip positioning
- Thick shoulder pads add comfort and improve stabilization during supine press
- Starting position handle located outside the unit for easy trainer or therapist adjustment
- Separate incremental adjustment for small weight increases



MULTI-HIP VY-2010

- 2:1 weight ratio for smaller increases between plates and faster movements
- Unique micro-adjustable pivot point offers precise positioning for a variety of users
- Large hand rails improve support and stability
- Separate incremental adjustment for small weight increases



LEG CURL / EXTENSION VY-2040

- Unique adjustable seat enables correct biomechanics
- Easy back-pad adjustments from seated position
- Adjustable range of motion for both exercises
- Separate incremental adjustments for small weight increases



SEATED LEG CURL / EXTENSION VY-6240M

- Adjustable starting point for precise range of motion
- Adjustable stop position limits range of motion during rehab
- Two incremental drop down plates allow small weight increases
- Locking ankle / tibia pad offers fixed positioning for entire range of motion



OLYMPIC FLAT BENCH VY-D78

- Sturdy main frame designed to provide proper positioning for spotter
- Front of bench and takeoffs protected by durable guards



OLYMPIC INCLINE BENCH VY-D79

- Sturdy main frame with large built-in spotter platform
- Front of bench and takeoffs protected by durable guards



OLYMPIC DECLINE BENCH VY-D80

- Sturdy main frame designed to provide proper positioning for spotter
- 2-piece leg pad system positions the user comfortably
- Front of bench and takeoffs protected by durable guards



FLAT BENCH VY-D59

- Single cross leg provides more freedom for user



MULTI-ADJUSTABLE BENCH VY-D85A

- Back adjusts into 5 positions: flat, 30, 45, 60 and 80 degrees
- Seat adjusts into 2 positions
- Handle and wheels provide easy movement



PREACHER CURL VY-D62

- Angled seat and arm pads keep user in proper position
- Clean front design allows unit to be used as a curl stand from the front



VKR W/ CHIN VY-D63C

- Compact design allows user to perform dips, chin-ups and leg raises



MULTI-ADJUSTABLE BENCH W/ DECLINE VY-D86

- Backrest adjusts into 17-degree decline, flat and 6 incline positions: 15, 30, 45, 60, 67 and 80 degrees
- Seat adjusts into 3 positions
- Adjustable rollers hold user in position while in decline



UTILITY BENCH VY-D87

- Simple design with footrests keeps user stable for a variety of exercises



BACK EXTENSION BENCH VY-D93

- Adjustable hip pads, stabilization handles and angled foot platform hold user in proper position



ADJUSTABLE INCLINE BENCH G1-FW153

- Easily adjusts to 6 positions from 0 to 75 degrees
- Seat pad position is fixed at 15 degrees
- Integrated wheels for easy transport



ADJUSTABLE DECLINE BENCH VY-D61

- Split, angled pad design with leg pads positions the user comfortably for decline exercises and abdominal work
- Available angles in degrees: 10, 13, 15, 17, 19, 21, 23, 25 and 28



ADJUSTABLE AB BENCH VY-D77

- Split-pad design and double-adjustable leg pads hold any size user in proper position
- Handle is mounted on front rollers, providing easy exit



WEIGHT TREE W/ OLYMPIC BAR HOLDERS VY-D67H

- Made of 5.1 x 5.1 cm / 2" x 2" tubing, featuring 6 weight-storage horns and 2 bar-storage tubes



BARBELL RACK VY-D68

- 2-sided horizontal set bar rack
- Holds 10 straight or E-Z Curl bars



GLUTE HAM BENCH VY-D96

- Handles for reverse hypers provide dual movement
- Fore / aft and vertical adjustment accommodate all user sizes



WEIGHT TREE VY-D67C

- Made of 5.1 x 5.1 cm / 2" x 2" tubing, featuring 5 weight-storage horns



2-TIER DUMBBELL RACK VY-D70

- 2-tier, 10-pair rack ideal for pro-style dumbbells
- Holds different weights of pro-style dumbbells without cradles:
 - 2.3-22.7 kg / 5-50 lbs. or
 - 25-45 kg / 55-100 lbs.



2-TIER HEX DUMBBELL RACK VY-D697

- 2-tier rack holds 13 pairs of rubber hex dumbbells weighing 1.4-22.7 kg / 3-50 lbs.



ANGLED SMITH MACHINE VY-M49

- Olympic bar is counterbalanced to 11.8 kg / 26 lbs.
- Olympic bar is mounted on linear bearings and shaft at a 7-degree angle
- Open-ended frame design provides easy access
- Flip in and out adjustable stops
- 12 integrated weight-storage horns



SMITH MACHINE G1-FW161

- 20 kg / 44 lb. takeoff for low starting resistance
- Bar travel limited to 72 cm / 28.5" from the floor
- 6 integrated weight-storage horns
- Flip in and out adjustable stops for easy access



PERFECT SQUAT VY-400

- Large, angled, heavy-duty footplate adds stability
- Adjustable starting position allows user to set pad height for squats or standing calf raises
- Shoulder pads maintain parallel position to floor throughout full range of motion
- 2 integrated weight-storage horns
- Ideal for squats, calf work and reverse lunges



LEG EXTENSION VY-401

- Self-adjusting tibia pad enhances comfort
- Back pad is adjustable from the seated position for proper alignment
- 2 integrated weight-storage horns



PRONE LEG CURL VY-402

- Divergent angle of lower-leg pad eliminates lower-back stress
- Neutral position handgrips enhance comfort and stability



BICEPS CURL VY-431

- Side arm pads encourage proper user positioning
- 1 integrated weight-storage horn
- Counterbalanced exercise arm offers optimal resistance



TRICEPS EXTENSION VY-432

- Adjustable knee pads help stabilize user during exercise
- Side arm pads encourage proper positioning
- 1 integrated weight-storage horn
- Counterbalanced exercise arm offers optimal resistance



POWER RACK VY-D47

- Fully enclosed style offers ideal spotting abilities
- As shown with adjustable safety bars and straight chin bar, plus band and weight storage
- J-hooks made of high-density polyethylene (HDPE) to protect bar knurling from scratches
- Visual height indicator and colored locking pin make bar-level changes quick and easy



HALF RACK VY-D690

- Open-front design gives users freedom of movement
- As shown with adjustable safety bars and straight chin bar, plus band and weight storage
- J-hooks made of high-density polyethylene (HDPE) to protect bar knurling from scratches
- Visual height indicator and colored locking pin make bar-level changes quick and easy
- Available as 2.1 and 2.3 m / 7' and 7'6" tall configurations



OPEN RACK VY-D694

- Designed for a variety of lifts, including presses, squats, overhead lifts and more
- As shown adjustable safety bars and straight chin bar, plus band and weight storage
- J-hooks made of high-density polyethylene (HDPE) to protect bar knurling from scratches
- Visual height indicator and colored locking pin make bar-level changes quick and easy



DOUBLE HALF RACK VY-D691

- Designed for training efficiency
- As shown with adjustable safety bars and straight chin bar, plus weight storage
- J-hooks made of high-density polyethylene (HDPE) to protect bar knurling from scratches
- Visual height indicator and colored locking pin make bar-level changes quick and easy



RUBBER PLATFORM W/ HARDWOOD INSERT

- Durable rubber training surface to absorb impact, dampen noise and protect flooring during Olympic lifts
- Hardwood center insert provides optimum foot grip and stability during explosive Olympic lifts
- Options available: Platform w/ Hardwood Insert (D47P) for use with the D47; Platform w/ Hardwood Insert (D690P) for use with the D690; Platform w/ Hardwood Insert (D691P) for use with the D691; Platform w/Hardwood Insert (D694P) for use with the D694



SOLID RUBBER SURFACE PLATFORM

- Durable rubber training surface to absorb impact, dampen noise and protect flooring during Olympic lifts
- Options available: Solid Rubber Surface Platform (DRP4794) for use with the D47 and D694; Solid Rubber Surface Platform (DRP90) for use with the D690; Solid Rubber Surface Platform (DRP91) for use with the D691



STAND-ALONE RUBBER PLATFORM W/ HARDWOOD INSERT PS86

- 183 x 244 cm / 6' x 8' durable rubber training surface to absorb impact, dampen noise and protect flooring during explosive Olympic lifts
- Hardwood center insert provides optimum foot grip and stability during explosive Olympic lifts
- Also available: 244 x 244 cm / 8' x 8' Stand-alone Platform w/ Hardwood Insert (PS88)



STAND-ALONE RUBBER PLATFORM RP86

- Durable rubber training surface to absorb impact, dampen noise and protect flooring during Olympic lifts

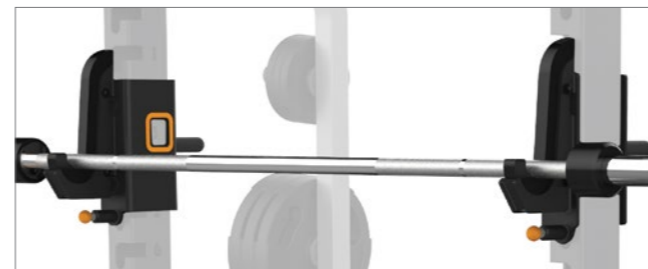

REVERSE J-HOOKS DOPT1R

- Made of high-density polyethylene (HDPE) to protect bar knurling
- For use on the outside of the following Power or Open Racks: D47 and D694
- Available in Ridge Black only



DIP BARS DOPT3

- Attaches to rack uprights for body-weight dips
- For use on the following racks: D690 and D691
- Also available: Reverse Dip Bars (DOPT3R) for use on the following racks: D47, D694
- Available in Ridge Black only

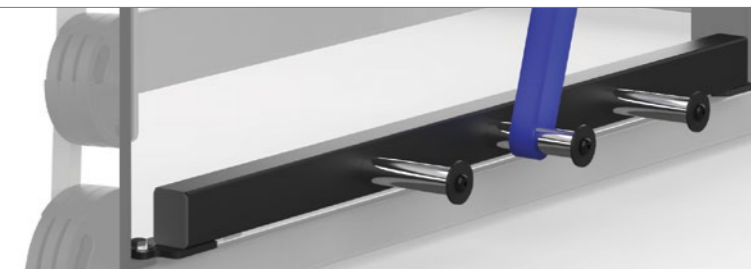

3-PEG BAND PEGS DOPT4

- Band pegs provide added training variety
- For use on the following racks: D47, D694
- Available in Ridge Black only



2-PEG BAND PEGS DOPT5

- Band pegs provide added training variety
- For use on the following racks: D690 and D691
- Available in Ridge Black only



SQUAT HANDLES DOPT6

- Squat handles can be set at any height on all rack uprights
- Available in Ridge Black only



CUSTOM PLATFORM LOGO OPT10

- Proudly display your facility logo on the platform



PLATFORM RAMP OPT11

- Ramp allows for gradual incline to Varsity Series rack platforms
- Replaces standard platform framework
- Available only in Ridge Black



LAND MINE ATTACHMENT DOPT13

- Attaches to any Varsity Series rack for rotational training (bar not included)
- Available only in Ridge Black



JAMMIN ARMS W/ BAND ATTACHMENT DOPT17B

- Angled pressing arms with band attachments for added training variety with speed and resistance
- For use on the following racks: D690 and D691
- Also available: Reverse Jammin Arms w/ Band Attachment (DOPT17RB) for use on the following racks: D47 and D694



SAFETY ARM STORAGE OPT23

- Bolt-on storage for safety arms provides easy access to arms when not in use
- For use on the following racks: D690 and D691
- Available only in Ridge Black



DOCKING KIT W/ NO PLATFORM DOPT29

- Connects MG-A695 and VY-D695 Flat-to-incline Bench w/ Horizontal Adjustment directly to rack without a platform
- Available only in Ridge Black



NAMEPLATE OPT14U

- Proudly display your logo above your rack



CORE HANDLE OPT16

- Used with an Olympic bar and Land Mine Attachment for added training variety
- Available only in Ridge Black



JAMMIN ARMS DOPT17

- Angled pressing arms can be placed at 13 different heights for added training variety
- For use on the following racks: D690 and D691
- Also available: Reverse Jammin Arms (DOPT17R) for use on the following racks: D47 and D694

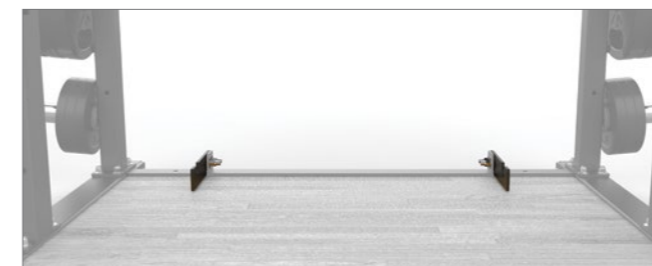

DOCKING KIT W/ PLATFORM DOPT29P

- Connects MG-A695 and VY-D695 Flat-to-incline Bench w/ Horizontal Adjustment directly to rack when using a platform
- Available only in Ridge Black



BATTLE ROPE ATTACHMENT DOPT31

- For rope training as an anchor point on any Varsity Series rack
- Available only in Chrome finish



ROTATING CHIN HANDLES OPT42

- Handles rotate into multiple positions for added exercise variety
- Available in Ridge Black only



BOLT-ON OLYMPIC BAR HOLDERS DOPT44

- Two bolt-on vertical Olympic bar holders
- For use on the following racks: D47, D690, D694
- Available in Ridge Black only



BOLT-ON SPOTTER STANDS DOPT45

- Two bolt-on spotter stands
- For use on the following racks: D47, D690, D694
- Also available: DOPT45DH for use on the D691
- Available in Ridge Black only



BOLT-ON FRONT BAND PEG OPT46

- Two bolt-on upper band pegs for added training variety
- Available in Ridge Black only



HORIZONTAL PLATE RACK VY-D306

- Holds up to (8) 20.4-kg / 45-lb. bumper plates 38 cm / 15" off the floor
- Space between rungs is 11.4 cm / 4.5"
- Available in Ridge Black only



FLAT-TO-INCLINE BENCH W/ HORIZONTAL ADJUSTMENT VY-D695

- Locking rods for attachment to Power Rack docking station
- Spring pin adjustment for horizontal length
- 4 positions: flat, 30, 45 and 80 degrees
- Handle and integrated wheels for easy movement

*Optional docking kit required to secure bench to racks



VARSITY SERIES OPTIONS & COMPONENTS (P/N)

DOPT1R Reverse J-hooks	OPT11 Platform Ramp	DOPT29 Docking Kit w/ No Platform	D690P Platform w/ Hardwood Insert
DOPT3 Dip Bars	DOPT13 Land Mine Attachment	DOPT29P Docking Kit w/ Platform	D691P Platform w/ Hardwood Insert
DOPT3R Reverse Dip Bars	OPT14U Nameplate (Universal Mount)	DOPT31 Battle Rope Attachment	D694P Platform w/ Hardwood Insert
DOPT4 3-peg Band Pegs	OPT16 Core Handle*	OPT42 Rotating Chin Handles	DRP4794 Solid Rubber Surface Platform
DOPT5 2-peg Band Pegs	DOPT17 Jammin' Arms	DOPT44 Bolt-on Olympic Bar Holder (Pair)	DRP90 Solid Rubber Surface Platform
DOPT6 Squat Handles	DOPT17B Jammin' Arms w/ Band Attachment	DOPT45 Bolt-On Spotter Stand (Pair)	DRP91 Solid Rubber Surface Platform
DOPT7 Step-up Platform	DOPT17R Reverse Jammin' Arms	DOPT45DH Bolt-On Spotter Stand (Pair)	
DOPT7R Reverse Step-up Platform	DOPT17RB Reverse Jammin' Arms w/ Band Attachment	OPT46 Bolt-On Front Band Peg	
OPT10 Custom Platform Logo*	OPT23 Safety Arm Storage	D47P Platform w/ Hardwood Insert	

* Must be used with associated option

D47		D690		D690-7		D691		D694	
OPT10	DOPT13	OPT2	DOPT13	OPT10	DOPT17	OPT2	DOPT13	OPT2	DOPT13
OPT11	DOPT17R	OPT10	DOPT17	OPT11	DOPT17B	OPT10	DOPT17	OPT10	DOPT17R
OPT14	DOPT17RB	OPT11	DOPT17B	OPT16	DOPT29P	OPT11	DOPT17B	OPT11	DOPT17RB
OPT16	DOPT25	OPT14	DOPT29P	OPT23	DOPT29	OPT14	DOPT29P	OPT14	DOPT29P
OPT18	DOPT29P	OPT16	DOPT29	DOPT3	DOPT31	OPT16	DOPT29	OPT16	DOPT29
DOPT1R	DOPT29	OPT23	DOPT31	DOPT5	DOPT45	OPT23	DOPT31	OPT24	DOPT31
DOPT3R	DOPT31	OPT24	DOPT45	DOPT6	OPT46	OPT24	DOPT45DH	DOPT1R	DOPT45
DOPT4	DOPT45	DOPT3	OPT46	DOPT7	D690P	DOPT3	OPT46	DOPT3R	OPT46
DOPT6	OPT46	DOPT5	D690P	DOPT13	DRP90	DOPT5	D691P	DOPT4	DRP4794
DOPT7R	D47P	DOPT6	DRP90			DOPT6	DRP91	DOPT6	D694P
DOPT12	DRP4794	DOPT7				DOPT7		DOPT7R	

Only one chin up option available per rack. All 691 models accept two (one per side).

Varsity Selectorized	Product Dimensions						Product Weight		Weight Stack	
	Metric (cm)			English (Inches)			Metric	English	Metric	English
VY-2003M Leg Press	178	117	175	70	46	69	307	675	138	305
VY-2010 Multi-hip	114	117	168	45	46	66	280	618	138	305
VY-2040 Leg Curl / Extension	140	99	157	55	39	62	299	657	121	265
VY-6240M Seated Leg Curl / Extension	147	119	178	58	47	70	231	510	96	212

Varsity Multi-Stations	Product Dimensions						Product Weight		Weight Stack	
	Metric (cm)			English (Inches)			Metric	English	Metric	English
VY-6044 Functional Trainer 1:2	107	180	208	42	71	82	311	686	71	156
VY-6047 Functional Trainer 1:4	107	180	208	42	71	82	376	830	103	228
G1-MG30 3-stack Multi-gym	282	274	218	111	108	86	592	1305	(3) 91	(3) 200

Varsity Free Weights	Product Dimensions						Product Weight	
	Metric (cm)			English (Inches)			Metric	English
VY-D78 Olympic Flat Bench	142	122	130	56	48	51	54	120
VY-D79 Olympic Incline Bench	155	122	152	61	48	60	82	180
VY-D80 Olympic Decline Bench	178	122	117	70	48	46	69	153
VY-D59 Flat Bench	122	56	43.5	48	22	17	19	42
VY-D85A Multi-adjustable Bench	147	56	48	58	22	19	43	94
VY-D86 Multi-adjustable Bench w/ Decline	190	64	56	63	25	22	54	118
VY-D87 Utility Bench	132	56	79	52	22	31	26	57
VY-D62 Preacher Curl	104	74	104	41	29	41	43	95
VY-D63C VKR w/ Chin	135	107	244	53	42	96	109	240
VY-D93 Back Extension Bench	124	66	94	49	26	37	39	85
G1-FW153 Adjustable Incline Bench	154	61	47	61	24	19	41	90
VY-D61 Adjustable Decline Bench	152	64	79	60	25	31	44	96
VY-D77 Adjustable Ab Bench	147	56	114	58	22	45	44	97
VY-D96 Glute Ham Bench	140	76	127	55	30	50	79	175
VY-D67C Weight Tree	64	51	99	25	20	39	17	38
VY-D67H Weight Tree w/ Olympic Bar Holders	79	61	122	31	24	48	29	63
VY-D68 Barbell Rack	145	76	168	57	30	66	57	125
VY-D70 2-tier Dumbbell Rack	58	234	81	23	92	32	84	186
VY-D697 2-tier Hex Dumbbell Rack	58	234	81	23	92	32	72	158

Varsity Plate-Loaded	Product Dimensions						Product Weight	
	Metric (cm)			English (Inches)			Metric	English
VY-M49 Angled Smith Machine	107	218	211	42	86	83	212	467
G1-FW161 Smith Machine	205	141	229	81	56	90	135	297
VY-400 Perfect Squat	157	84	168	62	33	66	147	325
VY-401 Leg Extension	102	157	117	40	62	46	91	200
VY-402 Prone Leg Curl	173	91	72	68	36	30	91	200
VY-431 Biceps Curl	97	107	112	38	42	44	68	150
VY-432 Triceps Extension	97	107	140	38	42	55	68	150

Varsity Racks	Product Dimensions						Product Weight	
	Metric (cm)			English (Inches)			Metric	English
VY-D47 Power Rack	183	187	236.5	72	73.5	93	170	375
VY-D690 Half Rack	141	187	236.5	55.5	73.5	93	129.5	285
VY-D694 Open Rack	183	187	236.5	72	73.5	93	138.5	305
VY-D691 Double Half Rack	218.5	187	236.5	86	73.5	93	211	465
VY-D306 Horizontal Plate Rack	122	43	58	48	17	23	25	55
VY-D695 Flat-to-incline Bench w/ Horizontal Adjustment	135	79	51	53	31	20	64	140

Options	Product Dimensions						Product Weight	
	Metric (cm)			English (Inches)			Metric	English
DOPT1R Reverse J-hooks	35	9	33	13.5	3.5	13	12	26
DOPT3 Dip Bars	89	70	25	35	27	10	16	35
DOPT3R Reverse Dip Bars	84	69	26	33	27	10	11	24
DOPT4 3-peg Band Pegs	20	102	8	8	40	3	12	26
DOPT5 2-peg Band Pegs	50	6	25	19.5	2.25	9.5	7	15
DOPT6 Squat Handles	23	23	13	9	9	5	8	16
DOPT7 Step-up Platform	81	61	36	32	24	14	19	41
DOPT7R Reverse Step-up Platform	79	61	37	31	24	14.25	21	46
OPT10 Custom Platform Logo								
OPT11 Platform Ramp	15	107	8	6	42	3	10	22
DOPT13 Land Mine Attachment	48	30	13	19	12	5	9	20
OPT14U Nameplate - Universal Mount	102	1	20	40	0.25	8	2	5
OPT16 Core Handle	48	79	5	19	31	2	5	10
DOPT17 Jammin Arms	94	53	64	37	21	25	54	118
DOPT17B Jammin Arms w/ Band Attachment	92	59	94	36	23	37	64	140
DOPT17R Reverse Jammin Arms	89	56	69	35	22	27	54	118
DOPT17RB Reverse Jammin Arms w/ Band Attachment	94	56	96	37	22	37.5	64	140
OPT23 Safety Arm Storage (Pair)	20	20	8	8	8	3	3	6
DOPT29 Varsity Docking Kit w/ No Platform	21	6	11	8	2	4	2	4
DOPT29P Varsity Docking Kit w/ Platform	21	6	6	8	2	2	2	2.5
DOPT31 Battle Rope Attachment	18	23	17	7	9	6.5	3	6.5
OPT35 Straight Chin Bar	243.9	25.7	17.8	96	10.1	7	20.8	45.7
OPT36 Dual-sided Fat/Straight Chin Bar	243.9	52.4	17.8	96	20.7	7	27.7	61.1
OPT42 Rotating Chin Handles	110	16.5	33	43	6.5	13	11	23
DOPT44 Bolt-on Olympic Bar Holders (Pair)	23.2	10.2	27	9.25	4	10.6	5.7	12.5
DOPT45 Bolt-On Spotter Stand (Pair)	53.5	81.5	23	21	32	9	31	68
DOPT45DH Bolt-On Spotter Stand (Pair)	102	76.5	23	40	30	9	45.5	100
OPT46 Bolt-On Front Band Peg	28	16	27	11	6.25	10.5	4	9
D47P Platform w/ Hardwood Insert	346	254	7	136	100	2.5	198	435
D690P Platform w/ Hardwood Insert	305	254	7	120	100	2.5	189	415
D691P Platform w/ Hardwood Insert	305	254	7	120	100	2.5	189	415
D694P Platform w/ Hardwood Insert	346	254	7	136	100	2.5	198	435
DRP4794 Solid Rubber Surface Platform	346	254	7	136	100	2.5	227	500
DRP90 Solid Rubber Surface Platform	305	254	7	120	100	2.5	214	470
DRP91 Solid Rubber Surface Platform	305	254	7	120	100	2.5	214	470

STRENGTH WARRANTY (NORTH AMERICA ONLY)

Frame (Not Coatings)**	10 years
Weight Stacks	5 years
Pulleys	5 years
Pivot Bearings	5 years
Other Items Not Specified	3 years
Labor	3 years
Upholstery / Cables / Springs / Grips	1 year
Accessories	6 months

* Dimensions listed are maximum in-use dimensions

** Frame is defined as the welded-metal base of the unit and does not include removable parts.

NOTE: All specifications are subject to change without notice. Actual products may differ from those pictured in this catalog. Olympic bars, dumbbells and weight plates are not included unless specified. Visit www.matrixfitness.com for latest warranty information.

VARSIY STANDARD FRAME COLORS

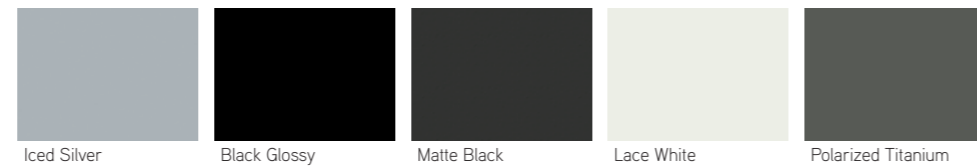

VARSIY FRAME COLOR OPTIONS

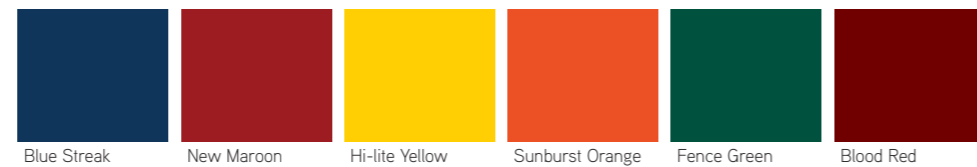

VARSIY UPHOLSTERY COLOR OPTIONS



Frame and upholstery colors applicable to North America. Product pricing is reflective of **standard** upholstery only. Other color options available at an additional charge. NOTE: Actual product colors may vary from what is shown here. † Iced Silver is stocked frame color. Additional lead times may apply for other frame colors.



A TRULY GLOBAL COMPANY

Australia / New Zealand

Johnson Health Tech Australia Pty. Ltd.
p: 61-3-5136-3100
e: sales@jhata.com.au
w: au.matrixfitness.com

Brazil

Johnson Health Tech Brasil
p: 55-19-2107-5300
e: contato@johnsonhealthtech.com.br
w: br.matrixfitness.com

Canada

Johnson Health Tech Canada/STAK Fitness
p: 514-336-0006
e: info@stakfitness.com
w: ca.matrixfitness.com

China

Johnson Health Tech (Shanghai) Co., Ltd.
p: 86-21-32503800
e: danielhsu@johnsonfitness.com
w: cn.matrixfitness.com

Denmark

Johnson Health Tech Denmark
p: 31-30-2445-435
e: info@matrixfitness.nl
w: dk.matrixfitness.com

France

Johnson Health Tech France
p: 33-130-68280
e: denis.daon@jhtfrance.fr
w: fr.matrixfitness.com

Germany / Austria

Johnson Health Tech GmbH
p: +49 (0) 2234/ 9997-100
e: mail@johnsonfitness.eu
w: de.matrixfitness.com

Greece / Cyprus / Bulgaria

Johnson Health Tech Hellas SA
p: 30-211-4112797
e: g.papageorgiou@jht.gr
w: gr.matrixfitness.com

Hong Kong

Johnson Health Tech - Hong Kong
p: 852-2302-0596
e: lindatang@johnsonfitness.com
w: hk.matrixfitness.com

Italy

Johnson Health Tech Italia Spa
p: 39-073-62269
e: jht@jht.it
w: it.matrixfitness.com

Japan

Johnson Health Tech Japan
p: 81-3-5419-3560
e: info@johnsonjapan.com
w: jp.matrixfitness.com

Korea

Johnson Health Tech Co., Ltd. Korea
p: 82-2-6731-0175
e: sales@kr.johnsonfitness.com
w: kr.matrixfitness.com

Malaysia

Johnson Fitness (Malaysia) SDN. BHD.
p: 60-3-5632-8273
e: deanchu@johnsonfitness.com
w: my.matrixfitness.com

Mexico

Johnson Health Tech Mexico
p: 52-55-7012-7810
e: joseguillermo.maciell@jhtmexico.mx
w: mx.matrixfitness.com

Netherlands / Belgium / Luxembourg

Johnson Health Tech Netherlands B.V.
p: 31-30-2445-435
e: info@matrixfitness.nl
w: nl.matrixfitness.com

Philippines

Johnson Health Tech Philippines Inc.
p: 63-2-631-5810
e: Katsuya.Ito@johnsonfitness.com
w: ph.matrixfitness.com

Poland

Johnson Health Tech Sp. Z O. O.
p: 48-222-809-430
e: kontakt@johnsonfitness.eu
w: pl.matrixfitness.com

Romania

Johnson Health Tech Romania
p: 44-771-581-246
e: ionut.vlad@jht.ro
w: ro.matrixfitness.com

Spain / Portugal

Johnson Health Tech Ibérica SL
p: 34-914-885525
e: info@jht.es
w: es.matrixfitness.com

Switzerland

Johnson Health Tech (Schweiz) GmbH
p: 41-44-843-30-30
e: office@johnsonfitness.eu
w: ch.matrixfitness.com

Taiwan

Johnson Health Tech-Taiwan
p: 886-4-25667100
e: harrysai@johnsonfitness.com
w: tw.matrixfitness.com

Thailand

Johnson Health Tech (Thailand) Co., Ltd.
p: 66-2-7519-360
e: daniellai@johnsonfitness.com
w: th.matrixfitness.com

United Arab Emirates / Jordan / Kuwait / Oman / Qatar

Johnson Health Tech United Arab Emirates
p: 971-44567939
e: sales@uae.johnsonfitness.com
w: ae.matrixfitness.com

United Kingdom

Johnson Health Tech UK Ltd
p: 44-1782-644900
e: sales@matrixfitness.co.uk
w: uk.matrixfitness.com

United States

Johnson Health Tech North America
p: 866-693-4863
e: info@matrixfitness.com
w: matrixfitness.com

Vietnam

Johnson Health Tech (Vietnam) Co. Ltd.
p: 84-8-38227011
e: sales.vn@johnsonfitness.com
w: vn.matrixfitness.com



MATRIX

About Matrix Fitness

Matrix is a brand of Johnson Health Tech (JHT). JHT has been producing premium fitness equipment since 1975 and is among the fastest-growing manufacturers of fitness equipment in the world. It has earned both ISO 9002 and 9001 certifications. A truly global company with 26 subsidiaries worldwide, JHT has the intellectual resources necessary to produce the most technologically advanced equipment on the market and the economies of scale needed to deliver the best value possible.

Matrix Fitness

1600 Landmark Drive
Cottage Grove, WI 53527 USA

matrixfitness.com

Toll-Free 866.693.4863

Facsimile 608.839.8687

📍 [matrixfitnessusa](https://www.facebook.com/matrixfitnessusa) 📱 [@matrixfitnessusa](https://www.instagram.com/matrixfitnessusa)

MATRIX
Strong • Smart • Beautiful

© 2018 Matrix Fitness. All Rights Reserved.
Product specifications subject to change without notice.

AUTHORIZED MATRIX FITNESS DISTRIBUTOR

Warranties

Cardio Warranty

	T 7XI/T 7XE/T 5X T READMILL	T 3XE/T 3X/T 3XH T READMILL	T 1XE/T 1X T READMILL †
*Frame	7 Years	7 Years	7 Years
Drive Motor	Lifetime	7 Years	3 Years
Parts	3 Years	3 Years	3 Years
Labor	3 Years	3 Years	3 Years
**Wear Items	90 Days	90 Days	90 Days

	A7XI/A7XE/A5X/A3XE/A3X ASCENT	E7XI/E7XE/E5X/E3XE/E3X ELLIPTICAL	KRANKCYCLE® BY MATRIX
*Frame	7 Years	7 Years	5 Years
JID Hybrid Generator	5 Years	5 Years	
Parts	3 Years	3 Years	2 Years
Labor	3 Years	3 Years	90 Days
**Wear Items	90 Days	90 Days	90 Days

	S7XI/S7XE/S5X/S3XE/S3X STEPPER	C7XI/C7XE/C5X/C3XE/C3X CLIMBMILL	H7XI/H7XE/H5X/H3XE/H3X HYBRID
*Frame	7 Years	7 Years	7 Years
JID Hybrid Generator	5 Years	5 Years	5 Years
Parts	3 Years	3 Years	3 Years
Labor	3 Years	3 Years	3 Years
**Wear Items	90 Days	90 Days	90 Days

	U7XI/U7XE/U5X/U3XE/U3X UPRIGHT	R7XI/R7XE/R5X/R3XE/R3X RECUMBENT	E1XE/E1X/R1XE/R1X/U1XE/U1X †

*Frame	7 Years	7 Years	7 Years
JID Hybrid Generator	5 Years	5 Years	5 Years
Parts	3 Years	3 Years	3 Years
Labor	3 Years	3 Years	3 Years
**Wear Items	90 Days	90 Days	90 Days

	MATRIX DIGITAL TV	ENTERTAINMENT	ROWER
Parts	3 Years		3 Years
Labor	3 Years		3 Years
Stands		1 Year	
**Wear Items	90 Days	90 Days	2 Years - Rope, Seat, Foot Support 1 Year - Other

** Wear items include: Headphone Jack, USB Port, iPod Connector, Batteries. Belts, Straps. No Labor.
† Warranty limited to 6 hours of use per day. Full commercial warranty not available on 1-Series cardio.

S-DRIVE WARRANTY			
*Frame			7 Years
Parts			3 Years
Labor			3 Years
Wear Items (Harness System)			6 Months

Strength Warranty

	ULTRA/VERSA/AURA/MAGNUM/VARSITY/CONNEXUS	G1 STRENGTH
**Frame (Not coatings)	10 Years	10 Years
Weight Stacks	5 Years	
Pulleys	5 Years	

Pivot Bearings	5 Years	
Other items not specified	3 Years	
Labor	3 Years	
Upholstery/Cables/Springs/Grips	1 Year	90 Days
Accessories	6 Months	
Parts		1 year
Labor (excluding upholstery/cables/grips)		1 year
** Frame is defined as the welded metal base of the unit and does not include removable parts.		

EXCLUSIVE REMEDY

The exclusive remedy for any of the above warranties shall be repair or replacement of defective Parts, or the supply of Labor to cure any defect, per the terms of the Commercial Warranty. All Labor shall be supplied by the local Matrix certified technician. The Product must be located within that service provider's service area. Products located outside service area will not be covered by the Labor warranty.

EXCLUSIONS AND LIMITATIONS

1. This warranty applies only to the original owner and is not transferable.
2. Under no circumstances will MATRIX FITNESS be liable by virtue of this warranty or otherwise for damage to any person or property whatsoever for any special, indirect, incidental, secondary or consequential losses, damages or expenses in connection with exercise products.
3. This warranty is expressly limited to the repair or replacement of a defective Frame, Motor, Electronic component, or Part. Repair or replacement will be at the discretion of MATRIX FITNESS, and is the sole remedy of the warranty.
4. Do not use equipment in any location that is not climate controlled, such as but not limited to garages, porches, pool rooms, saunas, bathrooms, car ports or outdoors. Failure to comply may void the warranty.
5. This warranty does not cover normal wear and tear - including but not limited to: USB port, headphone jack and iPod cord, cuts in upholstery, damage caused externally that is not due to a manufacturer defect, improper assembly or maintenance, or installation of parts or accessories not originally intended or compatible with the MATRIX FITNESS Product as sold.
6. This warranty does not cover damage or failure due to accident, abuse, corrosion, discoloration of paint or plastic, neglect, theft, vandalism, fire, flood, wind, lightning, freezing, or other natural disasters of any kind, power reduction, fluctuation or failure from whatever cause, unusual atmospheric conditions, collision, introduction of foreign objects into the covered unit, or modifications that are unauthorized or not recommended by MATRIX FITNESS.
7. Parts reconditioned to As New Condition by MATRIX FITNESS or its vendors may sometimes be supplied as warranty replacement parts and constitute fulfillment of warranty terms. Any warranty replacement parts shall be warranted for the remainder of the original warranty term.

8. The warranty does not cover damage or equipment failure due to electrical wiring that is not in compliance with applicable electrical codes and MATRIX FITNESS' Owner's Manual specifications.
9. Matrix Ultimate™ treadmill decks will NOT be replaced unless both surfaces are worn through. Deck & belt replacement limited to one per treadmill.

NOTE: Historically, one surface of the average Ultimate Deck and belt will last 4 years in a high use facility.

This warranty shall NOT apply to the following:

1. Failure to provide reasonable and necessary maintenance as outlined in the Owner's Manual.
2. Software limitations and upgrades.
3. Batteries or other consumable goods.
4. Cosmetic items.
5. Repairs performed on equipment missing a serial number or with a serial number tag that has been altered or removed.
6. Service calls to correct installation of the equipment or instructing on use of equipment.
7. Pick-up, delivery or freight charges involved with repairs.
8. Any labor charges incurred beyond the applicable labor warranty.

MATRIX FITNESS expressly disclaims all other warranties, express or implied, including but not limited to all warranties of fitness for a particular purpose or of merchantability. This warranty gives you specific legal rights, and your rights may vary from state to state.