

**Xerox Data Systems**

**XEROX**

701 South Aviation Boulevard  
El Segundo, California 90245  
213 679-4511

# **SIGMA 8 Computer Reference Manual**

FIRST EDITION

90 17 49A

January 1971

Price \$5.75

## RELATED PUBLICATIONS

<u>Title</u>	<u>Publication No.</u>
XDS Sigma Glossary of Computer Terminology	90 09 57
XDS Symbol/Meta-Symbol Reference Manual	90 09 52
XDS Macro-Symbol Reference Manual	90 15 78

ALL SPECIFICATIONS SUBJECT TO CHANGE WITHOUT NOTICE

# CONTENTS

<p><b>1. SIGMA 8 SYSTEM</b> <span style="float: right;">1</span></p> <p>Introduction _____ 1</p> <p>General Characteristics _____ 1</p> <p>Scientific Features _____ 3<sup>1</sup></p> <p>Input/Output Capabilities _____ 4</p> <p>Time-Sharing Features _____ 4</p> <p>Real-Time Features _____ 5</p> <p>Multiusage Features _____ 5</p> <p>Multiprocessing Features _____ 6</p> <p>    Multiprocessor Interlock _____ 6</p> <p>    Homespace _____ 6</p> <p>    Multiport Memory System _____ 6</p> <p>    Manual Partitioning Capability _____ 6</p> <p>    Multiprocessor Control Function _____ 6</p> <p>    Shared Input/Output _____ 6</p> <p><b>2. SIGMA 8 SYSTEM ORGANIZATION</b> <span style="float: right;">7</span></p> <p>Central Processing Unit _____ 7</p> <p>    General Registers _____ 7</p> <p>    Memory Control Storage _____ 7</p> <p>    Computer Modes _____ 7</p> <p>    Information Format _____ 10</p> <p>    Information Boundaries _____ 10</p> <p>    Instruction Register _____ 10</p> <p>Main Memory _____ 11</p> <p>    Memory Unit _____ 12</p> <p>    Homespace _____ 13</p> <p>    Memory Reference Address _____ 13</p> <p>    Addressing _____ 14</p> <p>    Address Modification _____ 16</p> <p>    Memory Address Control _____ 17</p> <p>    Program Status Doubleword _____ 17</p> <p>Interrupt System _____ 19</p> <p>    Internal Interrupts _____ 20</p> <p>    External Interrupts _____ 21</p> <p>    States of an Interrupt Level _____ 21</p> <p>    Control of the Interrupt System _____ 22</p> <p>    Time of Interrupt Occurrences _____ 22</p> <p>    Single-Instruction Interrupts _____ 23</p> <p>Trap System _____ 23</p> <p>    Trap _____ 23</p> <p>    Trap Entry Sequence _____ 23</p> <p>    Trap Masks _____ 23</p> <p>    Trap Condition Code _____ 25</p> <p>    Trap Addressing _____ 25</p> <p>    Nonallowed Operation Trap _____ 25</p> <p>    Unimplemented Instruction Trap _____ 27</p> <p>    Push-Down Stack Limit Trap _____ 27</p> <p>    Fixed-Point Overflow Trap _____ 27</p> <p>    Floating-Point Arithmetic Fault Trap _____ 28</p> <p>    CALL Instruction Trap _____ 29</p> <p>    Processor Detected Faults _____ 29</p> <p>    Trap Conditions During "Anticipate"         Operations _____ 31</p> <p>    Register Altered Bit _____ 31</p>	<p><b>3. INSTRUCTION REPERTOIRE</b> <span style="float: right;">33</span></p> <p>Load/Store Instructions _____ 35</p> <p>Analyze/Interpret Instructions _____ 46</p> <p>Fixed-Point Arithmetic Instructions _____ 48</p> <p>Comparison Instructions _____ 54</p> <p>Logical Instructions _____ 57</p> <p>Shift Instructions _____ 58</p> <p>    Floating-Point Shift _____ 60</p> <p>Conversion Instructions _____ 61</p> <p>Floating-Point Arithmetic Instructions _____ 62</p> <p>    Floating-Point Numbers _____ 62</p> <p>    Floating-Point Add and Subtract _____ 64</p> <p>    Floating-Point Multiply and Divide _____ 64</p> <p>    Condition Codes for Floating-Point         Instructions _____ 65</p> <p>Byte-String Instructions _____ 67</p> <p>Push-Down Instructions _____ 72</p> <p>    Stack Pointer Doubleword (SPD) _____ 72</p> <p>    Push-Down Condition Code Settings _____ 73</p> <p>Execute/Branch Instructions _____ 77</p> <p>    Nonallowed Operation Trap During Execution         of Branch Instruction _____ 77</p> <p>CALL Instructions _____ 79</p> <p>Control Instructions _____ 80</p> <p>    Program Status Doubleword _____ 80</p> <p>    Loading the Memory Write Protection         Locks _____ 84</p> <p>    Interruption of MMC _____ 84</p> <p>    Read Direct, Internal Computer Control         (Mode 0) _____ 85</p> <p>    Read Direct, Interrupt Control         (Mode 1) _____ 86</p> <p>    Write Direct, Internal Computer Control         (Mode 0) _____ 87</p> <p>    Write Direct, Interrupt Control         (Mode 1) _____ 88</p> <p>Input/Output Instructions _____ 89</p> <p>    I/O Addresses _____ 89</p> <p>    Processor Addresses         (Bits 19-23) _____ 89</p> <p>    Device Controller Addresses         (Bits 24-31) _____ 89</p> <p>    I/O Unit Address Assignment _____ 90</p> <p>    I/O Status Response _____ 90</p> <p>    Status Information for SIO _____ 92</p> <p>    General Registers _____ 92</p> <p><b>4. INPUT/OUTPUT OPERATIONS</b> <span style="float: right;">99</span></p> <p>Operational Command Doublewords _____ 100</p> <p>    Order _____ 100</p> <p>    Memory Byte Address _____ 100</p> <p>    Flags _____ 100</p> <p>    Byte Count _____ 102</p> <p>Control Command Doublewords _____ 102</p>
---	--

5. OPERATOR CONTROLS	104
Processor Control Panel	104
Control Mode	104
POWER	105
MEMORY CLEAR	105
SYS RESET	105
I/O RESET	105
LOAD	105
UNIT ADDRESS	105
SENSE	105
NOT NORMAL	105
HALT	105
WAIT	106
RUN	106
Program Status Doubleword	106
INSERT	107
CPU RESET	107
INTERRUPT	107
ADDRESS STOP	107
SELECT ADDRESS	108
DISPLAY (Switch)	108
INSTR ADDR	108
DISPLAY (Indicators)	108
DISPLAY FORMAT	109
FORMAT SEL	109
DATA	109
STORE	109
COMPUTE	109
Maintenance Controls	109
ALARM	110
MARGINS	110
PHASES	110
CLOCK MODE	110
SNAP	110
MEMORY MODE	110
W. D. TIMER	111
SCAN	111
EXT DIO	112
Operating Procedures	112
Loading Operation	112
Fetching and Storing Procedure	113

## APPENDIXES

A. REFERENCE TABLES	114
XDS Standard Symbols and Codes	114
XDS Standard Character Sets	114
Control Codes	114
Special Code Properties	114
XDS Standard 8-Bit Computer Codes (EBCDIC)	115
XDS Standard 7-Bit Communication Codes (USASCII)	115
XDS Standard Symbol-Code Correspondences	116
Hexadecimal Arithmetic	120
Addition Table	120
Multiplication Table	120
Table of Powers of Sixteen <sub>10</sub>	121
Table of Powers of Ten <sub>16</sub>	121
Hexadecimal-Decimal Integer Conversion Table	122
Hexadecimal-Decimal Fraction Conversion Table	128

Table of Powers of	132
Mathematical Constants	132

B. SIGMA 8 INSTRUCTION LIST	133
C. INSTRUCTION TIMING	134
Timing Considerations	134
Effects of Memory Interference	134
Effects of Indexing	134
Effects of Indirect Addressing	134
Effects of Register-to-Register Operations	134
D. SYSTEM RELIABILITY AND MAINTAINABILITY	144
System Maintainability Features	144
CPU Features	145
Main Memory Features	147
Multiplexor Input/Output Processor (MIOP) Features	147
High-Speed RAD I/O Processor (HSRIOP) Features	148
E. GLOSSARY OF SYMBOLIC TERMS	149

## ILLUSTRATIONS

SIGMA 8 Computer System	v
1. A Typical SIGMA 8 System	8
2. Central Processing Unit	9
3. Information Boundaries	10
4. Addressing Logic	15
5. Index Displacement Alignment	16
6. Interrupt Priority Chain	20
7. Operational States of an Interrupt Level	21
8. Processor Control Panel	104

## TABLES

1. Homespace Layout	13
2. SIGMA 8 Interrupt Locations	19
3. Summary of SIGMA 8 Trap Locations	24
4. TCC Setting for Instruction Exception Trap X'4D'	30
5. Registers Changed at Time of a Trap Due to an Operand Access	32
6. Status Word 0	41
7. Status Word 1	42
8. Status Word 2	42
9. ANALYZE Table for SIGMA 8 Operation Codes	47
10. Floating-Point Number Representation	63
11. Condition Code Settings for Floating-Point Instructions	65
12. Status Response Bits for I/O Instructions	91
13. Program Status Doubleword (PSD) Indicators	106
C-]. Basic Instruction Timing	135

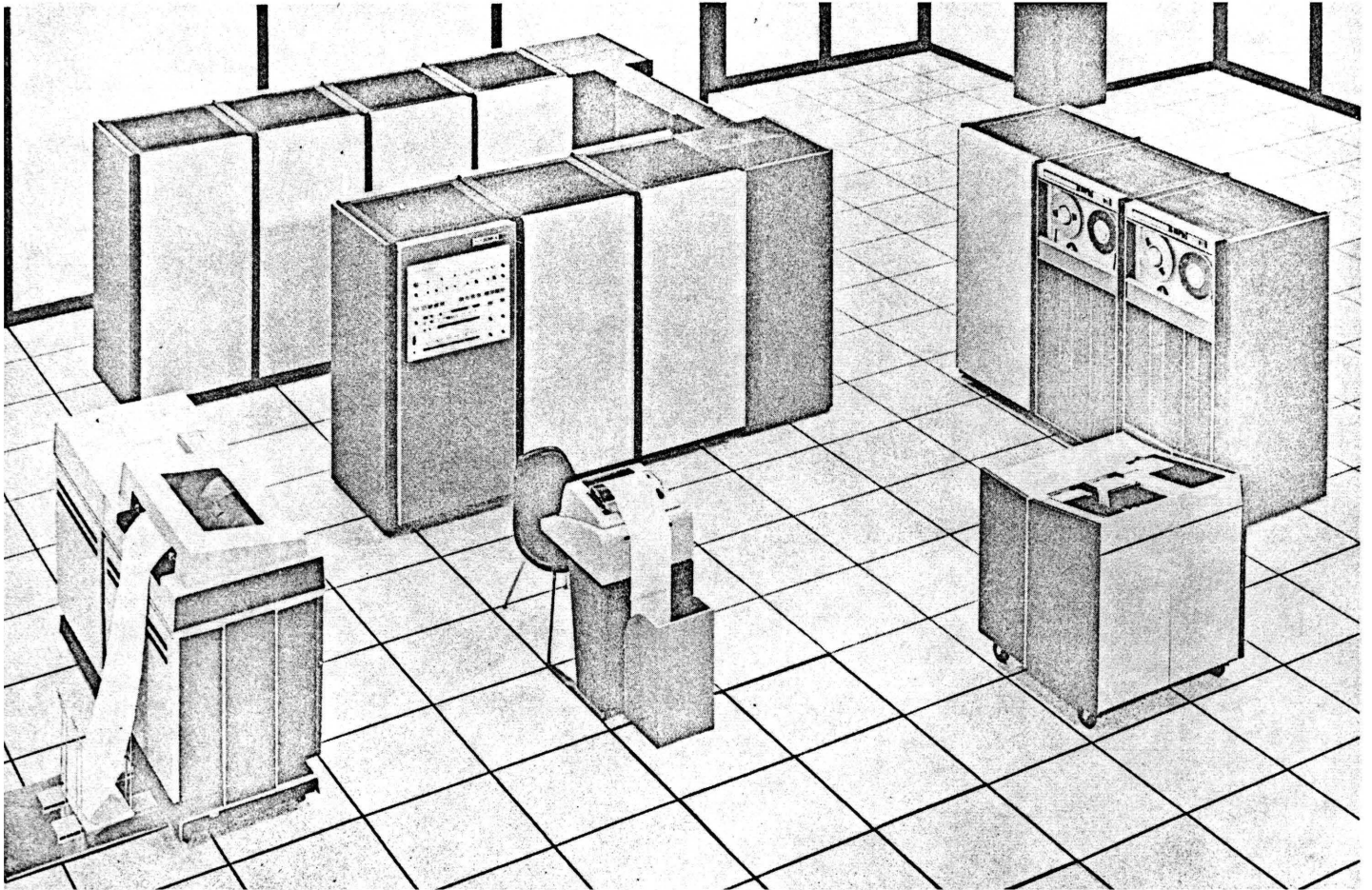

SIGMA 8 Computer System

# 1. SIGMA 8 SYSTEM

## INTRODUCTION

The XDS SIGMA 8 Computer System is a high-speed, general-purpose digital computer system. It is designed for a variety of scientific, real-time, and time-sharing applications. A basic system includes a central processing unit (CPU), a main memory subsystem, and an independent input/output subsystem. Each major system element performs asynchronously with respect to other elements.

The basic system can be readily expanded to accommodate the user's requirements. Main memory has addressing space for 131,072 words. Memory access paths can be increased from the basic two ports to a maximum of 12 ports. Input/output capability can be increased by adding more input/output processors (IOPs), device controllers, and I/O devices.

The CPU has a large instruction set that includes floating-point instructions. A special feature called "look-ahead" enables the CPU to overlap instruction execution with memory accessing, thereby reducing program execution time.

A main memory of up to 131,072 (128K) words is available. The minimum system size is 16,384 (16K) words. System memory sizes are obtainable in 8K word increments. The minimum memory configuration of 16K words consists of two ports and two 8K word banks. Each bank can be expanded to 16K words, yielding a modular unit of 32K words. Each unit is expandable to 12 ports in single port increments. The maximum configuration, therefore, consists of four 32K word modular units of eight 16K word banks and 12 ports per unit.

Each bank operates asynchronously, and address interleaving can be provided between adjacent banks. This multibank, multiaccess memory subsystem with interleaving achieves system performance far in excess of single memory bank designs. The SIGMA 8 system can include up to 11 independent I/O processors (limited only by port expansion capability) of two types — multiplexor I/O processors and high-speed RAD I/O processors — which can transfer data at rates up to three million bytes per second, concurrent with CPU instruction execution.

The SIGMA 8 computer design is compatible with the SIGMA 5 computer. Therefore, comprehensive, modular software, requiring no reprogramming is available, including operating systems, assemblers, compilers, mathematical and utility routines.

Reliability, maintainability, and availability have been significantly improved over previous SIGMA computers. A partitioning feature, for example, permits faulty units or an entire subsystem, consisting of a CPU, memory unit, IOP, and attached peripherals to be isolated from the system for diagnosis and repair while the primary system continues operation.

This manual describes the general characteristics and features, system organization, instruction set, I/O operations, operator controls, and timing of the system.

## GENERAL CHARACTERISTICS

A SIGMA 8 computer system has features and operating characteristics that permit efficient functioning in scientific, multiprocessing, time-sharing, real-time, and multi-usage environments:

- Word-oriented memory (32-bit word plus parity bit) which can be addressed and altered as byte (8-bit), halfword (2-byte), word (4-byte), and doubleword (8-byte) quantities.
- Memory expandable from 16,384 (16K) to 131,072 (128K) words in increments of 8,192 (8K) words (where  $K = 1024$ ).
- Direct addressing of entire memory.
- Indirect addressing with or without post-indexing.
- Displacement index registers, automatically self-adjusting for all data sizes.
- Immediate operand instructions, for greater storage efficiency and increased speed.
- 16 general-purpose registers, expandable to 64 (in blocks of 16) reduce data transfer to and from registers in a multiusage environment.
- Memory write protection preventing inadvertent destruction of critical areas of memory.
- Watchdog timer to assure nonstop operation.
- Real-time priority interrupt system with automatic identification and priority assignment, fast response time, and up to 238 levels that can be individually armed, enabled, and triggered by program control.
- Instructions with long execution times can be interrupted to minimize response time to interrupts.
- Automatic traps for error or fault conditions, with masking capability and maximum recoverability, under program control.
- Power fail-safe for automatic, safe shutdown in event of power failure.
- Multiple interval timers with a choice of resolutions for independent time bases.

■ Privileged instruction logic for program integrity in multiusage environments.

■ Complete instructions set that includes:

- Byte, halfword, word, and doubleword operations.
- Use of all memory-referencing instructions for register-to-register operations, with or without indirect addressing and post-indexing, and within normal instruction format.
- Multiple register operations.
- Fixed-point integer arithmetic operations in halfword, word, and doubleword modes.
- Floating-point hardware operations in short and long formats with significance, zero, and normalization control and checking, all under full program control.
- Full complement of logical operations (AND, OR, exclusive OR).
- Comparison operations, including compare between limits (with limits in memory or in registers).
- Call instructions that permit up to 64 dynamically variable, user-defined instructions, and allow a program access to operating system functions without operating system intervention.
- Push-down stack operations (hardware implemented) of single or multiple words, with automatic limit checking, for dynamic space allocation, subroutine communication, and recursive routine capability.
- Automatic conversion operations, including binary/BCD and any other weighted-number systems.
- Analyze instruction that facilitates effective address computation.
- Interpret instruction that increases speed of interpretive programs.
- Shift operations (left and right) of word or doubleword, including logical, circular, arithmetic, searching shift, and floating-point modes.

■ Built-in reliability and maintainability features that include:

- Diagnostic programs with capabilities for: system verification and testing to determine the faulty unit; unit functional testing to

determine the specific function of a unit that is faulty; and fault location diagnosing to analyze what physical component is malfunctioning.

- Extensive error logging. When a fault is detected, system status and fault information are available for program retrieval and logging for subsequent analysis.
- Full parity checking on all data and addresses communicated in either direction on busses between memory units and processors, providing fault detection and location capability to permit the operating system or diagnostic program to quickly determine a faulty unit.
- Address stop feature that permits operator or maintenance personnel to:

Stop on any instruction address.

Stop on any memory reference address.

Stop when any word in a selected page of memory is referenced.

- Programmable "snapshot" registers that enable diagnostic routines to compare contents of a snapshot register with known correct information, thus accurately determining system fault conditions.
- CPU traps, that provide for detection of a variety of CPU and system fault conditions, designed to enable a high degree of system recoverability.
- Partitioning features that enable system reconfiguration. SIGMA 8 units can be partitioned from the system by selectively disabling them from busses. Thus, faulty units or an entire subsystem, consisting of a CPU, memory unit, input/output processor (IOP), and attached peripherals, can be isolated from the operational system to enable diagnosis and repair of a faulty unit while the primary system continues operation.

■ Independently operating I/O system with the following features:

- Direct input/output of a full word, without use of a channel.
- Up to eleven I/O processors (restricted only by port limitations).
- Multiplexor I/O processors (MIOP) with dual channel capability, providing for simultaneous operation of up to 24 devices on one channel, and concurrently, simultaneous operation of eight devices on the other channel.

- High-speed Rapid Access Data I/O processor (HSRIOP) for use with XDS high-speed RAD storage units, allowing data transfer rates of up to three million bytes per second.
  - Both data and command chaining on all IOPs for gather-read and scatter-write operations.
  - Up to 32,000 output control signals and input test signals.
- Comprehensive array of modular software that is program compatible with XDS SIGMA 5, 6<sup>†</sup>, and 7<sup>†</sup> computers:
- Expands in capability and speed as system grows.
  - Operating systems: Batch Processing Monitor (BPM), Batch Time-Sharing Monitor (BTM), and Real-Time Batch Monitor (RBM).
  - General-Purpose Compilers: Extended XDS FORTRAN IV, XDS FORTRANIV-H, BASIC, and FLAG.
  - Assemblers: Symbol, Macro-Symbol, and Meta-Symbol.
  - Library: Mathematical, utility, and input/output programs.
  - Business software: Data Management System (DMS-1), Generalized Sort and Merge, XDS ANS COBOL, Manage, Terminal-Oriented Manage, and 1401 Simulator.
  - Application software: Functional Mathematical Programming System (FMPS), FMPS Matrix Generator/Report Writer (GAMMA 2), Simulation Language (SL-1), Circuit Analysis Systems (CIRC-AC, CIRC-DC), Graphic Display Library (GDL-1), and General Purpose Discrete Simulator (GPDS).
- Standard and special-purpose peripheral equipment including:
- Rapid Access Data (RAD) files: Capacities to 6.2 million bytes per unit; transfer rates of three million bytes per second; average access times from 17 milliseconds.
  - Magnetic tape units: 7-track and 9-track systems, IBM-compatible; high-speed units operating at 150 inches per second with transfer rates up to 120,000 bytes per second; and other units operating at 75 inches per second with transfer rates up to 60,000 bytes per second, and at 37.5 inches per second with transfer rates up to 20,800 bytes per second.
  - Displays: Graphic display has standard character generator, vector generator, and close-ups, as well as light pen, and alphanumeric/function keyboard.
  - Card equipment: Reading speeds up to 1500 cards per minute; punching speeds up to 300 cards per minute; intermixed binary and EBCDIC card codes.
  - Line printers: Fully buffered with speeds up to 1,500 lines per minute; 132 print positions with 64 characters.
  - Keyboard/printers: 10 characters per second; also available with paper tape reader (20 characters per second) and punch (10 characters per second).
  - Paper tape equipment: Readers with speeds up to 300 characters per second; punches with speeds up to 120 characters per second.
  - Graph plotters: Digital incremental, providing drift-free plotting in two axes in up to 300 steps per second at speeds from 30 millimeters to 3 inches per second.
  - Data communications equipment: Complete line of character-oriented and message-oriented equipment to connect remote user terminals (including remote batch terminals) to the computer system via common carrier lines or connect local terminals directly.

## SCIENTIFIC FEATURES

Scientific computing applications are characterized by emphasis on computation and internal data handling. Most operations are performed in floating-point format. Other typical characteristics include binary to decimal number conversion (for printing or display), and input/output at standard speeds. The SIGMA 8 computer system includes the following scientific features:

Floating-Point Hardware. Floating-point instructions are available in both short (32-bit) and long (64-bit) formats. Under program control, the user may select optional zero checking, normalization, and significance checking (which causes a trap when a post-operation shift or more than two hexadecimal places occurs in the fraction of a floating-point number). Significance checking permits use of the short floating-point format for high processing speed and storage economy and of the long format when loss of significance is detected.

Indirect Addressing. Indirect addressing facilitates table linkage and permits keeping data sections of a program separate from procedure sections for ease of maintenance.

Displacement Indexing: Indexing by means of a "floating" displacement permits accessing a desired unit of data

<sup>†</sup> Providing memory map has not been used.



without considering its size. The index registers automatically align themselves appropriately; thus, the same index register may be used on arrays with different data sizes. For example, in a matrix multiplication of any array of full word, single-precision, fixed-point numbers, the results may be stored in a second array as double-precision numbers using the same index quantity for both arrays. If an index register contains the value of  $k$ , then the user always accesses the  $k$ th element, whether it is a byte, halfword, word, or doubleword. Incrementing by various quantities according to data size is not required; instead, incrementing is always by units in a continuous array table regardless of the size of data element used.

**Instruction Set.** More than 100 major instructions permit short, highly optimized programs to be written, which are rapidly assembled and minimize both program space and execution time.

**Translate Instruction.** The Translate instruction permits rapid translation between any two 8-bit codes; thus data from a variety of input sources can be handled and reconverted easily for output.

**Conversion Instructions.** Two generalized conversion instructions provide for bidirectional conversions between internal binary and any other weighted number system, including BCD.

**Call Instructions.** These four instructions permit handling up to 64 user-defined subroutines, as if they were build-in machine instructions, and gaining access to specified operating system services without requiring its intervention.

**Interpret Instruction.** The Interpret instruction simplifies and speeds interpretive operations such as compilation, thus reducing space and time requirements for compilers and other interpretive systems.

**Four-Bit Condition Code.** This simplifies the checking of results by automatically providing information on almost every instruction execution, including indicators for overflow, underflow, zero, minus, and plus, as appropriate, without requiring an extra instruction execution.

## INPUT/OUTPUT CAPABILITIES

**Multiplexing Input/Output Processor (MIOP).** Once initialized, I/O processors operate independently of the CPU, leaving it free to provide faster response to system needs. The MIOP requires minimal interaction with the CPU by using channel command doublewords, which permit both command chaining and data chaining without intervening CPU control. I/O equipment speeds range from slow rates involving human interaction (teletypewriter, for example) to transfer rates of rotating memory devices of up to one million bytes per second. Many devices can be operated simultaneously.

**Direct Data Input/Output (DIO).** DIO facilitates in-line program control of asynchronous or special-purpose devices. With this feature information can be transmitted directly to or from general-purpose registers so that an I/O channel need not be used for relatively infrequent transmissions.

**High-Speed Rad Input/Output Processor (HSRIOP).** This feature is similar to multiplexing input/output except that one RAD per channel controller is operating at a time. This high-speed channel contains the buffering and priority logic sufficient to sustain transfer rates up to three million bytes per second. In a typical time-sharing application, this enables a program swap into or out of main memory in less than 40 milliseconds.

## TIME-SHARING FEATURES

Time-sharing is the ability of a system to share its total capacities among many users at the same time. Each user can be performing a different task (requiring a different share of the available resources) and may be on-line in an interactive, "conversational" mode with the computer. Other users may be entering work to be processed that requires only final output.

The SIGMA 8 system provides the time-sharing computer features described below.

**Rapid Context Saving.** When changing from one user to another, the operating environment can be switched quickly and easily. Stack-manipulating instructions permit storing in a push-down stack of 1 to 16 general-purpose registers by a single instruction. Stack status is updated automatically and information in the stack can be retrieved when needed (also, by a single instruction). The current program status doubleword (PSD), which contains the entire description of the current user's environment and mode of operation, can be stored anywhere in memory and a new PSD loaded, all with a single instruction.

**User Protection.** The slave mode feature restricts each user to his own set of instructions while reserving to the operating system certain "privileged" (master mode) instructions that could destroy another user's program if used incorrectly.

**Input/Output Capability.** Time-sharing input/output requirements are handled by the same general-purpose input/output capabilities described above.

**Nonstop Operation.** A "watchdog" timer assures that the system continues to operate even in case of halts or delays due to failure of special I/O devices. Multiple real-time clocks with varying resolutions permit independent time bases for flexible allocation of time slices to each user.

## REAL-TIME FEATURES

Real-time applications are characterized by a need for (1) hardware that provides quick response to an external environment, (2) speed great enough to keep up with the real-time process itself, and (3) sufficient input/output flexibility to handle a wide variety of data types at varying speeds. The SIGMA 8 system includes provisions for the following real-time computing features.

Multilevel, True Priority Interrupt System. The real-time-oriented SIGMA 8 system provides quick response to interrupts by means of up to 224 external interrupt levels. The source of each interrupt is automatically identified and responded to according to its priority. (This function is programmable.) For further flexibility, each level can be individually disarmed (to discontinue input acceptance) and disabled (to defer responses) under program control. Use of the disarm/disable feature makes programmed dynamic reassignment of priorities quick and easy, even while a real-time process is in progress. In establishing a configuration for the system, each group of up to 16 interrupt levels can have its priority assigned in different ways to meet the specific needs of a problem.

Programs that deal with interrupts from specially designed equipment sometimes must be checked out before the equipment is actually available. To permit simulating this special equipment, any SIGMA 8 interrupt level can be "triggered" by the CPU through execution of a single instruction. This capability is also useful in establishing a hierarchy of responses. For example, in responding to a high-priority interrupt, after the urgent processing is completed, it may be desirable to assign a lower priority to the remaining portion so that the interrupt routine is free to respond to other critical stimuli. The interrupt routine can accomplish this by triggering a lower-priority level, which processes the remaining data only after other interrupts have been handled.

Certain instructions (READ DIRECT and WRITE DIRECT, described in Chapter 3) allow the program to completely interrogate the condition of the interrupt system at any time and to restore that system at a later time.

Nonstop Operation. When connected to special devices the computer can sometimes become excessively delayed if the special device does not respond quickly. A built-in watchdog timer assures that the SIGMA 8 computer cannot be delayed for an excessive length of time.

Real-Time Clocks. Many real-time functions must be timed to occur at specific instants. Other timing information is also needed — for example, elapsed time since a given event, or the current time of day. SIGMA 8 can contain up to four real-time clocks with varying degrees of resolution to meet these needs. These clocks also allow easy handling of separate time bases and relative time priorities.

Rapid Context Switching. When responding to a new set of interrupt-initiated circumstances, a computer system must preserve the current operating environment, for continuance

later, while setting up the new environment. This changing of environments must be done quickly, with a minimum of "overhead" time costs. In the SIGMA 8 system, each one of up to four blocks of general-purpose arithmetic registers can, if desired, be assigned to a specific environment. All relevant information about the current environment (instruction address, current general register block, memory-protection key, etc.) is kept in a 64-bit program status doubleword (PSD). A single instruction stores the current PSD anywhere in memory and loads a new one from memory to establish a new environment, which includes information identifying a new block of general-purpose registers. A SIGMA 8 system can thus preserve and change its operating environment completely through the execution of a single instruction.

Memory Protection. Both foreground (real-time) and background programs can be run concurrently in a SIGMA 8 system because a foreground program is protected against destruction by an unchecked background program.

Variable Precision Arithmetic. Much of the data encountered in real-time systems are 16 bits or less. To process this data efficiently, SIGMA 8 provides halfword arithmetic operations in addition to fullword operations. Doubleword arithmetic operations (for extended precision) are also included.

Direct Data Input/Output. For handling asynchronous I/O, a 32-bit word can be transferred directly to or from a general-purpose register so that an I/O channel need not be occupied with relatively infrequent and nonperiodic transmissions.

## MULTIUSAGE FEATURES

As implemented in the SIGMA 8 system, "multiusage" combines two or more computer application areas. The most difficult general computing problem is the real-time application because of its severe requirements. Similarly, the most difficult multiusage problem is a time-sharing application that includes one or more real-time processes. Because the SIGMA 8 system has been designed on a real-time base, it is uniquely qualified for a mixture of applications in a multiusage environment. Many hardware features that prove valuable for certain application areas are equally useful in others, although in different ways. This multiple capability makes SIGMA 8 particularly effective in multiusage applications. The major SIGMA 8 multiusage computer features are described below.

Priority Interrupt. In a multiusage environment, many elements operate asynchronously. Thus, having a true priority interrupt system is especially important. With it the computer system corresponds quickly, and in proper order, to the many demands being made upon it, without the high overhead costs of complicated programming, lengthy execution time, and extensive storage allocations.

Quick Response. The many features that combine to produce a quick-response system (multiple register blocks,

rapid context saving, multiple push-pull operations) benefit all users because more of the machine's power is available at any instant for useful work.

Memory Protection. The memory protection feature guarantees the integrity of programs essential to critical real-time applications.

Input/Output. Because of its wide range of capacities and speeds, the SIGMA 8 I/O system simultaneously satisfies the needs of many different application areas economically, both in terms of equipment and programming.

Instruction Set. The large SIGMA 8 instruction set provides the computational and data-handling capabilities required for widely differing application areas; therefore, each user's program length and running time is decreased, and the speed of obtaining results is increased.

## MULTIPROCESSING FEATURES

SIGMA 8 is designed to function as a shared-memory multiprocessor system. It can contain up to four central processing units and up to 11 input/output processors (the sum of both types of processors is restricted by the maximum memory port limitation of 12). All processors in a SIGMA 8 system address memory uniformly.

This section describes the major features of SIGMA 8 that will allow growth from a monoprocessor to a multiprocessor system.

### MULTIPROCESSOR INTERLOCK

In a multiprocessor system, one of the central processing units often needs exclusive control of a system resource. This resource may be a region of memory, a particular peripheral device or, in some cases, a specific software process. A special instruction provides this required multiprocessor interlock. The special instruction, LOAD AND SET, unconditionally sets a "1" bit in the sign position of the referenced memory location during the restore cycle of the memory operation. If this bit had been previously set by another processor, the interlock is said to be "set" and the testing program proceeds to another task. If the sign bit of the tested location is a zero, the resource is allocated to the testing processor, and simultaneously the interlock is set for any other processor.

### HOMESPACE

Since all processors in a multiprocessor system address memory in a uniform manner, it is necessary to retain a private memory that is unique to each processor for its trap and interrupt locations, I/O communication locations, etc. This private memory is called Homespace and consists of 1,024 words for each CPU. Each Homespace region begins with real address zero. The implicitly assigned trap locations, interrupt locations, and IOP communication locations, plus the 16 locations that are reserved for the

registers, occupy the first 320 locations of Homespace. The remaining words in the Homespace region can be used as private, independent storage by the CPU.

## MULTI-PORT MEMORY SYSTEM

SIGMA 8 has growth capability of up to 12 ports per memory unit. A memory unit consists of two banks of 8K words, each expandable to 16K, in which each bank can be concurrently operating when addressed by two of the possible 12 ports.

This system architecture allows flexibility in growth patterns and provides a large memory bandwidth, essential to multiprocessor systems.

## MANUAL PARTITIONING CAPABILITY

SIGMA 8 has manual partitioning capability for all system units. Thus, besides its primary advantage of increased throughput capability, a secondary advantage of a multiprocessor system is its fail-soft ability. Any SIGMA 8 unit can be partitioned by selectively disabling it from the system busses. Faulty units are thus isolated from the operational system. Reenabling the connection allows repaired units to be returned to service.

## MULTIPROCESSOR CONTROL FUNCTION

A multiprocessor control function is provided on all multiprocessor systems. This function provides three basic features:

1. Control of the External Direct Input/Output bus (External DIO), used for controlling system maintenance and special purpose units such as A/D converters.
2. Central control of system partitioning.
3. Interprocessor interrupt connection, allowing one processor to directly signal another processor that an action is to be taken.

## SHARED INPUT/OUTPUT

Provisions have been made in a SIGMA 8 multiprocessor system for any CPU to direct I/O actions to any I/O processor. That is, any CPU can issue an SIO, TIO, TDV, or HIO instruction to begin, stop, or test any I/O process. However, the end-action sequence of the I/O process is directed at one of the possible four CPUs. This feature (accomplished by setting a pair of configuration control switches) allows assigning I/O end-action tasks to a single processor and avoids conflict resolution problems.

## 2. SIGMA 8 SYSTEM ORGANIZATION

The primary elements of a basic SIGMA 8 computer system, as illustrated in Figure 1, are central processor units, memory units, and input/output processors. These elements permit the total computer system to be viewed as a group of program-controlled subsystems communicating with a common memory. Each subsystem operates asynchronously and semi-independently, automatically overlapping the operation of the other subsystems for greater speed (when circumstances permit). A CPU subsystem primarily performs overall control and data reduction tasks while each IOP (MIOP or HSRIOP) subsystem performs the tasks associated with the exchange of digital information between the main memory and selected peripheral devices. A basic system may be expanded by increasing the number of memory units (up to 4), increasing the number of IOPs (up to 11, including MIOPs and HSRIOPs), or by increasing the number of central processors (up to 4).

### CENTRAL PROCESSING UNIT

This section describes the organization and operation of the SIGMA 8 central processing unit in terms of instruction and data formats, information processing, and program control. Basically, a SIGMA 8 CPU consists of a fast memory and an arithmetic and control unit as illustrated in Figure 2.

### GENERAL REGISTERS

An integrated-circuit memory, consisting of sixteen 32-bit general-purpose registers, is used within the SIGMA 8 CPU. These 16 registers of fast memory are referred to as a register block. A SIGMA 8 system may contain up to 4 register blocks. A 4-bit control field (called the register block pointer) in the Program Status Doubleword (PSD) selects the block currently available to a program. The 16 general registers selected by the register block pointer are referred to as the current register block. The register block pointer can be changed when the computer is in the master mode.

Each general register in the current register block is identified by a 4-bit code in the range 0000 through 1111 (0 through 15 in decimal, or X'0' through X'F' in hexadecimal notation). Any general register may be used as a fixed-point accumulator, floating-point accumulator, temporary data storage location, or to contain control information such as a data address, count, pointer, etc. General registers 1 through 7 may be used as index registers, and registers 12 through 15 may be used as a decimal accumulator capable of containing a decimal number of 31 digits plus sign. Registers 12 through 15 are always used when a decimal instruction is simulated by standard XDS software.

### MEMORY CONTROL STORAGE

The CPU has a high-speed integrated-circuit memory for storage of memory write-protection codes. This storage can be changed when the computer is in the master mode.

Memory Write Protection. The memory write-protection feature includes the necessary integrated-circuit memory for the memory write locks. These locks operate in conjunction with a 2-bit field, called the write key, in the program status doubleword. The locks and the key determine whether any program may alter any word located within the main memory. The write key can be changed only when the computer is in the master mode. (The functions of the locks and key are described in the section "Memory Address Control".)

### COMPUTER MODES

A SIGMA 8 computer operates in either master or slave mode. The mode of operation is determined by the control bit in the program status doubleword. (See "Program Status Doubleword".)

#### MASTER MODE

In this mode, the CPU can perform all of its control functions and can modify any part of the system. The only restrictions placed upon the CPU's operation in this mode is that imposed by the write locks on certain protected parts of memory. It is assumed that there is a resident operating system (operating in the master mode) that controls and supports the operation of other programs (which may be in the master or slave mode).

#### SLAVE MODE

The slave mode of operation is the problem-solving mode of the computer. In this mode, all "privileged" operations are prohibited. Privileged operations are those relating to input/output and to changes in the basic control state of the computer. All privileged operations are performed in the master mode by a group of privileged instructions. Any attempt by a program to execute a privileged instruction while the computer is in the slave mode results in a trap. The master/slave mode control bit can be changed when the computer is in the master mode. However, a slave mode program can gain direct access to certain executive program operations by means of CALL instructions without requiring executive program intervention. The operations available through CALL instructions are established by the resident operating system.

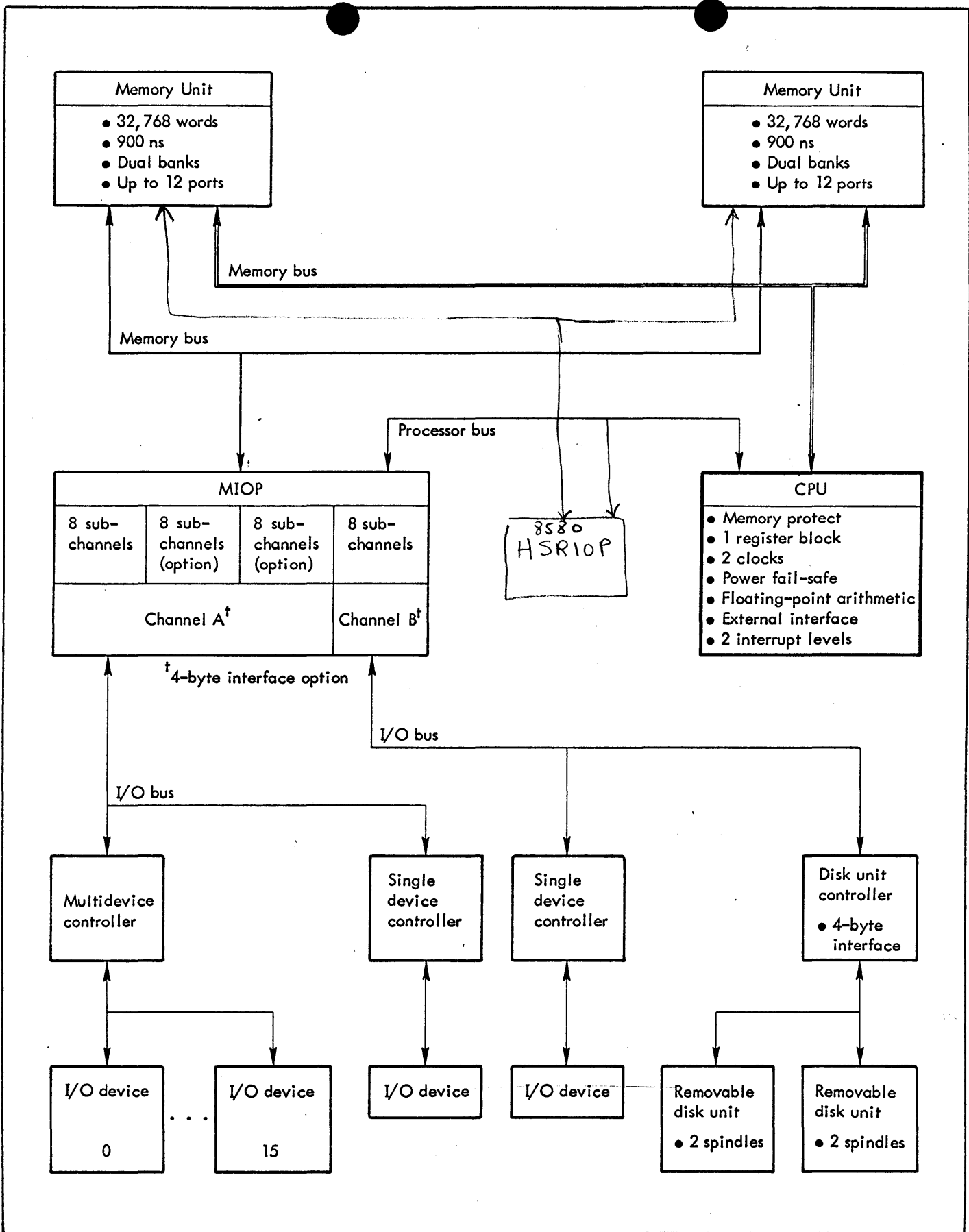

Figure 1. A Typical SIGMA 8 System

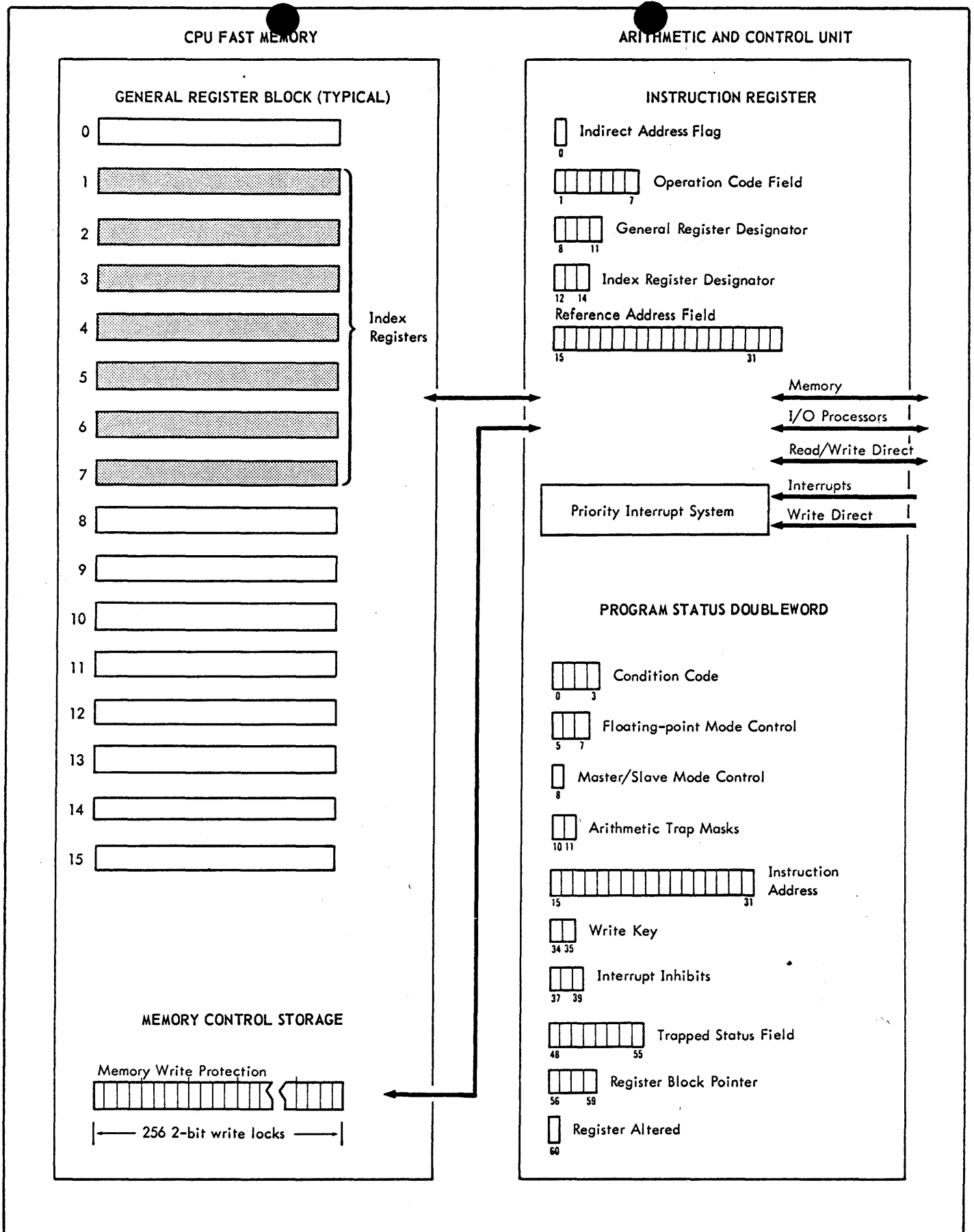
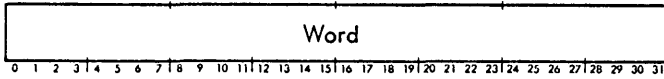

Figure 2. Central Processing Unit

## INFORMATION FORMAT

Nomenclature associated with digital information within the SIGMA 8 computer system is based on functional and/or physical attributes. A "word" of digital information may be either an instruction word or a data word.

The basic element of SIGMA 8 information is a 32-bit word, in which the bit positions are numbered from 0 through 31, as follows:



A SIGMA 8 word can be divided into two 16-bit parts (halfwords) in which the bit positions are numbered from 0 through 15, as follows:

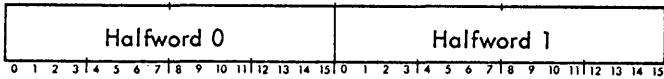

A SIGMA 8 word can also be divided into four 8-bit parts (bytes) in which the bit positions are numbered from 0 through 7, as follows:

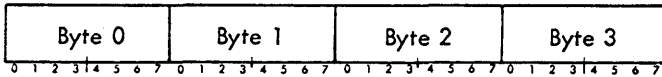

Two SIGMA 8 words can be combined to form a 64-bit element (a doubleword) in which the bit positions are numbered from 0 through 63, as follows:



For fixed-point binary arithmetic, each element of information represents numerical data as a signed integer (bit 0 represents the sign, remaining bits represent the magnitude, and the binary point is assumed to be just to the right of the least significant or rightmost bit). Negative values are represented in two's complement form. Other formats required for floating-point and decimal instructions are described in Chapter 3.

## INFORMATION BOUNDARIES

SIGMA 8 instructions assume that bytes, halfwords, and doublewords are located in main memory according to the following boundary conventions:

1. A byte is located in bit positions 0 through 7, 8 through 15, 16 through 23, or 24 through 31 of a word.
2. A halfword is located in bit positions 0 through 15 or 16 through 31 of a word.
3. A doubleword is located so that bits 0 through 31 are contained within an even-numbered word, and bits 32 through 63 are contained within the next consecutive (odd-numbered) word.

The various information boundaries are illustrated in Figure 3.

## INSTRUCTION REGISTER

The instruction register contains the instruction that is currently being executed by the CPU. The format and fields of the two general types of instructions (immediate operand and memory-reference) are described below.

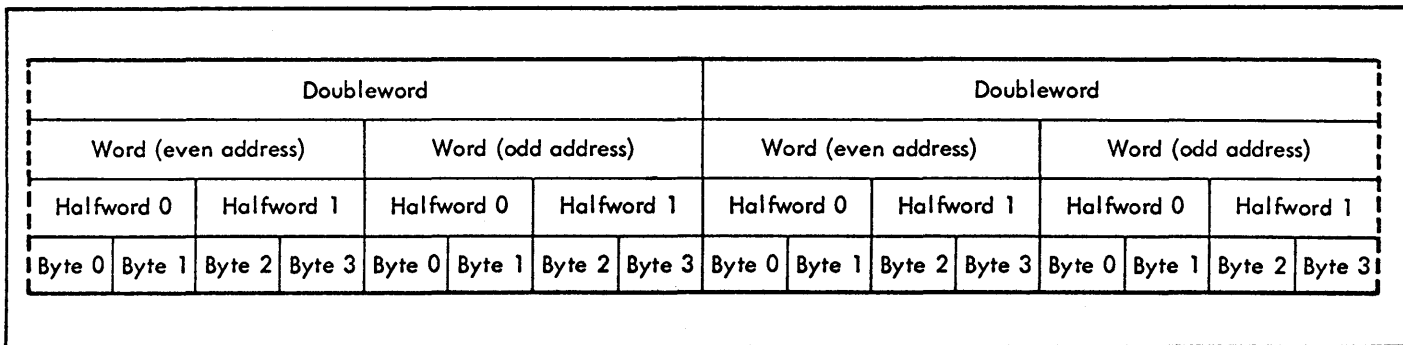
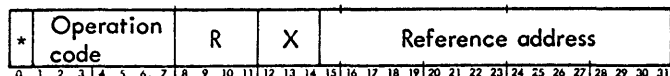

Figure 3. Information Boundaries

## MEMORY-REFERENCING INSTRUCTIONS

Most SIGMA 8 CPU instructions make reference to an operand located in main memory. The format for this type of instruction is



### Bits Description

- 0 This bit position indicates whether indirect addressing is to be performed. Indirect addressing (one level only) is performed if this bit position contains a 1 and is not performed if this bit position contains a 0.
- 1-7 Operation Code. This 7-bit field contains the code that designates the operation to be performed. See the inside front and back covers as well as Appendix B for complete listings of operation codes.
- 8-11 R field. For most instructions this 4-bit field designates one of 16 general registers of the current register block as an operand source, result destination, or both.
- 12-14 X field. This 3-bit field designates any one of general registers 1-7 of the current register block as an index register. If X is equal to 0, indexing will not be performed; hence, register 0 cannot be used as an index register. (See "Address Modification" for a more complete description of the SIGMA 8 indexing process.)
- 15-31 Reference Address. This 17-bit field normally contains the reference address of the instruction operand. Depending on the address modification (direct/indirect or indexing) required, the reference address is translated into an effective address. (See "Memory Reference Addresses" for further details.)

## IMMEDIATE OPERAND INSTRUCTIONS

Some SIGMA 8 CPU instructions are of the immediate operand type, which is particularly efficient because the required operand is contained within the instruction word. Hence, memory reference, indirect addressing, and indexing are not required.

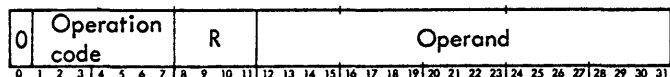

### Bits Description

- 0 This bit position must be coded with a 0. If this bit is coded with a 1, the instruction is interpreted as being nonexistent. (See "Trap System".)
- 1-7 Operation Code. This 7-bit field contains a code that designates the operation that will be performed. When any immediate operand operation code is encountered, the CPU interprets the contents of bits 12-31 of the instruction word as an operand. Immediate operand operation codes are as follows:
 

Operation Code	Instruction Name	Mnemonic
X'02'	Load Conditions and Floating Control Immediate	LCFI
X'20'	Add Immediate	AI
X'21'	Compare Immediate	CI
X'22'	Load Immediate	LI
X'23'	Multiply Immediate	MI
- 8-11 R field. This 4-bit field designates one of 16 general registers of the current register block. This register may contain another operand and/or be designated as the register in which the results of this operation will be stored or accumulated.
- 12-31 Operand. This 20-bit field contains the immediate operand. Negative numbers are represented in two's complement form. For arithmetic operations, bit 12 (the sign bit) is extended (duplicated) to the left through position 0 to form a 32-bit operand.

The byte string instructions (described in Chapter 3) are similar to immediate operand instructions in that they can not be modified by indexing. If a byte string instruction is indirectly addressed, it is treated as a nonexistent instruction by the computer.

## MAIN MEMORY

This section describes the organization and operation of the main memory and the various modes and types of addressing, including indexing.



## MEMORY UNIT

The main memory for SIGMA 8 is physically organized as a group of "units". A memory unit is the smallest, logically complete part of the system, and the smallest part that can be logically isolated from the rest of the memory system. A memory unit always consists of two physical memory banks. Both memory banks may be simultaneously and asynchronously operating. Each memory unit has a set of from 2 to 12 "ports" or access points that are common to both banks within the unit; that is, all ports in a given memory unit provide access to both banks within that unit. The minimum SIGMA 8 system of 16,384 words consists of one memory unit with two ports and two banks of 8192 words each.

## MEMORY BANK

A memory bank is the basic functionally independent element of the memory system. It consists of magnetic storage elements, drive and sense electronics, control timing, and data registers. A bank consists of 8,192 memory locations expandable to 16,384. Each location stores a 32-bit information word (instruction or data), plus a parity bit.

## MEMORY INTERLEAVING

Memory interleaving is a built-in hardware feature that distributes sequential addresses into independently operating memory banks which are of equal size. Interleaving increases the probability that a processor can gain access to a given memory location without encountering interference from other processors.

Two-way interleaving between two equal size banks within a unit causes even addresses to be assigned to bank A and odd addresses to bank B. Four-way interleaving between two equal size units (each with two equal size banks) causes every fourth address to be assigned to its respective bank.

## MEMORY UNIT STARTING ADDRESS

Each memory unit in the SIGMA 8 system is provided its individual identity by means of starting address switches. These switches define the range of addresses to which the unit responds when servicing memory requests. All addresses, including the starting address, for a given unit are the same for all ports in that unit; that is, the address of a given word remains the same regardless of the port used to access the word. The starting address of a unit must be on a boundary equal to a multiple of the size of the unit. In the event that the unit is interleaved with another unit, the starting address for the combined units must be on a boundary equal to a multiple of the total size of the interleaved assembly.

## MEMORY PORTS

The memory ports of a memory unit are the connecting points between processors (IOPs and CPUs) and memory banks, and

they permit the processor access memory locations. Each memory unit may have from 2 to 12 independent access ports. A memory unit port is effectively a switch between all the busses entering that unit and the two banks that make up the unit. As an example, a unit that has four busses connected to it and two banks within it would have a port structure designated as a 4 x 2 switch. The ports examine incoming addresses to determine if the request is for a bank within the memory unit. They also determine the priority of memory requests received simultaneously.

The minimum number of ports for a SIGMA 8 system is two, one for the CPU and one for an IOP. The number of ports may be expanded, in increments of one, to a maximum of 12.

## PORT PRIORITY

The multiport structure and the dual-bank memory (within each unit) allow two simultaneous requests for memory to be processed immediately, providing that the requests are received on different ports, for different banks, and neither bank is busy. If a requested bank is busy, or if simultaneous requests are received for the same bank, the memory port logic selects the highest priority request first.

Normally, all ports in a memory unit operate on a priority chain, with port number 0 having the highest priority and port number "n" having the lowest. In general, CPUs are connected to the higher priority ports and IOPs are connected to the lower priority ports. If simultaneous requests are received for a single bank on port 2 and port 4, port 2 has access to the memory bank first.

In addition to the normal priority that prevails among the ports, as described above, each port has two priority levels (a normal priority and a high priority). A processor will usually request the normal priority level; however, under certain conditions a processor may request high priority access to a given port (e.g., an IOP will wait with a low priority memory request until half of its available buffering has been filled on input or empties on output; it then requests a high priority memory reference). If one port receives a high priority request, that port's priority is then higher than the normal priority of all other ports. If more than one port is on a high priority at the same time, the normal sequence of priority will prevail among those ports on high priority.

## CPU PORT

When the memory is quiescent, the port selection logic is set to a condition that automatically selects port 0. The elimination of switching time (to select a port) results in a timing preferential for the processor connected to port 0. This is particularly advantageous for a monoprocessing system where the CPU would normally be connected to port 0 of each memory unit.

## HOMESPACE

In SIGMA 8 multiprocessing system, all processors address memory in the same manner. However, since the CPUs do not share the same interrupt or trap systems, it is necessary to provide private storage for each CPU to contain its trap and interrupt locations, I/O communication locations, and general registers. This private storage is called Homespace.

Each CPU contains a Homespace bias. The Homespace bias is the address of a 16K region of main memory, of which the first 1,024 words is Homespace. After an effective address is generated in the CPU, and just before it is sent to memory, the most significant 7 bits are tested. If all bits are equal to zero, then a 3-bit Homespace bias is inserted in place of the most significant three bits. This means that any time the CPU makes a reference to the first 1,024 words of real memory, that reference may be relocated by means of the Homespace bias.

The 3-bit Homespace bias is supplied by a set of three switches in a SIGMA 8 CPU. They can be changed manually to move the Homespace region from one area to another within the 8 possible areas.

When multiprocessors are used, a given CPU may reference the Homespace region of other processors by using the normal memory addresses for that region. The only exception to this is that the Homespace of a CPU that is set at real memory location zero, cannot be referenced by any other CPU. However, the CPU that has its Homespace at real location zero may reference the Homespace of all other CPUs.

Each Homespace region contains all the trap locations, interrupt locations, and IOP communication locations for a given CPU (see Table 1). These implicitly assigned memory locations plus the 16 locations that are reserved for the general registers, occupy the first 320 locations of Homespace. The remaining words in the Homespace region can be used as private, independent storage by the CPU.

### MEMORY REFERENCE ADDRESS

Homespace memory locations 0 through 15 are not normally accessible to the programmer because their memory addresses are reserved as register designators for "register-to-register" operations. However, an instruction can treat any register of the current register block as if it were a location in main memory. Furthermore, the register block can be used to hold an instruction (or a series of up to 16 instructions) for execution just as if the instruction (or instructions) were in main memory. The only restriction upon the use of the register block for instruction storage is:

If an instruction accessed from a general register uses the R field of the instruction word to designate the next higher-numbered register, and execution of the instruction would alter the contents of the register so designated, the contents of that register should not be used as the next instruction in sequence because the operation of the instruction in the affected register would be unpredictable.

Table 1. Homespace Layout

Dec.	Hex.	Function	
000 : 015	000 : 00F	Addresses of general registers	
016 : 031	010 : 01F	Reserved for future use	
032 033	020 021	CPU/IOP communication locations	
034 : 063	022 : 03F	Load routine or reset recovery routine	
064 : 079	040 : 04F	Trap locations	
080 : 085	050 : 055	Override group	Internal Interrupts, group X'0'
086	056	Processor fault	
087	057	Memory fault	
088 : 091	058 : 05B	Counter group	
092 : 095	05C : 05F	<i>1 I/O console I/O group 2 reserved</i>	
096 : 111	060 : 06F	External Interrupts, group X'2'	
:	:	:	
304 : 319	130 : 13F	External Interrupts, group X'F'	
320 : 1023	140 : 3FF	Reserved locations	

Description of the various types of addresses used in the SIGMA 8 are based upon terms and concepts defined below. References are made to Figure 4, which illustrates the control flow and data flow during address generation.

Instruction Address. This is the address of the next instruction to be executed. The 17-bit instruction address is contained within bits 15-31 of the program status doubleword.

Reference Address. This is the 17-bit address associated with any instruction contained within bits 15-31 of the instruction itself. The reference address may be modified by using indirect addressing or indexing. A reference address becomes an effective address after the indirect addressing and/or post-indexing (if required) is performed. (See Figure 4.)

Direct Reference Address. If neither indirect addressing nor indexing is called for by the instruction (i.e., if bit position 0 and the X field of the instruction are 0), the reference address of the instruction (as defined above) becomes the effective address.

Indirect Reference Address. When bit position 0 of any instruction (except immediate operand and byte string instructions) is a 1, indirect addressing is specified. That is, bits 15 through 31 of the instruction word are not used as a direct reference address. Instead, bits 15 through 31 of the instruction word point to (address) a location which contains the direct reference address. Contents of bit positions 15 through 31 of the referenced location constitute the direct reference address. Indirect addressing can be performed only once during each instruction (one level) and indexing (if specified) is performed after the direct reference address has replaced the indirect reference address. Performing the indexing operation after the indirect address operation is referred to as post-indexing. Refer to "Address Modification" for further details.

Index Reference Address. If indexing is called for by the instruction (a nonzero value in bit positions 12-14 of the instruction), the direct or indirect reference address is modified by addition of the displacement value in the general register (index) called for by the instruction (after scaling the displacement according to the instruction type). This final reference address value (after indirect addressing, indexing, or both) is defined as the effective address of the instruction. Indexing after indirect addressing is called postindexing. (See "Address Modification" for further details.)

Displacements. Displacements are 19-, 18-, 17-, or 16-bit values used in index registers and by byte string instructions to generate effective addresses of the appropriate size (byte, halfword, word, or doubleword).

Register Address. If any instruction produces an address that is a memory reference (i.e., a direct, indirect, or indexed reference address) in the range 0 through 15, the CPU does not attempt to read from or write into main

memory. Instead, the low-order bits of the reference address are used as a general register address, and the general register (of the current register block) corresponding to this address is used as the operand location or result destination. Thus, the instruction can use any register in the current register block as the source of an operand, the location of a direct address, or the destination of a result. Such usage is referred to as a "register-to-register" operation.

Actual Address. An actual address is the address value actually used by the CPU to access main memory via the memory address register (see Figure 4). If the effective address is  $X'0' - X'F'$ , one of the general registers is addressed. All actual addresses are 16, 17, 18, or 19 bits as required to address a doubleword, word, halfword, or byte, (i.e., an effective address is transformed into an actual address whenever Homespaceing is performed).

Effective Address. The effective address is defined as the final address computed for an instruction (output from the address generator in Figure 4). The effective address is usually used as the address of an operand location or result destination. However, some instructions do not use the effective address as a location reference; instead, the effective address is used to control the operation of the instruction (as in a shift instruction), to designate the address of an input/output device (as in an input/output instruction), or to designate a specific element of the system (as in a READ DIRECT or WRITE DIRECT instruction).

Effective Location. An effective location is defined as the actual location (in main memory or in the current register block) that is to receive the result of a memory-referencing instruction, and is referenced by means of an effective address.

Effective Operand. An effective operand is defined as the contents of an actual location (in main memory or in the current register block) that is to be used as an operand by a memory-referencing instruction, and is referred to by means of an effective address.

## ADDRESSING

Except for the special type of addressing that is performed only by some interrupt and trap instructions, all SIGMA 8 addressing is as follows:

1. Each reference address is a 17-bit word address.
2. The reference address may be direct or indirect, with or without postindexing.
3. Displacements associated with indexing are automatically aligned, as required, for doubleword, word, halfword, or byte operations; and the effective address is either a 16-bit doubleword address, 17-bit word address, 18-bit halfword address, or a 19-bit byte address.
4. Memory write protection is automatically invoked.

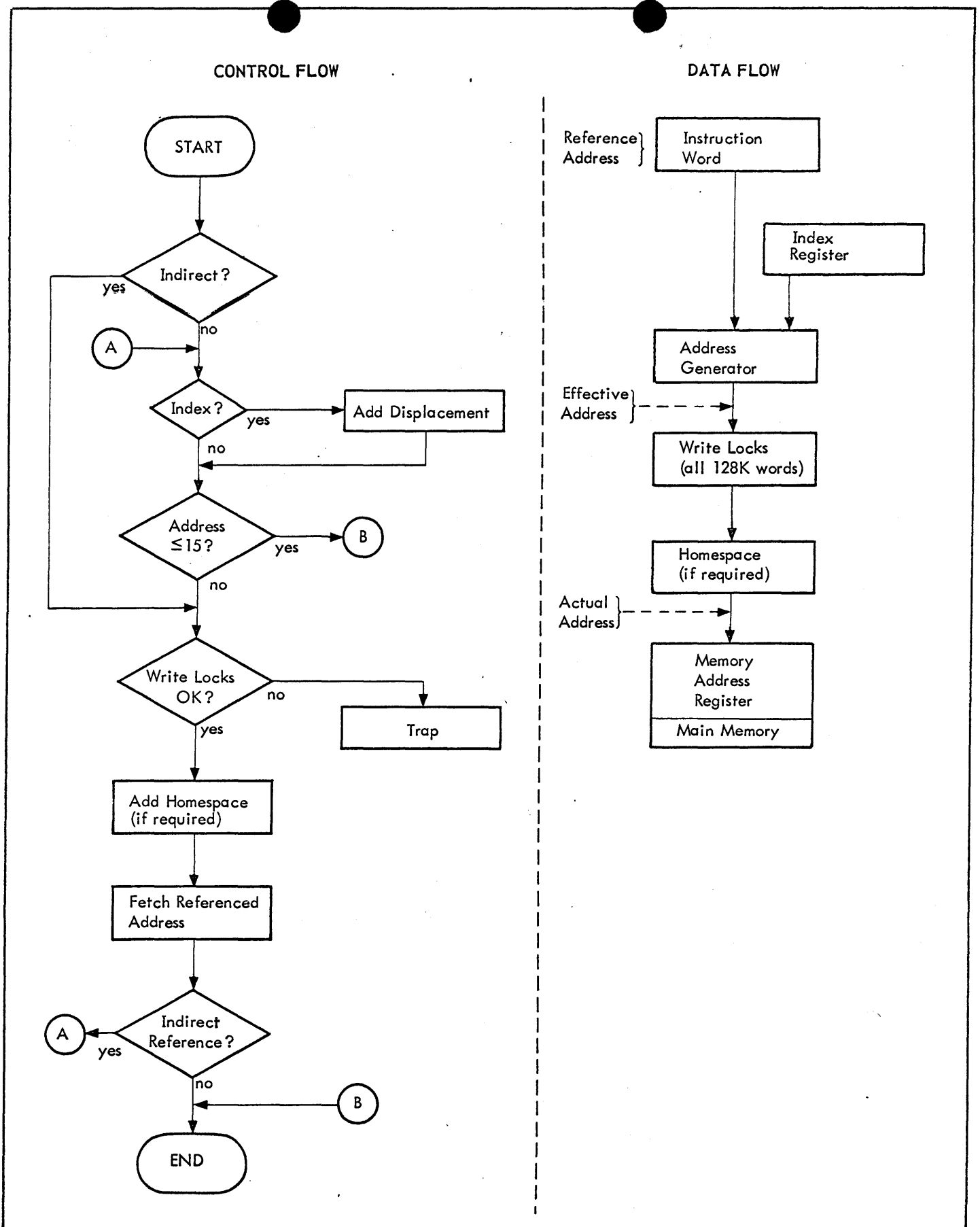

Figure 4. Addressing Logic

## ADDRESS MODIFICATION

### INDIRECT ADDRESSING

The 7-bit operation code field of the SIGMA 8 instruction word format provides for up to 128 instruction operation codes, nearly all of which can use indirect addressing (the exceptions, already mentioned, are the immediate-addressing instructions). The indirect addressing operation is limited to one level, as called for by the indirect address bit (bit position 0) of the instruction word. Indirect addressing does not proceed to further levels, regardless of the contents of the word location pointed to by the reference address field of the instruction. Indirect addressing occurs before indexing; that is, the 17-bit reference address field of the instruction is used to obtain a word, and the 17 low-order bits of the word thus obtained effectively replace the initial reference field; then indexing is carried out according to the operation code of the instruction.

### INDEXING AND INDEX REGISTERS

The X field of the normal instruction format permits any one of registers 1 through 7 in the current register block to be designated as an index register. The contents of this register are then treated as a 32-bit displacement value.

The indexing technique employed in SIGMA is unique. SIGMA instructions provide for operations on bytes, halfwords, words, and doublewords. These units of information are typically organized in lists that are processed sequentially. The SIGMA indexing technique is based on the concept that the index register contains an integer value ( $k$ ) that permits the accessing of the  $k$ th item of a list (where  $k = 0$  refers to the first item,  $k = 1$  refers to the second item, etc.), independent of the kind of data that is in the list. Thus, a byte-addressing instruction that is indexed accesses the  $k$ th byte of a list; a halfword-addressing instruction that refers to the same index register obtains the  $k$ th halfword of a list; a word-addressing instruction that refers to the same index register obtains the  $k$ th word of a list; and a doubleword-addressing instruction that is indexed with the same register obtains the  $k$ th doubleword of a list.

Figure 5 shows how the indexing operation takes place. As the instruction is brought from memory, it is loaded into a 34-bit instruction register that initially contains 0's in the 2 low-order bit positions (32 and 33). The displacement value from the index register is then aligned with the instruction register (as an integer) relative to the addressing type of the instruction. That is, if it is a byte-addressing instruction, the displacement is lined up so that its low-order bit is aligned with the least significant bit of the

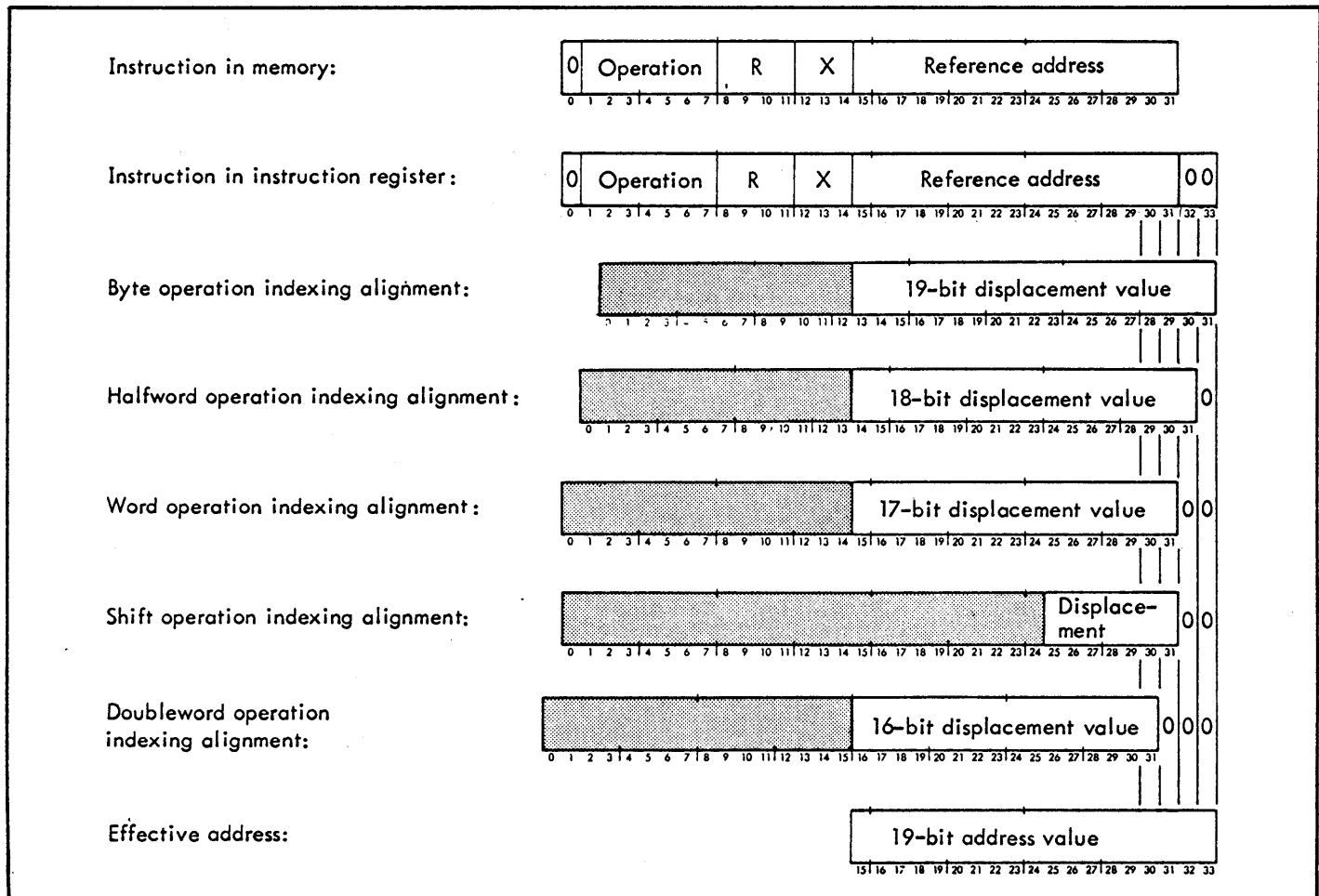

Figure 5. Index Displacement Alignment

34-bit instruction register. The displacement is shifted one bit to the left of this position for a halfword-addressing instruction, two bits to the left for a word-addressing instruction, and three bits to the left for a doubleword-addressing instruction. An addition process then takes place to develop a 19-bit address, which is referred to as the effective address of the instruction. High-order bits of the 32-bit displacement field are ignored in the development of this effective address (i.e., the 15 high-order bits are ignored for word operations, the 25 high-order bits are ignored for shift operations, and the 16 high-order bits are ignored for doubleword operations). However, the displacement value can cause the effective address to be less than the initial reference address within the instruction if the displacement value contains a sufficient number of high-order 1's (i.e., the displacement is a negative integer in two's complement form).

The effective address of an instruction is always a 19-bit byte address value; however, this value is automatically adjusted to the SIGMA 8 information boundary conventions. Thus, for halfword-addressing instructions, the low-order bit of the effective halfword address is 0; for word-addressing instructions, the 2 low-order bits of the effective word address are 0's; and for doubleword-addressing instructions, the 3 low-order bits of the effective doubleword address are 0's.

If no indexing is used with a byte-addressing instruction, the effective byte is the first byte (bit positions 0-7) of a word location. If no indexing is used with a halfword-addressing instruction, the effective halfword is the first halfword (bit positions 0-15) of a word location. A doubleword operation always involves a word at an even-numbered word address and the word at the next sequential (odd-numbered) word address. If an odd-numbered word location is specified in a doubleword-addressing instruction, the low-order bit of the effective address field (bit position 31) is automatically forced to 0. Thus, an odd-numbered word address (referring to the middle of a doubleword) designates the same doubleword as an even-numbered word address, when used in a doubleword-addressing instruction.

## MEMORY ADDRESS CONTROL

In a SIGMA 8 computer, the use of main memory by a program is controlled by the memory locks. The memory locks provides memory write protection for all modes of programs within the 131,072 words of memory.

### MEMORY WRITE LOCKS

Memory protection is provided by a lock and key technique. A 2-bit write-protect lock (WL) is provided for each 512-word page of the 128K words of memory addresses. The write-protect locks consist of 256 2-bit write locks, each assigned to a 512-word page of addresses as shown below.

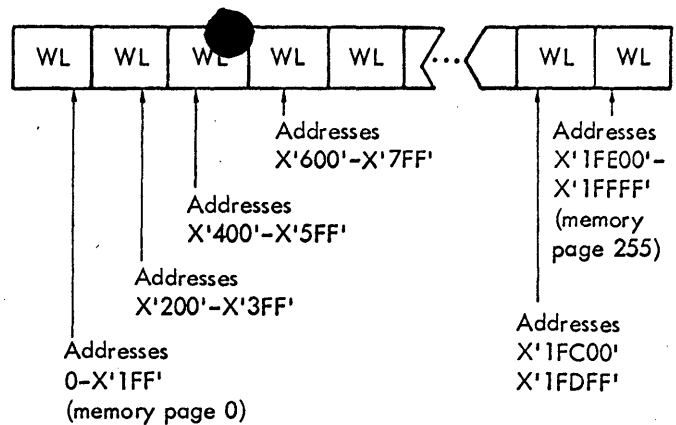

The write-protect locks can be changed only by executing the privileged instruction MOVE TO MEMORY CONTROL (see "Control Instruction").

The write key (a 2-bit field in PSD for any operating program) works in conjunction with the lock storage to determine whether any program (slave or master mode) can write into a specific page of main memory locations. The keys and locks control access for writing, according to the following rules.

1. A lock value of 00 means that the corresponding memory page is "unlocked"; write access to that page is permitted independent of the key value.
2. A key value of 00 is a "skeleton" key that will open any lock; thus, write access to any memory page is permitted independent of its lock value.
3. A lock value other than 00 for a memory page permits write access to that page only if the key value is identical to the lock value.

Thus, a program can write into a given memory page if the lock value is 00, if the key value is 00, or if the key value matches the lock value.

The locks and keys are examined to determine whether the program (master or slave mode) is allowed to alter the contents of the main memory location. If an instruction attempts to write into a write-protected memory page, the computer aborts the instruction, and traps to HomeSpace location X'40', which is the "nonallowed operation" trap (see "Trap System").

## PROGRAM STATUS DOUBLEWORD

The critical control conditions of a SIGMA 8 CPU are defined within 64 bits of information. These 64 bits are collectively referred to as the current program status doubleword (PSD). The current PSD may be considered as a 64-bit internal CPU register, although it actually exists as a collection of separate registers and flip-flops. When stored in memory, the PSD has the following format:

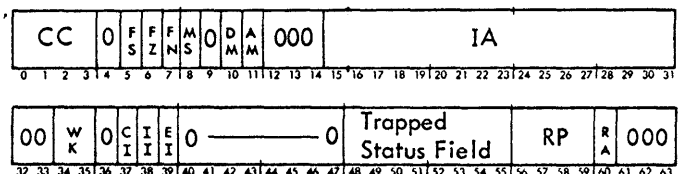

<u>Designation</u>	<u>Function</u>	<u>Designation</u>	<u>Function</u>
CC	<p><u>Condition code.</u> This generalized 4-bit code indicates the nature of the results of an instruction. The significance of the condition code bits depends on the particular instruction just executed. After an instruction is executed, the instructions BRANCH ON CONDITIONS SET (BCS) and BRANCH ON CONDITIONS RESET (BCR) can be used singly or in combination, to test for a particular condition code setting (these instructions are described in Chapter 3, "Execute/Branch Instructions").</p> <p>In some operations, only a portion of the condition code is involved; thus, the term CC1 refers to the first bit of the condition code, CC2 to the second bit, CC3 to the third bit, and CC4 to the fourth bit. Any program can change the current value of the condition code by executing either the instruction LOAD CONDITIONS AND FLOATING CONTROL IMMEDIATE (LCFI) or the instruction LOAD CONDITIONS AND FLOATING CONTROL (LCF). Any program can store the current condition code by executing STORE CONDITIONS AND FLOATING CONTROL (STCF). These instructions are described in Chapter 3, "Load/Store Instructions".</p>	DM	<p><u>Decimal mask.</u> This bit position is used only to preserve the status of the decimal arithmetic fault trap mask when a SIGMA 6, 7, or 9 program is being executed. The decimal mask bit does not affect the operation of the SIGMA 8 computer in any other way.</p>
		AM	<p><u>Arithmetic mask.</u> The fixed-point arithmetic overflow trap is in effect when this bit is a 1. The instructions that can cause fixed-point overflow are described in the section "Trap System". The arithmetic trap mask can be changed by a master mode program executing either the instruction LPSD or the instruction XPSD.</p>
		IA	<p><u>Instruction address.</u> This 17-bit field contains the address of the next instruction to be executed.</p>
		WK	<p><u>Write key.</u> This field contains the 2-bit key used in conjunction with the memory protection feature. A master mode program can change the write key by executing either the instruction LPSD or the instruction XPSD.</p>
FS	<u>Floating significance mode control.</u>	CI	<u>Counter interrupt group inhibit.</u>
FZ	<u>Floating zero mode control.</u>	II	<u>Input/output interrupt group inhibit.</u>
FN	<p><u>Floating normalize mode control.</u> The three floating-point mode bits (FS, FZ, and FN) control the operation of the computer with respect to floating-point significance checking, the generation of zero results, and the normalization of the results of floating-point additions and subtractions, respectively. (The floating-point mode controls are described in Chapter 3, "Floating-point Instruction".) Any program can change the state of the current floating-point mode controls by executing either the instruction LCFI or the instruction LCF. Any program can store the current state of the current floating-point mode controls by executing the instruction STCF.</p>	EI	<p><u>External interrupt group inhibit.</u> The three inhibit bits (CI, II, and EI) determine whether certain interrupts may occur. The functions of the interrupt inhibits are described in the section "Interrupt System". A master mode program can change the interrupt inhibits by executing LPSD, XPSD, or the instruction WRITE DIRECT (WD). The WD instruction is described in Chapter 3, "Control Instructions".</p>
		TSF	<p><u>Trapped status field.</u> This field is used for the tracing of faults during trap conditions. (For a detailed explanation, see "Trap System", including Table 5, in this chapter.)</p>
MS	<p><u>Master/slave mode control.</u> The computer is in the master mode when this bit is a 0; or in the slave mode when this bit is a 1. A master mode program can change the mode control by executing either the instruction LOAD PROGRAM STATUS DOUBLEWORD (LPSD) or the instruction EXCHANGE PROGRAM STATUS DOUBLEWORD (XPSD). These two privileged instructions are described in Chapter 3, "Control Instructions".</p>	RP	<p><u>Register pointer.</u> This 4-bit field selects one of the four possible blocks of general-purpose registers as the current register block. Unused codes within this field are reserved for future use. A master mode program can change the register pointer by executing LPSD, XPSD, or the instruction LOAD REGISTER POINTER (LRP). The LRP instruction is described in Chapter 3, "Control Instructions".</p>

Designation      Function

RA      Register altered bit. In the event of a trap entry, this bit is set to 1 when any general register or location in memory has been altered in the execution or partial execution of the instruction that caused the trap.

"armed", it advances to the waiting state. When all the conditions for its acknowledgment have been achieved, the interrupt level advances to the active state, where it causes the computer to take an instruction from a specific location in memory. The computer may execute many instructions between the time that the interrupt-requesting condition is sensed and the time that the actual interrupt acknowledgment occurs.

### INTERRUPT SYSTEM

When a condition that will result in an interrupt is sensed, a signal is sent to an interrupt level. If that level is

Up to 238 interrupt levels are normally available, each with a unique location (see Table 2) assigned in main memory, with a unique priority, and capable of being selectively armed and/or enabled by the CPU. Also, any interrupt

Table 2, SIGMA 8 Interrupt Locations

Location		WRITE DIRECT Register bit <sup>†</sup>	Function	Availability	PSD Inhibit	WRITE DIRECT Group code <sup>††</sup>		
Dec.	Hex.							
80 81	50 51	none	Power on Power off	standard	none	none		
82 83	52 53	16 17	Counter 1 count pulse Counter 2 count pulse	optional (as a set)				
84 85 86 87	54 55 56 57	18 19 20 21	Counter 3 count pulse Counter 4 count pulse Processor fault Memory fault	standard				
88 89	58 59	22 23	Counter 1 zero Counter 2 zero	optional (as a set)			CI	X'0'
90 91	5A 5B	24 25	Counter 3 zero Counter 4 zero	standard				
92 93	5C 5D	26 27	Input/Output Control Panel	standard				
94 95	5E 5F		Reserved for future use Reserved for future use					
96 : : 111	60 : : 6F	16 : : 31	External Group 2	optional	EI	X'2'		
112 : : 127	70 : : 7F	16 : : 31	External Group 3			X'3'		
: : : 288	: : : 120	: : : 16	External Group 14			X'E'		
303	12F	31						
304 : : 319	130 : : 13F	16 : : 31	External Group 15			X'F'		

<sup>†</sup>When the privileged instruction WRITE DIRECT is used in the interrupt control mode to operate on interrupt levels, the interrupt levels are selected by specific bit positions in register R. The numbers in this column indicate the bit position in register R that corresponds to the various interrupt levels.

<sup>††</sup>The numbers in this column indicate the group codes (for use with WRITE DIRECT) of the various interrupt levels.



level can be "triggered" by the CPU (supplied with a signal at the same physical point where the signal from the external source would enter the interrupt level). The triggering of an interrupt permits the testing of special systems programs before the special systems equipment is actually attached to the computer, and also permits an interrupt-servicing routine to defer a portion of the processing associated with an interrupt level by processing the urgent portion of an interrupt-servicing routine, triggering a lower-priority level (for a routine that handles the less-urgent part), then clearing the high-priority interrupt level so that other interrupts may occur before the deferred interrupt response is processed.

SIGMA 8 interrupts are arranged in groups that are connected in a predetermined priority chain by groups of levels. The priority of each level within a group is fixed; the first level has the highest priority and the last level has the lowest. The user has the option of ordering a machine with a priority chain starting with the override group and connecting all remaining groups in any sequence. This allows the user to establish external interrupts above, between, or below the counter and input/output groups of internal interrupts. Figure 6 illustrates this with a configuration that a user might establish, where (after the override group) the counter group of internal interrupts is given the second-highest priority, followed by the first group of external interrupts, then the input/output group of internal interrupts, and finally all succeeding groups of external interrupts.

### INTERNAL INTERRUPTS

Internal interrupts include those standard interrupts that are normally supplied with a SIGMA 8 system, as well as the additional counter interrupts.

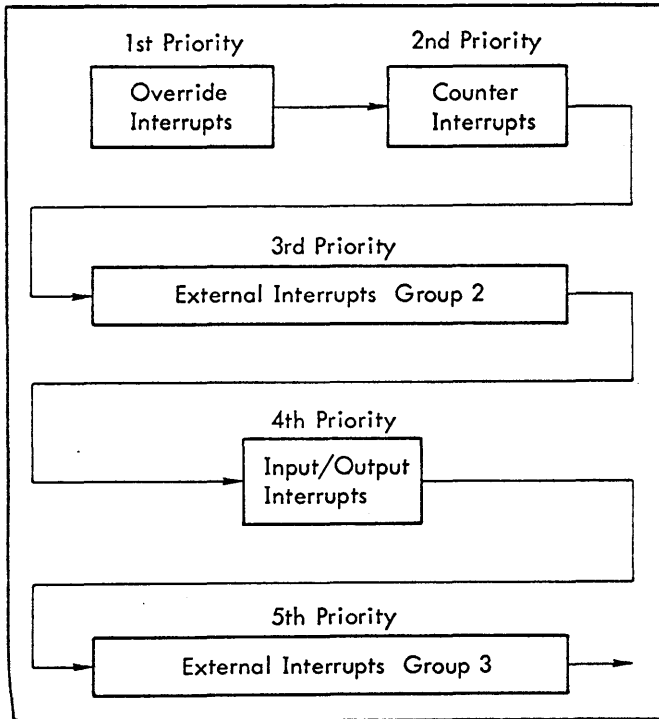

Figure 6. Typical Interrupt Priority Chain

### OVERRIDE GROUP (LOCATIONS X'50' TO X'57')

The eight interrupt levels of this group always have the highest priority in a SIGMA 8 system and can never be inhibited. The power fail-safe feature includes the power on and power off interrupt levels. A system can contain 2 or 4 count-pulse interrupt levels that are triggered by pulses from clock sources. Counter 4 has a constant frequency of 500 Hz. Counters 1, 2, and 3 can be individually set to any of four manually switchable frequencies – the commercial line frequency, 500 Hz, 2 kHz, or a user-supplied external signal – that may be different for each counter. (All counter frequencies are synchronous except for the line frequency and the signal supplied by the user.) Each of the count-pulse interrupt locations must contain one of the modify and test instructions (MTB, MTH, or MTW) or an XPSD instruction. When the modification (of the effective byte, halfword, or word) causes a zero result, the appropriate counter-equals-zero interrupt (see "Counter-Equals-Zero Group") is triggered.

The override group also includes a processor fault and a memory fault interrupt level. The processor fault interrupt level is triggered by a signal from an input/output processor (IOP) or another CPU when these devices detect certain fault conditions. The memory fault interrupt level is triggered by a signal that the memory generates when it detects certain fault conditions. (See "Trap System" for further details on processor and memory faults.)

### COUNTER-EQUALS-ZERO GROUP (LOCATIONS X'58' TO X'5B')

Each interrupt level in the counter-equals-zero group (called a counter-equals-zero interrupt) is associated with a count-pulse interrupt in the override group. When the execution of a modify and test instruction in the count-pulse interrupt location causes a zero result in the effective byte, halfword, or word location, the corresponding counter-equals-zero interrupt is triggered. The counter-equals-zero interrupts can be inhibited or permitted as a group. If bit position 37 (CI) of the current program status doubleword contains a 0, the counter-equals-zero interrupts are allowed to interrupt the program being executed. However, if the CI bit is a 1, the counter-equals-zero interrupts are not allowed to interrupt the program. These interrupts wait until the CI bit is reset to 0 and then interrupt the program according to priority.

### INPUT/OUTPUT GROUP (LOCATIONS X'5C' AND X'5D')

This interrupt group includes two standard interrupts: the I/O interrupt and the control panel interrupt. The I/O interrupt level accepts interrupt signals from the standard I/O system. The I/O interrupt location is assumed to contain an EXCHANGE PROGRAM STATUS DOUBLEWORD (XPSD) instruction that transfers program control to a routine for servicing all I/O interrupts. The I/O routine then contains an ACKNOWLEDGE I/O INTERRUPT (AIO) instruction that identifies the source and reason for the interrupt.

The control panel interrupt level is connected to the INTERRUPT button on the process control panel. The control panel interrupt level can thus be triggered by the computer operator, allowing him to initiate a specific routine.

The interrupts in the input/output group can be inhibited or permitted by means of bit position 38 (II) of the program status doubleword. If II is a 0, the interrupts in the I/O group are allowed to interrupt the program being executed. However, if the II bit is a 1, the interrupts are inhibited from interrupting the program.

### EXTERNAL INTERRUPTS

A SIGMA 8 system can contain up to 14 groups of optional interrupt levels, with 16 levels in each group. As shown in Figure 6, the groups can be connected in any priority sequence.

All external interrupts can be inhibited or permitted by means of bit position 39 (EI) of the program status doubleword. If EI is a 0, external interrupts are allowed to interrupt the program. However, if EI is a 1, all external interrupts are inhibited from interrupting the program.

### STATES OF AN INTERRUPT LEVEL

A SIGMA 8 interrupt level is mechanized by means of three flip-flops. Two of the flip-flops are used to define any of four mutually exclusive states: disarmed, armed, waiting, and active. The third flip-flop is used as a level-enable.

The various states and the conditions causing them to change state are described in the following paragraphs. A conceptual diagram of the operational states of the interrupt system is shown in Figure 7.

#### DISARMED

When an interrupt level is in the disarmed state, no signal to that interrupt level is admitted, no "record" is retained of the existence of the signal, nor is any program interrupt caused by it at any time.

#### ARMED

When an interrupt level is in the armed state, it can accept and remember an interrupt signal. The receipt of such a signal advances the interrupt level to the waiting state. (If the level is already in a waiting or active state, as a result of a previous interrupt signal, the second interrupt signal has no effect.)

#### WAITING

When an interrupt level in the armed state receives an interrupt signal, it advances to the waiting state, and remains in the waiting state until it is allowed to advance to the active state. If the level-enable flip-flop is off, the interrupt level can undergo all state changes except that of moving from the waiting to the active state. Furthermore, if this flip-flop is off, the interrupt level is completely removed from the chain that determines the priority of access to the CPU. Thus, an interrupt level in the waiting state

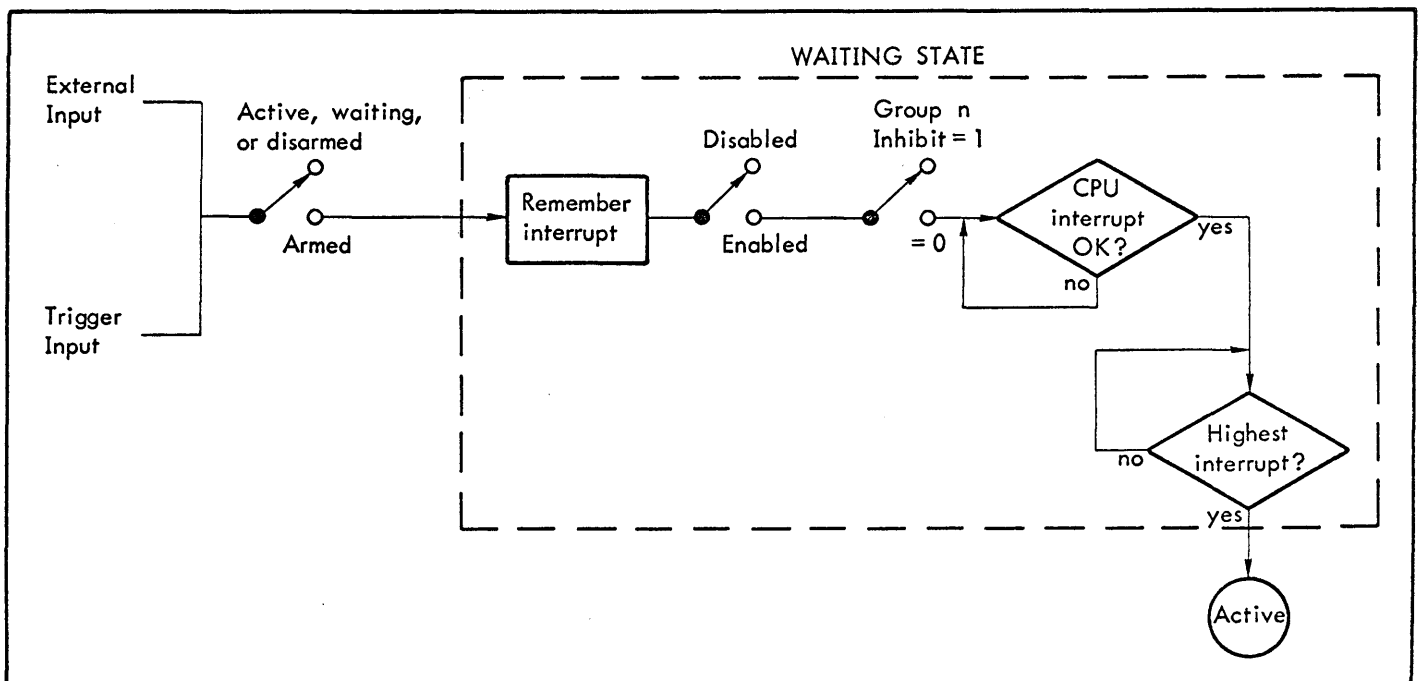

Figure 7. Operational States of an Interrupt Level

with its level-enable in the off condition does not prevent an enabled, waiting interrupt of lower priority from moving to the active state. (Additional interrupt signals received by an interrupt level in the waiting state are ignored.)

When an interrupt level is in the waiting state, the following conditions must all exist simultaneously before the level advances to the active state.

1. The level must be enabled (i. e., its level-enable flip-flop must be set to 1).
2. The group inhibit (CI, II, or EI, if applicable) must be a 0.
3. No higher-priority interrupt level is in the active state or is in the waiting state and totally enabled (i. e., enabled and not inhibited).
4. The CPU must be at an interruptable point in the execution of a program.

## ACTIVE

When an interrupt meets all of the conditions necessary to permit it to move from the waiting state to the active state, it is permitted to do so by being acknowledged by the computer, which then executes the contents of the assigned interrupt location as the next instruction. The instruction address portion of the program status doubleword remains unchanged until the instruction in the interrupt location is executed.

The instruction in the interrupt location must be one of the following: XPSD, MTB, MTH, or MTW. If the execution of any other instruction in an interrupt location is attempted as the result of an interrupt level advancing to the active state, an instruction exception trap occurs.

The use of the privileged instruction XPSD in an interrupt location permits an interrupt-servicing routine to save the entire current machine environment and establish a new environment. If working registers are needed by the routine and additional register blocks are available, the contents of the current register block can be saved automatically with no time loss. This is accomplished by changing the value of the register pointer, which results in the assignment of a new block of 16 registers to the routine.

An interrupt level remains in the active state until it is cleared (removed from the active state) by the execution of the LPSD instruction or the WD instruction. An interrupt-servicing routine can itself be interrupted (whenever a higher priority interrupt level meets all of the conditions for becoming active) and then continued (after the higher priority interrupt is cleared). However, an interrupt-servicing routine cannot be interrupted by a lower priority interrupt as long as the higher priority interrupt level remains in the active state. Any signals received by an interrupt level in the active state are ignored. Normally, the interrupt-servicing routine clears its interrupt level and transfers program control back to the point of interrupt by

means of an LPSD instruction with the same effective address as the XPSD instruction in the interrupt location.

## CONTROL OF THE INTERRUPT SYSTEM

The SIGMA 8 system has two points of interrupt control. One point of interrupt control is at the individual interrupt level. The WD instruction can be used to individually arm, disarm, enable, disable, or trigger any interrupt level except for the power fail-safe interrupts (which are always armed, always enabled, and cannot be triggered).

The second point of interrupt control is achieved by means of the interrupt inhibits (CI, II, and EI) in the program status doubleword. If an interrupt inhibit is set to 1, all interrupt levels in the corresponding group are effectively disabled, i. e., no interrupt in the group may advance from the waiting state to the active state and the group is removed from the interrupt recognition priority chain. Thus, a waiting, enabled interrupt level (in a group that is not inhibited) is not prevented from interrupting the program by a higher priority, waiting, enabled interrupt level in a group that is inhibited. However, if an interrupt group is inhibited while a level in that group is in the active state, no lower priority interrupt level may advance to the active state.

The RD instruction may be used to determine which interrupt levels in a selected group are in the armed or waiting state, in the waiting or active state, or enabled. Chapter 3 contains a description of the RD instruction.

## TIME OF INTERRUPT OCCURRENCES

The SIGMA 8 CPU permits an interrupt to occur during the following time intervals (related to the execution cycle of an instruction) provided that the control panel COMPUTE switch is in the RUN position and no "halt" condition exists:

1. Between instructions: an interrupt is permitted between the completion of any instruction and the initiation of the next instruction.
2. Between instruction iterations: an interrupt is also permitted to occur during the execution of the following multiple-operand instructions:

Move Byte String (MBS)

Compare Byte String (CBS)

Translate Byte String (TBS)

Translate and Test Byte String (TTBS)

Move to Memory Control (MMC)

The control and intermediate results of these instructions reside in registers and memory; thus, the instruction can be interrupted between the completion of one iteration (operand execution cycle) and the point in time (during the next

iteration) when a memory location register is modified. If an interrupt occurs during this time, the current iteration is aborted and the instruction address portion of the program status doubleword remains pointing to the interrupted instruction. After the interrupt-servicing routine is completed, the instruction continues from the point at which it was interrupted and does not begin anew.

## SINGLE-INSTRUCTION INTERRUPTS

A single-instruction interrupt occurs in a situation where an interrupt level is activated, the current program is interrupted, the single instruction in the interrupt location is executed, the interrupt level is automatically cleared and armed, and the interrupted program continues without being disturbed or delayed (except for the time required for the single instruction).

If any of the following instructions is executed in any interrupt location, then that interrupt automatically becomes a single-instruction interrupt:

Modify and Test Byte (MTB)

Modify and Test Halfword (MTH)

Modify and Test Word (MTW)

A modify and test instruction modifies the effective byte, halfword, or word (as described in the section "Fixed-point Arithmetic Instructions") but the current condition code remains unchanged (even if overflow occurs). The execution of a modify and test instruction in an interrupt location, is independent of the write-protection locks; thus, a memory protection violation trap cannot occur (a nonexistent memory address will cause an unpredictable operation). Also the fixed-point overflow trap cannot occur as the result of overflow caused by executing MTH or MTW in an interrupt location.

The execution of a modify and test instruction in an interrupt location automatically clears and arms the corresponding interrupt level, allowing the interrupted program to continue.

When a modify and test instruction is executed in a count-pulse interrupt location, all of the above conditions apply, in addition to the following: if the resultant value in the effective location is zero, the corresponding counter-equals-zero interrupt is triggered.

## TRAP SYSTEM

### TRAP

A trap is similar to an interrupt in that program execution automatically branches to a predesignated location when a trap condition occurs. A trap differs from an interrupt in that a trap location must contain an XPSD instruction. Depending on the type of trap, the trap instruction is either executed immediately (i.e., current instruction is aborted) or upon completion of the current instruction.

The trap instruction is not held in abeyance by higher priority traps. Interrupts on the other hand may have an entire sequence of instructions executed before actual interrupt action occurs.

## TRAP ENTRY SEQUENCE

A trap entry sequence begins when the CPU detects the trap condition and ends when the new PSD has successfully replaced the old PSD. Detection of any condition listed in Table 3, which summarizes the trap system, results in a trap to a unique location in memory. When a trap condition occurs, the CPU sets the trap state. The operation currently being performed by the CPU may or may not be carried to completion, depending on the type of trap. In any event, the instruction is terminated with a trap sequence. In this sequence, the program counter is not advanced; instead, the XPSD instruction in the location associated with the trap is executed. If any interrupt level is ready to enter the active state at the same time that an XPSD trap instruction is in process, the interrupt acknowledgment will not occur until the XPSD trap instruction is completed. If the trap location does not contain an XPSD instruction, a second trap sequence is immediately invoked. (See "Instruction Exception Trap".) The operation of the XPSD instruction is described in Chapter 3, under "Control Instructions".

## TRAP MASKS

The programmer may mask the four trap conditions described below. Other traps can not be masked.

1. The push-down stack limit trap is masked within the stack pointer doubleword for each individual stack.
2. The fixed-point overflow trap is masked in bit position 11 (AM) of the PSD. If bit position 11 (AM) of the PSD contains a 1, the trap is allowed to occur. If bit position 11 contains a 0, the trap is not allowed to occur. AM can be masked by operator intervention or by execution of either of the privileged instructions XPSD or LPSD.
3. The floating-point significance check trap is masked by a combination of the floating significance (FS), floating zero (FZ), and floating normalize (FN) mode control bits (see "Floating-Point Arithmetic Fault Trap"). FS, FZ, and FN can be set or cleared by the execution of any of the following instructions:

LOAD CONDITIONS AND FLOATING CONTROL (LCF)

LOAD CONDITIONS AND FLOATING CONTROL IMMEDIATE (LCFI)

EXCHANGE PROGRAM STATUS DOUBLEWORD (XPSD)

LOAD PROGRAM STATUS DOUBLEWORD (LPSD)

Table 3. Summary of SIGMA 8 Trap Locations

Location		Function	PSD Mask Bit	Time of Occurrence	Trap Condition Code
Dec.	Hex.				
64	40	Nonallowed operation			
		1. Nonexistent instruction	None	At instruction decode.	Set TCC1
		2. Nonexistent memory address	None	Prior to memory access.	Set TCC2
		3. Privileged instruction in slave mode	None	At instruction decode.	Set TCC3
		4. Memory protection violation	None	Prior to memory access.	Set TCC4
65	41	Unimplemented instruction	None	At instruction decode.	None
66	42	Push-down stack limit reached	TW TS	At the time of stack limit detection. (The aborted push-down instruction does not change memory, registers, or the condition code.)	None
67	43	Fixed-point arithmetic overflow	AM	For all instructions except DW and DH, trap occurs after completion of instruction. For DW and DH, instruction is aborted with memory, registers, CC1, CC3, and CC4 unchanged.	None
68	44	Floating-point arithmetic fault		At detection.	
		1. Characteristic overflow	None	{ (The floating-point instruction is aborted without changing any registers. The condition code is set to indicate the reason for the trap.)	None
		2. Divide by zero	None		None
3. Significance check	FS, FZ, FN	None			
69	45	Reserved			
70	46	Watchdog Timer Runout	None	At runout. (The Processor Detected Fault or PDF flag will be set.)	Set TCC1 if instruction successfully completed. Set TCC2 if processor bus hang-up. Set TCC3 if memory bus hang-up. Set TCC4 if DIO bus hang-up.



that are indirectly addressed (1 in bit position of instruction).

If a nonexistent instruction is detected, the computer traps to Homespace location X'40' at the time the nonexistent instruction is decoded. No general registers or memory locations are changed, and the PSD points to the instruction trapped. The operation of the XPSD in Homespace trap location X'40' (with respect to the condition code and instruction address portions of the PSD) is as follows:

1. Store the current PSD. The condition codes stored are those that existed at the end of the last instruction prior to the nonexistent instruction.
2. Load the new PSD. The current PSD is replaced by the contents of the doubleword location following the doubleword location in which the current PSD was stored.
3. Modify the new PSD.
  - a. Set CC1 to 1. The other condition code bits remain unchanged from the values loaded from memory.
  - b. If bit position 9 of XPSD contains a 1, the program counter is incremented by 8. If bit position 9 of XPSD contains a 0, the program counter remains unchanged from the value loaded from memory.

#### NONEXISTENT MEMORY ADDRESS

Any attempt to access a nonexistent memory address causes a trap to Homespace location X'40' at the time of the request for memory service. A nonexistent memory address condition is detected when an actual address is presented to the memory system. (Refer to Table 5 for possible changes to registers and memory locations.) The operation of the XPSD in Homespace trap location X'40' is as follows:

1. Store the current PSD.
2. Load the new PSD.
3. Modify the new PSD.
  - a. Set CC2 to 1. The other condition code bits remain unchanged from the values loaded from memory.
  - b. If bit position 9 of XPSD contains a 1, the program counter is incremented by 4. If bit position 9 of XPSD contains a 0, the program counter remains unchanged from the value loaded from memory.

#### PRIVILEGED INSTRUCTION IN SLAVE MODE

An attempt to execute a privileged instruction while the CPU is in the slave mode causes a trap to Homespace

location X'40' before the privileged operation is performed. No general registers or memory locations are changed, and the PSD points to the instruction trapped. The operation of the XPSD in Homespace trap location X'40' is as follows:

1. Store the current PSD.
2. Load the new PSD.
3. Modify the new PSD.
  - a. Set CC3 to 1. The other condition code bits remain unchanged from the values loaded from memory.
  - b. If bit position 9 of XPSD contains a 1, the program counter is incremented by 2. If bit position 9 of XPSD contains a 0, the program counter remains unchanged from the values loaded from memory.

The operation codes 0C and 0D, and their indirectly addressed forms, 8C and 8D, are both nonexistent and privileged. If any one of these operation codes is used while the CPU is in the slave mode, both CC1 and CC3 are set to 1's after the current PSD is modified, and if bit position 9 of XPSD contains a 1, the program counter is incremented by 10. All other nonexistent operation codes are treated as nonprivileged and, if used, will trap with CC1 set to 1.

#### MEMORY PROTECTION VIOLATION

A memory protection violation occurs because of a memory write-lock violation (by any program) within the 128K words of memory. When memory protection violation occurs, the CPU aborts execution of the current instruction without changing protected memory and traps to Homespace location X'40'. (Refer to Table 5 for possible changes to registers and memory locations.) The operation of the XPSD in Homespace trap location X'40' is as follows:

1. Store the current PSD.
2. Load the new PSD.
3. Modify the new PSD.
  - a. Set CC4 to 1. The other condition code bits remain unchanged from the values loaded from memory.
  - b. If bit position 9 of XPSD contains a 1, the program counter is incremented by 1. If bit position 9 of XPSD contains a 0, the program counter remains unchanged from the value loaded from memory.

An attempt to access a memory location that is both protected and nonexistent causes both CC2 and CC4 to be set to 1's after the current PSD has been modified, and if bit position 9 of XPSD contains a 1, the program counter is incremented by 5.

## UNIMPLEMENTED INSTRUCTION TRAP

The decimal instructions (available on other Sigma computers) are treated as unimplemented instructions to aid software simulation. The instructions are as follows:

<u>Instruction Name</u>	<u>Mnemonic</u>	<u>Operation Code</u>
Decimal Load	DL	X'7E'
Decimal Store	DST	X'7F'
Decimal Add	DA	X'79'
Decimal Subtract	DS	X'78'
Decimal Multiply	DM	X'7B'
Decimal Divide	DD	X'7A'
Decimal Compare	DC	X'7D'
Decimal Shift Arithmetic	DSA	X'7C'
Pack Decimal Digits	PACK	X'76'
Unpack Decimal Digits	UNPK	X'77'
Edit Byte String	EBS	X'63'

If an attempt is made to execute a decimal instruction (directly or indirectly addressed) the computer traps to Homespace location X'41', the unimplemented instruction trap. An indirectly addressed EBS instruction is always treated as a nonexistent instruction rather than as an unimplemented instruction.

The operation of the XPSD in trap Homespace location X'41' is as follows:

1. Store the current PSD. The condition code stored is that which existed at the end of the instruction immediately prior to the unimplemented instruction.
2. Load the new PSD. The condition code and the instruction address portions of the PSD remain at the values loaded from memory.

### PUSH-DOWN STACK LIMIT TRAP

Push-down stack overflow or underflow can occur during execution of any of the following instructions:

<u>Instruction</u>	<u>Mnemonic</u>	<u>Operation Code</u>
Push Word	PSW	X'09'
Pull Word	PLW	X'08'
Push Multiple	PSM	X'0B'

<u>Instruction</u>	<u>Mnemonic</u>	<u>Operation Code</u>
Pull Multiple	PLM	X'0A'
Modify Stack Pointer	MSP	X'13'

During the execution of any stack-manipulating instruction (see "Push-down Instructions"), the stack is either pushed (words added to stack) or pulled (words removed from stack). In either case, the space (S) and words (W) fields of the stack pointer doubleword are tested prior to moving any words. If execution of the instruction would cause the space (S) field to become less than 0 or greater than  $2^{15}-1$ , the instruction is aborted with memory and registers unchanged. If TS (bit 32) of the stack pointer doubleword is set to 0, the CPU traps to Homespace location X'42'. If TS is set to 1, the trap is inhibited and the CPU processes the next instruction. If execution of the instruction would cause the words (W) field to become less than 0 or greater than  $2^{15}-1$ , the instruction is aborted with memory and registers unchanged. If TW (bit 48) of the stack pointer doubleword is set to 0, the CPU traps to Homespace location X'42'. If TW is set to 1, the trap is inhibited and the CPU processes the next instruction. If trapping is inhibited, CC1 or CC3 is set to 1 to indicate the reason for aborting the instruction. The stack pointer doubleword, memory, and registers are modified only if the instruction is successfully executed.

If a push-down instruction traps, the execution of XPSD in Homespace trap location X'42' is as follows:

1. Store the current PSD. The condition codes that are stored are those that existed prior to execution of the aborted push-down instruction.
2. Load the new PSD. The condition code and instruction address portions of the PSD remain at the values loaded from memory.

### FIXED-POINT OVERFLOW TRAP

Overflow can occur for any of the following instructions:

<u>Instruction</u>	<u>Mnemonic</u>	<u>Operation Code</u>
Load Absolute Word	LAW	X'3B'
Load Absolute Doubleword	LAD	X'1B'
Load Complement Word	LCW	X'3A'
Load Complement Doubleword	LCD	X'1A'
Add Halfword	AH	X'50'
Subtract Halfword	SH	X'58'
Divide Halfword	DH	X'56'



<u>Instruction</u>	<u>Mnemonic</u>	<u>Operation Code</u>
Add Immediate	AI	X'20'
Add Word	AW	X'30'
Subtract Word	SW	X'38'
Divide Word	DW	X'36'
Add Doubleword	AD	X'10'
Subtract Doubleword	SD	X'18'
Modify and Test Halfword	MTH	X'53'
Modify and Test Word	MTW	X'33'
Add Word to Memory	AWM	X'66'

Except for the instructions DIVIDE HALFWORD (DH) and DIVIDE WORD (DW), the instruction execution is allowed to proceed to completion. CC2 is set to 1 and CC3 and CC4 represent the actual result (0, -, or +) after overflow.

If the fixed-point arithmetic trap mask (bit 11 of PSD) is a 1, the CPU traps to Homespace location X'43' instead of executing the next instruction in sequence.

For DW and DH, the instruction execution is aborted without changing any register, and CC2 is set to 1; but CC1, CC3, and CC4 remain unchanged from their values at the end of the instruction immediately prior to the DW or DH. If the fixed-point arithmetic trap mask is a 1, the CPU traps to location X'43' instead of executing the next instruction in sequence.

The execution of XPSD in Homespace trap location X'43' is as follows:

1. Store the current PSD. If the instruction trapped was any instruction other than DW or DH, the stored condition code is interpreted as follows:

<u>CC1<sup>†</sup></u>	<u>CC2</u>	<u>CC3</u>	<u>CC4</u>	<u>Meaning</u>
- <sup>††</sup>	1	0	0	Result after overflow is zero.
-	1	0	1	Result after overflow is negative.

<sup>†</sup>CC1 remains unchanged for instructions LCW, LAW, LCD, and LAD.

<sup>††</sup>A hyphen indicates that the condition code bits are not affected by the condition given under the "Meaning" heading.

<u>CC1<sup>†</sup></u>	<u>CC2</u>	<u>CC3</u>	<u>CC4</u>	<u>Meaning</u>
-	1	1	0	Result after overflow is positive.
0	-	-	-	No carry out of bit 0 of the adder (add and subtract instructions only).
1	-	-	-	Carry out of bit 0 of the adder (add and subtract instructions only).

If the instruction trapped was a DW or DH, the stored condition code is interpreted as follows:

<u>CC1</u>	<u>CC2</u>	<u>CC3</u>	<u>CC4</u>	<u>Meaning</u>
- <sup>††</sup>	1	-	-	Overflow

2. Load the new PSD. The condition code and instruction address portions of the PSD remain at the value loaded from memory.

## FLOATING-POINT ARITHMETIC FAULT TRAP

Floating-point fault detection is performed after the operation called for by the instruction code is performed, but before any results are loaded into the general registers. Thus, the floating-point operation that causes an arithmetic fault is not carried to completion in that the original contents of the general registers are unchanged.

Instead, the computer traps to Homespace location X'44' with the current condition code indicating the reason for the trap. A characteristic overflow or an attempt to divide by zero always results in a trap condition. A significance check or a characteristic underflow results in a trap condition only if the floating-point mode controls (FS, FZ, and FN) in the current program status doubleword are set to the appropriate state.

If a floating-point instruction traps, the execution of XPSD in Homespace trap location X'44' is as follows:

1. Store the current PSD. If division is attempted with a zero divisor or if characteristic overflow occurs, the stored condition code is interpreted as follows:

<u>CC1</u>	<u>CC2</u>	<u>CC3</u>	<u>CC4</u>	<u>Meaning</u>
0	1	0	0	Zero divisor.
0	1	0	1	Characteristic overflow, negative result.
0	1	1	0	Characteristic overflow, positive result.

If none of the above conditions occurred but characteristic underflow occurs with floating zero mode bit (FZ) = 1, the stored condition code is interpreted as follows:

CC1	CC2	CC3	CC4	Meaning
1	1	0	1	Characteristic underflow, negative result.
1	1	1	0	Characteristic underflow, positive result.

If none of the above conditions occurred but an addition or subtraction results in either a zero result (with FS = 1 and FN = 0), or a postnormalization shift of more than two hexadecimal places (with FS = 1 and FN = 0), the stored condition code is interpreted as follows:

CC1	CC2	CC3	CC4	Meaning
1	0	0	0	Zero result of addition or subtraction.
1	0	0	1	More than two post-normalizing shifts, negative result.
1	0	1	0	More than two post-normalizing shifts, positive result.

2. Load the new PSD. The condition code and instruction address portions of the PSD remain at the values loaded from memory.

### CALL INSTRUCTION TRAP

The four CALL instructions (CAL1, CAL2, CAL3, and CAL4) cause the computer to trap to Homespace location X'48' (for CAL1), X'49' (for CAL2), X'4A' (for CAL3), or X'4B' (for CAL4). Execution of XPSD in the trap location is as follows:

1. Store the current PSD. The stored condition code bits are those that existed prior to the CALL instruction.
2. Load the new PSD.
3. Modify the new PSD.
  - a. The R Field of the CALL instruction is logically ORed with the condition code register as loaded from memory.
  - b. If bit 9 of XPSD contains a 1, the R field of the CALL instruction is added to the program counter. If bit 9 of XPSD contains a 0, the program counter remains unchanged from the value loaded from memory.

**Note:** Return from a CALL trap will be to the trapping instruction + 1.

## PROCESSOR DETECTED FAULTS

The Processor Detected Fault (PDF) flag is hardware flag used in the SIGMA 8 system to aid in solving the multiple error problem. Most traps occur because of some dynamic programming consideration (i.e., overflow, attempted division by zero, incorrect use of an instruction or address, etc.) and recovery is easily handled by another software subroutine. However, with certain classes of errors, if a second error occurs while the computer is attempting to recover from the first error, unpredictable results occur. Included in this class of traps is the parity error trap, some cases of the instruction exception trap, and the watchdog timer runout trap. Upon the first occurrence of this type of trap, the PDF flag is set.

When the PDF flag is set, the processor fault interrupt, the memory fault interrupt, and count pulse interrupts are automatically inhibited. The other interrupts, with the exception of power fail-safe, may or may not be inhibited as specified by the PSD, which is loaded when the trap entry XPSD is executed. The PDF flag is normally reset by the last instruction of a trap routine, which is an LPSD instruction having bit 10 equal to 0 and bit 11 equal to 1.

If a second PDF is detected before the PDF flag is reset, the CPU becomes "hung-up" until the PDF flag is reset either by the operator pressing the CPU RESET or the SYS RESET switches on the processor control panel; or, in a multiprocessor system, by another CPU executing an RIO instruction.

The reset (RIO) function on a processor bus addressing a CPU will cause a reset of that CPU. If the CPU is "hung-up", this reset will cause the following actions:

1. The processor fault status register is cleared.
2. The PDF flag is cleared and the processor fault interrupt generated flag is cleared.
3. The PSD is cleared to zero except that the instruction address is set to Homespace location X'26'. This is the same condition for the PSD that results from pressing the SYS RESET switch on the processor control panel.
4. The CPU will begin execution with the instruction contained in Homespace location X'26'.

### WATCHDOG TIMER RUNOUT TRAP

The watchdog timer is a two-phase timer that monitors and controls the maximum amount of CPU time each instruction can take. The timer is normally in operation at all times and is initialized at the beginning of each instruction. If the instruction is completed before the end of phase 1, the timer is reset. If the instruction is completed after phase 1 but before the end of phase 2, a trap to Homespace location X'46' occurs immediately after the instruction is completed, and TCC1 is set to indicate successful completion of the instruction. Additional information as to probable cause of delay is provided: TCC2 is set if the CPU was

using the processor bus, TCC3 is set if the CPU was using the memory bus, or TCC4 is set if the CPU was using the DIO bus. If the instruction is not completed by the time the watchdog timer has advanced through phase 2, the instruction is aborted, TCC1 is set to 0, and a trap occurs immediately to Homespace location X'46'. In addition, TCC2, TCC3, or TCC4 will be set as described above. The register altered flag of the PSD is also set if any register or main memory location had been changed when the trap occurred.

A watchdog timer runout is considered a CPU fault and the PDF is set.

## INSTRUCTION EXCEPTION TRAP

The instruction exception trap occurs whenever the CPU detects a set of operations that are called for in an instruction but can not be executed because of either a hardware restriction or a previous event.

The different conditions that cause the instruction exception trap are:

1. A processor-detected fault that occurs during the execution of an interrupt or trap entry sequence. An interrupt or trap entry sequence is defined as the sequence of events that consists of: (a) initiating on interrupt or trap; (b) accessing the instruction in the interrupt or trap location; and (c) executing that instruction, including the exchange of the PSD, if required. Note that instructions executed as a result of the interrupt or trap other than the instruction located at the interrupt or trap location are not considered part of the entry sequence.
2. An illegal instruction is found in the trap (not XPSD) or interrupt (not XPSD, MTB, MTH, MTW) location when executing a trap or interrupt sequence.
3. The register pointer (bits 56-59) of the PSD is set to a nonexistent register block as a result of an LRP, LPSD, or XPSD.
4. Bit positions 12-14 of the MOVE TO MEMORY CONTROL (MMC) instruction are interpreted as an illegal configuration. That is, any configuration other than 001.
5. The set of operations, primarily doubleword and byte string instructions, that yield an unpredictable result when an incorrect register is specified; this type of fault is called "invalid register designation" and includes the following instructions:<sup>†</sup>

### Odd Register Specified

Add Doubleword (AD)

Subtract Doubleword (SD)

### Odd Register Specified (cont.)

Floating Add Long (FAL)

Floating Subtract Long (FSL)

Floating Multiply Long (FML)

Floating Divide Long (FDL)

Translate Byte String (TBS)

Translate and Test Byte String (TTBS)

Move to Memory Control (MMC)

Trap Condition Code. The Trap Condition Code (TCC) differentiates between the different fault types. Some of the fault conditions (as listed in Table 4) may occur and/or be detected during a trap or interrupt entry sequence. In this case, the trapped status field, bits 48-55 of the PSD, is set to equal the least significant eight bits of the address of the trap or interrupt instruction in which the trap occurred; that is, the trapped status field will point to the trap or interrupt location that was in effect when the fault occurred. In the event that the fault occurs in a normal program instruction, the trapped status field has no meaning.

Table 4 shows the settings of the TCC and trapped status field for the various fault types.

Table 4. TCC Setting for Instruction Exception Trap X'4D'

Fault Type	TCC 1 2 3 4	Trapped Status Field (PSD bits 48-55)
XPSD in trap or interrupt location tries to set register pointer to nonexistent register block.	1 0 0 0	8 least significant bits of trap or interrupt address.
XPSD, LPSD, or LRP not in a trap or interrupt sequence tries to set register pointer to nonexistent register block.	0 0 0 0	No meaning.
Trap or interrupt sequence and processor detected fault.	1 1 1 1	8 least significant bits of trap or interrupt address.
Trap or interrupt sequence with invalid instruction.	1 1 0 0	8 least significant bits of trap or interrupt address.
MMC configuration invalid.	0 0 1 0	No meaning.
Invalid register designation.	0 0 0 1	No meaning.

<sup>†</sup>"Invalid register designation" faults do not set the PDF flag.

## PARITY ERROR TRAP

Two types of parity errors may be detected in the addressing and memory logic.

1. Data Bus Check. If the CPU detects a parity error on data received from memory and the memory does not also indicate a parity error on the information sent, a data bus check occurs. The data bus check causes the CPU to trap to Homespace location X'4C', and sets TCC3 to 1.
2. Memory Parity Error. When a CPU receives a signal from the memory indicating memory parity error, this fault occurs. The CPU traps to Homespace location X'4C'. In addition, on a memory-detected parity error trap, the memory bank will "snapshot" the address causing the trap.

The memory parity error signal is generated:

1. When the memory is performing a read operation and a parity error is detected in the data as read from the memory elements.
2. When the memory is performing a partial write operation and a parity error is detected when reading the word to be changed. This is done before the new information is inserted and the data restored to memory.
3. When a parity error is detected in the memory on an address received on the memory bus. If the address bus check occurs on a write request, the memory is not accessed. On a read request, dummy data with incorrect parity is sent to the processor.
4. When a parity error is detected on data received by the memory from the memory bus.
5. If the memory has a port selection error in attempting to establish priority for requests received on two or more ports. The memory parity error signal is generated on the busses from all ports affected by the selection error.
6. If the LOAD MEMORY STATUS instruction is used and the condition code that is set prior to execution of the instruction is reserved (i.e., not implemented in the memory logic), the memory will interpret it as a read-type instruction, send back a parity error signal and all zeros on the data bus, and "snapshot" the address in the Memory Status Register.

Any of these six conditions will also cause a Memory Fault Interrupt to occur.

## TRAP CONDITIONS DURING "ANTICIPATE" OPERATIONS

During the time that the SIGMA 8 is executing a current instruction, it is also performing operations in anticipation of the next instruction, as specified by the instruction

address. These operations (accessing the next instruction, the associated operand, and/or indirect address, etc.) may encounter trapping conditions. Whether a corresponding trap will occur is contingent on the current instruction. Traps due to the current instruction and traps due to branch operations will inhibit traps due to operations performed in anticipation of the next instruction.

If the current instruction is a successful branch instruction, the instruction sequence is changed. Therefore, operations performed in anticipation of the next instruction are no longer valid, and any traps associated with these operations are disregarded.

If the current instruction encounters a trap, it takes precedence over the next instruction and any anticipated trap. At the end of the trap routine these operations will be reperformed and the proper trap action will occur at this time.

At the end of the execution of current (nonbranching) instructions, trap conditions detected during "anticipate" operations have priority over an interrupt. These trap conditions include nonexistent memory, access protection violation, nonexistent instruction, privileged instruction in slave mode, and parity error.

## REGISTER ALTERED BIT

Complete recoverability after a trap may require that no main memory location, no fast memory register, and no part (or flags) of the PSD be changed when the trap occurs. If any of these registers or flags are changed, the Register Altered bit (60) of the old PSD is set to 1 and is saved by the trap XPSD.

Changes to CC1-4 cause the Register Altered bit to be set only if the instruction requires these condition code bits as subsequent inputs.

Traps caused by conditions detected during operand fetch and store memory cycles, such as nonexistent memory, access protection violation, and memory parity error may or may not leave registers, memory, and PSD unchanged, depending on when they occur during instruction execution. Generally, these traps are recoverable. This is done by checking for protection violations and nonexistent memory at the beginning of execution in case of a multiple operand access instruction, restoring the original register contents if execution cannot be completed because of a trap, and not loading the first half of the PSD until a possible trap condition due to access of the second half could have been detected. Table 5 contains a list of SIGMA 8 instructions and indicates for these instructions what registers, memory locations, and PSD bits, if any, have been changed when a trap due to an operand access memory cycle occurs.

Table 5. Register Changed at Time of a Trap Due to an Operand Access

Instructions	Changes
AI, CI, LCFI, LI, MI	Immediate type, no operand access.
CAL1-CAL4, SF, S, WAIT, RD, WD, RIO, POLR, POLP, DSA	No operand access.
LRA	Has operand access but traps are suppressed; register bits and condition codes are set instead.
LB, LCF, LRP, CB LH, LAH, LCH, AH, SH, MH, DH, CH LW, LAW, LCW, AW, SW, MW, DW, CW LD, LAD, LCD, AD, SD, CD, CLM, CLR EOR, OR, AND, LS, INT, CS FAS, FSS, FMS, FDS, FAL, FSL, FML, FDL	No operand store, registers and PSD unchanged when trap due to operand fetch. CC1-4 may be changed but are not used as input to any of these instructions.
AWM, XW, STS, MTB, MTH, MTW STB, STCF, STH, STW, LAS	Registers and memory are preserved, condition codes may be changed but are not used as input to these instructions.
STD	If a trap occurs, the first word (odd address) may have been stored already. The Register Altered bit is set in this case.
EXU, BCR, BCS BAL, BDR, BIR	If the branch condition is true (always for EXU and BAL) and a trap occurs due to access of the indirect address or of the next (branched to or executed) instruction, the register used is left unchanged and the program address saved in the PSD is the address of the branch or execute instruction.
MBS, CBS, TBS, TTBS, MMC, LM, STM, PLM, PSM	These instructions check for <u>protection violations</u> and nonexistent memory at both ends of the data area at the beginning of execution (see individual instruction descriptions). If any traps occur during execution, e.g., because of parity errors, the instruction is aborted, indicating in the registers at which point. In general, memory will be altered and the Register Altered bit set.
CVA, CVS	If a trap occurs, the instruction will be aborted before altering registers. CC1-4 may be changed but not used as input to any of these instructions.
XPSD, LPSD	If a trap occurs due to storing the old PSD or fetching the new PSD, the instruction is aborted before changing the old PSD.
SIO, TIO, TDV, HIO, AIO	Protection violations are not possible during execution of these instructions; therefore, a trap will only occur due to a parity error when accessing the CPU/IOP communication locations (Homespace location X'20' or X'21'). If a parity error trap does not occur when accessing these locations (either by the CPU or IOP), the instruction will abort with CC3 set to 1. (See "Input/Output Instructions", Chapter 3.)

### 3. INSTRUCTION REPERTOIR

This chapter describes all SIGMA 8 instructions, grouped in the following functional classes:

1. Load and Store
2. Analyze and Interpret
3. Fixed-Point Arithmetic
4. Comparison
5. Logical
6. Shift
7. Conversion
8. Floating-Point Arithmetic
9. Byte String
10. Push Down
11. Execute and Branch
12. Call
13. Control
14. Input/Output

SIGMA 8 instructions are described in the following format:

MNEMONIC <sup>①</sup> INSTRUCTION NAME <sup>②</sup>  
 (Addressing Type <sup>③</sup>, Privileged <sup>④</sup>,  
 Interrupt Action <sup>⑤</sup>)

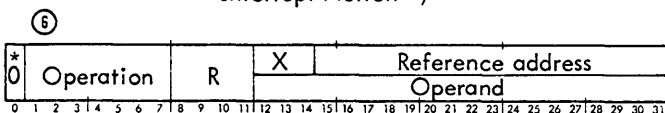

Description <sup>⑦</sup>

Affected <sup>⑧</sup>

Trap <sup>⑨</sup>

Symbolic Notation <sup>⑩</sup>

Condition Code Settings <sup>⑪</sup>

Trap Action <sup>⑫</sup>

Example <sup>⑬</sup>

1. MNEMONIC is the code used by the SIGMA 8 assemblers to produce the instruction's basic operation code.

2. INSTRUCTION NAME is the instruction's descriptive title.
3. The instruction's addressing type is one of the following:
  - a. Byte index alignment: the reference address field of the instruction (plus the displacement value) can be used to address a byte in main memory or in the current block of general registers.
  - b. Halfword index alignment: the reference address field of the instruction (plus the displacement value) can be used to address a halfword in main memory or in the current block of general registers.
  - c. Word index alignment: the reference address field of the instruction (plus the displacement value) can be used to address any word in main memory or in the current block of general registers.
  - d. Doubleword index alignment: the reference address field of the instruction (plus the displacement value) can be used to address any doubleword in main memory or in the current block of general registers. The addressed doubleword is automatically located within doubleword storage boundaries.
  - e. Immediate operand: the instruction word contains an operand value used as part of the instruction execution. If indirect addressing is attempted with this type of instruction (i.e., bit 0 of the instruction word is a 1), the instruction is treated as a nonexistent instruction, and the computer unconditionally aborts execution of the instruction (at the time of operation code decoding) and traps to Homespace location X'40', the "nonallowed operation" trap. Indexing does not apply to this type of instruction.
  - f. Immediate displacement: the instruction word contains an address displacement used as part of the instruction execution. If indirect addressing is attempted with this type of instruction, the computer treats the instruction as a nonexistent instruction, and the computer unconditionally aborts execution of the instruction (at the time of operation code decoding) and traps to Homespace location X'40'. Indexing does not apply to this type of instruction.
4. If the instruction is not executable while the computer is in the slave mode, it is labeled "privileged". If execution of a privileged instruction is attempted while the computer is in the slave mode, the computer unconditionally aborts execution of the instruction (at the time of operation code decoding) and traps to Homespace location X'40'.

5. If the instruction can be successfully resumed after its execution sequence has been interrupted by an interrupt acknowledgment, the instruction is labeled "continue after interrupt". In the case of the "continue after interrupt" instructions, certain general registers contain intermediate results or control information that allows the instruction to continue properly.

6. Instruction format:

- a. Indirect addressing – If bit position 0 of the instruction format contains an asterisk (\*), the instruction can use indirect addressing; however, if bit position 0 of the instruction format contains a 0, the instruction is of the immediate operand type, which is treated as a nonexistent instruction if indirect addressing is attempted (resulting in a trap to Homespace location X'40').
- b. Operation code – The operation code field (bit positions 1–7) of the instruction is shown in hexadecimal notation.
- c. R field – If the register address field (bit positions 8–11) of the instruction format contains the character "R", the instruction can specify any register in the current block of general registers as an operand source, result destination, or both; otherwise, the function of this field is determined by the instruction.
- d. X field – If the index register address field (bit positions 12–14) of the instruction format contains the character "X", the instruction specifies indexing with any one of registers 1 through 7 in the current block of general registers; otherwise, the function of this field is determined by the instruction.
- e. Reference address field – Normally, the address field (bit positions 15–31) of the instruction format is used as the reference address value (see Chapter 2). This reference address field is also used to address I/O systems (see I/O instructions later in this chapter and also Chapter 4). For immediate operand instructions, this field is augmented with the contents of the X field, as illustrated, to form a 20-bit operand.
- f. Value field – In some fixed-point arithmetic instructions, bit positions 12–31 of the instruction format contain the word "value". This field is treated as a 20-bit integer, with negative integers represented in two's complement form.
- g. Displacement field – In the byte string instructions, bit positions 12–31 of the instruction format contain the word "displacement". In the execution of the instruction, this field is used to modify the source address of an operand, the destination address of a result, or both.

h. Ignored field – In the instruction format diagrams, any area that is shaded represents a field or bit position that is ignored by the computer (i. e., the content of the shaded field or bit has no effect on instruction execution) but should be coded with 0's to preclude conflict with possible modifications.

In any format diagram of a general register or memory word modified by an instruction, a shaded area represents a field whose content is indeterminate after execution of the instruction.

- 7. The description of the instruction defines the operations performed by the computer in response to the instruction configuration depicted by the instruction format diagram. Any instruction configuration that causes an unpredictable result is so specified in the description.
- 8. All programmable registers and storage areas that can be affected by the instruction are listed (symbolically) after the word "Affected". The instruction address portion of the program status doubleword is considered to be affected only if a branch condition can occur as a result of the instruction execution, since the instruction address is updated (incremented by 1) as part of every instruction execution.
- 9. All trap conditions that may be invoked by the execution of the instruction are listed after the word "Trap". SIGMA 8 trap locations are summarized in the section "Trap System" in Chapter 2.
- 10. The symbolic notation presents the instruction operation as a series of generalized symbolic statements. The symbolic terms used in the notation are defined in Appendix D, "Glossary of Symbolic Terms".
- 11. Condition Code settings are given for each instruction that affects the condition code. A 0 or a 1 under any of columns 1, 2, 3, or 4 indicates that the instruction causes a 0 or 1 to be placed in CC1, CC2, CC3, or CC4, respectively, for the reasons given. If a hyphen (-) appears in columns 1, 2, 3, or 4, that portion of the condition code is not affected by the reason given for the condition code bit(s) containing a 0 or 1. For example, the following condition code settings are given for a comparison instruction:

1	2	3	4	Result of comparison
-	-	0	0	Equal.
-	-	0	1	Register operand is arithmetically less than effective operand.
-	-	1	0	Register operand is arithmetically greater than effective operand.
-	1	-	-	The logical product of the two operands is nonzero.
-	0	-	-	The logical product (AND) of the two operands is zero.

CC1 is unchanged by the instruction. CC2 indicates whether or not the two operands have 1's in corresponding bit positions, regardless of their arithmetic relationship. CC3 and CC4 are set according to the arithmetic relationship of the two operands, regardless of whether or not the two operands have 1's in corresponding bit positions. For example, if the register operand is arithmetically less than the effective operand and the two operands both have 1's in at least one corresponding bit position, the condition code setting for the comparison instruction is:

```

1 2 3 4
- 1 0 1

```

The above statements about the condition code are valid only if no trap occurs before the successful completion of the instruction execution cycle. If a trap does occur during the instruction execution, the condition code is normally reset to the value it contained before the instruction was started and the register altered bit (PSD 60) is set to 1 if a register has been altered. Then the appropriate trap location is activated.

12. Actions taken by the computer for those trap conditions that may be invoked by the execution of the instruction are described. The description includes the criteria for the trap condition, any controlling trap mask or inhibit bits, and the action taken by the computer. In order to avoid unnecessary repetition, the three trap conditions that apply to all instructions (i.e., non-allowed operations, parity error, and watchdog timer timeout) are not described for each instruction.
13. Some instruction descriptions provide one or more examples to illustrate the results of the instruction. These examples are intended only to show how the instructions operate, and not to demonstrate their full capability. Within the examples, hexadecimal notation is used to represent the contents of general registers and storage locations. Condition code settings are shown in binary notation. The character "x" is used to indicate irrelevant or ignored information.

## LOAD/STORE INSTRUCTIONS

The following load/store instructions are implemented in SIGMA 8 computers:

<u>Instruction Name</u>	<u>Mnemonic</u>
Load Immediate	LI
Load Byte	LB
Load Halfword	LH
Load Word	LW
Load Doubleword	LD

<u>Instruction Name</u>	<u>Mnemonic</u>
Load Complement Halfword	LCH
Load Absolute Halfword	LAH
Load Complement Word	LCW
Load Absolute Word	LAW
Load Complement Doubleword	LCD
Load Absolute Doubleword	LAD
Load Real Address	LRA
Load and Set	LAS
Load Memory Status	LMS
Load Selective	LS
Load Multiple	LM
Load Conditions and Floating Control Immediate	LCFI
Load Conditions and Floating Control	LCF
Exchange Word	XW
Store Byte	STB
Store Halfword	STH
Store Word	STW
Store Doubleword	STD
Store Selective	STS
Store Multiple	STM
Store Conditions and Floating Control	STCF

SIGMA 8 load and store instructions operate with information fields of byte, halfword, word, and doubleword lengths. Load instructions load the information indicated into one of the general registers in the current register block. Load instructions do not affect main memory storage; however, nearly all load instructions provide a condition code setting that indicates the following information about the contents of the affected general register(s) after the instruction is successfully completed:

Condition code settings:

<u>1</u>	<u>2</u>	<u>3</u>	<u>4</u>	<u>Result</u>
-	-	0	0	Zero — the result in the affected register(s) is all 0's.
-	-	0	1	Negative — register R contains a 1 in bit position 0.



1 2 3 4 Result

- - 1 0 Positive – register R contains a 0 in bit position 0, and at least one 1 appears in the remainder of the affected register(s) (or appeared during execution of the current instruction.)
- 0 - - No fixed-point overflow – the result in the affected register(s) is arithmetically correct.
- 1 - - Fixed-point overflow – the result in the affected register(s) is arithmetically incorrect.

Store instructions affect only that portion of memory storage that corresponds to the length of the information field specified by the operation code of the instruction; thus, register bytes are stored in memory byte locations, register halfwords in memory halfword locations, register words in memory word locations, and register doublewords in memory doubleword locations. Store instructions do not affect the contents of the general register specified by the R field of the instruction, unless the same register is also specified by the effective address of the instruction.

**LI** LOAD IMMEDIATE  
(Immediate operand)

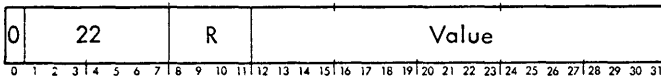

LOAD IMMEDIATE extends the sign of the value field (bit position 12 of the instruction word) 12 bit positions to the left and then loads the 32-bit result into register R.

Affected: (R), CC3, CC4  
(I)<sub>12-31SE</sub> → R

Condition code settings:

1 2 3 4 Result in R

- - 0 0 Zero
- - 0 1 Negative
- - 1 0 Positive

If LI is indirectly addressed, it is treated as a nonexistent instruction, in which case the computer unconditionally aborts execution of the instruction (at the time of operation code decoding) and traps to Homespace location X'40' with the contents of register R and the condition code unchanged.

**LB** LOAD BYTE  
(Byte index alignment)

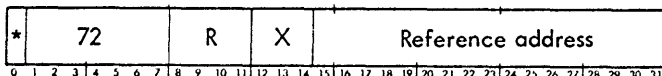

LOAD BYTE loads the effective byte into bit positions 24-31 of register R and clears bit positions 0-23 of the register to all 0's.

Affected: (R), CC3, CC4  
EB → R<sub>24-31</sub>; 0 → R<sub>0-23</sub>

Condition code settings:

1 2 3 4 Result in R

- - 0 0 Zero
- - 1 0 Nonzero

**LH** LOAD HALFWORD  
(Halfword index alignment)

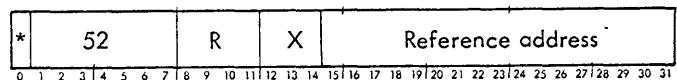

LOAD HALFWORD extends the sign of the effective halfword 16 bit positions to the left and then loads the 32-bit result into register R.

Affected: (R), CC3, CC4  
EH<sub>SE</sub> → R

Condition code settings:

1 2 3 4 Result in R

- - 0 0 Zero
- - 0 1 Negative
- - 1 0 Positive

**LW** LOAD WORD  
(Word index alignment)



LOAD WORD loads the effective word into register R.

Affected: (R), CC3, CC4  
EW → R

Condition code settings:

1 2 3 4 Result in R

- - 0 0 Zero
- - 0 1 Negative
- - 1 0 Positive

**LD** LOAD DOUBLEWORD  
(Doubleword index alignment)

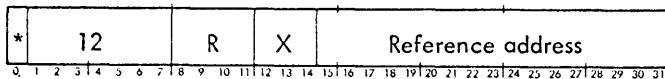

LOAD DOUBLEWORD loads the 32 low-order bits of the effective doubleword into register Ru1 and then loads the 32 high-order bits of the effective doubleword into register R.

If R is an odd value, the result in register R is the 32 high-order bits of the effective doubleword. The condition code settings are based on the effective doubleword, rather than the final result in register R (see example 3, below).

Affected: (R), (Ru1), CC3, CC4  
 $ED_{32-63} \rightarrow Ru1$ ;  $ED_{0-31} \rightarrow R$

Condition code settings:

1 2 3 4 Effective doubleword

- - 0 0 Zero
- - 0 1 Negative
- - 1 0 Positive

Example 1, even R field value:

	<u>Before execution</u>	<u>After execution</u>
ED	= X'0123456789ABCDEF'	X'0123456789ABCDEF'
(R)	= xxxxxxxx	X'01234567'
(Ru1)	= xxxxxxxx	X'89ABCDEF'
CC	= xxxx	xx10

Example 2, odd R field value:

	<u>Before execution</u>	<u>After execution</u>
ED	= X'0123456789ABCDEF'	X'0123456789ABCDEF'
(R)	= xxxxxxxx	X'01234567'
CC	= xxxx	xx10

Example 3, odd R field value:

	<u>Before execution</u>	<u>After execution</u>
ED	= X'0000000012345678'	X'0000000012345678'
(R)	= xxxxxxxx	X'00000000'
CC	= xxxx	xx10

**LCH** LOAD COMPLEMENT HALFWORD  
(Halfword index alignment)

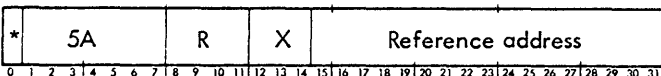

LOAD COMPLEMENT HALFWORD extends the sign of the effective halfword 16 bit positions to the left and then loads the 32-bit two's complement of the result into register R. (Overflow cannot occur.)

Affected: (R), CC3, CC4  
 $-[EH_{SE}] \rightarrow R$

Condition code settings:

1 2 3 4 Result in R

- - 0 0 Zero
- - 0 1 Negative
- - 1 0 Positive

**LAH** LOAD ABSOLUTE HALFWORD  
(Halfword index alignment)

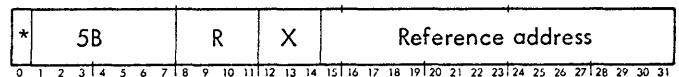

If the effective halfword is positive, LOAD ABSOLUTE HALFWORD extends the sign of the effective halfword 16 bit positions to the left and then loads the 32-bit result in register R. If the effective halfword is negative, LAH extends the sign of the effective halfword 16 bit positions to the left and then loads the 32-bit two's complement of the result into register R. (Overflow cannot occur.)

Affected: (R), CC3, CC4  
 $|EH_{SE}| \rightarrow R$

Condition code settings:

1 2 3 4 Result in R

- - 0 0 Zero
- - 1 0 Nonzero

**LCW** LOAD COMPLEMENT WORD  
(Word index alignment)

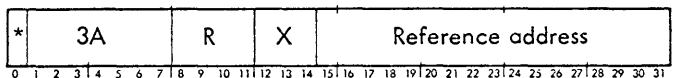

LOAD COMPLEMENT WORD loads the 32-bit two's complement of the effective word into register R. Fixed-point overflow occurs if the effective word is  $-2^{31}$  (X'80000000'), in which case the result in register R is  $-2^{31}$  and CC2 is set to 1; otherwise, CC2 is reset to 0.

Affected: (R), CC2, CC3, CC4 Trap: Fixed-point overflow.  
 $-EW \rightarrow R$

Condition code settings:

1	2	3	4	Result in R
-	0	0	0	Zero
-	-	0	1	Negative
-	0	1	0	Positive
-	0	-	-	No fixed-point overflow
-	1	0	1	Fixed-point overflow

If CC2 is set to 1 and the fixed-point arithmetic trap mask (AM) is a 1, the computer traps to Homespace location X'43' after execution of LOAD COMPLEMENT WORD; otherwise, the computer executes the next instruction in sequence.

**LAW** LOAD ABSOLUTE WORD  
(Word index alignment)

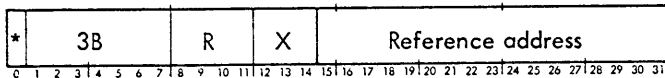

If the effective word is positive, LOAD ABSOLUTE WORD loads the effective word into register R. If the effective word is negative, LAW loads the 32-bit two's complement of the effective word into register R. Fixed-point overflow occurs if the effective word is  $-2^{31}$  (X'80000000'), in which case the result in register R is  $-2^{31}$  and CC2 is set to 1; otherwise, CC2 is reset to 0.

Affected: (R), CC2, CC3, CC4 Trap: Fixed-point overflow  
|EW| → R

Condition code settings:

1	2	3	4	Result in R
-	0	0	0	Zero
-	-	1	0	Nonzero
-	0	-	-	No fixed-point overflow
-	1	0	1	Fixed-point overflow (sign bit on)

If CC2 is set to 1 and the fixed-point arithmetic trap mask (AM) is a 1, the computer traps to Homespace location X'43' after execution of LOAD ABSOLUTE WORD; otherwise, the computer executes the next instruction in sequence.

**LCD** LOAD COMPLEMENT DOUBLEWORD  
(Doubleword index alignment)



LOAD COMPLEMENT DOUBLEWORD forms the 64-bit two's complement of the effective doubleword, loads the

32 low-order bits of the result into register Ru1, and then loads the 32 high-order bits of the result into register R.

If R is an odd value, the result in register R is the 32 high-order bits of the two's complemented doubleword. The condition code settings are based on the two's complement of the effective doubleword, rather than the final result in register R.

Fixed-point overflow occurs if the effective doubleword is  $-2^{63}$  (X'8000000000000000'), in which case the result in registers R and Ru1 is  $-2^{63}$  and CC2 is set to 1; otherwise, CC2 is reset to 0.

Affected: (R), (Ru1), CC2, CC3, CC4 Trap: Fixed-point overflow

$[-ED]_{32-63} \rightarrow Ru1; [-ED]_{0-31} \rightarrow R$

Condition code settings:

1	2	3	4	Two's complement of effective doubleword
-	0	0	0	Zero
-	-	0	1	Negative
-	0	1	0	Positive
-	0	-	-	No fixed-point overflow
-	1	0	1	Fixed-point overflow

If CC2 is set to 1 and the fixed-point arithmetic trap mask (AM) is a 1, the computer traps to Homespace location X'43' after execution of LOAD COMPLEMENT DOUBLEWORD; otherwise, the computer executes the next instruction in sequence.

**Example 1, even R field value:**

	Before execution	After execution
ED	= X'0123456789ABCDEF'	X'0123456789ABCDEF'
(R)	= xxxxxxxx	X'FEDCBA98'
(Ru1)	= xxxxxxxx	X'76543211'
CC	= xxxx	x001

**Example 2, odd R field value:**

	Before execution	After execution
ED	= X'0123456789ABCDEF'	X'0123456789ABCDEF'
(R)	= xxxxxxxx	X'FEDCBA98'
CC	= xxxx	x001

**LAD** LOAD ABSOLUTE DOUBLEWORD  
(Doubleword index alignment)

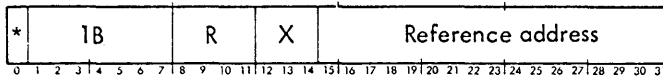

If the effective doubleword is positive, LOAD ABSOLUTE DOUBLEWORD loads the 32 low-order bits of the effective doubleword into register Ru1, and then loads the 32 high-order bits of the effective doubleword into register R. If R is an odd value, the result in register R is the 32 high-order bits of the effective doubleword. The condition code settings are based on the effective doubleword, rather than the final result in register R.

If the effective doubleword is negative, LAD forms the 64-bit two's complement of the effective doubleword, loads the 32 low-order bits of the two's complemented doubleword into register Ru1, and then loads the 32 high-order bits of the two's complemented doubleword into register R. If R is an odd value, the result in register R is the 32 high-order bits of the two's complemented doubleword. The condition code settings are based on the two's complement of the effective doubleword, rather than the final result in register R.

Fixed-point overflow occurs if the effective doubleword is  $-2^{63}$  (X'8000000000000000'), in which case the result in registers R and Ru1 is  $-2^{63}$  and CC2 is set to 1; otherwise, CC2 is reset to 0.

Affected: (R), (Ru1), CC2, CC3, CC4 Trap: Fixed-point overflow

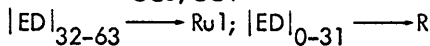

Condition code settings:

1 2 3 4 Absolute value of effective doubleword

- 0 0 0 Zero
- - 1 0 Nonzero
- 0 - - No fixed-point overflow
- 1 0 1 Fixed-point overflow (sign bit on)

If CC2 is set to 1 and the fixed-point arithmetic trap mask (AM) is a 1, the computer traps to HomeSpace location X'43' after execution of LOAD ABSOLUTE DOUBLEWORD; otherwise, the computer executes the next instruction in sequence.

Example 1, even R field value:

	<u>Before execution</u>	<u>After execution</u>
ED	= X'0123456789ABCDEF'	X'0123456789ABCDEF'
(R)	= xxxxxxxx	X'01234567'
(Ru1)	= xxxxxxxx	X'89ABCDEF'
CC	= xxxx	x010

Example 2, even R field value:

	<u>Before execution</u>	<u>After execution</u>
ED	= X'FEDCBA9876543210'	X'FEDCBA9876543210'
(R)	= xxxxxxxx	X'01234567'
(Ru1)	= xxxxxxxx	X'89ABCDF0'
CC	= xxxx	x010

Example 3, odd R field value:

	<u>Before execution</u>	<u>After execution</u>
ED	= X'0123456789ABCDEF'	X'0123456789ABCDEF'
(R)	= xxxxxxxx	X'01234567'
CC	= xxxx	x010

**LRA** LOAD REAL ADDRESS  
(Byte, halfword, word, or doubleword index alignment, privileged)

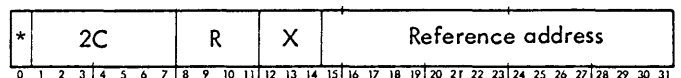

LOAD REAL ADDRESS loads register R with control information (i.e., state of the write locks) and the effective address of the byte, halfword, word, or doubleword pointed to by the reference address. The information loaded is determined by the setting of CC1 and CC2 at the beginning of instruction execution. Indexing displacement is also governed by CC1 and CC2. The desired value of the condition code can be set with LCF or LCFI.

<u>CC1</u>	<u>CC2</u>	<u>Displacement in index</u>
0	0	Byte
0	1	Halfword
1	0	Word
1	1	Doubleword

The resultant contents of register R are as follows:

<u>Bits</u>	<u>Contents</u>
0	Always zero.
1	Real Address Not Valid Flag (set if LRA indirectly addresses a nonexistent address, an address that has a parity error, or an address less than 16).

Bits      Contents

2,3      Write Lock Codes.

4-12      Reserved.

13-31      Effective Address (as determined by the setting of CC1 and CC2).

Affected: (R), CC3, CC4

CC3 is set to one if nonexistent memory is invoked; CC4 is set to one if Homespace bias is used in the resultant effective address.

When LRA is executed as the operand of an ANALYZE instruction, word addressing is assumed (word index alignment is performed).

**LAS**      LOAD AND SET  
(Word index alignment)

*	26	R	X	Reference address																											
0	1	2	3	4	5	6	7	8	9	10	11	12	13	14	15	16	17	18	19	20	21	22	23	24	25	26	27	28	29	30	31

LOAD AND SET loads the effective word into R and unconditionally sets bit 0 of the effective word location in memory to 1. Register R contains the previous contents of the effective word location (i.e., before being modified, if required). The effective address always references memory even if it is less than 16.

Affected: (R) CC3, CC4  
EW → R  
1 → EW<sub>0</sub>

Condition code settings:

1 2 3 4      Result in R

- - 0 0      Zero
- - 0 1      Negative
- - 1 0      Positive

Note: Write locks are used to protect memory during the execution of LAS. Traps are not inhibited during its execution.

**LMS**      LOAD MEMORY STATUS  
(Word index alignment, privileged)

*	2D	R	X	Reference address																											
0	1	2	3	4	5	6	7	8	9	10	11	12	13	14	15	16	17	18	19	20	21	22	23	24	25	26	27	28	29	30	31

LOAD MEMORY STATUS is used to determine memory bank status and/or to perform diagnostic action on a memory bank. The effective address is used to determine the memory bank. The condition code setting immediately before execution determines the diagnostic action to be performed. The effective address always references memory even if it is less than 16. The condition code can be set to the desired value before execution of LMS with the LCF or LCFI instructions. Register R is loaded with the result of the action.

Affected: (R)

Trap: See "Trap System", Chapter 2.

Condition code settings:

1 2 3 4      LMS Action

- 0 0 0 0      Load and set – causes the same action as the LOAD AND SET (LAS) instruction. Normal traps are allowed including write protect.
- 0 0 0 1      Read and inhibit parity – loads the effective word into R. If a memory parity error is detected, the memory does not take a "snapshot" or generate a Memory Fault Interrupt (MFI). It does, however, generate the Memory Parity Error signal. The CPU inhibits the trap that would ordinarily occur for the memory parity error.
- 0 0 1 0      Read and change parity – loads the effective word into R. The memory reads the location and unconditionally restores the word with the invalid parity bit. The parity bit transmitted to the processor is the original parity bit. Parity error traps and memory fault interrupts are not inhibited by this instruction.
- 0 0 1 1      Reserved.
- 0 1 0 0      Reserved.
- 0 1 0 1      Reserved.
- 0 1 1 0      Reserved.
- 0 1 1 1      Set memory status register – transfers the effective word from R to memory. The memory

1 2 3 4 LMS Action

bank will interpret the word and change its own timing as follows:

Word Bits      Interpretation

8 9 10 11

1 0 0 0    Set clock margin 0, early write half cycle.

0 1 0 0    Set clock margin 1, late write half cycle.

0 0 1 0    Set clock margin 2, early strobe.

0 0 0 1    Set clock margin 3, late strobe.

1 0 0 0    Read status word 0<sup>†</sup> – loads status word 0 into R (see Table 6).

1 0 0 1    Read status word 1<sup>†</sup> – loads status word 1 into R (see Table 7).

1 0 1 0    Read status word 2<sup>†</sup> – loads status word 2 into R (see Table 8).

1 1 0 0    Read status word 0 and clear all status bits.

1 1 0 1    Reserved.

1 1 1 0    Read status word 2<sup>†</sup> and clear all status bits.

1 1 1 1    Clear memory – clears the effective word. All traps are allowed including write protect violation.

The status of the word loaded (if any) is stored in the condition code bits at the conclusion of execution as follows:

CC1: Memory Parity Error (from memory)

CC2: Data Bus Check (from CPU)

CC3: Parity Bit (from memory)

CC4: 0

<sup>†</sup>Primarily of diagnostic concern.

Table 6. Status Word 0

Field	Bits	Comments
Memory fault types	0	Reserved.
	1	Data parity error detected on read.
	2	Data parity error detected on partial write.
	3	Address bus parity error.
	4	Data bus parity error on full or partial write.
	5	Loop check data parity error.
	6	Port selection error.
	7	Basic memory unit over-temperature or power supply failures.
	8-11	Reserved.
Subsequent faults	12	After a snapshot is taken, this bit is a 1 if two or more subsequent memory faults occur before status register is cleared.
Last parity bit written	13	When initial snapshot was taken, the value of the last parity bit written into main memory is stored in this position.
Bank number	14	Bit 14 is the most significant bit of bank number in the unit.
	15	Bit 15 is the least significant bit of bank number in the unit.
	16-19	Reserved.
Port number	20	} Group 1
	21	
	22	
	23	

Table 6. Status Word 0 (cont.)

Field	Bits	Comments
Port number (cont.)	24	Port 5
	25	Port 6
	26	Port 7
	27	Port 8
	28	Port 9
	29	Port 10
	30	Port 11
	31	Port 12
		<p>Group 2</p> <p>Group 3</p> <p><u>Note:</u> Ports are installed in groups as shown.</p>

Table 7. Status Word 1 (cont.)

Field	Bits	Comments
	8-13	Reserved
Clock margin	14	Clock margin 0, early write half cycle.
	15	Clock margin 1, late write half cycle.
	16	Clock margin 2, early strobe.
	17	Clock margin 3, late strobe.
	18-31	Reserved

Table 7. Status Word 1

Field	Bits	Comments	
Interleave mode	0,1	<u>0 1</u>	
		0 0	No interleave
		0 1	2-way interleave
		1 0	Interleave between two units (4-way)
		1 1	Reserved
Bank size	2,3	<u>2 3</u>	
		0 0	8K
		0 1	16K
		1 0	Reserved
		1 1	Reserved
Memory unit number	4-7	This field specifies the memory unit number, as follows: bit 4 is the most significant bit; bit 7 is the least significant bit.	

Table 8. Status Word 2

Field	Bits	Comments
	0-14	Reserved
Interleaved address of fault	15-31	

**LS** LOAD SELECTIVE  
(Word index alignment)

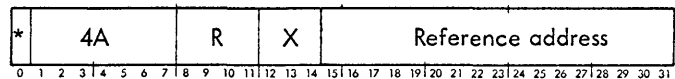

Register Ru1 contains a 32-bit mask. If R is an even value, LOAD SELECTIVE loads the effective word into register R in those bit positions selected by a 1 in corresponding bit positions of register Ru1. The contents of register R are not affected in those bit positions selected by a 0 in corresponding bit positions of register Ru1.

If R is an odd value, LS logic ANDs the contents of register R with the effective word and loads the result into register R. If corresponding bit positions of register R and the effective word both contain 1's, a 1 remains in register R; otherwise, a 0 is placed in the corresponding bit position of register R.

Affected: (R), CC3, CC4

If R is even,  $[EW_n(Ru1)]_u[(R)_n(\overline{Ru1})] \longrightarrow R$

If R is odd,  $EW_n(R) \longrightarrow R$

Condition code settings:

1	2	3	4	Result in R
-	-	0	0	Zero.
-	-	0	1	Bit 0 of register R is a 1.
-	-	1	0	Bit 0 of register R is a 0 and bit positions 1-31 of register R contain at least one 1.

Example 1, even R field value:

	Before execution	After execution
EW	= X'01234567'	X'01234567'
(Ru1)	= X'FF00FF00'	X'FF00FF00'
(R)	= xxxxxxxx	X'01xx45xx'
CC	= xxxx	xx10

Example 2, odd R field value:

	Before execution	After execution
EW	= X'89ABCDEF'	X'89ABCDEF'
(R)	= X'F0F0F0F0'	X'80A0C0E0'
CC	= xxxx	xx01

**LM** LOAD MULTIPLE  
(Word index alignment)



LOAD MULTIPLE loads a sequential set of words into a sequential set of registers, the set of words to be loaded begins with the word pointed to by the effective address of LM, and the set of registers begins with register R. The set of registers is treated modulo 16 (i. e., the next register loaded after register 15 is register 0 in the current register block).

The number of words to be loaded into the general registers is determined by the setting of the condition code

immediately before the execution of LM. (The desired value of the condition code can be set with LCF or LCFI.) An initial value of 0000 for the condition code causes 16 consecutive words to be loaded into the register block.

Affected: (R) to (R+CC-1)

$(EWL) \longrightarrow R; \dots (EWL+CC-1) \longrightarrow R+CC-1$

The LM instruction may cause a trap if the operation extends into a nonexistent memory region. It is detected before the actual operation begins and the trap occurs immediately.

**LCFI** LOAD CONDITIONS AND FLOATING CONTROL IMMEDIATE  
(Immediate operand)

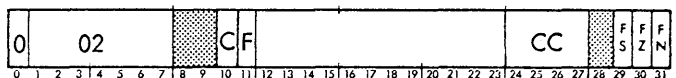

If bit position 10 of the instruction word contains a 1, LOAD CONDITIONS AND FLOATING CONTROL IMMEDIATE loads the contents of bit positions 24 through 27 of the instruction word into the condition code; however, if bit 10 is 0, the condition code is not affected.

If bit position 11 of the instruction word contains a 1, LCFI loads the contents of bit positions 29 through 31 of the instruction word into the floating significance (FS), floating zero (FZ), and floating normalize (FN) mode control bits, respectively (in the program status doubleword); however, if bit 11 is 0, the FS, FZ, and FN control bits are not affected. The functions of the floating-point control bits are described in the section "Floating-Point Arithmetic Instructions".

Affected: CC, FS, FZ, FN

If  $(I)_{10} = 1$ ,  $(I)_{24-27} \longrightarrow CC$

If  $(I)_{10} = 0$ , CC is not affected

If  $(I)_{11} = 1$ ,  $(I)_{29-31} \longrightarrow FS, FZ, FN$

If  $(I)_{11} = 0$ , FS, FZ, and FN not affected

Condition code settings, if  $(I)_{10} = 1$ :

1	2	3	4
$(I)_{24}$	$(I)_{25}$	$(I)_{26}$	$(I)_{27}$

If LCFI is indirectly addressed, it is treated as a nonexistent instruction, in which case the computer unconditionally aborts execution of the instruction (at the time of operation



code decoding) and traps to Homespace location X'40' with the condition code unchanged.

**LCF** LOAD CONDITIONS AND FLOATING CONTROL  
(Byte index alignment)

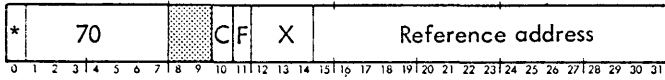

If bit position 10 of the instruction word contains a 1, LOAD CONDITIONS AND FLOATING CONTROL loads bits 0 through 3 of the effective byte into the location code; however, if bit 10 is 0, the condition code is not affected.

If bit position 11 of the instruction word contains a 1, LCF loads bits 5 through 7 of the effective byte into the floating significance (FS), floating zero (FZ), and floating normalize (FN) mode control bits, respectively; however, if bit 11 is 0, the FS, FZ, and FN control bits are not affected. The functions of the floating-point mode control bits are described in the section "Floating-Point Arithmetic Instructions".

Affected: CC, FS, FZ, FN

If  $(I)_{10} = 1$ ,  $EB_{0-3} \rightarrow CC$

If  $(I)_{10} = 0$ , CC not affected

If  $(I)_{11} = 1$ ,  $EB_{5-7} \rightarrow FS, FZ, FN$

If  $(I)_{11} = 0$ , FS, FZ, FN not affected

Condition code settings, if  $(I)_{10} = 1$ :

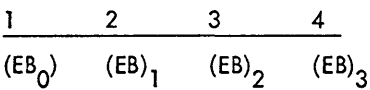

**XW** EXCHANGE WORD  
(Word index alignment)



EXCHANGE WORD exchanges the contents of register R with the contents of the effective word location.

Affected: (R), (EWL), CC3, CC4  
(R)  $\longleftrightarrow$  (EWL)

Condition code settings:

1 2 3 4 Result in R

- - 0 0 Zero

- - 0 1 Negative

- - 1 0 Positive

**STB** STORE BYTE  
(Byte index alignment)

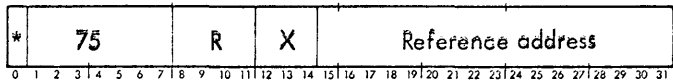

STORE BYTE stores the contents of bit positions 24-31 of register R into the effective byte location.

Affected: (EBL)  
(R)<sub>24-31</sub>  $\rightarrow$  EBL

**STH** STORE HALFWORD  
(Halfword index alignment)



STORE HALFWORD stores the contents of bit positions 16-31 of register R into the effective halfword location. If the information in register R exceeds halfword data limits, CC2 is set to 1; otherwise, CC2 is reset to 0.

Affected: (EHL), CC2  
(R)<sub>16-31</sub>  $\rightarrow$  EHL

Condition code settings:

1 2 3 4 Information in R

- 0 - -  $(R)_{0-16} = \text{all 0's or all 1's.}$

- 1 - -  $(R)_{0-16} \neq \text{all 0's or all 1's.}$

**STW** STORE WORD  
(Word index alignment)

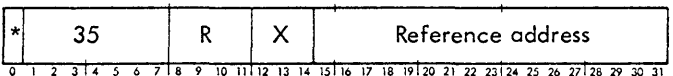

STORE WORD stores the contents of register R into the effective word location.

Affected: (EWL)  
(R)  $\rightarrow$  EWL

**STD STORE DOUBLEWORD**  
(Doubleword index alignment)

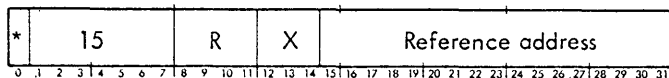

STORE DOUBLEWORD stores the contents of register R into the 32 high-order bit positions of the effective doubleword location and then stores the contents of register Ru1 into the 32 low-order bit positions of the effective doubleword location.

Affected: (EDL)  
(R) → EDL<sub>0-31</sub>; (Ru1) → EDL<sub>32-63</sub>

Example 1, even R field value:

	Before execution	After execution
(R)	= X'01234567'	X'01234567'
(Ru1)	= X'89ABCDEF'	X'89ABCDEF'
(EDL)	= xxxxxxxxxxxxxxxxxxxx	X'0123456789ABCDEF'

Example 2, odd R field value:

	Before execution	After execution
(R)	= X'89ABCDEF'	X'89ABCDEF'
(EDL)	= xxxxxxxxxxxxxxxxxxxx	X'89ABCDEF89ABCDEF'

**STS STORE SELECTIVE**  
(Word index alignment)

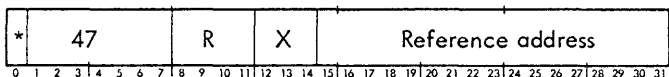

Register Ru1 contains a 32-bit mask. If R is an even value, STORE SELECTIVE stores the contents of register R into the effective word location in those bit positions selected by a 1 in corresponding bit positions of register Ru1; the effective word remains unchanged in those bit positions selected by a 0 in corresponding bit positions of register Ru1.

If R is an odd value, STS logically inclusive ORs the contents of register R with the effective word and stores the result into the effective word location. The contents of register R are not affected.

Affected: (EWL)

If R is even,  $[(R) \wedge (Ru1)] \cup [EW \overline{(Ru1)}] \rightarrow EWL$

If R is odd,  $(R) \cup EW \rightarrow EWL$

Example 1, even R field value:

	Before execution	After execution
(R)	= X'12345678'	X'12345678'
(Ru1)	= X'F0F0F0F0'	X'F0F0F0F0'
EW	= xxxxxxxx	X'1x3x5x7x'

Example 2, odd R field value:

	Before execution	After execution
(R)	= X'00FF00FF'	X'00FF00FF'
EW	= X'12345678'	X'12FF56FF'

**STM STORE MULTIPLE**  
(Word index alignment)

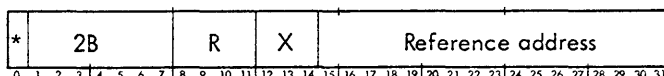

STORE MULTIPLE stores the contents of a sequential set of registers into a sequential set of word locations. The set of locations begins with the location pointed to by the effective word address of STM, and the set of registers begins with register R. The set of registers is treated modulo 16 (i.e., the next sequential register after register 15 is register 0). The number of registers to be stored is determined by the value of the condition code immediately before execution of STM. (The condition code can be set to the desired value before execution of STM with LCF or LCFI.) An initial value of 0000 for the condition code causes 16 general registers to be stored.

Affected: (EWL) to (EWL + CC - 1)  
(R) → EWL; ..., (R + CC - 1) → EWL + CC - 1

The STM instruction causes a trap if its operation extends into a page of memory that is protected by the write locks. A trap also occurs if the operation extends into a non-existent memory region. In either case, the trap is detected before the actual operation begins and will occur immediately.

**STCF STORE CONDITIONS AND FLOATING CONTROL**  
(Byte index alignment)

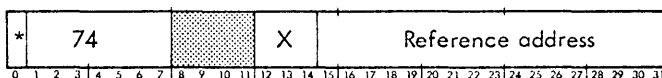

STORE CONDITIONS AND FLOATING CONTROL stores the current condition code and the current values of the floating significance (FS), floating zero (FZ), and floating

normalize (FN) mode control bits of the program status doubleword into the effective byte location as follows:

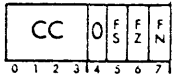

Affected: (EBL)  
(PSD)<sub>0-7</sub> → EBL

## ANALYZE/INTERPRET INSTRUCTIONS

**ANLZ** ANALYZE  
(Word index alignment)

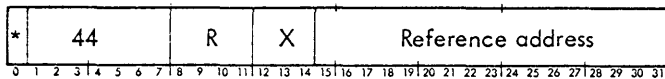

The ANALYZE instruction treats the effective word as a SIGMA 8 instruction and calculates the effective address that would be generated by the instruction if the instruction were to be executed. ANALYZE produces an answer to the question, "What effective address would be used by the instruction location at N if it were executed now?". The ANALYZE instruction determines the addressing type of the "analyzed" instruction, calculates its effective address (if the instruction is not an immediate-operand instruction), and loads the effective address into register R as a displacement value (the condition code settings for the ANALYZE instruction indicate the addressing type of the analyzed instruction).

The nonexistent instruction, the privileged instruction violation, and the unimplemented instruction trap conditions can never occur during execution of the ANLZ instruction. However, either the nonexistent memory address condition or the memory protection violation trap condition (or both) can occur as a result of any memory access initiated by the ANLZ instruction. If either of these trap conditions occurs, the instruction address stored by an XPSD in trap Homespace location X'40' is always the address of the ANLZ instruction.

When the ANALYZE instruction is executed and a trap condition occurs, it never traps.

If no trap condition occurs, ANLZ will execute normally and return the effective address of the instruction analyzed. Table 9 shows how SIGMA 8 operation codes will be interpreted by ANLZ.

The detailed operation of ANALYZE is as follows:

1. The contents of the location pointed to by the effective address of the ANLZ instruction is obtained.

This effective word is the instruction to be analyzed. From a memory-protection viewpoint, the instruction (to be analyzed) is treated as an operand of the ANLZ instruction; that is, the analyzed instruction may be obtained from any memory area to which the program has read access.

2. If the operation code portion of the effective word specifies an immediate-addressing instruction type, the condition code is set to indicate the addressing type, and instruction execution proceeds to the next instruction in sequence after ANLZ. The original contents of register R are not changed when the analyzed instruction is of the immediate-addressing type.

If the operation code portion of the effective word specifies a reference-addressing instruction type, the condition code is set to indicate the addressing type of the analyzed instruction and the effective address of the analyzed instruction is computed (using all of the normal address computation rules). If bit 0 of the effective word is a 1, the contents of the memory location specified by bits 15-31 of the effective word are obtained and then used as a direct address. The nonallowed operation trap (memory protection violation or nonexistent memory address) can occur as a result of the memory access. Indexing is always performed (with an index register in the current register block) if bits 12-14 of the analyzed instruction are nonzero. The effective address of the analyzed instruction is aligned as an integer displacement value and loaded into register R, according to the instruction addressing type, as follows:

Byte Addressing:

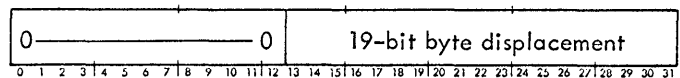

Halfword Addressing:

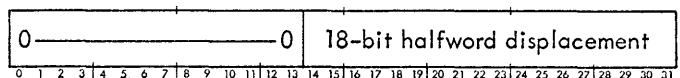

Word Addressing:

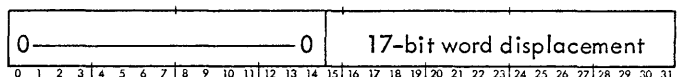

Doubleword Addressing:

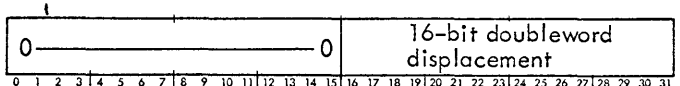

Operation codes and mnemonics for the SIGMA 8 instruction set are shown in Table 9. Circled numbers in the

table (designating groups of instructions within the bold lines) indicate the condition code value (decimal), shown in condition code settings below, available to the next instruction after ANALYZE when a direct-addressing operation code in the corresponding addressing type is analyzed.

Affected: (R), CC

Condition code settings:

1 2 3 4 Instruction addressing type

0 0 - 0 Byte

0 0 - 1 Immediate, byte

0 1 - 0 Halfword

1 0 - 0 Word

1 0 - 1 Immediate, word

1 1 - 0 Doubleword

- - 0 - Direct addressing ( $EW_0 = 0$ )

- - 1 - Indirect addressing ( $EW_0 = 1$ )

**INT** INTERPRET  
(Word index alignment)

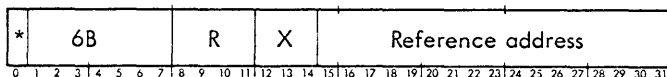

INTERPRET loads bits 0-3 of the effective word into the condition code, loads bits 16-31 of the effective word into bit positions 16-31 of register Ru1 (and loads 0's into bit positions 0-15 of register Ru1), loads bits 4-15 of the effective word into bit positions 20-31 of register R (and clears the remaining bits of register R). If R is an odd value, INT loads bits 0-3 of the effective word into the condition code, loads bits 16-31 of the effective word into bit positions 16-31 of register R, and loads 0's into bit positions 0-15 of register R (bits 4-15 of the effective word are ignored in this case).

Affected: (R), (Ru1), CC

$EW_{0-3} \rightarrow CC$

$EW_{4-15} \rightarrow R_{20-31}; 0 \rightarrow R_{0-19}$

$EW_{16-31} \rightarrow Ru1_{16-31}; 0 \rightarrow Ru1_{0-15}$

Table 1. ANALYZE Table for SIGMA 8 Operation Codes

X'n'	X'00'+n	X'20'+n	X'40'+n	X'60'+n
00	-	AI	TTBS	CBS
01	-	CI	TBS	MBS
02	LCFI (9)	LI	- (1)	-
03	-	MI	-	-
04	CAL1	SF	ANLZ	BDR
05	CAL2	S	CS	BIR
06	CAL3	LAS	XW	AWM
07	CAL4	-	STS	EXU
08	PLW	CVS	EOR	BCR
09	PSW	CVA (8)	OR	BCS
0A	PLM	LM	LS	BAL
0B	PSM	STM	AND	INT
0C	-	LRA <sup>†</sup>	SIO <sup>†</sup>	RD <sup>†</sup>
0D	-	LMS <sup>†</sup>	TIO <sup>†</sup>	WD <sup>†</sup>
0E	LPSD <sup>†</sup> (12)	WAIT <sup>†</sup>	TDV <sup>†</sup>	AIO <sup>†</sup>
0F	XPSD <sup>†</sup>	LRP <sup>†</sup>	HIO <sup>†</sup>	MMC <sup>†</sup>
10	AD	AW	AH	LCF
11	CD	CW	CH	CB
12	LD	LW	LH	LB
13	MSP	MTW	MTH	MTB
14	-	-	-	STCF
15	STD	STW	STH	STB (0)
16	-	DW	DH (4)	-
17	-	MW	MH	-
18	SD	SW	SH	-
19	CLM	CLR	-	-
1A	LCD	LCW	LCH	-
1B	LAD	LAW	LAH	-
1C	FSL	FSS	-	-
1D	FAL	FAS	-	-
1E	FDL	FDS	-	-
1F	FML	FMS	-	-

<sup>†</sup>Privileged instructions.

Condition code settings:

1 2 3 4  
 $EW_0$   $EW_1$   $EW_2$   $EW_3$

Example 1, even R field value:

	Before execution	After execution
EW	= X'12345678'	X'12345678'
(R)	= xxxxxxxx	X'00000234'
(Ru1)	= xxxxxxxx	X'00005678'
CC	= xxxx	0001

## FIXED-POINT ARITHMETIC INSTRUCTIONS

The following fixed-point arithmetic instructions are included as a standard feature of the SIGMA 8 computer.

<u>Instruction Name</u>	<u>Mnemonic</u>
Add Immediate	AI
Add Halfword	AH
Add Word	AW
Add Doubleword	AD
Subtract Halfword	SH
Subtract Word	SW
Subtract Doubleword	SD
Multiply Immediate	MI
Multiply Halfword	MH
Multiply Word	MW
Divide Halfword	DH
Divide Word	DW
Add Word to Memory	AWM
Modify and Test Byte	MTB
Modify and Test Halfword	MTH
Modify and Test Word	MTW

The fixed-point arithmetic instruction set performs binary addition, subtraction, multiplication, and division with integer operands that may be data, addresses, index values, or counts. One operand may be either in the instruction word itself or may be in one or two of the current general registers; the second operand may be either in main memory or in one or two of the current general registers. For most of these instructions, both operands may be in the same general register, thus permitting the doubling, squaring, or clearing the contents of a register by using a reference address value equal to the R field value.

All fixed-point arithmetic instructions provide a condition code setting that indicates the following information about the result of the operation called for by the instruction:

Condition code settings:

1 2 3 4 Result

- - 0 0 Zero — the result in the specified general register(s) is all zeros.

1 2 3 4 Result

- - 0 1 Negative — the instruction has produced a fixed-point negative result.

- - 1 0 Positive — the instruction has produced a fixed-point positive result.

- 0 - - Fixed-point overflow has not occurred during execution of an add, subtract, or divide instruction, and the result is correct.

- 1 - - Fixed-point overflow has occurred during execution of an add, subtract, or divide instruction. For addition and subtraction, the incorrect result is loaded into the designated register(s). For a divide instruction, the designated register(s), and CC1, CC3, and CC4 are not affected.

0 - - - No carry — for an add or subtract instruction, there was no carry of a 1-bit out of the high-order (sign) bit position of the result.

1 - - - Carry — for an add or subtract instruction, there was a 1-bit carry out of the sign bit position of the result. (Subtracting zero will always produce carry.)

AI      ADD IMMEDIATE  
(Immediate operand)

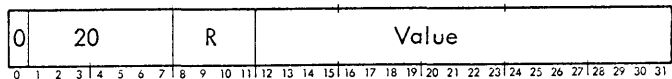

The value field (bit positions 12-31 of the instruction word) is treated as a 20-bit, two's complement integer. ADD IMMEDIATE extends the sign of the value field (bit position 12 of the instruction word) 12 bit positions to the left, adds the resulting 32-bit value to the contents of register R, and loads the sum into register R.

Affected: (R), CC      Trap: Fixed-point overflow  
(R) + (I)<sub>12-31SE</sub> → R

Condition code settings:

1 2 3 4 Result in R

- - 0 0 Zero

- - 0 1 Negative

- - 1 0 Positive

- 0 - - No fixed-point overflow

- 1 - - Fixed-point overflow

0 - - - No carry from bit position 0

1 - - - Carry from bit position 0

If AI is indirectly addressed, it is treated as a nonexistent instruction, in which case the computer unconditionally aborts execution of the instruction (at the time of operation code decoding) and traps to Homespace location X'40' with the contents of register R and the condition code unchanged.

If CC2 is set to 1 and the fixed-point arithmetic trap mask (AM) is a 1, the computer traps to Homespace location X'43' after loading the sum into register R; otherwise, the computer executes the next instruction in sequence.

**AH** ADD HALFWORD  
(Halfword index alignment)

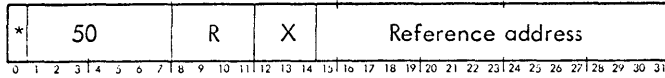

ADD HALFWORD extends the sign of the effective halfword 16 bit positions to the left (to form a 32-bit word in which bit positions 0-15 contain the sign of the effective halfword), adds the 32-bit result to the contents of register R, and loads the sum into register R.

Affected: (R), CC Trap: Fixed-point overflow  
(R) + EH<sub>SE</sub> → R

Condition code settings:

- |   |   |   |   |                              |
|---|---|---|---|------------------------------|
| 1 | 2 | 3 | 4 | Result in R                  |
| - | - | 0 | 0 | Zero                         |
| - | - | 0 | 1 | Negative                     |
| - | - | 1 | 0 | Positive                     |
| - | 0 | - | - | No fixed-point overflow      |
| - | 1 | - | - | Fixed-point overflow         |
| 0 | - | - | - | No carry from bit position 0 |
| 1 | - | - | - | Carry from bit position 0    |

If CC2 is set to 1 and the fixed-point arithmetic trap mask is 1, the computer traps to Homespace location X'43' after loading the sum into register R; otherwise, the computer executes the next instruction in sequence.

**AW** ADD WORD  
(Word index alignment)

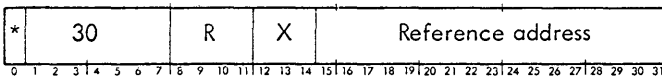

ADD WORD adds the effective word to the contents of register R and loads the sum into register R.

Affected: (R), CC Trap: Fixed-point overflow  
(R) + EW → R

Condition code settings:

- |   |   |   |   |                              |
|---|---|---|---|------------------------------|
| 1 | 2 | 3 | 4 | Result in R                  |
| - | - | 0 | 0 | Zero                         |
| - | - | 0 | 1 | Negative                     |
| - | - | 1 | 0 | Positive                     |
| - | 0 | - | - | No fixed-point overflow      |
| - | 1 | - | - | Fixed-point overflow         |
| 0 | - | - | - | No carry from bit position 0 |
| 1 | - | - | - | Carry from bit position 0    |

If CC2 is set to 1 and the fixed-point arithmetic trap mask (AM) is a 1, the computer traps to Homespace location X'43' after loading the sum into register R; otherwise, the computer executes the next instruction in sequence.

**AD** ADD DOUBLEWORD  
(Doubleword index alignment)



ADD DOUBLEWORD adds the effective doubleword to the contents of registers R and Ru1 (treated as a single, 64-bit register); loads the 32 low-order bits of the sum into register Ru1 and then loads the 32 high-order bits of the sum into register R. R must be an even value; if R is an odd value, the computer traps with the contents in register R unchanged.

Affected: (R), (Ru1), CC Trap: Fixed-point overflow, instruction exception  
(R, Ru1) + ED → R, Ru1

Condition code settings:

- |   |   |   |   |                              |
|---|---|---|---|------------------------------|
| 1 | 2 | 3 | 4 | Result in R, Ru1             |
| - | - | 0 | 0 | Zero                         |
| - | - | 0 | 1 | Negative                     |
| - | - | 1 | 0 | Positive                     |
| - | 0 | - | - | No fixed-point overflow      |
| - | 1 | - | - | Fixed-point overflow         |
| 0 | - | - | - | No carry from bit position 0 |
| 1 | - | - | - | Carry from bit position 0    |

If CC2 is set to 1 and the fixed-point arithmetic trap mask (AM) is a 1, the computer traps to Homespace location X'43' after loading the sum into registers R and Ru1; otherwise, the computer executes the next instruction in sequence.

The R field of the AD instruction must be an even value for proper operation of the instruction; if the R field of AD is an odd value, the instruction traps to Homespace location X'4D', the instruction exception trap.

Example 1, even R field value:

	Before execution	After execution
ED	= X'33333333EEEEEEEE'	X'33333333EEEEEEEE'
(R)	= X'11111111'	X'44444445'
(Ru1)	= X'33333333'	X'22222221'
CC	= xxxx	0010

**SH** SUBTRACT HALFWORD  
(Halfword index alignment)

*	58	R	X	Reference address																											
0	1	2	3	4	5	6	7	8	9	10	11	12	13	14	15	16	17	18	19	20	21	22	23	24	25	26	27	28	29	30	31

SUBTRACT HALFWORD extends the sign of the effective halfword 16 bit positions to the left (to form a 32-bit word in which bit positions 0-15 contain the sign of the effective halfword), forms the two's complement of the resulting word, adds the complemented word to the contents of register R, and loads the sum into register R.

Affected: (R), CC      Trap: Fixed-point overflow  
-EH<sub>SE</sub> + (R) → R

Condition code settings:

1	2	3	4	Result in R
-	-	0	0	Zero
-	-	0	1	Negative
-	-	1	0	Positive
-	0	-	-	No fixed-point overflow
-	1	-	-	Fixed-point overflow
0	-	-	-	No carry from bit position 0
1	-	-	-	Carry from bit position 0

If CC2 is set to 1 and the fixed-point arithmetic trap mask (AM) is a 1, the computer traps to Homespace location X'43' after loading the sum into register R; otherwise, the computer executes the next instruction in sequence.

**SW** SUBTRACT WORD  
(Word index alignment)

*	38	R	X	Reference address																											
0	1	2	3	4	5	6	7	8	9	10	11	12	13	14	15	16	17	18	19	20	21	22	23	24	25	26	27	28	29	30	31

SUBTRACT WORD forms the two's complement of the effective word, adds that complement to the contents of register R, and loads the sum into register R.

Affected: (R), CC      Trap: Fixed-point overflow  
-EW + (R) → R

Condition code settings:

1	2	3	4	Result in R
-	-	0	0	Zero
-	-	0	1	Negative
-	-	1	0	Positive
-	0	-	-	No fixed-point overflow
-	1	-	-	Fixed-point overflow
0	-	-	-	No carry from bit position 0
1	-	-	-	Carry from bit position 0

If CC2 is set to 1 and the fixed-point arithmetic trap mask (AM) is a 1, the computer traps to Homespace location X'43' after loading the sum into register R; otherwise, the computer executes the next instruction in sequence.

**SD** SUBTRACT DOUBLEWORD  
(Doubleword index alignment)

*	18	R	X	Reference address																											
0	1	2	3	4	5	6	7	8	9	10	11	12	13	14	15	16	17	18	19	20	21	22	23	24	25	26	27	28	29	30	31

SUBTRACT DOUBLEWORD forms the 64-bit two's complement of the effective doubleword, adds the complemented doubleword to the contents of registers R and Ru1 (treated as a single, 64-bit register), loads the 32 low-order bits of the sum into register Ru1 and loads the 32 high-order bits of the sum into register R. R must be an even value; if R is an odd value, the computer traps with the contents in register R unchanged.

Affected: (R), (Ru1), CC      Trap: Fixed-point overflow, instruction exception  
-ED + (R, Ru1) → R, Ru1

Condition code settings:

1	2	3	4	Result in R, Ru1
-	-	0	0	Zero
-	-	0	1	Negative
-	-	1	0	Positive
-	0	-	-	No fixed-point overflow
-	1	-	-	Fixed-point overflow
0	-	-	-	No carry from bit position 0
1	-	-	-	Carry from bit position 0

If CC2 is set to 1 and the fixed-point arithmetic trap mask (AM) is a 1, the computer traps to Homespace location X'43' after the result is loaded into registers R and Ru1; otherwise, the computer executes the next instruction in sequence.

The R field of the SD instruction must be an even value for proper operation of the instruction; if the R field of SD is an odd value, the instruction traps to Homespace location X'4D', instruction exception trap.

**MI** MULTIPLY IMMEDIATE  
(Immediate operand)

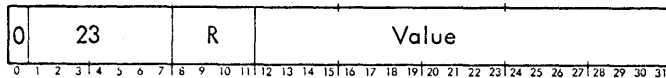

The value field (bit positions 12-31 of the instruction word) is treated as a 20-bit, two's complement integer. MULTIPLY IMMEDIATE extends the sign of the value field (bit position 12) of the instruction word 12 bit positions to the left and multiplies the resulting 32-bit value by the contents of register Ru1, then loads the 32 high-order bits of the product into register R, and then loads the 32 low-order bits of the product into register Ru1.

If R is an odd value, the result in register R is the 32 low-order bits of the product. Thus, in order to generate a 64-bit product, the R field of the instruction must be even and the multiplicand must be in register R+1. The condition code settings are based on the 64-bit product formed during instruction execution, rather than on the final contents of register R. Overflow cannot occur.

Affected: (R), (Ru1), CC2, CC3, CC4  
 $(Ru1) \times (I)_{12-31SE} \longrightarrow R, Ru1$

Condition code settings:

1 2 3 4 64-bit product

- - 0 0 Zero.
- - 0 1 Negative.
- - 1 0 Positive.
- 0 - - Result is correct, as represented in register Ru1.
- 1 - - Result is not correctly representable in register Ru1 alone.

If MI is indirectly addressed, it is treated as a nonexistent instruction, in which case the computer unconditionally aborts execution of the instruction (at the time of operation code decoding) and traps to Homespace location X'40' with the contents of register R, register Ru1, and the condition code unchanged; otherwise, the computer executes the next instruction in sequence.

Example 1, even R field value:

	Before execution	After execution
(I) <sub>12-31</sub> =	X'70000'	X'70000'
(R) =	xxxxxxxx	X'00007000'
(Ru1) =	X'10001000'	X'70000000'
CC =	xxxx	x110

Example 2, odd R field value:

	Before execution	After execution
(I) <sub>12-31</sub> =	X'01234'	X'01234'
(R) =	X'00030002'	X'369C2468'
CC =	xxxx	x010

**MH** MULTIPLY HALFWORD  
(Halfword index alignment)

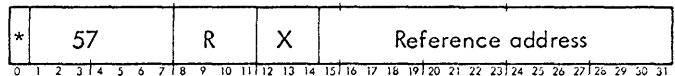

MULTIPLY HALFWORD multiplies the contents of bit positions 16-31 of register R by the effective halfword (with both halfwords treated as signed, two's complement integers) and stores the product in register Ru1 (overflow cannot occur). If R is an even value, the original multiplier in register R is preserved, allowing repetitive halfword multiplication with a constant multiplier; however, if R is an odd value, the product is loaded into the same register. Overflow cannot occur.

Affected: (Ru1), CC3, CC4  
 $(R)_{16-31} \times EH \longrightarrow Ru1$

Condition code settings:

1 2 3 4 Result in Ru1

- - 0 0 Zero
- - 0 1 Negative
- - 1 0 Positive

Example 1, even R field value:

	Before execution	After execution
EH =	X'FFFF'	X'FFFF'
(R) =	X'xxxx000A'	X'xxxx000A'
(Ru1) =	xxxxxxxx	X'FFFFFFF6'
CC =	xxxx	xx01



Example 2, odd R field value:

	Before execution	After execution
EH	= X'FFFF'	X'FFFF'
(R)	= X'xxxx000A'	X'FFFFFFF6'
CC	= xxxx	xx01

**MW** MULTIPLY WORD  
(Word index alignment)

*	37	R	X	Reference address																											
0	1	2	3	4	5	6	7	8	9	10	11	12	13	14	15	16	17	18	19	20	21	22	23	24	25	26	27	28	29	30	31

MULTIPLY WORD multiplies the contents of register Ru1 by the effective word, loads the 32 high-order bits of the product into register R and then loads the 32 low-order bits of the product into register Ru1 (overflow cannot occur).

If R is an odd value, the result in register R is the 32 low-order bits of the product. Thus, in order to generate a 64-bit product, the R field of the instruction must be even and the multiplicand must be in register R+1. The condition code settings are based on the 64-bit product formed during instruction execution, rather than on the final contents of register R.

Affected: (R), (Ru1), CC  
(Ru1) × EW → R, Ru1

Condition code settings:

1	2	3	4	64-bit product
---	---	---	---	----------------

- - 0 0 Zero.
- - 0 1 Negative.
- - 1 0 Positive.
- 0 - - Result is correct, as represented in register Ru1.
- 1 0 0 Result is not correctly representable in register Ru1 alone.

**DH** DIVIDE HALFWORD  
(Halfword index alignment)

*	56	R	X	Reference address																						
5	6	7	8	9	10	11	12	13	14	15	16	17	18	19	20	21	22	23	24	25	26	27	28	29	30	31

DIVIDE HALFWORD divides the contents of register R (treated as a 32-bit fixed-point integer) by the effective halfword and loads the quotient into register R. If the absolute value of the quotient cannot be correctly represented in 32 bits, fixed-point overflow occurs; in which

case CC2 is set to 1 and the contents of register R, and CC1, CC3, and CC4 are unchanged.

Affected: (R), CC2, CC3, CC4  
(R) ÷ EH → R

Condition code settings:

1	2	3	4	Result in R
---	---	---	---	-------------

- 0 0 0 Zero quotient, no overflow.
- 0 0 1 Negative quotient, no overflow.
- 0 1 0 Positive quotient, no overflow.
- 1 - - Fixed-point overflow.

If CC2 is set to 1 and the fixed-point arithmetic trap mask (AM) is a 1, the computer traps to HomeSpace location X'43' with the contents of register R, CC1, CC3, and CC4 unchanged.

**DW** DIVIDE WORD  
(Word index alignment)

*	36	R	X	Reference address																											
0	1	2	3	4	5	6	7	8	9	10	11	12	13	14	15	16	17	18	19	20	21	22	23	24	25	26	27	28	29	30	31

DIVIDE WORD divides the contents of registers R and Ru1 (treated as a 64-bit fixed-point integer) by the effective word, loads the integer remainder into register R and then loads the integer quotient into register Ru1. If a nonzero remainder occurs, the remainder has the same sign as the dividend (original contents of register R). If R is an odd value, DW forms a 64-bit register operand by extending the sign of the contents of register R 32 bit positions to the left, then divides the 64-bit register operand by the effective word, and loads the quotient into register R. In this case, the remainder is lost and only the contents of register R are affected.

If the absolute value of the quotient cannot be correctly represented in 32 bits, fixed-point overflow occurs; in which case CC2 is set to 1 and the contents of register R, register Ru1, CC1, CC3, and CC4 remain unchanged; otherwise, CC2 is reset to 0, CC3 and CC4 reflect the quotient in register Ru1, and CC1 is unchanged.

Affected: (R), (Ru1), CC2, CC3, CC4  
(R, Ru1) ÷ EW → R (remainder), Ru1(quotient)

Condition code settings:

1	2	3	4	Result in Ru1
---	---	---	---	---------------

- 0 0 0 Zero quotient, no overflow.
- 0 0 1 Negative quotient, no overflow.

1 2 3 4 Result in Ru1

- 0 1 0 Positive quotient, no overflow.
- 1 - - Fixed-point overflow.

If CC2 is set to 1 and the fixed-point arithmetic trap mask (AM) is a 1, the computer traps to Homespace location X'43' with the original contents of register R, register Ru1, CC1, CC3, and CC4 unchanged; otherwise, the computer executes the next instruction in sequence.

**AWM** ADD WORD TO MEMORY  
(Word index alignment)



ADD WORD TO MEMORY adds the contents of register R to the effective word and stores the sum in the effective word location. The sum is stored regardless of whether or not overflow occurs.

Affected: (EWL), CC      Trap: Fixed-point overflow  
EW + (R) → EWL

Condition code settings:

1 2 3 4 Result in EWL

- - 0 0 Zero
- - 0 1 Negative
- - 1 0 Positive
- 0 - - No fixed-point overflow
- 1 - - Fixed-point overflow
- 0 - - - No carry from bit position 0
- 1 - - - Carry from bit position 0

If CC2 is set to 1 and fixed-point arithmetic trap mask (AM) is a 1, the computer traps to Homespace location X'43' after the result is stored in the effective word location; otherwise, the computer executes the next instruction in sequence.

**MTB** MODIFY AND TEST BYTE  
(Byte index alignment)

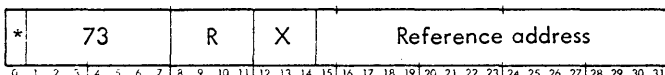

If the value of the R field is nonzero, the high-order bit of the R field (bit position 8 of the instruction word) is extended 4 bit positions to the left, to form a byte with bit positions 0-4 of that byte equal to the high-order bit of the R field. This byte is added to the effective byte and then (if no memory protection violation occurs) the sum is

stored in the effective byte location and the condition code is set according to the value of the resultant byte. This process allows modification of a byte by any number in the range -8 through +7, followed by a test.

If the value of the R field is zero, the effective byte is tested for being a zero or nonzero value. The condition code is set according to the result of the test, but the effective byte is not affected. A memory write-protection violation cannot occur in this case.

Affected: CC if (I)<sub>8-11</sub> = 0;  
(EBL) and CC if (I)<sub>8-11</sub> ≠ 0

If (I)<sub>8-11</sub> ≠ 0, EB + (I)<sub>8-11</sub>SE → EBL and set CC

If (I)<sub>8-11</sub> = 0, test byte and set CC

Condition code settings:

1 2 3 4 Result in EBL

- 0 0 0 Zero
- 0 1 0 Nonzero
- 0 - - - No carry from byte
- 1 - - - Carry from byte

If MTB is executed in an interrupt location, the condition code is not affected (see Chapter 2, "Single-Instruction Interrupts").

**MTH** MODIFY AND TEST HALFWORD  
(Halfword index alignment)

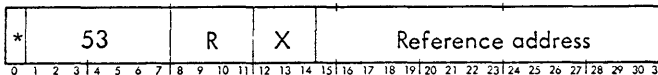

If the value of the R field is nonzero, the high-order bit of the R field (bit position 8 of the instruction word) is extended 12 bit positions to the left, to form a halfword with bit positions 0-11 of that halfword equal to the high-order bit of the R field. This halfword is added to the effective halfword and then (if no memory protection violation occurs) the sum is stored in the effective halfword location and the condition code is set according to the value of the resultant halfword. The sum is stored regardless of whether or not overflow occurs. This process allows modification of a halfword by any number in the range -8 through +7, followed by a test.

If the value of the R field is zero, the effective halfword is tested for being a zero, negative, or positive value. The condition code is set, according to the result of the test, but the effective halfword is not affected. A memory write-protection violation cannot occur in this case.

Affected: CC if  $(I)_{8-11} = 0$ ; Trap: Fixed-point overflow (EHL) and CC if  $(I)_{8-11} \neq 0$

If  $(I)_{8-11} = 0$ , test halfword and set CC

(If  $(I)_{8-11} \neq 0$ ,  $EH + (I)_{8-11SE} \rightarrow$  EHL and set CC

Condition code settings:

1 2 3 4 Result in EHL

- - 0 0 Zero
- - 0 1 Negative
- - 1 0 Positive
- 0 - - No fixed-point overflow
- 1 - - Fixed-point overflow
- 0 - - - No carry from halfword
- 1 - - - Carry from halfword

If CC2 is set to 1 and the fixed-point arithmetic trap mask (AM) is a 1, the computer traps to Homespace location X'43' after the result is stored in the effective halfword location; otherwise, the computer executes the next instruction in sequence. However, if MTH is executed in an interrupt location, the condition code is not affected (see Chapter 2, "Single-Instruction Interrupts").

**MTW**      **MODIFY AND TEST WORD**  
(Word index alignment)

*	33	R	X	Reference address																											
0	1	2	3	4	5	6	7	8	9	10	11	12	13	14	15	16	17	18	19	20	21	22	23	24	25	26	27	28	29	30	31

If the value of the R field is nonzero, the high-order bit of the R field (bit position 8 of the instruction word) is extended 28 bit positions to the left, to form a word with bit positions 0-27 of that word equal to the high-order bit of the R field. This word is added to the effective word and then (if no memory protection violation occurs) the sum is stored in the effective word location and the condition code is set according to the value of the resultant

word. The sum is stored regardless of whether or not overflow occurs. This process allows modification of a word by any number in the range -8 through +7, followed by a test.

If the value of the R field is zero, the effective word is tested for being a zero, negative, or positive value. The condition code is set according to the result of the test, but the effective word is not affected. A memory write-protection violation cannot occur in this case.

Affected: CC if  $(I)_{8-11} = 0$ ; Trap: Fixed-point overflow (EWL) and CC if  $(I)_{8-11} \neq 0$

If  $(I)_{8-11} = 0$ , test word and set CC

(If  $(I)_{8-11} \neq 0$ ,  $EW + I_{8-11SE} \rightarrow$  EWL and set CC

Condition code settings:

1 2 3 4 Result in EWL

- - 0 0 Zero
- - 0 1 Negative
- - 1 0 Positive
- 0 - - No fixed-point overflow
- 1 - - Fixed-point overflow
- 0 - - - No carry from word
- 1 - - - Carry from word

If CC2 is set to 1 and the fixed-point arithmetic trap mask (AM) is a 1, the computer traps to Homespace location X'43' after the result is stored in the effective word location; otherwise, the computer executes the next instruction in sequence. However, if MTW is executed in an interrupt location, the condition code is not affected (see Chapter 2, "Single-Instruction Interrupts").

## COMPARISON INSTRUCTIONS

The following comparison instructions are available on SIGMA 8 computers:

Instruction Name	Mnemonic
Compare Immediate	CI
Compare Byte	CB
Compare Halfword	CH
Compare Word	CW

<u>Instruction Name</u>	<u>Mnemonic</u>
Compare Doubleword	CD
Compare Selective	CS
Compare With Limits in Register	CLR
Compare With Limits in Memory	CLM

All SIGMA 8 comparison instructions produce a condition code setting that is indicative of the results of the comparison, without affecting the effective operand in memory or the contents of the designated register.

**CI** COMPARE IMMEDIATE  
(Immediate operand)

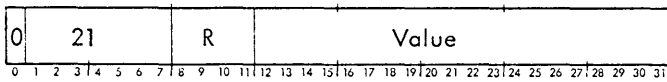

COMPARE IMMEDIATE extends the sign of the value field (bit position 12) of the instruction word 12 bit positions to the left, compares the 32-bit result with the contents of register R (with both operands treated as signed fixed-point quantities), and then sets the condition code according to the results of the comparison.

Affected: CC2, CC3, CC4  
(R) : (I)<sub>12-31SE</sub>

Condition code settings:

1	2	3	4	Result of Comparison
-	-	0	0	Equal.
-	-	0	1	Register value less than immediate value.
-	-	1	0	Register value greater than immediate value.
-	0	-	-	No 1-bits compare, (R) n (I) <sub>12-32SE</sub> = 0.
-	1	-	-	One or more 1-bits compare, (R) n (I) <sub>12-32SE</sub> ≠ 0.

If CI is indirectly addressed, it is treated as a nonexistent instruction, in which case the computer unconditionally aborts execution of the instruction (at the time of operation code decoding) and then traps to Homespace location X'40' with the condition code unchanged.

**CB** COMPARE BYTE  
(Byte index alignment)

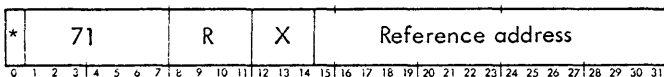

COMPARE BYTE compares the contents of bit positions 24-31 of register R with the effective byte (with both bytes treated as positive integer magnitudes) and sets the condition code according to the results of the comparison.

Affected: CC2, CC3, CC4  
(R)<sub>24-31</sub> : EB

Condition code settings:

1	2	3	4	Result of Comparison
-	-	0	0	Equal.
-	-	0	1	Register byte less than effective byte.
-	-	1	0	Register byte greater than effective byte.
-	0	-	-	No 1-bits compare, (R) <sub>24-31</sub> n EB = 0.
-	1	-	-	One or more 1-bits compare, (R) <sub>24-31</sub> n EB ≠ 0.

**CH** COMPARE HALFWORD  
(Halfword index alignment)

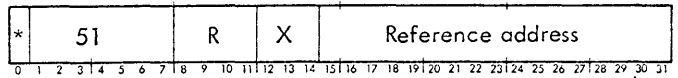

COMPARE HALFWORD extends the sign of the effective halfword 16 bit positions to the left, then compares the resultant 32-bit word with the contents of register R (with both words treated as signed, fixed-point quantities) and sets the condition code according to the results of the comparison.

Affected: CC2, CC3, CC4  
(R) : EH<sub>SE</sub>

Condition code settings:

1	2	3	4	Result of Comparison
-	-	0	0	Equal.
-	-	0	1	Register word less than effective halfword with sign extended.
-	-	1	0	Register word greater than effective halfword with sign extended.
-	0	-	-	No 1-bits compare, (R) n EH <sub>SE</sub> = 0.
-	1	-	-	One or more 1-bits compare, (R) n EH <sub>SE</sub> ≠ 0.

**CW** COMPARE WORD  
(Word index alignment)

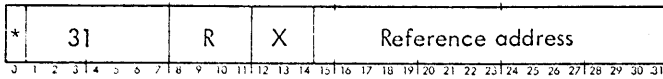

COMPARE WORD compares the contents of register R with the effective word, with both words treated as signed fixed-point quantities, and sets the condition code according to the results of the comparison.

Affected: CC2, CC3, CC4  
(R) : EW

Condition code settings:

1	2	3	4	Result of Comparison
-	-	0	0	Equal.
-	-	0	1	Register word less than effective word.
-	-	1	0	Register word greater than effective word.
-	0	-	-	No 1-bits compare, (R) n EW = 0.
-	1	-	-	One or more 1-bits compare, (R) n EW ≠ 0.

**CD** COMPARE DOUBLEWORD  
(Doubleword index alignment)

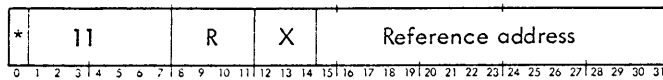

COMPARE DOUBLEWORD compares the effective doubleword with the contents of registers R and Ru1 (with both doublewords treated as signed, fixed-point quantities) and sets the condition code according to the results of the comparison. If the R field of CD is an odd value, CD forms a 64-bit register operand (by duplicating the contents of register R for both the 32 high-order bits and the 32 low-order bits) and compares the effective doubleword with the 64-bit register operand. The condition code settings are based on the 64-bit comparison.

Affected: CC3, CC4  
(R, Ru1) : ED

Condition code settings:

1	2	3	4	Result of Comparison
-	-	0	0	Equal.
-	-	0	1	Register doubleword less than effective doubleword.
-	-	1	0	Register doubleword greater than effective doubleword.

**CS** COMPARE SELECTIVE  
(Word index alignment)

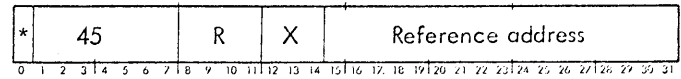

COMPARE SELECTIVE compares the contents of register R with the effective word in only those bit positions selected by a 1 in corresponding bit positions of register Ru1 (mask). The contents of register R and the effective word are ignored in those bit positions designated by a 0 in corresponding bit positions of register Ru1. The selected contents of register R and the effective word are treated as positive integer magnitudes, and the condition code is set according to the result of the comparison. If the R field of CS is an odd value; CS compares the contents of register R with the logical product (AND) of the effective word and the contents of register R.

Affected: CC3, CC4  
If R is even: (R) n (Ru1) : EW n (Ru1)  
If R is odd: (R) : EW n (R)

Condition code settings:

1	2	3	4	Results of Comparison under Mask in Ru1
-	-	0	0	Equal.
-	-	0	1	Register word less than effective word.
-	-	1	0	Register word greater than effective word. (if R is even)

**CLR** COMPARE WITH LIMITS IN REGISTERS  
(Word index alignment)

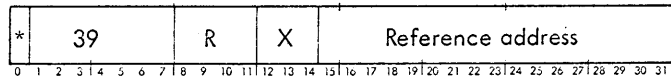

COMPARE WITH LIMITS IN REGISTERS simultaneously compares the effective word with the contents of register R and with the contents of register Ru1 (with all three words treated as signed fixed-point quantities), and sets the condition code according to the results of the comparisons.

Affected: CC  
(R) : EW, (Ru1) : EW

Condition code settings:

1	2	3	4	Result of Comparison
-	-	0	0	Contents of R equal to effective word.
-	-	0	1	Contents of R less than effective word.
-	-	1	0	Contents of R greater than effective word.
0	0	-	-	Contents of Ru1 equal to effective word.
0	1	-	-	Contents of Ru1 less than effective word.
1	0	-	-	Contents of Ru1 greater than effective word.

**CLM** COMPARE WITH LIMITS IN MEMORY  
(Doubleword index alignment)

*	19	R	X	Reference address																											
0	1	2	3	4	5	6	7	8	9	10	11	12	13	14	15	16	17	18	19	20	21	22	23	24	25	26	27	28	29	30	31

COMPARE WITH LIMITS IN MEMORY simultaneously compares the contents of register R with the 32 high-order bits of the effective doubleword and with the 32 low-order bits of the effective doubleword, with all three words treated as 32-bit signed quantities, and sets the condition code according to the results of the comparisons.

Affected: CC  
(R) : ED<sub>0-31</sub>; (R) : ED<sub>32-63</sub>

Condition code settings:

1	2	3	4	Result of Comparison
-	-	0	0	Contents of R equal to most significant word, (R) = ED <sub>0-31</sub>
-	-	0	1	Contents of R less than most significant word, (R) < ED <sub>0-31</sub>
-	-	1	0	Contents of R greater than most significant word, (R) > ED <sub>0-31</sub>
0	0	-	-	Contents of R equal to least significant word, (R) = ED <sub>32-63</sub>
0	1	-	-	Contents of R less than least significant word, (R) < ED <sub>32-63</sub>
1	0	-	-	Contents of R greater than least significant word, (R) > ED <sub>32-63</sub>

**LOGICAL INSTRUCTIONS**

All logical operations are performed bit by corresponding bit between two operands; one operand is in register R and the other operand is the effective word. The result of the logical operation is loaded into register R.

**OR** OR WORD  
(Word index alignment)

*	49	R	X	Reference address																											
0	1	2	3	4	5	6	7	8	9	10	11	12	13	14	15	16	17	18	19	20	21	22	23	24	25	26	27	28	29	30	31

OR WORD logically ORs the effective word into register R. If corresponding bits of register R and the effective word are both 0, a 0 remains in register R; otherwise, a 1 is placed in the corresponding bit position of register R. The effective word is not affected.

Affected: (R), CC3, CC4  
(R) ∪ EW → R, where 0 ∪ 0 = 0, 0 ∪ 1 = 1, 1 ∪ 0 = 1, 1 ∪ 1 = 1

Condition code settings:

1	2	3	4	Result in R
-	-	0	0	Zero.
-	-	0	1	Bit 0 of register R is a 1.
-	-	1	0	Bit 0 of register R is a 0 and bit positions 1-31 of register R contain at least one 1.

**EOR** EXCLUSIVE OR WORD  
(Word index alignment)

*	48	R	X	Reference address																											
0	1	2	3	4	5	6	7	8	9	10	11	12	13	14	15	16	17	18	19	20	21	22	23	24	25	26	27	28	29	30	31

EXCLUSIVE OR WORD logically exclusive ORs the effective word into register R. If corresponding bits of register R and the effective word are different, a 1 is placed in the corresponding bit position of register R; if the contents of the corresponding bit positions are alike, a 0 is placed in the corresponding bit position of register R. The effective word is not affected.

Affected: (R), CC3, CC4  
(R) ⊕ EW → R, where 0 ⊕ 0 = 0, 0 ⊕ 1 = 1, 1 ⊕ 0 = 1, 1 ⊕ 1 = 0

Condition code settings:

1	2	3	4	Result in R
-	-	0	0	Zero.
-	-	0	1	Bit 0 of register R is a 1.
-	-	1	0	Bit 0 of register R is a 0 and bit positions 1-31 of register R contain at least one 1.

**AND** AND WORD  
(Word index alignment)

*	4B	R	X	Reference address																											
0	1	2	3	4	5	6	7	8	9	10	11	12	13	14	15	16	17	18	19	20	21	22	23	24	25	26	27	28	29	30	31

AND WORD logically ANDs the effective word into register R. If corresponding bits of register R and the effective word are both 1, a 1 remains in register R; otherwise, a 0 is placed in the corresponding bit position of register R. The effective word is not affected.

Affected: (R), CC3, CC4  
(R) ∩ EW → R, where 0 ∩ 0 = 0, 0 ∩ 1 = 0, 1 ∩ 0 = 0, 1 ∩ 1 = 1

Condition code settings:

- | 1 | 2 | 3 | 4 | Result in R   |
|---|---|---|---|---|
| - | - | 0 | 0 | Zero.   |
| - | - | 0 | 1 | Bit 0 of register R is a 1.   |
| - | - | 1 | 0 | Bit 0 of register R is a 0 and bit positions 1-31 of register R contain at least one 1. |

## SHIFT INSTRUCTIONS

The instruction format for logical, circular, arithmetic, and searching shift operations is:

S SHIFT  
(Word index alignment)

*	25	R	X	Reference address																											
				Type	Count																										
0	1	2	3	4	5	6	7	8	9	10	11	12	13	14	15	16	17	18	19	20	21	22	23	24	25	26	27	28	29	30	31

If neither indirect addressing nor indexing is called for in the instruction SHIFT, bit positions 21-23 of the reference address field determine the type, and bit positions 25-31 determine the direction and amount of the shift. If only indirect addressing is called for in the instruction, bits 15-31 of the instruction are used to access the indirect word and then bits 21-31 of the indirect word determine the type, direction, and amount of the shift. If only indexing is called for in the instruction, bits 21-23 of the instruction word determine the type of shift; the direction and amount of shift are determined by bits 25-31 of the instruction plus bits 25-31 of the specified index register. If both indirect addressing and indexing are called for in the instruction, bits 15-31 of the instruction are used to access the indirect word and then bits 21-23 of the indirect word determine the type of shift; the direction and amount of the shift are determined by bits 25-31 of the indirect word plus bits 25-31 of the specified index register.

Bit positions 15-20 and 24 of the effective address are ignored. Bit positions 21, 22, and 23 of the effective address determine the type of shift, as follows:

21	22	23	Shift Type
0	0	0	Logical, single register
0	0	1	Logical, double register
0	1	0	Circular, single register
0	1	1	Circular, double register
1	0	0	Arithmetic, single register
1	0	1	Arithmetic, double register
1	1	0	Searching, single register
1	1	1	Searching, double register

Bit positions 25 through 31 of the effective address are a shift count that determines the direction and amount of the shift. The shift count (C) is treated as a 7-bit signed binary integer, with the high-order bit (bit position 25) as the sign (negative integers are represented in two's complement form). A positive shift count causes a left shift of C bit positions. A negative shift count causes a right shift of |C| bit positions. The value of C is within the range:  $-64 \leq C \leq +63$ .

All double-register shift operations require an even value for the R field of the instruction, and treat registers R and R+1 as a 64-bit register with the high-order bit (bit position 0 of register R) as the sign for the entire register. If the R field of SHIFT is an odd value and a double-register shift operation is specified, a register doubleword is formed by duplicating the contents of register R for both the 32 high-order bits and the 32 low-order bits of the doubleword. The shift operation is then performed and the 32 high-order bits of the result are loaded into register R.

Overflow occurs (on left shifts only) whenever the value of the sign bit (bit position 0 of register R) changes. At the completion of logical left, circular left, arithmetic left, and searching left shifts, the condition code is set as follows:

1	2	3	4	Result of Shift
0	-	-	-	Even number of 1's shifted off left end of register R.
1	-	-	-	Odd number of 1's shifted off left end of register R <sup>t</sup> .
-	0	-	-	No overflow on left shift.
-	1	-	-	Overflow on left shift.
-	-	-	0	Searching shift terminated with R <sub>0</sub> equal 0.
-	-	-	1	Searching shift terminated with R <sub>0</sub> equal 1.

At the completion of right shifts, the condition code is set as follows:

1	2	3	4	Result of Shift
0	0	-	0	Searching shift terminated with R <sub>0</sub> equal 0.
0	0	-	1	Searching shift terminated with R <sub>0</sub> equal 1.

### Logical Shift, Single Register

*	25	R	X	Reference address																											
				0	0	0	Count																								
0	1	2	3	4	5	6	7	8	9	10	11	12	13	14	15	16	17	18	19	20	21	22	23	24	25	26	27	28	29	30	31

If the shift count, C, is positive, the contents of register R are shifted left C places, with 0's copied into vacated bit

<sup>t</sup>Not applicable for searching shift.

positions on the right. (Bits shifted past  $R_0$  are lost.) If  $C$  is negative, the contents of register  $R$  are shifted right  $|C|$  places, with 0's copied into vacated bit positions on the left. (Bits shifted past  $R_{31}$  are lost.)

Affected: (R), CC1, CC2

#### Logical Shift, Double Register

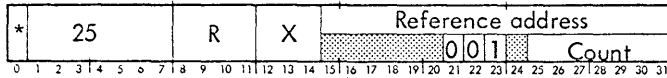

If the shift count,  $C$ , is positive, the contents of registers  $R$  and  $Ru1$  are shifted left  $C$  places, with 0's copied into vacated bit positions on the right. Bits shifted past bit position 0 of register  $Ru1$  are copied into bit position 31 of register  $R$ . (Bits shifted past  $R_0$  are lost.) If  $C$  is negative, the contents of registers  $R$  and  $Ru1$  are shifted right  $|C|$  places with 0's copied into vacated bit positions on the left. Bits shifted past bit position 31 of register  $R$  are copied into bit position 0 of register  $Ru1$ . (Bits shifted past  $Ru1_{31}$  are lost.)

Affected: (R), (Ru1), CC1, CC2

#### Circular Shift, Single Register



If the shift count,  $C$ , is positive, the contents of register  $R$  are shifted left  $C$  places. Bits shifted past bit position 0 are copied into bit position 31. (No bits are lost.) If  $C$  is negative, the contents of register  $R$  are shifted right  $|C|$  places. Bits shifted past bit position 31 are copied into bit position 0. (No bits are lost.)

Affected: (R), CC1, CC2

#### Circular Shift, Double Register

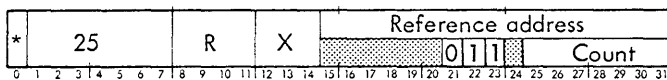

If the shift count,  $C$ , is positive, the contents of registers  $R$  and  $Ru1$  are shifted left  $C$  places. Bits shifted past bit position 0 of register  $R$  are copied into bit position 31 of register  $Ru1$ . (No bits are lost.) If  $C$  is negative, the contents of registers  $R$  and  $Ru1$  are shifted right  $|C|$  places. Bits shifted past bit position 31 of register  $Ru1$  are copied into bit position 0 of register  $R$ . (No bits are lost.)

Affected: (R), (Ru1), CC1, CC2

#### Arithmetic Shift, Single Register

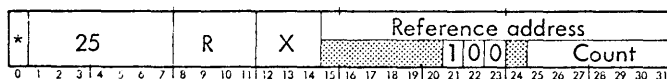

If the shift count,  $C$ , is positive, the contents of register  $R$  are shifted left  $C$  places, with 0's copied into

vacated bit positions on the right. (Bits shifted past  $R_0$  are lost.) If  $C$  is negative, the contents of register  $R$  are shifted right  $|C|$  places, with the contents of bit position 0 copied into vacated bit positions on the left. (Bits shifted past  $R_{31}$  are lost.)

Affected: (R), CC1, CC2

#### Arithmetic Shift, Double Register

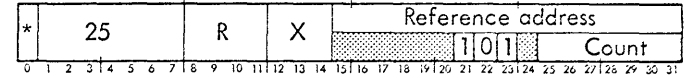

If the shift count,  $C$ , is positive, the contents of registers  $R$  and  $Ru1$  are shifted left  $C$  places, with 0's copied into vacated bit positions on the right. Bits shifted past bit position 0 of register  $Ru1$  are copied into bit position 31 of register  $R$ . (Bits shifted past  $R_0$  are lost.) If  $C$  is negative, the contents of registers  $R$  and  $Ru1$  are shifted right  $|C|$  places, with the contents of bit position 0 of register  $R$  copied into vacated bit positions on the left. Bits shifted past bit position 31 of register  $R$  are copied into bit position 0 of register  $Ru1$ . (Bits shifted past  $Ru1_{31}$  are lost.)

Affected: (R), (Ru1), CC1, CC2

#### Searching Shift, Single Register

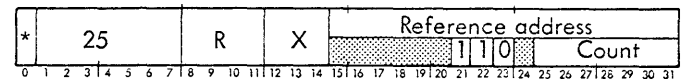

The searching shift is circular in either direction. If the shift count,  $C$ , is positive, the contents of register  $R$  are shifted left  $C$  bit positions or until a 1 appears in bit position 0. If  $C$  is negative, the contents are shifted right  $|C|$  positions or until a 1 appears in bit position 0. When the shift is terminated, the remaining count is stored in register 1, which is dedicated to the searching shift instruction. Bits 0-24 of register 1 are cleared and the remaining count is loaded into bits 25-31. If the initial contents of bit 0 is equal to 1, then no bits are shifted by the instruction. In this case the original count in the instruction is stored in register 1.

Searching shift causing a change in bit position 0 causes CC2 to be set to 1. If bit position 0 is not changed during a searching shift, CC2 is cleared. If a searching shift is terminated with bit position 0 equal to 1, CC4 is set to 1; otherwise, CC4 is cleared.

Affected: (R), (R1), CC2, CC4

#### Searching Shift, Double Register

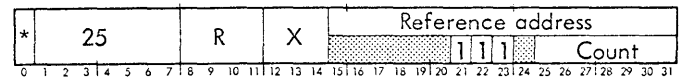

The searching shift is circular in either direction. If the shift count,  $C$ , is positive, the contents of registers  $R$  and  $Ru1$  are shifted left  $C$  bit positions or until a 1 appears in bit position 0 of register  $R$ . If  $C$  is negative, the contents are shifted right  $C$  positions or until a 1 appears in bit position 0. When the shift is terminated, the remaining



count is stored in register 1, which is decremented to the searching shift instruction. Bits 0-24 of register 1 are cleared and the remaining count is loaded into bits 25-31.

Searching shift causing a change in bit position 0 causes CC2 to be set to 1. If bit position 0 is not changed during a searching shift, CC2 is cleared. If a searching shift is terminated with bit position 0 equal to 1, CC4 is set to 1; otherwise, CC4 is cleared.

Affected: (R), (Ru1), (R1), CC2, CC4

## FLOATING-POINT SHIFT

Floating-point numbers are defined in the "Floating-Point Arithmetic Instructions" section. The format for the floating-point shift instruction is:

SF SHIFT FLOATING  
(Word index alignment)



If indirect addressing or indexing is called for in the instruction word, the effective address is computed as for the instruction SHIFT except that bit position 23 of the effective address determines the type of shift. If bit 23 is a 0, the contents of register R are treated as a short-format floating-point number; if bit 23 is a 1, the contents of registers R and Ru1 are treated as a long-format floating-point number.

The shift count, C, in bit positions 25 through 31 of the effective address determines the amount and direction of the shift. The shift count is treated as a 7-bit signed binary integer, with the high-order bit (bit position 25) as the sign (negative integers are represented in two's complement form).

The absolute value of the shift count determines the number of hexadecimal digit positions the floating-point number is to be shifted. If the shift count is positive, the floating-point number is shifted left; if the count is negative, the number is shifted right.

SHIFT FLOATING loads the floating-point number from the register(s) specified by the R field of the instruction into a set of internal registers. If the number is negative, it is two's complemented. A record of the original sign is retained. The floating-point number is then separated into a characteristic and a fraction, and CC1 and CC2 are both reset to 0's.

A positive shift count produces the following left shift operations:

1. If the fraction is normalized (i.e., is less than 1 and is equal to or greater than 1/16), or the fraction is all 0's, CC1 is set to 1.
2. If the fraction field is all 0's, the entire floating-point number is set to all 0's (true zero), regardless of the sign and the characteristic of the original number.

3. If the fraction is not normalized, the fraction field is shifted 1 hexadecimal digit position (4 bit positions) to the left and the characteristic field is decremented by 1. Vacated digit positions at the right of the fraction are filled with hexadecimal 0's.

If the characteristic field underflows (i.e., is all 1's as the result of being decremented), CC2 is set to 1. However, if the characteristic field does not underflow, the shift process (shift fraction, and decrement characteristic) continues until the fraction is normalized, until the characteristic field underflows, or until the fraction is shifted left C hexadecimal digit positions, whichever occurs first. (Any two, or all three, of the terminating conditions can occur simultaneously.)

4. At the completion of the left shift operation, the floating-point result is loaded back into the general register(s). If the number was originally negative, the two's complement of the resultant number is loaded into the general registers(s).

5. The condition code settings following a floating-point left shift are as follows:

1	2	3	4	Result
-	-	0	0	True zero (all 0's).
-	-	0	1	Negative.
-	-	1	0	Positive.
0	0	-	-	C digits shifted (fraction unnormalized, no characteristic underflow).
1	-	-	-	Fraction normalized (includes true zero).
-	1	-	-	Characteristic underflow.

A negative shift count produces the following right shift operations (again assuming that negative numbers are two's complemented before and after the shift operation):

1. The fraction field is shifted 1 hexadecimal digit position to the right and the characteristic field is incremented by 1. Vacated digit positions at the left are filled with hexadecimal 0's.
2. If the characteristic field overflows (i.e., is all 0's as the result of being incremented), CC2 is set to 1. However, if the characteristic field does not overflow, the shift process (shift fraction, and increment characteristic) continues until the characteristic field overflows or until the fraction is shifted right |C| hexadecimal digit positions, whichever occurs first. (Both terminating conditions can occur simultaneously.)
3. If the resultant fraction field is all 0's, the entire floating-point number is set to all 0's (true zero), regardless of the sign and the characteristic of the original number.

- At the completion of the shift operation, the floating-point result is loaded back into the general register(s). If the number was originally negative, the two's complement of the resultant number is loaded into the general register(s).
- The condition code settings following a floating-point right shift are as follows:

1	2	3	4	Result
-	-	0	0	True zero (all zeros).
-	-	0	1	Negative.
-	-	1	0	Positive.
0	0	-	-	C  digits shifted (no characteristic overflow).
0	1	-	-	Characteristic overflow.

#### Floating Shift, Single Register

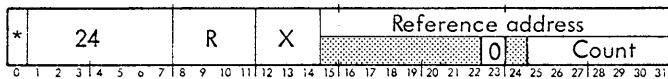

The short-format floating-point number in register R is shifted according to the rules established above for floating-point shift operations.

Affected: (R), CC

#### Floating Shift, Double Register

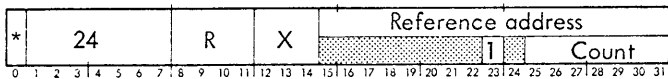

The long-format floating-point number in registers R and Ru1 is shifted according to the rules established above for floating-point shift operations. (If the R field of the instruction word is an odd value, a long-format floating-point number is generated by duplicating the contents of register R, and the 32 high-order bits of the result are loaded into register R.)

Affected: (R), (Ru1), CC

## CONVERSION INSTRUCTIONS

The following two conversion instructions are provided by the SIGMA 8 computer:

Instruction Name	Mnemonic
Convert by Addition	CVA
Convert by Subtraction	CVS

These two conversion instructions can be used to accomplish bidirectional translation between binary code and any other weighted binary code, such as BCD.

The effective addresses of the instructions CONVERT BY ADDITION and CONVERT BY SUBTRACTION each point to the starting location of a conversion table of 32 words, containing weighted values for each bit position of register Ru1. The 32 words of the conversion table are considered to be 32-bit positive quantities, and are referred to as conversion values. The intermediate results of these instructions are accumulated in internal CPU registers until the instruction is completed; the result is then loaded into the appropriate general register. Both instructions use a counter (n) that is set to 0 at the beginning of the instruction execution and is incremented by 1 with each iteration, until a total of 32 iterations have been performed.

If a memory parity or protection violation trap occurs during the execution of either instruction, the instruction sequence is aborted (without having changed the contents of register R or Ru1) and may be restarted (at the beginning of the instruction sequence) after the trap routine is processed.

#### CVA CONVERT BY ADDITION (Word index alignment)

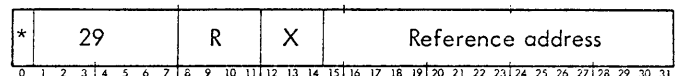

CONVERT BY ADDITION initially clears the internal A register and sets an internal counter (n) to 0. If bit position n of register Ru1 contains a 1, CVA adds the nth conversion value (contents of the word location pointed to by the effective address plus n) to the contents of the A register, accumulates the sum in the A register, and increments n by 1. If bit position n of register Ru1 contains a 0, CVA only increments n. If n is less than 32 after being incremented, the next bit position of register Ru1 is examined, and the addition process continues through n equal to 31; the result is then loaded into register R. If, on any iteration, the sum has exceeded the value  $2^{32}-1$ , CC1 is set to 1; otherwise, CC1 is reset to 0.

Affected: (R), CC1, CC3, CC4  
 $0 \rightarrow A, 0 \rightarrow n$

If  $(Ru1)_n = 1$ , then  $(EWL + n) + (A) \rightarrow A, n + 1 \rightarrow n$

If  $(Ru1)_n = 0$ , then  $n + 1 \rightarrow n$

If  $n < 32$ , repeat; otherwise,  $(A) \rightarrow R$  and continue to next instruction.

Condition code settings:

1	2	3	4	Result in R
-	-	0	0	Zero.
-	-	0	1	Bit 0 of register R is a 1.

1 2 3 4 Result in R

- - 1 0 Bit 0 of register R is a 0 and bit positions 1-31 of register R contain at least one 1.

0 - - - Sum is correct (less than  $2^{32}$ ).

1 - - - Sum is greater than  $2^{32}-1$ .

**CVS CONVERT BY SUBTRACTION**  
(Word index alignment)

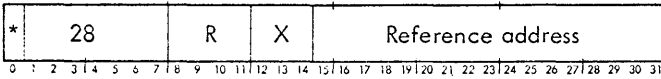

CONVERT BY SUBTRACTION loads the internal A register with the contents of register R, clears the internal B register, and sets an internal counter (n) to 0. All conversion values are considered to be 32-bit positive quantities. If the nth conversion value (the contents of the word location pointed to by the effective address plus n) is equal to or less than the current contents of the A register, CVS increments n by 1, adds the two's complement of the nth conversion value to the contents of the A register, stores the sum in the A register, and stores a 1 in bit position n of the B register. If the nth conversion value is greater than the current contents of the A register, CVS only increments n by 1. If n is less than 32 after being incremented, the next conversion value is compared and the process continues through n equal to 31; the remainder in the A register is loaded into register R, and the converted quantity in the B register is loaded into register Ru1.

Affected: (R), (Ru1), CC3, CC4

(R) → A, 0 → B, 0 → n

If  $(EWL + n) \leq (A)$  then  $A - (EWL + n) \rightarrow A$ ,  
 $1 \rightarrow B_n$ ,  $n + 1 \rightarrow n$

If  $(EWL + n) > (A)$  then  $n + 1 \rightarrow n$

If  $n < 32$ , repeat; otherwise, (A) → R, (B) → Ru1 and continue to the next instruction.

Condition code settings:

1 2 3 4 Result in Ru1

- - 0 0 Zero.

- - 0 1 Bit 0 of register Ru1 is a 1.

- - 1 0 Bit 0 of register Ru1 is a 0 and bit positions 1-31 of register Ru1 contain at least one 1.

**FLOATING-POINT ARITHMETIC INSTRUCTIONS**

The following floating-point arithmetic instructions are available to SIGMA 8 computers:

Instruction Name	Mnemonic
Floating Add Short	FAS
Floating Add Long	FAL
Floating Subtract Short	FSS
Floating Subtract Long	FSL
Floating Multiply Short	FMS
Floating Multiply Long	FML
Floating Divide Short	FDS
Floating Divide Long	FDL

**FLOATING-POINT NUMBERS**

SIGMA 8 accommodates two number formats for floating-point arithmetic: short and long. A short-format floating-point number consists of a sign (bit 0), a biased<sup>†</sup> base 16 exponent, which is called a characteristic (bits 1-7), and a six-digit hexadecimal fraction (bits 8-31). A long-format floating-point number is followed by an additional eight hexadecimal digits of fractional significance and occupies a doubleword memory location or an even-odd pair of general registers.

A SIGMA 8 floating-point number (N) has the following format:

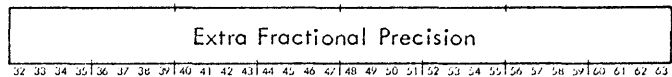
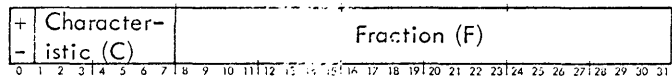

A floating-point number (N) has the following formal definition:

1.  $N = F \times 16^{C-64}$  where  $F = 0$  or  $16^{-6} \leq |F| \leq 1$  (short format) or  $16^{-14} \leq |F| \leq 1$  (long format) and  $0 \leq C \leq 127$ .

<sup>†</sup>The bias value of  $40_{16}$  is added to the exponent for the purpose of making it possible to compare the absolute magnitude of two numbers, i.e., without reference to a sign bit. This manipulation effectively removes the sign bit, making each characteristic a 7-bit positive number.

2. A positive floating-point number with a fraction of zero and a characteristic of zero is a "true" zero. A positive floating-point number with a fraction of zero and a nonzero characteristic is an "abnormal" zero. For floating-point multiplication and division, an abnormal zero is treated as a true zero. However, for addition and subtraction, an abnormal zero is treated the same as any nonzero operand.
3. A positive floating-point number is normalized if and only if the fraction is contained in the interval
 
$$1/16 \leq F < 1$$
4. A negative floating-point number is the two's complement of its positive representation.
5. A negative floating-point number is normalized if and only if its two's complement is a normalized positive number.

By this definition, a floating-point number of the form

1xxx xxxx 1111 0000 ... 0000

is normalized, and a floating-point number of the form

1xxx xxxx 0000 0000 ... 0000

is illegal and, whenever generated by floating-point instructions, is converted to the form

1yyy yyyy 1111 0000 ... 0000

where yy ... y is 1 less than xx ... x. Table 10 contains examples of floating-point numbers.

#### Modes of Operation

SIGMA 8 contains three mode control bits that are used to qualify floating-point operations. These mode control bits

Table 10. Floating-Point Number Representation

Decimal Number	Short Floating-Point Format									Hexadecimal Value		
	±	C			F							
$+(16^{+63})(1-2^{-24})$	0	111	1111	1111	1111	1111	1111	1111	1111	1111	7F	FFFFFF
$+(16^{+3})(5/16)$	0	100	0011	0101	0000	0000	0000	0000	0000	0000	43	500000
$+(16^{-3})(209/256)$	0	011	1101	1101	0001	0000	0000	0000	0000	0000	3D	D10000
$+(16^{-63})(2047/4096)$	0	000	0001	0111	1111	1111	0000	0000	0000	0000	01	7FF000
$+(16^{-64})(1/16)$	0	000	0000	0001	0000	0000	0000	0000	0000	0000	00	100000
0 (called true zero)	0	000	0000	0000	0000	0000	0000	0000	0000	0000	00	000000
$-(16^{-64})(1/16)$	1	111	1111	1111	0000	0000	0000	0000	0000	0000	FF	F00000
$-(16^{-63})(2047/4096)$	1	111	1110	1000	0000	0001	0000	0000	0000	0000	FE	801000
$-(16^{-3})(209/256)$	1	100	0010	0010	1111	0000	0000	0000	0000	0000	C2	2F0000
$-(16^{+3})(5/16)$	1	011	1100	1011	0000	0000	0000	0000	0000	0000	BC	B00000
$-(16^{+63})(1-2^{-24})$	1	000	0000	0000	0000	0000	0000	0000	0000	0001	80	000001
<u>Special Case</u>												
$-(16^e)(1)$	1	$\overline{e}$			0000	0000	0000	0000	0000	0000		
is changed to												
$-(16^{e+1})(1/16)$	1	$\overline{e+1}$			1111	0000	0000	0000	0000	0000		
whenever generated as the result of a floating-point instruction.												

are identified as FS (floating significance), FZ (floating zero), and FN (floating normalize), and are contained in bit positions 5, 6, and 7, respectively, of the program status doubleword (PSD<sub>5-7</sub>).

The floating-point mode is established by setting the three floating-point mode control bits. This can be performed by any of the following instructions:

<u>Instruction Name</u>	<u>Mnemonic</u>
Load Conditions and Floating Control	LCF
Load Conditions and Floating Control Immediate	LCFI
Load Program Status Doubleword	LPSD
Exchange Program Status Doubleword	XPSD

The floating-point mode control bits are stored by executing either of the following instructions:

<u>Instruction Name</u>	<u>Mnemonic</u>
Store Conditions and Floating Control	STCF
Exchange Program Status Doubleword	XPSD

### FLOATING-POINT ADD AND SUBTRACT

The floating normalize (FN), floating zero (FZ), and floating significance (FS) mode control bits determine the operation of floating-point addition and subtraction (if characteristic overflow does not occur) as follows:

FN Floating normalize:

FN = 0 The results of additions and subtractions are to be postnormalized. If characteristic underflow occurs, if the result is zero, or if more than two postnormalization hexadecimal shifts are required, the settings for FZ and FS determine the resultant action. If none of the above conditions occurs, the condition code is set to 0010 if the result is positive or to 0001 if the result is negative.

FN = 1 Inhibit postnormalization of the result of additions and subtractions. The settings of FZ and FS have no effect on the instruction operation. If the result is zero, the result is set to true zero and the condition code is set to 0000. If the result is positive, the condition code is set to 0010. If the result is negative, the condition code is set to 0001.

FZ Floating zero: (applies only if FN = 0)

FZ = 0 If the final result of an addition or subtraction operation cannot be expressed in normalized form because of the characteristic being reduced below zero, underflow has occurred, in which case the result is set equal to true zero and the condition code is set to 1100. (Exception: if a trap results from significance checking with FS = 1 and FZ = 0, an underflow generated in the process of postnormalizing is ignored.)

FZ = 1 Characteristic underflow causes the computer to trap to HomeSpace location X'44' with the contents of the general registers unchanged. If the result is positive, the condition code is set to 1110. If the result is negative, the condition code is set to 1101.

FS Floating significance: (applies only if FN = 0)

FS = 0 Inhibit significance trap. If the result of an addition or subtraction is zero, the result is set equal to true zero, the condition code is set to 1000, and the computer executes the next instruction in sequence. If more than two hexadecimal places of postnormalization shifting are required and characteristic underflow does not occur, the condition code is set to 1010 if the result is positive, or to 1001 if the result is negative; then, the computer executes the next instruction in sequence. (Exception: if characteristic underflow occurs with FS = 0, FZ determines the resultant action.)

FS = 1 The computer traps to HomeSpace location X'44' if more than two hexadecimal places of postnormalization shifting are required or if the result is zero. The condition code is set to 1000 if the result is zero, to 1010 if the result is positive, or to 1001 if the result is negative; however, the contents of the general registers are not changed. (Exception: if a trap results from characteristic underflow with FZ = 1, the results of significance testing are ignored.)

If characteristic overflow occurs, the CPU always traps to HomeSpace location X'44' with the general registers unchanged and the condition code set to 0110 if the result is positive, or to 0101 if the result is negative.

### FLOATING-POINT MULTIPLY AND DIVIDE

The floating zero (FZ) mode control bit alone determines the operation of floating-point multiplication and division

(if characteristic overflow does not occur and division by zero is not attempted) as follows:

**FZ Floating zero:**

**FZ = 0** If the final result of a multiplication or division operation cannot be expressed in normalized form because of the characteristic being reduced below zero, underflow has occurred. If underflow occurs, the result is set equal to true zero and the condition code is set to 1100. If underflow does not occur, the condition code is set to 0010 if the result is positive, to 0001 if the result is negative, or to 0000 if the result is zero.

**FZ = 1** Underflow causes the computer to trap to Homespace location X'44' with the contents of the general registers unchanged. The condition code is set to 1110 if the result is positive, or to 1101 if the result is negative. If underflow does not occur, the resultant action is the same as that for FZ = 0.

If the divisor is zero in a floating-point division, the computer always traps to Homespace location X'44' with the general registers unchanged and the condition code set to 0100. If characteristic overflow occurs, the computer always traps to Homespace location X'44' with the general registers unchanged and the condition code set to 0110 if the result is positive, or to 0101 if the result is negative.

**CONDITION CODES FOR FLOATING-POINT INSTRUCTIONS**

The condition code settings for floating-point instructions are summarized in Table 11. The following provisions apply to all floating-point instructions:

1. Underflow and overflow detection apply to the final characteristic, not to any "intermediate" value.
2. If a floating-point operation results in a trap, the original contents of all general registers remain unchanged.

Table 11. Condition Code Settings for Floating-Point Instructions

Condition Code 1 2 3 4	Meaning If No Trap to Homespace Location X'44'	Meaning If Trap to Homespace Location X'44' Occurs
0 0 0 0 0 0 0 1 0 0 1 0	$A \times 0$ , $0/A$ , or $-A + A$ <sup>①</sup> with FN=1 N < 0 N > 0	* <sup>②</sup> * *
0 1 0 0 0 1 0 1 0 1 1 0	* <sup>②</sup> * *	Divide by zero Overflow, N < 0 Overflow, N > 0
③ $\left\{ \begin{array}{l} 1 0 0 0 \\ 1 0 0 1 \\ 1 0 1 0 \end{array} \right.$	$-A + A$ <sup>①</sup> N < 0 N > 0	$-A + A$ N < 0 N > 0
1 1 0 0 1 1 0 1 1 1 1 0	Underflow with FZ=0 and no trap by FS=1 <sup>①</sup> * *	* Underflow, N < 0 Underflow, N > 0
<p><b>Notes:</b> ① Result set to true zero            ② "*" indicates impossible configurations            ③ Applies to add and subtract only where FN=0</p>		

- 3. All shifting and truncation are performed on absolute magnitudes. If the fraction is negative, then the two's complement is formed after shifting or truncation.

**FAS FLOATING ADD SHORT**  
(Word index alignment)

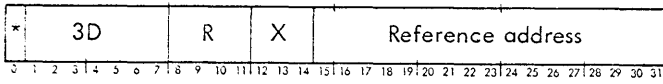

The effective word and the contents of register R are loaded into a set of internal registers and a low-order hexadecimal zero (guard digit) is appended to both fractions, extending them to seven hexadecimal digits each. FAS then forms the floating-point sum of the two numbers. If no floating-point arithmetic fault occurs, the sum is loaded into register R as a short-format floating-point number.

Affected: (R), CC  
(R) + EW → R      Trap: Floating-point arithmetic fault

**FAL FLOATING ADD LONG**  
(Doubleword index alignment)

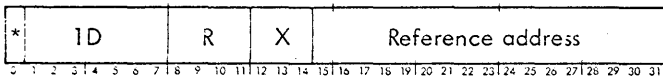

The effective doubleword and contents of registers R and Ru1 are loaded into a set of internal registers.

The operation of FAL is identical to that of FLOATING ADD SHORT (FAS) except that the fractions to be added are each 14 hexadecimal digits long, guard digits are not appended to the fractions, and R must be an even value for correct results. If no floating-point arithmetic fault occurs, the sum is loaded into registers R and Ru1 as a long-format floating-point number.

Affected: (R), (Ru1), CC  
(R, Ru1) + ED → R, Ru1      Trap: Floating-point arithmetic fault, instruction exception

The R field of the FAL instruction must be an even value for proper operation of the instruction; if the R field of FAL is an odd value, the instruction traps to Homespace location X'4D', the instruction exception trap.

**FSS FLOATING SUBTRACT SHORT**  
(Word index alignment)

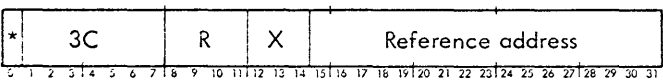

The effective word and the contents of register R are loaded into a set of internal registers.

FLOATING SUBTRACT SHORT forms the two's complement of the effective word and then operates identically to FLOATING ADD SHORT (FAS). If no floating-point

arithmetic fault occurs, the difference is loaded into register R as a short-format floating-point number.

Affected: (R), CC  
(R) - EW → R      Trap: Floating-point arithmetic fault

**FSL FLOATING SUBTRACT LONG**  
(Doubleword index alignment)



The effective doubleword and the contents of registers R and Ru1 are loaded into a set of internal registers.

FLOATING SUBTRACT LONG forms the two's complement of the effective doubleword and then operates identically to FLOATING ADD LONG (FAL). If no floating-point arithmetic fault occurs, the difference is loaded into registers R and Ru1 as a long-format floating-point number.

Affected: (R), (Ru1), CC  
(R, Ru1) - ED → R, Ru1      Trap: Floating-point arithmetic fault, instruction exception

The R field of the FSL instruction must be an even value for proper operation of the instruction; if the R field of FSL is an odd value, the instruction traps to Homespace location X'4D', the instruction exception trap.

**FMS FLOATING MULTIPLY SHORT**  
(Word index alignment)



The effective word (multiplier) and the contents of register R (multiplicand) are loaded into a set of internal registers, and both numbers are then prenormalized (if necessary). The product of the fractions contains 12 hexadecimal digits. If no floating-point arithmetic fault occurs, the product is loaded into register R as a properly truncated short-format floating-point number.

The result of floating-multiply is always postnormalized. At most, one place of postnormalizing shift may be required. Truncation takes place after postnormalization.

Affected: (R), CC  
(R) x EW → R      Trap: Floating-point arithmetic fault

**FML FLOATING MULTIPLY LONG**  
(Doubleword index alignment)



The effective doubleword (multiplier) and the contents of registers R and Ru1 (multiplicand) are loaded into a set of internal registers. FLOATING MULTIPLY LONG then

operates identically to FLOATING MULTIPLY SHORT (FMS), except that the multiplier and the multiplicand fractions are each 14 hexadecimal digits long, the product fraction is 28 hexadecimal digits long, and R must be an even value for correct results. If no floating-point arithmetic fault occurs, the postnormalized product is truncated to a long-format floating-point number and loaded into registers R and Ru1.

Affected: (R), (Ru1), CC Trap: Floating-point arithmetic fault, instruction exception  
 (R, Ru1) × ED → R, Ru1

The R field of the FML instruction must be an even value for proper operation of the instruction; if the R field of FML is an odd value, the instruction traps to Homespace location X'4D', the instruction exception trap.

**FDS** FLOATING DIVIDE SHORT  
 (Word index alignment)



The effective word (divisor) and the contents of register R (dividend) are loaded into a set of internal registers and both numbers are then prenormalized (if necessary). FLOATING DIVIDE SHORT then forms a floating-point quotient with a 6-digit, normalized hexadecimal fraction. If no floating-point arithmetic fault occurs, the quotient is loaded into register R as a short-format floating-point number.

Affected: (R), CC Trap: Floating-point arithmetic fault  
 (R) ÷ EW → R

**FDL** FLOATING DIVIDE LONG  
 (Doubleword index alignment)



The effective doubleword (divisor) and the contents of registers R and Ru1 (dividend) are loaded into a set of internal registers. FLOATING DIVIDE LONG then operates identically to FLOATING DIVIDE SHORT (FDS), except that the divisor, dividend, and quotient fractions are each 14 hexadecimal digits long, and R must be an even value for correct results. If no floating-point arithmetic fault occurs, the quotient is loaded into registers R and Ru1 as a long-format floating-point number.

Affected: (R), (Ru1), CC Trap: Floating-point arithmetic fault, instruction exception  
 (R, Ru1) ÷ ED → R, Ru1

The R field of the FDL instruction must be an even value for proper operation of the instruction; if the R field of FDL is an odd value, the instruction traps to Homespace location X'4D', the instruction exception trap.

Four instructions provide for the manipulation of strings of consecutive bytes. The byte string instructions and their mnemonic codes are as follows:

Instruction Name	Mnemonic
Move Byte String	MBS
Compare Byte String	CBS
Translate Byte String	TBS
Translate and Test Byte String	TTBS

These instructions are in the immediate displacement class and are memory-to-memory operations. These operations are under the control of information that must be loaded into certain general registers before the instruction is executed. These instructions may be interrupted at various stages of their execution; upon return, execution continues from the point of interruption.

The general format for the information in the instruction word and in the general registers is as follows:

Instruction word:

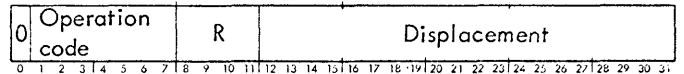

Contents of register R:

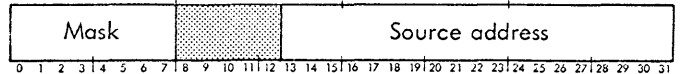

Contents of register Ru1:

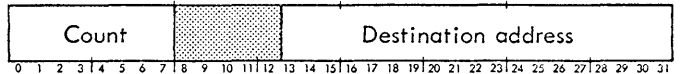

Designation	Function
Operation	The 7-bit operation code of the instruction. (If any byte string instruction is indirectly addressed, the computer traps to Homespace location X'40' at the time of operation code decoding.)
R	The 4-bit field that identifies register R of the current general register block.



<u>Designation</u>	<u>Function</u>
Displacement	A 20-bit field that contains a signed byte displacement value, used to form an effective byte address. The displacement value is right-justified in the 20-bit field, and negative values are in two's complement form.
Mask	An 8-bit field used only with TRANSLATE AND TEST BYTE STRING. The purpose of this field is explained in the detailed discussion of the TTBS instruction.
Source Address	A 19-bit field that normally contains the byte address of the first (most significant) byte of the source byte string operand. The effective source address is the source address in register R plus the displacement value in the instruction word.
Count	An 8-bit field that contains the true count (from 0 to 255) of the number of bytes involved in the operation. This field is decremented by 1 as each byte in the destination byte string is processed. A 0 count means "no operation" with respect to the registers and main memory.
Destination Address	A 19-bit field that contains the byte address of the first (most significant) byte of the destination byte string operand. This field is incremented by 1 as each byte in the destination byte string is processed.

In any byte string instruction, any portion of register R or Ru1 that is not explicitly defined (i.e., bit positions 8-12), should be coded with zeros.

Since the value Ru1 is obtained by performing a logical inclusive OR with the value 0001 and the value of the R field of the instruction word, the two control registers are R and R + 1 if R is even. However, if R is an odd value, register R contains an address value that functions both as a source operand address and as a destination operand address. Also, if register 0 is designated in any byte string instruction (except for TRANSLATE AND TEST BYTE STRING), its contents are ignored and a zero source address value is obtained. Thus, the following three cases exist for most byte string instructions, depending on whether the value of the R field of the instruction word is even and nonzero, odd, or zero:

#### Case I: R is even and nonzero

The effective source address is the address in register R plus the displacement in the instruction word; the destination address is the address in register R + 1, but without the displacement added.

#### Case II: R is odd

The effective source address is the address in register R plus the displacement in the instruction word; the destination address is also the address in register R, but without the displacement added.

#### Case III: R is zero

The effective source address is the displacement value in the instruction word; the destination address is the address in register 1. In this case, the source byte string operand is always a single byte.

In the descriptions of the byte-string instructions, the following abbreviations and terms are used:

D	Displacement, $(I)_{12-31}$ .
SA	Source address, $(R)_{13-31}$ .
ESA	Effective source address, $[(R)_{13-31} + (I)_{12-31}]_{13-31}$ .
	The contents of bit positions 13-31 of register R are added (right aligned) to the contents of bit positions 12-31 of the instruction word; the 19 low-order bits of the result are used as the effective source address.
C	Count, $(Ru1)_{0-7}$ .
DA	Destination address, $(Ru1)_{13-31}$ .
SBS	Source byte string, the byte string that begins with the byte location pointed to by the 19-bit effective source address and is C bytes in length (if R is nonzero) or is 1 byte in length if R is 0).
DBS	Destination byte string, the byte string that begins with the byte location pointed to by the destination address and is always C bytes in length.

#### TRAPS BY BYTE STRING INSTRUCTIONS

Byte string instructions cause a trap if either of the byte strings addressed come from pages of memory that are protected by write locks. A trap also occurs if either byte string is fully or partly contained within pages of memory that are physically not present. A check for these access trap conditions are made prior to initiation of any byte relocation or general register change. These tests are performed for MOVE BYTE STRING and COMPARE BYTE STRING. These tests are performed only for the source byte string for TRANSLATE BYTE STRING and TRANSLATE AND TEST BYTE STRING, since there is no assurance that the translate table will be accessed in its entirety in the

course of execution. If an access protection violation were to occur in trying to reach a byte in the translate table during the course of execution, then the instruction would trap and result in a partially executed condition. The registers would be restored, however, in such a manner that the instruction could be resumed after the protection violation had been corrected. When a trap occurs resulting in a partially executed instruction, the Register Altered indicator will be set.

**MBS MOVE BYTE STRING**  
(Immediate displacement, continue after interrupt)

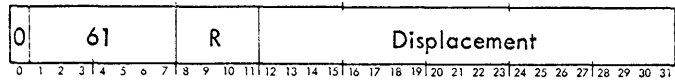

MOVE BYTE STRING copies the contents of the source byte string (left to right) into the destination byte string. The previous contents of the destination byte string are destroyed, but the contents of the source byte string are not affected unless the destination byte string overlaps the source byte string.

When the destination byte string overlaps the source byte string, the resulting destination byte string contains one or more repetitions of bytes from the source byte string. Thus, if a destination byte string of C bytes begins with the kth byte of a source byte string (numbering from 1), the first k-1 bytes of the source byte string are duplicated in the destination byte string x number of times, where  $x = C/(k-1)$ . For example, if the destination byte string begins with the second byte of the source byte string, the first byte of the source byte string is duplicated throughout the destination byte string.

If both byte strings begin with the same byte (i.e.,  $k = 1$ ) and the R field of MBS is nonzero, the destination byte string is read and replaced into the same memory locations. However, if both byte strings begin with the same byte and the R field of MBS is zero, the first byte of the byte string is duplicated throughout the remainder of the byte string (see "Case III", below).

Affected: (DBS), (R), (Ru1)  
(SBS) → DBS

If MBS is indirectly addressed, it is treated as a non-existent instruction, in which case the computer unconditionally aborts execution of the instruction (at the time of operation code decoding) and traps to Homespace location X'40' with the contents of register R and the destination byte string unchanged. See "Traps by Byte String Instructions" (in this section) for other trap conditions.

Case I: even, nonzero R field (Ru1 = R + 1)

Contents of register R:

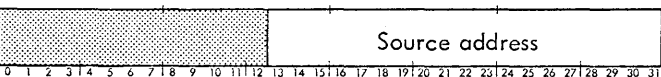

Contents of register R+1:

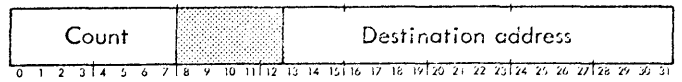

The source byte string begins with the byte location pointed to by the source address in register R plus the displacement in MBS; the destination byte string begins with the byte location pointed to by the destination address in register R+1. Both byte strings are C bytes in length. When the instruction is completed, the destination and source addresses are each incremented by C, and C is set to zero.

Case II: odd R field (Ru1 = R)

Contents of register R:

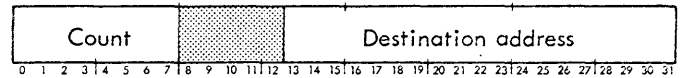

The source byte string begins with the byte location pointed to by the address in register R plus the displacement in MBS; the destination byte string begins with the byte location pointed to by the destination address in register R. Both byte strings are C bytes in length. When the instruction is completed, the destination address is incremented by C, and C is set to zero.

Case III: zero R field (Ru1 = 1)

Contents of register I:

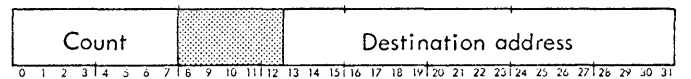

The source byte string consists of a single byte, the contents of the byte location pointed to by the displacement in MBS; the destination byte string begins with the byte location pointed to by the destination address in register I and is C bytes in length. In this case, the source byte is duplicated throughout the destination byte string. When the instruction is completed, the destination address is incremented by C and C is set to zero.

**CBS COMPARE BYTE STRING**  
(Immediate displacement, continue after interrupt)

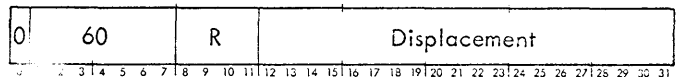

COMPARE BYTE STRING compares, as magnitudes, the contents of the source byte string with the contents of the destination byte string, byte by corresponding byte, beginning with the first byte of each string. The comparison continues until the specified number of bytes have been compared or until an inequality is found. When CBS is terminated, CC3 and CC4 are set to indicate the result of

the last comparison. If the CBS instruction terminates due to inequality, the count in register Ru1 is one greater than the number of bytes remaining to be compared; the source address in register R and the destination address in register Ru1 indicate the locations of the unequal bytes.

Affected: (R), (Ru1), CC3, CC4  
(SBS) : (DBS)

Condition code settings:

1	2	3	4	Result of CBS
-	-	0	0	Source byte string equals destination byte string.
-	-	0	1	Source byte string less than destination byte string.
-	-	1	0	Source byte string greater than destination byte string.

If CBS is indirectly addressed, it is treated as a nonexistent instruction, in which case the computer unconditionally aborts execution of the instruction (at the time of operation code decoding) and traps to Homespace location X'40' with the contents of register R and the destination byte string unchanged. See "Traps By Byte String Instructions" (in this section) for other trap conditions.

#### Case I: even, nonzero R field (Ru1=R+1)

Contents of register R:

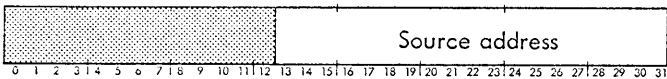

Contents of register R+1:

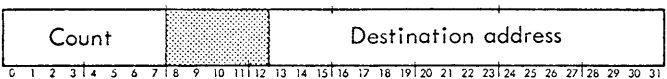

The source byte string begins with the byte location pointed to by the source address in register R plus the displacement in CBS; the destination byte string begins with the byte location pointed to by the destination address in register R+1. Both byte strings are C bytes in length.

#### Case II: odd R field (Ru1=R)

Contents of register R:

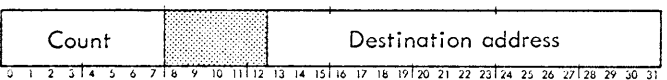

The source byte string begins with the byte location pointed to by the address in register R plus the displacement in CBS; the destination byte string begins with the

byte location pointed to by the destination address in register R. Both byte strings are C bytes in length.

#### Case III: zero R field (Ru1=1)

Contents of register 1:

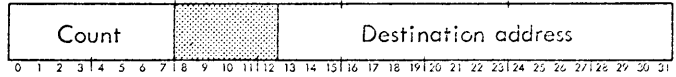

The source byte string consists of a single byte, the contents of the location pointed to by the displacement in CBS; the destination byte string begins with the byte location pointed to by the destination address in register 1 and is C bytes in length. In this case, the source byte is compared with each byte of the destination byte string until an inequality is found.

#### TBS TRANSLATE BYTE STRING

(Immediate displacement, continue after interrupt)

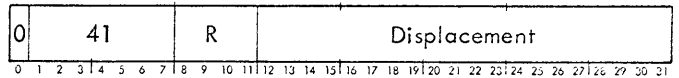

TRANSLATE BYTE STRING replaces each byte of the destination byte string with a source byte located in a translation table. The destination byte string begins with the byte location pointed to by the destination address in register Ru1, and is C bytes in length. The translation table consists of up to 256 consecutive byte locations, with the first byte location of the table pointed to by the displacement in TBS plus the source address in register R. A source byte is defined as that which is in the byte location pointed to by the 19 low-order bits of the sum of the following values.

1. The displacement in bit positions 12-31 of the TBS instruction.
2. The current contents of bit positions 13-31 of register R (source address).
3. The numeric value of the current destination byte, the 8-bit contents of the byte location pointed to by the current destination address in bit positions 13-31 of register (Ru1).

Affected: (DBS), (Ru1) Trap: Instruction exception translated (DBS) → DBS

The R field of the TBS instruction must be an even value for proper operation of the instruction; if the R field of TBS is an odd value, the instruction traps to Homespace location X'4D', instruction exception trap.

If TBS is indirectly addressed, it is treated as a nonexistent instruction, in which case the computer unconditionally aborts execution of the instruction (at the time of operation code decoding) and traps to Homespace location X'40' with the contents of register R and the destination byte string unchanged.

See "Traps By Byte String Instructions" (in this section) for other trap conditions. Note that the check for access trap conditions is done only for the source byte string.

Case I: even, nonzero R field (Ru1=R+1)

Contents of register R:

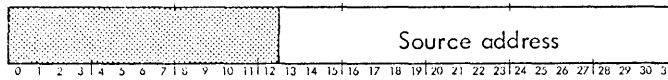

Contents of register R+1:

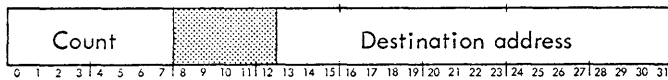

The destination byte string begins with the byte location pointed to by the destination address in register R+1 and is C bytes in length. The source byte string (translation table) begins with the byte location pointed to by the displacement in TBS plus the source address in register R. When the instruction is completed, the destination address is incremented by C, C is set to zero, and the source address remains unchanged.

Case II: odd R field (Ru1=R)

Because of the interruptible nature of TRANSLATE BYTE STRING, the instruction traps with the contents of register R unchanged when an odd-numbered general register is specified by the R field of the instruction word.

Case III: zero R field (Ru1=1)

Contents of register 1:

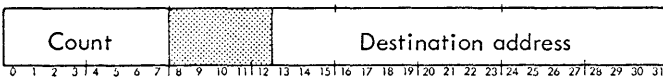

The destination byte string begins with the byte location pointed to by the destination address in register 1 and is C bytes in length. The source byte string (translation table) begins with the location pointed to by the displacement in TBS. When the instruction is completed, the destination address is incremented by C and C is set to zero.

**TTBS** TRANSLATE AND TEST BYTE STRING  
(Immediate displacement, continue after interrupt)

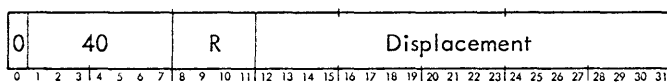

TRANSLATE AND TEST BYTE STRING compares the mask in bit positions 0-7 of register R with source bytes in a byte translation table. The destination byte string begins with

the byte location pointed to by the destination address in register Ru1, and is C bytes in length. The byte translation table and the translation bytes themselves are identical to that described for the instruction TRANSLATE BYTE STRING. The destination byte string is examined (without being changed) until a translation byte (source byte) is found that contains a 1 in any of the bit positions selected by a 1 in the mask. When such a translation byte is found, TTBS replaces the mask with the logical product (AND) of the translation byte and the mask, and terminates with CC4 set to 1. If the TTBS instruction terminates due to the above condition, the count (C) in register Ru1 is one greater than the number of bytes remaining to be compared and the destination address in register Ru1 indicates the location of the destination byte that caused the instruction to terminate. If no translation byte is found that satisfies the above condition after the specified number of destination bytes have been compared, TTBS terminates with CC4 reset to 0. In no case does the TTBS instruction change the source byte string.

Affected: (R), (Ru1), CC4 Trap: Instruction exception

If translated (SBS) n mask ≠ 0, translated (SBS) n mask → mask and stop

If translated (SBS) n mask = 0, continue

Condition code settings:

1	2	3	4	Result of TTBS
-	-	-	0	Translation bytes and the mask do not compare 1's any place.
-	-	-	1	The last translation byte compared with the mask contained at least one 1 corresponding to a 1 in the mask.

The R field of the TTBS instruction must be an even value for proper operation of the instruction; if the R field of TTBS is an odd value, the instruction traps to HomeSpace location X'4D', the instruction exception traps.

If TTBS is indirectly address, it is treated as a nonexistent instruction, in which case the computer unconditionally aborts execution of the instruction (at the time of operation code decoding) and traps to HomeSpace location X'40' with the contents of register R and the destination byte string unchanged.

See "Traps By Byte String Instructions" (in this section) for other trap conditions. Note that the check for access trap conditions is done only for the source byte string.

Case I: even, nonzero R field (Ru1=R+1)

Contents of register R:

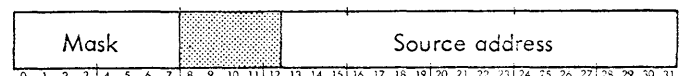

Contents of register R+1:

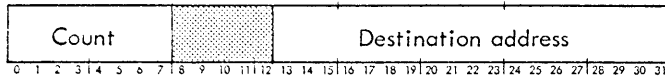

The destination byte string begins with the byte location pointed to by the destination address in register R + 1 and is C bytes in length. The source byte string (translation table) begins with the byte location pointed to by the displacement in TTBS plus the source address in register R.

Case II: odd R field

Because of the interruptible nature of TRANSLATE AND TEST BYTE STRING the instruction traps with the contents of register R unchanged when an odd-numbered general register is specified by the R field of the instruction word.

Case III. zero R field (Ru=1)

Contents of register 1:

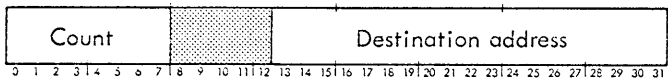

The destination byte string begins with the byte location pointed to by the destination address in register 1 and is C bytes in length. The source byte string (translation table) begins with the location pointed to by the displacement in TTBS. In this case, the instruction automatically provides a mask of eight 1's. (This is an exception to the general rule, used in the other byte string instructions, that register 0 provides all 0's as its contents.)

### PUSH-DOWN INSTRUCTIONS

The term "push-down processing" refers to the programming technique (used extensively in recursive routines) of storing the context of a calculation in memory, proceeding with a new set of information, and then activating the previously stored information. Typically, this process involves a reserved area of memory (stack) into which operands are pushed (stored) and from which operands are pulled (loaded) on a last-in, first-out basis. The SIGMA 8 computer provides for simplified and efficient programming of push-down processing by means of the following instructions:

<u>Instruction Name</u>	<u>Mnemonic</u>
Push Word	PSW
Pull Word	PLW
Push Multiple	PSM
Pull Multiple	PLM
Modify Stack Pointer	MSP

### STACK POINTER DOUBLEWORD (SPD)

Each of these instructions operates with respect to a memory stack that is defined by a doubleword located at the effective address of the instruction. This doubleword, referred to as a stack pointer doubleword (SPD), has the following structure:

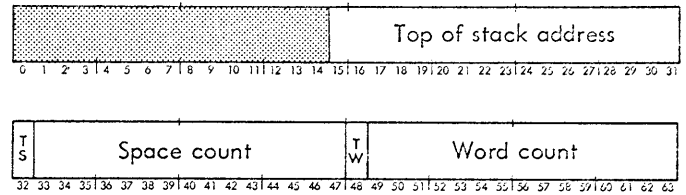

Bit positions 15 through 31 of the SPD contain a 17-bit address field that points to the location of the word currently at the top (highest-numbered address) of the operand stack. In a push operation, the top-of-stack address is incremented by 1 and then an operand in a general register is pushed (stored) into that location, thus becoming the contents of the new top of the stack, the contents of the previous top of the stack remain unchanged. In a pull operation, the contents of the current top of the stack are pulled (loaded) into a general register and then the top-of-stack address is decremented by 1; the previous contents of the stack remain unchanged.

Bit positions 33 through 47 of the SPD, referred to as the space count, contain a 15-bit count (0 to 32,767) of the number of word locations currently available in the region of memory allocated to the stack. Bit positions 49 through 63 of the SPD, referred to as the word count, contain a 15-bit count (0 to 32,767) of the number of words currently in the stack. In a push operation, the space count is decremented by 1 and the word count is incremented by 1; in a pull operation, the space count is incremented by 1 and the word count is decremented by 1. At the beginning of all push-down instructions, the space count and the word count are each tested to determine whether the instruction would cause either count field to be incremented above the upper limit of  $2^{15}-1$  (32,767), or to be decremented below the lower limit of 0. If execution of the push-down instruction would cause either count limit to be exceeded, the computer unconditionally aborts execution of the instruction, with the stack, the stack pointer doubleword, and the contents of general registers unchanged. Ordinarily, the computer traps to Homespace location X'42' after aborting a push-down instruction because of impending stack limit overflow or underflow, and with the condition code unchanged from the value it contained before execution of the instruction.

However, this trap action can be selectively inhibited by setting either (or both) of the trap inhibit bits in the SPD to 1.

Bit position 32 of the SPD, referred to as the trap-on-space (TS) inhibit bit, determines whether the computer will trap to Homespace location X'42' as a result of

impending overflow or underflow of the space count (SPD<sub>33-47</sub>), as follows:

TS Space count overflow/underflow action

- 0 If the execution of a pull instruction would cause the space count to exceed 2<sup>15</sup>-1, or if the execution of a push instruction would cause the space count to be less than 0, the computer traps to Homespace location X'42' with the condition code unchanged.
- 1 Instead of trapping to Homespace location X'42', the computer sets CC1 to 1 and then executes the next instruction in sequence.

Bit position 48 of the SPD, referred to as the trap-on-word (TW) inhibit bit, determines whether the computer will trap to Homespace location X'42' as a result of impending overflow or underflow of the word count (SPD<sub>49-63</sub>), as follows:

TW Word count overflow/underflow action

- 0 If the execution of a push instruction would cause the word count to exceed 2<sup>15</sup>-1, or if the execution of a pull instruction would cause the word count to be less than 0, the computer traps to Homespace location X'42' with the condition code unchanged.
- 1 Instead of trapping to Homespace location X'42', the computer sets CC3 to 1 and then executes the next instruction in sequence.

**PUSH-DOWN CONDITION CODE SETTINGS**

If the execution of a push-down instruction is attempted and the computer traps to Homespace location X'42', the condition code remains unchanged from the value it contained immediately before the instruction was executed.

If the execution of a push-down instruction is attempted and the instruction is aborted because of impending stack limit overflow or underflow (or both) but the push-down stack limit trap is inhibited by one (or both) of the inhibits (TS and TW), then, CC1 or CC3 is set to 1 (or both are set to 1's) to indicate the reason for aborting the push-down instruction, as follows:

1 2 3 4 Reason for abort

- 0 - 1 - Impending overflow of word count on a push operation or impending underflow of word count on a pull operation. The push-down stack limit trap was inhibited by the TW bit (SPD<sub>48</sub>).
- 1 - 0 - Impending overflow of space count on a pull operation or impending underflow of space count on a push operation. The push-down stack limit trap was inhibited by the TS bit (SPD<sub>32</sub>).

1 2 3 4 Reason for abort

- 1 - 1 - Impending overflow of word count and underflow of space count on a push operation or impending overflow of space count and underflow of word count on a pull operation. The push-down stack limit trap was inhibited by both the TW and the TS bits.

If a push-down instruction is successfully executed, CC1 and CC3 are reset to 0 at the completion of the instruction. Also, CC2 and CC4 are independently set to indicate the current status of the space count and the word count, respectively, as follows:

1 2 3 4 Status of space and word counts

- 0 - 0 The current space count and the current word count are both greater than zero.
- 0 - 1 The current space count is greater than zero, but the current word count is zero, indicating that the stack is now empty. If the next operation on the stack is a pull instruction, the instruction will be aborted.
- 1 - 0 The current word count is greater than zero, but the current space count is zero, indicating that the stack is now full. If the next operation on the stack is a push instruction, the instruction will be aborted.

If the computer does not trap to Homespace location X'42' as a result of impending stack limit overflow/underflow, CC2 and CC4 indicate the status of the space and word counts at the termination of the push-down instruction, regardless of whether the space and word counts were actually modified by the instruction. In the following descriptions of the push-down instructions, only those condition code configurations are given that can actually be produced by the instruction, provided that the computer does not trap to Homespace location X'42'.

**PSW PUSH WORD**  
(Doubleword index alignment)

*	09	R	X	Reference address																											
0	1	2	3	4	5	6	7	8	9	10	11	12	13	14	15	16	17	18	19	20	21	22	23	24	25	26	27	28	29	30	31

PUSH WORD stores the contents of register R into the push-down stack defined by the stack pointer doubleword located at the effective doubleword address of PSW. If the push operation can be successfully performed, the instruction operates as follows:

1. The current top-of-stack address (SPD<sub>15-31</sub>) is incremented by 1 to point to the new top-of-stack location.
2. The contents of register R are stored in the location pointed to by the new top-of-stack address.

3. The space count (SPD<sub>33-47</sub>) is decremented by 1 and the word count (SPD<sub>49-63</sub>) is incremented by 1.

4. The condition code is set to reflect the new status of the space count.

Affected: (SPD),(TSA+1), Trap: Push-down stack limit  
CC

$$(SPD)_{15-31} + 1 \longrightarrow SPD_{15-31}$$

$$(R) \longrightarrow (SPD)_{15-31}$$

$$(SPD)_{33-47} - 1 \longrightarrow SPD_{33-47}$$

$$(SPD)_{49-63} + 1 \longrightarrow SPD_{49-63}$$

Condition code settings:

1 2 3 4 Result of PSW

0 0 0 0 Space count is greater than 0.

0 1 0 0 Space count is now 0.

0 0 1 0 Word count =  $2^{15} - 1$ ,  
TW = 1.

1 1 0 0 Space count = 0,  
TS = 1.

1 1 0 1 Space count = 0, word  
count = 0, TS = 1.

1 1 1 0 Word count =  $2^{15} - 1$ ,  
space count = 0,  
TW = 1, and TS = 1.

Instruction  
completed

Instruction  
aborted

4. The condition code is set to reflect the status of the new word count.

Affected: (SPD),(R),CC Trap: Push-down stack limit

$$((SPD)_{15-31}) \longrightarrow R; (SPD)_{15-31} - 1 \longrightarrow SPD_{15-31}$$

$$(SPD)_{33-47} + 1 \longrightarrow SPD_{33-47}$$

$$(SPD)_{49-63} - 1 \longrightarrow SPD_{49-63}$$

Condition code settings:

1 2 3 4 Result of PLW

0 0 0 0 Word count is greater than 0.

0 0 0 1 Word count is now 0.

0 0 1 1 Word count = 0, TW = 1.

0 1 1 1 Space count = 0,  
word count = 0, TW = 1.

1 0 0 0 Space count =  $2^{15} - 1$ ,  
TS = 1.

1 0 1 1 Space count =  $2^{15} - 1$ ,  
word count = 0, TS = 1,  
and TW = 1.

Instruction  
completed

Instruction  
aborted

PSM PUSH MULTIPLE  
(Doubleword index alignment)

*	08	R	X	Reference address																											
0	1	2	3	4	5	6	7	8	9	10	11	12	13	14	15	16	17	18	19	20	21	22	23	24	25	26	27	28	29	30	31

PUSH MULTIPLE stores the contents of a sequential set of general registers into the push-down stack defined by the stack pointer doubleword located at the effective doubleword address of PSM. The condition code is assumed to contain a count of the number of registers to be pushed into the stack. (An initial value of 0000 for the condition code specifies that all 16 general registers are to be pushed into the stack.) The registers are treated as a circular set (with register 0 following register 15) and the first register to be pushed into the stack is register R. The last register to be pushed into the stack is register R + CC - 1, and the contents of this register become the contents of the new top-of-stack location.

If there is sufficient space in the stack for all of the specified registers, PSM operates as follows:

1. The contents of registers R to R + CC - 1 are stored in ascending sequence, beginning with the least...

PLW PULL WORD  
(Doubleword index alignment)

*	08	R	X	Reference address																											
0	1	2	3	4	5	6	7	8	9	10	11	12	13	14	15	16	17	18	19	20	21	22	23	24	25	26	27	28	29	30	31

PULL WORD loads register R with the word currently at the top of the push-down stack defined by the stack pointer doubleword located at the effective doubleword address of PLW. If the pull operation can be performed successfully, the instruction operates as follows:

1. Register R is loaded with the contents of the location pointed to by the current top-of-stack address (SPD<sub>15-31</sub>).
2. The current top-of-stack address is decremented by 1, to point to the new top-of-stack location.
3. The space count (SPD<sub>33-47</sub>) is incremented by 1 and the word count (SPD<sub>49-63</sub>) is decremented by 1.

pointed to by the current top-of-stack address (SPD<sub>15-31</sub>) plus 1 and ending with the current top-of-stack address plus CC.

- The current top-of-stack address is incremented by the value of CC, to point to the new top-of-stack location.
- The space count (SPD<sub>33-47</sub>) is decremented by the value of CC and the word count is incremented by the value of CC.
- The condition code is set to reflect the new status of the space count.

Affected: (SPD), (TSA+1) to (TSA+CC), CC      Trap: Push-down stack limit

$$(R) \rightarrow (SPD)_{15-31} + 1 \dots (R+CC-1) \rightarrow (SPD)_{15-31} + CC$$

$$(SPD)_{15-31} + CC \rightarrow SPD_{15-31}$$

$$(SPD)_{33-47} - CC \rightarrow SPD_{33-47}$$

$$(SPD)_{49-63} + CC \rightarrow SPD_{49-63}$$

Condition code settings:

1	2	3	4	Result of PSM
0	0	0	0	Space count > 0.
0	1	0	0	Space count = 0.
0	0	1	0	Word count + CC > 2 <sup>15</sup> -1, TW = 1.
1	0	0	0	Space count < CC, TS = 1.
1	0	0	1	Space count < CC, word count = 0, TS = 1.
1	0	1	0	Space count < CC, word count + CC > 2 <sup>15</sup> -1, TS = 1, and TW = 1.
1	1	0	0	Space count = 0, TS = 1.
1	1	0	1	Space count = 0, word count = 0, TS = 1.
1	1	1	0	Space count = 0, word count + CC > 2 <sup>15</sup> -1, TS = 1, and TW = 1.

Instruction completed

Instruction aborted

If the instruction operation extends into a page of memory that is protected by the write locks, a memory protection trap occurs. If the operation extends into a memory region that is physically not present, the nonexistent memory address trap occurs. In either case, if a trap occurs during the execution of this instruction, it is detected before the actual operation begins and the trap occurs immediately.

**PLM PULL MULTIPLE**  
(Doubleword index alignment)

*	OA	R	X	Reference address																											
0	1	2	3	4	5	6	7	8	9	10	11	12	13	14	15	16	17	18	19	20	21	22	23	24	25	26	27	28	29	30	31

PULL MULTIPLE loads a sequential set of general registers from the push-down stack defined by the stack pointer doubleword located at the effective doubleword address of PLM. The condition code is assumed to contain a count of the number of words to be pulled from the stack. (An initial value of 0000 for the condition code specifies that 16 words are to be pulled from the stack.) The registers are treated as a circular set (with register 0 following register 15), the first register to be loaded from the stack is register R + CC - 1, and the contents of the current top-of-stack location become the contents of this register. The last register to be loaded is register R.

If there is a sufficient number of words in the stack to load all of the specified registers, PLM operates as follows:

- Registers R + CC - 1 to register R are loaded in descending sequence, beginning with the contents of the location pointed to by the current top-of-stack address (SPD<sub>15-31</sub>) and ending with the contents of the location pointed to by the current top-of-stack address minus CC-1.
- The current top-of-stack address is decremented by the value of CC, to point to the new top-of-stack location.
- The space count (SPD<sub>33-47</sub>) is incremented by the value of CC and the word count is decremented by the value of CC.
- The condition code is set to reflect the new status of the word count.

Affected: (SPD), (R+CC-1) to (R), CC      Trap: Push-down stack limit

$$((SPD)_{15-31}) \rightarrow R + CC - 1, \dots,$$

$$((SPD)_{15-31} - |CC - 1|) \rightarrow R$$

$$(SPD)_{15-31} - CC \rightarrow SPD_{15-31}$$

$$(SPD)_{33-47} + CC \rightarrow SPD_{33-47}$$

$$(SPD)_{49-63} - CC \rightarrow SPD_{49-63}$$



Condition code settings:

1	2	3	4	Result of PLM	
0	0	0	0	Word count > 0	} Instruction completed
0	0	0	1	Word count = 0	
0	0	1	0	Word count < CC, TW = 1	} Instruction aborted
0	0	1	1	Word count = 0, TW = 1	
0	1	1	0	Space count = 0, word count < CC, TW = 1	
0	1	1	1	Space count = 0, word count = 0, TW = 1	
1	0	0	0	Space count + CC > 2 <sup>15</sup> -1, TS = 1	
1	0	1	0	Space count + CC > 2 <sup>15</sup> -1, word count < CC, TS = 1, and TW = 1	
1	0	1	1	Space count + CC > 2 <sup>15</sup> -1, word count = 0, TS = 1, and TW = 1	

If the instruction operation extends into a page of memory that is protected by the write locks, the memory protection trap occurs. If the operation extends into a memory region that is physically not present, the nonexistent memory address trap occurs. In either case, if a trap occurs during the execution of this instruction, it is detected before the actual operation begins and the trap occurs immediately.

**MSP MODIFY STACK POINTER**  
(Doubleword index alignment)



MODIFY STACK POINTER modifies the stack pointer doubleword, located at the effective doubleword address of MSP by the contents of register R. Register R is assumed to have the following format:

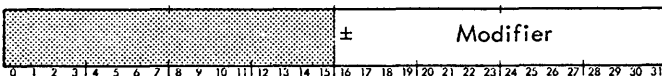

Bit positions 16 through 31 of register R are treated as a signed integer, with negative integers in two's complement form (i.e., a fixed-point halfword). The modifier is algebraically added to the top-of-stack address, subtracted from the space count, and added to the word count in the stack pointer doubleword. If, as a result of MSP, either the space count or the word count would be decreased below 0 or increased above 2<sup>15</sup>-1, the instruction is aborted. Then, the computer either traps to HomeSpace location X'42' or sets the condition code to reflect the reason for aborting, depending on the stack limit trap inhibits.

If the modification of the stack pointer doubleword can be successfully performed, MSP operates as follows:

1. The modifier in register R is algebraically added to the current top-of-stack address (SPD)<sub>15-31</sub>, to point to a new top-of-stack location. (If the modifier is negative, it is extended to 17 bits by appending a high-order 1.)
2. The modifier is algebraically subtracted from the current space count (SPD)<sub>33-47</sub> and the result becomes the new space count.
3. The modifier is algebraically added to the current word count (SPD)<sub>49-63</sub> and the result becomes the new word count.
4. The condition code is set to reflect the new status of the new space count and new word count.

Affected: (SPD), CC      Trap: Push-down stack limit

$$(SPD)_{15-31} + (R)_{16-31SE} \longrightarrow SPD_{15-31}$$

$$(SPD)_{33-47} - (R)_{16-31} \longrightarrow SPD_{33-47}$$

$$(SPD)_{49-63} + (R)_{16-31} \longrightarrow SPD_{49-63}$$

Condition code settings:

1	2	3	4	Result of MSP	
0	0	0	0	Space count > 0, word count > 0.	} Instruction completed
0	0	0	1	Space count > 0, word count = 0.	
0	1	0	0	Space count = 0, word count > 0.	
0	1	0	1	Space count = 0, word count = 0, modifier = 0.	

If CC1, or CC3, or both CC1 and CC3 are 1's after execution of MSP, the instruction was aborted but the push-down stack limit trap was inhibited by the trap-on-space inhibit (SPD<sub>32</sub>), by the trap-on-word inhibit (SPD<sub>48</sub>), or both. The condition code is set to reflect the reason for aborting as follows:

1	2	3	4	Status of space and word counts
-	-	-	0	Word count > 0.
-	-	-	1	Word count = 0.
-	-	0	-	0 ≤ word count + modifier ≤ 2 <sup>15</sup> -1.
-	-	1	-	Word count + modifier < 0, and TW = 1 or word count + modifier > 2 <sup>15</sup> -1, and TW = 1.

1	2	3	4	Status of space and counts
-	0	-	-	Space count > 0.
-	1	-	-	Space count = 0.
0	-	-	-	$0 \leq \text{space count} - \text{modifier} \leq 2^{15} - 1$ .
1	-	-	-	Space count - modifier < 0, and TS = 1 or space count - modifier > $2^{15} - 1$ , and TS = 1.

## EXECUTE/BRANCH INSTRUCTIONS

The EXECUTE instruction can be used to insert another instruction into the program sequence, and the branch instructions can be used to alter the program sequence, either unconditionally or conditionally. If a branch is unconditional (or conditional and the branch condition is satisfied), the instruction pointed to by the effective address of the branch instruction is normally the next instruction to be executed. If a branch is conditional and the condition for the branch is not satisfied, the next instruction is normally taken from the next location, in ascending sequence, after the branch instruction.

### NONALLOWED OPERATION TRAP DURING EXECUTION OF BRANCH INSTRUCTION

A branch instruction has two possible places from which the next instruction may be taken: the location following the branch instruction or the location that may be branched to. It is possible that either of these two locations may be in a protected memory region or in a region that is physically nonexistent. The execution of the branch does not cause a trap unless the instruction that is actually to follow the branch instruction is in a protected or nonexistent memory region. Traps do not occur because of any anticipation on the part of the hardware.

A nonallowed operation trap condition during execution of a branch instruction will occur for the following reasons:

1. The branch instruction is indirectly addressed and the branch conditions are satisfied, but the address of the location containing the direct address is either nonexistent or unavailable for read access to the program in the slave mode.
2. The branch instruction is unconditional (or the branch is conditional and the condition for the branch is satisfied), but the effective address of the branch instruction is nonexistent.

If either of the above situations occurs, the computer aborts execution of the branch instruction and executes a nonallowed operation trap.

Prior to the time that an instruction is accessed from memory for execution, bit positions 15-31 of the program status doubleword contain the address of the instruction, referred to as the instruction address. At this time, the computer traps to HomeSpace location X'40' if the address of the instruction is nonexistent. If the instruction address is

existent, the instruction is accessed and the instruction address portion of the program status doubleword is incremented by 1, so that it now contains the address of the next instruction in sequence (referred to as the updated instruction address).

If a trap condition occurs during the execution sequence of any instruction, the computer decrements the updated instruction address by 1 and then traps to the location assigned to the trap condition. If neither a trap condition nor a satisfied branch condition occurs during the execution of an instruction, the next instruction is accessed from the location pointed to by the updated instruction address. If a satisfied branch condition occurs during the execution of a branch instruction (and no trap condition occurs), the next instruction is accessed from the location pointed to by the effective address of the branch instruction.

### EXU EXECUTE (Word index alignment)

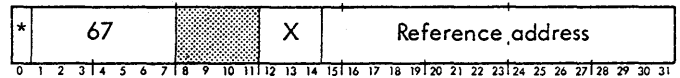

EXECUTE causes the computer to access the instruction in the location pointed to by the effective address of EXU and execute the subject instruction. The execution of the subject instruction, including the processing of trap and interrupt conditions, is performed exactly as if the subject instruction were initially accessed instead of the EXU instruction. If the subject instruction is another EXU, the computer executes the subject instruction pointed to by the effective address of the second EXU as described above. Such "chains" of EXECUTE instructions may be of any length, and are processed (without affecting the updated instruction address) until an instruction other than EXU is encountered. After the final subject instruction is executed, instruction execution proceeds with the next instruction in sequence after the initial EXU (unless the subject instruction is an LPSD or XPSD instruction, or is a branch instruction and the branch condition is satisfied).

If an interrupt activation occurs between the beginning of an EXU instruction (or chain of EXU instructions) and the last interruptible point in the subject instruction, the computer processes the interrupt-servicing routine for the active interrupt level and then returns program control to the EXU instruction (or the initial instruction of a chain of EXU instructions), which is started anew. Note that a program is interruptible after every instruction access, including accesses made with the EXU instruction, and the interruptibility of the subject instruction is the same as the normal interruptibility for that instruction.

If a trap condition occurs between the beginning of an EXU instruction (or chain of EXU instructions) and the completion of the subject instruction, the computer traps to the appropriate trap location. The instruction address stored by the XPSD instruction in the trap location is the address of the

EXU instruction (or the initial instruction in a chain of EXU instructions).

Affected: Determined by subject instruction      Traps: Determined by subject instruction

Condition code settings: Determined by subject instruction

**BCS**      **BRANCH ON CONDITIONS SET**  
(Word index alignment)

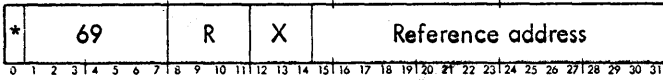

BRANCH ON CONDITIONS SET forms the logical product (AND) of the R field of the instruction word and the current condition code. If the logical product is nonzero, the branch condition is satisfied and instruction execution proceeds with the instruction pointed to by the effective address of the BCS instruction. However, if the logical product is zero, the branch condition is unsatisfied and instruction execution then proceeds with the next instruction in normal sequence.

Affected: (IA) if  $CC \ n \ R \neq 0$

If  $CC \ n \ (I)_{8-11} \neq 0$ ,  $EA_{15-31} \rightarrow IA$

If  $CC \ n \ (I)_{8-11} = 0$ , IA not affected

If the R field of BCS is 0, the next instruction to be executed after BCS is always the next instruction in ascending sequence, thus effectively producing a "no operation" instruction.

**BCR**      **BRANCH ON CONDITIONS RESET**  
(Word index alignment)



BRANCH ON CONDITIONS RESET forms the logical product (AND) of the R field of the instruction word and the current condition code. If the logical product is zero, the branch condition is satisfied and instruction execution then proceeds with the instruction pointed to by the effective address of the BCR instruction. However, if the logical product is nonzero, the branch condition is unsatisfied and instruction execution then proceeds with the next instruction in normal sequence.

Affected: (IA) if  $CC \ n \ R = 0$

If  $CC \ n \ (I)_{8-11} = 0$ ,  $EA_{15-31} \rightarrow IA$

If  $CC \ n \ (I)_{8-11} \neq 0$ , IA not affected

If the R field of BCR is 0, the next instruction to be executed after BCR is always the instruction located at the effective address of BCR, thus effectively producing a "branch unconditionally" instruction.

**BIR**      **BRANCH ON INCREMENTING REGISTER**  
(Word index alignment)



BRANCH ON INCREMENTING REGISTER increments the contents of general register R by 1. If the result is a negative value, the branch condition is satisfied and instruction execution then proceeds with the instruction pointed to by the effective address of the BIR instruction. However, if the result is zero or a positive value, the branch condition is not satisfied and instruction execution proceeds with the next instruction in normal sequence.

Affected: (R), (IA)

$(R) + 1 \rightarrow R$

If  $(R)_0 = 1$ ,  $EA_{15-31} \rightarrow IA$

If  $(R)_0 = 0$ , IA not affected

If the branch condition is satisfied and the effective address of BIR is nonexistent, the computer aborts execution of the BIR instruction and traps to Homespace location X'40'. In this case, the instruction address stored by the XPSD instruction in location X'40' is the address of the aborted BIR instruction. If a memory parity error occurs due to the accessing of the instruction to which the program is branching, the computer aborts execution of the BIR and traps to Homespace location X'4C' with register R unchanged.

**BDR**      **BRANCH ON DECREMENTING REGISTER**  
(Word index alignment)



BRANCH ON DECREMENTING REGISTER decrements the contents of general register R by 1. If the result is a positive value, the branch condition is satisfied and instruction execution then proceeds with the instruction pointed to by the effective address of the BDR instruction. However, if the result is zero or a negative value, the branch condition

is unsatisfied and instruction execution proceeds with the next instruction in normal sequence.

Affected: (R), (IA)

(R) - 1 → R

If  $(R)_0 = 0$  and  $(R)_{1-31} \neq 0$ ,  $EA_{15-31} \rightarrow IA$

If  $(R)_0 = 1$  or  $(R) = 0$ , IA not affected

If the branch condition is satisfied and the effective address of BDR is nonexistent, the computer aborts execution of the BDR instruction and traps to Homespace location X'40'. In this case, the instruction address stored by the XPSD instruction in location X'40' is the address of the aborted BDR instruction. If a memory parity error occurs due to the accessing of the instruction to which the program is branching, the computer aborts execution of the BDR and traps to Homespace location X'4C' with register R unchanged.

**BAL** BRANCH AND LINK  
(Word index alignment)



BRANCH AND LINK determines the effective address, loads the updated instruction address (the address of the next instruction in normal sequence after the BAL instruction) into bit positions 15-31 of general register R, clears bit positions 0-14 of register R to 0's and then replaces the updated instruction address with the effective address. Instruction execution proceeds with the instruction pointed to by the effective address of the BAL instruction.

Affected: (R), (IA)

$IA \rightarrow R_{15-31}; 0 \rightarrow R_{0-14}; EA_{15-31} \rightarrow IA$

If the branch condition is satisfied and the effective address of BAL is nonexistent, the computer aborts execution of the BAL instruction and traps to Homespace location X'40' (nonallowed operation trap). In this case, the instruction address stored by the XPSD instruction in location X'40' is the address of the aborted BAL instruction. If a memory parity error occurs due to the accessing of the instruction to which the program is branching, the computer aborts execution of the BAL and traps to Homespace location X'4C' with register R unchanged.

**CALL INSTRUCTIONS**

Each of the four CALL instructions causes the computer to trap to a specific location for the next instruction in sequence. The four CALL instructions, their mnemonics, and the locations to which the computer traps are:

Instruction Name	Mnemonic	Trap Home-space Location
CALL 1	CAL1	X'48'
CALL 2	CAL2	X'49'
CALL 3	CAL3	X'4A'
CALL 4	CAL4	X'4B'

Each of these four trap locations must contain an EXCHANGE PROGRAM STATUS DOUBLEWORD (XPSD) instruction. Execution of XPSD in the trap location for a CALL instruction is described under "Control Instructions, XPSD Exchange Program Status Doubleword". If the XPSD instruction is coded with bit position 9 set to 1, the next instruction (executed after the XPSD) is taken from one of 16 possible locations, as designated by the value in the R field of the CALL instruction. Each of the 16 locations may contain an instruction that causes the computer to branch to a specific routine; thus, the four CALL instructions can be used to enter any of as many as 64 unique routines.

**CALL1** CALL 1  
(Word index alignment)

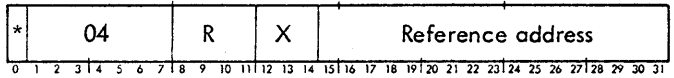

CALL 1 causes the computer to trap to Homespace location X'48'.

**CALL2** CALL 2  
(Word index alignment)



CALL 2 causes the computer to trap to Homespace location X'49'.

**CALL3** CALL 3  
(Word index alignment)

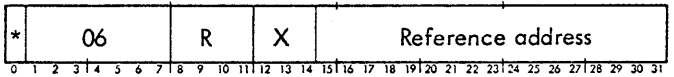

CALL 3 causes the computer to trap to Homespace location X'4A'.

**CALL4** CALL 4  
(Word index alignment)



CALL 4 causes the computer to trap to Homespace location X'48'.

**CONTROL INSTRUCTIONS**

The following privileged instructions are used to control the basic operating conditions of the SIGMA 8 computer:

Instruction Name	Mnemonic
Load Program Status Doubleword	LPSD
Exchange Program Status Doubleword	XPSD
Load Register Pointer	LRP
Move to Memory Control	MMC
Wait	WAIT
Read Direct	RD
Write Direct	WD

If execution of any control instruction is attempted while the computer is in the slave mode (i.e., while bit 8 of the current program status doubleword is a 1), the computer unconditionally traps to Homespace location X'40' prior to executing the instruction.

**PROGRAM STATUS DOUBLEWORD**

The SIGMA 8 program status doubleword has the following structure when stored in memory:

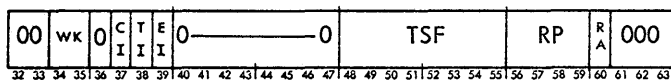
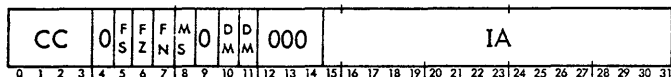

Bit Positions	Designation	Function
---------------	-------------	----------

0-3	CC	Condition code
5	FS	Floating significance mask
6	FZ	Floating zero mask
7	FN	Floating normalize mask
8	MS	Master/slave mode control

Bit Positions	Designation	Function
10	DM	Decimal arithmetic trap mask
11	AM	Fixed-point arithmetic overflow trap mask
15-31	IA	Instruction address
34,35	WK	Write key
37	CI	Counter interrupt group inhibit
38	II	I/O interrupt group inhibit
39	EI	External interrupt inhibit
48-55	TSF	Trap status field
56-59	RP	Register pointer
60	RA	Register altered

The detailed functions of the various portions of the SIGMA 8 program status doubleword are described in Chapter 2, "Program Status Doubleword".

**LPSD** LOAD PROGRAM STATUS DOUBLEWORD  
(Doubleword index alignment, privileged)

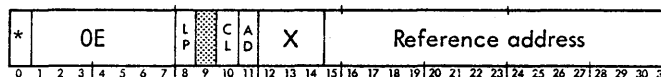

LOAD PROGRAM STATUS DOUBLEWORD replaces bits 0 through 39 of the current program status doubleword with bits 0 through 39 of the effective doubleword.

The following conditional operations are performed:

1. If bit position 8 (LP) of LPSD contains a 1, bits 56 through 59 of the current program status doubleword (register pointer) are replaced by bits 56 through 59 of the effective doubleword; if bit 8 of LPSD is a 0, the current register pointer value remains unchanged.
2. If bit position 10 (CL) of LPSD contains a 1, the highest-priority interrupt level currently in the active state is cleared (i.e., reset to either the armed state or the disarmed state); the interrupt level is armed if bit 11 of LPSD (AD) is a 1, or is disarmed if bit 11 of LPSD is 0. If bit 10 of LPSD is a 0, no interrupt level is affected in any way, regardless of whether bit 11 of LPSD is 1 or 0. If bit 10 of the LPSD is a 0 and bit 11 of the LPSD is a 1, the PDF flag is cleared. (Interrupt levels are described in detail in Chapter 2, "Interrupt System".)

Bit Position 10 (CL)	Bit Position 11 (AD)	Function
1	0	Clear and disarm interrupt level
1	1	Clear and arm interrupt level
0	1	Clear PDF flag
0	0	No control action

Those portions of the effective doubleword that correspond to undefined fields in the program status doubleword are ignored.

Affected: (PSD), interrupt system if  $(I)_{10} = 1$

$ED_{0-3} \rightarrow CC$ ;  $ED_{5-7} \rightarrow FS, FZ, FN$

$ED_8 \rightarrow MS$

$ED_{10} \rightarrow DM$ ;  $ED_{11} \rightarrow AM$

$ED_{15-31} \rightarrow IA$

$ED_{34-35} \rightarrow WK$

$ED_{37-39} \rightarrow CI, II, EI$ ; if  $(I)_8 = 1$ ,  $ED_{56-59} \rightarrow RP$

If  $(I)_{10} = 1$  and  $(I)_{11} = 1$ , clear and arm interrupt

If  $(I)_{10} = 1$  and  $(I)_{11} = 0$ , clear and disarm interrupt

If  $(I)_{10} = 0$  and  $(I)_{11} = 1$ , clear PDF flag

**XPSD** EXCHANGE PROGRAM STATUS DOUBLEWORD  
(Doubleword index alignment, privileged)

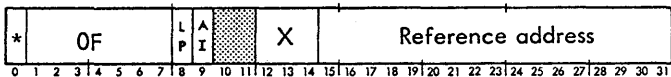

EXCHANGE PROGRAM STATUS DOUBLEWORD stores the currently active PSD in the doubleword location addressed by the effective address of the XPSD instruction. The following doubleword is then accessed from memory and loaded into the active PSD registers.

The XPSD instruction is used for three distinct types of operations: as a normal instruction in an ongoing program; as an interrupt instruction; and as a trap instruction.

An XPSD instruction (in an interrupt location) executed as a result of an interrupt is called an interrupt instruction. An XPSD instruction (in a trap location) executed as a result of a trap entry operation is called a trap instruction. An XPSD instruction encountered in the course of execution

of a normal program (that is, not as an interrupt instruction nor as a trap instruction) is a normal instruction.

Control bits used in the XPSD instructions are:

Bit Position	Designation	Control Function	Where Used
8	LP	Load pointer control	All XPSDs
9	AI	Address increment	Trap XPSD

The effective address of an XPSD instruction is generated in one of the following ways:

#### XPSD (normal and interrupt instructions)

When either of these XPSD instructions are executed, the effective address is generated according to the normal rules for addressing. Bit position 9 is not effective during these instructions and must be a zero.

#### XPSD (trap instruction)

An XPSD executed as a trap instruction (as defined above) may have the effective address and condition codes modified as a function of bit position 9.

If bit position 9 of XPSD contains a 0, the instruction address portion of the new PSD always remains at the value established by the second effective doubleword. Bit position 9 of XPSD is effective only if the instruction is being executed as the result of a nonallowed operation trap or a CALL instruction trap. Bit position 9 of XPSD must be coded with a 0 in all other cases; otherwise, the results of the XPSD instruction are undefined.

The following additional operations are performed on the new program status doubleword if, and only if, the XPSD is being executed as the result of a nonallowed operation (trap to Homespace location X'40') or a CALL instruction (trap to Homespace location X'48', X'49', X'4A', or X'4B'):

1. Nonallowed operations – the following additional functions are performed when XPSD is being executed as a result of a trap to Homespace location X'40':
  - a. Nonexistent instruction – if the reason for the trap condition is an attempt to execute a non-existent instruction, bit position 0 of the new program status doubleword (CC1) is set to 1. Then, if bit 9 (AI) of XPSD is a 1, bit positions 15–31 of the new program status doubleword (next instruction address) are incremented by 8.

- b. Nonexistent memory address — the reason for the trap condition is an attempt to access or write into a nonexistent memory region, bit position 1 of the new program status doubleword (CC2) is set to 1. Then, if bit 9 of XPSD is a 1, the instruction address portion of the new program status doubleword is incremented by 4.
- c. Privileged instruction violation — if the reason for the trap condition is an attempt to execute a privileged instruction while the computer is in the slave mode, bit position 2 of the new program status doubleword (CC3) is set to 1. Then, if bit position 9 of XPSD is 1, the instruction address portion of the new program status doubleword is incremented by 2.
- d. Memory protection violation — if the reason for the trap condition is an attempt to write into a memory region to which the program does not have proper access, bit position 3 of the new program status doubleword (CC4) is set to 1. Then, if bit 9 of XPSD is a 1, the instruction address portion of the new program status doubleword is incremented by 1.

There are certain circumstances under which two of the above nonallowed operations can occur simultaneously. The following operation codes (including their counterparts) are considered to be both nonexistent and privileged: X'0C' and X'0D'. If either of these operation codes is used as an instruction while the computer is in the slave mode, CC1 and CC3 are both set to 1's; if bit 9 of XPSD is a 1, the instruction address portion of the new program status doubleword is incremented by 10. If an attempt is made to write into a memory region that is both nonexistent and prohibited to the program by means of the memory control feature, CC2 and CC4 are both set to 1's; if bit 9 of XPSD is a 1, the instruction address of the new program status doubleword is incremented by 5.

- 2. CALL instructions — the following additional functions are performed when XPSD is being executed as a result of a trap to Homespace location X'48', X'49', X'4A', or X'4B'.
  - a. The R field of the CALL instruction causing the trap is logically inclusively ORed into bit positions 0-3 (CC) of the new PSD.
  - b. If bit position 9 of XPSD contains a 1, the R field of the CALL instruction causing the trap is added to the instruction address portion of the new PSD.

The current program status doubleword is stored in the doubleword location pointed to by the effective address of XPSD in the following form:

Program status doubleword:

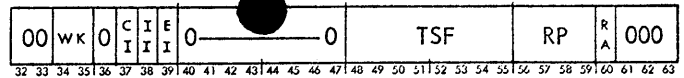
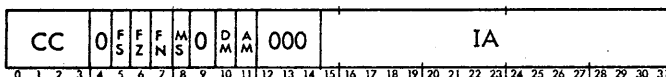

The current program status doubleword (as illustrated above) is replaced by a new program status doubleword as described below.

- 1. The effective address of XPSD is incremented by 2 so that it points to the next doubleword location. The contents of the next doubleword location are referred to as the second effective doubleword, or ED2.
- 2. Bits 0-35 of the current program status doubleword are unconditionally replaced by bits 0-35, of the second effective doubleword. The affected portions of the program status doubleword are:

Bit Position	Designation	Function
0-3	CC	Condition code
5-7	FS, FZ, FN	Floating control
8	MS	Master/slave mode control
10	DM	Decimal arithmetic trap mask
11	AM	Fixed-point arithmetic trap mask
15-31	IA	Instruction address
34-35	WK	Write key

- 3. A logical inclusive OR is performed between bits 37 through 39 of the current program status doubleword and bits 37 through 39 of the second effective doubleword.

Bit Position	Designation	Function
37	CI	Counter interrupt inhibit
38	II	I/O interrupt inhibit
39	EI	External interrupt inhibit

If any (or all) of bits 37, 38, or 39 of the second effective doubleword are 0's, the corresponding bits in the current program status doubleword remain unchanged; if any (or all) of bits 37, 38, or 39 of the second effective doubleword are 1's, the corresponding bits in the current program status doubleword are

set to 1's. See "Interrupt System", Chapter 2, for a detailed discussion of the interrupt inhibits.

- If bit position 8 (LP) of XPSD contains a 1, bits 56 through 59 of the current program status doubleword (register pointer) are replaced by bits 56 through 59 of the second effective doubleword; if bit 8 of XPSD is a 0, the current register pointer value remains unchanged.

Affected: (EDL), (PSD)

PSD → EDL

ED2<sub>0-3</sub> → CC; ED2<sub>5-7</sub> → FS, FZ, FN

ED2<sub>8</sub> → MS

ED2<sub>10</sub> → DM; ED2<sub>11</sub> → AM; ED<sub>15-31</sub> → IA

ED2<sub>34-35</sub> → WK

ED2<sub>37-39</sub> ∪ CI, II, EI → CI, II, EI

If (I)<sub>8</sub> = 1, ED2<sub>56-59</sub> → RP

If (I)<sub>8</sub> = 0, RP not affected

If nonexistent instruction, 1 → CC1 then, if (I)<sub>9</sub> = 1, IA + 8 → IA

If nonexistent memory address, 1 → CC2 then, if (I)<sub>9</sub> = 1, IA + 4 → IA

If privileged instruction violation, 1 → CC3 then, if (I)<sub>9</sub> = 1, IA + 2 → IA

If memory protection violation, 1 → CC4 then, if (I)<sub>9</sub> = 1, IA + 1 → IA

If CALL instruction, CC ∪ CALL<sub>8-11</sub> → CC then, if (I)<sub>9</sub> = 1, IA + CALL<sub>8-11</sub> → IA

If (I)<sub>9</sub> = 0, IA not affected

**LRP** LOAD REGISTER POINTER  
(Word index alignment, privileged)

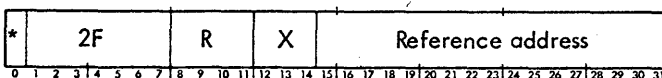

LOAD REGISTER POINTER loads bits 26 and 27 of the effective word into the register pointer (RP) portion of the

current program status doubleword. Bit positions 0 through 25 and 28 through 31 of the effective word are ignored, and no other portion of the program status doubleword is affected. If the LOAD REGISTER POINTER instruction attempts to load the register pointer with a value that points to a nonexistent block of general registers, the computer traps to Homespace location X'4D'.

Affected: RP

Trap: Instruction exception

EW<sub>26-27</sub> → RP

**MMC** MOVE TO MEMORY CONTROL  
(Word index alignment, privileged, continue after interrupt)

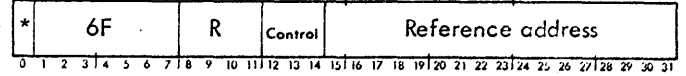

MOVE TO MEMORY CONTROL loads a string of one or more words into the write lock registers. Bit positions 12 through 14 of MMC specify that the memory control registers are to be loaded. Indexing is not permitted.

Bit Position

12 13 14 Function

0 0 1 Load memory write protection locks.

An attempt to execute an MMC instruction with any control code other than the above causes the instruction to trap to Homespace location X'4D', the instruction exception trap.

Bit positions 15-31 of MMC are ignored insofar as the operation of the instruction is concerned, and the results of the instruction are the same whether MMC is indirectly addressed or not.

The R field of MMC designates an even-odd pair of general registers (R and Ru1) that are used to control the loading of the specified bank of memory control registers. Registers R and Ru1 are assumed to contain the following information:

Register R:

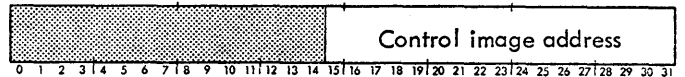

Register Ru1:



Register R contains the address of the first word of the control image to be loaded into the specified block of memory control registers. Bit positions 0 through 7 of register Ru1 contain a count of the number of words to be loaded. (If bits 0-7 of register Ru1 are initially all 0's, a word count of 256 is implied.)

Bit positions 15 through 22 of register Ru1 point to the beginning of the memory region controlled by the registers to be loaded.





moved from RUN to IDLE and back to RUN while the CPU is waiting, instruction execution proceeds with the next instruction in sequence after the WAIT instruction.

Affected: PC

If WAIT is indirectly addressed and the indirect reference address is nonexistent, the nonallowed operation trap to Homespace location X'40' will not occur. The effective address of the WAIT instruction, however, is not used as a memory reference (thus does not affect the normal operation of the instruction).

**RD READ DIRECT**  
(Word index alignment, privileged)

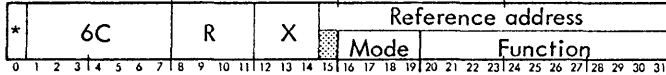

The CPU is capable of directly communicating with other elements of the SIGMA 8 system, as well as performing internal control operations, by means of the READ DIRECT/WRITE DIRECT (RD/WD) lines. The RD/WD lines consist of 16 address lines, 32 data lines, two condition code lines, and various control lines that are connection to various CPU circuits and to special systems equipment.

READ DIRECT causes the CPU to present bits 16 through 31 of the effective address to other elements of the SIGMA 8 system on the RD/WD address lines. Bits 16-31 of the effective address identify a specific element of the SIGMA 8 system that is expected to return information (two condition code bits plus a maximum of 32 data bits) to the CPU. The significance and number of data bits returned to the CPU depend on the selected element. If the R field of RD is nonzero, up to 32 bits of the returned data are loaded into general register R; however, if the R field of RD is zero, the only action taken is the setting of the condition codes as indicated by the particular form of the instruction.

Bits 16-19 of the effective virtual address of RD determine the mode of the RD instruction, as follows:

Bit Position

16	17	18	19	Mode	
0	0	0	0		Internal computer control.
0	0	0	1		Interrupt control.
0	0	1	0		XDS testers.
0	0	1	1	}	Assigned to various groups of standard XDS products.
⋮					
1	1	1	0		
1	1	1	1		

**READ DIRECT,  
INTERNAL COMPUTER CONTROL (MODE 0)**

In this mode, the computer is able to read the sense switches, the interrupt inhibit bits of the PSD, and the "snapshot" register, as follows.

**READ SENSE SWITCHES**

The following configuration of RD can be used to read the control panel SENSE switches:

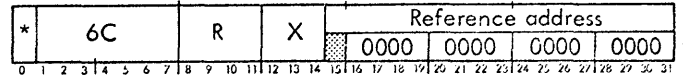

If a particular SENSE switch is set, the corresponding bit of the condition code is set to 1; if a SENSE switch is zero the corresponding bit of the condition code is set to 0 (see "SENSE" in Chapter 5).

In this case, only the condition code is affected.

**READ SNAPSHOT SAMPLE REGISTER**

Each CPU will contain an internal snapshot sample register to aid in diagnostic programming. The following configuration of RD is used to record the snapshot sample register:

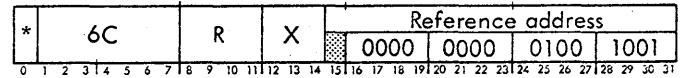

If the R field of RD is nonzero, the contents of the snapshot sample register are transferred to the specified R register.

Affected: (R), CC

(Sample Register) → R

**Condition Code Settings:**

1	2	3	4	Result
-	-	0	0	Clock Counter = 0, end of instruction not reached.
-	-	0	1	Clock Counter = 0, end of instruction.
-	-	1	0	Armed but not "snapped".

**READ INTERRUPT INHIBITS**

The following configuration of RD can be used to read the contents of the interrupt inhibit field:

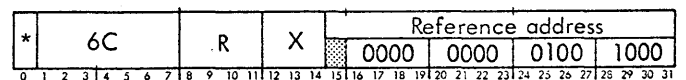

If the R field of RD is nonzero, the contents of the interrupt inhibit field (bits 37, 38, 39) of the program status doubleword are transferred to the least significant 3 bits



16 17 18 19 Mode

0 0 1 0 XDS testers

0 0 1 1 }  
 .  
 .  
 .  
 1 1 1 0 } Assigned to various groups of standard XDS products

1 1 1 1 Special systems control (for customer use with specially designed equipment)

**WRITE DIRECT,  
INTERNAL COMPUTER CONTROL (MODE 0)**

**SET INTERRUPT INHIBITS**

The following configuration of WD can be used to set the interrupt inhibits (bit positions 37-39 of the PSD).

*	6D				R	X	Reference address																										
0	1	2	3	4	5	6	7	8	9	10	11	12	13	14	15	16	17	18	19	20	21	22	23	24	25	26	27	28	29	30	31		
																0000	0000	0011	0	C	I	E											

A logical inclusive OR is performed between bits 29-31 of the effective address and bits 37-39 of the PSD. If any (or all) or bits 29-31 of the effective address are 1's, the corresponding inhibit bits in the PSD are set to 1's; the current state of an inhibit bit is not affected if a corresponding bit position of the effective address contains a 0.

**RESET INTERRUPT INHIBITS**

The following configuration of WD can be used to reset the interrupt inhibits:

*	6D				R	X	Reference address																										
0	1	2	3	4	5	6	7	8	9	10	11	12	13	14	15	16	17	18	19	20	21	22	23	24	25	26	27	28	29	30	31		
																0000	0000	0010	0	C	I	E											

If any (or all) of bits 29-31 of the effective address are 1's, the corresponding inhibit bits in the PSD are reset to 0's; the current state of an inhibit bit is not affected if a corresponding bit position of the effective address contains a 0.

**SET ALARM INDICATOR**

The following configuration of WD is used to set the ALARM indicator on the maintenance section of the processor control panel.

*	6D				X	Reference address																											
0	1	2	3	4	5	6	7	8	9	10	11	12	13	14	15	16	17	18	19	20	21	22	23	24	25	26	27	28	29	30	31		

If the COMPUTE switch on the processor control panel is in the RUN position and the AUDIO switch on the maintenance section of the processor control panel is in the ON position, a 1000-Hz signal is transmitted to the computer speaker. The signal may be interrupted by moving the COMPUTE switch to the IDLE position, by moving the AUDIO switch to the OFF position, or by resetting the ALARM indicator.

**RESET ALARM INDICATOR**

The following configuration of WD is used to reset the ALARM indicator:

*	6D				R	X	Reference address																										
0	1	2	3	4	5	6	7	8	9	10	11	12	13	14	15	16	17	18	19	20	21	22	23	24	25	26	27	28	29	30	31		

The ALARM indicator is also reset by means of either the CPU RESET/CLEAR switch or the SYS RESET/CLEAR switch on the processor control panel.

**TOGGLE PROGRAM-CONTROLLED-FREQUENCY FLIP-FLOP**

The following configuration of WD is used to set and reset the CPU program-controlled-frequency (PCF) flip-flop:

*	6D				R	X	Reference address																										
0	1	2	3	4	5	6	7	8	9	10	11	12	13	14	15	16	17	18	19	20	21	22	23	24	25	26	27	28	29	30	31		

The output of the PCF flip-flop is transmitted to the computer speaker through the AUDIO switch on the maintenance section of the processor control panel. If the PCF flip-flop is reset when the above configuration of WD is executed, the WD instruction sets the PCF flip-flop; if the PCF flip-flop was previously set, the WD instruction resets it. A program can thus generate a desired frequency by setting and resetting the PCF flip-flop at the appropriate rate. Execution of the above configuration of WD also resets the ALARM indicator.

**LOAD INTERRUPT INHIBITS**

The following configuration of WD can be used to transfer the contents of the specified R register (R<sub>29-31</sub>) to the Interrupt Inhibit field (PSD<sub>37-39</sub>).

*	6D				R	X	Reference address																										
0	1	2	3	4	5	6	7	8	9	10	11	12	13	14	15	16	17	18	19	20	21	22	23	24	25	26	27	28	29	30	31		

Affected: (PSD<sub>37-39</sub>)

(R<sub>29-31</sub>) → PSD<sub>37-39</sub>

## LOAD SNAPSHOT CONTROL REGISTER

The following configuration of WD is used to arm the snapshot feature.

*	6D	R	X	Reference address																															
0	1	2	3	4	5	6	7	8	9	10	11	12	13	14	0000	0000	0100	1001	15	16	17	18	19	20	21	22	23	24	25	26	27	28	29	30	31

The contents of the specified R register are transferred to the snapshot control register with the following format:

CC	CS	Instruction address																													
0	1	2	3	4	5	6	7	8	9	10	11	12	13	14	15	16	17	18	19	20	21	22	23	24	25	26	27	28	29	30	31

Bit Position	Designation	Function
0-7	CC	<u>Clock Counter.</u> Contains the number of clock pulses, which determine the time the snapshot sample register is strobed after instruction address recognition.
10-14	CS	<u>Condition Select.</u> Determine which of several possible internal states of the hardware to record. <sup>†</sup>
15-31	IA	<u>Instruction Address.</u> The address used by the snapshot feature is the 17-bit address in positions 15-31 of the PSD.

Affected: (Snapshot Control Register)

(R) — Snapshot Control Register

## SET INTERNAL CONTROLS

The following configuration of WD is used to set the CPU clock margin controls.

*	6D	R	X	Reference address																															
0	1	2	3	4	5	6	7	8	9	10	11	12	13	14	0000	0000	0100	0101	15	16	17	18	19	20	21	22	23	24	25	26	27	28	29	30	31

<sup>†</sup> A separate document, XDS SIGMA 8 Engineering Support Manual will contain this information.

The contents of the specified R register, bits 8 and 9, are used to set the internal CPU margin controls as follows:

Bit 8	Bit 9	Clock Margins
0	0	Norm
0	1	Hi
1	0	Lo
1	1	Reserved

All unused bits of the specified R register are disregarded.

## WRITE DIRECT, INTERRUPT CONTROL (MODE 1)

The following configuration of WD is used to set and reset the various states of the individual interrupt levels within the CPU interrupt system:

*	6D	R	X	Reference address																																
0	1	2	3	4	5	6	7	8	9	10	11	12	13	14	0001	0	Code	0000	Group	15	16	17	18	19	20	21	22	23	24	25	26	27	28	29	30	31

Bits 28 through 31 of the effective address specify the identification number (see Table 2) of the group of interrupt levels to be controlled by the WD instruction.

The R field of the WD instruction specifies a general register that contains the selection bits for the individual interrupt levels within the specified group (see Table 2, Chapter 2). Bit position 16 of register R contains the selection bit for the highest-priority (lowest-numbered) interrupt level within the group, and bit position 31 of register R contains the selection bit for the lowest-priority (highest-numbered) interrupt level within the group.

Each interrupt level in the designated group is operated on according to the function code specified by bits 21 through 23 of the effective address of WD. The codes and their associated functions are as follows:

Code	Function
000	Set active all selected levels currently in the armed or waiting states.
001 <sup>††</sup>	Disarm all levels selected by a 1; all levels selected by a 0 are not affected.

<sup>††</sup> These codes clear the current interrupts, i.e., remove from the active or waiting state all levels selected by a 1 (see Figure 7).

Code	Function
010 <sup>†</sup>	Arm and enable all levels selected by a 1; all levels selected by a 0 are not affected.
011 <sup>†</sup>	Arm and disable all levels selected by a 1; all levels selected by a 0 are not affected.
100	Enable all levels selected by a 1; all levels selected by a 0 are not affected.
101	Disable all levels selected by a 1; all levels selected by a 0 are not affected.
110	Enable all levels selected by a 1 and disable all levels selected by a 0.
111	Trigger all levels selected by a 1. All such levels that are currently armed advance to waiting state.

### INPUT/OUTPUT INSTRUCTIONS

SIGMA 8 I/O instructions permit a CPU to initiate, test, and control I/O operations. SIGMA 8 I/O systems consist of special- and general-purpose Input/Output Processors (IOPs), e.g., High-Speed RAD I/O Processor (HSRIOP), Multiplexor I/O Processor (MIOP), single- and multi-device controllers, and a variety of standard peripheral devices (printers, disks, tapes, etc.). Standard I/O operations are performed with the I/O instructions listed below.

Instruction Name	Mnemonic
Start Input/Output	SIO
Test Input/Output	TIO
Test Device	TDV
Halt Input/Output	HIO
Reset Input/Output	RIO
Poll Processor	POLP
Poll and Reset Processor	POLR
Acknowledge Input/Output Interrupt	AIO

If execution of any input/output instruction (always privileged) is attempted while the computer is in the slave mode (i.e., while bit 8 of the current program status doubleword is a 1), the computer unconditionally aborts execution of the instruction (at the time of operation code decoding) and traps to Homespace location X'40'.

<sup>†</sup>These codes clear the current interrupts, i.e., remove from the active or waiting state all levels selected by a 1 (see Figure 7).

### I/O ADDRESSES

An I/O device is selected by the effective address of the I/O instruction. Indirect addressing and/or indexing may be performed, as for other word-addressing instructions, to compute the effective address of the I/O instruction. However, the effective address is not used as a memory reference. For all I/O instructions, except AIO, the 13 low-order bits of the effective address (bits 19-31) constitute an I/O address. For the AIO instruction, the device causing the interrupt returns its 13-bit I/O address as part of the response to the AIO instruction.

An effective I/O address is subdivided into a processor address and a device controller address.

### PROCESSOR ADDRESSES (BITS 19-23)

The 32 processor addresses (PA) may be assigned in the following manner:

1. The assignment of addresses is mutually exclusive, that is, no two processors may have the same address.
2. The four highest addresses (X'1C' - X'1F') are reserved for addressing CPUs in a multiprocessor system.
3. The remaining 28 addresses may be assigned to MIOPs, High-Speed RAD IOPs, or to any other IOP that is compatible with the SIGMA 8 computer system.
  - a. SIGMA 8 MIOPs require an even-odd pair of addresses. The even address (bit 23 is 0) selects Channel A and the odd address (bit 23 is 1) selects Channel B. If the MIOP only has Channel A, the odd address is preempted and reserved.
  - b. A SIGMA 8 HSRIOP may be assigned an even or an odd address. However, the address cannot be one that has been reserved for Channel B of an existing MIOP.

### DEVICE CONTROLLER ADDRESSES (BITS 24-31)

There are two types of device controller addresses. If the device controller controls a single unit, bit 24 is 0 and bits 25-31 constitute a single code specifying a particular combination of device controller (DC) and device. Normally, these codes refer to device controllers that drive only a single device, such as a card reader, card punch, or line printer.

Type 1: Addressing single-unit device controllers (bit 24 = 0)

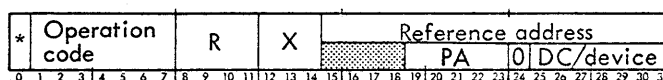

If the device controller (DC) can control more than one device, bit 24 is a 1 and bits 25-31 are subdivided into a device controller address (bits 25-27) and a device address

(bits 28-31). This form of I/O addressing is used for device controllers, such as magnetic tape or rapid access data (RAD) controllers, that control information exchange with only one device at a time from a set of as many as 16 devices.

Type 2: Addressing multiunit device controllers (bit 24 = 1)

*	Operation code	R	X	Reference address																												
0	1	2	3	4	5	6	7	8	9	10	11	12	13	14	15	16	17	18	19	20	21	22	23	24	25	26	27	28	29	30	31	

SIGMA 8 MIOPs permit multiunit device controllers to be installed into the first eight subchannels of Channel A and the eight subchannels of Channel B.

### I/O UNIT ADDRESS ASSIGNMENT

Device controller numbers are normally assigned to an IOP in numerical sequence, beginning with zero and continuing through the highest number recognized by the IOP. In the case of multiunit device controllers, the device controller number must be in the range X'0' through X'7' because the I/O address field structure allows for a 3-bit multiunit device controller number. In the case of single-unit device controllers, any of the available numbers in the range X'0' through X'1F' may be assigned to the device controller, provided that the same number has not already been assigned to a multiunit device controller. For example, if device controller number X'0' is assigned to a magnetic tape unit controller, the number X'0' cannot also be used for a card reader (although the coding of the I/O address field would be different in bit position 24).

### I/O STATUS RESPONSE

All I/O instructions result in the condition code bits (CC1-CC3) being set to denote the nature of the I/O response. By coding the R field of the I/O instruction, additional I/O status information may be loaded into either two, one, or no general registers. If the R field is coded with a zero, no additional I/O status information will be returned. If the R field is coded with an odd value, one "word" of additional I/O status information will be loaded into the specified general register. If the R field is coded with an even (and nonzero) value, two "words" of additional I/O status information will be loaded into register R and register Ru1. However, the requested additional I/O status information will not be returned to the specified general registers if the I/O address of the I/O instruction was not recognized, or the addressed device controller is attached to a "busy" IOP, or if a memory parity error or data bus fault was detected when the IOP read the CPU/IOP communication locations in main memory. The format of the additional I/O status information that is loaded into the general registers for all I/O instructions, except AIO, is shown below.

Word into register R when R is even and not 0:

Subchannel status	0	0	Current command doubleword address																												
0	1	2	3	4	5	6	7	8	9	10	11	12	13	14	15	16	17	18	19	20	21	22	23	24	25	26	27	28	29	30	31

Word into register Ru when R is even and not 0; or word in R when R is odd:

Status	Byte count																														
0	1	2	3	4	5	6	7	8	9	10	11	12	13	14	15	16	17	18	19	20	21	22	23	24	25	26	27	28	29	30	31

Subchannel Status. See "General Registers, Subchannel Status Response Bits".

Current Command Doubleword Address. After the addressed device has received an order, this field contains the 16 high-order bits of the main memory address for the command doubleword currently being processed for the addressed device.

Status. The meaning of this field depends on the particular I/O instruction being executed and on the selected I/O device (see Table 12).

Byte Count. After the addressed device has received an order, this field contains a count of the number of bytes yet to be transmitted by the operation called for by the order.

### SIO START INPUT/OUTPUT (Word index alignment, privileged)

Instruction Register

*	4C	R	X	Reference address																												
0	1	2	3	4	5	6	7	8	9	10	11	12	13	14	15	16	17	18	19	20	21	22	23	24	25	26	27	28	29	30	31	

General Register 0

0	0	First command doubleword address																													
0	1	2	3	4	5	6	7	8	9	10	11	12	13	14	15	16	17	18	19	20	21	22	23	24	25	26	27	28	29	30	31

START INPUT/OUTPUT performs the following:

1. Initiates an input or output operation.
2. Specifies which IOP, channel, device controller, and input/output device is to be selected (bits 19-31 of the effective address of the instruction word).
3. Specifies the address of the first command doubleword for the subsequent I/O operation (bits 16-31 of general register 0).
4. Specifies how much additional status information is to be returned from the I/O system (R field, bits 8-11, of instruction word).
5. Specifies which general registers are to be loaded with the requested status information (R field, bits 8-11, of instruction word).

General register 0 is temporarily dedicated during SIO instruction execution and must contain the doubleword memory address of the first command doubleword specifying the operation to be started. The required address information must be in general register 0 when the SIO is executed.

Table 12. Status Response Bits for I/O Instructions

Position and State in Register Ru1																	
Device Status Byte							Operational Status Byte								Significance for SIO, HIO, and TIO	Significance for TDV	
0	1	2	3	4	5	6	7	8	9	10	11	12	13	14			15
1	-	-	-	-	-	-	-	-	-	-	-	-	-	-	-	interrupt pending	data overrun
-	0	0	-	-	-	-	-	-	-	-	-	-	-	-	-	device ready	} unique to the device and the device controller
-	0	1	-	-	-	-	-	-	-	-	-	-	-	-	-	device not operational	
-	1	0	-	-	-	-	-	-	-	-	-	-	-	-	-	device unavailable	
-	1	1	-	-	-	-	-	-	-	-	-	-	-	-	-	device busy	
-	-	-	0	-	-	-	-	-	-	-	-	-	-	-	-	device manual	
-	-	-	1	-	-	-	-	-	-	-	-	-	-	-	-	device automatic	
-	-	-	-	1	-	-	-	-	-	-	-	-	-	-	-	device unusual end	
-	-	-	-	-	0	0	-	-	-	-	-	-	-	-	-	device controller ready	
-	-	-	-	-	0	1	-	-	-	-	-	-	-	-	-	device controller not operational	
-	-	-	-	-	1	0	-	-	-	-	-	-	-	-	-	device controller unavailable	
-	-	-	-	-	1	1	-	-	-	-	-	-	-	-	-	device controller busy	
-	-	-	-	-	-	-	0	-	-	-	-	-	-	-	-	reserved	
-	-	-	-	-	-	-	-	1	-	-	-	-	-	-	-	incorrect length	} same as for SIO, HIO, and TIO
-	-	-	-	-	-	-	-	-	1	-	-	-	-	-	-	transmission data error	
-	-	-	-	-	-	-	-	-	-	1	-	-	-	-	-	transmission memory error	
-	-	-	-	-	-	-	-	-	-	-	1	-	-	-	-	memory address error	
-	-	-	-	-	-	-	-	-	-	-	-	1	-	-	-	IOP memory error	} reserved
-	-	-	-	-	-	-	-	-	-	-	-	-	1	-	-	IOP control error	
-	-	-	-	-	-	-	-	-	-	-	-	-	-	1	-	IOP halt	
-	-	-	-	-	-	-	-	-	-	-	-	-	-	-	1	High-speed RIOP busy	

Position and State in Register R																
Device Status Byte							Operational Status Byte								Significance for AIO	
0	1	2	3	4	5	6	7	8	9	10	11	12	13	14		15
1	-	-	-	-	-	-	-	-	-	-	-	-	-	-	-	} unique to the device and the device controller
-	1	-	-	-	-	-	-	-	-	-	-	-	-	-	-	
-	-	1	-	-	-	-	-	-	-	-	-	-	-	-	-	
-	-	-	1	-	-	-	-	-	-	-	-	-	-	-	-	
-	-	-	-	1	-	-	-	-	-	-	-	-	-	-	-	} reserved
-	-	-	-	-	1	-	-	-	-	-	-	-	-	-	-	
-	-	-	-	-	-	1	-	-	-	-	-	-	-	-	-	
-	-	-	-	-	-	-	1	-	-	-	-	-	-	-	-	
-	-	-	-	-	-	-	-	1	-	-	-	-	-	-	-	incorrect length
-	-	-	-	-	-	-	-	-	1	-	-	-	-	-	-	transmission data error
-	-	-	-	-	-	-	-	-	-	1	-	-	-	-	-	zero byte count interrupt
-	-	-	-	-	-	-	-	-	-	-	1	-	-	-	-	channel end interrupt
-	-	-	-	-	-	-	-	-	-	-	-	1	-	-	-	unusual end interrupt
-	-	-	-	-	-	-	-	-	-	-	-	-	0	-	-	} reserved
-	-	-	-	-	-	-	-	-	-	-	-	-	-	0	-	
-	-	-	-	-	-	-	-	-	-	-	-	-	-	-	0	





Bit Position	Function
1,2	<u>Device Condition.</u> If bits 1 and 2 are 00 (device "ready"), all device conditions required for proper operation are satisfied. If bits 1 and 2 are 01 (device "not operational"), the addressed device has developed some condition that will not allow it to proceed; in either case, operator intervention is usually required. If bits 1 and 2 are 10 (device "unavailable"), the device has more than one channel of communication available and it is engaged in an operation controlled by an IOP other than the one specified by the I/O address. If bits 1 and 2 are 11 (device "busy"), the device has accepted a previous SIO instruction and is already engaged in an I/O operation.
3	<u>Device Mode.</u> If this bit is 1, the device is in the "automatic" mode; if this bit is 0, the device is in the "manual" mode and requires operator intervention. This bit can be used in conjunction with bits 1 and 2 to determine the type of action required. For example, assume that a card reader is able to operate, but no cards are in the hopper. The card reader would be in state 000 (device "ready", but manual intervention required), where the state is indicated by bits 1, 2, and 3 of the I/O status response. If the operator subsequently loads the card hopper and presses the card reader START switch, the reader would advance to state 001 (device "ready" and in automatic operation). If the card reader is in state 000 when an SIO instruction is executed, the SIO would be accepted by the reader and the reader would advance to state 110 (device "busy", but operator intervention required). Should the operator then place cards in the hopper and press the START switch, the card reader state would advance to 111 (device "busy" and in "automatic" mode), and the input operation would proceed. Should the card reader subsequently become empty (or the operator press the STOP switch) and command chaining is being used to read a number of cards, the card reader would return to state 110. If the card reader is in state 001 when an SIO instruction is executed, the reader advances to state 111, and the input operation continues as normal. Should the hopper subsequently become empty (or should the operator press the card reader STOP switch) and command chaining is being used to read a number of cards, the reader would go to state 110 until the operator corrected the situation.
4	<u>Device Unusual End occurred during last operation.</u> If this bit is 1, the reason for the indication is an error or a "fault" condition. For a fault condition, the device has halted at other than its normal stopping point. In either

Bit Position	Function
5,6	<u>Device Controller Condition.</u> If bits 5 and 6 are 00 (device controller "ready"), all device controller conditions required for its proper operation are satisfied. If bits 5 and 6 are 01 (device controller "not operational"), some condition has developed that does not allow it to operate properly. In either case, operator intervention is usually required. If bits 5 and 6 are 10 (device controller "unavailable"), the device controller is currently engaged in an operation controlled by an IOP other than the one addressed by the I/O instruction. If bits 5 and 6 are 11 (device controller "busy"), the device controller has accepted a previous SIO instruction and is currently engaged in performing an operation for the addressed IOP.
7	<u>Unassigned.</u>
8	<u>Incorrect Length.</u> This bit is set to 1, if incorrect length is signaled by the device controller to the IOP during the previous operation. Incorrect length is caused by a channel end (or end of record) condition occurring before the device controller has received a "count done" signal from the IOP, or is caused by the device controller receiving a count done signal before channel end (or end-of-record), e.g., count done before 80 columns have been read from a card.
9	<u>Transmission Data Error.</u> This bit is set to 1 if the device controller or IOP detects a parity error or data overrun in the transmitted information.
10	<u>Transmission Memory Error.</u> This bit is set to 1 if a memory parity error is detected during a data input/output operation.
11	<u>Memory Address Error.</u> This bit is set to 1 if a nonexistent memory address is detected during a chaining operation or a data input/output operation.
12	<u>IOP Memory Error.</u> This bit is set to 1 if the IOP detects a memory parity error while fetching a command.
13	<u>IOP Control Error.</u> This bit is set to 1 if the IOP detects two successive Transfer in Channel commands.



**TDV TEST DEVICE**  
(Word index alignment, privileged)

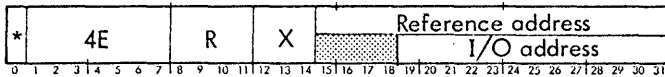

TEST DEVICE is used to provide information about a device other than that obtainable by means of the TIO instruction. The operation of the selected IOP, device controller, and device are not affected, and no operations are initiated or terminated. The responses to TDV provide the program with information giving details on the condition of the selected device, the number of bytes remaining to be transmitted in the current operation, and the present point at which the IOP is operating in the command list. If the R field of the TDV instruction is 0 or if no I/O address recognition exists, or if the device is attached to a "busy" HSRIOP, the condition code is set, but no general registers are affected. If the R field of TDV is an odd value, the condition code is set and the device status and byte count are loaded into register R as follows:

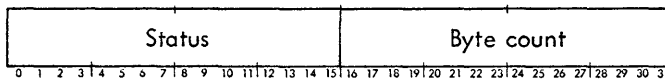

Status Response Bits (see Table 13):

Bit Position	Function
0	<u>Data Overrun</u> . This bit is set to 1 if a data overrun has occurred in the current I/O operation. A data overrun is a situation wherein the device controller is ready to transmit data to the IOP but the IOP has not received the previous data, or the device controller requires data but cannot obtain it from the IOP. In either case, the condition is caused by an equipment malfunction or by the total I/O data rate exceeding system limits.
1-7	Unique to the device.
8-15	Same as for bits 8-15 of the status information for instruction SIO.

The count information shows the number of bytes remaining to be transmitted in the current operation at the time of the TDV instruction. If the value of the R field of TDV is an even value and not 0, the condition code is set, register R+1 is loaded as shown above, and register R is loaded as follows:

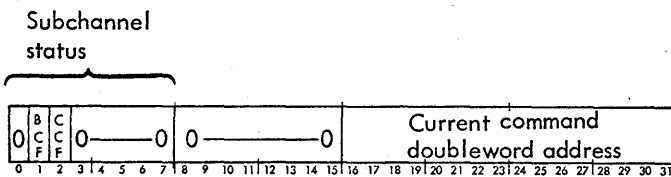

The current command doubleword address has the same interpretation as for the instruction SIO.

Affected: (R), (Ru1), CC1, CC2, CC3

*of the*  
The meaning of the condition code during a TDV is:

1	2	3	4	Result of TDV
0	0	0	-	I/O address recognized, no device-dependent condition present, and status information in general registers is correct.
0	0	1	-	I/O address recognized and no device-dependent condition present; however, status information in general register is incorrect.
0	1	0	-	I/O address recognized and device-dependent condition is present.
0	1	1	-	I/O address recognized and device-dependent condition is present but status information in the general register is incorrect.
1	0	0	-	I/O address recognized but device controller is attached to a busy high-speed RIOP or an MIOOP operating in the "burst" mode. No status information is returned to general registers.
1	0	1	-	Reserved.
1	1	0	-	I/O address not recognized and no status information is returned to the general registers.
1	1	1	-	I/O address not recognized and no status information is returned to the general registers because a memory parity error or a bus check fault occurred when the IOP read the CPU/IOP communication locations in main memory or a parity error was detected when writing into the communication locations.

**HIO HALT INPUT/OUTPUT**  
(Word index alignment, <sup>†</sup> privileged)

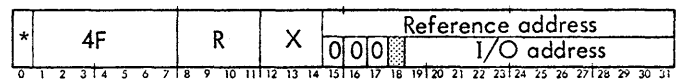

HALT INPUT/OUTPUT causes the addressed device to immediately halt its current operation (perhaps improperly, in the case of magnetic tape units, when the device is forced to stop at other than an interrecord gap). If the device is in an interrupt-pending condition, the condition is cleared.

<sup>†</sup>When indexing operation code 4F instructions (HIO, RIO, POLP, POLR), the programmer must make certain that the summation of the contents of the index register and the I/O address (bits 19-31 of the instruction word) does not affect bits 15-17 of the final effective address. When indirect addressing is used, the contents of the indirect address location (bits 15, 16, and 17) must specify the desired operation code extension.

If the R field of the HIO instruction is 0 or if no I/O address recognition exists, no general registers are affected, but the condition code is set. If the R field is an odd value, the condition code is set and the following information is loaded into register R.



The status information returned for HIO has the same interpretation as that returned for the instruction SIO and shows the I/O status at the time of the halt. The count information shows the number of bytes remaining to be transmitted at the time of the halt. If the R of HIO is an even value and not 0, the condition code is set, register R+1 is loaded as shown above, and register R contains the following information:

Subchannel status

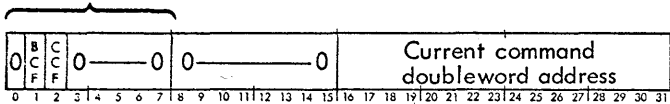

The current command doubleword address has the same interpretation as that for the instruction SIO.

The HIO instruction must have zeros in bit positions 15, 16, and 17 to differentiate it from the RIO, POLP, and POLR instructions, which also have X'4F' as an operation code (bits 1-7).

Affected: (R), (Ru1), CC1, CC2, CC3

The meaning of the condition code during an HIO instruction is:

- |   |   |   |   |  |
|---|---|---|---|--|
| 1 | 2 | 3 | 4 | Result of HIO  |
| 0 | 0 | 0 | - | I/O address recognized, device controller not busy and status information in general registers is correct.   |
| 0 | 0 | 1 | - | I/O address recognized, device controller not busy but status information in general registers is incorrect.   |
| 0 | 1 | 0 | - | I/O address recognized but device controller was busy at the time of the HIO.  |
| 0 | 1 | 1 | - | I/O address recognized but device controller was busy at the time of the HIO and the status information in the general registers is incorrect.                                       |
| 1 | 0 | 0 | - | I/O address recognized but device controller is attached to a busy high-speed RIOP or an MIOP operating in the "burst" mode. No status information is returned to general registers. |

1 2 3 4 Result of HIO

- |   |   |   |   |   |
|---|---|---|---|---|
| 1 | 0 | 1 | - | Reserved  |
| 1 | 1 | 0 | - | I/O address not recognized.   |
| 1 | 1 | 1 | - | I/O address not recognized; instruction terminated because a memory parity error or a bus check fault was detected when reading CPU/IOP communication locations in main memory or a memory parity error was detected when writing into the communication locations. |

**RIO** RESET INPUT/OUTPUT  
(Word index alignment,<sup>†</sup> privileged)

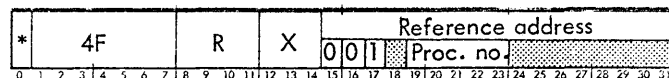

RESET INPUT/OUTPUT causes the selected IOP to generate an I/O reset signal to all devices attached to it. In addition to the operation code of X'4F', bits 15, 16, and 17 must be coded as 001, respectively.

An RIO instruction resets the selected IOP in the same manner as the I/O RESET switch on the Processor Control Panel (PCP). However, unlike the switch, the RIO instruction resets only the addressed IOP and may be controlled by the executing program.

Processor addresses (bits 19-23) having values of X'1C', X'1D', X'1E', and X'1F' are reserved for CPUs in a multi-processor system. Addresses between X'00' to X'1C' may be assigned to other processors in the system. An RIO instruction addressed to a CPU is used to reset that CPU only in a special case. This special case is the result of a double fault (described in the "Trap System", Chapter 2). When the double fault occurs, the CPU raises the Processor Fault Interrupt (PFI), loads the error status register, and goes to a PCP idle state. The CPU that responds to the PFI will use the POLP or POLR instruction to determine the source of the PFI. The error status may be logged (as programmed). The responding CPU may then issue an RIO instruction to the "faulted" CPU, which resets and forces execution to start at location X'26'.

Status information is returned only in the condition code bits.

Affected: CC1, CC2, CC3.

1 2 3 4 Result of RIO

- |   |   |   |   |                             |
|---|---|---|---|-----------------------------|
| 0 | 0 | 0 | - | I/O address recognized.     |
| 1 | 1 | 0 | - | I/O address not recognized. |

**POLP** POLL PROCESSOR  
(Word index alignment,<sup>†</sup> privileged)

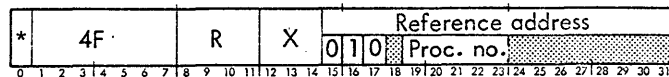

<sup>†</sup>See footnote to HIO instruction.



Standard I/O system interrupts can be generated for the following conditions:

Condition	Interrupt Prerequisite <sup>†</sup>	Status Bit Set
Zero byte count	IZC = 1	10
Channel end	ICE = 1	11
Transmission memory error	IUE = 1, HTE = 1	12
Incorrect length	IUE = 1, HTE = 1 and SIL = 0	8, 12
Memory address error, IOP memory error, or IOP control error	IUE = 1	12
Transmission data error	IUE = 1, HTE = 1	9, 12
Device unusual end	IUE = 1	12
IOP halt	IUE = 1	12

When a device interrupt condition occurs, the IOP forwards the request to the CPU interrupt system I/O interrupt level. If this interrupt level is armed, enabled, and not inhibited, the CPU eventually acknowledges the interrupt request and executes the XPSD instruction in main memory location X'5C', which leads to the execution of an AIO instruction.

For the purpose of acknowledging standard I/O interrupts, the IOPs, device controllers, and devices are connected in a preestablished priority sequence that is customer-assigned and is independent of the physical locations of the portions of the I/O system in a particular installation.

If the R field of the AIO instruction is 0 or if no device interrupt request is present, the condition code is set but the general register is not affected. If the R field of AIO is not 0, the condition code is set and register R is loaded with the following information:

DC status	IOP status	0	0	IOP address	DC address
0 1 2 3 4 5 6 7 8 9 10 11 12 13 14 15 16 17 18 19 20 21 22 23 24 25 26 27 28 29 30 31					

<sup>†</sup>IZC, ICE, IUE, HTE, and SIL refer to flag bits in the IOP command doublewords (see Chapter 4).

Status Response Bits (Table 12):

Bit Position	Function
0-7	These bits are unique to the device.
8	<u>Incorrect Length</u> . As defined for SIO, above.
9	<u>Transmission Data Error</u> . As defined for SIO, above.
10	<u>Zero Byte Count Interrupt</u> . This bit is set to 1 if the interrupt on zero byte count flag is 1 and zero byte count is detected.
11	<u>Channel End Interrupt</u> . This bit is set to 1 if the interrupt at channel end flag is 1 and channel end is reported by the device to the IOP.
12	<u>Unusual End Interrupt</u> . This bit is set to 1 if the interrupt at unusual end flag is 1 and unusual end is reported by the device to the IOP, or if IOP halt is signaled to the device controller by the IOP.
13-18	<u>Unassigned</u> . These bits are set to 0.
19-23	<u>Processor Address</u> . Contain the address of the responding processor.
24-31	<u>Device Controller/Device Address</u> . Contain the address of the responding device controller. If bit 24 is 0, bits 25-31 constitute a common device controller and device code; if bit 24 is 1, bits 25-27 constitute a device controller code and bits 28-31 identify a device attached to that device controller.

The AIO instruction resets the interrupt request signal for the I/O device responding to the AIO (i.e., the device identified by bits 19-31 of R).

Affected: (R), CC1, CC2, CC3

Condition code setting for AIO are shown below.

1	2	3	4	Result of AIO
0	0	0	-	Normal interrupt recognized.
0	0	1	-	Normal interrupt recognized but a memory parity error also detected in the status information.
0	1	0	-	Unusual condition interrupt recognized.
0	1	1	-	Unusual condition interrupt recognized and a parity error was detected in the status information.
1	1	0	-	No I/O device requesting an interrupt.

## 4. INPUT/OUTPUT OPERATIONS

In a SIGMA 8 system, input/output operations are primarily under control of one or more input/output processors (IOPs). This allows the CPU to concentrate on program execution, free from the time-consuming details of I/O operations.

Any I/O event that requires CPU intervention is brought to its attention by means of the interrupt system (see Chapter 2). For a detailed description of SIGMA 8 I/O instructions, see Chapter 3.

In the following discussion, the terminology conventions used are: The CPU executes instructions, the IOP executes commands, and the device controllers and I/O devices execute orders. To illustrate, the CPU will execute the START INPUT/OUTPUT (SIO) instruction to initiate an I/O operation. During the course of an I/O operation, the IOP might issue a command called Control, to transmit a byte to a device controller or I/O device that interprets the byte as an order, such as Rewind.

Each SIGMA 8 IOP operates independently after being started by a CPU. An IOP automatically picks up a chain of one or more commands from memory and executes these commands until the chain is completed or truncated as the result of an "unusual end" condition.

A multiplexor IOP can simultaneously operate up to 32 device controllers using both Channels A and B. Each device controller is assigned its own subchannel and chain of I/O commands. A high-speed RAD IOP (HSRIOP) can communicate with up to four Model 7212 RAD storage units. However, due to its high transfer rate capability, the HSRIOP remains connected until termination of the data in/data out sequence.

The flexible SIGMA 8 I/O structure permits both command chaining (making possible multiple-record operations) and data chaining (making possible scatter-read and gather-write operations) without intervening CPU control. Command chaining refers to the execution of a sequence of I/O commands, under control of an IOP, on more than one physical record. Thus, a new command must be issued for each physical record even if the operation to be performed for a record is the same as that performed for the previous record. Data chaining refers to the execution of a sequence of I/O commands, under control of an IOP, that gather (or scatter) information within one physical record from (or to) more than one region of memory. Thus, a new command must be issued for each portion of a physical record when the data associated with that physical record appears (or is to appear) in noncontiguous locations in memory. For example, if information in specific columns of two cards in a file are to be stored in specific regions of memory, the I/O command list might appear as follows:

1. Read card, store columns 1-10, data chain.
2. Store columns 11-60, data chain.
3. Store columns 61-80, command chain.

4. Read card, store columns 1-40, data chain.
5. Store columns 41-80.

The SIGMA 8 CPU plays a minor role in the execution of an I/O operation. The CPU-executed program is responsible for creating and storing the command list (prepared prior to the initiation of any I/O operation) and for supplying the IOP with a pointer to the first command in the I/O command list. Most of the communication between the CPU and the I/O system is carried out through memory.

The following is an example of the sequence of events that occurs during an I/O operation:

1. A CPU-executed program writes a sequence of I/O commands (doublewords) in memory.
2. The CPU executes the START INPUT/OUTPUT (SIO) instruction and furnishes the IOP with a 13-bit I/O address (designating the device to be started) and a 16-bit first command address (designating the actual memory doubleword location where the first command for this device is located). At this point, either the device is started (if in the "ready" condition with no device interrupt pending) or an instruction reject occurs. The CPU is informed by condition code settings which of the two alternatives has occurred. If the SIO instruction is accepted, the command counter portion of the IOP register associated with the designated device controller is loaded with the first command address. From this time until the full sequence of I/O commands has been executed, the main program of the CPU need play no role in the I/O operation. At any time, however, the CPU may obtain status information on the progress of the I/O operation without interfering with it.
3. The device is now in the "busy" condition. When the device determines that it has the highest priority for access to the IOP, it requests service from the IOP with a service call. The IOP obtains the address of the first command doubleword of the I/O sequence (from the command counter associated with this device). The IOP then fetches the I/O command doubleword from memory, loads the doubleword into another register associated with the device, and transmits the first order (extracted from the command doubleword) to it.
4. Each command counter contains the memory address of the current I/O command in the sequence for its device. When the device requires further servicing, it makes a request to the IOP, which then repeats a process similar to that of step 3.
5. If a data transmission order has been sent to a device, control of the transmission resides in it. As each character is obtained by the I/O device, the IOP is signaled



that data is available. The IOP uses the information stored in its own registers to control the information interchange between the I/O device and the memory, on either a word-by-word or character-by-character basis, depending on the nature of the device.

- When all information exchanges called for by a single I/O command doubleword have been completed, the IOP uses the command counter to obtain the next command doubleword for execution. This process continues until all such command doublewords associated with the I/O sequence have been executed.

## OPERATIONAL COMMAND DOUBLEWORDS

Operational command doublewords have the following format:

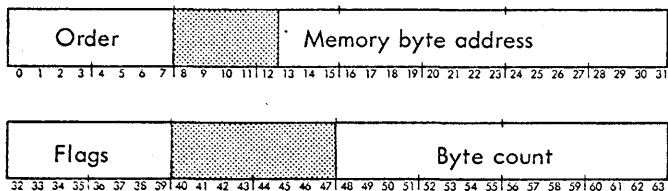

### ORDER

Bit positions 0 through 7 of the command doubleword contain the I/O order for the device controller or device. The I/O orders are shown below<sup>†</sup>. Bits represented by the letter "M" specify orders or special conditions to the device and are unique for each type of device.

Bit positions								Order
0	1	2	3	4	5	6	7	
M	M	M	M	M	M	0	1	Write
M	M	M	M	M	M	1	0	Read
M	M	M	M	M	M	1	1	Control
M	M	M	M	0	1	0	0	Sense
M	M	M	M	1	1	0	0	Read Backward

**Write.** The Write order causes certain device controllers to initiate an output operation. Bytes are read in ascending sequence from the memory location specified by the memory byte address field of the command doubleword. The output operation continues until the device signals "channel end", or until the byte count is reduced to 0 and no further data chaining is specified. Channel end occurs when the device has received all information associated with the output operation, completed all checks, and no longer requires the use of IOP facilities for the operation. Data chaining is described later in this chapter.

<sup>†</sup> Not all I/O devices recognize all the orders shown. See the particular XDS SIGMA peripheral device reference manual for orders applicable to that device.

**Read.** The Read order causes certain device controllers to initiate an input operation. Bytes are stored in memory in ascending sequence, beginning at the location specified by the memory byte address field of the command doubleword. The input operation continues until the device signals channel end, or until the byte count is reduced to 0 and no data chaining is specified. Channel end occurs when the device has transmitted all information associated with the input operation and no longer requires the use of IOP facilities for the operation.

**Control.** The Control order is used to initiate special operations by certain devices. For magnetic tape, it is used to issue orders such as Rewind, Backspace Record, Backspace File, etc. Most orders can be specified by the M bits of the Control order; however, if additional information is required for a particular operation (e.g., the starting address of a disk seek), the memory byte address field of the command doubleword specifies the starting address of the bytes that are to be transmitted to the device controller for the additional information. When all bytes necessary for the operation have been transmitted, the device controller signals channel end.

**Sense.** The Sense order causes certain devices to transmit one or more bytes of information, describing its current state. The bytes are stored in memory in ascending sequence, beginning with the address specified by the memory byte address field of the command doubleword. The number of bytes transmitted is a function of the device and the condition it describes. The Sense order can be used to obtain the current sector address from a disk or RAD storage unit.

**Read Backward.** The Read Backward order causes certain devices (at present, 9-track magnetic tape units) to be started in reverse, and bytes to be transmitted to the IOP for storage into memory in descending sequence, beginning at the location specified by the memory byte address field of the command doubleword. In all other respects, Read Backward is identical to Read, including reducing the byte count with each byte transmitted.

### MEMORY BYTE ADDRESS

For all operational I/O command doublewords, bit positions 13-31 of the doubleword provide a 19-bit memory byte address, designating the memory location for the next byte of data. For all orders other than Read Backward, this field (as stored in an IOP register) is incremented by 1 as each byte is transmitted in the I/O operation; for the Read Backward order, the field is decremented by 1 as each byte is transmitted.

### FLAGS

For all operational I/O command doublewords, bit positions 32-39 of the doubleword provide the IOP with eight flags that specify how to handle chaining, error, and interrupt situations.

The three flags (IZC, ICE, and HTE) pertaining to IOP interrupt action control whether IOP will request an I/O interrupt to be triggered when a specified condition occurs during an I/O operation. These flags do not affect the I/O interrupt levels. Furthermore, in order for the flags to be effective, the I/O interrupt level (X'5C') must first be placed in the desired state (i. e., armed and enabled) via interrupt write control instructions (mode 1).

The functions of the eight flags are explained below.

Bit

Position    Function

32 (DC)    Data chain. If this flag is 1, data chaining is called for when the current byte count is reduced to 0. The next command doubleword is fetched and loaded into the IOP register associated with the device controller, but the new order code is not passed out to the device controller; thus, the operation called for by the previous order is continued. (Except for Transfer in Channel command doublewords, which are explained later in this chapter, the new command doubleword is used only to supply a new memory address, a new count, and new flags.) If the data chain flag is 0, no further data chaining is called for. Channel end is initiated either by the device running out of information, or by the byte count being reduced to 0. At channel end, the device may accept a new SIO instruction, provided that a device interrupt is not pending and no "fault" condition exists.

33 (IZC)    Interrupt at zero byte count. If this flag is 1, the IOP requests the I/O interrupt (location X'5C') to be triggered when the byte count of this command doubleword (as stored in the IOP register) is reduced to 0. An AIO instruction executed after the interrupt is acknowledged results in a 1 in bit position 10 of register R (status information) to indicate the reason for the interrupt.

34 (CC)    Command chain. If this flag is 1, command chaining is called for when channel end occurs. If the previous operation did not terminate with a "fault" or "unusual end" condition, the next command doubleword is fetched and loaded into the IOP register associated with the device controller, and the new order code is passed out to the device controller. If the CC flag is 0, no further command chaining is called for. If both data and command chaining are called for in the same command doubleword, data chaining occurs if the byte count is reduced to 0 before channel end, and command chaining occurs if channel end occurs before the byte count is reduced to 0.

35 (ICE)    Interrupt at channel end. If this flag is 1, the IOP requests the I/O interrupt (location X'5C') to be triggered when channel end occurs for the operation being controlled by this command

Bit

Position    Function

35 (ICE)    doubleword. An AIO instruction executed after the interrupt is acknowledged results in a 1 in bit position 11 of register R (status information) to indicate the reason for the interrupt. If the ICE flag is 0, no interrupt is requested.

36 (HTE)    Halt on transmission error. If this flag is 1, any error condition associated with data transmission (transmission data error, transmission memory error, incorrect length error) detected in the device controller or IOP results in halting the I/O operation being controlled by this command doubleword. If the HTE flag is 0, an error condition does not cause the I/O operation to halt, although the error conditions are recorded in the IOP register and returned as part of the status information for the instructions SIO, HIO, and TIO.

The HTE flag must be coded identically in every command doubleword associated with the same physical record. This means that when data chaining occurs, the HTE flag in the new IOP command doubleword must be the same as the HTE flag in the previous IOP command doubleword. This restriction applies to data chaining only, and not to command chaining.

37 (IUE)    Interrupt on unusual end. If this flag is 1, the device controller requests the I/O interrupt (location X'5C') to be triggered when a "fault" condition or unusual termination is encountered. A fault is a condition requiring the device to halt, irrespective of the coding of the HTE flag. Examples of faults are torn magnetic tape and jammed cards. When unusual termination is detected by the device or IOP, further servicing of the commands for that device is suspended. An AIO instruction executed after the interrupt is acknowledged results in a 1 in bit position 12 of register R (status information) to indicate the reason for the interrupt. If the IUE flag is 0, no interrupt is requested.

38 (SIL)    Suppress incorrect length. If this flag is 1, an incorrect length indication by the device controller is not to be classified as an error by the IOP, although the IOP retains the incorrect length indication and provides an indicator (bit 8 of register Ru), the status response for SIO, HIO, AIO, and TIO) to the program. If the SIL flag is 0, an incorrect length is considered an error and the IOP performs as specified by the HTE and IUE flags. Incorrect length is caused by a "channel end" condition occurring before the device controller has received a "count done"

Bit Position	Function
--------------	----------

38 (SIL) (cont.)	signal from the IOP, or is caused by the device controller receiving a count done signal before end of record, e.g., count done before 80 columns have been read from a card. Normally, a count done signal is sent to the device controller by the IOP to indicate that all data transfer associated with the current operation has been completed. The IOP is capable of suppressing an error condition on incorrect length, since there are many situations in which incorrect length is a legitimate condition and not a true error.
---------------------	--

39 (S)	<u>Skip</u> . If this flag is 1, the input operation (Read or Read Backward) controlled by this command doubleword continues normally, except that no information is stored in memory. When used in conjunction with data chaining, the skip operation provides the capability for selective reading of portions of a record.
--------	---

If the S flag is 1 for an output (Write) operation, the IOP does not access memory, but transmits zeros as data instead (i.e., the IOP transmits the number of X'00' bytes specified in the byte count of the command doubleword). This allows a program to punch a blank card (by using the S bit and a Punch Binary order with a byte count of 120) without requiring memory access for data. If the S flag is 0, the I/O operation proceeds normally.

### BYTE COUNT

For all operational I/O command doublewords, bit positions 48-63 of the doubleword provide for a 16-bit count of the number of bytes to be transmitted in the I/O operation; thus, 1 to 65,536 bytes (16,384 words) can be specified for transfer before command or data chaining is required. This field (as stored in an IOP register) is decremented by 1 after each byte is transmitted in the I/O operation; thus, it always contains a count of the number of bytes to be transmitted and this count is returned as part of the response information for the instructions, SIO, HIO, TIO, and TDV. An initial byte count of 0 is interpreted as 65,536 bytes.

### CONTROL COMMAND DOUBLEWORDS

In addition to the operational command doubleword, there are two control command doublewords with different formats that provide control information for the IOP.

The Transfer in Channel command doubleword has the following format:

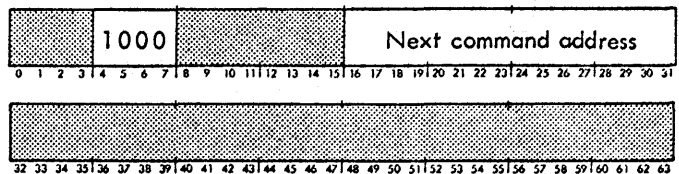

Transfer in Channel. The Transfer in Channel command is executed within the IOP and has no direct effect on any of the I/O system elements external to the addressed IOP. The primary purpose of this command is to permit branching within the command list so that the IOP can, for example, repeatedly transmit the same set of information a number of times. When the IOP executes the Transfer in Channel command, it loads the command counter for the device controller it is currently servicing with the next command address field of the Transfer in Channel command, loads the new command doubleword specified by this address into the IOP registers associated with the device controller, and then executes the new command. (Bit positions 0-3, 8-15, and 32-63 of the command doubleword for Transfer in Channel are ignored.) Transfer in Channel thus allows a command list to be broken into noncontiguous groups of commands. When used in conjunction with command chaining, Transfer in Channel facilitates the control of devices such as unbuffered card punches or unbuffered line printers. The current flags are not altered during this command; thus, the type of chaining called for in the previous command doubleword is retained until changed by a command doubleword following Transfer in Channel.

For example, assume that it is desired to present the same card image twelve times to an unbuffered card punch. The punch counts the number of times that a record is presented to it and, when twelve rows have been punched, causes the IOP to skip the command it would be executing next. Thus, a command list for punching two cards might look like the following example:

Location	Command
:	:
:	:
A	Punch row for card 1, command chain.
	Transfer in Channel to A.
B	Punch row for card 2, command chain.
	Transfer in Channel to B.
	Stop.
:	:
:	:

The Transfer in Channel command also can be used in conjunction with data chaining. As one example, consider a situation often encountered in data acquisition applications, where data is transmitted in extremely long, continuous streams. In this case, the data can be stored alternately in two or more buffer storage areas so that computer processing

can be carried out on the data in the buffer while additional data is being input into the other buffer. The command list for such an application might look like the following example:

<u>Location</u>	<u>Command</u>
:	:
A	Read data, store into buffer 1, data chain.
	Store into buffer 2, data chain.
	Transfer in Channel to A.
:	:
:	:

If the IOP encounters two successive Transfer in Channel commands, this is considered an IOP control error, resulting in the IOP setting the IOP control error status bit (bit 13 of register Ru1) and issuing an "IOP Halt" signal to the device controller. The IOP then halts further servicing of this command list.

The Stop command doubleword has the following formats:

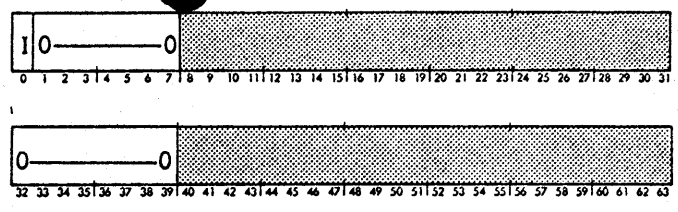

Stop. The Stop command causes certain devices to stop, generate a "channel end" condition, and also request the I/O interrupt (location X'5C') to be triggered if bit 0 in the Stop command is a 1. An AIO instruction executed after the interrupt is acknowledged results in a 1 in bit position 7 of register R (status information) to indicate the reason for the interrupt. (Bit positions 32-39 of the command doubleword for Stop must be zero; bit positions 8-31 and 40-63 are ignored). The Stop command is primarily used to terminate a command chain for an unbuffered device, as illustrated in the first example given for the Transfer in Channel command.

# 5. OPERATOR CONTROLS

## PROCESSOR CONTROL PANEL

The SIGMA 8 processor control panel (PCP) is shown in Figure 8. The controls and indicators are divided into two sections. The upper section, which is labeled MAINTENANCE SECTION, contains most of the controls and indicators used by maintenance personnel. The DISPLAY FORMAT indicator and FORMAT SEL switch located in the lower section are also primarily used by maintenance personnel. All other controls and indicators located in the lower section of the PCP are normally used by operating personnel to load, execute, and troubleshoot programs.

A three-position rotary switch, located in the upper left-hand corner and labeled EXT CONT/LOCAL NORM/LOCAL MAINT, is a control mode selector for the PCP. It is set

either to the LOCAL NORM position for normal operations or to the LOCAL MAINT position for maintenance operations. The EXT CONT position is reserved for future use. Hereafter, this switch will be referred to as the Control Mode switch.

## CONTROL MODE

When the Control Mode switch is in the LOCAL MAINT position, all switches on the control panel are enabled. When the Control Mode switch is in the LOCAL NORM position, all switches are enabled except the following:

1. The FORMAT SEL switch is disabled and forced to appear in the NORMAL position, regardless of the position of the switch.

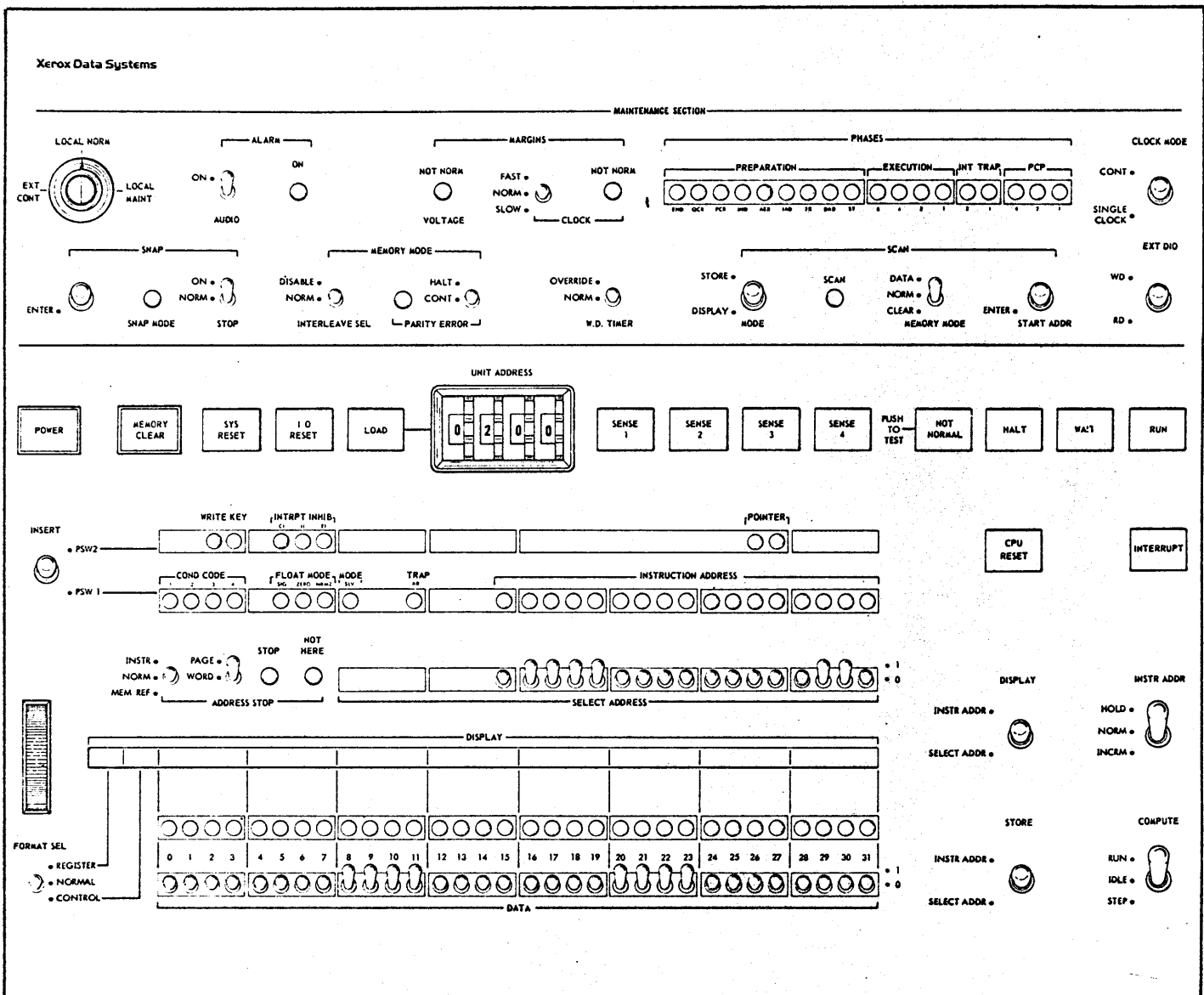

Figure 8. Processor Control Panel

2. The SNAP switches are disabled.
3. The EXT DIO switch is disabled.
4. The CLOCK MARGINS switch is disabled and forced to appear in the NORM position.
5. The CLOCK MODE switch is disabled and forced to appear in the CONT position.
6. The SCAN switches are disabled.

### POWER

The POWER switch controls ac power to the central processor and to units under its direct control. The POWER indicator is lighted when ac power is on.

### MEMORY CLEAR

The MEMORY CLEAR switch clears all CPU memory. When this switch is pressed, the SCAN light illuminates and remains on until all memory is cleared. The contents of the general registers remain unaltered during the operation. It is recommended that CPU RESET be pressed before using the MEMORY CLEAR switch. Homespace bias is automatically suppressed during the clear operation.

### SYS RESET

The SYS RESET (system reset) switch performs the combined functions of the CPU RESET switch and the I/O RESET switch. The SYS RESET switch also initializes all memories connected to the system. The initialization of memories does not change the contents of any memory locations; only memory port logic is reset.

### I/O RESET

The I/O RESET switch initializes the standard input/output system. When the switch is pressed, all peripheral devices under control of the central processor are reset to the "ready" condition, and all status, interrupt, and control indicators in the input/output system are reset. The I/O RESET switch does not affect the central processor.

### LOAD

The LOAD switch is active only when the COMPUTE switch is in the IDLE position. When this momentary action switch is pressed, a load program is written into memory locations X'22' through X'2B' for an input operation that uses the peripheral unit selected by the UNIT ADDRESS switches. CPU RESET or SYS RESET must be performed before using this switch.

Detailed loading operation is described in the section "Loading Operation".

### UNIT ADDRESS

Four UNIT ADDRESS switches select the peripheral unit to be used in the loading process. The two switches on the left designate an input/output processor (IOP). The leftmost switch has two positions, numbered 0 and 1. The next switch has 16 positions, numbered hexadecimally 0 through F. The two rightmost switches each have 16 positions, numbered hexadecimally 0 through F, which designate the device controller/device that is under control of the selected IOP.

### SENSE

The four SENSE switches and indicators are monitored under program control to set the condition code position of the program status doubleword (PSD). When a READ DIRECT instruction is executed in the internal control mode, the condition code is set according to the state of the four SENSE switches. If a SENSE switch is in the set (1) position (indicator lighted), the corresponding bit of the condition code is set to 1; if a SENSE switch is in the reset (0) position (indicator unlighted), the corresponding bit of the condition code is reset to 0.

### NOT NORMAL

The NOT NORMAL indicator informs the user that normal program execution may be inhibited by the PCP. The NOT NORMAL indicator is lighted when any of the following occurs:

1. The Control Mode switch is in the LOCAL MAINT position.
2. The INTERLEAVE SEL switch is in the DISABLE position.
3. The CLOCK MODE switch is in the unmarked center position.
4. The W. D. TIMER switch is in the OVERRIDE position.
5. The PARITY ERROR switch is in the HALT position.

When the NOT NORMAL momentary action switch is depressed, a control panel lamp test is performed. This test turns on all indicators in the MAINTENANCE section, the DISPLAY lights, and the STOP and NOT HERE lights, without affecting machine operation.

### HALT

The HALT indicator is lighted when the CPU is in the IDLE state.

**WAIT**

The WAIT indicator is lighted when any of the following halt conditions exists:

1. The computer has executed a WAIT instruction.
2. The CPU RESET or SYS RESET switch is pressed when the COMPUTE switch is in the IDLE position.
3. The COMPUTE switch is in the IDLE position and the POWER switch turns power on or power is applied to the CPU.

**RUN**

The RUN indicator is lighted when the COMPUTE switch is in the RUN position and no halt condition exists.

**PROGRAM STATUS DOUBLEWORD**

Two rows of binary indicators display the current PSD. For convenience, the second portion of the PSD, labeled PSW2, is arranged above the first portion, labeled PSW1. The PSD display consists of the indicators shown in Table 13.

Table 13. Program Status Doubleword (PSD) Indicators

PSD Portion	Indicator	Function	PSD Bit Position	PSD Designation
PSW2	WRITE KEY	Write key status	34, 35	WK
	INTRPT INHIB	Interrupt inhibits status		
	CI	Counter interrupt group inhibit	37	CI
	II	Input/output interrupt group inhibit	38	II
	EI	External interrupt inhibit	39	EI
	POINTER	Register block pointer	58-59	RP
PSW1	COND CODE	Condition code		
	1	Condition code 1	0	CC1
	2	Condition code 2	1	CC2
	3	Condition code 3	2	CC3
	4	Condition code 4	3	CC4
	FLOAT MODE	Floating-point mode controls		
	SIG	Significance trap mask	5	FS
	ZERO	Zero trap mask	6	FZ
	NRMZ	Normalize mask	7	FN
	MODE	Computer mode control		
	SLV	Master/slave mode control	8	MS
	TRAP	Arithmetic trap mask		
AR	Fixed-point arithmetic overflow trap mask	11	AM	
	INSTRUCTION ADDRESS	Instruction address	15-31	IA

The INSERT switch permits manual changes to the PSD. The switch is stationary and inactive in the center (normal) position and momentary in the upper (PSW2) and lower (PSW1) positions. When the INSERT switch is moved to the PSW1 or PSW2 position, the corresponding half of the PSD is changed, as necessary, and the corresponding indicators display the information that has been entered from the 32 DATA switches located at the bottom of the control panel.

**CPU RESET**

The CPU RESET switch initializes the central processor. When this switch is pressed, the following operations are performed:

1. All interrupt levels are reset to the disarmed and disabled state.
2. The ALARM indicators (visual and audio) are reset.
3. All PSD bits are reset except for the INSTRUCTION ADDRESS.
4. The INSTRUCTION ADDRESS indicators are set to X'26'.
5. The WAIT indicator is set, indicating the CPU is in the WAIT state.

The CPU RESET switch does not affect any operation that may be in process in the standard input/output system.

**INTERRUPT**

The operator uses the INTERRUPT switch to activate the control panel interrupt. If the control panel interrupt (level X'5D') is armed when the INTERRUPT switch is pressed, a single pulse is transmitted to the interrupt level, advancing it to the waiting state. The INTERRUPT indicator is lighted when the control panel interrupt level is in the waiting state and it remains lighted until the interrupt level advances to the active state (at which time the INTERRUPT indicator is turned off). If the control panel interrupt level is disarmed (or already in the active state) when the INTERRUPT switch is pressed, no computer or control panel action occurs. If the control panel interrupt level advances to the waiting state and the level is disabled, the INTERRUPT indicator remains lighted until the level is either enabled and allowed to advance to the active state or is returned to the armed or disarmed state. The INTERRUPT switch is always operative.

The ADDRESS STOP section of the control panel consists of two switches, a STOP indicator, and a NOT HERE indicator.

The two ADDRESS STOP switches latch in all positions and are labeled INST/NORM/MEM REF and PAGE/WORD. They are used in conjunction with the SELECT ADDRESS switches and the COMPUTE switch to cause the CPU to establish a halt condition and turn on the ADDRESS STOP indicator whenever the CPU accesses an instruction or a memory address.

**PAGE/WORD**

When the PAGE/WORD switch is in the PAGE position, it causes the address stop feature to ignore the nine least significant SELECT ADDRESS switches. In effect, this enables the address stop feature when any word in a selected page is addressed.

When the PAGE/WORD switch is in the WORD position, all 17 SELECT ADDRESS switches are used to specify an address.

**INSTR/NORM/MEM REF**

When the INST/NORM/MEM REF (instruction/normal/memory reference) switch is in the NORM position, it is inactive and the address stop feature is inhibited.

When this switch is in the MEM REF position and the COMPUTE switch is in the RUN position, a halt condition occurs when the CPU accesses a memory reference address equal to the address contained by the 17 SELECT ADDRESS switches, subject to the constraints of the PAGE/WORD switch, as described above. The value of the INSTRUCTION ADDRESS indicators at the time of the halt is determined by the sequence of instructions being executed at the time of memory reference.

When the INSTR/NORM/MEM REF switch is in the INSTR position and the COMPUTE switch is in the RUN position, a halt condition occurs when the CPU accesses an instruction whose address is equal to that contained in the 17 SELECT ADDRESS switches, subject to the constraints of the PAGE/WORD switch. The INSTRUCTION ADDRESS indicators at the time of the halt normally will equal the SELECT ADDRESS value, and the instruction pointed to by the INSTRUCTION ADDRESS will appear on the DISPLAY indicators.

The ADDRESS STOP halt condition is reset when the COMPUTE switch is moved from RUN to IDLE; if the COMPUTE switch is then moved back to RUN (or to STOP), the instruction shown in the DISPLAY indicators is the next instruction executed. No interrupt is allowed to proceed from the waiting to the active state while the ADDRESS STOP halt condition exists.

The ADDRESS STOP function is disabled during the time that the SNAP is armed.



## STOP

The STOP indicator lights to indicate that the machine is halted due to either an INSTR-ADDRESS STOP or MEM REF-ADDRESS STOP. The STOP indicator is turned off when the COMPUTE switch is moved from RUN to IDLE.

## NOT HERE

The NOT HERE indicator is lighted when a nonexistent memory location is referenced. It is automatically reset at the end of each memory cycle, or when the RESET switch is depressed.

## SELECT ADDRESS

The SELECT ADDRESS switches are used in conjunction with

1. The ADDRESS STOP switches (INSTR/NORM/MEM REF and PAGE/WORD) to select the address at which a program will be halted.
2. The STORE switch to select the location to be altered.
3. The DISPLAY switch to select the word to be displayed.
4. The SCAN MODE switches to establish an upper boundary of the memory scan operation.
5. The SCAN-START ADDR switch to enter a starting address of the memory scan operation.

Each SELECT ADDRESS switch represents a 1 in the upper position or a 0 in the lower position.

## DISPLAY (SWITCH)

The DISPLAY switch displays the contents of a general register or a memory location. The DISPLAY switch is stationary and inactive in the center (unmarked) position and momentary in the INSTR ADDR and SELECT ADDR positions. When the switch is moved to the INSTR ADDR or SELECT ADDR position, the contents of the location pointed to by the INSTRUCTION ADDRESS indicators or the SELECT ADDRESS switches, respectively, are shown in the DISPLAY indicators.

If the final memory address is nonexistent, the CPU does not trap and the DISPLAY indicators are indeterminate.

## INSTR ADDR

The INSTR ADDR (instruction address) switch is latching and inactive in the NORM position, latching in the HOLD position, and momentary in the INCRM position.

When the INSTR ADDR switch is in the HOLD position, the normal process of incrementing the INSTRUCTION ADDRESS portion of the PSD with each instruction execution is

inhibited. With the INSTR ADDR switch in the HOLD position and the COMPUTE switch in the RUN position, the instruction in the location pointed to by the value of the INSTRUCTION ADDRESS indicators is executed repeatedly, with the INSTRUCTION ADDRESS indicators remaining unchanged. Moving the COMPUTE switch to the momentary STEP position while the INSTR ADDR switch is in the HOLD position causes the instruction in the location pointed to by the value of the INSTRUCTION ADDRESS indicators to be executed each time the COMPUTE switch is moved to the STEP position. The INSTRUCTION ADDRESS indicators normally remain unchanged. During HOLD operations, the INSTRUCTION ADDRESS may be altered as a result of a trap, interrupt, LPSD, XPSD, or branch instruction.

Each time the INSTR ADDR switch is moved from the NORM position to the INCRM position, the following operations are performed:

1. The current value of the INSTRUCTION ADDRESS indicators is incremented by 1.
2. Using the new value of the INSTRUCTION ADDRESS indicators, the contents of the location pointed to by the INSTRUCTION ADDRESS are displayed in the DISPLAY indicators.

If the final memory address is nonexistent, the CPU does not trap and the DISPLAY indicators are indeterminate.

## DISPLAY (INDICATORS)

The 32 DISPLAY indicators may display an instruction, data word, or maintenance data. When the Control Mode switch is in the LOCAL NORM position, the FORMAT SEL switch is forced into the NORMAL mode and the DISPLAY switch, COMPUTE switch, and INSTR ADDR switch can be used to display the contents of a memory location or the current contents of the internal CPU instruction register.

When the DISPLAY switch is placed in the INSTR ADDR position, the contents of the location indicated by the INSTRUCTION ADDRESS indicators are displayed in the DISPLAY indicators. When the DISPLAY switch is placed in the SELECT ADDR position, the contents of the location selected by the SELECT ADDRESS switches is displayed in the DISPLAY indicators. When the INSTR ADDR switch is placed in the INCRM position, the INSTRUCTION ADDRESS is incremented by one and the contents of the location is displayed in the DISPLAY indicators.

When the COMPUTE switch is placed in the STEP position, the contents of the location displayed in the INSTRUCTION ADDRESS will be executed and the next instruction in the sequence in the internal CPU instruction register will be displayed in the DISPLAY indicators.

To display maintenance data, the Control Mode switch must be in the LOCAL MAINT position, and the FORMAT SEL switch may be placed in either the CONTROL position or the REGISTER position to have control words or internal register contents displayed in the DISPLAY indicators. The

specific control word or internal register selected is controlled by the thumbwheel adjacent to the roll chart on the DISPLAY FORMAT.

## DISPLAY FORMAT

The DISPLAY FORMAT feature, which is used by maintenance personnel, is inactive whenever the Control Mode switch is in the LOCAL NORM position. A chart comprised of 16 lines of printed information is mounted on a roller located directly behind the slot in the panel labeled DISPLAY FORMAT. Associated with the chart is a 16-position switch (thumbwheel-actuated) and a 3-position FORMAT SEL switch, which selects various internal registers of the CPU for display.

## FORMAT SEL

The 3-position FORMAT SEL (format select) switch is labeled CONTROL/NORMAL/REGISTER. In the NORMAL position, the DISPLAY FORMAT and FORMAT SEL features are inactive and the DISPLAY lights show the CPU internal instruction register. When the FORMAT SEL switch is in the REGISTER position and the Control Mode switch is in the LOCAL MAINT position, the contents of the selected internal register will appear in the DISPLAY indicators. When the FORMAT SEL switch is in the CONTROL position and the Control Mode switch is in the LOCAL MAINT position, specific control information, as indicated by the DISPLAY FORMAT chart, appears in the DISPLAY indicators.

## DATA

The 32 DATA switches alter the contents of the PSD when used in conjunction with the INSERT switch, or alter the contents of memory or a general register when used in conjunction with the STORE switch. Each DATA switch is latching in both the upper and center positions. In the center position, a DATA switch represents a 0; in the upper position, a 1.

## STORE

The STORE switch alters the contents of a general register or a memory location. The switch is stationary and inactive in the center (unmarked) position and momentary in the INSTR ADDR and SELECT ADDR positions. When the switch is moved to the INSTR ADDR position, the current value of the DATA switches is stored in the location pointed to by the INSTRUCTION ADDRESS indicators; when the switch is moved to the SELECT ADDR position, the current value of the DATA switches is stored in the location pointed to by the SELECT ADDRESS switches. The contents of the addressed location are altered regardless of write protection.

## COMPUTE

The COMPUTE switch controls the execution of instructions. The IDLE and RUN positions are both latching; the STEP position is momentary. When the COMPUTE switch is in the IDLE position, all other control panel switches are operative and the ADDRESS STOP halt and the WAIT instruction halt conditions are reset (cleared). No interrupts are allowed in this mode.

When the COMPUTE switch is moved from IDLE to RUN, the RUN indicator is lighted and the current setting of the INSTRUCTION ADDRESS indicators is taken as the address of the next instruction to be executed, regardless of the contents of the DISPLAY indicators.

When the COMPUTE switch is in the RUN position, the only operative switches are POWER, INTERRUPT, ADDRESS STOP, INSTR ADDR (in the HOLD position), and the switches in the maintenance section except SCAN, EXT DIO, and SNAP ENTER.

Each time the COMPUTE switch is moved from IDLE to STEP, the following operations occur:

1. The instruction pointed to by the current value of the INSTRUCTION ADDRESS indicators is executed.
2. The current value of the INSTRUCTION ADDRESS indicators is incremented by 1. If the "stepped" instruction (executed by moving the COMPUTE switch from IDLE to STEP) is a branch instruction and the branch branch should occur, the INSTRUCTION ADDRESS indicators are set to the value of the effective address of the branch instruction.
3. The instruction in the location pointed to by the new value of the INSTRUCTION ADDRESS indicators is displayed in the DISPLAY indicators.

If an instruction is being stepped, all interrupt levels are temporarily inhibited while the instruction is being executed; however, a trap condition can occur while the instruction is being executed. In this case, the XPSD instruction in the appropriate trap location is executed as if the COMPUTE switch were in the RUN position. Thus, if a trap condition occurs during a stepped instruction, the PSD display automatically reflects the effects of the XPSD instruction, and the DISPLAY indicators then contain the first instruction of the trap routine.

## MAINTENANCE CONTROLS

The controls and indicators located in the MAINTENANCE SECTION of the PCP, as well as the DISPLAY FORMAT and FORMAT SEL switches (described previously), are used primarily during computer maintenance and diagnostic operations.

## ALARM

Audio and visual alarms may be used to attract the computer operator's attention. The alarms are turned on and off (under program control) by executing a properly coded WRITE DIRECT instruction. When the visual ALARM indicator is lighted and the AUDIO switch is ON, a 1000-Hz signal is sent to the computer speaker; when the AUDIO switch is not in the ON position, the speaker is disconnected. (The AUDIO switch does not affect the state of the visual ALARM indicator.) The ALARM indicator is reset (turned off) whenever either the CPU RESET or the SYS RESET switch is pressed or a properly coded WRITE DIRECT instruction is executed.

The AUDIO switch controls all signals to the computer speaker, whether from the 1000-Hz signal or program-controlled frequency flip-flop.

## MARGINS

The CPU clock frequency may be changed to values above and below the normal operating values by manually setting the CLOCK MARGIN switch or by programming via an appropriate internal WRITE DIRECT instruction. The CLOCK MARGIN switch overrides program control when set to the FAST or SLOW position. When set to the NORMAL position, clock margins are under program control. The NOT NORM CLOCK indicator will be lighted whenever the clock frequency is not normal due to programming or switch settings of FAST or SLOW.

The system voltage margin, for a single processor system, or the CPU voltage margin, for a multiprocessor system, is indicated by the VOLTAGE NOT NORM light. The VOLTAGE NOT NORM light will be on if any power supply in the system is on HIGH or LOW MARGINS.

## PHASES

The PHASES indicators display certain internal operating phases of the computer. The PREPARATION indicators display computer phases during preparation sequences. The PCP indicators display computer phases during processor control panel operations. The EXECUTION indicators display computer phases during the execution portion of an instruction cycle. The INT/TRAP (interrupt/trap) indicators are individually lighted when an interrupt or a trap condition occurs. When the COMPUTE switch is in the IDLE position, all PHASES indicators are normally off except for the rightmost PCP indicator (indicating the idle phase for processor control panel functions).

## CLOCK MODE

The CLOCK MODE switch controls the internal computer clock. When the switch is in the CONT (continuous) position, the clock operates at normal speed. However, when the CLOCK MODE switch is in the inactive (center) position, the clock enters an idle state and can be made to

generate one clock pulse each time the switch is moved to the SINGLE CLOCK position. When the clock is pulsed by the CLOCK MODE switch, the PHASES indicators reflect the computer phase during each pulse of the clock.

## SNAP

All logic that is displayable on the PCP can be monitored with the snapshot control logic. Snapshot control logic is preset (armed) by executing a WRITE DIRECT (Load Snapshot Control Register) instruction or, when the COMPUTE switch is in the IDLE position, by moving the SNAP ENTER switch to the ENTER position. Moving the ENTER switch from the latching and inactive center position selects the following conditions (duplicates the function performed by the appropriate internal WRITE DIRECT instruction):

1. A clock count number (obtained from DATA switches 0-7).
2. A register or group of control elements to be recorded (obtained from DATA switches 10-14).
3. An instruction address (obtained from DATA switches 15-31).

When the COMPUTE switch is in the RUN position and the selected address matches the instruction address of the PSD, the clock counter is decremented by each CPU clock pulse, starting with the first phase of execution. When the clock counter reaches a value of 1, the selected logic is clocked by the current selected CPU clock into a 32-bit "snap" register and the snap condition is reset. The contents of the "snap" register can then be recorded by a READ DIRECT instruction under program control or visually displayed with the use of FORMAT SEL and DISPLAY FORMAT switches. The SNAP STOP switch can be used to stop the clock at time of the snap condition by setting it to the ON position. This switch is inactive in the NORM position. The halt condition, resulting from the SNAP STOP switch stopping the clock at snap time, can be reset by placing the STOP switch to the NORM position, which disables the STOP switch, or by placing the CLOCK MODE switch to center (unmarked) position, which keeps the clock stopped, then moving the SNAP STOP switch to the NORM position and SINGLE CLOCK the CLOCK MODE switch to reset the stop on snap condition, and then set the CLOCK MODE switch to CONT position.

## SNAP MODE

The SNAP MODE indicator shows that the snap feature is armed and waiting to "snap", and is reset only if the snap has occurred or CPU RESET or SYS RESET has been performed.

## MEMORY MODE

MEMORY MODE switches and indicator are comprised of an INTERLEAVE SEL switch, a PARITY ERROR switch, and a PARITY ERROR indicator.

## INTERLEAVE SEL

When the INTERLEAVE SEL (interleave select) switch is in the NORM position, memory address interleaving occurs normally; however, when the switch is in the DISABLE position, memory addresses are not interleaved between memory banks.

## PARITY ERROR

The PARITY ERROR switch is inactive in the CONT position. When it is set to the HALT position, a parity error resulting from memory operation will establish a CPU halt condition by stopping the CPU clock at the time the CPU detects the parity error. At this time the PARITY ERROR light is on. This condition is removed by CPU RESET, SYS RESET, or by setting the PARITY ERROR switch to the CONT position.

## W.D. TIMER

When the W. D. TIMER (watchdog timer) switch is in the NORM position, the watchdog timer is operative; when the switch is in the OVERRIDE position, the watchdog timer is inactive.

## SCAN

The SCAN portion of the control panel consists of the MODE switch, SCAN light, MEMORY MODE switch, and START ADDR switch. These controls enable the operator to continuously cycle memory between selected lower and upper addresses at a rate simulating the faster CPU operation with memory. Only memory is affected. All the switches are active only when the COMPUTE switch is in the IDLE position. Homespace bias is suppressed during the SCAN operation.

The starting address (first address read or modified by the SCAN operation) is entered by using the START ADDR switch in conjunction with the SELECT ADDRESS switches, which are active only when the COMPUTE switch is in the IDLE position. Placing the START ADDR switch in the ENTER position enters the contents of the SELECT ADDRESS switches into an internal CPU register (P), which designates a starting address.

The upper address (the last address read or modified by the SCAN operation) is then set into the SELECT ADDRESS switches, and the ADDRESS STOP switch set to the MEM REF position.

The memory scan operation can be initiated by first placing the MEMORY MODE switch to DATA (for a store or display) or CLEAR (only for a store operation), then the MODE switch to STORE or DISPLAY. When this is performed, the SCAN operation starts continuously reading from or storing into consecutive memory locations, as a function of whether the MODE switch was set to DISPLAY or STORE, respectively. The SCAN operation begins with the starting

address (set into P), and continues until the memory address equals the value of the SELECT ADDRESS switches. Then, if the ADDRESS STOP switch is set to MEM REF, the scan continues again from the starting address. If the ADDRESS STOP switch is in the NORM position, all memory will be scanned.

The scan operation continues indefinitely in this manner until the MEMORY MODE switch is set to the NORM position, which forces the CPU to the IDLE state. The SCAN light is on during the memory scan operation.

During a store scan, if the MEMORY MODE switch is set to DATA, the contents of the DATA switches are written into memory. If the MEMORY MODE switch is set to CLEAR, the memory is cleared in the "operational" mode.

During a display scan, the MEMORY MODE switch must be in the DATA position. Data from memory is displayed on the DISPLAY lights when the display is selecting the CPU bus.

The PARITY ERROR switch can be used during the scan to halt the operation on a memory parity error. At the time of the halt, the memory parity error light is on and the DISPLAY lights indicate the failing data when the display is selecting the CPU bus. CPU RESET will reset this condition.

## MODE

The MODE switch is effective only when the COMPUTE switch is in the IDLE position and the Control Mode switch is in the LOCAL MAINT position. This is a three-position switch, latching in the inactive center position and momentary in the DISPLAY and STORE positions where it initiates a memory scan operation in conjunction with the MEMORY MODE switch.

## MEMORY MODE

The MEMORY MODE switch is a three-position (all latching) switch, which must be set to either the DATA or CLEAR position, prior to setting the MODE switch to STORE or DISPLAY to start a scan operation. The memory scan operation is terminated when the MEMORY MODE switch is returned to NORM.

## START ADDR

The START ADDR switch is effective only when the COMPUTE switch is in the IDLE position and the Control Mode switch is in the LOCAL MAINT position. This is a two-position switch, latching in the center position where it is inactive, and momentary in the ENTER position where it enters the state of the SELECT ADDRESS switches into an internal CPU register (P), which designates the starting address of the scan.

## SCAN

The SCAN indicator is on during memory scan operations initiated by the MODE switch or the MEMORY CLEAR switch.

## EXT DIO

The EXT DIO (external direct input/output) switch controls the DIO interface directly from the PCP switches. This switch is active only when the COMPUTE switch is in the IDLE position.

When the EXT DIO switch is in the momentary RD (read direct) position, the least significant 16 switches of the SELECT ADDRESS switches directly control the DIO address lines. The read/write direct line on the DIO interface is set to indicate a read direct operation. The read direct operation is completed with the data response returned to the SNAP register.

The WD (write direct) position is also momentary. Operations in the WD position are the same as described above for the RD position, except that the contents of the DATA switches are sent on the DIO data lines, and the read/write direct line indicates a write direct operation.

The EXT DIO switch is inactive in the center position (latching).

## OPERATING PROCEDURES

### LOADING OPERATION

This section describes the procedures for initially loading programs into memory from certain peripheral units attached to an input/output processor (IOP) in the SIGMA 8 system. The computer operator may initiate a loading program from the processor control panel (with the Control Mode switch in the LOCAL MAINT or LOCAL NORM position).

#### BOOTSTRAP LOADING PROGRAM

The LOAD switch and the UNIT ADDRESS switches prepare a SIGMA 8 computer for a load operation. When the LOAD switch is pressed, the following bootstrap program is stored in memory locations X'22' through X'2B':

Location (Hex.)	(Dec.)	Contents (Hexadecimal)	Symbolic Form of Instruction
22	34	22110029	LI, 1
23	35	64100023	BDR, 1
24	36	68000028	BCR, 0 40

Location (Hex.)	(Dec.)	Contents (Hexadecimal)	Symbolic Form of Instruction
25	37	0000xxxx <sup>†</sup>	
26	38	2200y015 <sup>††</sup>	LI, 0
27	39	CC000025	SIO, 0 *37
28	40	CD000025	TIO, 0 *37
29	41	69C00022	BCS, 12 34
2A	42	020y00A8 <sup>††</sup>	
2B	43	0E000058	

When the LOAD switch is pressed, the selected peripheral device is not activated and no other indicators or controls are affected; only memory is altered.

#### LOAD PROCEDURE

To ensure correct loading operation, the following sequence should always be used to initiate the loading process:

1. Place the COMPUTE switch in the IDLE position.
2. Press the SYS RESET switch.
3. Set the UNIT ADDRESS switches to the address of the desired peripheral unit.
4. Press the LOAD switch.
5. Place the COMPUTE switch in the RUN position.

After the COMPUTE switch is placed in the RUN position, in step 5, the following actions occur:

1. The first record on the selected peripheral device is read into memory locations X'2A' through X'3F'. (The previous contents of general register 0 are destroyed as a result of executing the bootstrap program in locations X'26' through X'29'.)
2. After the record has been read, the next instruction is taken from location X'2A' (provided that no error condition has been detected by the device or the IOP).

<sup>†</sup>The x's in location X'25' represent the value of the UNIT ADDRESS switches at the time the LOAD switch is pressed. The values can range from X'0000' to X'1FFF'.

<sup>††</sup>The y's in locations X'26' and X'2A' represent the value of the Homespace bias at the time the LOAD switch is pressed. Homespace bias is loaded automatically (from Homespace bias switches) into bit positions 16 through 18 in X'26' and bit positions 13 through 15 in X'2A'.

3. When the instruction in location X'2A' is executed, the unit device and device controller selected for loading can accept a new SIO instruction.
4. Further I/O operations from the load unit may be accomplished by coding subsequent I/O instructions to indirectly address location X'25'.

#### LOAD OPERATION DETAILS

The first executed instruction of the bootstrap program (in location X'26') loads general register 0 with the doubleword address of the first I/O command doubleword. The I/O address for the SIO instruction in location X'27' is the 13 low-order bits of location X'25' (which have been set equal to the load unit address as a result of pressing the LOAD switch). During execution of the SIO instruction, general register 0 points to locations X'2A' and X'2B' as the first I/O command doubleword for the selected device. This command doubleword contains an order that instructs the selected peripheral device to read 88 (X'58') bytes into consecutive memory locations starting at word location X'2A' (byte location X'A8'). At the completion of the read operation, neither data chaining nor command chaining is called for in the I/O command doubleword. Also, the Suppress Incorrect Length flag is set to 1 so that an incorrect length indication will not be considered an error. (This means that no transmission error halt will result if the first record is either less than or greater than 88 bytes. If the record is greater than 88 bytes, only the first 88 bytes will be stored in memory.)

After the SIO instruction has been executed, the computer executes a TIO instruction with the same effective address as the SIO instruction. The TIO instruction is coded to accept only condition code data from the IOP. The BCS instruction in location X'29' will cause a branch to X'22' (a LOAD IMMEDIATE instruction), if either CC1 or CC2 (or both) is set to 1. Execution of the LI instruction at X'22' loads a count of X'10029' into register 1. The following BDR instruction at X'23' uses this as a "delay" count before execution of the BCR instruction in X'24', which unconditionally branches to the TIO in X'28'. Sufficient delay is introduced between execution of consecutive TIO instructions when testing the IOP so that excessive interference with the IOP cannot occur. In normal operation, CC1 is reset to 0 and CC2 remains set to 1 until the device can accept another SIO instruction, at which time the next instruction will be taken from location X'2A'.

If a transmission error or equipment malfunction is detected by either the device or the IOP, the IOP instructs the device to halt and initiate an "unusual end" interrupt

signal (as specified by the appropriate flags in the I/O command doubleword). The "unusual end" interrupt will be ignored, however, since all interrupt levels have been disarmed by pressing the SYS RESET/CLEAR switch prior to loading. The device will not accept another SIO while the device interrupt is pending and, therefore, the BCS instruction in location X'29' will continue to branch to location X'22'. The correct operator action at this point is to repeat the load procedure. If there is no I/O address recognition of the load unit, the SIO instruction will not cause any I/O action and CC1 will continue to be set to 1 by the SIO and TIO instructions thus causing the BCS instruction to branch.

#### FETCHING AND STORING DATA

To fetch data from a memory location and display it:

1. Set COMPUTE switch to IDLE.
2. Set SELECT ADDRESS switches to desired address.
3. Depress DISPLAY switch to SELECT ADDR.

Contents of designated memory location will be displayed in the DISPLAY indicators.

To fetch and display data from successive memory locations:

1. Set COMPUTE switch to IDLE.
2. Set DATA switches to desired address.
3. Depress INSERT switch to PSW1.
4. Depress DISPLAY switch to INSTR ADDR.

Contents of first memory location will be displayed in the DISPLAY indicators.

5. Depress INSTR ADDR switch to INCRM.

Contents of successive memory locations will be displayed in the DISPLAY indicators for each depression of the INSTR ADDR switch.

To store data in a designated memory location:

1. Set COMPUTE switch to IDLE.
2. Set SELECT ADDRESS switches to desired address.
3. Set DATA switches to desired storage value.
4. Depress STORE switch to SELECT ADDR.

# APPENDIX A. REFERENCE TABLES

This appendix contains the following reference material:

## Title

XDS Standard Symbols and Codes

XDS Standard 8-Bit Computer Codes (EBCDIC)

XDS Standard 7-Bit Communication Codes (USASCII)

XDS Standard Symbol-Code Correspondences

Hexadecimal Arithmetic

Addition Table

Multiplication Table

Table of Powers of Sixteen<sub>10</sub>

Table of Powers of Ten<sub>16</sub>

Hexadecimal-Decimal Integer Conversion Table

Hexadecimal-Decimal Fraction Conversion Table

Table of Powers of Two

Mathematical Constants

## **XDS STANDARD SYMBOLS AND CODES**

The symbol and code standards described in this publication are applicable to all XDS products, both hardware and software. They may be expanded or altered from time to time to meet changing requirements.

The symbols listed here include two types: graphic symbols and control characters. Graphic symbols are displayable and printable; control characters are not. Hybrids are SP, the symbol for a blank space, and DEL, the delete code which is not considered a control command.

Three types of code are shown: (1) the 8-bit XDS Standard Computer Code, i.e., the XDS Extended Binary-Coded-Decimal Interchange Code (EBCDIC); (2) the 7-bit United States of America Standard Code for Information Interchange (USASCII); and (3) the XDS standard card code.

## **XDS STANDARD CHARACTER SETS**

### 1. EBCDIC

57-character set: uppercase letters, numerals, space, and & - / . < > ( ) + ! \$ \* : ; , % # @ ' =

63-character set: same as above plus / ! \_ ? " ~

89-character set: same as 63-character set plus lowercase letters

### 2. USASCII

64-character set: upper case letters, numerals, space, and ! " \$ % & ' ( ) \* + , - . / \ ; : = < > ? @ \_ [ ] ^ #

95-character set: same as above plus lowercase letters and { } | ~ `

## **CONTROL CODES**

In addition to the standard character sets listed above, the XDS symbol repertoire includes 37 control codes and the hybrid code DEL (hybrid code SP is considered part of all character sets). These are listed in the table titled XDS Standard Symbol-Code Correspondences.

## **SPECIAL CODE PROPERTIES**

The following two properties of all XDS standard codes will be retained for future standard code extensions:

1. All control codes, and only the control codes, have their two high-order bits equal to "00". DEL is not considered a control code.
2. No two graphic EBCDIC codes have their seven low-order bits equal.

## XDS STANDARD 8-BIT COMPUTER CODES (EBCDIC)

		Most Significant Digits																	
		0	1	2	3	4	5	6	7	8	9	A	B	C	D	E	F		
Hexadecimal	Binary	0000	0001	0010	0011	0100	0101	0110	0111	1000	1001	1010	1011	1100	1101	1110	1111		
	Least Significant Digits	0	0000	NUL	DLE	ds	SP	&	-									0	
1		0001	SOH	DC1	ss					/		a	j		\	A	J	1	
2		0010	STX	DC2	fs							b	k	s	{	B	K	S	2
3		0011	ETX	DC3	si							c	l	t	}	C	L	T	3
4		0100	EOT	DC4								d	m	u	[	D	M	U	4
5		0101	HT	LF NL		Will not be assigned					e	n	v	]	E	N	V	5	
6		0110	ACK	SYN								f	o	w		F	O	W	6
7		0111	BEL	ETB								g	p	x		G	P	X	7
8		1000	EOM BS	CAN								h	q	y		H	Q	Y	8
9		1001	ENQ	EM								i	r	z		I	R	Z	9
A		1010	NAK	SUB		^	!	~	:										
B		1011	VT	ESC		.	\$	,	#										
C		1100	FF	FS		<	*	%	@										
D		1101	CR	GS		(	)	_	'										
E		1110	SO	RS		+	;	>	=										
F		1111	SI	US			~	?	"										DEL

**NOTES:**

- 1 The characters ^ \ { } [ ] are USASCII characters that do not appear in any of the XDS EBCDIC-based character sets, though they are shown in the EBCDIC table.
- 2 The characters ^ | ~ appear in the XDS 63- and 89-character EBCDIC sets but not in either of the XDS USASCII-based sets. However, XDS software translates the characters ^ | ~ into USASCII characters as follows:
 

EBCDIC	=	USASCII
^	=	\ (6-0)
	=	(7-12)
~	=	~ (7-14)
- 3 The EBCDIC control codes in columns 0 and 1 and their binary representation are exactly the same as those in the USASCII table, except for two interchanges: LF/NL with NAK, and HT with ENQ.
- 4 Characters enclosed in heavy lines are included only in the XDS standard 63- and 89-character EBCDIC sets.
- 5 These characters are included only in the XDS standard 89-character EBCDIC set.

## XDS STANDARD 7-BIT COMMUNICATION CODES (USASCII)<sup>1</sup>

		Most Significant Digits								
		0	1	2	3	4	5	6	7	
Decimal (rows)	(col's.)	0000	0001	0010	0011	0100	0101	0110	0111	
	Binary	x000	x001	x010	x011	x100	x101	x110	x111	
Least Significant Digits	0	0000	NUL	DLE	SP	0	@	P	\	p
	1	0001	SOH	DC1	!	1	A	Q	a	q
	2	0010	STX	DC2	"	2	B	R	b	r
	3	0011	ETX	DC3	#	3	C	S	c	s
	4	0100	EOT	DC4	\$	4	D	T	d	t
	5	0101	ENQ	NAK	%	5	E	U	e	u
	6	0110	ACK	SYN	&	6	F	V	f	v
	7	0111	BEL	ETB	'	7	G	W	g	w
	8	1000	BS	CAN	(	8	H	X	h	x
	9	1001	HT	EM	)	9	I	Y	i	y
	10	1010	LF NL	SUB	*	:	J	Z	j	z
	11	1011	VT	ESC	+	;	K	[	^	{
	12	1100	FF	FS	,	<	L	\		
	13	1101	CR	GS	-	=	M	]	~	}
	14	1110	SO	RS	.	>	N	^	~	~
	15	1111	SI	US	/	?	O	_	o	DEL

**NOTES:**

- 1 Most significant bit, added for 8-bit format, is either 0 or an even-parity bit for the remaining 7 bits.
- 2 Columns 0-1 are control codes.
- 3 Columns 2-5 correspond to the XDS 64-character USASCII set. Columns 2-7 correspond to the XDS 95-character USASCII set.
- 4 On many current teletypes, the symbol
 

^	is		(5-14)
_	is	~	(5-15)
~	is	ESC or ALTMODE control (7-14)	

 and none of the symbols appearing in columns 6-7 are provided. Except for the three symbol differences noted above, therefore, such teletypes provide all the characters in the XDS 64-character USASCII set. (The XDS 7015 Remote Keyboard Printer provides the 64-character USASCII set also, but prints ^ as ^.)
- 5 On the XDS 7670 Remote Batch Terminal, the symbol
 

!	is		(2-1)
[	is	^	(5-11)
]	is		(5-13)
^	is	~	(5-14)

 and none of the symbols appearing in columns 6-7 are provided. Except for the four symbol differences noted above, therefore, this terminal provides all the characters in the XDS 64-character USASCII set.



## XDS STANDARD SYMBOL-CODE CORRESPONDENCE

EBCDIC†		Symbol	Card Code	USASCII††	Meaning	Remarks
Hex.	Dec.					
00	0	NUL	12-0-9-8-1	0-0	null	00 through 23 and 2F are control codes.  EOM is used only on XDS Keyboard/ Printers Models 7012, 7020, 8091, and 8092.
01	1	SOH	12-9-1	0-1	start of header	
02	2	STX	12-9-2	0-2	start of text	
03	3	ETX	12-9-3	0-3	end of text	
04	4	EOT	12-9-4	0-4	end of transmission	
05	5	HT	12-9-5	0-9	horizontal tab	
06	6	ACK	12-9-6	0-6	acknowledge (positive)	
07	7	BEL	12-9-7	0-7	bell	
08	8	BS or EOM	12-9-8	0-8	backspace or end of message	
09	9	ENQ	12-9-8-1	0-5	enquiry	
0A	10	NAK	12-9-8-2	1-5	negative acknowledge	
0B	11	VT	12-9-8-3	0-11	vertical tab	
0C	12	FF	12-9-8-4	0-12	form feed	
0D	13	CR	12-9-8-5	0-13	carriage return	
0E	14	SO	12-9-8-6	0-14	shift out	
0F	15	SI	12-9-8-7	0-15	shift in	
10	16	DLE	12-11-9-8-1	1-0	data link escape	Replaces characters with parity error.
11	17	DC1	11-9-1	1-1	device control 1	
12	18	DC2	11-9-2	1-2	device control 2	
13	19	DC3	11-9-3	1-3	device control 3	
14	20	DC4	11-9-4	1-4	device control 4	
15	21	LF or NL	11-9-5	0-10	line feed or new line	
16	22	SYN	11-9-6	1-6	sync	
17	23	ETB	11-9-7	1-7	end of transmission block	
18	24	CAN	11-9-8	1-8	cancel	
19	25	EM	11-9-8-1	1-9	end of medium	
1A	26	SUB	11-9-8-2	1-10	substitute	
1B	27	ESC	11-9-8-3	1-11	escape	
1C	28	FS	11-9-8-4	1-12	file separator	
1D	29	GS	11-9-8-5	1-13	group separator	
1E	30	RS	11-9-8-6	1-14	record separator	
1F	31	US	11-9-8-7	1-15	unit separator	
20	32	ds	11-0-9-8-1		digit selector	20 through 23 are used with Sigma 7 EDIT BYTE STRING (EBS) instruction — not input/output con- trol codes. 24 through 2E are unassigned.
21	33	ss	0-9-1		significance start	
22	34	fs	0-9-2		field separation	
23	35	si	0-9-3		immediate significance start	
24	36		0-9-4			
25	37		0-9-5			
26	38		0-9-6			
27	39		0-9-7			
28	40		0-9-8			
29	41		0-9-8-1			
2A	42		0-9-8-2			
2B	43		0-9-8-3			
2C	44		0-9-8-4			
2D	45		0-9-8-5			
2E	46		0-9-8-6			
2F	47		0-9-8-7			
30	48		12-11-0-9-8-1			30 through 3F are unassigned.
31	49		9-1			
32	50		9-2			
33	51		9-3			
34	52		9-4			
35	53		9-5			
36	54		9-6			
37	55		9-7			
38	56		9-8			
39	57		9-8-1			
3A	58		9-8-2			
3B	59		9-8-3			
3C	60		9-8-4			
3D	61		9-8-5			
3E	62		9-8-6			
3F	63		9-8-7			

† Hexadecimal and decimal notation.

†† Decimal notation (column-row).

XDS STANDARD SYMBOL-CODE CORRESPONDENCE (cont.)

EBCDIC <sup>†</sup>		Symbol	Card Code	USASCII <sup>††</sup>	Meaning	Remarks
Hex.	Dec.					
40	64	SP	blank	2-0	blank	41 through 49 will not be assigned.
41	65		12-0-9-1			
42	66		12-0-9-2			
43	67		12-0-9-3			
44	68		12-0-9-4			
45	69		12-0-9-5			
46	70		12-0-9-6			
47	71		12-0-9-7			
48	72		12-0-9-8			
49	73		12-8-1			
4A	74		12-8-2			
4B	75		12-8-3			
4C	76		12-8-4			
4D	77		12-8-5			
4E	78		12-8-6			
4F	79	12-8-7				
50	80	&	12	2-6	ampersand	51 through 59 will not be assigned.
51	81		12-11-9-1			
52	82		12-11-9-2			
53	83		12-11-9-3			
54	84		12-11-9-4			
55	85		12-11-9-5			
56	86		12-11-9-6			
57	87		12-11-9-7			
58	88		12-11-9-8			
59	89		11-8-1			
5A	90		11-8-2			
5B	91		11-8-3			
5C	92		11-8-4			
5D	93		11-8-5			
5E	94		11-8-6			
5F	95	11-8-7				
60	96	-	11	2-13	minus, dash, hyphen	62 through 69 will not be assigned.
61	97		0-1			
62	98		11-0-9-2			
63	99		11-0-9-3			
64	100		11-0-9-4			
65	101		11-0-9-5			
66	102		11-0-9-6			
67	103		11-0-9-7			
68	104		11-0-9-8			
69	105		0-8-1			
6A	106		12-11			
6B	107		0-8-3			
6C	108		0-8-4			
6D	109		0-8-5			
6E	110		0-8-6			
6F	111	0-8-7				
70	112	^	12-11-0			70 through 79 will not be assigned.
71	113		12-11-0-9-1			
72	114		12-11-0-9-2			
73	115		12-11-0-9-3			
74	116		12-11-0-9-4			
75	117		12-11-0-9-5			
76	118		12-11-0-9-6			
77	119		12-11-0-9-7			
78	120		12-11-0-9-8			
79	121		8-1			
7A	122		8-2			
7B	123		8-3			
7C	124		8-4			
7D	125		8-5			
7E	126		8-6			
7F	127	8-7				
70	112	~ or ~	11	2-13	tilde or logical not	On Model 7670, ~ is not available, and ~ = USASCII 5-14.
71	113		0-1			
72	114		11-0-9-2			
73	115		11-0-9-3			
74	116		11-0-9-4			
75	117		11-0-9-5			
76	118		11-0-9-6			
77	119		11-0-9-7			
78	120		11-0-9-8			
79	121		0-8-1			
7A	122		12-11			
7B	123		0-8-3			
7C	124		0-8-4			
7D	125		0-8-5			
7E	126		0-8-6			
7F	127	0-8-7				
70	112	-	11	2-13	minus, dash, hyphen	62 through 69 will not be assigned.
71	113		0-1			
72	114		11-0-9-2			
73	115		11-0-9-3			
74	116		11-0-9-4			
75	117		11-0-9-5			
76	118		11-0-9-6			
77	119		11-0-9-7			
78	120		11-0-9-8			
79	121		0-8-1			
7A	122		12-11			
7B	123		0-8-3			
7C	124		0-8-4			
7D	125		0-8-5			
7E	126		0-8-6			
7F	127	0-8-7				
70	112	-	11	2-13	minus, dash, hyphen	62 through 69 will not be assigned.
71	113		0-1			
72	114		11-0-9-2			
73	115		11-0-9-3			
74	116		11-0-9-4			
75	117		11-0-9-5			
76	118		11-0-9-6			
77	119		11-0-9-7			
78	120		11-0-9-8			
79	121		0-8-1			
7A	122		12-11			
7B	123		0-8-3			
7C	124		0-8-4			
7D	125		0-8-5			
7E	126		0-8-6			
7F	127	0-8-7				
70	112	-	11	2-13	minus, dash, hyphen	62 through 69 will not be assigned.
71	113		0-1			
72	114		11-0-9-2			
73	115		11-0-9-3			
74	116		11-0-9-4			
75	117		11-0-9-5			
76	118		11-0-9-6			
77	119		11-0-9-7			
78	120		11-0-9-8			
79	121		0-8-1			
7A	122		12-11			
7B	123		0-8-3			
7C	124		0-8-4			
7D	125		0-8-5			
7E	126		0-8-6			
7F	127	0-8-7				
70	112	-	11	2-13	minus, dash, hyphen	62 through 69 will not be assigned.
71	113		0-1			
72	114		11-0-9-2			
73	115		11-0-9-3			
74	116		11-0-9-4			
75	117		11-0-9-5			
76	118		11-0-9-6			
77	119		11-0-9-7			
78	120		11-0-9-8			
79	121		0-8-1			
7A	122		12-11			
7B	123		0-8-3			
7C	124		0-8-4			
7D	125		0-8-5			
7E	126		0-8-6			
7F	127	0-8-7				
70	112	-	11	2-13	minus, dash, hyphen	62 through 69 will not be assigned.
71	113		0-1			
72	114		11-0-9-2			
73	115		11-0-9-3			
74	116		11-0-9-4			
75	117		11-0-9-5			
76	118		11-0-9-6			
77	119		11-0-9-7			
78	120		11-0-9-8			
79	121		0-8-1			
7A	122		12-11			
7B	123		0-8-3			
7C	124		0-8-4			
7D	125		0-8-5			
7E	126		0-8-6			
7F	127	0-8-7				
70	112	-	11	2-13	minus, dash, hyphen	62 through 69 will not be assigned.
71	113		0-1			
72	114		11-0-9-2			
73	115		11-0-9-3			
74	116		11-0-9-4			
75	117		11-0-9-5			
76	118		11-0-9-6			
77	119		11-0-9-7			
78	120		11-0-9-8			
79	121		0-8-1			
7A	122		12-11			
7B	123		0-8-3			
7C	124		0-8-4			
7D	125		0-8-5			
7E	126		0-8-6			
7F	127	0-8-7				

<sup>†</sup> Hexadecimal and decimal notation.

<sup>††</sup> Decimal notation (column-row).

XDS STANDARD SYMBOL-CODE CORRESPONDENCES (continued)

EBCDIC <sup>†</sup>		Symbol	Card Code	USASCII <sup>††</sup>	Meaning	Remarks
Hex.	Dec.					
80	128	a	12-0-8-1	6-1		80 is unassigned. 81-89, 91-99, A2-A9 comprise the lowercase alphabet. Available only in XDS standard 89- and 95-character sets.
81	129					
82	130					
83	131					
84	132					
85	133					
86	134					
87	135					
88	136					
89	137					
8A	138		12-0-8-2			8A through 90 are unassigned.
8B	139					
8C	140					
8D	141					
8E	142					
8F	143					
90	144					
91	145					
92	146	j	12-11-8-1	6-10		
93	147					
94	148					
95	149					
96	150					
97	151					
98	152					
99	153					
9A	154					
9B	155					
9C	156	k	12-11-1	6-11		
9D	157					
9E	158					
9F	159					
A0	160					
A1	161					
A2	162					
A3	163					
A4	164					
A5	165					
A6	166					
A7	167					
A8	168					
A9	169					
AA	170					
AB	171					
AC	172					
AD	173					
AE	174					
AF	175					
A0	160	l	11-0-8-1	7-3		
A1	161					
A2	162					
A3	163					
A4	164					
A5	165					
A6	166					
A7	167					
A8	168					
A9	169					
AA	170					
AB	171					
AC	172					
AD	173					
AE	174					
AF	175					
A0	160	m	11-0-2	7-4		
A1	161					
A2	162					
A3	163					
A4	164					
A5	165					
A6	166					
A7	167					
A8	168					
A9	169					
AA	170					
AB	171					
AC	172					
AD	173					
AE	174					
AF	175					
A0	160	n	11-0-3	7-5		
A1	161					
A2	162					
A3	163					
A4	164					
A5	165					
A6	166					
A7	167					
A8	168					
A9	169					
AA	170					
AB	171					
AC	172					
AD	173					
AE	174					
AF	175					
A0	160	o	11-0-4	7-6		
A1	161					
A2	162					
A3	163					
A4	164					
A5	165					
A6	166					
A7	167					
A8	168					
A9	169					
AA	170					
AB	171					
AC	172					
AD	173					
AE	174					
AF	175					
A0	160	p	11-0-5	7-7		
A1	161					
A2	162					
A3	163					
A4	164					
A5	165					
A6	166					
A7	167					
A8	168					
A9	169					
AA	170					
AB	171					
AC	172					
AD	173					
AE	174					
AF	175					
A0	160	q	11-0-6	7-8		
A1	161					
A2	162					
A3	163					
A4	164					
A5	165					
A6	166					
A7	167					
A8	168					
A9	169					
AA	170					
AB	171					
AC	172					
AD	173					
AE	174					
AF	175					
A0	160	r	11-0-7	7-9		
A1	161					
A2	162					
A3	163					
A4	164					
A5	165					
A6	166					
A7	167					
A8	168					
A9	169					
AA	170					
AB	171					
AC	172					
AD	173					
AE	174					
AF	175					
A0	160	s	11-0-8	7-10		
A1	161					
A2	162					
A3	163					
A4	164					
A5	165					
A6	166					
A7	167					
A8	168					
A9	169					
AA	170					
AB	171					
AC	172					
AD	173					
AE	174					
AF	175					
B0	176	\	11-0-8-2	5-12	backslash	
B1	177					
B2	178					
B3	179					
B4	180					
B5	181					
B6	182					
B7	183					
B8	184					
B9	185					
BA	186					
BB	187					
BC	188					
BD	189					
BE	190					
BF	191					
B0	176	{	11-0-8-3	7-11	left brace	
B1	177					
B2	178					
B3	179					
B4	180					
B5	181					
B6	182					
B7	183					
B8	184					
B9	185					
BA	186					
BB	187					
BC	188					
BD	189					
BE	190					
BF	191					
B0	176	}	11-0-8-4	7-13	right brace	
B1	177					
B2	178					
B3	179					
B4	180					
B5	181					
B6	182					
B7	183					
B8	184					
B9	185					
BA	186					
BB	187					
BC	188					
BD	189					
BE	190					
BF	191					
B0	176	[	11-0-8-5	5-11	left bracket	
B1	177					
B2	178					
B3	179					
B4	180					
B5	181					
B6	182					
B7	183					
B8	184					
B9	185					
BA	186					
BB	187					
BC	188					
BD	189					
BE	190					
BF	191					
B0	176	]	11-0-8-6	5-13	right bracket	On Model 7670, [ is 2. On Model 7670, ] is 1. B6 through BF are unassigned.
B1	177					
B2	178					
B3	179					
B4	180					
B5	181					
B6	182					
B7	183					
B8	184					
B9	185					
BA	186					
BB	187					
BC	188					
BD	189					
BE	190					
BF	191					

<sup>†</sup>Hexadecimal and decimal notation.

<sup>††</sup>Decimal notation (column-row).

XDS STANDARD SYMBOL-CODE CORRESPONDENCE (cont.)

EBCDIC <sup>†</sup>		Symbol	Card Code	USASCII <sup>††</sup>	Meaning	Remarks
Hex.	Dec.					
C0	192		12-0			C0 is unassigned. C1-C9, D1-D9, E2-E9 comprise the uppercase alphabet.  CA through CF will not be assigned.
C1	193	A	12-1	4-1		
C2	194	B	12-2	4-2		
C3	195	C	12-3	4-3		
C4	196	D	12-4	4-4		
C5	197	E	12-5	4-5		
C6	198	F	12-6	4-6		
C7	199	G	12-7	4-7		
C8	200	H	12-8	4-8		
C9	201	I	12-9	4-9		
CA	202		12-0-9-8-2			
CB	203		12-0-9-8-3			
CC	204		12-0-9-8-4			
CD	205		12-0-9-8-5			
CE	206		12-0-9-8-6			
CF	207		12-0-9-8-7			
D0	208		11-0		D0 is unassigned.  DA through DF will not be assigned.	
D1	209	J	11-1	4-10		
D2	210	K	11-2	4-11		
D3	211	L	11-3	4-12		
D4	212	M	11-4	4-13		
D5	213	N	11-5	4-14		
D6	214	O	11-6	4-15		
D7	215	P	11-7	5-0		
D8	216	Q	11-8	5-1		
D9	217	R	11-9	5-2		
DA	218		12-11-9-8-2			
DB	219		12-11-9-8-3			
DC	220		12-11-9-8-4			
DD	221		12-11-9-8-5			
DE	222		12-11-9-8-6			
DF	223		12-11-9-8-7			
E0	224		0-8-2		E0, E1 are unassigned.  EA through EF will not be assigned.	
E1	225		11-0-9-1			
E2	226	S	0-2	5-3		
E3	227	T	0-3	5-4		
E4	228	U	0-4	5-5		
E5	229	V	0-5	5-6		
E6	230	W	0-6	5-7		
E7	231	X	0-7	5-8		
E8	232	Y	0-8	5-9		
E9	233	Z	0-9	5-10		
EA	234		11-0-9-8-2			
EB	235		11-0-9-8-3			
EC	236		11-0-9-8-4			
ED	237		11-0-9-8-5			
EE	238		11-0-9-8-6			
EF	239		11-0-9-8-7			
F0	240	0	0	3-0	FA through FE will not be assigned.  Special - neither graphic nor control symbol.	
F1	241	1	1	3-1		
F2	242	2	2	3-2		
F3	243	3	3	3-3		
F4	244	4	4	3-4		
F5	245	5	5	3-5		
F6	246	6	6	3-6		
F7	247	7	7	3-7		
F8	248	8	8	3-8		
F9	249	9	9	3-9		
FA	250		12-11-0-9-8-2			
FB	251		12-11-0-9-8-3			
FC	252		12-11-0-9-8-4			
FD	253		12-11-0-9-8-5			
FE	254		12-11-0-9-8-6			
FF	255	DEL	12-11-0-9-8-7	delete		

<sup>†</sup> Hexadecimal and decimal notation.

<sup>††</sup> Decimal notation (column-row).

# HEXADECIMAL ARITHMETIC

## ADDITION TABLE

0	1	2	3	4	5	6	7	8	9	A	B	C	D	E	F
1	02	03	04	05	06	07	08	09	0A	0B	0C	0D	0E	0F	10
2	03	04	05	06	07	08	09	0A	0B	0C	0D	0E	0F	10	11
3	04	05	06	07	08	09	0A	0B	0C	0D	0E	0F	10	11	12
4	05	06	07	08	09	0A	0B	0C	0D	0E	0F	10	11	12	13
5	06	07	08	09	0A	0B	0C	0D	0E	0F	10	11	12	13	14
6	07	08	09	0A	0B	0C	0D	0E	0F	10	11	12	13	14	15
7	08	09	0A	0B	0C	0D	0E	0F	10	11	12	13	14	15	16
8	09	0A	0B	0C	0D	0E	0F	10	11	12	13	14	15	16	17
9	0A	0B	0C	0D	0E	0F	10	11	12	13	14	15	16	17	18
A	0B	0C	0D	0E	0F	10	11	12	13	14	15	16	17	18	19
B	0C	0D	0E	0F	10	11	12	13	14	15	16	17	18	19	1A
C	0D	0E	0F	10	11	12	13	14	15	16	17	18	19	1A	1B
D	0E	0F	10	11	12	13	14	15	16	17	18	19	1A	1B	1C
E	0F	10	11	12	13	14	15	16	17	18	19	1A	1B	1C	1D
F	10	11	12	13	14	15	16	17	18	19	1A	1B	1C	1D	1E

## MULTIPLICATION TABLE

1	2	3	4	5	6	7	8	9	A	B	C	D	E	F
2	04	06	08	0A	0C	0E	10	12	14	16	18	1A	1C	1E
3	06	09	0C	0F	12	15	18	1B	1E	21	24	27	2A	2D
4	08	0C	10	14	18	1C	20	24	28	2C	30	34	38	3C
5	0A	0F	14	19	1E	23	28	2D	32	37	3C	41	46	4B
6	0C	12	18	1E	24	2A	30	36	3C	42	48	4E	54	5A
7	0E	15	1C	23	2A	31	38	3F	46	4D	54	5B	62	69
8	10	18	20	28	30	38	40	48	50	58	60	68	70	78
9	12	1B	24	2D	36	3F	48	51	5A	63	6C	75	7E	87
A	14	1E	28	32	3C	46	50	5A	64	6E	78	82	8C	96
B	16	21	2C	37	42	4D	58	63	6E	79	84	8F	9A	A5
C	18	24	30	3C	48	54	60	6C	78	84	90	9C	A8	B4
D	1A	27	34	41	4E	5B	68	75	82	8F	9C	A9	B6	C3
E	1C	2A	38	46	54	62	70	7E	8C	9A	A8	B6	C4	D2
F	1E	2D	3C	4B	5A	69	78	87	96	A5	B4	C3	D2	E1

**TABLE OF POWERS OF SIXTEEN**

$16^n$					$n$	$16^{-n}$							
	1				0	0.10000	00000	00000	00000	x	10		
	16				1	0.62500	00000	00000	00000	x	10 <sup>-1</sup>		
	256				2	0.39062	50000	00000	00000	x	10 <sup>-2</sup>		
	4	096			3	0.24414	06250	00000	00000	x	10 <sup>-3</sup>		
	65	536			4	0.15258	78906	25000	00000	x	10 <sup>-4</sup>		
	1	048	576		5	0.95367	43164	06250	00000	x	10 <sup>-6</sup>		
	16	777	216		6	0.59604	64477	53906	25000	x	10 <sup>-7</sup>		
	268	435	456		7	0.37252	90298	46191	40625	x	10 <sup>-8</sup>		
	4	294	967	296	8	<b>0.23283</b>	<b>06436</b>	<b>53869</b>	<b>62891</b>	x	10 <sup>-9</sup>		
	68	719	476	736	9	0.14551	91522	83668	51807	x	10 <sup>-10</sup>		
	1	099	511	627	776	10	0.90949	47017	72928	23792	x	10 <sup>-12</sup>	
	17	592	186	044	416	11	0.56843	41886	08080	14870	x	10 <sup>-13</sup>	
	281	474	976	710	656	12	0.35527	13678	80050	09294	x	10 <sup>-14</sup>	
	4	503	599	627	370	496	13	0.22204	46049	25031	30808	x	10 <sup>-15</sup>
	72	057	594	037	927	936	14	0.13877	78780	78144	56755	x	10 <sup>-16</sup>
1	152	921	504	606	846	976	15	0.86736	17379	88403	54721	x	10 <sup>-18</sup>

**TABLE OF POWERS OF TEN**

$10^n$					$n$	$10^{-n}$					
	1				0	1.0000	0000	0000	0000		
	A				1	0.1999	9999	9999	999A		
	64				2	0.28F5	C28F	5C28	F5C3	x	16 <sup>-1</sup>
	3E8				3	0.4189	374B	C6A7	EF9E	x	16 <sup>-2</sup>
	2710				4	0.68DB	8BAC	710C	B296	x	16 <sup>-3</sup>
	1	86A0			5	0.A7C5	AC47	1B47	8423	x	16 <sup>-4</sup>
	F	4240			6	0.10C6	F7A0	B5ED	8D37	x	16 <sup>-4</sup>
	98	9680			7	0.1AD7	F29A	BCAF	4858	x	16 <sup>-5</sup>
	5F5	E100			8	0.2AF3	1DC4	6118	73BF	x	16 <sup>-6</sup>
	3B9A	CA00			9	0.44B8	2FA0	9B5A	52CC	x	16 <sup>-7</sup>
	2	540B	E400		10	0.6DF3	7F67	5EF6	EADF	x	16 <sup>-8</sup>
	17	4876	E800		11	0.AFEB	FF0B	CB24	AAFF	x	16 <sup>-9</sup>
	E8	D4A5	1000		12	0.1197	9981	2DEA	1119	x	16 <sup>-9</sup>
	918	4E72	A000		13	0.1C25	C268	4976	81C2	x	16 <sup>-10</sup>
	5AF3	107A	4000		14	0.2D09	370D	4257	3604	x	16 <sup>-11</sup>
	3	8D7E	A4C6	8000	15	0.480E	BE7B	9D58	566D	x	16 <sup>-12</sup>
	23	86F2	6FC1	0000	16	0.734A	CA5F	6226	F0AE	x	16 <sup>-13</sup>
	163	4578	5D8A	0000	17	0.8877	AA32	36A4	B449	x	16 <sup>-14</sup>
	DE0	B6B3	A764	0000	18	0.1272	5DD1	D243	ABA1	x	16 <sup>-14</sup>
8AC7	2304	89E8	0000		19	0.1D83	C94F	B6D2	AC35	x	16 <sup>-15</sup>

## HEXADECIMAL-DECIMAL INTEGER CONVERSION TABLE

The table below provides for direct conversions between hexadecimal integers in the range 0-FFF and decimal integers in the range 0-4095. For conversion of larger integers, the table values may be added to the following figures:

Hexadecimal	Decimal	Hexadecimal	Decimal
01 000	4 096	20 000	131 072
02 000	8 192	30 000	196 608
03 000	12 288	40 000	262 144
04 000	16 384	50 000	327 680
05 000	20 480	60 000	393 216
06 000	24 576	70 000	458 752
07 000	28 672	80 000	524 288
08 000	32 768	90 000	589 824
09 000	36 864	A0 000	655 360
0A 000	40 960	B0 000	720 896
0B 000	45 056	C0 000	786 432
0C 000	49 152	D0 000	851 968
0D 000	53 248	E0 000	917 504
0E 000	57 344	F0 000	983 040
0F 000	61 440	100 000	1 048 576
10 000	65 536	200 000	2 097 152
11 000	69 632	300 000	3 145 728
12 000	73 728	400 000	4 194 304
13 000	77 824	500 000	5 242 880
14 000	81 920	600 000	6 291 456
15 000	86 016	700 000	7 340 032
16 000	90 112	800 000	8 388 608
17 000	94 208	900 000	9 437 184
18 000	98 304	A00 000	10 485 760
19 000	102 400	B00 000	11 534 336
1A 000	106 496	C00 000	12 582 912
1B 000	110 592	D00 000	13 631 488
1C 000	114 688	E00 000	14 680 064
1D 000	118 784	F00 000	15 728 640
1E 000	122 880	1 000 000	16 777 216
1F 000	126 976	2 000 000	33 554 432

Hexadecimal fractions may be converted to decimal fractions as follows:

- Express the hexadecimal fraction as an integer times  $16^{-n}$ , where n is the number of significant hexadecimal places to the right of the hexadecimal point.

$$0. CA9BF3_{16} = CA9 BF3_{16} \times 16^{-6}$$

- Find the decimal equivalent of the hexadecimal integer

$$CA9 BF3_{16} = 13\ 278\ 195_{10}$$

- Multiply the decimal equivalent by  $16^{-n}$

$$\begin{array}{r} 13\ 278\ 195 \\ \times 596\ 046\ 448 \times 10^{-16} \\ \hline 0.791\ 442\ 096_{10} \end{array}$$

Decimal fractions may be converted to hexadecimal fractions by successively multiplying the decimal fraction by  $16_{10}$ . After each multiplication, the integer portion is removed to form a hexadecimal fraction by building to the right of the hexadecimal point. However, since decimal arithmetic is used in this conversion, the integer portion of each product must be converted to hexadecimal numbers.

Example: Convert  $0.895_{10}$  to its hexadecimal equivalent

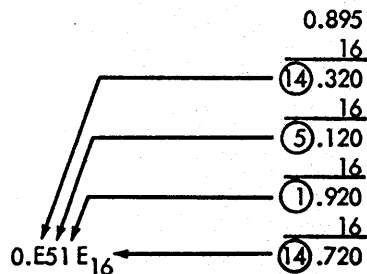

	0	1	2	3	4	5	6	7	8	9	A	B	C	D	E	F
000	0000	0001	0002	0003	0004	0005	0006	0007	0008	0009	0010	0011	0012	0013	0014	0015
010	0016	0017	0018	0019	0020	0021	0022	0023	0024	0025	0026	0027	0028	0029	0030	0031
020	0032	0033	0034	0035	0036	0037	0038	0039	0040	0041	0042	0043	0044	0045	0046	0047
030	0048	0049	0050	0051	0052	0053	0054	0055	0056	0057	0058	0059	0060	0061	0062	0063
040	0064	0065	0066	0067	0068	0069	0070	0071	0072	0073	0074	0075	0076	0077	0078	0079
050	0080	0081	0082	0083	0084	0085	0086	0087	0088	0089	0090	0091	0092	0093	0094	0095
060	0096	0097	0098	0099	0100	0101	0102	0103	0104	0105	0106	0107	0108	0109	0110	0111
070	0112	0113	0114	0115	0116	0117	0118	0119	0120	0121	0122	0123	0124	0125	0126	0127
080	0128	0129	0130	0131	0132	0133	0134	0135	0136	0137	0138	0139	0140	0141	0142	0143
090	0144	0145	0146	0147	0148	0149	0150	0151	0152	0153	0154	0155	0156	0157	0158	0159
0A0	0160	0161	0162	0163	0164	0165	0166	0167	0168	0169	0170	0171	0172	0173	0174	0175
0B0	0176	0177	0178	0179	0180	0181	0182	0183	0184	0185	0186	0187	0188	0189	0190	0191
0C0	0192	0193	0194	0195	0196	0197	0198	0199	0200	0201	0202	0203	0204	0205	0206	0207
0D0	0208	0209	0210	0211	0212	0213	0214	0215	0216	0217	0218	0219	0220	0221	0222	0223
0E0	0224	0225	0226	0227	0228	0229	0230	0231	0232	0233	0234	0235	0236	0237	0238	0239
0F0	0240	0241	0242	0243	0244	0245	0246	0247	0248	0249	0250	0251	0252	0253	0254	0255

HEXADECIMAL - DECIMAL INTEGER CONVERSION TABLE (cont.)

	0	1	2	3	4	5	6	7	8	9	A	B	C	D	E	F
100	0256	0257	0258	0259	0260	0261	0262	0263	0264	0265	0266	0267	0268	0269	0270	0271
110	0272	0273	0274	0275	0276	0277	0278	0279	0280	0281	0282	0283	0284	0285	0286	0287
120	0288	0289	0290	0291	0292	0293	0294	0295	0296	0297	0298	0299	0300	0301	0302	0303
130	0304	0305	0306	0307	0308	0309	0310	0311	0312	0313	0314	0315	0316	0317	0318	0319
140	0320	0321	0322	0323	0324	0325	0326	0327	0328	0329	0330	0331	0332	0333	0334	0335
150	0336	0337	0338	0339	0340	0341	0342	0343	0344	0345	0346	0347	0348	0349	0350	0351
160	0352	0353	0354	0355	0356	0357	0358	0359	0360	0361	0362	0363	0364	0365	0366	0367
170	0368	0369	0370	0371	0372	0373	0374	0375	0376	0377	0378	0379	0380	0381	0382	0383
180	0384	0385	0386	0387	0388	0389	0390	0391	0392	0393	0394	0395	0396	0397	0398	0399
190	0400	0401	0402	0403	0404	0405	0406	0407	0408	0409	0410	0411	0412	0413	0414	0415
1A0	0416	0417	0418	0419	0420	0421	0422	0423	0424	0425	0426	0427	0428	0429	0430	0431
1B0	0432	0433	0434	0435	0436	0437	0438	0439	0440	0441	0442	0443	0444	0445	0446	0447
1C0	0448	0449	0450	0451	0452	0453	0454	0455	0456	0457	0458	0459	0460	0461	0462	0463
1D0	0464	0465	0466	0467	0468	0469	0470	0471	0472	0473	0474	0475	0476	0477	0478	0479
1E0	0480	0481	0482	0483	0484	0485	0486	0487	0488	0489	0490	0491	0492	0493	0494	0495
1F0	0496	0497	0498	0499	0500	0501	0502	0503	0504	0505	0506	0507	0508	0509	0510	0511
200	0512	0513	0514	0515	0516	0517	0518	0519	0520	0521	0522	0523	0524	0525	0526	0527
210	0528	0529	0530	0531	0532	0533	0534	0535	0536	0537	0538	0539	0540	0541	0542	0543
220	0544	0545	0546	0547	0548	0549	0550	0551	0552	0553	0554	0555	0556	0557	0558	0559
230	0560	0561	0562	0563	0564	0565	0566	0567	0568	0569	0570	0571	0572	0573	0574	0575
240	0576	0577	0578	0579	0580	0581	0582	0583	0584	0585	0586	0587	0588	0589	0590	0591
250	0592	0593	0594	0595	0596	0597	0598	0599	0600	0601	0602	0603	0604	0605	0606	0607
260	0608	0609	0610	0611	0612	0613	0614	0615	0616	0617	0618	0619	0620	0621	0622	0623
270	0624	0625	0626	0627	0628	0629	0630	0631	0632	0633	0634	0635	0636	0637	0638	0639
280	0640	0641	0642	0643	0644	0645	0646	0647	0648	0649	0650	0651	0652	0653	0654	0655
290	0656	0657	0658	0659	0660	0661	0662	0663	0664	0665	0666	0667	0668	0669	0670	0671
2A0	0672	0673	0674	0675	0676	0677	0678	0679	0680	0681	0682	0683	0684	0685	0686	0687
2B0	0688	0689	0690	0691	0692	0693	0694	0695	0696	0697	0698	0699	0700	0701	0702	0703
2C0	0704	0705	0706	0707	0708	0709	0710	0711	0712	0713	0714	0715	0716	0717	0718	0719
2D0	0720	0721	0722	0723	0724	0725	0726	0727	0728	0729	0730	0731	0732	0733	0734	0735
2E0	0736	0737	0738	0739	0740	0741	0742	0743	0744	0745	0746	0747	0748	0749	0750	0751
2F0	0752	0753	0754	0755	0756	0757	0758	0759	0760	0761	0762	0763	0764	0765	0766	0767
300	0768	0769	0770	0771	0772	0773	0774	0775	0776	0777	0778	0779	0780	0781	0782	0783
310	0784	0785	0786	0787	0788	0789	0790	0791	0792	0793	0794	0795	0796	0797	0798	0799
320	0800	0801	0802	0803	0804	0805	0806	0807	0808	0809	0810	0811	0812	0813	0814	0815
330	0816	0817	0818	0819	0820	0821	0822	0823	0824	0825	0826	0827	0828	0829	0830	0831
340	0832	0833	0834	0835	0836	0837	0838	0839	0840	0841	0842	0843	0844	0845	0846	0847
350	0848	0849	0850	0851	0852	0853	0854	0855	0856	0857	0858	0859	0860	0861	0862	0863
360	0864	0865	0866	0867	0868	0869	0870	0871	0872	0873	0874	0875	0876	0877	0878	0879
370	0880	0881	0882	0883	0884	0885	0886	0887	0888	0889	0890	0891	0892	0893	0894	0895
380	0896	0897	0898	0899	0900	0901	0902	0903	0904	0905	0906	0907	0908	0909	0910	0911
390	0912	0913	0914	0915	0916	0917	0918	0919	0920	0921	0922	0923	0924	0925	0926	0927
3A0	0928	0929	0930	0931	0932	0933	0934	0935	0936	0937	0938	0939	0940	0941	0942	0943
3B0	0944	0945	0946	0947	0948	0949	0950	0951	0952	0953	0954	0955	0956	0957	0958	0959
3C0	0960	0961	0962	0963	0964	0965	0966	0967	0968	0969	0970	0971	0972	0973	0974	0975
3D0	0976	0977	0978	0979	0980	0981	0982	0983	0984	0985	0986	0987	0988	0989	0990	0991
3E0	0992	0993	0994	0995	0996	0997	0998	0999	1000	1001	1002	1003	1004	1005	1006	1007
3F0	1008	1009	1010	1011	1012	1013	1014	1015	1016	1017	1018	1019	1020	1021	1022	1023



HEXADECIMAL - DECIMAL INTEGER CONVERSION TABLE (Cont.)

	0	1	2	3	4	5	6	7	8	9	A	B	C	D	E	F
400	1024	1025	1026	1027	1028	1029	1030	1031	1032	1033	1034	1035	1036	1037	1038	1039
410	1040	1041	1042	1043	1044	1045	1046	1047	1048	1049	1050	1051	1052	1053	1054	1055
420	1056	1057	1058	1059	1060	1061	1062	1063	1064	1065	1066	1067	1068	1069	1070	1071
430	1072	1073	1074	1075	1076	1077	1078	1079	1080	1081	1082	1083	1084	1085	1086	1087
440	1088	1089	1090	1091	1092	1093	1094	1095	1096	1097	1098	1099	1100	1101	1102	1103
450	1104	1105	1106	1107	1108	1109	1110	1111	1112	1113	1114	1115	1116	1117	1118	1119
460	1120	1121	1122	1123	1124	1125	1126	1127	1128	1129	1130	1131	1132	1133	1134	1135
470	1136	1137	1138	1139	1140	1141	1142	1143	1144	1145	1146	1147	1148	1149	1150	1151
480	1152	1153	1154	1155	1156	1157	1158	1159	1160	1161	1162	1163	1164	1165	1166	1167
490	1168	1169	1170	1171	1172	1173	1174	1175	1176	1177	1178	1179	1180	1181	1182	1183
4A0	1184	1185	1186	1187	1188	1189	1190	1191	1192	1193	1194	1195	1196	1197	1198	1199
4B0	1200	1201	1202	1203	1204	1205	1206	1207	1208	1209	1210	1211	1212	1213	1214	1215
4C0	1216	1217	1218	1219	1220	1221	1222	1223	1224	1225	1226	1227	1228	1229	1230	1231
4D0	1232	1233	1234	1235	1236	1237	1238	1239	1240	1241	1242	1243	1244	1245	1246	1247
4E0	1248	1249	1250	1251	1252	1253	1254	1255	1256	1257	1258	1259	1260	1261	1262	1263
4F0	1264	1265	1266	1267	1268	1269	1270	1271	1272	1273	1274	1275	1276	1277	1278	1279
500	1280	1281	1282	1283	1284	1285	1286	1287	1288	1289	1290	1291	1292	1293	1294	1295
510	1296	1297	1298	1299	1300	1301	1302	1303	1304	1305	1306	1307	1308	1309	1310	1311
520	1312	1313	1314	1315	1316	1317	1318	1319	1320	1321	1322	1323	1324	1325	1326	1327
530	1328	1329	1330	1331	1332	1333	1334	1335	1336	1337	1338	1339	1340	1341	1342	1343
540	1344	1345	1346	1347	1348	1349	1350	1351	1352	1353	1354	1355	1356	1357	1358	1359
550	1360	1361	1362	1363	1364	1365	1366	1367	1368	1369	1370	1371	1372	1373	1374	1375
560	1376	1377	1378	1379	1380	1381	1382	1383	1384	1385	1386	1387	1388	1389	1390	1391
570	1392	1393	1394	1395	1396	1397	1398	1399	1400	1401	1402	1403	1404	1405	1406	1407
580	1408	1409	1410	1411	1412	1413	1414	1415	1416	1417	1418	1419	1420	1421	1422	1423
590	1424	1425	1426	1427	1428	1429	1430	1431	1432	1433	1434	1435	1436	1437	1438	1439
5A0	1440	1441	1442	1443	1444	1445	1446	1447	1448	1449	1450	1451	1452	1453	1454	1455
5B0	1456	1457	1458	1459	1460	1461	1462	1463	1464	1465	1466	1467	1468	1469	1470	1471
5C0	1472	1473	1474	1475	1476	1477	1478	1479	1480	1481	1482	1483	1484	1485	1486	1487
5D0	1488	1489	1490	1491	1492	1493	1494	1495	1496	1497	1498	1499	1500	1501	1502	1503
5E0	1504	1505	1506	1507	1508	1509	1510	1511	1512	1513	1514	1515	1516	1517	1518	1519
5F0	1520	1521	1522	1523	1524	1525	1526	1527	1528	1529	1530	1531	1532	1533	1534	1535
600	1536	1537	1538	1539	1540	1541	1542	1543	1544	1545	1546	1547	1548	1549	1550	1551
610	1552	1553	1554	1555	1556	1557	1558	1559	1560	1561	1562	1563	1564	1565	1566	1567
620	1568	1569	1570	1571	1572	1573	1574	1575	1576	1577	1578	1579	1580	1581	1582	1583
630	1584	1585	1586	1587	1588	1589	1590	1591	1592	1593	1594	1595	1596	1597	1598	1599
640	1600	1601	1602	1603	1604	1605	1606	1607	1608	1609	1610	1611	1612	1613	1614	1615
650	1616	1617	1618	1619	1620	1621	1622	1623	1624	1625	1626	1627	1628	1629	1630	1631
660	1632	1633	1634	1635	1636	1637	1638	1639	1640	1641	1642	1643	1644	1645	1646	1647
670	1648	1649	1650	1651	1652	1653	1654	1655	1656	1657	1658	1659	1660	1661	1662	1663
680	1664	1665	1666	1667	1668	1669	1670	1671	1672	1673	1674	1675	1676	1677	1678	1679
690	1680	1681	1682	1683	1684	1685	1686	1687	1688	1689	1690	1691	1692	1693	1694	1695
6A0	1696	1697	1698	1699	1700	1701	1702	1703	1704	1705	1706	1707	1708	1709	1710	1711
6B0	1712	1713	1714	1715	1716	1717	1718	1719	1720	1721	1722	1723	1724	1725	1726	1727
6C0	1728	1729	1730	1731	1732	1733	1734	1735	1736	1737	1738	1739	1740	1741	1742	1743
6D0	1744	1745	1746	1747	1748	1749	1750	1751	1752	1753	1754	1755	1756	1757	1758	1759
6E0	1760	1761	1762	1763	1764	1765	1766	1767	1768	1769	1770	1771	1772	1773	1774	1775
6F0	1776	1777	1778	1779	1780	1781	1782	1783	1784	1785	1786	1787	1788	1789	1790	1791

HEX DECIMAL - DECIMAL INTEGER CONVERSION TABLE (cont.)

	0	1	2	3	4	5	6	7	8	9	A	B	C	D	E	F
700	1792	1793	1794	1795	1796	1797	1798	1799	1800	1801	1802	1803	1804	1805	1806	1807
710	1808	1809	1810	1811	1812	1813	1814	1815	1816	1817	1818	1819	1820	1821	1822	1823
720	1824	1825	1826	1827	1828	1829	1830	1831	1832	1833	1834	1835	1836	1837	1838	1839
730	1840	1841	1842	1843	1844	1845	1846	1847	1848	1849	1850	1851	1852	1853	1854	1855
740	1856	1857	1858	1859	1860	1861	1862	1863	1864	1865	1866	1867	1868	1869	1870	1871
750	1872	1873	1874	1875	1876	1877	1878	1879	1880	1881	1882	1883	1884	1885	1886	1887
760	1888	1889	1890	1891	1892	1893	1894	1895	1896	1897	1898	1899	1900	1901	1902	1903
770	1904	1905	1906	1907	1908	1909	1910	1911	1912	1913	1914	1915	1916	1917	1918	1919
780	1920	1921	1922	1923	1924	1925	1926	1927	1928	1929	1930	1931	1932	1933	1934	1935
790	1936	1937	1938	1939	1940	1941	1942	1943	1944	1945	1946	1947	1948	1949	1950	1951
7A0	1952	1953	1954	1955	1956	1957	1958	1959	1960	1961	1962	1963	1964	1965	1966	1967
7B0	1968	1969	1970	1971	1972	1973	1974	1975	1976	1977	1978	1979	1980	1981	1982	1983
7C0	1984	1985	1986	1987	1988	1989	1990	1991	1992	1993	1994	1995	1996	1997	1998	1999
7D0	2000	2001	2002	2003	2004	2005	2006	2007	2008	2009	2010	2011	2012	2013	2014	2015
7E0	2016	2017	2018	2019	2020	2021	2022	2023	2024	2025	2026	2027	2028	2029	2030	2031
7F0	2032	2033	2034	2035	2036	2037	2038	2039	2040	2041	2042	2043	2044	2045	2046	2047
800	2048	2049	2050	2051	2052	2053	2054	2055	2056	2057	2058	2059	2060	2061	2062	2063
810	2064	2065	2066	2067	2068	2069	2070	2071	2072	2073	2074	2075	2076	2077	2078	2079
820	2080	2081	2082	2083	2084	2085	2086	2087	2088	2089	2090	2091	2092	2093	2094	2095
830	2096	2097	2098	2099	2100	2101	2102	2103	2104	2105	2106	2107	2108	2109	2110	2111
840	2112	2113	2114	2115	2116	2117	2118	2119	2120	2121	2122	2123	2124	2125	2126	2127
850	2128	2129	2130	2131	2132	2133	2134	2135	2136	2137	2138	2139	2140	2141	2142	2143
860	2144	2145	2146	2147	2148	2149	2150	2151	2152	2153	2154	2155	2156	2157	2158	2159
870	2160	2161	2162	2163	2164	2165	2166	2167	2168	2169	2170	2171	2172	2173	2174	2175
880	2176	2177	2178	2179	2180	2181	2182	2183	2184	2185	2186	2187	2188	2189	2190	2191
890	2192	2193	2194	2195	2196	2197	2198	2199	2200	2201	2202	2203	2204	2205	2206	2207
8A0	2208	2209	2210	2211	2212	2213	2214	2215	2216	2217	2218	2219	2220	2221	2222	2223
8B0	2224	2225	2226	2227	2228	2229	2230	2231	2232	2233	2234	2235	2236	2237	2238	2239
8C0	2240	2241	2242	2243	2244	2245	2246	2247	2248	2249	2250	2251	2252	2253	2254	2255
8D0	2256	2257	2258	2259	2260	2261	2262	2263	2264	2265	2266	2267	2268	2269	2270	2271
8E0	2272	2273	2274	2275	2276	2277	2278	2279	2280	2281	2282	2283	2284	2285	2286	2287
8F0	2288	2289	2290	2291	2292	2293	2294	2295	2296	2297	2298	2299	2300	2301	2302	2303
900	2304	2305	2306	2307	2308	2309	2310	2311	2312	2313	2314	2315	2316	2317	2318	2319
910	2320	2321	2322	2323	2324	2325	2326	2327	2328	2329	2330	2331	2332	2333	2334	2335
920	2336	2337	2338	2339	2340	2341	2342	2343	2344	2345	2346	2347	2348	2349	2350	2351
930	2352	2353	2354	2355	2356	2357	2358	2359	2360	2361	2362	2363	2364	2365	2366	2367
940	2368	2369	2370	2371	2372	2373	2374	2375	2376	2377	2378	2379	2380	2381	2382	2383
950	2384	2385	2386	2387	2388	2389	2390	2391	2392	2393	2394	2395	2396	2397	2398	2399
960	2400	2401	2402	2403	2404	2405	2406	2407	2408	2409	2410	2411	2412	2413	2414	2415
970	2416	2417	2418	2419	2420	2421	2422	2423	2424	2425	2426	2427	2428	2429	2430	2431
980	2432	2433	2434	2435	2436	2437	2438	2439	2440	2441	2442	2443	2444	2445	2446	2447
990	2448	2449	2450	2451	2452	2453	2454	2455	2456	2457	2458	2459	2460	2461	2462	2463
9A0	2464	2465	2466	2467	2468	2469	2470	2471	2472	2473	2474	2475	2476	2477	2478	2479
9B0	2480	2481	2482	2483	2484	2485	2486	2487	2488	2489	2490	2491	2492	2493	2494	2495
9C0	2496	2497	2498	2499	2500	2501	2502	2503	2504	2505	2506	2507	2508	2509	2510	2511
9D0	2512	2513	2514	2515	2516	2517	2518	2519	2520	2521	2522	2523	2524	2525	2526	2527
9E0	2528	2529	2530	2531	2532	2533	2534	2535	2536	2537	2538	2539	2540	2541	2542	2543
9F0	2544	2545	2546	2547	2548	2549	2550	2551	2552	2553	2554	2555	2556	2557	2558	2559

HEXADECIMAL - DECIMAL INTEGER CONVERSION TABLE (cont.)

	0	1	2	3	4	5	6	7	8	9	A	B	C	D	E	F
A00	2560	2561	2562	2563	2564	2565	2566	2567	2568	2569	2570	2571	2572	2573	2574	2575
A10	2576	2577	2578	2579	2580	2581	2582	2583	2584	2585	2586	2587	2588	2589	2590	2591
A20	2592	2593	2594	2595	2596	2597	2598	2599	2600	2601	2602	2603	2604	2605	2606	2607
A30	2608	2609	2610	2611	2612	2613	2614	2615	2616	2617	2618	2619	2620	2621	2622	2623
A40	2624	2625	2626	2627	2628	2629	2630	2631	2632	2633	2634	2635	2636	2637	2638	2639
A50	2640	2641	2642	2643	2644	2645	2646	2647	2648	2649	2650	2651	2652	2653	2654	2655
A60	2656	2657	2658	2659	2660	2661	2662	2663	2664	2665	2666	2667	2668	2669	2670	2671
A70	2672	2673	2674	2675	2676	2677	2678	2679	2680	2681	2682	2683	2684	2685	2686	2687
A80	2688	2689	2690	2691	2692	2693	2694	2695	2696	2697	2698	2699	2700	2701	2702	2703
A90	2704	2705	2706	2707	2708	2709	2710	2711	2712	2713	2714	2715	2716	2717	2718	2719
AA0	2720	2721	2722	2723	2724	2725	2726	2727	2728	2729	2730	2731	2732	2733	2734	2735
AB0	2736	2737	2738	2739	2740	2741	2742	2743	2744	2745	2746	2747	2748	2749	2750	2751
AC0	2752	2753	2754	2755	2756	2757	2758	2759	2760	2761	2762	2763	2764	2765	2766	2767
AD0	2768	2769	2770	2771	2772	2773	2774	2775	2776	2777	2778	2779	2780	2781	2782	2783
AE0	2784	2785	2786	2787	2788	2789	2790	2791	2792	2793	2794	2795	2796	2797	2798	2799
AF0	2800	2801	2802	2803	2804	2805	2806	2807	2808	2809	2810	2811	2812	2813	2814	2815
B00	2816	2817	2818	2819	2820	2821	2822	2823	2824	2825	2826	2827	2828	2829	2830	2831
B10	2832	2833	2834	2835	2836	2837	2838	2839	2840	2841	2842	2843	2844	2845	2846	2847
B20	2848	2849	2850	2851	2852	2853	2854	2855	2856	2857	2858	2859	2860	2861	2862	2863
B30	2864	2865	2866	2867	2868	2869	2870	2871	2872	2873	2874	2875	2876	2877	2878	2879
B40	2880	2881	2882	2883	2884	2885	2886	2887	2888	2889	2890	2891	2892	2893	2894	2895
B50	2896	2897	2898	2899	2900	2901	2902	2903	2904	2905	2906	2907	2908	2909	2910	2911
B60	2912	2913	2914	2915	2916	2917	2918	2919	2920	2921	2922	2923	2924	2925	2926	2927
B70	2928	2929	2930	2931	2932	2933	2934	2935	2936	2937	2938	2939	2940	2941	2942	2943
B80	2944	2945	2946	2947	2948	2949	2950	2951	2952	2953	2954	2955	2956	2957	2958	2959
B90	2960	2961	2962	2963	2964	2965	2966	2967	2968	2969	2970	2971	2972	2973	2974	2975
BA0	2976	2977	2978	2979	2980	2981	2982	2983	2984	2985	2986	2987	2988	2989	2990	2991
BB0	2992	2993	2994	2995	2996	2997	2998	2999	3000	3001	3002	3003	3004	3005	3006	3007
BC0	3008	3009	3010	3011	3012	3013	3014	3015	3016	3017	3018	3019	3020	3021	3022	3023
BD0	3024	3025	3026	3027	3028	3029	3030	3031	3032	3033	3034	3035	3036	3037	3038	3039
BE0	3040	3041	3042	3043	3044	3045	3046	3047	3048	3049	3050	3051	3052	3053	3054	3055
BF0	3056	3057	3058	3059	3060	3061	3062	3063	3064	3065	3066	3067	3068	3069	3070	3071
C00	3072	3073	3074	3075	3076	3077	3078	3079	3080	3081	3082	3083	3084	3085	3086	3087
C10	3088	3089	3090	3091	3092	3093	3094	3095	3096	3097	3098	3099	3100	3101	3102	3103
C20	3104	3105	3106	3107	3108	3109	3110	3111	3112	3113	3114	3115	3116	3117	3118	3119
C30	3120	3121	3122	3123	3124	3125	3126	3127	3128	3129	3130	3131	3132	3133	3134	3135
C40	3136	3137	3138	3139	3140	3141	3142	3143	3144	3145	3146	3147	3148	3149	3150	3151
C50	3152	3153	3154	3155	3156	3157	3158	3159	3160	3161	3162	3163	3164	3165	3166	3167
C60	3168	3169	3170	3171	3172	3173	3174	3175	3176	3177	3178	3179	3180	3181	3182	3183
C70	3184	3185	3186	3187	3188	3189	3190	3191	3192	3193	3194	3195	3196	3197	3198	3199
C80	3200	3201	3202	3203	3204	3205	3206	3207	3208	3209	3210	3211	3212	3213	3214	3215
C90	3216	3217	3218	3219	3220	3221	3222	3223	3224	3225	3226	3227	3228	3229	3230	3231
CA0	3232	3233	3234	3235	3236	3237	3238	3239	3240	3241	3242	3243	3244	3245	3246	3247
CB0	3248	3249	3250	3251	3252	3253	3254	3255	3256	3257	3258	3259	3260	3261	3262	3263
CC0	3264	3265	3266	3267	3268	3269	3270	3271	3272	3273	3274	3275	3276	3277	3278	3279
CD0	3280	3281	3282	3283	3284	3285	3286	3287	3288	3289	3290	3291	3292	3293	3294	3295
CE0	3296	3297	3298	3299	3300	3301	3302	3303	3304	3305	3306	3307	3308	3309	3310	3311
CF0	3312	3313	3314	3315	3316	3317	3318	3319	3320	3321	3322	3323	3324	3325	3326	3327

HEXADECIMAL - DECIMAL INTEGER CONVERSION TABLE (cont.)

	0	1	2	3	4	5	6	7	8	9	A	B	C	D	E	F
D00	3328	3329	3330	3331	3332	3333	3334	3335	3336	3337	3338	3339	3340	3341	3342	3343
D10	3344	3345	3346	3347	3348	3349	3350	3351	3352	3353	3354	3355	3356	3357	3358	3359
D20	3360	3361	3362	3363	3364	3365	3366	3367	3368	3369	3370	3371	3372	3373	3374	3375
D30	3376	3377	3378	3379	3380	3381	3382	3383	3384	3385	3386	3387	3388	3389	3390	3391
D40	3392	3393	3394	3395	3396	3397	3398	3399	3400	3401	3402	3403	3404	3405	3406	3407
D50	3408	3409	3410	3411	3412	3413	3414	3415	3416	3417	3418	3419	3420	3421	3422	3423
D60	3424	3425	3426	3427	3428	3429	3430	3431	3432	3433	3434	3435	3436	3437	3438	3439
D70	3440	3441	3442	3443	3444	3445	3446	3447	3448	3449	3450	3451	3452	3453	3454	3455
D80	3456	3457	3458	3459	3460	3461	3462	3463	3464	3465	3466	3467	3468	3469	3470	3471
D90	3472	3473	3474	3475	3476	3477	3478	3479	3480	3481	3482	3483	3484	3485	3486	3487
DA0	3488	3489	3490	3491	3492	3493	3494	3495	3496	3497	3498	3499	3500	3501	3502	3503
DB0	3504	3505	3506	3507	3508	3509	3510	3511	3512	3513	3514	3515	3516	3517	3518	3519
DC0	3520	3521	3522	3523	3524	3525	3526	3527	3528	3529	3530	3531	3532	3533	3534	3535
DD0	3536	3537	3538	3539	3540	3541	3542	3543	3544	3545	3546	3547	3548	3549	3550	3551
DE0	3552	3553	3554	3555	3556	3557	3558	3559	3560	3561	3562	3563	3564	3565	3566	3567
DF0	3568	3569	3570	3571	3572	3573	3574	3575	3576	3577	3578	3579	3580	3581	3582	3583
E00	3584	3585	3586	3587	3588	3589	3590	3591	3592	3593	3594	3595	3596	3597	3598	3599
E10	3600	3601	3602	3603	3604	3605	3606	3607	3608	3609	3610	3611	3612	3613	3614	3615
E20	3616	3617	3618	3619	3620	3621	3622	3623	3624	3625	3626	3627	3628	3629	3630	3631
E30	3632	3633	3634	3635	3636	3637	3638	3639	3640	3641	3642	3643	3644	3645	3646	3647
E40	3648	3649	3650	3651	3652	3653	3654	3655	3656	3657	3658	3659	3660	3661	3662	3663
E50	3664	3665	3666	3667	3668	3669	3670	3671	3672	3673	3674	3675	3676	3677	3678	3679
E60	3680	3681	3682	3683	3684	3685	3686	3687	3688	3689	3690	3691	3692	3693	3694	3695
E70	3696	3697	3698	3699	3700	3701	3702	3703	3704	3705	3706	3707	3708	3709	3710	3711
E80	3712	3713	3714	3715	3716	3717	3718	3719	3720	3721	3722	3723	3724	3725	3726	3727
E90	3728	3729	3730	3731	3732	3733	3734	3735	3736	3737	3738	3739	3740	3741	3742	3743
EA0	3744	3745	3746	3747	3748	3749	3750	3751	3752	3753	3754	3755	3756	3757	3758	3759
EB0	3760	3761	3762	3763	3764	3765	3766	3767	3768	3769	3770	3771	3772	3773	3774	3775
EC0	3776	3777	3778	3779	3780	3781	3782	3783	3784	3785	3786	3787	3788	3789	3790	3791
ED0	3792	3793	3794	3795	3796	3797	3798	3799	3800	3801	3802	3803	3804	3805	3806	3807
EE0	3808	3809	3810	3811	3812	3813	3814	3815	3816	3817	3818	3819	3820	3821	3822	3823
EF0	3824	3825	3826	3827	3828	3829	3830	3831	3832	3833	3834	3835	3836	3837	3838	3839
F00	3840	3841	3842	3843	3844	3845	3846	3847	3848	3849	3850	3851	3852	3853	3854	3855
F10	3856	3857	3858	3859	3860	3861	3862	3863	3864	3865	3866	3867	3868	3869	3870	3871
F20	3872	3873	3874	3875	3876	3877	3878	3879	3880	3881	3882	3883	3884	3885	3886	3887
F30	3888	3889	3890	3891	3892	3893	3894	3895	3896	3897	3898	3899	3900	3901	3902	3903
F40	3904	3905	3906	3907	3908	3909	3910	3911	3912	3913	3914	3915	3916	3917	3918	3919
F50	3920	3921	3922	3923	3924	3925	3926	3927	3928	3929	3930	3931	3932	3933	3934	3935
F60	3936	3937	3938	3939	3940	3941	3942	3943	3944	3945	3946	3947	3948	3949	3950	3951
F70	3952	3953	3954	3955	3956	3957	3958	3959	3960	3961	3962	3963	3964	3965	3966	3967
F80	3968	3969	3970	3971	3972	3973	3974	3975	3976	3977	3978	3979	3980	3981	3982	3983
F90	3984	3985	3986	3987	3988	3989	3990	3991	3992	3993	3994	3995	3996	3997	3998	3999
FA0	4000	4001	4002	4003	4004	4005	4006	4007	4008	4009	4010	4011	4012	4013	4014	4015
FB0	4016	4017	4018	4019	4020	4021	4022	4023	4024	4025	4026	4027	4028	4029	4030	4031
FC0	4032	4033	4034	4035	4036	4037	4038	4039	4040	4041	4042	4043	4044	4045	4046	4047
FD0	4048	4049	4050	4051	4052	4053	4054	4055	4056	4057	4058	4059	4060	4061	4062	4063
FE0	4064	4065	4066	4067	4068	4069	4070	4071	4072	4073	4074	4075	4076	4077	4078	4079
FF0	4080	4081	4082	4083	4084	4085	4086	4087	4088	4089	4090	4091	4092	4093	4094	4095

# HEXADECIMAL-DECIMAL FRACTION CONVERSION TABLE

Hexadecimal	Decimal	Hexadecimal	Decimal	Hexadecimal	Decimal	Hexadecimal	Decimal
.00 00 00 00	.00000 00000	.40 00 00 00	.25000 00000	.80 00 00 00	.50000 00000	.C0 00 00 00	.75000 00000
.01 00 00 00	.00390 62500	.41 00 00 00	.25390 62500	.81 00 00 00	.50390 62500	.C1 00 00 00	.75390 62500
.02 00 00 00	.00781 25000	.42 00 00 00	.25781 25000	.82 00 00 00	.50781 25000	.C2 00 00 00	.75781 25000
.03 00 00 00	.01171 87500	.43 00 00 00	.26171 87500	.83 00 00 00	.51171 87500	.C3 00 00 00	.76171 87500
.04 00 00 00	.01562 50000	.44 00 00 00	.26562 50000	.84 00 00 00	.51562 50000	.C4 00 00 00	.76562 50000
.05 00 00 00	.01953 12500	.45 00 00 00	.26953 12500	.85 00 00 00	.51953 12500	.C5 00 00 00	.76953 12500
.06 00 00 00	.02343 75000	.46 00 00 00	.27343 75000	.86 00 00 00	.52343 75000	.C6 00 00 00	.77343 75000
.07 00 00 00	.02734 37500	.47 00 00 00	.27734 37500	.87 00 00 00	.52734 37500	.C7 00 00 00	.77734 37500
.08 00 00 00	.03125 00000	.48 00 00 00	.28125 00000	.88 00 00 00	.53125 00000	.C8 00 00 00	.78125 00000
.09 00 00 00	.03515 62500	.49 00 00 00	.28515 62500	.89 00 00 00	.53515 62500	.C9 00 00 00	.78515 62500
.0A 00 00 00	.03906 25000	.4A 00 00 00	.28906 25000	.8A 00 00 00	.53906 25000	.CA 00 00 00	.78906 25000
.0B 00 00 00	.04296 87500	.4B 00 00 00	.29296 87500	.8B 00 00 00	.54296 87500	.CB 00 00 00	.79296 87500
.0C 00 00 00	.04687 50000	.4C 00 00 00	.29687 50000	.8C 00 00 00	.54687 50000	.CC 00 00 00	.79687 50000
.0D 00 00 00	.05078 12500	.4D 00 00 00	.30078 12500	.8D 00 00 00	.55078 12500	.CD 00 00 00	.80078 12500
.0E 00 00 00	.05468 75000	.4E 00 00 00	.30468 75000	.8E 00 00 00	.55468 75000	.CE 00 00 00	.80468 75000
.0F 00 00 00	.05859 37500	.4F 00 00 00	.30859 37500	.8F 00 00 00	.55859 37500	.CF 00 00 00	.80859 37500
.10 00 00 00	.06250 00000	.50 00 00 00	.31250 00000	.90 00 00 00	.56250 00000	.D0 00 00 00	.81250 00000
.11 00 00 00	.06640 62500	.51 00 00 00	.31640 62500	.91 00 00 00	.56640 62500	.D1 00 00 00	.81640 62500
.12 00 00 00	.07031 25000	.52 00 00 00	.32031 25000	.92 00 00 00	.57031 25000	.D2 00 00 00	.82031 25000
.13 00 00 00	.07421 87500	.53 00 00 00	.32421 87500	.93 00 00 00	.57421 87500	.D3 00 00 00	.82421 87500
.14 00 00 00	.07812 50000	.54 00 00 00	.32812 50000	.94 00 00 00	.57812 50000	.D4 00 00 00	.82812 50000
.15 00 00 00	.08203 12500	.55 00 00 00	.33203 12500	.95 00 00 00	.58203 12500	.D5 00 00 00	.83203 12500
.16 00 00 00	.08593 75000	.56 00 00 00	.33593 75000	.96 00 00 00	.58593 75000	.D6 00 00 00	.83593 75000
.17 00 00 00	.08984 37500	.57 00 00 00	.33984 37500	.97 00 00 00	.58984 37500	.D7 00 00 00	.83984 37500
.18 00 00 00	.09375 00000	.58 00 00 00	.34375 00000	.98 00 00 00	.59375 00000	.D8 00 00 00	.84375 00000
.19 00 00 00	.09765 62500	.59 00 00 00	.34765 62500	.99 00 00 00	.59765 62500	.D9 00 00 00	.84765 62500
.1A 00 00 00	.10156 25000	.5A 00 00 00	.35156 25000	.9A 00 00 00	.60156 25000	.DA 00 00 00	.85156 25000
.1B 00 00 00	.10546 87500	.5B 00 00 00	.35546 87500	.9B 00 00 00	.60546 87500	.DB 00 00 00	.85546 87500
.1C 00 00 00	.10937 50000	.5C 00 00 00	.35937 50000	.9C 00 00 00	.60937 50000	.DC 00 00 00	.85937 50000
.1D 00 00 00	.11328 12500	.5D 00 00 00	.36328 12500	.9D 00 00 00	.61328 12500	.DD 00 00 00	.86328 12500
.1E 00 00 00	.11718 75000	.5E 00 00 00	.36718 75000	.9E 00 00 00	.61718 75000	.DE 00 00 00	.86718 75000
.1F 00 00 00	.12109 37500	.5F 00 00 00	.37109 37500	.9F 00 00 00	.62109 37500	.DF 00 00 00	.87109 37500
.20 00 00 00	.12500 00000	.60 00 00 00	.37500 00000	.A0 00 00 00	.62500 00000	.E0 00 00 00	.87500 00000
.21 00 00 00	.12890 62500	.61 00 00 00	.37890 62500	.A1 00 00 00	.62890 62500	.E1 00 00 00	.87890 62500
.22 00 00 00	.13281 25000	.62 00 00 00	.38281 25000	.A2 00 00 00	.63281 25000	.E2 00 00 00	.88281 25000
.23 00 00 00	.13671 87500	.63 00 00 00	.38671 87500	.A3 00 00 00	.63671 87500	.E3 00 00 00	.88671 87500
.24 00 00 00	.14062 50000	.64 00 00 00	.39062 50000	.A4 00 00 00	.64062 50000	.E4 00 00 00	.89062 50000
.25 00 00 00	.14453 12500	.65 00 00 00	.39453 12500	.A5 00 00 00	.64453 12500	.E5 00 00 00	.89453 12500
.26 00 00 00	.14843 75000	.66 00 00 00	.39843 75000	.A6 00 00 00	.64843 75000	.E6 00 00 00	.89843 75000
.27 00 00 00	.15234 37500	.67 00 00 00	.40234 37500	.A7 00 00 00	.65234 37500	.E7 00 00 00	.90234 37500
.28 00 00 00	.15625 00000	.68 00 00 00	.40625 00000	.A8 00 00 00	.65625 00000	.E8 00 00 00	.90625 00000
.29 00 00 00	.16015 62500	.69 00 00 00	.41015 62500	.A9 00 00 00	.66015 62500	.E9 00 00 00	.91015 62500
.2A 00 00 00	.16406 25000	.6A 00 00 00	.41406 25000	.AA 00 00 00	.66406 25000	.EA 00 00 00	.91406 25000
.2B 00 00 00	.16796 87500	.6B 00 00 00	.41796 87500	.AB 00 00 00	.66796 87500	.EB 00 00 00	.91796 87500
.2C 00 00 00	.17187 50000	.6C 00 00 00	.42187 50000	.AC 00 00 00	.67187 50000	.EC 00 00 00	.92187 50000
.2D 00 00 00	.17578 12500	.6D 00 00 00	.42578 12500	.AD 00 00 00	.67578 12500	.ED 00 00 00	.92578 12500
.2E 00 00 00	.17968 75000	.6E 00 00 00	.42968 75000	.AE 00 00 00	.67968 75000	.EE 00 00 00	.92968 75000
.2F 00 00 00	.18359 37500	.6F 00 00 00	.43359 37500	.AF 00 00 00	.68359 37500	.EF 00 00 00	.93359 37500
.30 00 00 00	.18750 00000	.70 00 00 00	.43750 00000	.B0 00 00 00	.68750 00000	.F0 00 00 00	.93750 00000
.31 00 00 00	.19140 62500	.71 00 00 00	.44140 62500	.B1 00 00 00	.69140 62500	.F1 00 00 00	.94140 62500
.32 00 00 00	.19531 25000	.72 00 00 00	.44531 25000	.B2 00 00 00	.69531 25000	.F2 00 00 00	.94531 25000
.33 00 00 00	.19921 87500	.73 00 00 00	.44921 87500	.B3 00 00 00	.69921 87500	.F3 00 00 00	.94921 87500
.34 00 00 00	.20312 50000	.74 00 00 00	.45312 50000	.B4 00 00 00	.70312 50000	.F4 00 00 00	.95312 50000
.35 00 00 00	.20703 12500	.75 00 00 00	.45703 12500	.B5 00 00 00	.70703 12500	.F5 00 00 00	.95703 12500
.36 00 00 00	.21093 75000	.76 00 00 00	.46093 75000	.B6 00 00 00	.71093 75000	.F6 00 00 00	.96093 75000
.37 00 00 00	.21484 37500	.77 00 00 00	.46484 37500	.B7 00 00 00	.71484 37500	.F7 00 00 00	.96484 37500
.38 00 00 00	.21875 00000	.78 00 00 00	.46875 00000	.B8 00 00 00	.71875 00000	.F8 00 00 00	.96875 00000
.39 00 00 00	.22265 62500	.79 00 00 00	.47265 62500	.B9 00 00 00	.72265 62500	.F9 00 00 00	.97265 62500
.3A 00 00 00	.22656 25000	.7A 00 00 00	.47656 25000	.BA 00 00 00	.72656 25000	.FA 00 00 00	.97656 25000
.3B 00 00 00	.23046 87500	.7B 00 00 00	.48046 87500	.BB 00 00 00	.73046 87500	.FB 00 00 00	.98046 87500
.3C 00 00 00	.23437 50000	.7C 00 00 00	.48437 50000	.BC 00 00 00	.73437 50000	.FC 00 00 00	.98437 50000
.3D 00 00 00	.23828 12500	.7D 00 00 00	.48828 12500	.BD 00 00 00	.73828 12500	.FD 00 00 00	.98828 12500
.3E 00 00 00	.24218 75000	.7E 00 00 00	.49218 75000	.BE 00 00 00	.74218 75000	.FE 00 00 00	.99218 75000
.3F 00 00 00	.24609 37500	.7F 00 00 00	.49609 37500	.BF 00 00 00	.74609 37500	.FF 00 00 00	.99609 37500

HEXADECIMAL - DECIMAL FRACTION CONVERSION TABLE (cont.)

Hexadecimal	Decimal	Hexadecimal	Decimal	Hexadecimal	Decimal	Hexadecimal	Decimal
.00 00 00 00	.00000 00000	.00 40 00 00	.00097 65625	.00 80 00 00	.00195 31250	.00 C0 00 00	.00292 96875
.00 01 00 00	.00001 52587	.00 41 00 00	.00099 18212	.00 81 00 00	.00196 83837	.00 C1 00 00	.00294 49462
.00 02 00 00	.00003 05175	.00 42 00 00	.00100 70800	.00 82 00 00	.00198 36425	.00 C2 00 00	.00296 02050
.00 03 00 00	.00004 57763	.00 43 00 00	.00102 23388	.00 83 00 00	.00199 89013	.00 C3 00 00	.00297 54638
.00 04 00 00	.00006 10351	.00 44 00 00	.00103 75976	.00 84 00 00	.00201 41601	.00 C4 00 00	.00299 07226
.00 05 00 00	.00007 62939	.00 45 00 00	.00105 28564	.00 85 00 00	.00202 94189	.00 C5 00 00	.00300 59814
.00 06 00 00	.00009 15527	.00 46 00 00	.00106 81152	.00 86 00 00	.00204 46777	.00 C6 00 00	.00302 12402
.00 07 00 00	.00010 68115	.00 47 00 00	.00108 33740	.00 87 00 00	.00205 99365	.00 C7 00 00	.00303 64990
.00 08 00 00	.00012 20703	.00 48 00 00	.00109 86328	.00 88 00 00	.00207 51953	.00 C8 00 00	.00305 17578
.00 09 00 00	.00013 73291	.00 49 00 00	.00111 38916	.00 89 00 00	.00209 04541	.00 C9 00 00	.00306 70166
.00 0A 00 00	.00015 25878	.00 4A 00 00	.00112 91503	.00 8A 00 00	.00210 57128	.00 CA 00 00	.00308 22753
.00 0B 00 00	.00016 78466	.00 4B 00 00	.00114 44091	.00 8B 00 00	.00212 09716	.00 CB 00 00	.00309 75341
.00 0C 00 00	.00018 31054	.00 4C 00 00	.00115 96679	.00 8C 00 00	.00213 62304	.00 CC 00 00	.00311 27929
.00 0D 00 00	.00019 83642	.00 4D 00 00	.00117 49267	.00 8D 00 00	.00215 14892	.00 CD 00 00	.00312 80517
.00 0E 00 00	.00021 36230	.00 4E 00 00	.00119 01855	.00 8E 00 00	.00216 67480	.00 CE 00 00	.00314 33105
.00 0F 00 00	.00022 88818	.00 4F 00 00	.00120 54443	.00 8F 00 00	.00218 20068	.00 CF 00 00	.00315 85693
.00 10 00 00	.00024 41406	.00 50 00 00	.00122 07031	.00 90 00 00	.00219 72656	.00 D0 00 00	.00317 38281
.00 11 00 00	.00025 93994	.00 51 00 00	.00123 59619	.00 91 00 00	.00221 25244	.00 D1 00 00	.00318 90869
.00 12 00 00	.00027 46582	.00 52 00 00	.00125 12207	.00 92 00 00	.00222 77832	.00 D2 00 00	.00320 43457
.00 13 00 00	.00028 99169	.00 53 00 00	.00126 64794	.00 93 00 00	.00224 30419	.00 D3 00 00	.00321 96044
.00 14 00 00	.00030 51757	.00 54 00 00	.00128 17382	.00 94 00 00	.00225 83007	.00 D4 00 00	.00323 48632
.00 15 00 00	.00032 04345	.00 55 00 00	.00129 69970	.00 95 00 00	.00227 35595	.00 D5 00 00	.00325 01220
.00 16 00 00	.00033 56933	.00 56 00 00	.00131 22558	.00 96 00 00	.00228 88183	.00 D6 00 00	.00326 53808
.00 17 00 00	.00035 09521	.00 57 00 00	.00132 75146	.00 97 00 00	.00230 40771	.00 D7 00 00	.00328 06396
.00 18 00 00	.00036 62109	.00 58 00 00	.00134 27734	.00 98 00 00	.00231 93359	.00 D8 00 00	.00329 58984
.00 19 00 00	.00038 14697	.00 59 00 00	.00135 80322	.00 99 00 00	.00233 45947	.00 D9 00 00	.00331 11572
.00 1A 00 00	.00039 67285	.00 5A 00 00	.00137 32910	.00 9A 00 00	.00234 98535	.00 DA 00 00	.00332 64160
.00 1B 00 00	.00041 19873	.00 5B 00 00	.00138 85498	.00 9B 00 00	.00236 51123	.00 DB 00 00	.00334 16748
.00 1C 00 00	.00042 72460	.00 5C 00 00	.00140 38085	.00 9C 00 00	.00238 03710	.00 DC 00 00	.00335 69335
.00 1D 00 00	.00044 25048	.00 5D 00 00	.00141 90673	.00 9D 00 00	.00239 56298	.00 DD 00 00	.00337 21923
.00 1E 00 00	.00045 77636	.00 5E 00 00	.00143 43261	.00 9E 00 00	.00241 08886	.00 DE 00 00	.00338 74511
.00 1F 00 00	.00047 30224	.00 5F 00 00	.00144 95849	.00 9F 00 00	.00242 61474	.00 DF 00 00	.00340 27099
.00 20 00 00	.00048 82812	.00 60 00 00	.00146 48437	.00 A0 00 00	.00244 14062	.00 E0 00 00	.00341 79687
.00 21 00 00	.00050 35400	.00 61 00 00	.00148 01025	.00 A1 00 00	.00245 66650	.00 E1 00 00	.00343 32275
.00 22 00 00	.00051 87988	.00 62 00 00	.00149 53613	.00 A2 00 00	.00247 19238	.00 E2 00 00	.00344 84863
.00 23 00 00	.00053 40576	.00 63 00 00	.00151 06201	.00 A3 00 00	.00248 71826	.00 E3 00 00	.00346 37451
.00 24 00 00	.00054 93164	.00 64 00 00	.00152 58789	.00 A4 00 00	.00250 24414	.00 E4 00 00	.00347 90039
.00 25 00 00	.00056 45751	.00 65 00 00	.00154 11376	.00 A5 00 00	.00251 77001	.00 E5 00 00	.00349 42626
.00 26 00 00	.00057 98339	.00 66 00 00	.00155 63964	.00 A6 00 00	.00253 29589	.00 E6 00 00	.00350 95214
.00 27 00 00	.00059 50927	.00 67 00 00	.00157 16552	.00 A7 00 00	.00254 82177	.00 E7 00 00	.00352 47802
.00 28 00 00	.00061 03515	.00 68 00 00	.00158 69140	.00 A8 00 00	.00256 34765	.00 E8 00 00	.00354 00390
.00 29 00 00	.00062 56103	.00 69 00 00	.00160 21728	.00 A9 00 00	.00257 87353	.00 E9 00 00	.00355 52978
.00 2A 00 00	.00064 08691	.00 6A 00 00	.00161 74316	.00 AA 00 00	.00259 39941	.00 EA 00 00	.00357 05566
.00 2B 00 00	.00065 61279	.00 6B 00 00	.00163 26904	.00 AB 00 00	.00260 92529	.00 EB 00 00	.00358 58154
.00 2C 00 00	.00067 13867	.00 6C 00 00	.00164 79492	.00 AC 00 00	.00262 45117	.00 EC 00 00	.00360 10742
.00 2D 00 00	.00068 66455	.00 6D 00 00	.00166 32080	.00 AD 00 00	.00263 97705	.00 ED 00 00	.00361 63330
.00 2E 00 00	.00070 19042	.00 6E 00 00	.00167 84667	.00 AE 00 00	.00265 50292	.00 EE 00 00	.00363 15917
.00 2F 00 00	.00071 71630	.00 6F 00 00	.00169 37255	.00 AF 00 00	.00267 02880	.00 EF 00 00	.00364 68505
.00 30 00 00	.00073 24218	.00 70 00 00	.00170 89843	.00 B0 00 00	.00268 55468	.00 F0 00 00	.00366 21093
.00 31 00 00	.00074 76806	.00 71 00 00	.00172 42431	.00 B1 00 00	.00270 08056	.00 F1 00 00	.00367 73681
.00 32 00 00	.00076 29394	.00 72 00 00	.00173 95019	.00 B2 00 00	.00271 60644	.00 F2 00 00	.00369 26269
.00 33 00 00	.00077 81982	.00 73 00 00	.00175 47607	.00 B3 00 00	.00273 13232	.00 F3 00 00	.00370 78857
.00 34 00 00	.00079 34570	.00 74 00 00	.00177 00195	.00 B4 00 00	.00274 65820	.00 F4 00 00	.00372 31445
.00 35 00 00	.00080 87158	.00 75 00 00	.00178 52783	.00 B5 00 00	.00276 18408	.00 F5 00 00	.00373 84033
.00 36 00 00	.00082 39746	.00 76 00 00	.00180 05371	.00 B6 00 00	.00277 70996	.00 F6 00 00	.00375 36621
.00 37 00 00	.00083 92333	.00 77 00 00	.00181 57958	.00 B7 00 00	.00279 23583	.00 F7 00 00	.00376 89208
.00 38 00 00	.00085 44921	.00 78 00 00	.00183 10546	.00 B8 00 00	.00280 76171	.00 F8 00 00	.00378 41796
.00 39 00 00	.00086 97509	.00 79 00 00	.00184 63134	.00 B9 00 00	.00282 28759	.00 F9 00 00	.00379 94384
.00 3A 00 00	.00088 50097	.00 7A 00 00	.00186 15722	.00 BA 00 00	.00283 81347	.00 FA 00 00	.00381 46972
.00 3B 00 00	.00090 02685	.00 7B 00 00	.00187 68310	.00 BB 00 00	.00285 33935	.00 FB 00 00	.00382 99560
.00 3C 00 00	.00091 55273	.00 7C 00 00	.00189 20898	.00 BC 00 00	.00286 86523	.00 FC 00 00	.00384 52148
.00 3D 00 00	.00093 07861	.00 7D 00 00	.00190 73486	.00 BD 00 00	.00288 39111	.00 FD 00 00	.00386 04736
.00 3E 00 00	.00094 60449	.00 7E 00 00	.00192 26074	.00 BE 00 00	.00289 91699	.00 FE 00 00	.00387 57324
.00 3F 00 00	.00096 13037	.00 7F 00 00	.00193 78662	.00 BF 00 00	.00291 44287	.00 FF 00 00	.00389 09912

HEXADECIMAL - DECIMAL FRACTION CONVERSION TABLE (cont.)

Hexadecimal	Decimal	Hexadecimal	Decimal	Hexadecimal	Decimal	Hexadecimal	Decimal
.00 00 00 00	.00000 00000	.00 00 40 00	.00000 38146	.00 00 80 00	.00000 76293	.00 00 C0 00	.00001 14440
.00 00 01 00	.00000 00596	.00 00 41 00	.00000 38743	.00 00 81 00	.00000 76889	.00 00 C1 00	.00001 15036
.00 00 02 00	.00000 01192	.00 00 42 00	.00000 39339	.00 00 82 00	.00000 77486	.00 00 C2 00	.00001 15633
.00 00 03 00	.00000 01788	.00 00 43 00	.00000 39935	.00 00 83 00	.00000 78082	.00 00 C3 00	.00001 16229
.00 00 04 00	.00000 02384	.00 00 44 00	.00000 40531	.00 00 84 00	.00000 78678	.00 00 C4 00	.00001 16825
.00 00 05 00	.00000 02980	.00 00 45 00	.00000 41127	.00 00 85 00	.00000 79274	.00 00 C5 00	.00001 17421
.00 00 06 00	.00000 03576	.00 00 46 00	.00000 41723	.00 00 86 00	.00000 79870	.00 00 C6 00	.00001 18017
.00 00 07 00	.00000 04172	.00 00 47 00	.00000 42319	.00 00 87 00	.00000 80466	.00 00 C7 00	.00001 18613
.00 00 08 00	.00000 04768	.00 00 48 00	.00000 42915	.00 00 88 00	.00000 81062	.00 00 C8 00	.00001 19209
.00 00 09 00	.00000 05364	.00 00 49 00	.00000 43511	.00 00 89 00	.00000 81658	.00 00 C9 00	.00001 19805
.00 00 0A 00	.00000 05960	.00 00 4A 00	.00000 44107	.00 00 8A 00	.00000 82254	.00 00 CA 00	.00001 20401
.00 00 0B 00	.00000 06556	.00 00 4B 00	.00000 44703	.00 00 8B 00	.00000 82850	.00 00 CB 00	.00001 20997
.00 00 0C 00	.00000 07152	.00 00 4C 00	.00000 45299	.00 00 8C 00	.00000 83446	.00 00 CC 00	.00001 21593
.00 00 0D 00	.00000 07748	.00 00 4D 00	.00000 45895	.00 00 8D 00	.00000 84042	.00 00 CD 00	.00001 22189
.00 00 0E 00	.00000 08344	.00 00 4E 00	.00000 46491	.00 00 8E 00	.00000 84638	.00 00 CE 00	.00001 22785
.00 00 0F 00	.00000 08940	.00 00 4F 00	.00000 47087	.00 00 8F 00	.00000 85234	.00 00 CF 00	.00001 23381
.00 00 10 00	.00000 09536	.00 00 50 00	.00000 47683	.00 00 90 00	.00000 85830	.00 00 D0 00	.00001 23977
.00 00 11 00	.00000 10132	.00 00 51 00	.00000 48279	.00 00 91 00	.00000 86426	.00 00 D1 00	.00001 24573
.00 00 12 00	.00000 10728	.00 00 52 00	.00000 48875	.00 00 92 00	.00000 87022	.00 00 D2 00	.00001 25169
.00 00 13 00	.00000 11324	.00 00 53 00	.00000 49471	.00 00 93 00	.00000 87618	.00 00 D3 00	.00001 25765
.00 00 14 00	.00000 11920	.00 00 54 00	.00000 50067	.00 00 94 00	.00000 88214	.00 00 D4 00	.00001 26361
.00 00 15 00	.00000 12516	.00 00 55 00	.00000 50663	.00 00 95 00	.00000 88810	.00 00 D5 00	.00001 26957
.00 00 16 00	.00000 13113	.00 00 56 00	.00000 51259	.00 00 96 00	.00000 89406	.00 00 D6 00	.00001 27553
.00 00 17 00	.00000 13709	.00 00 57 00	.00000 51856	.00 00 97 00	.00000 90003	.00 00 D7 00	.00001 28149
.00 00 18 00	.00000 14305	.00 00 58 00	.00000 52452	.00 00 98 00	.00000 90599	.00 00 D8 00	.00001 28746
.00 00 19 00	.00000 14901	.00 00 59 00	.00000 53048	.00 00 99 00	.00000 91195	.00 00 D9 00	.00001 29342
.00 00 1A 00	.00000 15497	.00 00 5A 00	.00000 53644	.00 00 9A 00	.00000 91791	.00 00 DA 00	.00001 29938
.00 00 1B 00	.00000 16093	.00 00 5B 00	.00000 54240	.00 00 9B 00	.00000 92387	.00 00 DB 00	.00001 30534
.00 00 1C 00	.00000 16689	.00 00 5C 00	.00000 54836	.00 00 9C 00	.00000 92983	.00 00 DC 00	.00001 31130
.00 00 1D 00	.00000 17285	.00 00 5D 00	.00000 55432	.00 00 9D 00	.00000 93579	.00 00 DD 00	.00001 31726
.00 00 1E 00	.00000 17881	.00 00 5E 00	.00000 56028	.00 00 9E 00	.00000 94175	.00 00 DE 00	.00001 32322
.00 00 1F 00	.00000 18477	.00 00 5F 00	.00000 56624	.00 00 9F 00	.00000 94771	.00 00 DF 00	.00001 32918
.00 00 20 00	.00000 19073	.00 00 60 00	.00000 57220	.00 00 A0 00	.00000 95367	.00 00 E0 00	.00001 33514
.00 00 21 00	.00000 19669	.00 00 61 00	.00000 57816	.00 00 A1 00	.00000 95963	.00 00 E1 00	.00001 34110
.00 00 22 00	.00000 20265	.00 00 62 00	.00000 58412	.00 00 A2 00	.00000 96559	.00 00 E2 00	.00001 34706
.00 00 23 00	.00000 20861	.00 00 63 00	.00000 59008	.00 00 A3 00	.00000 97155	.00 00 E3 00	.00001 35302
.00 00 24 00	.00000 21457	.00 00 64 00	.00000 59604	.00 00 A4 00	.00000 97751	.00 00 E4 00	.00001 35898
.00 00 25 00	.00000 22053	.00 00 65 00	.00000 60200	.00 00 A5 00	.00000 98347	.00 00 E5 00	.00001 36494
.00 00 26 00	.00000 22649	.00 00 66 00	.00000 60796	.00 00 A6 00	.00000 98943	.00 00 E6 00	.00001 37090
.00 00 27 00	.00000 23245	.00 00 67 00	.00000 61392	.00 00 A7 00	.00000 99539	.00 00 E7 00	.00001 37686
.00 00 28 00	.00000 23841	.00 00 68 00	.00000 61988	.00 00 A8 00	.00001 00135	.00 00 E8 00	.00001 38282
.00 00 29 00	.00000 24437	.00 00 69 00	.00000 62584	.00 00 A9 00	.00001 00731	.00 00 E9 00	.00001 38878
.00 00 2A 00	.00000 25033	.00 00 6A 00	.00000 63180	.00 00 AA 00	.00001 01327	.00 00 EA 00	.00001 39474
.00 00 2B 00	.00000 25629	.00 00 6B 00	.00000 63776	.00 00 AB 00	.00001 01923	.00 00 EB 00	.00001 40070
.00 00 2C 00	.00000 26226	.00 00 6C 00	.00000 64373	.00 00 AC 00	.00001 02519	.00 00 EC 00	.00001 40666
.00 00 2D 00	.00000 26822	.00 00 6D 00	.00000 64969	.00 00 AD 00	.00001 03116	.00 00 ED 00	.00001 41263
.00 00 2E 00	.00000 27418	.00 00 6E 00	.00000 65565	.00 00 AE 00	.00001 03712	.00 00 EE 00	.00001 41859
.00 00 2F 00	.00000 28014	.00 00 6F 00	.00000 66161	.00 00 AF 00	.00001 04308	.00 00 EF 00	.00001 42455
.00 00 30 00	.00000 28610	.00 00 70 00	.00000 66757	.00 00 B0 00	.00001 04904	.00 00 F0 00	.00001 43051
.00 00 31 00	.00000 29206	.00 00 71 00	.00000 67353	.00 00 B1 00	.00001 05500	.00 00 F1 00	.00001 43647
.00 00 32 00	.00000 29802	.00 00 72 00	.00000 67949	.00 00 B2 00	.00001 06096	.00 00 F2 00	.00001 44243
.00 00 33 00	.00000 30398	.00 00 73 00	.00000 68545	.00 00 B3 00	.00001 06692	.00 00 F3 00	.00001 44839
.00 00 34 00	.00000 30994	.00 00 74 00	.00000 69141	.00 00 B4 00	.00001 07288	.00 00 F4 00	.00001 45435
.00 00 35 00	.00000 31590	.00 00 75 00	.00000 69737	.00 00 B5 00	.00001 07884	.00 00 F5 00	.00001 46031
.00 00 36 00	.00000 32186	.00 00 76 00	.00000 70333	.00 00 B6 00	.00001 08480	.00 00 F6 00	.00001 46627
.00 00 37 00	.00000 32782	.00 00 77 00	.00000 70929	.00 00 B7 00	.00001 09076	.00 00 F7 00	.00001 47223
.00 00 38 00	.00000 33378	.00 00 78 00	.00000 71525	.00 00 B8 00	.00001 09672	.00 00 F8 00	.00001 47819
.00 00 39 00	.00000 33974	.00 00 79 00	.00000 72121	.00 00 B9 00	.00001 10268	.00 00 F9 00	.00001 48415
.00 00 3A 00	.00000 34570	.00 00 7A 00	.00000 72717	.00 00 BA 00	.00001 10864	.00 00 FA 00	.00001 49011
.00 00 3B 00	.00000 35166	.00 00 7B 00	.00000 73313	.00 00 BB 00	.00001 11460	.00 00 FB 00	.00001 49607
.00 00 3C 00	.00000 35762	.00 00 7C 00	.00000 73909	.00 00 BC 00	.00001 12056	.00 00 FC 00	.00001 50203
.00 00 3D 00	.00000 36358	.00 00 7D 00	.00000 74505	.00 00 BD 00	.00001 12652	.00 00 FD 00	.00001 50799
.00 00 3E 00	.00000 36954	.00 00 7E 00	.00000 75101	.00 00 BE 00	.00001 13248	.00 00 FE 00	.00001 51395
.00 00 3F 00	.00000 37550	.00 00 7F 00	.00000 75697	.00 00 BF 00	.00001 13844	.00 00 FF 00	.00001 51991

HEXADECIMAL - DECIMAL FRACTION CONVERSION TABLE (cont.)

Hexadecimal	Decimal	Hexadecimal	Decimal	Hexadecimal	Decimal	Hexadecimal	Decimal
.00 00 00 00	.00000 00000	.00 00 00 40	.00000 00149	.00 00 00 80	.00000 00298	.00 00 00 C0	.00000 00447
.00 00 00 01	.00000 00002	.00 00 00 41	.00000 00151	.00 00 00 81	.00000 00300	.00 00 00 C1	.00000 00449
.00 00 00 02	.00000 00004	.00 00 00 42	.00000 00153	.00 00 00 82	.00000 00302	.00 00 00 C2	.00000 00451
.00 00 00 03	.00000 00006	.00 00 00 43	.00000 00155	.00 00 00 83	.00000 00305	.00 00 00 C3	.00000 00454
.00 00 00 04	.00000 00009	.00 00 00 44	.00000 00158	.00 00 00 84	.00000 00307	.00 00 00 C4	.00000 00456
.00 00 00 05	.00000 00011	.00 00 00 45	.00000 00160	.00 00 00 85	.00000 00309	.00 00 00 C5	.00000 00458
.00 00 00 06	.00000 00013	.00 00 00 46	.00000 00162	.00 00 00 86	.00000 00311	.00 00 00 C6	.00000 00461
.00 00 00 07	.00000 00016	.00 00 00 47	.00000 00165	.00 00 00 87	.00000 00314	.00 00 00 C7	.00000 00463
.00 00 00 08	.00000 00018	.00 00 00 48	.00000 00167	.00 00 00 88	.00000 00316	.00 00 00 C8	.00000 00465
.00 00 00 09	.00000 00020	.00 00 00 49	.00000 00169	.00 00 00 89	.00000 00318	.00 00 00 C9	.00000 00467
.00 00 00 0A	.00000 00023	.00 00 00 4A	.00000 00172	.00 00 00 8A	.00000 00321	.00 00 00 CA	.00000 00470
.00 00 00 0B	.00000 00025	.00 00 00 4B	.00000 00174	.00 00 00 8B	.00000 00323	.00 00 00 CB	.00000 00472
.00 00 00 0C	.00000 00027	.00 00 00 4C	.00000 00176	.00 00 00 8C	.00000 00325	.00 00 00 CC	.00000 00474
.00 00 00 0D	.00000 00030	.00 00 00 4D	.00000 00179	.00 00 00 8D	.00000 00328	.00 00 00 CD	.00000 00477
.00 00 00 0E	.00000 00032	.00 00 00 4E	.00000 00181	.00 00 00 8E	.00000 00330	.00 00 00 CE	.00000 00479
.00 00 00 0F	.00000 00034	.00 00 00 4F	.00000 00183	.00 00 00 8F	.00000 00332	.00 00 00 CF	.00000 00481
.00 00 00 10	.00000 00037	.00 00 00 50	.00000 00186	.00 00 00 90	.00000 00335	.00 00 00 D0	.00000 00484
.00 00 00 11	.00000 00039	.00 00 00 51	.00000 00188	.00 00 00 91	.00000 00337	.00 00 00 D1	.00000 00486
.00 00 00 12	.00000 00041	.00 00 00 52	.00000 00190	.00 00 00 92	.00000 00339	.00 00 00 D2	.00000 00488
.00 00 00 13	.00000 00044	.00 00 00 53	.00000 00193	.00 00 00 93	.00000 00342	.00 00 00 D3	.00000 00491
.00 00 00 14	.00000 00046	.00 00 00 54	.00000 00195	.00 00 00 94	.00000 00344	.00 00 00 D4	.00000 00493
.00 00 00 15	.00000 00048	.00 00 00 55	.00000 00197	.00 00 00 95	.00000 00346	.00 00 00 D5	.00000 00495
.00 00 00 16	.00000 00051	.00 00 00 56	.00000 00200	.00 00 00 96	.00000 00349	.00 00 00 D6	.00000 00498
.00 00 00 17	.00000 00053	.00 00 00 57	.00000 00202	.00 00 00 97	.00000 00351	.00 00 00 D7	.00000 00500
.00 00 00 18	.00000 00055	.00 00 00 58	.00000 00204	.00 00 00 98	.00000 00353	.00 00 00 D8	.00000 00502
.00 00 00 19	.00000 00058	.00 00 00 59	.00000 00207	.00 00 00 99	.00000 00356	.00 00 00 D9	.00000 00505
.00 00 00 1A	.00000 00060	.00 00 00 5A	.00000 00209	.00 00 00 9A	.00000 00358	.00 00 00 DA	.00000 00507
.00 00 00 1B	.00000 00062	.00 00 00 5B	.00000 00211	.00 00 00 9B	.00000 00360	.00 00 00 DB	.00000 00509
.00 00 00 1C	.00000 00065	.00 00 00 5C	.00000 00214	.00 00 00 9C	.00000 00363	.00 00 00 DC	.00000 00512
.00 00 00 1D	.00000 00067	.00 00 00 5D	.00000 00216	.00 00 00 9D	.00000 00365	.00 00 00 DD	.00000 00514
.00 00 00 1E	.00000 00069	.00 00 00 5E	.00000 00218	.00 00 00 9E	.00000 00367	.00 00 00 DE	.00000 00516
.00 00 00 1F	.00000 00072	.00 00 00 5F	.00000 00221	.00 00 00 9F	.00000 00370	.00 00 00 DF	.00000 00519
.00 00 00 20	.00000 00074	.00 00 00 60	.00000 00223	.00 00 00 A0	.00000 00372	.00 00 00 E0	.00000 00521
.00 00 00 21	.00000 00076	.00 00 00 61	.00000 00225	.00 00 00 A1	.00000 00374	.00 00 00 E1	.00000 00523
.00 00 00 22	.00000 00079	.00 00 00 62	.00000 00228	.00 00 00 A2	.00000 00377	.00 00 00 E2	.00000 00526
.00 00 00 23	.00000 00081	.00 00 00 63	.00000 00230	.00 00 00 A3	.00000 00379	.00 00 00 E3	.00000 00528
.00 00 00 24	.00000 00083	.00 00 00 64	.00000 00232	.00 00 00 A4	.00000 00381	.00 00 00 E4	.00000 00530
.00 00 00 25	.00000 00086	.00 00 00 65	.00000 00235	.00 00 00 A5	.00000 00384	.00 00 00 E5	.00000 00533
.00 00 00 26	.00000 00088	.00 00 00 66	.00000 00237	.00 00 00 A6	.00000 00386	.00 00 00 E6	.00000 00535
.00 00 00 27	.00000 00090	.00 00 00 67	.00000 00239	.00 00 00 A7	.00000 00388	.00 00 00 E7	.00000 00537
.00 00 00 28	.00000 00093	.00 00 00 68	.00000 00242	.00 00 00 A8	.00000 00391	.00 00 00 E8	.00000 00540
.00 00 00 29	.00000 00095	.00 00 00 69	.00000 00244	.00 00 00 A9	.00000 00393	.00 00 00 E9	.00000 00542
.00 00 00 2A	.00000 00097	.00 00 00 6A	.00000 00246	.00 00 00 AA	.00000 00395	.00 00 00 EA	.00000 00544
.00 00 00 2B	.00000 00100	.00 00 00 6B	.00000 00249	.00 00 00 AB	.00000 00398	.00 00 00 EB	.00000 00547
.00 00 00 2C	.00000 00102	.00 00 00 6C	.00000 00251	.00 00 00 AC	.00000 00400	.00 00 00 EC	.00000 00549
.00 00 00 2D	.00000 00104	.00 00 00 6D	.00000 00253	.00 00 00 AD	.00000 00402	.00 00 00 ED	.00000 00551
.00 00 00 2E	.00000 00107	.00 00 00 6E	.00000 00256	.00 00 00 AE	.00000 00405	.00 00 00 EE	.00000 00554
.00 00 00 2F	.00000 00109	.00 00 00 6F	.00000 00258	.00 00 00 AF	.00000 00407	.00 00 00 EF	.00000 00556
.00 00 00 30	.00000 00111	.00 00 00 70	.00000 00260	.00 00 00 B0	.00000 00409	.00 00 00 F0	.00000 00558
.00 00 00 31	.00000 00114	.00 00 00 71	.00000 00263	.00 00 00 B1	.00000 00412	.00 00 00 F1	.00000 00561
.00 00 00 32	.00000 00116	.00 00 00 72	.00000 00265	.00 00 00 B2	.00000 00414	.00 00 00 F2	.00000 00563
.00 00 00 33	.00000 00118	.00 00 00 73	.00000 00267	.00 00 00 B3	.00000 00416	.00 00 00 F3	.00000 00565
.00 00 00 34	.00000 00121	.00 00 00 74	.00000 00270	.00 00 00 B4	.00000 00419	.00 00 00 F4	.00000 00568
.00 00 00 35	.00000 00123	.00 00 00 75	.00000 00272	.00 00 00 B5	.00000 00421	.00 00 00 F5	.00000 00570
.00 00 00 36	.00000 00125	.00 00 00 76	.00000 00274	.00 00 00 B6	.00000 00423	.00 00 00 F6	.00000 00572
.00 00 00 37	.00000 00128	.00 00 00 77	.00000 00277	.00 00 00 B7	.00000 00426	.00 00 00 F7	.00000 00575
.00 00 00 38	.00000 00130	.00 00 00 78	.00000 00279	.00 00 00 B8	.00000 00428	.00 00 00 F8	.00000 00577
.00 00 00 39	.00000 00132	.00 00 00 79	.00000 00281	.00 00 00 B9	.00000 00430	.00 00 00 F9	.00000 00579
.00 00 00 3A	.00000 00135	.00 00 00 7A	.00000 00284	.00 00 00 BA	.00000 00433	.00 00 00 FA	.00000 00582
.00 00 00 3B	.00000 00137	.00 00 00 7B	.00000 00286	.00 00 00 BB	.00000 00435	.00 00 00 FB	.00000 00584
.00 00 00 3C	.00000 00139	.00 00 00 7C	.00000 00288	.00 00 00 BC	.00000 00437	.00 00 00 FC	.00000 00586
.00 00 00 3D	.00000 00142	.00 00 00 7D	.00000 00291	.00 00 00 BD	.00000 00440	.00 00 00 FD	.00000 00589
.00 00 00 3E	.00000 00144	.00 00 00 7E	.00000 00293	.00 00 00 BE	.00000 00442	.00 00 00 FE	.00000 00591
.00 00 00 3F	.00000 00146	.00 00 00 7F	.00000 00295	.00 00 00 BF	.00000 00444	.00 00 00 FF	.00000 00593



TABLE OF POWERS OF TWO

MATHEMATICAL CONSTANTS

$2^n$	$n$	$2^{-n}$
1	0	1.0
2	1	0.5
4	2	0.25
8	3	0.125
16	4	0.062 5
32	5	0.031 25
64	6	0.015 625
128	7	0.007 812 5
256	8	0.003 906 25
512	9	0.001 953 125
1 024	10	0.000 976 562 5
2 048	11	0.000 488 281 25
4 096	12	0.000 244 140 625
8 192	13	0.000 122 070 312 5
16 384	14	0.000 061 035 156 25
32 768	15	0.000 030 517 578 125
65 536	16	0.000 015 258 789 062 5
131 072	17	0.000 007 629 394 531 25
262 144	18	0.000 003 814 697 265 625
524 288	19	0.000 001 907 348 632 812 5
1 048 576	20	0.000 000 953 674 316 406 25
2 097 152	21	0.000 000 476 837 158 203 125
4 194 304	22	0.000 000 238 418 579 101 562 5
8 388 608	23	0.000 000 119 209 289 550 781 25
16 777 216	24	0.000 000 059 604 644 775 390 625
33 554 432	25	0.000 000 029 802 322 387 695 312 5
67 108 864	26	0.000 000 014 901 161 193 847 656 25
134 217 728	27	0.000 000 007 450 580 596 923 828 125
268 435 456	28	0.000 000 003 725 290 298 461 914 062 5
536 870 912	29	0.000 000 001 862 645 149 230 957 031 25
1 073 741 824	30	0.000 000 000 931 322 574 615 478 515 625
2 147 483 648	31	0.000 000 000 465 661 287 307 739 257 812 5
4 294 967 296	32	0.000 000 000 232 830 643 653 869 628 906 25
8 589 934 592	33	0.000 000 000 116 415 321 826 934 814 453 125
17 179 869 184	34	0.000 000 000 058 207 660 913 467 407 226 562 5
34 359 738 368	35	0.000 000 000 029 103 830 456 733 703 613 281 25
68 719 476 736	36	0.000 000 000 014 551 915 228 366 851 806 640 625
137 438 953 472	37	0.000 000 000 007 275 957 614 183 425 903 320 312 5
274 877 906 944	38	0.000 000 000 003 637 978 807 091 712 951 660 156 25
549 755 813 888	39	0.000 000 000 001 818 989 403 545 856 475 830 078 125
1 099 511 627 776	40	0.000 000 000 000 909 494 701 772 928 237 915 039 062 5
2 199 023 255 552	41	0.000 000 000 000 454 747 350 886 464 118 957 519 531 25
4 398 046 511 104	42	0.000 000 000 000 227 373 675 443 232 059 478 759 765 625
8 796 093 022 208	43	0.000 000 000 000 113 686 837 721 616 029 739 379 882 812 5
17 592 186 044 416	44	0.000 000 000 000 056 843 418 860 808 014 869 689 941 406 25
35 184 372 088 832	45	0.000 000 000 000 028 421 709 430 404 007 434 844 970 703 125
70 368 744 177 664	46	0.000 000 000 000 014 210 854 715 202 003 717 422 485 351 562 5
140 737 488 355 328	47	0.000 000 000 000 007 105 427 357 601 001 858 711 242 675 781 25
281 474 976 710 656	48	0.000 000 000 000 003 552 713 678 800 500 929 355 621 337 890 625
562 949 953 421 312	49	0.000 000 000 000 001 776 356 839 400 250 464 677 810 668 945 312 5
1 125 899 906 842 624	50	0.000 000 000 000 000 888 178 419 700 125 232 338 905 334 472 656 25
2 251 799 813 685 248	51	0.000 000 000 000 000 444 089 209 850 062 616 169 452 667 236 328 125
4 503 599 627 370 496	52	0.000 000 000 000 000 222 044 604 925 031 308 084 726 333 618 164 062 5
9 007 199 254 740 992	53	0.000 000 000 000 000 111 022 302 462 515 654 042 363 166 809 082 031 25
18 014 398 509 481 984	54	0.000 000 000 000 000 055 511 151 231 257 827 021 181 583 404 541 015 625
36 028 797 018 963 968	55	0.000 000 000 000 000 027 755 575 615 628 913 510 590 791 702 270 507 812 5
72 057 594 037 927 936	56	0.000 000 000 000 000 013 877 787 807 814 456 755 295 395 851 135 253 906 25
144 115 188 075 855 872	57	0.000 000 000 000 000 006 938 893 903 907 228 377 647 697 925 567 626 953 125
288 230 376 151 711 744	58	0.000 000 000 000 000 003 469 446 951 953 614 188 823 848 962 783 813 476 562 5
576 460 752 303 423 488	59	0.000 000 000 000 000 001 734 723 475 976 807 094 411 924 481 391 906 738 281 25
1 152 921 504 606 846 976	60	0.000 000 000 000 000 000 867 361 737 988 403 547 205 962 240 695 953 369 140 625
2 305 843 009 213 693 952	61	0.000 000 000 000 000 000 433 680 868 994 201 773 602 981 120 347 976 684 570 312 5
4 611 686 018 427 387 904	62	0.000 000 000 000 000 000 216 840 434 497 100 886 801 490 560 173 988 342 285 156 25
9 223 372 036 854 775 808	63	0.000 000 000 000 000 000 108 420 217 248 550 443 400 745 280 086 994 171 142 578 125

Constant	Decimal Value	Hexadecimal Value
$\pi$	3.14159 26535 89793	3.243F 6A89
$\pi^{-1}$	0.31830 98861 83790	0.517C C187
$\sqrt{\pi}$	1.77245 38509 05516	1.C58F 891C
$\ln \pi$	1.14472 98858 49400	1.250D 048F
$e$	2.71828 18284 59045	2.87E1 5163
$e^{-1}$	0.36787 94411 71442	0.5E2D 58D9
$\sqrt{e}$	1.64872 12707 00128	1.A612 98E2
$\log_{10} e$	0.43429 44819 03252	0.6F2D EC55
$\log_2 e$	1.44269 50408 88963	1.7154 7653
$\gamma$	0.57721 56649 01533	0.93C4 67E4
$\ln \gamma$	-0.54953 93129 81645	-0.8CAE 98C1
$\sqrt{2}$	1.41421 35623 73095	1.6A09 E668
$\ln 2$	0.69314 71805 59945	0.8172 17F8
$\log_{10} 2$	0.30102 99956 63981	0.4D10 4D42
$\sqrt{10}$	3.16227 76601 68379	3.2988 075C
$\ln 10$	2.30258 40929 94046	2.4D76 3777

# APPENDIX B. SIGMA 8 INSTRUCTION LIST

<u>Mnemonic</u>	<u>Code</u>	<u>Instruction Name</u>	<u>Page</u>	<u>Mnemonic</u>	<u>Code</u>	<u>Instruction Name</u>	<u>Page</u>
<u>LOAD/STORE</u>				<u>SHIFT</u>			
LI	22	Load Immediate	36	S	25	Shift	58
LB	72	Load Byte	36	SF	24	Shift Floating	60
LH	52	Load Halfword	36	<u>CONVERSION</u>			
LW	32	Load Word	36	CVA	29	Convert by Addition	61
LD	12	Load Doubleword	37	CVS	28	Convert by Subtraction	62
LCH	5A	Load Complement Halfword	37	<u>FLOATING-POINT ARITHMETIC</u>			
LAH	5B	Load Absolute Halfword	37	FAS	3D	Floating Add Short	66
LCW	3A	Load Complement Word	37	FAL	1D	Floating Add Long	66
LAW	3B	Load Absolute Word	38	FSS	3C	Floating Subtract Short	66
LCD	1A	Load Complement Doubleword	38	FSL	1C	Floating Subtract Long	66
LAD	1B	Load Absolute Doubleword	39	FMS	3F	Floating Multiply Short	66
LRA	2C	Load Real Address	39	FML	1F	Floating Multiply Long	66
LAS	26	Load and Set	40	FDS	3E	Floating Divide Short	67
LMS	2D	Load Memory Status	40	FDL	1E	Floating Divide Long	67
LS	4A	Load Selective	42	<u>BYTE STRING</u>			
LM	2A	Load Multiple	43	MBS	61	Move Byte String	69
LCFI	02	Load Conditions and Floating Control Immediate	43	CBS	60	Compare Byte String	69
LCF	70	Load Conditions and Floating Control	44	TBS	41	Translate Byte String	70
XW	46	Exchange Word	44	TTBS	40	Translate and Test Byte String	71
STB	75	Store Byte	44	<u>PUSH DOWN</u>			
STH	55	Store Halfword	44	PSW	09	Push Word	73
STW	35	Store Word	44	PLW	08	Pull Word	74
STD	15	Store Doubleword	45	PSM	0B	Push Multiple	74
STS	47	Store Selective	45	PLM	0A	Pull Multiple	75
STM	2B	Store Multiple	45	MSP	13	Modify Stack Pointer	76
STCF	74	Store Conditions and Floating Control	45	<u>EXECUTE/BRANCH</u>			
<u>ANALYZE/INTERPRET</u>				<u>CALL</u>			
ANLZ	44	Analyze	46	CAL1	04	Call 1	79
INT	6B	Interpret	47	CAL2	05	Call 2	79
<u>FIXED-POINT ARITHMETIC</u>				<u>CONTROL</u>			
AI	20	Add Immediate	48	LPSD	0E	Load Program Status Doubleword	80
AH	50	Add Halfword	49	XPSD	0F	Exchange Program Status Doubleword	81
AW	30	Add Word	49	LRP	2F	Load Register Pointer	83
AD	10	Add Doubleword	49	MMC	6F	Move to Memory Control	83
SH	58	Subtract Halfword	50	WAIT	2E	Wait	84
SW	38	Subtract Word	50	RD	6C	Read Direct	85
SD	18	Subtract Doubleword	50	WD	6D	Write Direct	86
MI	23	Multiply Immediate	51	<u>INPUT/OUTPUT</u>			
MH	57	Multiply Halfword	51	SIO	4C	Start Input/Output	90
MW	37	Multiply Word	52	TIO	4D	Test Input/Output	94
DH	56	Divide Halfword	52	TDV	4E	Test Device	95
DW	36	Divide Word	52	HIO	4F	Halt Input/Output	95
AWM	66	Add Word to Memory	53	RIO	4F	Reset Input/Output	96
MTB	73	Modify and Test Byte	53	POLP	4F	Poll Processor	96
MTH	53	Modify and Test Halfword	53	POLR	4F	Poll and Reset Processor	97
MTW	33	Modify and Test Word	54	AIO	6E	Acknowledge Input/Output Interrupt	97
<u>COMPARISON</u>				<u>LOGICAL</u>			
CI	21	Compare Immediate	55	OR	49	OR Word	57
CB	71	Compare Byte	55	EOR	48	Exclusive OR Word	57
CH	51	Compare Halfword	55	AND	4B	AND Word	57
CW	31	Compare Word	56				
CD	11	Compare Doubleword	56				
CS	45	Compare Selective	56				
CLR	39	Compare with Limits in Register	56				
CLM	19	Compare with Limits in Memory	57				

# APPENDIX C. INSTRUCTION TIMING

## TIMING CONSIDERATIONS

Because of SIGMA 8's complexity, simple timing formulas cannot exactly express central processor operations. Timings and formulas in this section are a reasonable approximation of actual SIGMA 8 performance, taking all factors into consideration. However, system performance can be established using benchmark programs under actual operating system environments.

All times are based on the assumption that, whenever the CPU requests a service cycle from a particular memory bank, it never waits for such service due to other devices (such as IOPs), which are connected to that memory bank.

Execution times depend not only on the nature of the specific instructions but also on the configuration of memory banks in the system, and the placement of instructions and operands in memory. Basic timing information is summarized in Table C-1. Execution times for instructions assume the most common conditions that the user can expect to encounter in his program. These basic execution times must be increased to account for the effects of memory interference, indexing, and indirect addressing. These effects are discussed in the following paragraphs.

## EFFECTS OF MEMORY INTERFERENCE

Memory interference will affect central processor speed, which varies with the memory cycle time, the number of memory banks capable of running in parallel, and the function being executed. Interference is minimized by interleaving memory banks to allow maximum memory overlap.

In a typical instruction mix used in scientific/engineering applications, the percentages of the instructions executed might be as follows:

Type of Instruction	Percent
Floating-point	8.5
Fixed-point (including loads and stores)	53.0
Branch	27.5
Miscellaneous	11.0

The effect of memory interference on the above instruction mix in an 8-bank system for 100 instructions is an increase of approximately 7.4 microseconds or an average of 74 nanoseconds per instruction. With a minimum memory configuration (two memory banks of 8K words each), the effect of memory interference increases to an average of 290 nanoseconds per instruction.

## EFFECTS OF INDEXING

Indexing causes a maximum increase of 260 nanoseconds in the execution time of an instruction. Many instructions are limited in speed due to memory access time. Indexing is often performed in conjunction with memory accesses. This overlapping of indexing with memory time allows the effective time due to indexing to be 260 nanoseconds less the memory overlap time. For a typical scientific mix of instructions, the average memory overlap is 120 nanoseconds. The typical indexing time would then be 140 nanoseconds.

## EFFECTS OF INDIRECT ADDRESSING

Indirect addressing requires a memory access. This access may be from the general registers or main memory.

1. Indirect addressing from general registers requires a maximum time of 960 nanoseconds.
2. Indirect addressing from main memory requires a maximum time of 1.050 microseconds.

The maximum time required for indirect addressing is reduced when the indirect memory request is overlapped with instruction execution. This effect is instruction dependent.

## EFFECTS OF REGISTER-TO-REGISTER OPERATIONS

If the reference address is X'0' through X'F', the operand is accessed from the appropriate general register rather than from main memory. The additional time required for this operation varies from 155 to 445 nanoseconds, depending on the sequence of instructions being executed.

The major factors determining the additional time required for register-to-register operations are the type of instruction (multiple operands versus single-operand instructions) being executed and the type of instruction preceding the instruction in question.

For multiple operand type of instructions (Multiples, Push/Pulls, Byte Strings, etc.), the average delay for operands other than the first of the string is approximately 260 nanoseconds for load-type instructions and 155 nanoseconds for store-type instructions.

For all initial operands pointed to by the effective address of the instruction, the delay due to register-to-register operations is dependent on the preceding instruction as follows:

1. If the preceding instruction is generally greater than 1 microsecond, then the typical delay is 445 nanoseconds.
2. If the preceding instruction is generally less than 1 microsecond, then the typical delay is 235 nanoseconds.

Table C-1. Basic Instruction Timing

Instruction Mnemonic	Time ( $\mu\text{sec}$ )	Notes
AD	1.66	
AH	.73	
AI	.73	
AIO	$6.78 + D$	$R \neq 0$ . Includes 3 $\mu\text{sec}$ to claim the processor bus. $D$ = turnaround time on the interface.
AIO	$5.96 + D$	$R = 0$ . Includes 3 $\mu\text{sec}$ to claim the processor bus. $D$ = turnaround time on the interface.
AND	.73	
ANLZ	$3.34 + P$	$P$ = Time required for address preparation (indexing and/or indirect).
AW	.73	
AWM	1.77	
BAL	.9	
BCR	.81	Branch
BCR	1.63	No Branch
BCS	.81	Branch
BCS	1.63	No Branch
BDR	1.10	Branch
BDR	1.63	No Branch
BIR	1.1	Branch
BIR	1.63	No Branch
CAL1-4	1.98	
CB	.81	
CBS	$4.3 + .6N$	$N$ = number of destination bytes processed.
CD	1.4	
CH	.81	
CI	.80	
CLM	1.4	

Table C-1. Basic Instruction Timing (cont.)

Instruction Mnemonic	Time ( $\mu$ sec)	Notes
CLR	.92	
CS	1.33	
CVA	$8.57 + .6N$	N = number of 1's in the word converted.
CVS	<b>27.43</b>	
CW	.81	
DH	9.5	
DW	9.5	
EOR	.73	
EXU	1.2	Add execution time for subject instruction.

Table C-1. Basic Instruction Timing (con)

Instruction Mnemonic	Time ( $\mu$ sec)	Notes
FAL	2.9 (min)	No prealignment or postnormalization required.
FAL	3.35 (typical)	One hexadecimal prealignment and one hexadecimal postnormalization.
FAL	9.82 (max)	Unnormalized operands.
FAS	2.05 (min)	No prealignment or postnormalization required.
FAS	2.54 (typical)	One hexadecimal prealignment and one hexadecimal postnormalization.
FAS	5.33 (max)	Unnormalized operands.
FDL	17.46 (min)	Nonzero, normalized operands. Minimum time is also typical time.
FDL	24.58 (max)	Unnormalized operands.
FDS	7.69 (min)	Nonzero, normalized operands. Minimum time is also typical time.
FDS	10.86 (max)	Unnormalized operands.
FML	6.27 (min)	Nonzero, normalized operands. Minimum time is also typical time.
FML	10.83 (max)	Unnormalized operands.
FMS	3.32 (min)	Nonzero, normalized operands. Minimum time is also typical time.
FMS	6.12 (max)	Unnormalized operands.
FSL	2.9 (min)	No prealignment or postnormalization required.
FSL	3.35 (typical)	One hexadecimal prealignment and one hexadecimal postnormalization.

Table C-1. Basic Instruction Timing (cont.)

Instruction Mnemonic	Time ( $\mu\text{sec}$ )	Notes
FSL	9.82 (max)	Unnormalized operands.
FSS	2.05 (min)	No prealignment or postnormalization required.
FSS	2.54 (typical)	One hexadecimal prealignment and one hexadecimal postnormalization.
FSS	5.33 (max)	Unnormalized operands.
HIO	$7.37 + D$	R = even, $\neq 0$ . Includes 3 $\mu\text{sec}$ to claim the processor bus. D = turnaround time on the interface.
HIO	$6.78 + D$	R = odd. Includes 3 $\mu\text{sec}$ to claim the processor bus. D = turnaround time on the interface.
HIO	$5.96 + D$	R = 0. Includes 3 $\mu\text{sec}$ to claim the processor bus. D = turnaround time on the interface.
INT	.73 .75	R = odd. R = even.
LAD	1.66	
LAH	.81	
LAS	1.94	
LAW	.73	
LB	.73	
LCD	1.66	

Table C-1. Basic Instruction Timing ( )

Instruction Mnemonic	Time ( $\mu\text{sec}$ )	Notes
LCF	.73	
LCFI	.73	
LCH	.73	
LCW	.73	
LD	1.58	
LH	.73	
LI	.73	
LM	$2.8 + .8N$	N = number of words moved.
LMS	1.94	
LPSD	3.63	
LRA	1.06	
LRP	.73	
LS	.99	
LW	.73	
MBS	$3.4 + .6N$	N = number of destination bytes processed regardless of word or byte boundaries.
MH	2.44	
MI	3.32	
MMC	$3.42 + 2.51N$	N = number of words moved.
MSP	4.75	
MTB	1.77	



T C-1. Basic Instruction Timing (cont.)

Instruction Mnemonic	Time ( $\mu\text{sec}$ )	Notes
MTH	1.77	
MTW	1.77	
MW	3.32	
OR	.73	
PLM	$7.75 + .39N$	N = number of words moved.
PLW	6.03	
PSM	$7.32 + .65N$	N = number of words moved.
PSW	5.86	
RD	1.41	Internal
RD	$2.07 + .24N$	External N = integer (0, 1, 2, ...), dependent on delay in external device.
S (left)	$1.5 + .06N$	N = number of bit positions shifted.
S (right)	$1.6 + .06N$	N = number of bit positions shifted.
S (searching left)	$2.9 + .06N$	N = number of bit positions shifted.
S (searching right)	$2.7 + .12N$	N = number of bit positions shifted.
SD	1.66	
SF (left)	$2.0 + .23N$	Single N = number of hexadecimal positions shifted.

Table C-1. Basic Instruction Timing (con)

Instruction Mnemonic	Time ( $\mu\text{sec}$ )	Notes
SF (left)	$2.1 + .23N$	Double. N = number of hexadecimal positions shifted.
SF (right)	$2.5 + .23N$	Single. N = number of hexadecimal positions shifted.
SF (right)	$2.6 + .23N$	Double. N = number of hexadecimal positions shifted.
SH	.73	
SIO	$7.37 + D$	R = even, $\neq 0$ . Includes 3 $\mu\text{sec}$ to claim the processor bus. D = turnaround time on the interface.
SIO	$6.78 + D$	R = odd. Includes 3 $\mu\text{sec}$ to claim the processor bus. D = turnaround time on the interface.
SIO	$5.96 + D$	R = 0. Includes 3 $\mu\text{sec}$ to claim the processor bus. D = turnaround time on the interface.
STB	1.77	
STCF	1.77	
STD	2.42	
STH	1.77	
STM	$2.1 + .65N$	N = number of words moved.
STS	1.81	

Table C-1. Basic Instruction Timing (cont.)

Instruction Mnemonic	Time ( $\mu\text{sec}$ )	Notes
STW	1.77	
SW	.73	
TBS	$5.9 + 2.25N$	$N$ = number of destination bytes processed.
TDV	$7.37 + D$	$R$ = even, $\neq 0$ . Includes 3 $\mu\text{sec}$ to claim the processor bus. $D$ = turnaround time on the interface.
TDV	$6.78 + D$	$R$ = odd. Includes 3 $\mu\text{sec}$ to claim the processor bus. $D$ = turnaround time on the interface.
TDV	$5.96 + D$	$R = 0$ . Includes 3 $\mu\text{sec}$ to claim the processor bus. $D$ = turnaround time on the interface.
TIO	$7.37 + D$	$R$ = even, $\neq 0$ . Includes 3 $\mu\text{sec}$ to claim the processor bus. $D$ = turnaround time on the interface.
TIO	$6.78 + D$	$R$ = odd. Includes 3 $\mu\text{sec}$ to claim the processor bus. $D$ = turnaround time on the interface.
TIO	$5.96 + D$	$R = 0$ . Includes 3 $\mu\text{sec}$ to claim the processor bus. $D$ = turnaround time on the interface.
TTBS	$13 + 1.9N$	$N$ = number of destination bytes processed.

Table C-1. Basic Instruction Timing ( )

Instruction Mnemonic	Time ( $\mu\text{sec}$ )	Notes
WAIT	.73	Minimum time.
WD	1.41	Internal
WD	$2.07 + .24N$	External N = integer (0, 1, 2, ...), dependent on delay in external device.
XPSD	5.43	
XW	1.77	

## APPENDIX D. SYSTEM RELIABILITY AND MAINTAINABILITY

The SIGMA 8 computer system has many new design features that provide the user with reliable operation and efficient maintenance. For example, the extent to which a system can be partitioned into separate units for either checkout or maintenance is a "fail-soft" feature (i.e., ability to keep remainder of a system operational in case of failure of any given unit), which was a major design goal for SIGMA 8 development.

The new design features are outlined in the following sections:

System Maintainability Features

CPU Features

Main Memory Features

Multiplexor Input/Output Processor Features

High-Speed RAD I/O Processor Features

### SYSTEM MAINTAINABILITY FEATURES

SIGMA 8 computer systems are maintained by means of the following:

#### 1. Diagnostic Programs

Diagnostic programs for centralized SIGMA 8 units (CPUs, memory units, and IOPs) use built-in hardware features to detect and isolate system faults. Interface with maintenance personnel is simplified and is provided through a local keyboard-printer or a remote keyboard printer connected via a telephone line. Diagnostic programs are designed with a multilevel structure consisting of the following capabilities.

- a. System verification and testing to determine which unit is faulty.
- b. Unit functional testing to determine the specific function that is faulty.
- c. Fault location diagnosis to analyze which component is malfunctioning.

#### 2. Snapshot Logic

Snapshot logic enables diagnostic programs to retrieve control flip-flops and internal register contents that are not otherwise "visible" to a program. This feature makes it possible to determine system status at the time a fault occurs and to locate the source of a fault condition down to the level of a small set of replaceable elements. (See "CPU Features".)

#### 3. Status and Fault Retrieval

When a fault is detected, system status and fault information is available for program retrieval and error logging for subsequent analysis.

#### 4. Partitioning Feature

A SIGMA 8 system can be reconfigured through the use of reconfiguration controls. SIGMA 8 units can be partitioned out of the system by selectively disabling them from the busses. Thus, faulty units can be isolated from the system, or an entire subsystem (including a CPU in a multiprocessing environment) can be partitioned from the primary system to permit diagnosis and repair of a faulty unit. Repaired units can be returned to service by reenabling the connections. A set of reconfiguration control panels are centrally located to accomplish this function.

#### 5. RESET I/O (RIO) Instruction

This instruction provides programmed I/O Reset that operates exactly as though the I/O Reset had been initiated with the switch on the processor control panel (PCP). The addressed IOP and all peripheral devices connected to it are initialized. Special coding of RIO will reset a CPU. (See RIO instruction, Chapter 3.)

#### 6. Parity Checking

Parity on all data and addresses communicated in either direction on busses between memory units and processors (CPUs, MIOPs, and HSRIOPs) is checked. This feature provides fault detection and location capabilities that enhance the ability of an operating system or diagnostic program to quickly determine which unit is faulty.

#### 7. Clock and Voltage Margins

Centralized units are provided with clock and voltage margin capabilities that assist maintenance personnel or diagnostic programs to quickly locate the source of an intermittent fault. Programmable clock margin control is provided and status is available for program retrieval. NOT NORMAL conditions are indicated on the PCP.

#### 8. Alternate Processor Bus (optional)

This feature provides a redundant connection of the IOPs and CPUs in a system. It is used in partitioning centralized units for diagnostic or reconfiguration purposes.

## 9. Unique Processor Numbers

All processors have unique numbers so that they can be identified in communications on the processor bus.

## 10. Processor Fault Interrupt

A processor fault interrupt (PFI) signal is generated by processors (CPUs, MIOPs, and HSRIOPs) when certain fault conditions are detected. The interrupt signal is transmitted via the processor bus to all CPUs in the system (except to the CPU generating the PFI) for special fault handling.

## 11. Status Instructions

The two instructions, POLL PROCESSOR (POLP) and POLL AND RESET PROCESSOR (POLR), are used to determine status. All processors in a SIGMA 8 system retain the status of faults, internal conditions, and processor identification. When a Processor Fault Interrupt (PFI) occurs, the CPU(s) that receive the interrupt must determine which processor caused the PFI and the nature of the fault.

The POLP instruction causes the addressed processor to return the contents of its fault status register and, in the condition code bits, indicate whether the processor had detected a fault and generated PFI. (See POLP instruction, Chapter 3.)

The POLR instruction performs the same functions as POLP but, in addition, causes the addressed processor to reset the contents of the processor fault register and reset the PFI signal. (See POLR instruction, Chapter 3.)

## CPU FEATURES

### 1. Processor Control Panel (PCP)

The PCP (see Chapter 5) is divided into two sections. The upper portion (MAINTENANCE SECTION) contains controls and indicators used exclusively by maintenance personnel. The lower portion is used primarily by operating personnel to load, execute, and troubleshoot programs. A Control Mode switch disables certain maintenance functions during normal operation.

### 2. Maintenance Display

Various phases, control flip-flops, and registers of the CPU and decimal unit can be displayed on the PCP. A 16-position thumbwheel switch identifies and selects display information during maintenance activities.

### 3. Snapshot Logic

All CPU logic that can be displayed on the PCP can be monitored by a program with the snapshot logic. At a

preselected clock time of a given instruction execution, selected logic is stored into a 32-bit snapshot register. The contents of the snapshot register are then retrieved by a specially coded READ DIRECT instruction. By comparing the "snapped" information with known correct information, the diagnostic program can accurately determine a specific fault. The failing component can then be identified. Snapshot action can also be initiated at the PCP, and the contents of the snapshot register displayed.

### 4. Clock and Voltage Margins

Clock margin control is accomplished manually at the PCP with the **CLOCK MARGIN** switch or under program control with a properly coded WRITE DIRECT instruction. Three clock rates are provided:

- NORMAL
- FAST
- SLOW

Voltage margin controls are also provided at each local d. c. power supply within a unit.

### 5. Memory Clear and Scan

Manual memory clear and scan capabilities are provided to enable operators or maintenance personnel to rapidly clear or read selected data from, or store selected data into, any or all consecutive CPU main memory locations. During the read scan operation, the CPU can be made to halt on a memory parity error, at which time the address and data of the indicated memory location can be displayed.

### 6. Address Stop Feature

This feature allows the operator or maintenance personnel to:

- a. Stop on any instruction whose address equals the SELECT ADDRESS switch value. At the time of the halt, the instruction pointed to by the SELECT ADDRESS appears in the DISPLAY indicators.
- b. Stop on any memory reference indicated by the SELECT ADDRESS switch.
- c. Stop when any word in a selected page is referenced.

### 7. Manual I/O Instruction Execution

The PCP allows manual execution of READ/WRITE DIRECT instructions while the CPU is in the idle mode. This feature is in addition to the programmable interrogation provided via the READ/WRITE DIRECT instructions (see Chapter 3). Thus, all devices connected to

the direct I/O or maintenance interface may be examined manually by maintenance personnel.

## 8. Single Clock Mode

The CPU has a single clock mode of operation that enables maintenance personnel to execute an instruction from the PCP, one internal phase at a time.

## 9. W. D. Timer Override

The operation of the watchdog timer can be selectively overridden to aid maintenance personnel in diagnosing related machine faults (see Chapter 5).

## 10. CPU Traps

CPU traps are provided for a variety of detected CPU and system fault conditions. The trap system (see Chapter 2) provides a high degree of system recoverability. Indicators and audit trails enable the system programmer to accurately determine the status of the machine at the time of the trap. CPU fault conditions are:

- a. **Memory Parity Error** — When a CPU receives a signal from the memory indicating a memory parity error, the CPU traps. The condition code identifies the memory parity error trap condition.
- b. **Data Bus Check** — If the CPU detects a parity error on data received from memory, and the memory does not also indicate a parity error on the information sent, then a data bus check occurs. Likewise, the data bus check occurs if the memory indicates a parity error, but the CPU does not detect the parity error on the information received. Occurrence of the data bus check condition causes the CPU to trap.
- c. **Watch Dog Timer** — The watch dog timer prevents the CPU from being "hung up" due to internal faults or faults in other units. When the timer times out, the CPU traps and sets the condition code indicating which fault has occurred.
- d. **Instruction Exceptions** — If a CPU encounters an illegal condition in certain CPU operations, an instruction exception fault is detected and causes a trap. Included as instruction exceptions are:
  - A processor-detected fault occurring during the execution of an interrupt or trap entry sequence.

- An illegal instruction in a trap (not XPSD) or interrupt (not XPSD, MTB, MTH, MTW) location when operating a trap or interrupt sequence.
- The setting of the register pointer of the PSD to a nonexistent register block as a result of an LRP, LPSD, or XPSD.
- An illegal MOVE MEMORY CONTROL (MMC) instruction.
- An invalid register (odd) for an instruction (doubleword and byte string) that would yield an unpredictable result.

## 11. Processor Fault Interrupt

Whenever a CPU fault is detected, a Processor Detected Fault (PDF) flag is set in that CPU. If a second fault is detected (with PDF set), the CPU will generate and transmit the Processor Fault Interrupt (PFI) to any other CPUs in the system and enter a WAIT state that requires a Reset function to clear. Another CPU (in a multiprocessor system) may issue an RIO instruction to the malfunctioning CPU, which will clear the machine (in the same way as a CPU RESET or SYS RESET would), and cause it to resume execution at a predetermined instruction location. For a monoprocessor, operator action is required.

## 12. Automatic Instruction Fetch Retry

When fault conditions are detected on overlapped instruction fetch operations, the fetch is aborted and an automatic instruction fetch retry is attempted. If the fault recurs on the second attempt, the CPU traps in the normal manner.

## 13. Partitioning Feature

Various partitioning features in the SIGMA 8 CPU enable system reconfiguration. These features are locally controlled by switches and are readable by specially coded READ DIRECT instructions (see Chapter 3).

- a. **Homespace bias switches** enable placing the Home-space for each CPU in different physical locations of memory (see "Homespace", Chapter 2).
- b. **CPU-IOP control bus selection** is provided for the purpose of switching the CPU from primary to alternate processor busses. Thus, a failed CPU may be effectively partitioned out of the system; also, an entire subsystem consisting of an IOP, including attached peripherals, CPU, and memory unit can be partitioned from the primary system via this switch and the memory port disable switches, to allow diagnosis of any unit in the subsystem while the primary system continues operation.

- c. The direct I/O bus and maintenance interface bus may be selectively disabled from the CPU.

## MAIN MEMORY FEATURES

### 1. Snapshot Logic

Each memory bank contains snapshot logic that is automatically activated when a memory fault occurs to record the nature and environment of the fault. The contents of the memory snapshot words (each 32 bits in size) can be retrieved by the use of the instruction, LOAD MEMORY STATUS (see Chapter 3). This feature may be used by the operating system for error logging, or by a diagnostic program to assist in fault locating. Notification of a fault occurrence is via the Memory Fault Interrupt.

### 2. Memory Fault Detection

Memory fault detection covers the following types of faults:

- a. Parity errors detected on information read out of the memory bank.
- b. Parity errors detected on addresses received from processors.
- c. Parity errors detected on data received from processors.
- d. Port selection errors detected if more than one port is simultaneously selected for one bank. Under this condition, the memory aborts the requested operation without modifying the contents of any memory location.
- e. Memory bank operational status, e.g., overtemperature, d.c. voltages out of tolerance, etc.
- f. Data loop checks that provide additional fault detection on read operations. As data is gated onto the memory bus for transmission to a processor, it is also gated from the bus back through the input path, clocked into a register, and checked for parity. Thus, the integrity of the line drivers/receivers at the memory is tested on every read cycle.

### 3. Memory Interleave Switch

The interleaved mode of memory operation may be disabled for certain diagnostic purposes with a switch located on the PCP (see Chapter 5).

### 4. Clock Margin Switches

Clock margins are controlled manually by means of switches or by use of the LOAD MEMORY STATUS instruction. Voltage margin control is also provided at each local d.c. power supply within a unit.

### 5. Partitioning of Memory

Partitioning of memory units is allowed on a memory port basis where each memory bus connection may selectively be disabled. Starting address switches allow the memory system to remain a contiguous unit after partitioning. A centrally located reconfiguration control panel for each memory unit is provided for this purpose.

### 6. Memory Mode Feature

Two additional memory modes of operation are provided for testing memory units. These modes are called Read and Inhibit Parity and Read and Change Parity (see Chapter 3).

- a. During the Read and Inhibit Parity operation, a word is read from memory and transmitted to the requesting processor. If a parity error is detected in the memory bank, the memory is prohibited from taking any snapshot and does not generate the Memory Fault Interrupt. It does transmit the Parity Error signal, however. The CPU recognizes this mode of operation and inhibits the trap that might occur for memory parity error and data bus check and, instead, records these attributes in the condition code at the conclusion of the instruction. If there is no parity error, the instruction is treated as a normal LOAD WORD instruction, except for the setting of the condition code.
- b. During the Read and Change Parity operation, a word is read from memory and transmitted to the requesting processor. In the write half cycle, the word is restored to memory, and the word with an invalid parity bit is unconditionally restored. This allows the parity generation and checking logic of the memory to be tested.

## MULTIPLEXOR INPUT/OUTPUT PROCESSOR (MIOP) FEATURES

### 1. Maintenance Interface Bus

The maintenance interface bus (a special mode of the direct I/O bus) is connected to each MIOP from the CPU for maintenance purposes. The MIOP responds in the following way to special WRITE DIRECT and READ DIRECT instructions executed by the CPU.

- a. Under RD control, monitors one of 32 selectable groups of MIOP logic.
- b. Under WD control, steps the clock control of the MIOP in a single-phase mode.
- c. Under WD control, a snapshot mode of operation selects a display group and stores it in a snapshot register at the end of a preset countdown for later monitoring by an RD instruction.



- d. Under WD control, writes directly into an addressed subchannel.
- e. Under RD control, reads directly from an addressed subchannel.
- f. Under WD control, sets the clock margins to fast, normal, or slow rates.

## 2. Parity Checking

Parity is checked on information brought out of the MIOP's local memory for each subchannel. A fault is reported to the system via the Processor Fault Interrupt.

## 3. Maintenance Subcontroller

A maintenance subcontroller feature on each I/O channel assists in diagnosing the I/O system. A diagnostic program controls and monitors the maintenance subcontroller via the maintenance interface and the I/O bus. The following functions can be accomplished:

- a. Simulation of a device controller that responds to commands sent to it by the MIOP and receives and sends strings of data bytes.
- b. Monitoring of IOP bus during diagnostic operations.
- c. Exercising of the IOP at variable rates up to and including its maximum rate.
- d. Self-testing of the maintenance subcontroller logic.

## 4. Clock and Voltage Margins

Clock margins are programmatically controlled by a specially coded WRITE DIRECT instruction (see Chapter 3). Voltage margin controls are provided at each d. c. power supply.

## 5. Partitioning of MIOPs

Partitioning of MIOPs is accomplished by disabling the primary (or alternate) processor bus connection and disabling the appropriate memory port(s). A centrally located reconfiguration control panel is provided for this purpose.

## HIGH-SPEED RAD I/O PROCESSOR (HSRIOP) FEATURES

### 1. Maintenance Interface Bus

The maintenance interface bus (a special mode of the direct I/O bus) is connected to the HSRIOP from the CPU for maintenance purposes. The HSRIOP responds

in the following ways to special WRITE DIRECT and READ DIRECT instructions executed by the CPU:

- a. Under WD control, selects a phase that causes the HSRIOP to halt when entered during execution of any HSRIOP operation. At this time, the HSRIOP may be "snapped" for diagnostic purposes, via RD control.
- b. Under RD control, "snaps" one of seven selectable groups of internal HSRIOP logic.
- c. Under WD control, steps the clock control of the HSRIOP in a single-phase mode.
- d. Under WD control, selectively sets various fault indicators (e.g., device and memory faults) to simulate actual fault occurrence. This feature allows the diagnostic to test for correct HSRIOP response under these fault conditions.
- e. Under WD control, selectively initiates one of two test modes of the HSRIOP in which the HSRIOP responds to normal I/O instructions while simulating action of the storage units. In this way, major portions of the HSRIOP logic can be diagnosed separately from the storage units.

### 2. Test Mode 1.

This is called the "short loop" test and is initiated via maintenance interface WD action. In this test mode, the HSRIOP responds to Write and Read I/O commands. Data is transferred from memory into the data buffer and sent back to memory. The memory interface, data buffer, and control logic are checked in Test Mode 1.

### 3. Test Mode 2

This is called the "long loop" test and is initiated via maintenance interface WD action. In this test mode, the HSRIOP responds to Write and Read I/O commands. Data is transferred from memory through the data buffer, through the deskew logic, and then back to memory via the data buffer again. Assuming the "short loop" test was successful, the deskew logic is specifically checked in Test Mode 2.

### 4. Clock and Voltage Margins

Clock margins for the HSRIOP are not applicable because of its unique design. Voltage margin controls are provided at each local d. c. power supply.

### 5. Partitioning of HSRIOPs

Partitioning of HSRIOPs is accomplished by disabling the primary (or alternate) processor bus connection and inhibiting the appropriate memory port(s). A centrally located reconfiguration control panel is provided for this purpose.

## APPENDIX E. GLOSSARY OF SYMBOL TERMS

Term	Meaning	Term	Meaning
( )	Contents of.	EBL	Effective byte location – byte location pointed to by effective address of an instruction for byte operation.
n	AND (logical product, where $0 \wedge 0 = 0$ , $0 \wedge 1 = 0$ , $1 \wedge 0 = 0$ , and $1 \wedge 1 = 1$ ).	ED	Effective doubleword – 64-bit contents of effective doubleword location (EDL).
u	OR (logical inclusive OR, where $0 \vee 0 = 0$ , $0 \vee 1 = 1$ , $1 \vee 0 = 1$ , and $1 \vee 1 = 1$ ).	EDL	Effective doubleword location – doubleword location pointed to by effective address of an instruction for a doubleword operation. If odd-numbered word location is specified, low-order bit of effective address field (bit position 31) is automatically forced to 0. Hence, odd-numbered word address (referring to middle of doubleword) designates same doubleword as even-numbered word address when used for a doubleword operation.
⊕	EOR (logical exclusive OR, where $0 \oplus 0 = 0$ , $0 \oplus 1 = 1$ , $1 \oplus 0 = 1$ , and $1 \oplus 1 = 0$ ).	EH	Effective halfword – 16-bit contents of effective halfword location, or (EHL).
AM	Fixed-point arithmetic trap mask – bit position 11 of PSD. If set (=1), computer traps to Homespace location X'43' after executing an instruction causing fixed-point overflow; if not set, computer does not trap.	EHL	Effective halfword location – halfword location pointed to by effective address of an instruction for halfword operation.
CC	Condition code – 4-bit value (bit positions labeled CC1, CC2, CC3, and CC4), established as part of the execution of most SIGMA 8 instructions.	EI	External interrupt group inhibit – bit position 39 of PSD. If set (=1), all interrupt levels within this group are inhibited.
CI	Counter interrupt group inhibit – bit position 37 of PSD. If set (=1), all interrupt levels within this group are inhibited.	ESA	Effective source address – in byte string instructions, address of the source byte string.
DA	Destination address – in byte string instructions, address of the destination byte string.	EW	Effective word – 32-bit contents of effective word location (EWL).
DBS	Destination byte string – operand specified by byte string instruction.	EWL	Effective word location – word location pointed to by effective address of an instruction for a word operation.
EA	Effective address – address value obtained as result of indirect addressing and/or indexing.	FN	Floating normalize mode control – bit position 7 of PSD. If not set, results of floating-point additions and subtractions are to be normalized; if set (=1), results are not normalized.
EB	Effective byte – 8-bit contents of effective byte location (EBL).		

Term	Meaning	Term	Meaning
FS	Floating significance mode control – bit position 5 of PSD. If set (=1), computer traps to location X'44' when more than two hexadecimal places of postnormalization shifting are required for a floating-point addition or subtraction; if not set, no significance checking is performed.	RA (cont)	main memory in address range 16 through 131,071. This address value is initial address value for any subsequent address computations.
FZ	Floating zero mode control – bit position 6 of the PSD. If set (=1), computer traps to location X'44' when either characteristic underflow or zero result occurs for a floating-point multiplication or division; if not set, characteristic underflow and zero result are treated as normal conditions.	RP	Register pointer – bit positions 56–59 of PSD; bits 58 and 59 select one of four possible register blocks; bits 56 and 57 are reserved.
I	Instruction register – internal CPU register that holds instructions obtained from memory while they are being decoded.	Ru1	Odd register address value – register Ru1 is general register pointed to by value obtained by logically ORing 0001 into address for register R. Thus, if R field of instruction contains even value, $Ru1 = R + 1$ and if R field contains odd value, $Ru1 = R$ .
IA	Instruction address – 17-bit value that defines address of instruction immediately prior to the time that it is executed.	SA	Source address – in byte string instructions, contents of specified R register.
II	I/O interrupt group inhibit – bit position 38 of the PSD. If set (=1), all interrupt levels within this group are inhibited.	SBS	Source byte string – operand specified by byte string instruction.
MS	Master/slave mode control – bit position 8 of PSD. When set (=1), computer is in slave mode; when not set, computer is in master mode.	SE	Sign extension – some instructions operate on two operands of different lengths; they are made equal in length by extending sign of shorter operand by required number of bit positions. For positive operands, result of sign extension is high-order 0's prefixed to the operand; for negative operands, high-order 1's are prefixed to operand. Sign extension process is performed after operand accessed from memory and before operation called for by instruction code is performed.
PSD	Program status doubleword – collection of separate registers and flip-flops treated as a 64-bit internal CPU register to store and display critical control information.	SPD	Stack pointer doubleword – contains the context (TSA, space count, word count, and TS, TW inhibit bits) of the push-down instructions.
R	General register address value – 4-bit contents of bit positions 8–11 (R field) of instruction word, also expressed symbolically as (1)8–11. In instruction descriptions, register R is general register (of current register block) that corresponds to R field address value.	TCC	Trap condition code – 4-bit value (bit positions labeled TCC1, TCC2, TCC3, and TCC4), established as part of trap operations.
RA	Reference address – contents of bit positions 15–31 of instruction word, a 17-bit field capable of directly addressing any general register in current register block (by using a value in range 0–15) or any word in	TS	Trap-on-space inhibit bit – conditions push-down stack limit trap for impending overflow or underflow of space count.
		TSA	Top-of-stack address – pointer that points to highest-numbered address of operand stack in push-down instructions.

Term	Meaning	Term	Meaning
TW	Trap-on-word inhibit bit – conditions push-down stack limit trap for impending overflow or underflow of word count.	X (cont)	word. In instruction word, if $X = 0$ , no indexing is performed; if $X \neq 0$ , indexing is performed (after indirect addressing if indirect addressing is called for) with general register X in current register block.
WK	Write key – bit positions 34 and 35 of PSD; they are evaluated by the memory write-protect feature to determine accessibility of memory by current program.	X'n'	Hexadecimal qualifier – hexadecimal value (n) is unsigned string of hexadecimal digits (0 through 9 and A through F) surrounded by single quotation marks and preceded by the qualifier "X" (for example, $7B0_{16}$ is written X'7B0'.
X	Index register address value – 3-bit contents of bit positions 12-14 (X field) of instruction		

# XDS SIGMA 3 INSTRUCTION LIST (MNEMONIC)

Mnemonic	Code	Instruction Name	Page	Mnemonic	Code	Instruction Name	Page
AD	10	Add Doubleword	49	LCW	3A	Load Complement Word	37
AH	50	Add Halfword	49	LD	12	Load Doubleword	37
AI	20	Add Immediate	48	LH	52	Load Halfword	36
AIO	6E	Acknowledge Input/Output Interrupt	97	LI	22	Load Immediate	36
AND	48	AND Word	57	LM	2A	Load Multiple	43
ANLZ	44	Analyze	46	LMS	2D	Load Memory Status	40
AW	30	Add Word	49	LPSD	0E	Load Program Status Doubleword	80
AWM	66	Add Word to Memory	53	LRA	2C	Load Real Address	39
				LRP	2F	Load Register Pointer	83
BAL	6A	Branch and Link	79	LS	4A	Load Selective	42
BCR	68	Branch on Conditions Reset	78	LW	32	Load Word	36
BCS	69	Branch on Conditions Set	78				
BDR	64	Branch on Decrementing Register	78	MBS	61	Move Byte String	69
BIR	65	Branch on Incrementing Register	78	MH	57	Multiply Halfword	51
				MI	23	Multiply Immediate	51
CAL1	04	Call 1	79	MMC	6F	Move to Memory Control	83
CAL2	05	Call 2	79	MSP	13	Modify Stack Pointer	76
CAL3	06	Call 3	79	MTB	73	Modify and Test Byte	53
CAL4	07	Call 4	80	MTH	53	Modify and Test Halfword	53
CB	71	Compare Byte	55	MTW	33	Modify and Test Word	54
CBS	60	Compare Byte String	69	MW	37	Multiply Word	52
CD	11	Compare Doubleword	56				
CH	51	Compare Halfword	55	OR	49	OR Word	57
CI	21	Compare Immediate	55				
CLM	19	Compare with Limits in Memory	57				
CLR	39	Compare with Limits in Register	56	PLM	0A	Pull Multiple	75
CS	45	Compare Selective	56	PLW	08	Pull Word	74
CVA	29	Convert by Addition	61	PO LP	4F	Poll Processor	96
CVS	28	Convert by Subtraction	62	PO LR	4F	Poll and Reset Processor	97
CW	31	Compare Word	56	PSM	0B	Push Multiple	74
				PSW	09	Push Word	73
DH	56	Divide Halfword	52				
DW	36	Divide Word	52	RD	6C	Read Direct	85
				RIO	4F	Reset Input/Output	96
EOR	48	Exclusive OR Word	57	S	25	Shift	58
EXU	67	Execute	77	SD	18	Subtract Doubleword	50
				SF	24	Shift Floating	60
FAL	1D	Floating Add Long	66	SH	58	Subtract Halfword	50
FAS	3D	Floating Add Short	66	SIO	4C	Start Input/Output	90
FDL	1E	Floating Divide Long	67	STB	75	Store Byte	44
FDS	3E	Floating Divide Short	67	STCF	74	Store Conditions and Floating Control	45
FML	1F	Floating Multiply Long	66	STD	15	Store Doubleword	45
FMS	3F	Floating Multiply Short	66	STH	55	Store Halfword	44
FSL	1C	Floating Subtract Long	66	STM	28	Store Multiple	45
FSS	3C	Floating Subtract Short	66	STS	47	Store Selective	45
				STW	35	Store Word	44
HIO	4F	Halt Input/Output	95	SW	38	Subtract Word	50
INT	68	Interpret	47	TBS	41	Translate Byte String	70
				TDV	4E	Test Device	95
LAD	18	Load Absolute Doubleword	39	TIO	4D	Test Input/Output	94
LAH	5B	Load Absolute Halfword	37	TTBS	40	Translate and Test Byte String	71
LAS	26	Load and Set	40				
LAW	38	Load Absolute Word	38	WAIT	2E	Wait	84
LB	72	Load Byte	36	WD	6D	Write Direct	86
LCD	1A	Load Complement Doubleword	38				
LCF	70	Load Conditions and Floating Control	44	XPSD	0F	Exchange Program Status Doubleword	81
LCFI	02	Load Conditions and Floating Control Immediate	43	XW	46	Exchange Word	44
LCH	5A	Load Complement Halfword	37				

No DECIMAL INSTRUCTIONS