



INNOVATION, PERFORMANCE AND COMMITMENT SINCE 1953

A central image shows a wooden clipboard with a silver clip at the top. A white sheet of paper is attached to the clipboard, featuring a handwritten quote in blue ink. To the left of the clipboard is a white soccer ball with black panels. Below the soccer ball is a red and white American football. To the right of the clipboard is a white baseball with red stitching. Further to the right is a large orange basketball with black lines. A silver whistle with a black strap is hanging from the left side of the clipboard. The background is a textured, light-colored surface with blue and green watercolor-like washes.

*"Set your goals high,  
and don't stop  
till you get there."*

*- Bo Jackson*

2015

ALL SPORTS



TAKE THIS CATALOG WITH YOU





**The NOVA World Cup Anchor is the ideal style for your Soccer program. All surface friendly, long lasting and will fit any goal! page 31**



**Jaypro has the solution for leaning or rusted systems, our Hoop Rejuvenator Kits will save time, effort and money! pages 74-75**



**Stop chasing the ball on those missed shots, check out our Portable Field Netting and other "FieldPro" Field Netting Systems. pages 97-99**





We ensure High Quality Sports Equipment for Years of Use!

DESIGN

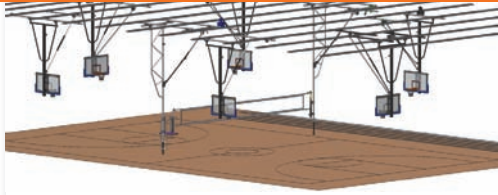

ENGINEERING



MANUFACTURING



At Jaypro Sports, we make it easy for Facility Planners to design sports equipment into their Facility with our new Architect and Specification Center located at [www.JayproSpecs.com](http://www.JayproSpecs.com).

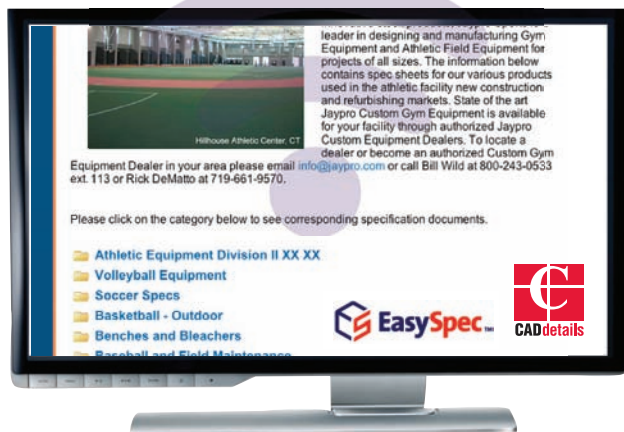

Don't see what you're looking for in our catalog? Or need information on custom products? Contact Jaypro Customer Service at 800-243-0533.

	<b>FEATURED PRODUCTS</b> . . . . . 2-3
	<i>New and Innovative products featuring Team Pink</i>
	<b>Volleyball</b> . . . . . 4-17
	<i>Indoor &amp; Outdoor Systems, Floor Sleeves, Nets, Referee Stands &amp; Training Equipment</i>
	<b>Soccer</b> . . . . . 18-37
	<i>Goals, Indoor/Outdoor, Youth, Nets, Rebounders, Anchors, Post Pads &amp; Combo Goals</i>
	<b>Football</b> . . . . . 38-44
	<i>Goal Posts, Post Pads, Shoulder Pad &amp; Helmet Carts, Training Aids, Field &amp; Turf Accessories</i>
	<b>Field Hockey/Lacrosse</b> . . . . . 45-47
	<i>Official Goals, Practice Goals, Folding Goals and Nets</i>
	<b>Baseball</b> . . . . . 48-66
	<i>Batting Cages, Pitching Screens, Field Mats &amp; Covers, Bases, Mounds, Drags &amp; Foul Poles</i>
	<b>Field Marking</b> . . . . . 67-69
	<i>Dry, Wet &amp; Combo Markers, Line Layout &amp; Marking Systems</i>
	<b>Scoreboards &amp; Sports Training</b> . . . 70-71
	<i>Scoreboards &amp; Sports Training Machines</i>
	<b>Basketball</b> . . . . . 72-83
	<i>Outdoor Units, Hoop Rejuvenator, Padding, Backboards, Goals &amp; Edge Padding</i>
	<b>Indoor Gymnasium</b> . . . . . 84-95
	<i>Portables, Wall Mounted Backstops, Safety Strap, Winches, Height Adjusters, Curtains &amp; Wall Pads</i>
	<b>Outdoor Field</b> . . . . . 96-99
	<i>Ultimate Athletic Field &amp; Field Netting</i>
	<b>Benches and Bleachers</b> . . . . . 100-107
	<i>Bleachers, Scorers Table &amp; Players Benches</i>
	<b>Ball Storage</b> . . . . . 108-111
	<i>Ball Carriers &amp; Carts</i>
	<b>P.E., Recreation</b> . . . . . 112-117
	<i>P.E. Equipment, Backboard Adapter, Game Standards &amp; Tetherball</i>
	<b>Tennis, Index and Terms</b> . . . . . 118-120
	<i>Posts, Nets, &amp; Tennis Bench, Index, Terms &amp; Conditions</i>





NEW

VOLLEYBALL SOCCER FOOTBALL LACROSSE BASEBALL FIELD MARKING SCOREBOARD BASKETBALL GYMNASIUM FIELD SEATING BALL STORAGE PHYS. ED. TENNIS



**Football Helmet Storage Cart;**  
PAGE 42



**World Cup Anchor Cart;** PAGE 31



**Soccer Net Clips;**  
PAGE 32



**Football Kicking Cage;** PAGE 44



**Field ID Numbers;**  
PAGES 33 & 47



**Wide-Body Ball Carts;**  
PAGE 110



**Mini Top Roll Curtain;** PAGE 85



**Scoreboards;** PAGE 70

**Sports Attack Training;**  
PAGE 71



**FieldPro Discus Cage;** PAGE 99



**Volleyball Court Line;**  
PAGE 17





# Jaypro's Team Pink Program



FUNDING RESEARCH TO FIND A CURE

Jaypro Sports is proud to introduce the Team Pink Program which will help support the Terri Brodeur Breast Cancer Foundation. A portion of the proceeds from sales will benefit the TBBCF. This Foundation is a, 501 (c) (3) non-profit organization and is dedicated to fighting this devastating disease. This Foundation is different from other breast cancer foundations in that **100%** of the gross fundraising dollars goes directly to breast cancer research. Please visit [www.tbbcf.org](http://www.tbbcf.org) for more information or to donate to this very worthy cause!



Upright Pads, PAGES 13 & 14  
Net Tape, PAGE 11



LadyPro Carbon  
PAGE 8

**Dress up your Volleyball System with our Pink Upright Pads and the Team Pink Net Tape. Purchase the LadyPro Carbon Volleyball System and a portion will be donated to the Terri Brodeur Breast Cancer Foundation.**



Sit in comfort on these  
bright Plank Pads PAGE 104



Powdercoat PINK  
any Bench or  
Bleacher PAGES 100-107



Football Post  
Pads in Pink  
PAGE 41



Add a little  
"Pink" to your  
Soccer Goal  
with sand bags  
and net clips  
PAGES 31-32



Show your  
Spirit with a  
new and  
exciting Edge  
Pad color  
PAGE 81

NEW VOLLEYBALL SOCCER FOOTBALL LACROSSE BASEBALL FIELD MARKING SCOREBOARD BASKETBALL GYMNASIUM FIELD SEATING BALL STORAGE PHYS. ED. TENNIS



Jaypro has taken the guesswork out of ordering additional accessories for our best selling systems.

Choose the package that fits your programs needs and save!

**FREE LETTERING**  
on  
Upright Padding  
System  
Packages  
(PVL-39)

Deluxe Featherlite Package Shown (PVB-5PKGDX)

## PATENTED FLEX NET

Don't have a Jaypro system but want the benefits of the Flex Net?

No Problem...

The Flex Net will adapt to most existing system uprights!



**Spend Time Setting Up Your Shot, Not Your Net!**

- ✓ Quick Set-Up
- ✓ Easy to Use
- ✓ Superb Net Tension
- ✓ No Extra Cables or Straps

See Page 10 for details...

All Recreational and Multi-Purpose Game Standards can be found in the Physical Education section on pages 112-115!







## Standard Powerlite System Package

### Package includes:

Powerlite International Net System  
 (PVB-7000 or PVB-6500, page 6)  
 Folding Referee Stand (VRS-6000) and Padding  
 (VRS-60P, page 14)  
 Single Net Keeper (VNK11, page 11)  
 Hammock Drill Cart (HSVBC24, page 15)  
 Cable/Buckle Covers (VCC-12, page 13)  
**Plus... FREE LETTERING on Upright Padding, a \$318 value!!!**

**PVB-7PKG** 3-1/2" **\$4,239 package**  
 (price if purchased separately \$5,104)

**PVB-6PKG** 3" **\$4,339 package**  
 (price if purchased separately \$5,204)

**A SAVINGS OF \$865**

## Deluxe Powerlite System Package

### Package includes:

Powerlite International Net System  
 (PVB-7000 or PVB-6500, page 6)  
 Folding Referee Stand (VRS-6000) and Padding (VRS-60P, page 14)  
 Single Net Keeper (VNK11, page 11)  
 Hammock Drill Cart (HSVBC24, page 15)  
 Cable/Buckle Covers (VCC-12, page 13)  
 Volleyball Equipment Carrier (EC-500, page 15)  
 The Spiker (TS612, page 16)  
**Plus... FREE LETTERING on Upright Padding, a \$318 value!!!**

**PVB-7PKGDX** 3-1/2" **\$4,739 package**  
 (price if purchased separately \$5,672)

**PVB-6PKGDX** 3" **\$4,839 package**  
 (price if purchased separately \$5,772)

**A SAVINGS OF \$933**

## Standard Featherlite System Package

### Package includes:

Featherlite Collegiate Net System  
 (PVB-5000 or PVB-4500, page 7)  
 Folding Referee Stand (VRS-6000) and Padding  
 (VRS-60P, page 14)  
 Single Net Keeper (VNK11, page 11)  
 Hammock Drill Cart (HSVBC24, page 15)  
 Cable/Buckle Covers (VCC-12, page 13)  
**Plus... FREE LETTERING on Upright Padding, a \$318 value!!!**

**PVB-5PKG** 3-1/2" **\$3,599 package**  
 (price if purchased separately \$4,344)

**PVB-4PKG** 3" **\$3,699 package**  
 (price if purchased separately \$4,444)

**A SAVINGS OF \$745**

## Deluxe Featherlite System Package

### Package includes:

Featherlite Collegiate Net System  
 (PVB-5000 or PVB-4500, page 7)  
 Folding Referee Stand (VRS-6000) and Padding (VRS-60P, page 14)  
 Single Net Keeper (VNK11, page 11)  
 Hammock Drill Cart (HSVBC24, page 15)  
 Cable/Buckle Covers (VCC-12, page 13)  
 Volleyball Equipment Carrier (EC-500, page 15)  
 The Spiker (TS612, page 16)  
**Plus... FREE LETTERING on Upright Padding, a \$318 value!!!**

**PVB-5PKGDX** 3-1/2" **\$4,069 package**  
 (price if purchased separately \$4,912)

**PVB-4PKGDX** 3" **\$4,169 package**  
 (price if purchased separately \$5,012)

**A SAVINGS OF \$843**



# #1 Selling Volleyball with our Pate

## Industry Best Infinite Height Adjustment

### Powerlite International Net System for 3-1/2"

Simply the best world class volleyball net system available today! Designed for International, Collegiate and Advanced High School Level. Lightweight aluminum uprights with Infinite Height Adjustment range from 6' 6" to 8' 2". Uprights are designed to fit 3-1/2" diameter sleeves. Look on page 12 for measuring instructions. All competition systems meet NCAA, NFHS and USVBA specifications and come with a **10 Year Limited Warranty on the uprights**. **Center package includes:** center pole with winch, patented Flex net and upright padding, which can be purchased in addition to these systems for a two-court set-up!

<b>PVB-7000</b>	Complete System	116 lbs.	<b>\$3,389</b>
<b>PVB-70U</b>	Upright Only (includes winch)	82 lbs.	<b>\$2,469</b>
<b>PVBC-700</b>	Center Package	62 lbs.	<b>\$2,369</b>

### Powerlite International Net System for 3"

Same as the PVB-7000 system except the uprights have a factory installed adapter. Uprights are designed to fit 3" diameter sleeves.

<b>PVB-6500</b>	Complete System	117 lbs.	<b>\$3,489</b>
<b>PVB-65U</b>	Upright Only (includes winch)	83 lbs.	<b>\$2,569</b>
<b>PVBC-650</b>	Center Package	63 lbs.	<b>\$2,469</b>

**48 HOUR  
QUICK SHIP**

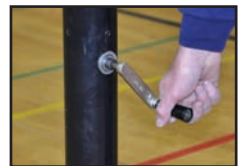

### System Features:



**Patented Flex Net**



**Recessed Polymer  
Pulley Wheel**



**Worm Drive Winch**



**Powder Coated  
Tough Finish**





# System in America nted Flex Net!



## Industry Best Pin Stop Height Adjustment

### Featherlite Collegiate Net System for 3-1/2"

The most affordable, high performance, all aluminum net system available today! Designed for Collegiate and High School Level. Lightweight aluminum uprights with 16 Pin Stop Height Adjustment range from 6' 6" to 8' 2". Uprights are designed to fit 3-1/2" diameter sleeves. Look on page 12 for measuring instructions. **Center package includes:** center pole with winch, patented Flex net and upright padding, which can be purchased in addition to these systems for a two-court set-up!

**Best Seller!**

**48 HOURS QUICK SHIP**

<b>PVB-5000</b>	Complete System	104 lbs.	<b>\$2,629</b>
<b>PVB-51U</b>	Upright Only (includes winch)	70 lbs.	<b>\$1,759</b>
<b>PVBC-500</b>	Center Package	60 lbs.	<b>\$1,659</b>



### Featherlite Collegiate Net System for 3"

Same as the PVB-5000 system except the uprights have a factory installed adapter. Uprights are designed to fit 3" diameter sleeves.

<b>PVB-4500</b>	Complete System	105 lbs.	<b>\$2,729</b>
<b>PVB-45U</b>	Upright Only (includes winch)	71 lbs.	<b>\$1,859</b>
<b>PVBC-450</b>	Center Package	56 lbs.	<b>\$1,759</b>



### Complete System Includes:



**Uprights with Worm Drive Winch**



**Patented Flex Net**  
See page 10



**Upright Padding**  
See page 13 for pad color



**Antennae**  
See page 11

### Floor Sleeve Info, see page 12



**PVB-70S**

### Folding Referee Stand Info, see page 14



**VRS-6000**



NEW VOLLEYBALL SOCCER FOOTBALL LACROSSE BASEBALL FIELD MARKING SCOREBOARD BASKETBALL GYMNASIUM FIELD SEATING BALL STORAGE PHYS. ED. TENNIS



PVB-8000

## LadyPro Carbon Women's Volleyball System Carbon Ultralite Telescoping Volleyball System

Jaypro's new top of the line, carbon volleyball systems include the only all carbon uprights on the market. Fabricated from state-of-the-art carbon composite material, specially wound to offer the rigidity of steel yet significantly lighter in weight than aluminum. Available in 3" or 3-1/2" diameter and fixed women's height of 7'-4-1/8" or our new telescoping option with a height adjustment range from intramurals to mens competition. **Complete system includes: Uprights with Worm Drive Winch, Patented Flex Net, Upright Padding and Antennae.**

Adjustable feet have up to 3" of fine tuning

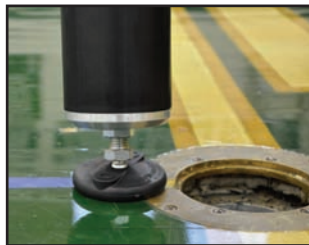

NEW telescoping option with our Carbon uprights

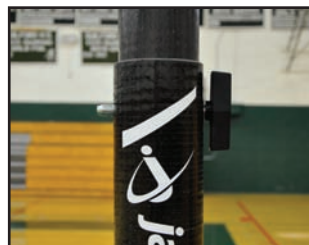

PVB-9000

### LadyPro Carbon 3-1/2" Complete Women's System

**PVB-8000** 74 lbs. **\$4,295 system**

### LadyPro Carbon 3-1/2" Uprights Only (includes winch)

**PVB-80U** 40 lbs. **\$3,399 pair**

### LadyPro Carbon 3" Complete Women's System

**PVB-8500** 77 lbs. **\$4,395 system**

### LadyPro Carbon 3" Uprights Only (includes winch)

**PVB-85U** 43 lbs. **\$3,499 pair**

### Carbon Ultralite 3-1/2" Complete Telescoping System

**PVB-9000** 78 lbs. **\$5,295 system**

### Carbon Ultralite 3-1/2" Uprights Only (includes winch)

**PVB-90U** 44 lbs. **\$4,399 pair**

### Carbon Ultralite 3" Complete Telescoping System

**PVB-9500** 81 lbs. **\$5,395 system**

### Carbon Ultralite 3" Uprights Only (includes winch)

**PVB-95U** 47 lbs. **\$4,499 pair**

## Second Floor Competition Net Systems

These systems are designed for use where floor sleeves are impractical. Floor anchors are used instead of floor sleeves. The strong base design and world class uprights provide top level performance without the use of cables or wires. Meets all NCAA, NFHS and USVBA specifications. Designed for Collegiate and High School Level. 3-1/2" O.D. Aluminum uprights available with Infinite Height Adjustment range of 6' 6" to 8' 2" (PVB-2700) -OR- 16 Pin Stop Height Adjustment range of 6' 6" to 8' 2" (PVB-2500). Hand knob assemblies secure the steel T-bases to anchors in the floor for added safety and security. The standard pad as well as the base pad are included in these systems!

### PVB-2700 Infinite Height Adjustment

**Complete System**

**PVB-2700** 202 lbs. **\$3,699 system**

### Uprights Only (includes winch)

**PVB-270UB** 155 lbs. **\$2,699 pair**

### Center Package

**PVBC-270** **\$2,599 package**

### PVB-2500 Pin Stop Height Adjustment

**Complete System**

**PVB-2500** 192 lbs. **\$3,179 system**

### Uprights Only (includes winch)

**PVB-250UB** 145 lbs. **\$1,899 pair**

### Center Package

**PVBC-250** **\$1,799 package**

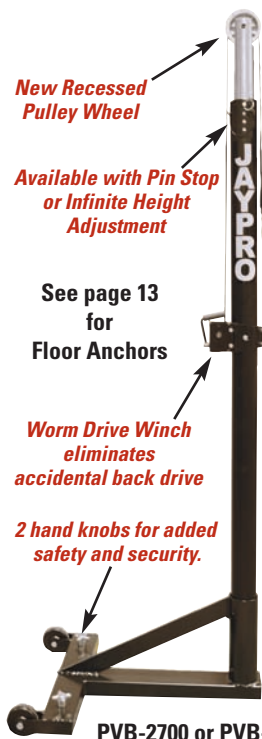

PVB-2700 or PVB-2500



PVB-60P Post Pad see page 13

Standard pad and base pad are included in the above systems!

Replacement Base Pad For 2nd floor competition systems only. See page 13 for pad colors.

**PVB-25P** **\$299 pair**



See page 13 for Floor Anchor details  
**FP-89** **\$105 each**



**FP-90** **\$89 each**



**FP-100** **\$158 each**





NEW VOLLEYBALL SOCCER FOOTBALL LACROSSE BASEBALL FIELD MARKING SCOREBOARD BASKETBALL GYMNASIUM FIELD SEATING BALL STORAGE PHYS. ED. TENNIS

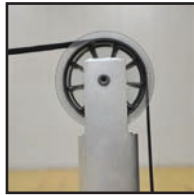

**Recessed Pulley Wheel**



**Pin Stop Height Adjustment**

### Steel Collegiate Net System

Designed for International, Collegiate and High School Level. Durable steel uprights with 16 Pin Stop Height Adjustment range from 6' 6" to 8' 2". Uprights are designed to fit 3-1/2" diameter sleeves. See pages 6-7 for what is included in a complete system and center package. Refer to page 12 for measuring instructions.



**Complete System**

**PVB-1500** 152 lbs. **\$2,539 system**

**Uprights Only (includes winch)**

**PVB-150U** 118 lbs. **\$1,549 pair**

**Center Package**

**PVBC-150** 80 lbs. **\$1,449 package**

PVB-1500

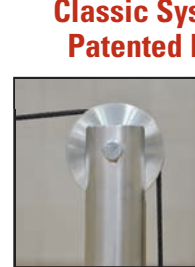

**Recessed Pulley Wheel**



**Pin Stop Height Adjustment**

### Classic Steel Collegiate Net System

Designed for International, Collegiate and High School Level. Durable steel uprights with 16 Pin Stop Height Adjustment range from 6' 6" to 8' 2". Uprights are designed to fit 3" diameter sleeves. See pages 6-7 for what is included in a complete system and center package. Refer to page 12 for measuring instructions.



**Complete System**

**PVB-3000** 157 lbs. **\$2,539 system**

**Uprights Only (includes winch)**

**PVB-30U** 123 lbs. **\$1,549 pair**

**Center Package**

**PVBC-300** 93 lbs. **\$1,449 package**

PVB-3000

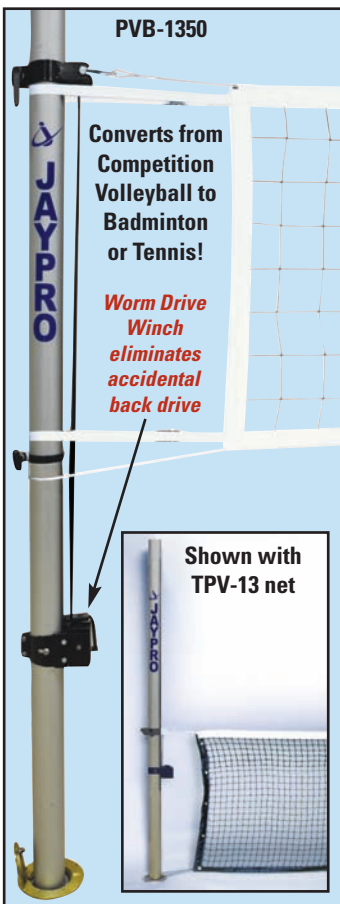

PVB-1350

**Converts from Competition Volleyball to Badminton or Tennis!**

**Worm Drive Winch eliminates accidental back drive**

**Shown with TPV-13 net**

### Multi-Purpose Aluminum Net System

Easily converts from a competition volleyball net system to a badminton or tennis net system by adjusting the sliding collars. **10 Year Limited Warranty on uprights.** 3-1/2" O.D. Anodized Aluminum Upright. High School, Intramural and Recreational Competition. Infinite Setting Sliding Collar Height Adjustment. Uprights are designed to fit 3-1/2" diameter sleeves. Refer to page 12 for measuring instructions.

**Complete System**

(Includes uprights, competition net, standard pads, antennae)

**PVB-1350** 116 lbs. **\$1,995 system**

**Uprights Only**

(Includes winch)

**PVB-13U** 83 lbs. **\$1,329 pair**

**Center Package**

(Includes upright, winch, pad & net)

**PVBC-130** 51 lbs. **\$1,229 package**

**Tennis Net (39" W x 36" L)**

**TPV-13** 6 lbs. **\$189 each**



BSO-2U

### Competition Badminton System

2-3/8" O.D. Steel Upright. High School, Intramural and Recreational Competition. Fixed Net Height.

**Badminton System**

**BSO-2U** 47 lbs. **\$569 pair**

**Badminton Net**

(Size: 30" W x 21" L)

**BND-1** 5 lbs. **\$52 each**

**Floor Sleeve & Cover**

2-3/8" I.D. x 10" deep.

**BSO-2G**

Brass 23 lbs. **\$349 pair**

**BSO-2G-CP**

Chrome 23 lbs. **\$349 pair**

**See page 12 for Floor Sleeve details**



## "Flex Net" International

Designed for International, Collegiate and High School competition. The Patented Flex Net eliminates all cumbersome cables and replaces them with heavy-duty woven nylon top and bottom bands. The headband attaches directly to the winch leader strap to provide superb net tension. Patent # 5,358,257. Due to varying court sizes, the net body may not match your court width.

### "Flex Net" International

Best Seller!

Item	For Uprights set between	Net Size	4' Strap Included	Price
<b>PVBN-6</b>	35' - 37'	39"W x 32'L	No	<b>\$469 each</b>

### Alternate Size Nets

Item	For Uprights set between	Net Size	4' Strap Included	Price
<b>PVBN-628</b>	30' - 32'	39"W x 28'L	No	<b>\$429 each</b>
<b>PVBN-628ADJ</b>	32' - 35'	39"W x 28'L	Yes	<b>\$469 each</b>
<b>PVBN-6ADJ</b>	37' - 40'	39"W x 32'L	Yes	<b>\$498 each</b>



Flex Net Offers Superb Net Tension and Quick & Easy Set-up!

48 HOUR QUICK SHIP



No extra cables or tie offs!

Adjustable straps designed to attach to the existing bottom band for additional length.

Don't have a Jaypro system but want the benefits of the Flex Net? No Problem... The Flex Net will adapt to most existing system uprights!

### Flex Net with Adapter Cords

Includes patented Flex Net (PVBN-6) with 1/4" diameter anchor cord and clips. The adapter cords connect your existing winch and anchor upright to the top of the Flex Net. Can be used on most manufacturers' systems such as Porter, Senoh, Spalding, Bison, MacGregor, Stackhouse, Schelde or other similar systems. (Anchor cord to be cut to length in the field to adapt to your specific system.)

**PVBN-6AK** 14 lbs. **\$498 each**

### Flex Net with Adapter Strap

Includes patented Flex Net (PVBN-6) with 2" W adjustable strap. The adapter strap "bridges" the top of the Flex Net to the anchor upright. Can be used on Schelde or other similar systems.

**PVBN-6J** 13 lbs. **\$479 each**

48 HOUR QUICK SHIP

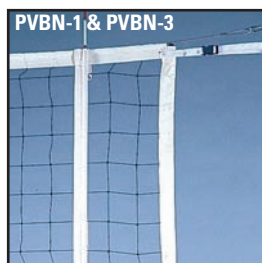
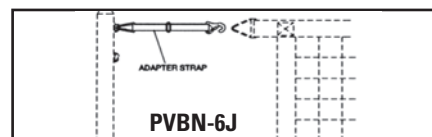
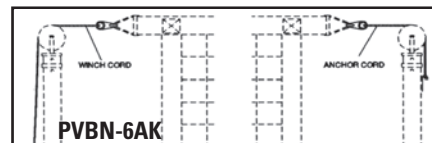

### High School Net

High school competition net for Jaypro's PVB-1350, OCV-900 and similar net systems. Twin quick-lock side tension straps ensure proper net tension. **36"W x 32'L**.

**PVBN-1** 12 lbs. **\$209 each**

### Collegiate Net

Collegiate competition net is same as PVBN-1 only the size is **39"W x 32'L**.

**PVBN-3** 13 lbs. **\$229 each**

Best Seller!

Volleyball Net (Our best nylon, rope cable)

**VBN-32** 36"W x 32'L 4 lbs. **\$92 each**

Volleyball Net (2.5 mm poly with rope cable)

**VBD-6** 36"W x 32'L 4 lbs. **\$83 each**

Volleyball Net (2.5 mm poly with steel cable)

**VBD-3** 36"W x 32'L 5 lbs. **\$89 each**

Badminton Net (Lightweight with rope cable)

**BND-1** 30"W x 21'L 5 lbs. **\$52 each**

Tennis Net (Lightweight with rope cable)

**TDP-42** 39"W x 42'L 7 lbs. **\$148 each**

48 HOUR QUICK SHIP





**Custom Volleyball Net Tape** A perfect way to show school spirit (where regulations allow). Customized vinyl tape with hook and loop attachment. Sized for a 32' net, 3" high. Team Pink selection now available. Extended lead time applies. Contact Customer Service for artwork details. Does not ship from Jaypro's CT warehouse. Call for freight quote.

**CVNT-1**

3 lbs.

**\$349 each**

**CVNT-1PK**

3 lbs.

**\$349 each**

Store those nets securely, neatly and easily in minimal space. Constructed of rigid thick wall 1.5" square steel tube and transported by three 4" non marring swivel casters. Head band is wound cleanly and tangle free. Powder coated blue for years of surface protection. For additional protection, net storage bags are included.



Easily wind your nets on a free standing, transportable rack to keep your nets clean and tangle free. Visit us online at [www.jaypro.com/videos](http://www.jaypro.com/videos) to see the Net Keeper in action!



**Single Net Keeper**  
Holds 1 net, 1 bag provided.

**VNK11** 20 lbs. **\$239 each**



**Double Net Keeper**  
Holds 2 nets, 2 bags provided.

**VNK22** 24 lbs. **\$269 each**



**Triple Net Keeper**  
Holds 3 nets, 3 bags provided.

**VNK33** 42 lbs. **\$309 each**

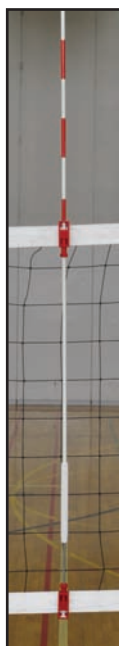

**Antennae**

Official antennae quickly clamps directly to the top and bottom of the net. Attachment adjustments are made easily from the floor. Fits both 36" and 39" nets. 72" long, red and white.

**VBA-80** 3 lbs. **\$148 pair**



**VBA-80**



**VBA-4**

**Antennae**

2 piece antennae slide into hook and loop attached sleeve. Fits 36" or 39" wide nets.

**VBA-4** 3 lbs. **\$106 pair**



Don't let this happen to your net, secure it with a net bag only from Jaypro!



**Replacement Net Keeper Storage Bag**  
Protection for your nets, keeps cords and cables off the floor.

**VNKBAG** 1 lb. **\$29 each**



**Boundary Tapes**

2" white boundary tapes with hook-and-loop closure. Fits 36" or 39" wide nets.

**VA-22** 1 lb. **\$29 pair**



**Best in the Industry!**

**Chrome Finish**  
PVB-75CVR-CP

**Brass Finish**  
PVB-711



PVB-70S

Generally, floor sleeves are 3", 3-1/2" or 4". Jaypro uprights are either 3" or 3-1/2". To ensure a proper fit, measure your existing floor sleeves prior to selecting a system. (See below for measuring instructions). Select the appropriate adapter (bottom of page) that fits your measurements and system of choice.

Do not measure cover plate

Measure the distance between red arrows for accurate dimension

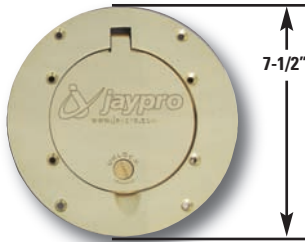

7-1/2"

**Floor Sleeve & Cover - 3-1/2"**

Sleeves are 3-1/2" I.D. x 10" deep. Lockable hinged cover plate is 7-1/2" O.D. and is made of heavy cast brass or chrome to prevent basketball dead spots.

<b>PVB-75S</b>	Brass	22 lbs.	<b>\$419 pair</b>
<b>PVB-75S-CP</b>	Chrome	22 lbs.	<b>\$419 pair</b>



**Floor Sleeve & Cover - 3"**

Same as PVB-75S except sleeve is 3" I.D. x 10" deep.

<b>PVB-70S</b>	Brass	22 lbs.	<b>\$419 pair</b>
<b>PVB-70S-CP</b>	Chrome	22 lbs.	<b>\$419 pair</b>



- See below for reducing your floor sleeve diameter! -

**Floor Sleeve & Cover - 2-3/8"**

Same as PVB-75S except sleeve is 2-3/8" I.D. x 10" deep.

<b>BSO-2G</b>	Brass	23 lbs.	<b>\$349 pair</b>
<b>BSO-2G-CP</b>	Chrome	23 lbs.	<b>\$349 pair</b>

**Cover Plate Only**

<b>PVB-711</b>	7-1/2"	Brass	6 lbs.	<b>\$189 each</b>
<b>PVB-75CVR-CP</b>	7-1/2"	Chrome	6 lbs.	<b>\$189 each</b>
<b>PVB-85CVR</b>	8-1/2"	Brass	7 lbs.	<b>\$199 each</b>

**Second Floor Sleeve Bracket**

For second story installation of floor sleeves or where there is less than 12" of clearance in the sub-floor. Mounting hardware not included.

<b>SB-10</b>	67 lbs.	<b>\$289 each</b>
--------------	---------	-------------------

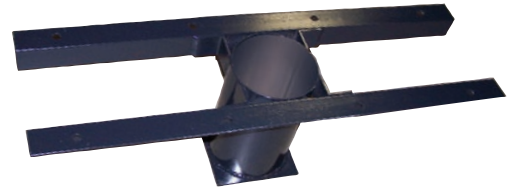

**Sleeve Inserts**

Sleeve insert used to **make deeper floor sleeve a shorter depth**. Specify current depth and inside diameter when ordering.

<b>PVB-DEP</b>	6 lbs.	<b>\$69 each</b>
----------------	--------	------------------

<b>SVL-3238</b>	Modifies your 3" inside diameter to 2-3/8" ID*	12 lbs.	<b>\$72 each</b>
<b>PVB-ID</b>	Modifies your 3-1/2" inside diameter to 3" ID*	8 lbs.	<b>\$62 each</b>
<b>SVL-3528</b>	Modifies your 3-1/2" inside diameter to 2-3/8" ID* 14 lbs.		<b>\$79 each</b>
<b>SVL-4035</b>	Modifies your 4" inside diameter to 3-1/2" ID*	9 lbs.	<b>\$66 each</b>

\* Specify sleeve depth when ordering.

Depths other than the standard 10" are special order items (non-returnable). Custom sizes (depths) may require longer lead time.

**SLEEVE INSERT MEASUREMENT**

To ensure proper fit of sleeve inserts, please provide the following dimensions of your sleeves when ordering.

- A) Depth of sleeve itself
- B) Depth from bottom of sleeve to playing surface
- C) Inside diameter of sleeve

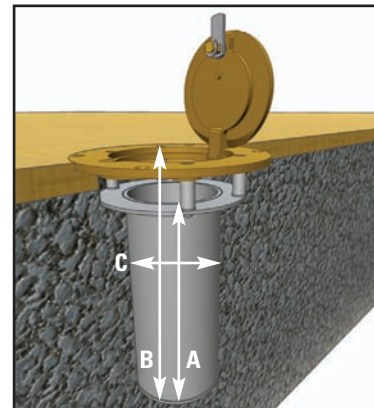

## Floor Anchors

### Floor Anchor

Billet steel body gives 9000 lb. pullout strength intended for all floor applications except floating wood floors. 3-1/4" chrome cover. Center is 1/2"-13 thread with spring loaded closure plug.

May also be used without the extension bolt on wood, tile or synthetic surfaces applied directly over concrete slab, or on a floating wood floor for light duty performance.

**FP-89** 3 lbs. **\$105 each**

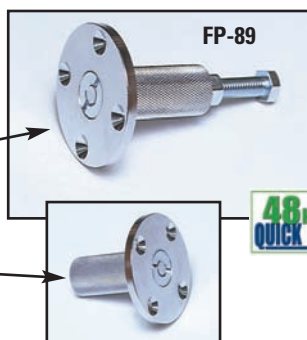

### Floor Anchor

Brass cover plate and anchor work independently to allow for installation into floating wood floors.

**FP-100** 4 lbs. **\$158 each**

### Floor Anchor

Same construction as FP-89 except cylinder width is only 1-1/2".

**FP-90** 3 lbs. **\$89 each**



All floor anchors come with our exclusive removable cylinder in case stripping occurs.



## Padding



### Official Standard Pad

6'H post pad constructed of 2" thick polyurethane foam wrapped in 14 oz. vinyl in your choice of color. Attaches with hook and loop closure flaps. Meets specifications for competitive play. Specify color from chart below when ordering. Shown with optional custom lettering.

**PVB-60P** 18 lbs. **\$429 pair**

### Custom Lettering

Put your school name on your pads! White vinyl letters as shown. 3-9 letters on one side of one pad.

**PVL-39** white lettering **\$159**

**PVB-60P**  
Standard Pad  
shown with  
custom lettering

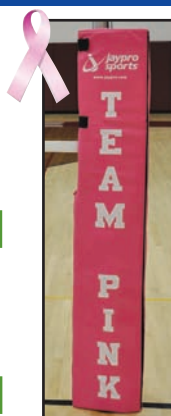

### Cable/Buckle Cover

Vinyl covered foam with hook-and-loop attachment protects against exposed net cables and buckles. Pad is 12" long. White only.

**VCC-12** 4 lbs. **\$64 pair**

**NEW** **Pad Color Choices**, Colors displayed may not be an exact match

pink	red	navy blue	yellow	light blue	gray	black	maroon	forest green	kelly green	royal blue	tan	purple	orange

## System Accessories



### Wall Rack

Heavy-duty steel rack attaches to wall and holds 3 posts in upright position for easy storage.

**VBWR-1** 8 lbs. **\$185 each**

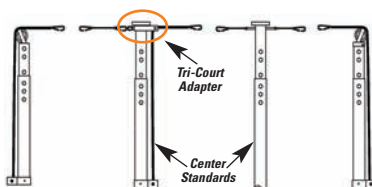

### Volleyball System Tri-Court Adapters

Connects two center standards into a third court. Improves the tension out of middle net. Easily attaches onto existing center standards. 7" H x 3"

**PVB-303CAK** For PVB-3000 system 6 lbs. **\$139 each**

**PVB-35TCA** For PVB-7000, 6500, 5000, 4500 & 1500 systems 6 lbs. **\$139 each**

**PVBWINCH** Worm Drive Winch Replacement includes leader strap & handle 6 lbs. **\$369 each**

**HM5044** Cargo Buckle Winch Replacement 3 lbs. **\$72 each**

**PVB101A** Leader Strap for HM5044 2 lbs. **\$52 each**

**PVB603** Leader Strap for PVBWINCH 1-1/2" W 1 lb. **\$62 each**

**VBW-HANDLE-08** Handle for PVBWINCH - (For winches purchased after 2008) 1 lb. **\$52 each**

**PVB6071** Handle for Telescoping Height Adjustment & Old Blue Style Winch (Requires a 3/8" Allen Wrench) 1 lb. **\$32 each**

**PVB512** Pin Chain Assembly 1500/5000/4500 2 lbs. **\$12 each**



NEW VOLLEYBALL SOCCER FOOTBALL LACROSSE BASEBALL FIELD MARKING SCOREBOARD BASKETBALL GYMNASIUM FIELD SEATING BALL STORAGE PHYS. ED. TENNIS



The most durable stand on the market! Shown with VRS-60P optional padding.

## Introducing a MEGA addition to our Referee Stands!



Easily folds and rolls for storage.

### The "MEGA REF" Folding Referee Stand

The most durable stand on the market! Constructed of 1-5/8" O.D. heavy wall steel with a durable powder coated finish. Includes a welded frame platform support, four legs with protective rubber tips and four 4" non-marring wheels in the front for easy transport. Folds to 84"H x 30"W x 10"D for compact storage. Vinyl coated, padded platform for referee comfort is 48" above the floor.

**VRS-8000** 82 lbs. **\$849 each**

Constructed of 1-5/8" heavy wall powder coated pipe

Vinyl coated and padded platform for referee comfort

All welded frame support with non-slip foot treads

Double wheels on each leg for easy transport

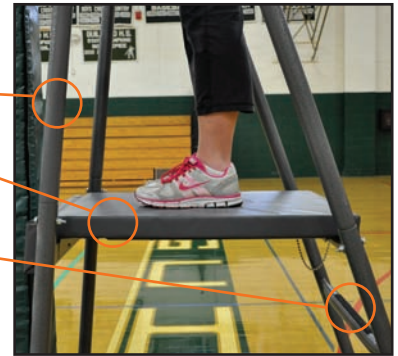

VRS-6000 with VRS-60P pad

### Folding Referee Stand

This free standing referee stand can be used with any net system. Sturdy 1-5/16" diameter powder coated steel frame has 4 legs with protective rubber tips and 4" non-marring wheels in the front for easy transport. Folds to 84"H x 30"W x 10"D for compact storage. Vinyl coated, padded platform is 48" above the floor. Shown with optional padding.

**VRS-6000** 64 lbs. **\$629 each**



Easily folds and rolls for storage.



VRS-3000 with VRS-30P pad



### Adjustable Referee Stand\*

Clamps onto any telescoping pole net system. Sturdy 1-5/16" diameter powder coated steel frame with 2 leg design. Telescoping feet allow height adjustment. Includes wheels for easy transport and vinyl coated, padded platform. Shown with optional padding. \*Please note: This Referee Stand does not fit PVB-1350 or OCV-900 systems

**VRS-3000** 55 lbs. **\$659 each**



### Referee Stand Pad for the VRS-8000 & VRS-6000

Fits both the VRS-8000 and VRS-6000 referee stand. 1" thick polyurethane foam wrapped in 14 oz. vinyl in your choice of color. Meets specifications for competitive play. Specify color from chart below when ordering.

**VRS-60P** 18 lbs. **\$306 each**



### Referee Stand Pad for the VRS-3000

Same specifications as the VRS-60P but fits the VRS-3000 referee stand.

**VRS-30P** 18 lbs. **\$289 each**

### Pad Color Choices Colors displayed may not be an exact match

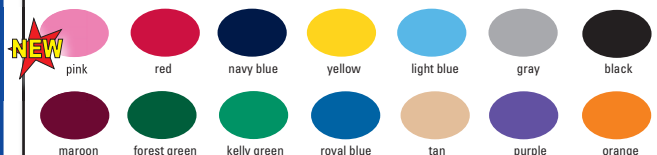

## 4 Standard Carrier



EC-500

## 6 Standard Carriers



EC-1000



Heavy duty welded steel frame transports and stores volleyball uprights, nets, pads and other equipment. Comes with a tough, blue powder coated finish. Large casters provide smooth portability. Deluxe and Vertical models include vinyl storage bag.

<b>EC-500</b>	Standard	42" L x 32" W	Holds 4 poles	51 lbs.	<b>\$329 each</b>
<b>EC-1000</b>	Deluxe	48" L x 36" W	Holds 6 poles	77 lbs.	<b>\$499 each</b>
<b>VEC-1</b>	Vertical	60" L x 35" W	Holds 6 poles	98 lbs.	<b>\$299 each</b>



VEC-1



HSVBC24

**Back-saving height for quick and easy access to the balls!**



### Hammock Drill Cart

Features a low profile making it easier to turn, reach and spike. Sturdy steel frame is collapsible for easy storage. Includes matching nylon carry bag with shoulder strap. Holds up to 24 balls. 48" L x 22" W x 12" D x 40" H.

<b>HSVBC24</b>	21 lbs.	<b>\$159 each</b>
----------------	---------	-------------------

### ToteMaster™ Open Top Storage Cart



TE-PE01

Two full size open top storage baskets for storage of volleyball equipment. Holds 33 volleyballs, net, pads and other equipment. Two 360° hangers rotate for storage. Swivel casters for easy indoor transport. Powder coated frame for extra durability. Size: 48" L x 26" W x 54" H.

<b>TE-PE01</b>	48 lbs.	<b>\$249 each</b>
----------------	---------	-------------------



BC3

### Wide-Body Ball Carts

BC3 holds 12 balls or BC4 holds 16 balls with a wide body design for stability. Heavy duty steel frame with chrome finish. Easy assembly.

### Three-Tier

39-1/2" H x 8-1/2" W x 39" L

<b>BC3</b>	15 lbs.	<b>\$70 each</b>
------------	---------	------------------

### Four-Tier

39-1/2" H x 8-1/2" W x 51-1/2" L

<b>BC4</b>	19 lbs.	<b>\$75 each</b>
------------	---------	------------------

### Deluxe Ball Carriers

The most rugged and durable carriers available today. Innovative easy access design holds up to 15 or 21 volleyballs. All welded 1" O.D. steel side frames. 1" O.D. steel crossbars. Four heavy-duty swivel casters for portability. Tough powder coated finish. **Lifetime Warranty on frame and casters!**

#### 15 Ball Carrier

36" H x 22" W x 39" L

<b>BBC-12RB</b>	Royal Blue
<b>BBC-12BK</b>	Black
<b>BBC-12RD</b>	Red

27 lbs.	<b>\$149 each</b>
---------	-------------------

#### 21 Ball Carrier

36" H x 22" W x 60" L

<b>BBC-18RB</b>	Royal Blue
<b>BBC-18BK</b>	Black
<b>BBC-18RD</b>	Red

41 lbs.	<b>\$172 each</b>
---------	-------------------



BBC-12BK



BC4

**Your choice of three colors!**







TS612

**The Spiker**

Used to develop spiking and serving skills. 6' to 12' aluminum telescoping pole with foam ball holder. Includes polyethylene base.

TS612

11 lbs.

\$239 each



TJ612

**The Jumper**

Used to measure jump reach. Color coded spring pegs in 1" increments. 6' to 12' aluminum telescoping pole. Includes polyethylene base.

48 HOUR QUICK SHIP

TJ612 10 lbs.

\$199 each



TA115

**The Attacker**

Used for game-like blocking situations. Two adjustable 1' x 1.5' foam blocking surfaces. Four knobs for easy adjustment. Includes polyethylene base.

48 HOUR QUICK SHIP

TA115 15 lbs.

\$299 each



TB11

**The Blocker**

Used for defending the blocked spike. Aluminum pole adjusts up to 11' and includes 2' x 3' foam blocking surface. Includes polyethylene base.

48 HOUR QUICK SHIP

TB11 13 lbs.

\$289 each

**Package Deal on Training Equipment...**

**Purchase The Spiker, The Jumper, The Attacker and The Blocker as a PACKAGE and SAVE!**

48 HOUR QUICK SHIP

VTAPACK

49 lbs.

\$709 package

(price if purchased separately \$1,026)

**A SAVINGS OF \$317**

*Make it easier to train on your own with the optional royal blue polyethylene base.*

48 HOUR QUICK SHIP

**Optional Polyethylene Base (Fillable with sand)**

FPB1

13 lbs.

\$40 each

**Other Attack Volleyball Machines are available at [www.jaypro.com](http://www.jaypro.com)**

*Shown with optional ball bag, purchase separately on page 71*

**Attack II Volleyball Machine**

The Attack II delivers thousands of reps in daily practice of serve receiving, digging and spiking. Accuracy and repeatability are assured in every drill, eliminating time-wasting errant hits. With a ball release point of 5'6" to 8'-6", it offers a full range of spins, throwing both sharp topspins and breaking floaters to simulate match situations. Spiking over Women's net at speeds up to 70 MPH. Fits through a standard doorway and into any standard size SUV or pick-up.

VBSA-2

190 lbs.

\$3,149 each



4" x 4" Extruded Heavy Wall Aluminum with additional lateral support

Never replace your wood poles again!

OCC-500

### Coastal Competition

4" square extruded heavy wall aluminum uprights designed to withstand coastal winds and weather. Adjustable winches for play at any height. Includes ground sleeves, installation tool, 2 winches and weather resistant net. **Limited Lifetime Warranty on uprights.**

OCC-500 178 lbs.

\$1,395 system



### Replacement Net

OCC-500N 8 lbs.

\$179 each



OCV-900

### Competition Outdoor Volleyball

3-1/2" O.D. powder coated steel uprights with fixed net heights for men and women's play. Includes rust resistant ratchet and 36" aluminum ground sleeves with top caps. Nets available separately, see page 10 (PVCN-6J shown or PVCN-1). **According to FIVB regulations, the sand must be at least 15-3/4" deep and composed of fine, loosely compacted grains. This system will accommodate from 12" to 16" of sand.**

OCV-900 170 lbs.

\$999 system



OS-350

### Recreational Outdoor Volleyball

2-3/8" O.D. galvanized steel uprights accommodate volleyball, badminton or tennis. Includes rust resistant ratchet and PVC ground sleeves with top caps. Nets available separately, see page 10. (VCN-32, VBD-6 or VBD-3)

OS-350 80 lbs.

\$599 system



### Center Package

OCV-900C 90 lbs.

\$589

*Note: Sleeves are designed to be set even with the playing surface. Contact factory for special installation requirements.*



**Adjustable Volleyball Court Line**  
Durable 2" wide black webbed volleyball boundary line adjusts from 30' x 60' to FIVB regulation 8m x 16m. Includes four 8" corner stakes with bungee cord to ensure adjustment to court boundary. Includes plastic reel for easy assembly and storage.

**NEW**

AVCL-2 2 lbs.

\$59 each



# Soccer Goal Safety is our Business!

## SECURE 4 SAFETY

### Check It - Secure It - Test It - Respect It



Soccer Goal Safety Program from Jaypro Sports

*Jaypro Sports is committed to safety on the field. Because of this we have created the Secure 4 Safety Program, which promotes soccer goal safety.*

## ASTM TESTING



In our ongoing effort to provide athletes with the safest environment possible, Jaypro has worked with the ASTM (American Standards for Tests and Measurement) to create new standards for portable soccer goals in the U.S. The goals in this catalog so marked have been tested in accordance with the standards set forth by the ASTM committee for portable soccer goal safety. (ASTM Designation: F2056 and F2673). The United States Consumer Product Safety Commission has determined that portable official soccer goals should be anchored or counter-weighted at all times.

**All Jaypro goals that meet NFHS, NCAA and FIFA specification are marked in this section, refer to [www.jaypro.com](http://www.jaypro.com) for more information on ASTM guidelines and standards.**

## ANCHOR OPTIONS

Throughout the Soccer section, Jaypro has listed the counterweight required for each soccer goal, like the icon shown below. Even with the ASTM requirement met in our testing, all soccer goals that are not permanently anchored must have a certain counterweight required on the rear frame of the goal. Our new labeling system will also inform you on the weight that is required on each goal. Please refer to [www.jaypro.com](http://www.jaypro.com) for a complete list of counterweight requirements for your particular goal. On-goal weights and in-ground anchors are available on pages 31-32 of this section.



**IN-GROUND ANCHORS  
OR 140 LBS. OF  
COUNTERWEIGHT  
REQUIRED PER GOAL**



Model #: **SGP-600**  
800-243-0533  
[www.jaypro.com](http://www.jaypro.com)

**THIS GOAL MEETS ALL SAFETY REQUIREMENTS OF: ASTM F2056 & ASTM F2673**  
WHEN COUNTER BALANCE WEIGHT IS USED AS THE ONLY MEANS OF PREVENTING TIPOVER, A MINIMUM OF 140 LBS. MUST BE PLACED ON THE REAR CROSSBAR. WEIGHT SHOULD BE DIVIDED EQUALLY AND PLACED NEAR EACH REAR CORNER.

SEE MANUFACTURER'S INSTRUCTIONS FOR MORE DETAILS ON ANCHORING.

SL0046

## OUR GUARANTEE

### Jaypro Sports "Honest Guarantee"

Don't be fooled by misleading "lifetime guarantees" in the industry. They often aren't accurately defined when reading the fine print, leaving customers confused and frustrated. Jaypro is proud to offer "The Honest Guarantee." Our official soccer goals are designed and manufactured with the highest standards in quality and safety that we can confidently guarantee them against defects and workmanship. All Official and NOVA goals are guaranteed for 12 years. All nets and vinyl products are guaranteed for 1 year. Any product without a specific guarantee listed is guaranteed for 3 years.

**It's that simple!**





# Simply the BEST Soccer Goals in the Industry... go ahead and compare!

## InNOVation™ Series Soccer

### Exclusive Jaypro Features Include:



Flush Net Clips



Easy Track™ Net Clips



Optional Easy Attach Wheel Kits



Auxiliary Backstays on some units



Jaypro Powder Coat



ASTM Certified

## NOVA Ultimate™ Folding

SGP-600FS

Shown with optional two-tone net!

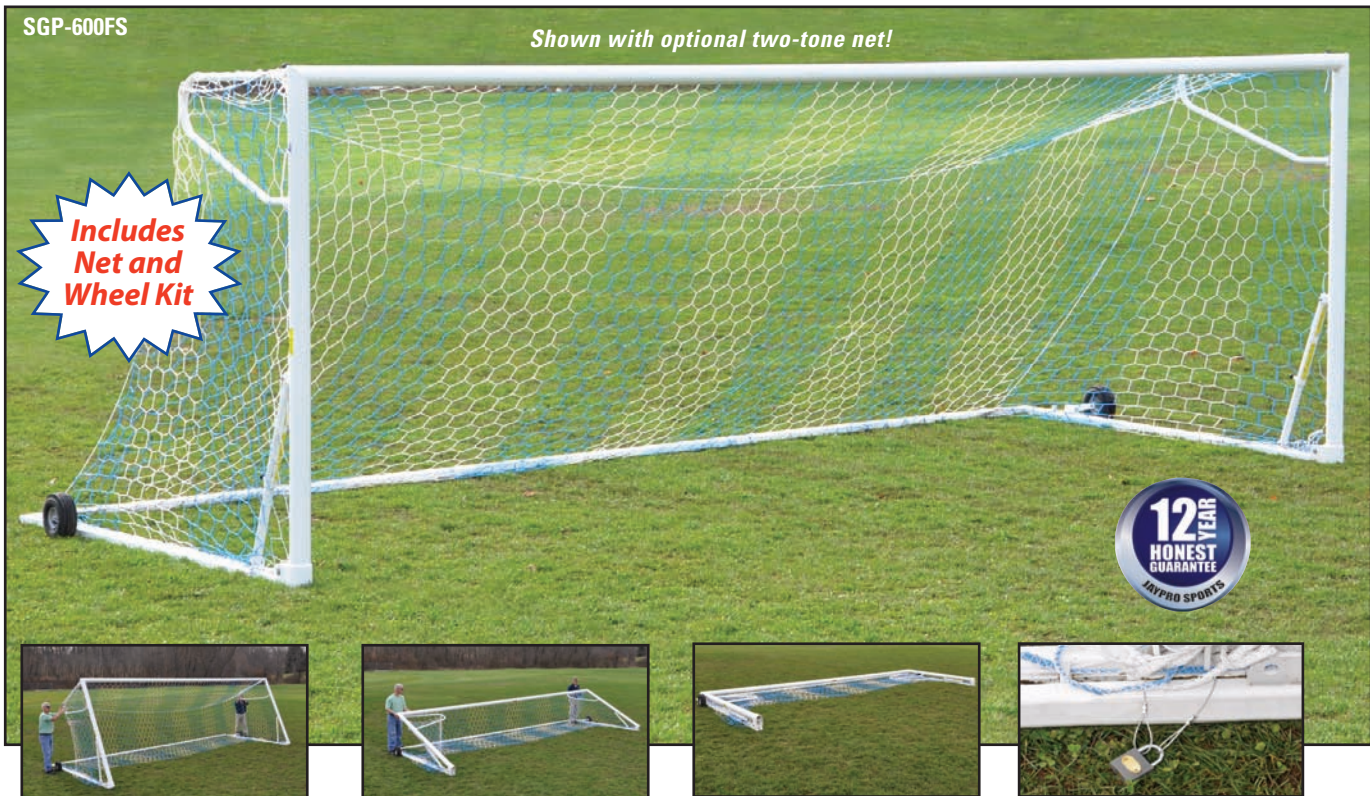

Step 1: X-clusive Patented spring aided design ensures goal folds safely



Step 2: Fold in backstays



Step 3: Locks in folded position for storage and safety



Prevent unsupervised use and accidental tip over (with customer supplied lock)

**The Safest Portable Soccer Goal in the World!** Patented spring assist designs allows goal to be raised or lowered in minutes. Official size 8' H x 24' W x 4' B x 10' D. Powder coated goal is 4" O.D. extruded aluminum with a 2" x 4" base frame and 1.7" O.D. aluminum backstays. Features exclusive flush mount Easy Track™ net attachment system and stainless steel hardware. Meets NFHS, NCAA and FIFA specifications. Includes 4mm white official net and 10" no-flat wheels. Ground anchors (pages 31-32) available separately.

SGP-600FS

475 lbs.

\$5,595 pair



IN-GROUND ANCHORS OR 140 LBS. OF COUNTERWEIGHT REQUIRED PER GOAL



Jaypro XCLUSIVE Easy Track™ Net Clips

NEW VOLLEYBALL SOCCER FOOTBALL LACROSSE BASEBALL FIELD MARKING SCOREBOARD BASKETBALL GYMNASIUM FIELD SEATING BALL STORAGE PHYS. ED. TENNIS



## NOVA Premiere™



SGP-600

SGP-600 Shown with 2 tone net, optional wheel kits and sand bags



International style, all aluminum goal. Official size 8' H x 24' W x 4' B x 10' D. Powder coated goal is 4" O.D. extruded aluminum with a 2" x 4" base frame and 1.7" O.D. aluminum European and auxiliary backstays. Features exclusive flush mount Easy Track™ net attachment system. Meets NFHS, NCAA and FIFA specifications. Ground anchors (pages 31-32), wheel kits (below) and nets (page 30) available separately.

SGP-600

446 lbs.

\$4,795 pair



IN-GROUND ANCHORS  
OR 140 LBS. OF  
COUNTERWEIGHT  
REQUIRED PER GOAL



Jaypro  
XCLUSIVE  
Easy Track™  
Net Clips

## NOVA Premiere™ Adjustable



SGP-600AX

Same as the SGP-600 but has an infinitely adjustable rear crossbar allowing the goal to fit under any football goal post. No fixed settings, No fixed depth on the rear crossbar, move it a yard, a foot or an inch! To attach the goal securely to the goal post see (page 41) for details. Ground anchors (pages 31-32), wheel kit (right) and nets (page 30) available separately.

SGP-600AX

364 lbs.

\$4,989 pair



## NOVA Premiere™ Soccer Packages

- 1 pair **SGP-600** NOVA Premiere Official Goals
- 1 pair **SN-2BLKW** 5mm, 5.5" hex mesh two tone white/black nets
- 2 sets **SAS-95** Auger anchors
- 1 set **NSGWK** NOVA Goal wheel kit

A SAVINGS OF \$482

SGP-600PKGBLK 531 lbs.

\$5,199 package

- 1 pair **SGP-600** NOVA Premiere Official Goals
- 1 pair **SN-2BLUW** 5mm, 5.5" hex mesh two tone white/blue nets
- 2 sets **SAS-95** Auger anchors
- 1 set **NSGWK** NOVA Goal wheel kit

A SAVINGS OF \$482

SGP-600PKGBLU 531 lbs.

\$5,199 package



NSGWK

## Optional Wheel Kit

Includes 4 large 10" "no flat" tires. Easily attaches to any NOVA base. (SGP-600, and NOVA Club round and square). Wheel engagement is quick and easy. One kit fits 2 goals.

NSGWK

45 lbs.

\$449 kit







## World™ Fold-Up



SGP-660



This all aluminum, international style goal is field maintenance friendly with a fold-up rear frame that can be temporarily pinned or permanently locked in a raised position for mowing. Official size 8' H x 24' W x 6' B x 6' D. Powder coated goal is 4" O.D. extruded aluminum with a 2" x 4" base frame and three 2-3/8" galvanized steel back posts. Features exclusive flush mount Easy Track™ net attachment system and stainless steel hardware. Includes ground sleeves for semi-permanent installation and world competition Hex net. Meets NFHS, NCAA and FIFA specifications.

**SGP-660**

534 lbs.

**\$4,795 pair**



## Classic World™ Semi-Permanent



SGP-550

Same as the SGP-660 but without the fold-up rear frame.

**SGP-550**

432 lbs.

**\$3,395 pair**



Jaypro  
**XCLUSIVE**  
Easy Track™  
Net Clips

## Soccer Field Netting

### FieldPro Soccer Ball Stop System 20' x 65'

Stop wasting time during practices and games chasing missed shots or errant passes and ensure the safety of athletes, coaches and spectators on adjacent fields. 20'H x 65'L backstop is designed specifically to fit behind soccer goals. Includes four 4" O.D. heavy wall aluminum uprights with black powder coated finish, ground sleeves, corrosion resistant hardware and 3-1/2" square mesh #36 knotless nylon black net with 1/4" rope border. Net can easily be raised and lowered with a rope and pulley system. Custom sizes also available, see pages 97-99.

**FNSB-65**

250 lbs.

**\$2,095 each**

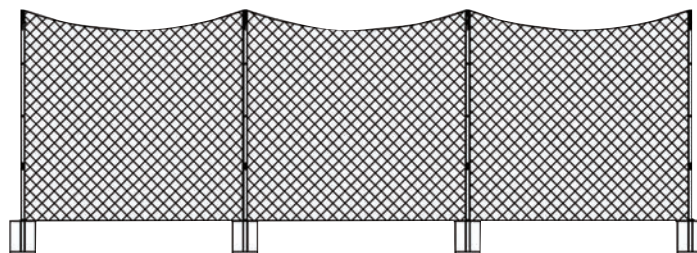



## Classic™ Official Round

## Classic™ Official Square



Shown with SN-2BLUW hex net.

A true Jaypro Classic. Official size 8' H x 24' W x 4' B x 10' D. Powder coated goal is 4" O.D. for the round goal or 4" square extruded aluminum with 1.9" O.D. galvanized steel backstays and rear crossbar. Features exclusive flush mount Easy Track™ net attachment system. Meets NFHS, NCAA and FIFA specifications. Ground anchors (pages 31-32), nets (page 30) and wheel kits (below) available separately. Semi-permanent goals, European backstays and ground sleeves available below.

**SGP-400**

420 lbs.

**\$2,795 pair**



**SGP-760**

416 lbs.

**\$2,795 pair**



**IN-GROUND ANCHORS OR 160 LBS. OF COUNTERWEIGHT REQUIRED PER GOAL**



### Classic Wheel Kit

Includes 4 large 10" "no flat" tires with fasteners for attachment to goals, SGP-760, SGP-400 and SGP-100. One kit fits 2 goals.

**CSGWK**

45 lbs.

**\$449 kit**



**IN-GROUND ANCHORS OR 140 LBS. OF COUNTERWEIGHT REQUIRED PER GOAL**

## Classic™ Official Soccer Packages

- 1 pair **SGP-400** Classic Round Official Goals
- 1 pair **SND-8** 4mm, 5.5" square mesh white nets
- 2 sets **SAS-95** Auger anchors
- 1 set **CSGWK** Classic Goal wheel kit

**A SAVINGS OF \$362**

**SGP-400PKG**

496 lbs.

**\$3,249 package**

- 1 pair **SGP-760** Classic Square Official Goals
- 1 pair **SND-8** 4mm, 5.5" square mesh white nets
- 2 sets **SAS-95** Auger anchors
- 1 set **CSGWK** Classic Goal wheel kit

**A SAVINGS OF \$362**

**SGP-760PKG**

500 lbs.

**\$3,249 package**

## Classic™ Official Round Semi-Permanent

Same features as the SGP-400 but with 10' long uprights for insertion into the ground.

**SGP-440** Galvanized Steel Backstays 306 lbs. **\$2,398 pair**

**SGP-440EB** European Backstays 306 lbs. **\$2,498 pair**

**SGP-445G** Ground Sleeves (set of 4) 28 lbs. **\$479 set**



**SGP-440 (round) and SGP-730 (square)**

## Classic™ Official Square Semi-Permanent

Same features as the SGP-760 but with 10' long uprights for insertion into the ground.

**SGP-730** Galvanized Steel Backstays 241 lbs. **\$2,398 pair**

**SGP-730EB** European Backstays 241 lbs. **\$2,498 pair**

**SGP-735G** Ground Sleeves (set of 4) 28 lbs. **\$479 set**



**SGP-440EB (round) and SGP-730EB (square)**



**Jaypro XCLUSIVE**  
Easy Track™ Net Clips



NEW VOLLEYBALL SOCCER FOOTBALL LACROSSE BASEBALL FIELD MARKING SCOREBOARD BASKETBALL GYMNASIUM FIELD SEATING BALL STORAGE PHYS. ED. TENNIS



## Team™ Official Square



Available in Two Sizes!

Budget friendly goals. Official size 8' H x 24' W x 4' B x 10' D and Junior size 7' H x 21' W x 3' B x 8' D. Powder coated goal is 4" x 2" steel with 1.9" O.D. galvanized steel backstays and rear crossbar. Features "money clip" style net attachment system. Meets NFHS and NCAA specifications. Ground anchors (pages 31-32), nets (page 30) and wheel kits (below) available separately.

**SGP-100** Team Official 571 lbs. **\$2,195 pair**  **SGP-100JR** Team Junior 485 lbs. **\$1,795 pair**



**IN-GROUND ANCHORS OR 170 LBS. OF COUNTERWEIGHT REQUIRED PER GOAL**



*Comes with exclusive "money clip" style net attachment*



**IN-GROUND ANCHORS OR 190 LBS. OF COUNTERWEIGHT REQUIRED PER GOAL**



**Classic Wheel Kit**  
Includes 4 large 10" "no flat" tires with fasteners for attachment to goals, SGP-760, SGP-400 and SGP-100. One kit fits 2 goals.

**CSGWK** 45 lbs. **\$449 kit**

### SAFETY FEATURES



Rear ground crossbar and steel backstays improve stability and safety.

Backstays run back 10' for a more stable base as opposed to 8' and 9' like most other goals.

**Ground anchors are recommended, see pages 31-32.**

## Team™ Official Round Semi-Permanent



**A Military Favorite!** Official size 8' H x 24' W. Powder coated uprights and crossbar are 4" O.D. 14 gauge steel. Designed without backstays for permanent/semi-permanent installation. Includes nets, net clips and net pegs. Ground sleeves for semi-permanent installation available separately.

**Ground Sleeves for Semi-Permanent Installations**  
Aluminum ground sleeves for semi-permanent installation of SGP-200. Includes locking cap. Each set includes four sleeves.

**SGP-200** 280 lbs. **\$1,795 pair** 

**SGP-200G** Ground Sleeves (set of 4) 28 lbs. **\$479 set**



# Jaypro InNOVA<sup>tion</sup>™ "CLUB GOALS"

**The safest, most durable Club Goals in the industry!**

Powder coated, all aluminum, portable goal offers a full ground base frame made of 4" x 2" extruded aluminum. Features flush mount Easy Track™ net attachment system and stainless steel hardware. Exclusive 1-5/16" European and auxiliary backstays for a unique look. Available with 3" O.D. or 4" x 2" extruded front frame. Entire goal is powder coated white... tough and durable! All NOVA Club Goal packages come complete with one pair of goals, one pair of 4" square mesh white nets, Easy Track™ net clips and a set of eight Auger style anchors. For additional styles of anchors, see (pages 31-32). Optional wheel kits are available separately (below).

### Complete Set Includes:



Round or Square Club Goal



Nets



Easy Clips™



Auger style Anchors



Easy Track™ Net Clips



## NOVA Club™ Round

NOVA Club Round	Weight	Counter Weight 	Size	Price	NOVA Club Square	Weight	Counter Weight 
RCG-24S	402 lbs.	150 lbs.	8'H x 24'W x 4'B x 9'D	\$3,659 set	SCG-24S	472 lbs.	140 lbs.
RCG-21S	358 lbs.	170 lbs.	7'H x 21'W x 3'B x 8'D	\$3,379 set	SCG-21S	418 lbs.	160 lbs.
RCG-18S	310 lbs.	240 lbs.	6'6"H x 18'6"W x 2'B x 6'D	\$3,279 set	SCG-18S	362 lbs.	240 lbs.
RCG-12S	264 lbs.	240 lbs.	6'6"H x 12'W x 2'B x 6'D	\$2,859 set	SCG-12S	306 lbs.	240 lbs.
RCG-9S	218 lbs.		4'6"H x 9'W x 2'B x 5'D	\$2,369 set	SCG-9S	250 lbs.	
RCG-6S	198 lbs.		4'6"H x 6'W x 2'B x 5'D	\$2,049 set	SCG-6S	224 lbs.	

## NOVA Club™ Square



Move your Club Goals around your field with ease with our optional wheel kit.



### NOVA Wheel Kit

Includes 4 large 10" "no flat" tires. Easily attaches to any NOVA base. (SGP-600, and NOVA Club round and square). Wheel engagement is quick and easy. One kit fits 2 goals.

NSGWK 45 lbs.

\$449 kit



NSGWK



## CLASSIC Club Goal

Natural finish, all aluminum, portable goal offers a 3 piece construction including 2 all welded side frames with patented counterweight and crossbar. Goal frame is 4" x 2" with 2" O.D. backstays. 2" O.D. galvanized steel rear ground crossbar is included on the three larger sizes. All Economical Classic Club goal packages come complete with one pair of goals, one pair of 4" square mesh white nets, hook-and-loop net straps and a set of eight Auger style anchors. For additional styles of anchors, see (pages 31-32). Optional wheel kits are available separately (below).

NEW VOLLEYBALL SOCCER FOOTBALL LACROSSE BASEBALL FIELD MARKING SCOREBOARD BASKETBALL GYMNASIUM FIELD SEATING BALL STORAGE PHYS. ED. TENNIS

### Complete Set Includes:



**Square Club Goal with patented counterweight**



**Nets - 4" sq. mesh, white**



**Rear Ground Crossbars 24' - 21' & 18'6" goals**



**Hook-and-loop net attachment**



**Auger style Anchors**



All welded side frames for increased durability!

### SAFETY FEATURE

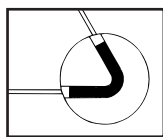

**Patented built-in Counter-weight**

The Classic Club Goals are counter-weighted for additional safety and stability. Solid steel bars are hidden inside the backstays to help prevent accidental tip over.

Item	Size	Weight	Price	Counter Weight
CSG-824S	8'H x 24'W x 4'B x 9'D	395 lbs.	\$2,398 set	140 lbs.
CSG-721S	7'H x 21'W x 3'B x 8'D	345 lbs.	\$2,198 set	160 lbs.
CSG-618S	6'6"H x 18'6"W x 2'B x 6'D	299 lbs.	\$1,998 set	240 lbs.
CSG-612S	6'6"H x 12'W x 2'B x 6'D	188 lbs.	\$1,698 set	240 lbs.
CSG-409S	4'6"H x 9'W x 2'B x 5'D	157 lbs.	\$1,498 set	
CSG-406S	4'6"H x 6'W x 2'B x 5'D	145 lbs.	\$1,398 set	

### Which size goal does your Program need?

Age Group	Recommended Goal Size	Maximum Ball Size	Minimum Players/Team
U-13	8' x 24'	5	11 vs 11
U-12	Up to 8' x 24'	5	11 vs 11
U-11	Up to 8' x 24'	4	9 vs 9
U-10	Up to 8' x 24'	4	8 vs 8
U-9	Up to 6.5' x 18.5'	4	6 vs 6
U-8	Up to 6.5' x 12'	3	4 vs 4
U-6 / U-7	Up to 4' x 6'	3	3 vs 3



CSGWK

### Classic Wheel Kit

Includes 4 large 10" "no flat" tires with fasteners for attachment to goals, SGP-760, SGP-400 and SGP-100. Can also be used with Classic Club Goals fitted with optional rear ground crossbars. One kit fits 2 goals.

**CSGWK**

45 lbs.

**\$449 kit**



**Deluxe Official Futsal Goal**

Powder coated, portable goal offers an extruded aluminum frame featuring our exclusive flush mount Easy Track™ net attachment system. Official size 6' 7" H (2m) x 9' 10" W (3m) meets specifications. Includes non-marring floor protectors, 4" sq. mesh net and Easy Clips™.

**FSG67910** 240 lbs. **\$2,598 pair**

**Futsal Goal Replacement Net**

**FSG67910N** 8 lbs. **\$159 pair**

**Futsal Goal Wheel Kit**

**FSGWK** 40 lbs. **\$449 pair**



**FSGWK  
Wheel Kit**



**Jaypro  
XCLUSIVE  
Easy Track™  
Net Clips**

**Quick Set Up Goal**

Convenient for any league or backyard use as it sets up in minutes. Goal size 8' H, adjusts to 8', 16' or 24' wide. 2" O.D. aluminum frame assembles quickly with quick release & push pins. Includes goal, net, 6 net pegs, indoor floor pads, and carry bag.

**SEYL-824** 52 lbs. **\$795 each**

**Replacement Net**

**SEYL-24NHP** 7 lbs. **\$119 each**



**ALL SURFACE  
FRIENDLY**



**Complete Set includes: goal, net, net pegs, anti-skid pads and carry bag!**



**SMG-8HP**

On the grass or in the gym.

**Rugged Play Goal**

Heavy duty steel goal for precision shooting drills or short-sided games. Great for youth leagues or the back yard! 4'H x 8'W x 4'D - great for 4 vs. 4 play! Sturdy 2" O.D. galvanized steel construction with powder coated finish. **Includes Net** - 4" square, 2.5 mm orange polyethylene. For outdoor and indoor use.

**SMG-8HP** Goal 50 lbs. **\$229 each**

**SMG-8NHP** Replacement Net 1 lb. **\$39 each**



**Quick push-pins make break-down easy for transporting goal. Includes rubber feet to protect gym floor!**

**ALL SURFACE  
FRIENDLY**

**48 HOUR  
QUICK SHIP**

## Two Goals In One!

4' x 6' Goal -OR- Flip to 3' x 6' Goal

**Two-For Youth Goal**

Ideal youth goal - two sizes in one with easy push pin assembly. Powder coated 1.5" O.D. aluminum frame with black 1-3/4" sq. mesh net and hook and loop net attachments.

**48 HOUR  
QUICK SHIP**

**MPG-46** Goal 23 lbs. **\$249 each**

**MPG-46N** Replacement Net 2 lbs. **\$39 each**



**MPG-46**

**Quick push-pins make break-down easy for transporting goal.**



## Indoor/Outdoor Folding Steel Goal

Uniquely designed goal provides outstanding performance and versatility. Perfect for competitive indoor play and an ideal outdoor training and youth goal! 7'H x 12'W x 4'D. 2" O.D. zinc undercoat with powder coated steel construction provides excellent durability. 1-5/16" O.D. zinc undercoated steel backstays fold without removing net. Non-marking floor protectors included for indoor use. See pages 31-32 for ground anchors for outdoor use. Includes 4" sq. mesh net with hook and loop net straps to eliminate lacing.

**Best Seller!**

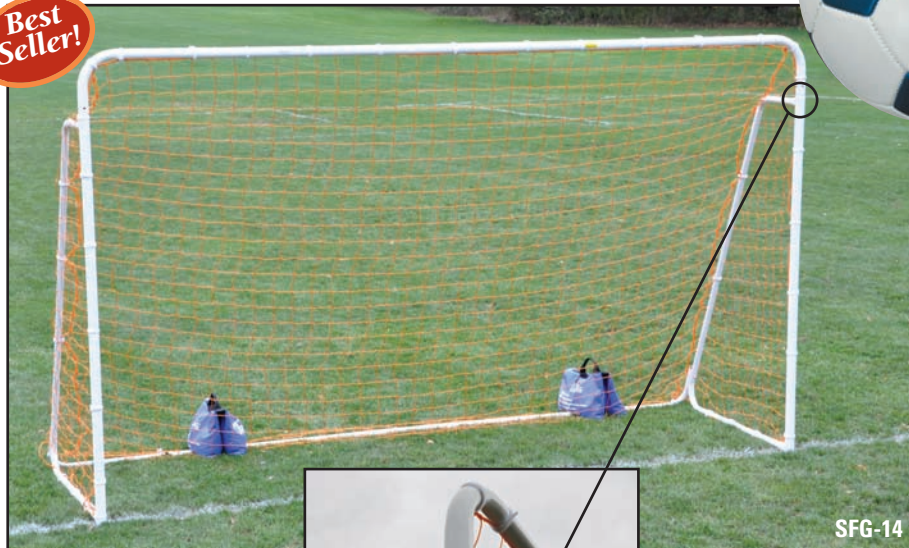

SFG-14

**SFG-14** 161 lbs. **\$749 pair**



**Replacement Net**  
**SFG-14N** 4 lbs. **\$129 pair**

**ALL SURFACE FRIENDLY**

**48 HOUR QUICK SHIP**



**Folds for portability and storage!**



**2" O.D. Steel Pipe is both strong and durable for Youth play!**

See pages 31-32 for ground anchors for outdoor use



**All portable, short sided goals fold for easy transport and storage.**

**All welded side frames for increased durability!**

**Included rear ground crossbars add strength and stability!**



PSS-608

### Portable, Short Sided Soccer Goals

1-5/16" O.D. galvanized powder-coated white steel frame. Welded side frames and rear ground crossbars for added strength and stability. Snap pins to lock frame in place for added safety. Includes ground anchors, nets, 2.5 mm, twisted, 4" sq. mesh and net ties. Folds for easy transportation and storage.

#### Great for 4 vs 4 play

**PSS-612** 6'H x 12'W x 31"D

**Powder Coated White Goal** 63 lbs. **\$289 each**

**PSS-612N**

**Replacement Net** 3 lbs. **\$46 each**

**PSS-608** 6'H x 8'W x 31"D

**Powder Coated White Goal** 60 lbs. **\$269 each**

**PSS-608N**

**Replacement Net** 2 lbs. **\$44 each**

**PSS-510** 5'H x 10'W x 34"D

**Powder Coated White Goal** 57 lbs. **\$249 each**

**PSS-510N**

**Replacement Net** 2 lbs. **\$42 each**

#### Great for 3 vs 3 play

**PSS-406** 4'H x 6'W x 24"D

**Powder Coated White Goal** 40 lbs. **\$229 each**

**PSS-406N**

**Replacement Net** 2 lbs. **\$38 each**

**ALL SURFACE FRIENDLY**

**48 HOUR QUICK SHIP**

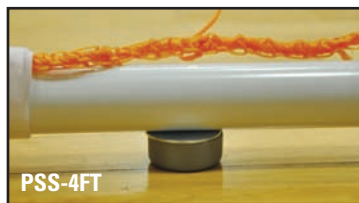

### Optional Floor Protector Kit

Use your PSS goals indoors! Optional floor protector kit ensures that your gym floors will not get scratched! Self-threading screws with 4 rubber feet.

**PSS-4FT** 2 lbs. **\$29 kit**

NEW VOLLEYBALL SOCCER FOOTBALL LACROSSE BASEBALL FIELD MARKING SCOREBOARD BASKETBALL GYMNASIUM FIELD SEATING BALL STORAGE PHYS. ED. TENNIS



Priced in Pairs



<b>SGPU4830R</b>	Jaypro Pop-Up Goals - Small Red	4 lbs.	<b>\$79 pair</b>
<b>SGPU7240B</b>	Jaypro Pop-Up Goals - Large Blue	6 lbs.	<b>\$99 pair</b>

Use Outdoor  
or Indoor!

<b>STG-23</b>	Goal - 2'H x 3'W	20 lbs.	<b>\$108 each</b>
<b>STG-23N</b>	Replacement Net	3 lbs.	<b>\$54 each</b>
<b>STG-34</b>	Goal - 3'H x 4'W	25 lbs.	<b>\$169 each</b>
<b>STG-34N</b>	Replacement Net	4 lbs.	<b>\$64 each</b>
<b>STG-46</b>	Goal - 4'H x 6'W	39 lbs.	<b>\$229 each</b>
<b>STG-46N</b>	Replacement Net	5 lbs.	<b>\$82 each</b>

**Roll-A-Goal**

This attractive versatile goal is great for short sided games and developing shooting skills.

Available in three sizes: small (2'H x 3'W), medium (3'H x 4'W) or large (4'H x 6'W) - great for 3 vs 3 play. 1-5/16" O.D. steel frame folds flat for compact storage and includes front wheels for easy transporting. Includes durable knotless nylon net with vinyl sleeves that attach with hook and loop. No lacing required! For outdoor and indoor use.

**ALL SURFACE  
FRIENDLY**

*Non marking wheels  
transport goal  
quickly and easily!*

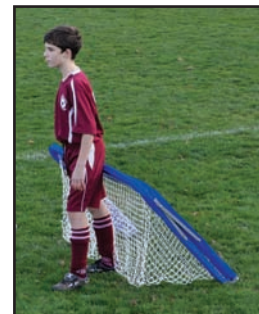

ASR33BK

**Folds flat for easy transportability perfect for the backyard, driveway or the soccer field!**

**Adjustable Soccer Rebounder**

A great training device for developing players, especially goalies! Available size: 40"H x 40"W rebound surface. 1.25" O.D. heavy duty, powder coated steel black frame and support base. Three adjustable playback angles. White mesh net with 1/8" black cord.

<b>ASR33BK</b>	21 lbs.	<b>\$249 each</b>
----------------	---------	-------------------







Available in Two Sizes!

**48 HOUR QUICK SHIP**

STG-824

STG-718

Carry Bag Included with both Training Goals and Rebounders!

### Portable Training Goal

This **light weight, stable** goal is perfect for European style training. Available in two sizes: Large (8'H x 24'W) and Medium (7-1/2'H x 18'W). 2" O.D. Heavy wall aluminum frame with white powder coated finish. Includes 4" square mesh nylon net. Stabilizing ground base plate included. Includes a carry bag.

<b>STG-718</b>	Medium Training Goal	44 lbs.	<b>\$599 each</b>
<b>STG-718N</b>	Medium Replacement Net	4 lbs.	<b>\$69 each</b>
<b>STG-824</b>	Large Training Goal	62 lbs.	<b>\$669 each</b>
<b>STG-824N</b>	Large Replacement Net	5 lbs.	<b>\$99 each</b>



STGRB824

Available in Two Sizes!

Stable anchored base

Heavy-duty wall construction for a long lasting rebounder!

### Stable Anchored Base!

Anchoring to the ground is much easier! The powder coated white ground base assembly lies flat on the ground. The ground stake is inserted through the middle of the base to anchor it to the ground. Then the upright is placed over a sleeve on the base assembly, resulting in a stable goal with no visible anchor to cause a tripping hazard!

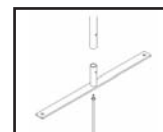

### Soccer Rebounder

Same construction as above training goals but also includes additional bottom crossbar with extra anchored base, white 1-1/2" sq. mesh net with 1/8" cord and bungee net attachments. Includes a carry bag.

<b>STGRB718</b>	Medium Rebounder	48 lbs.	<b>\$669 each</b>
<b>RB718N</b>	Medium Rebound Net	5 lbs.	<b>\$89 each</b>
<b>STGRB824</b>	Large Rebounder	67 lbs.	<b>\$795 each</b>
<b>RB824N</b>	Large Rebound Net	6 lbs.	<b>\$109 each</b>



### Replacement Equipment Carry Bag

The bag makes the goal or rebounder easy to transport and is convenient for storage. Heavy duty Cordura black bag and reinforced zipper. Includes carry straps and handles on each end. Large bag will hold our SEYL-824 goal. Medium bag will hold the above training goals and rebounders. Small bag will hold the MPG-46 goal and miscellaneous items.

<b>ECB-LG</b>	Large Bag	6 lbs.	<b>\$79 each</b>
<b>ECB-MD</b>	Medium Bag	5 lbs.	<b>\$69 each</b>
<b>ECB-SM</b>	Small Bag	4 lbs.	<b>\$59 each</b>

**48 HOUR QUICK SHIP**



### Bungees

Replace old and worn bungees. 6" long. Comes in bags of 30. Two (2) bags are required for the STGRB718 Medium Rebounder and three (3) bags are required for the STGRB824 Large Rebounder.

<b>STGRB718B</b>	6" Bungees	2 lbs.	<b>\$29 bag</b>
------------------	------------	--------	-----------------





**Easy Track™ Net Clips**  
fit securely and flush in  
our goals. Check out  
our **NEW Colors**  
on page 32!

**Net Pegs**  
Prevents ball  
from passing  
under the net.



**NP-25** 3 lbs.

\$42 set of 25

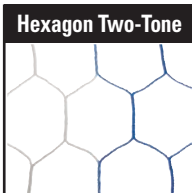

Hexagon Two-Tone

Offering  
the Two-Tone  
Hexagon Net  
in four colors!

48 HOUR  
QUICK SHIP



Braid Top Quality

Choose from  
economical  
"twist" nets or the  
more durable  
"braided" nets

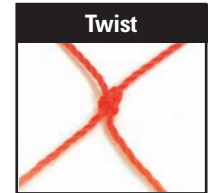

Twist

	Model	Size	Mesh	Twine	Color	Weight	Price
OFFICIAL	SND-8*	8' x 24' x 4' x 10'	5.5" sq.	4mm Braid		White	25 lbs. \$229 pr
	SND-7*	8' x 24' x 4' x 10'	5.5" sq.	4mm Braid		Orange	25 lbs. \$229 pr
	SN-40B*	8' x 24' x 4' x 10'	5.5" sq.	4mm Braid		Blue	25 lbs. \$229 pr
	SN-40R*	8' x 24' x 4' x 10'	5.5" sq.	4mm Braid		Red	25 lbs. \$229 pr
	SN-40Y*	8' x 24' x 4' x 10'	5.5" sq.	4mm Braid		Yellow	25 lbs. \$229 pr
	SN-HTTP-W*	8' x 24' x 4' x 10'	5.5" hex	5mm Braid		White	30 lbs. \$329 pr
	SGP-550N*	8' x 24' x 6' x 6' BOX	5.5" hex	5mm Braid		White	25 lbs. \$329 pr
	SN-6BLUW*	8' x 24' x 6' x 6' BOX	5.5" hex	5mm Braid		White/Blue	25 lbs. \$299 pr
	SN-6GRNW*	8' x 24' x 6' x 6' BOX	5.5" hex	5mm Braid		White/Green	25 lbs. \$299 pr
	SN-6REDW*	8' x 24' x 6' x 6' BOX	5.5" hex	5mm Braid		White/Red	25 lbs. \$299 pr
	SN-6BLKW*	8' x 24' x 6' x 6' BOX	5.5" hex	5mm Braid		White/Black	25 lbs. \$299 pr
	SN-2BLUW*	8' x 24' x 4' x 10'	5.5" hex	5mm Braid		White/Blue	30 lbs. \$299 pr
	SN-2GRNW*	8' x 24' x 4' x 10'	5.5" hex	5mm Braid		White/Green	30 lbs. \$299 pr
SN-2REDW*	8' x 24' x 4' x 10'	5.5" hex	5mm Braid		White/Red	30 lbs. \$299 pr	
SN-2BLKW*	8' x 24' x 4' x 10'	5.5" hex	5mm Braid		White/Black	30 lbs. \$299 pr	
CLUB	SEYL-24NHP*	8' x 24' x 0' x 8'	5.5" sq.	2.5mm Twist		Orange	14 lbs. \$119 ea
	SCN-24*	8' x 24' x 4' x 10'	4" sq.	3mm Twist		White	20 lbs. \$179 pr
	SCN-21	7' x 21' x 3' x 8'	4" sq.	3mm Twist		White	11 lbs. \$169 pr
	SCN-18	6-1/2' x 18-1/2' x 2' x 6'	4" sq.	3mm Twist		White	10 lbs. \$149 pr
	SCN-12	6-1/2' x 12' x 2' x 6'	4" sq.	3mm Twist		White	8 lbs. \$139 pr
	SCN-9	4-1/2' x 9' x 2' x 5'	4" sq.	3mm Twist		White	6 lbs. \$119 pr
	SCN-6	4-1/2' x 6' x 2' x 5'	4" sq.	3mm Twist		White	6 lbs. \$109 pr
YOUTH	SFG-14N	7' x 12' x 1' x 4'	4" sq.	2.5mm Twist		Orange	6 lbs. \$129 pr
	SMG-8NHP	4' x 8' x 0' x 4'	4" sq.	2.5mm Twist		Orange	5 lbs. \$39 ea
	PSS-612N	6' x 12' x 0' x 4'	4" sq.	2.5 mm Twist		Orange	3 lbs. \$46 ea
	PSS-608N	6' x 8' x 0' x 4'	4" sq.	2.5mm Twist		Orange	2 lbs. \$44 ea
	PSS-510N	5' x 10' x 0' x 4'	4" sq.	2.5 mm Twist		Orange	2 lbs. \$42 ea
PSS-406N	4' x 6' x 0' x 3'	4" sq.	2.5mm Twist		Orange	2 lbs. \$38 ea	

\* Official Size Nets



## World Cup Anchor



**ALL SURFACE FRIENDLY**

Stackable design for easy storage



Keep your soccer goals safe from tipping and up to code with weight requirements



Ideal where in-ground anchoring devices are not appropriate. Tank style anchor has a 4-3/8"W x 3-1/4"H opening designed to fit over any round or flat rear crossbar. Hard plastic shell will not crack when filled in the field with 50 lbs of concrete, 39 lbs of sand or 24 lbs of water. Large carry handle and stackable design allow for convenient storage. Overall size 8-1/2"H x 12"W. Comes in bright yellow for visibility and safety. Please check the ASTM counterweight requirements for your specific goal when ordering to ensure proper anchoring.

- SGA-50** Set of 4 12 lbs. \$289 set
- SGA-51** Single 3 lbs. \$79 each

## Counterweight Requirements for Soccer Goals

All soccer goals that are not permanently anchored must have a certain amount of counterweight, even when the goals have met all ASTM requirements. The chart below is the counterweight requirements for Jaypro's soccer goals.

	Item #	Counterweight required per goal	NOVA World Cup Anchors or Sand Bags required per goal
8' x 24' Official	SGP-600FS	140 lbs.	3 per goal
	SGP-600	140 lbs.	3 per goal
	SGP-400	160 lbs.	4 per goal
	SGP-760	140 lbs.	3 per goal
	SGP-100	170 lbs.	4 per goal
8' x 24' Club	RCG-24S	150 lbs.	3 per goal
	SCG-24S	140 lbs.	3 per goal
	CSG-824S	140 lbs.	3 per goal
7' x 21' Jr	SGP-100JR	190 lbs.	4 per goal
7' x 21' Club	RCG-21S	170 lbs.	4 per goal
	SCG-21S	160 lbs.	4 per goal
	CSG-721S	160 lbs.	4 per goal
	RCG-18S	240 lbs.	5 per goal
6.5' x 18.5' Club	SCG-18S	240 lbs.	5 per goal
	CSG-618S	240 lbs.	5 per goal
	RCG-12S	240 lbs.	5 per goal
6.5' x 12' Club	SCG-12S	240 lbs.	5 per goal
	CSG-612S	240 lbs.	5 per goal

**NEW**

**Multi-Use Soccer Cart**  
Heavy duty utility cart especially designed for hauling soccer field equipment. Easily transport your awkward and often heavy equipment; such as goal anchors, corner flags, balls and any other equipment needed for games and practices. Measures 26"W x 51"L, with fold down sides for easy loading. *Pull by hand or tow by ATV or utility tractor.* Travel on (4) 13"x 5"W pneumatic turf tires, which are rated to hold up to 350 lbs. each. Holds up to 16 NOVA World Cup anchors.

**Easily carry over 800 lbs. of equipment!**

**SGA-CART** \$649 each

### Sand Bag Anchor

Ideal where in-ground anchoring devices are not appropriate. Fill in the field with 50 lbs. of dry sand. Choose from steel carry handle (SWB-451) or nylon strap design (SWB-451W). Also available in pink. (May come in different colors)



### Sand Bag with Steel Handle

- SWB-451** 2 lbs. \$58 each
- SWB-454** 8 lbs. \$212 set of 4

### Pink Bag with Steel Handle

- SWB-451PK** 2 lbs. \$58 each
- SWB-454PK** 8 lbs. \$212 set of 4



### Sand Bag with Nylon Strap

- SWB-451W** 2 lbs. \$42 each
- SWB-454W** 8 lbs. \$149 set of 4



### Pink Bag with Nylon Strap

- SWB-451WP** 2 lbs. \$42 each
- SWB-454WP** 8 lbs. \$149 set of 4

**48 HOURS QUICK SHIP**

**ALL SURFACE FRIENDLY**



NEW VOLLEYBALL SOCCER FOOTBALL LACROSSE BASEBALL FIELD MARKING SCOREBOARD BASKETBALL GYMNASIUM FIELD SEATING BALL STORAGE PHYS. ED. TENNIS



NEW VOLLEYBALL SOCCER FOOTBALL LACROSSE BASEBALL FIELD MARKING SCOREBOARD BASKETBALL GYMNASIUM FIELD SEATING BALL STORAGE PHYS. ED. TENNIS

Soil: Loose and Sandy

Soil: Firm and Compressed

Soil: Firm and Tightly Compacted

217RP



**Auger**  
18" steel auger with steel wire lanyard.

**SAS-95** 5 lbs.

**\$69 set of 4**



SAS-95

**J-Hook Stake**  
Rugged 18" J-style steel stake with steel wire lanyard.



**SGA-91** 16 lbs.

**\$99 set of 4**



SGA-91

**Spike**  
18" long 3/4" galvanized steel stake with steel wire lanyard.



**SS-18** 12 lbs.

**\$108 set of 4**



SS-18



**Youth Goal Anchor**  
3/8" diameter, 15.5" long. **Not appropriate for official goals.**

**217RP** 2 lbs.

**\$35 set of 4**



**Weight Anchor**  
40 pound anchor weights for indoor or outdoor surface anchoring.



**SGA-40**

43 lbs.

**\$159 each**

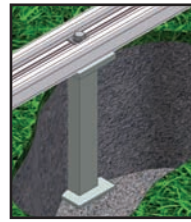

**In-Ground Anchor**

In-ground goal anchors provide the surest means of anchoring - will neither pull out nor slide off the base frame. Securely anchors any portable NOVA goal, or existing goal with minor modification. Set includes two anchors for one goal.



**SGA-60**

13 lbs.

**\$199 set of 2**



**D1315**

**Soccer Ball Bag**  
All-purpose nylon mesh ball and utility bag. Easy to use cord clasp. Size: 24" x 36"

**D1315**

1 lb.

**\$6 each**



**Ball Storage Bag**

Heavy duty mesh and Cordura ball bag. Draw string for closure and two straps to carry like a backpack. Holds up to 17 balls. 20" x 35" black.

**BLBG-20**

2 lbs.

**\$39 each**



**BLBG-20**

**Soccer Goal Post Pads**

Unique shock absorbent pad provides extra margin of safety! 1" thick, 6' high, made from closed cell waterproof and cut resistant white foam. Firm surface maintains golf like rebound characteristics. Complies with NFHS rule 1-4-1. Easy clip attachment. Set of 2 covers one goal.



Used on all 4" square, 4" round and 2x4" rectangular goals. Jaypro's SGP, SCG and CSG goals.

**SPP-4** 10 lbs.

**\$389 set**

Used on all 3" round goals. Jaypro's RCG goals.

**SPP-3** 10 lbs.

**\$299 set**



**SPP-4**



**Easy Clips™**

These rigid plastic clips fit securely into Easy Track™ so net won't slip. Bag of 100 clips. One bag includes enough clips for one pair of goals. **Colors available: white, pink, black, red and blue.**

**EC-824**

**EC-824**

white 1 lb.

**\$82 bag**

**EC-824PK**

pink 1 lb.

**\$82 bag**

**EC-824BK**

black 1 lb.

**\$82 bag**

**EC-824RD**

red 1 lb.

**\$82 bag**

**EC-824BL**

blue 1 lb.

**\$82 bag**



**Net Clips**

Exclusive design, treated steel "money clip". For use with existing pre-drilled 5/16" diameter holes. 70 clips per kit. Includes plastic retainers. Enough for one pair of 8' x 24' goals.

**SNT-180**

2 lbs.

**\$72 kit**

Same as SNT-180, except with self-drilling screws for aluminum goals. Space at 14".

**SNT-200**

2 lbs.

**\$67 kit**

**Hook-and-Loop Closure**

Custom cut your own straps. White hook-and-loop closure is 1-1/2" wide x 75' long. Enough to fit one pair of official goals.

**VNS-25** 6 lbs.

**\$79 each**



**VNS-25**

**Hook-and-Loop Closure Strips**

Convenient hook-and-loop closure tape net strips secure net without lacing.

Fits up to 2" O.D. tubing

**SINT-20** 2 lbs.

**\$34 kit of 20**

Fits 4" x 2" or 3" O.D. tubing - Kits will fit two (2) Classic Club Goals.

Fits 4'6"x6', 4'6"x9' & 6'6"x12' Club goals

**SINT-40** 2 lbs.

**\$44 kit of 40**

Fits 6'6"x18'6", 7'x21' & 8'x24' Club goals

**SINT-60** 2 lbs.

**\$54 kit of 60**



**SINT-20**





### Disk Cone

Lightweight markers for practice and drills. 2-1/4" H and 7-5/8" diameter base. Easily carried, won't tip over, highly visible. Comes in 4 colors.

<b>D272BL</b>	blue	1 lb.	<b>\$0.82 each</b>
<b>D272OR</b>	orange	1 lb.	<b>\$0.82 each</b>
<b>D272RD</b>	red	1 lb.	<b>\$0.82 each</b>
<b>D272YW</b>	neon yellow	1 lb.	<b>\$0.82 each</b>

### Disk Cone

Colored cones are now available in quantities of 100 per set.

<b>D272BL-100</b>	blue	15 lbs.	<b>\$72 set</b>
<b>D272OR-100</b>	orange	15 lbs.	<b>\$72 set</b>
<b>D272RD-100</b>	red	15 lbs.	<b>\$72 set</b>
<b>D272YW-100</b>	neon yellow	15 lbs.	<b>\$72 set</b>



### Disk Cone Carrier

Durable white vinyl-coated 5mm steel frame. Size: 7" dia. x 12"H. Holds up to 200 disk cones (not included).

<b>DCC7</b>	1 lb.	<b>\$5 each</b>
-------------	-------	-----------------

## Package & SAVE!



### Disk Package

Disk cone carrier (DCC7) and 30 cones (D272) of each color, blue, orange, red and neon yellow. 120 total cones!

<b>DCPKG</b>	20 lbs.	<b>\$84 package</b>
--------------	---------	---------------------

### Training Cones

Bright orange, solid plastic stackable cones with perimeter base. Available in two sizes.



<b>D171</b>	9"H cone	1 lb.	<b>\$1.79 each</b>
<b>D175</b>	12"H cone	1.5 lbs.	<b>\$3.29 each</b>

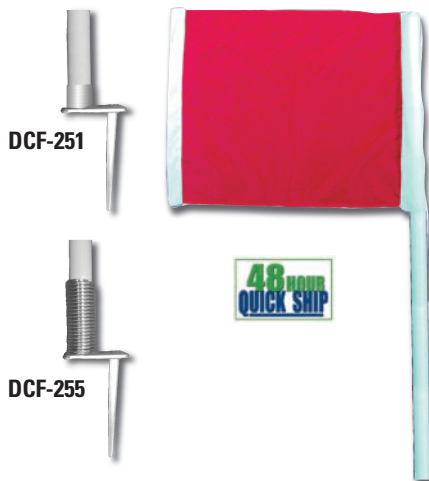

### Deluxe Corner Flags

60" high, 3/4" thick PVC pole with heavy-duty base and square red and white flag. Each set includes four flags.

<b>DCF-251</b>	8 lbs.	<b>\$84 set</b>
----------------	--------	-----------------

### Deluxe Training Flags

Spring loaded base ideal for training drills and safety corner flags. Each set includes four flags.

<b>DCF-255</b>	8 lbs.	<b>\$94 set</b>
----------------	--------	-----------------



### Field ID Markers

14" x 14" vinyl markers with corner grommets to put on the back of the net of each goal. Specify color and numbers when ordering.

<b>FIM-14</b>	1 lb.	<b>\$19 each</b>
---------------	-------	------------------



### Cone Cart

Durable 1" dia. steel powder coated blue frame. Includes large 8" diameter wheels for use indoor and outdoors. Rubber stopper protects gym floors. Will hold up to 130 standard 12" cones.

<b>CNCART</b>	22 lbs.	<b>\$159 each</b>
---------------	---------	-------------------



### Corner Flags

Can be used on turf, indoor or outdoors, official 5' high, 1" diameter PVC poles. Set includes 4 poles, 4 flags and 4 black rubber bases.

<b>RBF-4</b>	50 lbs.	<b>\$220 set</b>
--------------	---------	------------------



### Flag Base Bag

Transport the rubber bases in this vinyl carry bag. 12"W x 12"D x 14"H. Each bag holds (4) bases.

<b>RBF-BASE</b>	3 lbs.	<b>\$25 each</b>
-----------------	--------	------------------

**Wet and Dry Field Marking products and Line Layout Systems are located on pages 67-69**

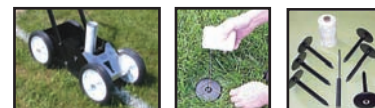





SR-12

**Speed Rings**

Twelve rings per set (4 of each: red, blue and yellow), 18" diameter x 3/4" wide flat rings.

SR-12

3 lbs.

\$29 set



SCSPCHT

**Speed Chute**

Ultimate training device for improving speed, strength and resistance. Provides up to 15 lbs. of resistance, includes adjustable strap with hook and loop closure.

SCSPCHT

1 lb.

\$39 each



SL-20

**Speed Ladder**

20'L x 20"W with (24) adjustable flat rungs. Carrier handle included.

SL-20

6 lbs.

\$38 each



SARC-12

**Passing Arc**

Constructed of yellow PVC. Spikes for easy insertion in ground. Size: 20" x 12". Set of 12. Includes carry bag.

SARC-12

9 lbs.

\$79 set



RBCS-6

**Coaching Sticks**

Can be used on turf, indoor or outdoors, official 5' high, 1" diameter PVC poles. Set includes 6 poles and 6 black rubber bases.

RBCS-6

70 lbs.

\$260 set

**ALL SURFACE  
FRIENDLY****Flag Base Bag**

Transport the rubber bases in this vinyl carry bag. 12"W x 12"D x 14"H. Holds (4) bases. (2 bags required per set)



RBF-BASE

3 lbs.

\$25 each



SCSPDKIT

**Speed Agility Kit**

Kit includes: Fast foot ladder 4mtr (2 pieces), Hurdle 6", 9" & 12" (2 of ea), Speed chute, Speed harness, Speed resistor, Reaction ball senior, Evasion belt, Ten Saucer cones and a carry bag.

SCSPDKIT

17 lbs.

\$179 set

**NEW****Strike Attack Soccer Machine**

Battery powered machine provides reliable service on any soccer field or playing surface. A realistic curve and bend of the ball can be consistently delivered and easily controlled. Balls can be delivered at speeds up to 75 mph and distances of 70 yards or more. The type of spin, height and direction desired can be locked into place to ensure precise repetition focused on your specific training objectives.

SASM-1

250 lbs.

\$4,199 each

**STRIKE  
ATTACK**





Call Customer Service for Details on Pricing and Options.



Color Choices: Gray, Navy Blue, Royal Blue, Red, Black, Maroon or Green

## Soccer Shelter

**Features include:** 17'W x 6' 4"H x 5'D. Powder coated steel frame. Removable top for quick and easy (dis)assembly. Includes 4 auger stakes for grass or 4 sand bags (filled in the field) for turf anchoring (specify when ordering). Wheel Kit. **Available Options:** Optional Team Name/Logo. Zippered sides to improve ventilation and wind passage. Additional sizes and styles available. See pages 106-107 for optional matching color player bench choices. Does not ship from Jaypro's CT warehouse. Call for Options, Pricing and Freight Quote.

## Portable Team Benches

Convenient, collapsible benches fold in seconds, include carry bag and end gear pockets. Weight capacity per seat is 250 lbs. Comes in two sizes: 3 person and 6 person.



TMBNCH6

Gear pocket located on the end of the bench.

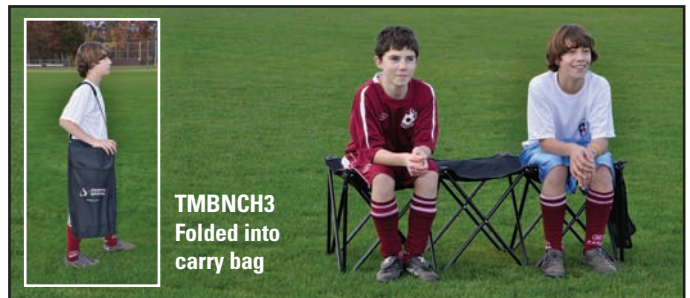

TMBNCH3  
Folded into  
carry bag

**TMBNCH6** 6 person 104"x 19"x 17" 19 lbs. **\$149 each**

**TMBNCH3** 3 person 53"x 19"x 17" 13 lbs. **\$79 each**



FLD-B5



### Field-To-Go Team Bench

Five person bench with end cup holders folds compactly into a 6" x 21" x 32" carry bag. Each seat supports up to 250 lbs.

**FLD-B5** 27 lbs. **\$129 each**



CSTOOL

DCSTOOLWB

### Coaches Stools

Foldable coaches stools with hook-and-loop carry strap. Weight capacity 275 lbs.

**CSTOOL** No Back  
18"x 11"x 11" 2 lbs. **\$28 each**

**DCSTOOLWB** Back  
30"x 15.5"x 13" 3 lbs. **\$39 each**



See pages 100-107 for additional player and spectator seating.



## ALL ALUMINUM! Removable European Backstays



Removable Standard Backstays



Football Goal



4" O.D. Crossbars, strong gussets for a clean look!

### Deluxe Official Soccer/Football Goal

This durable combination of official soccer and football goals is an excellent addition to any multi-purpose athletic facility. 8' x 24' x 10' x 4" (soccer goal dimensions). Main soccer uprights and crossbars are 4" O.D. round extruded aluminum featuring our Easy Track™ net attachment system. Reinforced corners for extra strength and durability. Removable soccer backstays are 2" O.D. 10' H top football uprights are 2-3/8" aluminum. Tough powder coated white finish. Meets NFHS and NCAA specifications. Designed for permanent or semi-permanent installation. Nets, page 30, post padding, page 41 and ground sleeves, below, available separately.

**FBSC-240** Goal w/Standard Backstays 500 lbs. **\$4,295 pair**

**FBSC-240EB** Goal w/European Backstays 470 lbs. **\$4,395 pair**



← Easy Track™ net attachment system!



Easy Clips™ are included!

### Aluminum Ground Sleeves

Set of 4 aluminum ground sleeves with locking caps for semi-permanent installation.

**SGP-445G** 28 lbs. **\$479 set**



FBSC-120  
Base Goal with no Backstays



FBSC-120  
Base Goal for Football



FBSC-120FBS  
Full Backstays



FBSC-120EBS  
European Backstays

### Official Soccer/Football Goal

For shared football and soccer fields. Meets high school regulations for competition football and soccer. Soccer goal dimensions are 8' x 24', and football crossbar is 10' high. Football uprights can be installed at high school (23' 4") or collegiate (18' 6") widths, or removed for soccer play. Goal support uprights are constructed of 2" x 4" 14 gauge steel tubing. Top football uprights are 2" square steel tube, extending 10' above the crossbar. Finish is tough durable white powder coat over zinc rich primer. Includes "money clip" style net attachment. Permanent or semi-permanent installation, using optional ground sleeves (see below). Nets (page 30) and backstays purchased separately.

### Base Combo Goal with no Backstays

Use SEYL-24NHP net with no top depth, 8' x 24' x 0' x 8' (ordered separately on page 30).

**FBSC-120** 650 lbs. **\$2,795 pair**



### Standard Backstay Kit

Set of 4 removable full soccer backstays made from 1.66" O.D. galvanized steel tubing. Use with standard official size net, 8' x 24' x 4' x 10' (ordered separately on page 30).

**FBSC-120FBS** 140 lbs. **\$629 set**

### European Backstay Kit

Set of 4 removable European backstays made from 1.66" O.D. aluminum tubing, with 4' depth. Use with standard official size net, 8' x 24' x 4' x 10' (ordered separately on page 30).

**FBSC-120EBS** 45 lbs. **\$599 set**

### Ground Sleeves

Optional 24" ground sleeves for semi-permanent installation. Includes 4 sleeves and locking caps.

**SGP-722G** 15 lbs. **\$465 set**





## FOOTBALL/SOCCER COMBO

### Portable Practice Football/Soccer Combo Goal - High School

Soccer shooting area 8'H x 24"W. High school football crossbar 23' 4"W. Constructed of 2" O.D. galvanized steel. Four easy roll wheels allow complete mobility. Light but stable. Great for multipurpose or practice fields. Net (below) and Wind Streamers (page 41) sold separately.

**PCG-800** 400 lbs. **\$1,995 each**

### Portable Combo Goal Net

5.5" sq. mesh, 2.5 mm orange polyethylene net.

**SEYL-24NHP** 7 lbs. **\$119 each**

**PNT-1** Powder Coat **\$100 each**



Easy Roll Wheels

PCG-800 shown with SEYL-24NHP

## FOOTBALL ONLY

### Portable Practice Football Goal - High School

20'H x 23'4"W

**PPG-4HS** 375 lbs. **\$1,795 each**

### Portable Practice Football Goal - Collegiate

20'H x 18'6"W

**PPG-4C** 375 lbs. **\$1,795 each**

### H-Frame Football Goal Post

H-style goal post meets official NFHS specifications. Constructed with heavy wall 4" O.D. heavy wall Aluminum tubing. Measures 23'-4"W x 20'H. Uprights extend 10' above crossbar. **Goal is powder coated white.** Designed for permanent installation.

**HFGP-3** 400 lbs. **\$1,995 pair**



HFGP-3

### Official Rugby Goal

Official size Rugby goal measures 18'-4"W (5.6m) x 32'H (9.8m). Uprights extend 22' above crossbar. Uprights made with 4" O.D. Sch 40 aluminum tubing. Crossbar is 4" O.D. 8 gauge aluminum tubing. Tough powder coated white finish. Designed for permanent installation.

**RGP-3** 580 lbs. **\$3,795 pair**

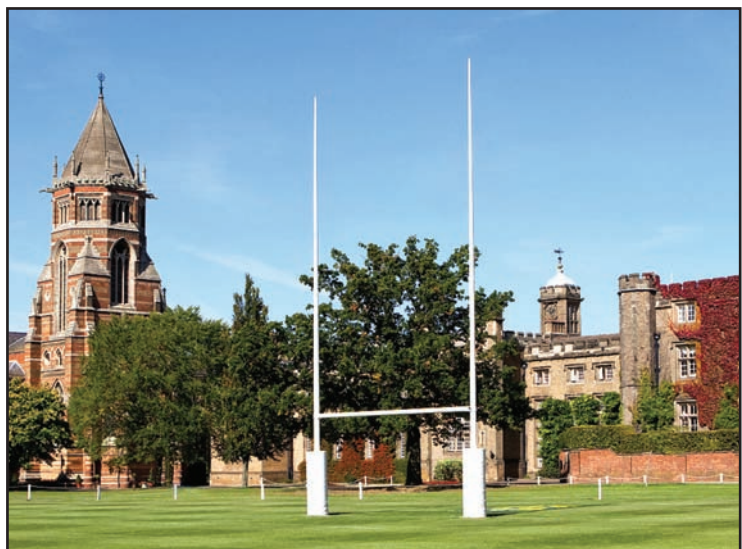





**Fully Adjustable in 2 Directions ensuring the crossbar and uprights are level and plumb!**

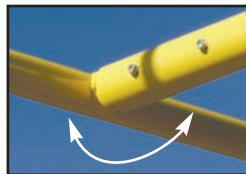
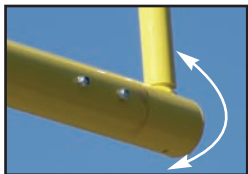

### Economical Steel Football Goal Post

- Zinc and powder coated steel goosenecks available in 4-1/2" with 5' offset OR 5-9/16" with 6' offset
- 20' high 2-3/8" top aluminum uprights
- Permanent or adjustable leveling plate installation
- Ground sleeves available separately (below) for semi-permanent installation
- Meets NFHS & NCAA specifications
- **Collegiate goal posts also available, please call or visit our website for details.**
- **See page 41 for goal post accessories**

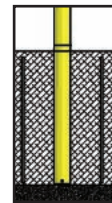

Install directly into concrete or into optional ground sleeve.

**-OR-**

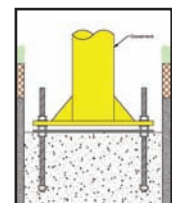

Exclusive adjustable leveling plate allows for correct alignment after installation.

	Offset	Color	Gooseneck	Semi-Permanent/Permanent Item #	Price	Leveling Plate Item #	Price
<b>High School</b> 23' 4" wide	5'	Yellow	4-1/2"	FBGP-620YW	\$4,295 pair	FBGP-600YW	\$5,295 pair
	5'	White	4-1/2"	FBGP-620	\$4,295 pair	FBGP-600	\$5,295 pair
	6'	Yellow	5-9/16"	FBGP-720YW	\$6,295 pair	FBGP-700YW	\$6,995 pair
	6'	White	5-9/16"	FBGP-720	\$6,295 pair	FBGP-700	\$6,995 pair

**Collegiate sizes also available - Please call for details and information!**

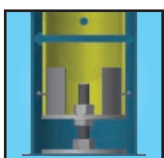

#### Ground Sleeve with Height Adjuster

Make life easier with this adjustable ground sleeve. Get the perfect alignment with a simple tweak rather than starting from scratch.

<b>FBGPGS-5</b>	4-1/2" dia.	\$895 pair
<b>FBGPGS-6</b>	5-9/16" dia.	\$995 pair

#### Standard Ground Sleeve

<b>FBSLV5</b>	4-1/2" dia.	\$795 pair
<b>FBSLV6</b>	5-9/16" dia.	\$845 pair

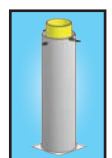

# Max-1 All Aluminum Goal Posts



NEW VOLLEYBALL SOCCER FOOTBALL LACROSSE BASEBALL FIELD MARKING SCOREBOARD BASKETBALL GYMNASIUM FIELD SEATING BALL STORAGE PHYS. ED. TENNIS

## Max-1 All Aluminum Football Goal Post

- All aluminum construction
- 6-5/8" crossbar and gooseneck available with 6' or 8' offset
- 4" top uprights available in 20' or 30' heights
- Permanent or adjustable leveling plate installation
- 8' offset is perfect for multi-purpose fields and can be used with soccer goal models SGP-600AX, SGP-400, SGP-760 and CSG-824S
- Meets NFHS & NCAA specifications
- **Expandable 18'6" -23'4"** (below) or **Collegiate 18'6"**(online) goal posts also available
- See page 41 for ground sleeves, access frames, hinge kits and other accessories



*Collegiate sizes available for Max-1 Goal Posts, please call or visit our website for details.*



**Most impressive goal on the market using 6-5/8" Aluminum material!**

	Model	Offset	Uprights	Semi-Permanent/Permanent Item #	Price	Leveling Plate Item #	Price
<b>High School</b> 23' 4" wide	Max-1	6'	20'	FBGP-520	\$7,495 pair	FBGP-420	\$8,995 pair
	Max-1	6'	30'	FBGP-530	\$7,895 pair	FBGP-430	\$9,295 pair
	Max-1	8'	20'	FBGP-820	\$7,695 pair	FBGP-920	\$9,295 pair
	Max-1	8'	30'	FBGP-830	\$8,095 pair	FBGP-930	\$9,595 pair

## Expandable Crossbar

Telescoping design allows crossbar width to adjust for official use at 23' 4" (High School) and at 18' 6" (College). Anti-rotation feature holds upright in place allowing one person to adjust. The 8' gooseneck model used with our adjustable rear crossbar soccer goals is ideal for multi-purpose facilities.



	Model	Offset	Uprights	Semi-Permanent/Permanent Item #	Price	Leveling Plate Item #	Price
<b>Expandable 18' 6" - 23' 4"</b>	Max-1	6'	20'	FBGP-520AX	\$8,695 pair	FBGP-420AX	\$9,995 pair
	Max-1	8'	20'	FBGP-820AX	\$8,895 pair	FBGP-920AX	\$10,295 pair





## FieldPro Football Ball Stop System

Backstops are installed behind football goal posts to keep field goals and extra point kicks inside the field. 40'W net can easily and quickly be raised and lowered during games or practice with a rope and marine style swivel pulley system with integrated ball bearings. Includes heavy duty 6-5/8" diameter aluminum poles, ground sleeves, corrosion resistant hardware and 3-1/2" square mesh #36 knotless nylon black net with 1/4" rope border. Available in 30' or 40' heights. Poles can be powder coated black, call Customer Service for details. More Field Netting is available on pages 97-99.

**FNFB-30** 30'H x 40'W 530 lbs. **\$4,195 each**

**FNFB-40** 40'H x 40'W 762 lbs. **\$6,595 each**

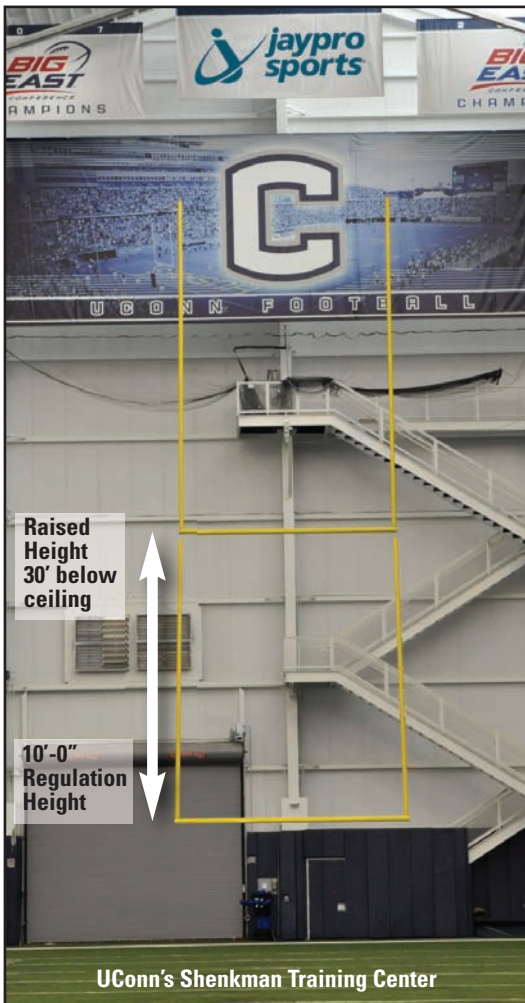
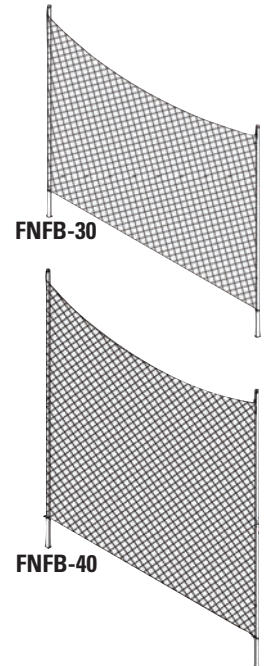

## Indoor - Ceiling Suspended and Retractable Football Goal Posts

Ceiling hung football goal posts for indoor practice facilities. Allows kickers to practice indoors, or for use during indoor scrimmages. Material sizes are the same as found on high end outdoor goal posts. Crossbar is 6-5/8" O.D. Aluminum tubing by 18'-6" wide. Uprights are made from 4" O.D. Aluminum tubing, and measure 30 feet tall. Comes with a leveling feature to ensure the crossbar is level. Powder coated yellow.

### Ceiling Suspended Goal Post

Suspended directly beneath the building structure, attaches directly to rigid frame girders, building trusses, I-beams or roof purlins. Comes complete with all attachment and suspension hardware.

**CSGP-1** 390 lbs. **\$2,895 each**

### Retractable Ceiling Suspended Goal Post

Similar to the CSGP-1 but includes a 1 HP hoisting system to raise the goal post out of the way when not in use. Comes complete with 1 HP electric winch, pulley and cable system, and all attachment and hoisting hardware. Winch mounts directly to end wall structure.

**CSGP-2** 510 lbs. **\$4,649 each**

**23'-4" width goal post  
(High School dimensions)  
also available.**

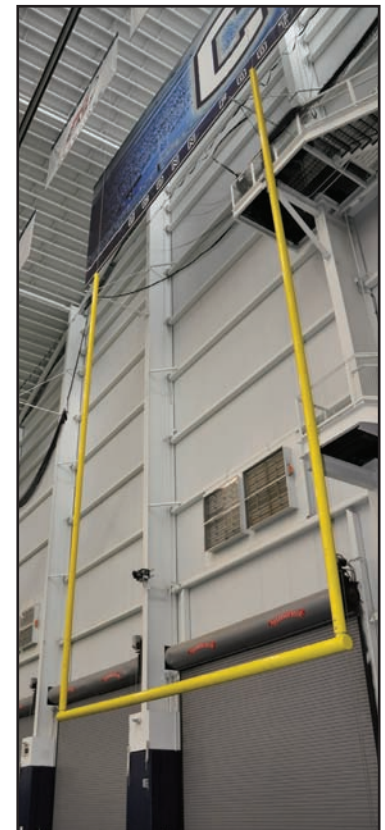

**Retractable ceiling suspended football goal posts for indoor practice facilities. Raise the goal post out of the way when not in use!**

## Max-1 Accessories

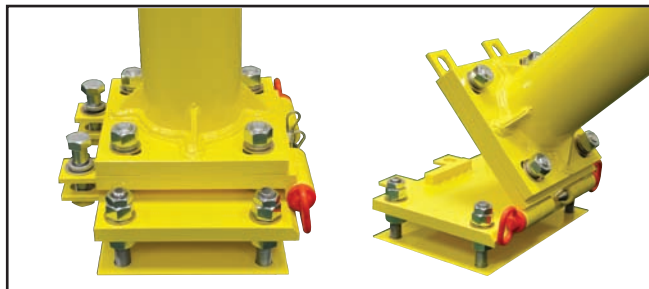

### Football Hinge Kit

Ideal for multi-purpose facilities, the hinge kit allows any surface mounted Max-1 goal to be lowered and dismantled from ground level by a maintenance crew. Opposing pull pins offer easy separation of the hinge plates. The welded shackle bracket on the Max-1 gooseneck offers an attachment point for a cable or hoist. Requires the FBGPAF-2 access frame kit (available separately, see to right).

**FBHG-1**

**\$695 each**

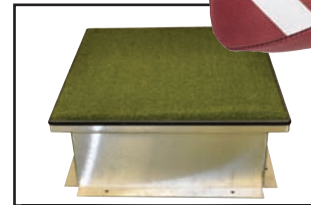
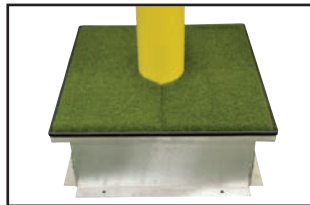

### Access Frame and Covers

For use with semi-permanent goal posts requiring removal. Can be used on grass or turf fields. Turf cover hides anchoring hardware while allowing access when required. Constructed of aluminum, pressure treated plywood and artificial turf. Includes two frames and four turf covered plates; two split panels for use with goal post and two full panels for when goal post is removed. Available in two sizes (larger size used with goal post hinge kit).

**FBGPAF-1** 18-1/4" L x 18-1/4" W x 8" H

**\$1,295 pair**

**FBGPAF-2** 29" L x 29" W x 11-5/8" H

(for use with goal post hinge kit)

**\$1,495 pair**



### Soccer/Football Anchor Kits

Fastens the rear crossbar of the soccer goal to the football goal gooseneck.

**SFGA-6** 6-5/8" O.D. Gooseneck

**\$139 each**

**SFGA-5** 5-9/16" O.D. Gooseneck

**\$129 each**

**SFGA-4** 4-1/2" O.D. Gooseneck

**\$119 each**



### Wind Streamers

4" W x 42" L w/ grommets.

**WS-42**

1 lb.

**\$20 pair**

### Ground Sleeve w/ Height Adjuster

Make life easier with this adjustable ground sleeve. Get the perfect alignment with a simple tweek rather than starting from scratch.

6-5/8" diameter

**FBGPGS-8**

**\$1,149 pair**

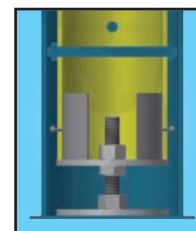

### Standard Ground Sleeve

6-5/8" diameter

**FBSLV8**

**\$895 pair**

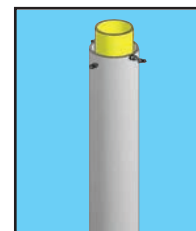

## Goal Post Padding



### Pro-Style Round Post Protector Pads

Professional style pads for 4-1/2", 5-9/16" or 6-5/8" O.D. goal posts. 6' H pads are made of 6" thick foam covered by 14 oz vinyl. Hook and loop attachment. See below for color selections.

**PPP-500** 4-1/2" O.D. Post 35 lbs.

**\$749 pair**

**PPP-700** 5-9/16" O.D. Post 40 lbs.

**\$795 pair**

**PPP-800** 6-5/8" O.D. Post 45 lbs.

**\$949 pair**



Shown with custom lettering



**NEW COLOR!**

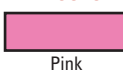

Pink



### Economy Post Protector Pads

Designed for 4-1/2" O.D. goal posts. 6' H pad is made of 4" thick foam covered by 14 oz vinyl. Grommet attachment, cord included. See below for color selections.

4-1/2" O.D. Post

**PPP-5**

18 lbs.

**\$425 pair**



### Custom Lettering

(As shown to the left) Put your school name on your pads! White vinyl letters as shown. 3-9 letters on one pad.

**PVL-39**

white lettering

**\$159**



Please Note: Colors may not be an exact match.





NEW VOLLEYBALL SOCCER FOOTBALL LACROSSE BASEBALL FIELD MARKING SCOREBOARD BASKETBALL GYMNASIUM FIELD SEATING BALL STORAGE PHYS. ED. TENNIS



Heavy-duty swivel casters

48 HOUR QUICK SHIP

### Shoulder Pad *StackMaster™*

Roll-a-way 1-5/16" O.D. steel storage/transportation rack holds up to 42 shoulder pads. **Powder coated for extra durability!** Heavy-duty swivel casters assure complete portability even when fully loaded. 2'W x 6'6"H.



SP-2

**SP-2** 37 lbs. **\$195 each**



48 HOUR QUICK SHIP

### Shoulder Pad *StackMaster™* Cart

SP4

Transport and store 60-80 shoulder pads on this deluxe 4-wheel cart. This all-steel unit moves easily on four heavy-duty non-marking casters and has a removable transport handle. Size 24"W x 60"L x 70"H.

**SP4** 69 lbs. **\$269 each**



H-1



48 HOUR QUICK SHIP

### Helmet *StackMaster™*

This heavy duty portable helmet storage/transportation rack holds up to 56 helmets. Rugged all-welded steel base has 4 swivel casters for easy portability. 2'6"W x 6'3"H.

**H-1** 59 lbs. **\$239 each**



**NEW**

### Helmet *StackMaster™* Cart

Transport and store 60 football helmets with masks on this 4-wheel cart. Constructed of 1" O.D. chrome steel tubing and includes 4" casters for easy mobility. Will fit through a standard doorway. Can also be used for lacrosse and baseball batting helmets. Size 24"W x 61"L x 64"H.

Heavy-duty swivel casters

**FHC-1** 61 lbs. **\$259 each**



## Save \$\$\$ with a Package Deal on Storage Equipment for the Football Program...

**FRP-2** Football Rack Package, Includes a SP4 & a H-1

**A SAVINGS OF \$89**

Priced Separately at \$508

**\$419 package**

### Snap Attack Football Machine

The Snap Attack is a snap, pass and kick machine that will maximize your time on the most difficult to practice phases of the game. Features include universal ball feed cradle, elevation control and lever clamp combined with a locating pin to make changes from spirals to kick-offs easy and quick. Speeds of 70+ mph and distances of 100 yards for passes and punts, 70+ yards for kick-offs and 5-15 yards for snap-tight spirals. Ball release points at 5' for passes and ground level for snaps.

**SAFM-1** 90 lbs.

**\$4,199 each**



**NEW**

*Wet and Dry Field Marking products and Line Layout Systems are located on pages 67-69*





- ① Fully padded chain suspended lower frame
- ② 12" heavy duty swivel casters
- ③ Reinforced heavy walled steel frame
- ④ Easily adjust the frame height from 42" to 66" with handle pull pin



### The Lowdown Linemen Chute

Train your linemen and backers to stay low. Run your blocking scheme and trap drills. Wide open access from all sides. Black weather resistant mesh fabric screen is light weight, durable and won't scratch player's helmets. Telescoping legs allow frame height to be easily adjusted. Frame can be angled to any position by adjusting the support chains. Comes standard with four 12" heavy duty pneumatic swivel casters to allow easy transport and storage. Upper frame is made of heavy walled steel and reinforced for added stability, while lower frame is made of light weight aluminum. Comes in two sizes, 30' x 6' and 20' x 6'. Available in neon yellow.



<b>FBLC-20</b>	20' x 6'	450 lbs.	<b>\$3,195 each</b>
<b>FBLC-30</b>	30' x 6'	500 lbs.	<b>\$4,395 each</b>



**FBWSM**

### Crushable Sideline Markers

Self-standing with weighted bottom. 12"H numerals on both sides, stores flat. Heavy duty cover. 11 piece set. Does not ship from Jaypro's CT warehouse. Call for freight quote.

<b>FBWSM</b>	39 lbs.	<b>\$325 set</b>
--------------	---------	------------------

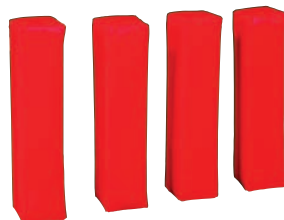

**FBPYLN**

### Free Standing and Anchorless Pylons

Self standing end zone pylon. Weighted bottom. 4 piece set. Official size: 4"L x 4"W x 18"H. Does not ship from Jaypro's CT warehouse. Call for freight quote.

<b>FBPYLN</b>	12 lbs.	<b>\$49 set</b>
---------------	---------	-----------------



**FBPRCRV**

### Curved Pro Body Shield

Precurved 4" thick foam. Vinyl cover with handles. Royal Blue. Size: 24" x 16" x 4". Does not ship from Jaypro's CT warehouse. Call for freight quote.

<b>FBPRCRV</b>	4 lbs.	<b>\$72 each</b>
----------------	--------	------------------



### Chain Sets

Completely padded. Bright orange targets. Plated chain and swivel hooks eliminate kinks and knots. Comes in 2 sizes. Does not ship from Jaypro's CT warehouse. Call for freight quote.

<b>FCS-8</b>	8'	15 lbs.	<b>\$339 each</b>
<b>FCS-7</b>	7'	8 lbs.	<b>\$225 each</b>



**FFD-10**

### Flip Down Indicator

Completely padded. Super durable numbers. Does not ship from Jaypro's CT warehouse. Call for freight quote.

<b>FFD-10</b>	8 lbs.	<b>\$225 each</b>
---------------	--------	-------------------



### SackBack Tackle Sled

Please call or visit us online to get all the info on our sleds and training equipment! Does not ship from Jaypro's CT warehouse. Call for freight quote.

<b>TKSLDV</b>	Varsity	225 lbs.	<b>\$969 each</b>
<b>TKSLDP</b>	Pro	295 lbs.	<b>\$1,169 each</b>



## Linemen Chute - Single or Multiple

Great instruction tool to teach the basics of coming off the ball low and drive upward. Adjustable entrance with three height positions. Heavy-duty 1-5/8" steel tube frame with long lasting powder coated finish. **Chutes can be attached to each other to replicate entire line.** Overall size: 4'L x 5'H.



**FBLMCH**

55 lbs.

**\$179 each**



## Offering a Football Training Package to help save your Program \$\$\$...

**FBTP-3** Football Training Package, Includes a FBLMCH, a FBHSTP & a PK-64  
**A SAVINGS OF \$68** Priced Separately at \$587 **\$519 package**



### Professional Portable Kicking Cage

Portable kicking cage for quick warm up. Heavy duty 1-5/16" galvanized steel frame with a deep net to help contain balls. Folds down easily for storage. Includes a black Cordura carry bag for transport (78" x 11" diameter). Heavy-duty knottless nylon kicking net. Size: 48"W x 48"D x 86"H.

**PKC-1** 37 lbs. **\$489 each**

Replacement Net

**PKC-1N** 5 lbs. **\$129 each**



Carry Bag Included!



PK-64

Weighted Base!

### Portable Kicking Cage

Assembles in minutes **without** tools. Rugged 1-5/8" powder coated frame is designed for maximum stability. 6'6"H x 4' W. Includes heavy-duty, slip-on nylon net. Weighted base (26 lbs.).

**PK-64** 35 lbs. **\$169 each**



### High Stepper Agility Trainer

Designed for building foot speed and agility. Powder coated steel tube frame with suspended rope running grid with 16 squares. Adjust to five different heights to increase leg lift. Designed for quick assembly and safety with tubing frame outside the running grid. 20' L with 6"W.

**FBHSTP** 45 lbs.

**\$239 each**

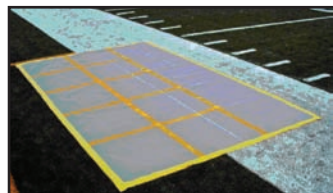

## Call for info on all our Turf Protector Products

Cross-Over Zone® Track Protector, Huddle Zone® Special Team Mat, Bench Zone® Sideline Track Protector, Bench Zone® Sideline Turf Protector





## Official Field Hockey Goals with Bottom Boards

This attractive goal meets official specifications. Steel construction is extremely durable. Goal size is 7'H x 12'W x 4'D. Heavy Duty 2" x 2" square steel goal face. Rear frame constructed of 1-5/16" O.D. galvanized steel powder coated white. All welded side frames and top rear cross bar for maximum stability. **Jaypro Exclusive! Official black bottom boards of 1/2" thick High Density Polyethylene that will never fade or break!** Unique "money clip" style net clips simplify net attachment. Meets NCAA, NFHS and FIH specifications. Nets available separately, see below. Optional heavy-duty 10" no-flat wheel kit available for easy transport, see below.

**OFHG7124** 534 lbs. **\$2,495 pair**



## Official Field Hockey Bottom Board

Includes black high density polyethylene boards and all necessary hardware for attachment to most goals.

**FHG-16** 164 lbs. **\$1,039 pair**

**Transports Easy With Large 10" No-Flat Wheels!**

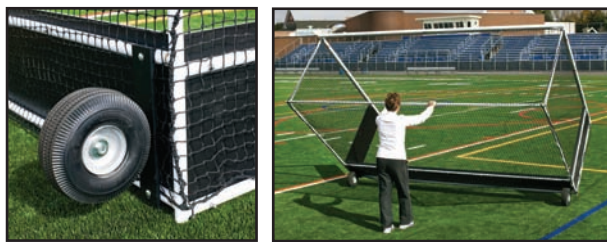

## Optional Wheel Kit

Optional "tip and roll" wheel kit makes our goals easy to transport! Four heavy duty 10" no-flat wheels. One set fits one pair of goals.



**FHGWK** 49 lbs. **\$329 set**

## Official Field Hockey Net

7'H X 12'W X 4'D weatherproof 1-3/4" sq. mesh, 2.5 mm polyethylene material.

**FHND-8** 19 lbs. **\$199 pair**



NEW

## Offering a Field Hockey Package to help save your Program \$\$\$...

**OFHG7124PKG** Field Hockey Package, Includes a OFHG7124, a FHND-8 and a FHGWK

**A SAVINGS OF \$324** Priced Separately at \$3,023 **\$2,699 package**



## Official Field Hockey Goals without Bottom Boards

Same as the above goal, minus the bottom boards.

**OFHGNBB** 370 lbs. **\$1,449 pair** 

## Optional Wheel Kit

Optional "tip and roll" wheel kit makes our goals easy to transport! Four heavy duty 10" no-flat wheels. One set fits one pair of goals.

**FHGWK** 49 lbs. **\$329 set**

## Practice Field Hockey Goal

Official size 7'H x 12'W x 4'D with 1-5/16" O.D. galvanized steel frame and cast aluminum corner fittings for easy assembly. **Includes net (black).**

**PFHG-41** 63 lbs. **\$495 each** 

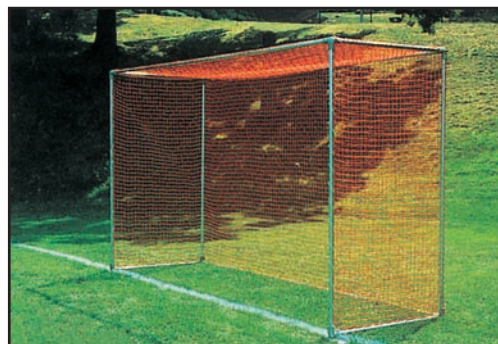

NEW VOLLEYBALL SOCCER FOOTBALL LACROSSE BASEBALL FIELD MARKING SCOREBOARD BASKETBALL GYMNASIUM FIELD SEATING BALL STORAGE PHYS. ED. TENNIS



**6' x 6' GOAL**

LG-50

Five Year Warranty!

**Deluxe Official Lacrosse Goals**

This ultimate Lacrosse goal has mitered and welded corners for exceptional performance. Full size 6'H x 6'W x 7'D meets all NCAA and NFHS requirements for men's lacrosse. 1/4" steel net tie rail for a clean goal face and bottom. 2" O.D. steel pipe construction for full NCAA compliance. Powder coated orange over rust-proof zinc coated steel pipe. **Nets available separately**, see below.

LG-50

170 lbs.

\$649 pair



*Net rail keeps the goal face and bottom frame free from tape and string for an attractive, professional appearance*



*Rear brace lays flat along the ground to eliminate any obstruction to the ball.*

**NEW****Offering a Lacrosse Goal Package to help save your Program \$\$\$...**

LG-50PKG

Lacrosse Goal Package, Includes (1 pair) LG-50 Goals and (2) LGN-50 Nets

A SAVINGS OF \$32

Priced Separately at \$927

\$895 package

LG-540



Includes Net!

*Net has a pocket that lies under the goal to help put on the net and keep it in place!*

**Deluxe Practice Lacrosse Goals**

A great value goal! Full size 6' x 6' x 7'. 1.75" O.D. steel powder coated for extra durability. Deluxe 2.5mm net included.

LG-540

Goal

37 lbs.

\$199 each

**LACROSSE NETS****Competition Lacrosse Net**

5mm knotless netting, 1-1/2" squares. Official size 6' x 6' x 7'. Meets all NFHS and NCAA regulations. Weatherproof white polyester with natural UV stabilizer. Triple stitched webbing binder. Includes lacing cord.

LGN-50

15 lbs.

\$139 each

**Practice Lacrosse Net**

3mm knotless netting, 1-1/2" squares. Official size 6' x 6' x 7'. Meets all NFHS and NCAA regulations. Weatherproof white polyester with natural UV stabilizer. Triple stitched webbing binder. Includes lacing cord.

LGN-30

13 lbs.

\$98 each

**Practice Lacrosse Net**

2.5mm knotless white netting, 1-1/2" squares. Official size 6' x 6' x 7'. Includes lacing cord.

LGN-25

11 lbs.

\$74 each





## Box Lacrosse

Official indoor lacrosse goal. Designed for 6 vs 6 play. 4'H x 4'W x 4'D. Constructed of 2" O.D. steel with mitered and welded corners for exceptional performance. 1/4" steel net tie rail for clean goal face and bottom. Powder coated orange over rust-proof zinc coated steel. Includes 3 mm, 1-1/2" sq. mesh knotless polyester net with lacing cord.

<b>LG-44B</b>	Goal with net	49 lbs.	<b>\$249 each</b>
<b>LGN-44</b>	Replacement net	6 lbs.	<b>\$75 each</b>



*This smaller Box Lacrosse Goal has the features along the net rail and rear brace that is evident on our Deluxe Lacrosse Goals!*

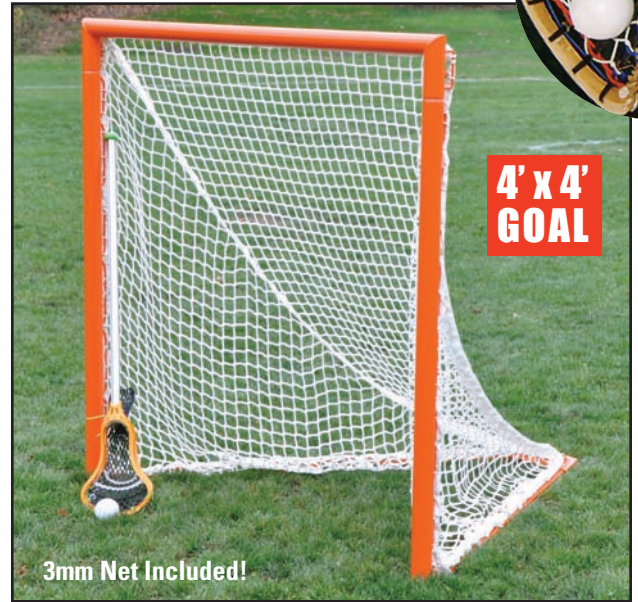

**4' x 4' GOAL**

3mm Net Included!



## Lacrosse Folding Goal

Great for back yard practice or take it with you to the field! 6' x 6' lacrosse goal is constructed of heavy duty 1" aluminum tubing that is powder coated white. Net comes already attached to the frame, making it easy to unfold and set up in seconds! Collapses down to 4'H x 8" x 8" and fits into a convenient carry bag. Goal anchors included.

**LG-66FL**



Carry Bag Included!

<b>LG-66FL</b>	39 lbs.	<b>\$169 each</b>
----------------	---------	-------------------

## Lacrosse/Multi-Sport Ball Stop System

### 15' x 65' FieldPro System

Stop wasting time during practices and games chasing missed shots or errant passes and ensure the safety of athletes, coaches and spectators on adjacent fields. 15'H x 65'L backstop is designed ideally to fit behind lacrosse goals. Includes four 4" O.D. heavy wall aluminum uprights with black powder coated finish, ground sleeves, corrosion resistant hardware and 1-3/4" square mesh #36 knotless nylon black net with 1/4" rope border. Net can easily be raised and lowered with a rope and pulley system.



<b>FNMB-65</b>	15'H x 65'W	<b>\$2,295 each</b>
----------------	-------------	---------------------

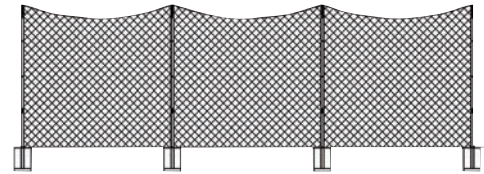

## Lacrosse Rebound Net

Work on your shots and passes with this adjustable rebounder! Durable steel tube frame is 4'W x 8'H. Rebounding target net area is 4'H x 3'W. Adjust the angle with a simple turn of a hand knob.

<b>LAX-RBD</b>	35 lbs.	<b>\$239 each</b>
----------------	---------	-------------------



**LAX-RBD**

## Lacrosse Target Net

Apply to the front of your goal for a challenging practice. Carry bag included.

<b>LAX-TN</b>	2 lbs.	<b>\$69 each</b>
---------------	--------	------------------



**LAX-TN**



## Field ID Markers

14" x 14" vinyl markers with corner grommets to put on the back of the net of each goal. Specify color and numbers when ordering.

<b>FIM-14</b>	1 lb.	<b>\$19 each</b>
---------------	-------	------------------

*Wet and Dry Field Marking products and Line Layout Systems are located on pages 67-69*





The **BIG LEAGUE!**

Shown with optional ricochet padding upgrade kit.

Compare us to  
the Competition!



Dodd Stadium  
Home of the  
**Tigers**  
CONNECTICUT

### The "BIG LEAGUE" Professional Portable Batting Cage

**Standard Features Include:** Size open: 18'W x 22'D x 12'H, folded down: 18'W x 12'D x 5'H. Constructed of heavy-duty 2" Sch 40 Aluminum tube. Black heavy duty #42 climatized nylon net with rear net baffle. 4' x 6' x 4" thick thud pad, vinyl skirt & standard black ricochet padding on all overhead framing. Dual coaches' stands with leaning bar that also serves as a convenient strut holder. **Jaypro Exclusives! Patent Pending. Locking quick release safety strut clamps (see page 50); swivel side wheels that lock into position; rear wheel handle can be lifted or lowered to move cage.**

**BGLC-7500RB** Royal Blue



**BGLC-7500RD** Red



**BGLC-7500NB** Navy Blue



**BGLC-7500BK** Black



**BGLC-7500GR** Green



600 lbs.

\$4,995 each



Dual Coaches  
Stand & Strut  
Holder

Rear Wheel  
Handle



**BLN-3** Replacement Net

75 lbs.

\$759 each

#### Replacement Skirt

Royal Blue (RB), Black (BK), Red (RD), Green (GR), Navy Blue (NB)

**SKT-75XX** 30 lbs.

\$359 each

#### Replacement Thud Pad

Royal Blue (RB), Black (BK), Red (RD), Green (GR), Navy Blue (NB). Does not ship from Jaypro's CT warehouse. Call for freight quote.

**THUD-46XX** 20 lbs.

\$399 each

#### Ricochet Padding Upgrade Kit

Upgrade your cage with durable vinyl covers. Wraps around foam ricochet padding. Hook and loop attachment. Kit is 21 six foot lengths. Royal Blue (RB), Black (BK), Red (RD), Green (GR), Navy Blue (NB)

**RPAD-UKITXX** 10 lbs.

\$649 kit



18" diameter x 8"W pneumatic side wheels lock into position and swivel to change direction!



Coaches Storage Bin with perforated aluminum and hinged cover.

Coaches Storage Bin

**BL-CSBIN** \$149 each



Optional Tow Hitch Conversion Kit allows your cage to be towed with any utility vehicle!

Tow Hitch Conversion Kit

**BL-TOWKIT** \$195 each

Please visit our website or call Customer Service for more information.





## The GRAND SLAM!

Best Seller!

Compare us to the Big Bubba!



48 HOUR QUICK SHIP



Shown with optional skirt graphics and additional ricochet padding.

### The "GRAND SLAM" Semi-Professional Portable Batting Cage

#1 style for Spring Training Camps! Designed for semi-professional and collegiate use. **Standard Features Include:** Size is 18'W x 22'D x 12'H. Constructed of 2" heavy wall aluminum tubing. Easy to fold and collapses to just 5' high. Frame features handy strut holders too! Coaches rear safety railing for safe viewing. Enhance your unit with the optional coaches stand. Transports easily on three 16" pneumatic turf wheels. Black heavy duty #42 climatized nylon net. Includes heavy vinyl coated nylon skirt that protects the metal frame and gives the pitcher an attractive visual backstop. Rear net baffle reduces wear and tear on net and skirt. 60' of ricochet cushion reduces rebound and frame damage. **Jaypro Exclusive! Patent Pending. Locking quick release safety strut clamps (see page 50).**

505 lbs.

\$4,195 each



**BBGS-18**  
Green



**BBGS-18RB**  
Royal Blue



**BBGS-18RD**  
Red



**BBGS-18NB**  
Navy Blue



This unit collapses easily, provides handy strut storage, and folds to a compact size that's easy to transport.

#### Optional Graphics

**SKT-LOGO** Name & Logo printed on skirt  
Call for price quote

#### Replacement Skirt

Green (GR), Red (RD), Royal (RB), Navy (NB)

**SKT-75XX**

30 lbs.

\$359 each

#### Replacement Nets

**BLN-3**

18'x22'x12'

75 lbs.

\$759 each

#### Old Style: Prior to 2013

**GSN-1**

17'6"x18'x12'

65 lbs.

\$749 each

#### Optional Viewing Stand

Now coaches can view batting practice from this convenient adjustable stand.

**CVS-10**

24 lbs.

\$329 each

#### Additional Ricochet Cushion

**BPD-6**

6' lengths

2 lbs.

\$26 each

#### Additional Weather Resistant Tape

**PDT-3**

60 yd rolls

2 lbs.

\$62 each

NEW VOLLEYBALL SOCCER FOOTBALL LACROSSE BASEBALL FIELD MARKING SCOREBOARD BASKETBALL GYMNASIUM FIELD SEATING BALL STORAGE PHYS. ED. TENNIS





### The "LITTLE SLAM" Portable Batting Cage

Designed for collegiate or high school use, this portable batting cage offers many of the features of the Grand Slam but at a more competitive price. **Standard Features Include:** Size is 17' 6"W x 12'D x 12"H. Constructed of 2" heavy wall aluminum tubing. Transports easily on three 16" pneumatic turf wheels. Black heavy duty #42 climatized nylon net with rear baffle. Optional vinyl skirt protects the metal frame while giving the pitcher an attractive visual backdrop. 24' of ricochet cushion reduces rebound and frame damage. **Jaypro Exclusive! Patent Pending. Locking quick release safety strut clamps (see below).**

**BBL-12**

410 lbs.

**\$3,395 each**



Get the look and feel of a Pro Cage, on a budget!



Provides handy strut storage.



Easy to fold and collapse for transport or storage. Shown with optional vinyl skirt.

**Jaypro Exclusive - Optional Vinyl Skirt Colors**

**SKT-20 (Green) SKT-20RB (Royal Blue)**

**SKT-20RD (Red) SKT-20NB (Navy Blue)**

23 lbs.

**\$329 each**

Replacement Net

**LSN-2**

55 lbs.

**\$749 each**



Powder Coated Green



The **LINE DRIVE!**

### The "LINE DRIVE" High School Foldable and Portable Batting Cage

**Standard Features Include:** Size is 16'6"W x 16'6"D x 12"H. Fold's down to 48"H. Constructed of 2" flo-coated galvanized steel with green powder coat finish. 16" pneumatic wheels. Oversize rear wheel cranks and swivels for easy mobility. Includes heavy duty, #42 knotless nylon weather treated netting with rear baffle. Includes 18' of ricochet padding. **Jaypro Exclusive! Patent Pending. Locking quick release safety strut clamps (see below).**



Conveniently folds to 4' H. This unit collapses smoothly for easy transport and provides handy strut storage.

Shown with optional vinyl skirt and additional ricochet cushion.



**BBLD-5000**

650 lbs.

**\$3,395 each**

Replacement Net

**LDN-5**

34 lbs.

**\$749 each**

Optional Vinyl Skirt

**SKT-50**

23 lbs.

**\$329 each**

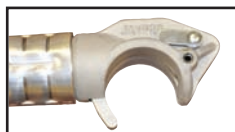

### Jaypro Exclusive! Patent Pending

Locking quick release safety strut clamps prevent inadvertent and dangerous release. These struts are standard with all Jaypro Batting Cages!

Call Jaypro for details on all options for our batting cages, or visit [www.jaypro.com](http://www.jaypro.com) for information!







**Perpendicular Style with Polyester Coating**

## The Arch™ BACKSTOP

**Only from Jaypro: A Backstop in COLORS!!!**  
**Available in Black, Brown and Green!**  
 Call Customer Service for Details and Pricing



### Permanent Baseball / Softball Backstops

Upright sections: 10'W x 12'H. Main upright 2-3/8" O.D. x .095"W galvanized steel. Fasteners: all galvanized fittings, nuts, bolts. Fence Fabric: 9 gauge smooth galvanized. Crossbars: 1-5/8" O.D. x .085"W galvanized steel. Backstop sections are not prefabricated chain link. Overhang sections: 10'W x 6'D.

### AVAILABLE COMBINATIONS

Item	Description	Weight	Price
BSP-30	3 Panel only	552 lb/ea	\$1,899
BSP-30-6	3 Panels, 1 Center Overhang	682 lb/ea	\$2,199
BSP-33-2	3 Panels, 1 Center, 2 Wing Overhangs	860 lb/ea	\$2,999
BSP-40	4 Panels only	727 lb/ea	\$2,499
BSP-40-66	4 Panels, 2 Center Overhangs	956 lb/ea	\$3,295
BSP-44-22	4 Panels, 2 Center, 2 Wing Overhangs	1134 lb/ea	\$3,995



**ALL BACKSTOPS SHIP TRUCK, CALL FOR A FREIGHT QUOTE!**



*Backstop Padding*

### Backstop Padding

Backstop padding is 2" thick high impact foam and has grommet flaps on all 4 sides for attachment to chain link fencing. 2' folding sections (available in solid or alternating colors). Available in several sizes and colors. Eco-friendly padding and optional graphics available, call for details and pricing. Does not ship from Jaypro's CT warehouse. Call for freight quote.



*Backstop Padding shown with Optional Graphics*



Item	Size	Price
BSP236	3' x 6'	\$279
BSP238	3' x 8'	\$289
BSP2310	3' x 10'	\$345
BSP2312	3' x 12'	\$389

Item	Size	Price
BSP246	4' x 6'	\$289
BSP248	4' x 8'	\$345
BSP2410	4' x 10'	\$399
BSP2412	4' x 12'	\$459

### Backstop & Field Wall Colors

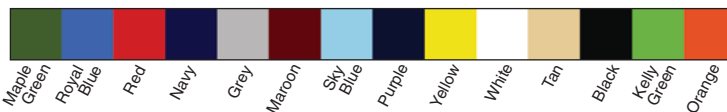

### Field Wall Padding

Field Wall padding is 2" thick high impact foam on 3/4" outdoor water sealed wood ply boarding. Available in several sizes and colors. Eco-friendly padding and optional graphics available, call for details and pricing. Does not ship from Jaypro's CT warehouse. Call for freight quote.

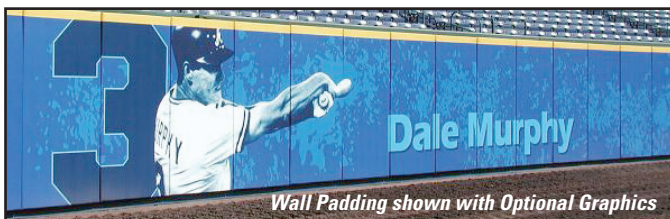

*Wall Padding shown with Optional Graphics*



Item	Size	Price
FWP246	4' x 6'	\$359
FWP248	4' x 8'	\$465

Item	Size	Price
FWP2410	4' x 10'	\$615
FWP2412	4' x 12'	\$709



*Wall Padding*

NEW VOLLEYBALL SOCCER FOOTBALL LACROSSE BASEBALL FIELD MARKING SCOREBOARD BASKETBALL GYMNASIUM FIELD SEATING BALL STORAGE PHYS. ED. TENNIS



48 HOURS  
QUICK SHIP

- Larger in size to accommodate the Pro Player
- No-Flat Tires for easy Transporting
- Heavy Wall Aluminum Construction
- Double-Sided Slip-On Net

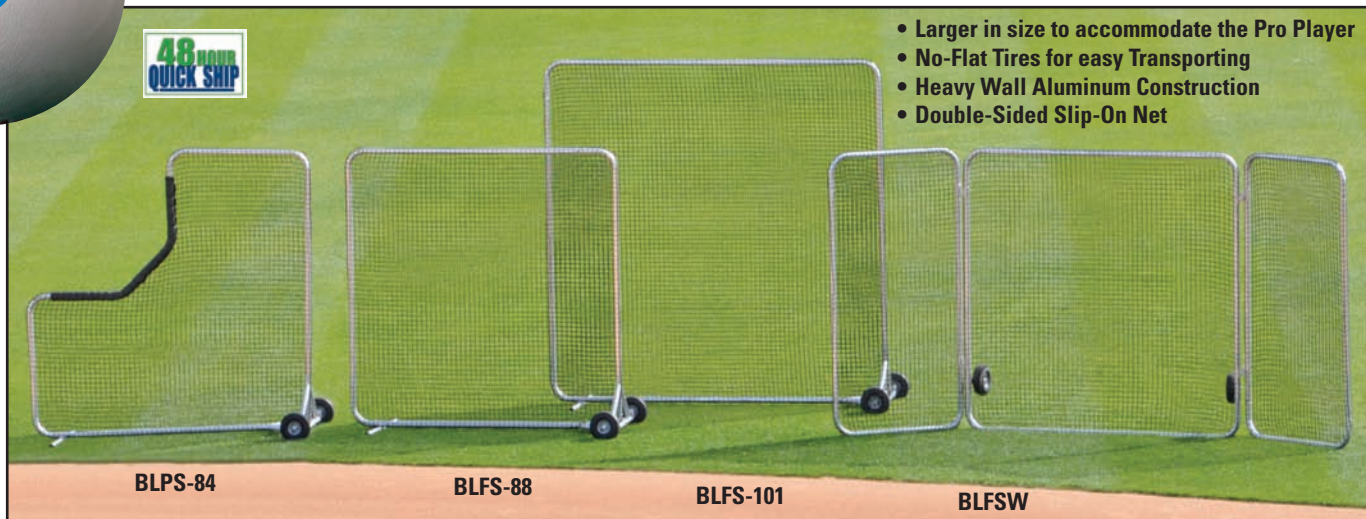

BLPS-84

BLFS-88

BLFS-101

BLFSW

Constructed of heavy wall schedule 40 aluminum 2" O.D. pipe. Heavy duty legs are welded to provide extra rigidity. Comes with black, rugged, weatherproof #42 knotless nylon double-sided slip-on net. Includes **two 10" diameter x 4"W NO-FLAT TIRES** that make transporting the unit easy.



**Big League Pitcher's  
Safety Protector**

Larger L-shaped design with padded hip protector provides safety for pitchers. Size is 8'H x 8'W. Refer to page 31 for sandbags for extra support.

#### L-Screen

**BLPS-84**

45 lbs.

**\$749 each**

#### L-Screen Replacement Net

**BLPS-84N**

3 lbs.

**\$189 each**

**Heavy duty 2"  
legs and supports  
are welded for  
extra strength**



**Includes two  
10" x 4"  
NO-FLAT TIRES!**



**Big League Fungo  
Screens**

Larger size to protect your fielders from stray balls. Size's are 8'H x 8'W and 10'H x 10'W. Refer to page 31 for sandbags for extra support.

#### 8 x 8 Screen

**BLFS-88**

45 lbs.

**\$759 each**

#### 10 x 10 Screen

**BLFS-101**

55 lbs.

**\$849 each**

#### 8 x 8 Replacement Net

**BLFS-88N**

3 lbs.

**\$189 each**

#### 10 x 10 Replacement Net

**BLFS-101N**

4 lbs.

**\$229 each**



**Big League Fungo  
Screen with Wings**

Tri-fold screen. Main screen is 8'H x 8'W with two 8'H x 4'W wings. This provides an overall screen size of 8'H x 16'W. Wings fold in, and 2 no-flat tires help with easy transport. Refer to page 31 for sandbags for extra support.

#### Screen

**BLFSW**

90 lbs.

**\$999 each**

#### Wing Replacement Net

**BLFSW-N**

3 lbs.

**\$99 each**

#### Center Replacement Net

**BLFS-88N**

3 lbs.

**\$189 each**

**Great for 2nd base or Infield protection!**

**Fold the wings in  
and you are ready  
to move!**

**Transporting this unit  
is quick and easy!**



Dodd Stadium  
Home of the **CONNECTICUT  
Tigers**

#### Optional Safeoam Padding

Optional padding for the pitcher's safety protector frame and fielder's screens. Royal blue, red and green padding is sold in 8' lengths and attaches with ties. Ties are sold separately and include 100 ties per bag. Does not ship from Jaypro's CT warehouse. Call for freight quote.

Royal Blue

Red

Green

**SF-PREMRB SF-PREMRD SF-PREMGR** Safeoam Padding **\$59 each**

**SF-TIESRB SF-TIESRD SF-TIESGR** 19" Ties **\$42 bag**



**For additional  
safety, use  
sandbags to  
counterweight  
your screens!**



**Refer to page 31 for details.**







**Net and Wheel Kit Included!**

Constructed of heavy gauge 1-5/8" O.D. galvanized steel tubing with a durable, attractive green powder coated finish. Heavy duty 2" square galvanized steel legs provide extra rigidity. **Long lasting, high quality black, rugged, weatherproof #42 knotless nylon double-sided slip-on net.** Includes two 8" diameter wheels that make transporting unit easy.

### Collegiate Fielder's Screens

Required protection screens for players during batting and fielding practice. 7'H x 7'W and 10'H x 10'W.

- FS-77** 7 x 7 complete screen 67 lbs. **\$299 each**
- FS-101** 10 x 10 complete screen 77 lbs. **\$349 each**
- FS-77N** 7 x 7 replacement net 3 lbs. **\$119 each**
- FS-101N** 10 x 10 replacement net 4 lbs. **\$149 each**
- FSE-76N** 7 x 6 Green Economy net 3 lbs. **\$72 each**



**2" square galvanized steel legs help support and steady even the biggest screen!**

### Collegiate Pitcher's Safety Protector

Versatile 7' x 7' "L-Shape" design accommodates left or right-hand pitchers. Works with pitching machine or live arm delivery.

- PS-84** 7 x 7 L-complete screen 67 lbs. **\$299 each**
- PS-84N** 7 x 7 L-replacement net 3 lbs. **\$109 each**
- PSE-76N** 7 x 6 Green Economy net 3 lbs. **\$82 each**

## BEST VALUE SERIES

**A Jaypro Collegiate Style Screen is an Excellent Choice for College or High School Use as well as our Best Value. Durable Powder Coated Finish, Heavy Duty Stable Legs, Slip-On Nylon Nets and Wheel Kits make these Units Hard to Beat!**



**SBPE-77**

### Softball Protector Screen

Ideal for softball pitchers. 7'H x 7'W frame with a cutout. **Net and wheel kit included.**

- SBPE-77** 7 x 7 complete screen 67 lbs. **\$299 each**
- SBPE-77N** 7 x 7 replacement net 3 lbs. **\$109 each**



Refer to page 31 for sandbags for extra support.



**Net and Wheel Kit Included!**



**PSTS-77**

### Portable Soft Toss/Batting Practice Screen

Heavy duty frame for use with both baseball and softball. Balls are collected in the sock for re-use. 7'H x 7'W. **Net and wheel kit included.**

- PSTS-77** 7 x 7 complete screen 67 lbs. **\$349 each**
- PSTS-77N** 7 x 7 replacement net 3 lbs. **\$149 each**
- PSTS-76N** 7 x 6 Green Economy net 3 lbs. **\$82 each**



NEW VOLLEYBALL SOCCER FOOTBALL LACROSSE BASEBALL FIELD MARKING SCOREBOARD BASKETBALL GYMNASIUM FIELD SEATING BALL STORAGE PHYS. ED. TENNIS



**Easy to Install...**  
**Easy to set up and take down the net!**



**Batting Tunnel Turf available on page 55**

## TUNNEL FRAMES

### Professional Outdoor Batting Tunnel Frame

Individual hoist lines makes for easy installation and removal of net. Clean design with less structure for ball to ricochet off. Supports are curved to provide 2 feet of offset, and made of 4" O.D. aluminum tubing, offering ease of removal and storage. Includes ground sleeves. Accommodates both 12' and 14' wide nets. (Nets sold separately).

<b>PROTF-70</b>	12'H x 70'L	400 lbs.	<b>\$3,995 each</b>	<b>PROTF-55</b>	12'H x 55'L	350 lbs.	<b>\$3,695 each</b>
-----------------	-------------	----------	---------------------	-----------------	-------------	----------	---------------------

All Tunnel Frames & Nets ship via Truck

## TUNNEL NETS

### All-Star Series Tunnel Nets (Nylon)

Most Popular for ceiling suspended cages. #36 thread count UV protected. 1-3/4" square mesh. Black, twisted knotted nylon. 3/8" twisted poly rope borders.

<b>BBC36-7014</b>	12'H x 14'W x 70'L	125 lbs.	<b>\$1,699 each</b>
<b>BBC36-7012</b>	12'H x 12'W x 70'L	118 lbs.	<b>\$1,649 each</b>
<b>BBC36-5514</b>	12'H x 14'W x 55'L	90 lbs.	<b>\$1,449 each</b>
<b>BBC36-5512</b>	12'H x 12'W x 55'L	85 lbs.	<b>\$1,399 each</b>

### Major League UV Stabilized Tunnel Nets

#42 thread count, 1-3/4" square mesh, black knotless nylon netting, UV stabilized.

<b>BBC-470</b>	12'H x 14'W x 70'L	160 lbs.	<b>\$1,299 each</b>
<b>BBC-370</b>	12'H x 12'W x 70'L	130 lbs.	<b>\$1,249 each</b>
<b>BBC-270</b>	12'H x 14'W x 55'L	32 lbs.	<b>\$1,049 each</b>

### Pro Climatized Tunnel Nets

#42 thread count. 1-3/4" square mesh. 2.5mm polyethylene filament fiber. Best filament for outdoor use. Twisted knot construction will not run if cut. High abrasion resistant. Roped perimeter & corners.

<b>BBCP-7014</b>	12'H x 14'W x 70'L	125 lbs.	<b>\$1,099 each</b>
<b>BBCP-7012</b>	12'H x 12'W x 70'L	118 lbs.	<b>\$949 each</b>
<b>BBCP-5514</b>	12'H x 14'W x 55'L	90 lbs.	<b>\$849 each</b>
<b>BBCP-5512</b>	12'H x 12'W x 55'L	85 lbs.	<b>\$799 each</b>

### Collegiate Climatized Tunnel Nets

#24 thread count. 1-3/4" square mesh. 2.0mm polyethylene filament fiber. Same features as our Pro series, but for youth.

<b>BBCC-7014</b>	12'H x 14'W x 70'L	78 lbs.	<b>\$849 each</b>
<b>BBCC-7012</b>	12'H x 12'W x 70'L	72 lbs.	<b>\$799 each</b>
<b>BBCC-5514</b>	12'H x 14'W x 55'L	71 lbs.	<b>\$749 each</b>
<b>BBCC-3514</b>	12'H x 14'W x 35'L	45 lbs.	<b>\$479 each</b>



**Pitcher's Safety Protector**  
 Versatile 7' x 7' "L-Shape" design accommodates left or right-hand pitchers. Works with pitching machine or live arm delivery. Use in or out of the batting tunnel. Details on page 53.



### Cage Saver Target

This 6'H x 5'W heavy duty tarp is made of **40 oz. reinforced vinyl**. Brass grommets along edges ensures a tight fit. Black vinyl with white strike zone. Includes two straps with clips to hang. Does not ship from Jaypro's CT warehouse. Call for freight quote.

<b>CST65</b>	11 lbs.	<b>\$165 each</b>
--------------	---------	-------------------





BBTF-70

### Semi-Permanent Outdoor Batting Tunnel Frames

Economic and durable. Constructed of 2" O.D. galvanized steel tube. Net hangs on 3 rows of 3/16" galvanized aircraft cable. Includes ground sleeves. Accommodates both 12' and 14' wide nets. (Nets sold separately).

<b>BBTF-70</b> - 5 wickets	12'H x 70'L	250 lbs.	<b>\$1,989 each</b>
<b>BBTF-55</b> - 4 wickets	12'H x 55'L	225 lbs.	<b>\$1,749 each</b>

### Surface Mounted Outdoor Batting Tunnel Frames

Same construction as our Semi-Permanent Outdoor Batting Tunnel Frames, but frames have integral 6" x 6" mounting plate for surface mounted installation. (Nets sold separately).

<b>BBTFSM-70</b> - 5 wickets	12'H x 70'L	250 lbs.	<b>\$2,195 each</b>
<b>BBTFSM-55</b> - 4 wickets	12'H x 55'L	225 lbs.	<b>\$1,895 each</b>

All Tunnel Frames & Nets ship via Truck

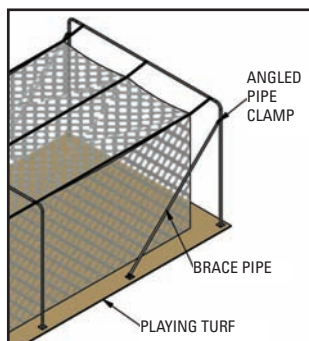

BBTF-BRKIT

**BBTF-BRKIT**

150 lbs.

**\$595 kit**

Only for use with 1.9" O.D. frames.

Secure all 4 corners!

### Batting Tunnel Frame Brace Kit

Add diagonal braces to the end frames of your wicket style tunnel frame. Provides added support to prevent end frames from bowing in due to cable tension. **Includes 4 braces, fittings and attachment hardware for 2" O.D. pipe.** Works with either semi-permanent or surface mounted installations.

### Batting Mat with Lines

6' L x 12' W. Inlaid white lines. Available in green or red clay. Indoor/Outdoor use. Spike-resistant artificial turf with throw down home plate. Thick foam backing. Does not ship from Jaypro's CT warehouse. Call for freight quote.

<b>BML612G</b>	Green	57 lbs.	<b>\$429 each</b>
<b>BML612CL</b>	Red Clay	57 lbs.	<b>\$429 each</b>

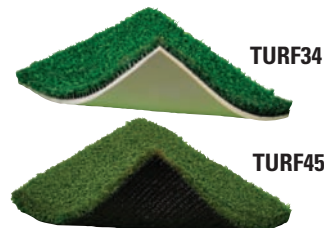

### Batting Tunnel Turf

Artificial turf available by the roll. Used for batting cage floors, dugouts, baselines, bullpens, coaches boxes, walkways, etc. Excess turf may be trimmed in the field. All turf is green and sold by the square foot. Minimum roll length is 70'. Does not ship from Jaypro's CT warehouse. Call for freight quote.

**TURF34 is a 34 oz. turf with 5 mm foam backing available in 12' wide rolls**

**TURF45 is a 45 oz. turf with unitary backing available in 15' wide rolls**

**TURF34**

**\$4.19 square foot**



**TURF45**

**\$4.49 square foot**





BBC-700M

**Ceiling Suspended Retractable Batting Cage\***

Motorized retractable batting cage. Easily raises and lowers from the ceiling using a drive shaft powered by a 1 HP electric winch, key switch operated. Size is 10'H x 12'W x 70'L. Frame is constructed of heavy walled 2" aluminum tube. Net included. To complete your installation, order one of the ceiling mounting kits below.

\* 14' wide and other size cages also available!

**BBC-700B** Baseball 675 lbs. **\$5,895 each**

**BBC-700M** Multi-Sport 675 lbs. **\$6,595 each**

**Kit A**

Direct Attached: For cages centered directly beneath a beam or bar joist (system will be attached directly to single beam or bar joist).

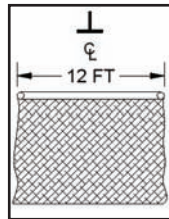
**BBC-UBKIT****\$329 each****Kit B**

Spanning Parallel 5 ft on center or less: For cages whose centerline is located between two beams or bar joists that are spaced 5 ft apart or less.

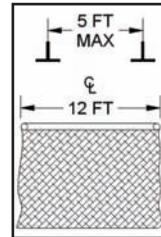
**BBC-UP5KIT****\$639 each****Kit C**

Spanning Parallel 5 ft to 8 ft on center: For cages whose centerline is located between two beams or bar joists that are spaced greater than 5 ft but not over 8 ft apart.

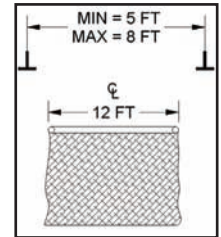
**BBC-KIT58****\$1,395 each****Kit D**

Spanning Perpendicular not greater than 8 ft on center: For cages oriented perpendicular to beams or bar joists that are spaced no greater than 8 ft apart.

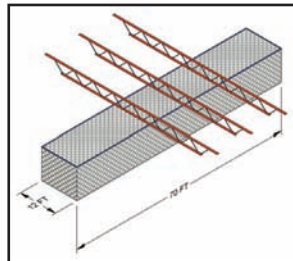
**BBC-PERPKIT****\$2,395 each****Kit E**

Peaked or Rigid Frame Building: (call for pricing). For cages being placed in a peaked rigid frame building. Drive supports to be chained down from roof purlins with rigid winch support.

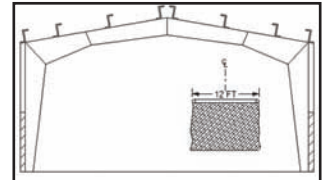
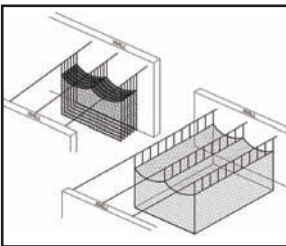
**BBC-RIGKIT****Call for Pricing****Thicker Cable + More Attachment Hardware = Better Quality!****Cable Suspended Tunnel Kit**

Maximizes your over-head space when net is in stored position. Allows support cables to be placed higher in the ceiling, up to 30 ft. Net is suspended on 1/8" aircraft cable every 3 ft on center. (nets & wall attachments sold separately, see below).

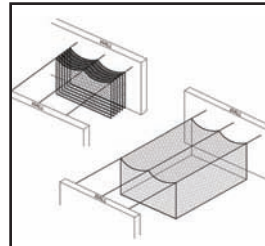
**BBC-SPDKT****\$929 each****Cable Supported Tunnel Kit**

Net attaches directly to cables that run from wall to wall. Attachment every 1'! Net slides easily against the wall for storage. Consists of (3) 100 ft rolls of 1/4" galvanized aircraft cable, plus all necessary hardware. (nets & wall attachments sold separately, see below).

**BBC-SPRTKT****\$549 each****Wall Mounting Kit**

(6) finished wood pads and steel mounting plates to attach to concrete, block or steel framed walls. Wall anchors not included. To be supplied by installer depending on wall specifications.

**BBC-WLKT****\$599 each****Replacement Indoor Tunnel Nets**

**BBC36-7012** #42 1-3/4" square mesh, black knotted nylon netting, UV stabilized (12'H x 12'W x 70'L)

**\$1,649 each**

**BBC-700N** #252 3/4" square mesh, knotless nylon netting, UV stabilized (11'H x 12'W x 70'L)

**\$2,495 each**



## Athletic Field Covers Available!

Assorted size Field Covers, Rolling Tubes and Fitted Sideline Covers are available.

Visit [www.jaypro.com](http://www.jaypro.com) or call customer service for details.

### Weighted Spot Covers

Covers that don't require any stakes or sandbags! 6 oz. polyethylene with weighted hem. Silver/White. Does not ship from Jaypro's CT warehouse. Call for freight quote.



Model	Description	Price
WWMC18	Mound Cover 18' - round	\$589
WWMC20	Mound Cover 20' - round	\$685
WWMC26	Mound Cover 26' - round	\$899

### Pitcher's Mound, Home Plate, and Base Covers

Lightweight, durable covers to protect your field's dirt areas. Rip resistant 6 oz woven polyethylene covers are heat sealed to ensure waterproof protection. Grommets are at 3'-4" intervals. **2 Year Prorated Warranty** against breakdown from UV sunlight. Stakes included. Does not ship from Jaypro's CT warehouse. Call for freight quote.

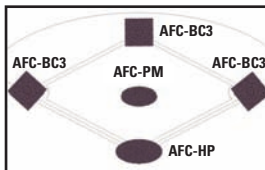

**Color** Silver/White (reversible)



Model	Description	Dimensions	Price
AFC-PM	Pitcher's Mound (including 7 stakes)	20' Round	\$255
AFC-HP	Home Plate (includes 9 stakes)	26' Round	\$359
AFC-BC3	Bases-Set (includes 15 stakes)	10' x 10' set of 3	\$235



### Armor Mesh Windscreen

14 oz. woven, extrusion vinyl coated polyester mesh available 6' or 9'H. Fabricated with IncrediSeal™ heat sealed hem providing a clean look and eliminating the risk of stitches or seams coming undone! Provides 75% shade. Wind vents and cable ties sold separately. Colors shown below. **5 Year Warranty**. Does not ship from Jaypro's CT warehouse. Call for freight quote.

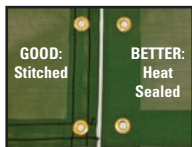

**Heat sealed hem for extra durability**

WSCRN-6	6' height	\$0.89 square foot
WSCRN-9	9' height	\$0.99 square foot

TuffPrint Lettering and Logo's  
**WSCRNLG** Call for details and pricing



TWS-6



Dugout Canopy

### Classic Wind Screen

An attractive yet economical wind screen that will meet all of your privacy, wind and background needs. Can also be used as a dugout canopy! Open mesh 8.2 oz/sq yd PVC coated polyester provides up to 84% shade. Includes reinforced hems and rust resistant grommets spaced at 18" intervals. Wind screens higher than 6' require a centered, horizontal lacing lip along the entire length. 18" dia. half moon wind vents are recommended to allow for wind passage, purchased separately. Plastic cable ties for installation are purchased separately. Comes in 6' or 9' high. **3 Year Warranty**. Colors shown below. **Customize your windscreen**. Does not ship from Jaypro's CT warehouse. Call for freight quote.

Item	Description	Price
TWS-6	6' High Screen	\$.69 sq. ft.
TWS-9	9' High Screen	\$.72 sq. ft.
PCT-100	Plastic Cable Ties	\$11 set of 100
HMV-18	Half Moon Wind Flap	\$3.45 ea



**Note: maximum length of a single piece wind screen is 100'. Screens over 100' will be made in sections.**

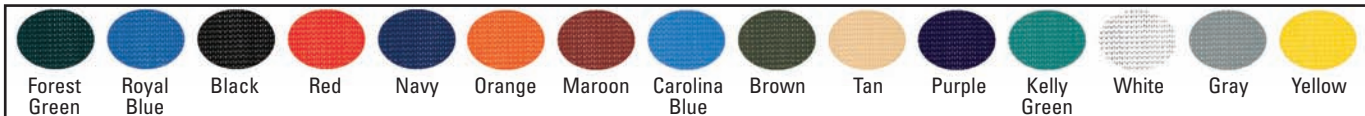





## "Professional" Foul Poles

One Piece Welded Wing Panel Construction!  
Tough powder coated finish in brilliant yellow.

*These Foul Poles are designed to withstand up to 120 mph winds.*

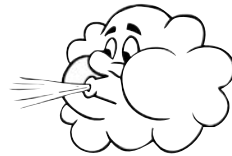

### 20' Professional Foul Pole

One piece welded steel construction designed for permanent, semi-permanent or surface mount installation. Main upright is 3-1/2" O.D. SS 40 zinc coated steel tubing. 18"W x 12'H fully welded wing panel includes heavy duty 1-1/2" x 13 gauge expanded metal mesh, designed to optimize air passage. See page 59 for optional ground sleeves for semi-permanent installation.

**BBFP-20** 570 lbs. **\$2,395 pair**



**BBFP-20SM** 570 lbs. **\$3,195 pair**

### 30' Professional Foul Pole

Two piece telescoping design for permanent, semi-permanent or surface mount installation. Main upright is 5.0" O.D. Schedule 40 zinc coated steel tubing. Upper frame consists of a top upright made from 4.0" O.D. 8 gauge zinc coated tubing, with a fully welded wing panel constructed from 2.0" steel tube. 18"W x 18'H wing panel includes heavy duty 1-1/2" x 13 gauge expanded metal mesh, designed to optimize air passage. See page 59 for optional ground sleeves for semi-permanent installation.

**BBFP-30** 850 lbs. **\$3,995 pair**



**BBFP-30SM** 850 lbs. **\$4,495 pair**

### Over 30' Professional Foul Pole

Please call Customer Service with your specifications, wants and needs. Permanent, semi-permanent or surface mounted options available.

Call Customer Service for details



**Surface and Wall Mount Installation is Available on our entire line of Foul Poles!**

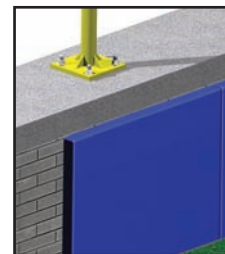

### Outfield Distance Markers

Outfield distance markers are printed digitally with 13 oz. reinforced vinyl fabric. Available with numbers and background colors of your choice (specify colors when ordering). Banner colors: forest green, red, yellow, royal blue, gray, tan and black. Font colors: white, yellow, black and blue. 27" x 36" banner available with 14" numbers. 38" x 56" banner available with 24" numbers. Does not ship from Jaypro's CT warehouse. Call for freight quote.

**ODM-23** 27" x 36" Marker **\$120 each**

**ODM-35** 38" x 56" Marker **\$130 each**

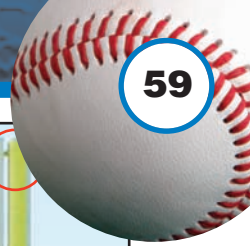

## Collegiate Foul Poles

Tough powder coated finish in brilliant yellow, making it easy to see day or night



### Collegiate 30' Foul Pole

Two piece telescoping pole. Base pole is 4-1/2" O.D. heavy walled steel tubing with 4.0" O.D. upper pole 18"W x 18"H bolt-on wing panel is all steel expanded metal. Tough powder coated finish over zinc undercoating. Designed for permanent or semi-permanent (with optional sleeve) installation. When installed, pole is 30 ft. above ground.

**BBCFP-30**

650 lbs.

**\$2,495 pair**



### Collegiate 20' Foul Pole

Heavy duty 3-1/2" O.D. Steel upright with 18"W x 12"H wing panel. Bolt-on wing panel is all steel expanded metal. Tough powder coated finish over zinc undercoating. Designed for permanent or semi-permanent (with optional sleeve) installation. When installed, pole is 20 ft. above ground.

**BBCFP-20**

300 lbs.

**\$1,449 pair**



### 12' Baseball/Softball Foul Pole

Give your field a Major League look without the cost. Heavy duty steel 3-1/2" O.D. main post with 18"W x 6"H wing panel. Bolt-on wing panel is all steel expanded metal. Tough powder coated finish over zinc undercoating. Designed for permanent or semi-permanent (with optional sleeve) installation. When installed, pole is 12 ft. above ground.

**BBSBFP-12**

200 lbs.

**\$969 pair**

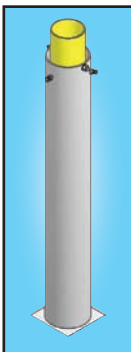
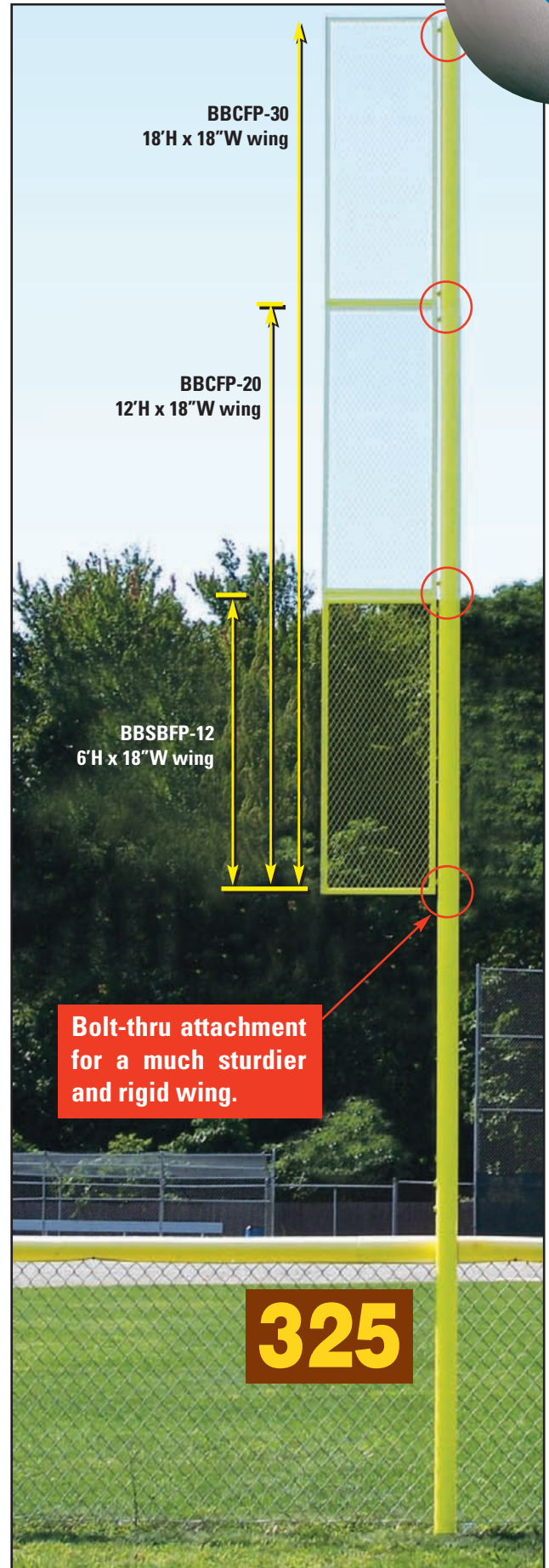

#### Optional Foul Pole Ground Sleeves

For semi-permanent installation of foul poles. Facilitates installation and maintenance.

**FPS-12** 12' Foul Pole Sleeves 18 lbs. **\$219 pair**

**FPS-20** 20' Foul Pole Sleeves 24 lbs. **\$259 pair**

**FPS-30C** 30' Foul Pole Sleeves 36 lbs. **\$289 pair**  
for BBCFP-30 only

**FPS-30P** 30' Foul Pole Sleeves 40 lbs. **\$449 pair**  
for BBFP-30 only





BB-200

**"Flex" Style Bases\***

Ideal for recreational play or competition. 15" x 15" x 3". Shock absorbing and compresses on impact. Includes three impact bases, three anchors and three 1-1/2" solid rubber plugs.

BB-200

33 lbs.

**\$219 set****\* Includes Anchors and Plugs!**

BB-500

**Best Seller!****Pro-Style "Hollywood" Bases\***

The highest quality, longest lasting base available. 15" x 15" x 3". Used by professional baseball players. Tapered lip digs into the dirt. Recommended for advanced levels of play only. Bases do not compress. Includes three bases, three anchors and three 1-1/2" solid rubber plugs. See page 62 to package with a Base Cart and save money!

BB-500

39 lbs.

**\$199 set**

Fully compliant with Little League® Rule 1.06!

BB-700

**"Breakaway" Style Base Set**

Fully compliant with Little League® Rule 1.06! Quick release base disengages from stationary rubber base plate upon impact. Official size 15" x 15" x 3". Set includes three base covers, three rubber base plates and three 1-1/2" anchors.

BB-700

39 lbs.

**\$299 set**

BB-600

**"Bolco" Style Bases\***

Official 15" x 15" x 3". Heavy-duty injected vinyl cover with bonded polyester foam core. Set includes three bases, bolt on plates and 1" anchors.

BB-600

28 lbs.

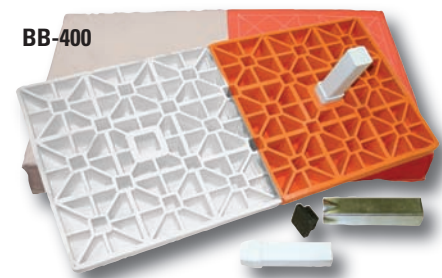
**\$225 set**

BB-400

**Double First Base\***

Reduces collisions. Compresses upon impact. 30" x 15" x 3". Features a double anchoring system. Includes double first base with two anchors and two 1-1/2" solid rubber plugs.

BB-400

26 lbs.

**\$149 each****\* Includes Anchors and Plugs!**

BB-150

**Double Recreation First Base**

30" x 15" x 3". Foam filled with nylon quilted cover. Includes straps and three spikes.

BB-150

5 lbs.

**\$49 each**

HP-300

BB-350

**Rubber Throw Down Home Plate & Bases**

Heavy-duty, molded rubber. Waffle bottom. Bases are 13-1/2" square and 1/2" thick.

HP-300

Home Plate 7 lbs.

**\$16 each**

BB-350

Bases 9 lbs.

**\$38 set of 3**

BB-100

**Official Size Economy Bases**

15" x 15" x 3". Foam filled bases with heavy-duty, quilted covers. Includes three bases with two nylon straps and two steel anchors per base.

BB-100

10 lbs.

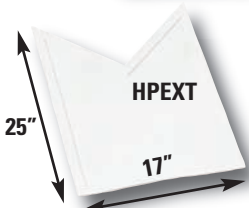
**\$54 set**

HPEXT

**Home Plate Extension**

Provides an extended strike zone, making it more visible for umpires to make the call. Made from white molded vinyl.

HPEXT

2 lbs.

**\$19 each**

BB-50

**Throw Down Bases**

For indoor or outdoor use. Flexible, washable rubber. Set includes three bases, home plate and a pitching rubber.

BB-50

5 lbs.

**\$16 set**

Visit [www.jaypro.com](http://www.jaypro.com) or call Customer Service for Details and Information on other types of Bases.





**HP-250**

**Best Seller!**

**HP-200**

**Major League Home Plate**  
High durability, molded rubber construction. Stanchion mounted steel plate. Easily removed for maintenance or storage. Comes with sleeve or five removable zinc-plated spikes.

**HP-200** Plate with 1-1/2" Anchor 16 lbs. **\$99 each**

**HP-250** Plate with Spikes 16 lbs. **\$129 each**

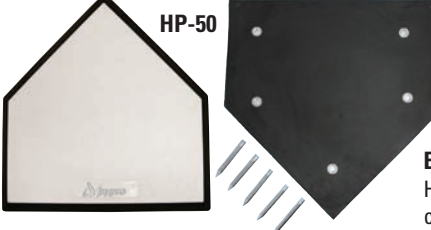

**HP-50**

**Economy Home Plate**  
High durability, molded rubber construction with five removable spikes.

**HP-50** 10 lbs. **\$33 each**

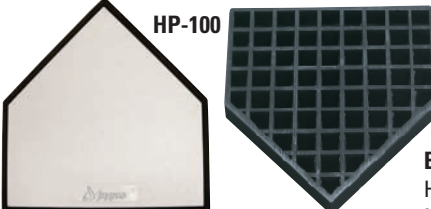

**HP-100**

**Bury-All Home Plate**  
High durability, all rubber construction. No corners or edges to catch spikes. Non-skid rubber surface. Waterproof.

**HP-100** 24 lbs. **\$89 each**



**HP-150**

**Bury-All Home Plate**  
High durability, wood filled construction. No corners or edges to catch spikes. Non-skid rubber surface. Waterproof.

**HP-150** 29 lbs. **\$99 each**

**48 HOUR QUICK SHIP**  
**ENTIRE PAGE**



**Best Seller!**

**PR-624**

**Professional Pitching Rubber**  
Major league size: 6" x 24". High-durability molded rubber exterior. Interior PVC tube provides maximum longevity. Fill with dirt or concrete for the most stable, rugged four-sided pitching rubber available.

**PR-624** 20 lbs. **\$99 each**

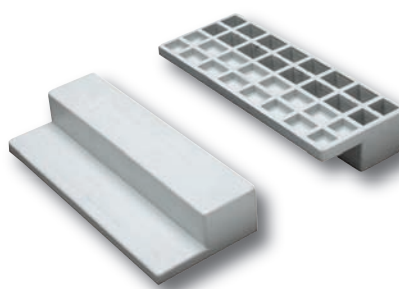

**Step Down Pitching Rubber**  
Official size - 24" long. Step down style for better footing. Reduces pitcher's mound maintenance. Heavy-duty, all rubber construction or wood filled.

**PR-524** 19 lbs. **\$82 each**

**Step Down Pitching Rubber**  
Little League size - 18" long

**PR-518** 10 lbs. **\$67 each**

**Step Down P.R. 24" L Wood-Filled**

**PR-550** 19 lbs. **\$92 each**



**A. Removable Pitching Rubber**  
Official 24" size or Youth 18" size. For use on diamonds where various levels of play may require different pitching distances. Includes ground anchors made of heavy duty steel.

**PR-424** Official 14 lbs. **\$79 each**

**PR-418** Youth Size 10 lbs. **\$76 each**

**B. Movable Pitchers Plate with Spikes**  
Heavy molded rubber. Include three removable metal spikes. Official size and Youth 18" size.

**PR-324** Official 10 lbs. **\$20 each**

**PR-318** Youth Size 10 lbs. **\$17 each**

**Professional Pitching Rubber**  
Little League size - 18" long.

**PR-618** 10 lbs. **\$76 each**



## Combine and Save!



**48 HOUR QUICK SHIP**

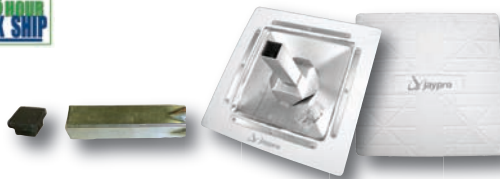

### StackMaster™ Professional Base Package

Save money with this package! Get the base cart along with our Pro-Style "Hollywood" bases (BB-500). These bases are the highest quality, longest lasting available! To add a dig-out tool, see below.

**BCARTSET** 72 lbs. **\$339 each**

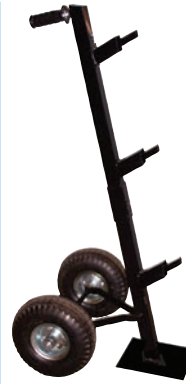

### StackMaster™ Professional Base Cart

Simplifies transporting and storage of heavy pro bases. Heavy duty square steel frame and pneumatic tires. Positions bases for easy cleaning and touch up. Stores both male and female style base receptacles. Easy assembly. Cannot be used with BB-200 or BB-400 bases.

**BBBCART** 33 lbs. **\$199 each** **48 HOUR QUICK SHIP**

### Pre Assembled Recycled Rubber Base Anchor Foundation

The fastest, easiest way to install base anchors! Pre-assembled anchor foundation comes ready to install. Includes female anchor. Fits 1-1/2" anchors. Not designed for Bolco bases. Available individual or in sets of three. Does not ship from Jaypro's CT warehouse. Call for freight quote.

#### Designed for Hollywood and Magnetic style bases:

**PABF1** Individual Base 3 lbs. **\$59 each**

**PABF3** Set of 3 9 lbs. **\$155 set**

#### Designed for Bolco style bases:

**PABF1-B** Individual Base 3 lbs. **\$65 each**

**PABF3-B** Set of 3 9 lbs. **\$160 set**

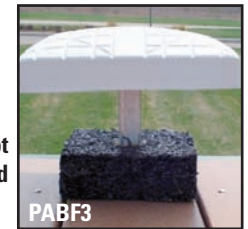

Base not included

PABF3

#### Base Rubber Plugs

**BB-PLUG** 1 lb. **\$5 each**

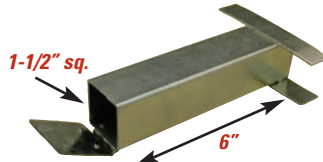
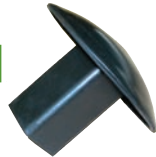

#### Base Anchors

**BB-ANCHOR** 1 lb. **\$9 each**

#### Base Dig-Out Tool

**BB-DIGOUT** 1 lb. **\$9 each**



Use for both 1-1/2" and 1-3/4" sleeves!

#### Big League Base Plug

**BB-BLBP** 1 lb. **\$12 each**



#### Replacement Anchor Plug

**BB-RAP** 1 lb. **\$7 each**

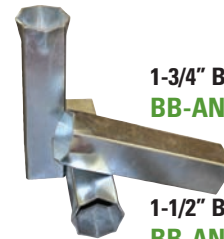

#### 1-3/4" Base Anchors - Set of 3

**BB-ANCHOR175** 3 lbs. **\$35 set**

#### 1-1/2" Base Anchors

**BB-ANCHOR150** 1 lb. **\$11 each**

### StackMaster™ Batting Helmet Storage Rack

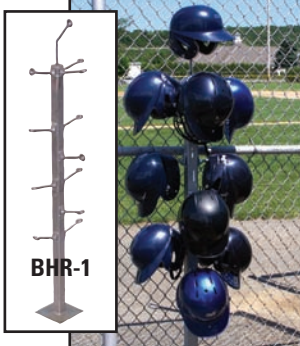

BHR-1

**48 HOUR QUICK SHIP**

Space saver in the dug out. Gets helmets stored properly for ready use. Store up to 12 helmets. Galvanized steel frame for long time outdoor use. Anchor to ground for secure installation.

**BHR-1** 28 lbs. **\$179 each**



PBR-14

#### Permanent Bat Rack

Heavy duty galvanized steel bat rack. Holds up to 14 bats. Permanently mounts directly to dugout surface.

**PBR-14** 33 lbs. **\$159 each**

#### Deluxe Batting Tee

Exceptionally durable construction for years of quality performance. Includes official size rubber home plate. Approximate telescoping adjustment height is 22" to 37". Ball not included.

**BT-4** 11 lbs. **\$35 each**



BT-4



BT-1

**48 HOUR QUICK SHIP**

#### Super Batting Tee

Ideal for all ages and abilities! Durable rubber construction features a heavy weighted rubber base with steel insert for added weight. Approximate telescoping height is 22" to 37". Ball not included.

**BT-1** 12 lbs. **\$28 each**

NEW VOLLEYBALL SOCCER FOOTBALL LACROSSE BASEBALL FIELD MARKING SCOREBOARD BASKETBALL GYMNASIUM FIELD SEATING BALL STORAGE PHYS. ED. TENNIS



## Pitching Machines



HABPM-100

**HACK ATTACK™**



HABPM-100JR

**JUNIOR HACK ATTACK™**

### Hack Attack Baseball/Softball Pitching Machine

The Hack Attack is designed for all levels of play; College, High School, Youth League and even the Major Leagues. Features a unique 3 wheel design that changes the breaking pitch plane by the turn of a dial. Underhand feeding motion, acceleration and release emulates a live pitcher. Dial-in pitch selection without head adjustments maximizes practice time. Choose from fastballs, risers, drops, right and left handed screwballs. Pivots instantly for pop-ups, fly balls and grounders. Speeds 35-100 mph and has a distance of 43 feet. Power supply 110 VAC - 2000W generator with inverter technology (not included). Works with all ball types including leather. Comes fully assembled.

#### Baseball

**HABPM-100** 135 lbs. **\$3,499 each**

#### Softball

**HASPM-200** 135 lbs. **\$3,499 each**

### Hack Attack Junior Baseball/Softball Pitching Machine

Same features as the Hack Attack, except this is designed for younger players. Speeds from 35-70 mph.

#### Baseball Junior

**HABPM-100JR** 75 lbs. **\$2,399 each**

#### Softball Junior

**HASPM-200JR** 75 lbs. **\$2,399 each**



BCT-100

### Baseball Cart

Heavy duty 1½" O.D. powder coated steel frame. Large capacity basket 17"W x 24"D x 16"H holds hundreds of baseballs or softballs. Oversized 14" never-go-flat tires for easy transport.

**BCT-100** 35 lbs. **\$199 each**



Little League Game Mound (PPM-69)

### TRUE PITCH OFFICIAL GAME MOUNDS

Mounds (official size) are portable and can be carried by 2 people. Quality constructed. Made of reinforced fiberglass shell covered with durable artificial turf. Pitching rubber included. The tapered sharp edge makes a smooth transition to your existing field. Use with turf shoes only - no cleats. Does not ship from Jaypro's CT warehouse. Call for freight quote.

Model	League	Ages	Dimensions	Weight	Price
PPM-69	Little	9-12	6'10"W x 9'2"L x 6"H	180 lb/ea	\$3,039
PPM-810	Pony	12-15	8'W x 10'L x 8"H	220 lb/ea	\$3,549
PPM-1012	Senior	15 & Up	10'W x 12'6"L x 10"H	340 lb/ea	\$4,499



Call for freight quote. All True Pitch Mounds have a fiberglass base with a **Limited 3 Year Warranty** - no warranty on turf.



PPM-95G



Mound Caddy included!

### ProMounds Collegiate & ProModel Mounds with Turf

Made of heavy duty foam with skid proof rubber armor that will not damage floors. Can be used indoors or out. Improved reinforced back end for added durability. Made of spike-proof turf and available in two sizes (Professional: 9'L x 5'W x 10"H or Collegiate: 9'L x 4'W x 10"H). Includes a mound caddy and recessed tape measure to measure distance from home to rubber. Available in green or red clay. Does not ship from Jaypro's CT warehouse. Call for freight quote.

#### Professional: 9'L x 5'W x 10"H

**PPM-95G** Green 125 lbs. **\$1,349 each**

**PPM-95CL** Clay 125 lbs. **\$1,349 each**

#### Collegiate: 9'L x 4'W x 10"H

**PPM-94G** Green 100 lbs. **\$1,249 each**

**PPM-94CL** Clay 100 lbs. **\$1,249 each**



PPM-95CL



ST75PC

### Scorers Table

Top quality, aluminum scorers table. 7.5'L x 10"W Aluminum seat and 19" wide table top. 2" x 2" heavy-duty galvanized steel legs for superior rust resistance. Same high quality as our full line of player benches. **Powder coat your table for a custom look!** Please specify plank and leg color choice/s when ordering.

Length	Natural Finish	Natural Finish Price	Powder Coated	Powder Coated Price	Weight
7-1/2'	ST75	\$489	ST75PC	\$579	90 lbs.



48 HOURS  
QUICK SHIP**Batter's Box Template**

Aluminum frame lightweight template for quick and easy striping of batters boxes. Foldable for easy storage and transport. Carry handle aligns with home plate for proper positioning. Frame leaves 2" pattern for chalking. Available in three sizes: Official, Little League or Softball.

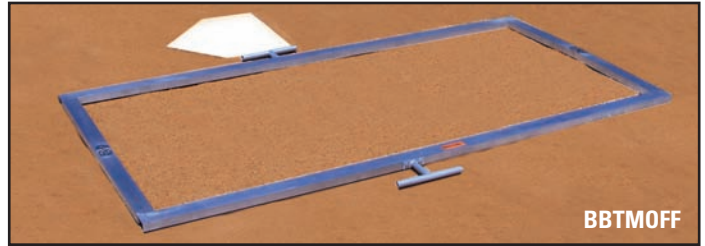
**Official 4'x6'****BBTMOFF** 29 lbs. **\$269 each****Little League 3'x6'****BBTMLL** 28 lbs. **\$249 each****Softball 3'x7'****BBTMSB** 29 lbs. **\$249 each**

BBTMOFF



MSG-1

**Mound Slope Gauge**

Alignment gauge made of one-piece, heavy duty aluminum. A bubble level is attached for proper leveling. Includes metal ruler for measuring mound slope drops. Two support rods included, one is adjustable for leveling the gauge. Stores easily in PVC container, which it also ships in. Includes complete instructions for mound slope construction and maintenance. Assembly required to install handle and braces. Does not ship from Jaypro's CT warehouse. Call for freight quote.

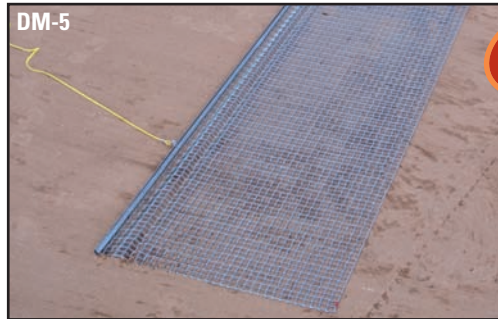
**MSG-1** 12 lbs. **\$249 each**

DM-5

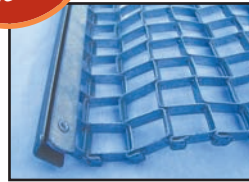
**Best Seller!**48 HOURS  
QUICK SHIP**Infield Drag Mat**

Flexible plated steel mesh mat with 1-5/16" galvanized steel drag bar and a 3/8" polypropylene rope handle. Available in 3', 5' and 6' widths. **18 Month Warranty.**

**DM-5** 3'D x 5'W 27 lbs. **\$149 each****DM-34** 4'D x 3'W 21 lbs. **\$129 each****DM-63** 3'D x 6'W 33 lbs. **\$219 each****DM-6** 6'D x 6'W 65 lbs. **\$329 each**

DL6

**Drag Lite**

Offers an adjustable scarifier blade that breaks up hard surfaces and then grooms to a "ready to play" condition. 10' heavy-duty pull chain. Available in either 3' or 6' wide. 3' model can be pulled comfortably by hand and 6' pulled by truck. **1 Year Warranty.** Does not ship from Jaypro's CT warehouse. Call for freight quote.

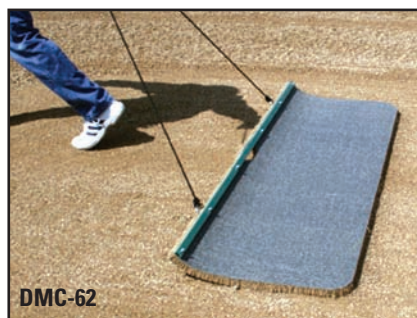
**DL3** 3' Wide 31 lbs. **\$229 each****DL6** 6' Wide 55 lbs. **\$349 each**

DMC-62

**Cocoa Hand Drag Mat**

Great for between innings! Similar to Infield version but 2' long and equipped with rope handle. Available in either 4' or 6' wide. Includes steel lead bar. **1 Year Warranty.** Does not ship from Jaypro's CT warehouse. Call for freight quote.

**DMC-42** 2'D x 4'W 25 lbs. **\$209 each****DMC-62** 2'D x 6'W 36 lbs. **\$259 each**

NDX-32

**X-Drag Hand Nail Drag**

Ideal for baselines, cutouts and home plate areas, as well as daily topdressing layer. Constructed of plastic lumber and hardened steel spikes. Size: 3' x 2' - can be pulled for 2' wide or 3' wide work. Pull rope included. Does not ship from Jaypro's CT warehouse. Call for freight quote.

**NDX-32** 35 lbs. **\$339 each**



**Comes with a 12" Double Dipped Vinyl Grip on the Handle**

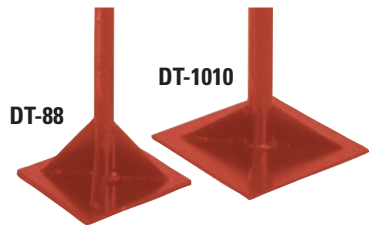

### Dirt Tamp

Durable, all steel construction. Available in 8" x 8" or 10" x 10" size.

**DT-88** 8" x 8" 12 lbs. **\$83 each**

**DT-1010** 10" x 10" 15 lbs. **\$90 each**



### Loop Hoe

60" powder-coated aluminum handle with 6" non-slip vinyl grip.

**LH-60** 2 lbs. **\$41 each**



**Ideal for spreading top dressing!**

### Sifting Shovel

Perforated scoop sifts debris from all types of soils. Virtually indestructible. 42"L handle, 14" x 17" scoop.

**SS42** 5 lbs. **\$112 each**



### Field Rake

The strongest and most durable rake available. Made of an aluminum/magnesium alloy. Large 36" or 42" grading edge with heavy-duty cleaning teeth. 66" lightweight, aluminum handle.

**Best Seller!**

**FR-36** 36" Field Rake 6 lbs. **\$72 each**

**FR-42** 42" Field Rake 6 lbs. **\$82 each**

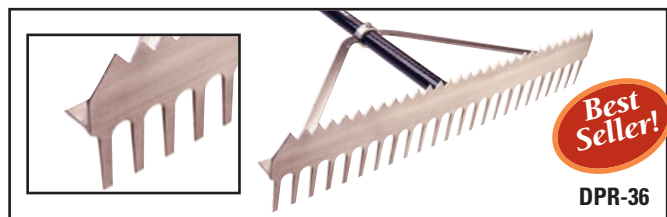

### Double Play Rake

66" powder-coated aluminum handle w/5" non-slip vinyl grip, and high-grade aluminum head and bracing. Available in 24" or 36" head sizes.

**Best Seller!**

**DPR-24** 24" Double Play Rake 6 lbs. **\$83 each**

**DPR-36** 36" Double Play Rake 6 lbs. **\$88 each**

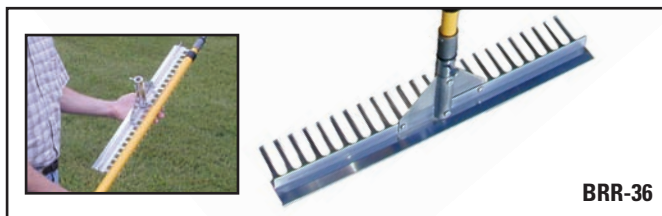

### Base Runner Rake

Same as FR-36 but it includes a telescopic double locking fiberglass handle. This durable landscape rake is a great addition for your maintenance tools. Easily adjusts from 30" to 70". Breaks down for easy storage.

**BRR-36** Base Runner Rake 5 lbs. **\$99 each**



### Double Play Scarifier Broom

Aluminum powder coated blue handle, 28" head with scarifying edge and two rows of removable bristles.

**DPSB-28** 8 lbs. **\$145 each**



### Monster Drag Broom

Heavy duty aluminum construction with 2 rows of removable bristles and massive 7' head. Foam covered handle.

**MDB-84** 13 lbs. **\$240 each**

### Double Play Monster Drag Broom

Same as MDB-84 plus an aggressive scarifying edge on flip side.

**DPMD-84** 17 lbs. **\$269 each**

**Visit [www.jaypro.com](http://www.jaypro.com) for more Field Maintenance Products!**



## Temporary Fencing Available!

Also have One-Piece Kits for Softball, Little League and Baseball. Visit [www.jaypro.com](http://www.jaypro.com) or call customer service for details.



CFC-250

### Fence Top Protection

Reduce player injuries, increase visibility and field attraction. 4" diameter corrugated plastic pre-slit for easy installation to top fence rail. Secure with tie wraps every 2'. Ties are sold separately. Does not ship from Jaypro's CT warehouse. Call for freight quote.



CFC-ITOOOL

Installation tool makes installing quick and easy!



Yellow	Description	Price
<b>CFC-100YW</b>	100' Coil Fence Crown	\$179 each
<b>CFC-250YW</b>	250' Coil Fence Crown	\$259 each
<b>CFC-TIESYW</b>	19" Ties	\$47 / bag of 100
<b>CFC-ITOOOL</b>	Installation Tool	\$76 each



### Safety Top Cap

An attractive fence top that also provides protection. Simply snap over the top of the fence and lock to the wire mesh with the included steel hog rings. Made of HDPE plastic with UV stabilizers. Includes five 8'L sections and 15 hog rings per set. Comes with a **25 Year Limited Warranty!** Does not ship from Jaypro's CT warehouse. Call for freight quote.

STC-8

Yellow

\$125 set



### Safeoam for Railings and Tubing

Tubular foam padding has thick extra-durable skin coating. Comes in 8 ft. lengths and pre-slit for easy installation. Fits completely over any 2-1/8" diameter or less round pipe. Secure with tie wraps every 2'. Minimum of 6 pieces. Sold in 8' sections. Please specify yellow, royal blue, red or green. Ties are sold separately and include 100 ties per bag. **5 Year Limited Warranty.** Does not ship from Jaypro's CT warehouse. Call for freight quote.



Colors shown may not be an exact match.

Description	Yellow	Royal Blue	Red	Green	Price
<b>Safeoam Tubular Padding</b>	<b>SF-PREMYW</b>	<b>SF-PREMRB</b>	<b>SF-PREMRD</b>	<b>SF-PREMGR</b>	\$59 ea
<b>19" Ties</b>	<b>SF-TIESYW</b>	<b>SF-TIESRB</b>	<b>SF-TIESRD</b>	<b>SF-TIESGR</b>	\$42 bag

Use Safeoam Padding to protect your Pitching and Fielding Screens...



### Deluxe Fence Top and Rail Padding

Ideal padding for dug-out railing and fence tops. 2" thick foam is encased in 18 oz. vinyl with grommets for attachment every 6". Sold in 6' long sections in your choice of colors: royal blue, forest green, red, gray, black and white. Please specify color when ordering. **1 Year Limited Warranty.** Does not ship from Jaypro's CT warehouse. Call for freight quote.



PRAFTP6

\$145 per 6' section



Great For Railings And Fence Tops!



## Turn our Dry Line marker into a Combo Marker, both Wet and Dry applications!

NEW VOLLEYBALL SOCCER FOOTBALL LACROSSE BASEBALL FIELD MARKING SCOREBOARD BASKETBALL GYMNASIUM FIELD SEATING BALL STORAGE PHYS. ED. TENNIS



Fold in handles and handle frame for easy storage in tight spaces



Adjust line width 2" and 4" wide

Adjustable collars keep the handles at the desired height and angle

Access window for viewing

Side storage box



FLMR-100HD shown with optional field accessories

### Dry Line Field Markers

All dry line field markers come with the following features: Handle mounted control levers for instant on/off gate opening. Precision control for 2" or 4" lines. Dual wheel drive ensures consistent feed, without slip. 18 gauge steel hoppers and frame. The FLMR-100HD and FLMR-50HD both come with a useful side mounted storage box for holding tools and field implements. Stainless steel hardware. Tough, powder coated forest green finish.

#### 100 lb. Heavy Duty Field Marker

100 lb. capacity. **Jaypro Exclusive:** Four 10" no-flat wheels, easily handles any terrain! Dual heavy duty handles are comfortably spaced and sturdy. Handles fold inward for easy storage in tight spots. Entire handle frame folds forward for off-season storage. Heavy gauge steel plate framework is rugged and durable. Base frame contains access window for viewing of line as dispensed. Unit contains all necessary holes and openings to easily add optional aerosol spray kit.

**FLMR-100HD** 70 lbs. **\$369 each**

#### 50 lb. Heavy Duty Field Marker

50 lb. capacity. Same construction and features as the FLMR-100HD (above).

**FLMR-50HD** 60 lbs. **\$339 each**

#### Two Wheel Field Marker

25 lb. capacity. Two wheels provide for easy maneuvering around home plate.

**FLMR-25** 20 lbs. **\$169 each**

#### Mini Dry Line Field Marker

Perfect for touch ups and small applications. 200 yard capacity (holds up to 10 lbs. of lime or chalk). Produces 2" wide lines.

**FLMR-10** 15 lbs. **\$94 each**

*Refer to the next page to see how to convert this unit to a Combo Marker!*



## Combo Marker

Turn our 100 lb. and 50 lb. Dry Line Markers into Combo Markers with our Aerosol Spray Kit!



### Optional Aerosol Spray Kit

Add spray capability to your dry line marker. Kit comes complete with applicator assembly, mounting brackets, air deflector and side mounted holding basket, which holds two aerosol cans. Easily installs in minutes.

**FLMR-AKIT**

7 lbs.

**\$79 kit**

## Package Deal on Field Marking Equipment...



### BASIC PACKAGE INCLUDES:

Dry Line Marker (FLMR-50HD, page 67)  
Base Runner Rake (BRR-36, page 65)  
Base Dig-Out Tool (BB-DIGOUT, page 62)  
Pro Line Layout & Marking System (FM-LM1, page 69)  
Official Batter's Box Template (BBTMOFF, page 64)

**FMP-10FF**

**SAVINGS OF \$130**

**\$685 package**

Same as above except with

Softball Batter's Box Template (BBTMSB, page 64)

**FMP-1SB**

**SAVINGS OF \$125**

**\$670 package**

Same as above except with

Little League Batter's Box Template (BBTMLL, page 64)

**FMP-1LL**

**SAVINGS OF \$125**

**\$670 package**



### DELUXE PACKAGE INCLUDES:

**All listed items for the Basic Package plus:**  
3' x 5' Infield Drag Mat (DM-5, page 64)  
Mini Dry Line Field Marker (FLMR-10, page 67)  
Wet Paint Adapter Kit (FLMR-AKIT, above)

**FMPD-20FF**

**SAVINGS OF \$167**

**\$970 package**

Same as above except with

Softball Batter's Box Template (BBTMSB, page 66)

**FMPD-2SB**

**SAVINGS OF \$162**

**\$955 package**

Same as above except with

Little League Batter's Box Template (BBTMLL, page 66)

**FMPD-2LL**

**SAVINGS OF \$162**

**\$955 package**



### Athletic Field Marking Dust

Bright white premium marking dust complies with the NCAA rules for athletic marking dust. Used on baseball, softball, football, soccer or any athletic field. Officially approved. Economical. Harmless to skin, clothes and turf. Easy to apply. Does not ship from Jaypro's CT warehouse. Call for freight quote.

**AFMD50**

Pallet of 40 (50 lb. bags)

2060 lbs.

**\$325 each**





Folds down easily for storage!

FME-501

**Best Seller!**



### Economy Paint Marker

Rugged, dependable striper. Aerosol paint sold separately. Folds down for storage. Easy to transport. Adjustable line width from 2" - 4". **Limited Lifetime Warranty!**

**FME-501** 28 lbs. **\$142 each**



### NewRider™ Airless Riding Field Stripper

**NEW**

Ideal for sports complexes or schools and municipalities with multiple fields. Designed for natural or artificial turf with water or oil based paints. Fully adjustable .44 gpm, 0-3000 psi airless pump. Spray gun with reversible tip for 2"-6" lines and 25' hose. 10.5hp Briggs & Stratton engine with electric start. 25 gallon paint capacity and 2.5 gallon purge tank for easy clean up. **3 Year Warranty.** Does not ship from Jaypro's CT warehouse. Call for freight quote.

**FM-AIRFS** 600 lbs. **\$9,995 each**



FMWAND

### Field Marking Wand

Marking straight lines is quick and easy. Holds one aerosol can.

**FMWAND** 5 lbs. **\$52 each**



### EcoLiner™ Battery Powered Field Stripper

**NEW**

Ideal for striping one field at a time. Quickly and easily paint quality lines for hours on a single charge. Features heavy duty, 3 gpm, 0-45 psi diaphragm pump

powered by a 12 volt battery. 5 gallon pail paint capacity. Spray gun with 10' hose for line widths 2" - 6". Hand operated, handle mount controls. Equipped with quick charge 120V plug in battery charger, on-board clean water reservoir and no-flat tires. **1 Year Warranty.** Does not ship from Jaypro's CT warehouse. Call for freight quote.

**FM-ECOBP** 78 lbs. **\$1,095 each**



### Self Propelled Airless Striping Machine

**NEW**

Self propelled, variable speed friction drive, dual handles with cushioned grips and all welded steel construction. 5 gallon paint capacity for water or oil based paints. Self propelled by a 126cc Subaru engine. Airless spray gun with reversible tip, 2-6" adjustable line width with 25' hose. Easy clean-up. **3 Year Warranty!**

**FM-4600SP** 230 lbs. **\$3,399 each**



## Line Layout & Marking Systems

### Pro Line Layout and Marking System

Use to mark your field for any sport! Quickly mark any size field. Measure once and easily re-stripe year after year. Includes locators, starting tool and 600' cord. Made of durable polypropylene plastic.

<b>FM-LM1</b>	<b>12 piece Baseball Line Layout</b>	<b>\$99 kit</b>
<b>FM-LM2</b>	<b>15 piece Soccer Line Layout</b>	<b>\$219 kit</b>
<b>FM-LM5</b>	<b>50 piece Football Line Layout</b>	<b>\$369 kit</b>
<b>FM-LM4</b>	<b>14 piece Lacrosse Line Layout</b>	<b>\$69 kit</b>
<b>FM-LM0</b>	<b>6 piece Replacement Kit</b>	<b>\$159 kit</b>



### Aerosol Paints (with universal spray tip)

White (GL-101) Royal Blue (GL-107) Yellow (GL-108) Red (GL-110)

**Other colors also available, visit [www.jaypro.com](http://www.jaypro.com).** Does not ship from Jaypro's CT warehouse. Call for freight quote.

<b>GL-101</b>	<b>White Only - (12) 18 oz. cans</b>	<b>18 lbs.</b>	<b>\$49 case</b>
	<b>All Other Colors - (12) 18 oz. cans</b>	<b>18 lbs.</b>	<b>\$59 case</b>

**Best Seller!**

### Buy in Bulk & Save White Only pallet of 60 cases

**PNTPKG-1** **Plus FREE FREIGHT!!!** 1150 lbs. **\$2,569 each**



NEW VOLLEYBALL SOCCER FOOTBALL LACROSSE BASEBALL FIELD MARKING SCOREBOARD BASKETBALL GYMNASIUM FIELD SEATING BALL STORAGE PHYS. ED. TENNIS





NEW

**Baseball/Softball Scoreboard**

Ideal for Baseball and Softball fields. High visibility 18" LED digits: HOME, GUEST and INNING. 4" BALL, STRIKE, OUT, H & E. Rugged powder coated aluminum enclosures and removable panels for easy cleaning. See color chart. 2.4GHz integrated wireless. Wireless tabletop controller and an adjustable 8 tone 125db horn. **5 Year Limited Warranty.** Does not ship from Jaypro's CT warehouse. Call for freight quote. Size: 4'H x 9'W x 4-1/4"D

BBSBS-49 120 lbs.

\$3,195 each



NEW

**Football Scoreboard**

Ideal for any Football field. High visibility 24" LED digits: HOME, GUEST and TIME. 18" DOWN, TO GO, BALL ON, QTR & TOL. 10" Football image to show possession. Rugged powder coated aluminum enclosures and removable panels for easy cleaning. See color chart. 2.4GHz integrated wireless. Wireless tabletop controller and an adjustable 8 tone 125db horn. **5 Year Limited Warranty.** Does not ship from Jaypro's CT warehouse. Call for freight quote. Size: 7'6"H x 22'4"W x 4-1/4"D

FBS-722 900 lbs.

\$12,195 each

**Basketball Scoreboard**

Ideal solution for your gymnasium. High visibility 13" LED digits: HOME, TIME and GUEST. 10" PERIOD, FOULS, TOL and PLAYER-FOULS. 2" BONUS & POSSESSION DOTS/ARROWS. Rugged powder coated aluminum enclosures and removable panels for easy cleaning. See color chart. 2.4GHz integrated wireless. Wireless tabletop controller. **5 Year Limited Warranty.** Does not ship from Jaypro's CT warehouse. Call for freight quote. Size: 5'H x 9'W x 4-1/4"D

BSKS-59 150 lbs.

\$4,495 each

**Multi-Sport Portable Scoreboard Package**

Ideal for facilities offering multiple sports. High visibility 10" LED digits: HOME, TIME and GUEST. 7" PERIOD. 2" TIME OUTS LEFT DOTS. Rugged powder coated aluminum enclosures and removable panels for easy cleaning. See color chart. 2.4GHz integrated wireless and adjustable 8 tone 125db horn. Comes complete with Wireless hand held controller and portable caddy for easy transport. **5 Year Limited Warranty.** Does not ship from Jaypro's CT warehouse. Call for freight quote. Board: 2'4"H x 6'W x 4-1/4"D, Caddy: 5'6"W x 4'7"H x 2'7"D

MSPS-26PKG 255 lbs.

\$5,395 each



NEW

**Lacrosse Scoreboard**

Ideal for indoor or outdoor Lacrosse fields. High visibility 18" LED digits: HOME, GUEST, TIME and QUARTER. 13" PLAYER and PENALTY. 4" TOL DOTS. Rugged powder coated aluminum enclosures and removable panels for easy cleaning. See color chart. 2.4GHz integrated wireless. Wireless tabletop controller and an adjustable 8 tone 125db horn. **5 Year Limited Warranty.** Does not ship from Jaypro's CT warehouse. Call for freight quote. Size: 8'2"H x 11'W x 4-1/4"D

LXS-811 290 lbs.

\$8,295 each

**Enclosure Color Choices**

Colors displayed may not be an exact match



Use with Shot and Play clocks. Includes built in real time clock to keep time of day. Has an operating distance of up to 1,000 feet. Buttons with tactile done feedback and large transfective LCD screen. Supports external Run/Stop/reset switch to allow for additional clock operators. Power requirements: DC-5V, max 1.0 amp, from external power supply or PC. Internal rechargeable lithium-polymer battery. Does not ship from Jaypro's CT warehouse. Call for freight quote. Size: 12"H x 4"W x 9"D

WTTC-1 3 lbs.

\$725 each



NEW

**Shot and Play Clock**

Ideal for sports facilities. High visibility 13" LED digits. Rugged powder coated aluminum enclosures and removable panels for easy cleaning. See color chart. 2.4GHz integrated wireless with an adjustable 8 tone 125db horn. Controller purchased separately. Does not ship from Jaypro's CT warehouse. Call for freight quote. Size: 2'H x 1'9"W x 4-1/4"D

SPC-2 25 lbs.

\$2,995 set



## Baseball



**NEW**

HABPM-100



### Hack Attack Baseball Pitching Machine

The Hack Attack is designed for all levels of play; College, High School, Youth League and even the Major Leagues. Features a unique 3 wheel design that changes the breaking pitch plane by the turn of a dial. Underhand feeding motion, acceleration and release emulates a live pitcher. Dial-in pitch selection without head adjustments maximizes practice time. Choose from fastballs, risers, drops, right and left handed screwballs. Pivots instantly for pop-ups, fly balls and grounders. Speeds 35-100 mph and has a distance of 43 feet. Power supply 110 VAC - 2000W generator with inverter technology (not included). Works with all ball types including leather. Comes fully assembled.



**NEW**

HABPM-100JR



### Baseball

**HABPM-100** 135 lbs.

**\$3,499 each**

### Softball

**HASPM-200** 135 lbs.

**\$3,499 each**

### Hack Attack Junior Baseball Pitching Machine

Same features as the Hack Attack, except this is designed for younger players. Speeds from 35-70 mph.

### Baseball Junior

**HABPM-100JR** 75 lbs.

**\$2,399 each**

### Softball Junior

**HASPM-200JR** 75 lbs.

**\$2,399 each**

## Soccer



**NEW**

### Strike Attack Soccer Machine

Battery powered machine provides reliable service on any soccer field or playing surface. A realistic curve and bend of the ball can be consistently delivered and easily controlled. Balls can be delivered at speeds up to 75 mph and distances of 70 yards or more. The type of spin, height and direction desired can be locked into place to ensure precise repetition focused on your specific training objectives.

**SASM-1** 250 lbs.

**\$4,199 each**

## Football



**NEW**

### Snap Attack Football Machine

The Snap Attack is a snap, pass and kick machine that will maximize your time on the most difficult to practice phases of the game. Features include universal ball feed cradle, elevation control and lever clamp combined with a locating pin to make changes from spirals to kick-offs easy and quick. Speeds of 70+ mph and distances of 100 yards for passes and punts, 70+ yards for kick-offs and 5-15 yards for snap-tight spirals. Ball release points at 5' for passes and ground level for snaps.

**SAFM-1** 90 lbs.

**\$4,199 each**

## Volleyball



**NEW**

### Attack II Volleyball Machine

The Attack II delivers thousands of reps in daily practice of serve receiving, digging and spiking. Accuracy and repeatability are assured in every drill, eliminating time-wasting errant hits. With a ball release point of 5'6" to 8'-6", it offers a full range of spins, throwing both sharp topspins and breaking floaters to simulate match situations. Spiking over Women's net at speeds up to 70 MPH. Fits through a standard doorway and into any standard size SUV or pick-up.

**VBSA-2** 190 lbs.

**\$3,149 each**

### Attack II Ball Bag

Heavy duty canvas. Easily attaches and detaches to the Attack II model. Two recommended per unit. Each bag holds 15 balls.

**VBSA-BAG**

**\$149 each**





66" Play Safe Area

6" X 6"  
POLEPole & Backboard Edge  
Padding Included!

LS-200



LS-200RS

**The Playground**

Upright and 5' 6" angled extension arm are constructed of 6" square steel. This fixed height unit buries 48" into the ground. Official size 42" x 72" Acrylic or Steel backboard. Height can be adjusted after court resurfacing or for kid's play. Heavy-duty flex goal with nylon net. **Pole and backboard edge padding included with the Acrylic board (LS-200), pole padding included with the Steel board (LS-200RS).**

<b>LS-200</b>	Acrylic Board	550 lbs.	\$2,295 each
<b>LS-200RS</b>	Steel Board	545 lbs.	\$2,295 each
<b>LD-200</b>	Double Board	850 lbs.	\$3,395 each



40" Play Safe Area

Pole Padding  
Included!4" X 4"  
POLE

400-FA-FG



400-AC-FG

**The Church Yard**

Upright and 40" angled extension arm are constructed of 4" square steel. This fixed height unit buries 48" into the ground. 36" x 48" Acrylic or 36" x 54" Fan Aluminum Backboard. Heavy-duty flex goal with nylon net. **Pole and backboard edge padding included. Fan backboard does not include edge padding.**

<b>400-AC-FG</b>	Acrylic Board	350 lbs.	\$1,395 each
<b>400-FA-FG</b>	Fan Aluminum Board	300 lbs.	\$1,349 each





*Bolt-On Replacement Edge Padding for these units can be found on Page 81.*



**6" x 6" POLE**

**42" Play Safe Area at 10'  
53" Play Safe Area at 7'6"**

**Pole & Backboard Edge Padding Included!**

**The Park**

Upright is constructed of 6" square steel with a 40" double arm extension. This surface mount unit has a height adjustment range from 7'6" to 10'. Official size 42" x 72" Acrylic Backboard. Heavy-duty flex goal with nylon net. **Pole and backboard edge padding included.**

TSP-200

**TSP-200** 500 lbs. **\$2,395 each**



**4" x 4" POLE**

**36" Play Safe Area at 10'**

**Pole & Backboard Edge Padding Included!**

TSP-44

**The Resident**

Upright is constructed of 4" square steel with a 40" double arm extension. This surface mount unit has a height adjustment range from 7'6" to 10'. Official size 36" x 48" Acrylic Backboard. Heavy-duty flex goal with nylon net. **Pole and backboard edge padding included.**

**TSP-44** 350 lbs. **\$1,495 each**





**Pole Padding**  
For 6" x 6" poles. 6'H x 2" thick black padding that attaches to pole with hook-and-loop closure.

**PP-66** 3 lbs. **\$189 each**

For 4" x 4" poles. 6'H x 2" thick black padding that attaches to pole with hook-and-loop closure.

**PP-44** 3 lbs. **\$149 each**



# Hoop Rejuvenator™ Kits

## Attach to your Existing Goosenecks



Is your playground basketball system leaning, rusted, or non-regulation height? Does your budget prohibit tearing out your old system and installing a new one?

**Jaypro has the solution... Don't remove it – Improve it!**

Upgrade your basketball system with Jaypro's new Patent Pending Hoop Rejuvenator™. Replace your rusted steel backboard and rejuvenate it back to regulation height without the added cost and aggravation of excavating your old gooseneck and replacing it.

- Choose either H-Frame design (shown) or Direct Mount
- Allows for adjusting the goal height after resurfacing. (Up to 6" on H-Frames and 5" on Direct Mount units)
- Plumbs boards on leaning goosenecks.
- Designed to fit all standard mounting plates and goosenecks, 4-1/2" O.D. and up. For 3-1/2" O.D. goosenecks use Aluminum Fan board only.
- Offered with Acrylic, Steel or Aluminum Fan backboards.
- All kits include our Ultimate Breakaway Playground Goal (UBG-500F).
- Includes Stainless Hardware and can of spray-on Zinc Galvanize to paint over rusted areas on the gooseneck.



**Acrylic Board**



**Hoop Rejuvenator™ H-Frame Kit**  
42" x 72" Rectangular Acrylic Board  
UBG-500F Breakaway Goal

215 lbs.

**HRKIT-AC**

**\$1,499 each**

**Aluminum Fan Board**



**Hoop Rejuvenator™ H-Frame Kit**  
36" x 54" Aluminum Fan Board  
UBG-500F Breakaway Goal

119 lbs.

**HRKIT-FA**

**\$1,249 each**

**Steel Board**

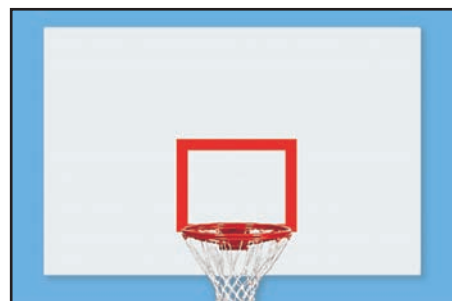

**Hoop Rejuvenator™ H-Frame Kit**  
42" x 72" Rectangular Steel Board  
UBG-500F Breakaway Goal

206 lbs.

**HRKIT-RC**

**\$1,549 each**

**Hoop Rejuvenator™ Direct Mount Kit**  
42" x 72" Rectangular Acrylic Board  
UBG-500F Breakaway Goal

190 lbs.

**HRKIT-AC-DIR**

**\$1,299 each**

**Hoop Rejuvenator™ Direct Mount Kit**  
36" x 54" Aluminum Fan Board  
UBG-500F Breakaway Goal

101 lbs.

**HRKIT-FA-DIR**

**\$1,049 each**

**Hoop Rejuvenator™ Direct Mount Kit**  
42" x 72" Rectangular Steel Board  
UBG-500F Breakaway Goal

185 lbs.

**HRKIT-RC-DIR**

**\$1,299 each**



# Ultimate Adjustable Gooseneck with The Hoop Rejuvenator™

## Always Regulation Height, Never out of Plumb

A complete system that offers the benefits of the Hoop Rejuvenator™ with a rugged heavy-wall, 4-1/2" O.D. galvanized steel upright. The H-frame style has a 4 foot extension. Comes standard with the Ultimate Playground Breakaway Goal (UBG-500F) found on page 83. Visit our web site at [www.jaypro.com](http://www.jaypro.com) for more information and details.



**Ultimate Adjustable Gooseneck**  
with 42" x 72" Rectangular Acrylic Board  
UBG-500F Breakaway Goal

**JAG-AC** 370 lbs.

**\$2,249 each**



**Ultimate Adjustable Gooseneck**  
with 36" x 54" Aluminum Fan Board  
UBG-500F Breakaway Goal

**JAG-FA** 274 lbs.

**\$1,969 each**

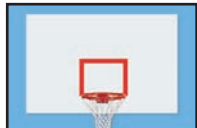

**Ultimate Adjustable Gooseneck**  
with 42" x 72" Rectangular Steel Board  
UBG-500F Breakaway Goal

**JAG-RC** 361 lbs.

**\$2,249 each**

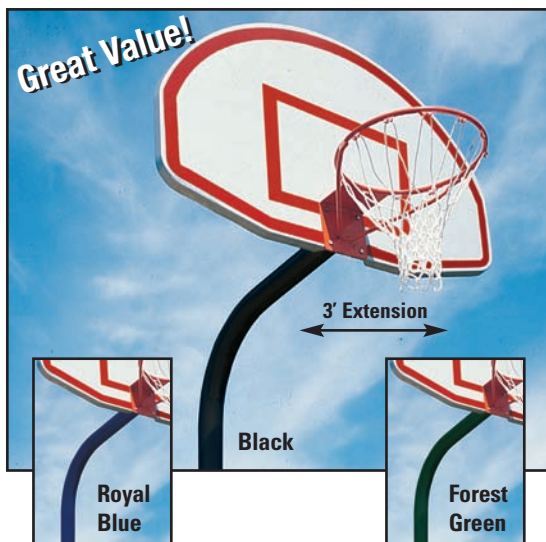

### 3-1/2" Round Post 3' Extension, Direct Mount

Rugged 3-1/2" O.D. zinc undercoated steel upright with 3' extension. Uprights are powder coated in your choice of black, royal blue or forest green. **Fan-Shaped Aluminum Backboard** - 36" x 54" powder coated white with border and target. **Single Rim Goal** - Heavy duty goal and nylon net included. Backboard and goal are directly mounted for exceptional strength.

**455-FABT-SR-BK** 3' Ext. - Black 144 lbs. **\$995 each**

**455-FABT-SR-RB** 3' Ext. - Royal Blue 144 lbs. **\$995 each**

**455-FABT-SR-FG** 3' Ext. - Forest Green 144 lbs. **\$995 each**



**POST AVAILABLE IN COLORS!**



Black



Royal Blue



Forest Green



### Basketball Pole Padding

30" wide pad is designed to wrap around a 4-1/2" O.D. post. Foam filler is 4" thick high density polyurethane and 14oz vinyl cover has grommet flaps for rear lacing. Cord included. Pad is 6' high. See right for color selections.

**PPP-5HP** 9 lbs. **\$259 each**



### Pro-Style Round Protector Pads

Professional style pads for 4-1/2" O.D. post. Foam filler is 6" thick cylindrical high density polyurethane foam with rear cut-out for easy attachment. 14 oz. nylon reinforced vinyl cover completely encloses the foam filler. Vinyl cover has full length hook-and-loop closure flap. Pad is 6' high. See right for color selections.

**PPP-500HP** 16 lbs. **\$379 each**



*Colors shown may not be an exact match.*

### Pro-Style Round Protector Pads

Same as the PPP-500HP except made for 5-9/16" O.D. post. See right for color selections.

**PPP-700HP**

20 lbs. **\$449 each**





4-1/2" diameter post  
with 4' offset  
-OR-  
5-9/16" diameter post  
with 6' offset



As simple  
as 1, 2, 3!

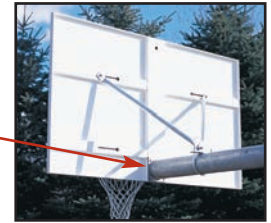

Backboard and Goal direct mount  
to welded plate on gooseneck for  
durability and stability.

Powder Coated Post Available -  
Please Call for Pricing or Details.

### Step 1:

Choose Pole



### Step 2:

Choose Board



### Step 3:

Choose Goal



4-1/2" Diameter Gooseneck Post 4' Offset	Super Goal GBSG-50	Double Rim GDR-54	Playground Goal UBG-500	Breakaway Playground UBG-500F
Fan Aluminum ALB-24BT	<b>996-FABT-SG</b> 277 lbs. \$1,195	<b>996-FABT-DR</b> 279 lbs. \$1,199	<b>996-FABT-UG</b> 288 lbs. \$1,279	<b>996-FABT-UB</b> 290 lbs. \$1,349
Solid Steel 850-RB-BB	<b>996-RS-SG</b> 361 lbs. \$1,395	<b>996-RS-DR</b> 363 lbs. \$1,399	<b>996-RS-UG</b> 372 lbs. \$1,464	<b>996-RS-UB</b> 374 lbs. \$1,534
Perforated Steel SR-PERF	<b>996-PERF-SG</b> 391 lbs. \$1,550	<b>996-PERF-DR</b> 393 lbs. \$1,555	<b>996-PERF-UG</b> 402 lbs. \$1,615	<b>996-PERF-UB</b> 404 lbs. \$1,685
Perforated Aluminum AL-PERF	<b>996-ALP-SG</b> 341 lbs. \$1,550	<b>996-ALP-DR</b> 343 lbs. \$1,555	<b>996-ALP-UG</b> 352 lbs. \$1,615	<b>996-ALP-UB</b> 354 lbs. \$1,685
Acrylic ACRB-72	<b>996-AC-SG</b> 366 lbs. \$1,529	<b>996-AC-DR</b> 369 lbs. \$1,534	<b>996-AC-UG</b> 377 lbs. \$1,549	<b>996-AC-UB</b> 379 lbs. \$1,669

5-9/16" Diameter Gooseneck Post 6' Offset	Super Goal GBSG-50	Double Rim GDR-54	Playground Goal UBG-500	Breakaway Playground UBG-500F
Fan Aluminum ALB-24BT	<b>656-FABT-SG</b> 357 lbs. \$1,780	<b>656-FABT-DR</b> 359 lbs. \$1,785	<b>656-FABT-UG</b> 368 lbs. \$1,856	<b>656-FABT-UB</b> 370 lbs. \$1,926
Solid Steel 850-RB-BB	<b>656-RS-SG</b> 441 lbs. \$2,090	<b>656-RS-DR</b> 443 lbs. \$2,095	<b>656-RS-UG</b> 452 lbs. \$2,075	<b>656-RS-UB</b> 454 lbs. \$2,145
Perforated Steel SR-PERF	<b>656-PERF-SG</b> 471 lbs. \$2,190	<b>656-PERF-DR</b> 473 lbs. \$2,195	<b>656-PERF-UG</b> 482 lbs. \$2,260	<b>656-PERF-UB</b> 484 lbs. \$2,330
Perforated Aluminum AL-PERF	<b>656-ALP-SG</b> 421 lbs. \$2,190	<b>656-ALP-DR</b> 423 lbs. \$2,195	<b>656-ALP-UG</b> 432 lbs. \$2,260	<b>656-ALP-UB</b> 434 lbs. \$2,330
Acrylic ACRB-72	<b>656-AC-SG</b> 446 lbs. \$2,174	<b>656-AC-DR</b> 448 lbs. \$2,179	<b>656-AC-UG</b> 457 lbs. \$2,244	<b>656-AC-UB</b> 459 lbs. \$2,244

# Outdoor Straight Pole Adjustable Units



Backboard and goal direct mount to welded plate. Support struts for additional support.



Double units available, call for details.



## Step 1:

Choose Pole



## Step 2:

Choose Board



## Step 3:

Choose Goal



4-1/2" Diameter Straight Post 4' Offset	Super Goal GBSG-50	Double Rim GDR-54	Playground Goal UBG-500	Breakaway Playground UBG-500F
Fan Aluminum ALB-24BT	SPA4-FABT-SG 322 lbs. \$1,167	SPA4-FABT-DR 324 lbs. \$1,172	SPA4-FABT-UG 333 lbs. \$1,237	SPA4-FABT-UB 335 lbs. \$1,307
Solid Steel 850-RB-BB	SPA4-RS-SG 406 lbs. \$1,467	SPA4-RS-DR 408 lbs. \$1,472	SPA4-RS-UG 417 lbs. \$1,537	SPA4-RS-UB 419 lbs. \$1,607
Perforated Steel SR-PERF	SPA4-PERF-SG 436 lbs. \$1,451	SPA4-PERF-DR 438 lbs. \$1,456	SPA4-PERF-UG 447 lbs. \$1,521	SPA4-PERF-UB 449 lbs. \$1,591
Perforated Aluminum AL-PERF	SPA4-ALP-SG 386 lbs. \$1,451	SPA4-ALP-DR 388 lbs. \$1,456	SPA4-ALP-UG 397 lbs. \$1,521	SPA4-ALP-UB 399 lbs. \$1,591
Acrylic ACRB-72	SPA4-AC-SG 411 lbs. \$1,467	SPA4-AC-DR 413 lbs. \$1,472	SPA4-AC-UG 422 lbs. \$1,537	SPA4-AC-UB 424 lbs. \$1,607

5-9/16" Diameter Straight Post 6' Offset	Super Goal GBSG-50	Double Rim GDR-54	Playground Goal UBG-500	Breakaway Playground UBG-500F
Fan Aluminum ALB-24BT	SPA6-FABT-SG 402 lbs. \$1,680	SPA6-FABT-DR 404 lbs. \$1,685	SPA6-FABT-UG 413 lbs. \$1,756	SPA6-FABT-UB 415 lbs. \$1,826
Solid Steel 850-RB-BB	SPA6-RS-SG 451 lbs. \$1,990	SPA6-RS-DR 453 lbs. \$1,995	SPA6-RS-UG 462 lbs. \$1,975	SPA6-RS-UB 464 lbs. \$2,045
Perforated Steel SR-PERF	SPA6-PERF-SG 481 lbs. \$2,090	SPA6-PERF-DR 483 lbs. \$2,095	SPA6-PERF-UG 492 lbs. \$2,160	SPA6-PERF-UB 494 lbs. \$2,230
Perforated Aluminum AL-PERF	SPA6-ALP-SG 431 lbs. \$2,090	SPA6-ALP-DR 433 lbs. \$2,095	SPA6-ALP-UG 442 lbs. \$2,160	SPA6-ALP-UB 444 lbs. \$2,230
Acrylic ACRB-72	SPA6-AC-SG 456 lbs. \$2,074	SPA6-AC-DR 458 lbs. \$2,079	SPA6-AC-UG 467 lbs. \$2,144	SPA6-AC-UB 469 lbs. \$2,144

NEW VOLLEYBALL SOCCER FOOTBALL LACROSSE BASEBALL FIELD MARKING SCOREBOARD BASKETBALL GYMNASIUM FIELD SEATING BALL STORAGE PHYS. ED. TENNIS



## Glass Backboards

## A Jaypro® Replacement Package: Backboard, Goal and Edge Padding!



## THE "UNBREAKABLE" PACKAGE

Combine  
All Three  
And Save!

## Replacement Package

Combine our 42" x 72" Unbreakable Rectangular Glass Backboard (GBRUB-42), Collegiate "Revolution" Goal (GBA-642) and Bolt-On Edge Padding (MBBP-6) and save! *Please specify backboard edge padding color when ordering, see page 81 for color selections.*



BBRP-42

230 lbs.

\$1,195 each



Limited Lifetime Warranty!

## 42" Unbreakable Rectangular Glass Backboard

Unique design allows the impact load on goal to be transferred directly to an engineered lower reinforced steel frame member, without putting any stress on the glass. High strength, clear anodized aluminum channel outer frame, which is lightweight and attractive. 42" x 72" by 1/2" thick rectangular tempered glass. Direct mount or four corner mounting applications: 4" x 5" hole pattern, or 35-1/2" x 62/66" mounting dimensions. Pre-drilled for "Safe-Pro" bolt on edge padding. Meets all NCAA and NGHS specifications.

GBRUB-42

190 lbs.

\$899 each



Same as GBRUB-42 except backboard is 42" x 54".

GBRUB-54

150 lbs.

\$695 each



## 48" Rectangular Glass Backboard

Similar features except backboard is 48" x 72". Hole pattern is 5" x 5", or 42" x 63/66" mounting dimensions.

GBAFR-48

200 lbs.

\$995 each



## 42" Rectangular Glass Conversion Backboard

Converts a fan shaped backboard to a rectangular shaped backboard. Eliminates the need to alter either the playing court or backstop system. 42" x 72" by 1/2" thick rectangular tempered glass. 4" x 5" hole pattern, 20" x 35" mounting dimensions. High strength, clear anodized aluminum frame. Meets all NCAA and NFHS specifications.

GCBB-35

230 lbs.

\$1,095 each



*Note: The glass itself is not unbreakable. Breakage in transit, during mounting, malicious act or deliberate attempts to damage are not covered under warranty. Boards used with height adjusters below 10' are not covered under warranty.*



GCBB-35 Shown with optional goal and edge padding. See pages 81-83 for details.



## LED Backboard Light Kit

Connects with most shot clocks allowing backboard to light up when shot clock or game time reaches zero and when final segment counts down to zero. One each consists of 5 bright LED strips, fits 42" x 72" backboards. Requires 9VDC-17VDC (formal specified voltage is 10.5VDC). Most kits include, but not limited to: light strips, Y-cable, alignment guides, 10'L lower supply DC cable and installation manual. Hook up and wiring varies by shot clock manufacturer and should be done by a qualified installer. Please specify the Manufacturer and model of existing unit. Does not ship from Jaypro's CT warehouse. Call for freight quote.

BB-LED42

25 lbs.

Call for Pricing

When selecting a replacement for an existing backboard, it is important to identify some key factors that can create problems with the installation. There are two major differences in how a board may be attached to the backstop unit, either direct mount or corner mount. Direct mount is identified by a centrally located fitting or fixture attached to the board directly behind the rim; while corner mount features independent attachments at each corner of the board. The correct identification of the type of mounting structure is critical in selecting the correct replacement board. Digital photos of your equipment would be beneficial, and could help us help you in evaluating a replacement. We will be happy to work with you to insure that your replacement board installs without incident. If replacing a fan shaped board, order a glass conversion board (GCBB-35).



## TrueBounce® Backboards

### Patented Perforated Polycarbonate Backboard

**We can retro-fit to most indoor/outdoor support structures!** Perforated holes release the ball's energy creating a "true bounce" off the backboard. 1/2" polycarbonate board is shatterproof, 250x stronger and 30% lighter than conventional glass backboards. Sound and wind resistant construction, graffiti, UVF and scratch resistant coating. Comes in three sizes, see below. Custom trim available in 10 stock colors. Manufactured in the USA. Does not ship from Jaypro's CT warehouse. Call for freight quote.

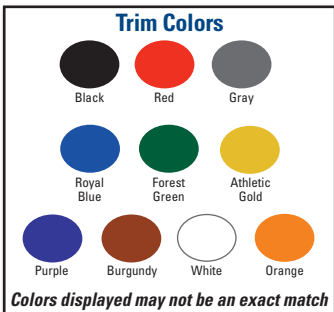

36" x 54" Backboard

3654CB

75 lbs.

\$1,425 each

42" x 72" Backboard

4272CB

130 lbs.

\$2,045 each

48" x 72" Backboard

4872CB

150 lbs.

\$2,045 each

## Steel Backboards



### Rectangular Perforated Steel Backboard

Rugged 42" x 72" 11 gauge steel face has 1/4" diameter perforations to provide an open area to minimize wind resistance. Rear support frame allows for multiple mounting conversions. Durable white powder coated finish with a silk-screened orange target and border. 5" x 5" goal mounting pattern.

SR-PERF

170 lbs.

\$749 each



### Rectangular Steel Backboard

Rugged 42" x 72" 12 gauge steel. Rear welded 20" x 35" mounting pattern. Durable white powder coated finish. 5" x 5" goal mounting pattern.

850RB-BB

200 lbs.

\$829 each

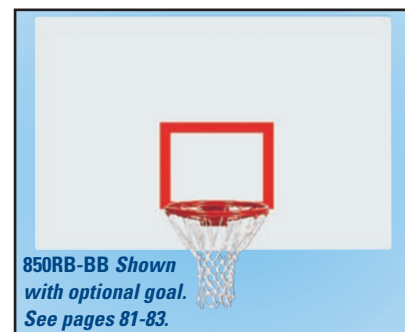

## Aluminum Backboards

### Rectangular Perforated Aluminum Backboard

42" x 72" aluminum face has 1/4" diameter perforations to provide an open area to minimize wind resistance. Rear support frame allows for multiple mounting conversions. Durable white powder coated finish with a silk-screened orange target and border. 5" x 5" goal mounting pattern.

AL-PERF

120 lbs.

\$799 each

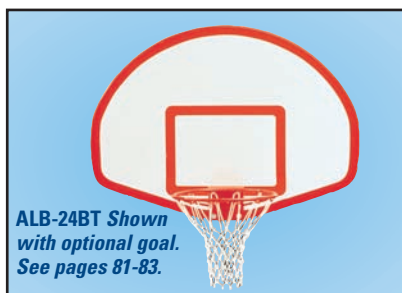

### Fan Aluminum Backboard with Border and Target

36" x 54" cast aluminum with 1-1/2" flange. Painted white with orange target and border markings. 5" x 5" goal mounting pattern. **Lifetime Guarantee!**

ALB-24BT

56 lbs.

\$529 each



close up of hole pattern



## Acrylic Backboards

**42" Rectangular Acrylic Backboard**

42" x 72" rectangular acrylic backboard. Includes border and target. 5" x 5" goal mounting pattern.

**ACRB-72M** 145 lbs. **\$849 each** 

**36" Rectangular Acrylic Backboard**

36" x 48" rectangular acrylic backboard. Includes border and target. 4" x 5" goal mounting pattern.

**LS-44AB** 75lbs. **\$649 each** 

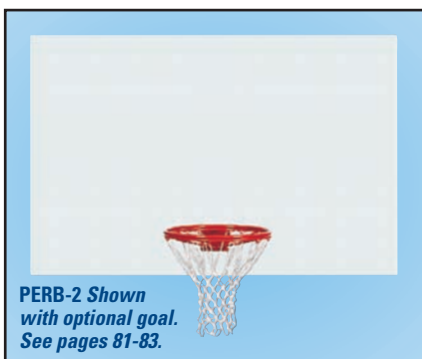

## Polyethylene Backboards

**42" Rectangular Polyethylene Backboard**

42" x 72" rectangular polyethylene construction. 5" x 5" hole pattern, direct mount. 8 counter sunk mounting holes.

**PERB-2** 112 lbs. **\$679 each** 

**Fan Shaped Poly Backboard**

Official size 39" x 54" x 1" thick HD polyethylene. 5" x 5" goal mount pattern.

**FGBB-1** 62 lbs. **\$449 each** 

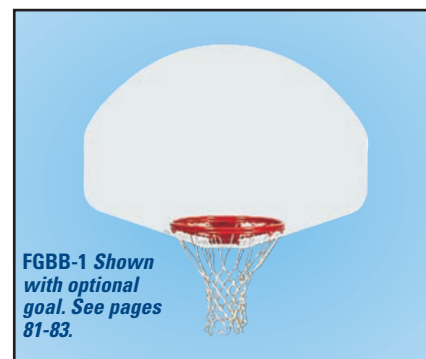

These indestructible backboards are great for playgrounds with all levels of play!

## Fiberglass and Wood Backboards Available!

Call Customer Service or Visit [www.jaypro.com](http://www.jaypro.com) for Information and Details.

**Possession Indicator**

Red LED display in a durable plastic case. Toggle switch operation, includes top red indicator lights and an AC adapter with a 15' long cord.

**POSIND1** 3 lbs. **\$139 each**

**Basketball Court Stencil**

Quickly, easily and accurately allows you to paint a regulation basketball court on any driveway, patio or play area in the yard. No measuring or guesswork! Simply unroll the precision-cut stencils, tape down, and you are ready to go. A free paint roller is included. Just roll the paint over the stencil holes, when you are finished painting, pull up the stencil and your court is ready for play. Finished court size is approx. 13' x 21'.

**BCS-1** 5 lbs. **\$42 each**

**Table Top Scoreboard**

Economical rugged table top design offers built-in rear control panel with visual display. Digits are lit by LED lights in amber and gold. Scores up to 199 and timer goes up/down to 99:59. Buzzer sounds automatically at end of period or manually. Uses 110v with 15' power cord. Size: 15"H x 24"W x 10"D.

**TTS10** 12 lbs. **\$679 each**

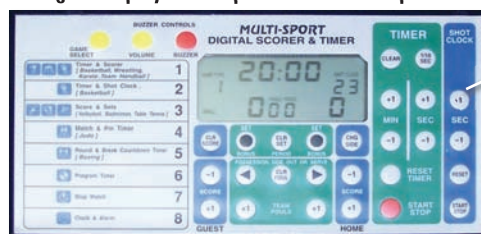
**Digital display control panel on back for operator.**

**BEST ON THE MARKET!**



# Safe-Pro™ Edge Padding

## “Safe-Pro” Bolt-On Edge Padding

The MBBP-6 bolts easily to all 72” official glass backboards and is available in 16 vibrant colors. Meets all NCAA, NFHS and FIBA specifications. Available colors shown on right (from top to bottom) Our **NEW COLOR: TEAM PINK** along with our existing colors Cardinal, Burnt Orange, Purple, Old Gold, Royal Blue, Scarlet, Navy Blue, Yellow, Forest Green, Orange, Maroon, Kelly Green, Black, Columbia Blue, Gray and Light Purple. **10 Year Replacement Warranty.**

- |                                |                                 |
|--------------------------------|---------------------------------|
| <b>MBBP-6PK</b> – Pink         | <b>MBBP-6FG</b> – Forest Green  |
| <b>MBBP-6C</b> – Cardinal      | <b>MBBP-6OR</b> – Orange        |
| <b>MBBP-6TO</b> – Burnt Orange | <b>MBBP-6M</b> – Maroon         |
| <b>MBBP-6P</b> – Purple        | <b>MBBP-6KG</b> – Kelly Green   |
| <b>MBBP-6OG</b> – Old Gold     | <b>MBBP-6BK</b> – Black         |
| <b>MBBP-6RB</b> – Royal Blue   | <b>MBBP-6CB</b> – Columbia Blue |
| <b>MBBP-6S</b> – Scarlet       | <b>MBBP-6GY</b> – Gray          |
| <b>MBBP-6NB</b> – Navy Blue    | <b>MBBP-6LP</b> – Light Purple  |
| <b>MBBP-6YW</b> – Yellow       |                                 |

**10** 10 Year Replacement Warranty



**MBBP-6** 22 lbs. **\$189 each**



The form fit pad with pin style attachment eliminates sagging of the pad underneath the rim.

**Bolt-On Edge Padding Includes 2 Steel Connectors For Perfect Pad Alignment!**

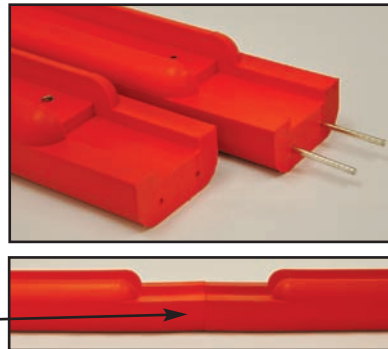

## “Safe-Pro” 54 Bolt-On Edge Padding

Same as above except available in a 54” size. Available colors are scarlet, Gray, black and royal blue. **10 year warranty.**

<b>54” - Scarlet</b> <b>MBBP-54S</b>	<b>54” - Gray</b> <b>MBBP-54GY</b>	<b>54” - Black</b> <b>MBBP-54BK</b>	<b>54” - Royal Blue</b> <b>MBBP-54RB</b>	16 lbs.	<b>\$179 each</b>
---	---------------------------------------	--	---	---------	-------------------

## Bolt-On Edge Padding

### 1.5” Bolt-On Edge Padding for Wood or Acrylic Backboards

Molded tough “L” shape urethane material. Fits any 48”W Acrylic board. Indoor or outdoor use.

Molded tough “L” shape urethane material. Fits any 72”W Acrylic or Wood board. Indoor or outdoor use.

Molded tough “U” shape urethane material. Fits any 72”W Wood board. Indoor or outdoor use.

<b>EP-48</b> 48” - Black <b>\$159 each</b>	<b>EP-46</b> 72” - Black <b>\$179 each</b>	<b>MBBP-WB</b> 72” - Gray 16 lbs. <b>\$269 each</b>
--	--	---

## Glue-On Edge Padding

### Glue-On Edge Padding

Made of self-skinning urethane foam and a tough molded urethane skin to provide the exterior with a uniform colored appearance. Meets all NCAA and NFHS specifications. Available in gray. Fits 1-1/2” or 2” thick backboard. **One Year Warranty.**

### 1-1/2” Edge Padding

**GBB-15** 5 lbs. **\$179 each**

### 2” Edge Padding

**GBB-2** 6 lbs. **\$179 each**

NEW VOLLEYBALL SOCCER FOOTBALL LACROSSE BASEBALL FIELD MARKING SCOREBOARD BASKETBALL GYMNASIUM FIELD SEATING BALL STORAGE PHYS. ED. TENNIS



# The "Revolution" and "Shot" Series of Breakaway Goals from Jaypro!

## Collegiate "Revolution" and "Shot" Goals

These high performance case hardened designs are not only the most durable goals on the market, but they also adjust for all levels of play. These NCAA, NFHS and FIBA compliant goals adjust from **140 lbs. to 250 lbs.** even after **50,000 revolutions**, while maintaining all of it's rebound features. Your choice of **"Revolution" Hideaway** or **"Shot" Pigtail** net attachment and size. Includes mounting hardware and anti-whip net. Please check existing hole patterns for correct replacements!

**7** Year Limited Warranty

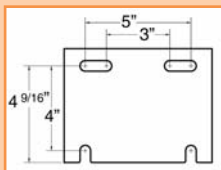
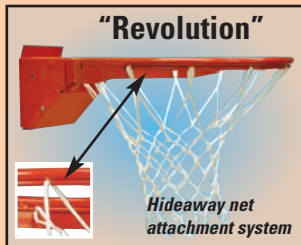

GBA-642 Mounting Plate  
GBA-542 Mounting Plate

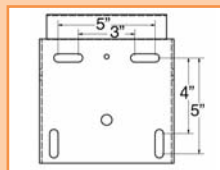

GBA-648 Mounting Plate  
GBA-548 Mounting Plate

### Collegiate "Revolution" Goals

**GBA-642** Hideaway for 42" board 26 lbs. **\$279 each**

**GBA-648** Hideaway for 48" board 26 lbs. **\$279 each**

### Collegiate "Shot" Goals

**GBA-542** Pigtail for 42" board 26 lbs. **\$265 each**

**GBA-548** Pigtail for 48" board 26 lbs. **\$265 each**

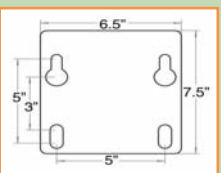

GBA-180 Mounting Plate

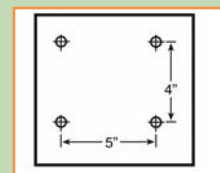

GBA-18042 Mounting Plate

### Competitor 180° Breakaway Goals

Fully adjustable, positive lock releasing goal is made to break from any angle. Meets all NCAA, FIBA and NFHS rules. Hideaway net attachment. Includes nylon net and zinc plated mounting hardware for 42" or 48" glass board.

**GBA-18042** 42" board 39 lbs. **\$420 each**

**GBA-180** 48" board 39 lbs. **\$430 each**



### Competitor Scholastic Breakaway Goal - Adjustable

This extremely durable breakaway goal can be adjusted to withstand different levels of pressure. Fits 5" x 4" hole patterns for all models of glass 42" backboards. Positive lock holds solid playing position. Includes durable powder coated finish and pigtail ring. Meets NCAA and NFHS specifications. Includes mounting hardware and heavy duty nylon net.

**GBA-342A** 26 lbs.

**\$179 each**



**Best Seller!**

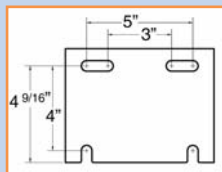

GBA-342A Mounting Plate  
GBA-600 Mounting Plate

### Competitor Pro Breakaway Goal - Adjustable

This goal has the same durable features as GBA-342A (above) plus pro level hideaway net attachment system. Includes mounting hardware and heavy-duty nylon net.

**GBA-600** 26 lbs.

**\$189 each**



### Shooter's Ring

Attaches to all standard basketball goals to create a smaller diameter rim for shooting practice. The all metal ring design requires no tools for quick and easy installation.

**SHOTRING**

4 lbs.

**\$24 each**



### Rebound Ring

Designed to develop rebounding skills and keeps the ball from falling through the rim. Attaches to any 18" goal with 3 screws.

**RBRING**

3 lbs.

**\$24 each**

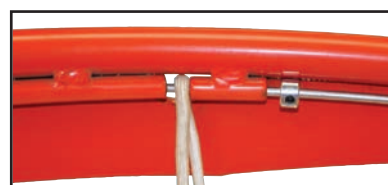

### Hideaway Rim Steel Replacement Ring

Can be used with any rim with hideaway net attachment. Simply slide through brackets to attach net.

**BBSR-R**

1 lb.

**\$13 each**



## Fixed Goals - Single Rims

### Economy Single Rim Front Mount

Official powder coated orange. Includes nylon net and zinc plated mounting hardware.

**G-35**

12 lbs.

**\$52 each**

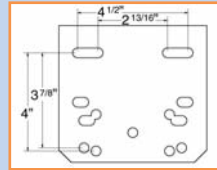

*G-35 Mounting Plate*



### Single Rim Goal

Official size 18" ring of 5/8" steel; 7/16" round steel brace. Official powder coated orange. Includes nylon net and zinc plated mounting hardware. Universal hole pattern.

**GB-55**

13 lbs.

**\$72 each**

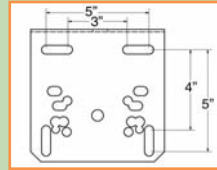

*GB-55 Mounting Plate*



### Super Goal

Official size, 5/8" high-tensile alloy rim is 1-1/2 times the strength of normal rim material. 5/8" support arms provide superior support. Durable, baked powder coated finish. Includes nylon net and zinc plated mounting hardware. Universal hole pattern.

**GBSG-50**

16 lbs.

**\$89 each**

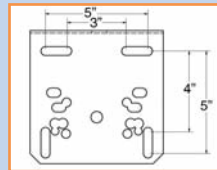

*GBSG-50 Mounting Plate*



## Fixed Goals - Double Rims

### Double Rim Goal

Super durable, official size 18" double ring of 5/8" and 1/2" welded together for added strength and rigidity. Official powder coated orange. Includes nylon net and zinc plated mounting hardware. Universal hole pattern.

**GDR-54**

18 lbs.

**\$105 each**

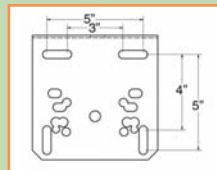

*GDR-54 Mounting Plate*



### Ultimate Playground Goal

The strongest outdoor fixed rim available! Double, solid rim design with universal hole mounting pattern. No-fail net lock system. Powder coated finish. Includes premium nylon net. Can be used with chain net.

**UBG-500**

27 lbs.

**\$149 each**

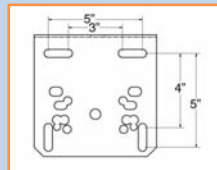

*UBG-500 Mounting Plate  
UBG-500F Mounting Plate*



### Ultimate Playground Breakaway Goal

Can be used indoor and outdoors. Includes nylon net. Can use with chain net. Official Universal hole pattern.

**UBG-500F**

29 lbs.

**\$199 each**



### Nylon Net - 12 loop design, 680/32 braided white

**JNY-4HP**

1 lb.

**\$5 each**

"Anti-Whip" Nylon - 12 loop, 120 threaded, heavy-duty braided cord stops from flipping onto rim

**JNY-6HP**

1 lb.

**\$14 each**

Standard Chain Net, heavy-duty "S" hooks - fits any style goal

**J-3**

2 lbs.

**\$29 each**

### Removable Goal Bracket Kit

Stop theft, potential damage and unwanted play with this removable goal bracket. Perfect for park and recreation courts! Long lasting stainless steel bracket will fit most front mount backboards with a 5" x 5" goal mounting pattern. Not to be used with breakaway goals. Best if used with GB-55, GBSG-50 or GDR-54. Kit includes bracket, hardware and padlock.



**GAK-5**

5 lbs.

**\$59 each**



Renovating or building a new facility? Jaypro offers a full range of products and the engineering experience to help with design and installation.

**Direct Drive Winch**  
Page 88

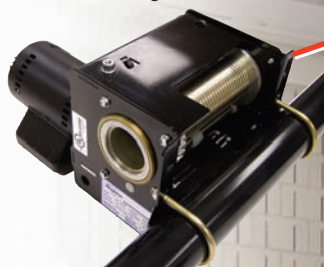

**Safety Strap**  
Page 88



**Shot Clock Mounting Bracket**  
Call for Details



**Basketball Backstops**  
Call for Details

**Height Adjuster**  
Page 89



**Backboard Edge Padding**  
Page 81

**Replacement Package**  
Page 78

## From the small Gymnasium to the large Multi Use Facility, Jaypro has over 60 years of Expertise to Design and Facilitate your Project!

Online files are available at [www.jayprospecs.com](http://www.jayprospecs.com) to help the Architects and Designers with their projects. EasySpec is another tool available to help configure valid building products in real time. Download CSI Specifications, Product Cut Sheets, REVIT Files, CAD Drawings, Load Charts, Installation Instructions and more!

**Facility Gym Equipment available thru select authorized Jaypro Sports Construction Dealers!**





## Gym Divider Curtains

Looking for a way to divide your sports facility? Jaypro offers a variety of divider curtains that are both functional and attractive. Choose from the power controlled Fold Up, Top Roll or Slope Fold options or the manual Walk Draw option. Available in solid vinyl or vinyl coated mesh with several color options. Custom made to your facilities size requirements.

**Best Seller!**

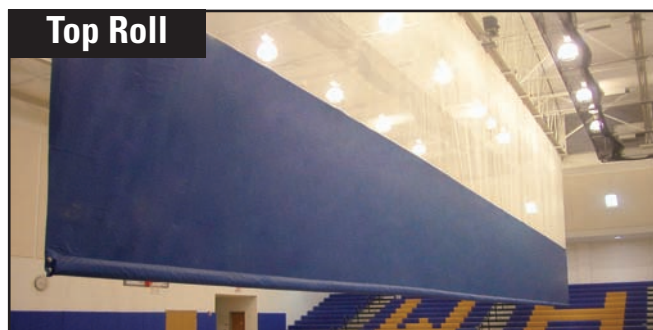
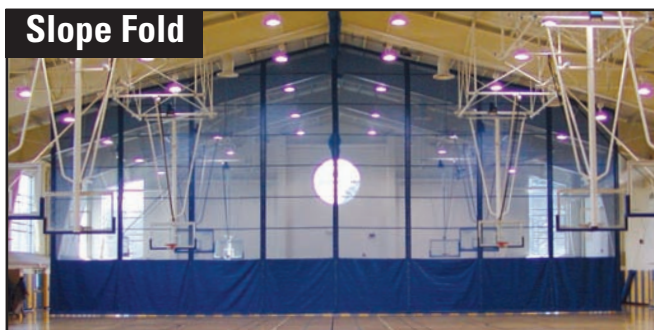
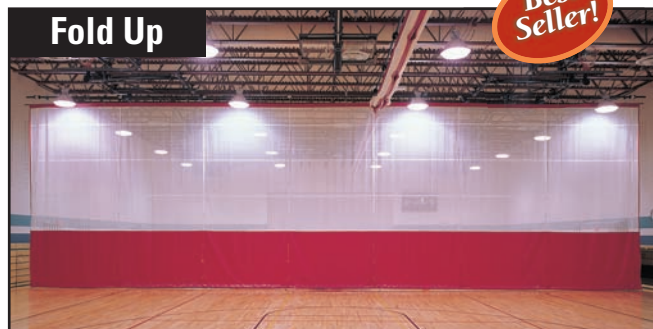
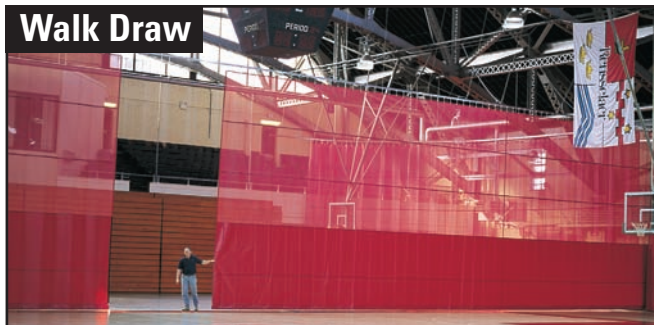

## Mini Top Roll Curtain

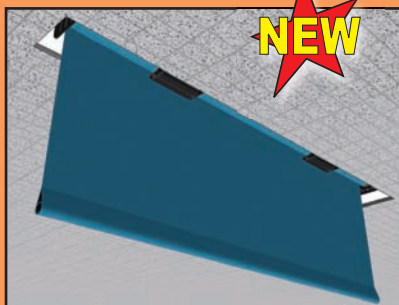

- ✓ Use in many different locations
- ✓ Not just for gymnasiums anymore
- ✓ Separate meeting rooms
- ✓ Close off areas
- ✓ Print School graphics or advertising on curtain
- ✓ Electrically controlled
- ✓ Developed for and used at Barclays Arena in Brooklyn, NY

The NEW versatile Mini Top Roll Curtain can be used anywhere in small spaces in Schools or Facilities to provide separation or blackout. Disappears up into or behind the ceiling structure and rolls down at the touch of a button. Constructed of 14 oz. or 18 oz. reinforced vinyl and 9 oz. vinyl coated polyester mesh. Designed to be compact and tight fitting to the ceiling structure. Driven by an internal tubular motor requiring 120 volt power.

**TC-710** Call Customer Service for pricing and details

MH-D-A

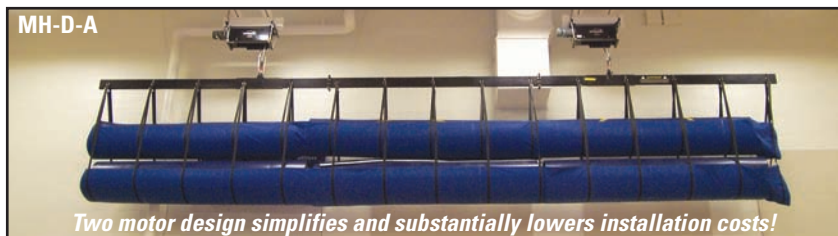

### Matlok™ Wrestling Mat Storage System Safety Strap

Pioneer of the first ever safe strap for Mat Storage Systems! Fully patented, tested and validated by an international testing laboratory and have an unmatched **1 Year Warranty.**



**ML-2000** 84 lbs.

**\$1,295 each**

### Securelift™ Wrestling Mat Storage System

Eliminate the risk of injury to students, athletes, and coaches from manually lifting and transporting heavy, awkward mats. Gain valuable storage space and extend the life of your wrestling mats! Simply roll the mat(s) onto the sling, attach the sling to the load bar, turn the key to raise the unit and store at ceiling height. **See specs for steel/structural requirements.** Available in Single, Double and Mini sizes, call for pricing or visit [www.jaypro.com](http://www.jaypro.com) for details.

NEW VOLLEYBALL SOCCER FOOTBALL LACROSSE BASEBALL FIELD MARKING SCOREBOARD BASKETBALL GYMNASIUM FIELD SEATING BALL STORAGE PHYS. ED. TENNIS



## Telescoping frame allows for precise positioning of the backboard off the wall.

System comes complete and ready for installation - no cutting of pipes is necessary for units over 4' face of bank. (some drilling is required). Attractive silver semi-gloss powder coated finish on all frame pipes and steel fittings.

2"x 8" Southern Yellow Pine mounting wood boards are ready for use: drilled and counter-bored, edges rounded & surfaces sanded with lacquer finished front, back and all edges. (Optional vertical wood stringers available, call for info).

1/4" Zinc-plated steel chain, 3/8" Quick links and turnbuckles

Heavy duty welded steel fittings provided with four (4) 1/2" diameter mounting bolts each (compare with competitor's 2)



Heavy duty stamped steel fittings mount board directly to frame. **Jaypro Exclusive Design!**

Heavy Walled 1.90" & 1.66" O.D. Frame Pipes. Smaller O.D. pipe telescopes into larger O.D. pipe for up to 48" of adjustability at time of install



Heavy duty stamped steel fittings with four (4) 1/2" attachment bolts and grade 5 steel hinge bolts. **Jaypro Exclusive Design!**

### Includes:

- Choice of Unbreakable 42" Rectangular Glass Backboard (GBRUB-42) or Aluminum Fan Board with Border and Target (ALB-24BT)
- Breakaway Rim (GBA-642 for Glass Board) or (GBA-542 for Fan Board)

### Options:

- Optional color edge padding available (not shown). See page 81.
- Optional Height Adjuster (see page 89 for details).

**Wall Anchors not included (order separately depending on your wall construction)**

## STATIONARY BACKSTOP SYSTEM

Economical non-folding wall mounted backstop

Wall to Face of Backboard	42" Glass Board	Price	Aluminum Fan Board	Price
2'- 4' Extension	ST24GB	\$1,695	ST24FA	\$1,595
4'- 6' Extension	ST46GB	\$1,895	ST46FA	\$1,795
6'- 8' Extension	ST68GB	\$1,995	ST68FA	\$1,895
8'- 10' Extension	ST810GB	\$2,295	ST810FA	\$2,195
10'- 12' Extension	ST1012GB	\$2,349	ST1012FA	\$2,249

## HEIGHT ADJUSTERS FOR WALL MOUNTS

Order with Stationary, Fold-Up or Side-Fold Backstops

**Ordering Instructions** - To order your wall-mounted backstop with a height adjuster, simply add the part number of the height adjuster style desired as a suffix to the system model number. (Example: ST68GB-EHAPW, Stationary backstop with an electric height adjuster with power wand control). See page 89 for Height Adjuster details.

### Manual Height Adjuster

**AHA** 180 lbs. **\$1,343 kit**

### Electric Height Adjuster with Key Switch

**EHAKS** 195 lbs. **\$2,576 kit**

### Electric Height Adjuster with Power Wand Control (order power wand separately)

**EHAPW** 200 lbs. **\$2,674 kit**

SR5187  HM2711

**"Double" Dual Expansion Machine Bolt Wall Anchor** For solid concrete walls, including Pre-Cast Concrete or Filled Block.

**HM2711** **\$4 each**

**SR5187** 1/2" Threaded Rod - 12" long **\$4 each**

**SR5276** 1/2" Threaded Rod - 18" long **\$4.50 each**

HM6212 

**No. 1 Type Tumble Toggle Wall Anchor**

For hollow walls, Non-Filled CMU (when anchoring into hollow block wall).

**HM6212** **\$6 each**



**"Safe-Pro" Bolt-On Edge Padding**

See page 81 for details.

16 lbs. **\$189 each**



## FOLD UP BACKSTOP SYSTEM

Backboard folds up against the wall for storage. Backstop is raised or lowered by manual (TW-700M) or electric winch (TW-2000-1), both sold separately. Adequate ceiling height is required to accommodate backstop in the folded up position. Jaypro recommends the use of safe straps (PL-1000) on all units, see page 88. To add height adjusters, see page 89.



Wall to Face of Backboard	42" Glass Board	Price	Aluminum Fan Board	Price
4'- 6' Extension	FU46GB	\$2,349	FU46FA	\$2,249
6'- 8' Extension	FU68GB	\$2,395	FU68FA	\$2,295
8'- 10' Extension	FU810GB	\$2,695	FU810FA	\$2,595
10'- 12' Extension	FU1012GB	\$2,749	FU1012FA	\$2,649



Fold up (side view)

### Electric Winch with Wall Mounting Kit

Includes TW-2000 electric winch (see page 88 for winch details) plus finished wood mounting boards and hardware.

**TW-2000KT1**

**\$1,395 each**

### Manual Winch with Wall Mounting Kit

Includes TW-700M manual winch (see page 88 for winch details) plus finished wood mounting boards and hardware. Manual winch handle sold separately.

**TW-700MKT1**

**\$775 each**



(Shown with optional height adjuster and Posilok safety strap).

### Safety Strap with Wall Mounting Kit

Includes PL-1000 Safety Strap (see page 88 for details) plus finished wood mounting boards and hardware.

**PL-1000KT1**

**\$625 each**

## SIDE FOLD BACKSTOP SYSTEM

Backboard folds to the side, against the wall for storage. May be built to fold in either direction. Spring loaded locking pin holds backstop in both playing and stored position. Adequate ceiling height and wall clearance is required to accommodate backstop in the side folded position. To add height adjusters, see page 89.

Wall to Face of Backboard	42" Glass Board	Price	Aluminum Fan Board	Price
4'- 6' Extension	SF46GB	\$1,949	SF46FA	\$1,849
6'- 8' Extension	SF68GB	\$1,995	SF68FA	\$1,895
8'- 10' Extension	SF810GB	\$2,195	SF810FA	\$2,095
10'- 12' Extension	SF1012GB	\$2,249	SF1012FA	\$2,149

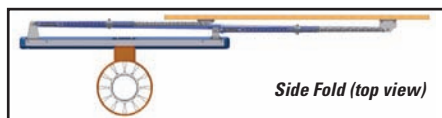

Side Fold (top view)



### IMPORTANT NOTES FOR WALL MOUNTED BACKSTOPS:

1. Wall mounted basketball systems should only be installed on walls capable of supporting the weight of the backstop plus the additional weight of a player hanging off the rim. If you are unsure if your wall is capable of handling such loads consult an architect, structural engineer or contractor.
2. Wall mounted basketball systems require a minimum ceiling height and unobstructed wall height, depending on distance from the wall. Please refer to the backstop dimensional drawings and charts on [www.Jaypro.com](http://www.Jaypro.com) or call.
3. Jaypro Sports bears no responsibility for the structural integrity of the walls these backstops are mounted to.
4. Installation should only be done by a qualified installer using suitable wall anchors. Please contact Jaypro Sports for assistance in locating a qualified installer.
5. Jaypro Sports recommends two types of wall anchors depending on whether the anchoring is done into solid concrete or hollow block. When anchoring to Un-Filled CMU walls, often both anchors are required. Order wall anchors separately.
6. Jaypro Sports recommends that all basketball backstops be inspected on an annual basis to ensure all wall anchors are sound, fasteners are secured and cables are not worn. Please contact Jaypro Sports for assistance in locating a qualified installer.

NEW VOLLEYBALL SOCCER FOOTBALL LACROSSE BASEBALL FIELD MARKING SCOREBOARD BASKETBALL GYMNASIUM FIELD SEATING BALL STORAGE PHYS. ED. TENNIS



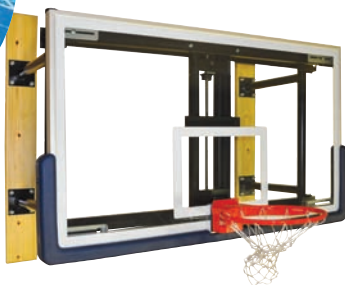

### Wall Mount Shooting Station

Great for young kids learning shooting skills and the art of free throws. Adjusts quickly and easily from 8' to 10'. **3' Face of Bank**. Comes complete with our full size non breakable rectangular glass backboard (GBRUB-42) and our Revolution Breakaway rim with hideaway net attachment for added safety (GBA-642). Wood backing included. An included adjustment handle will move the board up and down to your desired height, anywhere from 8' to 10'. Match your school colors with an optional "Safe-Pro" edge pad (MBBP-6XX on page 81). See page 86 for mounting hardware.

<b>WMWH</b>	Package with height adjuster	440 lbs.	<b>\$2,795 each</b>
<b>WMSS</b>	Package without height adjuster	285 lbs.	<b>\$1,995 each</b>



### Adjustable Wall Mount Shooting Station

Height adjustable from 7.5' to 10'. Acrylic backboard with aluminum backboard frame available in two sizes - 36" x 48" x 1/2" or 36" x 60" x 1/2". Extension from wall to backboard ranges from 33" - 44" depending on height. Heavy duty flex goal with nylon net and black edge padding (not shown) included. Indoor and outdoor use. See page 86 for mounting hardware.

<b>WM-48</b>	48" Board	<b>\$1,169 each</b>
<b>WM-60</b>	60" Board	<b>\$1,289 each</b>



*Hand crank for height adjustment*

## Basketball Backstop Winches



*Optional electric key switch utilizing a single key to both raise and lower a backstop.*



**Direct Drive Oil & Maintenance Free  
No Belts or Chains 1-Year Warranty!**

### Direct Drive Backstop Winch

Designed to raise and lower basketball backstop units. Features a 1 HP, instantly reversing, 115 volt, single phase torque motor that delivers at least **800 pounds of line pull** at a speed of 11 ft/minute, a unidirectional worm brake and self locking worm drive, optional 3 position key switch and universal mounting bracket to fit 3-1/2" O.D. pipe. Maintenance free operation. Remote receivers and control systems available separately. See page 87 for wall installation.

<b>TW-2000-1</b>	72 lbs.	<b>\$1,149</b>	+ any required hardware & cable. Call for info.
<b>KS-13</b>	2 lbs.	<b>\$79</b>	Key Switch

### Manual Winch

This state-of-the-art manual winch is compact and easy to use. Composite gears are self lubricating and eliminate the need for oil. Unique worm brake and grooved drum helps prevent backdrive and cable from kinking. Cable retention roller prevents unspooling of cable. Not for use on back-stops with ceiling height over 27'.

**1-Year Warranty!**

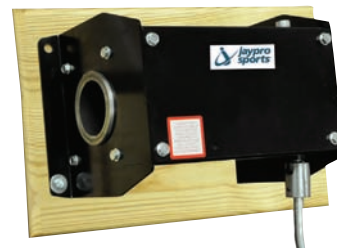

<b>TW-700M</b>	24 lbs.	<b>\$725 each</b>
<b>TW-700MKT1</b>	Includes Wall Mounting Kit	<b>\$775 each</b>
<b>TW700H</b>	Handle	<b>\$299 each</b>



**5-Year Warranty!**

### SecureLift™ Backstop Winch

Designed to raise and lower basketball backstop units. Features a 1 HP, instantly reversing motor that delivers **1250 pounds of line pull** at a speed of 11 ft/minute and newly designed limit switch. Large grooved cable drum ensures long cable life and proper coiling. Positive locking in worm gear provides a strong hold under load. Maintenance free operation. Standard key switch operation with remote receivers and control systems available separately.

<b>JP-3500</b>	70 lbs.	<b>\$1,349 each</b>
----------------	---------	---------------------



**SAFETY FEATURE:**  
The ED-902 includes unique anti-torque safety attachment that prevents "kick-back" during operation providing an extra measure of safety.

### Manual Winch Operator

Heavy duty portable winch operator is designed for use with the TW-700M manual winch to raise and lower all types of backstops. Comes with attractive carry/storage case.

<b>ED-902</b>	19 lbs.	<b>\$775 each</b>
---------------	---------	-------------------



### Posilok™ Backstop Safety Strap

Designed to automatically lock a backstop in position should a malfunction occur during raising or lowering the unit. Features a belt capable of withstanding 7300 pound loads, visible maximum safe extension patch and Telltale Indicator that notifies when the safety strap has been called into action. Other features include a self-checking, fail safe locking mechanism, automatic reset, stronger clamping system and versatile mounting. **1 Year Warranty**

<b>PL-1000</b>	17 lbs.	<b>\$559 each</b>
----------------	---------	-------------------



**Patented Design...  
exclusively from Jaypro!**

**HEIGHT ADJUSTERS:**

**Aluminum Height Adjuster** - Adjust the height of your backboard and rim from 10' to 8'. Lightweight and easy to operate. Constructed of extruded aluminum interlocking channels, which provides tighter clearances resulting in less shake than other height adjusters on the market - even at the lower playing heights. Choose either manual operation or electric control. The electric height adjuster is driven by a 1/6 HP motor, requiring 120 volt power. Electric height adjusters may be hard wired, or temporarily powered off a standard 120 volt electrical wall outlet.

**HEIGHT ADJUSTER STYLES:**

**Manual Height Adjuster (AHA)** - Easily raises and lowers the backboard with a manual hand crank **HA-1H** (provided). The manual height adjuster may also be controlled using a portable Cordless Drill operator **CD-80H** purchased separately (see below).

**Electric Height Adjuster with Key Switch Control (EHAKS)**- Requires running a dedicated 120 volt, 15 amp circuit to the wall mounted key switch and motor. Three position, momentary operated key switch provided.

**Electric Height Adjuster with Power Wand Control (EHAPW)**- Control your electric height adjuster without the added expense of hard wiring. Does not require an electrician or permanent electrical wiring. Height adjuster comes with a built-in power wand receptacle. To operate, simply plug Power Wand into receptacle and any 120 volt, 15/20 amp wall outlet. (**HAPW-100** Power Wand purchased separately).

**OPERATORS:**

**Power Wand Controller** - Easy to use, portable hand held controller, plugs into standard 120 volt, 15/20 amp electrical wall outlet. Operates by moving the momentary toggle switch to desired position.

**Manual Hand Crank** - Replacement hand crank for manual height adjuster (6' long).

**HAPW-100** 10 lbs. **\$349 each**

**HA-1H** 5 lbs. **\$69 each**



**Cordless Manual Height Adjuster Operator**

Heavy duty 18 volt Cordless Drill for operating the AHA-XX manual backstop height adjuster. Comes with charger, two batteries and an attractive carry/storage case.

**CD-80H** 18 lbs. **\$695 each**



*Ceiling Suspended Single Drop Series with Electric Motor*

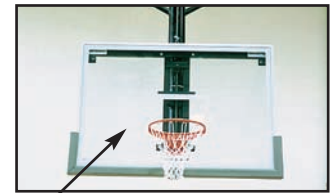

*The narrow profile of the AHA height adjuster maintains a visually "clean" target area.*

## Height Adjuster Kits for Existing Backstops

Take the guess work out of how to add a height adjuster to your existing backstop. Kits fit most common backstop frames. **Kits include: height adjuster** (choose manual or electric), **42" rectangular glass backboard** (GBRUB-42), **breakaway rim** (GBA-642), and **all mounting hardware** to attach to your center strut (6" OD to 6-5/8" OD) or double drop (H-frame) backstops. To order, choose your style of backstop and desired height adjuster (see description above). Double drop kits have mounting holes that are drilled in the field so they can fit most any frame width. See page 81 for edge padding info. Please call for assistance if you have any other configuration that is not listed below.

**CENTER STRUT FRAMES**

**Manual Height Adjuster**

**GBCS-AHA** 330 lbs. **\$1,800 kit**

**Electric Height Adjuster with Key Switch**

**GBCS-EHAKS** 345 lbs. **\$3,121 kit**

**Electric Height Adjuster with Power Wand Control**

**GBCS-EHAPW** 350 lbs. **\$3,219 kit**

**DOUBLE DROP FRAMES**

**Manual Height Adjuster**

**GBDD-AHA** 400 lbs. **\$1,981 kit**

**Electric Height Adjuster with Key Switch**

**GBDD-EHAKS** 415 lbs. **\$3,214 kit**

**Electric Height Adjuster with Power Wand Control**

**GBDD-EHAPW** 420 lbs. **\$3,312 kit**

*Center Strut Frame*



*Double Drop Frame*

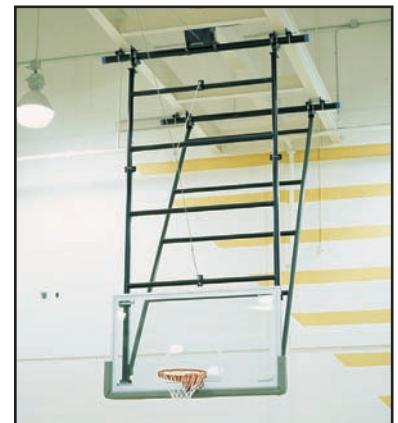

NEW VOLLEYBALL SOCCER FOOTBALL LACROSSE BASEBALL FIELD MARKING SCOREBOARD BASKETBALL GYMNASIUM FIELD SEATING BALL STORAGE PHYS. ED. TENNIS



## The "ELITE" Series of Adjustable Portable Backstops

Choose the portable that best fits your needs with our 8', 5'6" and 4'6" extension models.

**Shot Clock Mounting Bracket  
for Portable Backstop**  
Shot Clock not included.

**PBEL-SCBEA** 30 lbs. **\$349 each**



**Optional Graphics  
Available!**

**Call Customer Service  
for Details and Pricing.**



**jaypro**  
**ELITE  
9600**

**96" Play Safe Area**

**Backstop & Backboard  
Edge Padding Included**

**Adjustable in 6" increments from  
8' to 10' from the floor.  
Spring assisted one person set up!**

**PBEL96**

### Jaypro Elite 9600

**Our BEST Competition Goal!** Features 96" extension, 42" x 72" unbreakable glass backboard, direct mount 180° break away rim and bolt on backboard padding. Six 8" diameter non-marking, non-skid wheels for easy transport, double rear wheels to help widen the load. Stabilizing front foot pads independently adjustable for leveling the unit. Rear anchor kit included to meet NCAA and NFHS Rules for Competition Portable Goals. Instock padding of royal blue or red, other colors available. Optional graphics on padding, please call customer service for details. Ballast weight of 1000 lbs. included.

**PBEL96**

2600 lbs.

**\$9,095 each**

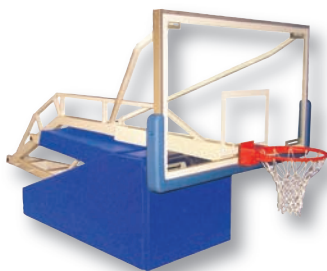

***Folds down to compact storage position.  
Designed to fit through standard double  
size doorways (height-wise).  
Fits through door width of 76"***

**Call or visit [www.jaypro.com](http://www.jaypro.com)  
for complete specifications.**

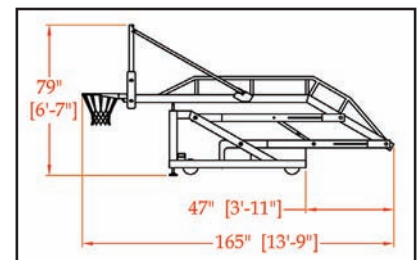

**PBEL96 folded dimensions**

**Flatbed tow truck, forklift or loading dock required to unload all units.**

## The "ELITE" Series of Adjustable Portable Backstops

Choose the portable that best fits your needs with our 8', 5'6" and 4'6" extension models.



66" Play Safe Area

Backstop & Backboard  
Edge Padding Included

Optional  
Graphics  
Available!

PBEL66

Adjustable in 6" increments from  
8' to 10' from the floor.  
Spring assisted one person set up!

### Jaypro Elite 6600

Features 66" extension, 42" x 72" unbreakable glass backboard (GBRUB-42) with a **Limited Lifetime Warranty**, a direct mount Collegiate "Revolution" goal (GBA-642) with a **7 Year Limited Warranty** and bolt on backboard padding. 8" diameter non-marking, non-skid wheels for easy transport. Stabilizing front foot pads independently adjustable for leveling the unit. Instock padding of royal blue or red, other colors available. Optional graphics on padding, please call customer service for details. Ballast weight of 800 lbs. included. **Optional rear anchor kit available below.**

**PBEL66**

2400 lbs.

**\$7,995 each**

Rear Anchor Kit - See page 92 for details.

**PBELKIT-100** Floating wood floors 3 lbs.

**\$199 each**

**PBELKIT-89** All other floor types 3 lbs.

**\$199 each**

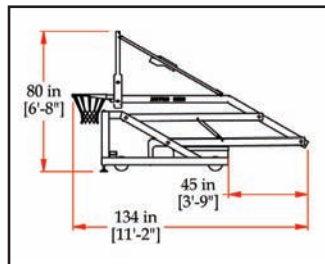

PBEL66 folded dimensions

*Folds down to compact storage position.  
Designed to fit through standard double  
size doorways (height-wise).  
Fits through door width of 76"*

Call or visit [www.jaypro.com](http://www.jaypro.com)  
for complete specifications.

**Flatbed tow truck, forklift or loading dock required to unload all units.**



## The "ELITE" Series of Adjustable Portable Backstops



**ELITE 5400**



54" Play Safe Area

Backstop & Backboard Edge Padding Included

Optional Graphics Available!

Spring Assisted, One Person Setup!

### Jaypro Elite 5400

This versatile sidecourt unit features a 54" extension, 42" x 54" unbreakable glass backboard (GBRUB-42) with a **Limited Lifetime Warranty**, a direct mount Collegiate "Revolution" goal (GBA-642) with a **7 Year Limited Warranty** and bolt on backboard padding. 8" diameter non-marking, non-skid wheels for easy transport. Stabilizing front foot pads independently adjustable for leveling the unit. Instock padding of royal blue or red, other colors available. Optional graphics on padding, please call customer service for details. Ballast weight of 800 lbs. included. **Optional rear anchor kit available below.** (Also available with a larger 42" x 72" unbreakable glass backboard. Includes 1000 lbs. of ballast weight.)

<b>PBEL54</b>	42" x 54" Board	1600 lbs.	<b>\$6,495 each</b>	
<b>PBEL5472</b>	42" x 72" Board	1850 lbs.	<b>\$7,195 each</b>	

**Adjustable in 6" increments from 8" to 10' from the floor. Fits through door width of 58" for the PBEL54 and 76" for the PBEL5472.**

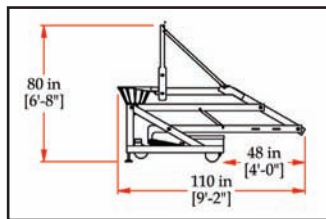

PBEL54 folded dimensions

### Rear Anchor Kit

Includes threaded floor anchor and all hardware necessary to attach to built in rear eye bolt.

<b>PBELKIT-100</b>	Floating wood floors	3 lbs.	<b>\$199 each</b>
<b>PBELKIT-89</b>	All other floor types	3 lbs.	<b>\$199 each</b>

## Adjustable Portable Recreational Backstop



Supplied to the 2014 Kevin Ollie Basketball Camp held at the University of Connecticut



48" Play Safe Area

Backstop Padding Included

No tools are required for the fully-collapsible unit to pass through a 48" doorway without disassembly.

PBB-200

### Portable Basketball Unit

A top-notch portable system designed to meet the demands of adult recreation with the flexibility to meet all the needs of elementary level activities. Acrylic backboard is 32" x 48" x 3/8". Easily adjusts for smooth height setting from 6'6" to 10' no tools required! Direct mount Collegiate "Revolution" goal (GBA-642) with a **7 Year Limited Warranty!** Backboard extension is 48" at 10' high. Some assembly is required. Rust-resistant powder coated finish. Customer supplied ballast required is 300 to 350 pounds. Front mast padding color choices are available on page 75.

<b>PBB-200</b>	500 lbs.	<b>\$2,895 each</b>	
Optional Backboard Edge Padding - Black Only			
<b>EP-48</b>	16 lbs.	<b>\$159 each</b>	
Replacement Backboard - 32" x 48"			
<b>AB-4832</b>	75 lbs.	<b>\$425 each</b>	



Fold down for easy storage!

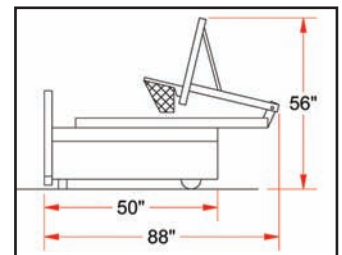

PBB-200 folded dimensions

**WARNING!** Failure to install customer supplied ballast according to instructions provided could result in serious injury.



NEW VOLLEYBALL SOCCER FOOTBALL LACROSSE BASEBALL FIELD MARKING SCOREBOARD BASKETBALL GYMNASIUM FIELD SEATING BALL STORAGE PHYS. ED. TENNIS

## Jaypro is proud to offer Wall Pads for your Facility!



### Standard Wall Pads

Padding provides excellent wall protection to absorb shock impact and reduce noise levels in any facility. Vinyl covered panels are made of 2" thick foam with OSB exterior grade wood backing. Mounting options include 1" nailing margin or Z clip channel (shown below). Mounting hardware not included. Does not ship from Jaypro's CT warehouse. Call for freight quote.

### Standard Class A Flame Retardant Pad

Similar to standard wall pads except include a 2" highly flame resistant polymerized open cell foam. Does not ship from Jaypro's CT warehouse. Call for freight quote.

### Standard Wall Pads

Description	Size	Description	Weight	Price
JWC-J006	2' x 6'	Standard Wall Pad w/1" lip	26 lbs.	\$125
JWC-J006Z	2' x 6'	Standard Wall Pad w/Z-clip	26 lbs.	\$145
JWC-J005	2' x 5'	Standard Wall Pad w/1" lip	22 lbs.	\$115
JWC-J005Z	2' x 5'	Standard Wall Pad w/Z-clip	22 lbs.	\$155

### Standard Class A Flame Retardant Pad

Description	Size	Description	Weight	Price
JWCA-J006	2' x 6'	Class A Wall Pad w/1" lip	33 lbs.	\$209
JWCA-J006Z	2' x 6'	Class A Wall Pad w/Z-clip	36 lbs.	\$219
JWCA-J005	2' x 5'	Class A Wall Pad w/1" lip	28 lbs.	\$199
JWCA-J005Z	2' x 5'	Class A Wall Pad w/Z-clip	30 lbs.	\$209

**Wall padding is available in standard 2' x 5' or 2' x 6' panels. Custom sizes, lettering, graphics and eco-friendly wall pads also available. Please call for details and pricing.**

### Installation Techniques

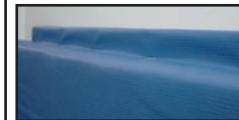

1" Nail Margins



Z-Clip Mounting

### Wall Padding Colors Choices: Color may not be an exact match

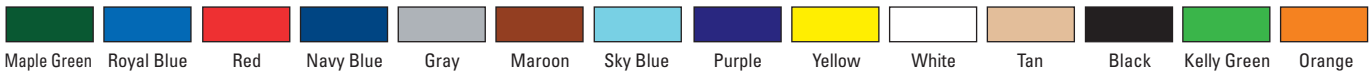

**Column and Corner Pads, I-Beam Wraps and Stage Padding are all Available, Please Call for Details and Pricing.**

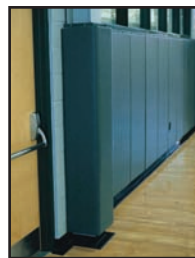

Column Pads



Corner Pads



I-Beam Wrap



Stage Padding



### DUAL PURPOSE WALL / TUMBLING MAT

4' x 6' non-folding mat serves as wall padding or as a tumbling mat. Vinyl covered 2" thick foam pad features 4 carrying handles and 1-1/2" W hook-and-loop closures on all four sides. Please specify color when ordering.

GMVH-1

\$345 each



### HOOK & LOOP CLOSURE WALL HANGING STRIP

For use with our GMVH-1 wall mat. The 2" wide aluminum strip is easily mounted to any gymnasium wall. Pressure-sensitive 1-1/2" W hook-and-loop closure securely bonds to the aluminum strip for long lasting use. Sold in 4' sections only.

VMH-13

1 lb.

\$26 each





NEW VOLLEYBALL SOCCER FOOTBALL LACROSSE BASEBALL FIELD MARKING SCOREBOARD BASKETBALL GYMNASIUM FIELD SEATING BALL STORAGE PHYS. ED. TENNIS



Protect your gym during nonathletic events with ultra durable 3-ply fabric. Flame retardant, antibacterial, antifungal and rot/mildew resistant. Constructed in 10'W sections for easy handling. Meets California Fire Marshall Spec. Floor covering: specify dimensions needed. We suggest adding 6"-12" for overlapping each section. 5' wide minimum charge. Does not ship from Jaypro's CT warehouse. Call for freight quote.

### Gym Guard Color Selections

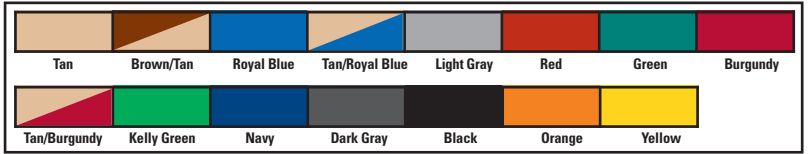

18 oz. available in solid colors only. Colors shown may not be an exact match.

18 oz. Fabric  
**GGFPS-16** 5 Year Warranty **\$0.85 sq. ft.**

22 oz. Fabric  
**GGFPS-22** 7 Year Warranty **\$0.99 sq. ft.**

27 oz. Fabric  
**GGFPS-24** 8 Year Warranty **\$1.20 sq. ft.**

### Safety Storage Racks

All steel construction with 8" diameter non-marking wheels that lock and swivel. Includes two hand cranks. Does not ship from Jaypro's CT warehouse. Call for freight quote.

- MSR-6** 6 Roll Rack **\$2,999 each**
- MSR-8** 8 Roll Rack **\$3,449 each**
- MSR-10** 10 Roll Rack **\$3,649 each**

## Gym Guard Floor Protection Accessories Available!

Tape, Dispenser, Power Winder, Brush Assembly and more Racks. Call Customer Service or visit [www.jaypro.com](http://www.jaypro.com) for Info and Details.

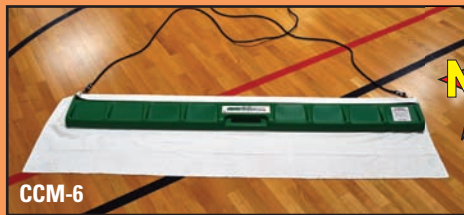

CCM-6

**NEW**



KCP-1

Item	Description	Price
<b>CCM-6</b>	6' Courtclean Mop	\$499 each
<b>CCT-6</b>	6' Courtclean Towel	\$42 each
<b>KCP-1</b>	Keyclean Pro Set	\$289 each
<b>KCPD-2</b>	Keyclean Pro Pads	\$63 each
<b>CCSS-1</b>	1 Gallon Super Shine-All	\$49 each

### Courtclean

Have a clean and safe floor in minutes with this damp mop system! **Courtclean:** 6' mop made of rotationally molded linear density polyethylene material. Comes with a convenient built-in carrying handle, hook and loop fasteners that keep the towel in place and a sturdy metal pull strap fastener. (Includes mop and towel). Replacement towels purchased separately. **Keyclean Pro:** Two large 18"x24" mops made with highly absorbent microfiber pads, attaches to a 6' adjustable two-piece aluminum handle. (Includes 2 mops and 2 pads). Replacement pads purchased separately. Fast drying, slip resistant to reduce injuries and reduces refinishing frequency. Does not ship from Jaypro's CT warehouse. Call for freight quote.

### Scorers Tables with Shatterproof Graphic Face Panels

Illuminated scorers tables with school spirit that comfortably seats up to 3-4 people. Two styles to choose from: Free Standing or Bleacher Mount in either 8ft. or 10 ft. lengths. All tables are 120VAC, 60 Hz. Includes lockable swivel casters with 3" poly wheels. Counter top includes multiple cup holders and also folds vertically for storage. Large access holes for console and laptop cords or other electronics. Under the counter storage bins hold extension cords, power adapters and other accessories. Removeable face panels for multiple sponsors or team logos. Graphics included - artwork provided by customers. Comes in 8 colors: Black, Navy Blue, Royal Blue, Purple, Dark Green, Maroon, Red or Green. Please call Customer Service for more details and information. Refer to page 80 for Possession Indicator. Does not ship from Jaypro's CT warehouse. Call for freight quote.



ST-8BM



ST-10FS

### FREE STANDING

**ST-8FS** 8 ft. long 357 lbs. **\$3,199 each**

**ST-10FS** 10 ft. long 454 lbs. **\$3,399 each**

### BLEACHER MOUNT

**ST-8BM** 8 ft. long 397 lbs. **\$3,649 each**

**ST-10BM** 10 ft. long 637 lbs. **\$3,869 each**

## Player Seating Available!



For the sideline, locker room even VIP guests. Quality steel framed seating with vinyl covered cushions. 24 piece minimum order required. **Player seating is custom. To receive a quote, please submit an electronic copy of your logo, logo placement, lettering, colors required and quantity. Lead time on custom seating orders is approximately 4-6 weeks from sample approval after order placement.**



**Note: Due to differences in wall construction, Jaypro does not provide anchors or mounting hardware to attach the wall stringers to gym walls. Consult your architect or contractor to determine the best and safest installation methods for your facility.**

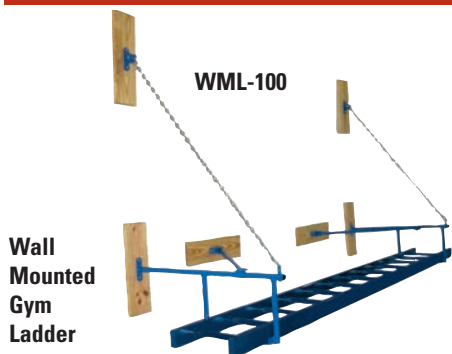

**Wall Mounted Gym Ladder**

**Textured Surface for Safety!**

Develop physical fitness, strength and coordination! Powder coated "rough" blue finish over steel, and the supports are welded for strength and durability. The inner braces provide stability for lateral movement. The ladder is attached with wood stringers (included) and is further supported with a heavy duty chain. Frame extends 48" from wall. Ladder is 18"W x 12"L.

**WML-100** 187 lbs. **\$1,595 each**

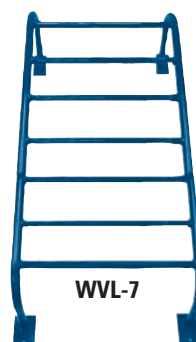

**WVL-7**

**Vertical Climbing Ladder**

Features 1-5/16" O.D. steel tubing construction with rough blue powder coated finish. Heavy duty wall mounting plates. Size is 22"W x 60"L.

**WVL-7** 77 lbs. **\$339 each**



**WGC-20**

**Wall Grid Climber**

Features 1-5/16" O.D. steel tubing construction with rough, blue powder coated finish. Grid is 4 x 5 rows with 6" pattern. Heavy duty wall mounting plates. Size is 30"W x 45"L.

**WGC-20** 72 lbs. **\$465 each**



**EWM-30**

**Adjustable Wall-Mounted Chinning Bar**

Perfect for elementary through university level use. Provides 2' of height adjustment in 6" increments. All-welded 30"W steel frame work has a powder coated finish. Oak backmounts for illustrative purposes only.

**EWM-30** 28 lbs. **\$249 each**

**Jump Rope Rack**

Keep your jump ropes untangled and ready for use. Wall mounted all steel construction. Features five 10" long pegs for storage. Powder coated finish. 27" long.



**PE-110**

**PE-110** 5 lbs. **\$45 each**



**OBR-16**

**Portable Bicycle Rack**

All-welded frame constructed of 1-5/8" galvanized steel with gray powder coated finish. Available in 2 sizes designed to hold bicycles or mopeds.

Item	Capacity	Size	Weight	Price
<b>OBR-16</b>	16	102"L x 30"W x 30"H	67 lbs.	\$595
<b>OBR-10</b>	10	67"L x 30"W x 30"H	60 lbs.	\$495
<b>OBR-8</b>	8	55"L x 30"W x 30"H	56 lbs.	\$469
<b>OBR-6</b>	6	47"L x 30"W x 30"H	49 lbs.	\$449

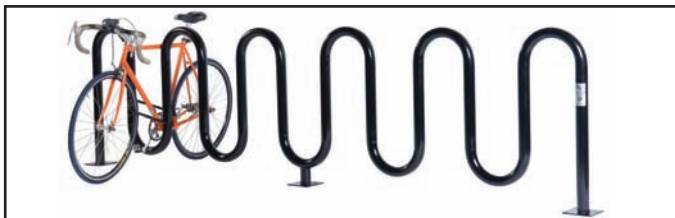

**Wave Bicycle Rack**

A contemporary bike rack available in ground or surface mount styles. Constructed with 2-3/8" O.D. schedule 40 tubing. 36" H with 12" spacing between waves. Powder coated finish available in colors shown to right. Standard powder coated color is black. **1 year warranty.** Please specify color when ordering. Does not ship from Jaypro's CT warehouse. Call for freight quote.

**Wave Bicycle Rack - Below Grade Mount - Galvanized**

Item	Capacity	Length	Weight	Galvanized
<b>HDWBR-7</b>	7	64"	74 lbs.	\$535
<b>HDWBR-9</b>	9	87"	96 lbs.	\$735



**Below Grade Mount - Powder Coated**

Item	Powder Coated
<b>HDWBR-7PC</b>	\$535
<b>HDWBR-9PC</b>	\$735

**Wave Bicycle Rack - Surface Mount - Galvanized**

Item	Capacity	Length	Weight	Galvanized
<b>HDWBR-7SM</b>	7	64"	74 lbs.	\$555
<b>HDWBR-9SM</b>	9	87"	96 lbs.	\$755



**Surface Mount - Powder Coated**

Item	Powder Coated
<b>HDWBR-7SMPC</b>	\$555
<b>HDWBR-9SMPC</b>	\$755

**Color Choices for Wave Rack** Colors shown may not be an exact match.





NEW VOLLEYBALL SOCCER FOOTBALL LACROSSE BASEBALL FIELD MARKING SCOREBOARD BASKETBALL GYMNASIUM FIELD

SEATING BALL STORAGE PHYS. ED. TENNIS



**Are you in the process of constructing a new field or facility? Jaypro can help. We offer products for several sports that you can “package” together to outfit your field.**

*Renovating or building a new field is a huge undertaking. Jaypro can assist you through the process from start to finish. We offer specifiable products in several sports that will meet, if not exceed your programs needs. Time management is important so let us start by helping you with product selection. Let us help you package your field construction projects to save time and \$\$\$ for your facility!*





## Lacrosse/Multi-Sport Ball Stop System

### 15' x 65' FieldPro Multi-Sport Ball Stop System

Stop wasting time during practices and games chasing missed shots or errant passes and ensure the safety of athletes, coaches and spectators on adjacent fields. 15'H x 65'L backstop is designed ideally to fit behind lacrosse and field hockey goals. Includes four 4" O. D. heavy wall aluminum uprights with black powder coated finish, ground sleeves, corrosion resistant hardware and 1-3/4" square mesh #36 knotless nylon black net with 1/4" rope border. Net can easily be raised and lowered with a rope and pulley system.

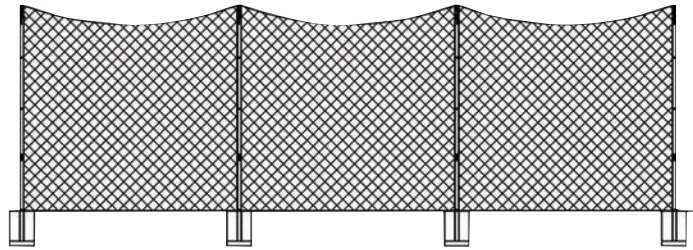

**FNMB-65**

15'H x 65'W

**\$2,295 each**

## Football Ball Stop System



### FieldPro Football Ball Stop System

Backstops are installed behind football goal posts to keep field goals and extra point kicks inside the field. 40'W net can easily and quickly be raised and lowered during games or practice with a rope and marine style swivel pulley system with integrated ball bearings. Includes heavy duty 6-5/8" diameter aluminum poles, ground sleeves, corrosion resistant hardware and 3-1/2" square mesh #36 knotless nylon black net with 1/4" rope border. Available in 30' or 40' heights. Poles can be powder coated black, call Customer Service for details.

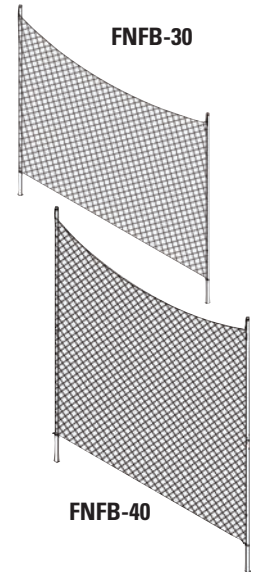

**FNFB-30**

**FNFB-40**

**FNFB-30** 30'H x 40'W 530 lbs. **\$4,195 each**

**FNFB-40** 40'H x 40'W 762 lbs. **\$6,595 each**

## Soccer Ball Stop System

### 20' x 65' FieldPro Soccer Ball Stop System

Stop wasting time during practices and games chasing missed shots or errant passes and ensure the safety of athletes, coaches and spectators on adjacent fields. 20'H x 65'L backstop is designed specifically to fit behind soccer goals. Includes four 4" O.D. heavy wall aluminum uprights with black powder coated finish, ground sleeves, corrosion resistant hardware and 3-1/2" square mesh #36 knotless nylon black net with 1/4" rope border. Net can easily be raised and lowered with a rope and pulley system.



**FNSB-65**

250 lbs.

**\$2,095 each**

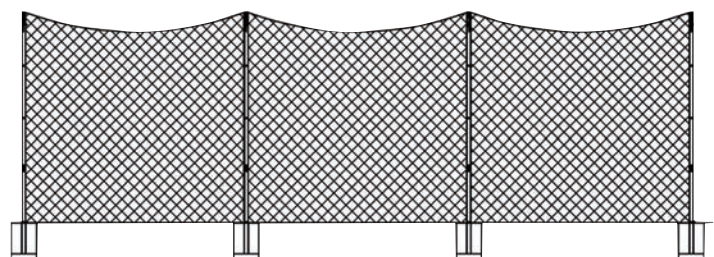

NEW VOLLEYBALL SOCCER FOOTBALL LACROSSE BASEBALL FIELD MARKING SCOREBOARD BASKETBALL GYMNASIUM FIELD SEATING BALL STORAGE PHYS. ED. TENNIS



# FieldPro Netting™

## Safety, Goal Backstop or Perimeter Netting Systems for all Turf fields

*In today's congested sports complexes with multi-use fields in close proximity to each other, keeping balls within the confines of the field is important. Stop wasting time during practices and games chasing missed shots or errant passes. Ensure the safety of athletes, coaches and spectators alike on adjacent fields and tracks. Jaypro's FieldPro Netting Systems offer ultimate design flexibility to suit your backstop and perimeter netting needs.*

Offered in six different heights and pole styles.

- The **10 ft. Straight Pole System**, with multi-sport net, is ideal for use as a Lacrosse or Field Hockey backstop net. The net is clipped at the top and bottom of each pole for easy removal.
- The **15 ft., 20 ft. and 30 ft. Straight Pole Systems** come with an easy to use hoisting system, which allows quick and easy lowering or removal of the net after the game, the season, or before a big storm. Reinstalling the net is a snap - all from ground level, no need for a ladder.
- The **20 ft. Offset Pole System** provides 3 ft. of offset, which is ideal for use around the perimeter of soccer and baseball/softball fields. Plus, an added measure of safety from ricocheting balls.
- The **12 ft. Portable System** is ideal where in-ground netting systems are not appropriate. Used to divide any field or space to keep separation of sports or activities, indoors or outdoors. Poles are easily transported on a tip and roll base. Includes corrosion resistant hardware, cable clamps and sliding rings for easy net assembly.
- All in-ground systems come with **Ground Sleeves and Caps**, to allow for complete system removal.
- **Basic Features and Recommendations:** Maximum pole spacing is 20 ft. We recommend netting system to be set back at least 25 ft. from the playing field. Features include hoisting system (excluding 10 ft. and 12 ft. poles) and stainless hardware. Ground sleeves with caps come standard with all In-Ground systems. Tip and roll bases with 5 gallon jugs (filled in the field) and 10" diameter tires come standard with the Portable system.

### In-Ground Systems



10 ft. Straight Pole with Optional Powder Coating



20 ft. Straight Pole



20 ft. Offset Pole

### Portable System



**No Flat Tires!!**



Can be used inside as dividers



Tip & roll base for easy transport



Four jugs weigh down each base

**ALL SURFACE FRIENDLY**



Shown with optional base covers



## Configure your Netting System

### Step 1 Pick Your Pole

#### System Height and Pole Style:

10 ft. Straight	Heavy-wall 2-3/8" O.D., Aluminum Tube	<b>FN-10</b>
15 ft. Straight	Heavy-wall 4.0" O.D. Aluminum Tube	<b>FN-15</b>
20 ft. Straight	Heavy-wall 4.0" O.D. Aluminum Tube	<b>FNS-20</b>
20 ft. Offset	Heavy-wall 4.0" O.D. Aluminum Tube	<b>FNO-20</b>
30 ft. Straight	Heavy-wall 6-5/8" O.D. Aluminum Tube	<b>FNS-30</b>
12 ft. Portable	Heavy-wall 2-3/8" O.D., Aluminum Tube	<b>PFN-12</b>

### Step 2 Pick Your Net

#### Nets:

- A** Multi-Sport, 1-3/4", #36 knotted nylon sq. mesh, UV treated, with 1/4" rope border
- B** Soccer/Football, 3-1/2", #36 knotted nylon sq. mesh, UV treated, with 1/4" rope border
- C** 1-3/4" knot-less HTPP sq. mesh, UV treated, with 1/4" rope border
- D** 4" knot-less HTPP sq. mesh, UV treated, with 1/4" rope border

### Step 3 Determine Length & Build your System

#### EXAMPLE:

15 ft. Straight Pole: **FN-15**  
with a Multi-Sport nylon net: **A**  
Would like it to be 180 feet long...

This would be my item number: **FN-15-A x 180'**

### Step 5

Call Jaypro  
**(800) 243-0533**  
for Pricing Details  
and Information!

### Step 4 Options to Consider

Portable System Base Covers (standard color is red)

**PFN-BCVR** 2 lbs. \$49 each

In-Ground Pole Option: Powder Coated Black Finish (Please Specify)



**NEW**



## Basic Portable Field Netting Package

**PFN-1260PKG**

12'H x 60'L Portable Netting System (includes 4 black powder coated poles, 4 bases, 16 five gallon jugs, 1-3/4" knotted nylon net, hardware and 4 vinyl base covers)

567 lbs.

**\$3,295 package**

## FieldPro Discus Cage



**NEW**

High School Discus cage. Consists of (6) offset poles, made of heavy wall 4" aluminum pipe. Poles are 14'6" H and have a 24" offset to minimize ricochet. Net is heavy duty weather treated black nylon, with a 1-7/8" mesh. Net measures 14'H x 54'L and comes with ground anchors to hold net in place at all times. Includes a pulley hoisting system that allows for easy net removal and set-up, as well as ground sleeves and covers, for complete system removal during the off season. Meets all NFHS rules and regulations, and is designed to accommodate a 34.92 degree throwing sector. **Optional 7'H Perimeter Barrier net, for added layer of protection.**

**DCHS-35**  
**DCPN-7**

Discus Cage  
Perimeter Net

Call for Pricing  
Call for Pricing



# Aluminum Tip & Roll Standard Bleacher



BLCH-4TRG

### Tip and Roll Bleacher

All aluminum seat planks and understructure provide a lightweight, stable bleacher that is easily tipped for easy mobility. Seat planks are 10" wide non-skid aluminum. Transition foot prevents floor marking. Includes (4) 4" non-marring swivel casters. **Preferred bleachers are the same as our standard aluminum bleachers but with the addition of double foot planks on all rows.** Four row bleachers do not exceed 30" in height, therefore guard rails may not be needed! (Check your local codes).



### STANDARD FOOT PLANKS NATURAL FINISH



### STANDARD FOOT PLANKS POWDER COATED COLORS



Standard Natural Finish Bleachers					
Rows	Length	Seats	Item #	Price	Weight
2	7-1/2'	10	BLCH-275TRG	\$749	75 lbs.
	15'	20	BLCH-2TRG	\$1,099	135 lbs.
	21'	30	BLCH-221TRG	\$1,449	180 lbs.
	27'	38	BLCH-227TRG	\$1,749	225 lbs.
3	7-1/2'	15	BLCH-375TRG	\$999	118 lbs.
	15'	30	BLCH-3TRG	\$1,399	210 lbs.
	21'	42	BLCH-321TRG	\$1,799	270 lbs.
	27'	54	BLCH-327TRG	\$2,299	330 lbs.
4	7-1/2'	20	BLCH-475TRG	\$1,299	155 lbs.
	15'	40	BLCH-4TRG	\$1,999	310 lbs.
	21'	52	BLCH-421TRG	\$2,349	415 lbs.
	27'	70	BLCH-427TRG	\$2,699	520 lbs.

Standard Powder Coated Bleachers					
Rows	Length	Seats	Item #	Price	Weight
2	7-1/2'	10	BLCH-275TRGPC	\$829	75 lbs.
	15'	20	BLCH-2TRGPC	\$1,195	135 lbs.
	21'	30	BLCH-221TRGPC	\$1,599	180 lbs.
	27'	38	BLCH-227TRGPC	\$1,999	225 lbs.
3	7-1/2'	15	BLCH-375TRGPC	\$1,149	118 lbs.
	15'	30	BLCH-3TRGPC	\$1,549	210 lbs.
	21'	42	BLCH-321TRGPC	\$1,995	270 lbs.
	27'	54	BLCH-327TRGPC	\$2,499	330 lbs.
4	7-1/2'	20	BLCH-475TRGPC	\$1,449	155 lbs.
	15'	40	BLCH-4TRGPC	\$2,099	310 lbs.
	21'	52	BLCH-421TRGPC	\$2,599	415 lbs.
	27'	70	BLCH-427TRGPC	\$3,199	520 lbs.



BLCH-3TRGPC

NEW VOLLEYBALL SOCCER FOOTBALL LACROSSE BASEBALL FIELD MARKING SCOREBOARD BASKETBALL GYMNASIUM FIELD SEATING BALL STORAGE PHYS. ED. TENNIS





### Tip and Roll Bleacher

All aluminum seat planks and understructure provide a lightweight, stable bleacher that is easily tipped for easy mobility. Seat planks are 10" wide non-skid aluminum. Transition foot prevents floor marking. Includes (4) 4" non-marring swivel casters. **Preferred bleachers are the same as our standard aluminum bleachers but with the addition of double foot planks on all rows.** Four row bleachers do not exceed 30" in height, therefore guard rails may not be needed! (Check your local codes). Show your team or school pride with powder coated bleachers. See chart for available colors on both the planks and understructure.

### PREFERRED DOUBLE FOOT PLANKS NATURAL FINISH



### PREFERRED DOUBLE FOOT PLANKS POWDER COATED COLORS

Preferred Natural Finish Bleachers					
Rows	Length	Seats	Item #	Price	Weight
2	7-1/2'	10	BLDP-275TRG	\$869	100 lbs.
	15'	20	BLDP-2TRG	\$1,249	170 lbs.
	21'	30	BLDP-221TRG	\$1,669	230 lbs.
	27'	38	BLDP-227TRG	\$2,049	290 lbs.
3	7-1/2'	15	BLDP-375TRG	\$1,199	150 lbs.
	15'	30	BLDP-3TRG	\$1,649	265 lbs.
	21'	42	BLDP-321TRG	\$2,099	360 lbs.
	27'	54	BLDP-327TRG	\$2,449	455 lbs.
4	7-1/2'	20	BLDP-475TRG	\$1,649	210 lbs.
	15'	40	BLDP-4TRG	\$2,399	405 lbs.
	21'	52	BLDP-421TRG	\$2,849	540 lbs.
	27'	70	BLDP-427TRG	\$3,299	675 lbs.

Preferred Powder Coated Bleachers					
Rows	Length	Seats	Item #	Price	Weight
2	7-1/2'	10	BLDP-275TRGPC	\$899	100 lbs.
	15'	20	BLDP-2TRGPC	\$1,349	170 lbs.
	21'	30	BLDP-221TRGPC	\$1,849	230 lbs.
	27'	38	BLDP-227TRGPC	\$2,249	290 lbs.
3	7-1/2'	15	BLDP-375TRGPC	\$1,249	150 lbs.
	15'	30	BLDP-3TRGPC	\$1,799	265 lbs.
	21'	42	BLDP-321TRGPC	\$2,299	360 lbs.
	27'	54	BLDP-327TRGPC	\$2,849	455 lbs.
4	7-1/2'	20	BLDP-475TRGPC	\$1,799	210 lbs.
	15'	40	BLDP-4TRGPC	\$2,449	405 lbs.
	21'	52	BLDP-421TRGPC	\$3,149	540 lbs.
	27'	70	BLDP-427TRGPC	\$3,699	675 lbs.



### Color Choices for Bleachers

**Plank and understructure colors shown. Please specify plank and understructure color when ordering.**



NEW VOLLEYBALL SOCCER FOOTBALL LACROSSE BASEBALL FIELD MARKING SCOREBOARD BASKETBALL GYMNASIUM FIELD SEATING BALL STORAGE PHYS. ED. TENNIS



BLCH-4AL

### All Aluminum Bleacher

All aluminum seat planks and understructure provide a lightweight, stable bleacher. Seat planks are 10" wide non-skid aluminum. Four row bleachers do not exceed 30" in height, therefore guard rails may not be needed! (Check your local codes).



### STANDARD FOOT PLANKS NATURAL FINISH



### STANDARD FOOT PLANKS POWDER COATED COLORS

Standard Natural Finish Bleachers

Rows	Length	Seats	Item #	Price	Weight
3	15'	30	BLCH-3AL	\$1,349	240 lbs.
	21'	42	BLCH-321AL	\$1,699	340 lbs.
	27'	54	BLCH-327AL	\$2,199	440 lbs.
4	15'	40	BLCH-4AL	\$1,899	320 lbs.
	21'	52	BLCH-421AL	\$2,299	440 lbs.
	27'	70	BLCH-427AL	\$2,649	560 lbs.

Standard Powder Coated Bleachers

Rows	Length	Seats	Item #	Price	Weight
3	15'	30	BLCH-3ALPC	\$1,449	240 lbs.
	21'	42	BLCH-321ALPC	\$1,949	340 lbs.
	27'	54	BLCH-327ALPC	\$2,449	440 lbs.
4	15'	40	BLCH-4ALPC	\$2,049	320 lbs.
	21'	52	BLCH-421ALPC	\$2,549	440 lbs.
	27'	70	BLCH-427ALPC	\$2,999	560 lbs.



BLCH-4ALPC

### CONVERT YOUR EXISTING OUTDOOR BLEACHERS TO INDOOR!

#### Indoor Conversion Kit for 2, 3 and 4-Row Bleachers

Set of 12 rubber feet to attach to bottom of legs. Sturdy design allows for converting 7-1/2', 15', 21' or 27' Aluminum Bleachers from outdoor to indoor use.



BLCHICK34

4 lbs.

\$49 set





# Aluminum Outdoor Preferred Bleacher



BLDP-4AL

## All Aluminum Bleacher

All aluminum seat planks and understructure provide a lightweight, stable bleacher. Seat planks are 10" wide non-skid aluminum. **Preferred bleachers are the same as our standard aluminum bleachers but with the addition of double foot planks on all rows.** Four row bleachers do not exceed 30" in height, therefore guard rails may not be needed! (Check your local codes). Show your team or school pride with powder coated bleachers. See chart for available colors on both the planks and understructure.

### PREFERRED DOUBLE FOOT PLANKS NATURAL FINISH



### PREFERRED DOUBLE FOOT PLANKS POWDER COATED COLORS

Preferred Natural Finish Bleachers					
Rows	Length	Seats	Item #	Price	Weight
3	15'	30	BLDP-3AL	\$1,549	290 lbs.
	21'	42	BLDP-321AL	\$1,899	415 lbs.
	27'	54	BLDP-327AL	\$2,349	540 lbs.
4	15'	40	BLDP-4AL	\$2,299	395 lbs.
	21'	52	BLDP-421AL	\$2,799	550 lbs.
	27'	70	BLDP-427AL	\$3,249	705 lbs.

Preferred Powder Coated Bleachers					
Rows	Length	Seats	Item #	Price	Weight
3	15'	30	BLDP-3ALPC	\$1,749	290 lbs.
	21'	42	BLDP-321ALPC	\$2,249	415 lbs.
	27'	54	BLDP-327ALPC	\$2,799	540 lbs.
4	15'	40	BLDP-4ALPC	\$2,499	395 lbs.
	21'	52	BLDP-421ALPC	\$3,099	550 lbs.
	27'	70	BLDP-427ALPC	\$3,449	705 lbs.

**Color Choices for Bleachers**

**Plank and understructure colors shown. Please specify plank and understructure color when ordering.**



BLDP-4ALPC



**144 Possible Color Combinations!**

Jaypro's four row bleachers may not require guard rails since the height is less than 30" from the ground. Check your local requirements.

**Four Row Bleacher**

NEW VOLLEYBALL SOCCER FOOTBALL LACROSSE BASEBALL FIELD MARKING SCOREBOARD BASKETBALL GYMNASIUM FIELD SEATING BALL STORAGE PHYS. ED. TENNIS



NEW VOLLEYBALL SOCCER FOOTBALL LACROSSE BASEBALL FIELD MARKING SCOREBOARD BASKETBALL GYMNASIUM FIELD SEATING BALL STORAGE PHYS. ED. TENNIS

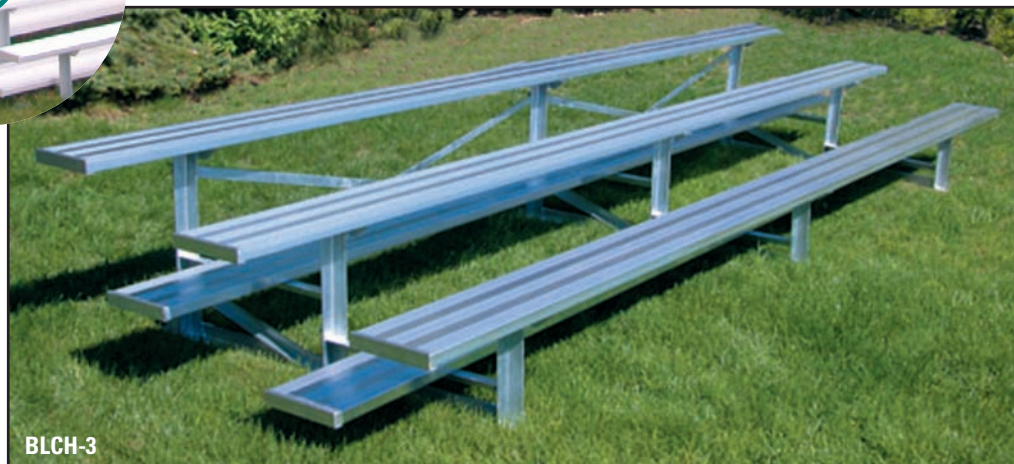

BLCH-3

### Outdoor Aluminum and Steel Bleachers

All aluminum seat planks and galvanized steel understructure provide a lightweight, stable bleacher. Seat planks are 10" wide non-skid aluminum. Planks are supported by a strong, galvanized steel understructure made of 3/16" x 1-1/2" steel angle. Dual braces and rear stabilizing bar are included for additional strength and stability.

**Color Choices for Bleachers**

**Plank and understructure colors shown. Please specify plank and understructure color when ordering.**

### STANDARD FOOT PLANKS NATURAL FINISH



### STANDARD FOOT PLANKS POWDER COATED COLORS

Standard Natural Finish Bleachers					
Rows	Length	Seats	Item #	Price	Weight
3	15'	30	BLCH-3	\$1,299	305 lbs.
	21'	42	BLCH-321	\$1,649	425 lbs.
	27'	54	BLCH-327	\$2,149	545 lbs.
4	15'	40	BLCH-4	\$1,849	390 lbs.
	21'	52	BLCH-421	\$2,299	520 lbs.
	27'	70	BLCH-427	\$2,649	650 lbs.

Standard Powder Coated Bleachers					
Rows	Length	Seats	Item #	Price	Weight
3	15'	30	BLCH-3PC	\$1,449	305 lbs.
	21'	42	BLCH-321PC	\$1,899	425 lbs.
	27'	54	BLCH-327PC	\$2,399	545 lbs.
4	15'	40	BLCH-4PC	\$1,999	390 lbs.
	21'	52	BLCH-421PC	\$2,499	520 lbs.
	27'	70	BLCH-427PC	\$2,949	650 lbs.



### 7' Bleacher or Bench Plank Pad

Create comfortable seating for your players or spectators. Simply buckle the straps under the plank for installation. Pads are 7'L x 10"W x 1-3/8" thick. Designed for 7-1/2', 15' (requires 2 pads) or 21' (requires 3 pads) planks. Please specify color when ordering. Extended lead time may apply. Does not ship from Jaypro's CT warehouse. Call for freight quote.

**PLKPAD7**      5 lbs.      **\$125 each**

**Available Colors**

Navy	Dk Purple	Pink	Lime	Kelly Green	Lt Blue
Royal Blue	Forest Green	Yellow	Orange	Red	Burgundy
Brown	Beige	White	Gray	Charcoal	Black



### Bleacher Transport Kit

Move your bleachers from field to field. Fits any angle framed 2, 3, 4 or 5 row bleacher, 15', 21' or 27' long. Includes two 4.8" x 12" wheels. Wheels and tongue are easily removed when not in use. Additional mounting brackets and axle receivers for additional bleachers purchased separately.

<b>BLCH-TOW4515</b>	15' Long	<b>\$795 each</b>
<b>BLCH-TOW4521</b>	21'-27' Long	<b>\$895 each</b>
<b>BLCH-TMKIT</b>	Mounting Kit	<b>\$229 each</b>



# Powder Coat Your Bleachers!

**Color your Planks... Color your Hand Rails... Color your Understructure... Color your Enclosure... We Dare the Competition to Match That!**



BLCH-10GR



BLCH-521ASGRPC

### Bleachers with Guard Rail or Chain Link with or without Aisle

All aluminum seat planks and galvanized steel understructure provide a lightweight, stable bleacher. Seat planks are 10" wide non-skid aluminum. Planks are supported by a strong, galvanized steel understructure made of 3/16" x 1-1/2" steel angle. Dual braces and rear stabilizing bar are included for additional strength and stability. Risers and double foot planks above 30" for added safety. Aisle option includes a 2" O.D. handrail in the center of the bleacher. Show your team or school pride with powder coated bleachers. **See chart for available colors on the planks, understructure and guard rails.**



			Standard Natural Finish Bleachers				Powder Coated Bleachers	
Rows	Length	Seats	Enclosure	Item #	Price	Weight	Item #	Price
5	15'	50	Guard Rail	BLCH-5GR	\$4,895	1172 lbs.	BLCH-5GRPC	\$5,399
	15'	50	Chain Link	BLCH-5C	\$4,295	1012 lbs.	N/A	N/A
	21'	62	Guard Rail	BLCH-521GR	\$5,495	1452 lbs.	BLCH-521GRPC	\$6,995
	21'	62	Chain Link	BLCH-521C	\$5,215	1252 lbs.	N/A	N/A
	21'	58	Guard Rail w-Aisle	BLCH-521ASGR	\$7,495	1500 lbs.	BLCH-521ASGRPC	\$8,295
	27'	80	Guard Rail	BLCH-527GR	\$6,995	1732 lbs.	BLCH-527GRPC	\$7,449
10	27'	80	Chain Link	BLCH-527C	\$5,995	1492 lbs.	N/A	N/A
	15'	100	Guard Rail	BLCH-10GR	\$10,995	2500 lbs.	N/A	N/A
	21'	140	Guard Rail	BLCH-1021GR	\$13,995	2700 lbs.	N/A	N/A
	21'	114	Guard Rail w-Aisle	BLCH-1021ASGR	\$15,495	3000 lbs.	N/A	N/A
	27'	170	Guard Rail	BLCH-1027GR	\$16,995	3464 lbs.	N/A	N/A
	27'	134	Guard Rail w-Aisle	BLCH-1027ASGR	\$17,995	3700 lbs.	N/A	N/A



**Any Color Combination of Plank, Understructure or Guard Rail on our 5 Row Bleachers!**

**COLORS**

### Bring Your Existing Five Row Bleachers Up To Local Codes With Jaypro's Universal Enclosure!

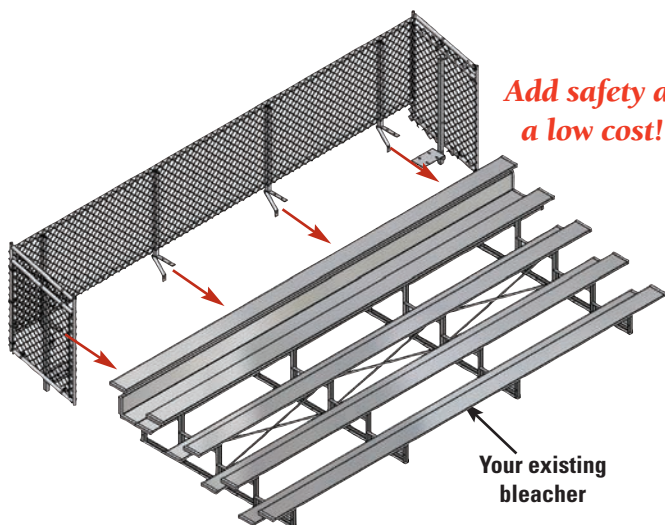

**Add safety at a low cost!**

#### Universal Enclosure For Five Row Bleacher

Comply with your local safety code by adding a chain link enclosure to your existing five row bleacher. Bolts onto 15', 21' or 27' bleachers. Fits most bleachers.

**This enclosure will ensure no exposed seat is higher than 30" and comes with a footboard and kickboard to complete the upgrade!**

Univ. Encl for 5-Row 15' Bleacher <b>BLCH5CUE15</b>	250 lbs.	<b>\$2,295 each</b>
Univ. Encl for 5-Row 21' Bleacher <b>BLCH5CUE21</b>	275 lbs.	<b>\$2,895 each</b>
Univ. Encl for 5-Row 27' Bleacher <b>BLCH5CUE27</b>	300 lbs.	<b>\$3,695 each</b>



NEW VOLLEYBALL SOCCER FOOTBALL LACROSSE BASEBALL FIELD MARKING SCOREBOARD BASKETBALL GYMNASIUM FIELD SEATING BALL STORAGE PHYS. ED. TENNIS



# Player Benches

**48 HOUR QUICK SHIP**



## Three Mounting Choices:

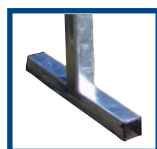

Portable Mounting

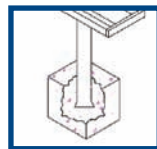

Permanent Installation



Surface Mounting

### Player Benches

Constructed of 10" wide non skid aluminum seat planks and 2" x 2" heavy duty, galvanized steel legs for superior rust resistance and superior stability. Available with or without a seat back in your choice of portable, permanent or surface installed units. Jaypro player benches are available powder coated in team or school colors - a durable and attractive finish that is scratch resistant and long lasting. A floor protection kit is available for indoor use, see below. All but the 7-1/2' models ship by truck. **Natural finish standard benches ship within 48 hours.**

Length	Natural Finish Without Seat Back				Natural Finish With Seat Back					
	Mounting Configuration			Price	Weight	Mounting Configuration			Price	Weight
Portable	Permanent	Surface	Portable			Permanent	Surface			
7-1/2'	PB-75	PB-75PI	PB-75SM	\$239	33 lbs.	PB-80	PB-80PI	PB-80SM	\$339	60 lbs.
15'	PB-15	PB-15PI	PB-15SM	\$329	57 lbs.	PB-20	PB-20PI	PB-20SM	\$539	100 lbs.
21'	PB-5	PB-5PI	PB-5SM	\$449	79 lbs.	PB-10	PB-10PI	PB-10SM	\$689	135 lbs.
27'	PB-95	PB-95PI	PB-95SM	\$519	101 lbs.	PB-90	PB-90PI	PB-90SM	\$769	175 lbs.



### Color Choices for Benches



Plank and leg colors shown.  
Please specify plank and leg color when ordering.



### Optional Floor Protector Kit

Optional floor protector kit ensures that your gym floors will not get scratched! Self-threading screws with 4 rubber feet. Two feet needed per leg.

**PSS-4FT**

2 lbs.

**\$29 kit**



When ordering, please specify leg and plank colors.

**Jaypro Team Colored Benches are available in an unbelievable 144 Possible Combinations!**

Length	Powder Coated Without Seat Back				Powder Coated With Seat Back					
	Mounting Configuration			Price	Weight	Mounting Configuration			Price	Weight
Portable	Permanent	Surface	Portable			Permanent	Surface			
7-1/2'	PB-75PC	PB-75PIPC	PB-75SMPC	\$309	33 lbs.	PB-80PC	PB-80PIPC	PB-80SMPC	\$449	60 lbs.
15'	PB-15PC	PB-15PIPC	PB-15SMPC	\$389	57 lbs.	PB-20PC	PB-20PIPC	PB-20SMPC	\$679	100 lbs.
21'	PB-5PC	PB-5PIPC	PB-5SMPC	\$519	79 lbs.	PB-10PC	PB-10PIPC	PB-10SMPC	\$809	135 lbs.
27'	PB-95PC	PB-95PIPC	PB-95SMPC	\$619	101 lbs.	PB-90PC	PB-90PIPC	PB-90SMPC	\$909	175 lbs.



NEW VOLLEYBALL SOCCER FOOTBALL LACROSSE BASEBALL FIELD MARKING SCOREBOARD BASKETBALL GYMNASIUM FIELD SEATING BALL STORAGE PHYS. ED. TENNIS

## Pro-Player Bench

Similar to our Standard Player Benches but with extra support and comfort to accommodate pro level players! We have added additional leg supports and cross bracing for strength. The Aluminum seat plank is larger at 12"W, 20"H and contoured for comfort. Our 2" x 2" square heavy duty galvanized steel legs offer superior stability. **Powder coat your bench for a custom look!** Please specify plank and leg color choice/s when ordering.

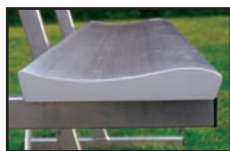

Contoured 12" seat plank sits 3" higher than a standard bench.

Additional leg support and cross bracing for added strength.



PB-20PROPC

Length	Natural Finish Pro-Player Bench			Powder Coated Pro-Player Bench	
	Item #	Price	Weight	Item #	Price
15'	PB20-PRO	\$999	124 lbs.	PB20-PROPC	\$1,149
21'	PB10-PRO	\$1,199	161 lbs.	PB10-PROPC	\$1,399

PBS-80



**Powder coat your bench for a custom look!** When ordering, please specify colors for planks and legs.



PBS-20PC

### Players Bench with Shelf

10" wide non-skid aluminum planks and 2" x 2" heavy duty galvanized steel legs for superior rust resistance. The 20" wide shelf can be used for helmets, gloves, water and other miscellaneous items. Same high quality as our full line of player benches. **Natural finish standard benches ship within 48 hours.**

Length	Natural Finish Players Bench with Shelf			Powder Coated Players Bench with Shelf	
	Item #	Price	Weight	Item #	Price
7-1/2'	PBS-80	\$519	95 lbs.	PBS-80PC	\$629
15'	PBS-20	\$759	130 lbs.	PBS-20PC	\$969
21'	PBS-10	\$999	185 lbs.	PBS-10PC	\$1,359
27'	PBS-90	\$1,599	240 lbs.	PBS-90PC	\$1,949

## Wall Mounted Aluminum Players Bench

10" wide non-skid aluminum planks with corrosion resistant aluminum under structure. The under structure is mounted to the wall with stainless steel hardware. **Powder coat your bench for a custom look!** Please specify plank and under structure color choice/s when ordering.



PBW-95PC

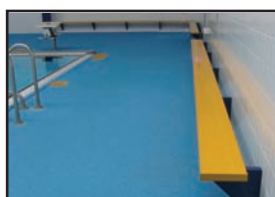

Length	Natural Finish			Powder Coated	
	Item #	Price	Weight	Item #	Price
7-1/2'	PBW-75	\$299	20 lbs.	PBW-75PC	\$339
15'	PBW-15	\$359	40 lbs.	PBW-15PC	\$419
21'	PBW-5	\$469	60 lbs.	PBW-5PC	\$549
27'	PBW-95	\$530	80 lbs.	PBW-95PC	\$649



ST75PC

## Scorers Table

Top quality, aluminum scorers table. 7.5'L x 10"W Aluminum seat and 19" wide table top. 2" x 2" heavy-duty galvanized steel legs for superior rust resistance. Same high quality as our full line of player benches. **Powder coat your table for a custom look!** Please specify plank and leg color choice/s when ordering.

Length	Natural Finish	Natural Finish Price	Powder Coated	Powder Coated Price	Weight
7-1/2'	ST75	\$489	ST75PC	\$579	90 lbs.



NEW VOLLEYBALL SOCCER FOOTBALL LACROSSE BASEBALL FIELD MARKING SCOREBOARD BASKETBALL GYMNASIUM FIELD SEATING BALL STORAGE PHYS. ED. TENNIS



TE-2

Holds approximately 20-25 balls



Can be used indoors or outdoors!

Great for pool areas!



TE-2

## ToteMaster™ – The Original!

All-purpose carrier provides large holding capacity for all types of equipment. Rugged construction features include 3/16" all-welded steel powder coated wire with 3" square mesh, four heavy duty swivel wheels and a hinged cover that can be locked for secure storage. 3'L x 2'W x 3'H.

TE-2

48 lbs.

\$239 each



Just pop open, put on the wheels and go!

No assembly required!



TE-30

## Mini ToteMaster™

Same construction features as the TE-2 except the overall size is 21"L x 21"W x 30"H.

TE-30

26 lbs.

\$159 each

## ToteMaster™ with All Terrain Wheels!

All the great features of the original Totemaster, except with two heavy duty swivel wheels and two fixed all terrain wheels. Now you can use your carrier outdoors!

AT-5

63 lbs.

\$299 each



AT-5



TE-60

Best Seller!

## ToteMaster™ Plus

This larger version of the Original Totemaster™ unit features an internal divider to keep equipment separate and a split top for easy opening and closing of the unit. The rugged construction features 3/16" all-welded steel powder coated wire with 3" square mesh and upgraded, larger heavy duty swivel wheels. The cover can also be locked for secure storage. 5'L x 2'W x 3'H.

TE-60

76 lbs.

\$325 each







AT-10

### ToteMaster™ - FieldCart

All purpose carrier provides large holding capacity for all types of equipment. Constructed of 3/16" all welded steel powder coated wire with 3" square mesh. Includes 6" semi-pneumatic front swivel casters and 20" semi-pneumatic all terrain rear wheels providing 10" of ground clearance. Lockable hinged cover.

Overall size: 51"L x 48"H x 25"W  
Basket size: 41"L x 27"H x 23"W

**AT-10** 65 lbs. **\$389 each**

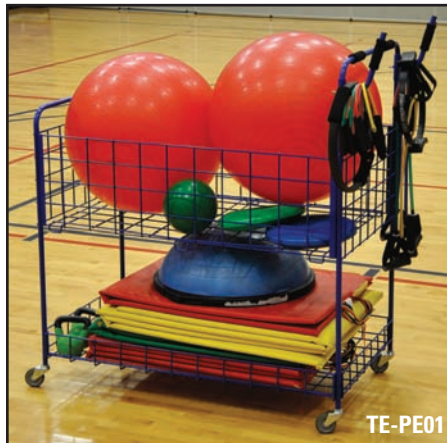

TE-PE01

### ToteMaster™ - Open Top Storage Cart

Two full size open top storage baskets for various equipment storage, mesh is 4"x 3". Two 360° hangers rotate for hoop and jump rope storage. Swivel casters for easy indoor transport. Powder coated frame for extra durability. Optional side shelf available separately for additional storage. Size: 48"L x 26"W x 54"H.

**TE-PE01** 48 lbs. **\$249 each**

**TE-PESHELF** 2 lbs. **\$16 each**



TE-PE02

### ToteMaster™

#### Deluxe Open Top Storage Cart

Same as the TE-PE01 except includes large all terrain wheels, has four 360° hangers and one side storage shelf. Additional storage shelves are available separately. Size: 48"L x 26"W x 58"H.

**TE-PE02** 56 lbs. **\$299 each**

## Atlas Series



BBABL-1

**Rugged 1" square steel**

**Non marking swivel casters**



BBABL-2



**Includes Mesh Hamper Liner**

Constructed of thick wall 1" steel tube. These units are rugged and strong enough for an assortment of medicine balls. Heavy duty non marking swivel casters for easy transport. Protective powder coating (blue) for longer life.



### ToteMaster™ "Atlas" Ball Locker

This unit is lockable with customer supplied lock, and a hinged top. Will store up to 28 basketballs and up to 35 volleyballs. Assembles to 47"L x 24"W x 37"H.

**BBABL-1** 75 lbs. **\$359 each**

### ToteMaster™ - Ball Locker & Hamper

Constructed of 1" round steel tube. Comes with mesh liner kit. Powder coated blue for tough surface protection. Larger 8" all terrain wheels with directional swivels allow for outside use. Stores up to 28 basketballs. Hamper liner makes for excellent storage for towels or uniforms. This unit is lockable with customer supplied lock. Assembles to 45"L x 24"W x 35"H.

**BBABL-2** Locker 60 lbs. **\$369 each**



BBABC-1



BBABC-2

### ToteMaster™ - "Atlas" Ball Cart

The multiple level racks store up to 15 balls. Constructed of 1" square steel. Includes four non marking swivel casters. Assembles to 51-1/2"L x 18"W x 36"H.

**BBABC-1** 30 lbs. **\$239 each**

### ToteMaster™ - "Atlas" Double Ball Cart

The multiple level racks store up to 30 balls. Constructed of 1" square steel. Includes four non marking swivel casters. Assembles to 51.5"L x 24"W x 36"H.

**BBABC-2** 55 lbs. **\$339 each**



## DELUXE BASKETBALL CARRIERS

The most rugged and durable carriers available today. Innovative easy access design holds up to 12 or 18 basketballs. All welded 1" O.D. steel side frames. 1" O.D. steel crossbars. Four heavy-duty swivel casters for portability. Tough powder coated finish. **Lifetime Warranty on frame and casters!**

### Twelve Ball Carrier

36"H x 22"W x 39"L

**BBC-12RB** Royal Blue

**BBC-12BK** Black

**BBC-12RD** Red

27 lbs. **\$149 each**

### LIFETIME WARRANTY!

Jaypro's basketball carriers are the most durable in the industry, we stand on it!



### Your choice of three colors!

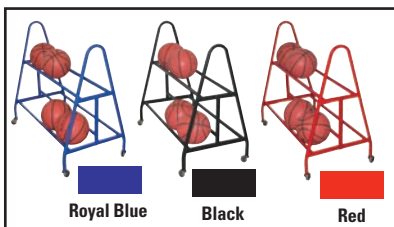

Royal Blue

Black

Red

All welded side frames



BBC-12RB

Also holds Volleyballs and Medicine Balls



### Eighteen Ball Carrier

36"H x 22"W x 60"L

**BBC-18RB** Royal Blue

**BBC-18BK** Black

**BBC-18RD** Red

41 lbs. **\$172 each**



DTBR-19

### StackMaster™ Double Basketball and Volleyball Wall Storage Rack

Holds up to 16 basketballs or 30 volleyballs securely in a lockable steel rack. Locking bars at top and bottom to secure balls after loading. Locks not included. 1" steel tubing is powder coated black. Does not include mounting hardware. Size: 66"H x 32"W x 13"D.

**PE-240** 20 lbs. **\$179 each**

### StackMaster™ Basketball Wall Storage Rack

Holds up to 6 basketballs securely in a lockable steel rack. Locking bars at top and bottom to secure balls after loading. 1" steel tubing is powder coated black. Does not include mounting hardware. Size: 66"H x 15"W x 12"D.

**PE-140** 13 lbs. **\$109 each**



PE-240



PE-140

### Deluxe Training Ball Rack

Durable ball rack designed to feed the top seven balls to the shooter. Excellent for shooting competitions and free throw practice. Holds 19 regulation basketballs. Strong 1" O.D. powder coated black tubing on rails and ends. Special extra-heavy duty non-marking wheels (front two are lockable). Assembles to 44"H x 18"W x 61"L.

**DTBR-19** 45 lbs. **\$199 each**

**NOTE: Due to differences in wall construction, Jaypro does not provide anchors or mounting hardware to attach the wall stringers to gym walls. Consult your architect or contractor to determine the best and safest installation methods for your facility.**



ENTIRE PAGE

### Wide-Body Ball Carts

BC3 holds 12 balls or BC4 holds 16 balls with a wide body design for stability. Heavy duty steel frame with chrome finish. Easy assembly.

#### Three-Tier

39-1/2"H x 8-1/2"W x 39"L

**BC3** 15 lbs. **\$70 each**

#### Four-Tier

39-1/2"H x 8-1/2"W x 51-1/2"L

**BC4** 19 lbs. **\$75 each**



BC3



BC4





## Do you know what's living on your sports balls?

**Yuck!** Sport balls are notorious for picking up and spreading germs and bacteria that can cause infections such as, MRSA, Whooping Cough, Pink Eye, STAPH, H1N1, Influenza and many other harmful diseases. It's a health risk! Is this what you want circulating through your sports program?



*These images are actual culture samples from schools around the United States.*

*The **germninja**® is designed to kill germs on sports balls and protect students/athletes of all ages from bacteria and viruses that cause disease.*

## CHEMICAL FREE!

We use the same technology that Operating Rooms use to sterilize its equipment, but we apply it to a sports ball. Jaypro sanitizes sports balls with ultraviolet light, killing off harmful micro-organisms without ruining the surface of the ball.

**Safe for all sports balls, leaves no residue behind!**



NEW VOLLEYBALL SOCCER FOOTBALL LACROSSE BASEBALL FIELD MARKING SCOREBOARD BASKETBALL GYMNASIUM FIELD SEATING BALL STORAGE PHYS. ED. TENNIS



*"Germninja is a revolutionary product that will help protect your athletes from viruses. It's a proven and effective way to help prevent germs spreading within your Team."*

**Hugh McCutchen, Head Coach**  
University of Minnesota

### germninja®

*The germninja® Ultraviolet Sports Ball Sanitizer is your teams defense against bacteria and germs that cause contagious infections.*

Kills bacteria and germs that can cause Strep, Staph, H1N1, E.coli, Salmonella, MRSA, Influenza, Whooping Cough, and other contagious infections. Chemical free nontoxic technology that is made in the USA. 50% of plastic used in this device is made from recycled materials. Safe for all sports balls, leaves no residue behind. Unique design allows balls to roll past the sanitizing lights to ensure every nook and cranny is disinfected. An optional cover is available for the unit, call for details and pricing. Call Customer Service for information on sponsoring a germninja® for your school system!

**GNJA1**

150 lbs.

**\$2,295 each**



*Keep your sports balls clean and sanitized after passing through the germninja® - store them in one of these two germninja® carts. Each cart includes an antimicrobial liner made with Argent 47, a specially woven silver embedded fabric, which has natural antimicrobial properties.*



**TENINJA-SPLIT**  
Half Liner 51 lbs.

**\$289 each**

**TENINJA-CART**  
Full Liner 52 lbs.

**\$389 each**



Patent Pending

# jaypro GymGlide™

## RECREATIONAL GAME STANDARD

NEW VOLLEYBALL SOCCER FOOTBALL LACROSSE BASEBALL FIELD MARKING SCOREBOARD BASKETBALL GYMNASIUM FIELD SEATING BALL STORAGE PHYS. ED. TENNIS



### Jaypro GymGlide™ Recreational Game Standard

Never tip to move or store! Equal to a 220 lb game standard. Telescoping upright includes lever-released composite height adjustment collars. Powder coated cast iron base rides on retractable front swivel wheels. Available in 5 base colors: Royal Blue, Dark Green, Yellow, Red and White.

	Royal Blue	<b>GGG-100RB</b>	170 lbs.	<b>\$598 each</b>
	Dark Green	<b>GGG-100DG</b>	170 lbs.	<b>\$598 each</b>
	Yellow	<b>GGG-100YW</b>	170 lbs.	<b>\$598 each</b>
	Red	<b>GGG-100RD</b>	170 lbs.	<b>\$598 each</b>
	White	<b>GGG-100W</b>	170 lbs.	<b>\$598 each</b>



See page 113 for GymGlide Nets

### From Gym to Storage in 4 Easy Steps!



Engage Wheels

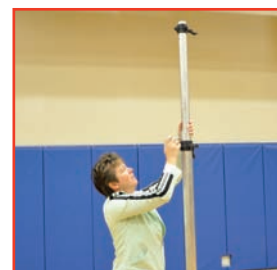

Slide Down Telescopic Upright



Roll to Storage



Store Safely



Never Tip to Move!  
Never Tip to Store!

Telescoping Aluminum Upright!

Unique Design: 155 lb. base with holding capacity equivalent to standard 220 lb. bases!

GymGlide Base Color Choices:



Scan to follow us online!

GGG-100RB



Tough Powder Coated Cast Iron Base



# GymGlide Packages

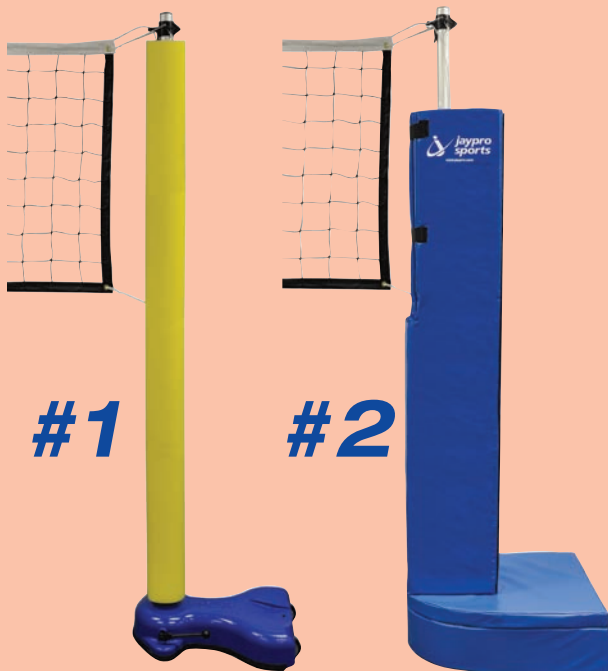

## GymGlide Package #1

- 2 each **GG-100XX\*** GymGlide Game Standard
- 2 each **GG-UPAD** GymGlide Upright Pad
- 1 each **VBN-32** Volleyball Net

**A SAVINGS OF \$129**

**Priced Separately at \$1,398**

**GG-100PKG**

348 lbs.

**\$1,269 package**

\* Please Specify Color

## GymGlide Package #2

- 2 each **GG-100XX\*** GymGlide Game Standard
- 2 each **GG-BPAD\*** GymGlide Base Pad
- 2 each **PVB60PHP\*** GymGlide Post Pad
- 1 each **VBN-32** Volleyball Net

**A SAVINGS OF \$205**

**Priced Separately at \$2,324**

**GG-100PKGDX**

372 lbs.

**\$2,119 package**

\* Please Specify Color



### GymGlide Economy Upright Pad

Fits GymGlide uprights. 2" thick foam pads are pre-slit for easy installation. Comes in an 8' section and can be cut in the field. Available in safety yellow.

**GG-UPAD** 2 lbs. **\$55 each**

### Deluxe Post Pad

2" thick foam pad covered with vinyl. Hook-and-loop attachment. See to right for available colors.

**PVB60PHP** 9 lbs. **\$259 each**



**GG-BPAD**

### GymGlide Base Pad

Fits GymGlide game standard. 2" thick foam pad covered with vinyl. Available in royal blue, forest green, yellow and red.

**GG-BPAD** 5 lbs. **\$259 each**

### Pad Color Choices Colors displayed may not be an exact match



## STANDARD NETS



**Volleyball Net**  
Nylon, rope cable  
36"W x 32'L

**VBN-32** 4 lbs.  
**\$92 each**

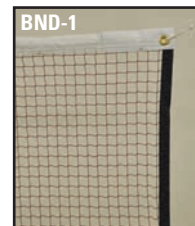

**Badminton Net**  
Lightweight, rope cable  
30"W x 21'L

**BND-1** 5 lbs.  
**\$52 each**

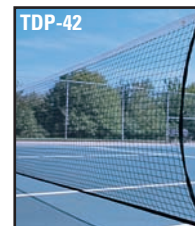

**Tennis Net**  
Lightweight, rope cable  
39"W x 42'L

**TDP-42** 7 lbs.  
**\$148 each**



## Multi-Purpose Game Standards

The most versatile piece of gymnasium equipment available. Standards set up in minutes and provide a wide range of fun-filled activities for any age group. Steel bases are 24" diameter & available in 3 sizes: 75 lb., 145 lb. and 220 lb. Uprights are 2" diameter x 10' high (two piece). Exclusive safety hub. Includes sliding eye bolt collars that allow for easily adjustable net heights. Bases include rubber rims to protect floor and two 4" non-marring wheels for easy portability.

See page 113 for Nets.

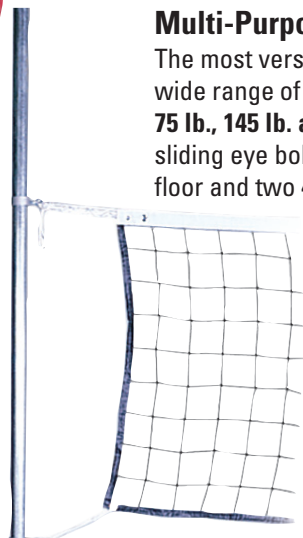

Easily adjust the net height with sliding collars



Game standards tip and roll for easy portability!

MP-521R

48 HOUR QUICK SHIP

Item	Size in lbs.	Color	Weight	Price
AS-475R	75	Royal Blue	203 lbs.	\$629 pair
AS-475RR	75	Red	203 lbs.	\$629 pair
MP-500R	145	Royal Blue	333 lbs.	\$798 pair
MP-500RG	145	Green	333 lbs.	\$798 pair
MP-500RR	145	Red	333 lbs.	\$798 pair
MP-500RW	145	White	333 lbs.	\$798 pair
MP-500RY	145	Yellow	333 lbs.	\$798 pair
MPC-5145R*	145	Royal Blue	167 lbs.	\$409 each
MP-521R	220	Royal Blue	487 lbs.	\$998 pair
MP-521RR	220	Red	487 lbs.	\$998 pair
MPC-5211R*	220	Royal Blue	244 lbs.	\$509 each

\* Center poles allow for a 2 court setup



Game Standard Base Color Choices:



### EXCLUSIVE "SAFETY HUB"

Jaypro's exclusive "safety hub" allows for easy assembly and prevents unauthorized tampering.

Extra drive pin secures the upright to the hub for an extra margin of safety

Nut is welded to hub so it can not be lost

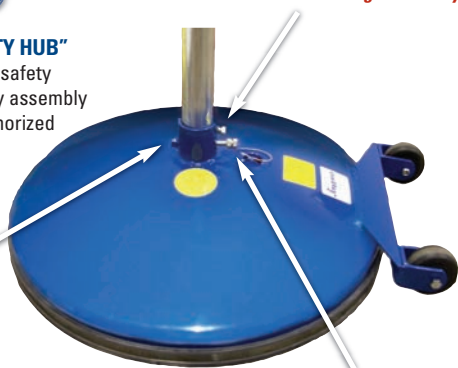

Shown in Royal Blue

Safety bolt is tethered to hub so it cannot be lost.

## IMPORTANT SAFETY NOTICE

Game standards are heavy pieces of gymnasium equipment and require proper set-up, handling and maintenance by trained supervisory personnel only.



### Base Pad

Fits 24" diameter portable bases. Two piece foam pad is 2" thick and covered with vinyl. Available in Red.

PBC-24 6 lbs. **\$279 each**



For Indoor or Outdoor Use!

JT-175R

### Economy Practice Tennis Standards

This pair of 44"H, 2" O.D. galvanized steel standards include two 145 lb. rubber-mounted roll-a-way bases. Suitable for indoor or outdoor use.

JT-175R 314 lbs. **\$779 pair**



### Economy Tennis Net

Lightweight construction makes this net ideal for use with our portable standards. Body is a tough #336, 1-1/2" sq. mesh weather-resistant black knotless nylon. 2" wide white vinyl headband with black taped side and bottom edges. Top cable is 1/4" dia. nylon cord. 42'L x 39"H

TDP-42 7 lbs. **\$148 each**

**\$148 each**



## Easy Play Game Standard

Great for volleyball, badminton, tennis, basketball rims and other games!

6-5/8" diameter powder coated steel base includes 6" non marring wheels and is filled with 105 lbs of customer supplied ballast. Two piece 10' H, 2" O.D. galvanized steel upright includes sliding collars for various net heights. Overall size 40" W x 32" D. Net and other accessories sold separately.

**EZ-55HP** 64 lbs. **\$289 each**

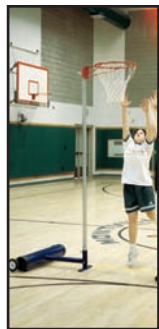

EZNB-10



EZBB-8

### Net Ball Adapter

Includes goal, net and mounting hardware. Fits any 2" O.D. game standard upright.

**EZNB-10** 15 lbs. **\$129 each**

### Elementary Basketball Adapter

Includes backboard, goal, net and mounting frame. Fits any 2" O.D. game standard upright. Maximum goal height is 7' for safety. For indoor use only.

**EZBB-8** 46 lbs. **\$389 each**

*Weight never comes off the floor making the EZ-55HP the easiest game standard to move!*

*See page 113 for Nets.*

*Easy to tip and roll!*

**48 HOUR QUICK SHIP**



EZ-55HP

### SS-320R

#### Deluxe Game Standards

2-3/8" O.D x 8' H galvanized steel uprights with net tensioning ratchet. 24" dia. steel base includes hand knob and guy wire for firm anchoring and two 4" wheels. Two floor anchors required (available on page 13).

**SS-320R** 142 lbs. **\$795 pair**

#### Deluxe Center Standard

(not shown) Single upright used with the SS-320R for a two court set-up. Two floor anchors required (available on page 13).

**SSC-321R** 75 lbs. **\$495 each**



*Floor anchors required. See page 13.*

### AS-300

#### T-Base Game Standards

2-3/8" O.D x 8' H galvanized steel uprights with net tensioning ratchet. 2" x 4" T style steel base includes hand knob and guy wire for firm anchoring and two 4" wheels. Two floor anchors required (available on page 13).

**AS-300** 90 lbs. **\$585 pair**

#### Center

(not shown) Single upright used with the AS-300 for a two court set-up. H style base requires two floor anchors (available on page 13).

**ASC-301** 50 lbs. **\$395 each**



### Portable Tetherball Pole

This all-time favorite playground activity can now be played indoors or outdoors. The sturdy 10', 2" O.D. galvanized steel upright has a 12" long pre-assembled leader chain. The 24" dia. x 75 lb. steel base has a protective rubber rim and two non-marring wheels for easy roll-a-way port-ability. Ball purchased separately.

**TBP-275R** 100 lbs. **\$399 each** 

### Semi-Permanent Outdoor Tetherball Pole

(Not Shown) A fun-filled game for any outdoor playground set-up. Upright is 2" O.D. galvanized steel and includes an 18" long aluminum ground sleeve with cast aluminum top cap for semi-permanent installation. Installed pole is 8-1/2'H. Ball purchased separately.

**TBP-200** 18 lbs. **\$169 each** 

### Mega-Duty Permanent Tetherball Pole

(Not Shown)

2-3/8" O.D. galvanized steel with cap and leader chain. Ball purchased separately.

**TBP-250** 38 lbs. **\$199 each** 

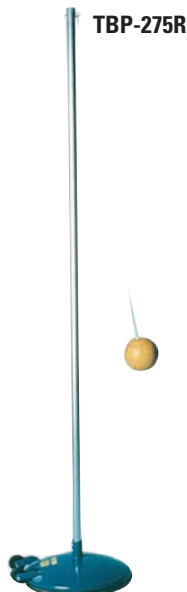

**Tetherball**  
Ultra-cushioned, sponge rubber construction in yellow. Includes recessed rope holder and nylon rope.

**TBP-BALL** 3 lbs. **\$18 each**



## New Generation Little Champ™ - The BEST, now even BETTER!

Great for youth leagues and developing elementary shooting skills.



Easy and safe one person install



**SAFETY FEATURE!**  
Frame does not extend below backboard



Quick & easy height adjustment



Hinged rim folds up and rear frame folds in for compact storage



Fully collapsible with dual wheels for easy transport

### Little Champ™ Easy Adjust Backboard Adapter

- Safely attaches to **ANY** goal & backboard. **CAN NOT** be dislodged during play
- Installs in seconds by one person from floor - lightweight aluminum construction
- **QUICK & EASY** height adjustable from floor - 6-1/2' to 8-1/2' - no need to disassemble
- **FOR SAFETY** - No structure ever extends below backboard

- The ultimate in compact storage with hinging rim and folding aluminum frame
- Adjustable frame overcomes sagging rims
- Dual wheels for easy transport
- Moves backboard 2' closer to foul line
- Comes complete with fan shaped backboard, attachment frame and official size goal with nylon net. Comes fully assembled

### Little Champ™ Easy Adjust Backboard Adapter (single)

**LC-6HP**

49 lbs.

**\$669 each**

### Little Champ™ Easy Adjust Backboard Adapter (pair)

**LC-6**

98 lbs.

**\$1,269 pair**

## Little Champ™ 8.5



LC-2



Safe and easy to install, no damage to the rim!

### Little Champ™ 8.5 Backboard Adapter

Converts existing backboard to youth regulation height of 8'6". Designed to fit on any style rim and rectangular backboard, with or without edge padding. Frame features adjustment hinge to ensure the board is always plumb. Our exclusive hinged rim folds up and the rear frame folds down for storage. Includes fan shaped backboard, attachment frame and official size 5/8" goal with nylon net.

### Little Champ™ 8.5 Backboard Adapter (single)

**LC-2HP**

38 lbs.

**\$499 each**

### Little Champ™ 8.5 Backboard Adapter (pair)

**LC-2**

76 lbs.

**\$989 pair**

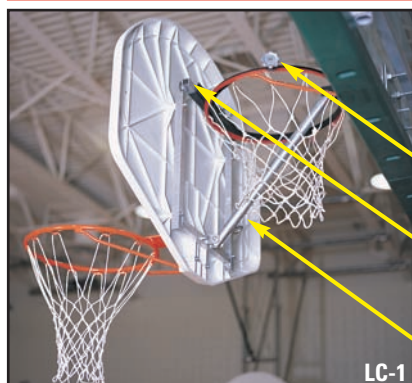

### Little Champ™ CLASSIC Backboard Adapter

Quickly converts regulation height courts to official youth goal height of 8'6" and brings the goal 2' closer to the foul line. Includes full-sized fan shaped backboard with aluminum backframes and official size 5/8" goals with nylon nets.



Lightweight aluminum frame fits securely in steel channel

Hand knobs easily secure the Little Champ (black ring) to the existing goal

Diagonal support adds strength and rigidity

### Little Champ™ CLASSIC Backboard Adapter (single)

**LC-1HP**

46 lbs.

**\$449 each**

### Little Champ™ CLASSIC Backboard Adapter (pair)

**LC-1**

92 lbs.

**\$849 pair**

### FSGB-1 Replacement Backboard

20 lbs.

**\$219 each**

NEW VOLLEYBALL SOCCER FOOTBALL LACROSSE BASEBALL FIELD MARKING SCOREBOARD BASKETBALL GYMNASIUM FIELD SEATING BALL STORAGE PHYS. ED. TENNIS



## Deluxe Floor Hockey Goals

The best and most durable hockey goals available. Lightweight 1-5/16" O.D. galvanized steel with mounted rubber feet to protect gym floor. Tough, polyethylene nets are 1-3/4" mesh and have a colorful sleeve-type binding (one red, one blue). 4'H x 6'W x 20"D.

**FHGN-33**

67 lbs.

**\$794 pair**

## Replacement Nets

Replacement nets for FHGN-33 are 1-3/4" square mesh and constructed of extra durable, twisted polyester. Nets have a colorful sleeve-type binding (one red, one blue).

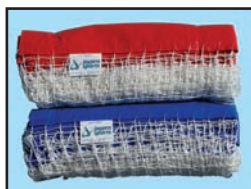

**FHN-36**

5 lbs.

**\$159 pair**

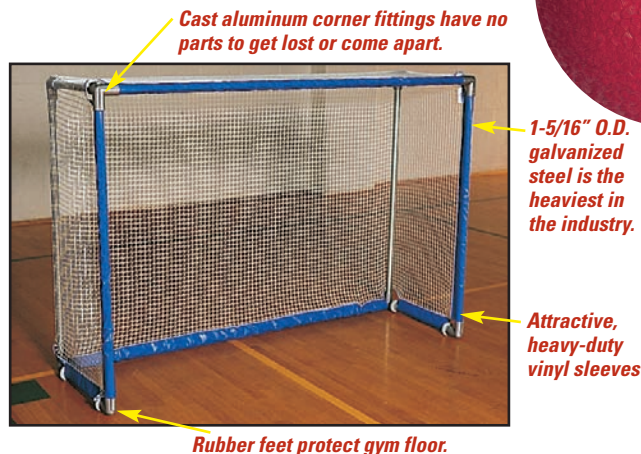

**FHG-46PR**



*Non marking wheels transport goal quickly and easily!*

## Folding Multi-Purpose Goal

Use this convenient goal for quick games in the gym, street or driveway. Rolls easily on non-marking wheels and folds flat for storage. 4'H x 6'W. 1-5/16" O.D. steel frame that includes a durable knotless nylon net with vinyl sleeves (one red, one blue) with hook-and-loop closure.

**FHG-46PR**

Goals

78 lbs.

**\$398 pair**

**FHG-46N**

Red Net

5 lbs.

**\$79 each**

**STG-46N**

Blue Net

5 lbs.

**\$79 each**



## Archery Target Stand

Steel tube storage stand with powder coated finish. Adjustable for 24"-48" targets. Firmly holds targets in place. Wheeled for easy transport. Color: Silver.

**PE-120**

10 lbs.

**\$74 each**



## Archery Tripod Target Stand

Steel tube storage stand with powder coated finish. Falls to tripod position for stability. For 24"-48" targets. Firmly holds targets in place. Cushioned footing for indoor/outdoor areas. Color: Silver.

**PE-121**

10 lbs.

**\$54 each**



## Throw Down Bases

For indoor or outdoor use. Flexible, washable rubber. Set includes three bases, home plate and pitching rubber.

**BB-50**

2 lbs.

**\$16 set**



**PE-FLXBX**

## Torso Flexibility Box

Designed to test individuals maximum reach and torso flexibility. Durable steel construction with foot rest plate. Accurately measures in inches and centimeters. Size: 20"L x 12"W x 12"H.

**PE-FLXBX**

12 lbs.

**\$149 each**

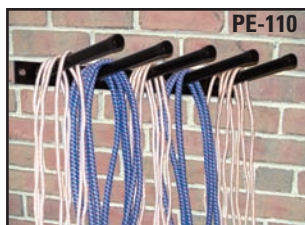

**PE-110**

## Jump Rope Rack

Keep your jump ropes untangled and ready for use. Wall mounted all steel construction. Features five 10" long pegs for storage. Powder coated finish. 27" long.

**PE-110**

5 lbs.

**\$45 each**



## Cone Cart

Durable 1" dia. steel powder coated blue frame. Includes large 8" dia. wheels for use indoor and outdoors. Rubber stopper protects gym floors. Will hold up to 130 standard 12" cones.

**CNCART**

3 lbs.

**\$159 each**



**CNCART**





## Experience The "Tennis Club" Look! Deluxe Internal Wind Club Tennis Posts in Round or Square

### Deluxe Internal Wind Club Tennis Posts

Offers the "Tennis Club" look and durability of institutional posts. 11 gauge steel posts include solid stainless steel internal worm gear with self locking mechanism that prevents recoiling during winding and removable handle. Available in 3" round in green or black or 3" square in green. Nets available separately (see page 119). Ground sleeves available for semi-permanent installation.

<b>RTP-300</b>	ROUND - Green	46 lbs.	<b>\$319 pair</b>
<b>RTP-300BK</b>	ROUND - Black	46 lbs.	<b>\$299 pair</b>
<b>STP-200</b>	SQUARE - Green	58 lbs.	<b>\$319 pair</b>

### Replacement Winch

<b>RTP-300WH</b>	ROUND Winch & Handle	4 lbs.	<b>\$89 each</b>
<b>STP-200WH</b>	SQUARE Winch & Handle	4 lbs.	<b>\$89 each</b>

### Ground Sleeves

<b>STPGS-2</b>	Ground Sleeve for STP-200	24"L	<b>\$99 pair</b>
<b>RTPGS-3</b>	Ground Sleeve for RTP-300	24"L	<b>\$99 pair</b>

### Heavy Duty Permanent /Semi Permanent Tennis Posts

3-1/2" O.D. powder coated steel posts include steel top pulley caps with 1-3/4" diameter aluminum pulley. Tensioning ratchet has spring-loaded safety latch and removable handle. Nets and ground sleeves for semi-permanent installation available separately.

<b>TP-125</b>	69 lbs.	<b>\$389 pair</b>
---------------	---------	-------------------

### Galvanized Steel Tennis Posts

(Not shown.) Constructed with unpainted galvanized steel post. Includes same net tension device as TP-125.

<b>TPGS-35</b>	68 lbs.	<b>\$389 pair</b>
----------------	---------	-------------------

<b>TP-150G</b>	Ground Sleeve for 3-1/2" semi-permanent use	12 lbs.	<b>\$149 pair</b>
----------------	---	---------	-------------------

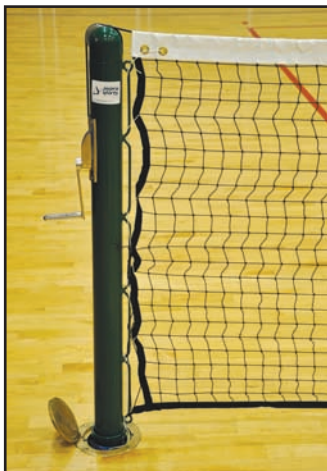

### Deluxe Internal Wind Indoor Tennis Posts

Indoor tennis posts with the durability of our institutional series posts. 3" round, 11 gauge steel posts with powder coated green or black finish for excellent durability. Solid stainless steel internal worm gear winch with self locking gear mechanism to prevent re-coil during winding. Removable winch handle for safety. Includes 36' long net. Use in existing 10" deep floor sleeves spaced at standard volleyball distance (36').

<b>ITS-300</b>	Green Posts	46 lbs.	<b>\$489 pair</b>
<b>ITS-300BK</b>	Black Posts	46 lbs.	<b>\$489 pair</b>

<b>PVB-70S</b>	Floor Sleeve & BRASS Hinged Cover for 3" I.D. x 10" deep	22 lbs.	<b>\$419 pair</b>
<b>PVB-70S-CP</b>	Floor Sleeve & CHROME Hinged Cover for 3" I.D. x 10" deep	22 lbs.	<b>\$419 pair</b>



### Tournament Deluxe Tennis Net

Constructed of durable **3.5 mm braided** black polyethylene netting. Quadruple stitched heavy-duty polyester web headband with a 3/16" dia. vinyl-coated steel cable. Top five rows are double mesh. Includes synthetic-taped bottom edges and grommeted side pockets with dowels. 42'L x 42"H

**Best Seller!**

**48 HOUR QUICK SHIP**

**TTN-3**

**21 lbs.**

**\$229 each**

### Collegiate Model Tennis Net

Constructed of 2.5 mm twisted black polyethylene netting. Quadruple-stitched heavy-duty double thickness headband with a 1/8" dia. vinyl coated steel cable. Top five rows are double mesh. Black synthetic-taped side and bottom edges. 42'L x 42"H

**48 HOUR QUICK SHIP**

**TPL-5**

**18 lbs.**

**\$169 each**

### Country Club Pro Tennis Net

Constructed of heavy-duty 3.6 mm braided polyethylene body, 38 oz. reinforced vinyl headband. Heavy duty vinyl coated side and bottom tapes, side pockets with metal dowels. 42'L x 42"H

**CCPTN42**

**20 lbs.**

**\$199 each**



**48 HOUR QUICK SHIP**

### Economy Tennis Net

Lightweight construction makes this net ideal for use with our portable standards. Body is a tough #336, 1-1/2" sq. mesh weather-resistant black knotless nylon. 2" wide white vinyl headband with black taped side and bottom edges. Top cable is 1/4" dia. nylon cord. 42'L x 42"H

**TDP-42**

**7 lbs.**

**\$148 each**

### Tennis Net

To be used with volleyball systems. 36'L x 42"H

**TPV-13**

**6 lbs.**

**\$189 each**



### 4' Court Side Tennis Bench

10" wide non-skid aluminum powder coated green planks and 2" x 2" heavy duty galvanized steel legs for superior rust resistance. Same high quality as our full line of player benches!

**PB40PC**

**50 lbs.**

**\$329 each**



### Roldri® Sponge Roller

This 36" wide seamless Tennis Court Roller is made from tough, durable polyvinyl alcohol. The non-deteriorating foam is molded directly onto the roller core for a seamless fit to ensure rapid, streak less drying.

**TCSR**

**TCSR**

**Entire Roller 8 lbs.**

**\$74 each**

**TCSR-RR**

**Roller Only 2 lbs.**

**\$42 each**



### Heavy Duty Ratchet Reel for TP-125

Sturdy construction with removable handle and safety latch to prevent fly-away. Fits existing posts. Ratchet painted green. Tough, long-lasting galvanized steel handle.

**RT-5PC**

**4 lbs.**

**\$72 each**



### Tennis Post Top Cap for TP-125

Fits 3-1/2" O.D. posts. Steel powder coated green. 1-3/4" pulley sheave and set screws.

**CAP-35**

**2 lbs.**

**\$22 each**

### Center Strap

2" wide adjustable nylon webbing with double snap hook.

**CS-1**

**1 lb.**

**\$12 each**

### Center Strap Anchor

All-aluminum construction with stainless steel drive pin for easy snap assembly.

**A-2**

**1 lb.**

**\$38 each**

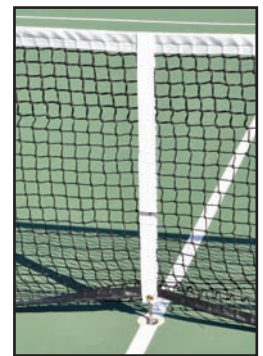

### Classic Wind Screen

An attractive yet economical wind screen that will meet all of your privacy, wind and background needs. Open mesh 8.2 oz/sq yd PVC coated polyester provides up to 84% shade. Includes reinforced hems and rust resistant grommets spaced at 18" intervals. **3 Year Warranty.** Refer to page 58 for colors and details. **Customize your windscreen.** Does not ship from Jaypro's CT warehouse. Call for freight quote.

**TWS-6 6' height**

**\$0.69 sq. ft.**

**TWS-9 9' height**

**\$0.72 sq. ft.**

### Armor Mesh Windscreen

14 oz. woven, extrusion vinyl coated polyester mesh available 6' or 9'H. Fabricated with IncrediSeal™ heat sealed hem providing a clean look and eliminating the risk of stitches or seams coming undone! Provides 75% shade. Wind vents and cable ties sold separately. Colors shown on page 58. Does not ship from Jaypro's CT warehouse. Call for freight quote.

**WSCRN-6 6' height**

**\$0.89 sq. ft.**

**WSCRN-9 9' height**

**\$0.99 sq. ft.**



**WSCRN-9**



Product	Page	Product	Page
<b>A</b>		Scoreboards	70, 80
Aerosol Paint	69	Scorer's Tables	63, 94, 107
Agility Training	34, 44	Shooting Stations	88
Archery Stands	117	Shoulder Pad Storage	42
Artificial Turf	55	Side Fold Backstops	87
<b>B</b>		Sideline Seating	35, 94
Backboard Adapters	116	Sideline Markers	42
Backboard Edge Padding	81	Soccer Goal Anchors	31-32
Backboards	78-80	Soccer Goal Net Attachments	32
Backstop Padding	51	Soccer Goal Pads	32
Badminton System	9	Soccer Goal Wheel Kits	20, 22-25
Ball Bags	32	Soccer Goals - Club	24-25
Ball Racks	15, 109-110	Soccer Goals - Official	19-23
Ball Storage	15, 32, 63, 108-111	Soccer Goals- Youth	26-28
Base Accessories	62	Soccer Nets	30
Base Plugs	62	Soccer Rebounders	29
Baseball Backstops	51	Soccer Shelter	35
Baseball Bases	60	Soccer Training Tools	34
Basketball Nets	83	Soccer/Football Combo Goals	36-37
Basketball Posts - Outdoor	72-77	Soft Toss Screens	53
Basketball Rims	82-83	Speed Training	34
Basketball Winches	88	Sports Training Machines	71
Bat Rack	62	Stationary Backstops	86
Batters Box Template	64	Storage Carts	11, 15, 42, 108-110
Batting Cages	48-50	<b>T</b>	
Batting Mats	55	Team Benches	35, 102-103
Batting Tees	62	Tennis Accessories	119
Batting Tunnel Frames - Indoor	56	Tennis Nets	119
Batting Tunnel Frames - Outdoor	54-55	Tennis Posts	118
Batting Tunnel Nets	54, 56	Tetherball	115
Bike Racks	95	Tip & Roll Bleachers	100-101
Bleacher Enclosure Kit	105	Totemasters™	108-109
Bleacher Transport Kit	103	<b>V</b>	
Bleachers	100-105	Volleyball Antennae	11
<b>C</b>		Volleyball Equipment Carriers	15
Chinning Bar	95	Volleyball Floor Anchors	13
Combination Goals	36-37	Volleyball Floor Sleeves	12
Cones	33	Volleyball Nets	10
Corner Flags	33	Volleyball Net Keepers	11
<b>D</b>		Volleyball Referee Stands	14
Discus Cage	99	Volleyball Standard Pads	13
Divider Curtains	85	Volleyball System Accessories	13
Drag Mats	64	Volleyball System Packages	4-5
Dry Line Markers	67	Volleyball Systems - Indoor	6-9
Edge Padding	77	Volleyball Systems - Outdoor	17
<b>F</b>		Volleyball Training Aids	16
Fence Top Protection	66	Volleyball Winches	13
Field Covers	57	<b>W</b>	
Field Hockey Goals	45	Wall Ladders	95
Field Hockey Nets	45	Wall Mounted Backstops	86-88
Field I.D. Markers	33, 47	Wall Pads	93
Field Maintenance	64-65	Windscreen	57, 119
		Wrestling Mat Storage System	85
<b>Product</b>	<b>Page</b>		
Field Markers	67, 69		
Field Marking Dust	68		
Field Marking Packages	68		
Field Marking System	68		
Field Netting	21, 40, 47, 97-99		
Field Rakes	65		
Field Wall Padding	51		
Fielder's Screens	52-53		
Floor Hockey Goals	117		
Floor Hockey Nets	117		
Fold Up Backstops	87		
Football Field Accessories	43-44		
Football Goal Ground Sleeves	38, 41		
Football Goal Post Pads	41		
Football Goals - Official	37-40		
Football Goals - Practice	37		
Football Hinge Kit	41		
Football Storage Equipment	42		
Football Training	42-44		
Foul Poles	58-59		
<b>G</b>			
Game Standards	114-115		
germinija™	111		
Gym Floor Protection	94		
GymGlide™	112-113		
<b>H</b>			
Height Adjusters	89		
Home Plates	60-61		
Hoop Rejuvenator™	74		
<b>K</b>			
Kicking Cages	44		
<b>L</b>			
Lacrosse Goals	46-47		
Lacrosse Nets	46		
Lineman Chutes	43		
Little Champ™ Basketball Adapters	116		
<b>M</b>			
Mound Covers	57		
<b>O</b>			
Outfield Distance Markers	58		
<b>P</b>			
Physical Education	112-117		
Pitching Machines	63		
Pitching Mounds	63		
Pitching Rubbers	61		
Pitching Screens	52-53		
Player Seating	35, 94		
Players Benches	35, 106-107		
Portable Basketball Units	90-92		
Post Protector Pads	41, 75		
<b>R</b>			
Rail Padding	66		
Rugby Goal	37		
<b>S</b>			
Safety Straps	85, 88		
Sand Bags	31		





## CUSTOMER INFORMATION AND TERMS & CONDITIONS

### Contact Us:



Ph: 800-243-0533  
860-447-3001



Email: info@jaypro.com



On-line: www.jaypro.com



Fax: 800-988-3363  
860-444-1779



Mail: 976 Hartford Tpke  
Waterford, CT 06385

### How do I place an order?

Schools and municipalities are required to fax, email or mail a purchase order to receive Net 30 terms. Prepaid orders can be placed with a credit card over the phone, on our website or can be mailed in with a check. Confirmations will be sent via email only upon request.

### How will my order ship?

All small parcels ship via UPS or FedEx. Items marked with the truck icon  will ship via common carrier. A contact name and phone number are required for carrier convenience. Deliveries to a non-commercial address carry an additional fee. Commercial addresses have a receiving dock/area and have someone present to offload and sign for deliveries during normal business hours. Drivers delivering truck shipments are only required to move freight to the edge of their truck. Truck accessorial options (inside delivery, 24 hour notification, lift gates, etc.) carry additional charges. All deliveries are FOB Waterford, CT or manufacturer. Refused shipments will incur charges for both directions of travel and are subject to a 20% restocking fee. Original freight will not be reimbursed. Express delivery may be available for small parcels. Please contact Customer Service for details.

### When will I receive my order?

Jaypro is committed to shipping orders for all stock items within 48 hours. Once your order leaves our facility, transit times will vary from 1-6 business days depending on your location. Out of stock or custom items, and items shipped from separate locations may have extended lead-times.

### Quotes

Quote requests may be faxed, mailed, or emailed at any time. Jaypro will return a written quote including a quote number and expiration date. When ordering, a copy of the quote or the quote number must be referenced for the pricing to be honored. All verbal quotes (pricing and freight) are estimates only. Jaypro is not responsible for honoring verbal estimates as pricing and freight costs are subject to change without notice.

### Prices

Prices are subject to change without notice. Prices are in US dollars. Jaypro is not responsible for international exchange rates.

### Discrepancies & Returns

All discrepancies must be reported within 30 days of the ship date. Jaypro is not responsible for any claims after 30 days. We reserve the right to replace, repair or refund as appropriate.

### Returns

Jaypro will accept the authorized return of all standard products for any reason within 30 days of the ship date. SPECIAL ORDER/ CUSTOM COLOR ITEMS ARE NOT RETURNABLE. Customers must obtain a return authorization number from Jaypro after supplying the invoice number, item number, and reason for return. Please contact Jaypro prior to making any returns as unauthorized returns may not be accepted. Customer is responsible for a 20% restocking fee and return freight charges. Original freight charges will not be reimbursed. All returned merchandise must be in its original packaging and must include the return authorization number on the label.

### Freight Damages & Discrepancies

Damages or shortages must be reported within 30 days of the ship date. It is the responsibility of the customer to sign the delivery receipt as damaged or short. Jaypro is allowed by the carrier 30 days from the delivery date to file a claim on shipments with noted damage or shortages and 10 days on concealed damage. If Jaypro is notified within this time

frame, we will replace as needed and file the claim with the carrier. If we are notified after this time frame, it is the responsibility of the customer to secure settlement with the carrier and to purchase replacements.

### Payment Terms

We accept checks, American Express, Discover, MasterCard, and Visa. Approved schools and municipalities are required to submit a purchase order and will be billed Net 30 from the invoice date. In our efforts to go paperless, invoices will only be emailed, therefore an email address must be provided on the purchase order. We encourage customers to make ACH payments whenever possible. Please contact our accounting department for required set-up information. All past due accounts are subject to a 1.5% per month (18% per year) interest charge and collection costs. Any approved account choosing to pay by credit card after the invoice date may be subject to a 3% credit card processing fee. Returned checks will result in processing fees added to customer accounts and may result in suspension of credit privileges. The check writer is also responsible for all other check recovery costs (\$35 fee), including attorneys' fees, court costs, and taxes.

### Tax

Connecticut residents are subject to 6.35% sales tax and New Jersey residents are subject to 7% sales tax unless a copy of the tax exempt form or resale certificate is provided. Tax exemption is only applicable if the purchase and payment are made by the exempt organization. Personal purchases for the organization are not tax exempt.

### Warranty & Product Information

Limited Warranty: Jaypro warrants most of our products against defects in workmanship and material for three years from the date of shipment, unless otherwise noted in the catalog. Nets are warranted for one year. Warranties on other manufacturer's products shown in our catalog may vary and are subject to change without notice. Normal deterioration of products due to weather, wear and tear or other causes that do not affect the functional use are not covered by the warranty. In no case do we warrant any product's safe and useful life to be greater than twelve years. Alteration or modification of the product voids any warranty. Jaypro reserves the right to repair, replace, or refund as appropriate. Please contact Jaypro for instructions and return authorization. This limited warranty is exclusive and in lieu of all other warranties, expresses or implied, including warranties of merchantability and fitness for a particular purpose. Jaypro shall not be liable for any incidental or consequential damages of any nature whatsoever. This warranty gives you specific legal rights, and may have other rights, which vary from state to state.

### Product Redesign

Jaypro reserves the right to redesign or change material of products shown in this catalog in order to improve safety, durability, or value.

### Warning

All sporting activities carry the risk of injury to the participants. Improperly maintained equipment and inadequately supervised programs are significant contributing factors. All equipment must be thoroughly inspected and maintained to reduce risk to the users.

### Thank You

We appreciate your business. Whether you are a returning customer, or if it is your first experience with us, we will do whatever we can within reason to ensure your complete satisfaction. Please contact our Customer Service Department should you have any questions about our products, policies, or services.

We reserve the right to correct typographical errors.



MS2015A



Jaypro Sports LLC  
976 Hartford Turnpike  
Waterford, CT 06385

PRESORTED STD  
U.S. Postage Paid  
Bolingbrook, IL  
Permit No. 648

Contact your local Jaypro Dealer  
or Jaypro at:

Phone: (Toll Free) 800-243-0533  
860-447-3001

Fax: (Toll Free) 800-988-3363  
860-444-1779

Jaypro Sports LLC © 2015

The Quality and Value You Expect From Jaypro! • [www.jaypro.com](http://www.jaypro.com)

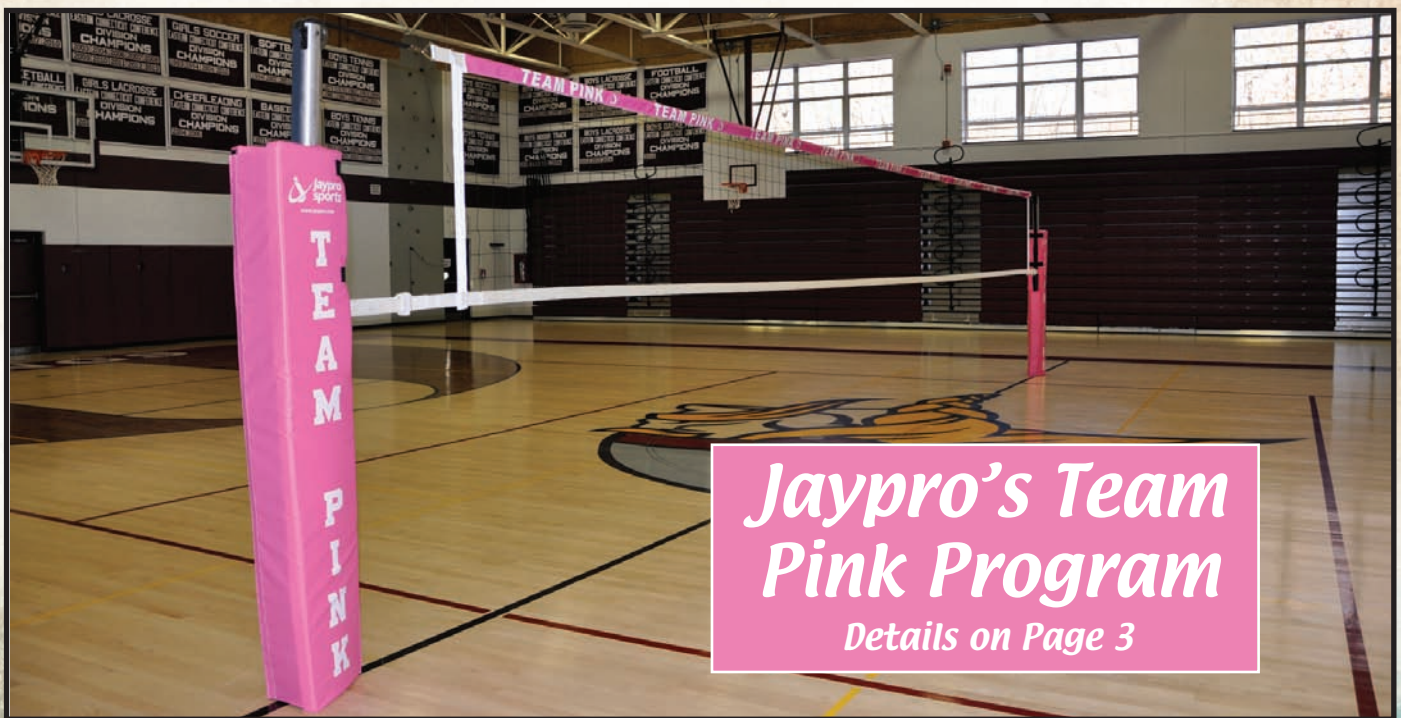

Jaypro's Team  
Pink Program

Details on Page 3

Join us on facebook

[fb.com/JayproSportsLLC](http://fb.com/JayproSportsLLC)

Follow us on  
twitter

@JayproSports

Contact your local Jaypro Representative or Jaypro today!

Benches & Bleachers • Portable Backstops • Field Maintenance & Protection • Foul Poles • Official & Club Soccer Goals  
Youth Training/Practice Goals • Soccer Training Aids • Football Goal Posts • Combo Goals • Volleyball Net Systems  
Referee Stands • Game Standards • Lacrosse & Field Hockey Goals • Outdoor & Indoor Basketball Systems  
Backboards, Rims & Nets • Storage Carts • Ball Carriers • Tennis Posts & Nets • Windscreens • Bike Racks • Wall Pads

Call Jaypro Toll Free: 800-243-0533