

Contents

Contents	1
Committee Contacts.....	2
Editorial.....	4
Henry Sutton 1856 - 1914	6
TV on the Air.....	10
A comparison of two mixers	14
A Very Colourful Time.	18
Morse Message Generator.....	23
Deadline	25
Black Level Clamped Transmitters	26
The Panasonic NV-RX9B	31
Circuit Notebook No. 63.	34
Dual Video Filter.....	41
Video low pass filter	42
Whatever Happened to BetWiXt?	47
AR5000 - a multiple talent	49
Satellite TV News	52
Rally 98.....	62
23cm Panel Antennas.....	64
A drive unit for NBTv on an oscilloscope.....	73
CMOS imagers reach CCD quality	78
Using a Vectorscope	79
Now that GW3FDZ... ..	87
Post and News	89
For Sale	91
Wanted.....	95
Index of Advertisers.....	96

CQ-TV is produced on a P6 Gateway 2000 PC computer system, using the Word for Windows word processing package. The camera-ready artwork is produced on an Hewlett Packard LaserJet 4 printer.

Edited by Ian Pawson, circuits drawn by Allan Robinson, proof read by Peter Delaney. All rights reserved, all wrongs denied.

© 1998 by the BATC.

Printed by *Cramphorn Printers Ltd.*, 15c Paynes Lane, Rugby, CV21 2UH, England

Committee Contacts

BATC Chairman: Trevor Brown G8CJS

Club affairs, Video tape library, Technical queries, especially relating to handbook projects. 14 Stairfoot Close, Adel, Leeds, LS16 8JR. Tel: 01132 670115. E-mail: chairman@batc.org.uk

BATC General Secretary: Paul Marshall G8MJW

General club correspondence and business. Library queries relating to the borrowing or donation of written material. Fern House, Church Road, Harby, Notts., NG23 7ED. Tel: 01522 703348.
Email secretary@batc.org.uk

BATC Hon. Treasurer: Brian Summers G8CQS

Enquiries regarding club finances, Donations, and constitutional enquiries. 9 Prior Croft Close, Camberley, Surrey, GU15 1DE. Tel: 01276 677879, Mobile 0850 014892

CQ-TV Magazine: Editor Ian Pawson

Anything for publication in CQ-TV, Articles, Review items, Letters to the editor, and other material except as below. 14 Lilac Avenue, Leicester, LE5 1FN, England. Tel: 0116 276 9425 Email: editor@batc.org.uk

Photographs for the CQ-TV covers:- Please send any photographs by post, electronic images by email, to the editor at the above addresses.

TV on the Air:- Graham Hankins G8EMX, 11 Cottesbrook Road, Acocks Green, Birmingham, B27 6LE. Tel: 0121 707 4337.
Email: tvoa@batc.org.uk

Satellite TV News:- Paul Holland G3TZO, Chatterton, Chapel Lane, Threapwood, Nr. Malpas, Cheshire, SY14 7AX. Tel: 01948 770429, Email: satnews@batc.org.uk

CQ-TV Advertising Manager: Chris Smith (G1FEF) 35 Pytchley Road, Rushden, Northants, NN10 9XB. Tel: 01933 777385 Fax: 01933 777577. Email: adman@batc.org.uk

CQ-TV Awards:- Bob Webb G8VBA, 78 Station Road, Rolleston on Dove, Burton on Trent, Staffs., DE13 9AB. Tel: 01283 814582

Exhibitions

Mike Wooding G6IQM, 5 Ware Orchard, Barby, Nr. Rugby, CV33 8UF.
Tel: 01788 890365, Fax: 01788 891883, Mobile: 0860 857434
Email: rally98@batc.org.uk

Club Sales

Members Services:- PCB's, components, camera tubes, accessories, etc. (NOT PUBLICATIONS). Peter Delaney G8KZG, 6 East View Close, Wargrave, Berkshire, RG10 8BJ. Tel: 0118 940 3121

Publications:- Handbooks, Back copies CQ-TV, and anything related to the supply of BATC publications. Paul Marshall, Fern House, Church Road, Harby, Notts., NG23 7ED, England.

E-mail: publications@batc.org.uk

Membership

Anything to do with membership, including new applications, queries about new and existing membership, non-receipt of CQ-TV, subscriptions, membership records, data protection act. Dave Lawton G0ANO, 'Grenehurst', Pinewood Road, High Wycombe, Bucks., HP12 4DD. Tel: 01494 528899. E-mail: memsec@batc.org.uk

Club Liaison:- And anything of a political nature, co-ordination of ATV repeater licences. Graham Shirville G3VZV, The Hill Farm, Potsgrove, Milton Keynes, Bucks., MK17 9HF. Tel: 01525 290343. E-mail g3vzv@amsat.org

Contests:- Richard Guttridge G4YTV, Ivy House, Rise Road, Skirlaugh, Hull, HU11 5BH. Tel: 01964 562498

BATC BBS Sysop:- Brian Kelly GW6BWX, 12 Cotswold Way, Risca, Gwent, NP1 6QT. Tel: 0410 279606,. E-mail: bbs@batc.org.uk *Please note that the BBS is currently 'off the air'*

Repeater Liaison:- General enquiries and repeater affiliation. Graham Hankins G8EMX, 11 Cottesbrook Road, Acocks Green, Birmingham, B27 6LE. Tel: 0121 707 4337.

BATC web master

Anything to do with the BATCs web site. E-mail: webmaster@batc.org.uk

The chairman has decided not to supply an editorial for this issue.

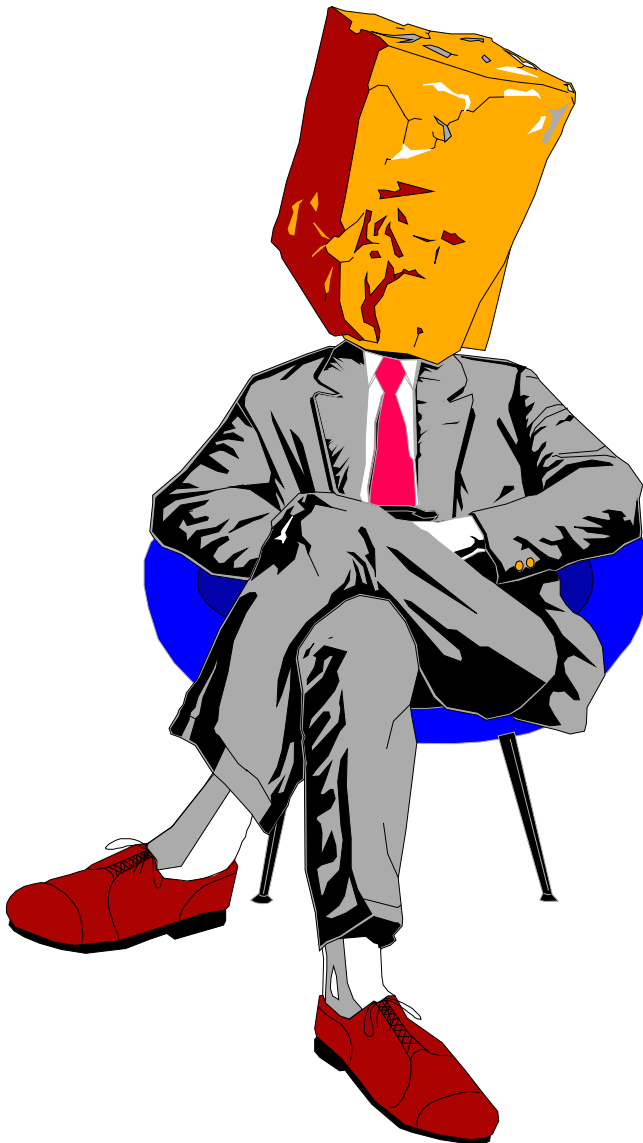

TREVOR BROWN - BATC Chairman.

GB3XT KITS & BITS

GUNNMOD2 3cms ATV. TX. kit. Very popular full feature Gunn diode TX. Complete with pre-tuned oscillator head. £30.00. PCB. kit less oscillator head £20.00

TVRO3 ATV Tuneable IF/RX. kit. Fully featured 750-1700mhz input. 12vDC operation. No setting up or alignment required. SMPSU for LNB. 5.5 - 8MHz subcarrier. vid gain. etc, etc. £50.00

24cms HIGH GAIN LOW NOISE GASFET PRE-AMP kit. 40db gain 1db NF. band pass helical filtering. 12-18vDC feed via co-ax. 40db gain. Designed specifically for ATV. but good for all modes £60.00

DTMF DECODER kit. Very high quality decoder IC. All o/p's buffered. Will directly drive TTL/CMOS or relays. Can be used to control whatever your imagination thinks of. £12.00

3cms LNB's. All 9.0GHz LO. Brand new circular input. 38-40mm mounting. will mount directly on most offset satellite dishes. 0.7db NF. £43.00. 1.0 - 1.2db £37.00.. 22mm Circular wave guide input types 0.7db £45.00 1.0 - 1.2db £40.00. Brand new with integral 20db antenna 0.8db NF £50.00 Several other types available. Please contact.

STOP PRESS. Under development and available soon.

COLLINEAR ANTENNAS Several types of collinear antennas are under development. The range will provide gains up to 20 db with either circular or coroidal beam patterns. These will be ideal for local working, band monitoring or for a repeater. All types will be fully weather proofed.

22mm CIRCULAR TO WG16 TRANSITIONS Yes copper pipe can be used as waveguide. I have developed and will shortly make available a transition to convert WG16 to 22mm circular pipe. It operates over the whole band with very low S.W.R. (< 1.2 - 1) and may be used in either direction, i.e. 22mm circular to WG16. These allow my 22mm LNB's to be used with WG16 waveguide.

DIELECTRIC LAUNCHER (ANTENNA) My new design of dielectric launchers provide a novel compact type of antenna for the 3CMs amateur service. They will be available in a range of gains (Beamwidths) and supplied with WG16 square flange (circular flange to special order) or 22mm circular wave guide connection.

Assuming all goes to plan I should have these exiting new products available for early next year. (I only have my 'spare' time for this work).

24cms ATV TX.

Unfortunately the old TX kit had to be discontinued due to a major component being no longer available. A new design is under development. Watch this space.

All kits contain all board mounted components and full comprehensive instructions.

Prices are all inclusive of P&P etc. (+ 10% abroad) PCB's are available assembled and tested at extra charge. **SAE. (to take A4 paper) for further details or call.**

Orders and enquiries to:- BOB PLATTS G8OZP. 220 ROLLESTON ROAD. BURTON UPON TRENT. STAFFS. DE13 0AY. PHONE 01283 531443 7 - 9PM WEEKDAYS PLEASE.

Henry Sutton 1856 - 1914

In 1885 Australian Henry Sutton improved on Paul Nipkow's disk devising what he called his Telephane system - the first real television proposal which involved scanning, synchronising, a light sensitive cell and a control valve (vacuum tube) but no vision signal amplifiers.

Source: Cambridge Biographical Dictionary

Henry Sutton (born Sept 3, 1856, died 1914 Ballarat), grew up in the Victorian gold field town of Ballarat where his father Richard had settled in 1853. "Seeking amusement in his tent at night he set about constructing a concertina, a device invented in England by Charles Wheatstone, the 'father' of the telegraph" This was the beginnings of Sutton's Music Emporium which traded in Melbourne for over the next 100 years.

By the time Henry Sutton was 14, "he had read every book on science and engineering in the library of the Mechanics Institute ...and before reaching 25 had invented a new type of lead storage battery, a torpedo, a colour printing process, telegraph facsimile and a method of using gas and water pipes for signalling. And working in the isolation of Ballarat far from the company of other scientists and technicians, completely ignorant of Thomas Edison's work, Sutton invented a carbon filament lamp. Sadly Edison had invented the same device just 16 days earlier."

A brief account of Alexander Graham Bell's telephone in the Scientific American was sufficient to enable Sutton to devise 20 different types of telephone, and to install probably "Australia's first telephone line" between the music emporium and the warehouse. "Shortly thereafter Bell visited Ballarat, where he was truly astonished by Sutton's achievements."

Later and from Wither's History of Ballarat of 1887...

"Mr Sutton has designed but not yet constructed, an apparatus by which he hopes to be able to see here in Ballarat, by the aid of electricity, the race for the Melbourne Cup."

The diagram refers specifically to the use of a Nipkow Disk (patented in 1884) for scanning so Sutton was obviously aware of Paul Nipkow's work but he predated by three decades the development of mechanically scanned systems by John Logie Baird.

THE TELEGRAPHIC JOURNAL AND
ELECTRICAL REVIEW

(November 7, 1890)

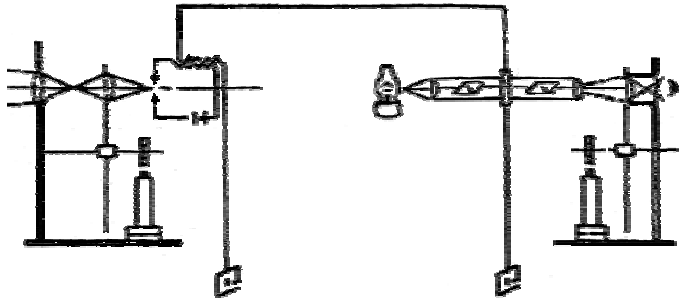
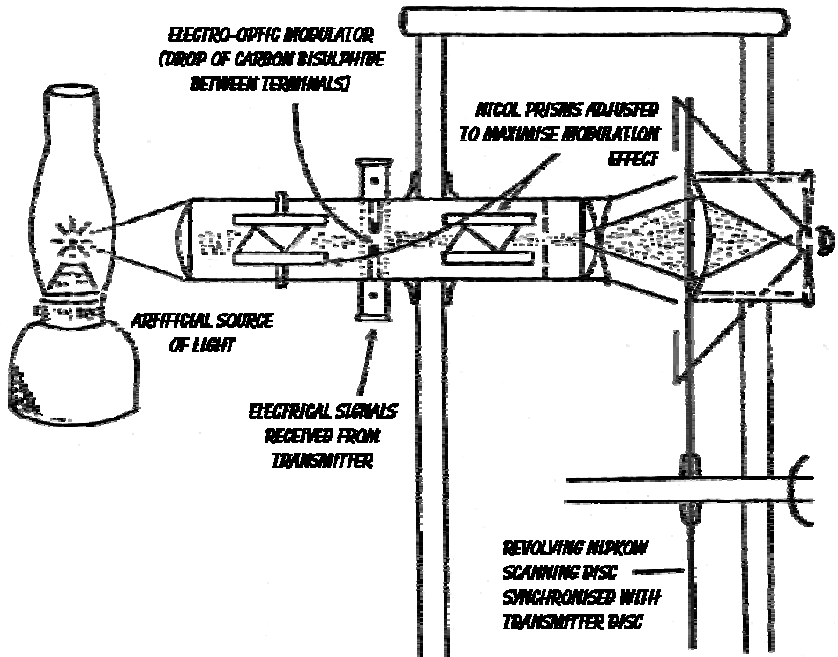

FIG. 5 ARRANGEMENT OF CIRCUITS



SCHEMATICS OF SUTTON'S TELEPHANE (DEvised 1885)

(SUTTON (1890), FIG. 4)

Henry Sutton's Telephane System of 1885.

Henry Sutton 1856 - 1914

Henry Sutton's Telephane System of 1885.

Source: The Telegraphic Journal and Electrical Review of 7 November 1890.

As we now know, Baird's system was rendered obsolete by fully electronic systems, and Sutton's version would have been no more successful. However, Baird in the 1920's may well have been influenced by Sutton's publication in 1890.

If Baird can be described as the "father of Television" then Sutton would have to be one of the grandfathers.

Source: (Australian) Amateur Radio, Feb. 1996, pp12/13

I welcome your email to add (or offer corrections) to the above information. Thank you.

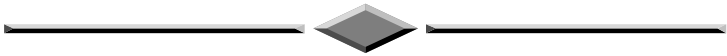

A BBC OB unit, October 1993.

Worthing & District Video Repeater Group

GB3VR & GB7VRB

1Watt FM-TV 24cms Transmitter

The 1 watt transmitter generates its signal at the wanted frequency which can be set anywhere in the band, colour or B/W. On board intercarrier sound and fixed pre-emphasis are standard features. The kit includes the PCB all the on board components, pre-drilled heat sink, an Eddystone Di-cast box and full and comprehensive instructions. Building time is three evenings work. The new price for this kit is £80.00, P&P £2.50. Over 650 units sold to the Amateur market alone.

This is probably the biggest selling TX kit in the world!!!

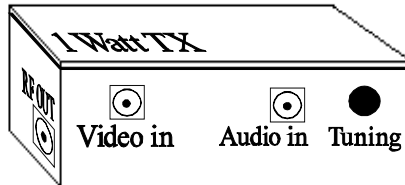

Two channel phased locked loop kit.

This add-on kit vastly improves the overall stability of the 1 watt transmitter. Two crystal locked channels and a third free running tuning position are available. Kit price £30.00

Amiga ATV Program-2

The New Amiga ATV program has more features than ever, up to 56 testcards, 20 wipes, superb text control, 30 screens of text messages, QRA calc, Testcard music, selectable displays, and this version has a DTMF tone pad to control your repeater. All testcards are over-scan i.e. the whole screen is used, Load in your own customised testcards, Extra large text, scrolling text, clock, callsign extensions, Hot key operation, Doc reader, ATV Cli, Cross Hatches, Purity and a comprehensive section for genlock users. For any Amiga with 1meg or more, state callsign and QRA (if known) when ordering, this three disk set is now only £10.00 P&P 75p

Spectrum ATV Program

Still selling after all these years, why, its good, its cheap and it works on all spectrum based machines. The 48k version has over 60 commands which include 7 Testcards, Memo pad, clock, maps, tones, QRA locator, various size printing, plus disk transfer routines and much more. Now only £5.00 P&P 75p

PC ATV is coming.

Orders should be sent to:-

Treasurer of GB3VR, R. Stephens, 21 St. James Ave., Lancing, Sussex, BN15 0NN. Cheques payable to "W&DVRG" Tel (01903) 765760 7 to 8pm.

By Graham Hankins, G8EMX.

Well I've sent packet messages to 'em, I have E-mailed members of their committee but, apart from an acknowledgement, no firm info. has been sent by the Leicester

Repeater Group, which provides 24cm ATV repeater GB3GV. LRG newsletter 'LENS' devotes most of its

October 97 issue to the 50MHz repeater GB3UM (in memory of Jack Hum G5UM) but gives 'GV only a cursory mention.: "It's still around and waiting for people to work it".

My messages asked for the usual hardware details, facilities etc and offered talks in the Leicester area to boost interest. But, as this piece is finalised to meet the next deadline, all I have is my off-air pics of 'GV ident cards - enjoy!

The Kent Television Group letterhead features a TV set displaying colour bars. KTG secretary and technical co-ordinator Chris Gibbs G8GHH sends an update of the Isle of Sheppey repeater GB3KT: "KT continues to give good service, although the ageing dual-slot antenna will need replacing this year. The KTG has now grown to 45 members and its existence has stirred up some local enthusiasm for ATV - including a bit of homebrew, which is all too scarce in these days of 'plug and play'!"

A completed Affiliation Form arrived from the North Norfolk Repeater Group with an apology from Mark Farnworth G4WVU for the info being : "seriously late". Never mind Mark, better late than.....hi.

Mark has made liberal use of my 'Short Form' response sheet to send the sort of info. I'm after: "The 'box' has been on-air continuously since April 1990. The PA runs about 11W (after filter) into an Alford-Slot; another



A.S. is the main RX antenna but six 'Bow tie' antennas are d.t.m.f. selectable on receive. Antennas are mounted on a 70ft mast. CMOS logic provides a signal meter, testcards and information pages."

Activity in North Norfolk is low, Mark comments, but GB3TN has a steady group of local users - G0FUF, G7KZZ, G8VLL, G4TUK, G0ISU. During summer months many Dutch and German ATV stations can be worked through GB3TN, and the TX can be disabled for up to 5 minutes so that other repeaters can be looked for. Plans for Summer '98 are replacement of some of the Bow-Tie antennas and a general overhaul of the LDF 550 feeders. Mark adds: "TN has only failed twice in 8 years - one TX driver gave up and a video switching IC caused some blank thro' video about 3 years ago".

Must keep mentioning the Birmingham situation and the Beacons Repeater Group. A licence application for the 10GHz unit (Sedgley) has been sent off so results are awaited, and a dual Alford-Slot antenna has been ordered for the 1.3GHz unit to be put in North Birmingham. I was hoping to include a photo of the Alford Slot (I know you know what they look like) but at the time of writing it had not yet been delivered.

Now Michael Sheffield ZL1ABS in New Zealand may already have sent this to our editor, but in case he hasn't, here's an E-mail from Auckland (anyway, it's proved I can save from Eudora E-mail in Windows 95, rename, and copy into TopCopy Plus! - of course you can, say all the BATC computer experts!)

So, from the Auckland ATV Interest Group of the Auckland VHF Group inc:

Kit Sets

The Auckland VHF Group inc. trading table is considering the production of some kit sets of parts to build some projects of an ATV nature.

Indications of interest are needed to help decide which of the possible options to pursue and how many units to produce.

The following kit sets are being considered:

- a) 23cm FM-TV Transmitter with PLL frequency control, tuneable 1250 to 1280MHz, 2 Watts output power
- b) German/Australian Subcarrier Stereo sound generator, 5.5 MHz + 5.74 MHz FM carriers with 54kHz modulated pilot, Stereo/Bilingual mode switching subtones, Stereo audio matrix (suitable to use with above transmitter)
- c) 23cm FM-TV receiver using a TVRO tuner head

- d) German/Australian Subcarrier Stereo sound receiver, automatic
- e) Stereo/Bilingual mode switching, Stereo dematrix (suitable to use with above receiver)
- f) 23cm GA-AS FET preamp
- g) 70cm GA-AS FET preamp
- h) Medium res Callsign/Pattern Video generator, Two colour, EPROM programmed, accurate timebase using single chip SPG, colour bars mode, RGB encoder
- i) Teletext style colour Video generator, EPROM programmed, RGB encoder

Please send indications of interest (including quantities) in kit sets to Michael ZL1ABS to pass on to the Trading table manager.

73

Now some 'normal' ATV news from Auckland. Grant ZL1WTT, Quentin ZL1QF & Ralph ZL1TBG have had some good contacts on 23cm FM-ATV during the Christmas holidays. 40km path worked both ways from Whitford to Albany Hill. 80km path worked both ways from Whitford to Dome Valley (where the Rodney 730 repeater is located). There were relays of the received signals (in colour with sound) via 70cm from Whitford and Albany Hill to ZL1BQ ATV repeater channel 39 Nihitupu. Radar QRM showed up as horizontal white lines across the screen of varying intensity (as the radar scanner turned).

The transmitters were homebrew (2 to 5 Watts) and the receivers used TVRO tuner units with high gain preamps. The aerials were: long loop Yagi, multiple quad radiator broadside array and long linear Yagi.

Circuit boards for a 23cm FM ATV exciter are available from Wayne Griffin ZL1UJK phone 09-5289118. A PLL unit, for the exciter, using locally available components has been prototyped. A board for it is coming out in February. A complete set of boards for the German / Australian Stereo sound system (5.5MHz + 5.74MHz subcarriers), including the stereo matrix/de-matrix and the 54kHz modulated pilot signals is nearly ready as well. Stereo sound is used all the time on 23cm contacts from Wayne ZL1UJK at Glen Innes to Grant ZL1WTT at Manukau. 73 de Michael Sheffield

Packet ZL1ABS@ZL1AB.#11.AKL.NZL.OC

E-mail z1abs@pop3.xtra.co.nz

Sending reports to TVOA

Talking of E-mail, yes I have now signed up to Demon Internet! My E-mail address is the unimaginative graham@ghank.demon.co.uk

You can also send your report to me via packet - G8EMX @ GB7SOL.#29.GBR.EU

Don't forget, it's not just 1.3GHz; let's here some news of 70cm ATV contacts, 10GHz, any other ATV band AND Slow - Scan!

73 and P5 for now, de Graham Hankins G8EMX, 11 Cottesbrook Road, Acocks Green, Birmingham, B27 6LE.

Following a comment made in last issues TVOA, (CQ-TV 181, page 30) I have been contacted by the chairman of the North Kent Repeater Group. He asks me to point out that the problem with the Alford Slot aerial was caused by the cable rubbing bare on the inside of the slot, causing the 'rusty bolt' effect. It was NOT waterlogged as was stated. Also, the cost of the aerial was met from subscriptions and, consequentially, did not cause 'a large drain on finances'. - ED

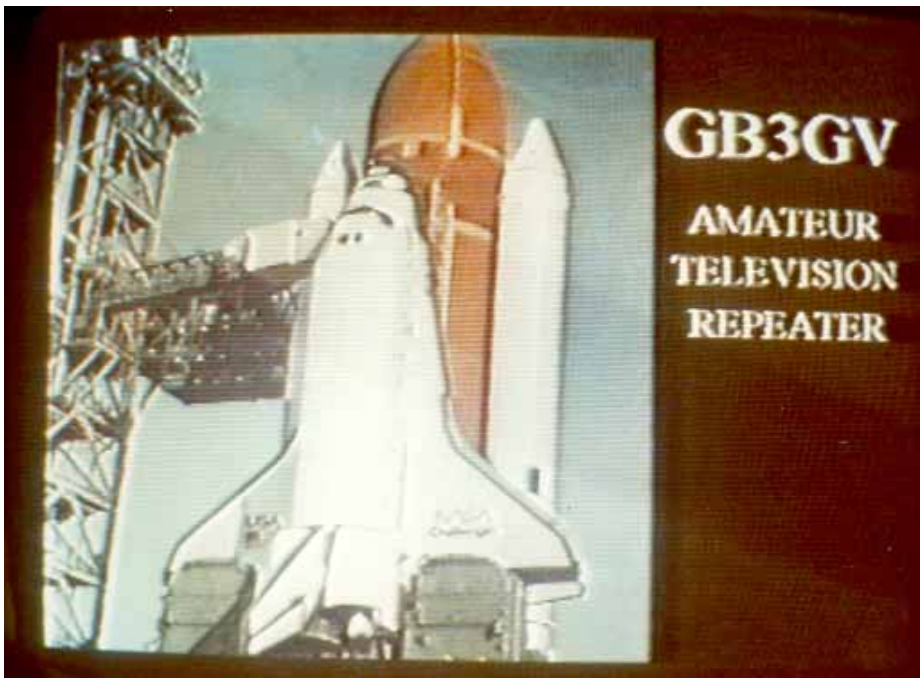

Off air ident page from the Leicester repeater

A comparison of two mixers

By Tony Jaques, G3PTD

Processing “real” video signals may not be the fashionable way to go about things nowadays. However I do have friends who are following, or rather fighting with, the computerised way of doing things, so I had no doubts about wanting to do it the “proper” old fashioned way.

I naturally thought in terms of building a pair of frame store re-synchronisers to feed into a conventional mixer, until I realised that it was cheaper to buy a ready made mixer with the store(s) built in. Oh well, another DIY avenue dies!

Information - what information?

I soon found out that there was no way that most manufacturers were prepared to let me have any useful information about their products. Colour brochures telling me how many million silly tricks it would do, yes; but no clue about such things as one or two stores, and whether field or frame.

So in the end I opted for the Videonics MX1 - mainly because Videonics do give some clues on their interesting Internet site. They also claim a performance to broadcast standards, FCC admittedly, but still broadcast.

Vision Mixers - what's a vision mixer then?

The next problem was that, far from being able to see one connected up, there was no Manchester shop interested in stocking one, and as for finding anyone who could speak intelligently about such things! Evidently a village of only five million people is too small a market to be worth bothering with.

So I had to order it unseen from a company in Edinburgh.

It came

If I had been able to try the mixer first it would have been rejected at the first button push!

Wait while it thinks

The most noticeable thing was the length of time that the mixer took to think before deciding to do as it was told. There was half a second between pressing a “cut” button, and the cut actually occurring. This

would make the mixer practically useless for any live work. An attempt to cut at the end of a sentence usually caught the next three or four words before the cut happened, and of course missed the start of the new shot. Even as a tape editing mixer it would need some interesting pre-rolls to be worked out.

Row, row, row your boat..

Paddle action was hopeless, again mainly because of the reaction time.

For instance, suppose that a fast mix was needed. Even at its fastest the "Auto Take" button gave too slow a result.

Doing the operation manually could be expected to cure that problem, but what actually happened is that, after pushing the paddle over quickly, one could sit back and wait for it to happen half a second later, and slowly!

Talking technical

There were a few technical problems as well, though they fade into insignificance by contrast with the operational shortcomings just described.

Visible disturbances

For example, near the start of any auto transition, and just after the end of it, there was a burst of a low frequency disturbance in picture amplitude visible near to the top and bottom of frame.

Hum

After being on for several hours there was a noticeable hum running through, though at low amplitude. This was also evident as a line phase modulation at mains rate.

Colour bars

A nice feature of the mixer is that it includes a colour bar generator. Unfortunately though, the output is only useable until some mixer transition has occurred. After that there is noticeable field rate phase modulation of the bars, and a ragging in the right hand side of alternate bars.

This means that before bars and tone can be laid on a tape the mixer has to be switched off and on again.

The bars are then OK, but of course the mixer has then forgotten any setting changes.

On the other hand

Apart from these matters, the vision quality is very good.

75% colour bars passed through with all amplitudes correct, and only a slight chroma twittering to show that there was more than a piece of wire in the way.

The picture was stable, and with correct timings.

Ergonomically I liked the mixer. Controls were sensibly placed, and the preview facilities were excellent.

It went back!

After talking to the salesman (who, by the way, agreed with my opinion of the MX1) about his Panasonic WJ-AVE55, I decided to pay a bit more to exchange the MX1 for that.

The Panasonic

Technical performance

If I get picky, I can see that the mixer is not quite up to the technical standard of the Videonics unit in some ways.

Subcarrier frequency

For instance, in the unit that I have the subcarrier frequency was initially 38Hz high. After half an hour or so it dropped to 25Hz high. The frequency was reset to be 10Hz high at switch on. It was then pretty close after a coffee!

Picture set-up

Secondly the video output has a 2% pedestal, compared to the input signals, but unfortunately the AUTO FADE goes to a true black. I would have preferred a true black on both, but in any case I feel that they should be the same.

Lastly chroma response. I measure the chroma level on 75% (EBU) bars as down by 10% at the mixer output (on both A and B bus inputs). This is with the user adjustable chroma gain "flat".

There does not seem to be an internal adjustment for that, so I cheated by adding a John Goode Video processor to the output, which also takes care of the 2% set-up.

Disturbing cuts

It is sometimes possible to see a slight line disturbance on cuts (on the same bank). When it is considered that the whole point of a re-synchroniser is to avoid just that, this does seem at first sight to be a surprising failure.

It eventually occurred to me that such cuts occur on the *inputs* of the stores, so in reality the cut is still non-synchronous at the point at which it occurs. The disturbance must be the store writing process locking to the new source. It's what comes of not paying for a store for each input I suppose!

It is easily possible to get around it by instead doing a mix between A and B banks, with the mix speed set to its fastest. At that the result is visibly a cut, so although it's not ideal it works.

In use

I also like the Panasonic unit ergonomically. In some ways I prefer it to the Videonics mixer:-

- The buttons have a “click” action, where the MX1 had “Sinclair Spectrum” keys.
- Because the WJ-AVE55 has two frame stores, it is in some ways more versatile than the American unit.
- The preview facilities are similar to the Videonics mixer, with the exception that it does not display all four inputs at once (in a row) as the MX1 does.

But more to the point, it does what I tell it to, and just when I tell it to do it!

World Wide Web

The BATC web site contains electronic versions of CQ-TV and the articles index, in Acrobat .pdf format. The URL is:-

<http://www.batc.org.uk>

A feature is a software download area. This page contains programs, data and code from articles in CQ-TV as well as other programs related to amateur television.

A Very Colourful Time.

By Dicky Howett

Dicky Howett returns to the heated days of early British colour TV.

In 1955, the BBC embarked on a series of live, experimental colour TV broadcasts from Studio A, Alexandra Palace. The BBC's research department at Kingswood Warren supplied an adapted-to-405-line NTSC American colour studio system built in conjunction with Marconi's.

Janie Marden,
1973



Initially, slides and films were transmitted after hours using the medium-power reserve transmitters at Alexandra Palace. Later, in November 1956 live-action shows beamed from the Channel 1 transmitter at Crystal Palace took place.



Edna Savage and Alex Mackintosh, 1970

The intention was to mount a 'normal' colour TV service in order to assess the quality of the transmitted image. Selected homes in the area were equipped either with 405 line colour sets, or asked to log the compatibility, or otherwise, of the black and white image on standard black and white sets. The live colour programmes were produced by BBC director Michael Leeston-Smith and these included drama, talks, ballet, music (The Hot Colour Club) and light entertainment.

Labouring under the fierce colour lights in the cause of TV science were Cy Grant, Janie Marden, Carole Carr, Sylvia Peters, a dance troupe called the TV Silhouettes and Phillip Harben who demonstrated cooking. (Cookery was a tricky subject for the colour cameras, because it was discovered that food looks terribly unappetising if the colours are wrong.

A Very Colourful Time.

Fillet steak and cabbage proved a difficult test although, apparently, cheese photographed well.) In all cases these little programmes were mounted to establish the quality and stability of the system. There was no intention to explore production techniques. As a consequence, the technicians retained gleeful overriding control of programme content.



Silhouettes 1956-57

Technically, the minimum Studio A line-up comprised two Marconi cameras (RCA design) on pedestal mounts, each with four lenses (maximum aperture f4.5); one 16mm film or slide flying spot scanner; a 35mm Cintel film scanner; one simple vision mixing panel allowing cuts, mixes, fades and superimpositions from all channels; and three 2lin. colour monitors.

Of the cameras themselves, it was reported that in spite of their weight and length (6ft 6in.) they proved quite manoeuvrable on their pedestals, which had assisted elevation by means of hydraulic rams. The fixed (non-tilting) view-finders gave the cameramen some trouble which limited the height of shots to the height of the cameramen. The lens turrets were very quick to swing and were reasonably silent. They gave consistent results working at

an aperture of f5.6. However, the picture definition was poor due mainly to the many dimensional registration problems, both in the three-tube cameras and the three-gun shadow mask monitors. To overcome these problems all shots were framed 15-20 per cent closer than normal monochrome practice. Matching of cameras was also a great problem. Colour response varied all the time. The valve-driven cameras suffered from overheating, with resultant loss of definition. They had to be allowed a few hours cooling off time between rehearsal and transmission, (as no doubt did the performers). Other common faults occurred in colour registration, as well as shading (usually magenta or green), microphony and dichroic filter reflections within the cameras. To compound matters, the picture monitors (shadow mask type as well as a huge three-tube projection model) were very unstable at all times. It was also thought that panning and tilting the cameras through the Earth's magnetic field would mean constant re registration by test card. Fortunately, in practice this was not the case.

It was concluded in a report issued later that 'the BBC's 405-line NTSC system is undoubtedly capable of offering a most exciting improvement to present monochrome standards'. Even so, the report shrewdly suggested that before embarking on large scale colour television broadcasting the system would have to be capable of giving consistently improved horizontal and vertical definition, as well as even better colour.

In 1957, MPs at Westminster had the opportunity to view a half-hour light entertainment colour show. Six 21 in. colour sets, and four black and white receivers were installed in Committee Room Number 4. Five of the colour sets were of a type designed by the BBC's Research Department. The sixth was supplied to special order. The four black and white receivers were standard commercial models. As reported in the Daily Express, the black and white pictures looked pretty glum. On the other hand, the colour pictures looked a bit too florid, like an over-dressed, over-painted woman. But the MPs were enthusiastic. What did they see? Some "quite beautiful" close-ups of flowers and bees, butterflies and dancing girls. In the studio, Carole Carr sang 'Smoke Gets In Your Eyes' against a changing background of harsh greens and blues. She appeared later in an Edwardian get-up which excellently showed off a golden dress and vividly flowered hat. But Members must have reserved their opinions about making political appearances in TV colour when they saw naturalist James Fisher and Dr W. E Swinton showing off crystals and art objects. Here, the colour was at its worst, with the men's faces a plum shade and hands a deep salmon pink.

Up at Alexandra Palace, one of the cameras broke down for two hours. An official said: "We were all mucking in with soldering irons and a plan on the floor". Such is history.

A Very Colourful Time.

But does anything visual survive of these experimental BBC colour broadcasts? Actually, yes, but not a lot. Apart from a brief sequence of Studio "A" filmed in colour for the otherwise black and white 1959 BBC documentary "This Is The BBC", there are a few production stills, some taken by director Michael Leeston-Smith. His colour slides include shots of the performers and the 'teapot' caption which opened the tests every night. Leeston-Smith told the present writer that his colour programmes were actually tele-recorded by the research department for later assessment. Investigations have shown that nothing of Leeston-Smith's productions survive, however there is in existence some unique colour footage displayed recently at the National Film Theatre during a presentation recalling 30 years (from July 1967) of British colour television.

This colour footage includes scenes taken from the screen during a live test, described as having taken place in 1954, which historically seems a shade too early. Live cameras weren't installed (at the earliest) in Studio A until July 1956. The telerecording shows Leslie Mitchell in close-up interviewing two ladies. The picture quality is very poor displaying all the faults attributed to the three-tube colour system.

Later, the BBC colour experimental studio moved to studio H at Lime Grove. During 1966, a cameraman called John Humphries shot on 8mm colour, a closed circuit production of "The Black and White Minstrel Show". Despite many hours of colour trials in Studio H, the Humphries film is the only known record of colour television from that studio.

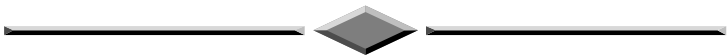

New NBTV web address

Grant Dixon's homepage on the Internet has moved to a new location <http://homepages.wyenet.co.uk/gdixon> this page is devoted to promoting the Narrow-Band Television Association. Doug Pitt is the Secretary of the Association that exists to keep alive an interest in the early 30-line Baird Television. There are links to other sites on the net covering this subject. Grant's page also covers some other non-TV subjects.

Morse Message Generator

By Brian Kelly, GW6BWX

This is a small part of an ongoing ATV repeater project that may be of use for other purposes. Intended for GB3ZZ, it is the Morse ident generator section of a new computerised control system. The present controller suffers from a minor problem due to the tone generator timing, it relies heavily on processor interrupts (IRQs), which slow the systems response to a users DTMF commands. Although the problem only shows during the periodic identification, Murphy's Law states this will always happen while a command is being sent. To relieve the strain on the main system processor, the new logic unit uses a network of PIC devices, each responsible for a single task but all co-ordinated from a central program.

The design here will produce a Morse code message as a tone at full or reduced volume setting. The intention is to use full volume for ident when the repeater is in beacon mode and the less obtrusive reduced volume then it is accessed. In the repeater environment, driving the RA (port A) lines makes selection of message and volume and the trigger to start the message is a logic high pulse on RA4. In the complete unit, all RA lines are driven by a 4-bit internal data bus (RA0 - RA3) with a decoded address line feeding RA4. The chip appears to the main processor as a write-only peripheral. Once started, the message will run to completion, the trigger only needs to be present for a few microseconds. If the trigger is left active, the message will simply keep repeating.

Toggling RB0 (port B) produces the tone at an audible rate; the pitch can be varied by changing a value in the program. The character speed is similarly adjustable, the variables for both these settings are commented on in the program listing. The volume is dropped if necessary by sinking some of the output current into the RB2 pin. This pin is tri-stated (made high impedance) for normal volume but assumes a logic low state when low volume is needed. By selecting suitable external resistors, the level drop can be set from insignificant to almost zero volume. At the same time as generating tones on RB0, an "envelope" of the Morse is available at RB1 and a "message in progress" is available at RB3.

As this design is part of GB3ZZ Mk 3, the messages are preset to be applicable for that repeaters use. It is quite simple to change the messages to any pattern of dits and dahs desired by using new values in the data tables. Simply imagine the Morse to be a string of 1's and 0's using the correct number of each to form the correct tone lengths and gaps. Each "1" and "0" is one dit length so use 3 ones to make a dah, 3 zeros to make the gap between characters and 5 zeros for the gap between words.

Morse Message Generator

For example, “ABC DE” would be:

10111 000 111010101 000 11101011101 00000 1110101 000 1

Now regroup the ones and zeros into blocks of four:

1011 1000 1110 1010 1000 1110 1011 1010 0000 1110 1010 001

If the last block has less than four digits, append zeroes to make it up to four. The total number of blocks must be even, if you end up with an odd number, add a block of “0000” at the end. Now you have to convert the blocks from binary to hexadecimal, this isn’t as painful as it sounds, just use this conversion table:

0000 = 0	0001 = 1	0010 = 2	0011 = 3
0100 = 4	0101 = 5	0110 = 6	0111 = 7
1000 = 8	1001 = 9	1010 = A	1011 = B
1100 = C	1101 = D	1110 = E	1111 = F

so “ABC DE” becomes B8 EA 8E BA 0E A2

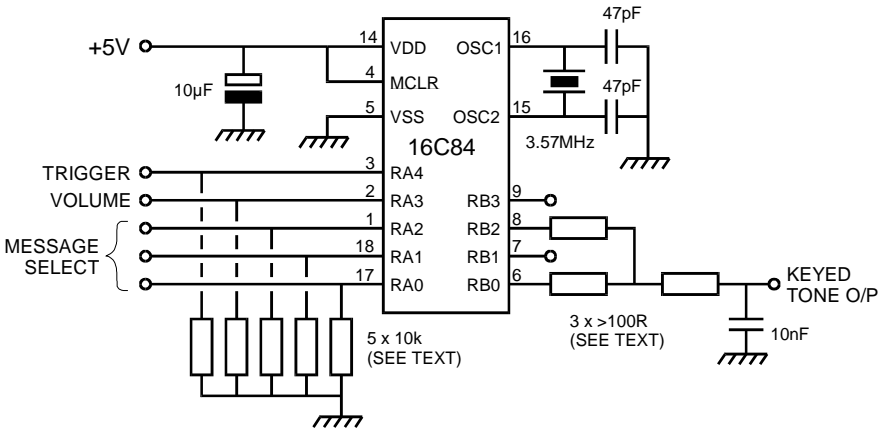

Fig. 1. The Morse generator circuit diagram

From the resulting numbers you should be able to see how the table in the program is built up. The only other thing you need to do is add “FF” at the end of each message, this is treated as a reset by the program and it goes back to look for the next trigger pulse. If you really like typing, you can enter all the zeros and ones in groups of eight directly into the program but being lazy I prefer to use hexadecimal.

There is a limit of 256 lines in the message table but in reality this is far more than you are ever likely to need. The selection is set at 8 different messages by placing the message number on RA0-2 with RA3 selecting the volume.

Don't use series output resistors below 100 ohms or the port drive capability may be exceeded. If driving a loudspeaker directly, use a high impedance one and prevent back-EMF spikes by wiring a diode across it, cathode to the live end and anode to ground. If driving an amplifier, use resistors of 10K or more to reduce the current drawn by the circuit. Pull the RA inputs to ground via 10K resistors if not being actively driven low.

The Software for this project is available from our web site. The file, tone.zip, contains an ASCII text version of the article, a full, commented, assembler listing and a hex dump listing. Point your browser at <http://www.batc.org.uk/software/tone.zip>. The file size is 4k7.

Deadline

Will all contributors please note that the deadline for articles for CQ-TV 183 is June 20th 1998. Please send your contributions in as soon as you can *prior* to this date.

If you would like to contribute an article for publication in CQ-TV, then please send it to the editor, either by post, or preferably by email. If you don't use a word processor, plain ASCII text is fine. Please see page 2 for address details.

The CQ-TV Word 6/7 document template can be downloaded from our web site. Select the CQ-TV magazine link from the home page at <http://www.batc.org.uk>



Black Level Clamped Transmitters

By Ian M. Waters, G3KKD

This article describes a modification to the conventional ATV transmitter in which a circuit is added to clamp the signal to black level at the point of modulation.

This gives several advantages:

The clamp will correct any low frequency distortion which may be on the modulating video and will remove any bounce with rapid changes in picture content or when cutting between sources.

The clamp will ensure that the frequency transmitted when the signal is at black level is held constant.

In a conventional ac coupled transmitter the black level frequency will shift with changes in picture content or average picture level (APL). This causes the signal to deviate beyond the limits of the channel, as defined by receiver IF bandwidth, by demodulator limits, or by any channel filters that may be used. This in turn leads to picture/sync distortion or loss of synchronisation.

The black level clamp overcomes these difficulties. By holding the black level frequency constant the sync pulses are transmitted correctly regardless of APL.

It is necessary to consider “What should the black level frequency be?” For channel RT1-2, for instance nominally 1249MHz, it certainly should not be 1249MHz, although I have seen crystals on offer for use with phase locked loops which give this frequency. If we say that the channel is 14MHz wide and the vision signal/sync ratio is 70:30, then the black level frequency should be approx. $0.3 \times 14\text{MHz}$ above the lower channel limit. For RT1-2 this is 1246.2MHz. Tests carried out watching the look-through picture via the GB3PV repeater, while varying the frequency of an accessing transmitter, has proved this to be the optimum setting.

It is now necessary to ask “How should the frequency control voltage be provided?” It could either be by a simple potentiometer or by a phase locked loop. In the transmitter I have constructed, I have used a phase locked loop based on the SP5060 chip, with the reference frequency in the region of 4.9MHz supplied by a high stability tuneable Vakar oscillator.

While this gives a very smooth and stable frequency control it does have a disadvantage. This is the basic problem of all PLL circuits that try to control the frequency of a frequency-modulated oscillator. That is that the

frequency control loop is always fighting against the modulation! When the modulation does not contain a large 50Hz component, i.e. bright sky over dark land, all is well. However if a large 50Hz component is present, the loop filtering is not adequate and a 50Hz sinewave of about 20% of peak demodulated amplitude is superimposed on the signal. By disturbing the nice flat black level this partly negates the benefits of the clamp. As the whole signal is modulated by the sinewave, the signal/sync ratio is not changed and synchronisation is not usually disturbed. It is not possible to increase the loop filtering as this leads to instability. I will leave the reader to decide if a PLL is a benefit or not. I feel that, as we do not habitually transmit pictures with a high 50Hz content, its use is beneficial.

Circuit of Clamped Modulator (Fig 1).

The video amplifier and pre-emphasis circuits are conventional, in fact I stole them from the Solent design. Thanks! Video at full level is also applied to the EL4581CN sync separator chip that gives a nice comp sync waveform at pin 1. This is differentiated, delayed and then squared up by two inverters (pins 13-12 and 11-10 of the 4069) in cascade. The positive going clamp pulse so produced is used to control two sections in parallel of the quad bilateral switch (4066) via pins 5 and 13. The degree of differentiation controls the width of the clamp pulse, which is adjusted to fit nicely into the back porch.

The video signal passes from the pre-emphasis circuit via a 0.22 μ F clamp capacitor and a 6MHz sub-carrier trap to the modulating diode (not shown). The modulator side of the clamp capacitor is clamped during each back porch to the frequency controlling voltage (applied to pins 2, 3 and 8 of the 4066). The frequency control voltage is provided at low impedance by a 2N3053 emitter follower. It is decoupled by a 100 μ F capacitor that is the largest value that can be used. The 3 μ 3 inductance in parallel with 390pF, between pins 1, 4 and 9 of the 4066 and the clamp capacitor, provides a high impedance at 4.43MHz to prevent the clamp from damaging the colour burst.

The circuit connected to pin 6 of the 4066 needs explanation. When there is no video modulation present, no clamp pulse is produced and the two sections of the 4066 clamp are open circuit. There is thus no control of the TX frequency. During normal operation sync at pin 1 of the sync separator is inverted by a section of the 4069 (pins 9-8) and then rectified to give a positive voltage of about 4 volts at pin 5 of the 4069. Pin 6 is thus low and the switch controlled by pin 6 in the 4066 is open circuit and inoperative. When modulation is not present pin 5 of the 4069 is low and pin 6 high. The 4066 switch so conducts and connects the modulator to the frequency control voltage.

Circuit of the VFO and PLL (Fig 2).

The output of a stable Vakar oscillator, tuneable from 4.84MHz (for 1240MHz) to 4.94MHz (for 1265MHz), is fed via an emitter follower buffer and a level control potentiometer (to set the level at 400mV rms.) to pin 10 of the SP5060 PLL chip. Pin 2 is fed with a carrier frequency sample from the transmitter output. The D.C. output of the BC 107, which is part of the conventional SP5060 circuit, feeds via a 4k7k resistor to the 2N3053 emitter follower. If a potentiometer, rather than the PLL, were to be used it would be connected at this point.

Note Re Deviation Adjustment.

When setting up the deviation by the first Bessel null method (for details see CQ-TV 157 page 26) it is necessary to disable the clamp circuit. If this is not done it will, in the absence of sync, short out the 1.482MHz sine wave test signal used. To do this link LK3 is opened and a 10k resistor connected temporarily, as shown in Fig 1, from the frequency control volts to the modulation line.

Component details

The following are the winding details for the inductors:-

- L1 - 15 turns close wound using 0.013inch enamelled copper wire on a 0.3inch former with an adjustable dust core.
- L2 - 40 turns close wound using 0.005inch enamelled copper wire on a 0.15inch former with a fixed dust core. Probably about 1mH.
- Vaircap - 1 section cut off from a multiple varicap as used for tuning MW/SW radios. E.g. BB212. 55pF @0.5V, 50pF @5.5V.
- 6MHz trap - C = 47pF, L = 20 turns wave wound 0.005inch enamelled copper wire on a 0.2inch former with an adjustable dust core.
- The resistor used when setting up the deviation is 10k.

**Please mention that you saw it
in CQ-TV when responding to
advertisers.**

The Panasonic NV-RX9B

By David Hemingway, G8EGG

With the New Year sales in full swing I decided to explore the possibility of upgrading my portable VCR/Camera unit – a vintage Ferguson model, to a much more sophisticated camcorder. I decided that I would stay with VHS rather than change to the 8mm format, as I wanted to be able to play back the recorded tapes on a standard recorder. This means Compact VHS and a cassette adapter.

Most of the sale offers were for 8mm format; the only VHS machines available seemed to be JVC or Panasonic. I decided on the Panasonic. And found only two models in the sales, one a discontinued model and the second the lowest of the current range without the frills of other models. I purchased the latter a NV-RX9B.

This model has a wide-angle lens with 14X zoom, with video and audio output via phono plugs, there is no separate microphone input. The camera is held in the palm of the right hand where all camera controls are conveniently available to the fingers and thumb of the hand – convenient that is for the right handed not quite so convenient for the left handed! There is a small (special) socket located in the battery recess for dc input when a battery is not available. VCR and other set up controls are located behind a small flap at the top of the unit, a switch which toggles between camera and VCR is also on the top of the unit with LED indicators. The viewfinder eyepiece can be angled to about 80 degrees from horizontal.

The most important (to me) feature of the machine is that when it is in VCR mode the camera continues to operate when the tape is stopped (not pause). This means that it is possible to use the camera section for transmitting live pictures from the shack or whilst portable. It is not necessary to have a tape on the machine however the camera shuts down after about 6 minutes in this mode. The recorder part of the unit will work in standard or long play. Time used and time remaining are available on the viewfinder, as is battery condition. The machine uses 4.8V battery packs the battery supplied lasts about 50 minutes before recharging. Larger capacity NiCd or NiH batteries are available. A mains charger is supplied together with a lead which provides DC for the camera from the mains. No doubt it would be possible to use this lead with a larger capacity battery whilst out portable. A 12 volt lead with built in regulator for mobile use is available as an accessory; a 12 volt charger is also available.

The horizontal resolution I measured from the Camera is about 350 lines and from tape about 250 lines – based on a Marconi Test Card and a 14” television. I assume that with a proper monitor a better resolution would be found. The camera has a low light level stated to be 0.3 Lux, I have no means of checking this – but it works reasonably well at night with sodium street lighting. The colours were of course poor; I checked the colour subcarrier frequency and found it to be about 10 Hz down on camera, the VCR being about 3 Hz up. The BBC frequency being used as standard was 4.433625 MHz

The only problems that I envisage at the moment with the Camcorder relate to the automatic Iris, Focus and white balance, there being no manual override to any of these. A remote control would definitely be an advantage. A tripod is needed when using the maximum zoom with a distant object. The camera has titling capabilities, but as these are built into the unit they are of little use to me. The date and time may have a use in the future (Contest?).

Picture resolution and colour rendition is superb, and the low light capabilities make this a good quality unit for general purposes. The camera cannot be genlocked - but how many ‘domestic’ units can? Having used the camera for a few days I don’t think that it would be possible to purchase as good a unit for the stated list price (about £450) from another manufacturer. At the discounted price, I think it was a bargain.

Free Internet Dial-Up Accounts for BATC members

Caladan Communications, a UK based Internet Services Provider are pleased to be able to offer BATC members free dial-up access to internet e-mail and news services.

Contact Chris Smith (G1FEF) for more details:

E-mail: sales@caladan.co.uk Fax: 01933 777577

Web site: <http://www.caladan.co.uk/batc>

Or write to:

‘Free BATC offer’
Caladan Communications
35 Pytchley Road,
Rushden,
Northants NN10 9XB

VHF COMMUNICATIONS

VHF COMMUNICATIONS magazine is published quarterly and is available from **KM Publications**, 5 Ware Orchard, Barby, Nr. Rugby, CV23 8UF, England.

Telephone: 44 (0) 1788 890365, Fax: 44 (0) 1788 891883

Email: vhfsubs@vhfcomm.co.uk



The 1997 subscription rate is £18.00 for cash or personal cheque (drawn on a UK bank, or bearing the name of a UK banking agent), postal orders or bankers draft made payable to VHF Communications. Payment may also be made by any major credit card at £18.90. The subscription included surface mail charges, airmail is extra at £6.50 per year (£6.85 by credit card). The magazine is a MUST for the radio amateur and professional engineer interested in VHF, UHF and Microwave working, containing, as it does, detailed construction articles for equipment operating in these bands.

Back Issues: special offers - enquire for details

Binders to hold 12 issues £5.50

Complete Index 1970 - 1995..... £2.75

Email: vhfsubs@vhfcomm.co.uk Web site: <http://www.vhfcomm.co.uk>

Secure credit card page: <https://www.vhfcomm.co.uk/saleform.htm>

By John Lawrence, GW3JGA

Crystal Oscillators

Oscillators are required in television and other electronic equipment for the generation of different frequencies and for timing purposes. The frequency accuracy and stability that is required depends on the particular application. Where the application is very basic, say, the flashing of an LED, then a simple RC oscillator is adequate.

For greater stability the frequency might be controlled by the resonant frequency of an LC circuit, for example, the tuning (local) oscillator of a radio receiver. The LC oscillator can provide even higher accuracy and stability by carefully choosing the materials used in the LC circuit, by ensuring good mechanical stability and by minimising changes in the ambient temperature.

The next stage of improvement is to replace the LC circuit with a ceramic resonator or quartz crystal. These piezo-electric devices convert mechanical resonance to electrical characteristics similar to the LC circuit but operate at a fixed frequency which is determined at the time of manufacture. They have a very high 'Q' and are less affected by changes in ambient temperature.

Ceramic resonators are low cost, less than £1, and are quite suitable in the clock oscillator of a microcomputer and wherever a simple reasonably stable oscillator is required. The quartz crystal oscillator has the best properties of all in terms of initial calibration accuracy and stability. It is the essential circuit for accurate timing in quartz watches and clocks, in television for waveform timing, colour and sound sub-carrier generation and re-generation, transmitter frequency control, receiver read-out, and control many other aspects of communication.

A comparison chart of typical accuracy / stability is shown in Fig.1.

Oscillator Circuits [1]

“An oscillator circuit requires that two conditions be satisfied, firstly, that it contains an amplifier having sufficient gain to overcome the loss due to its feedback network and secondly, that the phase shift around the whole loop is zero at the wanted frequency. It must be ensured also that the loop gain at other frequencies where the phase shift might be zero, is less than at the wanted frequency. For example, a crystal oscillator which is

intended to operate at the crystal's third overtone frequency could operate at its fundamental instead.

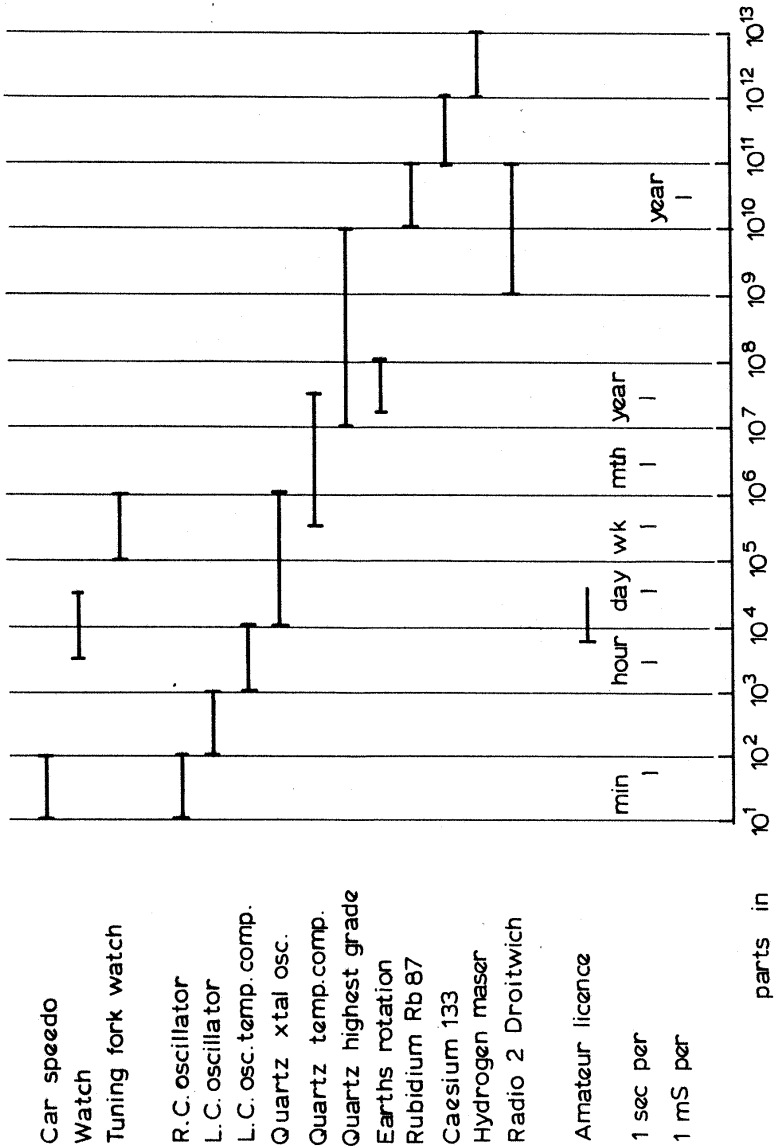
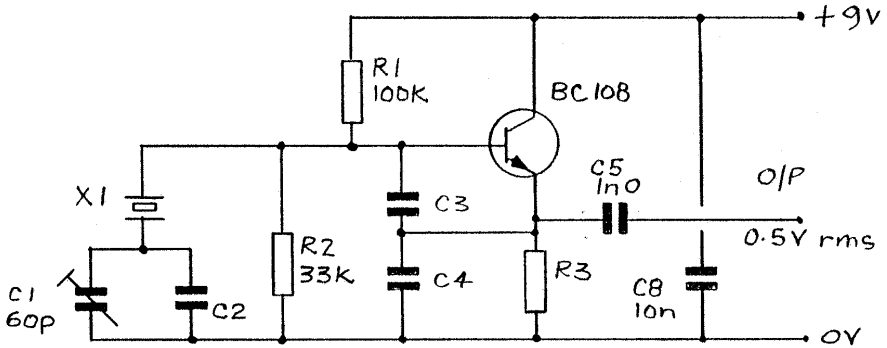

Fig. 1. Comparison Chart of Typical Accuracy / Stability

When power is first applied to an oscillator the signal amplitude builds up until it is limited by the non-linearity of its maintaining amplifier, or by an external level-control circuit. The former case is the limiting method employed in all but high-precision oscillators, the output waveform is therefore dependent upon the type of amplifier and its method of limiting, and the point of signal extraction. Any point in the circuit can be chosen to extract the signal as long as impedance levels are borne in mind. It is important that any loading be as light as possible to maintain a high circuit Q and, thereby, good short term stability and low phase noise.



f(MHz)	R3	C2(pF)	C3(pF)	C4(pF)
0.95-3	3k3	not used	220	220
3-6	3k3	33	150	150
6-10	2k2	33	150	150
10-18	1k2	not used	100	100
18-21	680	not used	68	33

Fig. 2. Load-resonant Fundamental Crystal Oscillator

The Circuit Condition

Some oscillator circuits require crystal calibration at series resonance, while others require load-resonance calibration with the stated load capacitance value. The appropriate circuit condition must be stated when ordering crystals or, while they will oscillate, they will not do so at the desired marked frequency.”

Crystals in the range 1 - 30 MHz are usually manufactured and offered to operate in the load-resonance condition and are resonant at their marked frequency with a specified capacitance of 20 pF or 30 pF. The actual frequency can usually be ‘pulled’ about +/- 100 p.p.m. (+/- 0.01%) by varying the value of the capacitance and this feature is used in phase-

locked loop operation. See Circuit Notebook No.62. 'TV Off-Air Frequency Standard'. A typical transistor powered load-resonant fundamental crystal oscillator circuit is shown in Fig.2.

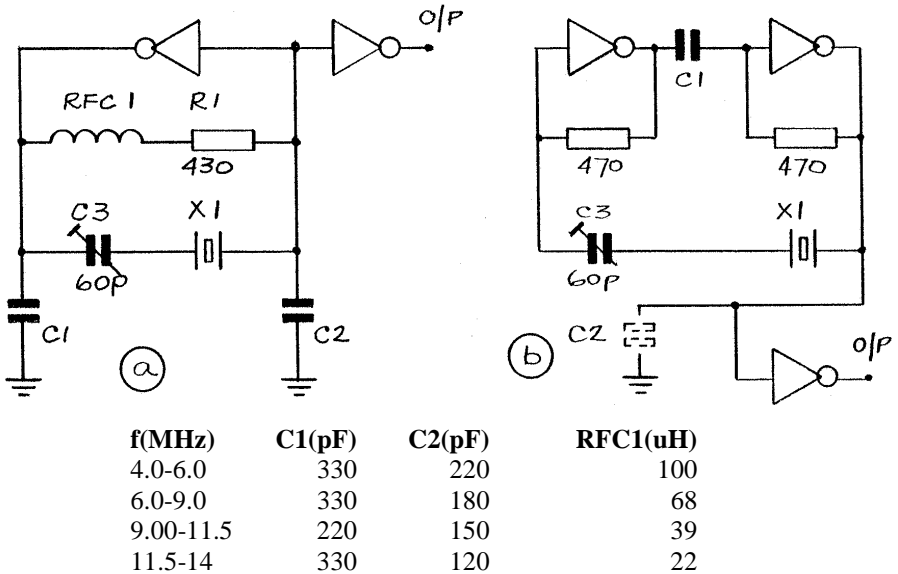

Fig. 3.TTL Clock Oscillators

TTL Clock Oscillators [1]

“Many circuits have appeared over the years which use TTL inverters and gates as active elements. Often such designs are prone to oscillate at unwanted frequencies or, for a variety of reasons, do not operate properly. Even certain integrated circuits which have been designed specifically for the purpose can be troublesome.

Fig.3 shows two circuits using TTL gates, 7400,7402,7404 etc. The approximate frequency ranges shown apply only to standard TTL ICs, although with higher bias resistors the low power families can be used to advantage. In these two circuits, the value of C1 and C2, should be determined experimentally. For the frequency range 4 to 14 MHz, the circuit in Fig. 3a will give good results. Unused inputs of NAND gates should be connected to the positive supply and those of NOR types, to earth.

TTL gate circuits cannot be fully recommended if the highest stability is required. Random phase shift within the IC will cause jitter and the relatively high crystal drive level does not make for good long term stability. A conventional discrete component oscillator as shown in Fig. 2., followed by a buffer amplifier provides a better way of obtaining a stable design.”

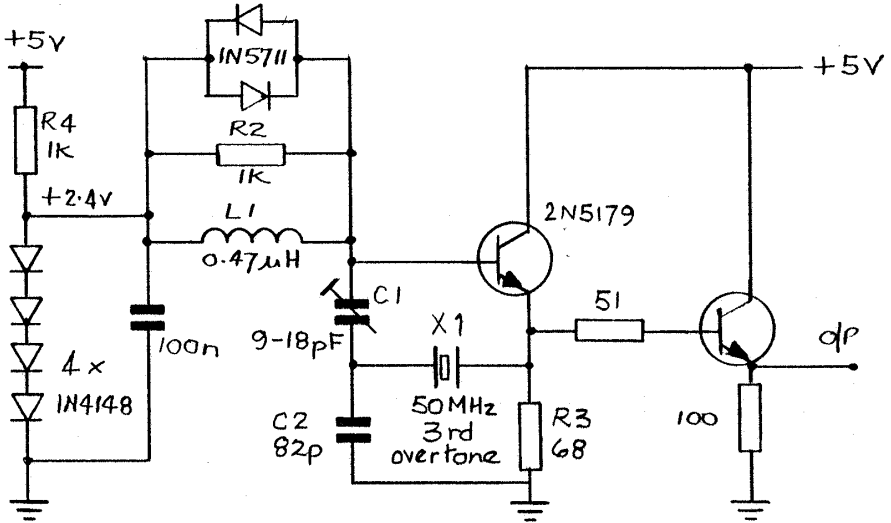

Fig. 4. 50 MHz Overtone Crystal Oscillator

Overtone Oscillators

It is difficult to manufacture crystals having fundamental frequencies higher than about 30 MHz. For higher frequencies the crystal is operated in overtone mode, usually third or fifth overtone. Operation in fifth overtone can provide frequencies up to about 200 MHz. A typical circuit for operation at 50 MHz is shown in Fig.4. Further information on overtone oscillators is given in [6].

General purpose crystals for popular frequencies are available from Maplin, Electromail (Electrocomponents) and Farnell. Crystals for more specialised use may be ordered from IQD Ltd. and other specialist suppliers.

Acknowledgement

Much of the above information has been drawn from the excellent and very practical “Applications” section of Reference [1].

References

- [1] Crystal Product Data Book, IQD Ltd., Crewkerne, Somerset, TA18 7AR. Tel. (01460) 74433, Fax.(01460) 72578
- [2] Circuit Techniques for Clock Sources, Jim Williams, Application Note 12, Linear Applications Handbook, Linear Technology (UK) Ltd., The Coliseum, Riverside Way, Camberly Surrey, GU15 3YL. Tel. (01276) 677676, Fax.901276) 64851
- [3] Crystal Oscillator Circuits, Radio Communication Handbook, 6th Den. RSGB, p. 5.7 - 5.10
- [4] Quartz Crystals in OscillatorsThe ARRL Handbook for Radio Amateurs, 1997, ARRL, p 14.21 - 14.28
- [5] Frequency-Control Systems, Doug Demo, Practical RF Design Manual, Prentice Hall, p. 38 - 54
- [6] Local Oscillator Sources, RSGB Microwave Handbook, Vol. 2. Common Equipment p. 8.1 - 8.18



Sevenside Television Group

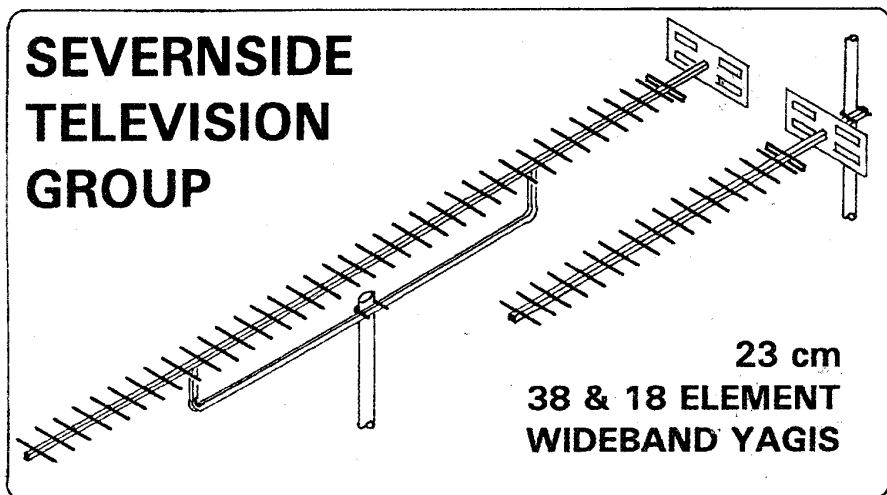

All of our 23 cm Aerials are specifically designed for ATV use - although they can be used for other modes as well. Wideband characteristics mean that you need only one aerial to cover the repeater input and output channels. Our famous wideband yagis come fully assembled in two versions:

38 ELEMENT HIGH GAIN: 14 dB gain, 1.8 m long, **£26.00** plus postage.

18 ELEMENT STANDARD: 10 dB gain, 0.9 m long, **£15.00** plus postage

Don't forget our **20 ELEMENT CONVERSION KIT**, which converts your existing 18-element aerial to the full **38-element** high gain specification: **£13.00** plus postage. Our 23cm **TROUGH REFLECTOR** is quite unique, combining 11dB gain with wide bandwidth *and* wide beamwidth. It's also compact, just 0.55 m high, 0.35 m wide and 0.3 m deep. Supplied as a kit of predrilled and preformed parts for easy "Screwdriver" assembly: **£19.00** plus postage. All aerials feature an SWR of less than 1.5:1 and are supplied with mast clamps suitable for masts up to 55mm diameter. Mast poles shown are not supplied.

POSTAGE: **£3.75** for one aerial, **£5.00** for two or more. Telephone orders with cash on delivery: **£2.75** supplement per order, Orders from outside of the UK - please write for carriage quotation.

CHEQUES payable to "SEVERNSIDE TELEVISION GROUP" and send to 18, Linnet Close, Patchway, Bristol BS12 5RN. Telephone (evenings and weekends only please) 0117 969 8136. Please allow 28 days for delivery.

Dual Video Filter

Micro Linear's ML6428 is a dual filter that replaces the 16 inductors, capacitors and resistors needed to clean up video signals. The device includes a summing circuit that forms composite video, and three 75ohm video amplifiers that boost the composite and S-video outputs.

The chip is used to filter video that has been converted from digital to analogue. It improves image quality in equipment such as set-top boxes, VCRs, DVD players, PCs, digital cameras and large screen TVs.

The filters and output amplifiers are highly integrated on the ML6428, and the inclusion of the summing circuit aids in the speedy production of the composite video.

The device's two fourth-order Butterworth low-pass filters achieve outstanding performance, says the company, with minimal overshoot and flat group delay. The filters have 1dB pass band flatness. They smooth out the quantisation effect of D/A conversion.

The company says the parts will greatly simplify the tasks of engineers by providing a drop-in replacement for a complex discrete design and finicky high-frequency amplifiers.

As well as reducing board space, the device also eliminates the need for the D/A normally used to produce the composite video output by internally generating the signal from the Y (luma) and C (chroma).

The two inputs to the chip are Y and C. Outputs include a filtered and amplified Y and C, which is known as S-video. The third output is composite video (CV) which is formed by the internal summing of the Y and C signals. All three amplifiers directly drive the standard 75 and 150ohm cables to monitors and TVs.

Micro Linear. Tel: 01844 263052 Fax: 01844 263051

Reprinted from Electronic Times, 23rd February 1998

Video low pass filter

By Martin Früchte, DF9CR

Many electrical testcard generators and computers connected to ATV transmitters as the video source increase the H.F. bandwidth unnecessarily because of their steep pulse edges. Therefore any video transmitter should have a low pass filter included in the modulation input.

The filter described here is mounted into a BNC plug that gets a socket attached to the cable entry, and it needs no calibration.

Mounting

The double sided PCB is made from 1.5mm epoxy (FR4) and 10x14 mm small. On the upper side are mounted the SMD components, the lower side is ground. Assembling the PCB into the BNC plug (for Aircell7 cable) needs some skill. First we drill the cable entry 9mm wide and apply a 3/8 inch screw thread for the BNC socket.

The inner connector

gets extended by 2mm silver wire or a tiny brass pipe by 3.5mm. For mounting and soldering of the plug, PCB and socket we need to cut another BNC plug as a mounting case. The PCB is pushed into this case and pressed against the disk within the plug case by the socket screwed into it. Now we solder both inner connectors to the PCB, also the disk on both sides. All components are attached and aligned now.

Very carefully we dismount the mounting case again and solder the PCBs ground side to the outer case threads with sufficient heat. After cooling down the disk is soldered to the ground side with care. Now the whole thing gets assembled and screwed into the plug case by hand. We apply glue or nail varnish to secure it.

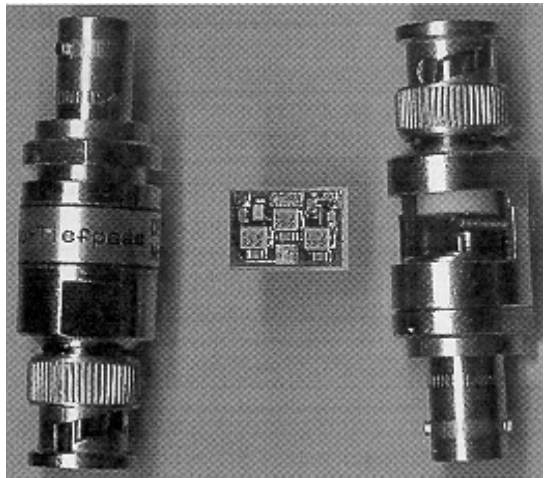

To give some idea of the filters actual size shown against two BNC connectors

Usage

The low pass filter is plugged in line into the video input of the transmitter, and the quality of the received picture should not be degraded. There is no calibration needed, as the tolerances of the components have been considered during the design. By only viewing the TV screen it is not possible to confirm the correct function of this filter (only on a spectrum analyser).

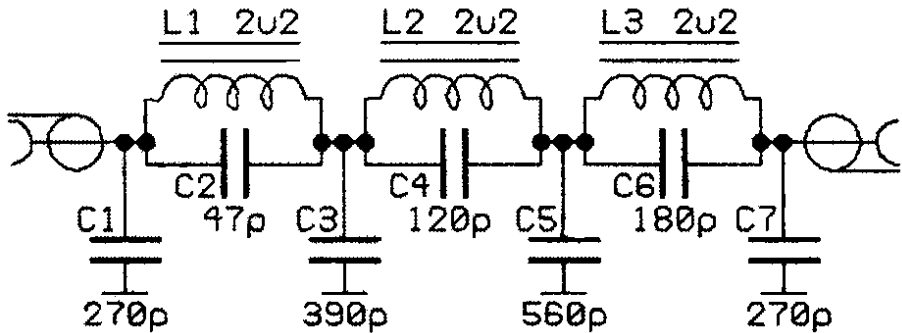

The circuit diagram for the filter.

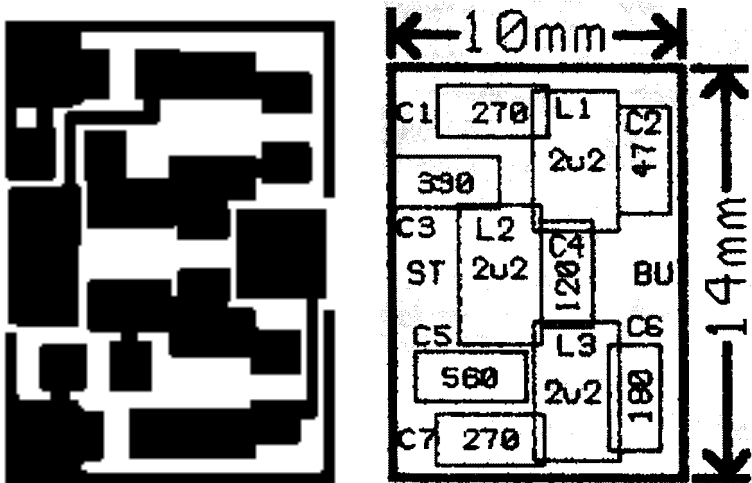

PCB pattern and component overlay (much enlarged)

Components List

Double sided PCB material 14mm x10mm, 1.5mm thick, grade FR4

BNC flange panel socket

BNC plug for the Aircell 7 cable

L1, L2, L3 2 μ H Simid 02 Pattern 1210

C1	270pF	C2	47pF
C3	390pF	C4	120pF
C5	560pF	C6	180pF
C7	270pF		

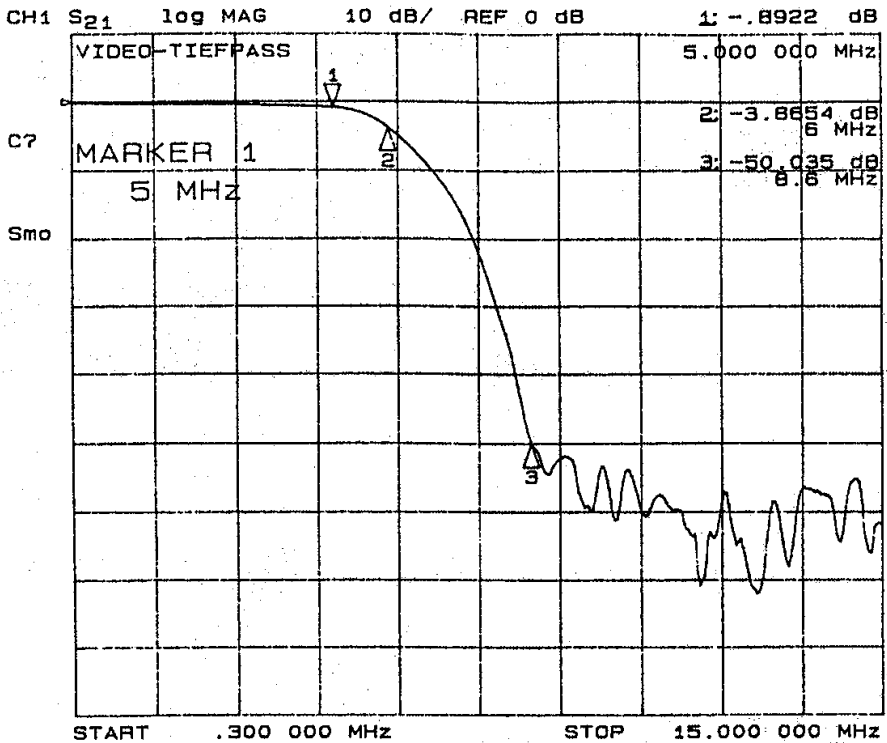

Selectivity and Insertion Loss

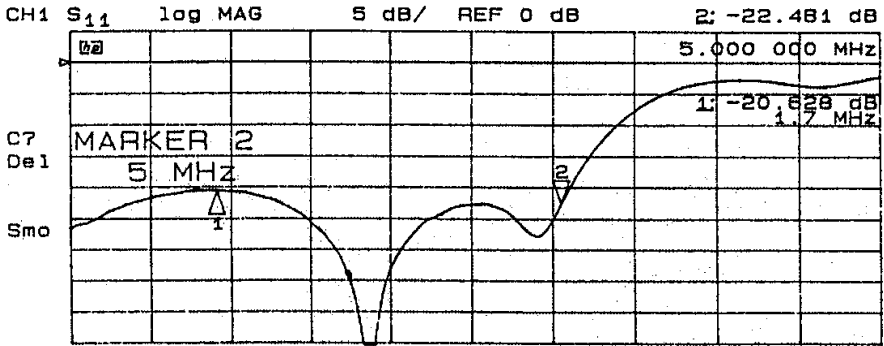

Return attenuation at the Input

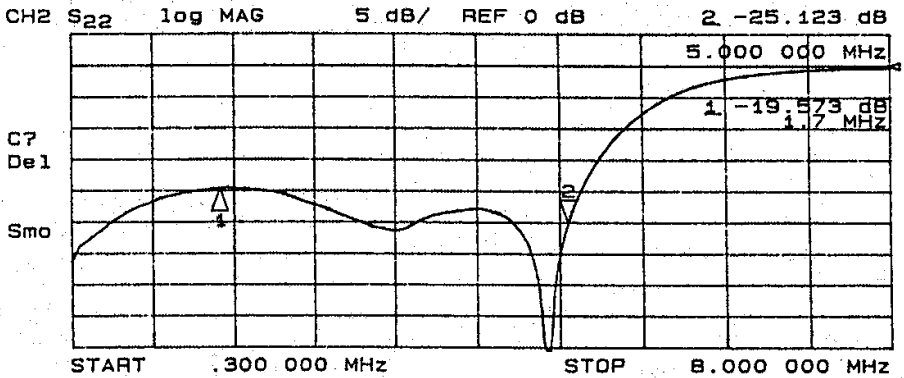

Return attenuation at the Output

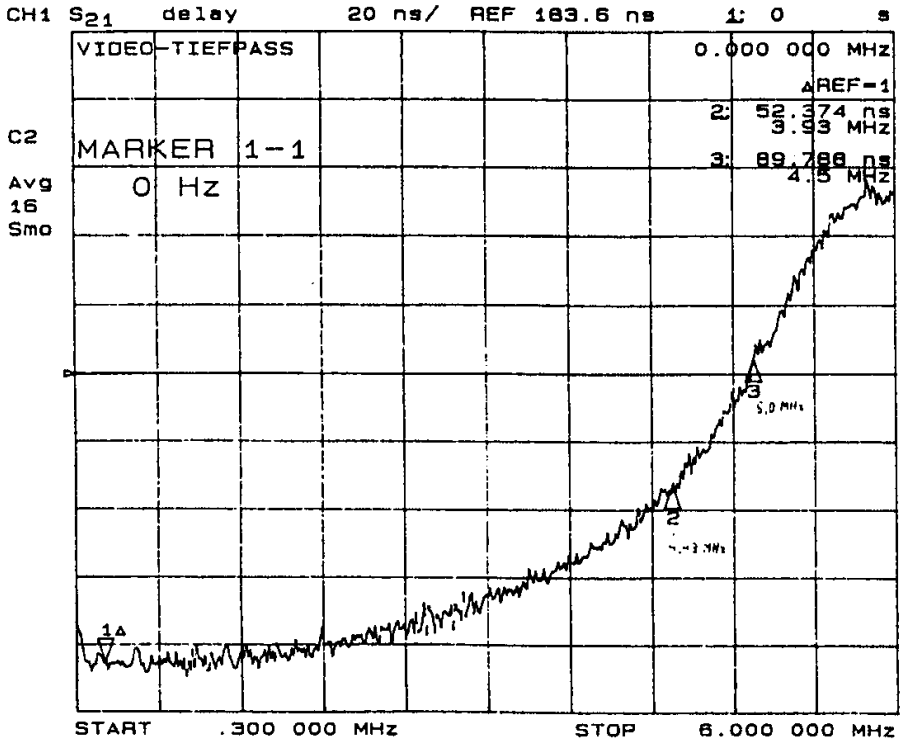

Group Delay

This article first appeared in TV-Amateur No 107

Translated by Klaus Kramer, DL4KCK. Captions translated by Andy Emmerson

Whatever Happened to BetWiXt?

By Brian Kelly, GW6BWX

The BBS isn't there anymore, and my postman hates me for all the mail I've received about it! The truth is, the BBS is still alive and kicking, in fact it's been upgraded yet again and now supports POP3 mail and HTML screens, just like a WWW system but, for most people, much faster.

The problem isn't the BBS, it's the phone lines to it. I'll now relate a tale of woe, although regular callers will already be well aware of the troubles I've had.

Back in February 1997, one of the two lines to the BBS packed in completely, it had no dial tone, no line voltage and nobody could call in on it. The fault was reported no less than 14 times by voice and by 7 letters to BT's repair service but they refused to look at the problem. BT have a "loophole" in their fault reporting procedure which prevents them accepting residential fault reports on 154 and also prevents business line faults being reported on 151. They also define any number that has more than one line must be a business line. That left the BBS in no mans land, a residential number with two lines. As they believe this can't exist, neither 151 or 154 would accept the call, both referring me to the other! Even demands to speak to the managers on both numbers were refused.

After six months of dead line, I decided to pay only for the working line, enclosing with the payment a letter explaining my actions. BT claim they never received the letter, despite cashing the cheque from the same envelope and promptly blocked the other BBS line from dialling out. This effectively cut off the Internet mail feed which relies on the BBS dialling the mail hub to connect to the network.

I protested strongly, to which BT claimed I had never reported any faults (in truth, they never ACCEPTED any) and they threatened me with legal proceedings unless I paid in full. Time for drastic action! I wrote a four page account to BT's manager, explaining in great detail exactly what had happened and I delivered it by hand, obtaining a receipt for it and taping the whole hand over on a camcorder. This time they couldn't deny receiving it and at long last I was contacted by the manager. "We'll look into it Sir" he said, "and in the meanwhile, please pay your bill". I gave him a short lecture on bills and his anatomy.

There's a saying "the light at the end of the tunnel is probably an oncoming train". How true; BT reacted by completely cutting all my lines, voice included and sending me yet another bill. This bill included international calls and 32 unidentified calls to "lo-call" services. None of

Whatever Happened to BetWiXt?

which had been dialled. On the blower again, this time using my office phone as all the home ones are dead. “There must have been a mistake Sir, while we look into it, please pay the bill” they said. BT refused to budge an inch, so I gave them an ultimatum, they either repaired all the lines within 12 hours or I would remove them myself. I actually waited four days and there was no sign of BT so I cut the lines and neatly coiled them behind the pole across the street. Guess what, another bill for more calls came in! I spoke to their manager again and faced with the fact that BT had disconnected the lines and I had removed them, they had to admit that the calls could not possibly be made by me or the BBS. At that point they relented and cancelled all the bills, formally closing all accounts. I politely asked them for a letter explaining what had gone wrong and apologising for their error. Their response was an absolute refusal.

So what happens now? The BBS is all ready to go but has the brakes firmly applied. A cable TV company will be starting installation of TV and phone lines starting in May but can't give a definite date for visiting the BBS address. Being in a relatively remote location it could be some time after May before BetWiXt mansions is wired up.

If anyone is in a position to take over the BBS before then, please contact me. I assure you it is hard work but can be rewarding. The hardware and user database cannot be transferred however. The computer is part of a network and the user database is protected by the Data Protection Act and my own promise never to divulge personal information.



AR5000 - a multiple talent

By Klaus Wings, DL9KAS

The AOR AR5000 receiver works from 10kHz to 2.5GHz in all usual modes and bandwidths and has been available for two years now. I bought mine 18 months ago for control purposes at our beacon transmitters DB0JW on 2m, 70cm, 23cm and 13cm. At once I used it as a calibration tool as it outdoes several more expensive devices by 1 Hz scanning steps and a TCXO (crystal oven). If you connect a spectrum analyser (i.e. HP141T) to the IF output you get a super fine analyser with a sensitivity of -129dBm.

But the device is more powerful yet - and that is interesting to ATV people. In TV-AMATEUR I read about FM-ATV reception with the AR5000. That took my attention, and I considered testing this function for myself. The device "FM DEMO 20" from "Schuster" was already at hand, I only had to convert the 10.7 MHz IF output to 70 MHz.

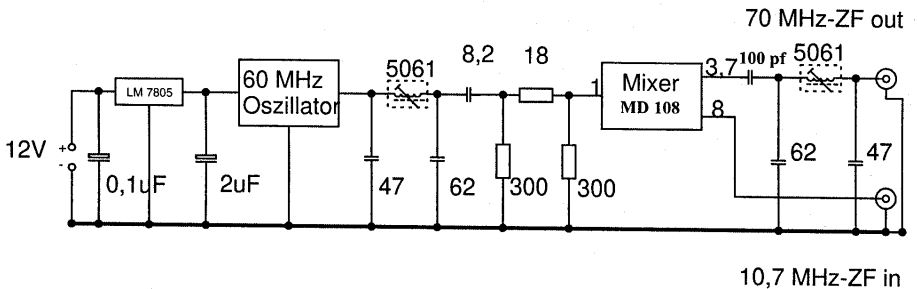

Circuit diagram for the converter

In my scrap box I found a TTL crystal oscillator and a Schottky mixer, so it did not take long to get it to work. On a small piece of Veroboard I mounted a 5V regulator, the oscillator for 60 MHz, a low pass filter made of one Neosid coil Nr. 5061 and two SMD capacitors in order to suppress any harmonics from the oscillator. The filtered 60 MHz signal runs via 8.2pF and a 3dB attenuator - made of three SMD resistors - to pin 1 of the ANZAC mixer MD108. Its pin Nr.8 gets the 10.7 MHz IF out of the AR5000 - and there is the new 70 MHz IF at pin 3+7 of the MD108. This signal is fed through another Neosid filter Nr. 5061 to the "FM DEMO 20" or any TV sat receiver with looped through 70 MHz IF (like Echostar

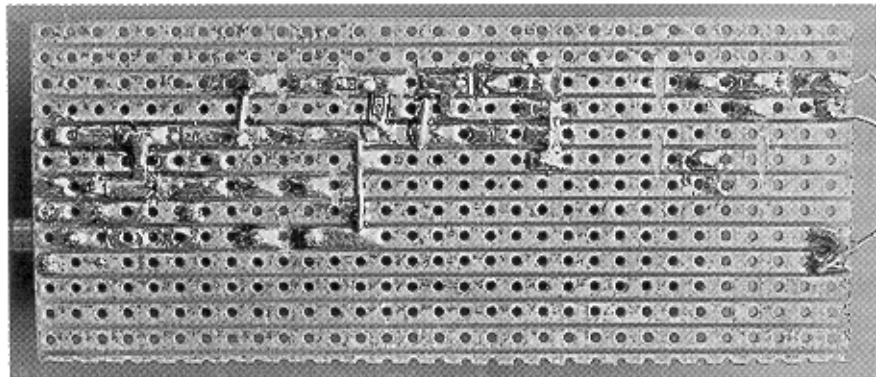
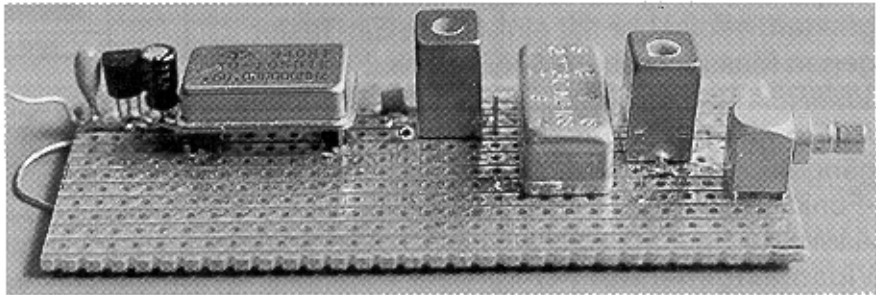
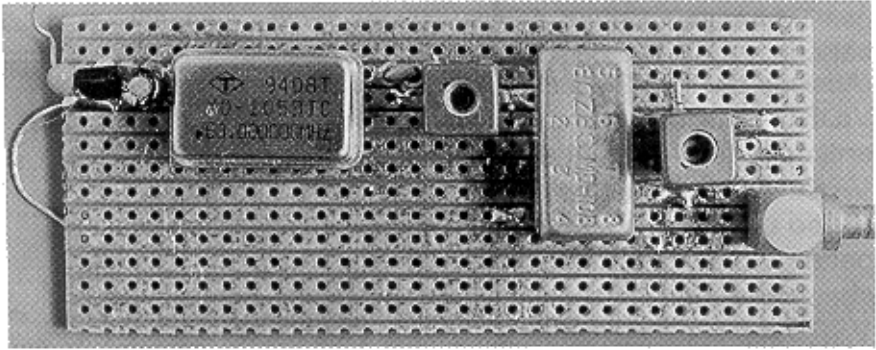

Views of the circuit assembled on Veroboard. The simplicity of the construction is evident from the low component count

SR 50), and now you are equipped for FM-ATV reception. To my greatest pleasure a superb picture from our ATV repeater DB0KWE appeared!

Encouraged by this I went on to the 13cm band - on 2343 MHz (DB0CD) nothing was to be seen! Somewhat disappointed I scanned to 2329 MHz and directed my antenna to DB0QJ in Siegen, 129 km away. Oh boy, I got spoiled by a P5 picture. Similarly DB0NWD (89 km away) came in at once. Then another try to get DB0CD. With an exactly directed aerial I happened to have a decent picture quality.

Now I compared the results with a Chaparral Arabsat LNB and found both systems - using a suitable preamp - being equally useful. With the AR5000 you know exactly which frequency to tune to, and you have an (uncalibrated) S-meter reading. You can save every repeater frequency to one of the many memory locations. Another interesting feature is the possibility to demodulate AM-TV signals (commercial or on amateur radio bands from 70 cm to 13 cm) using a modern hyperband TV receiver connected to the converter described above.

Its circuit diagram is too simple to require any explanation. The adjustment should bring no problems: direct your antenna to the next ATV repeater, tune the AR5000 to its output frequency and adjust L1 and L2 to the best possible picture quality - that's all. If you can equip yourself with a spectrum analyser you are able to optimise the filter passband. Have fun with building and experimenting!

This article first appeared in TV-Amateur No 107

Translated by Klaus Kramer, DLAKCK. Captions translated by Andy Emmerson

Visit our Web site at www.batc.org.uk to view or download electronic versions of recent issues of CQ-TV



By Paul Holland G3TZO

A shortened “Sat News” again this time due to publishing deadlines. With still relatively few able to view the many new digital services I have taken a break from listing the myriad new services appearing across nearly every satellite in the sky. Instead there is news of a SAT PC Card for use with existing analogue services, news of new satellite launches and belatedly, just as the EBU goes digital, there are details of a simple circuit for receiving Sound In Synch services. This issue sees the start of using the millennium compliant date format as suggested by Ian Galpin G1SMD. If it looks strange or you don't like it blame Ian or perhaps Peter Mandelson - not me !!

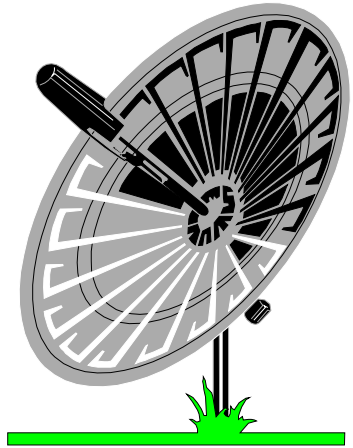

Astra 1K

Astra 1K, the eleventh satellite in the Astra series, will be deployed at the orbital position of 19.2° East by 2000 year end. The spacecraft is specified for three distinct missions;

- to provide full replacement capacity for Astra 1B, plus back-up capacity for the Astra A, C and D bands. This mission will allow broadcasters to continue existing analogue services well into the next millennium.
- to allow for additional transmission capacity and for geographical expansion of the Astra coverage area towards Central and Eastern Europe, including the European part of the CIS. This will be achieved through the geographic re-use of Ku-band frequencies. Taking full advantage of the frequency re-use capabilities of the Astra 1K spacecraft, the overall transmission capacity at 19.2° East will increase from the current 120 transponders up to 144.
- to carry additional Ka-Band capacity providing full back-up for the Astra 1H Ka-band payload.

Astra 1K is an Aérospatiale Spacebus 3000B3S satellite with a Ku-band repeater manufactured by Alcatel. This very versatile satellite will be equipped with 9 antenna reflectors, notably allowing for frequency re-use.

It will feature 52 high-power Ku-band transponders for the first five years of operation (46 transponders at end of life) as well as a two-transponder Ka-Band payload. The Ku-Band transponders will be powered by 105 Watt TWTAs (Travelling Wave Tube Amplifiers) and the Ka-band payload by 66 Watt TWTAs. The spacecraft will be capable of generating 13 kilowatts of electrical power and will weigh, depending on the launch vehicle, between 4.5 and five tonnes. SES' contract with Aérospatiale calls for the satellite to be compatible both with the Ariane and Proton launch vehicles. The spacecraft is designed for a 13 to 16-year lifetime depending on the propulsion system.

Off Air Pictures



From Hot Bird 2 at 13.0 Deg E. Digital service from the Italian broadcaster Telepiù. Freq 12.034 Ghz (V) SR 27.5 & FEC ¾



Digital DX from Thaicom2/3 UTV/MCOT Service Freq 3.880 Ghz (H) SR 27.5 & FEC 3/4

Intelsat News

- INTELSAT 804 was expected to commence commercial service at its orbital allocation of 64 degrees east beginning 1998 Feb, upon completion of orbital manoeuvres and in-orbit testing. INTELSAT 804 was launched by an Ariane 42L launch vehicle and is deployed at 64 degrees east. INTELSAT 804 is the 27th satellite in the INTELSAT global fleet and also the sixth serving the Indian Ocean Region. From this location, the satellite, which contains 38 C-band and 6 Ku-band transponders, will provide a full range of voice/data and video services to INTELSAT customers throughout top markets in Europe, Asia and Africa. Its high power C-band coverage allows reception through antennas as small as 1.8 meters.
- INTELSAT and Columbia Communications Corporation have resolved arguments as to who owned rights to the 319 Degrees E/319.5 degrees E orbital slot . Under the terms of the agreement, Columbia will cease operation of the TDRS-4 spacecraft at the 319 degrees E/41 degrees W location by 1998 May 15. In its place, Columbia will take title to the INTELSAT 515 spacecraft, to be renamed Columbia 515, and begin operating that satellite by 1998 April 1 at 322.5 degrees E/37.5 degrees W. Columbia will lease back to INTELSAT at no charge a number of transponders on the Columbia 515 satellite.
- INTELSAT has chosen Arianespace and the Ariane 5 launch system for three INTELSAT IX satellites. The Ariane 5 system, will lift off three INTELSAT IX satellites into geostationary transfer orbit starting in 2000. All launches will take place from the European Spaceport in Kourou, French Guyana. The INTELSAT IX series is manufactured by Space Systems/Loral in Palo- Alto, California. Their average mass at lift-off is 9,500/10,500 lb. They will be INTELSAT's largest capacity satellites and will carry 44 C-band and 12 Ku-band transponders for multi-purposes telecommunications services over the Indian and Atlantic Ocean regions.

New Products

GALAXIS PC-Sat-Card

A PC card developed by Galaxis enables reception of radio and television programmes directly from the satellite to the PC. The PC-Sat-Card also gives scope for processing of television pictures and displaying videotext on the PC. Other key features of the card include;:

- functions with all modern PCI VGA cards using PCI technology.

- television picture is freely scaleable from window icon size to full pictures with maximum PAL resolution.
- programmable list of all TV and radio channels.
- suitable for all different LNBs
- videotext functions including compilation of page list, editing, background search, printing etc.
- simultaneous presentation of all receivable channels in multiplex operation.

The PC card is well connected with,

- audio outputs for sound card (internal)
- audio inputs for CD reproduction (internal)
- audio output through 3.5 mm stereo latch (connection for active loudspeakers)
- programmable scart connection
- for video output (video recorder control)
- for video input (external video source)
- for external decoder operation
- for stereo audio output
- integrated satellite tuner with standard F-connector input

The PC card can be used in conjunction with different decoders by means of the TT media port. - for Pay-TV decoding and Pay-TV radio reception for decoding and processing of data services and for digital and terrestrial radio reception. For details check the Galaxis Web page at;

<http://www.galaxis.de/products/eprod000.htm>

Astra 2A

Astra 2A is scheduled for launch onboard a Russian Proton rocket in May, more than half a year later than originally scheduled. Astra 2B will launch towards the end of the year. and will use an Ariane 4 launch vehicle Together, both spacecraft will provide 56 active transponders. In the meantime Astra 1D will provide capacity for digital testing at 28.0 Deg E using its 18 transponders in the frequency range 11.70 - 12.10 Ghz. Astra 1D has transmission characteristics identical to the ones of the upcoming Astra 2A. ASTRA 1 E has taken over all transmissions from ASTRA 1 D.

Confirmed private and public SES customers for Astra 2A digital transmission capacity include:

- BSkyB: 14 transponders
- BBC: 2 transponders
- Flextech: 2 transponders
- Discovery: 1 transponder
- UKTV: 1 transponder
- Viacom: 1 transponder
- Turner Broadcasting: ½ transponder

Furthermore, at least 2 ½ transponders will be used for the multiplexing of TV, radio and multimedia services of several other UK-targeting broadcasters.

News in brief

- Direct PC will switch from Eutelsat II F3 to Hotbird 3 (13 degree East) to increase its penetration to Eastern Europe.
- Hot Bird 5 will launch later this year and will replace EUTELSAT II-F1 at 13 Deg E. This will give considerably improved performance over the series II craft with reception over mainland Europe with a 60cm antenna.
- Tele X was deorbited on 16 Jan.
- Galaxy 8I is now at 95 Deg W.
- Intelsat 515 is drifting West.
- Nato 4B is drifting West.
- Skynet 4D is at 5 Deg East.
- Intelsat 804 has moved to 64 Deg East.
- DFH 22 is drifting West and has probably reached its end of life
- Intelsat 503 has been deorbited
- Palapa B2P has been deorbited
- Jcsat 1 has been relocated at 111 Deg E

Sound in Synch

Just twelve months ago there was considerable interest in the many SIS transmissions, particularly from Eutelsat II F4 at 7.0 Deg E. Although many of those signals are now digital there are occasional SIS feeds to be seen from a number of orbital positions. The following circuit will recover video, but not audio, for any remaining SIS signals which may be found.

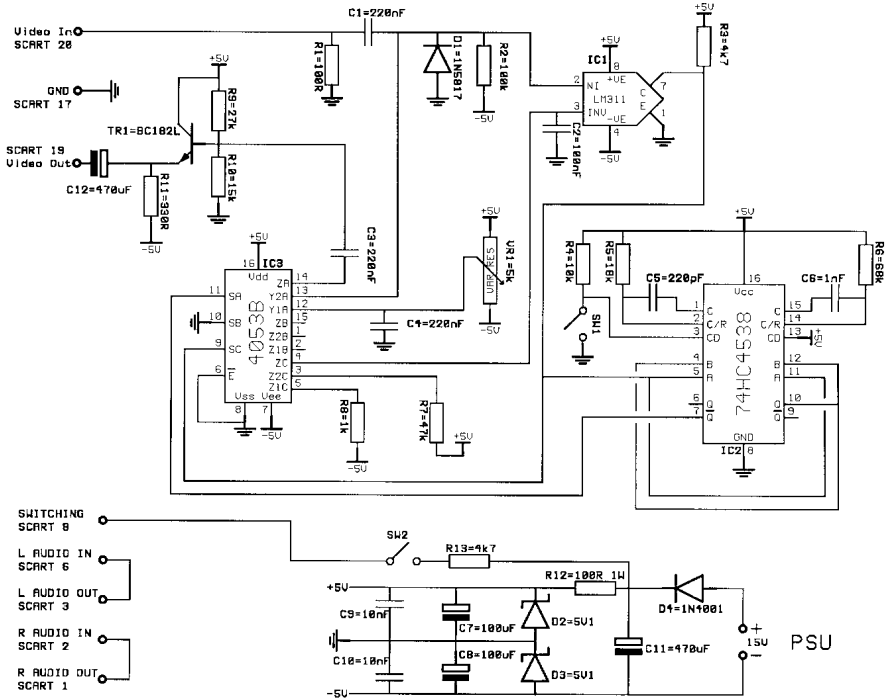

The raw video signal is AC coupled and filtered to remove the 25Hz triangular energy dispersal signal, and the negative peaks are clamped to a known level by the diode D1. This diode can be replaced by any Schottky diode of around 1A, or replaced by a standard 1A fast diode (e.g. UF4001). This diode needs a low on resistance (less than 1 ohm), yet needs to switch at line rate (15.625kHz). Rectifier diodes such as the 1N4001 are too slow, and signal diodes have too high on resistance. This clamped video signal is still not accurate enough to allow the syncs to be detected - variances in picture brightness still cause the negative peak value to change by 100mV. The LM311 is setup as a self-adjusting -ve peak detector. It does this by charging the capacitor C2 on pin 3 to be the same level as the lowest sync. The charge current is switched by the C switch in the 4053 analogue switch. Component values are chosen to allow a 30mV tolerance for the next sync. Once the leading edge of the sync has been detected, a new sync of the correct duration (approx 3usec) is generated by half of the 4538 monostable. This signal is used to switch the video output to a fixed DC level set by the 5k preset. During this time the raw video input is switching between 0V and peak white (the SIS info!), and this part of the signal is suppressed. The second half of the 4538 is set-

up as a 55usec timer, which inhibits triggering of itself and the first half of the 4538. This prevents spurious signals from generating false sync pulses. Finally, the regenerated video output is buffered by a simple NPN emitter follower. No attempt has been made to keep impedances to 75 ohm - the circuit is very much a get-it-working-whatever design (i.e. a hack!).

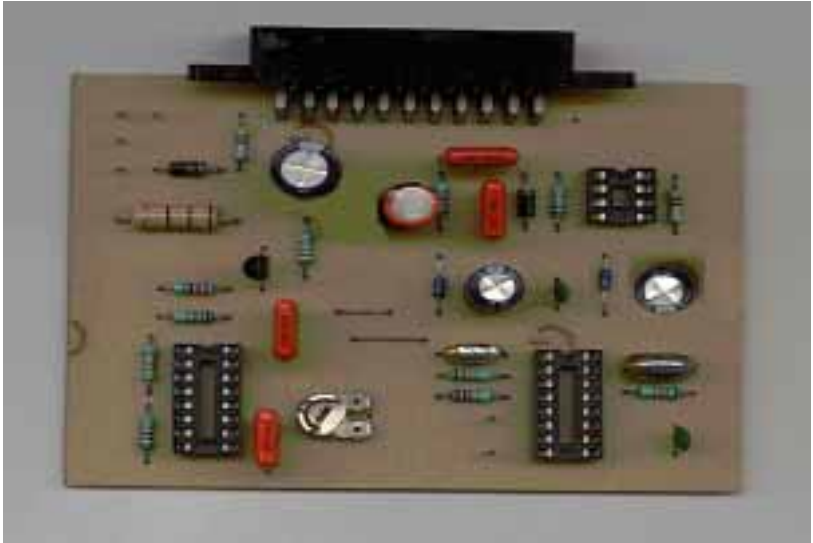

PCB (not full size)

The circuit is courtesy of Dr. N. J. Flowers with additional set up information provided on his web page at; <http://www.eee.bham.ac.uk/flowersnj/>

(EMAIL: N.J.Flowers@bham.ac.uk)

HOT Bird 4

Hot Bird 4 launched successfully at the end of February and is now located at 13.0 Deg E. Hot Bird 4 is equipped with 20 Transponders operating in the 10.7 - 10.95 Ghz and 12.5 - 12.75 Ghz range. This satellite is the first to include a on board digital multiplexing capability called Skyplex. Skyplex has been developed in order to uplink television or multimedia services from different locations whilst maintaining a single multiplexed downlink signal in the DVB format to domestic digital receivers or PC's. It allows broadcasting of low bit rate video, audio or data digital streams.

Hot Bird 4 has capability for multiplexing up to 6 independent uplink carriers with a useful bit rate of approximately 6 Mbit/s. Hot Bird 5, when launched later this year will have increased capacity to eight uplinks with

the ability to operate with downlink speeds as low as 350 kbit/s. Onboard the satellite the Skyplex equipment demodulates the different uplink signals, multiplexes the different bit streams onto a single digital stream and then formats for modulation of the downlink signal. Signals can be clear or encrypted in different standards.

Hot Bird 4 Transponder Frequency Plan:

Tp	Freq (Ghz)	Pol	Tp	Freq (Ghz)	Pol
111	10.72713	h	110	10.71918	v
113	10.77508	h	112	10.75754	v
115	10.81508	h	114	10.79950	v
117	10.85344	h	116	10.83426	v
119	10.89180	h	118	10.87262	v
121	10.93016	h	120	10.91098	v
95	12.61574	h	122	10.94934	v
97	12.65410	h	96	12.63492	v
99	12.69246	h	98	12.67328	v
101	12.73082	h	100	12.71328	v

From the Postbag

Following my comments in the last issue regarding lack of feedback reader Ian Galpin writes saying “*that a lot of interest in amateur satellite reception has waned since the introduction of digital*

transmissions and as more and more uplinks have become digital”. Ian goes on to say “*Surely the answer must be to be able to receive digital transmissions without having to spend vast amounts of money, isn't this where the Personal Computer comes in to play? I have a win TV card in my computer, and I can also play MPEG 1 digital CDI discs, so is there no way that can enable a computer to be used to receive and decode digital transmissions (via a standard satellite receiver output). I can feed auxiliary and SVHS inputs in to my TV card, surely the easiest way of decoding digital MPEG transmissions would be to utilise a PC, although, I have never read any information on this particular subject, or indeed have I ever heard of anyone who has attempted to do this*”. In my view the future use of PC's for receiving DVB compliant digital services can only be a matter of time. There are already analogue TV/Radio/Satellite cards for PC's on the market which will surely develop further with the growth

of interest in Internet/Business data services via satellite. This in turn will stimulate the growth of new and improved hardware and software. The next Cable & Satellite show at Olympia will give a clue to the speed of developments.

For those interested in making a quality connection using the ubiquitous F connector reader Jim Watkins wrote in to say he has found some which quote a 22dB return loss @2ghz and 36dB @1ghz. The connectors, made by Trompeter Electronics in the states, are of the crimp variety and go under the part no PL130 C-F3. They are specified to suit a cable known as ls 59 which is similar to a double screen RG59. They are stocked in the UK by Greenwood Electronics Components Ltd., (FAX: 0 118 933 3878). The price is about £4 each.

A reader looking for information is Michael Clarke who has recently joined the BATC. Michael is seeking information, advice and perhaps a circuit for a RAINBOW SAT-TV-RX made by a company called PDS. The receiver is manually tuned and operates on 12-15v DC. Michael is keen to know if anyone has come across one of these receivers before and would like a circuit and information. He can be contacted via me or direct on 01-365-6-21436 (N Ireland).

A final word comes from Swiss ATV President, Michel Vonlanthen, HB9AFO who wrote in to say that *"I appreciate very much your articles. You are doing a very nice job for all of us, active ATV'ers. Thanks and 73. please continue!..."* Thanks to you Michel and one or two others who were kind enough to write or call.

D Box - New Software

New and experimental software by "Dr.Overflow" based on the Nokia-mediamastr hardware has been released for those experimenting with software control of the popular D Box digital receiver. Details are available on the Web via <http://home.t-online.de/home/herrmann.uli/dvb98.zip>

Signal to Noise v Bit Error Rate

In the days of analogue reception the key performance parameter for analogue reception has been Carrier/ Noise ration (C/N). C/N at the antenna influences the final S/N ratio at the receiver output. For digital transmission it is the BER (Bit Error Rate) which counts. The picture/sound performance depends on the Eb/No value corresponding with a certain BER. Eb/No means: Energy per Information Bit/Noise Power. In order to get the ITU-quality level 5 a BER of 10 (up -6) is necessary. For analogue downlink a S/N of 40dB delivers a good quality. 15dB S/N in a digital downlink gives the same result. To determine the

E_b/N_0 : $C/N + 10 \log(1/\text{data rate in bit/s}) + 10 \log(\text{tx-bandwidth in Hz})$. If you compare a digital downlink budget with an analogue, you see that a lower C/N is required for digital transmissions (for instance: 11.5dB(analogue)= around 9.9dB (digital)).

Digital Receivers

Digital TV services have now been operating for nearly two years in some cases but the availability of equipment which is flexible enough to receive all these transmissions is still not with us. The main constraints remain in that;

- There are multiple incompatible encryption standards
- Not all receivers have the necessary Conditional Access Module installed to receive encrypted services
- Even Free To Air (FTA) unencrypted services sometimes require a CAM and valid smart card to be receivable using some receivers
- Some receivers are incapable of receiving Single Channel Per Carrier (SCPC) transmissions
- Some receivers limit the number of digital bouquets that can be stored
- CAM's for FTA receivers equipped with a DVB Common Interface (CI) slot are still not widely available

At the time of writing there is still not a single receiver that provides the capability (given access to a working smart card) to receive all the digital services currently available. At £350 - £500 a go the current crop of receivers are likely to be considerably outdated in just 12 months from now. Hang on to your money is my advice.

If you *are* tempted then a new receiver made in the UK will be available shortly. It's from RSD, better known as the designer of the Macab D2MAC boxes amongst other things. It doesn't have a CAM or CAM socket as it's only intended for free-to-air reception. It does have a good menu with 999 channel storage, SCPC channel naming and a user-friendly English menu (other languages available also). New software can be downloaded via its RS232 port. LNB's can be controlled via Voltage (13/17v), 22KHz tone or via DiSeqc. The qpsk demodulator uses the Hyundai "Odeum" chipset which is not the same as the TV/Com chips used by Nokia (although Hyundai now own TV/Com) also. In general, it's faster to respond than the Nokia 9xxx boxes - partly due to the use of a 33MHz CPU. In fact RSD will be one of the first companies to market with a product using Coldfire - they were an early beta customer for it.

Sunday April 26th SPORTS CONNEXION COVENTRY

Doors open at 10.00 (09.30 for disabled)

Entrance £1.50 & £1.00p for OAP and under 14s

All the usual features of BATC rallies: over 200 trading tables, Bring & Buy, large outdoor flea market, specialist more television displays, ex broadcast vehicles, etc.

GB6ATV talk in on S22 and GB3CV (RB9)

Full refreshment facilities - licensed bar.

All enquiries: Mike Wooding G6IQM

Tel: 01788 890365 Fax: 01788 891883

email: rally98@batc.org.uk

The Location

The **Sports Connexion** lies approximately 3 miles south of Coventry city centre and is at the junction of the A445 and the A423, the full address is: *Sports Connexion, Leamington Road, Ryton-on-Dunsmore, Nr. Coventry*. It is within easy reach of the M1, M6, M40, M42 and M45. The major road links to and from Coventry and bypasses around the city make the location very easy to get to.

For those who wish overnight accommodation in the area the nearest hotel/motel is the Coventry Knight Hotel (01203 301585) which is approximately 2 miles from the venue and is located at the junction of the A45 and the A445.

For those who wish to camp or caravan, as usual the site at the Bull and Butcher (01203 301400) on the A445 1 mile south of the venue is ideal. The pub does excellent meals too - maybe I shall see you there on Saturday night - mine's a pint of Kilkenny's.

Coventry Amateur Radio Society will be providing the talk-in station again on S22 and GB3CV (RB9) using the special callsign GB6ATV. Many thanks to the GB3CV repeater group for allowing us to use the repeater again for this purpose.

There will be a specialist area available in the Banbury Room (adjacent the bar) for anyone wishing to display ATV equipment. If you wish to do this please contact me as shown below to book a table, these are free of charge and only available to members, trading from them will not be permitted. Other specialist groups may also have displays in this area.

Finally, as ever, the usual plea for help. I have to admit that to some extent it actually worked last year! I shall be on site on Saturday from around 1500 setting up the hall and from 0630 on Sunday morning. If you can spare an hour or two on either day please come and help.

If you can help on Saturday please telephone me during the previous week or on my mobile on the Saturday, to confirm the time we can have access to the hall. Thanks in advance!

OK that's it. I hope to see you ALL there. Please come and make yourself known to me and the rest of the Committee.

73 ... Mike

Tel: 01788 890365; Fax: 01788 891883; Mobile: 0468 925351; email: rally98@batc.org.uk

23cm Panel Antennas

By Paul Melbourne G8GML and Ian Waters G3KKD.

This article describes a range of panel antennas developed by G8GML. It is a sequel to an article by John Stockley, G8MMY, published in CQ-TV 180. His article described a panel antenna with a single bay of 4 loops and a gain of 12dB, which he suggested as suitable for portable use.

The antennas described in this article are based on similar principles, with 1, 2, 4 and 8 bays, each of 6 loops, intended mainly for fixed station use. They are used extensively by members of the Cambridge (GB3PV) ATV group. The results are excellent and definitely superior to long Yagis.

These antennas are similar in principle to those described in the UHF Compendium, but with a slightly different design. They employ 6 loops with a larger aspect ratio, which permits a higher stacking gain.

The family of panel antennas consists of:

- 1 bay of 6 loops .gain 16 dBd.
- 2 bays of 6 loops .gain 19 dBd.
- 4 bays of 6 loops .gain 22 dBd,.
- 8 bays of 6 loops .gain 25 dBd.

Accepting that absolute gain measurements are difficult to perform, the gains of the 2 and 4 bay panels have been arrived at by comparing the signal received from a distant beacon using these panels, with that received using two reference antennas. The reference antennas employed were a circular waveguide antenna and a DL6WU 43 element very long Yagi. These are said to have gains of 8 and 17dBd respectively. While the absolute gains of these two references could not be checked, it was encouraging that the gain difference between them was 9dB as it should be. In fact during the tests a total of 11 antennas of various types by various makers were measured. The beacon signal was received by reflection from a huge aircraft hangar, which helps to overcome ground reflections, and Fresnel zone problems. The gains of the 1 and 2 bay panels were not checked but it may be expected that they have the figures given.

These panels are stable in all weather conditions whereas Yagis tend to de-tune when wet or covered in frost.

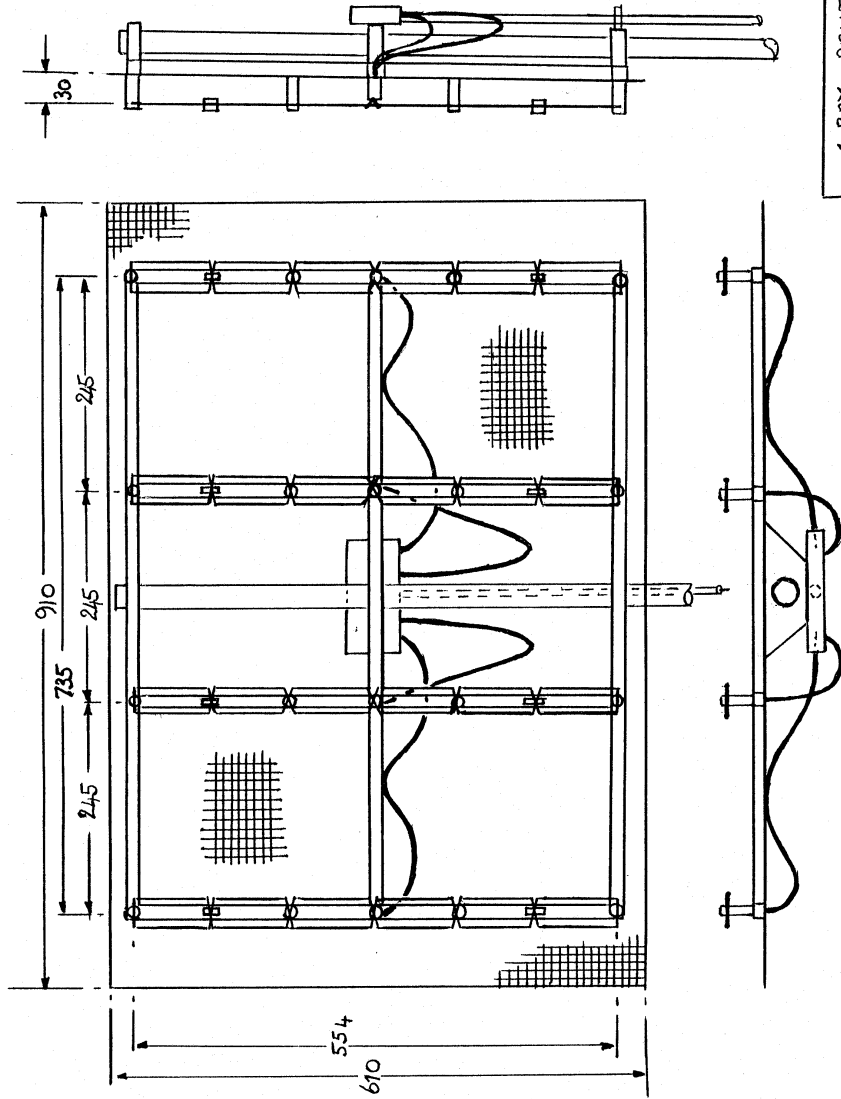

4 BAY PANEL
ANTENNA DIMS mm.
DRAWING 1.

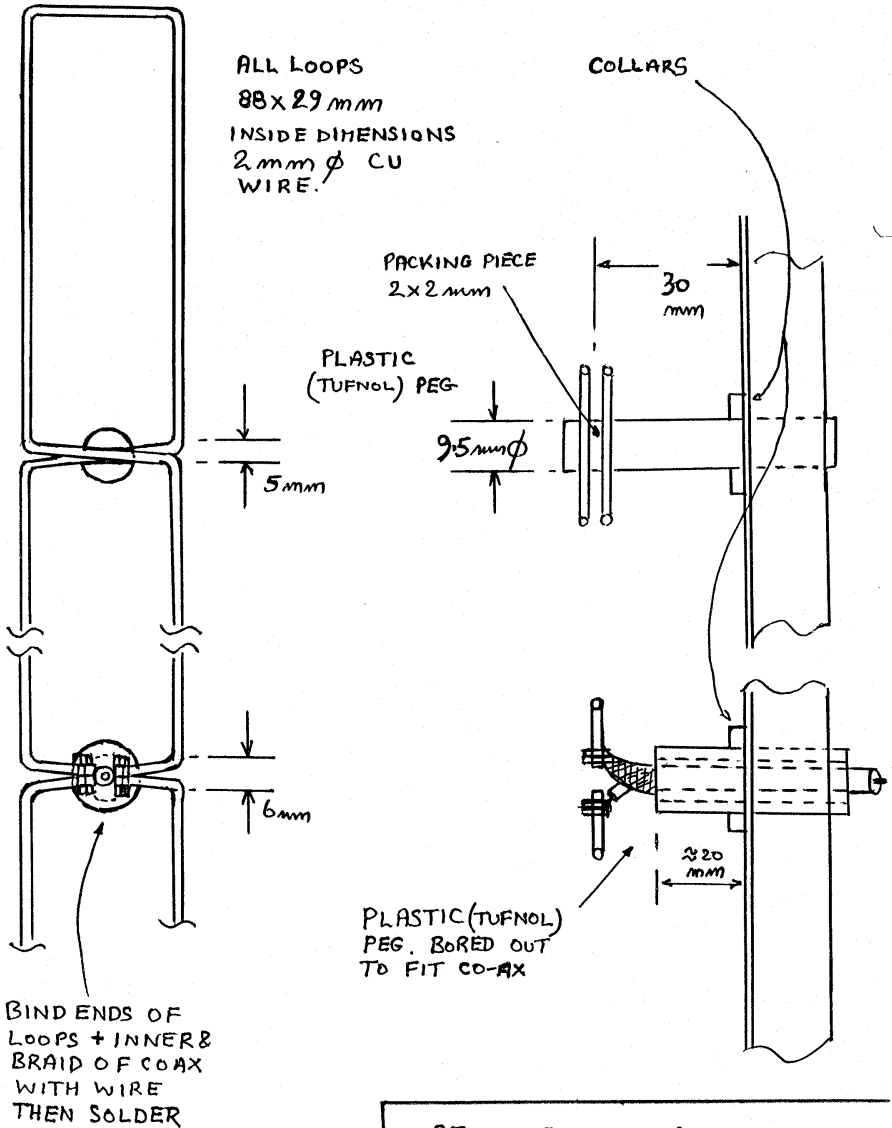

23 CM PANEL ANTENNAS
DETAIL OF LOOPS, SUPPORTS
AND FEEDER CONNECTION.
DRAWING 2.

Construction

The following is a description of a panel antenna with 4 bays each of 6 loops in front of a mesh reflector constructed by O3KKD and in use at his QTH. It has a gain, arrived at as described above, of 22dBd.

The 4 bay antenna, in common with all versions, employ a mesh for the reflector, sheets of which may be obtained from garden centres. These sheets are each 3 x 2 ft, they are plated and have a mesh size of about 1/2 x 1/2 inch.

The design for the 6 loop x 4 bay panel is shown in drawing 1. The reflector mesh is supported on a framework made from 15mm square section aluminium tube or perhaps hardwood. Joints are reinforced by gusset plates. It will be seen that a vertical support member is positioned behind each bay of loops to give support for the radiating elements. For smaller panels the design is reduced in width as required. The panel is supported on the pole by 3 brackets bolted to the horizontal frame members and bored out to clamp on the pole. This gives a very rigid structure.

Drawing 2 shows the construction of the radiating loops which are made of 2mm diameter copper wire. Each loop has internal dimensions of 88 x 29mm. This loop geometry gives an impedance of 33ohms. There are 6 loops in each vertical row, with 3 above and 3 below the feed point. Three 33ohms in series gives 100ohms and the two halves of the row in parallel give a feed point impedance of 50ohms.

The top and bottom of each row together with the cross points, 2 and 4 are supported on plastic pegs which fit into holes in the support frame. Crossover points 1 and 5 are not supported, but the crossovers are insulated using spacers as shown in drawing 3.

The distribution feeders, which use 5mm OD 50ohm coax, pass through pegs similar to those described above, but bored out to just clear the cable. These are made shorter to allow the cable inner and braid to be separated and connected to the loops. They are bound with wire and then soldered. In the 3KKD version Tufnol has been used for the pegs, which were provided with collars, which rest on the front face of the reflector. Other materials probably hardwood could perhaps be used. The pegs are retained in the frame by gluing and the distribution cables are retained inside their pegs using Isopon resin, which seems to be very resistant to the weather.

All cross over, support and connection points are also covered with several coats of Isopon.

23cm Panel Antennas

DETAIL OF NON-SUPPORTED LOOP CROSS OVER

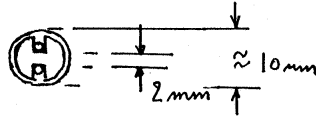
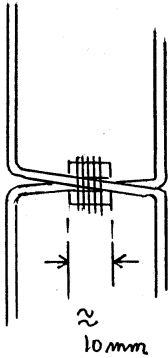

PLASTIC PEG WITH SLOTS
CUT ON 2 SIDES, BIND WITH
STRING & SEAL WITH ISOPON

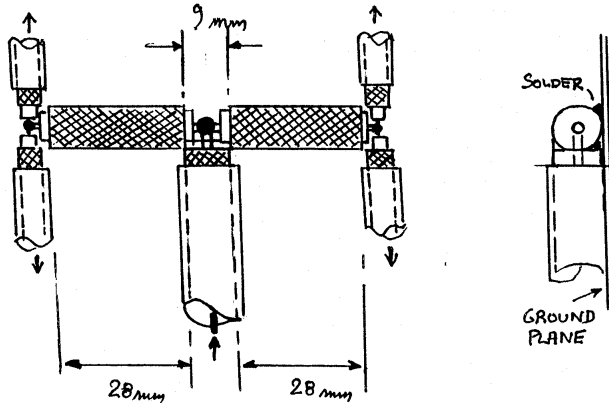

ALL CABLES ARE 50Ω
BRAIDS SOLDERED TO
GROUND PLANE
ALL DISTRIBUTION
FEEDERS IDENTICAL LENGTH

2, 50Ω DISTRIBUTION FEEDERS IN
PARALLEL = 25Ω, 2 MATCHING
TRANSFORMERS NEED TO BE 100Ω
TO CONNECT IN PARALLEL TO
MAIN FEEDER ∴ $Z_T = \sqrt{25 \times 100}$
= 50Ω.

DETAIL OF POWER SPLITTER FOR 4 BAY PANEL ANTENNA

DRAWING 3.

The distribution feeders, which must all be of exactly the same length, connect to the power splitter contained in a sealed box mounted on the rear side of the pole. A small drain hole is a good idea. For correct phasing it is important that the centres of the coaxes all go to the same sides of the loops. The power splitter for the 4 bay panel is shown in drawing 3. It takes the form of a T splitter made from two 28mm lengths of 50ohm

cable. All cable braids are soldered down to a ground plane. For weather protection all cables enter and leave by the bottom of the box, with those distribution feeders shown on drawing 3 going upward being turned inside the box to leave through the bottom.

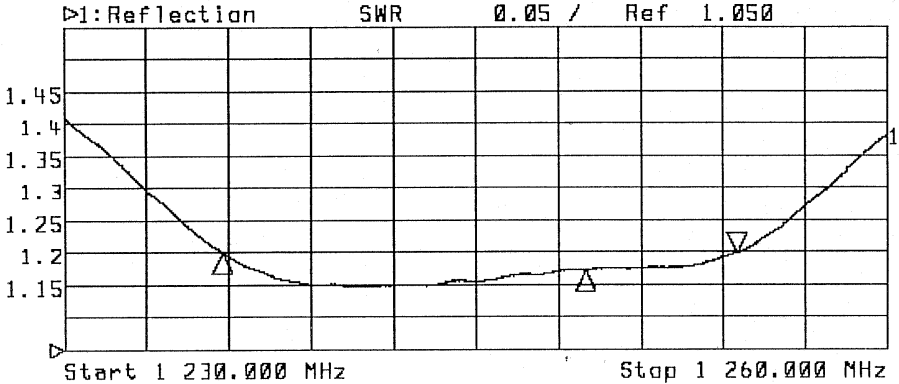

▶2: Reflection Smith 200 mU FS

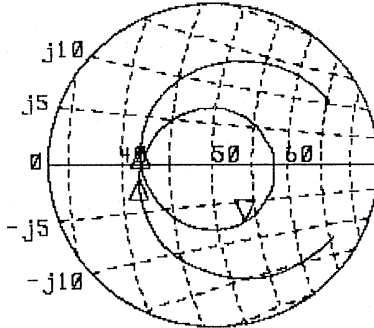

Start 1 230.000 MHz Stop 1 260.000 MHz

1: Mkr (MHz)		2: Mkr (MHz)		Ohm	Ohm
1:	1249.00	1.173	1>	1249.00	53.41 -7.526
2:	1235.80	1.201	2:	1235.80	41.79 -1.503
3>	1254.48	1.199	3:	1254.48	41.93 1.819

DRAWING 4

Power Distribution for 1 and 2 Bay Panels

As the feed impedance of a single bay of loops is 50ohms, no matching or distribution arrangements are necessary. For a 2 bay panel a power splitter similar to that shown in drawing 3 is used, except that the arms of the T are made from 70ohm cable and only one 50ohm distribution feeder is connected to each outer end. Drawing 4 shows the VSWR of the 2 bay panel used by C6FKS as measured by G1TFK.



8 Bay Panel

An 8 bay panel has been constructed and is in use at G8GML. This is shown in drawing 5. It consists of two 4 bay panels, as described above, mounted one above the other. This increases the gain by reducing the width of the vertical radiation pattern, while keeping the horizontal pattern similar. The spacing between the bottom of the top row of loop and the top of the bottom loop is 76mm. The horizontal spacing between the rows of loops has also been increased from 245mm centre to centre to 305mm.

The power distribution arrangement uses two 4-way splitters, similar to those used with the 4 bay panel, in turn fed by a 2-way splitter as used with the 2 bay design. The feed arrangements have been changed to be as shown in drawing 5 with bays 1, 2, 5 and 6 fed by one splitter, while bays 3, 4, 7 and 8 are fed by the other.

The gain of this large panel has been measured as 25dBd, so if fed from a Mitsubishi brick, with say 15W output and allowing a 1dB feeder loss, an

23cm Panel Antennas

ERP of 3.76kW may be obtained. This certainly puts a good noise free picture into the Cambridge GB3PV repeater. As this gain is similar to that of an 8ft parabolic dish, the antenna could be considered for EME communication! It is very much easier to make and less expensive than a dish.



23cm Panel Antennas

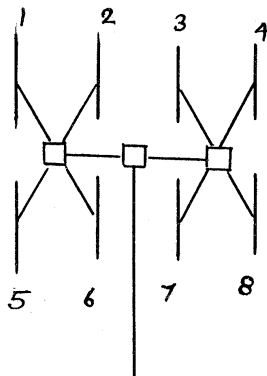
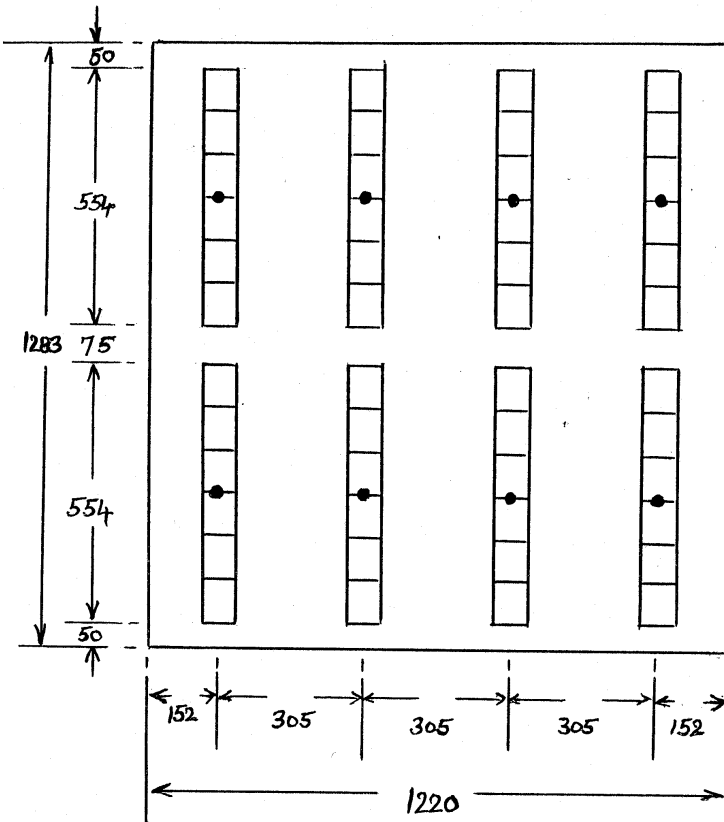

8 BAY PANEL ANTENNA
& FEEDING SYSTEM
DIMENSIONS IN mm
DRAWING 5

A drive unit for NBTV on an oscilloscope

By Grant Dixon

(Reprinted from the NBTVA Newsletter)

Those of you who think that TV always has hundreds of scanning lines should think again as the circuits here are for a 32 line system similar to that devised by J. L. Baird and transmitted by the BBC in the early 1930s.

In Baird's time the cathode ray oscilloscope was almost non-existent; it came into general use in the 1930s. At the present time with CRTs everywhere it seems a logical method of displaying NBTV pictures.

If you are choosing an oscilloscope for this purpose, then you should select one which will accept X, Y & Z inputs. The Z input is for the modulating signal and this usually goes through an amplifier to the grid (or cathode) of the CRT. Some oscilloscopes make a direct connection here and a modulating voltage of 80 to 100volts may be needed. Check that an amplifier is present and it will give full modulation with an input of a few volts.

Do not attempt to use the internal timebase of the oscilloscope, as the waveform is not always a simple sawtooth. Choose a 'scope which has two amplifiers and has a switch position labelled X, Y. An external timebase unit can then be built to feed these two inputs.

In Fig. 1 we have the timebases and spot-wobble generator; the same circuit is used for all three but they have different time constants. Note that the spot-wobble waveform is a sawtooth as this is much better than a sine wave which dwells at the edges and moves rapidly in the middle of its travel, thus giving brighter edges to the broadened scan line.

In the circuit used, a capacitor is charged by a constant current transistor thus giving a linear voltage ramp. The capacitor is then discharged by a unijunction (TIS43). The waveform across the capacitor is fed through a double emitter follower which has a very high input impedance and thus imposes almost no load on the generator circuit. There follows an inverter stage, to allow for scan reversal, and an output stage. The spot-wobble generator runs at a very much higher frequency and its output has to be attenuated before it is added to the frame scan output stage. If this is used with a monitor which has magnetic deflection then a much higher amplitude signal will be needed as the scan coils will present a rather high impedance at the spot-wobble frequency.

Fig 1, The timebase unit, is shown on the next page.

Fig 2, The Video processing unit, is shown on the previous page.

The NBTV signal to be displayed is assumed to be at the standard 1v level and is fed into the CAMERA input of Fig. 2. For experiments with tape recording a separate TAPE input is provided which has two stages giving phase correction and LF boost. A panel switch selects between these two inputs. The selected signal goes through an inverter stage and two stages of video output which has a panel mounted contrast control. The oscilloscope which I use is a Gould Model OS300 and this requires about 12v of signal to fully modulate the beam. As the unit is powered from +15v and -15v lines this is easily obtainable.

Brightness, height, width and positioning of the raster are all adjusted by controls on the 'scope. Contrast, spot-wobble and phase inversion (for negative pictures) are panel controls on the unit.

After a number of experiments, the sync separator shown has proved to be the most reliable. The 1v signal is amplified and then compared with a DC level in the second 741. When the clipping level is adjusted correctly you should see clean sync pulses at the test point (TP). These are prevented from going negative (with respect to ground) by the diode and are fed to the negative going trigger inputs of the 4528 which is a dual retriggerable monostable. One of the monostables has a time constant which is just over one NBTV line in length, thus it is retriggered and held high whilst pulses are arriving, but when a pulse is missing it drops back to zero, thus producing a negative going pulse at the Q output for frame synchronisation.

The other monostable has a time constant, which is just over the sync pulse in length, and this produces a positive going pulse at the Q output. As we need negative pulses to feed to the TIS43s the line sync pulses are taken from the 'inverted Q' output.

The whole unit was built on two PCBs and housed in a small metal case with a power lead connecting it to a separate +15 / 0 / -15 volt power supply. +12 / 0 / -12 will work equally well if this is more convenient. This is the unit, which I used to display pictures at the last NBTVA Convention at Loughborough. I can supply prints of the PCBs used, but am not able to supply ready-made boards.

Please note that fig. 1, as published in NBTVA contained some errors. These have been corrected by the author for this version.

The author can be contacted, via email, at nbtv@batc.org.uk

MAINLINE ELECTRONICS

2 exciting new kits recently added to our catalogue

DIGITAL FREQUENCY DISPLAY

A high-quality microcontroller based unit capable of measuring up to 32 MHz as a basic unit, or by preselecting an IF offset by means of a trimpot it can be used as the frequency readout of a Tx or Rx by adding/subtracting the offset from the LO. Also, by adding a suitable prescaler it can be used up to 8 GHz. 16 character LCD display with 100 Hz resolution - e.g. 14.257 MHz USB - the mode display is set by external resistors and can be programmed to show: AM, FM, CW, USB, LSB, FSK, FAX, or can be left blank.

Kit (no case): DFD1 £42.46 + VAT

Assembled (no case): DFD2 £47.20 + VAT

DIGITAL INDUCTANCE/CAPACITANCE METER

A real breakthrough in L/C measuring equipment at the price. A must for home constructors to help identify components and as an aid to winding coils, etc. At 5 samples per second the unit will also track whilst checking adjustable components. Microcomputer based.

Once you own one you will wonder how you managed without it!

Basic specification: 0.001 μ H to 100 mH (150 mH typical)

0.1 pF to 1 μ F non-polarised (1.5 μ F typical)

Auto-ranging and self-calibrating - 16 character intelligent LCD display

4 digit resolution - accuracy typ. 1% of reading - direct display in engineering units, μ H, pF, etc. Powered by 9V battery.

Kit inc. box and hardware:LCMKIT£79.00 + VAT

Built and tested (no battery):LCMBLT£94.00 + VAT



P&P free in UK, Overseas extra. VAT is 17.5%



**MAINLINE ELECTRONICS, P.O. BOX 235, LEICESTER,
LE2 9SH, UK.**

TEL: (0)116 277 7648/278 0891 FAX: (0)116 247 7551

CMOS imagers reach CCD quality

CMOS imagers are approaching and exceeding their CCD equivalents, according to Rockwell Semiconductor Systems. It is launching a companion compression chip to go with its camera-on-a-chip for a low-cost PC video camera.

The imaging technology has been developed at Rockwell's Science Centre in California for military and space applications. Rockwell built the world's largest CMOS IR imager in the Hubble space telescope as well as 1000 X 1000-pixel arrays in every main astronomical observatory,

The first production imagers are of equal quality to current CCD parts, while future parts will exceed it, says the company. This technology is critical to Rockwell as it sees the camera being combined with a GSM chipset and MPEG4 compression in a mobile phone to create a portable videophone.

The pixel processor takes the digital output of the camera and compresses the images to get the data over the Universal Serial Bus (USB) of a PC without using an add-in card. The first showing of the chip will be at Cebit in Europe in March 1998.

At the moment, the maximum rate over USB is 7.5frame/s, but Rockwell claims the compression chip will allow 30frame/s at CIF resolution (352 X 288-pixel) through a proprietary compression algorithm.

The CMOS imagers use a third to a tenth of the power of CCDs, and can be made on standard CMOS lines rather than a dedicated CCD process.

Integrating the 10bit A/D converter and timing and control logic on to the camera, coupled with the image compression and USB interface in the companion chip, reduces a PC video camera to just two chips plus EEPROM and a clock crystal.

The CIF resolution imager will sample next month to customers, followed by higher pixel resolutions of 640 X 480, 800 X 600 and 960 X 720, all sampling in May 1998.

Reprinted from Electronics Times, 23rd February 1998

Using a Vectorscope

By John Stockley, G8MNY

What is it? A vectorscope is a piece of test gear that can actually show the colour phase angles used in PAL (or NTSC) TV systems on a polar display. It is used for the alignment of PAL coders or getting the best from colour TV cameras. A colour bar generator is needed to use the vectorscope to the full and to show faults on video amps, TX/RX, VCRs, Mixers, etc. Fig 1 shows an ideal 100% colour bar and fig 2 the more common simple colour bars with the 3 generating colour waveforms.

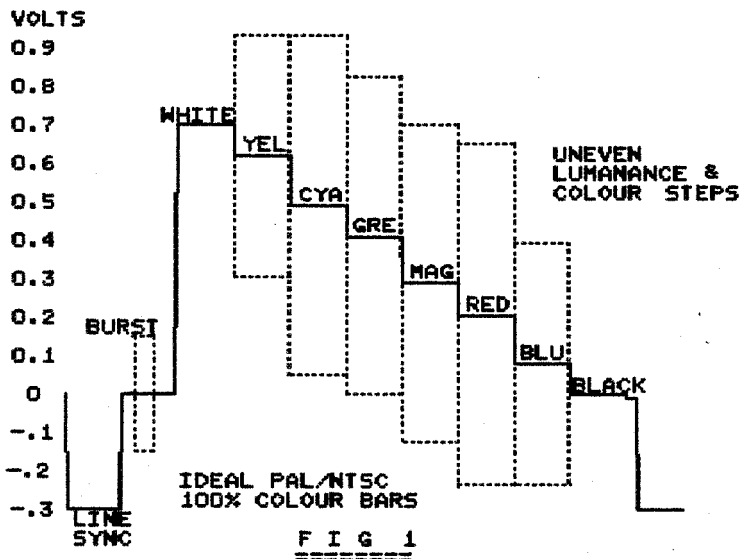

How is it different from a scope? With a colour bar signal, instead of just showing the colour subcarrier amplitudes added to the luminance plus syncs and burst that a scope does (fig 1), it gives a 6 dot display (NTSC) that indicates the relative phase angles and amplitudes of the 6 colours and a central dot for no colour. With PAL there are actually 2x6 dots as the “V” coder signal (vertical Y axis) is mirrored (inverted) every other line, hence “Phase Alternate Line”. See fig 3.

How does it work? The colour signal is first separated off with a filter in the normal way, then using a locally locked up crystal reference oscillator, decoded into the two “U” (yellow-blue) and “V” (red-green) coder colour components. This is done in a “simple” colour decoder which is not the same as a normal colour TV decoder as there is no 64uS (1H) delay line to

average out the colour phase errors. The decoded “U” and “V” signals are then displayed on the X and Y plates of the CRT respectively to give the vector display as in fig 3.

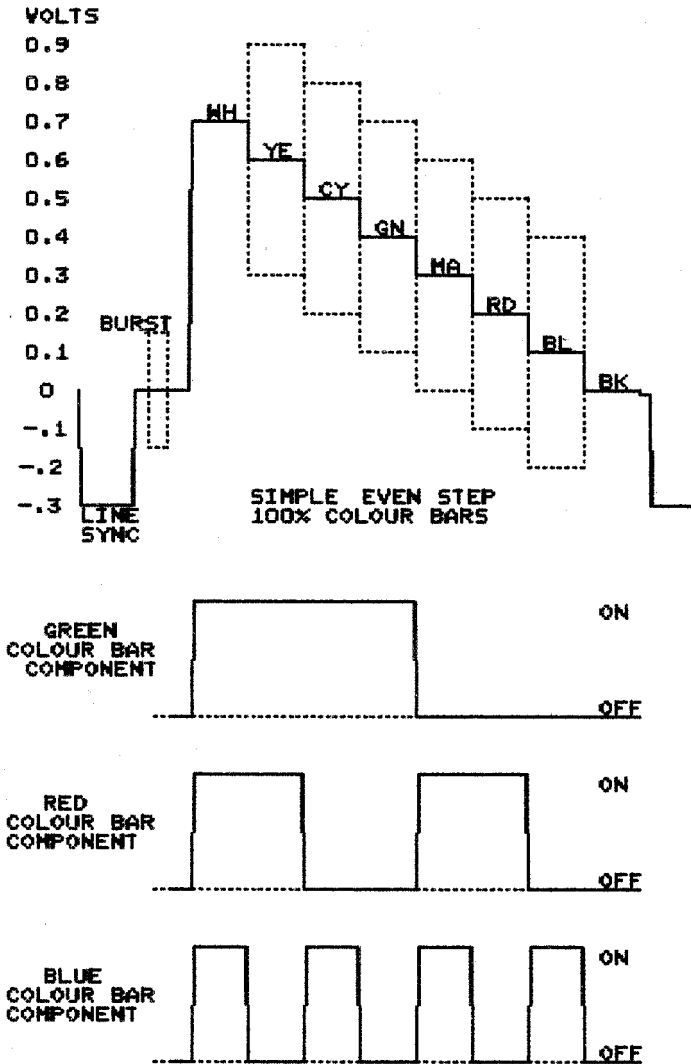

CRT Markings. The Vectorscope tube is etched with X and Y axis and small and large boxes showing the ideal and acceptable positions for colour bars. The colour burst is displayed along 2 reference lines 90 deg

apart that have reference angles marked astride the left hand axis (on axis for NTSC). There are 2 calibrated lengths on these lines for 100% and 75% saturated colour bar tests, the input gain is altered to match the standard used.

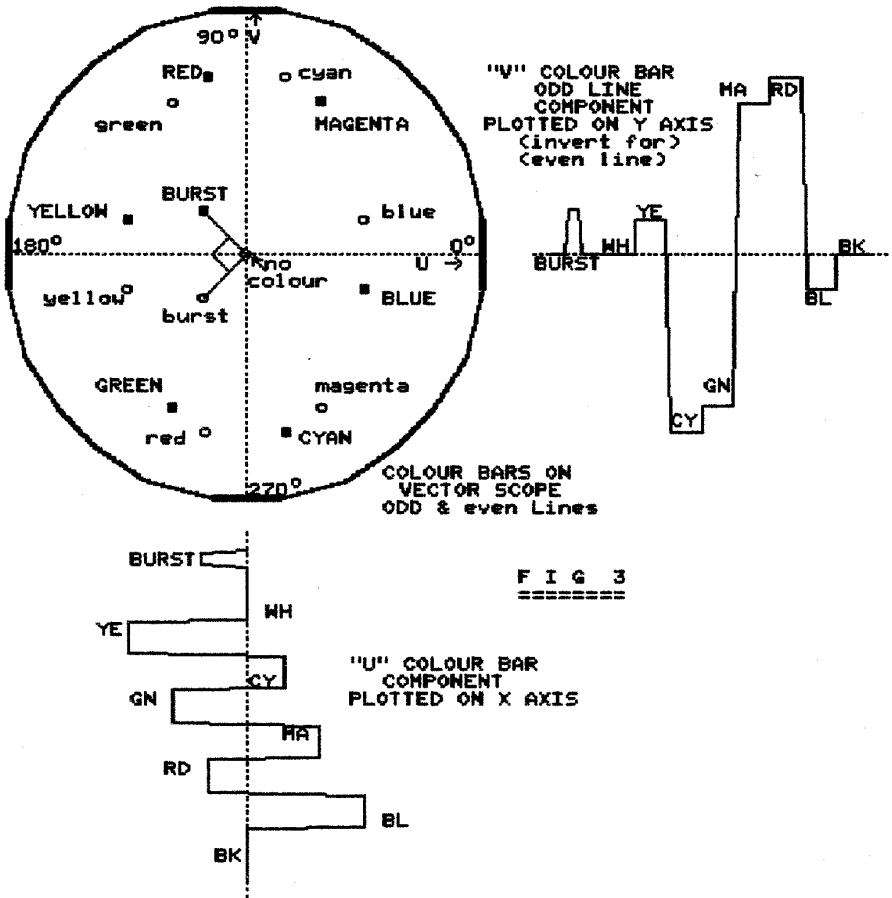

Calibration Signal. Most Vectorscopes have an in-built calibrator, this is actually an unlocked subcarrier of known amplitude, that decodes as a circle of known radius. When the X and Y decoder gains are maladjusted the circle becomes a vertical or horizontal ellipse. When the decoder quadrature is wrong the display shows two overlapping diagonal ellipses, as the calibration signal is switched by 180 deg. In line display mode calibrators give a 1 volt peak-peak reference line.

Other inputs. Most vectorscopes have local and external reference input, or even two separate display inputs, these are useful when comparing

Using a Vectorscope

genlock phase alignment (fig 4), frequency accuracy (beat with off-air), or differences in a colour signal through a device like a mixer, buffer amp, or just a length of coax. External subcarrier and syncs input are also often provided. With several inputs, there are normally separate phase rotation controls to allow for superimposition of the displays with different phases. Remember inputs should be correctly sourced and terminated in 75 ohms!

Line modes.

More complex vectorscopes also have conventional composite video line "scope" mode, as well as a filtered Y luminance, "V" or "U" coder colour component, and red, green, and blue full decode displays as in figs 2 and 3. These features let you examine in detail differences in a coder or colour source.

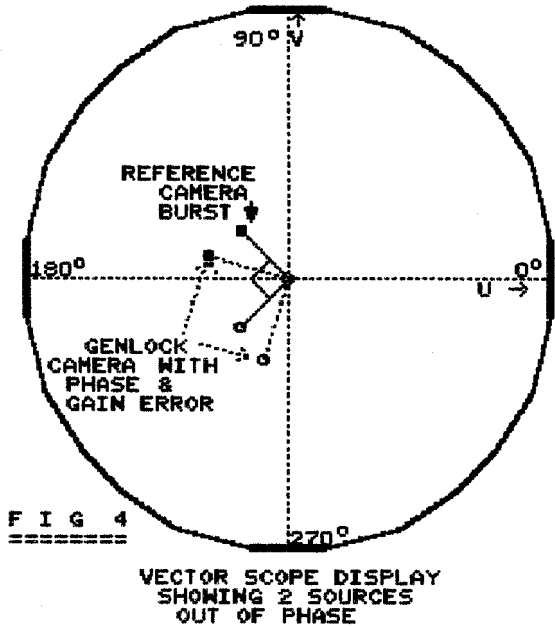

Colour Distortion measurements.

Other than just reading the error positions off the display in vector (fig 5) or line mode, measuring vectorscopes have differential modes "Diff Gain" and "Diff Phase". These need a special test signal that consists of a stepped grey scale (6 steps standard or line ramp) added to a constant amplitude and phase colour subcarrier except during the line syncs, fig 6. This test signal then can be put through any device such as a video amplifier, and the difference in colour subcarrier gain and colour phase distortion caused by the changing luminance level can be measured.

The gain change is measured with a the output of a highly amplified subcarrier level detector on a % distortion scale, fig 7. The phase change uses a precision variable delay line to move the highly amplified "V" signal trace until the phase change has been accounted for, then the exact delay angle can be read off the vernier delay line scale in fractions of

degrees of subcarrier, fig 8. This can show up the difference of just a few cm of cable length on genlocked cameras!

Triggering. As PAL has different colour coding between lines some vector scopes have an alternate line "V" signal switching to invert the display to provide a "double vision" version of the simpler 6 colour dot NTSC type of display. This is very useful for showing up in-balance in the PAL colour inversion coder circuit, as each colour is now a pair of dots near the ideal points. Alternatively the simpler 6 dot display can be obtained by blanking off the unwanted non NTSC (inverted) coded lines.

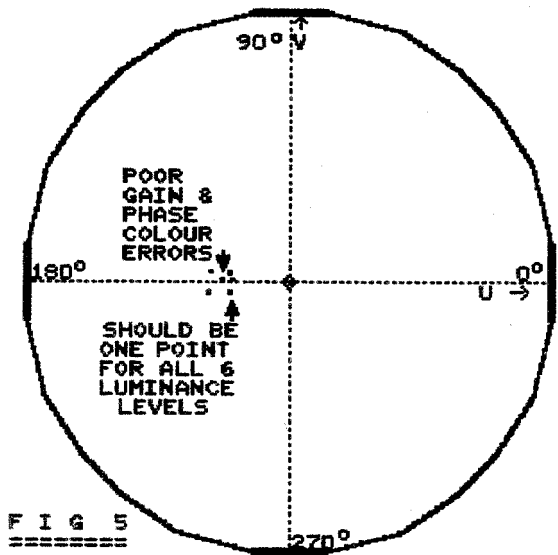

FIG 5
=====

VECTOR SCOPE DISPLAY
TEST SIGNAL

each colour is now a pair of dots near the ideal points. Alternatively the simpler 6 dot display can be obtained by blanking off the unwanted non NTSC (inverted) coded lines.

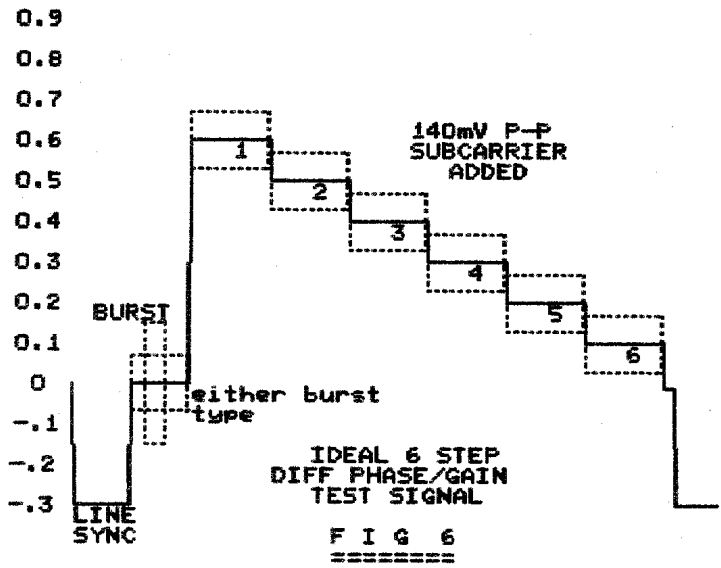
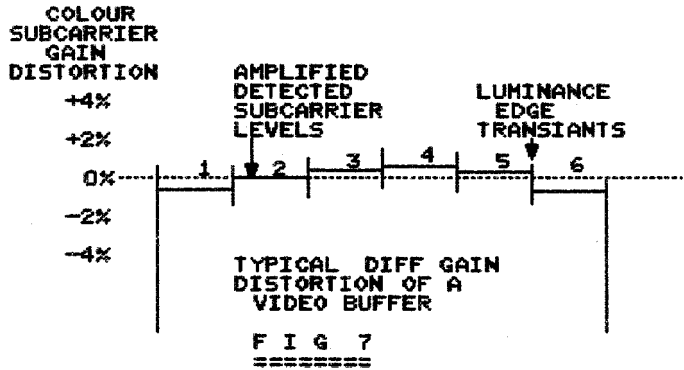

FIG 6
=====

VITS.

Vertical Insertion Test Signal (interfield) is used by broadcasters to measure (and automatically correct) the colour and luminance distortion of the Tx system almost frame by frame. It uses a 6 step colour test staircase, after a luminance and colour pulse and bars tests, fig 9 and 10. It is sent after the teletext on lines 19-20 and 332-333 depending on the broadcaster, other types of test lines are also sent. A VITS capable vectorscope usually has programmable counters for these test lines, and a bright up display to just display the line(s) selected.



In Use.

Some of the improvements to adjustments are very subtle on the PAL TV screen, but others can stop colour flickering, line pairing, reverse colours etc. With the PAL system many faults don't show up at all when the signal is P5 (which is why it is better than NTSC), but with weak amateur signals PAL coder can cause the colour TV receiver to struggle if the colour parts are not correct.

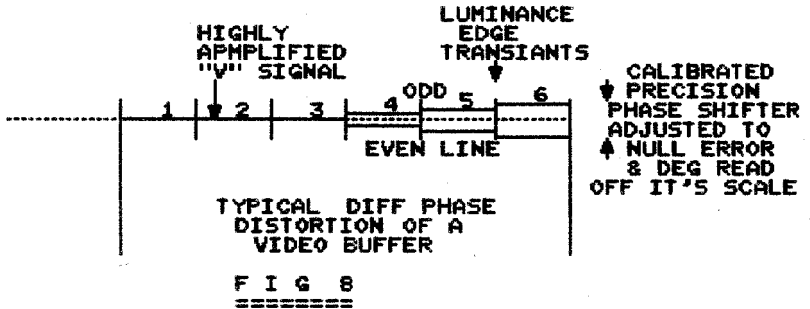

Using the vectorscope to show weak signals may be difficult as they are designed for P5 only. With some modifications for noisy syncs an

acceptable display can be obtained, allowing colour frequency to easily be compared and strange colour effects to be identified.

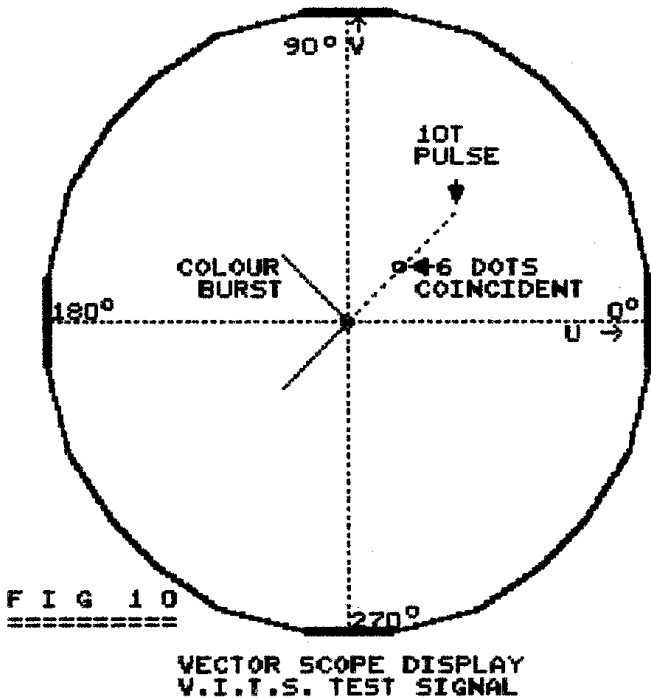
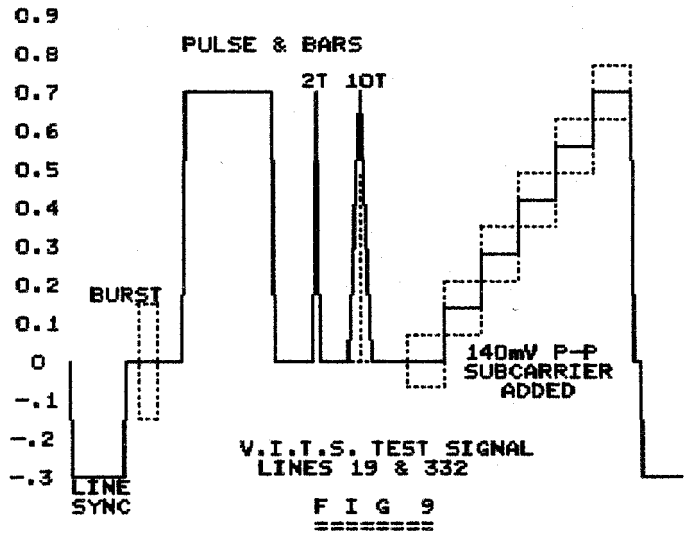

DX-TV RECEIVER SYSTEM

Variable vision IF bandwidth Multi-system sound

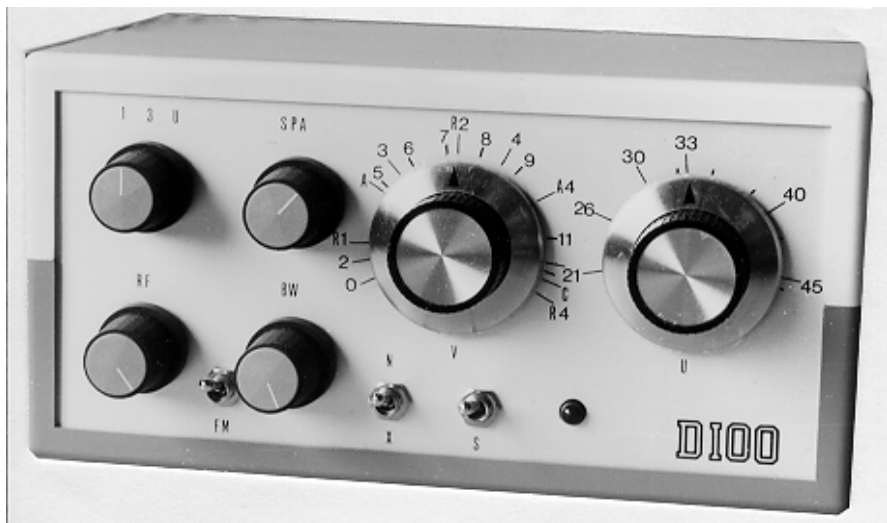

New 'SUPER-X' model now available, send SAE for more technical info now.

The D-100 'Super-X' receiver provides multi-system sound reception plus reduced vision I.F. bandwidth feature to recover signals normally lost in the noise when using a conventional I.F. bandwidth.

There are two outputs, one feeds a TV at channel 65 for vision, while another feeds an FM radio for sound. By simply matching the sound to the picture, multi-system reception is achieved, without the need for a special TV set.

DX-100 'SUPER-X' CONVERTER..... **£138-00**

Illustrated Catalogue of Equipment & Publications only £0.75
(refundable with the first order)

We can also manufacture aerials to your own design (one-off or multiples),

HS PUBLICATIONS

7 Epping Close, Derby DE22 4HR, England

Tel: 01332 38 16 99

Now that GW3FDZ...

By Derek Whitehead, GW3FDZ

Now that GW3FDZ (Derek in Dyffryn Ardudwy) and GW0GZQ (Pat in Moylgrove) are regular viewers on 23cms of each other they are getting itchy feet to establish some new links to Eire with EI3FW and hopefully others as a previous link on 70cms is now ruined by what appears to be local telemetry by Railtrack (shared band!!!!)

In view of this plans are being prepared for a test of various routes with the help of the N.Wales group during the early Bank Holiday in May. This stalwart northern group consisting of GW3JGA (John), GW4KAZ (Brian), GW8PBX (David) and GW8FEY (Barry) therefore promptly decided that it would be a good idea to test out paths to Derek and Pat from the proposed first site which would or hopefully could be used in the future as a jumping off point to Eire. The chosen spot was the site of the local TV transmitter at Arfon which is situated half way between Porthmadog and Caernarfon at a height of 1000feet. It was also decided that at the same time they would take a look at how good a signal could be received at this site from GB3TM, the ATV repeater on Anglesey.

Tuesday the 10th of May was the day of reckoning. The group set off from Bangor in N.Wales around eleven am with Brian as an advanced guard. The inevitable happened in that the weather was absolutely atrocious with mist to the ground and a relative humidity of one hundred per cent. Meanwhile, Derek and Pat in their *warm* shacks were busy tweaking equipment waiting for the call on two metres. Our stalwart group on the other hand by now thoroughly soaked and wondering what on earth they were doing at such an unearthly spot excelled themselves by getting all their mobile equipment in operation. The following report which was sent to all concerned by e mail in the evening explains all.

Quote:- The wind was light, just as well as we could not find any suitable fixings for the mast and had to resort to the armstrong method (Barry.)

Technically all went well, the signal from 3TM through the 1316 MHz filter was P5 free of any other signals. Without the filter there were spurious broadcast signals all over the band. When receiving signals from Derek at P5, there was no problem but when we turned the beam, say 10 degrees, the signal dropped and then the spurious signals reappeared. With Pat, it was more difficult, the beam heading was much more critical and although we received a P4/5 signal it fluctuated considerably and broadcast signals would capture the receiver at times.

Now that GW3FDZ...

We used two receivers, a Maspro Sat RX with Gas Fet pre-amp and 5 pole filter for GB3TM and a home built one based on a Wood & Douglas module but with no preamp. This second RX is not as sensitive as the other but overloads less easily. The ant was a 3JVL loop yagi - good performance. The antenna was about 5m yagi. The TX was a Worthing kit driving a Mitsubishi module providing about 16 watts output.

We also tried a Sevenside long yagi and two other receiving setups, a Camtec and another Maspro and results were again very encouraging. Unquote.

Attached are pictures received by the warm shack group, which explains all. In view of the incredible success of this venture it is now certain that the first weekend in May is definitely on.

Watch this space!

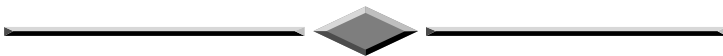

Bob Platts setting up for 'across the sea to Holland' microwave ATV



Please send all correspondence for **Post and News** to the CQ-TV Editor. Ian Pawson, 14 Lilac Avenue, Leicester, LE5 1FN, England.

Tel: 0116 276 9425.

E-mail editor@batc.org.uk

ATV news from Auckland

January 1998

Grant ZL1WTT, Quentin ZL1QF & Ralph ZL1TBG have had some good contacts on 23cm FM-ATV these holidays. 40km path worked both ways from Whitford to Albany hill. 80km path worked both ways from Whitford to Dome Valley (where the Rodney 730 repeater is located). There were relays of the received signals (in colour with sound) via 70cm from Whitford & Albany hill to ZL1BQ ATV repeater channel 39 Nihiotupu. Radar QRM showed up as horizontal white lines across the screen of varying intensity (as the radar scanner turned).

The transmitters were homebrew (2 to 5 Watts) and the receivers used TVRO tuner units with high gain preamps. The aerials were long loop Yagi, quad radiator broadside array multiple and long linear Yagi.

Circuit boards for a 23cm FM ATV exciter are available from Wayne Griffin ZL1UJK phone 09-5289118. A PLL unit, for the exciter, using locally available components has been prototyped. A board, for it, is coming out in February. A complete set of boards for the German/Australian Stereo sound system (5.5MHz + 5.74MHz subcarriers), including the stereo matrix/de-matrix and the 54kHz modulated pilot signals, is nearly ready as well. Stereo sound is used all the time on 23cm contacts from Wayne ZL1UJK @Glen Innes to Grant

ZL1WTT @Redoubt rd, Manukau.

The next ATV net on the 70cm National system is to be held on the last Wednesday evening of January (the 28th) at 8pm. If the channel is busy, the net will start as soon as it becomes free. Grant ZL1WTT is to be the net controller. 73 de Michael Sheffield

Michael Sheffield ZL1ABS, 176 Albany Highway, Albany, Auckland, NZ 1331. Phone 00649 4159584; email zl1abs@xtra.co.nz, Packet ZL1ABS@ZL1AB.#11.AKL.NZL.OC

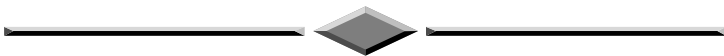

We have received a letter from ANTA, the French ATV association, sending good wishes to all 'friends' for the New Year. 'Friends' because we are all TV amateurs.

In this letter was an account of the General Meeting of ANTA and one of the items concerned the proposal by the French Civil Aviation Authority to set up some powerful Radar transmitters in the Paris region and also at Strasbourg and Mulhouse-Basle, these would be working on a frequency of 1255MHz.

Thanks to a protest by ANTA a meeting was arranged on 14th October last to discuss the matter and was attended by 4 ANTA members, F1NSU, F3PJ, F3YX, and F8MM; in addition on the amateur side were three observers from other radio amateur associations. On the other side were 7 representatives of the Administration covering the Aviation, Military and Frequency Control Authorities. The meeting was very cordial and ANTA was assured that every effort would be made to ensure that TV amateurs could co-exist with the requirements of the Civil Aviation Authority. A second meeting is planned.

We should congratulate our French friends that they have succeeded in establishing a warm and friendly direct contact with the Authorities and wish them every success in their endeavours.

The next General Meeting of ANTA is on April 19th in the morning at a VHF/UHF rally at SEIGY, dept 41

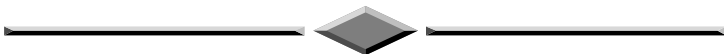

24th May 1998, 22nd East Suffolk Wireless revival, Ipswich, Stoke High School. SSE of the main railway station, map ref. TM164435. Radio and computer rally open 10am until 4pm. Talk-in on S22. Details from Sam Jewell G4DDK. Tel: 01394 448495. Email: jewell@btinternet.com

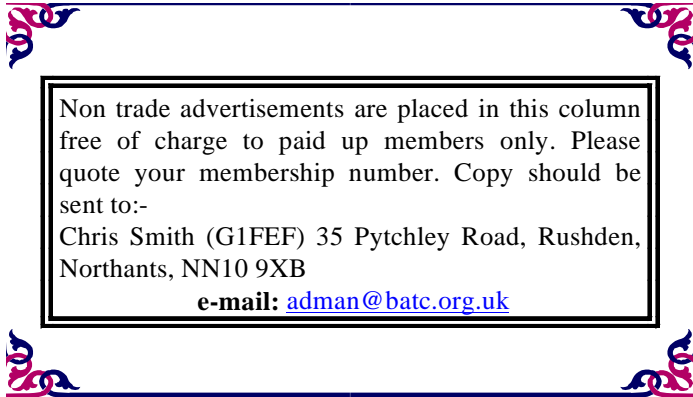

For Sale

Sony PAL superimposer SMI-7074P with genlock, cache disk and SMC-709G microcomputer/keyboard. With handbooks and software. Condition unknown but likely psu fault. First £50 secures. System DVP by 'GML' with control unit. Appears to be some sort of 2-channel digital video effects processor. And in very clean condition. Offers? Lots of Barco video projector spares, lenses and accessories still available, plus a couple of projectors. *Contact Trevor Wiltshire, G8AKA. Tel: 0118 970 1163*

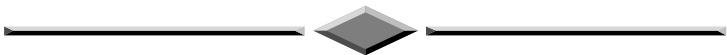

Video Production / Post Production Equipment For Sale

Cameras 2 x Panasonic MS1 SVHS camcorders complete with hard carrying cases, charging units and a number of batteries £675.00 ono each.

Tripods 1 x Manfrotto tripod professional model *Q75 with fluid effect head and ball joint level adjustment £95.00

1 x Slik easi glide video tripod with fluid effect head £45.00

Microphone 1 x Sennheiser condenser microphone £45.00

Vision Mixer 1 x Panasonic WJ MX 30 Vision mixer £1,875.00 ono

Edit controller 1 x Panasonic VW-EC31O 5 pin edit controller £225 ono

Recorder 1 players 2 x Panasonic FS 200 SVHS super 4 head video player / recorders with TBC and Nicam Hi Fi stereo £675 ono each

For Sale

Monitors 2 x Panasonic TO 14 Ri audio 1 video inputs £85 each 1 x Sony PVM 1300E with ROB input £85

CD_Player 1 x Technics SL -PG34OA CD player £95

Most of the equipment is complete with boxes and instructions. For further information please telephone **Harold Brent, GOEZW on 01773 810010**

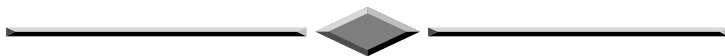

Shack sale

CQ-TV type callsign generator with built in p/s	£50.00
phillips mono camera with p/s	£45.00
12" mono video monitor	£5.00
12" video video monitor	£5.00
9" green screen video monitor	£5.00
phillips perdio mains/batt 405 tn collectors item	£50.00
vhf linear needs repair 75 watts	£10.00
roberts radio mains/batt collectors item	£30.00
pye case type batt radio collectors item	£25.00
drae 13.5 volts 12 amp p/s	£50.00
sanyo betamax vcr	£25.00
14" colour tx9 tx with video/audio in/out	£50.00

Sinclair spektrum 48k built in dk/tronics keyboard with tape. Recorder + software two speke type printers + other hardware £75.00

70 cms preamp	£5.00
70 cms preamp	£5.00
microwave modules frequency counter	£50.00
v.l.f. Converter	£25.00
6 metre converter	£15.00
pair of cb txirx hand helds	£5.00
70 cms atv cqtv type converter with built in psu	£10.00
3.5 MHz to 150 MHz vswr metre	£15.00
datong morse tutor "model d70"	£40.00
multi band hand held type radio	£5.00
realistic 6 channel hand held type scanner	£5.00
microwave modules 70 cms atv down converter	£50.00
3.5 MHz to 150 MHz vswr metre	£5.00
Fortop 70cms atv rxitx	£150.00
micro head boxed large	£10.00
micro head boxed small	£5.00
9 volt/500ma p/s/u	£2.00

12" Pye b/w portable tv	£10.00
8" Sony b/w video monitor	£10.00
8" Hitachi b/w video monitor	£10.00
HMV 405 b/w portable tn collectors item	£15.00
airmec normende colour pattern generator	£125.00
prism 1000 modem	£5.00
micron ax12400 modem	£10.00
12" colour portable tn Hitachi	£75.00
14" colour r.g.b. monitor	£75.00
5" b/w nat pan tn	£10.00
chromascope p135	£125.00
70cms t/jx r/x 10 watts tn transceiver	£50.00
frdx 400 H.F. receiver	£75.00
16" remote teletext colour t/v with video input	£75.00
betamax Sony c5e video recorder	£20.00
betamax Sanyo video recorder	£20.00
vhs Ferguson videostar video recorder	£85.00
compuadd 14" vga colour monitor	£45.00
kw 2000a hf 100 watt transceiver with p/s	£75.00
avo8 marks	£75.00
khp 30 high voltage probe	£15.00
trinicon colour camra	£65.00
Sanyo camcorder with leads 2 batts charger ect.	£135.00
deac cc3o6c nicad charger	£40.00
heathkit daystrom afirf sig gen	£45.00
heathkit c3u r-c bridge	£40.00
12 to 15 volt 10 amp p/s	£35.00
12 to 15 volt 7.5 t0 14amp p/s	£35.00
70 cms preamp kit still in box	£5.00
bbc b computer with twin disk drives and plinth	
+ lots of software ect	£150.00
23cms ATV t/x r/x 1 watt output	£150.00
23cms100 watt atv pa 2c39a	£350.00

Please contact Brian Bean, G6PKS on 0181 304 3992 (evenings and weekends.)

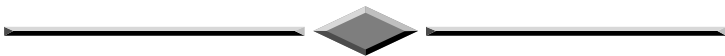

Panasonic camcorder M10 fill size VHS with hard case and spare battery £330. **Contact Mr. B. Bambury of 01386 830863.**

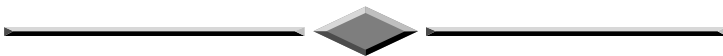

TV Typewriter as featured in a recent issue of CQ-TV, overlays text on standard 625-line video signal. Fully tested, works superbly. Neatly boxed in grey/white Verobox, complete with keyboard (you just add a 9V wall-socket power supply). Offered below cost at £100. **Andy Emmerson G8PTH, 71 Falcutt Way, Northampton, NN2 8PH. 01604-844130.**

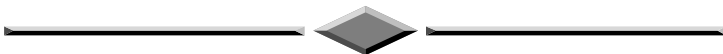

For Sale or swap.

PCB's for Grass Valley video switcher model 100, Control processor, Video processor, power supply and cpu for control panel. Only missing from complete, control panel and enclosure. This is easy to build because cpu is there. Complete with all manuals for model 100 swap for twt 24GHz or 18GHz. (for use on 24GHz). **Offers to: Hans Holsink PE1CKK van Kinsbergenlaan 43, 1215RP Hilversum, Holland. Email hansckk@dutch.nl**

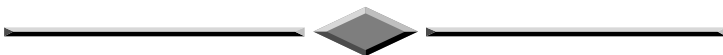

Blue cap LNBs for sale £2 including postage. Various satellite receivers for sale many makes available cheap prices from £5 each. New 60cm mesh dish reflectors. £4 each. New, boxed 35cm BSB dishes with LNBs complete £15 each. Spares and hard to get components for Worthing/Solent ATV transmitters. Call or Email for more details. See my home page: home.clara.net/johnnyg/index.html

Contact: John Grandshaw , G8IKP, QTHR, 01305 832548 . Email: johnnyg@clara.net

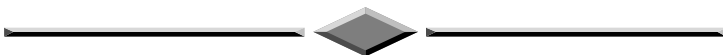

For Sale...Video 2000 Full technical manual for Philips VR2020. Large, about 2" thick. £10 + P&P. **Contact Grant Dixon on 01989-562715**

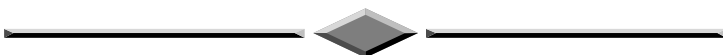

Chokes:Parmeko Neptune 20H 80m/A, 50H 25m/A and 5 open frame unmarked (1 1/2 to 2 1/2 lbs.ea.) £15.00 Home brew 250/300 volt stabilised supply -500-350-0-350-500 120mA to 5Z3 rect. 2x4uF 750V metal cased caps with choke to 2x807 output valves. Separate LT supply Trans. £25.00 Pair 12E1 valves to improve the above £10.00 CRT 7BP7A £5.00 2 x Londex Co-Ax relays type 7026 with plugs for 3/8" solid co-ax. #10.00 3 x 8 foot lengths 3/8" solid co-ax fitted same plugs as for relays £5.00 Postage extra but most items rather heavy so prefer collect. **John Kanaar, Crowthorne. Tel:01344 776342**

Wanted

Needed to fix a System Video 1204A waveform monitor:-

1 mains transformer (Any 1200 series transformer should do)

1 CRT D14-221 GH (but ideally GH-SV2)

Please contact:- **Tony Jaques, G3PTD, 88 Sandy Lane, Stretford, Manchester, M32 9BX. Tel and fax 0161 865 9398.**

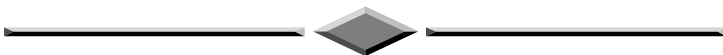

Does anyone have a Lens for Sony DXC-M3P colour video camera. I need the correct lens with auto iris control. It appears to have a very long focal plane to mount distance due to the three tube optics. **Bill Hall G3RMX 52,Barleygate, Leven, Beverley, East Yorks HU17 5NU Telephone 01964 542534.**

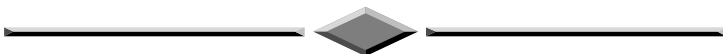

Wanted : Two Numicator tubes (neon number displays), ITT type 5870S as used in Advance TC17 counter. **Pete Carliell 12 Huntsmoor Rd, Ewell, Surrey. 0181 3379688 Email: peter.carliell@bbc.co.uk**

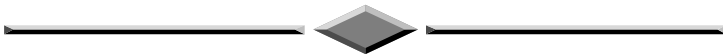

For my collection of working historic microphones.

BBC/STC 4104, or equivalent, commentators 'lip' microphone. STC 4021 'Apple & Biscuit' moving coil microphone, also the STC three-pole cable connector that plugs into the back of the 4021 and other STC microphones.

Index of Advertisers

Bird Elements for my Model 43, any of the following would be of interest, 25E, 50E, 100E, 25J, 50J, 25K, 50K.

John Lawrence GW3JGA, 40 Aberconway Road, Prestatyn, Denbighshire, LL19 9HL, (01745) 853255. Email: jlawrence@enterprise.net

Index of Advertisers

GB3XT Kits and Bits5
HS Publications86
Mainline Electronics77
Sevenside Television Group40
VHF Communications33
Worthing & Districe Video Repeater Group.....9

