

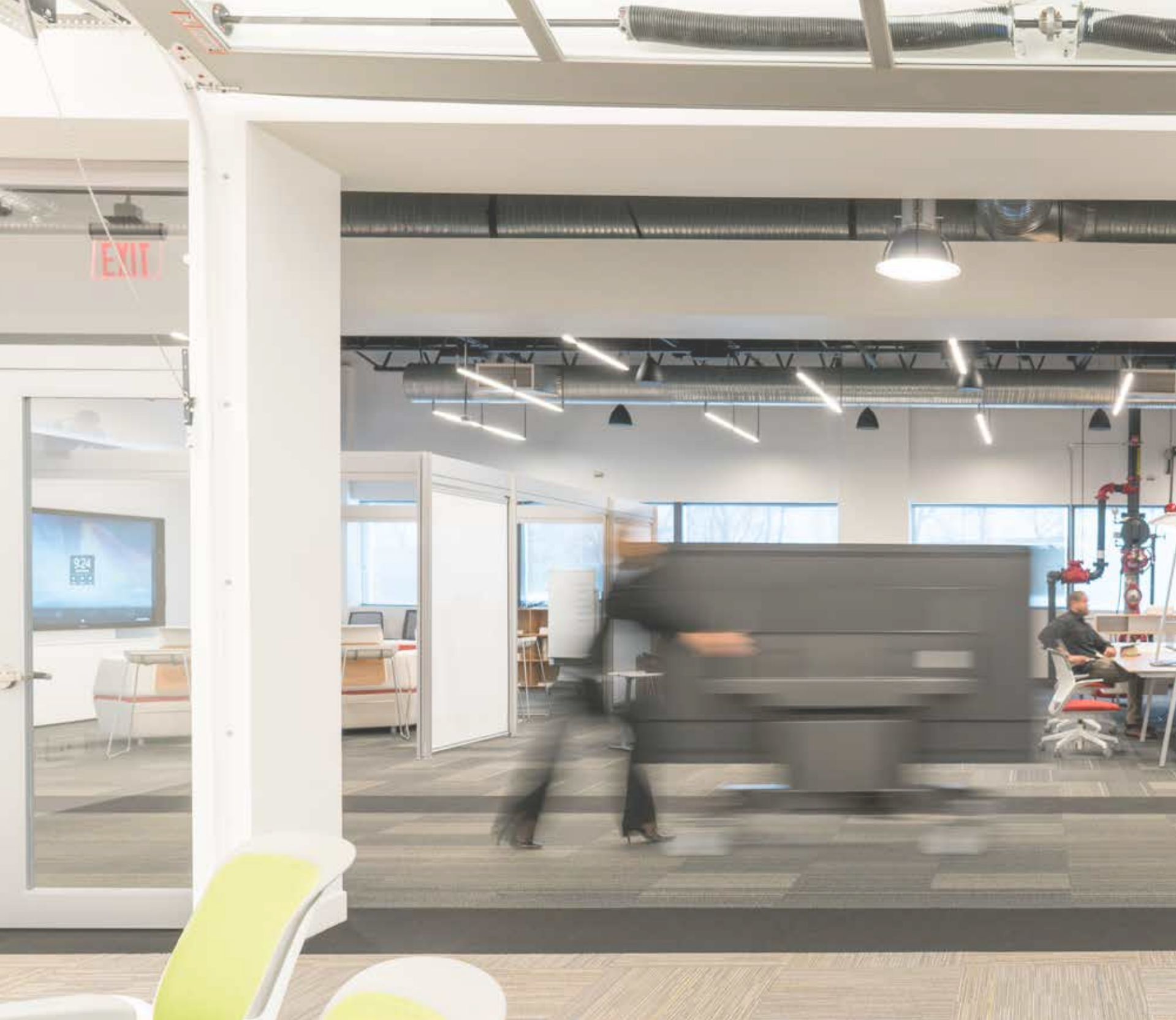

**ADVANCED**  
**WORKPLACE**  
SOLUTIONS



# ADVANCED WORKPLACE SOLUTIONS



<b>CUSTOMIZABLE CABINETS</b>	<b>08</b>
Low Profile Cabinets	10
Standard Profile Cabinets	12
Deep Profile Cabinets	14
Styles	16
Video Mounts	18
Camera/Speaker Mounts	20
Interiors	22
Accessories	30
Preconfigured Solutions	35
Projector Cabinets	40
<b>DISPLAY STANDS</b>	<b>42</b>
Electric Lift Mobile Stands	44
Fixed Height Mobile Stands	46
Microsoft Surface Hub 2S	48
Cisco Solutions	50
Accessories	52
<b>ON-WALL SOLUTIONS</b>	<b>54</b>
Strut 170 Wall Stand	55
Electric Lift Wall Stand	56
ADA Rail System One	57
Manual Lift/Tilt Mounts	58
<b>TABLES</b>	<b>59</b>
Unifi Huddle	60
Unifi Huddle Lite	62
Unifi Meeting Tables	64
Infiniti Meeting Tables	66
<b>PARTNERS</b>	<b>68</b>
<b>DESIGN &amp; ENGINEERING SERVICES</b>	<b>69</b>
<b>ORDER GUIDE</b>	<b>70</b>



# MAKING YOUR WORKPLACE AN EXTENSION OF YOUR WORKFORCE

It's not furniture – it's the most important set of tools you provide to your employees and visitors.

At Salamander Designs, we get it. We've been designing and manufacturing premium quality furniture for residential and commercial audio/video integration for more than 25 years. All products are custom made in a 100% solar-powered USA facility, quick shipped within days and backed by a lifetime warranty which includes the most superior support.

Salamander's expert design team and build-to-order formula serve a wide range of markets and a commanding cross section of global companies including General Electric, Sony, Microsoft, ExxonMobil, Bank of America and Dell.

Our advanced, flexible solutions are carefully designed to support Integrators, Architects, Designers, Facility Managers and everyday users.

And we treat every customer as if they were our only customer. That's our promise to you.

“As we ramped up our Boston Interim Site build-out, we turned to Salamander Designs for quality solutions geared to our needs. They provided high quality, innovative, customized, AV-integrated products with quick delivery. We gained installation efficiencies and seamless execution.”

- Tom Kapitan  
GE Senior IT Leader Digital Operation



Designed in a  
100% solar powered  
USA facility



Uniquely  
quick-shipped  
within days



Backed by superior  
service & lifetime  
warranty



MADE IN USA

# TECH-CENTRIC FURNITURE SYSTEM

Everything we produce is technology-centric. This means, not only is it beautiful, it's engineered to perform for every AV application and customer you encounter. And, for a lifetime.

You can expect timeless styles and maximum flexibility for professional AV cabinets, mobile flat panel stands, motorized stands, on-wall solutions and more. Whether budgeting a capital expenditure to equip your entire workforce or purchasing one low-profile cabinet to upgrade your reception area, we provide expert engineering, design and manufacture for all your needs.

Salamander products deploy quickly, and are upgradeable and retro-fit friendly. Our adaptable furniture supports ever-changing technologies and is easily refreshed in lieu of replacement. Simple to install, technologically savvy and built to last. Guaranteed.



Most technologically savvy, flexible products available

Faster, far less costly installations

All Compliance and Certifications so you can specify with confidence

Complete AV solutions with designer style & extraordinarily long life



**RAPID  
DEPLOYMENT**

**Exceptionally rapid  
deployment – days  
rather than weeks**

**REDUCE**

**Reduce other trades,  
saving time and money**

**Turnkey systems that  
decrease wall cutting and  
running wires**

**TURNKEY  
SYSTEMS**

# BY YOUR SIDE, AT YOUR SERVICE, WE DELIVER

Successful custom integration requires the perfect storm of skills— that’s what sets you apart from your peers. We get that.

We also know having the right team involved from start to finish of your project gives you peace of mind knowing your reputation and customers are in capable hands. Salamander has the experience you need for successful product development — core systems, plus custom design, engineering and manufacturing knowhow that brings your product quickly to life.

**Our modular solutions move much faster from decision to delivery. We build turnkey systems in the US and quick ship. You save time, money and hassle. AND we can assist with refurbishing and upgrades, including finish matching.**

We can help speed up the entire project, as our unique modular configuration allows you to pre-wire and set up rack cart systems in advance. Installations come together faster as items arrive. Your team can reposition, service and upgrade systems in hours – rather than days.

# CUSTOMIZABLE CABINETS

All pieces are built to order, manufactured in the USA and backed by a Lifetime Warranty. Select from our wide variety of styles, materials, sizes and finishes of furniture to support technology, unified communication and maximum user engagement with designer style.



## DESIGN YOUR OWN IN 5 EASY STEPS

- 1 The Frame** - Choose from four frames in various heights & widths.
- 2 Style** - Select a style with top and footing options.
- 3 Display** - Integrated mounts support single or dual monitors.
- 4 Interiors** - Outfit each bay with functional storage, pro racks and more.
- 5 Accessories** - Enhance the performance of your cabinet with accessories.

### PRECONFIGURED SOLUTIONS

For quick ordering, start with a preconfigured cabinet solution. See page 35.

#### Cabinets Feature:

- Aluminum frame
- Designer styles
- Wire management
- Soft-close doors
- Adjustable interiors
- Fully customizable



- 1 Frame
- 2 Style
- 3 Video Mount
- 4 Interiors
- 5 Accessories



Designed For Touchscreens



Ergonomic - minimal screen reach



Wall Mounted - provides convenience and frees up floor space



ADA COMPLIANT SOLUTIONS

## 12" DEEP MODELS

### Designed for Interactive Flat Panel Displays

Low-profile, shallow depth cabinets are sleek, streamlined solutions for supporting AV/IT technology. Our innovative design conceals all equipment and cables, and simple installation allows them to be affixed to any wall without special preparation. A unique, shallow depth provides a comfortable working position for interactive display users.

\* Shown with optional video mounts and interiors.

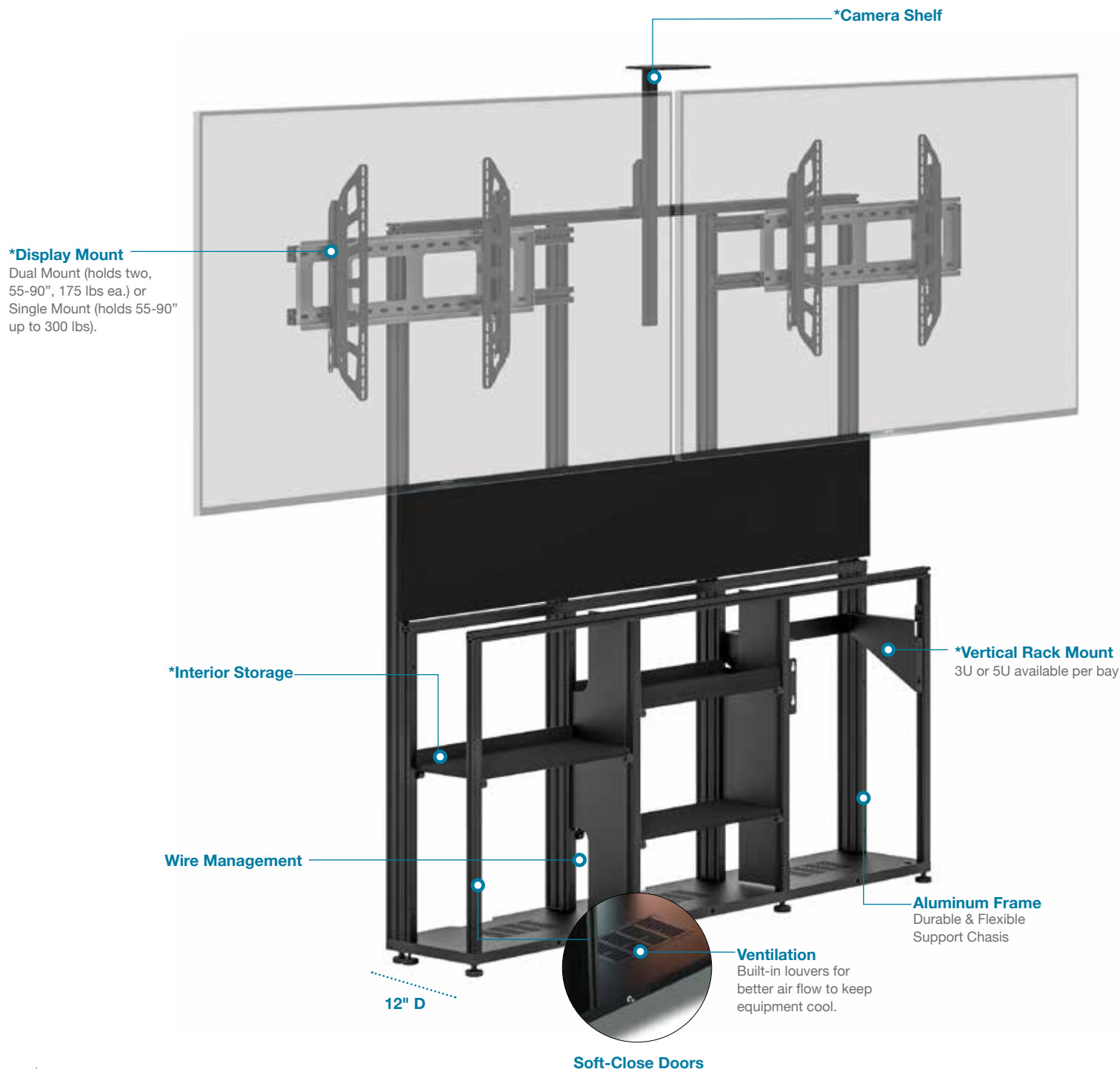

### 8 BAYS

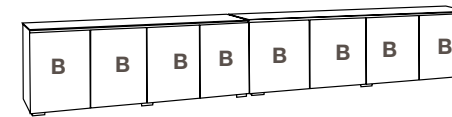

**C/D1/387/**  
~171"W x 31.25"H x 12"D

### 4 BAYS

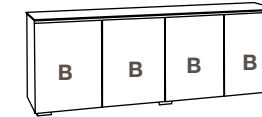

**C/D1/347/**  
~85.5"W x 31.25"H x 12"D

### 3 BAYS

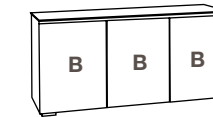

**Model: C/D1/337/**  
~64.75"W x 31.25"H x 12"D

### 2 BAYS

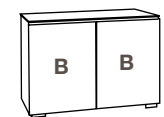

**C/D1/323/**  
~44"W x 31.25"H x 12"D

### 6 BAYS

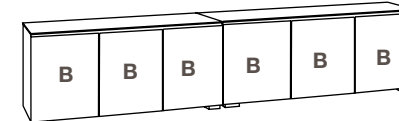

**C/D1/367/**  
~130"W x 31.25"H x 12"D

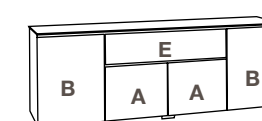

**C/D1/345/**  
~85.5"W x 31.25"H x 12"D

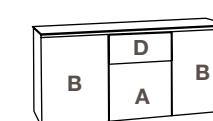

**C/D1/336/**  
~64.75"W x 31.25"H x 12"D

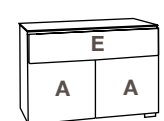

**C/D1/329/**  
~44"W x 31.25"H x 12"D

### 1 BAY



**C/D1/317/**  
~23.25"W x 31.25"H x 12"D

### Interior Dimensions

<b>A : Single-Width Compartment</b>	19.75"W x 11"D x 17.75"H
<b>B : Single-Width Compartment</b>	19.75"W x 11"D x 27.75"H
<b>D : Single-Width Speaker/Multi-Functional Compartment</b> * Includes Speaker Grill	19.75"W x 11"D x 9"H
<b>E : Double-Width Speaker/Multi-Functional Compartment</b> * Includes Speaker Grill	40.5"W x 11"D x 9"H

### Speaker Integration

Models 345, 336 and 329 accommodate a wide range of speaker types and sizes.



- 1 Frame
- 2 Style
- 3 Video Mount
- 4 Interiors
- 5 Accessories

- Designed for Integrated AV/IT
- Robust, Large-Capacity
- Low Impact Installation

## 21" DEEP MODELS

### Designed for Fully Integrated Technologies

These robust, large-capacity cabinet systems house all electronics, including integrated support for AV/IT systems. Freestanding and fully integrated cabinets are perfect for retrofit installations, allowing for quick and efficient installation.

\* Shown with optional video mounts and interiors.

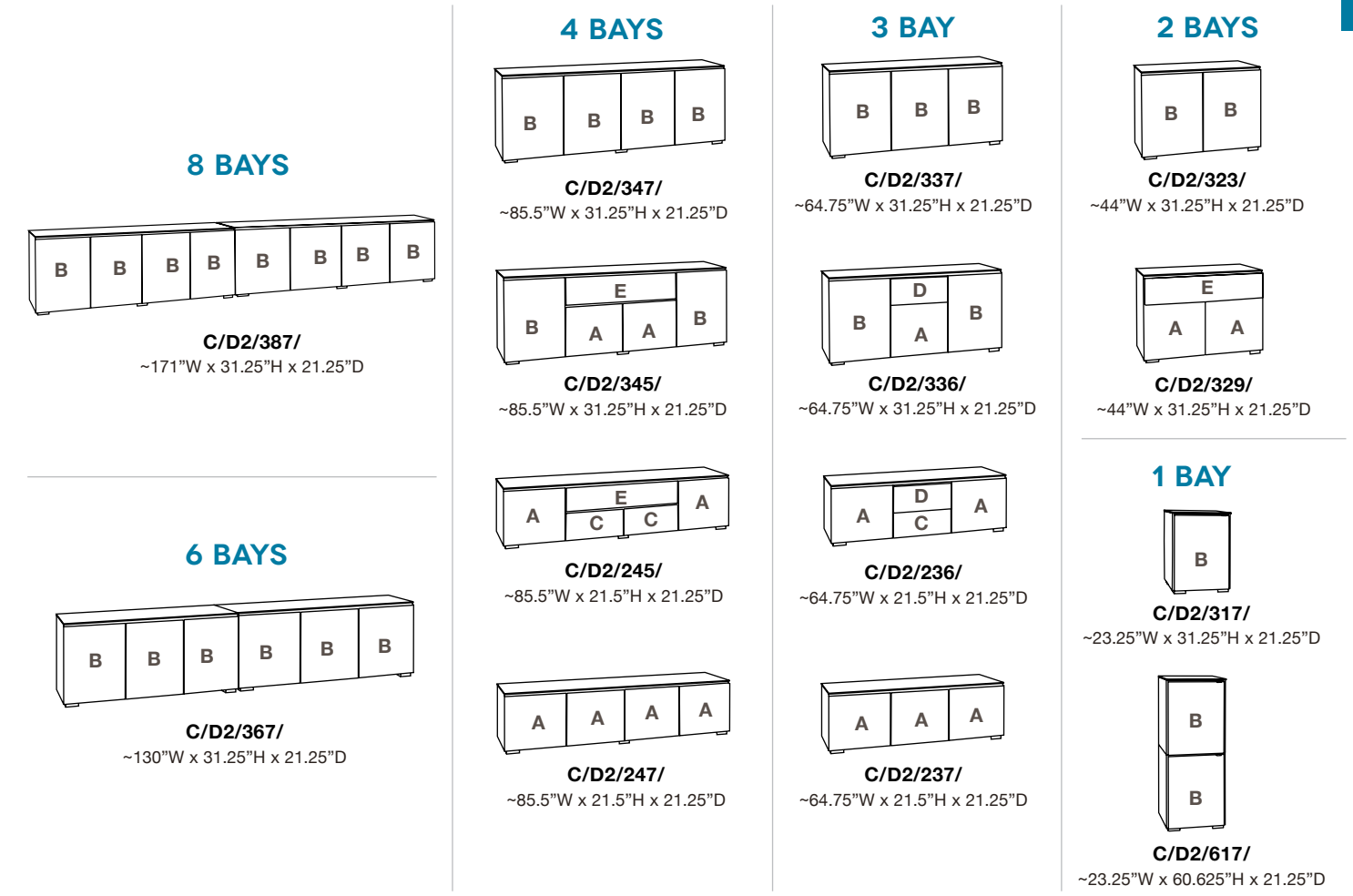
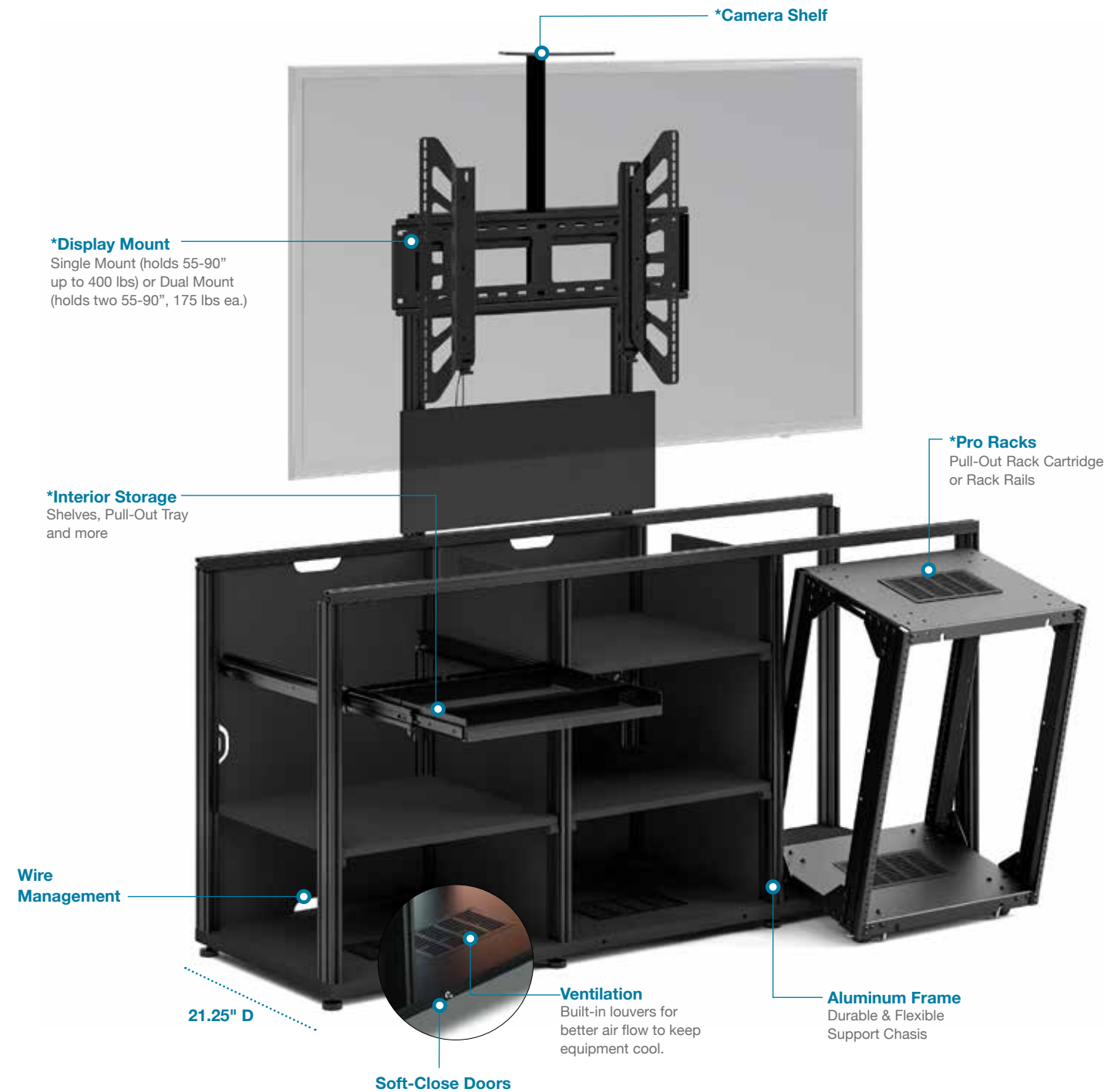

### Speaker Integration

Models 345, 336, 329, 245 & 236 accommodate a wide range of speaker types and sizes.



### Interior Dimensions

<b>A : Single-Width Compartment</b>	19.75"W x 19.5"D x 17.75"H
<b>B : Single-Width Compartment</b>	19.75"W x 19.5"D x 27.75"H
<b>C : Drawer</b>	18.625"W x 18"D x 7.75"H
<b>D : Single-Width Speaker/Multi-Functional Compartment</b> * Includes Speaker Grill	19.75"W x 19.5"D x 9"H
<b>E : Double-Width Speaker/Multi-Functional Compartment</b> * Includes Speaker Grill	40.5"W x 19.5"D x 9"H



- 1 Frame
- 2 Style
- 3 Video Mount
- 4 Interiors
- 5 Accessories

- Designed for Over-Sized Professional AV/IT Components
- Robust, X-Large Capacity
- Low Impact Installation

## 30" DEEP MODELS

### Designed for Pro AV/IT

Pro Deep Profile Cabinets accommodate extra-deep components, allowing easy access to rear connections and cabling, and providing storage for accessories and workplace technologies. Simple, low-impact standardized installation simplifies deployment.

\* Shown with optional interiors.

### 1 BAY

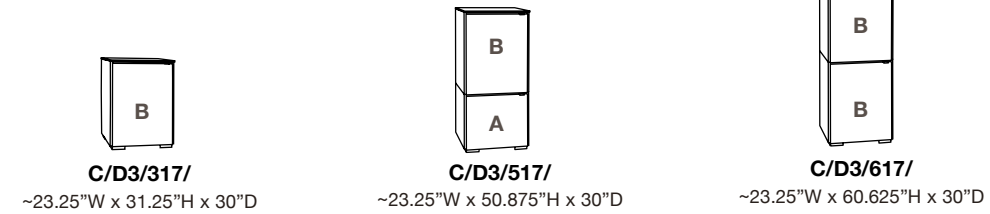

### 6 BAYS

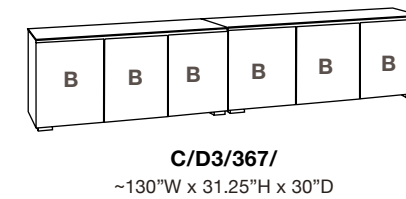

### 4 BAYS

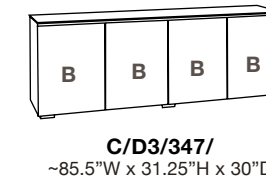

### 3 BAY

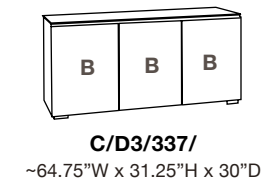

### 2 BAYS

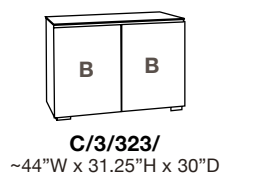

### 8 BAYS

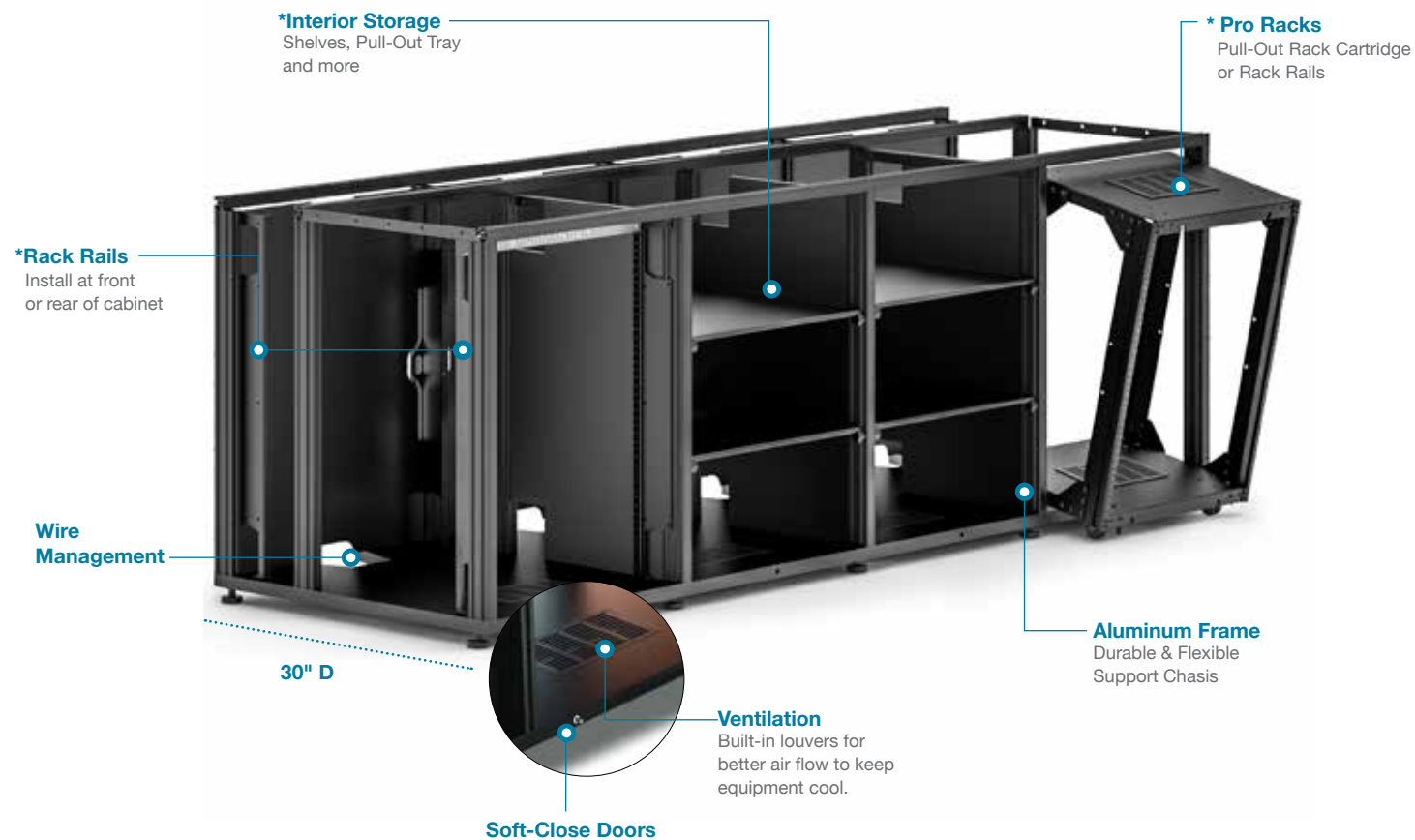
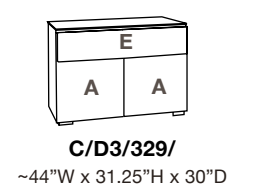
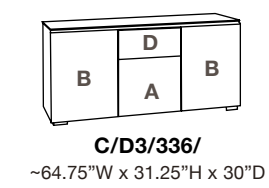
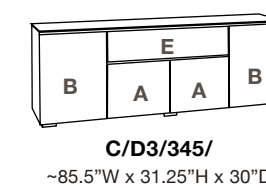
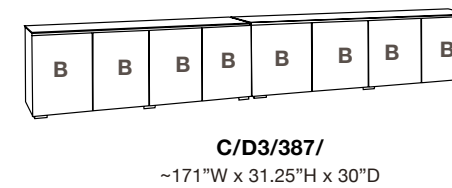

### Interior Dimensions

<b>A : Single-Width Compartment</b>	19.75"W x 28.5"D x 17.75"H
<b>B : Single-Width Compartment</b>	19.75"W x 28.5"D x 27.75"H
<b>D : Single-Width Speaker/Multi-Functional Compartment</b> * Includes Speaker Grill	19.75"W x 28.5"D x 9"H
<b>E : Double-Width Speaker/Multi-Functional Compartment</b> * Includes Speaker Grill	40.5"W x 28.5"D x 9"H

### Speaker Integration

Models 345, 336 and 329 accommodate a wide range of speaker types and sizes.



- 1 Frame
- 2 Style
- 3 Display
- 4 Interiors
- 5 Accessories



We select the finest materials and finishes. Choose from sleek, hand-polished, high-gloss finishes to richly textured real wood fronts or a contemporary beveled edge style with a mix of materials.















If you are looking for something different or special, please contact us to discuss custom options.

### Fixed Top Styles

\*\*Barcelona Style only available in standard profile.

### Styles

**\*All styles come standard with leveler feet.**

 <b>MILAN*</b> Dimensional, Diamond Pattern, White	 <b>MIAMI*</b> Gloss Warm White	 <b>ZURICH*</b> Opium Brown, Linear Texture Doors	 <b>SEATTLE*</b> Alpi Gray Oak, Vertical Grass Textured	 <b>CHICAGO*</b> Black Oak, Grass-Textured Doors
 <b>BERLIN*</b> Wenge, Wave-Texture Doors	 <b>DENVER – OAK*</b> Natural Oak, Bark-Textured Doors	 <b>DENVER – WALNUT*</b> Medium Walnut, Bark-Textured Doors	 <b>SIENNA*</b> Medium Walnut, Flat-Front Wood Doors	 <b>SIENNA*</b> Gray Walnut, Flat-Front Wood Doors
 <b>SIENNA*</b> Black Oak, Flat-Front Wood Doors	 <b>SIENNA*</b> Wenge Oak, Flat-Front Wood Doors	 <b>SIENNA*</b> Natural Oak, Flat-Front Wood Doors	 <b>SIENNA*</b> American Cherry, Flat-Front Wood Doors	 <b>**BARCELONA W/GW</b> Natural Walnut, Warm White Doors, Beveled Edge Top <i>*Matching Top Included</i>

Select a top to match your style.

### Solid Surface Tops – 1/2" (12mm) thick

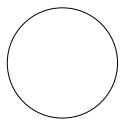
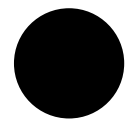
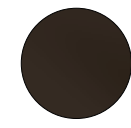
		
<b>Warm White Solid Surface</b>	<b>Matte Black Solid Surface</b>	<b>Chocolate Brown, Black Core Solid Surface</b>

### Glass Tops – 3/8" (10mm) thick

\*Glass tops only available on standard profile cabinets.



\*Black Glass



### Virtually unlimited design options with custom finish matching.

Match your finishes using our in-house finishing or spec a custom high-pressure laminate.



### Custom Finish Matching

Match your finishes using our in-house finishing department.

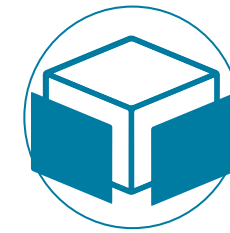

### Fabricate Your Own

Custom Millwork Specifications Available



### Footing Options

Complete a style with designer footing or wall mounting kits. Footing options are not available for Barcelona styles.

See page 34.



- 1 Frame
- 2 Style
- 3 Display
- 4 Interiors
- 5 Accessories



### XL Single Display Mount

<b>FI/CQ/PMXL/S</b>	<b>Single XL Display Mount for 4-Bay Cabinets</b>
---------------------	---

- Holds displays 65-100", up to 400 lbs (181 kg)
- VESA Compliant:  
Horizontal: 400, 600, 800, 1000, 1200mm  
Vertical: 400, 500, 600mm
- Centerline of screen 58" (473mm) (from cabinet bottom)
- 63" Vertical Posts
- Modesty panel included, choose black or matching wood



### Single Display Mounts

<b>FI/CN/PM/S</b>	<b>Single Display Mount for 2-Bay Cabinets</b>
<b>FI/CL/PM/S</b>	<b>Single Display Mount for 3-Bay Cabinets</b>
<b>FI/CQ/PM/S</b>	<b>Single Display Mount for 4-Bay Cabinets</b>

- Holds displays 50-103", up to 175 lbs (80 kg)
- VESA Compliant: Horizontal 200-800mm, Vertical 200-500mm
- Adjustable Center Line of Screen: 61.5" (1562mm) / 59.75" (1518mm) / 58"(1473mm) / 56" (1422mm)
- 63" Vertical Posts
- Modesty panel included, choose black or matching wood



### XL Single Display Mount

<b>FI/CQ2/PMXL/S</b>	<b>Single XL Display Mount for 4-Bay Cabinets</b>
----------------------	---

- Holds displays 65-100", up to 400 lbs (181 kg)
- VESA Compliant:  
Horizontal: 400, 600, 800, 1000, 1200mm  
Vertical: 400, 500, 600mm
- Centerline of screen 58" (473mm) (from cabinet bottom)
- 63" Vertical Posts
- Modesty panel included, choose black or matching wood



### Single Display Mounts

<b>FI/CN/PM/S</b>	<b>Single Display Mount for 2-Bay Cabinets</b>
<b>FI/CL/PM/S</b>	<b>Single Display Mount for 3-Bay Cabinets</b>
<b>FI/CQ/PM/S</b>	<b>Single Display Mount for 4-Bay Cabinets</b>

- Holds displays 50-103", up to 175 lbs (80 kg)
- VESA Compliant: Horizontal 200-800mm, Vertical 200-500mm
- Adjustable Center Line of Screen: 61.5" (1562mm) / 59.75" (1518mm) / 58"(1473mm) / 56" (1422mm)
- 63" Vertical Posts
- Modesty panel included, choose black or matching wood

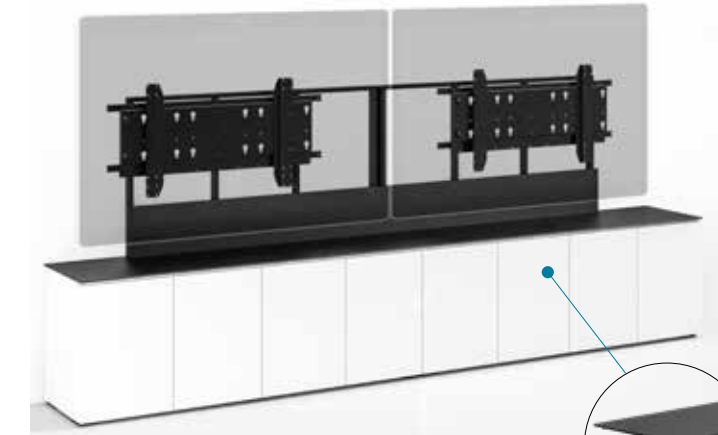

**Modesty Panel**  
Available in black or matching wood.

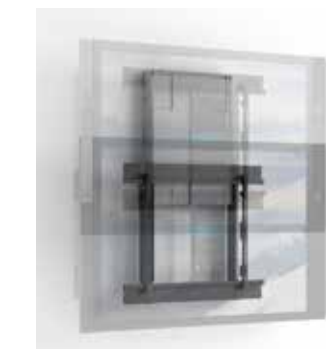
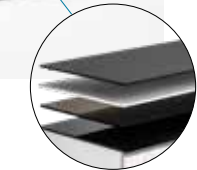

### EZ-Touch Lift Single Display Mount

<b>FI/CL/EZ2</b>	<b>Single XL Display Mount for 3-Bay Cabinets</b>
------------------	---

- Holds up to 65", 48 - 61 lbs (22 - 27.6 kg)
- VESA Compliant: Horizontal 200-800mm, Vertical 100-440mm
- Adjustable counter-spring provides smooth, effortless and intuitive high-low transition
- Vertical range is 15.7" (399mm)
- Extremely reliable; tested to 60,000 cycles or 10 years of usage
- Measures: 37.7"W (958mm) x 65"H (1626mm) x 6"D (152mm)
- Center line of Screen: 66"max (1676mm) - 50.5" min (1283mm)
- Bottom of Screen: 50"max (1270mm) - 34.5" min (876mm)
- Integrated mount with 11.75"H (298mm) black modesty panel
- Compatible with 3-Bay cabinets

### Dual Display Mounts

<b>FI/CL/PM/D</b>	<b>Dual Display Mount for 3-Bay Cabinets</b>
<b>FI/CQ/HDPM/D</b>	<b>Dual Display Mount for 4-Bay Cabinets</b>
<b>FI/CQSP/HDPM/D</b>	<b>Dual Display Mount for 6-Bay Cabinets</b>

- Holds displays (2) 55-90", up to 175 lbs (79kg) ea
- VESA Compliant: Horizontal 200 - 800mm, Vertical 200 - 500mm
- Adjustable Center Line of Screen: 61.5" (1562mm) / 59.75" (1518mm) / 58"(1473mm) / 56" (1422mm)
- 63" Vertical Posts
- Modesty panel included, choose black or matching wood

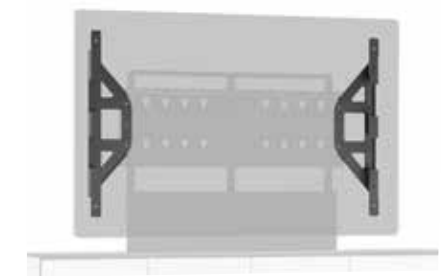

### Webex Board Pro Adapter Kit

<b>CA/MAC9</b>	<b>Cisco Webex Board 55 Adapter Kit</b>
<b>CA/MAC10</b>	<b>Cisco Webex Board 75 Adapter Kit</b>

- Adapter kit includes two interface brackets that mount to Webex Board Pro
- Compatible with Salamander Stands and Cabinets



### Cisco® Webex Board Pro Cabinet Solutions

Salamander cabinet systems house all electronics, including integrated support for AV and IT systems. Fully integrated, Salamander Cabinets are perfect for retrofit installations, allowing for quick and efficient installation without involving additional trades people to install electrical wiring or reinforce walls.

\*Available in several configurations and many finishes to match any decor.

- 1 Frame
- 2 Style
- 3 **Display**
- 4 Interiors
- 5 Accessories



Bring flexibility and finishing touches to every meeting system with Salamander’s Tech Shelves. Tech Shelves allow for an integrated camera to be placed above or below the display screen and are fully height adjustable for proper positioning. Use multiple Tech Shelves to support touch controllers.

## Tech Shelf

		Max reach from centerline of Display Vesa Bracket to Shelf	
		Displays 50" to 70"	Displays 75"+
FPSA/TS1/75	7"W x 5"D Tech Shelf 24" Post	23	NA
FPSA/TS2/75	7"W x 5"D Tech Shelf 36" Post	NA	34
FPSA/TS1/128	12"W x 8"D Tech Shelf 24" Post	23	NA
FPSA/TS2/128	12"W x 8"D Tech Shelf 36" Post	NA	34
FPSA/TS1/278	27"W x 8"D Tech Shelf 24" Post	23	NA
FPSA/TS2/278	27"W x 8"D Tech Shelf 36" Post	NA	34
FPSA/TS1/329	32"W x 9"D Tech Shelf 24" Post	23	NA
FPSA/TS2/329	32"W x 9"D Tech Shelf 36" Post	NA	34
FPSA/TS1/VR	Vaddio & Logitech Rally Round Shelf 24" Post	23	NA
FPSA/TS2/VR	Vaddio & Logitech Rally Round Shelf 36" Post	NA	34

- Custom sized shelf for camera, speaker or controller
- Fully adjustable height
- Mounts above or below video display
- Maximum Weight Capacity of 10 lbs (2 kgs)

See all Tech Shelf details:  
[salamandercommercial.com/product/tech-shelf/](https://salamandercommercial.com/product/tech-shelf/)



Bring flexibility and finishing touches to every meeting system with Salamander’s Tech Brackets. Tech Brackets allow for an integrated camera to be placed above or below the display screen and are fully height adjustable for proper positioning. Tech Brackets adhere to the furniture system and can easily extend out from the display to conference camera and center speakers.

## Tech Bracket

		Max reach from centerline of Display Vesa Bracket to Shelf	
		Displays 50" to 70"	Displays 75"+
FPSA/TB1/12	12"W Tech Bracket 24" Post	22.5	NA
FPSA/TB2/12	12"W Tech Bracket 36" Post	NA	33.5
FPSA/TB1/17	17"W Tech Bracket 24" Post	22.5	NA
FPSA/TB2/17	17"W Tech Bracket 36" Post	NA	33.5
FPSA/TB1/CFX	Crestron Flex SB1 Bracket 24" Post	22.5	NA
FPSA/TB2/CFX	Crestron Flex SB1 Bracket 36" Post	NA	33.5

- Fully adjustable height
- Mount camera/speaker above or below video display
- Accommodates most video/audio conference systems
- Universal mounting plate pattern: 0-16" (0-410mm)
- Max weight capacity of 25 lbs (11 kgs)

See all Tech Shelf details:  
[salamandercommercial.com/product/tech-bracket/](https://salamandercommercial.com/product/tech-bracket/)

- 1 Frame
- 2 Style
- 3 Display
- 4 Interiors
- 5 Accessories

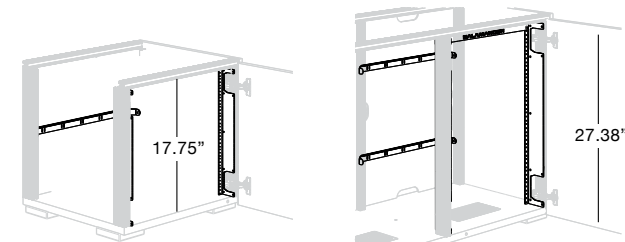
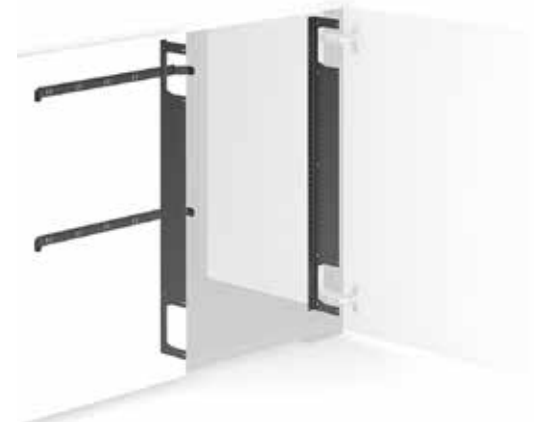
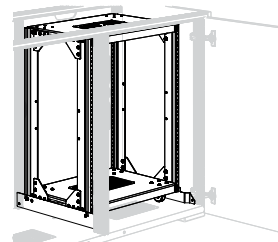
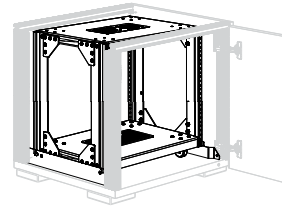

## Rack Cartridge Active Cooling

<b>FI/CR/AC1</b>	Single Bay Cabinet, Vented Stretcher
<b>FI/CR/AC2</b>	Two Bay Cabinet, Vented Stretcher
<b>FI/CR/AC3</b>	Three Bay Cabinet, Vented Stretcher
<b>FI/CR/AC4</b>	Four Bay Cabinet, Vented Stretcher
<b>FI/CR/AC</b>	Rack Cartridge Active Cooling Fan

- 1 vented stretcher and 1 fan per bay required
- Exhaust fan vents warm air. (Air flow: 38 CFM)
- Thermostatically controlled cooling system turns on at approx 80° F, maximum speed is reached at 95° F.
- Quiet 18 dBA fans
- Power consumption: 2.2 W max
- Thermistor: Remote with 30" lead
- USA Compatible, Export Version Available
- CE & RoHS compliant

## Pull-Out Rack Cartridge

<b>FI/C20/CRK/A</b>	7-U Adjustable Depth Pull-Out Rack Cartridge
<b>FI/C30/CRK/A</b>	13-U Adjustable Depth Pull-Out Rack Cartridge
<b>FI/C20/CRK/B</b>	7-U Pull-Out Rack Cartridge
<b>FI/C30/CRK/B</b>	13-U Pull-Out Rack Cartridge

- Pull-out 19" standard rack with rails front and back
  - Cabinet guide rails and in-line caster base provide simple use and transport
  - Weight capacity of 200 lb
  - Heavy duty bearing wheels for easy installation, removal, and manoeuvring of full equipment racks during service
  - Rugged 12-gage powder coated steel construction
  - Flexible wire management wire loom allows for removal of rack from cabinet with 360 degrees of access to components without disconnecting from cabinet. An absolute step up from slide out and rotational racks service constraints.
  - Tool-less removal / installation for service
- Adjustable Depth Rack Cartridge**
- Adjustable in 1" increments from 16 to 20".
  - Use with Deep Profile Cabinets to take advantage of the full range of adjustability.
  - Can be used in a 21"D cabinets (from 16 – 18" range) with an extended rear panel.

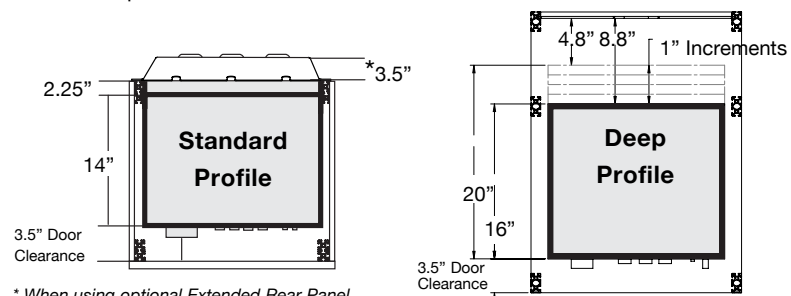

## Rack Rail Kits

<b>FI/C20/RMK/A</b>	Pro Rack Rails 20A Kit
<b>FI/C30/RMK/A</b>	Pro Rack Rails 30A Kit

- Universal holes are spaced on consecutive intervals of 5/8" and 1/2" allowing for mounting of equipment with attachment holes either wide or universally spaced
- Threaded for 10-32 screws. Black powder coated steel
- Rack Rail sets (2) may be attached to front or rear of the cabinet and are reversible for use without doors (diagram above)
- Rails are compatible with all industry standard 19" components and accessories

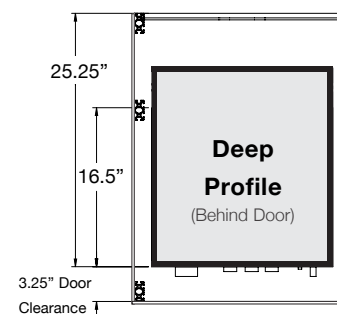
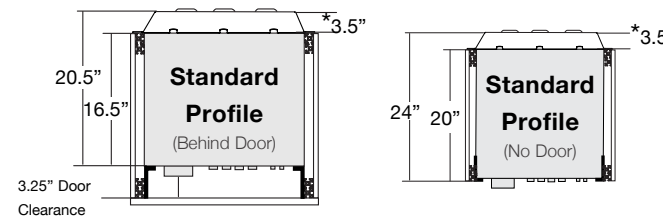

## Component-Length Rack Rails

<b>FI/RM4U</b>	4-U Rack Rails, 7"H
<b>FI/RM3U</b>	3-U Rack Rails, 5.25"H
<b>FI/RM2U</b>	2-U Rack Rails, 3.6"H
<b>FI/RM1U</b>	1-U Rack Rails, 1.75"H

- Attaches to front or rear cabinet posts
- Doors can be used with component length rails, placed away from hinges
- Allow for 1.5" clearance for each hinge
- Includes two, black, powder coated rails per set. Threaded for 10-32 screws.

- 1 Frame
- 2 Style
- 3 Display
- 4 Interiors
- 5 Accessories



## Wire Lacing Bars for Cartridge

<b>RM/LB2</b>	<b>Pull-Out Rack Cartridge Lacing Bar, Set of 2</b>
---------------	---

- Mounts to Rack Cartridge and any 19" standard rack
- Infinitely adjustable wire management
- Includes one velcro wrap strap
- Black powder coated steel



## Wire Lacing Bar Kit

<b>FI/RMLB</b>	<b>Cabinet Mounted Wire Lacing Bar Kit, Set of 3</b>
----------------	--

- Mounts to vertical cabinet posts
- Black powder coated steel
- Set of 3 lacing bars



## Vertical Racks

<b>FI/RM/VR/3U</b>	<b>Vertical Rack Mount, 3U</b>
<b>FI/RM/VR/5U</b>	<b>Vertical Rack Mount, 5U</b>

- Rack is mounted to cabinet frame or wall, for industry standard 19" pro audio rack mounting
- 3 and 5 rack units of vertical mounted, knob up component storage
- Threaded for 10-32 screws
- Black powder coated steel
- Lift and load design for easy install



## Power Distribution Unit

<b>SA/RM/PDU</b>	<b>Power Distribution Unit, 9 Outlets</b>
------------------	---

- Multi-port rack mounted Power Distribution Unit with surge protection
- 8 Rear Ports, 1 Front Port
- Maximum Output Current: 15 Amps
- See full specs on page 31
- USA Compatibility
- Premium quality Furman brand



## Vented Shelves

<b>RM/VS1U</b>	<b>Vented Shelf, 1U - 14"D</b>
<b>RM/VS2U</b>	<b>Vented Shelf, 2U - 14"D</b>
<b>RM/VS3U</b>	<b>Vented Shelf, 3U - 14"D</b>
<b>RM/VS4U</b>	<b>Vented Shelf, 4U - 14"D</b>

- Mounts to Pull-Out Rack Cartridge and any 19" standard rack
- 19" EIA standard rack mount, 14" deep, vented shelf
- Black powder coated steel



## Face Plates

<b>RM/VFP1U</b>	<b>Vented Face Plate, 1U</b>
<b>RM/VFP2U</b>	<b>Vented Face Plate, 2U</b>
<b>RM/VFP3U</b>	<b>Vented Face Plate, 3U</b>
<b>RM/VFP4U</b>	<b>Vented Face Plate, 4U</b>

- Mounts to Pull-Out Rack Cartridge and any 19" standard rack
- Black powder coated steel
- Perforated 16ga steel for component air flow (allows 62% free air flow)

## ACTIVE COOLING



## Bottom Vent Active Cooling

<b>FI/BVAC</b>	<b>Bottom Vent Active Cooling</b>
----------------	-----------------------------------

- Exhaust fan vents warm air. (Air Flow: 38 CFM)
- Thermostatically controlled cooling system turns on at approx 80° F, maximum speed is reached at 95° F.
- Noise Level: (18 dBA) four 80mm fans
- Airflow direction: Intake
- Power consumption: 2.2 W max
- Thermistor: Remote with 20" lead
- USA Compatible
- Export Version Available



## Vertically Active Cooling Kit

<b>FI/SA/1UAC</b>	<b>1U Vertically Mounted Active Cooling Kit</b>
-------------------	---

- Airflow: 40 to 180 CFM
- Operating Temperature: 14 to 230°F
- Noise Level: 9 to 32 dBA
- Airflow direction: Front Exhaust
- Power consumption: 8 W
- Power In: 100 to 240V AC
- Bearings: Dual Ball
- USA Compatible
- Export Version Available

[See more on Cooling on page 29](#)

- 1 Frame
- 2 Style
- 3 Display
- 4 Interiors
- 5 Accessories



### 3" Drawer

- Metal construction, matte black finish
- Interior: 17.125"W x 15.875"D x 3.5"H
- Maximum Weight Capacity: 30 lbs

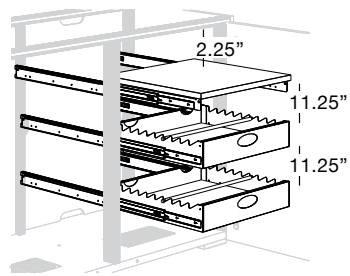

**FI/C30/SLK/C Shelving 30C Kit**

- (1) Pull-Out Shelf
- (2) 3" Drawers

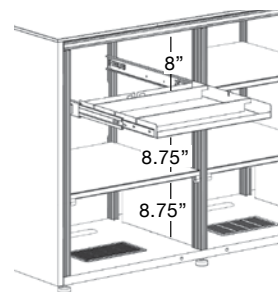

**FI/C30/SLK/D Shelving 30D Kit**

- (1) Pull-Out Tray
- (1) Adjustable Shelf

### Pull-Out Storage Tray

- Utilizes heavy duty ball bearing slides
- Black steel body with felt liner
- Maximum Weight Capacity: 50 lbs
- 17.25" W (438 mm) x 16" D (406 mm) x 1.625" H (42 mm)
- 2 dividers located at 4" 8.5" and 12.75" from the front edge

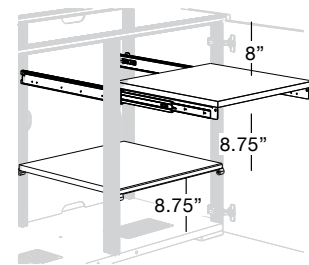

**FI/C30/SLK/B Shelving 30B Kit**

- (1) Pull-Out Shelf
- (1) Standard Shelf

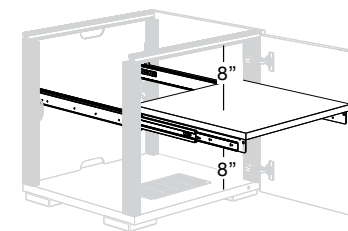

**FI/C20/SLK/B Shelving 20B Kit**

- (1) Pull-Out Shelf

All shelf and drawer positions are fully adjustable. Dimensions shown are factory assembled locations.

### Adjustable Shelves

- Fully adjustable
- Matte black, powder-coated MDF
- Weight Capacity: 75 lbs (34 kgs)
- 19.68"W (502 mm) x 17.5"D (445 mm) x .625"TH (16 mm)

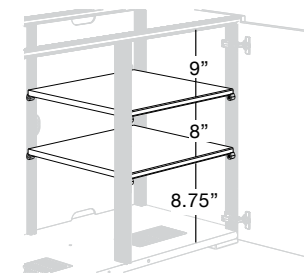

**FI/C30/SLK/A Shelving 30A Kit**

- (2) Standard Shelf

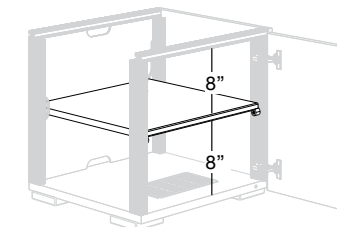

**FI/C20/SLK/A Shelving 20A Kit**

- (1) Standard Shelf

### Adjustable Trays

- Compatible with Low Profile Cabinets only
- 19.75"W (502mm) x 7.875"D (200mm) x 1.5"H (38mm)
- Maximum Weight Capacity of 30 lbs (13.6 kgs)
- Constructed of 1/2" (12mm) MDF
- Shelves can be used flat or add a backstop or two to convert shelves to adjustable trays

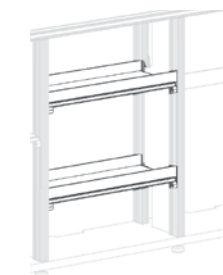

**FI/C30DI/SLK/A Shelving 30A Kit**

- (2) Standard Shelves
- (4) Shelf Stops

- 1 Frame
- 2 Style
- 3 Display
- 4 Interiors
- 5 Accessories



**File Storage**



**Waste Bins**



**Refrigeration**



**Standard Active Cooling Rears**



**Extended Active Cooling Rears**

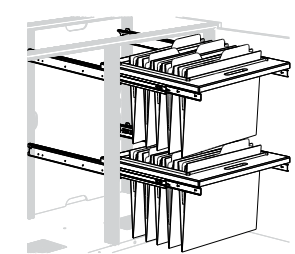

**FI/C30/FSK/A  
File Storage 30A Kit**

(2) Hanging File

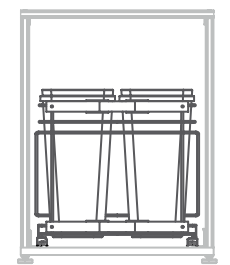

**FI/C30/TRK/C  
Waste Receptacles 30C Kit**

(2) 32qt Bins with handles that lift out for emptying  
Door pulls out to make operation a single motion

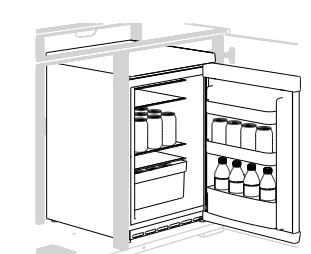

**FI/C30/RGK/A  
Refrigeration 30A**

(1) Refrigerator

- Built into a cabinet bay and hidden
- 2.5 Cubic feet capacity
- Factory Installed
- USA Compatible

<b>FI/AC20</b>	<b>Active Cooling Rear Panel for 20"H Cabinets</b>
<b>FI/AC30</b>	<b>Active Cooling Rear Panel for 30"H Cabinets</b>

- Exhaust fan vents warm air. (Air Flow: 130 CFM)
- Thermostatically controlled cooling system turns on at approx 80° F, maximum speed is reached at 95° F.
- Noise Level: (19 dBA) dual 120mm fans
- Airflow direction: Exhaust
- Power consumption: 2.9 W max
- Thermistor: Remote with 20" lead
- USA Compatible
- Export Version Available

<b>FI/XR20/AC</b>	<b>Extended, Active Cooling Rear Panel for 20"H Cabinets</b>
<b>FI/XR30/AC</b>	<b>Extended, Active Cooling Rear Panel for 30"H Cabinets</b>

- Exhaust fan vents warm air. (Air Flow: 130 CFM)
- Thermostatically controlled cooling system turns on at approx 80° F, maximum speed is reached at 95° F.
- Noise Level: (19 dBA) dual 120mm fans
- Airflow direction: Exhaust
- Power consumption: 2.9 W max
- Thermistor: Remote with 20" lead
- USA Compatible
- Export Version Available

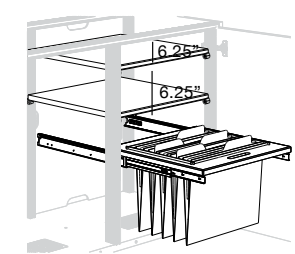

**FI/C30/FSK/B  
File Storage 30B Kit**

(2) Standard Shelves  
(1) Hanging File

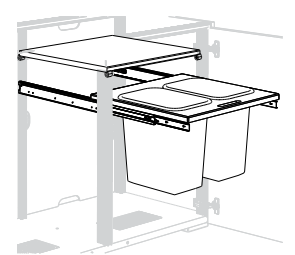

**FI/C30/TRK/A  
Waste Receptacles 30A Kit**

(1) Pull-Out Trash & Recycling Bin  
(1) Shelf

**Waste Bins (cont.)**

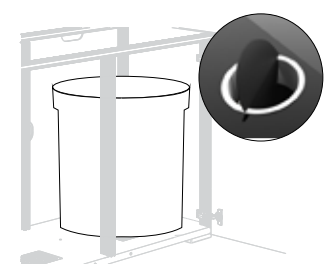

**FI/C30/TRK/B  
Waste Receptacle 30B Kit**

Top Shelf Grommet Cut-Out  
(1) Trash Bin



**Standard Rears**

<b>203-720</b>	<b>Standard Rear Panel for 20"H Cabinets</b>
<b>203-730</b>	<b>Standard Rear Panel for 30"H Cabinets</b>

- Easy access, pinch-out panels



**Extended Rears**

<b>FI/XR20</b>	<b>Extended Rear Panel for 20"H Cabinets</b>
<b>FI/XR30</b>	<b>Extended Rear Panel for 30"H Cabinets</b>

- Adds 3.5" to inside depth of cabinet, extending to 23.5"
- Constructed of heavy-weight black powder-coated steel

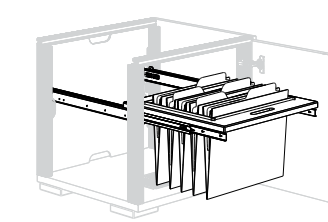

**FI/C20/FSK/A  
File Storage 20A Kit**

(1) Hanging File

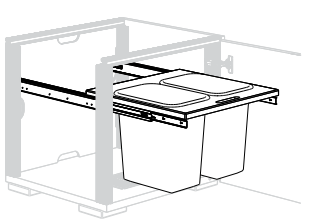

**FI/C20/TRK/A  
Waste Receptacles 20A Kit**

(1) Pull-Out Trash & Recycling Bin



**Locking Rears**

<b>FI/C30/LRP</b>	<b>Locking Rear Panel for 30"H Cabinets</b>
-------------------	---



- 1 Frame
- 2 Style
- 3 Display
- 4 Interiors
- 5 Accessories

Salamander's cabinets feature quality craftsmanship and high-fidelity sound by Leon Speakers. Each speaker is hand-crafted and built-to-order to fit seamlessly into our cabinets. Each speaker features world-class Peerless woofers and cloth-dome tweeters, creating a high-fidelity system with exceptional sonic clarity.

- Custom built to seamlessly integrate with cabinets
- Exclusive mounting brackets allow for articulation to optimize sound dispersion
- High-performance sound platform, world-class woofers and cloth-dome tweeters for exceptional sonic clarity
- Solid MDF construction, meticulously crafted by hand in the USA



## Center Channel

<b>FI/SPK1/C</b>	<b>Center Channel, Fits Single-Width Bay</b>
------------------	--

- 5" midrange woofers; 1" audiophile-grade tweeters
- Matte black finish, sealed MDF enclosure with removable, black grill
- Impedance: 8Ω
- Rec. Power: 50-250W
- Maximum Output: 104 dB avg; 110 dB peak
- Coverage: Horiz: 110°; Vert: 140°
- Freq. Response: 74-22kHz (+/- 3dB)
- Sensitivity: 88dB@2.83V/1m
- Connections: 5-way binding post
- Mounting: Includes swivel/tilt bracket, Infinitely adjustable +15° -15°

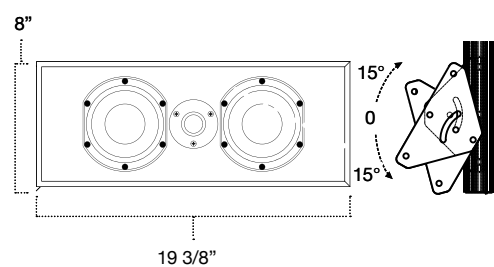

## Soundbar / LCR (Left-Center-Right)

<b>FI/SPK2/C</b>	<b>Soundbar, Fits Double-Width Bay</b>
<b>FI/SPK3/C</b>	<b>Soundbar, Fits Triple-Width Bay</b>

- 5" midrange woofers; 1" audiophile-grade tweeters
- Matte black finish, sealed MDF enclosure with removable, black grill
- Impedance: 6Ω
- Rec. Power: 50-250W
- Maximum Output: 101 dB avg; 110 dB peak
- Coverage: Horiz: 110°; Vert: 140°
- Freq. Response: 74-22kHz (+/- 3dB)
- Sensitivity: 88dB@2.83V/1m
- Connections: 5-way binding post
- Mounting: Includes swivel/tilt bracket, Infinitely adjustable +15° -15°

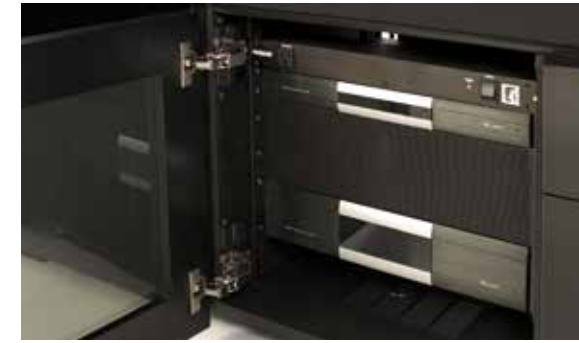
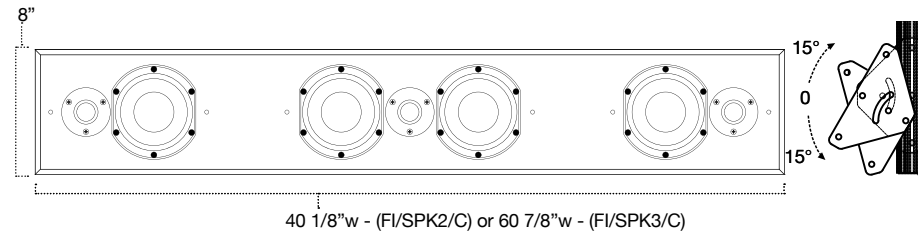

## Power Distribution Unit

<b>FI/RM/PDU</b>	<b>Multi-port rack mounted Power Distribution Unit with surge protection.</b>
------------------	---



- 8 Rear Ports, 1 Front Port
- Maximum Output Current: 15 Amps
- Line Cords: 6 ft. captive, 14 AWG, with 3-conductor Edison Plug
- Operating Voltage: 120VAC 60Hz
- Spike Protection Mode: Line to neutral
- Energy Dissipation: 170 Joules
- Peak Impulse Current: 12,000 Amps
- Maximum Continuous Operating Voltage: 130 VAC RMS
- Let Through Voltage (@ 125 amps, 8/20uS waveform): 400 volts
- Noise Attenuation (Transverse Mode): Greater than 23db, 200Khz to 10MHz
- Dimensions: 1.75" H x 19" W x 3.75" D
- Weight: 4.9 lbs. (2.2 kg)
- Safety Agency Listing: cTUVus
- Three Year Limited Warranty: Covering defects in materials and workmanship
- USA Compatible
- Premium Furman Brand



## Power & USB Ports

<b>FI/PWR/AC</b>	<b>2 AC Power Outlet, Black</b>
<b>FI/PWR/USB</b>	<b>2 USB and 1 AC Power Outlet, Black</b>

- Cable is pre-wired and requires no electrical wiring by the installer
- ETL listed, UL Rated 817D, CSA STD 22.2 42.1-00
- Includes 3ft. Pre-wired Power Cord and Décor Wall Plate
- USA Compatible

- |                             |  |
|-----------------------------|--|
| <b>Power Receptacle:</b>    | <b>USB:</b>                                |
| - UL Listed Receptacle 351B | - Save space-no adapter required           |
| - Tamper Resistant          | - USB Power Rating: 5V DC/CC 700mA         |
| - Power Rating: 15A-125V    | - Indicator light confirms charging status |



## Power Conditioner

<b>FI/RM/PCK</b>	<b>Power Conditioner Kit with Mounting Bracket</b>
------------------	--

- Includes 8 AC Outlets, 2 CATV connectors, 2 pair of satellite connectors, in/out telco connectors with phone line splitter, 8' power cord, accepts add-on signal line modules.
- 1650 Joules single pulse energy dissipation
- Measures: 12"W x 5"D x 1.7"H
- Lifetime product and \$5 million connected equipment protection provided by Panamax
- Connects to the aluminium frame slot, can be mounted to interior or rear of cabinet
- USA Compatible

- 1 Frame
- 2 Style
- 3 Display
- 4 Interiors
- 5 Accessories

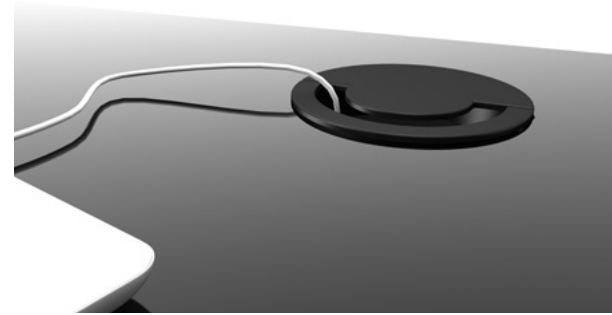

## Brush Cable Port

<b>FI/CP1/BK</b>	Rectangular Brush Cable Port, Matte Black
------------------	---

- Opening: 1.3" x 2.63"
- Ports can be installed on cabinet tops, end panels and modesty panels. Call for details

## Round Cable Port

<b>FI/CP2/BK</b>	3-3/8" Round Cable Port, Matte Black
<b>FI/CP2/SN</b>	3-3/8" Round Cable Port, Satin Nickel

- 3/8" cable thickness clearance. Splits to fit large ends of wires
- Installed on cabinet tops only. Call for details.

## Security Locks

<b>FI/C/DL/</b>	<b>Door Lock</b> - Black (FI/C/DL/BK), Bronze (FI/C/DL/BZ), Nickel (FI/C/DL/NK), White (FI/C/DL/WH)
<b>FI/C30/LRP</b> * Standard/Deep Profile Cabinet Only	<b>Locking Rear Panel for 30"H Cabinets</b>
<b>FI/C/MDL</b>	<b>Invisible Magnetic Door Locks</b>

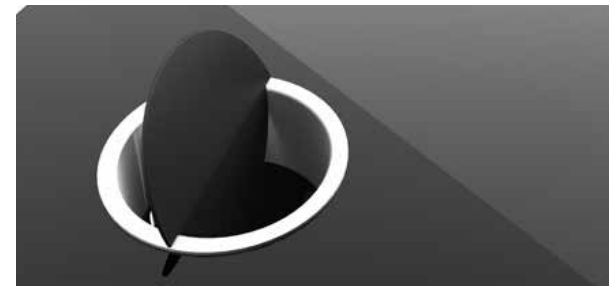
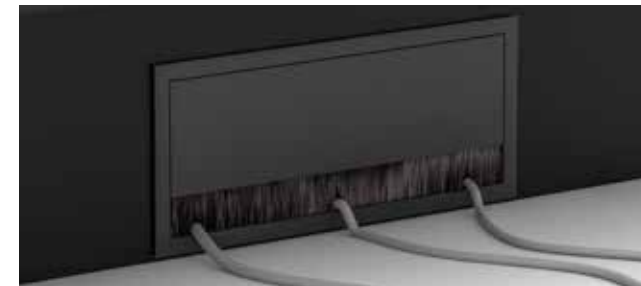

## Rectangular Cable Port

<b>FI/CP3/A</b>	Rectangular Brush Cable Port, Satin Black
-----------------	---

- 13 7/8" W x 2 13/16" H
- Ports can be installed on cabinet tops, end panels and modesty panels. Call for details.

## Trash Port

<b>FI/TP1/SS</b> * Standard/Deep Profile Cabinet Only	6" Round Trash Port, Satin Stainless Steel
<b>FI/TP1C/BK</b> * Standard/Deep Profile Cabinet Only	Cover for Round Trash Port, Matte Black

- Installed on cabinet tops only. Call for details.



## Lighting System

<b>SD/LS2/W</b>	<b>Lighting System with Remote</b> , White LED 15" Bar (Expandable)
<b>SD/LSX15/W</b>	<b>Expansion Lights Bar, 15" White LED, set of 2</b>
<b>SD/LSX24/W</b>	<b>Expansion Lights Bar, 24" White LED, set of 2</b>

- LED technology for low energy use, low heat and longer life
- Infrared remote for full dimming and program control
- Adjustable Light temperature from cool white (6500 Kelvin) to warm (3200 Kelvin). LED back-lighting lighting reduces eye-strain.
- Sleep timer, auto-off feature
- Low profile design fits in small spaces
- Power Supply: 110/240V, interchangeable international plugs included
- USA Compatible

## Wood Block Feet



<b>FI/BF2/4/B</b>	Set of 4 - Black
<b>FI/BF2/4/E</b>	Set of 4 - Espresso
<b>FI/BF2/6/B</b>	Set of 6 - Black
<b>FI/BF2/6/E</b>	Set of 6 - Espresso
<b>FI/BF2/8/B</b>	Set of 8 - Black
<b>FI/BF2/8/E</b>	Set of 8 - Espresso

- Adds 1.25" to cabinet height. 150 lb capacity, each foot.
- Hidden adjustable levers.
- Can be installed on Low Profile Cabinets

## Heavy Duty Casters



<b>FI/HDC/4</b>	Set of 4 - Heavy Duty Casters, Black
<b>FI/HDC/6</b>	Set of 6 - Heavy Duty Casters, Black
<b>FI/HDC/8</b>	Set of 8 - Heavy Duty Casters, Black

- Adds 4" to cabinet height. 250 lb capacity, each wheel.

## Tube Base



<b>FI/TB/N/B</b>	Tube Base for Twin-Width Cabinet, Black
<b>FI/TB/L/B</b>	Tube Base for Triple-Width Cabinet, Black
<b>FI/TB/Q/B</b>	Tube Base for Quad-Width Cabinet, Black

- Adds 5" to cabinet height. 600 lb capacity.

## Stiletto Feet



<b>FI/SFA/4</b>	Set of 4 - Stiletto Feet, Aluminum
<b>FI/SFB/4</b>	Set of 4 - Stiletto Feet, Black
<b>FI/SFA/6</b>	Set of 6 - Stiletto Feet, Aluminum
<b>FI/SFB/6</b>	Set of 6 - Stiletto Feet, Black
<b>FI/SFA/8</b>	Set of 8 - Stiletto Feet, Aluminum
<b>FI/SFB/8</b>	Set of 8 - Stiletto Feet, Black

- Adds 6" to cabinet height. 150 lb capacity, each foot.

## Robot Feet



<b>FI/RFB/4</b>	Set of 4 - Robot Feet, Black
<b>FI/RFB/6</b>	Set of 6 - Robot Feet, Black
<b>FI/RFB/8</b>	Set of 8 - Robot Feet, Black

- Adds 3" to cabinet height. 150 lb capacity, each foot.

## Wall Mounting Kit



<b>CU/WK1</b>	Wall Kit for Single-Width Cabinet
<b>CN/WK1</b>	Wall Kit for Twin-Width Cabinet
<b>CL/WK1</b>	Wall Kit for Triple-Width Cabinet
<b>CQ/WK1</b>	Wall Kit for Quad-Width Cabinet

### ORDERING FOOTING

Single-Width	Set of 4
Twin-Width	Set of 4
Triple-Width	Set of 8
Quad-Width	Set of 10

# PRECONFIGURED CABINET SOLUTIONS

Cabinet Solutions are our most popular configurations in the market, preconfigured for quick ordering and rapid deployment.

- Preconfigured for Rapid Deployment
- Includes Solid Surface Tops
- Add or Remove Accessories to Suit Your Needs



## Dual Display Low Profile Cabinets

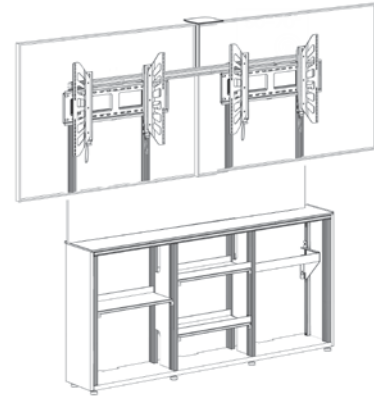
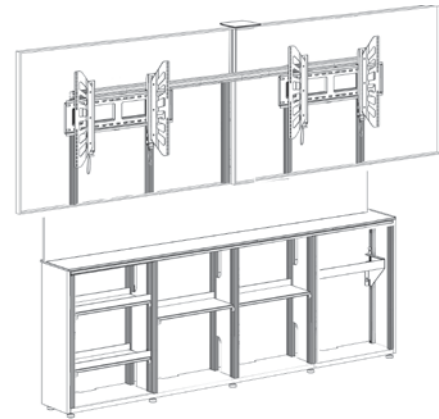
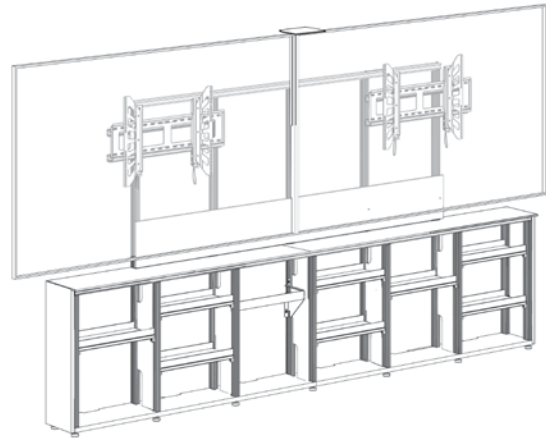

**D1/367AM2/**  
**6-Bay, Low-Profile Wall Cabinet**  
**Dual Display\***

- Dual Display Mount:  
 Holds 50-90", 175 lbs (79kg) each
- Single Camera Shelf
- (8) Adjustable Trays
- (1) 3-U Vertical Rack Rail
- 31.25"H (795mm) x 129.75"W (3296mm)  
 x 12"D (305mm)

\* Ships as two cabinets to be mated together.

**D1/347AM2/**  
**4-Bay, Low-Profile Wall Cabinet**  
**Dual Display**

- Dual Display Mount:  
 Holds 55-90", 175 lbs (79kg) each
- Single Camera Shelf
- (4) Adjustable Trays
- (1) 3-U Vertical Rack Rail
- 31.25"H (795mm) x 85.5"W (2172mm)  
 x 12"D (305mm)

**D1/337AM2/**  
**3-Bay, Low-Profile Wall Cabinet**  
**Dual Display**

- Dual Display Mount:  
 Holds 50-60", 175 lbs (79kg) each
- Single Camera Shelf
- (3) Adjustable Trays
- (1) 3-U Vertical Rack Rail
- 31.25"H (795mm) x 64.75"W (1645mm)  
 x 12"D (305mm)

## Single Display Low Profile Cabinets

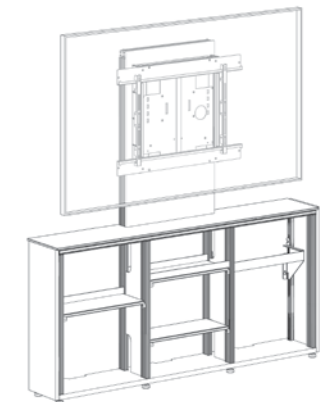
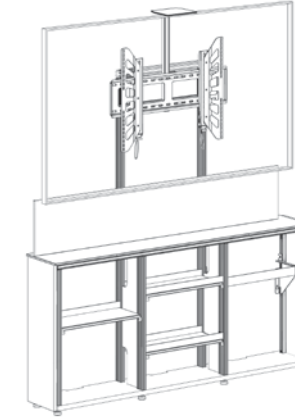
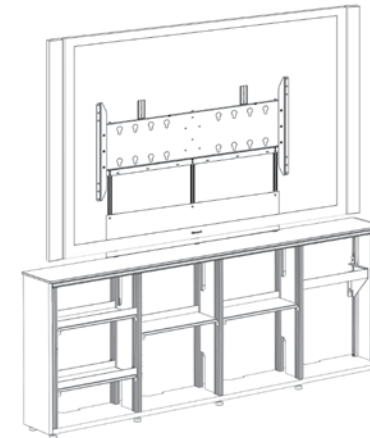

**D1/347AMXL/**  
**4-Bay, Low-Profile Wall Cabinet**  
**Single XL Display**

- XL Single Display Mount:  
 Holds 65-100", 400 lbs (181kg)
- (4) Adjustable Trays
- (1) 3-U Vertical Rack Rail
- Cisco Webex Board Adapter Available
- 31.25"H (795mm) x 85.5"W (2172mm)  
 x 12"D (305mm)

**D1/337AM1/**  
**3-Bay, Low-Profile Wall Cabinet**  
**Single Display**

- Single Display Mount:  
 Holds 50-70", 175 lbs (79kg)
- Single Camera Shelf
- (3) Adjustable Trays
- (1) 3-U Vertical Rack Rail
- 31.25"H (795mm) x 64.75"W (1645mm)  
 x 12"D (305mm)

**D1/337AL/**  
**3-Bay, Low-Profile Wall Cabinet**  
**EZ-Touch Lift Display**

- EZ-Touch Lift Mount:  
 Holds up to 65", 81-145 lbs (37-66kg)
- (3) Adjustable Trays
- (1) 3-U Vertical Rack Rail
- 31.25"H (795mm) x 64.75"W (1645mm)  
 x 12"D (305mm)

## Low Profile Cabinets

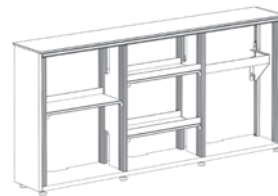
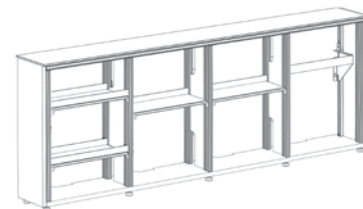
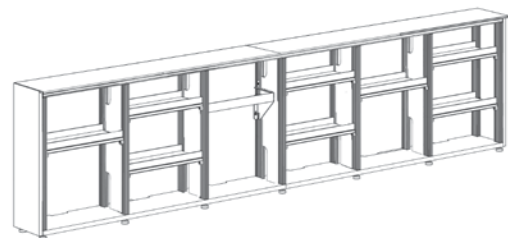

**D1/367A/**  
**6-Bay, Low-Profile Wall Cabinet**

- (8) Adjustable Trays
- (1) 3-U Vertical Rack Rail
- 31.25"H (795mm) x 129.75"W (3296mm) x 12"D (305mm)

\* Ships as two cabinets to be mated together.

**D1/347A/**  
**4-Bay, Low-Profile Wall Cabinet**

- (4) Adjustable Trays
- (1) 3-U Vertical Rack Rail
- 31.25"H (795mm) x 85.5"W (2172mm)  
 x 12"D (305mm)

**D1/337A/**  
**3-Bay, Low-Profile Wall Cabinet**

- (3) Adjustable Trays
- (1) 3-U Vertical Rack Rail
- 31.25"H (795mm) x 64.75"W (1645mm)  
 x 12"D (305mm)

## Dual Display Standard Profile Cabinets

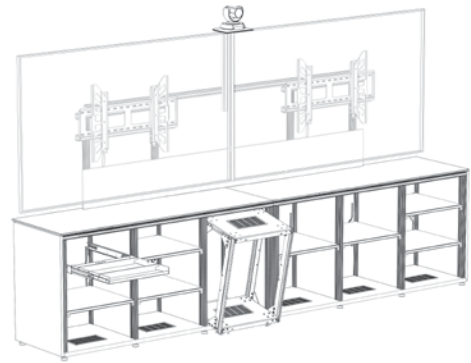

**D2/367BM2/**  
6-Bay, Standard Profile Cabinet, Dual Display

- Dual Monitor Mount: Holds displays (2) 55-90", up to 175 lbs (80kg) ea.
- Single Camera Shelf
- (1) Pull-Out Storage Tray
- (7) Adjustable Shelves
- (1) 13-U Pull-Out Rack Cartridge
- (5) Removable Rear Panels
- (1) Active Cooling Rear Panel
- 31.25"H (795mm) x 129.75"W (3296mm)

\* Ships as two cabinets to be mated together.

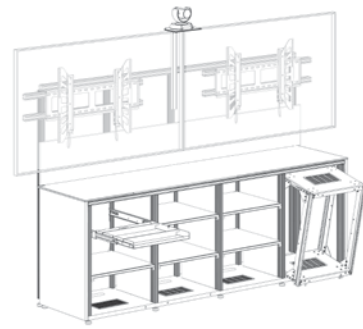

**D2/347BM2/**  
4-Bay, Standard Profile Cabinet, Dual Display

- Dual Monitor Mount: Holds displays (2) 55-90", up to 175 lbs (80kg) ea.
- Single Camera Shelf
- (1) Pull-Out Storage Tray
- (5) Adjustable Shelves
- (1) 13-U Pull-Out Rack Cartridge
- (3) Removable Rear Panels
- (1) Active Cooling Rear Panel
- 31.25"H (795mm) x 85.5"W (2172mm)

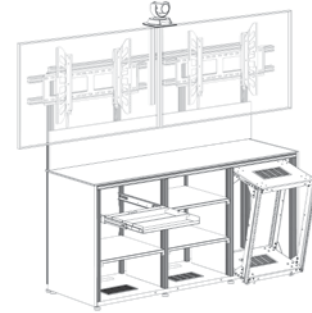

**D2/337BM2/**  
3-Bay, Standard Profile Cabinet, Dual Display

- Dual Monitor Mount: Holds displays (2) 55-90", up to 175 lbs (80kg) ea.
- Single Camera Shelf
- (3) Pull-Out Storage Tray
- (7) Adjustable Shelves
- (1) 13-U Pull-Out Rack Cartridge
- (2) Removable Rear Panels
- (1) Active Cooling Rear Panel
- 31.25"H (795mm) x 64.75"W (1645mm)

## Standard Profile Cabinets

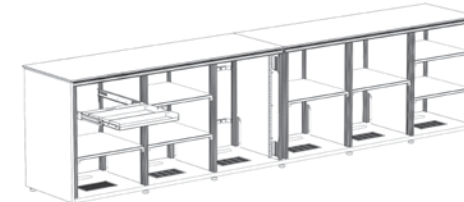

**D2/367A/**  
6-Bay, Standard Profile Cabinet

- (1) Pull-Out Storage Tray
- (7) Adjustable Shelves
- (1) 15-U Rack Rails
- (5) Removable Rear Panels
- (1) Active Cooling Rear Panel
- 31.25"H (795mm) x 129.75"W (3296mm)

\* Ships as two cabinets to be mated together.

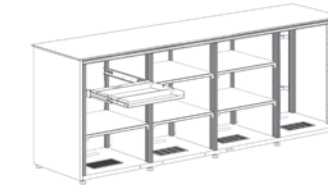

**D2/347A/**  
4-Bay, Standard Profile Cabinet

- (1) Pull-Out Storage Tray
- (5) Adjustable Shelves
- (1) 15-U Rack Rails
- (3) Removable Rear Panels
- (1) Active Cooling Rear Panel
- 31.25"H (795mm) x 85.5"W (2172mm)

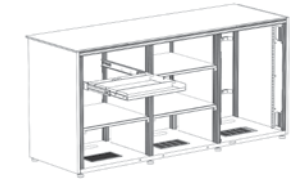

**D2/337A/**  
3-Bay, Standard Profile Cabinet

- (1) Pull-Out Storage Tray
- (3) Adjustable Shelves
- (1) 15-U Rack Rails
- (2) Removable Rear Panels
- (1) Active Cooling Rear Panel
- 31.25"H (795mm) x 64.75"W (1645mm)

## Single Display Standard Profile Cabinets

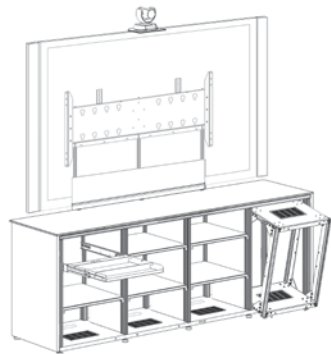

**D2/347AMXL/**  
4-Bay, Standard Profile Cabinet, XL Single Display

- Single Monitor Mount: Holds displays 65-100", up to 400 lbs (181kg)
- (1) Pull-Out Storage Tray
- (5) Adjustable Shelves
- (1) 13-U Pull-Out Rack Cartridge
- (3) Removable Rear Panels
- (1) Active Cooling Rear Panel
- 31.25"H (795mm) x 85.5"W (2172mm)

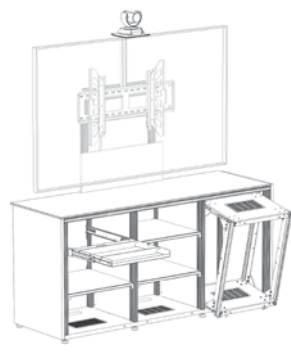

**D2/337BM1/**  
3-Bay, Standard Profile Cabinet, Single Display

- Single Monitor Mount: Holds displays 50-70", up to 175 lbs (80kg)
- Single Camera Shelf
- (1) Pull-Out Storage Tray
- (3) Adjustable Shelves
- (1) 13-U Pull-Out Rack Cartridge
- (2) Removable Rear Panels
- (1) Active Cooling Rear Panel
- 31.25"H (795mm) x 64.75"W (1645mm)

## Deep Profile Rack Cabinets



**D3/337B/**  
3-Bay, Deep Profile Cabinet

- (3) 15-U Rack Rails
- (2) Removable Rear Panels
- (1) Active Cooling Rear Panel
- (6) Lacing Bars
- 31.25"H (795mm) x 64.75"W (1645 mm)



**D3/323B/**  
2-Bay, Deep Profile Cabinet

- (2) 15-U Rack Rails
- (1) Removable Rear Panels
- (1) Active Cooling Rear Panel
- (4) Lacing Bars
- 31.25"H (795mm) x 44"W (1118mm)



**D3/317B/**  
1-Bay, Deep Profile Cabinet

- (1) 15-U Rack Rails
- (1) Active Cooling Rear Panel
- (2) Lacing Bars
- 31.25"H (795mm) x 23.25"W (591mm)

# PROJECTOR INTEGRATED CABINETS

A simple installation with no need to open the wall or ceiling to run cables. All supporting components can be enclosed in the cabinet to provide a beautiful and simple solution.

DESIGNED FOR



Model:  
LS500



Model:  
DH765Z-UST  
DW763Z-UST



Model:  
LG HU85LA  
HU915Q



Model:  
LSP7TF  
LSP9TF



**Easy to Install Optional Fan Kit**  
prevents heat build-up with  
thermostatically controlled fans.



# DISPLAY STANDS

Salamander's Mobile Stands provide robust and deployable solutions for all your interactive display needs. These advanced stands provide accessible, comfortable, ergonomic positioning that improves productivity and user experience.



**COLLABORATION  
READY**



**WORK-PLACE  
READY**



**PRESENTATIONS**



**EASILY  
TRANSPORTED**



Designed For  
Touchscreens



ADA  
COMPLIANT  
SOLUTIONS



DISPLAY STANDS

## 1 Stand

## 2 Accessories

**Large Handles** and a wide stance provide superior stability and maneuverability

**Fully Adjustable Motor Control** improves user experience and productivity for any size user for any work assignment

**\*ADA COMPLIANT**  
Wide base stance allows convenient accessibility

**Wire Management** allows for clean and uncluttered installation

**High Performance Locking Casters** provide smooth transport over any surface

**Accessories** include a retractable cable reel, storage compartment for rack mounted gear, rear attaching shelf for laptops and keyboards, a storage compartment cover, and even road cases for the Stand and display attached.

**Compact, Telescoping Design** minimizes storage and transport requirements



### CASTER WHEELS

4" (100mm) HD, Non Marking, Brakes on two

### ELECTRICAL INFORMATION

Input: 90V - 240V ~, 48 Hz - 63HZ  
Duty Cycle: 10% Max 2min / 18min

### POWER CABLE

IEC - Type Class 2, 2-prong  
USA Included: (PN 400-590)

Available: EU (PN 400-591)

UK (PN 400-592)

New Zealand, Australia and others (PN 400-593)

## ELECTRIC LIFT

Fully adjustable, electric lift, mobile stands that offer convenience, flexibility, and designer style. The sleek, compact design moves easily between spaces and is designed for touchscreen in working, drafting, collaboration, and presentation positions.



### FPS1XL/EL/GG XL Electric Lift Mobile Stand

Compatible with most large displays up to 98" and 300 lbs (136 kg).

**VESA Compliant:**  
Horizontal: 400, 500, 600, 700, 800, 900, 1000, 1100, 1200, 1300mm  
Vertical: 100, 200, 300, 400, 500, 600mm

**White Panel Model:** FPS1XL/EL/VW  
**Export Model:** FPS1XL/EL/GG/EX

**Microsoft Models**  
Gray - FPS1XL/EL/MS/GG  
White - FPS1XL/EL/MS/VW

**Cisco Webex Board**  
FPS1XL/FH/C3/GG

**Cisco Webex Board Pro**  
FPS1/EL/CSP75/GG  
FPS1/EL/CSP55/VW



### FPS2/EL/GG Electric Lift Mobile Stand

Compatible with most large displays up to 70" and 175 lbs (79 kg).

**VESA Compliant:**  
Horizontal: 200, 250, 300, 350, 400, 450, 500, 600, 650, 700mm  
Vertical: 200, 300, 350, 400mm

**White Panel Model:** FPS2/EL/VW  
**Export Model:** FPS1/EL/GG/EX

**Microsoft Models**  
Gray - FPS2/EL/MS/GG  
White - FPS2/EL/MS/VW

**Cisco Webex Board**  
FPS1/EL/CS/GG

**Cisco Webex Board Pro**  
FPS1/EL/CSP75/GG  
FPS1/EL/CSP55/VW



### FPS2/ELT/GG Electric Lift & Tilt Mobile Stand

Compatible with most large displays up to 70" and 175 lbs (79 kg).

**VESA Compliant:**  
Horizontal: 200, 250, 300, 350, 400, 450, 500, 550, 600, 650, 700, 750, 800, 850, 900mm  
Vertical: 100, 200, 300, 350, 400mm

**White Panel Model:** FPS2/ELT/VW  
**Export Model:** FPS2/ELT/GG/EX

**Microsoft Models**  
Gray - FPS2/ELT/MS/GG  
White - FPS2/ELT/MS/VW

**Warning:** Some interactive panels are not recommended for use in horizontal position. Check with manufacturer. Tilt position limits can be custom programmed by factory.

Mobile Stand Accessories  
see page 52-53 & 67



1 Stand

2 Accessories

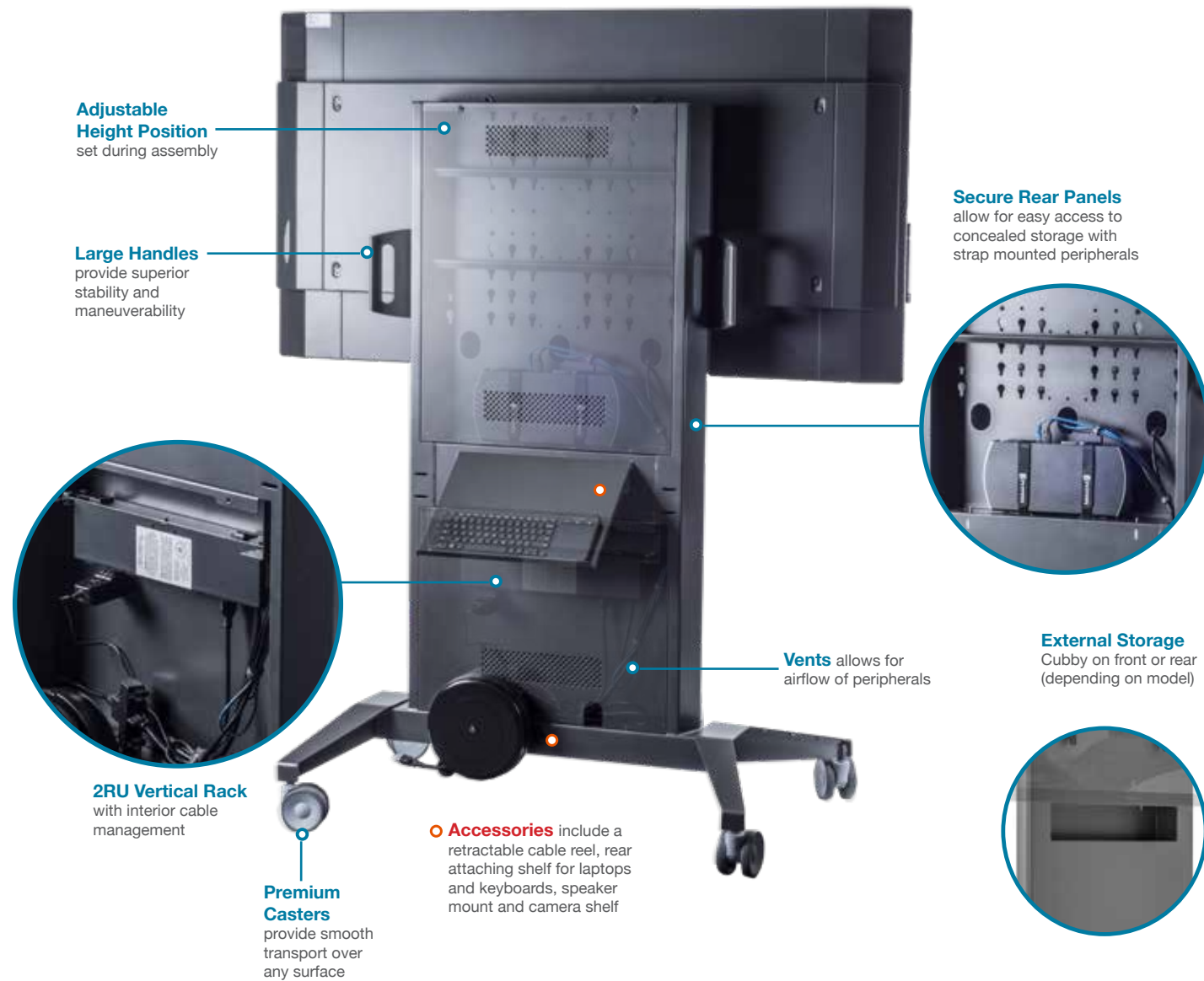

## FIXED HEIGHT

Fixed height, mobile stands were designed to meet your needs, these stands deliver sleek design, functionality and mobility.



**FPS1XL/FH/GG**  
**XL Fixed Height Mobile Stand**

Compatible with most large displays up to 98" and 400 lbs (181 kg) Features a rear storage cubby. Includes Microsoft Surface Hub 2 Mounting adapter (CA/MAC4) VESA 350 x 350

**VESA Compliant:**  
Horizontal: 200, 300, 400, 500, 600, 700, 800, 900, 1000, 1100, 1200mm  
Vertical: 200, 300, 350, 400, 500, 600mm

**Microsoft Models**  
FPS1XL/FH/MS/GG

**Cisco Webex Board**  
FPS1XL/FH/C3/GG



**FPS1/FH/GG**  
**Fixed Height Mobile Stand**

Compatible with most large displays up to 70" and 175 lbs (79 kg). Features a front storage cubby.

**VESA Compliant:**  
Horizontal: 200, 250, 300, 350, 400, 450, 500, 600, 650, 700mm x  
Vertical: 200, 300, 350, 400mm

**Microsoft Models**  
FPS1/FH/MS/GG

**Cisco Webex Board**  
FPS1XL/FH/C2/GG

**Cisco Webex Board Pro**  
FPS1XL/FH/CSP75/GG



### ACCESSORIES



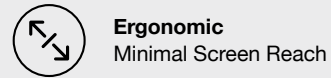

## MICROSOFT CERTIFIED MOBILE STANDS

SUPERIOR MOUNTING SOLUTIONS FOR SURFACE HUB 2S



**Gray - FPS2/ELT/MS/GG**  
**White - FPS2/ELT/MS/VW**  
**Electric Lift & Tilt Mobile Stand**

- Motorized electric lift and tilt with wired remote with independent lift/tilt control
- Range of travel, Center of screen: Min – 33.33" (847 mm) and Max 58.92" (1497 mm)
- Superior mobility. High quality, commercial grade locking casters and integrated handles provide easy maneuverability and transport



**Gray - FPS2/EL/MS/GG**  
**White - FPS2/EL/MS/VW**  
**Electric Lift Mobile Stand**

- Motorized electric lift with wired remote
- Range of travel, Center of screen: Min – 36.83" (935.5 mm) and Max 62.42" (1585.5 mm)
- Superior mobility. High quality, commercial grade locking casters and integrated handles provide easy maneuverability and transport



**FPS1/FH/MS/GG**  
**Fixed Height Stand**

- Range of travel, Center of screen: Min – 48.28" (1226 mm) and Max 58.28 (1480 mm)



**50" Surface Hub 2S Battery Storage Case**

**FPSA/MSB**

**50" Surface Hub 2S Battery Storage Case**

- Secures APC™ Mobile Battery to Salamander Designs FPS Electric Lift and Fixed Height Stands
- Enables additional component storage below battery thanks to a slim design
- Ensures long-lasting durability with premium, laser cut steel construction
- Charge battery and operate stand with minimal effort by adding our standard cable reel accessory
- Product Dimensions 16.2" W (411 mm) x 24.16" H (614mm) x 3.76" D (95mm)
- Enjoy total peace of mind with our Lifetime Limited Warranty

\*Battery not included

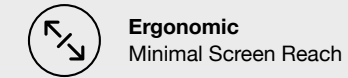

## MICROSOFT CERTIFIED SURFACE HUB 2S XL MOBILE STANDS

SUPERIOR MOUNTING SOLUTIONS FOR SURFACE HUB 2S



**FPS1XL/FH/MS/GG**  
**X-Large Fixed Height Stand**

- Range of travel, Center of screen: Min – 48.28" (1226 mm) and Max 58.28 (1480 mm)



**Gray - FPS1XL/EL/MS/GG**  
**White - FPS1XL/EL/MS/VW**  
**X-Large Electric Lift Mobile Stand**

- Motorized electric lift with wired remote
- Range of travel, Center of screen: Min – 36.83" (935.5 mm) and Max 62.42" (1585.5 mm)
- Superior mobility. High quality, commercial grade locking casters and integrated handles provide easy maneuverability and transport

### Surface Hub 2S 85" Mounting Adapter Kit



<b>CA/MAC5</b>	<b>Surface Hub 2S 85" Mounting Adapter Kit</b>
----------------	--

- Mount the SH2 85" to any VESA compliant wall mount or stand using the universal spacer kit.

# MOBILE / DISPLAY STANDS

## WEBEX® BOARD PRO MOUNTING SOLUTIONS



Designed For  
Touchscreens



Ergonomic  
Minimal Screen Reach



ADA  
COMPLIANT  
SOLUTIONS



### Electric Lift Mobile Stand

55", Gray	FPS1/EL/CSP55/GG
75", Gray	FPS1/EL/CSP75/GG
55", White	FPS1/EL/CSP55/VW
75", White	FPS1/EL/CSP75/VW

- Motorized electric lift with wired remote
- Range of travel, Center of screen:  
Min – 36.83" (935.5 mm) and  
Max 62.42" (1585.5 mm)
- Superior mobility. High quality, commercial grade locking casters and integrated handles provide easy maneuverability and transport
- Telescopic design allows compact position for transport and storage

### XL Fixed Height Stands

75", Gray	FPS1XL/FH/CSP75/GG
-----------	--------------------

- Supports Webex Board Pro 75
- Superior mobility. High quality commercial grade locking casters and integrated handles provide easy maneuverability and transport
- Internal storage for rack mounted (2RU) electronic components, peripherals and accessories
- Center of screen: Min – 48.28" (1226 mm) and Max 58.28 (1480 mm)



## WEBEX® BOARD MOUNTING SOLUTIONS



Designed For  
Touchscreens



Ergonomic  
Minimal Screen Reach



ADA  
COMPLIANT  
SOLUTIONS



### Cisco® Webex Board 70" Electric Lift Mobile Display Stand FPS1/EL/C2/GG

- 47.84" W (1215 mm) x 45.14 – 70.7" H (1146.6 – 1796.6mm) x 27.38" D (695mm)
- Interior equipment mounting area for electronic components, peripherals and accessories



### Cisco® Webex Board 55" Electric Lift Mobile Display Stand FPS1/EL/CS/GG

- 47.84" W (1215 mm) x 45.14 – 70.7" H (1146.6 – 1796.6mm) x 27.38" D (695mm)
- Interior equipment mounting area for electronic components, peripherals and accessories



### Cisco® Webex Board 85" Electric Lift Mobile Display Stand FPS1XL/EL/C3/GG

- 47.84" W (1215 mm) x 45.14 – 70.7" H (1146.6 – 1796.6mm) x 27.38" D (695mm)
- Interior equipment mounting area for electronic components, peripherals and accessories



### Cisco® Webex Board 85" Fixed Height Mobile Display Stand FPS1XL/FH/C3/GG

- 47.84" W (1215 mm) x 45.14 – 70.7" H (1146.6 – 1796.6mm) x 27.38" D (695mm)
- Interior equipment mounting area for electronic components, peripherals and accessories



### Cisco® Webex Board 70" Fixed Height Mobile Display Stand FPS1XL/FH/C2/GG

- 47.84" W (1215 mm) x 45.14 – 70.7" H (1146.6 – 1796.6mm) x 27.38" D (695mm)
- Interior equipment mounting area for electronic components, peripherals and accessories

## 1 Frame

## 2 Accessories



### Road Case, ATA Style

<b>IN STOCK</b>	Call 800-535-9910 or email, <a href="mailto:custom@salamanderdesigns.com">custom@salamanderdesigns.com</a> for details
-----------------	--

- Easy deploy-ability of mobile stands
  - Combine a mobile stand with a road case to provide secure and convenient transport of your display.
  - Roll-in Style on Casters
  - Saves on Freight
  - Ensures device is protected
- Not compatible with fixed height stands*



### Cable Reels

<b>FPSA/CR</b>	Retractable Power Cable Reel, 30' Payout
<b>FPSA/CR/CAT6</b>	Retractable CAT6 Cable Reel, 20' Payout

#### Power Cable Reel

- Tri-tap, female plugs with USA NEMA 5-15 male plug
- 30 foot retractable cable with 24" pigtail
- Max Rating - 10A, 125V, Indoor, Dry Location, General Use Cord Reel Only
- Cable: 16 AWG/3C, 105C

#### CAT6 Cable Reel

- 20 foot retractable cable with 36" pigtail

### Integrated Storage



**FPSA/SC/GT**  
3U Secure Equipment Storage Cover

- 31"W (787mm) x 25"H (635mm) x 7.5"D (190mm)

**FPSA/SC2/GT**  
5U Secure Equipment Storage Cover

- 31"W (787mm) x 25"H (635mm) x 10.5"D (266mm)
- Cable management
- Constructed of steel

*Not compatible with fixed height stands*



**FPSA/KS/GT**  
Keyboard Storage Shelf

- Attaches to the FPS Series Mobile Stands to store keyboards and other peripherals.
- 22.5"W (572mm) x 16.5"H (419mm) x 2"D (51mm)



**FPSA/AS1**  
Small Shelf with Mounting Straps

- Supports any small peripheral device
  - 12"W (305mm) x 4"H (102mm) x 4"D (102mm)
- Not compatible with fixed height stands*



### Vertical Rack Mounts

<b>FPSA/VR/3U</b>	3U Rack Mounting Equipment Bracket
<b>FPSA/VR/5U</b>	5U Rack Mounting Equipment Bracket

- The Vertical Mounting Bracket integrates with the FPS Series Mobile Stands to integrate industry standard 19" Rack Gear, 3 or 5 Rack Units (RU).
  - Lift and load design for easy install
  - 22.5" (572mm) W x 16.5" (419mm) "H x 7.5" (190mm) D
- Not compatible with fixed height stands*



### Power Distribution Unit

<b>SA/RM/PDU</b>	Power Distribution Unit, 9 Outlets
------------------	------------------------------------

- Multi-port rack mounted Power Distribution Unit with surge protection.
- 8 Rear Ports, 1 Front Port
- Maximum Output Current: 15 Amps
- See full specs on page 31.
- USA Compatible

### Audio / Video Integration



**FPSA/SBK**  
Tech Bracket

- Extends out from display to accommodate most center speakers.
- Mounting holes up to 14.5"W (368.3mm)



**FPSA/CS**  
Tech Shelf

- Fully adjustable height
- 10"W (254mm) x 6"D (152mm) x .5" (12.7mm)

### Wireless Remote



**FPSA/RF1**  
Wireless Remote Control with Memory

- Allows more mobility and flexibility when controlling the electric lift function of the FPS Electric Stands.

*Not compatible with fixed height stands*

[See models on pages 21-22](#)



## ON-WALL SOLUTIONS

### Strut 170 Wall Stand

The Strut Wall Stand is a sleek, streamlined solution for supporting AV/IT technology. Featuring ultra-low-impact installation with no wall construction or down time, the modular design supports video displays while securely concealing small electronics, computers and cables. Ultra-simple installation allows the Strut 170 Wall Stand to be affixed to any wall without special preparation and is ideal for every application from entryway and retail digital signage, to training, video conferencing and beyond.

#### Display Mount

- Holds 55-98", 225 lbs (102kg)
- VESA Compliant: 600x400
- Adjustable Center Line of Screen: 54-68"
- Optional Mounting Extension Kit (CA/MAC8) provides additional 4" of vertical adjustment to display position and expands VESA to 600x600.
- CA/MAC8 mounting adapter and CA/MAC5 spacer adapters are required when mounting 85" Microsoft Surface Hub 2S.

#### Storage Compartment

- Includes Rack rail for 1RU Component storage
- Additional 1 RU rack brackets available (SA/RM1U)



### Single Bay, Fixed Height Single Display



STR170/FH1/AC/BK American Cherry    STR170/FH1/BO/BK Black Oak    STR170/FH1/GW/BK Gray Walnut    STR170/FH1/MW/BK Medium Walnut    STR170/FH1/NO/BK Natural Oak    STR170/FH1/WG/BK Wenge    STR170/FH1/WH/BK White

### ACCESSORIES



Tech Shelf  
FPSA/CS



1 RU Vented Shelf  
RM/VS1U



Tech Bracket  
FPSA/SBK

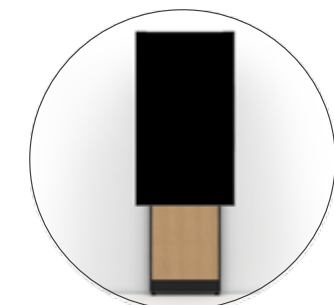

Portrait & Landscape Mounting

Electric-lift, wall stand features an accessible, compact, low profile design that conceals all equipment and cabling.

- Fully adjustable motor control improves user experience and productivity for any size user for any work assignment.
- Saves on engineering, trades and permitting as there is no need to mount display to a wall.
- Constructed with powder coated welded steel.
- Custom finishes and custom matched wood panels are available.
- Compact, Telescoping design hides cables and equipment.
- Wire Management allows clean and uncluttered installation.



### Electric Lift Wall Stand

Gray - FPS2W/EL/MS/GG  
White - FPS2W/EL/MS/VW

- Motorized electric lift with wired remote
- Range of travel, Center of screen:  
Min – 34.01" (863.8 mm) and Max 59.6" (1513.8 mm)
- Interior equipment mounting area for electronic components, peripherals and accessories

### Cisco® Webex Board Pro Electric Lift Wall Stand

Gray - FPS2WXL/EL/CSP75/GG  
White - FPS2W/EL/CSP55/GG/VW

- Motorized electric lift with wired remote
- Range of travel, Center of screen:  
Min – 34.01" (863.8 mm) and Max 59.6" (1513.8 mm)
- Interior equipment mounting area for electronic components, peripherals and accessories



### ACCESSORIES



Tech Shelf  
FPSA/CS



Wireless Remote  
Control with Memory  
FPSA/RF1



ADA Rail System

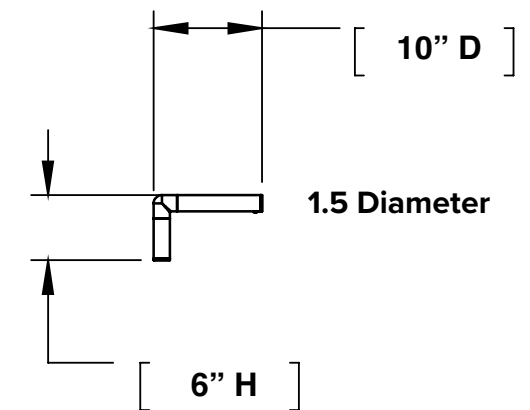

### ADA Rail System One

ADA compliant detectable barrier that solves protrusion issues caused by wall mounted video displays. Modular system designed for displays 55-86" with durable, long lasting, brushed stainless steel finish. Easy to install to wall, no floor drilling required.

ADA RAIL MODEL	DISPLAY SIZE DIAGONAL	MAX DISPLAY WIDTH FOR ALLOWABLE ADA OVERHANG
AR1/48/SS	43"	56"
	49"	Compatible with Single Displays; 43", 49", 55"
	55"	
AR1/60/SS	65"	68"
	75"	Compatible with Single Displays; 65", 75"
AR1/72/SS	85"	80"
	86"	Compatible with Single Displays; 85", 86"
	DUAL 43"	
AR1/84/SS	98"	92"
	DUAL 49"	
AR1/108/SS	DUAL 55"	116"
	DUAL 65"	

- Brushed Stainless steel finish is durable and long lasting
- Max Allowable Display protrusion from Wall is 14" with Rail System

# WALL MOUNTS / EZ-TOUCH MANUAL LIFT



**EZ1/ML360**  
EZ Touch Wall Mount Manual Assist Lift  
Range of Travel 25.6" (650mm)

Holds displays up to 90", 196-361 lbs (89-164 kg)

VESA Compliant: 1200 x 600mm

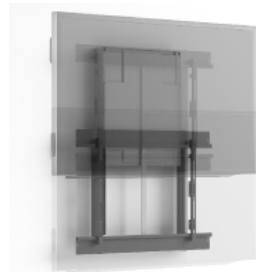

**EZ1/ML145**  
EZ Touch Wall Mount Manual Assist Lift  
Range of Travel 16" (400mm)

Holds displays up to 65", 78-140 lbs (36-64 kg)

VESA Compliant:  
Horizontal 200 - 800mm  
Vertical 100 - 440mm

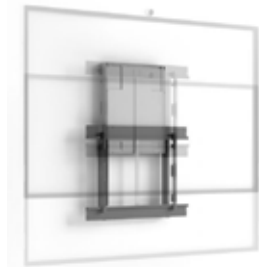

**EZ1/ML209**  
EZ Touch Wall Mount Manual Assist Lift  
Range of Travel 16" (400mm)

Holds displays up to 85", 134-197 lbs (61-90 kg)

VESA Compliant:  
Horizontal 200 - 800mm  
Vertical 100 - 440mm

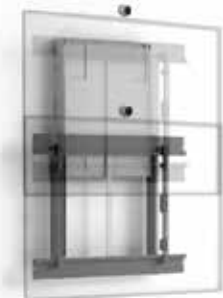

**EZ1/ML095**  
EZ Touch Wall Mount Manual Assist Lift  
Range of Travel 16" (400mm)

Holds displays up to 50", 41-85 lbs (18-38 kg)

VESA Compliant:  
Horizontal 200 - 800mm  
Vertical 100 - 440mm

Salamander Designs EZ-Touch Wall Mounts provide effortless, manual high/low adjustment which is hidden behind the touch screen. Patented design features spring-assisted counterbalance technology.



# MEETING TABLES

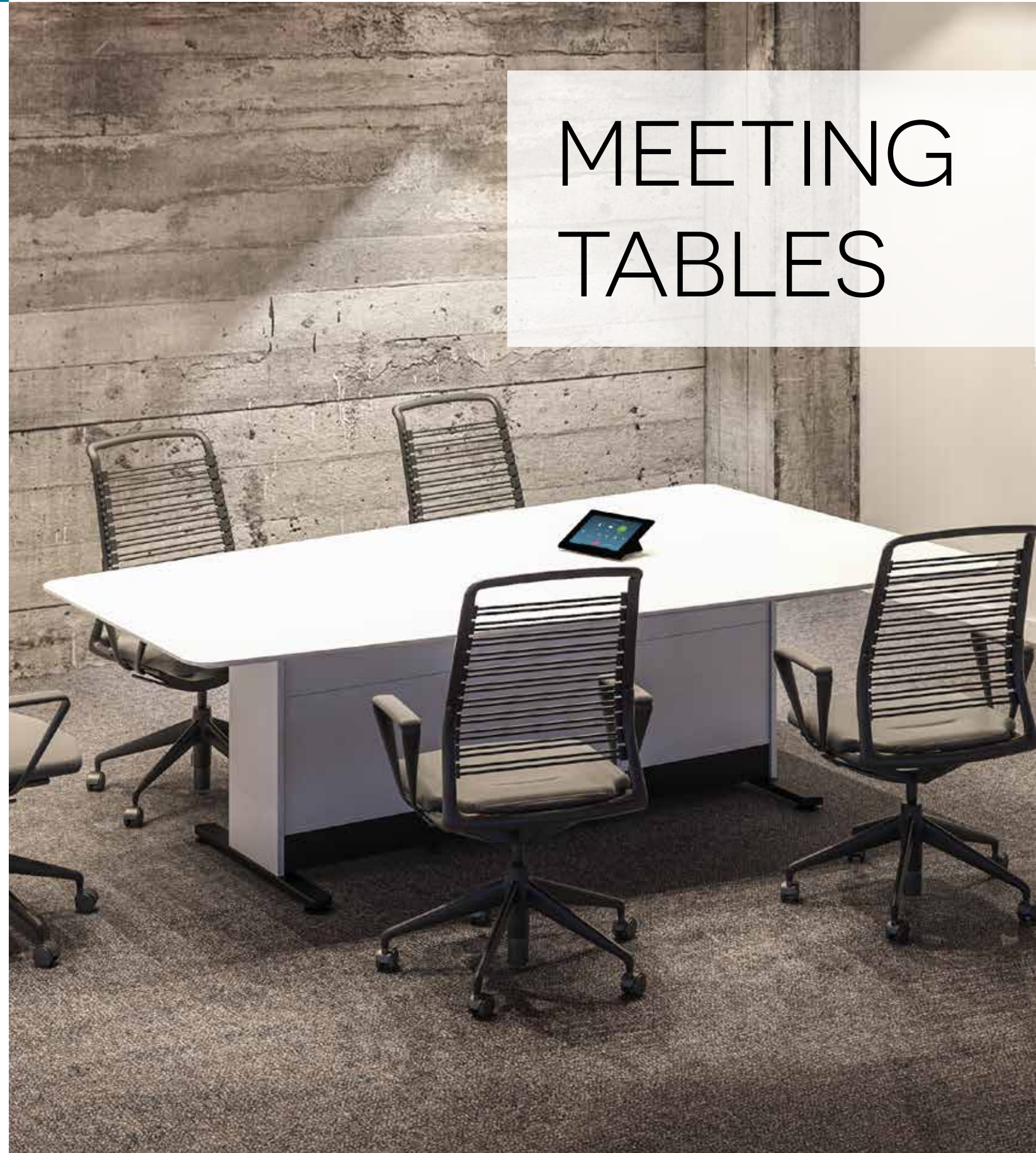



ADA Compliant

## Unifi™ Huddle

Ideal for 2 to 5 people seated, Unifi Huddle offers select mounting solutions to support virtually any unified communication technology. A premium-grade Cabinet features storage for larger AV systems with quick access and easy cable management. Other thoughtful options include power distribution and cooling systems.

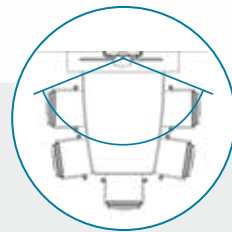
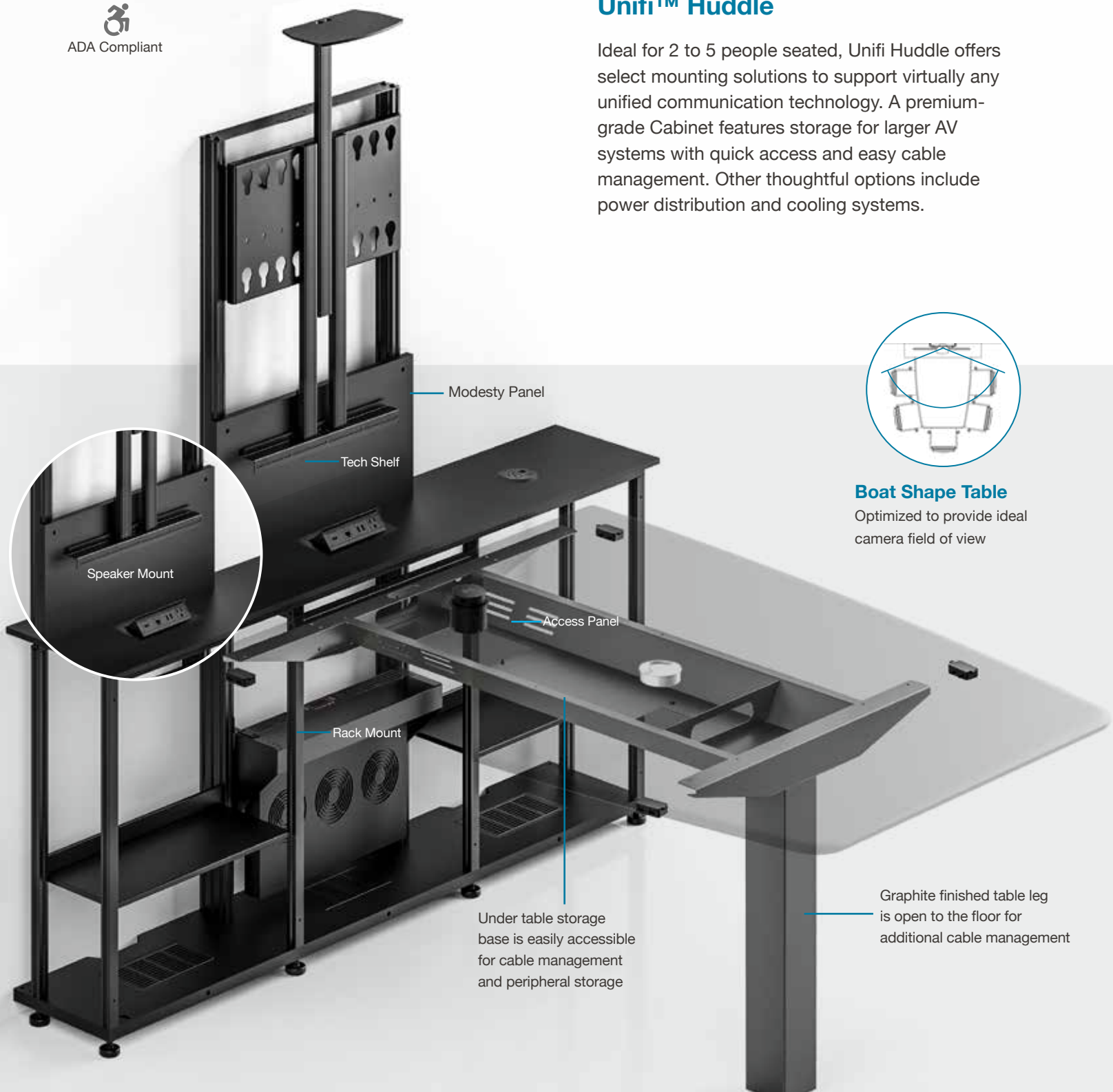

### Boat Shape Table

Optimized to provide ideal camera field of view

Graphite finished table leg is open to the floor for additional cable management

Under table storage base is easily accessible for cable management and peripheral storage



**Low Impact Installation**  
Easy to deploy, simple to move



**Aluminum Chassis Cabinet**  
Includes 3RU vertical rack and adjustable tray shelves



**Wire Management**  
Throughout open cabinet, back with fully open interior and raceway up to display and to table



ADA Compliant

Cabinet Finishes	Single Display	Dual Display	No Display	4'x5' Table Top
<b>Warm White Gloss</b> (Laminate)	D1/338AM1/SN/GW/BK	D1/338AM2/SN/GW/BK	D1/338A/SN/GW/BK	<b>Warm White</b> 3/4" Seamless TP4860A/S/WW
<b>Slate Gray Matte</b> (Laminate)	D1/338AM1/SN/SG/BK	D1/338AM2/SN/SG/BK	D1/338A/SN/SG/BK	<b>Slate Gray</b> 3/4" Seamless TP4860A/S/SG
<b>Gray Oak</b> (Veneer)	D1/338AM1/SN/GO/BK	D1/338AM2/SN/GO/BK	D1/338A/SN/GO/BK	<b>Satin Black</b> 3/4" Seamless TP4860A/S/BK
<b>Black Oak</b> (Veneer)	D1/338AM1/SN/BO/BK	D1/338AM2/SN/BO/BK	D1/338A/SN/BO/BK	<b>Solid Black</b> 1/2" Solid Black Compact Core* TP4860A/C/BK1
<b>Wengé Oak</b> (Veneer)	D1/338AM1/SN/WO/BK	D1/338AM2/SN/WO/BK	D1/338A/SN/WO/BK	
<b>Natural Oak</b> (Veneer)	D1/338AM1/SN/NO/BK	D1/338AM2/SN/NO/BK	D1/338A/SN/NO/BK	

Cabinet: 65" (W) x 31" (H) x 12" (D)

Table: 60" (L) x 48" (W) x 29" (H)

## Huddle Storage Cabinet

A variety of laminate and real wood veneer finishes with black cabinet top.



Cabinet Measures: 65" (W) x 31" (H) x 12" (D)



**Butter-knife Edge**  
3/4" Seamless Powder-Coated MDF

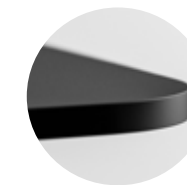

**Square Edge**  
1/2" Solid Black (Only)

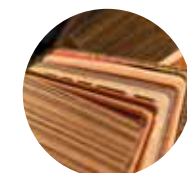

\*Custom HPL Laminates Available  
Call or details.





ADA Compliant

## Unifi™ Huddle Lite

The smaller Unifi Huddle Lite accommodates 2 to 3 people at seated and cafe-height, ideal for fast-paced environments where people gather often in an impromptu manner. The Unifi Lite is available with or without integrated display mount and features a unique under table storage base is easily accessible for small AV systems.

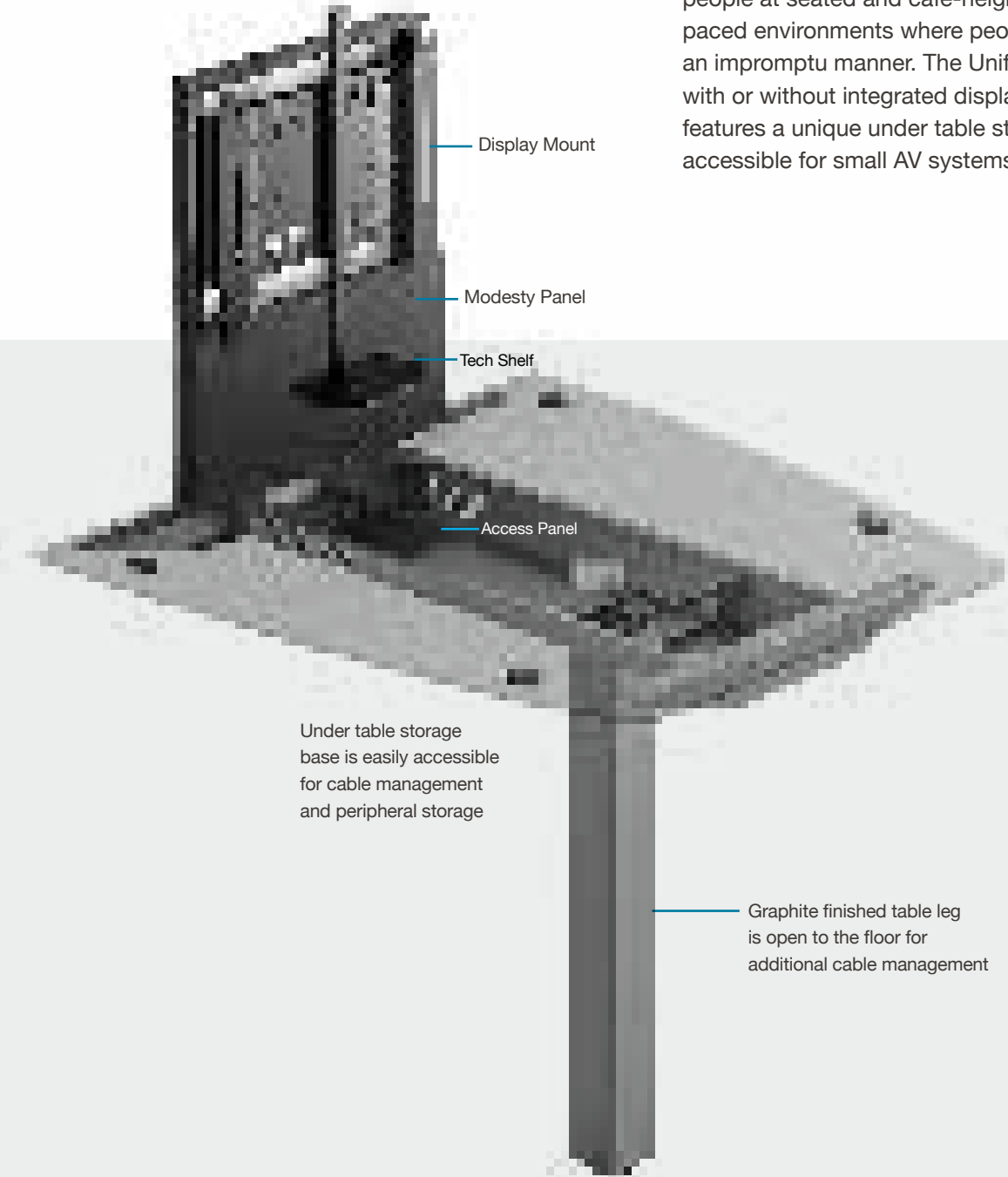

Display Mount

Modesty Panel

Tech Shelf

Access Panel

Under table storage base is easily accessible for cable management and peripheral storage

Graphite finished table leg is open to the floor for additional cable management

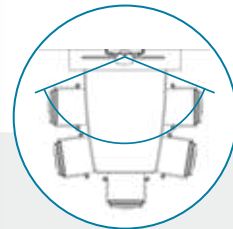

### Boat Shape Table

Optimized to provide ideal camera field of view



**Low Impact Installation**  
Easy to deploy, simple to move



**Wire Management**  
Throughout fully open interior and raceway up to display



Cafe Height Single Display

Cafe Height No Display

Standard Height Single Display

Standard Height No Display

Cafe Table: 48" (L) x 48" (W) x 39" (H)  
60" (L) x 48" (W) x 39" (H)

Standard Table: 48" (L) x 48" (W) x 29" (H)  
60" (L) x 48" (W) x 29" (H)



Cafe Height Single Display

Cafe Height No Display

Standard Height Single Display

Standard Height No Display

<b>Warm White</b> 3/4" Seamless		UHL40AM1/G/S/WW	UHL40A/G/S/WW	UHL30AM1/G/S/WW	UHL30A/G/S/WW
<b>Slate Gray</b> 3/4" Seamless		UHL40AM1/G/S/SG	UHL40A/G/S/SG	UHL30AM1/G/S/SG	UHL30A/G/S/SG
<b>Satin Black</b> 3/4" Seamless		UHL40AM1/G/S/BK	UHL40A/G/S/BK	UHL30AM1/G/S/BK	UHL30A/G/S/BK
<b>Solid Black</b> 1/2" Solid Black Compact Core*		UHL40AM1/G/S/BK1	UHL40A/G/S/BK1	UHL30AM1/G/S/BK1	UHL30A/G/S/BK1

Cafe Table: 48" (L) x 48" (W) x 39" (H)  
60" (L) x 48" (W) x 39" (H)

Standard: 48" (L) x 48" (W) x 30" (H)  
60" (L) x 48" (W) x 30" (H)

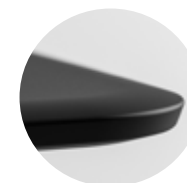

**Butter-knife Edge**  
3/4" Seamless  
Powder-Coated MDF

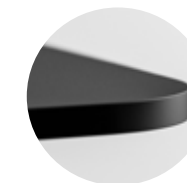

**Square Edge**  
1/2" Solid Black (Only)

## Unifi Meeting Tables

An award-winning complete series of 6 to 16-foot tables with innovative pedestal that allows virtually all wiring, power supplies, A/V components and cables to be hidden.

### Charge and Connect

- Top surface cable cubby and connections
- Under surface charging ports
- Pedestal located power ports
- Custom cut-in of any customer supplied device

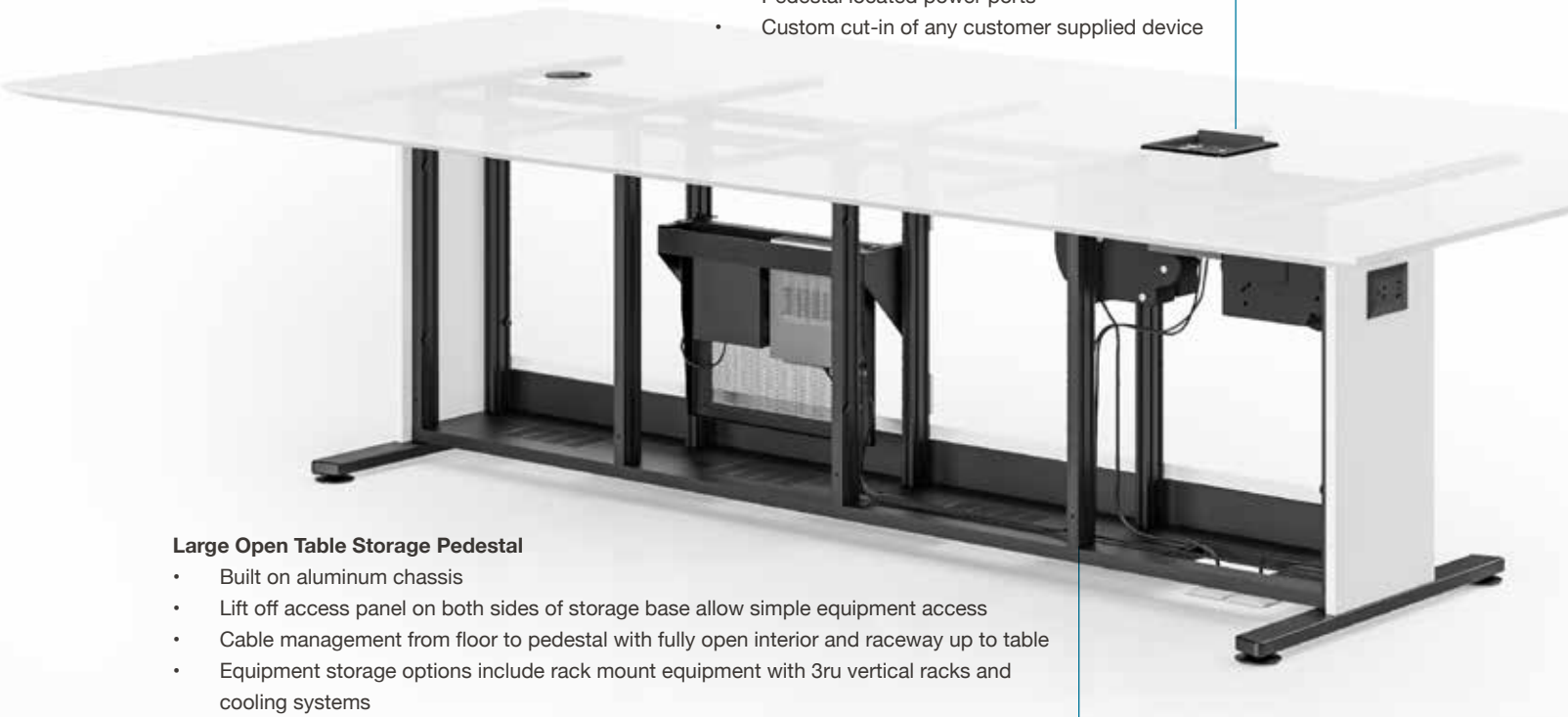

### Large Open Table Storage Pedestal

- Built on aluminum chassis
- Lift off access panel on both sides of storage base allow simple equipment access
- Cable management from floor to pedestal with fully open interior and raceway up to table
- Equipment storage options include rack mount equipment with 3ru vertical racks and cooling systems
- Ample space to accommodate large cable retractor systems
- Vented pedestal provides convention cooling

## Pedestal Finishes

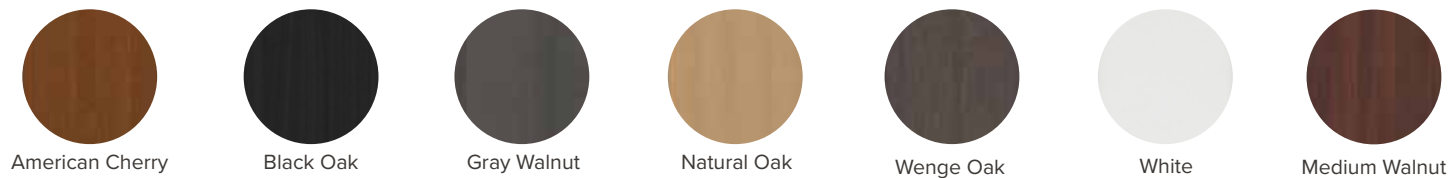

## Shapes + Sizes

Rectangular, trapezoid or boat shapes in two table width (4' and 5') and up to 6 lengths (6', 8', 10', 12', 14' and 16').



Rectangular



Trapezoid

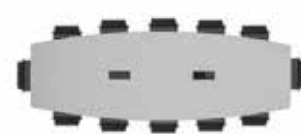

Boat

## Storage Pedestal

A variety of laminate and real wood veneer finishes with black legs and toe-kick.



White, Laminate



Siena, Black Oak Wood



Siena, Gray Walnut Wood



Siena, Medium Walnut Wood



Siena, Wengé Oak Wood



Siena, American Cherry



Siena, Natural Oak Wood



### Low Impact Installation

Easy to deploy, simple to move



### \*Custom HPL Laminate Tops and Pedestals

Call for details.

## Table Surfaces

Square, Plywood Edge

Matching, Knife Edge

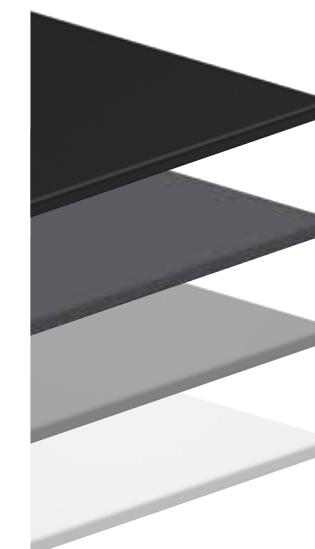
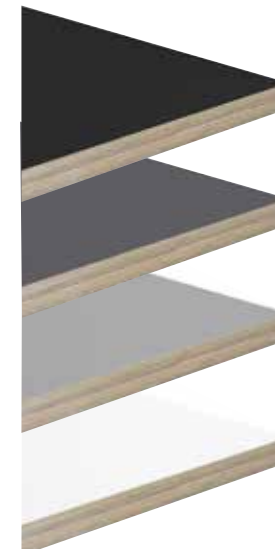

## Table Edges

### Wilsonart® Traceless™ Ultra Matte Laminates

Super durable table top surface, with a soft-to-the-touch super matte, unique fingerprint-resistant, technology that ensures smears, smudges and streaks are seldom seen.

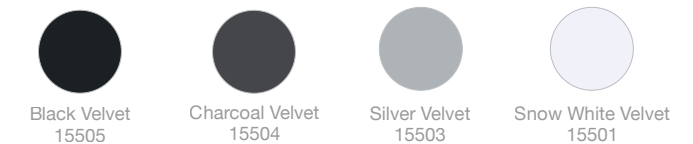

### Wilsonart® Satin High Pressure Laminates



## Infiniti Meeting Tables

Salamander Designs goes to infinity and beyond with the Infiniti™ Table series that is exclusively made to provide complete, unmatched video conferences and meeting experiences. A striking series of 6-to-14-person workplace tables, Infiniti offers innovative, trapezoid shapes made to optimize today's conferencing so that all participants can be seen, heard and fully engage – no matter where they are located. Featuring museum-quality design and artful styling, there are no other conference tables like these on the market.

- Extruded aluminum, ladder frame in a satin anodized finish
- Cable routing from base of front or rear pedestal and fully along the table rail frame from end to end
- Floor coring for cable up and into the pedestals. Rear pedestal has a cable access panel for management

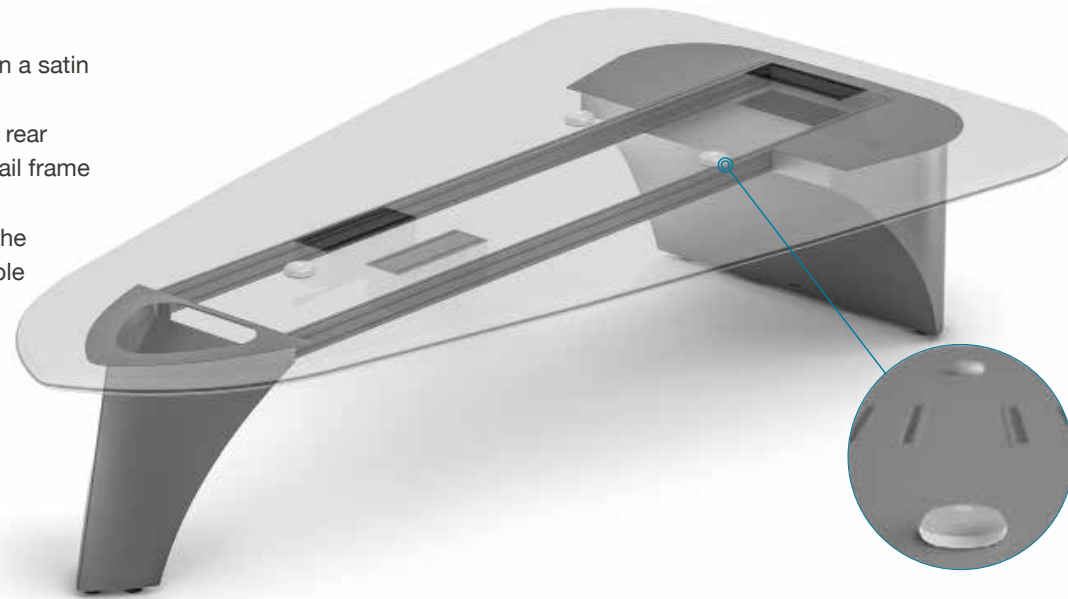

**+** Specify Your Own Device with a Custom Cut-In

## Shapes + Sizes

Organic Trapezoidal shape is precision engineered to provide the ideal user experience for video conferencing, no matter where participants are located.

### 6 Seater Table

Overall Size	Seats
7'W x 10'L	6



### 8 Seater Table

Overall Size	Seats
7'W x 13'L	8



### 10 Seater Table

Overall Size	Seats
7'W x 16'L	10



### 12 Seater Table

Overall Size	Seats
8'W x 18'L	12



### 14 Seater Table

Overall Size	Seats
8'W x 21'L	14



## Surface + Edges

Top surface is a matte, fingerprint resistant, high-pressure laminate in a dove gray color approved by Cisco for optimal light reflectivity and coloration.

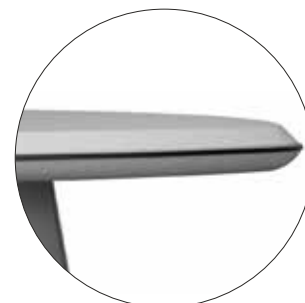

Dove Gray



Natural Oak



# KNOW HOW TO EXPAND YOUR DESIGN POSSIBILITIES

No one knows your workplace environment better than you do. And no one knows how to turn your custom workplace furniture ideas into reality better than we do.

Collaborating with an experienced team from start to finish of your project allows you peace of mind knowing your investment and ideas are in capable hands. Our custom design services include the ability to manufacture from hand drawings, photos or your specs; then color match finishes and incorporate design elements to meet your requirements.

Our mission – and passion – is to engineer, manufacture and deliver the highest quality product that exceeds your design goals without compromising your intent. That's knowhow.



Mobile Furniture



Our expert design team & build-to-order formula serve a wide range of global companies

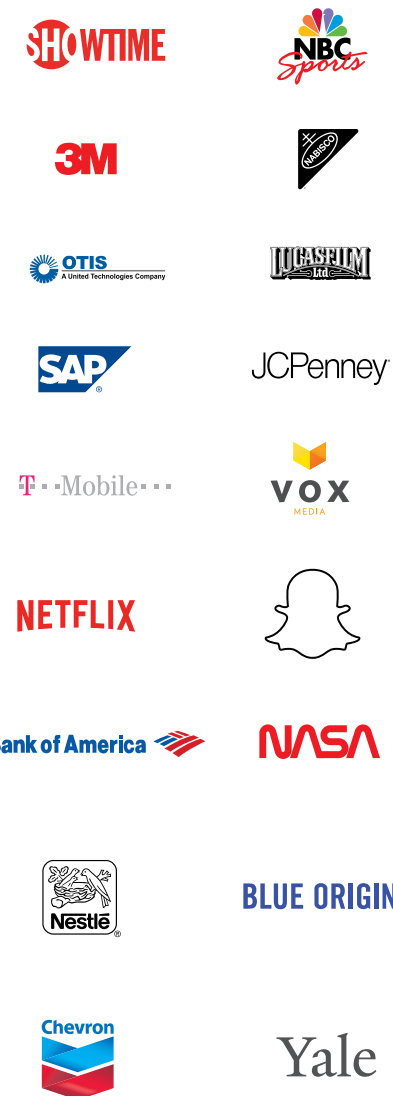

# DESIGN & ENGINEERING SERVICES



Brand Display Stands with your logo or full-wrap graphic. Call for details.



# ORDER GUIDE

## Cabinet Accessories Compatibility

	LOW PROFILE 12" Deep	STANDARD PROFILE 21" Deep	DEEP PROFILE 30" Deep	UST PROJECTORS 21" Deep
Display Mounts	•	•	•	•
Camera Shelf	•	•	•	
Pull-Out Rack Cartridge		•	•	
Adjustable Pull-Out Rack Cartridge		•	•	
Component-Length Rack Rails		•	•	•
Vertical Rack	•	•	•	•
Rack Mounted, Lacing Bars		•	•	•
Rack Mounted, Vented Shelves		•	•	•
Rack Mounted, Face Plates		•	•	•
Adjustable Trays	•			
Adjustable Shelves		•	•	•
Pull-Out Tray		•	•	•
3" Drawer		•	•	•
6" Drawer		•	•	•
File Storage		•	•	
Waste Bins		•	•	
Refrigerator		•	•	
Rears (Standard, Active, Extended)		•	•	•
Bottom Vent Active Cooling	•	•	•	•
Speakers	•	•	•	
Power Distribution Unit (with Racking)	•	•	•	•
Power & USB Ports	•	•	•	•
Power Conditioner	•	•	•	
Rectangular Cable Ports (w/Display Mounts)	•	•	•	•
Circular Cable Port	•	•	•	•
Trash Port		•	•	
Security Locks	•	•	•	•
Lighting System	•	•	•	•
Wheels		•	•	•
Footing	•	•	•	•
Tube Base		•	•	•
Wall Mounting Kit	•	•		•

# ORDER GUIDE

## Preconfigured Cabinet Solution Models

See page 36

	MIAMI BLACK TOP Gloss Warm White Door, with 1/2" (12 mm) White, Solid Surface Top	MIAMI WHITE TOP Gloss Warm White Door, with 1/2" (12 mm) Black, Solid Surface Top	MILAN BLACK TOP Dimensional, Diamond Pattern White Door, 1/2" (12 mm) Black, Solid Surface Top	MILAN WHITE TOP Dimensional, Diamond Pattern White Door, 1/2" (12 mm) White, Solid Surface Top	BARCELONA WALNUT/WHITE Natural Walnut, Warm White Doors, Beveled Edge Top
6-Bay, Low-Profile, Cabinet Dual Monitor Bundle 129.75"W x 31.25"H x 12"D	D1/367AM2/MM/GW/BK	D1/367AM2/MM/GW/WH	D1/367AM2/ML/WH/BK	D1/367AM2/ML/WH/WH	
6-Bay, Low-Profile, Cabinet No Monitor Bundle 129.75"W x 31.25"H x 12"D	D1/367A/MM/GW/BK	D1/367A/MM/GW/WH	D1/367A/ML/WH/BK	D1/367A/ML/WH/WH	
4-Bay, Low-Profile, Cabinet Dual Monitor Bundle 85.5"W x 31.25"H x 12"D	D1/347AM2/MM/GW/BK	D1/347AM2/MM/GW/WH	D1/347AM2/ML/WH/BK	D1/347AM2/ML/WH/WH	
4-Bay, Low-Profile, Cabinet Single Monitor Bundle 85.5"W x 31.25"H x 12"D	D1/347AM1/MM/GW/BK	D1/347AM1/MM/GW/WH	D1/347AM1/ML/WH/BK	D1/347AM1/ML/WH/WH	
4-Bay, Low-Profile, Cabinet Single XL Monitor Bundle 85.5"W x 31.25"H x 12"D	D1/347AMXL/MM/GW/BK	D1/347AMXL/MM/GW/WH	D1/347AMXL/ML/WH/BK	D1/347AMXL/ML/WH/WH	
4-Bay, Low-Profile, Cabinet No Monitor 85.5"W x 31.25"H x 12"D	D1/347A/MM/GW/BK	D1/347A/MM/GW/WH	D1/347A/ML/WH/BK	D1/347A/ML/WH/WH	
3-Bay, Low-Profile, Cabinet Dual Monitor Bundle 64.75"W x 31.25"H x 12"D	D1/337AM2/MM/GW/BK	D1/337AM2/MM/GW/WH	D1/337AM2/ML/WH/BK	D1/337AM2/ML/WH/WH	
3-Bay, Low-Profile, Cabinet Single Monitor Bundle 64.75"W x 31.25"H x 12"D	D1/337AM1/MM/GW/BK	D1/337AM1/MM/GW/WH	D1/337AM1/ML/WH/BK	D1/337AM1/ML/WH/WH	
3-Bay, Low-Profile, Cabinet No Monitor Bundle 64.75"W x 31.25"H x 12"D	D1/337A/MM/GW/BK	D1/337A/MM/GW/WH	D1/337A/ML/WH/BK	D1/337A/ML/WH/WH	
6-Bay, Standard Profile, Cabinet Dual Monitor Bundle 129.75"W x 31.25"H x 21.25"D	D2/367BM2/MM/GW/BK	D2/367BM2/MM/GW/WH	D2/367BM2/ML/WH/BK	D2/367BM2/ML/WH/WH	NA
6-Bay, Standard Profile, Cabinet No Monitor Bundle 129.75"W x 31.25"H x 21.25"D	D2/367A/MM/GW/BK	D2/367A/MM/GW/WH	D2/367A/ML/WH/BK	D2/367A/ML/WH/WH	NA
4-Bay, Standard Profile, Cabinet Dual Monitor Bundle 86.5"W x 31.25"H x 21.25"D	D2/347BM2/MM/GW/BK	D2/347BM2/MM/GW/WH	D2/347BM2/ML/WH/BK	D2/347BM2/ML/WH/WH	D2/347BM2/BA/NW/GW
4-Bay, Standard Profile, Cabinet Single Monitor Bundle 85.5"W x 31.25"H x 21.25"D	D2/347BM1/MM/GW/BK	D2/347BM1/MM/GW/WH	D2/347BM1/ML/WH/BK	D2/347BM1/ML/WH/WH	D2/347BM1/BA/NW/GW
4-Bay, Standard Profile, Cabinet No Monitor Bundle 85.5"W x 31.25"H x 21.25"D	D2/347A/MM/GW/BK	D2/347A/MM/GW/WH	D2/347A/ML/WH/BK	D2/347A/ML/WH/WH	D2/347A/BA/NW/GW
3-Bay, Standard Profile, Cabinet Dual Monitor Bundle 64.75"W x 31.25"H x 21.25"D	D2/337BM2/MM/GW/BK	D2/337BM2/MM/GW/WH	D2/337BM2/ML/WH/BK	D2/337BM2/ML/WH/WH	D2/337BM2/BA/NW/GW
3-Bay, Standard Profile, Cabinet Single Monitor Bundle 64.75"W x 31.25"H x 21.25"D	D2/337BM1/MM/GW/BK	D2/337BM1/MM/GW/WH	D2/337BM1/ML/WH/BK	D2/337BM1/ML/WH/WH	D2/337BM1/BA/NW/GW
3-Bay, Standard Profile, Cabinet No Monitor Bundle 64.75"W x 31.25"H x 21.25"D	D2/337A/MM/GW	D2/337A/MM/GW/WH	D2/337A/ML/WH/BK	D2/337A/ML/WH/WH	D2/337A/BA/NW/GW
3-Bay, Deep Profile, Cabinet Solution 64.75"W x 31.25"H x 30"D	D3/337BM2/MM/GW/BK	D3/337BM2/MM/GW/WH	D3/337BM2/ML/WH/BK	D3/337BM2/ML/WH/WH	D3/337BM2/BA/NW/GW
2-Bay, Deep Profile, Cabinet Solution 44"W x 31.25"H x 30"D	D3/337BM1/MM/GW/BK	D3/337BM1/MM/GW/WH	D3/337BM1/ML/WH/BK	D3/337BM1/ML/WH/WH	D3/337BM1/BA/NW/GW
1-Bay, Deep Profile, Cabinet Solution 23.25"W x 31.25"H x 30"D	D3/337A/MM/GW	D3/337A/MM/GW/WH	D3/337A/ML/WH/BK	D3/337A/ML/WH/WH	D3/337A/BA/NW/GW

# ORDER GUIDE

## Preconfigured Cabinet Solution Models

See page 14

	<b>BERLIN</b> Wenge, Wave-Texture Doors with 1/2" (12 mm) Black, Solid Surface Top	<b>CHICAGO</b> Black Oak, Grass-Textured Doors with 1/2" (12 mm) Black, Solid Surface Top	<b>DENVER WALNUT</b> Medium Walnut, Bark-Textured Doors with 1/2" (12 mm) Black, Solid Surface Top	<b>DENVER OAK</b> Natural Oak, Bark-Textured Doors with 1/2" (12 mm) Black, Solid Surface Top	<b>ZURICH</b> Linear Texture - Opium Brown Doors with 1/2" (12 mm) Black, Solid Surface Top
<b>6-Bay, Low-Profile, Cabinet Dual Monitor Bundle</b> 129.75"W x 31.25"H x 12"D	D1/367AM2/BL/WE	D1/367AM2/CH/OB	D1/367AM2/DV/MW	D1/367AM2/DV/NO	D1/367AM2/ZU/OB
<b>6-Bay, Low-Profile, Cabinet No Monitor Bundle</b> 129.75"W x 31.25"H x 12"D	D1/367A/BL/WE	D1/367A/CH/OB	D1/367A/DV/MW	D1/367A/DV/NO	D1/367A/ZU/OB
<b>4-Bay, Low-Profile, Cabinet Dual Monitor Bundle</b> 85.5"W x 31.25"H x 12"D	D1/347AM2/BL/WE	D1/347AM2/CH/OB	D1/347AM2/DV/MW	D1/347AM2/DV/NO	D1/347AM2/ZU/OB
<b>4-Bay, Low-Profile, Cabinet Single Monitor Bundle</b> 85.5"W x 31.25"H x 12"D	D1/347AM1/BL/WE	D1/347AM1/CH/OB	D1/347AM1/DV/MW	D1/347AM1/DV/NO	D1/347AM1/ZU/OB
<b>4-Bay, Low-Profile, Cabinet Single XL Monitor Bundle</b> 85.5"W x 31.25"H x 12"D	D1/347AMXL/BL/WE	D1/347AMXL/CH/OB	D1/347AMXL/DV/MW	D1/347AMXL/DV/NO	D1/347AMXL/ZU/OB
<b>4-Bay, Low-Profile, Cabinet No Monitor Bundle</b> 64.75"W x 31.25"H x 12"D	D1/347A/BL/WE	D1/347A/CH/OB	D1/347A/DV/MW	D1/347A/DV/NO	D1/347A/ZU/OB
<b>3-Bay, Low-Profile, Cabinet Dual Monitor Bundle</b> 64.75"W x 31.25"H x 12"D	D1/337AM2/BL/WE	D1/337AM2/CH/OB	D1/337AM2/DV/MW	D1/337AM2/DV/NO	D1/337AM2/ZU/OB
<b>3-Bay, Low-Profile, Cabinet Single Monitor Bundle</b> 64.75"W x 31.25"H x 12"D	D1/337AM1/BL/WE	D1/337AM1/CH/OB	D1/337AM1/DV/MW	D1/337AM1/DV/NO	D1/337AM1/ZU/OB
<b>3-Bay, Low-Profile, Cabinet No Monitor Bundle</b> 64.75"W x 31.25"H x 12"D	D1/337A/MM/BL/WE	D1/337A/MM/CH/OB	D1/337A/ML/DV/MW	D1/337A/ML/DV/NO	D1/337A/ML/ZU/OB
<b>6-Bay, Standard Profile, Cabinet Dual Monitor Bundle</b> 129.75"W x 31.25"H x 21.25"D	D2/367BM2/BL/WE	D2/367BM2/CH/OB	D2/367BM2/DV/MW	D2/367BM2/DV/NO	D2/367BM2/ZU/OB
<b>6-Bay, Standard Profile, Cabinet No Monitor Bundle</b> 129.75"W x 31.25"H x 21.25"D	D2/367A/BL/WE	D2/367A/CH/OB	D2/367A/DV/MW	D2/367A/DV/NO	D2/367A/ZU/OB
<b>4-Bay, Standard Profile, Cabinet Dual Monitor Bundle</b> 85.5"W x 31.25"H x 21.25"D	D2/347BM2/BL/WE	D2/347BM2/CH/OB	D2/347BM2/DV/MW	D2/347BM2/DV/NO	D2/347BM2/ZU/OB
<b>4-Bay, Standard Profile, Cabinet Single Monitor Bundle</b> 85.5"W x 31.25"H x 21.25"D	D2/347BM1/BL/WE	D2/347BM1/CH/OB	D2/347BM1/DV/MW	D2/347BM1/DV/NO	D2/347BM1/ZU/OB
<b>4-Bay, Standard Profile, Cabinet No Monitor Bundle</b> 85.5"W x 31.25"H x 21.25"D	D2/347A/BL/WE	D2/347A/CH/OB	D2/347A/DV/MW	D2/347A/DV/NO	D2/347A/ZU/OB
<b>3-Bay, Standard Profile, Cabinet Dual Monitor Bundle</b> 64.75"W x 31.25"H x 21.25"D	D2/337BM2/BL/WE	D2/337BM2/CH/OB	D2/337BM2/DV/MW	D2/337BM2/DV/NO	D2/337BM2/ZU/OB
<b>3-Bay, Standard Profile, Cabinet Single Monitor Bundle</b> 64.75"W x 31.25"H x 21.25"D	D2/337BM1/BL/WE	D2/337BM1/CH/OB	D2/337BM1/DV/MW	D2/337BM1/DV/NO	D2/337BM1/ZU/OB
<b>3-Bay, Standard Profile, Cabinet No Monitor Bundle</b> 64.75"W x 31.25"H x 21.25"D	D2/337A/BL/WE	D2/337A/CH/OB	D2/337A/DV/MW	D2/337A/DV/NO	D2/337A/ZU/OB
<b>3-Bay, Deep Profile Cabinet Solution</b> 64.75"W x 31.25"H x 30"D	D3/337BM2/BL/WE	D3/337BM2/CH/OB	D3/337BM2/DV/MW	D3/337BM2/DV/NO	D3/337BM2/ZU/OB
<b>2-Bay, Deep Profile Cabinet Solution</b> 44"W x 31.25"H x 30"D	D3/323BM1/BL/WE	D3/323BM1/CH/OB	D3/323BM1/DV/MW	D3/323BM1/DV/NO	D3/323BM1/ZU/OB
<b>1-Bay, Deep Profile Cabinet Solution</b> 23.25"W x 31.25"H x 30"D	D3/317A/BL/WE	D3/317A/CH/OB	D3/317A/DV/MW	D3/317A/DV/NO	D3/317A/ZU/OB

## Deep Profile Cabinet Models

Models do not include tops, rears or interiors.

See page 14

	<b>BERLIN</b>	<b>CHICAGO</b>	<b>DENVER WALNUT</b>	<b>DENVER OAK</b>	<b>MIAMI</b>	<b>MILAN</b>
<b>317</b> 23.25"W x 31.25"H x 30"D	C/D3/317BL/WE	C/D3/317CH/BO	C/D3/317DV/MW	C/D3/317DV/NO	C/D3/317MM/GW	C/D3/317ML/WH
<b>517</b> 23.25"W x 50.875"H x 30"D	C/D3/317BL/WE	C/D3/317CH/BO	C/D3/317DV/MW	C/D3/317DV/NO	C/D3/317MM/GW	C/D3/317ML/WH
<b>617</b> 23.25"W x 60.625"H x 30"D	C/D3/617BL/WE	C/D3/617CH/BO	C/D3/617DV/MW	C/D3/617DV/NO	C/D3/617MM/GW	C/D3/617ML/WH
<b>323</b> 44"W x 31.25"H x 30"D	C/D3/323BL/WE	C/D3/323CH/BO	C/D3/323DV/MW	C/D3/323DV1NO	C/D3/323MM/GW	C/D3/323ML/WH
<b>337</b> 64.75"W x 31.25"H x 30"D	C/D3/337BL/WE	C/D3/337CH/BO	C/D3/337DV/MW	C/D3/337DV/NO	C/D3/337MM/GW	C/D3/337ML/WH
<b>347</b> 85.5"W x 31.25"H x 30"D	C/D3/347BL/WE	C/D3/347CH/BO	C/D3/347DV/MW	C/D3/347DV/NO	C/D3/347MM/GW	C/D3/347ML/WH
<b>367</b> 129.75"W x 31.25"H x 30"D	C/D3/367BL/WE	C/D3/367CH/BO	C/D3/367DV/MW	C/D3/367DV/NO	C/D3/367MM/GW	C/D3/367ML/WH
<b>329</b> 44"W x 31.25"H x 30"D	C/D3/329BL/WE	C/D3/329CH/BO	C/D3/329DV/MW	C/D3/329DV/NO	C/D3/329MM/GW	C/D3/329ML/WH
<b>336</b> 64.75"W x 31.25"H x 30"D	C/D3/336BL/WE	C/D3/336CH/BO	C/D3/336DV/MW	C/D3/336DV/NO	C/D3/336MM/GW	C/D3/336ML/WH
<b>345</b> 85.5"W x 31.25"H x 30"D	C/D3/345BL/WE	C/D3/345CH/BO	C/D3/345DV/MW	C/D3/345DV/NO	C/D3/345MM/GW	C/D3/345ML/WH

	<b>ZURICH</b>
<b>317</b> 23.25"W x 31.25"H x 30"D	C/D3/317ZU/OB
<b>517</b> 23.25"W x 50.875"H x 30"D	C/D3/517ZU/OB
<b>617</b> 23.25"W x 60.625"H x 30"D	C/D3/617ZU/OB
<b>323</b> 44"W x 31.25"H x 30"D	C/D3/323ZU/OB
<b>337</b> 64.75"W x 31.25"H x 30"D	C/D3/337ZU/OB
<b>347</b> 85.5"W x 31.25"H x 30"D	C/D3/347ZU/OB
<b>367</b> 129.75"W x 31.25"H x 30"D	C/D3/367ZU/OB
<b>329</b> 44"W x 31.25"H x 30"D	C/D3/329ZU/OB
<b>336</b> 64.75"W x 31.25"H x 30"D	C/D3/336ZU/OB
<b>345</b> 85.5"W x 31.25"H x 30"D	C/D3/345ZU/OB

## Projector Cabinet Models

See page 40

		<b>BERLIN</b>	<b>CHICAGO</b>	<b>DENVER OAK</b>
<b>EPSON</b>	SPEAKER	X/EPS236BL/WE	X/EPS236CH/BO	X/EPS236DV/NO
	NO SPEAKER	X/EPS237BL/WE	X/EPS237CH/BO	X/EPS237DV/NO
<b>VIVITEK</b>	SPEAKER	X/VIV236BL/WE	X/VIV236CH/BO	X/VIV236DV/NO
	NO SPEAKER	X/VIV237BL/WE	X/VIV237CH/BO	X/VIV237DV/NO

## Continued Projector Cabinet Models

		<b>DENVER WALNUT</b>	<b>MIAMI</b>	<b>MILAN</b>	<b>ZURICH</b>	<b>PROJECTOR MODELS</b>
<b>EPSON</b>	SPEAKER	X/EPS236DV/MW	X/EPS236MM/GW	X/EPS236ML/GW	X/EPS236ZU/OB	EPSON LS100
	NO SPEAKER	X/EPS237DV/MW	X/EPS237MM/GW	X/EPS237ML/GW	X/EPS237ZU/OB	
<b>VIVITEK</b>	SPEAKER	X/VIV236DV/MW	X/VIV236MM/GW	X/VIV236ML/GW	X/VIV236ZU/OB	VIVITEK DH765Z-UST, DW763Z-UST
	NO SPEAKER	X/VIV237DV/MW	X/VIV237MM/GW	X/VIV237ML/GW	X/VIV237ZU/OB	

# ORDER GUIDE

## Standard Profile Cabinet Models

Models do not include tops, rears or interiors.

See page 12

	BERLIN	CHICAGO	DENVER WALNUT	DENVER OAK	MIAMI	MILAN
<b>317</b> 23.25"W x 31.25"H x 21.25"D	C/D2/317BL/WE	C/D2/317CH/BO	C/D2/317DV/MW	C/D2/317DV/NO	C/D2/317MM/GW	C/D2/317ML/WH
<b>617</b> 23.25"W x 60.625"H x 21.25"D	C/D2/617BL/WE	C/D2/617CH/BO	C/D2/617DV/MW	C/D2/617DV/NO	C/D2/617MM/GW	C/D2/617ML/WH
<b>323</b> 44"W x 31.25"H x 21.25"D	C/D2/323BL/WE	C/D2/323CH/BO	C/D2/323DV/MW	C/D2/323DV1NO	C/D2/323MM/GW	C/D2/323ML/WH
<b>337</b> 64.75"W x 31.25"H x 21.25"D	C/D2/337BL/WE	C/D2/337CH/BO	C/D2/337DV/MW	C/D2/337DV/NO	C/D2/337MM/GW	C/D2/337ML/WH
<b>347</b> 85.5"W x 31.25"H x 21.25"D	C/D2/347BL/WE	C/D2/347CH/BO	C/D2/347DV/MW	C/D2/347DV/NO	C/D2/347MM/GW	C/D2/347ML/WH
<b>367</b> 129.75"W x 31.25"H x 21.25"D	C/D2/367BL/WE	C/D2/367CH/BO	C/D2/367DV/MW	C/D2/367DV/NO	C/D2/367MM/GW	C/D2/367ML/WH
<b>329</b> 44"W x 31.25"H x 21.25"D	C/D2/329BL/WE	C/D2/329CH/BO	C/D2/329DV/MW	C/D2/329DV/NO	C/D2/329MM/GW	C/D2/329ML/WH
<b>336</b> 64.75"W x 31.25"H x 21.25"D	C/D2/336BL/WE	C/D2/336CH/BO	C/D2/336DV/MW	C/D2/336DV/NO	C/D2/336MM/GW	C/D2/336ML/WH
<b>345</b> 85.5"W x 31.25"H x 21.25"D	C/D2/345BL/WE	C/D2/345CH/BO	C/D2/345DV/MW	C/D2/345DV/NO	C/D2/345MM/GW	C/D2/345ML/WH
<b>236</b> 64.75"W x 21.5"H x 21.25"D	C/D2/236BL/WE	C/D2/236CH/BO	C/D2/236DV/MW	C/D2/236DV/NO	C/D2/236MM/GW	C/D2/236OML/WH
<b>245</b> 85.5"W x 21.5"H x 21.25"D	C/D2/245BL/WE	C/D2/245CH/BO	C/D2/245DV/MW	C/D2/245DV/NO	C/D2/245MM/GW	C/D2/245ML/WH
<b>237</b> 64.75"W x 21.5"H x 21.25"D	C/D2/237BL/WE	C/D2/237CH/BO	C/D2/237DV/MW	C/D2/237DV/NO	C/D2/237MM/GW	C/D2/237ML/WH
<b>247</b> 85.5"W x 21.5"H x 21.25"D	C/D2/247BL/WE	C/D2/247CH/BO	C/D2/247DV/MW	C/D2/247DV/NO	C/D2/247MM/GW	C/D2/247ML/WH

	ZURICH		BARCELONA WALNUT/WHITE
<b>317</b> 23.25"W x 31.25"H x 21.25"D	C/D2/317ZU/OB	<b>317</b> 23.25"W x 31.25"H x 21.25"D	C/D2/317BA/NW/GW
<b>617</b> 23.25"W x 60.625"H x 21.25"D	C/D2/617ZU/OB	<b>617</b> 23.25"W x 64.5"H x 21.25"D	C/D2/617BA/NW/GW
<b>323</b> 44"W x 31.25"H x 21.25"D	C/D2/323ZU/OB	<b>323</b> 44"W x 31.25"H x 21.25"D	C/D2/323BA/NW/GW
<b>337</b> 64.75"W x 31.25"H x 21.25"D	C/D2/337ZU/OB	<b>337</b> 64.75"W x 31.25"H x 21.25"D	C/D2/337BA/NW/GW
<b>347</b> 85.5"W x 31.25"H x 21.25"D	C/D2/347ZU/OB	<b>347</b> 85.5" W x 31.25"H x 21.25"D	C/D2/347BA/NW/GW
<b>367</b> 129.75"W x 31.25"H x 21.25"D	C/D2/367ZU/OB		
<b>329</b> 44"W x 31.25"H x 21.25"D	C/D2/329ZU/OB	<b>329</b> 44"W x 31.255"H x 21.25"D	C/D2/329BA/NW/GW
<b>336</b> 64.75"W x 31.25"H x 21.25"D	C/D2/336ZU/OB	<b>336</b> 64.75"W x 31.25"H x 21.25"D	C/D2/336BA/NW/GW
<b>345</b> 85.5"W x 31.25"H x 21.25"D	C/D2/345ZU/OB	<b>345</b> 85.5"W x 31.25"H x 21.25"D	C/D2/345BA/NW/GW
<b>236</b> 64.75"W x 21.5"H x 21.25"D	C/D2/236ZU/OB	<b>236</b> 64.75"W x 21.5"H x 21.25"D	C/D2/236BA/NW/GW
<b>245</b> 85.5"W x 21.5"H x 21.25"D	C/D2/245ZU/OB	<b>245</b> 85.5" W x 21.5"H x 21.25"D	C/D2/245BA/NW/GW
<b>237</b> 64.75"W x 21.5"H x 21.25"D	C/D2/237ZU/OB	<b>237</b> 64.75"W x 21.5"H x 21.25"D	C/D2/237BA/NW/GW
<b>247</b> 85.5"W x 21.5"H x 21.25"D	C/D2/247ZU/OB	<b>247</b> 85.5" W x 21.5"H x 21.25"D	C/D2/247BA/NW/GW

## Low Profile Cabinets Models

Models do not include tops, rears or interiors.

See page 10

	BERLIN	CHICAGO	DENVER WALNUT	DENVER OAK
<b>317</b> 23.25"W x 31.25"H x 12"D	C/D1/317BL/WE	C/D1/317CH/BO	C/D1/317DV/MW	C/D1/317DV/NO
<b>323</b> 44"W x 31.25"H x 12"D	C/D1/323BL/WE	C/D1/323CH/BO	C/D1/323DV/MW	C/D1/323DV1NO
<b>337</b> 64.75"W x 31.25"H x 12"D	C/D1/337BL/WE	C/D1/337CH/BO	C/D1/337DV/MW	C/D1/337DV/NO
<b>347</b> 85.5" W x 31.25"H x 12"D	C/D1/347BL/WE	C/D1/347CH/BO	C/D1/347DV/MW	C/D1/347DV/NO
<b>367</b> 129.75"W x 31.25"H x 12"D	C/D1/367BL/WE	C/D1/367CH/BO	C/D1/367DV/MW	C/D1/367DV/NO
<b>329</b> 44"W x 31.25"H x 12"D	C/D1/329BL/WE	C/D1/329CH/BO	C/D1/329DV/MW	C/D1/329DV/NO
<b>336</b> 64.75"W x 31.25"H x 12"D	C/D1/336BL/WE	C/D1/336CH/BO	C/D1/336DV/MW	C/D1/336DV/NO
<b>345</b> 85.5"W x 31.25"H x 12"D	C/D1/345BL/WE	C/D1/345CH/BO	C/D1/345DV/MW	C/D1/345DV/NO

	ZURICH	MIAMI	MILAN
<b>317</b> 23.25"W x 31.25"H x 12"D	C/D1/317ZU/OB	C/D1/317MM/GW	C/D1/317ML/WH
<b>323</b> 44"W x 31.25"H x 12"D	C/D1/323ZU/OB	C/D1/323MM/GW	C/D1/323ML/WH
<b>337</b> 64.75"W x 31.25"H x 12"D	C/D1/337ZU/OB	C/D1/337MM/GW	C/D1/337ML/WH
<b>347</b> 85.5" W x 31.25"H x 12"D	C/D1/347ZU/OB	C/D1/347MM/GW	C/D1/347ML/WH
<b>367</b> 129.75"W x 31.25"H x 12"D	C/D1/367ZU/OB	C/D1/367MM/GW	C/D1/367ML/WH
<b>329</b> 44"W x 31.25"H x 12"D	C/D1/329ZU/OB	C/D1/329MM/GW	C/D1/329ML/WH
<b>336</b> 64.75"W x 31.25"H x 12"D	C/D1/336ZU/OB	C/D1/336MM/GW	C/D1/336ML/WH
<b>345</b> 85.5"W x 31.25"H x 12"D	C/D1/345ZU/OB	C/D1/345MM/GW	C/D1/345ML/WH

## Mobile Display Stand Compatible Accessories See page 42

	FS1XL/EL/GG XL Electric Lift Mobile Stand	FS1/EL/GG Electric Lift Mobile Stand	FS2/ELT/GG Electric Lift & Tilt Mobile Stand	FS1XL/FH/GG XL Fixed Height Mobile Stand	FS1/FH/GG Fixed Height Mobile Stand	FS2W/EL/GG Electric Lift Wall Stand
Cable Reels	•	•	•	•	•	
Power Distribution Unit	•	•	•	•	•	
Vertical Rack Mount	•	•	•			
Equipment Storage Cover	•	•	•			
Keyboard Storage Shelf	•	•	•	•	•	
Small Shelf with Straps	•	•	•			
Tech Bracket	•	•	•	•	•	
Tech Shelf	•	•	•	•	•	•
Wireless Remote	•	•	•			•
Road Case	•	•	•			

# CUSTOM MADE EASY

Salamander specializes in custom  
designing and manufacturing  
high-performing furniture solutions  
for complex projects.

**Call us for a free design consultation.**



**SALAMANDER DESIGNS**  
811 Blue Hills Avenue  
Bloomfield, CT 06002

**[salamandercommercial.com](http://salamandercommercial.com)**  
**[custom@salamanderdesigns.com](mailto:custom@salamanderdesigns.com)**

