

# RED CARPET STUDIOS LTD • GARDEN 2020

*Giftware for Home and Garden*





Garden Gnomes pg 129



Solar Stakes pgs 48-51

\* PLEASE SEE UPDATED TERMS & CONDITIONS ON PAGES 142 & 146

### CATALOG NOTATIONS



= PROP 65 WARNING  
[www.P65Warnings.ca.gov](http://www.P65Warnings.ca.gov)



= GLOW IN THE DARK, SOLAR, or LIGHTS UP



= OVERSIZED FREIGHT

### STOP BY OUR SHOWROOMS!

Atlanta  
Americas Mart • Building 2 • 17th Floor • Suite 1713B • RCS Gifts  
Americas Mart • Building 2 • 17th Floor • Suite 1713A • Bill Curlee

Columbus  
Columbus Marketplace • #210, Mark Williams & Company

Dallas  
Dallas Market Center • #1600 • Cathy & Co., Inc

Denver  
Denver Merchandise Mart • 1229 • United Giftware Sales Group

Las Vegas  
World Market Center • Building C • Suite C-0891 • Next Step Reps

Minneapolis  
Minneapolis Mart • Green 465 • BPA Sales

Seattle  
Seattle Mart • #105 • DandyLines

Visit Our Website!

[www.rcsgifts.com](http://www.rcsgifts.com)



Spinners pgs 35-48



Flower Stakes pgs 49-53

# *Brilliant* & **BOLD**

Brighten any garden, yard, or porch with RCS Gifts new collection of garden décor. Finishes that sparkle and glimmer in the sun, as well as, colorful characters are throughout the assortment of chimes, spinners, balancers, bird houses and more. New collections of multi-purpose planters with sports themed, statuary, unique hanging planters and expanded animal themes based on our best-selling designs. All created to enhance any outdoor or indoor space. Have fun in the garden with over 170 new items from RCS Gifts!

Order Toll Free 1.877.985.0405 • Fax 1.513.774.1601

Visit our website or call to receive a complete catalog to see all styles of fashion and garden giftware RCS offers.

[www.rcsgifts.com](http://www.rcsgifts.com) | 3

# 3D Animal Planters

MGO • INDOOR/OUTDOOR USE • DRAINAGE HOLE

18-PC ASSORTMENT  
**21050-18-00903**  
  
 8 09048 99482 7



12.3" X 7.09" X 12.80"  
**Owl Planter**  
 21051-2-0561  
  
 8 09048 21051 4



13.78" X 9.13" X 8.66"  
**Dog with Stone Planter**  
 21055-2-0561  
  
 8 09048 21055 2



9.84" X 5.91" X 14.57"  
**Rabbit Planter**  
 21052-2-0561  
  
 8 09048 21052 1



14.96" X 11.22" X 10"  
**Cat with Stone Planter**  
 21056-2-0561  
  
 8 09048 21056 9



12.20" X 7.49" X 16.41"  
**Cat Planter**  
 21053-2-0581  
  
 8 09048 21053 8



14.17" X 7.68" X 13.19"  
**Dog Planter**  
 21054-2-0581  
  
 8 09048 21054 5



13.98" X 6.90" X 8.11"  
**Fox with Stone Planter**  
 21057-2-0561  
  
 8 09048 21057 6

 = GLOW IN THE DARK, SOLAR, or LIGHTS UP



13.38" X 9.84" X 12.05"  
Rooster with Stone  
Planter

21058-2-0561



15.35" X 10.63" X 14.17"  
Swan with Stone  
Planter

21059-2-0581





## Sport Planters

MGO • INDOOR/OUTDOOR USE • DRAINAGE HOLE

6-PC ASSORTMENT  
20130-6-00501



11.81" DIA X 10.24"  
Basketball Planter  
20131-2-0571



16.92" X 10.24" X 9.84"  
Football Planter  
20132-2-0571



11.81" DIA X 9.84"  
Soccer Planter  
20133-2-0571



= GLOW IN THE DARK, SOLAR, or LIGHTS UP



6-PC ASSORTMENT  
**21040-6-0079**  
  
 8 09048 21040 8

## Denim Planters

MGO • INDOOR/OUTDOOR USE • DRAINAGE HOLE



14.57" X 6.30" X 7.87"  
**Denim Shoe Planter**  
 21041-2-0051

  
 8 09048 21041 5



10.24" X 7.87" X 14.17"  
**Denim Vest Planter**  
 21043-2-0581

  
 8 09048 21043 9



13.78" X 8.66" X 6.30"  
**Denim Cap Planter**  
 21042-2-0051

  
 8 09048 21042 2

# Indigo Terra Cotta Planters

4.72" DIA X 3.94"(14" WITH ROPE) • TERRA COTTA  
 • JUTE • INDOOR/OUTDOOR USE • \$2.50 EACH

12-PC ASSORTMENT  
 20216-2-0003

8 09048 20216 8



# Leaf Terra Cotta Planters

4.72" DIA" X 3.94"(14" WITH ROPE) • TERRA COTTA  
 • JUTE • INDOOR/OUTDOOR USE • \$2.50 EACH

12-PC ASSORTMENT  
 20217-2-0003

8 09048 20217 5



= GLOW IN THE DARK, SOLAR, or LIGHTS UP



12-PC ASSORTMENT  
20218-2-0003



## Pastel Terra Cotta Planters

4.72" DIA X 3.94"(14" WITH ROPE) • TERRA COTTA  
• JUTE • INDOOR/OUTDOOR USE • \$2.50 EACH



12-PC ASSORTMENT  
20219-2-0003



## Textured Terra Cotta Planters

4.72" DIA X 3.94"(14" WITH ROPE) • TERRA COTTA  
• JUTE • INDOOR/OUTDOOR USE • \$2.50 EACH



# Terra Cotta w/ Macrame Planters

4.72" DIA X 3.94"(14" WITH ROPE) • TERRA COTTA  
• JUTE • INDOOR/OUTDOOR USE • \$2.50 EACH

12-PC ASSORTMENT  
20211-2-0003



12-PC ASSORTMENT  
20212-2-0003



= GLOW IN THE DARK, SOLAR, or LIGHTS UP

24-PC ASSORTMENT  
20213-2-0042



## Terra Cotta Mini Planters

2.76" DIA X 2.36" • TERRA COTTA  
• INDOOR/OUTDOOR USE • \$1.00 EACH



12-PC ASSORTMENT  
20210-1-0042



## Planter Stands

4.7" X 4.7" X 4.7" • IRON • INDOOR/OUTDOOR USE • \$2.00 EACH  
POTS NOT INCLUDED



# Statuary Planters

RESIN • INDOOR/OUTDOOR USE • DRAINAGE HOLE

8-PC ASSORTMENT  
21020-8-00071



6.3" X 10.43" X 12.4"  
Girl w/ Flower Pot  
Statuary Planter  
21022-2-0522



6.3" X 10.43" X 12.4"  
Boy w/ Flower Pot  
Statuary Planter  
21027-2-0522



10.04" X 7.09" X 13.19"  
Little Boy Statuary  
Planter  
21024-2-0002



10.04" X 7.09" X 13.19"  
Little Girl Statuary  
Planter  
21023-2-0002



= GLOW IN THE DARK, SOLAR, or LIGHTS UP



**\*\*NOT IN ASSORTMENT**  
**8.86" X 6.3" X 20.08"**  
**St. Francis Statuary Planter**  
 21021-2-0522



8 09048 21021 7



**FLORAL HEADBAND  
 LIGHTS UP!**

**\*\*NOT IN ASSORTMENT**  
**10.63" X 6.89" X 8.46"**  
 **Solar Angel Kneeling Statuary Planter**  
 21025-2-0002



8 09048 21025 5

**FLORAL HEADBAND  
 LIGHTS UP!**

**\*\*NOT IN ASSORTMENT**  
**10.63" X 6.89" X 8.46"**  
 **Solar Angel Sitting Statuary Planter**  
 21026-2-0002



8 09048 21026 2



 = GLOW IN THE DARK, SOLAR, or LIGHTS UP

 = OVERSIZED FREIGHT

# Bike & Wagon Planters



METAL • WOOD



 43.75" X 17.87" X 23.5"

 **Bike Wagon Planter-Blue**  
20075-1-00501



 40" X 13.75" X 25.72"  
 **Bike Wagon Planter-Rustic**  
20076-1-00021



 27.75" X 17.25" X 27.75"

 **Wagon Planter**  
20078-2-0058



 **WARNING:** THIS PRODUCT CAN EXPOSE YOU TO CHEMICALS INCLUDING LEAD WHICH IS (ARE) KNOWN TO THE STATE OF CALIFORNIA TO CAUSE CANCER, BIRTH DEFECTS, OR OTHER REPRODUCTIVE HARM. FOR MORE INFORMATION, GO TO [WWW.P65WARNINGS.CA.GOV](http://WWW.P65WARNINGS.CA.GOV)

 = GLOW IN THE DARK, SOLAR, or LIGHTS UP

# Wheelbarrow Planters

METAL • PLANTERS COME NESTED



29.92" X 10.23" X 10.23"

22.83" X 7.87" X 8.66"

18.11" X 5.70" X 5.90"

**Wheelbarrow Planters- Set of 3**  
21031-2-0054



# Metal Wagon Planter

METAL • INDOOR/OUTDOOR USE



14.57" X 5.51" X 6.1"

**Long Wagon Planter**  
20065-2-0052



# Rustic Planters

IRON • INDOOR/OUTDOOR USE



12" DIA X 9.84"  
4 Pot Bucket  
Planter

20012-2-0002



9.06" X 8.27" X 7.87"  
4 Pot Bucket House  
Planter

20121-2-0571



12.20" X 7.09" X 7.09"

Planter City  
20124-2-0561



 = GLOW IN THE DARK, SOLAR, or LIGHTS UP





10.04" X 7.28" X 13.39"  
**Water Tower Planter**  
20109-3-0541



SM-4.72" DIA X 12.20"  
MD-5.7" DIA X 15.35"  
LG-6.69" DIA X X 19.90"

**Faucet Planters -  
Set of 3**  
20009-2-0522



# Rustic Planters

IRON • INDOOR/OUTDOOR USE



8.26" X 7.48" 42.91"

**Shovel 4 Pot Plant Stand**

20011-2-0052



8 09048 20011 9



12" X 6.5" X 36"

 **Shovel w/2 Planters Stake**

34352-2-0052



8 09048 34352 6

 **WARNING: THIS PRODUCT CAN EXPOSE YOU TO CHEMICALS INCLUDING LEAD WHICH IS (ARE) KNOWN TO THE STATE OF CALIFORNIA TO CAUSE CANCER, BIRTH DEFECTS, OR OTHER REPRODUCTIVE HARM. FOR MORE INFORMATION, GO TO [WWW.P65WARNINGS.CA.GOV](http://WWW.P65WARNINGS.CA.GOV)**



 = GLOW IN THE DARK, SOLAR, or LIGHTS UP



9.65" X 8.46" X 4.33"  
**Coffee Cup Scene  
 Planter - Blue**  
 20122-3-0511



9.65" X 8.46" X 4.33"  
**Coffee Cup Scene  
 Planter - Natural**  
 20123-3-0511



# Rustic Planters

IRON • INDOOR/OUTDOOR USE



15.75" X 6.69" X 13.78"  
19.69" X 8.66" X 19.9"

**Oval Suitcase Planters**  
- Set of 2  
20008-2-0054



12.4" X 12.4" X 43.5"

**3 Tier w/Bird  
Planter**  
20104-3-0562



8.46" X 7.87" X 11.41"

**Cascade Pots w/Bird  
Planter**  
20026-4-0531



 = GLOW IN THE DARK, SOLAR, or LIGHTS UP



20.47"X 5.11" X22.04"

**Heart Wreath Planter**  
20003-2-0513



8 09048 20003 4



18.8" DIA X 3.93"

**Pot Wreath Planter**  
20021-2-0092



8 09048 20021 8



## Nesting Metal Planters

METAL • WOOD HANDLES • INDOOR/OUTDOOR USE

SM: 10.63" X 5.12" X 3.54"

MD: 12.6" X 6.3" X 3.94"

LG: 13.39" X 7.28" X 4.33"

**Metal Pot w/ Handles  
Oval Planters**

- Set of 3

20019-4-0021



8 09048 20019 5



SM: 8.46" X 6.1" X 4.92"

MD: 9.45" X 7.09" X 5.51"

LG: 10.43" X 8.07" X 5.9"

**"Flowers" Metal**

**Oval Pot w/ Handles**

**Planters - Set of 3**

21075-4-0021



8 09048 21075 0



 = GLOW IN THE DARK, SOLAR, or LIGHTS UP



# Nesting Metal Planters

METAL • INDOOR/OUTDOOR USE



SM: 9.84" X 5.12" X 3.94"  
 MD: 11.81" X 5.81" X 5.325"  
 LG: 13.75" X 6.94" X 5.94"

 **Nesting Oval Planters**  
 - Set of 3 Cream  
 21071-2-0592



SM: 9.84" X 5.12" X 3.94"  
 MD: 11.81" X 5.81" X 5.325"  
 LG: 13.75" X 6.94" X 5.94"

 **Nesting Oval Planters**  
 - Set of 3 Blue  
 21072-2-0592



SM: 3.94" DIA X 4.33"  
 MD: 4.72" DIA X 5.12"  
 LG: 6.3" DIA X 2.76"

 **Bucket Planters**  
 - Set of 3 Blue  
 21073-2-0051



SM: 3.94" DIA X 4.33"  
 MD: 4.72" DIA X 5.12"  
 LG: 6.3" DIA X 2.76"

 **Bucket Planters**  
 - Set of 3 Cream  
 21074-2-0051



 **WARNING: THIS PRODUCT CAN EXPOSE YOU TO CHEMICALS INCLUDING LEAD WHICH IS (ARE) KNOWN TO THE STATE OF CALIFORNIA TO CAUSE CANCER, BIRTH DEFECTS, OR OTHER REPRODUCTIVE HARM. FOR MORE INFORMATION, GO TO WWW.P65WARNINGS.CA.GOV**



# Metal Planters with Tray Sets

METAL • INDOOR/OUTDOOR USE



**2 Pots in Twisted Oval Holder - Teal**  
20004-3-0001

11.5" X 5.75" X 9.75"



8 09048 20004 1



**2 Pots in Twisted Oval Holder - Cream**  
20005-3-0001

11.5" X 5.75" X 9.75"



8 09048 20005 8



**3 Buckets with Tray - Buttercream**  
20036-6-0070

12.59" 3.94" 4.13"



8 09048 20036 2



**3 Buckets with Tray - Teal**  
20037-6-0070

12.59" 3.94" 4.13"



8 09048 20037 9

**WARNING:** THIS PRODUCT CAN EXPOSE YOU TO CHEMICALS INCLUDING LEAD WHICH IS (ARE) KNOWN TO THE STATE OF CALIFORNIA TO CAUSE CANCER, BIRTH DEFECTS, OR OTHER REPRODUCTIVE HARM. FOR MORE INFORMATION, GO TO [WWW.P65WARNINGS.CA.GOV](http://WWW.P65WARNINGS.CA.GOV)



= GLOW IN THE DARK, SOLAR, or LIGHTS UP



24-SETS ASSORTMENT  
VINTAGE FRUIT LABEL CAN PLANTERS  
20220-24-00021  
8 09048 20220 5

# Vintage Label Can Planter Sets

METAL • PAPER • INDOOR/OUTDOOR USE • \$5.00 PER SET  
SM: 2.825" DIA X 4"H(8.5W/HANDLE)  
LG: 3.625" DIA X 4.5"H(9.5W/HANDLE)



24-SETS ASSORTMENT  
VINTAGE FLOWER LABEL CAN PLANTERS  
20230-24-00021  
8 09048 20230 4



# Plant Penguin

3.75"W X 7.5"T • 100% NYLON • SOLD IN 3 PACKS • HOLDS VARIOUS SIZED CLAY POTS, (6" IS IDEAL) PLANT PENGUINS CAN BE LINKED TOGETHER WITH THEIR UNIQUE HOOKING SYSTEM

**Plant Penguin**  
30292-12-0050



3 PIECES PER PACKAGE  
11.125" T X 7.625" W (IN PACKAGE)



## CREATE BEAUTIFUL HANGING GARDENS

The Plant Penguin is a great alternative to the traditional hanging basket. Each **Plant Penguin** holds a pair of clay pots side-by-side under its "wings". The look can be enhanced by hooking several **Plant Penguins** together to create a beautiful hanging garden of virtually any length.



= GLOW IN THE DARK, SOLAR, or LIGHTS UP

# Garden Hooks/Shepherd Poles

METAL • H-STAKE BASE • HANG PLANTS, CHIMES OR BIRDHOUSES ANYWHERE IN YOUR YARD OR WALKWAYS

GARDEN HOOKS

Display seasonal plants along your walkway or back porch.



**36" Garden Hook - Sm**  
30051-6-0050  
8 09048 30051 2

Watch the hummingbirds buzz around your yard with our red 4 Spout Glass Hummingbird Feeder (41212).



**48" Garden Hook - Med**  
30052-6-5760  
8 09048 30052 9

Hang your favorite chime, like our Cosmix™ Rainbow Chime (10107) near your patio to enjoy the breeze with a light song.



**72" Garden Hook - Lg**  
30053-4-0590  
8 09048 30053 6

**WARNING: THIS PRODUCT CAN EXPOSE YOU TO CHEMICALS INCLUDING LEAD WHICH IS (ARE) KNOWN TO THE STATE OF CALIFORNIA TO CAUSE CANCER, BIRTH DEFECTS, OR OTHER REPRODUCTIVE HARM. FOR MORE INFORMATION, GO TO WWW.P65WARNINGS.CA.GOV**

# Garden Hook Stake

METAL • 4 PRONG BASE STAKE



12.75" X 7.5" X 49"

**Butterfly**  
30041-2-0001  
8 09048 30041 3



13" X 7.5" X 49.25"

**Bird**  
30042-2-0001  
8 09048 30042 0

**WARNING: THIS PRODUCT CAN EXPOSE YOU TO CHEMICALS INCLUDING LEAD WHICH IS (ARE) KNOWN TO THE STATE OF CALIFORNIA TO CAUSE CANCER, BIRTH DEFECTS, OR OTHER REPRODUCTIVE HARM. FOR MORE INFORMATION, GO TO WWW.P65WARNINGS.CA.GOV**

# Deck Base

METAL • ADJUSTABLE

- DISPLAYS GARDEN FLAGS & YARD ART OUTSIDE OF THE GARDEN ON DECKS, PATIOS & MORE.
- POWDER COATED METAL
- ADJUSTS TO FIT MOST H-STAKES

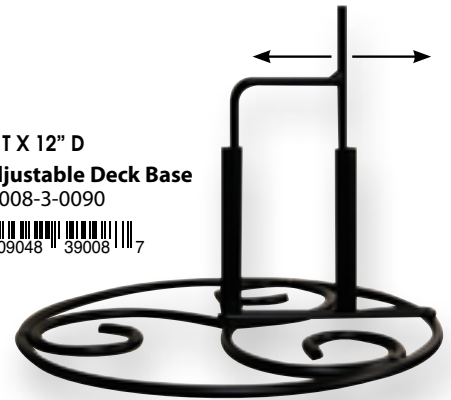

5" T X 12" D  
 **Adjustable Deck Base**  
39008-3-0090  
8 09048 39008 7

# Garden Hooks

WINDOW HANGERS, HOOKS AND ROTATING MOTORS



**WINDOW HANGER**  
**32-PC ASSORTMENT**  
 2 DISPLAYS WITH  
 32PCS IN EACH DISPLAY  
**98958-1-0088**  
 8 09048 98958 8

2.75" T • PVC • NYLON • SUCTION CUP APPLI-  
 CABLE ON FLAT/SMOOTH SURFACES (GLASS/  
 STEEL/WOOD • INDOOR/OUTDOOR USE •  
 UNLOCK/LOCK FUNCTION •  
 ANGLE (0-90 DEGREES) • \$2.75 EACH

**WARNING:** THIS PRODUCT CAN EXPOSE YOU TO CHEMICALS INCLUDING PH THALATE WHICH IS (ARE) KNOWN TO THE STATE OF CALIFORNIA TO CAUSE REPRODUCTIVE HARM. FOR MORE INFORMATION, GO TO [WWW.P65WARNINGS.CA.GOV](http://WWW.P65WARNINGS.CA.GOV)



15" TALL  
**Copper Plated  
 Hooks**  
 30001-1-0085  
 • 72 pcs per display



15" TALL  
**Smoked Steel  
 Hooks**  
 30004-1-0024  
 • 48 pcs per display



15" TALL  
**Copper Plated  
 Hooks**  
 30002-1-0003  
 • 36 pcs per display



APPROX. 7.5" L • REQUIRES 1 D SIZE  
 BATTERY (NOT INCLUDED)



**Rotating Cylinder  
 Motor-White**  
 28796-12-0550  
 • Approx. 40-50 RPM



**Rotating Cylinder  
 Motor-Black (Slow)**  
 28793-12-0550  
 • Approx. 20-25 RPM



**Rotating Cylinder  
 Motor-Black**  
 28795-12-0550  
 • Approx. 40-50 RPM



= GLOW IN THE DARK, SOLAR, or LIGHTS UP



## Wire Planter Stands on Wheels

METAL • LOCKING WHEELS • INDOOR/OUTDOOR USE • SHIPS KD AND NESTED



SM-11" DIA X 22.5"H  
 MD-13" DIA X 26.5"H  
 LG-15" DIA X 30.5"H

**Wire Planter on  
 Wheels - Set of 3  
 Buttercream**  
 21047-2-0009





## Tiered Plant Stands

100% IRON • POWDER COATED



26" X 17"; 18" X 10"  
Tiered Planter Stand  
- Set of 2 Rustic  
20058-2-0004



26" X 17"; 18" X 10"  
Tiered Planter Stand  
- Set of 2 Black  
20059-2-0004



 = GLOW IN THE DARK, SOLAR, or LIGHTS UP



## Stool/Plant Stands

100% IRON • POWDER COATED • PLASTIC FEET



STACKABLE



 **Galvanized Stool/  
Plant Stand**

- Set of 3  
20015-2-0523



SM-7.78" DIA X 10.24"H  
MD-9.05" DIA X 13.78"H  
LG-10.63" DIA X 16.92"H

 **WARNING: THIS PRODUCT CAN EXPOSE YOU TO CHEMICALS INCLUDING LEAD WHICH IS (ARE) KNOWN TO THE STATE OF CALIFORNIA TO CAUSE CANCER, BIRTH DEFECTS, OR OTHER REPRODUCTIVE HARM. FOR MORE INFORMATION, GO TO WWW.P65WARNINGS.CA.GOV**

## Plant Stands

100% IRON • POWDER COATED • INCLUDES RUBBER FEET



3" T X 6" DIA. (PETITE)  
3.5" T X 8" DIA. (SMALL)  
3.5" T X 10" DIA. (MEDIUM)  
4" T X 12" DIA. (LARGE)

 **Round Black**  
- Set of 4 Plant Stands

39003-2-0052 (Set of 4)



3" T X 6" DIA. (PETITE)  
3.25" T X 8" DIA. (SMALL)  
3.5" T X 10" DIA. (MEDIUM)  
4" T X 12" DIA. (LARGE)

 **Round Washed Ivory**  
- Set of 4 Plant Stands

39005-2-0052



 **WARNING: THIS PRODUCT CAN EXPOSE YOU TO CHEMICALS INCLUDING LEAD WHICH IS (ARE) KNOWN TO THE STATE OF CALIFORNIA TO CAUSE CANCER, BIRTH DEFECTS, OR OTHER REPRODUCTIVE HARM. FOR MORE INFORMATION, GO TO WWW.P65WARNINGS.CA.GOV**

# Rain Chains

METAL • STAINLESS STEEL • GLASS ACCENTS

GUIDES RAIN WATER VISIBLY DOWN CHAINS OR CUPS FROM THE ROOF TO THE GROUND, RAIN CHAINS TRANSFORM A PLAIN GUTTER DOWNSPOUT INTO A PLEASING WATER FEATURE

18-PC ASSORTMENT  
34520-18-00924



5.30" X 61.81"  
**Butterfly Rain Chain**  
34511-2-0591  
8 09048 34511 7



6" X 72"  
**Cosmix Cosmix and Patina Butterflies Rain Chain**  
34521-2-0052  
8 09048 34521 6



6" X 72"  
**Cosmix and Butterflies Rain Chain**  
34522-2-0052  
8 09048 34522 3



7.09" X 76.38"  
**Dragonfly Rain Chain**  
34523-2-0522  
8 09048 34523 0

= GLOW IN THE DARK, SOLAR, or LIGHTS UP





5.51" X 64.17"  
**Birds and Bells  
 Rain Chain**  
 34525-2-0522

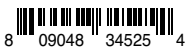

2.76" X 61.81"  
**Hummingbirds and  
 Bells Rain Chain**  
 34526-2-0522



3.93" X 72.83"  
**Umbrellas Rain Chain**  
 34513-2-0003



5.11" X 70.86"  
**Sailboats Rain Chain**  
 34514-2-0052



4.53" X 66.54"  
**Hearts and Bells  
 Rain Chain**  
 34524-2-0522



# Rain Gauges

8.1" X 3.5" X 35.5" • METAL • GLASS

8-PC ASSORTMENT  
34530-8-00401

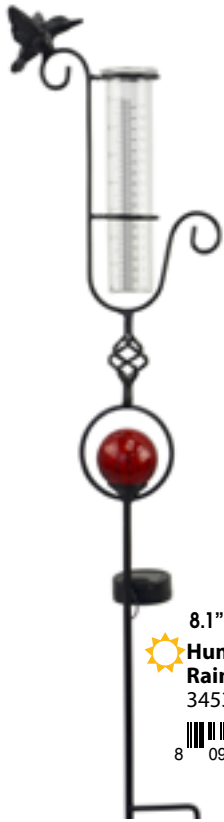

8.1" X 3.5" X 35.5"  
☀️ **Hummingbird Solar Rain Gauge**  
34531-2-0531

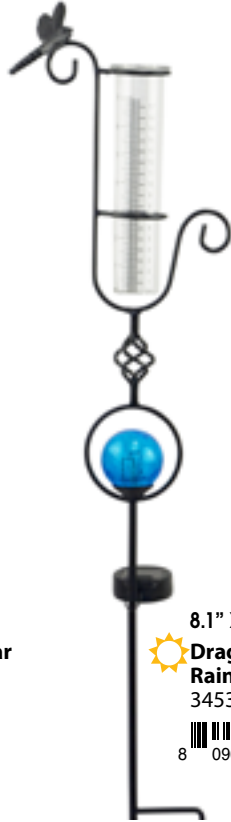

8.1" X 3.5" X 35.5"  
☀️ **Dragonfly Solar Rain Gauge**  
34532-2-0531

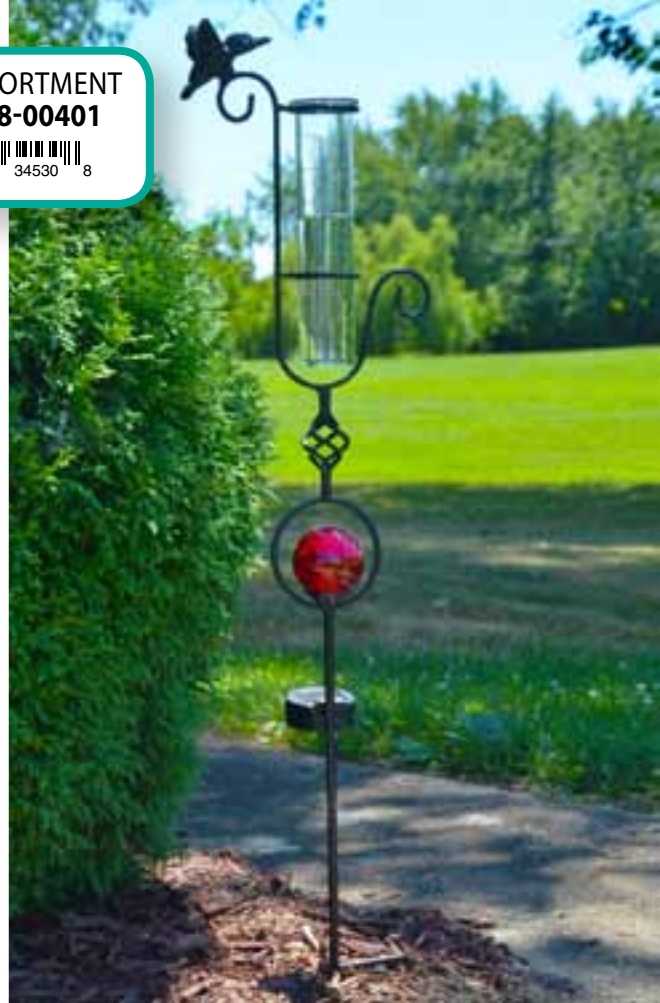

12.8" X 2.76" X 36.22"  
☀️ **Butterfly Rain Gauge - Yellow**  
34533-2-0521



12.8" X 2.76" X 36.22"  
☀️ **Butterfly Rain Gauge - Blue**  
34534-2-0521



☀️ = GLOW IN THE DARK, SOLAR, or LIGHTS UP

# Large Peacock Spinner

44.88" X 10.63" X 69.29" • METAL

LARGE SPINNER

5.77 FEET!!

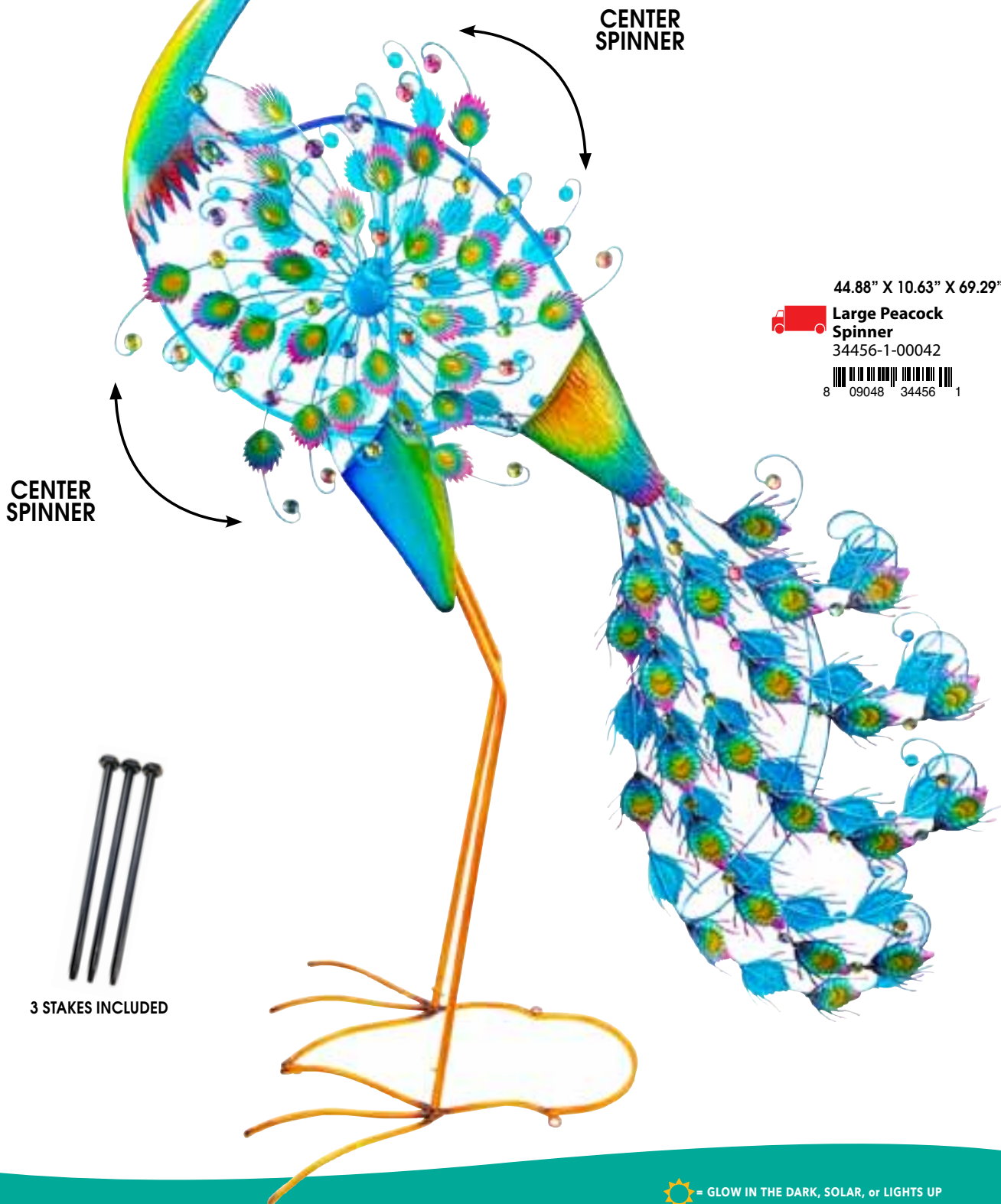

44.88" X 10.63" X 69.29"

 **Large Peacock Spinner**  
34456-1-00042



# Wind Art Spinner Stakes

- STEEL
- 4-PRONG STAKE BASE
- OVERSIZED FREIGHT

**15% FREIGHT CAP!** **YOUR PRICE: \$ 1,131.50**

**Large Scale Spinner Assortment**  
 90989-18-051311  
 • Includes 18 pieces  
 • 15% Freight Cap Including Oversize



SEE THIS AND MORE ASSORTMENTS  
 ON PAGES 138-141



**WIND POWERED LIGHTS!**

Wind Powered Technology  
 Light Up These Art In Motion  
 Spinners. The More They Spin,  
 The Brighter They Light Up!



 **24" W X 75" H**

 **75" Multi Color Petal**  
 34417-2-0577



**LIGHTS UP BLUE  
 WITH WIND POWER!**



 **24" W X 75" H**

 **Yellow, Green, Blue  
 Petals Spinner**  
 34474-2-0577



**LIGHTS UP BLUE  
 WITH WIND POWER!**

 = GLOW IN THE DARK, SOLAR, or LIGHTS UP



 23"W X 84"H  
 **Yellow and Blue Flower Power Spinner**  
 34475-2-0057





LIGHTS UP YELLOW WITH WIND POWER!



ALL LARGE SPINNERS HAVE A 4-PRONG STAKE BASE



 23"W X 84"H  
 **Pink and Blue Flower Power Spinner**  
 34476-2-0057



LIGHTS UP YELLOW WITH WIND POWER!

# Wind Art Spinner Stakes

STEEL • 4-PRONG STAKE BASE  
• OVERSIZED FREIGHT

28"W X 72"H



72" Zig Zag  
34415-2-0576



ALL LARGE SPINNERS HAVE  
A 4-PRONG STAKE BASE



30"W X 88"H



88" Triple Ball  
34419-2-0059



= GLOW IN THE DARK, SOLAR, or LIGHTS UP







 **84" Multi Color**  
34416-2-0006

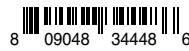

**24" W X 84" H**  
**Red, Yellow, Green,**  
**Blue Circles and**  
**Feathers Spinner**  
34448-2-0526



**24" W X 84" H**  
 **84" Circle/Flower**  
**and Mirrors**  
34407-2-0055



**18" W X 84" H**  
 **84" Multi Cup Sphere**  
**and Cork Screw**  
34437-2-0087



# Wind Art Spinner Stakes

STEEL • 4-PRONG STAKE BASE • OVERSIZED FREIGHT

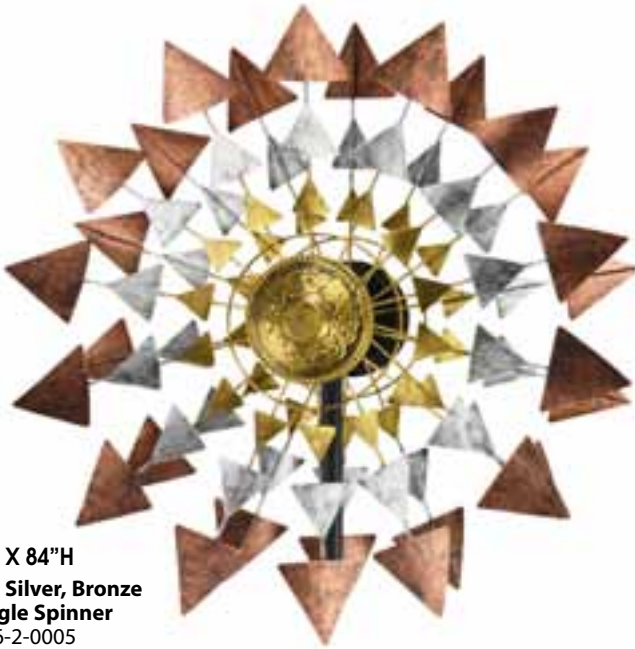

24"W X 84"H  
Gold, Silver, Bronze  
Triangle Spinner  
34446-2-0005



24"W X 84"H  
Blue and Bronze  
Double Leaf Spinner  
34449-2-0575



28"W X 20"L X 11"H  
Stake Base Display  
39001-2-0571

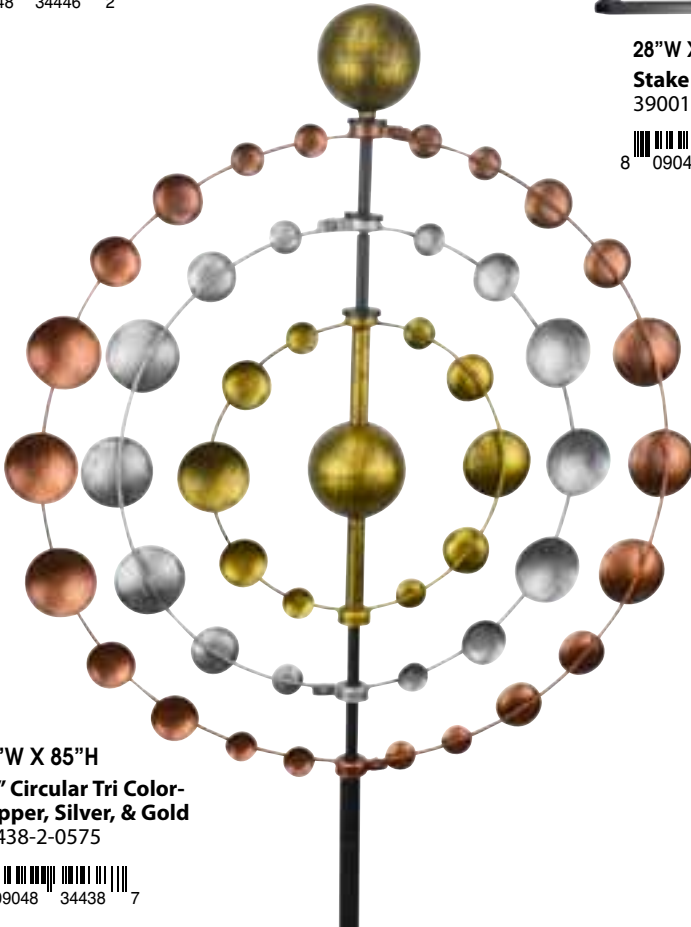

28"W X 85"H  
85" Circular Tri Color-  
Copper, Silver, & Gold  
34438-2-0575



24"W X 84"H  
84" Blue & Bronze  
Leaves  
34420-2-0055



= GLOW IN THE DARK, SOLAR, or LIGHTS UP

= OVERSIZED FREIGHT





 **24" W X 84" H**  
 **84" Solar Pinwheel with Cups**  
 34408-2-0575

 8 09048 34408 0

**BALL LIGHTS UP  
 RED, BLUE AND  
 GREEN**



**ALL LARGE SPINNERS HAVE  
 A 4-PRONG STAKE BASE**



 **24" W X 84" H**  
 **84" Solar Multi Color Windmill**  
 34409-2-0584

 8 09048 34409 7

**BALL LIGHTS UP  
 RED, BLUE AND  
 GREEN**



 = GLOW IN THE DARK, SOLAR, or LIGHTS UP

 = OVERSIZED FREIGHT

# Garden Spinners/ Stakes

METAL • POWDER COATED • H-BASE STAKE • POLES KD



24.02"W X 8.27" X 62.99"H

**Flip Flop Double**  
34468-2-0063



24.02"W X 8.27" X 62.99"H  
3.15" DIA (SOLAR BALL)  
SOLAR BALL CAN CHANGE  
COLORS OR STAY SOLID WHITE



**Shovel Double**  
34429-2-0573



LIGHTS UP!



# Garden Spinners/ Stakes

METAL • POWDER COATED • H-BASE STAKE • VINTAGE FINISH • POLES KD



23.62" X 7.48" X 72.05"  
**Butterfly Double**  
34445-2-0054



22.83" X 7.48" X 72.05"  
**Sailboat**  
34469-2-0055



# Garden Spinners/Stakes

METAL • POWDER COATED • H-BASE STAKE • VINTAGE FINISH • POLES KD



19"W X 64"H

**64" Multi Color Swirl**  
34401-2-0053



12"W X 48"H

**Triple Flower**  
34402-2-0052



13"W X 57"H

**Circles**  
34424-2-0581



19.69"W X 62.99"H

**Heart Shape Suncatcher**  
34425-2-0052



12.25"W X 42.5"H

 **Faucet Flower Solar Spinner**  
34414-2-0012



12"W X 48"H  
**Pink & Orange Flower Spinner**  
32608-2-0531



 = GLOW IN THE DARK, SOLAR, or LIGHTS UP



46.5" H  
**Peacock Stake**  
 34443-3-0001



14" X 48"  
**Green, Blue, Yellow  
 Flower Spinner/  
 Trellis**

34497-2-0562



14" X 48"  
**Color Blast Circles  
 Spinner/Trellis**



# Flower Spinners/Stakes — Deck Base

IRON • METAL • PLASTIC • CRUSHED GLASS • H-BASE STAKE

METAL • ADJUSTABLE

- DISPLAYS GARDEN FLAGS & YARD ART OUTSIDE OF THE GARDEN ON DECKS, PATIOS & MORE.
- POWDER COATED METAL
- ADJUSTS TO FIT MOST H-STAKES

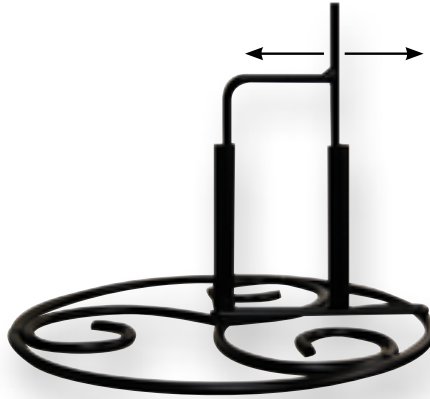

 **Adjustable Deck Base**  
39008-3-0090



 **WARNING:** THIS PRODUCT CAN EXPOSE YOU TO CHEMICALS INCLUDING LEAD WHICH IS (ARE) KNOWN TO THE STATE OF CALIFORNIA TO CAUSE CANCER, BIRTH DEFECTS, OR OTHER REPRODUCTIVE HARM. FOR MORE INFORMATION, GO TO [WWW.P65WARNINGS.CA.GOV](http://WWW.P65WARNINGS.CA.GOV)



20.86" X 11.02" X 90.94"

**Multi Flower w/  
Cardinal**

34478-2-0526



21.25" X 23.23" X 47.24"

**3 Flowers Spinner**

34489-2-0572



 = GLOW IN THE DARK, SOLAR, or LIGHTS UP

# Bike Garden Spinners/Stakes

METAL • POWDER COATED • H-BASE STAKE

SPINNER/STAKES



14.71"W X 51.18"H

**Blue Bike**  
34459-2-0081



14.71"W X 51.18"H

**Yellow Bike**  
34460-2-0081

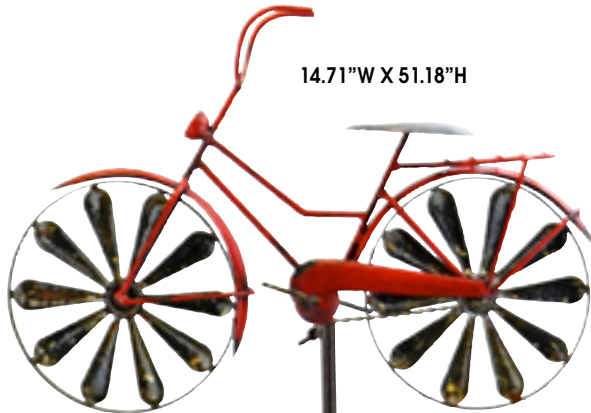

14.71"W X 51.18"H

**Red Bike**  
34461-2-0081

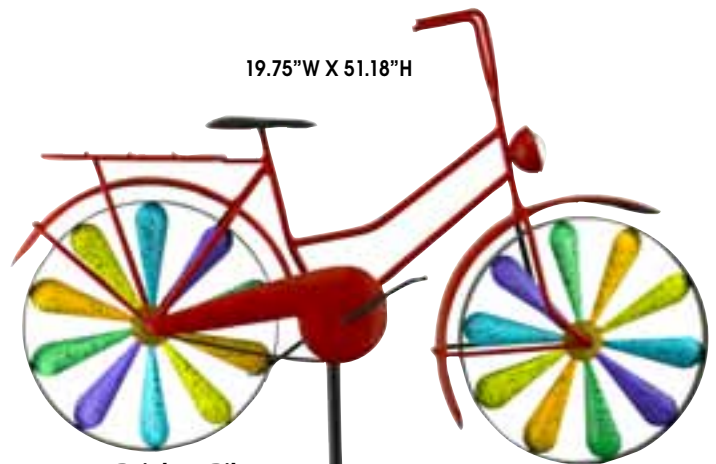

19.75"W X 51.18"H

**Rainbow Bike**  
34479-2-0081



# Garden Spinners/Stakes

METAL • POWDER COATED • H-BASE STAKE



20.87"W X 62.99"H

 **Green Tractor Solar Spinner Stake**  
34466-2-0572



LIGHTS UP!

# Solar Stake Lights

35" T WITH STAKE • 2 LED BULBS LIGHT UP GLOBE



 **WARNING: THIS PRODUCT CAN EXPOSE YOU TO CHEMICALS INCLUDING LEAD WHICH IS (ARE) KNOWN TO THE STATE OF CALIFORNIA TO CAUSE CANCER, BIRTH DEFECTS, OR OTHER REPRODUCTIVE HARM.**

FOR MORE INFORMATION, GO TO [WWW.P65WARNINGS.CA.GOV](http://WWW.P65WARNINGS.CA.GOV)

 **Red & Yellow Swirl**  
35301-2-0522



 **Yellow & Red Spots**  
35303-2-0522



 = GLOW IN THE DARK, SOLAR, or LIGHTS UP



12-PC ASSORTMENT  
35370-12-00621



# Solar Flower Stake Lights

24" T WITH STAKE • METAL • SOLAR CHARGED

SOLAR STAKES



LIGHTS UP!



**Solar Flower Stake-Blue**

35371-3-0501



8 09048 35371 6

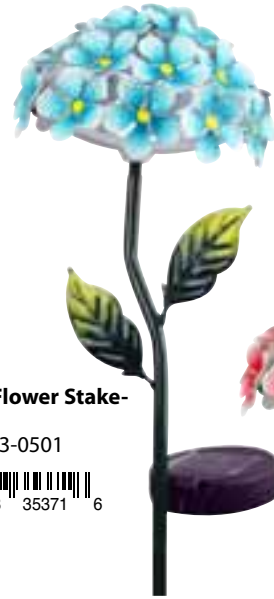

**Solar Flower Stake-Pink**

35373-3-0501



8 09048 35373 0

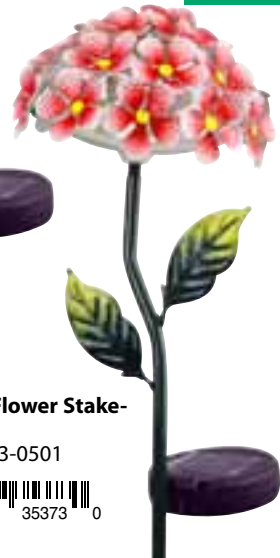

**Solar Flower Stake-Purple**

35372-3-0501



8 09048 35372 3



**Solar Flower Stake-Yellow**

35374-3-0501



8 09048 35374 7



**WARNING: THIS PRODUCT CAN EXPOSE YOU TO CHEMICALS INCLUDING LEAD BATTERY WHICH IS (ARE) KNOWN TO THE STATE OF CALIFORNIA TO CAUSE CANCER, BIRTH DEFECTS, OR OTHER REPRODUCTIVE HARM. FOR MORE INFORMATION, GO TO [WWW.P65WARNINGS.CA.GOV](http://WWW.P65WARNINGS.CA.GOV)**



= GLOW IN THE DARK, SOLAR, or LIGHTS UP



= OVERSIZED FREIGHT

# Bluebell Glass Flower Twinkle Solar Stakes

39.37" T • METAL • GLASS • PLASTIC • H-BASE STAKE

8-PC ASSORTMENT  
35380-8-00061



**Bluebell Glass Solar Stake-Clear**  
35381-2-0002



**Bluebell Glass Solar Stake-Purple**  
35382-2-0002



**Bluebell Glass Solar Stake-Blue**  
35383-2-0002



**Bluebell Glass Solar Stake-Yellow**  
35384-2-0002



LIGHTS UP!



= GLOW IN THE DARK, SOLAR, or LIGHTS UP

6-PC ASSORTMENT  
95310-6-00951



# Solar Flower Stakes

8.66" X .78" X 38.58" • IRON • GLASS • PLASTIC • H-BASE STAKE



TOP VIEW



**Solar 5 Glass Flowers Stake - Blue**

35315-2-0562



LIGHTS UP!



TOP VIEW

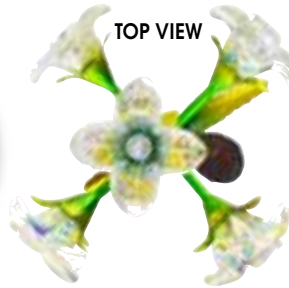

**Solar 5 Glass Flowers Stake - Clear**

35316-2-0562

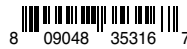

TOP VIEW



**Solar 5 Glass Flowers Stake - Purple**

35317-2-0562



# Carnation Flower Stake

9.84" X 3.94" X 26.61" • METAL • SPRING ACTION FLOWER • H STAKE

12-PC ASSORTMENT  
35360-12-00231



**Carnation Stake -  
Fuchsia**  
35361-4-0011



**Carnation Stake -  
Orange**  
35362-4-0011



**Carnation Stake -  
Purple**  
35363-4-0011



= GLOW IN THE DARK, SOLAR, or LIGHTS UP

12-PC ASSORTMENT  
35390-12-00231



8 09048 35390 7

# Mum Flower Stake

9.84" X 3.94" X 26.61" • METAL  
• SPRING ACTION FLOWER • H STAKE

FLOWER STAKES



**Mum Stake - Purple**  
35391-4-0011



8 09048 35391 4



**Mum Stake - Fuchsia**  
35392-4-0011



8 09048 35392 1



**Mum Stake - Orange**  
35393-4-0011

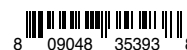

8 09048 35393 8



= GLOW IN THE DARK, SOLAR, or LIGHTS UP

= OVERSIZED FREIGHT

**\$539.00** **YOUR PRICE:**  
**VALUE** **\$ 494.00**

**Colorful Characters  
Balancer Assortment**

- 90984-24-00494  
• Includes 24 pieces  
• Free Display (09945) if requested



SEE THIS & MORE ASSORTMENTS ON PGS 138-141

**Balancing Buddies™**

METAL • POWDER COATED • 3 PRONG STAKE

10-PC ASSORTMENT  
**34100-10-00902**



**26" X 5.5" X 51.75"**  
**Yellow and Red Birds**  
34101-2-0512



**26" X 5.5" X 51.75"**  
**Dark Blue and Yellow Birds**  
34102-2-0512



**26" X 4.25" X 51.75"**  
**Teal and Green Birds**  
34103-2-0512



**32" X 5.75" X 52.17"**  
**Colorful Birds**  
34105-2-0002



**29.13" X 2.75" X 50.39"**  
**Colorful Owls**  
34143-2-0002



= GLOW IN THE DARK, SOLAR, or LIGHTS UP

8-PC ASSORTMENT  
34140-8-00561



# Balancing Buddies™

METAL • POWDER COATED • 3 PRONG STAKE

BALANCERS



26.5" X 5" X 55"

**Cat and Mouse**

34104-2-0522

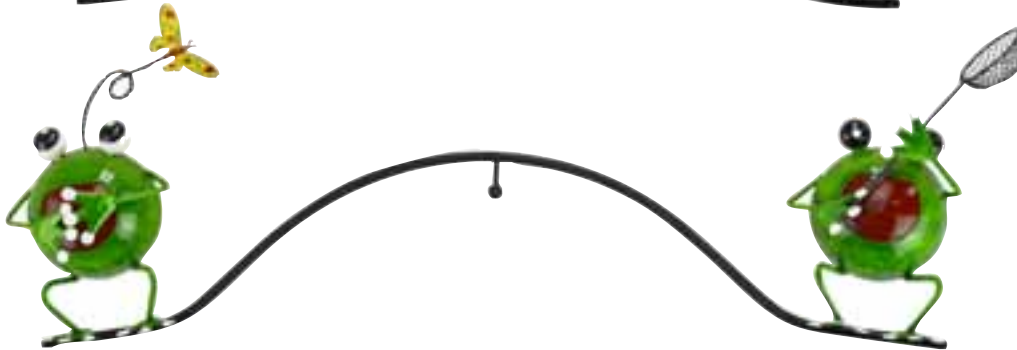

29" X 4.5" X 55.12"

**Frogs with Nets**

34106-2-0002



26.77" X 3.14" X 48.42"

**Colorful Cat and Dog**

34141-2-0002



26.77" X 2.75" X 48.42"

**Colorful Frogs**

34142-2-0002



**\$458.00** **YOUR PRICE:**  
**VALUE** **\$ 413.00**

**Rustic Balancer Assortment**

90980-24-00314

- Includes 24 pieces
- Free Display (09945) if requested



8 09048 90980 7

SEE THIS & MORE ASSORTMENTS ON PGS 138-141

**Balancing Buddies™**

METAL • POWDER COATED

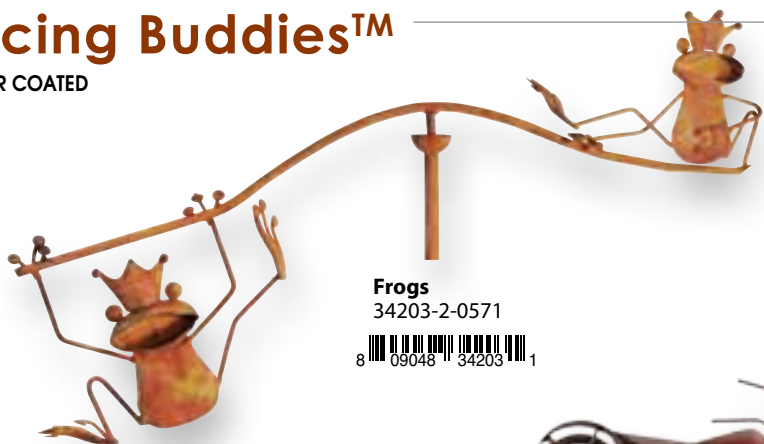

**Frogs**

34203-2-0571



8 09048 34203 1

**Old Crows**

34202-2-0571



8 09048 34202 4



**Perched Owls**

34204-2-0571



8 09048 34204 8



31.5" X 60.5"



**\*\*NOT IN ASSORTMENT**

22" W X 51.75" T

**Motorcycle**

34209-2-0581



8 09048 34209 3



**\*\*NOT IN ASSORTMENT**

25" X 5.75" X 62.75"

**Frog**

34219-2-0002



8 09048 34219 2

**Bird**

34220-2-0012



8 09048 34220 8



29" X 48.5" T

**Owl**

34226-2-0091



8 09048 34226 0



= GLOW IN THE DARK, SOLAR, or LIGHTS UP



29.5" X 6.5" X 55.5"

**Rainy Day Crow**  
34227-2-0091



29" W X 51.25" T

**Mother Bird and Nest**  
34229-2-0571



## Stone Balancing Buddies™

METAL • RESIN STONE ACCENTS • GLASS MARBLE ACCENTS • H-STAKE BASE

\*\*NOT IN ASSORTMENT

42" TALL

**Butterflies**  
34211-2-0571



42" TALL

**Dragonfly**  
34212-2-0571



## Small Balancing Buddies™

17" W X 25" T • METAL • H-STAKE BASE

**Small Old Crows**  
34255-2-0001



**Small Frogs**  
34254-2-0001



= GLOW IN THE DARK, SOLAR, or LIGHTS UP

= OVERSIZED FREIGHT

# Wind Art Balancers<sup>®</sup>

WINGS MOVE WITH THE WIND AND FLOAT UP AND DOWN PRODUCING SMOOTH AND REALISTIC MOTION  
 • METAL

8-PC ASSORTMENT  
**34320-8-00061**



WINGS MOVE  
 UP & DOWN

### Jeweled Butterfly

34321-2-0002



\*\*IN 90980 ASSORTMENT



44" W X 17" D X 44" H  
 (POLE ALONE: 43.5" T)

## Deck Base

METAL • ADJUSTABLE

- DISPLAYS GARDEN FLAGS & YARD ART OUTSIDE OF THE GARDEN ON DECKS, PATIOS & MORE.
- POWDER COATED METAL
- ADJUSTS TO FIT MOST H-STAKES

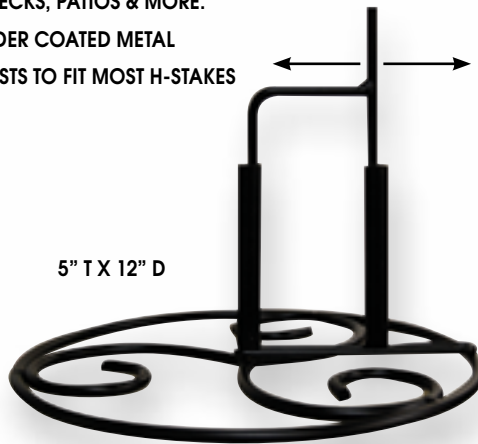

5" T X 12" D

### Adjustable Deck Base

39008-3-0090

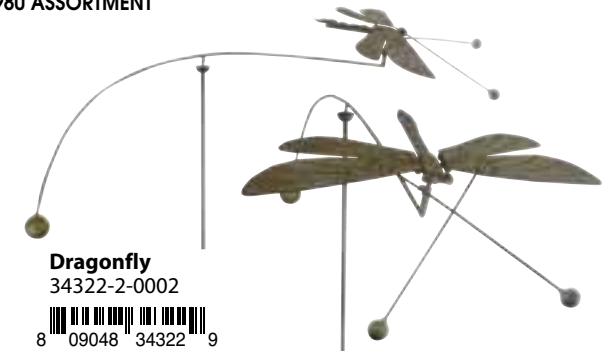

### Dragonfly

34322-2-0002



\*\*IN 90980 ASSORTMENT

41" W X 18.5" D X 44" H  
 (POLE ALONE: 43.5" T)



### Crow

34323-2-0002



34.5" W X 15" D X 44" H  
 (POLE ALONE: 43.5" T)

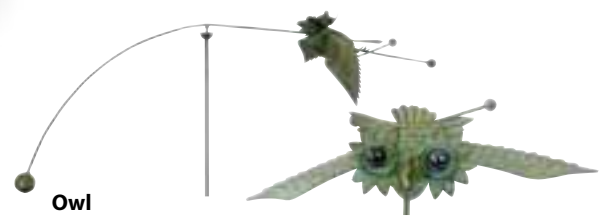

### Owl

34324-2-0002



32" W X 15.75" D X 44" H  
 (POLE ALONE: 43.5" T)

**WARNING:** THIS PRODUCT CAN EXPOSE YOU TO CHEMICALS INCLUDING LEAD WHICH IS (ARE) KNOWN TO THE STATE OF CALIFORNIA TO CAUSE CANCER, BIRTH DEFECTS, OR OTHER REPRODUCTIVE HARM. FOR MORE INFORMATION, GO TO [WWW.P65WARNINGS.CA.GOV](http://WWW.P65WARNINGS.CA.GOV)

= GLOW IN THE DARK, SOLAR, or LIGHTS UP

# Rocker Balancer

14" X 5" X 37" • METAL • GLASS



TOP VIEW

**Three Color Butterflies**

34151-2-0051



8 09048 34151 5

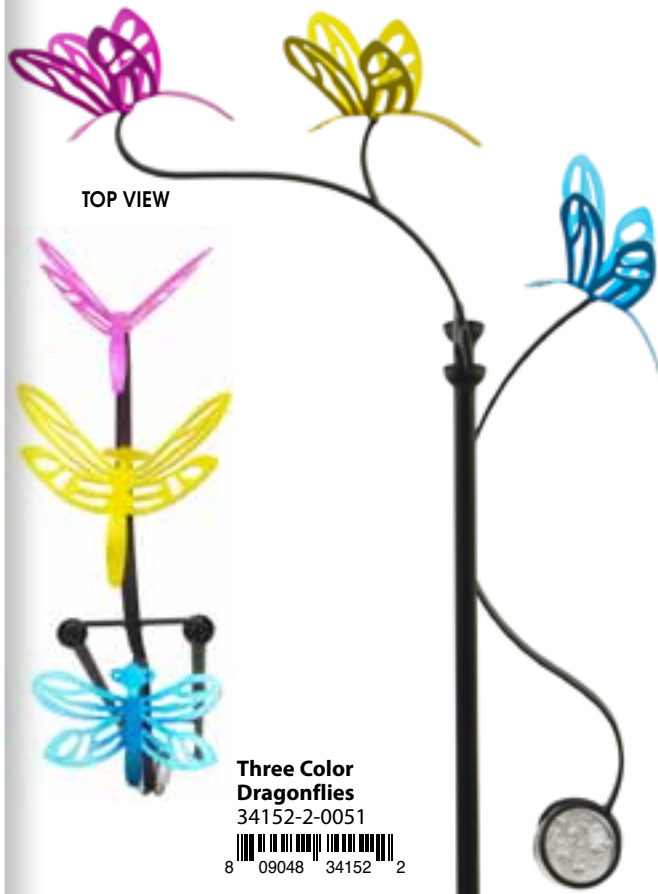

TOP VIEW

**Three Color Dragonflies**

34152-2-0051



8 09048 34152 2

# Rocker Stakes

11.8"W X 38.9"H • METAL • GLASS • 4 PRONG BASE STAKE

6-PC ASSORTMENT

34220-6-00711



WINGS MOVE  
UP & DOWN  
AS BIRD ROCKS  
BACK & FORTH



Owl  
34221-2-0591



Cardinal  
34222-2-0591



Crow  
34224-2-0591

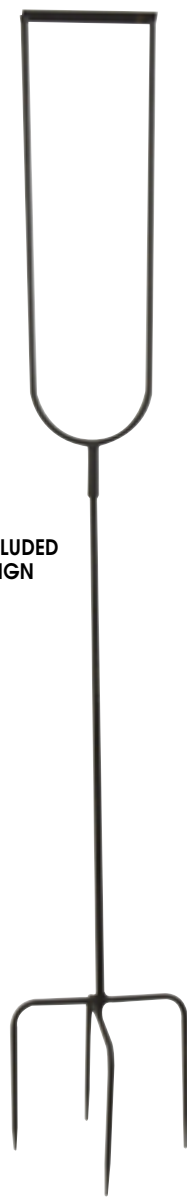

ROCKER POLE INCLUDED  
WITH EACH DESIGN

= GLOW IN THE DARK, SOLAR, or LIGHTS UP

# Fishing Pole Stake

38.9" H • METAL • 4 PRONG BASE STAKE

FISHING POLE STAKE



GREAT SPINNING ACTION!



POLE HOLDS UP TO 2.2 LBS



POLE SOLD SEPARATELY  
TO HANG YOUR OWN ITEM!

**Pole**  
39009-4-0580

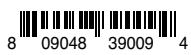

# Rustic Windmills

METAL • POWDER COATED • EASY ASSEMBLY • STAKES INCLUDED • OVERSIZED FREIGHT



20" W X 57.5" T



**Rooster**

34265-2-0573



8 09048 34265 9

5 FOOT  
9 INCHES



28.5" X 18.5" X 67"



**Rustic Rooster**

34294-2-0059



8 09048 34294 9

8" X 60" (5 FT 8 INCHES TALL)



**Small**

34291-2-0059



8 09048 34291 8

= GLOW IN THE DARK, SOLAR, or LIGHTS UP





ITEM 34297 - MEDIUM WINDMILL IS PICTURED

# Galvanized & Rust Windmills

METAL • POWDER COATED • EASY ASSEMBLY • STAKES INCLUDED • OVERSIZED FREIGHT

WINDMILLS

20.5" X 16.5" X 58.5"



**Small**  
34298-2-0006



29" X 23.75" X 79.75"



**Medium**  
34297-2-0059



36.25" X 28" X 100.5"



**Large**  
34299-1-00521



**\$ 782.50**  
VALUE

**YOUR PRICE:**  
\$ 722.50

**Spinner/Geo/Twister Assortment**

99097-A-05229

- Includes 78 pieces
- Free Display (09910) if requested



SEE THIS & MORE ASSORTMENTS ON PGS 138-141

# 3D Butterfly Suncatchers

4.5" L SPIRAL • STAINLESS STEEL  
• GLASS MARBLE ACCENT • NO RUST  
• USE WITH 98958 WINDOW HANGER  
ON PAGE 28 AND 94

**NO RUST**

18-PC ASSORTMENT  
**31110-18-05571**



**Butterfly Suncatcher-  
Green**

31111-3-0580



**Butterfly Suncatcher-  
Pink**

31112-3-0580



**Butterfly Suncatcher-  
Purple**

31113-3-0580



## 3D Suncatchers

9" L SPIRAL • STAINLESS STEEL • GLASS MARBLE ACCENT • NO RUST • USE WITH 98958  
WINDOW HANGER ON PAGE 28 AND 94



**Star Suncatcher-  
Blue**

31114-3-0011



**Flower Suncatcher-  
Purple**

31115-3-0011



**Heart Suncatcher-  
Red**

31116-3-0011



= GLOW IN THE DARK, SOLAR, or LIGHTS UP



24-PC ASSORTMENT  
31098-24-00201



# Mini Suncatchers

10" H • STAINLESS STEEL • CRYSTAL ACCENT • NO RUST  
• \$4.25 EACH • USE WITH 98958 WINDOW HANGER ON PAGE 28 AND 94

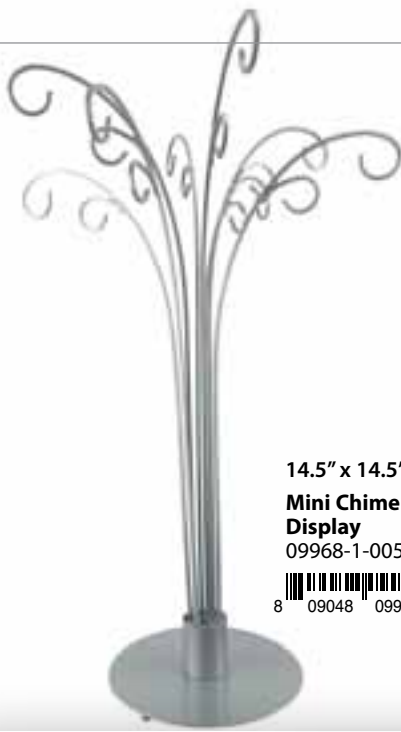

14.5" x 14.5" x 25"

**Mini Chime KD Display**  
09968-1-0052



16-PC ASSORTMENT  
31120-16-0088



# Garden Suncatchers

3.82" X 1.5" X 13" • STAINLESS STEEL • CRYSTAL ACCENT • NO RUST  
• USE WITH 98958 WINDOW HANGER ON PAGE 28 AND 94



**Tree of Life Suncatcher-  
Green Crystal**  
31123-4-0550



**Hummingbird Suncatcher-  
Red Crystal**  
31124-4-0550



**Butterfly Suncatcher-  
Purple Crystal**  
31125-4-0550



**Dragonfly Suncatcher-  
Blue Crystal**  
31126-4-0550



# Mirrored Iridescent Geo Spinner

STAINLESS STEEL • GLASS • 3D • NO RUST  
 SWIVEL S-HOOK FOR EASY HANGING & SMOOTH SPINNING  
 • USE WITH 98958 WINDOW HANGER ON PAGE 28 AND 94

NO RUST

8-PC ASSORTMENT

2 OF EACH DESIGN

31170-8-00231

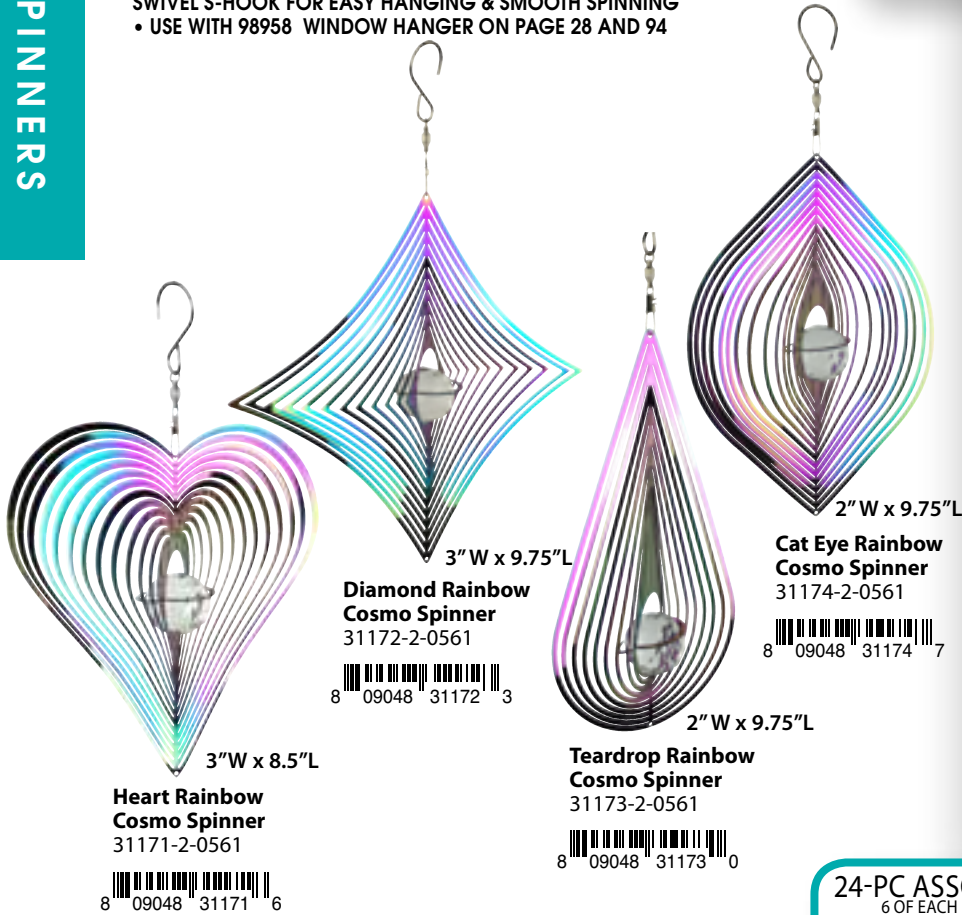

3" W x 8.5" L

**Heart Rainbow  
Cosmo Spinner**  
31171-2-0561



3" W x 9.75" L

**Diamond Rainbow  
Cosmo Spinner**  
31172-2-0561

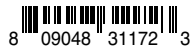

2" W x 9.75" L

**Cat Eye Rainbow  
Cosmo Spinner**  
31174-2-0561



2" W x 9.75" L

**Teardrop Rainbow  
Cosmo Spinner**  
31173-2-0561

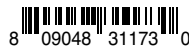

# Mirrored Iridescent 3" Mini Geo Spinners

STAINLESS STEEL • GLASS • 3D • \$3.50 EACH • NO RUST  
 • USE WITH 98958 WINDOW HANGER ON PAGE 28 AND 94

NO RUST

24-PC ASSORTMENT

6 OF EACH DESIGN IN

1 COUNTERTOP DISPLAY

31099-1-0048



= GLOW IN THE DARK, SOLAR, or LIGHTS UP

24-PC ASSORTMENT  
32010-24-00021



# Geo Spinners w/ Danglers

4" DIA X 20" H • STAINLESS STEEL • GLASS MARBLE ACCENT • NO RUST  
• USE WITH 98958 WINDOW HANGER ON PAGE 28 AND 94

GEO SPINNERS



**Owl**  
32011-4-0050  
8 09048 32011 4

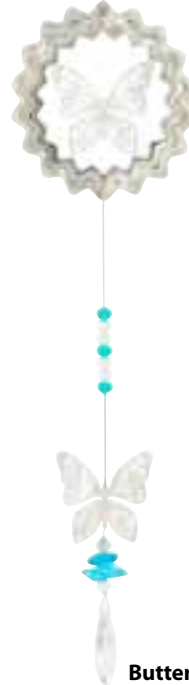

**Butterfly**  
32012-4-0050  
8 09048 32012 1



**Tree of Life**  
32013-4-0050  
8 09048 32013 8

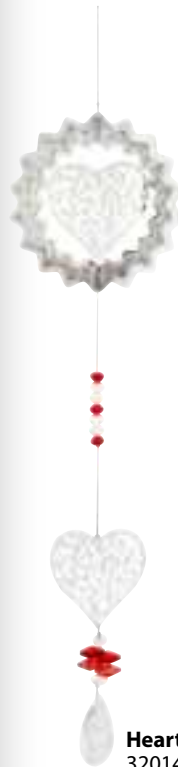

**Heart**  
32014-4-0050  
8 09048 32014 5



**Hummingbird**  
32015-4-0050  
8 09048 32015 2



**Dragonfly**  
32016-4-0050  
8 09048 32016 9

Patent# D487, 034 S, Patent# D497, 833 S, Patent# D505, 639 S

= GLOW IN THE DARK, SOLAR, or LIGHTS UP

= OVERSIZED FREIGHT

Order Toll Free 1.877.985.0405 • Fax 1.513.774.1601

Visit our website or call to receive a complete catalog to see all styles of fashion and garden giftware RCS offers.

# Cyclones™

11" L • GLASS MARBLE ACCENT • PLATED COPPER OR CHROME  
 • USE WITH 98958 WINDOW HANGER ON PAGE 28 AND 94

18-PC ASSORTMENT  
**32000-18-0009**



**Copper w/ Red Ball**  
 32001-6-0050



**Smoke w/ Blue Ball**  
 32002-6-0050



 **Copper w/  
 Glow in the Dark Ball**  
 32003-6-0500



**32003  
 Ball Glows**

# Rainbow Spinner

15" L • CRYSTAL ACCENT • SWIVEL S-HOOK FOR EASY HANGING & SMOOTH SPINNING

**Rainbow**  
 31331-3-0521

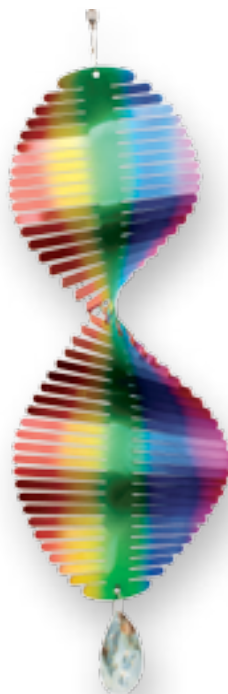

 = GLOW IN THE DARK, SOLAR, or LIGHTS UP

12-PC ASSORTMENT  
32170-12-00702



# Chakra Spinners

6" X 23.5" L • STAINLESS STEEL • ACRYLIC • BEAD ACCENTS • NO RUST  
• SWIVEL S-HOOK FOR EASY HANGING & SMOOTH SPINNING

NO RUST

SPINNERS



**Chakra**  
31095-3-0051  
8 09048 31095 5

**7TH - CROWN**  
• COSMIC CONSCIOUSNESS  
• UNDERSTANDING  
• ENLIGHTENMENT

**6TH - 3RD EYE**  
• CLAIRVOYANCE  
• INTUITION  
• PSYCHIC SENSES

**5TH - THROAT**  
• COMMUNICATION  
• CREATIVITY  
• HEALING

**4TH - HEART**  
• LOVE  
• HOPE  
• COMPASSION

**3RD - NAVAL**  
• ENERGY  
• VITALITY  
• DESIRE + POWER

**2ND - SACRAL**  
• EMOTIONS  
• SEXUALITY  
• INTIMACY

**1ST - ROOT**  
• SURVIVAL INSTINCT  
• SECURITY  
• GROUNDING



**Iridescent Chakra**  
32171-3-0591  
8 09048 32171 5



**Tree of Life**  
32172-3-0051  
8 09048 32172 2



**Iridescent Tree of Life**  
32173-3-0591  
8 09048 32173 9

# Colored Cosmix™

14" L • HANDCRAFTED COPPER PLATED METAL • BAKED METAL CLEAR COAT • 3D • SWIVEL S-HOOK FOR EASY HANGING & SMOOTH SPINNING

16-PC ASSORTMENT  
31090-16-00291



**Purple**  
31091-4-0021



**Red**  
31092-4-0021



**Blue**  
31093-4-0021



**Green**  
31094-4-0021



# Chrome Cosmix™

HANDCRAFTED CHROME PLATED METAL • GLASS MARBLE & CRYSTAL ACCENTS • 3D • SWIVEL S-HOOK FOR EASY HANGING & SMOOTH SPINNING

14-PC ASSORTMENT  
31070-14-00871



**11" Chrome Single Crystal**  
31071-4-0011



**14" Chrome Double**  
31074-4-0071



**11" Chrome Teardrop**  
31072-6-0011



= GLOW IN THE DARK, SOLAR, or LIGHTS UP

Patent# D487, 034 S, Patent# D497, 833 S, Patent# D505, 639 S

# Mirrored Iridescent Cosmix™

STAINLESS STEEL • GLASS • 3D • NO RUST • SWIVEL S-HOOK FOR EASY HANGING & SMOOTH SPINNING



NO RUST



**11" Rainbow  
w/Crystal**  
31063-4-0051



**14" Double Rainbow**  
31065-2-0522

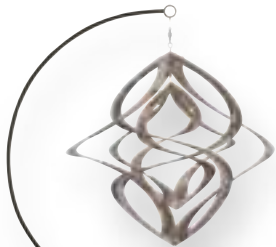

12.5" W x 67" T

- Cosmix™ not included.
- Powder coated
- Also holds bird feeders, and more

**29" Semi-Circle Yard Stand**  
09916-4-0511

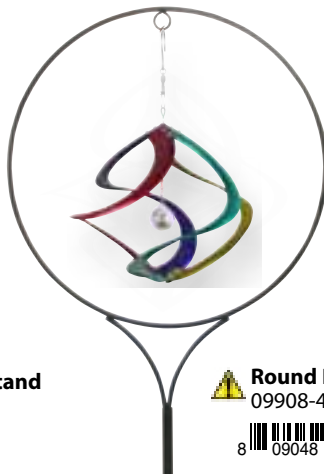

24" W x 54" T

- Cosmix™ not included.
- Powder coated
- Also holds bird feeders, and more

**Round Ring Yard Stand**  
09908-4-0521



**WARNING:** THIS PRODUCT CAN EXPOSE YOU TO CHEMICALS INCLUDING LEAD WHICH IS (ARE) KNOWN TO THE STATE OF CALIFORNIA TO CAUSE CANCER, BIRTH DEFECTS, OR OTHER REPRODUCTIVE HARM. FOR MORE INFORMATION, GO TO [WWW.P65WARNINGS.CA.GOV](http://WWW.P65WARNINGS.CA.GOV)

**\$ 754.00  
VALUE**

**YOUR PRICE:  
\$ 699.00**

## Colored Cosmix™ Assortment

31000-E-00996

- Includes 44 pieces (includes 31161, 31162, 31163 on page 74)
- Includes 36 pc Copper Hooks
- Free Display (09901) if requested



SEE THIS AND MORE ASSORTMENTS ON PAGES 138-141

# Heart Cosmix™

14" • METAL • CRYSTAL ACCENT  
• 3D SWIVEL S-HOOK FOR EASY HANGING & SMOOTH SPINNING



**Red  
w/Heart**  
31066-4-0041



# 4 Color Cosmix™

11" • 4 COLORS • METAL • CRYSTAL ACCENTS • 3D SWIVEL S-HOOK FOR EASY HANGING & SMOOTH SPINNING



**Circus w/ Crystal**  
31062-4-0511



Patent# D487, 034 S, Patent# D497, 833 S, Patent# D505, 639 S

= GLOW IN THE DARK, SOLAR, or LIGHTS UP

Order Toll Free 1.877.985.0405 • Fax 1.513.774.1601

Visit our website or call to receive a complete catalog to see all styles of fashion and garden giftware RCS offers.

= OVERSIZED FREIGHT

www.rcsgifts.com | 71

COSMIX™

**\$ 785.00**  
**VALUE**

**YOUR PRICE:**  
**\$ 730.00**

**Cosmix™ Starter Assortment**

31000-A-00807

- Includes 49 pieces
- Includes 36 piece Copper Hooks
- Free Display (09901) if requested



SEE THIS AND MORE ASSORTMENTS ON PAGES 138-141

**Cosmix™**

HANDCRAFTED COPPER PLATED METAL • GLASS MARBLE & CRYSTAL ACCENTS • 3D • SWIVEL S-HOOK FOR EASY HANGING & SMOOTH SPINNING



**14" with Flower**  
31041-4-0531



**17" Spiral Planet**  
31054-4-0002



**14" with Heart**  
31042-4-0531



**11" Single Planet**  
31051-4-0001



**17" Double**  
31055-4-0042



= GLOW IN THE DARK, SOLAR, or LIGHTS UP

Patent# D487, 034 S, Patent# D497, 833 S, Patent# D505, 639 S



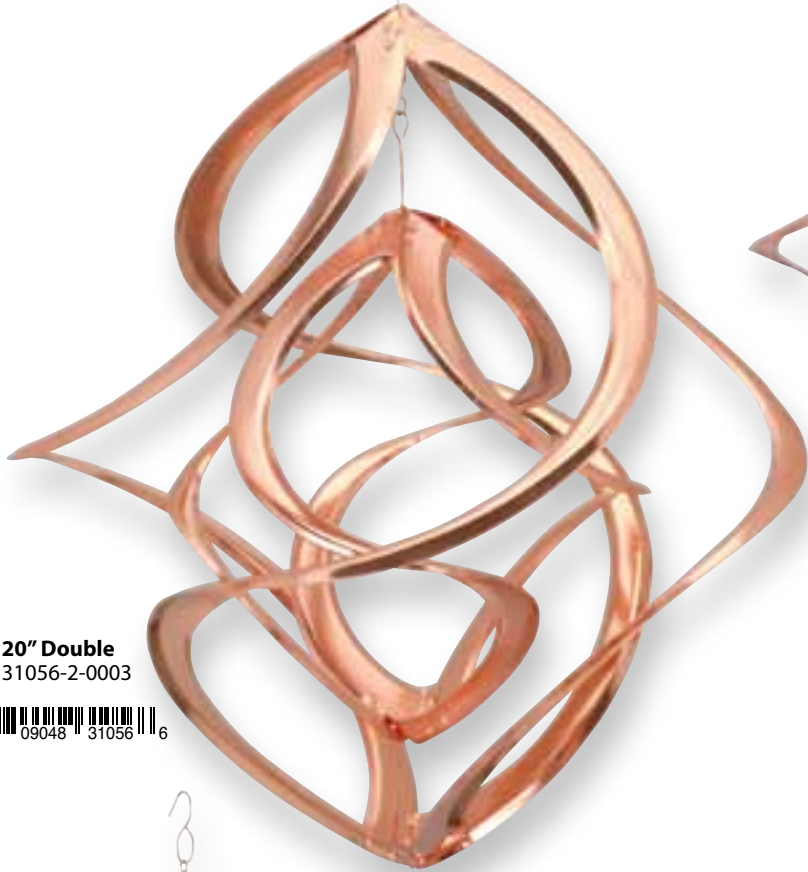

**20" Double**  
31056-2-0003



**11" Single Crystal**  
31057-4-0001



**14" Double**  
31058-4-0041



**11" Teardrop**  
31059-4-0001



Topside is Verdi-Gris

**14" Double Patina & Copper Plated**  
31061-4-0041



# Multi Colored Large Cosmix™

METAL • 3D • SWIVEL S-HOOK FOR EASY HANGING & SMOOTH SPINNING

12-PC ASSORTMENT  
31160-12-00072



9.45"W x 36.22"L

**Multi Color with Tail**  
31161-4-0522



7.78"W x 28.35"L

**Americana with Tail**  
31162-4-0522



9.45"W x 27.95"L

**Multi Color with Ball**  
31164-4-0522



= GLOW IN THE DARK, SOLAR, or LIGHTS UP

Patent# D487, 034 S, Patent# D497, 833 S, Patent# D505, 639 S



# Large Cosmix™ Chimes

IRON

COSMIX™ CHIMES



9.06"W x 43.31"L

**Large Multi Color  
Cosmix Chime**

10134-2-0532



9.45"W x 43.31"L

**Large Americana  
Cosmix Chime**

10135-2-0532



Patent# D487, 034 S, Patent# D497, 833 S, Patent# D505, 639 S

 = GLOW IN THE DARK, SOLAR, or LIGHTS UP

Order Toll Free 1.877.985.0405 • Fax 1.513.774.1601

Visit our website or call to receive a complete catalog to see all styles of fashion and garden giftware RCS offers.

 = OVERSIZED FREIGHT

www.rcsgifts.com | 75

**\$ 925.00** **YOUR PRICE:**  
**VALUE** **\$ 865.00**

**Best Sellers Chimes Assortment**

10000-A-00918

- Includes 75 pieces
- FreeDisplay (09910) if requested



SEE THIS AND MORE ASSORTMENTS  
ON PAGES 138-141

**Cosmix™**  
**Wind Chimes**

HANDCRAFTED COPPER PLATED METAL

- CRYSTAL OR GLASS ACCENTS
- ANODIZED ALUMINUM TUBES

12-PC ASSORTMENT  
**10130-12-00831**

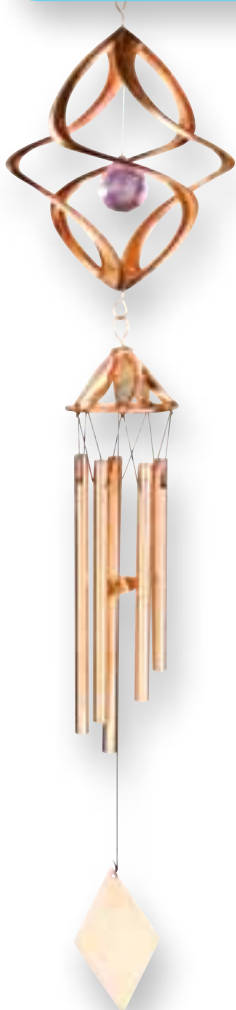

25" L

**Purple**  
10101-3-0511

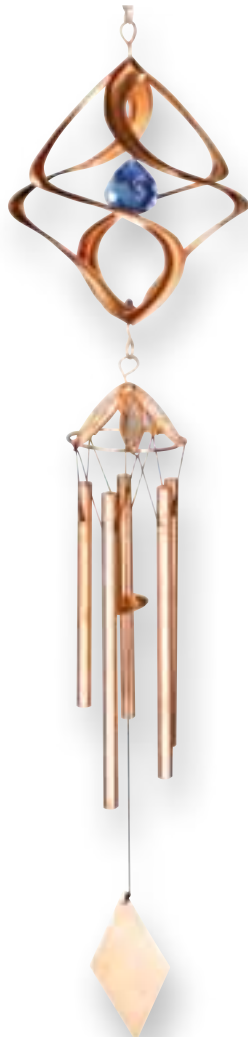

25" L

**Blue**  
10103-3-0511

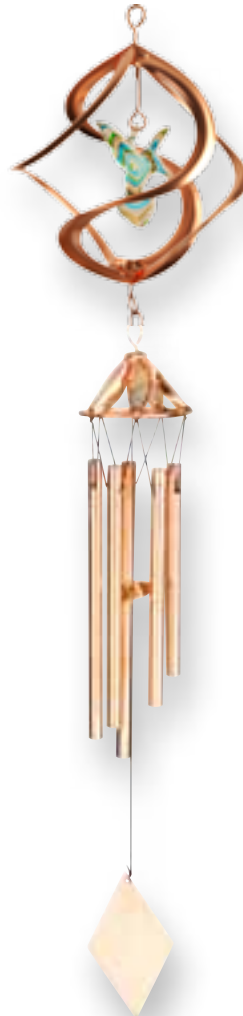

25" L

**Hummingbird**  
10131-3-0511

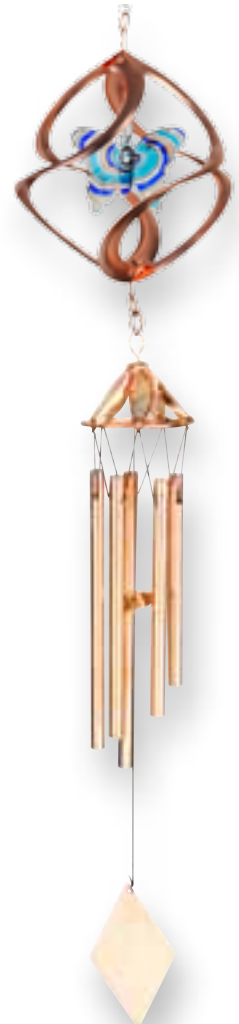

25" L

**Butterfly**  
10132-3-0511

**WARNING: THIS PRODUCT CAN EXPOSE YOU TO CHEMICALS INCLUDING LEAD WHICH IS (ARE) KNOWN TO THE STATE OF CALIFORNIA TO CAUSE CANCER, BIRTH DEFECTS, OR OTHER REPRODUCTIVE HARM. FOR MORE INFORMATION, GO TO WWW.P65WARNINGS.CA.GOV**

= GLOW IN THE DARK, SOLAR, or LIGHTS UP

Patent# D487, 034 S, Patent# D497, 833 S, Patent# D505, 639 S

# Cosmix™ Wind Chimes

METAL • STEEL • CRYSTAL OR GLASS ACCENTS

COSMIX™ CHIMES



33" L

**Rainbow Chime**  
10107-3-0531



25.5" L

 **Iridescent Chime**  
10109-3-0051



 **WARNING: THIS PRODUCT CAN EXPOSE YOU TO CHEMICALS INCLUDING LEAD WHICH IS (ARE) KNOWN TO THE STATE OF CALIFORNIA TO CAUSE CANCER, BIRTH DEFECTS, OR OTHER REPRODUCTIVE HARM. FOR MORE INFORMATION, GO TO WWW.P65WARNINGS.CA.GOV**

Patent# D487, 034 S, Patent# D497, 833 S, Patent# D505, 639 S

 = GLOW IN THE DARK, SOLAR, or LIGHTS UP

Order Toll Free 1.877.985.0405 • Fax 1.513.774.1601

Visit our website or call to receive a complete catalog to see all styles of fashion and garden giftware RCS offers.

 = OVERSIZED FREIGHT

www.rcsgifts.com | 77

# Mini Garden Chimes Assortment

10" L • ALUMINUM • STAINLESS STEEL • CRYSTAL • \$5.00 EACH  
 • USE WITH 98958 WINDOW HANGER ON PAGE 28 AND 94

24-PC ASSORTMENT  
**10855-1-00021**  
  
 8 09048 10855 2

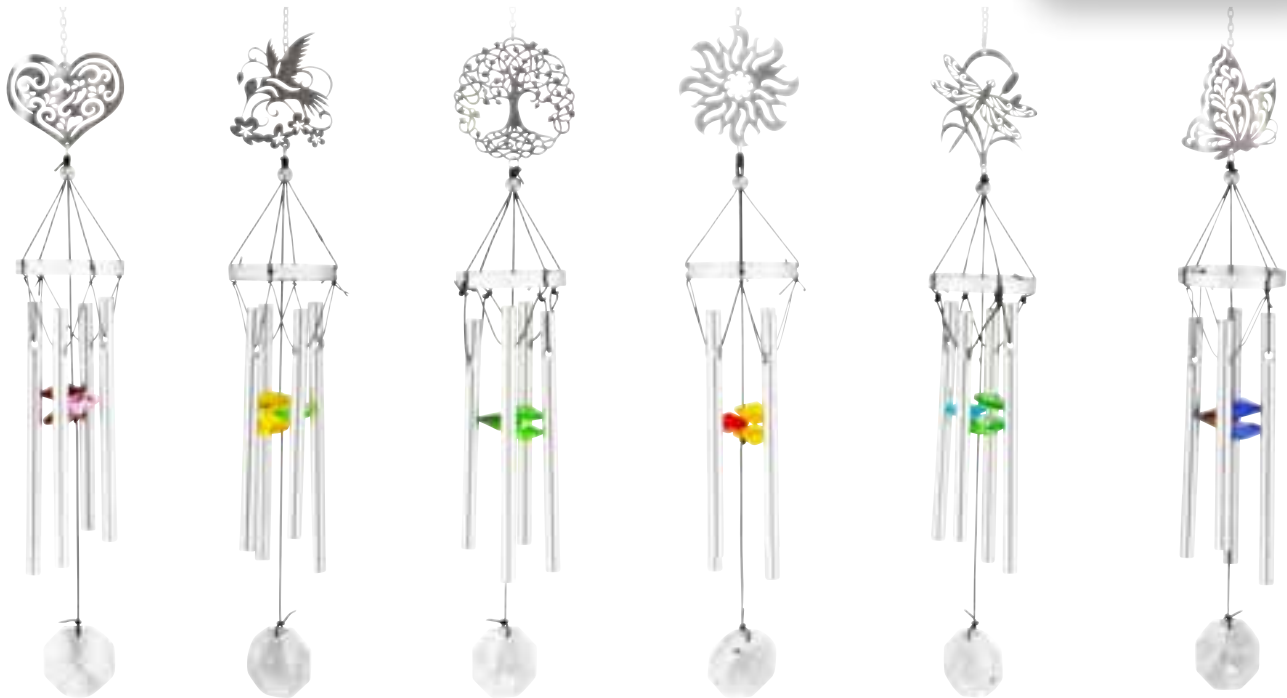

# Small Heart Chimes Assortment

18" L • GLASS • STEEL • ALUMINUM • \$6.00 EACH  
 • USE WITH 98958 WINDOW HANGER ON PAGE 28 AND 94

24-PC ASSORTMENT  
**10856-1-00441**  
  
 8 09048 10856 9



14.5" x 14.5" x 25"  
**Mini Chime KD Steel Display**  
 09968-1-0052  
 • Holds 16 pieces  
  
 8 09048 09968 3



18-PC ASSORTMENT  
10360-18-00891



# Geo Chimes

STAINLESS STEEL • STEEL • ALUMINUM

**\$ 962.00** YOUR PRICE:  
**VALUE** **\$ 902.00**

**NEW Chimes Assortment**

10000-B-00209

- Includes 76 pieces
- FreeDisplay (09910) if requested

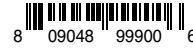

SEE THIS AND MORE ASSORTMENTS  
ON PAGES 138-141

WIND CHIMES



6" X 1.8" X 22"

**Butterfly Geo Chime**  
10361-3-0011



6" X 1.8" X 22"

**Owl Geo Chime**  
10363-3-0011



6" X 1.8" X 22"

**Hummingbird Geo Chime**  
10365-3-0011



6" X 1.8" X 22"

**Dragonfly Geo Chime**  
10362-3-0011



6" X 1.8" X 22"

**SunGeo Chime**  
10364-3-0011



6" X 1.8" X 22"

**Pineapple Geo Chime**  
10366-3-0011



# Flying 3D Chimes

STAINLESS STEEL • STEEL • ALUMINUM • CRYSTAL  
 • USE WITH 98958 WINDOW HANGER ON PAGE 28 AND 94

6-PC ASSORTMENT  
**10390-6-0057**

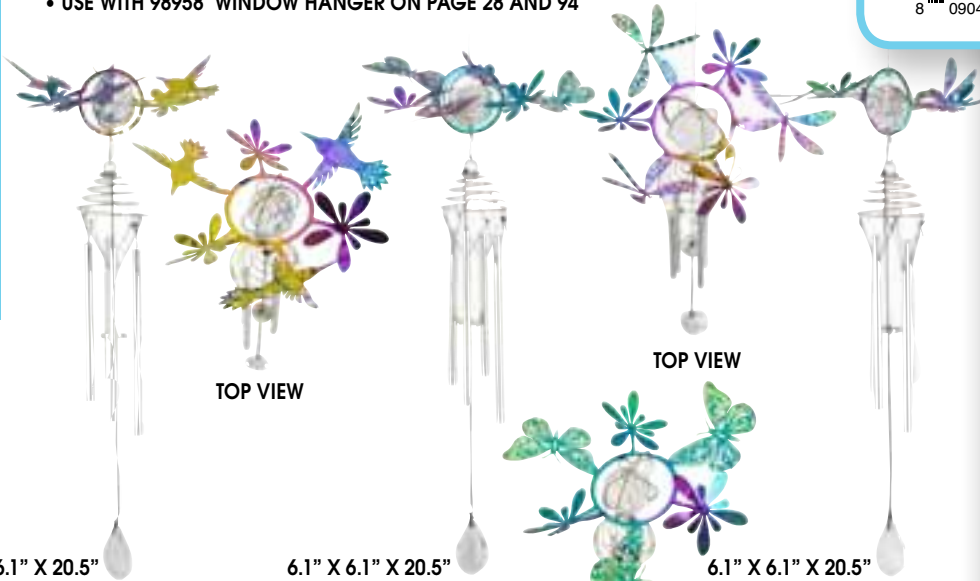
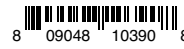

TOP VIEW

TOP VIEW

TOP VIEW

6.1" X 6.1" X 20.5"

6.1" X 6.1" X 20.5"

6.1" X 6.1" X 20.5"

**Flying 3D Hummingbird  
 Iridescent Chime**  
 10391-2-0521

**Flying 3D Butterfly  
 Iridescent Chime**  
 10392-2-0521

**Flying 3D Dragonfly  
 Iridescent Chime**  
 10393-2-0521



# Iridescent Shadow Chimes

STAINLESS STEEL • STEEL • ALUMINUM • CRYSTAL  
 • USE WITH 98958 WINDOW HANGER ON PAGE 28 AND 94

12-PC ASSORTMENT  
**10370-12-00201**



4.1" X 1.75" X 18"

4.1" X 1.75" X 18"

4.1" X 1.75" X 18"

4.1" X 1.75" X 18"

**18" Iridescent Butterfly  
 Shadow Chime**  
 10371-3-0580

**18" Iridescent Dragonfly  
 Shadow Chime**  
 10372-3-0580

**18" Iridescent Hummingbird  
 Shadow Chime**  
 10373-3-0580

**18" Iridescent Owl  
 Shadow Chime**  
 10374-3-0580



= GLOW IN THE DARK, SOLAR, or LIGHTS UP





8-PC ASSORTMENT  
10380-8-00041



# Iridescent Shadow Chimes

STAINLESS STEEL • STEEL • PLASTIC

WIND CHIMES



5.2" X 4.7" X 36"  
**36" Iridescent Butterfly  
Shadow Chime**  
10381-2-0571



5.2" X 4.7" X 36"  
**36" Iridescent Dragonfly  
Shadow Chime**  
10382-2-0571



5.2" X 4.7" X 36"  
**36" Iridescent Hummingbird  
Shadow Chime**  
10383-2-0571



5.2" X 4.7" X 36"  
**36" Iridescent Owl Shadow  
Chime**  
10384-2-0571



**\$ 595.00** **YOUR PRICE:**  
**VALUE \$ 540.00**

**Shadow Chimes Assortment**

10000-S-00025

- Includes 65 pieces
- FreeDisplay (09901) if requested



SEE THIS AND MORE ASSORTMENTS  
ON PAGES 138-141

**Mini Shadow Chime Assortment**

14" CHIME • 15" X 9" X 17.625" RACK • METAL

- 6 OF EACH DESIGN • DISPLAY INCLUDED • \$2.50 EACH
- USE WITH 98958 WINDOW HANGER ON PAGE 28 AND 94

**42-PC ASSORTMENT**  
**10857-1-00501**



DISPLAY INCLUDED

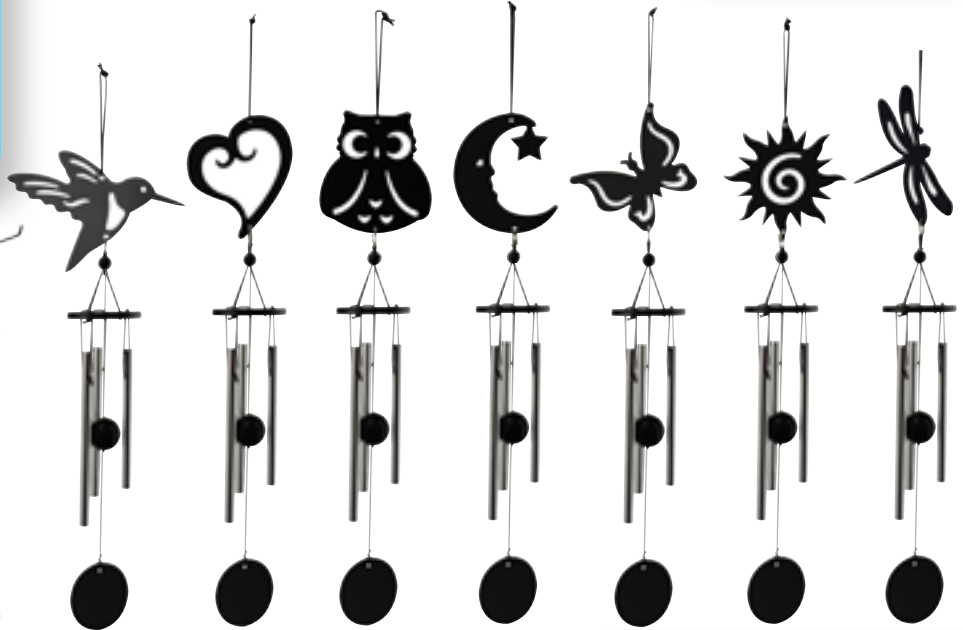

**Small Shadow Chimes**

ALUMINUM • IRON • CRYSTAL • USE WITH 98958 WINDOW HANGER ON PAGE 28 AND 94

**16-PC ASSORTMENT**  
**10440-16-0088**



2.95" x 2.36" x 25"

**Cat Small Shadow Chime**

10441-4-0050



3.94" x 2.36" x 25"

**Butterfly Small Shadow Chime**

10442-4-0550



3.94" x 2.36" x 25"

**Hummingbird Small Shadow Chime**

10443-4-0550



3.54" x 2.36" x 25"

**Rooster Small Shadow Chime**

10444-4-0550



16-PC ASSORTMENT  
10450-16-00401



# Bronze Shadow Wind Chime

ALUMINUM • IRON • MDF • ACRYLIC

WIND CHIMES



4.33" x 3.94" x 33"  
**Tree of Life Bronze Shadow Chime**  
10451-4-0560



5.12" x 3.94" x 33"  
**Hummingbird Bronze Shadow Chime**  
10452-4-0560



4.33" x 3.94" x 33"  
**Dragonfly Bronze Shadow Chime**  
10453-4-0560



5.12" x 3.94" x 33"  
**Butterfly Bronze Shadow Chime**  
10454-4-0560



# Shadow Wind Chimes

METAL • ALUMINUM

12-PC ASSORTMENT

10220-12-00411



40" L

**Butterfly**  
10221-3-0590



40" L

**Hummingbird**  
10222-3-0590



40" L

**Sun**  
10223-3-0590



40" L

**Owl**  
10224-3-0590



# Shadow Chimes

ALUMINUM • IRON • MDF

12-PC ASSORTMENT  
10460-12-00411



5.51" x 4.72" x 40"  
**Dragonfly Shadow Chime**  
10461-3-0590



5.51" x 4.72" x 40"  
**Hummingbird Shadow Chime**  
10462-3-0590



5.51" x 4.72" x 40"  
**Butterfly Shadow Chime**  
10463-3-0590



5.91" x 4.72" x 40"  
**Bless This House Shadow Chime**  
10464-3-0590



# Silhouettes Chimes

ALUMINUM • IRON • MDF • ACRYLIC

12-PC ASSORTMENT  
10430-12-00021



4.92" x 4.92" x 34"  
**Cat Silhouettes Chime**  
10431-3-0001



4.92" x 4.92" x 34"  
**Dragonflies Silhouettes Chime**  
10432-3-0001



4.92" x 4.92" x 34"  
**Butterflies Silhouettes Chime**  
10433-3-0001



4.92" x 4.92" x 34"  
**Hummingbirds Silhouettes Chime**  
10434-3-0001



= GLOW IN THE DARK, SOLAR, or LIGHTS UP



# Tune Wind Chimes

ALUMINUM • IRON • MDF



5.12" X 5.12" X 40"  
**Tune Chime - Gray**  
 10214-2-0512

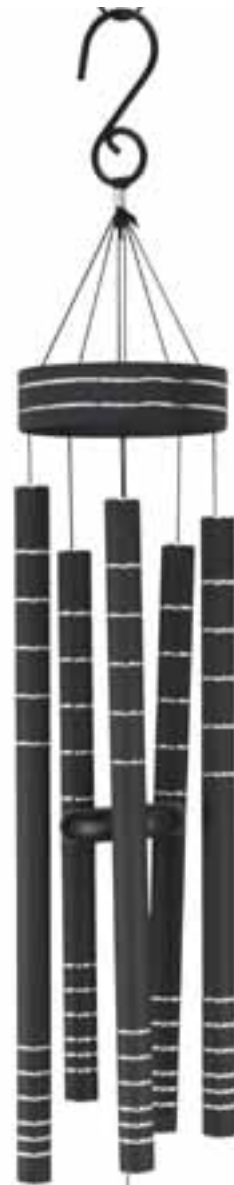

5.12" X 5.12" X 40"  
**Tune Chime - Black**  
 10215-2-0512



# Twinkle Solar Jar Chimes

IRON • GLASS • PLASTIC • TWINKLE LIGHTS INSIDE JAR/BOTTLE

6-PC ASSORTMENT  
10260-6-00531



8 09048 10260 4



7.09"W X 43.31" L

**Owl Jar Solar Chime - Orange**

10261-2-0522



8 09048 10261 1



LIGHTS UP!

6.10"W X 40.56" L

**Frog Jar Solar Chime - Green**

10262-2-0522



8 09048 10262 8



13.39"W X 43.31" L

**Butterfly Jar Solar Chime - Rainbow**

10263-2-0522



8 09048 10263 5

= GLOW IN THE DARK, SOLAR, or LIGHTS UP





6-PC ASSORTMENT  
10420-6-0009



# Flower In A Pot Chimes

IRON • GLASS • PLASTIC



LIGHTS UP!



4.72" X 3.54" X 29.52"

**Glass Flower in a Pot Chime - Pink**  
10421-2-0051



4.72" X 3.54" X 29.52"

**Glass Flower in a Pot Chime - Blue**  
10422-2-0051



4.72" X 3.54" X 29.52"

**Glass Flower in a Pot Chime - Purple**  
10423-2-0051



# Solar Wind Chimes

METAL • GLASS • PLASTIC • SOLAR POWERED GLOWING BALL OR TWINKLE LIGHTS



BALL LIGHTS UP  
RED, BLUE  
AND GREEN!



Scan QR code  
below to  
watch video  
of globe  
changing colors!



 32"L  
 **Black**  
10861-2-0021  



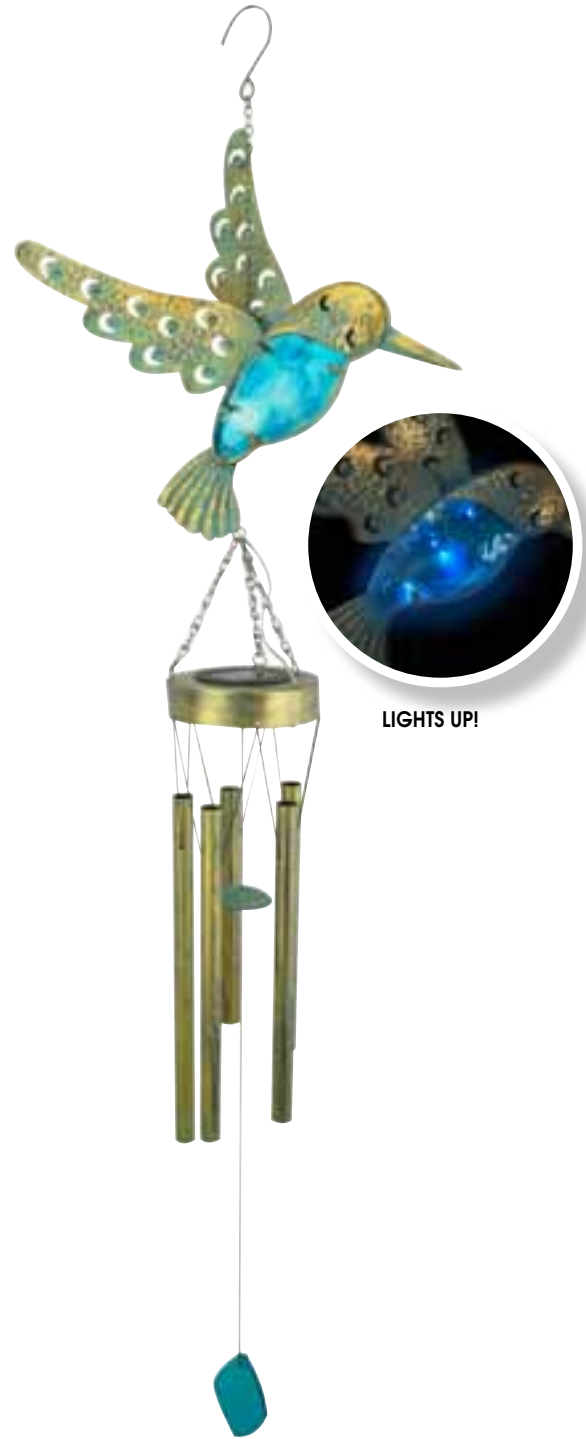

 32"L  
 **Rustic**  
10862-2-0021  

LIGHTS UP!

11.811"W x 46.46"H  
 **Hummingbird  
Solar Chime -  
Brushed Gold**  
10294-2-0002  

 **WARNING: THIS PRODUCT CAN EXPOSE YOU TO CHEMICALS INCLUDING LEAD WHICH IS (ARE) KNOWN TO THE STATE OF CALIFORNIA TO CAUSE CANCER, BIRTH DEFECTS, OR OTHER REPRODUCTIVE HARM. FOR MORE INFORMATION, GO TO WWW.P65WARNINGS.CA.GOV**

 = GLOW IN THE DARK, SOLAR, or LIGHTS UP

90 | [www.rcsgifts.com](http://www.rcsgifts.com)  = OVERSIZED FREIGHT

15-PC ASSORTMENT  
10280-15-0057



# Garden Pals Chimes

METAL • GLASS • PLASTIC

WIND CHIMES



29" L

**Peacock Pink/Blue**  
10281-3-0050



29" L

**Frog Green**  
10282-3-0050



29" L

**Hummingbird Green**  
10283-3-0050

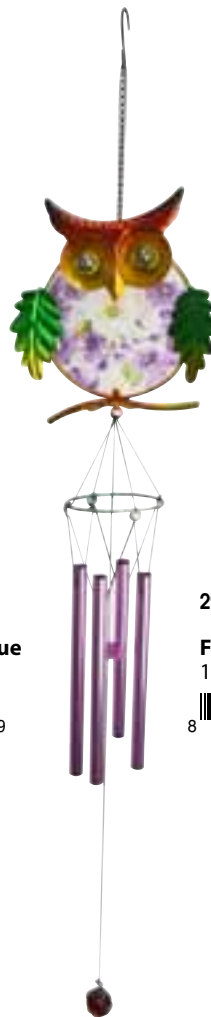

29" L

**Owl Orange**  
10284-3-0050

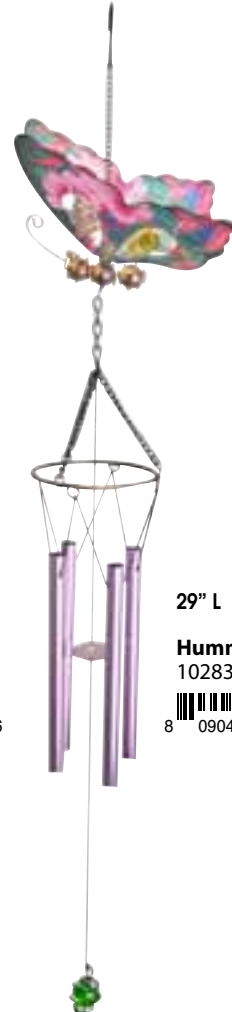

29" L

**Butterfly Pink**  
10285-3-0050



# Metal Flower Chimes

IRON • PLASTIC • GLASS

12-PC ASSORTMENT  
10400-12-00021

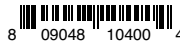

7.28" X 3.93" X 37.4"  
**Metal Flower Chime - Red**  
10401-4-0001



7.28" X 3.93" X 37.4"  
**Metal Flower Chime - Yellow**  
10402-4-0001



7.28" X 3.93" X 37.4"  
**Metal Flower Chime - Blue**  
10403-4-0001



= GLOW IN THE DARK, SOLAR, or LIGHTS UP



6-PC ASSORTMENT  
10410-6-0018



# Daisy Flower Chimes

IRON • GLASS

WIND CHIMES



8.07" X 3.74" X 41.3"  
**Daisy Flower Chime - Pink**  
10411-2-0531



8.07" X 3.74" X 41.3"  
**Daisy Flower Chime - Purple**  
10412-2-0531



8.07" X 3.74" X 41.3"  
**Daisy Flower Chime - Yellow**  
10413-2-0531



# Garden Hooks

WINDOW HANGERS, HOOKS AND ROTATING MOTORS



**WINDOW HANGER**  
**32-PC ASSORTMENT**  
 2 DISPLAYS WITH  
 32PCS IN EACH DISPLAY  
**98958-1-0088**  
 8 09048 98958 8

2.75" T • PVC • NYLON • SUCTION CUP APPLI-  
 CABLE ON FLAT/SMOOTH SURFACES (GLASS/  
 STEEL/WOOD • INDOOR/OUTDOOR USE •  
 UNLOCK/LOCK FUNCTION •  
 ANGLE (0-90 DEGREES) • \$2.75 EACH



**WARNING:** THIS PRODUCT CAN EXPOSE YOU TO CHEMICALS INCLUDING PH THALATE WHICH IS (ARE) KNOWN TO THE STATE OF CALIFORNIA TO CAUSE REPRODUCTIVE HARM. FOR MORE INFORMATION, GO TO [WWW.P65WARNINGS.CA.GOV](http://WWW.P65WARNINGS.CA.GOV)



15" TALL  
**Copper Plated Hooks**  
 30001-1-0085  
 • 72 pcs per display  
 8 09048 30001 7



15" TALL  
**Smoked Steel Hooks**  
 30004-1-0024  
 • 48 pcs per display  
 8 09048 30004 8

15" TALL  
**Copper Plated Hooks**  
 30002-1-0003  
 • 36 pcs per display  
 8 09048 30002 4

APPROX. 7.5" L • REQUIRES 1 D SIZE BATTERY (NOT INCLUDED)



**Rotating Cylinder Motor-White**  
 28796-12-0550  
 • Approx. 40-50 RPM  
 8 09048 28796 7



**Rotating Cylinder Motor-Black (Slow)**  
 28793-12-0550  
 • Approx. 20-25 RPM  
 8 09048 28793 6

**Rotating Cylinder Motor-Black**  
 28795-12-0550  
 • Approx. 40-50 RPM  
 8 09048 28795 0

9-PC ASSORTMENT  
10470-9-0567



# Garden Bell Chimes

METAL • GLASS

WIND CHIMES

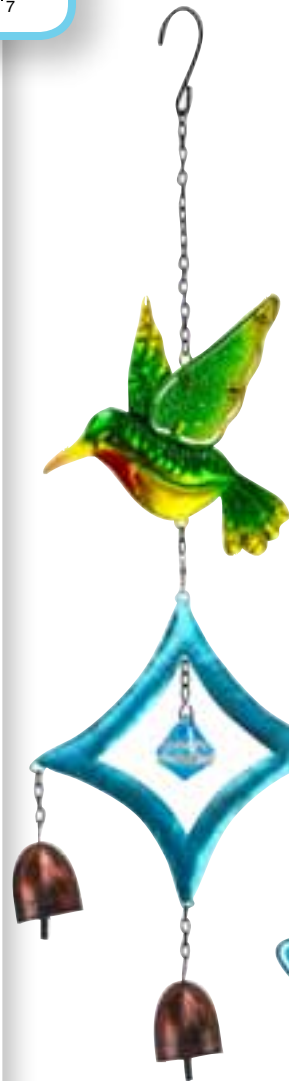

6.25" x 1.33" x 21"

**Hummingbird**  
10471-3-0580



6.88" x 1.33" x 21.6"

**Butterfly**  
10473-3-0580



7" x 1.33" x 22"

**Dragonfly**  
10472-3-0580



# Nature's Jewels Bell Chimes

JEWELLED & DISTRESSED BELL ACCENTS • METAL • GLASS

10-PC ASSORTMENT  
10200-10-00011

8 09048 99060 7



23" L  
**Hummingbird**  
10201-2-0011

8 09048 10201 7



23" L  
**Butterfly**  
10204-2-0011

8 09048 10204 8



23" L  
**Peacock**  
10208-2-0011

8 09048 10208 6



23" L  
**Cardinal**  
10202-2-0011

8 09048 10202 4



23" L  
**Owl**  
10205-2-0011

8 09048 10205 5

 = GLOW IN THE DARK, SOLAR, or LIGHTS UP

 = OVERSIZED FREIGHT





# Glass Bell Bottom™ Chimes

GLASS TOP • MARBLE ACCENTS • METAL BELLS

WIND CHIMES



24.5" L X 12"W

**Butterfly**  
10341-3-0531



24.5" L X 11.81"W

**Dragonfly**  
10342-3-0531



# Karen Penner™ Doorknob Chime

SCULPTED DETAILING • HAND PAINTED



20" L  
**Vintage Door Lock**  
13334-3-0531



# Glass Fish Chime

COLORED GLASS • METAL • ACCENT MARBLE



5.7" W x 23" H  
**Fish**  
11211-3-0001



# Heartland Chimes

SCULPTED DETAILS • HAND PAINTED • SOLID ALUMINUM BARS • USE WITH 98958 WINDOW HANGER ON PAGE 28 AND 94



23" L  
**Tractor**  
13355-3-0521



23" L  
**Silver Camper**  
13366-3-0521



22" L  
**Fishing Hat**  
13373-3-0541



TOP VIEW



COPPER/CHROME/STEEL/IRIDESCENT PLATED • CRYSTAL OR GLASS MARBLE ACCENTS  
• SWIVEL HOOK FOR EASY SPINNING

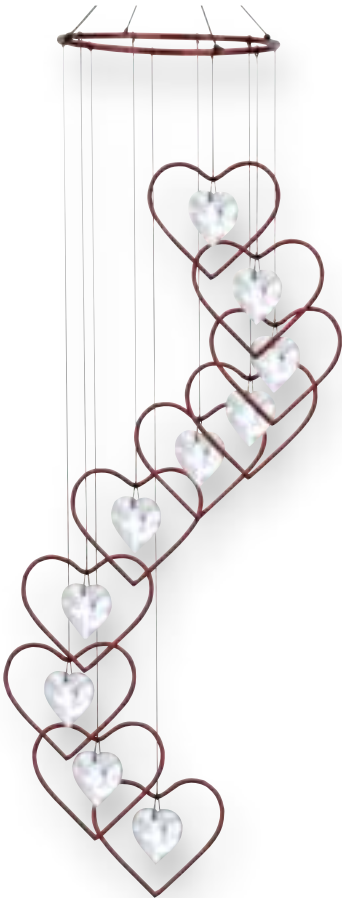

6" X 6" X 36"  
**Red Heart Ring  
w/ Heart Crystals**  
11026-2-0051



6" X 6" X 36"  
**Copper Teardrop Ring  
w/ Teardrop Crystals**  
11027-2-0051



6" X 6" X 36"  
**Teardrop Glass  
Rainbow**  
11029-2-0051



3.74" X 3.74" X 30"  
**Butterflies - Blue**  
11046-3-0001



3.74" X 3.74" X 30"  
**Butterflies - Orange**  
11047-3-0001



# Spinner Chimes

IRON • GLASS

12-PC ASSORTMENT  
10310-12-00091



11.5" W X 44.09" L

**Sun Dual Spinner Chime**

10311-3-0571



12" W X 44.09" L

**Rainbow Star Dual Spinner Chime**

10312-3-0571



12.40" X 5.31" X 44.09"

**Rainbow Fire Spinner Chime**

10313-2-0571



= GLOW IN THE DARK, SOLAR, or LIGHTS UP



# Flower Spinner Chimes

IRON • GLASS • PLASTIC

SPINNER CHIMES

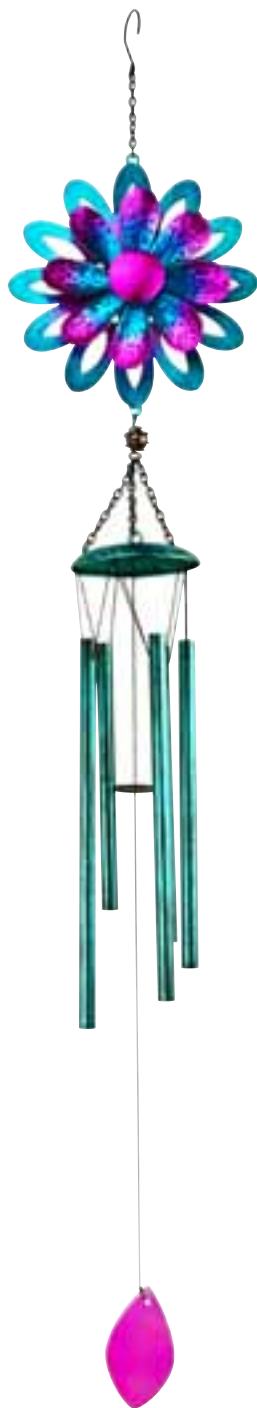

7.08" X 3.74" X 39.37"

**Blue Flower Spinner Chime**

10315-2-0521



7.08" X 3.74" X 39.37"

**Yellow Flower Spinner Chime**

10316-2-0521



# Solar Windmill Chimes

IRON • GLASS • PLASTIC

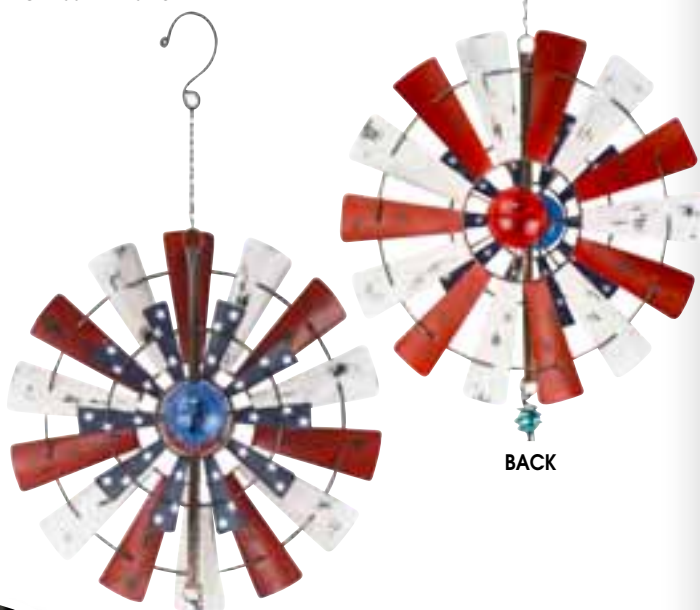

BACK



LIGHTS UP!



15" W X 67" L

 **American Windmill  
Solar Spinner Chime**  
10299-2-0054



# Patriotic Tune Chimes

ALUMINUM • PLASTIC

PATRIOTIC CHIMES



8" X 8" X 56"

**56" Patriotic Tune Chime**  
10301-2-0054



8 09048 10301 4



6.3" X 6.3" X 36"

**36" Patriotic Tune Chime**  
10302-2-0582



8 09048 10302 1



# Military Suncatchers

6" X 1.1" X 6" • GLASS • METAL • SUCTION CUP INCLUDED

\*A portion of the sales price goes to the support of the USMC Morale, Welfare and Actives Funding.



**Army Suncatcher**  
35001-4-0090



**Air Force Suncatcher**  
35002-4-0090



**Marines Suncatcher**  
35003-4-0090



**Navy Suncatcher**  
35004-4-0090



**Fire Department Suncatcher**  
35005-4-0090



**Coast Guard Suncatcher**  
35009-4-0090



= GLOW IN THE DARK, SOLAR, or LIGHTS UP = OVERSIZED FREIGHT



\*A portion of the sales price goes to the support of the USMC Morale, Welfare and Actives Funding.

# Military Geos

8" X .1" X 8" • STAINLESS STEEL

MILITARY



**Army Geo**

35011-4-0001



**Air Force Geo**

35012-4-0001

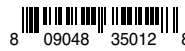

**Marines Geo**

35013-4-0001



**Navy Geo**

35014-4-0001



**Fire Department Geo**

35015-4-0001



**Coast Guard Geo**

35019-4-0001

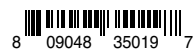

™ Department of the Navy. Officially Licensed Product of the Department of the Navy.

® Department of the Air Force. Officially Licensed Product of the Department of the Air Force. (www.airforce.com)

® United States Marine Corps. Officially Licensed Product of the United States Marine Corps (www.marines.com and 1.800.marines).

This product is licensed by the U.S. Army. In accordance with federal law, the Army receives a portion of the proceeds from the sales of the licensed products.

Officially Licensed Product of the United States Coast Guard.

Order Toll Free 1.877.985.0405 • Fax 1.513.774.1601



= GLOW IN THE DARK, SOLAR, or LIGHTS UP



= OVERSIZED FREIGHT

# Patriot Spiral Chimes

32" L • PRINTED ON METAL • ACRYLIC STARS • DOUBLE SIDED

\*A portion of the sales price goes to the support of the USMC Morale, Welfare and Actives Funding.



**Army Spiral Chime**  
15181-3-0521



**Air Force Spiral Chime**  
15182-3-0521

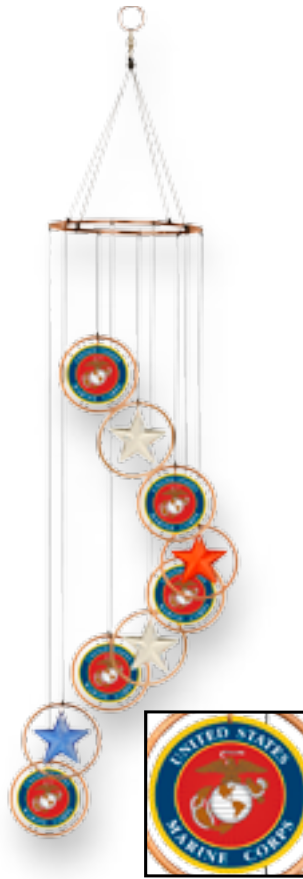

**Marines Spiral Chime**  
15183-3-0521



**Navy Spiral Chime**  
15184-3-0521



# Patriot Chimes

21" L • SCULPTED IN DETAIL • HAND PAINTED • GLASS MARBLE ACCENTS • METAL CHIME BARS • DOUBLE SIDED

\*A portion of the sales price goes to the support of the USMC Morale, Welfare and Actives Funding.



**Army Chime**  
15171-4-0001



**Air Force Chime**  
15172-4-0001



**Marines Chime**  
15173-4-0001



**Navy Chime**  
15174-4-0001



**Fire Department Chime**  
15175-4-0001

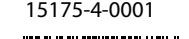

= GLOW IN THE DARK, SOLAR, or LIGHTS UP = OVERSIZED FREIGHT

\*A portion of the sales price goes to the support of the USMC Morale, Welfare and Actives Funding.

# Military Signs

10.5"W X 14.75"H X 1.75"D • MDF

MILITARY



**Army Sign**  
35141-2-0511



**Air Force Sign**  
35142-2-0511



**Marines Sign**  
35143-2-0511

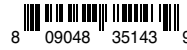

**Navy Sign**  
35144-2-0511

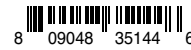

\*A portion of the sales price goes to the support of the USMC Morale, Welfare and Actives Funding.

# Military Bird Houses

6.5" X 3.94" X 8.74" • MDF • IRON • SCULPTED DETAILING • CLEAN OUT HOLE



**Army Bird House**  
45181-2-0511



**Air Force Bird House**  
45182-2-0511



**Marines Bird House**  
45183-2-0511



**Navy Bird House**  
45184-2-0511



™ Department of the Navy. Officially Licensed Product of the Department of the Navy.

© Department of the Air Force. Officially Licensed Product of the Department of the Air Force. (www.airforce.com)

© United States Marine Corps. Officially Licensed Product of the United States Marine Corps (www.marines.com and 1.800.marines).

This product is licensed by the U.S. Army. In accordance with federal law, the Army receives a portion of the proceeds from the sales of the licensed products.



= GLOW IN THE DARK, SOLAR, or LIGHTS UP



= OVERSIZED FREIGHT

# Military Gnomes

13.25"H X 5" DIA BASE • POLYRESIN  
EACH OF THE 4 SERVICES RECEIVE A PORTION OF THE SELLING PRICE

\*A portion of the sales price goes to the support of the USMC Morale, Welfare and Actives Funding.



**Army Gnome**  
35161-4-0571



**Air Force Gnome**  
35162-4-0571



**Marines Gnome**  
35163-4-0571



**Navy Gnome**  
35164-4-0571



**Fire Department Gnome**  
35165-4-0571



**Police Department Gnome**  
35166-4-0571



= GLOW IN THE DARK, SOLAR, or LIGHTS UP = OVERSIZED FREIGHT

\*A portion of the sales price goes to the support of the USMC Morale, Welfare and Actives Funding.

# Military Garden Stones

10" T X 10.5" W X 2.5" D • RESIN • 2 USA FLAGS INCLUDED EXCEPT WITH 35186 • 2 HOLES FOR FLAG PLACEMENT

MILITARY



**Army**  
35181-4-0561



**Air Force**  
35182-4-0561



**Marines**  
35183-4-0561



SIDE VIEW  
OF STONE



**Navy**  
35184-4-0561

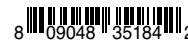

**Fire Department**  
35185-4-0561



**Police Department**  
35196-4-0561



™ Department of the Navy. Officially Licensed Product of the Department of the Navy.

© Department of the Air Force. Officially Licensed Product of the Department of the Air Force. ([www.airforce.com](http://www.airforce.com))

© United States Marine Corps. Officially Licensed Product of the United States Marine Corps ([www.marines.com](http://www.marines.com) and 1.800.marines).

This product is licensed by the U.S. Army. In accordance with federal law, the Army receives a portion of the proceeds from the sales of the licensed products.

Order Toll Free 1.877.985.0405 • Fax 1.513.774.1601

Visit our website or call to receive a complete catalog to see all styles of fashion and garden giftware RCS offers.



GLOW IN THE DARK, SOLAR, or LIGHTS UP



OVERSIZED FREIGHT

# Military Keepsakes

3" DIA • RIBBON HANGER • DOUBLE SIDED

\*A portion of the sales price goes to the support of the USMC Morale, Welfare and Actives Funding.



**Army Keepsake**  
35151-6-0030



**Air Force Keepsake**  
35152-6-0030



**Marines Keepsake**  
35153-6-0030



**Navy Keepsake**  
35154-6-0030



**Coast Guard Keepsake**  
35155-6-0030



# Patriot Plaque/Stepping Stones

6" X.5" • POLYRESIN • KEYHOLE FOR HANGING • PADS ON BACK

\*A portion of the sales price goes to the support of the USMC Morale, Welfare and Actives Funding.



**Army Plaque**  
35191-6-0560



**Marines Plaque**  
35193-6-0560



**Airforce Plaque**  
35192-6-0560



**Navy Plaque**  
35194-6-0560



= GLOW IN THE DARK, SOLAR, or LIGHTS UP

= OVERSIZED FREIGHT

<sup>TM</sup> Department of the Navy. Officially Licensed Product of the Department of the Navy.

© Department of the Air Force. Officially Licensed Product of the Department of the Air Force. (www.airforce.com)

© United States Marine Corps. Officially Licensed Product of the United States Marine Corps (www.marines.com and 1.800.marines).

Officially Licensed Product of the United States Coast Guard.

All items in catalog ©2000-2020 Red Carpet Studios, Ltd. All Rights Reserved.

# Military Double Sided Stickers

\*A portion of the sales price goes to the support of the USMC  
Morale, Welfare and Actives Funding.

2 PACK: 3.5" DIA(SM)/5.875" DIA(LG) • INDOOR/OUTDOOR USE • \$3.00 PER PACK

MADE IN THE USA MILITARY DOUBLE SIDED STICKERS COME IN TWO SIZES AND HAVE ADHESIVE ON ONE SIDE. THIS STICKER CAN BE PLACED IN WINDOWS AND IS READABLE FROM ALL SIDES. USE ON YOUR CAR WINDOW, HOME WINDOW, CAR BUMPER, LOCKER, BOOKS, ETC.

MILITARY



**Army Double Sided Stickers**  
35111-6-0030



**Air Force Double Sided Stickers**  
35112-6-0030



**Marines Double Sided Stickers**  
35113-6-0030



**Navy Double Sided Stickers**  
35114-6-0030



**Coast Guard Double Sided Stickers**  
35115-6-0030



**Fire Dept Double Sided Stickers**  
35116-6-0030



**Police Double Sided Stickers**  
35117-6-0030



**\$3.00 per pack/min 6**

**2 Pack includes  
1- 3.5" diameter  
and  
1- 5.875" diameter**

™ Department of the Navy. Officially Licensed Product of the Department of the Navy.

© Department of the Air Force. Officially Licensed Product of the Department of the Air Force. (www.airforce.com)

© United States Marine Corps. Officially Licensed Product of the United States Marine Corps (www.marines.com and 1.800.marines).

This product is licensed by the U.S. Army. In accordance with federal law, the Army receives a portion of the proceeds from the sales of the licensed products.

Officially Licensed Product of the United States Coast Guard.

Order Toll Free 1.877.985.0405 • Fax 1.513.774.1601

= GLOW IN THE DARK, SOLAR, or LIGHTS UP

= OVERSIZED FREIGHT

# Garden Fountains

METAL • PUMP INCLUDED

21.65" X 12.20" X 15.75"

**Turtle Fountain**  
40264-2-0004



8 09048 40264 3

16.93" X 11.02" X 14.76"

**Frog Fountain**  
40265-2-0004



8 09048 40265 0



= GLOW IN THE DARK, SOLAR, or LIGHTS UP



# Memorial Garden Stones

RESIN • SCULPTED IN DETAIL



9.45" X 2.55" X 10.2"

**Memorial Garden Stone w/ Mini Chimes**  
35197-2-0571



8 09048 35197 2



9.45" X 2.55" X 10.2"

**Memorial Garden Stone w/ Photo Frame**  
35198-2-0571



8 09048 35198 9

Allows you to place a favorite 4.5" x 5" photo of your loved one.



Allows you to place a favorite 4" x 6" photo of your pet.

10" X 3" X 10.5"

**Faithful Companion**  
35186-4-0561

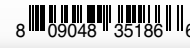

8 09048 35186 6



= GLOW IN THE DARK, SOLAR, or LIGHTS UP

= OVERSIZED FREIGHT

# Bug Hummingbird Feeders

6.75" X 5.5" X 21.5" • GLASS • METAL

**\$ 568.00** **YOUR PRICE:**  
**VALUE** **\$ 513.00**

**Hummingbird Feeder Assortment**

- 41100-A-00315  
 • Includes 60 pieces  
 • Free Display (09901) if requested



8 09048 99983 9

SEE THIS AND MORE ASSORTMENTS  
ON PAGES 138-141



**Hummingbird Feeder  
Tube & Stopper Kit**  
98957-12-0510



8 09048 98957 1



**Blue Bug**  
41087-3-0011



8 09048 41087 7



**Purple Bug**  
41088-3-0011



8 09048 41088 4



= GLOW IN THE DARK, SOLAR, or LIGHTS UP

12-PC ASSORTMENT  
41080-12-00621

8 09048 41080 8

# Glass Hummingbird Feeders

GLASS • RUBBER • METAL • S-HOOK INCLUDED

HUMMINGBIRD  
FEEDERS



4.33" X 4.33" X 10.23"  
**Multi Color Glass Ball**  
41083-3-0001

8 09048 41083 9



4.33" X 4.33" X 10.23"  
**Blue Glass Ball**  
41084-3-0001

8 09048 41084 6



4.92" X 4.92" X 11.81"  
**Yellow, Red, and  
White Glass Pear**  
41085-3-0011

8 09048 41085 3



4.92" X 4.92" X 11.81"  
**Multi Color Glass  
Pear**  
41086-3-0011

8 09048 41086 0

8-PC ASSORTMENT  
41090-8-00401

8 09048 41090 7

# Glass Balloon Hummingbird Feeders

GLASS • IRON • PLASTIC



4.61" X 4.61" X 8.46"  
**Multi Color Stripe**  
41091-2-0031

8 09048 41091 4



4.61" X 4.61" X 8.46"  
**Patriotic Stripe**  
41092-2-0031

8 09048 41092 1



5" X 5" X 8.46"  
**Balloon Glass -  
Purple**  
41093-2-0031

8 09048 41093 8



5" X 5" X 8.46"  
**Balloon Glass - Blue**  
41094-2-0031

8 09048 41094 5

# 2 Glass Cup Hummingbird Feeder w/Suction Cup

5.11" X 1.41" X 5.82" • PETG • PP • TPE • PA6/GF30



 **2 Glass Cup Feeder w/ Suction Cup**  
41259-12-0060



 **WARNING: THIS PRODUCT CAN EXPOSE YOU TO CHEMICALS INCLUDING PH THALATE WHICH IS (ARE) KNOWN TO THE STATE OF CALIFORNIA TO CAUSE REPRODUCTIVE HARM. FOR MORE INFORMATION, GO TO WWW.P65WARNINGS.CA.GOV**



# Floral Hummingbird Feeders w/ Suction Cup

3.5" X 3.15" X 3.5" • RESIN • PLASTIC

**Orange Flower w/ Suction Cup**  
41081-6-0570



**Red Flowers w/ Suction Cup**  
41082-6-0570



 = GLOW IN THE DARK, SOLAR, or LIGHTS UP

# Hummingbird Feeder Sets

4.7" X 3" X 1.8"

FEEDER - PETG • PP • PE • TPR •  
 SUCTION CUP - NYLON + 30% GLASS FIBER + PVC  
 DOUBLE HOOK - HDPE  
 DRIP RESISTANT SPOUT • HOLDS 2.30 OZ EACH



HOLDS UP TO 5 LBS

1.3" X 1.3" X 6"

 **Double Hummingbird Feeder with Hook Set**  
 41254-12-0060



4.7" X 3" X 1.8"

 **Hummingbird Feeder Window Hook Set**  
 41255-12-0540



 **WARNING: THIS PRODUCT CAN EXPOSE YOU TO CHEMICALS INCLUDING PH THALATE WHICH IS (ARE) KNOWN TO THE STATE OF CALIFORNIA TO CAUSE REPRODUCTIVE HARM. FOR MORE INFORMATION, GO TO [WWW.P65WARNINGS.CA.GOV](http://WWW.P65WARNINGS.CA.GOV)**

# Hummingbird Feeders

PVC, PA6/GF30 - HOOK • PP - BASE • PE - FLOWER • PETG - BOTTLE • WIRE • MULTI FEED



5.35" X 4.56" X 9.64"

 **Feeder w/ Suction Cup**  
 41258-8-0070



 **WARNING: THIS PRODUCT CAN EXPOSE YOU TO CHEMICALS INCLUDING PH THALATE WHICH IS (ARE) KNOWN TO THE STATE OF CALIFORNIA TO CAUSE REPRODUCTIVE HARM. FOR MORE INFORMATION, GO TO [WWW.P65WARNINGS.CA.GOV](http://WWW.P65WARNINGS.CA.GOV)**

**\$ 694.00** **YOUR PRICE:**  
**VALUE** **\$ 634.00**

**Bird House/Feeder Assortment**

- 90976-A-00875  
 • Includes 54 pieces  
 • Free Display (09910) if requested



SEE THIS AND MORE ASSORTMENTS  
ON PAGES 138-141

# Hook Feeders

METAL • USE WITH APPLES,  
ORANGES, PEARS, ETC.



**4.75" X 4.25" X 13.75"**  
**Single Hook Apple**  
**Bird Feeder**  
 40062-4-0540



**4.5" X 4.25" X 13.5"**  
**Double Hook Apple**  
**Bird Feeder**  
 40061-4-0540



= GLOW IN THE DARK, SOLAR, or LIGHTS UP

= OVERSIZED FREIGHT



# Tree Face Bird Feeders

RESIN • NATURAL STONE POWDER • JUTE HANGER • DRAIN HOLE

7.87" X 6.89" X 10.63"

**Smiling Tree Man  
Bird Feeder**

40071-4-0561



7.09" X 5.12" X 11.61"

**Old Man w/ Book and  
Lantern Bird Feeder**

40072-4-0561



# Stained Glass Bird Feeders

7.87" X 5.11" X 22.04" • GLASS • METAL



**Hummingbird  
Stained Glass  
Bird Feeder**

40063-2-0051



**Butterfly  
Stained Glass  
Bird Feeder**

40064-2-0051



# 3D Bird Baths

GLASS • METAL • 3 PRONG STAKE

10-PC ASSORTMENT  
40270-10-00062



20.9" X 8.5" X 38.2

**Flamingo Bird Bath**  
40271-2-0052



TOP VIEW



TOP VIEW

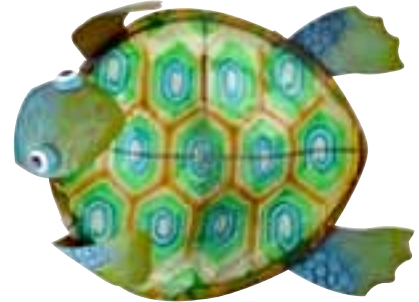

14.57" X 11.61" X 29.13"

**Turtle Bird Bath**  
40272-2-0052

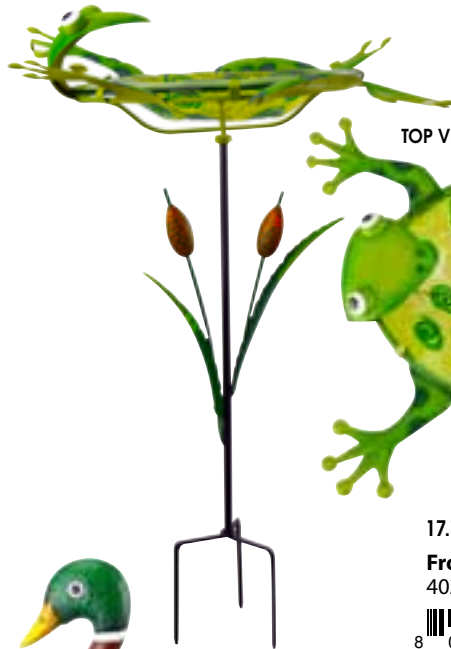

TOP VIEW

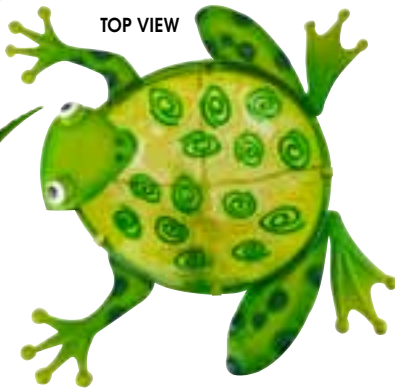

17.72" X 18.11" X 29.13"

**Frog Bird Bath**  
40273-2-0052



TOP VIEW

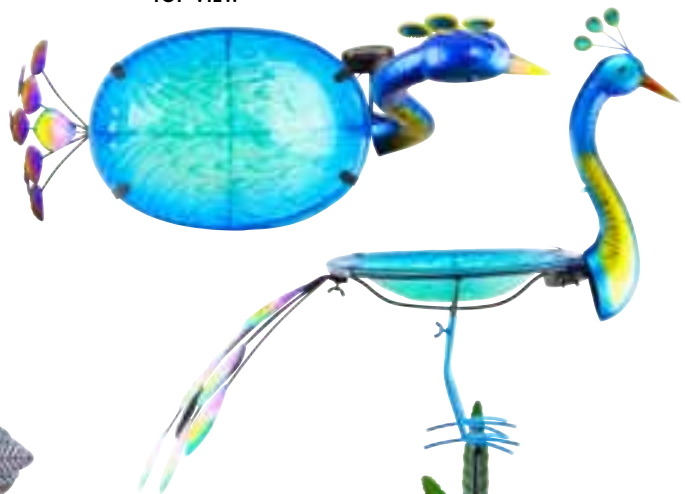

24.41" X 10.24" X 33.46"

**Peacock Bird Bath**  
40275-2-0572



TOP VIEW



17.70" X 8.30" X 28"

**Duck Bird Bath**  
40274-2-0572



= GLOW IN THE DARK, SOLAR, or LIGHTS UP



## Fairy Bird Houses

RESIN • NATURAL STONE POWDER • CLEAN OUT HOLE



4.53" X 4.53" X 8.27"

**Stone Bird House**  
40921-2-0021



8 09048 40921 5

5.12" X 4.33" X 9.25"

**Flowers and Tree Bird House**  
40922-2-0021



8 09048 40922 2



## Owl Bird House

WOOD • STEEL • JUTE • CLEAN OUT HOLE

8.15" X 3.35" X 10"

**Colorful Owl Bird House**  
40911-2-0531



8 09048 40911 6

# Patchwork Bird Houses

MDF • JUTE • PAPER • RESIN • IRON • CLEAN OUT HOLE



7.9" X 5.9" X 7.9"

**Blue Patchwork Bird House**  
40856-2-0511



7.9" X 5.9" X 7.9"

**Yellow Patchwork Bird House**  
40822-2-0511



# 3D Whitewash Bird Houses

MDF • IRON • JUTE • CLEAN OUT HOLE



5.78" X 3.54" X 8.26"

**Flower Whitewash Bird House**  
40848-2-0001



5.12" X 4.33" X 8.07"

**Butterfly Whitewash Bird House**  
40849-2-0001



 = GLOW IN THE DARK, SOLAR, or LIGHTS UP



## Barn Quilt Bird Houses

MDF • RESIN • IRON • JUTE • PAPER • CLEAN OUT HOLE



5.9" X 4.5" X 8.66"

**Red Barn Quilt  
Bird House**

40845-2-0511



5.9" X 4" X 9.84"

**Blue Barn Quilt  
Bird House**

40846-2-0531



## Church Bird House

MDF • IRON • JUTE • RESIN • HAND PAINTED • CLEAN OUT HOLE

7.08" X 4.52" X 11.22"

**Church Bird House**

40847-2-0521



## Rustic Bird House w/ Handle

MDF • IRON • JUTE • CLEAN OUT HOLE



6.22" X 3.94" X 8.85"

**Teal Rustic Bird House w/ Handle**  
40858-2-0011



## Reclaimed Wood Bird House

MDF • JUTE • PAPER • IRON • CLEAN OUT HOLE



5.25" X 4.75" X 8"

**Red Wine Reclaimed Wood Bird House**  
40855-2-0001



## Patriotic Ceramic Knob Bird House

WOOD • RESIN • SCULPTED DETAILING • HAND PAINTED  
CLEAN OUT HOLE



6.1" X 3.9" X 8.7"

**God Bless America**  
40967-2-0001



## Birdie In The Woods™ Bird Houses

CAST RESIN • SCULPTED IN DETAIL • HAND PAINTED • DRAINAGE HOLE  
• CLEANOUT HOLE • EASY HANGING



8.25" L X 4.25" H X 4" W

**Red Truck**  
40963-2-0531



9" L X 5" H X 4.5" W

**Silver Camper**  
40989-2-0531



= GLOW IN THE DARK, SOLAR, or LIGHTS UP



12-PC ASSORTMENT  
41050-12-00081



# Outdoor Faces™ Bird Houses

STONE POWDER • RESIN • PLASTIC • SCULPTED IN DETAIL • HAND PAINTED • DRAINAGE HOLE • CLEANOUT HOLE • EASILY HUNG ON ONE NAIL

BIRD HOUSES



10.25" X 9.75" X 4.85"  
**Sun Face**  
49034-2-0051



14" T X 7.25" W X 4.5" D  
**Long Face Hank**  
41051-2-0051



BIRDS ENTER HOUSE THROUGH HOLE IN NOSE.

10" T X 9" W X 4.5" D  
**Billy**  
41052-2-0051



13.5" T X 7.5" W X 5" D  
**Harry**  
41053-2-0051



10" T X 7" W  
**St. Francis**  
41055-2-0051



9" T X 7" W X 5" D  
**Black Bear**  
41057-2-0051



# Outdoor Faces™

14" T X 7.5" W • RESIN • SCULPTED IN DETAIL • HAND PAINTED • EASY TO HANG

24-PC ASSORTMENT  
49000-24-00082



THESE WHIMSICAL FACES ARE A GREAT WAY TO ADD CHARACTER TO ANY TREE OR SPICE UP THAT ORDINARY FENCE. EACH PIECE IS CAST IN RESIN AND IS READY FOR HANGING.



**Old Man**  
49001-4-0080



**Saint Francis**  
49002-4-0080



**Deer**  
49003-4-0531



**Billy**  
49012-4-0531



**Hank**  
49013-4-0531



**Black Bear**  
49015-4-0531



= GLOW IN THE DARK, SOLAR, or LIGHTS UP

12-PC ASSORTMENT  
49020-12-00261



# Tree Faces™

RESIN • SCULPTED IN DETAIL • HAND PAINTED  
• EASY TO HANG OR STAND

TREE FACES



9.45" X 3.15" X 13.39"

**Long Beard Old Man**  
49021-4-0531



8.46" X 3.15" X 10.24"

**Happy Face**  
49022-4-0531



8.46" X 3.15" X 10.24"

**Tree Knots**  
49023-4-0531



# Gnome Window Tree Faces™

5.31" X 6.69" X 1.57" • RESIN

6-PC ASSORTMENT  
49060-6-0009



**Gnome in Window Tree Face-Giggles**  
49061-2-0051



**Gnome in Window Tree Face-Bird**  
49062-2-0051



# Glow In The Dark Tree Faces™

5.31" X 6.69" X 1.57" • RESIN



**Gnome in Window Tree Face-Beard**  
49063-2-0051



**Man w/Mustache Glow In The Dark Tree Face**  
49052-4-0570



**Man w/Big Nose Glow In The Dark Tree Face**  
49053-4-0570







12-PC ASSORTMENT  
20500-12-00231



## Garden Gnomes

RESIN • SCULPTED IN DETAIL • HAND PAINTED

5.91" X 4.72" X 7.48"

**Gnome with Squirrel  
Statuary**  
20507-4-0011



5.31" X 5.71" X 7.09"

**Gnome with Rabbit  
Statuary**  
20508-4-0011



4.92" X 6.3" X 7.87"

**Gnome with Bird  
Statuary**  
20509-4-0011



# LED Dancing Ears Animal Hats

ONE SIZE FITS MOST • 100% POLYESTER  
HAT 12"X 8" • LENGTH 29.5"  
• 3 LR44 BATTERIES (PER SIDE) INCLUDED

20-PC ASSORTMENT

68270-20-00002

\$10.00 PER HAT  
WHEN BUYING ASSORTMENT



*Ears move Up  
and Down!*



*Lights  
Up!*

*Press Paws for Ear  
Motion and Lights*



= GLOW IN THE DARK, SOLAR, or LIGHTS UP



**Unicorn**  
68272-4-0011  
8 09048 68272 4



**Bunny**  
68275-4-0011  
8 09048 68275 5



**Elephant**  
68277-4-0011  
8 09048 68277 9



**Puppy Dog**  
68276-4-0011  
8 09048 68276 2



**Pig**  
68278-4-0011  
8 09048 68278 6



# Animal Hats

ONE SIZE FITS MOST • 100% POLYESTER  
HAT 7.88" X 5.9" • LENGTH 37"

32-PC ASSORTMENT  
68250-32-00272

8 09048 68250 2



**Elephant**  
68251-4-0580

8 09048 68251 9



**Dog**  
68253-4-0580

8 09048 68253 3



**Cow**  
68256-4-0580

8 09048 68256 4



 = GLOW IN THE DARK, SOLAR, or LIGHTS UP

 = OVERSIZED FREIGHT



**Pink Bunny**  
68258-4-0580



**White Bunny**  
68257-4-0580



**Penguin**  
68261-4-0580



**Snow Leopard**  
68263-4-0580



**Tiger**  
68265-4-0580



# Happy Groovers

SOLAR POWERED • FLOWERS & LEAVES WIGGLE • WORKS WITH INDOOR LIGHT • USE IN CAR, WINDOW OR OFFICE • DOUBLE SIDED FOAM STICKER INCLUDED • \$2.00 EACH

48-PC ASSORTMENT  
49096-1-0069 \*\*\*



\*\*\* 4 COUNTERTOP DISPLAYS  
65 STYLES (2 EACH/DISPLAY)



# Small Glass Tree with Bird Ornaments

8.25" X 3" BASE TALL • GLASS • INCLUDES ASSORTED ORNAMENTS  
• BIRDS MAY VARY



Evergreen Tree w/  
Glass Bird Ornaments

89911-2-0001



SMILE!



HAVE A NICE DAY!



SMILEY



COLOR SWIRLS



PAINT SPLATTERS



BLACK SWIRLS

= GLOW IN THE DARK, SOLAR, or LIGHTS UP

**RFID Hard Case Wallet**  
**12-PC ASSORTMENT**  
**49168-2-0042**



\*\*\* INCLUDES COUNTERTOP DISPLAY  
 4 OF EACH DESIGN (3 DESIGNS)

# RFID Hard Case Wallet Assortment

2.95" X 0.78" X 4.33" • PP/PVC • \$2.00 EACH  
 PDQ - 8.26" X 7.75" 4.52"

NOVELTY

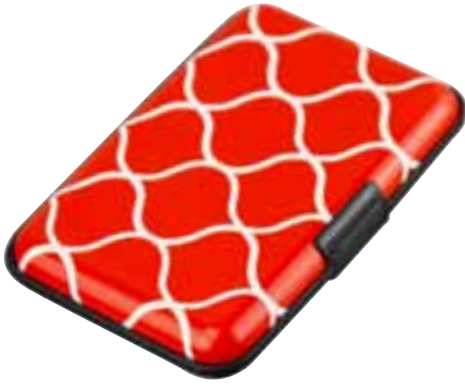

**WARNING:** THIS PRODUCT CAN EXPOSE YOU TO CHEMICALS INCLUDING LEAD WHICH IS (ARE) KNOWN TO THE STATE OF CALIFORNIA TO CAUSE CANCER, BIRTH DEFECTS, OR OTHER REPRODUCTIVE HARM. FOR MORE INFORMATION, GO TO [WWW.P65WARNINGS.CA.GOV](http://WWW.P65WARNINGS.CA.GOV)

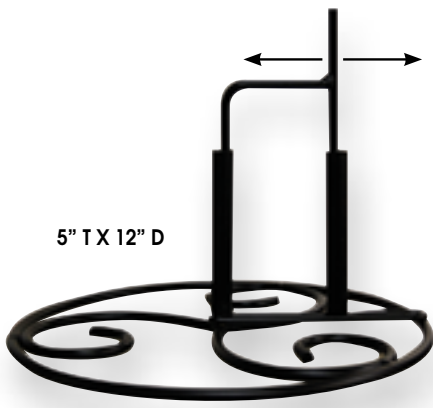

5" T X 12" D

- Displays garden flags & yard art outside of the garden on decks, patios & more.
- Powder Coated Metal
- Adjusts to fit most H-stakes

 **Adjustable Deck Base**  
39008-3-0090



28" W X 20" L X 11" H

**Stake Base Display**  
39001-2-0571



 **WARNING: THIS PRODUCT CAN EXPOSE YOU TO CHEMICALS INCLUDING LEAD WHICH IS (ARE) KNOWN TO THE STATE OF CALIFORNIA TO CAUSE CANCER, BIRTH DEFECTS, OR OTHER REPRODUCTIVE HARM. FOR MORE INFORMATION, GO TO WWW.P65WARNINGS.CA.GOV**



**\*\*FREE WITH \$500 STAKE PURCHASE\*\***

35.04" W X 14.17" L X 4.53" H

**Stake Display**  
09904-1-0005



**\*\*FREE WITH \$400 BALANCER PURCHASE\*\***

- Metal
- Displays 9 balancer tops. (not included)

22" W X 75" T

**Balancer Display**  
09945-1-0004





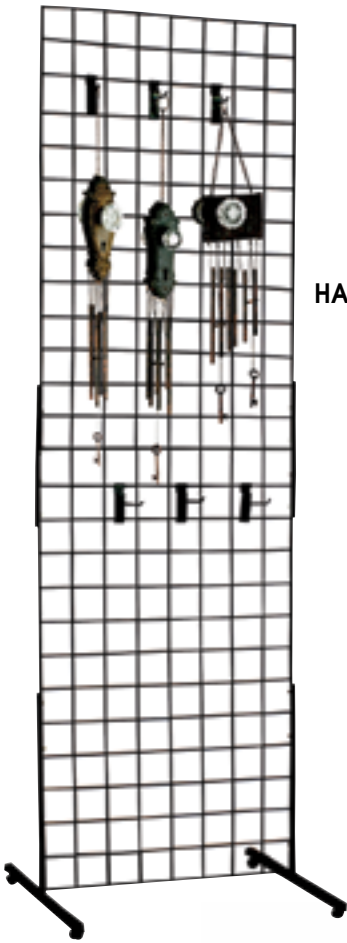

**\*\*FREE WITH \$700  
HANGING PRODUCT PURCHASE\*\***

78" T X 24" W

- Includes 50 hooks
- Great for displaying birdhouses, tree faces, feeders and chimes

**Standing Grid Display**  
09931-1-0007



**\*\*FREE WITH \$250  
MINI CHIMES/GEOS PURCHASE\*\***

14.5" x 14.5" x 25"

**Mini Chime KD Steel  
Display**

09968-1-0052

- Holds 16 pieces



**\*\*FREE WITH \$550  
SPINNER/Geo PURCHASE\*\***

8'6" T X 30" DIA.

- Holds 17 pieces (not included with display)
- 6'6" T with top display hook removed – holds 16 pieces

**Cosmix™ Display**  
09901-1-0055



**\*\*FREE WITH \$600  
HANGING PRODUCT PURCHASE\*\***

81" T X 40" W

- Holds 64 pieces
- Includes sign for top

**Chime/Charm Display**  
09910-1-0006



**GREAT SAVINGS!**

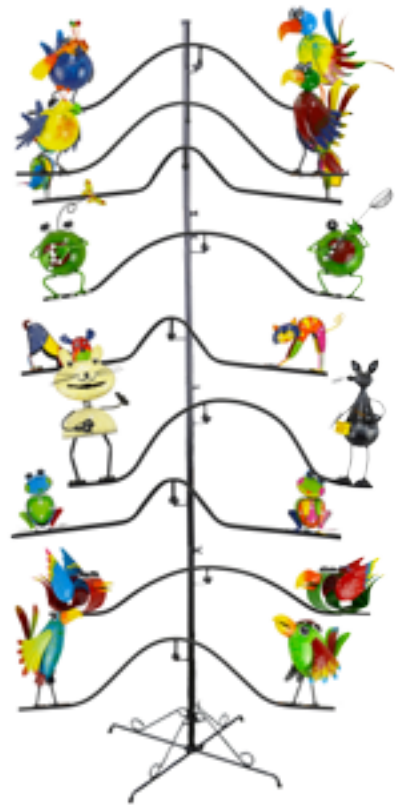

**\$458.00 VALUE**    **YOUR PRICE: \$ 413.00**

**Rustic Balancer Assortment**  
 90980-24-00314  
 • Includes 24 pieces  
 • Free Display (09945) if requested



8 09048 90980 7

**\$539.00 VALUE**    **YOUR PRICE: \$ 494.00**

**Colorful Characters Balancer Assortment**  
 90984-24-00494  
 • Includes 24 pieces  
 • Free Display (09945) if requested



8 09048 90984 5

**15% FREIGHT CAP!**    **YOUR PRICE: \$ 1,131.50**

**Large Scale Spinner Assortment**  
 90989-18-051311  
 • Includes 18 pieces  
 • 15% Freight Cap Including Oversize



8 09048 90989 0

 = GLOW IN THE DARK, SOLAR, or LIGHTS UP

**GREAT SAVINGS!**

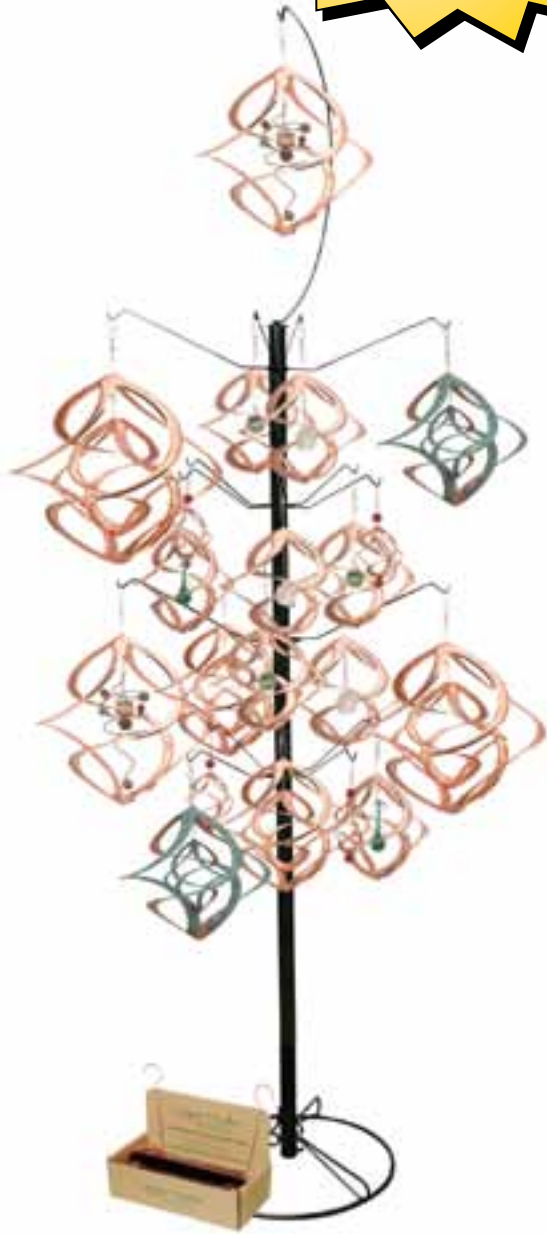
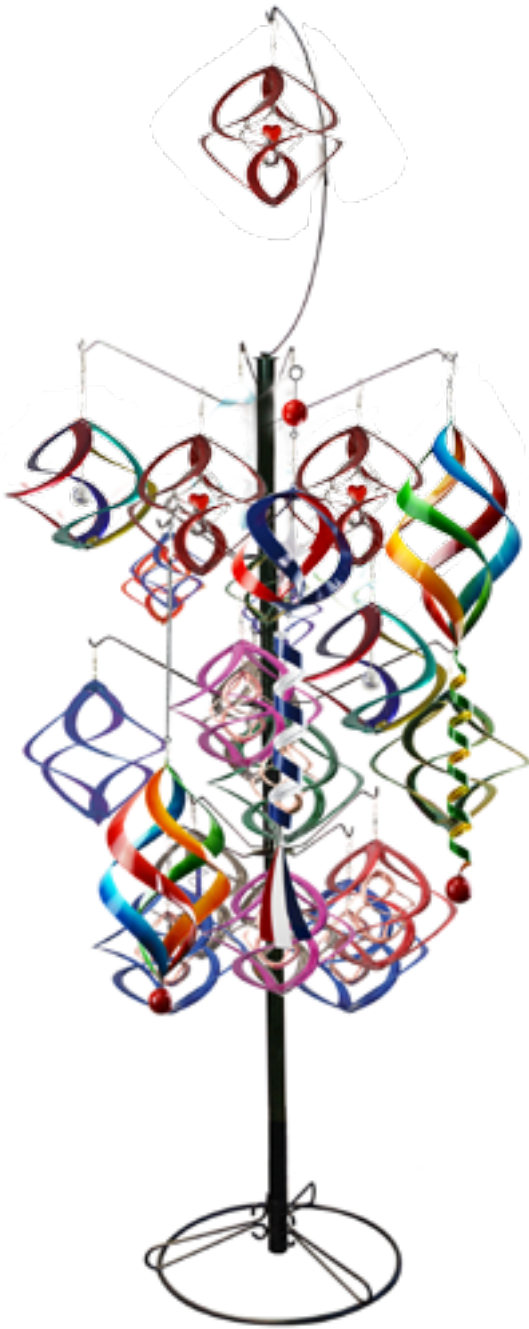

**\$ 754.00**  
**VALUE**

**YOUR PRICE:**  
**\$ 699.00**

**Colored Cosmix™ Assortment**

31000-E-00996

- Includes 44 pieces (includes 31161, 31162, 31163 on page 74)
- Includes 36 pc Copper Hooks
- Free Display (09901) if requested



8 09048 99990 7

**\$ 785.00**  
**VALUE**

**YOUR PRICE:**  
**\$ 730.00**

**Cosmix™ Starter Assortment**

31000-A-00807

- Includes 49 pieces
- Includes 36 piece Copper Hooks
- Free Display (09901) if requested



8 09048 99930 3

**GREAT SAVINGS!**



**\$ 568.00** **YOUR PRICE:**  
**VALUE** **\$ 513.00**

**Hummingbird Feeder Assortment**  
41100-A-00315  
• Includes 60 pieces  
• Free Display (09901) if requested



8 09048 99983 9

**\$ 694.00** **YOUR PRICE:**  
**VALUE** **\$ 634.00**

**Bird House/Feeder Assortment**  
90976-A-00875  
• Includes 54 pieces  
• Free Display (09910) if requested



8 09048 90976 0

**\$ 782.50** **YOUR PRICE:**  
**VALUE** **\$ 722.50**

**Spinner/Geo/Twister Assortment**  
99097-A-05229  
• Includes 78 pieces  
• Free Display (09910) if requested



8 09048 99097 3

= GLOW IN THE DARK, SOLAR, or LIGHTS UP

**GREAT SAVINGS!**

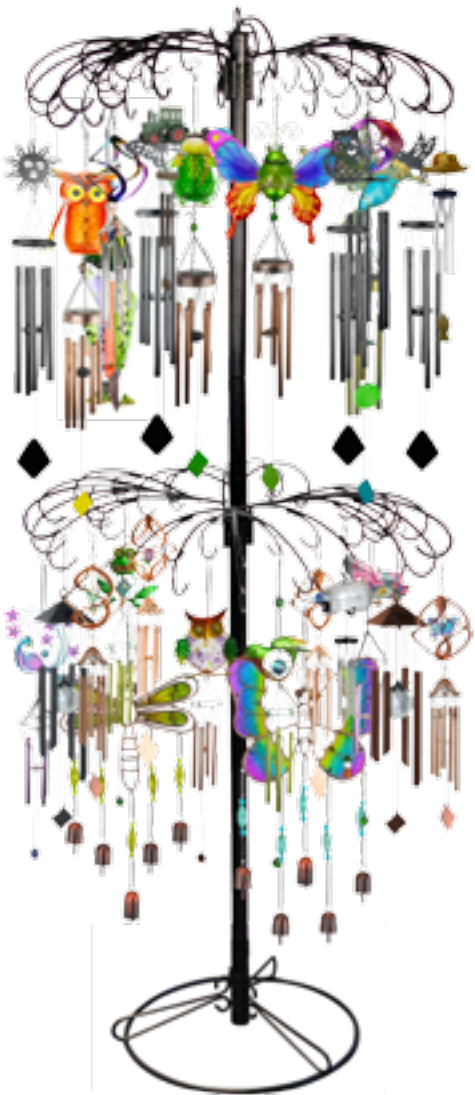

**\$ 925.00** **YOUR PRICE:**  
**VALUE** **\$ 865.00**

**Best Sellers Chimes Assortment**  
10000-A-00918

- Includes 75 pieces
- FreeDisplay (09910) if requested



8 09048 99985 3

**\$ 962.00** **YOUR PRICE:**  
**VALUE** **\$ 902.00**

**NEW Chimes Assortment**  
10000-B-00209

- Includes 76 pieces
- FreeDisplay (09910) if requested



8 09048 99900 6

**\$ 595.00** **YOUR PRICE:**  
**VALUE** **\$ 540.00**

**Shadow Chimes Assortment**  
10000-S-00025

- Includes 65 pieces
- FreeDisplay (09901) if requested



8 09048 99484 1



Stop by Our Newest Showrooms  
& check out our 2019 Fall Line!

Atlanta  
Atlanta Mart • Building 2  
17th Floor • Suite 1713B

Las Vegas  
World Market Center • Building C  
Suite C-0891 • Next Step Reps

Visit Our Website!  
[www.rcsgifts.com](http://www.rcsgifts.com)



Price: \$5.00



**Red Carpet Studios, Ltd.**  
107 Northeast Drive  
Loveland, Ohio 45140

**Local** 1-513-774-1600  
**Toll Free** 1-877-985-0405  
**Fax** 1-513-774-1601  
**Email** mail@rcsgifts.com

PRSR STD  
U.S. POSTAGE  
**PAID**  
CINCINNATI, OH  
PERMIT NO. 6657

**WATCH FOR THE  
2020 RCS HOLIDAY  
COLLECTION  
COMING EARLY 2020!**



**Bird Feeders**  
pages 114-119



**Planters**  
pages 4-31



**Chimes**  
pages 75-103

[www.rcsgifts.com](http://www.rcsgifts.com)

SHOWROOM

Atlanta Mart • Building 2 • 17th Floor • Suite 1713B