

An aerial photograph of a city skyline at sunset. The sky is a warm, golden-orange color. In the foreground, several construction cranes are visible, along with a large construction site. The city buildings are densely packed, and the overall scene is bathed in the soft light of the setting sun.

# Eaton EMEA 3ph UPS accessories

**EATON**

*Powering Business Worldwide*

# Why Eaton?

Eaton is dedicated to ensuring that reliable, efficient and safe power is available when it's needed most. With unparalleled knowledge of electrical power management across industries, experts at Eaton deliver customized, integrated solutions to solve our customers' most critical challenges.

Our focus is on delivering the right solution for the application. But we offer more than just innovative products. We also provide an unwavering commitment to personal support, that makes customer success a top priority.

## Table of contents

<b>Eaton battery cabinets</b>	<b>3</b>
<b>Pre-assembled battery strings</b>	<b>5</b>
<b>Lithium Ion Solutions</b>	<b>6</b>
<b>Eaton supercapacitor cabinets</b>	<b>7</b>
<b>Eaton battery breaker kits</b>	<b>8</b>
<b>UPS battery switchgear (UBS)</b>	<b>9</b>
<b>External maintenance Bypass Switches (MBS)</b>	<b>10</b>
<b>Eaton 93PM specific options</b>	<b>12</b>
<b>Power Xpert 9395P specific options</b>	<b>14</b>
<b>Eaton 93PS specific options</b>	<b>15</b>
<b>Eaton 9PHD specific options</b>	<b>15</b>
<b>Eaton 93 STS</b>	<b>16</b>
<b>Eaton Synchronization options</b>	<b>17</b>

Eaton's range of accessories for 3ph UPS systems provides flexible installation options that expedite deployment and save valuable space. The aesthetically designed accessories enable coordinated solutions that enhance both safety and reliability while reducing installation time and total cost. They are designed, manufactured and tested according to relevant standards. Eaton accessory offering consists of both general and product line specific options.



Visit [www.eaton.com](http://www.eaton.com) or contact local sales for more information.



# Eaton battery cabinets

## Quality and safety

All Eaton battery cabinet solutions have been designed with long experience, specifically to be used with Eaton 3ph UPS. Quality is ensured by utilizing standardized processes, testing and careful consideration of details, such as customer interface, proper cooling, air circulation and sizing protective equipment. The Eaton battery cabinets are designed in according to UPS standard IEC 62040, thus making it safe to use. Cabinets are always available at least in an IP20 enclosure to protect personnel nearby them. Available up to IP54 protection, the Eaton battery cabinet solutions are also appropriate for preserving the batteries from external sources.

## Easy to operate

Eaton battery cabinets come with a user guide for easy installation and operation. Most cabinet types are equipped with wheels for easy offloading and positioning the cabinets. For the marine use, there are lifting equipment available for easier hailing of the cabinets at the yard.

## Lower installation cost

Cabinets with batteries pre-installed by Eaton, ensure rapid deployment of cabinets, thus reducing installation time and cost at site significantly.





## Serviceability





Eaton battery cabinets are fully front-accessible. They come with either battery slide out trays or removable battery torpedoes for easy maintenance of the batteries. A DC-rated battery circuit breaker provides protection and enables isolation for maintenance.

## Look and feel

Eaton battery cabinets form a lineup and match design with Eaton UPS giving a uniform appearance and minimizing footprint.

Contact local Eaton sales for support with runtimes and battery cabinet selection.

Battery cabinet family	Features	Width (mm)	Height (mm)	Depth (mm)	Weight (kg)	Remarks
EBC-A	 Battery cabinet for 8-20 kVA power range.	335	1300	750	85	empty
	Cabinet equipped with 63 A breaker.				349	with max batteries
	Max battery quantity 3x32 pcs					
	Cabinet is designed to be used with Eaton 91PS/93PS/93E UPSs up to 20 kVA					
EBC-B	 Battery cabinet for 8-40 kVA power range.	761	1750	750	152	empty
	Cabinet equipped with 63 A or 160 A breaker.				742	with max batteries
	Max battery quantity 32 pcs					
	Cabinet is designed to be used with Eaton 91PS/93PS/93E UPSs up to 40 kVA					
EBC-C	 Battery cabinet for 30-100 kVA power range. a)	585	1876	914	169	empty
	Cabinet equipped with 200 A breaker.				1061	with max batteries. Varies based on used battery type
	Max battery quantity 40 pcs					
	Cabinet is designed to be used with Eaton 91PS/93PS/93PM/93E UPSs up to 100 kVA					
EBC-E	 Battery cabinet for 30-200 kVA power range. a)	1125	1890	804	412	empty
	Cabinet equipped with 400 A breaker.				2116	with max batteries. Varies based on used battery type
	Max battery quantity 40 pcs					
	Cabinet is designed to be used with Eaton 93PM/9395P/93E UPSs up to 200 kVA					

Battery cabinet family	Features	Width (mm)	Height (mm)	Depth (mm)	Weight (kg)	Remarks
<b>EBC-F</b> 	Industrial / Marine cabinet for up to 30-100 kVA power range a)	625 c)	1978 c)	937 c)	226	empty
	Cabinet equipped with 200 A breaker				970	with max batteries. Varies based on used battery type and cabinet options
	Max battery quantity 40 pcs					
	Cabinet is designed to be used with Eaton 9PHD UPS products up to 100 kVA					
	Optional lifting lugs available					
	Optional air outlet connector to external ventilation system available					
	Available with vibration damper brackets or wheels Available as IP23/33/54					
<b>EBC-G</b> 	Battery cabinet for 30-200 kVA power range.	1118 c)	1978 c)	1091 c)	750	empty
	Cabinet equipped with 400 A breaker				2560	with max batteries. Varies based on used battery type and cabinet options
	Max battery quantity 40 pcs					
	Cabinet is designed to be used with Eaton 9PHD UPS products up to 200 kVA					
	Optional lifting lugs available b)					
	Optional air outlet connector to external ventilation system available					
	Available with vibration damper brackets or wheels Optional seismic support for models with wheels Available as IP23/33/54					
<b>EBC-I</b> 	Marine cabinet for up to 8-20 kVA power range	356	1500	875	100	empty
	Cabinet equipped with 63 A breaker				350	with max batteries. Varies based on used battery type and cabinet options
	Max battery quantity 3x32 pcs					
	Cabinet is designed to be used with Eaton 93PS Marine UPS products up to 20 kVA IP23 protection					
<b>EBC-J</b> 	Battery cabinet for 8-60 kVA power range.	535	1745	971	175	empty
	Cabinet equipped with 200 A breaker				900	with max batteries. Varies based on used battery type and cabinet options
	Max battery quantity 2x36 pcs					
	Cabinet is designed to be used with Eaton 93PS and 9PHD Marine UPS products up to 100 kVA IP22 protection					

- a) Multiple cabinets can be used for higher powers  
b) Lifting lugs cannot be used if batteries inside  
c) Exact dimensions depends on fixation type

# Pre-assembled battery strings

Pre-assembled battery strings reduce time of installing and replacing batteries. Whether you are a distributor storing UPS's without batteries or a contractor installing a UPS long before startup you might want to install the batteries just before commissioning to avoid unnecessary aging.



Part number	Description	KIT details
P-103002001	KIT 93PS-20 BATTERY ACCESSORIES (1 STRING)	Battery trays and interconnecting cables for one string of batteries - no batteries (10/15/20 kW frames). Available for Eaton 91PS/93PS.
P-103003010-001	KIT 9XPS-20 BATTERY STRING 9AH	Battery trays, interconnecting cables and 3-5y batteries for one string (10/15/20 kW frames). Available for Eaton 91PS/93PS/93PS Marine/9x55.
P-103003010-002	KIT 9XPS-20 BATTERY STRING 9AH LL	Battery trays, interconnecting cables and 6-9y batteries for one string (10/15/20 kW frames). Available for Eaton 91PS/93PS/93PS Marine/9x55.
P-103002002	KIT 93PS-40 BATTERY ACCESSORIES (1 STRING)	Battery trays and interconnecting cables for one string of batteries - no batteries (30/40 kW frame). Available for Eaton 91PS/93PS.
P-103003010-003	KIT 9XPS-40 BATTERY STRING 9AH	Battery trays, interconnecting cables and 3-5y batteries for one string (30/40 kW frame). Available for Eaton 91PS/93PS.
P-103003010-004	KIT 9XPS-40 BATTERY STRING 9AH LL	Battery trays, interconnecting cables and 6-9y batteries for one string (30/40 kW frame). Available for Eaton 91PS/93PS.
P-103003010-005	KIT 93PM-50 BATTERY STRING 9AH	Battery trays, interconnecting cables and 3-5y batteries for one string. Available for Eaton 93PM.
P-103003010-006	KIT 93PM-50 BATTERY STRING 9AH LL	Battery trays, interconnecting cables and 6-9y batteries for one string. Available for Eaton 93PM.

## Lithium Ion solutions

Lithium Ion batteries are a good alternative to traditional VRLA battery technology, bringing improvements in product foot print, weight, design life, temperature tolerance and capability to support cyclical load. In addition Lithium Ion batteries always comes with the possibility to remotely monitor battery level information.

With these benefits the total cost of ownership is often lower compared to VRLA batteries. Additionally, Lithium Ion batteries can allow using UPS and batteries in applications and environments, where VRLA batteries simply didn't survive.

Contact local Eaton sales for support with Lithium Ion battery selection.



# Eaton supercapacitor cabinets

Eaton supercapacitor cabinets for 3ph UPSs introduce a very low maintenance solution for short runtime (<1 min) applications. Supercapacitor provides a solution where batteries cannot work - in hot environment, places with no possibility for hydrogen removal, areas requiring weight limitation or sites with no easy access for periodic replacement of batteries. They are easily scalable by adding an extra string in parallel with old capacitors.

## Features:

- High efficiency - low operational costs
- Fast recharge (5-6 times to runtime)
- High ambient temperature range
- Life time up to 20 years
- Suitable for cyclic operation
- Internal fuses provides protection
- Battery circuit breaker enables isolation for maintenance
- Daisy-chain cabinets for extended runtime



Eaton Supercapacitor cabinet



Eaton supercapacitors and a supercapacitor module



Part number	Description	KIT details	Width (mm)	Height (mm)	Depth (mm)
P-105000092-001	ESC-A-0x20-EMPTY-BB-400A-24V	Empty supercapacitor cabinet with 24 V shunt trip coil. Can be equipped with 2 strings of supercapacitors	600	2065	1040
P-105000092-002	ESC-A-1x10-XLM62R1137A-R-BB-400A-24V	Supercapacitor cabinet with 1 string of supercapacitors and 24 V shunt trip coil.	600	2065	1040
P-105000092-003	ESC-A-2x10-XLM62R1137A-R-BB-400A-24V	Supercapacitor cabinet with 2 string of supercapacitors and 24 V shunt trip coil.	600	2065	1040
P-105000092-004	ESC-A-0x20-EMPTY-BB-400A-48V	Empty supercapacitor cabinet with 48 V shunt trip coil. Can be equipped with 2 strings of supercapacitors	600	2065	1040
P-105000092-005	ESC-A-1x10-XLM62R1137A-R-BB-400A-48V	Supercapacitor cabinet with 1 string of supercapacitors and 48 V shunt trip coil.	600	2065	1040
P-105000092-006	ESC-A-2x10-XLM62R1137A-R-BB-400A-48V	Supercapacitor cabinet with 2 string of supercapacitors and 48 V shunt trip coil.	600	2065	1040

Contact local Eaton sales for support with runtimes and battery cabinet selection.

# Eaton battery breaker kits

Eaton battery breaker kits includes a wide range of breakers to be used with external UPS battery solutions like racks and DC switchgear.

## Features:

- Kits include a breaker, a shunt trip coil for remote tripping and AUX contact for remote monitoring. Some larger models also include the extension handle and additional terminals for bigger cables
- 24 V Shunt trip coil is for the Eaton 93PS and 93PM UPS families, 48 V for Power Xpert 9395P products

Contact local Eaton sales for support with selecting breakers.



Eaton Circuit-breaker, 3 poles, NZM2 frame



Eaton Circuit-breaker, 3 poles, NZM3 frame

Part number	Description	KIT details
<b>String breakers for single battery strings (Breakers can also be used as main DC breakers for battery systems)</b>		
P-122000254	KIT EXT BATT MCCB 80 A 24 V ST	Breaker, 24 V shunt trip coil with AUX contact, double contact element
P-122000255	KIT EXT BATT MCCB 160 A 24 V ST	Breaker, 24 V shunt trip coil with AUX contact, double contact element
P-122000256	KIT EXT BATT MCCB 200 A 24 V ST	Breaker, 24 V shunt trip coil with AUX contact, double contact element
P-122000241	KIT EXT BATT MCCB 400 A 24 V ST	Breaker, 24 V shunt trip coil with AUX contact, double contact element
P-122000242	KIT EXT BATT MCCB 400 A 48 V ST	Breaker, 48 V shunt trip coil with AUX contact, double contact element

Part number	Description	KIT details
<b>Main DC breakers for battery systems</b>		
P-122000184	KIT EXT BATT MCCB 500 A 24 V ST	Breaker, 24 V shunt trip coil with AUX contact, double contact element
P-122000180	KIT EXT BATT MCCB 700 A 24 V ST	Breaker, 24 V shunt trip coil with AUX contact, additional 95-200 mm <sup>2</sup> terminals extension handle for the breaker
P-122000257	KIT EXT BATT MCCB 700 A 48 V ST	Breaker, 48 V shunt trip coil with AUX contact, additional 95-200 mm <sup>2</sup> terminals extension handle for the breaker
P-122000258	KIT EXT BATT MCCB 800 A 48 V ST	Breaker, 48 V shunt trip coil with AUX contact, additional 95-200 mm <sup>2</sup> terminals extension handle for the breaker
P-122000269	KIT EXT BATT MCCB 1250 A 48 V ST	Breaker, 48 V shunt trip coil with AUX contact, additional terminals for M12 bolt, extension handle for the breaker, interpole barriers
P-122000270	KIT EXT BATT MCCB 1600 A 48 V ST	Breaker, 48 V shunt trip coil with AUX contact, additional terminals for M12 bolt, extension handle for the breaker, interpole barriers



# UPS Battery Switchgear (UBS)

Eaton UPS Battery Switchgear family consists of single breaker with casing and multi breaker solutions with main DC breaker and dedicated battery string breakers.

## Features:

- All breakers in the family, include a shunt trip coil (24 VDC) and auxiliary contacts for remote tripping and monitoring
- Models with multiple breakers include wall mounting kit which enables cable routing behind the casing
- Single breaker models up to 500 A have a plastic casing. Single 700 A and models with multiple breakers come with metal casing
- All UPS Battery Switchgear products are designed and tested by the switchgear standard IEC 61439-2

Contact local Eaton sales for support with selecting breakers.



Eaton UBS with a main breaker and string breakers



Eaton UBS with a single breaker

Part number	Description	Width (mm)	Height (mm)	Depth (mm)	Weight (kg)
P-105000004-021	UPS BATTERY SWITCHGEAR 80 A	250	420	300	8
P-105000004-003	UPS BATTERY SWITCHGEAR 200 A	250	420	300	12
P-105000004-006	UPS BATTERY SWITCHGEAR 400 A	375	500	320	16
P-105000004-012	UPS BATTERY SWITCHGEAR 700 A	600	1005	300	70
P-105000004-004	UPS BATTERY SWITCHGEAR 200 A + 2x125 A	600	1203	420(a)	100
P-105000004-005	UPS BATTERY SWITCHGEAR 200 A + 4x125 A	600	1203	420(a)	100
P-105000004-007	UPS BATTERY SWITCHGEAR 400 A + 2x200 A	600	1203	420(a)	100
P-105000004-008	UPS BATTERY SWITCHGEAR 400 A + 4x125 A	600	1203	420(a)	100
P-105000004-020	UPS BATTERY SWITCHGEAR 400 A + 3x200 A	600	1203	420(a)	100
P-105000004-013	UPS BATTERY SWITCHGEAR 700 A + 2x400 A	800	1608	420(a)	120
P-105000004-014	UPS BATTERY SWITCHGEAR 700 A + 4x200 A	800	1608	420(a)	120
P-105000004-016	UPS BATTERY SWITCHGEAR 700 A + 3x400 A	800	1608	420(a)	120

(a) Casing depth 300 mm. 120 mm added if used with wall mounting kit.



# External Maintenance Bypass Switches (MBS)

External Maintenance Bypass Switches (MBS) increase safety and reliability by enabling seamless transfers to bypass and isolation of the UPS system for maintenance. Eaton External MBSs are designed to UPS standard IEC 62040. External MBSs are available for power range from 8 kW to 150 kW

## Features:

- Cabinet color: Black
- IP rating: IP21 / 22
- Operation Temperature: 0-40 °C
- 100/150 kW models with interlocking plate
- All cabinets are wall-mounted



External MBS 50 kW



External MBS 100 kW and 150 kW



External MBS 100 kW and 150 kW door closed

## External MBS wiring diagrams

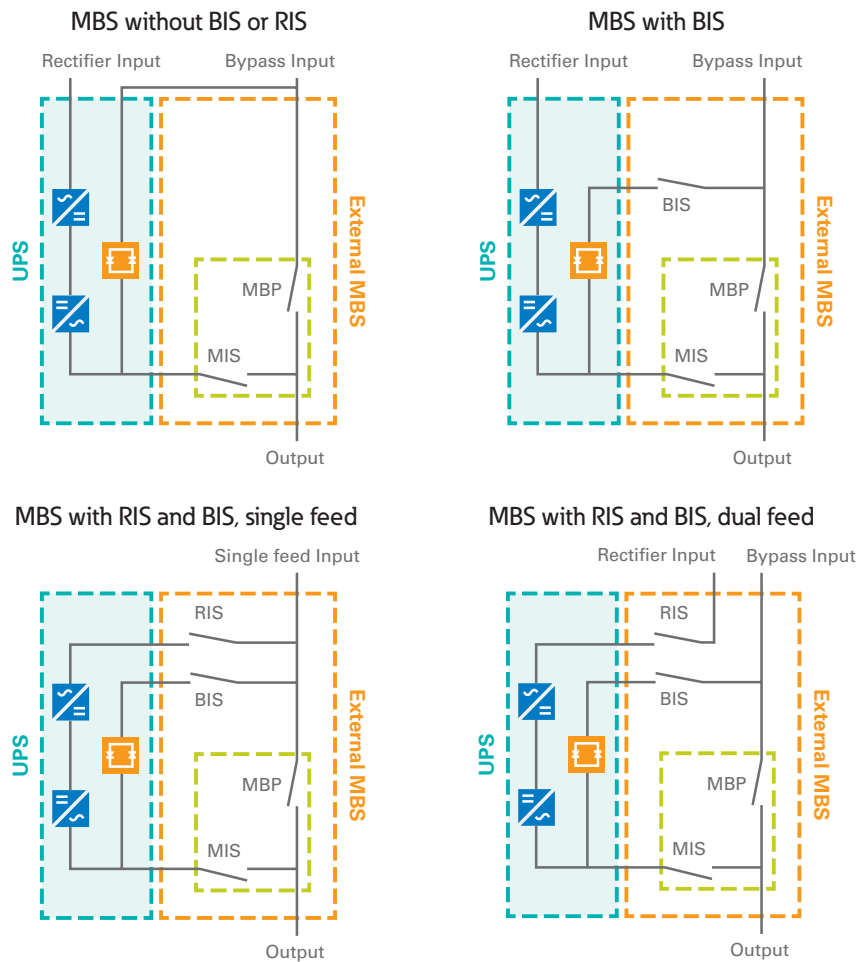

Part number	Description	Width (mm)	Height (mm)	Depth (mm)	Weight (kg)
<b>1PH MBSs</b>					
P-105000088-002	EXTERNAL MBS 15 kW 1PH	506	514	275	22
P-105000088-003	EXTERNAL MBS 15 kW 1PH WITH BIS	506	514	275	24
P-105000089-002	EXTERNAL MBS 30 kW 1PH	506	514	275	23
P-105000089-003	EXTERNAL MBS 30 kW 1PH WITH BIS	506	514	275	25
<b>3PH MBSs</b>					
P-105000044-002	EXTERNAL MBS 20 kW	506	514	275	26
P-105000044-003	EXTERNAL MBS 20 kW WITH BIS	506	514	275	27
P-105000044-004	EXTERNAL MBS 20 kW WITH BIS AND RIS (SINGLE FEED)	506	514	275	27
P-105000045-002	EXTERNAL MBS 40 kW	506	514	275	26
P-105000045-003	EXTERNAL MBS 40 kW WITH BIS	506	514	275	27
P-105000045-004	EXTERNAL MBS 40 kW WITH BIS AND RIS (SINGLE FEED)	506	514	275	27
P-105000003-020	EXTERNAL MBS 50 kW	560	635	159	25
P-105000003-046	EXTERNAL MBS 50 kW WITH BIB	560	635	159	26
P-105000003-022	EXTERNAL MBS 100 kW	710*	1553	260	87
P-105000003-023	EXTERNAL MBS 100 kW WITH BIB	710*	1553	260	95
P-105000003-024	EXTERNAL MBS 100 kW WITH BIB AND RIB (DUAL/SINGLE FEED)	710*	1553	260	108
P-105000003-026	EXTERNAL MBS 150 kW	710*	1553	260	87
P-105000003-027	EXTERNAL MBS 150 kW WITH BIB	710*	1553	260	95
P-105000003-028	EXTERNAL MBS 150 kW WITH BIB AND RIB (DUAL/SINGLE FEED)	710*	1553	260	108

\*200 mm is required for both sides of the cabinet for air flow.

# Eaton 93PM Specific options and accessories

For the Eaton 93PM UPS family, there is a wide range of special options available. Deployment of the UPS system with these options is much easier, when airflow and cabling routes can be managed.

## Eaton 93PM Top air exhaust kit

The Top Air Exhaust -kit converts the UPS cabinet airflow from Front-to-Rear to Front-to-Top. This enables direct placement against a wall and directing UPS exhaust away from any adjacent battery cabinets to prevent heating of the batteries and the resultantly reduced battery life. This kit is available for Eaton 93PM 80-500 kW units. This kit can only be assembled on the Eaton factory.

## Eaton 93PM Top Cable access kit

The Top Cable Access -kit adds ample space for top cable entry while maintaining a compact footprint. This kit is available for Eaton 93PM 30-150 kW units.

## Eaton 93PM Sidecar MBS for 200 kW frame, SIAC

Sidecar Integrated Accessory Cabinet (SIAC) MBS option for the Eaton 93PM 200 kW frame, expands the MBS offering up to 200 kW. Sidecar MBS option adds safety and reliability by enabling seamless and easy transfers to bypass for the UPS system maintenance. This kit can only be assembled on the Eaton factory.

## Eaton 93PM EMC C2 kit for 30-50 kW units

As a default, all Eaton 93PM units are in EMC category C3. With EMC kit Eaton 93PM UPS with single 30-50 kW power module in 50 kW frame is suitable for environments requiring EMC category C2. This kit can only be assembled on the Eaton factory.

### Available options

- Maintenance Bypass
- Coated circuit boards
- Factory tests
- Special colors
- Frequency conversion mode
- Internal batteries
- Internal super capacitors
- Seismic kits



Eaton 93PM 30-150 kW unit with Top cable access kit



Eaton 93PM 200 kW unit with SIAC MBS dual feed (door removed)



Eaton 93PM 200 kW with SIAC MBS and Top air exhaust kit

## SIAC MBS wiring diagrams

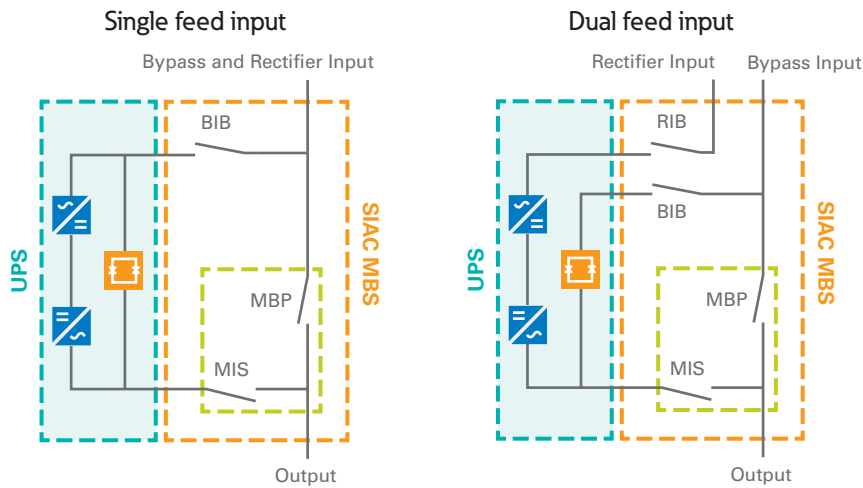

Part number	Description	Width (mm)	Height (mm)	Depth (mm)	Weight (kg)
<b>Eaton 93PM Top air exhaust kit</b>					
P-103000926	93PM top air exhaust kit 80-150 kW units	560	1885	200 (a)	21
P-103000927	93PM top air exhaust kit 160-200 kW units	760	1885	200 (a)	28
Optional part of complete UPS, contact local sales	93PM top air exhaust kit for 500 kVA frame units	1521	1968	200 (a)	60
<b>Eaton 93PM Top Cable access kit</b>					
P-103000719	93PM top cable access kit 30-150 kW units	100 (b)	1885	920	18
<b>Eaton 93PM Sidecar MBS for 200 kW frame (SIAC)</b>					
P-103001249-002	Sidecar Integrated Accessory Cabinet MBS 200 kW, single feed	206 (c)	1885	920	44 (d)
P-103001249-004	Sidecar Integrated Accessory Cabinet MBS 200 kW, dual feed	206 (c)	1885	920	44 (d)

(a) Adds 200mm to the total depth of the UPS

(b) Adds 100mm to the total width of the UPS

(c) Adds 206mm to the total width of the UPS. Original connection area is replaced with SIAC MBS

(d) The total installed weight of UPS cabinet with SIAC option is 600kg

### Other

P-103001257	Single feed kit for 100 and 150 kW frames, busbars	Inside the UPS frame. No notable effect on the UPS dimensions
P-103001256	Single feed kit for 200 kW frame, cables	Inside the UPS frame. No notable effect on the UPS dimensions
Optional part of complete UPS, contact local sales	Single feed kit for 500 kW frame, busbars	Inside the UPS frame. No notable effect on the UPS dimensions
P-103000650	KIT 93PM 30-50 kW EMC-C2	Inside the UPS frame. No notable effect on the UPS dimensions
P-103000847	Parallel kit to connect two parallel 93PM frames	Inside the UPS frame. No notable effect on the UPS dimensions



# Power Xpert 9395P Specific options and accessories

For the Power Xpert 9395P product family there is a very wide offering of options and modifications available. Outside of the standard offering, Power Xpert 9395P units can be widely modified based on the customer requirements.

[Please contact local Eaton sales for support with Power Xpert 9395P products.](#)

## UPM Status LEDs

Power module status lights allow the user to detect the system status with one look. The power module lights change color depending upon their status. This optional feature makes the visual detection of the UPS system status easier, increasing operational safety and reducing the time required for trouble shooting.

## HMI Display

As a default, there is a 7" display in the Power Xpert 9395P units up to 600 kVA. In the bigger 900 kVA and 1200 kVA units 10" display will be installed by default. Optionally this bigger 10" display can be installed into smaller units also.

## Available options

- Seismic kits
- Special colors
- Higher IP ratings
- Alternative layout design (L- and U- shapes)
- Separate rectifier feeds
- No neutral kits
- Factory tests
- Frequency conversion mode
- Flanges
- Maintenance Bypass (up to 300 kVA)



Power Xpert 9395P 1200 kVA with status LED lights

Part number	Info
Optional part of complete UPS, contact local sales	Status LED light (1 per power module)
1029274	Single feed kit for 250-600 kVA, AI
1028997	Single feed kit for 900-1200 kVA, AI
P-103000824	Single feed kit for 900-1200 kVA, Cu
HPO-1040817	Aluminum Gland plate for 9395P 300 kVA and 600 kVA frames (1 piece)
HPO-1040802	Aluminum Gland plate for 9395P 900 kVA and 1200 kVA frames (1 piece)
P-103000777	Kick plate for 9395P 300 kVA frame
P-103000102	Kick plate for 9395P 600 kVA frame
P-103000107	Kick plate for 9395P 900 kVA frame
P-103000089	Kick plate for 9395P 1200 kVA frame

# Eaton 93PS Specific options and accessories

For the Eaton 93PS UPS family, there are available options for increasing protection against dripping water, enabling single feed connection and paralleling UPSs.

## Available options

- Seismic kits
- Coated circuit boards
- Factory tests
- Special colors
- Frequency conversion mode
- Internal batteries
- Internal super capacitors
- Maintenance Bypass

Part number	Description	
P-103002165	KIT 93PS-20 SINGLE FEED	Inside the UPS frame. No notable effect on the UPS dimensions
P-103000847	Parallel kit to connect two parallel 93PS frames	Inside the UPS frame. No notable effect on the UPS dimensions
P-103002688	KIT 93PS 20 kW IP21	Increased depth within required clearances for maintenance/air flow.
P-103002689	KIT 93PS 40 kW IP21	Increased depth within required clearances for maintenance/air flow.
P-105000111-002	91PS/93PS 8-10 BATTERY SIDECAR 1x32 9AHLL	Additional battery string to increase autonomy time of UPS. Increases width of the UPS by 16,5 cm.
P-103002588	KIT 93PS-20 POWER CABLE BOX	Connection area expansion kit for 91PS/93PS 10-20 kW frames
P-103003732	KIT 9XPS-40 POWER CABLE BOX	Connection area expansion kit for 91PS/93PS 30-40 kW frames



Eaton 93PS

# Eaton 9PHD Specific options and accessories

For the Eaton 9PHD product family there is a very wide offering of options and modifications available. Outside of the standard offering, the 9PHD units can be widely modified based on the customer requirements.

Please contact local Eaton sales for support with 9PHD products.

## Available options

- Seismic kits
- Special colors
- Higher IP ratings up to IP54
- Marine solutions
- No neutral kits
- Internal transformers
- Wide voltage range (380-480 V)
- Factory tests
- Frequency conversion mode
- Lifting lugs
- Top air exhaust kits
- Insulation monitoring relays
- Up to 125 kVA + 100 kVA transformers in one matching transformer cabinet
- Internal batteries
- Maintenance Bypass



Eaton 9PHD marine UPS with IP54 filters. Spacious power cabling area on the right side

# Eaton 93 STS

Eaton 93 STS family provides Static Transfer Switches for seamless and reliable automatic transfer from one power source to another.

## Seamless power transfer

- 3-phase Static Transfer Switch, for automatic transfer of critical AC loads to and from one power source to another, without interruption
- Rated from 100 A to 1250 A
- Available in 3- and 4-pole versions

## Reliable performance

- Continuous monitoring of sources ensures automatic and instantaneous power transfer, without cross-connecting the sources
- Retransfer is also automatic, and there is the capability for manual transfer if required
- All the system control boards feature redundant internal power distribution
- A dual manual bypass is built in, to enable safe maintenance with no disruption of the power supply
- A global installed base reflects the widespread acceptance and popularity of the Eaton 93 STS

## Connectivity and easy management

- The Eaton 93 STS has RS232 and RS485 interfaces, with Modbus protocol. It also features output relay contacts
- There is a built-in HMI and system mimic panel. The LCD screen and block diagram of the STS – with integrated LEDs – allows a quick check of the switch's operating status
- Metering, alarms and event logs are also provided
- The Eaton 93 STS range is supplied in a free-standing cabinet



Eaton 93 STSs

Part number	Description	Width (mm)	Height (mm)	Depth (mm)	Weight (kg)
P-105000040-001	93 STS 100 A, 4-pole	820	1475	835	265
P-105000040-002	93 STS 250 A, 4-pole	820	1475	835	290
P-105000040-003	93 STS 400 A, 4-pole	820	1475	835	305
P-105000040-007	93 STS 630 A, 4-pole	1220	1900	860	615
P-105000040-004	93 STS 800 A, 4-pole	1220	1900	860	660
P-105000040-005	93 STS 1000 A, 4-pole	1220	1900	860	710
P-105000040-006	93 STS 1250 A, 4-pole	2000	2100	1000	800
P-105000030-001	93 STS 100 A, 3-pole	820	1475	835	265
P-105000030-002	93 STS 250 A, 3-pole	820	1475	835	290
P-105000030-003	93 STS 400 A, 3-pole	820	1475	835	305
P-105000030-007	93 STS 630 A, 3-pole	1220	1900	860	615
P-105000030-004	93 STS 800 A, 3-pole	1220	1900	860	660
P-105000030-005	93 STS 1000 A, 3-pole	1220	1900	860	710
P-105000030-006	93 STS 1250 A, 3-pole	2000	2100	1000	800

# Eaton synchronization options

There are three types of options available for Eaton UPS products synchronizing their outputs for various purposes.

## Sync Control II

- Device to keep two separate Eaton UPS system outputs in sync to each other
- Typical requirement when two UPS systems are feeding inputs of an STS (static transfer switch)
- Having systems synced allows the STSs make seamless transfers between system
- Either system can be a sync master in this application
- Can't be used to parallel outputs of two systems

## Fixed Master Sync Control

- Purpose of this device is the same as the Sync Control II, but the master is always fixed
- Typical applications are where multiple UPS systems need to be synced to one master system
- Alternatively fixed master can be used to sync Eaton UPS as permanent slave and the other UPS (static or rotary type) system as fixed master
- Can't be used to parallel outputs of two systems

## Power Block Sync

- Allows using one maintenance UPS system for multiple UPS systems
- Can be used for scaling up the installation by adding more UPS systems
- Used to firmly synchronize two separate Power Xpert 9395P systems in order to temporarily parallel outputs of both systems
- Allows for example to transfer loads from one system to another while UPS systems remain online and loads protected
- Can be called as UPS protected bus bar transfer
- Power Block Sync system is to be used only temporarily during load transfers

Contact local Eaton sales for support with selecting the right sync control unit.



Eaton Sync Control II



