

M-4665/0508-COM

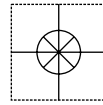

User's Guide

RD5100 COMMUNICATION INTERFACE

INSTRUCTION MANUAL

Shop online at

omega.com[®]

Ω OMEGA[®]

omega.com

e-mail: info@omega.com

*For latest product manuals:
omegamanual.info*

ISO 9001
CERTIFIED
CORPORATE QUALITY

STAMFORD, CT

ISO 9002
CERTIFIED
CORPORATE QUALITY

MANCHESTER, UK

Ω OMEGA[®]

omega.com®

ΩOMEGA®

OMEGAnet® Online Service
omega.com

Internet e-mail
info@omega.com

Servicing North America:

U.S.A.:
ISO 9001 Certified
One Omega Drive, P.O. Box 4047
Stamford, CT 06907-0047
TEL: (203) 359-1660
FAX: (203) 359-7700
e-mail: info@omega.com

Canada:
976 Bergar
Laval (Quebec) H7L 5A1, Canada
TEL: (514) 856-6928
FAX: (514) 856-6886
e-mail: info@omega.ca

For immediate technical or application assistance:

U.S.A. and Canada: Sales Service: 1-800-826-6342/1-800-TC-OMEGA®
Customer Service: 1-800-622-2378/1-800-622-BEST®
Engineering Service: 1-800-872-9436/1-800-USA-WHEN®

Mexico:
En Español: (001) 203-359-7803
FAX: (001) 203-359-7807
e-mail: espanol@omega.com
info@omega.com.mx

Servicing Europe:

Czech Republic: Frystatska 184, 733 01 Karviná, Czech Republic
TEL: +420 (0)59 6311899
FAX: +420 (0)59 6311114
Toll Free: 0800-1-66342
e-mail: info@omegashop.cz

Germany/Austria: Daimlerstrasse 26, D-75392 Deckenpfronn, Germany
TEL: +49 (0)7056 9398-0
FAX: +49 (0)7056 9398-29
Toll Free in Germany: 0800 639 7678
e-mail: info@omega.de

United Kingdom:
ISO 9002 Certified
One Omega Drive, River Bend Technology Centre
Northbank, Irlam, Manchester
M44 5BD United Kingdom
TEL: +44 (0)161 777 6611
FAX: +44 (0)161 777 6622
Toll Free in United Kingdom: 0800-488-488
e-mail: sales@omega.co.uk

It is the policy of OMEGA Engineering, Inc. to comply with all worldwide safety and EMC/EMI regulations that apply. OMEGA is constantly pursuing certification of its products to the European New Approach Directives. OMEGA will add the CE mark to every appropriate device upon certification.

The information contained in this document is believed to be correct, but OMEGA accepts no liability for any errors it contains, and reserves the right to alter specifications without notice.

WARNING: These products are not designed for use in, and should not be used for, human applications.

Where Do I Find Everything I Need for Process Measurement and Control? **OMEGA...Of Course!** *Shop online at omega.com*

TEMPERATURE

- ☑ Thermocouple, RTD & Thermistor Probes, Connectors, Panels & Assemblies
- ☑ Wire: Thermocouple, RTD & Thermistor
- ☑ Calibrators & Ice Point References
- ☑ Recorders, Controllers & Process Monitors
- ☑ Infrared Pyrometers

PRESSURE, STRAIN AND FORCE

- ☑ Transducers & Strain Gages
- ☑ Load Cells & Pressure Gages
- ☑ Displacement Transducers
- ☑ Instrumentation & Accessories

FLOW/LEVEL

- ☑ Rotameters, Gas Mass Flowmeters & Flow Computers
- ☑ Air Velocity Indicators
- ☑ Turbine/Paddlewheel Systems
- ☑ Totalizers & Batch Controllers

pH/CONDUCTIVITY

- ☑ pH Electrodes, Testers & Accessories
- ☑ Benchtop/Laboratory Meters
- ☑ Controllers, Calibrators, Simulators & Pumps
- ☑ Industrial pH & Conductivity Equipment

DATA ACQUISITION

- ☑ Data Acquisition & Engineering Software
- ☑ Communications-Based Acquisition Systems
- ☑ Plug-in Cards for Apple, IBM & Compatibles
- ☑ Datalogging Systems
- ☑ Recorders, Printers & Plotters

HEATERS

- ☑ Heating Cable
- ☑ Cartridge & Strip Heaters
- ☑ Immersion & Band Heaters
- ☑ Flexible Heaters
- ☑ Laboratory Heaters

ENVIRONMENTAL MONITORING AND CONTROL

- ☑ Metering & Control Instrumentation
- ☑ Refractometers
- ☑ Pumps & Tubing
- ☑ Air, Soil & Water Monitors
- ☑ Industrial Water & Wastewater Treatment
- ☑ pH, Conductivity & Dissolved Oxygen Instruments

WARRANTY/DISCLAIMER

OMEGA ENGINEERING, INC. warrants this unit to be free of defects in materials and workmanship for a period of **13 months** from date of purchase. OMEGA's WARRANTY adds an additional one (1) month grace period to the normal **one (1) year product warranty** to cover handling and shipping time. This ensures that OMEGA's customers receive maximum coverage on each product.

If the unit malfunctions, it must be returned to the factory for evaluation. OMEGA's Customer Service Department will issue an Authorized Return (AR) number immediately upon phone or written request. Upon examination by OMEGA, if the unit is found to be defective, it will be repaired or replaced at no charge. OMEGA's WARRANTY does not apply to defects resulting from any action of the purchaser, including but not limited to mishandling, improper interfacing, operation outside of design limits, improper repair, or unauthorized modification. This WARRANTY is VOID if the unit shows evidence of having been tampered with or shows evidence of having been damaged as a result of excessive corrosion; or current, heat, moisture or vibration; improper specification; misapplication; misuse or other operating conditions outside of OMEGA's control. Components in which wear is not warranted, include but are not limited to contact points, fuses, and triacs.

OMEGA is pleased to offer suggestions on the use of its various products. However, OMEGA neither assumes responsibility for any omissions or errors nor assumes liability for any damages that result from the use of its products in accordance with information provided by OMEGA, either verbal or written. OMEGA warrants only that the parts manufactured by it will be as specified and free of defects. OMEGA MAKES NO OTHER WARRANTIES OR REPRESENTATIONS OF ANY KIND WHATSOEVER, EXPRESS OR IMPLIED, EXCEPT THAT OF TITLE, AND ALL IMPLIED WARRANTIES INCLUDING ANY WARRANTY OF MERCHANTABILITY AND FITNESS FOR A PARTICULAR PURPOSE ARE HEREBY DISCLAIMED. LIMITATION OF LIABILITY: The remedies of purchaser set forth herein are exclusive, and the total liability of OMEGA with respect to this order, whether based on contract, warranty, negligence, indemnification, strict liability or otherwise, shall not exceed the purchase price of the component upon which liability is based. In no event shall OMEGA be liable for consequential, incidental or special damages.

CONDITIONS: Equipment sold by OMEGA is not intended to be used, nor shall it be used: (1) as a "Basic Component" under 10 CFR 21 (NRC), used in or with any nuclear installation or activity; or (2) in medical applications or used on humans. Should any Product(s) be used in or with any nuclear installation or activity, medical application, used on humans, or misused in any way, OMEGA assumes no responsibility as set forth in our basic WARRANTY/DISCLAIMER language, and, additionally, purchaser will indemnify OMEGA and hold OMEGA harmless from any liability or damage whatsoever arising out of the use of the Product(s) in such a manner.

RETURN REQUESTS/INQUIRIES

Direct all warranty and repair requests/inquiries to the OMEGA Customer Service Department. BEFORE RETURNING ANY PRODUCT(S) TO OMEGA, PURCHASER MUST OBTAIN AN AUTHORIZED RETURN (AR) NUMBER FROM OMEGA'S CUSTOMER SERVICE DEPARTMENT (IN ORDER TO AVOID PROCESSING DELAYS). The assigned AR number should then be marked on the outside of the return package and on any correspondence.

The purchaser is responsible for shipping charges, freight, insurance and proper packaging to prevent breakage in transit.

FOR **WARRANTY** RETURNS, please have the following information available BEFORE contacting OMEGA:

1. Purchase Order number under which the product was PURCHASED,
2. Model and serial number of the product under warranty, and
3. Repair instructions and/or specific problems relative to the product.

FOR **NON-WARRANTY** REPAIRS, consult OMEGA for current repair charges. Have the following information available BEFORE contacting OMEGA:

1. Purchase Order number to cover the COST of the repair,
2. Model and serial number of the product, and
3. Repair instructions and/or specific problems relative to the product.

OMEGA's policy is to make running changes, not model changes, whenever an improvement is possible. This affords our customers the latest in technology and engineering.

OMEGA is a registered trademark of OMEGA ENGINEERING, INC.

© Copyright 2006 OMEGA ENGINEERING, INC. All rights reserved. This document may not be copied, photocopied, reproduced, translated, or reduced to any electronic medium or machine-readable form, in whole or in part, without the prior written consent of OMEGA ENGINEERING, INC.

Contents

Introduction	1
1 Overview	2
1.1 485 communication interface	2
1.2 Communication protocol	2
2 Communication specifications	2
3 Confirmation and setting method of communication specification	3
4 Connection	4
4.1 Precautions during connection	4
4.2 Communication cable	5
4.3 Connection of RS-485	7
5 MODBUS protocol	8
5.1 Transmission mode of message	9
5.2 Data time interval	10
5.3 Message configuration	10
5.4 Method of creating message	16
5.5 Function code	17
5.6 Process during abnormality	21
5.7 Print message function	23
5.8 Reference table	24
6 Before connecting to the network	81
6.1 Allocation of IP address	82
6.2 Communication error of Ethernet	83

Introduction

This instruction manual explains the handling and specifications about 3 communication interfaces (RS-485, USB, Ethernet) in the common communication interface edition of Hybrid recorder RD5100 series. Each individual part is divided into “RS485”, “USB”, “Ethernet” and common part is collectively explained. Hence read the part that is required.

Confirm the communication interface of the purchased RD5100 series by model code.

RD5100 series

RD51□□-□□□

└─ Communication interface

N: None

1: RS-485+USB+Ethernet+Contact point 1 output (Contact point 1 output mechanical relay 'a' contact point output)

1. Other instruction manuals to be referred to

As this manual gives a limited explanation about the communication interface, refer to the instruction manual of this instrument itself for the operation methods etc.

※For the PC to be used refer to the instruction manual of that PC.

2. Precaution table

Precautions

In between the sentences in this instruction manual there are explanations. It is the description of things that are to be observed during operation and at the time of handling the communication interface. If these things are not followed the device may be damaged and the performance will drop remarkably or operation may not run properly.

Precautions

- (1) The contents of this document may be changed without notice in the future.
- (2) All the possible care has been taken while creating this manual. However if you come across any mistake, or have any doubts or if you notice any description leakage etc. contact the shop from where you purchased the product or contact our company's nearest branch office.
- (3) Please note that irrespective of (2) we will not be responsible for the effect of operation result.

1 Overview

In communication interface of RD5100 there are 3 types viz. **RS-485, USB, Ethernet** available and are used for communicating with the personal computer (Hereafter referred to as PC). PC can receive measurement data from RD5100, various parameters can be set and operation commands can be executed.

Connection count of RD5100 is 1 USB and maximum 31 RS-485.

1.1 RS-485 communication interface

RS-485 communication interface can communicate by connecting in series multiple (maximum 31) RD5100 series machines through the signal that conforms to RS-485.

Although the number of PCs having RS-485 is less, it can be easily connected by using RS-232C \longleftrightarrow RS-485 signal converter, as it is a serial communication.

As this company also has line converters for RS-232C \longleftrightarrow RS-485 signal conversion, you can place an order for them.

1.2 Communication protocol

RD5100 series uses MODBUS protocol (MODBUS is a registered trademark of SCHNEIDER Company) as communication protocol

MODBUS protocol has 2 modes viz. RTU mode and ASCII mode and they can be toggled using key settings. MODBUS protocol has operation function and, settings and send function of measurement data.

2 Communication specifications

- Asynchronous method
- Half duplex communication method (Polling selecting method)
- Protocol: MODBUS protocol/usual protocol (Compatible with LE1000)
- Transmission speed: 19200, 9600, 4800, 2400, 1200 bps switching possible (differs depending on the protocol)
- Start bit: 1 bit
- Data length: 7 bits/8 bits switching is possible
- Parity bit: Even (even parity)/Odd (odd parity)/Non (No parity) switching is possible
- Stop bit: 1 bit/2 bits switching over is possible
- Transmission code: Binary/ASCII (Differs depending on the protocol)
- Error check: Differs depending on the protocol
- External instrument priority communication method
- Data transmission procedure: No procedure
- Usage signal name: Send and receive data only (Without using control signal)

3 Confirmation of communication specifications, and setting method

Go to the settings display mode by clicking the Menu key. A window opens and a list of setting items is displayed, select **COM.** and click the Enter key. The following settings screen is displayed. Confirm the specifications and do the settings as per the requirement.

Communication port	
EtherNet	RS-422A/485
MAC 00 00 00 00 00 00	Address <input type="text" value="1"/>
<input type="checkbox"/> IP auto config.	Baudrate <input type="text" value="19200"/> ▼
IP address <input type="text" value="192"/> . <input type="text" value="168"/> . <input type="text" value="254"/> . <input type="text" value="254"/>	Character <input type="text" value="8N1"/> ▼
Subnet mask <input type="text" value="255"/> . <input type="text" value="255"/> . <input type="text" value="255"/> . <input type="text" value="0"/>	RTU/ASCII <input type="text" value="RTU"/> ▼
Gateway <input type="text" value="192"/> . <input type="text" value="168"/> . <input type="text" value="254"/> . <input type="text" value="254"/>	
Port No. <input type="text" value="11111"/>	<input type="button" value="Set"/>

22039-550069

- **Instrument address:** Setting range from 1-99 can be entered directly using the number keys.
- **Transmission speed:** Select either of 9600,19200bps.
- **Character:** Select from the code given in the table below.

Code	Length of data	Parity	Stop bit
7E1	7 bits	Even	1
7E2			2
701		Odd	1
702			2
8N1	8 bits	None	1
8N2			2
8E1		Even	1
8E2			2
801		Odd	1
802			2

※ RTU mode is 8 bits only

- **RTU/ASCII:** Select either of RTU, ASCII, PRIVATE.

Confirm all the settings or finish all the setting changes then take the cursor to button and end after clicking the Enter key.

4 Connection

4.1 Precautions while doing the connections

4.1.1 Communication terminal

Terminal layout differs depending on the communication interface that is specified.

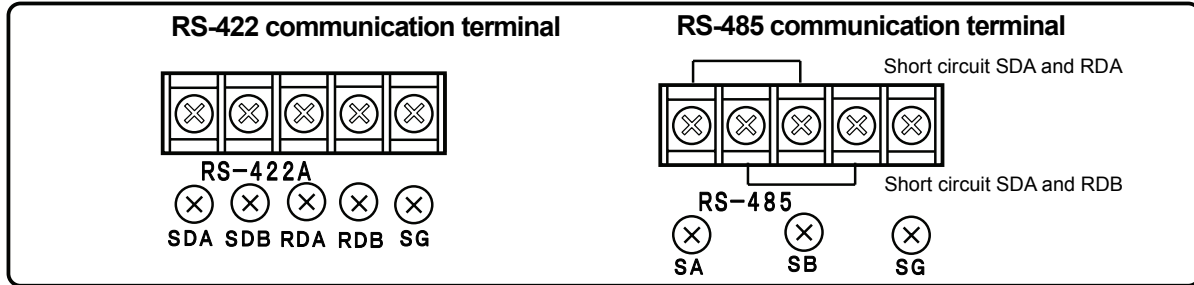

4.1.2 Total extension of RS-422A/485 communication cable is less than 1.2km

Wiring interval between each instrument can be anything but the total extension distance of the cable is within 1.2 kms.

(Line converter LE5000 of the farthest terminal)

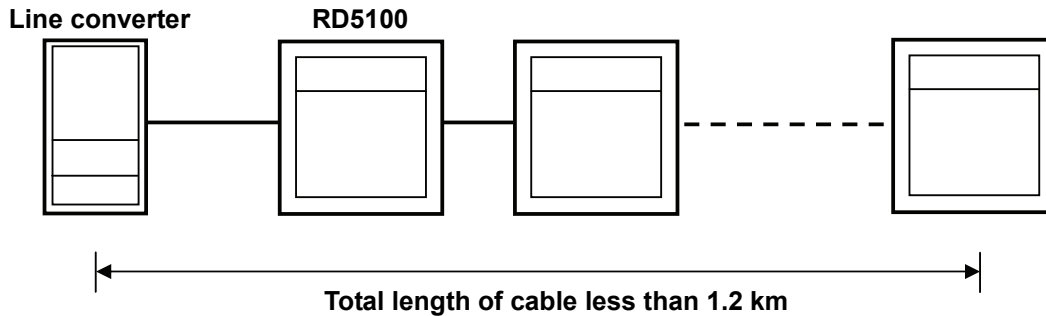

4.1.3 Take prevention measures to prevent noise mixing.

In order to avoid the effect of noise keep a distance of minimum 50cm or more between the power line and other communication lines.

4.1.4 Always do crimp style terminal processing.

Due to one of the causes of communication defect the connection is lost. Always process the communication cable of the terminal using crimp style terminal with insulated sleeve of O type or Y type. (Terminal screws of LE5000 line converter are M3.5mm)

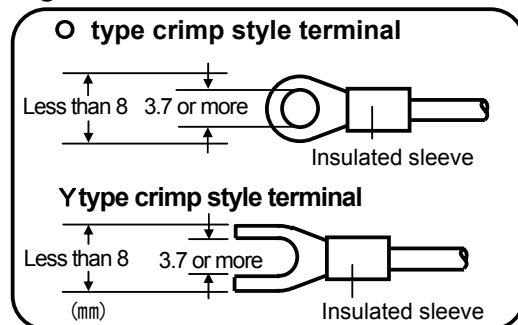

4.1.5 Apply terminating resistance.

In case of using RS-485 communication, apply a resistance of 100Ω to RD5100 to be placed in the last terminal. (For details refer to 4.3)

(General metal coating resistance will do. It is available in this company, place an order with us.)

4.1.6 Number of connection machines of RD5100



For RS-485 : Maximum 31

4.2 Cable for communication

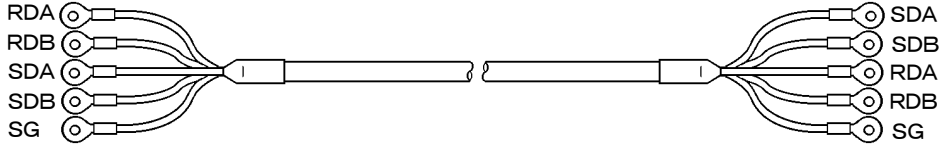
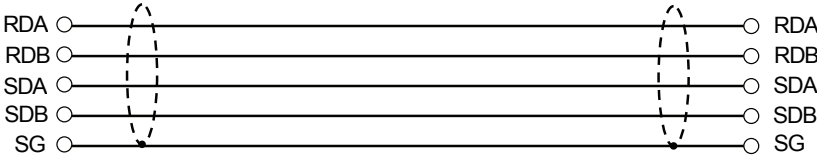

Before connecting be prepared with cable exclusively for communication. It is available in our company also; hence you may place an order with us.

4.2.1 Communication cable for RS-422A

① Connection between line converter and LE5000

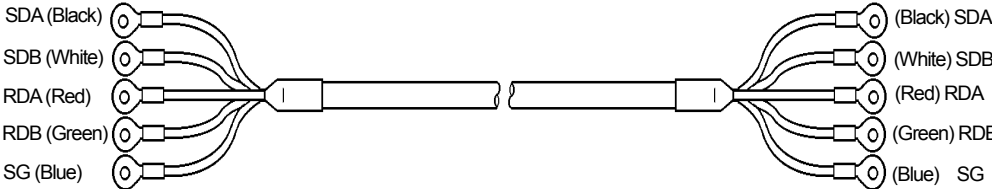
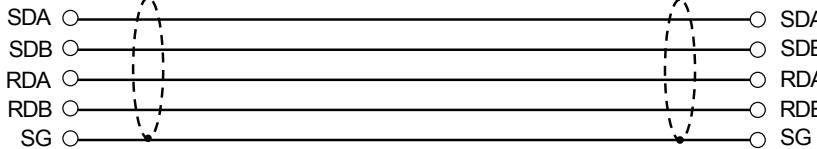

Cable	O type crimp style terminal ↔ O type crimp style terminal RS-422A cable (For line converter)
Form	 <p>Line converter side</p> <p>LE5000 side</p> <p>It is a 2 core CVVS wire that is twisted and it is further twisted to 4 core cable and SG (Signal Grand) wire is available on both sides. As there is no SG converter on line converter side, use it after disconnecting.</p>
Internal connection	
Format code	RZ-CRA2 □□  Cable length 1-99m (specified)

② Connection between LE5000s

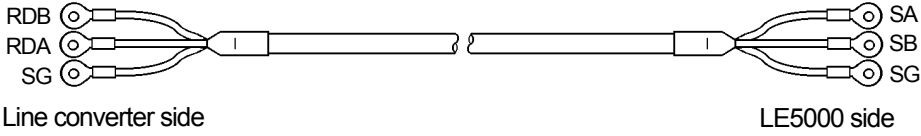
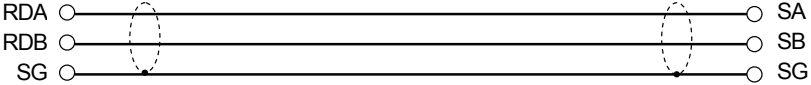

Cable	O type crimp style terminal ↔ O type crimp style terminal RS-422A cable (For series)
Form	 <p>LE5000 side</p> <p>LE5000 side</p> <p>It is a 2 core VCTF wire that is twisted and it is further twisted to 4 core cable and SG (Signal Grand) wire is available on both sides.</p>
Internal connection	
Format code	RZ-CRA1 □□  Cable length 01-99m (specified)

4.2.1 Communication cable for RS-485

① Connection between line converter and RD5100

Cable	O type crimp style terminal ↔ O type crimp style terminal (For line converter)
Form	 <p>Line converter side</p> <p>LE5000 side</p> <p>It is a CVVS wire that is twisted to 2 core cable and SG (Signal Grand) wire is available in both the terminals. As there is no SG converter on line converter side, use it after disconnecting.</p>
Internal connection	
Format code	RZ-LEC□□□ (For line converter)  <p>Cable length 1-200m (specified)</p>

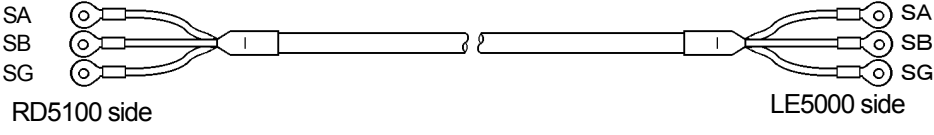
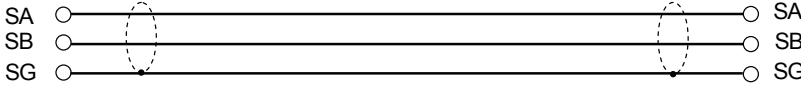
② Connection between RD5100s

Cable	O type crimp style terminal ↔ O type crimp style terminal (For series)
Form	 <p>RD5100 side</p> <p>LE5000 side</p> <p>It is a CVVS wire that is twisted to 2 core cable and SG (Signal Grand) wire is available in both the terminals.</p>
Internal connection	
Format code	RZ-LEC□□□ (For series)  <p>Cable length 1-200m (specified)</p>

4.3 RS-485 connection

Connect RS-485 communication interface to PC using line converter. As the line converter and PC use only 3 signals viz. send, receive and signal ground and no other control signal is used, wiring process in the connector needs to be similar to that of RS-232C connection. (For details refer to line converter instruction manual.)

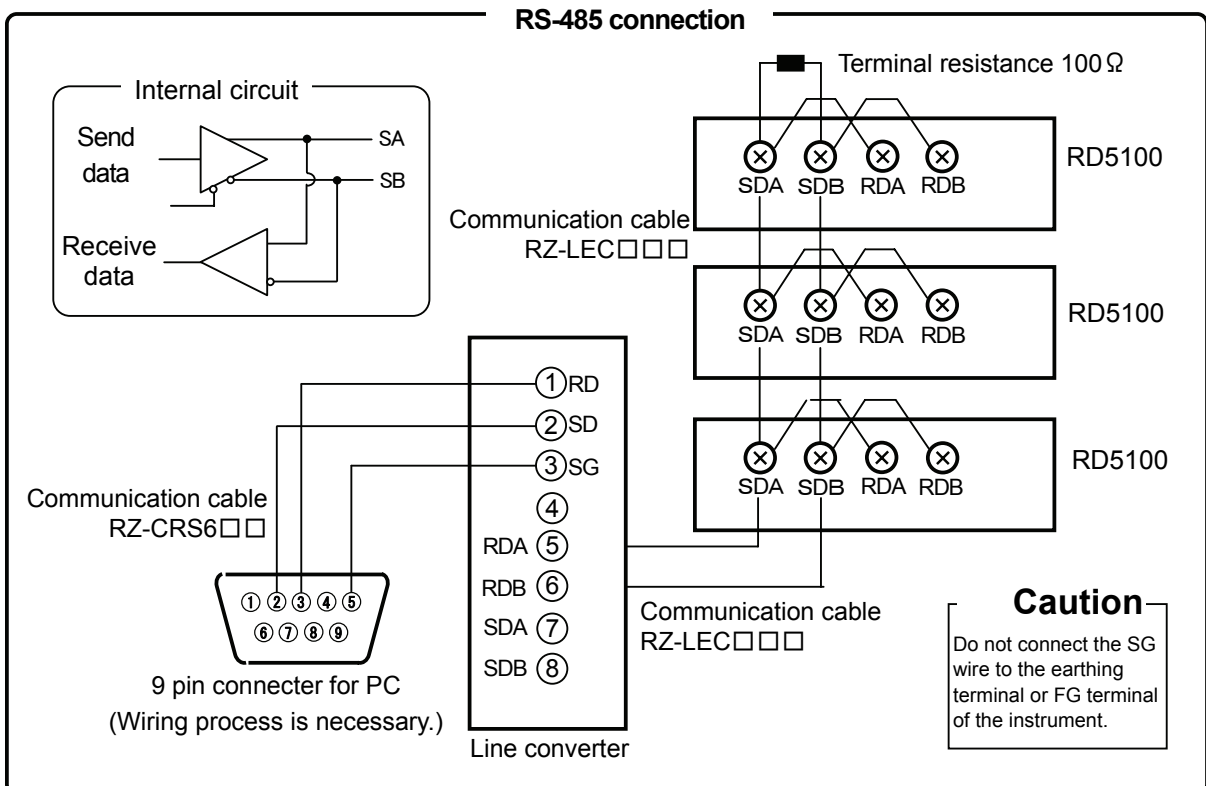
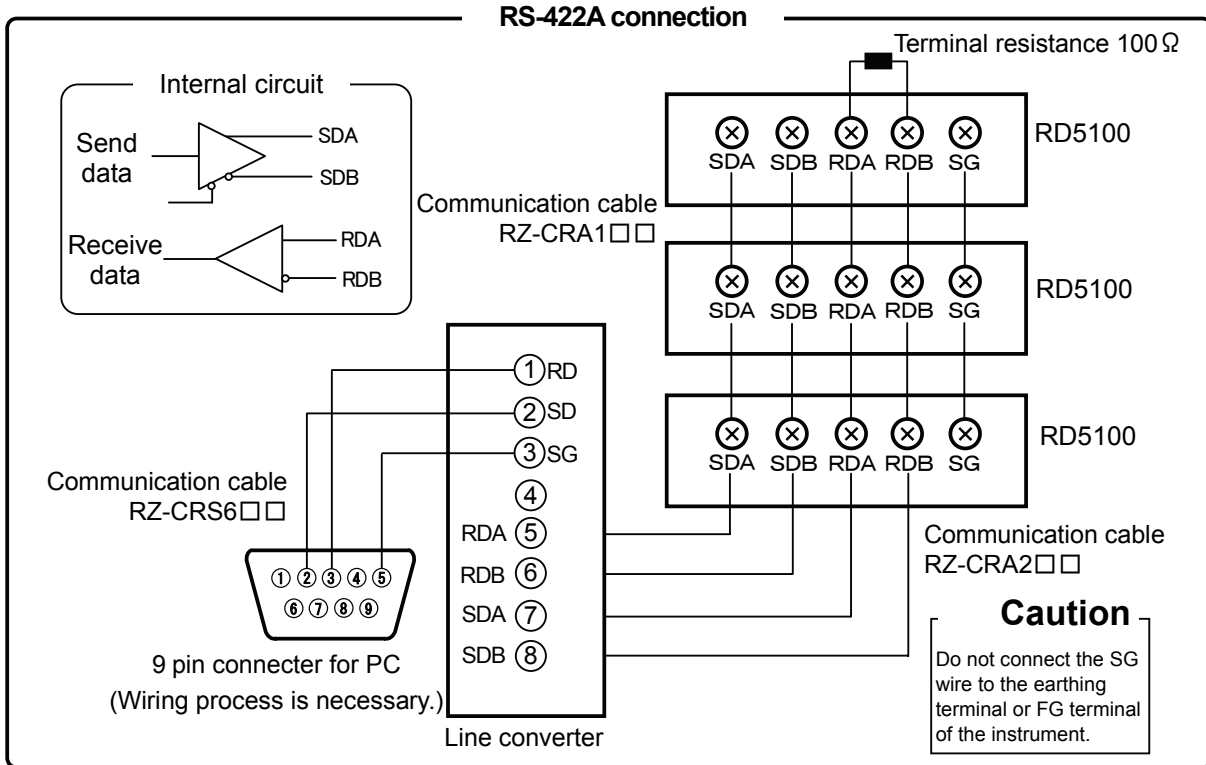

5 MODBUS protocol

Precautions and basic procedure of communication

Caution

1. Error occurs if data is requested immediately after starting the power supply.

RD5100 can be communicated with, any time. Response is output anytime for the data request from PC.

However at the time of starting the power supply, response is not output normally, until the data of the channel is gathered. For example, time necessary to gather data of RD5100 36 point analyzer, is around 20 seconds. If data is requested in that time Error No. 12 (Setting mode error) is returned.

2. As the control signal wire is not used, consider resending the command.

Serial interface of RD5100 communicates without using control wire. Hence consider resending the command as reception defect may occur depending on RD5100 status.

3. Do not remove any device or communication cable and do not ON-OFF the power supply during communication.

If device or cable that makes up the serial interface is removed in between or if power is switched ON or OFF, operation may stop and error may occur. If this happens reset all the devices that make up the serial interface and do the process all over again.

4. Send the next command after confirming that the communication drive is switched OFF.

In RS-485, if multiple instruments are connected in same communication line, then only 1 machine in which instrument numbers are specified from the PC, drives the communication line. At that time in order to receive all the characters in the PC for sure, let some time lapse after the last character is sent and then switch OFF the drive of communication line. If PC sends a command for the next device before it becomes OFF, then the signal crashes and normal communication is not done hence take care in case of high speed PCs. This interval is around 5ms.

5.1 Message transmission mode

There are 2 types of modes viz. RTU (Remote Terminal Unit) mode and ASCII mode and they can be selected by key settings.

(Table 1. Comparison of RTU mode and ASCII mode)

Items		RTU mode	ASCII mode
Interface		RS-485	
Communication method		0 {Half duplex asynchronous method	
Communication speed		9600, 19200bps	
Transmission code		Binary	ASCII
Error detection (Error check)	Vertical direction	Parity	
	Average direction	CRC-16	LRC
Character configuration	Start bit	1 bit	
	Data bit	8 bits	7 bits, 8 bits
	Parity bit	None, odd, even	None (Note), odd, even
	Stop bit	1, 2 bits	
Message start code		None	: (Colon)
Message end code		None	CR, LF
Data time interval		Less than 28 bit hours	Less than 1 second

(Note) When data bit is 7 bits, "Parity bit None" is not applicable.

5.1.1 Transmission data

RTU mode is binary transmission. ASCII mode divides 8 bit binary of RTU into high order low order 4 bits and does the respective character conversion (0-9, A-F).

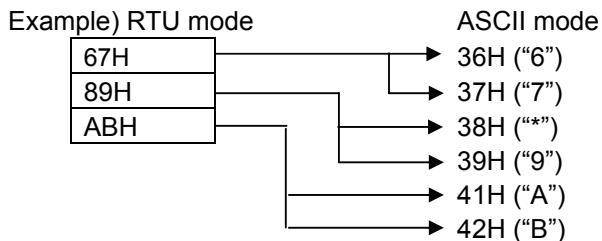

The message length of the RTU mode is half as compared to the ASCII mode hence the transmission efficiency is better.

5.1.2 Message frame configuration

RTU mode is made up of message part only.

ASCII mode is made up of beginning character ": (colon, 3AH)", message and end character "CR (carriage return, 0DH) + LF (Line feed, 0AH)".

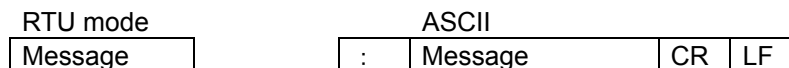

For the message of ASCII mode, as the beginning character is ":", trouble shooting is easy. This is an added advantage.

5.2 Data time interval

RTU mode time: Less than 28 bit hours (9600bps time: 2.8msec, 19200nps time: 1.4msec)

ASCII mode time: Less than 1 second

At the time of sending the message, see to it that the time interval of the data that consists of one message does not exceed the time interval mentioned above. If the time interval mentioned above is exceeded, the receiving side (this instrument), in order to judge that the sending is finished from the send side, processes an abnormal message as received data.

In RTU mode message characters should be continuously send however in ASCII mode, as the interval between the characters is maximum 1 second, even though the process speed of the master (PC) is comparatively slow, it can be used.

5.3 Message configuration

MODBUS message along with RTU and ASCII mode has the following configuration.

Slave address
Function code
Data
Error check

5.3.1 Slave address

Slave address is set in advance in a range of 1-31 using the key settings. Master usually communicates with 1 slave. All the devices that are connected receive the message from the master in common however, only the slave that matches with the slave address in the command message responds to that message.

Slave address "0" is used in the messages (Broadcast) for all the slaves from the master. In this case slave does not return response.

5.3.2 Function code

Function code is the code to be executed in the slave and each data is roughly categorized as follows. For details refer to the reference table.

- ① **Digital settings value:** Recording ON/OFF, data print execution etc. and mainly function change parameters
- ② **Digital input data:** Parameters of external contact point input status, input data status, alarm activation status etc.
- ③ **Analog settings value:** Various setting information. Numeric value range is a numeric value within a range of 16 bits.
-32763 to 32767 (For details refer to reference table).
- ④ **Analog input data:** Measurement data, instrument specification information etc. Numeric value range outputs a numeric value within a range of 16 bits.

(Table 2. Function code table)

Code	Function	Unit	MODBUS original function (Reference)
01	Reading digital (ON/OFF) settings value	1 bit	Reading the status of coil
02	Reading the digital input data	1 bit	Reading the input relay status
03 60 62	Reading the analog setting value	16 bits	Reading the contents of maintenance register
04	Reading the analog input data	16 bits	Reading the contents of input register
05	Writing digital setting value	1 bit	Changing the status of single coil
06	Writing analog setting value	16 bits	Writing to single maintenance register
08	Sending the reception data (For examination)		Loop back test
16 61 63	Writing multiple analog setting value		Writing to multiple maintenance register

5.3.3 Data part

Data structure differs depending on the function code. In case of requests from the master, it is made up of, code number (Relative number calculated from reference number mentioned hereafter) of the target data to be read and data count etc. Response from the slave consists of data etc. that is requested.

Basic data of MODBUS is on a whole an integer of 16 bits and existence of a mark is decided for each data. Hence put the decimal point at a different place and make it an integer value or keep the position of the decimal fixed, and display formally using the upper and lower limit of the scale. In LE5000 there is a method of assigning a decimal point at a different position.

Caution

In the data part, specific numeric value such as input data is assigned as the error data. When using this data, first does error decision for the data, then combine the decimal point data. If you combine the decimal point data first, the error data is mistaken as the normal data.

5.3.4 Reference number

There is a number called "Reference number" assigned to the data in RD5100, and this number is necessary for reading and writing the data. Data in RD5100 is categorized as "Digital setting value", "Digital input data", "Analog input data" and "Analog setting value" depending on its type. Number specification in the message is done by "Relative number" that corresponds to the respective reference number.

(Table 3. Reference number and relative number)

Data type	Reference number	Relative number	MODBUS original (Reference)
Digital setting value	1 to 1000	Reference number-1	Coil
Digital input data	10001 to 20000	Reference number-10001	Input relay
Analog input data	30001 to 40000	Reference number-30001	Input register
Analog setting value	40001 to 50000	Reference number-40001	Maintenance register

Example) "100" becomes the relative number of channel 1 data of "Reference number 30101".

(Table 4. Reference number)

Data type	Parameter	Reference number	Corresponding function code	Reference table
Digital setting value	Key lock Recording ON/OFF Feed Print list Print message Data print	1 to 50	01 (READ) 05 (WRITE)	5.8.1 Clause
Digital input data	External drive status (Contact point input) Measurement data status Alarm status	10001 to 11500	02 (READ)	5.8.2 Clause
Analog input data	Function information Measurement data	30001 to 30050 30101 to 30300	04 (READ)	5.8.3 Clause
Analog setting value	Channel common setting 1 Clock setting External drive functional settings Arbitrary intermittent period setting Channel speed setting Data interval recording setting Logging recording setting Data print setting Select recording format Parallel pointer scale setting Alarm dead band setting Setting for each channel Range number setting RJ internal/external setting Range setting Scale setting Burn out setting Sensor correction Digital filter Unit settings Tag settings Alarm settings Calculation settings Recording scale settings Calculation constant setting Difference calculation setting Partial reduction magnification recording Parallel pointer scale settings Auto range settings Each channel settings Memory card settings Print communication Setting for each intermittent number Data communications input Setting common to channels	40001 to 40200 40001 to 40008 40009 to 40017 40018 40019 to 40027 40033 to 40037 40038 to 40042 40043 40049 40050 to 40075 40081 40102 to 47300 40102 40103 40104 to 40106 40107 to 40109 40110 40111 40112 40119 to 40122 40125 to 40128 40133 to 40163 40165 40166 to 40168 40169 to 40176 40177 to 40180 40181 to 40187 40188 40189 to 40194 40202 to 47300 47906 to 47920 48003 to 48050 48101 to 48850 49001 to 49100 49101 to 49150	03 (READ) 06 (WRITE) 16 (WRITE)	5.8.4 Clause

(Table 4. Reference number for RD5200/RD5300)

Data type	Parameter	Reference number	Corresponding function code	Reference table
Analog input setting value	Calculation character string (RD5200 only) RD5300 responds with option	23720 to 27250	62 (READ) 63 (WRITE)	5.8.5 Clause
	Channel parameter of CH101 to CH599 (LE5300 only)	40101 to 47300	60 (READ) 61 (WRITE)	
Analog input data	CH73 to CH599 Reading measurement data	30245 to 31300	04 (READ)	

5.3.5 Error check

Error check of transmission frame differs depending on the mode.

RTU mode: CRC-16

ASCII mode: LRC

5.3.5.1 Calculation of CRC-16

CRC method divides using generating polynomials, the information to be sent and sends the rest of the information by attaching it. Generating polynomials are as follows.

$$1 + X^2 + X^{15} + X^{16}$$

Calculate to the target from slave data up to the end of the data by the following procedure.

- 1) Initialization (=FFFFH) of data of CRC-16 (consider as X)
- 2) Exclusive logical OR of data 1 and X (EX-OR) → X
- 3) Shift X 1 bit to the right → X
- 4) If there is a carry, get A001H and EX-OR else go to 5). → X
- 5) Repeat 3) and 4) until it shifts 8 times.
- 6) Following data and EX-OR of X. → X
- 7) Same as 3) - 5).
- 8) Repeat till the last data.
- 9) Create message in the order, low order and high order of calculated 16 bit data (X).

Example) When data is

02H	07H
-----	-----

, CRC becomes 1241H

hence error check data becomes

41H	12H
-----	-----

.

Reference: CRC-16 calculation program

```
10 D(1) = &H2 : D(2) = &H7 : N = 2
20 GOSUB *CRCMAKE
30 END
40
100 *CRCMAKE
110 CRC = &HFFFF
120 FOR I = 1 TO N
130 CRC = CRC XOR D(I)
140 FOR J = 1 TO 8
150 CY = CRC AND &H1
160 IF CRC < 0 THEN P = &H4000 ELSE
    P = 0: GOTO 180
170 CRC = CRC AND &H7FFF
180 CRC = CRC ¥ 2
190 CRC = CRC OR P
200 IF CY = 1 THEN CRC = CRC XOR
    &HA001
210 NEXT J
220 NEXT I
230 IF CRC < 0 THEN P = &H80 ELSE
    P = 0: GOTO 250
240 CRC = CRC AND &H7FFF
250 C1 = CRC AND &HFF
260 C2 = (CRC AND &H7F00) ¥ 256
270 C2 = C2 OR P
280 D(N+1) = C1 : D(N+2) = C2
290 RETURN
```

5.3.5.2 LRC calculation method

Calculate to the target from slave data up to the end of the data by the following procedure.

- 1) Create message in RTU mode.
- 2) Add from the beginning (slave address) of the data to the end. $\rightarrow X$
- 3) Get the complement (Bit inversion) of X. $\rightarrow X$
- 4) Subtract 1. ($X=X+1$)
- 5) Attach X as LRC at the end of the message.
- 6) Convert everything into ASCII character.

Example) When data is

02H	07H
-----	-----

 ; LRC becomes F7H hence binary message becomes

02H	07H	F7H
-----	-----	-----

 and ASCII message becomes

30H	32H	30H	37H	46H	37H
-----	-----	-----	-----	-----	-----

.

5.3.6 Precautions at the time of data processing

- ① As the measurement data and decimal point position are assigned to different numbers, it is necessary to use the information of both at the time of replaying the data.
- ② As each 1 data can be accessed (changed), precautions are necessary at the time of setting the associated data. For example, Initialization process etc. of the associated data due to change in range number. Process contents are mentioned in reference number table.
- ③ At the time of executing settings by key (in case of setting status by Enter key), settings by communication cannot be received. To avoid this first do the key lock and then do the settings by communication.
- ④ Read and write the data in the range stipulated by the reference number. In case of reading and writing for reference number that is other than stipulated reference number, instrument operation may be affected
- ⑤ Reading and writing to multiple reference numbers that are not in series is also possible but if reference number that is not stipulated is the starting number then an error (error 02H) occurs.
- ⑥ At the time of reading multiple reference numbers, the data of the reference number that is not stipulated becomes "0".
- ⑦ In case of writing to multiple reference numbers, if error is detected, all the settings become disabled.

5.4 Method of creating a message

Message consists of ①Step address, ②Function code, ③Data part, and ④Error check code. (Refer to 5.3)

Message that can be read once is within the following range.

Data count
120 units

Method of creating a message is explained in the following example.

Example) Reading the measurement data of RD5100 “Channel 1” of “Slave address 02”

5.4.1 RTU mode message

① **Slave address: 02** (

02H

)

② **Function code: 04** (

04H

)

It is “Reads the analog input data (Reading the contents of input register)”. When function code is “04”; specify the “relative number of data 2 bytes” to be read in data part and “data count 2 byte” to be read. (Refer to 5.3. Refer to 5.3.2 for “Function code: 04”)

※It is necessary to confirm the number of bytes of data.

③ **Data part: Relative number 100** (

00H	64H
-----	-----

) **at the beginning,**
count 2 (

00H	02H
-----	-----

)

Measurement data (analog input data) is stored in reference number “30001 to 40000” (Refer to 5.3.4 Table 3). As per the reference table it is understood that integer part of CH1 is stored in “30101” and decimal point position is stored in “30102”. (For reading the measurement data, refer to 5.5.4.)

Relative number of beginning “reference number 30101” is 30101-30001=100, if it is expressed in 2 bytes it becomes

“

00H	64H
-----	-----

 ” (Refer to 5.3.4).

Count of data to be read is the integer part CH. 1 and decimal point position “2” and if it is to be expressed in 2 bytes it becomes “

00H	02H
-----	-----

 ”.

④ **Error check: Calculated by CRC-16 2730H** (

30H	27H
-----	-----

)

Error check in RTU mode is done by CRC-16. (Refer to 5.3.5.1)

Data of basic part of message is

02H	04H	00H	64H	00H	02H
-----	-----	-----	-----	-----	-----

 as per ①-③, and CRC-16 is 2730H.

Thus the error check data is

30H	27H
-----	-----

⑤ **Message:** Message is created with the configuration

02H	04H	00H	64H	00H	02H	30H	27H
-----	-----	-----	-----	-----	-----	-----	-----

 . (Refer to 5.3)

5.5.2 Reading the digital input data (Reading the status of input relay)

[Function code: 02(02H)]

Only the specified count reads “digital (ON/OFF) input data of series of numbers”, from specified number. ON/OFF data consists of reply message data where in 8 units are arranged in numerical order in 1 data (1 byte). LSB (DO side) of each data is the digital data of the young number. When the read count is not in multiples of 8, the unnecessary bits become 0. Response example is similar to “Function code 01”. However starting number (Relative number) is “Reference number - 10001”.

5.5.3 Reading analog settings value (Reading the contents of maintenance register)

[Function code: 03 (03H)/60 (3CH)/62 (3EH)]

Only the specified count reads “analog settings value (2 bytes:16 bits) data” of series of numbers, from specified numbers. Data consists of response message data, arranged in numeric order and split into high order 8 bits and low order 8 bits.

Example) Reading the clock information “Year month date” of slave 2.

(Reading of 3 analog settings value reference number from 40001 to 40003 of slave 2.)

Reference number	40001	40002	40003
Data	98 (3938H)	12 (3132H)	25 (3235H)

← Example)
Data of December 25, 1998

(RTU mode)

Master → Instrument

Slave address	02H
Function code	03H
Starting number (H)	00H
Starting number (L)	00H
Count (H)	00H
Count (L)	03H
CRC (L)	05H
CRC (H)	F8H

Instrument → Master (Normal)

Slave address	02H
Function code	03H
Data count	06H
Data of Year(H)	39H
Data of Year (L)	38H
Data of Month (H)	31H
Data of Month (L)	32H
Data of Date(H)	32H
Data of Date (L)	35H
CRC (L)	EBH
CRC (H)	6DH

<ASCII mode error check>

LRC	F8H
-----	-----

LRC	BAH
-----	-----

Note) Starting number (Relative number) is “Reference number - 40001”. (Decimal 0 (=40001-40001) → Hexadecimal 00H)

Note) When function code is 62, “Reference number - 20001”

Note) Data count is number of bytes of data.

(It differs from request count. In the example Request count is 3 and data count is 6)

Note) There is a limitation on the data count of the message (that this instrument can send) that can be received at a time.

(Refer to 5.4)

5.5.4 Reading the analog input data (Reading the contents of input register)

[Function code: 04 (04H)]

Only the specified count reads “analog settings value (2 bytes: 16 bits) data” of series of numbers, from specified numbers. Data consists of response message data arranged in numeric order and split into high order 8 bits and low order 8 bits. Response example is similar to “Function code 03”. However starting number (Relative number) is "Reference number - 30001".

5.5.5 Writing digital settings value (Changing the status of single coil)

[Function code: 05 (05H)]

Consider digital settings value of specified number as specified status (ON/OFF).

Example) Executing 'Print message' of slave 2. (Switch ON the digital settings value reference number 20 of slave 2.

(RTU mode)

Master → Instrument

Slave address	02H
Function code	05H
Settings value number (H)	00H
Settings value number (L)	13H
Settings status (H)	FFH
Settings status (L)	00H
CRC (L)	7DH
CRC (H)	CCH

Instrument → Master (Normal)

Slave address	02H
Function code	05H
Settings value number (H)	00H
Settings value number (L)	13H
Settings status (H)	FFH
Settings status (L)	00H
CRC (L)	7DH
CRC (H)	CCH

<ASCII mode error check>

LRC	E7H
-----	-----

LRC	E7H
-----	-----

Note) In case of normal response, response is same as that of command message.

Note) Setting value number (Relative number) is "Reference number -1". (Decimal 19 (=20-1) → Hexadecimal 13H)

Note) "FF00H" is set at the time of execution. In key lock and recording ON/OFF, "000H" is set in case of OFF and "FF00H" is set in case of ON.

Note) If slave address is 0 all the slaves execute this command. But no slave address responds.

5.5.6 Writing analog settings value (Writing to unit maintenance register)

[Function code:06 (06H)]

Analog settings value of specified number is considered to be the specified value.

Example) Alarm dead band of slave 2 is set to 0.5%.

(Consider "5" as analog settings value reference number 40081 of slave 2.)

(RTU mode)

Master → Instrument

Slave address	02H
Function code	06H
Settings value number (H)	00H
Settings value number (L)	50H
Setting data (H)	00H
Setting data (L)	05H
CRC (L)	49H
CRC (H)	EBH

Instrument → Master (Normal)

Slave address	02H
Function code	06H
Settings value number (H)	00H
Settings value number (L)	50H
Setting data (H)	00H
Setting data (L)	05H
CRC (L)	49H
CRC (H)	EBH

<ASCII mode error check>

LRC	A3H
-----	-----

LRC	A3H
-----	-----

Note) In case of normal response, response is same as that of command message.

Note) Setting value number (Relative number) is "Reference value -40001". (Decimal 80(=40081-40001) → Hexadecimal 50H)

Note) If slave address is 0 all the slaves execute this command. But no slave address responds.

5.5.7 Loop back test

[Function code: 08 (08H)]

Transmission check is performed between master slaves. Responding is done depending on the specified diagnosis code. In this instrument "return check to send the received data as it is" is performed and diagnosis code "0000H" is fixed.

Example) Execute "loop back test" in slave 2

(RTU mode)

Master → Instrument		Instrument → Master (Normal)	
Slave address	02H	Slave address	02H
Function code	08H	Function code	08H
Diagnosis code (H)	Fixed	Diagnosis code (H)	00H
Diagnosis code (L)		Diagnosis code (L)	
Optional data	*	Received data	*
Optional data	*	Received data	*
CRC (L)	*	CRC (L)	*
CRC (H)	*	CRC (H)	*

5.5.8 Writing multiple analog setting values (Writing to multiple maintenance register)

[Function code: 16 (10H)/61 (3DH)/63 (3FH)]

Analog settings value of count specified from the specified number, is considered to be the specified value. Data is split into high order 8 bits and low order 8 bits and arranged in numerical order and then sent.

Example) Time of slave 2 is set as 15 hours 30 minutes 00 seconds.

(Set 3 analog settings value reference number of slave 2, from 40004 to 40006.)

Reference number	40004	40005	40006
Data	15 (3135H)	30 (3330H)	00 (3030H)

(RTU mode)

Master → Instrument		Instrument → Master (Normal)	
Slave address	02H	Slave address	02H
Function code	10H	Function code	10H
Starting number (H)	00H	Starting number (H)	00H
Starting number (L)	03H	Starting number (L)	03H
Count (H)	00H	Count (H)	00H
Count (L)	03H	Count (L)	03H
Data count	06H	CRC (L)	70H
First data (H)	31H	CRC (H)	3BH
First data (L)	35H		
Second data (H)	33H		
Second data (L)	30H		
Third data (H)	30H		
Third data (L)	30H		
CRC (L)	80H		
CRC (H)	36H		

(ASCII mode error check)

LRC	B9H	LRC	E8H
-----	-----	-----	-----

Note) Starting number (Relative value) is "Reference number - 40001". (Decimal 3 (=40004-40001) → Hexadecimal 03H)

Note) When function code is 63, "Reference number - 20001"

Note) If slave address is 0 all the slaves execute this command. But no slave address responds.

Note) There is a limitation on the data count of the message (that this instrument can receive) that can be sent at a time. (Refer to 5.4)

5.6 Process during abnormality

Response is as follows when there is an error in the contents of the message from master.

5.6.1 For no response

In the following cases the message is ignored and there is no response.

- ① When transmission error (over run, framing, parity, CRC or LRC) is detected in the message.
- ② When the slave address in the message is not one's own address.
- ③ When the data interval of the message is long.
RTU mode... 28 bits or more
ASCII mode...1 second or more
- ④ When transmission parameter does not match.
- ⑤ When received message exceeds 512 bytes.

Note 1) In write function when slave address is "0", message is executed if there is no error in the message, but there is no response. Also there is no response in case of overwriting error in the message. Hence when slave address is "0", whether normal or abnormal cannot be judged just by response.

Note 2) When using USB and TCP/IP, respond by using the following formats except with errors at the physical layer.

Slave address
88H
Error code
CRC(L)
CRC(H)
Error code
99H: CR error

5.6.2 Error message response

In the contents of the message from the master, if following error is detected and not the error in 5.6.1, code showing those error contents responds as "error message".

Format of the error message is as follows.

Slave address
Function code+80H
Error code
CRC (L)
CRC (H)

Function code	Function code+80H
01	81H
02	82H
03	83H
04	84H
05	85H
06	86H
08	88H
16	90H
60	BCH
61	BDH
62	BEH
63	BFH
70	C6H
71	C7H

Error codes are as follows

Error code	Contents
01H	Function code defect When function code that is not specified is received
02H	Relative number (Reference number) defect When received starting number or settings value number are other than specified
03H	Data count defect In case of any of the following <ul style="list-style-type: none"> ① When received function code and data count do not match In case of function code "16", when "data count" is not twice that of "count" In case of function code "16", when data count does not match with the "received data count". ② When count of the data to be sent in response to the received message exceeds the specified count Maximum 120 units
11H	Out of setting value range (Set error) In case of any of the following <ul style="list-style-type: none"> ① When month, day, hours, minutes and range no. is other than specified ② When settings value (binary) exceeds the range "-30000 to 30000" ③ When data communication input data (binary) exceeds the range "-32765 to 32765" However, exceeding binary expression (-32768), data exceeding the range (32767 or -32767), burn out data (32766), invalid data (-32766) can be received. ④ When decimal point data exceeds the range "0-3" ⑤ When time interval settings of 'fixed time recording' cannot be executed due to chart speed ⑥ When there is a contradiction in the direction of increase and decrease in 'partial reduction magnification settings' and auto range settings ⑦ When RJ internal settings are out of thermocouple input range
12H	Cannot be set <ul style="list-style-type: none"> ① When message is received in any of the following cases Immediately after starting the power supply during initialization (When this instrument is performing initial display) Pointer scale connection mode Check mode ② When setting message is received in any of the following cases At the time of setting, using the front key or at the time of setting confirmation When "data print", "list" command is received during recording OFF status When parameter settings of multiple channels is received in parameter settings of each channel When parameter settings of option function that is not loaded are received ("0" is sent as response for the read message.)

5.7 Print message function

It is possible to print on the chart of this instrument the optional characters by communication.

(Printing specifications)

	Channel specifications exist	No channel specifications
Count of characters to be printed	Maximum 75 characters	Maximum 80 characters
Type of characters to be printed	English alphanumeric characters (upper case/lower case), symbols, Katakana (At the time of using Katakana, communication is always done by 8 bit data length)	
Print color	Black	
Feed specification	It can be specified whether to print after dividing the analog recording or whether to print on analog recording	

(Procedure)

- ① Print color, feed specifications, print contents are sent from the master to this instrument.
(Refer to reference number: 48001 to 48050)
- ② Execution message is sent from master to this instrument.(Reference number:20 Refer to 5.5.5)

Note) If ② is executed without executing ①, the contents printed previously are reprinted. If message printing is not done even once, nothing is printed.

5.8 Reference table

5.8.1 Digital settings value

R/W.....R: READ, W: WRITE

Reference Number	Application Function code	R/W	Contents	Details
01	01 05	R W	Key lock	0 (000h) = Key lock disabled 1 (FF00h) = Key lock enabled Contents in the () are the contents at the time of function code 05 Error code: 01H, 02H, 03H, 11H, 12H
17	01 05	R W	Recording ON/OFF	0 (000h) = Recording OFF 1 (FF00h) = Recording ON Contents in the () are the contents at the time of function code 05 Error code: 01H, 02H, 03H, 11H, 12H
18	01 05	R W	Execute feed	0 = Recording non execution (End execution) 1 (FF00h) = Recording in process (Start execution) Contents in the () are the contents at the time of function code 05 10mm feed for every execution reception Error code: 01H, 02H, 03H, 11H, 12H
19	01 05	R W	Execute print list	0 = Recording non execution (End execution) 1 (FF00h) = Recording being done (Start execution) Contents in the () are the contents at the time of function code 05 Error code: 01H, 02H, 03H, 11H, 12H
20	01 05	R W	Execute print message	0 = Recording non execution (End execution) 1 (FF00h) = Recording being done (Start execution) Contents in the () are the contents at the time of function code 05 Error code: 01H, 02H, 03H, 11H, 12H
21	01 05	R W	Execute all CH data print	When function code is 01 000000 = Recording non execution 000001 = Execute all CH 000010 = Execute CH001 to CH099 0000100 = Execute CH101 to CH199 0001010 = Execute CH201 to CH299 0010000 = Execute CH301 to CH399 0100000 = Execute CH401 to CH499 1000000 = Execute CH501 to CH599 When function code is 05 0 = End execution, FF00h = Start execution Error code: 01H, 02H, 03H, 11H, 12H
22			Execute CH001 to CH099	
23			Execute CH101 to CH199	
24			Execute CH201 to CH299	
25			Execute CH301 to CH399	
26			Execute CH401 to CH499	
27			Execute CH501 to CH599	

5.8.2 Digital input data

R/W.....R: READ, W: WRITE

Reference Number	Application Function code	R/W	Contents	Details
10009 10010 10011 10012	02	R	Status of external drive 1 Status of external drive 2 Status of external drive 3 Status of external drive 4	Status of external drive contact point input 0: OFF 1: ON
10101 10102	02	R	CH1 status 1	Status expression in 2 bits 00: Measurement value 01: Calculation data 10: Communication input data Error code: 01H, 02H, 03H
10105 10106 10107 10108	02	R	CH1 status 2	Status expression in 4 bits 0000: Normal data 0001: + Over range 0010: - Over range 0100: Burn out 1000: Invalid data (Initializing, acquiring data, no range settings) Error code: 01H, 02H, 03H
10109 10110 10111 10112	02	R	CH1 alarm level 1 CH1 alarm level 2 CH1 alarm level 3 CH1 alarm level 4 Activation status	0: Alarm not activated 1: Alarm activated Error code: 01H, 02H, 03H
10117 10118	02	R	CH2 status 1	Express status in 2 bits 00: Measurement value 01: Calculation data 10: Communication input data Error code: 01H, 02H, 03H
10121 10122 10123 10124	02	R	CH2 status 2	Status expression in 4 bits 0000: Normal data 0001: + Over range 0010: - Over range 0011: Burn out 1000: Invalid data (Initializing, acquiring data, no range settings) Error code: 01H, 02H, 03H
10125 10126 10127 10128	02	R	CH2 alarm level 1 CH2 alarm level 2 CH2 alarm level 3 CH2 alarm level 4 Activation status	0: Alarm not activated 1: Alarm activated Error code: 01H, 02H, 03H

Reference number	Application Function code	R/W	Contents	Details
10133 to 10134	02	R	CH3 status 1	Similar to CH1
10137 to 10140	02	R	CH3 status 2	Similar to CH1
10141 to 10144	02	R	Activation status of CH3 alarm level 1 to CH3 alarm level 4	Similar to CH1
10149 to 10150	02	R	CH4 status 1	Similar to CH1
10153 to 10156	02	R	CH4 status 2	Similar to CH1
10157 to 10160	02	R	Activation status of CH4 alarm level 1 to CH4 alarm level 4	Similar to CH1
10165 to 10166	02	R	CH5 status 1	Similar to CH1
10169 to 10172	02	R	CH5 status 2	Similar to CH1
10173 to 10177	02	R	Activation status of CH5 alarm level 1 to CH5 alarm level 4	Similar to CH1
10181 to 10182	02	R	CH6 status 1	Similar to CH1
10185 to 10188	02	R	CH6 status 2	Similar to CH1
10189 to 10192	02	R	Activation status of CH6 alarm level 1 to CH6 alarm level 4	Similar to CH1
10197 to 10198	02	R	CH7 status 1	Similar to CH1
10201 to 10204	02	R	CH7 status 2	Similar to CH1
10205 to 10208	02	R	Activation status of CH7 alarm level 1 to CH7 alarm level 4	Similar to CH1
10213 to 10214	02	R	CH8 status 1	Similar to CH1
10217 to 10220	02	R	CH8 status 2	Similar to CH1
10221 to 10224	02	R	Activation status of CH8 alarm level 1 to CH8 alarm level 4	Similar to CH1
10229 to 10230	02	R	CH9 status 1	Similar to CH1
10233 to 10236	02	R	CH9 status 2	Similar to CH1
10237 to 10240	02	R	Activation status of CH9 alarm level 1 to CH9 alarm level 4	Similar to CH1
10245 to 10246	02	R	CH10 status 1	Similar to CH1
10249 to 10252	02	R	CH10 status 2	Similar to CH1
10253 to 10256	02	R	Activation status of CH10 alarm level 1 to CH10 alarm level 4	Similar to CH1
10261 to 10262	02	R	CH11 status 1	Similar to CH1
10265 to 10268	02	R	CH11 status 2	Similar to CH1
10269 to 10272	02	R	Activation status of CH11 alarm level 1 to CH11 alarm level 4	Similar to CH1
10277 to 10278	02	R	CH12 status 1	Similar to CH1
10281 to 10284	02	R	CH12 status 2	Similar to CH1
10285 to 10288	02	R	Activation status of CH12 alarm level 1 to CH12 alarm level 4	Similar to CH1
10293 to 10294	02	R	CH13 status 1	Similar to CH1
10297 to 10300	02	R	CH13 status 2	Similar to CH1
10301 to 10304	02	R	Activation status of CH13 alarm level 1 to CH13 alarm level 4	Similar to CH1
10309 to 10310	02	R	CH14 status 1	Similar to CH1
10313 to 10316	02	R	CH14 status 2	Similar to CH1
10317 to 10320	02	R	Activation status of CH14 alarm level 1 to CH14 alarm level 4	Similar to CH1
10325 to 10326	02	R	CH15 status 1	Similar to CH1
10329 to 10332	02	R	CH15 status 2	Similar to CH1
10333 to 10336	02	R	Activation status of CH15 alarm level 1 to CH15 alarm level 4	Similar to CH1
10341 to 10342	02	R	CH16 status 1	Similar to CH1
10345 to 10348	02	R	CH16 status 2	Similar to CH1
10349 to 10352	02	R	Activation status of CH16 alarm level 1 to CH16 alarm level 4	Similar to CH1

Reference number	Application Function code	R/W	Contents	Details
10357 to 10358	02	R	CH17 status 1	Similar to CH1
10361 to 10364	02	R	CH17 status 2	Similar to CH1
10365 to 10368	02	R	Activation status of CH17 alarm level 1 to CH17 alarm level 4	Similar to CH1
10373 to 10374	02	R	CH18 status 1	Similar to CH1
10377 to 10380	02	R	CH18 status 2	Similar to CH1
10381 to 10384	02	R	Activation status of CH18 alarm level 1 to CH18 alarm level 4	Similar to CH1
10389 to 10390	02	R	CH19 status 1	Similar to CH1
10393 to 10396	02	R	CH19 status 2	Similar to CH1
10397 to 10400	02	R	Activation status of CH19 alarm level 1 to CH19 alarm level 4	Similar to CH1
10405 to 10406	02	R	CH20 status 1	Similar to CH1
10409 to 10412	02	R	CH20 status 2	Similar to CH1
10413 to 10416	02	R	Activation status of CH20 alarm level 1 to CH20 alarm level 4	Similar to CH1
10421 to 10422	02	R	CH21 status 1	Similar to CH1
10425 to 10428	02	R	CH21 status 2	Similar to CH1
10429 to 10432	02	R	Activation status of CH21 alarm level 1 to CH21 alarm level 4	Similar to CH1
10437 to 10438	02	R	CH22 status 1	Similar to CH1
10441 to 10444	02	R	CH22 status 2	Similar to CH1
10445 to 10448	02	R	Activation status of CH22 Alarm level 1 to CH22 Alarm level 4	Similar to CH1
10453 to 10454	02	R	CH23 status 1	Similar to CH1
10457 to 10460	02	R	CH23 status 2	Similar to CH1
10461 to 10464	02	R	Activation status of CH23 alarm level 1 to CH23 alarm level 4	Similar to CH1
10469 to 10470	02	R	CH24 status 1	Similar to CH1
10473 to 10476	02	R	CH24 status 2	Similar to CH1
10477 to 10480	02	R	Activation status of CH24 alarm level 1 to CH24 alarm level 4	Similar to CH1
10485 to 10486	02	R	CH25 status 1	Similar to CH1
10489 to 10492	02	R	CH25 status 2	Similar to CH1
10493 to 10496	02	R	Activation status of CH25 alarm level 1 to CH25 alarm level 4	Similar to CH1
10501 to 10502	02	R	CH26 status 1	Similar to CH1
10505 to 10508	02	R	CH26 status 2	Similar to CH1
10509 to 10512	02	R	Activation status of CH26 alarm level 1 to CH26 alarm level 4	Similar to CH1
10517 to 10518	02	R	CH27 status 1	Similar to CH1
10521 to 10524	02	R	CH27 status 2	Similar to CH1
10525 to 10528	02	R	Activation status of CH27 alarm level 1 to CH27 alarm level 4	Similar to CH1
10533 to 10534	02	R	CH28 status 1	Similar to CH1
10537 to 10540	02	R	CH28 status 2	Similar to CH1
10541 to 10544	02	R	Activation status of CH28 alarm level 1 to CH28 alarm level 4	Similar to CH1
10549 to 10550	02	R	CH29 status 1	Similar to CH1
10553 to 10556	02	R	CH29 status 2	Similar to CH1
10557 to 10560	02	R	Activation status of CH29 alarm level 1 to CH29 alarm level 4	Similar to CH1

Reference number	Application Function code	R/W	Contents	Details
10565 to 10566	02	R	CH30 status 1	Similar to CH1
10569 to 10572	02	R	CH30 status 2	Similar to CH1
10573 to 10576	02	R	Activation status of CH30 alarm level 1 to CH30 alarm level 4	Similar to CH1
10581 to 10582	02	R	CH31 status 1	Similar to CH1
10585 to 10588	02	R	CH31 status 2	Similar to CH1
10589 to 10592	02	R	Activation status of CH32 alarm level 1 to CH32 alarm level 4	Similar to CH1
10597 to 10598	02	R	CH33 status 1	Similar to CH1
10601 to 10604	02	R	CH33 status 2	Similar to CH1
10605 to 10608	02	R	Activation status of CH33 alarm level 1 to CH33 alarm level 4	Similar to CH1
10613 to 10614	02	R	CH34 status 1	Similar to CH1
10617 to 10620	02	R	CH34 status 2	Similar to CH1
10621 to 10624	02	R	Activation status of CH34 alarm level 1 to CH34 alarm level 4	Similar to CH1
10629 to 10630	02	R	CH35 status 1	Similar to CH1
10633 to 10636	02	R	CH35 status 2	Similar to CH1
10637 to 10640	02	R	Activation status of CH35 alarm level 1 to CH35 alarm level 4	Similar to CH1
10645 to 10646	02	R	CH36 status 1	Similar to CH1
10649 to 10652	02	R	CH36 status 2	Similar to CH1
10653 to 10656	02	R	Activation status of CH36 alarm level 1 to CH36 alarm level 4	Similar to CH1
10661 to 10662	02	R	CH37 status 1	Similar to CH1
10665 to 10668	02	R	CH37 status 2	Similar to CH1
10669 to 10672	02	R	Activation status of CH37 alarm level 1 to CH37 alarm level 4	Similar to CH1
10677 to 10678	02	R	CH38 status 1	Similar to CH1
10681 to 10684	02	R	CH38 status 2	Similar to CH1
10685 to 10688	02	R	Activation status of CH38 alarm level 1 to CH38 alarm level 4	Similar to CH1
10693 to 10694	02	R	CH39 status 1	Similar to CH1
10697 to 10700	02	R	CH39 status 2	Similar to CH1
10701 to 10704	02	R	Activation status of CH39 alarm level 1 to CH39 alarm level 4	Similar to CH1
10709 to 10710	02	R	CH40 status 1	Similar to CH1
10713 to 10716	02	R	CH40 status 2	Similar to CH1
10717 to 10720	02	R	Activation status of CH40 alarm level 1 to CH40 alarm level 4	Similar to CH1
10725 to 10726	02	R	CH41 status 1	Similar to CH1
10729 to 10732	02	R	CH41 status 2	Similar to CH1
10733 to 10736	02	R	Activation status of CH41 alarm level 1 to CH41 alarm level 4	Similar to CH1
10741 to 10742	02	R	CH42 status 1	Similar to CH1
10745 to 10748	02	R	CH42 status 2	Similar to CH1
10749 to 10752	02	R	Activation status of CH42 alarm level 1 to CH42 alarm level 4	Similar to CH1
10757 to 10758	02	R	CH43 status 1	Similar to CH1
10761 to 10764	02	R	CH43 status 2	Similar to CH1
10765 to 10768	02	R	Activation status of CH43 alarm level 1 to CH43 alarm level 4	Similar to CH1

Reference number	Application Function code	R/W	Contents	Details
10773 to 10774	02	R	CH44 status 1	Similar to CH1
10777 to 10780	02	R	CH44 status 2	Similar to CH1
10781 to 10784	02	R	Activation status of CH44 alarm level 1 to CH44 alarm level 4	Similar to CH1
10789 to 10790	02	R	CH45 status 1	Similar to CH1
10793 to 10796	02	R	CH45 status 2	Similar to CH1
10797 to 10800	02	R	Activation status of CH45 alarm level 1 to CH45 alarm level 4	Similar to CH1
10805 to 10806	02	R	CH46 status 1	Similar to CH1
10809 to 10812	02	R	CH46 status 2	Similar to CH1
10813 to 10816	02	R	Activation status of CH46 alarm level 1 to CH46 alarm level 4	Similar to CH1
10821 to 10822	02	R	CH47 status 1	Similar to CH1
10825 to 10828	02	R	CH47 status 2	Similar to CH1
10829 to 10832	02	R	Activation status of CH47 alarm level 1 to CH47 alarm level 4	Similar to CH1
10837 to 10838	02	R	CH48 status 1	Similar to CH1
10841 to 10844	02	R	CH48 status 2	Similar to CH1
10845 to 10848	02	R	Activation status of CH48 alarm level 1 to CH48 alarm level 4	Similar to CH1
10853 to 10854	02	R	CH49 status 1	Similar to CH1
10857 to 10860	02	R	CH49 status 2	Similar to CH1
10861 to 10865	02	R	Activation status of CH49 alarm level 1 to CH49 alarm level 4	Similar to CH1
10870 to 10871	02	R	CH50 status 1	Similar to CH1
10874 to 10877	02	R	CH50 status 2	Similar to CH1
10878 to 10881	02	R	Activation status of CH50 alarm level 1 to CH50 alarm level 4	Similar to CH1
10886 to 10887	02	R	CH51 status 1	Similar to CH1
10890 to 10893	02	R	CH51 status 2	Similar to CH1
10894 to 10897	02	R	Activation status of CH51 alarm level 1 to CH51 alarm level 4	Similar to CH1
10902 to 10903	02	R	CH52 status 1	Similar to CH1
10906 to 10909	02	R	CH52 status 2	Similar to CH1
10910 to 10913	02	R	Activation status of CH52 alarm level 1 to CH52 alarm level 4	Similar to CH1
10918 to 10919	02	R	CH53 status 1	Similar to CH1
10922 to 10925	02	R	CH53 status 2	Similar to CH1
10926 to 10929	02	R	Activation status of CH53 alarm level 1 to CH53 alarm level 4	Similar to CH1
10934 to 10935	02	R	CH54 status 1	Similar to CH1
10938 to 10941	02	R	CH54 status 2	Similar to CH1
10942 to 10945	02	R	Activation status of CH54 alarm level 1 to CH54 alarm level 4	Similar to CH1
10950 to 10951	02	R	CH55 status 1	Similar to CH1
10954 to 10957	02	R	CH55 status 2	Similar to CH1
10958 to 10961	02	R	Activation status of CH55 alarm level 1 to CH55 alarm level 4	Similar to CH1
10966 to 10967	02	R	CH56 status 1	Similar to CH1
10970 to 10973	02	R	CH56 status 2	Similar to CH1
10974 to 10977	02	R	Activation status of CH56 alarm level 1 to CH56 alarm level 4	Similar to CH1

Reference number	Application Function code	R/W	Contents	Details
10982 to 10983	02	R	CH57 status 1	Similar to CH1
10986 to 10989	02	R	CH57 status 2	Similar to CH1
10990 to 10993	02	R	Activation status of CH57 alarm level 1 to CH57 alarm level 4	Similar to CH1
10998 to 10999	02	R	CH58 status 1	Similar to CH1
11002 to 11005	02	R	CH58 status 2	Similar to CH1
11006 to 11009	02	R	Activation status of CH58 alarm level 1 to CH58 alarm level 4	Similar to CH1
11014 to 11015	02	R	CH59 status 1	Similar to CH1
11018 to 11021	02	R	CH59 status 2	Similar to CH1
11022 to 11025	02	R	Activation status of CH59 alarm level 1 to CH59 alarm level 4	Similar to CH1
11030 to 11031	02	R	CH60 status 1	Similar to CH1
11034 to 11037	02	R	CH60 status 2	Similar to CH1
11038 to 11041	02	R	Activation status of CH60 alarm level 1 to CH60 alarm level 4	Similar to CH1
11046 to 11047	02	R	CH61 status 1	Similar to CH1
11050 to 11053	02	R	CH61 status 2	Similar to CH1
11054 to 11057	02	R	Activation status of CH61 alarm level 1 to CH61 alarm level 4	Similar to CH1
11062 to 11063	02	R	CH62 status 1	Similar to CH1
11066 to 11069	02	R	CH62 status 2	Similar to CH1
11070 to 11073	02	R	Activation status of CH62 alarm level 1 to CH62 Alarm level 4	Similar to CH1
11078 to 11079	02	R	CH63 status 1	Similar to CH1
11082 to 11085	02	R	CH63 status 2	Similar to CH1
11086 to 11089	02	R	Activation status of CH63 Alarm level 1 to CH63 Alarm level 4	Similar to CH1
11094 to 11095	02	R	CH63 status 1	Similar to CH1
11098 to 11101	02	R	CH63 status 2	Similar to CH1
11102 to 11105	02	R	Activation status of CH63 Alarm level 1 to CH63 Alarm level 4	Similar to CH1
11110 to 11111	02	R	CH64 status 1	Similar to CH1
11114 to 11117	02	R	CH64 status 2	Similar to CH1
11118 to 11121	02	R	Activation status of CH64 Alarm level 1 to CH64 Alarm level 4	Similar to CH1
11126 to 11127	02	R	CH65 status 1	Similar to CH1
11130 to 11133	02	R	CH65 status 2	Similar to CH1
11134 to 11137	02	R	Activation status of CH65 Alarm level 1 to CH65 Alarm level 4	Similar to CH1
11142 to 11143	02	R	CH66 status 1	Similar to CH1
11146 to 11149	02	R	CH66 status 2	Similar to CH1
11150 to 11153	02	R	Activation status of CH66 Alarm level 1 to CH66 Alarm level 4	Similar to CH1
11158 to 11159	02	R	CH66 status 1	Similar to CH1
11162 to 11165	02	R	CH66 status 2	Similar to CH1
11166 to 11169	02	R	Activation status of CH66 Alarm level 1 to CH66 Alarm level 4	Similar to CH1
11174 to 11175	02	R	CH67 status 1	Similar to CH1
11178 to 11181	02	R	CH67 status 2	Similar to CH1
11182 to 11185	02	R	Activation status of CH67 Alarm level 1 to CH67 Alarm level 4	Similar to CH1

R/W.....R: READ, W: WRITE

Reference number	Application Function code	R/W	Contents	Details
11190 to 11191	02	R	CH68 status 1	Similar to CH1
11194 to 11197	02	R	CH68 status 2	Similar to CH1
11198 to 11201	02	R	Activation status of CH68 Alarm level 1 to CH68 Alarm level 4	Similar to CH1
11206 to 11207	02	R	CH69 status 1	Similar to CH1
11210 to 11213	02	R	CH69 status 2	Similar to CH1
11214 to 11217	02	R	Activation status of CH69 Alarm level 1 to CH69 Alarm level 4	Similar to CH1
11222 to 11223	02	R	CH70 status 1	Similar to CH1
11226 to 11229	02	R	CH70 status 2	Similar to CH1
11230 to 11233	02	R	Activation status of CH70 Alarm level 1 to CH70 Alarm level 4	Similar to CH1
11238 to 11239	02	R	CH71 status 1	Similar to CH1
11242 to 11245	02	R	CH71 status 2	Similar to CH1
11246 to 11249	02	R	Activation status of CH71 Alarm level 1 to CH71 Alarm level 4	Similar to CH1
11254 to 11255	02	R	CH72 status 1	Similar to CH1
11258 to 11261	02	R	CH72 status 2	Similar to CH1
11262 to 11265	02	R	Activation status of CH72 Alarm level 1 to CH72 Alarm level 4	Similar to CH1

5.8.3 Analog input data

1) Reading instrument specification

R/W.....R: READ, W: WRITE

Reference number	Application Function code	R/W	Contents	Details
30001	04	R	Instrument name character 1,2	ASCII"LE" (Fixed) Error code: 01H, 02H, 03H, 12H
30002	04	R	Instrument name character 3,4	ASCII"51"or"52" Error code: 01H, 02H, 03H, 12H
30003	04	R	Instrument name character 5,6	ASCII...1st digit: input, 2nd digit: output 1st digit...0:None, 1: 12 points, 2: 24 points, 3:36 points 2nd digit...0: None, 1: 12 points, 2: 24 points, 3: 36 points Error code: 01H, 02H, 03H, 12H
30009	04	R	ROM version character 1,2	ASCII 2 digits Error code: 01H, 02H, 03H, 12H
30010	04	R	ROM version character 3,4	ASCII 2 digits Error code: 01H, 02H, 03H, 12H
30011	04	R	ROM version character 5,6	ASCII 2 digits Error code: 01H, 02H, 03H, 12H
30017	04	R	Input points	0: None, 12, 24, 36 Error code: 01H, 02H, 03H, 12H
30025	04	R	Alarm output points	0: None, 12, 24, 36 Error code: 01H, 02H, 03H, 12H
30026	04	R	External drive	0:Does not exist 1: Exists Error code: 01H, 02H, 03H, 12H
30027	04	R	Communication type	0:None,1: RS-422A, RS-485, USB, EtherNet Error code: 01H, 02H, 03H, 12H
30028	04	R	Option information	0:None,1:Calculation Error code: 01H, 02H, 03H, 12H

2) Reading measurement data

R/W.....R: READ, W: WRITE

Reference number	Application function code	R/W	Contents	Details
30101	04	R	CH1 data	DATA: -32765 to 32765 -32768: Binary expression exceeded 32767: + Exceeded range -32767: - Exceeded range 32766: Burn out data -32766: Invalid data Error code: 01H, 02H, 03H, 12H
30102	04	R	CH1 decimal point status	Data status, event status, decimal point (described later) Error code: 01H, 02H, 03H, 12H
30103	04	R	CH2 data	Similar to CH1 Error code: 01H, 02H, 03H, 12H

Reference Number	Application function code	R/W	Contents	Details
30104	04	R	CH2 decimal point status	Similar to CH1 Error code: 01H, 02H, 03H, 12H
30105	04	R	CH3 data	Similar to CH1 Error code: 01H, 02H, 03H, 12H
30106	04	R	CH3 decimal point status	Similar to CH1 Error code: 01H, 02H, 03H, 12H
30107	04	R	CH4 data	Similar to CH1 Error code: 01H, 02H, 03H, 12H
30108	04	R	CH4 decimal point status	Similar to CH1 Error code: 01H, 02H, 03H, 12H
30109	04	R	CH5 data	Similar to CH1 Error code: 01H, 02H, 03H, 12H
30110	04	R	CH5 decimal point status	Similar to CH1 Error code: 01H, 02H, 03H, 12H
30111	04	R	CH6 data	Similar to CH1 Error code: 01H, 02H, 03H, 12H
30112	04	R	CH6 decimal point status	Similar to CH1 Error code: 01H, 02H, 03H, 12H
30113	04	R	CH7 data	Similar to CH1 Error code: 01H, 02H, 03H, 12H
30114	04	R	CH7 decimal point status	Similar to CH1 Error code: 01H, 02H, 03H, 12H
30115	04	R	CH8 data	Similar to CH1 Error code: 01H, 02H, 03H, 12H
30116	04	R	CH8 decimal point status	Similar to CH1 Error code: 01H, 02H, 03H, 12H
30117	04	R	CH9 data	Similar to CH1 Error code: 01H, 02H, 03H, 12H
30118	04	R	CH9 decimal point status	Similar to CH1 Error code: 01H, 02H, 03H, 12H
30119	04	R	CH10 data	Similar to CH1 Error code: 01H, 02H, 03H, 12H
30120	04	R	CH10 decimal point status	Similar to CH1 Error code: 01H, 02H, 03H, 12H
30121	04	R	CH11 data	Similar to CH1 Error code: 01H, 02H, 03H, 12H
30122	04	R	CH11 decimal point status	Similar to CH1 Error code: 01H, 02H, 03H, 12H
30123	04	R	CH12 data	Similar to CH1 Error code: 01H, 02H, 03H, 12H
30124	04	R	CH12 decimal point status	Similar to CH1 Error code: 01H, 02H, 03H, 12H
30125	04	R	CH13 data	Similar to CH1 Error code: 01H, 02H, 03H, 12H
30126	04	R	CH13 decimal point status	Similar to CH1 Error code: 01H, 02H, 03H, 12H
30127	04	R	CH14 data	Similar to CH1 Error code: 01H, 02H, 03H, 12H

Reference Number	Application function code	R/W	Contents	Details
30128	04	R	CH14 decimal point status	Similar to CH1 Error code: 01H, 02H, 03H, 12H
30129	04	R	CH15 data	Similar to CH1 Error code: 01H, 02H, 03H, 12H
30130	04	R	CH15 decimal point status	Similar to CH1 Error code: 01H, 02H, 03H, 12H
30131	04	R	CH16 data	Similar to CH1 Error code: 01H, 02H, 03H, 12H
30132	04	R	CH16 decimal point status	Similar to CH1 Error code: 01H, 02H, 03H, 12H
30133	04	R	CH17 data	Similar to CH1 Error code: 01H, 02H, 03H, 12H
30134	04	R	CH17 decimal point status	Similar to CH1 Error code: 01H, 02H, 03H, 12H
30135	04	R	CH18 data	Similar to CH1 Error code: 01H, 02H, 03H, 12H
30136	04	R	CH18 decimal point status	Similar to CH1 Error code: 01H, 02H, 03H, 12H
30137	04	R	CH19 data	Similar to CH1 Error code: 01H, 02H, 03H, 12H
30138	04	R	CH19 decimal point status	Similar to CH1 Error code: 01H, 02H, 03H, 12H
30139	04	R	CH20 data	Similar to CH1 Error code: 01H, 02H, 03H, 12H
30140	04	R	CH20 decimal point status	Similar to CH1 Error code: 01H, 02H, 03H, 12H
30141	04	R	CH21 data	Similar to CH1 Error code: 01H, 02H, 03H, 12H
30142	04	R	CH21 decimal point status	Similar to CH1 Error code: 01H, 02H, 03H, 12H
30143	04	R	CH22 data	Similar to CH1 Error code: 01H, 02H, 03H, 12H
30144	04	R	CH22 decimal point status	Similar to CH1 Error code: 01H, 02H, 03H, 12H
30145	04	R	CH23 data	Similar to CH1 Error code: 01H, 02H, 03H, 12H
30146	04	R	CH23 decimal point status	Similar to CH1 Error code: 01H, 02H, 03H, 12H
30147	04	R	CH24 data	Similar to CH1 Error code: 01H, 02H, 03H, 12H
30148	04	R	CH24 decimal point status	Similar to CH1 Error code: 01H, 02H, 03H, 12H
30149	04	R	CH25 data	Similar to CH1 Error code: 01H, 02H, 03H, 12H
30150	04	R	CH25 decimal point status	Similar to CH1 Error code: 01H, 02H, 03H, 12H
30151	04	R	CH26 data	Similar to CH1 Error code: 01H, 02H, 03H, 12H

Reference Number	Application function code	R/W	Contents	Details
30152	04	R	CH26 decimal point status	Similar to CH1 Error code: 01H, 02H, 03H, 12H
30153	04	R	CH27 data	Similar to CH1 Error code: 01H, 02H, 03H, 12H
30154	04	R	CH27 decimal point status	Similar to CH1 Error code: 01H, 02H, 03H, 12H
30155	04	R	CH28 data	Similar to CH1 Error code: 01H, 02H, 03H, 12H
30156	04	R	CH28 decimal point status	Similar to CH1 Error code: 01H, 02H, 03H, 12H
30157	04	R	CH29 data	Similar to CH1 Error code: 01H, 02H, 03H, 12H
30158	04	R	CH29 decimal point status	Similar to CH1 Error code: 01H, 02H, 03H, 12H
30159	04	R	CH30 data	Similar to CH1 Error code: 01H, 02H, 03H, 12H
30160	04	R	CH30 decimal point status	Similar to CH1 Error code: 01H, 02H, 03H, 12H
30161	04	R	CH31 data	Similar to CH1 Error code: 01H, 02H, 03H, 12H
30162	04	R	CH31 decimal point status	Similar to CH1 Error code: 01H, 02H, 03H, 12H
30163	04	R	CH32 data	Similar to CH1 Error code: 01H, 02H, 03H, 12H
30164	04	R	CH32 decimal point status	Similar to CH1 Error code: 01H, 02H, 03H, 12H
30165	04	R	CH33 data	Similar to CH1 Error code: 01H, 02H, 03H, 12H
30166	04	R	CH33 decimal point status	Similar to CH1 Error code: 01H, 02H, 03H, 12H
30167	04	R	CH34 data	Similar to CH1 Error code: 01H, 02H, 03H, 12H
30168	04	R	CH34 decimal point status	Similar to CH1 Error code: 01H, 02H, 03H, 12H
30169	04	R	CH35 data	Similar to CH1 Error code: 01H, 02H, 03H, 12H
30170	04	R	CH35 decimal point status	Similar to CH1 Error code: 01H, 02H, 03H, 12H
30171	04	R	CH36 data	Similar to CH1 Error code: 01H, 02H, 03H, 12H
30172	04	R	CH36 decimal point status	Similar to CH1 Error code: 01H, 02H, 03H, 12H
30173	04	R	CH37 data	Similar to CH1 Error code: 01H, 02H, 03H, 12H
30174	04	R	CH37 decimal point status	Similar to CH1 Error code: 01H, 02H, 03H, 12H
30175	04	R	CH38 data	Similar to CH1 Error code: 01H, 02H, 03H, 12H

Reference Number	Application function code	R/W	Contents	Details
30176	04	R	CH38 decimal point status	Similar to CH1 Error code: 01H, 02H, 03H, 12H
30177	04	R	CH39 data	Similar to CH1 Error code: 01H, 02H, 03H, 12H
30178	04	R	CH39 decimal point status	Similar to CH1 Error code: 01H, 02H, 03H, 12H
30179	04	R	CH40 data	Similar to CH1 Error code: 01H, 02H, 03H, 12H
30180	04	R	CH40 decimal point status	Similar to CH1 Error code: 01H, 02H, 03H, 12H
30181	04	R	CH41 data	Similar to CH1 Error code: 01H, 02H, 03H, 12H
30182	04	R	CH41 decimal point status	Similar to CH1 Error code: 01H, 02H, 03H, 12H
30183	04	R	CH42 data	Similar to CH1 Error code: 01H, 02H, 03H, 12H
30184	04	R	CH42 decimal point status	Similar to CH1 Error code: 01H, 02H, 03H, 12H
30185	04	R	CH43 data	Similar to CH1 Error code: 01H, 02H, 03H, 12H
30186	04	R	CH43 decimal point status	Similar to CH1 Error code: 01H, 02H, 03H, 12H
30187	04	R	CH44 data	Similar to CH1 Error code: 01H, 02H, 03H, 12H
30188	04	R	CH44 decimal point status	Similar to CH1 Error code: 01H, 02H, 03H, 12H
30189	04	R	CH45 data	Similar to CH1 Error code: 01H, 02H, 03H, 12H
30190	04	R	CH45 decimal point status	Similar to CH1 Error code: 01H, 02H, 03H, 12H
30191	04	R	CH46 data	Similar to CH1 Error code: 01H, 02H, 03H, 12H
30192	04	R	CH46 decimal point status	Similar to CH1 Error code: 01H, 02H, 03H, 12H
30193	04	R	CH47 data	Similar to CH1 Error code: 01H, 02H, 03H, 12H
30194	04	R	CH47 decimal point status	Similar to CH1 Error code: 01H, 02H, 03H, 12H
30195	04	R	CH48 data	Similar to CH1 Error code: 01H, 02H, 03H, 12H
30196	04	R	CH48 decimal point status	Similar to CH1 Error code: 01H, 02H, 03H, 12H
30197	04	R	CH49 data	Similar to CH1 Error code: 01H, 02H, 03H, 12H
30198	04	R	CH49 decimal point status	Similar to CH1 Error code: 01H, 02H, 03H, 12H
30199	04	R	CH50 data	Similar to CH1 Error code: 01H, 02H, 03H, 12H

Reference Number	Application function code	R/W	Contents	Details
30200	04	R	CH50 decimal point status	Similar to CH1 Error code: 01H, 02H, 03H, 12H
30201	04	R	CH51 data	Similar to CH1 Error code: 01H, 02H, 03H, 12H
30202	04	R	CH51 decimal point status	Similar to CH1 Error code: 01H, 02H, 03H, 12H
30203	04	R	CH52 data	Similar to CH1 Error code: 01H, 02H, 03H, 12H
30204	04	R	CH52 decimal point status	Similar to CH1 Error code: 01H, 02H, 03H, 12H
30205	04	R	CH53 data	Similar to CH1 Error code: 01H, 02H, 03H, 12H
30206	04	R	CH53 decimal point status	Similar to CH1 Error code: 01H, 02H, 03H, 12H
30207	04	R	CH54 data	Similar to CH1 Error code: 01H, 02H, 03H, 12H
30208	04	R	CH54 decimal point status	Similar to CH1 Error code: 01H, 02H, 03H, 12H
30209	04	R	CH55 data	Similar to CH1 Error code: 01H, 02H, 03H, 12H
30210	04	R	CH55 decimal point status	Similar to CH1 Error code: 01H, 02H, 03H, 12H
30211	04	R	CH56 data	Similar to CH1 Error code: 01H, 02H, 03H, 12H
30212	04	R	CH56 decimal point status	Similar to CH1 Error code: 01H, 02H, 03H, 12H
30213	04	R	CH57 data	Similar to CH1 Error code: 01H, 02H, 03H, 12H
30214	04	R	CH57 decimal point status	Similar to CH1 Error code: 01H, 02H, 03H, 12H
30215	04	R	CH58 data	Similar to CH1 Error code: 01H, 02H, 03H, 12H
30216	04	R	CH58 decimal point status	Similar to CH1 Error code: 01H, 02H, 03H, 12H
30217	04	R	CH59 data	Similar to CH1 Error code: 01H, 02H, 03H, 12H
30218	04	R	CH59 decimal point status	Similar to CH1 Error code: 01H, 02H, 03H, 12H
30219	04	R	CH60 data	Similar to CH1 Error code: 01H, 02H, 03H, 12H
30220	04	R	CH60 decimal point status	Similar to CH1 Error code: 01H, 02H, 03H, 12H
30221	04	R	CH61 data	Similar to CH1 Error code: 01H, 02H, 03H, 12H
30222	04	R	CH61 decimal point status	Similar to CH1 Error code: 01H, 02H, 03H, 12H
30223	04	R	CH62 data	Similar to CH1 Error code: 01H, 02H, 03H, 12H

Reference Number	Application function code	R/W	Contents	Details
30224	04	R	CH62 decimal point status	Similar to CH1 Error code: 01H, 02H, 03H, 12H
30225	04	R	CH63 data	Similar to CH1 Error code: 01H, 02H, 03H, 12H
30226	04	R	CH63 decimal point status	Similar to CH1 Error code: 01H, 02H, 03H, 12H
30227	04	R	CH64 data	Similar to CH1 Error code: 01H, 02H, 03H, 12H
30228	04	R	CH64 decimal point status	Similar to CH1 Error code: 01H, 02H, 03H, 12H
30229	04	R	CH65 data	Similar to CH1 Error code: 01H, 02H, 03H, 12H
30230	04	R	CH65 decimal point status	Similar to CH1 Error code: 01H, 02H, 03H, 12H
30231	04	R	CH66 data	Similar to CH1 Error code: 01H, 02H, 03H, 12H
30232	04	R	CH66 decimal point status	Similar to CH1 Error code: 01H, 02H, 03H, 12H
30233	04	R	CH67 data	Similar to CH1 Error code: 01H, 02H, 03H, 12H
30234	04	R	CH67 decimal point status	Similar to CH1 Error code: 01H, 02H, 03H, 12H
30235	04	R	CH68 data	Similar to CH1 Error code: 01H, 02H, 03H, 12H
30236	04	R	CH68 decimal point status	Similar to CH1 Error code: 01H, 02H, 03H, 12H
30237	04	R	CH69 data	Similar to CH1 Error code: 01H, 02H, 03H, 12H
30238	04	R	CH69 decimal point status	Similar to CH1 Error code: 01H, 02H, 03H, 12H
30239	04	R	CH70 data	Similar to CH1 Error code: 01H, 02H, 03H, 12H
30240	04	R	CH70 decimal point status	Similar to CH1 Error code: 01H, 02H, 03H, 12H
30241	04	R	CH71 data	Similar to CH1 Error code: 01H, 02H, 03H, 12H
30242	04	R	CH71 decimal point status	Similar to CH1 Error code: 01H, 02H, 03H, 12H
30243	04	R	CH72 data	Similar to CH1 Error code: 01H, 02H, 03H, 12H
30244	04	R	CH72 decimal point status	Similar to CH1 Error code: 01H, 02H, 03H, 12H

5.8.4 Analog setting value

1) Common parameters

R/WR/W.....R:READ, W: WRITE

Reference Number	Application function code	R/W	Contents	Details
40001	03 06 16	R W W	Clock settings (Year)	ASCII 2 digits (First digit can also be a space code) 00 to 97: Year 2000 to Year 2097 98 to 99: Year 1998 to Year 1999 Error code: 01H, 02H, 03H, 11H
40002	03 06 16	R W W	Clock settings (Month)	ASCII 2 digits (First digit can also be a space code) 01 to 12 Error code: 01H, 02H, 03H, 11H
40003	03 06 16	R W W	Clock settings (Month)	ASCII 2 digits (First digit can also be a space code) 01 to 31 Leap year judgment, odd month, even month judgment Error code: 01H, 02H, 03H, 11H
40004	03 06 16	R W W	Clock settings (Hours)	ASCII 2 digits (First digit can also be a space code) 00 to 23 Error code: 01H, 02H, 03H, 11H
40005	03 06 16	R W W	Clock settings (Minutes)	ASCII 2 digits (First digit can also be a space code) 00 to 59 Error code: 01H, 02H, 03H, 11H
40006	03 06 16	R W W	Clock settings (Seconds)	ASCII 2 digits (First digit can also be a space code) 00 to 59 Error code: 01H, 02H, 03H, 11H
40007	03	R	Era name first 2 digits	ASCII 2 digits 19, 20 Error code: 01H, 02H, 03H, 12H
40008	03	R	Era name last 2 digits	ASCII 2 digits 00 to 99 Error code: 01H, 02H, 03H, 12H
40009	03 06 16	R W W	External drive 1 function	0: No function assigned 1: Chart speed 1 2: Chart speed 2 3: Chart speed 3 4: Stop and execute recording 5: Data print 6: Memory card trigger
40010	03 06 16	R W W	External drive 2 functions	
40011	03 06 16	R W W	External drive 3 functions	
40012	03 06 16	R W W	External drive 4 functions	Writing is valid only with external drive option Error code: 01H, 02H, 03H, 11H, 12H
40017	03	R	Execute chart number	1 to 3 Read only is valid Error code: 01H, 02H, 03H, 11H, 12H

Reference Number	Application function code	R/W	Contents	Details
40018	03 06 16	R W W	Optional intermittent period	3 to 60: 3 to 60 seconds 1 second step Error code: 01H, 02H, 03H, 11H, 12H
40019	03 06 16	R W W	Chart speed 1 settings	1 to 1500: 1 to 1500 mm/h 1mm step Error code: 01H, 02H, 03H, 11H
40021	03 06 16	R W W	Chart speed 1 synchronous mode	0: Chart speed 1 synchronous, 1: Scan period synchronous Error code: 01H, 02H, 03H, 11H
40022	03 06 16	R W W	Chart speed 2 settings	1 to 1500: 1 to 1500 mm/h 1mm step Writing is valid only with external drive option Error code: 01H, 02H, 03H, 11H, 12H
40024	03 06 16	R W W	Chart speed 2 synchronous mode	0: Chart speed 1 synchronous, 1: Scan period synchronous Writing is valid only with external drive option Error code: 01H, 02H, 03H, 11H, 12H
40025	03 06 16	R W W	Chart speed 3 settings	1 to 1500: 1 to 1500 mm/h 1mm step Writing is valid only with external drive option Error code: 01H, 02H, 03H, 11H, 12H
40027	03 06 16	R W W	Chart speed 3 synchronous mode	0: Chart speed 1 synchronous, 1: Scan period synchronous Writing is valid only with external drive option Error code: 01H, 02H, 03H, 11H, 12H
40033	03 06 16	R W W	Data interval settings Format number	1: Chart blank part, 6: 6CH/1 line, 10: 10CH/1 line 0: None Error code: 01H, 02H, 03H, 11H
40034	03 06 16	R W W	Data interval settings Interval (Hours)	ASCII 2 digits (First digit can also be a space code) 00 to 23 Error code: 01H, 02H, 03H, 11H
40035	03 06 16	R W W	Data interval settings Interval (Minutes)	ASCII 2 digits (First digit can also be a space code) 00 to 59 Error code: 01H, 02H, 03H, 11H
40036	03 06 16	R W W	Data interval settings Start time (Hours)	ASCII 2 digits (First digit can also be a space code) 00 to 23 Error code: 01H, 02H, 03H, 11H
40037	03 06 16	R W W	Data interval settings Start time (Minutes)	ASCII 2 digits (First digit can also be a space code) 00 to 59 Error code: 01H, 02H, 03H, 11H
40038	03 06 16	R W W	Key lock settings Format number	6: 6CH/1 line, 10: 10CH/1 line 0: None Error code: 01H, 02H, 03H, 11H
40039	03 06 16	R W W	Key lock settings Interval (Hours)	ASCII 2 digits (First digit can also be a space code) 00 to 24 Error code: 01H, 02H, 03H, 11H

Reference Number	Application function code	R/W	Contents	Details
40040	03 06 16	R W W	Key lock settings Interval (Minutes)	ASCII 2 digits (First digit can also be a space code) 00 to 59 Error code: 01H, 02H, 03H, 11H
40041	03 06 16	R W W	Key lock settings Start time (Hours)	ASCII 2 digits (First digit can also be a space code) 00 to 23 Error code: 01H, 02H, 03H, 11H
40042	03 06 16	R W W	Key lock settings Start time (Minutes)	ASCII 2 digits (First digit can also be a space code) 00 to 59 Error code: 01H, 02H, 03H, 11H
40043	03 06 16	R W W	Print data, settings Format number	6: 6CH/1 line, 10: 10CH/1 line Error code: 01H, 02H, 03H, 11H
40049	03 06 16	R W W	Recording format type	0: Standard, 1: Auto range switching 2: Reduce or magnify the part, 3: Parallel pointer scale Error code: 01H, 02H, 03H, 11H, 12H
40050	03 06 16	R W W	Parallel recording Area count	2 to 5 Error code: 01H, 02H, 03H, 11H, 12H
40051	03 06 16	R W W	Parallel recording First area setting 1	ASCII 2 digits (First digit can also be a space code) 01 - intermittent number count Error code: 01H, 02H, 03H, 11H, 12H
40052	03 06 16	R W W	Parallel recording First area delimiter 1	0: No settings, 1:/ ,2: - Error code: 01H, 02H, 03H, 11H, 12H
40053	03 06 16	R W W	Parallel recording First area setting 2	ASCII 2 digits (First digit can also be a space code) 01 to Intermittent number count, 00H: No settings Error code: 01H, 02H, 03H, 11H, 12H
40054	03 06 16	R W W	Parallel recording First area delimiter 2	0: No settings, 1:/ ,2: - Error code: 01H, 02H, 03H, 11H, 12H
40055	03 06 16	R W W	Parallel recording First area setting 3	ASCII 2 digits (First digit can also be a space code) 01 to Intermittent number count, 00H: No settings Error code: 01H, 02H, 03H, 11H, 12H
40056	03 06 16	R W W	Parallel recording Second area setting 1	ASCII 2 digits (First digit can also be a space code) 01 to Intermittent number count, 00H: No settings Error code: 01H, 02H, 03H, 11H, 12H
40057	03 06 16	R W W	Parallel recording First area delimiter 1	0: No settings, 1:/ , 2: - Error code: 01H, 02H, 03H, 11H, 12H
40058	03 06 16	R W W	Parallel recording Second area settings 2	ASCII 2 digits (First digit can also be a space code) 01 to Intermittent number count, 00H: No settings Error code: 01H, 02H, 03H, 11H, 12H

Reference Number	Application function code	R/W	Contents	Details
40059	03 06 16	R W W	Parallel recording Second area delimiter 2	0: No settings, 1:/, 2: - Error code: 01H, 02H, 03H, 11H, 12H
40060	03 06 16	R W W	Parallel recording Second area settings 3	ASCII 2 digits (First digit can also be a space code) 01 to Intermittent number count, 00H: No settings Error code: 01H, 02H, 03H, 11H, 12H
40061	03 06 16	R W W	Parallel recording Third area settings 1	ASCII 2 digits (First digit can also be a space code) 01 to Intermittent number count, 00H: No settings Error code: 01H, 02H, 03H, 11H, 12H
40062	03 06 16	R W W	Parallel recording Third area delimiter 1	0: No settings, 1:/, 2: - Error code: 01H, 02H, 03H, 11H, 12H
40063	03 06 16	R W W	Parallel recording Third area settings 2	ASCII 2 digits (First digit can also be a space code) 01 to Intermittent number count, 00H: No settings Error code: 01H, 02H, 03H, 11H, 12H
40064	03 06 16	R W W	Parallel recording Third area delimiter 2	0: No settings, 1:/, 2: - Error code: 01H, 02H, 03H, 11H, 12H
40065	03 06 16	R W W	Parallel recording Third area settings 3	ASCII 2 digits (First digit can also be a space code) 01 to Intermittent number count, 00H: No settings Error code: 01H, 02H, 03H, 11H, 12H
40066	03 06 16	R W W	Parallel recording Fourth area settings 1	ASCII 2 digits (First digit can also be a space code) 01 to Intermittent number count, 00H: No settings Error code: 01H, 02H, 03H, 11H, 12H
40067	03 06 16	R W W	Parallel recording Fourth area delimiter 1	0: No settings, 1:/, 2: - Error code: 01H, 02H, 03H, 11H, 12H
40068	03 06 16	R W W	Parallel recording Fourth area settings 2	ASCII 2 digits (First digit can also be a space code) 01 to Intermittent number count, 00H: No settings Error code: 01H, 02H, 03H, 11H, 12H
40069	03 06 16	R W W	Parallel recording Fourth area delimiter 2	0: No settings, 1:/, 2: - Error code: 01H, 02H, 03H, 11H, 12H
40070	03 06 16	R W W	Parallel recording Fourth area settings 3	ASCII 2 digits (First digit can also be a space code) 01 - intermittent number count, 00H: No settings Error code: 01H, 02H, 03H, 11H, 12H
40071	03 06 16	R W W	Parallel recording Fifth area settings 1	ASCII 2 digits (First digit can also be a space code) 01 to Intermittent number count, 00H: No settings Error code: 01H, 02H, 03H, 11H, 12H
40072	03 06 16	R W W	Parallel recording Fifth area delimiter 1	0: No settings, 1:/, 2: - Error code: 01H, 02H, 03H, 11H, 12H

R/W.....R: READ, W: WRITE

Reference Number	Application function code	R/W	Contents	Details
40073	03 06 16	R W W	Parallel recording Fifth area settings 2	ASCII 2 digits (First digit can also be a space code) 01 to Intermittent number count, 00H: No settings Error code: 01H, 02H, 03H, 11H, 12H
40074	03 06 16	R W W	Parallel recording Fifth area delimiter 2	0: No settings, 1:/, 2: - Error code: 01H, 02H, 03H, 11H, 12H
40075	03 06 16	R W W	Parallel recording Fifth area settings 3	ASCII 2 digits (First digit can also be a space code) 01 to Intermittent number count, 00H: No settings Error code: 01H, 02H, 03H, 11H, 12H
40081	03 06 16	R W W	Alarm dead band	01 to 99 (Decimal point 1 digit fixed) Error code: 01H, 02H, 03H, 11H, 12H

*Method of setting is the same as parallel recording settings key operation

(Example) First area setting for 01 to 03/06

Reference number 40051	01	(3031H)
Reference number 40052	-	(0002H)
Reference number 40053	03	(3033H)
Reference number 40054	/	(0001H)
Reference number 40055	06	(3036H)

2) Setting parameter for each channel

(Note) Write error of multiple settings value where channel is mounted, occurs. (Error code 12H)

R/W.....R: READ, W: WRITE

Reference Number	Application function code	R/W	Contents	Details
40102	03 06 16	R W W	CH1 range number	ASCII code 2 digits (First digit can also be a space code) 00H: No settings Error code: 01H, 02H, 03H, 11H, 12H
40103	03 06 16	R W W	CH1 RJ internal/external	0: External, 1: Internal * "0: External" is fixed except for thermocouple Error code: 01H, 02H, 03H, 11H, 12H
40104	03 06 16	R W W	CH1 range lower limit value	-30000 to 30000 * Thermocouple, thermometer input should be within the measurement range Error code: 01H, 02H, 03H, 11H, 12H
40105	03 06 16	R W W	CH1 range upper limit	-30000 to 30000 * Thermocouple, thermometer input should be within the measurement range Error code: 01H, 02H, 03H, 11H, 12H
40106	03 06 16	R W W	CH1 range decimal point	Range decimal point position 0 to 3 * Same decimal point position of both upper and lower limit value of range Error code: 01H, 02H, 03H, 11H, 12H
40107	03 06 16	R W W	CH1 scale lower limit	-30000 to 30000 * The value of thermocouple and thermometer resistance input should be the same as lower limit of range Error code: 01H, 02H, 03H, 11H, 12H
40108	03 06 16	R W W	CH1 scale upper limit	-30000 to 30000 * The value of thermocouple and thermometer resistance input should be the same as upper limit of range Error code: 01H, 02H, 03H, 11H, 12H
40109	03 06 16	R W W	CH1 scale decimal point	Scale decimal point position 0 to 3 * The decimal point value of both upper and lower limit of scale should be the same Error code: 01H, 02H, 03H, 11H, 12H
40110	03 06 16	R W W	CH1 burn out	0: Does not exist, 1: Exists * At the time of voltage input (V), "0: * None" fixed Error code: 01H, 02H, 03H, 11H, 12H
40111	03 06 16	R W W	CH1 sensor correction	-30000 to 30000 * Decimal point position uses scale decimal point position Error code: 01H, 02H, 03H, 11H, 12H
40112	03 06 16	R W W	Digital filter	0: None, 1: Strong, 2: Medium, 3: Weak Error code: 01H, 02H, 03H, 11H, 12H
40119	03 06 16	R W W	CH1 unit character 1,2	ASCII code 2 digits (No settings is 00H) Error code: 01H, 02H, 03H, 11H, 12H
40120	03 06 16	R W W	CH1 unit character 3,4	ASCII code 2 digits (No settings is 00H) Error code: 01H, 02H, 03H, 11H, 12H
40121	03 06 16	R W W	CH1 unit character 5,6	ASCII code 2 digits (No settings is 00H) Error code: 01H, 02H, 03H, 11H, 12H

Reference Number	Application function code	R/W	Contents	Details
40122	03 06 16	R W W	CH1 unit character 7,8	ASCII code 2 digits (No settings is 00H) Error code: 01H, 02H, 03H, 11H, 12H
40125	03 06 16	R W W	CH1 tag character 1,2	ASCII code 2 digits (No settings is 00H) Error code: 01H, 02H, 03H, 11H, 12H
40126	03 06 16	R W W	CH1 tag character 3,4	ASCII code 2 digits (No settings is 00H) Error code: 01H, 02H, 03H, 11H, 12H
40127	03 06 16	R W W	CH1 tag character 5,6	ASCII code 2 digits (No settings is 00H) Error code: 01H, 02H, 03H, 11H, 12H
40128	03 06 16	R W W	CH1 tag character 7,8	ASCII code 2 digits (No settings is 00H) Error code: 01H, 02H, 03H, 11H, 12H
40133	03 06 16	R W W	CH1 level 1 alarm Mode	0:None, 1: Upper limit, 2: Lower limit, 3:Change rate ascending limit 4: Change rate descending limit, 5: Differential upper limit, 6: Differential lower limit Error code: 01H, 02H, 03H, 11H, 12H
40134	03 06 16	R W W	CH1 level 1 alarm Settings value	-30000 to 30000 (Decimal point position uses scale decimal point) Error code: 01H, 02H, 03H, 11H, 12H
40135	03 06 16	R W W	CH1 level 1 alarm Output relay	01 to 999, 00H: No settings Error code: 01H, 02H, 03H, 11H, 12H
40136	03 06 16	R W W	CH1 level 1 alarm AND/OR	0: OR, 1: AND Error code: 01H, 02H, 03H, 11H, 12H
40137	03 06 16	R W W	CH1 level 1 alarm Reference CH	BINARY 2 digits 01 to 72, 0000H: No settings *Valid in case of differential alarm Error code: 01H, 02H, 03H, 11H, 12H
40138	03 06 16	R W W	CH1 level 1 alarm Sample count	ASCII code 2 digits (First digit can also be a space code) 01 to 20, 00H: No settings *Valid in case of change rate alarm Error code: 01H, 02H, 03H, 11H, 12H
40139	03 06 16	R W W	CH1 level 1 alarm Alarm dead band	0 to 30000 (Decimal point position uses scale decimal point but calculation output channel uses calculation data decimal point) Error code: 01H, 02H, 03H, 11H, 12H
40141	03 06 16	R W W	CH1 level 2 alarm Mode	0:None, 1: Upper limit, 2: Lower limit, 3:Change rate ascending upper limit 4: Change rate descending limit, 5: Differential upper limit, 6: Differential lower limit Error code: 01H, 02H, 03H, 11H, 12H
40142	03 06 16	R W W	CH1 level 2 alarm Settings value	-30000 to 30000 (Scale decimal point is used as decimal point position) Error code: 01H, 02H, 03H, 11H, 12H
40143	03 06 16	R W W	CH1 level 2 alarm Output relay	01 to 999, 00H: No settings Error code: 01H, 02H, 03H, 11H, 12H

Reference Number	Application function code	R/W	Contents	Details
40144	03 06 16	R W W	CH1 level 2 alarm AND/OR	0: OR, 1: AND Error code: 01H, 02H, 03H, 11H, 12H
40145	03 06 16	R W W	CH1 level 2 alarm Reference CH	BINARY 2 digits 01 to 72, 0000H: No settings *Valid in case of differential alarm Error code: 01H, 02H, 03H, 11H, 12H
40146	03 06 16	R W W	CH1 level 2 alarm Sample count	ASCII code 2 digits (First digit can also be a space code) 01 to 20, 00H: No settings *Valid in case of change rate alarm Error code: 01H, 02H, 03H, 11H, 12H
40147	03 06 16	R W W	CH1 level 2 alarm Alarm dead band	0 to 30000 (Decimal point position uses scale decimal point) but calculation output channel uses calculation data decimal point) Error code: 01H, 02H, 03H, 11H, 12H
40149	03 06 16	R W W	CH1 level 3 alarm Mode	0: None, 1: Upper limit, 2: Lower limit, 3: Change rate ascending upper limit 4: Change rate descending limit, 5: Differential upper limit, 6: Differential lower limit Error code: 01H, 02H, 03H, 11H, 12H
40150	03 06 16	R W W	CH1 level 3 alarm Settings value	-30000 to 30000 (Scale decimal point is used as decimal point position) Error code: 01H, 02H, 03H, 11H, 12H
40151	03 06 16	R W W	CH1 level 3 alarm Output relay	01 to 999, 00H: No settings Error code: 01H, 02H, 03H, 11H, 12H
40152	03 06 16	R W W	CH1 level 3 alarm AND/OR	0: OR, 1: AND Error code: 01H, 02H, 03H, 11H, 12H
40153	03 06 16	R W W	CH1 level 3 alarm Reference CH	BINARY 2 digits 01 to 72, 0000H: No settings *Valid in case of differential alarm Error code: 01H, 02H, 03H, 11H, 12H
40154	03 06 16	R W W	CH1 level 3 alarm Sample count	ASCII code 2 digits (First digit can also be a space code) 01-20, 00H: No settings *Valid in case of change rate alarm Error code: 01H, 02H, 03H, 11H, 12H
40155	03 06 16	R W W	CH1 level 3 alarm Alarm dead band	0 to 30000 (Decimal point position uses scale decimal point) but calculation output channel uses calculation data decimal point) Error code: 01H, 02H, 03H, 11H, 12H
40157	03 06 16	R W W	CH1 level 4 alarm Mode	0: None, 1: Upper limit, 2: Lower limit, 3: Change rate ascending upper limit 4: Change rate descending limit, 5: Differential upper limit, 6: Differential lower limit Error code: 01H, 02H, 03H, 11H, 12H
40158	03 06 16	R W W	CH1 level 4 alarm Settings value	-30000 to 30000 (Scale decimal point is used as decimal point position) Error code: 01H, 02H, 03H, 11H, 12H
40159	03 06 16	R W W	CH1 level 4 alarm Output relay	01 to 999, 00H: No settings Error code: 01H, 02H, 03H, 11H, 12H
40160	03 06 16	R W W	CH1 level 4 alarm AND/OR	0: OR, 1: AND Error code: 01H, 02H, 03H, 11H, 12H

Reference Number	Application function code	R/W	Contents	Details
40161	03 06 16	R W W	CH1 level 4 alarm Reference CH	BINARY 2 digits 01 to 72, 0000H: No settings *Valid in case of differential alarm Error code: 01H, 02H, 03H, 11H, 12H
40162	03 06 16	R W W	CH1 level 4 alarm Sample count	ASCII code 2 digits (First digit can also be a space code) 01 to 20, 00H:No settings *Valid in case of change rate alarm Error code: 01H, 02H, 03H, 11H, 12H
40163	03 06 16	R W W	CH1 level 4 alarm Alarm dead band	0 to 30000 (Decimal point position uses scale decimal point) but calculation output channel uses calculation data decimal point) Error code: 01H, 02H, 03H, 11H, 12H
40165	03 06 16	R W W	CH1 calculation number	0: No calculation, 1: Square root calculation, 2: Natural logarithm calculation 3: Common logarithm calculation, 4: Addition calculation, 5: Temperature and humidity calculation 6: Data communication input, 7: Arithmetic operation 1 8: Arithmetic operation 2, 9: Maximum value calculation, 10: Minimum value calculation 11: Average calculation, 12: Exponent calculation 20: Difference calculation between CH, 21: Reference value difference calculation Error code: 01H, 02H, 03H, 11H, 12H
40166	03 06 16	R W W	CH1 recording scale Lower limit	-30000 to 30000 Error code: 01H, 02H, 03H, 11H, 12H
40167	03 06 16	R W W	CH1 recording scale Upper limit	-30000 to 30000 Error code: 01H, 02H, 03H, 11H, 12H
40168	03 06 16	R W W	CH1 recording cable Decimal point	Recording scale decimal point position 0 to 3
40169	03 06 16	R W W	CH1 calculation constant A	In case of arithmetic operation 1, 2: -30000 to 30000 In case of addition, maximum, minimum, average calculation: Interval (Hours) ASCII 2 digits (00 to 24, 99: External drive [At the time of addition only]) 00H in case of other calculations Error code: 01H, 02H, 03H, 11H, 12H
40170	03 06 16	R W W	CH1 calculation constant A Decimal point	In case of arithmetic operation 1, 2: 0 to 3 00H in case of others Error code: 01H, 02H, 03H, 11H, 12H
40171	03 06 16	R W W	CH1 calculation constant B	In case of arithmetic operation 1, 2: -30000 to 30000 In case of addition, maximum, minimum, average calculation: Interval (Minutes) ASCII code 2 digits (00 to 59 First digit can also be a space code) 00H in case of other calculations Error code: 01H, 02H, 03H, 11H, 12H
40172	03 06 16	R W W	CH1 calculation constant B Decimal point	In case of arithmetic operation 1, 2: 0 to 3 00H in case of others Error code: 01H, 02H, 03H, 11H, 12H
40173	03 06 16	R W W	CH1 calculation constant C	Arithmetic calculation 1, In case of reference value difference calculation: -30000 to 30000 In case of addition, maximum, minimum, average calculation: Interval (Hours) ASCII 2 digits (00 to 23, 99: External drive [At the time of addition only]) 00H in case of other calculations Error code: 01H, 02H, 03H, 11H, 12H

Reference Number	Application function code	R/W	Contents	Details
40174	03 06 16	R W W	CH1 calculation constant C Decimal point	In case of arithmetic operation 1, 2: 0 to 3 00H in case of others Error code: 01H, 02H, 03H, 11H, 12H
40175	03 06 16	R W W	CH1 calculation constant D	In case of arithmetic operation 1, 2: -30000 to 30000 In case of addition, maximum, minimum, average calculation: Interval (Minutes) ASCII code 2 digits (00 to 59 First digit can also be a space code) 00H in case of other calculations Error code: 01H, 02H, 03H, 11H, 12H
40176	03 06 16	R W W	CH1 calculation constant D Decimal point	In case of arithmetic operation 1, 2: 0 to 3 00H in case of others Error code: 01H, 02H, 03H, 11H, 12H
40177	03 06 16	R W W	CH1 calculation Target X CH	BINARY 2 digits 01 to 36, 0000H: No settings Error code: 01H, 02H, 03H, 11H, 12H
40178	03 06 16	R W W	CH1 calculation Target Y CH	BINARY 2 digits 01 to 36, 0000H: No settings Error code: 01H, 02H, 03H, 11H, 12H
40179	03 06 16	R W W	CH1 calculation Data decimal point	0 to 3 Error code: 01H, 02H, 03H, 11H, 12H
40180	03 06 16	R W W	CH1 calculation Target Z CH	BINARY 2 digits 01 to 36, 0000H: No settings Error code: 01H, 02H, 03H, 11H, 12H
40181	03 06 16	R W W	CH1 Partial reduction magnification recording 0% value	-30000 to 30000 (Scale decimal point is used as decimal point position) Error code: 01H, 02H, 03H, 11H, 12H
40182	03 06 16	R W W	CH1 Partial reduction magnification recording First intermittent %	0 to 99 0: No settings Error code: 01H, 02H, 03H, 11H, 12H
40183	03 06 16	R W W	CH1 Partial reduction magnification recording First intermittent value	-30000 to 30000 (Scale decimal point is used as decimal point position) Error code: 01H, 02H, 03H, 11H, 12H
40184	03 06 16	R W W	CH1 Partial reduction magnification recording Second intermittent %	0 to 99 0: No settings of second intermittent point Error code: 01H, 02H, 03H, 11H, 12H
40185	03 06 16	R W W	CH1 Partial reduction magnification recording Second intermittent value	-30000 to 30000 (Scale decimal point is used as decimal point position) Error code: 01H, 02H, 03H, 11H, 12H
40186	03 06 16	R W W	CH1 Partial reduction magnification recording Third intermittent %	-30000 to 30000 (Scale decimal point is used as decimal point position) Error code: 01H, 02H, 03H, 11H, 12H
40187	03 06 16	R W W	CH1 Partial reduction magnification recording Third intermittent value	-30000 to 30000 (Scale decimal point is used as decimal point position) Error code: 01H, 02H, 03H, 11H, 12H

Reference Number	Application function code	R/W	Contents	Details
40188	03	R	CH1 parallel pointer scale	1 to 5
	06	W	Assigned area	Error code: 01H, 02H, 03H, 11H, 12H
	16	W		
40189	03	R	CH1 auto range setting	-30000 to 30000 (Scale decimal point is used as decimal point position)
	06	W	First range lower limit value	-32768: No settings
	16	W		Error code: 01H, 02H, 03H, 11H, 12H
40190	03	R	CH1 auto range setting	-30000 to 30000 (Scale decimal point is used as decimal point position)
	06	W	CH1 range upper limit	-32768: No settings (But it gives an error if -32768 is selected when lower limit setting is enabled)
	16	W		Error code: 01H, 02H, 03H, 11H, 12H
40191	03	R	CH1 auto range setting	-30000 to 30000 (Scale decimal point is used as decimal point position)
	06	W	Second range upper limit	-32768: No settings
	16	W		Error code: 01H, 02H, 03H, 11H, 12H
40192	03	R	CH1 auto range setting	-30000 to 30000 (Scale decimal point is used as decimal point position)
	06	W	Third range upper limit	-32768: No settings
	16	W		Error code: 01H, 02H, 03H, 11H, 12H
40193	03	R	CH1 auto range setting	-30000 to 30000 (Scale decimal point is used as decimal point position)
	06	W	Fourth range upper limit value	-32768: No settings
	16	W		Error code: 01H, 02H, 03H, 11H, 12H
40194	03	R	CH1 auto range setting	-30000 to 30000 (Scale decimal point is used as decimal point position)
	06	W	Fifth range upper limit value	-32768: No settings
	16	W		Error code: 01H, 02H, 03H, 11H, 12H

3) -1 range number table

Input category		Range number	ASCII code	Measurement range			Decimal point position	
Direct current voltage		01	3031	-10.000	to	10.000 mV	3	
		02	3032	-20.000	to	20.000 mV	3	
		03	3033	-40.00	to	40.00 mV	2	
		04	3034	-80.00	to	80.00 mV	2	
		05	3035	-1.250	to	1.250 V	3	
		06	3036	-2.500	to	2.500 V	3	
		07	3037	-5.000	to	5.000 V	3	
		08	3038	-10.000	to	10.000 V	3	
Thermocouple		K	21	3231	-200.0	to	500.0 °C	1
			22	3232	-200.0	to	900.0 °C	1
			23	3233	-200.0	to	1370.0 °C	1
		E	24	3234	-200.0	to	250.0 °C	1
			25	3235	-200.0	to	500.0 °C	1
			26	3236	-200.0	to	900.0 °C	1
		J	27	3237	-200.0	to	350.0 °C	1
			28	3238	-200.0	to	700.0 °C	1
			29	3239	-200.0	to	1200.0 °C	1
		T	31	3331	-200.0	to	400.0 °C	1
		R	33	3333	0.0	to	1760.0 °C	1
		S	35	3335	0.0	to	1760.0 °C	1
		B	36	3336	0.0	to	1820.0 °C	1
		N	37	3337	0.0	to	600.0 °C	1
			38	3338	0.0	to	1000.0 °C	1
			39	3339	0.0	to	1300.0 °C	1
		WRe5-WRe26	40	3430	0.0	to	2315.0 °C	1
		W-WRe26	41	3431	0.0	to	2315.0 °C	1
		PtRh40-PtRh20-	43	3433	0.0	to	1888.0 °C	1
		NiMo-Ni	46	3436	-50.0	to	1310.0 °C	1
Platinel II	48	3438	0.0	to	500.0 °C	1		
	49	3439	0.0	to	950.0 °C	1		
	50	3530	0.0	to	1395.0 °C	1		
U	52	3532	-200.0	to	350.0 °C	1		
	53	3533	-200.0	to	600.0 °C	1		
L	54	3534	-200.0	to	350.0 °C	1		
	55	3535	-200.0	to	700.0 °C	1		
	56	3536	-200.0	to	900.0 °C	1		
Resistance thermometer		Pt100	70	3730	-50.0	to	50.0 °C	1
			71	3731	-100.0	to	130.0 °C	1
			72	3732	-200.0	to	250.0 °C	1
			73	3733	-200.0	to	550.0 °C	1
		JPt100	74	3734	-50.0	to	50.0 °C	1
			75	3735	-100.0	to	130.0 °C	1
			76	3736	-200.0	to	250.0 °C	1
77	3737		-200.0	to	550.0 °C	1		
Contact point		80	3830	0 (OFF)/1 (ON)			0	
Parse		81	3831	0	to	29999	0	

Reference Number	Application function code	R/W	Contents	Details
40202 to 40294	03 06 16	R W W	CH 2 settings parameter	Same as CH1 parameter (40102 to 40194) Reference number: Reference number of CH1 + 100
40302 to 40394	03 06 16	R W W	CH 3 settings parameter	Same as CH1 parameter (40102 to 40194) Reference number: Reference number of CH1 + 200
40402 to 40494	03 06 16	R W W	CH 4 settings parameter	Same as CH1 parameter (40102 to 40194) Reference number: Reference number of CH1 + 300
40502 to 40594	03 06 16	R W W	CH 5 settings parameter	Same as CH1 parameter (40102 to 40194) Reference number: Reference number of CH1 + 400
40602 to 40694	03 06 16	R W W	CH 6 settings parameter	Same as CH1 parameter (40102 to 40194) Reference number: Reference number of CH1 + 500
40702 to 40794	03 06 16	R W W	CH 7 settings parameter	Same as CH1 parameter (40102 to 40194) Reference number: Reference number of CH1 + 600
40802 to 40894	03 06 16	R W W	CH 8 settings parameter	Same as CH1 parameter (40102 to 40194) Reference number: Reference number of CH1 + 700
40902 to 40994	03 06 16	R W W	CH 9 settings parameter	Same as CH1 parameter (40102 to 40194) Reference number: Reference number of CH1 + 800
41002 to 41094	03 06 16	R W W	CH10 settings parameter	Same as CH1 parameter (40102 to 40194) Reference number: Reference number of CH1 + 900
41102 to 41194	03 06 16	R W W	CH11 settings parameter	Same as CH1 parameter (40102 to 40194) Reference number: Reference number of CH1 + 1000
41202 to 41294	03 06 16	R W W	CH12 settings parameter	Same as CH1 parameter (40102 to 40194) Reference number: Reference number of CH1 + 1100
41302 to 41394	03 06 16	R W W	CH13 settings parameter	Same as CH1 parameter (40102 to 40194) Reference number: Reference number of CH1 + 1200
41402 to 41494	03 06 16	R W W	CH14 settings parameter	Same as CH1 parameter (40102 to 40194) Reference number: Reference number of CH1 + 1300
41502 to 41594	03 06 16	R W W	CH15 settings parameter	Same as CH1 parameter (40102 to 40194) Reference number: Reference number of CH1 + 1400
41602 to 41694	03 06 16	R W W	CH16 settings parameter	Same as CH1 parameter (40102 to 40194) Reference number: Reference number of CH1 + 1500

Reference Number	Application function code	R/W	Contents	Details
41702 to 41794	03 06 16	R W W	CH17 settings parameter	Same as CH1 parameter (40102 to 40194) Reference number: Reference number of CH1 + 1600
41802 to 41894	03 06 16	R W W	CH18 settings parameter	Same as CH1 parameter (40102 to 40194) Reference number: Reference number of CH1 + 1700
41902 to 41994	03 06 16	R W W	CH19 settings parameter	Same as CH1 parameter (40102 to 40194) Reference number: Reference number of CH1 + 1800
42002 to 42094	03 06 16	R W W	CH20 settings parameter	Same as CH1 parameter (40102 to 40194) Reference number: Reference number of CH1 + 1900
42102 to 42194	03 06 16	R W W	CH21 settings parameter	Same as CH1 parameter (40102 to 40194) Reference number: Reference number of CH1 + 2000
42202 to 42294	03 06 16	R W W	CH22 settings parameter	Same as CH1 parameter (40102 to 40194) Reference number: Reference number of CH1 + 2100
42302 to 42394	03 06 16	R W W	CH23 settings parameter	Same as CH1 parameter (40102 to 40194) Reference number: Reference number of CH1 + 2200
42402 to 42494	03 06 16	R W W	CH24 settings parameter	Same as CH1 parameter (40102 to 40194) Reference number: Reference number of CH1 + 2300
42502 to 42594	03 06 16	R W W	CH25 settings parameter	Same as CH1 parameter (40102 to 40194) Reference number: Reference number of CH1 + 2400
42602 to 42694	03 06 16	R W W	CH26 settings parameter	Same as CH1 parameter (40102 to 40194) Reference number: Reference number of CH1 + 2500
42702 to 42794	03 06 16	R W W	CH27 settings parameter	Same as CH1 parameter (40102 to 40194) Reference number: Reference number of CH1 + 2600
42802 to 42894	03 06 16	R W W	CH28 settings parameter	Same as CH1 parameter (40102 to 40194) Reference number: Reference number of CH1 + 2700
42902 to 42994	03 06 16	R W W	CH29 settings parameter	Same as CH1 parameter (40102 to 40194) Reference number: Reference number of CH1 + 2800
43002 to 43094	03 06 16	R W W	CH30 settings parameter	Same as CH1 parameter (40102 to 40194) Reference number: Reference number of CH1 + 2900
43102 to 43194	03 06 16	R W W	CH31 settings parameter	Same as CH1 parameter (40102 to 40194) Reference number: Reference number of CH1 + 3000

Reference Number	Application function code	R/W	Contents	Details
43202 to 43294	03 06 16	R W W	CH32 settings parameter	Same as CH1 parameter (40102 to 40194) Reference number: Reference number of CH1 + 3100
43302 to 43394	03 06 16	R W W	CH33 settings parameter	Same as CH1 parameter (40102 to 40194) Reference number: Reference number of CH1 + 3200
43402 to 43494	03 06 16	R W W	CH34 settings parameter	Same as CH1 parameter (40102 to 40194) Reference number: Reference number of CH1 + 3300
43502 to 43594	03 06 16	R W W	CH35 settings parameter	Same as CH1 parameter (40102 to 40194) Reference number: Reference number of CH1 + 3400
43602 to 43694	03 06 16	R W W	CH36 settings parameter	Same as CH1 parameter (40102 to 40194) Reference number: Reference number of CH1 + 3500
43702 to 43794	03 06 16	R W W	CH37 settings parameter	Same as CH1 parameter (40102 to 40194) Reference number: Reference number of CH1 + 3600
43802 to 43894	03 06 16	R W W	CH38 settings parameter	Same as CH1 parameter (40102 to 40194) Reference number: Reference number of CH1 + 3700
43902 to 43994	03 06 16	R W W	CH39 settings parameter	Same as CH1 parameter (40102 to 40194) Reference number: Reference number of CH1 + 3800
44002 to 44094	03 06 16	R W W	CH40 settings parameter	Same as CH1 parameter (40102 to 40194) Reference number: Reference number of CH1 + 3900
44102 to 44194	03 06 16	R W W	CH41 settings parameter	Same as CH1 parameter (40102 to 40194) Reference number: Reference number of CH1 + 4000
44202 to 44294	03 06 16	R W W	CH42 settings parameter	Same as CH1 parameter (40102 to 40194) Reference number: Reference number of CH1 + 4100
44302 to 44394	03 06 16	R W W	CH43 settings parameter	Same as CH1 parameter (40102 to 40194) Reference number: Reference number of CH1 + 4200
44402 to 44494	03 06 16	R W W	CH44 settings parameter	Same as CH1 parameter (40102 to 40194) Reference number: Reference number of CH1 + 4300
44502 to 44594	03 06 16	R W W	CH45 settings parameter	Same as CH1 parameter (40102 to 40194) Reference number: Reference number of CH1 + 4400
44602 to 44694	03 06 16	R W W	CH46 settings parameter	Same as CH1 parameter (40102 to 40194) Reference number: Reference number of CH1 + 4500

Reference Number	Application function code	R/W	Contents	Details
44702 to 44794	03 06 16	R W W	CH47 settings parameter	Same as CH1 parameter (40102 to 40194) Reference number: Reference number of CH1 + 4600
44802 to 44894	03 06 16	R W W	CH48 settings parameter	Same as CH1 parameter (40102 to 40194) Reference number: Reference number of CH1 + 4700
44902 to 44994	03 06 16	R W W	CH49 settings parameter	Same as CH1 parameter (40102 to 40194) Reference number: Reference number of CH1 + 4800
45002 to 45094	03 06 16	R W W	CH50 settings parameter	Same as CH1 parameter (40102 to 40194) Reference number: Reference number of CH1 + 4900
45102 to 45194	03 06 16	R W W	CH51 settings parameter	Same as CH1 parameter (40102 to 40194) Reference number: Reference number of CH1 + 5000
45202 to 45294	03 06 16	R W W	CH52 settings parameter	Same as CH1 parameter (40102 to 40194) Reference number: Reference number of CH1 + 5100
45302 to 45394	03 06 16	R W W	CH53 settings parameter	Same as CH1 parameter (40102 to 40194) Reference number: Reference number of CH1 + 5200
45402 to 45494	03 06 16	R W W	CH54 settings parameter	Same as CH1 parameter (40102 to 40194) Reference number: Reference number of CH1 + 5300
45502 to 45594	03 06 16	R W W	CH55 settings parameter	Same as CH1 parameter (40102 to 40194) Reference number: Reference number of CH1 + 5400
45602 to 45694	03 06 16	R W W	CH56 settings parameter	Same as CH1 parameter (40102 to 40194) Reference number: Reference number of CH1 + 5500
45702 to 45794	03 06 16	R W W	CH57 settings parameter	Same as CH1 parameter (40102 to 40194) Reference number: Reference number of CH1 + 5600
45802 to 45894	03 06 16	R W W	CH58 settings parameter	Same as CH1 parameter (40102 to 40194) Reference number: Reference number of CH1 + 5700
45902 to 45994	03 06 16	R W W	CH59 settings parameter	Same as CH1 parameter (40102 to 40194) Reference number: Reference number of CH1 + 5800
46002 to 46094	03 06 16	R W W	CH60 settings parameter	Same as CH1 parameter (40102 to 40194) Reference number: Reference number of CH1 + 5900
46102 to 46194	03 06 16	R W W	CH61 settings parameter	Same as CH1 parameter (40102 to 40194) Reference number: Reference number of CH1 + 6000
46202 to 46294	03 06 16	R W W	CH62 settings parameter	Same as CH1 parameter (40102 to 40194) Reference number: Reference number of CH1 + 6100

Reference Number	Application function code	R/W	Contents	Details
46302 to 46394	03 06 16	R W W	CH63 settings parameter	Same as CH1 parameter (40102 to 40194) Reference number: Reference number of CH1 + 6200
46402 to 46494	03 06 16	R W W	CH64 settings parameter	Same as CH1 parameter (40102 to 40194) Reference number: Reference number of CH1 + 6300
46502 to 46594	03 06 16	R W W	CH65 settings parameter	Same as CH1 parameter (40102 to 40194) Reference number: Reference number of CH1 + 6400
46602 to 46694	03 06 16	R W W	CH66 settings parameter	Same as CH1 parameter (40102 to 40194) Reference number: Reference number of CH1 + 6500
46702 to 46794	03 06 16	R W W	CH67 settings parameter	Same as CH1 parameter (40102 to 40194) Reference number: Reference number of CH1 + 6600
46802 to 46894	03 06 16	R W W	CH68 settings parameter	Same as CH1 parameter (40102 to 40194) Reference number: Reference number of CH1 + 6700
46902 to 46994	03 06 16	R W W	CH69 settings parameter	Same as CH1 parameter (40102 to 40194) Reference number: Reference number of CH1 + 6800
47002 to 47094	03 06 16	R W W	CH70 settings parameter	Same as CH1 parameter (40102 to 40194) Reference number: Reference number of CH1 + 6900
47102 to 47194	03 06 16	R W W	CH71 settings parameter	Same as CH1 parameter (40102 to 40194) Reference number: Reference number of CH1 + 7000
47202 to 47294	03 06 16	R W W	CH72 settings parameter	Same as CH1 parameter (40102 to 40194) Reference number: Reference number of CH1 + 7100

4) Memory card settings

R/W.....R: READ, W: WRITE

Reference Number	Application function code	R/W	Contents	Details
47906	03 06 16	R W W	Memory card recording Recording format	0: Binary, 1: Text, 2: Binary (Floating decimal point) 3: Text (Extension) Error code: 01H, 02H, 03H, 11H, 12H
47907	03 06 16	R W W	Memory card recording Recording interval	0: 0.1 seconds, 1: 0.2 seconds, 3: 1 second, 4: 2 seconds, 5: 3 seconds, 6: 5 seconds, 7: 10 seconds, 8: 15 seconds, 9: 20 seconds, 10: 30 seconds, 11: 1 minute, 12: 2 minutes, 13: 3 minutes, 14: 5 minutes, 15: 10 minutes, 16: 15 minutes, 17: 20 minutes, 18: 30 minutes, 19: 60 minutes Error code: 01H, 02H, 03H, 11H, 12H
47908	03 06 16	R W W	Memory card recording Select recording start trigger	0: None, 1: Key, 2: Time, 3: Alarm output No. 4: External contact Error code: 01H, 02H, 03H, 11H, 12H
47909	03 06 16	R W W	Memory card recording Recording start time (hour)	0 to 23, When start trigger is output relay, output relay No. Error code: 01H, 02H, 03H, 11H, 12H
47910	03 06 16	R W W	Memory card recording Recording start time (minute)	0 to 59, Start trigger other than time, pretrigger sample number (0 to 100) Error code: 01H, 02H, 03H, 11H, 12H
47911	03 06 16	R W W	Memory card recording Select recording end trigger	1: Key, 2: Time, 3: Alarm output relay No. 4: External contact Error code: 01H, 02H, 03H, 11H, 12H
47912	03 06 16	R W W	Memory card recording Recording time (hour)	0 to 24 Error code: 01H, 02H, 03H, 11H, 12H
47913	03 06 16	R W W	Memory card recording Recording time (minute)	0 to 59 Error code: 01H, 02H, 03H, 11H, 12H

5) Printing communication

When channel is specified message of maximum 75 characters and when channel is not specified message of maximum 80 characters can be printed.

Here the printing characters are set. The print color is black only.

It is executed by executing message printing of reference number 20.

R/W.....R: READ, W: WRITE

Reference Number	Application function code	R/W	Contents	Details
48003	06 16	W W	Message printing Printing characters 1,2	ASCII code 2 characters * Characters after 00H are disabled Error code: 01H, 02H, 03H, 11H, 12H
48004	06 16	W W	Message printing Printing characters 3,4	ASCII code 2 characters Error code: 01H, 02H, 03H, 11H, 12H
48005	06 16	W W	Message printing Printing characters 5,6	ASCII code 2 characters Error code: 01H, 02H, 03H, 11H, 12H
48006	06 16	W W	Message printing Printing characters 7,8	ASCII code 2 characters Error code: 01H, 02H, 03H, 11H, 12H
48007	06 16	W W	Message printing Printing characters 9,10	ASCII code 2 characters Error code: 01H, 02H, 03H, 11H, 12H
48008	06 16	W W	Message printing Printing characters 11,12	ASCII code 2 characters Error code: 01H, 02H, 03H, 11H, 12H
48009	06 16	W W	Message printing Printing characters 13,14	ASCII code 2 characters Error code: 01H, 02H, 03H, 11H, 12H
48010	06 16	W W	Message printing Printing characters 15,16	ASCII code 2 characters Error code: 01H, 02H, 03H, 11H, 12H
48011	06 16	W W	Message printing Printing characters 17,18	ASCII code 2 characters Error code: 01H, 02H, 03H, 11H, 12H
48012	06 16	W W	Message printing Printing characters 19,20	ASCII code 2 characters Error code: 01H, 02H, 03H, 11H, 12H
48013	06 16	W W	Message printing Printing characters 21,22	ASCII code 2 characters Error code: 01H, 02H, 03H, 11H, 12H
48014	06 16	W W	Message printing Printing characters 23,24	ASCII code 2 characters Error code: 01H, 02H, 03H, 11H, 12H
48015	06 16	W W	Message printing Printing characters 25,26	ASCII code 2 characters Error code: 01H, 02H, 03H, 11H, 12H
48016	06 16	W W	Message printing Printing characters 27,28	ASCII code 2 characters Error code: 01H, 02H, 03H, 11H, 12H
48017	06 16	W W	Message printing Printing characters 29,30	ASCII code 2 characters Error code: 01H, 02H, 03H, 11H, 12H
48018	06 16	W W	Message printing Printing characters 31,32	ASCII code 2 characters Error code: 01H, 02H, 03H, 11H, 12H
48019	06 16	W W	Message printing Printing characters 33,34	ASCII code 2 characters Error code: 01H, 02H, 03H, 11H, 12H
48020	06 16	W W	Message printing Printing characters 35,36	ASCII code 2 characters Error code: 01H, 02H, 03H, 11H, 12H
48021	06 16	W W	Message printing Printing characters 37,38	ASCII code 2 characters Error code: 01H, 02H, 03H, 11H, 12H
48022	06 16	W W	Message printing Printing characters 39,40	ASCII code 2 characters Error code: 01H, 02H, 03H, 11H, 12H

Reference Number	Application function code	R/W	Contents	Details
48023	06	W	Message printing	ASCII code 2 characters
	16	W	Printing characters 41,42	Error code: 01H, 02H, 03H, 11H, 12H
48024	06	W	Message printing	ASCII code 2 characters
	16	W	Printing characters 43,44	Error code: 01H, 02H, 03H, 11H, 12H
48025	06	W	Message printing	ASCII code 2 characters
	16	W	Printing characters 45,46	Error code: 01H, 02H, 03H, 11H, 12H
48026	06	W	Message printing	ASCII code 2 characters
	16	W	Printing characters 47,48	Error code: 01H, 02H, 03H, 11H, 12H
48027	06	W	Message printing	ASCII code 2 characters
	16	W	Printing characters 49,50	Error code: 01H, 02H, 03H, 11H, 12H
48028	06	W	Message printing	ASCII code 2 characters
	16	W	Printing characters 51,52	Error code: 01H, 02H, 03H, 11H, 12H
48029	06	W	Message printing	ASCII code 2 characters
	16	W	Printing characters 53,54	Error code: 01H, 02H, 03H, 11H, 12H
48030	06	W	Message printing	ASCII code 2 characters
	16	W	Printing characters 55,56	Error code: 01H, 02H, 03H, 11H, 12H
48031	06	W	Message printing	ASCII code 2 characters
	16	W	Printing characters 57,58	Error code: 01H, 02H, 03H, 11H, 12H
48032	06	W	Message printing	ASCII code 2 characters
	16	W	Printing characters 59,60	Error code: 01H, 02H, 03H, 11H, 12H
48033	06	W	Message printing	ASCII code 2 characters
	16	W	Printing characters 61,62	Error code: 01H, 02H, 03H, 11H, 12H
48034	06	W	Message printing	ASCII code 2 characters
	16	W	Printing characters 63,64	Error code: 01H, 02H, 03H, 11H, 12H
48035	06	W	Message printing	ASCII code 2 characters
	16	W	Printing characters 65,66	Error code: 01H, 02H, 03H, 11H, 12H
48036	06	W	Message printing	ASCII code 2 characters
	16	W	Printing characters 67,68	Error code: 01H, 02H, 03H, 11H, 12H
48037	06	W	Message printing	ASCII code 2 characters
	16	W	Printing characters 69,70	Error code: 01H, 02H, 03H, 11H, 12H
48038	06	W	Message printing	ASCII code 2 characters
	16	W	Printing characters 71,72	Error code: 01H, 02H, 03H, 11H, 12H
48039	06	W	Message printing	ASCII code 2 characters
	16	W	Printing characters 73,74	Error code: 01H, 02H, 03H, 11H, 12H
48040	06	W	Message printing	ASCII code 2 characters)
	16	W	Printing characters 75,76	Error code: 01H, 02H, 03H, 11H, 12H
48041	06	W	Message printing	ASCII code 2 characters
	16	W	Printing characters 77,78	Error code: 01H, 02H, 03H, 11H, 12H
48042	06	W	Message printing	ASCII code 2 characters
	16	W	Printing characters 79,80	Error code: 01H, 02H, 03H, 11H, 12H
48043	06	W	Message printing	BINARY: 2 digits
	16	W	Channel specification	001 to Channel count, 0000H: No channel specification Error code: 01H, 02H, 03H, 11H, 12H

6) Settings parameter for every dotting number

(Note) Write error of multiple settings value where channel is mounted, occurs. (Error code 12H)

R/W.....R: READ, W: WRITE

Reference Number	Application function code	R/W	Contents	Details
48101	03 06 16	R W W	Intermittent number 1 Input channel	BINARY 2 digits 001 to Channel count, 0000H:No settings Error code: 01H, 02H, 03H, 11H, 12H
48102	03 06 16	R W W	Intermittent number 1 Recording color	1: Green, 2: Yellowish green, 3: Orange, 4: Red, 5: Magenta, 6: Brown, 7: Bluish green 8: Purple, 9: Bluish purple, 10: Black Error code: 01H, 02H, 03H, 11H, 12H
48103	03 06 16	R W W	Intermittent number 1 Recording ON/OFF	0: OFF, 1: ON Error code: 01H, 02H, 03H, 11H, 12H
48104	03 06 16	R W W	Parallel recording area number	1 to 5 Error code: 01H, 02H, 03H, 11H, 12H

Reference Number	Application function code	R/W	Contents	Details
48111 to 48114	03 06 16	R W W	Intermittent number 2 Settings parameter	Similar to intermittent number 1 (48101 to 48104) Reference Number: Reference number of intermittent number 1 + 10
48121 to 48124	03 06 16	R W W	Intermittent number 3 Settings parameter	Similar to intermittent number 1 (48101 to 48104) Reference Number: Reference number of intermittent number 1 + 20
48131 to 48134	03 06 16	R W W	Intermittent number 4 Settings parameter	Similar to intermittent number 1 (48101 to 48104) Reference Number: Reference number of intermittent number 1 + 30
48141 to 48144	03 06 16	R W W	Intermittent number 5 Settings parameter	Similar to intermittent number 1 (48101 to 48104) Reference Number: Reference number of intermittent number 1 + 40
48151 to 48154	03 06 16	R W W	Intermittent number 6 Settings parameter	Similar to intermittent number 1 (48101 to 48104) Reference Number: Reference number of intermittent number 1 + 50
48161 to 48164	03 06 16	R W W	Intermittent number 7 Settings parameter	Similar to intermittent number 1 (48101 to 48104) Reference Number: Reference number of intermittent number 1 + 60
48171 to 48174	03 06 16	R W W	Intermittent number 8 Settings parameter	Similar to intermittent number 1 (48101 to 48104) Reference Number: Reference number of intermittent number 1 + 70
48181 to 48184	03 06 16	R W W	Intermittent number 9 Settings parameter	Similar to intermittent number 1 (48101 to 48104) Reference Number: Reference number of intermittent number 1 + 80
48191 to 48194	03 06 16	R W W	Intermittent number 10 Settings parameter	Similar to intermittent number 1 (48101 to 48104) Reference Number: Reference number of intermittent number 1 + 90
48201 to 48204	03 06 16	R W W	Intermittent number 11 Settings parameter	Similar to intermittent number 1 (48101 to 48104) Reference Number: Reference number of intermittent number 1 + 100
48211 to 48214	03 06 16	R W W	Intermittent number 12 Settings parameter	Similar to intermittent number 1 (48101 to 48104) Reference Number: Reference number of intermittent number 1 + 110

Reference Number	Application function code	R/W	Contents	Details
48221 to 48224	03 06 16	R W W	Intermittent number 13 Settings parameter	Similar to intermittent number 1 (48101 to 48103) Reference Number: Reference number of intermittent number 1 + 120
48231 to 48234	03 06 16	R W W	Intermittent number 14 Settings parameter	Similar to intermittent number 1 (48101 to 48103) Reference Number: Reference number of intermittent number 1 + 130
48241 to 48244	03 06 16	R W W	Intermittent number 15 Settings parameter	Similar to intermittent number 1 (48101 to 48103) Reference Number: Reference number of intermittent number 1 + 140
48251 to 48254	03 06 16	R W W	Intermittent number 16 Settings parameter	Similar to intermittent number 1 (48101 to 48103) Reference Number: Reference number of intermittent number 1 + 150
48261 to 48264	03 06 16	R W W	Intermittent number 17 Settings parameter	Similar to intermittent number 1 (48101 to 48103) Reference Number: Reference number of intermittent number 1 + 160
48271 to 48274	03 06 16	R W W	Intermittent number 18 Settings parameter	Similar to intermittent number 1 (48101 to 48103) Reference Number: Reference number of intermittent number 1 + 170
48281 to 48284	03 06 16	R W W	Intermittent number 19 Settings parameter	Similar to intermittent number 1 (48101 to 48103) Reference Number: Reference number of intermittent number 1 + 180
48291 to 48294	03 06 16	R W W	Intermittent number 20 Settings parameter	Similar to intermittent number 1 (48101 to 48103) Reference Number: Reference number of intermittent number 1 + 190
48301 to 48304	03 06 16	R W W	Intermittent number 21 Settings parameter	Similar to intermittent number 1 (48101 to 48103) Reference Number: Reference number of intermittent number 1 + 200
48311 to 48314	03 06 16	R W W	Intermittent number 22 Settings parameter	Similar to intermittent number 1 (48101 to 48103) Reference Number: Reference number of intermittent number 1 + 210
4321 to 48324	03 06 16	R W W	Intermittent number 23 Settings parameter	Similar to intermittent number 1 (48101 to 48103) Reference Number: Reference number of intermittent number 1 + 220
48331 to 48334	03 06 16	R W W	Intermittent number 24 Settings parameter	Similar to intermittent number 1 (48101 to 48103) Reference Number: Reference number of intermittent number 1 + 230
48341 to 48344	03 06 16	R W W	Intermittent number 25 Settings parameter	Similar to intermittent number 1 (48101 to 48103) Reference Number: Reference number of intermittent number 1 + 240
48351 to 48354	03 06 16	R W W	Intermittent number 26 Settings parameter	Similar to intermittent number 1 (48101 to 48103) Reference Number: Reference number of intermittent number 1 + 250
48361 to 48364	03 06 16	R W W	Intermittent number 27 Settings parameter	Similar to intermittent number 1 (48101 to 48103) Reference Number: Reference number of intermittent number 1 + 260

Reference Number	Application function code	R/W	Contents	Details
48371 to 48374	03 06 16	R W W	Intermittent number 28 Settings parameter	Similar to intermittent number 1 (48101 to 48103) Reference Number: Reference number of intermittent number 1 + 270
48381 to 48384	03 06 16	R W W	Intermittent number 29 Settings parameter	Similar to intermittent number 1 (48101 to 48103) Reference Number: Reference number of intermittent number 1 + 280
48391 to 48394	03 06 16	R W W	Intermittent number 30 Settings parameter	Similar to intermittent number 1 (48101 to 48103) Reference Number: Reference number of intermittent number 1 + 290
48401 to 48404	03 06 16	R W W	Intermittent number 31 Settings parameter	Similar to intermittent number 1 (48101 to 48103) Reference Number: Reference number of intermittent number 1 + 300
48411 to 48414	03 06 16	R W W	Intermittent number 32 Settings parameter	Similar to intermittent number 1 (48101 to 48103) Reference Number: Reference number of intermittent number 1 + 310
48421 to 48424	03 06 16	R W W	Intermittent number 33 Settings parameter	Similar to intermittent number 1 (48101 to 48103) Reference Number: Reference number of intermittent number 1 + 320
48431 to 48434	03 06 16	R W W	Intermittent number 34 Settings parameter	Similar to intermittent number 1 (48101 to 48103) Reference Number: Reference number of intermittent number 1 + 330
48441 to 48444	03 06 16	R W W	Intermittent number 35 Settings parameter	Similar to intermittent number 1 (48101 to 48103) Reference Number: Reference number of intermittent number 1 + 340
48451 to 48454	03 06 16	R W W	Intermittent number 36 Settings parameter	Similar to intermittent number 1 (48101 to 48103) Reference Number: Reference number of intermittent number 1 + 350
48461 to 48464	03 06 16	R W W	Intermittent number 37 Settings parameter	Similar to intermittent number 1 (48101 to 48103) Reference Number: Reference number of intermittent number 1 + 360
48471 to 48474	03 06 16	R W W	Intermittent number 38 Settings parameter	Similar to intermittent number 1 (48101 to 48103) Reference Number: Reference number of intermittent number 1 + 370
48481 to 48484	03 06 16	R W W	Intermittent number 39 Settings parameter	Similar to intermittent number 1 (48101 to 48103) Reference Number: Reference number of intermittent number 1 + 380
48491 to 48494	03 06 16	R W W	Intermittent number 40 Settings parameter	Similar to intermittent number 1 (48101 to 48103) Reference Number: Reference number of intermittent number 1 + 390
48501 to 48504	03 06 16	R W W	Intermittent number 41 Settings parameter	Similar to intermittent number 1 (48101 to 48103) Reference Number: Reference number of intermittent number 1 + 400
48511 to 48514	03 06 16	R W W	Intermittent number 42 Settings parameter	Similar to intermittent number 1 (48101 to 48103) Reference Number: Reference number of intermittent number 1 + 410

Reference Number	Application function code	R/W	Contents	Details
48521 to 48524	03 06 16	R W W	Intermittent number 43 Settings parameter	Similar to intermittent number 1 (48101 to 48103) Reference Number: Reference number of intermittent number 1 + 420
48531 to 48534	03 06 16	R W W	Intermittent number 44 Settings parameter	Similar to intermittent number 1 (48101 to 48103) Reference Number: Reference number of intermittent number 1 + 430
48541 to 48544	03 06 16	R W W	Intermittent number 45 Settings parameter	Similar to intermittent number 1 (48101 to 48103) Reference Number: Reference number of intermittent number 1 + 440
48551 to 48554	03 06 16	R W W	Intermittent number 46 Settings parameter	Similar to intermittent number 1 (48101 to 48103) Reference Number: Reference number of intermittent number 1 + 450
48561 to 48564	03 06 16	R W W	Intermittent number 47 Settings parameter	Similar to intermittent number 1 (48101 to 48103) Reference Number: Reference number of intermittent number 1 + 460
48571 to 48574	03 06 16	R W W	Intermittent number 48 Settings parameter	Similar to intermittent number 1 (48101 to 48103) Reference Number: Reference number of intermittent number 1 + 470
48581 to 48584	03 06 16	R W W	Intermittent number 49 Settings parameter	Similar to intermittent number 1 (48101 to 48103) Reference Number: Reference number of intermittent number 1 + 480
48591 to 48594	03 06 16	R W W	Intermittent number 50 Settings parameter	Similar to intermittent number 1 (48101 to 48103) Reference Number: Reference number of intermittent number 1 + 490
48601 to 48604	03 06 16	R W W	Intermittent number 51 Settings parameter	Similar to intermittent number 1 (48101 to 48103) Reference Number: Reference number of intermittent number 1 + 500
48611 to 48614	03 06 16	R W W	Intermittent number 52 Settings parameter	Similar to intermittent number 1 (48101 to 48103) Reference Number: Reference number of intermittent number 1 + 510
48621 to 48624	03 06 16	R W W	Intermittent number 53 Settings parameter	Similar to intermittent number 1 (48101 to 48103) Reference Number: Reference number of dotting number 1 + 520
48631 to 48634	03 06 16	R W W	Intermittent number 54 Settings parameter	Similar to intermittent number 1 (48101 to 48103) Reference Number: Reference number of intermittent number 1 + 530
48641 to 48644	03 06 16	R W W	Intermittent number 55 Settings parameter	Similar to intermittent number 1 (48101 to 48103) Reference Number: Reference number of intermittent number 1 + 540
48651 to 48654	03 06 16	R W W	Intermittent number 56 Settings parameter	Similar to intermittent number 1 (48101 to 48103) Reference Number: Reference number of intermittent number 1 + 550
48661 to 48664	03 06 16	R W W	Intermittent number 57 Settings parameter	Similar to intermittent number 1 (48101 to 48103) Reference Number: Reference number of intermittent number 1 + 560

Reference Number	Application function code	R/W	Contents	Details
48671 to 48674	03 06 16	R W W	Intermittent number 58 Settings parameter	Similar to intermittent number 1 (48101 to 48103) Reference Number: Reference number of intermittent number 1 + 570
48681 to 48684	03 06 16	R W W	Intermittent number 59 Settings parameter	Similar to intermittent number 1 (48101 to 48103) Reference Number: Reference number of intermittent number 1 + 580
48691 to 48694	03 06 16	R W W	Intermittent number 60 Settings parameter	Similar to intermittent number 1 (48101 to 48103) Reference Number: Reference number of intermittent number 1 + 590
48701 to 48704	03 06 16	R W W	Intermittent number 61 Settings parameter	Similar to intermittent number 1 (48101 to 48103) Reference Number: Reference number of intermittent number 1 + 600
48711 to 48714	03 06 16	R W W	Intermittent number 62 Settings parameter	Similar to intermittent number 1 (48101 to 48103) Reference Number: Reference number of intermittent number 1 + 610
48721 to 48724	03 06 16	R W W	Intermittent number 63 Settings parameter	Similar to intermittent number 1 (48101 to 48103) Reference Number: Reference number of intermittent number 1 + 620
48731 to 48734	03 06 16	R W W	Intermittent number 64 Settings parameter	Similar to intermittent number 1 (48101 to 48103) Reference Number: Reference number of intermittent number 1 + 630
48741 to 48744	03 06 16	R W W	Intermittent number 65 Settings parameter	Similar to intermittent number 1 (48101 to 48103) Reference Number: Reference number of intermittent number 1 + 640
48751 to 48754	03 06 16	R W W	Intermittent number 66 Settings parameter	Similar to intermittent number 1 (48101 to 48103) Reference Number: Reference number of intermittent number 1 + 650
48761 to 48764	03 06 16	R W W	Intermittent number 67 Settings parameter	Similar to intermittent number 1 (48101 to 48103) Reference Number: Reference number of intermittent number 1 + 660
48771 to 48774	03 06 16	R W W	Intermittent number 68 Settings parameter	Similar to intermittent number 1 (48101 to 48103) Reference Number: Reference number of intermittent number 1 + 670
48781 to 48784	03 06 16	R W W	Intermittent number 69 Settings parameter	Similar to intermittent number 1 (48101 to 48103) Reference Number: Reference number of intermittent number 1 + 680
48791 to 48794	03 06 16	R W W	Intermittent number 70 Settings parameter	Similar to intermittent number 1 (48101 to 48103) Reference Number: Reference number of intermittent number 1 + 690
48801 to 48804	03 06 16	R W W	Intermittent number 71 Settings parameter	Similar to intermittent number 1 (48101 to 48103) Reference Number: Reference number of intermittent number 1 + 700
48811 to 48814	03 06 16	R W W	Intermittent number 72 Settings parameter	Similar to intermittent number 1 (48101 to 48103) Reference Number: Reference number of intermittent number 1 + 710

7) Data communications input

R/W.....R: READ, W: WRITE

Reference Number	Application function code	R/W	Contents	Details
49001	03 06 16	R W W	CH1 Data communications input Data	-30000 to 30000 Error code: 01H, 02H, 03H, 11H, 12H
49002	03 06 16	R W W	CH1 Data communications input Decimal point position	0 to 3 Error code: 01H, 02H, 03H, 11H, 12H
49003 to 49004	03 06 16	R W W	CH2 Data communications input	Similar to CH1 (49001 to 49002) Reference number: Reference number of CH1 +2
49005 to 49006	03 06 16	R W W	CH3 Data communications input	Similar to CH1 (49001 to 49002) Reference number: Reference number of CH1 +4
49007 to 49008	03 06 16	R W W	CH4 Data communications input	Similar to CH1 (49001 to 49002) Reference number: Reference number of CH1 +6
49009 to 49010	03 06 16	R W W	CH5 Data communications input	Similar to CH1 (49001 to 49002) Reference number: Reference number of CH1 +8
49011 to 49012	03 06 16	R W W	CH6 Data communications input	Similar to CH1 (49001 to 49002) Reference number: Reference number of CH1 +10
49013 to 49014	03 06 16	R W W	CH7 Data communications input	Similar to CH1 (49001 to 49002) Reference number: Reference number of CH1 +12
49015 to 49016	03 06 16	R W W	CH8 Data communications input	Similar to CH1 (49001 to 49002) Reference number: Reference number of CH1 +14
49017 to 49018	03 06 16	R W W	CH9 Data communications input	Similar to CH1 (49001 to 49002) Reference number: Reference number of CH1 +16
49019 to 49020	03 06 16	R W W	CH10 Data communications input	Similar to CH1 (49001 to 49002) Reference number: Reference number of CH1 +18
49021 to 49022	03 06 16	R W W	CH11 Data communications input	Similar to CH1 (49001 to 49002) Reference number: Reference number of CH1 +20
49023 to 49024	03 06 16	R W W	CH12 Data communications input	Similar to CH1 (49001 to 49002) Reference number: Reference number of CH1 +22
49025 to 49026	03 06 16	R W W	CH13 Data communications input	Similar to CH1 (49001 to 49002) Reference number: Reference number of CH1 +24
49027 to 49028	03 06 16	R W W	CH14 Data communications input	Similar to CH1 (49001 to 49002) Reference number: Reference number of CH1 +26

Reference Number	Application function code	R/W	Contents	Details
49029 to 49030	03 06 16	R W W	CH15 Data communications input	Similar to CH1 (49001 to 49002) Reference number: Reference number of CH1 +28
49031 to 49032	03 06 16	R W W	CH16 Data communications input	Similar to CH1 (49001 to 49002) Reference number: Reference number of CH1 +30
49033 to 49034	03 06 16	R W W	CH17 Data communications input	Similar to CH1 (49001 to 49002) Reference number: Reference number of CH1 +32
49035 to 49036	03 06 16	R W W	CH18 Data communications input	Similar to CH1 (49001 to 49002) Reference number: Reference number of CH1 +34
49037 to 49038	03 06 16	R W W	CH19 Data communications input	Similar to CH1 (49001 to 49002) Reference number: Reference number of CH1 +36
49039 to 49040	03 06 16	R W W	CH20 Data communications input	Similar to CH1 (49001 to 49002) Reference number: Reference number of CH1 +38
49041 to 49042	03 06 16	R W W	CH21 Data communications input	Similar to CH1 (49001 to 49002) Reference number: Reference number of CH1 +40
49043 to 49044	03 06 16	R W W	CH22 Data communications input	Similar to CH1 (49001 to 49002) Reference number: Reference number of CH1 +42
49045 to 49046	03 06 16	R W W	CH23 Data communications input	Similar to CH1 (49001 to 49002) Reference number: Reference number of CH1 +44
49047 to 49048	03 06 16	R W W	CH24 Data communications input	Similar to CH1 (49001 to 49002) Reference number: Reference number of CH1 +46
49049 to 49050	03 06 16	R W W	CH25 Data communications input	Similar to CH1 (49001 to 49002) Reference number: Reference number of CH1 +48
49051 to 49052	03 06 16	R W W	CH26 Data communications input	Similar to CH1 (49001 to 49002) Reference number: Reference number of CH1 +50
49053 to 49054	03 06 16	R W W	CH27 Data communications input	Similar to CH1 (49001 to 49002) Reference number: Reference number of CH1 +52
49055 to 49056	03 06 16	R W W	CH28 Data communications input	Similar to CH1 (49001 to 49002) Reference number: Reference number of CH1 +54
49057 to 49058	03 06 16	R W W	CH29 Data communications input	Similar to CH1 (49001 to 49002) Reference number: Reference number of CH1 +56

Reference Number	Application function code	R/W	Contents	Details
49059 to 49060	03 06 16	R W W	CH30 Data communications input	Similar to CH1 (49001 to 49002) Reference number: Reference number of CH1 +58
49061 to 49062	03 06 16	R W W	CH31 Data communications input	Similar to CH1 (49001 to 49002) Reference number: Reference number of CH1 +60
49063 to 49064	03 06 16	R W W	CH32 Data communications input	Similar to CH1 (49001 to 49002) Reference number: Reference number of CH1 +62
49065 to 49066	03 06 16	R W W	CH33 Data communications input	Similar to CH1 (49001 to 49002) Reference number: Reference number of CH1 +64
49067 to 49068	03 06 16	R W W	CH34 Data communications input	Similar to CH1 (49001 to 49002) Reference number: Reference number of CH1 +66
49069 to 49070	03 06 16	R W W	CH35 Data communications input	Similar to CH1 (49001 to 49002) Reference number: Reference number of CH1 +68
49071 to 49072	03 06 16	R W W	CH36 Data communications input	Similar to CH1 (49001 to 49002) Reference number: Reference number of CH1 +70

8) Parameters common to the channels

R/W.....R: READ, W: WRITE

Reference Number	Application function code	R/W	Contents	Details
49101	03 06 16	R W W	Settings guide language	0: English, 1: Japanese Error code: 01H, 02H, 03H, 11H, 12H
49103	03 06 16	R W W	Time display type	0: Year month date, 1:Month date year, 2: Date month year Error code: 01H, 02H, 03H, 11H, 12H
49104	03 06 16	R W W	Summer time Switching	0: Except summer time, 1: Summer time Error code: 01H, 02H, 03H, 11H, 12H
49106	03 06 16	R W W	File output settings	01 to 999, 00H: No output Error code: 01H, 02H, 03H, 11H, 12H
49111	03 06 16	R W W	Switch display Auto/Const	0: Auto, 1: Const Error code: 01H, 02H, 03H, 11H, 12H
49112	03 06 16	R W W	Switch display 1CH/12CH/36CH	1: 1 CH display, 2: 12 CH display, 3: 36 CH display Error code: 01H, 02H, 03H, 11H, 12H
49113	03 06 16	R W W	Switch display Unit/Tag	0: Unit, 1: Tag Error code: 01H, 02H, 03H, 11H, 12H
49114	03 06 16	R W W	Channel update period 1CH	1: 1 second, 2: 2 seconds, 3: 3 seconds, 5: 5 seconds, 10: 10 seconds, 30: 30 seconds Error code: 01H, 02H, 03H, 11H, 12H
49115	03 06 16	R W W	Channel update period 12CH	1: 1 second, 2: 2 seconds, 3: 3 seconds, 5: 5 seconds, 10: 10 seconds, 30: 30 seconds Error code: 01H, 02H, 03H, 11H, 12H
49116	03 06 16	R W W	Channel update period 36CH	1: 1 second, 2: 2 seconds, 3: 3 seconds, 5: 5 seconds, 10: 10 seconds, 30: 30 seconds Error code: 01H, 02H, 03H, 11H, 12H
49117	03 06 16	R W W	Recording light brightness settings	0: OFF, 1 to 4 (Beginning value 4) Error code:01H,02H,03H,11H,12H
49118	03 06 16	R W W	Display brightness settings	1 to 4 (Beginning value 4) Error code: 01H, 02H, 03H, 11H, 12H
49119	03 06 16	R W W	Recording light OFF Timer	0: None, 1: 1 minute, 2: 2 minutes, 3: 3 minutes, 5:5 minutes Error code: 01H, 02H, 03H, 11H, 12H
49120	03 06 16	R W W	Display OFF Timer	0: None, 1: 1 minute, 2: 2 minutes, 3: 3 minutes, 5:5 minutes Error code: 01H, 02H, 03H, 11H, 12H

5.8.5 Function for RD5200 (RD5300 responds with option)

1) Character string of calculation

R/W.....R: READ, W: WRITE

Reference Number	Application function code	R/W	Contents	Details
23720	62 63	R W	CH37 character of calculation 1,2	ASCII code 2 digits (No setting is 00H) Error code: 01H, 02H, 03H, 11H, 12H
23721	62 63	R W	CH37 character of calculation 3,4	ASCII code 2 digits (No setting is 00H) Error code: 01H, 02H, 03H, 11H, 12H
23722	62 63	R W	CH37 character of calculation 5,6	ASCII code 2 digits (No setting is 00H) Error code: 01H, 02H, 03H, 11H, 12H
23723	62 63	R W	CH37 character of calculation 7,8	ASCII code 2 digits (No setting is 00H) Error code: 01H, 02H, 03H, 11H, 12H
23724	62 63	R W	CH37 character of calculation 9,10	ASCII code 2 digits (No setting is 00H) Error code: 01H, 02H, 03H, 11H, 12H
23725	62 63	R W	CH37 character of calculation 11,12	ASCII code 2 digits (No setting is 00H) Error code: 01H, 02H, 03H, 11H, 12H
23726	62 63	R W	CH37 character of calculation 13,14	ASCII code 2 digits (No setting is 00H) Error code: 01H, 02H, 03H, 11H, 12H
23727	62 63	R W	CH37 character of calculation 15,16	ASCII code 2 digits (No setting is 00H) Error code: 01H, 02H, 03H, 11H, 12H
23728	62 63	R W	CH37 character of calculation 17,18	ASCII code 2 digits (No setting is 00H) Error code: 01H, 02H, 03H, 11H, 12H
23729	62 63	R W	CH37 character of calculation 19,20	ASCII code 2 digits (No setting is 00H) Error code: 01H, 02H, 03H, 11H, 12H
23730	62 63	R W	CH37 character of calculation 21,22	ASCII code 2 digits (No setting is 00H) Error code: 01H, 02H, 03H, 11H, 12H
23731	62 63	R W	CH37 character of calculation 23,24	ASCII code 2 digits (No setting is 00H) Error code: 01H, 02H, 03H, 11H, 12H
23732	62 63	R W	CH37 character of calculation 25,26	ASCII code 2 digits (No setting is 00H) Error code: 01H, 02H, 03H, 11H, 12H
23733	62 63	R W	CH37 character of calculation 27,28	ASCII code 2 digits (No setting is 00H) Error code: 01H, 02H, 03H, 11H, 12H
23734	62 63	R W	CH37 character of calculation 29,30	ASCII code 2 digits (No setting is 00H) Error code: 01H, 02H, 03H, 11H, 12H
23735	62 63	R W	CH37 character of calculation 31,32	ASCII code 2 digits (No setting is 00H) Error code: 01H, 02H, 03H, 11H, 12H
23736	62 63	R W	CH37 character of calculation 33,34	ASCII code 2 digits (No setting is 00H) Error code: 01H, 02H, 03H, 11H, 12H
23737	62 63	R W	CH37 character of calculation 35,36	ASCII code 2 digits (No setting is 00H) Error code: 01H, 02H, 03H, 11H, 12H

Reference Number	Application function code	R/W	Contents	Details
23738	62 63	R W	CH37 character of calculation 37,38	ASCII code 2 digits (No setting is 00H) Error code: 01H, 02H, 03H, 11H, 12H
23739	62 63	R W	CH37 character of calculation 39,40	ASCII code 2 digits (No setting is 00H) Error code: 01H, 02H, 03H, 11H, 12H
23740	62 63	R W	CH37 character of calculation 41,42	ASCII code 2 digits (No setting is 00H) Error code: 01H, 02H, 03H, 11H, 12H
23741	62 63	R W	CH37 character of calculation 43,44	ASCII code 2 digits (No setting is 00H) Error code: 01H, 02H, 03H, 11H, 12H
23742	62 63	R W	CH37 character of calculation 45,46	ASCII code 2 digits (No setting is 00H) Error code: 01H, 02H, 03H, 11H, 12H
23743	62 63	R W	CH37 character of calculation 47,48	ASCII code 2 digits (No setting is 00H) Error code: 01H, 02H, 03H, 11H, 12H
23744	62 63	R W	CH37 character of calculation 49,50	ASCII code 2 digits (No setting is 00H) Error code: 01H, 02H, 03H, 11H, 12H
23820 to 23844	62 63	R W	CH38 character of calculation 1 to 50	Similar to CH37 (23720 to 23744) Reference number: Reference number of CH37 +100
23920 to 23944	62 63	R W	CH39 character of calculation 1 to 50	Similar to CH37 (23720 to 23744) Reference number: Reference number of CH37 +200
24020 to 24044	62 63	R W	CH40 character of calculation 1 to 50	Similar to CH37 (23720 to 23744) Reference number: Reference number of CH37 +300
24120 to 24144	62 63	R W	CH41 character of calculation 1 to 50	Similar to CH37 (23720 to 23744) Reference number: Reference number of CH37 +400
24220 to 24244	62 63	R W	CH42 character of calculation 1 to 50	Similar to CH37 (23720 to 23744) Reference number: Reference number of CH37 +500
24320 to 24344	62 63	R W	CH43 character of calculation 1 to 50	Similar to CH37 (23720 to 23744) Reference number: Reference number of CH37 +600
24420 to 24444	62 63	R W	CH44 character of calculation 1 to 50	Similar to CH37 (23720 to 23744) Reference number: Reference number of CH37 +700
24520 to 24544	62 63	R W	CH45 character of calculation 1 to 50	Similar to CH37 (23720 to 23744) Reference number: Reference number of CH37 +800
24620 to 24644	62 63	R W	CH46 character of calculation 1 to 50	Similar to CH37 (23720 to 23744) Reference number: Reference number of CH37 +900
24720 to 24744	62 63	R W	CH47 character of calculation 1 to 50	Similar to CH37(23720 to 23744) reference number: Reference number of CH37 +1000

Reference Number	Application function code	R/W	Contents	Details
24820 to 24844	62 63	R W	CH48 character of calculation 1 to 50	Similar to CH37 (23720 to 23744) Reference number: Reference number of CH37 +1100
24920 to 24944	62 63	R W	CH49 character of calculation 1 to 50	Similar to CH37 (23720 to 23744) Reference number: Reference number of CH37 +1200
25020 to 25044	62 63	R W	CH50 character of calculation 1 to 50	Similar to CH37 (23720 to 23744) Reference number: Reference number of CH37 +1300
25120 to 25144	62 63	R W	CH51 character of calculation 1 to 50	Similar to CH37 (23720 to 23744) Reference number: Reference number of CH37 +1400
25220 to 25244	62 63	R W	CH52 character of calculation 1 to 50	Similar to CH37 (23720 to 23744) Reference number: Reference number of CH37 +1500
25320 to 25344	62 63	R W	CH53 character of calculation 1 to 50	Similar to tCH37 (23720 to 23744) Reference number: Reference number of CH37 +1600
25420 to 25444	62 63	R W	CH54 character of calculation 1 to 50	Similar to CH37 (23720 to 23744) Reference number: Reference number of CH37 +1700
25520 to 25544	62 63	R W	CH55 character of calculation 1 to 50	Similar to CH37 (23720 to 23744) Reference number: Reference number of CH37 +1800
25620 to 25644	62 63	R W	CH56 character of calculation 1 to 50	Similar to CH37 (23720 to 23744) Reference number: Reference number of CH37 +1900
25720 to 25744	62 63	R W	CH57 character of calculation 1 to 50	Similar to CH37 (23720 to 23744) Reference number: Reference number of CH37 +2000
25820 to 25844	62 63	R W	CH58 character of calculation 1 to 50	Similar to CH37 (23720 to 23744) Reference number: Reference number of CH37 +2100
25920 to 25944	62 63	R W	CH59 character of calculation 1 to 50	Similar to CH37 (23720 to 23744) Reference number: Reference number of CH37 +2200
26020 to 26044	62 63	R W	CH60 character of calculation 1 to 50	Similar to CH37 (23720 to 23744) Reference number: Reference number of CH37 +2300
26120 to 26144	62 63	R W	CH61 character of calculation 1 to 50	Similar to CH37 (23720 to 23744) Reference number: Reference number of CH37 +2400
26220 to 26244	62 63	R W	CH62 character of calculation 1 to 50	Similar to CH37 (23720 to 23744) Reference number: Reference number of CH37 +2500
26320 to 26344	62 63	R W	CH63 character of calculation 1 to 50	Similar to CH37 (23720 to 23744) Reference number: Reference number of CH37 +2600

Reference Number	Application function code	R/W	Contents	Details
26420 to 26444	62 63	R W	CH64 character of calculation 1 to 50	Similar to CH37 (23720 to 23744) Reference number: Reference number of CH37 +2700
26520 to 26544	62 63	R W	CH65 character of calculation 1 to 50	Similar to CH37 (23720 to 23744) Reference number: Reference number of CH37 +2800
26620 to 26644	62 63	R W	CH66 character of calculation 1 to 50	Similar to CH37 (23720 to 23744) Reference number: Reference number of CH37 +2900
26720 to 26744	62 63	R W	CH67 character of calculation 1 to 50	Similar to CH37 (23720 to 23744) Reference number: Reference number of CH37 +3000
26820 to 26844	62 63	R W	CH68 character of calculation 1 to 50	Similar to CH37 (23720 to 23744) Reference number: Reference number of CH37 +3100
26920 to 26944	62 63	R W	CH69 character of calculation 1 to 50	Similar to CH37 (23720 to 23744) Reference number: Reference number of CH37 +3200
27020 to 27044	62 63	R W	CH70 character of calculation 1 to 50	Similar to CH37 (23720 to 23744) Reference number: Reference number of CH37 +3300
27120 to 27144	62 63	R W	CH71 character of calculation 1 to 50	Similar to CH37 (23720 to 23744) Reference number: Reference number of CH37 +3400
27220 to 27244	62 63	R W	CH72 character of calculation 1 to 50	Similar to CH37 (23720 to 23744) Reference number: Reference number of CH37 +3500

5.8.6 Function for RD5300

1) Parameter settings of channel 101 to 599

R/W.....R: READ, W: WRITE

Reference Number	Application function code	R/W	Contents	Details
40101	60 61	R W	Channel select	0: CH001 to 099, 1: CH101 to 199, 2: CH201 to 299, 3: CH301 to 399, 4: CH401 to 499, 5: CH501 to 599
40102 to 40194 Except 40195 and 40169 to 40180	60 61	R W	Channel *01 ※) * is designated by 40101	Similar to CH1 parameter Refer to 5.8.4
40201 to 40294 Except 40295 and 40269 to 40280	60 61	R W	Channel *02 ※) * is designated by 40101	Similar to CH1 parameter Refer to 5.8.4 ※) 40201 is common with 40101
40301 to 40394 Except 40395 and 40369 to 40380	60 61	R W	Channel *03 ※) * is designated by 40101	Similar to CH1 parameter Refer to 5.8.4 ※) 40301 is common with 40101
40401 to 40494 Except 40495 and 40469 to 40480	60 61	R W	Channel *04 ※) * is designated by 40101	Similar to CH1 parameter Refer to 5.8.4 ※) 40401 is common with 40101
40501 to 40594 Except 40595 and 40569 to 40580	60 61	R W	Channel *05 ※) * is designated by 40101	Similar to CH1 parameter Refer to 5.8.4 ※) 40501 is common with 40101
40601 to 40694 Except 40695 and 40669 to 40680	60 61	R W	Channel *06 ※) * is designated by 40101	Similar to CH1 parameter Refer to 5.8.4 ※) 40601 is common with 40101
40701 to 40794 Except 40795 and 40769 to 40780	60 61	R W	Channel *07 ※) * is designated by 40101	Similar to CH1 parameter Refer to 5.8.4 ※) 40701 is common with 40101
40801 to 40894 Except 40895 and 40869 to 40880	60 61	R W	Channel *08 ※) * is designated by 40101	Similar to CH1 parameter Refer to 5.8.4 ※) 40801 is common with 40101
40901 to 40994 Except 40995 and 40969 to 40980	60 61	R W	Channel *09 ※) * is designated by 40101	Similar to CH1 parameter Refer to 5.8.4 ※) 40901 is common with 40101
41001 to 41094 Except 41095 and 41069 to 41080	60 61	R W	Channel *10 ※) * is designated by 40101	Similar to CH1 parameter Refer to 5.8.4 ※) 41001 is common with 40101
41101 to 41194 Except 41195 and 41169 to 41180	60 61	R W	Channel *11 ※) * is designated by 40101	Similar to CH1 parameter Refer to 5.8.4 ※) 41101 is common with 40101

Reference Number	Application function code	R/W	Contents	Details
41201 to 41294 Except 41295 and 41269 to 41280	60 61	R W	Channel *12 ※) * is designated by 40101	Similar to CH1 parameter Refer to 5.8.4 ※) 41201 is common with 40101
41301 to 41394 Except 41395 and 41369 to 41380	60 61	R W	Channel *13 ※) * is designated by 40101	Similar to CH1 parameter Refer to 5.8.4 ※) 41301 is common with 40101
41401 to 41494 Except 41495 and 41469 to 41480	60 61	R W	Channel *14 ※) * is designated by 40101	Similar to CH1 parameter Refer to 5.8.4 ※) 41401 is common with 40101
41501 to 41594 Except 41595 and 41569 to 41580	60 61	R W	Channel *15 ※) * is designated by 40101	Similar to CH1 parameter Refer to 5.8.4 ※) 41501 is common with 40101
41601 to 41694 Except 41695 and 41669 to 41680	60 61	R W	Channel *16 ※) * is designated by 40101	Similar to CH1 parameter Refer to 5.8.4 ※) 41601 is common with 40101
41701 to 41794 Except 41795 and 41769 to 41780	60 61	R W	Channel *17 ※) * is designated by 40101	Similar to CH1 parameter Refer to 5.8.4 ※) 41701 is common with 40101
41801 to 41894 Except 41895 and 41869 to 41880	60 61	R W	Channel *18 ※) * is designated by 40101	Similar to CH1 parameter Refer to 5.8.4 ※) 41801 is common with 40101
41901 to 41994 Except 41995 and 41969 to 41980	60 61	R W	Channel *19 ※) * is designated by 40101	Similar to CH1 parameter Refer to 5.8.4 ※) 41901 is common with 40101
42001 to 42094 Except 42095 and 42069 to 42080	60 61	R W	Channel *20 ※) * is designated by 40101	Similar to CH1 parameter Refer to 5.8.4 ※) 42001 is common with 40101
42101 to 42194 Except 42195 and 42169 to 42180	60 61	R W	Channel *21 ※) * is designated by 40101	Similar to CH1 parameter Refer to 5.8.4 ※) 42101 is common with 40101
42201 to 42294 Except 42295 and 42269 to 42280	60 61	R W	Channel *22 ※) * is designated by 40101	Similar to CH1 parameter Refer to 5.8.4 ※) 42201 is common with 40101
42301 to 42394 Except 42395 and 42369 to 42380	60 61	R W	Channel *23 ※) * is designated by 40101	Similar to CH1 parameter Refer to 5.8.4 ※) 42301 is common with 40101

Reference Number	Application function code	R/W	Contents	Details
42401 to 42494 Except 42495 and 42469 to 42480	60 61	R W	Channel *24 ※) * is designated by 40101	Similar to CH1 parameter Refer to 5.8.4 ※) 42401 is common with 40101
42501 to 42594 Except 42595 and 42569 to 42580	60 61	R W	Channel *25 ※) * is designated by 40101	Similar to CH1 parameter Refer to 5.8.4 ※) 42501 is common with 40101
42601 to 42694 Except 42695 and 42669 to 42680	60 61	R W	Channel *26 ※) * is designated by 40101	Similar to CH1 parameter Refer to 5.8.4 ※) 42601 is common with 40101
42701 to 42794 Except 42795 and 42769 to 42780	60 61	R W	Channel *27 ※) * is designated by 40101	Similar to CH1 parameter Refer to 5.8.4 ※) 42701 is common with 40101
42701 to 42794 Except 42795 and 42769 to 42780	60 61	R W	Channel *27 ※) * is designated by 40101	Similar to CH1 parameter Refer to 5.8.4 ※) 42701 is common with 40101
42801 to 42894 Except 42895 and 42869 to 42880	60 61	R W	Channel *28 ※) * is designated by 40101	Similar to CH1 parameter Refer to 5.8.4 ※) 42801 is common with 40101
42901 to 42994 Except 42995 and 42969 to 42980	60 61	R W	Channel *29 ※) * is designated by 40101	Similar to CH1 parameter Refer to 5.8.4 ※) 42901 is common with 40101
43001 to 43094 Except 43095 and 43069 to 43080	60 61	R W	Channel *30 ※) * is designated by 40101	Similar to CH1 parameter Refer to 5.8.4 ※) 43001 is common with 40101
43101 to 43194 Except 43195 and 43169 to 43180	60 61	R W	Channel *31 ※) * is designated by 40101	Similar to CH1 parameter Refer to 5.8.4 ※) 43101 is common with 40101
43201 to 43294 Except 43295 and 43269 and 43280	60 61	R W	Channel *32 ※) * is designated by 40101	Similar to CH1 parameter Refer to 5.8.4 ※) 43201 is common with 40101
43301 and 43394 Except 43395 and 43369 to 43380	60 61	R W	Channel *33 ※) * is designated by 40101	Similar to CH1 parameter Refer to 5.8.4 ※) 43301 is common with 40101
43401 to 43494 Except 43495 and 43469 to 43480	60 61	R W	Channel *34 ※) * is designated by 40101	Similar to CH1 parameter Refer to 5.8.4 ※) 43401 is common with 40101

Reference Number	Application function code	R/W	Contents	Details
43501 to 43594 Except 43595 and 43569 to 43580	60 61	R W	Channel *35 ※) * is designated by 40101	Similar to CH1 parameter Refer to 5.8.4 ※) 43501 is common with 40101
43601 to 43694 Except 43695 and 43669 to 43680	60 61	R W	Channel *36 ※) * is designated by 40101	Similar to CH1 parameter Refer to 5.8.4 ※) 43601 is common with 40101
43701 to 43794 Except 43795 and 43769 to 43780	60 61	R W	Channel *37 ※) * is designated by 40101	Similar to CH1 parameter Refer to 5.8.4 ※) 43701 is common with 40101
43801 to 43894 Except 43895 and 43869 to 43880	60 61	R W	Channel *38 ※) * is designated by 40101	Similar to CH1 parameter Refer to 5.8.4 ※) 43801 is common with 40101
43901 to 43994 Except 43995 and 43969 to 43980	60 61	R W	Channel *39 ※) * is designated by 40101	Similar to CH1 parameter Refer to 5.8.4 ※) 43901 is common with 40101
44001 to 44094 Except 44095 and 44069 to 44080	60 61	R W	Channel *40 ※) * is designated by 40101	Similar to CH1 parameter Refer to 5.8.4 ※) 44001 is common with 40101
44101 to 44194 Except 44195 and 44169 to 44180	60 61	R W	Channel *41 ※) * is designated by 40101	Similar to CH1 parameter Refer to 5.8.4 ※) 44101 is common with 40101
44201 to 44294 Except 44295 and 44269 to 44280	60 61	R W	Channel *42 ※) * is designated by 40101	Similar to CH1 parameter Refer to 5.8.4 ※) 44201 is common with 40101
44301 to 44394 Except 44395 and 44369 to 44380	60 61	R W	Channel *43 ※) * is designated by 40101	Similar to CH1 parameter Refer to 5.8.4 ※) 44301 is common with 40101
44401 to 44494 Except 44495 and 44469 to 44480	60 61	R W	Channel *44 ※) * is designated by 40101	Similar to CH1 parameter Refer to 5.8.4 ※) 44401 is common with 40101
44501 to 44594 Except 44595 and 44569 to 44580	60 61	R W	Channel *45 ※) * is designated by 40101	Similar to CH1 parameter Refer to 5.8.4 ※) 44501 is common with 40101
44601 to 44694 Except 44695 and 44669 to 44680	60 61	R W	Channel *46 ※) * is designated by 40101	Similar to CH1 parameter Refer to 5.8.4 ※) 44601 is common with 40101

Reference Number	Application function code	R/W	Contents	Details
44701 to 44794 Except 44795 and 44769 to 44780	60 61	R W	Channel *47 ※) * is designated by 40101	Similar to CH1 parameter Refer to 5.8.4 ※) 44701 is common with 40101
44801 to 44894 Except 44895 and 44869 and 44880	60 61	R W	Channel *48 ※) * is designated by 40101	Similar to CH1 parameter Refer to 5.8.4 ※) 44801 is common with 40101
44901 and 44994 Except 44995 and 44969 to 44980	60 61	R W	Channel *49 ※) * is designated by 40101	Similar to CH1 parameter Refer to 5.8.4 ※) 44901 is common with 40101
45001 to 45094 Except 45095 and 45069 to 45080	60 61	R W	Channel *50 ※) * is designated by 40101	Similar to CH1 parameter Refer to 5.8.4 ※) 45001 is common with 40101
45101 to 45194 Except 45195 and 45169 to 45180	60 61	R W	Channel *51 ※) * is designated by 40101	Similar to CH1 parameter Refer to 5.8.4 ※) 45101 is common with 40101
45201 to 45294 Except 45295 and 45269 to 45280	60 61	R W	Channel *52 ※) * is designated by 40101	Similar to CH1 parameter Refer to 5.8.4 ※) 45201 is common with 40101
45301 to 45394 Except 45395 and 45369 to 45380	60 61	R W	Channel *53 ※) * is designated by 40101	Similar to CH1 parameter Refer to 5.8.4 ※) 45301 is common with 40101
45401 to 45494 Except 45495 and 45469 to 45480	60 61	R W	Channel *54 ※) * is designated by 40101	Similar to CH1 parameter Refer to 5.8.4 ※) 45401 is common with 40101
45501 to 45594 Except 45595 and 45569 to 45580	60 61	R W	Channel *55 ※) * is designated by 40101	Similar to CH1 parameter Refer to 5.8.4 ※) 45501 is common with 40101
45601 to 45694 Except 45695 and 45669 and 45680	60 61	R W	Channel *56 ※) * is designated by 40101	Similar to CH1 parameter Refer to 5.8.4 ※) 45601 is common with 40101
45701 and 45794 Except 45795 and 45769 to 45780	60 61	R W	Channel *57 ※) * is designated by 40101	Similar to CH1 parameter Refer to 5.8.4 ※) 45701 is common with 40101
45801 to 45894 Except 45895 and 45869 to 45880	60 61	R W	Channel *58 ※) * is designated by 40101	Similar to CH1 parameter Refer to 5.8.4 ※) 45801 is common with 40101

Reference Number	Application function code	R/W	Contents	Details
45901 to 45994 Except 45995 and 45969 to 45980	60 61	R W	Channel *59 ※) * is designated by 40101	Similar to CH1 parameter Refer to 5.8.4 ※) 45901 is common with 40101
46001 to 46094 Except 46095 and 46069 to 46080	60 61	R W	Channel *60 ※) * is designated by 40101	Similar to CH1 parameter Refer to 5.8.4 ※) 46001 is common with 40101
46101 to 46194 Except 46195 and 46169 to 46180	60 61	R W	Channel *61 ※) * is designated by 40101	Similar to CH1 parameter Refer to 5.8.4 ※) 46101 is common with 40101
46201 to 46294 Except 46295 and 46269 to 46280	60 61	R W	Channel *62 ※) * is designated by 40101	Similar to CH1 parameter Refer to 5.8.4 ※) 46201 is common with 40101
46301 to 46394 Except 46395 and 46369 to 46380	60 61	R W	Channel *63 ※) * is designated by 40101	Similar to CH1 parameter Refer to 5.8.4 ※) 46301 is common with 40101
46401 to 46494 Except 46495 and 46469 to 46480	60 61	R W	Channel *64 ※) * is designated by 40101	Similar to CH1 parameter Refer to 5.8.4 ※) 46401 is common with 40101
46501 to 46594 Except 46595 and 46569 to 46580	60 61	R W	Channel *65 ※) * is designated by 40101	Similar to CH1 parameter Refer to 5.8.4 ※) 46501 is common with 40101
46601 to 46694 Except 46695 and 46669 to 46680	60 61	R W	Channel *66 ※) * is designated by 40101	Similar to CH1 parameter Refer to 5.8.4 ※) 46601 is common with 40101
46701 to 46794 Except 46795 and 46769 to 46780	60 61	R W	Channel *67 ※) * is designated by 40101	Similar to CH1 parameter Refer to 5.8.4 ※) 46701 is common with 40101
46801 to 46894 Except 46895 and 46869 to 46880	60 61	R W	Channel *68 ※) * is designated by 40101	Similar to CH1 parameter Refer to 5.8.4 ※) 46801 is common with 40101
46901 to 46994 Except 46995 and 46969 to 46980	60 61	R W	Channel *69 ※) * is designated by 40101	Similar to CH1 parameter Refer to 5.8.4 ※) 46901 is common with 40101
47001 to 47094 Except 47095 and 47069 to 47080	60 61	R W	Channel *70 ※) * is designated by 40101	Similar to CH1 parameter Refer to 5.8.4 ※) 47001 is common with 40101

R/W.....R: READ, W: WRITE

Reference Number	Application function code	R/W	Contents	Details
47101 to 47194 Except 47195 and 47169 to 47180	60 61	R W	Channel*71 ※) * is designated by 40101	Similar to CH1 parameter Refer to 5.8.4 ※) 47101 is common with 40101
47201 to 47294 Except 47295 and 47269 to 47280	60 61	R W	Channel *72 ※) * is designated by 40101	Similar to CH1 parameter Refer to 5.8.4 ※) 47201 is common with 40101

2) Reading measurement data of channel 73 to 599

R/W.....R: READ, W: WRITE

Reference Number	Application function code	R/W	Contents	Details
30245	04	R	CH73 data	DATA:-32765 to 32765 -32768: Binary expression over 32767:+ Over range -32767:- Over range 32766: Burn out data -32766: Invalid data Error code: 01H, 02H, 03H, 12H
30246	04	R	CH73 decimal point status	Data status, Event status, Decimal point Error code: 01H, 02H, 03H, 12H
3****	04	R	CH74 to CH598 data	Similar to CH73 Error code: 01H, 02H, 03H, 12H
3#####	04	R	CH74 to CH598 decimal point status	Similar to CH73 Error code: 01H, 02H, 03H, 12H
31297	04	R	CH599 data	Similar to CH73 Error code: 01H, 02H, 03H, 12H
31298	04	R	CH599 decimal point status	Similar to CH73 Error code: 01H, 02H, 03H, 12H

※) Reference number [3****] **** = 101 + (channel number -1) ×2

※) Reference number [3#####] ##### = 102 + (channel number -1) ×2

Example) In case of channel 74 : 101 + (74-1) ×2 = 247 . . . Reference number : 30247

Example) In case of channel 74 : 102 + (74-1) ×2 = 248 . . . Reference number : 30248

6 Before connecting to the network

In order to communicate the PC and this instrument with Ethernet, it is necessary to set the IP address to recognize this instrument.

IP address is set in the sequence given below.

1. Default values settings of the Ethernet for this instrument are as follows.

Settings	Default value
IP address	192. 168. 254. 254
Subnet mask	255. 255. 255. 0
Gateway address	0. 0. 0. 0

2. IP address settings of the PC changes as follows.

Settings	Default value
IP address	192. 168. 254. 1
Subnet mask	255. 255. 255. 0
Gateway address	0. 0. 0. 0.

Ethernet is communicated by the combination of the IP address and sub net mask. In case of default settings of this instrument, only the instrument that is set from 192. 168. 254. 1 to 192. 168. 254. 253 can be communicated. Accordingly, here, the PC is set to 192. 168. 254. 1.

3. The PC and this instrument are connected by using the method mentioned in "I Handling Manual" 4-3.
4. After entering http://192.168.254.254 in the URL input column of PC browser software (Internet Explorer etc.), input user name [blank] and password [3571]. This instrument is now connected. Select [Basic Settings] on the screen, and set according to the network for which IP address of this instrument, subnet mask and gateway address is to be connected to this instrument. Inquire about the value to be set to the Network Administrator.

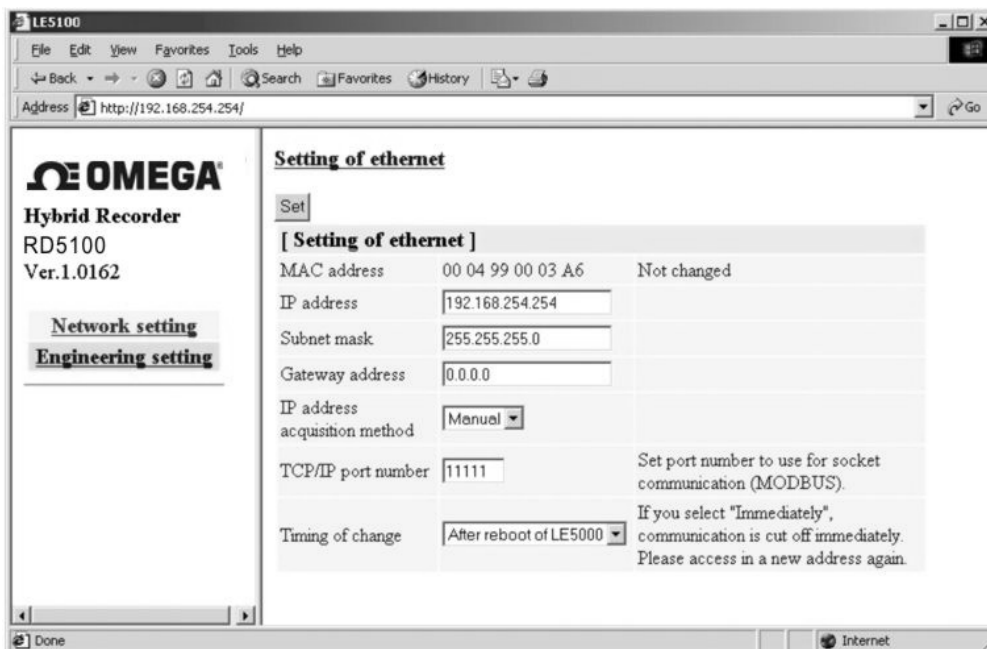

6.1 Allocation of IP address

■ IP address allocation

IP address is allocated to RD5100 when it is installed in the network.

Allocation of IP address includes the following 3 types and it depends on the setting contents of [RD5100 Basic Parameter] page → [IP address acquisition method] on Parameter Settings Web Page.

- 1) Manual
- 2) Allocation by DHCP

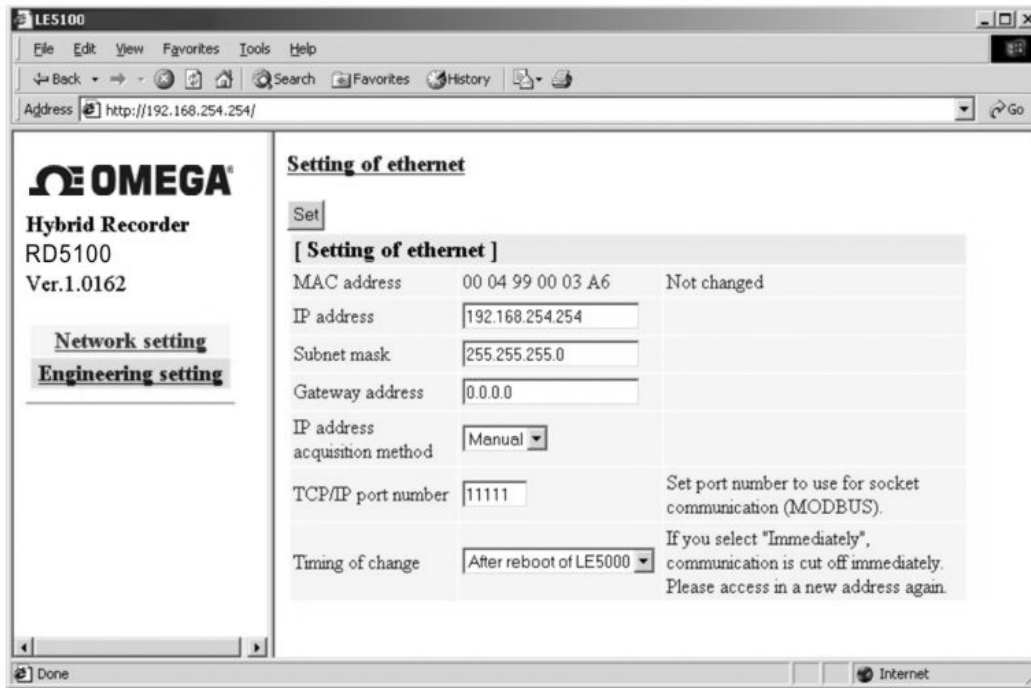

1. Displays [RD5100 Basic Parameter] on IP Address Settings Web Page for setting the IP address.

● Manual

When [IP address acquisition method] is set to [Manual], IP address specified by the user is used. Any IP address is set by [Basic Parameter] → [IP address] on Parameter settings Web Page. It is set to "Manual" during settings.

● Allocation by DHCP

When [Get IP address method] is set to "DHCP", RD5100 inquires the IP address to the DHCP server on Ethernet during startup. If the IP address is assigned from the DHCP server, then that IP address is used. When the IP address cannot be obtained from the DHCP server due to the reasons such as there is no DHCP server on the Ethernet (timeout 1 minute), IP address during settings is used.

6.2 Communication error of Ethernet

Operate RD5100 as follows, when communication error occurs.

- When there is no response from Host (PC etc.) on Ethernet
When data is transmitted from RD5100 to the Host on Ethernet, and there is no response (ACK) from the Host, RD5100 repeats the retry (about 3 minutes). When there is failure in the transmission retry, RD5100 closes the TCP.

When Host requests for the TCP connection to RD5100, before RD5100 closes the TCP, RD5100 returns the RST packet and denies the connection. (Number of sessions: When exceeded 2)

Further, RD5100 transmits the RST in the following cases

- When there is connection request to the Host, when the connection is not allowed
 - When the TC Packet from other than the connected system is received
 - When RST packet is received from the communicating system
- When unexpected response is received
Basically, the unexpected response is ignored. However, the PC disconnects immediately when the TCP connection is forcibly disconnected or when the RST packet is received.