

Locomotive Systems Products

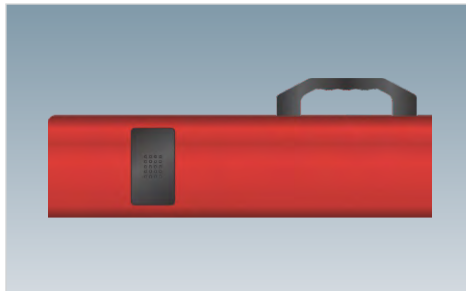

HOT Series
Head of Train Devices

G1 - G4



EOT Series
End of Train Devices

G5 - G8



EOT Phone Home Series
End of Train Communications

G9 - G10



HOT / EOT Repeater Units

G11 - G12



Locomotive Testing Units

G13 - G16

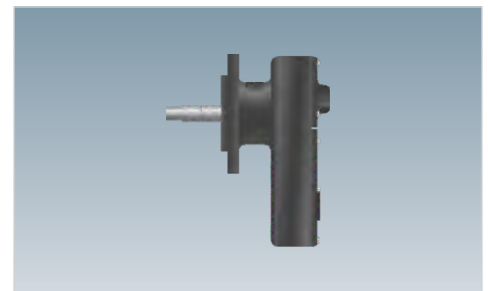

Axle Drives

G17 - G20

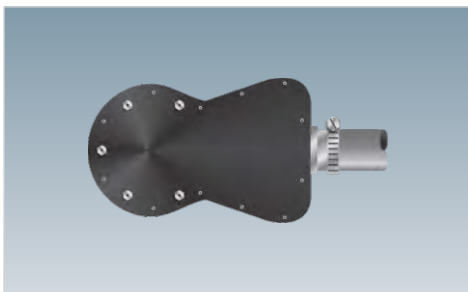

Axle Generators

G21 - G22

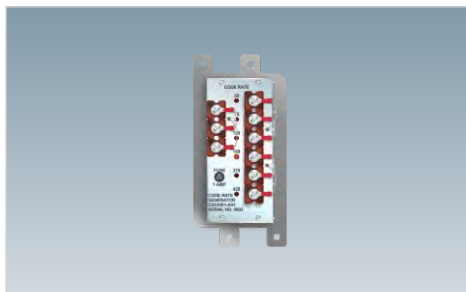

Code Rate Generators / Decoders

G23 - G24

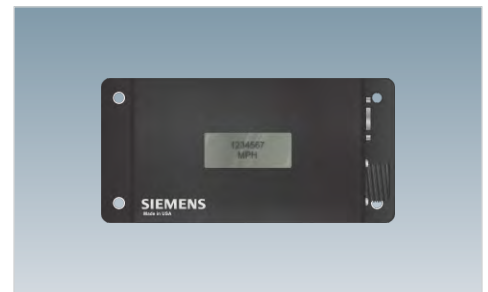

Odometers

G25 - G26



Speedometers

G27 - G30



Universal Interface Panels

G31 - G32

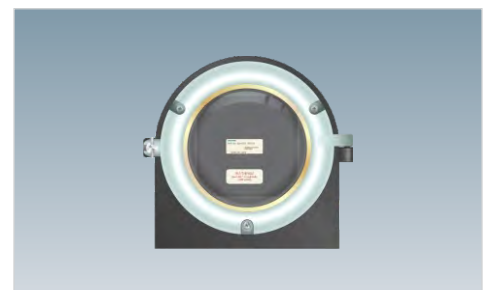

Ditch Lights

G33 - G36



HGR Series
Heater Ground Relays

G37 - G39



MPBI
Multiple Penalty Brake Interface

G40

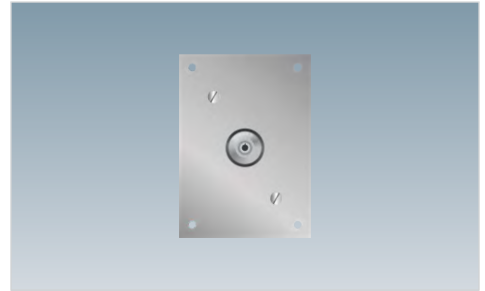

Maintenance Key Switch

G41

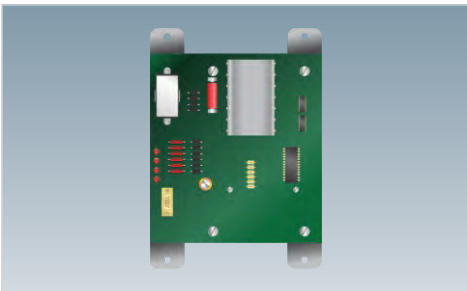

GPS Onboard Monitoring Unit

G42

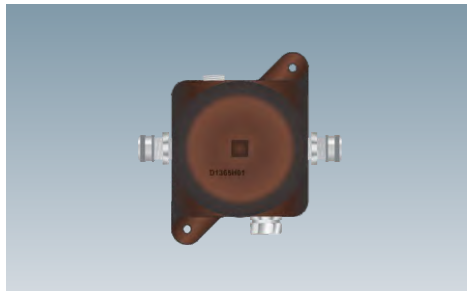

Track Receiver Junction Box

G43



ADU Series
Aspect Display Units

G44

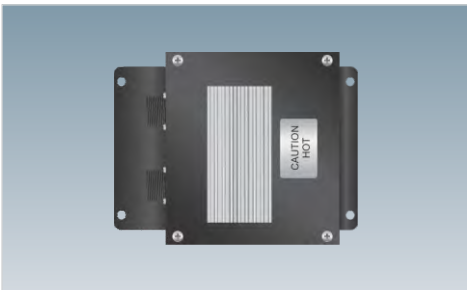

Locomotive Power Supplies

G45 - G47



Q2518
Locomotive Alerter System Controller

G48



Decelerometers

G49 - G50



CHMM Series
Crash Hardened Memory Modules

G51 - G52



Locomotive Event Recorders

G53 - G55



Event Recorder
CMM / EDAP / COMBINED

G56



HOT Series

Head of Train Devices

Overview



Head of Train Device console model shown for reference purposes only! Actual unit selected may vary in mounting and features.

Features

- Built-in status indicators for arming, communications, motion detection, highly visible marker (HVM), brakes and batteries.
- Built-in keypad and display for configuration, troubleshooting and diagnostics.
- Able to process End Of Train / Head Of Train communications tests, armament requests and emergency braking commands.
- Fully supports standard AAR protocols.
- Provides ability to be used as both an internal and / or external event recorder.

SIEMENS Head Of Train (HOT) units are available in either a cab mounted model or an integrated model.

The integrated HOT unit is intended for integration into pre-existing locomotive cab electronics such as the General Electric® IFC systems or EMD® / Rockwell® ICE or FIRE systems.

The cab mounted HOT Telemetry unit is intended for application to the top of the locomotive control stand or other suitable locations.

Siemens also offers a model that serves as a direct replacement for the Ansaldo STS® Digitair® console mounted unit.

Both series of HOT units, when used with a **SIEMENS** End Of Train (EOT) unit, will provide the locomotive engineer with important information regarding the operation of the train.

These conditions include brake pipe pressure (PSI) and various status conditions. All HOT units will also process EOT / HOT communications tests, armament requests, and emergency brake commands resulting from an emergency switch activation or external emergency input.

NYK:V3465/R

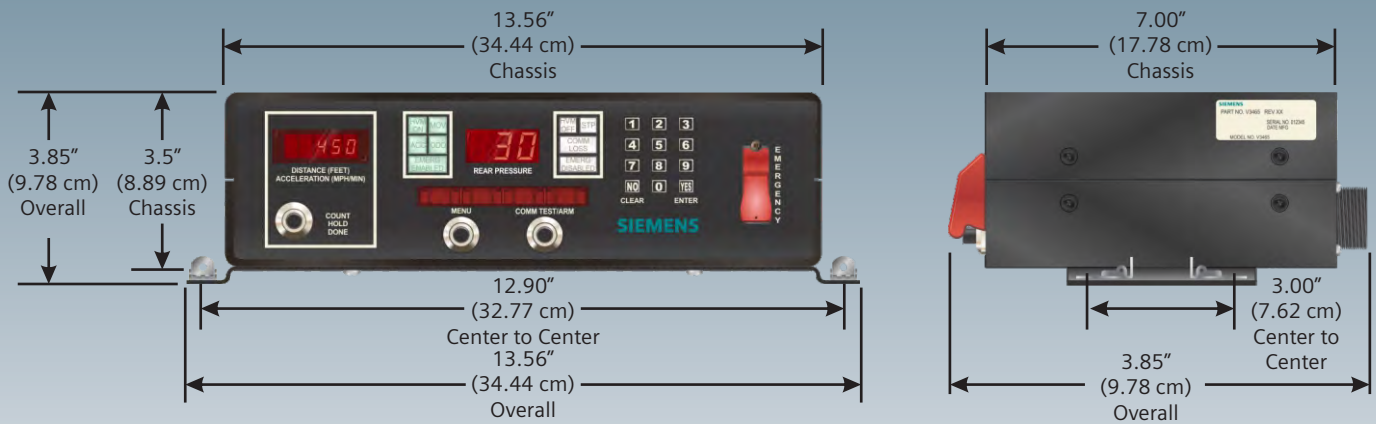

Full Size Console Unit

- Weight is approx. 11 lbs. (4.99 kgs.) including mounting foot
- Operates in -40° F to +160° F (-40°C to +70°C) @ up to 95% Non-Condensing Relative Humidity
- 13.56" (34.44 cm) Wide x 8.41" (21.36 cm) Deep x 3.85" (9.78 cm) Tall
- Includes Ritron® dual band radio
- (1) NYK:QP-52321 mounting plate
- NYK:QP-16371 PUMP® software update program
- Bootloader firmware
- Application firmware

NYK:VK-3465/R

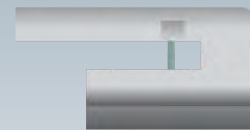

Antenna



Instruction Manual

Full Size Console w/ Setup Kit

- (1) NYK:V3465/R Full Size Console Unit
- (1) NYK:Q9266/20 20' (6 m) antenna cable
- (1) Instruction manual
- (1) NYK:06955 450 MHz - 465 MHz antenna
- (1) NYK:Q9077/15C Input / Power cable

NYK:V3467/R

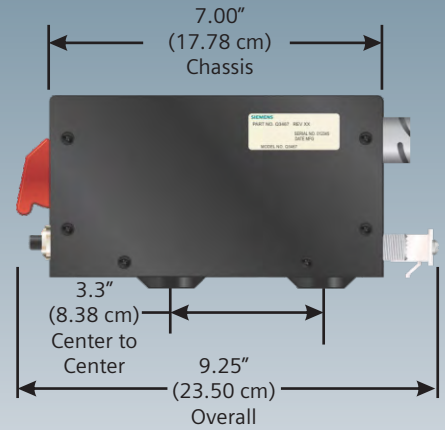
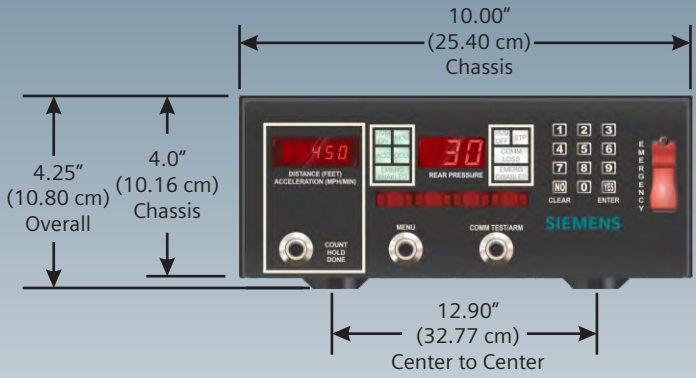

Compact Console Unit

- Weight is approx. 6 lbs. (2.72 kgs.) including mounting foot
- Operates in -40° F to +160° F (-40°C to +70°C) @ up to 95% Non-Condensing Relative Humidity
- 10.00" (25.40 cm) Wide x 9.25" (23.50 cm) Deep x 4.25" (10.80 cm) Tall
- Includes Ritron® dual band radio
- (1) NYK:QP-52321 mounting plate
- NYK:QP-16371 PUMP® software update program
- Bootloader firmware
- Application firmware

NYK:VK-3467/R



Antenna



Instruction Manual

Compact Size Console Unit w/ Setup Kit

- (1) NYK:V3460 Full Size Console Unit
- (1) NYK:Q9266/20 20' (6 m) antenna cable
- (1) Instruction manual
- (1) NYK:06955 450 MHz - 465 MHz antenna
- (1) NYK:Q9077/15C Input / Power cable

NYK:V3451/R2

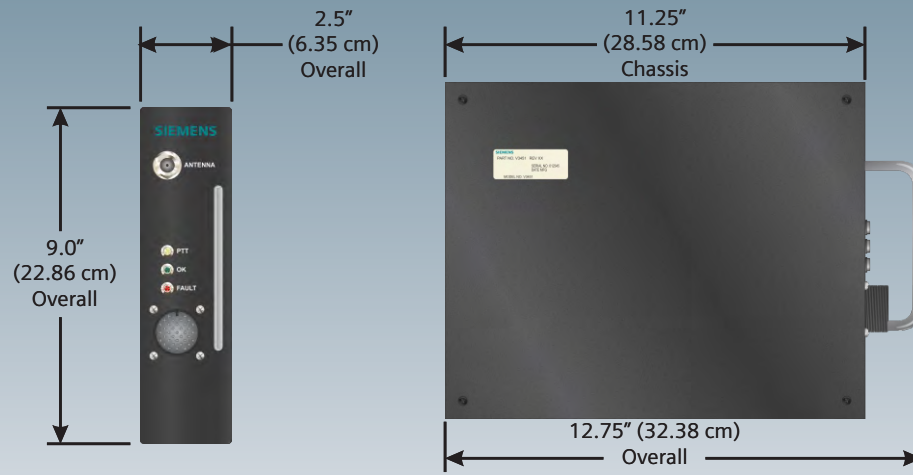

Integrated Unit

- Weight is approx. 3 lbs. (1.36 kgs.) including mounting foot
- Operates in -40° F to +160° F (-40°C to +70°C) @ up to 95% Non-Condensing Relative Humidity
- 2.5" (6.35 cm) Wide x 11.25" (28.58 cm) Deep x 9.0" (22.86 cm) Tall
- Includes Ritron® dual band radio
- NO mounting plate
- NYK:QP-16371 PUMP® software update program
- Bootloader firmware
- Application firmware

NYK:V3452/R2

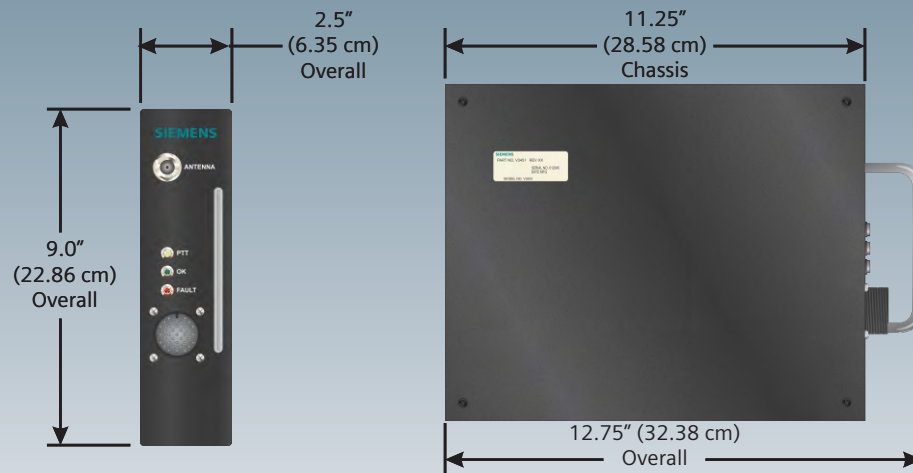

Integrated Unit

- Weight is approx. 3 lbs. (1.36 kgs.) including mounting foot
- Operates in -40° F to +160° F (-40°C to +70°C) @ up to 95% Non-Condensing Relative Humidity
- 2.5" (6.35 cm) Wide x 11.25" (28.58 cm) Deep x 9.0" (22.86 cm) Tall
- Includes Ritron® dual band radio
- NO mounting plate
- NYK:QP-16371 PUMP® software update program
- Bootloader firmware
- Application firmware



EOT Series

End of Train Devices

Overview



Features

- Single, Push-Button Operation
- Single-LED Visibility Marker
- Cellular Data Service with Over-the-Air Upgrades
- 8 Watt Narrow-Band Radio with Waiver on Annual Calibration
- Internal Event Recorder and GPS Receiver
- Enclosed Antenna and AEI Tag

*Head of Train Device console model shown for reference purposes only!
Actual unit selected may vary in mounting and features.*

SIEMENS End of Train Devices is available with or without EOT Phone Home service.

When used in conjunction with the **SIEMENS** Head of Train Device (HOT) it provides information to the locomotive engineer about the operational conditions / statuses of the train.

Some of the statuses include:

- Brake pipe pressure (psi)
- Arming Status (Emergency feature enabled or disabled)
- Communication Status (Good / Comm-Loss, rear-to-front or front-to-rear)
- Motion Detection (Moving or stopped)
- High Visibility Marker (HVM) Status (On, off or defective)
- Brake value (Normal, emergency or defective)
- Battery State Status (Good, low or dead)
- Battery Charge Status (% depleted, in charge units)

NYK:QK-3920-01

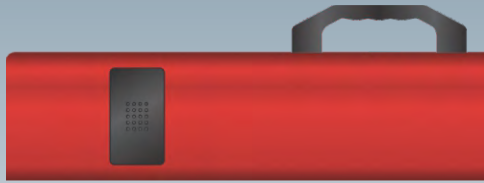

**EOT with EOT Phone Home Included
(Red Standard Model)**

- Weight is approx. 26.5 lbs. (12.02 kgs.)
- Operates in -40° F to +160° F (-40°C to +70°C) @ up to 95% Non-Condensing Relative Humidity
- 4.50" (11.43 cm) Wide x 8.40" (21.34 cm) Deep x 27.00" (68.58 cm) Tall
- Operating voltage 12.5 V to 13.0 V
- Power supply 12 V, 3.4 Ah
- Charge port 10 pin MS3102E-18-1S connector
- Includes EOT Phone Home service
- Includes cell modem

NYK:QK-3920-02

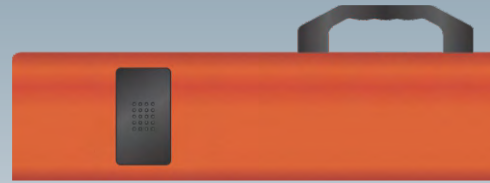

**EOT with EOT Phone Home Included
(Orange Standard Model)**

- Weight is approx. 26.5 lbs. (12.02 kgs.)
- Operates in -40° F to +160° F (-40°C to +70°C) @ up to 95% Non-Condensing Relative Humidity
- 4.50" (11.43 cm) Wide x 8.40" (21.34 cm) Deep x 27.00" (68.58 cm) Tall
- Operating voltage 12.5 V to 13.0 V
- Power supply 12 V, 3.4 Ah
- Charge port 10 pin MS3102E-18-1S connector
- Includes EOT Phone Home service
- Includes cell modem

NYK:QK-3920-03

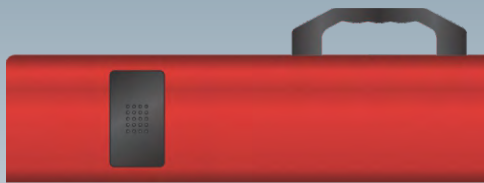

**EOT with EOT Phone Home Included
(Red Smart Charge Model)**

- Weight is approx. 26.5 lbs. (12.02 kgs.)
- Operates in -40° F to +160° F (-40°C to +70°C) @ up to 95% Non-Condensing Relative Humidity
- 4.50" (11.43 cm) Wide x 8.40" (21.34 cm) Deep x 27.00" (68.58 cm) Tall
- Operating voltage 12.5 V to 13.0 V
- Power supply 12 V, 3.4 Ah
- Charge port 10 pin MS3112E-10-6S connector
- Includes EOT Phone Home service
- Includes cell modem

NYK:QK-3920-04

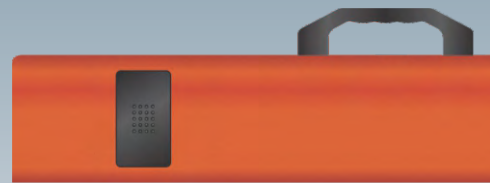

**EOT with EOT Phone Home Included
(Orange Smart Charge Model)**

- Weight is approx. 26.5 lbs. (12.02 kgs.)
- Operates in -40° F to +160° F (-40°C to +70°C) @ up to 95% Non-Condensing Relative Humidity
- 4.50" (11.43 cm) Wide x 8.40" (21.34 cm) Deep x 27.00" (68.58 cm) Tall
- Operating voltage 12.5 V to 13.0 V
- Power supply 12 V, 3.4 Ah
- Charge port 10 pin MS3112E-10-6S connector
- Includes EOT Phone Home service
- Includes cell modem

SIEMENS Part Number	End of Train Device Maintenance Parts
NYK:QP-35056	Dump Pilot Valve
NYK:QP35057	APG Control Valve
NYK:59208	APG Assembly
NYK:52616	Clamp Nut Bar
NYK:59062	Latch Handle
NYK:61013	Electronic Interface Module
NYK:62174	Power Module
NYK:62176/PC	Clamp Assembly
NYK:65105/ORG	Orange Enclosure
NYK:65105/RED	Red Enclosure
NYK:65106/ORG	Orange Enclosure Cover
NYK:65106/RED	Red Enclosure Cover
NYK:QP-52516	Mounting Bracket
NYK:QP-70312	Chassis Harness

Applicable for all End of Train (EOT) Devices

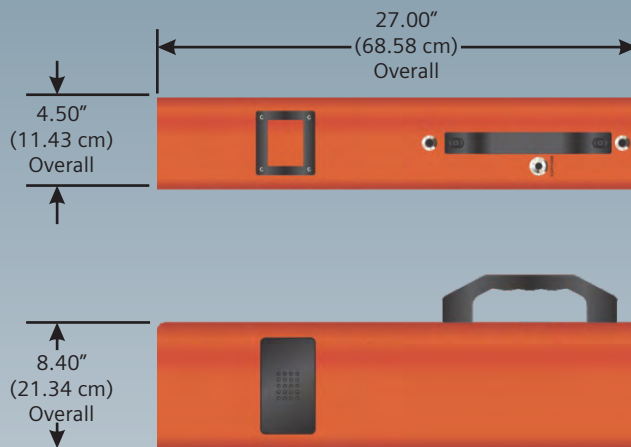



EOT Phone Home Service

Overview



SIEMENS End of Train (EOT) Phone Home solution is a subscription based Telemetry Management Software as a Service (SaaS) application that is designed to support multiple manufacturers and empowers railroad operations personnel to efficiently deploy, monitor, track, maintain and manage End of Train (EOT) devices ubiquitously with the ease of a browser based interface.

It has an intuitive user interface that quickly enables even the most casual user to rapidly become proficient in accessing information relative to their interest. Advanced users will also appreciate the ability to perform their tasks with ease utilizing innovative capabilities such as:

- Locating missing EOT devices and providing mapped directions
- Tracing travel paths and tracking trains
(as a backup to other systems)
- Configuration management of advanced settings
- Track and trace of device maintenance upgrades
- Disabling devices that are lost or misappropriated
- Billing for device utilization by other railroads
- Automated reporting for optimizing device utilization

Most knowledge users are familiar with web browsers and as such, the Phone Home solution is validated to support the latest versions of Microsoft® Internet Explorer®, Google® Chrome®, and Apple® Safari®, which reduces training costs and provides IT departments a robust environment for managing version control and security policies.

Features

- Color coded Key Performance Indicators (KPIs) for EOT status.
- Clustering to efficiently manage map real-estate.
- Paste link feature for proficient collaboration.
- Multiple map base layers for visualizing mapping features.
- Hyperlinked status bar for current quick scroll view of common EOT statuses.
- Search options dialog box for effortless queries.
- Saved searches feature for rapid retrieval of common queries.
- Run History Report function with multiple file formats.



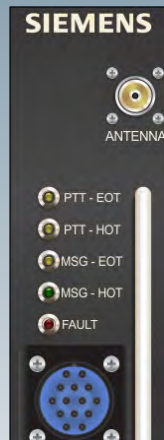

HOT / EOT Series

Repeater Modules

Overview



*Model NYK:Q3442 HOT / EOT Series Repeater Module
shown for reference purposes only!
Actual software may vary in mounting and features.*

SIEMENS HOT / EOT Series Repeaters are designed to assist communications between **SIEMENS** Head of Train (HOT) and **SIEMENS** End of Train (EOT) transceivers where the transmission / reception of these devices may be impeded by other transceivers.

Supports AAR standard transmission protocol on frequency pairs 457.9375 MHz and 452.9375 MHz and are designed to operate without any user input needed. Once initialized, LED indicators on the front of the unit provide indications of operating status.

NYK:Q3440/R



NYK:Q3442



Integrated Unit

- Weight is approx. 7 lbs. (3.18 kgs.) including mounting plate
- Operates in -40° F to +160° F (-40°C to +70°C) @ up to 95% Non-Condensing Relative Humidity
- 2.7" (6.86 cm) Wide x 13.34" (33.88 cm) Deep x 9.2" (23.69 cm) Tall
- Includes 457.9375 MHz and 452.9375 MHz VHF Ritron® radios
- (1) NYK:52316 mounting plate
- (1) NYK:70126/RR antenna cable
- (1) NYK:70145/8 antenna cable

Integrated Unit for General Electric® IFC, EMD/Rockwell® ICE™ or FIRE™ systems.

- Weight is approx. 7 lbs. (3.18 kgs.) including mounting plate
- Operates in -40° F to +160° F (-40°C to +70°C) @ up to 95% Non-Condensing Relative Humidity
- 2.7" (6.86 cm) Wide x 13.34" (33.88 cm) Deep x 9.2" (23.69 cm) Tall
- Includes 457.9375 MHz and 452.9375 MHz UHF Ritron® radios
- (1) NYK:52316 Mounting plate
- (2) NYK:06966 antenna cables

Applicable for all HOT / EOT Repeater modules

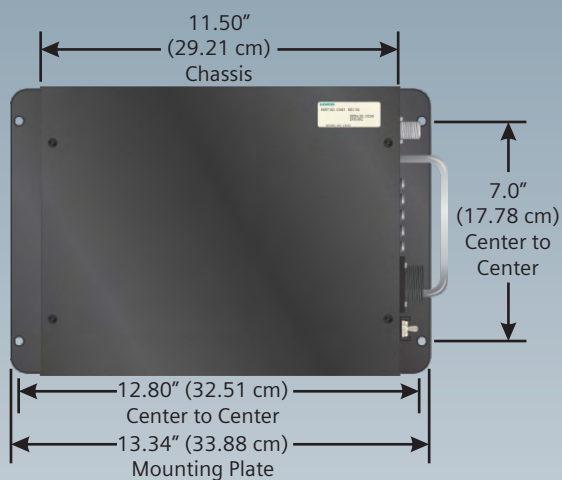



Testing Units

Overview



*Model NYK:Q1400 Testing Unit shown for reference purposes only!
Actual software may vary in mounting and features.*

SIEMENS Locomotive Testing Units provide an array of diagnostic, testing and recording capabilities. This allows maintainers to perform necessary mandated testing and servicing of equipment in actual environments. Units are encased in durable Pelican® brand case for years of rugged performance.

Other testing units may be available that are not listed. Please contact the Siemens Technical Assistance for Rail Automation Team for further details.

NYK:Q1230



Basic Recorder / Tester Unit

- Weight is approx. 10 lbs. (4.53 kgs.) including mounting plate
- Operates in -40° F to +160° F (-40°C to +70°C) @ up to 95% Non-Condensing Relative Humidity
- 16.0" (40.64 cm) Wide x 13.1" (32.27 cm) Deep x 6.90" (17.53 cm) Tall
- Simple 1 button testing
- Tests recording devices in actual operating environments
- Encased in durable Pelican® brand case

NYK:Q1400



Speed Test Unit

- Weight is approx. 3 lbs. (1.36 kgs.) including mounting foot
- Operates in -40° F to +160° F (-40°C to +70°C) @ up to 95% Non-Condensing Relative Humidity
- 16.0" (40.64 cm) Wide x 13.1" (32.27 cm) Deep x 6.90" (17.53 cm) Tall
- Simulates speeds from 0 mph (0 kph) to 100 mph (160 kph)
- Simulates frequencies from 15 Hz to 4000 Hz
- Axle drive outputs can be set to 20p, 60p, 120p, 247p or 249p
- Wheel size diameter can be set from Ø 37.0" (93.98 cm) to 50" (127.00 cm)
- Encased in durable Pelican® brand case

NYK:Q3431/NB



EOT / HOT Testing Unit

- Weight is approx. 11 lbs. (3.18 kgs.) including mounting plate
- Operates in -40° F to +160° F (-40°C to +70°C) @ up to 95% Non-Condensing Relative Humidity
- 16.0" (40.64 cm) Wide x 13.1" (32.27 cm) Deep x 6.90" (17.53 cm) Tall
- Tests HOT and EOT devices in actual operating environments
- Meets or exceeds annual Federal Railroad Administration calibration requirements without removing HOT devices from locomotives
- Provides a Pass / Fail indication for radio frequencies, deviations and signal strengths
- 120 VAC or 12 VDC operation
- Encased in durable Pelican® brand case

NYK:Q3433/NB



EOT / HOT Testing Unit

- Weight is approx. 11 lbs. (3.18 kgs.) including mounting plate
- Operates in -40° F to +160° F (-40°C to +70°C) @ up to 95% Non-Condensing Relative Humidity
- 16.0" (40.64 cm) Wide x 13.1" (32.27 cm) Deep x 6.90" (17.53 cm) Tall
- Tests HOT and EOT devices in actual operating environments
- Meets or exceeds annual Federal Railroad Administration calibration requirements without removing HOT devices from locomotives
- Provides a Pass / Fail indication for radio frequencies, deviations and signal strengths
- 120 VAC or 12 VDC operation
- Encased in durable Pelican® brand case

NYK:D3005H15-A01



ATC Tester Unit

- Weight is approx. 3 lbs. (1.36 kgs.) including mounting foot
- Operates in -40° F to +160° F (-40°C to +70°C) @ up to 95% Non-Condensing Relative Humidity
- 16.0" (40.64 cm) Wide x 13.1" (32.27 cm) Deep x 6.90" (17.53 cm) Tall

NYK:D3883H32-A01



ACSES transponder simulator control portable tester

- Weight is approx. 10 lbs. (4.53 kgs.) including mounting plate
- Operates in -40° F to +160° F (-40°C to +70°C) @ up to 95% Non-Condensing Relative Humidity
- 16.0" (40.64 cm) Wide x 13.1" (32.27 cm) Deep x 6.90" (17.53 cm) Tall



Axle Drives

Overview

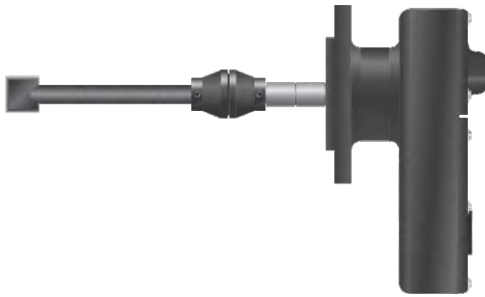

*Model Q1165 Axle Drive shown for reference purposes only!
Actual software may vary in mounting and features.*

SIEMENS Axle Drives feature solid cast aluminum housing and dual internal bearings for longevity. They can be supplied with either 20 or 60 electrical pulses per wheel revolution.

The dual bearing configuration virtually eliminates any failures due to excessive stresses from the unsprung axle as the locomotive traverses either rough road crossings or bad joints. These situations can cause premature fatigue on single bearing model axle drives and therefore failures with a critical component of the event recording or speed indicating system.

A direct replacement for most 20 or 60 pole axle drives in use today, and can be supplied with any length paddle assembly needed by the using railroad including a "peg" drive for some axle applications.

Optional Universal Axle Drive Paddle is constructed with a high tech thermal molded plastic and is a one size fits all solution. Supplied in standard 10" (25.4 cm) length and pre-marked and pre-drilled for easy field modification to field sizes of either 7.5" (19.05 cm) or 3.5" (8.89 cm) long.

NYK:Q1123

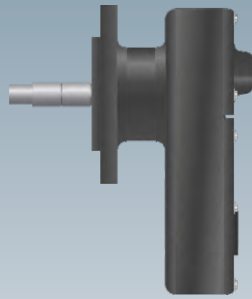

20 Pulses Per Minute

- Weight is approx. 9 lbs. (4.08 kgs.)
- Operates in -40° F to +160° F (-40°C to +70°C) @ up to 95% Non-Condensing Relative Humidity
- 6.13" (15.57 cm) Wide x 8.13" (20.32 cm) Deep x 9.72" (24.69 cm) Tall
- Cast aluminum housing
- Dual bearing configuration
- NO paddle axle drive shaft assembly
- NO PEG drive shaft assembly
- NO cables

NYK:Q1124

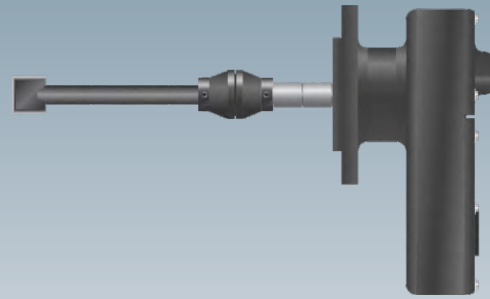

20 Pulses Per Minute w/ Paddle Axle Drive Assembly

- Weight is approx. 9.8 lbs. (4.45 kgs.)
- Operates in -40° F to +160° F (-40°C to +70°C) @ up to 95% Non-Condensing Relative Humidity
- 6.13" (15.57 cm) Wide x 17.50" (44.45 cm) Deep x 9.72" (24.69 cm) Tall
- Cast aluminum housing
- (1) NYK:Q1123 Axle Drive (20 Pulses Per Minute) assembly
- (1) NYK:QP-52170 Paddle Axle Drive Assembly
- NO PEG drive shaft assembly
- NO cables

NYK:Q1126

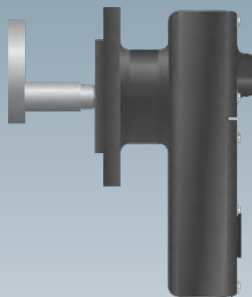

20 Pulses Per Minute w/ PEG Axle Drive Assembly

- Weight is approx. 9.4 lbs. (4.26 kgs.)
- Operates in -40° F to +160° F (-40°C to +70°C) @ up to 95% Non-Condensing Relative Humidity
- 6.13" (15.57 cm) Wide x 8.38" (21.29 cm) Deep x 9.72" (24.69 cm) Tall
- Cast aluminum housing
- (1) NYK:Q1123 Axle Drive (20 Pulses Per Minute) assembly
- NO paddle axle drive assembly
- (1) NYK:52272 Peg Drive Assembly
- NO Cables

NYK:Q1127

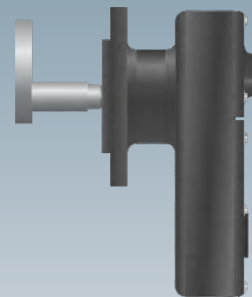

20 Pulses Per Minute w/ PEG Axle Drive Assembly and Cables

- Weight is approx. 11 lbs. (4.99 kgs.) including cables
- Operates in -40° F to +160° F (-40°C to +70°C) @ up to 95% Non-Condensing Relative Humidity
- 16.0" (40.64 cm) Wide x 13.1" (32.27 cm) Deep x 6.90" (17.53 cm) Tall
- Cast aluminum housing
- (1) NYK:Q1123 Axle Drive (20 Pulses Per Minute) assembly
- NO paddle axle drive shaft assembly
- (1) NYK:52272 Peg Drive Shaft Assembly
- (1) NYK:09255 16.5' (5 m) cable

NYK:Q1163

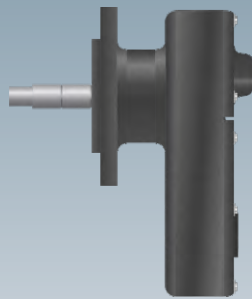

60 Pulses Per Minute

- Weight is approx. 9 lbs. (4.08 kgs.)
- Operates in -40° F to +160° F (-40°C to +70°C) @ up to 95% Non-Condensing Relative Humidity
- 6.13" (15.57 cm) Wide x 8.13" (20.32 cm) Deep x 9.72" (24.69 cm) Tall
- Cast aluminum housing
- Dual bearing configuration
- NO paddle axle drive shaft assembly
- NO PEG drive shaft assembly
- NO cables

NYK:Q1164

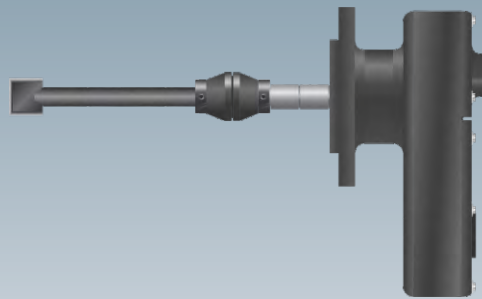

60 Pulses Per Minute w/ Paddle Axle Drive Shaft Assembly

- Weight is approx. 9.8 lbs. (4.45 kgs.)
- Operates in -40° F to +160° F (-40°C to +70°C) @ up to 95% Non-Condensing Relative Humidity
- 6.13" (15.57 cm) Wide x 17.50" (44.45 cm) Deep x 9.72" (24.69 cm) Tall
- Cast aluminum housing
- (1) NYK:Q1163 Axle Drive (60 Pulses Per Minute) assembly
- (1) NYK:QP-52170 Paddle Axle Drive Shaft Assembly
- NO PEG drive shaft assembly
- NO cables

NYK:52508/20P

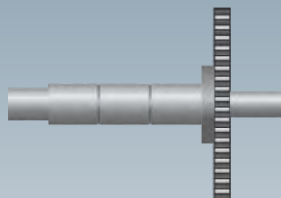

Axle Drive Shaft Assembly for 20 Pulses Per Minute

- Weight is approx. 2 lbs. (0.91 kgs.)
- Operates in -40° F to +160° F (-40°C to +70°C) @ up to 95% Non-Condensing Relative Humidity

NYK:52508/60P

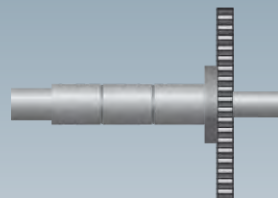

Axle Drive Shaft Assembly for 60 Pulses Per Minute

- Weight is approx. 2 lbs. (0.91 kgs.)
- Operates in -40° F to +160° F (-40°C to +70°C) @ up to 95% Non-Condensing Relative Humidity

NYK:52170



Paddle Axle Drive Shaft Assembly for 20 Pulses Per Minute

- Weight is approx. 2 lbs. (0.91 kgs.)
- Operates in -40° F to +160° F (-40°C to +70°C) @ up to 95% Non-Condensing Relative Humidity
- Pre-marked and pre-drills to field modify for either a 7.5" (19.05 cm) or 3.5" (8.89 cm) long

NYK:52272

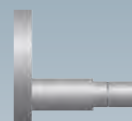

PEG Drive Shaft Assembly for 20 Pulses Per Minute

- Weight is approx. 1 lbs. (0.45 kgs.)
- Operates in -40° F to +160° F (-40°C to +70°C) @ up to 95% Non-Condensing Relative Humidity

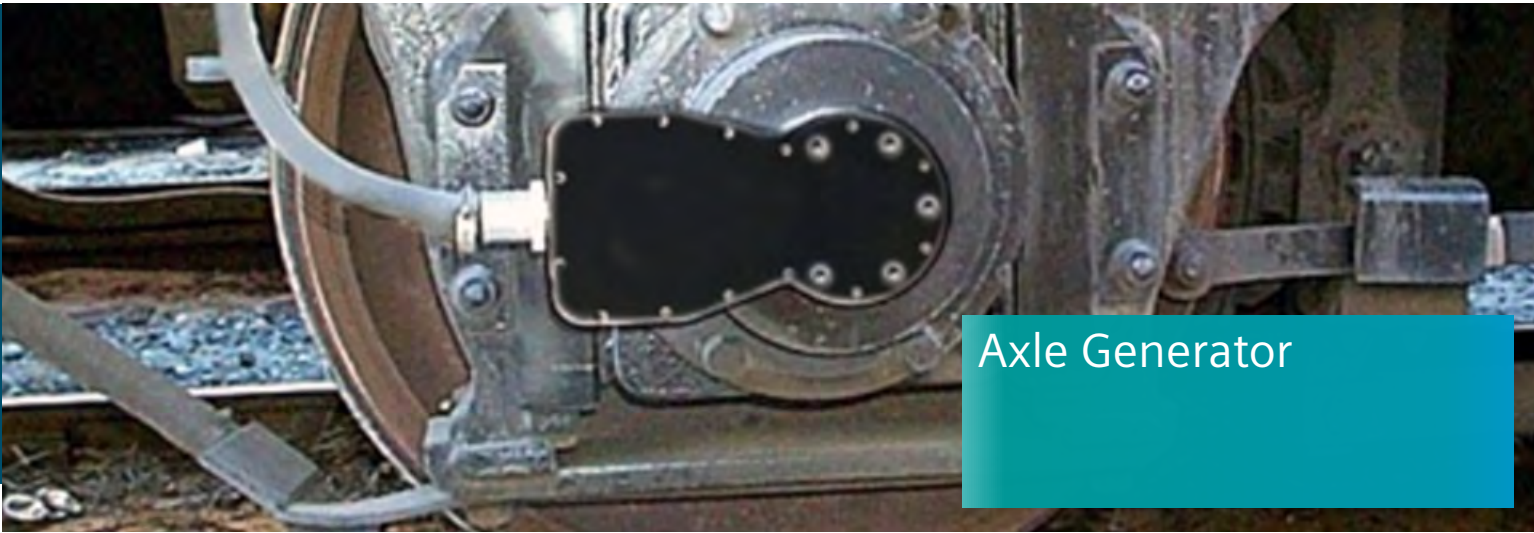

Axle Generator

Overview



*Axle Generator shown for reference purposes only!
Actual unit selected may vary in mounting and features.*

SIEMENS Axle Generator uses internal speed sensors to count pulses related to specific gear rotations. Speed data is relayed to the onboard computer for determination of potential overspeed conditions. It contains (3) magnetic reluctance type speed sensors. The first two sensors are driven from a 60 tooth gear and the remaining sensor is driven from a 40 tooth gear.

Other configurations may be available that are not listed. Please contact the **SIEMENS** Technical Assistance for Rail Automation Team for further details.

NYK:D60001-A01

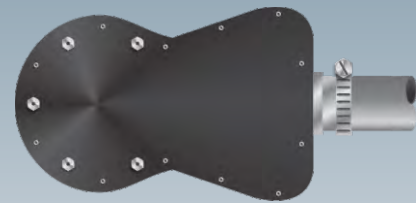

- Meets or exceeds applicable AREMA® specifications on recommended practices regarding 3000 VAC breakdown voltage.
- Easily mountable on standard relay racks, instrument house backboards or can even be shelf mounted when removing included mounting bracket
- Weight is approx. 15 lbs. (6.80 kgs.) including connectors
- Operates in -40° F to +160° F (-40°C to +70°C) @ up to 95% Non-Condensing Relative Humidity
- 6.3 VAC 3.5 Amp power supply
- (1) 15 Amp battery fuse
- (1) 1.5 Amp line fuse
- (4) Output battery connections
- 115 VAC Input connection
- 12 VDC Input connection

Optional Accessories

Part Number	Description
NYK:D1365H01-A12	Junction box
NYK:B600010-A01	Spline assembly

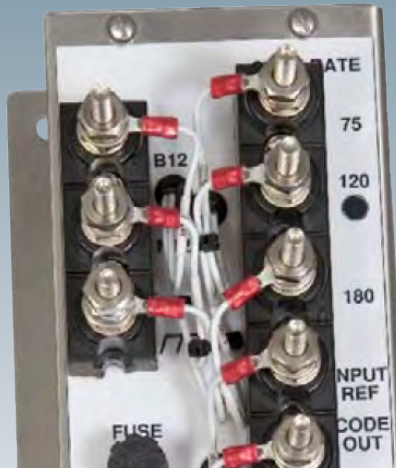

Code Rate Generators / Decoders

Overview

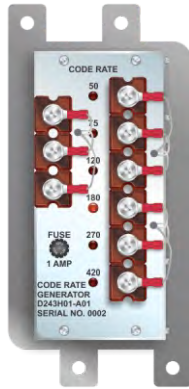

*Code Rate Generator / Decoder shown for reference purposes only!
Actual unit selected may vary in mounting and features.*

SIEMENS Code Rate Generator is a microprocessor based unit used to drive code following relays. The unit generates various code rates depending on model.

An integrated LED flashes at the generated code rate. The attached mounting plate can be supplied with different dimensions to match various relay mounting patterns.

Features

- Solid state design that replaces older relays
- Vital design ensures that transmitted code is never greater than the one selected
- Stainless steel enclosure, hardware and mounting plate
- Utilizes industry standard AAR terminals

NYK:D243H01-A01

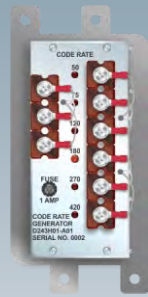

Code Rate Generator

- Weight is approx. 4 lbs. (1.81 kgs.)
- Operates in -40° F to +160° F (-40°C to +70°C) @ up to 95% Non-Condensing Relative Humidity
- 8 VDC - 15 VDC voltage range
- Current sinking outputs
- 250 mA nominal input current (*neglecting load current*)
- Open drain FET output load
- Outputs rated at 0.75A @ 12 V
- Generates code rates 50, 75, 120, 180, 270 and 420

NYK:D887H01-A01

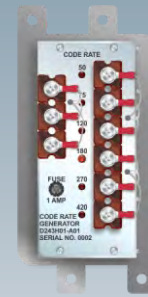

Code Rate Decoder

- Weight is approx. 4 lbs. (1.81 kgs.)
- Operates in -40° F to +160° F (-40°C to +70°C) @ up to 95% Non-Condensing Relative Humidity
- 8 VDC - 15 VDC voltage range
- 250 mA nominal input current (*neglecting load current*)
- 12 V nominal relay coil with > 500 Ω output load
- Outputs rated at 0.75A @ 12 V
- Generates code rates 75, 120, and 180

Applicable for all Code Rate Generators and Decoders

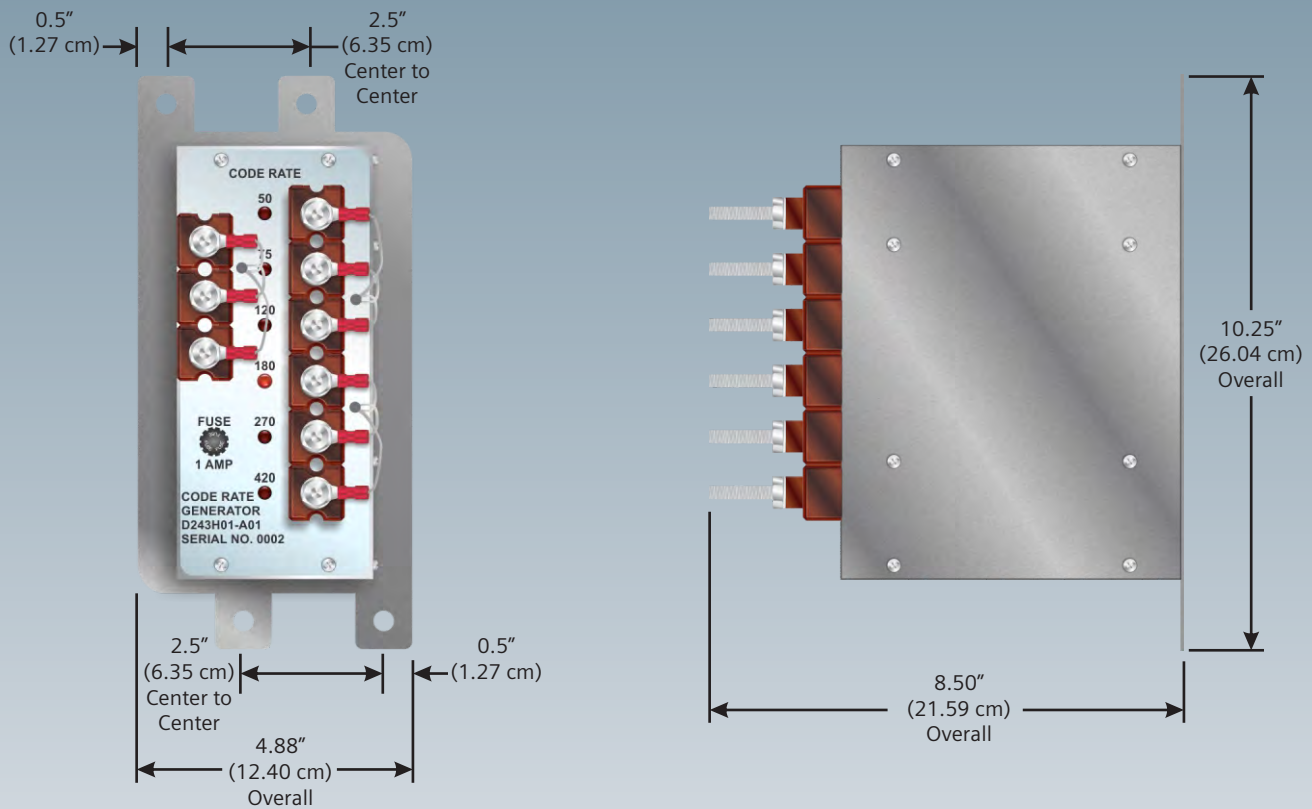



Odometers

Overview

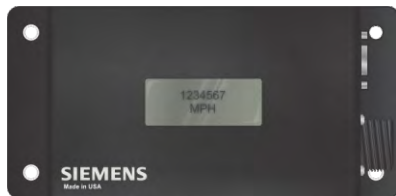

*Model NYK:Q1860 Odometer shown for reference purposes only!
Actual unit selected may vary in mounting and features.*

SIEMENS Odometer is a self-contained module for permanently recording vehicle mileage. Vehicle mileage, in 1 mile increments to 9,999,999 miles on Q1860 model (1 kilometer increments to 9,999,999 kilometers on Q1860/M model) is continuously displayed on the integrated and back-lit Liquid Crystal Display (LCD).

Accumulated mileage is stored in 10 mile (10 kilometer) increments in non-volatile memory for permanent recording. Installation consists of physically mounting the electronics enclosure and completing the wiring to power and the axle alternator of the vehicle. The serial communication interface, a standard DB-9 computer connector, allows various operating parameters to be changed including the axle alternator poles per revolution, wheel diameter and initial mileage setting.

NYK:Q1860

NYK:Q1860/M



- Weight is approx. 4 lbs. (1.81 kgs.)
- Operates in -40° F to +160° F (-40°C to +70°C) @ up to 95% Non-Condensing Relative Humidity
- Measures in MPH

- Weight is approx. 4 lbs. (1.81 kgs.)
- Operates in -40° F to +160° F (-40°C to +70°C) @ up to 95% Non-Condensing Relative Humidity
- Measures in KPH

Applicable for all Odometers

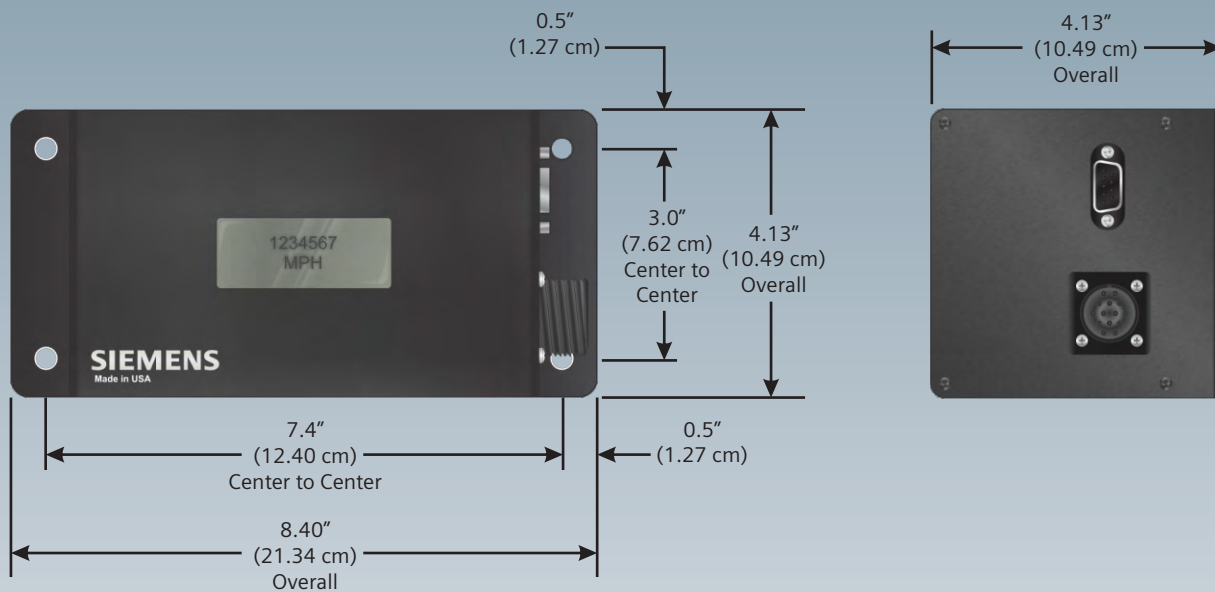



Locomotive

QSI Series

Dual Range Locomotive Speed Indicators

Overview



*Model NYK:Q1830 Speed Indicator shown for reference purposes only!
Actual unit selected may vary in mounting and features.*

SIEMENS QSI Series Dual Range Locomotive Speed Indicators are a complete line of locomotive speed indicators in both English and Metric versions. The speed indicators all offer the accuracy and reliability only 100% digital components can provide.

Designed for simple retrofitting, units are available in single and dual display configurations with integrated odometer and accelerator functions.

Foot pattern and cable arrangement allows for a bolt for bolt, pin for pin replacement of existing analog electronic speed indicators.

It can operate from any number of end of axle electronic axle drives, and accepts industry standard (20) and (60) pulses per revolution inputs.

Encased in a rugged aluminum shell and utilizing minimum cab space the speed indicator is able to provide an output to the locomotive magnet valve when the vehicle matches or goes over the overspeed setting of the unit.

Features

- Built-in accelerometer capable of displaying the acceleration and deceleration of the locomotive in either SAE or Metric speed measurements.
- Built-in odometer able to display increments and decrements of travel based on the direction of the locomotive providing true net distance from any movement.
- Built-in dual display allows for viewing for either / or train engineer and / or conductor points of view.
- Built-in overspeed alert which will drive a standard Salem® SA-812A magnet valve (or equivalent).
- Rugged solid state segment display, thus no meter movements to wear out or break.
- Built-in penalty alerter light / horn interface to existing devices. *(on select models only)*
- Built-in (4) position dimmer control for ease of reading in any ambient lighting condition.
- Available Vigilance Alerter System activation output. *(on select models only)*

SIEMENS Part Number	Speed Preset	Speed Readout	Adjustable Wheel Size	Alerter Activation Output	Overspeed Range	Recovery Delay
NYK:Q1810	None	English Only	36 mm- 42 mm	None	5 mph - 99 mph	30 sec
NYK:Q1810-74	74 mph	English Only	36 mm- 42 mm	None	5 mph - 99 mph	30 sec
NYK:Q1810/M-120	120 kph	English / Metric	36 mm- 42 mm	None	5 mph - 99 mph 8 kph - 159 kph	30 sec
NYK:Q1812	None	English Only	36 mm- 42 mm	Vigilance	5 mph - 99 mph	30 sec
NYK:Q1812-69	69 mph	English Only	36 mm- 42 mm	Vigilance	5 mph - 99 mph	30 sec
NYK:Q1818-74	74 mph	English Only	30 mm- 38 mm	Vigilance	5 mph - 99 mph	30 sec
NYK:Q1818-80	80 mph	English Only	30 mm- 38 mm	Vigilance	5 mph - 99 mph	30 sec
NYK:Q1820	None	English Only	36 mm- 42 mm	Vigilance	5 mph - 99 mph	30 sec
NYK:Q1820-45	45 mph	English Only	36 mm- 42 mm	Vigilance	5 mph - 99 mph	30 sec
NYK:Q1820-71	71 mph	English Only	36 mm- 42 mm	Vigilance	5 mph - 99 mph	30 sec
NYK:Q1820-74	74 mph	English Only	36 mm- 42 mm	Vigilance	5 mph - 99 mph	30 sec
NYK:Q1820-80	80 mph	English Only	36 mm- 42 mm	Vigilance	5 mph - 99 mph	30 sec
NYK:Q1821	None	Metric Only	36 mm- 42 mm	Vigilance	8 kph - 160 kph	30 sec
NYK:Q1830	None	English Only	36 mm- 42 mm	Vigilance	5 mph - 99 mph	1 sec
NYK:Q1830-10	10 mph	English Only	36 mm- 42 mm	Vigilance	5 mph - 99 mph	1 sec
NYK:Q1830-69	69 mph	English Only	36 mm- 42 mm	Vigilance	5 mph - 99 mph	1 sec
NYK:Q1830-74	74 mph	English Only	36 mm- 42 mm	Vigilance	5 mph - 99 mph	1 sec

Locomotive Systems Products

Speed Indicator Power Cable (20) Pole

SIEMENS Part Number	Description
NYK:Q9011/10B	10' (3 m) long, 90° "B" Break
NYK:Q9011/10C	10' (3 m) long, 90° "C" Break
NYK:Q9011/15B	15' (4.5 m) long, 90° "B" Break
NYK:Q9011/15C	15' (4.5 m) long, 90° "C" Break
NYK:Q9011/20B	20' (6 m) long, 90° "B" Break
NYK:Q9011/20C	20' (6 m) long, 90° "C" Break

Speed Indicator Power Cable (60) Pole

SIEMENS Part Number	Description
NYK:Q9012/10B	10' (3 m) long, 90° "B" Break
NYK:Q9012/10C	10' (3 m) long, 90° "C" Break
NYK:Q9012/15B	15' (4.5 m) long, 90° "B" Break
NYK:Q9012/15C	15' (4.5 m) long, 90° "C" Break
NYK:Q9012/20B	20' (6 m) long, 90° "B" Break
NYK:Q9012/20C	20' (6 m) long, 90° "C" Break

Speed Indicator / Alserter Interface Cables

SIEMENS Part Number	Description
NYK:Q9038/15C	15' (4.5 m) long, 90° "C" Break
NYK:Q9038/25C	25' (7.5 m) long, 90° "C" Break
NYK:Q9038/30C	30' (9 m) long, 90° "C" Break

Applicable for all Speed Indicators





Universal Interface Panels

Overview

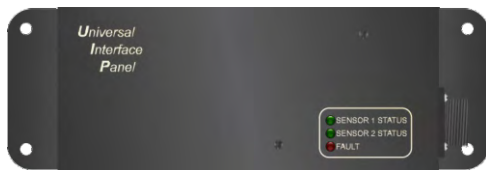

Model NYK:Q1250 Universal Interface Panel shown for reference purposes only! Actual unit selected may vary in mounting and features.

SIEMENS Universal Interface Panels are a self contained, microprocessor driven device which translates input signals from traction motor speed sensors to industry standard (and user selectable) wheel rotation frequencies.

Designed to replace existing locomotive mechanical axle drive assemblies with solid state sensors and by physically locating the sensors inside the locomotive; increased mechanical reliability is obtained.

Each of two (2) input, processing and output stages electrically independent; hence, the existing locomotive scheme for providing redundant speed input signals is maintained.

Provides outputs to other locomotive borne devices which control the authority for movement along the right-of-way, the output accuracy of the QUIP is within 1% of the input signal over the entire 10 HZ to 10KHZ range on all output channels.

Failure modes for the Universal Interface Panel have been investigated through the use of Failure Mode Effects Analysis (FMEA) techniques for hardware, software and the interaction between these components. Any failure from any source will be detected and provide relay output of the fault condition to any externally connected device.

Features

- Adjustable overspeed function
- 74 VDC Power
- 30 second overspeed recovery delay
- (1) 20 pole output
- (1) 60 pole output
- (1) 1:500 pole output

SIEMENS Part Number	Preset	Self Test Switch Option	Locomotive Systems Products
NYK:Q1250	None	NO	
NYK:Q1251	128 PPWR	YES	
NYK:Q1253	249 PPWR	NO	
NYK:Q1254	128 PPWR	NO	
NYK:Q1260	249 PPWR	NO	



Ditch Lights

Overview



*Model NYK:Q2014 Ditch Light shown for reference purposes only!
Actual unit selected may vary in mounting and features.*

SIEMENS Ditch Lights are a complete lighting system to retrofit existing on-board locomotive lights which provides additional visibility during night time operation as well as additional protection at grade crossings. Available in either a 32Vdc or 5Vdc versions and powered by an external lighting controller.

Whenever the headlight of the lead locomotive is placed in the high beam position, the ditch lights are constantly illuminated. Whenever speeds are greater than 8 mph (13 kph), whenever the locomotive horn is blown, or when the manual mushroom switch pendant is pressed, the Ditch Lights enter into an alternating wig / wag flashing pattern at 1 second intervals.

Additionally, the lights will continue to flash for approximately 30 seconds before they are extinguished.

Available ditch light brackets can be used for precise aiming of the ditch lights according to railroad specifications.

Features

- Available in either a 32Vdc or 74Vdc versions
- Steel enclosure for rugged durability
- Provides additional visibility during night time operations

NYK:Q2014/30V

NYK:Q2014/75V



Type 1 - 30 V

- Weight is approx. 7 lbs. (3.18 kgs.)
- Operates in -40° F to +160° F (-40°C to +70°C) @ up to 95% Non-Condensing Relative Humidity
- Type 1 assembly
- Requires 30 V Bulb

Type 1 - 75 V

- Weight is approx. 7 lbs. (3.18 kgs.)
- Operates in -40° F to +160° F (-40°C to +70°C) @ up to 95% Non-Condensing Relative Humidity
- Type 1 assembly
- Requires 75 V Bulb

Applicable for all NYK:Q2014 Type 1 Ditch Lights

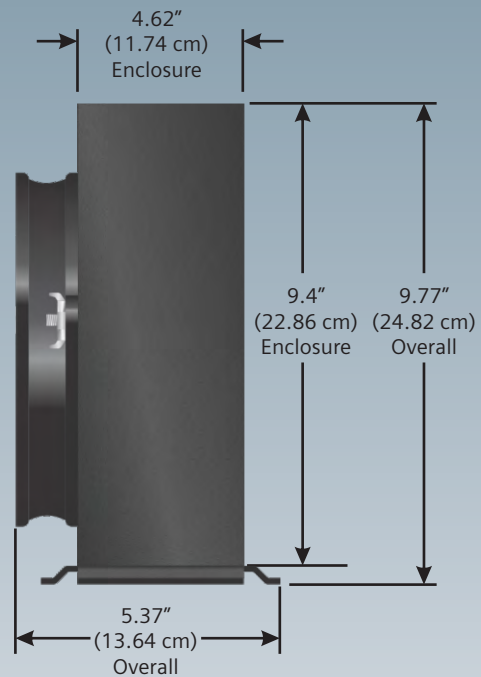

NYK:Q2015/30V

NYK:Q2015/75V

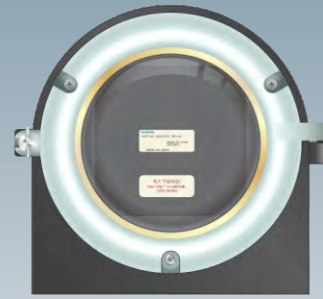
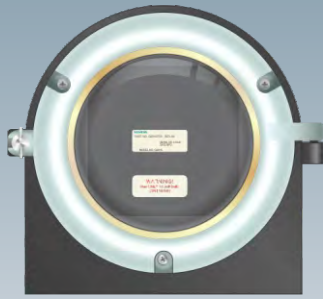

Type 2 - 30 V

- Weight is approx. 7 lbs. (3.18 kgs.)
- Operates in -40° F to +160° F (-40°C to +70°C) @ up to 95% Non-Condensing Relative Humidity
- Type 1 assembly
- Requires 30 V Bulb

Type 2 - 75 V

- Weight is approx. 7 lbs. (3.18 kgs.)
- Operates in -40° F to +160° F (-40°C to +70°C) @ up to 95% Non-Condensing Relative Humidity
- Type 1 assembly
- Requires 75 V Bulb

Applicable for all NYK:Q2015 Type 2 Ditch Lights

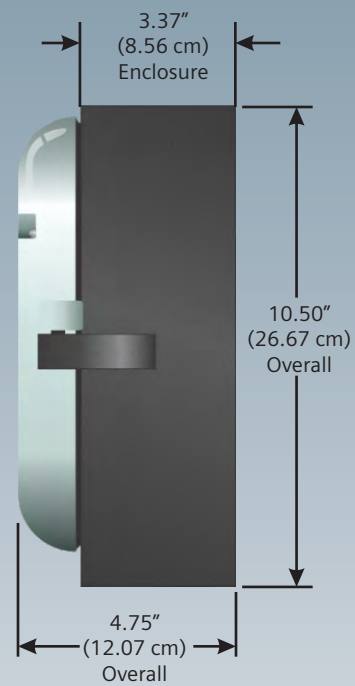
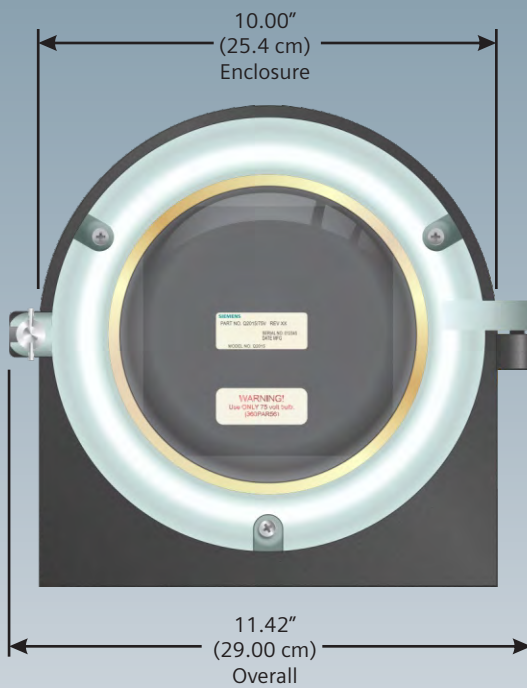

NYK:Q2030C

NYK:Q2032C



Ditch Light Controller

- Weight is approx. 8.2 lbs. (3.72 kgs.)
- Operates in -40° F to +160° F (-40°C to +70°C) @ up to 95% Non-Condensing Relative Humidity
- Controls up to (4) @ up to 75 V bulbs
- 10 second wig / wag timing
- 8 mph trigger for lights

Ditch Light Controller

- Weight is approx. 8.6 lbs. (3.90 kgs.)
- Operates in -40° F to +160° F (-40°C to +70°C) @ up to 95% Non-Condensing Relative Humidity
- Controls up to (4) @ up to 75 V bulbs
- 10 second wig / wag timing
- 5 mph trigger for lights

Applicable for all Ditch Light Controllers

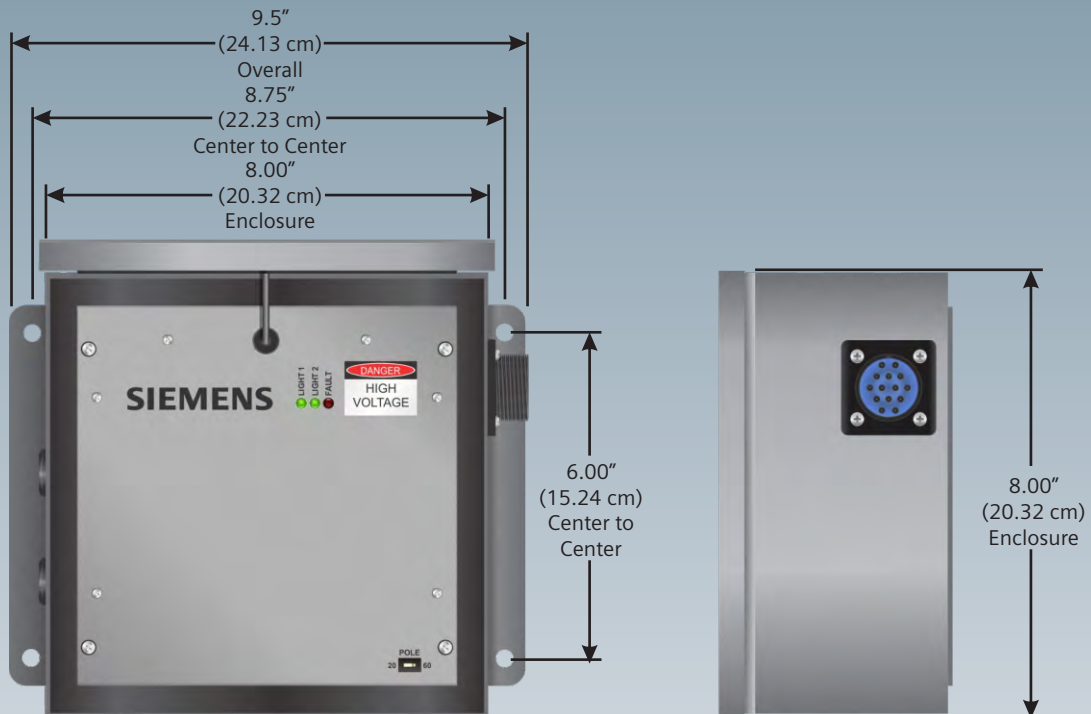



Heater Ground Relays

Overview



*Model NYK:D3676H01 Heater Ground Relay shown for reference purposes only!
Actual unit selected may vary in mounting and features.*

SIEMENS Heater Ground Relays provide dual channel fault current monitoring protection for heater systems. Able to be reset automatically with programmable trip threshold settings. Contains both internal and external trip indicators. Available in either a 600 VDC or 750 VDC version.

NYK:D1582H01

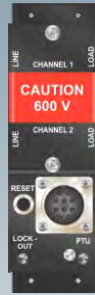

600 VDC

- Weight is approx. 6.4 lbs. (2.90 kgs.)
- Operates in -40° F to +160° F (-40°C to +70°C) @ up to 95% Non-Condensing Relative Humidity

NYK:D3676H01



750 VDC

- Weight is approx. 7.6 lbs. (3.45 kgs.)
- Operates in -40° F to +160° F (-40°C to +70°C) @ up to 95% Non-Condensing Relative Humidity

Applicable for all NYK:D1582H01 Heater Ground Relays

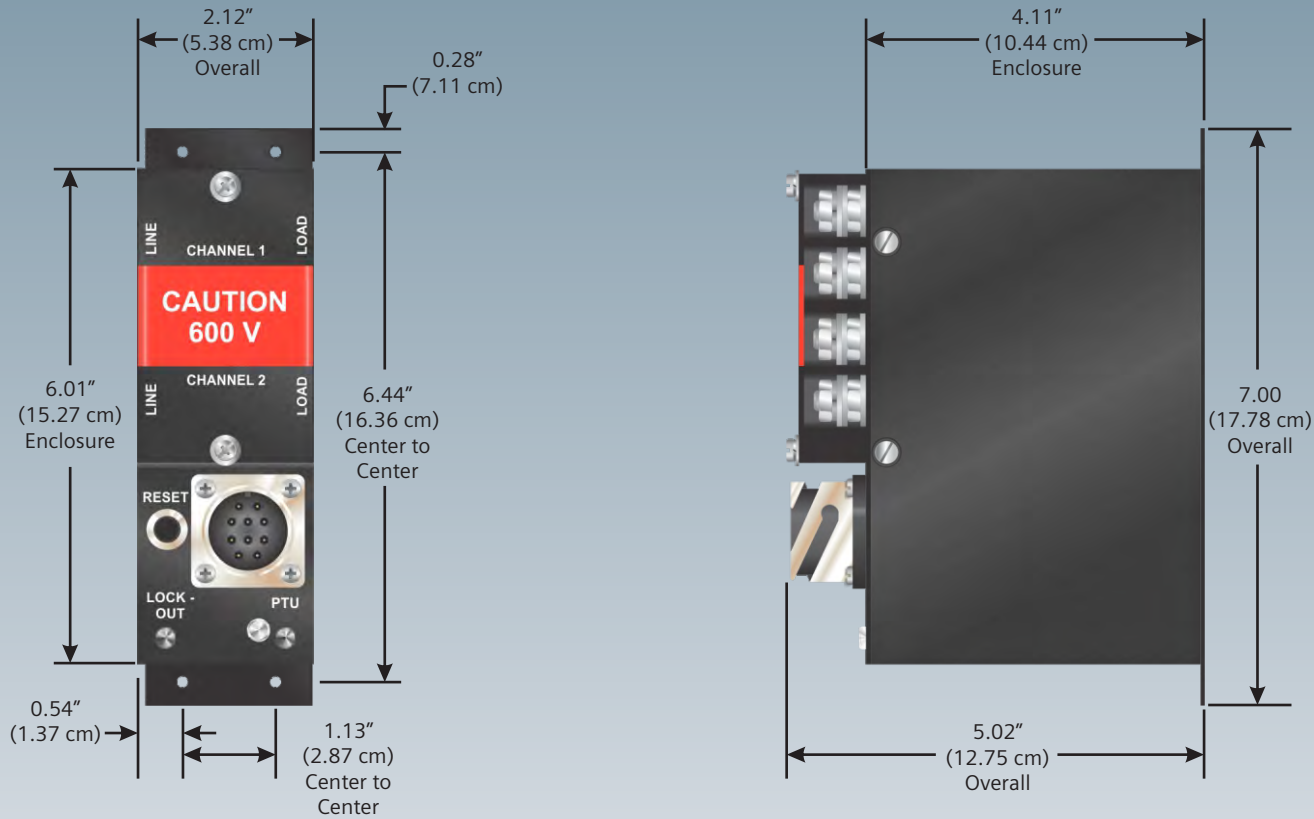

Applicable for all NYK:D3676H01 Heater Ground Relays

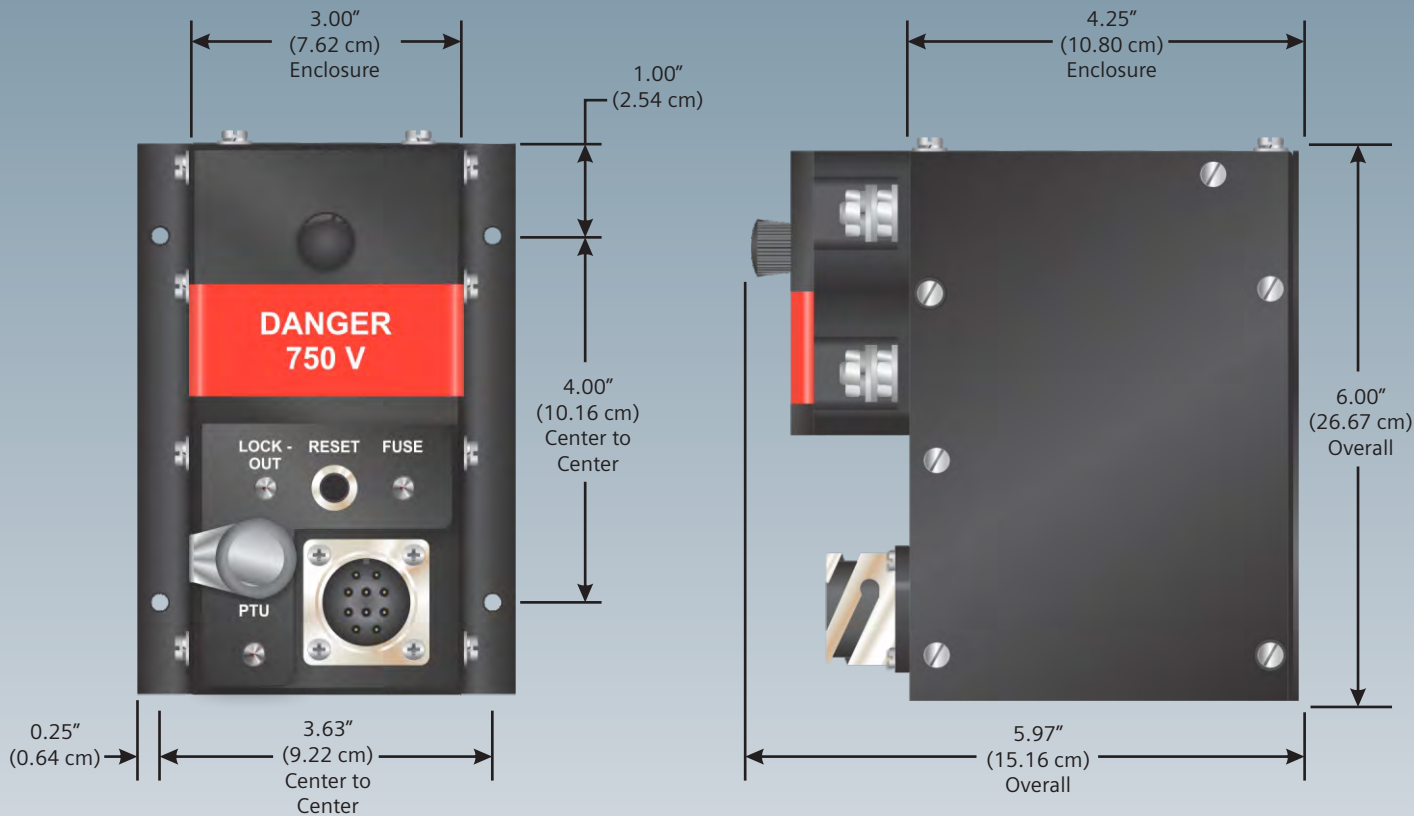



MPBI

Multiple Penalty Brake Interface

Overview

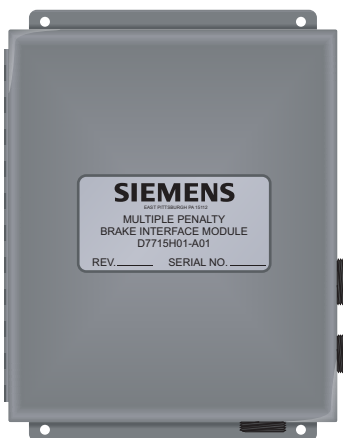

Multiple Penalty Brake Interface Module shown for reference purposes only! Actual unit selected may vary in mounting and features.

SIEMENS Multiple Penalty Brake Interface (MPBI) is intended to provide a vital “AND” function to allow multiple train control system's penalty brake outputs access to a single penalty brake input to the brake system.

Train Control Systems

The MPBI device provides support for the various train control systems in use today:

- Siemens Cab Signaling System (ATC / ACSES)
- Alstom® ITCS® / X-ITCS® Cab Signaling System
- Ansaldo STS® MicroCad® Cab Signaling System
- Wabtec® I-ETMS™

The MPBI provides railroads with a safe and convenient way to connect their various Positive Train Control (PTC) systems on board their vehicles to the single penalty brake.

Features

- Solid-state LED Indicators
- Lamp Test Pushbutton
- Microprocessor Based
- Vital Design
- Up to 4 Inputs
- Multiple Cutout Options
- Source of Penalty Indicators

SIEMENS Part Number	Description
NYK:D7715H03-A01	Penalty Brake Cutout Switch
NYK:D7715H04-A01	Penalty Brake Indicator
NYK:D7715H03-A01	Penalty Brake Interface Module



Maintenance Key Switch

Overview



Model NYK:C655H01-A02 Maintenance Key Switch shown for reference purposes only! Actual unit selected may vary in mounting and features.

SIEMENS Maintenance Key Switch provides exceptional maintenance security and safety in a single compact lightweight aluminum design. Locking cylinder is surrounded by a strong electro-less nickle plated steel body for added security.

The locking cylinders are designed to be “self-cleaning”, sweeping out dirt and grit when operated by controlled keys that are only available to the railroad.

Key retaining design traps the key in the padlock so that it cannot be removed when in the ON position.

NYK:C655H01-A02

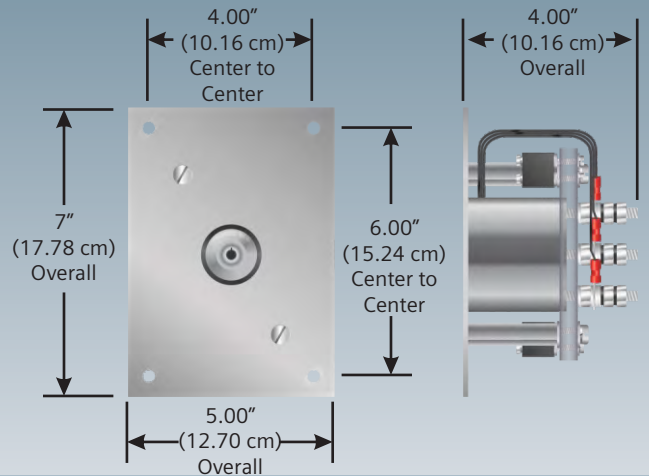

- Weight is approx. 3.0 lbs. (1.36 kgs.)
- Operates in -40° F to +160° F (-40°C to +70°C) @ up to 95% Non-Condensing Relative Humidity
- (2) NO and (2) NC contacts, 15A
- 15A
- 125 VAC
- Connection by AAR terminals

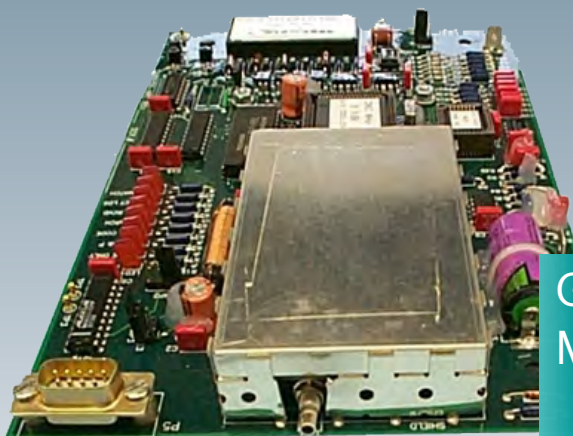

GPS Onboard Monitoring Unit

Overview

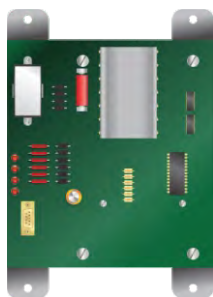

Model NYK:D1563H18-A01 GPS Onboard Monitoring Unit shown for reference purposes only! Actual unit selected may vary in mounting and features.

SIEMENS GPS Onboard Monitoring Unit works by continually comparing satellite-derived coordinates to coordinates in the cab system's onboard database. Database mapping and interface services are also available.

NYK:D1563H18-A01

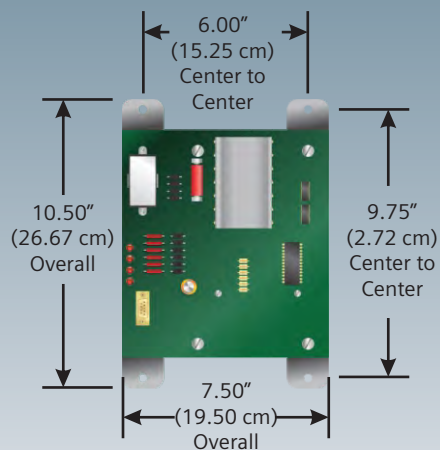

- Weight is approx. 3.0 lbs. (1.36 kgs.)
- Operates in -40° F to +160° F (-40°C to +70°C) @ up to 95% Non-Condensing Relative Humidity



Track Receiver Junction Box

Overview

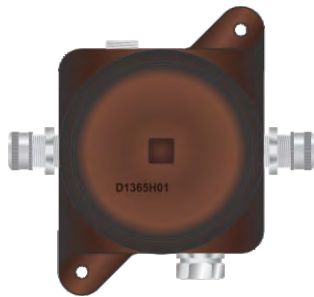

Model NYK:D1365H01-A01 Track Receiver Junction Box shown for reference purposes only! Actual unit selected may vary in mounting and features.

SIEMENS Track Receiver Junction Boxes are used to wire a pair of track receivers in a series-aiding configuration, providing a single-cable run to the equipment enclosure.

NYK:D1365H01-A01

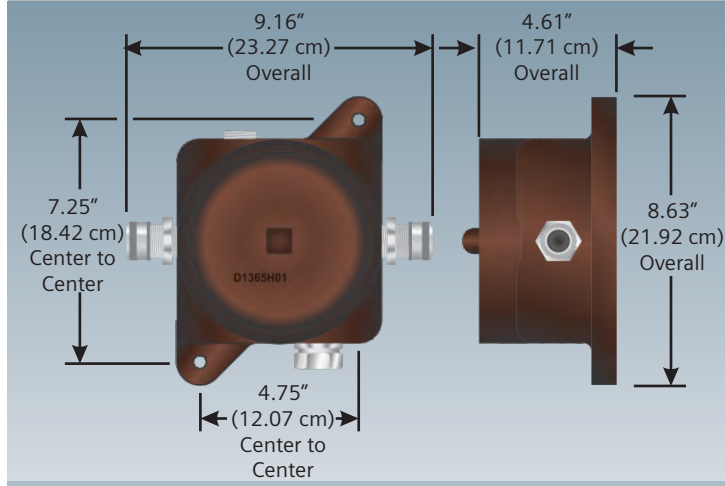

- Weight is approx. 22.0 lbs. (9.98 kgs.)
- Operates in -40° F to +160° F (-40°C to +70°C) @ up to 95% Non-Condensing Relative Humidity

Aspect Display Units

Overview



*Aspect Display Unit shown for reference purposes only!
Actual unit selected may vary in mounting and features.*

Federal Railroad Administration (FRA)
Positive Train Control (PTC) Type approved for
Northeast Corridor (NEC)

SIEMENS Aspect Display Unit (ADU) provides a primary visual interface between a train's vehicle operator and the cab signaling systems. The ADU's rugged design is suitable for use onboard any type of vehicle. The ADU's microprocessor combines indications from industry standard positive train control protection systems such as Automatic Train Control (ATC) and Advanced Civil Speed Enforcement System (ACSES) in order to present their required respective data concisely thru the ADU onboard display.

The ADU connects serially to either ATC system directly or third-party ATC systems thru a separate ATC Interface Unit (AIU).

Features

Solid state LED indicators provide reliable, long lasting color with high visibility in all lighting conditions, including on bright sunny days. Alphanumeric display creates an environment for easily reading aspects from multiple railroads as well as important message information. Display automatically dims when necessary to handle varying environmental lighting conditions.

Built in Sonalerts draw vehicle operator's attention to the ADU when needed to advise of changes in speed information displayed.



Assembly configurations shown are only a small sampling of commonly ordered assemblies. Other configurations may be available upon request. Please contact the Technical Assistance for Rail Automation team @ 1-800-793-7233 (Option 1) or RA.RailTechSupport.ic@siemens.com for additional details.



Locomotive Power Supplies

Overview

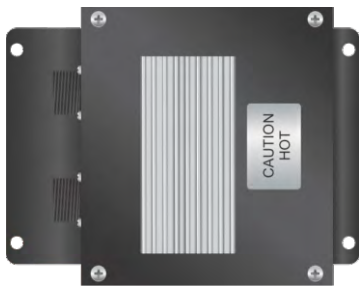

Model NYK:D1517H01-A01 Locomotive Power Supply shown for reference purposes only! Actual unit selected may vary in mounting and features.

NYK:D1517H01-A01

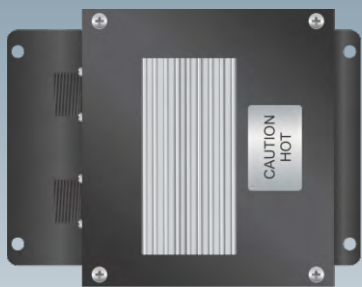

ACSES Radio Power Supply

- Weight is approx. 2.8 lbs. (1.27 kgs.)
- Operates in -40° F to +160° F (-40°C to +70°C) @ up to 95% Non-Condensing Relative Humidity
- 13.6 VDC output set point

NYK:D5600H01-A01



32 VDC

- Weight is approx. 4.3 lbs. (1.95 kgs.)
- Operates in -40° F to +160° F (-40°C to +70°C) @ up to 95% Non-Condensing Relative Humidity

NYK:D1567H08-A01



36 VDC

- Weight is approx. 4.3 lbs. (1.95 kgs.)
- Operates in -40° F to +160° F (-40°C to +70°C) @ up to 95% Non-Condensing Relative Humidity

NYK:D5600H01-A02



12 VDC (CTV)

- Weight is approx. 4.3 lbs. (1.95 kgs.)
- Operates in -40° F to +160° F (-40°C to +70°C) @ up to 95% Non-Condensing Relative Humidity

Applicable for all NYK:D1517H01 Locomotive Power Supplies

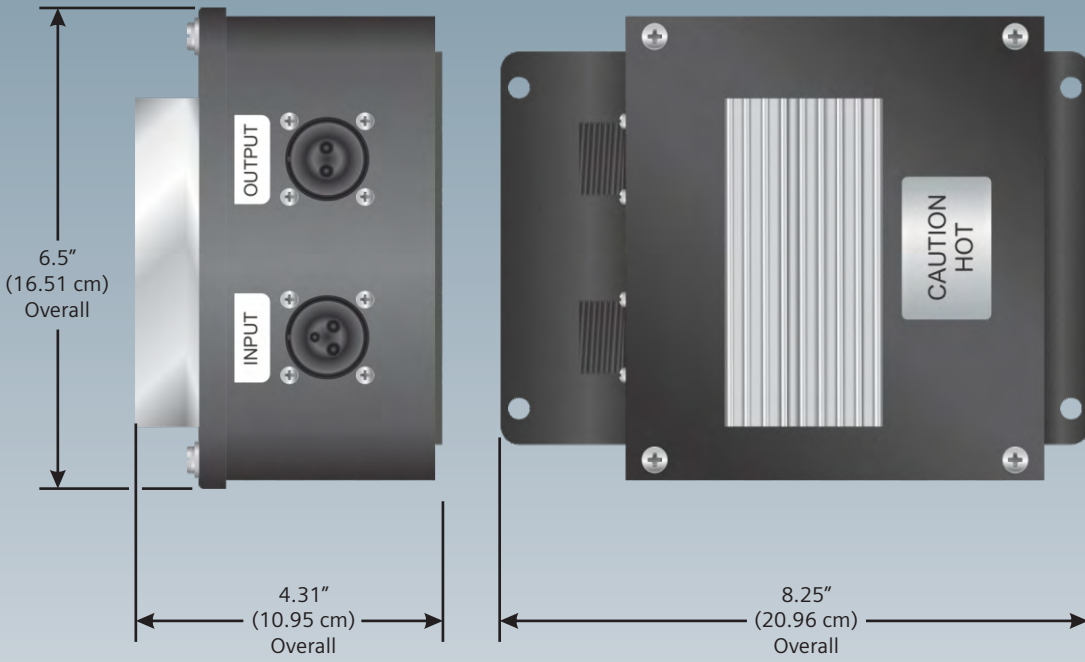

Applicable for all NYK:D5600H01 Locomotive Power Supplies





Q2518

Locomotive Alerter System Controller

Overview



SIEMENS Q518 Locomotive Alerter System Controller provides a Locomotive Engineer reset timer which assures the locomotive crew is attentive to the operation of the locomotive at all times.

Unit is used in conjunction with the **SIEMENS** Q2505 Alerter Light / Horn unit or **SIEMENS** QSI Series Speed Indicators to provide visual and audible signals to the locomotive crew.

In the event that the crew is unable to continue to operate the locomotive, and have not responded to the alerter system visual and audible alarms, the alerter system will initiate a penalty brake application of the train brakes.

Under normal operating conditions, the alerter system does not interfere with the customary activities of the engineer since the alerter system is reset by all of the train crew operated locomotive controls.

Features

- Provides full redundancy by incorporating (2) microprocessors to not only monitor all inputs to the unit but also control half of the unit's visual indicators and (1) of the (2) audible horns.
- Provides Speed Dependent Timing Cycle which allows the locomotive speed signal to vary unit's timing cycle. As the speed of the locomotive increases, the timing cycle decreases.
- Includes Body on Board (BOB) function which requires one (1) acknowledgment by locomotive crew of the visual and audible alarm indications before the system will increase the timing cycle above its most restrictive setting. This ensures that a minimum distance will be traveled if the locomotive brakes are released without a crew member on board that is capable of operating the locomotive.
- Includes Repetitive Reset Disable which monitors the manual reset switch input for the presence of repetitive inputs. Any mechanical or electrical means of providing repetitive resets to the manual reset switch input will not be processed as a valid timing or alarm cycle reset.
- Features a self test mode, allowing railroad maintenance personnel to quickly evaluate all functions and reset inputs.
- Features a modular design, which allows each component of the unit to be changed quickly, when required.



Decelerometer

Overview



*Model NYK:D1563H18-A01 Decelerometer shown for reference purposes only!
Actual unit selected may vary in mounting and features.*

SIEMENS Decelerometer are a solid state design, vital, microprocessor-controlled device used to determine a vehicle's deceleration rate.

Designed using fail-safe principles to ensure that deceleration rate cannot be erroneously obtained. These include both Class I hardware/software and Class II hardware principles.

Depending on model Interfacing can be accomplished using any of the following (3) methods:

- Serial Peripheral Interface (SPI)
Industry standard serial interface requiring implementation of software communications protocol.
- Asynchronous Serial Interface (ASI)
Industry standard RS-485 protocol.
- 32 Volt DC Isolated Output
Isolated 32 VDC appears across the device's two brake rate output pins when the deceleration rate is achieved.

NYK:D177H01-A01

NYK:D177H01-A02

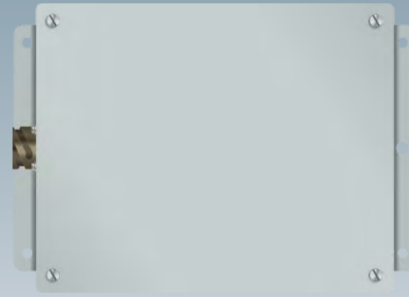
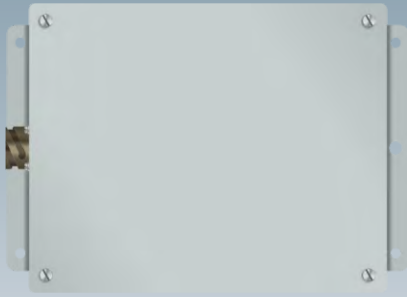

- Weight is approx. 4.3 lbs. (1.95 kgs.)
- Operates in -40° F to +160° F (-40°C to +70°C) @ up to 95% Non-Condensing Relative Humidity
- 1.80 MPH/s (2.90 KPH/s) (1.12 m/s²) maximum detectable deceleration rate
- Accurate to 0.05 MPH/s (0.08 KPH/s)

- Weight is approx. 4.3 lbs. (1.95 kgs.)
- Operates in -40° F to +160° F (-40°C to +70°C) @ up to 95% Non-Condensing Relative Humidity
- 3.6 MPH/s (5.79 KPH/s) (3.36 m/s²) maximum detectable deceleration rate
- Accurate to 0.10 MPH/s (0.16 KPH/s)

Applicable for all NYK:D177H01 Decelerometers

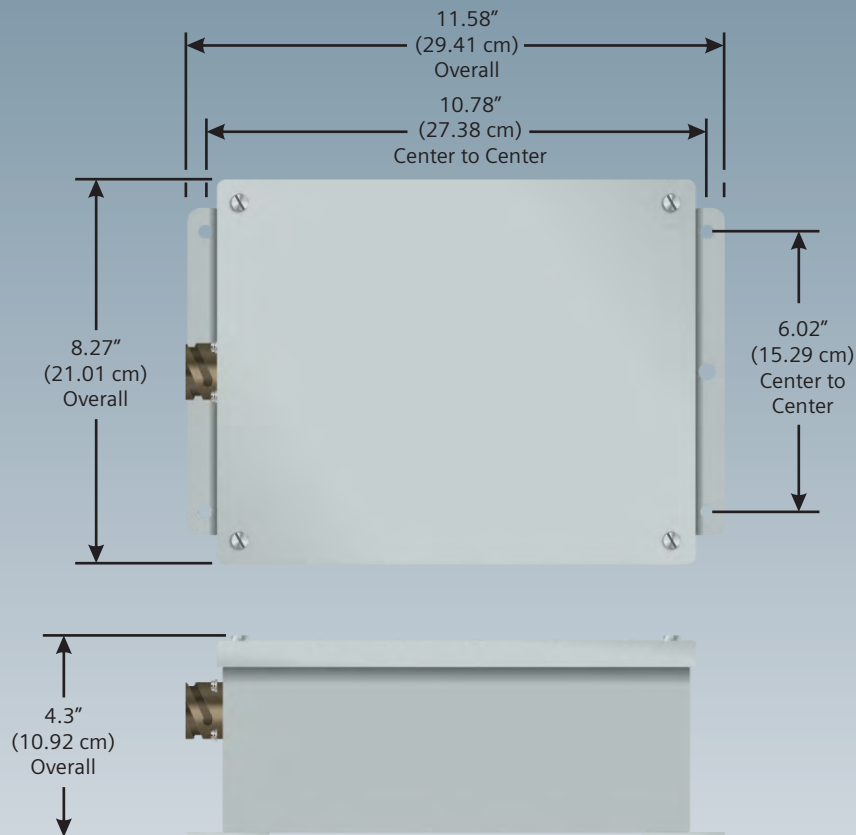



CHMM Series

Crash Hardened Memory Modules

Overview



*Model NYK:Q1603 CHMM Series Crash Hardened Memory Module shown for reference purposes only!
Actual unit selected may vary in mounting and features.*

SIEMENS Crash Hardened Memory Module (CHMM Series) is an external memory back-up device designed to interface with an existing on-board event recorder.

The purpose of the CHMM is to store data recorded by the event recorder and to protect that data under certain extraordinary conditions.

Features

- Meets all FRA 49 CFR 229 Appendix D requirements for locomotive crashworthy event recorder memory
- Compact design maximizes mounting options on all locomotives
- (4) ethernet ports and (6) functional serial ports for external equipment interface
- Inputs in EMP Class C or D
- USB and Ethernet download capable
- Scalable storage up to 128 GB

NYK:Q1602

NYK:Q1603-02



Crash Hardened Memory Module

- Weight is approx. 15.5 lbs. (6.97 kgs.)
- Operates in -40° F to +160° F (-40°C to +70°C) @ up to 95% Non-Condensing Relative Humidity
- Operating voltage 74 VDC
- Records minimum of (48) hours of event data
- (1) RS-232 / RS-422 / RS-485 port

Crash Hardened Memory Module w/ Handle

- Weight is approx. 16.8 lbs. (7.57 kgs.)
- Operates in -40° F to +160° F (-40°C to +70°C) @ up to 95% Non-Condensing Relative Humidity
- Operating voltage 74 VDC
- Records minimum of (48) hours of event data
- (1) RS-232 / RS-422 / RS-485 port
- Designed to work in conjunction with external event recorder

Applicable for all CHMM Series Crash Hardened Memory Modules

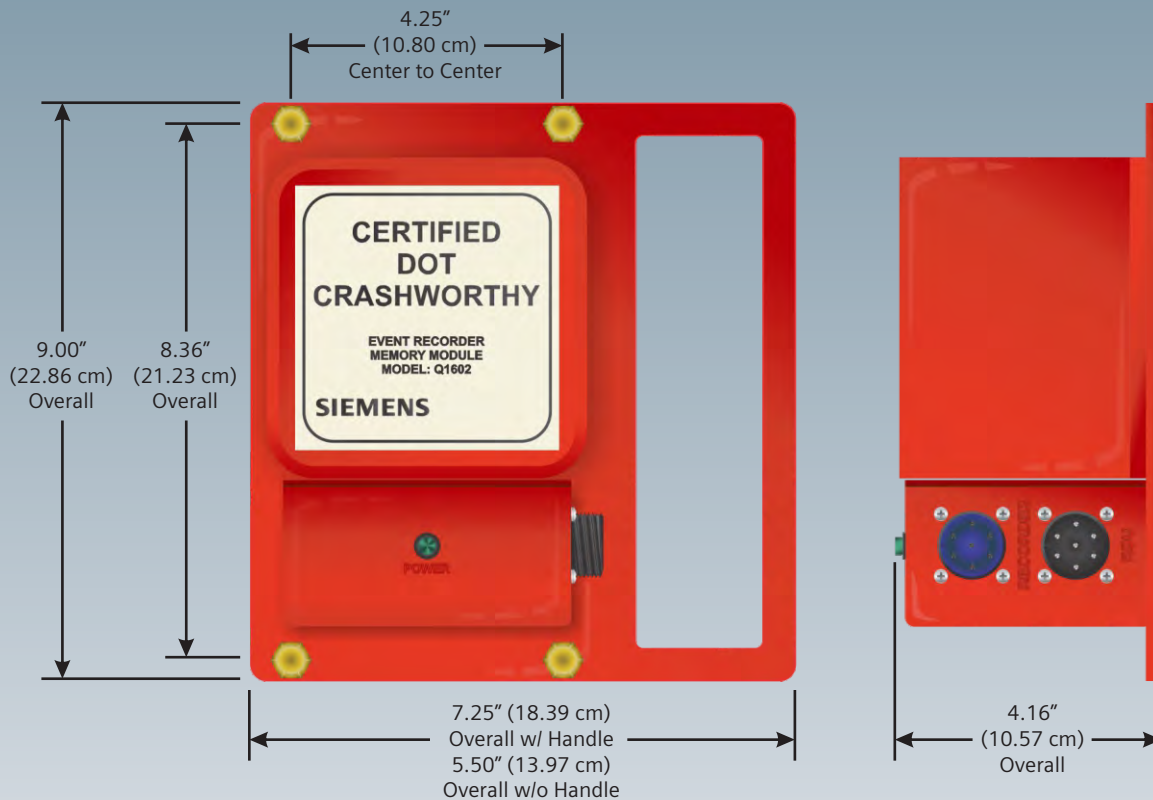



Locomotive Event Recorders

Overview



Model NYK:Q1046 Locomotive Event Recorder shown for reference purposes only! Actual unit selected may vary in mounting and features.

SIEMENS Locomotive Event Recorders provides the Locomotive Engineer with the ability to record the overall operation of a locomotive.

A minimum of 48 hours of recorded data is stored in non-volatile flash Random Access Memory (RAM). As the memory is filled to capacity, the oldest data is overwritten with newly acquired data. No batteries are required to retain recorded data in the event recorder.

A lithium battery located inside the event recorder enclosure powers the internal real time clock. The battery is only used when locomotive battery power is not available and has a life of approximately five (5) years.

All electrical connections to the event recorder are terminated at a series of Amphenol MS (military style) connectors. Pre-assembled wiring harnesses for connecting the locomotive electrical signals to the event recorder are provided with the system.

The event recorder integrates the electronic recorder and air line connections in a NEMA 4 style water-resistant enclosure. A separate air brake system monitor and the associated interconnecting wiring are eliminated.

NYK:Q1040E

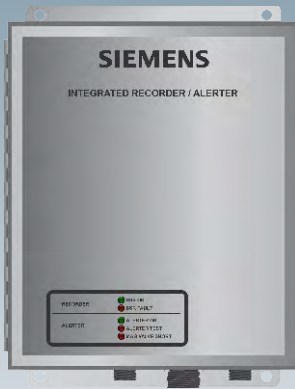

- Weight is approx. 18 lbs. (8.16 kgs.)
- Operates in -40° F to +160° F (-40°C to +70°C) @ up to 95% Non-Condensing Relative Humidity
- Type 40 Enclosure
- With Direct Brake

NYK:Q1044E



- Weight is approx. 18 lbs. (8.16 kgs.)
- Operates in -40° F to +160° F (-40°C to +70°C) @ up to 95% Non-Condensing Relative Humidity
- Type 44/ Enclosure
- With Direct Brake

NYK:Q1046E

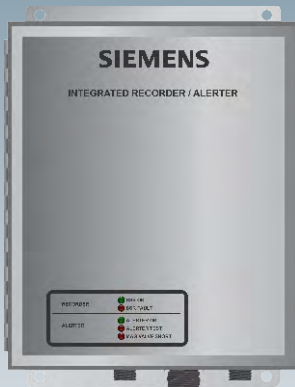

- Weight is approx. 18 lbs. (8.16 kgs.)
- Operates in -40° F to +160° F (-40°C to +70°C) @ up to 95% Non-Condensing Relative Humidity
- Type 46 Enclosure
- With Direct Brake

NYK:Q1048E

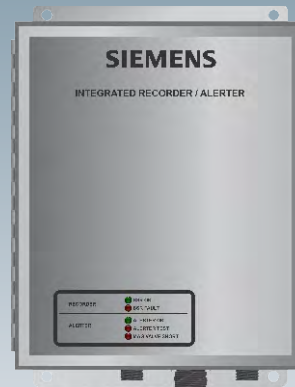

- Weight is approx. 18 lbs. (8.16 kgs.)
- Operates in -40° F to +160° F (-40°C to +70°C) @ up to 95% Non-Condensing Relative Humidity
- Type 48 Enclosure
- With Direct Brake

NYK:Q1050E

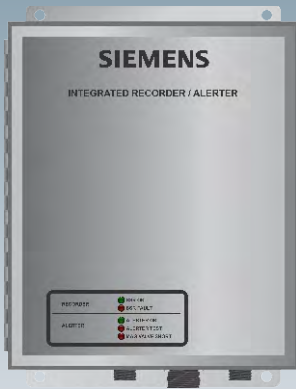

- Weight is approx. 18 lbs. (8.16 kgs.)
- Operates in -40° F to +160° F (-40°C to +70°C) @ up to 95% Non-Condensing Relative Humidity
- Type 50 Enclosure
- With Direct Brake

NYK:Q1067E



- Weight is approx. 18 lbs. (8.16 kgs.)
- Operates in -40° F to +160° F (-40°C to +70°C) @ up to 95% Non-Condensing Relative Humidity
- Type 67 Enclosure
- With Pump

NYK:Q1029

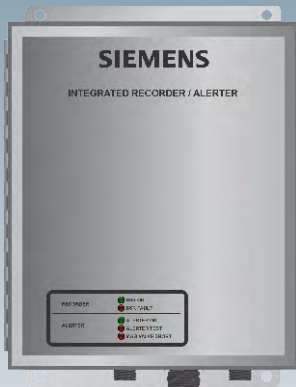

- Weight is approx. 18 lbs. (8.16 kgs.)
- Operates in -40° F to +160° F (-40°C to +70°C) @ up to 95% Non-Condensing Relative Humidity
- Type 29 Enclosure
- With camera interface

Available
2018



Locomotive Systems Products

Overview



SIEMENS Locomotive Event Recorder is an FRA fully compliant, configurable alerter / recorder leveraging decades of experience in event recorder development in North America and Europe.

It is designed to fit all freight locomotive and transit vehicle applications, with models targeting legacy and new locomotive architectures and housed within an IP65 sealed enclosure. It contains various communications ports (RS232/422/485 serial, 10/100 and 10/100/1000 ethernet and USB 3.0) as well as selectable ranges on analog inputs and selectable filtering and debouncing on digital outputs. Inputs and outputs are isolated on all except legacy replacement versions.

Available with integrated manifold (with (3) analog pressure sensors and (5) digital pressure switches) or connector to support external manifold.

Easy front panel customization allows new variant versions to be quickly created to match existing legacy cabling and connectors within existing locomotives.

Drop-in replacement units are backward-compatible with legacy Quantum event recorders for easy retrofitting. LDARS compatible models are configured in EDAP only, CMM only, and EDAP / CMM combined versions.

Features

- Data recorder with optional, integrated crashworthy memory. (32) GB standard expandable to (256) GB
- Interfaces for discrete and networked data collection from onboard systems.
- Option for storage of digitized video data with integrated CMM.
- EDAP ONLY VERSION provides standalone unit to interface with discrete onboard subsystems and send information to standalone CMM in accordance with the LDARS specification.
- CMM ONLY VERSION provides standalone unit to communicate with networked onboard subsystems to send information to integrated CMM in accordance with the LDARS specification
- EDAP / CMM COMBINED VERSION provides unit to interface with discrete and networked onboard subsystems to send information to integrated CMM in accordance with LDARS specifications
- Equipped with a full featured data playback and analysis tool (DAREC) with advanced user-defined functionality.
- Configurable integrated alerter function allows implementation of any user-defined Vigilance Alerter System algorithms.
- Available MVB bus interface (Optional)

Miscellaneous

SIEMENS now offers a variety of new product offerings to address a multitude of client centric needs. Please contact the **SIEMENS** Technical Assistance for Rail Automation Team to discuss details about your specific design application requirements.



Cab Signaling Systems



Scanner Antenna



Intermittent Train Stop Systems



Variable Timers



**Mini, Midi and Maxi
Track Receivers**

