



**SIEMENS**

*Ingenuity for life*



# product news

Innovations for the  
Digital Enterprise

November 2020

[siemens.com/tia](https://www.siemens.com/tia)



- › Cover
- › Contents / Navigation
- Future of Automation**
- › The factory of the future
- Products**
- › Totally Integrated Automation
- › Industrial Security
- › Robotics
- › Industrial Edge
- › MindSphere
- › Controller
- › Distributed I/O Systems
- › Human Machine Interface
- › PC-based Automation
- › Power Supplies
- › Process Automation
- › Drive Systems
- › Industrial Communication
- › Industrial Identification and Locating
- › Industry Services
- › Smart Electrification
- › Imprint

Navigation



scroll  
backwards



scroll  
forwards



Menu / Table  
of Contents

## Autonomous Factory

# The factory of the future

The future of production is undergoing an extreme transformation. More and more requirements from the B2C world are also affecting requirements in the B2B world. Companies today are under tremendous pressure to make their production both economical and ecological. Whether it is short innovation cycles or a steadily growing demand for customized products, the future of production is entirely customer-focused.

### A constant stream of new products – without engineering

In the past, frequent changes in incoming orders and a wide variety of production configurations often meant added expenditures for manufacturing. Since then, a fundamental transformation has been under way in factories, away from sequential production and toward autonomous manufacturing. In the production of the future, people and machines will work at small, separate workstations while automated guided vehicles transport products and the necessary components and tools between them. The system is based on modular, autonomous machines that continuously optimize themselves and operate extremely flexibly and efficiently.

These autonomous, decoupled manufacturing units quickly form new assembly cells and can produce constantly varying products without repeated manual engineering. Each machine is assigned skills based on the product ordered. The manufacturing steps are engineered by an

AI-based system that performs a producibility check that determines whether all the necessary skills for manufacturing the product are available in the factory. The requisite production steps are then combined in an optimal sequence, fully automatically and without reprogramming.

### Artificial intelligence as the foundation of production

Autonomy in production is made possible by digitalization. Based on a digital twin of the product to be manufactured, AI algorithms enable the system to detect product variants, check material availability, and plan the steps necessary for manufacturing the product. AI also enables sensors and actuators to perform human-like actions like identifying parts and positions for gripping an object.

Production as a whole also makes its own decisions and organizes itself. Many assembly steps can be performed in any order. A central, AI-based system ensures the highest possible output and monitors optimal utilization and compliance with delivery deadlines. The system always knows the status of production at every workstation down to the smallest detail. This kind of autonomous factory generates and uses tremendous amounts of data, is protected by customized and proven cybersecurity concepts, utilizes AI, and supports the next industrial revolution by making autonomous decisions in real time. ■

› [siemens.com/futureofautomation](https://www.siemens.com/futureofautomation)



## Integration<sup>3</sup> – Totally Integrated Automation

# End-to-end consistency as the foundation of digitalization

To get the most out of a company's potential, all components and competencies at all levels need to interact with each other – for maximum data transparency. The answer to this challenge is Totally Integrated Automation (TIA). The world's leading automation concept provides absolute end-to-end consistency in three dimensions.

TIA enables a seamless interaction between all automation components, the software involved, and higher-level systems and services (Integration<sup>1</sup>). This is ensured by consistent data management, worldwide standards, uniform interfaces, and openness – from the field level to the company management level (Integration<sup>2</sup>). Tomorrow's technologies are already being integrated today, step-by-step, for a secure investment – whatever phase your company is in (Integration<sup>3</sup>).

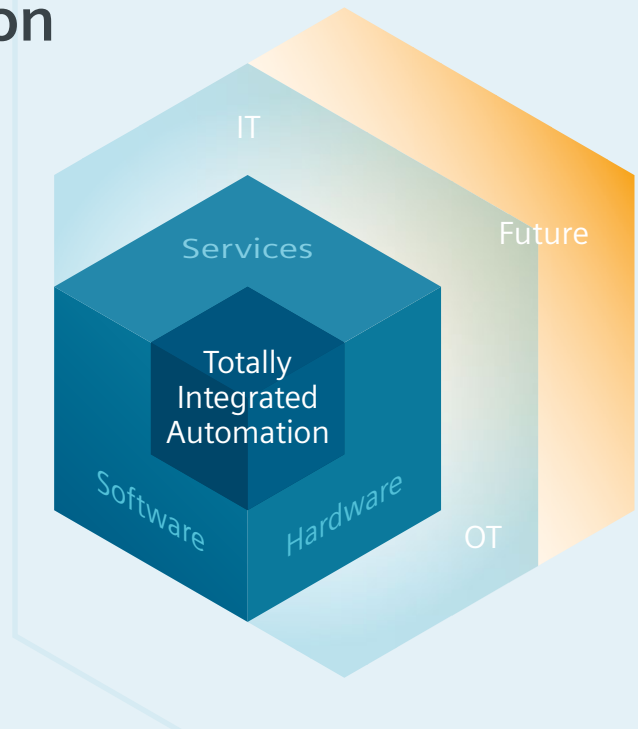

### Integration<sup>1</sup>

The basis of TIA is the stable automation core with its integrated hardware and software portfolio plus specific services – from consulting to implementation and optimization of machines and plants. The comprehensive portfolio grows to keep pace with the steady flow of new requirements. For example, Industrial Edge technologies will gradually be integrated into the TIA portfolio. IT technologies are shifting to manufacturing, where Edge devices already have enough processing power to run certain applications and can orchestrate communications with other parts of the factory. With Industrial Edge, users themselves decide whether the data remains on-site or is processed in the cloud. As a result, everyone can use the best solution for their needs, either with Siemens equipment or tailored to the infrastructure. (Read more about Siemens Industrial Edge on pages 10–13.)

### Integration<sup>2</sup>

Data is increasingly becoming the key to competitive advantages, and it also lays the groundwork for new business models. This can be illustrated using the recall of defective products as an example. To minimize costs and keep the number of products to be recalled as low as possible, it's essential to accurately identify the quantity of defective products. This requires a high level of data transparency from production (Operational Technology area). To accomplish this, sensors at the field level first generate the data and make it available via Simatic controllers. Subsequently, the data needs to be transferred from the OT area to the company's higher-level IT systems, where it's available to be analyzed for targeted recall actions. TIA supports these processes with seamless OT/IT connectivity, thanks to uniform interfaces and the necessary openness for easy implementation of, for example, OPC UA companion specifications via TIA Portal. New technologies in the IT area are continually supplementing the extensive analysis options in the OT area: for example, via SCADA systems. This is where Edge computing and solutions for higher-level cloud systems such as MindSphere come into play with its apps for production machines and systems.



### Integration<sup>3</sup>

Technologies such as Edge computing and artificial intelligence (AI) aren't just a milestone in OT/IT integration – they also generate new opportunities along the entire value chain. Collecting, monitoring, and analyzing machine and plant data at the edge of the network creates added value for systems or machines. From the targeted prediction of machine failures to a quality assurance based on process data without costly physical quality control to self-optimizing systems in which AI algorithms reveal their full potential. (Read more about artificial intelligence in autonomous systems on page 3.)

### Highlights

- Easy implementation of **OPC UA companion specifications in TIA Portal** (Siemens OPC UA Modeling Editor SIOME)
- **Use of IT technologies such as Edge computing** that offer a platform for future technologies such as artificial intelligence (AI)

The advantages of TIA comprise an ever-growing, seamlessly integrated portfolio of hardware, software, and services to be used from the field level to the company management level, and in which innovations are gradually being integrated to make companies future-proof for existing and upcoming challenges. ■

› [siemens.com/tia](https://www.siemens.com/tia)

TIA Portal V17

# More efficient engineering with more options

The parallelization of work steps can significantly increase engineering efficiency – provided that workflows are appropriately standardized to ensure that the processes work together smoothly and flawlessly. TIA Portal provides users with a continuous engineering workflow and offers end-to-end standardization of automation through TIA Portal libraries that store tested modules for its user’s programs. TIA Portal also enables fully integrated engineering workflows based on the model of Continuous Integration, in which developers work as a coordinated team on automation projects.

Efficient engineering also means designing applications instead of programming them. Two new control program editors have been added to TIA Portal V17 for graphical configuration. The

CFC Editor for Simatic S7-1500 can be used to interconnect function blocks as a continuous function chart (CFC) and therefore easily configure a signal flow diagram. This is especially valuable for users who already use CFCs in other projects and can now use the familiar program structure in TIA Portal as well. Developers can also create functions as a cause-and-effect matrix (CEM) by simply interconnecting ready-made logic modules in the CEM Editor for Simatic S7-1500 and S7-1200. Using a matrix, developers can configure the dependencies between the modules according to the principle of cause and effect. This type of configuration is especially straightforward thanks to the graphical user interface. It’s also very useful for troubleshooting logical connections between machine states, because relationships between modules are displayed at a glance.

Users can currently test all the functions of TIA Portal in the cloud free of charge for 21 days. Subscription licensing models for TIA Portal will be available in the future, both in the cloud and with local installation. For even more flexible use in automation projects, TIA Portal Cloud will be offered with TIA Portal V17 for the first time as a subscription model for commercial use. ■

> [siemens.com/tia-portal](https://www.siemens.com/tia-portal)

## Highlights

- Standardization with more **flexible library concepts**
- **Collaborative work on projects** with the project server and multiusers
- **Increased software quality** with TIA Portal Test Suite
- **New functions** for user management
- **Centralized reporting and diagnostic concepts** with OPC UA Alarms and Conditions
- Creating simple web-based visualization solutions with **Unified View of Things**

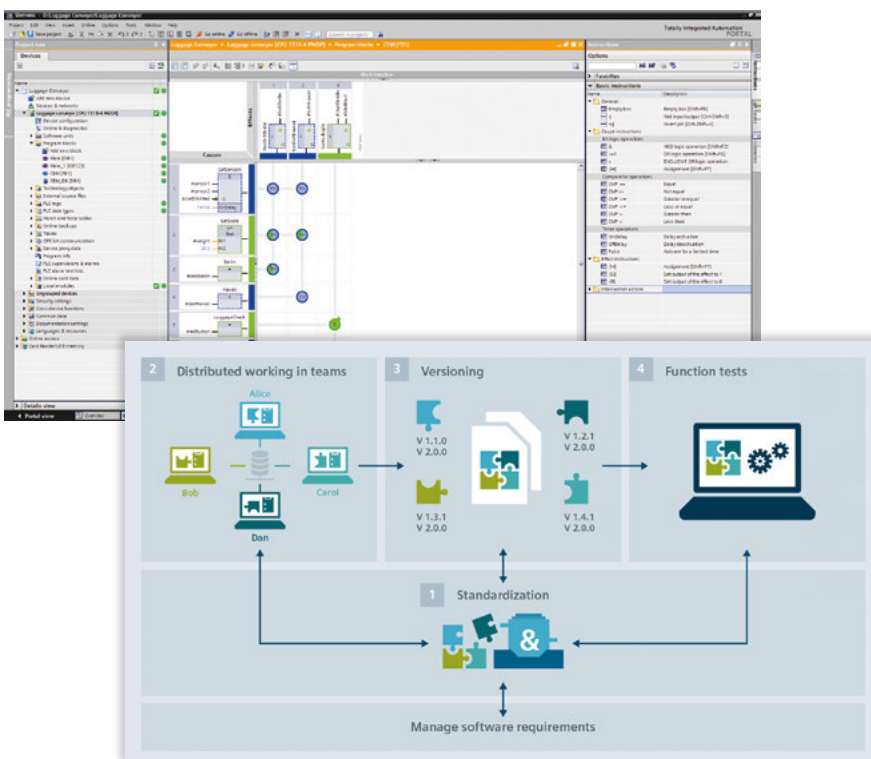

## Simulation and virtual commissioning with TIA Portal

# Simulation reveals new horizons

The virtual commissioning of machines and plants helps save valuable time during commissioning on-site. By simulating machine and plant behavior with a digital twin, that same twin can be used across the entire lifecycle of a machine or plant – right up to customer acquisition, or as a realistic model for the virtual showroom.

When production machines are being developed, the simulation of automation, electrical, and mechanical systems can be used to parallelize the design and engineering processes and test them in advance in a digital development environment. A corresponding model can also be used to verify entire production lines prior to physical commissioning. By eliminating the time-consuming process of coordinating individual components, the line can be put into operation faster.

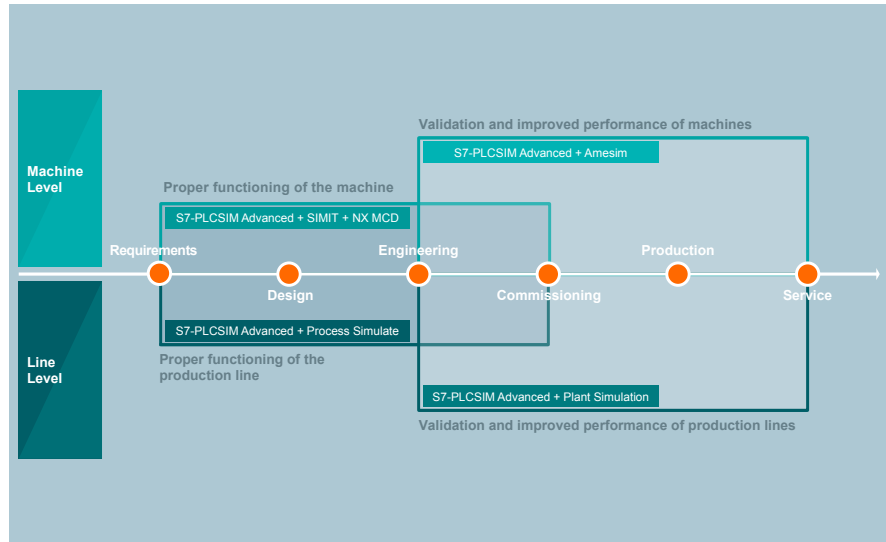

A digital twin can also be used to map logistics and material flows: for example, to design conveyor lines and to identify the optimal operating parameters for the conveyor technology. Simulation also helps boost the productivity of machines and

plants in operation. A model can be used to determine whether motors and other components contain sufficient reserves for improved performance, whether a higher load will result in vibration, and whether the automation response times are sufficient.

A coordinated portfolio of modeling tools and powerful automation hardware is the foundation for all these applications. From the virtual PLC and the modeling of mechatronic and mechanical components to solutions for modeling physical parameters, users can develop a digital twin to meet their needs in their TIA Portal project – and optimize their processes as a result. ■

> [siemens.com/simulation-for-automation](https://www.siemens.com/simulation-for-automation)

## Highlights

- **Simcenter Amesim** for performance evaluation and optimization of multi-physics systems
- **Tecnomatix Process Simulate** for designing and validating complex processes in production cells
- **Tecnomatix Plant Simulation** for simulating and optimizing material flows
- **NX Mechatronics Concept Designer** for the mechatronic and kinematic modeling of machines
- **Simit** for testing the control program, taking into account the behavior of the electrical system
- **S7-PLCSIM Advanced** for simulating Simatic S7-1500 controllers
- **Simatic S7-1500 controller and TIA Portal** as a powerful automation system

## TIA Portal V17 and Simatic S7 controllers: integrated security functions

# High-level cybersecurity

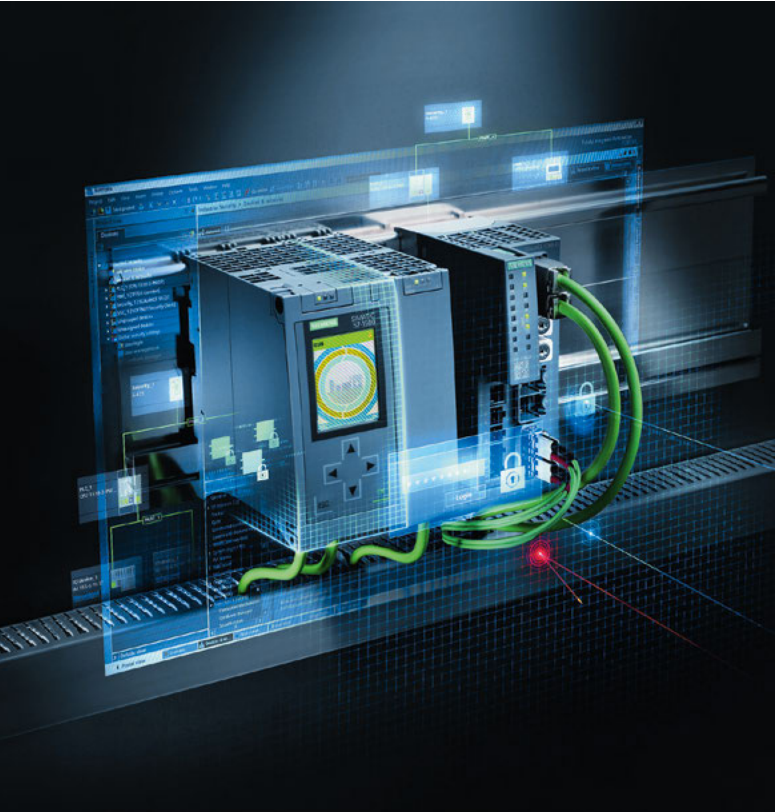

Cyberthreats to OT and automation systems are increasing every day. TIA Portal and the Simatic S7 controllers offer integrated security functions that are being further developed and expanded with version V17. For some security settings, a so-called security by default strategy is already being followed, which also minimizes cyber risks. With the PLC protection levels, for example, the password assignment is automatically activated, so the user is comfortably guided through the configuration using the wizard. This reduces the risk of errors, offers transparency, and facilitates handling with maximum user-friendliness. Users may deactivate the wizard if necessary, but they must do this consciously, which prevents them from forgetting to assign passwords.

Each user should only be able to access specific devices and functions depending on their role and rights, which is handled by TIA Portal user management. In version V17, users are granted additional function rights to permit a more detailed allocation of rights such as access to safety functions. The UMC (User Management Component) option package offers the opportunity to incorporate user management in a central user management (e.g., Active Directory). Single sign-on (SSO) is also supported, which makes it possible to change from HMI Runtime to TIA Portal with no additional manual log-on when both are installed on the same computer. Even older devices that support authentication using Simatic Logon can be connected to UMC in version V17.

Another aspect of security is secure communication. OPC UA allows secure and encrypted communication between S7-1500 controllers and third-party devices. Version V17 supports automatable certificate management for dynamically configuring OPC UA server certificates in the controller (OPC UA GDS support), making the system much easier to use.

An additional highlight is the TLS-based protection of Simatic S7 communication between controllers, TIA Portal, and HMI stations. This provides a higher level of security, thanks to the latest security standards (TLS 1.3). It also allows users to encrypt communication and apply their own certificates. ■

› [siemens.com/industrialsecurity](https://www.siemens.com/industrialsecurity)

### Highlights

- **User management and access control** with single sign-on for TIA Portal and HMI
- **Improved certificate management** for OPC UA on S7-1500 CPUs
- **Greater communication security** for PG/PC controller communication
- **Security by default** with Simatic S7 protection levels



## Simatic Robot Integrator app/Simatic Robot Library

# Easily integrate robots from a wide range of manufacturers

More and more sectors are using industrial robots. Integrating these robots requires knowledge of specific robot programming tools, which isn't always available in-house. The Simatic Robot Integrator app makes a quick and easy job of integrating robots from different manufacturers in the machine concept, with no need for specialized engineering or programming knowledge or external specialists. Users just need to be familiar with TIA Portal.

The app uses a shared engineering environment and a single uniform operating philosophy for PLC and robots. This reduces time spent on engineering and on training operating personnel. Vendor-neutral robot programming and identical faceplates for robots from different manufacturers increase efficiency. Vendor-neutral robot programming also makes it possible to reduce errors when accepting programs – and this also reduces error costs. In addition, users can access all the diagnostic options offered by Simatic controllers, including for the robot cell, which allows optimization of remote maintenance.

Until now, a TIA Portal library was only available for some robot manufacturers. When there was a change of manufacturer, the library also had to be replaced. The new universal interface of the Simatic Robot Library makes it easy to program and commission robots from all major manufacturers. Robot engineering only has to be generated once, and it can then be reused for other manufacturers. ■

> [siemens.com/robot-integrator](https://www.siemens.com/robot-integrator)

### Highlights

- **Uniform robot programming** in TIA Portal
- **Simple programming using Simatic HMI**, regardless of robot manufacturer
- **Engineering time reduced by up to 30%**

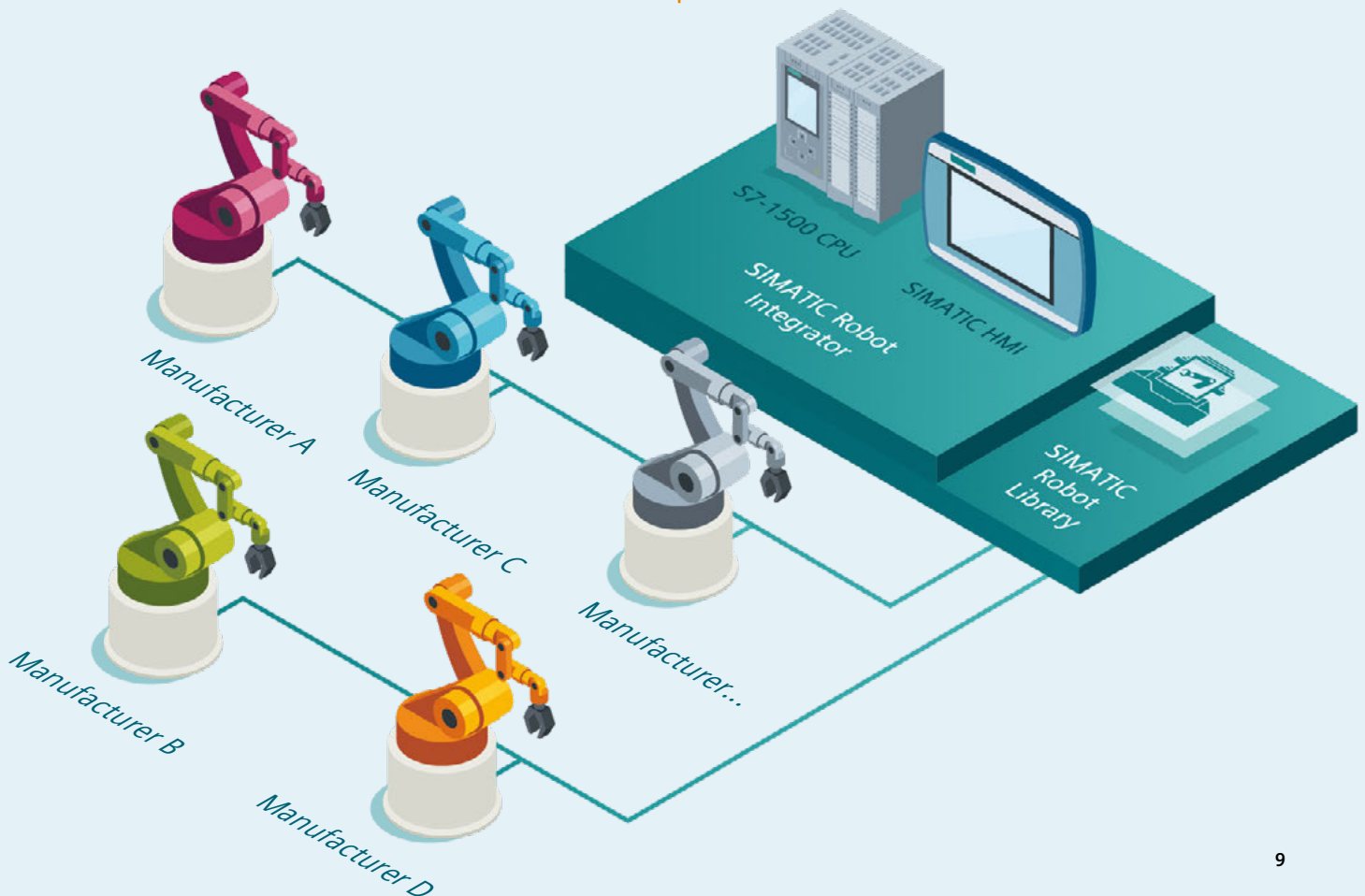

Siemens Industrial Edge

# Intelligence in production

More and more companies are recognizing the importance and necessity of processing and analyzing production data on an even larger scale. Siemens offers consistent, end-to-end industrial IoT solutions for simple data integration and analysis, from production to the cloud, using MindSphere and Industrial Edge. Industrial Edge permits local, decentralized data processing and preprocessing directly at the machine. This guarantees minimal latency, reduced costs for data storage, and secure handling of sensitive data. Since September 2020 – and after intensive collaborations with a number of pilot customers – companies worldwide now have access to the open Industrial Edge platform as a ready-to-use solution.

Industrial Edge brings typical IT standards such as central software management and device management, container-based applications (Docker), and high-level language-based data analysis and processing closer to the data source. This enables IT managers to perform simple, controlled, and highly automated software rollouts in production. A key feature of this solution is decentralized data processing and analysis using Edge devices at the production level or integrated into the automation portfolio. One example is the new Simatic HMI Unified Comfort Panel. The functions of this HMI panel, which is now also Edge-capable, can be expanded with the aid of apps. (Read more about Simatic HMI Unified Comfort Panel on page 25.)

## Highlights

- Efficient **integration of IT and data processing functions** in automation
- **Automation of IT processes** for software deployment close to production
- Edge applications for **data processing, analysis, and exchange at the machine level**
- **User-friendly management, operation, and scaling** of hundreds of Edge devices worldwide **using** appropriate **apps**
- In conjunction with cloud systems, Industrial Edge lays the **foundation for new business models in machine building**, thanks to the use of apps for worldwide machine data analysis

The Industrial Edge Management System is the central infrastructure for managing hundreds of Edge devices of all types – factory-wide or even worldwide. The system can either be installed in production for users whose focus is on data security and control, or it can be installed in cloud infrastructures. Edge application software and updates, such as security-critical firmware updates, can be applied centrally and remotely via over-the-air updates on connected Edge devices. Wide-ranging user management helps administrators with planned rollouts and the finely differentiated allocation of rights so that high plant and software availability can be guaranteed. The Edge Management System also ensures access to the central Industrial Edge marketplace where app developers, system integrators, machine builders, and users can offer and exchange apps. For the Simatic environment, for example, the marketplace offers the flexible Performance Insight performance monitoring tool that monitors the most important KPIs of machines, production lines, and entire plants. For the machine tool industry, Analyze MyWorkpiece/Monitor provides quality monitoring: for example, when evaluating workpiece quality and detecting tool wear.

Users can effortlessly port existing software and applications to Industrial Edge while benefitting from integrated security and connectivity to automation and to the cloud. Docker, the open-source container technology, runs on all Edge devices and can be used to easily and scalably integrate data processing and analysis capabilities into automation using typical IT functions and high-level languages such as C, C++, Java Python, and Node.js. Once programmed, these capabilities can be used on any hardware. For exchanging data with automation, production IT, and cloud systems, protocols such as OPC UA Client/Server, Modbus TCP, TCP/IP, Simatic S7, Sinumerik, Simotion, EtherNet/IP, and MQTT are integrated as standard.

Industrial Edge devices like Simatic IPC227E are ideal for acquiring and analyzing data right in the manufacturing environment. Edge-capable automation devices like controllers (Simatic S7-1500 with TM MFP), HMIs (Simatic HMI Unified Comfort Panels), and network routers (Ruggedcom RX1500 with APE1808 module) are available or are currently being planned in order to expand the integrated Edge functionality and provide maximum viability for the future. ■

> [siemens.com/industrial-edge](https://www.siemens.com/industrial-edge)

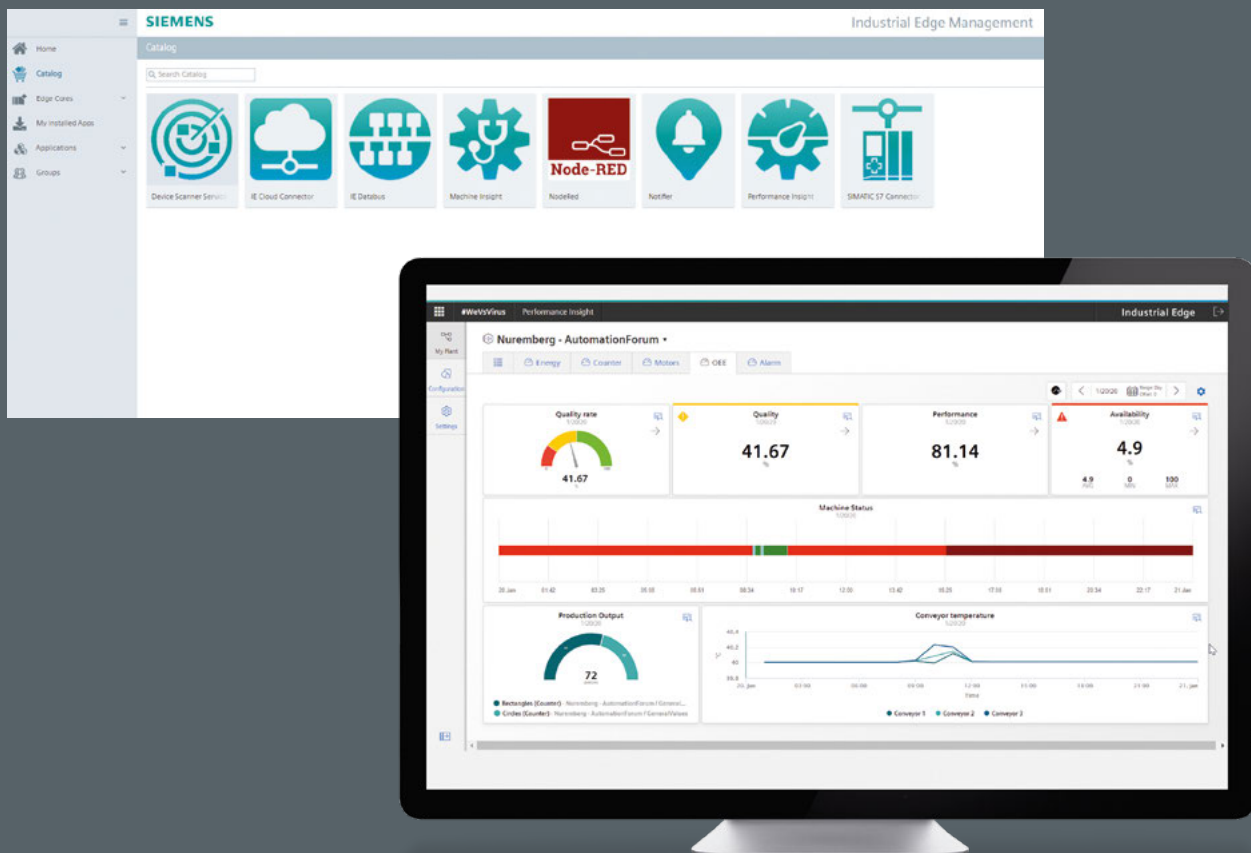

## Industrial Edge apps

# Install and go!

The Industrial Edge apps from Siemens allow users to use data from machines and plants right on-site on their Industrial Edge devices without expending the effort to integrate them into the automation technology. Industrial Edge apps can be used to perform many different tasks related to performance and process visualization, including data preprocessing, management of automation devices, machine interaction, and machine service. The data is analyzed directly on-site at the machine in the Edge device, which allows Industrial Edge apps to identify the potential for improvement and optimize processes in operations and service – even without a cloud connection.

Using the **Inventory** Industrial Edge app, users can get a quick overview of all the devices in the network and their software versions in order to generate an inventory list and optimize warehousing or schedule service activities like firmware updates. In the future, it will be possible to use the **Simatic Automation Tool** Industrial Edge app to commission Simatic devices and perform service activities like allocating IP addresses or firmware updates for multiple devices simultaneously on one Industrial Edge device, independently of TIA Portal. This not only saves time, it also reduces sources of error.

It's essential that the huge volumes of data produced by automated machines and plants be processed locally, whether to take optimal advantage of the bandwidth available in the network or to filter out sensitive or irrelevant data before it's transferred to a higher-level system or cloud. With the **Flow Creator** Industrial Edge app, this data preprocessing can be integrated into a graphical user interface based on data flows with no specialized programming knowledge required. The **LiveTwin** Industrial Edge app moves the simulation of a production process in machines or plants out of the IT world and directly into production. It can be used to supply real-time data to simulation models on Industrial Edge devices and to compare real processes with simulated processes in order to optimize operation and maintenance.

Another major area of application for Industrial Edge apps is visualizing and analyzing data. The advantage is that integrated connectivity enables the direct transfer of machine data from the machine controller to the Edge device, where it's then analyzed. For example, the **Performance Insight** Industrial Edge app can compile key performance indicators on availability, quality, and quantities produced in freely configurable dashboards and display them on a variety of different terminals (including smartphones) and users. The **Energy Manager** Industrial Edge app improves energy transparency for various media and types of energy and helps optimize the energy consumption and carbon footprint of production.

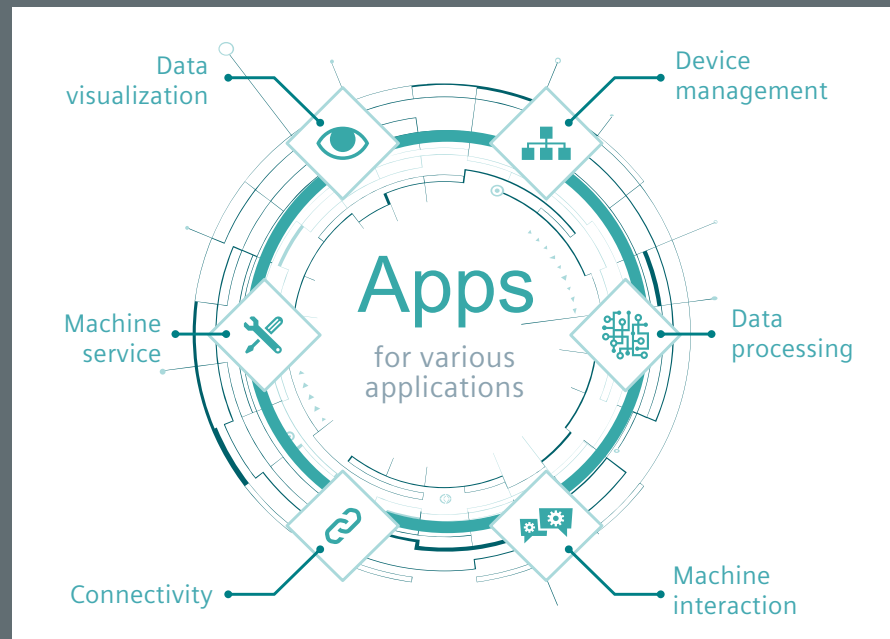

## Collaboration Board

# Tracking down errors faster



To improve machine service, users can also access recorded data on machine states and alarms or diagnostic data. The **Machine Insight** Industrial Edge app correlates this data with itself and with corresponding KPIs so that sources of error can be easily identified and selectively corrected. Last but not least, the **Notifier** Industrial Edge app forwards notifications of errors, alarms, and service requests to specific users and groups without routing them via other systems, using easily definable rules. As part of the comprehensive industrial IoT solution from Siemens, a variety of apps can be operated close to production using Industrial Edge or centrally using MindSphere, depending on the user's requirements. ■

> [siemens.com/simaticapps](https://www.siemens.com/simaticapps)

### Highlights

- **A wide range of functions** for many applications
- **Simple configuration**, even of **complex functions** like simulations and KPI analyses
- **No programming effort** required
- Integrated in the **Industrial Edge ecosystem**
- **Ongoing support and updates to Edge apps** by Siemens

### Highlights

- **Investigates causes of errors using** methods like **Ishikawa or 5 Why**
- **Simple configuration** based on the user's own production layout and with their own machine displays
- **Language switching between German and English** for work in international teams
- **Adaptable views, documentation of ideas, and voting tools** for working efficiently

The MindSphere app Collaboration Board replaces earlier, commonly used methods for determining the causes of errors with a data-based analysis that's available digitally to all stakeholders. The app supports location-independent collaboration in teams and an exchange of information between different factories. Via a guided process, users can also define questions, select machines and plants, and integrate the data acquired in MindSphere to enable a comprehensive analysis of error profiles. The results can help plant operators and maintenance managers extend the service life of their machines and plants. ■

> [siemens.com/simaticapps](https://www.siemens.com/simaticapps)



MindSphere

# Our future is getting smarter

How can I control my production more efficiently? How can I minimize downtime? How can I improve my products? How can I take advantage of the potential of the Industrial IoT, customized for my company? How can we prepare our infrastructure, cities, and services to meet future challenges? MindSphere has the answers. This "Industrial IoT as a service" solution uses sophisticated analysis functions and AI to implement IoT solutions from the Edge to the cloud.

**Simple:** Built on the Mendix application platform, MindSphere enables its users to quickly develop and integrate customized IoT applications. The goal is to create apps that are easy to use and understand and that allow customers to use and perform uncomplicated analyses of the data from their machines, logistics, and products.

**Secure:** As a leading IoT as a service solution, MindSphere offers the option of storing data in a cloud and, of course, on the customer's premises. Analysis and processing are performed according to the strictest ISO-certified security regulations – because MindSphere turns today's data into tomorrow's capital.

**Step-by-step:** MindSphere accompanies customers on their path to digitalization starting on first day, including the connection of the first machines, the analysis of data for performance and system optimization of machines and

processes, and the design of a complex location or even a cross-company system with digital twins that provide a virtual model of all processes in real time.

**Value creation:** Downtime is prevented thanks to predictive maintenance. Sequences and manufacturing processes are optimized, development is accelerated, products are improved, and new services and business models are created. Prominent customers are already benefiting from this added value worldwide. ■

### Easy introduction to the IIoT

With its "start for free" offering, MindSphere gives all interested parties an opportunity to try out and use the analysis capabilities step by step and free of charge. Guided tours, preconfigured apps, templates, and APIs facilitate entry into the world of the Industrial IoT without a large investment – including detailed data analyses and the visualization of KPIs on the user's own dashboard.

> [siemens.mindsphere.io](https://siemens.mindsphere.io)

#### Applications

Powerful industry solutions with advanced analytics



Develop robust industrial IoT solutions faster with global scalability

## MindSphere

#### Edge Management

Edge Device Management, Edge App Management, and Edge App Store

#### Connectivity

Connect products, plants, systems, machines and enterprise applications



#### Edge Apps

Siemens, partner (OEM), and 3rd-party Edge Apps

#### Edge Devices

Multiple enabled devices hosting the Industrial Edge platform

Simatic S7-1500, S7-1200, LOGO!

# Cloud connectivity for PLCs of all sizes



## Highlights

- **Scalable portfolio** for connecting to the cloud using open protocols **for all cloud platforms**
- **Unlimited data storage and analysis opportunities** in the cloud
- **Easy setup** for cloud connections with **LOGO! Soft Comfort wizard**
- **Security assured by TLS certificates** from the AWS cloud to LOGO!

Data is among the most valuable assets a plant owns. The data gathered in automation systems is useful for analyzing the manufacturing process and determining the actual condition of machines and plants. Analyzing this data can optimize the process, improve product quality, and provide material for reviewing the use of resources and making it more efficient. This data also lays the foundation for a wide range of innovative solutions, including machine learning for autonomous machines, artificial intelligence, and predictive maintenance. The data is gathered, sorted, and made available in the cloud, to which all controllers can establish a connection, either directly or via IT mechanisms.

Siemens provides a scalable portfolio for connecting to cloud platforms. All PLCs – from the powerful Simatic S7-1500 to S7-1200 and LOGO!, the smallest in the series – use the open MQTT protocol for this purpose. Devices that can't connect directly to the cloud can use IoT/Edge gateways.

Version 8.3 of LOGO!, the controller for small automation tasks, now offers a cloud connection for the first time. Thanks to its Ethernet interface and the associated connection options, LOGO! can be used as a gateway to the cloud,

regardless of whether the system is controlled by LOGO!, Simatic, or third-party systems. This means that when the controller has only limited storage space available, data can be moved to the cloud. Therefore, users have the opportunity to gather data from individual machines in a centralized location, provide remote access to distributed systems, implement new models like pay-per-use, and much more.

LOGO! 8.3 is very easy to set up using LOGO! Soft Comfort, which can also be used to configure and activate the cloud connection. The free "LOGO! Web Editor" (LWE) can be used to create a dashboard for cloud data. Just like before, you do not need HTML skills to be able to create websites that can be accessed either locally or globally via the cloud. The data gathered in the cloud is available for additional processing and analysis. Whether it is a benchmark for power data, predictive maintenance, or turning service concepts into reality, LOGO! opens up a wealth of opportunities. ■

- › [siemens.com/s7-1500](https://www.siemens.com/s7-1500)
- › [siemens.com/s7-1200](https://www.siemens.com/s7-1200)
- › [siemens.com/logo](https://www.siemens.com/logo)

## Simatic S7-1200, FW 4.5 / Simatic S7-1500, FW V2.9

# OT meets IT: next steps



A uniform web editor for all devices is a winning feature of the new firmware version of the Simatic S7-1200 and S7-1500 controllers. It enables automation web programming (AWP) comparable to an HMI setup, which allows users to create websites easily with no prior HTML programming knowledge. Users save time and effort because the web editor can be used for both CPU websites and HMI images. HTML programmers can program AWP pages directly for the CPU and upload them without stopping the CPU.

Simatic S7-1500 FW V2.9 has also been equipped with DHCP/DNS and OPC UA interfaces with GDS for improved IT connectivity. These enable network configuration, addressing, and certificate handling. For example, certificates can be updated via TIA Portal or the separate GDS server, which simplifies the setup process. To meet the enhanced security requirements easily and automatically, the security functions have been expanded to include standard security presets for communication and user management. If required, customers also have the option to adjust the settings to provide a lower level of protection.

### Highlights

- **Review of runtime licenses** for PLC (e.g., OPC UA) for **easy license management** at the CPU end
- **OPC UA expansions:** display and acknowledge important information such as alarms on customer-preferred external systems (Simatic S7-1500); complex data types for improved scalability (Simatic S7-1200)
- **Fail-safe redundancy** available for the first time for applications with stringent demands for availability and fail-safe operation (new Simatic CPU 1518 HF)
- **50% more program memory and three times more data storage (60 MB)** for implementing much larger projects and quantity structures than in the past (all Simatic CPU 1518 types)
- **Motion control:** support for linear motors and expansion of trace functionality (Bode diagrams)

In conjunction with the redundant Simatic S7-1500 R/H systems in particular, the new active backplane bus for distributed Simatic ET 200MP stations provides improved system availability. This makes it possible to hot-swap modules: if modules fail, they can be swapped with the system running in the case of Simatic ET 200MP/Simatic S7-1500 IOs. Unaffected modules remain in operation throughout.

The new Simatic CPU 1518T/TF versions for high-end motion control applications meet exacting demands for performance and axis quantity structures. The motion control T-CPU's also have expanded synchronization functions such as master value-coupled correction profiles on the following axis, desynchronization of gearing and camming to achieve a set position, a new cam disk type, and expanded cam disk diagnostics. ■

- [siemens.com/s7-1200](https://www.siemens.com/s7-1200)
- [siemens.com/s7-1500](https://www.siemens.com/s7-1500)





## Simatic S7-1500 TM MFP

# Edge integration for Simatic S7-1500

The new TM MFP technology module will seamlessly integrate Edge computing into the Simatic S7 controller in the future. Using this multifunctional platform, you can integrate a broad range of independent applications. In addition to being able to use optional software packages/applications (e.g., Proneta) and Edge apps (e.g., Simatic Flow Creator), the tool is also open to customer-specific high-level language expansions to adapt protocols or preprocess data.

With Edge runtime, Simatic S7-1500 TM MFP is prepared for Siemens Industrial Edge applications at the controller level, and it can be centrally and scalably connected to any Simatic S7-1500 CPU (1511 to 1518). The backplane bus will then enable high-performance data communication in real time. There is also the option to communicate via Ethernet with any Simatic S7-1200 or Simatic Drive Controller and process the data from these units at the controller level. ■

› [siemens.com/s7-1500](https://www.siemens.com/s7-1500)

### Highlights

- **Benefits of a cloud system** combined with the **strengths of a local solution**
- **A variety of data backup options:** local, cloud-based, hybrid
- Based on **Simatic Industrial OS**

## Simatic S7-1500 TM NPU / ET 200MP

# Artificial intelligence for automation tasks

Artificial intelligence is making inroads into automation with the new Simatic S7-1500 TM NPU assembly for the Simatic S7-1500 controller and the Simatic ET 200MP I/O system. The module can be seamlessly integrated into the Simatic automation system to provide a simple and profitable combination of AI algorithms and PLC logic. Users will enjoy many benefits: Automating manual tasks using machine learning saves time and labor. Increasing the level of automation in production also helps to significantly improve overall quality. The module can be used in a wide range of applications: for example, in robotics, condition monitoring for object recognition, and visual and sensor-assisted quality assurance.

The TM NPU assembly can be installed centrally behind an S7-1500 CPU as well as locally behind an Simatic ET 200MP interface module. This solution can also be scaled to meet requirements by installing multiple modules in sequence. For operation, the assembly uses a separately trained neural network that is installed in the assembly using an SD card. This is one of the areas where automation experts and machine learning experts are working hand in hand to turn an AI-based solution into a reality. Users can connect Gigabit Ethernet and USB3.1-compatible sensor technology such as cameras to the integrated interfaces on the module. CPU data transmitted via the backplane bus can also be

### Highlights

- Equipped with the **AI-capable Myriad X Vision Processing Unit Chip** from Intel Movidius
- **Intuitive handling** at the machine level, even for non-AI experts
- **Maintenance-free**, no mechanically movable components
- **No negative impact on PLC program performance**

used as input data. The processing result is analyzed in the TM NPU. ■

› [siemens.com/s7-1500-tm-npu](https://www.siemens.com/s7-1500-tm-npu)

## Simatic ET 200MP / S7-1500: 64-channel digital modules, 16-channel analog input modules

# Economical and space-saving modules

High-density 35-mm wide I/O modules are now available for the Simatic S7-1500 controller and Simatic ET 200MP distributed I/O system product range. The 64-channel digital modules enable the design of extremely space-saving configurations for medium-sized and large plants and are ideal for applications in the semiconductor and electronics industries. Because space in clean rooms is very expensive, a large number of signals have to be recorded in the smallest possible space. These modules are also available in sinking input and sinking output versions – a connection and wiring technology that's practically standard in the two industries mentioned. In addition to 64-channel input and output modules, a mixed module with 32 inputs and 32 outputs is also available for optimal scalability.



The 16-channel analog input modules can be deployed wherever a large number of analog signals need to be collected, whether it is HVAC applications, furnaces, or water/wastewater treatment. Thanks to their 16-bit resolution and operational error limit of  $\pm 0.5\%$ , they can also be used in a wide range of applications. Thanks to the concentration on the most frequently used measurement types "current" and "voltage," the modules can be offered at a very affordable price. Tried-and-tested system functions such as MSI, diagnostics, and two-limit value alarms for upper and lower limits have been retained.

The digital and analog modules can be operated centrally with Simatic S7 Profibus. They can be configured using either TIA Portal or a GSD/GSDML file: the latter also permits the use of any Profinet I/O controller. ■

› [siemens.com/et200mp](https://www.siemens.com/et200mp)

### Highlights

#### Digital modules:

- **Easy and open configuration** because there are no parameters to be set
- **Flexible wiring due to** the use of **Simatic Top Connect**
- **Optimized usability thanks** to the assignment of **channel status LEDs directly to the terminal**

#### Analog input modules:

- **Simple engineering**
- **Flexible wiring** thanks to front connectors with push-in or screw connection technology
- Highly robust thanks to **integrated shielding concept**
- Support for **current measuring ranges from 0/4 to 20 mA and  $\pm 20$  mA** and **voltage measuring ranges from  $\pm 1$  V to  $\pm 10$  V**

## Simatic ET 200MP: active backplane bus

# Increased plant availability

Starting immediately, an active backplane bus is available for the Simatic S7-1500 I/O modules for operation with Simatic ET 200MP and Profinet. The device comes with 4, 8, or 12 slots. In addition to reaction-free hot swapping of I/O modules during operation, reserves can also be maintained for later use. This significantly increases plant availability.

The active backplane bus is used in applications where high demands are placed on plant availability and even a short downtime would result in severe economic damage (e.g., logistics plants).

The backplane bus is also used in plants that are difficult to access due to their geographic location and that need to continue running for several days after a single I/O module fails (such as offshore facilities in oil production). To operate, the active backplane bus is simply inserted into the existing Simatic S7-1500 mounting rail. This means that the mounting dimensions of the ET 200MP remain the same even when it uses the active backplane bus. Based on the shared component principle, existing plants are also easy to upgrade. ■

› [siemens.com/et200mp](https://www.siemens.com/et200mp)



## Highlights

- **Scalable and space-saving design** thanks to varying number of slots
- **No increase in mounting depth** when the backplane bus is inserted between the modules and the mounting rail
- **Simple engineering** because no slot rules need to be observed



## Simatic ET 200SP: F-TM ServoDrive

# Even more flexible drive control

The new firmware V1.1. of the F-TM ServoDrive technology module for the Simatic ET 200SP drive system now makes it possible to control motors with incremental encoders, and not just motors with IQ encoders. In conjunction with EC motors, it enables dynamic and precise positioning up to 280 W in a highly compact installation. Thanks to engineering in TIA Portal, the module greatly simplifies drive design, commissioning, and service. The HSP V16 2.0 hardware support package has made commissioning even easier: The most important controller parameters can be entered both offline and online in the commissioning screen and immediately optimized as needed.

Step-by-step tutorials introduce beginners to drive control with Simatic ET 200SP. A starter kit is available, comprising the F-TM ServoDrive actuator with the associated BaseUnit (U0), an IM 155 interface module for Profinet, the EC142.20 ebm-papst motor, and the associated connecting cables. ■

› [siemens.com/micro-drive](https://www.siemens.com/micro-drive)

## Highlights

- **Safety extra-low-voltage drive controller** for ET 200SP: 24 to 48 V DC, up to 280 W
- **Controllable incremental encoder:** A-, B-, Z-track; differential or single-ended
- **Worldwide use:** CE, cUL, EAC, RCM, KC certifications
- **High power density:** 20 mm wide

## Simatic ET 200SP AI Energy Meter

# Extended field of application, greater flexibility

Simatic ET 200SP AI Energy Meter makes the energy requirements of individual components in a production plant transparent at the machine level. The module range has been expanded with many new functions. The successor modules to the 400- and 480-V standard modules are equipped with an electronic power supply over 24 V DC that also allows them to be used in plants with no neutral conductors or IT networks. The functions of the new standard modules were also aligned with those of the High Feature (HF) versions. Because the connection and data interfaces are identical, there's greater flexibility when using HF and standard Energy Meter modules. Innovative cross-compatibility also allows the use of standard or HF Energy Meter modules with an identical hardware configuration. ■

> [siemens.com/et200sp](https://www.siemens.com/et200sp)



### Highlights

- **Network analysis function** with HF module
- Standard modules available for **current measurement via 333-mV current/voltage transformer** or **Rogowski coils**
- **Extensive auxiliary functions** such as additional current input for measuring neutral conductor current, timestamp of minimum/maximum values, reactive power compensation, and user-defined compilation of measured values for quick and easy access to data records

## Simatic ET 200SP F-TM Count HF

# Reliable counting and more

### Highlights

- **Compact design:** 15 mm
- **Reliable recording of high-frequency signals** up to 200 kHz
- **Integrated safety functions:** SOS (safe operating stop), SLS (safely limited speed), SDI (safe direction), SSM (safe speed monitor)
- Usable up to **PL e / Cat. 4 / SIL 3**

Reliable pulse recording can be used today in a wide variety of applications, from speed monitoring of turbines and wind turbines to reliable position monitoring in the field of stagecraft technology and flow monitoring of compressors and pumps. The fail-safe F-TM Count HF technology module is as compact as a standard module. The module requires a certified sin/cos encoder for signal detection. This enables it to detect signals with a frequency up to 200 kHz. Other than the count value, F-TM Count HF also offers the option to transmit the recorded pulses to the F-CPU in units such as speed, frequency, and dura-

tion. The integrated safety functions can be executed and a violation of conditions can be transmitted to the F-CPU directly. F-TM Count HF is completed by a best-in-class diagnostics concept that also covers areas such as wire break and phase shifting. ■

> [siemens.com/et200sp](https://www.siemens.com/et200sp)



## Simatic ET 200SP IM155-6MF HF

# Other functions that can be retrofitted

### Highlights

- **Configuration control:** low-effort management and retrofitting of machine options via the user program (without changing the hardware configuration)
- **Dynamic parameter change during ongoing operation** for a batch-dependent modification of module properties
- **Reading of individually compiled measured-value sets from Energy Meter via data records** for the cyclic transfer of measured values
- **Data record-based functions** of I/O modules **via Modbus TCP protocol** can be implemented (e.g., with DALI module or Siwarex modules)

With the IM155-6MF HF MultiFieldbus interface module, the ET 200SP I/O system can be operated on both a Profinet controller and an EtherNet/IP or Modbus TCP controller. Among other things, the module is used in applications where only Modbus TCP or EtherNet/IP controllers could formerly be used, such as energy data acquisition by means of the AI Energy Meter module. With the new firmware version V5.1, numerous added functions are available that allow users to read and write data records while using the Modbus TCP protocol. As with Profinet operation, defective interface modules can be easily replaced via EtherNet/IP and Modbus TCP without PG. For plants with firmware version 5.1, this can even be done without a reconfiguration. The MultiFieldbus interface module can also be used with BusAdapter with a fiber-optic cable interface.

In the case of interface modules with older firmware versions, the firmware update can be retrofitted using the MultiFieldbus Configuration Tool (MFCT) as of version V5.1. ■

› [siemens.com/et200sp](https://www.siemens.com/et200sp)



## Simatic ET 200SP PN/MF coupler

# Data coupler with MultiFieldbus interface

The new MultiFieldbus PN/MF coupler allows a simple, deterministic data exchange between controllers with different Ethernet protocols, even across network boundaries. This makes it ideal for integrating Simatic controllers into existing machines and plants without a great deal of effort. The data exchange between controllers is via Profinet IO and EtherNet/IP. Virtual input/output modules also make configuration as easy as it is with the PN/PN coupler. Comprehensive diagnostic information on the opposite network side is available via a data status byte. Plant operators benefit from fast service and reduced downtime. ■

› [siemens.com/et200sp](https://www.siemens.com/et200sp)

### Highlights

- **Easy data exchange** between Profinet and EtherNet/IP controllers
- **Secure transmission of I/O data** between connected controllers across network boundaries
- **High interference immunity** because the opposite network side isn't influenced by network and communication interference



## Simatic ET 200AL IO-Link I/O modules

# Suitable for all requirements



### Highlights

- **Robust insulated housing** in the Simatic ET 200AL design
- **Compact housing dimensions** either 30 mm or 45 mm wide
- **Connection to IO-Link master** under IP67 and IP20 degree of protection
- **Simple engineering** by means of IODD device description
- Support for the **IO-Link "Common Profile"**

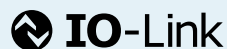

The IO-Link communication standard serves to standardize communication between machine and plant controllers and between sensors, actuators, and other field devices. Simatic ET 200AL IO-Link I/O modules provide users with a well-balanced portfolio of digital input, output, and input/output modules in the Simatic ET 200AL design that enable the connection of standard sensors and actuators. Signals can be transmitted and power supplied via IO-Link, which reduces costs for connection technology. The Simatic ET 200AL IO-Link I/O modules take deliberate advantage of these benefits. Connecting the IO-Link I/O modules to the IO-Link master creates a star-shaped structure of I/O modules (star topology) via a point-to-point connection. The IO-Link star topology can be combined with any fieldbus line topology of other Simatic ET 200 I/O modules, which means that they can be optimally adapted to the requirements of machines and plants. ■

› [siemens.com/et200al](https://www.siemens.com/et200al)

## Distributed I/O Systems

## Simatic ET 200AL F-DI/F-DQ

# Compact, robust, reliable

With the F-DI 4/F-DQ 2 module, a fail-safe mixed module is added to the product portfolio of Simatic ET 200AL distributed I/O systems under degree of protection IP65/67. The compact, lightweight housing accommodates fail-safe digital inputs and outputs that are already designed for two channels, which allows the connection of safe sensors and actuators directly to the machines on-site. Via the M12 connection, either two individual sensors or one two-channel sensor can be connected on the input side: for example, a position switch or light curtain. The modules are connected by a Simatic ET 200AL or ET 200SP interface module. The Profisafe address is stored in a pluggable F-coding element that can easily be moved in the event of a module replacement, with no need to reset the DIL switches. Any problems that occur during operation – for example, with the connected sensors – can be pinpointed quickly, thanks to channel-granular diagnostics. ■

› [siemens.com/et200al](https://www.siemens.com/et200al)



### Highlights

- **Robust insulated housing** in the Simatic ET 200AL design
- **Compact housing dimensions:** 45 mm wide
- **Four fail-safe digital inputs**
- 24 V DC (M12)
- **Two fail-safe digital outputs** 24 V DC/2 A, plus/minus switching (M12)
- Usable up to **PL e / Cat. 4 / SIL 3**

## Simatic ET 200eco PN M12-L

# Machine-level block I/O devices with a high degree of protection

Siemens has launched a new generation of machine-level block I/O devices in the form of the Simatic ET 200eco PN M12-L. The new I/O family with IP65/67 degree of protection initially includes five digital I/O devices and an IO-Link master device that offer a whole range of new functions for implementing modern machine concepts.

The new devices are supplied with power by an M12-L-coded plug, which provides a considerably higher current-carrying capacity and enables longer cable routes in the field. Individually configurable M12 sockets allow the devices to be flexibly adapted to sensors and actuators. Users also benefit from greater machine and plant transparency, because they have simultaneous access to the current switching state of module inputs and outputs from multiple controllers, which eliminates additional programming overhead. ■

> [siemens.com/et200ecopn](https://www.siemens.com/et200ecopn)



## Highlights

- M12-L-coded **power connector** with up to 2 x 12 A
- **8-port-IO-link master:** engineering with S7-PCT
- **Monitoring and diagnosis** of the 1L+ and 2L+ power supplies
- **Isochronous mode** can be used up to the input and output
- **Multi-shared input / multi-shared output (MSI/MSO)** for simultaneous acquisition of I/O data on two controllers
- **Shared device** for distribution of channels between two controllers for **flexible automation concepts**



## Siplus HCS4200

# Heating solution with 26 percent more power

The modular, compact, and extremely space-saving HCS4200 heating control system comes with a variety of power output and communication interface modules as well as rack sizes, which makes it very easy to adapt to many industrial heating applications. The midrange phase angle, flexible, and high-end power output modules (POMs) can now be used with a new fan module that enables a total current of maximum 126 A per POM instead of the former 100 A. Instead of four outputs, six high-end outputs can now be operated with a maximum power rating of 4,600 kW at 230 V.

Quick to commission and requiring minimal wiring effort, the Siplus heating control systems are easy to integrate into automation using TIA Portal engineering framework. Intelligent control routines ensure uniform load distribution and loading of the network. Integrated diagnostic functions enable fast detection and pinpointing of faults. ■

> [siemens.com/hcs](https://www.siemens.com/hcs)

## Highlights

- **26% more current per POM** thanks to a fan module
- **WinCC heater control** for WinCC Advanced Panels
- **HCS program library** and sample applications for simplified engineering



## Simatic WinCC Unified System

# Turn visualization ideas into reality – flawlessly

SIMATIC WinCC Unified is a new visualization system combining Simatic WinCC Unified visualization software and Simatic HMI Unified Comfort Panel control units that is designed to overcome the challenges of digitalization in mechanical engineering and plant construction. Simatic WinCC Unified offers a wide range of options for industry-specific requirements, and its open interfaces mean it can be expanded to suit user-specific applications. Four new Plant Intelligence options now extend the visualization system to include functions for greater transparency, structured planning in the production process, and fast orchestration and adaptation of production sequences to control and monitor recipe-driven processes.

The Plant Intelligence option Performance Insight includes a formula editor for calculating key performance indicators (KPIs) in accordance with ISO standard 22400 and a comprehensive selection of WinCC controls to display and analyze them. The performance, quality, and availability of production plants can be visualized using a range of formats such as bar charts, Gantt diagrams, and multiline displays, in order to calculate overall equipment effectiveness (OEE). Plant operators can record production process status in full, from the factory level down to individual machines, to enable a systematic detection of optimization potential for the entire plant.

The calendar function allows plans for production workflows to be displayed in a structured form. It can define machine and plant run times and create standard templates for regular production days and shifts. The calendar function can also be used to plan process implementation relative to a timeline. This can, for example, ensure that a machine is started up at the correct time before a work shift begins. By taking operating time into consideration, this option allows production processes and events to be planned more efficiently.

### Highlights

- Easy calculation and representation of key performance indicators (KPIs) using **“WinCC Unified Performance Insight”**
- Structured planning of production workflows using **“WinCC Unified Calendar”**
- Central orchestration of production workflows using **“WinCC Unified Line Coordination” (LCS)**
- Flexible planning of production workflows standardized in accordance with ISA-88 using **“WinCC Unified Sequence (SES)”**
- **New applications** for the WinCC Unified system **with Industrial Edge and View of Things**



WinCC Unified Line Coordination (LCS) lets you automate recipe- and batch-controlled production processes. Complex production sequences of interlinked machines in the production line can be coordinated, synchronized, and monitored with Simatic S7-1500 and WinCC Unified. Using standard functions, the new software option is adapted to the technological requirements of various processes, including standardizing production processes using a recipe system. The software package provides the necessary engineering and runtime components for recipe management as well as control elements for visualization. The latest version of LCS supports production workflows programmed in Simatic S7-1500 or in WinCC Unified Sequence (SES).

The Plant Intelligence option Sequence (SES) lets users flexibly structure and automate individual production stages at the machine and system section levels. Production sequences and parameters can be adjusted even

during operation, without changing the PLC program. Operators can manually intervene in the automatic step sequence online, for example, if the quality of raw materials fluctuates or if a different sequence of individual production steps is required to ensure flexible routes through the production process. SES fulfills real-time requirements because the step chains are executed on the Simatic S7-1500 controller, which results in reliable plant operation and a high level of system availability.

Thanks to its innovations, the WinCC Unified system creates new opportunities: Industrial Edge devices can now be used as a target system for Runtime, and WinCC Unified View of Things allows simple visualizations right on the Simatic S7-1500 controller. ■

- > [siemens.com/wince-unified](https://www.siemens.com/wince-unified)
- > [siemens.com/wince-unified-software](https://www.siemens.com/wince-unified-software)

## Simatic HMI Unified Comfort Panel

# Integrating Siemens Industrial Edge

Simatic HMI Unified Comfort Panels offer support for Siemens Industrial Edge as standard. This leads to completely new possibilities such as functional expansion using apps. For example, Performance Insight lets you analyze and optimize performance right at the machine using current operational data; or thanks to Energy Manager for ISO 50001-compliant power transparency, you can run an end-to-end analysis of power costs. (See pages 10–13 for more on Siemens Industrial Edge and Industrial Edge apps.)

In the new V17 version, the 7" to 22" Unified Comfort Panels have been expanded to offer a whole range of new functions. Of special interest is remote access via web browser, which enables multiple users to operate machines independently; support for two-handed operation in conjunction with multitouch; client and server communication via OPC UA DA; and new controls. Expansions that facilitate the implementation of standard functions and simpler engineering complete the new developments. ■

**Discounted starter kits can be ordered from [siemens.com/starter-kit-ucp](https://www.siemens.com/starter-kit-ucp)**

- > [siemens.com/wince-unified-hardware](https://www.siemens.com/wince-unified-hardware)
- > [siemens.com/unified-comfort-panels](https://www.siemens.com/unified-comfort-panels)



## Highlights

- **Remote clients via web browser**
- Apps are easy to install with **Edge Management**
- Install **up to six applications** and **run up to four applications in parallel**

## WinCC Open Architecture V3.18

# Dashboarding made easy

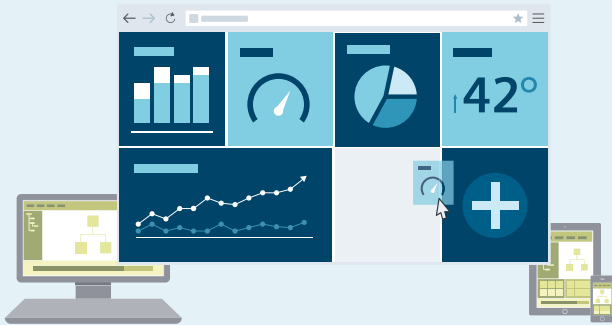

### Highlights

- **Easy dashboarding**
- NGA (Next Generation Archiver) **logging expanded to include PostgreSQL and MSSQL**
- New **drivers: Omron-Fins, Sinumerik powerline**
- Expansions for **UI, OPC UA, Node-RED, security**

The release of the latest product version of WinCC Open Architecture V3.18 is planned for spring of 2021. It will come with many new features, including a new function that simplifies the creation of web dashboards. A wizard will let you easily modify widgets and set their parameters, which means they can be personalized, and users will find it easier to display the data they have compiled.

The new product version will also offer important expansions of existing WinCC OA functions such as OPC UA, Node-RED, and security upgrades. To facilitate the practical use of WinCC OA in state-of-the-art IT environments, the new version also supports Docker as another option for virtualization. The developers of the new version placed special emphasis on correcting errors in existing features and improving feature quality. The result should be an even higher quality for WinCC OA in the future. ■

> [siemens.com/winc-open-architecture](https://www.siemens.com/winc-open-architecture)

## Human Machine Interface

## Simatic HMI KTP700F Mobile Arctic

# Mobile panels for low ambient temperatures

The KTP700F Mobile Arctic control unit is designed for use in weather-protected industrial environments with low ambient temperatures: for example, in cold stores. The 7.0" TFT screen is made of coated glass, and the integrated touch pen is designed to be easy for operators to use even when wearing thick gloves. The accessories (cables and connection box) have also been strengthened for low-temperature environments. The mobile panel can be configured via WinCC Comfort (V15 SP1 or later). ■

> [siemens.com/mobile-panels](https://www.siemens.com/mobile-panels)



### Highlights

- **Expanded temperature range** for operation between  $-28^{\circ}\text{C}$  and  $+45^{\circ}\text{C}$
- **High-resolution TFT screen** in widescreen format with 16 million colors
- Suitable for **operation with pen or fingers or wearing gloves**
- **Safety functions:** key-operated switch, enabling switch, emergency STOP button

## Simatic IWP1500 MT

# Control panel with automatic website access

The Simatic IWP1500 MT industrial web panel comes with a touchscreen in high-resolution 15" widescreen format. A state-of-the-art HTML5 browser offers a user-friendly way to display and handle HTML5 pages via the web panel: You can display data on websites clearly in kiosk mode. The website is accessed automatically when you start up, as long as you have a web server connection established. Function keys can be freely configured using the web-based keyboard.

The parameterization and setup process for Simatic IWP1500 MT is very simple: Users have access to a user-friendly start page with additional interfaces for logging in, uploading/exporting, function keys, and network, browser, system, and start settings. No configuration is required. ■

> [siemens.com/webpanel](https://www.siemens.com/webpanel)



### Highlights

- Integrated **web browser: Chromium** based on Linux
- **Glass front** with capacitive multitouch (PCAP)
- **High resolution** and high readability (1,366 x 768 pixels)
- Many **integrated interfaces** (2 x Ethernet 1 Gbit ports switched, 4 x USB interfaces)
- **Sturdy and maintenance-free**: no wearing parts like fans and hard drives; casing has a die-cast aluminum front

## Simatic TP Basic Keyless

# Keyless operation and monitoring

### Highlights

- **Operation** entirely **by touch**
- **High resolution and color depth** with 65,500 colors
- **Basic functions identical for all TPs**, regardless of selected device size

Three devices in the second-generation Simatic HMI Basic Panel family for high-quality display and operation are now also available in "keyless" form, in other words with no function keys and with neutral front. All functions of the TP400 Basic Keyless, TP700 Basic Keyless, and TP900 Basic Keyless models can be performed by touch. With the new version of the WinCC software in TIA Portal, it's easy to configure and operate Simatic Basic Keyless devices, just like the corresponding standard items. ■

> [siemens.com/basic-panels](https://www.siemens.com/basic-panels)



## Simatic IPC227G / IPC277G

# Compact and full of power

Featuring the latest Intel Atom x6000E processor technology, Simatic IPC2x7G is the next logical stage in E-Generation. The outstanding attributes of the new nanobox and panel PCs are their extremely compact size, sturdy structure, and maintenance-free operation, which enables them to remain highly flexible in tough environments. Computing performance is much improved compared with the previous versions: Along with various innovations in the details, the new nano IPCs cover a significantly wider range of applications, including complex control, display, and communication tasks. Simatic IPC2x7G is also suitable for data collection, as a data gateway, and for data monitoring and data pre-processing. The high performance offered by this new generation also makes it the ideal platform for Industrial Edge and artificial intelligence (AI) applications. ■

- > [siemens.com/ipc227g](https://www.siemens.com/ipc227g)
- > [siemens.com/ipc277g](https://www.siemens.com/ipc277g)



### Highlights

- Externally replaceable solid-state drive (SSD), 240 GB or higher, for **flexible storage options**
- **Multiple interfaces for high connectivity:** 3 x Gigabit Ethernet (IE/PN), 4 x USBs 3.0, up to 2 x COMs (optional)
- Panel PCs with **screens from 7" to 22"**
- **Highly flexible for expansion** with 2 x M.2 module slots and NVRAM modules (remanence, optional)



### Highlights

#### Simatic IPC347G

- **A wide range of interfaces** for easy connection to automation and IT systems
- **Maintenance-friendly casing**, thanks to front-mounted USB functionality and fans accessible from outside

#### Simatic IPC547J

- The **latest interface technology:** USB 3.1, M.2 NVMe internal SSD, 3 x graphic interfaces with 4K monitor support
- **More user-friendly** thanks to additional front LEDs showing the Ethernet status
- **Improved flexibility and security** with up to 3 x Intel Gigabit Ethernet on board

## Simatic IPC347G / IPC547J

# Perfect for industrial applications

Simatic Rack PCs offer enough system power for the most demanding applications, making them the optimal choice for a broad range of tasks in all industries. Two new versions are available, Simatic IPC347G and IPC547J. The entry-level Simatic IPC347G is appropriate for production applications that require a sturdier unit and greater availability compared with office PCs. Simatic IPC347G is designed for continuous 24-hour use, especially in tough industrial environments. This robust unit has state-of-the-art dual- and quad-core processors and is also extremely efficient. The powerful Simatic IPC547J rack IPC is highly suited for use as a compact industrial workstation and server for fast parallel processing of large data volumes. The new model scores with maximum system performance thanks to the latest Intel processors and offers twice as much main storage as its predecessor at 128 GB. ■

- > [siemens.com/ipc347g](https://www.siemens.com/ipc347g)
- > [siemens.com/ipc547j](https://www.siemens.com/ipc547j)

## Sitop PSU6200

# The all-rounder – for a wide range of applications

With just a glance at the Sitop PSU6200 product range, the change is obvious: In the past, only 1-phase power supplies were available, but users can now have 4- and 8-channel selectivity modules, redundancy modules, a buffer module, and 3-phase and ATEX-certified power supplies with a conformal coating. The power supplies also have a diagnostic interface for integration into the automation system.

A starter package is available for quick introduction, so users can thoroughly assess the benefits of the standard power supply in conjunction with selective fusing. ■

› [siemens.com/sitop-psu6200](https://www.siemens.com/sitop-psu6200)



### Highlights

- Sitop PSU6200 1/3 AC, 24-V power supply (also ATEX certified)
- Sitop PSU6200 1 AC, 12-V, and 48-V power supply
- Sitop RED1200, SEL1200/1400, BUF1200 selectivity, redundancy, and buffer modules
- Starter package with Sitop PSU6200 1 AC / 24 V, 10 A, and SEL1400, 4-channel, 40 A



### Highlights

- 1-phase power supply with 4 x 5-A nominal output current; 3-phase power supply with 4 x 5 A, 20 A, 4 x 10 A, and 40 A
- Quick and easy connection of add-on modules with no wiring effort using System Clip Link
- Comprehensive diagnostics for predictive maintenance with Profinet and OPC UA

## Sitop PSU8600

# Maximum flexibility and availability

The modular Sitop PSU8600 power supply system includes base units for operation on 1- or 3-phase grids. The power supply system can be expanded to up to 36 outputs using CNX8600 expansion modules. Each output is flexible and can be set to 4 V to 28 V during operation, either manually or using a control program. Maintenance-free BUF8600 buffer modules and a UPS8600 UPS module let you bridge power interruptions lasting from seconds to several hours. The two integrated Ethernet/Profinet interfaces and OPC UA provide access to extensive diagnostic and maintenance information that can be analyzed in the Simatic S7 controller or other automation systems. This makes it easier to locate faults and reduce downtimes. ■

› [siemens.com/sitop-psu8600](https://www.siemens.com/sitop-psu8600)

## Simatic PCS neo

# Collaborate more efficiently worldwide

Simatic PCS neo, the newly developed and completely web-based system software, offers brand-new possibilities for users in the age of digitalization. The system allows users to access all relevant data and work in parallel on projects worldwide via a central, object-oriented data management. With its flexible licensing model, Simatic PCS neo offers additional transparency and cost-efficiency, and complies with the latest standards in modern software licensing. Via the “my Simatic PCS neo” comprehensive web platform, users can also access an entirely new realm of information management across the entire lifecycle of their projects and plants.

The new system uses the Simatic hardware portfolio and the application architecture of the comprehensive Simatic PCS 7 version 9 process control system. This protects existing investments and ensures future viability. ■

› [siemens.com/simatic-pcs-neo](https://www.siemens.com/simatic-pcs-neo)



## Highlights

- **Intuitive graphical user interface (GUI)** for all users and applications in a single workbench
- **Direct and secure system access** via all HTML5-compatible end devices
- **Maximum scalability**, from small process modules to world-scale plants

## PlantSight

# Cloud services for the digital twin



## Highlights

- **Asset Integrity:** continuous monitoring and optimization of plant assets
- **Visual integration:** different data from different sources in one single portal
- **Updated information at a fingertip:** faster and better decisions based on contextualized information
- **Improved team collaboration** between disciplines

Every plant or asset is documented in data. All this data and information is scattered across multiple platforms and in various formats. PlantSight consolidates the assets of a plant, by bringing together different types of data from different sources into a single source of truth. PlantSight is a cloud-based information-centric solution that provides a digital twin to access information throughout the entire plant lifecycle. This assists engineering and operations functions that want to ensure the digital blueprint reflects the actual plant by accessing 1D, 2D, and 3D data and documents and comparing it with real-time data after collection, aggregation, and visualization to give meaningful insights into the actual behavior and performance. This represents the plant engineering and operating DNA created throughout the engineering lifecycle and collected during the operation lifecycle, providing the best possible foundation for decision-making, irrespective of role, function, or discipline. ■

› [siemens.com/plantsight](https://www.siemens.com/plantsight)

## Simatic ET 200SP HA F-DI/DQ

# Powerful peripheral system goes safety

The new digital fail-safe modules for Simatic ET 200SP HA now make it possible to also harness the benefits of the scalable peripheral system in process safety applications. Redundantly designed components significantly increase the availability of plants and safety-related applications. In addition to the option to redundantly connect the Simatic ET 200SP HA station via the Profinet interface, the standard and fail-safe peripheral modules can also be used redundantly. The compact design of the module (just 22.5 mm wide), the tool-free connection using push-in terminals, and fixed wiring ensure space-saving and efficient installation and assembly. ■

› [siemens.com/simatic-et200spha](https://www.siemens.com/simatic-et200spha)



### Highlights

- 16 channels for **digital inputs** or 10 channels for **digital outputs**
- Certified for **safety applications up to SIL 3**
- **Programmable diagnostic functions**
- Installation up to **Ex zone 2**
- Extended temperature range: **-40°C to +70°C**
- Can be used at elevations up to **4,000 m**

## Comos

# Integrated plant management for efficient processes



Comos provides the process industry with a software solution for the holistic management of plant projects – from engineering, operation, and modernization to dismantling. Comos functions as a global data center and thus ensures a seamless flow of project-relevant information. Everyone involved in the project always has access to up-to-date, consistent data. Changes in the project are

visible in real time. After commissioning, Comos enables the precise planning, implementation, and analysis of all maintenance activities in a single system. The software solution therefore lays the foundation for a highly efficient workflow throughout the entire plant lifecycle. ■

› [siemens.com/comos](https://www.siemens.com/comos)

### Highlights

- **Consistent database** worldwide
- Data access at any time and anywhere, even from **mobile devices**
- **Easy integration** into existing IT environments
- **Cost savings** thanks to optimized engineering processes and maintenance strategies

## Digitalization in drive technology

# Process data decentrally with Edge computing

Converters already collect a large amount of data in industry today, and they often forward it to a higher-level controller via a fieldbus. Several thousand parameters are processed that provide information on the drive itself and on the entire drive train: including, for example, the status of a geared motor, any defects, and operational data. The added value is in analyzing this data.

Digitalizing their drive trains supports machine builders and users along the entire value chain, from design and planning to engineering, production, and services. In the future, in addition to efficient engineering tools, connectivity, apps, and analytics, the Siemens digitalization portfolio will also include virtualization and simulation.

To make data in the field even easier and more flexible to use, Edge computing is now supplementing the potential of pure cloud solutions. The data is collected in the machine directly at the drive, where it is processed with no latency. Because there is no time delay between drive activity and analysis, it is possible to respond quickly when a problem or fault becomes apparent. When Sinamics frequency converters are connected to Siemens Industrial Edge, intelligent algorithms identify patterns and detect anomalies in these patterns and their causes. They can then provide early indications of the "health" of the drive train and application and of any need for maintenance. If deviations are detected during operation – for example, caused by wear – warning notifications are issued.

For example, the belt tension of the tilter can be monitored on baggage conveyers in airports. The belts are driven by a servo geared motor and frequency converter and require a specific tension so that the application runs smoothly. If a visualization of the data analyses shows irregularities in the drive system, belt maintenance can be promptly triggered. This is how digitalization allows problems to be discovered and corrected before they occur. ■

› [siemens.com/digital-drives](https://www.siemens.com/digital-drives)



## Highlights

- **Engineering tools:** TIA Selection Tool/Sizer, DT Configurator, and Sinamics Startdrive
- **Virtualization and simulation:** digital twin of the drives
- **Connectivity:** connection of drives to relevant platforms such as MindSphere and Siemens Industrial Edge
- **Apps and analytics:** knowledge generated from drive data using apps and data analysis models



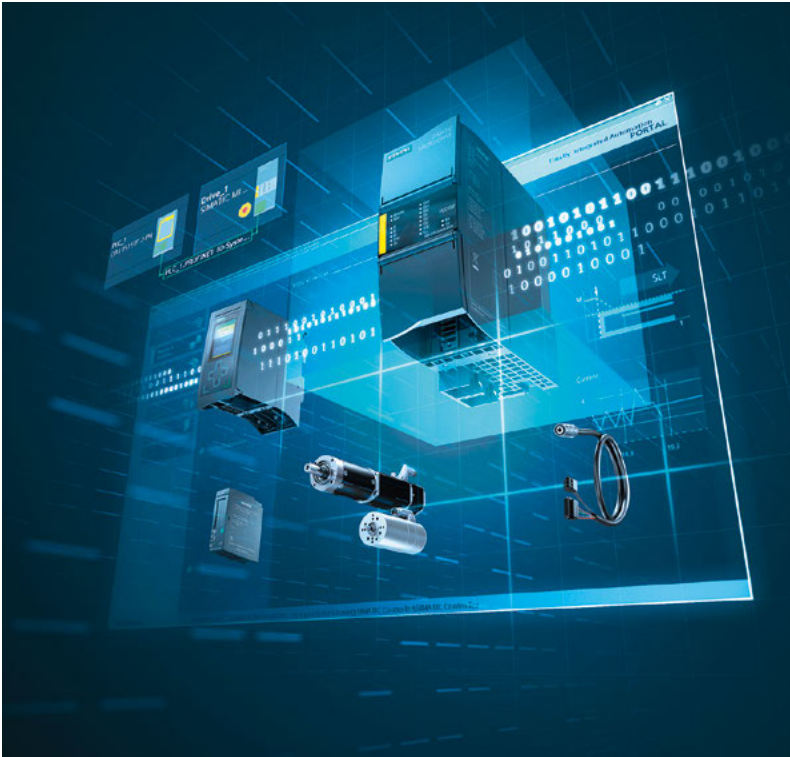

## Highlights

- **Fast and safe communication** via Profinet
- **PDC (ProfiDriveControl):** Safety Integrated with extended safety functions
- **F-TM ServoDrive:** power density with integrated STO function (SIL2/hardwired)
- **Easy commissioning** and service via TIA Portal
- **Easy selection and dimensioning** in TIA Selection Tool
- **New module** PDC600/F

## Simatic Micro-Drive

# Ideal drive solution for safety extra-low voltage

Simatic Micro-Drive is versatile, seamless, and safe. The new servo drive system for applications in the safety extra-low voltage range from 24 to 48 V is ideal for a number of different applications, including precise positioning, shuttles for storage and retrieval machines and storage systems, automated guided vehicles (AGVs), and medical technology. Among other things, its compact design and easy wiring and installation ensure top performance, while Safety Integrated provides maximum safety.

Simatic Micro-Drive PDC (ProfiDriveControl) and Simatic Micro-Drive F-TM ServoDrive, the new drive controller module for Simatic ET 200SP, complement each other's performance perfectly. They complete the portfolio with versatile motors and connecting cables, while the broad range of motion control functionalities is completed by controllers such as Simatic.

To ensure that the drive technology meets as many customer requirements as possible, Siemens utilizes individual and supplementary products from selected partners (Dunkermotoren, ebm-papst, Harting, and KnorrTec) for the motors and connecting cables. This gives users access to a custom combination of products from the Siemens Product Partner Program.

With Simatic Micro-Drive, the drive controller and motors are fully integrated into the Siemens automation technology based on Totally Integrated Automation (TIA). In addition, versatile tools covering the entire machine-building cycle ensure extremely efficient engineering and fast commissioning. Therefore, the servo drive system provides the perfect entry to digitalization. (Read more about Simatic Micro-Drive F-TM ServoDrive on page 19.) ■

› [siemens.com/micro-drive](https://www.siemens.com/micro-drive)

## Simotics XP / Simotics XP Chemstar

# Converter operation and more

### Highlights

- Available from **0.09 to 1,000 kW** with **cast-iron enclosure**
- **Ex db type of protection** now also available in **group IIB or IIC**
- **Efficiency class IE3** as standard, including for Ex eb - Ex ec, Ex tb, Ex tc, also in IE4
- Degrees of protection from **IP55 to IP66**
- **Simotics XP Chemstar** industry solution

Simotics XP, the integrated platform for explosion-protected motors, is again expanding its applications with more features. With Simotics XP motors in a flameproof enclosure (Ex db), a premium insulation now enables converter operation up to 690 volts, including in the potentially explosive zone 1, with no need for a filter.

Another highlight is the certified conductive paint. Thanks to its anti-static properties, it permits operation even in environments with explosive dust that has a high electrostatic charge. The offering also includes versions with an aluminum enclosure



for low power ratings up to 18.5 kW and motor protection via an integrated temperature sensor, including for the Ex eb type of protection. ■

› [siemens.com/simotics-xp](https://www.siemens.com/simotics-xp)

## Simotics Connect 400 / Sidrive IQ Fleet

# The quick and easy path to the digital motor

In the case of low-voltage motors, the simplest route to digitalization is via the Simotics Connect 400 plug-and-play connectivity module and the Sidrive IQ Fleet MindSphere analysis app. Users quickly obtain a comprehensive overview of the operational and condition data of motors used in various applications: for example, for pumps, fans, and compressors. In just a few steps, everything is installed, and the motor is online. The condition data allows users to draw conclusions about applications and how to optimize ongoing processes, and it also delivers recommendations when targeted maintenance can prevent unscheduled downtime. In addition to monitoring the "health" of the motor fleet, the app embedded in the MindSphere ecosystem offers almost unlimited possibilities for activating new digital customer business models. ■

› [siemens.com/digital-motor](https://www.siemens.com/digital-motor)

### Highlights

- **Flexible, scalable, low-risk solution for implementing new digital business models**, thanks to free access to MindSphere and asset-based expansion options
- **Available in 45 regions worldwide** (Argentina, Australia, Chile, China, Ecuador, the European Economic Area,\* United Kingdom, Hong Kong, India, Indonesia, Canada, Mexico, New Zealand, Peru, Russia, Singapore, South Africa, Switzerland, Thailand, Turkey, United States)
- **Continuous overview of the condition of monitored motors**, thanks to automatic, direct, secure data transfer from the field level to the cloud

\*Excluding Greece, Iceland, Liechtenstein, Malta, and Cyprus

MindSphere

## Sinamics G115D

# The new distributed drive system

For the first time, Siemens presents a converter solution that comes as a complete drive system for horizontal conveyor applications. Sinamics G115D is a combination of gearbox, motor, and frequency converter all in one solution.

The newest member of the Sinamics distributed converters offerst optimal coordination with the single components – they are even delivered fully assembled – and strong support for existing software tools. This end-to-end solution displays more features and a greater flexibility than before for both machine builders and end users, particularly because it is certified as a global motor. For more comfort, the Smart Access Module is now available for Sinamics G115D too, enabling wireless access to the system for the entire Sinamics G series.

Pressing issues of horizontal conveyor plants can be met, especially those of intralogistics and airports. In these markets, a growing number of parcel deliveries must be managed while space is getting scarce. The Sinamics G115D is a good companion in this endeavor: It operates reliably under harsh conditions and in limited space. The number of deliveries is best monitored with the MindSphere app Analyze MyDrives. It gives a comprehensive overview of the system's performance and material flow, and enables users to ensure its availability, with these results: work-



flows can be streamlined, failures can be predicted and prevented, and maintenance can be done when it's convenient, not when it's necessary.

Rising energy prices and a growing ecological awareness have led to the use of energy-efficient motors. Sinamics G115D is optimized for asynchronous IE3 and IE4 reluctance motors. These combinations prove to be highly economical.

With this underlying system of checks and analyses, horizontal conveyor plants are even fit to leverage web-based platforms to become a part in a connected industry and take full advantage of the IoT. The all-in-one solution is fully integrated into TIA Portal, making interaction with existing high-level automation systems a simple task as well as reducing engineering efforts and commissioning costs. The Sinamics G115D gives machine builders and users a powerful instrument to tackle present and future challenges of their markets. ■

> [siemens.com/sinamics-g115d](https://www.siemens.com/sinamics-g115d)

## Highlights

- **One complete solution**
- **Easy selection of drives** with TIA Selection Tool and **commissioning** with Sinamics Startdrive
- Full **integration in TIA Portal** and **MindSphere connectivity**
- **Safety functionality STO** within Profisafe
- Works under **harsh conditions** up to  $-30^{\circ}\text{C}$

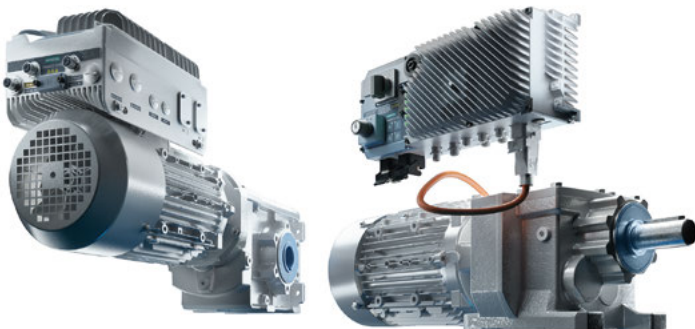

## Sinamics accessories

## Installing cables in a limited space

### Highlights

- Simple optional **expansion of the Sinamics G120 and G120X converter series**
- Option to **route up to four smaller cables** (120 mm<sup>2</sup> cross section) for connection to the line supply and motor
- Efficient and **space-saving installation of cables for frame size FSG**

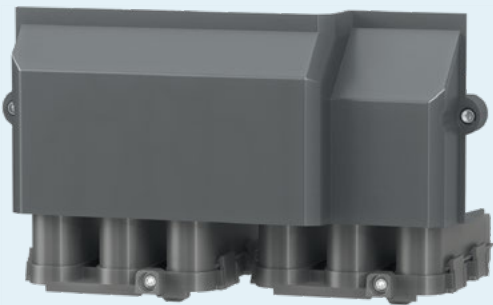

With the Sinamics G120 and G120X converter series, Siemens is offering modular, multifunctional frequency converters that address a wide range of requirements and applications. Both converter series have been expanded to include an additional option, the Sinamics FSG Adapter for the frame size FSG. All cables can be connected to the bottom of the Sinamics FSG Adapter for a simple and alternative cabinet design. ■

› [siemens.com/sinamics-g120](https://www.siemens.com/sinamics-g120)

## Sinamics Control Unit Adapter Kit CUA20

## Variant for DNV-GL-certified cabinet designs



The modular, multifunctional Sinamics G120 frequency converter now offers a supplementary option for DNV-GL-certified cabinet construction which now also meets for example marine specifications. The Sinamics Control Unit Adapter Kit CUA20 can be installed to the left or right of the PM240-2 power module and allows the devices installed in the cabinet to be separated spatially and thermally from the power module and control unit. CUA20 consists of the power module interface (PM-IF) adapter for snapping onto the power module, the attachment adapter for the control unit, and the preassembled cable for connecting the two adapters. ■

› [siemens.com/sinamics-g120](https://www.siemens.com/sinamics-g120)

### Highlights

- Power range from **0.55 to 250 kW**
- Adapter Kit for **DNV-GL-certified cabinet designs**, e.g., in marine industry but also in other industries and fields of application.
- **Compatible with Sinamics CU230P-2, CU240E-2, and CU250S-2 control units** in the Sinamics G120 converter series

## Industrial 5G

# Private 5G networks for the industry

The new 5G communication standard opens up important perspectives for new, flexible factory concepts for all industries.

5G will offer three main scenarios:

- **Enhanced Mobile Broadband (eMBB)**  
(Release 15: December 2018) High data rates for data-driven use cases, (e.g., high-definition video streaming).
- **Ultra-Reliable Low-Latency Communication (URLLC)**  
(Release 16: July 2020) High reliability and low latency for mission-critical applications, (e.g., for mobile robots, autonomous logistics, automated guided vehicles (AGVs), safety applications, etc.).
- **Massive Machine-Type Communication (mMTC)**  
(Release 17: December 2021) Connection of a large number of devices, (e.g., for IIoT applications, where typically many connected devices are deployed in a small area).

Not all the promising features of 5G are available right from the start. The three main scenarios of 5G are based on the Releases 15, 16, and 17 of the mobile wireless standard of the 3rd Generation Partnership Project (3GPP). The 3GPP is responsible for the global standardization of mobile wireless networks. Release 15 and 16 have already been released. Based on these releases, wireless chips and industrial hardware are being developed.

In the Automotive Test Center in Nuremberg, Germany, Siemens is testing 5G in a private stand-alone 5G network in an industrial environment. The network was set up with Siemens 5G prototypes based on Releases 15 and 16. It offers the opportunity to evaluate the performance of 5G communications under real industrial conditions and test future industrial applications (e.g., controlling automated guided vehicles via a private 5G infrastructure).

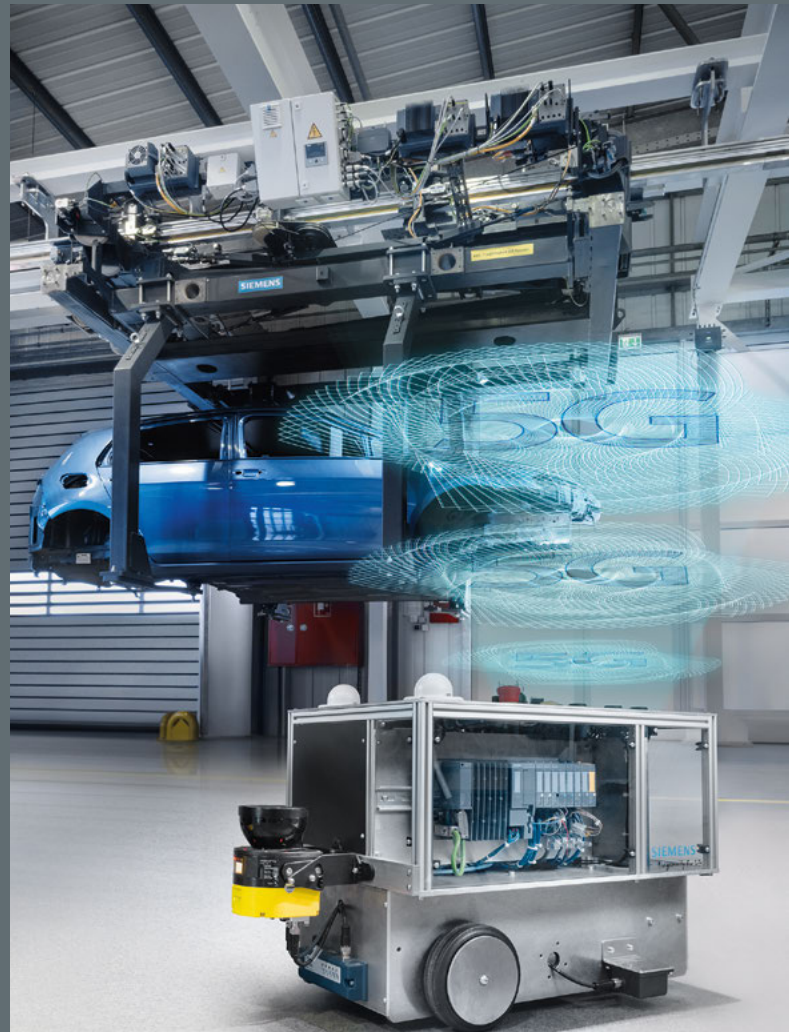

Private 5G networks offer many benefits – especially for industrial use cases. The network owner can shape the network and its performance according to their needs. Communication networks in industrial applications need to provide low latency and high reliability – bandwidth is of secondary importance. Additionally, private 5G networks offer higher data privacy. In a self-owned network, the data stay on-site, and the owner can decide which data are processed or shared with other systems (e.g., clouds).

Supporting solutions for private networks, together with Release 16, industry-grade hardware, and the support of industrial protocols such as OPC UA and Profinet, make 5G truly fit for industry! ■

› [siemens.com/industrial-5g](https://www.siemens.com/industrial-5g)

## CloudConnect

# The professional path from sensor to cloud



Cloud computing is the first step toward profiting from the benefits of digitalization in industry, which include shorter development cycles, higher productivity, and improved quality.

But this can only work if the cloud receives valid data from the field level. Power consumption, temperature, vibration, and the corresponding curve progressions over time provide indications of plant status and process quality. When combined with more information such as the type of material used or tool condition, this data creates entirely new possibilities: for example, improved product quality, process optimization, and the option for preventive maintenance.

With CloudConnect products, this information can be optimally transferred to a wide variety of cloud platforms, including MindSphere, Microsoft Azure, and Amazon Web Services (AWS). ■

› [siemens.com/cloudconnect](https://www.siemens.com/cloudconnect)

## Highlights

### Simatic CP 1545-1 for modern TIA installations

- Easy and professional transfer of Simatic S7-1500 field-level data to cloud systems
- Integrated Stateful Inspection firewall for protection from unauthorized access
- Trigger management for event-driven and cyclic communication
- Full integration in TIA Portal

### Simatic CloudConnect 7 for existing plants

- Simatic CC712: connection of one Simatic S7-300 or one S7-400 via Industrial Ethernet using the S7 protocol
- Simatic CC716: connection of one to seven Simatic S7 controllers via Industrial Ethernet or Profibus/MPI interface
- Quick and fault-free configuration using data transfers from Step 7
- Reduced network load and costs for data exchanges, thanks to event-driven communication

### Ruggedcom RX1400 with CloudConnect for extreme conditions

- All-in-one cellular router for data acquisition, filtering, and conversion
- IIoT data transfer to cloud-based solutions
- Trigger management for event-driven and cyclic communication

## CloudConnect

# Additional options with a firmware update

## Highlights

- **Openness by means of an OPC UA client function** for the standardized connection of lower-level field devices
- **Expanded payload editor** for MQTT messages
- **Plant optimization** with cloud applications using the **MQTT subscribe function**

With the new firmware V1.5 for the Industrial IoT Gateway Simatic CloudConnect 7, the additional requirements of cloud applications are easily met. The OPC UA client function makes it extremely easy to connect all field devices with cloud applications that permit data access via an OPC UA server interface (e.g., Simatic Ident products). The new payload editor allows users to flexibly adapt CloudConnect 7 to all applications and customer-specific formats. Process values are precisely positioned at the requisite points in the format, making costly and time-consuming reformatting a thing of the past. Thanks



to support from the MQTT subscribe function, the approved process values of the controller connected via Simatic CloudConnect 7 can also be changed in the cloud application, for example to optimize processes. ■

> [siemens.com/cloudconnect](https://www.siemens.com/cloudconnect)

## 19" module frame, IE FC Keystone, and FO LC coupler

# Straightforward cabling for data centers

## Highlights

- **Reliable communication** in industrial data centers
- **Error-free transition** between industrial and patch cables
- **End-to-end portfolio** of FastConnect cable technology

In addition to robust components, industrial data centers need cabling suitable for industrial use. The 19" module frame is available as a patch system in which both copper and fiber-optic connectors can be installed in less time and without errors.

The 19" module frame is installed in the 19" control cabinet using the integrated mounting brackets. The IE FC Keystone RJ45 and FO LC coupler connectors are snapped into one of the 24 openings in the 19" module frame. However, they aren't only used in 19" mounting frames. Their flexible modular principle means that they can also be used for a range of installation scenarios: for example, connecting two cables or mounting on a 35 mm DIN top-hat rail.

In conjunction with a Cat6<sub>A</sub> cable, the IE FC RJ45 Keystone from the FastConnect product range is also designed for data rates of up to 10 Gbit/s, making it appropriate for the high data rates found in data centers. ■

> [siemens.com/fastconnect](https://www.siemens.com/fastconnect)

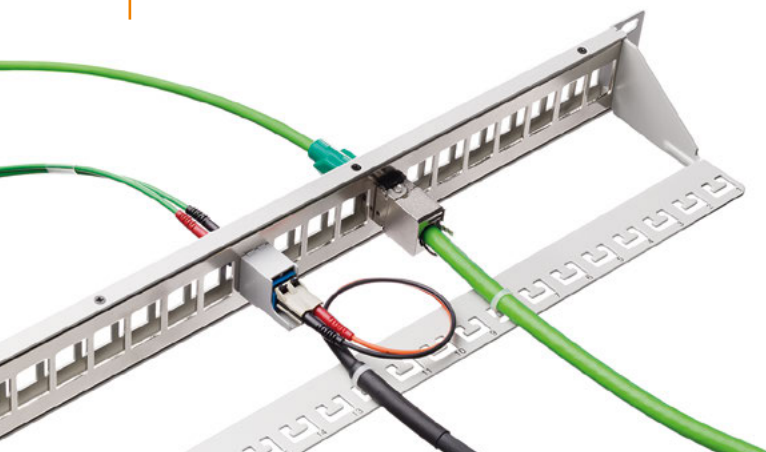

## Scalance X – Power over Ethernet (PoE)

# Power and data for PoE-capable terminal devices

### Highlights

- **Comprehensive PoE portfolio** including IE switches, power supply units, and end devices
- **Up to 210 W internal power** with no additional PoE power supply
- **Unmanaged and managed PoE switches** with 10 Gbit/s ports



Industry uses the Power over Ethernet (PoE) technology known from office and home applications and adds the Scalance XC-200PoE, XR-100PoE WG, and XR-300PoE WG Industrial Ethernet switches to the Scalance X family portfolio. PoE switches that are suitable for powering surveillance cameras, Scalance W IWLAN Access Points, Simatic RTLS Gateways, and Simatic MV500 optical identification systems are now available for the entire industrial network.

PoE-capable Scalance X switches are used in various sectors, including automation technology, infrastructure and tunnel applications, and transportation. To optimize the PoE power budget allocation, optimized settings can be configured on the end device to supplement the standardized performance classes. If the switch's internal power is insufficient, the new Scalance PSR9230PoE power supply units provide additional power of up to 600 W to Scalance XR-300PoE WG.

The new PoE switches supply data and power for up to 26 end devices via a FastConnect cable. Equipped to meet the latest IEEE 802.3bt standard, they supply 30 W per port. In the case of the 10-Gbit/s copper ports on Scalance XR-300PoE WG products, they even supply 60 W per port. All Scalance X-PoE versions with fiber-optic interfaces also have two 10-Gbit/s ports each for transmitting at high data rates. Furthermore the 10 Gbit/s ports on Scalance XR-300PoE WG devices are designed as combo ports, which enables them to supply energy-intensive devices (such as high-resolution HD cameras and cameras with integrated heaters) with both the necessary energy (up to 60 W) and sufficient bandwidth (up to 10 Gbit/s). ■



› [siemens.com/poe](https://www.siemens.com/poe)



## IE/PB Link HA

# Profinet network transition for process automation

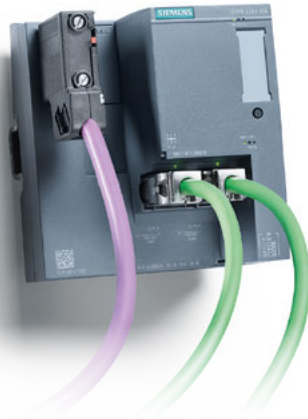

### Highlights

- Implementation of highly available, redundant **Profinet infrastructures** – via both an MRP ring and redundant Profinet infrastructures (R1)
- Phased use of **modern Profinet networks** in processing plants
- **Reliable operation**, including in harsh ambient conditions (NE21,  $-40^{\circ}\text{C}$  to  $+70^{\circ}\text{C}$ , conformal coating)

IE/PB Link HA is optimized for use in the process industries and allows Profibus field devices to be connected to a redundant controller such as the Simatic S7-400H.

IE/PB Link HA functions as a Profinet S2 device and supports Profinet H-CiR (Configuration in RUN) in making changes during normal operation. The PN IO controller treats the connected Profibus DP slaves as PN IO devices with a Profinet interface, with the IE/PB Link HA as their proxy. This means that the IE/PB Link HA can integrate existing Profibus segments in PCS 7 plants with redundant networks. Changes can also be made to the configuration of the connected Profibus DP slaves during normal operation. ■

› [siemens.com/ie-pb-link](https://www.siemens.com/ie-pb-link)

## Industrial Communication

### Power Line Booster

# Communication on conductive media

The Power Line Booster (PLB) communication system transmits data via conductive media. These media can be sliding contact systems (graphite/copper on copper) such as those used in electric monorail conveyors, skillet conveyors, storage and retrieval systems, and crane systems, and they can also be ring slider systems like those used in rotary machines, such as amusement park rides and stranding machines. The PLB prioritizes cyclic Profinet telegrams to ensure real-time conditions. It ensures that all devices can receive or send the high-priority Profinet IO data within a defined period of time.

With the PLB's new Firmware V2, up to 40 carriages can be configured in one 250 m segment. The concatenation of multiple segments allows a plant to be extended over any distance using Profinet IO. Expanded diagnostic functions also make commissioning and maintenance much easier. Among other things, the new PLB offers a test run for determining communication quality across the line, as well as overviews for measuring the data rate to detect rail defects or sliding contact wear early on. ■

› [siemens.com/powerlinebooster](https://www.siemens.com/powerlinebooster)



### Highlights

- **Profinet and Ethernet signal transmission** from a plant controller (e.g., Simatic CPU) to mobile or rotary **Simatic control units**
- **Expanded diagnosis** of sliding contact communication for commissioning and maintenance
- **Integration in existing Simatic solutions** with no need for additional configuration

| Sinec

# Software for the modern industrial network

The new products in the Sinec software family help meet the challenges of digitalization, which include a continuous increase in the number of network subscribers, requirements for security and transparency, and the growing complexity of networks.

To supplement the Sinec NMS (Network Management System), the portfolio is being expanded to include the new Sinec PNI (Primary Network Initialization) setup tool that facilitates a quick and easy initial setup of Scalance and Ruggedcom devices in the network and enables the user-friendly basic initialization and accessibility of these network components. It can also be used to initialize controllers/CPUs – making it easy, for example, to assign IP addresses and device names.

Sinec INS (Infrastructure Network Services) is a software tool for central network services that are frequently required, especially in the area of operational technology (OT). It enables OT itself to access these services directly – decoupled from IT services –, set up an autonomous network and host the services. Via a uniform user interface, Sinec INS provides users with an overview of all the network services necessary for operating an industrial network. ■

› [siemens.com/sinec](https://www.siemens.com/sinec)

## Highlights

- **Quick and easy initial setup** of Scalance and Ruggedcom network components using Sinec PNI
- **Central network services** visible at a glance **with Sinec INS**
- **New version V1.0 SP1 of Sinec NMS:** Security-related network settings can be conveniently managed through firewall and NAT management with device-specific rules, rule-based configuration of the network infrastructure, and Syslog client



## Ruggedcom APE1808

# A utility-grade platform for cybersecurity and Edge computing



Ruggedcom APE1808 is the latest utility-grade application processing engine (APE) for the RX1500 Multi-Service Platform. It can run commercially available Siemens and third-party applications, eliminating the need for an external industrial PC. It provides a standards-based platform for running advanced cybersecurity applications such as intrusion detection systems (IDSs), deep packet inspections (DPIs), and next generation firewalls (NGFWs) from industry leaders in cybersecurity. The APE1808 can operate from  $-40^{\circ}\text{C}$  to  $+75^{\circ}\text{C}$ , which makes it suitable for applications in industries characterized by harsh environments, including electrical power, oil and gas, and transportation. Ruggedcom APE1808 can be inserted directly into devices from the RX1500 product family. It allows for the seamless integration of Edge applications into the network architecture, thereby extending the open Siemens Industrial Edge ecosystem to harsh environments. Even demanding data processing tasks such as network traffic analyses can be executed with APE1808 functioning as an Edge device; this eliminates more hardware investments for additional Edge computing resources. As the hardware backbone of software solutions for industrial cybersecurity and Edge computing, Ruggedcom APE1808 offers much-needed flexibility in a fast-changing landscape. ■

► [siemens.com/ape](https://www.siemens.com/ape)

## Highlights

- Intel quad-core **x86\_64 architecture**
- **8 GB RAM, 64 GB storage**, and TPM support
- Available with **Debian Linux** or **Windows 10 IoT Enterprise**
- **Interfaces:** display port video connector, micro SD card slot, 2 x USB 3.0 ports, 2 x Gigabit Ethernet ports

## Simatic MV500

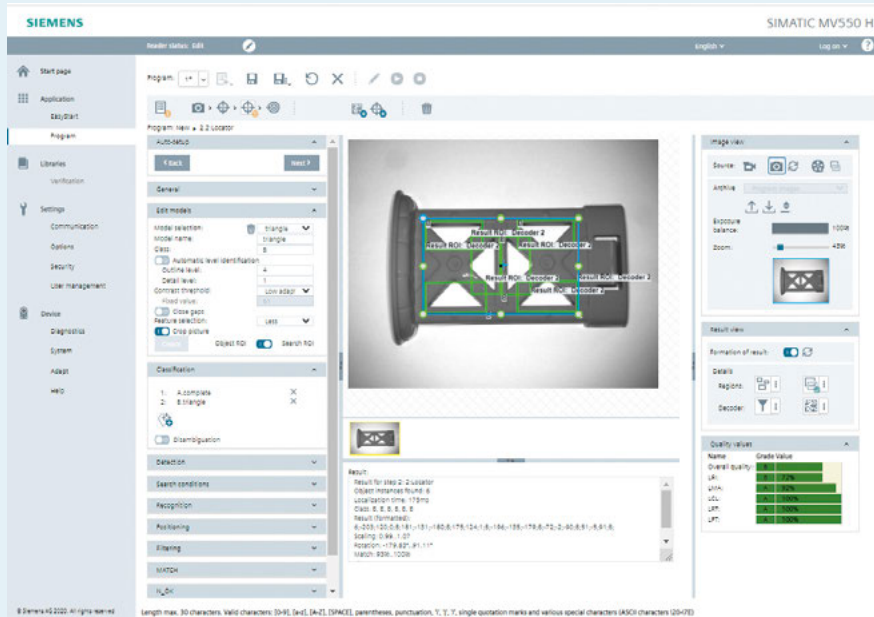
Even faster and more reliable  
object recognition

With Firmware V2.1, the Pat-Genius object recognition license is now available for all devices of the Simatic MV500 family. This means that now it's possible to read 1D barcodes and 2D matrix codes, and also check predetermined structures in the image, regardless of the object pose. With Pat-Genius, programs can be realized with the subtasks object, position and text recognition as well as presence and completeness check. This in turn permits applications such as pick-and-place, quality control, position detection, and quantity monitoring to be implemented quickly and reliably.

Thanks to the multicore processor used in Simatic MV500 devices, the Pat-Genius license operates at least four times faster than the previous

Simatic MV440 series. The increased image resolution of up to 5.3 MP compared to previous series allows the doubling of the object sizes for the mentioned tasks or the doubling of the image resolution.

The new image preprocessing feature also improves recognition performance, which allows users to reliably identify images in the event of poor quality.

Pat-Genius can be retrofitted to any device in the Simatic MV500 family. Existing test programs of the Simatic MV440 series can still be used unchanged on the Simatic MV500 devices. The license can be used simultaneously with all other Simatic MV500 series function packages. ■

➤ [siemens.com/mv500](https://www.siemens.com/mv500)

## Highlights

- Optical readers with **high image resolution of up to 5.3 MP** and a **large working memory up to 2 GB**
- **Variety of individual configurable accessories** such as e-focus lenses and flexibly controllable ring lights
- Flexible **recognition of trained objects**
- Various **test samples can be used in parallel in one program** – for complex testing without re-image feed and summary results formation
- **Easy to use**, thanks to a uniform operating concept

## Simatic RF1070R OEM

Reader for customized  
design

## Highlights

- **Simple, secure, and documented access** to machinery and plants
- **Config card** for customer-specific parameterization of the reader
- **USB interface** for integration in software applications and hardware solutions
- **Serial RS232 interface** for integration into Profibus, Profinet, and EtherNet/IP networks via Simatic RF166C and RF18xC/CI, and for connection to the Simatic ET 200pro (Simatic RF170C), Simatic ET 200SP distributed I/O systems, PCs, and third-party HMIs



The Simatic RF1000 family is being expanded to include the OEM version of the Simatic RF1070R reader with a neutral housing and non-glued neutral front foil. This allows users to either create customer-specific foil designs, or use the reader with the standard neutral front foil with no company reference. Simatic RF1070R OEM operates in accordance to the well-known standards ISO 14443 A/B and ISO 15693, but also supports the technologies Legic Prime and Legic Advant. ■

> [siemens.com/rf1000](https://www.siemens.com/rf1000)



## Simatic RF100C

Enhanced functionality  
thanks to firmware update

With firmware V1.3, the new generation of communication modules (CMs) Simatic RF100C gets additional functions. The EtherNet/IP and XML protocols are now available for all Ethernet-based modules. For example, XML can now also be used for programming Simatic RF100C – in addition to Profinet with the function block Ident-Profile and FB45 as well as OPC UA. Users can continue using Profinet and Industrial Ethernet for the host connection as in the past, or from now on they can use the EtherNet/IP protocol. For controllers with this protocol, the Ident profile function block is available in the form of a library for Rockwell systems. Additional readers and devices can be operated on all CMs via the Freeport setting – especially Simatic RF1040R/RF1070R and Simatic MV320. ■

> [siemens.com/communication-modules](https://www.siemens.com/communication-modules)

## Highlights

- **Connect up to two RS232 devices or up to four RS422 devices** to a Simatic RF100C using the Freeport protocol
- **Simatic RF166C** now also **supports Simatic RF600 readers**
- Complete **replacement of the modules RFID 181EIP and Simatic RF182C**

## Simatic RTLS with Location Intelligence

# Greater transparency in production and logistics



The web-based Location Intelligence software expands Simatic RTLS to include the digital twin of performance, and it can be accessed directly from local ERP or MES systems. Thanks to the intelligent linkage of the transponder ID and order data and the use

of virtually defined areas known as geofences, dynamic data can be analyzed and visualized, and events processed in real time. The combination of location and business information based on the position data offers users a new, transparent overview of the material flow, order information, and possible problem areas. At the same time, users can identify previously untapped potential for optimization by means of real-time analyses and make decisions more quickly. ■

› [siemens.com/rtls](https://www.siemens.com/rtls)

## Highlights

- **Paperless display of order information** on Simatic RTLS ePaper transponders by linking the transponder ID to the existing order data
- **Real-time order tracking** provides a transparent overview of the material flow
- **Searches are reduced** thanks to real-time visualization on terminals of all relevant objects

## Simatic RTLS with SieTrace

# Future-proof design of all operating procedures

## Highlights

- Detects compliance with prescribed **social distancing in the workplace**
- **Visualizes data** via the SieTrace software
- **Simulates and manages** potential risks

Simatic RTLS can measure, monitor, and maintain social distancing between employees in order to protect them. Wearable Simatic RTLS transponders that interact with infrastructure devices track employee movement, and the SieTrace software uses an algorithm to process the data and determine the distances between employees. If the distance falls below 1.5 meters, a warning signal is sent via the RTLS transponder's e-link display. This ensures that social distancing can be guaranteed on company premises and that those



employees who could be affected in the event of a risk scenario are quickly identified. In addition, the real-time data can also be combined with the digital twin of the real production environment to increase plant productivity. ■

› [siemens.com/rtls](https://www.siemens.com/rtls)

## Predictive Services for Drive Systems / Motor Assistant

# Optimized maintenance for maximum productivity

### Highlights

- **Predictive Services**
  - **Transparent maintenance** activities and spare parts needed to minimize risk
  - **Improved productivity** with optimized maintenance cycles and activities
  - **Enhanced efficiency of maintenance activities and order processes** using MindSphere applications
- **Motor Assistant**
  - **Increased system availability and rapid response time**
  - **Cost-effective smartphone-based solution** for even low shaft heights
  - **Easy app-based access to service support** for technical explanations, spare parts, and more

Downtime is costly. With Predictive Services, you can avoid unplanned system downtime thanks to optimized maintenance scheduling. How? By combining the expertise of the service experts at Siemens with our state-of-the-future technologies such as artificial intelligence. Every sector needs its own specific set of Predictive Services. For drive systems, Predictive Services provides a complete forecast for motors and drives by seamlessly integrating all maintenance, spare part, and condition monitoring data in conjunction with analytics. The starting point is the Predictive Service Assistance MindSphere application, which helps customers maintain an overview of assets and maintenance triggers: for example, using defined KPIs and operating hours, and predictive analytics. The application also offers transparency and detailed information about the correct spare parts and recommended and forthcoming maintenance work. It also comes with an

assistant for planning, performing, and documenting maintenance activities, and it provides an easy ordering function via the Siemens Service Mall and Global Service Platform (GSP).

To improve the availability of their production systems, users need to be able to monitor the status of the motors with low shaft heights in their systems. Help is available with the new Motor Assistant function in the SIOS (Siemens Industry Online Support) app, with no need to install a sensor. Motor Assistant records audio files onto your smartphone from the running motor and analyzes them by comparing them with the baseline reference. Users then receive an indication of the "health" of their motor and an appropriate service recommendation, if necessary. ■

› [siemens.com/drivesystems-services](https://www.siemens.com/drivesystems-services)





## Sitrain access

# More than just a video platform

Sitrain access is the Siemens digital learning platform for industry. It facilitates innovative digital learning and professional development in all sectors. It's online, flexible, continuous, and personalized. Our knowledge offerings are curated by our experts, arranged in modular form, and can be accessed to meet your own requirements.

The digital learning services provided by Sitrain access cover a range of topics pertaining to the Siemens product portfolio and help ensure greater transparency for all users: Learners know how far they have progressed, what knowledge they still need, and the best way to obtain it. Companies receive support with skills management, which enables them to guide their employees' professional development. All learning content is structured in a modular format and

can be utilized as you see fit after you subscribe: Users can train whenever, wherever, and however they want.

Sitrain access offers even more benefits for both companies and their employees: Sitrain training course experts have developed extensive tested content to ensure that users get the best possible knowledge services. The virtual training environment includes a large number of exercises, and in conjunction with a broad range of media and a vibrant community, an ideal learning outcome is ensured. Sitrain access is much more than just a video platform: Constant additions to its content, along with the ability to monitor your progress and complete practical exercises, fulfill all the requirements for ongoing learning. ■

› [siemens.com/sitrain-access](https://www.siemens.com/sitrain-access)

### Highlights

- Always **available, regardless of time, location, or device**, including mobile devices via an app
- **Scalable** for businesses of all sizes
- With **Virtual Exercise Lab**, the practical application is now possible in the virtual world

## DCS Modernization Services

# Holistic modernization of process control systems

DCS Modernization Services is a perfect solution for plant managers who need to modernize their existing distributed control system (DCS), upgrade to virtual systems, or expand the plant. After the project data have been evaluated, specific work packages are compiled according to customer needs. Depending on requirements, an upgrade from Teleperm or from Simatic PCS 7 systems is also possible. The holistic, personalized end-to-end support helps users remain competitive over the long term by modernizing their systems. ■

› [siemens.com/dms-sios](https://www.siemens.com/dms-sios)

### Highlights

- **Cost-effective conversion**
- Extensive tests and virtual system **keep risk to a minimum**
- Short or **no downtime**
- **Defined conversion schedule**
- **Full range of services from a single source** and direct from the manufacturer



## Electrification in the digital age

# Energy data as the backbone of IoT



Control-panel builders face a variety of challenges, starting with planning the correct components and the associated engineering. Planning and engineering tools are used to generate digital twins of control panels, switchboards, and busbar trunking systems for visualizing interactions between electrification and automation components and for planning end-to-end solutions. This prevents faults during subsequent operation and significantly reduces planning effort. Customers are provided with a complete product range for a fully digital workflow, from CAx data and integration into e-engineering systems to planning software and graphical configuration programs with integrated ordering functions.

Thanks to the integration of protection, switching, and measuring devices into TIA Portal and Energy Suite, configuration and energy data is also available in the automation environment. This enables well-coordinated and simplified engineering and production processes. Protection, switching, and measuring devices installed in control panels, switch-

boards, and busbar trunking systems initially record relevant characteristics such as power, current, voltage, and temperature. This data can then be visualized on the diagnostics station – the digital twin of the switchboard – and transmitted to open, cloud-based IoT (Internet of Things) operating systems such as MindSphere for additional processing. Analyzing the data reveals starting points for improving energy efficiency as well as opportunities for predictive maintenance (e.g., for checking system and device status). This makes it possible to recognize impending faults well ahead of time, which in turn minimizes downtime. Gateways and IoT data platforms make it easy to connect to the IoT. The gateways and platforms collect and process power and status data and serve as a central interface to local monitoring systems and open cloud systems such as MindSphere.

In addition to integration into existing networks, the data can also be transferred via busbar trunking systems using powerline technology. An additional data cable is no longer needed. In data centers, busbar trunking

## Highlights

- **Control perfection:** Sirius industrial controls for simple engineering, targeted use in applications, and maximum transparency in the plant
- **Smart Control Panel Design:** for cost-effective, standards-compliant electrical planning in TIA Selection Tool
- **Power Distribution:**
  - **Sentron:** communication-capable protection, switching, and measuring devices with matching software solutions for transferring and analyzing energy data on site and to the cloud
  - **Sivacon:** switchboards and busbar trunking systems for reliable power distribution and intelligent data and process management
  - **Sivacon 8PS, LData:** busbar trunking system up to 2.500 A for tomorrow's data centers

systems simplify planning and support fast installation and flexible and reliable operation. ■

- > [siemens.com/controlpanel](https://www.siemens.com/controlpanel)
- > [siemens.com/lowvoltage/digitalization](https://www.siemens.com/lowvoltage/digitalization)
- > [siemens.com/sivacon-S8](https://www.siemens.com/sivacon-S8)
- > [siemens.com/sivacon-8PS](https://www.siemens.com/sivacon-8PS)

## Sentron powermind / 7KN Powercenter 3000

# Intelligent cloud solutions for energy data



### Highlights

- **Sentron powermind**
  - **Intuitive operation** with no specific IT knowledge
  - Display of energy data in **user-friendly dashboards**
- **7KN Powercenter 3000**
  - **Intelligent data collector** for up to 40 measuring and protection devices
  - **Preprocessing and bundling of data** for a reduced transmission volume

With the new Sentron powermind cloud app, energy data in buildings, infrastructure, and industrial plants can be monitored and analyzed right in MindSphere. Users see a real-time overview of current energy consumption and trends over time, both for entire systems and as individual electrical loads. Using this information, companies can derive optimization measures to reduce their energy consumption, costs, and CO<sub>2</sub> emissions.

With the help of the 7KN Powercenter 3000 IoT data platform, energy data can be centrally collected and individually transferred directly to MindSphere.

Corresponding cloud applications enable comprehensive, cross-location analyses that make it possible to access the energy distribution system and all values and statistics at any time and from any location. Control and preventive maintenance can also be performed remotely. Warning indicators allow users to respond to faults immediately and to quickly and easily locate errors. ■

- › [siemens.com/powermonitoring](https://www.siemens.com/powermonitoring)
- › [siemens.com/lowvoltage/digitalization](https://www.siemens.com/lowvoltage/digitalization)

## Sentron powermanager power monitoring software

# Monitoring and reporting for energy and cost efficiency

The Sentron powermanager power monitoring software displays important data from individual devices and the overall system on a straightforward dashboard and analyzes energy consumption. Sentron powermanager can be used as stand-alone software or integrated into the Desigo CC building management system from Siemens, which also enables additional regression analyses. By comparing consumption data with information from presence detectors, for example, users can determine whether energy for lighting, heating, and air conditioning is being used in temporarily unoccupied parts of the building. Small and medium-sized enterprises in particular

can easily identify potential savings and system errors, reduce energy costs, and cut CO<sub>2</sub> emissions thanks to intuitive operation of Sentron powermanager. ■

- › [siemens.com/powermonitoring](https://www.siemens.com/powermonitoring)



### Highlights

- **Evaluates electrical characteristics** such as voltage, current, and power quality
- **Flexible display of analyses** in configurable dashboards or report templates
- **Automatic notification of users** via e-mail or text message in the event of irregularities in energy consumption or unusual system behavior



## Smart Control Panel Design

# The new standard in electrical design

Electrical planners are often confronted with the challenge of having to select not only the correct components for a motor-starting application but also all the parameters associated with the motor feeder, including the appropriate cables and calculations associated with short-circuits and overloads. Siemens now offers a comprehensive and simple solution to this problem.

Using Control Panel Design Assistant in TIA Selection Tool, the user can design and dimension the main electrical components of a machine in compliance with standards. Electrical planners can simply enter the motor data and the desired cable parameters such as method of installation, number of loaded circuits or cables, and ambient temperatures. At the press of a button, all the components, cable cross sections, and short-circuit ratings for fuseless motor feeders up to 250 kW are automatically displayed for the IEC standard region and for the North American market, where NEC, UL 508A, and NFPA79 are the standards for designing electrical equipment.

Control Panel Design Assistant not only provides users with the right switchboards and standard-compliant calculated values; it also supports them in visually designing the main circuit. In addition, the entire system is displayed in the detailed single-line diagram typical of electrical designs. Finally, all the technical data and calculation results are output in the form of complete PDF documentation.

This makes the work of planners much easier. The right switchboards for a direct online motor are sometimes difficult to select, because the device combinations have to serve as suitable switching and protection devices for the motor, including in the case of an overload or short-circuit. Selecting the right cables all the way to the motor is equally important. When planning the cable layout, electrical designers need to comply with all specifications from IEC 60204-1, UL 508A, and other standards. They can do this much more quickly and easily using the new Control Panel Design Assistant in TIA Selection Tool, because they no longer need to manually calculate the cable cross section and short-circuit currents.



1.

Easy dimensioning

**A new dimension  
of dimensioning**

2.

Digital expertise on standards

**Standard conformity  
with no worries**

3.

Consistent workflow

**Electrical engineering  
with unlimited creativity**

4.

Supported portfolio

**Intelligent devices for  
versatile solutions**



To begin with their configuration, electrical planners just need the current version of the TIA Selection Tool and some basic input data to describe the mechanical load. On this basis, tool users are guided step-by-step through the freely selectable parameters of the configuration process. To determine the cable cross section, for example, they can easily select their method of installation, the number of loaded circuits or cables, and the ambient temperature. The result: cables that are optimally designed for the prevailing conditions at the machine, which are also standard-compliant. Everything happens so quickly and easily that it is no problem to also test out the influence of the various parameters: for example, the effects of the control cabinet air-conditioning system on the cable cross sections.

Users are also shown the correct devices for the entire motor feeder, which they can then easily add to an order

list in a subsequent step. They are also provided with complete documentation of the technical data and calculations, which they need, for example, for verifying short-circuit strength. The verification of short-circuit strength is performed based on the risk assessment of electrical equipment for machines and is also mandated by the new version of DIN EN 60204-1, "Electrical equipment of machines", published in June 2019, or UL-508A. This not only saves electrical planners valuable time right from the outset, it also guarantees that the cables and short-circuit ratings conform to standards.

For more information on control panel design in TIA Selection Tool, to download the tool, and to learn about other tools from Siemens for routine electrical design work, visit: ■

► [siemens.com/controlpanel/cpd](https://www.siemens.com/controlpanel/cpd)

## Highlights

- Fuseless and fused **load feeders according to IEC up to 250 kW**, fuseless **load feeders according to UL up to 500 hp**
- Generates complete **EPLAN projects**
- Selection of suitable **switching and protection devices for the motor**
- Visual planning of main circuit in a **single-line diagram**
- **Determines total current** based on a selectable Rated Diversity Factor (RDF)

## Sirius 3RT10, 3RT20 contactors with fail-safe control input

# Innovative, powerful, fail-safe

The proven 3RT1 with fail-safe control input are now being joined by a 3RT20 with fail-safe control input. The new F-PLC contactors 3RT2 in the power range from 18,5 to 55 kW and the 3RT1 up to 250 kW/400 V make it much easier to design fail-safe applications. Because the Sirius contactors can be controlled directly from fail-safe controllers. Due to the contactors' increased power consumption, a coupling level has usually been required in the higher power ranges. This is no longer necessary with the new F-PLC contactors. The new contactors are the logical continuation and further development of the Sirius modular system in the area of safe switching. The fail-safe inputs make it possible to attain SIL 2 or PL c according to IEC 62061 or ISO 13849-1 with only one contactor and SIL 3 or PL e with two contactors in series. ■

> [siemens.com/sirius-control](https://www.siemens.com/sirius-control)

### Highlights

- **Safe switching** of electrical loads
- **No need for additional** positively driven **coupling relays**
- Much **simpler safety assessment**



## Sirius 3RV2926/36/46-3. / 3RV2926-1. door-coupling rotary operating mechanisms Sirius 3RV2 motor starter protectors

# Securely lock the control cabinet door

The new Sirius 3RV2926/36/46-3. door-coupling rotary operating mechanisms for harsh conditions and Sirius 3RV2926-1. for standard conditions prevent the control cabinet door from being opened unintentionally. The 3RV2 motor starter protectors are mounted in the control cabinet and operated externally by a door-coupling rotary operating mechanism. As soon as the control cabinet door is closed, the operating mechanism is coupled. When the motor starter protector closes, the coupling is locked, which prevents the door from being opened with the motor starter protector in the ON position. The Sirius 3RV2926/36/46-3. door-coupling rotary operating mechanisms consist of an actuator, coupling driver, 300-mm-long extension shaft (8 x 8 mm), spacer, and two metal

brackets into which the motor starter protector is inserted. Sirius 3RV2926-1. consists of an actuator, coupling driver, and 130/330-mm-long extension shaft (6 x 6 mm).

The portfolio of 3RV20 motor starter protectors without phase unbalance detection has been expanded for use as a system protection switch. Thirteen products are now available for 1-, 2-, and 3-phase loads for a rated current from 4 A to 100 A. ■

> [siemens.com/sirius-control](https://www.siemens.com/sirius-control)

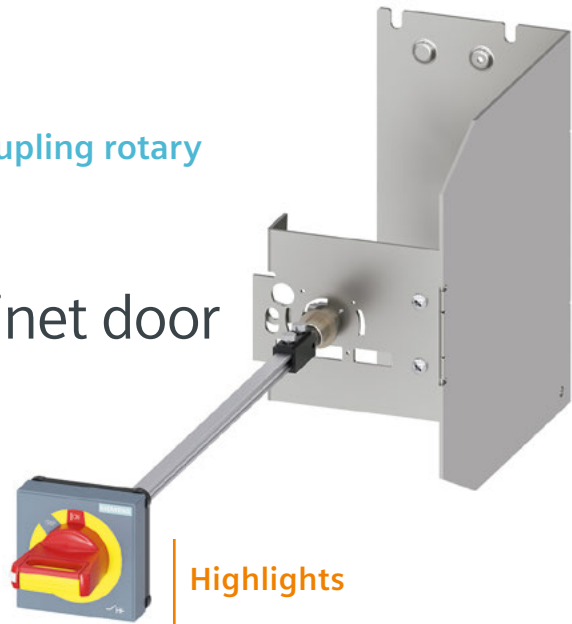

### Highlights

- **Trip position indicator** on the outside of the door
- **Sirius 3RV26/36/46-3.**
  - **IP65** degree of protection
  - Main control switch version per **UL 508 A / NFPA79**
  - Compliance with requirements for **isolating function** per **IEC 60947-2**

## Sirius ACT ID key-operated switches

# Programmable identification solutions

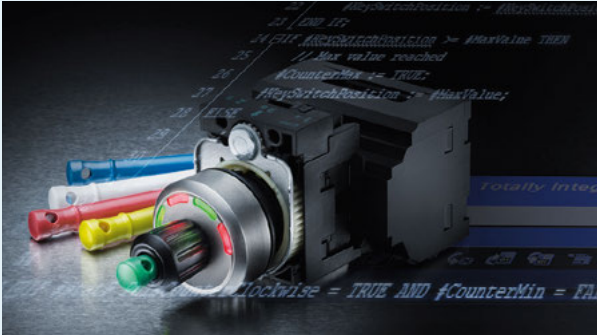

### Highlights

- **Individual authorization management** with unambiguous identification
- **Alternative to conventional key systems**
- **LEDs** can be **animated and illuminated** as required
- **Option to analyze** all activities for each key **using IO-Link**
- **Free use of transmitted signals** (impulse rotate left/right, key inserted, key ID)

A freely programmable version has been added to the Sirius ACT ID key-operated switch portfolio. The main focus of this version is on individual authorization management and the unambiguous identification of users, although it also enables potentiometer functions.

The ID key-operated switch is primarily used in industrial plants with a large number of safety-related functions that require different authorization levels to operate switches. With the new version, plant operators are no longer limited to 50 programmable authorizations; they can now take advantage of unlimited programming flexibility. Freely programming the electronic module or electronic switch via IO-Link requires developer and programming expertise (Step 7) in TIA Portal. ■

► [siemens.com/sirius-act](https://www.siemens.com/sirius-act)

## Sirius 3UG5 DC load-monitoring relay

# Load monitoring up to 60 volts

In single- or dual-channel mode, the compact Sirius 3UG5 DC load-monitoring relays monitor the direct current (DC load circuit), voltage level, and actual power output in a device and issue a warning if one of these values is above or below the limits defined. Current, voltage, and power output are monitored separately. Applications requiring DC monitoring can be found in a variety of industries, including automotive production and DC energy storage.

The new versions of the DC load-monitoring relay cover a voltage range up to a maximum of 60 V with a 2% setting accuracy. This makes them ideal for applications that use batteries: for example, for monitoring battery charge and discharge in automated guided vehicles (AGVs) and for lighting and watering systems in greenhouses. ■

► [siemens.com/relays](https://www.siemens.com/relays)

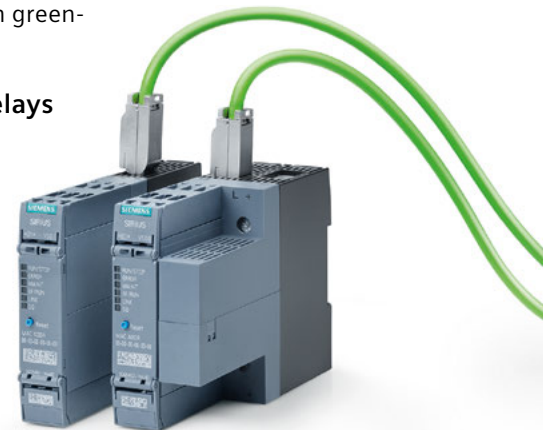

### Highlights

- Operating voltage range from **0 to 800 V** and **0 to 60 V**
- **Two versions: 22.5 mm overall width** with 2 x 8 A / 1 x 16 A and **45 mm overall width** with up to 63 A
- Separate detection of power consumption and energy recovery for an **optimal energy balance**
- **Operating hours and operating switching cycle counters** permit preventive maintenance
- Commissioning as well as **access to measured values and status information also possible via Profinet**



### 3WA air circuit breaker

## Seamless integration into digital environments

The new 3WA air circuit breaker combines all the functions that electrification components need to fulfill in digital enterprises today. It reliably protects people and plants from electrical accidents and damage, is extremely versatile, and can be integrated into all types of switchgear. It also features a long service life, low maintenance effort, and innovative functions for consistent, end-to-end e-engineering. This extremely flexible air circuit breaker ensures a high level of efficiency throughout the workflow. Its reliable recording of energy data makes energy flows transparent. The 3WA air circuit breaker fits perfectly into the digitalization landscape. ■

> [siemens.com/3WA](https://www.siemens.com/3WA)

### Highlights

- Individually selectable and **upgradable functions** for extreme flexibility
- **Simple and economical integration and retrofit** of the 3WL air circuit breaker with the 3WA air circuit breaker in the switchgear
- **Powerful communication option** for secure data transmission

### Sentron 7KM PAC2200 CLP

## Delimitation of third-party quantities for own power generation

Since January 1, 2020, the Energy Collection Act has required German electricity customers to detect self-generated and self-consumed electricity by means of measurement systems compliant with measurement and calibration law and delimit it from third-party quantities in precise 15-minute intervals. They are supported by the Sentron 7KM PAC2200 CLP (Certified Load Profile) measuring device, which combines all required functions in one device, including a MID-compliant meter, integrated 15-minute load profile memory, internal device clock, logbook, and feedback-free Ethernet interface. ■

> [siemens.com/powermonitoring](https://www.siemens.com/powermonitoring)



### Highlights

- **Load profile memory compliant with calibration law** and national approval according to PTB-A 50.7
- **Load profile memory with a two-year memory depth** for all billing-related data
- **Time synchronization** with the legal time via **SNTP**
- **Detects incidents relevant to calibration law** per PTB-A 50.7
- Easy integration into existing IT infrastructure with **integrated web server, DHCP, Modbus TCP**

Published by  
© Siemens AG 2020

Digital Industries  
Factory Automation  
P.O. Box 48 48  
90026 Nuremberg  
Germany

For the U.S. published by  
Siemens Industry Inc.  
100 Technology Drive  
Alpharetta, GA 30005  
United States

For further information please visit: [siemens.com/tia](http://siemens.com/tia)

Photos: Siemens AG, unless otherwise stated

Subject to changes and errors. The information given in this document only contains general descriptions and/or performance features which may not always specifically reflect those described, or which may undergo modification in the course of further development of the products. The requested performance features are binding only when they are expressly agreed upon in the concluded contract.

#### Security information

Siemens provides products and solutions with industrial security functions that support the secure operation of plants, systems, machines, and networks. In order to protect plants, systems, machines, and networks against cyberthreats, it is necessary to implement – and continuously maintain – a holistic, state-of-the-art industrial security concept. Siemens' products and solutions only form one element of such a concept. The customer is responsible for preventing unauthorized access to its plants, systems, machines, and networks. Systems, machines, and components should only be connected to the enterprise network or the Internet if and to the extent necessary and with appropriate security measures (e.g., use of firewalls and network segmentation) in place. Additionally, Siemens' guidance on appropriate security measures should be taken into account. For more information about industrial security, please visit [siemens.com/industrialsecurity](http://siemens.com/industrialsecurity).

DESIGO, ET 200MP, ET 200SP, LOGO!, MindSphere, S7-300, S7-400, S7-1200, S7-1500, SCALANCE, SENTRON, SICAM, SIDRIVE IQ, SIMATIC, SIMATIC CloudConnect 7, SIMATIC Field PG, SIMATIC HMI, SIMATIC IOT2000, SIMATIC IPC, SIMATIC MV, SIMATIC PCS 7, SIMATIC PCS neo, SIMATIC RF, SIMIT, SIMOGEAR, SIMOTICS, SIMOTION, SINAMICS, SINAUT, SINEC, SINEMA, SINUMERIK, SINUMERIK 840, SIPLUS, SIPROTEC, SIRIUS, SITOP, SITRAIN, SIVACON, SIWAREX, TIA, TIA Portal, WinCC are registered trademarks of Siemens AG. Any unauthorized use is prohibited. All other designations in this document may represent trademarks whose use by third parties for their own purposes may violate the proprietary rights of the owner.

#### Follow us:

[twitter.com/siemensindustry](https://twitter.com/siemensindustry)  
[youtube.com/siemens](https://youtube.com/siemens)  
[linkedin.com/company/siemens](https://linkedin.com/company/siemens)  
[ingenuity.siemens.com](http://ingenuity.siemens.com)