

# Practical Computing

60p

August 1980

Volume 3 Issue 8

**Adventure II—  
a game for  
the intrepid**

**Reviews:  
Fair hard-disc**

**Texas  
Instruments  
TI-99/4**

**CompuTech  
sales ledger**

**Standardising  
software  
in schools**



# The best computers PLUS the best service

At MicroCentre, we're concentrating our resources on what we genuinely believe are the very best computers available today. . . . Cromemco computers, naturally. This way we can offer you the best deal possible.

## What we don't do

What we don't do is spread our expertise thinly amongst umpteen different systems, or try to stock every S100 product on the market. We don't claim to offer "impartial" advice on the best buy. And we don't sell from price lists or catalogues.

## The MicroCentre approach

Some micro-computer suppliers work like that, but we don't. Because we realise that when you're buying a computer you want more than the "brochures and boxes" approach. You want to see computers running; to try them out with different software products; to study the documentation; above all, you want expert answers to your most searching questions.

## Cromemco specialists

That's why we've specialised in Cromemco systems. Not simply because we think Cromemco systems are the best serious computers available at the price.



MicroCentre's Cromemco demonstration room, with the full range of Cromemco computers, peripherals, operating systems and software products on permanent exhibition. Why not pay us a visit? We're only an hour's Shuttle flight from Heathrow!



Cromemco Model Z-2H hard disc computer. 10 megabyte hard disc, 2 floppy discs, Z-80 computer and 64K memory. MicroCentre price £5,326.

But because by doing so we can dedicate our time, energy and resources to giving you the highest standard of Cromemco support possible.

demonstration; expect the full range of Cromemco peripherals; single-user and multi-user systems; and interactive graphics.

## Demonstrations

So when you visit MicroCentre expect to find Cromemco systems on permanent

## Software

Expect a choice of operating systems and compilers to evaluate; expect complete documentation; and expect the largest collection of Cromemco systems software in the UK.

## Expertise

Expect to find in-depth professional expertise at MicroCentre, the kind that is only acquired by installing Cromemco systems all over Britain. Expect a thorough appreciation of how Cromemco systems can be applied . . . in business, scientific research, industrial engineering, medicine and education.

## Support

Expect to get frank, accurate answers to your questions at MicroCentre. Above all, once you've bought a Cromemco system from us, expect to get a very high standard of technical support with your hardware enhancements and continuing software needs.

At MicroCentre, simply expect the best.

## For Cromemco... call the experts

NOW IN SPACIOUS  
NEW SHOWROOMS

Tel. 031-556 7354

# MicroCentre

STILL IN  
CENTRAL EDINBURGH

Complete Micro Systems Ltd., 30 Dundas Street, Edinburgh EH3 6JN

● Circle No. 101



Adventure II — create your own epic adventures with our program on page 68.

**Editor**

**Peter Laurie**

**Staff Writer**

**Duncan Scot**

**Production Editor**

**Toby Wolpe**

**Art**

**Margaret Smith**

**Editorial Secretary**

**Susie Manning**

**Consultants:**

**Technical Nick Hampshire**

**Software Mike McDonald**

**Videotex Peter Sommer**

**Editorial: 01-261 8752**

**Advertisement Manager**

**Tom Moloney 01-261 8107**

**Advertisement Executives**

**David Lake 01-261 8056**

**Jeff Weinrich 01-261 8057**

**Midlands office:**

**David Harvett 021-356 4838**

**Northern office:**

**Ron Southall 061-872 8861**

**Advertisement Secretary**

**Stephanie Hill**

**Publisher**

**Chris Hipwell**

Published by IPC Electrical Electronic

Press Ltd, Dorset House, Stamford

Street, London SE1 9LU, tel 01-261

8000, Telex/grams 25137 BISPRSG

Typesetting and artwork by Bow-

Towning Ltd, London EC1

Printed by Eden Fisher Ltd, Southend-

on-Sea

Distributed by IPC Sales and Distri-

bution Ltd, 40 Bowling Green Lane,

London EC1R 0NE

Subscriptions: U.K., £8 per annum;

Overseas £14 per annum; airmail

rates available on application to

Subscription Manager, IPC Business

Press (S & D) Ltd, Oakfield House,

Perrymount Road, Haywards Heath,

Sussex RH16 3DH, tel 0444 59188

© IPC Business Press Ltd 1980

ISSN 0141-5433

Would-be authors are welcome to send articles to the Editor but PC cannot undertake to return them. Payment is at £30 per published page. Programs intended for publication should ideally be justified to 22 or 44 or 66 characters per line.

Every effort is made to check articles and listings but PC cannot guarantee that programs will run and can accept no responsibility for any errors.

# CONTENTS

- 43 Editorial** / The copyright controversy
- 44 Feedback** / A mainframe glossary; virtues of Pascal; machine-code tips
- 48 Printout** / Exidy's exit from the microcomputer market; low-priced software range; Pet Show report
- 55 User Groups** / An alphabetical break-down of user groups, region by region
- 56 Computech sales ledger** / Mike McDonald reviews the Computech package designed to run on the Apple II and ITT 2020
- 62 Texas Instruments TI-99/4** / We assess the home computer from Texas Instruments
- 66 Rair hard-disc system** / The Winchester-based offering from Rair tested by David Watt
- 68 Adventure II** / Generate your own adventures with our Adventure-creating program which does not require disc storage
- 76 Hornets' nest** / Fiction by GK Blackwell
- 82 The Transam Tuscan design story** / In part two, Mike Hughes, designer of the Tuscan, has to make the Z-80 chip imitate its forerunner, the 8080.
- 90 Software standardisation in schools** / The MUSE software standards and their importance outlined by Charles Sweeten
- 94 Supertank** / The second and final part of Bob Merry's war game
- 101 Applications** / A 380-Z at London's Royal School of Mining has revolutionised the search for new materials for use in industrial processes
- 108 Byte and bit manipulation** / Part five of David Peckett's look at machine code now takes in the Z-80 chip
- 117 6502 Special**
- 119 ZX-80 Line-up**
- 121 Tandy Forum**
- 125 Pet Corner**
- 129 Apple Pie**
- 131 Robotics** / The last part of Mark Witkowski's series deals with the likely impact of robotics on industry
- 136 Software Buyers' Guide**
- 172 Diary**
- 173 Book reviews**
- 174 Glossary** / The final part of the terminological gamut with W-Z
- Prestel page number 45631** / The *Practical Computing* Prestel pages

# DIRTY MAINS! CORRUPT DATA?

Is your computer suffering from the effects of unstable mains or from high voltage transients and momentary supply breaks, which you probably do not even notice otherwise?

Have you counted the cost of the loss of a day's data input or, worse still, the corruption of a whole programme?

If not, when you do you may get an unpleasant surprise — particularly if you then compare it with the low cost of a Galatrek Constant Voltage Transformer.



For a cost ranging from only £75 (ex workd) + VAT you can get:-

- \* STABILISATION OF  $\pm 1\%$
- \* TRANSIENT ATTENUATION
- \* MOMENTARY POWER BACK-UP
- \* RAPID RESPONSE
- \* OUTPUT TOTALLY ISOLATED
- \* PROTECTION FOR STABILISER AND EQUIPMENT UNDER OVERLOAD AND SHORT-CIRCUIT CONDITIONS

Standard range covers ratings from 250VA to 5kVA. Higher ratings to order.

Model AK250 at £75 ex works + VAT, one of a range of 90 models covering most voltages.

Galatrek VOLSTAB Constant Voltage Transformers are based on a Galatrek innovation on the well established ferro-resonant saturable reactor technique. They offer high performance with minimal size and weight at a highly competitive price.

They contain no moving parts and are very reliable in service. They will provide close regulation within the limits specified. So consider carefully the Six Star Features listed above. And consider carefully the cost of system 'hiccups' resulting from mains supply irregularities.

Then complete the coupon below to secure your copy of our new 12 page catalogue listing our whole range of stabilisers and cutouts. Or ring Ron Koffler on 0492 640311.



Scotland Street, Llanrwst,  
Gwynedd LL26 0AL. North Wales, Britain.  
Telephone: Llanrwst (0492) 640311  
Telex: 617114 Answer back—GALAHU  
Telegraphic Address GALAWATT.

U.K. Marketing Agent:  
Danesbury Marketing Ltd.,  
Tavistock House,  
Bedford MK40 2QD  
Tel: 0234 213571 Telex: 825633 OTSS-B

CUTOUT NOW AND POST TODAY

ON FREEPOST LL99 No stamp necessary

Mark first class

- PLEASE recommend a stabiliser for the following:

.....

- PLEASE send me your new 12 page catalogue

Name .....

Sent By .....

Tel No .....

Tick if trade  Tick if OEM

Address .....

.....

.....

PC8

The  Cromemco

# Z-2H

THE  
MARKET  
LEADER



**11 Megabytes of hard disc storage in a fast,  
new, table-top computer.**

- Fast Z80A 4MHz processor
- 11-megabyte hard disc drive
- Two floppy disc drives
- 64K RAM memory
- RS-232 serial interface
- Printer interface
- Extensive software available

Camberley	Microbits, Camberley, Surrey 0276 34044
Cambridge	Cambridge Computer Store, Cambridge 0223 68155
Dublin	Lendac Data Systems Ltd., Dublin 372052
Ilford	The Byte Shop, Ilford, Essex 01-554 2177 also at Tottenham Court Road, London 01-636 0647
Leeds	Holdene Ltd., Leeds 0532 459459 also at Wilmslow, Cheshire 0625 529486
London	Digitus Ltd., London W1 01-636 0105
Manchester	Computer Workshop, Manchester 061-632 2269 also at West Park, Leeds 0532 788466
Newbury	Newbear Computing Store, Newbury, Berks 0635 30505
Newport	Micromedia Systems, Newport, Gwent 0633 50528
Nottingham	Computerland Ltd., Nottingham 0602 40576 also at Birmingham 021-622 7149; Manchester 061-236 4737; Glasgow 041-332 2468
Sheffield	Hallam Computer Systems, Sheffield 0742 663125
Southampton	Xitan Systems Ltd., Southampton 0703 38740
St. Austell	Benchmark Computer Systems Ltd., St. Austell 0726 61000



**comart specialists in microcomputers**

Comart Ltd., P.O. Box 2, St. Neots, Huntingdon, Cambs, PE19 4NY. Tel: (0480) 215005 Telex: 32514

• Circle No. 103

# MACRO-MICROS FROM COMPUTER CENTRE

Tandy and Apple computer owners don't have to throw away their present investment to have 8 inch disc drives ADD a **MEGABYTE** to your **EXISTING TANDY** or **APPLE** machine for under £1000 (+ VAT)

## TANDY TRS80 OWNERS

Run up to four 8 inch drives or a mixture of 5¼ and 8 inch drives...AND standard CP/M..... Simple to install plug-in adaptors re-arrange the ROM and RAM in your system to allow a STANDARD CP/M capable of running our FREE 42 volumes of the User Group library and any CP/M software.

## APPLE / ITT OWNERS

A plug-in controller lets your system run up to four 8 inch disc drives. We can't offer you a system to mix 5¼ and 8 inch or CP/M but that extra MEGABYTE for under £1000 (+ VAT) may be all that you need!

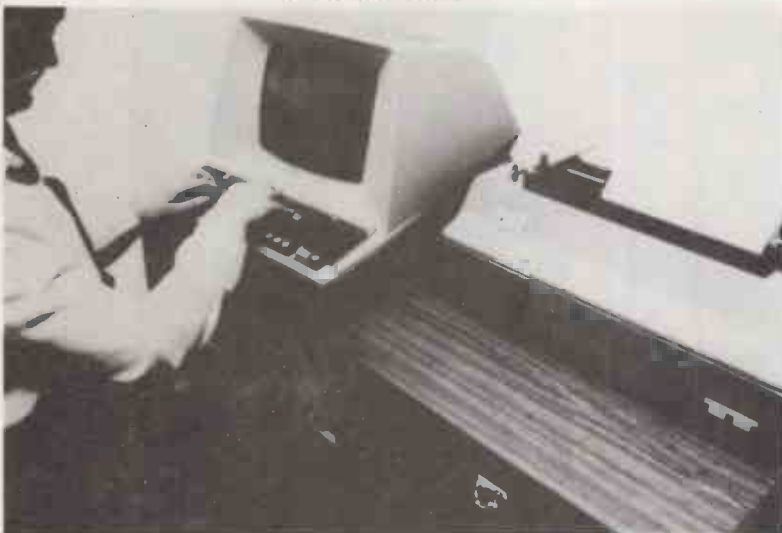

## MORE THAN WORDS CAN SAY THE COMPUTER CENTRE WORD CENTRE

- SPECIAL WORD PROCESSING VDU
- 48K BYTES Z80 MICRO
- TWIN 8 INCH DRIVES
- QUME DAISY WHEEL PRINTER
- £4600 + VAT

Our word centre is a purpose designed hardware and software combination which solves your WORD PROCESSING problem. Your secretary will appreciate the IBM type writer layout of the VDU keyboard; and the special function keys for straight forward editing of; the WORDSTAR software package is designed to meet the needs of both the inexperienced 'temp' as well as the 'ace' secretary; the 'golf ball' quality output from the printer with page and heading control, right adjusted text, etc, is what its all about and the QUME does it better!

And when your WORD PROCESSING is finished earlier, there will be time left over to do other computing work as well! This is THE WORD PROCESSING machine that supports BASIC, FORTRAN, COBOL and the best range of BUSINESS PACKAGE software available - because our WORD CENTRE also runs the most widely used micro disc operating system - CP/M

## TANDY TRS80 MODEL 2 OWNERS

Save money on your 8 inch add on drives..... We buy disc drives by the thousand direct from manufacturers, we don't have expensive overheads of high street shops, so we can offer top quality add on drives for less than half price! AND your add on drive can be DOUBLE sided giving ONE MEGABYTE of storage for under £600 (+ VAT)

**If you are a buyer for a company or an OEM looking for several MODEL 2 machines as well as drives we can offer BIG DISCOUNTS on BOTH!! Ask for details.**

We also offer STANDARD CP/M for TANDY Model 2.

**20 MEGABYTE WINCHESTER SYSTEMS**

just plug into your existing 8" floppy controller for under £2500. Call for more details

# OFF THE SHELF AVAILABILITY FROM COMPUTER CENTRE

## KIT PACKAGES

### MINI KIT

The lowest priced CP/MZ80 Micro in UK. Add our power and terminal. Minifloppy 16KB RAM, Z80, CTC, serial + parallel I/O, S100 motherboard, connectors, manuals, CP/M system. Free basic and Algol. Optional two drive case illustrated and power supply. £149.00



**£800**

### MAXI KIT

5 1/4" drive, CP/M disc operating system, 16K bytes, Z80, serial and parallel I/O, S100 motherboard, connectors and cables

Optional power supply kit. £77.00

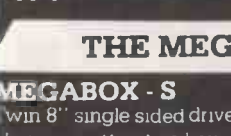

**£911**

## THE MEGABOX

### MEGABOX - S

Twin 8" single sided drives plus Power Supply Unit in an attractive box  
Up to two megabytes  
Attractive 3U case  
Fan cooling  
Mains switch

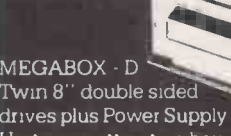

**£913**

### MEGABOX - D

Twin 8" double sided drives plus Power Supply Unit in an attractive box £1090.00p

## 8 INCH DRIVE

### SCHUGART COMPATIBLE

Single/dual density disc drive  
Assembled and guaranteed



**£350**

Double sided version £450

## MINI FLOPPY

Double/single density hard or soft sector, used for TRS80, North Star etc. Assembled and guaranteed



**£175**

## TRS 80 EXPANSION

### DISC DRIVE

5 1/4" disc drive + power supply in attractive case



**£199**

## PRICE LIST

### OEM PACKAGED SYSTEMS

OEM PACKAGED SYSTEMS	ASSEM
OEM1. Z80, 32KB, 1SER, 1PAR. 2 x 1/4 MEG Disks	1970.00
OEM2. Z80, 48KB, 1SER, 1PAR. 2 x 1/2 MEG Disks	2270.00
OEM3. 4MHz, 64KB, 2SER, 1PAR. 2 x 1 MEG Disks	3570.00

### DISC DRIVES

SA400 mini floppy disc drive	175.00
DRI 7100 8 inch drive (single sided)	350.00
DRI 7200 8 inch drive (double sided)	450.00

### VDU'S

Pentland (full spec)	590.00
----------------------	--------

### PRINTERS

DRI 6320 (140 cps Max) 132 chts, Tractor Feed	1500.00
ANADEX 8000	499.00

### SOFTWARE

CP/M operating system + 6 manuals + basic E	70.00
Library index (42 volumes available)	2.80
Library copies on 8 inch media	4.40
Library copies on 8 inch media (10 or more)	3.40
Microsoft BASIC	193.00
Microsoft FORTRAN	267.00
Micro focus compact COBOL	376.00
Micro focus forms	75.00
UCSD PASCAL	193.00
Microsoft BASIC compiler	211.00
WORDSTAR	193.00

### MPU

MPU	KIT	ASSEM
CB2 Z80A 1EEE S100	112.00	136.00
IDS Z80A CPU BOARD		115.00
SBC 100 Z80 +.serial + parallel	155.00	197.00
SBC 200	182.00	242.00

### DISC CONTROLLERS

Tarbell single density	132.00	188.00
Tarbell double density	188.00	244.00
Versafloppy 1 single density	135.00	190.00
Versafloppy 2 double density	184.00	241.00
Nat Mux double density		215.00
Tarbell Cassette Interface		104.00

### MEMORY

8K bytes Econoram 2 (4MHz) static ram	84.00	100.00
16K bytes Econoram 4 (4MHz) static ram	145.00	178.00
24K bytes static	214.00	259.00
32K bytes static ram	302.00	349.00
Expandoram 2 (Dynamic) 64K population	663.00	713.00
Expandoram 1 (Dynamic) 64K population	366.00	416.00

### I/O

2SIO ( 2 serial full hand shaking uarts)	105.00	136.00
IO4 2 serial/parallel	86.00	129.00

### SPECIAL BOARDS

VDB-8024 (80 chts x 24 lines) video	194.00	263.00
PB1 2716/2708 eprom programmer	78.00	122.00
Memtech 3MHz floating point board		280.00
Prototype board		16.60
2708 prom board (ex proms)	52.00	63.00
VB1 16/32x64 video	78.00	107.00
MT3 11 slot motherboard		21.00
S100 extender + logic probe		31.20

Dealer, Educational and Quantity Discount Available.

## OEM RANGE



FROM UNDER  
**£2000**

- Up to 2 Megabytes of floppy disc storage
- High speed Z80 micro
- Up to 64K bytes fast ram storage
- High level operating system (supports Cobol, Fortran, APL, Basic, Pascal, Wordstar)
- 2 drive minimum system under £2000

Available off the shelf in an attractive case, the Computer Centre OEM 2 provides a powerful main frame computer

System builders are free to add peripherals to suit the final applications. The operating system provided with the OEM 2 is a powerful upward compatible extension to CP/M and will support up to 128 mega byte disc storage

A 10 mega byte fixed disc is already planned and should be available as an extra during 1980.

Another remarkable extension to the OEM range is the availability of the multi terminal operating system. But with hardware costs as low as the OEM, the market for sharing the system is likely to be small!!!

**OEM's are invited to write or call for details**

## NEW PRODUCTS

Now available from stock, new plug in card/cards to enable Tandy owners to run CP/M and/or two 8" disc drives.

Full range of power supplies, Firmware, Connectors and IC's

• Circle No. 104

All advertised items generally in stock. Cash with order ensures same day despatch. Add 2% postage and 15% VAT to advertised prices. I enclose cheque for £

Send:  Catalogue (please tick)

Name .....

Address .....

Send .....

# COMPUTER CENTRE

THE DISCOUNT COMPUTER STORE

9 De la Beche Street, Swansea, SA1 3EX. Tel: 0792 460023 Telex: 48638

PC8

# NANOCOMPUTER.®

## THE COMPUTER FOR LEARNING ALL ABOUT COMPUTERS.

The microprocessor boom has left in its wake a scarcity of engineers who need to know how to realise to the full the potential of these powerful devices.

SGS-ATES, who have been producing microprocessors longer than any other European manufacturer, are now producing the NANOCOMPUTER, a professional and complete educational microcomputer system specially designed for learning all about microcomputers.

Teaching and Learning: two facets of a single problem.

All learning must be a blend of teaching reinforced with practical training.



*NBZ80-S. CPU board, experiment board, keyboard, card frame/power supply, connecting wires, training books Vol. 1 and 3, Technical Manual.*

The NANOCOMPUTER has been designed to be both tutor and training aid.

It is the result of SGS-ATES many years experience not just in component and systems production but also in the training of both design and production engineers at the

very highest level.

The NANOCOMPUTER, based on the powerful Z80 microprocessor produced by SGS-ATES, is not just a microcomputer but rather a complete, modular educational system designed to grow with the student.

It comes complete with text books in the major European languages, technical manuals and experiment kits.

All these features make the NANO-



COMPUTER an obvious choice not only for supervised courses in schools but also for the engineer who wants to learn in a more personal way all about micro-computers.

**NANO-COMPUTER: a modular system.**

The conceptual design of the NANOCOMPUTER, specially created for educational use, combines the exactness of science with the flexibility demanded by the learning process which must be at the same time both theoretical and practical.

The NANO-COMPUTER in its simplest form, NBZ80-B, allows even the newcomer to micro-processors to master programming techniques.

Further up the scale the NBZ80-S introduces him to logical circuits then takes him on to learning how to interface a microprocessor with external devices.

Each learning step taken by the stu-

dent is matched by the NANOCOMPUTER which has been designed for expansion, with a series of upgrade kits, from the simple NBZ80-B through to the NBZ80-S onto a final version with which he can learn not just about programming in the BASIC high-level language but how to use it as an integral part of a hardware system.



*NBZ80-B. CPU board, keyboard, card frame/power supply, training book Vol. 1, Technical Manual.*

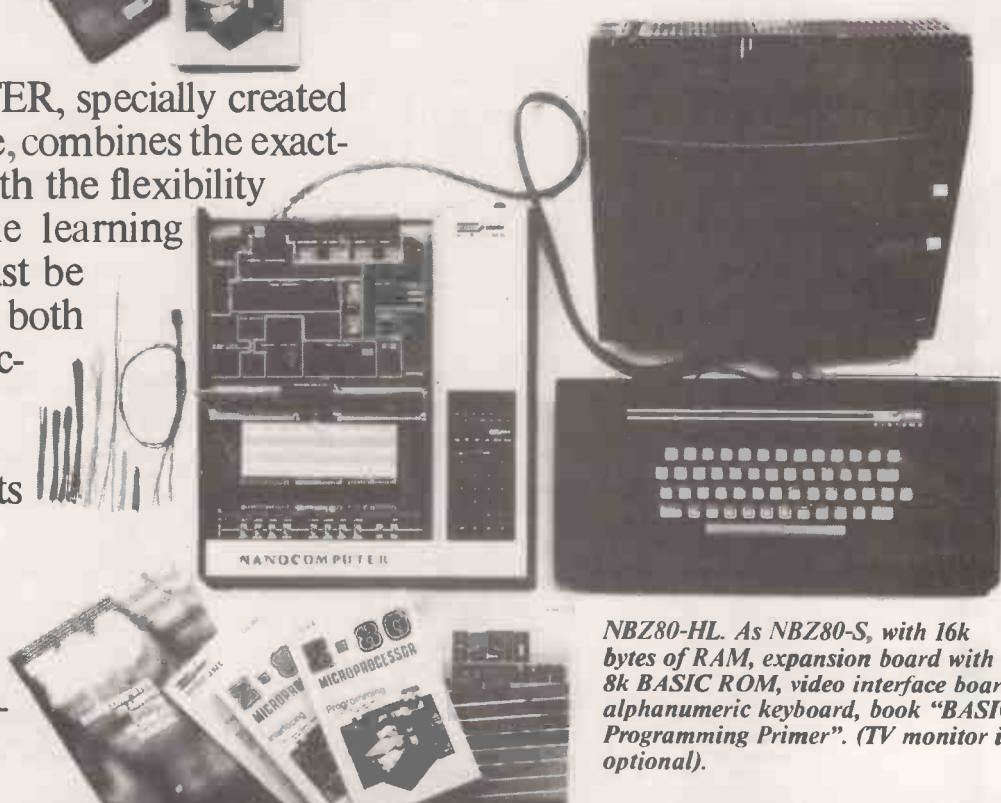

*NBZ80-HL. As NBZ80-S, with 16k bytes of RAM, expansion board with 8k BASIC ROM, video interface board, alphanumeric keyboard, book "BASIC Programming Primer". (TV monitor is optional).*

Please send more information about your NANOCOMPUTER®

PC8

Name \_\_\_\_\_ Address \_\_\_\_\_

City \_\_\_\_\_ Country \_\_\_\_\_

Profession \_\_\_\_\_

Send to: SGS-ATES (UK) Ltd.  
Planar House - Walton Street  
Aylesbury - Bucks.  
Tel. (0296) 5977



SGS-ATES (UK) Ltd. - Planar House - Walton Street - Aylesbury - Bucks - Tel.: (0296) 5977 - Telex 83245. • SPECIALIST MICROPROCESSOR DISTRIBUTORS: Cambridge Microcomputers Ltd. - Cambridge Science Park - Milton Road - Cambridge - Tel. (0223) 314666 • Midwich Computer Company Ltd. - 9 Churchgate Street - Old Harlow - Essex CM17 0JS - Tel. (0279) 412605 • Distrionic Ltd. - 50/51, Burnt Mill - Elizabeth Way - Harlow - Essex - Tel. (0279) 32947 - Telex 81387 • Quarndon (Semiconductors) Electronics Ltd. - Slack Lane - Derby DE3 3ED - Tel. (0332) 32651 - Telex 37163.

• Circle No. 105



Software for most popular 8080/Z80 computer disk systems including  
**NORTH STAR HORIZON, VECTOR MZ, OHIO SCIENTIFIC,  
 CROMEMCO, PROCESSOR TECHNOLOGY, RAIK BLACK BOX,  
 DYNABYTE, SD SYSTEMS, RESEARCH MACHINES, ALTAIR,  
 EXIDY SORCERER, IMSAI, HEATH, and 8" IBM formats**

Software  
with / Manual  
Manual / Alone

Software  
with / Manual  
Manual / Alone

- MDBS** - Micro Data Base System. Full network data base with all features of MDBS plus multi-level Read/Write protection for FILE, SET, RECORD and ITEM. Concise representation of one to one SET relationships. Supports multiple owner and multiple record types within SETs. MDBS files are fully compatible.
- MDBS-DRS** - MDBS with Dynamic Restructuring System option which allows altering MDBS data bases when new ITEMS, RECORDS, or SETs are needed without changing existing data.  
 HDBS-Z80 version ..... £135/£25  
 MDBS-Z80 version ..... £395/£25  
 MDBS-DRS-Z80 version ..... £455/£25  
 8080 Version available at £45 extra  
 Z80 version requires 20K RAM. 8080 version requires 24K RAM. (Memory requirements are additional to CP/M and application program.)  
 When ordering HDBS or MDBS please specify if the version required is for 1) Microsoft L80 i.e. FORTRAN-80, COBOL-80, BASIC COMPILER, 2) MBASIC 4, XX, or 3) BASIC-80 5.0.
- PASCAL/M** - Compiler generates P code from extended L language implementation of standard PASCAL. Supports overlay structure through additional procedure and the SEGMENT procedure type. Provides convenient string handling capability with the added variable type STRING. Untyped files allow memory image I/O. Requires 56K CP/M ..... £195/£20
- PASCAL/Z** - Z80 native code PASCAL compiler. Produces optimised portable reentrant code. All interfacing to CP/M is through the support library. The package includes compiler companion macro assembler and source for the library. Requires 56K and Z80 CPU. Version 2 includes all of Jensen/Wirth except variant records ..... £155/£15  
 Version 3 Upgrade with variant records and strings expected 2/80 ..... £205/£15
- PASCAL/MT** - Subset of standard PASCAL. Generates ROMable 8080 machine code. Symbolic debugger included. Supports interrupt procedures, CP/M file I/O and assembly language interface. Real variables can be BCD, software floating point, or AMD 9511 hardware floating point. Version 3 includes Sets, Enumeration and Record data types. Manual explains BASIC to PASCAL conversion. Source for the run time package requires MAC (See under Digital Research). Requires 32K ..... £135/£20
- TINY C** - interactive interpretive system for teaching structured programming techniques. Manual includes full source listings ..... £45/£30
- BDS C COMPILER** - Supports most major features of language, including Structures, Arrays, Pointers, recursive function evaluation, linkable with library to 8080 binary output. Lacks data initialization, long & float type and static & register class specifiers. Documentation includes "C" Programming Language book by Kernighan & Ritchie ..... £60/£10
- WHITESMITHS' C COMPILER** - The ultimate in systems software tools. Produces faster code than Pascal with more extensive facilities. Conforms to the full UNIX Version 7 C language, described by Kernighan and Ritchie, and makes available over 75 functions for performing I/O, string manipulation and storage allocation. Compiler output in A-Natural source. Supplied with A-Natural. Requires 60K CP/M ..... £325/£20
- POLYVUE/80** - Full screen editor for any CRT with XY cursor positioning. Includes vertical and horizontal scrolling, interactive search and replace, automatic text wrap around for word processing, operations for manipulating blocks of text; and comprehensive 70 page manual ..... £70/£12
- POLYTEXT/80** - Text formatter for word processing applications. Justifies and paginates source text files. Will generate form letters with custom fields and conditional processing. Support for Daisy Wheel printers includes variable pitch justification and motion optimization. ..... £45/£10
- ALGOL 60 Compiler** - Powerful block-structured language featuring economical run time dynamic allocation of memory. Very compact (24K total RAM) system implementing almost all Algol 60 report features plus many powerful extensions including string handling, direct disk address I/O etc. Requires Z80 CPU ..... £110/£12
- Z80 Development Package** - Consists of (1) disk file line editor, with global inter and intra-line facilities; (2) Z80 relocating assembler, Zilog Mostek mnemonics, conditional assembly and cross reference table capabilities; (3) linking loader producing absolute Intel hex disk file for CP/M LOAD, DDT or SID facilities ..... £50/£12
- ZDT** - Z80 Debugger to trace, break and examine registers with standard Zilog/Mostek mnemonic disassembly displays. Facilities similar to DDT £20 when ordered with Z80 Development Package ..... £30/£7
- DISTEL** - Disk based disassembler to Intel 8080 or TDL/Xitan Z80 source code, listing and cross reference files. Intel or TDL Xitan pseudo ops optional. Runs on 8080. .... £35/£7
- DISILOG** - As Distel to Zilog Mostek mnemonic files. Runs on Z80 only ..... £35/£7
- TEXTWRITER III** - Text formatter to justify and paginate letters and other documents. Special features include insertion of text during execution from other disk files or console, permitting recipe documents to be created from linked fragments on other files. Has facilities for sorted index, table of contents and footnote insertion. Ideal for contracts manuals, etc. .... £75/£3

- POSTMASTER** - A comprehensive package for mail list maintenance that is completely menu driven. Features included keyed record extraction and label production. A form letter program is included which produces neat letters on single sheet or continuous forms. Compatible with NAD files. Requires CBASIC-2 ..... £85/£10
- XASM 68** - Non-macro cross assembler with nested conditionals and full range of pseudo operations. Assembles from standard Motorola MC6800 mnemonics to intel hex ..... £115/£15
- XASM 65** - As XASM-68 for Technology MCS-6500 series mnemonics ..... £115/£15
- WHATSIT?** - Interactive data base system using associative tags to retrieve information by subject. Hashing and random access used for fast response. Requires CBASIC ..... £70/£15
- XYBASIC** Interactive Process Control BASIC - Full disk BASIC features plus unique commands to handle bytes, rotate and shift, and to test and set bits. Available in integer, Extended and ROMable versions.  
 Integer Disk or Integer ROMable ..... £165/£16  
 Extended Disk or Extended ROMable ..... £215/£15
- SMAL/80** Structured Macro Assembly Language - Package of powerful general purpose text macro processor and SMAL structured language compiler. SMAL is an assembler language with IF-THEN-ELSE, LOOP-REPEAT-WHILE, DO-END, BEGIN-END constructs ..... £40/£10
- SELECTOR III-C2** - Data Base Processor to create and maintain multi Key data bases. Prints formatted, sorted reports with numerical summaries or mailing labels. Comes with sample applications including Sales Activity, Inventory, Payables, Receivables, Check Register, and Client/Patient Appointments, etc. Requires CBASIC Version 2. Supplied in source code. .... £185/£12
- CPM/374X Utility Package** - has full range of functions to create or re-name an IBM 3741 volume, display directory information and edit the data set contents. Provides full file transfer facilities between 3741 volume data sets and CP/M files ..... £125/£7
- BASIC UTILITY DISK** - Consists of (1) CRUNCH-14 Compacting utility to reduce the size and increase the speed of programs in Microsoft Basic and TRS-80 Basic. (2) DPFUN - Double precision subroutines for computing nineteen transcendental functions including square root, natural log, log base 10, sin, arc sin, hyperbolic sin, hyperbolic arc sin, etc. Furnished in source on diskette and documentation ..... £30/£10
- THE STRING BIT** - Fortran character string handling. (M) Routines to find, fill, pack, move, separate, concatenate and compare character strings. This package completely eliminates the problems associated with character string handling in FORTRAN. Supplied with source ..... £30/£10
- BSTAM** - Utility to link one computer to another also equipped with BSTAM. Allows file transfers at full data speed (no conversion to hex), with CRC block control check for very reliable error detection and automatic retry. We use it! It's great! Full wildcard expansions to send \*.COM, etc. 9600 baud with wire, 300 baud with phone connection. Both ends need one. Standard and M versions can talk to one another ..... £75/£5

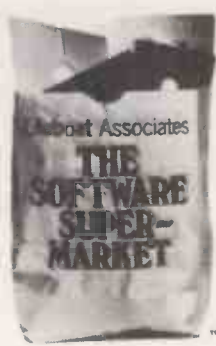

Orders must specify disk type and format, e.g. North Star-Horizon single density.

Add VAT to orders for software (not manuals alone) Add 50p per item postage and packing (minimum £1)

All orders must be prepaid (except COD or credit card) Make cheques POs etc payable to Lifeboat Associates.

Manual costs are deductible from subsequent software purchase

**Lifeboat Associates**  
 32 Neal Street  
 London WC2H 9PS  
 01-379 7931

(M) Modified version available for use with CP/M as implemented on Heath and TRS-80 Model 1 computers.

(L) User license agreement for this product must be signed and returned to Lifeboat Associates before shipment may be made.

\*CP/M is a trademark of Digital Research  
 \*\*Z80 is a trademark of Zilog Inc.

The Software Supermarket is a trademark of Lifeboat Associates  
 EFFECTIVE MARCH 1980

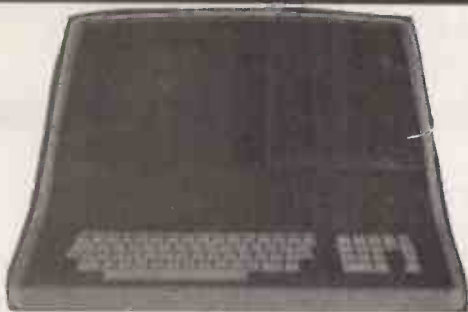

## SUPERBRAIN

### Intelligent Video Terminal Systems

#### 350K or 700K of Disk Storage

There's been a lot of talk lately about intelligent terminals with small systems capability. And, it's always the same. The systems which make the grade in performance usually flunk the test in price. At least that was the case until Intertec introduced its SuperBrain line of video terminals with the best PPRs (Price/Performance Ratios) in the history of the industry.

SuperBrain users get exceptional performance for just a fraction of what they'd expect to pay. Standard SuperBrain features include: two double density mini-floppies with 350K bytes of disk storage, 32K of ram memory (expandable to 64K) to handle even the most sophisticated programs, a CP/M Disk Operating System with a high powered text editor, assembler, debugger and a disk formatter. And, with SuperBrain's S-100 bus adaptor, you can add all the programming power you will ever need...almost any type of S-100 compatible bus accessory.

SuperBrain's CP/M operating system boasts an overwhelming amount of available software in BASIC, FORTRAN, COBOL, and APL. Whatever your application... General Ledger, Accounts Receivable, Payroll, Inventory or Word Processing, SuperBrain is tops in its class. And the SuperBrain QD boasts the same powerful performance but also features a double-sided drive system to render more than 700K bytes of disk storage and a full 64K of RAM. All standard!

Whatever model you choose, you'll appreciate the careful attention given to every engineering detail. A full ASCII keyboard with numeric pad and user-programmable function keys. A non-glare, specially focused, 12-inch CRT for sharp images everywhere on the screen. Twin Z-80 microprocessors to insure efficient data transfer to auxiliary peripheral devices. Dual universal RS-232 communications ports for serial data transmission. And, a single board design to make servicing a snap!

Your operators will appreciate SuperBrain's good looks and you'll appreciate SuperBrain's outstanding value. Because as your processing needs become more sophisticated, you can add auxiliary hard disk storage...up to 96 megabytes.

Truly incredible performance. All in a single, smart looking, self-contained desktop unit. And, all for a price that's substantially less than the competition.



## COMPUSTAR™ MULTI-USER TERMINAL SYSTEM

At last, there's a multi-user microcomputer system designed and built the way it ought to be. No more ugly, bulky boxes and those endless miles and miles of entangled cabling. With the CompuStar, there is only one box - the unit itself. Complete with screen, keyboard, dual drive system and multi-user connectors. And what a beautiful addition it makes to any environment. The sleek, desk-top enclosure houses all the computer power you'll ever need and allows for the convenient connection of up to 15 additional users, a printer, a modem and a hard-disk drive system - all via a single, user-accessible rear panel. Now that's truly amazing, isn't it?

But the real beauty of the CompuStar is its "shared logic" design concept. Each user station contains its own distinct microprocessor and RAM. The result is lightning fast program execution. Even when all 16 users are on-line. Even when all are performing different tasks! A special multiplexer circuit in the CompuStar ties all external users together to "share" the system's disk resources so that no single user ever need wait on another. An incredibly exciting concept!

A remarkable breakthrough in price/performance, the CompuStar boasts nearly 1 megabyte of online mini-disk storage (almost 2 megabytes on CompuStar II) and can be easily expanded to 20, 36 or 96 megabytes of hard-disk in just seconds. And since each user station can accommodate up to 64K of RAM, a total of over one million bytes can be incorporated into the system to tackle even your most difficult programming tasks.

CompuStar user stations can be configured in a countless number of ways. A series of three intelligent-type terminals are offered. Each is a perfect cosmetic and electrical match to the system. The CompuStar 10 - a 32K programmable RAM-based terminal (expandable to 64K) is just right if your requirement is a data entry or inquiry/response application.

And, if your terminal needs are more sophisticated, select either our CompuStar 20 or CompuStar 40 as user stations. Both units offer dual disk storage in addition to the disk system in the CompuStar. The Model 20 features 32K of RAM (expandable to 64K) and 350K of disk storage. The Model 40 comes equipped with 64K of RAM and over 700K of disk storage. But, most importantly, no matter what your investment in hardware, the possibility of obsolescence or incompatibility is completely eliminated since user stations can be configured in any fashion you like whenever you want - at amazingly low cost!

Software costs are low, too. CompuStar's Disk Operating System is the industry standard CP/M. And, an impressive array of application software is readily available to run on this system. Some powerful programming languages are available, too. Basic, Fortran and Cobol. As well as several specialised communication packages. All in all, the CompuStar handles just about all of your data processing needs at only a fraction of the cost of comparable systems.

## DISK STORAGE

### Options for the Superbrain and CompuStar Video Terminal

#### Three Specially-Designed Models

Now there's a sound and simple solution to your disk storage needs. Intertec has devised three "small" solutions to what used to be a big problem for intelligent terminal and microcomputer users. How did we do it? Easy. In just seconds, a Century Data Systems "Marksman" Winchester drive or a Control Data Corporation Cartridge Module Drive (CMD) can be interfaced via a single connector on either our CompuStar Multi-User Terminal System or the SuperBrain Video Computer. And we've taken all the guess-work out of the interface. Our uniquely designed disk controller/interface is "pre-installed" at the factory in preparation for quick and easy connection to your Intertec system. Just plug the drive into the nearest power source and plug your Intertec system into the drive. Really! It's that simple! All of the interfacing software has already been written. So you can be up and running...with up to 96 megabytes of super powerful hard disk storage...in just seconds.

"Backup" for the 20 megabyte Century Data drive is provided via the dual disk system housed in the CompuStar or the SuperBrain. The Control Data CMD Drive features a removable, front-insertable top loading cartridge of 16 megabyte capacity plus a fixed disk capacity of either 16 or 80 megabytes.

Each drive is shipped equipped with an EIA standard 19" rack mounting system and heavy duty chassis slide mechanisms to permit easy accessibility for fast and efficient servicing.

Whether your choice is the Winchester type drive or the CDC CMD, you'll appreciate their ease of installation and inherent reliability. And, the wide variety of field maintenance programs available on each model will help you maintain your system and protect your original investment for many years.

\*\*\*\* WIDELY USED IN UK AND USE \*\*\*\*  
\*\*\*\* TESTED AND PROVEN \*\*\*\*  
\*\*\*\* POWER AT YOUR FINGERTIPS \*\*\*\*  
\*\*\*\* JUST COMPARE THIS LIST \*\*\*\*

- ◆◆ ROBUST SET OF PROGRAMS WITH ERROR TRAPS COVERING PET DOS RENAME MALFUNCTIONS, CASUAL USER ERROR, DISK FAILURES, PET DOS MISMANAGEMENT BLOCK ALLOCATIONS, DISK FAILURES, FAST SINGLE KEY STROKE ENTRIES, CONTROLLED INPUT WITH VISIBLE LINE LENGTH, AND DATE VERIFICATIONS PREVENTING ERRONEOUS DATE ENTRY.
- ◆◆ COMPREHENSIVE DATABASE MANAGEMENT SYSTEM INCLUDES
  - \*\*\*\* FILE CREATE / DELETE / SEARCH
  - \*\*\*\* RECORD CREATE / DELETE / SEARCH / AMEND / PRINT 4WAYS
  - \*\*\*\* RECORD SORT BY ANY FIELD BOTH ALPHA OR NUMERIC
  - \*\*\*\* RECORD INDEX, FIELD, & FIELD ELEMENT SEARCH (EG NO, TOWN OR SURNAME)
  - \*\*\*\* FOUR ARITHMETIC FUNCTIONS TO USE AS CALCULATOR ON LAST FOUR FIELDS
  - \*\*\*\* AUTO CHECK TO PREVENT DOUBLE ENTRY WITH FILE MANAGEMENT SYSTEM DYNAMICALLY ALLOCATING INFORMATION FOR MINIMUM DISK SPACE CONSUMPTION.
- ◆◆ AUTO INVOICE NUMBERING (WITH OVERRIDE OPTION), PLUS AUTO PRINTOUT INTEGRATED WITH ADDRESS AND STOCK FILES FOR PAYMENT TERM DISCOUNT, AGENT ALLOCATION, PRICE INDEX RETRIEVAL AND AUTO STOCK UPDATE. NOMINAL CODES RETRIEVED FROM ADDRESS FILES MAY BE OPTIONALLY OVERRIDDEN.
- ◆◆ POWERFUL ALTERNATIVE DOUBLE ENTRY SYSTEM (GENERAL AND OPEN ITEM) INCLUDING NOMINAL CODES PROVIDING A BUREAU TYPE FACILITY FOR TRACKING MONTHLY TRADING FIGURES AND TAX ACCRUALS.
- ◆◆ CURRENTLY USING 16 SALE AND 16 PURCHASE COMMODITY CODES WHICH ARE AUTOMATICALLY WRITTEN INTO LEDGERS FROM ADDRESS FILES (INCLUDES OVERRIDE OPTION)
- ◆◆ AUTOMATIC TRIPLE POSTING OF SALES / PURCHASES TO INVOICE & GENERAL & OPEN ITEM LEDGERS WITH COMPLETE AUDIT TRAIL TO INCLUDE ACCOUNT VERIFICATION OF PAYMENTS IN / OUT, SO THAT DISCREPANCIES ARE RE-ALLOCATED TO OUTSTANDING ACCOUNTS, OR OPTIONALLY WRITTEN OFF AS DISCOUNTS TO THE CASH BOOK. THIS FACILITATES PART PAYMENTS.
- ◆◆ FINAL LIQUIDITY STRIKES A COMPLETE AUDIT TRAIL BALANCE WITH CREDITORS AND DEBTORS O/S AMOUNTS, BANK BALANCES, STOCK MOVEMENTS, AND REMAINING STOCK VALUE TO GIVE PROFITABILITY OF COMPANY IN BOTH FINANCIAL AND STOCK ASSET TERMS.
- ◆◆ POWERFUL ACCOUNT TRACKING FACILITIES INCLUDE AUTO STATEMENT PRODUCTION FOR ALL ACCOUNTS EXCLUDING NIL BALANCES, WITH DATE COMPARISON ANALYSIS TO 'CURRENT' '30 DAYS' '60 DAYS' '90 DAYS' AND APPROPRIATE MESSAGES WHEN A DATE BLOCK HAS AN INCLUSION.
- ◆◆ COMPLETE SEARCH / CREATE / AMEND / DELETE / SORT / FACILITIES ON ANY SIGNIFICANT LEDGER HEADING AGAINST EITHER OPEN OR GENERAL LEDGER IN DATE / INVOICE / ACCOUNT / AGENT / NOMINAL CODE / HEADINGS. FOR FULL INFORMATION RETRIEVAL SUCH AS A SHORTLIST OF OVERDUE ACCOUNT FOR A SPECIFIED MONTH, ACCOUNT LEDGER CARD RETRIEVAL, NOMINAL ANALYSIS ETC.
- ◆◆ FAST INPUT ECHO FUNCTION TO ENABLE REDUCTION OF KEYSTROKES ON REPETITIVE DATA, PLUS PRINT AUDIT TRAIL OF ANY FILE CHANGES.

- ◆◆ NO - - - special printed stationery needed so 100 INVOICES COST YOU A FRACTION OF A PENNY EACH, AND THEY ARE FORMATTED PRECISELY TO FIT IN A STANDARD RYMAN WINDOW ENVELOPE FOR CONVENIENT POSTING. TRACKING PROGRAM ENABLING PRINTING OF PAST INVOICES - RECALL ON SCREEN. PLUS MONITOR OF SPECIFIED SALES - PURCHASES OF COMMODITIES BY CODE.
- ◆◆ MONTHLY QUARTERLY TAX CALCULATIONS PLUS STANDARD MAILING TICKET PRINT FACILITIES.
- ◆◆ ADD-ON OPTION OF AUTO STOCK MOVEMENT REPORT AND UPDATE QUANTITY ON HAND PLUS VALUATION OF RESIDUE AS RESULT OF PURCHASES AND SALES.
- ◆◆ ADD-ON OPTION OF AUTO BANK UPDATE FROM RECEIVABLES AND PAYABLES AGAINST LEDGERS
- ◆◆ PET STORES UP TO 2200 ADDRESSES OR UP TO 4000 SIMPLE LEDGER RECORDS ON ONE DISKETTE WITH 160K OF USER MENU CALLABLE PROGRAMS FROM OTHER DISK. - - - ONLY ONE PROGRAM DISK - - - AND THE HARD CORE PROGRAMS CAN'T BE BUSTED.
- ◆◆ SUBSTANTIAL USER GROUP IN UK AND ABROAD WITH ALL POSITIVE FEEDBACK IMPLEMENTED EVERY 3/4 WEEKS AND RE-DISTRIBUTED FREE OF CHARGE EXCEPT COST OF DISK AND MAILING 50 TO 70 POUNDS P.A.I. SO YOU BECOME PART OF A COMMONWEALTH OF USERS WORKING WITH AN IDENTITY OF INTERESTS.
- ◆◆ THIS MUST BE SURELY THE MOST COMPREHENSIVE, COMPACT, PROVEN, AND COST-EFFECTIVE ONGOING PACKAGE ON THE MARKETPLACE AT THIS POINT IN TIME.
- ◆◆ TOTAL PRICE VERSION 3 475 POUNDS. ADD-ON STOCK OPTION 100 POUNDS. ADD ON BANK OPTION. 100 POUNDS. REMAINING PROGRAMS 19,20,22,23 JOINTLY 100 POUNDS.
- ◆◆ THINK OF JUST KEYING IN 100 INVOICES, 30 CHECKS? (PROVIDED YOU LEFT YOUR PRINTER ON WITH PAPER IN) YOU COULD LEAVE OUR PROGRAMS TO DO ALL THE SECRETARIAL POSTING AUTOMATICALLY, AFTER WHICH YOU MAY SET IN MOTION THE AUTO STATEMENT RUN, THEN YOU CAN SIMPLY POST OUT ALL PAPERWORK WITH STATEMENTS AGE ANALYSED WITH APPROPRIATE COMMENTS
- ◆◆ CP/M VERSION SPECIAL NOTE \*\*\* WRITTEN ON THE NEW SUPERBRAIN PROCESSOR WITH THREE HIGHER LEVELS OF OPERATION:
  - \*\*\*\* 1 - ALL FILES ARE FULLY RANDOM ACCESS SO RETRIEVAL OF ANY RECORD IN THE SYSTEM TAKES NO LONGER THAN SEVERAL SECONDS FOLLOWED IMMEDIATELY WITH THE OPTION TO AMEND PRINT DELETE QUIT OR CARRY ON SEARCHING THROUGH ANY FIELD.
  - \*\*\*\* 2 - ENTIRE FORMER SET OF PET PROGRAMS ARE NOW JUST ONE PROGRAM RESIDENT IN CORE. ONCE INVOKED FROM DISK UNDER MBASIC1 THE USER MAY INSERT TWO EMPTY DATA DISKS IN BOTH DRIVES OF THE SYSTEM ENABLING A HIGHER MAGNITUDE OF DISK SPACE FOR MORE DATA STORAGE. (STANDARD SUPERBRAIN TWIN DRIVES CAN STORE 3200 STOCK ITEMS OR 4600 LEDGER RECORDS. 160K SUPERBRAINS CAN STORE 7000 NAMES AND ADDRESSES OR 900 STOCK ITEMS OR 12000 LEDGER RECORDS \* ALL INSTANTLY RETRIEVABLE! NEW 20 MEGABYTE HARD DISK STORAGE CAN HANDLE 40000 NAMES AND ADDRESSES OR 80000 LEDGER ENTRIES.
  - \*\*\*\* 3 - FULLY TRANSLATABLE PROGRAM WITH RESIDENT VOCABULARY WHICH MAY BE TRANSLATED INTO ANY FOREIGN LANGUAGE IN A MATTER OF HOURS.

WE EXPORT TO ALL COUNTRIES CALLERS ONLY BY APPOINTMENT  
CONTACT TONY WINTER ON 01.636.8210  
89 BEDFORD COURT MANSIONS, BEDFORD AVENUE, LONDON W.C.1.

NOTE!!! ALL VERSIONS, ESPECIALLY 9.00 USE BROAD FINANCIAL PRINCIPLES AND % .00 IS ONE 16K CORE PROGRAM  
RELEASING BOTH DISK DRIVES FOR DATA STORAGE, AS WELL AS BEING TRANSLATEABLE INTO ANY FOREIGN LANGUAGE

**\*\*\* MAIN MENU DISPLAY \*\*\***

NEW! PRODUCED IN U.K. AND WIDELY USED IN ENGLAND AND U.S.A.  
COMPLETE BUSINESS PACKAGE

INCLUDES EVERYTHING FROM INVENTORY TO SALES SUMMARY PROMPTS USER AND VALIDATES ENTRIES. MENU DRIVEN

BUS VER 3.00 TO VER 9.00 PET AND CP/M  
APPROXIMATELY 60-100 ENTRIES/INPUTS REQUIRE 2-4 HOURS WEEKLY  
AND ENTIRE BUSINESS IS UNDER CONTROL

\* PROGRAMS ARE INTEGRATED. . . SELECT FUNCTION BY NUMBER. . . . .

- |                               |                                  |
|-------------------------------|----------------------------------|
| 01 = *ENTER NAMES & ADDRESSES | 13 = *PRINT CUSTOMERS STATEMENTS |
| 02 = *ENTER/PRINT INVOICES    | 14 = *PRINT SUPPLIER STATEMENTS  |
| 03 = *ENTER PURCHASES         | 15 = *PRINT AGENT STATEMENTS     |
| 04 = *ENTER A'C RECEIVABLES   | 16 = *PRINT TAX STATEMENTS       |
| 05 = *ENTER A'C PAYABLES      | 17 = GENERAL HELP                |
| 06 = *ENTER 'UPDATE INVENTORY | 18 = ALTER VOCABULARIES          |
| 07 = ENTER 'UPDATE ORDERS     | 19 = PRINT YEAR AUDIT            |
| 08 = *ENTER 'UPDATE BANKS     | 20 = PRINT PROFIT 'LOSS A'C      |
| 09 = *REPORT SALES LEDGER     | 21 = ENDMONTH MAINTAINANCE       |
| 10 = *REPORT PURCHASE LEDGER  | 22 = PRINT CASHFLOW FORECAST     |
| 11 = *INCOMPLETE RECORDS      | 23 = ENTER PAYROLL (NO RELEASE)  |
| 12 = *EXAMINE PRODUCT SALES   | 24 = EXIT SYSTEM                 |

ENTER WHICH ONE?

**DATABASE MANAGEMENT INCLUDES**

\*\*\* FILE CREATE'DELETE'SEARCH. \*\*\* RECORD CREATE'DELETE'SEARCH'4 OPTION PRINT.  
\*\*\* RECORD SORT ANY FIELD ALPHA OR NUMERIC. \*\*\* INDEX SEARCH OR GENERAL SCAN'PRINT IN ANY FIELD  
(EG TOWN OR NAME). \*\*\* 4 ARITHMETIC FUNCTIONS TO USE AS CALCULATOR ON LAST 4-FIELDS. \*\*\* AUTO CHECK  
TO PREVENT DOUBLE ENTRY TO FILE MANAGEMENT SYSTEM, DYNAMICALLY ALLOCATING INFORMATION TO MINIMISE  
DISK SPACE CONSUMPTION.

VERY FLEXIBLE. EASY TO USE

G.W. COMPUTERS U.K. ARE THE PRODUCERS OF THIS BEAUTIFUL PACKAGE

VER 3.00 (EXC PROG 19,20,22,23) = 475.00, VER 4.00 INCLUDES AUTO STOCK-UPDATE = 575.00,  
VER 5.00 INCLUDES AUTO BANK UPDATE = 675.00, VER 6.00 IN CORE = 775.00, VER 7.00 (INC 19,20,22,23)  
NOT YET RELEASED = 875.00, VER 8.00 RANDOM ACCESS = 900.00, VER 9.00 TRANSLATEABLE = 975.00.  
+ + + EACH LEVEL OVERRIDES LOWER ONE

**IMPORTANT!!!**

WE ALSO SELL THE HARDWARE FOR THE ABOVE TASKS TO ENABLE THE PURCHASE FROM ONE SOURCE.  
NOTE THAT A \*\*\* COMPLETE \*\*\* CBM SYSTEM WITH BUS VER 3 IS 2215 POUNDS AND A \*\*\* COMPLETE \*\*\* SUPERBRAIN  
SYSTEM WITH BUS VER 3 AND DEC PRINTER IS 3345 POUNDS.

PET + PET + PET + PET + PET	SOFTWARE	+	SOFTWARE	SUPERBRAIN	+	SUPERBRAIN
CBM 3032 32K 650.00	BUS VER 3.00 475.00		475.00	SUPERGRAIN 320K		1795.00
CBM 3040 DISKS 650.00	BUS VER 4.00 575.00		575.00	TWIN Z80 64K + CRT		
CBM 3022 PRINTER 425.00	BUS VER 5.00 675.00		675.00	+ 2 D'D - S'S DRIVE		
CBM 8032 32K 875.00	BUS VER 6.00 775.00		775.00	SUPERBRAIN 800K		2500.00
CBM 8050 1MEG DISKS 875.00	BUS VER 7.00 875.00		875.00	TWIN Z80 64K + CRT		
CBM EPSON PRINTER 395.00	BUS VER 8.00 900.00		900.00	+ 2 D'D - D'S DRIVE		
CBM MULTI USER 650.00	BUS VER 9.00 975.00		975.00	M'USER S'BRAIN		3950.00
CBM 3032 + EPSON +	CBM WORDPRO II 75.00		75.00	LINKS UP TO 16		
CBM 3040 + BUS V3 2215.00	CBM WORDPRO III 150.00		150.00	SUPERBRAINS ON		
	CPM WORD-STAR 250.00		250.00	MULTI TASKING		
PRINTERS + PRINTERS + PRINTERS	CPM MBASIC 80 150.00		150.00	COMPUSTAR		
DIABLO 1650 40CPS 2150.00	CPM COBOL 80 320.00		320.00	20 MEG ADD-ON		5250.00
DOLPHIN 125CPS BD80 495.00	CPM PASCAL MT 150.00		150.00	S'BRAIN HARD DSK		
OKIDATA MICROLINE 575.00	CPM FORTRAN 80 200.00		200.00	INTERTUBE III		450.00
PAPER TIGER 195CPS 575.00	CPM DATASTAR 175.00		175.00	EMULATOR TERM'L		495.00
TELETYPE 43SR 30CPS 875.00	CPM PASCAL-M 250.00		250.00	NEW MULTI TERM'L		
DEC-LA34 TRACT 30CP 875.00	CPM BYSTAM S'BRAIN 75.00		75.00	EMULATES FOUR		
NEC-SPINWRITER 1595.00	CPM SUPERSORT 120.00		120.00	TERMINALS BY		
QUME DAISY SPRINT5 1950.00	CPM BASIC COMPILER 190.00		190.00	SPECIAL FUNCTION		
TEXAS 810 150CPS 1390.00	CPM DESPOOL 30.00		30.00			
	CPM BYSTAM IMS'N-STAR 75.00		75.00	TANDY MODEL II 1950.00		
SPECIALS + SPECIALS + SPECIALS	CPM TEXTWRITER 75.00		75.00	APPLE II 16K 675.00		
N'STAR QUAD. 7MEG 1500.00	CPM POSTMASTER 75.00		75.00	COMPUCOLOR 32K 1750.00		
IMS 5000 48K D'D 1500.00	CPM SELECTOR 3 180.00		180.00	IEEE TO RS232 150.00		
COMPUTHINK * 800K * 795.00	CPM CBASIC 75.00		75.00	IEEE TO PARALLEL 160.00		
2 WAY CRDLESS PHONE 195.00	CPM MACRO 80 75.00		75.00	IEEE'RS232 BI'DI 195.00		
TELEPHONE ANSWER 230.00	CPM W'STAR M'MERGE 310.00		310.00	IEEE MODEM 295.00		
1 WAY CRDLESS PHONE 80.00				CAT MODEM 135.00		
				WARRANTY		
				90 DAY FREE REPLACEMENT		

+ + + + + SPECIAL INSTITUTION AND UNIVERSITY DISCOUNTS + + + + +  
STOCK AND COMING ROUND. (BARCLAYCARD WELCOME OTHERWISE CHEQUE WITH ORDER)  
CONTACT TONY WINTER 01.636.8210  
89 BEDFORD CT MANS, BEDFORD AVE W.C.1.

# Letter<sup>S</sup> from America

**A** is for Apple II and III – we sell them both **from £695**

**B** is for Bismark – the game that puts your Apple in the North Atlantic with you in command **only £45**

**C** is for columns – 80 in all – the new Videoterm card turns your Apple into a true computer screen **only £225**

**D** is for Disk Drives – bigger and better storage for your Apple – from 256K to 10Mb. **from £900**

**E** is for Eighty Eight T – the low cost full function printer which not only works – it's quiet and looks good **only £395**

**F** is for Flight Simulator – take off for the wide blue yonder with your Apple as the plane! **only £15**

**G** is for Graphics – superb and in 3D **only £75**

**H** is for Hawaii – where we'll be on holiday if only you'd buy some!

## The Computer Shop

Computers for Science, Business and Education.

54 High Street, Banbury, Oxon. 40 Prospect Street, Caversham, Reading, Berks. 25 Havelock Street, Swindon, Wilts.  
Telephone: Banbury (0295) 3477 Telephone: Reading (0734) 481555 Telephone: Swindon (0793) 694061

• Circle No. 108

## RESEARCH RESOURCES LTD.

Microcomputers for Education, Science and Technology

### MULTI-USER 128K GIMIX 6809 COMPUTER

- Robust, reliable S50 Mainframe, 16/8-bit processor.
- INTEGRAL Twin mini-floppy disk drives – 340K.
- Fast 2MHz RAM Boards, switch selectable.
- Wide range of software – fully compatible with SWTP/FLEX.
- PASCAL, Scientific BASIC Interpreter/Compiler, multi user BASIC Pilot, Editor, Assembler, Debug, Text processor etc.
- Exclusive to RRL – LAB-BASIC, SAM (Statistical Analysis for Microcomputers), A to D, D to A converters.
- SPECIAL terms for SWTP users wishing to upgrade to GIMIX.

●● RRL Specialises in designing microcomputing systems for educational and scientific use. We will supply the complete system – processor, VDU, printer, special interfaces, software etc – to solve your problem.

●● For further information please contact our offices and showrooms at:  
**RESEARCH RESOURCES LTD, 40 Stonehills, Welwyn Garden City, Herts AL86PD. Tel. (07073) 26633**



#### SOFTWARE and HARDWARE for EXPERIMENTS and CONTROL

Big disk drives are expensive? RRL has developed a software package (POLYFLEX) which enables numerous linked micro-processors to TIMESHARE a 16 or 2.5 Megabyte disk system. Another RRL exclusive (LAB-BASIC) enables each user to run control programs; all software is available on both 6800 and 6809 systems.

• Circle No. 109

PO Box 2  
St Neots  
Cambridgeshire

Dear Sir

**The benefits of word processing are here for all!**

The **Comart VDM** Video Display Module plugs easily into the North Star Horizon Computer S100 Bus and, together with the Comart Monitor and VDM \*Star word processing software, provides the facilities of "instant display" word processing on a general purpose microcomputer.

Text may be entered, edited and standard paragraphs inserted with true upper & lower case display then rapidly printed in your chosen format.

The VDM transforms the Horizon into a valuable word processor yet change the diskette software and it resumes its role as a general-purpose Computer . . . . **Real Flexibility!**

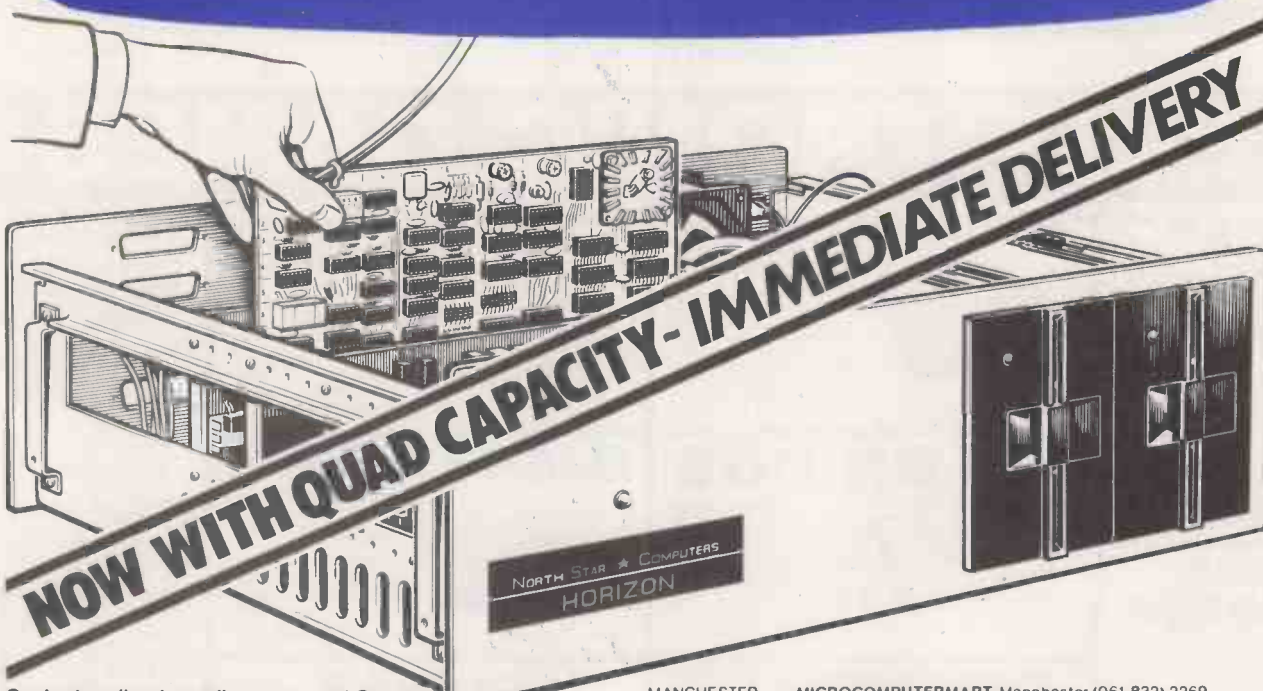

Contact us direct or call your nearest Comart dealer

CAMBRIDGE  
CAMBERLEY  
ILFORD

**CAMBRIDGE COMPUTER STORE**, Cambridge (0223) 68155  
**MICROBITS**, Camberley, Surrey (0276) 34044  
**THE BYTE SHOP**, Ilford, Essex 01-554 2177

LEEDS

also at Tottenham Court Road, London 01-636 0647

**HOLDENE LIMITED**, Leeds (0532) 459459

also at Wilmslow, Cheshire (0625) 529486

LONDON  
LUTON

**DIGITUS LIMITED**, London W1 01-636 0105

**ISHERWOODS**, Luton, Bedfordshire (0582) 424851

MANCHESTER

**MICROCOMPUTERMART**, Manchester (061-832) 2269

also at West Park, Leeds (0532) 788466

NEWBURY

**NEWBEAR COMPUTING STORE**, Newbury, Berks (0635) 30505

also at Stockport, Cheshire (061-491) 2290

NEWPORT  
NOTTINGHAM

**MICROMEDIA SYSTEMS**, Newport, Gwent (0633) 50528

**COMPUTERLAND LIMITED**, Nottingham (0602) 40576

also at Birmingham (021-622) 7149

Manchester 061-236 4737

Glasgow (041 332) 2468

SHEFFIELD  
SOUTHAMPTON

**HALLAM COMPUTER SYSTEMS**, Sheffield (0742) 663125

**XITAN SYSTEMS LIMITED**, Southampton (0703) 38740



**comart specialists in microcomputers**

Comart Ltd., P.O. Box 2, St. Neots, Huntingdon, Cambs, PE19 2AF. Tel: (0480) 215005 Telex: 32514

• Circle No. 110

## MICROCOMPUTER SHOPPING MADE SIMPLE

The Slough Microshop is the Thames Valley Specialist in microcomputer systems — for business, professional or personal use. Our services include:

- \* TAILORMADE OR PACKAGED SOFTWARE
- \* COMPLETE HARDWARE MAINTENANCE SERVICE
- \* FULL DEMONSTRATION EQUIPMENT

We are the officially approved stocklist for  
**COMMODORE PET**  
**EXIDY SORCERER**  
**NORTH STAR HORIZON**  
**APPLE II**  
**IMS 5000/8000**  
**EQUINOX 300**

Ask for a demonstration. Phone or call into the Slough Microshop showroom — where microcomputer shopping is made simple.

## THE SLOUGH MICROSHOP

120 High Street Slough Berkshire  
 Telephone: Slough 72470 or 22855

• Circle No. 111

# Master Your Micro FAST with...

Little Genius floppy diskette based courses will teach you, how to use your system and how to realise the full potential of the "Mighty Micro". These fully interactive computer lessons will guide you quickly to a high level of understanding and confidence in your ability to make the most of your microcomputer system.

Courses now available:

- Applesoft BASIC
- Advanced Applesoft BASIC
- Using your Apple
- Palsoft BASIC
- Advanced Palsoft BASIC
- Using your 2020
- PET BASIC
- Advanced PET BASIC



## Little Genius

Each course, comprising a floppy diskette, and starting instructions, costs only £40.00 plus VAT.

SPECIAL "3 in one" OFFER for 3 courses covering the same system only £99.00 plus VAT.

Little Genius courses are available from most computer retail outlets, or direct mail order from:

### LITTLE GENIUS

Suite 504, Albany House, 324 Regent Street, London W1R 5AA.  
 Telephone: 01-580 6361

• Circle No. 112

# ELECTRONIC GAMES

## ATARI



SPECIAL PRICE  
**£86 + VAT**

## INTELLIVISION MATTEL



£173.87 + VAT

Available August 1980  
 This is the most advanced TV game in the world. Expandable next year into a full microcomputer. COLOUR CATALOGUE AVAILABLE WITH DETAILS ON ALL THE CARTRIDGES

## CHESS



Send for further details.

### COMPUTERS

NEW RANGE AVAILABLE AUGUST 1980  
 We specialise in computer chess machines & stock over 13 different models from £20 to £300

## BRIDGE



### COMPUTER

- ★ Plays 1/2/3 or 4 Hands
- ★ Problem Mode
- ★ Audio Feedback
- ★ Instant Response
- ★ Auto scorekeeping

## BACKGAMMON



### COMPUTERS

OMAR 1  
 OMAR 2  
 CHALLENGER  
 GAMMONMASTER

From £38 to £108. Send for further details.

## TELETEXT



RADOFIN  
 TELETEXT  
 Add on Adaptor

£199 + VAT

## SPACE INVADERS



HAND HELDS + CARTRIDGES  
 ATARI ACETRONIC  
 PRINZTRONIC  
 RADOFIN - DATABASE etc.

We keep a full range!  
 Send for cartridge lists stating which machine you own.

## DRAUGHTS

### COMPUTER



- ★ Solves Problems
- ★ Rejects illegal moves
- 2 level machine £43 + VAT
- 4 level machine £77.78 + VAT

## LEISURE

- ★ CHEAP TV GAMES
- ★ TELEPHONE ANSWERING MACHINES
- ★ AUTO DIALLERS
- ★ CALCULATORS
- ★ DIGITAL WATCHES
- ★ PRESTEL
- ★ HAND HELD GAMES

## 27 TUNE DOOR BELL

£17.13 + VAT



## FREE CATALOGUE

For a free copy of our 32 page catalogue, send a 12p stamp to Silica Shop Ltd or Telephone 01-301 1111

MAIL ORDER SERVICE — Free postage & Packing

TELEPHONE & MAIL ORDERS - accepted on:  
 Access ★ Barclaycard ★ American Express ★ Diners Club

CALLERS WELCOME — at our shop in Welling — Demonstrations daily  
 Open from 9am-5pm Mon-Sat (9am-1pm Wed)

GUARANTEE — Full 12 months + After Sales Support!

We have comprehensive brochures on all products. Please let us know what you are interested in and we will send you detailed brochures AND our own 32 page catalogue covering most games on the market.

## SILICA SHOP

SILICA SHOP LTD., Dept. PC 8  
 102 Bellegrove Road  
 Welling, Kent DA16 3QF  
 Tel: 01-301 1111

• Circle No. 113



# Solve your Business Energy Crisis

with a

## Z-Plus Microcomputer System

A state of the Art Microcomputer System. The first Multi-user Microcomputer to employ separate memory and CPU for each user.

The Modular design means you can upgrade the single user Z-plus Micro computer adding hard disk and additional Terminals as required.

Price: 1 Megabyte **£3950**,  
2 Megabyte **£4450** plus VAT

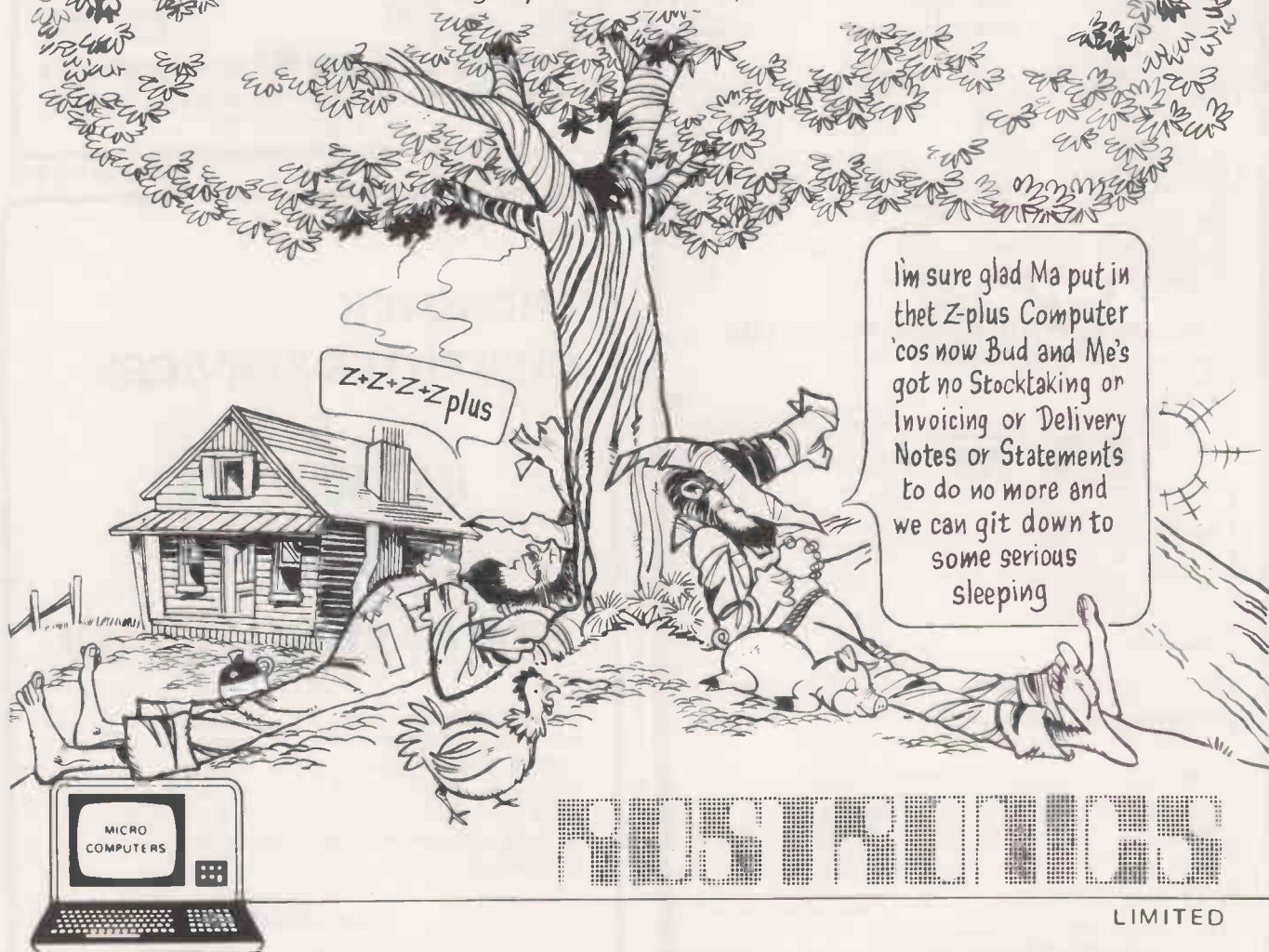

# ROSTRONICS

LIMITED

The Z System is marketed throughout the U.K. & Europe and is available through a number of selected dealers.

115-117 WANDSWORTH HIGH STREET, LONDON SW18 4HY  
Telephone: 01-874 1171 Telex: 8813089 INTPRM G

• Circle No. 114

**MAIL ORDER  
from Intex**

**SERVICE  
FOR YOU!**

MAIL ORDER DEPARTMENT.  
CASH WITH ORDER ONLY  
OFFICIAL ORDERS ACCEPTED  
FROM SCHOOLS, COLLEGES AND  
GOVERNMENT OFFICES  
ALL GOODS DESPATCHED BY RETURN  
OF POST

OR YOU WILL BE NOTIFIED OF ANY DELAY  
AND OFFERED AN ALTERNATIVE OR THE  
RETURN OF YOUR MONEY.

PET		DEMAGNETISERS	
2001-8	495.00	CURVED HEAD(MAINS)	3.50
3016	875.00	CASSETTE (BATTERY)	12.00
3032	795.00		
C2N CASSETTE DECK	55.00	WORKBOOKS	
IEEE TO IEEE LEAD	25.00	TIS WORKBOOKS (NO VAT)	
P/ET TO IEEE LEAD	20.00	SET OF 6	18.00
3040 DISK	795.00		
COMPUTHINK 400K FOR		CONNECTORS	
8K VIA EXP/PET	825.00	PET USER/IEEE PORT	1.25
FOR 16/32K	895.00	PET 2ND CASS PORT	.95
800K UNIT	1145.00	COVERS FOR USER/IEEE	
24K EXPANDAPET	320.00	PORT CONNECTOR	2.50
		D52 RS232 CONNECTORS	
		MALE/FEMALE	3.25
		COVERS	2.50
INTERFACES			
SMALL SYS SERIAL C	120.00	KIM	
SERIAL B BI-DIR	185.00	KIM 1	99.95
TNW2000 BI-DIR	145.00	KIM 3B	99.95
ALL IEEE/RS232		KIM 4	69.95
PETSET 1 A/D	165.00		
STOCKISTS OF PETSOFT &		NASCOM	
APPLESOFT PACKAGES.		NASCOM 1 (KIT)	125.00
COMMODORE SOFTWARE		NASCOM 1 (BUILT)	140.00
		NASCOM 2 (KIT)	295.00
PAPER		POWER SUPPLY (KIT)	29.50
TCM100 ROLLS	2.50		
ANADEX/PET 80 COL	...x..**	SEND FOR OUR FULL	
TELETYPE 132 COL	15.00	SOFTWARE & MAIL ORDER	
CASSETTES		PRICE LIST -	
C15 HIGHGRADE CASS IN		CUST COVERS	
CASES PER 10	4.00	PET (ALL MODELS)	5.75
		PET 3040	3.50
DISKETTES		COMPUTHINK DISK	3.00
PET/APPLE D/DENS		ANADEX DP8000	3.50
PER 10 IN LIB. CASE	30.00	T/T 43 PRINTER	5.75
BASF D/S D/D			
PER 10 IN CASE	35.00		

ALL PRICES ARE EX.VAT.  
PLEASE ADD 75P P&P ON SMALL ITEMS  
2.50 ON LARGER ITEMS



Don't delay  
SEND  
NOW!



Name \_\_\_\_\_

Address \_\_\_\_\_  
\_\_\_\_\_ PC

Please send me \_\_\_\_\_ at £ \_\_\_\_\_

for the \_\_\_\_\_ system

Please send me your catalogue  (tick)

Total £ \_\_\_\_\_ Signature \_\_\_\_\_

BARCLAY CARD  ACCESS  CHEQUE  (tick)

Credit Card No. \_\_\_\_\_

INTEX DATALOG LTD., Eaglescliffe Industrial  
Estate, Eaglescliffe, Stockton. Tel. 781193

**Intex**

• Circle No. 115

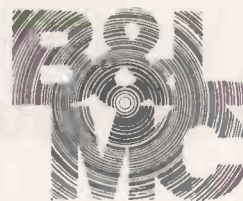

## Micro-Computer Centre for the MIDLANDS

Nascom and Commodore Specialists

A full range of micro computers and peripherals are  
available, whether buying or browsing we can give  
helpful and friendly advice.

Commodore Business Systems are suitable for the  
professional office, the small business or the sole trader.  
We will be pleased to give advice and a demonstration.

Nascom 2 systems can be fully built and tested to  
order. We are sole distributors for the Micro Type case  
for Nascom 1 and 2, also stockists of the William Stuart  
colour graphics and full range of 'add-ons'.



**Business & Leisure Micro Computers**

16 The Square, Kenilworth, Warwickshire CV8 1EB.  
Tel: (0926) 512127

• Circle No. 116

## MICROTEK COMPUTER SERVICES

for

**IMS 5000, 8000**

and

**NORTH STAR HORIZON**

We have many software packages for these  
machines, including Stock Control, Accounting,  
Payroll, Word Processing and Mailing.  
However, if you are fed-up with looking at stan-  
dard packages then why not let us design and  
write a system specially for YOU! If you are  
interested, contact:

John Rothwell  
on  
Orpington 26803 or write  
to 50 CHISLEHURST ROAD,  
ORPINGTON, KENT

• Circle No. 117



**ARE YOU LOOKING FOR A COMPUTER SYSTEM,  
VDU'S, PRINTERS, CONSULTANCY SERVICES,  
APPLICATION SOFTWARE PACKAGES,  
BESPOKE SOFTWARE AND SERVICE?**

**LOOK NO FURTHER**

We specialise in configuring Z-80 based micro-computer systems and software to your requirements.

We can assist you in making the right decision for your computing requirements.

We have many years of experience of Mainframe, Mini and Micro computers from hardware design, applications programming to commercial systems design and implementation and consultancy.

We can also offer hire-purchase and leasing facilities over 3, 4 or 5 years for as little as £23 per month per £1000 plus V.A.T.

**CONTACT US NOW**

*FOR:*

ZILOG; CROMEMCO, NORTH STAR, SORCERER, ELBIT, LEAR SIEGLER, HAZELTINE,  
OKI, DOLPHIN, NEC AND MANY OTHERS.



**34b London Road  
Blackwater Camberley  
Surrey England  
Tel: Camberley (0276) 34044  
Telex: 858893**

*A Division of Crayworth (Computer Services) Ltd.*

• Circle No. 118

# V. & T. ELECTRONICS

## NASCOM 2 microcomputer

**READY BUILT & TESTED £250.00**

Please note that the 8K Basic will not function without expansion RAM

## NASCOM RAM BOARD TYPE 'B'

Holds up to 48K with 16K dynamic RAM ready built & tested

**£150.00**

## 3A POWER SUPPLY **£34.50**

Ready built & tested

## 8A POWER SUPPLY **£105.00**

Ready built & tested

## NASCOM IMP PRINTER **£325.00**

60 lines per minute 80 characters per second

## MEMORY

8 × 4116 200 ns D RAM **£30.00**

1 + 2708 450 ns EPROM **£5.00**

1 × 2516 450 ns EPROM 5V **£12.50**

*PLEASE ADD V.A.T. AT 15%*

**82 CHESTER ROAD,  
LONDON N19 5BZ**

**TELEPHONE 01-263 2643**

• Circle No. 119

**IF . . .** you want the best service  
you need professional advice  
years of experience impress you  
you are trying to find the best computer equipment  
as well as the finest software . . .

## MICROSOLVE

is the Company to contact

We cover a full range of equipment including the **APPLE II** (from £695/16K); the **MICROSTAR** multi-user system (from £4,950) and the powerful **ALPHA MICRO** which will run 1 to 22 terminals — the most cost effective system available today.

WE OFFER A COMPLETE SERVICE which encompasses advice, systems design, sale and installation of computer and peripherals, as well as tailor-made software, where necessary. There are fully documented **ACCOUNTING** and **WORD PROCESSING PACKAGES** etc., for **ACCOUNTANTS, SOLICITORS, MANUFACTURERS, RETAILERS, MEDICAL PRACTITIONERS** in fact all business applications.

ALSO in stock are **PRINTERS, VDUs, CONTINUOUS STATIONERY, DISKETTES, DISK BOXES**, all from the best names in the computer world — **TEXAS, LEAR SEIGLER, TALLY, QUME, PAPER TIGER** etc.

So if you either wish to buy a computer to program yourself or take advantages of our service — **TELEPHONE NOW FOR AN APPOINTMENT.**

**MICROSOLVE COMPUTER SERVICES LTD.**

3rd Flor (rear), **MIDDLESEX HOUSE,**  
29-45 High Street, **EDGWARE, Middlesex.**

01-951 0218/9/0

(exit 4 M1/20 mins. West End). prices ex. VAT.

• Circle No. 120

# 'TUSCAN' FROM TRANSAM

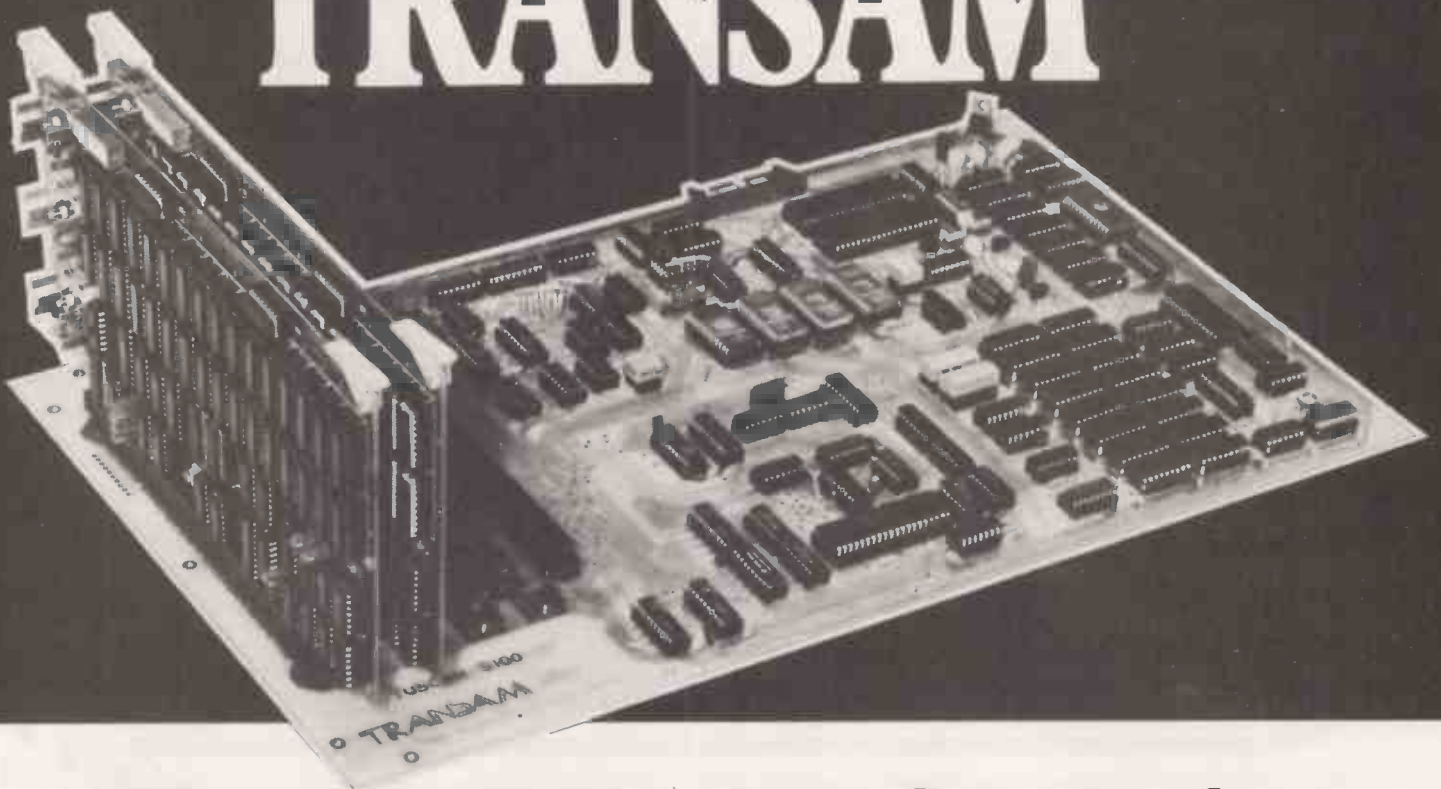

## Take a step up to your next Computer!

### THE CONCEPT

How many ways are there to build an S100 system? Not many, and all expensive. TUSCAN changes all that.

Five S100 boards on one single board — just for starters. Plus five extra slots for future expansion.

What a combination! Z80 and S100 with the TRANSAM total package of system and applications software.

How do we do it? Our prices start at £195 and you can build up in easy stages to a fully CP/M compatible disc based system. Something to think about!

### THE HARDWARE

The first Z80 single board computer with integral S100 expansion. British designed to the new IEEE (8 BIT) S100 specification, the TUSCAN offers total system flexibility. A flexibility available now.

The board holds the equivalent of a Z80 cpu card, 8k ram, 8k rom video and I/O cards with 5 spare S100 expansion slots and offers a price/performance ratio which is hard to beat.

Just compare our price with a commercial S100 ten slot motherboard with this specification.

### THE SOFTWARE

TUSCAN offers the user the choice of system monitor, editor, resident 8k basic, resident Pascal compiler or full CP/M disk operating system. All options are upwards

compatible and fully supported with applications software. Both 5¼" and 8" drives are supported in double density.

### THE PACKAGE

TUSCAN is available in kit form or assembled. With several hardware and software options to suit your requirements and budget. Attractive desk top case also available holds 2 x 5¼" Drives.

# TRANSAM

## NOBODY DOES IT BETTER!

Send to Transam Components Ltd., 12 Chapel Street, London NW1

I am interested in the TUSCAN Z80 based single board computer with S100 expansion and enclose a S.A.E. for further details.

Name \_\_\_\_\_

Address \_\_\_\_\_

Telephone \_\_\_\_\_

PC8

TRANSAM COMPONENTS LTD., 12 CHAPEL STREET, LONDON NW1. TEL: 01-402 8137. TELEX: 444198



**apple computer**  
Sales and Service



## MICROWARE COMPUTERS LTD. OF HULL

**CAN GIVE YOU ALL THE SUPPORT YOU WOULD NEED**

 **COMMODORE PET FROM 8K @ £475**

 **apple II plus FROM 16K @ £695**

**MICROSTAR (MULTI-USER) 64K, FROM £4,950**

**PLUS SOFTWARE FOR ALL THREE  
AND A WIDE RANGE OF PRINTERS FROM £349 to £2,500**

PLEASE CALL US OR SEND DIRECT FOR FULL DETAILS,  
AND REMEMBER WE OFFER A COMPLETE MAIL ORDER SERVICE  
TO ANYWHERE IN THE COUNTRY, OR YOU CAN CALL DIRECT  
AT OUR OFFICE ON HESSLE HIGH ROAD IN HULL.

To **Microware Computers**

**1133 HESSLE HIGH ROAD  
HULL HU4 6SB.  
Tel. (0482) 562107**

NAME .....

ADDRESS .....

.....

.....

Tel: .....

**PLEASE RUSH ME FULL  
DETAILS OF:**

APPLE

PET

MICROSTAR

PLEASE TICK

PC8

**Microware Computers** 1133 HESSLE HIGH ROAD HULL HU4 6SB, Tel. (0482) 562107

• Circle No. 122

## GATE MICROSYSTEMS LIMITED SCOTLAND'S COMPLETE MICROCOMPUTER SERVICE



*Announce:*

### SUP'R'TERMINAL

SUP'R'TERMINAL IS AN 80 COLUMN BY 24 LINE PLUG-IN  
COMPATIBLE BOARD FOR THE APPLE II COMPUTER

#### SPECIFICATIONS

- 80 Columns by 24 lines, upper and lower case; all 128 ASCII characters.
- Upper and Lower case data entry using the APPLE II keyboard.
- Includes an Upper and lower case 5x8 dot matrix ASCII character set, and inverse alpha characters.
- Character set can be user definable
- Includes VBC™ (video balance circuit) which enables the use of displaying 80 columns on an inexpensive 8 MHz CRT monitor
- Shift Lock Feature
- Works with APPLE PASCAL and APPLE BASIC
- Incorporates PASCAL and BASIC control characters
- ALL monitor-type escapes are valid
- Follows protocols of PASCAL and BASIC operating systems
- Compatible with ALL APPLE II peripherals.
- Effective baud rate greater than 10,000; fast scrolling and clearing
- Synchronous operation with APPLE II
- Can be used with APPLE II communication interface board to act as self contained terminal for time-sharing or other applications.

**£245.00**  
Ex VAT.

**GATE MICROSYSTEMS LIMITED**  
**THE NETHERGATE CENTRE, 66 NETHERGATE, DUNDEE**  
**TEL: (0382) 28194**

• Circle No. 123



# TERODEC

## IS READY WITH SYSTEMS

### INTERTEC SUPERBRAIN

More than an intelligent terminal the SuperBrain user gets exceptional computing power at low price.

- 32Kbytes of RAM (expandable to 64K).
- Dual double density mini floppies (320Kbytes).
- Dual 4MHz Z-80 CPU's.
- 80 x 25 High quality 12" display.
- Full ASCII keyboard.
- CP/M operating system.
- Dual synchronous/asynchronous RS232C ports.
- Interfaces to most printers.
- Wide range of standard software (FORTRAN, BASIC, CBASIC-2, COBOL, PASCAL, Sales Ledger, Bought Ledger, Nominal Ledger, Stock Control, IBM 3780/2780/3270 Emulation and more).
- Attractive integral desk top design.

SuperBrain with 64K

£1950.00



### DELTA DPS 64/1

Professional computing system with all the features necessary for the business or scientific user.

- 64Kbytes of 4MHz RAM, operating without wait states.
- Dual double density single sided 8" drives (1 Mbyte).
- Disc storage expandable to four 8" double sided double density drives (4 Mbytes), fixed and cartridge drives.
- CP/M1.4 standard (CP/M2.0 option).
- Expandable to multi-user (CP/M2.0 with MPM).
- RAM expandable to 512KBytes multiuser.
- Large range of standard Compilers, Interpreters, Assemblers and Applications Packages available.
- TV1912 80 x 24 VDU as standard.
- Interfaces to most VDUs and printers.

£3099.00

DPS 64/2 the same spec as DPS 64/1 with 2 Mbytes of disk storage (2 double sided double density drives)

£3404.00



### TERODEC TMZ-80 Range

Microcomputers with unrivalled flexibility to solve your business computing problems.

- Choice of operating systems — CP/M1.4 or CP/M2.0.
- Interfaces to most VDU's, line, dotmatrix, daisywheel printers and modems.
- 64Kbytes of RAM as standard (512Kbytes multiuser).
- Single or multiprocessor.
- 1-4Mbytes floppy disk storage.
- Fixed or cartridge disks.
- 4MHz Z-80 CPU.
- Comprehensive range of compilers interpreters assemblers and applications packages.
- Attractively styled workstation.

TMZ-80-1 1Mbyte 64K with VDU CP/M1.4 and workstation

£3995.00

TMZ-80-2 2Mbyte 64K with VDU CP/M1.4 and workstation

£4295.00

TMZ-80-2 4Mbyte 64K with VDU CP/M1.4 and workstation

£5595.00



TERODEC are the sole U.K. distributor for DELTA PRODUCTS and CENTRAL DATA CORPORATION.

OEM AND Dealer Enquiries Invited

TERODEC (MICROSYSTEMS) LTD  
17 The Gallop, Yateley,  
Camberley, Surrey.  
Tel: (0252) 874790  
(0344) 51160

All information is correct at the time of going to press. Prices exclude VAT and unless stated delivery.

# ALAN PEARMAN LTD

Robust Business Systems at realistic prices, and software rapidly\*\* adaptable to precisely your own needs.

The following Turnkey systems are all complete with easy-on-the-eye green phosphor screen, printer, and 64K RAM, plus Virtual Memory Capability, plus 112 character sets, and all necessary operating software — no hidden extras:

#### MINI SYSTEM:

£3225 + VAT

Two minifloppy disk drives with up to ½ Mbyte of online storage, packaged in an attractive desk-top integral case;

#### STANDARD SYSTEM:

£495 + VAT

Two 8" disk drives with 1 Mbyte of storage — fast access for V.M. — can be optionally mounted unobtrusively in a desk unit to harmonise with your office furniture;

#### SUPER SYSTEM:

£9750 + VAT

10 Megabytes of storage, and a 12Mbyte cartridge tape backup facility. The whole system is the size of a small suitcase, and weighs less than 50lbs!

*\*\*Our systems are all written in APL, quite simply the most concise computer language devised: systems are more flexible, easier to use, and are written around 5 times faster than systems written in conventional languages. From your, the user's, point of view, this results in cheaper software, attuned to your requirements, and the opportunity to be freed from the comprehension barrier between software writers and businessmen with real-life problems.*

APL Software Packages	
MICROFIN — Financial Modelling	£445
MUTABLE — Report Formatter	£195
STAPL — Statistical functions	£635
APLOT — Graphics	£555
XAPL — Communications	£250
APL-ED — Word Processor	£195
APLAN — Financial Planning	£285
Micro-APL Interpreters	
Vanguard Systems APL/V80 (Z80 micros)	£225
Softronics APL (8080, 8085, Z80 micros)	£175
TIS APL (Z80 micros) Superbrain, Cromemco configurations available	£345
PASCAPL (an APL written in PASCAL)	£25

Courses	
Intensive Week-end Courses in APL — send for details.	
Consultancy	
Advice on APL system implementation and customer-defined systems written	
Books	
APL and Insight (£2.25) Starmap (£1.50) Algebra (£4.65) Management Problem-solving with APL (£9.15)	
Structured Programming in APL (£4.95)	
APL — An Interactive Approach (£8.75)	
Course in APL with Applications (£9.30)	
Intro to APL and Computer Programming (£8.25) Elementary Analysis (£3.12)	
APL for Teachers (£0.50) APL for Scientists and Engrs (£0.50) and many others.	
Publications	
APL Implementations on a Z80 micro £2.95	
Self Instruction in APL on a micro £19.99	

For details on any of these areas, telephone  
Chester (0244) 46024/21084  
or write to

A.P. Limited, FREEPOST, Chester CH3 5YZ

• Circle No. 125

## Happy Memories

4116	200ns	£4.50	4116	150ns	£5.50
2114	200ns	£4.75	2114	450ns	£4.25
2708	450ns	£4.95	2716	5 volt	£16.95
21L02	450ns	85p	21L02	250ns	£1.25

VERBATIM mini discs soft sectored —  
with FREE library case £19.95 per ten

## SALE

We're moving shortly to new premises and  
don't want to carry much.  
Bargains from Sat. 26th April

All prices include VAT.  
30p postage on orders below £10.  
Access & Barclaycard.

All orders to:  
Dept. PC

19 Bevois Valley Road,  
Southampton,  
Hants. SO2 0JP  
Tel: (0703) 39267

• Circle No. 126

# ANADEx DP8000 PRINTERS

offered at  
**£350.00**

Due to our changing to 132 character Printers, we are selling used Anadex DP8000 Printers, all less than a year old, for £350.00.

V.A.T. & Delivery extra.

Contact:

FARMPLAN  
NETHERTON  
ROSS-ON-WYE, HEREFORDSHIRE  
Tel: (0989) 4321

• Circle No. 127



# COMPUTECH for **Apple**

# COMPUTECH for **ITT**

Well proven software (several hundred packages already licensed) for business applications on the ITT 2020 and Apple microcomputers.

*Prices excluding V.A.T for cash with order, F.O.B London NW3*

PAYROLL	(300+ Employees, 100 Departments, hourly, weekly, monthly. Very powerful but easy to use).	£375
SALES LEDGER	(500+ Accounts, 100 Departments).	£295
PURCHASES LEDGER	(500+ Accounts, 100 Departments).	£295
GENERAL (OR NOMINAL) LEDGER	(1000 Accounts, 100 Analyses, multi-purpose package).	£295
UTILITIES DISK 1	(Diskette patch, slot to slot copy, zap etc).	£20
APPLEWRITER	(Word Processing)	£42
VISICALC	(Financial Modelling, Costing, Analysis)	£95

## AND NOW HARDWARE!

COMPUTECH DIPLOMAT H/S SERIAL INTERFACE £80

This card has been designed and built to the same professional standards that have resulted in the success of our software. The DIPLOMAT observes the proper "handshaking" protocol so that you can drive fast printers and send and receive data from other peripherals at high speeds without loss of data. Switch (& software) selectable baud rates to 19200 and many other options. Plug compatible with 'terminal' or 'modem' wired peripherals. Guaranteed.

THE FABULOUS MICROMUX 8000 from £800

This is a brand new product, an asynchronous serial multiplexor with up to 16 ports, any one of which may communicate with any other independently, like a 'telephone exchange' for data! Built in test function. Firmware may be customised for special applications. Available in multiples of 4 ports up to 16.

## COMPUTECH SYSTEMS

168, Finchley Road, London NW3 6HP. Tel: 01-794 0202

AGENTS THROUGHOUT THE UK AND OVERSEAS

• Circle No. 128

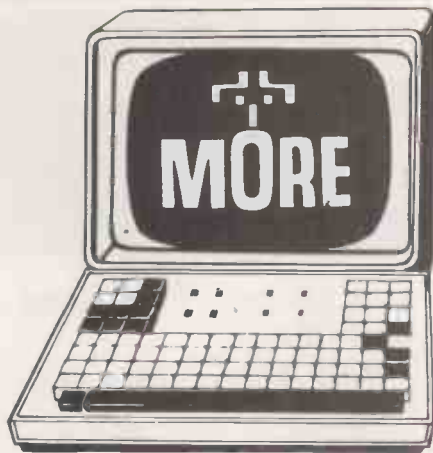

If your PET is hungry for 5¼" flexible disks, we can feed him.

Control Dataset high quality 5¼" flexible disks are readily available at major office equipment suppliers. Or you can order them direct from us.

For a list of stockists, or details of our mail order service, contact us at Control Dataset Ltd., P.O. Box 16, Argyle Way, Stevenage SG1 2AB, Herts. (Tel: 0438-3399)

**CONTROL  
DATASET**  
  
CONTROL DATA

• Circle No. 129

# MONITORS MONITORS MONITORS



UNCASED 9"  
UNCASED 12"  
CASED 9"  
CASED 10"  
CASED 12"  
MONITOR TUBES

SELF CONTAINED MONITOR PCB's

## CROFTON ELECTRONICS

Crofton Electronics Limited  
35 Grosvenor Road, Twickenham, Middlesex.

Tel: 01 891 1513

• Circle No. 130

## Information is power . . .

. . .but disorganised data and jumbles of paper mean that your business is running at less than its best.

**Database Management Systems bring those information problems under control.**

We specialise in small database management systems — and small refers to the cost, not the performance, with machines capable of handling up to 300 Mbytes of hard-disc storage with full network abilities. That's more than 100,000 text pages instantly retrievable from any of up to sixteen terminals — the electronic filing cabinet!

**Ohio Scientific** systems combine this with computing abilities that are better than most — better and simpler expansion, faster operation, lower overall cost. Complete database systems start at about £2500; hard-disc systems from £6500 (excl. VAT). For *real* computing — large databases, industrial control and data acquisition, high speed processing — and solutions that won't break your budget, Ohio Scientific from Mutek is your first choice.

**Experience counts.** . . . Ohio Scientific are the market leaders in database management computer systems, and all our staff have had plenty of experience in hardware and software aspects of the computer industry. We have used Ohio Scientific computer systems in a wide range of applications — let us show you how these superb systems can be used in your application.

**We supply solutions.** . . . not just the hardware! Call us and talk to our engineers and programmers, for practical answers to your questions.

**Mutek — real database management . . . for less than you expect**  
Mutek — the independent Ohio Scientific specialists — Quarry Hill, Box, Wilts. Tel: Bath (0225) 743289

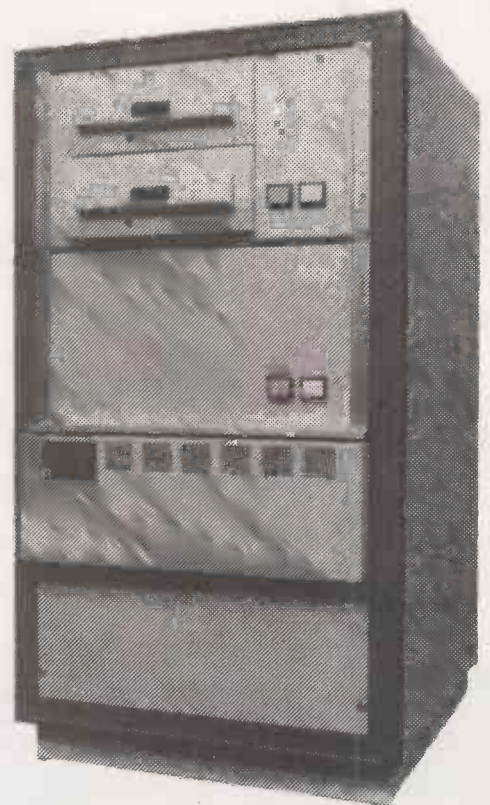

• Circle No. 131

# VECTOR GRAPHIC COMPLETE SYSTEMS

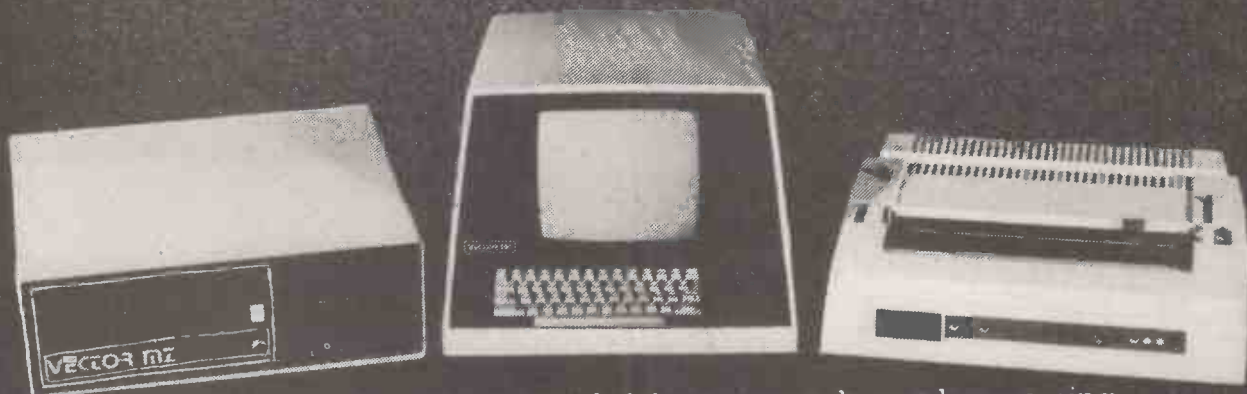

Micro-computers for research, laboratory work, word processing, business systems, Schools, Colleges, Universities and Industry. At Almarc, when you buy Vector Graphic Micro-computers, you get Almarc's experience of over 200 systems installed throughout the U.K. and their back-up of full service facilities carried out by experienced staff. Plus an ever growing list of compatible software including:  
Pascal, Fortran, Cobol, APL, Algol, C Basic Compiler, etc.

#### Vector MZ

- 56K Bank Selectable Ram.
- 3 Serial Ports, 2 Parallel Ports.
- Twin Disc Drives, 630K Capacity.
- 280 CPU, with Fast 4MHZ Clock.
- Prom Programmer (2708).
- Interrupt Handling on I/O Board.
- 18 slot Motherboard.

#### Vector System B

- Vector Mindless Terminal.
  - Flashwriter II Video Board (24 × 80).
  - MDOS + CP/M2 Operating System.
- Plus Microsoft Version, 5 basic options.  
Plus many S100 Bus add-ons, such as Extra Memory, A/D-D/A Boards, High Resolution Graphics, etc.

#### Vector System 2800

- Vector System 3 Terminal.
- Dual 8" Disc Drives.
- Capacity 2.4 Megabytes (IBM format).
- 56K RAM.
- Z80A CPU, 4MHZ.
- 1 Serial, 3-8-bit parallel ports.
- CP/M2, Raid, Scope, Microsoft Basic 80

We will be pleased to demonstrate any of the Vector Graphic Systems, please contact:

**ALMARC**  
**DATA SYSTEMS LTD**

906 Woodborough Road, Nottingham. Telephone: (0602) 625035

Specialists in Vector Graphic Equipment.

# computer

a new concept in  
computer control

built on peripheral highway

apple and other interfaces  
from £120

digital controller    analog controller  
from £150

relays from £10

digital sensors    analog sensors  
from £10

all you need for control application  
in the laboratory, home, and industry

dealer enquiries welcome

BUSINESS COMPUTER SERVICES  
POLLARDS FARMHOUSE, CLANVILLE  
NR. ANDOVER, HAMPSHIRE  
TELEPHONE 026470300

• Circle No. 133

## ARE YOU ILL-TREATING YOUR PET?

IS YOUR PET TIRED, LISTLESS & IRRITABLE ?  
THEN FEED IT MORE NOURISHING SOFTWARE  
FROM THE NEW

# Softcentre

RANGE

DOZENS OF EXCITING, INTERESTING & EDUCATIONAL  
PROGRAMS, MOST WITH SUPERB GRAPHICS & MANY  
WRITTEN BY JIM BUTTERFIELD

**GAMES = BUSINESS = EDUCATION  
SCIENTIFIC & UTILITY**

SEND STAMP FOR CATALOGUE TO DISTRIBUTORS

**OPTELCO    26 ALBANY ROAD  
RAYLEIGH ESSEX**

(FREE VOUCHER WORTH £2 WITH CATALOGUE)

\*\*\*\*\*  
AREA AGENCIES & OVERSEAS DISTRIBUTORS INVITED  
\*\*\*\*\*  
PROGRAMMERS! HAVE YOU WRITTEN REALLY ORIGINAL PROGRAMS  
OF OUTSTANDING QUALITY ? WE PAY GOOD ROYALTIES FOR THE  
RIGHT MATERIAL - SEND CASSETTE FOR ASSESSMENT AND YOU  
WILL RECEIVE ANY OFFER WITHIN A WEEK !  
\*\*\*\*\*

P.S. LOTS OF SOUND & PRINTER PROGRAMS IN THE RANGE

**Buying the right apple  
software to do the job,  
at the right price,  
can be a job  
in itself!**

But it doesn't have to be.

Micro Management now have available a comprehensive range of quality software for business and commercial applications. Each package is user-tested before being released, and when released, carries our own guarantee. Software of such a high standard at a realistic price is hard to find, so end your search by asking for Micro Management software.

Micro Management software is available from your nearest dealer, or direct from us. We also offer a tailor-made service to suit your company's individual requirements.



13-15 Connaught Avenue, Frinton-on-Sea, Essex. Tel: (02556) 4592  
and 32 Princes Street, Ipswich, Suffolk. Tel: (0473) 57871

### PAYROLL

The Micro Management Payroll offers the following facilities and benefits:

- Credit Transfers
- Pay Slips
- Day Books
- Cash Breakdown
- Dept Analysis
- Year End Print Out
- Average of 100 Employees in 10 minutes
- Six Variable Additions/ Deductions
- All Tax Codes
- Easy Tax Changes
- Operator Code Protected
- No Computer Knowledge Needed

• Only £145 incl. p&p (ex VAT)

• Circle No. 134

# DATA LINK

## Microcomputer Systems Limited

Systems software for business, industrial and scientific applications

From the Micro City of the Future

### image data

32K System with dual 5 1/4" disk drives, keyboard, VDU and printer **£2339.00**  
As above with visual display terminal and daisy wheel printer **£4866.00**  
Made in Bristol

### APPLE/ITT 2020

Apple II Plus 16K (B&W) **£695**  
ITT 2020 16K (Colour) **£778**  
Disk Drive with Controller **£349**  
Dual Headed Disk Drive 1/4 MB **£480**  
16K Add-ons **£69**  
Alf Music Synthesizer **£135**  
CCS HS Serial Card **£113**  
Comm. Card **£130**  
ROM Plus Board **£110**  
Clock Card **£152**

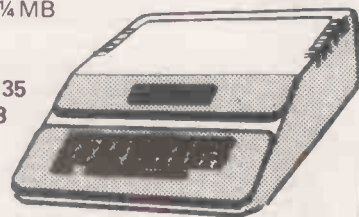

AUTHORISED APPLE SERVICE CENTRE

### SOFTWARE

We have second to none programming facilities, both in-house and through an associated Company: Management Services and Systems Ltd.  
All our programs are original and fully guaranteed E.G.  
Mailing List **£50** Stock Control **£200**  
Integrated Accounts Package **£800** (Sales/Purchase/Nominal Ledgers/Invoicer)  
Sales Management Package **£400**  
Critical Path Analysis POA Contract Estimating POA  
Programs are written for both the Apple and Image Data systems. They can be tailored to meet a customer's particular requirements.

### PRINTERS

Centronics 730 **£525**  
Centronics 737 (Five Euro Language Ch. Sets) **£656**  
Paper Tiger (with graphics) **£598**  
Qume Sprint 5 **£1845**  
Microhush **£266**  
Silenttype **£349**

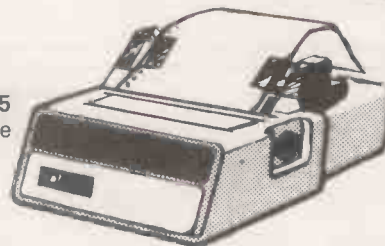

### Systems Furniture

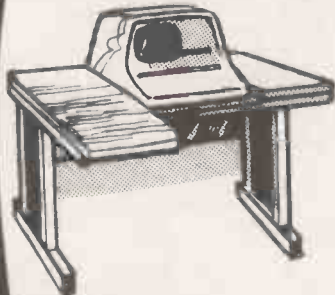

#### Apple Systems Desk **£152.00**

We now have available an exciting new range of GESIKA systems furniture specially imported from Germany by BEAM P.O.A.

ALL PRICES QUOTED EX VAT

### COMPUTER STATIONERY and ACCESSORIES

9" Plain Listing Paper (per 2000 sheets) **£16.00**  
12.27/32" Listing Paper (per 2000 sheets) **£20.00**  
Microhush Thermal Paper (2 rolls) **£4.00**  
Customised Computer Stationery (Invoices/Statements/etc) P.O.A.  
BASF 5 1/4" Diskettes **£2.50**  
BASF 8" Diskettes **£3.00**  
Library Cases for 5 1/4" **£2.64**  
Library Cases for 8" **£3.50**  
Diskette Tray with Lockable lid for 5 1/4" **£16.00**  
Diskette Tray with Lockable lid for 8" **£22.00**  
Dust Covers **£5.50**

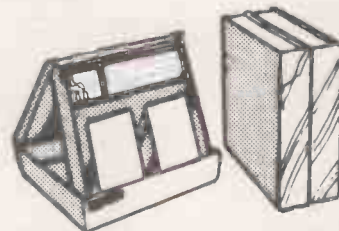

We also stock an extremely comprehensive range of computer books

# DATA LINK

10 Waring House, Redcliffe Hill, Bristol BS16TB  
Telephone: Bristol (0272) 213427

# Software for TRS80<sup>®</sup>

## ACCEL Compiler for TRS80 BASIC

Speeds execution of correct Level 2, BASIC programs by compiling the common statements to Z80 machine-code.

- Develop and debug normally.
- Compile for production work.

ACCEL (16K) Great value at..... £19.95

DLOAD	Load program segments.....	£4.95
ZBUG	Debug Z80 programs.....	£11.95
TSAVE	Prepare system tapes.....	£4.95
RENUM	ReNUMBER BASIC programs.....	£5.95
FGRAF	Fast Graphics.....	£4.95
XREF	Program cross-reference.....	£5.95
SDUMP	Symbolic dump.....	£2.95
LIFE	(16K) 48 x 64.....	£3.00
USRN	Multiple USR calls.....	£2.95



SOUTHERN SOFTWARE PO Box 39, Eastleigh, Hants. SO5 5WQ

Southern Software programs are self-relocating, load-anywhere, machine-code, well documented. They run in 4K Level 2, unless otherwise stated.

• Circle No. 136

# Your key. To MICROCOMPUTERS

This coupon will bring you details of our new complete home computer course.

You will learn all the basic principles of computer technology and receive full instruction on computer functions and programming. Tuition is carried out at your own pace on your own home computer and is supervised by our qualified computer staff.

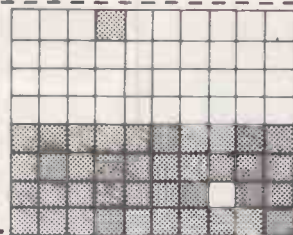

FREE BROCHURES

## TUTORCOURSE HOME COMPUTER

Please rush me details of your HOME COMPUTER COURSE

Send today for a brochure on this exciting new course.

Name \_\_\_\_\_

Address \_\_\_\_\_



PC8 Block Caps. Please

Post now, without obligation to:

**British National Radio & Electronics School.**

P.O.Box 156, Jersey, Channel Isles

• Circle No. 137

# TRS-80 OWNERS!

## MODEL I

### LEVEL II CASSETTE

### DISK

### MODEL II

Adventures: - Adventureland* £8.50 Pirates Cove* £8.50 Mission Impossible* £8.50 The Count* £8.50 Voodoo Castle* £8.50 Strange Odyssey* £8.50 Mystery Fun House* £8.50 Pyramid of Doom* £8.50 Ghost Town* £8.50 Adventure Sampler* £5.50 Air Raid* £8.50 Alien Invaders £8.50 Amaz'in Mazes £5.00 Android NIM £8.50 Backgammon £5.00 Balloon Race £5.00 Barricade* £8.50 Baseball £5.00 Battleship £8.50 Bee Wary £8.50 Bingo £4.00 Bowling (Ten Pin) £5.00 Breakaway £4.00 Bridge Challenger £8.50 Challenge £6.00 Concentration £5.00 Cribbage £5.00 Dogstar £6.00 Fastgammon £10.00 Galactic Blockade £5.00 Galactic Empire £8.50 Galactic Revolution £8.50 Galactic Trader £8.50 Game of Life* £6.00 Hangman £4.00 Hit The Box £6.00 I Ching £5.00 Kamikaze £5.00 Kreigspiel £5.00 Lost Dutchmans Gold £6.00 Mastermind II* £5.00 Mean Checkers* £11.00 Noughts & Crosses £4.00 Othello III £4.00 Pentominoes £6.00	Pork Barrel £8.50 Pre School Games £8.50 PR Dogfight £8.50 Remainder £8.50 Robots £8.50 Round The Horn £8.50 Safari £8.50 Santa Paravia £8.50 APL-80* (Incl Book) £8.50 Accounts REC II £5.50 Appointment Log £8.50 Astronomy II £5.00 Basic IP* £8.50 Basic Toolkit* £5.00 Biorythms £5.00 Calendar Functions £5.00 Data Base II £8.50 Debug* £5.00 Electric Pencil* £8.50 Electronics Asst. £8.50 EMU 6502 £4.00 ESP Tester £5.00 File Handling £4.00 Finance I £8.50 Finance II £6.00 Forth (Incl. Primer) £5.00 Fourier Transforms £5.00 Graph Builder £6.00 G.S.F.* £10.00 General Accounting £5.00 Ham Radio £8.50 Histogram/Scattergram £8.50 Home Finance £8.50 Inst. Calculator £6.00 Inventory Mod. £4.00 Inventory FP. £6.00 Inventory Control £5.00 IQ Builder (Vocab) £5.00 IQ Builder (Spelling) £5.00 IQ Builder (Stories) £6.00 IQ Builder (Pre School) £5.00 IQ Builder (Numbers) £11.00 IRV* £4.00 Keyboard 80* £4.00 Level III Basic* £6.00	Linear Programming £6.00 Magic Paper Calculator £5.00 Math Drill £5.00 Math Library I £4.00 Math Library II £4.00 Math Library III £5.00 Microtext Editor £5.00 Minicrossword £5.00 Mortgage Calculator £17.50 Personal Finance £13.50 Pascal* (Incl. Manual) £6.00 Personal X-REF £7.50 Pilot 2.2* £11.00 Pre Flight £11.00 Renumber* £4.00 RPN Calculator £7.50 RSM 2 Monitor* £16.00	£7.50 A.P.L. Incl. Book £8.50 Accounts Receivable II £4.00 Advanced Personal Finance £8.50 Amateur Radio System £8.50 Auto Disk Directory £18.00 Compress It £6.00 Data Base III £7.50 Dynamic Data Base £5.00 Electric Pencil* £6.00 Forth* (Incl. Primer) £26.00 General Ledger II £8.50 Inventory 2.2 £9.00 Inventory 2.3 £11.00 Inventory II £8.50 KVP Extender* £6.00 Level I in Level II* £14.50 Mailist IV Newdos Plus* Payroll Print Spooler* Roots RSM 2D Monitor* Simplify-It SRIPSIT* ST-80D* Terminal ST-80 III* Terminal Text-80 Word Processor	£30.00 CP/M 2.2 (Cybernetics) £40.00 CBasic-2 £13.50 Inventory System (Graham Dorian) £8.50 Pascal Z Ver3.0 £13.50 Postmaster £25.00 Supersort III £75.00 £45.00 £40.00 £30.00 £40.00 £50.00 £16.00 £13.50 £40.00 £47.50 £249.00 £16.50 £12.50 £15.00 £13.50 £65.00 £40.00 £80.00 £30.00	WORD PROCESSORS Electric Pencil II (CP/M) £175.00 Inventory System £190.00 Magic Wand (CP/M) £200.00 Wordstar (CP/M) £240.00 Wordstar/Mallmerge (CP/M) £300.00 BUSINESS SYSTEMS Osbourne & Associates Programmes in CBasic: £150.00 Accounts Rec & Payable £150.00 General Ledger £150.00 Manuals Available Separately for most of the above Programmes. CP/M USERS GROUP 23 Volumes Each £20.00 ALL PRICES INCLUDE FIRST CLASS POST AND PACKING (UK ONLY). SEND 50p FOR FURTHER PROGRAMME DETAILS
--	--	---	--	--	---



## MICROCOMPUTER APPLICATIONS

11 RIVERSIDE COURT, CAVERSHAM, READING RG4 8AL, ENGLAND

TELEPHONE: (0734) 470425





# SORCERER

CP/M™  
S100  
Z80

For the serious user:  
Business  
Education  
Amateur

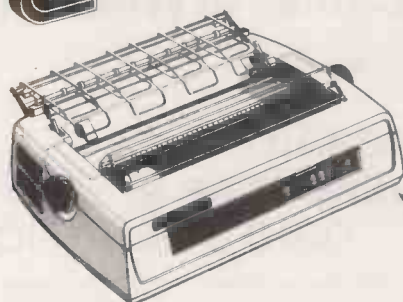

PIO + RS232/20ma serial O/P  
Dual 1200 baud cassette O/P

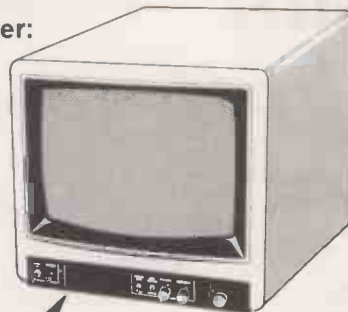

Memory mapped  
30 lines x 64 characters  
upper/lower case + 128  
programmable graphics

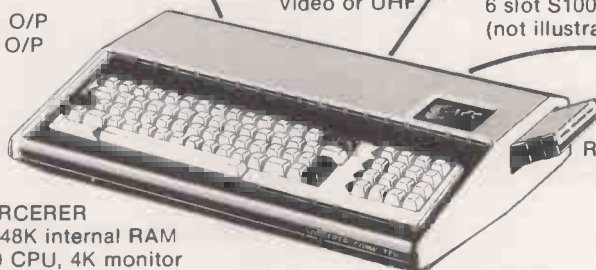

SORCERER  
16-48K internal RAM  
Z80 CPU, 4K monitor

Video or UHF

6 slot S100 expansion  
(not illustrated)

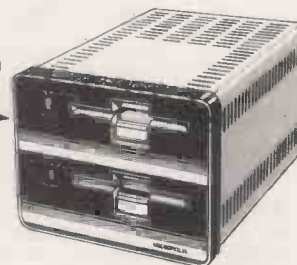

ROMPAC

Micropolis 630K dual disk  
CP/M or Micropolis MDOS

## STANDARD SORCERER

- \* Displays 30 lines of 64 characters - more than any other personal computer. 79 key stepped typewriter-style keyboard with separate numeric pad for fast data entry.
- \* Plug in ROMPAC cartridges for programming languages, special applications (e.g. word processing) or creating a user's dedicated system. Sorcerer is supplied with 8K Microsoft BASIC ROMPAC
- \* Composite video output for video monitor or UHF output for use with an unmodified TV set at nominal extra charge.
- \* Z80 CPU with up to 48K RAM on-board.
- \* 4K power-on monitor in ROM allowing machine code programming, batch processing, memory transfers and copying, alteration of memory locations, use of cassette files.
- \* Dual 300 or 1200 baud cassette ports with motor control
- \* Parallel I/O port and serial RS232 port for direct connection to printers or use as a terminal to a larger computer - no expensive 'extra' communications interfaces
- \* Full upper/lower case ASCII characters plus 128 user programmable graphics (64 default to standard graphics symbols if undefined). Default graphics above ordinary characters on keytops.

16K £749.00      32K £799.00      48K £849.00

### Expansion Capabilities

- \* 6 slot S100 expansion for memory up to 56K RAM, disc drives (5 1/4" or 8") etc. Standard bus means that you are not dependent on equipment from a single manufacturer **£240.00**
- \* Micropolis double density 5 1/4" drives with MDOS and Disc BASIC:  
First drive (incl. controller card) single 315K **£690.00**  
Additional drives (max 4 drives/controller) 315K **£390.00**
- \* FDM 180 Disk Unit: Micropolis Disk Drive, plugs directly into Sorcerer, does not require S100 Unit:  
Single 315K Disk Drive (c/w CP/M and Microsoft BASIC) **£599.00**  
Single 315K Add-on Disk Drive. **£450.00**
- \* CP/M industry standard disk operating system **£75.00**
- \* Development ROMPAC - Z80 assembler, loader, editor, debugger **£70.00**
- \* EPROM PAC for loading dedicated software up to 16K **£35.00**
- \* Configuring programs allow Sorcerer to be used as a 'dumb' terminal or, with CP/M, as an intelligent terminal.

### Programming Languages

The following programming languages are available for CP/M:

Microsoft Disk BASIC interpreter (BASIC 80 - compatible compiler), CBASIC2 (compiled BASIC), FORTRAN 80 and COBOL-80, ALGOL 60 - A Z80 system with graphics, string handling and random-access filehandling.

All Exidy products are covered by 12 months warranty.  
CP/M™ is a trademark of Digital Research.  
All prices exclusive of VAT

## THE WORDPROCESSING WIZARD!

Sorcerer's upper/lower case typewriter keyboard and unusually large display (30 lines of text; approximately equivalent to one double-spaced typed page) makes it ideal for word processing applications. The Exidy word processor PAC is a sophisticated screen editor and text formatter with automatic text wrap-around, left and right justification, proportional letter spacing (on disk only with Spinwriter) and many other formatting facilities. It can also search for and replace strings, move and merge blocks of text and a macro facility allows specification of tasks such as mail-merge letter typing. Letters and texts can be stored on cassette or disks (one disk will store approximately 300,000 characters and costs less than five pounds. 32K or 48K RAM is recommended.

Word Processor PAC **£120.00**      Disk Version: **£118.75**

C.Itoh 8300 dot matrix printer -40, 80 and 120 characters per line on 9 1/2" wide paper, 125 characters/second, upper/lower case, tractor feed, forms positioning **£499.00**

NEC Spinwriter solid font printer -variable horizontal and vertical spacing, proportional spacing, interchangeable fonts, carbon or fabric ribbon, 55 characters/second, paper up to 16" wide **£1,900.00**

Example system: 32K Sorcerer, video monitor, FDM 180 Disk Unit with CP/M and Microsoft BASIC, C.Itoh 8300 printer, Word Processor on disk and CP/M. **£2,225.00**

### Business Software

Besides its word processing capabilities, Sorcerer can run a wide range of business software thanks to the widely used CP/M disk operating system available for the Micropolis disk drives. Programs available include:

Payroll: (requires CP/M and CBASIC2) **£250.00**

General Ledger, Job Costing, Accounts Receivable, Accounts Payable: (all require CP/M and CBASIC2) **£335.00 each**

For further information and list of dealers,  
please contact the sole U.K. distributors.

GEOFF WILKINSON, Dept. PC.1

## LIVEPORT

### DATA PRODUCTS

The Ivory Works, St. Ives, Cornwall TR26 2HF  
Telephone: (0736) 798157

PLEASE SEND DETAILS OF THE EXIDY RANGE/WORD PROCESSOR

NAME \_\_\_\_\_

ADDRESS \_\_\_\_\_

PCB



# Dysan Diskettes



Consistently the best you can buy.

Dysan diskettes are literally the best you can buy. Month to month, year to year you can rely on only the best quality.

- APPROVED BY LEADING DRIVE MAKERS
- FULLY ON AND OFF TRACK MODULATION TESTED
- CERTIFIED 100% ERROR FREE
- SINGLE & DOUBLE DENSITY
- SINGLE & DOUBLE SIDED

Tell us which computer or word processor you have and we'll tell you which diskette you need.

## HAL COMPUTERS LIMITED

133 Woodham Lane New Haw  
Weybridge Surrey KT15 3NJ  
Tel: 0932 48346/7  
Telex: 8813487

• Circle No. 139

# AERCO GEMSOFT

## APPLE 2 Comes to Woking!

Aerco Gemsoft have just opened their new computer division in Woking and invite you to drop in for a look at some real computers:—

### APPLE 2

#### SUPERBRAIN

#### MICROSTAR 45

#### OHIO SCIENTIFIC

We are official Apple agents and southern area distributors for the Intertec Superbrain.

Apple 2 16K (Europlus 8 & W)	£750.00
Superbrain 64K (Twin Disks)	£1995.00
ITT 2020 16K (Colour)	£867.00
Microstar 45 Plus	£4950.00
Apple 2 Disk Units from	£355.00
16K Memory Upgrade Kit	£69.00
Serial/Parallel Interface Card	£110.00
Pascal Language Card	£296.00
Anadex DP-8000 Printer	£570.00
9" Hitachi Monitor	£132.00
12" Hitachi Monitor	£210.00
Auto-Start ROM	£40.00
Eurocolour Card	£69.00

### DISK BASED BUSINESS SOFTWARE FOR APPLE 2/ITT 2020

Sales Ledger Payroll  
Stock Control General Ledger  
Invoice Printer Price List Maintenance  
Please add 15% VAT to above prices.

Send S.A.E. for full catalogue containing over 100 programs for PET, Apple & Exidy Sorcerer. Trade enquiries welcome.

Gemsoft can supply you with a complete (and fully expandable!) Apple system off the shelf including twin disks & printer for £2431 + VAT.

We specialise in designing complete systems and our expert in-house programmers are available to write any customised software from business systems, through industrial control systems to scientific and research programs.

GEMSOFT LTD, 27 Chobham Road, Woking, Surrey. Phone Woking (04862) 22881.  
Open 6 days a week 9.30-5.30 p.m.

• Circle No. 140

# The Software Solution



We all know that a computer system is only as good as the software and that much of the applications software hitherto available has proved to be the weak link. Written in Microsoft basic for use with CP/M based hardware, Interface Software is probably the most comprehensive and robust application software currently available, which really will transform your micro-computer into an effective problem solving tool.

#### Applications Software

- Nominal Ledger
- Sales Ledger
- Purchase Ledger
- Payroll
- Incomplete Records
- Word Processing (Wordstar)
- Mailing Address
- Etc.,

#### Systems Software

- CP/M
- MP/M
- MBasic 5.0 (CP/M) Interpreter/Compiler
- CBasic (II) Interpreter/Compiler
- Fortron 80 Compiler
- Cobol 80 Interpreter/Compiler
- Pascal 8 (UCDS) Interpreter
- Z80 Macro Assembler

Recommended by Logitek for the ALTOS microcomputer and Rostronics for the Micromation but of course suitable for any CP/M based machine.

For more details contact Jim Reid or Sue Archer at:-

DEALER ENQUIRIES WELCOME.



INTERFACE SOFTWARE LIMITED,  
100, PARK STREET,  
CAMBERLEY,  
SURREY.  
Telephone (0276) 27982.

• Circle No. 141



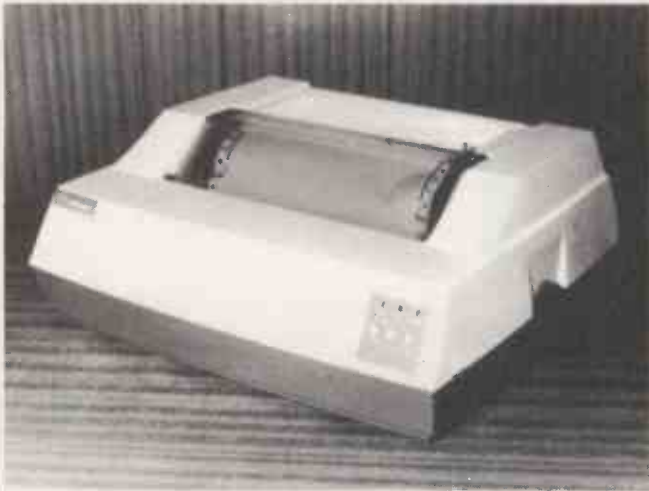

## 8300 RM PRINTER

80/132 ch per line (switchable); 125 c.p.s.; 2K Buffer; V24 RS232/Current loop interface; Speed switchable between 110-9600 baud; Double width char. available under software control; sprocket feed; 7 x 9 dot matrix; Paper width 4.5" to 9.5".

Price . . . . . £525 + carriage

### SPECTRONICS U.V. EPROM-ERASING LAMPS

PE14	Erases up to 6 chips, takes approx. 19 mins	£ 56.00
PE14T	Erases up to 6 chips, takes approx. 19 mins	£ 76.58
PE24T	Erases up to 9 chips, takes approx. 15 mins	£111.22
PR125T	Erases up to 16 chips, takes approx. 7 mins	£237.84
PR320T	Erases up to 36 chips, takes approx. 7 mins	£384.09

### U.V. EPROM ERASING CABINET

PC1000	Erases up to 72 chips, takes approx. 7 mins	£842.83
PC2000	Erases up to 144 chips, takes approx. 7 mins	£1227.69

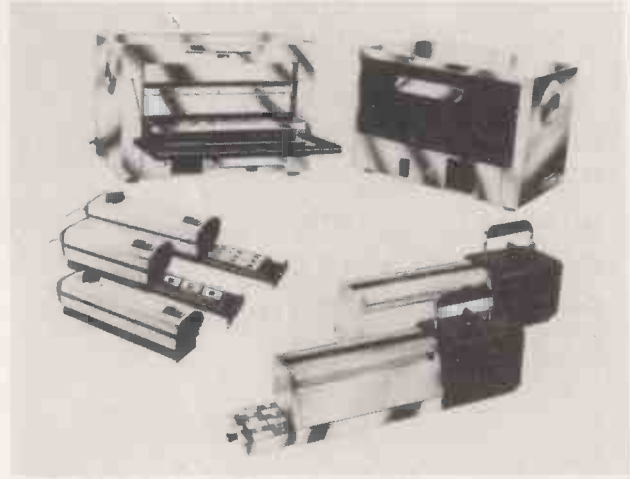

### SHARP MZ80K

Z-80 based CPU; 4K bytes monitor ROM; Internal memory expansion up to 48K bytes of RAM; 14K extended BASIC (occupies 14K bytes of RAM); 10" video display unit - 40 characters x 25 lines; 80 x 50 high resolution graphics; 78 key ASC11 keyboard alphabet (capital & small) plus graphics, Built in music function; Fast reliable cassette with tape counter-1200 bits/sec.; 50 pin universal BUS connector for system expansion-printers, floppy discs etc.

FROM		£520.00
Machine code tape and manual	£19.00	Sharp Monitor Listing (fully commented) £15.00
Assembly code tape and manual	£45.00	Sharp basic manual £ 7.00

## Look!

### SPECIAL OFFER

2708	£ 5.99
4116	£ 5.99
2716(5v)	£18.50

### NEW BOOKS

	AUTHOR	PRICE
The S100 and other Micro-buses Software Development	Poe	£ 5.15
Computers & Commonsense	Jones	£14.45
Architecture of Small Computer Systems	Hunt	£ 3.95
Principles of Data-base Management	Lippiatt	£ 4.50
16-bit Microprocessor Architecture	Martin	£12.99
6502 Assembly Language Programming	Dolhoff	£16.70
Introductory Experiments with Digital Electronics and 8080A Book 1	Osbourne	£ 6.95
Book 2	Rony	£ 8.40
Microcomputers for Business Applications	Rony	£ 8.40
Handbook of Microprocessors, Microcomputers and Minicomputers	Barden	£ 5.80
Introduction to Microprocessors	Lenk	£11.65
The VNR Concise Encyclopedia of Mathematics	Levanthal	£ 9.45
Micro Program Software Development	Gellert	£15.35
Handbook of Electronic Analysis Using Programmable Calculators	Duncan	£13.45
	Murdock	£19.90

### GAMES

32 Basic Programs for the PET	Rugg	£ 8.90
Game Playing with Computers	Spencer	£10.20
Game Playing with Basic	Spencer	£ 4.20
Star Ship Simulation		£ 5.10
SARGON		£ 9.50

### BASIC

The Basic Handbook	Lien	£11.00
Learning Level II	Lien	£11.00
Basic with Business Applications	Lott	£ 8.40
Illustrated Basic	Alcock	£ 2.50

### Z80 BOOKS

Introduction to TRS80 Graphics	Inman	£ 5.75
Z80 Instant Programs (book) for Nascom	Hopton	£ 7.50
Z80 Instant Programs (cassette) for Nascom	Hopton	£10.00
Z80 Assembly Language Programming	Osbourne	£ 8.15

### 6502

Programming the 6502	R. Zaks	£ 7.95
6502 Applications Handbook	R. Zaks	£ 7.95

**Terms:** Official Orders (min. £10). Barclaycard & Access welcome. Add 15% to hardware prices. Book prices include p & p. Send for catalogue and booklist. All mail order to Newbury.

**Mail Order & Head Office:** 40 Bartholomew Street, Newbury, Berks. Tel: 0635 30505

**Manchester Showroom:** 220-222 Cheadle Heath, Stockport. Tel: 061 491 2290

**Birmingham Showroom:** 1st Floor Offices, Tivoli Centre, Coventry Road, Birmingham. Tel: 021 707 7170

# PETS NEW ULTRA LOW PRICES

ALL WITH LARGE GRAPHICS  
KEYBOARDS  
PRICES EXCLUDING VAT at 15%

8K £420      16K £500  
32K £600      C2N £50  
PET DUAL FLOPPY £700  
EPSON TX80B PRINTER £390  
BASE 2 M800 MST £390  
PROGRAMMERS TOOLKIT £45  
CABLES FROM £12

## PLUS NEW SUPER PET

WITH NEW LARGE SCREEN £900  
NORTH STAR HORIZON II £1500  
AIM/KIM EXPANSION KITS P.O.A.  
SOFTWARE AVAILABLE FOR  
NORTH STAR LOWEST PRICE  
IN UK  
FULL TECHNICAL SUPPORT  
FROM OUR OWN MAP LISTED  
ENGINEERS  
SUPERPET AVAILABLE  
2 WEEKS FROM ORDER

PRICES MAY VARY — PLEASE PHONE  
FOR MORE DETAILS.

**INTELLIGENT ARTEFACTS LTD**  
CAMBRIDGE RD, ORWELL  
ROYSTON, HERTS.

**INTELLIGENT ARTEFACTS LTD**

• Circle No. 143



A COMPANY DEDICATED TO THE SERVICE AND  
SUPPORT OF TERMINAL AND MICRO BASED  
SYSTEMS



#### WE FIX MICROS

PETS, APPLES, SUPERBRAIN, ETC. AT £25 PER FIX  
(PLUS PARTS AND V.A.T.) AT OUR BELPER WORKSHOP

Contact: JOHN REES



#### NATIONWIDE SITE SERVICE

FOR DEC LS111 BASED SYSTEMS AND TERMINALS

Contact: BARRY DUKES

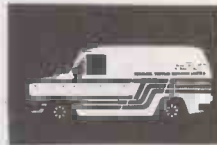

#### SPECIALIST TRANSPORTATION NETWORK

GETS THE GOODS WHERE YOU WANT THEM WHEN YOU WANT THEM  
- AT THE RIGHT PRICE

Contact: GORDON HADFIELD

A COMBINATION OF ALL THE ABOVE SERVICES OFFERS A COST  
EFFECTIVE COMPLETE SOLUTION  
IF YOU HAVE MULTIPLE TERMINALS OR SYSTEMS OUR UNIQUE  
TRI-CALL COLLECTION CONTRACT OFFERS MAXIMUM DISCOUNT ON  
SERVICE COSTS

Details on request



**TERMINAL SYSTEM SERVICES LIMITED**  
King Street, Belper, Derby DE5 1PW  
Telephone: Belper (077 382) 7771 & 7772.

• Circle No. 144

### ANDREWS COMPUTING LTD

## TRS-80 NASCOM 1 & 2

Now there is a range of quality software at real value for  
money prices.

For TRS-80 Level II (16K+)

**PASCAL Development System** £18.00  
Pascal Compiler  
Run Time P-Code Interpreter  
Compiler source code (in Pascal)  
Pascal Guide

Take a step into the future with this exciting product,  
which runs many times faster than Basic.

**BASIC III - The Level III Basic** £18.50  
Extended High Speed Graphics  
Renumbr Basic Programs  
Append Basic Programs  
Single key entry of Keywords  
Includes many features of Disk Basic and a superb  
demonstration program.

**GAMES Tape No. 7** £7.50  
33 Programs (Excellent Startrek)

**R-BUG Machine Code Monitor** £8.50  
All standard monitor facilities  
Enables System Tapes to be copied for backup purposes.

For NASCOM 1 & 2

**RENUMBER Nascom Basic** £6.00  
Renumbers Microsoft/Starbase (ROM or Tape)  
Basic. Available for T2, B-Bug, T4 and Nas-Sys  
monitors

For further details of our extensive range, send for free  
catalogue. All prices include VAT and P & P. Please state  
computer type when ordering.

**ANDREWS COMPUTING LTD**  
21 Lime Tree Drive, Farndon, Chester

• Circle No. 145

**INNOVATIVE**

# TRS-80 SOFTWARE

**FROM THE PROFESSIONALS**

## **MACHINE CODE FROM A PROGRAMMER'S VIEWPOINT**

- Ⓜ HOW TO M/C PROGRAM**
- Ⓜ ROM CALLS LISTED**
- Ⓜ RAM LEVEL 2 USAGE**
- Ⓜ DISKS EXPLAINED**

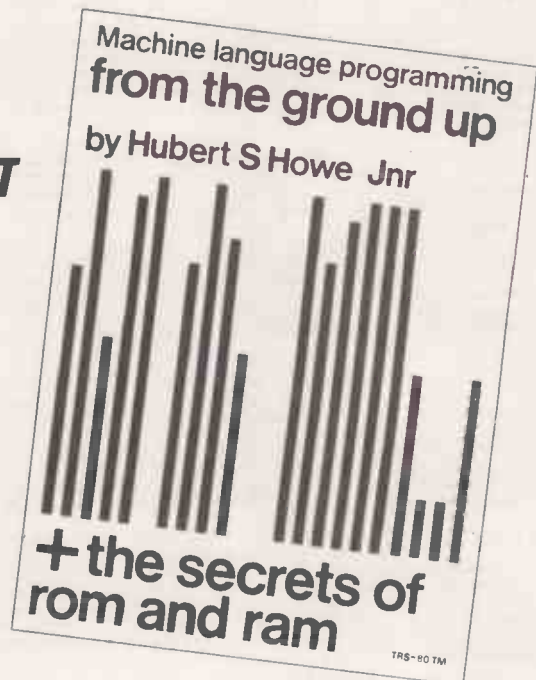

A book written by a well known programmer for people who not only want to learn machine code programming but who also want to use their knowledge in practical programming applications - from the ground up. Learning the Z-80 mnemonics, register handling and so on is important but what is essential is to be able to call the dozens of subroutines in Level 2 ROM, how to make use of the ROM user addresses in RAM and to know how the disk directories work. To learn your machine code programming from a book which does not contain this information is akin to driving a car without knowing the route you wish to take - it can be done but it is much easier knowing where you are going and how to get there !

Hubert Howe's book is written in easy to understand language and in a clear and logical manner. Two-thirds of the book is devoted to actual applications and examples. It assumes that the reader has no knowledge of the subject. If you can use Basic, you will understand this book.

# £ 8.50

Plus 50p P & P.



Send large SAE (27p) for our current catalogue of TRS-80 software. Add £1.85 for a binder

**A.J.HARDING (MOLIMERX)**

28 COLLINGTON AVENUE, BEXHILL-ON-SEA, E. SUSSEX. TEL: (0424) 220391

TELEX 86736 SOTEX G FOR A. J. HARDING



• Circle No. 146



# KRAM

KEYED RANDOM ACCESS METHOD

Now available in the UK!

KRAM is quite simply a revolution in microcomputer disk access techniques, and another FIRST for the PET! Just plug the KRAM ROM into your 16K/32K PET, load the rest of KRAM's machine language logic from disk (just like DOS), and with the ten commands illustrated below you have complete control of your disk data, either directly by individual key, or sequentially in forward or reverse ASCII order. KRAM is a development of "VSAM" mainframe techniques. KRAM is fast, compact, and does not interfere with BASIC. You'll wonder how you managed without it! Get cracking - get KRAM!

**CREATE** KCS="CREATE O:MAILFILE,170,15,1: SYS 24600  
This example tells KRAM to create an indexed file called MAILFILE on the disk in drive zero, with a record length of 120 characters and a key length of 20 characters which starts at position 1 of the record. KRAM looks at the RESERVED variable KCS to identify the function and its parameters; the SYS call tells KRAM to execute the function. The record length can be any value up to 254 characters and the key up to 48 characters, a total of 302. KRAM packs as many records into the 255 character disk block as necessary.

**OPEN** KCS="OPEN O:MAILFILE": SYS 24579 This tells KRAM that we will want to make accesses to the file called MAILFILE on the disk in drive zero. KRAM returns in location zero (peek (0)) the file number by which this file can be accessed during the rest of the program.

**ADD** KCS="ADD 1,NAS,ADS": SYS 24591 This tells KRAM to add to file number one the data in variable ADS whose key is NAS. For example in a mailing list, the key NAS might be the name 'SMITH A.J.' and ADS might be the address '120, HIGH STREET, ANYTOWN'. Any normal double character string variable can be used to denote the key and the record.

**GET** KCS="GET 1,NAS,ADS": SYS 24582 This tells KRAM to get from file number one the data belonging to the key NAS and put it into variable ADS. In our example, if NAS was 'SMITH A. J.', KRAM would read the address '120, HIGH STREET, ANYTOWN' from file and put it into variable ADS. If we weren't sure of the exact surname, we could give KRAM the key 'SM' and it would get for us the next alphabetically higher name beginning 'SM', together with its address! Or if we gave KRAM a blank key, it would find the first name and address on file.

**READ** KCS="READ 1,NAS,ADS": SYS 24585 This tells KRAM to read the data belonging to the next highest key following the name in NAS, and put it into variable ADS. In our example, a complete file of names and addresses could be read in alphabetical order, starting at any name in the file, simply by executing successive READ commands! For instance, having got Mr A. J. Smith from file, executing the READ command as above would get us say 'SMITH M.' in NAS together with his address in ADS.

**READ -** KCS="READ-1,NAS,ADS": SYS 24585 This works like READ except BACKWARDS! It tells KRAM to read the data belonging to the next lowest key preceding the name in NAS, and put it into ADS. For instance, having read 'SMITH M.' with the forward read, executing the backward read as above would get us 'SMITH A.J.' in NAS together with his address in ADS.

**PUT** KCS="PUT 1,NAS,ADS": SYS 24588 This tells KRAM to rewrite to file number one the data in variable ADS which belongs to key NAS. For instance, if we wanted to change Mr A.J. Smith's address, we would simply set NAS equal to 'SMITH A.J.', ADS equal to his new address, and execute the PUT function.

**DELETE** KCS="DELETE 1,NAS,ADS": SYS 24594 This tells KRAM to delete from file number one the key contained in NAS and its associated data contained in ADS. In our example, to delete Mr A. J. Smith from the file, we would simply set NAS equal to 'SMITH A.J.', ADS equal to his address, and execute the DELETE function. KRAM will release for further use the disk space made available by the deletion.

**CLOSE** KCS="CLOSE 1": SYS 24597 This tells KRAM that file one is finished with for now. KRAM updates the BAM on disk, but the file can still be used without another OPEN command.

**INITIALIZE** SYS 24600 This function is used at the beginning of each program to clear KRAM's work areas and buffers.

The examples above illustrate the use of KRAM in a mailing list application, with disk access times from less than one second. KRAM can of course be used in any application program with the Commodore disk where programmer time, user time and disk space are at a premium.

Each KRAM package includes a ROM which plugs into the middle ROM socket of the 16K/32K Pet, a demonstration disk with a mailing list program and a 40-page User Reference Manual. KRAM is available by post (cash with order) price £115 including VAT, or by credit card phone the KRAM 24 Hour Order Desk on 01-546 7256; or see your nearest dealer. (Quantity discounts available).

## Calco Software

Lakeside House, Kingston Hill, Surrey KT2 7QT 01-546-7256  
Mainframe software at a micro price

• Circle No. 147

## SPECIAL LOW PRICE OFFERS

**MEDIA 5 LTD.**  
COMPUTER TABLE (as illustrated). Fine quality teak effect on black metal frame. Height 24 3/4", Length 24", Width 18". £69.00 + £3 Carr. As above, but with casters £6.50. extra.



### CALCULATORS



TR81MR DESK TOP CALCULATOR (as illustrated) 7" x 5 1/2" x 1 1/2" approx. 8 digit green display, %, / and -/+ . Mains or battery operated. £15.95 + £1 p.&p.



TR121 (as illustrated) 12 digit LCD model. 4 basic, floating or set decimal point, % key and full memory. 7 1/2" x 5" x 1 1/4" approx. £24.95 + £1 p.&p. Mains adaptor for above £4.95.

**COMPUTER COVERS** sewn in high quality black vinyl. Pet Computer £8.95. Computhink ) Postage 50p for 1 Disk Unit £3.15. Microprinter M879 ) £ 75p 3 or 4 £6.60. Pet Printer £4.25. ) Packing 5 + f.o.c. Pet Floppy Disc Unit £4.25. )

**DISKETTE STORAGE SYSTEM**  
P.V.C. Diskette Storage Sleeve - holds two 5 1/2" diskettes and index cards. Pack of 10 plus 5 document sleeves (A4 size) £5.95. + 30p p.&p. A4 size Ring Binder for storage of above £1.50 + 30p p.&p.

All prices include V.A.T. Allow 21 days for delivery. Orders with cheque, credit-card number, or cash to: - MEDIA 5 Ltd., Watson Mill Lane, Sowerby Bridge, West Yorks. HX6 3BW. Tel: Halifax (0422) 33580. TRADE ENQUIRIES WELCOME

• Circle No. 148

## Da Vinci Computer Shop

65, High Street, Edgware, Middx HA8 7DD.

Open Mon-Fri 9-5:30 Sat 9:30-5:30 Tel 01-952 0526

**NEW PRICE PETS**  
CBM 32K £695.00  
CBM 3040 FLOPPY £695.00  
CBM 3022 PRINTER £425.00

**NEW 80 COLUMN SCREEN PET** £895.00  
**NEW 1 MEG DISC DRIVE** £895.00

**DA VINCI COMPUTER SHOP**  
OUR SYSTEMS ARE MASTERPIECES - COME AND SEE THEM!

SALES/PURCHASE - LEDGER ACCOUNTING INCOMPLETE RECORDS  
WORD PROCESSING. INVOICING - PAYROLL.  
STOCK CONTROL. INFORMATION RETRIEVAL  
DOME SPRINTS DASY PRINTER £2115.00

• Circle No. 149

# BIRMINGHAM COMPUTER CENTRE

COMPLETE BUSINESS SYSTEMS FROM THE PROFESSIONALS

## 3000 SERIES

8K with built-in cassette	£ 425
8K with professional keyboard	450
16K with professional keyboard	550
32K with professional keyboard	695
343K Twin Floppy Disk	£695
CN2 Cassette Deck	55
IEEE Cables — Pet	20
IEEE to IEEE	25
Tractor Feed Printer	425

## COMMODORE OFFICIAL DISTRIBUTOR



32K SYSTEM COMPLETE £1850

## NEW 8000 SERIES

8032 — 32K with 80 col Screen	£ 895
8050 — Twin Disk Drive 950K	895



Latest Apple II with Auto-Start Rom and Floating Point Basic.

48K + Disk Drive with Controller. + Eurocolour Card

£1100 + VAT



16K	£ 695
Disk Drive with Controller	349
Disk Drive without Controller	299
Eurocolour Card	69
Pascal Card	299
Centronics Type Inter	110
16K Upgrade	69
Monitor	115
Full Range of Software Available	

## SHARP MZ 80K



£780

A complete Personal Computer System. At an Economical Price

	£	
6	520	Hi-resolution monitor.
10	540	Fast cassette unit.
18	620	Extensive graphics plus
22	640	sound G&M.
34	740	

Widely accepted as the most powerful 8-bit cpu on the market. Floppy disk drive now available

## NEW MODEL: BD-80P THE NUMBER 1 HI-SPEED PROFESSIONAL MATRIX PRINTER.

Now with graphis plus 10 user defined 750K Buffer Standard with further 2K option RS232 Serial. or parallel interfall plus numerous advanced features.

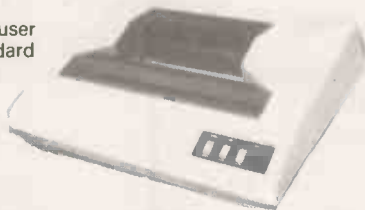

NEW-LOW—PRICE

£475

## THE ULTIMATE IN DAISYWHEEL PRINTERS RICOH.RP 1600

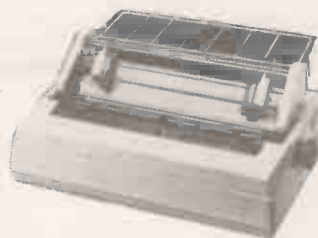

£1290

THE BEST WORDPROCESSOR. PRINTER. AVAILABLE  
DEALER ENQUIRIES WELCOME

## IF IT'S THE BEST WE STOCK IT

Complete range of — Off the Shelf Programs from the best in the country including:  
Commodore — Full range of Business Programs.  
Act — Complete range available  
Bristol Software Factory. Trader-Item-Monitor  
Computastore — Payroll  
Gamma-Winter — Complete Suit of Programs

Full range of Books and Magazines  
C15 — Super Quality Data Tapes Boxed 10 — £5.00  
Disks certified 5¼' Boxed 10 — £30.00  
Printer Ribbons — Listing Paper — Mailing Labels —  
Dust Covers, etc.  
Commodore 3032/16. D.O.S. 1H ROM.

\* SPECIAL PRICES FOR BETSI — KIMSI — MOTHERBOARDS — KIM.1. — PHONE FOR PRICE \*

SHOWROOMS OPEN DAILY. 9—6 P.M.  
LARGE CARPARK ADJACENT.

DEMONSTRATIONS AT YOUR CONVENIENCE.  
SALES • SERVICE • SATISFACTION



**CAMDEN ELECTRONICS**  
462 COVENTRY ROAD  
SMALL HEATH, BIRMINGHAM B10  
021-773 8240 — 021-772 5718

HP  
LEASING  
ETC

• Circle No. 150

# CHROMASONIC electronics

TELEPHONE 01-883 3705, 01-883 2289  
your soundest connections in the world of components

56 FORTIS GREEN ROAD  
MUSWELL HILL LONDON  
N10 3HN

Phone or send a S.A.E. for latest price list on all our range

## PETS

All with new keyboard and green screen

2001-8N 8K RAM	£449
2001-16N 16K RAM	£549
2001-32N 32K RAM	£649
CASSETTE DECK	£55

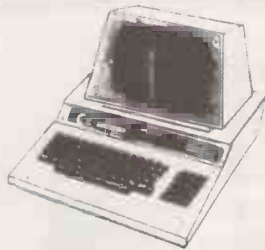

X-Y Plotters, Analogue to Digital Converters, 16 Channel Interfaces, B1 Directional Interfaces, etc.

## LS Series

74LS00	.18	74LS33	.26	74LS93	.60	74LS155	.72	74LS192	1.04	74LS273	1.70
74LS01	.18	74LS37	.23	74LS95	.81	74LS156	.72	74LS193	1.04	74LS279	.57
74LS02	.18	74LS38	.23	74LS96	1.16	74LS157	.57	*74LS194	.86	74LS283	1.09
74LS03	.19	74LS40	.20	74LS107	.32	74LS158	.57	74LS195	.97	74LS289	4.50
74LS04	.20	74LS42	.65	74LS109	.32	74LS160	1.09	74LS196	.97	74LS290	.91
74LS05	.22	74LS47	.81	74LS112	.32	74LS161	.69	74LS197	.97	74LS293	.81
74LS08	.20	74LS48	.81	74LS113	.32	74LS162	1.16	74LS221	.92	74LS295	1.30
74LS09	.22	74LS49	.81	74LS114	.32	74LS163	.69	74LS240	2.08	74LS298	1.16
74LS10	.20	74LS51	.18	74LS122	.69	74LS164	1.06	74LS241	2.08	*74LS348	1.39
74LS11	.20	74LS54	.18	74LS123	.72	74LS165	.72	74LS242	2.08	74LS352	1.04
74LS12	.20	74LS55	.18	74LS124	1.39	*74LS166	1.65	74LS243	2.08	74LS353	.92
74LS13	.37	74LS57	.33	74LS125	.36	74LS168	1.71	74LS245	2.50	*74LS362	4.21
74LS14	.65	74LS74	.30	74LS126	.36	74LS169	1.71	74LS247	1.09	74LS365	.55
74LS15	.20	74LS75	.40	74LS132	.60	74LS170	1.72	74LS248	1.09	74LS366	.55
74LS20	.20	74LS76	.27	74LS133	.39	74LS173	.81	74LS249	1.09	74LS367	.55
74LS21	.20	74LS78	.27	74LS136	.36	74LS174	.97	74LS251	.96	74LS368	.55
74LS22	.20	74LS83	.78	74LS138	.65	74LS175	.97	74LS253	.92	*74LS373	.78
74LS26	.20	74LS85	.81	74LS139	.66	74LS181	2.77	74LS257	.92	74LS386	.36
74LS27	.20	74LS86	.27	74LS145	.97	*74LS188	2.75	74LS258	.92	*74LS393	.84
74LS28	.22	74LS90	.57	74LS151	.81	74LS189	2.08	74LS259	1.39	*74LS568	1.17
74LS30	.20	74LS91	.97	74LS153	.52	74LS190	.86	74LS261	4.50	74LS670	1.71
74LS32	.26	74LS92	.69	74LS154	1.30	74LS191	.86	74LS266	.87		

Phone or send s.a.e. for latest price list on all our range.

Please add VAT 15% to all prices. Postage on computers, printers, and cassette decks charged at cost, all other items P.&P. 30p. Place your order using your Barclaycard or Access Card. (Minimum Telephone order £5.00). Trade and Export enquiries welcome. Credit Facilities arranged.



## THE FASTEST GROWING FOLLOWING KIT £199 OF THEM ALL

- Free sampler tape.
- 8K Basic in ROM
- 4K RAM expandable to 8K on board.
- Kansas City tape interface.
- RS232 Interface.
- Full QWERTY keyboard.



NEW MONITOR CHIP  
ALLOWS FULL  
CURSOR CONTROL  
AND EDITING £22

BUILT & TESTED  
£249

## PRINTERS

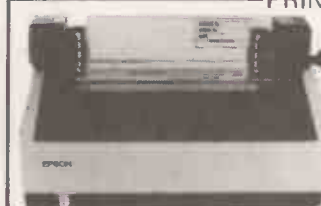

EPSON TX-80  
£395

Dot-matrix printer with Pet graphics Interface: Centronics parallel, options: PET, Apple and serial.

• Circle No. 151

Personal demonstrations available at all times in our new showrooms at 30 Lake Street. Also a large range of personal computers, books and magazines. Barclaycard and leasing facilities available.



# CompUtopia LIMITED

30 Lake Street, Leighton Buzzard, Bedfordshire  
Tel: (0525) 376600 24 hour Answering Service

## EPSON PRINTERS

- The TX-80 offers:
- 96 Ascii char. set and Pet Graphics
  - 80 col 150/125 char/sec
  - Condensed line, Enhanced print
  - 5x7 dot matrix, 6x7 dot matrix for graphics

Prices starting from £395 including delivery.

Interface boards and cables available for Pet, Apple, TRS 80.

IEEE488 and serial etc. for £45

OEM Prices available

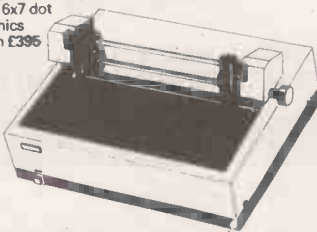

## PERIPHERALS

PRINTERS	
Texas Instruments Omni 810 Printer	£1450.00
Paper Tiger Printer with Graphics	£598.00
MONITORS	
VM129 HITACHI 12" B&W Video Monitor	£187.00
VM910 HITACHI 9" B&W Video Monitor	£127.00
ACCESSORIES	
Floppy Disk 5 1/4" Hard & Soft sectored pack of 10	£19.50
Floppy Disk 8" Hard & Soft sectored pack of 10	£22.00
C12 Computer cassettes pack of 10	£4.00
Computer Stationery	on request

## THE VIDEO GENIE SYSTEM EG 3003



At last, value for money in microcomputers.  
£425 incl VAT

- \*16k User RAM plus 12k Microsoft BASIC in ROM
- \*Fully TRS 80 level II software compatible
- \*Huge range of software already available
- \*Self contained, cassette, PSU & UHF modulator
- \*Simply plugs into video monitor or UHF TV
- \*Full expansion capability for disks & printer

## LS. CHIP PRICES

74LS02	£0.22
74LS08	£0.22
74LS10	£0.22
74LS32	£0.30
74LS74	£0.50
74LS86	£0.45
74LS93	£0.85
74LS100	£0.20
74LS132	£1.15
74LS138	£1.05
74LS175	£1.00
74LS191	£1.30
74LS244	£2.65
148SP	£0.95
1489P	£0.95

Memory Chips  
4116 16K Dynamic Ram £6.40 for 8 ..... £48.00

## APPLE

### HARDWARE

Apple 16K Video Output	£695.00
Disc Drive with Controller	£349.00
Disc Drive w/o Controller	£299.00
Pascal Language system	£299.00
Integer Card	£116.00
Eurocolour Card	£79.00
CCS Synch/Asynch Cards	£120.00
CCS Parallel Card	£90.00

### SOFTWARE

Computech Purchase Ledger	£296.00
Computech Sales Ledger	£296.00
Computech General Ledger	£296.00
Computech Payroll	£376.00
Computech Utilities	£20.00

Plus Software from Databank and many more



## TI 99/4

This TI Home computer helps take the guesswork out of problem solving, whilst also providing a "fun" way of education and giving stimulating entertainment for everyone. The TI 99/4 has all the features you have been waiting for ..... only £995\* complete with 14" colour TV with NTSC/PAL video input - or if sold separately TI console £665 and NTSC/PAL £375\*.

Call CompUtopia for comprehensive price list. \* Incl. VAT

Goods will be despatched within 24 hours of our acknowledgement giving precise delivery date. All prices include p&p within the UK. Please send cheques or postal orders or, if phoning your order, state Barclaycard number. For details please contact 30 Lake Street, Leighton Buzzard. Tel: (0525) 376600

• Circle No. 152

# Floppy Disk Systems AT LOW COST

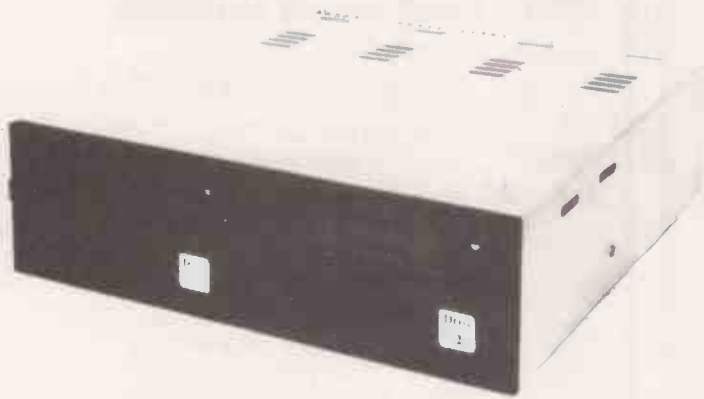

## FOR THE APPLE® II and ITT® 2020

- \* Mains Powered Dual Disk Unit.
- \* 2 Disks Each Giving 116K Bytes.
- \* Completely compatible with Apple® II and ITT® 2020 Disk controller cards.

Height: 92 mm    Width: 149 mm  
Length: 300 mm    Weight: 7.8 Kg.

**DUAL DISK UNIT £498**

## FOR THE TRS80, SWTP, SUPERBRAIN, NORTH STAR HORIZON, HEATHKIT ETC. ETC.

40 Track single disk unit	£236
77 Track single disk unit	£345
40 Track Dual disk unit	£440
77 Track Dual disk unit	£645

- \* Mains powered disk systems
- \* Shugart SA400 Interface compatibility
- \* Daisy chain up to four drives

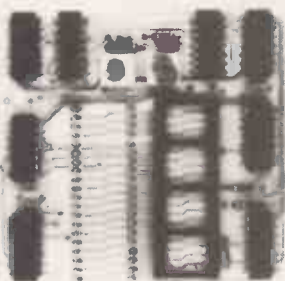
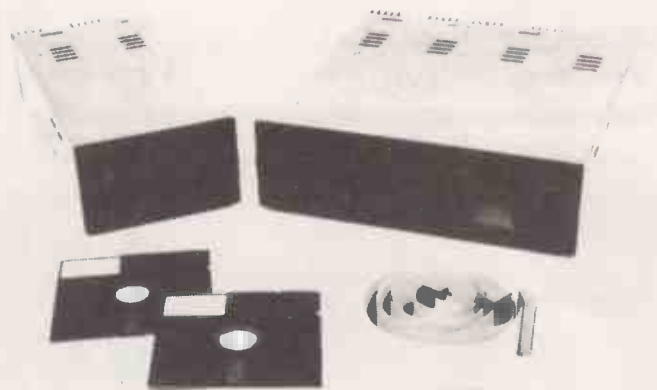

## FOR TRS80 USERS

The PERCOM DATA SEPARATOR eliminates read and verify errors on the inner (higher numbered) tracks of your Disk Systems. Plugs into the expansion interface. No soldering — takes 5 minutes to fit.

**£20 WITH FULL INSTALLATION INSTRUCTIONS**

TRS80 DISK CABLES:	2 Drive Cable	£22.50
	4 Drive Cable	£34.00

**Call your nearest dealer for a demonstration:**

*London Computer Store, 43, Grafton Way, London W1. Tel: 01-388-5721*

*Katanna Management Services, 22 Roughtons, Galleywood, Chelmsford, Essex. Tel: 0245-76127*

*Sevet Trading, 14, St. Paul's Street, Bristol 2. Tel: 0272-697757*

*EWL Computers Ltd., 8, Royal Crescent, Glasgow Tel: 041-332-7642*

*Data Plus Computer Services, 67, Bridge Street, Manchester. Tel: 061-832 3265*

**CUMANA LTD., 35, Walnut Tree Close, Guildford,  
Surrey. GU1 4UN.  
Tel: (0483) 503121  
Telex: 859680 (Input G)**

*Please add VAT to all prices.  
Delivery at cost will be advised  
at time of order.*

## INTEGRATED SMALL BUSINESS SOFTWARE ISBS

Professional Business Packages for Microcomputer systems include:

- PAYROLL
- STOCK CONTROL
- ORDER ENTRY & INVOICING
- COMPANY SALES
- COMPANY PURCHASES
- GENERAL ACCOUNTING
- NAME & ADDRESS SYSTEM

Available as individual modules or complete system to run on RAIK BLACK BOX, NORTHSTAR, HEATH, CROMEMCO, DYNABYTE, IMS 5000/8000, ALTOS, ALTAIR, SUPERBRAIN, MICROMATION and most other 8080 based systems.

Contact Lifeboat Associates, 32 Neal Street, London WC2 or your nearest dealer.

**GRAFFCOM** 52 SHAFTESBURY AVENUE  
SYSTEMS GROUP LONDON W1 01-734 8862

• Circle No. 154

## MICRO- FACILITIES

127 HIGH STREET  
HAMPTON HILL  
MIDDLESEX  
01-979 4546  
01-941 1197

### MIDDLESEX & S.W.LONDON

Approved Business Dealers for:

Commodore Computers & Business Packages  
Apple II  
North Star Horizon  
IMS 5000/8000 Series

As fully authorised Dealers for the above equipment, and as experienced data processing professionals, we are the best people to help you.

Our complete package offers you:

Free initial discussion & advice  
Systems Design & Programming  
Software Packages  
Supply & Installation of equipment  
Leasing & Financing terms  
Full Maintenance Contracts  
Genuine After Sales Service

Contact us to discuss your problems and requirements, we offer you a lot more; but only charge the same. Our ability will give you peace of mind and confidence that the job will be done properly.

• Circle No. 155

# printed continuous stationery

we can supply Printed Continuous Forms  
with your Company Name & Logo

**also**

ex-stock single-part listing paper  
11 x 8½, 11 x 9¾, 11 x 10¾, 12 x 8½, 11 x 9½  
Multiples, OTC and NCR.

for prices and details phone:-

## David Richards 01-520 8624

David Richards (Printers & Distributors) Ltd. 61/63 Hoe Street London E17 4SA

• Circle No. 156



Whether you're a software engineer looking for the best hardware — an educationalist requiring versatility and the ultimate in reliability — or an OEM demanding flexibility, the finest documentation available, and 'realistic' margins — Zenith Data Systems is your automatic choice.

### Z89 Series Microcomputer.

This highly advanced Microcomputer is the star of the Zenith range.

Specification includes:  
Floppy disc storage. 48K RAM.  
'Intelligent' video terminal.

Two Z80 Microprocessors. Choice of operating systems including CPM.

Standardised communication, RS 232. Prices from £1570

### Z11A Series 16-bit computer.

Based on the powerful new KD11-HA CPU (LSI — 11/2) it offers you the speed and versatility of a minicomputer at



Z89

Z19

### Z19 'Intelligent' Video Terminal.

Z80 based, it is capable of a multitude of high-speed functions. It has an easy-to-read, high resolution CRT. Heavy duty keyboard. 128 characters. Addressable cursor, relative and direct. Versatile edit functions. And E.I.A. RS 232/c at 110 to 9600 baud. Price. £735

# The Professionals

a microcomputer price. With memory\* to 32K words (64K Bytes). Seven additional I/O positions. PDP 11/03 compatible.

Systems from £4359.

\*Memory boards available from £562 per 16K.

### WH14 Serial Printer.

Microprocessor based electronics makes it capable of a wide variety of uses in most computing applications.

It features 5 x 7 dot matrix. Impact print. Operator/software selectable line width — 132, 96 and 80 characters per line. And sprocket paper feed with adjustable spacing. Price. £510

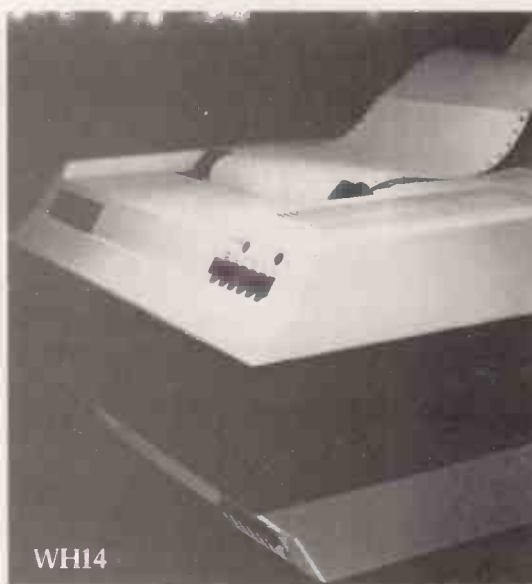

WH14



Z11A

**Zenith data systems**



THE ULTIMATE IN MICROCOMPUTERS

If you'd like more information about any or all of the Zenith Data Systems range, just contact us at Zenith Data Systems Division, Heath Electronics (U.K.) Limited, Dept (PC8), Bristol Road, Gloucester GL2 6EE. Telephone (0452) 29451. All prices are exclusive of VAT and delivery charges.

Generous OEM discounts available.

# Stop puzzling over the Micro Jigsaw and buy an operational system to fit your needs

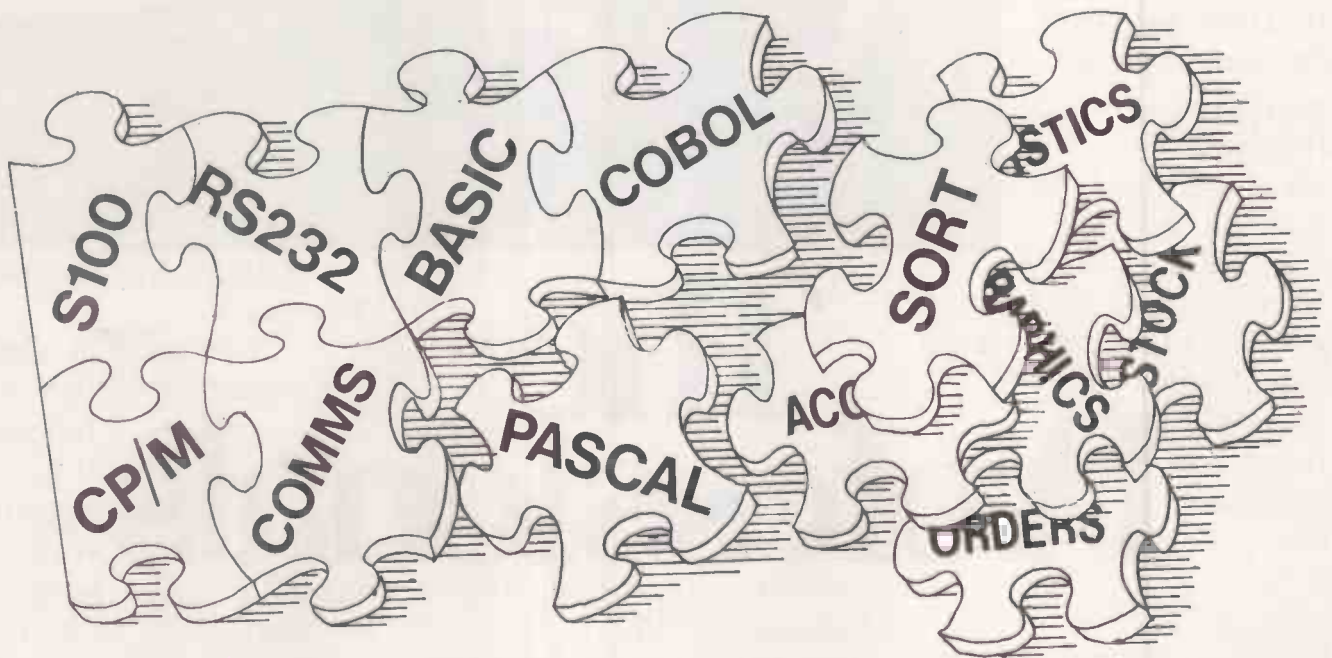

If only buying a microcomputer system was as simple as using one.

Just look at the advertisements in this magazine. When can you find time to digest them all?

There are millions of chips, thousands of boards and hundreds of peripherals, software systems and application packages. How do you pick the right ones to meet your requirements?

And put them together? And make them work? And add the specials you want?

At Digitus we have computer professionals working full-time putting systems together. Absorbing information. Testing equipment and software. Writing programs. Training users.

At one stop you can commission a complete system to fit your requirements.

Last year we supplied systems for: number processing, word processing, data processing,

graphics and machine control. Advised accountants, surveyors, archaeologists and engineers. Helped DP departments and small business men. Developed software for personnel, incomplete records, order processing, business games, linear programming, process control and terminal emulation. And were retained by other computer companies to advise on micros.

This year we can put even more experience to work so that you can benefit from micro technology ... in comfort.

Come and see us. Spend a few hours discussing your requirements. Attend a training course. Select a machine. Test drive some software.

Solve the micro puzzle. Buy an operational system that fits your needs.

Call for an appointment with one of our consultants.

# Digitus

Digitus Limited 9 Macklin Street Covent Garden London WC2 Tel: 01-405 6761

• Circle No. 158

# The copyright controversy

LAST MONTH, we drew attention to what may be a glaring gap in English law — computer software may not be protected by the Copyright Act.

The problems seems to be that the Act protects “literary works” which include “any written table or compilation” and writing is “any form of notation, whether by hand or by printing, typewriting or any similar process”. It is quite possible that a program in ROM or on a magnetic medium is not “writing” in that sense because it is invisible to the eye.

However, once a literary work is copyright, it is protected from unauthorised publication in “any material form”.

The effect might be that you would have to obtain copyright by listing the program on paper. Only then would reproduction in ROM or disc be protected.

Unfortunately, until someone fights a very expensive case in the High Court, we will have no precedent. *Practical Computing* feels that there should be an Act of Parliament to make it clear that computer software has the same protection as every other intellectual work.

Copyright is a type of protection best suited to essentially inactive things. Books, plays, poems do not alter directly other literary works: computer programs can be quite different. Let us consider three examples:

You buy a word processor program from Mr Programmer and use it to edit and format a book you are writing. Does Mr P have any copyright in the result?

You buy a sub-editing program from Mr P and use it in the same way. The program does not just follow orders as the word-processing program did, it makes some decisions about literary style. It prefers short words to long ones; it prefers “he ran for the train” to “he was running for the train”. It breaks up long paragraphs into shorter ones. Its effects are sufficiently marked that one can often tell that an author has used it. Who owns the copyright in the finished book?

You buy a chess playing program, like Sargon, and feed it some mid-game positions. The program then runs and you publish a book of end-games consisting of the positions generated by the program. Who owns the copyright — you or the writer of Sargon?

The commonsense view is that in the first case you have the copyright, in the second case, it is doubtful, in case three, the author of Sargon ought to have it.

The simple approach to computer software copyright simply asks who owns the copyright in the input — he then owns the copyright in the output. That obviously applies to the first case. In the second case, one might have doubts. It is obviously wrong in case three — the input there is simply some board positions which may demand no skill at all.

The trouble with this analysis is that input and program are different kinds of thing. They can alter in relative intellectual weight but not in essential character.

That fact is not really appreciated by commentators on computing who are not intimately involved in it. They tend to assume that a program is a series of mechanical commands that produce a fixed result.

For instance, a recent Bill introduced into the U.S. House of Representatives, called the Computer Copyright Act of 1980, defines a computer program as a “set of statements or instructions to be used directly or indirectly in a computer to bring about a certain result”.

That is clearly only half the story. Quite apart from the “certainty” of the result — the author obviously has not had much to do with computers — what a program does depends as much on the data it is fed as the “set of statements or instructions”. The data may be simple and the program complex as in the chess example, or the data

complex — at least to human perceptions — and the program simple as in the text editor.

As we know only too well, programs incorporate a great deal of creative thought. Sargon is a good example. It is possible to show that the complete game of chess is transcomputational — that is, even if you made all the matter and energy in the universe into a computer and ran it since the beginning of time, you could not analyse all the possible moves in the game of chess.

Consequently, any game which plays chess can do so only because its author has built in his own skill and judgment about how a game should go. In the third example, it is quite clearly that element which prevails in the output — it is that element which makes Sargon a better or worse chess-playing program than another.

One ought to treat the program in law as if it were a person, or the stored intellectual attributes of its author. If it does a purely mechanical task, it has no copyright. If it contributes the main intellectual content, with the human simply pressing the buttons to make it go, it ought to have the credit.

The next stage — not very far away — is when one program calls another to produce an output far removed from the abilities of the nominal owner of the input — which may be no more than a request. For instance, you have an expert system which is good at précis writing. You tell it to access the Encyclopaedia Britannica on Prestel and write a 300-word report on sickle-cell anaemia. Who own the copyright in the report?

The issue can clearly become so complicated that copyright may not be the best way to analyse it.

Law exists to resolve and, ideally, to prevent quarrels. In the field of copyright, it exists to assure authors the just fruits of their intellectual labour. In the process, it is to the benefit of all because if there were no protection, no-one would embark on intellectual work. The return in computing is not so much from the value of the output as the value of using the program which produces it. In other words, if I had written the précis-writing program in the example, I would not be terribly interested in the copyright in the 300-word report.

In most cases, I think, we can ignore copyright in the output as being of transient value. What matters is the programs themselves. At the moment, they are written by human hands and present no fundamental problem.

Yet the analysis merely delays the day when we will have to take copyright seriously. What happens when a program is used to create a program? Far-fetched? Unless you write in Hexadecimal machine-code instructions, you do it every day with high-level languages. The copyright problem in this case is obviated either by contract or neglect.

People are talking about proper program-writing programs and, in a sense VisiCalc — reviewed in June, *Practical Computing* — is one. You could presumably use VisiCalc to create a business-control program and sell it to users. Should the publishers of VisiCalc have a slice of your money? Maybe they should, but in the real world, this kind of accounting is going to become too complicated to be worthwhile. The convention of the industry may be that if you sell a program used to make other programs, you allow for that in the price you charge. So long as copyright law prevents people stealing the original software, you will be content.

Yet convention is not good enough because, as we pointed out last month, the man who is prepared to take what appears to be a hopeless case to court may well win simply because his opponents cannot afford to fight it. Uncertain law makes for bullies but a bad law may be better than no law at all.

Our Feedback columns offer readers the opportunity of bringing their computing experience and problems to the attention of others, as well as to seek our advice or to make suggestions, which we are always happy to receive. Make sure you use Feedback—it is your chance to keep in touch.

## Mainframe glossary

MAY I offer a glossary of terms from my mainframe days.

**Computer:** A machine for transferring boring clerical operations into boring manual operations.

**Program:** A set of instructions telling a computer how to loop and halt unexpectedly.

**System:** A collection of mutually incompatible programs.

**Parameter:** A means of introducing an element of uncertainty into a process.

**High-level language:** A programming language in which instructions are written in standard English. e.g.,

A.AC% =VAL(MID\$(FN.A3\$(B.AC\$(4,30))) + CHR\$(4))

**Debugging:** The process of replacing one error by another.

**Working program:** A program from which quite a few errors have been removed.

**Enhancement:** A way of re-introducing errors into a working program.

**Sort:** A program which enables random-accessed files to be held sequentially.

**Implementation:** The re-writing of a system in a hurry.

**Operator:** A person employed to slow a computer down to a manageable speed.

**Punched card:** The most inefficient form of data storage ever invented. The data is stored in holes in the card. As the card serves only to hold the holes in place, it is 100 percent redundant.

**Security dump:** Something you never have time to do because of all the disc crashes.

**Turn-round:** The delay between submitting a deck of cards to the computer and receiving back their remains.

John McMillan,  
Reading,  
Berkshire.

## Unjust rejection

I HAVE just read the editorial in the June issue of *Practical Computing*, and I feel I must comment on it.

I have no desire to enter the debate as to which languages should be used on micros in the future, that depends on the application and, as I hope to show, the programmer's previous experience. I am writing because I think that your rejection of Pascal on the basis of the fact that you were unable to get along with it is unjust.

High-level computer languages split into two groups, unstructural — Basic, Fortran, etc. — and structured — Algol, Pascal, etc. Anyone who has learnt one type of language and not the other finds it difficult to convert to the other. That, incidentally, is the main reason why

Fortran is still so popular among engineers when a structured language would be much better for their purposes in the long run.

To give a parallel example, in the field of typing. The QWERTY keyboard was designed originally to slow typists — the machines of that time could not keep up — but it is now so well established that a new, and considerably faster keyboard lay-out will find it almost impossible to break into the market even though it enables typing at dictation speed.

The point that I hope I have demonstrated is that changes requiring people to think in a new or considerably-revised way will usually be rejected even if they do provide considerable improvements in the long run.

You also say that recursion is only useful in solving a few mathematical problems. That is not so; recursion, in fact, makes the writing of most games programs a good deal simpler once you have mastered the technique — the same problem of rejection of new ideas occurs again.

The rejection of new ideas on the basis of not wanting to change old habits often means that the real benefits and disadvantages of, in this case, new programming languages become obscured.

T K Porter  
University of Warwick  
Coventry

● Our point is that the problem confronting the microcomputing community is not which language to use, but how to make micros useful to the world at large. The way forward will be through the introduction of computers to more professionals in many fields — it is more important that they find the standard language easy and natural to use than that it should be powerful in the way a computer scientist would use the word.

## Teletype 33 interface

WE HAVE a Teletype 33 and would like to use it to print from our Pet. For that, we need an interface. Has anyone built one that works? I understand that they are not available commercially. The difficulty is that it is 120V.

K R Wilkinson,  
Abbotsholme School,  
Uttoxeter,  
Staffordshire.

## Printer survey

IT SEEMS that at the moment the market is being flooded with various matrix printers in the £300 to £600 price bracket.

As I and, I am sure, many other potential buyers are waiting to see which offers the best value for money before taking the plunge and buying one, I would be glad if you could do a survey of the various types — some I suspect are the same printer in a different box — perhaps including the following: Nascom Imp, Superprint 800, Anadex DP-8000, RM 8300, Oki Microline and the Epson TX-80.

David Green,  
Nairobi,  
Kenya.

● A thorough guide to all the printers on the market will be appearing shortly.

## Viatron equipment

I HAVE recently acquired a Viatron System 21 together with a matching tape drive. If any readers have any relevant manuals they would be willing to loan or general information they could pass on regarding this and any other Viatron equipment, I would be very grateful. If there is anyone else struggling with one of these machines, perhaps we could start a Viatron users' group? Also, is there a 6800 — specifically MEK 6800 D2 — group still going somewhere?

Paul Dion,  
London, NW3.

## Microchess loses

I WONDER if your readers would be interested in the following very short win for white against Peter Jennings Microchess 2 program?

IQ level = 8

White	Pet
1. D2-D4	G8-F6
2. E2-E4	F6-E4
3. F1-C4	D7-D5
4. D1-F3	E4-F2?
5. C4-D5	F2-H1??
6. D5-F7+	YOU WIN

Black's time, 5 minutes 36 seconds.

An interesting feature of the game is that at level 8, Microchess 2 resigns by declaring 'You Win' one move before the impending mate.

Like the quick wins in the article, *Foxing the Pet*, *Practical Computing*, April, 1980, the mate is obtained by offering Black an advantage in material. However in this game, there is also an element of Microchess trying to be too clever.

That can be illustrated by attempting to repeat the moves with the IQ level set at 1. Moves 1 to 4 for White and moves 1 to 3 for Black turn out to be the same, but at move 4 Black now plays simply 4. D5-C4 easily avoiding the mating trap.

(continued on page 46)

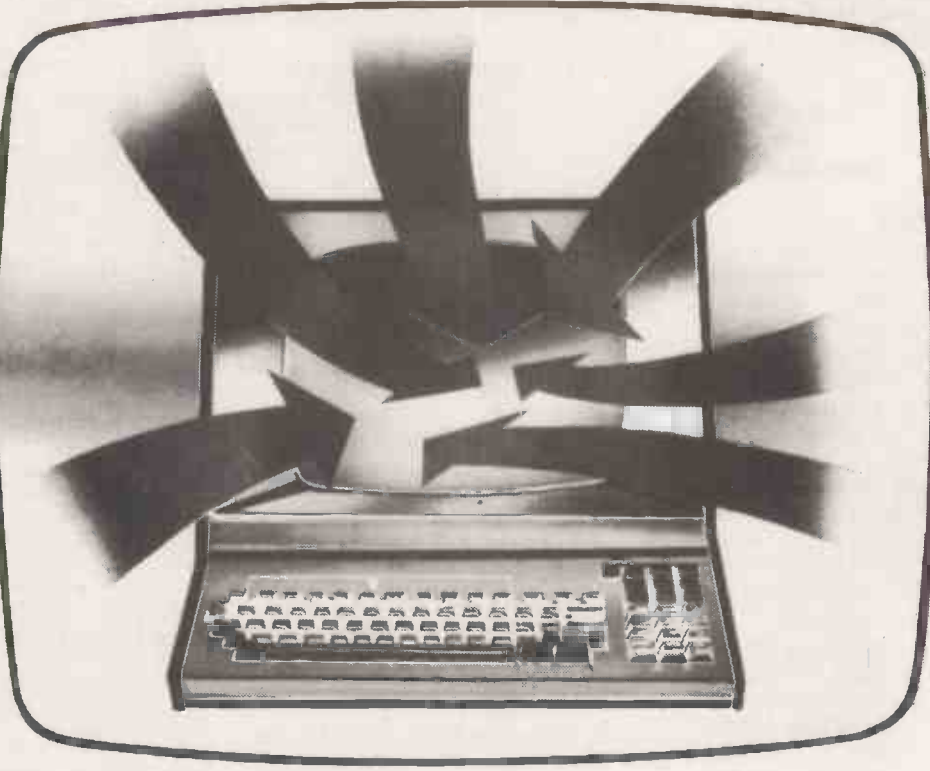

## BENEFIT INSTANTLY FROM YOUR APPLE II

Customer records - Direct mail -  
Membership lists - Subscription files -  
Inventory data - Employee records -  
Rental contracts.

**TRENDISK/1** is an all purpose data handling package which is easy to use without being laborious and verbose. **Trendisk/1** enables you to benefit immediately from your new micro and - **WITH NO PROGRAMMING EXPERTISE:**

- Define new files and specify what data is to be held in each record
- Add records to the file
- Delete or amend existing records
- Reference records using any item of data
- Search for records with parameters such as 'SIZE greater than 12 and COLOUR = RED and PRICE is less than £20.00'
- Browse through the file record-by-record printing selected details
- List information from the file
- Generate reports
- Print address labels
- Analyse/Adjust numerical data
- Resequence the file using any item.

- Use of standard file formats makes development of 'add-on' programs easy.

**Trendisk/1** runs on Apples with 32K of RAM (48K with Applesoft in RAM) with at least one diskette drive. The package supports Centronics-compatible printers using the parallel interface card.

**Diskette - Five Programs  
Only £75.00 (incl. VAT)**

Send now for your **free**  
Personal Computer Data Card!

For our 24 hour telephone ordering service call  
0423 711878, or complete the coupon:

Name \_\_\_\_\_  
Address \_\_\_\_\_  
\_\_\_\_\_  
\_\_\_\_\_  
\_\_\_\_\_  
Please send me Trendisk/1 at £75.00 incl. VAT  
Please send me your product catalogue  (tick)  
Please send me a Data Card   
Signature \_\_\_\_\_  
                       
Credit Card No \_\_\_\_\_  
Send to: **Microtrend Ltd.**,  
P.O. Box 51, Pateley Bridge,  
Harrogate, North Yorkshire HG3 5DP  
PCB



• Circle No. 159

(continued from page 44)

In contrast, at IQ level 4, the game proceeds along the same moves as level 8, except that in this case, black does not resign and is mated in 48 seconds by:

6. D5-F7 + E8-D7
7. F3-D5 + +

**P Schofield,**  
Horsforth,  
Leeds LS18 5HD.

## Aids for disabled

THE BRITISH Computer Society has a committee for the disabled, among whose aims are the development of computer-based aids for the disabled.

In the U.K., a number of people are developing aids for sufferers of almost every kind of disability, and the advent of the microcomputer has accelerated the trend to new inventions.

So far, little has been done to provide a means for such people to contact each other and discover what is being attempted. Many aids have been invented and developed one-off by the inventor for himself or for a friend or relation.

Such an inventor could have gained help from contact with others working on the same problem. As a first step towards the information service which we believe essential, the sub-committee is collecting the names and addresses of people and organisations working in the field.

We should be very glad to hear from any who are interested whether as sufferers, inventors or manufacturers. We feel sure that this is not merely a national problem and are seeking similar help from organisations for information science in most of the English-speaking world.

**Helen Townley,**  
The British Computer Society,  
13 Mansfield Street,  
London W1M 0BP.

## Apple for teacher

I AM an enthusiastic user and proud owner of an ITT 2020 Apple with a disc drive and use it to conduct highly-structured seminars in which audience participation produces data and the computer generates results which lead to further discussion.

It is also very useful for lecture presentation of standard teaching material as problems can be set and worked on-line. It saves slide preparation and is endlessly re-usable. Paging a screen of notes is very handy — I use a large black and white TV for that.

In my Palsoft version of Basic which I have in ROM, I cannot run integer or binary programs directly on disc. I wonder if any readers have a solution — the conversion routine to integer Basic supplied by the dealer works only with tapes and you cannot load integer programs with the DOS. Most published software is in integer Basic and if you buy a disc you can't run it on the ITT 2020 in Palsoft ROM — any suggestions?

Do any readers have an L-P package on disc in Applesoft Basic? If anyone does, I

would be happy to trade a correlation program in Applesoft on disc which I have developed for teaching purposes and which has been used successfully by students.

Thanks for your Apple Pie features.

**F W Lukey,**  
Kumasi,  
Ghana.

## Machine-code master

I HAVE been reading with not a little frustration your series on machine code programming for the 8080 and 6502 microprocessors. Frustration not because of the quality or content of the series which is excellent, but because from my point of view you are about a year too late.

Having written a fair number of machine-code routines for a multiplicity of subsequent applications, I found it useful to be able to transfer the routine efficiently into a Basic program in the form of data lines. With that in mind, I offer for sacrifice the enclosed tit-bits for your consideration in the hope that some of your budding machine-code freaks might find it useful.

The two routines are written so that one of them writes data lines and the other deletes them, which may seem obscure but it is frequently useful to be able to delete lines as new ways of writing the source code are discovered. Repeated typing of the line numbers followed by return can be wearisome if you are trying to get rid of 20 or 30 redundant Data lines.

Of course, the delete routine can be used to delete any lines — not necessarily data lines and I use it to delete both those program segments once their usefulness has been exhausted and the final version of the main program is being prepared.

### DATA-LINER <DELETE>

```
60000 REM*****
60010 REM*****LINE DELETER*****
60020 REM*****
60030 PRINT"JMN"
60040 PRINT"          3 LINE DELETER"
60050 PRINT"          "
60060 REM*****
60070 REM* ENTER FIRST AND LAST LINES*
60080 REM* OF BLOCK TO BE DELETED*
60090 REM*****
60100 INPUT"START LINE";SL
60110 INPUT"END LINE";EL
60120 PRINT"JMN";
60130 IF SL>EL THEN PRINT"J":END
60140 REM*****
60150 REM* SET LINE NO. COUNTER *
60160 REM* (STEP NO. CHOSEN TO SUIT) *
60170 REM*****
60180 FOR I=SL TO EL STEP 10
60190 X=X+1
60200 IF X>9 THEN GOTO 240
60210 PRINT I
60220 NEXT I
60230 X=X+1
60240 REM*****
60250 REM* PRESERVE VARIABLES *
60260 REM* AFTER LINE DELETION *
60270 REM*****
60280 PRINT"SL="I":EL="EL":GOTO 60120
60290 REM*****
60300 REM* AUTOMATIC 'RETURN' KEY *
60310 REM* LOAD KEYB/D INPUT BUFFER *
60320 REM* AND EXECUTE 10(MAX.) RETURNS*
60330 REM*****
60340 PRINT"J";
60350 POKE 158,X
60360 FOR J=1 TO X
60370 POKE 622+J,13
60380 NEXT J
60390 END
```

### DATA-LINER <WRITE>

```
60400 REM*****
60410 REM*****DATA-LINE WRITER*****
60420 REM*****
60430 PRINT"JMN"
60440 PRINT"          3 LINE WRITER"
60450 PRINT"          "
60460 PRINT"NOW YOU WILL BE ASKED FOR:"
60470 PRINT"THE START"
60480 PRINT"AND END ADDRESS OF THE"
60490 PRINT"MEMORY BLOCK"
60500 PRINT"TO BE SAVED AS DATA";
60510 PRINT"STATEMENTS"
60520 PRINT"NOW PRESS X OR Y TO SPECIFY";
60530 PRINT"THEM IN DECIMAL"
60540 PRINT"OR ELSE Z OR H TO SPECIFY";
60550 PRINT"THEM IN HEX"
60560 GETA$:IFA$="" THEN GOTO 60560
60570 IFA$<"D" AND A$<"H" THEN GOTO 60560
60580 REM*****
60590 REM* SPECIFY MEMORY BLOCK *
60600 REM* LOCATION AND CONVERT *
60610 REM* ADDRESSES TO DECIMAL *
60620 REM*****
60630 INPUT"START ADDRESS";SA$
60640 INPUT"END ADDRESS";EA$
60650 IFA$="H" THEN GOTO 60690
60660 SA=VAL(SA$)
60670 EA=VAL(EA$)
60680 GOTO 60750
60690 H$=SA$
60700 GOSUB 60940
60710 SA=N
60720 H$=EA$
60730 GOSUB 60940
60740 EA=N
60750 REM*****
60760 REM* CHECK SPACE AVAILABLE *
60770 REM* FOR NEW DATA LINES *
60780 REM*****
60790 INPUT"STARTING LINE NO.";SL
60800 LL=INT((EA-SA)/17*10+SL)
60810 IFFL<60000 THEN GOTO 60840
60820 PRINT"STARTING LINE TOO HIGH"
60830 GOTO 60790
60840 REM*****
60850 REM* WRITE DATA LINES *
60860 REM*****
60870 PRINT"JMN"SL"DATA ";
60880 FOR I=SA TO EA
60890 IF POS(A)>75 THEN GOSUB 61070
60900 PRINT" "PEEK(I);
60910 NEXT I
60920 GOSUB 61070
60930 GOTO 61300
60940 REM*****
60950 REM* HEX. CONVERSION SUBR. *
60960 REM*****
60970 N=0
60980 L=LEN(H$)
60990 FOR I=L TO 1 STEP -1
61000 MN=ASC(MID$(H$,I,1))
61010 IF MN<65 THEN GOTO 1040
61020 N=N+(MN-55)*16+(L-I)
61030 GOTO 61050
61040 N=N+(MN-48)*16+(L-I)
61050 NEXT I
61060 RETURN
61070 REM*****
61080 REM* INSERT COMMAS SUBR. *
61090 REM*****
61100 PRINT
61110 SL=SL+10
61120 LN=LEN(STR$(SL))+6
61130 X=X+1
61140 S=32768+LN+X*80
61150 F=S+80-LN
61160 FOR C=STOF
61170 Y=PEEK(C):Z=PEEK(C+1)
61180 IF Y=32 AND Z=32 THEN C=F:GOTO 61200
61190 IF Y=32 THEN POKE C,44
61200 NEXT C
61210 IF I=EA THEN RETURN
61220 IF X>9 THEN PRINT SL"DATA " : RETURN
61230 REM*****
61240 REM* PRESERVE VARIABLES *
61250 REM* AFTER LINE INSERTION *
61260 REM*****
61270 PRINT"SL="SL":SA="I":EA="EA";
61280 PRINT" :GOTO 60840"
61290 REM*****
61300 REM* AUTOMATIC 'RETURN' KEY *
61310 REM* LOAD KEYB/D INPUT BUFFER *
61320 REM* AND EXECUTE 10(MAX.) RETURNS*
61330 REM*****
61340 PRINT"J";
61350 POKE 158,X+1
61360 FOR J=1 TO X+1
61370 POKE 622+J,13
61380 NEXT J
61390 END
61400 REM*****
61410 REM* WRITTEN BY D.J.H. WARR 1980 *
61420 REM*****
```

**D Warr,**  
Oxford. 

# SUPERBRAIN™

WITH  
INTEGRAL  
VDU

**£1,995**  
COMPLETE  
(+VAT)

★ Full 64K RAM

★ Twin Z80A microprocessors

★ CP/M™ (2.2) operating system

★ Twin double density mini floppies (320K:670K optional)

SUPERBRAIN™ -stand alone system and intelligent terminal combined in a single desk top unit (14<sup>3</sup>/<sub>8</sub>"H×21<sup>3</sup>/<sub>8</sub>"W×23<sup>1</sup>/<sub>8</sub>"D).

Non-glare dynamically focused 12" CRT and Universal RS-232

Communications port. SOFTWARE PACKAGES AVAILABLE.

Full SUPERBRAIN™  
details from the  
following dealers:

**JAEMMA LTD.**,  
44 Manor Park Road, Castle Bromwich,  
BIRMINGHAM Tel: 021 7474531

**JENNINGS COMPUTER  
SERVICES LTD.**, 55/57 Fagley Road,  
BRADFORD 2, W. Yorks.  
Tel: 0274 637867

**COMPUTERISED BUSINESS  
SYSTEMS**, 32/34 Huntriss Row,  
SCARBOROUGH, N. Yorks.  
YO11 2ED. Tel: 0723 75787

**AERCO GEMSOFT**,  
27 Chobham Road, WOKING,  
Surrey GU21 1JD. Tel: 04862 22881

**O. C. T.**, Kimberley House,  
Vaughan Way, LEICESTER,  
LE1 4SG. Tel: 0533 28631

**MICRO BUSINESS SYSTEMS**,  
E Floor, Milburn House, Dean Street,  
NEWCASTLE-ON-TYNE, NE1 1LE.  
Tel: 0632 29593

**CULLOVILLE LTD.**, Thornfield,  
Woodhill Road, Sandon,  
CHELMSFORD, Essex.  
Tel: 024 541 3919

**PROMGLOW LTD.**, 12 Dene Road,  
New Southgate, LONDON N11 1ES.  
Tel: 01-368 9002

**SHEFFIELD COMPUTER CENTRE**,  
225 Abbeydale Road, SHEFFIELD,  
S7 1FJ. Tel: 0742 53519

**COSMOS COMPUTERS LTD.**,  
Blackhorse Road, LETCHWORTH,  
Herts. Tel: 046 26 6861

**BORDER COMPUTING**,  
Dog Kennel Lane, BUCKNELL,  
Shropshire SY7 0AX. Tel: 05474 368

**DAYTA**, 20B West Street,  
WILTON, Wilts. SP2 0DF.  
Tel: 072274 3898

**MICRO SOLUTION LTD.**,  
Park Farm House, Heythrop,  
CHIPPING NORTON, Oxfordshire  
OX7 5TW. Tel: 0608 3256

**MICROPEOPLE LTD.**,  
Microcomputer Consultancy Services,  
1 Union Street, LONG EATON,  
Nottingham, NG10 1HH.  
Tel: 06076 68923

**OMEGA ELECTRICS LTD.**,  
Flaxley Mill, Flaxley Road,  
MITCHELDEAN, Gloucestershire.  
Tel: 045 276 532

**AMA (COMPUTING) LTD.**,  
1 Frog Hall Lane, WARRINGTON  
WA2 7JJ. Tel: 0925 33137

**ROGIS SYSTEMS LTD.**,  
Keepers Lodge, Frittenden,  
Nr. CRANBROOK, Kent.  
Tel: 058 080 310

**GARCIA BUSINESS SYSTEMS**,  
106 High Street, BUSHEY, Herts.  
WD2 3DE. Tel: 01-950 6255

**ESCO COMPUTING LTD.**,  
74 Waterloo Street, GLASGOW,  
G2 7DA. Tel: 3041 204 1811

For dealer enquiries, contact

**ICARUS COMPUTER SYSTEMS LTD., 27 Greenwood Place, London NW5 1NN.**

SUPERBRAIN™ is the registered trademark of Intertec Data Systems.

CP/M™ is the registered trademark of Digital Research.

• Circle No. 160

# Exidy withdraws from microcomputer market

WHILE Nascom was sliding into receivership in the U.K., Exidy announced that it, for very different reasons, was pulling out of the micro field. It has sold the Sorcerer to Personal Micro Computers, a subsidiary of Recortec which has hitherto sold cassette-copying equipment for music and software publishers.

PMC also recently negotiated the U.S. distributorship rights for the Video Genie — the Hong Kong-built TRS-80 look-alike, which it is selling by mail order as the PMC-80.

Some reports claim that PMC has been able to sell only 200 of the systems. There are about 1,500 Sorcerers in the

U.K., nearly 10 percent of the total Exidy world sales of what was its only microcomputer system. Exidy claims that it

was unable to make the investment required to penetrate the microcomputer market. □

## New range of software at substantially lower cost

APPLIED Computer Techniques (ACT) has launched a new series of business software packages for the Pet which, it is claimed, offer competitive performance for substantially lower cost than their opposition.

Stock control, payroll and

ledger packages will cost between £50 and £125, which, says ACT, is less than half the cost of comparable packages from other software houses.

Other packages available from ACT Petsoft, which is now aiming for the business market, include the Wordcraft word-processor package and financial and business-modelling system VisiCalc.

Prices have been pitched deliberately low for maximum business, and user-support will still be from dealers, who will probably not be slow to point out that the lease cost per month of the latest Pet plus packages to run a small business amount to around £100 — less than the hire purchase payments on a car and substantially less than it costs to hire even a part-time office worker,

and the Commodore Pet has a further extension of its capabilities with a new disc drive which doubles its memory capacity. The new floppy disc drive unit is rated at 2MB unformatted and offers the user a total of 1.6MB on-line at what is said by the maker to be a lower cost per byte than any other system available. In practical terms, that means it is capable of storing, for example, 13,000 stock records.

Technical features include a double-sided, quadruple-density drive unit with 79 tracks per side; the Diskmen operating system and random or sequential file access. It is also compatible with existing ACT software through a conversion unit supplied with the drive unit. The manufacturer is CompuThink of California. □

## Teletext colour graphics add-on board for Nascom

MANY still seem to have faith in the Nascom and are confident that a market will still thrive for products which can enhance it. Winchester Technology, of Eastleigh, Hampshire, has just announced the first in what it claims will be a series of Nascom add-on boards, the WT625, a teletext colour graphics board which comprises a video buffer, control logic, PAL encoder and UHF modulator.

The WT625 board plugs directly into the Nascom extension board and provides the full range of teletext

display features including 13 colours, flashing characters and single-row, double-height characters. Prices are £136 with a 42-page manual. Details from (04215) 66916. □

The WT625 colour graphics board.



## Memorex makes fresh advance with first removable-storage mini disc system

WINCHESTER technology hard disc drives continue to develop rapidly. The latest advance is

from Memorex which has just launched the first mini disc drive with removable storage, a

total capacity of 25Mbytes; 12.5Mbytes of fixed storage and an additional 12.5Mbytes of removable disc storage.

Used with the 201 drive, the Memorex 2001 removable cartridge not only provides the drive with its own back-up, but allows the 201 to act as a back-up for other devices.

The size of the front panel of the 201 allows the disc drive to fit into a standard floppy drive cavity. Access times can be brought down to only 30 milliseconds and seek errors are estimated at one per 10<sup>6</sup> reads. □

the general market. Manufactured by Motorola, it has, for some incomprehensible reason, been called the MCM6665L25.

It is a 65,536-bit, high-speed — 250 nanosecond access — dynamic RAM requiring eight address lines. Complete address decoding is done on-chip with address latches incorporated. Operating from a single 5V power supply the chip dissipates less than 300mW.

The only reservation about this great advance in chip development is the price. A quick calculation on our 16K RAM micro shows that the price per byte of a 16K RAM is 0.3p whereas that of the 64K RAM works out more like 2p per byte. No doubt the price will eventually fall. Details from Crellon Electronics (06286) 4300. □

The fixed/removable, eight-in. rigid disc drive, the Memorex 201.







SECURITY Systems International has introduced an encryption system, Codedata, to secure vital data in microcomputer systems. Encryption time is 20microseconds per character and input/output time is about 2µs per character, so that relatively-large data rates, up to 15,000 characters per second, can be handled. Most systems will need a special interface. Details from SSI, Cambridge (022029) 223.

## First floppy disc drive for the AIM-65

MANY hobbyists must be feeling lost without a disc drive as more and more are being launched for even bottom-of-the-line systems. Portable Microsystems, of Brackley, Northamptonshire, has now announced the first floppy disc system for use with the AIM-65.

The minifloppy 5¼in. system, DAIM, includes a controller board, with 3.3K resident disc operating system, which plugs directly into the Rockwell expansion motherboard. The controller can take up to two drives giving 160K bytes of read/write memory.

DAIM is claimed to be completely compatible in both format and system functions with the System-65. Commands are provided to load/save source and object files, initialise a disc, list a file, list a disc directory, re-name files, delete and recover files and compress a disc to recover unused space.

DAIM was designed in the U.S. by the same company which developed the System-65 microprocessor / development system for Rockwell and is the first and only floppy disc

system available for use with the AIM. It costs £695 + VAT for a single drive, controller and power supply unit. PM Ltd, (0280) 702017.

PL/65, a high-level, system-implementation language, is now available for the AIM-65. Pelco Ltd, (0273) 722155.

The DAIM floppy disc system for use with the AIM-65 microcomputer.



## High technology must have venture capital

SIR KEITH Joseph, Secretary of State for Industry has repeated his call for more venture capitalists, of the kind he met on his recent visit to Silicon Valley in California, to invest in high technology.

Appropriately enough, a U.S. venture capital corp-

### Linker merges programs

"PROGRAM development can be halved", or so claims the supplier of a new Pet package which helps you merge commonly-used routines into new Basic programs. Called Linker, it has been designed for use with Commodore discs. The program is a cross between a link-editor and the append statement.

The main features are that when a subroutine is included in the program, it is not appended on to the end. Instead it is merged using the line numbers. Up to three subroutines can be merged simultaneously and one subroutine which has already been included can request another subroutine.

Also if a subroutine is changed on the main file, it should be a simple matter to update any programs which include the original version. Details from Dovetail Blackburn (0254) 665867.

oration, Venture Founders, has established a British subsidiary to finance new technology firms starting in the south of England.

The National Economic Development Council has published a study which shows that the West German government is spending £240 million a year subsidising its computer and microelectronics industry; Italy £1.5 billion over five years and France £3 billion a year just on its viewdata experiment.

### Rescue bid for Nascom

THE FIRST signs of a rescue attempt for the ill-fated Nascom are beginning to emerge.

John Margetts, a Nascom user and member of the Nascom microcomputer club, is considering forming a company, financed by Nascom users and distributors, to buy the company from the receiver. The receiver is reported to believe that the plan could be viable, although it is still unknown how much money would be required.

Margetts apparently hopes to raise the money by selling 50p shares in the company in blocks of 20. If any reader is interested in the scheme telephone Margetts at Cheltenham (0242) 511472.

THE Commodore-organised Pet Show, held at the Café Royal in London proved a useful opportunity for Pet dealers to show an impressive range of goods. Inside the ornate and chandaliered setting of the Empire Napoleon suite, 100 Pets lay waiting. There were little Pets, SuperPets, colour Pets, disco Pets and even a MuPet.

Officially the show was the launch of the new 8000 series



The Wordcraft 80 word-processor package on the SuperPet.

— the Commodore bid for the business market. The 8032 is an intelligently-designed upgrade of the original Pet. The screen is expanded from nine in. diagonally to 12 in., allowing 80 characters to be displayed on each of 25 lines — making it suitable for word processing and accounting applications.

Seasoned Pet users frowned over the business keyboard, standard in the industry but new to Pet, and tinkered with

The Commodore 8032 SuperPet.

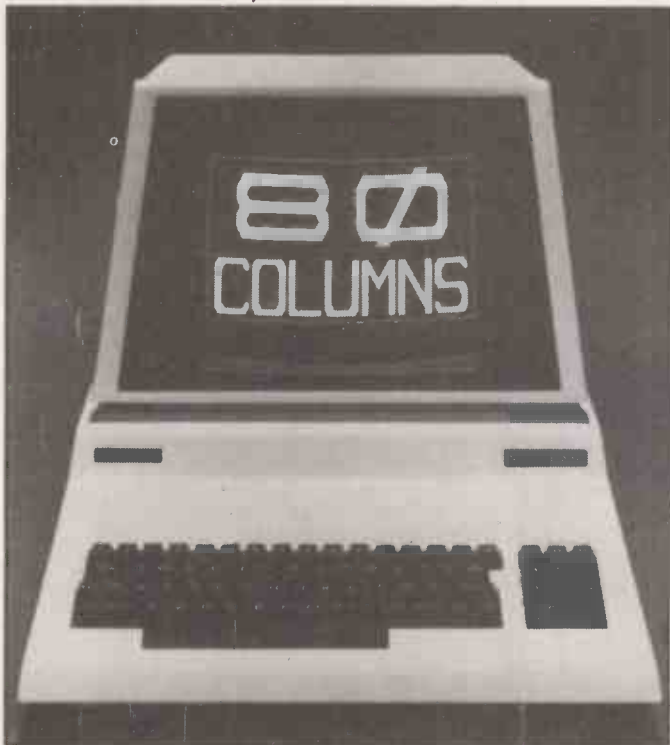

## Pet Show report

Tab, repeat and ESCape keys. Nervous-looking Commodore personnel demonstrated how the latter could be used to ESCape from quotes-mode or, followed by reverse, to activate some useful new programmed characters for screen editing.

In fact, screen control is now extremely versatile with scrolling up and down, line insertion and deletion, programmable screen eraser between specified points and a variable screen-window facility.

### Improved Basic

The Basic has been improved, garbage collection no longer appears to be taking industrial action, and disc operating commands are now included. That makes disc-handling almost a pleasure. Disc initialisation is automatic for one thing, and for another, the first program on a disc can now be called and run, simply by depressing the RUN/STOP key shifted — a definite improvement.

Dataview Ltd, the Colchester word-processing specialist, had wasted no time and was offering a version of the Wordcraft package on the SuperPet for £375.

A retail price of only £895 for the 8032 means the cost of

a word-processing system based on Wordcraft or Commodore Wordpro, plus disc and letter-quality printer, starts at around £3,200 + VAT. Rather better value than the dedicated word-processing systems which do not compute.

In contrast to the absurdly grand surroundings, some 50 companies conducted a cheerful trade from trestle-tables. Goodies on sale ranged from the plain daft — a computerised light rope — to the latest

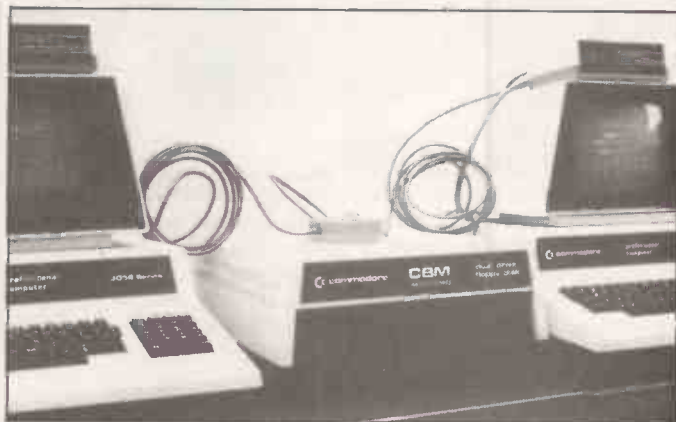

A multi-user system which allows up to eight Pets on a central disc drive is available from Taylor-Wilson of Solihull, West Midlands.

in multi-user disc systems. In the latter category was Canadian Bill Maclean's MuPet, a multi-plexed system linking up to eight Pets to a single disc drive.

Once daisy-chained together, the multi-user system operates in exactly the same way as any standard Pet and disc system. One likely application area must be in word processing where multiple-work-station systems still cost big money. Information from CompuScience of Canada, P.O. Box 121, Milton, Ontario.

### Multi-user system

Solihull, West Midlands dealer Taylor-Wilson was busy taking orders for a British multi-user system. Again, up to eight Pets can be connected to a central disc drive, the difference being that the system allowed positive lock-out to prevent the corruption of files by intruders. Any or all Pets so connected can have a printer, which is said to be usable at all times.

Taylor-Wilson suggests that the ideal application would be

where file updates are to be made at one location, for example, the stock room, and file interrogations at others, say the sales office and purchase ledger sections. Details from 05645-6192.

The sight of Arabic characters flashing across a colour TV screen attracted crowds to the stand of the Southern Users of Pet Association — SUPA for short. That was the Chromadaptor, an imaginative concept which allows a Pet to address 1,000 screen positions in which are 16 colours. Developed by Saleh Sadek, the prototype board shown is

expected to cost less than £200 when it goes into production.

Software supplies were raking in the cash. Intex Datalog in particular seemed to be going good business with a new Payroll system priced at £195. The hands-on enthusiasts, some of surprisingly tender years, had headed straight for the Commodore stand for the new Transam disc-based TCL Pascal compiler at the remarkably modest price of £120 + VAT.

Petsoft launched a new range of key business programs at low prices, including a new Stock package at £75, handling more than 6,000 items online, and a disc payroll system for £50.

Meanwhile, B&B Computers had produced a solution to what was described as the random-access problem. The cure consisted of a set of machine-code routines dubbed BBDOS which enable direct-access files as used in CompuThink disc systems to be implemented on Commodore disc drives. BBDOS costs £120. Information from B&B on 0204-26644.

• Circle No. 181 ▶

RAIR BLACK BOX  
MICROCOMPUTER

POWER

LOAD

RESET

RAIR MICROCOMPUTER  
BLACK BOX

*Discover the secrets of  
the RAIR Black Box*

# Britain's first computer kit.

## The Sinclair ZX80.

# £79.95

Price breakdown  
 ZX80 and manual: £69.52  
 VAT: £10.43  
 Post and packing FREE

Please note: many kit makers quote VAT-exclusive prices.

You've seen the reviews... you've heard the excitement... now make the kit!

This is the ZX80. 'Personal Computer World' gave it 5 stars for 'excellent value.' Benchmark tests say it's faster than all previous personal computers. And the response from kit enthusiasts has been tremendous.

To help you appreciate its value, the price is shown above with and without VAT. This is so you can compare the ZX80 with competitive kits that don't appear with inclusive prices.

### 'Excellent value' indeed!

For just £79.95 (including VAT and p&p) you get everything you need to build a personal computer at home... PCB, with IC sockets for all ICs; case; leads for direct connection to a cassette recorder and television (black and white or colour); *everything!*

Yet the ZX80 really is a complete, powerful, full-facility computer, matching or surpassing other personal computers at several times the price.

The ZX80 is programmed in BASIC, and you can use it to do quite literally anything from playing chess to managing a business.

The ZX80 is pleasantly straightforward to assemble, using a fine-tipped soldering iron. It immediately proves what a good job you've done: connect it to your TV... link it to an appropriate power source... and you're ready to go.

#### Your ZX80 kit contains...

- Printed circuit board, with IC sockets for all ICs.
- Complete components set, including all ICs - all manufactured by selected world-leading suppliers.
- New rugged Sinclair keyboard, touch-sensitive, wipe-clean.
- Ready-moulded case.
- Leads and plugs for connection to domestic TV and cassette recorder. (Programs can be **SAVED** and **LOADED** on to a portable cassette recorder.)
- FREE course in BASIC programming and user manual.

#### Optional extras

- Mains adaptor of 600 mA at 9 V DC nominal unregulated (available separately - see coupon).
- Additional memory expansion boards allowing up to 16K bytes RAM. (Extra RAM chips also available - see coupon).

\*Use a 600 mA at 9 V DC nominal unregulated mains adaptor. Available from Sinclair if desired (see coupon).

### The unique and valuable components of the Sinclair ZX80.

The Sinclair ZX80 is not just another personal computer. Quite apart from its exceptionally low price, the ZX80 has two uniquely advanced components: the Sinclair BASIC interpreter; and the Sinclair teach-yourself BASIC manual.

The unique Sinclair BASIC interpreter offers remarkable programming advantages:

- Unique 'one-touch' key word entry: the ZX80 eliminates a great deal of tiresome typing. Key words (**RUN**, **PRINT**, **LIST**, etc.) have their own single-key entry.
- Unique syntax check. Only lines with correct syntax are accepted into programs. A cursor identifies errors immediately. This prevents entry of long and complicated programs with faults only discovered when you try to run them.
- Excellent string-handling capability - takes up to 26 string variables of any length. All strings can undergo all relational tests (e.g. comparison). The ZX80 also has string input to request a line of text when necessary. Strings do *not* need to be dimensioned.
- Up to 26 single dimension arrays.
- FOR/NEXT loops nested up to 26.
- Variable names of any length.
- BASIC language also handles full Boolean arithmetic, conditional expressions, etc.
- Exceptionally powerful edit facilities, allows modification of existing program lines.
- Randomise function, useful for games and secret codes, as well as more serious applications.
- Timer under program control.
- PEEK and POKE enable entry of machine code instructions, USR causes jump to a user's machine language sub-routine.
- High-resolution graphics with 22 standard graphic symbols.
- All characters printable in reverse under program control.
- Lines of unlimited length.

### Fewer chips, compact design, volume production - more power per pound!

The ZX80 owes its remarkable low price to its remarkable design: the whole system is packed on to fewer, newer, more powerful and advanced LSI chips. A single SUPER ROM for instance, contains the BASIC interpreter, the character set, operating system, and monitor. And the ZX80's 1K byte RAM is roughly equivalent to 4K bytes in a conventional computer - typically storing 100 lines of BASIC. (Key words occupy only a single byte.) The display shows 32 characters by 24 lines.

And Benchmark tests show that the ZX80 is faster than all other personal computers.

No other personal computer offers this unique combination of high capability and low price.

Z80 A microprocessor - new, faster version of the famous Z-80 microprocessor chip, widely recognised as the best ever made.

Sockets for TV, cassette recorder, power supply.

SUPER ROM.

Clock.

Rugged flush, Sinclair keyboard.

RAM chips.

UHF TV modulator.

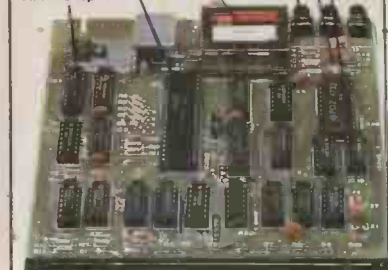

# plete

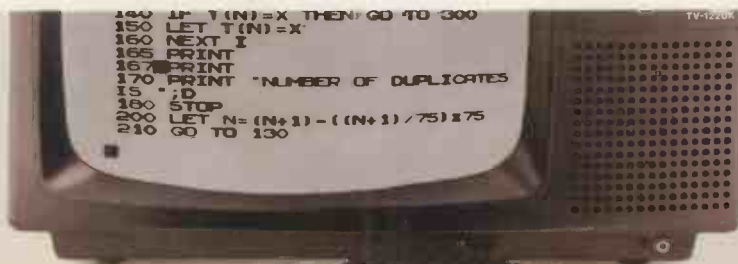

### The Sinclair teach-yourself BASIC manual.

If the specifications of the Sinclair ZX80 mean little to you – don't worry. They're all explained in the specially-written 128-page book free with every kit! The book makes learning easy, exciting and enjoyable, and represents a complete course in BASIC programming – from first principles to complex programs. (Available separately – purchase price refunded if you buy a ZX80 later.) A hardware manual is also included with every kit.

### The Sinclair ZX80. Kit: £79.95.

### Assembled: £99.95. Complete!

The ZX80 kit costs a mere £79.95. Can't wait to have a ZX80 up and running? No problem! It's also available, ready assembled and complete with mains adaptor, for only £99.95.

Demand for the ZX80 is very high: use the coupon to order today for the earliest possible delivery. All orders will be despatched in strict rotation. We'll acknowledge each order by return, and tell you exactly when your ZX80 will be delivered. If you choose not to wait, you can cancel your order immediately, and your money will be refunded at once. Again, of course, you may return your ZX80 as received within 14 days for a full refund. We want you to be satisfied beyond all doubt – and we have no doubt that you will be.

# sinclair ZX80

Science of Cambridge Ltd

6 Kings Parade, Cambridge, Cambs., CB2 1SN.  
Tel: 0223 311488.

### ORDER FORM

To: Science of Cambridge Ltd, 6 Kings Parade, Cambridge, Cambs., CB2 1SN.  
Remember: all prices shown include VAT, postage and packing. No hidden extras.  
Please send me:

Quantity	Item	Item price £	Total £
	Sinclair ZX80 Personal Computer kit(s). Price includes ZX80 BASIC manual, excludes mains adaptor.	£79.95	
	Ready-assembled Sinclair ZX80 Personal Computer(s). Price includes ZX80 BASIC manual and mains adaptor.	£99.95	
	Mains Adaptor(s) (600 mA at 9 V DC nominal unregulated).	8.95	
	Memory Expansion Board(s) (each one takes up to 3K bytes).	12.00	
	RAM Memory chips – standard 1K bytes capacity.	16.00	
	Sinclair ZX80 Manual(s) (manual free with every ZX80 kit or ready-made computer).	5.00	
		<b>TOTAL</b>	<b>£</b>

NB. Your Sinclair ZX80 may qualify as a business expense.

I enclose a cheque/postal order payable to Science of Cambridge Ltd for £ \_\_\_\_\_

Please print:

Name: Mr/Mrs/Miss \_\_\_\_\_

Address \_\_\_\_\_

PC8

• Circle No. 162

**TIME & COST  
RECORDING  
SYSTEM  
£300**

**INCOMPLETE  
RECORDS  
ACCOUNTING  
SYSTEM £450**

**SALES  
LEDGER  
SYSTEM  
£300**

**PURCHASE  
LEDGER  
SYSTEM  
£300**

**Padmede Computer Services  
Business Software for Apple/ITT 2020**

**STOCK  
CONTROL  
SYSTEM  
£300**

**INVOICING  
SYSTEM  
£300**

**INSURANCE  
BROKER  
SYSTEM  
£500**

**JOB  
COSTING  
SYSTEM  
£300**

## Padmede Computer Services

112/116-HIGH STREET  
ODIHAM  
NR. BASINGSTOKE  
HAMPSHIRE  
Tel: Odiham (025-671) 2434

If you wish to buy any of the above systems, please complete the coupon below and return to: Padmede Computer Services, 112/116 High Street, Odiham, Nr. Basingstoke, Hants.

	Manuals & Sample Reports	£	✓ Here if required	Apple/ITT Software	£	✓ Here if required
Padmede Purchase Ledger System		£5	<input type="checkbox"/>	£300		<input type="checkbox"/>
Padmede Sales Ledger System		£5	<input type="checkbox"/>	£300		<input type="checkbox"/>
Padmede Incomplete Records Accounting System		£5	<input type="checkbox"/>	£450		<input type="checkbox"/>
Padmede Invoicing System		£5	<input type="checkbox"/>	£300		<input type="checkbox"/>
Padmede Job Costing System		£5	<input type="checkbox"/>	£300		<input type="checkbox"/>
Padmede Time & Cost Recording System		£5	<input type="checkbox"/>	£300		<input type="checkbox"/>
Padmede Stock Control System		£5	<input type="checkbox"/>	£300		<input type="checkbox"/>
Padmede Insurance Broker System		£5	<input type="checkbox"/>	£500		<input type="checkbox"/>
Software Sampler		£10	<input type="checkbox"/>			<input type="checkbox"/>
	Total	_____		Total	_____	
	Zero VAT	_____		+ 15% VAT	_____	
Grand Total Cheque enclosed	Total	_____		Total	_____	

Name .....

Address .....

DEALER ENQUIRIES WELCOME

PC8

• Circle No. 182

PRACTICAL COMPUTING August 1980

• Circle No. 183

**AVON**  
**Bristol Computing Club**  
 Leo Wallis  
 6 Kilbernie Road  
 Bridge Farm Estate  
 Bristol BS14 0HY.  
 Tel: 0272 832453.  
**Brunel Computer Club**  
 Sid Rabone  
 18 Castle Road  
 Worle  
 Weston Super Mare  
 Avon BS22 9JW.  
 Tel: 0934 513068.

**BEDFORDSHIRE**  
**6502 Users' Working Party**  
 W R Wallenborn  
 21 Argyll Avenue  
 Luton LU3 1EG  
 Tel: 0582 26967 (evenings)  
**U.K. Intel MDS Users' Group**  
 Lewis Hard  
 29 Chaucer Road  
 Bedford.  
 Tel: 0234 41685.

**BERKSHIRE**  
**Pet Users' Club**  
**CBM U.K. Ltd**  
 Nora Sequeira  
 818 Leigh Road Trading Estate  
 Slough.  
 Tel: 0753 74111.

**BUCKINGHAMSHIRE**  
**TRS-80 User Group**  
 Brian Pain  
 40a High Street  
 Stony Stratford  
 Milton Keynes.  
 Tel: 0908 566660.

**CHESHIRE**  
**North-west Computer Club**  
 John Lightfoot  
 135 Ashton Drive  
 Frodsham, Warrington  
 Cheshire WA6 7PU.  
 Tel: 0928 31519.

**DEVON**  
**Exeter and District**  
**Amateur Computer Club**  
 D Bates  
 2 Station Road  
 Pinhoe, Exeter EX1 3SA.  
 Tel: 0392 69844.  
**Plymouth & District**  
**Amateur Computing Club**  
 Keith Gould  
 C/O JAD Ltd  
 21 Market Avenue, Plymouth  
 Tel: 0752 62616 (work)  
 07554 2399 (home).

**DURHAM**  
**Independent Pet Users' Group**  
 Jim Cocalis  
 20 Worcester Road  
 Newton Hall Estate  
 Durham.  
 Tel: 0385 67045.  
**London and South East**  
**Sharp MZ-80K User Group**  
 Joe Seet  
 16 Elmhurst Drive  
 Hornchurch, Essex RM11 1PE.  
 Tel: 04024 42905.  
**TRS-80 User Group**  
 Michael Dean  
 22 Roughtons  
 Galleywood  
 Chelmsford.  
 Tel: 0245 76127.  
**UK101 User Group**  
 Adrian Waters  
 117 Haynes Road

Hornchurch, Essex.  
 Tel: 494 0490.

**GLOUCESTERSHIRE**  
**Cheltenham Amateur**  
**Computer Club**  
 M P Pullin  
 45 Merestones Drive  
 The Park, Cheltenham.  
 Tel: 0242 25617.  
**9900 User Group**  
 Chris Cadogan  
 21 Thistle Downs  
 Northway Farm, Tewkesbury.  
 Tel: 0684 293821  
 Ext. 310.

**GWENT**  
**Amateur Computer Club**  
 Ian Hazell  
 50 Ringwood Hill  
 Newport, Gwent.  
 Tel: Alan Beale  
 0633 50207 or  
 Alan Wood 0222 791435.

**HAMPSHIRE**  
**Southampton Pascal**  
**Users' Group**  
 C/O Computer Studies Group,  
 University of Southampton  
 Southampton SO9 5NH.  
**Independent Pet Users' Group**  
 G A Parkin  
 Robert May's School  
 West Street, Odiham.  
 Tel: 025 671 2700.

**HERTFORDSHIRE**  
**The ACC Harrow Group**  
 N P Butcher  
 16 St. Peters Close  
 Bushey Heath  
 Watford.

**Harpenden Microcomputer**  
**Group**  
 David James  
 5 Ox Lane, Harpenden.  
 Tel: 05827 5366 (evenings).

**INTERNATIONAL**  
**International Association**  
**of Cromemco Users**  
 PO Box 17658  
 Irvine, California 92713 U.S.A.  
 Tel: 714 955 0432.

**KENT**  
**Gillingham User Group**  
 A Aylward  
 194 Balmoral Road  
 Gillingham.  
 Tel: 0634 56830.

**LANCASHIRE**  
**North-west Group Amateur**  
**Computer Club**  
 Ken Horton  
 50 Lymfield Drive  
 Worsley.  
 Tel: 061228 6333 Ext. 372.  
**TRS-80 Group**  
 Melvyn Franklin  
 50 Cow Lees  
 Westhoughton, Bolton.  
 Tel: 0942 670604.

**LINCOLNSHIRE**  
**Lincolnshire Microprocessor**  
**Society**  
 Eric Booth  
 Bishop Grossetest College  
 Newport, Lincoln.  
 Tel: 0522 27347.

**LONDON**  
**London CP/M Users' Group UK**  
 D Powys-Lybbe  
 C/O MML Ltd  
 11 Sun Street  
 Finsbury Square  
 London EC2.  
 Tel: 01-247 0691.  
**MK-14 User Club**  
 Geoff Phillips  
 8 Poolsford Road  
 NW9 6HP.  
 Tel: 01-200 6209  
 or 01-207 2000 Ext. 233.  
**North London Hobby**  
**Computer Club**  
 Richard Larkin  
 Dept. of Electronic &  
 Communications Engineering  
 Polytechnic of North London,  
 Holloway Road, N7 8DB.  
 Tel: 01-607 2789 Ext. 2172.

**OSI U.K. User Group**  
 Richard Elen  
 12 Bennerley Road  
 London SW11 6DS.  
**Pet Users' Club**  
 Richard Pawson  
 Commodore Systems Division  
 360 Euston Avenue,  
 NW1 3BL.  
 Tel: 01-388 5702.  
**Pet Users' Education Group**  
 Dr. Chris Smith  
 Dept. of Physiology  
 Queen Elizabeth College  
 Campden Hill Road  
 W8 7AH.  
 Tel: 01-937 5411 Ext. 429.  
**Southgate Computer Club**  
 Paul Woolley  
 Southgate Technical College  
 High Street N14 6BS.  
 Tel: 01-886 6521.  
**South East London**  
**Microcomputer Club**  
 Malcolm Beresford  
 153 Ardgowan Road  
 Catford, SE6 1U2.  
 Tel: 01-698 1422.

**MANCHESTER**  
**Amateur Computer Club**  
**(N.W.) Group**  
 Mrs J. Lomas  
 C/O Corrosion & Protection Centre  
 UMIST, Manchester.  
 Tel: 061 881 1933.  
**Independent Pet**  
**Users' Group**  
 G Squibb  
 108 Teddington Park Road  
 Teddington, Middlesex.  
 Tel: 01-977 2346

**MIDDLESEX**  
**Independent Pet Users' Group**  
 G Squibb  
 108 Teddington Park Road  
 Teddington, Middlesex.  
 Tel: 01-977 2346

**NORFOLK**  
**East Anglia Computer**  
**User Group**  
 Jan Rejzl  
 88 St. Benedicts  
 Norwich.  
 Tel: 0603 43184.

**NOTTINGHAMSHIRE**  
**U.K. Apple Users' Group**  
 Andy Witterick  
 5b The Poultry  
 Nottingham NG1 2HW.  
 Tel: 0602 583254.  
**Microcomputer Club**  
 K S Swainson  
 9 Brayton Crescent

Highbury Vale Estate  
 Bulwell  
 Nottingham NG6 9DZ.  
 Tel: 0602 751742.

**OXFORDSHIRE**  
**Research Machines**  
**Users' Group**  
 Tony Crowle  
 134 Howard Street, Oxford.

**STAFFORDSHIRE**  
**The Amateur Computer**  
**Club of North Staffs**  
 I. Roll  
 16 Hill Street  
 Hednesford  
 Staffs WS12 5DJ.  
 Tel: 05438 4363  
 or 0785 3251 Ext. 441 (work).

**SUSSEX**  
**Microcomputing Club**  
 Bernard Langton  
 228 St. Leonard's Road  
 Horsham  
 Sussex RH13 6AU.  
 Tel: 0403 61156.  
**Southern Users' of Pets**  
**Association (SUPA)**  
 Howard Pilgrim  
 42 Compton Road  
 Brighton BN1 5AN  
 Sussex.  
 Tel: 0273 561982.

**TYNE AND WEAR**  
**Newcastle Personal**  
**Computer Society**  
 Jeff Caff  
 4 Kingsley Place  
 Newcastle-Upon-Tyne  
 NE6 5AN  
 Tel: 0632 650653 (work)  
 or 0632 651707 (home).

**WEST MIDLANDS**  
**Amateur Computer Club**  
 John Tracey  
 100 Booth Close  
 Kingswinford  
 West Midlands.  
 Tel: 0384 70097.  
**Birmingham 7/68 User Group**  
 Sue Dunn  
 Newbear Computing Store  
 First Floor Offices,  
 Tivoli Centre, Coventry Road  
 Birmingham B26  
 Tel: 021 707 7170.  
**Midland User Group**  
**Amateur Computer Club**  
 Roy Diamond  
 27 Loweswater Road  
 Coventry CV3 2HJ.  
 Tel: 0203 454061.

**YORKSHIRE**  
**Leeds Branch British**  
**Computer Society**  
 David Sheppard  
 Datacall Ltd  
 177 Kirkstall Road  
 Leeds 4.  
 Tel: 0532 459625.  
**South Yorkshire Personal**  
**Computing Group**  
 Peter Johnson  
 15 Horndean Road  
 Sheffield S5  
 F5 0UJ.  
 Tel: 0742 387795.  
**West Yorkshire Micro-**  
**Computer Group**  
 Phillip Clark  
 Suite 204  
 Crown House,  
 Armsley Road  
 Leeds 12.

**This month, we review the Computech sales ledger package which runs on the Apple II and ITT 2020. It is based on a brought-forward principle, is not dependent on the usual fixed-period accounting and employs an efficient two-file system.**

COMPUTECH Systems is a private company based in London and involved in the production of commercial applications packages for the Apple II/ITT 2020 and other systems. With the sales ledger, there is a purchase ledger and nominal ledger package.

We ran the sales ledger system on an ITT 2020 with 48K of RAM and two mini-floppy drives with a Centronics 703 bi-directional matrix printer as the hard-copy device.

The sales ledger is based on a two-file system — one for customer account details and the other for sales transactions recording. The customer file and transactions file may reside on the same disc or separate discs and have a total capacity of 500 customers and 1,600 transactions per disc.

The design of the package is based on a brought-forward accounting principle and is not dependent on the usual fixed-period accounting. Transactions are held on disc and at all stages of reporting may be printed off within a range of start and finish dates defined by the user.

### Control account

A control account is held for each system which means that a large ledger may be spread over several discs each acting as an independent sales ledger, i.e., one for trade customers, one for wholesale customers and so on. As and when the transactions fill a disc, an accounts-rendered-carried-forward facility is available to clear the file.

The user has the option of configuring his own system in the way the machine slots are utilised for discs and printer and also in terms of the location on the discs

# Flexibility and system security are very impressive

of the respective files and programs.

The configuration ability also provides a high level of security, particularly where a user will wish to spread the ledger over several discs. It is achieved by logging into the configuration information the

by Mike McDonald

location and volume serial numbers of the discs containing the relevant files. The package checks each drive at run time and verifies that the correct discs are loaded before processing can continue.

The configuration file may be altered as the first activity in running the sales ledger and contains the following data:

- a. Type of printer — serial or parallel.
- b. Printer interface slot number.
- c. Printer lines per page.
- d. Disc controller slot.
- e. Program drive number.
- f. Customer file drive number.
- g. Transactions file drive number.
- h. Program volume number.
- i. Customer file volume number.
- j. Transactions file volume number.

The program is a single-source code module loaded into memory automatically as part of the disc boot procedure. The program occupies about 30K but does not have to be held on disc for further access once loaded, thus maximising disc storage.

For smaller volumes of data, users may hold all information on a single disc and need purchase only a single drive.

On loading and running the program, the user is given access to a master menu from which all functions are accessible. They are:

1. Sales invoice.
2. Credit note.
3. Cash and discount received.
4. Cash paid.
5. Journals.
6. Statements.
7. Balances.
8. Control account.
9. Customer.
10. C/FWD accounts rendered.

The first four options are transaction entries, the next four produce printed reports, option 9 is the customer file maintenance routine and 10 is a clear-down facility.

The sales ledger is a number-orientated package but permits the entry of account or customer names for search purposes. Once a match is made the user is requested to indicate if the name found is correct. A no will cause the system to continue the search.

### Display facilities

As well as displaying the full company name on a string search, the system also displays the account number which must then be entered before any processing can be performed.

Our first exercise was to set-up some customer accounts on file. The customer facility produces a screen format on which all details are entered, which comprise:

Account number	1-500
Account name	31 characters' maximum.
Three address lines	31 characters' maximum.
Credit limit	0.01 up to 999999.99 (entry).
Balance (opening)	-999999.99 to 999999.99
	(totals).
Turnover to date	-999999.99 to 999999.99.

Once entered, accounts cannot be deleted and only the name and address can be altered. Alterations to customer details are also handled as part of the customer facility. If a valid account number is entered against the number or name prompt, the system retrieves the account information detailed above and displays it on the screen format.

56

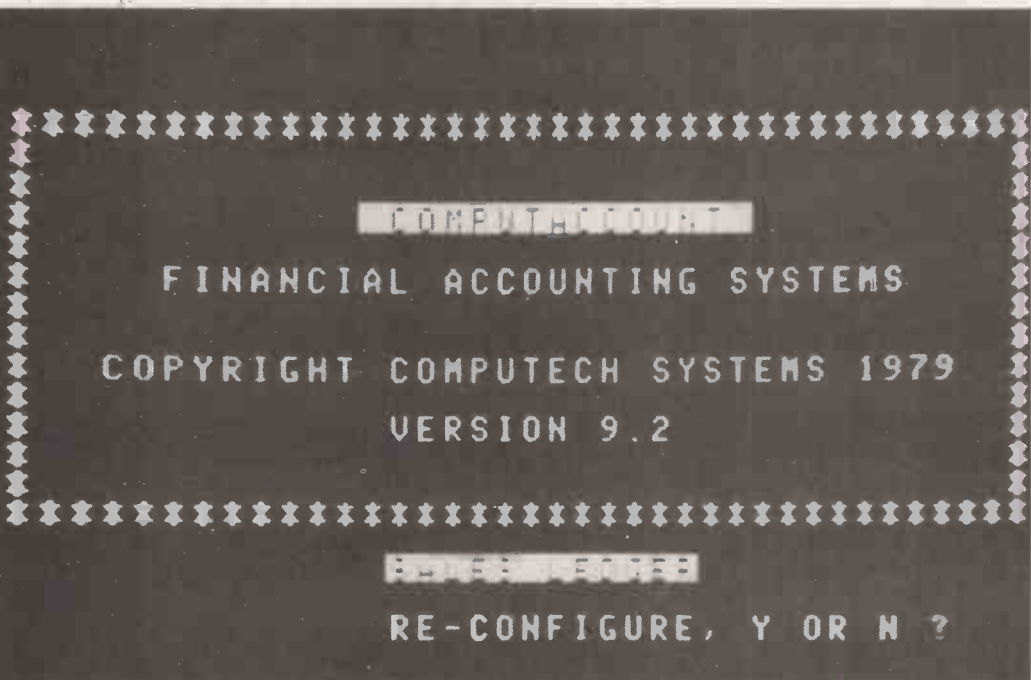



The user is then given the opportunity to alter any fields or move on to the next transaction. Account numbers are issued sequentially and the user may not allocate his numbers randomly.

The next available account number is shown if a string search is entered against which no match can be found, i.e., xxx. Instead, the system responds with a warning and the first free account number.

In the course of processing the balance and turnover to date, fields are updated with each transaction entered and the customer facility can be a useful account look-up routine showing the up-to-date status of account balances on the screen.

For entering transactions, the manual recommends that users should batch input documents into date and numerical order before entry. That causes the reporting to be more logical and could help prevent inadvertent entry of the same document. The four input transaction types all use the same screen format which shows:

Account number	Analysis
Account name	Amount
Date	VAT code
Reference	VAT/discout
Description	Total

Once a valid account number is keyed, the system displays the associated company name and prompts the user for each of the above fields. Each entry is validated for content and format, i.e., date, where possible. The reference is a five-digit field for invoice or docket number. We felt that it should be slightly larger for general application in a variety of businesses.

The description field may be up to 19 characters and is very useful. The analysis code is a two-digit numeric which the user may nominate say to identify a product or customer type.

## Analysis code

All transactions are grouped in value against each analysis code when the journals are printed and a value printed for each code. Up to 99 codes may be entered. The amount and VAT amount must be keyed as a number containing two decimal places which we found to be a nuisance but which is, no doubt, a good security feature against miskeying of, say, too many zeros.

A VAT code of A, higher rate, S, standard rate, Z, zero rate, or E, exempt, must also be entered. They are used strictly for summary reporting and there is no calculative check on the VAT amount entered. The system produces a total of VAT — plus goods automatically and allows the user to alter details — by re-entering the transaction — if entered incorrectly before posting. On posting, confirmation of entry is displayed and the screen format cleared ready for the next transaction.

Each of the other transaction types, i.e., credit note, cash received and cash paid, use the same screen format. In the cash received element, the discount is prompted instead of VAT and entered as a numeric value to produce a total value of the posting.

The cash paid facility hardly seems

```

ACCOUNT : 10
DATE : 27.03.88
REFCE : DR432
DESCRIPN : SHORT DELIVERY
ANALYSIS : 23
AMOUNT : 154.76
VAT CODE : S
VAT/DISC : 14.56
TOTAL : 169.32

CHECK OK TO ENTER Y OR N ?
    
```

necessary or appropriate but its existence is described as a means of manually countering incorrect entries to the ledger or refunding amounts after settlement of an invoice. The entry is a single value and does not include a VAT or discount element.

Each transaction is written to the disc when posted and is not held in core where it could be lost easily in a system crash or power loss.

Within each transaction facility, the string search routine is available and is started by entering a customer name instead of an account number. Each match is displayed with the account number and the user is asked whether it is the one. If a no is entered, the search continues. A yes returns the prompt — Enter Name or Number?

We felt that an improvement could be made to the invoice entry routine whereby accounts exceeding their credit limit are

*(continued on next page)*



(continued from previous page)

flagged or drawn to the operator's attention. That is done in the customer section when displaying account details and could be carried across to the transaction stage easily.

If accessing an overdrawn account, the offending balance is flashed in reverse and a bleep sounded. The manual recommends that input documents are batched and that batch totals are produced manually beforehand. Although the data entry is interactive and batch totalling is not carried out, a check can be performed by producing a journal print of the invoices within menu facility 5 for the date period of the transactions keyed.

Totals will be produced on that listing and should agree with the pre-check batch totals — hence the importance of sorting the input invoices into date/number sequence. If data is spuriously entered, the checking facility will be of little use.

This ledger package is unusual in that it does not rely on a fixed period of accounting for the purposes of account clearance, statement production and so

on. All of the reports offer the user the facility of entering the start and finish dates of the period being reported.

Because that could be dangerous due to overlapping reports, the user is advised to pre-set his accounting period dates and adhere to them — that provides plenty of flexibility. The running of the sales ledger could be geared better to the variations of seasonal peaks and troughs encountered in the course of business.

### Archival discs

It also means that accounts can be held on archival discs and reports produced for quarterly or half-yearly analysis for current or past years. Aging of balances is also on a nominated basis at the reporting stage and is highly flexible.

The only disadvantage of an open-ended system such as this is that keyed transactions are not date-checked and controls must be provided manually to ensure that documents are posted correctly. It would have been an advantage to have an automatic date facility at the time of entry for those

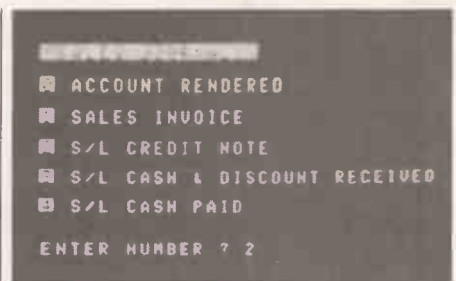

wishing to post on a same-day basis.

The most basic print routine is the journal listing facility, 5. The user is given a sub-menu from which he can choose:

0. Accounts rendered.
1. Sales invoice.
2. S/L credit note.
3. S/L cash & discount received.
4. S/L cash paid.

Each journal is printed from a nominated start-date to a nominated finish-date and each transaction on file produced under the headings; date, account number, account name, description, reference, analysis, VAT or discount, amount and amount total. For accuracy and aging calculation the print will include those transactions grouped within the date range on the disc.

If an invoice is entered late in the middle of a later period, it will not be listed, i.e., the listing stops when a date greater than the upper limit is reached — hence the importance of entering invoices in the correct date order.

### Account balances

The account-rendered listing is a simple summary of account balances rendered and does not produce the date. On each report, a total is produced for each column as well as a VAT analysis of goods and VAT and a total printed for each analysis code.

The statement print routine, option 6 of the menu, produces a standard-format statement print which may be for all accounts or for selected names or numbers. The headings are: date, description, reference, debit, credit, and balance.

The description is not that which is keyed by the user but one indicating the transaction type. The format is neat and arranged deliberately so that ordinary headed paper can be used for stationery.

The balances print facility 7 is a debtors' analysis report showing aged balances for a selected period. Balances are aged over four separate contiguous periods comprising current, plus one, plus two, and plus three.

On entering the routine, the user is prompted for a start date and then a plus one and plus two date. The plus three is assumed to be residual and brought forward sums.

A tabular report is then printed showing: account number, account name, credit limit, turnover to date, date of last transaction, balance, and totals for current, plus 1, plus 2, and plus 3. Each



column is totalled at the end of the report. The basic accounting assumptions made by the authors are:

- Accounts rendered are always allocated to the oldest period.
- Invoices are allocated strictly according to their date to the period defined by the user.
- Credit notes, cash and discount received and cash paid are all allocated to the earliest available balance.
- Credit balances are always treated as current period balances.

The control account is a print routine that produces the totals for accounts rendered, invoices, cash received, discount, cash paid, credit notes, and balances with totals, under the appropriate debit and credit headings. It is a self-balancing report that must also tally with the previous balance print run.

The final facility, 10, is the carried-forward-accounts-rendered routine. Its purpose is to clear-down the transactions on file and create new discs with carried-forward balances. That would be run normally according to the pre-set accounting periods and subject to the volume of transactions being passed through the package during those periods.

The system will warn the user automatically when volumes on the customer or transactions files are nearing their limits and will require the user to run the 10th option.

In general, the standard of reporting is very good and we liked the flexibility of altering the dimensions of the print formats through the configuration file. It means that almost any printer can be used with the package and a wide variety of pre-printed or plain stationery can be utilised.

The paging facility is also well programmed — i.e., skipping to a new page and re-printing headings for lengthy statements, etc.

The package is supplied as a manual and a floppy disc and costs £295. The manual is clear and easy to read and goes into great detail about the way the package works and the assumptions used in processing. There is a long section at the front that is a do-it-yourself guide to double-entry bookkeeping and a variety of tips for more advanced users on how to obtain the best results from the system or stretch it to deal with larger accounting systems. It states that all equipment is liable to go on the blink at some time or other.

That statement typifies the common-sense approach of the authors to the subject of security and disc back-ups although more could have been said about how to implement a rotational system of discs.

Recovery from accidental re-set is covered in sufficient detail to prevent most users from completely wreaking havoc. A whole series of numbered add-on bulletins had been appended to the

manual covering such subjects as: Use of the high-speed serial interface, DOS-reserved words and disc-error message numbers and descriptions, DOS 3.2 upgrades and dynamic allocation of devices, tips and hints for running under Applesoft (ROM) and Autostart, and disc errors and bugs.

While the manuals cover a good deal of ground and all possible contingencies, they are not well designed as reference documents. Finding particular items of information was not easy. Each user is supported directly by Computech both for news and upgrades and *ad hoc* queries.

## Conclusions

- We were impressed with the quality of the programming and security of the system.
- The screen formats are consistently applied making familiarisation easy and avoiding erroneous entries.
- Data entry fields are well validated and information is easy to change and alter.
- The analysis code system provides a user-definable reporting facility which should meet most prospects requirements.
- For the maximum benefit to be gained from the Computech sales ledger, prospective buyers should plan the way they intend to use the flexibility of the package rather than just installing and running.
- There is scope for planning transfer from manual systems to the package that should be taken advantage of. □

## CALLING ALL P.E.T. DEALERS AND USERS

See the **NEW 8032 SUPERPET** with 80 column screen on demonstration with our powerful **CREAMWOOD BUSINESS CONTROLLER**

*Ledger software packages offering the following features that every business needs: —*

- Generates Statements, Quotations, Invoices, and Mailing lists.
- Maintains up to 550 Accounts & 2400 transactions on each disk — can be extended without limit.
- Instant comprehensive display of Account. Information at anytime.
- Real time operation — no batch operations.
- Comprehensive printout of Accounts and Journals.
- Powerful Analysis features.
- Easy to use and Understand.
- Written by professionals in conjunction with Accountants.
- FROM £290 + VAT (retail.)

USERS: — Contact us for the name of your nearest dealer.

DEALERS: — Contact us for our very attractive dealer terms and demonstration package.

*N.B. Only approved P.E.T. BUSINESS SYSTEM DEALERS need apply.*

*Our large modern software shop is open Tuesday - Saturday 10AM - 6PM.*

### CREAMWOOD SOFTWARE PRODUCTS LTD.

380, STATION ROAD, HARROW, MIDDX. HA1 2DE.  
(3 MINS HARROW-ON-THE-HILL STN.)

MET LINE 01-863 0833

# Why PETSOFT Business Software



## WORDCRAFT

**WORDCRAFT** A true Word Processor for the 32K PET. Wordcraft is a genuine word processing system, easy to understand and use, but containing all the facilities normally found only on more expensive dedicated Word Processors. Features include scrolling in both vertical and horizontal directions (to overcome small screen size), up to 117 characters wide and 98 lines deep for a full page of text. Written entirely in machine code for speed and compactness. Truly the Rolls-Royce of PET Word Processors. Send for brochure. £325 on CompuThink or Commodore Disk.

## ACT SALES LEDGER

**ACT SALES LEDGER** A powerful system developed to ACT's own high standards. Provides full facilities for maintenance of the Sales Ledger, preparation of a list of outstanding balances and printing of statements. All data including new customer details, invoices, credits, cash and transfers are entered under step by step guidance on the display screen. Printed results include Audit List, Aged Debtors List, Control Accounts and Statements. For 32K PETs. Full manual supplied. Brochure available on request. £120 on Commodore Disk. £95 on Cassette.

## STOCK CONTROL

**STOCK CONTROL** Powerful and flexible stock system with full facilities for recording and control of stock information. An audit listing is automatically printed which itemises all transactions including the entry amendment and deletion of master stock information, issues receipts, allocations purchase orders. Printed reports include Full Stock Control, Stock Valuation, Reordering Report, Audit Listing, The system is highly flexible.

£50 on CompuThink or Commodore Disk.

## ACT PURCHASE LEDGER

**ACT PURCHASE LEDGER £120** Developed by ACT's own software teams this comprehensive package includes full facilities for the maintenance of the Purchase Ledger, the preparation of a list of outstanding balances and printing of remittance advices. The system produces the following printed results: Audit List, Aged Creditors List, Control Accounts, Purchase Ledger Record, Remittance Advice Cheques and Payments List. For 32K PETs. Full manual supplied. Brochure available on request. £120 on Commodore Disk. £95 on Cassette.

## PAYROLL 200

**PAYROLL 200** Comprehensive, easy-to-use package for small businesses with up to 200 employees. Facilities provided include Holiday Pay, Sick Pay, Bonus Payments and two rates of overtime, as well as allowing a 'Standard week' to be specified for each employee. Weekly and monthly summaries are provided and amendments necessary because of a Budget are made very easy. Prints wage slip and coin/note analysis. Tax & NI are computed automatically from knowledge of employees codes. Update service available. Full manual provided. £50 on Commodore or CompuThink Disk. Cassette system also available at £25

## PETPLAN BUSINESS SIMULATION

**PETPLAN BUSINESS SIMULATION** Petplan is a general management business simulation game which is exciting to play. Already it is widely used by colleges and Industrial Trainers to teach the skills needed to run a business. The program creates the model of a manufacturing company; you take the decisions. You will need to hire workers, invest in plant and premises, set advertising budgets and prices. At each stage screen reports (which may be printed out) show the results of decisions as they take effect. 50 page manual and voice guide on cassette. For 32K PETs. £60 on Cassette.



# are No.1 in...

# are for the PET

**VISICALC**  
PROBLEM SOLVING  
SOFTWARE

**VISICALC PROBLEM SOLVING SOFTWARE** Acclaimed by the press as the most outstanding piece of PET software yet written, VisiCalc is a new breed of problem solving software that takes the hard work out of planning, projections and costings. Once your first projection is complete, you are ready to use the powerful recalculation feature. It lets you ask 'What if', examining new options and planning for contingencies. What if sales drop 20% in October? Just type in the sales figures and VisiCalc instantly updates all other figures affected by October sales. Invaluable to businessmen and students alike. Full manual supplied. Available late June. £125 on Commodore Disk.



## Petsoft sell more programs in Britain than anyone else, for two simple reasons: Quality and Value!

You will find Petsoft programs on sale in more than 200 computer shops throughout the country, and in many more all over the world. We invite you to try them.

If you can't find the program you need, contact us directly. We offer over 200 titles and can supply you directly. We will even take credit card orders over the telephone. Since we normally carry all programs in stock, you won't have long to wait.

*PET is the trademark of Commodore.*

Petsoft is backed by the resources of Applied Computer Techniques Ltd., Britain's leading computing group. With over fifteen years experience of developing business software, ACT has a reputation second to none in the industry. That is your guarantee.

If you would like more information on any of the programs mentioned on these pages, clip out the coupon. We will see that a free copy of our complete PET software catalogue reaches you without delay.

### Plus

Some other PETSFT products described in our catalogue:

#### Programmers Toolkit £55

Plug-in ROM Chip adds nine useful commands to PET BASIC including RENUMBER, TRACE, DUMP, FIND and APPEND.

#### Talking Calculator £10

Calculator program with synthetic speech via user port sound generator.

#### Micro Pools Package £20

A scientific approach to winning the Football Pools, on cassette.

#### 6502 Assembler Tutorial £25

How to program in 6502 Assembly language. On CompuThink or Commodore Disk.

#### Presto Digitizer £42

Electronic tablet accepts handwritten input for the PET.

#### User Port Sound Generator £27

for Talking Calculator program, electronic music etc. With volume control.

#### 76 Common Basic Programs £15

Adam Osborne & Associates classic collection of financial and mathematical programs on cassette.



Radcliffe House, 66-68 Hagley Road  
Edgbaston, Birmingham B16 8PF  
Tel: 021-455 8585 Telex: 339396 ACTNET

Prices exclude VAT and were correct at time of going to press.

# ACT Petsoft

Please rush a FREE copy of the latest Petsoft catalogue to:

Name: .....

Address: .....

Postcode: .....

I have an  8K PET  
 16K PET  
 32K PET  
 No PET yet

• Circle No. 165  
61



# Texas TI-99/4 home computer lives up to expectations

IN 1978, the microcomputer industry was roused into animation by the announcement that a giant in electronics was to produce a personal computer. The giant was Texas Instruments.

Most people involved in electronics will know that when they examine a TTL, Transistor to Transistor Logic, IC, it is more often than not a Texas Instruments component. The Texas Instruments TTL Data book is accepted generally as the bible among reference works on components.

The opinion at the time of the announcement was that Texas Instruments would market the computer with its usual aggressiveness and make a major impact on the personal computer market. Questions were even posed about the survival of other microcomputers. Texas Instruments played the game well, of course, being deliberately reticent about details of its products.

## News and views

Then details began to filter through at Easter, 1979, and by mid-1979, a few people had even seen the product and the general opinion was that it was a damp squib, a disappointment — but with such high expectations what could one

expect? The rivals in the industry breathed a sigh of relief.

Now that the TI-99/4 has been launched and will be available for purchase — it has been available in the U.S. for a few months already — it is

---

by Vincent Tseng

---

worth asking whether the press and its rivals have been unfair to it.

The Texas Instruments TI-99/4 is supplied as a terminal keyboard with 41 keys in the QWERTY lay-out. To the right of the keys is a slot for plug-in solid-state software command modules — they resemble the plug-in cartridges on programmable TV games, i.e., encased ROMs on a circuit board.

It is supplied only with a 14in. colour TV monitor — the keyboard computer is not supplied on its own, and it is not compatible with U.K. domestic TVs. The colour monitor sold in the U.K. is a modified dual-standard, portable colour television, capable of receiving normal TV programmes. The display is 29 characters by 24 lines, displayable in 16 colours.

Graphics capability is available down to a single Pixel-point by user-defined characters, giving an effective resolution

of 256 × 192, using only part of the screen — the edges of the screen are not used due to the fall-off in definition. The 64-character ASCII upper-case set is available, but with user-definition, up to 128 characters are accessible.

The computer is based on the Texas TMS 9900 16-bit microprocessor maximum addressing range 64Kbytes. It has 26K of ROM for its Basic, monitor and utilities; 16Kbytes of RAM, and the plug-in modules can add up to 30K of extra ROM, making a total memory capacity of up to 72K.

## Command modules

The plug-in solid-state software command modules provide ready-to-run programs on various subjects — the concept is similar to the programmable TV games, although the TI-99/4 provides programs of a more serious nature. An important point to note is that Texas Instruments is marketing the TI-99/4 as a home/personal computer, and has, therefore, deliberately used some familiar and recognisable concepts, e.g., the TV, and plug-in cartridges.

The equipment is delivered in three large cardboard boxes. One for the colour TV, one for the computer with power

supply and connecting cables, and one containing a number of plug-in modules. The documentation pack of manuals is in the same box as the computer.

In the pack was a very useful booklet entitled "Read this first — quick steps to get you set-up and started". It is exactly what is needed, and other suppliers of equipment would do well to follow this example. Unfortunately, the first item in the booklet was a belated explanation on unpacking the equipment — to find the booklet, you must have done this already.

Perhaps Texas Instruments ought to consider attaching the booklet in a transparent polythene bag to the outside of the packing box. Another point is that the setting-up information looked as though it was for the U.S. version. Although that does not affect safety aspects, it is different in some details to the U.K. machine.

The components look obvious enough — one just attaches the power supply to the computer and connects the appropriate lead from the computer to the TV. The power supply is wedge-shaped, looking like a foot-pedal control of an electric sewing machine — not particularly attractive.

Switching-on the power from the mains, every thing worked as it said in the read-this-first booklet. That was fortunate, because the TV supplied has eight channel selectors and no mention was made of which channel had been pre-tuned for the computer.

## Pre-set tuners

Mine happened to be selected on channel seven — the required channel — already, but it might easily have been on another channel or de-selected in transit. No instructions, in fact, are supplied with the TV, and it was quite a while before I discovered how it could be tuned for TV programmes using the pre-set tuners.

The first screen displayed, announced "Texas Instruments Home Computer" with two multi-coloured bands and a beep sounded from the built-in speaker in the top-left-hand corner of the computer, just above the slot for plug-in modules. That is a confidence booster to reassure the user that everything is working. Sound can also be transmitted via the TV speaker with another connector and cable attached.

By pressing any key on the keyboard, as instructed on the first screen displayed, a menu of two or more items was displayed. The number of items depends on whether or not a plug-in module has been inserted. The first two items were always constant, being for Texas Instruments Basic and for equation calculator.

Items three and upwards are from the plug-in modules. A beep normally accompanies all computer operations. There is a volume control for the built-in speaker, although again it is not mentioned in the manuals.

The keyboard consisted of keys which

were similar to largish calculator keys. They were reasonable in both feel and size, but were not particularly good for fast typing. There is only one shift key, orange in colour, near the bottom-left-hand corner, and many of the common punctuation characters were on the shifted positions on the alphabets — that is non-standard for both typewriters and terminals.

Having only a single shift key makes the typing of shifted characters awkward and what makes it worse is that the key in the position where the second shift key is usually found, is, in fact, the enter key — also in orange. Part lines may be inadvertently entered when one is trying to shift a character.

Some of the often-used punctuation characters, which are not usually shifted in either terminals or typewriters, have to be shifted on the TI-99/4. The one I found most irritating was the comma key which is used frequently in Basic and really slows entry from the keyboard. Also, if flicked, the keys can be made to pop-out and, therefore, cannot be very child-proof.

The screen was very clear and stable, free from interference. Although the

### Summary specifications

CPU — Texas TMS-9900, 16-bit micro.  
 Memory — 26K ROMs with the monitor, Basic utilities, 16K RAM, with plug-in modules of up to an additional 30K.  
 Keyboard — 41-key QWERTY lay-out, some non-standard shift positions.  
 Display — 14in. modified, dual-standard, domestic TV.  
 Mass storage — audio cassette recorders, possible to cater for two recorders.  
 Sound — output by built-in speaker with volume control, also via the TV speaker.  
 Software — Texas Instruments Basic, equation, calculator and additional plug-in modules.

characters displayed were not as high-resolution or sharp as some of the other VDU screens, they were, nevertheless, very clear, mainly because of the size. The colour and separation was also very good, with only a tinge of colour fringing found when displaying alpha-numeric in black. All in all, a commendable performance, considering that it is only a domestic TV. The TV reception of normal programmes was poor using the built-in aerial.

Texas Instruments Basic has most of the common commands found in other popular versions of Basic. Noticeable by their absence are the PEEK and POKE statements, and any other command which allows the user to access the machine memory directly.

User-defined functions are not the usual "USER" or "USR", where they are machine-code routines, but are routines written in Basic which can be called by a user-defined name — more like a "macro", but in Basic.

Graphics are catered for by a number of sub-program routines which allow the user-definition of characters (CHAR), the

colour of that character (COLOR), repetition of a character horizontally or vertically (HCHAR or VCHAR) and the colour for the rest of the screen (SCREEN).

The COLOR command defines background and foreground colours for characters. Any character code from 32 to 159 decimal can be defined by the user. Note that the codes from 32 to 95 have default values to the standard 64-character ASCII set, but can be re-defined. The characters are in an 8 x 8 dot matrix and are defined by switching on the dots, in eight rows of eight bits, and each row is defined by two Hexadecimal characters.

## Good features

Other good features are the trace and untrace facilities, and the break (point) and unbreak setting commands. The stop command does not cause a break in the program, but is more like an end statement.

The range and accuracy of this version of Basic is good, with accuracy to 13 or 14 digits internally, with 10 displayed or six with exponentials. The range is more or less  $\pm 10^{-128}$  to  $\pm 10^{+128}$ , thus making it better than most scientific calculators.

The usual benchmarks, however, show that this is quite a slow Basic, being approximately three times slower on BMK 6 and 7 when compared to, say, the Nascom 2 and more than six times slower on BMK 8.

The equation calculator facility turns the TI-99/4 into a calculator, as well as enabling the writing of equations with a name — the unknown — on the left-hand side of the equals sign, and a number of variables of parameters on the right-hand side expression.

By entering values for the variables, the answer for the left-hand side will be given. The equation cannot be solved for an unknown on the right-hand side, as any unassigned value for parameters on the right is defaulted to the value of zero; any value assigned to the name on the left side is ignored in obtaining the result of the right-hand expression.

## Program checks

The range and accuracy are the same as in Texas Instruments Basic. I did not find this feature of any outstanding value as the functions are also available under Texas Instruments Basic.

Provisions exist for recording on to audio cassette tape — a lead is supplied to allow two audio cassette recorders to be used. Both can be read-from, but only one can be recorded-to. Remote-control jacks for starting and stopping both recorders are also provided via the lead.

The save command allows a read-after-write check of the program — a useful feature. To read-back a file, the command was OLD instead of the usual READ or LOAD. File names could not be given

(continued on next page)

(continued from previous page)

under Save with cassettes under Basic — one has to keep a separate record of the programs stored.

Under test, I found that it worked reasonably well with my cheap cassette recorder, but there were occasional errors in data on reading back. As there were no instructions in the manuals for cassette adjustments and since one could not drop into machine code to do more extensive testing, I can only report on a very limited usage. With the documentation there was a list of recommended recorders but most of them appear to be for the U.S. market.

Eight plug-in, solid-state software command modules are supplied with the machine.

These were:

- 1 Demonstration
- 2 Video graphs
- 3 American football
- 4 Physical fitness
- 5 Household money management
- 6 Pre-school early learning fun
- 7 Beginning grammar
- 8 Number magic

Others are available from Texas Instruments among which "Diagnostics" and "Video Games — 1" are impressive.

### Video graphs

Demonstration is exactly what it says it is — it was produced as a self-selling aid for shops and showrooms and gives a good demonstration of the range of capabilities of the TI-99/4. Video graphs was slightly disappointing: it consists of a few graphics games and demonstrations such as colour Life and the capability to have a keyboard-controlled sketchpad.

Although a screen can be recorded and loaded from cassette, there does not seem to be any link into Basic to allow preparation of graphics under this module for use in other programs.

Household money management is the

most serious program in the group, allowing the construction of a budget which shows the money figures in tabular form or in form of bar graphs in colour for easy assimilation and for judging trends.

There are 34 pre-selected numbered categories and they are changeable. There are more numbered categories from which to choose, 99 in fact, but the names associated with each number of the categories are fixed by the module. The program obviously allows cross-referencing of categories and the display of data from selected categories.

### Data saving

Saving of data can be to cassette, again no naming of files, but advice to mark the cassette clearly and backing-up is given in the instruction booklet. The three modules listed as 6, 7 and 8 are of an educational nature.

The Video games — 1 module was very impressive for the graphics capability demonstrated. For example, shapes — user-defined — can be given different priorities so that they can appear to "walk" behind or in front of other objects, without disturbing other neighbouring shapes.

A screen can have several independently-moving shapes. The games were very addictive — control was through a set of plug-in, hand joy-sticks — particularly the pin-ball game, where the rumoured highest score is more than 100,000.

The diagnostic module was more of a confidence test. The cassette test did little more than save data and perform a read-after-write check.

Overlays are provided for the keyboard with some of the modules for easier recognition of keys which have been re-defined for new functions.

Various expansion accessories exist, including RS232 interfaces, floppy disc drives and modems. The most interesting, though, was a voice-synthesis module and attachment which can, in effect, talk with a vocabulary of about 370 words.

All these accessories are connected in a cascade fashion via an edge-connector output which is behind a shutter on the right side of the TI-99/4.

Texas Instruments has maintained its high standard of documentation for the manuals supplied with the TI-99/4 which were the "Users' reference guide", "Beginners' Basic" and "Read this first". They were all readable and good for reference; the first two also gave many illuminating examples.

The only criticism is that some of the initial setting-up details are different for the machine available in the U.K. The booklets supplied with the modules, on the other hand, are not quite as consistent, some are obviously more than adequate, e.g., for games, but others, like Household money management and Diagnostic modules, could do with more details and illustrating examples, and possibly even explanations of how certain functions work.

### Conclusions

- Although many would claim that Texas Instruments has not gone far enough with the TI-99/4, or that it is a disappointment after all the build-up, I found that it lives up to expectations.
- The price of around £990, which includes the 14in. colour TV monitor, is perhaps slightly high, though.
- The plug-in module concept is good.
- The range already available shows at least that Texas Instruments can supply the applications for which its computer is intended.
- One major criticism is that the modules do not inter-link with the Basic which can extend the programming power of the TI-99/4.
- The addressing capability of up to 72Kbytes, when the maximum addressing range of the CPU, the TMS9900, is only 64K, is achieved by memory paging.
- Hence possibly the non-linking of the modules to Basic, but that can be overcome, especially if only certain parts of the module's routines are required.
- The absence of PEEK, POKE and machine-code accessibility may deter some potential buyers.
- The robustness of the unit to stand up to home use may be open to question.
- Documentation should be checked by Texas Instruments to ensure that details which were correct for the original U.S. model still hold true.
- Instructions are needed for the setting up and adjustment of the TV set supplied. □





# BYTESHOP COMPUTERLAND

your specialist Computerstore.

## *Cromemco System Three*

Well-proven systems for the serious user. Our computer stores are staffed by business experts, backed by first class maintenance support. Call in for advice and a demonstration of our range of systems.

The Cromemco buyer is choosing well-proven design, reliability and expandability. Start with a single terminal and grow into a multi-user system as your requirements expand. Excellent Cromemco software includes COBOL, FORTRAN and RPG-II. Ask for a demonstration of the Cromemco hard-disk and talk over with us how your application can be programmed.



## *North Star Horizon*

The reliable and long-established commercial favourite. Ask about our BYTE SHOP- developed packages – Invoicing, Sales and Purchase Ledger, Incomplete Records, Cash-Flow Analysis, Stock Control, etc. And use your Horizon to type perfect letters – it is an excellent word-processor.

**Nottingham**  
92a Upper Parliament Street  
Nottingham NG1 6LF  
Tel. 0602 40576 Telex. 377389

**Manchester**  
11 Gateway House  
Piccadilly Station Approach  
Manchester  
Tel. 061-236 4737 Telex. 666168

**Birmingham**  
94-96 Hurst Street  
Birmingham B5 4TD  
Tel. 021-622 7149 Telex. 336186

**Glasgow**  
Magnet House  
Waterloo Street  
Glasgow Tel. 041-221 7409  
Telex. 779263

**BYTESHOP  
COMPUTERLAND**  
– your specialist Computerstore.

**London**  
48 Tottenham Court Road  
London W185 4TD  
Tel. 01-636 0647

• Circle No. 166

# Greater speed and storage for Winchester-based Rair system

RAIR, the maker of the Intel 8085-based Black Box microcomputer system, started recently to supply a hard-disc system. Neatly styled, the same size and shape as the Black Box, 20in. by 16in. by 5¾in., the hard disc is supplied as one unit with self-contained power supply and disc controller.

The system uses the new Winchester storage technology and is based on International Memories Incorporated 7710 disc. That was one of the first of the new disc units available and is also used in the Corvus system for Apple microcomputers. The storage capacity is 11.5Mbytes unformatted which is reduced to 9.7Mbytes available to the user when formatted.

## Increased capacity

Rair also supply single- and double-sided, double-density mini-diskette drives. The single-sided drives provide 153Kbytes on-line storage per drive, and the double-sided drives 268Kbytes. Therefore, a system with four double-sided drives has a maximum capacity of slightly more than 1Mbyte — a hard disc increases that by nine times.

There are two parallel ports at the rear of the disc drive; the top port connects via a 5ft. ribbon cable to the Black Box, and the lower port is for connecting daisy-chained up to seven other disc units. Only one disc controller is needed to drive all the discs, which may be up to 25ft. apart if screen cabling is used. That gives almost 80Mbytes of directly-accessible information.

Power is supplied via the Black Box, so the disc goes on when the power switch on the computer is pressed. It takes about 15 seconds for the disc to come up to the operational speed of 3,600rpm. The Black Box uses the Digital Research CP/M operating system with some enhancements provided by Rair.

## File maintenance

The current version for use with the hard disc is version 2.0. It has been adapted to address up to 12 drives, four mini-diskette drives and eight hard discs. In addition, a forum of disc partitioning has been provided which allows up to 16 users to maintain files on the system. When in one user area, the operator may not access or update the files in another user's area.

Unfortunately, individual user areas may not be protected in any way, by entering password for example. To access the files in area two, the command "USER 2" is all that need be entered.

An additional command has been provided in version 2.0, the assignment command "ASS". It may be used to display the current user number, and disc assignments, and to change the disc assignments if required. Disc drives have

by David Watt

physical numbers 0-11, 0-3 for diskettes and 4-11 for the hard discs. They may be assigned logical names A to L — drive A is always used for loading the operating system when the re-set button is pressed on the computer.

When the computer is switched on, or the load button pressed, the system waits 15 seconds automatically for the hard disc to reach its operational speed, before continuing with the start-up procedure. That may not be necessary in future versions, as the operating system will be able to detect whether or not the disc is up to speed.

Besides the vastly-increased storage capacity of Winchester discs over floppy-

	Double-sided, double-density mini-diskettes (Msec)	Hard disc (Msec)
Track-to-track access time, minutes	30	10
Latency	100	8.3

Table 1.

disc systems, the other advantage of a hard-disc system is the improvement in speed of accessing the data compared to diskettes. Tables 1 and 2 illustrate something of the improvement on the RAIR system. Table 1 shows the manufacturer's published figures for disc accessing on mini diskettes and hard discs.

Latency is the average time taken for a particular disc sector to be located under the read/write heads once an access has been initiated, and is calculated simply as half the time taken for one revolution of the disc. Minimum track-to-track access time is time taken for the read/write heads to be positioned on an adjacent track. The maximum track-to-track access time on the hard disc is 100 Msec.

Table 2 shows the results of cover programs written in Microsoft Basic-80 to give the time taken to write 1,000 records sequentially, to write 1,000 records randomly, and to read 1,000 records randomly. The random tests were

performed without re-seeding the random number generator, so in each case the records were accessed in the same order.

The record size used in all the programs was 128bytes. The results show that for random file processing, which is required in the majority of data processing applications, the hard disc is four and a half to five times faster than floppy discs.

The write tests took longer than the reads because the system reads a record after writing it to check for errors.

## More efficient

It can also be seen that the time for 1,000 sequential writes was nearly identical for the hard disc and the diskette. According to Rair, that is due to inefficient input/output routines in CP/M, which were designed for floppy diskettes. In addition, the disc controller, made by IMI, transfers data over a byte-parallel interface rather than using direct memory access (DMA), which is much more efficient.

Rair is waiting for both a new controller to be developed and an improved version of CP/M, which together should offer a claimed 400-500 percent improvement in performance. The controller should provide DMA transfers, the option for not performing read-after-write checking — which is not as important for hard-disc systems as floppy discs because of the improved reliability — and firmware blocking and de-blocking. The controller will be capable of transferring records of sizes up to 16Kbytes.

The major problem with Winchester disc drives is how to back-up the data. Larger computers have exchangeable discs which may be copied and stored in a safe place, but this is too expensive for micro-computer systems.

## Two methods

At present, there are two methods for copying Winchester discs on microcomputers, either to copy to floppy discs, which is slow and requires a good deal of floppy discs but reliable and straightforward for the manufacturer to provide as it has not had to develop any new technology, or to copy to magnetic tapes.

New methods are being developed for copying large volumes of data to magnetic tapes using a process known as streaming which involves reading or writing the whole tape in one continuous operation — the tape is wound through at a constant rate from start to finish.

Rair has adopted the first method, because it claims tape streaming is not sufficiently reliable at the moment. It is

not possible to do read-after-write verification with streaming tapes and although there are methods for providing automatic error correction, they will not cope in cases where an area of tape is corrupt, as opposed to isolated errors.

## Back-up program

The back-up program has been provided to copy files from the hard disc to floppy discs. To make back-up as efficient as possible, the program copies to a whole diskette, including the three tracks used normally for the CP/M kernel, so each diskette may store up to 280Kbytes. Also, the back-up program provides facilities for copying only selected areas of the hard disc.

1. All files in all user areas.
2. Files matching a particular specification in all user areas.
3. All files in the current user area.
4. Selected files in the current user area.

Also the 'EXTRACT' option is provided to copy only those files which were updated since the last full back-up or extract. If it is necessary to copy files back from the floppy discs, the re-store option is used, first to copy back files from the last full back-up, then to copy back files from successive extracts.

## Copying discs

To copy a completely full disc would take about 33 double-sided, double-density diskettes, but, in practice, it should never be necessary to copy a full

Test	mini diskettes seconds	hard disc seconds	improvement percentage
Sequential write	46	44	.05
Sequential read	40	26	53
Random write	1302	288	352
Random read	1200	227	428

Table 2. Time taken to access 1,000 records.

disc — at least on a single hard-disc system.

## Directory listing

Each diskette takes about one minute and 15 seconds to copy, and copying 1.3Mbytes takes about 20 minutes including changing diskettes and obtaining a directory listing of files you wish to back-up.

The list price for a disc drive with a controller is £2,750; additional drives cost

only £2,500. The disc drive is extremely reliable although the power supply and controller are less so. Rair reckons on one fault a year, and cover the drive on their standard terms of one percent of cost price per month for full cover of parts and labour.

## Conclusions

- The Rair hard disc system offers significant advantages over floppy discs in increased data storage capacity, speed of operation and improved reliability.
- The hard disc is reasonably priced and attractively styled, at £2,750 for disc and controller, and £2,500 for additional drives. The Black Box will stack neatly on top of the disc unit, so storage is no problem.
- The system was reviewed at the Rair offices, so any problems were quickly answered by Rair staff, but they had very little documentation available on CP/M Version 2.0 and the back-up program.
- Rair has provided a solution to the problem of taking back-up copies of files, but I do not think it is ideal. Unfortunately, until more reliable and faster methods of back-up are found, it is a problem with which people are going to have to live.
- The enhancements due to version 2.2 of CP/M and the new disc controller should make an appreciable difference to the performance of the disc. □



# Adventure II — an epic game for non-disc systems

We present an Adventure-creating program for almost any system.

ADVENTURE is a very popular and addictive computer game, run on many large systems throughout the world. However, despite its popularity among those with access to large machines, it does not seem to have appeared on many microcomputers. The reasons for that are easy to see; Adventure is complex, large, requiring disc back-up and difficult to modify to produce new games.

## More general

Consideration of those problems led to the design and implementation of the simpler and more general Adventure program described in this article, suitable for most systems without the need for disc-backing store.

Adventure is a computerised version of the game Dungeons and Dragons, both of which are enormously popular. In Dungeons and Dragons a player is assigned the role of dungeon master, devising the dungeons which the other players explore in an attempt to acquire the treasures hidden there, often after having fought their way past monsters of various kinds.

Each player announces his action to the dungeon master who then tells him of the outcome, usually after spinning various dice to generate a random element.

Adventure, run on PDP-11 systems everywhere, is similar to Dungeons and Dragons except that the dungeons are devised by the original programmer and the computer then assumes the role of dungeon master.

## Interactive technique

The computer describes the situation to the user who replies with the action he has decided to take. The computer, in turn, informs him of the result. This player/computer interaction is best illustrated by a sample run of the program — the user response is in capital letters.

Somewhere nearby is Colossal Cave, where others have found fortunes in treasure and gold, though it is rumoured that some who enter are never seen again. Magic is said to work in the cave. I will be your eyes and hands. Direct me with commands of one or two words.

You are standing at the end of a road before a small brick building. Around you is a forest. A small stream flows out of the building and down a gully.

ENTER BUILDING

You are inside a building. A well house for a large spring.

There are some keys on the ground here. There is a shiny brass lamp nearby. There is

food here. There is a bottle of water here.  
GET KEYS  
OK  
GET LAMP  
OK  
RUB LAMP

Rubbing an electric lamp is not particularly rewarding. Anyway, nothing exciting happens.  
EXIT

You're at the end of the road again.

GO SOUTH

You are in a valley in the forest beside a stream tumbling along a rocky bed.

GO SOUTH

You are in a 20-ft. depression floored with bare dirt. Set into the dirt is a strong steel grate mounted in concrete. The grate is locked

UNLOCK GRATE

The grate is unlocked.

Once having opened the grate, for which he must have the keys, the player then has access to Colossal Cave where there are problems to solve and treasures to gather. However, if he does not have the keys, there is no way that the grate can be opened. In fact, it may take him a

by Ken Reed

while to find the entrance as it is all too easy to become lost in the forest.

As you can see from the example, playing Adventure is rather like reading a novel, with one important difference. Instead of following the story passively, the reader is involved actively, deciding what is the best action to take in a given situation, often having to think very carefully as the wrong decision may lead to death.

That affinity with a novel is Adventure's main disadvantage. Once all the problems have been solved, which may take several weeks, interest wanes and another Adventure is required.

The original version of Adventure, programmed by Will Crowther at Stanford Research Institute, is coded in Fortran, requires 64Kbytes of memory, disc back-up and is very difficult to modify to generate new games as many of its features are buried deep within the program code. That explains the current shortage of Adventures.

A better solution would be to have a general Adventure program driven by a separate database allowing new games to be generated without having to overcome the programming complexities every time. In fact, that approach was used by Scott Adams who has now produced a number of excellent adventures for some of the more popular systems such as the TRS-80 and Sorcerer.

The program described here carries this concept one step further. Instead of one person producing adventures for a limited range of systems the idea is to describe a program which can be implemented on almost any system and driven by an entirely separate and machine-independent database. That allows owners of the program to write adventures in a simple form and swap games with someone who may have an entirely different processor.

## Two segments

As mentioned earlier, Adventure II is split into two parts. The first is the program and the second the driving database. Before describing the program, it is worthwhile to look at the general structure of the database which has four main sections:

1. The vocabulary of words recognised in the game.
2. The objects that may be manipulated.
3. The places that may be visited.
4. The actions performed by specific words.

All that is required to produce the database, and the program is an assembler and examples of various table entries are shown for a Z-80-type assembler.

The vocabulary is held as the first four letters of a word followed by an identifying code. That permits the program to reduce words to simple numbers which are much easier to manipulate. It also allows different words to have the same code and hence the same meaning.

## Identifying code

For example, the words "DESCEND" and "DOWN", having roughly the same meaning, may be assigned the same identifying code. Hence the commands from the user "DOWN STEPS" and "DESCEND STEPS" may be handled by the same function. The table may be entered thus:

```
VOCAB: DEFM 'NORT'; Word "NORTH"
        DEFB 1 ; Identifying code
        "1"
        DEFM 'EAST'
        DEFB 2 ; EAST has code
        "2"
```

DEFM is the instruction to define an ASCII string and DEFB is to define a byte. The table has the name "VOCAB" and terminated by a byte of 0FFH (255 or -1). The words for movement — north, south, etc. — must have codes in the range 1 to 12 as the program prints the message — I cannot go in that direction — if it cannot find anything to do with words

in that range. Other unmatched words generate the simpler response: I can't.

Objects are anything which may be moved from one place to another and/or transformed from one thing to another. A lamp, for example, may be carried with the player and it may be transformed from a "LIT LAMP" to an "UNLIT LAMP" and, of course, back again.

Each object has an entry in each of two tables: the object location table which records the current position of the object and the object description table which contains the text used to describe the object.

The current location table is named "OBJLOC" and the descriptive text table "OBJTXT". OBJLO is terminated by a byte of 0FFH, OBJTXT needs no termination.

```

OBJLOC: DEFB 3,0 ; Object 0 at
          DEFB 5,0 ; location 3
          ; Object 1 at
          ; location 5
          ; Similarly for
          ; other objects
OBJTXT: DEFW M0 ; Address of text
          DEFW M1 ; for object 0
          ; Address of text
          ; for object 1
M0: DEFM 'A little ; Description of
      DEFB 80H ; object 0
          ; String termin-
          ; ator
M1: DEFM 'A bunch
      DEFB 80H ; of keys'
  
```

Note that the object position information is two bytes to allow it to be at a location — first byte is 0-225 — or in some special place, such as carried by the player — second byte is used. Also, the object description table OBJTXT contains the address of the actual description for each object.

## Simple indexing

That allows simple indexing by object number into the table to locate the real text. If it were not done that way, the table would be much harder to use as each entry would be of an unknown length. The byte 80H is used to terminate the string.

The locations are the places that the player may visit. They may be rooms, caves or anything desired by the Adventure writer. Each location has an entry in two tables: The description of the location and the list of directions the player may go from there. The location descriptions are held in a table named LOCTXT and the possible movements in MOVEMT. Both of those tables consist of pointers to the actual data as described for the object descriptions above.

```

MOVEMT: DEFW D0 ; Pointer to loc-
          DEFW D1 ; ation 0 moves
          ; Pointer to loc-
          ; ation 1 moves
          ; etc. for rest of
          ; locations
  
```

The following example movement shows an entry that says that word 0 takes  
*(continued on next page)*



(continued from previous page)

us to location 1 and word 3 will take us to location 5. Note that a -1 terminates the list.

```
D0:      DEFB 0,1,3,5,-1
LOCTXT: DEFW L0      ; Pointer to descriptions
          DEFW L1      ;
L0:      DEFM 'I am in an empty room'
          DEFB 80H
L1:      DEFM 'I am by a stream'
          DEFB 80H
```

The action table is the section of the database interpreted or executed by the main program. It consists of words, conditions and actions performed. If there is an entry in the table for the words entered by the user and the conditions specified are met, the actions are performed.

### Action table

For example, if the command "GET LAMP" has a corresponding entry in the action table and the condition that the lamp must be in sight are met, the database will instruct the program to mark the location of the lamp as carried. There is a similar table scanned before the player's turn to see if the computer wants anything to happen.

For example, he may be in the same room as a Vampire without a crucifix so the computer may make the Vampire attack. The user action table is named EVENT and the computer's table STATUS. Both have the same format:

```
EVENT:  DEFB 0,1      ; Words 0 and 1
          DEFW C0      ; Pointer to conditions
          DEFW A0      ; Pointer to actions
          DEFB 3,-1    ; Only word 3 required
          DEFW C1      ; Pointers
          DEFW A1      ;
CO:     DEFB 0,1,2,-1 ; Must be at location 1 (0,1)
          ; Object 2 must be here (1,2)
```

```
A0:     DEFB 5,3,-1   ; Print message 3
```

The lists of actions and conditions are terminated by a byte of 0FFH (-1). Note that the examples are only very small extracts from a real table. A full-size database may have up to 255 locations and any number of entries in the event and object tables.

### Pseudo-code

The requirement that the program be as small as possible means that it must be entered as an assembler program. However, as we want the program described to be suitable for any system, it leads to a slight problem over how we represent it.

Assembly listings for every processor would occupy far more space than the magazine can provide and flowcharts would not really describe the action of the program at the level of detail we want. For those reasons, the program is represented in pseudo-code.

For those not familiar with the term, pseudo-code is a non-existent language or shorthand representation of a program often used by programmers for detailed design when the actual target language is not yet known. Pseudo-code provides far more detail than flowcharts and is, in fact, detailed instructions for the actual coding of the program.

Although the listing should be more or less self-explanatory, it is worth mentioning two conventions used. If a variable is preceded by a "@", it means that the variable is used as a pointer to the data. For example, if "HL" contains the value 100 and we say "A=@HL", "A" is loaded with the contents of memory location 100.

A similar convention is used to identify the address of a variable except the "#" character is used — also used by the IF statement for not equal to. For example, if we say "HL=#OBJLOC", it means that the variable HL is loaded with the address of OBJLOC and not the contents.

Variables used are defined as either BYTE, 8-bit, or WORD, 16-bit, and the contents are assumed to be set to zero unless a value is included between two 'P's. For example, to define two 8-bit variables in memory, one set to zero and the other to 3 we use:

```
BYTE VARA,VARB/3/
```

A memory block is reserved by:

```
BYTE VARC/<7>/
```

which means reserve seven bytes of memory starting at label "VARC".

### Program arrays

That leads to the implementation of arrays used by the program. All references to arrays mean an offset to the base label of a memory area. For example, VARC(3) simply means the address found by adding three to the value of label VARC.

Thus VARC(0) is exactly equivalent to VARC. Remember that words occupy two bytes, so, if VARC was a word array, VARC(3) would actually be addressing VARC+6 and also VARC+7 for the top byte.

Knowing this, you should now be able to produce a version of the program for your particular system by working through the listing and generating the appropriate assembly code for your machine. If you have access to a medium-level language, such as PL/M for example, that is, of course, equally acceptable.

The pseudo-code program shown here has in fact been compiled by a specially-written compiler to ensure that it is sound.

Let us work through the program considering what makes it tick and explaining the meaning of the pseudo-code representation.

Referring to the listing, we can see that the first section is simply the definition of items not within this listing, that is the items marked "GLOBAL". Four sub-

routines not described here are called, but as these are relatively simple entities they should present no problem in coding.

The first subroutine required is called "SREPLY" and it is simply a routine to read a response from the user and return a value of one if it was a "Y", and a value of zero if it was a "N". The routine should check that either a "Y" or a "N" was entered and prompt "PLEASE ANSWER YES OR NO" for any other reply.

The second routine is named \$MESS and is the routine used to print messages on the console. It must take the ADDRESS of a message as a parameter and print all the bytes found there until a byte with the most significant bit set is encountered. The routine used also had the additional feature that it printed a return/line feed if it was called with an address of zero.

The next routine, \$LINE, is the opposite of \$MESS; it obtains a line from the user and passes back the address of the stored text.

### Random numbers

Finally, \$RAND is a routine which returns a random number in the range 0 to 100. Many people shudder at the thought of writing random-number generators but as we want only one number at a time and not a series, that is not as difficult as you may think.

It can be done by reading the refresh register if you have a Z-80 system, or if your keyboard is software-controlled, you may increment a counter in the keyboard — wait loop and use that value as the random number. If you want a more elegant solution, the random numbers used in the prototype program were generated using the algorithm:

[Generated number] = 11 x [Last generated number] + 999 MOD 101 although this does require 16-bit multiply and divide.

The next group of globals refer to the addresses of the various tables in the database.

### Variable definition

The last part of the section is the definition of the variables used by the program. Although some of them are defined as words, the only items which must be 16-bit are "Here" as it is compared to a 16-bit object location and the three "pointers" BC,DE and HL as they hold addresses used to point to the actual data required.

A further point is that some items are used for temporary storage only and may be replaced by the processor registers if you desire. The only variables that must be in memory are Here, the current location and User, the variables the database may access. If you run out of registers, remember they may be saved on the stack while a register is used for something else.

Proceeding to the code, we can see that the program begins at label "Start" which

simply sets the first location to zero. The code beginning at "Desc" describes the current location by printing the description found adding the contents of 'HERE' to the base address LOCTXT and using the pointer there.

The current location will, of course, change as the game progresses. A small piece of code checks to see if the database has set user flag zero and if so, we are in dark locations and object zero must be present (a lamp) to obtain the location description. Otherwise the message "Everything is dark. I cannot see" is displayed.

## Time limits

Two of the user flags are also decremented automatically if the database has set them non-zero. That allows time limits to be implemented for things like being in dark locations. A further flag is decremented a little later once per player's turn.

The code then goes on to scan through the object location table "Objloc" and if any objects position is the same as the current position "Here", the object description is printed.

Next, the program looks quickly at the status table which is effectively the computer's turn at the game. However, as the same mechanism which decodes the player's command is used, we will consider it later. That function, when completed, returns to the label "PROC".

The routine that obtains a line from the user is called (\$LINE) and the address of the entered text obtained. The routine used returned the address on the top of the stack and the instruction "HL = @ SP" finds that address.

## Line reduction

We then pick the first four letters of the first word and look it up in the vocabulary table. If the word is found, we do the same to the second word. If a particular word does not have an entry in the vocabulary table, we discard it and try the next.

That reduction of the line allows complex sentences like "TURN ON THE LAMP" to be reduced to simpler entities like "ON LAMP", provided the words TURN and THE are not in the vocabulary. Hence it is important to consider carefully which words are not in the vocabulary as well as which ones are.

If none of the entered words is found in the vocabulary, the message "I don't understand" is printed and we go and obtain another line from the player.

After we have converted the user's command into one or two single-byte codes, we take the first code and see if it is one of the words which cause movement at the location. If it is, the current position (HERE) is updated and we return to label "MOVED" to describe the new place. If it is not, we proceed to examine the main event table to see if there is an entry there.

If the first word code "W1" matches the first byte of an entry and "W2" matches the second byte, we proceed to extract the conditions and test them. If all the conditions are satisfied, we extract the list of actions and execute them.

If all the conditions do not match or the two-word codes do not match, we try the next entry in the table. That is repeated until an explicit command to leave the table is given or the table is exhausted.

The action or condition is decoded by using it as an index into a list of addresses for the function we want and simply moving the address to the program counter (PC). It can usually be done on most machines by pushing the address on to the stack and executing a return from subroutine instruction.

The comments in the program listing explain the operation in greater detail and indicate what actions and conditions are available.

Looking at some examples of a database should further clarify the operation of the program. To make the database more readable, the example extracts shown below were produced using a macro assembler and calling various macros to make the entries in the appropriate table.

## Vocabulary details

The following is a small section of the vocabulary from the author's test database. Note how abbreviations are also entered for words and given the same code. Hence "E" is equivalent to "EAST".

```
VOCAB:
TABLE <SOUT> ,1
TABLE <S> ,1
```

```
TABLE <EAST> ,2
TABLE <E> ,2
```

```
TABLE <WEST> ,3
TABLE <W> ,3
```

```
TABLE <NE> ,4
TABLE <NW> ,5
TABLE <SE> ,6
TABLE <SW> ,7
```

```
TABLE <UP> ,8
TABLE <U> ,8
```

```
TABLE <DOWN> ,9
TABLE <D> ,9
```

```
TABLE <NORT> ,12
TABLE <N> ,12
```

```
TABLE <END> ,13
TABLE <STOP> ,13
TABLE <QUIT> ,13
TABLE <ABOR> ,13
```

In the objects shown here, note how items which can change state are two objects although only one of the pair may exist at any given time.

```
OBJECT 0, <0,8>, <A lit lamp>
OBJECT 1, <S7,0>, <An old oil lamp>
OBJECT 2, <S5,0>, <A small cloth bag>
```

```
OBJECT 3, <S5A,0>, <A bottle of holy water>
OBJECT 4, <0,8>, <An empty bottle>
OBJECT 5, <0,8>, <A match>
OBJECT 6, <0,8>, <A spent match>
```

The first byte of the location information is used to mark the location of the object. If the second byte is non-zero, the object is at one of the special places. These are:

```
2 — Object is carried [512]
4 — Object is worn [1024]
8 — Object does not exist (yet) [2048]
```

The value in "[]" indicates the number obtained when the two bytes are considered as a single 16-bit word.

## Movement words

The first two locations of the example illustrate how movement can be accomplished by any words and not just directions. For example, the word "HELP" moves the player to location S1 which simply contains instructions for him. The word "BEGIN" is used to start the game.

```
LOC S0, <HELP,S1, BEGI,S2>
TXT <Welcome to Adventure!>
TXT <If you know what to do type BEGIN
otherwise type HELP>
```

```
LOC S1, <BEGI,S2>
TXT <I have managed to get myself lost in the
forest on my>
TXT <quest for the seven golden keys of
Waydor and I don't know>
TXT <what to do next. So it is up to you to
help me.>
TXT <>
TXT <Give me your instructions and I will
obey. For example, >
TXT <if you want me to go to the north, type
"GO NORTH", if>
TXT <we should come across some keys and
you want me to get>
TXT <them, type "GET THE KEYS".>
TXT <Some other words that you may find
useful are:>
TXT <INVENTORY to find out what I'm
carrying>
TXT <QUIT to give up.>
TXT <>
TXT <Type "BEGIN" when you are ready to
to start.>
```

```
LOC S2, <S,S4, PATH,S4>
TXT <I am in a clearing in a very dense
forest.>
TXT <There is a path leading off to the
south.>
LOC S5, <N,S2,E,S5,W,S6>
TXT <I am at a "T" junction with exits to the
north, west and east>
```

```
LOC S5, <W,S4,EXIT,S4,E,S5A,ALTA,
S5A>
TXT <I am amongst the ruins of a church.
At the far end there>
TXT <are the remains of an altar. The exit is
to the west.>
```

```
LOC S5A, <EXIT,S5,W,S5>
TXT <I'm beside the altar.>
```

```
LOC S6, <E,S4, IN,S7, CRYP,S7>
TXT <I'm outside the entrance of a crypt.>
```

```
LOC S7, <EXIT,S6, DOOR,S6>
TXT <I'm in a vaulted chamber. Thick
cobwebs hide the ceiling.
TXT <There is an empty coffin in the corner
and a passage leading>
TXT <off into darkness to the north.>
```

```
LOC S8, <D,S9, STEP,S9>
```

(continued on page 73)

# New Apple Software

TALKING DISK

TINY PASCAL

VISICALC

ACT Appleware bring you Britain's best range of software for the Apple.

including

*VISICALC*

£125

A powerful problem solving package that adapts itself to any numeric problem. 1980 Program of the Year.

*APPLE INVADERS*

Probably the best Apple version of this exciting space game.

*TINY PASCAL*

£12

No hardware needed to use this implementation of the acclaimed Pascal language. Just load and go.

*MICROCHESS*

£40

The most widely used personal computed chess program in the world. A great opponent for novices and advanced players.

£15

*TALKING DISK*

An exciting speech synthesis package containing five programs. Stores and retrieves your own voice data.

£14.95

*CCA DATA MANAGEMENT SYSTEM*

Names and addresses, inventory information—CCA handles any data that can be organized into records or files. Use it to build your own business system.

£75

*BRIDGE PARTNER*

You against the computer in over ten million different hands.

£ 10

Plus more than seventy other exciting programs in the latest Apple catalogue. Send or call for your free copy.

Try Appleware programs at your nearest dealer. Or order by mail. For credit card holders we accept telephone orders too.

# ACT Appleware

Software for Apple II Computer

Radclyffe House, 66/68 Hagley Road, Edgbaston, Birmingham B16 8PF  
Telephone 021-455 8585 Telex 339396

ACT Appleware  
Please rush me my free copy of the new Appleware catalogue.

My name is.....  
My address is.....

Postcode.....

Apple is the trademark of Apple Computers Inc.  
All prices quoted are exclusive of VAT and were correct at press date.

• Circle No. 167

PRACTICAL COMPUTING August 1980





(continued from previous page)

```

! Note that ObjLoc(0) is equivalent to simply ObjLoc
Descr: BEGIN IF (User#0)
      IF (User(3)#0)User(3)=User(3)-1
      IF (ObjLoc=Here)GO TO Seen ! Object here
      IF (ObjLoc=512)GO TO Seen ! Carried
      TYPE 'Everything is dark. I cannot see'
      IF (User(4)#0)User(4)=User(4)-1
      GO TO Command
      ENDIF
Match: HL=HL+1 ! Condition pointer
      BC=@HL ! Get it
      HL=HL+2 ! Point to actions
Check: IF (@BC=Bnes1)GO TO Doit ! End of conditions
      Btemp=@BC ! Get this condition
      BC=BC+1 ! Next operand
      Ctemp=@BC ! Preload
      PC=TABLE1(Btemp) ! Computed GO TO

Seen: CALL %Mess(Locxt(Here)) ! Describe Here
look: Flag=0 ! List objects here
      I=0
look1: IF (ObjLoc(I)=-1)GO TO command ! End of objects
      IF (ObjLoc(I)#Here)GO TO next
      BEGIN IF (Flag=0) ! Object here
        CALL %mess(0) ! New line
        TYPE 'I can also see' ! That message only once
        Flag=1
      ENDIF
      CALL %mess(Objxt(I)) ! Describe object
      CALL %mess(0)
next: I=I+1 ! Next entry
      GO TO look1

Command: HL=#Status ! See if anything happens
      GO TO Active

Proc: ! Returns here
      IF (User(2)#0)User(2)=User(2)-1 ! Count down active
      CALL %RAND(@Rnum) ! Keep random spinning
      CALL %Mess(0)
      CALL %Line ! Get a line
      HL=@SP ! Point to it
GETWD: CALL Lookup(%W1) ! See if we know it

      BEGIN IF (W1=Bnes1) ! Not found in table
        BEGIN IF (@HL=Cret) ! No more words
          TYPE 'I Just dont understand what you mean'
          BEGIN IF (word1>90)
            TYPE 'Perhaps if you used UPPER CASE ....'
          ENDIF
          GO TO Command ! Try again
        ENDIF
      ENDIF
Scan: BEGIN IF (@HL=Space) ! Next word
      HL=HL+1
      GO TO Getwd
      ENDIF
      IF (@HL=Cret)GO TO Err1 ! No more words
      HL=HL+1
      GO TO Scan
      ENDIF

! If we fall out here we have a known word in W1. Now see
! if we can find one for word number 2
W2=Bnes1 ! No word yet
Scan2: IF (@HL=Space)GO TO Second ! Found one
      IF (@HL=Cret)GO TO Allin ! NO more
      HL=HL+1
      GO TO Scan2

Second: HL=HL+1 ! Point to word
      CALL Lookup(%W2) ! See if an object
      BEGIN IF (W2=Bnes1) ! Not found
Scan3: IF (@HL=Cret)GO TO Allin ! Another word found
      IF (@HL=Space)GO TO Second ! Keep lookins
      HL=HL+1
      GO TO Scan3
      ENDIF

! See if this word causes a change of location
Allin: HL=Movemt(Here) ! Point to movements
Moveit: IF (@HL=Bnes1)GO TO Nonove ! End of list
      BEGIN IF (@HL=W1) ! Entry found
        HL=HL+1 ! Point to dest
        Btemp=@HL ! Go there
        Here=Btemp ! Keep to bytes
        GO TO Moved
      ENDIF
      HL=HL+2 ! Next entry
      GO TO Moveit
Nonove:

! Look up the words in the main event table to see
! what (if anything) happens.
HL=@Event ! Point to table
Doneit=0 ! Clear flag
Active: BEGIN IF (@HL=Bzero) ! End of table
      IF (Doneit#0)GO TO Command ! We did somethins
      BEGIN IF (W1#13) ! Explicit movement
        TYPE 'I cannot go in that direction'
      ELSE
        TYPE 'I cant'
      ENDIF
      GO TO Command ! Get another command
      ENDIF

      IF (@HL=Bnes1)GO TO Entry ! Any match
      IF (@HL=W1)GO TO Entry ! Exact match
      HL=HL+6 ! Next entry
      GO TO Active

Entry: HL=HL+1 ! Point to 2nd word
      IF (@HL=Bnes1)GO TO Match ! Any match
      IF (@HL=W2)GO TO Match ! Exact match
      HL=HL+5 ! Next entry
      GO TO Active

Doit: BC=@HL ! Point to actions
      HL=HL+2 ! Point to next entry
      Doneit=1 ! Say we have done something
Nxtact: IF (@BC=Bnes1)GO TO Active ! All done
      Btemp=@BC ! Get action
      BC=BC+1 ! Point to next
      Ctemp=@BC ! Preload value
      PC=TABLE2(Btemp) ! Computed GO TO

! In the followings TABLE3 is simply a continuation of TABLE2
! and not a sperate entity. It is done this way to keep the
! compiler happy as it can't handle continuation lines
BEGIN DATA
WORD TABLE2/A0,A1,A2,A3,A4,A5,A6,A7,A8,A9,A10/
WORD TABLE3/A11,A12,A13,A14,A15,A16,A17,Done/
END DATA

A0: TYPE 'I Have with me' ! Inventory
      Flag=0
      I=0
inven: IF (ObjLoc(I)=-1)GO TO inven0 ! End of list
      BEGIN IF (511<ObjLoc(I)<1025) ! Carried
        Flag=1
        CALL %mess(Objxt(I))
        BEGIN IF (ObjLoc(I)=1024) ! Worn
          TYPE 'which I am wearing'
        ELSE
          CALL %mess(0) ! New line
        ENDIF
      ENDIF
      nextob: I=I+1 ! Next entry
      GO TO inven
inven0: IF (Flag=0)TYPE 'Nothins at all'
      GO TO Done

A1: BEGIN IF (ObjLoc(Ctemp)#1024) ! Remove worn object
      TYPE 'I am not wearing it'
      GO TO Done
      ENDIF
      BEGIN IF (User(1)=4) ! Hands full
        TYPE 'I cant. My hands are full'
        GO TO Done
      ENDIF
      ObjLoc(Ctemp)=512 ! Say carried
      User(1)=User(1)+1 ! Update tote
      GO TO Nxtob

A2: BEGIN IF (User(1)=4) ! Pick up object
      TYPE 'I cannot carry any more'
      GO TO Done
      ENDIF
      BEGIN IF (ObjLoc(Ctemp)=Here) ! Saw carried
        ObjLoc(Ctemp)=512 ! Say carried
        User(1)=User(1)+1 ! Update total
        GO TO Nxtob
      ENDIF
      TYPE 'Im already carryins it'
      GO TO Done

```

```

A3: BEGIN IF (Objloc(Ctemp)=Here) | Drop object
      TYPE 'I dont have it'
      GO TO Done
ENDIF
IF (Objloc(Ctemp)=512)User(1)=User(1)-1
Objloc(Ctemp)=Here
GO TO Nxtop

A4: BEGIN IF (Objloc(Ctemp)=512) | Wear it
      Objloc(Ctemp)=1024 | Say carried
      User(1)=User(1)-1
      GO TO Nxtop
ENDIF
BEGIN IF (Objloc(Ctemp)=1024)
  - TYPE 'I am already wearing it'
ELSE
  TYPE 'I dont have it'
ENDIF
GO TO Done

A5: CALL @Mess(Messag(Ctemp)) | Type message
GO TO Nxtop | Get next action

A6: GO TO Desc | Describe location
A7: GO TO Proc | Proceed

AB: Here=Ctemp | Immediate move
GO TO Nxtop

A9: User(Ctemp)=255 | Set flag
GO TO Nxtop

A10: User(Ctemp)=0 | Clear flag
Nxtop: BC=BC+1
GO TO Nxtact

A11: DE=Objloc(Ctemp) | Swap objects
Objloc(Ctemp)=Objloc(Ctemp+1) | Move 1st object
Objloc(Ctemp+1)=DE | Move 2nd object
GO TO Nxtop

A12: STOP | Stop the program

A13: TYPE 'Okay' | Say okay
GO TO Done | And proceed

A14: TYPE 'Are you sure you want to quit now'
CALL $reply($i)
IF (i=0)GO TO Nxtact
STOP 'Okay ... bye'

A15: BC=BC+1 | Store value in flag
Btemp=@BC | Get it
User(Ctemp)=Btemp
GO TO Nxtop

A16: Objloc(Ctemp)=Here | Create object
GO TO Nxtop

A17: Objloc(Ctemp)=2048 | Destroy object
GO TO Nxtop

Done: GO TO Command

!
! Lookup - Find word in table
! Each entry consists of a four byte name
! followed by an byte identification code. Eg 'FREN'2
! This code is returned if found; otherwise -1.
!
SUBROUTINE lookup(DE)
LOOP J=0 TO 3 | Clear out word
  word1(J)=Space
ENDLOOP J

LOOP J=0 TO 3 | Extract 1st 4 letters
  IF (EHL=Space)GO TO Goturd | End of word
  IF (EHL=Cret)GO TO Goturd | End of line
  Word1(J)=EHL | Get character
  HL=HL+1
ENDLOOP J

Goturd: BC=@Vocab | Point to table
@DE=Bnes1 | Assume no match

Find: Flag=0 | findit flag
LOOP I=0 TO 3 | 4 bytes
  IF (@BC=Bnes1)RETURN | End of table
  IF (Word1(I)@BC)Flag=1 | No match
  BC=BC+1
ENDLOOP I

BEGIN IF (Flag=0) | Matched
  Btemp=@BC | Get ID
  @DE=Btemp | Pass it to caller
RETURN
ENDIF

BC=BC+1 | Skip over ID
GO TO Find | And try again

END
  
```

## ENTERPRISES

MAIL ORDERS, VISITS,  
TRADE ENQUIRIES  
WELCOME. CREDIT  
CARD ORDERS  
ACCEPTED BY  
TELEPHONE/TELEX  
Payment must be in  
sterling, on a UK bank.

Room PC  
11, Cambridge House  
Cambridge Road  
Barking, Essex  
IG11 8NT England  
Tel: 01-591 6511  
Telex: 892395 LPRISE

### BOOKS/MAGAZINES/SUBSCRIPTIONS

#### BY OSBORNE

Introduction to Microcomputers Series	
Vol 0: Beginners Books	£6.95
Vol 1: BASIC Concepts	£8.30
Vol 2: Some Real Microprocessors (without binder)	£18.95
Vol 2: Some Real Microprocessors (with binder)	£24.70
Vol 2: Updating supplement set Nos. 1-8	£18.95
Vol 3: Some Real Support Devices (without binder)	£11.95
Vol 3: Some Real Support Devices (with binder)	£17.70
Vol 3: Updating supplement set Nos. 1-6	£18.95
1 Binder (Specify for Vol 2 or 3)	£5.75
1 Updating supplement (Specify for Vol 2 or 3)	£4.00
PET and the IEEE 488 (GPIB) bus	£9.95
6800 Programming for Logic Design	£6.30
8080 Programming for Logic Design	£6.30
280 Programming for Logic Design	£6.30
280 Assembly Language Programming	£8.15
6502 Assembly Language Programming	£ 8.25
8080A/8085 Assembly Language Programming	£7.95
6800 Assembly Language Programming	£7.95
Accounts Payable and Accounts Receivable	£13.15
Payroll with Cost Accounting	£13.50
General Ledger	£12.25
Some Common BASIC Programs	£7.95
Running Wild	£2.50

#### MAGAZINE BACK ISSUES

Micro 6502 Journal	£1.75
Personal Computing	£1.95
Interface Age	£2.95
Dr Dobbs Journal	£1.95
Computer Music Journal	£3.75
Recreational Computing	£1.95
BYTE	£2.95
Creative Computing	£1.95
Calculators and Computers	£1.95
Keyboard Microcomputing	£2.95
Compute - for the 6502	£1.95

68 Micro	£1.95
80 Microcomputing	£2.25
On Computing	£1.95
Compute II - for the Single Board	£1.95
Magazine Storage Box (Holds 12)	£1.50

#### MAGAZINE SUBSCRIPTIONS (all processed within 3 weeks)

Micro 6502 Journal	(12 issues)	£13.50
68 Micro	(12 issues)	£17.50
Personal Computing	(12 issues)	£17.50
Interface Age	(12 issues)	£25.50
Dr Dobbs Journal	(10 issues)	£15.00
Recreational Computing	(6 issues)	£10.50
BYTE	(12 issues)	£25.00
Creative Computing	(12 issues)	£17.00
Keyboard Microcomputing	(12 issues)	£22.00
Compute for the 6502	(6 issues)	£10.50
80 Microcomputing	(12 issues)	£21.00
Compute II - for the Single Board	(6 issues)	£10.50

#### FOR THE 6502

See Magazines and Subscriptions!	See Osborne Books!
Best of Micro, Vol 1	£5.50
Best of Micro, Vol 2	£5.50
Programming the 6502 (Zacc)	£7.95
Programming the 6502 (Foster)	£6.75
6502 Applications	£7.95
6502 Software Gourmet Guide and Cookbook	£7.25
32 BASIC Programs for the PET	£10.10

#### FOR THE 8080

See Osborne Books!	
8080 Programmers Pocket Guide	£1.95
8080 Hex Code Card	£1.95
8080 Octal Code Card	£1.95
8080 Software Gourmet Guide & Cookbook	£7.15

8080/8085 Software Design	£6.75
8080 Standard Monitor	£9.95
8080 Standard Assembler	£9.95
8080 Standard Editor	£9.95
8080 Special Package: Monitor, Editor, Assembler	£20.00
BASEX: A Simple Language and Compiler for the 8080	£5.50

#### FOR FUN

SARGON - A Chess Game	£9.50
BASIC Computer Games	£5.00
More BASIC Computer Games	£5.50
What to do After you Hit Return	£9.95
8080 Galaxy Game	£6.95
SUPER-WUMPLUS - A game in 6800 Assembler Code & BASIC	£4.25
Computer Music Book	£6.75
Computer Rage (A board game)	£6.95
Artist and Computer	£3.95
Games, Tricks and Puzzles for a Hand Calculator	£2.49
Introduction to TRS 80 Graphics	£5.75
Take My Computer Please ... (Fiction)	£3.25
Introduction to Low Resolution Graphics for Pet, Apple, TRS80	£5.50
Starship Simulation	£4.50

#### FOR THE NOVICE

See Magazines and Subscriptions!	See Osborne Books!
Your Home Computer	£5.95
Getting Down to Business With Your Microcomputer	£5.50
Introduction to Personal and Business Computing	£5.50
Getting Involved with Your Own Computer	£5.50
How to Profit from Your Personal Computer	£8.50
Microcomputer Potpourri	£1.95
Hobby Computers are Here	£3.95
New Hobby Computers	£3.95
Understanding Microcomputers and Small Computer Systems	£6.95
Understanding Microcomputers and Small Computer Systems and Audio Cassette	£8.75
How to Make Money with Your Microcomputer	£5.75
From the Counter to the Bottom Line	£10.00

• Circle No. 168

# Hornets' nest

For around the thousandth time since leaving the house, the young man felt for the shiny new ultra-intelligent-machine (UIM) pendant round his neck. Third generation — same technology, they had told him, as the unit now directing operation MOP.

The pendant was a going-away present from his parents, and now Mark was heading downtown for a goodbye drink with some friends. He was early, but he didn't mind, he could use the time to think things over. Events had moved so fast in the last few months; it seemed like he'd just left college and tomorrow he was off to join the project team. Just at the right time, too. The Mars Oxygenation Programme, the big project of the decade, had been something of a sick joke until recently, but the latest news was that things were really moving now, thanks to the new director.

This thought sent his hand straying towards the pendant again, as he pushed open the barroom door. Whether he was just making sure it was still there or clutching it as a lucky talisman, no-one, not even he, could say — it just felt good to know it was there.

"Mind it don't bite you, sonny". He looked round sharply, grinned in response to the open, friendly smile from the old-timer who had spoken. The leathery face assumed a serious look as the man spoke again: "That's a mighty fine gadget, boy. A mite tidier than the first of them, way back in '83".

Mark looked with a new respect into those deep, piercing eyes, eyes which he suddenly realised, must have spent more hours prising secrets from glowing VDU screens and fathoming the intricacies of hand-soldered circuit boards than he would care to guess. Never before had he met one of the now almost legendary Silicon Valley prospectors.

The so-called prospectors had had their heyday in the '70s and '80s, when the rush to exploit the micro explosion was closely akin to the gold rush of a century or so before. Pioneers and visionaries, their uncanny talents for making microprocessors sing and dance or anything else that was useful or profitable — preferably both — were much in demand. Until, that is, the big business combines stepped in and everything became much more organised and much less exciting. Yet

developments were still accelerating, and there were stories.

Mark hadn't missed the cue in the Mother's last comment. Sensing a story, he returned the response clearly expected of him: "How do you mean, back in '83? It's well known that the first of the ultra-intelligent machines was Randolph's system, just after the turn of the millenium. It wasn't until '88 that the first system was generally accepted to have passed the Turing test for a thinking machine, and it was another 15 years before Paul Randolph coaxed such a system to produce the design for the first-generation UIMs. They produced the second generation just eight years ago and they were responsible for —", and he

by

G K Blackwell

glanced down at his pendant, embarrassed suddenly by his schoolboyish enthusiasm.

The oldest smiled. "You learned your lessons well, boy, but they don't tell you everything at school. In college they tell you a lot about Babbage and Hollerith, and fill your head with facts and figures about ACE and ENIAC, but they leave out the in-between years — the most interesting years, I reckon. They can't make you feel the heat, the smell, the taste of the atmosphere between those racks of valves; I was just a kid then, but I'll never forget".

He paused, sipped his beer. "By the time I left school, we were into the second generation, and the field was wide open. If you could spot a dud nickel delay line, or code a neat set of input/output routines, you could write your own ticket.

"Of course, when IBM produced 360s, then the 370s with their megabyte main-store and nanosecond cycle times, everyone said it was all up for the seat-of-the-pants programmers. Anyone with a Fortran or Cobol course behind them — they taught you about programming languages, didn't they? — could do anything they wanted as quick as it was needed, and even flowchart it in a way

that everyone could understand. I got a nice little number with a communications firm, doing work on CAD and control systems. I was just having some interesting results from the gadgets I'd hooked up when the micro started to make a splash, back in the mid-70s.

"Well, I could see the way the world was turning and I lashed out on as much of the stuff as I could. Soon, I'd wired together my own little multiprocessor set up, and I was adding to it every week. After a while, I looked round and found a few others who were interested, and we formed a kind of club. We'd meet at my place, some of them would bring systems they had put together, and we would trade ideas.

"There was a kid, about your age; no hardware of his own but, boy, there wasn't much he couldn't make a system do. Used to tap away at my set-up for hours, all night sometimes; didn't seem to have any other interests, nor any friends either, except us I suppose. I worried about that kid — just didn't seem healthy somehow.

"We had been going about five years, must have been '81, when a new gent' joined our club. I say gent' because he didn't seem our type at all, always wore a suit and tie and talked about micro-electronics like he'd just learnt it from a textbook. Turned out later that he had; he was a director for one of the big automobile firms".

At this point the man paused, as if startled at the revelation, and Mark took the opportunity to top up the glasses.

"Thanks, son. Well, as I was saying, it seems the automobile giants were worried. It was just before the petroleum synthesis process was perfected and it looked like the internal combustion engine was a dying breed. This gent's firm was diversifying, putting its capital into other profitable enterprises, and they had recently bought one of the biggest silicon chip producers in the States. This director was, so to speak, a talent scout for the firm, and he was impressed by the things we were doing. So much so, that he offered the kid and me key posts in a hush-hush project they were starting.

"Like everyone else, they were on the  
(continued on page 79)

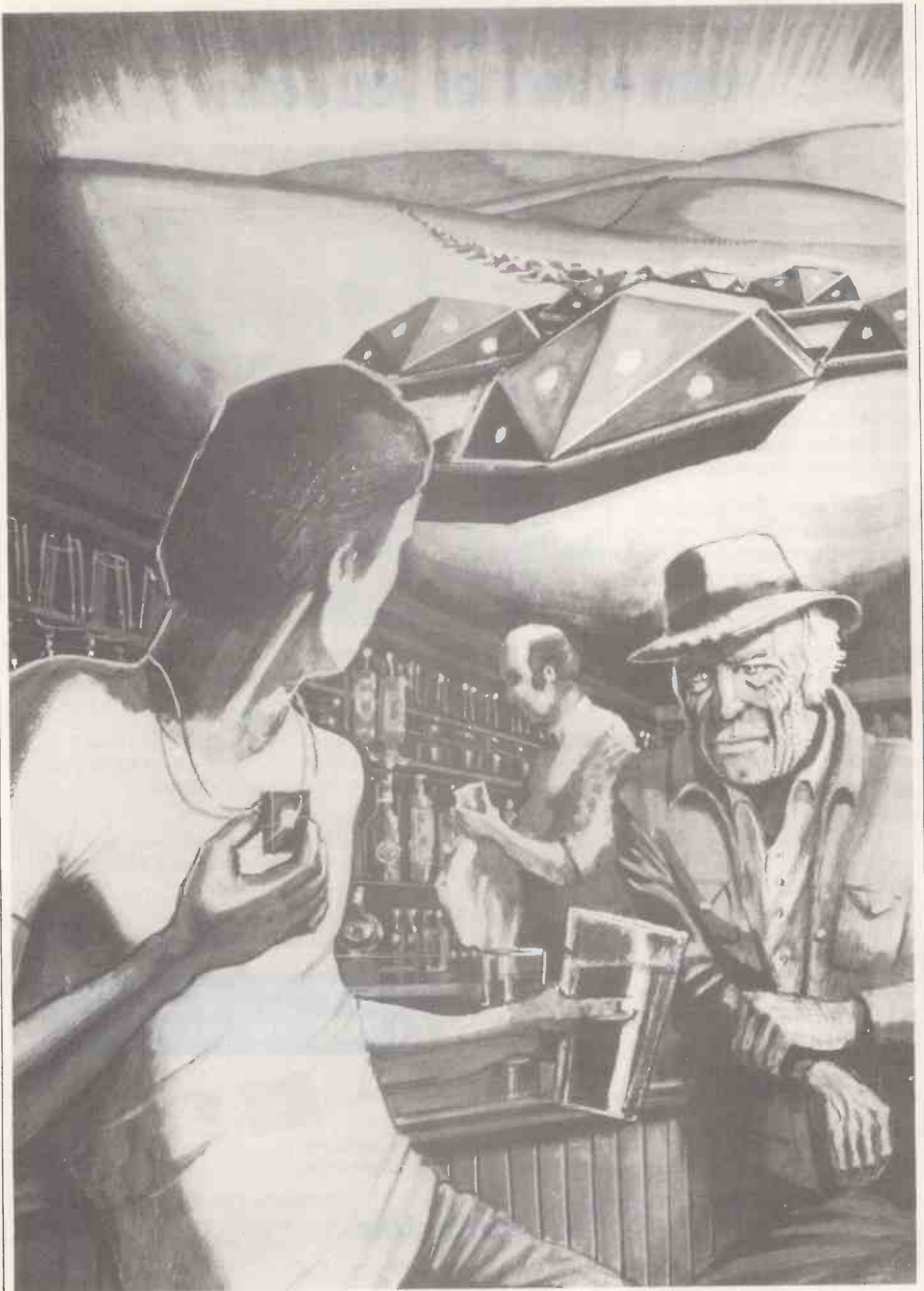

# The small business system that won't let you down

## VECTOR MZ FROM COMPUTASTORE

Computastore has combined the powerful Vector MZ microcomputer with the reliability of proven accounts packages to bring you the benefits of a Small Business Computer at a price you can afford. With a high speed printer, the total system costs £5500, including installation and training – no extras to pay.

The integrated accounts packages provide the flexibility and ease of operation that first time users demand. Operator training is provided at YOUR premises, using YOUR data to get your system working within days. And because our accounts software has been developed in-house, the standard packages can easily be tailored to meet your needs exactly.

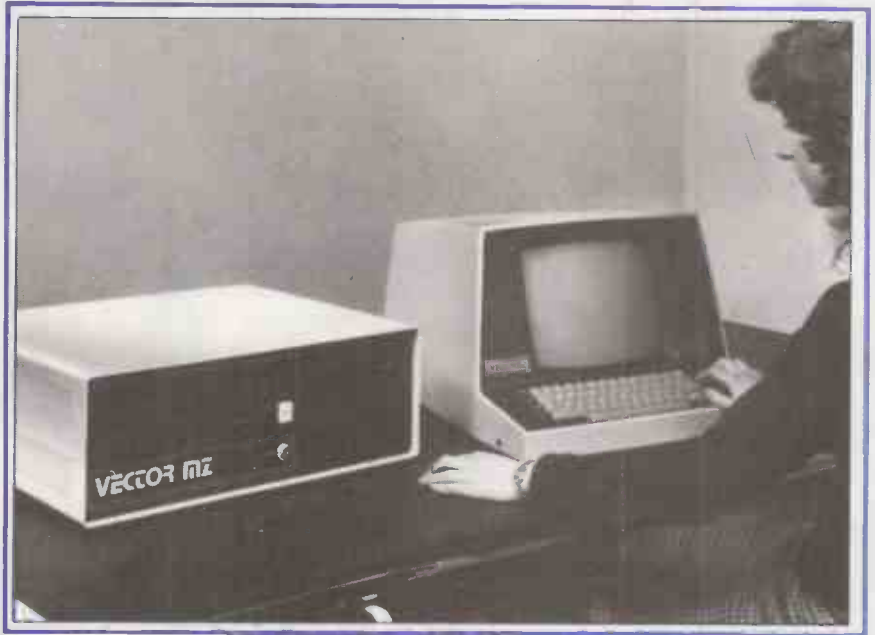

■ **SALES LEDGER:** Open item system, produces statements and current aged debtors balance at any time – not just at month end.

■ **PURCHASE LEDGER:** Open item system, produces aged creditors balance and remittance advices at any time – you choose the items you want to pay.

■ **NOMINAL LEDGER:** Links with both sales and purchase ledgers. Compares actual with budget, and with same period previous year.

■ **ONE OFF SOFTWARE:** We will be pleased to quote for any other commercial application.

■ **WORD PROCESSING OPTION:** Combine your word and data processing on the same system.

### TECHNICAL OVERVIEW:

Vector MZ: Industry standard CP/M operating system, 48K RAM, 630K Disk Drives, Fast Z80 microprocessor, S100 bus.

### Mindless Terminal:

High quality 80 x 24 upper and lower case display, Typewriter style keyboard, with numeric keypad.

### Texas Instruments 810:

150 c.p.s. high quality dot matrix printer.

**ONLY £1,700** 32K Vector MZ complete with 630K disk drives, CP/M, C/BASIC and NAD.

Full Range of Low Cost Accessories by Mail Order.  
\*Barclaycard and Access welcome.

HARDWARE, SOFTWARE and ACCESSORIES  
sold either as complete systems or separately.



All goods in stock NOW, so why not call in for a demonstration, or ring or write for further details.



**Computastore**

### Software That Means Business

16 John Dalton Street  
Manchester M2 6HG  
Tel: 061-832 4761

• Circle No. 169

(continued from page 76)

artificial intelligence kick, and had this big idea about machines building clever machines. The only difference was, they had the cash to back their big ideas. They already had a new site in the sticks, on the edge of the Colorado Desert; production lines set to roll off any design of chip you cared to ask for — all we had to do was to hook up a system that would design the new chips and control production.

"I was taken on as systems analyst, and when I heard what the system had to do, I insisted on taking the kid along to do the programming. They wanted to bring in a team of programmers, but this had to be a one-man job if we were going to succeed. The job specification was concise: rig-up a system that would turn out the most advanced processor possible, using all the CPUs, memory and backing store we wanted.

"Setting-up the database was a big job, of course; quite a lot of the scientific data we wanted still wasn't on chip at the time, and we had to set-up a text-reader to input nearly a library-full of science texts and formulae into the data banks. I figured any system aiming to design new circuits would have to be strong on electromagnetic field theory, so we piled in everything we could find on that. Seems unfair how you can get into such a heap of trouble just by being right.

"The other smart-Alec was one of the company directors. Reckon he was a sci-fi fan — had some scary ideas about machine intelligence and insisted we built Asimov's first law of robotics into the system. You know the deal?"

The younger man nodded and intoned, almost reverentially: "No robot can harm a human being, or, through inaction, allow a human being to come to harm". Mark, too, was a sci-fi fan, and to him Asimov was the Old Master.

"Yeah, that's it". The other sounded less enchanted, for some reason. "Well, that gave the kid some problems in his programming, I can tell you. It also meant we had to add a whole stack of human psychology and sociology journals to the data input, so the system would know about human behaviour. Mind you, that was nothing to the problems it landed us in later — friend Asimov has plenty to answer for.

"Well, I rigged up the sweetest little 12-processor system you ever did see, though I do say so myself. About five gigabytes of backing store, and direct control of the processing plant. As an afterthought, I linked in another CPU, out of phase with the others, to cut-in between cycles and check they were all OK; any CPU that went down would be switched out of the system automatically. Some say that was the unlucky move, adding the 13th processor, but I ain't superstitious.

"I didn't see anything of the kid for months. Sometimes when I looked in on

him he'd be working through a mile or two of program listing, else he'd be tapping away at his terminal, or putting a subroutine through its paces. He had his meals brought in to him, and even slept on a camp bed he had brought in. Didn't seem bothered about social niceties, either — you know, washing, shaving, changing his clothes — details like that. Visitors always left quickly — I think that suited him. Like I said before, there was something about that kid that wasn't healthy, and I don't just mean the smell.

"You know, the more I tell this story, the more I wonder. How could I have not seen it coming? Perhaps I was just too busy — perhaps I was just too dumb.

"Anyway, one day the kid wandered casually into my office, mentioned that the system was up and running, left and crashed out on his camp bed for 24 hours. It took me a few minutes to realise what he meant. I rushed out to the production lines to see. Nothing, of course. The system was chewing over all the facts and figures and formulae we had given it, and it was going to be some hours at least before it started spewing out the bright new future we were hoping for, in the shape of some super-powerful chip.

"Two days later, still nothing happening, I was getting worried. The kid, who by this time had even washed and shaved, tapped away at his monitor and told me confidently it was all OK. Apparently the system was referencing data on optimisation techniques; he figured it must have worked-out the circuit it wanted and was deciding on the best way of laying it. I was whacked — I'd been up for the last 48 hours — so I left him watching the show and went for some sleep".

The old-timer paused, stared reflectively into his glass for a few moments. Then he spoke again, more to himself than to Mark, as if the other's presence no longer mattered.

"I don't know how long I slept, but I woke up with one of the technicians shaking the living daylight out of me. He didn't say a word, just stepped across and pulled open the curtains, then waited for me to come and look.

"My first impression was that we were being invaded. A column of insects, soldier ants or locusts maybe, was heading into the complex from out in the desert, as far as the eye could see. Then I realised my mistake — the column was moving, slowly but steadily, away from the complex. Something was heading out of our production plant at the rate of thousands an hour, and had been for quite a few hours, by the looks of it.

"In the 10 seconds it took me to dress and get down there, the technician told me that the plant had started in the middle of the night. The products were unusual, but

they'd decided to turn in and leave it until I woke to study them — nothing odd was going on then.

Down on the sand, I watched them creeping out under one of the cargo doors. Not ants or locusts, more like beetles, Colorado beetles perhaps; brownish, with gold spots all over. I picked one up; it was shaped like a beetle, too — kind of oval, but with flat surfaces all round it and at the ends. The gold spots were on the flats, some sort of contacts, I suppose. I put it down, and it moved off again, same direction, same speed as all the others. We figured later that they all had a kind of linear motor built in, and were dragging themselves along the earth's magnetic field lines. You know, like the monorail systems, a kind of magnetic induction process. Very efficient, and no moving parts.

"Well, of course, we shut the plant down. Any fool could see that the system had gone a bit neurotic — leastways, that is what this particular fool figured. The kid settled back to his monitor to try and debug the system, while I took a team out to debug the desert — literally.

Two technicians had been out in a jeep to see where our bugs were heading, and they came back with a report that they were all piling up at a spot about three miles out, like some massive seething anthep. All we had to do was to get out there, wait till they all arrived, then shovel them into the back of a truck. On impulse, I took a few instruments out with us. I had a theory.

"I don't know how many there were in that pile, must've been thirty or forty thousand, and more arriving by the minute. I set-up my instruments as close to the pile as possible, and quickly confirmed my guess: this spot in the desert was a node in the earth's magnetic field, a kind of magnetic powerhouse. I was just congratulating myself on figuring this irrelevant detail when, all of a sudden, the lights went out. In the middle of the desert, mid-morning, it just went black. I stumbled around, tripped over my instruments, then hit a rock about four foot high. But there were no rocks here. I backed off, that heap of bugs had suddenly set rock-solid.

I heard people calling me, and ran towards the voices. Suddenly I was in blazing sunlight again, with the others just a few feet away. I looked back the way I had just come and saw nothing. Nothing but sand, and sky, and the stream of bugs from the plant, now disappearing as soon as they hit a certain point on the sand. The technicians told me I had suddenly disappeared, along with the heap of bugs, then just as suddenly stepped out from nowhere in front of them. I told them about the dark, and waved my arm back

(continued on next page)

(continued from previous page)

the way I'd just come — my arm disappeared. I pulled it back, stepped carefully in that direction. The technicians gasped — seems I had disappeared again — and I was back in the black.

"Electro-magnetic wave distortion — the old sci-fi invisibility field. So simple, just bend the light rays round whatever you want to hide, and you see past it, or through it as if it were not even there. Our heap of bugs was the first brain to overcome the technical problems and make it happen.

"We wasted about 10 minutes pacing out the size of the distortion field — walking in what looked like straight lines, but weren't — before it occurred to me to wonder just why our brainchild wanted to hide itself. We laid out some markers for the bombers — I was beginning to think at last — then piled into the truck. It only took us 10 seconds to confirm that the truck's electrics were dead, and figure where the blame lay. As we ran back to the complex I crossed-off mentally aircraft and guided weapons from my list of possibilities, and cursed myself for a fool for giving the monster such a thorough education.

"I was the last back, and I found the technicians with a group of workers, watching weird patterns drifting across one of the system's monitors which were dotted round the place. I turned away, and yelled at them to do the same, but I was too late. I went looking for the kid, and found him tapping away at his console while those patterns flickered across his VDU. He was keying in the parameters to re-start the system. That heap sure had everything under control — everything except me. I pulled off my shoe and knocked him cold, then I pulled the plug on that screen. While he came round, I disconnected all the other VDUs, though it didn't seem to do much for the zombies standing round them.

"The kid seemed none the worse for wear, apart from a lump on the head. I cut short his questions about the system, and asked for some straight answers to some very personal questions. I asked him about his childhood, his family, his friends, regular headshrinker stuff. He squirmed, it wasn't easy for him, but there were things I had to know.

"At last I had it. The kid had a standard set of hang-ups, was no more or less neurotic than your average introvert, but he majored on the theme of mankind being man's worst enemy, man needing protection from himself. That idea was bound to carry over, sub-consciously, into a program as complex as ours. Any superbrain with Asimov's first law built in had to disable man's worst enemy — harmlessly, of course.

"Our heap of bugs wasn't nuts. It was terrifyingly sane.

"There wasn't much time, it was sure to try and regain control somehow. There was no way of knowing how far afield it was interfering with TV broadcasts, taking over unsuspecting viewers, or what other tricks it had up its junctions. I told the kid the data modifications I wanted, and he keyed them in from his terminal, blind, with the screen covered over. Then he started the program again, from a re-start point shortly before the production routine, so it would refer to the new data before it set up the next production run. We sat back and waited.

"Four hours later the exodus began again, little electronic Colorado beetles creeping out to their rendezvous with nothingness. After another four hours I started switching-in one of the system monitors every 10 minutes, just for a few seconds. On the ninth try, the screen was clear. We drove out to the abandoned truck with a spare battery, and it started, no trouble. There was still no sign of the heap, and those new bugs were disappearing at steady rate".

Up to this point, Mark had listened, fascinated, but now he felt he must query what seemed to be an inconsistency. "Surely, if you had corrupted the database, the new chips would be faulty", he objected. "Wouldn't your bugheap, as you call it, simply have rejected them"?

The older man nodded. "That's true, son, it would, if my modifications had been out of line with the original data — but it wasn't.

"You see, boy, I wasn't the first one with bug problems. Middle of the last century, scientists controlled some types of insect pests effectively by sneaking large numbers of strong males, radiation-sterilised, into a swarm. These fellas came on strong with the lady bugs, making sure a whole load of the eggs never hatched. Wasn't long before the swarm dwindled and died away.

"My new chips were the sterile males for the bugheap. They were accepted because their data was consistent with the original chips".

"But what mod' did you make, to have that effect"? asked Mark. "Surely not just the old tie-the-computer-up-with-a-paradox routine"?

"Well, I suppose it was a kind of paradox, but I didn't see it like that. Not the type you mean — the statement I am now making is not true — or some such. I've never yet met a computer that became knotted-up in words the way we seem to. No, I simply added to its logic design data the fact that the original system had been designed, programmed and provided with data by humans. As I saw it, our only hope was if the new bugs carried that fact, in some shape or form, out to the heap".

Mark looked puzzled for about a minute, then smiled. "Clever, but how did you know it would work"?

"I didn't, but when it let go the monitors, I knew we had got through to it. The way I figure, it withdrew while it considered this fact that it was a product of man's worst enemy, so it might actually be a weapon without realising it, aimed at those it was trying to protect. Far as I know, it's still considering".

Mark gasped: "You mean it's still out there"?

"Well, I ain't moved it, son. You'll never find it, though, unless you walk straight into it. Don't look so worried, it's not done anything for a good few years, don't reckon it's fixing to start now.

The workers came round in 48 hours. So did all the others — local news said nearly every man, woman and child in an 80-mile zone had suffered a mysterious blackout. We never let on why — serves them right for watching so much TV.

"The auto bosses dismantled the plant, of course. Blamed us for wasting millions of their capital, and gave us the sack. They never discovered exactly what happened — the workers couldn't remember a thing, and we weren't set to tell them — they had enough to worry about keeping their investors happy.

"Well, boy, wouldn't you agree that our heap qualifies as the first of them ultra-intelligent machines? No, don't feel obliged to answer, I can see you have your doubts about my story. Reckon you'll be convinced soon, though, when your new director up on Mars starts thinking about those tracks up there they keep calling canals. I don't reckon that new machine will take long to figure it out. I just wish I'd been up there to help them when their systems cut loose, that's all. Well, 'bye son, good luck. Thanks for the drinks".

Mark had glanced down in embarrassment a moment before, but now his thoughts were in a turmoil. How did this man know where he was heading? Was he implying what he seemed to be implying? Mark looked-up, his mind full of questions, but only the swinging bar-room door marked the man's exit. From the door, there was no sign of him, up or down the street.

Mark raced to the bar. "Who was that man? Where does he live? What does he do"?

The bartender shrugged. "Old Jed? Oh, he's just some hillbilly lives out in the woods. Comes into town regular to pick up packages from the post office — electrical bits and such like, mostly. Some say he's got a still out in the woods, fixing moonshine. Few times folks been out looking for his place. Always come back saying they found themselves going back the way they came. Reckon they must have stopped off and sampled his produce".

The bartender grinned at his own joke, and turned back to wiping glasses. □



# Buying Computers?

Commodore PET 32K  
£675.75 plus VAT

Sharp MZ-80K  
£480.00 plus VAT

ITT 20/20 16K  
£607.00 plus VAT

ACT 808 inc dual  
disk drive  
£3950.00 plus VAT



ACT 808 inc dual  
disk drive  
£3950.00  
plus VAT

## We'll give you more than a good deal

**Under one roof in London's West End you can find:**

### **HARDWARE:**

A comprehensive range of hardware to meet most applications - and budgets, with terms to suit you.

### **SOFTWARE:**

Probably the widest range of off-the-shelf software in the UK. Try out the packages and choose the one that suits you, or take advantage of our consultancy services and we will analyse, recommend, demonstrate, modify and install the programs for you.

### **CONSULTANCY SERVICES:**

To apply micro computer systems to business, education or the home, make an appointment with our trained professionals for friendly advice based on extensive experience of discussing problems with many others like you.

### **MAINTENANCE AND REPAIR CLUB:**

A maintenance and repair club that guarantees microcomputer users minimum downtime at very attractive premiums.

### **REFERENCE MATERIAL:**

A library of publications covering all aspects of the microcomputer world,

including back issues of this and other important periodicals.

Whether you are an experienced micro user or a novice, looking for a system for the home, business or pleasure, the **LION MICROCOMPUTER CENTRE** is the single source to meet all your requirements.

**CALL IN ANY TIME.** We are open six days a week, for you to take advantage of the good deal you get when you buy from **LION**.

The above prices do not apply to account sales.



## LION MICRO-COMPUTERS

**SMALL COMPUTERS-TO MAKE YOUR BUSINESS BIGGER**  
Lion Computer Shops Ltd, Lion House, 227 Tottenham Court Road,  
London W1 (First Floor). Telephone: 01-637 1601.  
Telex: 28394 Lion G.  
Open 9 to 6, Monday to Saturday (Thursday to 7).



• Circle No. 170

# Up-to-date Z-80 has trouble impersonating simpler 8080

How do you make a Z-80 chip drive the S-100 busbar designed for use with the 8080 chip? That is the problem confronting Mike Hughes in the second part of the Transam Tuscan development story.

ALL microprocessors have a number of common hardware features. For a start, they all need power of some form — even though the number of power rails and voltages will vary from device to device. Every processor requires a clock signal — some draw it from an external source, some require more complex multi-phase clocks while others have all the necessary clock circuitry built into them.

They also have provision to control a system by means of groups of signals which spread like arteries interconnecting memory chips, I/O devices and the like back to the microprocessor which operates as a CPU. Those groups of signals are carried on wires called busbars.

The busbars fall into three classifications. The simplest to understand is the

most systems based on microprocessors are limited to 64K of memory.

It is not mandatory to have all that memory and some very small systems will operate with as little as 256 locations. It just means that the full potential of the microprocessor is not being used in those applications.

Because a microprocessor can do only one thing at a time, it has to perform operations sequentially receiving the timing from the clock. It does not, therefore, need to interrogate memory all the time and there will be many occasions when the address bus is not being used for its prime purpose.

Some processor chips have a secondary use for the address bus during those periods. In the case of the 8080, it is used

but, instead of duplicating the information on the most significant half, it places the contents of its accumulator — one of its most important internal registers — on those bits.

The reason is that the contents of the accumulator usually need to be conveyed to the outside world and having the data there at the same time as the address speeds the process.

Before becoming bogged-down, let us move on to another set of connections called the data bus. Most low-priced processor chips have eight lines in that busbar and they fall into the category of eight-bit processors.

There is another group of processors called 16-bit devices which, although similar, are not so common and are usually considerably more expensive. Tuscan was conceived as an eight-bit system.

To describe the function of the data bus, it is simpler if we stick to memory considerations. In an eight-bit system, every memory location will be capable of holding eight bits of data — a group of eight bits is called a byte.

## Data source

In the case of Random Access Memory (RAM), data can be put into the location or obtained from it. In the case of Read Only Memory (ROM or EPROM), the data contained in the memory is permanent and cannot be altered — hence it can only be used as a source of data.

A RAM location consists of eight flip flops which can contain binary codes from 00000000 to 11111111 — 00 to FF in Hexadecimal or 0 to 255 in decimal. It would seem an insoluble problem to have 65,536 of those locations connected individually back to the microprocessor chip — 524,288 wires would be needed.

Furthermore, that figure would have to be doubled if we had one set of wires for sending data out to the memory and another for receiving it from memory. To obviate the problem, the inputs to the eight flip flops are brought together throughout the whole memory system so that a common set of eight lines can feed data to all the locations simultaneously and that is where the decoded address signal from the address bus enters the picture — figure 1.

By having suitable gating on the inputs to the flip flops, only one location will be activated to accept the data which is on the common lines — the gating is enabled

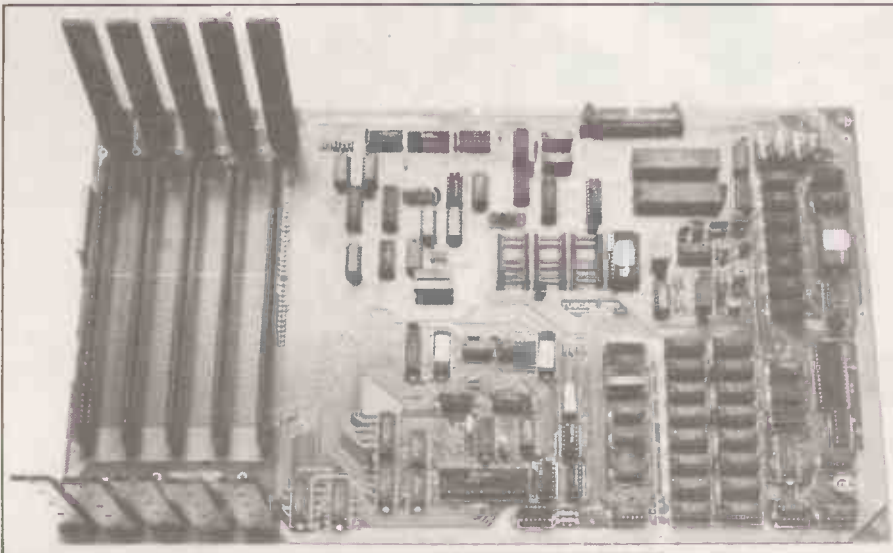

The basic Tuscan board featuring the Z-80 CPU, 8K RAM, 8K ROM, on-board video and I/O section with five spare S-100 expansion slots.

address busbar — abbreviated to address bus. In the more common microchips, it comprises 16 wires carrying binary signals in all permutations from 0000000000000000 to 1111111111111111 which can be written as 0000 to FFFF in Hexadecimal notation — 0 to 65535 in decimal.

The binary codes on those lines can be decoded by external circuitry to produce 65,536 signals which are used to interrogate a similar number of memory locations within the system architecture.

The locations are called addresses and for convenience, we say there are 64K possible addresses within a system having a 16-bit address bus. 1K is 1,024 addresses, including zero, therefore 64K is equivalent to our 65,536 locations. For this reason,

to provide up to 256 special addresses to access what are called I/O ports. A port is a name to describe a gate or flip flop which is used to interconnect the main computer system with peripheral devices in the outside world — keyboards, printers, VDUs, tape recorders and the like.

Because only 256 port addresses are permitted, it is necessary to use only eight bits of the address bus and the designers of the 8080, therefore, thought fit to duplicate I/O addresses on the least significant eight and the most significant eight address lines.

The Z-80 chip is similar in that it uses time-sharing to put out I/O addresses on the least significant eight bits of the bus

by the uniquely-decoded address. If we imagine those eight common lines emanating from the processor chip, we could call it a data output bus. What about obtaining data from a memory location to the processor?

Each memory location has a set of tri-state buffers — high, low or disconnected — on the outputs of its flip flops and in a similar manner, the outputs of those buffers are commoned together into eight lines. In simple terms, the address signal is used to activate only one of the 65,536 possible locations and the state of those flip flops is placed on the common lines.

## Differentiation

Again, imagine the eight lines fed back to the processor and we could call these a data input bus. In practice, a system based on that principle could work but further consideration reveals that a microprocessor will never want to write to and read from a memory location at the same time.

It is possible to parallel together the data output and data input busbars to produce what is called an eight-bit bi-directional data bus. The only problem encountered by doing that is how memory can differentiate between a memory-read and a memory-write operation.

The address signal alone is not sufficient to convey the information and if used by itself, would make the memory location attempt to accept and provide data simultaneously — clearly it would result in nonsense. Without going into the same detail, a similar problem exists when handling I/O ports.

To overcome the problem, we need extra signals to control the gating of the memory locations and I/O ports and those signals are provided by our third busbar called the control bus. The signals we require are defined easily and are four in number. They are memory read, memory write, I/O read and I/O write.

Clearly, they are signals which must have precise timing which is controlled by the microprocessor chip. It was the generation of those signals which required most thought in the design of the Tuscan system because it was in this area that the greatest conflict arose when trying to make a Z-80 chip drive an S-100 busbar.

The S-100 busbar was designed originally to be a standard arterial system to carry address, data, control and other signals throughout computers using the 8080 microprocessor as the central processing unit. As the 8080 is an early-generation device, the signals it produces

are not ideal by present-day standards.

Furthermore, the S-100 busbar was introduced before the advent of some specialised chips which modify the 8080 outputs to bring them more in line with current practice. It was designed with early semiconductor memory technology in mind. Having said that, one might think the S-100 busbar system a strange choice.

## Powerful changes

There have been, however, a number of changes to the S-100 specification which, although retaining much of the original 8080 requirements make it one of the most powerful and sophisticated of busbars. Above all, the S-100 is now accepted by the IEEE in the U.S. as standard and is being adopted rapidly as such internationally. There is a tremendous flurry of activity among manufacturers to produce accessories designed to interface with it.

To appreciate the problems in driving an S-100 bus from a Z-80, it is first of all necessary to understand some of the fundamental differences between the address, data and control busbars of the Z-80 and the 8080. First, it should be understood

*(continued on next page)*

Figure 1. Schematic illustration showing how the data, address and control busbars can be used to control a vast amount of memory with a minimum of common lines.

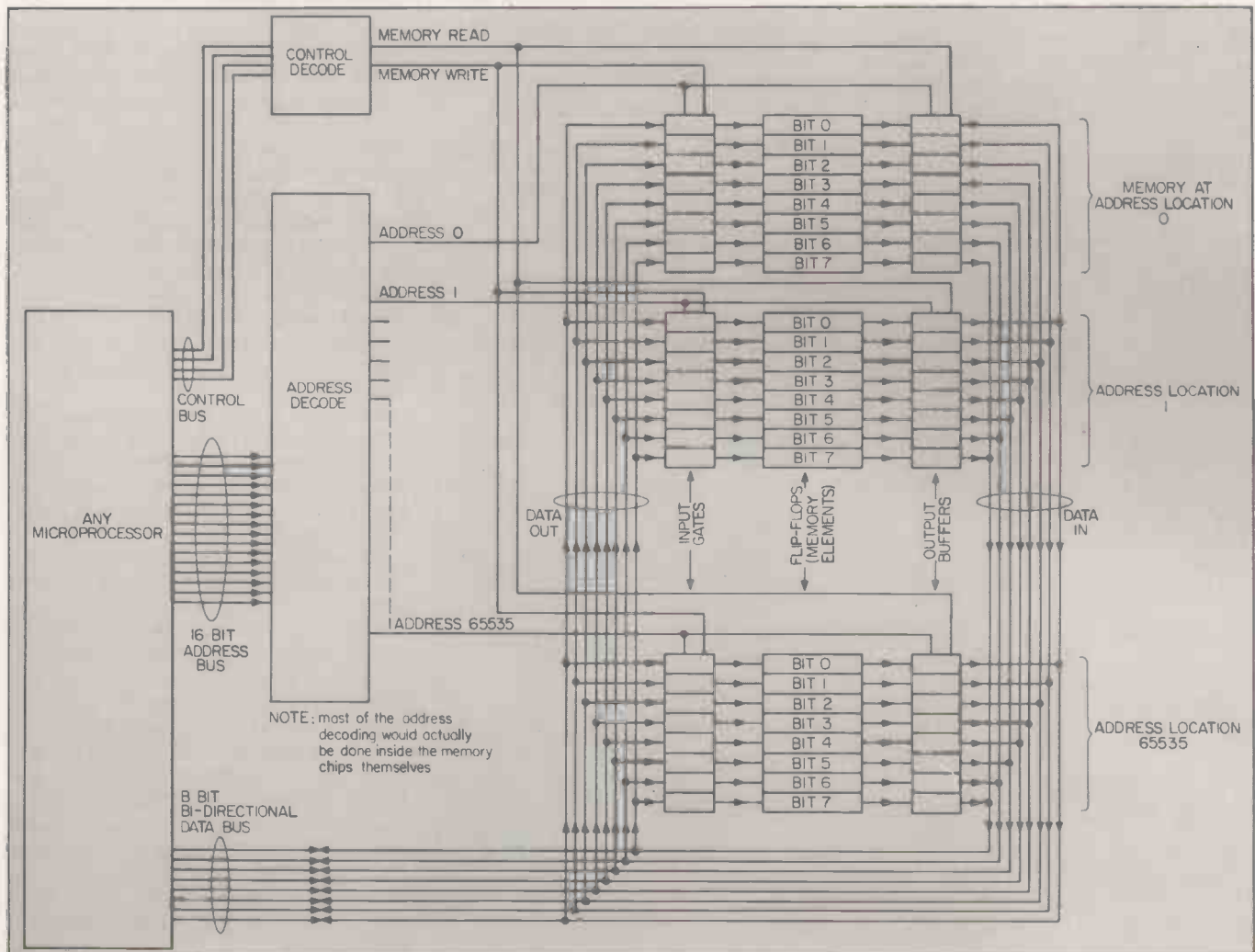

(continued from previous page)

that while the Z-80 needs only a rudimentary single-phase clock pulse to provide its timing, the 8080 needs a rather more complex two-phase clock with reasonably critical relative timings between the phases.

The two phases are called  $\theta_1$  and  $\theta_2$ ; the former is a narrow pulse while the latter is broader. The S-100 bus expects to have both signals appearing on a pair of its 100 lines so, although I was using a Z-80 chip which did not need both clock pulses, they would still have to be generated to comply with the standard — figure 2.

The only significant difference between the address lines of the two devices is that the 8080 duplicates I/O port addresses on the high- and low-order bytes whereas the Z-80 puts out accumulator data on the high byte with the port address on the low byte.

Clearly a conversion had to be made to those signals to make them comply with the 8080 specification but, as will be shown later, that was comparatively easy. The biggest difference occurs between the data and control busbars.

### Easy conversion

Although the 8080 has a number of rather special control signals it has nothing directly equivalent to the four fundamental control bus signals already defined. The Z-80, being a more up-to-date device, is more helpful in that respect and has four signals defined write, read, memory request and I/O request — figure 3a.

Between the four of them, it is reasonably easy to produce the four fundamental control-bus signals by simple

gating. To obtain signals of near equivalence from the 8080, one has to look rather more closely at its data bus specification.

I have already implied that the data bus can be carrying output data and the next moment be transmitting input data. There are other times within the 8080 operating cycle when conventional data is not required on the busbar at all and good use is made of those moments. The internal circuitry of the 8080 is arranged to share the data bus in a third direction. Very early in the processor's operating cycle, it outputs what is called a status byte on the eight bits of the data bus. The moment that occurs is defined by the coincidence of the  $\theta_1$  clock pulse and one of the special control signals mentioned called SYNC — figure 3b.

### Useful moments

That coincidence is detected usually by gating and is used to trigger a set of eight flip flops called catches whose inputs are connected to the data bus. The fleeting appearance of the status byte is thus caught in the latches and held for the duration of the machine cycle.

The eight bits of the status byte have specific designations which describe the type of operation the processor is executing during the cycle in progress. Going in order from the least to the most significant bit, the designations are as follows:

- D0 INTA This is "1" when an interrupt is acknowledged
- D1  $\overline{WO}$  This is "0" whenever data is to be written to memory or to an output port.
- D2 STACK This is "1" whenever data is to be written to or read from the stack portion of memory.
- D3 HLTA This goes to "1" whenever the

- D4 OUT This goes to "1" whenever data is to be written to an output port — note the subtle difference between this and  $\overline{WO}$ .
- D5 MI This is set to "1" to define an instruction fetch or an interrupt acknowledge cycle.
- D6 INP This goes to "1" during a read from an input port.
- D7 MEMR This is "1" whenever the memory is to be read.

That rather complicated looking set of signals is latched and present during the period between the current and the next machine cycle of the processor and can be used to define precisely what the chip is expecting to do during the current cycle.

Although the signals have to be obtained by de-multiplexing the data bus at the correct moment, they convey a good deal of information about the status of the machine and it could be said are more comprehensive than the control bus signals produced by the Z-80.

On their own, those latched signals are not of much value in controlling memory or the like because they are static for the duration of the machine cycle and to make memory, for example, output its data on to the data bus at the exact moment when the processor expects to set it, they have to be strobed by timing signals.

### Control lines

They are two more of the special control lines coming from the 8080 called DBIN and  $\overline{WR}$ . The former is a short pulse which goes to "1" at the precise moment the processor is expecting to receive an input — from I/O or memory — from the data bus while the latter goes to "0" at the moment the processor has placed valid output data on the busbar.

If DBIN is gated with the INP line of the status byte, it produced a signal equivalent to the I/O read signal of our fundamental control bus. Likewise,  $\overline{WR}$  suitably inverted and gated with the inverted out line of the status byte will give memory write.

Similarly, it is possible to produce an I/O write and a memory-read signal. It is further possible to produce other useful signals using different combinations of gating; one very important one is called interrupt acknowledge.

Although it is more complex to produce an operating control bus from an 8080 compared to that of a Z-80, the whole of the latching and decoding can be done with a single 8080 system control chip. Remember, however, I said that the S-100 busbar was conceived before the advent of some of the more sophisticated chips.

It is for that reason that the S-100 bus expects to see signals in the form of the latched status byte rather than the finally-decoded control signals — it was always assumed that the necessary gating from the status byte would be done on the individual peripheral S-100 cards. That requirement is retained in the current S-100 standard.

Figure 2. A comparison of the signals to and from the 8080 and Z-80 and the signal requirements of the S-100 bus.

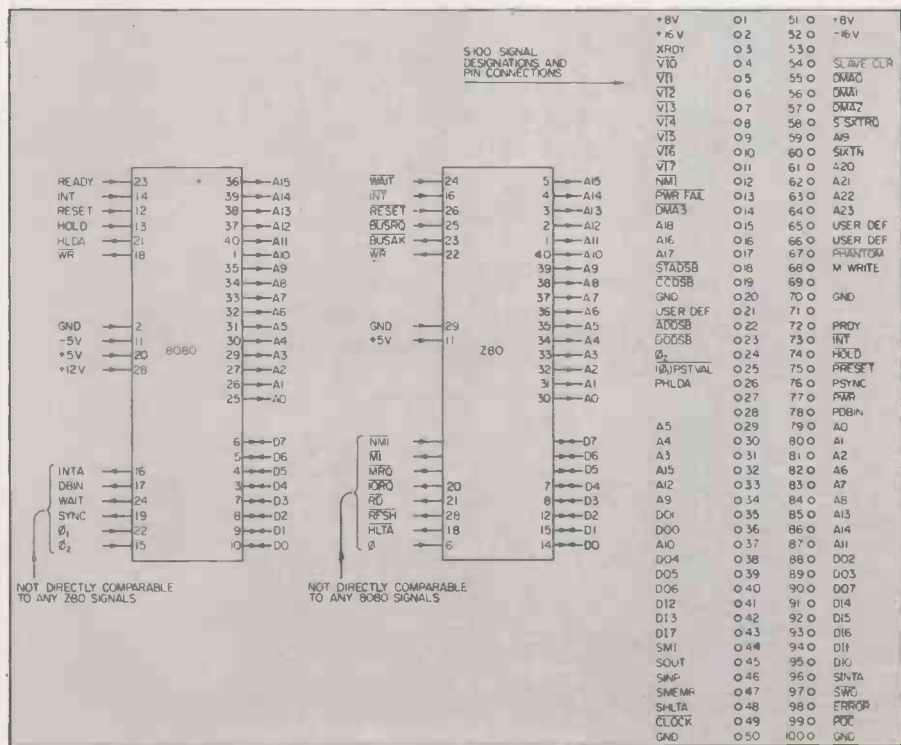

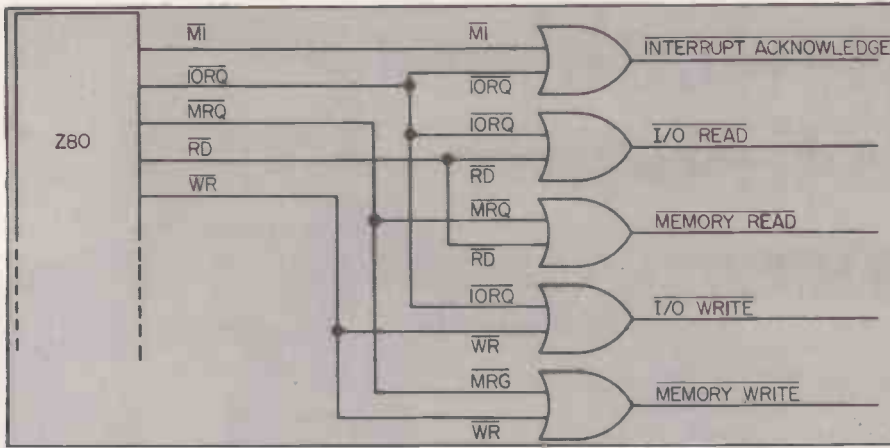

Figure 3a. The simplicity of producing the fundamental control signals on the Z-80.

Within the general area of status and control lines, the S-100 bus expects to see the following signals — a prefix of S denotes latched status while a prefix P implies a pulsed command type of signal. They should be compared to the status and control signals already described:

- SOUT PSTVAL Strobe defining the moment when the status data is valid
- SINP — equivalent to  $\theta 1$ .
- SMEMR Confirmation that the processor has released the system following a DMA request.
- SHLTA PHLDA
- SMI
- SINTA
- SWO PSYNC
- PWR
- PDBIN

They by no means represent all the signal requirements of the S-100 bus but include the ones which are most difficult to generate from a Z-80. In a nutshell, we have to take the end signals we require, i.e., the control signals from the Z-80, and degrade them backwards to the more complex fundamental signals originally produced by the 8080.

## Specific to general

While it is reasonably easy to work logically from the general to the specific, in this case one has to work from the specific back to the general which can be difficult when all the parameters you require are not contained within the initial specific example. That is precisely the problem I faced.

The only control signals the Z-80 produces are:

- BUSAK This acknowledges a DMA request and conveniently is almost identical to the PHLDA required by the S-100 bus.
- $\overline{MI}$  Again this is very similar to the 8080 M1 status bit.
- HLTA Similarly, it is identical to the 8080 MRQ.
- MRQ Memory request — not directly equivalent to any 8080 signals.
- RD Read. This is a general read for memory or I/O.
- $\overline{IORQ}$  I/O Request — not equivalent to the 8080.
- WR Write. This is almost equivalent to PWR but its timing has to be controlled carefully.

Note, in particular, the absence of the important timing signals equivalent to PDBIN, PSYNC and PSTVAL.

It is easy to obtain most of the S-100 signals from the Z-80 by gating the control

lines in various ways. However, the timing will not necessarily be correct. For example, the inverse of  $\overline{WR}$  "Anded" with the inverse of  $\overline{IORQ}$  will produce a pulse going to "1" whenever data on the data bus is to be output to an I/O port.

It represents the same condition which is described by the S-100 SOUT line but the S-100 standard requires this status signal to be latched and held for the full duration of the machine cycle — a pulse is not sufficient. The S-100 signal SWO should be at "0" whenever the cycle is a writing operation to memory or I/O and as far as the Z-80 is concerned, the condition is met whenever the cycle is not a read or an interrupt-acknowledge cycle — negative logic, I'm afraid.

If we could gate the Z-80 RD signal and its interrupt acknowledge with the correct logic, we would be well on the way to obtaining something like the signal required. The problem is that the Z-80 does not produce a straightforward interrupt-acknowledge signal; that has to be obtained by gating M1 with  $\overline{IORQ}$  — just one of those things sent, so successfully, to try us.

Without wasting time on the detail of the logic required to do that, let it be assumed that a pulse equivalent to the 8080 WO could be obtained with suitable gating. That alone will still not meet the S-

100 specification because it has to be latched for the whole of the cycle. The same problem arises for SINP, SMEMR, and SMI.

To generate the correct S-100 status signals, it is necessary to have some complex gating together with a latch and a suitable signal to trigger the latch when all the gate-derived signals are valid. Furthermore, to comply with S-100 specification, the latched signals must be stable early in the machine cycle during PSYNC — but PSYNC is not produced by a Z-80.

PSYNC is a pulse which, in the case of the 8080, occurs at the start of every machine cycle and has to last for a period of time related precisely to the clock phase. For the Z-80, that moment is very closely related to the start of the  $\overline{IORQ}$  and MRQ pulses but the Z-80 has a rather special memory request cycle which does not occur for the 8080 — this is the refresh cycle — so we would not want a PSYNC during the latter.

By gating together  $\overline{IORQ}$ , MRQ and the Z-80 special RFSH, it is possible to obtain an "Edge" which occurs at the same moment we want PSYNC to start. Unfortunately, the duration of the ensuing signal would be far too long to meet the S-100 specification — figure 4.

## Best solution

It is, however, possible to use the onset of the signal to trigger a monostable multivibrator which is set for the period required for the PSYNC pulse — the timing has to be defined by a resistance-capacitance (RC) circuit and obviously would have to be altered for different clock frequencies. I do not like mixing RC-dependent timing with logic but there seemed to be no better solution to derive the very important missing signal.

The timing of the PSYNC signal derived would be very close to the point of time when I would wish to latch the status signals but, due to propagation delays and other imponderables, one would not be able to use a conventional edge-triggered

(continued on page 87)

Figure 3b. The SYNC timing signal and the memory and I/O signals on the 8080.

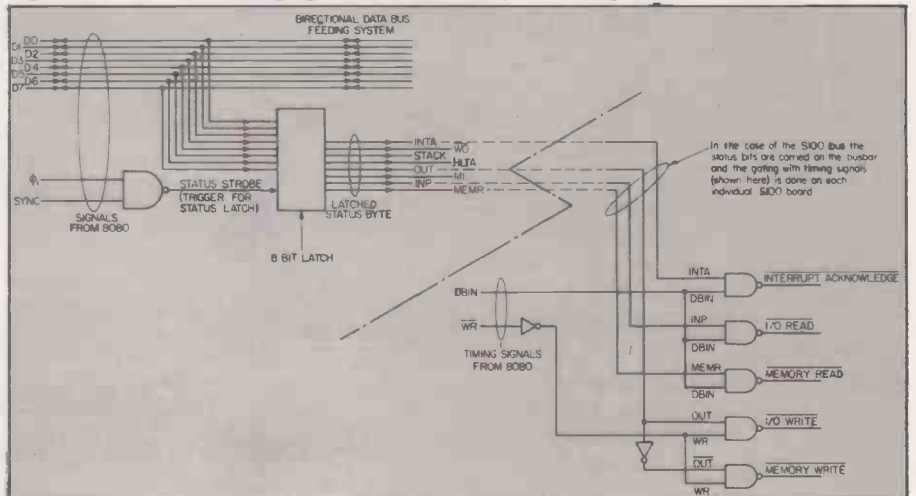

# “If you want what’s best for your PET, choose Commodore software.”



Kit Spencer  
General Manager  
of Commodore Systems  
360 Euston Road  
London NW1 3BL

The Commodore PET is Britain’s best selling micro-computer, with over 10,000 already installed in a wide range of fields, including Education, Business, Science and Industry.

This has led to a tremendous demand for high quality software.

And Commodore has met this demand by producing a first class range of programs, now available from the nationwide network of Commodore Dealers.

Commodore’s support also includes training courses, a Users’ Newsletter and Official Approval for compatible products of other manufacturers who reach agreed standards.

## COMMODORE PETPACS

Over 50 Petpacs of programs are available (mainly on cassette) from Commodore Dealers.

These cover such popular titles as Strathclyde Tutorial, Statistics pack 1, Assembler Development System, Stock Market Trends and the Treasure Trove Collection of game packs including the award winning Star Trek, which is packaged with Petopoly. Prices are from £5 to £50.

## TRAINING COURSES AND SEMINARS

PET systems are simple to use and any normal advice or assistance

## NEW BUSINESS SOFTWARE PROGRAMS ON DISK

Commodore’s Floppy Disk Unit and high-speed Printer, combine with the PET to form a complete system (ideal for running a business) for under £2,500.

Commodore also produce a growing range of business software on disk available from Official Business Software Dealers.

### Business Information System – COMBIS £150 + VAT

Combis facilitates the storage and instant retrieval of all kinds of company records, from personnel files to mailing lists and printed address labels.

### Stock Control – COMSTOCK £150 + VAT

Comstock provides an accurate, up-to-the-second, and comprehensive stock position for as many as 1,300 products.

### Word Processor – COMWORD £75 + VAT

Comword turns the system into an excellent word processor.

### Payroll – COMPAY £150 + VAT

Compay is a new, comprehensive payroll package.



you may need can be obtained from Commodore Dealers.

On the other hand, for rapid training on a basic or advanced level, you will certainly be interested in Commodore’s intensive 2 and 3 day residential courses. We also run one day general appreciation seminars.

## PET USERS’ NEWSLETTER

This is Commodore’s official method of sharing new information and ideas between the many thousands of PET users. The newsletter is published regularly and for an annual subscription of £10 you can start receiving copies now.

Look out for this sign. It tells you that compatible products of other manufacturers have met with our standards of approval.



(Tick the appropriate boxes)

To: Commodore Information Centre, 360 Euston Road, London NW1 3BL 01-388 5702

I am a PET owner  Please put me in touch with my nearest dealer   
Please send me details of: Commodore PET Software   
Training Courses & Seminars  I would like to receive the Users’  
Newsletter and enclose £10 annual subscription

Name \_\_\_\_\_ PC8

Address \_\_\_\_\_

Tel. No: \_\_\_\_\_

**commodore**  
We made small computers big business.



(continued from page 85)

latch — some of the setting-up signals would not be stable before the rising edge of PSYNC — so a D-type transparent latch would be necessary.

Another point which was worrying was the potential time delay caused by propagation through the various gates — some of which would cascade through as many as four or five stages. I was also concerned by the thought of all the chips required to carry-out the gating, remembering that all the "P"-type signals had to be generated as well.

The concept of Tuscan containing all the options we required embodied on a single manageable board raised considerable doubts as to the feasibility of discrete gating. To overcome both those issues, I decided that the best solution would be to use bi-polar read only memories to substitute for all the conventional logic. Not only would it reduce the chip count greatly, but it would ensure that all the propagation delays would be easily predictable — even though bi-polar PROMs are slightly slower than low-power TTL.

I would also have the added advantage that the PROMs would not need to be programmed until after the board had been laid-out and that would give me complete flexibility in deciding which pins out of the PROMs would carry which functions.

As an extra bonus, I would have the assurance that if I made a mistake in the logic design all I would need to do was re-program the PROM in question rather than alter the PCB lay-out.

## Conventional logic

The only area where I could foresee trouble was the gating needed to trigger the PSYNC monostable — I did not feel it wise to use a PROM for that application due to the high risk of "Glitches" during address changes so for safety, I decided to stick to conventional logic.

A very simple expedient was used to produce the correct phasing for the  $\theta_1$  and  $\theta_2$  clock signals. I chose to use the 8224 chip which had been designed specifically to produce an 8080 clock. As well as the two signals I required for the S-100 bus, it has a TTL output which would match the clock input requires of the Z-80 perfectly — figure 5.

I would, however, have to specify the manufacturer of the chip carefully because not all sources are capable of running satisfactorily with a single 5V power supply — for use with the 8080, +5V and +12V are needed but the +12V would have caused interfacing problems with the S-100 bus.

All output signals feeding the S-100 bus have to be buffered to ensure there is sufficient drive capability to cope with as many extra boards as the user might wish to plug into the busbar. A buffer in this context is a circuit element which increases the strength of a logic signal.

Using the PROMs for decoding the

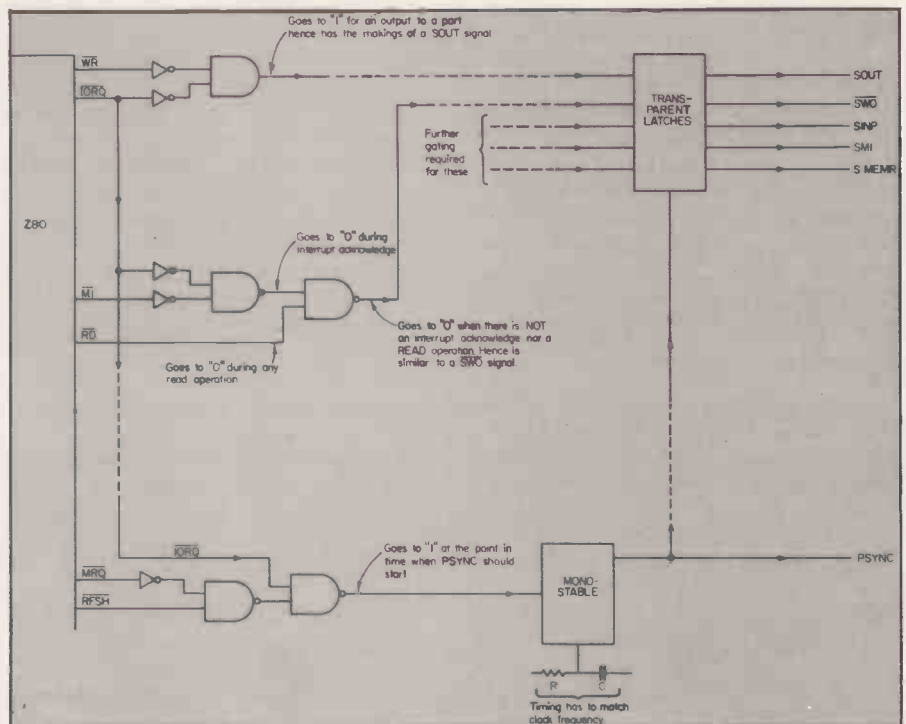

Figure 4. Combinational logic, generation of the SYNC pulse and the transparent latch.

control signals proved very convenient because the ones I had decided to use have a very high output-drive capability and requires no further buffering.

The transparent latch for the status lines similarly has high-drive potential. The clock signals from the 8224, on the other hand, do not have the same degree of "guts", so standard TTL inverters were used as buffers.

The 16 lines of the address bus had to be buffered suitably and at the same time, I had to carry-out the conversion from Z-80 standard to 8080 standard which proved relatively simple. Data selector chips would be used to allow the high-order byte of the address to be output under normal situations but during I/O operations the low-order byte would be switched on to the high-order byte lines. The Z-80 TORQ signal proved to be suited ideally as the control for this operation.

Having already said that microprocessors usually have bi-directional data busbars it seems, at first, strange that the S-100 busbar requires data to be transmitted on two separate busses. They are called data in and data out.

One reason for that requirement is historic and is related to the fact that early memory chips were designed to handle bi-directional data signals so it seems rather a retrograde step to split the data bus to comply with S-100 standards only to have to re-combine it later on.

The recent modifications to the S-100 standard have turned this apparent anomaly into a positive bonus because, by the clever use of extra control signals, the 16 lines given over to the data-in and data-out busbars can change over automatically to represent a single bi-directional 16-bit data bus.

That means that a single standard busbar can, if properly managed, double for eight-bit or 16-bit microprocessors. In really complex operations, it is even possible to have the two types of processor operating on the same busbar in the same system.

It is a simple matter to split a bi-directional busbar into its two components by using controlled tri-state buffers connected back to back. The buffer feeding the data-out bus can be operational all the time, but the signals from the data in buffer must be placed only on the internal bi-directional bus when the microprocessor expects to see them.

That moment corresponds to the PDBIN signal already described so I intended to use the control line, decoded from the PROM, to activate the tri-state outputs of the input buffer.

## Buffer factor

One important factor remained which involved the buffers. The S-100 bus has a very comprehensive set of DMA (Direct Memory Access) request lines called STADSB, CCDSB, ADDSB, DODSB and PHOLD. The first four signals force the internal processor to relinquish its control of the STATUS, CONTROL, ADDRESS and DATA OUT busses respectively whereas PHOLD forces the internal processor to relinquish control completely of the whole system including, in my interpretation, responsibility for refreshing dynamic memory.

To do that requires the lines in question to go tri-state for the duration of the DMA request. When the PHOLD request is received the internal processor has to acknowledge that it is prepared to release the busbars by issuing a signal back down

(continued on next page)

(continued from previous page)

the busbar which is called HLDA.

All the buffers I used for these sensitive regions had, therefore, to be capable of being forced into a tri-state condition on receipt of the correct signal. Again, to produce the correct signals, I would use a PROM to decode from the various DMA options.

There remained a number of other important S-100 signals either to generate or decode but none presented any significant problems.

## Input provision

To complete communications between the processor and the S-100 bus, I had to make provision for the input signals PRDY and XRDY which have identical functions. If either of these lines is taken to "0", the processor must half operations — in Z-80 parlance the processor must enter a wait state for the duration of the signal.

Various applications require the processor to suspend operations for a short period, particularly when slow peripheral devices are involved. Where it is necessary, the peripherals in question are expected to

pull either of the lines to a low-logic level. The Z-80 has a convenient wait input pin which could easily have been connected reasonably to the ORED combination of the two signals but I had a further complication with which to contend.

From the outset, I had been given a specification for Tuscan which required it to operate at a clock frequency of 2MHz as standard but with provision for it to be upgradable to a 4MHz system if ever it were required. Doubling the frequency would normally require halving of the access times for memories, making considerable increases in cost — much more than many people would be prepared to pay.

It is possible, however, to introduce a short delay in the operation of a Z-80 during all machine cycles by judicious use of the wait input which means that one could operate at a frequency of 4MHz but introduce a delay of about 20 percent which would allow low-speed memory to be used while still obtaining an 80 percent improvement in machine speed.

I obviously did not want to introduce this 20 percent delay when operating at 2MHz so had to introduce it as a simple

option selected by an on-board jumper connection.

The delay would be required during I/O request and memory request operations so the signals were taken and conditioned by the clock  $\phi_2$  in a two-stage counter before being combined with the  $\overline{\text{XRDY}}$  and  $\overline{\text{PRDY}}$  to feed the WAIT input of the Z-80.

## Reduced chip count

With this design philosophy, I would be able to make the Z-80 look, in hardware terms, as though it was an 8080 and therefore be fully-compatible with the S-100 busbar. Furthermore, I would be able to make the best possible use of PROMs to reduce the chip count thus saving board space.

All told, including buffers, the CPU of Tuscan would need only 21 chips and many of the types would be duplicated which would save money — it is always cheaper to buy several of a few devices rather than singles of many different types.

Having resolved the heart of the matter, I shall describe how the CPU was brought under control by resident firmware. □

Figure 5. A block schematic of the interfaces between Z-80 and S-100 bus.

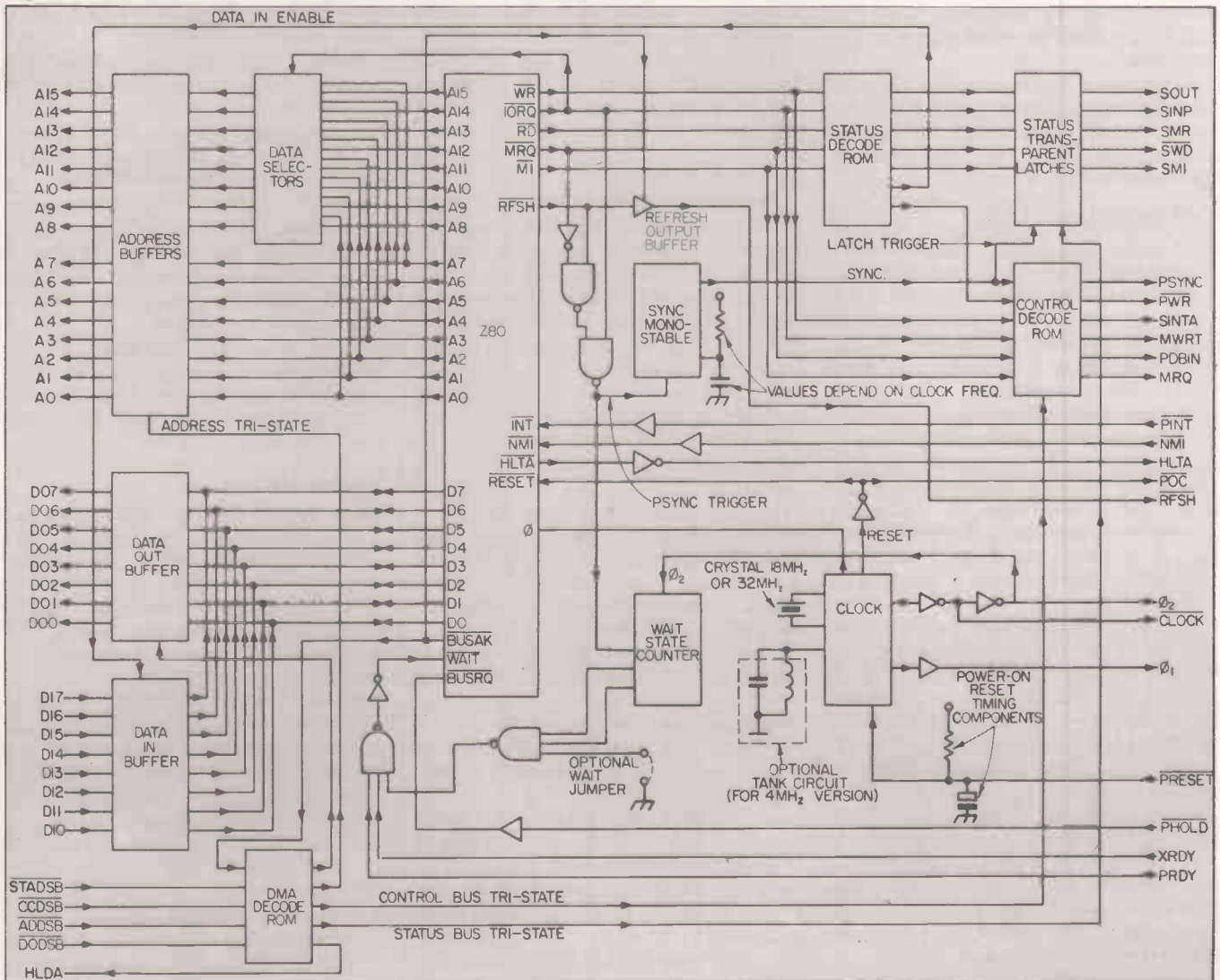



# Now you can control your business for less than £2,500.

This could be your best investment opportunity yet. A complete computerised business system, including a Floppy Disk Unit, high-speed Printer and *Britain's best selling microcomputer* – the Commodore PET. All for under £2,500.

## First Class Programs

A comprehensive range of first class programs is offered by *Commodore 'Business Software' Dealers*. These are available on disk from £50-£500. And they cover such applications as *Business Information, Stock Control, Word Processing, Payroll, Accounting and Mailing Systems*.

## Service and Support

With over 10,000 PET computers installed in the UK, dealer support is growing fast. A nationwide network of 90 official

*Commodore 'Business Software' Dealers* ensures that service and technical facilities are close to every PET user. Our dealers can even offer you a 24 hour on-site maintenance agreement.

## Training and Instruction

The PET Business System is self-contained and simple to use. Should you require personalised programs or extensive installation training this can be arranged with your *Commodore 'Business Software' Dealer* who can also give details of official *Commodore Training Courses*. These include intensive 2 & 3 day workshops to train you to write your own programs.

For full details about the Commodore PET Business System, Training Courses, Programs, and *'Business Software' Dealers*, simply fill in the coupon and post today.



To: Commodore Information Centre,  
360 Euston Road, London NW1 3BE.

Please send me details of the PET Computer Business Systems.

Name \_\_\_\_\_

Position \_\_\_\_\_

Company \_\_\_\_\_

Address \_\_\_\_\_

Tel. No. \_\_\_\_\_

If you have a particular application in mind please specify:

\_\_\_\_\_

\_\_\_\_\_

P.C.B.8

**commodore**  
We made small computers big business.

• Circle No. 172

Producing any kind of software is an expensive business. Charles Sweeten explains how funding for software development for secondary education is limited severely and how time and money will be wasted if individual schools write programs which cannot be transferred subsequently to other schools.

## Standardising software will avoid unnecessary waste

MUSE (Microcomputer Users in Secondary Education) has recently published a set of standards for Basic as implemented on the microcomputers commonly used in schools. The manufacturers whose systems have a significant share of the education market are Apple Computers, Commodore Business Machines, Research Machines and Tandy. Users of other equipment will be able to identify a subset of the language to conform with those standards.

### Idiosyncrasies

To have made the standards applicable to the last generation of computer systems would have been to deny the progress already achieved. It would also restrict future systems to such an extent that such standards would be ignored. By chance, the microcomputers noted use forms of Basic which have derived indirectly from the Microsoft version.

It is also surprising that most of the idiosyncrasies of the original version have survived through several generations. Thus, there exists an exceptional opportunity to fix a common language within education with a series of conventions which everybody can understand.

The purpose of those standards is to make it easier for program writers to write programs, to provide standards which program writers should attempt to meet and to make it possible to transfer programs between different systems.

### Foolproof input

A further purpose is to set a standard which programs written for the classroom should attempt to meet. To do that, there are suggestions about making input foolproof, and output program-proof, about providing initial values for the inexperienced user and about the options presented to the user while running the program.

It is important to stress that the standards do not attempt to achieve a non-trivial subset of Basic to run on any machine. Although restrictions have been made on the use of Basic keywords, it has

been made possible to use the full range for any system.

It is, arguably, more important to have standards for the appearance of software to the user than to have standards for the construction of programs. It would be immensely difficult to do that and yet allow individual style and collective progress.

If the linear Chelsea style, which at the time seemed revolutionary, had become mandatory, perhaps we would never have seen the prompt-orientated Hatfield style which now seems to represent an equal advance. For the moment, it is best to provide a sound framework on which to base any presentation and to ensure that those standards do nothing to inhibit ideas and experimentation in the areas of presentation to the user and teaching style.

### Presentation style

Nevertheless, a few recommendations about the style of presentation have been made since, to some extent, it affects the style of program construction.

Programs must keep to the subset of Basic that is defined. That allows the use of such functions as MID\$(X\$, A, B) and such statements as ON FNA (X) GOSUB 1100, 1200, 1300. The way that Basic should actually be expected to behave is also described. For example, VAL ("JOHN 23RD") will, in practice, produce different results on different machines. The exact value of the control variable after completion of a FOR NEXT sequence is unpredictable.

Programs must be constructed in modules — sometimes called subroutines or procedures. The modular concept is crucial to the understanding of the standards as it means that when a program is being composed, the author can concentrate on educational aims. A program specification might consist of:

1. Set default values.
2. Draw diagram.
3. Accept user command.
4. Display values.
5. Amend diagram.
6. Go to 3.

Each of the modules can be broken down into smaller ones, tested independently and even used again in another program. A number of tested subroutines has been made available to deal with more common needs and authors will be expected to use them or to use their own versions starting at the same line numbers.

### Variable names

Wherever possible, the subroutines have been written in Basic common to most machines and using special variable names. To find ZX, correct to ZY significant figures.

```
8200 REM
8210 J = INT (LOG (ABS(ZX))/LOG (10))
8220 J1 = 10^(ZY-J-1)
8230 ZX = INT (ZX*J1 + 5)/J1
8240 RETURN
```

That is a reasonable attempt but critical readers may discover that the routine gives annoying results on some machines at certain times. It is, therefore, capable of improvement, but until someone produces that improvement, we will have to make do.

When such an improvement is made, it will be a small task to substitute the new for the old, if we have followed the standards dutifully for line numbering our subroutines.

### Self-contained modules

Modules should be self-contained as far as possible. Program writers are encouraged to avoid writing modules which are forever calling other modules and so on. It makes the programs quite incomprehensible and requires a forbidding number of variable names to be used.

Subroutines should be neither so long that they are difficult to understand, nor so short that their use obscures the flow of the program. GOTO statements should be used only for small local jumps within a single module.

There has been much discussion about whether subroutine calls should be to a REM statement, which labels the subroutine, or to the next statement. While

being aware that some older computers must transfer to an executable statement, today's popular educational micros are more flexible. The standard recommends that subroutine calls (GOSUB) are to a REM statement. Modules and program sections are of four types:

MIPI	machine independent + program independent
MDPI	machine dependent + program independent
MIPD	machine independent + program dependent
MDPD	machine dependent + program dependent

Machine refers to the environment created by the combination of hardware and software. Machine-independent plus program-independent modules seem too good to be true, but a few are possible.

### Sample list

Here is a sample list of some of the types of subroutines which are useful within individual programs.

MIPI	command decoding program exit input procedure
MDPI	display routines graphical and tabular output
MIPD	specific procedures for a given purpose
MDPD	lines 80-90 only

Machine-dependent plus program-dependent modules are extremely inefficient since they involve the maximum of translation. It is for that reason that they are discouraged. Any single statement of that type is usually at lines 90-99. An example of such a statement would be CLEAR 400. However, any substantial program sections of that type, such as file handling, will have to be kept in self-contained sections in the main body of the program.

Where it is not possible to write in machine-independent Basic, a number of subroutines have been written for particular machines. To produce a histogram with graphics characters on the 380-Z, requires a subroutine at line 7000 and 12 variables need to be set. It must be easier than writing one's own version.

### Immediate advantage

So, authors will have an immediate advantage in having a range of standard routines available which have been tested thoroughly and which work in any program. There will be a further advantage in that these routines will have already been translated on to other machines.

Naturally, many authors want the fun of writing their own routines and standards such as these do not prevent it. Authors will have to follow the line-numbering and variable-naming conventions if they wish to participate in exchanging programs.

It is proposed that the standard for each machine should be free of copyright and MUSE has undertaken to form a library of routines which may prove useful to authors and teachers. They will be published from time to time with the latest versions for a number of common machine configurations.

For the moment, those routines which have been implemented are being released with the standards so that everyone who is interested will have the opportunity to contribute to the routines on any machine.

There would be chaos if the modules had overlapping line numbers. It is, therefore, proposed that MUSE maintains its library in an orderly fashion with particular routines at particular line numbers. Authors may ignore that but must realise that the job of transferring their work to other systems can only be done easily if machine-dependent routines can be swapped directly without altering the line numbers of control-transfer statements. To create maximum flexibility, re-numbering programs will be developed for each machine.

### Line numbering

Standard subroutine/modules will be either machine-dependent or machine-independent but in both cases they will be independent of the programs which use them. An example of a machine-dependent - plus - program - independent subroutine is.

```

8000 REM NUMERIC INPUT*****
8010 INPUT ZX ^
8020 IF LEN (ZX$)=0 THEN ZX$="NUL"
      :RETURN
8030 FOR J=1 TO LEN (ZX$)-2
8035 IF MID$(ZX,J,1)="E" THEN
      IF ABS(VAL(MID$(ZX$,J+1,3)))>20
      THEN ZX$="ERR":J=100
8040 NEXT J
8050 ZX=VAL(ZX$)
8060 IF LEFT$(ZX$,1)="0" OR LEFT$(
      ZX$,1)="." THEN ZX$="":
      RETURN
8070 IF ZX + "HELP" THEN RETURN
8080 IF ZX=0 THEN ZX$="ERR":
      RETURN
8090 ZX$="":RETURN
  
```

On the Pet, line 8101 must be replaced by a GOSUB to a subroutine which prevents a null input from stopping the program. The principles behind the standard line numbering and variable naming need to be outlined.

It is recommended that every program begins with lines 10 to 40 as shown. Lines 80 to 89 should contain statements peculiar to a particular version of Basic on that machine. An example follows:

```

10 REM *****TEACH*****
20 REM *****A.N. Author***
30 REM ****380Z DBAS9****
40 REM ***13/9/79,V1.2***
50 REM *****PRINTER*****
80 ZW = 79 :REM SCREEN WIDTH
90 CLEAR 400
  
```

The main program should start at line 1000 with a REM statement and should be split into convenient modules. In a complicated module, it may be useful to

have a control module between lines 500 and 999 which calls modules lying between lines 1000 and 4999. To clarify the idea of a control section, a simple example is given. It is not put forward as an example of good programming.

```

500 REM CONTROL
510 PRINT"command:";
520 INUT ZCS
530 GOSUB 9000
540 GOSUB 600
600 IF ZCS$="OPT" THEN 1200
610 IF ZCS$="VAL" THEN 1300
620 IF ZCS$="MOR" THEN 1800
630 IF ZCS$="RUN" THEN 1500
640 IF ZCS$="BYE" THEN 900
650 PRINT
660 PRINT"Command not recognised"
670 PRINT
680 RETURN
900 CLOSE
910 END
  
```

It is recommended that the main program is numbered as follows:

```

100-145 arrays, functions definitions
150-195 display program titles
200-495 program initialisation control
500-995 main program control if needed
1000-4990 main program (possibly
      subroutines)
      MIPD
5000-7990 subroutines : MDPI
8000-9990 subroutines : MIPI
  
```

Major modules should start at multiples of 1,000 and minor modules at multiples of 100. An explanation of the distinction between lines 500- and lines 1000- is in the full set of standards. Some machines do not have a re-numbering facility. In those cases, programs should be written starting at line 1000 and incrementing by 10. That leaves room to enter the essential lines at the beginning and to make use of standard subroutines.

Main program subroutines will not necessarily be able to start at round numbers, but authors should try to achieve that.

### Agreed routines

So that the standard routines should be available to different writers on different machines, it is necessary to reserve some variable names within the routines for passing values to and from the routines.

Some machine- and dialect-dependent parameters, such as screen height and width, need to be stored under agreed names. It is suggested that the following variable names are reserved:

```

G** Mainly for graphics handling.
J** Mainly for number formatting.
J and
J1-J9 For loops counting within program-
      independent modules.
Q* For loop counting in the main program.
Z** For system variables or for values to be
      passed to program-independent modules.
  
```

Of course, any letters chosen in that way are bound to conflict with somebody's ideas on variable naming. Mathematicians use I and J for matrix subscripts; G is gravity; Q is queue length. Every letter has its connotations, so an arbitrary choice was made. I and O were

*(continued on next page)*

(continued from previous page)

ruled out to avoid confusion with 1 and 0. That left J unattached, and Z and Q stand for less than other letters. G stands for graphics since that might need more standard variables than anything else.

The routine for converting a number to a given number of significant figures makes use of the variables J and J1. If these variables were being used elsewhere in the program to store certain values, use of the subroutine would alter the values and this would obviously be inconvenient.

## Possible problems

This example illustrates the kind of problems that could arise.

```
1000 REM EXAMPLE
1010 J1 = 5000
1020 ZY = 4
1030 FOR J = 1 to 5
1040 ZX = SQR(J1)
1050 GOSUB 8200
1060 PRINT ZX
1070 J1 = J1 + 100
1080 NEXT J
```

Instead of printing the square roots corrected to four significant figures of the number 5,000, 5,100, 5,200, 5,300, 5,400, the program will print the square root of 5,000 and will then print the square root of 102 again and again.

As we have seen, the variable names which start with Z are used for passing values to and from routines. In the

routine 8200 in the first illustration, ZX holds the value to be shortened and ZY holds the number of figures of accuracy required.

In another routine, ZX and ZY are the co-ordinates of a position on the display screen, and ZX is a string of symbols to be placed on the screen at the position ZX, ZY.

## Main principles

At this stage, it is worth reiterating the MUSE minimum program standards for educational applications software. Programs may use only the subset of Basic as defined. Other features of Basic may be used only in machine-dependent-plus-program-independent modules, which must be placed at the line number suggested. Programs must have the modular structure and be user-proof as described.

## Default values

Default values must be set automatically by the program and the essential line numbering must be used as defined. Programs must not use lines 5000 to 9999 except for program-independent modules. Variables starting with G, J, Z must not be used except with program independent modules.

The minimum documentation must be provided — specimen input and sample or

diagram of output, operating instructions if needed and a list of variables used with meanings.

The command style of presentation as developed by Hertfordshire is commended. Recommendations are made for option lists and menus and default values are recommended. The syntax of Basic is defined in great detail, not only in terms of the syntax itself, but in terms of the effects. The standards finish with 13 pages of subroutines and specifications for subroutines.

## Criticism easy

Copies of MUSE program standards are available from Charles Sweeten, 10 Rockingham Hills, Oundle, Peterborough PE8 4QA. It is easy to raise objections to any set of standards, but I hope that anyone who wishes to be destructive will also try to re-construct what they have destroyed.

Many people have co-operated in assembling the standards, but I do not expect that the result is by any means complete or even correct. We are at a stage of rapid development in computer use and it would be wrong to try to freeze progress or experimentation. Nonetheless, if a standard is accepted and an effective library established, the painful re-invention of square wheels will be avoided. □

## Superboard II

8k MICROSOFT BASIC 4k RAM  
- comes ready built (no hidden kit repair charges)  
fully expandable to 32k dual floppy  
system with printer.

Standard Superboard 50Hz £159.95 + VAT  
610 Expansion Board 8k RAM  
ONLY £159.95 + VAT

IP CD3P Minifloppy Disc, Cased,  
PSU, 2 copies DOS ONLY £275 + VAT

4k RAM ONLY £24 + VAT  
Plastic Case, Beige ONLY £26 + VAT

Challenger IP-Metal Cased, Superboard, PSU modulator ONLY £219 + VAT

NEW BUILT  
48 X 32 VIDEO  
VERSION  
£199 + VAT

50Hz version  
- NO FLICKER

## Super Print 800

80 COLUMN HIGH  
PERFORMANCE IMPACT PRINTER

The ideal companion for PET, APPLE, TRS80,  
Exidy, Superboard, CompuKit, Ohio  
Challengers and most micro's

Rugged metal enclosure makes it ideal  
for home computing, small business  
systems, data logging etc.

\*RS-232, 20mA, IEEE 488 and Centronics I/O  
\*16 Baud Rates to 19,200

\*60 Lines per minute - Bidirectional

\*5 print densities 72,80,96,120 or 132 Chr/Line

\*Self Test Switch \*2k Buffer

\*Tractor and Fast Paper Feed/Graphics

Model 800 MST ONLY £399 + VAT



Probably the most  
highly featured  
printer for the  
lowest cost!

## Low price PETS

- large keyboard  
16k - £549 + VAT  
32k - £649 + VAT



## ZT DRIVING COMPUTER



NEW

\*MPG Instant \*MPG Average \*Gals. used  
since fillup \*Miles to empty \*Elapsed time  
\*Time to empty ONLY £77.50 + VAT



## INTELLIGENT EPROM PROGRAMMER

Connects directly  
to TV. Develop,  
Copy, Burn,  
Verify 2708, 2716 and with modification 2516.

ONLY £120 + VAT Built & Tested  
£100+VAT Kit. £20+VAT Built Power Supply

## !!!! SPECIAL SCOOP !!!!

Verbatim Discs in fives  
5 1/4" - £1.85 (each) + VAT  
8" - £2.20 (each) + VAT

## VIDEO GENIE based on TRS80



Utilises Z80, 12k level II Basic, 16k RAM,  
Integral Cassette Deck, UHF O/P,  
all TRS80 features ONLY £369 + VAT

## STRINGY FLOPPY



NEW

Combines economy of cassette with speed &  
reliability of disc. (TRS80 exp.int.not req.)  
ONLY £189 + VAT (inc. 20 wafers (Tapes))

# Mighty Micro

In association with Watford Electronics

BUY IN CONFIDENCE - In the event that we are unable to deliver your goods within 7 days, we do not bank your remittance until such time we have the goods to despatch. If on receipt of your order, the goods do not meet with your satisfaction, return within 7 days for full refund. All goods covered by manufacturers guarantee.

Please add VAT at 15%. Carriage extra, will advise at time of order. Official orders welcome. Product details on request. Trade and export enquiries welcome.  
33 CARDIFF ROAD, WATFORD, HERTS. Telephone: (0923) 38923  
PO Box 17, 61 NEW MARKET SQ, BASINGSTOKE, HANTS. (0256) 56417  
Mail Order and Enquiries to Basingstoke



• Circle No. 173

# Buy a microcomputer for under £1,000 and you could be on your own! Unless it's a Commodore PET.



Commodore produce Britain's number one microcomputer. But we don't stop there. We also insist on providing comprehensive support throughout our national dealer network.

Our dealers can examine your needs and demonstrate which hardware and software will suit you best. Their trained engineers are always at hand and a 24-hour field maintenance service is available. Your local dealer can tell you more about the following Commodore Services.

## The Commodore PET

The Commodore PET computer range covers everything from the self-contained unit at under £500 to complete business systems at under £2,500.

## Commodore Business Software and Petpacks

Our software range covers hundreds of applications. Business software includes Sales and Purchase Ledgers, Accounting, Stock Control, Payroll, Word Processing and more. In addition over 50 Petpacks are available covering such titles as Strathclyde Basic Tutorial, Assembler Development System, Statistics, plus our Treasure Trove and Arcade series of games.

## Commodore Approved Products

Compatible products of other manufacturers with Commodore's mark of approval are also available.

## Commodore Courses

Commodore offer a range of residential training courses and one day seminars. An excellent start. And when you have installed your system the PET User's Club Newsletter can keep you informed of new ideas and latest developments.

### LONDON AREA

Adda Computers Ltd,  
W1, 01-408 1611  
Adda Computers Ltd,  
W5, 01-579 5845  
Advanced Management Systems,  
EC2, 01-638 9319  
Byteshop Computerland,  
W1, 01-636 0647  
C.S.S. (Business Equipment) Ltd,  
E8, 01-254 9293  
Capital Computer Systems,  
W1, 01-637 5551  
Centralex-London Ltd,  
SE13, 01-318 4213  
Cream Microcomputer Shop,  
HARROW, 01-863 0833  
Da Vinci Computer Shop,  
EDGWARE, 01-952 0526  
L & J Computers,  
NW9, 01-204 7525  
Home and Business Computers,  
E12, 01-472 5107  
Merchant Systems Limited,  
EC4, 01-353 1464  
Metyclean Ltd,  
SW1, 01-828 2511  
Micro Computation,  
N14, 01-882 5104  
Micro Computer Centre,  
SW14, 01-878 3206  
Sumlock Bondain Ltd,  
EC1, 01-250 0505  
Sumlock Bondain Ltd,  
EC4, 01-626 0487  
T.L.C. World Trading Ltd,  
WC2, 01-839 3894  
TOPS TV LTD,  
SW1, 01-730 1795

### HOME COUNTIES

G. M. Marketing,  
ANDOVER, 790922  
HSV Microcomputers,  
BASINGSTOKE, 62444  
MMS Ltd,  
BEDFORD, 40601  
Elex Systems Ltd,  
BRACKNELL, 52929  
DDM Direct Data Marketing Ltd,  
BRENTWOOD, 229379  
Amplicon Micro Systems Ltd,  
BRIGHTON, 562163  
RUF Computers (UK) Ltd,  
BURGESS HILL, 45211  
T & V Johnson (Microcomputers  
Etc) Ltd, CAMBERLEY, 20446  
Cambridge Computer Store,  
CAMBRIDGE, 65334  
Wego Computers Ltd,  
CATERHAM, 49235  
Dataview Ltd,  
COLCHESTER, 78811  
South East Computers Ltd,  
HASTINGS, 426844  
Alpha Business Systems,  
HERTFORD, 57423  
Brent Computer Systems,  
KINGS LANGLEY, 65056  
Isher-Woods Business Systems,  
LUTON, 416202  
South East Computers Ltd,  
MAIDSTONE, 681263  
Micro Facilities Ltd,  
MIDDLESEX, 01-979 4546  
J. R. Ward Computers Ltd,  
MILTON KEYNES 562850  
Sumlock Bondain (East Anglia) Ltd,  
NORWICH, 26259  
T & V Johnson (Microcomputers  
Etc) Ltd, OXFORD, 721461  
H.S.V. Microcomputers,  
SOUTHAMPTON, 22131  
Super-Vision,  
SOUTHAMPTON, 774023  
Xitan Systems Ltd,  
SOUTHAMPTON, 38740  
Squar R Dean Ltd,  
SOUTHEND-ON-SEA, 62707  
The Computer Room,  
TUNBRIDGE WELLS, 41645  
Orchard Electronics,  
WALLINGFORD 35529

Petalect Ltd,  
WOKING, 63901  
Oxford Computer Systems,  
WOODSTOCK, 811976

### MIDLANDS AND SOUTH HUMBERSIDE

Byteshop Computerland,  
BIRMINGHAM, 622 7149  
CPS (Data Systems) Ltd,  
BIRMINGHAM, 707 3866  
Camden Electronics,  
BIRMINGHAM, 773 8240  
Computer Services Midlands Ltd,  
BIRMINGHAM, 382 4171  
Callanos (Computers) Ltd,  
BURTON-ON-TRENT, 812380  
Ibek Systems,  
COVENTRY, 86449  
Jondane Associates Ltd,  
COVENTRY, 664400  
Davidson-Richards Ltd,  
DERBY, 356803  
Caddis Computer Systems Ltd,  
HINCKLEY, 613544  
H.B. Computers,  
KETERING, 83922  
Taylor-Wilson Systems Ltd,  
KNOWLE, 6192  
Machsiz Ltd,  
LEAMINGTON SPA, 312542  
Office Computer Techniques Ltd,  
LEICESTER, 28631  
Lowe Electronics,  
WATLOO, 2817  
Betas (Systems) Ltd,  
NOTTINGHAM, 48108  
Byteshop Computerland,  
NOTTINGHAM, 40576  
Keen Computers Ltd,  
NOTTINGHAM, 583254  
Tektada Computing,  
STOKE-ON-TRENT 813631  
Systems Micros,  
TELFORD, 460214  
McDowell Knagg & Associates,  
WORCESTER, 427077

### YORKSHIRE AND NORTH HUMBERSIDE

Ackroyd Typewriter & Adding  
Machine Co. Ltd, BRADFORD, 31835  
Allen Computers,  
GRIMSBY, 40568  
Microware Computers Ltd,  
HULL, 562107  
Microprocessor Services,  
HULL, 23146  
Holdene Ltd,  
LEEDS, 459459  
NSC Computer Shops Ltd,  
LEEDS, 788466

South Midlands Communications Ltd,  
LEEDS, 782326  
Yorkshire Electronics Services Ltd,  
MORLEY, 522181  
Computer Centre (Sheffield) Ltd,  
SHEFFIELD, 53519  
Electronic Services,  
SHEFFIELD, 668767  
Hallam Computer Systems Ltd,  
SHEFFIELD, 663125

### NORTH EAST

Dyson Instruments,  
DURHAM, 66937  
Currie & Maughan,  
GATESHEAD, 774540  
Wards (Office Supplies) Group,  
GATESHEAD, 605915  
Elfton Ltd,  
HARTLEPOOL, 61770  
Fiddes Marketing Limited,  
NEWCASTLE, 81517  
Newcastle Computer Services,  
NEWCASTLE, 615325  
Format Micro Centre,  
NEWCASTLE, 21093  
Tripoint Associated Systems  
Consultants Ltd,  
SUNDERLAND, 73310

### SOUTH WALES AND WEST COUNTRY

Radan Computational Ltd,  
BATH, 318483  
Computer Corner,  
BAYSTON HILL, 4250  
Bristol Computer Centre,  
BRISTOL, 23430  
C.S.S. (Bristol) Ltd,  
BRISTOL, 779452  
T & V Johnson (Microcomputers  
Etc) Ltd, BRISTOL, 422061  
Sumlock Tabdown Ltd,  
BRISTOL, 26685  
Sigma Systems,  
CARDIFF, 34869  
Office and Business Equipment  
(Chester) Ltd, DEESIDE, 817277  
A.C. Systems,  
EXETER, 71718  
Micro Media Systems,  
NEWPORT, 52726  
J.M. Computer Services Ltd,  
NEWQUAY, 2863  
Devon Computers,  
PRIGNTON, 526303  
J.A.D. Integrated Services,  
PLYMOUTH 62616  
Business Electronics,  
SOUTHAMPTON, 738248  
Computer Supplies (Swansea),  
SWANSEA, 290047

### NORTH WEST AND NORTH WALES

Tharstern Ltd,  
BURNLEY, 38481  
B+B (Computers) Ltd,  
BOLTON, 26644  
Preston Computer Centre,  
PRESTON, 57684  
Catlans (Computers) Ltd,  
WILMSLOW, 527166

### LIVERPOOL

Aughton Microsystems Ltd,  
LIVERPOOL, 548 7788  
B.E.C. Computers,  
LIVERPOOL, 263 5738  
Rockliff Brothers Ltd,  
LIVERPOOL, 521 5830

### MANCHESTER AREA

Byteshop Computerland,  
MANCHESTER, 236 4737  
Computastore Ltd,  
MANCHESTER, 832 4761  
Cytek (U.K.) Ltd,  
MANCHESTER, 872 4682  
Executive Reprographic Ltd,  
MANCHESTER, 228 1637  
N.S.C. Computer Shops Ltd,  
MANCHESTER, 832 2269  
Sumlock Electronic Services  
(Manchester) Ltd,  
MANCHESTER, 834 4233  
Professional Computer Services Ltd,  
OLDHAM, 624 4065  
D. Kipping Ltd,  
SALFORD, 834 6367  
Automated Business Equipment Ltd,  
STOCKPORT, 061-432 0708

### SCOTLAND

Holdene Microsystems Ltd,  
EDINBURGH, 668 2727  
Microcentre,  
EDINBURGH, 556 7354  
Aethrol Consultancy Services,  
GLASGOW, 641 7758  
Byteshop Computerland,  
GLASGOW, 221 7409  
Robox Ltd,  
GLASGOW, 221 5401  
Mac Micro,  
INVERNESS, 712 203  
Thistle Computers,  
KIRKWALL, 3140

### IRELAND

Softech Ltd,  
DUBLIN, 784739  
Medical & Scientific Computer  
Services Ltd, LISBURN, 77533

To: Commodore Information Centre,  
360 Euston Road, London W1 3BL. 01-388 5702

Please send me further information about the Commodore PET.

Name \_\_\_\_\_

Position \_\_\_\_\_

Address \_\_\_\_\_

Intended application \_\_\_\_\_

P.C.D.8

Do you own a PET? YES  NO

**commodore**

This list covers Dealer participating in our advertising.

• Circle No. 174

# Supertank

In part one, Bob Merry looked at the first section of the game and discussed its development. This month, he gives the remaining listing and explains how the problems were finally solved.

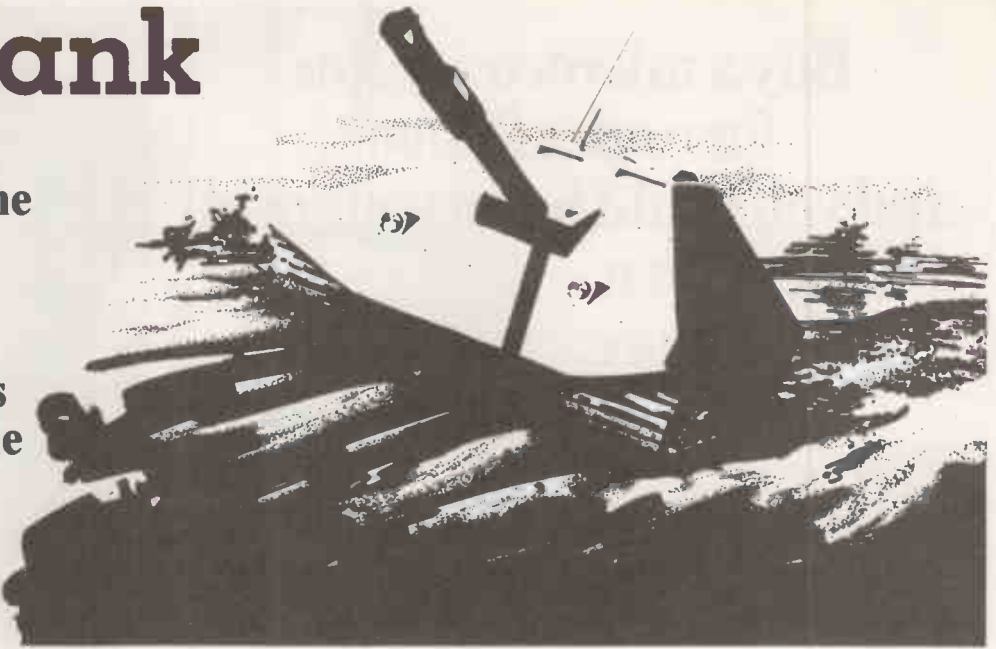

THE PROGRAMS for Supertank use the facility in Pet for overlaying a program with a new one while retaining the variables. It is done by using the command LOAD in the first program. The only condition is that the second program is the same length or shorter than the first.

In fact, after loading, the second program appears to be identical in length to the first. To understand that, consider how Pet knows where to find the end of a program — illustrated by figure 1.

Each line of program in memory consists of a link which tells Pet where to find the next line, the line number, the text of the line and a zero. The last line in the program is followed by a double zero.

When memory is empty after first switching-on, it contains a zero, a link and the double zero. As new lines are entered, the double zero is pushed higher in memory. Pet also keeps track of the end of Basic, the position of variables and so on, by the use of various pointers in memory locations 122 to 135.

## Second program

The loading of the second program does not alter the pointers or the position of the double zero in memory. That does not, of course, matter normally, except when you are trying to edit the second program.

Let us suppose you have developed the first program to the point where it seems to work. You now set about writing and entering the second program. The only way to test it is to SAVE it, return and LOAD the first one again, RUN it and make it call the second program.

Naturally enough, it does not work the first time and needs amending. If you add to the program in memory, however, you will push the double zero back and will finish with a program which appears to be longer than the first one.

What you must do before making

amendments is to go back and re-load the second program. It is very useful at that stage to make spare copies of both programs, as we are going to spend a good deal of time SAVEing the latest versions on to a master tape so that they can be tested.

If nothing else, a spare copy can be a godsend when, in a moment of confusion after so many re-recording sessions, you press PLAY and RECORD instead of just PLAY.

## New variables

Although new variables can be added by the second program to those already there from the first, it is a wise precaution to include them in the first program by assigning them an initial value. It has the effect of occupying seven bytes of memory and will give an out-of-memory error message if the first program grows too long.

Now let us look at the program itself. Originally, I had intended to use a straightforward sequence:

1. Player moves
2. Player attacks
3. Supertank moves
4. Supertank attacks

My first working program was of that form. However, during play-testing I found it was far too easy for Supertank to win. The player had to move his mobiles in close to score a reasonable number of hits and that left him a sitting target for the more powerful batteries of Supertank.

I solved the problem by making the mobiles more manoeuvrable — an extra movement turn between their attack and Supertank's move simulated it. Since the mobiles now moved twice, that is contained as a subroutine which occurs twice during each turn.

The program starts, in line 100, by filling the two strings, ACS and DNS. Although they were used in the first program and space is still reserved for

them in memory, the contents of each string are not carried forward and they must be re-defined.

Line 110 clears the top line, since we no longer need the co-ordinates along that edge, and subroutine 1220 prints Supertank's current strength along that line. It will be updated periodically during each turn. Subroutine 1520, called in line 120, counts the number of mobiles which have five engines or more left and are able to move.

If the player is not immobilised, Line 130 clears the bottom of the screen — subroutine 1240 — and goes on to the move subroutine at 1010. Subroutine 1230 enters a pause to let you read the message.

In the move subroutine, each mobile is taken in turn and checked for its ability to move. The number of spaces it can move depends on the number of engines it has left. The direction of move is selected by the player using the keypad. After each move has been entered, the new position is calculated in lines 1050-1130.

## Legality check

That must now be checked for legality. The mobile must stay on the map — 1140 — and can move only into a clear space or ram Supertank — he cannot move into a crater or a space occupied by one of his own men.

That is checked and if it is illegal, the rest of that mobile's move is forfeit via line 1280. If the required space is occupied by Supertank itself, the program branches to the ramming Supertank routine at 1290 which calculates a number of hits, H, depending on the strength of the mobile. Those hits reduce the number of Supertank's engines.

The mobile is also destroyed and a space is printed at its last position (1320). You could have finally defeated Supertank by that move, so it has to be checked (1330), but otherwise the values of MM(I), MF(I) and N are updated and the

program returns for the next mobile.

A normal move is completed in lines 1170 to 1200 and when all mobiles have been moved, the subroutine is ended.

The next phase is the player's attack, starting with a check in lines 140-150 of the remaining firepower. When Supertank reaches its secret target, it sets a flag, T, to 1 which triggers the message that this is the last attack.

Each mobile and each artillery unit attack in turn. The number of hits, H, is calculated using a formula based on the unit's firepower, a random factor, and the distance between the unit and Supertank.

The weighting factor of .9 at the end is chosen so that even the most distant units have a chance of scoring, although the maximum number of hits is limited to the firepower of the unit and can be scored only by an adjacent unit.

Each unit has the choice of aiming for engines or armament and the appropriate variable is adjusted. Various messages detailing results are contained in subroutines at 1430-1450.

### Last attack

If that was the last attack, Line 480 would direct the program to the loss sequence at 1550, but otherwise there is another movement phase similar to the first. In line 510, the flag, T, is checked — a value of 2 indicates that Supertank cannot move. That flag would have been set the first time subroutine 1500 was called.

Supertank's first choice of move is determined in lines 550-580 which cause

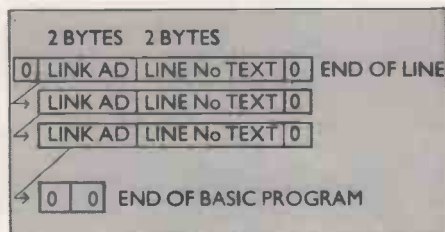

Figure 1.

Supertank to move along the X axis towards the TX column. It will move diagonally when the angle exceeds a certain value. The program also takes account of the possibility that the direct path to the target is blocked by craters.

Should Supertank's choice of move not be possible due to a crater or an artillery unit, Supertank will try all possible moves in turn (650-730). One other possibility is that it will ram a mobile. That is dealt with by subroutine 1360, which identifies the mobile it is destroying and calculates the damage caused to its engines.

Following the movement phase, Supertank attacks each defender in turn, dividing its firepower amongst the N survivors. That phase completes the turn and the program returns to 120.

As an exercise for the reader, try to discover all the possible twists and turns which arise from various combinations of factors. Everything is there for a reason — I produced several versions of Supertank before arriving at this one.

Each session of play-testing revealed new needs for modifications. Sometimes they were obvious errors, but sometimes they were more subtle. For example, in an

earlier version, I had not thought of what would happen if all the defenders were destroyed before Supertank reached its target.

In the event, Supertank kept moving until it reached the target. Line 990 now puts you out of your misery. I also had to include checks in each phase to see whether the phase was possible before announcing it on the screen.

If you write a program like Supertank and have play-tested it to your satisfaction, there is one final test you should perform — the idiot test.

I had reached an advanced stage with the program and had put it to one side as an almost finished project, when I was visited by a friend who shared my liking for games but had not played with a Pet before. "Try this", I said, offering him Supertank.

### Idiot factor

When I had played the game, I had evolved various tactics, which included withdrawing all my mobiles in the second movement phase as far as possible from harm's way.

John, however, left one of his in Supertank's path and it was rammed. All appeared to be well, except that Supertank's engines were not reduced — I had omitted SM=SM-H from line 1370 and would never have found it with my normal style of play.

From that, I learned that you cannot rely on the intelligence of the user and you must include checks on the validity of inputs.

```

100 AC#="#####":DN#="#####"
110 PRINT"0":FORI=1TO40:PRINT" ":NEXT:GOSUB1220
120 GOSUB1520:IFR1=0THEN140
130 GOSUB1240:PRINT"YOU MOVE":GOSUB1230
140 GOSUB1010:GOSUB1240:F=0:FORI=1TOMN:F=F+MF(I):NEXT
150 FORI=1TOAN:F=F+AF(I):NEXT
160 IFF=0THENPRINT"YOU HAVE NO FIREPOWER LEFT!":GOSUB1230:GOTO480
170 IFT=1THENPRINT"SUPERTANK AT TARGET!!!":PRINT"THIS IS YOUR LAST ATTACK":GOTO
190
180 PRINT"YOUR ATTACK"
190 GOSUB1230:FORI=1TOMN:IFMF(I)=0THEN330
200 H=INT(MF(I)*RND(1)/SQR((MX(I)-SX) ^2+(MY(I)-SY) ^2)+.9)
210 GOSUB1240:PRINT"MOBILE #":I:"ATTACKING-FIREPOWER":MF(I)
220 PRINT"ARMAMENT OR ENGINES(A/E)?":GOSUB1260
230 IFR#="A"THEN260
240 IFR#="E"THEN290
250 GOSUB1240:PRINT"ANSWER A OR E":GOSUB1260:GOTO230
260 SF=SF-H:IFSF<1THENSF=0
270 IFH=0THENGOSUB1450:GOTO320
280 GOSUB1430:PRINTSF:GOTO320
290 SM=SM-H:IFSM<1THENSF=0
300 IFH=0THENGOSUB1450:GOTO320
310 GOSUB1440:PRINTSM:
320 GOSUB1230:GOSUB1220:IFSF=0ANDSM<10THEN1540
330 NEXT:FORI=1TOAN:IFAF(I)=0THEN470
340 H=INT(AF(I)*RND(1)/SQR((AX(I)-SX) ^2+(AY(I)-SY) ^2)+.9)
350 GOSUB1240:PRINT"ARTILLERY #":I:"ATTACKING-FIREPOWER":AF(I)
360 PRINT"ARMAMENT OR ENGINES(A/E)?":GOSUB1260
370 IFR#="A"THEN400
380 IFR#="E"THEN430
  
```

(continued on page 97)

# ITT world-wide technology available locally from Telefusion.



The famous ITT 2020 Micro Computer is now available nationwide from Telefusion. Ideal for most small and medium-sized businesses, it's one of the most versatile and cost-efficient computers you can buy. And it's on quick delivery from Telefusion and their authorised dealers - with the backing of Telefusion's expert service network staffed by fully-trained and experienced micro-computer engineers.

The ITT 2020 can be teamed up with matching Floppy Disc Drive Units and Serial Printer. In other words, it can be made into a complete data processing system.

Why not contact us or one of our dealers listed below for a complete demonstration. Alternatively, an "on-site" demonstration can be arranged through our central Micro Computer Sales Office. Call Alan Webb, Bristol (0272) 211446.

ITT 2020 Micro Computer is a complete self-contained, ready-to-use computer. Standard features include:

- \*PALSOFT and monitor in ROM. \*Colour graphics.
- \*Sockets for up to 48k bytes RAM. \*Cassette interface.
- \*Typewriter-style ASCII keyboard. \*High-efficiency switching power supply and rugged structural foam case.

The ITT 2020 Micro Computer video display circuiting section displays memory as text, colour graphics or high resolution graphics - software selectable. Both graphics modes can be selected to include four lines of text at the bottom of the display area. In either graphics mode the user can select (under software control) one of two memory pages to be displayed.

Come in and see just how much it can do for you.

## Telefusion

Authorised Dealers: Demacan Ltd., 2 West Priory Close, Westbury on Trym, Bristol. Tel: 621920. Aries Business Machines, 21 Manor Walk, Thornbury, Bristol. Tel: 416189. Farmplan, Netherton Farm, Ross-on-Wye, Herefordshire. Tel: 4321. Ensign, 13-19 Milford Street, Swindon. Tel: 42615. Radan Computational Ltd., 19 Belmont, Bath. Tel: 318483. Data Lease Consultants, The Manor Court House, 9 Fore Street, Chard, Somerset. Tel: 5539. Guestel Ltd., Refuge House, 2-4 Henry Street, Bath. Tel: 65379. Brindiwel, 13 Brockridge Lane, Frampton Cotterell, Bristol. Tel: Winterbourne 774564. Data Link Micro Computer Systems, 10 Waring House, Redcliff Hill, Bristol. Tel: 213427. Dolphin Computer Sales Ltd., 17 Market Place, Tetbury, Glos. Tel: 53195. Data Wright Computer Services, 10 The Drive, Gosforth, Newcastle upon Tyne. Tel: 20946. Micro Business Centre, Castlebridge House, Lichfield Road, Wolverhampton. Tel: 732375/6/7. Or contact the Commercial Sales Manager at Telefusion: Dudley Street, Sedgley, West Midlands. Tel: 75961. Atlas Chambers, King Street, Leeds. Tel: 450453. 63 London Road, Norwich. Tel: 28441. 45 Church Road, Hove, Sussex. Tel: 723114. 61 Queens Square, Bristol. Tel: 211446. 35 Houghton Street, Southport. Tel: 31030. 15-17 City Road, London EC1. Tel: 01-628 9587.

• Circle No. 175

PRACTICAL COMPUTING August 1980



(continued from page 95)

```

390 GOSUB1240 :PRINT"ANSWER A OR E":GOSUB1260 :GOTO370
400 SF=SF-H:IFSF<1THENSF=0
410 IFH=0THENGOSUB1450 :GOTO460
420 GOSUB1430 :PRINTSF:GOTO460
430 SM=SM-H:IFSM<1THENSM=0
440 IFH=0THENGOSUB1450 :GOTO460
450 GOSUB1440 :PRINTSM:
460 GOSUB1230 :GOSUB1220 :IFSF=0ANDSM<10THEN1540
470 NEXT
480 IFT=1THEN1550
490 GOSUB1520 :IFR1=0THEN510
500 GOSUB1240 :PRINT"YOU MOVE AGAIN":GOSUB1230 :GOSUB1010
510 IFT=2THEN770
520 IFSM<10THENGOSUB1500 :GOTO770
530 GOSUB1240 :PRINT"SUPERTANK MOVING":GOSUB1230
540 FORL=1TOINT(SM/100+.9)
550 IFABS(SY-TY)<.5*ABS(SX-TX)THENY=SY:GOTO570
560 Y=SY+SGN(TY-SY)
570 IFSX=TXANDY<>TYTHENX=SX+1:GOTO590
580 X=SX+SGN(TX-SX)
590 J=0
600 IFX<1ORX>39ORY<1ORY>19THENJ=J+1:GOTO650
610 GOSUB1350 :IFPEEK(R1)=42ORPEEK(R1)=129THENJ=J+1:GOTO650
620 IFPEEK(R1)<>32THENGOSUB1360
630 PRINT"@";LEFT$(AC$,SX);LEFT$(DN$,SY);" "
640 PRINT"@";LEFT$(AC$,X);LEFT$(DN$,Y);" 33" :SX=X:SY=Y:GOTO750
650 X=SX:Y=SY:ONJGOTO660 ,670 ,680 ,690 ,700 ,710 ,720 ,730 ,740
660 X=SX+1:GOTO600
670 X=SX+1:Y=SY-1:GOTO600
680 X=SX+1:Y=SY+1:GOTO600
690 Y=SY-1:GOTO600
700 Y=SY+1:GOTO600
710 X=SX-1:GOTO600
720 X=SX-1:Y=SY-1:GOTO600
730 X=SX-1:Y=SY+1:GOTO600
740 GOSUB<
750 GOSUB1230 :IFSX=TXANDSY=TYTHENT=1:GOTO770
760 NEXT
770 IFT=2ANDF=0THEN1550
780 IFSF=0THEN1000
790 FORI=1TOMN:IFMM(I)=0ANDMF(I)=0THEN900
800 GOSUB1240 :PRINT"SUPERTANK ATTACKING MOBILE #":I:GOSUB1230
810 H=INT(SF*RND(1)/(N*SQR((SX-MX(I))^2+(SY-MY(I))^2))+.9)
820 IFH=0THENGOSUB1450 :GOTO900
830 IFMM(I)/300=MF(I)/10THEN860
840 MF(I)=MF(I)-H:IFMF(I)<1THENMF(I)=0
850 GOSUB1430 :PRINTMF(I):GOTO880
860 MM(I)=MM(I)-H:IFMM(I)<1THENMM(I)=0
870 GOSUB1440 :PRINTMM(I):
880 IFMM(I)=0ANDMF(I)=0THENGOSUB1460
890 GOSUB1230
900 NEXT:FORI=1TOAN:IFAF(I)=0THEN980
910 GOSUB1240 :PRINT"SUPERTANK ATTACKING ARTILLERY #":I:GOSUB1230
920 H=INT(SF*RND(1)/(N*SQR((SX-AX(I))^2+(SY-AY(I))^2))+.9)
930 IFH=0THENGOSUB1450 :GOTO980
940 AF(I)=AF(I)-H:IFAF(I)<1THENAF(I)=0
950 GOSUB1430 :PRINTAF(I):
960 IFAF(I)=0THENGOSUB1480
970 GOSUB1230
980 NEXT
990 IFN=0THEN1550
1000 GOTO120
1010 FORI=1TOMN:IFMM(I)<5THEN1210
1020 GOSUB1240 :PRINT"MOVE MOBILE #":I
1030 PRINT"UP TO";INT(MM(I)/10+.5);"SPACES-FIREPOWER IS";MF(I)
1040 FORJ=1TOINT(MM(I)/10+.5):GOSUB1260 :R=VAL(R$):IFR=0THENR=5
1050 X=MX(I):Y=MY(I):ONRGOTO1060 ,1070 ,1080 ,1090 ,1100 ,1110 ,1120 ,113

```

(continued on next page)

(continued from previous page)

```

1060 X=MX(I)-1:Y=MY(I)+1:GOTO1140
1070 Y=MY(I)+1:GOTO1140
1080 X=MX(I)+1:Y=MY(I)+1:GOTO1140
1090 X=MX(I)-1:GOTO1140
1100 X=MX(I)+1:GOTO1140
1110 X=MX(I)-1:Y=MY(I)-1:GOTO1140
1120 Y=MY(I)-1:GOTO1140
1130 X=MX(I)+1:Y=MY(I)-1
1140 IFX<1ORX>39ORY<1ORY>19THEN1280
1150 GOSUB1350 :IFPEEK(R1)◇32ANDPEEK(R1)◇147THEN1280
1160 IFPEEK(R1)=147THEN1290
1170 PRINT"§";LEFT$(AC$,MX(I));LEFT$(DN$,MY(I));" "
1180 PRINT"§";LEFT$(AC$,X);LEFT$(DN$,Y);"§";RIGHT$(STR$(I),1);"§"
1190 MX(I)=X:MY(I)=Y
1200 NEXT
1210 NEXT:RETURN
1220 PRINT"§§SUPERTANK'S FIREPOWER",SF;"§§ ENGINES",SM;"§§ " :RETURN
1230 FORK=1TO1500:NEXT:RETURN
1240 PRINT"§";LEFT$(DN$,20);" FORK=1TO199 PRINT" " :NEXT
1250 PRINT"§";LEFT$(DN$,20);:RETURN
1260 GETR$:IFR$=""THEN1260
1270 RETURN
1280 GOSUB1240 :PRINT"ILLEGAL MOVE! FORFEIT TURN":J=3:GOSUB1230 :GOTO1200
1290 GOSUB1240 :PRINT"RAMMING SUPERTANK"
1300 H=INT((10+MM(I)+MF(I))*RND(1)+5):SM=SM-H:IFSM<0THENSM=0
1310 PRINT"YOU'VE DESTROYED";H;" ENGINES":GOSUB1230 :GOSUB1220
1320 PRINT"§";LEFT$(AC$,MX(I));LEFT$(DN$,MY(I));" "
1330 IFSM<10ANDSF=0THEN1540
1340 MM(I)=0:MF(I)=0:N=N-1:J=3:GOTO1200
1350 R1=32768+X+40*Y:RETURN
1360 I=PEEK(R1)-176:IFI=0THENI=10
1370 H=INT(RND(1)*(10+MM(I)+MF(I))+5):SM=SM-H:IFSM<0THENSM=0
1380 GOSUB1240 :PRINT"SUPERTANK RAMS MOBILE #";I
1390 PRINT"LOSING";H;" ENGINES":GOSUB1230 :GOSUB1220
1400 IFSM<10ANDSF=0THEN1540
1410 MM(I)=0:MF(I)=0:N=N-1:IFSM<10THENGOSUB1500 :L=3
1420 RETURN
1430 PRINTH;"HITS ON MISSILE LAUNCHERS-NOW":RETURN
1440 PRINTH;"HITS ON ENGINES-NOW":RETURN
1450 PRINT"NO HITS SCORED":RETURN
1460 GOSUB1240 :PRINT"MOBILE #";I;"DESTROYED":N=N-1
1470 PRINT"§";LEFT$(AC$,MX(I));LEFT$(DN$,MY(I));" " :RETURN
1480 GOSUB1240 :PRINT"ARTILLERY #";I;"DESTROYED":N=N-1
1490 PRINT"§";LEFT$(AC$,AX(I));LEFT$(DN$,AY(I));" " :RETURN
1500 GOSUB1240 :PRINT"SUPERTANK CANNOT MOVE"
1510 PRINT"NOW YOU MUST DISARM IT TO WIN":T=2:GOSUB1230 :RETURN
1520 R1=0:FORK=1TOMH:IFMM(K)>4THENR1=R1+1
1530 NEXT:RETURN
1540 PRINT"§§CONGRATULATIONS !! YOU HAVE BEATEN SUPERTANK":END
1550 PRINT"§§SORRY!! YOU HAVE FAILED TO PREVENT A":PRINT"§§NUCLEAR HOLOCAUST"
1560 PRINT"§"
1570 PRINT"
1580 PRINT"
1590 PRINT"
1600 PRINT"
1610 PRINT"
1620 PRINT"
1630 PRINT"
1640 PRINT"
1650 PRINT"
1660 PRINT"
1670 PRINT"
1680 PRINT"
1690 PRINT"§
1700 PRINT"§
1710 PRINT"

```

READY.

# Why get your PET from HSV

Because HSV are an established and expanding computing services company in operation since 1973, covering the mid-south area. We offer a full bureau service and microcomputers backed by systems advice, after-sales support, maintenance.

Our interest does not stop at the sale of a PET - HSV assure full back-up support:-

- in-house analysts and programmers
- our own engineers operating from 2 service centres
- a range of specialist systems for business, industry and education
- instruction manuals, programme cassettes,
- add-on equipment and all other supplies
- ACT Series 800 and ADDS System 75 microcomputers.

## That's why!

HSV Limited, 22 Southampton Street, Southampton, Hants. Tel. (0703) 22131, and May Place, Basingstoke, Hants. Tel. (0256) 62444.

# HSV

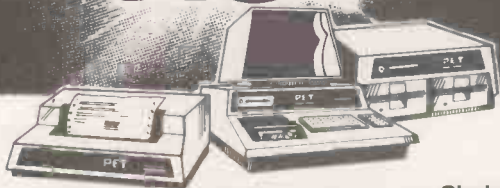

• Circle No. 176

# Now! Typewriter Quality Printing

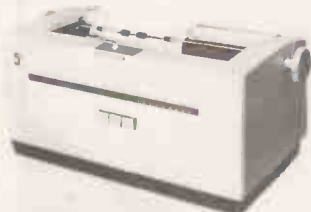

on your microcomputer for  
**£ 960** +VAT  
or Easy Terms

The CPS 3982 is a fully re-conditioned IBM 3982 'golf ball' printer with special CPS electronics designed for use with your microcomputer.

90 day warranty and nationwide maintenance service agreement available.

### Features

- Interchangeable golf ball print head (mathematical font available)
- 132 print positions
- Serial port 110 Baud via 25 way 'D' socket (RS 232 type)

### Options:-

- Pin feed platen
- PET IEEE interface
- APPLE Serial interface card

For more information and easy terms facilities  
phone 021-707 3866 Telex 312280 CPS G



## CPS (DATA SYSTEMS) LTD

Arden House, 1102 Warwick Road, Acocks Green, Birmingham B27 6BH

CPS are PET and APPLE Dealers

• Circle No. 177

## SOFTY Software Development System AND EPROM PROGRAMMER

EX-STOCK

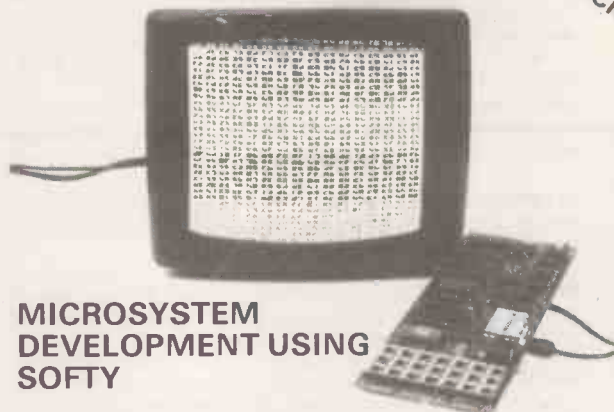

### MICROSYSTEM DEVELOPMENT USING SOFTY

SOFTY is intended for the development of programs which will eventually become software residing in ROM and forming part of a microsystem. During the development stage of a microsystem, SOFTY will be connected in place of the firmware ROM via a ribbon cable, terminated in a 24 pin DIL plug.

Data may be entered into the SOFTY RAM via the serial port, parallel port, direct memory access, or the keypad, and manipulated using the assembler key-functions. When the program has been entered, and the internal microprocessor can be 'turned off', and the external microsystem and it's resident microprocessor allowed to access and run the program in SOFTY's RAM and/or programming socket. In this way, modification can be made until the required program is complete - the contents of the RAM being clearly visible as a 'page' on TV or monitor. 4 pages are available, 2 of the Data RAM and 2 of the programming socket.

In the end, when the program is complete and working, the DIL plus is removed and replaced by an EPROM device programmed by SOFTY. SOFTY is able to program the 2704/2708/2716 family which have 3 voltage rails -

To help in the process of program development SOFTY has various assembler key-functions, which include - block shift without overwriting, block store, cursor control, match byte and displacement calculations (for jumps etc). A high speed cassette interface is also provided for storing working programs and useful subroutines.

SOFTY Kit-of-parts: (including zero insertion force socket for EPROM programmer) Price £115 (inc VAT, p&p). SOFTY built and tested - £138:00 (inc VAT, p&p). Built SOFTY power supply - £23:00 (inc VAT, p&p). Write or telephone for full details.

NEW

**SOFTY CONVERSION CARD** - EX-STOCK  
Enables SOFTY to program the single rail EPROMs 2508, 2758, 2516, (INTEL 2716), 2532.  
Selection of device type and 1K block are by 4 way pcb slide switches.  
Programming socket is zero insertion force. Supplied ready built & tested with Dip jumper for connection to SOFTY. £46:00 (inc VAT, p&p).

NEW

**SOFTY PRINTER CARD** - EX-STOCK  
● 40 column electrosensitive printer ● 5 x 7 dot matrix  
● software selection of characters per line (1 to 16 bytes)  
● push button printing of EPROM/RAM/Intercursor contents  
● Connects to SOFTY card edge ● Well documented ● Supplied ready built & tested, including power supply, edge connector & paper roll for £166:75 (inc VAT, p&p) Spare paper rolls (28-30metres/roll). Four rolls for £8.00 (inc VAT, p&p).

## MODEL 14 EPROM ERASERS

EX-STOCK



### MODEL UV 141 EPROM ERASER

- Fast erase times (typically 20 minutes for 2708 EPROM)
- 14 EPROM capacity
- Built-in 5 to 20 minute timer to cater for all EPROMs
- Safety interlocked to prevent eye and skin damage
- Convenient slide-tray loading of devices
- 'MAINS' and 'ERASE' indicators
- Rugged construction
- Priced at only £89.70 (inc VAT, p&p)

### MODEL UV 140 EPROM ERASER

Similar to Model UV141 but without timer

Low price at only £70.73 (inc VAT, p&p)

WRITE OR TELEPHONE FOR FULL DETAILS OR SEND CHEQUES/OFFICIAL COMPANY ORDERS TO:

## GP Industrial Electronics Limited

Skardon Works, Skardon Place, North Hill, Plymouth  
PL4 8HA. Telephone: Plymouth (0752) 28627  
TRADE AND EXPORT ENQUIRIES WELCOME

• Circle No. 178

# PETAID

## EVERY PET SHOULD HAVE ONE!



### SPECIAL OFFER JULY & AUGUST

From 15th July - 31st August.

ALL Stage One Software Products can be purchased DIRECT from Stage One Software at list price **LESS 25% + VAT.**

Please send C.W.O. payable to Stage One Software.

LAST DATE: 31st AUGUST

**NO** orders processed after that date.

Stage One Software, 6 Criterion Arcade,  
Old Christchurch Road, BOURNEMOUTH, Dorset.  
Tel: 0202 23570 or 295395

### PETAID

### EVERY PET SHOULD HAVE ONE!

**PURPOSE:** Provides the complete basic structure for file and screen creation and subsequent Insert, Amend, Delete, Display, Search and Print.

**BENEFITS:** Simple commands, no need for programming knowledge. Create your own screen and file layouts. Files up in hours. Highly structured in Basic. Simple appendment of further basic code for maths and specialised prints, well documented to allow the user to modify the program. Standard variables used, can halve the time for systems development. Common structure for ease of subsequent support. A very powerful STAND ALONE file create and retrieval system. The create file program can be used many times for various files. Further compatible utilities to be available.

**VERSIONS AVAILABLE:** Tape Files £52.95, Sequential Disk £150.65, Random Access Commodore Disk and Computhink 400K £208.15, Computhink 800K £231.15, Indexed Access Method Commodore Disk (Alpha Key Field) £288.65, Extract & Sort on Random Access or IAM Files £87.40.

All prices include V.A.T., Package and Postage.

**PRINTERS SUPPORTED:** Commodore, Anadex, Qume, Teletype 43.

**FEATURES.** The user may:

Define their own screen and file formats. Multiple disks per file. Very powerful search routine on any field and any content. Up to 50 separate search criteria or multiple simultaneous searches. Unlimited number of fields per record. PETAID programs within same Version are compatible with all PETAID created files of that version. Tape to Disk conversion utility as an extra.

### PACKAGES: ALL PACKAGES REQUIRE: 32K PET, COMMODORE DISK & PRINTER

**INCOMPLETE RECORD SYSTEM** PETAID Based Provides user specified Account Numbers, Titles and Final Account formats. Common input for new or carry forward clients. Up to 2300 Nominal Account Numbers. Unlimited transactions.  
Incomplete £862.50 Final Accounts £402.50

**BANK & RECONCILIATION** PETAID Based Bank Accounting System, automatic facility for standing orders and direct debits. Reminder for charges and interest. 2000 Transactions per Bank Account. £115

**ESTATE AGENTS PACKAGE** PETAID Based Property and Applicants registers for speedy selection of properties or Applicants. 325 Applicants or Properties per disk. £267.50

**MAILING SYSTEM** PETAID Based A complete Mailing Suite, labels, lists, multiple labels. Labels selective based on interest groups, etc. £115

**BOND & PENSION CALCULATIONS** Allows the Broker or Agent to use the PET as a selling AID to Demonstrate Bond & Pension and Insurance Quotations. £115

**QUOTE PROCESSOR** PETAID Based Word Processor in Basic with Mathematics for wordy and complex quotation production. 150 Paragraphs of 10 lines each with price field per line. £138

**GENERAL ACCOUNTING PACKAGE** PETAID Based Open item Sales, Purchase, Nominal, Rechargeable Costs, error and status checking (back up forced). One posting routine for all transactions. 4000 Accounts and 18400 live transactions. £690

### OTHER PROGRAMS

STOCK £115. BLDCK CDPY (Bad Blocks Dmitted) £28.75. DIARY PLANNER £115. DOUBLE PRECISION MATHS (M/C Code) £57.50.

### SOFTWARE SUPPORT SYSTEM

Stage One Software offers a special support and reporting system to enable the users of our Software to get the very best support and advice on how to gain maximum benefit from our packages. Enquiries

will be actioned promptly to provide a first class service which has so far been lacking in the Micro-computer industry.

Adde Computers  
LONDON W5 2NH  
Tel: 01 579 5845

Catlands Computers Ltd  
CHESHIRE  
Tel: 0625 527255

Metyclean Ltd  
LONDON SW1E 5JL  
Tel: 01 828 2511

Sheffield Computer Centre  
SHEFFIELD  
Tel: 0742 53519

R Ward & Son  
GATESHEAD, Tyne & Wear  
Tel: 0632 605915

Advanced Management Systems Ltd  
LONDON EC2Y 9AA  
Tel: 01 638 9319  
01 608 4975

D A M s Office Equipment Ltd  
LIVERPOOL  
Tel: 051 227 3301

Microware Computers Ltd  
HULL HU4 6SB  
Tel: 0482 5627107

Slough Microshop  
SLOUGH  
Tel: 0753 72470

Walters Computers Systems Ltd  
STOURBRIDGE, W Midlands  
Tel: 0562 885937

Alpha Business Systems  
HERTFORD  
Tel: 0992 57423

G M Marketing  
ANDOVER, Hants  
Tel: 026 471 410

Milequip Ltd  
GLOUCESTERSHIRE  
Tel: 059 451 624

Software Development Services Ltd  
DUBLIN 4  
Tel: Dublin 685755

Microcomputers Ltd  
KENDAL, Cumbria  
Tel: 096 82 4101

Amplikon Micro Systems Ltd  
BRIGHTON  
Tel: 0273 562613

JAD Integrated Services Ltd  
PLYMOUTH  
Tel: 0752 62816

MMS  
BEDFORD  
Tel: 0234 40602

Tekdata  
STOKE ON TRENT ST6 4PA  
Tel: 0782 813831

T & V Johnson (Microcomputers)  
CAMBERLEY, Surrey  
Tel: 0276 62506

Business Electronics  
SOUTHAMPTON  
Tel: 0703 738248

Jeffrey Martin Computer Services Ltd  
NEWQUAY  
Tel: 063 73 2863

RPL Microsystems  
DOUGLAS, I.O.M  
Tel: 0624 4247

Thistle Computers  
ORKNEY KW15 1HQ  
Tel: 0856 3140

Computer Services Midlands Ltd  
BIRMINGHAM B23 6DX  
Tel: 021 382 4171

Maiard Services (Fylde) Ltd  
POULTON LE FYLDE, Lancs  
Tel: 0253 823854

RUF Computers (UK) Ltd  
BURGESS HILL, Sussex  
Tel: 04446 45211

**\*SPECIAL OFFER\*  
JULY - AUGUST  
SEE ABOVE**



**MAIL ORDER** Written orders with cheque or Access/Visa No. to:

**STAGE ONE SOFTWARE** 6 Criterion Arcade, Old Christchurch Road,  
Bournemouth. 23570



Please supply: ITEM ..... QUANTITY .....

AMOUNT £ ..... CHEQUE NO. ....

Name .....

Address ..... ACCESS/VISA NO. ....

PC8

• Circle No. 179

PRACTICAL COMPUTING August 1980

# Prospecting for new materials with microprocessor-control

A Research Machines 380-Z is being used by the Solid State Ionics Unit at the Royal School of Mines in London to help evaluate new materials for industrial applications. Martin Hayman meets the men responsible for the establishment of the project and reports on its progress.

DAN WATERS of the Royal School of Mines, London, saw the writing on the wall when a U.S. visitor examined the researches in which he and his department, headed by Dr Brian Steele, had been engaged for several years.

## Steel fabrication

Dr Steele is a reader in materials science at the Solid State Ionics Unit and had been investigating new materials for industrial applications, notably for steel fabrication processes and for new, lightweight batteries; Dan Waters is something of a micro buff.

Much of the experimental work was laborious and tedious — it was necessary to determine empirically the impedances of materials under analysis at various

temperatures, throughout the frequency range.

At first, it had mostly been a case of stopwatch and note pad, but the U.S. visitor, seeing the experiment was on the right track but hopelessly slow at producing results, returned home, set-up the same experiment with microprocessor-control and data logging and within a few weeks had run the whole investigation.

## Beneficial warning

It was a salutary warning. Research budgets at universities are not on the increase; productivity is beginning to be invoked. Yet it is still possible to secure cash for capital investments and a change to microprocessor-control would free staff for more productive work.

In the first place, a more sophisticated data logger was required, one which could be programmed with a frequency sweep over a predetermined number of steps and would record the results in a rapidly-assimilable form. Such a machine is the Solartron 1170 FR, though its application in this instance is novel.

## Stress tester

Designed and used originally as a stress tester for airframes, it was used widely on the development of the Concorde. The airframe would be twisted in a simulation of all possible foreseen conditions of flight and the strain measured by sensors at selected points. The Solartron plotted the stress, x axis, against strain, y axis, and

*(continued on next page)*

Nicky Bonanos and Dan Waters. Bonanos helped Waters develop the program for the 380-Z. On the screen is a frequency analysis plot of a sample of zirconium.



(continued from previous page)

would display the resulting graph on an oscilloscope.

By a neat transformation, Dr Steele used the machine to plot voltage (x) input to the material — in this case various samples of zirconia — against the resistance (y) to yield values for the impedance. Mostly, at this stage, the unit was content to photograph the oscilloscope read-out and work by intuition. The shape of the curve was to trained eyes an indication of the usefulness of the particular sample for the purpose intended.

The purpose was at that time to develop a new form of oxygen probe for the smelting industry and, perhaps, for internal combustion engines. The oxygen probe may seem a marginal device, but in steel making it is vital to measure the presence of oxygen in the smelted metal, and to a lesser extent to monitor emissions from chimneys in all industries.

### Measurement problems

That is difficult to measure by chemical means at the high temperatures involved and the traditional ceramic-type probe has a short life expectancy. Hence, it may be seen, the U.S. visitor's interest in the experiment and doubtless his surprise that the results were being photographed from the oscilloscope rather than logged and processed by a micro.

The next development, then was to interface the Solartron with an intelligent, or at least smarter, logger. Dan Waters

was able to obtain two Research Machines 380-Zs and "lashed them together" with two Z-80 P10 chips — an intriguing piece of do-it-yourself which was not essential since both Solartron and, of course, Research Machines have suitable interfaces.

### Time saving

The first notable effect of using the micro as a controller was the time saving. It is a platitude that the micro does not in itself increase output; it maximises the use of existing installations or, in this case, staff.

Where the micro can now process a complete run in half an hour, staff would previously have dedicated about two days' work with the stopwatch "if nothing went wrong".

It also combatted a further problem of semi-automation. As an early time-saving experiment, Dan Waters had constructed a small process controller which logged and printed out impedance results but in this case, continuous running simply provided more data than could be handled. Simply, the mind boggled at the prospect of deciphering and interpreting a continuous and smudgy print-out on a paper reel.

With the micro, all the experiments can be compared directly on the same basis, whether done yesterday or six months previously. In effect, it has freed research students to concentrate on deriving meaning from the results rather than

spending hours simply logging them.

The work at the department is still expanding and three more 380-Zs are on order. The reason for continuing with the 380-Z is that the principal applications for the machine are controlling the experiments and logging and processing data; plenty of memory is required, but no more VDUs.

Waters did consider the Pet but decided against it because of the need for IEEE interfaces to the Solartron and is now wondering whether he might have done well to wait for the Winchester hard disc or double-sided 8in. discs instead of the standard 5¼in. drives.

### New avenues

In the meantime, a new avenue of approach presents itself — batteries. That has been a secondary activity but with giants like Exxon and Varta seriously looking to invest in new battery technology, there would appear to be plenty of mileage in research directed towards assessing the materials required to produce a battery reliable enough to charge and discharge several hundred times.

On a giant scale the materials might be required to act as a buffer for electrical power stations, hence reducing the need for installed capacity. With the EEC, the Science Research Council, Chloride and NATO all putting in a stake, this area of materials research certainly needed to be dragged into the micro era. □

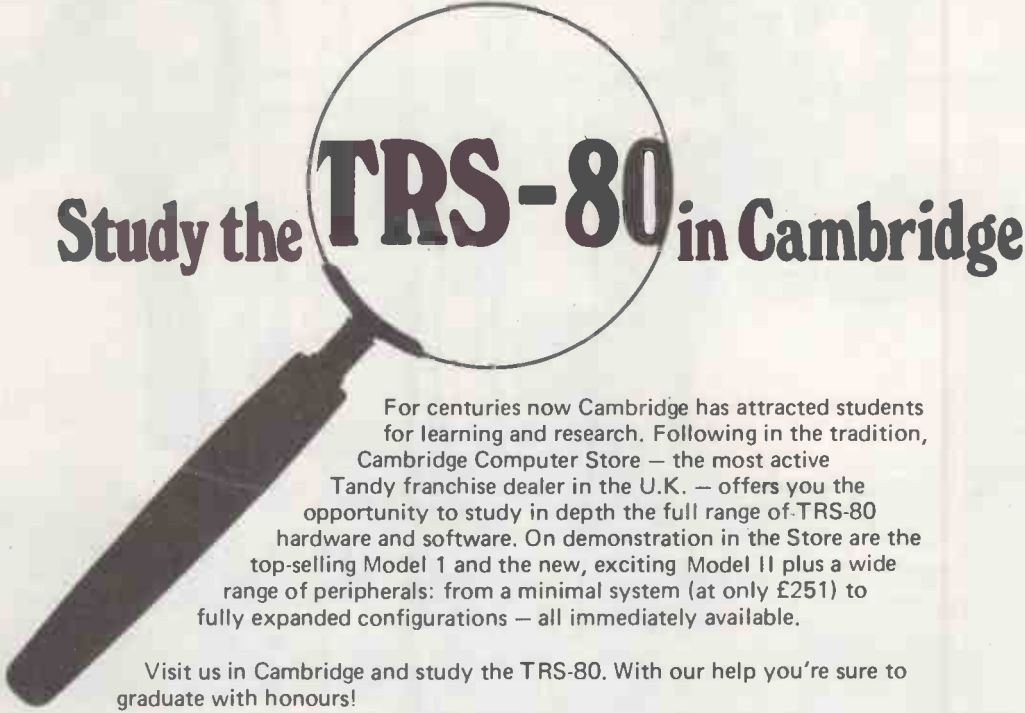

## Study the TRS-80 in Cambridge

For centuries now Cambridge has attracted students for learning and research. Following in the tradition, Cambridge Computer Store — the most active Tandy franchise dealer in the U.K. — offers you the opportunity to study in depth the full range of TRS-80 hardware and software. On demonstration in the Store are the top-selling Model 1 and the new, exciting Model II plus a wide range of peripherals: from a minimal system (at only £251) to fully expanded configurations — all immediately available.

Visit us in Cambridge and study the TRS-80. With our help you're sure to graduate with honours!

### Cambridge Computer Store

1 Emmanuel Street Cambridge CB1 1NE  
Telephone: (0223) 65334/68155

Apple : Cromemco : Hewlett-Packard : Horizon : Pet : Acorn : CompuKit : Sinclair : Houston : Infoton : Centronics : Qume : Word-Star

• Circle No. 180

PRACTICAL COMPUTING August 1980

• Circle No. 181 ►



*"As manager of Personal Computers, here at Computerland of San Francisco, evaluating new software products is part of my job. With all the word processors on the market today, I choose EasyWriter for my business and personal use."*

*—Karen Dexter Weiss*

# EasyWriter<sup>T.M.</sup>

## 80 COLUMNS OF WORD PROCESSING POWER FOR YOUR APPLE II COMPUTER

Finally . . . INFORMATION UNLIMITED SOFTWARE is able to bring you a complete word processing system for the Apple II. The new EasyWriter system gives you **80 columns of upper and lower case characters** for your Apple's video display, using the new SUP'R'TERM 1 board!



You can purchase the new EasyWriter 80 column word processing system from your nearest S.I. Dealer or directly from us

**Systematics International Ltd**  
Essex House, Cherrydown,  
Basildon, Essex  
(0268) 284601

A long time ago, we decided to bring you the best simple-to-use and understand tools for your computer system. Today we've taken another stride in that same direction. It took some doing, in both hardware and software, but we think you'll agree that for the buck, no one can touch us.

Check it out:

- 80 Columns on the Screen!
- Upper & Lower Case!
- Global Search & Replace!
- Underlining!
- Bidirectional Printing!
- Incremental Spacing!
- File Appending!
- 50 Pages of Text Per Disk!



Sole UK Distributors

- EasyWriter is a TM of Cap'n Software, Inc.
- Apple II is a TM of Apple Computers, Inc.

Newbury VDUs from £372 (SAVE c£75!) DEC  
 64K Memory Modules from £760 (SAVE  
 c£140!) LSI-11 Components and Options 15%  
 off (SAVE £££s!) DRV-11 Equivalent £120  
 (SAVE c£15!) Transdata Acoustic Couplers  
 from £166 (SAVE c£19!) North Star Horizon  
 Memory Modules £230 (SAVE c£30!) 25% off  
 Selected Conferences (SAVE £££s!)  
 Centronics Printers from £405 (SAVE c£45!)  
 Cole Terminal Desks from £78 (SAVE c£20!)  
 Diablo Printers from 12.5% off (SAVE £££s!)  
 Discounts being negotiated for Travel, Tickets,  
 Publications, Finance ... (SAVE YOUR  
 SUBSCRIPTION TO COMPUTERCLUB!)

**JOIN  
 NOW - FOR  
 A FREE ENTRY IN  
 COMPUTERCLUB'S  
 WIN-A-PET  
 COMPETITION**

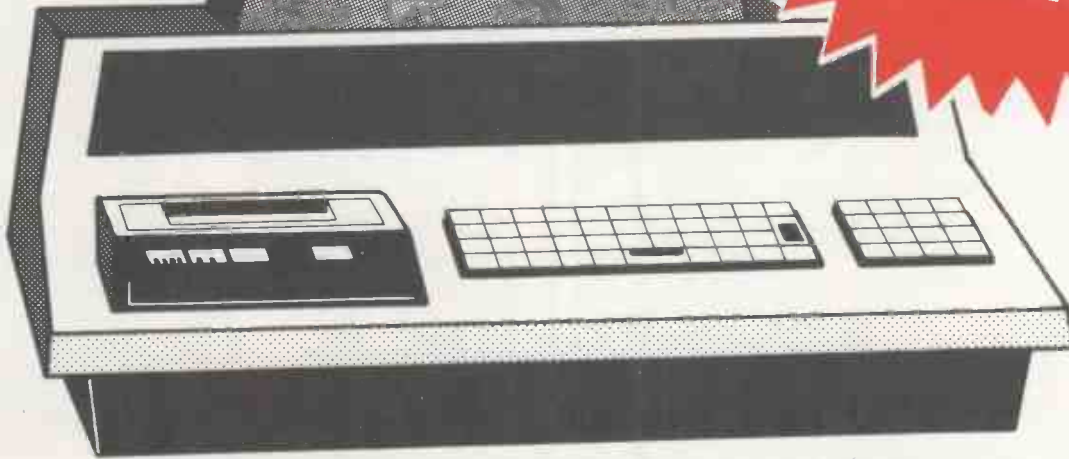

**YOU ARE ONE OF THE 'NOW'  
 COMPUTERPEOPLE-AREN'T YOU? JOIN**

# COMPUTERCLUB

## AND GET SOME REAL VALUE FOR YOUR MONEY (SEE SUMMER SPECIAL OFFER)

\*Discounts on Micros, Components, VDUs, Printers (already includes products from manufacturers such as DEC, North Star, Newbury Laboratories ... and more soon).

\*Discounts on Conferences, Seminars, Education Programmes, Publications ... International Travel offers to leading overseas events.

\*Newsletter with details of the above, Exhibition Tickets, Jobs, For Sale, Wanted, Swaps, Tips, User Groups ... and News of Interest to YOU.

Subscription saving discounts now available on systems, software, components and peripherals for **PET, SHARP, ITT, ACT, RICOH, OKI, EPSON, ANADEX, NASCOM, COMPUKIT, SUPER BRAIN** ... and lots more soon.

To COMPUTERCLUB,  
 42 Great Windmill Street, London W1V 7PA

Please enrol me as a Member of Computerclub before 31st August 1980 so that I can:

1. Take advantage of the 'Summer' Subscription that represents a *saving of £5.75* over the rate thereafter. And
2. So that my name will be included in the FREE Win-a-Pet Draw taking place on 1st September 1980.

I enclose a Cheque/Postal Order made payable to COMPUTERCLUB for £7.50 (£6.52 + 15% VAT - an official VAT receipt will be sent with your Membership Card).

Send me further details of Membership at £13.25 in the enclosed stamped addressed envelope.

Name \_\_\_\_\_

Address \_\_\_\_\_  
 \_\_\_\_\_  
 \_\_\_\_\_

Signed \_\_\_\_\_ Date \_\_\_\_\_

\*This offer applies to UK residents only.  
 Overseas subscription is £20.

PC8

• Circle No. 163

PRACTICAL COMPUTING August 1980



We are now entering our fourth financial year of dealing solely in the personal computer market — in fact, we started it! Over this period, Personal Computers Limited have formed a group of graduate specialists who will help you in the fields of word processing, financial planning, statistics, economic modelling, forecasting, accounting systems, foreign exchange, banking and oil exploration.

We also do rather well with computer graphics and highly recommend the graphics tablets and our plotter for Apple.

We can also offer two excellent items of software — **Format 40** and **Visicalc** — at a combined price of **ONLY £189**, and the **Super Sound Generator** for only **£90!** (excl. V.A.T.)



**8" Disk Drive (above left)**

Our 8" disks are still as popular as ever — 2 drives give you 1.2MB with all the reliable security of Shugart Technology. Easily interfaced to Apple, uses the same D.O.S.

**A.I.O. Serial and Parallel Card (above centre)**

Three hand-shake lines (R.T.S., C.T.S. and D.C.D.). Firmware for serial interfaces on-board, software for parallel printer available, 2 bi-directional 8 bit parallel ports, plus 4 additional interrupt and hand-shaking lines.

**Light Pen (above right)**

A much sought after product which we introduced to the U.K.

**80 Character Card (below left)**

... opens up the real commercial world for all Apple owners.

**Paper Tiger (Below centre)**

132 character line, plus graphics, 8 character sizes, ordinary paper, multiple copy, upper and lower case 96 character, parallel/serial, form control.

**Centronics 730 (Below right)**

A substantial, robust printer from a major manufacturer. 3 way paper handling system, 100 character per second. Special low-cost including interface. 96 characters.



**Items pictured**

**Sharp MZ — 80K**

A new generation of personal computer, self contained, versatile and starting at only £570 (excl. VAT). Explore the Zilog Z80 now the easy way. Disks and printer available shortly.

**Numeric Keypad**

... with 8 function keys is a must in all financial applications.

**TCM 100 & TCM 200**

... both now have graphics as well as their own power supply, essential with this type of printer.

**Qume Sprint 5**

The quality word processing printer. Clean, clear executive reports the way you want them. Can print up to 5760 points per square inch — or even print in 2 colours.

# This is what we do..

## and we do it rather well!



Personal Computers Limited

194-200 Bishopsgate, London EC2M 4NR. Tel. 01 626 8121

For further information, please complete this coupon and post to:  
 Personal Computers Limited, 194-200 Bishopsgate, London EC2M 4NR.  
 NAME \_\_\_\_\_ ADDRESS \_\_\_\_\_  
 \* Now here details for **APPLE III** <sup>105</sup> <sub>PC8</sub>

# THERE'S A WORLD OF DIFFERENCE In Business Software!

## Get the most out of your microcomputer Graham-Dorian's Integrated, On-Line Programs Are Fast, Efficient, And Easy To Use.

At any given time, your hardware is only as useful as the software you run in it. Our programs let you realize the full potential of your hardware.

Graham-Dorian provides highly detailed and well documented programs. All pre-tested on the job. Each so comprehensive that it takes little time to learn to run a program — even for someone who's never operated a computer before.

Graham-Dorian programs are on-line now working for us and others around the world. They are ready to go to work immediately or to be tailored for your more specific needs. Each package contains a software program in BAS and INT file form plus a user's manual and hard copy SOURCE LISTING.

Programs are compatible with most major computers using CP/M disk operating systems, and come in standard 8" or on various mini-floppy disks.

Graham-Dorian stand behind dealers with technical advice.

Yes, there's a world of difference in business software. Graham-Dorian has more per-package capabilities and more packages (with new ones added every few months).

### The Graham-Dorian line now includes these packages

- Nominal Ledger
- Purchase Ledger
- Sales Ledger
- Job Costing
- Order Entry & Invoicing
- Payroll
- Manufacturing Inventory
- Manufacturing Job Costing
- Wholesaler Inventory
- Retailer Inventory
- Cash Register
- Apartment
- Surveying
- Dental

CBASIC-2

Ask your dealer+ for a demonstration soon.



+ GDSS are appointing UK Dealers and European Distributors. Enquiries and applications invited.

\* CBASIC-2 is a trade mark (copyright 1980) of Compiler Systems, Inc. GDSS are the European Distributor for CBASIC-2.

**Graham-Dorian Software Systems**  
17 The Gallop, Yateley  
Camberley, Surrey.  
Tel: (0252) 874790 (0344) 51160.

# Practical Computing Back Issues

Each month, *Practical Computing* carries at least one hands-on test of a popular microcomputer for use in business, the home, schools and colleges. Each issue contains the kind of information you need — technical data and for the intelligent professional layman, unbiased critical comment on the strengths and weaknesses of each system or service reviewed.

All this makes *Practical Computing* an invaluable source of whys, wherefores, hows, ifs and buts of microcomputing.

Order your back issues now, by simply filling in our Back Numbers order form bound in every issue.

**October 1978 \***  
**Review 1:** Commodore Pet | **Review 2:** VDUs — Computer Workshop Ct-64, Strumtech Engineering ACT-1. Music on a KIM; Micro v Calculator; VAT accounting complete program Part 1.

**November 1978 \***  
**Review:** Tandy TRS-80. Projects for KIM: Pet goes to school; VAT accounting complete program Part 2; Complete game program — Mastermind; Software Dynamics Basic compiler review.

**December 1978 \***  
**Review:** Research Machines 380Z. Choosing your first computer; IIT interview; Complete games programs — Battleships, Racing Cars and Monsters; A microcomputerised reservation system.

**January 1979**  
**Review:** Nascom I Convert an IBM typewriter into a terminal Part 1; In-car computing — Pet in the Panther DeVille; Report from the Los Angeles Computer Faire; Pascal v Basic.

**February 1979**  
**Reviews:** Cromemco Z-2D. Low-cost peripherals. Systems for estate agents and doctors; A £1000 payroll system; IBM typewriter conversion Part 2; Complete game program — Warlock Warren.

**March 1979**  
**Review:** Single-board computers for less than £50 Low-cost stock-control systems; IBM typewriter conversion Part 3; New monthly column — Tandy Forum; Complete game program — NIM.

**April 1979 \***  
**Review:** North Star Horizon Business accounting systems; Apple II design story Part 1; Computerised school meals; Finance for school computing; Build your own frequency meter; Star Trek game.

**May 1979**  
**Reviews:** Exady Sorcerer, Science of Cambridge Mk 14; Printers for less than £1000; Order processing/invoicing packages; Retire with your computer; Apple II design story Part 2; Slalom game.

**June 1979**  
**Reviews:** Wordpucol II, Ohio Superboard II; Low-cost word-processing; Computing in a pharmacy; Designing a small business application Part 1; Computer v. Brain: Zombie game.

**July 1979 \***  
**Reviews:** AIM-65, SOL-20. Choosing your first computer; Interfacing Pet with a mainframe; Nascom story; Designing a small business application Part 2; Biorhythms program.

**August 1979**  
**Reviews:** Pet II KIM, Pros and Cost of PASCAL Microcomputer user groups. Designing a small business application Part 3; Interfacing Pet with a mainframe Part 2; Life game program.

**September 1979**  
**Reviews:** Powerhouse 2, Acorn Anadex and Heathkit printers Artificial Intelligence. Build your own joystick. Computer scene in the North-West; Mathematics on a Pet; Self-teaching games program.

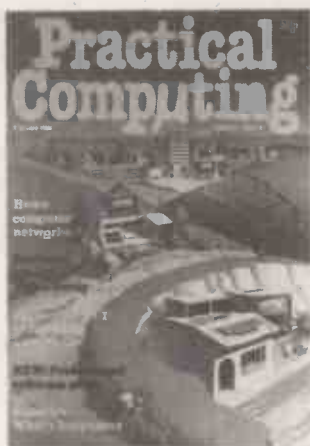

February 1979



June 1979



September 1979

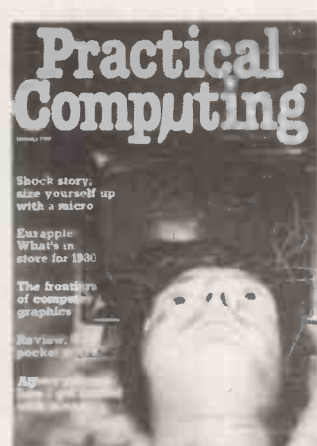

January 1980

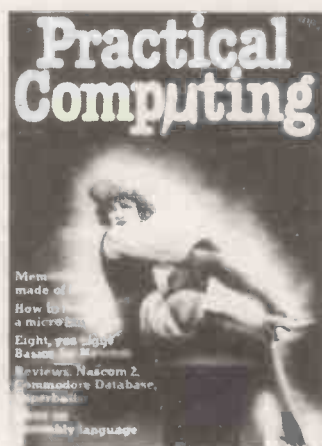

April 1980



July 1980

**October 1979**  
**Reviews:** Disc systems for the Apple II and Tandy; Build a music scoreboard; Instle Speak & Spell; Introduction to LISP; Inside Prestel.

**November 1979**  
**Reviews:** Rair Black Box and CS Text computer; Computers for the amateur; Learning programs and self-testing chip; Financial modeling.

**December 1979**  
**Reviews:** Transam Triton, Burroughs and IIT 2020. Corvus hard disk drive II. How to set up computer systems in schools. Tips for Sorcerer users. File handling techniques.

**January 1980**  
**Reviews:** Hewlett Packard HP-8C, TEL systems. Eurapple — What's in store for 1980. Computer graphics. Using a mouse to measure pain responses. Getting started with micros.

**February 1980 \***  
**Reviews:** Minimax. Add-on machine code chip for Pet. Video Genie; Personal computer networks; Multi computer electronics and miniaturisation; Blake 7, a simulated battle game; Model building for education; Robotics Part 1; Commodore printer; Micro in antique business; How to write better programs; High speed stepper motors and the Pet.

**March 1980**  
**Reviews:** Tandy TRS-80 model II, MBI System 7; Training schemes for programmers; Copyright Law and software; Computer date program; Sheer fun for Sorcerer; Pet; Robotics Part 2; The Game Master; three page celebration of games playing; Assembly language series part 1, machine code; Hardware Buyers' Guide.

**April 1980**  
**Reviews:** Nascom single-board Superbrain. Commodore database. Why PCs are made for this, latest technical news, data storage; How to raise cash for your own micro business; Eight Basics for Nascom; LA video link for London; Software Buyers' Guide.

**May 1980 \***  
**Reviews:** Z-Plus UK-101; Intelligent gambling, how the micro might forecast sports results; Videotex and the micro; Why good software is expensive; Cobol; Assembled language part 3; New monthly column — 6502 Special. COS for Apple II. Hardware Buyers' Guide.

**June 1980 \***  
**Reviews:** Panasonic JD-700U. VisiCalc. The electronic newsagent, newtrade applications; Latest developments in viewdata systems; Social services and micro applications; Electric motors as computer-controlled servo mechanisms; New monthly column — Sorcerer's Apprentice; COS for Apple II part 2. Software Buyers' Guide.

**July 1980**  
**Reviews:** Sharp PC-1211; Sinclair ZX-80; Payroll-200; Tuscan designer's story — Birth of a system, Part 1; Applications in medicine; The story of a modern service and his back room computer; Supertank, a war game; CPM explained; Cheap hard copy for Nascom 1; Hardware Buyers' Guide.

\* Limited Stocks

Fill in the coupon opposite and return it with your remittance to *Practical Computing*, General Sales Dept, Room CP34, Dorset House, Stamford Street, London SE1 9LU. Please note that back issues can be ordered only on the current order form.

# Byte and bit manipulation

This month, David Peckett widens the scope of his discussion of machine code to take in the more complex Z-80 and deals with the intricacies of byte and bit manipulation.

SO FAR, we've been looking at the 6502 and the roughly-comparable 8080A. The 6502, of course, is used widely in personal computers such as the Pet and Apple. On the other hand, although the 8080A is probably the most widely-used micro in the world, it isn't common in personal computers.

In the early part of the series, it was appropriate to look at the 8080A, since it

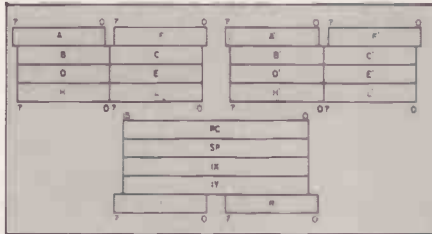

Figure 1a. Z-80 architecture.

shows an alternative approach to that taken by the 6502 designers. We are now at the stage of producing useful program segments, so I propose to change course slightly to look at the 8080A big cousin, the Zilog Z-80 — the micro used in computers such as the Nascom and the TRS-80.

As you will soon see, the Z-80 is much more complex than the 8080A, but has the significant ability to run 8080A machine code. However, it has a wide range of extra facilities which the 8080A does not begin to offer.

The Z-80 designers took the 8080A architecture as a starting point, and improved and extended it wherever they could. The result is a device with the configuration shown in figure 1a.

The first and most obvious difference is that it has two sets of working registers: A-L and A'-L'. The first set corresponds

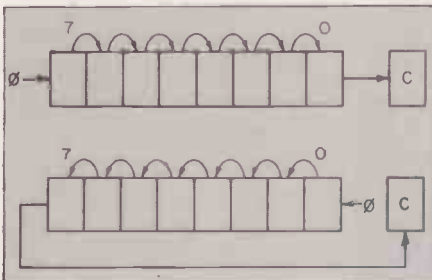

Figures 1b and 1c.

to the 8080A registers, and are effectively identical to them. The second set provides the same facilities as the first set and may be used as an alternative to it.

The micro can perform operations in either set of registers but, and this is important, cannot swap data between the two sets. For example, you cannot load B with the contents of L'. The chip has special instructions to select which set of registers it is to work in. The double set can make the Z-80 much faster than the

8080A in areas such as servicing interrupts.

The registers labelled F and F' are the flag registers and correspond to the 8080A PSW. The Z-80 has the same flags as the Intel micro, plus extra ones — figure 2b. The S, Z and C flags are identical to their counterparts in the 8080A; the H flag is the same as the 8080 "AC".

The flag labelled "P/V" is equivalent to the 8080A "P", but it is not just a parity flag. When set by a logical operation or a shift it behaves as a parity flag. However, when it is set by an arithmetic operation, including increment and decrement, it becomes an overflow flag, equivalent to the 6502 "V". It, thus, rectifies an important weakness of the 8080A. A few of the Z-80 special instructions use "P/V" as a "pseudo-Z" flag.

The "N" flag is an internal Z-80 flag, used during BCD arithmetic.

In figure 1a, PC and SP are identical to those in the 8080A. The IX and IY registers, however, are very useful additions. They are 16-bit index registers, and give the Z-80 a true indexing capability.

The final two registers are each eight-bits



Figure 2a. Arithmetic shift right.

long. "I" is the "Interrupt-page Address" register and is used in certain types of interrupt service routine. "R" is the "Memory-Refresh" register, which primarily controls dynamic RAM. It is not normally used in programs but is left to its own devices.

In programming the Z-80, the attraction is that it can use almost any 8080A machine-code program. One possible danger lies in the change from a "P" to a "P/V" flag. Nevertheless, it is very unlikely that an 8080A program would use the "P" flag in a way which would confuse the Z-80. Instruction timings are not always identical between the two micros, so that might cause problems with critically-timed programs.

The Z-80, however, has many more programming options than the 8080A. In particular, it has a much wider choice of addressing modes. It also has a useful group of instructions to perform such operations as block transfers, and searches for a character in a block of data.

To accommodate all the extra instructions, Z-80 operations can use up to four bytes. Either a two-byte instruction and a two-byte address, or a three-byte operation with a single byte of data. The

8080A-compatible instructions, of course, use the same opcodes as that micro.

The Z-80 assembly language is rather different from that for the 8080A. That



Figure 2b. Z-80 flag register.

might be confusing at first, but remember that the mnemonics are arbitrary labels for specific opcodes.

Z-80 mnemonics are more logical, and certainly more systematic, than those of the 8080A. They follow a rigid pattern of:



with all operations of a given type having the same mnemonic. For instance, all data transfers — register-register, immediate, to or from memory, etc. — are "LDS"s.

When 2 operands are needed, they are both shown:



As in the 8080A, data goes from op2 to op1.

The operands are well-chosen. Single registers are shown by their letters, e.g., B, D, and RPs are represented by a pair of letters, e.g., HL. References to memory, whether via a label, an RP or direct, are enclosed in brackets, and numeric labels or data are presented normally. One major difference is that "M" becomes "(HL)". Some 8080A/Z-80 equivalents are shown in table 1, and table 2 shows all the basic 8080A mnemonics we have met so far and their Z-80 counterparts.

From now on, I shall refer to the Z-80 rather than to the 8080A. However, I shall adhere to the 8080A-compatible instruc-

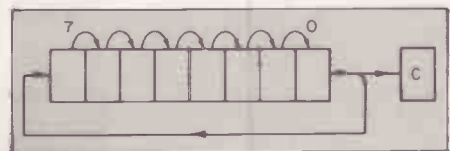

Figure 3a.

tions while I am comparing the 6502 and the Z-80.

At this stage, a few comments on specific Z-80 instruction may well be useful:

**DAA.** The 8080A "DAA" works properly only after addition; the instruction in the Z-80 works after subtraction as well.

**DJNZ.** This is a very useful instruction in loops. It decrements B, and makes a relative branch, not a jump, if the result is not zero. This speeds loops because:

```
DEC B
JP NZ, START ; END OF LOOP?
```

can be replaced with:

```
DJNZ START ;END OF LOOP?
```

So far in this series, we have looked at instructions which treat complete bytes of data as numbers or characters — they add and subtract them, load them and store them. That is reasonable enough — many micros are used as number-crunchers. However, it is not always the case.

For instance, we could be using the micro to control an external device, or to take-in and re-format data from, for example, a keyboard. In such cases, we must be able to manipulate individual bits in a byte.

At other times, we may need to change the position of a group of bits, while retaining their relationships, e.g., move bit 0-3 to become bits 2-5. This month, I'll describe the character- and bit-manipulation facilities which typical micros offer.

We often need to move complete groups of bits sideways, either to the right

8080A	Z-80
ADD M	ADD A,(HL)
JMP FINISH	JP FINISH
JNZ LOOP	JP NZ,LOOP
LDA \$BEEF	LD A,(\$BEEF)
LXI H,COUNT	LD HL,COUNT
MOV B,M	LD B,(HL)
MVI A,37	LD A,37
SHLD DATA	LD (DATA),HL
SUB C	SUB C
STAX B	LD (BC),A

Table 1. Typical 8080A and Z-80 instructions compared.

or the left, for a given number of bits. One reason for doing so is to shift a series of single bits into a position where we can read them, for instance, to test the status of a number of input lines.

Alternatively, we often use shifts during arithmetic, both during multi-byte operations and as a form of multiplication. Sometimes, after an operation has put bits into the lower nybble of a byte, they must be moved into the upper nybble to make room for more data.

Large computers often have powerful shift instructions, capable of moving, say, 64 bits through "n" positions with a single operation. In a micro, however, we must be satisfied with much more limited instructions. We can normally only move a single byte through one bit at a time. The range of possible shifts is often limited as well.

Let us look first at what might be possible and then at what we possess. Shifts fall into two main types — simple shifts and "rotates".

**Simple shifts.** If we want to move a byte sideways, we can use a simple shift. The

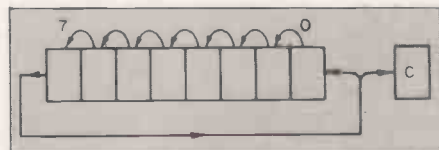

Figure 3b. operation will move the byte one bit to the right or left, and put the bit which falls-off into the carry.

What happens to the bit at the other end depends on the type of shift. In a

logical shift, the value of the bit in the hole is set to zero. Figures 1b and 1c show logical shifts to the right and left respectively.

The alternative is an arithmetic shift, in which an MSB hole is kept at its previous value, and an LSB hole is set to zero. It is particularly important in right shifts, where it means that the sign of the byte is retained. Figure 2a shows an arithmetic right shift. An arithmetic shift to the left is the same as a logical left shift — the former term is more often used because of the multiplication property of a left shift.

Simple shifts can be used to re-position a group of bits within a byte. They can also be used to read some or all of the bits in a byte, by shifting them into the carry where they can be tested.

**Rotations.** A rotation is exactly what the name implies. As in a simple shift, the byte is shifted one place so that a bit at one end falls from the word — normally, that bit is stored as the carry. Depending on the type of rotate, the hole which forms at the other end is filled with either what fell-off — eight-bit rotation — or with what was previously in the carry — nine-bit rotation.

The rotation could take place either to the right, i.e., the LSB falls out, or to the left, when the MSB falls out. Figures 3a and 3b show eight-bit right and left rotation, and figures 4a and 4b show nine-bit right and left rotations.

When are the two used? If, for instance, we want to test the status of each bit in a word, and leave it unchanged, we could do it with eight, eight-bit rotates. Following each rotate, the carry flag would show the status of the shifted bit, and appropriate action could be taken. After eight rotates, the word would be back where it started.

On the other hand, we may have four bytes representing a single 32-bit word to

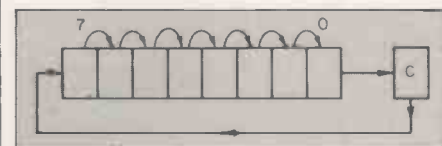

Figure 4a.

be shifted, for example, one bit left. An eight-bit left rotate, or left shift, on the least significant byte would put its MSB into the carry. A nine-bit rotate on the next byte moves this bit into the LSB, shifts the other bits up, and primes the carry with the second byte's MSB.

By doing two more nine-bit left rotates, we effectively move all 32 bits one bit to the left, leaving the MSB in the carry. This byte-to-byte carry property of the nine-bit rotation is invaluable when we do multiplication.

A point to note about shifts is that a single shift effectively multiplies or divides the shifted word by two. For example, consider the bit pattern:

00110101

That represents  $53_{10}$ . If we logically

8080A	Z-80
ACI d	ADC A,d
ADC r	ADC A,r
ADD r	ADD A,r
ADI d	ADD A,d
CMC	CCF
CMP r	CP r
CPI d	CP d
DAA	DAA
DAD rp	ADD HL,rp
DCR r	DEC r
DCX rp	DEC rp
DI	DI
EI	EI
INR r	INC r
INX rp	INC rp
JMP a	JP a
Jcnd a	JP cnd,a

8080A	Z-80
LDA a	LD A,(a)
LDAX rp	LD A,(rp)
LHLD a	LD HL,(a)
LXI rp,d	LD rp,d
MOV r <sub>1</sub> ,r <sub>2</sub>	LD r <sub>1</sub> ,r <sub>2</sub>
MVI r,d	LD r,d
NOP	NOP
PCHL	JP (HL)
SBB r	SBC A,r
SBI d	SBC A,d
SHLD a	LD (a),HL
STA a	LD (a),A
STAX rp	LD (rp),A
STC	SCF
SUB r	SUB r
SUI d	SUB d

Notes:  
 "a": Address 16 bits  
 "d": Data eight or 16 bits  
 "r": Register A-L, or M; 8080A, or HL Z-80  
 "rp": Register pair, 8080A format is: B,C etc. Z-80 format is: BC etc.  
 "cnd": Controlling condition for conditional jumps; can be: C, M, NC, NZ, P, PE, PO or Z

Table 2. Equivalent 8080A/Z-80 instructions.

shift it one bit to the left, we shall obtain:  
01101010

or  $106_{10}$ . The introduction of a "0" into the LSB retained the pure multiplying nature of the operation — hence its alternative name of arithmetic left shift.

Shifting the original bit to the right gives:

0011010

or  $26_{10}$ . This is an integer division by two, and the carry holds the remainder, one in this case.

You can see that a careful combination of shifts and adds can be used to multiply by any fixed integer, and to divide by a power of two. That can be very useful in a

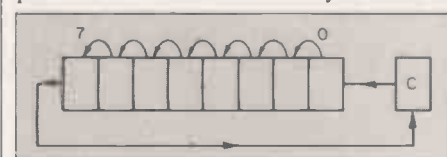

Figure 4b.

program which needs quick arithmetic with a constant.

**6502 shifts.** The 6502 offers only a limited choice of shifts. They are defined in table 1, and are: Nine-bit ROTate Right (ROR) and ROTate Left (ROL). Arithmetic Shift Left (ASL) and Logical Shift Right (LSR).

(continued on next page)

(continued from previous page)

These operations can shift the accumulator, or address in memory reached via a limited range of addressing modes.

**Z-80 shifts.** The Z-80 gives a wider choice than the 6502, and can perform eight- or nine-bit rotates, arithmetic and logical shifts right, and an arithmetic shift left: Rotate Left/Right past Carry (RLC, RRC) are eight-bit rotations. Rotate Left/Right through carry (RL, RR) are the nine-bit rotates. The arithmetic shift right has the mnemonic "SRA", and the logical shift right uses "SRL". The mnemonic for the arithmetic shift left is "SLA".

All these operations can be performed on any of the seven working registers, or on (HL), the memory location pointed to by the RP HL. They do not correspond directly to the equivalent instructions in the 8080A, which only offers rotates, and then only of A. These 8080A opcodes are preserved in the Z-80 as: Rotate Left/Right past Carry (RLCA, RRCA). Rotate Left/Right through carry (RLA, RRA).

Whenever you can, you should use these, as they operate faster than the more general Z-80 instructions.

The Z-80 also has what amounts to a 16-bit logical left shift. You will remember that "ADD HL, rp" gives a 16-bit add of an RP to HL. "ADD HL, HL" is, therefore, equivalent to multiplying HL by 2, which is the same as a left shift. Hence:

ADD HL, HL = 16-bit Left Shift

A good example of the use of shifts is a practical algorithm for multiplication. It uses shifts, both to read single bits and to multiply by powers of two.

In the third article in this series, we calculated (x\*y) by adding together "x"

Figure 5.

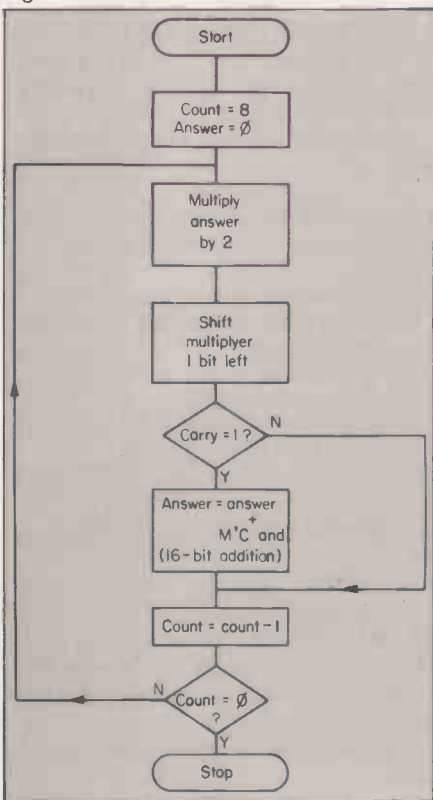

"y"s. There is a better way. If you use long multiplication to calculate, for example:

$$123 * 5678$$

you perform repeated multiplication and addition:

$$(123 * 5 * 1000) + (123 * 6 * 100) + (123 * 7 * 10) + (123 * 8)$$

which you could write as:

$$(((123 * 5 * 10 + 123 * 6) * 10 + 123 * 7) * 10 + 123 * 8)$$

You can use exactly the same technique

```

;SIX BIT MULTIPLICATION FOR 6502
;
;INITIALIZE REGISTERS
;
LDA #0 ;LOW BYTE OF RESULT
STA ANSWER+1
LDX #8 ;HIGH BYTE OF RESULT
LOOP ASL A ;MULTIPLY ANSWER
ROL ANSWER+1 ;BY 2 USING SHIFTS
ASL MPLIER ;READ MSB OF MULTIPLIER
BCC NOADD
;PERFORM 16-BIT ADDITION
CLC ;CLEAR CARRY FOR ADDITION
ADC MCAND ;HIGH BYTE OF RESULT
BCC NOADD ;MOVE CARRY TO HIGH BYTE?
INC ANSWER+1 ;YES
NOADD DEX ;FINISHED YET?
BNE LOOP
STA ANSWER ;SAVE LOW BYTES OF ANSWER
;
;FINISHED
  
```

Figure 6a.

in binary arithmetic. For example, you can calculate:

$$10101 * 11001$$

by computing:  
 $((((10101 * 1 * 2 + 10101 * 1) * 2 + 10101 * 0) * 2 + 10101 * 0) * 2 + 10101 * 1)$

Each multiplication by two corresponds, of course, to a left shift.

We can write this procedure as a flowchart — figure 5. That shows the multiplication of two, eight-bit numbers, with the 16-bit result going into "ANSWER". You can see that it uses shifts to give each doubling, and also uses shifts to read each bit of the multiplier, starting at the MSB. **6502 multiplication.** Figure 6a shows the code to implement figure 5 on a 6502. In the calculation, A is used as the lower byte of "ANSWER", while the high byte is manipulated directly. X is used as the loop counter, and the lack of other suitable internal registers forces us to operate on the multiplier ("MPLIER") and multiplicand ("MCAND") directly.

The 16-bit rotation of the answer uses an "ASL" to bring a "0" into the LSB; the carry goes into the high byte via a "ROL". We then have the usual clumsy 16-bit addition of the 6502. Finally, the low byte of the answer is put into memory from A.

The routine leaves the multiplier set to zero, but does not alter the value of the multiplicand.

**Z-80 multiplication.** Because the Z-80 has more internal registers, it does not have to operate on the main memory during the multiplication. The routine, therefore, will not destroy "MPLIER" or "MCAND".

The program is straightforward. The multiplier is stored in A, and B is used to hold the count so that we can use "DJNZ". The answer is formed in HL, which is operated on by "ADD HL, HL" to give a 16-bit shift. I have also put "MCAND" into DE so that I can use 16-bit addition and not worry about carry.

If you are using 16-bit addition with a Z-80, and the number which you are adding has only eight bits, it should go into the low byte, e.g., E, of the RP. The high byte must be zero. You will notice that I took care of this during the initialization; if I had forgotten to zero D, the results would have been garbage.

There are three basic logical operations which we can perform on bits: AND, OR and Exclusive-OR (XOR). They operate on pairs of bits, and also have complement forms, NAND, NOR and XOR — the last one is very unusual. Single bits can also be complemented. For reference, figures 7a, 7b and 7c show the truth tables of the three basic operations.

These are such useful functions that you'll find that a computer always offers some or all of them. In a typical micro, the operations will work only on bytes, and not isolated bits. That is no problem, because the micro actually performs the appropriate operation eight times — once for each pair of corresponding bits.

To give a few examples, using nybbles

```

;SIX BIT ADDITION FOR 680
;
;INITIALIZE REGISTERS
;
LD HL, MCAND ;SET POINTER
LD E, HL ;SET UP DE WITH 16-BIT
LD D, 0 ;MULTPLICAND FOR ADDING
LD A, (MPLIER) ;A IS COUNTER
LD B, 8 ;B IS COUNTER
LD HL, 0 ;ANSWER WILL FORM IN HL
;PERFORM MULTIPLICATION
;ANSWER WILL FORM IN HL
LOOP ADD HL, HL ;MULTIPLY ANSWER BY 2
RLA ;READ MSB OF MULTIPLIER
JP NC, NOADD ;BIT = "1"?
ADD HL, DE ;YES, ADD MCAND TO ANSWER
NOADD DJNZ LOOP ;FINISHED YET?
LD (ANSWER), HL ;YES, SAVE RESULT
;
;FINISHED
  
```

Figure 6b.

to keep the writing down:

$$\begin{array}{r}
 1001. 1010 = 1000 \\
 1001 + 1010 = 1011 \\
 1001 \oplus 1010 = 0011 \\
 1001 = 0110
 \end{array}$$

Remember that a "+", in this context, means "OR".

How can we use these operations? There are many possibilities, but some of the common ones are:

**Truncation.** It is sometimes necessary to truncate a byte, by setting, for example, the four MSBs to zero while retaining the four LSBs. We can use the AND function for this:

$$abcd\ egh.0000\ 1111 = 0000\ egh$$

**Augmentation.** That is the opposite of truncation. Sometimes, we must set specific bits to "1", while preserving the rest. The OR function is useful for this:

$$abcd\ egh + 0000\ 1111 = abcd\ 1111$$

**Complementing.** If we need to complement a whole byte, we often have an instruction to do this. Sometimes, there is no special instruction, or we want to complement only specific bits. In this kind of case, the XOR is useful:

$$abcd\ egh + 0000\ 1111 = abcd\ egh$$

Let us look now at the logical operations we have in the 6502 and Z-80. They are shown in this month's list of instructions, table 3; as you can see, the two micros have similar facilities.

**6502 bit manipulation.** The 6502 provides only the three basic dyadic, i.e., working on two operands, logical operations — AND, OR and XOR. All three work on the accumulator's contents and either immediate data or a byte in memory; the result is left in the accumulator. In some cases, it would be useful to have either X or Y as the second operand, but, unfortunately, it is not possible.

The 6502 does not have a complement instruction. However, we can use the XOR instead:

```
EOR # $FF ;COMPLEMENTS THE ACC
```

Obviously, that needs two bytes, as opposed to the single byte that a true complementing instruction would require.

If we want to form the two's complement of the accumulator, it is easy:

```
EOR # $FF ;ONES COMPLEMENT
CLC      ;ENSURE CARRY CLEAR
ADC #1   ;TWO'S COMPLEMENT
```

That takes five bytes; some micros can do it using a single instruction.

There is one more useful logical operation in the 6502 instruction set — "BIT" BIt Test. It is a logical version of the "CMP" used to compare bytes, and provides a useful way of checking to see if specific bits in a word are set.

The instruction ANDs together the contents of the accumulator and the data defined by the operand. The result is not stored anywhere, but is used to control the Z flag. At the same time, "BIT" sets the N flag to the value of the MSB (bit 7) of the operand, and the V flag to the value of the operand's bit 6. These functions are summarised in figure 8.

BIT is normally, but not exclusively, used to check for a single bit's being set. The accumulator is loaded with a 1 in the appropriate position, with all the other bits set to zero. This pattern is called a mask. BIT is then executed; if the tested bit is set, the AND will be TRUE, and Z, therefore, set to zero. The converse obviously applies, as well. The Z flag thus shows whether or not the result of the AND is zero.

Since N and V are set directly by BIT, there is no point in setting a mask for

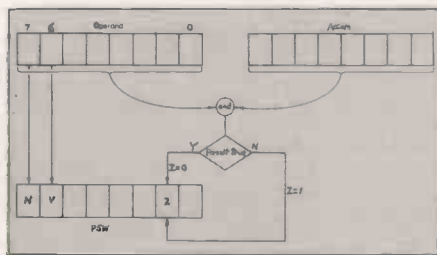

Figure 8.

either of the two MSBs; we can use whatever rubbish is in the accumulator.

BIT is very limited in the addressing modes it can use. Table 4 shows the modes available with this month's instructions — you can see that BIT uses only direct and Page-0 addressing.

**Z-80 bit manipulation.** As you can see from table 3, the Z-80 has the same basic bit manipulation instructions as the 6502

— AND, OR and XOR. The instructions have implied, register-based, and immediate forms.

Essentially, the instructions work exactly like their 6502 counterparts, but their detailed effects on the flags are

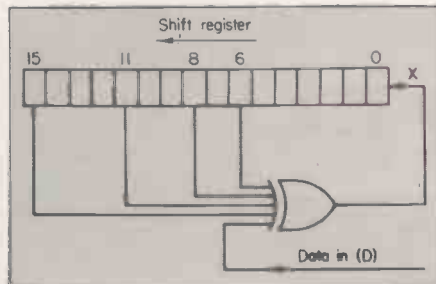

Figure 9.

different. Table 3 shows that more flags are modified by the Z-80 logical operations, and that all three logical operations set the carry flag to zero. Furthermore, the OR and XOR also clear the half-carry flag (H). The AND operation sets H to "1".

These flag manipulation properties can be useful. Data transfers in the Z-80 do not set the flags, unlike those in the 6502. However, sometimes we want to load A and test it. By ORing or ANDing A with itself, we can set the flags for testing without affecting the contents of A. For instance:

```
LD A,(HL) ;LOAD A
OR A      ;SET FLAGS
JP Z,ZERO ;TEST
```

We can also use "OR A" to clear the carry flag — we may well need to do this before a loop which performs multi-byte addition. The 6502, of course, has instructions to clear and set C, but the Z-80 can only set and complement it. To clear the carry with:

```
SCF ;CARRY = 1
CCF ;CARRY = 0
```

needs two bytes of code; "OR A" does it with one.

Another common requirement is to set the accumulator to zero. One way is obviously "LD A,0", which needs two bytes. A quicker and neater way is via "XOR A", which does the same job in a single byte.

One more trick we can perform with the Z-80 logical instructions is to test whether an RP has decremented to zero. Since the Z flag is not set when that happens, we have had to resort to clumsy constructions like:

```
LD A,0
CP L
JP NZ,NOTZRO ;LOW BYTE ZERO?
CP H
JP NZ,NOTZRO ;HIGH BYTE ZERO?
```

We can use the OR function to combine the contents of two, or more, registers:

```
LD A,L
OR H ;A = H.OR.L
JP NZ,NOTZRO ;ALL BITS ZERO?
```

This uses five bytes, compared to the 10 of the first method.

Like the 6502, the Z-80 has a bit-testing capability. It is, however, mechanised

differently. The command "BIT b,r" tests whether bit "b" — the bits are numbered from 0-7 — of register "r" — which includes (HL) — is "1". If it is, Z is cleared, otherwise Z is set to "1".

That mechanism is less flexible than that of the 6502. Only one bit can be tested at a time, and it is not practical for the program to calculate or modify the bit to be tested. Nevertheless, it is an advance on the 8080A, which has no bit-testing capability.

The Z-80 can also set or clear specific bits in any register, via the "SET b,r" and "RES b,r" operations. Again, only one bit at a time can be set or cleared and the programmer must select the appropriate bit explicitly. It does avoid the need to fiddle with "AND"s or "OR"s.

Unlike the 6502, the Z-80 can complement  
(continued on page 113)

Figures 7a, b and c.

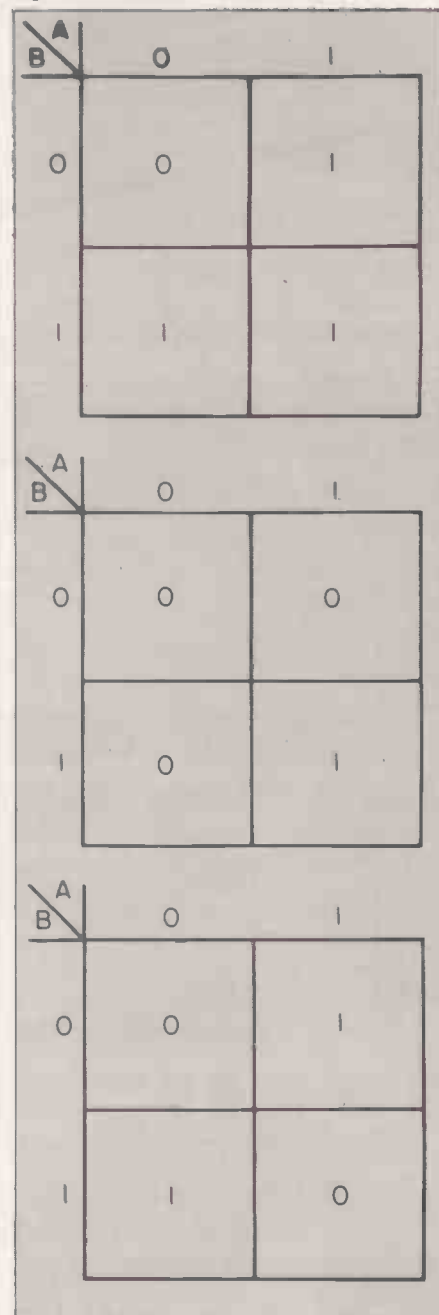

# FORTRONIC FOR SHARP



## SHARP MZ-80K Even lower prices!

- \*Integral cassette (1200 BPS) with tape counter.
- \*Z80 Microprocessor.
- \*78 Keys.
- \*256 Characters.
- \*40 x 25 Screen.
- \*High resolution graphics.
- \*Real time clock.
- \*Music capability (3 octaves).
- \*Coming soon MZ80FD twin floppy disc and MZ-80P3 Graphics Printer.

WE SERVICE THE MZ80K FROM OUR  
DEPOTS IN SCOTLAND AND ENGLAND

Model	Price	Total inc. VAT
20K	£480	£552.00
32K	£529	£608.35
36k	£549	£631.35
48k	£599	£688.85

Prices include UK delivery.

# FORTRONIC

For your micro systems.

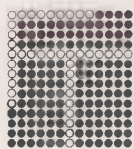

Fortronic Ltd, Holden Way,  
Donibristle Industrial Estate,  
Dunfermline.

Tel 0383 823121 Telex No 727438

• Circle No. 185

# ODDPOD

A REVOLUTIONARY NEW POCKET AID

Overall size:  
170mm x 90mm  
x 40mm



Oddpod will amaze you. It's the only hand-held language translator that really cares about language subtlety. And it can also be a lot more - a First Aid Guide, a Cocktail Recipe, a Telephone Directory, or anything else its unique 'Ami' Memory System is programmed to store, including customised data.

But until the new programs and customising facilities are finally ready, DDP offer you Oddpod as simply the best hand-held translator that money can buy. Now available in this country after great success in America, Oddpod is worked by 'Ami' micro-chip capsules. Each capsule you buy clips inside Oddpod together with a basic English capsule to allow a maximum of two languages to be cross-translated against English. Using a combination of keys and a phrase index printed on the back of Oddpod, you can quickly display translated words and sentences on Oddpod's screen. But such is Oddpod's respect for language complexity that multiple meanings and misspellings can be clarified and whole word categories can be sequentially displayed for inspection and learning.

**Price: £130**

inc. vat, p & p, operating instructions, two micro-capsules (English plus one other) and AC Adaptor

# BORIS

A FIENDISH CHESS OPPONENT

Overall Size:  
220mm x 220mm  
x 50mm approx.



Boris will test you. And humiliate you. And improve you. Boris is the chess computer that allows no quarter as you pit your wits against its super-rational micro-circuits and its time-related thresholds of difficulty! It's compact enough to travel with you, but big enough to always be the supreme test of any player.

**Price: £76**

inc. VAT p & p, operating instructions, clear plastic cover for board (not shown) and AC Adaptor.

To get either Oddpod or Boris, simply complete the details below and post us back this coupon.

Please send me:

- ..... (qty) Oddpod Language Translator(s)
- ..... (qty) Ami Language Capsule(s) as indicated below.
- ..... (qty) Boris Chess Game(s)

Please tick relevant box to indicate extra Oddpod language capsules required:  
(Three or more capsules £14.50 each inc. VAT & p & p)

French,  German,  Italian,  Spanish,  Japanese,

Phonetic (Pronunciation),  Calorie Counter

I enclose a cheque for/wish my Access/ Barclaycard/ American Express/ Diners Club Account to be debited with (delete as appropriate) the total sum of £..... as full payment and understand that I am to allow 21 days for delivery.

Name .....  
Address .....  
Tel. No. ....  
Credit Card No. ....

Signature .....  
 **Distributed Data Processing Ltd.**

Mail Order Dept., 17 Nobel Square, Basildon, Essex SS13 1DD

Tel. Basildon (0268) 727563

PC8

• Circle No. 186



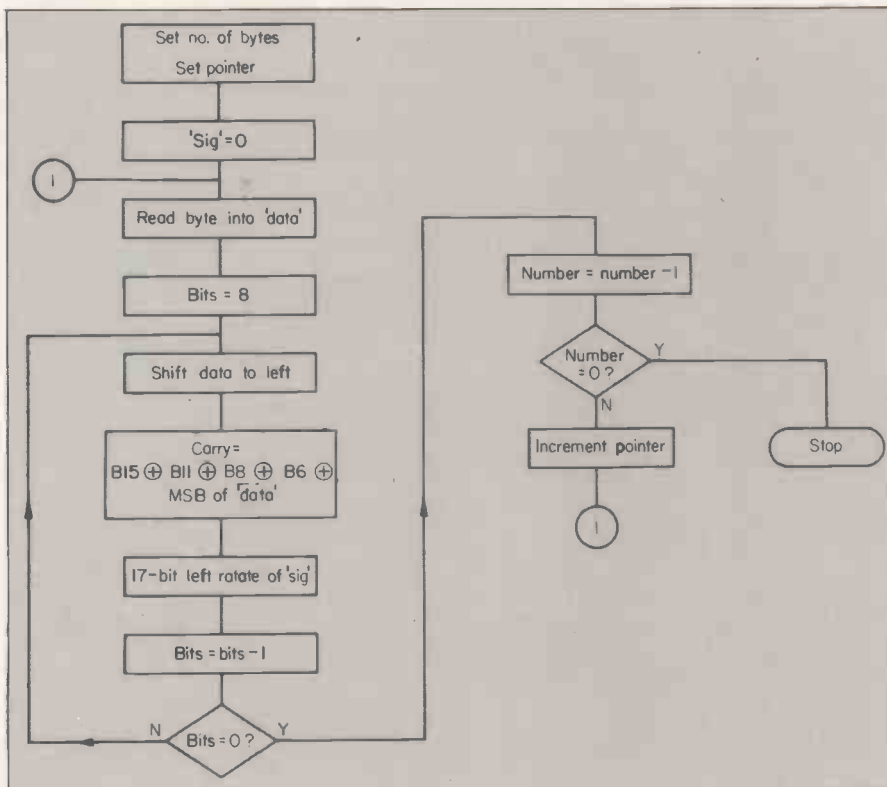

Figure 10.  
(continued from page 111)

ment A with "CPL". It works on A only and gives the one's complement of the data in the accumulator. "NEG", which has no 8080A equivalent, will give the two's complement of A.

**Extra Z-80 operation.** There is one more Z-80 instruction that is worth describing — the "EX DE,HL" (EXchange DE and HL).

As the mnemonic suggests, it swaps the contents of the two RPs DE and HL. It is useful to be able to do that if, say, you are maintaining two pointers, and need to use them in turn to manipulate two separate "HL"s.

You can see a typical microprocessor compromise here. Ideally, we should be able to swap any two RPs, but the Z-80 designers could not accommodate it.

When information is sent along a data link, e.g., from a disc unit to memory, there is always a danger of its being

corrupted. There are various ways of detecting errors, and in some cases correcting them; the use of parity bits is an obvious example. Another widely used technique is Cyclic Redundancy Checking (CRC).

The data being transmitted along the link is also fed serially to an input of an XOR gate; the other inputs to the gate are provided by specific bit positions in a shift-register. It is common to use a 16-bit shift register, and one possible configuration is shown in figure 9. In this case, the output of the XOR gate is defined by:

$$X = D \oplus b15 \oplus b11 \oplus b8 \oplus b6$$

As each bit of the data stream arrives, the contents of the register are shifted one bit left, and X becomes the new LSB. The old MSB falls from the end and disappears.

You can see that a 16-bit code builds-up in the register, and the value of the code depends on the data stream. At the end of the data transfer, the CRC code, or signature, is compared to one sent by the data source. If they are the same, it is almost certain that the data has been received correctly.

I am not going into the maths, but single-bit errors will always be detected. The chances of missing a multi-bit error are  $2^{-16}$ , or 0.0015 percent. I think you will agree that this is negligible.

Signatures are normally generated by hardware, as a software-based system would slow the data transfer. Nevertheless, we sometimes need to write a program to produce a CRC code, and a suitable flowchart is shown in figure 10. The routine assumes that the data to be tested is stored in memory. There are two reasons for not coding the data as it comes

in: generating a signature from incoming data would slow the data transfer too much; we haven't looked at input techniques yet.

Firstly, the routine initialises itself, and sets the signature registers ("SIG") to zero. It takes each byte of the data, and reads it one bit at a time, using a shift to move the MSB into the carry. The XOR equation is applied to the incoming data and the contents of "SIG" to form "X", which becomes the new LSB of "SIG".

When all eight bits of a word have been processed, the routine moves on to the next word, until the signature for all the data has been formed. Assume, for the sake of the example, that there will never be more than 255 words to process.

At the end of the routine, the data must be left, undisturbed, in its original locations.

How do we compute the XOR equation? What the equation says is: "Count the number of '1's on the right-hand side. If the number is odd, set X to '1', otherwise set it to '0'". We can do this by adding together the five bits on the right-hand side — the LSB of the sum is identical to the XOR answer, and we can read it directly.

Another term for this type of computation is "Modulo-2 Addition". The result is given by the remainder left over when

Figure 11a.

```

16502 CRC PROGRAM
;INITIALIZE THE REGISTERS
LDY #0 ;POINTER AND NUMBER OF BYTES
STY SIGHI ;SET SIGNATURE TO
STY SIGLO ;ZERO TO START
OUTLWP LDA (BASE),Y ;READ 1 BYTE OF DATA
STA DATA ;"DATA" IS WORKSTORE
LDX #8 ;INNER LOOP COUNTER
INLOOP ASL DATA ;SHIFT MSB TO CARRY
ROL SCATCH ;LSB IS MSB FROM "DATA"
LDA #00001000 ;SET MASK FOR BIT 11 OF SIG
BIT SIGHI
BPL MISS1 ;TEST MSB OF SIG
INC SCATCH ;LSB=LSB.XOR.BIT15
BIT SIGHI ;MUST RESET FLAGS
BEQ MISS2 ;TEST BIT11 OF SIG
LAC SCATCH ;LSB=LSB.XOR.BIT11
MISS2 LDA #00000001 ;MASK FOR BITS 8 OF SIG
BIT SIGHI
BEQ MISS3 ;TEST BIT8
LAC SCATCH ;LSB=LSB.XOR.BIT8
BIT SIGLO ;V-BIT6 OF SIG
BVC MISS4
INC SCATCH ;LSB=LSB.XOR.BIT6
INL SCATCH ;CARRY=RESULT OF XOR8
ROL SIGLO ;17-BIT LEFT
DEX SIGHI ;ROTATE
DEX
BEH INLOOP ;READ ALL BITS OF WORD?
INY ;POINT TO NEXT WORD
CPY NUMBER ;TEST FOR FINISH
BNE OUTLWP ;IF EQUAL, FINISHED
;END OF ROUTINE
    
```

```

Z80 CRC PROGRAM
;INITIALIZE THE REGISTERS
LD HL,(BASE) ;READ BASE ADDRESS
EX DE,HL ;BASE IN DE
LD HL,(NUMBER) ;READ NUMBER OF BYTES
ADE HL,DE ;HL=NUMBER-BASE
LD (TEST),HL ;SAVE FOR LATER TESTS
SIG WILL BE IN HL
OUTLWP LDA A,(DE) ;READ DATA BYTE
LD B,B ;INNER LOOP COUNTER
INLOOP ALCA ;READ MSB OF DATA
RL C ;LSB OF C=MSB OF DATA
BIT 7,H ;TEST BIT 15 OF SIG
JP Z,MISS1
INC C ;LSB=LSB.XOR.BIT15
JP BIT 1,H ;TEST BIT 11 OF SIG
INC C ;LSB=LSB.XOR.BIT11
BIT 0,H ;TEST BIT 8 OF SIG
JP Z,MISS2
INC C ;LSB=LSB.XOR.BIT8
BIT 6,L ;TEST BIT 6 OF SIG
JP Z,MISS3
INC C ;LSB=LSB.XOR.BIT6
MISS4 ADD HL,HL ;SHIFT SIG (LSB NOW=0)
BIT C ;READ XOR RESULT
JP Z,MISS5 ;IS IT "1"?
SET 0,L ;MOVE TO L
MISS5 DJNZ INLOOP ;FINISHED WITH BYTE?
INC DE ;YES, POINT TO NEXT BYTE
;TEST TO SEE WHETHER FINISHED
LD A,(TEST)
CP E ;LOW BYTE SAME AS TEST?
JP NZ,OUTLWP
LD A,(TEST+1)
CP D ;HIGH BYTE SAME AS TEST?
JP NZ,OUTLWP
LD (SIG),HL ;FINISHED. SAVE RESULT
;END OF ROUTINE
    
```

Figure 11b.

you divide the algebraic sum of all the bits by two, i.e., shift it to the right.

Enough of the theory — let us look at the programs.

**6502 CRC program.** Figure 11a gives a CRC program for a 6502.

The program zeros Y, which is used as a pointer to the data, and initialises the two bytes of "SIG". The program has to use indirect indexed addressing to reach the data, which could be anywhere in memory. Since the 6502 cannot use this mode in rotates, the data word is copied into a workspace, "DATA".

The MSB is read by shifting it into the

(continued on next page)

(continued from previous page)

carry, from where it is copied into the LSB of the scratchpad "SCRTCH". It does not matter what the rest of "SCRTCH" contains, as long as the LSB is set by the incoming data bit.

Each relevant bit of "SIG" is tested via a series of BITS. If the appropriate bit is set to "1", "SCRTCH" is incremented, effectively adding the value of the affected bit to the SB. The BITS make use of the instruction's property of copying the two MSBs of the tested byte into N and V; the test for bit 11 thus also tests bit 15. Unfortunately, since an increment of "SCRTCH" after the bit-15 test would re-set the zero flag, we must repeat the BIT to test bit 11. At least we do not have to re-set the mask.

When we have tested all four bits in "SIG", the LSB of "SCRTCH" is the modulo-two sum we are seeking. The rest of the byte contains rubbish, but we do not care about that. By concentrating all the manipulation on the LSB, the program is shortened, e.g., we never need to zero "SCRTCH".

The LSB of "SCRTCH" is then shifted into the carry from where, via two ROLs, it becomes the LSB of "SIG", the remainder of the bits in which are shifted to the left.

We repeat that for the next seven bits of "DATA", and increment Y to point to the next word. If Y is equal to the contents of "NUMBER" — the number of bytes to be CRC'ed — the routine finishes. We end with this kind of test because Y starts at zero, and does not reach "1" until the first byte has been processed.

**Z-80 CRC program.** The Z-80 program, although it follows the same flowchart, is very different in detail from that of the 6502. In particular, it makes as much use as possible of the micro's internal registers.

The program uses DE as a pointer to the word being manipulated, and initialises the RP via LD HL and an "EX DE,HL", the quickest 8080A-compatible 16-bit load of BC or DE. The address of the first byte above the block of data to be CRC'ed is found by an "ADD HL,DE", and saved for testing DE later.

We could use a simple loop counter to check the number of bytes, but there is no spare register, and so it is best to wait for the RP to point from the top of the list.

The final stage of initialisation is to zero HL, where the signature will form.

Table 4. 6502 addressing modes this month.

Mnem	Accum	Direct	Page-0	Immed	Index,X	Index,Y	Indir,X	P-*, Index,X	Indir,Y
AND		*	*	*	*	*	*	*	*
ORA		*	*	*	*	*	*	*	*
EOR		*	*	*	*	*	*	*	*
ASL	*	*	*	*	*	*	*	*	*
LSR	*	*	*	*	*	*	*	*	*
ROL	*	*	*	*	*	*	*	*	*
ROR	*	*	*	*	*	*	*	*	*
BIT		*	*	*	*	*	*	*	*

Operation	6502			Z-80		
	Mnem.	Flags	Effect	Mnem.	Flags	Effect
Logical AND	AND o	N,Z	A = A.d/(a)	AND p	All	A = A.p; C=0 H=1
Logical OR	ORA o	N,Z	A = A + d/(a)	OR p	All	A = A + p; C=0 H=0
Logical XOR	EOR o	N,Z	A = A + d/(a)	XOR p	All	A + A + p; C=0 H=0
One's complement	—			CPL	H=1	A = $\bar{A}$
Two's complement	—			NEG	All	Form 2's Comp
Arithmetic shift left	ASL A/a	N,Z,C	Shift A/(a)	SLA r	All	Shift r; H=0
Arithmetic shift right	—			SRA r	All	Shift r; H=0
Logical shift right	LSR A/a	N,Z,C	Shift A/(a) N=0	SRL r	All	Shift r; H=0
Eight-bit rotate left	—			RLCA or RLC r	C All	Rotate A Rotate r; H=0
Eight-bit rotate right	—			RRCA or RRC r	C All	Rotate A Rotate r; H=0
Nine-bit rotate left	—			RLA or RL r	C All	Rotate A Rotate r; H=0
Nine-bit rotate right	—			RRA or RR r	C All	Rotate A Rotate r; H=0
Bit test	BIT a	N,V,Z	See Text	BIT b,r	Z	Z = r <sub>b</sub>
Set bit	—			SET b,r	None	r <sub>b</sub> = 1
Clear bit	—			RES b,r	None	r <sub>b</sub> = 0
Exchange HL and DE	—			EX DE,HL	None	H = D; L = E D = H; E = L

Notes:  
 "a" = Address (defined by the program)  
 "d" = Data (defined by the program)  
 "o" = Operand — can be an address or data  
 "p" = Z-80 operand — a register or data  
 "r" = Any Z-80 register, including (HL)  
 "r<sub>b</sub>" = Bit "b" of register "r"  
 "·" = AND  
 "+" = OR  
 "⊕" = XOR  
 "/" = Either/or  
 Brackets: "Data at the address defined between the brackets"

Table 3. This month's instructions.

B is used, with a DJNZ, to count the eight iterations of the inner loop which read each bit of a word. The data word is stored in the accumulator; on each pass through the inner loop, A is shifted left to read the next bit into the CRC calculation.

As in the 6502 program, the Modulo-two addition concerns itself only with the LSB of the byte where the sum is being formed. In this case, it forms in C, and we are not worried what is in the seven MSBs of the register.

The data bit is positioned in the LSB of C by rotating C; each relevant bit of "SIG" is taken into account by a BIT. In that kind of application, where the mask changes every time, the Z-80 "BIT" is faster than that of the 6502.

Finally, at the end of each XOR

addition, HL is shifted left by an "ADD HL,LH", and the LSB of L is set with the value of the LSB of C the Modulo-two sum.

After each word has been processed, the pointer DE is incremented, and compared to the previously-calculated "top of the list" value. Unfortunately, it has to be done in two bytes.

The program's final act is to save the signature in "SIG".

In program segments in earlier parts of this series, the 8080A routine was usually shorter and faster than that for the 6502 — generally because of the power of the former micro's six registers. Similarly, in this case the Z-80 program is shorter.

This month, I have looked at the ways in which a micro can manipulate data as a pattern of bits, rather than as numbers or characters.

For example, the bits in a word may be completely unrelated, and show the status of a number of peripherals. That pattern manipulation facility is also very useful during multiplication and division.

If you want something to think about during the next month, how about considering the value of subroutines, which are segments of code, doing defined tasks, to which the program can jump? Is it useful to build a library of routines?



146 OXFORD STREET, LONDON, W. 1.  
 (next door to OXFORD WALK Shopping Centre)  
 We open Monday to Friday 9.30 to 5.30

**APPLE**

(A) = Applesoft (I) = Integer (M) = Machine Language (V) = Varies

(A)	TEXT RELOCATE (copies ANY disc file inc. text)	£ 15.00
(V)	SUPER INVADERS TAPE (High Res)	£ 12.00
(I)	APPLE PILOT (disc) (Language)	£ 30.00
(M)	VISCALC FINANCIAL CALCULATOR (disc)	£105.00
(M)	CCA DATA BASE (links to Viscalc) (disc)	£ 60.00
(M)	SARGON II Chess Tape (best available ***)	£ 20.00
(M)	MICROCHESS DISC	£ 17.00
(M)	MICROCHESS TAPE	£ 12.00
(I)	3 MILE ISLAND (nuclear disaster simulation) (Int. 48K disc)	£ 24.00
(A)	ENGINEERING MATHS TAPE (A)	£ 9.00
(A)	GENERAL MATHS TAPE (A)	£ 9.00
(I)	WILDERNESS CAMPAIGN TAPE (Adventure Int. HiRes graphics)	£ 9.00
(I)	WILDERNESS CAMPAIGN DISC	£ 12.00
(I)	DUNGEON CAMPAIGN TAPE (Adventure)	£ 8.00
(I)	DUNGEON CAMPAIGN DISC	£ 10.00
(I)	HIGHER GRAPHICS (Shape tables & graphics)	£ 15.00
(A)	AUTOSHAPe II (Superb shape table generator)	£ 25.00
(A)	MAGIC PAINTBRUSH (Graphic utilities inc. Arcade Invaders.)	£ 21.00
(I)	FORTE (Music language on disc)	£ 12.00
(I)	APPLE LISTNER (speech recognitions)	£ 10.00
(I)	APPLE TALKER (your Apple speaks)	£ 10.00
(A)	APPLE COLLISION (ARCADE STYLE GRAPHICS - maze & car race) (disc)	£ 10.00
(I)	APPLE 2I (HiRes Black/ack - super graphics)	£ 10.00
(A)	TEMPLE OF APSHAI (HiRes Adventure) (tape)	£ 15.00
(A)	TEMPLE OF APSHAI (disc)	£ 26.00
(A)	WIZARDS MOUNTAIN ADVENTURE (disc)	£ 11.00
(A)	MAD HATTER ADVENTURES (4) on disc	£ 28.00
(A)	BLANK DISCETTES (box of 10) guaranteed	£ 24.00
(A)	APPLE DISC TUTORIAL	£ 34.50
(V)	SOFTSIDE (APPLE) MAGAZINE	each £ 2.00
(V)	NIBBLE (APPLE) MAGAZINE	each £ 2.00
(V)	DISC UTILITY PACK (SWH) includes a/disc copy, disc patcher etc.	£ 15.00
(M)	COMPUTER BISMARCK superb battle game against the computer	£ 36.00
(M)	BRIDGE CHALLENGER	£ 9.00
(M)	ADVENTURE SAMPLER tape	£ 3.50
(M)	TANK WAR tape	£ 11.00
(M)	GLOBAL WAR (2 player war game) tape	£ 11.00
(A)	DATESTONES OF RYN tape	£ 9.00
(A)	DATESTONES OF RYN disc	£ 12.00
(A)	MORLOC'S TOWER Adventure (A) tape	£ 9.00
(A)	MORLOC'S TOWER Adventure (A) disc	£ 12.00

**TRS 80 All for minimum 16K Level II (unless otherwise stated)**

SLEUTH (Adventure with graphics and sound)	£ 9.00
QUEST	£ 9.00
BRIDGE CHALLENGER	£ 9.00
STIMULATING SIMULATIONS	£ 9.00
SANTA PARAVIA	£ 5.00
SCI FI SAMPLER	£ 5.00
SOFTSIDE MAGAZINE	each £ 2.00
SOFTSIDE MAGAZINE WITH CASSETTE OF PROGRAMS	each £ 6.00
SARGON II CHESS	£ 20.00
ALIEN INVADERS (machine code)	£ 7.50
SPACE BATTLES	£ 9.00
TIME TREK	£ 9.00
X WING II	£ 6.00
GALACTIC TRILOGY (disc)	£ 24.00
GALACTIC EMPRE	£ 9.00
GALACTIC TRADER	£ 9.00
GALACTIC REVOLUTION	£ 9.00
STAR TREK III 4 AND ENCOUNTER IN THE NEAR THOLION SECTOR	£ 9.00
DEAD STICK (land a space shuttle)	£ 6.00
DOG STAR ADVENTURE	£ 6.00
STARFLEET ORION (2 player space game)	£ 12.00
INVASION ORION (1 player space game)	£ 12.00
PARACHUTE I	£ 6.00
END ZONE II (American football)	£ 6.00
MICRO CHESS I 5	£ 12.00
MEAN CHECKERS MACHINE	£ 12.00
CRIBBAGE	£ 5.00
MASTERMIND II	£ 5.00
BRIDGE CHALLENGER (does not make trump?)	£ 9.00
PLAY IT AGAIN SAM (Simple Simon etc.)	£ 6.00
SHOOTING GALLERY	£ 6.00
AIR RAID (superb graphics)	£ 9.00
KAMIKAZE	£ 5.00
ENTRAPMENT	£ 6.00
TANK	£ 6.00
SUPER SUB	£ 6.00
GALAXY COMBAT	£ 3.00
AMAZIN MAZES	£ 5.00
FORK BARREL	£ 6.00
TAIPAN	£ 6.00
TYCOON	£ 5.00
KREIGSPILL	£ 5.00
ROUND THE HORN	£ 6.00
SAFARI	£ 6.00

These are sample pages from our NEW catalogue supplement.

We now offer BOOKS, PROGRAMS, HARDWARE and, best of all, SERVICE!

NOBODY, but NOBODY - has as wide a range of QUALITY programs as we do!

ALL our prices INCLUDE VAT (remember that when you compare our prices).

NEW PROGRAMS ARE ALWAYS WANTED - why put your programs with a smaller

company when we can distribute both here and in the States? 15% royalty paid.

A PRIZE OF £200 (in addition to royalties) for the best program submitted to us

and accepted by us for marketing each month until October 1980 for APPLE or TRS 80.

Please send me a FREE CATALOGUE .....

Please enter my subscription to 80 US Journal (TRS80) @ £14 p. a. ....

Please enter my subscription to SOFTSIDE magazine APPLE/TRS80\*\* (£25 p. a.)

\*\* Please circle APPLE or TRS80 for SOFTSIDE subscription

Please send the programs circled above .....

I enclose cheque/P.O./Money Order for .....

I wish to pay by ACCESS. My card No. is ..... Expiry date .....

SIGNATURE FOR ACCESS : .....

My name is : .....

Address : .....

# Apple Price List

Product Code	Description	Price (£)
<b>HARDWARE</b>		
A2S1016P	APPLE 16K VIDEO OUTPUT ONLY	695.00
A2M0003	DISC DRIVE WITHOUT CONTROLLER	299.00
A2M0004	DISC DRIVE WITH CONTROLLER	349.00
A2M0016	16K ADD ON RAM	69.00
<b>CARDS &amp; ACCESSORIES</b>		
A2B0001	PROTOTYPE/HOBBY CARD	15.00
A2B0002	PARALLEL PRINTER INTERFACE CARD	104.00
A2B0003	COMMUNICATIONS CARD	130.00
A2B0005	HIGH SPEED SERIAL INTERFACE CARD	113.00
A2B0006	PASCAL LANGUAGE SYSTEM	299.00
A2B0007	CENTRONICS CARD	130.00
A2B0009	APPLESOFT FIRMWARE CARD	116.00
A2B0010	INTEGER CARD	116.00
MHP-X003	MOUNTAIN HARDWARE CLOCK/CALENDAR CARD	160.00
MHP-X006	MOUNTAIN HARDWARE SUPERTALKER	171.00
MHP-X007	MOUNTAIN HARDWARE ROM PLUS BOARD	116.00
MHP-X015	MOUNTAIN HARDWARE ROMWRITER	101.00
E2B100	EUROCOLOUR CARD	79.00
E2B101	APPLE BLACK & WHITE MODULATOR	14.00
E2B102	A1-02 DATA ACQUISITION CARD	180.00
10-5-16	ALF MUSIC SYNTHESIZER CARD	142.00
10-5-17	ALF TIMING MODE INPUT BOARD	14.00
13-3-2	ALF ALBUM MUSIC DISKETTE NUMBER ONE	12.00
13-3-4	ALF ALBUM MUSIC DISKETTE NUMBER TWO	12.00
13-5-5	ALF ALBUM MUSIC DISKETTE CHRISTMAS	12.00
A2M0015	HEURISTICS SPEECH LAB	122.00
A2M0019	PROGRAMMERS AID 1	27.00
A2M0027	AUTO START ROM PACK	38.00
A2M0029	GRAPHICS TABLET	462.00
E2B104	HEURISTICS CONTROLLER 70	52.00
E2B105	HEURISTICS SPEECHLINK 2000	160.00
E2B107	IEEE INTERFACE	212.00
<b>SOFTWARE</b>		
A2D0005	CONTRIBUTED SOFTWARE VOL 3-5	60.00
A2D0006	CONTRIBUTED SOFTWARE VOL 1-2	27.00
A2D0009	MICROCHESS 2.0 CHESS DISK	15.00
A2D0010	DISC UTILITY PACK	15.00
A2D0012	APPLE BUSINESS CONTROLLER PROGRAM	340.00
A2D0013	APPLE POST PROGRAM	27.00
A2D0018	APPLE BOWLING DISCETTE	9.00
A2D0025	APPLE CASHIER PROGRAM	194.00
A2D0026	APPLE WORD PROCESSING PROGRAM	42.00
A2T0013	MICROCHESS 2.0 CHESS CASSETTE	15.00
E2D001	VISICALC DISC & BOOK COMPLETE	95.00

Product Code	Description	Price (£)
<b>DOCUMENTATION</b>		
A2L001A	APPLE II REFERENCE MANUAL	11.00
A2L0002	6502 HARDWARE MANUAL	9.00
A2L0003	6502 SOFTWARE MANUAL	9.00
A2L0005	APPLE II BASIC PROGRAM MANUAL	6.00
A2L0006	APPLE II REFERENCE MANUAL	6.00
A2L0012	DOS 3.2 MANUAL	6.00
A2L0018	APPLE II BASIC TUTORIAL MANUAL	6.00
<b>GENERAL ACCESSORIES</b>		
A2D0000	(10) BLANK APPLE DISCETTES	32.40
A2M0009	VINYL CARRYING CASE	16.00
AD/LB	MINI DISC LIBRARY BOX	2.64
MD5172	DISCOFLEX FILING CASE—MINI	12.64
APP1	APPLE DESK TWO TIER	145.00
APP2	PRINTER TABLE	92.00
APPLETEL	APPLETEL SYSTEM	595.00
DUST/APP	DUSTCOVER FOR APPLE II	5.35
E2B013	APPLEJUICE RESERVE POWER SUPPLY	148.00
<b>PRINTERS &amp; ACCESSORIES</b>		
A2M0034	SILENTYPE 80 COLUMN GRAPHICS PRINTER	349.00
A2C0001	10 ROLLS OF THERMAL PAPER FOR SILENTYPE PRINTER	28.00
HUSH100/A	MICROHUSH 100 PRINTER C/W APPLE INTERFACE	266.00
HUSHPAP	16 ROLLS THERMAL PAPER 80FT LONG	22.00
HUSHPAP/E	2 ROLLS THERMAL PAPER 80FT LONG	5.00
TIGER/G	PAPER TIGER PRINTER WITH GRAPHICS OPTION	598.00
TIGER/C	CONNECTOR CABLE FOR TIGER PRINTER	9.00
TIGER/D	GRAPHICS SOFTWARE FOR TIGER PRINTER	20.00
TIGER/P	TIGER PAPER 2,000 SHEETS 11" x 9 1/2" S/PART	35.92
TI810	TEXAS OMNI 810 PRINTER	1450.00
LP5	PAPER 2000 SHEETS 11" x 15" S/PART	14.06
LP9	PAPER 3000 SHEETS 8" x 12" S/PART	14.85
<b>VIDEO MONITORS</b>		
VM129	12" BLACK AND WHITE VIDEO MONITOR	189.00
VM910	9" BLACK AND WHITE VIDEO MONITOR	127.00
VM906	9" HIGH RESOLUTION BLACK AND WHITE VIDEO MONITOR	148.00
VM/C	CABLE FOR VIDEO MONITOR	9.00

Prices exclusive of carriage and VAT and are correct at time of going to press. Available from Apple Dealers all over the UK—for your nearest please contact Microsense Computers. Dealer/OEM enquiries welcome.

## microsense computers limited

Finway Road, Hemel Hempstead, Herts HP2 7PS  
Tel (0442) 481 51 and 411 91  
Telex: 825554 DATEFF G

116



SOLE UK DISTRIBUTOR

# apple computer

®Apple is a trade mark of Apple Computer Inc., Cupertino, C.A., USA



• Circle No. 188

## Clear-screen routine

ONE OF the more irritating features of the Standard CompuKit UK101 is the lack of a clear-screen routine complains L Rickwood of Norwich. To solve that, I have written a simple machine-code routine to do the job via the USR(X) function.

The routine is short — 20 bytes as opposed to 25 to 30 bytes of other routines I have seen — and very fast. The interesting feature however is that when loaded, it occupies no user workspace. That is achieved by placing it in the otherwise unused RAM at 0222<sub>16</sub> to 02FA<sub>16</sub>, specifically at 0222<sub>16</sub> to 0235<sub>16</sub>.

The advantages are, firstly, that no tedious partitioning of the workspace into Basic and machine-code area is required. Secondly, the program is unaffected by commands such as cold-start. In fact, once loaded it is available for use until deliberately wiped or the machine is switched-off — the vector must be re-set after cold-start.

The routine will operate in any RAM location since it uses only relative addressing.

Mnemonic*	Address Hex	Operator	code Hex	Hex
LDA #32	0222	A9	20	
LDX #00	0224	A2	00	
STA D300,X	0226	9D	00	D3
STA D200,X	0229	9D	00	D2
STA D100,X	022C	9D	00	D1
STA D000,X	022F	9D	00	D0
DEX	0232	CA		
BNE# -15	0233	D0	F1	
RTS	0235	60		

\* Numbers preceded by # are decimal, others are Hex.

Either: load using the 'M' function of D/C/W/M?

Or: load from Basic using:

For X = 546 to 565 : Read S : Poke X, S : Next  
Data 169,32,162,0,211,157,0,210  
Data 157,0,209,157,0,208,202,208,241,96

If located at 0222<sub>16</sub> (546<sub>10</sub>) to 0235<sub>16</sub> (565<sub>10</sub>), the routine can be accessed by X = USR(X) with USR(X) vector set at:

Poke 12,04  
Poke 11,34

On the UK101, the USR(X) vector is located in 11 and 12 (Dec). 12-high byte; 11-low byte.

To fill the screen with a character whose CHR\$ code is N, use POKE 547,N after the program is loaded. Alternatively, replace the second data item (32) with N.

## Video display

THE only disappointing feature of the Superboard II seems to be its video display, but I have discovered that Mutek has introduced an enhanced Superboard with a true 32 x 48 display writes P A Hague of Stockton, Cleveland. It is selling upgrading kit for normal Superboards at £40 which also allows the computer to run at 2MHz instead of 1MHz.

## Morse and RTTY

I RUN a UK101 and have been developing both hardware and software to enable me to run Morse code and RTTY Baudot writes Michael Taylor of Peterborough,

**THE 6502 SPECIAL is dedicated exclusively to the exchange of information between 6502 users. It is up to you, the reader, to help establish this page with your ideas, problems and guidance for other 6502 users. Please mark your letters 6502 Special. We pay £5 for each contribution published.**

Cambridgeshire. The hardware interface enables not only serial-to-parallel conversion but also software control of serial format and six output ports which can control the transceiver functions.

My software is in 6502 machine code and my most useful package is a 1K program which reads RTTY using a full screen display, sends RTTY and sends CW: Transmission can be direct from the keys, or from either one of seven memories, six of which are pre-loaded station information and the last being a loadable message store.

I also have a useful Basic note for UK101 users, a way of preventing the display of INPUT information. Normally on the UK101, all INPUT information is displayed on the VDU screen. The following allows INPUT without VDU display or line scrolling — even the prompt “?” is not displayed.

It is done by placing POKE 538, 138 before the INPUT, disabling all output operation.

After the INPUT the statement POKE 538, 105 will restore output operations. The action of the first POKE is to change the output vector (FF69 at 021a/b) to vector all output to a RTS, return from subroutine. The second POKE restores the original value.

An example is a code access to a program.

```
1 PRINT" Enter your code word"
2 Poke 538,138
3 INPUT A$
4 POKE 538,105
5 IF A$ = "CODE WORD" THEN GOTO 7
6 PRINT" WRONGG": GOTO 2
7 program protected by entry code word.
```

After RUN, the VDU remains locked-out following the “ENTER...” message until the correct word is entered, break/warm-start is made, or blind “return” “return” RUN 7 typed.

## Terminal width

IN THE June 6502 Special, there was a note to Superboard II users saying that POKE 15,0 causes the output of two line feeds instead of one writes Paul Morton of Stockton, Cleveland. I would like to point out that this location holds the terminal width, so that any other number can be Poked there to give you a variable-size terminal width — which gives rise to many interesting possibilities.

Also, location 14 holds the amount of characters the cursor has moved since the last carriage return. By continually Poking 14,0 during a program, carriage returns will be prohibited, e.g., you can have a screen full of pattern without any carriage returns spoiling it.

One very interesting point is that when you want to scan the keyboard during a program for a letter, instead of turning off Control C and Peeking and Poking, you can use one of the subroutines already present:

```
10 POKE 11,0 : POKE 12,253
20 X = USR (X)
30 A$ = CHR$(PEEK (531))
  By changing 30 to read:
30 A = PEEK (531)
you can input numbers.
```

## Cassette-output program

FOLLOWING the recent programs to save data for the CompuKit 101, writes Paul Chapman of Diss in Norfolk, here is a program which, when stored in the unused RAM (0222 → 02FF), will activate output to cassette if ‘CHR\$(1)’ is printed. All the following prints will go to the cassette until a ‘CHR\$(3)’ is printed, then all input is from the cassette until a ‘CHR\$(4)’ is printed. After loading the machine code program, type in Basic:

POKE 538,34: POKE 539,02

That initialises the routine by changing the output vector — that is necessary after every re-set, e.g.,

```
10 INPUT "DATA TO BE SETN"; A$
20 Print CHR$(1); : REM to switch-on cassette
30 Print A$ : REM SEND DATA
40 Print CHR$(2) : switch-off cassette
50 END
```

the opposite:

```
10 Print CHR$(3); : REM switch to load
20 Input A$ : REM get DATA
30 Print CHR$(4)
40 Print A$ : REM switch-off cassette
  input
  and print data.
50 END
```

If data is longer than the line length A, POKE 15,72

is needed during or before the program. The program can be enhanced to give all the graphic characters special functions. It should be noted that it is not advisable to give any standard characters special functions as they will occur during lists as well.

0222	C9	01	CMP	#01	
0224	F0	0A	BEQ	0230	
0226	C9	02	CMP	#02	
0228	D0	0C	BNE	0236	
022A	A9	00	LDA	#00	
022C	8D	05	02	STA	0205
022F	60		RTS		
0230	A9	01	LDA	#01	
0232	8D	05	02	STA	0205
0235	60		RTS		
0236	C9	03	CMP	#03	
0238	F0	0A	BEQ	0244	
023A	C9	04	CMP	#04	
023C	D0	0C	BNE	024A	
023E	A9	00	LDA	#00	
0240	8D	02	STA	0203	
0243	60		RTS		
0244	A9	FF	LDA	#FF	
0246	8D	03	02	STA	0203
0249	60		RTS		
024A	20	69	FF	JSR	FF69
024D	60		RTS		

# NEW



## ANADEX 9500 Series from STACK

### GENERAL SPECIFICATIONS

**Number of Columns:**

**Character Spacing:**

**Printing Rate:**

throughput-minimum  
maximum

**DP-9500**

132 or 175

10 or 13.3 cpi

selected by data  
source or by internal switch

150 or 200 cps

60lpm

200 lpm for 10 ch lines

**DP-9501**

132 or 220

10 or 16.7 cpi

120 or 200 cps

50lpm

### Features

- \* 132, 175 or 220 columns, 120, 150 or 200 characters per second
- \* 50-200 lines per minute, bi-directional printing with line scanning logic
- \* 150 M characters print head life
- \* 650 M characters with heavy duty head
- \* Tractor feed, multiple copy plain paper
- \* 7 x 9, 9 x 9 or 11 x 9 matrix with optional graphics capability
- \* Special character sets available as options
- \* 6 or 8 lines per inch, selectable
- \* 10, 13.3 or 16.7 cpi, selectable
- \* Communications control selectable

### Interfaces

Parallel bit (1 KHz max data rate), RS-232C and 20-60 mA current loop. All three included as standard, switch selectable.

### Baud Rates

50, 75, 110, 135, 150, 300, 600, 1200, 1800, 2200, 2400, 3600, 4800, 9600  
\*RS-232C only  
Switch selectable.

### Character Font

Standard 96 character ASCII set with true descenders and underlining selected by RS code. Double width printing selected by SI code. Alternative character sets available as plug-in EPROMS.

**DP-9500**

# £895

plus VAT

**DP-9501**

# £995

plus VAT

### Printing Method

9-wire dot-matrix, impact, bi-directional with line scanning logic.

### Ribbon

Black ribbon in replaceable cartridge. Life expectancy in excess of 6 million characters.

### Additional Features

Other operating features set by internal switches or by the data source include (a) 10 second time-out, (b) parity bit recognition, (c) byte length, (d) X-ON, X-OFF operation, (e) STX/ETX operation. Internal switches also provided to select (i) Truncate or wraparound print mode and (ii) Automatic line feed.

### Physical

Width 26.6" (67.6cms). Depth 15.4" (39.2cms). Height 8.3" (21.0cms).

### Graphics

Plug-in option enables printing of continuous graphics under control of data source, with resolution of 72 dots per inch vertically and 60 (DP-9500) or 75 (DP-9501) dots per inch horizontally.

### Buffer

500 bytes of FIFO as standard. Optional 2K additional.

### Paper (Fan-Fold)

Tractor fed, any width to maximum of 15.6" (397mm).

## Interfaces for 9500 Series

PET Parallel **£45**

Parallel Addressable **£106**

RS232 **£89**

RS232 Character Switchable **£132**

APPLE Parallel **£130**

RS232 Serial **£113**

Please ring Graham Knott or Jeff Orr  
for other interfacing requirements.  
Prices exclude VAT.

**Stack Computer Services Ltd**

290-298 Derby Road, Bootle,  
Liverpool L20 8LN.

**051-933 5511.**



• Circle No. 189

PRACTICAL COMPUTING August 1980

We have had so many requests for advice about software for the little ZX-80 that we have decided to start a club page devoted to the machine. If you have a contribution to make, write to *Practical Computing* marking your letter ZX-80 Line-up. We pay £5 for contributions published.

## Input check

AS MOST people have probably discovered, the ZX-80 1K RAM can hold programs of reasonable size, but problems occur if a large amount of screen output is required. Thus text must be kept to a minimum in print statements writes Bob Maunder.

Sophisticated input checking routines are also out of the question at present since little space would remain for the main program. Hence program robustness and good technique often has to be sacrificed to obtain something which works.

However, when memory expansion arrives we will all be busy re-hashing our programs. The following routine is a suggestion for checking numerical data entry — it only allows for positive numbers and any other modifications or contributions will be welcomed. N\$ = the number on entry and the routine puts it in, N.

```
500 LET N=0
510 IF N$="" THEN RETURN
520 LET C=CODE(N$)-28
530 LET Q=C>-1 AND C<10 AND
    N<3277 AND (NOT N=3276 OR NOT
    C>7)
540 IF NOT Q THEN RETURN
550 LET N=10*N+C
560 LET N$=TL$(N$)
570 GO TO 510
```

On exit from the routine, Q indicates whether the number is valid — Q=-1 or true — or in error — Q=0 or false.

There are reports of several ZX-80 owners starting to untangle the ROM monitor and interpreter; any useful entry points which anyone encounters would also be gratefully received.

## Heated discussion

THE ZX-80 cassette interface seems to be drawing conflicting comments. Personally, I have had several problems with **LOADing** and **SAVEing** which appear to happen particularly when the system, or rather the tiny heatsink, becomes hot.

Science or Cambridge states that it has been unable to reproduce the fault on the testbench. I have found that using the ZX-80 with the top of the case removed and with a larger heatsink on the 5V regulator gives improved results.

Alternatively, if you want to keep the system tidy, try fitting a thicker insulator between the heatsink and the PCB.

DIN connections at the cassette recorder end are proving generally unsatisfactory for **LOADing**: that is because the output signal level is too low since it comes from the recorder's pre-amp rather than from the loudspeaker output.

## Symbol Simon

The following game, Simon, continues Bob

Maunder of Middlesborough, displays an increasing number of symbols on the ZX-80 screen which must be copied correctly. The limit is 21 symbols and an option includes graphics characters accessible from the keyboard.

```
10 RANDOMISE
20 DIM P(20)
30 PRINT "SIMON"
40 PRINT "YOU ATTEMPT TO COPY
    SYMBOL"
50 PRINT "PATTERNS"
60 PRINT
70 PRINT "DO YOU WANT"
80 PRINT "1. NUMBERS"
90 PRINT "2. LETTERS"
100 PRINT "3. GRAPHICS"
110 PRINT "4. NUMBERS + LETTERS"
120 PRINT
130 PRINT "1 2 3 OR 4?"
140 INPUT C$
150 CLS
160 LET C = CODE(C$)-28
170 IF C>4 OR C<1 THEN GO TO 70
180 LET L = -27*(C=1 OR C=4)-37*(C=2)-
    (C=3)
190 LET M = -10*(C=1 OR C=3)-26*(C=2)-
    36*(C=4)
200 FOR N=2 TO 20
210 PRINT "PATTERN IS"
220 FOR I=0 TO N
230 LET P(I) = RND(M) + L
240 PRINT CHR$(P(I));
250 NEXT I
260 PRINT
270 PRINT "PRESS NEWLINE"
280 GO SUB 500
290 PRINT "NOW COPY IT"
300 INPUT G$
305 PRINT G$
310 FOR J=0 TO N
320 IF G$="" THEN GO TO 420
330 IF NOT CODE(G$)=P(J) THEN GO TO
    420
340 LET G$ = TL$(G$)
350 NEXT J
360 PRINT "CORRECT"
370 PRINT "PRESS NEWLINE FOR
    NEXT"
380 GO SUB 500
390 NEXT N
400 PRINT "CONGRATULATIONS —
    YOU WIN"
410 STOP
420 PRINT "WRONG — IT WAS";
430 FOR K=0 TO N
440 PRINT CHR$(P(K))-(NOT K<J AND
    NOT C=3)*128)
450 NEXT K
460 PRINT
470 PRINT "YOUR LIMIT WAS ";N+
    (N=2)*2;"SYMBOLS"
480 STOP
500 INPUT Z$
510 CLS
520 RETURN
```

If a symbol sequence is entered incorrectly the program highlights where the mistake was made using inverse video, except in the case of graphics characters as this would be confusing.

## Inverse video

THIS item is for readers still baffled by the ZX-80 operating manual's mysterious

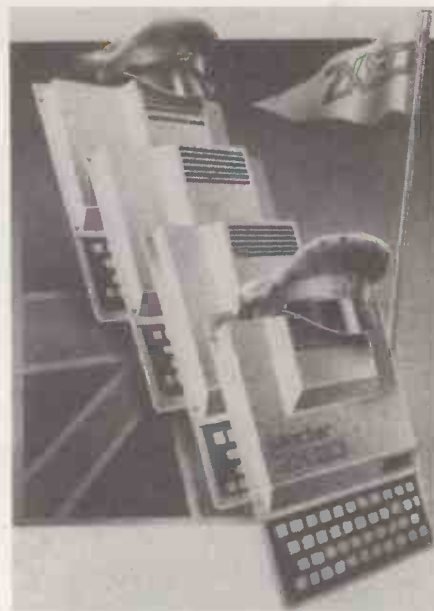

references in the ZX-80 operating manual to the **USR** function.

The first obvious requirement is at least a brush-acquaintance with Z-80 opcodes. The **USR** function assumes you have already stored a machine-code routine in memory. The easiest way of doing that is to set-up a dummy **REM** statement as the first line of the program, containing a large number of dummy characters, say, fullstops.

Having made a list of the machine-code routine, **POKE** the decimal values into memory starting at address 16427 — the address of the first fullstop in the **REM** statement. The last value should be a return instruction, e.g., decimal 201 — **RET** on the Z-80.

The **USR** function is unlike **GO SUB** in that it must be used within an instruction, e.g., **LET X = USR(16427)**. Its effect is to cause control to be transferred to the routine at the address in brackets and to return — providing you include a return statement — with the value held in the **HL** register pair, or, if that has not changed, with the original address value.

The following routine is not machine code but uses system variables to convert the first **PRINT** statement in a program to appear in the listing with text in inverse video — useful for highlighting titles.

```
10 PRINT " ANY TEXT "
.....
499 STOP
500 LET Q=0
510 FOR A=16424 TO 16499
520 LET C=PEEK(A)
530 IF C=1 AND Q THEN STOP
540 IF Q THEN POKE A, C + 128
550 IF C=1 THEN LET Q=-1
560 NEXT A
```

Lines 10 to 499 represent the main program and the routine at line 500 does the inversion. Start the routine by **RUN 500** and afterwards the listing will reveal the text in line 10 as being in inverse video. Lines 500 onwards may then be erased and the program **SAVEd** normally on cassette. □

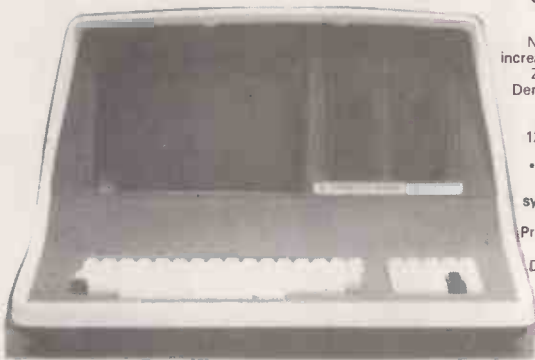

**NEW SUPERBRAIN  
DOUBLE DENSITY £1875  
QUAD DENSITY £2250**

Now with CP/M2.2, and increased disc storage. Twin Z80-A 4MHz. \*2 Double Density Disc Drives, giving 350/700K storage \*64K RAM. \*High resolution 12 Inch crt. 80 x 24 lines upper/lower case \* 2 RS-232 printer ports. \* CPM 2.2 operating system. \*MBasic, Cobol, Fortran, Pascal, Word Processing and Accounts packages available. Dealer Enquiries Invited.

**TRS-80  
MODEL II £1999**



State of The Art Second Generation Computer. Over 10,000 already sold in USA. 8 slot bus ensures expansion of hard discs and other peripherals. 76 Key professional keyboard, self test on power up. TRSDOS and Level III Basic STandard. CP/M available as option, making a wide range of accounting, educational, scientific and word processing packages instantly usable. Nationwide service through 180 Tandy Stores and Computer Centres.

**NEW TRS-80  
MODEL 1 48K  
system**



WITH DUAL DISC DRIVES. £1250. NEW GREEN SCREEN VDU, WITH ROCK STEADY DISPLAY. REDESIGNED 32K EXPANSION INTERFACE WITH TROUBLE FREE DISC OPERATION, TWO 40 TRACK TEAC DISC DRIVES, COMPLETE WITH CABLES. TRIDATA SALES, PURCHASE, INVOICING, PAYROLL PACKAGES AVAILABLE.

**LOW COST WORD PROCESSOR I**  
BASED ON TRS-80 LEVEL 2 16K. CASSETTE RECORDER, ELECTRIC PENCIL SOFTWARE, UPPER/LOWER CASE MOD, PRINTER INTERFACE AND OKI DOT MATRIX PRINTER. COMPLETE READY TO GO £1095. FREE MAILING LIST PROGRAM.

**WORD PROCESSOR II**  
SAME AS ABOVE BUT WITH 48K, 2 DISC DRIVES AND RICOH DAISY WHEEL PRINTER. £2575.

**WORD PROCESSOR III**  
BASED ON SUPERBRAIN COMPUTER SHOWN ABOVE. WITH RICOH PRINTER AND "MAGIC WAND" THE ULTIMATE IN WORD PROCESSING. LETTERS AUTOMATICALLY FORMATTED WITH ADDRESSES FETCHED FROM SEPARATE FILE. COMPLETE SYSTEM. £3395.  
INVOICING, STOCK CONTROL, SALES LEDGER, PURCHASE LEDGER, PAYROLL AVAILABLE FOR ABOVE COMPUTERS. FROM £250 PER PACKAGE.  
Prices quoted above do not include VAT. Phone or call for further details or demonstrations.

**60 CHARACTERS PER SECOND**

**RICOH RP-1600 THE FASTEST DAISY WHEEL PRINTER.** £1290 FAST, heavy duty commercial DAISY WHEEL printer, with high quality printout, coupled with low noise necessary for office environment. Nationwide service by NEXOS. 90 day warranty provided at your premises.

124 char: upper/lower case. \* 10/12 chars: per inch giving 136 or 163 columns. \* 15 inch wide friction platen. \* Top of the form, BOLDING, underline, and host of other features. \* Centronics type parallel interface as standard. Options: serial interface £60 \* PET interface £65 \* APPLE interface £75.



**ANADEX DP-8000  
NEW LOW PRICE £475.**

Fast 112 Characters per second. \* Both RS-232, and Centronics Parallel interfaces built in \* Upper/lower case £ sign.

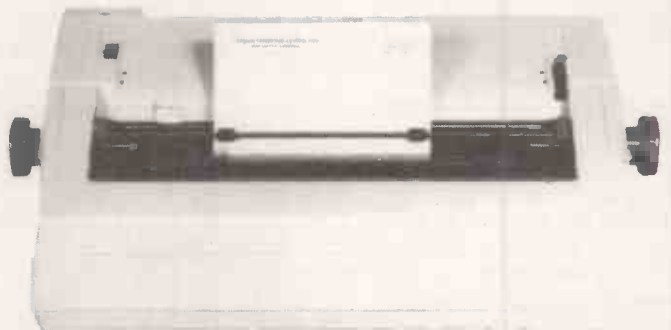

**OKI MICROLINE 80/132. The quiet printer you can live with £495.** The quietest Dot Matrix available. 40,80, or 132 cols per line. \* excellent print quality \* 3-way paper handling: Letterheads, Fan-fold, or Paper Rolls \* Graphics \* Ideal for software written for large 132 col printers \* Continuous rating printing day in and day out \* Centronics parallel standard. Options: RS-232, PET, APPLE. Dealer Enquiries invited.

**EPSON TX-80 £395**

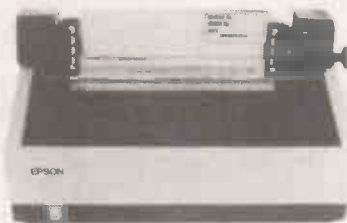

Dot-Matrix Printer with PET Graphics. Prints 80 columns on plain paper at 90 characters/second. Adjustable tractor \* Upper/lower case \* Double width printing \* Micro controlled \* Self test \* Heavy Duty Print Head using Jewell Bearings for long life \* Made by Shinshu Seiki an affiliate of Seiko Watch Co of Japan. Interface: Centronics Parallel. Options: PET, APPLE and Serial.

**LONDON COMPUTER CENTRE LTD**  
43, GRAFTON WAY,  
OFF TOTTENHAM COURT ROAD,  
LONDON W.1.  
TEL 01-388 5721  
OPENING HRS: 11-7 MON-FRI, 12-4 SATS.

**NORTHERN DEALER**  
MICRO SYS LTD  
58 HIGH STREET  
PRESCOTT  
MERSEYSIDE  
TEL: 051-426 7271

**MIDLANDS DEALER**  
HORIZON SOFTWARE LTD  
REGENT HOUSE  
16 WEST WALK  
LEICESTER LE1 7NG  
TEL: 0533 556550



## Powerful graphics

WHEN I first acquired my TRS-80, my initial impression was one of awe, particularly at the flexibility and speed of the VDU display compared to the printers of my previous experience, writes Ken Smith of Linton on Ouse in Yorkshire.

Once I started to program in earnest however, my initial joy turned to dismay. Efforts to produce pictures on the screen seemed futile. Graphics were a bind — a disaster — time-consuming and headache-making.

I spent the next two months regretting my decision to find an easier way into graphics. However, that period has passed and I now have a powerful set of routines and ideas to pass on.

Let us first look at definition. The screen is divided into a  $128 \times 48$  element display for raw graphics and  $64 \times 16$  locations for ASCII characters and pre-defined graphic symbols. If that is not clear, examine the video worksheet in the manual.

Raw graphics are used with the set and re-set function, by defining the 'X' and 'Y' axis [(0—127) and (0—47)]; whereas the pre-defined graphics are used with the PRINT @' (0—1023) or the 'POKE' (15360 to 16363) functions.

Set and re-set give the finest definition. A set of pre-defined symbols which will cover any combination of set re-set within a print or Poke location are provided on the TRS-80. Each 'Print location contains six set Pixels.

Figure 1. 1      2      Figure 2.

		
4	8	
16	32	

Each is numbered as in figure 1. That is the easy way to identify them. Add the values of the lit Pixels to 128, and you obtain the graphic code for that shape. Thus figure 2 becomes  $2 + 4 + 32 + 128 = 166$ . An easier way to see them is to use the routine on page C/2 of your manual.

We can now draw our picture by 'Print 0 X, CHR\$(Y); and so on. The technique uses 1/6 of the program statements but the grey matter involved in identifying the correct positioning and numbers is beyond me — and I suspect you. A quicker way to do the same thing is POKE (location) + 15360, graphic number.

For the weak of mind or faint at heart there is help. A J Harding (Molimerx) has a program which allows you to draw your picture using the cursor arrows and resolves the screen into location and graphics code.

It then pushes the information into several data lines. Erase the program lines, CSAVE, and all the work has been done. A quick restore, read and Poke enters your drawing into any program you write on top.

Of course, you can Poke anything you like on to the screen, all the ASCII character set, in fact. You can also Peek

**TANDY FORUM** is devoted to the Tandy TRS-80. Sometimes we will use it to pass on news about the TRS-80 but, above all, it is for users, and would-be users, of the well-established model I and now the new model II. With your tips, queries, moans and comments, this page can become a market-place for TRS-80 information.



the screen to see what is there. Very useful for games or specials — try:

```
10 CLS: INPUT A$(Input your message here)
20 A = LEN(A$):DIMAS(A)
30 FOR X = 1 TO A: AS(x) = MID$(A$,X,1):
NEXT
40 FOR X = 1 TO A: ?@127,AS(x);
50 FOR Y = 64 TO 126: POKE 15360 + Y,
PEEK(15360 + Y + 1):NEXT
60 NEXT: FOR X = 1 TO 3: GO TO 50;
NEXT: GO TO 40
```

On my machine, a prompt appears and any message I enter up to 255 characters moves across the screen, albeit slowly. It is rather slow to show the structure and to use most of the important graphic routines.

If we need to repeat a set of graphics continually or make a symbol or symbols move, we can make our graphics into a string.

```
10 AS = CHR$(179) + CHR$(157) + CHR$(140):CLS
20 ?@12,AS;
```

My screen shows a little rocket ship. If we rub it out we can move it. Add the following to your program

```
30 BS = CHR$(32) + CHR$(32) + CHR$(32)
40 ?@12,BS;
50 For X = 1 To 1023 step 3
60 ?@X,AS;: ?@X,BS;:NEXT
10 CLS
20?PEEK(14426)8;:GO TO 20
```

Run it, and you will be looking at a screen full of 0s. Press a cursor arrow — magic. Each cursor and combination has

a different number. What a useful thing. That is not a one shot effect like 'INKEYS' and you obtain a continuous result for as long as the key is held down.

Although this short routine loads in Basic, it has a machine-code routine which, combined with efficient use of Basic, makes it fast. Before typing-in, do the following: pull the plug from the auxiliary socket on the recorder, push back the lever in the top-left of the cassette tray; press record and play. Now type in:

```
10 Clear 50:FORX = 32000 TO 32009:READY
POKE X,Y:
NEXT: POKE 16526,O:POKE 16526,125:XX
= 15360:DEFINTZ:CLS
20Q =USR(0):Z = PEEK(XX):PRINT@Z*4,
STRING$(Z/4,Z),
GO TO 20
30 DATA 205,18,2,105,53,2,50,0,60,201
```

Now run. Try talking — a little louder perhaps. Is the LED on the recorder flickering? Play some music. The frequency response is best suited to voice or pop music, although anything with a beat works well.

## Data file method

I HAVE seen a number of items in Tandy Forum concerning the problems involved in using the cassette recorder for data files with the PRINT # statement writes John Heap, of Leeds. As many people have discovered, it is very slow and wearing on the cassette motor.

In January Tandy Forum, Martin Evans gave a method of using the same data file — held as a series of data statements — with a number of programs. What I have developed is a method of updating and saving the data file in its updated form. The program which follows serves as an example — it is a simple update of a file which consists of records made up of record number, reference number, quantity.

The method is based on the fact that the TRS-80 stores the program in terms of codes for reserved words and ASCII representations of the characters involved in program lines. To check that, try PEEKing at locations above 17129 on the 16K machine while referring to the new improved manual which contains a list of codes for the reserved words.

The program is loaded in the normal way and then RUN. Lines up to 100 tell the machine to accept another program — the data file, which is a set of DATA statements created beforehand and stored on cassette. That data file should consist of statements numbered higher than any line in the main program and with fields

(continued on next page)

(continued from previous page)

corresponding to the largest expected value, e.g., 5000 DATA 1,A001,01250 — if the maximum quantity to be stored is 99999. The last DATA statement should be an end of file record consisting of a record number of 99 which can be recognised by the program as an end-marker, e.g., 5100 DATA 99,9999,99999

The instructions printed on the screen by the program must now be followed:

1. CLOAD the data file.
2. POKE the values suggested into the locations given.
3. RUN 100 to start the main program.

The subroutine starting at line 1000 amends the data file. It is done by searching each program line in turn to see if it contains the code 136 for the reserved word DATA. If it does not, the program goes to the next program line by computing its start address from the values in the first two bytes of the line.

In the program, those are P1 and (P1+1) — the address of the next program line is given by (P1+1)\*256 + P1. The updated quantity is converted into a string, split into characters and the ASCII values for those characters are POKEd into the appropriate locations.

Lines 500-end save the updated data file to tape with a simple CSAVE instruction. Further experimentation should enable readers to construct quite sophisticated update programs using only one CLOAD and CSAVE for data input/output.

```

10 CLS
20 E=17129
30 S=E: E=PEEK(S+1)*256+PEEK(S):
  IF E<>0 GO TO 30
40 POKE 16549,INT(S/256):POKE 16548,
  S-INT(S/256)*256
50 PRINT"POSITION DATA TAPE AND
  CLOAD"
60 PRINT"THEN POKE 16548,233 AND
  POKE 16549,66"
70 PRINT"THEN RUN 100"
80 STOP
100 READ X3,Y3,Z3
110 IF X3="99" THEN 500
120 PRINT X3,Y3,Z3:PRINT
130 INPUT"ADDITION TO Z = ";Z1
140 IF Z1=0 THEN 100
150 Z=VAL(Z3):Z=Z+Z1:Z3=STR$(Z)
160 GOSUB 1000
170 GO TO 100
500 REM**END ROUTINE TO SAVE
  UPDATED DATA TO TAPE**
510 POKE 16549,INT(S/256):POKE 16548,
  S-INT(S/256)*256
520 PRINT"POSITION DATA TAPE AND
  CSAVE"
530 PRINT"THEN POKE 16548,233 AND
  POKE 16549,66"
540 END
1000 P1=17129
1010 IF PEEK(P1+4)=136 THEN 1030
1020 P1=PEEK(P1+1)*256+PEEK(P1):GO
  TO 1010
1030 A=6:V3=""
1040 V=PEEK(P1+A)
1050 IF V=44 THEN 1200
1060 V3=V3+CHR$(V)
1070 A=A+1:GO TO 1040
1200 IF V3=X3 THEN 1300
1210 GO TO 1020
1300 FOR K=1 TO LEN(V3)
1310 T3=MID$(V3,K,1)
1320 T=VAL(T3)
1330 Q=T+48
1340 POKE P1+A+5+K,Q
1350 NEXT K
  
```

## 1360 RETURN

### Example Data File

```

5000 DATA 1,A001,0025
5010 DATA 2,A002,0150
5020 DATA 3,A115,3250
5030 DATA 4,B106,0000
5040 DATA 5,A007,0785
5050 DATA 6,B200,1265
5060 DATA 99,9999,9999
  
```

## Passing variable data

A PROGRAM of interest to TRS-80 programmers who need to chain programs together and pass variable data between them has been submitted by G Reeves of Walsall, West Midlands. Of course, that can be accomplished by writing the data to disc or tape, but it tends to be impractical for many applications. An alternative

method is to Poke the data into protected memory. This small assembler program makes it very easy to do this from your Basic program.

The program uses all memory above its own end-point as a buffer in which to store data. You tell the program to store data by executing a USR call with an argument of 1. Then call it again for every variable you wish to store, using as an argument the VARPTR of the required variable. Having done that, you can link off to your next program.

To retrieve your data, execute a USR call with an argument of 2, do another call for each variable you wish to retrieve, using as an argument the VARPTR of the receiving variable. □

```

00100 ; PROGRAM TO PASS VARIABLES BETWEEN BASIC PROGRAMS
BE00 00110 ORG 0BE00H
BE00 C07F0A 00120 CALL 0A7FH ; GET USR ARGUMENT
BE03 3E00 00130 LD A,0 ; IS IT A
BE05 8C 00140 CF H ; VARPTR
BE06 2009 00150 JR NZ,GOTVAR ; IF NOT 0 IT IS
BE08 7D 00160 LD A,L ; GET REQUEST
BE09 3262BE 00170 LD (REQUEST),A ; AND SAVE IT
BE0C 2A60BE 00180 LD HL,(BUFBEG) ; INITIALISE BUFP0S
BE0F 1849 00190 JR FINISH ; ALL DONE-END
BE11 E5 00200 GOTVAR PUSH HL ; PUT HL
BE12 D0E1 00210 POP IX ; INTO IX
BE14 D04EFD 00220 LD C,(IX+253) ; GET TYPE/LENGTH
BE17 0600 00230 LD B,0 ; CLEAR FOR LDIR
BE19 ED5863BE 00240 LD DE,(BUFP0S) ; GET NEXT POSITION
BE1D 3A62BE 00250 LD A,(REQUEST) ; GET REQUEST CODE
BE20 FE01 00260 CP 01 ; IS IT A SAVE REQUEST
BE22 2813 00270 JR Z,SAVE ; YES
BE24 EB 00280 EX DE,HL ; ELSE SWAP MOVE REG'S
BE25 ED80 00290 LDIR ; AND MOVE DATA(RETRIEVE)
BE27 D07EFD 00300 LD A,(IX+253) ; GET TYPE BYTE
BE2A FE03 00310 CP 03 ; IS IT A STRING
BE2C 2020 00320 JR NZ,FINISH ; NO
BE2E E5 00330 PUSH HL ; PUT HL
BE2F FDE1 00340 POP IY ; IN IY
BE31 FD4EFD 00350 LD C,(IY+253) ; GET TEXT LENGTH
BE34 09 00360 ADD HL,BC ; ADD TO HL
BE35 1823 00370 JR FINISH ; AND END
BE37 D07EFD 00380 SAVE LD A,(IX+253) ; SAVE REQ,GET VAR TYPE
BE3A FE03 00390 CP 03 ; IS IT A STRING
BE3C 2019 00400 JR NZ,NOTSTR ; NO
BE3E EDA0 00410 LDI ; STORE LENGTH BYTE
BE40 D5 00420 PUSH DE ; PUT DE
BE41 FDE1 00430 POP IY ; INTO IY
BE43 13 00440 INC DE ; POINT TO
BE44 13 00450 INC DE ; BUFFER TEXT POSITION
BE45 FD7300 00460 LD (IY+0),E ; MODIFY
BE48 FD7201 00470 LD (IY+1),D ; TEXT POINTER
BE4B E5 00480 PUSH HL ; NOW LOAD UP HL
BE4C FDE1 00490 POP IY ; WITH
BE4E FD6601 00500 LD H,(IY+1) ; ACTUAL TEXT
BE51 FD6E00 00510 LD L,(IY+0) ; ADDRESS
BE54 D04E00 00520 LD C,(IX+0) ; GET LENGTH
BE57 ED80 00530 NOTSTR LDIR ; MOVE VARIABLE OR TEXT
BE59 EB 00540 EX DE,HL ; FOR COMMON FINISH
BE5A 2263BE 00550 FINISH LD (BUFP0S),HL ; SAVE FOR NEXT TIME
BE5D C39A0A 00560 JF 0A9AH ; RETURN TO BASIC
BE60 65BE 00570 BUFBEG DEFW BUFTXT ; BUFFER START
0001 00580 REQUEST DEFS 1 ; REQUEST CODE
BE63 65BE 00590 BUFP0S DEFW BUFTXT ; BUFFER-256 BYTES
0100 00600 BUFTXT DEFS 256
0000 00610 END
00000 TOTAL ERRORS
BUFBEG BE60 00570 00180
BUFP0S BE63 00590 00240 00550
BUFTXT BE65 00600 00570 00590
FINISH BE5A 00550 00190 00320 00370
GOTVAR BE11 00200 00150
NOTSTR BE57 00530 00400
REQUEST BE62 00580 00170 00250
SAVE BE37 00380 00270
  
```

# POWERFUL MICROS AT THE RIGHT PRICE

- Multi-User ● Multi-Tasking
- Multi-Language ● Hard Disc Storage ● Word Processing
- Priced from under £5000

Languages supported include – Basic, Cobol, Fortran.  
OEM, Educational and Dealer enquiries invited

## EQUINOX

COMPUTER SYSTEMS LIMITED  
Kleeman House, 16 Anning Street  
New Inn Yard, London EC2A 3HB  
Tel: 01-739 2387 & 01-729 4460



# ELIMINATE YOUR BACK-UP PROBLEMS

with our low cost cartridge drive



PRICE  
**£3950\***  
PLUS VAT

\*One-off OEM price

The Equinox KB10 Cartridge Drive allows S100 microsystems to transfer, read and write data at high speed. Its 5MB fixed and 5MB removable discs eliminate the need to provide separate data back-up. The removable 5MB disc allows for fast back-up and therefore unlimited off-line storage. Without sacrificing high performance, multiple users can operate the Equinox KB10 simultaneously using multi-user software. Equinox provides support for such software i.e., MVT/FAMOS, MP/M and OMNIX. CP/M is also supported.

## EQUINOX

COMPUTER SYSTEMS LIMITED

Kleeman House, 16 Anning Street, New Inn Yard,  
London EC2A 3HB. Tel: 01-739 2387/9 and 01-729 4460

• Circle No. 191

# Successful business?... Yes, with the Megamicro

average installed system  
less than **£8000** plus VAT

complete with  
**Hardware including printer**  
**Software including programs**  
**Staff training**  
**Installation & delivery**  
**Support by manufacturer**

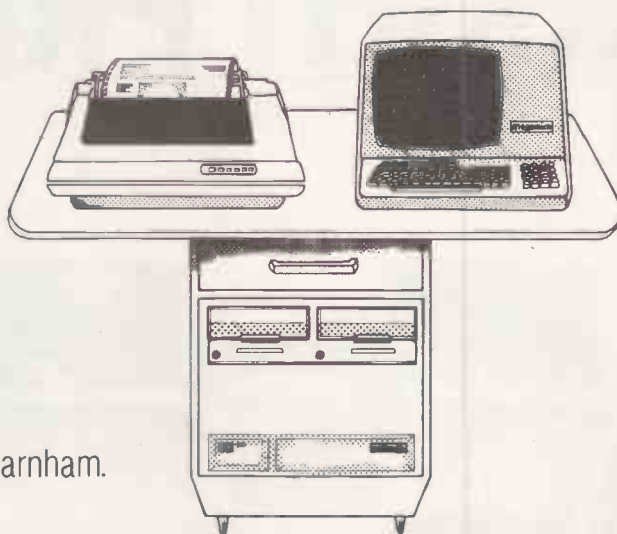

British built by:  
 Bytronix Microcomputers Ltd, 83, West Street, Farnham.  
 Telephone: (0252) 726814

• Circle No. 192



## L & J COMPUTERS



3 CRUNDALE AVENUE, KINGSBURY NW9 9PJ 01-204 7525

### THE "PET" SPECIALISTS

#### NEW LOW, LOW, 'PET' PRICES!!

Pet 8K (Large keys)	£420
16K	£499
32K	£630
Ext cassette decks (+ counter)	£ 55
PET Friction Feed printers	£400
AVAILABLE FROM STOCK	+ VAT
Printers/Disc Drives	Sundries
PET 3023	PET 3040
PET 3022	Compu 400K
Centronic 779	Compu 800K
Spinwriter	Interfaces

**TRY US!  
YOU WILL NOT BE  
DISAPPOINTED**

Tool kits: library cases  
 Disks: C12 Cassettes  
 Paper (roll & tractor feed)  
 Labels: Dust covers

WE ARE NOW TAKING ORDERS FOR THE  
**NEW 8000 SERIES CBM's**  
 FOR AUGUST DELIVERY

£\* ½ ¼ (80 col. screen: new keyboard) **£895**  
 8050 (974 K/Bytes: new DOS) **£895**  
 (sae for details: Demonstrations NOW)



COMPLETE SYSTEMS  
 FROM £1700!!

THE SYSTEMS WE SUPPLY & INSTALL ARE COMPLETE:  
 ESTIMATES GIVEN FREE WITH NO HIDDEN EXTRAS:  
 FULL BACK-UP: GUARANTEED EXPERTISE.

PRICES DO NOT INCLUDE VAT

PERSONAL SHOPPERS WELCOME  
 Phone & Mail Orders accepted.

#### SOFTWARE

As well as a full range of Petsoft and Commodore Software, we have some highly reliable "Home-Brewed" programs available.

**STOCK CONTROL & INVOICING** **£60**  
 (Handles up to 500 items - 32K) (180 on 16K). Stock depleted on invoicing, search etc. Cassette, disk (& print option).

**STOCK TAKING** **£230**  
 Basic program which can be tailored to suit most trades. Beautiful print-out!

**OUTSIDE SERVICES (For Mini-Cabs Etc)** **£220**  
 Weekly or monthly invoices - cheque writing facility - optional deductions. (16 or 32K + disk + printer).

**MACHINE HIRE** **£420**  
 Covers hiring of machines, customers, due & overdue. Hiring Charges: Machine History: Printouts for all Sections. Ideal for Typewriter & Plant Hire Firms.

**CASH BOOK** **£90**  
 Enter daily/weekly amounts - printout and totals, weekly/monthly analysis, totals and balances.

Sae for free software booklet

Specialists in: Commodore Business Programs  
 Bristol Trader, Item & Monitor  
 Superpay Word Processing

SPECIALISED SOFTWARE APPLICATIONS  
 UNDERTAKEN. RING FOR DETAILS

ALL GOODS SENT SAME DAY WHEREVER POSSIBLE  
 LARGE S.A.E. FOR LISTS ETC.



• Circle No. 193

### Art of simplicity

HERE ARE two methods of having more than one input on one line, which looks good and makes long data inputs easy to read, writes Kevin Jones of Lytham St Annes, Lancashire. A Pet will not accept something like:

```
10 INPUT "ACCOUNT NO.":N;
"AMOUNT":A
```

To overcome that problem, I originally experimented both with machine code and the Get instruction. However, these two solutions are the art of simplicity:

```
10 INPUT "ACCOUNT NO.":N
20 INPUT "cursor up and 20 cursor lefts
AMOUNT":A
```

The third method uses three program lines but fewer bytes. It is:

```
10 INPUT "ACCOUNT NO.":N
20 PRINT TAB(20)
30 INPUT "cursor up AMOUNT":A
```

which, of course, eliminates the cursor-rights. With different spacing the method has been used successfully for three inputs on one line.

### Reclaiming bytes

A PROGRAM written for the Pet with new ROMs which suppresses all unnecessary blanks in a program which has been loaded in core has been submitted by S P Folmer, Grantham, Lincolnshire.

Load the program to be modified and, if you have a "toolkit", append the program, type 'RUN 63000'. After a few seconds, relative to the size of your program, the program will display the line on which it is working. When the run is

```
63000 PØKE144,49:REM S.P. FØLME APRIL 1980
(c)
63001 DEFFNA(X)=PEEK(X):DEFFNB(X)=PEEK(X+1):
DEFFNC(X)=FNA(X)+256*FNB(X):FI=-1
63002 LP=1025:BL=0:PRINT"CLR":TAB(7):"*** BL
ANK SUPPRESSØN ***"
63003 L1=FNA(LP+2):L2=FNB(LP+2):LN=FNC(LP+2):
QU=0:L5=LP-BL:L6=FNC(LP)
63004 IFFIANDLN=63000THENL5=40:GØTØ63011
63005 IFFIGØTØ63011
63006 IFLN=63000THENL3=0:L4=L3:L7=L5+2:GØTØ63
012
63007 PØKELP+2-BL,L1:PØKELP+3-BL,L2:TP=LP+3:
PRINT"PRØCESSØING LINE":LN;"*"
63008 TP=TP+1:CH=PEEK(TP):IFCH=34ØRCH=143THEN
QU=NØTQU
63009 IFCH=32ANDNØTQUTHENBL=BL+1:GØTØ63008
63010 PØKETP=BL,CH:IFCH<>ØGØTØ63008
63011 LP=L6:L3=INT((LP-BL)/256):L4=LP-BL-L3*
256:IFFIANDL5<>4ØGØTØ63003
63012 PØKEL5,L4:PØKEL5+1,L3:IFFITHENFI=NØTFI
:GØTØ63002
63013 IFL5<>ØGØTØ63003
63014 PRINTBL;"←BLANKS SUPPRESSØED":PØKE
40,1:PØKE41,4:PØKE144,46
63015 L3=INT(L7/256):PØKE623,L3:L4=L7-L3*256:
PØKE42,L4:PØKE43,PEEK(623):CLR
"CLR=CLEAR SCREEN":"↑=CURSOR UP;
"↓=CURSOR DØWN":"←=CURSOR LEFT.
```

completed, all you have to do is save your program as usual. At end of run, my program will display the number of blanks it has suppressed.

Notice that the program deletes itself after execution. Also I have disabled the interrupt key as an abnormal termination would leave all linkage addresses in mid air.

The interrupt key is disabled by Poking location 144 with 49. The program finds the linkage address of line 6300 which is the cause of the apparent pause before execution and sets the start-of-text pointer to the value — locations 40 and 41.

That is done to fool the system into thinking that your program no longer exists thus enabling the program to shuffle



linkage pointers. If it did not do this, the system would hang during execution as some linkage pointers would be temporarily pointing to somewhere inside a line of program text instead of to the next linkage pointer. The program starts examining each line sequentially from the start of text.

If a non-blank value is found — blank = 32 — it is poked back into memory at address TP-BL, where TP is the text pointer and BL is the number of blanks found so far.

The same applies to a blank found between quotes or after a remark statement. If, however, a blank is found, no character is poked back into memory and B2 is incremented by one.

When it reaches line 63000 — LN = 63000 — it pokes a zero value in the last linkage pointer signifying end of text. It then re-sets the start of text pointer back to 1025, the normal value, and finally sets the start of variables pointer to two bytes after end of the text and clears all variable space, deleting itself.

I realise that all that sounds rather involved, but for those who wish to know still more about the subtleties, I suggest reading the Principal Pointers Into Pet RAM chapter in your CBM user manual. That is where I found all the information I required to write the program. For the others, I simply suggest you copy the program very carefully and enjoy the lovely extra bytes you can now claim back from your programs.

When I am developing and testing a program, I always put the emphasis on legibility which saves a good deal of time at this stage. Once satisfied with a program, its execution can be optimised significantly by squeezing out any unnecessary blanks. With small programs that will not pose much of a problem as the Pet has superb editing facilities.

With a large one, however, you could waste a whole frustrating evening doing that, which was my incentive for creating the program. It has saved me many hours and thousands of bytes.

### Readability improved

HERE ARE two ideas I have written for the Pet writes Mark Atherton of Liverpool. The first is to improve the readability of program listings.

As has been mentioned in previous Pet

corners, FOR loops should be indented. However, the Pet deletes any spaces after a line number and so colons have to be used. If you enclose the required spaces in shifted ampersands, the spaces are left:

```
10 FOR I = 1 TO 10
20 (&) (5 SPACES) (&)
30NEXT
```

When line 20 is LISTED the &s have gone. That also allows blank lines to be left e.g., type:

```
25 (&) (SPACE) (&)
```

and when LISTED the line is just a blank.

The other routine is used most effectively in games for added effect. Usually in a game when you are destroyed/eaten/killed/beaten a message such as BOOM!!, or some equivalent, is printed. That is slow and messy. This routine is very fast — it is machine code.

When called by a SYS (826), it will scan the screen instantly and make anything in ordinary field reverse field and vice versa. It can be very effective if called repeatedly with a small delay.

```
10 DATA A2,00,86,01,A2,7F,86,02,CA,AO,
00,B1,01,49,80,91,01,C8
20 DATA D0,F7,E6,02,E0,7A,D0,EE,60,
END
30 FOR I=1 TO127: READ A$:IF A$ =
"END" THEN 90
40 B$=LEFT$(A$,1):C$=RIGHTS
(A$,1)
50 T=t+VAL(C$)+16*VAL(B$)
60 IF VAL(C$)=0 AND C$<>
"Ø" THEN T=T+ASC(C$)-55
70 IF VAL(B$)=0 AND B$<>"Ø" THEN
T=T+16*(ASC(B$)-55)
80 PØKE 825+I,T:T=0:NEXT
90 REM YOUR PRØGRAM STARTS HERE
AND ROUTINE IS CALLED WITH
SYS 826
```

If there is too much snow, as on an old ROM Pet, PØKE the screen off before use and off again after the SYS.

### Program security

TO STOP others loading your disc programs or using your files on the Commodore disc drives, include control characters in the file name writes Jonathan Dick of Bristol. They do not show in the directory providing the file name starts with a quote character.

Because of that, a program which looks as if the file name is TEST might, as far as the disc is concerned, have several control characters embedded in it. For example, to save a program called HELLO so that nobody else can load it you might type: A\$=CHR\$(34)+CHR\$(1)+"H"+CHR\$(2)+"E"+CHR\$(9)+"LL"+CHR\$(3)+CHR\$(5)+"Ø"

Followed by a carriage-return. You would then type:

```
'SAVE"Ø":A$,8.'
```

That would save the program to disc with the control characters embedded in the filename. When a directory is called subsequently, you see double quotes, the program name, without control characters visible, and the file type indented further left than usually.

Because of the vast possible combinations of control characters and ordinary characters, you can put a 16-character file (continued on next page)

(continued from previous page)

name which is almost impossible for anyone to load unless they know what characters it contains.

To load the program, you do the same as when you save it apart from substituting the command LOAD for SAVE. The reason why control characters appear as reverse-field characters unless you put the CHR\$(34) at the start of the file name is that the file name appears in quotes in the directory.

The quote you insert closes the quotes before the file name is typed. You must always insert at least one other control character before the file name, otherwise someone might load it using the "\*" for pattern-matching, e.g., 'LOAD"0:" + CHR\$(34) + "H\*\*',8' for a file name which starts with an 'H'.

Something you must not do is put a protected program at the start of a disc otherwise it can be loaded by typing 'LOAD""',8'.

### Load problems

A SIMPLE method to avoid the successive LOAD problem on the CBM disc has been sent by G Thomas of Liverpool.

One problem with the CBM 3040 disc unit relates to the calling of one program from another via the LOAD statement. It will work only if the called program is of the same size, or smaller, than the calling program.

If it is not, the LOAD is executed, but the called program is truncated or corrupted and will not run. That is a nuisance if a user wishes to swap programs back and forth from a master routine or chain a large program.

The difficulty can be overcome, however, by fooling the Basic into thinking that it has more program in memory than is there. There are no pointers to the end of Basic but the pointers to the start of the variable table, which follows the Basic, serve the purpose. Take the case where the largest program in a suite is 10K.

Assuming that the Basic starts at location 1025, a 10K program will lift the top of Basic to 1025 + 10 \* 1024, or location 11265. By poking the low and high bytes of that address + 3 into locations 43 and 42, the pointers to the start of the variable table, the Basic space is expanded. Thus, the statement POKE 42,4: POKE 43,44 added to all programs in the suite will accommodate free loading of any of them.

It is important that the statement should immediately precede the LOAD statement, for if it does not, the variables generated in the calling program can be corrupted. A typical application will look something like:

```
1000 POKE 42,4: POKE 43,44
1010 LOAD"1:PROGRAMA",8: END
```

The procedure does not reduce the memory space available for variables and arrays in the calling program because the instruction is not executed until the

program has effectively ended. Thus, the calling program determines its own top of Basic in the usual way, to have it expanded only at its end. It is for that reason that the POKEs must immediately precede the LOAD.

### Banner maker

HERE is a little program from Compshop (Ireland) for making banners on your Pet or Epson printers.

```
1 OPEN:4
2 CMD1
3 LIST
4 REM" BANNER (C) COMPSHOP [IRELAND] 1980
5 PRINT""
6 RESTORE
10 INPUT" HORIZONTAL";X
20 INPUT" VERTICAL";Y
30 INPUT" CENTRED";L#
31 G1=0: IFL# > "P" THEN G1=1
33 INPUT" STATEMENT";A$
40 A=ASC(LEFT$(A$,1))
70 FORT=ITOLEN(A$)
80 P$=MID$(A$,T,1)
85 FORD=1 TO 50
95 READ$$(S(1),S(2),S(3),S(4),S(5),S(6),S(7))
100 IFFP$=" THEN B12
101 IFFP$=S$ THEN Z00
120 NEXT
200 RESTORE
210 X#=#
215 FORD=1 TO 7
218 FORK=8 TO 0 STEP-1
230 IFT2"K$(U) THEN Z70
240 J(9-K)=0
250 GOTO Z00
270 J(9-K)=1: S(U)=S(U)-2"K
272 IFS(U)=1 THEN B15
280 NEXT
445 FORT=1 TO X
447 PRINT#1, TAB(63-4.5*Y)*G1/(LEN(X$)+1);
450 FORB=1 TO F(U)
460 IF J(B)=0 THEN S00
465 FORT=1 TO Y: PRINT#1, X#;: NEXT
470 GOTO Z00
500 FORT=1 TO Y
510 FORT=1 TO LEN(X$)
520 PRINT#1, " ";: NEXT I1
530 NEXT I
600 NEXT B
620 PRINT#1, ""
630 NEXT T1
700 NEXT U
750 FORH=1 TO 2*X: PRINT#1, " ";: NEXT
800 NEXT T
806 FORH=1 TO 75: PRINT#1, " ";: NEXT
810 PRINT" MORE (YES/NO) ?"
811 INPUT$ IFR$="YES" THEN 5: IFR$="NO" THEN 820: GOTO 810
812 FORT=1 TO 7*X: PRINT#1, NEXT
813 GOTO Z00
815 F(U)=9-K: GOTO 445
820 END
899 DATA "0,0,0,0,0,0,0,0
900 DATA "A",585,37,35,34,35,37,585
901 DATA "B",125,131,258,258,290,183,181
902 DATA "E",512,274,274,274,274,258,258
903 DATA "T",2,2,2,512,2,2,2
904 DATA "U",256,257,129,65,129,257,256
905 DATA "L",512,257,257,257,257,257,257
906 DATA "S",69,139,274,274,274,163,69
907 DATA "O",125,131,258,258,258,131,125
908 DATA "K",512,7,9,17,33,193,512
909 DATA "P",512,18,18,18,18,2,2
910 DATA "X",512,17,17,41,69,131,258
911 DATA "B",512,274,274,274,274,274,239
912 DATA "D",512,258,258,258,258,131,125
913 DATA "H",512,17,17,17,17,17,512
914 DATA "M",512,7,13,25,13,7,512
915 DATA "Z",5,3,2,1,18,11,5
916 DATA "U",128,129,257,257,257,129,128
917 DATA "R",512,18,18,58,82,146,271
918 DATA "P",512,18,18,18,18,15
919 DATA "Q",125,131,258,258,322,131,381
920 DATA "V",8,9,17,481,17,9,8
921 DATA "U",64,65,129,257,129,65,64
922 DATA "X",388,69,41,17,41,69,388
923 DATA "Z",386,322,290,274,266,262,260
924 DATA "I",258,258,258,512,258,258,258
925 DATA "C",125,131,258,258,258,131,69
926 DATA "J",65,129,257,257,257,129,128
927 DATA "1",0,0,261,259,512,257,257
928 DATA "2",261,387,322,290,274,267,261
929 DATA "3",66,130,258,274,266,150,100
930 DATA "4",69,41,17,512,17,41,69
931 DATA "4",33,49,41,37,35,512,33
932 DATA "5",160,274,274,274,274,226
933 DATA "6",194,291,293,297,305,289,193
934 DATA "7",258,130,66,34,18,18,8
935 DATA "8",69,171,274,274,274,171,69
936 DATA "9",263,138,74,42,26,10,7
937 DATA "9",41,41,41,41,41,41,41
938 DATA ":",1,1,1,384,1,1,1
939 DATA "0",57,69,131,258,131,69,57
940 DATA ":",1,1,1,129,449,129,1,1
1000 STOP
1002 END
1003 CLOSE:4
READY.
```

### Pet news

ABOUT two years ago Channel Data Systems in Goleta, California, published the Pet Data Book. It started life as a ring binder, listing under various cross headings the software, peripherals and information sources for the Pet writes Julian Allason of Petsoft.

Channel Data could not have known that support for the Pet system would grow so rapidly. At the last time count,

there were more than 200 companies supplying goods for the Pet in the U.K. alone. That number is still growing which suggests whatever plans Commodore may have to market the Pet as a purely business system, there will always be a substantial number of users whose interest lies elsewhere.

The pure computing aspect of the Pet received a major shot in the arm with the release of a Pascal compiler written by T C L Software. T C L are part of Transam which manufactures the Triton and Tuscan microcomputers, and it is interesting that a British firm has succeeded where several U.S. software houses had failed.

Unlike most micro Pascal implementations, it is supplied on disc with no necessity for additional firmware. A 32K Pet is needed. There are two modes of operation. In the simplest, the Pascal compiler co-resides in RAM with your own program. Obviously, the program size is limited in that mode and users will probably find that better for learning the language.

Using the disc-based compiler, one has access to disc file handling and the full power of the language. Pet Pascal is available through Commodore dealers, price £420 inclusive of diskette and 105-page manual. Information from Transam on 01-402 8137.

The absence of the £ sign in the Pet character set has infuriated U.K. users since the system was launched. At last a solution is in sight. Petsoft and HB Computers are marketing a low-cost, high-resolution graphics board which allows up to 128 additional characters to be programmed.

Of course, it does a great deal more than that, allowing one quarter of the screen to be reserved for high-resolution graphics operations. The rest of the screen can be used in the normal text mode, a combination which will be welcomed by anyone who has attempted to wrestle with the problem of the low-density Pet plotting. It is available from most Pet dealers priced £99.50 plus VAT. Information from 021-455 8585.

It emerges from a recent survey of prospective microcomputer purchasers, that the single most popular application was electronic filing. Dataview, the Colchester-based Wordcraft experts has produced a disc-based package called Micro Clerk, specifically for the filing and retrieval of information. In fact, it can be used with the Wordcraft word processor or on its own.

The first part consists of a display editor for creating and correcting natural English records of notes, reports and letters. Part two is a program to extract from a text all paragraphs containing key words chosen by the user. They are highlighted to permit rapid identification of the information being retrieved.

Micro Clerk costs £159 plus VAT. Information from Dataview on 0206-78811. □

# SUPERBRAIN™



There's been a lot of talk lately about intelligent terminals with small systems capability. And, it's always the same. The systems which make the grade in performance usually flunk the test in price. At least that was the case until the SuperBrain graduated with the highest PPR (Price/Performance Ratio) in the history of the industry.

SuperBrain users get exceptional performance for just a fraction of what they'd expect to pay. Standard system features include: two double density mini-floppies with 320K bytes of disk storage, 64K of RAM memory to handle even the most sophisticated programs, a CP/M Disk Operating System with a high powered text editor, assembler, debugger and a disk formator. And, with SuperBrain's S-100 bus adaptor, you can add all the programming power you will ever need... even a 10 megabyte disk!

SuperBrain's CP/M operating system boasts an overwhelming amount of available software in BASIC, FORTRAN, COBOL, and APL. Whatever your application... General Ledger, Accounts Receivable, Payroll, Inventory or Word Processing... SuperBrain is tops in its class. But best of all, SuperBrain tackles your toughest jobs for less than one-third the cost of other similar systems.

You'll appreciate the careful attention given to every engineering detail. Standard SuperBrain features include: a full ASCII keyboard with numeric pad and user-programmable function keys. A non-glare, dynamically focused, 12-inch CRT for sharp images everywhere on the screen. Twin Z80 microprocessors to insure efficient data transfer to auxiliary peripheral devices. A universal RS-232 communications port for serial data transmission. And, a single board design to make servicing a snap!

Performance and packaging have never been better matched. Your operators will appreciate SuperBrain's good looks. You'll appreciate SuperBrain's outstanding value. Twin Z80A processors, dual double density disk drives, and a high resolution CRT terminal. All in a single, smart looking, self-contained desktop unit. And, all for a price that's substantially less than the competition!

Make no mistake about it. The freshman students in the small systems business can't begin to compete with this year's honor graduate. The SuperBrain. The only system at the top of its class in price and performance.

# £1395

**COMPLETE (+ VAT)**

**\* OUR PRICE IS THE R.R.P.**

**K.G.M. MICROS LTD  
88, HIGH STREET,  
SLOUGH, BERKS.  
TEL. SL. 38581**

**SUPERBRAIN™** is the registered trademark of Intertec Data Systems.

• Circle No. 194

# Now available on Earth



## THE SHARP MZ-80 COMPUTER SYSTEM

Sharp have been associated with many major advances in electronic technology in space and here on Earth. We have introduced the most sophisticated production techniques for electronic circuitry to set world renowned standards of reliability into every product.

That's why the MZ-80K and its range of peripherals is going to change the way you think about microcomputers. The Sharp MZ-80 System now includes the MZ-80K processor backed with the MZ-80FD dual drive, double sided mini-floppy disk unit to give rapid, effective, sequential and random access, to huge amounts of stored information with incredibly fast response times.

Our new MZ-80P3 printer makes a good impression as well. Its fine definition dot matrix

head prints across 80 columns, at 100 characters per second, with full graphics capabilities.

The Sharp MZ-80 System is a new approach to computer applications, and their efficient use by human beings.

Our aim is to make computers and their related equipment relatively simple and therefore better understood and better used by those they are designed to serve.

Whether you are looking for a business system, or a system for educational or personal use—take a look at Sharp, it will change the way you think about computers.



## COMPUTER APPLICATIONS

Send me details of the complete Sharp MZ-80 System and the name and address of my nearest stockist PC8

Name \_\_\_\_\_

Address \_\_\_\_\_

Sharp Electronics (UK) Limited, Sharp House, Thorp Road, Newton Heath, Manchester. M10 9BE Tel: 061-205 2333



## Binary-file finder

TO COPY a binary file, whether program, data or high-resolution graphics picture from one disc to another, you need to know its address and length parameters, writes D Leedham of Enfield, Middlesex.

The program Bloads the requested file, displays the start address and length in decimal and Hexadecimal and, if required, copies the file on to another disc.

The program is in Applesoft/Palsoft and as written is for a 48K machine. For a 32K machine, subtract 16,384 from each of the PEEK addresses in lines 60 and 70. For a 16K system, subtract 32,768.

The program will crash if the binary file is Bloaded into the area of memory occupied by the BFINDD program (\$800-\$AD6). You can still find the start address and length parameters, although without the copy facility, by using the following procedure:

```
BLOAD (filename)
LOAD BFINDD
RUN 60
```

A useful addition to the program would be an On Err Goto statement and routines for dealing with Disc Full, I/O Error, File Not Found and so on.

```
]LOAD BFINDD
```

### LIST

```
10 REM ** BINARY FILE FINDER **
20 TEXT : HOME
30 VTAB 10: INPUT "ENTER NAME OF
  BINARY FILE: ";NAMES$
40 D$ = CHR$(4)
50 PRINT D$;"BLOAD";NAMES$
60 A = PEEK (43634) + PEEK (43635) * 256
70 L = PEEK (43616) + PEEK (43617) * 256
80 HOME
90 VTAB 5: PRINT "FILENAME:
  ";NAMES$
100 VTAB 10: PRINT TAB (19);"DEC";
  TAB (27);"HEX"
110 D = A: GOSUB 270
120 PRINT : PRINT "START ADDRESS:";
  TAB (19);A; TAB (27);H$
130 D = L: GOSUB 270
140 PRINT : PRINT "LENGTH:"; TAB
  (19);L; TAB (27);H$
150 VTAB 22: PRINT "DO YOU WISH TO
  SAVE THIS FILE ON ANOT HER
  DISK? (Y OR N)"
160 GET R$
170 IF R$ = "Y" THEN 200
180 IF R$ = "N" THEN END
190 GOTO 150
200 HOME
210 VTAB 10: PRINT "INSERT NEW DISK
  AND PRESS RETURN."
220 GET R$: IF R$ < > CHR$(13) THEN
  210
230 PRINT : PRINT
240 PRINT D$;"BSAVE";NAMES$;"A";A;
  "L";L
250 PRINT D$;"VERIFY";NAMES$
260 END
270 REM ** DEC TO HEX ROUTINE **
280 H$ = ""
290 FOR I = 1 TO 4
300 T = INT (D/16):S = D-16*T+48
310 IF S > 57 THEN S=S+7
320 H$ = CHR$(S) + H$:D = T: NEXT I
330 RETURN
```

## Re-locating assembler

OWNERS of Euro Apples and ITT 2020s with Applesoft or Palsoft in ROM may be disappointed as I was that the mini-assembler facility is not available to them,

This section is open to the Apple user. In every issue we hope to print ideas, hints and comments about the Apple and its suppliers. They must come from you, so write and tell us what you know.



writes Malcolm Banthorpe of Northolt, Middlesex. However all is not lost as the assembler is listed in full in the Apple II reference manual.

It resides from F500 to F668 as listed. Re-location to any other address is a simple matter — apart from the tedium of typing 360 bytes of machine code — requiring that the destinations of JMP and JSR instructions within the 360 bytes be changed as appropriate.

I have an ITT 2020 with 48K of RAM and decided to re-locate the assembler to start at B500. The details of the necessary changes given serve as a guide to re-location to other addresses. Choosing a starting address of the form X500 minimises the number of changes required.

Assuming you are typing in the assembler starting at B500, the changes are as follows:

```
B535 becomes 4C 95 B5
B559 becomes 4C 95 B5
B5BD becomes 20 34 B6
B5DB becomes 20 34 B6
B5E5 becomes 20 34 B6
B631 becomes 4C 5C B5
B666 becomes 4C 92 B5
```

That is all there is to it. Providing you have not typed any errors, B666G will take you into the assembler which will function exactly as described in the book.

### Simon Goodwin's last-variable printer.

Address	Machine Code	Operation	Comment
0300-0311			HEX DUMP OF MESSAGE CODES
0300-	8D 87 AA AA AA A0 CC C1		
0308-	D3 D4 A0 D6 C1 D2 A0 BA		
0310-	A0 00		
*0320L			
0320-	AD 00 03	LDA	£0300
0323-	D0 03	BNE	£0328
0325-	4C 31 03	JMP	£0331
0328-	20 ED FD	JSR	£FD0D
032B-	EE 21 03	INC	£0321
032E-	4C 20 03	JMP	£0320
0331-	8D 21 03	STA	£0321
0334-	A5 81	LDA	£81
0336-	69 7F	ADC	#£7F
0338-	20 ED FD	JSR	£FD0D
033B-	A5 82	LDA	£82
033D-	69 7F	ADC	#£7F
033F-	20 ED FD	JSR	£FD0D
0342-	A9 8D	LDA	#£8D
0344-	20 ED FD	JSR	£FD0D
0347-	60	RTS	
0348-	EA	NOP	
0349-	EA	NOP	
034A-	EA	NOP	
034B-	EA	NOP	

Having ascertained that all is well, it is wise to save the assembler on tape for future use before doing anything else. Presumably the Sweet 16 Interpreter could be re-located in a similar manner. I would be interested to hear from anyone who has attempted that.

## Last-variable printer

SIMON Goodwin of Hereford has contributed the polished version of his assembler routine to print the last variable used by Applesoft Basic.

In essence, the routine could be written as a single line of immediate execution Basic, but when working with large programs, e.g., the tangled Chelsea College Epics, I have found it useful. It is easy to play with, unlike most assembler routines, so it should stimulate a little healthy experimentation.

There may be a string output routine somewhere in the monitor, but I can't find it so I have written my own which is the main part of the listing — it is a kind of combination 6502 For.Next loop and computed Goto, and may have other uses.

The routine can be used from any Applesoft program to find the name of the last variable handled by the computer, for example, before, an error has occurred. It is accessed by a call 800 from Applesoft, and can be either Bloaded or Poked into memory. It has no use with integer Basic programs, but could probably be modified to suit.

Use it to debug: next without for, illegal quantity, overflow, division by zero, errors in complex programs. The routine from £0320-£0333 can be used as a general-purpose machine-language routine to output up to 30 text characters in memory from 0300 onwards. Remember to end with CR and code (00).

# Keenstar

## Now the sky's the limit!



Keenstar. A great new range of exciting products that will enable you to exploit your micro to the maximum. Our reputation as one of the country's leading microcomputer consultants and supplier of leading brands is enhanced still further by this latest addition to our extensive range of micros, peripherals, software and services.

Micros such as Apple, Pet, North Star Horizon and Sharp. Fast and reliable printers from Anadex and Qume. Bespoke and packaged software. And a level of service second to none. From single applications to expandable systems. From full system design through installation, commissioning and staff training to outstanding after-sales-service.

Send off for the new Keenstar catalogue and you will see over 200 interface boards, special applications software and associated products. All designed to let you take the lid off computing. Why go elsewhere when you'll find all you need to build your microsystem under one roof. It's a roof to us, but with the advent of Keenstar there's no ceiling to your system! While you're waiting for your catalogue just browse through the tiny fraction of what is available listed below. Now that Keenstar's arrived you can really let your imagination loose.

### SI100 HARDWARE

K 20001 N 450ns static RAM Board	241.13
K 20002 N 300ns static RAM Board	269.50
K 20003 N 200ns static RAM Board	275.00
K 20004 N 2200 Mainframe	295.00
K 20005 N Wire Wrap Board	30.00
K 20006 N Solder Tail Board	30.00
K 20007 N Extender Board	30.00
K 20008 N 8080 CPU Assembled	180.00
K 20009 N Z-80 CPU Assembled	220.00
K 20010 N Memory Mapped Video Interface	160.00
K 20011 N I/O Mapped Video Interface	180.00
K 20012 N 80 x 24 Video Interface (2MHz)	295.00
K 20013 N 80 x 24 Video Interface (4MHz)	330.00
K 20014 N 80 x 51 Upgrade (2MHz)	70.00
K 20015 N 80 x 51 Upgrade (2MHz)	70.00
K 20016 N Parallel I/O Interface	110.00
K 20017 N 2P + 2S I/O Interface	175.00
K 20018 N Music Synthesiser (4)	220.00
K 20019 N Prototyping Board	65.00
K 20023 N 2708/2716 EPROM Programmer	180.00
K 20024 N 4K 1702 EPROM Board	110.00
K 20025 N 16K 2708 EPROM Board	130.00
K 20026 N Active Terminator	55.00
K 20027 N 15 Slot Motherboard	140.00
K 20028 N Extender Board	30.00

### APPLE HARDWARE

K 11502 A Sony Colour TV. S/colour	349.00
K 21001 A ROM/PROM Board	65.00
K 21002 A Programmable Timer	130.00
K 21003 A BCD Analogue to Digital	120.00
K 21005 A Wire Wrap	20.00
K 21006 A Solder Tail Board	20.00

K 21007 A Extender	20.00
K 21008 A Etch Board	20.00
K 21009 A Asynchronous serial card	130.00
K 21010 A Synchronous serial card	130.00
K 21011 A P.I.a.	110.00
K 21012 A Arithmetic Processor	280.00
K 21013 A Lower Case Adaptor	55.00
K 21014 A Apple Serial/Parallel Interface	130.00

### NORTH STAR SOFTWARE

K 02001 O Word Star	255.00
K 02002 O Wordmaster	75.00
K 02003 O Supersort I	125.00
K 02004 O Supersort II	105.00
K 02005 O Supersort III	75.00
K 02006 O Whatsit? (N. Star)	95.00
K 02007 O Whatsit? (CP/M)	125.00
K 02008 O CP/M	95.00

### PET SOFTWARE

K 03001 O 6502 Assembler	20.00
K 03002 O Microchess	15.00
K 03004 O Gammon Gambler	15.00
K 03005 O Time Trek	15.00
K 03006 O Graphics Pak	15.00
K 03007 O Stimulating Simulations	15.00
K 03008 O Bridge Partner	15.00

### PRINTERS

K 01030 P Anadex DP 8000	575.00
K 1083 P Qume 45 RO	2280.00

### APPLE BUSINESS SOFTWARE

K 01137 B Visi Calc	95.00
K 01176 B Desktop Plan	95.00
K 01182 B CCA Data Management	95.00

K 01183 B Whatsit?	99.00
K 01186 B EasyWriter - Original	95.00
K 01885 B EasyWriter Pro	180.00

### TERMINALS

K 11711 T Cifer (Wordstar terminal)	1150.00
-------------------------------------	---------

### APPLE SOFTWARE

K 01136 S Apple-Pip (disc Doctor-Apple)	95.00
K 01138 S Microchess	15.00
K 01138 S Warlords (tape)	7.00
K 01139 S Bridge Challenger	15.00
K 01178 S Checker King	15.00
K 01179 S Gammon Gambler	15.00
K 01180 S Bridge Partner	15.00
K 01181 S Stimulating Simulations	10.00
K 01184 S Apple-Doc	20.00

5b the Poultry, Nottingham NG1 2HW  
tel: 0602 583254  
telex: 37297 (keenco)

28 Lower Addiscombe Road  
Croydon CRO 6AA  
tel: 01-680 4646



**Keen Computer**

Please rush me the new Keenstar catalogue.

Name \_\_\_\_\_  
Position \_\_\_\_\_  
Organisation \_\_\_\_\_  
Address \_\_\_\_\_

PC8

• Circle No. 196

# How automation may affect our lives

In the final part of his series, Mark Witkowski examines the sizeable impact robots will make on industrial processes.

OF THE many forms a robot may take, the standard industrial robot is, and will continue to be for the foreseeable future, the most numerous and the type which will most affect our lives.

New uses being found continuously for such machines and the range of uses and the number of manufacturers which employ them must surely increase. They represent a bridge between the high initial cost of full 'hard' automation, with its lower running costs and the high overheads of employing people to make things.

## Low initial cost

Because of its flexibility, relatively low initial cost and re-usability, the robot is slowly finding a wider acceptance with the industrialists of the world, whereas full automation becomes expensive junk when a production run ceases.

Robots open to a much wider range of smaller industries the gains to be made from mechanisation and automation — automation closer to the cottage industry.

Robots are used in a wide range of processes and industries, anywhere where heavy items must be lifted, transported, placed accurately or where a job needs to trace a constant, repeatable path. They are used in an increasing number of light assembly tasks and for packaging goods.

Reasons vary why a robot may be introduced on to a production line. It may simply be that the introduction of soft-automation to a particular point in a production line is justified easily on economic grounds — it does the job adequately at the lowest cost. In a highly-competitive

field, that will be sufficient in itself.

However, in some trades, the number of skilled people may be insufficient and the robot represents a way of allowing manufacturing to continue. In some cases, extra consistency is brought by the introduction of robots allowing improved output quality, with fewer reject items and so increased customer satisfaction.

A note of caution is that in many cases, robots have little or no integral quality-control checking, so if things start to go wrong, they could go unnoticed for a significant period.

In other situations, the work a person is being asked to do may be in some way intolerable. There is physical danger when a man must work close to moving machinery or presses — robots may be used to feed these machines and take finished work from them.

Some jobs are dirty or involve hazardous chemicals, excessive dust or noise, in which case the individuals involved and their unions will expect higher pay. At the same time, the law dictates that working conditions be within certain bounds, which involve increasingly the installation of expensive environmental conditioning. Robots will function in a wider range of hostile situations and hence require less protection and can be cheaper overall.

## New techniques

It is possible that the new manufacturing processes could be introduced using robots from the outset, because previously they would have involved people in conditions too hazardous to contemplate. Robots may be regarded like any other

(continued on next page)

Figure 1.

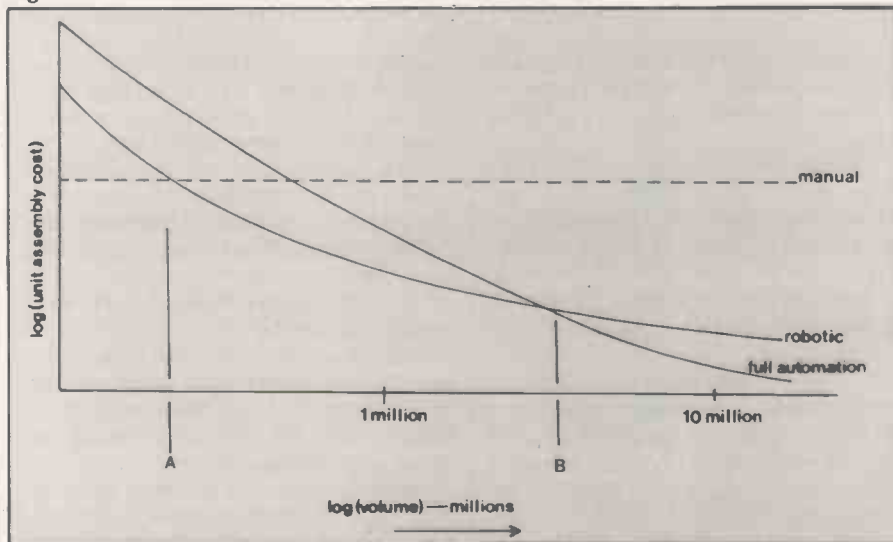

## JANE COATES ASSOCIATES

PROGRAMMING STATIONERY  
 BASIC Coding sheets ..... £2.00 per 100  
 Screen design sheets (80 x 25) ..... £1.50 per 100

BOOKLETS on BASIC Programming  
 BEGIN WITH BASIC ..... £2.00  
 DATA FILES ON CASSETTES ..... £4.00

SOFTWARE IN BASIC (8k PET CASSETTES)  
 SURGERY BOOKINGS ..... £15.00  
 INSURANCE DATA BASE ..... £35.00  
 STOCK INVENTORY ..... £10.00  
 HOTEL ROOM BOOKINGS ..... £25.00

BASIC TRAINING COURSES  
 Private courses on PETS  
 Afternoons and evenings. Write for details.

All prices include VAT & P&P.  
 Send chs/pos to:—

JANE COATES ASSOCIATES,  
 28 St. MARKS ROAD  
 MAIDENHEAD, BERKS. SL6 6DE.

• Circle No. 197

## FOR NASCOM 1&2

ADD EXTRA SCREEN CONTROL TO YOUR NASCOM.  
 BLANKS SCREEN LEAVES VIDEO RAM CONTENTS UNCHANGED.

SCREEN WHITE WITH BLACK LETTERING AND GRAPHICS.  
 ALL UNDER SOFT WARE CONTROL BY ALL MONITORS AND BASIC.

PLUGS INTO NASBUS NO MODIFICATIONS REQUIRED TO NASCOM. KIT CONTAINS PCB WITH GOLD EDGE CONNECTOR, LOW POWER IC'S SOCKETS, WIRE, AND CONSTRUCTION MANUAL. FOUR DECODED OUTPUTS ARE ALSO PROVIDED.

S.A.E. FOR FULL SPECIFICATION.

COMPLETE KIT £27.00  
 PCB AND MANUAL £14.00  
 INC. POST AND PACKING

R. W. ELECTRONICS  
 27 THE VINERIES  
 ACOCKS GREEN  
 BIRMINGHAM  
 B27 6SB

MAIL ORDER ONLY

• Circle No. 198

## Pedro Computer Services

Cassette Port Expander: £35.00  
 Expand your cassette port to take your soundbox, cassette recorder etc.

Simply slide a switch and select any device.  
 Expander extends to the side of your PET with a ribbon cable.

CB-2+ Soundbox: £15.00  
 Two in one soundbox for your Space Invader Games and PETSOFT programs.

PEDBASE II: £150.00  
 CBM disk based Database program which offers fast sort, search any field by key word, multiple key word search, multifield arithmetic, user defined field names, Text, Multi Report, and many other functions.

Booklets:  
 Pocket PET BASIC COMMANDS £0.95

To be released soon:  
 SOME USEFUL PET ROUTINES  
 SOME PEEK & POKE LOCATIONS  
 PET DISK TUTORIAL

41 Brockley Rise, London SE23 Tel: 01-291 4734

• Circle No. 199

## 6800 SOFTWARE

• EDITOR ASSEMBLER, supports all motorola mnemonics. Plus directives FCC, FCB, FDB, ORG, EQU, RMB, REM. 4K at 8000. Listing + Manual: £19.65

• STANDARD ASSEMBLER, as above without editor facilities. 2½K data/listing £7.50

• DIS ASSEMBLER, very powerful, converts object code to source code in a format suitable for reassembly. Has double check for valid opcode. Appx 2K data/listing £7.50

• 4K BASIC INTERPRETER suitable for ROM, C000-D000. Powerful arithmetic 9 digit E99. Manual + listing £9.50

• REALLOCATOR, relocates your machine code programs to run at another address. Monitor subroutines unaffected. Appx 1K data/list £5.50

• DEBUG TRACER, single step through your program, displays CC, A, B, INDX, SP, DATA, ADDR. Registers and memory can be altered whilst running. Appx 1½K £4.25

• Standard 300 baud cuts tapes available £2.00 extra per program.

OTHER SOFTWARE INCLUDES Basics, monitors, games etc. Send 50p for catalogue (deductable 1st purchase)

J. MORRISON (Micros)  
 2 Glensdale Street,  
 Leeds 9, Yorkshire  
 Telephone: Leeds 480987

• Circle No. 200

# SHOP WINDOW

## DISK DRIVES FOR TRS-80

Shugart SA400 disk drives housed in one or two module cabinets for only **£249 and £458 — no extras** our prices include power supply, cables and V.A.T. units are ready to plug in and use.

Microline 80 printers, Blandford Boxes, disks, tapes, paper, sleeves, manuals etc complete systems all at bargain prices.  
Hardware — software — components — ancillaries

**BLANDFORD COMPUTERS**  
SHAFESBURY LANE, BLANDFORD,  
DORSET  
BLANDFORD 53737 (5 lines)  
including evenings and weekends.

• Circle No. 201



## NASCOM 1 & 2

Due to great response we can NOW OFFER:

Invasion Earth (NS/G)	£9.95	Super Startrek*	£9.95
Space Fighter (NS/G)	£7.95	Slalom (NS/G)	£5.95
Alien Labyrinth (NS/G)*	£7.95	Labyrinth (NS/G)	£5.45
Secret Agent (NS/G)	£5.95	Minotaur (NS)	£5.95
Sheepdog Trial (NS)	£5.95	Othello	£5.45
3D Noughts & Crosses (NS)	£5.95	Code-Breaker	£4.95
Submarine Chase (G)	£5.45	Blorhythm (NS/G)	£4.45

(\*min 16K, G = graphics, NS = Nas-sys only)

WRITTEN ANY PROGRAMS? — WE PAY HANDSOME ROYALTIES!  
Send Chq/P.o + 45p/order p&p or SAE for catalogue.

Trade Enquiries Welcome

PROGRAM POWER

5 Wensley Road,

Leeds LS7 2LX

Tel: (0532) 683186

• Circle No. 202

## EXIDY SORCERER

GPW Your South Coast Dealer.

New low prices. Engineered systems. Word processing. Business applications.

48K £849.00 + VAT  
Micropolis Disc Drives for Tandy, Exidy, etc.

143K £339.00 + VAT

Tandy 315K £399.00 + VAT

315K (inc. S-100 drive) £699.00 + VAT

Exidy 630K (inc. S-100 drive) £1159.00 + VAT

GPW ELECTRONICS LIMITED,

55 COBHAM ROAD,

FERNDOWN INDUSTRIAL ESTATE,

FERNDOWN, WIMBORNE,

DORSET

Telephone 0202 893838

Telex 417111

• Circle No. 203

## AUTOSHAPE2 FOR APPLE II / ITT 2020

The easy way to make Hi-Res shape tables to use in your own programs, AND create a shape data bank for use in future tables. Simple commands let you draw vectors on Hi-Res "graph paper" — mistakes easily corrected with Delete Vectors command. Max. 500 vectors/shape, but any size due to screen wrap-around. At any time displayed shape can be saved in a file, or saved part-shapes appended to current shape, optionally rotated or reflected. A complete shape table is output as a text file of line numbered POKEs — you choose line nos. and memory location of table. Then use EXEC to merge with your program.

Autoshape2 (Applesoft) on disc with full instructions £25.

### SHAPE DATA BANKS FOR USE WITH AUTOSHAPE2

Full ASCII printable set as 95 separate recallable files, and assembled in one table in ASCII order £8  
Games symbols — set of 50 inc. card suits, Enterprise, explosions, etc. — as separate files £6  
Upper/lower Greek set + maths symbols — as separate files £5

B. LIENARD,

117 TOTTENHAM LANE, LONDON N8 9BH.

• Circle No. 204

(continued from previous page)

item of moving machinery and provision must be made to safeguard people who work close to them.

There are several economic factors in the use of industrial robots, both in the cost of their introduction, and the potential savings which should be made. The major initial outlay is the purchase of the robot or robots, though it may be advantageous from a cashflow or tax point of view to hire or lease equipment.

Coupled to that initial cost might be structural alterations to buildings, although that is seldom needed, installation charges, a stock of spares, staff training and programming costs. If the robot is being introduced at the expense of already existing jobs then re-training, re-location or redundancy payments may well be in order.

## Production line

On the other hand, the setting-up of a new production line or construction of a new factory must be a good time to consider the introduction of robotic devices. Running costs will include maintenance contracts and service costs, various staff costs, such as overseers and programmers.

There is always, of course, the possibility of mechanical failure and down-time with consequent loss of production, though robot manufacturers insist that their machines have a good reliability record and long mean times between failures.

Against those outlays, the major saving in expense is the manpower which would have to be employed to do the same job, including any fringe benefit — administrative and employment contributions have to be made. Remembering also that there may be less need for environmental control.

The formula is complicated by the fact that a robot is unlikely to do exactly the work of one man. Whatever the relative work rates, the robot should have to stop less frequently and it could be kept working over one, two or even three shifts per day.

In many cases, the robot cycle can be optimised to use the minimum energy and materials, which over many years of operation could represent a considerable saving.

Obviously before deciding to introduce robots on economic grounds all those factors, and any specific to a given industry, must be carefully weighed. In the majority of cases, the major expense will be the initial cost, the investment being spread over the life of the robot — perhaps five to eight years.

The major saving is the cost of equivalent human labour. In those countries where 'blue-collar' workers are paid relatively well, the use of robots will seem more attractive. Figure 1 shows the increasing advantages of robotics to the U.S. automotive industry in the face of

rapidly-rising labour costs — Engelburger 1979a for details of costings.

It is the responsibility of individual managers and production engineers to assess the merits of robotics in relation to manual methods or hard automation. Most robot manufacturers are only too willing to discuss the possibilities for the introduction of their machines.

Kusmierski (1979) discusses the relative merits of manual, robotic and the use of multi-axis, numerically-controlled machine tools in the drilling of bolt holes in the skin panels of a military fighter aircraft. He concludes that although such aircraft are made in relatively small quantities, around 3,000 in this case, the number of panels and the number of holes in each panel justifies the use of automation over manual drilling of the holes through templates. Because of their lower cost, and as they were capable of the accuracy called for, robots were appropriate to the task.

Figure 2 is a graphic representation of the cost per unit for the three possibilities, the curves being typical for a number of different examples. Point A on the figure will often be quoted as being around the 20,000 to 50,000 mark, point B at one to three million units produced.

Presumably relative costs will change as labour becomes more expensive and robots become relatively cheaper as a result of improved fabrication techniques. As robots become usable in the manufacture of more valuable items, their useful range will expand.

## Future well-being

The introduction of robots and other forms of modern technology is seen in many quarters as being essential to the future industrial well-being of the U.K. With that change is an inevitable disruption to the labour force.

In the past, the response by both management and unions to the problem has been, to say the least, unpredictable. At least one union, the Association of Scientific, Technical and Managerial Staffs (ASTMS) has considered this problem in some depth (ASTMS 1979), though with so few robots in the U.K. and so little experience with them, their comments are in the most part directed at other forms of "new technology".

The general tone of the document agrees that the introduction is needed for the long-term well-being of the nation, that this will, indeed, cause severe employment disruption, but that the unions should be involved in discussions at all levels as to how it may best be borne.

There is a good chance that most robots will not be used to replace directly people in jobs, but that the robot will be introduced into the production line as and where it is appropriate.

General Motors, for instance, are looking at the Programmable Universal Machine for Assembly (Beecher 1979),

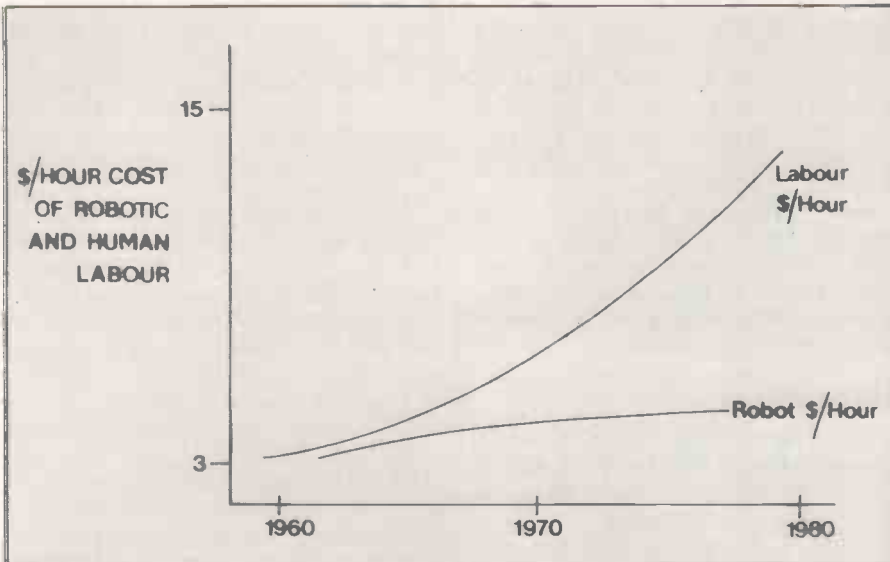

Figure 2.

Puma, as an assembly unit comprising robots, fixed automation, transfer devices, parts feeders and people in the assembly of some of the medium sized sub-assemblies to be found in cars.

Tele-operators are a second example of a robotic device in which a person plays an essential role. There are many examples of tasks where the skill and dexterity required is well in excess of that available with robot automation, yet the individual must remain at a distance from the job to be done.

Typical examples would be work in munitions factories, work with radioactive materials, undersea mining and space, where conditions are so dangerous, unpleasant, or where life-support systems are prohibitively expensive that a directly-controlled robot is an attractive proposition.

The army have a caterpillar-tracked vehicle 'wheelbarrow' to assist in bomb disposal operations. The high-energy neutrons generated by fusion reactors, such as the projected Joint European Torus (JET) leave high levels of residual radiation in the structure of the Torus so that remote manipulators will have to be used for all service operations, — Raimondi (1976).

### Remote manipulation

Those working with fission reactors and radioactive materials are no strangers to remote manipulation either. Apart from the familiar master-slave manipulators used in that industry, there is some interest in remotely-controlled mobile vehicles, equipped with manipulators and television cameras — Constant and Hill (1976).

Although the U.K. is somewhat timorous at the introduction of robots, a certain amount of action has occurred in the last few months. Hall automation has been bought by the giant GEC group. British Robot Systems Limited (BRSL), a new robot manufacturing company, has been set-up between the engineering firm

Remek Micro Electronic Ltd and the software house SPL International.

Its intention is both to manufacture robots and to sell complete robot systems to their customers. Unimation is opening a new factory at Telford, Shropshire, to manufacture its electric assembly robot, the Puma. British Leyland is introducing 36 welding robots to the new Mini Metro assembly line. There are, in any case, a number of other U.K. firms with robots under evaluation.

### Scientific research

The Science Research Council is to take new steps to support scientific research into industrial robotics, following the publication of the Roberts report (SRC 2979). This advisory panel reported that the SRC should take a 'major initiative' in industrial robotics.

That includes the appointment of a robotics program director who is to study the situation for 12 to 18 months. A report should be prepared in collaboration with the Department of Industry to determine research priorities. It also proposed that a professorship should be established in robotics.

In addition to the technical aspects of robotics, the Social Sciences Research Council (SSRC) should investigate the social aspects of robotics, a previously neglected area. The Roberts panel saw potential for the U.K. as a manufacturer of total robot systems and expertise.

To date, the SSRC has earmarked a sum of money to a programme of University/Industry research and development collaborations. The panel seemed uncertain how to fund the artificial intelligence end of robot research, whose contribution to industry is certainly on a longer time scale.

Artificial intelligence is reckoned generally to have suffered something of a blow after a rather discouraging report to the SRC in the early seventies (SRC 1973).

(continued on next page)

## CC MICRO SYSTEMS

APPLE II SOFTWARE SPECIALISTS  
ANNOUNCE

### MANAGEMENT INFORMATION SYSTEM

EASY TO USE DATABASE WITH  
3 YEAR SUPPORT CONTRACT  
£106  
FREE DEMONSTRATION

ALSO FIXED PRICE TAILORMADE SYSTEMS  
FOR FURTHER DETAILS CONTACT

CC MS, 48 MELROSE AVENUE, PENYLAN,  
CARDIFF. 0222 495257

• Circle No. 205

SIX MEGABYTE  
DUAL FLOPPY  
BUSINESS SYSTEMS  
SINGLE USER  
&  
MULTI-USER — MULTI PROCESSOR  
POWER  
LONG DISTANCES  
SUPER FAST SERVICING  
NO LIMIT TO NO. OF USERS

RAISESTAR LIMITED  
26 MANOR FARM WAY  
SHARNBROOK, BEDFORDSHIRE

• Circle No. 206

## Multi-tasking system for Nascom 1

available in Eprom or on  
cassette.

Call Ian Turnbull on  
0735 73618

• Circle No. 207

## 6800?

Let us help you over the  
software hurdle. A game?  
Try OTHELLO, available for  
FLEX on 5¼" disc £8.00 inc.  
We give free advice too.

COMPUSENSE LTD.  
P.O. BOX 169  
LONDON N13 4HT Tel 01-882 0681

• Circle No. 208

## TOPMARK Computers

dedicated to  
**APPLE II**



Simply the best!

Full details from Tom Piercy on  
Huntingdon (0480) 212563 or circle  
enquiry card.

• Circle No. 209

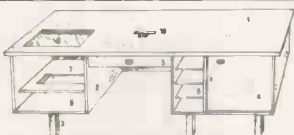

### 'MICRO-STATION'

Craftsman-made to office standards. Teak finish with unique features — all cables out of sight. Feed-through paper, sliding printer & drive shelves etc. 6' x 3' x 28" h to house ALL your peripherals in style.

£196 ex works, VAT +  
VEMBAROY LTD.

The Bringley, Church Street,  
Gt. Baddow, Essex  
0245-71726

• Circle No. 210

## IBM GOLF-BALL I/O WRITER

IBM-735 keyboard printers with changeable typeheads. Reconditioned and wired for interface to PET, APPLE TRS-80 etc. Will double as fully functional typewriter. Desk installed and free-standing units also some keyboardless printers available.

Interfaces & Decoders  
Ring Nick Goodwin at Executive Design  
on Bristol (0272) 30675

• Circle No. 211

Casio FX 502P	64.95
Casio FX 501P	45.95
Casio F.A.I.	19.95
HP 41C	184.95
HP 41C Printer	222.95
HP 41C Card/header	122.95
HP 67	203.00
HP 97	420.00
TI 59	169.95
TI 58C	82.95
TI 58	62.95
TI PROGRAMMER	44.95

TEL 01-636 8161  
ALL PRICES INC. VAT & P&P  
Eurocalc Dept. C.K.  
224 Tottenham Court Road,  
London W.1.

• Circle No. 212

(continued from previous page)

Paradoxically, the new report comes at a time when industrial robotics is feeling the effects of work done at artificial intelligence laboratories between five and 10 years ago, with more in the pipe-line, particularly as industrial robotics had been somewhat stagnant for some years.

Notwithstanding the SSRC 1973 Lighthill report, the SRC did continue to support artificial intelligence and the computing aspects of robotics as part of its general scientific funding policy, although without undue enthusiasm.

### Areas of interest

The Roberts report identified several areas of industrial robotics which need attention; the list seems to cover all known aspects of industrial robotics.

Advances in robot control and programming techniques are called for, and at all levels. There are many possibilities for improvements to the low-level servo- and dynamic-control problems, which are essentially in the control engineering domain.

How industrial robots should be programmed, both to maximum effect and with a certain regard to the poor soul who has to do it is more in the computer scientists preserve. Until recently, the only practicable industrial robot programming technique was 'teaching' it by leading it through the motions it was to make, either directly or using a joystick.

Now many robots are complete with a programming language for the mini or microcomputer which is integral with the robot system. Some of the robot programming languages were discussed in part four, along with the more direct teaching modes. Major differences between robot languages and conventional programming languages arise due to the need to handle vast quantities of largely-unpredictable data conditions.

Assembly robots must servo at multiple levels — internally about proprioceptive sensors to perform the basic actions, externally about the various sensors which must guide the work.

They must also recover from errors outside the bounds of the servo-loop parameters. When that happens, the control program must detect it and evoke an appropriate routine to restore the work sequence and re-synchronise the flow of the control program at their appropriate place.

In attempting to repair one fault, more can easily be caused and error recovery may have to be highly-sophisticated and robust — far more so than the main control program. Unfortunately, standard programming languages are based on the premise that the problem has a logical, structured solution. Few programmers are prepared for the deluge of sensory information that will be encountered in controlling a robot.

Most of it should be ignored as current-

ly correct, although it has to be checked because sooner or later it will herald something nasty. There is always the possibility of spurious data, or a spurious interpretation of the data. There are several adoptable strategies; one is to ignore errors and to sort the environment so it 'never' happens.

The whole thing can be abandoned at the first sign of trouble and started again from a predictable point. Limited checks can be made on the progress of the task, warnings and error messages generated if they fail, but generally with little attempt at repair. That represents the current level of industrial robot programming.

Even when the 'problem-solving' techniques described in part five are perfected and applied to manipulator control, and the robot can deduce which actions are likely to achieve a given goal, the chances are that a human will still have to lay down the options.

Before a robot can have any serious degree of manipulative skill, the capability for those programs to learn will have to be incorporated. Computer learning varies upwards from simple adaption, in which the overall flow of control is pre-defined and only various parameters are 'tweaked' to give the final behaviour.

That is done normally by having the machine make an action — either totally at random at first, or under some sub-optimal algorithm — and a second 'system' usually a person, corrects any mistakes he thinks the machine has made.

Any actions the robot makes are a reflection of the sensor values which arrive and the current, but changeable, state of the program's adaptation parameters. Each time the robot makes an incorrect movement, the adaptive parameters are adjusted so that the response is closer to the ideal set by the observer.

The machine will eventually always make exactly the correct response — the human and the machine have 'converged'. Such programs are clearly disrupted by the trainer being inconsistent in his response, doing things differently in equivalent situations. That may occur by accident if the person knows or can see something that the robot cannot sense.

### Learning algorithms

There are several such 'convergent' learning algorithms — Nilsson, 1965 — one of which has more recently been championed by Albus — Albus and Evans, 1976 — for the control of a multi-degree-of-freedom manipulator.

That is clearly a less direct and more sophisticated form of the robot training process than leading it through a sequence of actions. Adaptive learning relies almost totally on the sensor values to determine the next robot action. As we have seen in part four it is very difficult to include sensor information in the conventional training sequence.

While it is possible to justify 'training'

as the word for what the robot programmer does in a conventional training sequence, there is no reason to call what the robot does 'learning'. We would no more say a tape-recorder learned what it recorded.

The problem with adaptive training is that the robot must be led through the sequence many times, until it has it right. Even then, there is no real guarantee that a novel set of sensory inputs will not cause a totally spurious output to occur. Furthermore, each novel response corrected may affect other responses adversely, but that depends on the exact form of the algorithm.

Adaption is still far less sophisticated than the other forms of learning used by both humans and animals to develop manipulative and other skills. Learning proper is only part of a multi-stage process. Initially, the robot must observe through its sensors the effects its actions have in any number of different situations.

It makes the action, either as part of some behaviour pattern or of a learning process of discovery by experimentation, and observes the effects. It may then generalise, determine which of those things are universal or frequent, or which are specific to particular instances.

## Course of action

That information may be used by the other algorithms to effect a reasonable course of action. A moment's thought will reveal further complications and possibilities for refining the algorithms needed. They must be 'teachable' as well as learn on their own account. These techniques of learning programming have been discussed in more detail in *Practical Computing*, November 1979.

Apart from Albus, who in part bases his control model on the observations of Tinbergen about hierarchical control structure in some animal behaviour and in part on enurological observations — Albus 1979 — there are several other attempts to control robots with systems based on biological observations.

Sutro and Kilmer (1969) did work for NASA modelled on the visual process in the frog retina and an overall control structure based on a theory of the vertebrate brain. Their work was much influenced by the neurologist, physiologist and psychologist, Warren McCulloch. Friedman (1969) based the control strategies of his simulated robot ADROIT on theories from ethological studies of instinctive behaviour.

Whatever the desirability or value of having robots with more than a little intelligence of their own may be, the advantages of knowing how robots may be made intelligent are clear.

To design robots to do things adult people find straightforward, such as recognising and picking up objects, discovering what is going wrong, predic-

ting the effects of what they do and what will happen generally and communicating their skill and knowledge is beyond our understanding.

Yet it is those problems that are the block to many advances in robotics. We should study how the unco-ordinated graspings of a baby become the skilled and precise actions of a master craftsman.

With a worldwide robot population numbering thousands rather than millions, their potential is only just beginning to be felt. The answer is a research and development program with both the breadth to use and apply what knowledge we already have to our advantage and the depth to ensure a supply of new understanding to maintain and increase whatever benefits these technologies may bring.

Advice and information should be available to those who may need robots and we should investigate and discuss the social implications of the widespread introduction of robotics.

## References

- Albus J S (1979), *A model of the brain for robot control*. Byte, June to September 1979. part 1: *Defining notation*, 4-6 June, pp10-34. part 2: *A neurological model*, 4-7, July, pp54-95. part 3: *A comparison of the brain and our model*, 4-8, August, pp66-80. part 4: *Mechanisms of choice*, 4-9, September, pp130-148.
- Albus J S and Evans J M (1976). *Robot systems*. Scientific American 234-2, February, 1976, pp76-86b.
- ASTMS (1979). *Technological change and collective bargaining: a discussion document*. The Association of Scientific, Technical and Managerial Staffs.
- Beecher R C (1979) *Puma: A programmable universal machine for assembly*. Computer vision and sensor-based robots. Symposium at G M Research Labs, Dodd G G and Rossol mL, eds. New York: Plenum Press. pp141-152.
- Bublick T (1979) *The justification of an industrial robot*. Industrial robots Vol 1/Fundamentals Michigan: S M E pp39-49.
- Constant J A and Hill K J (1976). *Tele-operators in the nuclear industry*. 3CIRT/6ISIR paper H1, ppH1-1 to H1-12.
- Engelburger J F (1979a) *Robotics in 1984*. The Industrial Robot 6-3, September 1979, pp115-119.
- Engelburger J F (1979b) *Robots make economic and social sense*. Industrial robots Vol 2/Fundamentals. Michigan: SME pp35-38.
- Friedman L (1969) *Robot-control strategy*. First International Joint Conference on Artificial Intelligence — 1969, pp527-534.
- Kusmierski T (1979), *Robot applications in aerospace batch manufacturing*. Industrial robotics Vol 2/applications Michigan: SME pp169-182.
- Nilsson N J (1965) *Learning machines: foundations of trainable pattern-classifying systems*. New York: McGraw-Hill series in systems science.
- Raimondi T (1976) *Remote handling in the Joint European Torus (JET) fusion experiment*. Proceedings of the 24th conference on remote systems technology 1976. pp 188-195.
- SRC (1973). *Artificial intelligence: a paper symposium*. A general survey of artificial intelligence by Sir James Lighthill, with comments by N S Sutherland, R M Needham, H C Longuet-Higgings and D Michie. The Science Research Council. April 1973.
- SRC (1979). *Proposed new initiative in computing and computer applications: report of a Science Research Council panel*. Chairman: D H Roberts. The Science Research Council, March 1979.
- Sutro L and Kilmer W I (1969) *Assembly of computers to command and control a robot*. Spring Joint Conference on Computers 1969 pp113-137.
- Witkowski C M (1979) *Lessons in teaching computers to learn*. Practical Computing 2-11, November 1979, pp76-79.



**Modata**  
Digital Microsystems

### OVERPRICED COMPUTERS INADEQUATE PERSONAL MICROS?

Modata supply Dealers and OEMs with Digital Microsystems competitively priced Single and Multi-User computers which include Reliable Floppy and Hard Disk storage.

ie DSC-2: Z80 at 4MHz + 64Kb +  
2 x SSD 8" Floppies for IMb + CP/M  
£3525 E.U.

**WHY NOT FINDOUT MORE?  
0892 41555**

Modata Ltd. 30 St. Johns Road,  
Tunbridge Wells, Kent TN4 9NT

• Circle No. 213

## COMPUKIT SOFTWARE

STARTREK — MORE EXCITING THAN THE  
MOVIE — £6.75 REQUIRES 8K.

### ALSO AVAILABLE

JET FLIGHT — £3.75  
BOMBRUN — £3.25  
MINEFIELD — £3.25  
NIGHTMARE — £2.99  
RAM TEST — £2.25

ALL ON TAPE — PRICES FULLY INCLUSIVE.  
FOR DETAILS OF THESE AND OTHER GAMES  
SEND LARGE SAE TO:—

**J. M. ELECTRONICS,  
DEPT. PC8,  
P.O. BOX 71,  
NORWICH, NR6 7JE.**

### STOP PRESS

COMPUKIT + SUPERBOARD 2  
SOUND BOX NOW AVAILABLE.  
KIT: £14.95 incl. p+p  
READY ASSEMBLED: £19.95 incl. p+p.

• Circle No. 214

## R AND G MICRO'S

### \*\* DATA BASE II

Fast access file handling system

### \*\* DATA BASE II

Comprehensive report generator

- No rewrites when you need a new file structure.
- No knowledge of 'Basic' required.
- Cuts programming time by up to 90%.
- Files and reports created by questionnaire method.
- Gives you full control over number of records, file length, screen display, printer format etc.

### TECHNICAL ASPECTS

Record access by hash key  
Parameter file driven  
Written entirely in Basic  
File maintenance functions  
Report by conditions « » = / =  
Easy to use data validation throughout  
Result field generated by \* / + -

### USES

Stock, Finance, Sales, Prospect List,  
Mailing Lst etc.

### HARDWARE

Apple II 32K, 1 or 2 Disc Drive, with or  
without Line Printer.  
Price incl. Disc and Manual £45.00

**R AND G MICRO'S  
550 MIDLAND RD  
BLACKPOOL, LANCs.  
PHONE (0253) 692261/67091  
ACCESS OR BARCLAYCARD WELCOME**

• Circle No. 215



UNDER  
**£30**  
+  
VAT



**MICROCASE** "turns a board into a real computer"

STRONG — STYLISH —  
GUARANTEED

**NASCOM 1&2  
COMPUKIT  
SUPERBOARD**

& UNCUT FOR OEM USE

from your dealer or from  
SIMPLE SOFTWARE LTD  
15 HAVELOCK ROAD  
BRIGHTON SUSSEX



\* \* \* \* \*

**PET?**

PROGRAMMERS  
TOOLKIT 16/32K  
ONLY. LIMITED  
NUMBER AT:

**£40**  
+  
VAT

• Circle No. 216

## PIECE-WORK TRS-80

100 COST CENTRE CODES  
400 EMPLOYEES  
1650 TRANSACTIONS  
5 MANAGEMENT REPORTS  
£390 + VAT

CLIVE TAYLOR  
c/o ROC INSTRUMENT CO LTD,  
HAMSTEAD IND. ESTATE,  
OLD WASALL RD.,  
BIRMINGHAM B42 1DF  
021-358 2936

• Circle No. 217

## APPLE II: ITT 2020 AUTO-INDEX

The easiest-to-use and yet most sophisticated Master-Catalog programme available for the Apple II/ITT 2020. To create a master-catalog or index simply load each disc and press Return. Each programme title will be displayed in turn and if you wish to include it in your index you will be given the option to define a Disc Reference/Programme Category. An Edit/Manual Update facility is also included to allow entry of programme suite titles, etc., as well as deletion of titles.

The Interrogation facilities include, as well as display in alphabetical order and by programme type, sophisticated search routines to display by Disc Reference/Programme Category as well as by character string definition. All listings can be to a printer as well as to the screen.

Multiple indexes are supported, each of which can include up to 500 titles; and a facility is included to transfer Index (text) files from disc to disc. Requires 48K and one Disc Drive £18.00 inclusive. D. J. BOLTON, 1 BRANCH ROAD, PARK STREET, ST. ALBANS, HERTS.  
TEL: PARK STREET (0727) 72917

• Circle No. 218

# BUYERS' GUIDE

# Software

The Software Buyers' Guide is bigger and more comprehensive this month. The successful presentation used in the last guide has been retained but for easy reference, suppliers, applications and machine types are listed in alphabetical order. Application packages are listed by machine type, giving machine, company name, price and capacity.

The usual criteria have been applied. The minimum configuration is 32K of RAM, a disc and a printer; the price of the package must lie between £50 and £1,000; the companies listed are the source of the software or the main dealers in the U.K., and the capacity quoted is per disc or drive.

## Machine types by main applications

### Combined-Ledger/Stock/Invoicing

Machine type	Supplier Name	Price	Capacity
Commodore 3032	G W Computers Ltd	£275 - £575	1,000
Z-80/8080	Great Northern C S Ltd	£995	varies
Ohio Scientific	Microcomputer B M	£656	
Tandy TRS-80	Microcomputer Applications	£90 each	
Tandy TRS-80	T & V Johnson Ltd	£110	750 trans/disc
Commodore 3032	Bristol Software Factory	£300	1,000 A/Cs 6,000 trans
Apple II	Vlasak Electronics Ltd	£855	
CP/M North Star	Benchmark CS Ltd	£950	200 A/Cs 500 trans 300 ITM
Commodore 3032	Stage One Computers		
Commodore 3032	Commodore B M (U.K.) Ltd	£650	650 A/C/ledger
CP/M	Computastore Ltd	£1,000	
Tandy TRS-80	Mode Microcomputer Applications	£350	
Commodore 3032	Analog Electronics	£550	
Commodore 3032	Logma Systems Design	£600	1-6 shops
CP/M North Star	Instar Business Systems	£999	600-2,900
Z-80/8080	Graffcom Systems Ltd	£995	





## General Ledger

Machine Type	Supplier Name	Price	Capacity
Z-80/8080	Great Northern C S Ltd	£275	varies
Tandy TRS-80	Tridata Micros Ltd	P.O.A.	to be linked to S/L P/L
Apple II	Computech Systems	£295	500 A/Cs 1,600 trans
Commodore 3032	HB Computers Ltd	£200	linked to S/L & P/L
Apple II	Vlasak Electronics Ltd	£225	200 A/Cs 1,000 trans
CP/M	Computastore Ltd	£500	999 A/Cs 99 centres 9 companies
CP/M	Comput-A-Crop	£400	
CP/M North Star	Benchmark CS Ltd	£250	500 A/Cs 5,700 trans
Apple II	Microdigital Ltd	£295	
Commodore 3032	Analog Electronics	£450	
Commodore 3032	Bristol Software Factory	£300	1,000 A/Cs, 6,000 trans
Z-80/8080	Graffcom Systems Ltd	£390	

## Incomplete Records

Machine type	Supplier Name	Price	Capacity
CP/M	Profcomp Ltd	P.O.A.	2,000 entries
Commodore 3032	Micro Computation	£555	120 A/Cs 5,000 trans
Apple II/ITT 2	Padmede Computer Services	£450	900 A/Cs 2,000 trans/disc
Exidy Sorcerer	Basic Computing	£350	incl. Vasee also Micropute
Apple II	Personal Computers Ltd	£250	1,000 trans 2,600 A/Cs
Commodore 3032	Stage One Computers		

## Job Costing/Billing

Machine type	Supplier Name	Price	Capacity
CP/M	Graffcom Systems Ltd		100 activity codes
Z-80/8080	Great Northern C S Ltd	£330	varies
Apple II/ITT2	Padmede Computer Services	£300	1,000 A/Cs 99 centres
Apple II/ITT 2	Padmede Computer Services	£300	150 A/Cs
Commodore 3032	Stage One Computers		
Commodore 3032	CSM Ltd	£600	1,000 jobs, 100 people

## Mailing Systems

Machine type	Supplier Name	Price	Capacity
CP/M	Structured Systems Group	£50	varies
Apple II	Keen Computers Ltd	£300	500 addresses
Tandy TRS-80	T & V Johnson Ltd	P.O.A.	3,000 names/addresses
Z-80/8080	Micro Focus	£90	varies
CP/M	Graffcom Systems Ltd	£250	varies
Apple II/ITT 2	The Software House	£57	
Commodore 3032	Stage One Computers		
Apple/ITT 2020	Systematics Intl Ltd	£300	500 addresses
Apple II/ITT	Guestel Ltd	£190	400 addresses
Commodore 3032	MMS Computer Systems	£250	3,000 records
CP/M Horizon	Microtek Computer Services	£500	varies
Tandy TRS-80	Clearstone ADP	£50	660 entries

## Payroll

Machine type	Supplier Name	Price	Capacity
Apple	Algobel Computers Ltd	£295	500 employees
Commodore 3032	Computastore Ltd	£200	275 employees
		£350	500 employees
CP/M	Graffcom Systems Ltd	£500	250 employees
Tandy TRS-80	Tridata Micros Ltd	£218	400 employees
Apple II/ITT 2	Computech Systems	£379	
Apple II/ITT 2	T W Computers Ltd	£145	
Commodore	Petsoft Ltd	£50	200 employees
Commodore 3032	Landsler Software	£95	250 employees
Commodore 3032	L & J Computers	£220	
Tandy TRS-80	3-Line Computing	£140	
Apple II/ITT 2	Hewport Ltd	£400	100 month 50 weekly
		£500	
Apple II/ITT 2	Vlasak Electronics Ltd	£360	

## MAIL LIST for PET DISK AT LAST — A FULL FEATURE MAILING LIST PROGRAM USING PET DISK DIRECT ACCESS FACILITIES

All the usual features combined in a single program, plus: —

- Immediate display of any data for amendment.
- Labels printed in any sequence — e.g. sorted by postcode or company name.
- Record selection by Range or Mask.
- Extra code fields may be used for selection or sorting, but not printed on labels.

Program disc with demonstration system and full documentation £49 + VAT.

**RB** COMPUTING 101 Nether Currie  
Crescent, Currie,  
Midlothian, EH14 5JQ.  
Tel: 031-449 3102

Apple version also available Dealer enquiries welcome

• Circle No. 219

PROGRAMMER NORTH STAR-DOS/BASIC to assist with bespoke software. Must have experience Accounts/Management Information/Doctoring in operating system. Remuneration to be negotiated, would consider partnership/profit share.

Apply with cv to K. Baker-Munton,  
KINTOK, Bentons West, Bildeston,  
Ipswich, Suffolk.  
0449-740046



## MICROTYPE

MICROTYPE SERIES 80  
MICROCOMPUTER CASE

Ready cut for Superboard or UK101 complete with screws and instructions. Produced in strong, black ABS plastic.



ONLY £17.50  
+ VAT, post and  
packing inclusive.

Send cheques or Postal Orders to:  
Microtype, PO Box 104, Hemel Hempstead, Herts HP2 7QZ.  
SAE for details.

• Circle No. 220

## LINCOLNSHIRE APPLE DISTRIBUTORS

Stocks of Apples and most accessories Texas, Qume & Paper Tiger Printers 8" Discs, Corvus Disks for Apples.

### SOFTWARE

Financial Planning Databases Mailing Viscalc Accounts Word Processing. Also the well known "Estate Computer Systems" Estate Agents Package in use throughout the U.K.

**ESTATE COMPUTER SYSTEMS**  
30 Carre St., Sleaford, Lincs.  
Tel: (0529-305637)

• Circle No. 221



## TANDY TRS-80 TEXAS TI-99/4 in Bedfordshire

ELECTRON SYSTEMS  
6, PARK ROAD, SANDY  
Telephone 0767-81195

• Circle No. 222

### GLASGOW

### TRS 80

Keyboards, Systems, Discs, Printers etc.

## VICTOR MORRIS

TANDY  
DEALER

340 ARGYLE ST.  
GLASGOW G2

Tel. 041 221 8958 Telex 779874

• Circle No. 223

## Euro-Calc Ltd

APPLE II  
SHARP MZ 80K  
PET - HP85  
TI - CENTRONICS

PAPER, DISKS, TAPES ETC. EG.  
10 DISKS WITH FREE PLASTIC BOX  
£25 INC. VAT.

224 TOTTENHAM COURT RD.,  
London W.1.  
Tel: 01-636 5560

• Circle No. 224

### HOW'S YOUR MEMORY ?

6800/09 (1MHz) SS50 USERS  
EXPAND YOUR STORAGE  
CAPACITY WITH OUR LOW  
COST DYNAMIC RAM BOARDS.  
INVISIBLE REFRESH.

16K - - £175.00 PLUS VAT  
32K - - £265.00 PLUS VAT

C.W.O.  
TESTED & GUARANTEED

also  
PROTOTYPING BOARDS  
AVAILABLE - - £15. PLUS VAT  
PERIPHERAL & DATA SYSTEMS  
LTD. 37 TELEGRAPH STREET.  
COTTENHAM CAMBS. CB4 4TZ

• Circle No. 225

CP/M	Comput-A-Crop	£450	
Apple II	Microdigital Ltd	£375	
Commodore 3032	Commodore B M (U.K.) Ltd	£150	200 employees
Apple/ITT 2020	Systematics International Ltd	£295	350 employees
Commodore 3032	Analog Electronics	£90	
Commodore 3032	Intex Datalog Ltd	£195	200 employees
CP/M Horizon	Microtek Computer Services	Lease	varies
Tandy TRS-80	AJ Harding (Molimerx)	£95- £200	
Z-80/8080	Graffcom Systems Ltd	£490	250 employees

### Property Management

Machine type	Supplier Name	Price	Capacity
Z-80/8080	Graham Dorian Software	£325	varies
Apple II/ITT 2	Algobel Computers Ltd	£650	400 buildings 250 own 2,000 trans
CP/M	Algobel Computers Ltd	£650	2,000 trans

### Purchase Ledger

Machine type	Supplier Name	Price	Capacity
CP/M	Structured Systems Group	£460	varies
Commodore 3032	Microact Ltd	£350	2,000 A/Cs 7,000 trans
Z-80/8080	Great Northern C S Ltd	£275	varies
Tandy TRS-80	Tridata Micros Ltd	£225	175 A/Cs 1,350 trans
Apple II	Vlasak Electronics Ltd	£315	200 A/Cs 1,000 trans
Apple II	Computech Systems	£295	500 A/Cs 1,600 trans
Commodore 3032	HB Computers Ltd	£350	800 A/Cs 4,000 trans
CP/M	Computastore Ltd	£400	500 A/Cs 3,100 trans
Apple II/ITT 2	Padmede Computer services	£300	900 A/Cs 4,500 trans/disc
Exidy Sorcerer	Basic Computing	£125	incl. Vasee also Micropute
CP/M	Comput-A-Crop	£400	500 A/Cs
CP/M North Star	Benchmark CS Ltd	£250	500 A/Cs 2,000 trans
Apple II	Microdigital Ltd	£295	
Commodore 3032	Act (Petsoft) Ltd	£120	200 A/Cs 700 trans
Tandy TRS-80	AJ Harding (Molimerx)	£225	1,100 entries
Z-80/8080	Graffcom Systems Ltd	£440	

### Records Management (DBMS)

Machine type	Supplier Name	Price	Capacity
Commodore 3032	Commodore B M (U.K.) Ltd	£150	650
Commodore Pet	Stage One Computers	£120 & £180	165K
Apple II/ITT 2	T & V Johnson Ltd	£95	112K per drive
Ohio Scientific	Microcomputer B M	£175	
Commodore 3032	Amplicon M S Ltd	£140	1,500 records
Tandy TRS-80	T & V Johnson Ltd	£200	
Z-80/8080	Structures Systems Group	£135	varies
Commodore 3032	Compsoft Ltd	£95 ea	170,600-5,000 records
Apple/ITT	The Software House	£140	
Commodore 3032	Microact Ltd		400K - 800K
Apple/ITT 2020	Systematics International Ltd	£72 & £175	
Apple/ITT 2020	Systematics International Ltd	£125	1,000 references
Apple II	Courtman Micro Systems	£106	100K Characters
Apple II/ITT	Diskdean Ltd	£120	varies
CP/M SWTPC	Verwood Systems		
Ohio Challenger	U-Microcomputers Ltd	£175+	
Z-80/Cromemco	Xitan Systems Ltd	£850	4,000 records/disc

### Sales Ledger

Machine type	Supplier Name	Price	Capacity
Commodore 3032	Microact Ltd	£350	2,000 A/Cs 7,000 trans
Z-80/8080	Great Northern C S Ltd	£275	varies
Tandy TRS-80	Tridata Micros Ltd	£225	175 A/Cs 1,350 trans
Apple II	Vlasak Electronics Ltd	£315	200 A/Cs 1,000 trans

# Buyers' Guide

Apple II	Computech Systems	£295	500 A/Cs 1,600 trans
Commodore 3032	HB Computers Ltd	£350	800 A/Cs 4,000 trans
CP/M	Computastore Ltd	£400	500 A/Cs 3,500 trans
Apple II/ITT 2	Padmede Computer Services	£300	900 A/Cs 4,500 trans/disc
Exidy Sorcerer	Basic Computing	£125	incl. Vasee also Micropute
CP/M North Star	Benchmark CS Ltd	£250	500 A/Cs 2,000 trans
Apple II	Microdigital Ltd	£295	
Commodore 3032	Act (Petsoft) Ltd	£120	200 A/Cs 700 trans
Tandy TRS-80	AJ Harding (Molimerx)	£225	1,350 entries
Z-80/8080	Graffcom Systems Ltd	£440	

## Stock Systems

Machine type	Supplier Name	Price	Capacity
Apple II/ITT 2	Microdigital Ltd	£225	625 items
CP/M	Graffcom Systems Ltd	£350	520 - 6,000 items
Z-80/8080	Great Northern C S Ltd	£275	varies
Tandy TRS-80	Tridata Micros Ltd	£200	630 items/disc
Commodore 3032	Commodore B M (U.K.) Ltd	£150	650
Commodore 3032	Bristol Software Factory	£300	2,300
		£360	
Z-80/8080	Graham Dorian Software	£325	varies
Apple II/ITT 2	Vlasak Electronics Ltd	£285	
Commodore 3032	Petsoft Ltd	£50	2,000
Commodore 3032	L & J Computers	£120	3,400 items
Commodore 3032	Microact Ltd	£350	2,500 items 1,000 A/Cs
Tandy TRS-80	T & V Johnson Ltd	£115	1,000 items
Tandy TRS-80	T & V Johnson Ltd	£145	1,000 items/invoices
Commodore 3032	Aplicon M S Ltd	£750	500-600 items 255 A/Cs
Exidy Sorcerer	Basic Computing	£125	incl. Vasee also Micropute
Apple/ITT	The Software House	£80	
CP/M North Star	Benchmark CS Ltd	£450	1,000 items 750 trans
Commodore 3032	Stage One Computers		
Commodore 3032	Anagram Systems	£750	500-600 items 255 A/Cs
Commodore 3032	Logma Systems Design	£600	1-6 shops
Commodore 3032	Rockliff Brothers Ltd	£120	3,900 items
Commodore 3032	SA Systems	£650	300 records/disc
Commodore 3032	SMG Microcomputers	£395-£495	2,450-7,000 items
CP/M Horizon	Microtek Computer Services	£1,000	varies
Tandy TRS-80	Microgems Software	£150	1,000-2,000 items
Tandy TRS-80	AJ Harding (Molimerx)	£225	630 items
Tandy TRS-80	Cleartone ADP	POA	
Tandy TRS-80	SA Systems	£650	300 stock records
Z-80/8080	Graffcom Systems Ltd	£340	
Z-80/8080	Graffcom Systems Ltd	£580	
Z-80/MCZ	Software Architects Ltd	£600	varies
Commodore 3032	Act (Petsoft) Ltd	£75	
Apple/ITT 2020	Systematics International Ltd	£500	200-2,500 items
Z-80/8080	Rogis Systems Ltd	£500	900 - 3,500 items

## Word Processing

Machine type	Supplier Name	Price	Capacity
Commodore 3032	Commodore B M (U.K.) Ltd	£75 & £150	170 pages
Tandy TRS-80	T & V Johnson Ltd	£109	10,000 words
Ohio Scientific	Microcomputer B M	£116	
Apple II/ITT 2	Algobel Computers Ltd	£75	800 lines
Commodore 3032	Dataview Ltd	£159	
Commodore 3032	HB Computers Ltd	£70	39 A4 pages
Apple II/ITT 2	Vlasak Electronics Ltd	£120	
Z-80/8080	Structured Systems Group	£120	varies
Apple II	Personal Computers Ltd	£150	17 A4 pages
Commodore 3032	Stage One Computers		
Commodore 3032	Act (Petsoft) Ltd	£325	
CP/M	Computastore Ltd	£400	
Apple/ITT 2020	Systematics International Ltd	£75	
Apple II/ITT	Guestel Ltd	£190	100K characters



### Control Basic for NASCOM-1 Running under NASSYS-1

Runs in 2K and includes Peek, Poke Input, Output, and calls assembler language subroutines supplied in a 2716 5 volt Eprom Price £20.00.

Please specify RAM area on order. Coming — Double Density Floppy Disk controller for 5 1/2 & 8" drive, including D.M.A in a Eurocard with a 64 pin connector able to run on 8080, 8085, Z-80, 6502 processors. The card is supplied with software and driver routines.

Send for data sheet and prices.

**P. Vekinis**  
11 Avenue G. Mullie  
1200 Brussels  
Belgium  
Tel. 02/7626356

• Circle No. 226

### Would you like to work at GAMES CENTRE?

We are looking for Managers and Staff for our specialised games shops based in London

Write with details of your interests, background and expertise to:

**THE MANAGING DIRECTOR  
GAMES CENTRE  
16 HANWAY STREET  
LONDON W1A 2LS**

## BRISTOL & WEST APPLE SHARP MZ 80K H-P 85A

**dbm Systems & Software**  
58 Victoria St., Bristol 1  
Telephone 0272 214093

• Circle No. 227

### LOGICAL COMPUTING

#### APPLE & ITT 2020

ENGINEERING, SCIENTIFIC & MATHEMATICS SOFTWARE

Basic maths tapes	£10.00
Basic Tutorial tapes	£15.00
Roots of equations	£10.00
Bessel functions	£8.00
Biorhythms	£5.00

Send for complete list

STRUCTURAL ANALYSIS  
FLUID FLOW PROGRAMS  
FINITE ELEMENT SYSTEM under development.  
Software can be written to suit customers needs.  
Send for details:—

**LOGICAL COMPUTING**  
6 CRANBURY PLACE  
SOUTHAMPTON SO2 0LG

• Circle No. 228



## KEEP YOUR (TRS-80) COOL

... with a low-cost, quiet-running blower unit. Although designed for the TRS-80 it can be adapted for use on other micros. Prices, Excluding V.A.T.

Complete Blower Unit Kit **£43.60p**  
Blower Unit with Keyboard, Airbox only. **£26.00**

Keyboard Airbox **£15.80p**  
Expansion Interface Airbox Kit **£17.60p**  
P&P £1.20 on all items.

SAE for details  
Perlit Engineering Development Ltd,  
Balgay House, Inchture, Perthshire.  
Tel: (082-886) 242.

• Circle No. 229

## EXIDY SORCERER

48K **£849 + VAT**  
32K NOW ONLY **£799 + VAT**

Dealer for

## Bristol and South West

ELECTROPRINT (Mr. Tasker)

5 Kingsdown Parade • Bristol 6 • 292375

• Circle No. 230

## avrohurst LTD.

- Systems Analysis & Programming
- QUANTITY SURVEYING SYSTEMS
- Payroll, Accounting & Invoicing
- Hardware supplied if required

Enquiries — tel or write

Aurohurst Ltd. 186, Beehive Lane, Chelmsford CM2 96J  
tel: 354685

• Circle No. 231

## TRS-80 Disc System

Microfloppy disc system giving up to ¼M bytes per disc side and directly compatible with Tandy TRS-80 and Schugart SA400 drives.

Complete self contained unit in smart black case with internal power supply. Trade enquiries only please.

COMPUTER INSTRUMENTATION LTD.  
Chandlers Ford, Eastleigh, Hants.,  
England, SO5 3YY.  
Tel. (04215) 66321. Telex 47326.

• Circle No. 232

## Applications by machine

### Apple II/ITT 2020

Application	Supplier Name	Price	Capacity
Cash-flow/bank	Vlasak Electronics Ltd	£80	
Credit control	Microdigital Ltd	£130	
DBMS	The Software House	£140	
DBMS	T&V Johnson Ltd	£95	112K per drive
DBMS I & II	Systematics International Ltd	£75 & £175	
DBMS text files	Systematics International Ltd	£125	1,000 references
Estate agents' register	Vlasak Electronics Ltd	£120	
Estate agents' system	Systematics International Ltd	£850	
Financial planning	Systematics International Ltd	£295	
Incomplete records	Personal Computers Ltd	£250	1,000 trans 2,600 A/Cs
Incomplete records/nominal ledger	Padmede Computer Services	£450	900 A/Cs 2,000 trans/D
Job costing	Padmede Computer Services	£300	1,000 A/Cs 99 centres
Job-T&M cost recording	Padmede Computer Services	£300	APCs
Ledger general	Computech Systems	£295	500 A/Cs 1,600 trans
Ledger general	Microdigital Ltd	£295	
Ledger general	Vlasak Electronics Ltd	£225	200 A/Cs 1,000 trans
Ledgers/general sales purchase	Vlasak Electronics Ltd	£855	
Ledger purchase	Computech Systems	£295	500 A/Cs 1,600 trans
Ledger purchase	Microdigital Ltd	£295	
Ledger purchase	Padmede Computer Services	£300	900 A/Cs 4,500 trans
Ledger purchase	Vlasak Electronics Ltd	£315	200 A/Cs 1,000 trans
Ledger sales	Computech Systems	£295	500 A/Cs 1,600 trans
Ledger sales	Microdigital Ltd	£295	
Ledger sales	Padmede Computer Services	£300	900 A/Cs 4,500 trans
Ledger sales	Vlasak Electronics Ltd	£315	200 A/Cs 1,000 trans
Letter writer	Vlasak Electronics Ltd	£80	
Mail system	The Software House	£57	
Mailing and letter writer	Keen Computers Ltd	£300	500 addresses
Mailing system	Systematics International Ltd	£300	500 addresses
Modelling (VisiCalc)	Microsense Computers Ltd	£95	
Payroll	Algobel Computers Ltd	£295	500 employees
Payroll	Computech Systems	£379	
Payroll	Hewport Ltd	£400	100 months 50 weekly
Payroll	Microdigital Ltd	£500	
Payroll	Microdigital Ltd	£375	
Payroll	Systematics International Ltd	£295	350 employees
Payroll	TW Computers Ltd	£145	
Payroll	Vlasak Electronics Ltd	£360	
Property management	Algobel Computers Ltd	£650	400 buildings 250 own 20
Sales analysis	Microdigital Ltd	£200	500 A/Cs
Stock control	Microdigital Ltd	£225	625 items
Stock control	Systematics International Ltd	£500	200-2,500 items
Stock control	The Software House	£80	
Stock/purchase/order invoicing	Vlasak Electronics Ltd	£285	
Structural engineering design	James C Steadman	£200	
Word processing	Vlasak Electronics Ltd	£120	
Word processing	Algobel Computers Ltd	£75	800 lines
Word processing	Personal Computers Ltd	£150	17 A4 pages
Word processing	Systematics International Ltd	£75	
3-D graphics package	Blackpool & Fylde Coll	£150	
DBMS	Courtman Micro Systems	£106	100K characters
DBMS	Diskdean Ltd	£120	varies
Mailing/word processor	Guestel Ltd	£190	400 addresses
Word processor	Guestel Ltd	£190	100K characters

# Buyers' Guide

## Commodore 3032

Application	Supplier Name	Price	Capacity
Appointments planner	Commodore B M (U.K.) Ltd	£50	200 entries
Building conversion	Micro Computation	£300	320 clauses
		£400	
DBMS	Amplicon M S Ltd	£140	1500 records
DBMS	Commodore B M (U.K.) Ltd	£150	650
DBMS	Microact Ltd		400K-800K
DBMS MK I & II	Compsoft Ltd	£95 ea	17,600-5,000 records
DBMS sequential & random	Stage One Computers	£120 & £180	165K 165K
Estate agents' package	Stage One Computers	£250	325 properties
Hotel room system (INTG)	Landsler Software	£275	8X99 rooms for 400
Hotel system (+ billing)	Landsler Software	£450	130 rooms
Incomplete records A/C	Micro Computation	£555	120 A/Cs 5,000 trans
Incomplete records	Stage One Computers		
Insurance brokers' system	Stage One Computers		
Insurance renewals	Stage One Computers		650 policies
Job/apartments planner	Stage One Computers		
Job-time record costing	CSM Ltd.	£600	1,000 jobs, 100 people
Ledger general	Analog Electronics	£450	
Ledger general	HB Computers Ltd	£200	Linked to S/L & P/L
Ledger/general & purchase	Bristol Software Factory	£300	1,000 A/Cs 6,000 trans
Ledgers/general/sales/purchase	Analog Electronics	£550	
Ledger purchase	ACT (Petsoft) Ltd	£120	200 A/Cs 700 trans
Ledger purchase	HB Computers Ltd	£350	800 A/Cs 4,000 trans
Ledger purchase	Microact Ltd	£350	2,000 A/Cs 7,000 trans
Ledger sales	ACT (Petsoft) Ltd	£120	200 A/Cs 700 trans
Ledger sales	HB Computers Ltd	£350	800 A/Cs 4,000 trans
Ledger sales	Microact Ltd	£350	2,000 A/Cs 7,000 trans
Ledger/sales, purchase & general	Commodore BM (U.K.) Ltd	£650	650 A/C ledgers
Ledgers/sales, purchase & general	Stage One Computers		
Ledgers/stock/invoicing	GW Computers Ltd	£275	1,000
		£575	
Mailing system	Stage One Computers		
Ordercontrol	MMS Computer Systems	£250	3,600 orders
Payroll	Commodore BM (U.K.) Ltd	£150	200 employees
Payroll I & II	Computastore Ltd	£200 & £350	275 & 500 employees
Payroll	Landsler Software	£95	250 employees
Payroll	Petsoft Ltd	£50	200 employees
Payroll/invoicing	L&J Computers	£220	
Printers quote system	Microland	£175	
Stock control	Act (Petsoft) Ltd	£75	
Stock control	Amplicon MS Ltd	£750	500-600 items 255 A/Cs
Stock control	Commodore BM (U.K.) Ltd	£150	650 items
Stock control	Microact Ltd	£350	2,500 items 1,000 A/Cs
Stock control	Petsoft Ltd	£50	2,000 items
Stock control	Stage One Computers		
Stock control	Bristol Software Factory	£300	2,300 items
		£360	
Stock control	L&J Computers	£120	3,400 items
Window replacement	CSM Ltd	£500	
Word processing	Act (Petsoft) Ltd	£325	
Word processing	Dataview Ltd	£159	
Word processing	Stage One Computers		
Word processing	Commodore BM (U.K.) Ltd	£75	170 pages
		£150	
Word processing	HB Computers	£70	70
Work measurement	The Alphabet Company	£150	



**Some people would give anything to have your micro experience**

Especially if you have practical experience with PASCAL on the APPLE micro computer. Richard Kaluzynski will put you in touch with them.

Knight Computer Services Limited, 14 Old Park Lane, London W1Y 4NL. Tel: 01-491 4706.



Staff Services Division of BOC Datasolve Group and a member of Computing Services Association

• Circle No. 233

**apple II**  
in  
**sussex**

complete user service

Apple & Microstar hardware & software

systems for Micropad handprint data entry

**oval** computer systems

elm park, ferring, worthing, west sussex.

tel: 0903-44831

• Circle No. 234

**ITT Apple 2020**  
(Palsoft + Colour)

**BASIC SYSTEM** from £867.00  
**BUSINESS SYSTEM** from £2,400.00  
also

a range of printers & VDU's including **DIABLO DAISYWHEEL** printers from £1740.00

Larger Business systems also available.

Sales — Service — Supplies

**BRINDIWELL LTD**  
**Frampton Cotterell**  
**BRISTOL**

Tel: Winterbourne (0454) 774564

• Circle No. 235

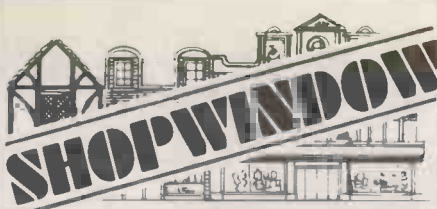

## OHIO SCIENTIFIC NEWS FLASH

### FULL RANGE OF SUPERBOARDS TO C3's

Best prices, best backup, best service from an Ohio Scientific factory appointed dealer/importer. Ring us for latest prices on boards, accessories, expansion, software etc.

50Hz Superboard prices start From £159 + VAT

C.T.S., 1 High Calderbrook Littleborough Lancs OL15 9NL

Tel: Littleborough (0706) 79332 ANYTIME

• Circle No. 236

## Vets for Pets

Anita Electronic Services (London) Ltd. are specialists in the repair and service of Commodore Pets.

We offer a fast on-site service, or alternatively repairs can be carried-out at our workshops should you wish to bring in your Pet.

Pet maintenance contracts are available at very competitive prices. Trade inquiries welcomed.

For further information tel. or write to:-

• We also specialise in the repair of all makes of office equipment.

**John Meade**  
Anita Electronic Services,  
15 Clerkenwell Close, London EC1  
01-253 2444

• Circle No. 237

## ITT2020 SOFTWARE APPLE II

### DATABASE is a program

that writes a program. DATABASE can create a flexible record-keeping system custom designed to YOUR specification.

HUNDREDS OF MEMBERSHIP DETAILS OF MEDICAL RECORDS APPLICATIONS MAILING LISTS, ETC a direct replacement for the CARD INDEX

Simply draw the format you require on the screen using the editor. Then let the computer do the rest! Easy to use.

FEATURES: protected screen editing automatic date and number checking comprehensive search & print functions £120+V.A.T. for the complete system!

Phone 01-242-7394 or write for details

**DISK DEAN LTD**  
23 BEDFORD ROW, LONDON WC1R 4EB

• Circle No. 238

Ledgers/jewellers	Logma Systems Design	£600	1-6 shops
Payroll	Analog Electronics	£90	
Payroll	Intex Datalog Ltd	£195	200 employees
Printers' job control	Stage One Computers	£450	130 jobs/disc
Sales analysis	Logma Systems Design	£600	1-6 shops
Stock control	Anagram Systems	£750	500-600 items, 255 A/Cs
Stock control	Rockliff Brothers Ltd	£120	3,900 items
Stock/farming livestock	SA Systems	£650	300 records/disc
Stock/invoicing	SMG Microcomputers	£395-£495	2,450-7,000 items
Stock/jewellers	Logma Systems Design	£600	1-6 shops

## CP/M

Application	Supplier Name	Price	Capacity
DBMS	Verwood Systems		varies
Hire purchase system	Graffcom Systems Ltd		P.O.A. 2,000 entries
Incomplete records	Profcomp Ltd		100 activity codes
Job-time recording	Graffcom Systems Ltd		500 A/Cs 5,700 trans
Ledger general	Benchmark CS Ltd	£250	
Ledger general	Comput-A-Crop	£400	
Ledger general	Computastore Ltd	£500	999 A/Cs 99 centres
Ledgers integrated stock	Instar Business Systems	£999	600-2,900
Ledger purchase	Benchmark CS Ltd	£250	500 A/Cs 2,000 trans
Ledger purchase	Comput-A-Crop	£400	500 A/Cs
Ledger purchase	Computastore Ltd	£400	500 A/Cs 3,100 trans
Ledger purchase	Structured Systems Group	£460	varies
Ledger sales	Benchmark CS Ltd	£250	500 A/Cs 2,000 trans
Ledger sales	Computastore Ltd	£400	500 A/Cs 3,500 trans
Ledgers/sales, & general	Computastore Ltd	£1,000	
Ledger/stock/invoicing	Benchmark CS Ltd	£950	200 A/Cs 500 trans
Mail list system	Graffcom Systems Ltd	£250	varies
Mailing DBMS	Microtek Computer Services	£500	varies
Mailing system	Structured Systems Group	£50	varies
Order entry & invoicing	Benchmark CS Ltd		
Order entry & invoicing	Graffcom Systems Ltd	£350	500-5,000 orders
Payroll	Comput-A-Crop	£450	
Payroll	Graffcom Systems Ltd	£500	250 employees
Payroll	Microtek Computer Services	Lease	varies
Property management	Algobel Computers Ltd	£650	2,000 trans
Purchasing system	Graffcom Systems Ltd	£450	540-7,000 invoices
Stock control	Graffcom Systems Ltd	£350	520-6,000 items
Stock control	Microtek Computer Services	£1,000	varies
Stock/inventory control	Benchmark CS Ltd	£450	1,000 items 750 trans
Word processing	Computastore	£400	

## Exidy Sorcerer

Application	Supplier Name	Price
Incomplete records	Basic Computing	£350
Ledger purchase	Basic Computing	£125
Ledger sales	Basic Computing	£125
Stock recording	Basic Computing	£125

## Ohio Scientific

Application	Supplier Name	Price
DBMS	Microcomputer BM	£175
DBMS	U-Microcomputers Ltd	£175+
Ledgers/stock/invoicing	Microcomputer BM	£656
Word processing	Microcomputer BM	£116

## Tandy TRS-80

Application	Supplier Name	Price	Capacity
DBMS	T&V Johnson Ltd	£200	
Financial analysis	AJ Harding (Molimerx)	£55	N/A
Invoicing	Tridata Micros Ltd	£75	Linked to stock SA
Ledger general	Tridata Micros Ltd	P.O.A.	Linked to S/L P/L
Ledgers/payroll various	Microcomputer Applications	£90 each	
Ledger purchase	Tridata Micros Ltd	£225	175 A/Cs 1,350 trans
Ledger Purchase	AJ Harding (Molimerx)	£225	1,100 entries
Ledger sales	AJ Harding (Molimerx)	£225	1,350 entries
Ledger sales	Tridata Micros Ltd	£225	175 A/Cs 1,350 trans
Ledgers/sales, purchase, general & invoice	Microcomputer Applications	£350	
Mailing system	Cleartone ADP	£50	660 entries
Payroll	AJ Harding (Molimerx)	£95-£200	
Stock control	AJ Harding (Molimerx)	£225	630 items
Stock control	Microgems Software	£150	1,000-2,000 items
Stock/farming livestock	SA Systems	£650	300 stock records
Stock/invoicing/order entry	Cleartone ADP	POA	

## Z-80/8080

Application	Supplier Name	Price	Capacity
Appointments system	Great Northern CS Ltd	£220	varies
		£275	
DBMS	Structured Systems Group	£135	varies
DBMS medical records	Xitan Systems Ltd	£850	4,000 records/disc
Job/client	Great Northern CS Ltd	£330	varies
Ledger general	Great Northern CS Ltd	£275	varies
Ledger general	Graffcom Systems Ltd	£390	
Ledgers general/sales/purchase	Graffcom Systems Ltd	£995	
Ledgers/payroll	Great Northern CS Ltd	£995	varies
Ledger purchase	Great Northern CS Ltd	£275	varies
Ledger purchase	Great Northern CS Ltd	£275	varies
Ledger purchase	Graffcom Systems Ltd	£440	
Ledger sales	Graffcom Systems Ltd	£440	
Ledger sales	Great Northern CS Ltd	£275	varies
Ledgers/stock invoicing	T&V Johnson Ltd	£110	750 trans/disc
Mailing system	T&V Johnson Ltd	P.O.A.	3,000 names/addresses
Mail list system	Micro Focus	£90	varies
Payroll	3-Line Computing	£140	
Payroll	Tridata Micros Ltd	£218	400 employees
Payroll	Graffcom Systems Ltd	£490	250 employees
Property management	Graham Dorian Software	£325	varies
Purchasing system (job)	Great Northern CS Ltd	£275	varies
Order entry/invoicing	Graffcom Systems Ltd	£340	
Order entry/invoicing	Software Architects Ltd	£600	varies
Sales analysis (retail)	Great Northern CS Ltd	£325	varies
Stock control	Graham Dorian Software	£325	varies
Stock control	Rogis Systems Ltd	£500	varies
Stock control (retail)	Great Northern CS Ltd	£275	varies
Stock control	Graffcom Systems Ltd	£340	
Stock control	Software Architects Ltd	£600	varies
Stock control	T&V Johnson Ltd	£115	1,000 items
Stock control/invoicing	T&V Johnson Ltd	£145	1,000 items/invoices
Stock control	Tridata Micros	£200	630 items/disc
Stock/order entry/invoice	Graffcom Systems Ltd	£580	
Word processor (EP)	T&V Johnson Ltd	£109	10,000 words
Word processing	Structured Systems Group	£120	varies



## EPROMPT ERASER

- CLEARS UP TO 32 CHIPS IN 30 MINS ON 200-250V A.C.
- CONTINUOUS 253.7nm BEAM, SAFE & SIMPLE. GUARANTEED
- £39 C.W.O. £40 NETT 30 DAYS: ALL INCLUSIVE!

TRADE ENQUIRIES INVITED FOR SUBSTANTIAL DISCOUNTS  
ALL ORDERS AND ENQUIRIES POST-FREE TO:

**TEX MICROSYSTEMS LTD.**

FREEMOBT, ST. ALBANS, HERTS. AL1 1BR  
ST. ALBANS 04077/TRING 4797

• Circle No. 239

## REMEMBER!

WE SUPPLY ALL TYPES OF MEMORIES AND LOW POWER SCHOTTKY AND C-MOS. SO USE YOUR MEMORY AND CALL US.

## DON'T FORGET

WE HAVE MOVED TO NEW PREMISES.

**MERFIELD'S ELECTRONICS LIMITED**

WHITE HORSE LANE,  
CANTERBURY, KENT CT1 2RU  
TELEX: 965386  
TEL: 0227-60604/64442

• Circle No. 240

## MASTERMIND?

Then you will appreciate how far *SUPERBRAIN* and *CIS COBOL* can go. Contact Bill Whaley at *The Micro-Solution*, sole UK distributor of *CIS COBOL* and *FORMS 2* for *SUPERBRAIN*, and you can mastermind a whole range of new opportunities for your *SUPERBRAIN* today.

THE MICRO-SOLUTION  
PARK FARM HOUSE,  
HEYTHROP,  
CHIPPING NORTON, OXON  
TEL: (0608) 3256

• Circle No. 241

## ITT/APPLE 2020

# £650

DEMONSTRATIONS GIVEN  
SUPPLY SOFTWARE AND ALL  
ACCESSORIES.

HAYDALE ELECTRONICS  
18 BASSEIN PARK ROAD  
LONDON W12. 01-788 0397

• Circle No. 242



# SHOP WINDOW

## APPLE & ITT2020 BUSINESS SOFTWARE

Professionally written packages now available with comprehensive manuals, built-in validity checks, interactive enquiry facilities, user options, satisfying accountancy, Inland Revenue and Customs & Excise requirements. On diskette under DOS 3.2. in Applesoft with SPACE utility. Not adaptations. Written for Apple System. Support all printer interfaces. Sales, Purchases and General Ledgers £295-00 each.  
Manual only £3.  
Payroll £375. Manual only £4.  
General Ledger supports Incomplete Records, Job Costing, Branch and Consolidated Accounts etc.  
General Ledger Applications Manual £10.  
Prices exclusive of V.A.T. From our shop or your nearest stockist.

**COMPUTECH SYSTEMS**  
168, Finchley Road, London, N.W.3.  
Tel: 01-794 0202

• Circle No. 243

## TRS-80 System

All items stocked, Barclaycard, Access & American Express are welcome, or apply for your own RADIO SHACK Charge Card. U.K. Delivery by Securicor. Direct and Personal Exports.

**RADIO SHACK LTD.**  
188 Broadhurst Gardens,  
London NW6 3AY.

Tel: 01-624 7174 Telex 23718

• Circle No. 244

## MICROLINE 80

A revolution in small matrix printers. High quality print, Tandy/Prestel graphics, 3 print sizes, line programmable. Standard version has both friction and pin feed.

Centronics input interface. Options: Tractor feed, Serial interface.

Standard model (inc paper dispenser)

Tractor feed £499.00 + VAT  
Serial interface £ 35.00 + VAT  
Serial interface £ 65.00 + VAT

GPW ELECTRONICS LIMITED,  
55 COBHAM ROAD,  
FERNDOWN INDUSTRIAL ESTATE,  
WIMBORNE, DORSET  
Telephone 0202 893838  
Telex 417111

• Circle No. 245

## WORD-PROCESSING

written by C.B.C. for

## APPLE & ITT 2020

Use your own Micro and Printer and enjoy features found on WP systems costing £000's more! Not to be confused with simple text editing.

**HUNDREDS SOLD IN THE 1st MONTH**  
Upper/lower case printing, full editing, format selection & change, save/recall of text, margin and R.H. justification, block insertion, mail-shots etc. etc. A professional Program!

Mk 2 version £40 incl. VAT/P&P  
Your order plus Cheque, P.O. or Access/Barclay number to:

**MILDMAY ELECTRONICS LTD.**  
200 Moulsham St., Chelmsford, Essex  
Dealer enq. invited, other prog. & aids avail.

• Circle No. 246

## Alphabetical list of suppliers

Supplier	Address	Sales contact
Act (Petsoft) Ltd 021-455-8585	Radclyffe House, 66-68 Hagley Road, Birmingham.	Sales
AJ Harding (Molimerx) 0424-22039	28 Collington Avenue, Bexhill-on-Sea, East Sussex.	John Harding
Algobel Computers Ltd 021-233-2407	33 Cornwall Buildings, Newhall St. Birmingham B3 3QR	Steven Linden
Amplicon M S Ltd 0273-562163	143A Ditchling Road, Brighton, Sussex BN1 6JA.	Jim Hicks
Anagram Systems 0403-68601	9 Michell Close, Horsham, West Sussex RH12 1JT.	John Quigley
Analog Electronics 0203-417761	47 Ridgeway Avenue, Coventry.	Mike Collier
Basic Computing 0535-65094	Oakworth Road, Keighley, West Yorkshire BD22 7LA.	S Willmott
Benchmark CS Ltd 0726-61000	Tremena Manor, Tremena Road, St Austell, Cornwall PL25 5QG.	Joe Swift
Blackpool & Fylde Coll. Bristol Software Factory 0272-20801	Palatine Road, Blackpool. Micro House, St Michael's Hill, Bristol BS2 8BS.	W J Kyle-Price
Clearstone ADP 0495-244555	Prince of Wales Industrial Estate, Abercarn, Gwent NP1 5RJ.	Nick Green
Commodore B M (U.K.) Ltd 0753-74111	818 Leigh Road Trading Estate, Slough, Berkshire.	Nick Horgan
Compsoft Ltd 2483-39665	Old Manor Lane, Chilworth, Guildford, Surrey.	Jenny Wilson
Comput-A-Crop 01-771 0867	32 Whitworth Road, London SE25 6XH.	David Nicholson
Computastore Ltd 061-832-4761	16 John Dalton Street, Manchester M2 6HG.	Laurence Payne
Computech Systems 01-794 0202	168 Finchley Road, London NW3.	G Stuckey
Courtman Micro Systems 0222-495257	48 Melrose Avenue, Penylan, Cardiff.	Peter Mart
CSM Ltd 021-382-4171	Refuge Assurance House, Sutton New Road, Erdington, Birmingham.	P Handover
Dataview Ltd Colchester 78811	Colchester, Essex.	
Diskdean Ltd 01-242 7394	23 Bedford Row, London WC1R 4EB.	Tony Winter
G W Computers Ltd 01-636 8210	89 Bedford Court Mansions, Bedford Avenue, London WC1.	Barbara Castledine
Graffcom Systems Ltd 01-734 8862	52 Shaftesbury Avenue, London W1V 6DE.	John Clifford
Graham Dorian Software 01-379 7931	C/O Lifeboat Associates, 32 Neal Street, London WC2H 9PS.	P Clark
Great Northern C S Ltd 0532-450667	15 Wellington Street, Leeds LS1 4DL.	Allen Timpany
Guestel Ltd 0225-65379	Refuge House, 2-4 Henry Street, Bath BA1 1J.	
Instar Business Systems 01-680 5330	61 High Street, Croydon.	
Intex Datalog Ltd 0642-781193	Eaglescliffe Industrial Estate, Eaglescliffe, Cleveland TS16 0PN.	James Steadman
James C Steadman 0903-814923	18 Manor Road, Upper Beeding, Steyning, Sussex BN4 3TJ.	Bob Ellis
Keen Computers Ltd 0602-583254	5B The Poultry, Nottingham.	J Goodman
L & J Computers 01-204 7525	3 Crundale Avenue, Kingsbury, London NW9 9PJ.	E Landsler
Landsler Software 01-399 2476/7	29A Tolworth Park Road, Surbiton, Surrey KT6 7RL.	Tim Hill
3-Line Computing 0482-445496	36 Slough Road, Hull HUS 1QL.	
Logma Systems Design Bolton 389854	2-10 Bradshawgate, Bolton, Lancashire.	Stuart Whittaker
HB Computers Ltd 0536-83922 & 520910	22 Newland Street Kettering, Northamptonshire	



# Buyers' Guide

Hewport Ltd 04254-77352 Micro Computation 01-882 5104 Micro Focus 01-379 7931 Microact Ltd 021-455-8585	20 Cunningham Close, Ringwood, Hampshire BH24 1XW 8 Station Parade, Southgate, London N14. C/O Lifeboat Associates, 32 Neal Street, London WC2H 9PS. Radclyffe House, 66-68 Hagley Road, Edgbaston, Birmingham B16 8PF. 32 Buckingham Avenue, Hucknall, Nottinghamshire. 50 Chislehurst Road, Orpington, Kent BR5 0DJ. 11 Riverside Court, Caversham, Reading RG4 8AL. 25 Brunswick Street, Liverpool, L2 0BJ. 17 Victoria Road, Scarborough, N Yorks YO11 1SB. Communique Place, 9 Presbury Place, Macclesfield, Cheshire. Finway Road, Hemel Hempstead, Hertfordshire HP2 7PS. 26 Mill Street, Bedford. 112/116 High Street, Odiham, Basingstoke, Hampshire.	D N Rogers Graham Dicker Chris Barnes John Farthing
Microgems Software 0602-275559 Microtek Computer Services 0689-26803 Microcomputer Applications 0734-470425 Microdigital Ltd 051-227-2535 Microland 0723-70715 Micropute 0625-612818	194-200 Bishopsgate London, EC4M 4NR. Radclyffe House, 66-68 Hagley Road, Edgbaston, Birmingham B16 8PF. 107 George Lane, South Woodford, London E18 1AN. 2 Rumford Street, Liverpool L2.	W S Jupp Graham Jones Rick Holland Don Cooper
Microsense Computers Ltd 0442-41191/48151 MMS Computer Systems 0234-40601 Padmede Computer Services 025-671 2434 Personal Computers Ltd 01-626 8121/2/3 Petsoft Ltd 021-455-8585	Keeper's Lodge, Frittenden, Cranbrook, Kent. Allington Lodge, Round End, Newbury, Berkshire RG14 6PL. 39 Windmill Street, Gravesend, Kent. 34-35 Dean Street, London W1V 5AP. 6 Criterion Arcade, Old Christchurch Road, Bournemouth, Hants. C/O Lifeboat Associates 32 Neal Street, London WC2H 9PS. Essex House, Cherrydown, Basildon, Essex. 165 London Road, Camberley, Surrey GU15 3JS. 293 London Road, Hazel Grove, Stockport, Cheshire. 2 Whitefriars Way, Sandwich, Kent, CT13 9AD. 146 Oxford Street, London, W1. Smithfield House, Digbeth, Birmingham B5 6BS. Winstanly Industrial Estate, Long Lane, Warrington. Verwood House, High Street, West Haddon, Northamptonshire. Thames Building, Dedmere Road, Marlow, Buckinghamshire SL7 1PB. 23 Cumberland Place, Southampton.	Steve Derrick Julian Allason Brian Whitcomb
Profcomp Ltd 01-989 8177 Rockliff Brothers Ltd 051-521 5830 Rogis Systems Ltd 0580-80310 SA Systems Newbury 45813 SMG Microcomputers Gravesend 55813 Software Architects Ltd 01-734 9402 Stage One Computers 0202-23570		John Packwood
Structured Systems Group 01-379 7931 Systematics International Ltd 0268-284601 T & V Johnson Ltd 0276-62506 T W Computers Ltd 061-456-8187 The Alphabet Company 0304 617209 The Software House 01-637 1587 Tridata Micros Ltd 021-622-6085 U-Microcomputers Ltd Warrington 54117 Verwood Systems 0788-87629 Vlasak Electronics Ltd 06284-74789 Xitan Systems Ltd 0703-38740		John Clifford R Young T Johnson G Thompson A L Minter Keith Jones A Plackowski



## MICRO ADS

are accepted from private readers only, pre-paid and in writing. 20p per word, minimum charge £2.

Make the most of your 380Z (low resolution) graphics. Machine-code PIC makes picture drawing easy. Cassette. Listing. £2. P.G. Lewis, 29, Brownhill Road, Chandlers Ford, Eastleigh, Hants.

COMPUKIT SOFTWARE: Startrek, Zombie, X-wing fighter(R), Life, 5k. Anti-aircraft, Computer Pirate(R), Hangman, NoughtVCross, Digiclock (HMS), Random Number (you-v-UK101), 4k. (R = real-time.) Most use good graphics. £3.50p. each from K.A. Spencer (PC), 33 Alpine Gdns., Bath.

UK101. 8K Ram, Beige case, 12" TV/VDU. New monitor. Plus 610 Expansion board, with 12K Ram and own 5V/3A PSU. Many programs. £500 or will split. Tel. Stevenage (0438) 68624. Anytime.

Sixteen MK4108 used Pet one year £25 o.n.o. (0272) 684688.

Pet 16K little used, perfect condition, CBM 3016, plus extra cassette deck. £650 o.n.o. Phone 01-979 2815 anytime.

T159, PC1000C printer, plus Navigation module and much more software. £245 for lot. Possibly split. P. Curran 051-494-0408.

5WTC CT64 VDU terminal, RS232 Interface, switchable baud rates, £100. Ring V. Yelland, 01-531 0716 after 6PM. (Walthamstow).

EXPANDOR IMPACT PRINTER (not dot matrix), parallel interface, service manual, spares list, electrical diagrams, tractor and friction feed, ASCII coded. £195. Bewdley (Worcs) 402885 — weekends only.

SHARP MZ-80 Star Trek with full sound. For 22K or larger. £6 to T. Garden, 23, Whitehill Court, Berkhamsted, Herts.

MICRO 99 CPU Board £100. Many more Kit systems see advert in last month's issue. Small items too numerous to mention. Phone Bedford 46032 for list.

SHARP MZ 80K, as new. £420.00 inc VAT. Over £130 below list. Telephone 0624 822463.

Large selection of APPLE programs at bargain prices. T.W. Kerruish, Quinton Lodge, Silverburn, Ballasalla, Isle of Man.

IBM 1131 computer, with golfball printer, paper tape reader and punch. Software and Operating/Field Maintenance manuals. Good condition. Buyer collects. £550. Tel: Maidstone 677120 Evenings.

TRS-80 32K with Dual Disks. New October. £1,350 o.n.o. for Quick Sale. Phone 0273-23020.

ITT 2020 (Apple) 16K, Palsoft, Colour Modulator, 4 months old, perfect. Includes tapes. £720. 051-334 2405 Evenings.

Play Space Invaders on your Nascom. Full feature, 3K object code. Many options. SAE for full details. J. Atkins, 37 Wellington Road, Maidenhead, Berks. Telephone 0628 35145.

Powertran Comp80, 5K RAM, 2K BASIC, Monitor, with Graphics and Graph Plotting. Includes 64x32 TV Monitor and Tape Recorder, Metal Case. Stafford 850 244.

NASCOM PROGRAMS in machine code. 20 useful, assorted programs to run under T2, B-Bug, T4 or Nas-sys. £3 or send SAE for further details. R. Sargent, 134 Stockham Park, Wantage, Oxon.

NASCOM, built, working, with T2. Offers over £100. 01-992 8418 Evenings.

Quality written Basic Software for most Micros, silly prices. SAE for details stating Micro to Howard Kirkland, 38 Melrose Gardens, Arborfield, Berkshire RG2 9PZ.

Nascom 1 (not working), 2K Basic 8K Ram, Memory Board, Buffer Board & Bug, Power supply £150. Phone Farnborough (Kent) 53085.

PET SCREEN'S Green perspex easy fitting £3.75. Contact R. Wilmot, 1 Retreat Cottages, Broadbridge Heath, Horsham, Sussex.

NASCOM II with 16K RAM board. Graphics, 8K BASIC. Professionally built and fully tested. You can try it before you buy it. £435. Tel: 01-953 9545.

ANADEx Printer for Sale. Complete with Pet Interface. Surplus to requirements and absolutely good as new. £375. Tel: 01-952 8955.

# Wego Computers Ltd



**C** CBM approved  
£59.55 + VAT

## Wego Sequential Switching Unit

Allows up to 5 devices to be connected to the mains, and with one switching operation power up and down all the devices, in the correct sequence.



£89.50 + VAT

## Numeric Key Pad for the Apple.

A 13 digit Key pad (0-9, -, ., ENTER) to run in parallel with the numeric section of the APPLE Keyboard. Supplied with connecting cable, plugs and sockets.



**C** CBM approved  
Prices from £620 + VAT

## Mark Sense Card Reader

"A pencil, a card, and this low-cost reader... it's the new, fast way to enter data into your microcomputer." Versions available able to communicate with PET, APPLE, TRS-80, or any S100 or RS232 bus. Ideal for business and education applications.

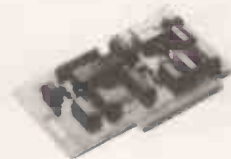

**S** Sole UK Distributors

## California Computer System Cards for the Apple.

Synch Serial Card	£106.37 + VAT
Asynch Serial Card	£106.37 + VAT
Para-1el Card	£ 79.77 + VAT
Arithmetic Proc. Unit	£265.97 + VAT
Programmable Timer	£106.37 + VAT
IEEE GPIB	£199.50 + VAT
A/D Converter	£ 99.72 + VAT
ROM/PROM Mod	£ 70.89 + VAT

Available from your local dealers, or direct from Wego Computers Ltd., 22A, High Street, Caterham, Surrey CR3 5UA. Tel: (0883) 49235 Telex: 8813791

Authorised COMMODORE APPLE Dealers

• Circle No. 255

## ARRAY Processing from Silicon Glen on the West Coast of Scotland

VIDEO VECTOR DYNAMICS Ltd. announces what will be one of the most significant innovations in microcomputing during the 1980s — the VP-9500 vector processor. The VP-9500 is a British-designed and manufactured vector processor consisting of a two to 16 long vector of pipe-lined floating point processors with individual data stacks, optimised to operate on arrays of floating point numbers of up to 16,384 elements. The VP-9500 provides floating point processing at up to 200 times faster than ordinary 4 MHz Z-80A microcomputers and 20-30 times faster than a PDP-11/34. The benchmarks on which these figures are based may be obtained on request.

The VP-9500 is constructed on one (up to 8 elements) or two (9 to 16 elements) glass fibre PCBs with full solder masking and silk-screened component locations. The precision board lay-out was generated on a CAD facility and etching was performed for us by the U.K.'s leading PCB manufacturer. The VP-9500 has its own on-board crystal clock and DIP switches allow it to be placed anywhere in the I/O space of any S-100 microcomputer running at any clock speed.

Every VP-9500 comes complete with VPLIB, our library of Microsoft FORTRAN-callable array processing routines. Typical calls to FPLIB are CALL VSQRT (A,C,N) where the square roots of all of the N floating point numbers in array A are calculated and placed in array C; and CALL VMUL (A,B,C,N) where the N elements of array A are multiplied by the corresponding elements of array B and the results stored in array C. VPLIB contains over 100 such routines.

The VP-9500 is designed for those high-speed, computationally-intensive tasks such as real-time collection/processing of video data, finite element analysis, crystallography, molecular modelling, graphics, signal processing and large-scale scientific/engineering calculations which are beyond the capabilities of conventional micro and minicomputers.

All VP-9500s are field-upgradeable to the top-of-the-range VP-9500/16. Optional extras include a front panel display (to replace the on-board display) to monitor the performance of the VP-9500, an S-100 EPROM card containing complete diagnostic software, a scalar FORTRAN library FASTLIB which replaces Microsoft's FORLIB by calls to the VP-9500 in addition to providing extra FORTRAN functions (TAN, ASIN, ACOS, SINH, COSH, NINT & RAN), custom additions to VPLIB and full maintenance contracts.

And the cost? From approximately £1,600 for a VP-9500/2, through £3,400 for the VP-9500/8 and up to £5,800 for the top-of-the-range VP-9500/16. Complete microcomputer systems in our MVP range include the MVP-9500/16 based on a 64KB, hard disc, Z-80A microcomputer with VDU and software for around £11,000. This is £5,000 cheaper than a PDP-11/34 system 20-30 times slower than MVP-9500/16.

If you need fast floating point performance but your requirement or your pocket doesn't run to a VP-9500, then you're looking for our scalar processor. The SP-9500 in conjunction with FASTLIB makes your existing Microsoft FORTRAN programs run up to 20 times faster simply by plugging in the SP-9500 board and replacing FORLIB with FASTLIB. The hidden bonus is that the SP-9500 uses a depopulated VP-9500 PCB and field hardware upgrading and integration of VPLIB is simplicity itself. The SP-9500/FASTLIB package costs £495.

Get into the '80s, the decade of the array processor, by contacting us at:

**VIDEO VECTOR DYNAMICS LTD**  
**39 Hope St., Glasgow G2 6AE;**  
**Telephone 041-226-3481/2**

• Circle No. 256

# What will you do with 12-year-old programmers when they reach 16?

Any microcomputer is a major investment for an educational establishment. Many potential users feel that a BASIC only computer is ample for their needs. That may be fine today, but with computer education starting so early you may in a surprisingly short time find you want more than current implementations of BASIC.

The 380Z is a computer that can grow to match your needs.

In the design of the 380Z our target user is the graduate research scientist. This ensures that the expandability and versatility needed tomorrow has been provided for in the computer you buy now.

approach will allow your students to advance.

380Z BASIC is not frozen in ROM. An enhanced BASIC could be loaded in mid 1980 and a BASIC with structured features sometime later.

On the 380Z the memory used by a BASIC interpreter can also be used for other software.

**Does our research-oriented design pay off in classroom hardware?**

Our scientific graphics was produced for the professional user. Interest in it for classroom use has been surprising.

The 380Z has the best graphics now available on a microcomputer,



freely mix upper and lower case text and diagrams.

Mains noise can cause system crashes which result in loss of programs and data. All current 380Zs include a mains filter which significantly reduces the chances of this happening.

**Don't buy a 380Z on patriotic grounds.**

Please only buy it if you would have bought it anyway. But remember, because it is designed and manufactured here you are bound to have better access to us for influence and help than if we were on the other side of an ocean.

Prices range from a 16K cassette 380Z @ £897 to a 56K Dual Full Floppy Disk 380Z @ £3322.



**Might you want to add disc storage in the next few years?**

*If you do:*

Given good hardware, software availability completely determines the flexibility and usefulness of your system. There is absolutely no question that a Z80 based micro-computer which uses the industry-standard CP/M\* disk operating system has several times more software on the market available to it than non CP/M computers.

Today you can purchase a mature CP/M BASIC, FORTRAN, COBOL or Text Processor for the 380Z. Soon there will be CP/M Pascal and Database Management systems.

CP/M software is several years ahead of software available for non CP/M family machines.

*If you don't:*

Remember that professionals writing packages for your cassette system will themselves often use a disk 380Z, and the power of their tools will influence what they produce.

For many people a disk machine is too expensive – but at least the 380Z

allowing multiple resolutions, multiple paging, fading and accurate control over colour. All these features help bring excitement to efforts in computer assisted learning.

Our standard machine comes with low resolution graphics and support for this from BASIC allows you to plot a point directly with a plot command – useful for training and teaching.

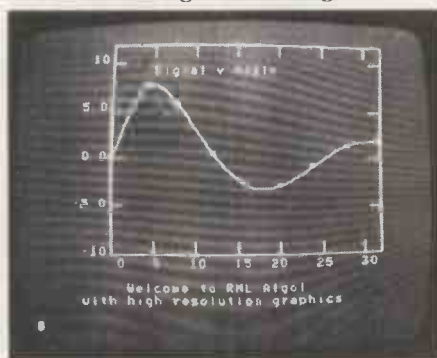

It is worth remembering too that neither our low resolution graphics nor our optional scientific (high resolution) graphics has any limiting effect on your memory usage, and in both you can

## LOWER COSTS

Three things have happened which make it easier to buy a 380Z.

ONE: From 1st November 1979 most prices have been reduced.

TWO: Schools and some colleges can now get a 5% discount on computer orders.

THREE: A new Local Authority quantity discount scheme has been introduced to make it easier for more users to benefit from quantity purchasing.

Please contact the Sales Office for details.

## RESEARCH MACHINES

RESEARCH MACHINES Ltd,  
PO. Box 75, Mill Street, Oxford, England.  
Telephone: Oxford (0865) 49791/2/3.  
Please send for full sales information.  
Prices do not include shipping costs or VAT @15%.

\* Trademark. Digital Research.

# Tandon MINI FLOPPY DISC DRIVES

## THE PROFESSIONAL DRIVE. NOW AVAILABLE FOR THE FIRST TIME TO PERSONAL COMPUTER USERS.

Complete Add — on boxed drives and integral power supply for TRS-80, North Star Horizon, Cromemco, S.W.T.P., Superbrain, Heathkit, Triton and others.

Now you can buy the Tandon drives which are supplied by your computer manufacturer as standard equipment, in boxed form ready to go, direct from the OEM distributor with full after sales service and user warranty.

**Fast access** — 5ms track to track  
**High Capacity** — 40 track

Highest reliability and accepted industry standard — over 70,000 of these American mini floppy drives are in use worldwide. Tandon drives are standard equipment on many professional computers including North Star, Cromemco, Wang, Ontel, Wordplex and many others.

### Single Disc Units

Single Sided	£250.00	Double Sided	£340.00
		or 77 track	

### Dual Disc Units

Single Sided	£430.00	Double Sided	£635.00
		or 77 track	

High quality Dyan diskettes for any of the drives also available.

**HAL COMPUTERS LIMITED**  
 133 Woodham Lane New Haw  
 Weybridge Surrey KT15 3NJ  
 Tel: Weybridge (0932) 48346/7  
 Telex: 8813487

• Circle No. 258

## LET'S TALK SENSIBLE PRICES

### MPI MODEL 88T MATRIX PRINTER

<b>Type of Printing</b>	Impact bidirectional, 7 x 7 dot matrix
<b>Print Rate</b>	100 Characters per second
<b>Character Set</b>	Full upper & lower case 96 char. ASCII set
<b>Print Format</b>	80, 96, or 132 characters per line
<b>Media</b>	Fanfold, single sheet or roll paper up to 9.5 ins. wide
<b>Paper Feed</b>	10 lines per second. User selectable pressure roller or tractor feed.
<b>Data Input</b>	Parallel (Centronics compatible) RS232C; TRS-80; Apple (Parallel Printer Interface Card) 20ma Current Loop.
<b>Baud Rate</b>	110, 150, 300, 600, 1200.
<b>Forms Control</b>	Top of Form (8 selectable form lengths) Skip over perforation.
<b>Operator Controls</b>	Top of Form Set, Forms feed, Self-Test Continuous Loop Cartridge, 20 yds 5 million character life.
<b>Ribbon</b>	
<b>Data Buffer</b>	Two lines standard, optional 1K and 2K.
<b>Physical Dimensions</b>	16.25 ins wide x 10.75 ins deep x 6.25 ins high. Weight: less than 15 lbs.

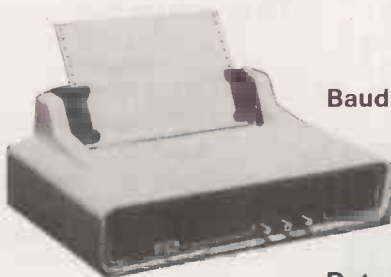

**£485**  
 + VAT

## COLIN BENTLEY ASSOCIATES LTD

4A Clock House, London Road, Waterlooville, Hants PO7 7EZ (07014) 51082

• Circle No. 259

# Computers? We'll help you pick and choose.



## What are NSC Computer Shops?

NSC Computer Shops, based in Manchester and Leeds, are backed by years of computing expertise. We aim to offer a specialist computer service to schools, universities and colleges as well as small private concerns.

## How can we help?

Are you thinking of becoming a first time computer user? Planning to expand existing facilities? Either way, at NSC Computer Shops we have all the specialist knowledge on systems and software and will be pleased to put you on the right track.

NSC Computer Shops' personal service doesn't end there either. Once the system to suit your needs is installed, we will continue to provide all the maintenance and back-up services you may need.

## What sort of systems can NSC Computer Shops offer?

We can provide a comprehensive range of systems. From Cromenco's System Three and Z2 H to Pet and Apple. Most of them will be in stock. So, if you can, visit us today.

## What about application software?

NSC Computer Shops can also provide a variety of application software to meet most of your requirements.

## How can you find out more?

Fill in the coupon today. Or, contact our branch at:  
**MANCHESTER**  
29 Hanging Ditch, Manchester M4 3ES Telephone: 061-832 2269



**NSC COMPUTER SHOPS**  
Here to help

Please send me more information about NSC Computer Shops.

- \* I will be a first time computer user
- \* I'm expanding my existing system which, at present, comprises...

\_\_\_\_\_

Name \_\_\_\_\_

Position \_\_\_\_\_

\*Name of College/School/University/Business: \_\_\_\_\_

Address \_\_\_\_\_

Telephone \_\_\_\_\_

\* Delete as appropriate

PC8

# PET users!

# SAVE UP TO 90% ON PROGRAM DEVELOPMENT TIME

by using **ComPasS**  
the new programming aid

## PLUS!

- Random access routines
- Effective data handling
- Flexible screen formatting
- Big savings in program testing
- Consistency with standard sub-routines
- Easier program maintenance

ComPasS is an easy-to-use new package containing parameter-driven BASIC programming routines to handle the input and output of data to and from tape and disc files. ComPasS will set you on the right course —and save you time, money and frustration.

Ring CPS or contact your nearest PET dealer.

**DEALERS!** TWO more NEW packages from CPS

'NEWSBOY' —a system for Newsagents accounting and delivery control (over 70 programs).

'GOLD' —a product costing and invoicing system for Manufacturing Jewellers.

'phone us for more information 021-707 3866



### CPS (DATA SYSTEMS) LTD

Arden House, 1102 Warwick Road,  
Acocks Green, Birmingham B27 6BH.  
Telephone: 021-707 3866  
Telex: 312280 CPS G

• Circle No. 261

## micrologic

for Business Systems  
based on the **apple II**  
Microcomputer



Complete systems from £2,500\*. Agents for Appeware. All standard programs available. Seminars arranged. Write or 'phone for list of dates & venues. Software to your own specification.

#### Visicalc

Performs many tasks: Estimating; Costing; Cash Flow Analysis and many others on your Apple. No programming knowledge required. **£95\***

#### Database

Allows you to create your own filing system. Search Routines, Print Routines. No Programming knowledge required. **£120\***

\* all prices ex. VAT

### micrologic apple

Sales and Service

TEMPLE HOUSE, 43-48 NEW STREET, BIRMINGHAM

021-643 0253

• Circle No. 262

## ITT/APPLE LETTERWRITER

The unique Guestel 360 letter writer combining text editing facilities with advanced mailing list and associated attributes file. An elegant machine code program with the following features — vertical scrolling, field, ??? stops, paragraph indent, alphabetical sorting, string search, right justification, full editing facilities and much more.

Displays in upper and lower case using our own plug-in lower case board.

£230 complete with plug-in lower case board.

£190 for those people who already have an LCB.

### BUY THE COPYRIGHT £500

That's right — an unprecedented offer — buy the right to reproduce the program as many times as you want for one small lump sum. Thereafter it's all profit — invest in the future. The applications are endless for a flexible database/text editor — Estate agents, Rental companies, Marketing agencies, Accountants, Clubs and Associations. The market is big enough for everyone — that's why we are prepared to sell it.

All prices ex VAT and pp

# GUESTEL LIMITED

GUESTEL LIMITED, REFUGE HOUSE,  
2-4 HENRY ST., BATH BA1 1JT.  
TEL: (0225) 65379

• Circle No. 263

# Write better programs for your pet using

## THE PET SUBROUTINE LIBRARY



*An anthology of PET subroutines including:*

Data input, special input routines to ensure correct data input — Reducing input errors by use of check digits — Date input verification and storage, avoid errors in date input — Screen formatting output — High density plotting, graphs, barplots and general purpose machine code point plotting routines — General purpose screen handler, a subroutine to perform all data input and output on the screen — Array sorts: bubblesorts, Sheilmetzner, and replacesort — Sorting and merging large disk files — Fast machine code sort package, including a binary search, data input and output to an array and machine code sort (100 element array in a couple of seconds) — Sorting with linked lists, stores data both in sorted and logical order — Sorted output on the printer, ideal for producing indexes — Sequential access disk files — Machine code sequential disk access, some ideas and tips on fast disk access — Random access disk files, an introduction with subroutines to write a random access file, either by record number or by key index — Disk utilities, display block map of disk or print contents of a disk sector — Menus for selecting options and linking programs together — Plus miscellaneous utility programs including repeat key, trace and screen printer.

**Price £10.00 all inclusive**

3040 format disk with all the subroutines from "LIBRARY OF PET SUBROUTINES"  
Price £10.00 inclusive

## THE PET REVEALED

Best selling reference book for the PET. Price £10.00

*Cheques payable to Computabits Ltd*

**COMPUTABITS LTD,**

P.O. BOX 13, YEOVIL, SOMERSET. Tel Yeovil 26522





# apple<sup>®</sup> computer

Sales and Service

**16K Apple £695**  
+ VAT and carriage

We also supply • Lear Siegler ADM3A — £515 for one.  
£500 each for two or more.



• Verbatim  
Single-sided minidiskette — £23 per  
box of 10.

— £21 for two  
boxes or more.  
Double-sided 8m. diskettes — £40 per box  
of 10  
— £38 for two  
boxes or more.  
Carriage inclusive, VAT extra.

We are also a Cromemco dealer supplying  
turnkey packages for Estate Agents, Solicitors  
and Wholesalers.

## Total Concept Systems Ltd

373 High Road Leyton, London E10. 01-539 7194 (day) 01-554 1152 (eve)

• Circle No. 265

# aculab

# floppy tape,

The tape that behaves like a disc,  
For TRS-80 LEVEL II.

Connects directly to TRS-80 Level 2 Keyboard. Operating and file handling software in ROM. 8 commands add 12 powerful functions to Level 2 BASIC. No buttons, switches or volume controls. Full control of all functions from Keyboard or program. Daisy chain multiple drives. Certified digital tape in endless loop cartridges. Reads and writes in FM format at 9000 Baud. Soft sectored with parity and checksum error detection for highly reliable operation—just like discs. Maintains directory with up to 32 files on each tape, tapes may be write-protected. Supports Basic and machine-language program files, memory image and random access data files. 12 character filespecs —: "FILENAME/EXT:d" (d is drive no. 0-7). Automatic keyboard debounce. Full manual with programming examples and useful file-handling routines.

COMMANDS (usually followed with a filespec and possible parameter list).

@SAVE, @LOAD, @RUN —for BASIC programs, machine language programs and memory image files. @GET, @PUT —moves a 256-byte record between a random access file and BASIC's data buffer. @KILL —removes a file from the directory and releases tape sectors for immediate re-use. @LIST —displays file directory along with sector allocation and free sectors. @NEW —formats tape and creates a blank directory.

**Master drive with PSU, Manual and a selection of tapes**

£167-00 +£2-00 pp+vat.

**Slave drives with PSU** £122-00 +£2-00 pp+vat.

(Export orders pp charged at cost)



For further  
information,  
Telephone  
**0525 371393**

**aculab** Ltd.  
24 Heath Road,  
Leighton Buzzard,  
Beds. LU7 8AB

• Circle No. 266



# SIRTON COMPUTERS



76 Godstone Road, Kenley (Nr Croydon) Surrey CR2 5AA  
Tel: 01-668 0761/2

## MIDAS S.100 SYSTEMS

**MIDAS 1 : From £895**  
**MIDAS 2 : From £1880**  
**MIDAS 3: From £2460**  
**MIDAS 4 : From £6300**

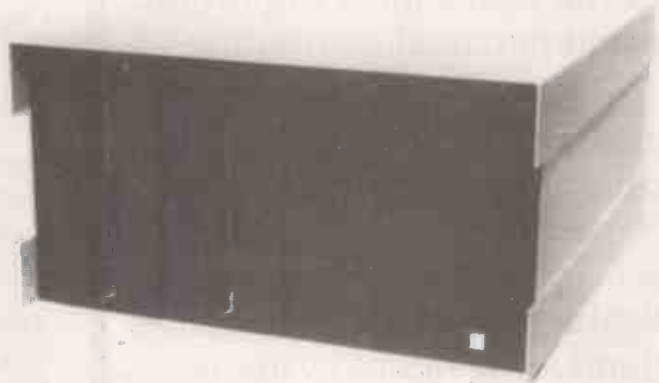

- Our versatile Z80 Microcomputers are available as standard units or custom configured to your exact specification from a comprehensive range of stocked S100 boards.
- Disc storage capacity of the MIDAS 3 can be 2M Bytes, expandable to over 20M Bytes with a Winchester Hard Disc Unit in our MIDAS 4 range.
- MIDAS runs CP/M and MP/M is also available. Other Software includes M-BASIC, C-BASIC, FORTRAN, COBOL, CIS-COBOL, PASCAL and Word Processing.
- **A MIDAS 3, with 64K RAM and 2M Bytes storage on two 8" drives with two Serial I/O Ports and CP/M 2 only £3200.**
- Printers, VDUs and other peripherals stocked to give complete package systems at keen prices.
- Business Packages include Accounts, Stock Control, Purchase Ledger etc etc.
- OEM and Dealer enquiries welcome.

## ITHACA DPS-1



With 4 MHz MPU-80 (Z80) CPU from £895.  
All Ithaca boards and many others available  
to make complete system.  
Also companion dual 8" Disc Drive Enclosure.

**WRITE OR PHONE FOR CATALOGUE**  
**SIRTON COMPUTERS WAS FORMERLY SIRTON PRODUCTS**

• Circle No. 267

# Micro U.K.

## The business & leisure microcomputer conference

### **The main event**

Micro UK is the conference component of the year's most important business and personal computing show,

Top-line US and European specialists are coming to London to present a comprehensive update on current advances in technology and to discuss the practical aspects of putting together and implementing micro systems successfully.

The multi-stream structure offers the widest possible subject choice and gives each delegate the flexibility to tailor his attendance to suit his own requirements.

The first two days concentrate on the use of micros in industry and commerce and the third day is devoted to a series of half-day teach-ins for the personal computer enthusiast.

Whether you come for one, two or three days, your conference fee buys you entry to the sessions of your choice, unrestricted access to the PCW exhibition (usually £2 per visit) and a chance to meet the speakers face-to-face in a special Micro UK feature.

### **Outline I**

### **each heading describes**

#### **Conference (4 and 5 September)**

##### **Technology Stream I**

###### **Processors and Memory**

memory chips – special purpose chips – bit slicing – new systems architecture – Motorola 6809 – Intel 8086 – Zilog Z8000 – 16 bit micros

###### **Storage Systems**

diskettes – single/double density – single/double sided – hard disks – 8" Winchester technology – fixed/changeable – costs and reliability

###### **Communications**

modem technology – PO facilities – data link controls – high level protocols – local area networks – Prestel – personal computer network

###### **Systems Review**

survey of micro systems – Texas Instruments TI 99/4 – Apple III – Triumph Adler Alphasonic – Sinclair ZX80 – other new releases

##### **Technology Stream II**

###### **Monitors and Operating Systems**

CP/M – MP/M – low level monitors – multi-tasking – multi-user operating systems – utility programs

###### **Languages**

BASIC – Business BASIC – Pascal – PL/1 – APL – language developments

###### **Programming and Quality Control**

program design – debugging tools – project control – program productivity

# Micro U.K.

is in conjunction with the third P

# Micro U.K.

4-6 September 1980  
Cunard Hotel, London.

## programme – as a half-day session

- Development Systems**  
development and programming aids – ROM – EPROM – simulators – testing
- Applications Stream**
- Retail and Distribution**  
stock control – order processing – point of sale – billing – financial management
- Manufacturing**  
process control – production control – inventory management – job scheduling
- Word Processing**  
special purpose/general purpose hardware – peripherals – displays and printers – cost justification
- Professional Office Systems**  
time recording – client billing – diary management – client services

### Teach-ins (6 September)

- Game Playing on Micros  
DIY Circuit Building  
Music and Microcomputers  
Micros for the Disabled  
Simulation and Business Games  
Technology and Concepts for the Businessman  
Building your own System  
The Personal Computer Network

Personal Computer World Show

## Meet the experts

As well as the wide-ranging 'traditional' conference sessions, Micro UK offers you a unique opportunity to meet some of the world's leading micro authorities face-to-face and get expert advice on your very own systems and equipment.

It's the next best thing to personal consultancy – and at a fraction of the cost.

This special feature is available on all three days only to Micro UK delegates. Get the full conference brochure now and make sure of your place. Phone the conference office on Uxbridge (0895) 30594 or clip the coupon below.

**The Micro UK Conference Office,**  
106 Pield Heath Road, Hillingdon,  
Middlesex UB8 3NL.

Please send me \_\_\_\_\_ copies of the full conference programme.

Name \_\_\_\_\_

Position \_\_\_\_\_

Organisation \_\_\_\_\_

Address \_\_\_\_\_

\_\_\_\_\_

\_\_\_\_\_

Tel. No: \_\_\_\_\_

PC8

## Horizon Business Systems



### HARDWARE

North Star Horizon with 56K Static RAM, 2 Quad capacity drives, 2 serial port, 2 parallel ports. £2260.00

Also SUPERBRAIN, Pet, Tandy.  
Choice of VDU's and Printers.

### SOFTWARE

#### A. Ledger System

Complete Ledger System including Sales, purchase and Nominal ledger, Trial balance, Profit and Loss Account, etc. £800.00

#### B. Book-Keeper

As Ledger system plus Petty Cash, Bank reconciliation etc.

#### C. Order Processing/ Stock Control

Specially designed for chemists. Also suitable for warehouses and retail shops.

Also Payroll, Incomplete records, Word Processing, Mail Shots, Insurance Broker System etc.

## MICROSYS LIMITED

58 HIGH STREET, PRESCOT,  
MERSEYSIDE L34 6HQ  
Tel: 051-426 7271

• Circle No. 269

**WHEN BUYING BUSINESS PROGRAMMES FOR THE APPLE IT MAKES SENSE TO CONSULT A USER OF THESE PROGRAMMES.**

### PROGRAMMES AVAILABLE

Visicalc  
Word Processing  
Database  
Solicitors Accounts  
Incomplete Records  
Estate Agents  
Hotels  
Asset Register  
Estate Management  
Payroll  
Invoicing  
Stock Control  
Club Records  
Insurance Brokers

Sales Ledger  
Purchase Ledger  
General Ledger  
Time Costing  
Medical Records  
Job Costing  
Advertising sequence  
Executive Diary  
Farmers  
Designers Package  
Cash Flow Forecast  
Direct Mailing  
Charitable Covenants  
Financial Planning

*In association with Business Computers (North West) Ltd, Official Apple Dealers, we are able to arrange the purchase of the equipment which, to local purchasers, enables us to give two days training at your premises free of charge.*

Ring Sue Hoban at 051 708-5620

**CUSTOMER ACCOUNTING SERVICES**  
FREEPOST Liverpool L1 1AB.

• Circle No. 270

## S-100 BOARDS

Fully Assembled and Tested

16K RAM Bank Selectable	£165
32K RAM Bank Selectable	£325
64K RAM Bank Selectable	£365
I/O 2 Serial Ports } 2 Parallel Ports }	= £125
Z.80 C.P.U. 4MHz	£150
Real Time Clock	£200

ALL NORTH STAR CROMEMCO COMPATIBLE  
PRICES EXCLUDE V.A.T.

Clenlo  
Computing  
Systems Ltd

15 SOUTH VIEW COURT  
THE WOODLANDS  
BEULAH HILL SE19 3EJ  
LONDON

Tel: 01-653-6028



## Business Software

**FOR Z-80 MICRO-COMPUTERS  
RUNS UNDER CPM  
FROM S.S.G.**

Analyst	£120
General Ledger	£340
Accounts Receivable	£340
Accounts Payable	£340
Payroll	£340
Inventory	£175
Nad (Modified Version)	£60
Q Sort	£50
Letteright	£80

PRICES EXCLUDE V.A.T.

Clenlo  
Computing  
Systems Ltd

15 SOUTH VIEW COURT  
THE WOODLANDS  
BEULAH HILL SE19 3EJ  
LONDON

Tel: 01-653-6028

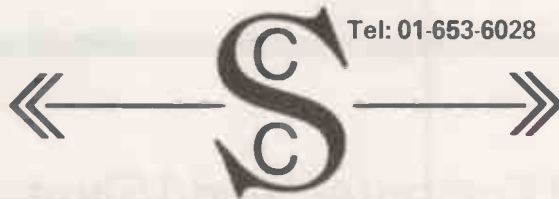

• Circle No. 271

# enter the computer age

## Stop Press!

WIN A TRIP TO  
HONG KONG —  
SEE YOUR DEALER  
FOR DETAILS.



## video genie system

**£425.50**  
INC VAT

See it at the following dealers:—

**3 Line Computing**  
Hull 445496

**Advance Television Services**  
ShIPLEY 585333

**Amateur Radio Shop**  
Huddersfield 20774

**Bredhurst Electronics**  
Handcross 400786

**Briers Polytechnic Bookshop**  
Middlesbrough 242017

**Buss Stop**  
Watford 40698  
Newport Pagnell 610625

**Cambridge Microcomputers Ltd.**  
Cambridge 314666

**Catronics Limited**  
Wallington 01 669 6700/1

**Cavern Electronics**  
Milton Keynes 314925

**Computer Business Systems**  
Lytham 730033

**Computerama Limited**  
Bath 28819

**Computopia Limited**  
Leighton Buzzard 376600

**Computer and Chips**  
St. Andrews 72569

**Derwent Radio**  
Scarborough 65996

**Eiron Computers Limited**  
Dublin 808575/805045

**Eley Electronics**  
Leicester 871522

**Gemsoft**  
Woking 22881

**Leisuretronics**  
Blackpool 27091

**Marton Microcomputer Services**  
Northampton 890661

**Matrix Computer Systems Limited**  
Beckenham 01 658 7508/7551

**Microdigital Limited**  
Liverpool 227 2535

**Midland Microcomputers**  
Nottingham 298281

**Microtime Products Limited**  
Watford 40588/9

**Mighty Micro Limited**  
Burnley 32209/53629

**MRS Communications**  
Cardiff 616936/7

**Optelco**  
Rayleigh 774089

**Route 66**  
New Cross 01 732 8608

**SMG Microcomputers**  
Gravesend 55813

**Tryfan Computers**  
Bangor 52042

**University Radio**  
Nottingham 45466

**Ward Electronics**  
Birmingham 021 554 0708

Sole Importers

# LOWE ELECTRONICS

Bentley Bridge, Chesterfield Road, Matlock, Derbyshire. DE4 5LE.

TRADE ENQUIRIES WELCOME



• Circle No. 272

The new powerful personal computer from Sweden...

Now looking for powerful retailers to be appointed for many areas in UK



**ABC80**

Now available from UK stocks

The microcomputer which outsells all others in Scandinavia.

Write: Dator Ltd. / Fox Oak / Seven Hills Road / Walton-on-Thames / Surrey kt 124 dg

• Circle No. 273

<p><b>SALE OF THE CENTURY</b> Sensational Price Reductions in Memories</p> <table border="0"> <tr><td>2114</td><td>450 NS</td><td>2.50</td></tr> <tr><td>2114</td><td>300 NS</td><td>2.75</td></tr> <tr><td>2114</td><td>200 NS</td><td>2.95</td></tr> <tr><td>4116</td><td>200 NS</td><td>3.00</td></tr> <tr><td>4315</td><td>450 NS 4K CMOS RAM (4K x 1)</td><td>9.95</td></tr> <tr><td>6514</td><td>450 NS 4K CMOS RAM (1k x 4)</td><td>7.95</td></tr> <tr><td>2708</td><td>450 NS</td><td>4.25</td></tr> <tr><td>2716</td><td>5V 450 NS</td><td>10.95</td></tr> <tr><td>2732</td><td>32K EPROM 5V 450 NS</td><td>29.95</td></tr> <tr><td>4116</td><td>150 NS</td><td>3.50</td></tr> </table>	2114	450 NS	2.50	2114	300 NS	2.75	2114	200 NS	2.95	4116	200 NS	3.00	4315	450 NS 4K CMOS RAM (4K x 1)	9.95	6514	450 NS 4K CMOS RAM (1k x 4)	7.95	2708	450 NS	4.25	2716	5V 450 NS	10.95	2732	32K EPROM 5V 450 NS	29.95	4116	150 NS	3.50	<p><b>NEW GI COMPUTER SOUND CHIP</b> AY-3-8910. As featured in July BYTE. Fantastically powerful sound &amp; music generator. Perfect for use with any 8 bit microprocessor. Contains 3 tone channels, noise generator, 3 channels of amplitude controls, 16 bit envelope period control, 2 parallel I/O, 3 D/A converters plus much more. All in 40 pin DIP. Super easy to interface to the S-100 or other Buses. ONLY £8.25 + VAT. Add £2.25 for 60 page data manual. Free copy of BYTE article.</p>	<p><b>SAM'S BOOKS AT LOWEST PRICES</b></p>																																																																																																																																																																																																																						
2114	450 NS	2.50																																																																																																																																																																																																																																																				
2114	300 NS	2.75																																																																																																																																																																																																																																																				
2114	200 NS	2.95																																																																																																																																																																																																																																																				
4116	200 NS	3.00																																																																																																																																																																																																																																																				
4315	450 NS 4K CMOS RAM (4K x 1)	9.95																																																																																																																																																																																																																																																				
6514	450 NS 4K CMOS RAM (1k x 4)	7.95																																																																																																																																																																																																																																																				
2708	450 NS	4.25																																																																																																																																																																																																																																																				
2716	5V 450 NS	10.95																																																																																																																																																																																																																																																				
2732	32K EPROM 5V 450 NS	29.95																																																																																																																																																																																																																																																				
4116	150 NS	3.50																																																																																																																																																																																																																																																				
<table border="0"> <tr><td><b>CPU'S</b></td><td></td><td></td><td></td></tr> <tr><td>6502</td><td>7.95</td><td>IBM Compatible</td><td>49.95</td></tr> <tr><td>Z80</td><td>7.95</td><td></td><td></td></tr> <tr><td>Z80A</td><td>9.95</td><td></td><td></td></tr> <tr><td>Z8001</td><td>125.00</td><td><b>CHARACTER GENERATOR</b></td><td></td></tr> <tr><td>Z8002</td><td>95.00</td><td>RO-3-2513UC</td><td>4.50</td></tr> <tr><td><b>DEVELOPMENT MODULE</b></td><td></td><td><b>UARTS</b></td><td></td></tr> <tr><td>Z8000DM</td><td>1099.00</td><td>AY-5-1013A</td><td>2.98</td></tr> <tr><td></td><td></td><td>AY-3-1015D</td><td>3.50</td></tr> <tr><td></td><td></td><td>IM6402</td><td>3.50</td></tr> <tr><td><b>FLOPPY DISK CONTROLLER</b></td><td></td><td><b>KEYBOARD ENCODER</b></td><td></td></tr> <tr><td>FD1771 B-01</td><td></td><td>AY-5-2376</td><td>7.95</td></tr> <tr><td>Single Density</td><td></td><td><b>SHIFT REGISTERS</b></td><td></td></tr> <tr><td>IBM</td><td></td><td>3341 PC FIFO</td><td></td></tr> <tr><td>Compatible</td><td>24.95</td><td>Z80A S10/1</td><td>34.95</td></tr> <tr><td>FD1791 B-01</td><td></td><td>Z80A S10/0</td><td>34.95</td></tr> <tr><td>Dual Density</td><td></td><td>Z80A S10/1</td><td>34.95</td></tr> </table>	<b>CPU'S</b>				6502	7.95	IBM Compatible	49.95	Z80	7.95			Z80A	9.95			Z8001	125.00	<b>CHARACTER GENERATOR</b>		Z8002	95.00	RO-3-2513UC	4.50	<b>DEVELOPMENT MODULE</b>		<b>UARTS</b>		Z8000DM	1099.00	AY-5-1013A	2.98			AY-3-1015D	3.50			IM6402	3.50	<b>FLOPPY DISK CONTROLLER</b>		<b>KEYBOARD ENCODER</b>		FD1771 B-01		AY-5-2376	7.95	Single Density		<b>SHIFT REGISTERS</b>		IBM		3341 PC FIFO		Compatible	24.95	Z80A S10/1	34.95	FD1791 B-01		Z80A S10/0	34.95	Dual Density		Z80A S10/1	34.95	<table border="0"> <tr><td>3341 APC FIFO</td><td></td><td>Z80 S10/2</td><td>29.95</td></tr> <tr><td>1 MHz</td><td>5.50</td><td>Z80A S10/2</td><td>34.95</td></tr> <tr><td>3342 PC 64 bit shift register</td><td>4.95</td><td>MC14412VL</td><td>7.97</td></tr> <tr><td>3347 PC 80 bit shift register</td><td>4.95</td><td><b>INTERFACE</b></td><td></td></tr> <tr><td><b>SUPPORT DEVICES</b></td><td></td><td>DM8123</td><td>125p</td></tr> <tr><td>6520</td><td>4.95</td><td>MC1488</td><td>90p</td></tr> <tr><td>6522</td><td>7.95</td><td>MC1489</td><td>90p</td></tr> <tr><td>6532</td><td>8.95</td><td>75150</td><td>125p</td></tr> <tr><td>6551</td><td>10.95</td><td>75154</td><td>125p</td></tr> <tr><td>Z80 PIO</td><td>6.95</td><td>75182</td><td>195p</td></tr> <tr><td>Z80A PIO</td><td>6.95</td><td>75322</td><td>250p</td></tr> <tr><td>Z80 CTC</td><td>5.95</td><td>75324</td><td>325p</td></tr> <tr><td>Z80A CTC</td><td>6.95</td><td>75361</td><td>350p</td></tr> <tr><td>Z80 DMA</td><td>19.95</td><td>75365</td><td>295p</td></tr> <tr><td>Z80 S10/0</td><td>29.95</td><td>75451</td><td>50p</td></tr> <tr><td>Z80A S10/0</td><td>34.95</td><td>75491/2</td><td>75p</td></tr> <tr><td>Z80 S10/1</td><td>29.95</td><td>8T26</td><td>175p</td></tr> <tr><td>Z80A S10/1</td><td>34.95</td><td>8T28</td><td>175p</td></tr> <tr><td></td><td></td><td>8T95</td><td>175p</td></tr> <tr><td></td><td></td><td>8T97</td><td>175p</td></tr> </table>	3341 APC FIFO		Z80 S10/2	29.95	1 MHz	5.50	Z80A S10/2	34.95	3342 PC 64 bit shift register	4.95	MC14412VL	7.97	3347 PC 80 bit shift register	4.95	<b>INTERFACE</b>		<b>SUPPORT DEVICES</b>		DM8123	125p	6520	4.95	MC1488	90p	6522	7.95	MC1489	90p	6532	8.95	75150	125p	6551	10.95	75154	125p	Z80 PIO	6.95	75182	195p	Z80A PIO	6.95	75322	250p	Z80 CTC	5.95	75324	325p	Z80A CTC	6.95	75361	350p	Z80 DMA	19.95	75365	295p	Z80 S10/0	29.95	75451	50p	Z80A S10/0	34.95	75491/2	75p	Z80 S10/1	29.95	8T26	175p	Z80A S10/1	34.95	8T28	175p			8T95	175p			8T97	175p	<table border="0"> <tr><td><b>COMPUTER BOOKS</b></td><td></td><td>Microcomputer — Analog Converter Software and Hardware Interfacing</td><td>£5.70</td></tr> <tr><td>Microcomputer Primer (2nd Edition)</td><td>NEW £7.17</td><td>The 8080A Bugbook: Microcomputer Interfacing and Programming</td><td>£6.30</td></tr> <tr><td>Microcomputers for Business Applications</td><td>£5.37</td><td>The S-100 and Other Micro Buses</td><td>£3.95</td></tr> <tr><td>The Howard W. Sams Crash Course in Microcomputers</td><td>NEW £10.50</td><td>The Cheap Video Cookbook</td><td>£3.75</td></tr> <tr><td>Fundamentals of Digital Computers (2nd Edition)</td><td>£5.97</td><td>TV Typewriter Cookbook</td><td>£5.97</td></tr> <tr><td>Getting Acquainted with Microcomputers</td><td>£5.37</td><td>Using the 6800 Microprocessor</td><td>£4.77</td></tr> <tr><td>How to Buy &amp; Use Minicomputers &amp; Microcomputers</td><td>£5.97</td><td>Z-80 Microcomputer Handbook</td><td>£5.37</td></tr> <tr><td>Computer Graphics Primer</td><td>NEW £7.77</td><td>8085 Microcomputer Design</td><td>NEW £5.97</td></tr> <tr><td>TEA: An 8080/8085 Co-Resident Editor/Assembler</td><td>NEW £5.37</td><td><b>COOKBOOKS</b></td><td></td></tr> <tr><td>6502 Software Design (Book 1)</td><td>£5.70</td><td>TTL Cookbook</td><td>£5.70</td></tr> <tr><td>(Book 2)</td><td>£5.97</td><td>Active-Filter Cookbook</td><td>£8.97</td></tr> <tr><td><b>BASIC Programming Primer</b></td><td>£5.37</td><td>TV Typewriter Cookbook</td><td>£5.97</td></tr> <tr><td>DEBUG: An 8080 Interpretive Debugger</td><td>£3.75</td><td>CMOS Cookbook</td><td>£6.30</td></tr> <tr><td>How to Program Microcomputers</td><td>£5.37</td><td>IC Timer Cookbook</td><td>£5.97</td></tr> <tr><td>Computer Dictionary (3rd Edition)</td><td>NEW £7.17</td><td>The Cheap Video Cookbook</td><td>£3.75</td></tr> <tr><td>Boolean Algebra for Computer Logic</td><td>£3.95</td><td>IC Converter Cookbook</td><td>£8.37</td></tr> <tr><td>Computers &amp; Programming Guide for Scientists &amp; Engineers (3rd Edition)</td><td>NEW £9.57</td><td>IC Op-Amp Cookbook (2nd Edition)</td><td>£8.97</td></tr> <tr><td>Microcomputer Interfacing with the 8255 PPI Chip</td><td>£5.37</td><td></td><td></td></tr> <tr><td>Programming &amp; Interfacing the 6502, with Experiments</td><td>NEW £7.17</td><td></td><td></td></tr> <tr><td>TRS-80 Interfacing</td><td>NEW £5.37</td><td></td><td></td></tr> <tr><td>Z-80 Microcomputer Design Projects</td><td>NEW £7.77</td><td></td><td></td></tr> <tr><td>Z-80 Microprocessor Programming &amp; Interfacing — Books 1 and 2</td><td>(Book 1) £6.97 (Book 2) £7.77</td><td></td><td></td></tr> <tr><td>Interfacing and Scientific Data Communications Experiments</td><td>£3.95</td><td></td><td></td></tr> <tr><td>Introductory Experiments in Digital Electronics and 8080A Microcomputer Programming and Interfacing</td><td>(Book 1) £7.77 (Book 2) £7.77</td><td></td><td></td></tr> </table>	<b>COMPUTER BOOKS</b>		Microcomputer — Analog Converter Software and Hardware Interfacing	£5.70	Microcomputer Primer (2nd Edition)	NEW £7.17	The 8080A Bugbook: Microcomputer Interfacing and Programming	£6.30	Microcomputers for Business Applications	£5.37	The S-100 and Other Micro Buses	£3.95	The Howard W. Sams Crash Course in Microcomputers	NEW £10.50	The Cheap Video Cookbook	£3.75	Fundamentals of Digital Computers (2nd Edition)	£5.97	TV Typewriter Cookbook	£5.97	Getting Acquainted with Microcomputers	£5.37	Using the 6800 Microprocessor	£4.77	How to Buy & Use Minicomputers & Microcomputers	£5.97	Z-80 Microcomputer Handbook	£5.37	Computer Graphics Primer	NEW £7.77	8085 Microcomputer Design	NEW £5.97	TEA: An 8080/8085 Co-Resident Editor/Assembler	NEW £5.37	<b>COOKBOOKS</b>		6502 Software Design (Book 1)	£5.70	TTL Cookbook	£5.70	(Book 2)	£5.97	Active-Filter Cookbook	£8.97	<b>BASIC Programming Primer</b>	£5.37	TV Typewriter Cookbook	£5.97	DEBUG: An 8080 Interpretive Debugger	£3.75	CMOS Cookbook	£6.30	How to Program Microcomputers	£5.37	IC Timer Cookbook	£5.97	Computer Dictionary (3rd Edition)	NEW £7.17	The Cheap Video Cookbook	£3.75	Boolean Algebra for Computer Logic	£3.95	IC Converter Cookbook	£8.37	Computers & Programming Guide for Scientists & Engineers (3rd Edition)	NEW £9.57	IC Op-Amp Cookbook (2nd Edition)	£8.97	Microcomputer Interfacing with the 8255 PPI Chip	£5.37			Programming & Interfacing the 6502, with Experiments	NEW £7.17			TRS-80 Interfacing	NEW £5.37			Z-80 Microcomputer Design Projects	NEW £7.77			Z-80 Microprocessor Programming & Interfacing — Books 1 and 2	(Book 1) £6.97 (Book 2) £7.77			Interfacing and Scientific Data Communications Experiments	£3.95			Introductory Experiments in Digital Electronics and 8080A Microcomputer Programming and Interfacing	(Book 1) £7.77 (Book 2) £7.77		
<b>CPU'S</b>																																																																																																																																																																																																																																																						
6502	7.95	IBM Compatible	49.95																																																																																																																																																																																																																																																			
Z80	7.95																																																																																																																																																																																																																																																					
Z80A	9.95																																																																																																																																																																																																																																																					
Z8001	125.00	<b>CHARACTER GENERATOR</b>																																																																																																																																																																																																																																																				
Z8002	95.00	RO-3-2513UC	4.50																																																																																																																																																																																																																																																			
<b>DEVELOPMENT MODULE</b>		<b>UARTS</b>																																																																																																																																																																																																																																																				
Z8000DM	1099.00	AY-5-1013A	2.98																																																																																																																																																																																																																																																			
		AY-3-1015D	3.50																																																																																																																																																																																																																																																			
		IM6402	3.50																																																																																																																																																																																																																																																			
<b>FLOPPY DISK CONTROLLER</b>		<b>KEYBOARD ENCODER</b>																																																																																																																																																																																																																																																				
FD1771 B-01		AY-5-2376	7.95																																																																																																																																																																																																																																																			
Single Density		<b>SHIFT REGISTERS</b>																																																																																																																																																																																																																																																				
IBM		3341 PC FIFO																																																																																																																																																																																																																																																				
Compatible	24.95	Z80A S10/1	34.95																																																																																																																																																																																																																																																			
FD1791 B-01		Z80A S10/0	34.95																																																																																																																																																																																																																																																			
Dual Density		Z80A S10/1	34.95																																																																																																																																																																																																																																																			
3341 APC FIFO		Z80 S10/2	29.95																																																																																																																																																																																																																																																			
1 MHz	5.50	Z80A S10/2	34.95																																																																																																																																																																																																																																																			
3342 PC 64 bit shift register	4.95	MC14412VL	7.97																																																																																																																																																																																																																																																			
3347 PC 80 bit shift register	4.95	<b>INTERFACE</b>																																																																																																																																																																																																																																																				
<b>SUPPORT DEVICES</b>		DM8123	125p																																																																																																																																																																																																																																																			
6520	4.95	MC1488	90p																																																																																																																																																																																																																																																			
6522	7.95	MC1489	90p																																																																																																																																																																																																																																																			
6532	8.95	75150	125p																																																																																																																																																																																																																																																			
6551	10.95	75154	125p																																																																																																																																																																																																																																																			
Z80 PIO	6.95	75182	195p																																																																																																																																																																																																																																																			
Z80A PIO	6.95	75322	250p																																																																																																																																																																																																																																																			
Z80 CTC	5.95	75324	325p																																																																																																																																																																																																																																																			
Z80A CTC	6.95	75361	350p																																																																																																																																																																																																																																																			
Z80 DMA	19.95	75365	295p																																																																																																																																																																																																																																																			
Z80 S10/0	29.95	75451	50p																																																																																																																																																																																																																																																			
Z80A S10/0	34.95	75491/2	75p																																																																																																																																																																																																																																																			
Z80 S10/1	29.95	8T26	175p																																																																																																																																																																																																																																																			
Z80A S10/1	34.95	8T28	175p																																																																																																																																																																																																																																																			
		8T95	175p																																																																																																																																																																																																																																																			
		8T97	175p																																																																																																																																																																																																																																																			
<b>COMPUTER BOOKS</b>		Microcomputer — Analog Converter Software and Hardware Interfacing	£5.70																																																																																																																																																																																																																																																			
Microcomputer Primer (2nd Edition)	NEW £7.17	The 8080A Bugbook: Microcomputer Interfacing and Programming	£6.30																																																																																																																																																																																																																																																			
Microcomputers for Business Applications	£5.37	The S-100 and Other Micro Buses	£3.95																																																																																																																																																																																																																																																			
The Howard W. Sams Crash Course in Microcomputers	NEW £10.50	The Cheap Video Cookbook	£3.75																																																																																																																																																																																																																																																			
Fundamentals of Digital Computers (2nd Edition)	£5.97	TV Typewriter Cookbook	£5.97																																																																																																																																																																																																																																																			
Getting Acquainted with Microcomputers	£5.37	Using the 6800 Microprocessor	£4.77																																																																																																																																																																																																																																																			
How to Buy & Use Minicomputers & Microcomputers	£5.97	Z-80 Microcomputer Handbook	£5.37																																																																																																																																																																																																																																																			
Computer Graphics Primer	NEW £7.77	8085 Microcomputer Design	NEW £5.97																																																																																																																																																																																																																																																			
TEA: An 8080/8085 Co-Resident Editor/Assembler	NEW £5.37	<b>COOKBOOKS</b>																																																																																																																																																																																																																																																				
6502 Software Design (Book 1)	£5.70	TTL Cookbook	£5.70																																																																																																																																																																																																																																																			
(Book 2)	£5.97	Active-Filter Cookbook	£8.97																																																																																																																																																																																																																																																			
<b>BASIC Programming Primer</b>	£5.37	TV Typewriter Cookbook	£5.97																																																																																																																																																																																																																																																			
DEBUG: An 8080 Interpretive Debugger	£3.75	CMOS Cookbook	£6.30																																																																																																																																																																																																																																																			
How to Program Microcomputers	£5.37	IC Timer Cookbook	£5.97																																																																																																																																																																																																																																																			
Computer Dictionary (3rd Edition)	NEW £7.17	The Cheap Video Cookbook	£3.75																																																																																																																																																																																																																																																			
Boolean Algebra for Computer Logic	£3.95	IC Converter Cookbook	£8.37																																																																																																																																																																																																																																																			
Computers & Programming Guide for Scientists & Engineers (3rd Edition)	NEW £9.57	IC Op-Amp Cookbook (2nd Edition)	£8.97																																																																																																																																																																																																																																																			
Microcomputer Interfacing with the 8255 PPI Chip	£5.37																																																																																																																																																																																																																																																					
Programming & Interfacing the 6502, with Experiments	NEW £7.17																																																																																																																																																																																																																																																					
TRS-80 Interfacing	NEW £5.37																																																																																																																																																																																																																																																					
Z-80 Microcomputer Design Projects	NEW £7.77																																																																																																																																																																																																																																																					
Z-80 Microprocessor Programming & Interfacing — Books 1 and 2	(Book 1) £6.97 (Book 2) £7.77																																																																																																																																																																																																																																																					
Interfacing and Scientific Data Communications Experiments	£3.95																																																																																																																																																																																																																																																					
Introductory Experiments in Digital Electronics and 8080A Microcomputer Programming and Interfacing	(Book 1) £7.77 (Book 2) £7.77																																																																																																																																																																																																																																																					
<p><b>NEW</b> 4k (1k x 4) CMOS RAM LOWER POWER 450 NS ONLY £7.95 8 For only £56 + VAT</p> <p>The Toshiba TC5514P (same as 6514) is a full static read write memory organized as 1024 words by 4 bits using CMOS technology. Because of ultra low power dissipation, the TC5514P can be used as battery operated portable memory system and also as a nonvolatile memory with battery back up. The TC5514P operates from a single 5V power supply with a static operation, so that the no refresh periods are required. This simplifies the power supply circuit design. The three state outputs simplify the memory expansion making the TC5514P suitable for use in a microprocessor peripheral memory. Since the minimum data retention voltage is 2V, the battery back up system needs only simple circuit. By using Toshiba's original CMOS technology, the device circuitry is not only simplified but wide operating margin and noise margin are also realized. The TC5514P family is moulded in a dual-in-line 18 pin plastic package, 0.3 inch in width.</p> <p><b>FEATURES</b></p> <ul style="list-style-type: none"> <li>• Low Power Dissipation             <ul style="list-style-type: none"> <li>• 10pW/BIT (TYP.) @3.0V (STANDBY)</li> <li>• 10µW/BIT (TYP.) @5.0V (OPERATING)</li> </ul> </li> <li>• Data Retention Voltage 2V to 5.5V</li> <li>• Single 5V Power Supply</li> <li>• 18 PIN Plastic Package</li> <li>• Full Static Operation</li> <li>• Three State Output</li> <li>• Input/Output TTL Compatible</li> <li>• Access Time 450 NS</li> </ul>	<p>All devices are brand new factory prime, full spec.</p> <p>Ordering Information: Unless otherwise stated, for orders under £50 add 50p p&amp;p. Add 15% VAT to total. No VAT on books. All items are subject to prior sale and therefore subject to availability. Prices are subject to change without notice.</p> <p><b>MicroByte,</b> Unit 9-10 1st Floor, Block E, 38 Mount Pleasant, London WC1X 0AP. Tel: 01-278 7369 or 01-837 1165 Telex: 8953084</p>																																																																																																																																																																																																																																																					

• Circle No. 274

# Introducing PEARL



Product of:  
Computer  
Pathways  
Unlimited, Inc.

**A Powerful Application Generator  
Produces Error-Free Automatic Rapid Logid  
Generates C BASIC 2 Programs and Compiles Them**

*Automatically Produces Programs For:*

Menu Selection	Level I	£90
File Update/Edit	Level II	£325
Report Generator	Level III	£625
Indexed File Reorganisation		
Indexed Access		

*All Prices Exclude V. A. T.*

Contact UK Distributer — Tel: 01-653 6028

Clenlo Computing Systems Ltd  
15 South View Court  
The Woodlands  
Beulah Hill SE19 3EJ  
London



## THE CLENLO CONQUERER



A Z-80 Microcomputer in an attractive Metal Cabinet, containing a 12 slot motherboard. Two serial and two parallel I/O ports are standard. Will accept a variety of S-100 compatible floppy and hard disc Drives.

16K RAM	650.00
32K RAM	805.00
48K RAM	960.00
64K RAM	1115.00

8" 500K Double Density Floppy Disc Drive and Controller.	700.00
Add On Unit	410.00

All prices exclude VAT

**Clenlo Computing  
Systems**



15 South View Court  
The Woodlands  
Beulah Hill  
London S.E.19.  
01-653 6028

# SHARP BY MAIL

## SHARP MZ-80K

20K RAM £477.50  
32K RAM £529.00  
36K RAM £549.00  
48K RAM £599.00

Inc. basic tape and manual



## SHARP MZ 80 P3

Line printer 80 Col.  
100 c.p.s. £517.00

## SHARP MZ 80 FD

Disc Drive Twin discs-double sided  
70K bytes per side £779.00



## SHARP MZ 80 I/O

Expansion Board interfaces  
Printer and Disc Drive to the MZ 80K £99.00

### SYSTEM PRICES

MZ 80K-36K RAM + MZ 80 P3 + MZ 80 FD + MZ 80 I/O £1849.00	MZ 80K-48K RAM + MZ 80 P3 + MZ 80 FD + MZ 80 I/O £1899.00
---	---

All machines and Peripherals tested prior to dispatch.

MACHINE LANGUAGE TAPE & MANUAL	£21.95
ASSEMBLER TAPES & MANUAL	£42.00
BEM C15 TAPES 10 FOR	£5.95
50 FOR	£26.95

## SHARP PC 1211 **NEW**

Hand held  
computer-  
1K Ram. Basic  
language.  
Alpha-  
numeric  
keyboard-  
24 character display  
**£89.95**



SHARP CE 121  
Tape interface **£13.95**

ADD 15% V.A.T. ALL MACHINES GUARANTEED 12 MONTHS

**BEM BUSINESS & ELECTRONIC MACHINES**

7 Castle St, Edinburgh EH2 3BB Tel 031-226 5454

ORDER FORM from NAME

ADDRESS

QUANTITY	DESCRIPTION	PRICE

Carriage FREE over £100 (add £2 if under)

I enclose my \*cheque/charge my Access/  
Barclaycard/ Trustcard/ Visa No.

ADD 15%  
V.A.T.

Signature

TOTAL

**CARD HOLDERS 'PHONE YOUR ORDER**  
-24 HOUR SERVICE. \*Delete as applicable

• Circle No. 276

## Original Software for Pet Users

### \*\*\*\* D.S.L. BASIC MANAGER \*\*\*\*

- Relocates Basic programs in memory
- Stores up to nine programs simultaneously
- Call and execute any program under menu control
- Routine called by single instruction from Basic
- No interference with normal Basic operation
- Many additional uses to the ingenious  
e.g. Pass parameters between programs,  
Transfer existing routines between programs.

PRICE - Cassette + Full documentation ..... £12.50

### \*\*\* D.S.L. WORD PROCESSOR \*\*\*

- Full menu control of all functions
- Text entry from keyboard or saved tape file
- Copy, relocate and delete
- Screen edit or auto-search replace function
- Print format control via text embedded characters
- Versions for PET or RS232 printer (Please state type)

PRICE - Cassette + Full documentation ..... £20

When ordering either program please state whether new or old RAM machine.

Prices include VAT and postage.

**DRAGON SYSTEMS LIMITED**  
54 Mansel St., Swansea, W. Glam.

• Circle No. 277

## MICRO BUSINESS CENTRE

### YOUR WEST MIDLAND APPLE II : ITT 2020 DEALERS SPECIALISTS IN QUALITY BUSINESS SOFTWARE

Integrated Stock/Invoice/ Sales/Purchase	Apple II 16K	£695
Payroll	ITT 2020 16K	£750
Sales Ledger	16K Upgrades	£79
Purchase Ledger	Disk Drive	£299
Nominal Ledger	With Contr.	£349
Stock Control	Printers	
Incomplete Records	OKI Microline	£495
Visicalc	Centronics 799	£825
Word Processing	Paper Tiger	£585
The Cashier -	Anadex DP 8000	£675
Complete Package	TCM200	£395
For Sole Trader		
Financial Planning		£295

\* special 0 4 GAMES DISK inc. SPACE INVADERS £10

ALL PRICES EX. VAT UNLESS STATED  
SEND REMITTANCE WITH ORDER

**CASTLEBRIDGE HOUSE**  
LICHFIELD ROAD, WEDNESFIELD  
WOLVERHAMPTON. TEL: (0902) 732687

DEMONSTRATIONS FREELY GIVEN BY APPOINTMENT  
BARCLAYCARD: ACCESS: TERMS ARRANGED

• Circle No. 278



# Grrraphics.

## The Paper Tiger™ puts more bite into everything you do.

The Paper Tiger strikes again. With DotPlot™ high performance graphics. Now you can get a powerful printer with state-of-the-art graphics for less than the price of most matrix printers alone.

DotPlot lets you print screen graphics, draw illustrations, write block letters, plot charts, and more. All under software control.

And, DotPlot includes an expanded 2K-byte buffer. It can hold text from a full 24-line by 80-column CRT screen.

That's not all. Every Paper Tiger gives you 8 software-selectable character sizes. 80 and 132 column formats. 96 upper/lower case characters. Reliable stepper-motor paper drive. Adjustable width tractor feed. Continuous duty cycle operation.

You get multi-part business forms handling. Forms control. Re-inking ribbon system. Parallel/serial interface. Self diagnostics. Paper-out sensor. Uni-directional print speeds to 198 characters/second. And more.

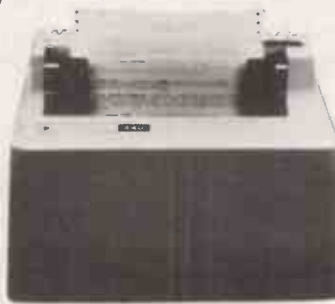

## microsense computers limited

Finway Road, Hemel Hempstead, Herts HP2 7PS  
Tel (0442) 48151 and 41191  
Telex: 825554 DATEFF G

Available from Apple Dealers throughout the UK.  
OEM/Dealer enquiries welcome.  
Recommended retail price £598 (excl. VAT)

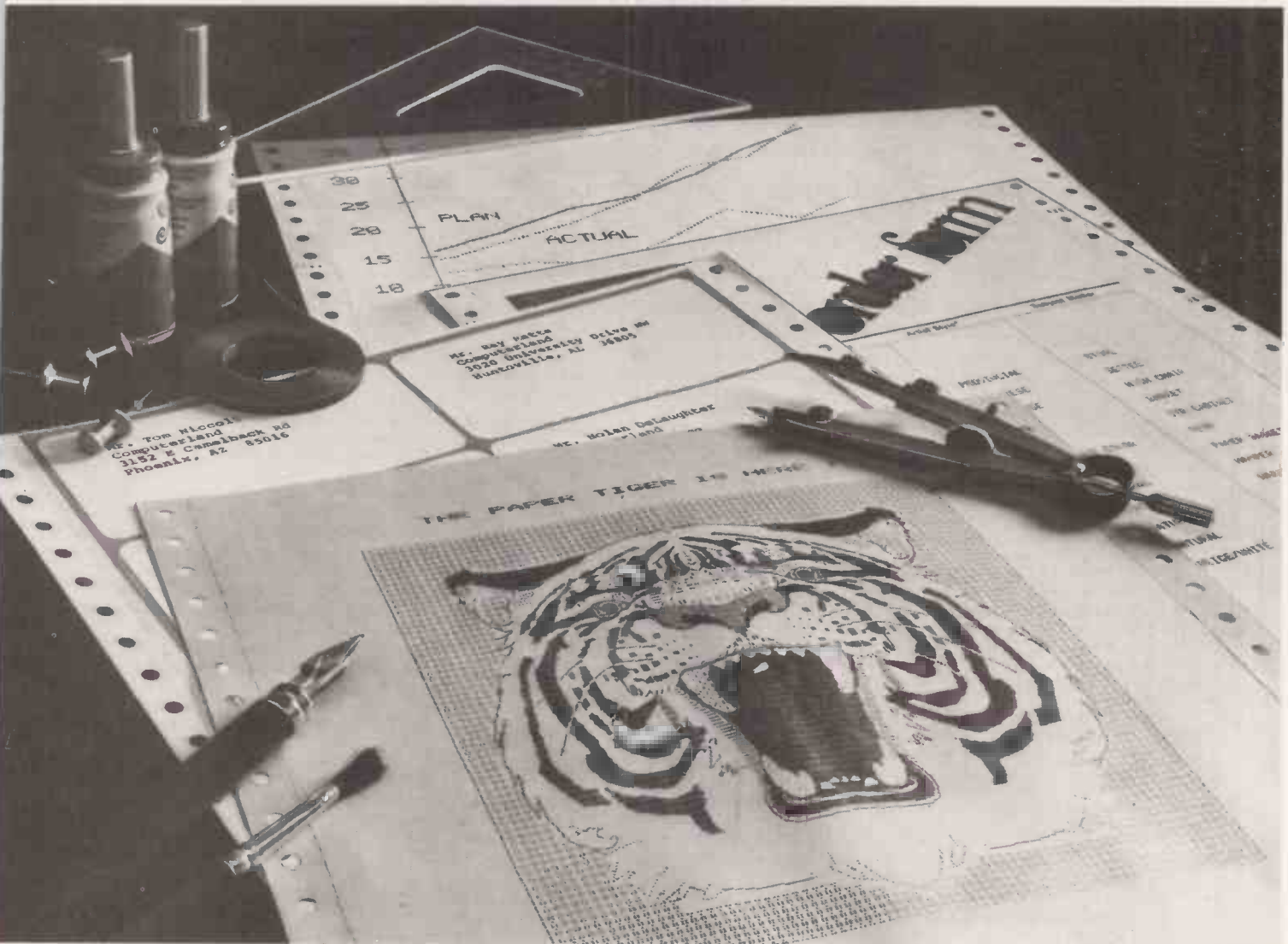

Microsense Computers are sole UK distributors for Apple Computers. Apple is a trademark of Apple Computer Inc., Cupertino, CA, USA.

• Circle No. 279

# COMPARE OUR PRICES

## TI810 PRINTER £1097.00 EACH

EXCLUSIVE OF VAT AND DELIVERY



**SD100** 64K R.A.M. TWIN 8" FLOPPIES OF ½ MB  
EACH (OPTIONAL 1MB)  
TWO Z80 PROCESSORS, 4MHz CLOCK

**£4,148 EACH**

**PLUS — ALL CAP-CPP  
MICROBOL PROGRAMS**

WE ALSO SUPPLY A **PROVEN QUANTITY SURVEYORS PACKAGE** FOR PRODUCING BILLS OF QUANTITY AND HANDLING POST CONTRACT WORK — USING THE NEDO FORMULA. THE PROGRAM IS WRITTEN IN **MICROBOL** AND WILL OPERATE ON ANY EQUIPMENT SUPPORTED BY CAP-CPP LTD. **WORD STAR** WITH THE ADDITION OF AN EXTRA INPUT STATION AND V.D.U. THE SD100, USING **COSMOS** OPERATING SYSTEM WILL ALLOW TWO PEOPLE TO OPERATE THIS POWERFUL PROGRAM SIMULTANEOUSLY.

CALL US NOW FOR DETAILS

**TYPICAL SYSTEM PRICE. SD100, TI810 PRINTER, PLUS CAP-CPP SALES, PURCHASE AND NOMINAL LEDGERS, INCLUDING DELIVERY, INSTALLATION AND OPERATOR TRAINING £7777.00**

[LEASE TERMS AVAILABLE]

## BARCELLOS LTD.

KIMBERLEY HOUSE, VAUGHAN WAY, LEICESTER TEL 0533-26584/5

PRICES EXCLUDE VAT

ALL PRICES CORRECT ON JULY 1ST 1980

OFFERS SUBJECT TO AVAILABILITY

• Circle No. 280

## The long awaited LEVEL IV BASIC For Tandy TRS 80 16K

Cassette based. Uses only 5K. Suitable 16K machines or over. Video Genie compatible. Return first class post service.

**MERGE** Enables any number of programs to be joined together, either with one residing in memory, or from separate tapes.

**BYTE SAVER** Runs through your program taking out all the unnecessary bytes, displaying the number as it goes along.

**DELAY** This command allows you to control the actual amount of delay you want on the screen's read-out. The speed can be varied by means of program statements.

**RESCUE** No more lost programs, as this command will bring a program back after accidentally being **NEWed**.

**DE-BOUNCE** The Tandy keyboard's infuriating bounce is taken care of with Level IV.

**SHIFT KEY ENTRIES** It has 26 Shift Key entries, whereas with holding down the shift key and pressing a single letter, a complete instruction appears in your program. For example, if you were to press the letter G **GOSUB** is written out for you. Or if you press R not only is **RUN** written out, but is also activated without having to press the Enter key!

**OWN SHIFT KEY ENTRIES** Any of the 26 Shift Key entries can be altered to suit individual needs, with entries up to 15 characters responding to any single letter.

**RE-NUMBERING** Level IV contains a complete re-numbering routine, allowing renumbering in eight different ways.

**ERROR MESSAGES** No need to look up those error codes anymore, all of them are fully spelled out.

**LOCKOUT RECOVERY** No longer need you be stuck in a loop and having to lose your program, for Level IV allows you to get out of the loop by using the Break key.

**FASTER GRAPHICS** You can generate graphics between points without having to define all the points. Graphs, pictures and animation are all easier.

**PUT@ AND GET@** Two extra graphic commands making graphics much easier to manipulate. Graphic arrays can be stored for later use on the same or a different portion of the screen.

### £34

Includes extensive instruction manual

(The price usually asked for Level III)  
**NOTHING EXTRA TO PAY**

**NEW MIDS** A new MIDS capability enables it to be used on the left side of an assignment statement as well as the right side, allowing use of MIDS to replace a portion of one string with another string.

**INSTR** This allows the searching of a string for a specified sub string. It allows designation of the fields for the search.

**MACHINE LANGUAGE** Ten different machine language user routines can exist in the memory at the same time. It is no longer necessary to **POKE** the starting address.

**LINE INPUT** This statement gives added capability to the normal **INPUT**, allowing a string variable name, including punctuations, to be used as the input. The normal Level II question mark is also optional.

**DEFINE OWN FUNCTION** Enables the programmer to define functions or operations that are repeated several times. All that is needed is to do a function call instead of writing the whole formula every time.

**INPUT LEN** This feature is used to give a time limit in response to an input statement. If the input is given before the limit the program continues normally, but if after it can be made to branch to any chosen line.

**HEX AND OCT** A routine is included that converts hexadecimal and octal numbers into decimal numbers.

**SYSTEM CLOCK** There is a command for either turning off, or on, the system clock, if you have an expansion box. Both commands can be program statements.

**ACCESS TO RS-232** A command makes it easy to output either a line printer or any other device to the RS-232 port.

**LOAD AND SAVE** The major problem of loading tapes with the TRS80 is volume setting, which is all a thing of the past with Level IV, as this is software controlled by three new commands, **LOAD; SAVE** and **SAVE?**

# Kansas

Kansas City Systems, Unit 3, Sutton Springs Wood,  
Chesterfield, Derbys. Tel 0246 850357

• Circle No. 281



PET 2001



from £425

commodore authorised dealers

TRS 80

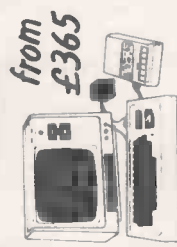

from £365

From Radio Shack Corp.

APPLE II

from £695



authorised dealers

SORCEROR

from £730

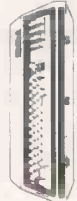

authorised dealers

ADVANCED SYSTEMS



163

# MICROCOMPUTERS ETC

Registered business name

For Hardware, Software, Peripherals, Consultancy and Competitive Prices.



## SOFTWARE

**PET**  
 PETSOFT authorised dealers - over 160 programmes on cassette and disk. Send for catalogue.  
**STAGE ONE COMPUTERS S/W dealers** - PETAID, Stock Control, etc. Send for list 74 Common BASIC Programs on one tape £15.00 P.O.A.  
**PETACT Business Software** - Sales and Purchase Ledger, Invoicing, etc. £150.00  
**CBM DISK-BASED BUSINESS SOFTWARE** £150.00  
**COMWORDPRO/COMWORDPRO II** powerful word processor, low/high level resp. £75/150.00  
**COMSTOCK** - STOCK CONTROL - gives complete stock ledger £150.00  
**COMBIS** - BUSINESS INFORMATION SYSTEM - Storage & Retrieval of all types of company records £150.00  
**COM ACCOUNTS** - Full Financial Business Accounting System incl: Sales, Purchase, Nominal Ledgers £650.00  
**COMPAY** - Finance, hourly, weekly or monthly paid employees £500.00  
**COMPLANNER** - Personal information tool for the busy executive £50.00  
 (We are authorised CBM Business Software Dealers) Send for List.  
**GD 1001** - Assembler Development System £75.00  
**GD 010** - Lisp Interpreter Language (Artificial Intelligence) £75.00  
**CAR INSURANCE QUOTATIONS** - computerised car insurance quotation suitable for insurance brokers (TVJ S/W) £25.00  
**MORTGAGE QUOTATIONS** - suitable for agents/mortgage brokers (TVJ S/W) £25.00  
**TRS 80 II SUITE** - computerised accounting for TRS 80 (TVJ SOFTWARE) £75.00  
**STOCK CONTROL** - complete inventory control - recorder level - P/O's etc. £95.00  
**CP/M** £75.00  
**BASIC** £95.00  
**FORTRAN** includes compiler, relocatable assembler text editor and linking loader £195.00  
**PASCAL** - tomorrow's programming language today £45.00  
**ELECTRIC PENCIL** - powerful word processor allows full cursor movement, insert/delete, string search block movement, adjustable line length, justification on cassette £95.00  
**ELECTRIC PENCIL as above** - disk version £8.00/£28.00  
**LOWER CASE MOD KIT ONLY/FITTED** for Electric Pencil £8.00/£28.00  
**DATA MANAGEMENT/REPORT GENERATOR** - easily formats disk files, allows entry, edit, delete and list of records and retrieves data for display or calculation on screen or printer £150.00  
**RSM-2D DISK MONITOR** - powerful system; manipulates disk data, has 2.80 break routine £25.00  
**ST800** communications software £60.00  
**NEWDOS** - TRSDOS with corrections and enhancements £25.00  
**NEWDOS** - as above but with further facilities £25.00  
**KBFIX**, Return Screen to printer in one step, DOS commands from BASIC, Level II, Superzap, Disassemble, load and save faster, list variables £49.00  
**LIBRARY 100** - an assortment of 100 programs £39.00  
**SARGON CHESS** - 16K Level II - the 1979 Champ Version I £14.00

**APPLE**  
 Microchess 2.0 Chess Disk £15.00  
 U-DRAW II - High Resolution graphics editor. Create a figure then rotate, expand, contract etc and save on disk £37.00  
 LISP - programming language suitable for research in artificial intelligence £52.00  
 3-MILE ISLAND - Complex disk based game simulating nuclear reactor £27.50  
 VISICALC - Instant Visual Calculation - provides a powerful planning and forecasting tool £95.00  
**APPLE WORD PROCESSOR** - Complete text editing, storage and retrieval of text (disk based) £42.00  
**LITTLE GENIUS** - Comprehensive disk based Apple Soft Tutorial £35.00  
 ACT Appeware and MUSE authorised software dealers - Many programs on cassette and disk. Send for list.  
**SORCEROR** many programs available - send for list.  
 Word Processor Rompage £120  
 Development Pac £70.00

\* 5% DISCOUNT ALLOWED FOR EDUCATIONAL ESTABLISHMENTS

## DISKS

**PET**  
 CBM 3040 (dual drive) 343K User storage\* £695.00  
 Computhink (dual drive) 400K £895.00  
 Computhink (dual drive) 800K storage £1145.00  
 TRS80 Microchips drive £315.00  
 Percom FD200 drive 110K £395.00  
 Microchips Dual Drive (384K storage) £350.00  
 Corvus HardDisk (11mb) £350.00  
**APPLE**  
 Apple Drive - 116K storage 1st drive £349.00  
 Apple Drive - 116K storage 2nd drive £299.00  
 Corvus HardDisk (11mb) £350.00  
**SORCEROR**  
 Exidy 143K storage £495.00  
 Exidy Dual drive (630K storage) £1195.00  
 Corvus HardDisk (11mb) £3500.00

\* £425.00

**PRINTERS**  
 CBM 3022 (80 col) with PET graphics printer (not incl) £425.00  
 TRS 80 Screen Printer (text) £345.00  
 New Radio Shack Micro Printer £245.00  
**GENERAL**  
 Teletype 43 KSR Serial Ipin or punch £825.00  
 RACAL Binder Printers - truly professional printers for microcomputers - high speed Iup to 280 cps, upper/lower case P.O.A.  
 OKI - parallel/serial Ipin or punch £499.00  
 Centronics 779 parallel tractor £825.00  
 DOLPHIN 8080P tractor printer (125 cps bi-directional, 40, 80 columns - optional 132; w/ case & graphics). Available with Serial, parallel or IEEE interface £825.00  
 Centronics tractor printer (120, 40, 80 columns) £395.00  
**HEATH WA 14** serial (80, 96, 132 cols selectable) £475.00 P.O.A.  
**TOLME** daisy wheel printer (40 cols) £266.00  
 TOLME/ARCHOUSE Thermal Printer (40 cols) £266.00  
**SILENT PRINTER for APPLE**... allows printing of high res. graphics £349

**ETC.**  
 Diskettes 5 1/4" 5.25mb boxed (min order 10) each £10.35p  
 C12 Cassettes (min order 10) each £10.35p  
 Ansbach phonemate telephone answering machine, voice operated twin cassette £199.00  
 Pace EZ-PHONE - Cordless Telephone £325.00  
 Hitachi Video Monitors 9" 17" resp. £127/£187  
**BOOKS** - large range of microcomputer related books and magazines  
**TERMINALS**  
 Pentland V1, 80 char / 24 lines 2 page memory £580.00  
**PROGRAMMABLE CALCULATORS, TEXAS INSTRUMENTS, Business Programmable Calculators** - complete range. Send for list + prices. (We are authorised TI dealers.)

## BASIC SYSTEMS

**PET 2001-8** (PET with 8K memory + integral cassette) \*£425.00  
**PET 3008 (8K)** with large keyboard\* £450.00  
**PET C2N** External Cassette Deck £53.00

**ACCESSORIES**  
 IEIEE-448/Centronics type parallel Interface £95.00  
 IEIEE to Pet Cable £19.00  
 IEIEE to IEIEE cable £24.00  
**PETSET 1 16 Channel AD Converter** for your Pet - plug in ROM chip 8K and 16/32K resp. £79/£59  
 c.w. all interfacing requirements £166.00

**BASIC SYSTEMS**  
 TRS 80, 16K Level II (as above with 16K memory) £499.00  
 TRS 80, Expansion Interface with 16K RAM £275.00  
 TRS 80, Expansion Interface with 32K RAM £360.00

**ACCESSORIES**  
 £35.00 Radio Shack Phone Modem £160.00  
 UHF Modulators (encased with leads for 625 lines) £20.00  
 £345.00 RAM upgrade (4-16K, 16-32K) £85.00  
 £135.00 32-48K supplied and fitted at our premises (KIT E80,000) £375.00  
 £49.00 S100 interface for TRS 80 (16 slots) and fitted £26.00  
**TRS80 CPU 2** speed mod.

**BASIC SYSTEM** - APPLESOFT extended basic in ROM - (16K RAM) - video output £695

**ACCESSORIES**  
 Real time clock/calendar card - £14.00  
 17/1000 sec to 388 days with interrupt, software controllable £128.00  
 Speechlab - provides voice control for the Apple £79.00  
 SuperTalker - adds human speech output £104.00  
 £113.00 'output' £136.00  
 £130.00 ALF Music Synthesizer Card £180.00  
 £130.00 A1-02 Data Acquisitor Card £180.00  
 £116.00 Graphics Tablet £462.00  
 AC Line Controller £270.00  
 RAM Upgrade (16-32K, 32-48K) £69.00  
 Hobby Prototype Card £20.00  
 £299.00 Romplus - w. i/c, mixed text/graphics £105.00

**BASIC SYSTEMS**  
 Sorcerer (inc UHF Modulator) 32K RAM £730.00  
 48K RAM £830.00  
**ACCESSORIES**  
 Exidy S100 Unit £240.00  
 Exidy Video Monitor £240.00  
 £1790.00 CP/M on Disk £145.00

**ADVANCED SYSTEMS**  
 TRS 80 Model II with integral B floppy disk drive and up to 64K RAM. Expandable up to 3 Megabytes Disk Storage (Available for demonstration - by appointment only). P.O.A.  
 ACT 800 Systems providing 108K RAM, 48K User RAM, full size screen, high-res graphics, Ultra-fast data access and up to 4-8 MBytes on-line disk storage P.O.A.

**PET BUSINESS SYSTEM** comprising CBM 3032 Micro computer, CBM 3040 Dual Disk Drive, CBM 3022 Tractor Feed Printer and all cables £895.00  
 £1799.00 - Dual Disk Drive giving 950K user storage £895.00

## IF YOU DON'T SEE IT - ASK IF WE HAVE IT



## T&J JOHNSON (MICROCOMPUTERS ETC) LTD

Member of the TV Johnson Group of Companies  
 Camberley (Head Office)  
 Johnson House,  
 Park Street (At Pembroke Broadway),  
 Camberley, Surrey, GU15 3PN.  
 ☎ (0276) 20446

Oxford  
 148 Cowley Road, Oxford  
 OX4 1JL  
 ☎ (0865) 721461

Bristol  
 Glastonbury Road, Bristol  
 BS 98B  
 ☎ (0272) 422061

+ Ansbach eves and w/ends, Telox 858893

Directors: Dr. R. King BA, MICE  
 S. Johnson, ACIB PRSC, MBIM  
 A. S. Barton ACI, ABIFA, CMAA

Hours of business  
 Mon-Fri, 9.30 - 5.30  
 Sat. 9.00 - 12.30

**Special Offers!**  
**News!** LOWER PRICES FOR PET Us 16, 100 Reduction on Super Pets (see above for details)  
**SUPER PETS ARE HERE!**  
 CBM 8032 - COMPUTER with 80 column screen & business keyboard £895.00  
 CBM 8050 - Dual Disk Drive giving 950K user storage £895.00

**ORDER NOW!**

PRICES EXCLUDE VAT, FREIGHT & HANDLING SEND FOR LIST FOR MORE INFORMATION  
 (All prices correct at time of compilation)



# SUPPORTS PAPER USERS

With sensible prices..

**RULED**  
**14 1/2" x 11" = £6.00**  
INC. P & P

**PLAIN**  
**9 1/2" x 11" = £6.00**  
INC. P & P

For sensible minimums..

of 500 sheets continuous stationery.

Details of other sizes, self adhesive labels etc:-



**01-642 8971**



• Circle No. 283

## MICRO MARKET

THE PROFESSIONAL PEOPLE  
ALL YOUR FAVOURITE SYSTEMS AT PRICES  
YOU CAN AFFORD

We offer a wide range of personal, professional and business systems, and peripherals at discount warehouse prices but with a support service more comprehensive and efficient than full price stores. All machines carry our extended no quibble warranty, and 'Micro Maintenance' offers you competitive maintenance agreements or repair services on all equipment after the warranty period. Our in-house software division is always available to offer advice and solutions to your software problems, as are the staff of 'Micro Maintenance' to help with your hardware and peripheral attachment difficulties.

EXTRACTS FROM OUR PRICE LIST

**COMPUTERS**  
**SUPERBRAIN** from £1850  
**EXIDY SORCERER** from £699  
**ALTOS** from £2158  
**VDU'S**  
**INTERTUBE II** from £525  
**PRINTERS**  
**PAPER TIGER (NOW WITH GRAPHICS AND 2K. BUFFER FEATURES AS STANDARD)** £525  
**ANADEX DP 8000** — £499  
**ANADEX DP 9500** — £950  
**SUPPLIES**

Full range of top quality Disks, Cassettes, Paper etc. always available.

ALL PRICES EXCLUDE V.A.T.

PHONE, CALL OR WRITE FOR COMPLETE PRICE LIST  
AND DEMONSTRATIONS

TEL: 01-751 5044/5 TWX: 8954428  
138 CHALMERS WAY, NORTH FELTHAM TRADING ESTATE  
FELTHAM, MIDDIX.

"MICRO MARKET AND MICRO MAINTENANCE ARE PART OF SUN  
COMPUTING SERVICES LTD"

• Circle No. 284

# XITAN SYSTEMS

## CROMEMCO SYSTEM 3

£4,054.00 for this system with vdu.

The ideal business system. System includes a full 64K fast RAM, dual full-size floppies (Persci 277), RS232 interface/20mamp loop for console device, parallel printer port (Centronics/Anadex compatible), 21 slots for expansion, Lear Siesler 24 lines or 80 chars vdu, and ... CROMEMCO's CDOS operating system with their 14 digit BCD extended disk Basic — ideal for those accurate large numbers required by successful businesses. CDOS is CP/M functionally equivalent, with many extra facilities. Optional extras from Xitan include Fortran, Cobol, Text Formatting, Z-80 macro-relocating assembler and DBMS at £59.00 each, CIS interactive screen handling Cobol at £425.00 (recommended to serious business users), Cromemco S100 boards, CP/M (we are an authorised oem distributor of Digital Research's CP/M) for the System 3, Wordmaster, Wordstar, Supersort, and CPM374X utilities.

COMING SOON! ... Full 7-terminal multi-user operating system from Cromemco for System 3 users. Up to 48K per user, all running independently. This operating system has to be seen to be believed. It will run any of the Cromemco provided and supported software packages, in any combination. Features include partition rescue facilities, allocating more memory to users, real-time clock for time/date stamping of jobs and disk queueing techniques. Buy your System 3 now, expand later as you need it.

Xitan Systems also supplies and stocks vdus, printers, NORTH STAR HORIZON computers, Commodore Business Machines PETs, S100 boards, and books. We are here to demonstrate the range of quality microcomputer systems available for use today. Ring up for an appointment now! You'll not be disappointed. We have Osborne's Sales Ledger and Payable Ledger in source form for use on Cromemco System 3 with CBASIC2, and we can offer a customising service on these programs. Additional software includes Microsoft Basic Interpreter and Compilers, Cbasic, Macro80, and CP/M for the North Star Horizon.

**Xitan Systems Ltd., 23 Cumberland Place, Southampton SO1 2BB.**

Tel: (0703) 38740

Hours Tue-Sat 9.30 am to 5.30 pm

• Circle No. 285

# NASCOM

Yes, we're still around



## NASCOM 2

Kit includes all parts to build CPU board which has resident 8K microsoft BASIC and 2K NAS-SYS 1 monitor for machine code programming.

Included with kit is a fully assembled LICON QWERTY SOLID STATE KEYBOARD specially designed to exploit the potential of the NAS-SYS monitor. Other interfaces include video to monitor or domestic TV, Kansas City standard cassette interface (300/1200 baud) or RS232/20mA teletype interface.

In addition to full character generator graphics ROM is provided to give BASIC on board graphics capability.

System uses Z80A which gives selectability between 2 or 4 MHz.

Nascom 2 Kit Price  
**£225 + VAT**

Power supply - 3 amp. Suitable for powering of basic Nascom 1 or 2 and memory expansion.

**£32.50 + VAT**

## NASCOM SOFTWARE

CPU card can accommodate either 8K of static memory or 8 2708 EPROMS. This allows for inclusion of standard firmware on board.

**ASSEMBLER** Version 2.0 of ZEAP (Z80 Editor Assembler Package) offers in 4K features found normally only in far larger programs. A comprehensive line editor is provided in addition to an assembler operating in standard Z80 mnemonics. Direct assembly to memory allows immediate program execution. ZEAP can take advantage of special features of NAS-SYS, which was itself developed on this assembler. Supplied on tape at £30.00 plus VAT or in 4 x 2708 EPROMs at £50.00 plus VAT.

**DISASSEMBLER** The NAS-DIS 3K disassembler reverses the effect of assemblers such as ZEAP by turning machine code into assembler program, automatically labelling and cross-referencing to produce a complete program listing, saving hours of tedious hand disassembly when program analysis is required. Supplied in 3 x 2708 EPROMs at £37.50 plus VAT.

### DIAGNOSTIC PACKAGE

NAS-DEBUG is a 1K addition to NAS-DIS which provides remarkable facilities for error elimination, including a full register display which may be edited by the cursor. An unusual feature is the provision for examination of the program in assembler as the machine single-steps through it. A second video page may be assigned to allow work on programs which use the screen.

A very powerful assembler-based system for program development could be realised on a NASCOM-2 with appropriate external memory by fitting the 8 ROMs containing ZEAP, NAS-DIS and NAS-DEBUG into the sockets on the computer board. This system would function immediately on switching on, without needing programs to be loaded from tape. Supplied in a 2708 EPROM at £15.00 plus VAT and must be operated with NAS-DIS.



All prices are manufacturers suggested prices.

## NAS-SYS 3. THE NEW OPERATING SYSTEM FOR NASCOM 2.

Supplied in 1 x 2716 EPROM. NAS-SYS 3 is the latest in the current series of Nascom monitors and includes features such as adjustable keyboard repeat and cursor speed, full interrupt handling and a number of powerful routines and commands making this probably the most comprehensive 2K monitor ever written for a microcomputer. £40 + VAT.

## RAMBOARDS

SERIES B ram board gives user option of 16K, 32K or 48K of DYNAMIC RAM. These boards can be arranged in page mode to allow use of up to 4 with NASCOM 2. Boards are fully buffered but PAGE MODE facility is an optional extra. This card can be used at 4MHz without wait state.

16K:£140 + VAT 32K:£200 + VAT 48K:£250 + VAT

## NASCOM IMP PLAIN PAPER PRINTER

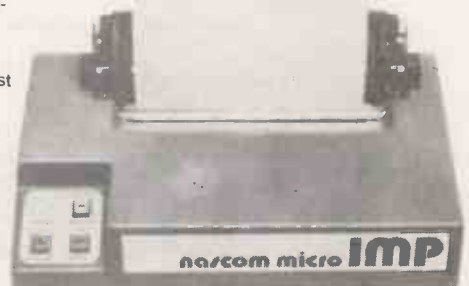

The Nascom IMP (Impact Matrix Printer) features:

- 60 lines per minute • 80 characters per line • Bi-directional printing • 10 line print buffer • Automatic CR/LF • 96 characters ASCII set (includes upper/lower case, \$, £) • Accepts 8 1/2" paper (pressure feed) • Accepts 9 1/2" paper (tractor feed) • Tractor/pressure feed • Baud rate from 110 to 9600 • External signal for optional synchronisation of baud rate • Serial RS232 interface.

**£325 + VAT**

## NASCOM-1 Kit Price £125 + VAT

12" x 8" PCB carrying 5L Si MOS packages. 16 1K MOS memory packages and 33 TTL packages. There is on-board interface for UHF or unmodulated video and cassette or teletype. The 4K memory block is assigned to the operating system, video display and EPROM option socket, leaving a 1K user RAM complete with keyboard.

**nm**  
Nascom Microcomputers

**NASCOM MICROCOMPUTERS LTD.**  
92 BROAD STREET, CHESHAM, BUCKS.

For full details please contact your nearest Nascom Distributor

**ADDA COMPUTERS**  
17-18 The Broadway, Ealing, London W5 2NH  
Tel: 01-579 5845

**\*BITS & PC's**  
18 Ryegarth, Wetherby, W. Yorks. Tel: 0937 63774

**\*BUSINESS & LEISURE MICROCOMPUTERS**  
16 The Square, Kenilworth, Warwickshire.  
Tel: 0926 512127

**BUSS STOP (PHOTO ACOUSTICS) LIMITED**  
255A St Albans Road, Watford, Herts.  
Tel: 0923 40698

**THE CAMERA CENTRE**  
122 Dalton Road, Barrow-in-Furness, Cumbria LA 14 1JH.  
Tel: 0229 20473

**COMP SHOP**  
14 Station Road, New Barnet, Herts. EN5 1QW.  
Tel: 01-441 2922

**COMPUTERLAND**  
92A Upper Parliament St, Nottingham.  
Tel: 0602 40576

**COMPUTERLAND**  
11 Gateway House, Station Approach, Piccadilly, Manchester 1.  
Tel: 061-236 4737

**COMPUTERLAND**  
94-96 Hurst Street, Birmingham.  
Tel: 021-622 7149

**COMPUTERLAND Magnet House**  
Waterloo Street, Glasgow. Tel: 041-221 7409

**COMPUTERLAND**  
426-428 Cranbrook Road, Gants Hill, Ilford, Essex.  
Tel: 01-554 2177

**COMPUTERLAND**  
48 Tottenham Court Road, London W1.  
Tel: 01-636 0647

**COMPUTER MANIA**  
The Priory, Great Milton, Oxon. Tel: Gt. Milton 729

**DATRON MICRO CENTRE**  
Latham House, 243 London Road, Sheffield. Tel: 0742 585490

**ELECTRONIC SERVICES**  
7 Berkeley Precinct, Eccleshall Road, Sheffield.  
Tel: 0742 668767

**\*ELECTROVALUE LIMITED**  
28 St Judes Road, Englefield Green, Egham, Surrey TW20 0HB.  
Tel: 07843 3603

**MICROTEK**  
54 Orford Street, Ipswich, Suffolk.

**\*ELECTROVALUE LIMITED**  
680 Burnage Lane, Manchester M19 1NA.  
Tel: 061-432 4945

**ELEY ELECTRONICS**  
112 Groby Road, Glenfield, Leics.  
Tel: 0533 871522

**HAPPY MEMORIES**  
19 Bevois Valley Road, Southampton, Hants.  
Tel: 0703 39267

**\*HENRYS RADIO**  
404 Edgware Road, London W2.  
Tel: 01-723 1008

**\*INTERFACE COMPONENTS**  
Oakfield Corner, Sycamore Road, Amersham, Bucks. Tel: 02403 22307

**INTEX DATALOG**  
Eaglescliff Industrial Estate, Eaglescliff, Stockton-on-Tees, Cleveland TS16 0PN.  
Tel: 0642 781193

**JPS**  
9 East Street, Colne, Huntingdon.  
Tel: 0487 840710

**A & G KNIGHT**  
108 Rosemount Place, Aberdeen AB2 4YW.  
Tel: 0224 630526

**\*LOCK DISTRIBUTION**  
Neville Street, Middleton Road, Oldham, Lancs OL9 6LF.  
Tel: 061-652 0431

**MICRODIGITAL**  
25 Brunswick Street, Liverpool L2.  
Tel: 051-227 2525

**NEWBEAR COMPUTING STORE LIMITED**  
40 Bartholomew Street, Newbury, Berks RG14 5LL.  
Tel: 0635 30505

**PIPS COMPUTER SERVICES**  
15 Sandhill, Quayside, Newcastle-on-Tyne.  
Tel: 0632 615939

**P & O COMPUTERS**  
529 Antrim Road, Belfast.  
Tel: 772417

**TARGET ELECTRONICS**  
16 Cherry Lane, Bristol BS1 3NG.  
Tel: 0272 421196

**TEKDATA**  
Federation Road, Burslem, Stoke-on-Trent.  
Tel: 0782 813631

**V & T ELECTRONICS**  
82 Chester Road, London N19.  
Tel: 01-263 2643

# LISP

## The different programming language for your Apple II

LISP is *the* language used in artificial intelligence research. It allows you to explore the world of non-numerical computation — language understanding, database, algebra, logic, pattern recognition . . .

The LISP system includes:

- 10 kbyte LISP interpreter on disc or cassette.
- Demonstration programs including a version of the "ELIZA" psychiatrist.
- 41 page manual

Available for £34.50 (inc. VAT) from Owl Computers or your local Apple dealer.



### Owl Computers

41 Stortford Hall Park,  
Bishop's Stortford, Herts CM23 5AJ  
Telephone: (0279) 52682

Apple dealer and software service

• Circle No. 287

# Newtronics

255 ARCHWAY ROAD, LONDON N. 6

TEL: 01-348 3325

### JUMP ON A S-100 BUS SYSTEM WITH THE EXPLORER/85 PRO KIT

**EXPLORER/85** the really expandable kit: FEATURES Fast 8085 cpu: Latest 8K Microsoft-80 Basic: 2K Monitor system: 1K Video RAM: Full Qwerty Keyboard (upper lower case): Interfaces for monitor/TV: Cassette with relay, and lots more 'goodies' supplied with full documentation. expandable to 64K: 6 S-100 Buses 4K version **£299**: 16K Dynamic RAM Bd version **£399**

**64K DYNAMIC RAM S-100 Bd:** Hidden refresh: Fast performance: low power: Latched data outputs: 200ns 4116 RAMS: Onboard crystal: 8K bank selectable: Designed for 8080: 8085: Z-80 systems: 16K kit **£149.00**: 16K expansion kit **£70.00**

### ELF11 SNIP LIMITED OFFER, ONLY £39.95

Kit includes 1802cpu. 265 RAM: 1861 Video chip: Dual Display: Hex Keyboard Fully expandable ideal starters Kit or control board.

**COMPUKIT UK101:6502** based: 8K Basic: Qwerty Keyboard: expandable to 8K on board: Complete with P.S.U & RF Modulator ... KIT verion **£199**: A&T **£249.00**: Plastic Cabinet **£29.00**: Assembler/Editor **£14.90**.

**WE ALSO STOCK PETS & ITT. LET US QUOTE YOU ALL PRICES QUOTED ARE EX VAT ADD 15% + P&P £2.30.**

ACCESS, BARCLAYCARD OR CHEQUE WITH ORDER.

• Circle No. 289



**CRYSTAL ELECTRONICS  
CC ELECTRONICS**

## XTAL Basic 2.2 NOW ON SHARP MZ80K

All of the features of SHARP BASIC and more. Occupies 5K less memory, thus effectively increasing memory size for programs.

MZ80K 20K RAM £520+VAT  
(with XTAL BASIC leaves 11K for programs)

XTAL BASIC for SHARP £40+VAT

Coming Soon — **PETSOFT\*** programs in XTAL BASIC format for SHARP & NASCOM — Prices as PETSOFT list +20%.

NASCOM 1 & 2 owners — XTAL BASIC 2.2 £35+VAT  
NEW EPROM version £100+VAT  
(please state monitor used)

EPROM version runs in EOOOH-FFFFH.

### APPLE II PLUS OWNERS

APPLE INTEGER BASIC on disc for 32K or 48K APPLE.  
Now you can run nearly *all* of your programs — £20+VAT

\* **PETSOFT** is a trademark of ACT PETSOFT LTD.

Members of Computer Retailers Association & Apple Dealers Association

Shop open 0930-1730 except Wed. & Sun.

40 Magdalene Road, Torquay, Devon, England. Tel: 0803 22699

Access and Barclaycard welcome.



• Circle No. 288

## Main London Sorcerer Stockists EMG 01-688 0088

We are specialists in complete installations tailor made for your business requirements:

WORD PROCESSING SYSTEM	<b>£1999</b>
ESTATE AGENT SYSTEM	<b>£2999</b>
LEADS AND SALES SYSTEM	<b>£2999</b>
INSURANCE AGENT SYSTEM	<b>£2999</b>
AGENCY SYSTEM	<b>£2999</b>
COMPLETE BUSINESS SYSTEM	<b>£3999</b>

### For the Sorcerer Specialist:

Sorcerer Systems Desk  
Mains Stabilisation  
Cooling Fan  
Memory Upgrades  
Servicing Undertaken  
WP Correspondence Course  
Link your Sorcerer to another Sorcerer  
Link your Sorcerer to a Main Frame  
Full software list on request

**6 COPIES OF SOURCE MAGAZINE ONLY £5**

Write to Dept PC6, EMG Microcomputers Ltd,  
30 Heathfield Road, Croydon, Surrey.

• Circle No. 290

£1150  
+ VAT

## VISUAL 100



The VISUAL 100 is a new microprocessor based video display terminal that offers total compatibility with the DEC VT100\* from both a software and operator point of view.

For the operator, the detached solid-state keyboard has been customized so that all key positions and LED indicators are in identical location to that of the VT100.

For the software, all codes and features have been implemented in a manner identical to the VT100 assuring plug-to-plug compatibility.

The big difference between the VISUAL 100 and the DEC VT100 is that the VISUAL 100 offers features not available on the VT100, or available only as extra-cost options. These added features include:

- **ETCHED NON-GLARE FACEPLATE**  
Your operator will appreciate viewing characters through an etched non-glare faceplate. This feature assures crisp, sharp character resolution even in the brightest office environ-

ments. Further, the tilt screen feature allows an adjustable viewing angle, 10° to 15°, for optimal viewing comfort.

- **ADVANCED VIDEO PACKAGE IS STANDARD**  
Blink, bold, reverse video, and underline video attributes which can be used alone or in any combination for enhanced video presentations.
- **CURRENT LOOP INTERFACE IS STANDARD**  
A 20mA current loop interface as well as an EIA RS232C Interface.
- **BUFFERED PRINTER INTERFACE OPTION**  
This option allows independent print/communication baud rates and independent parity. The printer option also allows the VISUAL 100 to function as a controller between host and printer, using "XON/XOFF" protocol. Printer busy can also be monitored using XON/XOFF, or control line.

Seeing is believing, so see for yourself. For a demonstration and a pleasant surprise on quantity pricing of the VISUAL 100, call or write us today.

£675  
+ VAT

## VISUAL 200



The VISUAL 200 is a new, low cost, microprocessor based video display terminal which truly stands above competitive teletype compatible terminals in its price range.

In addition to the most popular features available (or partially available) on competitive terminals, such as numeric pad, upper/lower case, editing, current loop, cursor addressing, columnar and field tab, etc., standard features which set the VISUAL 200 apart and reach the optimum in human engineering and operator comfort include:

- Detachable Keyboard
- Smooth Scroll
- Tilt Screen (10° to 15° viewing angle)
- Large 7 x 9 Dot Matrix Characters

Perhaps the most distinctive feature of the VISUAL 200 is the Switchable Emulation capability. A switch on the rear panel programs the terminal for code-for-code emulation of a Hazeltine 1500, ADDS 520, Lear Siegler ADM-3A or DEC VT-52. To an O.E.M. customer it means no change in software to displace the older, less powerful terminals in his product line with the new, reliable and low cost VISUAL 200. To a Distributor it means offering a single modern terminal which is compatible with all the software his customers have written for the older terminals. And you're not limited to merely emulating these older terminals; you can outperform them at the same time by taking advantage of the additional features of the VISUAL 200.

Reliability designed into the VISUAL 200 is evidenced by its solid state keyboard, single P.C. Board and self test diagnostics on power up.

Seeing is believing, so see for yourself. For a demonstration and a pleasant surprise on quantity pricing of the powerful, easy to use and reliable VISUAL 200, call or write us today.

### Standard Features

- 24 x 80 Screen Format
- 7 x 9 Dot Matrix
- Upper/Lower Case
- Numeric Pad
- Background/Foreground
- Blink Line
- Insert/Delete Line & Character
- Columnar and Field Tab
- Set/Clear Tab
- Security Mode (non-display)
- Clear End Line, Field & Page
- Clear Line
- Clear Screen
- Line Drawing
- Current Loop or RS-232 Interface
- Secondary Channel
- Composite Video
- Serial Copy Port
- Hold Screen
- Baud Rates to 19,200
- Self Test
- Cursor Addressing
- Cursor Control Keys
- Read Cursor Address
- Typematic Keys
- Smooth Scroll
- Microprocessor
- Detachable Keyboard
- Solid State Keyboard
- Read Terminal Status
- Tilt Screen
- Switchable Emulations

## THE FIRST MICROCOMPUTER WHOLESALER



We offer products from  
many manufacturers including:

Altos  
Centronics  
Century Data  
Control Data  
Datasouth  
Dyna Byte  
Exidy  
Hazeltine  
Houston Inst.

Impact Data  
Industrial Micro  
Integral Data  
Intertec  
Konan  
LRC Eaton  
Malibu  
Micro Peripherals  
N.E.C.

North Star  
Ohio Scientific  
Onyx  
PerSci  
Qume  
Soroc  
Televideo  
Texas Instruments  
Visual Technology

SIGMA (U.K.)  
6, THE JAYS,  
BURGESS HILL,  
SUSSEX

Telephone: 04446 44150

## DATASOUTH DS180 HIGH SPEED MATRIX PRINTER

£1490  
+ VAT



The Datasouth DS180 is a dot-matrix serial impact printer designed for high performance at an economical price. Application flexibility and a long list of standard features make the DS180 an ideal device for small business systems, distributed communications networks and intelligent terminals.

### HIGH SPEED PRINTING

Utilizing 180 cps optimized bidirectional printing, the DS180 offers higher throughput than any printer in its class. Its 9-wire printhead produces highly legible 9x7 characters with descenders for lower case letters and true underlining. All 96 ASCII characters may be printed across a 132 column line at 10 characters per inch. Expanded characters (5 cps) may be selected for high-lighting portions of the text.

### USER PROGRAMMABLE

The DS180 offers a large number of user programmable features, yet is easy to operate. A unique programming keypad with a non-volatile memory makes printer set-up quick and simple. Top of form, horizontal and vertical tabs, perforation skip-over and auto line feed are just a few of the features the user may select. Communications status may also be programmed and monitored using the indicator panel lights and LED display.

### ATTRACTIVE DESIGN

Compact, desk-top packaging allows the DS180 to fit into almost any installation. Its noise dampening cover makes it suitable for use in a quiet office environment. The cartridge ribbon makes routine changes clean, fast and convenient.

### MICROPROCESSOR ELECTRONICS

Through the use of state-of-the-art microprocessor electronics, reliability and maintainability have been greatly improved. The simple modular design of the DS180 provides easy access to all major components. A single printed circuit board contains both

the power supply electronics and digital controller for the printer. A self-test feature and diagnostic display panel help the user verify proper operation of the unit and isolate problems should they occur.

### COMMUNICATIONS

Interfaces on the DS180 include RS232 and 20mA current loop serial interfaces, and a Centronics compatible parallel interface. Baud rates from 110-9600 and parity selection may be keyed in by the user for his specific application.

### FORMS HANDLING

Adjustable tractor accommodate forms from 3-1/2 inches wide. A head-to-platen gap adjustment ensures optimum print quality on up to 6-part forms. Fanfold paper may be fed from the front or bottom of the DS180. A paper out sensor may be programmed to send a stop transmission character and sound an audible alarm.

### QUALITY MANUFACTURING

Reliable performance is ensured by a stringent quality control program. Datasouth uses pretested, high reliability parts from leading manufacturers. Multiple tests are performed on sub-assemblies during each stage of production, with each completed unit undergoing a final 24 hour print test and burn-in. The DS180 carries a 90 day warranty on materials and workmanship.

• Circle No. 291

**SUPPORT MEMBERS OF THE  
COMPUTER RETAILERS  
ASSOCIATION ...**



**THEY WILL SUPPORT YOU.**

For further details on the associations aims, membership, code of conduct etc.

Please contact: Mrs Helen Gibbons,  
Owles Hall, Buntingford, Hertfordshire SG9 9PL.  
Tel: Royston (0763) 71209

• Circle No. 292

**MICROPROCESSOR  
SYSTEMS ENGINEERS  
AND PROGRAMMERS  
WITH KNOWLEDGE OF  
INTEL MCS 80, 85 SERIES  
& MCS 48**

Required for Real time process control of Mass Transit and Automatic Fare Collection Equipment. The Company is part of a multi-national group which has successfully installed equipment in many major cities of the world including London, Madrid, Washington and Hong Kong. We are in an expanding market and offer competitive rewards and an environment to enable career development to Engineers with relevant experience. Pleasant offices and friendly atmosphere. Good holidays (this year's honoured) Subsidised canteen facilities Flexitime.

Apply to: Mrs D. Gammie, Personnel Officer,  
Cubic Tiltman Langley Ltd., 177, Nutfield Road,  
Merstham. Tel: Merstham 4021

• Circle No. 293



**centralex**

A comprehensive range of Microcomputers Equipment, Peripherals, Software and Services for those who value Professional Standards, Guidance and Continuing Support for Hardware and Software.

APPLE  
TEXAS  
MICROPOLIS  
DIABLO  
MICROLINE

PET  
OHIO SCIENTIFIC  
CENTRONICS  
QUME  
HITACHI

ITT 2020  
CROMEMCO  
ANADIX  
DEC  
LEXICON

EXIDY  
MICROSTAR  
INTEGRAL  
DATA GENERAL  
ETC. ETC.

HORIZON  
SHUGART  
TELETYPE  
EPSON

INFORMEX-80 Printer



Special offer - for a limited period

For PET, APPLE, EXIDY, TRS80, ETC  
A high quality, high speed printer  
(125 cps) Upper and lower case letters  
plus graphics as standard  
Interface and cable for TRS80, PET,  
APPLE or RS 232 £69 + VAT  
Tractor feed option only £39



ALSO Training, Consultancy, Systems Design,  
Programming and Software

PAYROLL - INVOICING - STOCK CONTROL -  
SALES/PURCHASE LEDGER - VAT - MEDICAL  
RECORDS - EDUCATIONAL & ENGINEERING  
PROGRAMMES - HOTEL RESERVATION - ESTATE  
AGENTS - BUILDING MAINTENANCE - COBOL -  
FORTRAN - ETC.

Maintenance Contracts including stand-by equipment during repair periods - Free Delivery Nationwide - Terms arranged - Credit Cards and official orders accepted.

• Circle No. 294



# Unique in concept - the home computer that grows as you do! New! - The Acorn Atom



**£120** An outstanding personal computer kit plus VAT and p&p.

Also available ready-built  
**£150** plus VAT and p&p

The ATOM - a definitive personal computer. Simple-to-build, simple-to-operate. But a really powerful full-facility computer. And designed on an expandable basis. You can buy a superb expanded package now - tailored to your needs. Or, you can buy just the standard Atom kit, and, as you grow in confidence and knowledge, add more chips. No need to replace your equipment. No need to worry that your investment will be overtaken by new technology. As you need more power, more facilities, you can add them!

\*The picture shown demonstrates mixed graphics and characters in three shades of grey provided by the Standard Atom.

## The standard ATOM kit includes:

- Full sized QWERTY keyboard
- Rugged polystyrene case
- Fibreglass PCB
- 2K RAM
- 8K ROM
- 23 integrated circuits
- Full assembly instructions including tests for fault-finding. (Once built, connect it to any domestic TV and power source)
- Power requirement: 8V at 800 M A. ATOM power unit available.

See coupon. PLUS FREE MANUAL written in two sections - teach yourself BASIC and machine code for those with no knowledge of computers, and a reference section giving a complete description of the ATOM's facilities. All sections are fully illustrated with example programs.

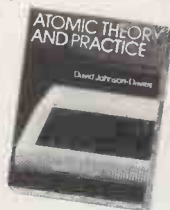

## The ATOM concept

Adding chips into sockets on the PCB allows you to progress in affordable steps to large-scale expansion. You can see from the specifications that the RAM can be increased to 12K allowing high resolution (256 x 192) graphics. Two further ROM chips, e.g. maths functions, can be added directly to the board giving a 16K capacity. In addition to 5 I/O lines partly used by the cassette interface, an optional VIA device can provide varied I/O and timer functions and via a buffer device allow direct printer drive. An optional module provides red, green and blue signals for colour. An in-board connector strip takes the ATOM communications loop interface. Any number of ATOMs may be linked to each other - or to a master system with mass storage/

hard copy facility. Interface with other ACORN cards is simplicity itself. Any one ACORN card may be fitted internally. So you can see there are a vast number of modular options and additions available, expanding with your ability and your budget.

## The ATOM hardware includes:

- Memory from 2K to 12K RAM on board (up to 35K in case)
- 8K to 16K ROM (two 4K additions)
- 6502 processor
- Video Display allows high resolution (256 x 192) graphics and red, green and blue output
- Cassette Interface - CUTS 300 baud
- Loudspeaker allows tone generation of any frequency
- Channel 36 UHF Modulator Output
- Bus output includes internal connections for Acorn Eurocard.

## The ATOM software includes:

- 32-bit arithmetic ( $\pm 2,000,000,000$ )
- High speed execution
- 43 standard/extended BASIC commands
- Variable length strings (up to 256 characters)
- String manipulation functions
- 27 32-bit integer variables
- 27 additional arrays
- random number function
- PUT and GET byte
- WAIT command for timing
- DO-UNTIL construction
- Logical operators (AND, OR, EX-OR)
- LINK to machine-code routines
- PLOT DRAW and MOVE.

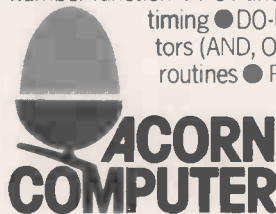

4a Market Hill,  
CAMBRIDGE CB2 3NJ

Your ACORN ATOM may qualify as a business expense. To order complete the coupon below and post to Acorn Computer for delivery within 28 days. Return as received within 14 days for full money refund if not completely satisfied. All components are guaranteed with full service/repair facility available.

Please send me the following items:

Quantity	Item	Item price inc. VAT+p&p	TOTALS
	ATOM KIT 8K + 2K (MIN)	@ £140.00	
	ATOM ASS 8K + 2K (MIN)	@ £174.50	
	ATOM KIT 12 + 12K (MAX)	@ £255.00	
	ATOM ASS 12 + 12K (MAX)	@ £289.50	
	1K RAM SETS	@ £11.22	
	4K FLOATING POINT ROM	@ £23.30	
	PRINTER DRIVE	6522 VIA @ £10.35	
		Buffer (LS 244) @ £3.17	
	MAINS POWER SUPPLY (1.5 amps)	@ £10.20	
		TOTAL	

To: Acorn Computer Ltd., 4a Market Hill, CAMBRIDGE CB2 3NJ

I enclose cheque/postal order for £

Please debit my Access/Barclaycard No. \_\_\_\_\_

Signature \_\_\_\_\_

Name (Please print) \_\_\_\_\_

Address \_\_\_\_\_

Telephone No. \_\_\_\_\_

Registered No: 1403810. VAT No: 215 400 220



PC/8/80

# NEW PRICES ON MEMORIES

2102L—450NS 1K × 1 SRAM	£ 0.55
2114-300NS 1K × 4 SRAM	£ 3.51
2114-200NS 1K × 4 SRAM	£ 3.86
4116-200NS 16K × 1 DRAM	£ 4.50
2708-450NS 1K × 8 EPROM	£ 4.39
2716-450NS 2K × 8 EPROM	£11.50
CARTER ASCII KEYBOARD	£39.50
AY—5-1013 UART	£ 2.60
2102L × 8 SRAM 450NS	£ 3.85
2114 × 8 SRAM 300NS	£24.45
2114 × 8 SRAM 200NS	£26.89
4116 × 8 DRAM 200NS	£31.35

Please add 50p Postage and 15% VAT to all orders.

**Strutt Ltd.**  
**Electronic Components Distributors**  
**3C, Barley Market St.**  
**Tavistock,**  
**Devon, PL19 0JF.**  
**Tel: Tavistock 0822 5439**  
**Telex 45263**

• Circle No. 296

## \* TX-80B 80 COLUMN DOT MATRIX PRINTER

### FEATURES

- Reliability
- Low cost
- 70 lines/minute
- Compact size
- 96 Chars + Pet Graphics
- Condensed line, enhanced print
- Self-test
- 5 x 7 dot. matrix, 6 x 7 for graphics
- Centronics parallel interface standard

**EPSON**  
**£375**  
**+ VAT**



### OPTIONS:

- PET, APPLE, TRS80, VIDEO GENIE, RS232, Interface board and cable £40 each + VAT
- NASCOM Interface cable £12.

### \* MEMORY BARGAINS

2114-450nsec, 4k x 1	1+	10+
4116-200ns, 16K x 1	2.75	2.45
DRAM Ceramic		
2708-450ns, 1K x 8	3.75	3.45
EPROM	4.05	3.75
2716-450ns, 2K x 8		
INTEL Type		
single +5V	12.70	11.95
2732-450ns, 4K x 8		
INTEL Type		
single +5V	35.50	31.45
2532-450ns, 4K x 8		
TEXAS Type	35.50	31.45



All components are manufactured by leading companies and guaranteed full specification.

### \* PET LOWER PRICES!

- with large keyboard
  - \*2001- 8K memory £420
  - \*2001-16K memory £495
  - \*2001-32K memory £595
- } + VAT
- 'THE PET REVEALED' BOOK £10



× £295  
+ VAT

### VIDEO GENIE SYSTEMS EG3003 —

Based on TRS-80, utilises Z80, 12K Level 11, Basic 16K RAM, INTEGRAL CASSETTE Deck, UHF O/P, All TRS-80 features.

**12" MONITOR**  
 Ideal for Personal and Business Computers **£85**

- Low Cost EPROM Eraser **£34 + VAT**
- High Speed Eraser typically 4-7 mins 2708 **£97 + VAT**

### Q-Tek Systems Ltd

2 Daltry Close, Old Town, Stevenage, Herts  
 Tel (0438) 65385



Leasing and servicing facilities available

• Circle No. 297

## HORIZON MULTI-USER SYSTEM

- \* VERY EFFICIENT \* BANK SWITCHING
- \* UP TO 10 USERS \* POSSIBLE 56K/USER

Many other features including printer lockout, automatic memory test, file lockout, interrupt driven printer spooler(s), autostarting for each user

### 3M Bytes DISC STORAGE

User new quad density double sided 5¼" drives we can supply Horizons with over 750KB per drive. Track to track times 3 ms - 10 times faster than Shugart minifloppies

### OTHER ITEMS

- \* 40 track DOS - 15% extra storage
- \* HMSBASIC - many useful extra functions
- \* 6MHz Z80B Horizon upgrade kit
- \* 270 cps Ink Jet Printer
- \* Many VDUs and Printers supplied



# Hotel MicroSystems Ltd

473 Staines Road Feltham Middx. TW14 8BL

Tel: 01-890 9696

• Circle No. 298

**THE LEADING EXHIBITION  
OF COMPUTERS,  
PERIPHERALS AND SYSTEMS**

# COMPEC

will be in the Grand Hall  
**OLYMPIA, LONDON**  
Nov 4, 5 & 6, 1980

**CAN YOU  
AFFORD TO MISS  
BRITAIN'S BIGGEST  
COMPUTER  
EXHIBITION?**

Sponsored by "Computer Weekly," "Data Processing," "Practical Computing" and "Systems International" and with the support of "Electronics Weekly" — all members of IPC Business Press, the world's largest publisher of specialist and business journals.

**GET YOUR TICKETS NOW — SAVE MONEY!**

If you send your request for tickets now you will pay only £1.50 per ticket (tickets £2 at the door)

To. Compec Tickets, IPC Exhibitions, 40 Bowling Green Lane, London EC1R 0NE Tel 01-837 3636

Please send me . . . . . advance registration tickets for Compec 80 at the privilege price of £1.50 per ticket.

Name \_\_\_\_\_ Address \_\_\_\_\_

\*Tickets £1.50 in advance, £2 at the door. Applications received after October 3rd, cannot be accepted.

**TRADE ONLY — NO SCHOOL PARTIES — NO ADMITTANCE UNDER 16**

ALL CHEQUES/MONEY ORDERS TO BE MADE PAYABLE TO IPC BUSINESS PRESS LTD IN UK STERLING

## August

- **4-8** **Introduction to the design of microprocessor-based systems.** Venue: Cambridge. Provides the basic techniques necessary for the design of microprocessor-based systems, with about 60 percent hands-on practical design work. Fee: £265 + VAT. Contact: Course Registrar, Cambridge Microcomputers Ltd, Cambridge Science Park, Milton Road, Cambridge CB4 4BN. Tel: (0223) 314666.
- **13-15** **Computer Graphics '80 International Conference and Exhibition.** Venue: The Metropole, Brighton. Highlights the developments of computer graphics during the decade and indicates the potential for graphics techniques in the 1980s. Fee: £195 + VAT. Contact: Online Conferences Ltd, Argyle House, Northwood Hills, Middlesex HA6 ITS: (09274) 28211.
- **14-15** **Distribution systems: analysis and design.** Venue: London. Explains the distribution business environment and covers techniques for designing computer-based systems to meet typical application requirements. Fee: £270. Contact: The Registrar, Infotech, Nicholson House, Maidenhead, Berkshire SL6 1LD. Tel: (0628) 39101.
- **19-21** **CICS for application programmers.** Venue: London. Designed for trainee programmers and system staff entering a CICS environment or for experienced staff involved in a change of software. Fee: £345. Contact: The Registrar, Infotech, Nicholson House, Maidenhead, Berkshire SL6 1LD. Tel: (0628) 39101.
- **20-21** **Microprocessors: management assessment.** Venue: London. Provides non-technical assessment of the nature of microprocessors, their potential applications and their cost/benefit implications. Designed for all levels of management in a position to make a realistic assessment of the implications of the microprocessors in their organisation. Fee: £350. Contact: The Registrar, Infotech Ltd, Nicholson House, Maidenhead, Berkshire SL6 1LD. Tel: (0628) 39101.
- **20-21** **Sales and forecasting systems: analysis and design.** Venue: London. Explains the sales and forecasting business environment and covers techniques for designing computer-based systems to meet typical application requirements. Fee: £270. Contact: The Registrar, Infotech, Nicholson House, Maidenhead, Berkshire SL6 1LD. Tel: (0628) 39101.
- **20-22** **FS990/4 floppy disc-based software development system.** Venue: Bedford. Designed for the technician or engineer who is familiar with the TMS 9900 instruction set and has knowledge and experience of microprocessor or minicomputer systems. Fee: £250 + VAT. Contact: Mike Hughes, Microprocessor Training Centre, Texas Instruments Ltd, Manton Lane, Bedford MK1 7PA. Tel: (0234) 67466.
- **26-27** **Requirements planning systems: analysis and design.** Venue: London. Explains the materials and inventory management business environment and covers techniques for designing computer-based systems to meet typical application requirements. Fee: £270. Contact: The Registrar, Infotech, Nicholson House, Maidenhead, Berkshire SL6 1LD. Tel: (0628) 39101.
- **27-28** **Microcomputers for commercial data processing.** Venue: London. Reviews the role of microprocessors in commercial applications, discusses the hardware and software capabilities of microprocessor systems and shows how they can be applied in the design of commercial data processing systems. Fee: £310. Contact: The Registrar, Infotech Ltd, Nicholson House, Maidenhead, Berkshire SL6 1LD. Tel: (0628) 39101.
- **27-29** **Microprocessor project management.** Venue: London. Provides a systematic and practical presentation of systems project management techniques. Fee: £395. Contact: The Registrar, Infotech Ltd, Nicholson House, Maidenhead, Berkshire SL6 1LD. Tel: (0628) 39101.
- **27-29** **Minicomputer system software.** Venue: London. Reviews the various types of operating systems available on minicomputers and shows how to select an operating system for a particular application. Fee: £395. Contact: The Registrar, Infotech Ltd, Nicholson House, Maidenhead, Berkshire SL6 1LD. Tel: (0628) 39101.
- **27-29** **OS JCL for application programmers.** Venue: London. Designed for trainee programmers and systems programming staff becoming involved in an OS-based environment. On completion, participants will be able to make optimum use of JCL statements and OS utilities to improve the efficiency and performance of application programs. Fee: £345. Contact: The Registrar, Infotech, Nicholson House, Maidenhead, Berkshire SL6 1LD. Tel: (0628) 39101.
- **28-29** **Production control systems: analysis and design.** Venue: London. Designed for systems staff requiring specialist knowledge in the business principles and design considerations of manufacturing systems to give a clear understanding of manufacturing and production control necessary to develop successful production requirement planning systems. Fee: £270. Contact: The Registrar, Infotech, Nicholson House, Maidenhead, Berkshire SL6 1LD. Tel: (0628) 39101.
- **28-29** **Introduction to microprocessing.** Venue: Bedford. Introductory course using the TMS 9900 minimum system. Fee: £95 + VAT. Contact: Mike Hughes, Microprocessor Training Centre, Texas Instruments Ltd, Manton Lane, Bedford, MK1 7PA. Tel: (0234) 67466.
- **28-29** **Structured walk-throughs.** Venue: London. Examines the use of the walk-through technique in monitoring and reviewing written output. Fee: £310. Contact: The Registrar, Infotech, Nicholson House, Maidenhead, Berkshire SL6 1LD. Tel: (0628) 39101.
- **29-31** **Practical Basic programming.** Venue: Manchester University. A weekend residential course for those with little or no computing background and who would like a thorough introduction to writing programs in Basic for microcomputers. About half of the course will consist of practical programming exercises on the Pet. Fee: £57.50. Contact: Sue Eden, University of Manchester, Department of Extra-mural Studies, Manchester M13 9PL. Tel: (061) 273 3333 ext. 3076. 

## Basic computing science: system software.

By P J Barker, published by Blackie and Son, (1980), 64 pages paperback £2.30 ISBN 0 216 90854 X.

SOFTWARE is divided traditionally into two classes: applications software, which is designed to serve some useful purpose; system software, which is designed to make applications software easier to write and run.

The book aims to provide A level computer science students with an insight into system software. It succeeds admirably, establishing the principles with examples, yet avoiding the trap of discussing a particular system to the exclusion of all others.

By assuming a basic understanding of computing, and software, the author has managed to pack information on a wide range of topics into 64 pages. He describes all the essentials of a general-purpose operating system; loader, peripheral handling and interrupts, memory management, multi-tasking and scheduling, multi-access and virtual machines.

He also describes the super-structure software; linkers, assemblers, compilers and interpreters, editors, utilities, file structure and job-control.

The book is likely to provide useful insights even for an experienced mainframe programmer. At the other extreme, it is useful for the novice microprocessor user to understand the range of facilities provided as standard on larger, general-purpose systems.

### Conclusions

● Although intended primarily for A level students, the book can be recommended to anyone who would like to understand operating systems and other system software.

### Program design and construction.

By David A Higgins, published by Prentice-Hall International, 200 pages, paperback, £6.45.

THERE IS a tendency in many programming books to assume we know exactly what we want to do and how to do it and that

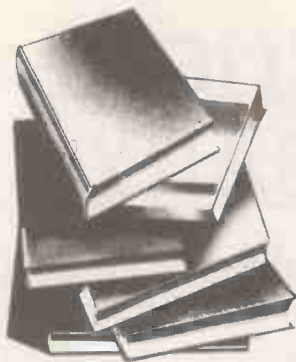

the major difficulties are the peculiarities of a particular Basic dialect or the nightmarish architecture of a new microprocessor. David Higgins' book provides a counterbalance, concentrating on the process of program design.

Most of the book is a step-by-step introduction to program design using the Warnier-Orr design methodology. Warner-Orr diagrams were developed by an American, Ken Orr, from earlier work by a Frenchman, J D Warnier.

In essence, the methodology is functional decomposition where an abstract high-level specification, such as play *Star Trek*, is broken down, step-by-step into progressively more detail, until at the most detailed level, each step is a statement or two in your favourite programming language.

Warnier-Orr extends this method by using some of the ideas of sets and subsets, and by providing guidance on database design, physical program design, and how to handle particular problems.

The examples in the book are games programs and programs for the small business user. The programming language used in all cases is a structured Basic.

The book contains a good deal of very sound advice on program design and on programming in general. It can be thoroughly recommended as an introduction to Warnier-Orr diagramming, for micro-computer, minicomputer and mainframe programmers. However, the Warnier-Orr methodology may seem unnecessarily artificial to some readers and not very helpful to others.

### Conclusions

● Most of the early benefits of

any design method derive from concentrating on some method.

● It makes sense to start with a design method which feels comfortable.

● Prospective purchasers of this book might like to consider the alternative methodologies available — Jackson, SADT, PSL, Mascot, etc. — before investing the time needed to master Warnier-Orr.

Martyn Thomas

## The computerisation of society

By Simon Nora and Alain Minc, MIT Press £7.75.

This book, by French mandarins Simon Nora and Alain Minc, addresses itself squarely to the question: what difference will computers really make? Commissioned originally by President Giscard d'Estaing in 1976, it became an immediate best-seller in France and now appears in an English translation for the first time.

It is easy to see why it is so popular and provoked such widespread discussion. Essentially, the authors believe that *télématiques* — data processing diffused through networks accessed easily by the public at large — will transform society.

That much is clear to most readers of newspapers in the western world. Yet few attempts have been made to imagine how that transformation will affect our society's way of life, and fewer still to devise practical strategies to work towards the kind of society which we might want; I discount, of course, the science fiction apocalypse ramblings of the wilder would-be prophets of the information society.

What is vital about Nora and Minc's report is it turns an analysis of data processing for all into a debate on the nature of French society and provokes the reader to think about the kind of society in which he wishes to live.

For they see the changes as not merely technological and elitist, but of vital concern to everybody and will be as great as the industrial revolution or even of the use of papyrus by the Egyptians. Taking as its starting point that information equals power — an urgent

point, and one that bears repetition — the authors do not fail to remark that the British were quicker off the mark in seizing hold of communications media in 1926. The book quickly makes the point that common availability of data networks will loosen the power of existing hierarchies, i.e., governments, but will not necessarily remove control from the centre.

Rather, the centre of influence will move progressively towards those who hold the key to the production and utilisation of such systems — notably the mammoth producers such as IBM and NASA, responsible respectively for the terminals and the satellite links.

That warning of cultural imperialism is not a moment too soon, for as the authors point out, many professional users in Europe already rely on U.S. data banks for both cheapness and convenience and will continue to do so until presented with a cheaper and better option.

The report goes on to argue in favour of a "communications international", bizarre though this may seem in a report to the President. It also makes some useful caveats on the potentially rigidifying effect of data processing, suggesting that stronger departments of government such as finance, police and armed forces will, under present conditions, always secure enough capability to increase their own influence while continuing to deny those resources to departments which serve the public such as education, health, justice and the local community, leading finally to the *Tout État* in which the strong become stronger and the weak weaker, leading to increasing centralisation.

### Conclusions

● The optimum solution, suggest Minc and Nora in the concluding pages of a book, which is essential reading for anyone who can be bothered to look up from the keyboard for a moment, is one where governments will plan effectively their own demise by handing over power to their own people. Martin Hayman

# A PRACTICAL GLOSSARY

## The final part of the terminological gamut with W-Z

### WAIT

A condition where the processor has suspended program execution, usually while waiting for data from memory or a peripheral.

### Wand

Or optical wand. It is a hand-held device for reading coded labels or tags, typically in a supermarket. Most work by detecting bars across the label, but some non-optical wands pick up other encoded data such as magnetic dots.

### Watson

Thomas J Watson died in 1956 but deserves a mention here because he invented IBM — he fostered its growth through the war years, epitomised the hard-sell go-getting U.S. salesman, and filled the company offices with THINK, a distinctly overrated and somewhat ridiculous slogan.

His son, Tom Watson Jr, became president of IBM in 1952 and guided the company solidly into its current dominance of the computer business. He stepped down two years ago and started an ambassadorial career for the U.S.A.

### WCS

Writable Control Store.

### Winchester

The Winchester has, if you excuse the expression, more firepower than any other form of memory available, in a smaller space and in a more convenient package.

A Winchester disc drive measures 4.5 x 9 x 18in., which caused it to be dubbed the lunchbox, and holds 11MByte. That is a good deal of memory, and you pay for it — about £3,500 at today's prices.

Its principal disadvantage is that discs are not exchangeable. Like many of the ground-breaking technologies, the Winchester was pioneered by IBM, who were looking to pack more memory into a smaller area. The obvious way to increase recording density is to fly the recording head closer to the disc.

To achieve the fine tolerances to re-play the signal reliably, IBM found that it was indispensable to

minimise the mechanical play in normal exchangeable discs and rigorously exclude dust and other atmospheric contaminants.

Those considerations led to the adoption of the sealed chamber and non-exchangeable discs. Further features of the Winchester are dedicated areas of the disc on which the record/replay head should land, thereby eliminating instability at start-up and shut-down, much improved aerodynamics of the head and lighter contact pressures — typically around 8gm.

One curious aspect of the Winchester is that discs are expected to last longer than their associated drives and circuitry.

The device has some snags, particularly associated with interfacing suitable back-up storage, but an incredible 250MB storage capacity on a single 8in. drive is predicted for 1984.

### Word

The word is the basic storage element in a computer. More literal stabs at definition include: a set of characters which have one addressable location and are treated as one unit; and: the basic entities of a language with defined meaning and possible relationships.

A word may have any number of bits, but is usually eight or 16 for micros and minis.

In practice, one word generally contains a number, a letter, or a coded program instruction.

### WPM

Words per minute — not a measure encountered frequently.

### Workspace

An area of memory set aside for short-term working storage but otherwise without predetermined use.

### Write

To put information into memory or on to disc or tape.

### Writable Control Store

A special type of fast-access memory into which the user can put specialised instructions or repetitive routines written in microcode.

WCS is expensive and difficult to use; it is generally provided

only on the more sophisticated minicomputers. Most of us do not need this capability — and few of us can afford it.

### Word processing

The buzzword of the late 1970s is likely to be surpassed in the 1980s by terms like office automation and the electronic office. For the moment, however, word processing is still an important concept.

The phrase covers the processing of text — which in practice equates to alpha-numeric information organised in variable-length files. Those are two important contrasts in data processing, where most information is numeric and most files contain groups of records of the same length — you know exactly how many characters you need for an invoice, a zap-the-Klingons game or an inventory record.

Yet you do not really know how long a letter, an article or a whole book is going to be. That has major implications for the type of software used to manipulate the records and that is why special WP software has appeared.

You can now buy a word-processor package for most micros. As we explained in the June, 1979 article, there are two parts to WP — the text editor, which edits text and an output program, which formats and prints it.

Purpose-built word processors still dominate the scene, of course. The screenless IPM typewriter-plus-memory systems had a head start — they appeared in the 1960s with text being stored on a tape unit connected to the typewriter.

Later, IBM produced a kind of magnetically-sensitive card with a reader unit also connected by cable to the typewriter.

Most of the world's WP installations still use that kind of equipment and IBM still sells it, but in the 1970s, screen-based word processors and floppy disc storage became available which heralded radical change.

Those screen/keyboard/printer/disc combinations are really dedicated microcomputers in a purpose-built package; most are software-driven, which means

you load the WP program from floppy disc at the start of the day, but very few can also be programmed by the user.

That is partly because the WP systems are programmed only in assembler, partly because the vendors do not want to have to provide any user-support other than operator training, and partly because the typical end-user — a secretary or converted typist — will not want to program.

The counter-argument is that you might as well make the most of the small computer. So more and more systems are appearing in the middle ground between dp and WP — microcomputers are acquiring WP packages, word processors appearing with Basic interpreters.

### Zilog

Interesting would-be success story. Three of the designers of the 8080 left Intel in 1974 to form their own company with funds from the oil giant Exxon. Their company is reportedly only just starting to make money, but their micro, the Z-80, is definitely one of the milestones in the business.

The Z-80 is faster than the 8080 and the other pioneer of eight-bit microprocessing, the Motorola M6800. It has more machine instructions — 158 — and it needs a simpler power supply — just one +5V source. Programs can be shorter, execution is quicker.

Every single 8080 instruction is supported, which means if you want to upgrade to a Z-80, you can retain all those programs you write for your 8080.

Zilog is not standing still. As well as many support chips, it packages the Z-80 into a working microcomputer configuration — the MCZ line — and it is starting to deliver its 16-bit micro, the Z-8000.

It also has one of the funniest examples of industry paraphernalia in the shape of its amazing comic-strip hero Captain Zilog.

As a name, by the way, Zilog means something — 'Z' stands for the last word, 'I' denotes integrated, and 'LOG' is logic. So Zilog is the last word in integrated logic. As well, we can allow them some poetic licence. 

## TRS-80 owners!! Double Disk Capacity with the Phantom Double-Density Module

Provides double density modification to your current TRS-80 Expansion interface

Increases storage capacity up to 204K bytes (on single 40 track drive.)

Includes all hardware and software.

**£165**



## Load TRS-80 programmes & data Fast!

with the Phantom  
Disk Drive system

\*23% more storage capacity than TRS-80  
\*40 track patch at no Extra charge.

Two drive system £495  
Four drive system £935  
Two drive cable £20  
Four drive cable £30

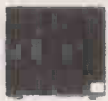

Single drive system

**£265**

## The only 16k complete computer for under £400

Keyboard computer, power supply, UHF modulator and all cables to plug into your own TV set and cassette recorder and go!!  
16K of user RAM for decent size programmes and data, sophisticated level II Microsoft BASIC.  
Complete with level I and level II programming manuals. What more could you ask?



TRS-80  
**£382**

Expansion interface £199.09  
4K level I computer £251.30



Now!  
Numeric keypad included

This lot must be today's best buy!

## Galaxy 2000 by Compu/Think

(1.8 Megabyte Disks) £2,950  
(2.4 Megabyte Disks) £3,960

SPECIAL — GALAXY prices include

Compu/Think Pagemate Database and Report Writer at no charge

The most advanced complete microcomputer system available. Includes CPU, 12" CRT, full keyboard, 2 quad-density disk drives, 2 megahertz 6502 hybrid processor (double speed), 108 K system memory, high resolution (512 x 240) graphics, programmable character fonts, microsoft extended BASIC, DOS with random access I/O, full complement of I/O ports, monitor with debug, trace and tiny assembler, fifth (PL/M and fourth combination) interpreter, complete editing and entry with split screen capability, 64 microprogrammable opcodes, business software (with Database) available.



2001-8N  
(8K RAM New large keyboard)

**£425**

NEW 80-Col.  
32k £825

## Super-Pets are here!

40 & 80 COLUMN

Now you can

— list unlistable programmes using the 6502 non-maskable interrupt facility! — just hit the new 'abort' button to jump out of programme into command mode  
— recover from crashes without switching off — just hit the new 'reset' button.

— add sound to your programmes!

The hardware is built-in — just write sounds into your programme using our simple directions.

2001 — 16N (16K RAM and new large keyboard) £550

2001 — 32N (32K RAM and new large keyboard) £890

External cassette deck, suitable for all Pets £53

CBM dual drive mini floppy £695

Tractor feed printer with Pet graphics £395

Pet high-res. graphics 200 x 320 £259

## Get into print this easy way!



EX-STOCK

### Anadex DP 800 dot-matrix printer

\*Speedy 112 ch/s bidir.  
\*Fits A4 page-up to 80 cols.  
\*Up to 4 copies. \*Precision form-filling with sprocket feed. \*Special headings using double-width chars. \*Modern paper format to match A4 filing systems. \*Other paper sizes with adj. sprocket.  
\*Full punctuation, U/L case, £ sign, 96-ch. set.  
\*Reliable — strongly built, 100 M.ch. head.

Knock down price!

**£499**

Interfaces and cables —  
Pet £45    Ohios £30  
TRS-80 £40    Sorcerer £25  
Apple £69



### IBM golfball printer ideal for word-processing

\*Forget expensive Spin-Wheel printers — the Golfball produces equal quality at up to 15 ch. per sec. \*Match various typewriter styles with IBM interchangeable heads. \*Completely reliable — each machine rebuilt by IBM trained engineers and fully guaranteed. \*Precision form-filling possible with 15 in. pin-feed platen.

Non-keyboard version

**£595**

Keyboard version £695 (illus)  
Interfaces and cables —  
Pet £45    Ohios £63  
TRS-80 £35    Sorcerer £25  
Apple £69



### Phantom 400/800 Thermal Printer

\*Stop disturbing others with noisy printout! \*Neat, clear, 96-ch. set, U/L case & symbols, in text mode.  
\*Fast, 48 ch/s bidir. \*Reliable — robust — only two driven parts.  
\*Plug in and go, built in PSU, detailed manual. Thermal paper in 80 ft rolls less expensive than electro-sensitive paper and now — dot hyphen addressable graphics too!!

For only **£249** (40 col) **A snip!**

80 col model (800) £359  
Interfaces and cables —  
Pet £45    Ohios £63  
TRS-80 £40    Sorcerer £25  
Apple £69

## Up to 1-6Mb for PET!

and 'on-line' with the CompuThink Disc System

\*Allows powerful business programmes using 16 Extra BASIC commands. \*Easy to connect and use — plugs directly into 16/32K PETs, detailed manual supplied. \*Simple startup (no difficult procedures to remember) as Disc Op. System in ROM. \*Ready to run — useful programmes supplied free; full set of professionally written business packages available — Sales and Purchase Ledger, Stock Control, Payroll etc., \*Real-Time processing, Engineering and Commercial boundaries overcome with full language support — Business BASIC, Assembler, FORTRAN, COBOL, PASCAL, FORTH, FIFTH, PLM, PILOT & CESIL.

24K Memory expansion with dual disc for old ROM 8K PET £275  
for new ROM 8K PET £320



Basic 400K  
dual disc  
system

only

**£840**

800K £1,095  
1.6 Mb £2,190

## You can afford to start computing now!

Fully tested complete  
with 4K RAM,  
Extra 4K RAM £35

**£220**

\*Powerful programming possible — 6502 processor, fast 8K Microsoft floating-point BASIC (easy to learn). Superior utilities, 53 key key-board, giving upper and lower case, user-definable keys, gaming and graphics chs. Ultra-fast and powerful machine code from keyboard.

\*No intricate soldering or metal work. Computer supplied assembled in ready-made case. \*Reasonable sized programmes in 4K RAM. \*Expandable to 24K RAM in case, drives discs, printer, available items include Assembler/Editor and Extended Monitor. \*Programme interchangeability/reliability — Kansas City tape interface. \*Save programmes on own cassette recorder — all cables supplied.

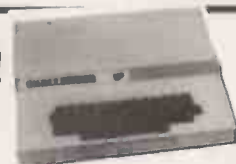

at a lower price  
than equivalent kits

LTD.

your dealer for Bath, Bristol and S.W

**Tel: Bath (0225) 333232**

5 Cleveland Place East, London Road, Bath, BA1 5DJ.

Special terms available for educational and government establishments — dealer enquiries invited.

24 hr ordering service  
Full after-sales  
service in our  
own workshops  
One year guarantee  
on all new machines



Please  
add £10  
Securitor  
delivery on  
computers etc  
plus 15% VAT  
on all prices

• Circle No. 299

**SPECIAL OFFER**

**AS RECOMMENDED BY COMPUTING TODAY — THE CENTRONICS 'MICRO-PRINTER'**

Ask most people what they would like as their first peripheral and the chances are they will say "Printer". Here is an attractive electrostatic printer from the famous firm of Centronics. Capable of printing in three sizes of typeface it is easily attached to your machine by way of the parallel interface. The logic is fully TTL compatible and STROBE, Acknowledge and Busy lines are provided to make life easy.

"Cost of this wonderful peripheral is a mere £195 + VAT The printer comes complete with documentation, connector and cleaning paper as well as a roll of the printing paper." (extract from COMPUTING TODAY).

**Ex-STOCK from HENRY'S  
Ideal for PETS-TANDY-NASCOM's**

**Specification**

- 150 lines per minute
- Selectable 20 40 80 columns
- 120 m/m aluminium — Finish paper unaffected by Heat, Light or Humidity.
- Full character ASC II set.
- Paper Feed, 220-240AC mains.
- On-Off Print Select.
- Paper Advance — Empty Controls.
- Size 10½ × 13½ × 4½" Weight 10lbs

**Ideal for Home or Small Business use.**

**LIMITED QUANTITY DON'T DELAY**

Brand new boxed fully guaranteed list price of this machine. £459.95 inc. VAT.

OUR PRICE

**£195.00** plus VAT

POST PAID

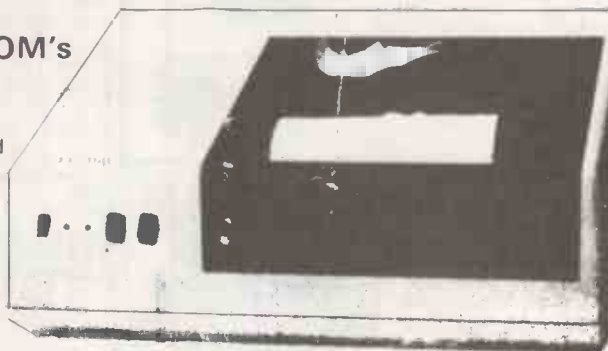

**CENTRONICS  
QUICK PRINTER**

Complete with documentation  
connector & Printing Paper

**HALF PRICE OFFER**

Just Plug in and it's ready to go!

AS RECOMMENDED BY "COMPUTING TODAY" MARCH/MAY 1980



Your London & National Nascom Distributor.  
Export Orders deduct VAT, but add 5% carriage  
Official Export & Educational Orders welcome  
Our Telex 262284 Mono Ref. 1400 Transonics

**COMPUTER  
BROCHURE  
FREE**

**SEND  
15p  
STAMP**



**HENRY'S**

Computer Kit Division

404 Edgware Road, London, W2, England  
01-402 6822



• Circle No. 300

# A SOUND INVESTMENT.

## MP 12 and MP 15 Microprocessor Cassettes

When you record on cheap cassettes you run a high risk of program failure, dropout errors and excessive headwear.

Saving pennies on an unsuitable cassette could turn out to be very costly. To make a long life, high quality microprocessor cassette needs both tape and cassette mechanism to operate together in harmony.

Backing up the microprocessor cassette technology is a background of more than 10 years of experience within the Group on the manufacture of computer tape, memory discs and cartridges. Pyral is one of Europe's foremost manufacturers of magnetic digital recording media.



## The perfect match of cassette body and tape.

For further information on the  
Microprocessor cassette and other  
Pyral products, send to:

Sales office: PYRAL MAGNETICS LTD, COURTLANDS ROAD, EASTBOURNE, SUSSEX. Tel: (0323) 638965 Telex: 877123

• Circle No. 301



# The Strong Silent Type



- Line printer quality at character printer price.
- 300 lines per minute.
- Serial or parallel interface.
- Centronics or Dataproducts Compatible.
- Electronic Vertical Forms Control.
- Highly efficient sound reducing cabinet.

OEM PRINTERS FROM

## KODE

Station Road, Calne, Wiltshire SN11 0JR.  
Telephone Calne (0249) 813771. Telex 449335

•Circle No. 302

## Advertisement Index

<b>A</b>		<b>D</b>		<b>L</b>		<b>Q</b>	
Acorn Computers	169	Datalink Micros	29	Lifeboat Associates	10, 11	Q Tek Systems	170
ACT Petsoft	60, 61	Datormark	158	Lionhouse Microcomputers	81		
Aculab	152	David Richards	40	Little Genius	16	<b>R</b>	
AJD Direct Supplies	16	Davinci	36	Liveport	31	Rair	51
A J Harding (Molimerx)	35	DDP	112	L & J Computers	124	Research Machines	147
Almarc	27	Digitus	42	London Computer Centre	120	Research Resources	14
Andrews Computing	34	Dragon Systems	160	Lowe Electronics	157	Rostronics	17
APL	24			LP Enterprises	75		
		<b>E</b>		<b>M</b>		<b>S</b>	
<b>B</b>		EMG	166	Media 5	36	Science of Cambridge	52, 53
Barcellos	162	Ess Gee Investments	156	Microbits	19	SGS Ates	8, 9
BEM	160	Equinox	123	Micro Business Centre	160	Sharp Electronics	128
Business Computer Services	28	<b>F</b>		Microbyte	158	Sigma UK	167
Business & Leisure Micros	18	Farmplan	24	Microcentre	2	Sirton Computers	153
BNR & ES	30	Fortronic	112	Microcomputer Applications	30	Slough Microshop	16
Byte Shop Computerland	65	<b>G</b>		Microcomputer Facilities	40	Southern Software	30
Bytronic	124	Galatrek Engineering	4	Micrologic	150	Stack	118
		Gate Microsystems	22	Micromanagement	28	Stage One	100
<b>C</b>		Gemsoft	32	Microsense	116, 161	Strutt	170
Calco Software	36	GP Industrial Electronics	99	Microsolve	20	Sun Computer Services	164
Cambridge Computer Store	102	Graffcom	40	Microsys	156	Systematics International	103
Camden Electronics	37	Grama Winter	12, 13	Microtek	18	<b>T</b>	
Chromasonic Electronics	38	Graham Dorian Software Systems	106	Micro UK	154, 155	Telefusion	96
Clenio Computing	159	Guestel	150	Microtrend	45	Terodec	23
Colin Bentley Associates	148	<b>H</b>		Microware	22	Terminal System Services	34
Comart	5, 15	Hal Computers	32, 148	Mighty Micro	92	The Computer Shop	14
Commodore	86, 89, 93	Happy Memories	24	Mutek	26	Total Concept Systems	152
Computerama	175	Henry's Radio	176	<b>N</b>		Transam	21
Computerbits	151	Hotel Microsystems	170	Nascom	165	T & V Johnson	163
Computer Centre	6, 7	HSV	99	Newbear	33	The Software House	115
Compec	171	<b>I</b>		Newtronics	166	<b>V</b>	
Comp Shop	178	Icarus	47	Northern Software Consultants	149	Video Vector Dynamics	146
Computech	25	Intelligent Arifacts	34	<b>O</b>		V & T Electronics	20
Computastore	78	Interface Software	32	Optelco	28	<b>W</b>	
Computopia	38	Ithaca Intersystems	180	Owl Computers	166	Wego Computers	146
Control Dataset	26	Informex Centralex	168	<b>P</b>		<b>X</b>	
Couchmead	54	Intex Datalog	18	Padmede	104	Xitan	164
CPS Data Systems	99, 150	<b>K</b>		Paper Shack	164	<b>Z</b>	
CRA	168	Kansas City Systems	162	Personal Computers	105	Zenith (Heathkit)	41
Cream Microcomputershop	59	Keen Computers	130	Petsoft (Appeware)	72		
Crofton Electronics	26	KGM	127	Pyral Magnetics	176		
Crystal Electronics	166	Kode	177				
Cubic Tillman Langley	168						
Cumana	39						

## COMPUPHONES

**YOU NEED NEVER MISS AN IMPORTANT CALL AGAIN TWO CORDLESS TELEPHONE SYSTEMS — DIRECT FROM USA**



**THE ALCOM** only **£147 + VAT**  
Base station connects to your telephone line. Remote handset clips to your belt and gives you push-button dialling — Bleeps when call arriving — Nicad rechargeable batteries. Charger in base unit.



**THE BOHSEI** only **£125 + VAT**  
Base station connects to your telephone line. Remote handset stylishly designed in red — Push button dialling comes complete with charger unit for batteries in handset.



**LOW COST TELEPHONE ANSWERING MACHINE** only **£99.95 + VAT**  
Microprocessor controlled answering machine. Plug into your phone line. Records any phone call messages. Remote bleeper enables you to listen to your messages from anywhere in the world. Uses standard cassettes. Comes complete with mains adaptor, microphone, remote bleeper, base unit, cassette with 30 sample pre-recorded messages.

### THE NEW ANADEX DP9501

**A PROFESSIONAL PRINTER**

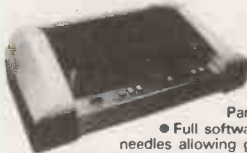

- Bi-directional printing
- Up to 220 chars/line with 4 print densities
- 500 char buffer
- RS232C and Centronics Parallel interface built in
- Full software control of matrix needles allowing graphics capability
- 200 chars/sec ● Adjustable width tractor feed.

All this for only **£995 + VAT.**

### NASCOM-2 WITH FREE POWER SUPPLY & 16K RAM B BOARD

only **£305 + VAT** Subject to Availability

### NASCOM 2 DISC DRIVES

Add a powerful, double density, mini floppy disc to your Nascom system.

- Disc Controller Card (includes Nasbus 6 S100 interface)
- Will control 4 Drives.
- CPM operating system.
- Extended Disc Basic Compiler.
- Power supply included

One Disc System — **£499 + VAT**  
Additional Disc Unit — **£299 + VAT**



## COMPLETE MICRO SYSTEMS

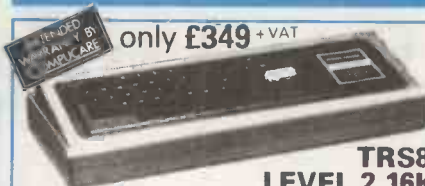

only **£349 + VAT**

**TRS80 LEVEL 2 16K**

Fully converted to UK T.V. Standard. Comes complete with easy to follow manuals. UK Power Supply — Cassette Leads — Sample tapes. Special box to enable you to plug into your own TV. Recommended for first time-buyers. Just plug in and go. Full Range of Software Available

Interface to Centronics Parallel for TRS80 **£75.00 + VAT**



only **£295 + VAT**  
Expand your TRS80 by 32K. 32K Memory on board. Centronics parallel port. Disk controller card. Real time clock. Requires Level II Basic. Interface for 2 cassette decks. complete with power supply.

**TRS80 EXPANSION INTERFACE**

### NEW REDUCED PRICES

8K **£399**  
16K **£499**  
32K **£599**

+ VAT

RRP £795 for 32K

**The PEDIGREE PETS** Very popular for home & business use. 8K Microsoft Basic in ROM. 8K Pet 32K & 16K with new improved keyboard. All with green screen.

Cassette Deck **£55** extra Full range of software available. Interface PET IEEE — Centronics Parallel. Not decoded **£49.00 + VAT** Decoded **£77.00 + VAT**



## PRINTERS

**SPECIAL SCOOP GET YOURSELF A PRINTER FOR YOUR PET AND SAVE A FORTUNE**

only **£349 + VAT**

Full Pet Graphics including cables. Ready to go.

**EX-STOCK.**



RRP **£540**

only **£479 + VAT**

**ANADEX DP8000**

Super Quality — Low cost printer. Tractor Feed with full 96 ASCII character set. Accepts RS232C at band rates between 100 and 9600 and Parallel Bit data. Attaches either directly or through interfaces to Pet, Apple, TRS80, Sorcerer, Nascom, CompuKit etc.

## MONITORS

EXTENDED WARRANTY BY COMPU CARE



**video 100**  
12" BLACK & WHITE LOW COST VIDEO MONITOR

only **£79 + VAT**

- Ideal for home, personal and business computer systems
- 12" diagonal video monitor ● Composite video input
- Composite video input ● Compatible with many computer systems ● Solid-state circuitry for a stable & sharp picture ● Video bandwidth - 12MHz + 3dB ● Input impedance - 75 Ohms ● Resolution - 650 lines Minimum in Central 80% of CRT; 550 Lines Minimum beyond central 80%.

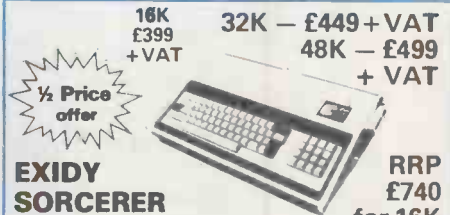

**EXIDY SORCERER**

RRP **£740 for 16K**

For Personal or Business Use  
16K, 32K or 48K memory. 8K Microsoft Basic in ROM. Dual Cassette I/O. RS232 I/O. Parallel I/O (Centronics). Expansion available through optional extra S100 Motherboard. 69 Key keyboard including 16 Key numeric pad.  
*Extended Warranty by COMPU CARE*

### WE ARE NOW STOCKING THE APPLE II EUROPLUS AT REDUCED PRICES



48K **£690**  
32K **£649**  
16K **£599**

+ VAT

Getting Started APPLE II is faster, smaller, and more powerful than its predecessors. And it's more fun to use too because of built-in features like:

- BASIC — The Language that Makes Programming Fun.
- High-Resolution Graphics (in a 54,000-Point Array) for Finely-Detailed Displays.
- Sound Capability that Brings Programs to Life.
- Hand Controls for Games and Other Human-Input Applications.
- Internal Memory Capacity of 48K Bytes of RAM, 12K Bytes of ROM; for Big-System Performance in a Small Package.
- Eight Accessory Expansion Slots to let the System Grow With Your Needs.

You don't need to be an expert to enjoy APPLE II. It is a complete, ready-to-run computer. Just connect it to a video display and start using programs (or writing your own) the first day. You'll find that its tutorial manuals help you make it your own personal problem solver.

### NEC SPINWRITER

only **£1599 + VAT**



NEC's high quality printer uses a print "thimble" that has less diameter and inertia than a daisy wheel, giving a quieter, faster, more reliable printer that can cope with plotting and printing (128 ASCII characters) with up to five copies, friction or tractor fed. The ribbon and thimble can be changed in seconds. 55 characters per second bidirectional printing — with red/black, bold, subscript, superscript, proportional spacing, tabbing, and much, much more.

### THE ATARI VIDEO COMPUTER GAMES SYSTEM

**£99.00 + VAT**

Atari's Video Computer System now offers more than 1300 different game variations and options in twenty great Game Program™ cartridges!

Have fun while you sharpen your mental and physical coordination. You can play rousing, challenging, sophisticated video games, the games that made Atari famous. You'll have thrill after thrill, whether you're in the thick of a dogfight, screaming around a racetrack, or dodging asteroids in an alien galaxy. With crisp bright colour (on colour TV) and incredible, true-to-life sound effects. With special circuits to protect your TV.

Most Cartridges only **£13.90 + VAT** Prices may vary with special editions  
Basic Maths, Airsea Battle, Black Jack, Breakout, Surround, Spacewar, Video Olympics, Outlaw, Basketball, Hunt & Score\*, Space War, Sky Diver, Air Sea Battle, Codebreaker\*, Miniature Golf.

Extra Paddle Controllers — **£14.90 + VAT**

\* Keyboard Controllers — **£16.90 + VAT**



**STOP PRESS SPACE INVADERS NOW IN STOCK £25 + VAT**

NOBODY CAN GET NEAR OUR PRICES EXCEPT OUR CUSTOMERS

## COMMERCIAL • EXPANDABLE • COMPLETE TRS 80 - MODEL II

EXTENDED WARRANTY BY COMPUKARE



This new unit from the world's most successful micro company is now available immediately with software.

The basic unit comes complete with 64 thousand characters (bytes) of Memory. The built in 8" Floppy disc adds another 1/2 million extra characters including the disc operating system. More disc expansion is now available.

The Model II is a complete unit with a full keyboard including a numeric pad and 12" screen which gives 24 lines of 80 characters. The computer is supplied with both the disc operating system and the Level III Basic.

A full self test routine is written into the power up procedure to eliminate incorrect operation. Both serial and parallel expansion sockets are standard. A printer is a plug-in operation.

Both hardware and software necessary to talk to a mainframe are included. Terminal usage is very possible. With the addition of CPM2 you can operate with COBOL, FORTRAN, MBASIC, CBASIC in which languages are many other applications packages i.e. accounting, payroll stock etc.

64K 1-Disk Model II **£1995.00** + VAT  
RRP £2250.00

CP/M2	<b>£95.00</b>
CIS COBOL	<b>£400.00</b>
C BASIC	<b>£75.00</b>
M BASIC	<b>£155.00</b>
FORTRAN	<b>£220.00</b>
WORDSTAR	<b>£255.00</b>

### 1 DISK EXPANSION Room for 3

500K per Drive gives total  
of 1.5M Byte — 1 Drive plus Cabinet **£799** + VAT

COMING SOON

26 megabyte  
Hard Disc  
multi-user  
DOS

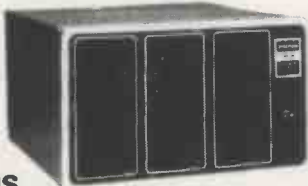

WE USE THIS  
MACHINE IN OUR BUSINESS

## COMPUKIT UK101 EUROPE'S FASTEST SELLING ONE BOARD COMPUTER



- ★ 6502 based system — best value for money on the market.
- ★ Powerful 8K Basic — Fastest around
- ★ Full Qwerty Keyboard
- ★ 4K RAM Expandable to 8K on board.
- ★ Power supply and RF Modulator on board.
- ★ No Extras needed — Plug-in and go.
- ★ Kansas City Tape Interface on board.
- ★ Free Sampler Tape including powerful Disassembler and Monitor with each Kit.
- ★ If you want to learn about Micros, but didn't know which machine to buy then **this is the machine for you.**

40 pin Expansion Jumper Cable for CompuKit expansion **£8.50** + VAT

Build, Understand and Program your own  
Computer for only a small outlay.

**KIT ONLY £179** + VAT  
**NO EXTRAS NEEDED**

The **CompuKit UK101** comes in kit form with all the parts necessary to be up and working, supplied. No extras are needed. After plugging in just press the reset keys and the whole world of computing is at your fingertips. Should you wish to work in the machine code of the 6502 then just press the M key and the machine will be ready to execute your commands and programmes. By pressing the C key the world of Basic is open to you. This machine is ideal to the computing student or Maths student, ideal to teach your children arithmetic, and is also great fun to use. Because of the enormous volume of users of this kit we are able to offer a **new reduced price of £179 + VAT**

Available ready assembled, tested & ready to go **£229** + VAT

**NEW MONITOR FOR  
COMPUKIT UK101** • In 2K Eprom 2716  
• Allows screen editing • Saves data on tape  
• Flashing cursor • Text scrolls down **£22.00** + VAT

## BITS & BYTES

8MHz Super Quality Modulators	<b>£4.90</b>
6MHz Standard Modulators	<b>£2.90</b>
C12 Computer Grade Cassettes	10 for <b>£4.00</b>
Anadex Printer Paper — 2000 sheets	<b>£25.00</b>
Floppy Discs 5 1/4" Hard and Soft Sectored	<b>£3.50</b>
Floppy Disc Library Case 5 1/4"	<b>£3.50</b>
Verocases for Nascom 1 & 2 etc.	<b>£24.90</b>
Keyboard Cases	<b>£9.90</b>

### FOR THE COMPUKIT

Assembler/Editor	<b>£14.90</b>
Screen Editor Tape	<b>£5.90</b>
<b>Game Packs</b>	
1. Four Games	<b>£5.00</b>
2. Four Games	<b>£5.00</b>
3. Three Games 8K only	<b>£5.00</b>
Space Invaders	<b>£5.00</b>
Chequers	<b>£3.00</b>
Real Time Clock	<b>£3.00</b>
Case for CompuKit	<b>£29.50</b>

All Prices exclusive VAT

EXTENDED WARRANTY BY COMPUKARE  
We give a full one year's warranty on all our products.

We now have in stock demonstration models of the Atari 800 and Texas 99/4.  
**COME AND SEE THEM**

### SPECIAL OFFER

We will part exchange your Sinclair ZX80 for any of our products.

Refurbished ZX80's—fully guaranteed **£69.90** + VAT  
(Supply dependant upon stocks).



We have one of the largest collections of Computer Books under one roof, along with racks of software for the PET and TRS80.

**COME AND SEE FOR YOURSELF**

### NEW TV GAME BREAK OUT

Has got to be one of the world's greatest TV games. You really get hooked. As featured in ETI. Has also 4 other pinball games and lots of options. Good kit for up-grading old amusement games.  
**MINI KIT** — PCB, sound & vision modulator, memory chip and de-code chip. Very simple to construct. **£14.90** + VAT  
**OR** PCB **£2.90** MAIN LSI **£8.50** Both plus VAT



"Europe's Largest Discount Personal Computer Store"

Please add VAT to all prices — including delivery. Please make cheques and postal orders payable to **COMPSHOP LTD.**, or phone your order quoting **BARCLAYCARD, ACCESS, DINERS CLUB** or **AMERICAN EXPRESS** number.  
**CREDIT FACILITIES ARRANGED** — send S.A.E. for application form.

14 Station Road, New Barnet, Hertfordshire, EN5 1QW Telex: 298755 TELCOM G  
Telephone: 01-441 2922 (Sales) 01-449 6596

OPEN · 10 am · 7 pm — Monday to Saturday  
Close to New Barnet BR Station — Moorgate Line.

★ **NOW IN IRELAND** at: 80 Marlborough St., Dublin 1. Tel: Dublin 749933  
★ **COMPSHOP USA**, 1348 East Edinger, Santa Ana, California, Zip Code 92705.  
Telephone: 0101 714 5472526

**COMP** COMPUTER COMPONENTS  
(Part of the Compshop Ltd. Group)



# At Intersystems, "dump" is an instruction.

## Not a way of life.

(Or, when you're ready for IEEE S-100, will your computer be ready for you?)



We're about to be gadflies again.

While everyone's been busy trying to convince you that large buses housed in strong metal boxes will guarantee versatility and ward off obsolescence, we've been busy with something better. Solving the *real* problem with the first line of computer products *built from the ground up to conform to the new IEEE S-100 Bus Standard*. Offering you extra versatility in 8-bit applications today. And a full 16 bits tomorrow.

We call our new line Series II™. And even if you don't need the full 24-bit address for up to 16 megabytes (!) of memory right now, they're something to think about. Because of all the perform-

ance, flexibility and economy they offer. Whether you're looking at a new mainframe, expanding your present one or upgrading your system with an eye to the future. (Series II boards are compatible with most existing S-100 systems and *all* IEEE S-100 Standard cards as other manufacturers get around to building them.)

Consider some of the features: Reliable operation to 4MHz and beyond. Full compatibility with 8- and 16-bit CPUs, peripherals and other devices. *Eight* levels of prioritized interrupts. Up to 16 individually-addressable DMA devices, with IEEE Standard overlapped operation. User-selectable functions addressed by DIP-switch or jumpers, eliminating soldering. And that's just for openers.

The best part is that all this heady stuff is available *now!* In our advanced processor—a full IEEE Bus Master featuring Memory Map™ addressing to a full megabyte. Our fast, flexible 16K Static RAM and 64K Dynamic RAM boards. An incredibly versatile and

economical 2-serial, 4-parallel Multiple I/O board. 8-bit A/D-D/A converter. Our Double-Density High-Speed Disk Controller. And what is undoubtedly the most flexible front panel in the business. Everything you need for a complete IEEE S-100 system. Available separately, or all together in our new DPS-1 Mainframe!

Whatever your needs, why dump your money into obsolete products labelled "IEEE timing compatible" or other words people use to make up for a lack of product. See the future now, at your Intersystems dealer or call/write for our new catalog. We'll tell you all about Series II and the new IEEE S-100 Bus we helped pioneer. Because it doesn't make sense to buy yesterday's products when tomorrow's are already here.

## InterSystems™

Ithaca Intersystems,  
58 Crouch Hall Road,  
London, N8 8HG. U.K.  
Telephone: 01-341-2447/Telex: 299568

