

12

DOCUMENT 370-83

BARKING SANDS, HAWAII

RANGE REFERENCE ATMOSPHERE
0-70 KM ALTITUDE

DECEMBER 1983

METEOROLOGY GROUP
RANGE COMMANDERS COUNCIL

WHITE SANDS MISSILE RANGE
KWAJALEIN MISSILE RANGE
YUMA PROVING GROUND

PACIFIC MISSILE TEST CENTER
NAVAL WEAPONS CENTER
ATLANTIC FLEET WEAPONS TRAINING FACILITY
NAVAL AIR TEST CENTER

EASTERN SPACE AND MISSILE CENTER
ARMAMENT DIVISION
WESTERN SPACE AND MISSILE CENTER
AIR FORCE SATELLITE CONTROL FACILITY
AIR FORCE FLIGHT TEST CENTER
AIR FORCE TACTICAL FIGHTER WEAPONS CENTER

DTIC
SERIALIZED
FEB 01 1984
E

AD A 137406

MG

DTIC FILE COPY

This document is approved
for public release, its
distribution is unlimited.

84 01 31 092

REPORT DOCUMENTATION PAGE		READ INSTRUCTIONS BEFORE COMPLETING FORM
1. REPORT NUMBER DOCUMENT 370-83	2. GOVT ACCESSION NO.	3. RECIPIENT'S CATALOG NUMBER
4. TITLE (and Subtitle) "Barking Sands, Hawaii, Range Reference Atmosphere, 0-70 Km Altitude"		5. TYPE OF REPORT & PERIOD COVERED
		6. PERFORMING ORG. REPORT NUMBER
7. AUTHOR(s) Meteorology Group Range Commanders Council White Sands Missile Range, NM 88002		8. CONTRACT OR GRANT NUMBER(s)
9. PERFORMING ORGANIZATION NAME AND ADDRESS Same as Block 7.		10. PROGRAM ELEMENT, PROJECT, TASK AREA & WORK UNIT NUMBERS
11. CONTROLLING OFFICE NAME AND ADDRESS Range Commanders Council ATTN: STEWS-SA-R White Sands Missile Range, NM 88002		12. REPORT DATE December 1983
		13. NUMBER OF PAGES 201
14. MONITORING AGENCY NAME & ADDRESS (if different from Controlling Office) Same as block 11.		15. SECURITY CLASS. (of this report) UNCLASSIFIED
		15a. DECLASSIFICATION/DOWNGRADING SCHEDULE
16. DISTRIBUTION STATEMENT (of this Report) Approved for Public Release; Distribution Unlimited.		
17. DISTRIBUTION STATEMENT (of the abstract entered in Block 20, if different from Report)		
18. SUPPLEMENTARY NOTES Supersedes Document 104-63, "Lihue, Kauai, Hawaii, Part 1" AD782653.		
19. KEY WORDS (Continue on reverse side if necessary and identify by block number) Range reference atmosphere, data quality control, coordinate system, computa- tion of statistical parameters, statistical models, orthogonal axes, thermo- dynamic quantities, data samples, altitude levels, derived monthly mean, annual mean model atmospheres.		
20. ABSTRACT (Continue on reverse side if necessary and identify by block number) FOREWORD -see attached.		

DOCUMENT 370-83

BARKING SANDS, HAWAII

**RANGE REFERENCE ATMOSPHERE
0-70 KM ALTITUDE**

December 1983

Prepared by

**Range Reference Atmosphere Committee
Meteorology Group
Range Commanders Council**

Published by

**Secretariat
Range Commanders Council
White Sands Missile Range, New Mexico 88002**

APPROVED FOR PUBLIC RELEASE: DISTRIBUTION UNLIMITED

TABLE OF CONTENTS

	<u>PAGE</u>
LIST OF ORGANIZATION ACRONYMS	v
FOREWORD	vii
CHAPTER I. INTRODUCTION	1
A. Definition and Purpose of the Range Reference Atmosphere	1
B. Scope of the Range Reference Atmosphere and Arrangement of Tables.	1
C. Data Quality Control Procedures.	2
D. Organization of the Chapters	3
CHAPTER II. WIND STATISTICS AND MODELS.	5
A. General Considerations	5
B. Coordinate System and Computation of Statistical Parameters	8
C. Statistical Wind Models.	10
D. Statistical Parameters With Respect to Any Orthogonal Axes	25
CHAPTER III. STATISTICS OF THERMODYNAMIC QUANTITIES AND MODELS	29
A. General Considerations	29
B. Establishing Data Samples at the Required Altitude Levels.	32
C. Computation of Statistical Parameters for Tables II and III.	36
D. Derived Monthly Mean and Annual Mean Model Atmospheres.	39
E. Thermodynamic Quantities Derivable from the Basic Tables.	40
CHAPTER IV. CONCLUSIONS AND RECOMMENDATIONS	47
REFERENCES	49
CONVERSION UNITS	53
APPENDIX A	109
APPENDIX B	175

LIST OF ORGANIZATION ACRONYMS

AD Armament Division

AFFTC Air Force Flight Test Center

AFSC Air Force Systems Command

AFSC/AFGL AFSC/Air Force Geophysics Laboratory

AFSC/SD AFSC/Space Division

AFSCF Air Force Satellite Control Facility

AFTFWC Air Force Tactical Fighter Weapons Center

AWS Air Weather Service

BMD Ballistic Missile Division

DOD Department of Defense

DOE Department of Energy

DOE/NTS DOE/Nevada Test Site

DPG Dugway Proving Ground

ESMC Eastern Space and Missile Center

ETR Eastern Test Range

KMR Kwajalein Missile Range

NASA National Aeronautics and Space Administration

NASA/MSFC NASA/Marshall Space Flight Center

NASA/WFC NASA/Wallops Flight Center

NOAA National Oceanic and Atmospheric Administration

NWC Naval Weapons Center

PMTC Pacific Missile Test Center

USA/DTC U.S. Army/Deseret Test Center

USAECOM U.S. Army Electronics Command

USAFETAC United States Air Force Environmental Technical Applications Center



Accession For	
NTIS GRA&I	<input checked="" type="checkbox"/>
DTIC TAB	<input type="checkbox"/>
Unannounced	<input type="checkbox"/>
Justification	
By	
Distribution/	
Availability Codes	
Dist	Avail and/or Special
A-1	

UTTR	Utah Test and Training Range
WSMC	Western Space and Missile Center
WSMR	White Sands Missile Range
WTR	Western Test Range
YPG	Yuma Proving Ground
6585TG	6585th Test Group
TSCF	Targeting Systems Characterization Facility

FOREWORD

Atmospheric parameters are essential to the research and development of missiles and aerospace vehicles. In the early 1960's, the need was recognized for realistic atmospheric models derived in a consistent manner for each of the several major test ranges. An atmospheric model derived from statistical data for a particular geographical location is referred to as a reference atmosphere.

The first Range Reference Atmosphere (RRA) was issued in 1963 by the Inter-Range Instrumentation Group (IRIG) for Cape Kennedy, Florida, and was followed by additional publications for several ranges up to 1974. Since that time, improved upper air data bases have become available from which to develop the RRA. These resulted from the extended period of records and from improvement in the upper air measuring program by rocketsondes for altitudes above the rawinsonde ceiling of 30 km. Revised and improved RRAs are justified for the following reasons:

- 1) Needs for more definitive statistical atmospheric models have arisen because of changes and advances in aerospace technology. The Space Transportation System (Space Shuttle) is one example.
- 2) Most ranges now have an extended and improved upper air data base from which to develop a more definitive RRA.
- 3) There are requirements for RRAs for new ranges and range sites.
- 4) There have been scientific advances in understanding the upper atmospheric structure and physical relationships.
- 5) Advances in statistical modeling techniques have been made because of the general availability of high-speed electronic computers. These have led to the adoption of advanced concepts in atmospheric modeling.

For these reasons, the Range Reference Atmosphere Committee (RRAC) was tasked by the Range Commanders Council Meteorology Group (RCC MG) to establish new and improved RRAs. The purpose, scope, and objectives of this task are outlined in the following paragraphs.

Purpose: This committee, Task MG-1, establishes RRAs for the several ranges as provided by the RCC. An RRA is a model of the Earth's atmosphere over a geographical location of interest, for use by DOD and other U.S. Government range users. The RRA is used to provide planning data for evaluating environmental constraints for the particular configurations of environment-sensitive systems and components being developed or undergoing tests.

Scope: Using the best available upper atmosphere data base to include rawinsonde, rocketsonde and possibly other high-altitude data sources for the range location, the task is to establish a model of certain statistics for wind and thermodynamic quantities derived in a uniform manner and published in a standardized format.

Objectives: The wind statistics shall be, insofar as practical, modeled to be consistent with rigorous mathematical probability properties of the multivariate normal probability theory. The thermodynamic quantities statistics shall be, insofar as practical, modeled to be consistent with the hydrostatic equation, the equation of state, and the probability principles that are related through these physical equations. The document shall serve as an authoritative source of information and as an atmospheric model for a particular range. The first in the series of revised RRAs to be published is for Kwajalein Missile Range (KMR) (publication date December 1982). The altitude range required for KMR is 0 to 70 km. The order of priority for the subsequent publications is:

<u>Range</u>	<u>Altitude Range Required</u>
1. AFFTC/Edwards AFB, CA	0 - 70 km ^a
2. ESMC/Cape Canaveral AFS, FL	0 - 70 km
3. WSMC/Vandenberg AFB, CA	0 - 70 km ^a
4. WSMR/White Sands, NM	0 - 70 km
5. PMTC/Point Mugu, CA	0 - 70 km
6. UTTR/Dugway (Michael AAF), UT	0 - 30 km ^b
7. AD/Eglin AFB, FL	0 - 30 km
8. ESMC/Ascension Island	0 - 70 km (Terminates at 66 km because of insufficient data)
9. NASA/Wallops Flight Center, VA	0 - 70 km
10. Taquac (Guam)	0 - 30 km
11. PMTC/Barking Sands, HI	0 - 70 km

In keeping with the RCC's objective of standardization, the modeling techniques, basic text, and tabulation format are to be the same for all RRAs. These new and revised RRAs present not only the mean values of the thermodynamic quantities (pressure, temperature, virtual temperature, and density), but also include statistical measures for the dispersion (i.e., standard deviations and skewness coefficients). New quantities presented are water vapor pressure and dewpoint temperature. The statistical modeling for the wind is entirely new. The new approach uses the properties of the bivariate normal probability distribution function.

- a. Use rocketsonde data from PMTC/Point Mugu for altitudes above 30 km.
 b. Consider augmenting data base from Ely or Salt Lake City.

All final computations were performed by the United States Air Force Environmental Technical Applications Center (USAFETAC) in response to a task from Eastern Space and Missile Center (ESMC).

The text was prepared jointly by USAFETAC and the NASA/George C. Marshall Space Flight Center's Space Sciences Laboratory, Atmospheric Sciences Division. The editing and preparation of the draft manuscript were performed by the NASA/MSFC organization.

The cochairmen express their gratitude to all RRAC members and their respective colleagues who have made significant technical contributions to the establishment of these RRAs.

Special thanks are tendered to Lt. B. Novograd for his diligence in forming the many computations and the development of the primary tables, I through IV. Special thanks goes to Lt. F. Wirsing for editing and formulating the equations for the derivable thermodynamic equations. These gentlemen performed this outstanding work under the direction of Major B. Lilius, USAFETAC.

Grateful acknowledgment goes to Mrs. Annette Tingle, NASA/MSFC, for editing the draft manuscript.

The RRAC consists of representatives from the U.S. Air Force, U.S. Army, National Aeronautics and Space Administration, U.S. Navy, and National Oceanic and Atmospheric Administration. The committee members for the RRA for the first publication are:

G. G. Boire, WSMC
O. H. Daniel, ESMC
R. de Violini, PMTC
F. G. Finger, NOAA/NWS
E. E. Fisher, HQ AFSC
B. R. Hixon, PMTC
J. M. Hobbie, KMR
E. J. Keppel, AD
S. F. Kubinski, WSMR
F. J. Schmidlin, NASA/WFC

O. E. Smith
Cochairman, NASA/MSFC

Maj. B. W. Galusha
Cochairman, USAF/ETAC

CHAPTER I. INTRODUCTION

A. Definition and Purpose of the Range Reference Atmosphere

A.1 Definition

A reference atmosphere is a statistical model of the Earth's atmosphere derived from upper air measurements over a particular geographical location. Hence, these Range Reference Atmospheres (RRAs) are atmospheric models developed by the Range Reference Atmosphere Committee (RRAC) in response to a task by the Range Commanders Council Meteorology Group (RCC MG) and published by the RCC Secretariat. The RCC MG, formerly called the Inter-Range Instrumentation Group/Meteorology Working Group (IRIG/MWG), published a series of RRAs during the period 1963 through 1974.

A.2 Purpose

A series of revised and expanded RRAs are to be published for locations of interest to the RCC. These publications are to serve as authoritative reference sources on certain upper air statistics and as atmospheric models for particular range sites. The technical usefulness of these documents for the ranges, range users, U.S. aerospace industries, and the scientific community is recognized because of the standardization of the development techniques and the presentation of the tabulations.

B. Scope of the Range Reference Atmosphere and Arrangement of Tables

B.1 Scope

The RRA contains tabulations for monthly and annual means, standard deviations, and skewness coefficients for windspeed, pressure, temperature, density, water vapor pressure, virtual temperature, and dewpoint temperature; the means and standard deviations for the zonal (U) and meridional (V) wind components; and the linear (product moment) correlation coefficient between the wind components. These statistical parameters are tabulated at the station elevation, at 1-km intervals from sea level to 30 km, and at 2-km intervals from 30 to 90 km. The wind statistics are given at approximately 10 m above the station elevations and at altitudes with respect to mean sea level thereafter. For those range sites without rocketsonde measurements, the RRAs terminate at 30 km altitude, or they are extended, if required, when rocketsonde data from a nearby launch site are available. There are four sets of tables for each of the 12 monthly reference periods and the annual reference period.

B.2 Arrangement of Tables

The statistical parameters for the RRA models are presented in four tables, as outlined in the following paragraphs.

Table I contains all the wind statistical parameters. This table gives the monthly and annual means and standard deviations of the U and V wind components and the linear (product moment) correlation coefficient between these

two components; the mean, standard deviation and skewness coefficient of the windspeed; and the number of wind observations (sample size).

Table II contains the monthly and annual means, standard deviations, and skewness values of pressure, temperature, and density, and the number of observations used for each of these thermodynamic quantities.

Table III contains the monthly and annual means, standard deviations and skewness values of the water vapor pressure, virtual temperature and dewpoint, and the number of observations for each of these moisture-related quantities. The statistical parameters for water vapor pressure and dewpoint terminate at 15 km altitude. Above 15 km the statistical parameters for virtual temperature are considered to be the same as those for temperature.

Table IV contains the monthly and annual mean atmospheric models for the thermodynamic variables: pressure, virtual temperature, and density. This table is derived from the monthly and annual mean virtual temperature versus altitude (geometric) using the hydrostatic equation and the equation of state. Also presented is the geopotential height corresponding to the tabulated geometric altitudes.

The physical unit for all wind parameters is meters per second. The physical unit for pressure is millibars; for temperature and virtual temperature, degrees Kelvin; for density, grams per cubic meter; and for water vapor pressure, millibars. In all cases the skewness coefficient and the correlation coefficient between wind components are unitless. All reference to altitude is geometric altitude and is expressed in kilometers. All reference to height is geopotential height and has the unit geopotential meters or kilometers. All geometric altitudes and geopotential heights are with respect to mean sea level.

C. Data Quality Control Procedures

A small portion (less than 10 percent) of the soundings in the data base used to calculate the RRA tables contained erroneous data values. The soundings which contained these erroneous values were eliminated from the data base using the following procedures:

- 1) Soundings containing gaps in their height data greater than 200 mb were rejected. This step was taken because some soundings only contained height values at their "mandatory" pressure levels, which were occasionally missing, resulting in soundings with no height information at all.

- 2) An initial set of RRA statistics was computed using all the remaining soundings. This initial set of statistics was used to determine data limits for the temperature, pressure, U and V components of the wind, and the dewpoint (for the 0- to 30-km portion of the RRA) or the density (for the 30- to 90-km portion of the RRA). The lower (upper) data limits were set at the mean value for a specific parameter, minus (plus) six standard deviations of that quantity. One pair of data limits was computed for each of these parameters: month of the year and data level.

3) This initial set of data limits was then used to screen the data base. All the soundings that contained values outside these data limits were rejected. A new RRA was then computed using the screened data base. This second RRA was used to generate a second set of data limits.

4) The second set of data limits was then used to screen the data base further. A new RRA was again generated. The skewness values in this RRA were then evaluated, according to empirical criteria specified in section II.A.3 of this document for the winds, and according to criteria in section III.A.3 for the thermodynamic quantities. If these criteria were satisfied, the new RRA was then used to generate a final set of data limits, which were used to control the quality of the data base for the final version of the RRA.

5) Occasionally, the third RRA that was generated did not satisfy all of the skewness criteria. This indicated that some incorrect values were still present in the data base. To complete quality control, steps 3 and 4 were repeated for additional iterations (usually one or two) until the resulting RRA satisfied the skewness criteria. At that point, a final set of data limits was generated. This final set of data limits was then used to control the quality of the data base and generate the final RRA.

D. Organization of the Chapters

Because there are plans to publish a series of RRAs, comments on the special organization of the document are in order. The RRA document is arranged in four chapters. Chapter I is the introduction. Chapter II, Wind Statistics and Models, contains the techniques used to arrive at the wind statistical parameters, table I, and the probability functions that are to be used as wind models to derive several wind statistics. Chapter III, Statistics of Thermodynamic Quantities and Models, contains the techniques used to arrive at the thermodynamic and moisture-related statistical parameters given in tables II and III and the atmospheric thermodynamic model presented in table IV. This chapter also contains sets of equations to calculate several atmospheric properties. Chapter IV contains the general conclusions and recommendations. These four chapters are reprinted without change for each documented RRA to assure consistency and for expediency in preparing the documentation. To account for variations particular to a specific RRA, two appendixes have been included. Appendix A, Examples of Wind Statistics, is designed to give a few illustrative examples of wind statistics for the specific RRA and cursory observations, comparisons, or comments on wind statistics. Appendix B, Range Specific Information, is designed to present specific information particular to the range, such as geographical location, data base, etc., and any cursory observations or comments on the thermodynamic quantities.

Read these appendixes! They are located as the last two units in the document because they may vary in length depending on the circumstances. Appendixes A and B and tables I, II, III, and IV are the only differences among the RRA documents published in this new RRA series.

CHAPTER II. WIND STATISTICS AND MODELS

A. General Considerations

A.1. Objectives

An objective of the RRA is to furnish minimum tabulation for the wind statistics. To meet this objective, the bivariate normal probability distribution was adopted as a statistical model for the wind treated as a vector quantity at the RRA data levels. Only five statistical parameters are required to completely describe this probability function. In Cartesian coordinates these parameters are the means and standard deviations of the two orthogonal components and the correlation coefficient between the two components. These five statistical parameters for the U and V (meteorological coordinates) components are given in table I. The statistical properties of the bivariate normal probability distribution are used to derive many wind statistics that are of interest to the ranges and range users. This procedure produces consistent wind statistics that are connected through rigorous mathematical probability functions. By using these functions, extensive tabulations of wind statistics are avoided.

The statistical properties of the bivariate normal probability distribution presented for the vector wind statistical model are:

- 1) The wind components are univariate normally distributed.
- 2) The conditional distribution of one component given a value of the other component is univariate normally distributed.
- 3) The windspeed is of the form of a generalized Rayleigh distribution.
- 4) The frequency distribution of wind direction can be derived.
- 5) The conditional distribution of windspeed given a value of wind direction (wind rose) can be derived.
- 6) The five tabulated wind statistical parameters with respect to the meteorological U and V coordinate system can be derived for any arbitrary rotation of the orthogonal axes.

The probability distribution functions and sets of equations to derive wind statistics for the previously stated properties of the vector wind model are presented in this chapter. Symbols used are summarized in table A. Illustrative examples are presented in appendix A. No attempt is made to give the derivation of the probability functions. The reader is referred to Smith (1976) for some derivations and several applications of the probability distribution properties for wind statistics.

A.2. Data Quality Control

The U and V components of the wind were used to generate data limits set at plus and minus six standard deviations from the mean for each of the

TABLE A. LIST OF SYMBOLS USED IN CHAPTER II

N	- The number of wind measurements in table I
r	- A general variable for the bivariate normal probability distribution in polar coordinates
R	- A generalized Rayleigh variable used for derived windspeed probability distribution
R (U, V)	- The linear (product moment) correlation coefficient between the zonal and meridional wind components in table I
SK (W)	- Skewness parameter for windspeed in table I
S (U)	- The standard deviation of the zonal wind component in table I
S (V)	- The standard deviation of the meridional wind component in table I
S (W)	- The standard deviation of windspeed in table I
t	- A standardized normal variate used in text table B
U	- The zonal wind component
UBAR	- The mean value of the zonal wind component in table I
V	- The meridional wind component
VBAR	- The mean value of the meridional wind component in table I
W	- Windspeed or modulus of wind vector, a scalar quantity
WBAR	- The mean value of windspeed in table I
X	- A general component variable or coordinate axis
Y	- A general component variable or coordinate axis
\bar{X}	- A general component mean value in the [x,y] coordinate system
\bar{Y}	- A general component mean value in the [x,y] coordinate system
α (alpha)	- Rotation angle for the [x,y] coordinate system

TABLE A. (concluded)

θ (theta) - Wind direction in the polar coordinate system

λ () (Lambda) - A parameter in the bivariate normal probability distribution in text table C

ξ (Xi) - The mean value in the standardized normal probability distribution used in text table B

π (Pi) - Constant = 3.14159 ...

ρ (Rho) - The general linear correlation coefficient between the two component variables in the [x,y] coordinate system

σ_x, σ_y - The general standard deviations of the x and y component variables in the [x,y] coordinate system.

quantities. These data limits were used to screen the wind data base, as described in section I.C. The data base was considered to be free from errors under the following conditions:

1) The skewness of the windspeed was below 4.0 at data levels where the mean windspeed was less than 15 m/s, and

2) The skewness of the windspeed was below 2.5 at data levels where the mean windspeed was greater than 15 m/s.

A.3 Limitations

For the wind statistics, the correlation coefficients for like wind components and unlike wind components between altitude levels were not computed. Therefore, wind statistics with respect to altitude (profile) cannot be derived from the RRA statistics. For wind profile modeling techniques the user is referred to Smith (1976). However, the wind statistics at discrete altitudes are valid; all of the probability distribution functions given in chapter II can be derived from the five wind component statistical parameters contained in table I, and the derived distributions can be considered as wind models at discrete altitudes.

By convention, in the statistical literature Greek letters are used for population or theoretically known parameters, and sample estimates are denoted by English alphabetical letters or with a "hat" (^) over the Greek letters. In chapter II Greek letters are used for the variances and the linear correlation coefficient, and the means are denoted by \bar{X} and \bar{Y} when dealing with the bivariate normal distribution. It will always be understood that table I contains sample estimates of the statistical parameters and they are with respect to the meteorological U and V coordinate system.

B. Coordinate System and Computation of Statistical Parameters

B.1. Coordinate System

Wind measurements are recorded in terms of magnitude and direction. The wind direction is measured in degrees clockwise from true north and is the direction from which the wind is blowing. The wind magnitude (the modulus of the vector) is the scalar quantity and is referred to as windspeed or scalar wind. A statistical description that accounts for the wind as a vector quantity is appropriate and requires a coordinate system.

For the RRA the standard meteorological coordinate system has been chosen for the wind statistics, all tables of statistical parameters, and related discussions because the coordinate system used in aerospace and related applied fields has not always been consistent.

Using figure 1, the polar and Cartesian forms for the meteorological coordinate system are defined:

W = windspeed, scalar wind, or magnitude of the wind vector in meters per second.

θ = wind direction. θ is measured in degrees clockwise from true north and is the direction from which the wind is blowing.

U = zonal wind component, positive west to east, in meters per second.

V = meridional wind component, positive south to north, in meters per second.

The components θ and W define the polar form, and the U-V components define the Cartesian forms:

$$U = -W \sin\theta, \quad 0 \leq \theta \leq 360^\circ \quad (1)$$

$$V = -W \cos\theta. \quad (2)$$

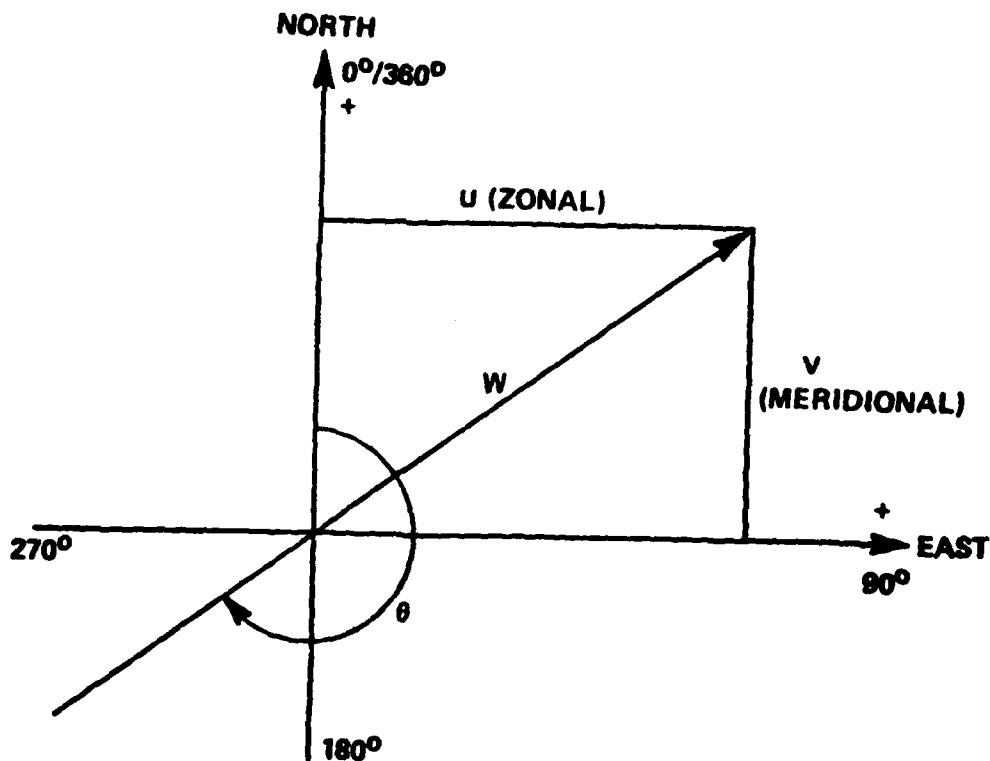

Figure 1. The meteorological coordinate system.

It is helpful to note the difference between the mathematical convention for a vector direction and the meteorological convention for wind direction:

$$\theta \text{ met} = 270 - \theta \text{ math} \quad (3)$$

when $0 \leq \theta \text{ math} \leq 270^\circ$

$$\theta \text{ met} = 360 + (270 - \theta \text{ math})$$

when $270 \leq \theta \text{ math} \leq 360^\circ$

B.2 Computation of Statistical Parameters

The wind statistical parameters in table I for the means and standard deviations of the U and V wind components and windspeed and the skewness parameter of windspeed were computed using the sums technique presented in chapter III.C.3. In addition, the linear (product moment) correlation coefficient between the U and V wind components, $r(u,v)$ in table I, was computed. This correlation coefficient is defined as

$$r(u,v) = \frac{\sum_{i=1}^n (U_i - \bar{U})(V_i - \bar{V})}{N s(u) \cdot s(v)} \quad (4)$$

These statistical parameters are with respect to the Standard Meteorological Coordinate System.

C. Statistical Wind Models

C.1. Wind Component Statistics

The univariate normal (Gaussian) probability distribution function is used to obtain wind component statistics. In generalized notations, this probability density function (pdf) is

$$f(t) = \frac{e^{-\frac{t^2}{2}}}{\sqrt{2\pi}} \quad (5)$$

where $t = (X - \xi) / \sigma_x$ is the standardized variate, with ξ defining the mean and σ_x the standard deviation. The probability distribution function (PDF) is

$$F(X) = \int_{-\infty}^X f(t) dt \quad (6)$$

Because this integral cannot be obtained in closed form, it is widely tabulated for zero mean and unit standard deviation. For a convenient reference for the RRA, selected values of $F(X)$ are given in table B. To emphasize the connotation of probability, $F(X)$ is shown in table B as $P\{X\}$. The t values in table B are used as multiplier factors to the standard deviation to express the probability that a normally distributed variable, X , is less than or equal to a given value as

$$P\{X \leq \text{mean} + t \sigma_x\} = \text{probability, } p \quad (7)$$

For example, when $t = 1.6449$, the probability that X is less than or equal to the mean plus 1.6449 standard deviations is 0.95. That value of X that is less than or equal to the mean plus 1.6449 standard deviations is called the 95th percentile value of X . Also given in table B are the numerical values to express the probability that X falls in the interval X_1 and X_2 ; i.e.,

$$P\{X_1 \leq X \leq X_2\} = \text{Interpercentile Range} \quad (8)$$

where

$$\begin{aligned} X_1 &= \bar{X} - t \sigma_x \\ X_2 &= \bar{X} + t \sigma_x \end{aligned}$$

For $t = 1.9602$ the probability that X lies in the interval X_1 and X_2 is 0.95. The values of X_1 and X_2 in this example comprise the 95th interpercentile range.

For a normally distributed variable, the mode (most frequent value) and the median (50th percentile value) are the same as the mean value. The means and standard deviations of the U and V wind components from table 1 are used in equations (7) and (8) to compute the percentile values and interpercentile ranges of the U and V wind components. When equation (7) is illustrated on a normal probability graph, a straight line is formed.

C.2. The Vector Wind Model

Because wind is a vector quantity having direction and magnitude that can be expressed as two components in an orthogonal coordinate system, a probability model that describes the joint relationship is the bivariate normal probability distribution. In general component notation, the bivariate normal probability density function (BNpdf) is

TABLE B. VALUES OF t FOR STANDARDIZED NORMAL
(UNIVARIATE) DISTRIBUTION FOR PERCENTILES
AND INTERPERCENTILE RANGES

t	$P(X)$	X	$P\{X_1 \leq X \leq X_2\}$ (%)
-3.0000	0.00135	$\xi - 3.0000 \sigma$	
-2.5758	0.00500	$\xi - 2.5758 \sigma$	
-2.3263	0.01000	$\xi - 2.3263 \sigma$	
-2.2365	0.01266	$\xi - 2.2365 \sigma$	
-2.0000	0.02275	$\xi - 2.0000 \sigma$	
-1.9602	0.02500	$\xi - 1.9602 \sigma$	
-1.6449	0.05000	$\xi - 1.6449 \sigma$	
-1.2816	0.10000	$\xi - 1.2816 \sigma$	
-1.0000	0.15866	$\xi - 1.0000 \sigma$	
-0.8416	0.20000	$\xi - 0.8416 \sigma$	
-0.6745	0.25000	$\xi - 0.6745 \sigma$	
-0.2533	0.40000	$\xi - 0.2533 \sigma$	
0.0000	0.50000	ξ	
0.2533	0.60000	$\xi + 0.2533 \sigma$	
0.6745	0.75000	$\xi + 0.6745 \sigma$	
0.8416	0.80000	$\xi + 0.8614 \sigma$	
1.0000	0.84134	$\xi + 1.0000 \sigma$	
1.2816	0.90000	$\xi + 1.2816 \sigma$	
1.6449	0.95000	$\xi + 1.6449 \sigma$	
1.9602	0.97502	$\xi + 1.9602 \sigma$	
2.0000	0.97725	$\xi + 2.0000 \sigma$	
2.2365	0.98734	$\xi + 2.2365 \sigma$	
2.3263	0.99000	$\xi + 2.3263 \sigma$	
2.5758	0.99500	$\xi + 2.5758 \sigma$	
3.0000	0.99865	$\xi + 3.0000 \sigma$	

where $X_1 = \xi - t\sigma$
 and $X_2 = \xi + t\sigma$

$$f(X,Y) = \frac{1}{2\pi\sigma_x\sigma_y\sqrt{1-\rho^2}} \left[\exp \frac{-1}{2(1-\rho^2)} \left\{ \frac{(X-\bar{X})^2}{\sigma_x^2} - \frac{2\rho(X-\bar{X})(Y-\bar{Y})}{\sigma_x\sigma_y} + \frac{(Y-\bar{Y})^2}{\sigma_y^2} \right\} \right] \quad -\infty \leq X \leq \infty \text{ and} \\ -\infty \leq Y \leq \infty \quad , \quad (9)$$

where the five parameters are \bar{x}, \bar{y} , the component means; σ_x, σ_y , the component standard deviations; and ρ , the correlation coefficient between the two component variables, X and Y .

For many applications the interest is in determining the probability that a point $\{X, Y\}$ will fall within a contour of equal probability density. The exponential terms of equation (9), when set equal to a constant, λ^2 , give a family of ellipses depending on the value of the constant. The ellipses have a common center at the point $\{\bar{X}, \bar{Y}\}$. Integration of equation (9) over the region bounded by the contours of equal probability density gives

$$P(\lambda) = 1 - e^{\frac{-\lambda^2}{2(1-\rho^2)}} \quad (10)$$

Solving for λ^2 and replacing $P(\lambda)$ by p gives

$$\lambda^2 = -2(1-\rho^2) \ln(1-p) \quad (11)$$

Now define

$$\lambda_e = \sqrt{2} \sqrt{-\ln(1-p)} \quad (12)$$

For ready reference and comparisons, λ_e is shown in table C for selected values of p .

TABLE C. VALUES OF λ FOR BIVARIATE NORMAL
DISBRIBUTION ELLIPSES AND CIRCLES

P(%)	λ_e (ellipse)	λ_c (circle)	P(%)	λ_e (ellipse)	λ_c (circle)
0.000	0.0000	0.0000	65.000	1.4490	1.0246
5.000	0.3203	0.2265	68.268	1.5151	1.0713
10.000	0.4590	0.3246	70.000	1.5518	1.0973
15.000	0.5701	0.4031	75.000	1.6651	1.1774
20.000	0.6680	0.4723	80.000	1.7941	1.2686
25.000	0.7585	0.5363	85.000	1.9479	1.3774
30.000	0.8446	0.5972	86.466	2.0000	1.4142
35.000	0.9282	0.6563	90.000	2.1460	1.5175
39.347	1.0000	0.7071	95.000	2.4477	1.7308
40.000	1.0108	0.7147	95.450	2.4860	1.7579
45.000	1.0935	0.7732	98.000	2.7971	1.9778
50.000	1.1774	0.8325	98.168	2.8284	2.0000
54.406	1.2533	0.8862	98.889	3.0000	2.1213
55.000	1.2637	0.8936	99.000	3.0348	2.1460
60.000	1.3537	0.9572	99.730	3.4393	2.4320
63.212	1.4142	1.0000	99.9877	4.2426	3.0000

$$\lambda_e = \sqrt{2} \sqrt{-\ln(1-P)}$$

$$\lambda_c = \sqrt{-\ln(1-P)}$$

The probability ellipse that contains p-percent of the wind vectors expressed in the most general form is the conic defined by

$$AX^2 + BXY + CY^2 + DX + EY + F = 0 \quad , \quad (13)$$

where

$$A = \sigma_y^2$$

$$B = -2\rho\sigma_x\sigma_y$$

$$C = \sigma_x^2$$

$$D = 2\sigma_x\sigma_y \rho\bar{Y} - 2\sigma_y^2\bar{X} = - (B\bar{Y} + 2A\bar{X})$$

$$E = 2\sigma_x\sigma_y \rho\bar{X} - 2\sigma_x^2\bar{Y} = - (B\bar{X} + 2C\bar{Y})$$

$$F = A\bar{X}^2 + C\bar{Y}^2 + B\bar{X}\bar{Y} - AC (1 - \rho^2) \lambda_e^2 \quad ,$$

and

$$\lambda_e = \sqrt{2} \sqrt{-\ln (1 - p)} \quad .$$

For graphical presentations, the range of the variable is important in order to arrange the scale. The largest and smallest values of X and Y for a given probability ellipse, p, are given by

$$X_{L,S} = \bar{X} \pm \sigma_x \lambda_e \quad (14)$$

$$Y_{L,S} = \bar{Y} \pm \sigma_y \lambda_e \quad , \quad (15)$$

where, as, before, $\lambda_e = \sqrt{2} \sqrt{-\ln(1-p)}$.

Although there are several approaches to graphing the probability ellipses, the following procedure is advantageous for electronic computer plotting. In establishing the computer plotting program, the sample estimates for $\bar{X}, \bar{Y}, \sigma_x, \sigma_y,$ and ρ are constants in equation (13). The user makes the choice of probability ellipses desired. Thus, p in equation (12) is programmed as a parameter. The largest and smallest values for X and Y are computed by equations (14) and (15) for the largest probability ellipse selected. This sets the graphical scale. Values of X within the range of "X smallest" to "X largest" are obtained by incrementing X between these limits. Using the quadratic equation, a solution for Y of equation (13) is made and plotted for each value of X . The centroid (\bar{X}, \bar{Y}) for the family of probability ellipses is plotted as a point. Labeling and other identification complete the plotting program.

For a given probability, equation (13) defines an ellipse that contains p -percent of the points X, Y . Since the entire area under the bivariate normal density function [equation (9)] is unity, upon integration for a given probability ellipse, that given ellipse contains p -percent of the total area. In the wind statistics, p -percent of the wind vectors fall within the specified probability ellipse. From this point of view, a specified probability ellipse gives the joint probability that p -percent of the $U-V$ components lie within the given ellipse.

When $\sigma_x^2 = \sigma_y^2 = \sigma^2$ and $\rho = 0$ in the bivariate normal distribution, the probability ellipses of equation (13) reduce to circles whose centers are at the means \bar{X}, \bar{Y} . The radii of the probability circles are $\sigma_{V1} \lambda_c$, where

$$\sigma_{V1} = \sqrt{2\sigma^2} \quad (16)$$

and

$$\lambda_c = \sqrt{-\ln(1-p)} \quad (17)$$

Values for λ_c for selected probabilities, p , are given in table C.

Because this function is simple, it can easily be graphed manually. However, the generalized plotting technique for electronic computer plotters, as represented by equation (13), can be advantageously used.

C.3. Derived Distributions for Wind Statistics

In this subsection the probability distribution functions and sets of equations are presented to derive certain probability distribution functions for wind statistics. These derived probability distributions are:

- 1) The conditional distribution of wind components
- 2) The generalized Rayleigh distribution for windspeed
- 3) The distribution for wind direction
- 4) The conditional distribution of windspeed given a wind direction (wind rose).

The required five statistical parameters for these derived distributions for wind statistics are given in table I.

C.3.1 The Conditional Distribution of Wind Components

Given that two random variables X and Y are bivariate normally distributed, the conditional distribution $f(Y|X)$ is read as $f(Y)$ given X , and likewise $f(X|Y)$ is read as $f(X)$ given Y . The conditional probability distribution function $F(Y|X)$ has the mean $E(Y|X)$ and variance $\sigma^2_{(y|x)}$, where

$$E(Y|X^*) = \bar{Y} + \rho \left(\frac{\sigma_y}{\sigma_x} \right) (X^* - \bar{X}) \quad (18)$$

and

$$\sigma^2_{(y|x^*)} = \sigma_y^2 (1 - \rho^2) \quad (19)$$

The conditional standard deviation is

$$\sigma_{(y|x^*)} = \sigma_y \sqrt{1 - \rho^2} \quad (20)$$

By interchanging the variables and parameters, the conditional distribution function for $F(X|Y^*)$ has the conditional mean

$$E(X|Y^*) = \bar{X} + \rho \left(\frac{\sigma_x}{\sigma_y} \right) (Y^* - \bar{Y}) \quad , \quad (21)$$

conditional variance

$$\sigma^2_{(x|y^*)} = \sigma_x^2 (1 - \rho^2) \quad , \quad (22)$$

and conditional standard deviation

$$\sigma_{(x|y^*)} = \sigma_x \sqrt{1 - \rho^2} \quad . \quad (23)$$

The preceding conditional probability distribution functions are univariate normal distributions for a (fixed) given value for one of the bivariate normal variables. Thus, the t-values given in table B are applicable for conditional probability statements. For example,

$$F(Y|X^*) = E(Y|X^*) + t\sigma_{(y|x^*)} \quad . \quad (24)$$

For $t = 1.6449$ there is a 95 percent chance that Y is less than or equal to $\bar{Y} + 1.6449 \sigma_{(y|x^*)}$ given that $X = X^*$. In symbols this statement reads

$$P \left\{ Y \leq E(Y|X^*) + 1.6449 \sigma_{(y|x^*)} \mid X = X^* \right\} = 0.9500 \quad . \quad (25)$$

Interval probability statements can also be made; namely,

$$P \left\{ Y_1 = E(Y|X^*) - t\sigma_{(y|x^*)} \leq Y \leq Y_2 = E(Y|X^*) + t\sigma_y \mid X = X^* \right\}$$

where X^* can take on any fixed value of X , but a convenient arrangement is to let $X^* = \bar{X} \pm t\sigma_x$.

The close connection of the regression function of Y on X to the conditional mean for the bivariate normal distribution is noted; namely,

$$Y = \bar{Y} + \rho \left(\frac{\sigma_y}{\sigma_x} \right) (X - \bar{X}) \quad . \quad (26)$$

Similarly, the regression function of X on Y is

$$X = \bar{X} + \rho \left(\frac{\sigma_x}{\sigma_y} \right) (Y - \bar{Y}) \quad . \quad (27)$$

These are linear functions and express the same results as would be obtained from a least-squares regression line.

C.3.2. The Generalized Rayleigh Distribution for Windspeed

If two random variables, X and Y, are bivariate normally distributed, then the probability distribution for the modulus, R, can be derived in terms of the five parameters that define the bivariate normal distribution.

$$R = \sqrt{X^2 + Y^2} \quad (28)$$

The distribution of R so derived is called a generalized Rayleigh distribution because there are no restrictions on the parameters. For applications to the RRA, the variable R is recognized as windspeed or the modulus of the wind vector.

The probability density function for R is expressed as

$$f(R) = a_0 R e^{-a_1 R^2} \left[I_0(a_2 R^2) I_0(a_3 R) + 2 \sum_{k=1}^{\infty} I_k(a_2 R^2) I_{2k}(a_3 R) \cos 2k\psi \right] R \geq 0 \quad . \quad (29)$$

The functions, $I_0(\cdot)$, $I_k(\cdot)$, and $I_{2k}(\cdot)$ are the modified Bessel functions of the first kind for zero order, kth order, and 2kth order. The coefficients are

$$a_0 = \exp \left[-\frac{1}{2} \left\{ \frac{\bar{X}^2}{\sigma_a^2} + \frac{\bar{Y}^2}{\sigma_b^2} \right\} \right] / \sigma_a \sigma_b ,$$

where σ_a^2 and σ_b^2 are the rotated variances to produce zero correlation between X and Y. σ_a and σ_b are the positive and negative roots¹ of the expression

$$\sigma_{(+,-)}^2 = \frac{1}{2} \left\{ \sigma_x^2 + \sigma_y^2 \pm \left[(\sigma_x^2 + \sigma_y^2)^2 - 4\sigma_x^2\sigma_y^2(1 - \rho^2) \right]^{1/2} \right\} ,$$

$$a_1 = (\sigma_x^2 + \sigma_y^2) / 4(1 - \rho^2) \sigma_x^2 \sigma_y^2 ,$$

$$a_2 = \frac{\left[(\sigma_x^2 - \sigma_y^2)^2 + 4\rho^2\sigma_x^2\sigma_y^2 \right]^{1/2}}{4(1 - \rho^2) \sigma_x^2 \sigma_y^2} ,$$

$$a_3 = \left[\left(\frac{\bar{X}}{\sigma_a} \right)^2 + \left(\frac{\bar{Y}}{\sigma_b} \right)^2 \right]^{1/2} ,$$

1. This computational form is obtained from the determinant

$$\begin{vmatrix} \sigma_x^2 - K & \sigma_x \sigma_y \rho \\ \sigma_x \sigma_y \rho & \sigma_y^2 - K \end{vmatrix} ,$$

where K is $\sigma_{(+,-)}^2$, and σ_a and σ_b are analogous to the standard deviation of the major and minor axes of the bivariate normal probability ellipse.

and

$$\tan \psi = \frac{\bar{Y}}{\bar{X}} \frac{\sigma_a^2}{\sigma_b^2} .$$

Since this density function cannot be integrated in closed form from zero to R, numerical integration is used to obtain practical results for the probability distribution function; i.e.,

$$F(R) = \int_0^R f(R) dR . \quad (30)$$

A number of special cases can be obtained from the general Rayleigh distribution [equation (29)], the simplest of which is to let $\sigma_x \equiv \sigma_y = \sigma$ and $\bar{X} = \bar{Y} = 0$ with independent variables X and Y. This gives

$$f(R) = \frac{R}{\sigma^2} e^{-R^2/2\sigma^2} , \quad (31)$$

which is recognized as the classical Rayleigh probability density function. The density function, equation (31), can be integrated in closed form over any range of the variable R. Hence, the probability distribution function, F(R), for equation (31) is

$$F(R) = 1 - \exp \left\{ \frac{-R^2}{2\sigma^2} \right\} . \quad (32)$$

C.3.3. The Derived Distribution of Wind Direction

Considering the wind as a vector quantity and bivariate normally distributed, the wind direction can be derived. This is done by first writing the bivariate normal probability density function in polar coordinates whose variables are

$$g(r, \theta) = rd_1 e^{-\frac{1}{2}(a^2 r^2 - 2br + c^2)} \quad (33)$$

(see footnote 2)

where

$$a^2 = \frac{1}{(1 - \rho^2)} \left[\frac{\sin^2 \theta}{\sigma_x^2} - \frac{2\rho \cos \theta \sin \theta}{\sigma_x \sigma_y} + \frac{\cos^2 \theta}{\sigma_y^2} \right]$$

$$b = \frac{-1}{(1 - \rho^2)} \left[\frac{\bar{x} \sin \theta}{\sigma_x^2} - \frac{\rho(\bar{x} \cos \theta + \bar{y} \sin \theta)}{\sigma_x \sigma_y} + \frac{\bar{y} \cos \theta}{\sigma_y^2} \right]$$

$$c^2 = \frac{1}{(1 - \rho^2)} \left[\frac{\bar{x}^2}{\sigma_x^2} - \frac{2\rho \bar{x} \bar{y}}{\sigma_x \sigma_y} + \frac{\bar{y}^2}{\sigma_y^2} \right]$$

$$d_1 = \frac{1}{2\pi \sigma_x \sigma_y \sqrt{1 - \rho^2}}$$

$r = \sqrt{x^2 + y^2}$ is the modulus of the vector or speed, and θ is the direction of the vector. After integrating $g(r, \theta)$ over $r = 0$ to ∞ , the probability density function of θ is

$$g(\theta) = \frac{d_1}{a^2} e^{-\frac{1}{2}c^2} \left[1 + \sqrt{2\pi} \left(\frac{b}{a}\right) e^{\frac{1}{2}\left(\frac{b}{a}\right)^2} \phi\left(\frac{b}{a}\right) \right] \quad (34)$$

2. This expression, equation (33), in Smith (1976) is given with respect to the mathematical convention for a vector direction.

where a^2 , b , c^2 , and d_1 are as previously defined in equation (33) and

$$\phi\left(\frac{b}{a}\right) = \phi(x) = \frac{1}{\sqrt{2\pi}} \int_{-\infty}^x e^{-\frac{1}{2}t^2} dt$$

is taken from tables of normal distribution functions or made available through a computer subroutine.

If desired, equation (34) can be integrated numerically over a chosen range of θ to obtain the probability that the vector direction will lie within the chosen range; i.e.,

$$F(\theta) = \int_{\theta_2}^{\theta_1} g(\theta) d\theta \quad . \quad (35)$$

One application may be to obtain the probability that the wind will flow from a given quadrant or sector as, for example, onshore.

C.3.4. The Derived Conditional Distribution of Windspeed Given the Wind Direction (Wind Rose)

Continuing with the considerations in section C.3.3. of this chapter, the conditional probability density function (pdf) for windspeed, r , given a specified value for the wind direction, θ , can be expressed as

$$f(r|\theta) = \frac{a^2 r e^{-\frac{1}{2}(a^2 r^2 - br)}}{1 + \sqrt{2\pi} \left(\frac{b}{a}\right) e^{\frac{1}{2}\left(\frac{b}{a}\right)^2} \phi\left\{\frac{b}{a}\right\}} \quad , \quad (36)$$

where the coefficients, a and b and the function $\phi\left\{\frac{b}{a}\right\}$ are as previously defined in equation (33) and in equation (34).

From equation (36) the mode (most frequent value) of the conditional windspeed given a specified value of the wind direction is the positive solution of the quadratic equation,

$$a^2 r^2 - br - 1 = 0 \quad , \quad (37)$$

which is

$$(\bar{r} | \theta) = \frac{1}{2a} \left[\left(\frac{b}{a} \right) + \sqrt{4 + \left(\frac{b}{a} \right)^2} \right] \quad (38)$$

The locus of the conditional modal values of windspeed when plotted in polar form versus the given wind directions forms an ellipse.

The noncentral moment for equation (36) is expressed as

$$\mu'_n = \int_0^{\infty} r^n f(r|\theta) dr \quad (39)$$

Now the first noncentral moment is identical to the first central moment or the expected value, $E(r|\theta)$. The integration of equation (39) for the first moment is sufficiently simple to yield practical computations and can be expressed as

$$E(r|\theta) = \frac{\left(\frac{b}{a} \right) + \left[1 + \left(\frac{b}{a} \right)^2 \right] \sqrt{2\pi} e^{-\frac{1}{2} \left(\frac{b}{a} \right)^2} \phi \left\{ \frac{b}{a} \right\}}{a \left[1 + \left(\frac{b}{a} \right) \sqrt{2\pi} e^{-\frac{1}{2} \left(\frac{b}{a} \right)^2} \phi \left\{ \frac{b}{a} \right\} \right]} \quad (40)$$

Hence, equation (40) gives the conditional mean value of the windspeed given a specified value for the wind direction.

The integration of equation (36) for the limits $r = 0$ to $r = r^*$ gives the probability that the conditional windspeed is $\leq r^*$ given a value for the wind direction, θ . This conditional probability distribution (PDF) can be written as

$$\Pr \left\{ r \leq r^* \mid \theta = \theta_0 \right\} = 1 - \left[\frac{e^{-\frac{1}{2} r_s^2 + \sqrt{2\pi} \left(\frac{b}{a} \right) \left\{ 1 - \phi(r_s) \right\}}}{e^{-\frac{1}{2} \left(\frac{b}{a} \right)^2 + \sqrt{2\pi} \left(\frac{b}{a} \right) \phi \left\{ \frac{b}{a} \right\}}} \right] \quad (41)$$

where

$$r_s = \left[a r^* - \left(\frac{b}{a} \right) \right]$$

By definition, equation (41) is an expression for a "wind rose." Empirical wind rose statistics are often tabulated or graphically illustrated giving the frequency that the windspeed is not exceeded for those windspeed values that lie within assigned class intervals of the wind direction. After evaluation of equation (41) for various values of windspeed, r^* , and the given wind directions, θ , interpolations can be performed to obtain various percentile values of the conditional windspeed.

For the special case when \underline{b} in equation (33) equals zero (i.e., for $\bar{x} \equiv \bar{y} = 0$), the conditional modal values of windspeeds [equation (38)], the conditional mean values of windspeeds [equation (40)], and the fixed conditional percentile values of windspeeds [interpolated from evaluations of equation (41)], when plotted in polar form versus the given wind directions, produce a family of ellipses.

For the special case when $\bar{x} = \bar{y} = 0$, equation (36) reduces to the following simple case:

$$\Pr \left\{ r \leq r^* \mid \theta = \theta_0 \right\} = 1 - e^{-\frac{a^2 r^{*2}}{2}} \quad (42)$$

There is a special significance of equation (42) when related to the bivariate normal probability distribution. If r^* and θ are measured from the centroid of the probability ellipse, then the probability that $r \leq r^*$ is the same as the given probability ellipse. Further, solving equation (42) for r^* , gives

$$r^* = \frac{1}{a} \sqrt{-2 \ln (1 - P)} \quad (43)$$

If a probability ellipse P is chosen, equation (42) gives the distance of r along any θ from the centroid of the ellipse to the intercept of the specified probability ellipse. If there is an interest in conditional probability of winds for a given θ relative to the monthly means, equation (43) is applicable. If it is desired to find the magnitude of the wind along any θ relative to the monthly mean to the intercept of a given probability ellipse, equation (43) is applicable.

D. Statistical Parameters With Respect To Any Orthogonal Axes

The five wind statistical parameters presented in table I are given with respect to the standard meteorological coordinate system; i.e., these parameters are for the U and V components. For many aerospace vehicles and range applications, there is a need for wind statistics with respect to orthogonal axes other than west to east and south to north. For example, it may be required to present wind statistics with respect to a flight azimuth of an

aerospace vehicle whose flight azimuth is α degrees from true north measured in a clockwise direction. The following sets of equations are presented to compute the five parameters for the new coordinate axes rotated α degrees clockwise from true north.

a. Rotation of the means through α degrees:

$$\bar{X}_\alpha = \bar{X} \cos (90 - \alpha) + \bar{Y} \sin (90 - \alpha) \quad (44)$$

$$\bar{Y}_\alpha = \bar{Y} \cos (90 - \alpha) - \bar{X} \sin (90 - \alpha) \quad (45)$$

b. Rotation of the variances through α degrees:

$$\begin{aligned} \sigma_{x_\alpha}^2 &= \sigma_x^2 \cos^2 (90 - \alpha) + \sigma_y^2 \sin^2 (90 - \alpha) \\ &+ 2\rho\sigma_x\sigma_y \cos (90 - \alpha) \sin (90 - \alpha) \end{aligned} \quad (46)$$

$$\begin{aligned} \sigma_{y_\alpha}^2 &= \sigma_y^2 \cos^2 (90 - \alpha) + \sigma_x^2 \sin^2 (90 - \alpha) \\ &- 2\rho\sigma_x\sigma_y \cos (90 - \alpha) \sin (90 - \alpha) \end{aligned} \quad (47)$$

c. Rotation of the linear correlation coefficient through α degrees:

$$\rho_\alpha = \frac{\text{cov} (X, Y)_\alpha}{\sigma_{x_\alpha} \sigma_{y_\alpha}} \quad (48)$$

where $\text{cov} (X, Y)_\alpha$ is the rotated covariance,

$$\begin{aligned} \text{cov} (X, Y)_\alpha &= \text{cov} (X, Y) [\cos^2 (90 - \alpha) - \sin^2 (90 - \alpha)] \\ &+ \cos (90 - \alpha) \sin (90 - \alpha) (\sigma_y^2 - \sigma_x^2) \end{aligned}$$

and

$$\text{cov}(X, Y) = \rho \sigma_x \sigma_y .$$

By using these rotational equations, the bivariate normal distribution with respect to any desired rotated coordinates can be obtained from sample estimates that have been computed with respect to a specific axis. The marginal distributions after rotation are also normally (univariate) distributed. Using the rotational equations greatly reduces computational efforts for applications requiring statistics with respect to several coordinate axes.

Appendix A presents some illustrative examples for the wind statistics of the specific RRA.

CHAPTER III. STATISTICS OF THERMODYNAMICS QUANTITIES AND MODELS

A. General Considerations

A.1. Objectives

The objective inherent in developing the thermodynamic section of the RRA was to describe the thermodynamic characteristics of the atmosphere using a minimum of data tabulations. A set of parameters was selected which, together, thermodynamically describe the climatological state of the atmosphere. These parameters are the pressure, temperature, density, dewpoint, virtual temperature, and water vapor pressure. Used together, these parameters permit the calculation of a large number of derived quantities. (Symbols used in the calculations in this chapter are summarized in table D.) Some of these quantities, such as the speed of sound, are dealt with in section III.E.

The probability distribution of each of the six thermodynamic RRA parameters is described by its mean value, its standard deviation, and its skewness. Several of these parameters (temperature, pressure, dewpoint and density) have probability distributions that are close to a univariate normal distribution; the others do not. The skewness parameter gives an estimate of the asymmetrical departures of a probability distribution.

Hydrostatically modeled mean values of pressure and density were calculated (table IV), so that users may determine the departure of the actual climatological values of these parameters from hydrostatic conditions. This was done by hydrostatically integrating the pressure from the lowest RRA data level to the termination altitude of the particular RRA.

A.2. Data Quality Control

Data limits derived from the following parameters were used to screen the thermodynamic portion of the RRA data base: temperature, pressure, dewpoint (for the 0- to 30-km portion only), and density (for the 30- to 70-km portion only). These limits were set to plus and minus six standard deviations from the mean values of each of these quantities. These limits were used to screen the thermodynamic portion of the RRA data base, according to the procedures described in section I.C. The data base used to generate the thermodynamic portion of the RRA (tables I, II, and IV) was considered to be free from errors under the following conditions:

- a) The skewness values of the pressure and temperature were between -2.5 and 2.5 at all data levels.
- b) The skewness values of the density were between -3.5 and 3.5 at data levels between 0 and 30 km.
- c) The skewness values of the density were between -3.0 and 3.0 at data levels between 30 and 70 km.
- d) The skewness values of the dewpoint were between -2.5 and 2.5 at all data levels with more than 10 data values.



TABLE D. LIST OF SYMBOLS USED IN CHAPTER III

C_s	- Speed of sound
C_d	- Collision diameter
E	- Vapor pressure
g_ϕ	- Gravity at latitude ϕ
H	- Geopotential height
H_m	- Geopotential height at a mandatory radiosonde data level
H_s	- Geopotential height at a significant radiosonde data level
K_t	- Coefficient of thermal conductivity
L	- Mean free path length
M	- Mean molecular weight of air at sea level
$M3Q$	- Annual or monthly third moment of quantity Q
n	- Refractive modulus
N	- Refractive index
NA	- Avogadro's constant
N_Q	- Number of values of quantity Q
P	- Pressure
P_m	- Pressure at a mandatory radiosonde data level
P_s	- Pressure at a significant radiosonde data level
P_h	- Hydrostatically integrated mean monthly or annual pressure
Q	- Any tabulated RRA quantity
R^*	- Universal gas constant
R'	- Specific gas constant of dry air
r', r^*	- Parameters used in converting z to h and vice versa

TABLE D. (concluded)

S	- Sutherland's constant, used in the calculation of dynamic viscosity
T	- Temperature
T_d	- Dew point
T_v	- Virtual temperature
T_{vm}	- Virtual temperature at a mandatory radiosonde data level
T_{vs}	- Virtual temperature at a significant radiosonde data level
V	- Mean air particle speed
V_c	- Mean collision frequency
w	- Parameter used in the hydrostatic interpolation of pressure and density
Z	- Geometric altitude
λ	- Wavelength
α_Q	- Skewness of quantity Q
β	- Constant used in the equation for viscosity
γ	- Ratio of specific heat at constant pressure to specific heat at constant volume
η	- Kinematic coefficient of viscosity
μ	- Dynamic coefficient of viscosity
ρ	- Density
ρ_h	- Mean monthly or annual density derived from pressure height
σ	- Standard deviation of the quantity Q

A.3 Limitation of Thermodynamic Statistics

The correlation coefficients between the thermodynamic quantities and the moisture-related quantities were not calculated at discrete altitudes, nor were any of the correlations between altitudes. Therefore, valid statistical dispersion models that require the relationship between two or more of these quantities at the same altitude or between altitudes cannot be derived. Approximations for the correlation coefficients between pressure, virtual temperature, and density at discrete altitudes may be obtained from the coefficients of variation as developed by Buell (1970). The coefficient of variation is the standard deviation divided by the mean. The mean values and the standard deviations are taken from table II. A model for the profile of monthly and annual mean pressure, virtual temperature, and density that is in excellent agreement with the respective statistical mean values is given by table IV. This agreement results because the physical relationships, given by the hydrostatic equation and the equation of state, were used to derive table IV. When only the monthly or annual mean values for pressure, virtual temperature, and density are required, it is recommended that table IV be used.

B. Establishing Data Samples at the Required Altitude Levels

This section describes the computational procedures used to establish data samples of the thermodynamic RRA parameters at the RRA data levels. References are cited only when an equation given is one of many available in the literature or when an equation is stated in an unusual form.

B.1. Conversion of Data Recorded in Geopotential Heights to Geometric Altitude

The upper-air rocketsonde observations used to obtain the table values above 30 km were recorded in terms of geometric altitude and can be interpolated directly to the altitude intervals shown in the tables. However, the radiosonde observations used to obtain the tabular values below 30 km were recorded in terms of geopotential heights. The change of coordinates from geopotential heights to geometric altitudes (h to z) is accomplished by calculating a table of geopotential heights that correspond exactly to the geometric altitudes at which the atmospheric parameters are tabulated. The radiosonde observations are then interpolated to these geopotential heights. The relationship used to calculate geometric altitude from geopotential height is

$$H = (r'z)/(r^*z) \quad , \quad (49)$$

where

$$r' = gr^*/9.80665$$

and

$$r^* = -2g_\phi / (\partial g_\phi / \partial z_0) \quad .$$

g_ϕ is the sea-level gravity at the latitude ϕ corresponding to the proper location. This value is given by (List, 1968)

$$g_\phi = 9.780356 (1 + 5.2885 \times 10^{-3} \sin^2 \phi - 5.9 \times 10^{-6} \sin^2 (2\phi)). \quad (50)$$

$\frac{\partial g_\phi}{\partial z_0}$ is the rate of change of gravity at the sea level. This quantity is given

by the equation

$$\frac{\partial g_\phi}{\partial z_0} = -3.085462 \times 10^{-6} + 2.27 \times 10^{-9} \cos (2\phi) - 2 \times 10^{-12} \cos (4\phi). \quad (51)$$

The units used for gravity are meters per square second, while the units for $\frac{\partial g_\phi}{\partial z_0}$ are per square second.

The resulting table of values of H obtained by using even increments of 2 in equation (49) is shown in table IV of the RRA. The values of H above 30 km are not used in the interpolation of original data, but are included for the convenience of the user.

B.2. Calculations on the Original Rawinsonde Data Records

It was necessary to interpolate the information from the original rawinsonde data records to the geometric altitudes specified as the RRA data levels. The parameters for which this interpolation was required were the temperature, dewpoint, and pressure. The other parameters were calculated from the interpolated values at each RRA data level. These "derived" parameters were the water vapor pressure, density, and virtual temperature.

B.2.1. Calculation of the Geopotential Height at Significant Levels

Two somewhat different interpolation procedures were used to obtain data from radiosonde and rocketsonde observations at the levels shown in the tables. The procedure used to interpolate radiosonde observations began with the calculation of virtual temperature at each data level in a sounding. The virtual temperature was computed by

$$T_v = T / (1 - 0.379 (e/p)) \quad (52)$$

where T_v and T are in degrees Kelvin and e and p are in millibars.

The radiosonde soundings contain a mix of data taken at "mandatory" and "significant" levels. Pressure, temperature, and dewpoint information was given in these soundings at both types of levels. However, geopotential height information was only given at the mandatory levels. The heights at the significant levels were "filled in" (calculated) hydrostatically using pressure and temperature data from these levels. This procedure permitted the use of most of the significant level data in the calculation of the RRA tables. The equation used for this process was

$$H_s = H_m + 29.2712617 \frac{(T_{vs} - T_{vm})}{2} \ln(P_s/P_m) , \quad (53)$$

where the subscripts s and m denote quantities at significant and mandatory levels. This equation was not used if the difference between two adjacent mandatory levels was greater than 200 mb. All soundings with such data gaps were rejected for use in compiling the RRA.

B.2.2. Temperature

Radiosonde temperatures were interpolated logarithmically with respect to pressure using the equation

$$T = T_U + (T_L - T_U) \frac{\ln p - \ln p_L}{\ln p_U - \ln p_L} , \quad (54)$$

where the subscripts U and L indicate values at the nearest data levels in the actual sounding above and below the interpolated level.

B.2.3. Pressure

The pressure values in each radiosonde sounding were interpolated to the RRA data levels using the equation

$$p = p_L \exp\left(\frac{H_L - H_U}{29.2712617 (0.5) (T_{vU} + T_{vL})}\right) \quad (55)$$

where the subscript L indicates virtual temperature, geopotential height, and pressure values at the data level below and closest to the level at which data were required.

B.2.4. Dewpoint Temperature

Dewpoint values were interpolated logarithmically with respect to pressure using the equation

$$T_d = T_{dU} + (T_{dL} - T_{dU}) \frac{(\ln p - \ln p_L)}{(\ln p_U - \ln p_L)} . \quad (56)$$

The subscripts U and L indicate data at the nearest upper and lower data levels in a sounding.

B.2.5. Derived Water Vapor Pressure

The water vapor pressure was calculated from the interpolated dewpoint values at the RRA data levels using Tetten's approximation:

$$e = 6.11 \text{ mb} \times 10^{7.5(T_d - 273.15)/(T_d - 35.86)} \quad (57)$$

B.2.6. Derived Density

The density values derived from radiosonde observations were calculated at the RRA data levels using the equation

$$\rho = 348.36787 p/T_v \quad (58)$$

B.2.7. Derived Virtual Temperature

The virtual temperature values were calculated at the RRA data levels for each sounding using the equation

$$T_v = T/(1 - 0.379(e/p)) \quad (59)$$

where T_v and T are in degrees Kelvin, and p and e are the pressure and vapor pressure, respectively, in millibars.

B.3. Calculations on the Original Rocketsonde Data Records

The rocketsonde data records used to calculate the RRA table values above 30 km were given in terms of geometric altitude. For this reason, slightly different calculations were required to convert the recorded data values to values at the RRA data levels. The pressure, temperature, and density were all interpolated to the RRA data levels; moisture-related parameters (virtual temperature, water vapor pressure, and dewpoint) were not calculated, since atmospheric moisture at altitudes above 30 km was considered to be negligible.

No interpolation was done across gaps in the pressure or temperature data within a sounding larger than 7,000 m. Data values at the RRA levels within such a gap were set to missing.

B.3.1. Temperature

Rocketsonde temperatures were interpolated linearly with respect to geometric altitude using the equation

$$T = T_U + (T_L - T_U) \frac{Z - Z_L}{Z_U - Z_L}, \quad (60)$$

where the subscripts U and L indicate values at the nearest data level in the actual sounding above and below the interpolated level.

B.3.2. Pressure

The pressure values in each rocketsonde sounding were interpolated to the RRA data levels using the equation

$$P = P_L \exp \left(- \frac{g_\phi}{R^*} \frac{M(Z - Z_L)}{\bar{T}_v} \cdot W^2 \right), \quad (61)$$

where $\bar{T}_v = \frac{T_{vU} + T_{vL}}{2}$ and $W = \frac{r^*}{\left(r^* + Z + \frac{Z - Z_L}{2} \right)}$.

B.3.3. Density

Rocketsonde density values were interpolated using the equation

$$\rho = \rho_L \exp \left(- \frac{g_\phi M}{R^*} \frac{(Z - Z_L)}{\bar{T}_v} \cdot W^2 \right), \quad (62)$$

where W is specified in section III.B.3.2.

C. Computation of Statistical Parameters for Tables II and III

A three-step procedure was used for computing the monthly and annual means, standard deviations, and skewness values from the data values at the RRA data levels. Initially, certain statistical sums were calculated and stored as the soundings in the data base were processed. These sums were then used to calculate the monthly statistics given in the RRA tables. The annual statistics were then calculated from these stored sums and the monthly statistics.

C.1. Stored Statistical Sums

The sums calculated were

$$\sum Q, \sum Q^2, \text{ and } \sum Q^3 ,$$

where Q is any one of the quantities given in the thermodynamic part of the RRA.

C.2. Calculation of the Monthly Statistics

C.2.1. Monthly Means

The mean monthly values of the thermodynamic RRA quantities were calculated using the equation

$$\bar{Q} = \sum Q / N_Q ,$$

where N_Q is the number of observed values of the quantity Q for a given month.

C.2.2. Monthly Standard Deviations

The monthly standard deviations of the thermodynamic RRA quantities were calculated using the equation

$$\sigma_Q = \sqrt{\frac{(N_Q \sum Q^2) - (\sum Q)^2}{N_Q \cdot (N_Q - 1)}} . \quad (63)$$

C.2.3. Monthly Skewness Values

The monthly skewness values of the windspeed and of the thermodynamic RRA quantities were calculated using the equation

$$\alpha_Q = \frac{M3_Q}{\sigma_Q^3} .$$

where $M3_Q$ is the third moment of the quantity Q, σ_Q is its standard deviation, and

$$M3_Q = \left[\frac{\sum Q^3}{N_Q} - \frac{3 \sum Q \sum Q^2}{N_Q^2} - \frac{2 \sum Q^3}{N_Q^3} \right] \cdot \frac{N_Q^2}{(N_Q - 1)(N_Q - 2)} . \quad (64)$$

C.3. Calculation of the Annual Statistics

Equations (63) and (64), used to calculate the monthly values of the standard deviations and skewness values, involve taking the differences between two pairs of large sums containing Q^2 and Q^3 , where Q is the thermodynamic RRA quantity. Using these equations to compute the annual statistics would have resulted in a substantial loss of precision, as these sums become larger by several orders of magnitude in such a case. This problem was avoided by calculating the annual means, standard deviations, and skewness values from the monthly statistics.

C.3.1 Annual Mean Values

The annual mean values of the thermodynamic RRA quantities were calculated using the equation

$$Q_{ANN} = Q_A / N_Q$$

where Q_A is the total of all observed values of Q and N_Q is the total number of observations of Q .

C.3.2. Annual Standard Deviations

The annual standard deviations of the thermodynamic RRA quantities were calculated using the equation

$$\sigma_{Q_{ANN}} = \sqrt{\frac{1}{N_Q} \sum_{i=1}^{12} (N_{Qi} \sigma_{Qi}^2) + \frac{1}{N_Q} \sum_{i=1}^{12} (N_{Qi} \bar{Q}_i^2) - Q_{ANN}^2} \quad (65)$$

where N_{Qi} = the number of data values for Q in month i ($i = 1$ to 12), Q_i = the monthly mean of Q , and σ_{Qi} = the standard deviation of quantity Q in month i .

C.3.3. Annual Skewness Values

The annual skewness values of the thermodynamic RRA quantities were calculated using the equation

$$\begin{aligned}
M_{3Q_{ANN}} = & \frac{1}{N} \sum_{i=1}^{12} (N_{Q_i} M_{3Q_i}) + \frac{3}{N_{Q_{ANN}}} \sum_{i=1}^{12} (N_{Q_i} \bar{Q}_i \sigma_{Q_i}^2) \\
& + \frac{1}{N_{Q_{ANN}}} \sum_{i=1}^{12} (N_{Q_i} Q_i^3) - \frac{3\bar{Q}_{ANN}}{N_{Q_{ANN}}} \sum_{i=1}^{12} (N_{Q_i} Q_i^2) \\
& - \frac{3\bar{Q}_{ANN}}{N_{Q_{ANN}}} \sum_{i=1}^{12} (N_{Q_i} \sigma_{Q_i}^2) + 2\bar{Q}_{ANN}^3, \quad (66)
\end{aligned}$$

where M_{3Q_i} = the third moment about the mean of quantity Q in month i and $M_{3Q_{ANN}}$ = the annual third moment about the mean of the quantity Q .

D. Derived Monthly Mean and Annual Mean Model Atmospheres

A set of modeled monthly mean and annual mean hydrostatic values of pressure and density was calculated from the lowest RRA data level (0 km, mean sea level) upwards to 30 km, and from 30 km upwards to 70 km. The integration from 0 to 30 km was computed independently of the integration from 30 to 70 km because of the difference in data sources. The two different values for 30 km are provided for comparison. When 30-km data are required, the values given in the 0- to 30-km table should be used. These hydrostatically modeled mean values, which are given in table IV, are useful as a check on the validity of the pressure and density values given in table II. In most cases, the values in tables II and IV for any given data level are within 1 percent of each other. The hydrostatic pressure values in table IV were calculated using the equation

$$p_1 = p_0 \exp \left(- \frac{0.034162 (H_1 - H_0)}{0.5 (T_{v_1} + T_{v_0})} \right), \quad (67)$$

where $H_1 - H_0$ is in meters and a "0" subscript refers to values at the RRA data level immediately below the level being checked. p_0 at the lowest data level is set equal to the RRA mean pressure; p_1 , calculated for the next highest data level, is taken as p_0 for the level above that. This process is repeated for all the other RRA data levels. The hydrostatic density corresponding to the hydrostatic pressures is calculated from these pressures and the RRA virtual temperature values using the formula

$$\rho_H = 348.36786 P_H / T_v, \quad (68)$$

where ρ_H and P_H are the hydrostatic density and pressure shown in table IV of the RRA.

E. Thermodynamic Quantities Derivable from the Basic Tables

Several other quantities can be calculated from the statistics listed in tables I and II. Primary physical constants used in these calculations are listed in table E. The equations given in this section can be used to calculate the approximate mean values of these quantities at each RRA data level. It is not possible to infer or derive any information concerning the standard deviation or skewness values of these quantities from the data in tables II and III of the RRA.

E.1. Mean Air Particle Speed

The mean air particle speed, V , is the arithmetic average of the speeds of all air particles in the volume element being considered. For a valid average to occur, there must be a sufficient number of particles involved to represent mean conditions. The equation for V for dry air is

$$V = \sqrt{\frac{8}{\pi} \cdot \frac{R \cdot T}{M}} \quad (69)$$

A computational form for dry air, using tabulated values, is

$$V = \sqrt{7.3094 \times 10^2 \times T} \text{ (meters per second)} \quad (70)$$

where T is the temperature in degrees Kelvin from table II. Equation (69), when corrected for moist air, becomes

$$V = \sqrt{\frac{8}{\pi} \cdot R' \cdot T_v} \quad (71)$$

The computational form for moist air is

$$V = \sqrt{7.3094 \cdot 10^2 \cdot T_v} \text{ (meters per second)} \quad (72)$$

where T_v is the virtual temperature in degrees Kelvin from table III.

TABLE E. LIST OF PRIMARY PHYSICAL CONSTANTS

P_o = standard atmospheric pressure at sea level
 = 1.013250×10^5 Newton/m² = 2116.22 lb/ft²

ρ_o = standard atmospheric density at sea level
 = 1.2250 kg/m³ = 0.076474 lb/ft³

T_o = standard temperature at sea level = 288.15 K = 15.0°C = 59.0°F

g_o = standard gravity at sea level at latitude 45°32'33"
 = 9.80665 m/s²

s = Sutherland's constant used in calculation of dynamic viscosity
 = 110.4 K

T_i = ice-point temperature at P_o = 273.15 K

β = constant used in calculation of dynamic viscosity
 = 1.458×10^{-6} kg/s m K^{1/2}
 = 7.3025×10^{-7} lb/s ft R^{1/2}

γ = ratio of specific heat of air at constant pressure to specific
 heat of air at constant volume
 = 1.4

C_D = mean effective collision diameter of air molecules
 = 3.65×10^{-10} m = 1.1975×10^{-9} ft

N_a = Avogadro's constant
 = 6.022169×10^{26} /kg mol = 2.73179×10^{26} /lb mol

R^* = gas constant = 8.31432 J/mol K

R' = gas constant for dry air = 2.8704×10^2 J/kg K

M = molecular weight of dry air = 28.966 g/mol

E.2 Mean Free Path

The mean free path, L , is the mean value of the distance traveled by each neutral air particle in a selected air parcel, between successive collisions with other particles in that parcel. A meaningful average requires that the selected parcel be large enough to contain a substantial number of particles. The equation for L is given by

$$L = \left(\frac{\sqrt{2}}{2\pi} \right) \left(\frac{R^*T}{N_a C_d^2 P} \right) , \quad (73)$$

where C_d is the effective collision diameter of the mean air molecules. The 1976 standard atmosphere value of 3.65×10^{-10} is valid for the range of altitudes in the RRA.

A computational form for moist air, using tabulated values, is

$$L = 2.335 \times 10^{-7} \frac{T}{P} \text{ (meters)} , \quad (74)$$

where T is the temperature in degrees Kelvin from table II and P is the pressure in millibars from table II.

A form of (73) to correct L for moist air is

$$L = \left(\frac{\sqrt{2}}{2\pi} \right) \frac{R^*MT_v}{N_a C_d^2} . \quad (75)$$

The computational form for moist air is

$$L = 2.3325 \times 10^{-7} \frac{T_v}{P} \text{ (meters)} , \quad (76)$$

where T_v is the virtual temperature in degrees Kelvin from table III and P is the pressure in millibars from table II.

E.3. Mean Collision Frequency

The mean collision frequency, V_c , is considered to be the average speed of air particles contained in an air parcel, divided by the mean free path of the particles inside that parcel. Computationally this is equivalent to

$$V_c = \frac{V}{L} \text{ (sec}^{-1}\text{)} \quad (77)$$

To determine V_c for dry air, use V and L from equations (70) and (74). To determine V_c for moist air, use V and L from equations (72) and (76).

E.4. Speed of Sound

The expression for the speed of sound, C_s , in meters per second in dry air, is

$$C_s = \sqrt{\frac{\gamma R T}{M}} \quad (78)$$

To compute C_s for dry air from tabulated values, use

$$C_s = \sqrt{4.0185 \times 10^2 \times T} \text{ (meters per second)} \quad (79)$$

where T is the temperature in degrees Kelvin from table II. One form for the speed of sound in moist air is

$$C_s \approx \sqrt{\gamma R T_v} \quad (80)$$

where T_v is the virtual temperature from table III. A computational form for moist air is

$$C_s \approx \sqrt{4.0185 \times 10^2 T_v} \text{ (meters per second)} \quad (81)$$

E.5. Dynamic Coefficient of Viscosity

The coefficient of dynamic viscosity, μ , is defined as a coefficient of internal friction developed where gas regions move adjacent to each other at different velocities. The following expression is taken from the U.S. Standard Atmosphere (1976):

$$\mu = \frac{\beta \cdot T^{3/2}}{T + S} \quad (82)$$

The computational form is

$$\mu = \frac{(1.458 \times 10^{-6}) T^{3/2}}{T + 110.4} \quad \text{(kilograms per second per meter)} \quad (83)$$

where T is the temperature in degrees Kelvin from table II.

E.6. Kinematic Coefficient of Viscosity

The kinematic coefficient of viscosity, designated as η , is defined to be the ratio of the dynamic coefficient of viscosity of a gas to its density, or

$$\eta = \mu / \rho \quad (84)$$

The computational form is

$$\eta = 1.0 \times 10^3 \mu / \rho \quad \text{(square meters per second)} \quad (85)$$

where μ is the dynamic coefficient of viscosity from equation (83) and ρ is the density in grams per cubic meter from table II.

E.7. Coefficient of Thermal Conductivity

The empirical expression used for the coefficient of thermal conductivity, designated as K_t , is given in the 1976 Standard Atmosphere as

$$K_t = \frac{2.65019 \times 10^{-3} \cdot T^{3/2}}{T + 245.4 \times 10^{-3} (12/T)} \quad \text{(watts per meter per degree Kelvin)} \quad (86)$$

where T is in degrees Kelvin.

E.8. Refractive Modulus and Refractive Index

The refractive modulus or refractivity (Selby and McClatchey, 1975; Smith and Weintraub, 1953) is defined as N, where

$$N = (n - 1) \cdot 10^6 \quad (87)$$

and n is the refractive index.

For microwave frequencies below approximately 30 GHz (equivalent to wavelengths above 1 cm), N , the refractive modulus, is given by the empirical equation

$$N = 77.6 \frac{P}{T_d} + 3.73 \times 10^5 \frac{e}{T^2} \quad (\text{dimensionless}), \quad (88)$$

where E and P are in millibars and T and T_d are in degrees Kelvin.

The following expression is valid for the visible and infrared wavelengths shorter than approximately 30 μm (0.03 mm).

$$N = 77.6 \frac{P}{T} + 0.584 \frac{P}{T\lambda} \quad (\text{dimensionless}), \quad (89)$$

where λ is the wavelength in microns and T is in degrees Kelvin.

The expression for N for the wavelength from 0.03 mm to 1 cm is an extremely complex function of wavelength.

CHAPTER IV. CONCLUSIONS AND RECOMMENDATIONS

Conclusions

This document satisfies the technical objectives established for the RRAC by the RCC MG. Upper air statistics and models for wind and thermodynamic quantities for the specific site have been derived in a consistent and uniform manner, which will be used in publications for all other assigned site locations. These RRAs represent an improvement over the previously published RRAs because of the availability of more extensive upper air data bases and the adaptation of more advanced statistical techniques. A statistical measure of central tendency (mean values) and a measure of dispersion (standard deviation with respect to the mean values) for monthly and annual reference periods have been tabulated for all variables in a consistent manner from data bases that have been edited and quality-controlled in the same manner. Further, a statistical measure for symmetry (skewness coefficient that involves the third statistical moment) has been tabulated for all variables except the U and V wind components. Even with these improvements, the user of these RRAs must recognize certain limitations of the statistical tabulations:

1) The wind profile structure with respect to altitude cannot be modeled from the RRA statistics because the interlevel and crosslevel correlations were not computed.

2) The profile structure with respect to altitude for any of the thermodynamic variables or any quantities derivable from these variables cannot be modeled because the prerequisite correlations were not computed. However, the profiles of monthly and annual means for pressure, virtual temperature, and density are in agreement (table IV) with the hydrostatic equation and the equation of state.

The preceding limitations are cited to prevent a misuse of the RRAs. More extensive statistical tabulations were beyond the scope of this committee's task. As greater insight is gained through usage of these RRAs, many adaptations of the statistical tabulations for specific engineering and scientific applications are envisioned.

Recommendations

It is recommended that the wind and thermodynamic statistical tabulations and attendant models contained in the RRAs be used as a standard reference source, as may be appropriate, by the ranges and range users. It is further recommended that the respective Range Staff Meteorologist or responsible agency staff member be consulted for the applicability of the RRAs for specific engineering applications.

REFERENCES

Buell, Eugene C.: "Statistical Relations in a Perfect Gas." Journal of Applied Meteorology, 9, 1970, pp. 729-731.

List, R. J., Editor: Acceleration of Gravity, Smithsonian Meteorological Tables, Sixth Ed. Smithsonian Institution, Washington, D.C., 1968, pp. 488.

Selby, J.E.A.; and McClatchey, R.A.: AFCRL-TR-75-0255, Atmospheric Transmittance from 0.25 to 28.5 μm - Computer Code Lowtran 3, Air Force Cambridge Research Laboratories. Available through the National Technical Information Service, Washington, D.C., 1975.

Smith, E.K.; and Weintraub, S.: "The Constants in the Equation for Atmospheric Refractive Index at Radio Frequencies," Proceedings of the Institute of Radio Engineers, 41, 8, August 1953, pp. 1035-1037.

Smith, O.E.: NASA TM X-73319, Vector Wind and Vector Wind Shear Models at 0-27 km Altitude for Cape Kennedy, Florida, and Vandenberg AFB, California. Prepared under sponsorship of the National Aeronautics and Space Administration. Available through the National Technical Information Service, Washington, D.C., July 1976.

U.S. Standard Atmosphere, 1976. Prepared under the sponsorship of the National Aeronautics and Space Administration, United States Air Force, and United States Weather Bureau. Available through U.S. Government Printing Office, Washington, D.C., October 1976.

PREVIOUS RANGE REFERENCE ATMOSPHERES PUBLISHED BY IRIG

Atlantic Missile Range Reference Atmosphere for Cape Kennedy, Florida (Part I), Document 104-63, April 16, 1963. (AD451780)

White Sands Missile Range Reference Atmosphere (Part I), Document 104-63, June 28, 1964. (AD451781)

Fort Churchill Missile Range Reference Atmosphere for Fort Churchill, Manitoba, Canada (Part I), Document 104-63, August 7, 1964. (AD634727)

Pacific Missile Range Reference Atmosphere for Eniwetok, Marshall Islands (Part I), Document 104-63, September 1, 1964. (AD479264)

Fort Greely Missile Range Reference Atmosphere (Part I), Document 104-63, October 6, 1964. (AD634726)

Eglin Gulf Test Range Atmosphere for Eglin AFB, Florida (Part I), Document 104-63, January 25, 1965. (AD472601)

Pacific Missile Range Atmosphere for Point Arguello, California (Part I), Document 104-63, April 1965. (AD472602)

Wallops Island Test Range Reference Atmosphere (Part I), Document 104-63, July 10, 1965. (AD474071)

Eastern Test Range Reference Atmosphere for Ascension Island, South Atlantic (Part I), Document 104-63, July 1966. (AD645591)

Johnston Island Test Site Reference Atmosphere (Part I), Document 104-63, January 1970. (AD782652)

Lihue, Kauai, Hawaii Reference Atmosphere (Part I), Document 104-63, January 1970. (AD782653).

Cape Kennedy, Florida Reference Atmosphere (Part II), Document 104-63, September 1971. (AD751581)

White Sands Missile Range Reference Atmosphere (Part II), Document 104-63, September 1971. (AD782654)

Wallops Island Test Range Reference Atmosphere (Part II), Document 104-63, September 1971. (ADA040280)

Fort Greely Missile Range Reference Atmosphere (Part II), Document 104-63, September 1971. (ADA040281)

Edwards Air Force Base Reference Atmosphere (Part I), Document 104-63, September 1972. (AD782651)

Kwajalein Missile Range Reference Atmosphere for Kwajalein, Marshall Islands (Part I), Document 104-63, October 1974. (ADA002664)

Pacific Missile Test Center Reference Atmosphere for Point Arguello, California (Part II), Document 104-63, November 1975. (ADA040279)

REVISED RANGE REFERENCE ATMOSPHERES PUBLISHED BY THE RCC

Kwajalein Missile Range, Kwajalein, Marshall Islands, Range Reference Atmosphere, 0-70 Km Altitude, Document 360-82, December 1982. (AD123424)

Cape Canaveral, Florida, Range Reference Atmosphere, 0-70 Km Altitude, Document 361-83, February 1983. (ADA125553)

Vandenberg Air Force Base, California, Range Reference Atmosphere, 0-70 Km Altitude, Document 362-83, April 1983.

Dugway, Utah, Range Reference Atmosphere, 0-30 Km Altitude, Document 363-83, June 1983.

Wallops Island, Virginia, Range Reference Atmosphere, 0-70 Km Altitude, Document 364-83, July 1983.

White Sands Missile Range, New Mexico, Range Reference Atmosphere, 0-70 Km Altitude, Document 365-83, August 1983.

Edwards AFB, California, Range Reference Atmosphere, 0-70 Km Altitude, Document 366-83, August 1983.

Eglin AFB, Florida, Range Reference Atmosphere, 0-30 Km Altitude, Document 367-83, September 1983.

Taguac, Guam Island, Range Reference Atmosphere, 0-30 Km Altitude, Document 368-83, September 1983.

Point Mugu, California, Range Reference Atmosphere, 0-70 Km Altitude, Document 369-83, September 1983.

In addition to the documents above and the present RRA for Barking Sands, Hawaii, the revised series will include an RRA for the following location:

Ascension Island, South Atlantic

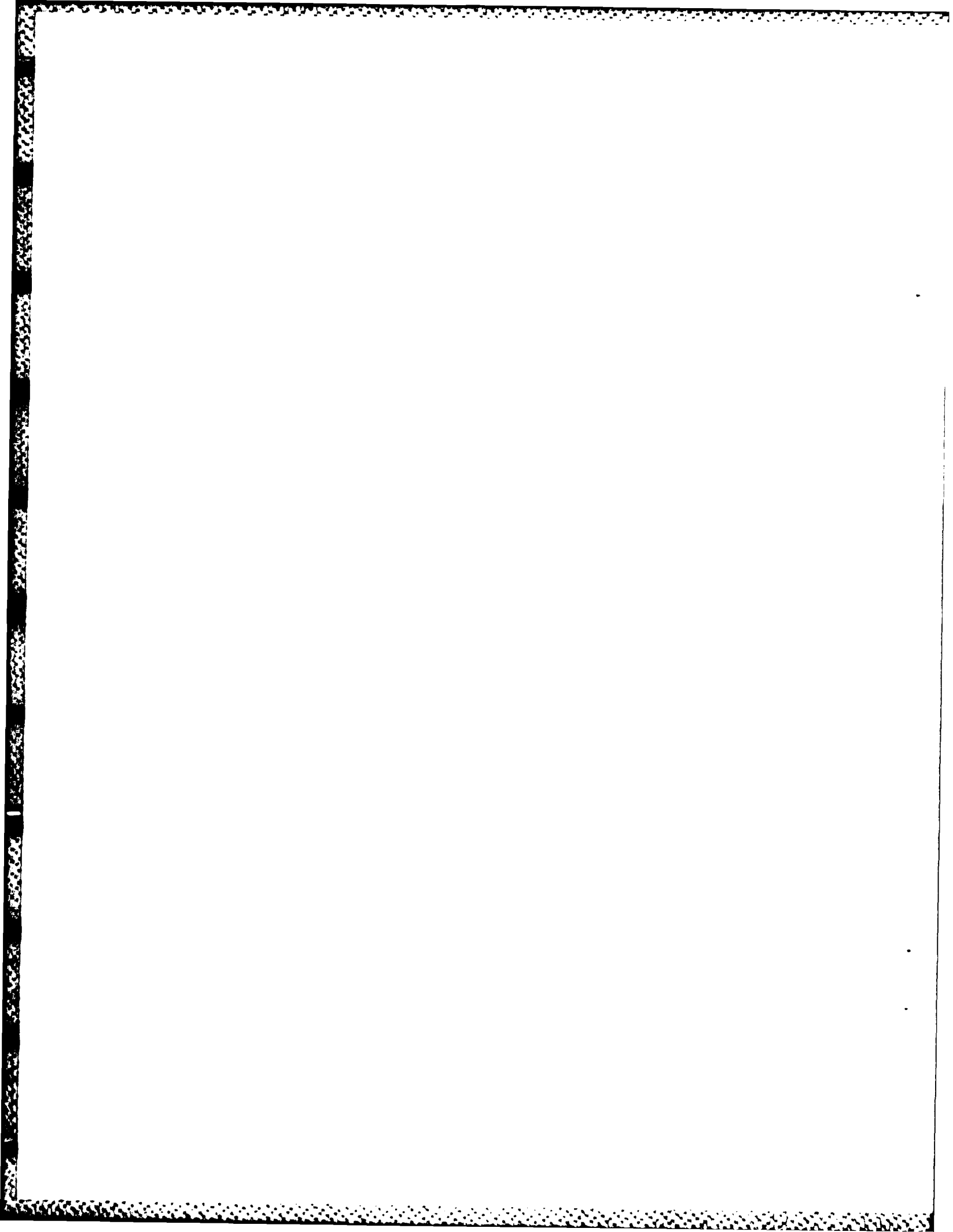

CONVERSION UNITS

Physical Constants and Conversion Factors

Numerical values in this document are given in the International System of Units (SI, *Système International d'Unités*). The values in parentheses are equivalent U.S. Customary Units, which are English units adapted for use by the United States of America. The SI and U.S. Customary Units provided in table F are those normally used for measuring and reporting atmospheric data.

By definition, the following fundamental conversion factors are exact:

<u>Type</u>	<u>U.S. Customary Units</u>	<u>Metric</u>
Length	1 U.S. yard (yd)	0.9144 meter (m)
Mass	1 avoirdupois pound (lb)	453.59237 gram (g)
Time	1 second (s)	1 second (s)
Temperature	1 degree Rankine (°R)	9/5 degree Kelvin (K)

To aid in the conversion of units, conversion factors based on the above fundamental conversion factors are given in table F.

TABLE F. FACTORS FOR CONVERSION UNITS

Type of Data	METRIC		U. S. CUSTOMARY				CONVERSION	
	Unit	Abbreviation	Unit	Abbreviation	Multiply	Bx	To Get	
TEMPERATURE Ambient Temperature	degree Celsius	C	degree Fahrenheit	F	$(F - 32)$	0.5556	C	
	degree Kelvin	K	degree Rankine	R	$^{\circ}R = 1.8 \times ^{\circ}C$ $^{\circ}R = 459.67 + ^{\circ}C$	1.8* 1.00* 1.00* 1.00* 1.00*	F 1.8 C 1.8 F 1.8 C 1.8 F 1.8	
Temperature Change	degree Celsius	C	degree Fahrenheit	F	$C \times 1.8 = F$	1.8*	temp. change F or R	
	degree Kelvin	K	degree Rankine	R	$K \times 1.8 = R$	1.8*	temp. change C or F	
DENSITY Water Vapor Vapor Concentration (Absolute Humidity) and Ambient Density	gram per cubic meter	$g\ m^{-3}$	gram per cubic foot	gr ft ⁻³		0.075 2.883 10 ⁻⁶ *	$g\ m^{-3}$ $g\ m^{-3}$ $g\ cm^{-3}$	
	gram per cubic centimeter	$g\ cm^{-3}$				4.370×10^{-5} 2.883×10^{-6}	$g\ ft^{-3}$ $g\ cm^{-3}$	
WIND Windspeed	meter per second	$m\ s^{-1}$	mile per hour	mph		2.2369	mph	
			knots	knots		0.44704*	$m\ s^{-1}$	
			feet per second	ft s ⁻¹		1.0936	knots	
						0.51444	$m\ s^{-1}$	
						0.668976	knots	
						1.15078	mph	
						3.2808	ft s ⁻¹	
						0.3048*	$m\ s^{-1}$	
DISTANCE Length	meter	m	feet	ft		3.2808	ft	
	micron	μ	inch	in.		0.3048*	in.	
	Angstrom unit	\AA				2.54×10^{-4} *	μ	
						2.54×10^{-8} *	\AA	
						10^{-6} *	μ	
						10^{-10} *	\AA	

* Defined exact conversion factor

TABLE F. (continued)

Type of Data	METRIC				U. S. CUSTOMARY				CONVERSION			
	Unit	Abbreviation	Unit	Abbreviation	Multiply	Div	Unit	Abbreviation	Multiply	Div	Unit	Abbreviation
DISTANCE (included)												
MASS Weight	gram		gram	g								
	kilogram		pound	lb								
PRESSURE Atmospheric	newton per square meter		inch of Mercury									
	millimeter of Mercury											
	bar											
	millibar											
	dynes per square centimeter (mikrobar)											
	kilogram force per square meter											

* Defined exact conversion factor

TABLE I-1. WIND STATISTICAL PARAMETERS

JANUARY

STATION - 911620		BARKING SANDS, HI									
Z	MEAN U	S.D. U	R(U,V)	MEAN V	S.D. V	MEAN WS	S.D. WS	SKREW WS	NOBS		
KM	M/S	M/S		M/S	M/S	M/S	M/S				
.005	-1.48	1.84	-.1367	-.14	3.07	2.67	2.44	1.29	339.		
1.000	.31	4.60	.0909	.80	5.55	6.00	4.08	.81	337.		
2.000	1.88	7.30	.2206	.84	5.29	7.78	4.98	.90	337.		
3.000	4.59	8.42	.2866	.49	5.64	9.15	6.34	1.29	337.		
4.000	6.97	9.44	.2794	-.43	6.62	11.46	7.07	1.06	337.		
5.000	9.76	10.20	.2039	-1.60	7.65	14.03	7.96	.63	337.		
6.000	12.19	11.25	.2232	-2.13	9.19	16.74	9.14	.52	335.		
7.000	14.73	12.08	.2037	-3.38	11.06	19.83	10.03	.56	333.		
8.000	18.10	13.59	.1855	-5.54	13.04	24.28	11.09	.50	331.		
9.000	21.91	15.21	.2489	-7.63	14.87	29.04	12.10	.31	331.		
10.000	25.29	16.18	.3418	-9.10	16.19	33.05	12.36	.10	326.		
11.000	28.00	15.88	.4116	-10.40	17.01	36.08	12.77	.07	319.		
12.000	29.62	17.41	.4202	-11.09	16.39	37.39	13.37	.47	319.		
13.000	29.66	16.77	.4146	-10.33	14.84	35.21	13.25	.48	318.		
14.000	27.27	15.12	.3578	-9.52	12.62	32.72	12.29	.36	315.		
15.000	23.26	13.30	.3478	-7.79	10.92	28.00	10.63	.17	314.		
16.000	18.17	11.19	.3098	-5.80	9.10	22.00	9.36	.26	308.		
17.000	12.39	9.44	.2140	-4.17	7.16	15.67	8.11	.43	308.		
18.000	6.80	7.67	.1512	-2.34	5.45	10.12	5.92	.93	307.		
19.000	1.72	5.55	.1317	-1.34	3.83	6.11	3.59	.65	303.		
20.000	-1.01	4.42	.1235	-1.08	2.88	4.71	2.79	.81	293.		
21.000	-2.28	4.57	.1464	-1.05	2.49	4.96	2.97	.80	289.		
22.000	-2.79	5.11	.0479	-.83	2.74	5.56	3.34	.76	287.		
23.000	-3.04	5.44	.0999	-.65	2.43	5.80	3.38	.70	278.		
24.000	-3.02	6.49	.0954	-.39	2.84	6.54	4.07	1.08	263.		
25.000	-2.81	7.36	.0606	.25	2.82	7.00	4.57	1.23	258.		
26.000	-1.46	7.76	.2390	.74	3.09	7.11	4.65	1.63	228.		
27.000	.75	8.10	.3701	.96	3.51	7.44	4.87	1.12	199.		
28.000	2.98	9.64	.3873	1.20	3.96	8.81	6.40	1.14	180.		
29.000	5.76	11.29	.4301	1.09	4.03	10.39	8.35	.91	118.		
30.000	8.70	12.41	.4313	.52	4.39	12.57	9.52	.82	105.		
32.000	7.12	13.19	.3429	-.30	4.89	13.31	8.41	.82	126.		
34.000	7.63	14.40	.2056	-.25	6.22	14.94	8.98	1.04	126.		
36.000	5.77	15.03	.3855	-.77	6.23	14.77	8.88	.88	126.		
38.000	4.59	16.30	.4875	.09	6.65	15.28	9.80	.92	126.		
40.000	2.59	16.22	.3803	1.40	7.94	15.54	9.56	1.09	126.		
42.000	2.17	16.12	.3940	2.80	8.54	15.72	9.81	1.30	126.		
44.000	1.50	17.09	.3416	2.75	9.52	17.73	10.17	.82	126.		
46.000	1.91	21.20	.2026	4.32	13.11	22.34	11.87	.79	126.		
48.000	2.94	24.45	.0453	9.57	13.74	26.54	13.35	.81	125.		
50.000	5.97	25.11	.0579	7.50	10.90	25.25	14.11	.72	123.		
52.000	12.17	26.06	.1031	5.08	11.24	27.11	15.48	.77	119.		
54.000	21.81	27.02	.1656	4.52	13.44	32.84	17.97	.58	116.		
56.000	32.21	28.84	.1653	6.80	14.90	40.65	21.92	.57	111.		
58.000	43.36	29.06	.3762	8.76	16.66	49.71	25.36	.07	93.		
60.000	52.01	24.89	.3074	7.77	16.00	55.46	21.19	-.51	67.		
62.000	52.93	22.72	.3845	3.94	12.69	54.97	21.59	-.39	40.		
64.000	62.61	19.14	.2581	1.48	14.81	64.61	17.95	-.40	23.		
66.000	61.92	22.22	.1934	-4.32	16.43	64.74	20.25	-.47	23.		
68.000	61.00	25.44	.1327	-10.47	15.42	64.65	22.80	-.39	23.		
70.000	58.89	27.37	-.0213	-8.80	15.24	62.55	24.41	-.39	20.		

TABLE I-2. WIND STATISTICAL PARAMETERS

FEBRUARY

STATION = 911620		BARKING SANDS, HI								
Z	MEAN U	S.D. U	R(U,V)	MEAN V	S.D. V	MEAN WS	S.D. WS	SKEW WS	NOBS	
KM	M/S	M/S		M/S	M/S	M/S	M/S			
.005	-.66	1.75	-.1134	-.23	2.44	2.22	2.15	1.47	342.	
1.000	-.92	4.21	.2134	.79	4.47	5.06	3.67	1.40	342.	
2.000	-.14	6.76	.3046	.97	4.42	6.83	4.32	1.06	342.	
3.000	2.27	7.73	.3535	.48	4.85	7.73	5.37	1.46	342.	
4.000	4.97	8.96	.2295	-.07	5.64	9.65	6.60	1.20	342.	
5.000	7.91	9.78	.1667	-1.32	6.79	11.39	7.90	1.08	342.	
6.000	10.94	10.30	.0810	-2.30	7.81	14.66	8.78	.77	342.	
7.000	13.96	11.05	.0613	-3.52	9.21	17.97	9.55	.47	340.	
8.000	17.07	12.00	.0819	-4.65	11.40	21.82	10.51	.38	337.	
9.000	20.67	13.23	.1078	-5.51	13.34	26.03	11.52	.22	336.	
10.000	24.49	13.89	.2129	-6.07	14.68	30.05	11.90	.04	329.	
11.000	27.63	14.47	.2964	-6.77	15.77	33.50	12.01	.06	324.	
12.000	29.47	15.07	.3276	-7.71	15.17	35.09	12.36	-.23	324.	
13.000	29.72	14.52	.3647	-8.39	14.03	34.82	12.15	.43	323.	
14.000	27.57	13.89	.3951	-8.25	12.18	32.21	11.45	.54	322.	
15.000	24.26	12.95	.3329	-7.03	9.74	28.09	10.53	-.67	320.	
16.000	19.18	10.66	.2134	-5.38	7.60	22.12	8.89	.63	317.	
17.000	13.31	8.30	.1931	-3.59	6.25	15.80	6.93	.59	314.	
18.000	7.83	7.25	.2094	-1.98	5.00	10.43	5.82	1.48	311.	
19.000	3.16	5.67	.1293	-1.39	3.69	6.42	4.05	1.29	306.	
20.000	.57	4.83	.0929	-1.37	2.62	4.94	2.80	1.14	301.	
21.000	-.80	4.64	.1456	-1.28	2.44	4.74	2.69	.69	289.	
22.000	-1.73	5.00	.0572	-1.20	2.52	5.24	2.86	.65	285.	
23.000	-2.32	4.85	.1328	-.85	2.26	5.03	3.06	.96	270.	
24.000	-2.46	5.38	.0455	-.43	2.83	5.64	3.36	.99	257.	
25.000	-1.93	6.23	.0612	.07	2.81	6.01	3.77	1.14	253.	
26.000	-.58	6.80	.0622	.30	2.65	6.23	3.84	.87	225.	
27.000	1.42	7.46	.1542	.77	2.82	6.96	4.20	.88	194.	
28.000	3.59	8.26	.2903	1.30	3.13	8.04	5.25	.91	182.	
29.000	6.76	9.04	.1548	1.40	3.42	9.64	6.90	.67	118.	
30.000	9.38	10.64	.0048	1.26	3.57	11.93	8.53	.50	100.	
32.000	11.70	10.44	.1085	-.79	4.94	14.44	7.87	.28	141.	
34.000	10.07	11.16	.0849	-.02	5.74	13.70	6.40	.82	141.	
36.000	7.25	13.32	.3778	-.80	6.38	13.59	9.54	1.30	141.	
38.000	3.28	15.64	.3963	-1.10	7.30	13.89	10.74	1.58	141.	
40.000	.84	18.08	.3034	1.72	8.32	16.43	11.31	1.44	141.	
42.000	1.13	19.40	.3309	4.89	7.85	18.34	11.85	1.33	142.	
44.000	3.41	21.50	.4608	6.11	8.53	20.18	13.68	1.49	142.	
46.000	7.55	22.59	.5966	7.25	10.56	22.44	15.00	1.17	142.	
48.000	12.37	22.81	.2895	5.88	9.64	23.73	15.32	1.06	142.	
50.000	18.30	23.78	.1524	4.74	8.99	26.77	16.86	1.00	141.	
52.000	26.12	23.22	.0921	6.18	10.94	32.81	17.32	.96	138.	
54.000	33.26	22.77	.1085	6.77	11.96	38.16	18.85	.53	133.	
56.000	38.13	22.57	.1682	8.91	11.36	42.61	18.82	-.36	119.	
58.000	45.26	18.84	.1180	10.72	11.42	48.25	17.87	-.35	104.	
60.000	51.33	19.30	.1419	9.78	12.77	54.60	16.79	-.51	90.	
62.000	56.04	19.59	.1394	8.33	14.66	59.10	17.77	-.50	42.	
64.000	57.24	21.28	.2304	1.57	17.26	59.55	21.77	-.34	23.	
66.000	56.40	23.92	.4320	-9.14	19.28	61.52	20.11	-.09	27.	
68.000	52.50	23.14	.3404	-13.57	17.06	57.96	19.79	-.12	27.	
70.000	48.02	20.02	-.0031	-12.56	20.16	52.30	18.17	-.32	27.	

TABLE I-3. WIND STATISTICAL PARAMETERS

MARCH

STATION - 911620		BARKING SANDS, HI								
Z	MEAN U	S.D. U	R(U,V)	MEAN V	S.D. V	MEAN WS	S.D. WS	SKEW WS	NOBS	
KM	M/S	M/S		M/S	M/S	M/S	M/S			
.005	-0.67	1.25	-.0193	-0.49	2.35	1.91	2.04	1.85	387.	
1.000	-2.10	3.69	.0399	.19	3.49	4.62	2.98	1.14	397.	
2.000	-2.16	6.18	.1414	.82	3.77	6.49	3.93	.89	387.	
3.000	-.25	6.53	.2243	-.17	4.14	6.49	4.21	1.62	387.	
4.000	1.38	7.27	.2644	-.56	4.61	7.18	4.96	1.43	387.	
5.000	3.41	7.93	.2070	-1.26	5.36	8.50	5.69	1.35	397.	
6.000	5.76	8.40	.2416	-1.95	6.44	10.44	6.31	.95	386.	
7.000	8.44	9.45	.2425	-2.61	7.65	13.14	7.29	.74	386.	
8.000	11.43	10.64	.2732	-3.21	9.40	16.34	8.68	.71	386.	
9.000	15.01	12.13	.3211	-4.41	11.83	20.60	10.34	.48	377.	
10.000	19.01	13.34	.3289	-5.99	14.78	25.64	11.63	.15	370.	
11.000	23.04	14.65	.3659	-7.48	16.80	30.41	12.57	.18	363.	
12.000	26.65	15.67	.4154	-8.21	16.97	33.71	13.21	.23	363.	
13.000	26.96	15.57	.4581	-8.65	15.12	33.36	12.62	.30	361.	
14.000	24.80	13.80	.3913	-8.33	12.73	30.14	11.31	.30	357.	
15.000	21.06	11.88	.3197	-7.25	10.21	25.41	9.77	.47	356.	
16.000	16.47	9.43	.2446	-5.94	8.07	19.97	7.65	.45	356.	
17.000	11.51	7.64	.1826	-4.29	6.44	14.42	6.55	.46	352.	
18.000	6.62	6.33	.0303	-3.02	5.15	9.60	5.23	.75	349.	
19.000	2.71	4.81	.1734	-2.08	3.58	5.88	3.60	1.42	342.	
20.000	.08	4.21	.2115	-1.36	2.60	4.39	2.64	1.16	335.	
21.000	-1.20	4.13	.1254	-.99	2.34	4.22	2.66	1.65	329.	
22.000	-1.76	4.28	.0399	-1.03	2.70	4.59	2.96	1.81	323.	
23.000	-2.34	4.29	.0262	-.83	2.42	4.57	3.07	2.24	300.	
24.000	-2.93	5.15	.0204	-.56	2.89	5.44	3.76	1.78	264.	
25.000	-2.98	5.53	.1269	-.09	2.83	5.85	3.64	1.13	276.	
26.000	-2.53	6.27	.1655	.63	2.75	6.21	3.87	1.13	246.	
27.000	-1.55	7.64	.1776	1.43	2.96	7.25	4.34	1.12	205.	
28.000	-.01	9.11	.1568	1.74	3.18	8.43	4.96	.98	197.	
29.000	1.84	10.32	.2054	2.18	3.56	9.73	5.64	.59	110.	
30.000	2.99	10.96	.3136	2.22	3.38	10.35	6.10	.49	99.	
32.000	8.67	10.79	-.0250	.17	4.74	12.99	6.67	.37	126.	
34.000	6.48	10.80	-.0277	.05	5.59	12.25	6.24	.70	126.	
36.000	3.75	10.29	.0992	1.54	5.37	10.79	5.82	1.29	126.	
38.000	2.00	11.15	.0177	1.48	5.76	11.13	6.23	1.08	126.	
40.000	2.71	12.10	.0970	1.60	6.81	12.42	6.87	.93	126.	
42.000	6.21	13.31	.2230	3.94	7.41	14.80	8.11	1.06	126.	
44.000	11.88	15.09	.2410	5.34	7.93	18.86	10.17	.82	125.	
46.000	18.26	16.10	.2778	5.97	8.50	23.40	12.30	.50	124.	
48.000	24.41	17.18	.2128	5.39	8.23	28.05	14.13	.71	123.	
50.000	28.60	17.53	.1535	4.90	8.44	31.89	14.19	.76	122.	
52.000	33.18	17.10	.3383	6.10	8.74	35.77	15.05	.42	121.	
54.000	36.14	18.00	.4158	6.61	8.00	38.51	15.93	.19	117.	
56.000	38.58	19.87	.2649	7.40	8.12	41.50	16.73	.11	112.	
58.000	40.14	20.95	.0318	10.29	10.08	44.16	17.48	-.10	90.	
60.000	42.78	19.81	-.1257	9.78	9.69	46.37	16.02	-.36	65.	
62.000	49.61	17.79	-.0550	6.86	9.39	51.18	17.05	-.66	34.	
64.000	54.58	17.24	.0073	-.31	9.72	55.64	16.43	-.47	25.	
66.000	47.72	19.10	.0704	-2.68	14.18	50.68	16.39	-.39	22.	
68.000	35.30	20.36	.0279	-5.30	12.93	39.76	16.12	-.08	21.	
70.000	19.92	23.76	-.1271	-7.06	9.93	28.00	17.09	.65	21.	

TABLE I-4. WIND STATISTICAL PARAMETERS

APRIL

STATION #	911620	BARKING SANDS, MI								
Z	MEAN U	S.D. U	R(U,V)	MEAN V	S.D. V	MEAN WS	S.D. WS	SKEW WS	NOBS	
KM	M/S	M/S		M/S	M/S	M/S	M/S			
.005	-1.33	1.35	-.0051	-.49	2.10	1.77	1.86	1.95	330.	
1.000	-2.44	2.86	.0159	.19	2.48	3.79	2.43	1.03	388.	
2.000	-3.42	4.84	.0303	.52	3.01	5.53	3.56	.98	387.	
3.000	-1.96	5.03	.1155	-.24	3.16	5.37	3.21	.94	387.	
4.000	-.55	5.67	.1559	-.60	3.74	5.74	3.71	1.16	387.	
5.000	1.26	6.33	.0948	-.97	4.50	6.69	4.36	1.07	397.	
6.000	3.21	7.19	.0978	-1.54	4.97	8.12	4.80	1.00	385.	
7.000	5.21	8.20	.0227	-1.89	5.44	9.77	5.65	.70	355.	
8.000	7.83	9.24	.1555	-2.18	6.40	12.12	6.74	.60	365.	
9.000	11.11	10.60	.2293	-2.50	7.71	15.30	8.19	.64	384.	
10.000	15.34	12.43	.2288	-2.71	9.09	19.34	10.25	.64	380.	
11.000	20.61	14.64	.1366	-2.88	10.47	24.37	12.76	.50	379.	
12.000	26.10	15.86	.2346	-3.07	11.02	29.38	14.15	.26	377.	
13.000	29.46	15.12	.2233	-3.26	10.59	32.14	13.62	.21	373.	
14.000	27.33	12.52	.2646	-3.49	8.65	29.52	11.05	.20	372.	
15.000	22.81	10.33	.2438	-3.36	7.50	24.67	9.10	.18	372.	
16.000	17.04	7.95	.2450	-2.83	5.93	18.64	6.90	.12	370.	
17.000	11.47	6.41	.1411	-2.34	4.58	12.98	5.55	.50	358.	
18.000	5.97	4.81	.1489	-1.57	3.71	7.71	4.00	.86	364.	
19.000	2.12	3.93	.1754	-.85	2.90	4.69	2.65	1.10	360.	
20.000	-.52	3.59	.2534	-.10	2.27	3.61	2.29	.75	353.	
21.000	-2.50	3.62	.1675	-.08	1.92	4.18	2.36	.59	346.	
22.000	-3.91	3.80	.0496	-.43	1.99	5.04	2.91	.74	345.	
23.000	-5.07	3.92	-.0305	-.44	1.74	5.75	3.35	.65	372.	
24.000	-6.03	4.55	-.0393	-.25	2.28	6.83	3.95	.55	326.	
25.000	-6.42	4.81	.0029	.16	2.47	7.35	4.06	.52	316.	
26.000	-6.25	5.27	.1035	.33	2.19	7.31	4.27	.57	285.	
27.000	-5.71	6.27	.0682	.64	2.65	7.68	4.49	.79	221.	
28.000	-5.01	7.31	.0377	.84	2.71	7.89	4.91	.77	211.	
29.000	-4.07	8.26	.0903	.96	2.97	8.13	5.29	.92	126.	
30.000	-3.83	8.88	.1107	.88	3.12	8.67	5.32	.82	106.	
32.000	-2.13	9.76	-.1363	.28	4.62	8.92	6.00	1.21	149.	
34.000	-3.60	10.06	-.2839	-.43	4.26	9.70	6.15	1.02	147.	
36.000	-4.47	9.77	-.1376	.74	4.89	10.08	6.16	.81	147.	
38.000	-3.73	9.63	.1082	.45	4.85	9.85	5.74	.85	147.	
40.000	-3.29	11.36	.0715	.03	4.91	10.99	6.51	1.03	147.	
42.000	-2.98	11.80	.1693	.89	5.32	11.64	6.40	.88	147.	
44.000	-2.54	12.73	.2501	2.65	5.75	12.70	6.81	.67	147.	
46.000	-.20	13.32	.2234	5.44	5.30	13.40	7.39	.89	144.	
48.000	3.85	13.83	.1699	6.64	6.74	14.73	8.01	1.12	142.	
50.000	6.13	14.18	.1463	5.39	6.59	14.46	10.06	1.18	140.	
52.000	6.52	14.50	.1456	4.40	8.10	15.25	10.19	1.10	141.	
54.000	5.57	15.21	.1418	5.85	7.90	16.14	9.85	1.03	139.	
56.000	6.24	17.11	.1501	8.49	8.74	18.59	11.52	.87	122.	
58.000	10.21	16.82	.0675	9.92	9.12	20.60	11.92	.98	105.	
60.000	11.33	17.61	.2217	7.59	8.75	20.57	12.10	.56	77.	
62.000	11.85	18.22	.0865	-.48	13.12	22.35	11.71	.43	45.	
64.000	8.38	18.97	.4091	-3.90	10.04	19.79	11.97	.63	28.	
66.000	-.45	19.49	-.0987	-9.02	13.14	23.04	9.22	.64	26.	
68.000	-11.06	18.98	-.0149	-14.18	14.96	27.08	12.54	.59	25.	
70.000	-22.46	19.53	-.2982	-11.52	14.20	33.13	10.08	.58	23.	

TABLE I-5. WIND STATISTICAL PARAMETERS

MAY

STATION = 911620		BARKING SANDS, HI									
Z	MEAN U	S.D. U	R(U,V)	MEAN V	S.D. V	MEAN WS	S.D. WS	SKEW WS	NOBS		
KM	M/S	M/S		M/S	M/S	M/S	M/S				
.005	-1.10	1.29	-.1653	-.23	2.02	1.64	1.77	1.89	369.		
1.000	-2.29	2.43	-.1155	.47	2.27	3.28	2.40	1.15	367.		
2.000	-3.24	4.26	.1064	.50	2.69	5.09	3.19	.72	367.		
3.000	-2.01	4.71	.2570	.06	3.35	5.36	2.94	.99	367.		
4.000	-5.60	5.47	.2725	-.19	3.54	5.65	3.29	.81	367.		
5.000	.80	6.20	.2778	-.57	4.06	6.40	3.85	1.07	367.		
6.000	2.07	6.86	.3365	-.87	4.80	7.37	4.56	1.06	367.		
7.000	3.57	7.88	.3386	-1.28	5.49	8.76	5.46	.92	367.		
8.000	5.34	8.95	.3763	-1.77	6.44	10.58	6.41	.83	365.		
9.000	7.64	10.61	.4089	-2.05	7.52	13.13	7.69	.82	365.		
10.000	10.28	12.72	.4017	-2.34	8.69	15.09	9.44	.85	363.		
11.000	13.63	15.35	.3958	-2.51	9.83	19.71	11.64	1.02	362.		
12.000	17.69	17.18	.4300	-2.40	10.42	23.11	13.71	.77	361.		
13.000	20.64	17.53	.4298	-2.50	10.04	25.14	14.41	.66	359.		
14.000	20.96	15.68	.3466	-2.54	8.67	24.23	13.39	.72	358.		
15.000	17.38	12.39	.3259	-2.19	7.21	19.99	10.60	.72	357.		
16.000	12.21	9.08	.3290	-1.28	5.65	14.26	7.84	.74	352.		
17.000	7.20	6.68	.2539	-.49	4.20	9.08	5.63	.87	349.		
18.000	2.65	5.08	.1579	.09	3.29	5.49	3.67	1.42	348.		
19.000	-1.37	4.10	.1444	.49	2.41	4.33	2.44	.71	345.		
20.000	-4.63	3.63	.1235	.31	1.98	5.57	2.76	.45	337.		
21.000	-7.11	3.77	.1064	.29	1.97	7.63	3.23	.28	326.		
22.000	-8.70	3.88	.0580	.27	1.84	9.02	3.57	.12	324.		
23.000	-10.10	3.88	-.0285	.10	1.73	10.31	3.71	-.16	310.		
24.000	-11.14	4.09	.0050	-.10	2.27	11.42	3.94	-.20	304.		
25.000	-11.87	4.48	.0674	.18	2.08	12.12	4.30	-.12	281.		
26.000	-12.16	4.78	-.0591	.31	2.16	12.43	4.59	-.11	252.		
27.000	-12.05	5.40	-.1250	.25	2.62	12.45	5.11	.11	203.		
28.000	-11.98	5.71	-.0131	.37	2.42	12.42	5.27	.04	194.		
29.000	-11.53	6.77	.1699	.17	3.13	12.44	5.79	.11	123.		
30.000	-11.29	7.50	.1537	.09	2.55	12.33	6.17	.17	104.		
32.000	-11.13	8.03	-.0181	.90	3.26	12.75	6.09	.72	150.		
34.000	-12.05	7.72	-.2158	.42	3.55	13.30	6.37	.56	150.		
36.000	-12.47	7.53	-.1239	.96	3.64	13.59	6.46	.41	150.		
38.000	-12.80	7.30	.0249	.54	4.31	14.01	6.31	.10	150.		
40.000	-15.06	7.85	.1793	.31	4.68	16.72	6.85	.24	150.		
42.000	-18.38	8.18	-.0465	.47	5.00	18.43	7.23	.16	153.		
44.000	-21.76	8.44	-.0500	3.63	4.97	22.82	7.85	.05	152.		
46.000	-22.89	9.16	.0287	6.29	4.92	24.59	8.16	-.07	151.		
48.000	-21.78	9.77	.0390	8.87	5.82	23.95	8.78	-.13	149.		
50.000	-21.76	10.78	.0521	7.12	5.63	24.21	9.26	.12	144.		
52.000	-23.45	11.38	-.1039	6.92	6.22	25.77	10.05	-.09	137.		
54.000	-25.65	11.72	-.0053	5.38	7.39	27.71	10.52	-.10	129.		
56.000	-26.49	13.26	.0982	7.09	8.22	29.25	11.78	.07	118.		
58.000	-25.57	14.13	.0206	8.60	8.24	29.46	11.21	.01	99.		
60.000	-24.13	14.34	-.1903	7.50	9.13	28.54	10.51	.29	74.		
62.000	-23.00	15.29	-.1335	4.27	13.01	29.73	12.53	.16	45.		
64.000	-23.70	15.04	.1140	-4.43	8.35	28.78	11.97	.03	32.		
66.000	-28.18	11.11	-.0889	-5.60	11.55	31.22	10.12	.70	32.		
68.000	-29.27	13.14	.0829	-8.27	15.40	34.59	11.36	.28	32.		
70.000	-38.25	17.24	.1674	-14.16	15.09	43.80	16.15	-.28	30.		

TABLE I-6. WIND STATISTICAL PARAMETERS

JUNE

STATION - 911620		BARKING SANDS, HI								
Z	MEAN U	S.D. U	R(U,V)	MEAN V	S.D. V	MEAN WS	S.D. WS	SKEW WS	NOBS	
KM	M/S	M/S		M/S	M/S	M/S	M/S			
.005	.04	1.26	-.0708	-.23	1.38	1.41	1.25	1.89	372.	
1.000	-2.36	2.37	-.0638	.21	1.42	3.08	1.94	.90	372.	
2.000	-5.01	4.23	-.0501	.01	2.43	6.15	3.34	.44	372.	
3.000	-4.16	4.46	.1113	-.48	3.01	6.04	3.15	.39	372.	
4.000	-3.09	5.13	.1147	-.39	3.61	6.16	3.31	.53	372.	
5.000	-1.87	5.61	.1029	-.17	4.23	6.43	3.40	.50	372.	
6.000	-.52	6.09	.1342	-.17	4.65	6.78	3.65	.71	372.	
7.000	.72	6.94	.1986	-.19	5.91	7.66	4.66	.71	372.	
8.000	2.07	8.24	.2503	-.10	7.04	9.60	5.41	.71	371.	
9.000	3.47	10.01	.2992	-.21	8.09	11.71	6.36	.64	370.	
10.000	5.53	12.19	.3802	-.21	9.39	14.23	8.02	.73	370.	
11.000	7.87	14.62	.3973	-.10	10.37	16.93	9.79	.69	369.	
12.000	10.17	16.43	.4040	-.12	11.06	19.10	11.40	.68	369.	
13.000	11.80	17.14	.4035	-.21	10.73	19.87	12.35	.71	369.	
14.000	11.49	15.12	.3505	-.25	9.27	17.71	11.51	.98	368.	
15.000	8.65	11.56	.3465	.19	6.85	13.35	8.77	1.04	366.	
16.000	4.62	7.97	.2156	.18	4.87	8.66	5.77	1.38	365.	
17.000	.01	5.34	.0820	.14	3.17	5.29	3.25	1.72	362.	
18.000	-4.44	4.23	-.0011	.31	2.65	5.95	3.04	.32	357.	
19.000	-8.08	3.59	.0692	.26	1.90	8.48	3.16	.02	351.	
20.000	-10.81	3.43	.1001	.31	1.59	10.95	3.37	-.13	342.	
21.000	-13.18	3.48	.0352	.09	1.94	13.33	3.45	-.15	336.	
22.000	-14.78	3.47	.0119	.18	1.93	14.93	3.36	-.12	333.	
23.000	-16.31	3.30	.0804	.08	1.88	16.42	3.23	-.19	320.	
24.000	-17.57	3.79	.0792	-.04	2.18	17.71	3.78	-.12	319.	
25.000	-18.59	3.83	-.0099	.15	2.18	18.72	3.83	-.17	298.	
26.000	-19.24	3.87	-.0249	.08	2.14	19.35	3.87	-.11	265.	
27.000	-19.64	4.06	.1044	-.05	2.78	19.83	4.05	-.15	207.	
28.000	-19.69	4.19	.0284	-.02	2.21	19.82	4.18	.12	191.	
29.000	-20.12	4.59	.0493	.19	2.80	20.32	4.56	.15	115.	
30.000	-21.13	4.87	-.0500	.18	1.90	21.22	4.85	.12	101.	
32.000	-21.28	5.54	-.0827	.95	2.72	21.48	5.51	-.04	134.	
34.000	-22.13	5.36	.1334	1.01	3.44	22.43	5.31	-.26	134.	
36.000	-23.95	5.82	-.0533	.44	3.44	24.22	5.71	-.26	134.	
38.000	-27.18	5.92	-.0219	.66	3.67	27.44	5.89	-.19	133.	
40.000	-30.89	5.90	.0729	.32	4.09	31.15	5.94	-.08	133.	
42.000	-35.62	7.57	.0549	.91	4.44	35.62	7.54	-.09	131.	
44.000	-39.46	7.48	-.2330	3.22	5.34	39.94	7.54	-.07	132.	
46.000	-41.05	7.75	.0228	4.86	5.36	41.70	7.64	-.03	128.	
48.000	-41.34	8.14	.0772	5.93	5.71	42.15	8.09	.06	124.	
50.000	-42.72	9.60	.0789	5.13	5.92	43.48	9.38	.08	122.	
52.000	-44.79	9.48	-.0007	5.51	6.87	45.68	9.31	.23	121.	
54.000	-45.12	10.47	-.0141	6.80	8.13	46.39	10.24	-.24	115.	
56.000	-43.93	12.66	-.0817	8.30	9.61	45.87	12.13	-.17	104.	
58.000	-41.42	12.49	-.0719	8.63	9.67	43.54	11.93	-.18	87.	
60.000	-40.29	12.76	-.0157	8.75	9.70	42.40	12.55	-.32	60.	
62.000	-37.04	14.55	.1951	6.41	10.96	39.38	13.79	-.10	37.	
64.000	-29.45	16.36	.2930	.88	14.19	33.39	14.53	-.24	23.	
66.000	-25.87	16.13	.2731	-9.38	12.76	30.30	15.96	.00	23.	
68.000	-30.90	19.25	.4628	-18.15	13.84	38.10	19.67	-.33	22.	
70.000	-33.06	22.02	.2545	-12.35	15.68	39.32	20.55	.38	22.	

TABLE I-7. WIND STATISTICAL PARAMETERS

JULY

STATION	911620	BARKING SANDS, HI								
Z	MEAN U	S.D. U	R(U,V)	MEAN V	S.D. V	MEAN WS	S.D. WS	SKEW WS	NOBS	
KM	M/S	M/S		M/S	M/S	M/S	M/S			
.005	-.02	1.20	-.1029	-.10	1.18	1.22	1.16	1.38	340.	
1.000	-2.83	2.13	.1220	-.06	1.32	3.24	1.94	.57	340.	
2.000	-5.70	3.71	.1189	-.06	2.24	6.34	3.32	.45	340.	
3.000	-4.69	3.83	.1718	-.27	2.94	5.88	3.27	.64	340.	
4.000	-3.57	4.29	.2759	-.22	3.39	5.67	3.23	.68	338.	
5.000	-1.94	5.07	.2574	.05	4.84	5.65	3.65	1.00	338.	
6.000	.37	5.59	.1761	.29	4.77	6.40	3.63	.76	338.	
7.000	2.35	6.33	.1593	.66	5.38	7.63	4.07	.65	337.	
8.000	4.57	7.34	.1765	1.00	6.14	9.47	4.86	.63	337.	
9.000	7.34	8.67	.1913	1.28	6.84	11.83	6.11	.61	335.	
10.000	10.33	10.16	.2208	1.81	7.92	14.73	7.67	.49	335.	
11.000	13.37	11.84	.2322	2.29	9.33	17.93	9.45	.35	332.	
12.000	16.38	12.99	.2010	2.61	10.32	20.86	10.72	.19	331.	
13.000	17.89	13.52	.1240	2.70	10.37	22.11	11.34	.19	327.	
14.000	15.95	12.70	.1152	3.07	8.60	19.63	10.66	.34	325.	
15.000	10.21	9.19	.0341	2.67	6.30	13.41	7.45	.52	325.	
16.000	2.97	5.98	.0016	1.97	4.20	7.08	3.99	.75	324.	
17.000	-3.58	3.84	-.0661	1.16	2.85	5.40	2.79	.64	320.	
18.000	-8.84	3.08	-.0522	.73	2.30	9.18	3.03	.05	318.	
19.000	-12.43	2.69	-.0176	.34	1.95	12.59	2.70	.09	315.	
20.000	-15.53	2.75	.0061	.32	1.88	15.65	2.75	.11	310.	
21.000	-17.39	2.76	.0305	.48	2.09	17.52	2.76	-.05	303.	
22.000	-19.10	2.91	.1679	.08	1.87	19.20	2.90	.02	293.	
23.000	-20.45	2.78	.1622	.11	1.84	20.53	2.70	.07	282.	
24.000	-21.38	3.25	.0785	.11	2.29	21.50	3.23	-.13	282.	
25.000	-22.43	3.69	-.0016	-.04	2.08	22.52	3.09	-.12	265.	
26.000	-23.32	3.18	-.0028	-.26	2.22	23.43	3.17	.04	232.	
27.000	-24.05	3.57	-.0502	-.21	2.45	24.18	3.55	-.03	191.	
28.000	-24.72	3.18	-.0369	-.33	2.30	24.83	3.14	.01	185.	
29.000	-25.15	3.31	-.0132	-.83	2.67	25.31	3.30	.12	109.	
30.000	-26.44	3.34	.1130	-.52	2.17	26.53	3.34	.25	99.	
32.000	-28.43	4.37	-.0328	2.63	2.82	28.09	4.35	-.23	142.	
34.000	-29.60	4.33	-.0199	1.77	3.56	29.87	4.29	.05	142.	
36.000	-32.74	5.36	.0423	.28	3.38	32.92	5.32	.14	142.	
38.000	-36.39	5.90	.1696	.64	4.01	35.63	5.83	.00	142.	
40.000	-39.53	6.15	-.0404	-.07	4.48	39.79	6.05	-.03	144.	
42.000	-44.13	7.02	-.1482	.33	5.51	44.48	6.97	.06	145.	
44.000	-47.27	7.36	-.1092	3.04	5.97	47.75	7.32	.03	144.	
46.000	-48.09	7.56	-.0307	5.29	5.18	49.55	7.52	.15	143.	
48.000	-49.93	8.46	.0203	5.12	6.00	50.61	8.35	.37	142.	
50.000	-50.76	9.17	-.0594	6.02	6.23	51.47	9.17	.56	137.	
52.000	-48.16	10.70	.0730	6.23	8.30	49.29	10.53	.50	130.	
54.000	-43.03	12.82	.0860	5.84	9.79	44.59	12.52	.09	122.	
56.000	-38.21	13.67	.1563	4.01	10.53	40.03	13.03	-.04	116.	
58.000	-33.13	16.19	.2753	6.32	11.11	36.60	13.49	.00	94.	
60.000	-23.98	17.25	.3221	5.06	13.87	30.33	12.71	.35	57.	
62.000	-18.33	20.58	-.0137	3.85	13.22	26.50	15.37	.15	34.	
64.000	-10.97	21.85	-.2537	-2.66	14.82	23.12	15.53	.43	26.	
66.000	-11.37	17.63	-.1754	-2.04	13.80	20.67	13.88	1.41	24.	
68.000	-14.43	16.51	-.0501	-6.10	13.63	22.91	12.83	.67	14.	
70.000	-19.04	21.80	.2679	-10.58	16.57	30.57	16.15	1.13	23.	

TABLE I-8. WIND STATISTICAL PARAMETERS

AUGUST

STATION = 911620		BARKING SANDS, HI							
Z	MEAN U	S.D. U	R(U,V)	MEAN V	S.D. V	MEAN WS	S.D. WS	SKEW WS	NOBS
KM	M/S	M/S		M/S	M/S	M/S	M/S		
.005	- .31	1.16	.0167	-.01	.96	1.18	.99	1.02	394.
1.000	-2.90	2.07	-.0346	-.13	1.31	3.26	1.94	.61	393.
2.000	-4.97	3.45	.0128	-.40	2.33	5.58	3.31	.52	392.
3.000	-3.79	3.42	.1681	-.49	2.73	5.06	2.87	.51	392.
4.000	-2.47	3.74	.2492	-.47	3.01	4.68	2.74	.71	391.
5.000	-.78	3.97	.2835	-.38	3.36	4.55	2.61	.75	391.
6.000	1.01	4.58	.2453	-.16	3.95	5.29	3.12	.76	391.
7.000	3.17	5.02	.2297	.27	4.46	6.49	3.62	.68	388.
8.000	5.67	5.85	.1650	.71	5.27	8.55	4.60	.57	384.
9.000	8.34	6.78	.1312	1.24	6.23	11.11	5.67	.38	384.
10.000	11.17	7.90	.1344	1.59	7.26	13.99	6.81	.20	381.
11.000	14.44	9.37	.0934	1.75	8.38	17.32	9.30	.20	380.
12.000	17.38	10.33	.0749	2.23	9.00	20.18	9.35	.16	380.
13.000	18.67	10.92	.1023	2.85	8.94	21.29	10.11	.19	379.
14.000	16.04	10.22	.0275	3.00	7.68	18.51	9.32	.42	375.
15.000	9.84	7.56	-.0392	2.57	5.94	12.34	6.71	.81	374.
16.000	2.76	5.08	-.0517	1.55	3.93	6.16	3.64	1.04	374.
17.000	-3.89	3.56	-.0453	.63	2.62	5.27	2.70	.54	372.
18.000	-9.07	3.04	.0122	.25	2.23	9.37	2.95	.16	370.
19.000	-12.73	2.75	.0615	.03	1.84	12.87	2.73	.19	364.
20.000	-15.64	2.85	-.0054	.08	1.71	15.73	2.84	.10	362.
21.000	-17.50	2.87	-.0135	.25	2.24	17.66	2.82	.18	354.
22.000	-18.97	2.83	.0316	.04	1.91	19.06	2.83	-.10	351.
23.000	-20.06	2.60	.0404	-.07	1.92	20.15	2.61	-.28	333.
24.000	-21.19	3.01	.1929	-.08	2.32	21.31	3.01	-.20	332.
25.000	-22.10	3.21	.2155	-.02	2.03	22.20	3.19	-.22	301.
26.000	-23.09	3.12	.0598	-.05	1.99	23.18	3.10	-.04	263.
27.000	-24.02	3.17	.1108	-.08	2.62	24.16	3.18	.06	230.
28.000	-24.89	2.80	.0500	-.21	2.03	24.97	2.79	.20	221.
29.000	-25.92	3.31	-.0068	-.27	2.57	26.05	3.30	-.03	156.
30.000	-27.45	3.15	-.1623	-.07	2.36	27.56	3.13	-.03	131.
32.000	-29.53	3.58	-.0157	2.05	2.85	29.80	3.60	-.57	141.
34.000	-29.48	4.94	-.2335	2.24	3.16	29.73	4.91	.00	141.
36.000	-30.96	5.56	-.2009	1.14	3.54	31.18	5.52	-.36	141.
38.000	-32.39	7.68	.1044	.42	4.11	32.74	7.30	-.57	141.
40.000	-34.04	8.41	-.0553	-.06	4.31	34.35	8.25	.07	142.
42.000	-35.63	9.09	.0486	-.35	4.87	35.97	9.03	.28	142.
44.000	-37.13	10.08	-.0814	1.83	5.86	37.67	9.95	.15	142.
46.000	-37.03	11.55	-.0079	4.31	6.56	37.95	11.20	.33	143.
48.000	-35.04	12.75	.0104	6.09	7.17	35.49	12.11	.16	143.
50.000	-29.27	14.52	-.1535	6.54	7.46	31.27	13.70	.35	141.
52.000	-23.73	14.95	-.0559	7.12	8.55	26.77	13.92	.46	134.
54.000	-17.45	13.15	.0769	7.38	9.57	22.15	11.48	.66	131.
56.000	-13.44	12.62	.0948	5.98	10.99	19.74	10.27	.77	115.
58.000	-8.18	12.68	-.0365	5.76	11.29	17.41	9.10	.57	94.
60.000	-6.40	14.78	-.0005	4.57	10.75	17.20	9.76	.81	54.
62.000	-5.08	14.20	.1864	-.45	10.47	15.60	9.36	.84	35.
64.000	-5.62	15.05	.1329	-3.70	8.19	15.72	9.24	.72	32.
66.000	-5.49	15.17	-.1208	-3.26	12.93	17.19	11.55	1.15	30.
68.000	-8.53	11.73	-.1471	-3.81	16.38	19.67	9.77	.83	28.
70.000	-10.58	15.91	-.0075	-8.79	17.15	23.93	12.22	.61	27.

TABLE I-9. WIND STATISTICAL PARAMETERS

SEPTEMBER

STATION = 911620		BARKING SANDS, HI								
Z	MEAN U	S.D. U	R(U,V)	MEAN V	S.D. V	MEAN WS	S.D. WS	SKEW WS	NOBS	
KM	M/S	M/S		M/S	M/S	M/S	M/S			
.005	-1.60	1.21	.1483	.01	1.04	1.32	1.10	2.00	365.	
1.000	-2.29	2.19	.0351	.11	1.51	2.06	1.95	.82	365.	
2.000	-3.26	3.74	.2854	-.11	2.21	4.22	3.11	.22	365.	
3.000	-3.49	3.89	.2506	-.63	2.60	5.16	2.78	.61	364.	
4.000	-2.62	4.20	.3225	-.52	2.93	4.99	2.91	.59	364.	
5.000	-1.41	4.33	.3032	-.50	3.63	5.03	2.97	.93	364.	
6.000	-.17	4.69	.1999	-.39	4.37	5.03	3.09	.53	364.	
7.000	1.60	5.58	.2156	-.03	5.24	6.59	3.68	.54	363.	
8.000	3.72	6.74	.2441	.25	6.16	8.66	4.70	.56	363.	
9.000	6.13	7.96	.2739	.39	6.93	10.76	5.79	.53	362.	
10.000	8.74	8.98	.3303	.79	7.66	13.19	6.74	.34	362.	
11.000	11.83	10.16	.3131	1.05	8.87	16.01	8.15	.37	361.	
12.000	14.31	10.38	.3337	1.05	9.08	17.91	8.87	.31	360.	
13.000	15.03	10.32	.2829	.95	9.01	18.23	9.06	.23	359.	
14.000	12.45	9.60	.2491	.87	7.75	15.43	8.25	.39	359.	
15.000	7.83	7.61	.2316	.63	6.25	10.92	6.25	.72	358.	
16.000	2.79	5.50	.2135	.18	4.65	6.62	3.96	.95	357.	
17.000	-2.05	4.06	.1903	-.15	3.22	4.99	2.60	.74	357.	
18.000	-6.40	3.60	.1097	-.25	2.47	7.66	3.20	.34	357.	
19.000	-9.57	3.04	-.0219	-.11	2.04	9.61	2.99	-.04	353.	
20.000	-11.64	3.06	.1377	-.01	1.80	11.59	3.02	-.12	347.	
21.000	-13.65	3.47	-.0209	.00	1.85	13.79	3.44	-.19	341.	
22.000	-15.03	3.32	-.1176	-.13	1.95	15.16	3.28	.09	341.	
23.000	-16.40	3.21	-.0198	-.21	1.77	16.50	3.19	.12	326.	
24.000	-17.50	3.55	.0065	-.07	2.23	17.64	3.56	-.01	323.	
25.000	-18.41	3.54	.0080	.08	2.19	18.54	3.51	-.23	306.	
26.000	-19.05	3.51	-.0571	.27	2.10	19.18	3.48	-.14	283.	
27.000	-19.61	3.84	-.0475	.15	2.60	19.78	3.83	-.15	232.	
28.000	-19.94	3.60	.0461	.22	2.26	20.09	3.55	-.05	217.	
29.000	-20.18	4.14	.1272	.27	2.97	20.41	4.08	-.09	129.	
30.000	-21.01	4.48	.0620	.18	2.15	21.13	4.43	-.24	107.	
32.000	-22.36	5.68	-.0332	2.05	3.15	22.70	5.59	-.33	125.	
34.000	-19.68	7.02	.0009	2.23	3.55	20.21	6.77	-.21	125.	
36.000	-17.05	8.65	-.0323	1.29	3.78	17.74	8.14	-.02	124.	
38.000	-14.54	9.28	.1022	.33	4.60	15.70	8.50	.47	125.	
40.000	-12.72	9.83	.1658	-.01	4.54	14.78	8.66	.74	125.	
42.000	-12.19	10.76	-.0929	-.02	4.84	14.48	8.83	.72	125.	
44.000	-12.27	12.21	.0607	1.13	5.90	15.57	9.62	.58	125.	
46.000	-9.48	11.08	-.0262	3.54	6.20	13.99	8.20	.52	114.	
48.000	-5.59	10.08	-.1877	5.34	7.02	12.59	7.16	.80	122.	
50.000	-2.36	10.13	-.1233	5.63	6.29	11.88	6.13	.86	120.	
52.000	-.07	10.18	-.1115	6.33	6.41	12.42	5.43	.45	118.	
54.000	2.70	9.85	-.1090	5.52	7.37	12.07	6.51	.47	113.	
56.000	5.33	9.25	-.0976	5.08	7.79	12.44	6.67	.48	104.	
58.000	6.46	9.83	.1178	3.37	8.65	13.37	6.67	.40	95.	
60.000	5.54	11.54	.0599	1.93	10.21	14.77	7.14	.48	60.	
62.000	3.94	12.01	.1602	-1.41	10.22	14.32	7.46	.44	37.	
64.000	-1.54	14.26	.2301	-3.65	11.69	16.56	8.41	.60	25.	
66.000	.63	11.94	-.1352	-1.83	12.33	15.76	6.14	.16	21.	
68.000	-.61	13.13	-.1810	-6.03	13.97	17.95	8.20	.38	20.	
70.000	-5.22	16.58	-.1517	-12.55	13.20	22.45	10.64	.19	20.	

TABLE I-10. WIND STATISTICAL PARAMETERS

OCTOBER

STATION = 911620		BARKING SANDS, HI							
Z	MEAN U	S.D. U	R(U,V)	MEAN V	S.D. V	MEAN WS	S.D. WS	SKEW WS	NOBS
KM	M/S	M/S		M/S	M/S	M/S	M/S		
.005	-.65	1.19	-.0453	-.17	1.60	1.54	1.43	1.75	376.
1.000	-2.21	2.54	.0812	.26	2.52	3.48	2.36	1.05	376.
2.000	-3.30	4.16	.1654	-.10	3.01	5.25	3.10	.69	376.
3.000	-2.40	4.38	.3053	-.36	3.36	5.27	2.91	.74	376.
4.000	-1.54	4.94	.3046	-.46	3.76	5.56	3.18	.73	375.
5.000	-.66	5.49	.237	-.80	4.55	6.22	3.63	.83	375.
6.000	.35	5.87	.2397	-1.02	5.54	7.00	4.16	1.04	375.
7.000	1.45	6.60	.2388	-1.05	6.52	8.11	4.82	1.04	375.
8.000	2.72	7.76	.3197	-1.22	7.52	9.73	5.54	.93	375.
9.000	4.40	9.16	.4150	-1.28	8.71	11.72	6.59	.93	374.
10.000	6.46	10.74	.4519	-1.41	9.82	13.95	7.77	.80	373.
11.000	8.91	12.25	.4522	-1.42	10.85	16.42	8.90	.59	373.
12.000	10.75	12.75	.4419	-1.36	11.09	17.65	9.55	.57	373.
13.000	11.39	12.77	.4336	-1.48	10.46	17.67	9.57	.56	373.
14.000	9.74	11.43	.3901	-1.46	8.88	15.26	8.56	.78	372.
15.000	7.40	9.49	.3267	-1.48	7.21	12.21	7.05	.72	370.
16.000	4.09	7.77	.2841	-1.46	5.87	9.22	5.34	.91	359.
17.000	.86	5.89	.1430	-1.17	4.52	6.55	3.77	.86	367.
18.000	-2.02	4.58	.0297	-.74	3.44	5.35	2.95	.82	363.
19.000	-4.42	3.98	.0347	-.41	2.40	5.69	3.00	.47	353.
20.000	-6.45	3.61	.0520	-.20	1.97	6.93	3.23	.08	348.
21.000	-8.08	3.63	.1281	-.17	2.04	8.42	3.44	.03	337.
22.000	-9.09	3.85	-.0265	-.13	1.97	9.38	3.66	.00	335.
23.000	-9.87	3.93	-.0139	-.17	1.96	10.13	3.76	.02	317.
24.000	-10.68	4.33	.0469	.05	2.55	11.04	4.17	.05	309.
25.000	-11.14	4.56	-.0572	.23	2.29	11.44	4.39	-.02	287.
26.000	-11.33	4.63	-.0588	.38	2.05	11.59	4.46	.02	256.
27.000	-10.94	4.86	.0005	.47	2.30	11.25	4.70	.10	219.
28.000	-10.56	5.25	.0957	.32	2.25	10.93	4.85	.17	209.
29.000	-10.20	6.23	.2470	.23	3.00	11.16	5.22	.31	130.
30.000	-9.58	7.07	.1156	.01	2.73	10.90	5.50	.27	113.
32.000	-5.55	7.82	.0455	.83	3.49	9.04	4.78	.39	129.
34.000	-.59	8.75	.0289	.89	3.55	8.19	4.78	.41	129.
36.000	5.89	10.53	-.0382	.75	4.38	10.69	7.09	.79	130.
38.000	11.68	11.21	-.0021	1.17	4.97	14.23	9.24	.58	130.
40.000	15.84	11.52	.1575	.57	4.77	17.39	10.20	.29	130.
42.000	19.53	12.26	.1826	2.00	5.94	21.10	11.20	.34	132.
44.000	23.15	12.61	.2577	4.01	6.20	24.64	11.92	.00	132.
46.000	27.64	13.70	.0520	4.83	5.81	29.09	12.73	-.25	132.
48.000	31.68	14.44	-.1166	4.82	6.19	32.91	13.78	-.28	132.
50.000	34.52	15.60	-.0911	5.05	7.27	35.91	14.95	-.23	131.
52.000	36.58	16.21	-.0352	5.11	7.25	37.84	15.72	-.11	127.
54.000	36.89	16.42	-.0784	6.29	7.24	38.36	15.82	-.18	122.
56.000	37.36	16.13	-.1614	7.33	7.75	39.21	15.24	-.06	117.
58.000	37.43	17.75	-.3011	8.19	7.64	39.80	16.12	.07	104.
60.000	37.79	18.96	.0267	6.53	8.21	39.78	17.70	.14	69.
62.000	38.46	18.55	-.2760	4.51	6.74	40.33	16.10	.12	42.
64.000	33.65	19.05	-.4289	3.05	10.19	35.96	17.60	.11	28.
66.000	28.57	19.81	-.3425	.77	10.64	31.65	17.70	-.30	26.
68.000	22.97	20.61	.1327	-.18	13.82	30.44	14.14	.45	25.
70.000	16.57	18.27	.0798	.06	13.84	25.96	10.45	.58	25.

TABLE I-11. WIND STATISTICAL PARAMETERS

NOVEMBER

STATION = 911620		BAR KING SANDS, HI							
Z	MEAN U	S.D. U	R(U,V)	MEAN V	S.D. V	MEAN WS	S.D. WS	SKEW WS	NOBS
KM	M/S	M/S		M/S	M/S	M/S	M/S		
.005	-0.81	1.23	-.0919	-.12	1.79	1.62	1.65	1.79	349.
1.000	-2.53	3.24	.0445	.77	3.83	4.61	3.31	1.76	346.
2.000	-3.37	5.35	.1274	.76	4.40	6.55	4.10	.85	346.
3.000	-2.00	5.53	.1467	.19	4.53	6.35	3.83	1.61	345.
4.000	-.99	5.92	.1658	-.38	4.93	6.55	4.17	1.35	344.
5.000	.43	6.69	.1175	-.68	6.02	7.53	4.97	1.16	344.
6.000	1.96	7.66	.1551	-1.56	6.62	8.91	5.65	1.14	344.
7.000	3.42	8.55	.1502	-2.02	7.61	10.54	5.95	1.09	344.
8.000	5.12	9.27	.2005	-2.38	8.77	12.07	6.96	1.11	343.
9.000	6.96	10.14	.2293	-2.62	9.78	13.85	7.85	.99	342.
10.000	9.04	11.19	.2609	-3.20	10.68	15.97	8.89	.83	340.
11.000	11.76	12.77	.2493	-3.40	11.83	18.69	10.14	.69	338.
12.000	13.98	13.73	.2435	-3.83	12.25	20.56	11.20	.53	338.
13.000	14.95	14.11	.2557	-4.47	12.03	21.30	11.54	.52	337.
14.000	13.50	12.79	.2372	-4.48	10.39	19.17	10.30	.63	335.
15.000	11.27	10.97	.2144	-3.62	8.60	16.17	8.52	.56	335.
16.000	7.84	8.79	.2094	-3.31	6.69	12.48	6.19	.49	335.
17.000	4.29	7.03	.1941	-2.72	5.26	9.06	4.65	.66	333.
18.000	1.09	5.42	.1093	-1.76	4.24	6.28	3.48	1.03	332.
19.000	-.89	4.38	.3051	-1.09	3.28	4.83	2.92	1.61	326.
20.000	-2.52	3.74	.2890	-.50	2.56	4.39	2.79	1.38	319.
21.000	-3.22	3.47	.1504	-.28	2.53	4.64	2.72	.89	312.
22.000	-3.54	3.98	.1286	-.44	2.62	5.13	3.01	.93	311.
23.000	-3.69	3.69	.0553	-.58	2.42	5.08	2.75	.59	301.
24.000	-3.75	4.14	.0513	-.61	2.89	5.56	2.99	1.00	298.
25.000	-3.25	4.75	.1144	-.05	3.15	5.64	3.34	1.03	287.
26.000	-2.33	5.17	.1560	.42	2.91	5.35	3.47	1.42	262.
27.000	-.88	5.74	.1843	.72	2.95	5.55	3.46	1.52	237.
28.000	1.70	6.60	.1811	1.23	2.95	6.34	4.06	1.34	225.
29.000	4.99	7.22	.0920	1.24	3.40	8.13	4.87	1.02	126.
30.000	8.99	8.40	.0834	.61	3.24	11.05	6.30	.83	111.
32.000	12.97	9.42	-.1166	.22	4.89	14.34	7.55	.62	102.
34.000	17.93	10.32	-.0443	.84	4.80	19.33	8.82	.16	102.
36.000	22.92	13.15	-.2683	-.15	5.04	24.09	11.95	.32	102.
38.000	27.99	14.55	-.1050	-.60	6.52	29.21	13.56	.55	103.
40.000	31.76	13.18	-.0197	-.11	7.55	32.79	12.78	.32	104.
42.000	36.35	12.45	-.0495	.33	6.85	37.01	12.49	.49	104.
44.000	42.48	12.03	-.1443		6.84	43.23	11.94	.23	104.
46.000	48.59	12.65	-.1070	4.08	7.71	49.45	12.49	-.03	102.
48.000	52.77	14.13	-.0153	5.13	9.64	53.97	13.75	-.23	101.
50.000	55.58	16.09	.0651	5.91	9.41	56.73	15.90	-.09	99.
52.000	57.20	16.77	.0516	5.50	11.04	58.65	16.22	-.18	99.
54.000	58.44	16.71	.1876	3.58	10.11	59.53	16.27	-.32	99.
56.000	58.72	19.34	.2430	3.71	10.09	59.82	18.93	-.43	93.
58.000	58.35	21.48	.1365	6.23	9.99	60.04	19.97	-.45	80.
60.000	60.74	22.93	.0920	8.30	10.83	63.05	20.52	-.42	55.
62.000	55.66	26.42	.1116	4.42	10.68	58.50	22.28	-.24	28.
64.000	46.70	27.77	.1193	3.76	12.90	51.53	21.26	.54	19.
66.000	36.57	20.74	-.1849	2.84	10.75	40.95	24.33	.73	19.
68.000	26.75	25.65	-.3034	-4.12	12.50	34.00	19.17	.62	19.
70.000	15.81	26.83	.0304	-1.57	18.16	29.56	19.80	1.33	18.

TABLE I-12. WIND STATISTICAL PARAMETERS

DECEMBER

STATION = 911620	BARKING SANDS, HI			MEAN V	S.D. V	MEAN WS	S.D. WS	SKEW WS	NOPS
Z	MEAN U	S.D. U	R(U,V)	M/S	M/S	M/S	M/S		
KM	M/S	M/S							
.005	-1.84	1.28	-.1458	-.37	2.31	1.95	2.01	1.64	319.
1.000	-2.05	4.21	.0440	.36	4.36	5.46	3.35	1.00	317.
2.000	-2.24	6.71	.2247	.57	4.94	7.56	4.17	.67	317.
3.000	-.49	7.32	.3122	.25	4.98	7.71	4.36	1.22	317.
4.000	1.02	7.95	.3339	-.43	5.69	8.48	4.96	1.10	317.
5.000	2.67	9.15	.2976	-1.36	7.08	10.34	5.98	.70	310.
6.000	4.72	9.84	.2599	-1.99	8.19	11.97	6.83	.75	310.
7.000	7.11	10.74	.3061	-2.51	9.75	14.22	8.04	.80	310.
8.000	9.26	12.18	.3532	-3.18	11.18	16.83	9.25	.89	315.
9.000	11.56	13.62	.3950	-4.34	12.84	19.77	10.54	.78	315.
10.000	14.07	14.79	.4377	-5.65	14.31	22.90	11.32	.59	313.
11.000	16.92	16.44	.4947	-6.31	15.53	26.23	12.17	.46	312.
12.000	19.46	16.99	.5604	-6.35	15.90	28.24	12.72	.53	313.
13.000	19.69	16.69	.5493	-6.40	14.71	27.73	12.69	.67	313.
14.000	18.60	14.84	.4639	-5.88	12.05	24.76	11.50	.78	311.
15.000	15.76	12.02	.3714	-5.66	10.63	21.11	9.59	.45	311.
16.000	12.20	9.89	.2549	-4.76	8.75	16.67	7.82	.41	311.
17.000	7.75	8.48	.2515	-3.68	7.06	12.37	6.50	.82	310.
18.000	2.83	6.48	.0970	-2.58	5.49	8.06	4.06	1.35	310.
19.000	-.56	4.94	.0383	-1.64	3.77	5.65	3.09	1.01	300.
20.000	-1.93	4.41	.0939	-.90	2.77	4.73	2.94	1.22	302.
21.000	-1.78	4.48	.1110	-.40	2.64	4.55	3.10	1.68	298.
22.000	-1.22	4.93	.1742	-.29	2.57	4.79	3.08	1.52	295.
23.000	-.77	5.07	.2320	-.44	2.40	4.80	3.03	1.58	282.
24.000	-.40	5.68	.1749	-.53	3.23	5.55	3.50	1.58	272.
25.000	-.02	6.10	.2580	-.23	3.57	5.68	4.20	1.70	268.
26.000	.64	6.49	.3448	.58	3.10	5.62	4.31	1.80	237.
27.000	1.78	6.97	.3514	.98	3.03	6.51	4.39	1.23	208.
28.000	3.21	7.85	.3524	1.21	3.55	7.84	4.93	.74	204.
29.000	5.41	8.80	.3917	1.32	4.02	9.73	5.43	.58	133.
30.000	7.29	9.68	.3258	.32	3.89	11.15	6.10	.49	126.
32.000	8.29	11.67	.1749	-.69	4.66	13.12	7.33	.52	103.
34.000	10.44	12.48	.3221	-.47	7.15	16.02	7.62	.61	103.
35.000	12.94	15.23	.3980	1.16	8.36	19.16	10.10	1.03	103.
38.000	16.81	17.24	.4100	1.01	8.23	22.37	12.07	.56	102.
40.000	22.23	19.97	.4407	1.54	9.54	27.71	14.69	.77	103.
42.000	26.93	22.80	.4550	4.53	11.46	32.95	17.54	.53	103.
44.000	32.76	25.73	.3672	6.57	11.88	38.59	20.66	.68	104.
46.000	36.05	27.42	.2841	9.06	13.48	42.60	22.27	.66	103.
48.000	37.26	26.77	.3540	10.05	13.15	43.33	22.30	.49	102.
50.000	36.73	26.67	.2178	9.68	14.85	43.86	21.13	.52	101.
52.000	36.63	26.82	.1823	9.97	16.60	43.89	22.48	.51	99.
54.000	38.93	27.98	.3142	10.05	14.75	44.65	24.52	.34	98.
56.000	39.74	28.45	.2583	11.18	17.12	47.35	23.64	.32	89.
58.000	42.92	28.90	.4665	11.71	16.57	49.79	24.56	.36	76.
60.000	45.54	28.72	.5023	12.69	17.02	51.76	25.74	.02	55.
62.000	42.63	25.14	.3119	14.00	19.67	49.07	24.78	-.29	27.
64.000	44.68	24.81	.2729	9.81	11.01	47.75	23.16	.07	16.
66.000	49.63	23.44	.4213	3.73	11.37	50.93	23.52	.13	14.
68.000	50.16	27.10	.3223	-2.17	16.13	53.23	25.59	-.22	13.
70.000	49.40	27.62	-.1825	-11.15	17.37	54.92	23.98	-.34	13.

TABLE I-13. WIND STATISTICAL PARAMETERS

ANNUAL

STATION • 911620		BARKING SANDS, HI							
Z	MEAN U	S.D. U	R(U,V)	MEAN V	S.D. V	MEAN WS	S.D. WS	SKEW WS	NOBS
KM	M/S	M/S		M/S	M/S	M/S	M/S		
.005	-.45	1.38	-.0730	-.22	1.95	1.63	1.75	2.00	4342.
1.000	-2.07	3.24	.0821	.32	3.15	4.03	2.93	1.52	4330.
2.000	-3.02	5.54	.1891	.35	3.54	6.15	3.82	.95	4320.
3.000	-1.60	6.16	.2609	-.11	3.87	6.24	4.06	1.71	4325.
4.000	-.17	6.97	.2276	-.40	4.39	6.74	4.76	1.76	4321.
5.000	1.55	7.79	.1437	-.79	5.25	7.69	5.69	1.67	4320.
6.000	3.39	8.55	.1195	-1.13	6.17	8.58	6.58	1.57	4315.
7.000	5.36	9.50	.0979	-1.43	7.29	10.79	7.59	1.42	4305.
8.000	7.60	10.73	.1036	-1.80	8.69	13.16	8.85	1.32	4287.
9.000	10.23	12.22	.1306	-2.23	10.18	16.04	10.27	1.13	4276.
10.000	13.13	13.65	.1695	-2.58	11.65	19.20	11.52	.86	4242.
11.000	16.30	15.17	.1960	-2.87	12.90	22.55	12.75	.69	4213.
12.000	19.17	16.13	.2148	-3.04	13.23	25.03	13.63	.60	4208.
13.000	20.37	16.11	.2144	-3.12	12.57	25.64	13.60	.54	4190.
14.000	18.67	14.66	.1509	-2.97	10.84	23.10	12.52	.59	4161.
15.000	14.82	12.54	.0648	-2.58	8.92	18.02	10.80	.70	4152.
16.000	9.85	10.48	-.0191	-2.15	6.95	13.48	8.85	.87	4137.
17.000	4.77	9.04	-.0904	-1.66	5.30	9.59	6.58	1.15	4112.
18.000	.00	7.95	-.1173	-1.04	4.10	7.83	4.45	1.22	4086.
19.000	-3.50	7.05	-.0953	-.62	2.99	7.31	4.23	.57	4024.
20.000	-6.01	6.92	-.0954	-.35	2.32	7.90	5.21	.60	3945.
21.000	-7.59	7.22	-.1042	-.24	2.27	8.94	5.92	.52	3853.
22.000	-8.60	7.71	-.0992	-.31	2.27	9.91	6.37	.44	3827.
23.000	-9.44	8.07	-.0768	-.32	2.09	10.59	6.82	.37	3651.
24.000	-10.22	8.70	-.0349	-.23	2.59	11.62	7.19	.32	3507.
25.000	-10.39	9.36	.0362	.06	2.57	12.07	7.53	.36	3393.
26.000	-10.26	10.14	.1377	.31	2.47	12.36	7.85	.32	3022.
27.000	-9.69	11.28	.2026	.50	2.82	12.81	8.09	.35	2535.
28.000	-8.91	12.58	.2777	.65	2.86	13.39	8.17	.28	2416.
29.000	-7.98	14.31	.2853	.64	3.32	14.43	8.48	.20	1490.
30.000	-7.06	16.14	.2137	.45	3.11	15.55	8.87	.16	1202.
32.000	-6.85	17.63	-.1859	.73	4.04	16.94	9.37	.21	1563.
34.000	-6.44	18.31	-.1120	.70	4.71	17.41	9.65	.27	1587.
36.000	-6.53	19.82	.0310	.55	5.01	18.50	10.90	.43	1507.
38.000	-6.53	21.94	.0808	.42	5.51	20.05	12.35	.52	1504.
40.000	-6.70	24.27	.1516	.58	6.14	22.25	13.31	.50	1571.
42.000	-6.69	27.23	.2512	1.77	6.82	24.89	14.71	.52	1576.
44.000	-6.01	30.55	.2069	3.63	7.31	27.93	16.00	.50	1575.
46.000	-4.05	33.10	.1342	5.46	8.16	30.35	16.96	.48	1562.
48.000	-1.41	34.73	.0812	6.35	8.59	31.79	17.67	.45	1547.
50.000	1.11	35.80	.0386	6.08	8.40	32.36	18.54	.49	1521.
52.000	3.90	35.55	.0328	6.15	9.43	33.48	19.94	.50	1483.
54.000	7.17	37.01	.0657	6.21	9.89	34.30	19.53	.43	1435.
56.000	10.19	37.71	.0977	7.01	10.79	35.83	20.23	.50	1320.
58.000	14.13	37.75	.1419	8.20	11.27	37.07	21.13	.51	1121.
60.000	18.23	38.32	.1650	7.59	11.84	38.82	22.21	.44	772.
62.000	17.64	37.90	.1460	4.27	12.76	37.79	22.46	.41	446.
64.000	17.12	37.49	.2153	-.41	12.47	36.32	23.25	.59	306.
66.000	14.62	36.91	.0955	-3.81	13.92	35.60	22.88	.75	287.
68.000	10.06	36.87	.0747	-7.96	15.40	35.09	21.60	.78	277.
70.000	3.77	37.67	.0970	-9.40	16.06	36.75	20.85	.73	257.

TABLE II-1. THERMODYNAMIC STATISTICAL PARAMETERS

JANUARY

STATION = 911620		MARKING SANDS, HI		S.D. T		SKEW T		MEAN D		S.O. D		SKEW D		NOBS P		NOBS T		NOBS D	
Z	MI	MEAN P	MB	MEAN T	DEG K	S.D. T	DEG K	SKEW T	G/MS	S.O. D	G/MS	SKEW D	NOBS P	NOBS T	NOBS D				
.000	1014.8000	3.6676	-44	293.70	2.32	0.03	1195.0000	12.7400	-13	313.	313.	313.	313.	313.	313.				
.005	1014.2000	3.7665	-47	293.64	2.38	-0.03	1195.0000	13.1100	-10	344.	344.	344.	344.	344.	344.				
1.000	903.5200	3.3410	-52	288.12	1.85	-0.57	1087.0000	6.3820	.14	344.	344.	344.	344.	344.	344.				
2.000	802.2500	3.1701	-47	283.71	2.57	-4.9	982.1000	9.0310	.38	344.	344.	344.	344.	344.	344.				
3.000	711.1400	3.2229	-54	279.89	2.61	-4.1	883.4000	7.2650	.03	344.	344.	344.	344.	344.	344.				
4.000	629.0100	3.2562	-55	274.54	2.66	-4.0	797.0000	6.4320	-13	344.	344.	344.	344.	344.	344.				
5.000	555.0200	3.3030	-65	268.61	2.88	-4.6	718.9000	6.0880	-07	344.	344.	344.	344.	344.	344.				
6.000	488.2400	3.4356	-69	262.14	3.25	-3.5	648.1000	6.0530	-15	344.	344.	344.	344.	344.	344.				
7.000	427.9600	3.5244	-71	255.24	3.51	-2.9	533.5000	5.8420	-30	343.	343.	343.	343.	343.	343.				
8.000	373.9800	3.6178	-72	248.29	3.79	-2.4	524.2000	5.9680	-43	342.	342.	342.	342.	342.	342.				
9.000	325.5100	3.6601	-68	241.66	3.92	-0.9	468.6000	6.0110	-61	342.	342.	342.	342.	342.	342.				
10.000	282.2400	3.6946	-56	235.27	3.84	-1.9	417.6000	5.8590	-58	340.	340.	340.	340.	340.	340.				
11.000	243.9200	3.4043	-42	228.83	3.52	-3.6	371.3000	5.2730	-64	337.	337.	337.	337.	337.	337.				
12.000	209.7700	3.1191	-31	222.54	3.24	-6.8	328.4000	4.8920	-81	336.	336.	336.	336.	336.	336.				
13.000	179.7500	2.8594	-24	216.10	3.03	-7.3	289.6000	4.7740	-89	335.	335.	335.	335.	335.	335.				
14.000	153.2800	2.5482	-20	210.09	2.96	-4.0	254.2000	4.9170	-66	332.	332.	332.	332.	332.	332.				
15.000	130.1100	2.1964	-23	204.48	2.81	-1.0	221.7000	4.7600	-56	331.	331.	331.	331.	331.	331.				
16.000	109.9800	1.8403	-28	200.21	2.69	-4.2	191.4000	4.4840	-23	326.	326.	326.	326.	326.	326.				
17.000	92.7530	1.4795	-30	197.90	3.13	-3.7	163.3000	4.4000	-25	324.	324.	324.	324.	324.	324.				
18.000	78.1220	1.1330	-28	198.12	3.71	-6.5	137.4000	3.8940	-45	322.	322.	322.	322.	322.	322.				
19.000	65.9470	.8414	-15	201.79	3.51	-4.4	113.9000	2.9480	-34	317.	317.	317.	317.	317.	317.				
20.000	55.6530	.6535	-05	206.28	2.76	-3.5	94.3400	1.9190	-23	313.	313.	313.	313.	313.	313.				
21.000	47.4530	.5345	.02	209.78	2.50	-2.9	78.8100	1.3380	-11	304.	304.	304.	304.	304.	304.				
22.000	40.4140	.4647	.04	212.43	2.48	-1.2	66.2800	.9768	.07	302.	302.	302.	302.	302.	302.				
23.000	34.4950	.4062	-01	214.61	2.40	-1.7	56.0000	.7424	-11	294.	294.	294.	294.	294.	294.				
24.000	29.4750	.3635	-02	216.56	2.58	-2.5	47.4200	.6302	-20	279.	279.	279.	279.	279.	279.				
25.000	25.2290	.3333	-10	218.41	2.74	-0.2	40.2500	.4812	-06	273.	273.	273.	273.	273.	273.				
26.000	21.6130	.3073	-10	220.36	2.62	-0.8	34.1700	.4613	-03	246.	246.	246.	246.	246.	246.				
27.000	18.5420	.2669	-18	222.33	2.65	.06	29.0600	.4452	-01	218.	218.	218.	218.	218.	218.				
28.000	15.9260	.2376	-15	224.61	2.86	.19	24.7000	.4119	-33	206.	206.	206.	206.	206.	206.				
29.000	13.7040	.2127	.07	226.33	2.92	.24	21.1000	.3807	-30	168.	168.	168.	168.	168.	168.				
30.000	11.7980	.1936	.27	227.97	3.11	.09	18.0300	.3575	-40	148.	148.	148.	148.	148.	148.				
31.000	8.8262	.1908	-11	232.59	4.30	.43	13.2200	.3059	-16	107.	107.	107.	107.	107.	107.				
32.000	6.6219	.1544	-03	236.38	5.20	-1.2	9.7660	.2651	.14	110.	110.	110.	110.	110.	110.				
33.000	4.9934	.1190	.00	241.81	5.00	-3.3	7.1930	.2061	.04	109.	109.	109.	109.	109.	109.				
34.000	3.7942	.0963	.04	247.79	4.88	-0.6	5.3330	.1603	-01	109.	109.	109.	109.	109.	109.				
35.000	2.9001	.0781	.14	254.09	6.49	-5.2	3.9760	.1203	-55	109.	109.	109.	109.	109.	109.				
36.000	2.2331	.0644	.17	260.11	6.16	-5.5	2.9850	.0975	-19	109.	109.	109.	109.	109.	109.				
37.000	1.7296	.0535	.13	265.48	6.81	-2.7	2.2590	.0730	.09	109.	109.	109.	109.	109.	109.				
38.000	1.3452	.0448	.05	268.89	6.61	.08	1.7430	.0552	.09	108.	108.	108.	108.	108.	108.				
39.000	1.0474	.0391	.05	269.38	6.35	-0.4	1.3590	.0441	.20	109.	109.	109.	109.	109.	109.				
40.000	.8147	.0322	-05	266.46	6.43	-5.6	1.0630	.0333	.21	107.	107.	107.	107.	107.	107.				
41.000	.6333	.0264	.22	264.33	6.39	-4.9	.8344	.0300	-47	101.	101.	101.	101.	101.	101.				
42.000	.4908	.0222	.33	263.90	6.45	-0.5	.6485	.0273	-29	96.	96.	96.	96.	96.	96.				
43.000	.3797	.0181	.46	262.33	6.91	-0.7	.5045	.0211	-20	93.	93.	93.	93.	93.	93.				
44.000	.2926	.0144	.30	260.12	6.77	-1.3	.3313	.0161	.05	78.	78.	78.	78.	78.	78.				
45.000	.2248	.0105	.26	255.01	6.13	-0.7	.3060	.0125	.46	57.	57.	57.	57.	57.	57.				
46.000	.1716	.0095	.31	250.52	7.83	-3.8	.2384	.0084	.41	32.	32.	32.	32.	32.	32.				
47.000	.1263	.0053	.13	241.34	7.69	-4.3	.1831	.0072	-38	17.	17.	17.	17.	17.	17.				
48.000	.0741	.0043	.29	243.44	6.67	-4.3	.1470	.0061	-20	18.	18.	18.	18.	18.	18.				
49.000	.0715	.0035	.45	222.83	5.45	.91	.1117	.0051	-10	18.	18.	18.	18.	18.	18.				
50.000	.0528	.0026	.93	218.06	5.83	-1.6	.0941	.0045	.28	16.	16.	16.	16.	16.	16.				

TABLE II-2. THERMODYNAMIC STATISTICAL PARAMETERS

FEBRUARY

STATION Z KPH	911620		BARKING SANDS-MI		S.D. T DEG K	SKEW T	MEAN D G/MS	S.D. D G/MS	SKEW D	NOBS P	NOBS T	NOBS D
	MEAN P PS	MEAN K	S.D. P PS	SKEW P								
0.000	1016.3000	3.9773	-0.77	231.85	2.25	.79	1197.0300	11.9700	-.20	317.	317.	317.
0.003	1015.7030	3.9705	-.75	233.71	2.33	.19	1197.0300	12.7700	-.17	341.	341.	341.
1.000	944.5000	3.1352	-.93	237.53	2.43	-.37	1083.0000	7.0570	.71	341.	341.	341.
2.000	603.4700	3.0317	-.99	233.45	1.73	-.19	954.6000	7.7890	.26	341.	341.	341.
3.000	712.0700	3.0393	-1.03	273.56	2.34	-.09	885.6000	6.6550	-.33	341.	341.	341.
4.000	659.7200	3.0500	-.98	274.37	2.71	.14	798.5000	6.5040	-.54	341.	341.	341.
5.000	595.6100	3.0541	-.93	259.50	3.07	-.03	649.0000	6.9780	-.02	341.	341.	341.
6.000	489.7400	3.1415	-.81	262.06	3.40	-.01	534.2000	6.8760	-.05	341.	341.	341.
7.000	428.4200	3.2941	-.73	248.19	4.21	-.06	524.8000	6.5455	-.50	340.	340.	340.
8.000	374.3000	3.4155	-.63	241.33	4.44	-.11	469.9000	6.1110	-.27	339.	339.	339.
9.000	365.8300	3.5883	-.62	241.33	4.30	-.20	418.5000	5.3090	-.23	329.	329.	329.
10.000	282.4200	3.6834	-.53	234.65	4.30	-.57	371.7000	5.1380	-.43	327.	327.	327.
11.000	243.9500	3.6677	-.41	228.59	3.89	-.10	289.6000	5.1870	-.81	334.	334.	334.
12.000	209.7500	3.3797	-.33	222.36	3.46	-.73	328.7000	5.3170	-.73	335.	335.	335.
13.000	179.7000	3.0570	-.28	216.26	2.78	-.10	294.1000	5.3710	-.63	332.	332.	332.
14.000	153.3100	2.6569	-.23	210.25	2.50	-.31	221.5000	5.4060	-.48	332.	332.	332.
15.000	130.1700	2.2119	-.16	204.78	2.61	.35	191.2000	5.2400	-.23	333.	333.	333.
16.000	110.6300	1.7774	-.11	200.60	3.24	.29	163.2000	4.9100	-.15	328.	328.	328.
17.000	92.1400	1.3307	-.10	193.29	3.71	.02	137.4000	3.9550	.04	324.	324.	324.
18.000	70.2770	1.0235	-.02	188.58	4.05	-.14	113.9000	2.6550	.23	317.	317.	317.
19.000	66.6240	.7825	.14	202.17	3.44	-.17	94.4000	1.7030	.18	237.	237.	237.
20.000	55.9630	.6175	.08	206.53	2.63	-.63	78.9500	1.6500	.13	233.	233.	233.
21.000	47.5420	.4657	-.10	203.61	2.24	-.19	66.3000	1.5600	.23	203.	203.	203.
22.000	40.4810	.4178	-.03	212.70	2.35	-.14	47.4300	.5737	.23	270.	270.	270.
23.000	34.5730	.2636	-.03	214.08	2.28	-.14	40.2700	.4980	.24	244.	244.	244.
24.000	29.5650	.3333	-.05	217.07	2.48	-.09	24.7400	.3783	.18	217.	217.	217.
25.000	25.3040	.3159	-.05	219.16	2.59	.06	24.1000	.4370	.24	244.	244.	244.
26.000	21.6970	.2952	-.03	223.35	2.61	.01	29.0600	.3783	.18	217.	217.	217.
27.000	18.6300	.2667	-.05	221.30	2.59	.30	21.1400	.3339	.28	170.	170.	170.
28.000	16.0160	.2432	-.05	225.51	2.89	-.06	18.0800	.2903	.01	145.	145.	145.
29.000	13.8020	.2302	.02	227.41	2.95	.30	13.1600	.2377	.46	111.	111.	111.
30.000	11.2000	.2146	.02	229.34	2.64	-.31	9.6900	.2079	.17	110.	110.	110.
32.000	8.8320	.1695	.30	235.19	4.25	-.02	7.2020	.1914	.16	110.	110.	110.
34.000	6.6304	.1258	.20	240.50	4.97	.16	5.3750	.1466	.05	114.	114.	114.
36.000	5.0653	.0958	.04	244.95	4.74	-.05	4.0250	.0395	.05	110.	110.	110.
38.000	3.8578	.0757	-.03	250.04	5.26	-.42	3.0410	.0795	.64	112.	112.	112.
40.000	2.9650	.0622	.12	255.84	5.47	-.62	2.3220	.0626	.18	114.	114.	114.
42.000	2.2795	.0542	-.01	261.34	5.58	-.87	1.7860	.0502	.36	112.	112.	112.
46.000	1.7650	.0452	-.08	267.39	5.94	-.35	1.3630	.0407	.54	110.	110.	110.
48.000	1.6666	.0327	-.27	267.56	5.97	-.10	1.0400	.0335	.09	107.	107.	107.
50.000	.9300	.0272	-.27	267.30	5.89	-.03	.8429	.0214	.25	108.	108.	108.
52.000	.6452	.0228	-.18	245.65	5.45	.25	.6216	.0216	-.27	104.	104.	104.
54.000	.5006	.0190	-.04	254.21	5.81	-.25	.5185	.0184	-.47	94.	94.	94.
56.000	.3790	.0159	-.04	251.78	5.56	-.09	.5115	.0184	-.28	83.	83.	83.
58.000	.3004	.0124	-.03	252.52	5.17	-.28	.4675	.0141	-.06	60.	60.	60.
60.000	.2319	.0102	-.11	255.43	5.94	.04	.2849	.0107	.06	34.	34.	34.
62.000	.1771	.0037	.36	251.72	7.29	.32	.1893	.0105	1.71	21.	21.	21.
64.000	.1328	.0090	.95	243.30	7.20	.68	.1471	.0089	1.54	18.	18.	18.
66.000	.0742	.0050	.76	234.59	9.00	.15	.1171	.0065	1.54	17.	17.	17.
68.000	.0734	.0040	.54	219.40	11.16	.97	.0977	.0044	.94	17.	17.	17.
70.000	.0744	.0040	.79	214.40	8.62	1.06	.0977	.0044	.94	17.	17.	17.

TABLE II-3. THERMODYNAMIC STATISTICAL PARAMETERS

MARCH

STATION = 911620		BARKING SANDS, HI		S.D. T		MEAN D		S.D. D		SKEW D		NOBS P		NOBS T		NOBS D	
Z	KN	S.D. P	MEAN P	MB	MB	DEG K	DEG K	G/M3	G/M3	G/M3	G/M3	G/M3	G/M3	G/M3	G/M3	G/M3	G/M3
.000	1017.6000	3.0135	294.73	-.66	2.22	1195.0000	10.5900	-.23	359.	359.	359.	359.	359.	359.	359.	359.	359.
.005	1017.2000	2.9325	294.64	-.72	2.25	1194.0000	10.6600	-.27	387.	387.	387.	387.	387.	387.	387.	387.	387.
1.000	906.2000	2.6336	268.13	-.91	1.44	1090.0000	5.9630	-.12	387.	387.	387.	387.	387.	387.	387.	387.	387.
2.000	804.5900	2.5242	283.62	-1.01	2.09	985.4000	6.5580	-.01	387.	387.	387.	387.	387.	387.	387.	387.	387.
3.000	713.1700	2.5089	279.63	-1.20	2.11	887.1000	5.9530	-.30	387.	387.	387.	387.	387.	387.	387.	387.	387.
4.000	630.6400	2.5520	274.22	-.92	2.36	800.1000	5.6980	-.18	387.	387.	387.	387.	387.	387.	387.	387.	387.
5.000	556.3500	2.6200	268.01	-.63	2.60	722.3000	5.3060	-.20	387.	387.	387.	387.	387.	387.	387.	387.	387.
6.000	489.2400	2.7997	261.30	-.71	2.69	631.6000	4.6570	-.10	387.	387.	387.	387.	387.	387.	387.	387.	387.
7.000	428.6600	2.9525	254.09	-.61	2.69	587.3000	4.4260	-.05	387.	387.	387.	387.	387.	387.	387.	387.	387.
8.000	374.2600	3.0238	246.78	-.55	3.18	528.1000	4.4090	-.24	387.	387.	387.	387.	387.	387.	387.	387.	387.
9.000	325.4300	3.1075	239.59	-.45	3.42	473.0000	4.5530	-.55	385.	385.	385.	385.	385.	385.	385.	385.	385.
10.000	281.7700	3.1435	232.89	-.35	3.85	421.5000	5.0950	-.67	385.	385.	385.	385.	385.	385.	385.	385.	385.
11.000	243.0900	3.1320	226.70	-.24	4.02	373.6000	5.4570	-.43	395.	395.	395.	395.	395.	395.	395.	395.	395.
12.000	208.6200	2.9157	221.10	-.16	3.70	329.1000	5.5340	-.33	385.	385.	385.	385.	385.	385.	385.	385.	385.
13.000	178.8200	2.6535	215.89	-.10	3.06	288.6000	5.4820	-.17	385.	385.	385.	385.	385.	385.	385.	385.	385.
14.000	152.5300	2.2589	210.79	-.06	2.91	252.1000	5.4100	-.15	383.	383.	383.	383.	383.	383.	383.	383.	383.
15.000	129.5800	1.8658	205.87	-.02	3.00	219.3000	5.0950	-.12	382.	382.	382.	382.	382.	382.	382.	382.	382.
16.000	109.7000	1.4842	202.04	.00	3.12	199.2000	4.6300	.02	381.	381.	381.	381.	381.	381.	381.	381.	381.
17.000	92.6760	1.1420	199.98	-.02	3.38	161.5000	4.1350	.13	378.	378.	378.	378.	378.	378.	378.	378.	378.
18.000	78.2220	.8539	200.57	-.02	3.41	135.9000	3.3110	.16	376.	376.	376.	376.	376.	376.	376.	376.	376.
19.000	66.1390	.6393	203.84	.00	3.24	113.1000	2.4510	.25	367.	367.	367.	367.	367.	367.	367.	367.	367.
20.000	56.0990	.5118	207.59	.00	2.74	94.1600	1.5780	.36	360.	360.	360.	360.	360.	360.	360.	360.	360.
21.000	47.7130	.4263	210.62	.02	2.33	78.6500	1.0480	.20	352.	352.	352.	352.	352.	352.	352.	352.	352.
22.000	40.6690	.3786	213.74	.16	2.49	65.2900	.8957	-.16	344.	344.	344.	344.	344.	344.	344.	344.	344.
23.000	34.7460	.3326	215.06	.14	2.45	56.0300	.6911	.05	325.	325.	325.	325.	325.	325.	325.	325.	325.
24.000	29.7250	.3124	218.27	.11	2.57	47.4500	.5690	.02	301.	301.	301.	301.	301.	301.	301.	301.	301.
25.000	25.1770	.2803	220.41	-.06	2.42	34.2400	.3786	.24	274.	274.	274.	274.	274.	274.	274.	274.	274.
26.000	21.8790	.2587	222.62	-.14	2.23	29.1500	.3332	.03	243.	243.	243.	243.	243.	243.	243.	243.	243.
27.000	18.8240	.2344	224.96	-.18	2.28	29.1500	.3332	.03	243.	243.	243.	243.	243.	243.	243.	243.	243.
28.000	16.2180	.2135	227.32	-.22	2.30	24.6500	.3105	-.13	230.	230.	230.	230.	230.	230.	230.	230.	230.
29.000	13.9970	.1938	229.21	-.13	2.47	21.6500	.2925	-.25	177.	177.	177.	177.	177.	177.	177.	177.	177.
30.000	12.0720	.1784	232.55	-.05	2.74	18.2100	.2696	-.67	147.	147.	147.	147.	147.	147.	147.	147.	147.
32.000	8.9939	.1509	237.00	-.49	4.33	13.2300	.2591	-.17	102.	102.	102.	102.	102.	102.	102.	102.	102.
34.000	6.7889	.1362	241.56	-.45	4.79	9.7200	.2077	-.28	103.	103.	103.	103.	103.	103.	103.	103.	103.
36.000	5.1475	.1150	245.62	-.35	4.52	7.2590	.1832	-.68	103.	103.	103.	103.	103.	103.	103.	103.	103.
38.000	3.9232	.0928	250.35	-.38	4.57	5.4540	.1469	-.61	102.	102.	102.	102.	102.	102.	102.	102.	102.
40.000	3.0059	.0748	255.35	-.41	4.50	4.1000	.1051	-.17	102.	102.	102.	102.	102.	102.	102.	102.	102.
42.000	2.3147	.0557	256.63	-.42	4.97	3.1050	.1029	-.09	102.	102.	102.	102.	102.	102.	102.	102.	102.
44.000	1.7901	.0437	253.22	-.35	4.86	2.3520	.0639	-.58	101.	101.	101.	101.	101.	101.	101.	101.	101.
45.000	1.3879	.0354	264.97	-.23	4.58	1.8250	.0458	-.28	100.	100.	100.	100.	100.	100.	100.	100.	100.
49.000	1.0773	.0299	266.19	-.24	4.48	1.4630	.0401	-.21	100.	100.	100.	100.	100.	100.	100.	100.	100.
50.000	.8380	.0234	266.72	-.07	4.17	1.0940	.0301	-.41	99.	99.	99.	99.	99.	99.	99.	99.	99.
52.000	.6518	.0193	265.95	-.01	4.18	.8537	.0248	-.09	100.	100.	100.	100.	100.	100.	100.	100.	100.
54.000	.5063	.0158	264.46	.06	4.11	.6663	.0196	-.27	98.	98.	98.	98.	98.	98.	98.	98.	98.
55.000	.3927	.0129	262.43	.13	4.53	.5214	.0169	-.30	96.	96.	96.	96.	96.	96.	96.	96.	96.
58.000	.3039	.0103	259.17	.23	4.49	.4083	.0131	-.41	80.	80.	80.	80.	80.	80.	80.	80.	80.
60.000	.2547	.0087	255.76	.21	4.73	.3194	.0107	-.10	58.	58.	58.	58.	58.	58.	58.	58.	58.
62.000	.1805	.0067	251.22	-.12	6.69	.2503	.0095	-.63	33.	33.	33.	33.	33.	33.	33.	33.	33.
64.000	.1351	.0049	241.69	.11	5.05	.1544	.0054	-.44	17.	17.	17.	17.	17.	17.	17.	17.	17.
66.000	.1019	.0039	233.05	.24	3.35	.1523	.0056	-.13	18.	18.	18.	18.	18.	18.	18.	18.	18.
68.000	.0761	.0031	219.45	.19	5.35	.1205	.0039	-.18	17.	17.	17.	17.	17.	17.	17.	17.	17.
70.000	.0558	.0023	213.92	.41	5.63	.0908	.0051	-.21	17.	17.	17.	17.	17.	17.	17.	17.	17.

TABLE II-4. THERMODYNAMIC STATISTICAL PARAMETERS

APRIL

STATION = 911620 Z M	BARKING SACS, MI		S.D. T		SKEH T		MEAN D		S.D. D		SKEH D		NOBS P		NOBS T		NOBS D	
	MB	S.D. P	DEG K	DEG K	SKEH K	DEG K	DEG K	G/MS	G/MS	G/MS	G/MS	SKEH P	NOBS P	NOBS T	NOBS D			
.000	1017.6000	2.6748	285.64	285.64	1.88	.08	1187.0000	6.5440	.16	374.	.16	374.	374.	374.				
.005	1017.3000	2.6744	285.59	285.59	1.92	.02	1186.0000	6.7950	.22	392.	.22	392.	392.	392.				
1.000	906.5000	2.5475	228.69	228.69	1.25	-.73	1069.0000	5.5670	.39	392.	.39	392.	392.	392.				
3.000	805.1100	2.2437	103.77	103.77	1.93	-.08	955.3000	6.0150	-.02	392.	-.02	392.	392.	392.				
3.000	713.7100	2.1445	276.67	276.67	1.84	-.03	827.0000	5.3470	-.02	392.	-.02	392.	392.	392.				
4.000	631.2100	2.1157	274.55	274.55	1.87	.02	809.0000	5.0030	-.18	392.	-.18	392.	392.	392.				
5.000	549.7000	2.0240	203.04	203.04	2.02	.01	721.0000	4.8100	-.29	342.	-.29	342.	342.	342.				
6.000	469.2000	2.0423	231.50	231.50	2.11	.09	651.1000	4.3040	-.60	391.	-.60	391.	391.	391.				
7.000	429.4000	2.1332	254.74	254.74	2.19	.02	586.7000	3.8200	-.17	391.	-.17	391.	391.	391.				
8.000	375.0300	2.1314	247.26	247.26	2.33	-.01	527.0000	3.5410	-.18	391.	-.18	391.	391.	391.				
9.000	326.1600	2.2097	239.67	239.67	2.48	.03	473.7000	3.2030	-.23	391.	-.23	391.	391.	391.				
10.000	282.3300	2.2708	224.23	224.23	2.77	.31	377.1000	3.2870	-.49	391.	-.49	391.	391.	391.				
11.000	243.3000	2.2617	201.49	201.49	2.99	.22	352.0000	3.4200	-.93	391.	-.93	391.	391.	391.				
12.000	208.7700	2.1193	218.59	218.59	2.97	.10	281.2000	4.5400	-.43	386.	-.43	386.	386.	386.				
13.000	179.4300	1.9563	213.49	213.49	2.78	-.22	252.7000	4.4070	-.02	383.	-.02	383.	383.	383.				
14.000	151.9500	1.7019	203.51	203.51	2.63	-.37	219.2000	4.0010	.12	383.	.12	383.	383.	383.				
15.000	129.0400	1.4172	203.34	203.34	2.63	-.06	187.3000	3.5530	.17	381.	.17	381.	381.	381.				
16.000	109.3200	1.1472	202.03	202.03	2.63	-.13	150.5000	3.1470	.26	381.	.26	381.	381.	381.				
17.000	92.4660	.9042	202.03	202.03	2.59	-.40	111.9000	1.8180	.52	374.	.52	374.	374.	374.				
18.000	78.2090	.7074	208.37	208.37	2.59	-.40	111.9000	1.8180	.52	374.	.52	374.	374.	374.				
19.000	66.2730	.5693	208.37	208.37	2.59	-.40	111.9000	1.8180	.52	374.	.52	374.	374.	374.				
20.000	56.3260	.4754	209.90	209.90	2.30	-.35	93.4900	1.2840	.42	359.	.42	359.	359.	359.				
21.000	47.9960	.4135	212.60	212.60	2.19	-.14	78.6400	.8713	-.10	350.	-.10	350.	350.	350.				
22.000	40.5320	.3532	215.05	215.05	2.12	-.11	66.3000	.7370	-.13	355.	-.13	355.	355.	355.				
23.000	35.0350	.3292	217.57	217.57	1.99	-.09	56.1000	.5930	-.23	344.	-.23	344.	344.	344.				
24.000	30.0060	.2993	220.12	220.12	2.09	-.18	47.4300	.4995	-.32	339.	-.32	339.	339.	339.				
25.000	25.7530	.2704	222.46	222.46	2.07	-.24	40.3300	.4375	-.44	328.	-.44	328.	328.	328.				
26.000	22.1450	.2448	224.70	224.70	1.97	-.09	34.3300	.3650	-.40	308.	-.40	308.	308.	308.				
27.000	19.0680	.2243	226.68	226.68	1.96	-.23	29.2800	.3422	-.21	268.	-.21	268.	268.	268.				
28.000	16.4370	.2033	223.07	223.07	2.03	-.23	25.0000	.3078	-.16	249.	-.16	249.	249.	249.				
29.000	14.1910	.1799	232.94	232.94	2.04	-.11	21.4100	.2647	-.15	198.	-.15	198.	198.	198.				
30.000	12.2670	.1559	232.77	232.77	2.05	.10	18.3000	.2280	-.46	170.	-.46	170.	170.	170.				
31.000	9.1634	.1466	238.14	238.14	3.36	.14	13.4400	.2007	-.08	123.	-.08	123.	123.	123.				
32.000	6.9304	.1231	242.33	242.33	3.43	-.18	9.0000	.1748	-.07	127.	-.07	127.	127.	127.				
33.000	5.2021	.1022	246.55	246.55	4.17	.73	7.4600	.1502	-.64	122.	-.64	122.	122.	122.				
34.000	4.0135	.0910	251.04	251.04	3.70	.46	5.2000	.1163	-.35	121.	-.35	121.	121.	121.				
35.000	3.0770	.0665	255.27	255.27	3.02	.00	4.1800	.0947	-.06	120.	-.06	120.	120.	120.				
36.000	2.3718	.0530	260.97	260.97	4.05	.03	3.1000	.0748	.17	120.	.17	120.	120.	120.				
37.000	1.8394	.0453	263.13	263.13	4.31	-.17	2.4100	.0578	-.12	119.	-.12	119.	119.	119.				
38.000	1.4265	.0373	267.13	267.13	3.18	.00	1.6300	.0472	-.18	117.	-.18	117.	117.	117.				
39.000	1.1095	.0283	268.29	268.29	3.95	-.08	1.4360	.0378	.05	114.	.05	114.	114.	114.				
40.000	.8633	.0235	267.98	267.98	4.24	-.18	1.1210	.0280	.19	113.	.19	113.	113.	113.				
41.000	.6718	.0194	267.00	267.00	3.93	-.17	.8758	.0229	.14	112.	.14	112.	112.	112.				
42.000	.5218	.0157	264.31	264.31	3.99	-.13	.6875	.0173	-.08	109.	-.08	109.	109.	109.				
43.000	.4045	.0133	260.72	260.72	4.72	.14	.5404	.0131	.39	100.	.39	100.	100.	100.				
44.000	.3120	.0114	255.92	255.92	5.05	.12	.4230	.0111	.53	85.	.53	85.	85.	85.				
45.000	.2392	.0075	252.02	252.02	5.30	-.02	.3106	.0097	.62	62.	.62	62.	62.	62.				
46.000	.1809	.0075	245.01	245.01	5.55	.60	.2571	.0074	.50	31.	.50	31.	31.	31.				
47.000	.1358	.0039	235.28	235.28	5.27	1.11	.2012	.0049	.19	16.	.19	16.	16.	16.				
48.000	.1014	.0036	229.67	229.67	5.91	1.04	.1516	.0043	.42	17.	.42	17.	17.	17.				
49.000	.0794	.0033	219.22	219.22	9.03	1.48	.1199	.0035	.26	17.	.26	17.	17.	17.				
50.000	.0548	.0015	213.16	213.16	4.41	-.24	.0894	.0025	-.41	16.	-.41	16.	16.	16.				

TABLE II-5. THERMODYNAMIC STATISTICAL PARAMETERS

MAY

STATION - 911620 Z KM	BARKING SANDS, HI		MEAN T		S.D. T		SKEW T	MEAN D G/M3	S.D. D G/M3	SKEW D	NOBS P	NOBS T	NOBS D
	S.D. P MB	SKEW P	DEG K	DEG K	DEG K	DEG K							
.000	1017.4000	2.0431	-0.02	290.18	1.67	.61	1179.0000	7.4500	-0.67	356.	356.	356.	
.005	1016.8000	2.0329	-0.62	298.16	1.66	.59	1179.0000	7.4100	-0.65	369.	369.	369.	
1.000	905.5000	1.7003	-0.60	293.64	1.03	.51	1084.0000	4.8260	-0.57	369.	369.	369.	
2.000	805.4100	1.6269	-0.63	284.68	1.89	.28	982.3000	5.9980	-0.04	368.	368.	368.	
3.000	714.2500	1.6363	-0.67	280.95	1.93	-.07	884.1000	5.4010	-0.02	368.	368.	368.	
4.000	632.1500	1.7749	-0.52	276.16	2.02	.19	795.5000	5.0540	-0.32	368.	368.	368.	
5.000	558.1700	1.8151	-0.30	270.27	2.08	.00	718.7000	4.6280	-0.21	368.	368.	368.	
6.000	491.4200	1.9463	-0.19	263.76	2.21	-.13	648.5000	4.2420	.03	368.	368.	368.	
7.000	431.1500	2.0716	-0.15	256.82	2.29	-.21	584.4000	3.8350	.24	368.	368.	368.	
8.000	376.9700	2.1352	-0.14	249.48	2.23	-.18	526.1000	3.2390	.22	368.	368.	368.	
9.000	328.2600	2.1973	-0.12	241.79	2.29	-.15	472.7000	3.0240	-.09	365.	365.	365.	
10.000	284.5000	2.2034	-0.10	234.02	2.25	.01	423.4000	2.9550	-.73	366.	366.	366.	
11.000	245.5400	2.1716	-0.06	226.37	2.22	.00	377.9000	2.9410	-1.16	366.	366.	366.	
12.000	210.7200	2.0064	-0.02	219.16	2.27	.06	335.0000	3.2110	-1.14	366.	366.	366.	
13.000	180.1300	1.8569	-0.02	212.71	2.44	.45	295.0000	3.7580	-.77	365.	365.	365.	
14.000	153.2800	1.6274	-0.02	207.89	2.71	.51	256.9000	4.2260	-.28	364.	364.	364.	
15.000	130.0100	1.3458	.05	204.83	2.90	-.07	221.1000	4.2370	.02	363.	363.	363.	
16.000	110.0300	1.0629	.10	203.35	2.60	.21	183.6000	3.4650	-.04	359.	359.	359.	
17.000	93.1870	.8599	.09	203.34	2.63	.04	159.7000	2.8490	.15	358.	358.	358.	
18.000	78.9040	.6970	.03	205.08	2.71	-.11	134.1000	2.2340	.19	356.	356.	356.	
19.000	66.9630	.5790	-.03	207.83	2.17	-.20	112.3000	1.6420	.25	352.	352.	352.	
20.000	56.9630	.4840	-.08	210.74	1.83	-.20	94.1700	1.2070	.17	347.	347.	347.	
21.000	48.5500	.4032	-.08	213.50	1.76	-.03	79.2400	.8293	.07	340.	340.	340.	
22.000	41.4730	.3516	-.03	216.06	1.83	-.14	66.8700	.7599	-.01	333.	333.	333.	
23.000	35.5090	.3104	.01	218.64	1.70	-.10	55.5800	.5500	.00	320.	320.	320.	
24.000	30.4300	.2834	.04	221.05	1.85	.09	47.9600	.4579	.06	313.	313.	313.	
25.000	26.1330	.2575	.06	223.35	1.71	.07	40.7800	.3752	.11	300.	300.	300.	
26.000	22.4920	.2310	.14	225.61	1.60	-.03	34.7300	.3083	.07	270.	270.	270.	
27.000	19.3760	.2027	.19	227.75	1.67	.07	29.6400	.2784	.05	242.	242.	242.	
28.000	16.7120	.1824	.19	229.63	1.54	.18	25.3500	.2518	.27	231.	231.	231.	
29.000	14.4330	.1647	.03	231.43	1.74	.30	21.7300	.2425	.18	184.	184.	184.	
30.000	12.4730	.1479	.05	233.00	1.80	.03	18.6500	.2152	.40	160.	160.	160.	
34.000	7.0335	.0530	.00	240.90	3.40	.07	10.1700	.1720	.00	123.	123.	123.	
36.000	5.3266	.0259	.18	245.05	3.28	.02	7.5590	.1291	-.51	123.	123.	123.	
38.000	4.0543	.0542	.46	249.47	3.93	-.11	5.6610	.1009	.47	121.	121.	121.	
40.000	3.1029	.0469	.59	255.25	3.63	.28	4.2340	.0697	-.23	120.	120.	120.	
42.000	2.3909	.0358	.81	260.64	3.74	-.15	3.1450	.0454	.59	123.	123.	123.	
44.000	1.8509	.0325	.90	264.96	3.34	-.69	2.4320	.0457	.29	120.	120.	120.	
46.000	1.4379	.0275	.85	267.38	3.86	-.25	1.8720	.0338	.70	119.	119.	119.	
48.000	1.1192	.0235	.71	269.30	3.94	-.14	1.4500	.0269	-.08	117.	117.	117.	
50.000	.8716	.0200	.60	270.60	4.26	-.48	1.1330	.0233	.33	113.	113.	113.	
52.000	.6771	.0162	.39	273.20	4.93	-.10	.8970	.0189	.09	108.	108.	108.	
54.000	.5248	.0123	.25	262.97	5.03	-.50	.6948	.0142	.19	101.	101.	101.	
56.000	.4056	.0117	.24	260.55	5.34	-.22	.5424	.0126	-.17	92.	92.	92.	
58.000	.3120	.0095	.35	256.69	4.47	-.06	.4233	.0098	-.42	76.	76.	76.	
60.000	.2369	.0081	.70	251.01	4.98	.73	.3314	.0096	-.75	59.	59.	59.	
62.000	.1828	.0062	.63	244.02	6.93	.40	.2610	.0079	-.29	35.	35.	35.	
64.000	.1359	.0027	1.10	230.63	5.38	.32	.2013	.0046	-1.02	20.	20.	20.	
66.000	.1013	.0017	.61	220.90	4.43	.30	.1574	.0037	-.79	19.	19.	19.	
68.000	.0747	.0016	.07	212.73	7.54	-.85	.1282	.0049	1.57	23.	23.	23.	
70.000	.0541	.0004	.23	207.05	5.82	.56	.0907	.0028	.04	20.	20.	20.	

TABLE II-6. THERMODYNAMIC STATISTICAL PARAMETERS

JUNE

STATION Z	MEAN P		DARKING SALES, HI		S.D. T SEC K	SKEW T	MEAN D G/M3	S.D. D G/M3	SKEW D	MGRS P	NOBS T	NOBS D
	KN	MB	S.D. P PS	SKEW P								
1.000	1017.3000	1.6634	-0.45	231.56	1.51	.48	1176.0000	6.4030	-.41	343.	343.	343.
.005	1016.7000	1.6757	-.43	231.53	1.49	.42	1175.0000	6.2120	-.39	370.	370.	370.
1.000	905.7400	1.4053	-.48	230.43	1.52	-.07	1081.0000	4.6050	.08	370.	370.	370.
2.000	605.9700	1.5190	-.40	265.07	2.14	-.20	978.0000	6.4050	-.20	370.	370.	370.
3.000	715.1900	1.5748	-.27	232.61	2.02	-.38	879.5000	5.6140	-.20	370.	370.	370.
4.000	633.4200	1.7510	-.22	277.46	1.93	-.08	794.1000	4.9330	.02	370.	370.	370.
5.000	559.6500	1.8467	-.05	271.52	2.01	-.36	717.1000	4.7080	.39	370.	370.	370.
6.000	493.0100	1.8333	.02	294.95	2.19	-.51	647.0000	4.6950	.38	370.	370.	370.
7.000	432.7600	1.9503	.60	317.30	2.25	-.53	574.5000	4.2710	.24	369.	369.	369.
8.000	375.5000	2.0333	.60	250.48	2.19	-.33	515.1000	3.6130	-.11	369.	369.	369.
9.000	329.8600	2.0544	-.09	242.90	2.18	-.27	472.3000	2.9330	-.15	369.	369.	369.
10.000	286.1000	2.0536	-.11	233.15	2.11	-.15	423.5000	2.7900	-.21	368.	368.	368.
11.000	247.1200	1.8763	-.15	227.48	1.94	-.09	378.5000	2.3740	-.23	368.	368.	368.
12.000	212.1700	1.8763	-.07	220.00	1.80	-.09	336.0000	2.5730	-.71	369.	369.	369.
13.000	181.4800	1.7355	.02	213.32	1.83	.24	295.4000	3.1100	-.09	367.	367.	367.
14.000	154.4800	1.5069	.19	208.38	2.36	.32	259.3000	3.6090	-.60	366.	366.	366.
15.000	131.1000	1.2515	.28	205.50	2.70	.21	222.3000	3.9090	-.10	365.	365.	365.
16.000	111.6800	1.0149	.29	204.10	2.65	.01	189.5000	3.7100	.17	364.	364.	364.
17.000	94.0310	.8225	.26	204.33	2.31	-.18	160.4000	2.4100	.28	364.	364.	364.
18.000	79.7420	.6959	.26	205.93	2.18	.11	134.9000	1.9460	.30	360.	360.	360.
19.000	67.7140	.5534	.60	202.95	1.78	-.12	113.1000	1.3730	.30	362.	362.	362.
20.000	57.0200	.4693	-.05	211.39	1.51	-.16	94.5000	.9607	.25	345.	345.	345.
21.000	49.1300	.4001	-.11	214.12	1.94	.03	79.5000	.7100	.05	340.	340.	340.
22.000	41.0300	.3009	-.16	216.70	1.44	.09	67.5100	.6516	.19	337.	337.	337.
23.000	35.8600	.3152	-.12	219.14	1.43	-.05	57.1000	.5043	.17	321.	321.	321.
24.000	30.0300	.2776	-.13	221.50	1.52	.11	48.0000	.4405	.00	319.	319.	319.
25.000	26.4050	.2474	-.13	223.53	1.46	-.09	41.2600	.4167	.07	304.	304.	304.
26.000	22.6030	.2182	-.09	225.80	1.42	-.10	35.1800	.3351	-.04	281.	281.	281.
27.000	19.6400	.1987	.04	227.71	1.57	-.10	30.0500	.2912	.02	238.	238.	238.
28.000	16.9250	.1714	-.19	229.38	1.55	.08	25.7200	.2336	.14	221.	221.	221.
29.000	14.6310	.1531	-.08	230.53	1.56	.34	22.0700	.2241	.03	178.	178.	178.
30.000	12.5440	.1355	-.25	232.39	1.71	-.66	19.5200	.1911	.60	153.	153.	153.
32.000	9.4126	.1457	.09	235.50	3.06	.58	13.9200	.2414	.16	109.	109.	109.
34.000	7.0655	.1181	.38	239.35	3.53	.23	10.3100	.1549	-.10	111.	111.	111.
36.000	5.3520	.1011	.56	244.04	3.65	-.64	7.6180	.1440	.24	111.	111.	111.
38.000	4.0764	.0839	.70	248.79	3.69	.05	5.7040	.1224	.23	109.	109.	109.
40.000	3.1169	.0680	.89	254.80	4.24	.33	4.2620	.1027	-.17	109.	109.	109.
42.000	2.4014	.0550	.91	260.53	4.13	-.72	3.2090	.0757	.61	107.	107.	107.
44.000	1.8590	.0446	.90	265.00	4.02	-.53	2.4430	.0555	.42	108.	108.	108.
46.000	1.4427	.0361	.92	269.66	3.72	-.71	1.8830	.0437	.50	106.	106.	106.
48.000	1.1220	.0297	.91	267.32	3.54	.01	1.4590	.0365	.75	104.	104.	104.
50.000	.8719	.0237	.94	265.76	4.27	-.18	1.1370	.0297	.69	97.	97.	97.
52.000	.6775	.0195	.69	263.29	4.07	-.50	.8305	.0232	.79	100.	100.	100.
54.000	.5657	.0153	.78	259.67	4.55	-.33	.6371	.0195	.51	97.	97.	97.
56.000	.4059	.0132	.73	253.20	4.50	-.13	.5474	.0147	.46	87.	87.	87.
58.000	.3125	.0118	.72	253.13	6.02	-.32	.4300	.0114	-.06	72.	72.	72.
60.000	.2375	.0090	1.28	248.37	6.20	.24	.3330	.0087	.47	47.	47.	47.
62.000	.1796	.0060	.29	244.84	7.56	.24	.2536	.0066	-.69	28.	28.	28.
64.000	.1318	.0021	-.02	233.09	6.32	-.33	.1659	.0052	.32	12.	12.	12.
66.000	.0936	.0018	.12	235.70	5.39	.18	.1514	.0039	-.72	13.	13.	13.
68.000	.0730	.0015	.05	212.70	6.44	.41	.1189	.0033	-.45	13.	13.	13.
70.000	.0532	.0013	-.12	209.09	8.39	-.58	.0887	.0030	-.04	13.	13.	13.

TABLE II-7. THERMODYNAMIC STATISTICAL PARAMETERS

JULY

STATION = 911620		BARKING SANDS, HI		S.D. T		MEAN T		S.D. T		SKEW T		MEAN D		S.D. D		SKEW D		MODES P		MODES T		MODES D	
Z	MO	MEAN P	S.D. P	SKEW P	MEAN T	DEG K	DEG K	SKEW T	MEAN D	G/M3	SKEW T	MEAN D	G/M3	SKEW D	MODES P	MODES T	MODES D	MODES P	MODES T	MODES D	MODES P	MODES T	MODES D
.000	1016.9000	1.4146	-.11	299.39	1.31	.45	1174.0000	5.7740	329.	-.61	329.	329.											
.005	1016.4000	1.4109	-.13	299.37	1.30	.45	1173.0000	5.7500	339.	-.61	339.	339.											
1.000	906.6700	1.1615	-.33	290.98	1.95	-.02	1079.0000	4.1890	339.	.07	339.	339.											
2.000	806.0500	1.1260	-.14	286.48	1.92	.39	976.7000	5.6150	339.	-.30	339.	339.											
3.000	715.2600	1.1711	-.03	282.23	1.92	-.05	681.3000	5.0740	339.	-.09	339.	339.											
4.000	633.3800	1.2656	-.31	277.05	1.96	-.45	795.4000	5.3150	337.	.53	337.	337.											
5.000	559.5100	1.3532	-.12	271.41	2.04	-.52	717.3000	4.7460	337.	.46	337.	337.											
6.000	492.9100	1.5294	-.29	265.05	2.16	-.39	647.2000	4.2590	337.	.29	337.	337.											
7.000	432.7200	1.6771	-.41	258.07	2.18	-.18	583.6000	3.6220	337.	.14	337.	337.											
8.000	378.6100	1.8211	-.37	250.69	2.19	-.13	525.7000	3.1670	336.	-.06	336.	336.											
9.000	329.9200	1.9331	-.32	243.11	2.22	.09	472.5000	2.7440	336.	-.29	336.	336.											
10.000	286.1900	1.9813	-.32	235.32	2.17	.11	423.5000	2.4660	335.	-.37	335.	335.											
11.000	247.2100	1.9851	-.28	227.63	2.01	-.03	378.3000	2.1070	335.	-.31	335.	335.											
12.000	212.2900	1.8637	-.21	220.27	1.77	-.20	335.7000	2.2910	335.	-.54	335.	335.											
13.000	181.6300	1.7356	-.15	213.85	1.74	.02	295.9000	3.0180	332.	-.79	332.	332.											
14.000	154.6900	1.4907	-.02	209.19	2.32	.31	257.7000	4.0880	331.	-.74	331.	331.											
15.000	131.3700	1.1895	-.15	206.38	2.74	.42	221.8000	4.1050	330.	-.36	330.	330.											
16.000	111.4000	.9174	.11	205.27	2.75	.15	189.1000	3.4850	329.	.19	329.	329.											
17.000	94.4470	.7082	-.08	205.63	2.21	-.23	160.0000	2.4010	327.	.53	327.	327.											
18.000	80.0910	.5756	-.21	207.05	1.73	-.11	134.8000	1.6340	324.	.18	324.	324.											
19.000	68.0910	.4718	-.27	209.27	1.38	-.12	113.4000	1.1830	320.	-.06	320.	320.											
20.000	57.9680	.3919	-.23	211.79	1.35	.27	95.3500	.9487	316.	-.29	316.	316.											
21.000	49.4420	.3315	-.18	214.48	1.38	.03	80.3100	.7303	306.	-.22	306.	306.											
22.000	42.2640	.2909	-.17	216.74	1.29	-.22	67.9300	.5683	303.	.17	303.	303.											
23.000	36.1970	.2563	-.20	218.90	1.29	-.10	57.6100	.4788	289.	-.05	289.	289.											
24.000	31.0290	.2286	-.22	221.07	1.50	.40	48.9000	.4487	286.	-.34	286.	286.											
25.000	26.6450	.2028	-.19	223.11	1.57	.14	41.6100	.3840	277.	-.32	277.	277.											
26.000	22.9030	.1807	-.15	224.91	1.58	.33	35.4900	.3219	251.	.32	251.	251.											
27.000	19.7170	.1627	-.14	225.64	1.70	.14	30.3100	.2874	216.	-.15	216.	216.											
28.000	16.9970	.1450	-.08	228.38	1.65	-.05	25.9300	.2402	205.	-.04	205.	205.											
29.000	14.6530	.1346	-.07	230.04	1.85	-.06	22.2000	.2072	169.	-.39	169.	169.											
30.000	12.6550	.1164	-.35	231.33	1.71	.16	19.0600	.1695	150.	-.53	150.	150.											
32.000	9.4143	.1198	.55	233.96	2.84	.18	14.0200	.1819	119.	.25	119.	119.											
34.000	7.0727	.0991	.57	237.71	3.33	-.45	10.3600	.1639	121.	-.45	121.	121.											
36.000	5.3420	.0892	.14	242.40	4.03	.25	7.6750	.1533	122.	.25	122.	122.											
38.000	4.0555	.0721	.54	246.99	3.70	-.68	5.7170	.0860	122.	-.68	122.	122.											
40.000	3.0945	.0623	.57	252.43	4.24	-.19	4.2690	.0825	124.	-.19	124.	124.											
42.000	2.3779	.0522	.50	255.52	4.17	-.19	3.2040	.0691	123.	-.19	123.	123.											
44.000	1.8358	.0435	.41	262.01	3.64	-.14	2.4390	.0557	119.	-.14	119.	119.											
45.000	1.4216	.0357	.38	264.29	4.03	-.46	1.8740	.0450	118.	-.46	118.	118.											
46.000	1.1032	.0294	.29	265.61	3.80	-.15	1.4470	.0358	117.	-.15	117.	117.											
50.000	.8564	.0246	.35	264.49	4.11	-.24	1.1280	.0303	114.	-.24	114.	114.											
52.000	.6631	.0205	.40	261.72	4.68	-.78	.6828	.0237	106.	-.78	106.	106.											
54.000	.5122	.0169	.40	259.39	5.33	-.55	.6878	.0200	101.	-.55	101.	101.											
56.000	.3947	.0141	.43	257.15	5.93	-.01	.5347	.0155	95.	-.01	95.	95.											
58.000	.3031	.0119	.52	254.03	7.03	.83	.4155	.0153	77.	.83	77.	77.											
60.000	.2320	.0091	.64	248.59	9.05	.77	.3245	.0111	46.	.77	46.	46.											
62.000	.0669	.0069	.58	240.63	10.84	.17	.2516	.0102	26.	.17	26.	26.											
64.000	.1285	.0045	.62	231.38	7.12	-.86	.1934	.0056	18.	-.86	18.	18.											
66.000	.0359	.0035	.52	224.67	6.24	-.63	.1455	.0074	17.	-.63	17.	17.											
68.000	.0708	.0024	.72	214.10	7.94	.55	.1153	.0062	17.	.55	17.	17.											
70.000	.0517	.0015	.54	208.81	8.75	-.69	.0863	.0051	17.	-.69	17.	17.											

TABLE II-8. THERMODYNAMIC STATISTICAL PARAMETERS

AUGUST

STATION Z	SI1620	MEAN P	S.D. P	BACKING	MEAN T	S.D. T	SKEM T	MEAN D	S.D. D	SKCH D	NOBS P	NOBS T	NOBS D
NO	MG	MM	MM	MM	DEG K	DEG K	G/M3	G/M3	G/M3				
1.000	1016.1000	1.5374	-.54	233.40	1.18	.36	1172.0000	5.2650	-.27	385.	385.	385.	
1.005	1015.6000	1.6047	-.95	292.35	1.19	.34	1172.0000	5.2370	-.25	393.	393.	393.	
1.010	905.0700	1.4105	-.57	291.44	.84	-.52	1076.0000	4.3140	-.19	393.	393.	393.	
2.000	805.7100	1.2173	-.18	283.59	1.80	.34	975.7000	5.5270	-.24	392.	392.	392.	
3.000	715.0100	1.3331	-.47	282.45	1.67	.62	830.6000	4.7300	-.10	392.	392.	392.	
4.000	633.2400	1.3031	-.44	277.50	1.67	.03	793.0000	4.6100	-.17	391.	391.	391.	
5.000	553.5400	1.3752	-.24	271.97	1.77	-.13	715.0000	4.2000	-.13	391.	391.	391.	
6.000	493.0500	1.4718	-.30	255.68	1.65	-.10	695.7000	3.8730	-.27	391.	391.	391.	
7.000	443.9000	1.5205	-.54	238.83	1.67	-.75	593.1000	3.3440	-.17	390.	390.	390.	
8.000	379.0100	1.6507	-.45	231.50	1.91	-.28	509.4000	2.9000	-.11	389.	389.	389.	
9.000	330.4200	1.7422	-.40	243.66	1.90	-.28	471.4000	2.6490	-.39	385.	385.	385.	
10.000	285.7800	1.7606	-.42	236.24	1.95	-.26	422.5000	2.5340	-.61	383.	383.	383.	
11.000	247.8300	1.7651	-.43	223.50	1.93	-.22	377.0000	2.2010	-.47	382.	382.	382.	
12.000	212.9500	1.6803	-.33	221.03	1.87	-.17	335.7000	2.1220	-.59	382.	382.	382.	
13.000	182.2600	1.5371	-.36	214.22	1.77	-.06	295.4000	2.5490	-.70	382.	382.	382.	
14.000	155.2600	1.3594	-.30	208.91	2.03	.37	259.0000	3.4370	-.65	378.	378.	378.	
15.000	131.7900	1.1497	-.23	205.65	2.43	-.19	190.2000	3.1350	-.08	376.	376.	376.	
16.000	111.6900	.9027	-.18	203.10	2.01	-.45	160.8000	2.1050	-.20	375.	375.	375.	
17.000	94.5480	.6042	-.10	205.91	1.65	-.29	135.2000	1.5110	-.18	374.	374.	374.	
18.000	80.2670	.5002	.05	209.16	1.46	-.15	113.6000	1.1340	-.05	369.	369.	369.	
19.000	69.2110	.4417	.22	211.60	1.51	-.17	95.6100	.6977	.00	366.	366.	366.	
20.000	58.0690	.3600	.27	214.07	1.47	.16	80.5000	.7332	-.06	362.	362.	362.	
21.000	49.5210	.3467	.25	213.29	1.44	-.18	68.1600	.6291	-.14	359.	359.	359.	
22.000	42.3200	.3083	.13	218.39	1.50	-.21	57.7900	.5152	.32	345.	345.	345.	
23.000	36.2270	.2902	.13	220.44	1.65	.05	49.0500	.4487	.14	339.	339.	339.	
24.000	31.0380	.2548	.15	222.55	1.54	-.13	41.7100	.3788	.11	315.	315.	315.	
25.000	26.6420	.2272	.33	224.47	1.95	-.07	35.5400	.3302	.07	283.	283.	283.	
26.000	22.9020	.2048	.47	226.15	1.62	-.23	30.3600	.3059	.18	249.	249.	249.	
27.000	19.7100	.1837	.48	227.75	1.59	-.08	25.6300	.2591	.27	240.	240.	240.	
28.000	16.9340	.1675	.65	227.21	1.83	.63	22.2500	.2261	.20	210.	210.	210.	
29.000	14.6470	.1533	.73	230.61	1.80	.66	19.0400	.1967	.50	191.	191.	191.	
30.000	12.6450	.1430	.03	233.64	2.06	.63	14.0100	.2009	-.58	119.	123.	117.	
31.000	9.3914	.1198	.27	237.75	3.24	.22	10.5300	.1544	-.33	120.	124.	126.	
32.000	7.0345	.1012	.05	242.02	3.42	.62	7.6420	.1340	-.53	121.	126.	121.	
33.000	5.3060	.0812	.36	246.34	3.91	-.60	5.7130	.1127	.18	121.	126.	121.	
34.000	4.0445	.0701	.42	248.14	4.20	-.10	4.0040	.0917	.73	102.	127.	122.	
35.000	3.0081	.0581	.47	257.05	4.43	.28	3.2010	.0819	-.15	121.	126.	126.	
36.000	2.3719	.0445	.43	263.98	4.67	-.55	2.4420	.0591	.10	120.	125.	120.	
37.000	1.8209	.0318	.40	263.73	3.46	-.19	1.8720	.0470	.42	121.	125.	121.	
38.000	1.4184	.0318	.29	264.07	5.16	-.83	1.4440	.0421	-.14	120.	124.	120.	
39.000	1.0394	.0318	.24	263.05	5.81	-.52	1.1210	.0305	-.19	118.	122.	120.	
40.000	.6533	.0216	.28	264.33	4.93	-.45	.8705	.0232	-.10	113.	117.	113.	
41.000	.6612	.0173	.22	261.88	4.81	-.44	.6803	.0186	-.29	110.	113.	110.	
42.000	.5119	.0173	.22	261.88	6.48	-.37	.5293	.0174	-.24	98.	100.	98.	
43.000	.3945	.0148	.30	259.35	7.00	.59	.4130	.0144	-.67	78.	82.	78.	
44.000	.3042	.0120	.31	256.55	7.24	-.55	.3154	.0121	-.22	41.	45.	41.	
45.000	.2319	.0097	.87	252.95	6.00	-.69	.2463	.0063	.50	28.	30.	28.	
46.000	.1748	.0069	1.77	244.53	6.00	-.69	.1908	.0059	-.81	24.	24.	24.	
47.000	.1307	.0024	.42	238.65	7.70	1.43	.1908	.0059	-.81	24.	24.	24.	
48.000	.0833	.0024	-.10	229.21	6.34	-.68	.1402	.0036	-.19	22.	22.	22.	
49.000	.0731	.0021	-.45	217.21	7.64	-.18	.1171	.0036	.06	20.	20.	20.	
50.000	.0535	.0019	-.16	211.21	5.89	.28	.0681	.0026	-.13	19.	19.	19.	

TABLE II-9. THERMODYNAMIC STATISTICAL PARAMETERS

SEPTEMBER

STATION = 911620		BARKING SANDS, HI		S.D. T		MEAN T		S.D. T		SKEW T		MEAN D		S.D. D		SKEW D		NOBS P		NOBS T		NOBS D	
Z	MEAN P	S.D. P	SKEW P	MEAN T	DEG K	S.D. T	DEG K	SKEW T	G/M3	MEAN D	G/M3	S.D. D	G/M3	SKEW D	NOBS P	NOBS T	NOBS D						
.000	1015.5000	1.6088	-.01	298.97	1.18	.14	1173.0000	5.5860	-.09	352.	352.												
.005	1014.9000	1.6049	-.01	298.93	1.19	.14	1173.0000	5.5390	-.10	361.	361.												
1.000	905.5200	1.4225	-.13	291.64	.93	-.55	1075.0000	4.1110	.50	361.	361.												
2.000	805.1800	1.3211	-.19	286.41	1.57	.25	975.4000	4.7480	.00	361.	361.												
3.000	714.6000	1.2868	-.17	282.75	1.75	-.02	878.5000	5.0280	-.05	361.	361.												
4.000	632.9500	1.4067	-.29	277.79	1.74	-.28	792.4000	4.6020	.09	351.	361.												
5.000	559.3100	1.4816	-.30	272.01	1.69	-.27	715.2000	3.7820	-.08	361.	361.												
6.000	492.8600	1.5752	-.35	265.50	1.79	-.39	645.6000	3.4520	-.18	361.	361.												
7.000	432.7700	1.6544	-.42	258.54	1.88	-.29	582.5000	3.2220	-.29	360.	360.												
8.000	378.7400	1.7538	-.36	253.13	1.97	-.15	524.8000	2.9310	-.43	360.	360.												
9.000	330.1100	1.8398	-.33	243.52	2.11	-.14	471.8000	2.6550	-.62	359.	359.												
10.000	286.4200	1.8827	-.32	235.80	2.14	-.09	422.8000	2.2970	-.63	358.	358.												
11.000	247.4900	1.9021	-.29	228.13	2.09	.23	375.3000	2.0360	-.59	357.	357.												
12.000	212.6000	1.7983	-.19	220.89	1.99	.02	295.9000	3.3530	-.32	356.	356.												
13.000	181.9700	1.6912	-.13	214.26	2.02	-.09	233.2000	3.5780	-.02	355.	355.												
14.000	154.9800	1.4973	-.05	208.87	1.95	-.09	190.8000	3.1470	.22	354.	354.												
15.000	131.5400	1.2530	.02	203.47	2.33	-.14	161.4000	2.5340	.58	354.	354.												
16.000	111.4100	1.0105	.02	203.47	2.33	-.14	135.2000	1.7230	.29	354.	354.												
17.000	94.3150	.8195	-.04	203.51	1.85	-.18	113.4000	1.2520	.21	349.	349.												
18.000	79.8980	.6812	-.03	205.84	1.85	-.18	80.3000	.8075	.21	341.	341.												
19.000	67.8430	.5783	.02	208.35	1.64	-.08	67.8300	.6573	.06	330.	330.												
20.000	57.7240	.5060	.00	211.04	1.59	.21	57.4400	.5353	.06	325.	325.												
21.000	49.2120	.4428	-.02	213.50	1.50	-.08	49.7400	.4573	.06	306.	306.												
22.000	42.0360	.3960	-.05	215.90	1.51	.23	35.3400	.3421	.21	281.	281.												
23.000	35.9750	.3489	-.05	218.18	1.56	.39	30.1600	.3389	.20	249.	249.												
24.000	30.8230	.3119	.10	222.32	1.70	.36	25.7900	.2973	.47	238.	238.												
25.000	26.4520	.2769	.11	229.44	1.73	.56	22.0800	.2724	.51	186.	186.												
26.000	22.7440	.2444	.48	224.20	1.68	.38	18.9200	.2272	.35	162.	162.												
27.000	19.5610	.2199	.63	225.97	1.83	-.01	13.8900	.2030	-.20	98.	97.												
28.000	16.8560	.1975	.66	227.70	1.64	.38	10.2500	.1427	-.05	99.	99.												
29.000	14.5430	.1810	.72	229.44	1.73	.24	7.6170	.1264	-.12	100.	100.												
30.000	12.4530	.1536	.65	231.12	1.93	-.35	5.6790	.1005	-.10	100.	100.												
31.000	9.3330	.1323	.03	234.15	3.35	-.61	4.2450	.0901	.11	101.	101.												
32.000	7.0149	.1063	.41	233.34	3.40	.03	2.4170	.0623	.31	101.	101.												
33.000	5.3004	.0999	.24	242.39	3.73	-.49	1.8500	.0432	.55	99.	99.												
34.000	4.0266	.0807	.66	246.93	3.65	-.87	1.4310	.0374	.26	97.	97.												
35.000	3.0742	.0673	.71	252.08	4.12	-.70	1.1150	.0272	.40	95.	95.												
36.000	2.3614	.0557	.71	258.22	4.32	-.75	.8711	.0225	.57	96.	96.												
37.000	1.8248	.0459	.63	262.69	4.89	-.52	.6816	.0183	.21	94.	94.												
38.000	1.4163	.0383	.69	266.47	3.93	-.44	.5349	.0151	.17	84.	84.												
39.000	1.1002	.0323	.32	267.77	4.43	-.28	.4179	.0122	-.24	72.	72.												
40.000	.8565	.0259	.58	267.22	4.38	-.41	.2961	.0100	-.60	28.	28.												
41.000	.6653	.0218	.53	266.14	4.54	-.10	.1937	.0035	.01	15.	15.												
42.000	.5174	.0186	.48	264.23	5.11	-.78	.1522	.0040	.40	14.	14.												
43.000	.4008	.0154	.20	260.92	5.30	-.60	.1185	.0030	.15	14.	14.												
44.000	.3091	.0129	.26	257.48	6.30	-.41	.0885	.0015	-.81	14.	14.												
45.000	.2391	.0113	.20	253.53	6.30	-.41	.0651	.0015	-.81	14.	14.												
46.000	.1805	.0095	.72	245.75	8.51	-.10	.0484	.0015	-.81	14.	14.												
47.000	.1323	.0074	.50	230.15	3.46	-.71	.0384	.0015	-.81	14.	14.												
48.000	.0932	.0061	.71	214.87	4.84	-.60	.0284	.0015	-.81	14.	14.												
49.000	.0732	.0045	.64	199.80	4.85	-.60	.0284	.0015	-.81	14.	14.												

TABLE II-10. THERMODYNAMIC STATISTICAL PARAMETERS

OCTOBER

STATION Z KM	911620		BARKING SANDS, HI		S.D. T DEG K	MEAN T DEG K	S.D. T DEG K	SKEN T	MEAN D G/M3	S.D. D G/M3	SKEN D	NOBS P	NOBS T	NOBS D
	MEAN P MB	S.D. P MB	SKEN P	SKEN P										
0.000	1015.6300	1.6339	-52	203.21	1.66	203.18	0.17	1177.0000	7.6260	-13	370.	370.	370.	
0.005	1015.6300	1.9463	-55	202.18	1.95	202.18	.15	1176.0000	7.0350	-14	377.	377.	377.	
1.000	905.4700	1.7453	-53	201.30	1.77	201.30	.13	975.7030	4.6270	-33	377.	377.	377.	
2.000	805.0500	1.6175	-38	203.33	1.84	202.56	-.37	879.1000	5.3120	-02	377.	377.	377.	
3.000	714.4700	1.6105	-33	202.56	1.84	202.56	-.33	723.6000	5.1790	.21	377.	377.	377.	
4.000	632.7400	1.7230	-32	277.32	1.94	271.39	-.50	716.7000	4.9710	.19	377.	377.	377.	
5.000	559.0300	1.7539	-24	271.39	2.03	264.95	-.33	646.8000	4.5090	.38	377.	377.	377.	
6.000	492.4400	1.8255	-28	264.95	2.16	267.53	-.31	533.3000	4.0530	.06	377.	377.	377.	
7.000	432.2600	2.0255	-41	267.53	2.26	250.64	-.39	523.3000	3.7220	-.07	377.	377.	377.	
8.000	378.2100	2.1031	-38	250.64	2.32	243.11	-.23	472.0000	3.3530	-.08	377.	377.	377.	
9.000	329.5800	2.1575	-42	243.11	2.30	235.41	-.21	422.0000	3.0950	-.05	376.	376.	376.	
10.000	285.6300	2.1756	-39	235.41	2.45	227.88	-.20	377.6000	2.8960	-.32	376.	376.	376.	
11.000	246.9600	2.1457	-37	227.88	2.47	220.69	-.26	334.9000	2.7200	-.59	375.	375.	375.	
12.000	212.1400	2.0179	-32	220.69	2.48	214.08	-.25	295.4000	2.5630	-.51	375.	375.	375.	
13.000	181.5400	1.9052	-33	214.08	2.31	206.64	-.21	269.2000	2.4110	-.36	374.	374.	374.	
14.000	154.6600	1.7178	-34	206.64	2.24	204.30	-.06	223.7000	2.2670	-.18	372.	372.	372.	
15.000	131.1600	1.4748	-35	204.30	2.50	191.7000	-.07	182.5000	2.1350	-.03	370.	370.	370.	
16.000	110.5600	1.2010	-38	201.59	2.63	182.5000	-.21	135.8000	1.9710	-.22	371.	371.	371.	
17.000	93.7730	.9522	-39	182.50	2.91	162.5000	-.11	94.8000	1.7410	-.06	359.	359.	359.	
18.000	79.2650	.7184	-39	203.42	2.95	162.5000	-.11	79.6000	1.5170	-.20	345.	345.	345.	
19.000	67.2080	.5744	-32	206.81	1.85	152.79	.49	67.1900	1.3073	-.20	341.	341.	341.	
20.000	57.1290	.4305	-26	209.95	2.01	142.74	.52	56.6500	1.1130	-.12	331.	331.	331.	
21.000	48.6680	.3210	-18	212.79	1.79	127.43	.34	48.2400	.9435	-.22	324.	324.	324.	
22.000	35.5480	.2364	-03	217.74	1.95	119.60	.20	41.0400	.7930	-.33	306.	306.	306.	
24.000	30.4450	.3130	.01	219.60	2.09	104.00	.04	34.0000	.6510	-.24	274.	274.	274.	
25.000	26.1210	.2775	-14	221.75	2.15	94.00	-.04	29.8100	.5352	.07	244.	244.	244.	
26.000	22.4450	.2517	-01	223.73	2.28	85.67	.07	25.6700	.4517	-.11	236.	236.	236.	
27.000	19.3090	.2283	.07	225.67	2.74	78.29	.02	21.8160	.3817	-.22	184.	184.	184.	
28.000	16.6360	.2033	.05	227.35	2.79	73.67	.05	18.6000	.3215	-.09	168.	168.	168.	
29.000	14.3540	.2033	.02	229.29	3.79	67.49	-.23	13.6900	.2670	-.37	100.	100.	100.	
30.000	12.3680	.1951	.05	231.16	4.23	61.67	-.58	10.1700	.2166	.44	100.	100.	100.	
32.000	9.2180	.1480	.47	234.67	4.08	54.46	-.28	7.5370	.1678	.46	101.	101.	101.	
34.000	6.9268	.1294	.65	237.49	5.33	46.46	-.44	5.6150	.1107	.19	102.	102.	102.	
36.000	5.2267	.1171	.66	241.67	4.89	38.49	-.72	4.1830	.0868	.65	102.	102.	102.	
38.000	3.9698	.0931	.89	246.46	5.02	29.27	-.54	2.3780	.0639	.88	102.	102.	102.	
40.000	3.0225	.0754	.95	252.49	4.38	263.62	-.05	1.8240	.0506	.55	102.	102.	102.	
42.000	2.3693	.0611	.85	259.27	4.63	268.01	-.09	1.4100	.0402	.59	102.	102.	102.	
44.000	1.8006	.0499	.78	263.62	4.47	267.31	-.68	1.1030	.0345	1.06	100.	100.	100.	
46.000	1.3378	.0408	.75	266.60	4.71	265.16	-.01	.6870	.0321	1.19	98.	98.	98.	
48.000	1.0667	.0360	.53	268.01	4.50	263.44	-.01	.6705	.0211	.02	94.	94.	94.	
50.000	.8475	.0293	.53	267.31	4.83	250.35	-.27	.5300	.0198	.18	88.	88.	88.	
52.000	.6632	.0253	.53	265.16	5.08	256.01	-.66	.4162	.0198	.67	77.	77.	77.	
54.000	.5118	.0194	.54	263.44	5.87	231.05	-.51	.3234	.0103	-.07	52.	52.	52.	
55.000	.3550	.0162	.54	250.35	9.24	246.11	1.60	.2516	.0115	-.15	29.	29.	29.	
56.000	.3059	.0132	.40	256.01	6.14	237.27	-.37	.1904	.0088	.65	18.	18.	18.	
60.000	.2340	.0083	-.19	251.05	4.93	227.83	-.02	.1165	.0054	.01	18.	18.	18.	
62.000	.1779	.0083	.12	246.11	6.38	214.27	-.25	.0895	.0040	-.37	18.	18.	18.	
64.000	.1332	.0062	.38	237.27	7.00	203.72	-.40	.0895	.0040	-.27	18.	18.	18.	
66.000	.0991	.0042	-.02	227.83										
68.000	.0730	.0029	-.25	214.27										
70.000	.0533	.0022	-.19	203.72										

TABLE II-11. THERMODYNAMIC STATISTICAL PARAMETERS

NOVEMBER

STATION = 911620	BARKING SANDS, HI	S.D. P	MEAN P	SKEW P	MEAN T	S.D. T	SKEW T	MEAN D	S.D. D	SKEW D	NOBS P	NOBS T	NOBS D
Z	MB	DEG K	DEG K	DEG K	DEG K	DEG K	G/MS	G/MS	G/MS	G/MS			
.000	1015.9000	2.5917	-1.02	286.24	1.79	.37	1185.0000	8.9160	-.56	327.	327.	327.	
.005	1015.4000	2.5795	-1.00	296.19	1.79	-.29	1185.0000	8.9450	-.45	346.	346.	346.	
1.000	905.4100	2.2396	-1.05	290.31	1.47	-.65	1080.0000	6.4330	.12	346.	346.	346.	
2.000	804.6900	2.1048	-.80	289.63	2.23	-.26	977.6900	7.2530	.10	346.	346.	346.	
3.000	713.9300	2.0953	-.80	281.94	2.24	-.09	930.2600	6.1160	-.19	346.	346.	346.	
4.000	632.0400	2.2458	-.65	276.69	2.37	-.32	794.5000	5.6430	.14	345.	345.	345.	
5.000	528.2600	2.2974	-.61	270.79	2.87	-.40	717.1000	4.9500	.01	344.	344.	344.	
6.000	491.6300	2.4142	-.56	264.27	2.35	-.37	647.1000	4.5530	-.12	344.	344.	344.	
7.000	431.4300	2.5158	-.60	257.36	2.39	-.51	593.2000	4.0400	-.22	344.	344.	344.	
8.000	377.3500	2.5065	-.58	250.05	2.42	-.44	525.1000	3.6010	-.53	344.	344.	344.	
9.000	328.7000	2.5462	-.61	242.43	2.49	-.24	471.8000	3.3370	-.62	344.	344.	344.	
10.000	285.0100	2.5253	-.62	234.76	2.54	-.08	422.5000	3.4390	-.77	343.	343.	343.	
11.000	246.1300	2.4694	-.59	227.35	2.53	-.10	377.2000	3.3950	-.77	343.	343.	343.	
12.000	211.3600	2.2834	-.49	220.32	2.59	-.01	334.2000	3.6270	-.88	343.	343.	343.	
13.000	180.8400	2.1276	-.38	213.83	2.71	-.33	294.6000	3.9670	-.81	341.	341.	341.	
14.000	153.9700	1.9102	-.28	208.37	2.72	-.45	257.4000	4.0620	-.59	341.	341.	341.	
15.000	130.5600	1.6606	-.25	203.58	2.49	.02	223.5000	3.6370	-.52	340.	340.	340.	
16.000	110.3500	1.3856	-.24	200.33	2.53	.45	191.9000	3.8320	-.34	338.	338.	338.	
17.000	93.1320	1.0950	-.27	193.12	2.72	.32	163.0000	3.4720	-.21	338.	338.	338.	
18.000	78.5770	.8531	-.36	200.65	2.97	.39	130.5000	2.9510	-.17	337.	337.	337.	
19.000	66.4820	.6764	-.50	204.67	2.95	.26	113.2000	2.0400	-.06	332.	332.	332.	
20.000	56.4340	.5653	-.73	208.62	2.05	.04	94.2500	1.3070	.08	327.	327.	327.	
21.000	48.0390	.4929	-.87	211.63	1.63	.79	85.00	.5233	.14	300.	300.	300.	
22.000	40.9710	.4403	-.89	214.31	1.92	.07	66.6000	.7831	-.24	318.	318.	318.	
23.000	35.0330	.3908	-.87	216.77	1.93	-.08	56.3000	.6015	-.65	309.	309.	309.	
24.000	29.9820	.3548	-.77	219.01	2.17	-.09	47.6900	.5373	-.78	304.	304.	304.	
25.000	25.7070	.3255	-.67	220.92	2.20	-.23	40.5400	.5212	-.80	294.	294.	294.	
26.000	22.0770	.2951	-.61	222.63	2.46	.20	29.4500	.3678	-.60	278.	278.	278.	
27.000	18.9720	.2640	-.51	224.45	2.68	.00	25.1500	.3223	-.62	250.	250.	250.	
28.000	16.3280	.2398	-.41	223.32	2.68	.00	25.1500	.3223	-.62	250.	250.	250.	
29.000	14.0740	.2114	-.22	227.92	2.73	.04	21.5100	.2598	-.43	197.	197.	197.	
30.000	12.1170	.1825	-.25	223.31	2.73	.04	18.4100	.2335	-.23	165.	165.	165.	
32.000	9.0482	.1604	-.61	233.32	4.17	.07	13.5500	.2223	.24	85.	85.	85.	
34.000	6.8018	.1361	-.35	230.91	4.91	.06	10.0100	.1960	-.16	83.	83.	83.	
35.000	5.1311	.1082	-.09	240.71	4.91	.13	7.4340	.1891	.01	85.	85.	85.	
38.000	3.8933	.0791	-.04	249.92	5.33	.41	5.5260	.1604	.25	83.	83.	83.	
40.000	2.9582	.0616	-.12	251.37	6.07	-.98	4.1160	.1189	.88	83.	83.	83.	
42.000	2.2755	.0495	-.05	258.23	4.85	-.40	3.0930	.0829	.24	82.	82.	82.	
44.000	1.7556	.0403	-.03	261.74	4.65	-.20	2.3350	.0559	.20	82.	82.	82.	
46.000	1.3612	.0343	-.18	265.70	5.51	-.84	1.7840	.0419	-.01	82.	82.	82.	
48.000	1.0580	.0293	-.45	267.51	4.87	-.32	1.3780	.0280	-.04	80.	80.	80.	
50.000	.8232	.0240	-.50	267.32	5.37	-.76	1.0720	.0275	-.02	79.	79.	79.	
52.000	.6405	.0204	-.52	265.67	6.11	-.55	.8390	.0228	-.28	77.	77.	77.	
54.000	.4973	.0173	-.37	261.07	5.79	-.65	.6359	.0179	-.92	76.	76.	76.	
56.000	.3959	.0147	-.24	261.65	6.29	-.81	.5135	.0173	-.13	69.	69.	69.	
58.000	.2933	.0123	-.04	260.69	6.60	-.21	.4025	.0125	-.93	61.	61.	61.	
60.000	.2292	.0109	-.09	258.29	5.82	-.66	.3128	.0119	-.46	44.	44.	44.	
62.000	.1750	.0078	.45	249.99	5.71	-.12	.2435	.0023	-.07	23.	23.	23.	
64.000	.1293	.0041	-.31	232.78	3.15	.08	.1697	.0062	-.07	13.	13.	13.	
66.000	.0979	.0032	-.30	233.08	6.22	-.30	.1463	.0034	-.38	13.	13.	13.	
68.000	.0731	.0025	-.61	217.73	8.31	-.10	.1164	.0045	-.64	14.	14.	14.	
70.000	.0533	.0021	-.35	210.33	4.34	-.21	.0862	.0029	-.55	12.	12.	12.	

TABLE II-12. THERMODYNAMIC STATISTICAL PARAMETERS

DECEMBER

Z	STATION = 911620	MEAN P	MG	S.D. P	BARKING SANDS, HI	MEAN T	DEG K	S.D. T	DEG K	MEAN D	G/M3	S.D. D	G/M3	SKEW D	NOBS D	SKEW T	NOBS T	NOBS P	SKEW P	NOBS P
.000	1016.1060	3.1271				294.11	2.09			1195.0000	10.9390			-.05	299.			299.		299.
.005	1015.6000	3.1200				294.02	2.14			1195.0000	11.1400			-.02	317.			317.		317.
1.000	905.1500	2.7413				299.09	1.69			1035.0000	7.4690			.14	317.			317.		317.
2.000	804.0360	2.6253				284.94	2.40			820.0000	7.4340			.35	317.			317.		317.
3.000	713.0960	2.6413				280.78	2.60			673.0000	6.0310			.14	317.			317.		317.
4.000	630.9700	2.6346				275.52	2.40			583.0000	5.0300			.07	317.			317.		317.
5.000	556.9700	2.6227				271.05	2.66			518.7000	5.4070			.34	317.			317.		317.
6.000	490.2500	2.6482				263.22	2.85			648.2000	5.0890			.30	317.			317.		317.
7.000	429.9100	3.0142				246.05	2.81			584.3000	4.3170			.70	317.			317.		317.
8.000	375.7800	3.0777				248.79	2.92			525.7000	3.9390			.12	316.			316.		316.
9.000	327.1300	3.1337				241.40	2.94			471.7000	3.8040			-.56	315.			315.		315.
10.000	283.5100	3.0908				234.06	2.93			421.7000	4.0020			-.89	315.			315.		315.
11.000	244.7200	3.0019				227.02	2.92			375.5000	4.3240			-.85	315.			315.		315.
12.000	210.1700	2.7195				220.51	2.82			331.9000	4.6190			-.95	315.			315.		315.
13.000	179.6300	2.4502				214.84	2.69			292.0000	4.6280			-.09	315.			315.		315.
14.000	153.2500	2.1576				206.19	2.49			255.2000	4.5250			-.93	314.			314.		314.
15.000	130.0400	1.7952				204.35	2.54			221.7000	4.4520			-.56	314.			314.		314.
16.000	109.9500	1.4605				200.52	2.67			191.0000	4.1470			-.49	314.			314.		314.
17.000	92.7800	1.1487				198.67	2.59			162.7000	3.7530			-.31	314.			314.		314.
18.000	78.2220	.8885				199.42	3.24			136.7000	3.1770			-.16	314.			314.		314.
19.000	66.1020	.5842				203.20	2.99			113.4000	2.3140			-.00	311.			311.		311.
20.000	56.0490	.5668				207.45	2.52			94.1400	1.5790			.25	307.			307.		307.
21.000	47.6720	.4735				210.78	2.17			78.6000	1.1120			.55	303.			303.		303.
22.000	40.6310	.4182				213.67	2.07			65.2500	.8795			.06	298.			298.		298.
23.000	34.7160	.3565				216.07	1.98			55.9200	.6247			.12	287.			287.		287.
24.000	29.6950	.3213				218.43	2.39			47.3700	.6141			.04	283.			283.		283.
25.000	25.4550	.2871				220.51	2.58			40.2200	.5330			.01	279.			279.		279.
26.000	21.6500	.2538				222.28	2.59			34.2500	.4595			.09	250.			250.		250.
27.000	18.7840	.2339				223.90	2.55			29.2300	.3990			.13	224.			224.		224.
28.000	16.1540	.2124				225.31	2.71			24.5300	.3497			.07	218.			218.		218.
29.000	13.0150	.1915				226.60	2.97			21.3000	.3190			.37	178.			178.		178.
30.000	11.2930	.1710				228.69	3.35			18.3000	.2797			.49	161.			161.		161.
32.000	8.9301	.1633				232.09	4.58			13.4200	.2487			.14	99.			99.		99.
34.000	6.7032	.1416				235.13	5.11			9.9300	.2055			.71	91.			91.		91.
36.000	5.0414	.1142				239.33	7.08			7.3470	.2531			.75	91.			91.		91.
38.000	3.8260	.0942				246.93	6.85			5.4020	.1600			.16	89.			89.		89.
40.000	2.9222	.0775				253.52	5.80			4.0180	.1206			-.49	89.			89.		89.
42.000	2.2479	.0631				259.05	5.46			3.0230	.0793			-.19	89.			89.		89.
44.000	1.7401	.0535				263.01	5.46			2.2370	.0743			.07	90.			90.		90.
46.000	1.3325	.0431				267.08	5.73			1.7570	.0611			.45	88.			88.		88.
48.000	1.0532	.0347				262.28	5.65			1.3660	.0512			.09	88.			88.		88.
50.000	.8201	.0279				268.22	5.98			1.0650	.0374			.27	87.			87.		87.
52.000	.6387	.0231				267.45	6.49			.8313	.0287			-.01	85.			85.		85.
54.000	.4958	.0194				265.48	6.28			.6511	.0228			.06	83.			83.		83.
56.000	.3954	.0159				263.62	7.22			.5091	.0184			.15	78.			78.		78.
58.000	.2979	.0129				262.56	7.66			.3976	.0147			.23	67.			67.		67.
60.000	.2307	.0111				263.47	6.65			.3112	.0105			.27	50.			50.		50.
62.000	.1731	.0074				240.53	6.02			.2410	.0103			.14	23.			23.		23.
64.000	.1318	.0057				243.97	6.03			.1834	.0082			.08	19.			19.		19.
66.000	.0982	.0039				231.08	9.21			.1480	.0070			-.20	12.			12.		12.
68.000	.0732	.0032				220.41	6.50			.1157	.0045			.31	12.			12.		12.
70.000	.0539	.0026				217.08	8.10			.0865	.0020			.49	12.			12.		12.

TABLE II-13. THERMODYNAMIC STATISTICAL PARAMETERS

ANNUAL

STATION Z	MEAN P MB	MEAN T DEG K	S.D. P MB	SKEW P	MEAN T DEG K	S.D. T DEG K	SKEW T	MEAN D G/N3	S.D. D G/N3	SKEW D	MOBS P	MOBS T	MOBS D
0.000	1016.5000	256.96	2.6578	-0.68	256.96	2.79	-1.48	1183.0000	12.6400	.58	4124.	4124.	4124.
.005	1015.9000	256.87	2.6928	-0.70	256.87	2.84	-1.51	1183.0000	12.6300	.61	4336.	4336.	4336.
1.000	965.7600	239.83	2.3850	-1.21	239.83	1.87	-1.60	1083.0000	7.7400	.41	4336.	4336.	4336.
2.000	894.8300	225.14	2.3441	-1.36	225.14	2.40	-1.29	973.9000	6.4700	.27	4334.	4334.	4334.
3.000	713.6000	231.27	2.4265	-1.42	231.27	2.39	-1.29	892.5000	6.4700	.08	4334.	4334.	4334.
4.000	641.0100	228.10	2.5632	-1.22	228.10	2.53	-1.37	765.0500	5.9700	.09	4230.	4230.	4230.
5.000	567.7400	228.27	2.7092	-1.12	228.27	2.70	-1.52	719.2000	5.8700	.14	4309.	4309.	4309.
6.000	491.1700	225.74	2.8652	-1.03	225.74	2.68	-1.24	608.1000	5.1000	.02	4246.	4246.	4246.
7.000	430.4100	225.73	3.0449	-0.91	225.73	3.02	-1.07	524.1000	4.5000	.13	4246.	4246.	4246.
8.000	376.7000	223.44	3.1450	-0.82	223.44	3.11	-1.08	505.7000	4.2300	.39	4318.	4318.	4318.
9.000	329.0200	222.03	3.1944	-0.87	222.03	3.13	-1.46	471.9000	4.0300	.66	4308.	4308.	4308.
10.000	284.4400	222.63	3.1646	-0.81	222.63	3.08	-1.28	422.1000	4.2300	.86	4298.	4298.	4298.
11.000	245.6200	227.42	3.0597	-0.72	227.42	2.90	-1.18	376.5000	4.4300	1.32	4291.	4291.	4291.
12.000	210.6200	227.60	2.7714	-0.62	227.60	2.87	-1.11	333.2000	4.4300	1.24	4286.	4286.	4286.
13.000	180.5400	214.57	2.4589	-0.51	214.57	2.73	-0.94	293.4000	4.3500	.89	4276.	4276.	4276.
14.000	153.8000	209.16	2.1523	-0.41	209.16	2.66	-0.86	256.2000	4.9200	.71	4254.	4254.	4254.
15.000	130.5400	205.12	1.8003	-0.37	205.12	2.76	-0.82	221.7000	4.5700	.44	4241.	4241.	4241.
16.000	110.5000	202.53	1.4968	-0.39	202.53	3.17	-0.83	190.1000	4.1000	.33	4221.	4221.	4221.
17.000	93.4390	201.69	1.2646	-0.32	201.69	3.83	-0.29	161.4000	3.6200	.32	4209.	4209.	4209.
18.000	78.9590	202.97	1.1265	-0.24	202.97	4.23	-0.51	135.6000	2.9420	.44	4187.	4187.	4187.
19.000	66.9370	205.09	1.0331	-0.11	205.09	3.62	-0.69	113.2000	2.8230	.17	4119.	4119.	4119.
20.000	56.8030	203.47	0.9460	-0.05	203.47	2.85	-0.62	94.5000	1.4580	.20	4062.	4062.	4062.
21.000	48.4330	212.27	0.8551	-0.04	212.27	2.51	-1.46	79.4500	1.3300	.23	3970.	3970.	3970.
22.000	41.3340	214.97	0.7806	-0.04	214.97	2.40	-1.48	66.9500	1.0430	.21	3921.	3921.	3921.
23.000	35.3540	217.30	0.7029	-0.02	217.30	2.29	-1.52	56.6200	0.8051	.06	3778.	3778.	3778.
24.000	30.2770	219.95	0.6345	-0.10	219.95	2.55	-1.54	48.0400	0.8051	.05	3681.	3681.	3681.
25.000	25.9660	221.62	0.5731	-0.14	221.62	2.62	-1.60	40.8200	0.7149	.06	3537.	3537.	3537.
26.000	22.3080	223.62	0.5181	-0.19	223.62	2.67	-1.43	34.7500	0.7889	.06	3440.	3440.	3440.
27.000	19.1850	225.53	0.4632	-0.21	225.53	2.67	-1.43	29.6300	0.5789	.03	2863.	2863.	2863.
28.000	16.5230	227.40	0.4177	-0.25	227.40	2.70	-1.49	25.3100	0.5304	.13	2731.	2731.	2731.
29.000	14.2030	229.12	0.3750	-0.27	229.12	2.83	-1.41	21.6700	0.4827	.16	2199.	2199.	2199.
30.000	12.3020	230.71	0.3353	-0.32	230.71	2.81	-1.47	18.5800	0.4359	.21	1921.	1921.	1921.
32.000	9.1741	234.85	0.2553	-0.39	234.85	4.05	-1.14	13.0700	0.3977	.33	1280.	1280.	1280.
34.000	6.2039	238.03	0.1613	-0.43	238.03	4.63	-1.14	10.0700	0.3019	.48	1233.	1233.	1233.
36.000	3.2178	243.18	0.1004	-0.37	243.18	4.90	-1.45	7.4700	0.2317	.44	1246.	1246.	1246.
38.000	3.9474	246.16	0.1253	-0.32	246.16	4.90	-1.10	5.2400	0.1604	.50	1249.	1249.	1249.
40.000	3.0340	246.80	0.0771	-0.25	246.80	5.01	-1.37	4.1200	0.1450	.40	1249.	1249.	1249.
42.000	2.3335	249.24	0.0744	-0.19	249.24	4.93	-1.46	3.1100	0.1104	.38	1247.	1247.	1247.
44.000	1.8534	253.74	0.0534	-0.14	253.74	5.10	-1.18	2.3900	0.0706	.37	1243.	1243.	1243.
46.000	1.4604	256.38	0.0456	-0.11	256.38	4.91	-1.15	1.8200	0.0604	.30	1273.	1273.	1273.
48.000	1.0813	257.30	0.0399	-0.15	257.30	4.95	-1.47	1.4170	0.0511	.23	1258.	1258.	1258.
50.000	0.8466	263.80	0.0300	-0.14	263.80	5.14	-1.49	1.1040	0.0399	.14	1237.	1237.	1237.
52.000	0.6580	265.41	0.0258	-0.07	265.41	5.27	-1.48	0.8632	0.0319	.15	1204.	1204.	1204.
54.000	0.5103	263.36	0.0208	-0.06	263.36	5.39	-1.21	0.6748	0.0257	.41	1162.	1162.	1162.
56.000	0.3947	267.73	0.0169	-0.01	267.73	5.95	-0.05	0.5374	0.0213	.40	1076.	1076.	1076.
58.000	0.3045	257.50	0.0135	0.06	257.50	6.42	-0.01	0.4121	0.0175	.29	906.	906.	906.
60.000	0.2338	253.49	0.0108	-0.15	253.49	6.84	-1.18	0.3213	0.0139	.24	623.	623.	623.
62.000	0.1776	247.12	0.0096	0.25	247.12	8.27	-0.08	0.2503	0.0113	.13	349.	349.	349.
64.000	0.1321	230.27	0.0055	0.42	230.27	7.46	-0.23	0.1931	0.0086	.05	208.	208.	208.
66.000	0.0930	230.07	0.0040	0.23	230.07	6.84	-0.01	0.1498	0.0066	.15	199.	199.	199.
68.000	0.0734	217.08	0.0031	0.38	217.08	8.19	0.54	0.1173	0.0055	.11	200.	200.	200.
70.000	0.0537	211.95	0.0023	0.37	211.95	7.45	-0.01	0.0882	0.0045	.04	191.	191.	191.

TABLE III-1. MOISTURE RELATED STATISTICAL PARAMETERS

JANUARY

STATION #	911620	BARKING SANDS, HI		TV	TV	SKEW TV	DEWPT T	S.D. OPT	SKEW OPT	NOBS T-P	NOBS TV
Z	VAPOR P	S.D. VP	SKEW VP	TV	TV	SKEW TV	DEWPT T	S.D. OPT	SKEW OPT	NOBS T-P	NOBS TV
	MEAN			MEAN	S.D.		MEAN	DEG K			
KH	MB	MB		DEG K	DEG K		DEG K	DEG K			
.000	18.722	3.539	.09	295.77	2.62	.04	289.36	3.04	-.48	313.	313.
.005	18.516	3.544	.15	295.69	2.68	-.01	289.18	3.08	-.38	344.	344.
1.000	12.761	2.660	.00	289.67	2.05	-.50	283.42	3.35	-.83	342.	344.
2.000	6.248	3.709	.06	284.62	2.56	-.51	270.08	11.68	-1.17	313.	344.
3.000	2.562	2.433	1.15	280.44	2.65	-.27	255.93	13.80	-.38	291.	344.
4.000	1.422	1.518	1.57	274.97	2.71	-.30	248.22	13.82	-.26	287.	344.
5.000	.862	.972	1.73	269.96	2.94	-.35	242.39	13.62	-.19	231.	344.
6.000	.530	.612	1.79	262.45	3.30	-.30	237.52	12.72	-.13	291.	344.
7.000	.303	.326	1.65	255.53	3.59	-.14	232.66	11.53	-.21	286.	343.
8.000	.172	.188	2.20	248.55	3.89	-.12	227.55	10.79	-.24	275.	342.
9.000	.073	.073	2.30	241.92	4.08	-.03	220.91	9.75	-.39	259.	340.
10.000	.028	.030	4.00	235.50	4.08	-.06	213.00	8.55	-.15	80.	340.
11.000	.013	.006	1.05	228.88	3.58	-.27	210.43	3.03	.02	27.	337.
12.000	.006	.002	.97	222.54	3.24	-.68	204.43	2.61	.35	24.	335.
13.000	.003	.001	.04	216.10	3.03	-.73	200.27	2.80	-.29	8.	335.
14.000	99.999	99.999	999.99	210.09	2.96	-.40	999.99	99.99	999.99	1.	332.
15.000	99.999	99.999	999.99	204.48	2.81	-.10	999.99	99.99	999.99	0.	331.
16.000	99.999	99.999	999.99	200.21	2.69	.42	999.99	99.99	999.99	0.	326.
17.000	99.999	99.999	999.99	197.90	3.13	.37	999.99	99.99	999.99	0.	324.
18.000	99.999	99.999	999.99	198.12	3.71	.65	999.99	99.99	999.99	0.	322.
19.000	99.999	99.999	999.99	201.79	3.51	.44	999.99	99.99	999.99	0.	317.
20.000	99.999	99.999	999.99	206.28	2.76	.35	999.99	99.99	999.99	0.	313.
21.000	99.999	99.999	999.99	209.78	2.50	.29	999.99	99.99	999.99	0.	304.
22.000	99.999	99.999	999.99	212.43	2.48	-.12	999.99	99.99	999.99	0.	302.
23.000	99.999	99.999	999.99	214.61	2.40	-.17	999.99	99.99	999.99	0.	294.
24.000	99.999	99.999	999.99	216.56	2.58	-.25	999.99	99.99	999.99	0.	279.
25.000	99.999	99.999	999.99	218.41	2.74	-.02	999.99	99.99	999.99	0.	273.
26.000	99.999	99.999	999.99	220.36	2.62	.08	999.99	99.99	999.99	0.	246.
27.000	99.999	99.999	999.99	222.33	2.65	.06	999.99	99.99	999.99	0.	218.
28.000	99.999	99.999	999.99	224.61	2.86	.18	999.99	99.99	999.99	0.	206.
29.000	99.999	99.999	999.99	226.33	2.92	.24	999.99	99.99	999.99	0.	168.
30.000	99.999	99.999	999.99	227.97	3.11	.09	999.99	99.99	999.99	0.	148.

TABLE III-2. MOISTURE RELATED STATISTICAL PARAMETERS

FEBRUARY

STATION #	VAPOR P	S.D. VP	SKEW VP	TV MEAN	TV S.D.	SKEW TV	DEWPT ?	S.D. DPT	SKEW DPT	NOBS T+P	NOBS TV
911626	BARBING SANDS, HI										
Z	MEAN	MB		DEG K	DEG K		MEAN	DEG K			
.000	18.214	3.130	.26	295.86	2.49	.29	288.98	2.72	-.17	317.	317.
.005	18.034	3.233	.25	295.70	2.64	.18	288.80	2.83	-.17	341.	341.
1.000	12.274	2.286	-.01	289.47	1.87	-.40	282.84	2.92	-.69	341.	341.
2.000	5.953	3.553	-.06	284.29	2.43	-.23	263.23	12.14	-1.17	317.	341.
3.000	2.005	2.326	1.24	280.05	2.38	.19	252.94	14.00	-.12	275.	341.
4.000	1.090	1.304	2.07	274.76	2.82	.20	245.08	13.40	-.06	269.	341.
5.000	.656	.815	2.03	269.86	3.18	.11	240.15	12.90	-.07	269.	341.
6.000	.475	.549	1.81	267.39	3.50	.01	235.23	12.85	-.13	266.	341.
7.000	.274	.310	2.10	254.54	4.00	.09	231.40	11.70	-.19	264.	341.
8.000	.151	.164	1.99	248.48	4.38	.04	226.44	10.60	-.29	252.	340.
9.000	.074	.071	1.95	241.63	4.68	.00	221.08	9.17	-.51	202.	339.
10.000	.034	.027	1.46	235.11	4.61	-.03	215.38	7.98	-.73	75.	339.
11.000	.016	.006	.48	228.65	4.02	-.38	212.11	2.82	.04	27.	337.
12.000	.007	.002	.72	222.36	3.46	-1.08	206.01	2.35	.38	26.	335.
13.000	.004	.001	.67	216.26	2.78	-.73	201.16	2.59	.35	9.	334.
14.000	99.939	99.939	999.99	210.25	2.50	.10	999.99	99.99	999.99	0.	332.
15.000	99.939	99.939	999.99	204.78	2.81	.31	999.99	99.99	999.99	0.	330.
16.000	99.999	99.999	999.99	200.66	3.24	.35	999.99	99.99	999.99	0.	328.
17.000	99.999	99.999	999.99	198.29	3.71	.29	999.99	99.99	999.99	0.	326.
18.000	99.999	99.999	999.99	199.58	4.05	.02	999.99	99.99	999.99	0.	324.
19.000	99.999	99.999	999.99	202.17	3.44	-.14	999.99	99.99	999.99	0.	317.
20.000	99.999	99.999	999.99	206.53	2.63	-.17	999.99	99.99	999.99	0.	311.
21.000	99.939	99.939	999.99	209.81	2.24	-.28	999.99	99.99	999.99	0.	297.
22.000	99.939	99.939	999.99	212.70	2.35	-.18	999.99	99.99	999.99	0.	293.
23.000	99.939	99.939	999.99	214.98	2.28	-.07	999.99	99.99	999.99	0.	293.
24.000	99.999	99.939	999.99	217.07	2.48	-.14	999.99	99.99	999.99	0.	270.
25.000	99.939	99.939	999.99	219.16	2.59	-.09	999.99	99.99	999.99	0.	266.
26.000	99.939	99.939	999.99	221.30	2.59	.06	999.99	99.99	999.99	0.	244.
27.000	99.999	99.999	999.99	223.35	2.61	.01	999.99	99.99	999.99	0.	217.
28.000	99.939	99.939	999.99	225.51	2.89	-.06	999.99	99.99	999.99	0.	207.
29.000	99.939	99.939	999.99	227.41	2.95	.30	999.99	99.99	999.99	0.	170.
30.000	99.939	99.939	999.99	229.34	2.64	.30	999.99	99.99	999.99	0.	145.

TABLE III-3. MOISTURE RELATED STATISTICAL PARAMETERS

MARCH

STATION = 911620		BARKING SANDS, HI		TV		TV		SKEW TV		DEWPT 1		S.D. OPT		SKEW OPT		NOBS T-P		NOBS TV		
Z	VAPOR P	S.D. VP	SKEW VP	TV	TV	SKEW TV	DEWPT 1	S.D. OPT	SKEW OPT	NOBS T-P	NOBS TV	MEAN	DEG K	MEAN	DEG K	NOBS T-P	NOBS TV	MEAN	DEG K	
KM	MB	MB	DEG K	MEAN	S.D.	DEG K	MEAN	DEG K	DEG K	NOBS T-P	NOBS TV	MEAN	DEG K	MEAN	DEG K	NOBS T-P	NOBS TV	MEAN	DEG K	
.000	18.623	3.029	.02	296.79	2.41	.30	289.34	2.61	-.32	353.	359.									
.005	18.468	3.012	.06	296.69	2.43	.34	289.21	2.61	-.27	387.	387.									
1.000	12.201	2.121	-.34	299.61	1.95	-.46	282.84	2.62	-1.28	385.	387.									
2.000	9.834	3.527	-.05	284.44	2.00	-.48	268.67	12.71	-1.23	359.	387.									
3.000	2.116	2.114	1.19	290.09	2.12	.23	252.71	14.78	-.32	318.	387.									
4.000	1.192	1.381	1.72	274.53	2.41	.13	245.91	13.72	-.06	316.	387.									
5.000	.752	.805	1.77	258.33	2.69	.10	241.11	13.04	-.07	315.	387.									
6.000	.429	.499	2.14	261.57	2.75	-.03	235.94	11.76	-.08	313.	387.									
7.000	.284	.314	1.88	254.29	2.94	-.12	232.14	11.25	-.17	327.	387.									
8.000	.149	.156	1.55	246.92	3.20	-.09	226.48	10.39	-.24	329.	387.									
9.000	.074	.072	1.54	233.71	3.44	.11	221.01	9.16	-.31	247.	395.									
10.000	.022	.026	4.35	232.94	3.91	.25	212.33	6.53	.24	76.	395.									
11.000	.010	.004	1.06	226.70	4.04	-.05	208.21	3.10	.17	33.	385.									
12.000	.005	.002	.90	221.10	3.70	-.37	204.01	2.60	.20	32.	385.									
13.000	.004	.003	3.09	215.89	3.08	-.42	201.54	3.14	1.14	21.	385.									
14.000	99.999	99.999	999.99	210.79	2.91	-.30	999.99	99.99	999.99	2.	383.									
15.000	99.999	99.999	999.99	205.87	3.00	-.02	999.99	99.99	999.99	0.	382.									
16.000	99.999	99.999	999.99	202.04	3.12	.03	999.99	99.99	999.99	0.	381.									
17.000	99.999	99.999	999.99	199.08	3.39	-.06	999.99	99.99	999.99	0.	378.									
18.000	99.999	99.999	999.99	200.57	3.41	-.08	999.99	99.99	999.99	0.	376.									
19.000	99.999	99.999	999.99	203.84	3.24	-.25	999.99	99.99	999.99	0.	367.									
20.000	99.999	99.999	999.99	207.99	2.74	-.31	999.99	99.99	999.99	0.	360.									
21.000	99.999	99.999	999.99	210.82	2.33	-.13	999.99	99.99	999.99	0.	352.									
22.000	99.999	99.999	999.99	213.74	2.49	.18	999.99	99.99	999.99	0.	344.									
23.000	99.999	99.999	999.99	216.06	2.45	.01	999.99	99.99	999.99	0.	325.									
24.000	99.999	99.999	999.99	219.27	2.57	-.07	999.99	99.99	999.99	0.	301.									
25.000	99.999	99.999	999.99	220.41	2.42	-.17	999.99	99.99	999.99	0.	289.									
26.000	99.999	99.999	999.99	222.62	2.23	.02	999.99	99.99	999.99	0.	274.									
27.000	99.999	99.999	999.99	224.96	2.28	.17	999.99	99.99	999.99	0.	243.									
28.000	99.999	99.999	999.99	227.32	2.30	.12	999.99	99.99	999.99	0.	230.									
29.000	99.999	99.999	999.99	229.21	2.47	.12	999.99	99.99	999.99	0.	177.									
30.000	99.999	99.999	999.99	230.95	2.74	-.16	999.99	99.99	999.99	0.	147.									

TABLE III-4. MOISTURE RELATED STATISTICAL PARAMETERS

APRIL

STATION • 911620		BARKING SANDS, HI		TV	TV	SKEW TV	DEWPT T	S.D. OPT	SKEW OPT	NOBS T-P	NOBS TV
Z	VAPOR P	S.D. VP	SKEW VP	TV	S.D.		MEAN				
KM	MEAN	MB		MEAN	DEG K		DEG K	DEG K			
	MB	MB		DEG K	DEG K		DEG K	DEG K			
.000	19.696	2.626	-.17	299.83	2.00	-.03	290.29	2.17	-.58	374.	374.
.005	19.582	2.651	-.13	298.77	2.04	-.08	290.19	2.20	-.52	392.	392.
1.000	12.780	1.924	-.04	250.24	1.37	-.73	283.60	2.32	-.43	392.	392.
2.000	6.555	3.129	-.27	264.68	1.85	-.11	271.79	9.90	-1.71	374.	392.
3.000	2.361	2.090	1.02	280.31	1.81	-.05	255.11	13.93	-.58	345.	392.
4.000	1.226	1.277	1.69	274.68	1.89	.06	246.82	13.57	-.31	332.	392.
5.000	.711	.837	2.12	268.92	2.06	-.01	240.38	13.25	-.13	334.	392.
6.000	.470	.498	2.05	262.14	2.14	.10	235.70	12.71	-.15	327.	391.
7.000	.242	.275	2.11	254.96	2.24	.03	230.22	11.74	-.24	318.	391.
8.000	.141	.156	1.93	247.48	2.40	.05	225.54	10.99	-.29	292.	391.
9.000	.080	.075	1.39	239.88	2.54	.09	221.38	9.83	-.52	208.	391.
10.000	.033	.029	1.72	232.12	2.72	.19	215.25	7.43	-.26	51.	391.
11.000	.012	.009	.96	224.83	2.77	.31	208.68	5.40	.09	40.	389.
12.000	.006	.004	1.34	218.59	2.99	.22	203.50	4.74	-.03	40.	389.
13.000	.003	.002	1.10	213.49	2.97	.16	198.37	4.72	.08	17.	386.
14.000	99.999	99.999	999.99	209.51	2.78	-.22	999.99	99.99	999.99	2.	383.
15.000	99.999	99.999	999.99	206.11	2.63	-.37	999.99	99.99	999.99	0.	383.
16.000	99.999	99.999	999.99	203.34	2.63	-.06	999.99	99.99	999.99	0.	381.
17.000	99.999	99.999	999.99	202.03	2.83	-.13	999.99	99.99	999.99	0.	391.
18.000	99.999	99.999	999.99	202.99	2.94	-.30	999.99	99.99	999.99	0.	380.
19.000	99.999	99.999	999.99	206.37	2.59	-.40	999.99	99.99	999.99	0.	374.
20.000	99.999	99.999	999.99	209.90	2.30	-.35	999.99	99.99	999.99	0.	360.
21.000	99.999	99.999	999.99	212.60	2.19	-.14	999.99	99.99	999.99	0.	360.
22.000	99.999	99.999	999.99	215.06	2.12	-.11	999.99	99.99	999.99	0.	355.
23.000	99.999	99.999	999.99	217.57	1.99	-.09	999.99	99.99	999.99	0.	344.
24.000	99.999	99.999	999.99	220.12	2.08	-.18	999.99	99.99	999.99	0.	339.
25.000	99.999	99.999	999.99	222.46	2.07	-.24	999.99	99.99	999.99	0.	328.
26.000	99.999	99.999	999.99	224.70	1.97	-.09	999.99	99.99	999.99	0.	308.
27.000	99.999	99.999	999.99	226.88	1.96	-.23	999.99	99.99	999.99	0.	268.
28.000	99.999	99.999	999.99	229.07	2.03	-.23	999.99	99.99	999.99	0.	249.
29.000	99.999	99.999	999.99	230.94	2.04	-.11	999.99	99.99	999.99	0.	198.
30.000	99.999	99.999	999.99	232.77	2.05	.10	999.99	99.99	999.99	0.	170.

TABLE III-5. MOISTURE RELATED STATISTICAL PARAMETERS

MAY

STATION = 911620		BARKING SANDS, HI		TV		TV		SKEW TV		DEWPT T		S.D. DPT		SKEW DPT		NOBS T+P		NOBS TV	
Z	VAPOR P	S.D. VP	SKEW VP	MEAN	S.D.	MEAN	S.D.			MEAN	MEAN	S.D.	SKEW						
KM	MB	MB		DEG K	DEG K	DEG K	DEG K			DEG K	DEG K	DEG K							
.000	20.664	2.699	-.08	305.49	1.79	291.05	2.13	.59		291.05	2.13		-.55			356.		356.	
.005	20.570	2.728	-.09	303.46	1.79	290.97	2.17	.58		290.97	2.17		-.55			363.		369.	
1.000	13.537	2.127	.12	291.29	1.15	294.45	2.43	.61		294.45	2.43		-.40			369.		369.	
2.000	7.020	3.208	-.26	293.64	1.82	272.91	9.45	.26		272.91	9.45		-1.61			356.		369.	
3.000	2.653	2.231	.04	281.45	1.80	256.81	13.05	.00		256.81	13.05		-.03			311.		368.	
4.000	1.361	1.365	1.67	275.51	2.06	248.72	12.72	.38		248.72	12.72		-.30			297.		368.	
5.000	.893	.905	1.77	270.57	2.14	244.66	12.34	.14		244.66	12.34		-.30			297.		368.	
6.000	.535	.575	1.68	264.01	2.25	238.46	11.92	-.06		238.46	11.92		-.26			295.		368.	
7.000	.304	.325	1.80	257.03	2.34	232.70	11.61	-.25		232.70	11.61		-.27			299.		368.	
8.000	.173	.167	1.57	249.65	2.26	228.16	10.41	-.26		228.16	10.41		-.45			287.		368.	
9.000	.092	.091	1.43	241.92	2.34	223.36	8.79	-.17		223.36	8.79		-.47			234.		366.	
10.000	.046	.035	1.27	234.12	2.35	218.85	6.12	.09		218.85	6.12		.20			70.		366.	
11.000	.015	.008	.81	226.37	2.22	211.68	4.19	.00		211.68	4.19		-.15			52.		366.	
12.000	.007	.004	1.47	219.16	2.27	205.57	3.74	.06		205.57	3.74		.26			52.		305.	
13.000	.005	.003	.33	212.71	2.44	204.69	3.55	.45		204.69	3.55		.01			11.		365.	
14.000	99.999	99.999	999.99	207.83	2.71	999.99	99.99	.51		999.99	99.99	999.99	999.99			1.		364.	
15.000	99.999	99.999	999.99	204.88	2.90	999.99	99.99	-.07		999.99	99.99	999.99	999.99			0.		363.	
16.000	99.999	99.999	999.99	203.35	2.60	999.99	99.99	.21		999.99	99.99	999.99	999.99			0.		359.	
17.000	99.999	99.999	999.99	203.34	2.63	999.99	99.99	.04		999.99	99.99	999.99	999.99			0.		358.	
18.000	99.999	99.999	999.99	205.08	2.71	999.99	99.99	-.11		999.99	99.99	999.99	999.99			0.		356.	
19.000	99.999	99.999	999.99	207.83	2.17	999.99	99.99	-.20		999.99	99.99	999.99	999.99			0.		352.	
20.000	99.999	99.999	999.99	210.74	1.83	999.99	99.99	-.20		999.99	99.99	999.99	999.99			0.		347.	
21.000	99.999	99.999	999.99	213.50	1.76	999.99	99.99	-.03		999.99	99.99	999.99	999.99			0.		340.	
22.000	99.999	99.999	999.99	216.06	1.83	999.99	99.99	-.14		999.99	99.99	999.99	999.99			0.		333.	
23.000	99.999	99.999	999.99	218.64	1.70	999.99	99.99	-.10		999.99	99.99	999.99	999.99			0.		320.	
24.000	99.999	99.999	999.99	221.05	1.85	999.99	99.99	.09		999.99	99.99	999.99	999.99			0.		313.	
25.000	99.999	99.999	999.99	223.35	1.71	999.99	99.99	.07		999.99	99.99	999.99	999.99			0.		300.	
26.000	99.999	99.999	999.99	225.61	1.60	999.99	99.99	-.03		999.99	99.99	999.99	999.99			0.		270.	
27.000	99.999	99.999	999.99	227.75	1.67	999.99	99.99	.07		999.99	99.99	999.99	999.99			0.		242.	
28.000	99.999	99.999	999.99	229.63	1.54	999.99	99.99	.18		999.99	99.99	999.99	999.99			0.		231.	
29.000	99.999	99.999	999.99	231.43	1.74	999.99	99.99	.30		999.99	99.99	999.99	999.99			0.		184.	
30.000	99.999	99.999	999.99	233.00	1.80	999.99	99.99	.03		999.99	99.99	999.99	999.99			0.		100.	

TABLE III-6. MOISTURE RELATED STATISTICAL PARAMETERS

JUNE

STATION = 911620		BARKING SANDS, HI		TV		TV		SKEW TV		DEWPT T		S.D. DPT		SKEW DPT		NOBS T+P		NOBS TV		
Z	VAPOR P	S.D. VP	SKEW VP	TV	TV	SKEW TV	DEWPT T	S.D. DPT	SKEW DPT	NOBS T+P	NOBS TV	MEAN	DEG K	MEAN	DEG K	NOBS T+P	NOBS TV	MEAN	DEG K	
	MEAN			MEAN	S.D.		MEAN													
	MB	MB		DEG K	DEG K		DEG K													
.000	21.600	2.861	-.12	301.39	1.66	.38	291.75	2.18	-.55	343.	343.									
.005	21.453	2.831	-.04	301.37	1.64	.34	291.65	2.16	-.46	370.	370.									
1.000	14.162	1.945	-.01	292.15	1.12	-.05	295.17	2.14	-.48	370.	370.									
2.000	7.351	3.483	-.22	287.12	2.03	.25	273.00	9.22	-1.37	343.	370.									
3.000	2.801	2.118	1.14	283.17	2.69	.23	259.03	11.56	-.81	310.	370.									
4.000	1.539	1.201	1.43	277.88	2.08	.20	251.77	11.18	-.81	301.	370.									
5.000	.934	.758	1.50	271.87	2.13	-.11	245.95	11.22	-.76	302.	370.									
6.000	.531	.472	1.57	265.24	2.32	-.26	241.15	10.59	-.85	303.	370.									
7.000	.363	.293	1.48	258.04	2.30	-.27	235.99	10.41	-.82	298.	370.									
8.000	.205	.162	1.33	250.69	2.33	.01	230.80	9.49	-.85	287.	309.									
9.000	.114	.091	1.58	243.08	2.34	.15	225.06	8.23	-.73	261.	309.									
10.000	.050	.037	1.18	235.28	2.22	-.05	219.37	6.56	-.20	100.	368.									
11.000	.017	.010	.92	227.48	1.94	.06	211.71	4.71	-.05	64.	368.									
12.000	.007	.004	.74	220.00	1.80	.09	205.42	3.80	-.12	65.	368.									
13.000	.004	.001	.20	213.32	1.83	.24	201.62	2.76	-.40	17.	367.									
14.000	.002	.001	.52	209.38	2.36	.32	197.27	2.23	-.12	12.	366.									
15.000	99.999	99.999	999.99	205.50	2.70	.21	999.99	99.99	999.99	0.	365.									
16.000	99.999	99.999	999.99	204.19	2.65	.01	999.99	99.99	999.99	0.	364.									
17.000	99.999	99.999	999.99	204.33	2.31	-.18	999.99	99.99	999.99	0.	364.									
18.000	99.999	99.999	999.99	205.93	2.18	.11	999.99	99.99	999.99	0.	360.									
19.000	99.999	99.999	999.99	208.55	1.78	-.12	999.99	99.99	999.99	0.	352.									
20.000	99.999	99.999	999.99	211.39	1.51	-.16	999.99	99.99	999.99	0.	345.									
21.000	99.999	99.999	999.99	214.12	1.54	.03	999.99	99.99	999.99	0.	340.									
22.000	99.999	99.999	999.99	216.70	1.44	.09	999.99	99.99	999.99	0.	337.									
23.000	99.999	99.999	999.99	219.14	1.43	-.05	999.99	99.99	999.99	0.	321.									
24.000	99.999	99.999	999.99	221.52	1.52	.11	999.99	99.99	999.99	0.	319.									
25.000	99.999	99.999	999.99	223.68	1.48	-.09	999.99	99.99	999.99	0.	304.									
26.000	99.999	99.999	999.99	225.80	1.42	-.10	999.99	99.99	999.99	0.	281.									
27.000	99.999	99.999	999.99	227.71	1.57	-.10	999.99	99.99	999.99	0.	238.									
28.000	99.999	99.999	999.99	229.38	1.55	.08	999.99	99.99	999.99	0.	221.									
29.000	99.999	99.999	999.99	230.99	1.56	.34	999.99	99.99	999.99	0.	178.									
30.000	99.999	99.999	999.99	232.38	1.71	-.06	999.99	99.99	999.99	0.	153.									

TABLE III-7. MOISTURE RELATED STATISTICAL PARAMETERS

JULY

STATION # 911620	BANKING SANDS, HI		TV	TV	SKEW TV	DEWPT T	S.D. DPT	SKEW DPT	NOBS T-P	NOBS TV
Z	VAPOR P	S.D. VP	SKEW VP	TV	S.D.	MEAN	DEG K	DEG K		
KM	MEAN	MB	DEG K	DEG K		DEG K	DEG K			
.000	22.139	2.701	.05	301.88	1.39	292.17	2.00	-.48	329.	329.
.005	22.080	2.694	.05	301.85	1.39	292.13	2.00	-.47	339.	339.
1.000	14.716	2.051	.14	292.78	1.05	285.75	2.16	-.33	339.	339.
2.000	7.580	3.490	-.16	287.52	1.78	274.11	9.26	-1.80	323.	339.
3.000	2.857	2.107	.95	282.75	1.75	259.07	12.11	-.92	297.	339.
4.000	1.408	1.143	1.56	277.43	1.98	250.67	11.04	-.67	271.	337.
5.000	.843	.689	1.47	271.74	2.08	244.92	10.61	-.64	261.	337.
6.000	.528	.483	2.21	265.32	2.21	239.77	10.37	-.55	269.	337.
7.000	.322	.294	2.24	259.31	2.24	234.78	10.10	-.63	262.	337.
8.000	.203	.170	1.59	250.90	2.26	230.61	9.42	-.68	253.	336.
9.000	.111	.082	1.22	243.28	2.24	225.69	8.31	-.91	230.	336.
10.000	.053	.029	1.04	235.45	2.23	220.70	4.99	-.51	67.	335.
11.000	.020	.010	.25	227.63	2.01	212.70	4.92	-.63	43.	335.
12.000	.008	.004	.10	220.27	1.77	206.70	3.76	-.62	43.	335.
13.000	.003	.001	-.34	213.85	1.74	200.74	3.10	-.67	14.	332.
14.000	99.999	99.999	999.99	209.19	2.32	999.99	99.99	999.99	1.	331.
15.000	99.999	99.999	999.99	205.38	2.74	999.99	99.99	999.99	0.	330.
16.000	99.999	99.999	999.99	202.27	2.78	999.99	99.99	999.99	0.	329.
17.000	99.999	99.999	999.99	200.63	2.21	999.99	99.99	999.99	0.	327.
18.000	99.999	99.999	999.99	207.05	1.73	999.99	99.99	999.99	0.	324.
19.000	99.999	99.999	999.99	209.27	1.38	999.99	99.99	999.99	0.	320.
20.000	99.999	99.999	999.99	211.79	1.35	999.99	99.99	999.99	0.	316.
21.000	99.999	99.999	999.99	214.48	1.38	999.99	99.99	999.99	0.	306.
22.000	99.999	99.999	999.99	216.74	1.29	999.99	99.99	999.99	0.	303.
23.000	99.999	99.999	999.99	218.90	1.29	999.99	99.99	999.99	0.	299.
24.000	99.999	99.999	999.99	221.07	1.50	999.99	99.99	999.99	0.	286.
25.000	99.999	99.999	999.99	223.11	1.57	999.99	99.99	999.99	0.	277.
26.000	99.999	99.999	999.99	224.91	1.58	999.99	99.99	999.99	0.	251.
27.000	99.999	99.999	999.99	226.64	1.70	999.99	99.99	999.99	0.	216.
28.000	99.999	99.999	999.99	228.30	1.65	999.99	99.99	999.99	0.	205.
29.000	99.999	99.999	999.99	230.04	1.89	999.99	99.99	999.99	0.	169.
30.000	99.999	99.999	999.99	231.33	1.71	999.99	99.99	999.99	0.	150.

TABLE III-8. MOISTURE RELATED STATISTICAL PARAMETERS

AUGUST

STATION = 911620		BARKING SANDS, HI		TV	TV	SKWH TV	DEWPT T	S.D. DPT	SKWH DPT	NOBS T+P	NOBS TV
Z	VAPOR P	S.D. VP	SKWH VP	MEAN	S.D.		MEAN				
KM	MB	MB		DEG K	DEG K		DEG K	DEG K			
.000	22.650	2.670	.05	301.95	1.29	.34	292.54	1.92	-.31	385.	385.
.005	22.557	2.691	.03	301.89	1.29	.32	292.47	1.95	-.33	393.	393.
1.000	14.920	2.213	.19	293.26	1.08	-.28	285.95	2.30	-.37	393.	393.
2.000	8.048	3.341	-.09	287.69	1.69	.22	275.54	7.48	-1.31	365.	392.
3.000	3.299	2.368	.97	293.04	1.65	.01	261.39	11.18	-.83	341.	392.
4.000	1.710	1.477	1.34	277.93	1.73	.18	252.27	12.07	-.55	309.	391.
5.000	.979	.880	1.62	272.33	1.85	.05	245.94	11.48	-.51	301.	391.
6.000	.632	.572	1.52	266.01	1.96	.02	241.24	11.04	-.46	292.	391.
7.000	.374	.326	1.59	259.13	2.00	-.15	235.88	10.74	-.55	297.	390.
8.000	.215	.190	1.62	251.77	2.04	-.21	230.89	9.88	-.65	297.	388.
9.000	.118	.093	1.32	244.18	2.03	-.15	225.59	8.69	-.85	270.	385.
10.000	.055	.044	1.30	238.47	2.11	-.04	219.68	7.93	-.74	95.	383.
11.000	.016	.010	.95	229.50	1.98	-.22	211.39	4.61	.03	52.	382.
12.000	.007	.004	.99	221.03	1.87	-.17	205.20	3.60	.03	52.	382.
13.000	.002	.001	.61	214.22	1.77	.06	197.81	2.95	.30	7.	382.
14.000	99.999	99.999	999.99	200.01	2.03	.37	999.99	99.99	999.99	0.	378.
15.000	99.999	99.999	999.99	205.65	2.45	.21	999.99	99.99	999.99	0.	376.
16.000	99.999	99.999	999.99	204.60	2.43	-.19	999.99	99.99	999.99	0.	376.
17.000	99.999	99.999	999.99	205.10	2.01	-.45	999.99	99.99	999.99	0.	375.
18.000	99.999	99.999	999.99	206.91	1.65	.29	999.99	99.99	999.99	0.	374.
19.000	99.999	99.999	999.99	209.16	1.46	-.15	999.99	99.99	999.99	0.	369.
20.000	99.999	99.999	999.99	211.60	1.51	-.17	999.99	99.99	999.99	0.	366.
21.000	99.999	99.999	999.99	214.07	1.47	.16	999.99	99.99	999.99	0.	362.
22.000	99.999	99.999	999.99	216.29	1.44	-.18	999.99	99.99	999.99	0.	359.
23.000	99.999	99.999	999.99	218.39	1.50	-.21	999.99	99.99	999.99	0.	345.
24.000	99.999	99.999	999.99	220.44	1.65	.05	999.99	99.99	999.99	0.	338.
25.000	99.999	99.999	999.99	222.55	1.54	-.13	999.99	99.99	999.99	0.	315.
26.000	99.999	99.999	999.99	224.47	1.55	-.07	999.99	99.99	999.99	0.	283.
27.000	99.999	99.999	999.99	226.15	1.62	-.23	999.99	99.99	999.99	0.	249.
28.000	99.999	99.999	999.99	227.75	1.59	-.09	999.99	99.99	999.99	0.	240.
29.000	99.999	99.999	999.99	229.31	1.83	.08	999.99	99.99	999.99	0.	210.
30.000	99.999	99.999	999.99	230.81	1.90	.26	999.99	99.99	999.99	0.	191.

TABLE III-9. MOISTURE RELATED STATISTICAL PARAMETERS

SEPTEMBER

STATION - 911620		BARKING SANDS, HI		TV	TV	SKEW TV	DEWPT ?	S.D. DPT	SKEW DPT	NOBS T-P	NOBS TV
Z	VAPOR P	S.D. VP	SKEW VP	MEAN	S.D.		MEAN				
KH	MB	MB		DEG K	DEG K		DEG K	DEG K			
.000	22.290	2.599	.60	301.48	1.34	.10	292.29	1.85	.06	352.	352.
.005	22.223	2.587	.61	301.43	1.34	.11	292.24	1.85	.07	361.	361.
1.000	14.749	2.150	.00	293.45	1.04	-.58	285.77	2.28	-.48	361.	361.
2.000	8.409	3.253	-.51	287.57	1.46	.10	276.26	7.29	-1.36	352.	361.
3.000	3.457	2.355	.68	283.40	1.74	.11	262.20	11.01	-.89	303.	361.
4.000	1.809	1.484	1.09	278.29	1.83	-.13	253.18	11.81	-.58	247.	361.
5.000	1.053	.949	1.63	272.44	1.84	-.04	246.70	11.46	-.50	294.	361.
6.000	.606	.526	1.50	265.94	1.95	-.11	241.13	10.60	-.53	270.	361.
7.000	.391	.384	1.87	258.85	2.05	-.06	236.02	10.17	-.50	285.	361.
8.000	.226	.195	1.73	251.42	2.15	.04	231.83	9.04	-.56	280.	360.
9.000	.119	.094	1.50	243.76	2.27	.02	226.39	7.81	-.50	251.	360.
10.000	.057	.048	1.65	236.02	2.30	.08	220.09	7.01	-.17	83.	359.
11.000	.017	.009	1.00	229.13	2.09	.00	211.87	4.08	.16	49.	358.
12.000	.007	.003	.93	220.89	1.99	.23	205.51	3.08	.28	50.	357.
13.000	.003	.001	-.22	214.26	2.02	.02	200.49	2.00	-.44	9.	357.
14.000	99.999	99.999	999.99	203.87	1.95	.20	999.99	99.99	999.99	0.	356.
15.000	99.999	99.999	999.99	205.31	2.24	-.09	999.99	99.99	999.99	0.	355.
16.000	99.999	99.999	999.99	203.47	2.33	-.14	999.99	99.99	999.99	0.	354.
17.000	99.999	99.999	999.99	203.61	2.27	-.49	999.99	99.99	999.99	0.	354.
18.000	99.999	99.999	999.99	205.84	1.85	-.18	999.99	99.99	999.99	0.	354.
19.000	99.999	99.999	999.99	208.35	1.64	-.08	999.99	99.99	999.99	0.	349.
20.000	99.999	99.999	999.99	211.04	1.59	.21	999.99	99.99	999.99	0.	347.
21.000	99.999	99.999	999.99	213.50	1.50	.41	999.99	99.99	999.99	0.	341.
22.000	99.999	99.999	999.99	215.90	1.51	.23	999.99	99.99	999.99	0.	338.
23.000	99.999	99.999	999.99	218.18	1.56	.21	999.99	99.99	999.99	0.	330.
24.000	99.999	99.999	999.99	220.32	1.70	-.08	999.99	99.99	999.99	0.	325.
25.000	99.999	99.999	999.99	222.32	1.69	-.11	999.99	99.99	999.99	0.	306.
26.000	99.999	99.999	999.99	224.20	1.68	.21	999.99	99.99	999.99	0.	281.
27.000	99.999	99.999	999.99	225.97	1.83	.39	999.99	99.99	999.99	0.	249.
28.000	99.999	99.999	999.99	227.70	1.64	.36	999.99	99.99	999.99	0.	230.
29.000	99.999	99.999	999.99	229.44	1.73	.56	999.99	99.99	999.99	0.	186.
30.000	99.999	99.999	999.99	231.12	1.93	.38	999.99	99.99	999.99	0.	162.

TABLE III-10. MOISTURE RELATED STATISTICAL PARAMETERS

OCTOBER

STATION = 911620		BARKING SANDS, HI		TV	TV	SKEW TV	DEWPT T	S.D. DPT	SKEW DPT	NOBS T+P	NOBS TV
Z	VAPOR P MEAN	S.D. VP	SKEW VP	MEAN DEG K	S.D. DEG K		MEAN DEG K				
KM	MB	MB						DEG K			
.000	21.969	2.825	-.01	300.66	1.83	.13	291.96	2.10	-.32	370.	370.
.005	21.826	2.831	.01	300.63	1.83	.12	291.93	2.11	-.29	377.	377.
1.000	14.517	2.320	-.16	297.09	1.18	-.06	285.50	2.55	-.72	377.	377.
2.000	8.199	3.508	-.30	297.45	1.66	-.00	275.57	8.22	-1.44	370.	377.
3.000	3.341	2.369	.81	292.15	1.81	-.27	261.67	10.77	-.62	331.	377.
4.000	1.004	1.531	1.28	277.77	1.98	-.23	253.93	11.18	-.42	314.	377.
5.000	1.004	.970	1.54	271.73	2.10	-.45	247.93	10.90	-.39	312.	377.
6.000	.679	.077	1.71	269.24	2.20	-.30	240.31	10.42	-.42	309.	377.
7.000	.309	.359	1.74	259.21	2.32	-.26	236.64	10.07	-.45	311.	377.
8.000	.212	.181	1.73	250.82	2.39	-.29	231.32	8.89	-.57	301.	377.
9.000	.111	.031	1.71	243.28	2.36	-.24	225.57	8.24	-.68	272.	376.
10.000	.059	.053	1.23	235.57	2.39	-.22	219.46	8.74	-.52	83.	376.
11.000	.018	.011	.92	227.88	2.45	-.20	212.01	4.63	.02	31.	376.
12.000	.008	.004	1.11	220.69	2.47	-.26	205.91	3.92	.11	31.	375.
13.000	99.999	99.999	999.99	214.09	2.48	-.26	999.99	99.99	999.99	0.	375.
14.000	99.999	99.999	999.99	209.64	2.31	-.21	999.99	99.99	999.99	0.	374.
15.000	99.999	99.999	999.99	204.30	2.24	-.06	999.99	99.99	999.99	0.	372.
16.000	99.999	99.999	999.99	201.69	2.50	.25	999.99	99.99	999.99	0.	371.
17.000	99.999	99.999	999.99	201.35	2.96	.07	999.99	99.99	999.99	0.	370.
18.000	99.999	99.999	999.99	203.42	2.91	-.21	999.99	99.99	999.99	0.	366.
19.000	99.999	99.999	999.99	203.81	2.45	-.10	999.99	99.99	999.99	0.	359.
20.000	99.999	99.999	999.99	209.95	2.01	.15	999.99	99.99	999.99	0.	354.
21.000	99.999	99.999	999.99	212.78	1.88	.34	999.99	99.99	999.99	0.	345.
22.000	99.999	99.999	999.99	215.43	1.66	.49	999.99	99.99	999.99	0.	341.
23.000	99.999	99.999	999.99	217.74	1.79	.52	999.99	99.99	999.99	0.	331.
24.000	99.999	99.999	999.99	219.88	1.95	.34	999.99	99.99	999.99	0.	324.
25.000	99.999	99.999	999.99	221.75	2.09	.29	999.99	99.99	999.99	0.	305.
26.000	99.999	99.999	999.99	223.73	2.15	.20	999.99	99.99	999.99	0.	274.
27.000	99.999	99.999	999.99	225.67	2.28	.04	999.99	99.99	999.99	0.	244.
28.000	99.999	99.999	999.99	227.35	2.40	-.04	999.99	99.99	999.99	0.	236.
29.000	99.999	99.999	999.99	229.29	2.74	-.11	999.99	99.99	999.99	0.	184.
30.000	99.999	99.999	999.99	231.16	2.79	-.01	999.99	99.99	999.99	0.	168.

TABLE III-11. MOISTURE RELATED STATISTICAL PARAMETERS

NOVEMBER

STATION	911620	BARKING	SAIDS, HI	TV	TV	SKEW TV	DEWPT T	S.D. DPT	SKEW DPT	HOUS 1+P	NOBS TV
Z	VAPOR P	S.D. VP	SKEW VP	MEAN	S.D.		MEAN	DEG K			
KM	MB	MB		DEG K	DEG K		DEG K	DEG K			
.000	20.744	3.076	.04	233.54	2.00	.38	231.03	2.41	-.41	327.	327.
.005	20.730	3.031	.03	238.50	1.93	.31	231.07	2.38	-.41	346.	346.
1.000	14.237	2.279	-.14	242.05	1.60	-.67	235.20	2.53	-.53	345.	346.
2.000	7.061	3.729	-.30	246.72	2.19	-.25	273.92	9.90	-1.42	327.	346.
3.000	3.030	2.504	.97	232.57	2.23	.11	259.35	12.22	-.46	232.	346.
4.000	1.656	1.515	1.39	277.16	2.40	-.18	251.98	11.49	-.29	259.	345.
5.000	1.006	1.005	1.66	271.22	2.38	-.18	246.01	11.37	-.25	259.	344.
6.000	.654	.651	1.85	264.68	2.49	-.09	241.19	11.46	-.41	258.	344.
7.000	.384	.396	1.96	257.74	2.54	-.21	235.77	10.89	-.37	257.	344.
8.000	.225	.210	1.51	250.37	2.54	-.16	231.01	10.09	-.47	257.	344.
9.000	.115	.101	1.54	242.72	2.57	-.10	225.48	8.60	-.57	224.	344.
10.000	.054	.051	1.31	234.99	2.69	-.04	218.53	9.00	-.45	75.	343.
11.000	.014	.009	.74	227.35	2.54	.11	210.51	4.13	.17	22.	343.
12.000	.006	.003	1.04	220.32	2.59	-.01	204.70	3.06	.43	32.	343.
13.000	99.999	99.999	999.99	213.89	2.71	-.33	999.99	99.99	999.99	1.	343.
14.000	99.999	99.999	999.99	238.37	2.72	-.45	999.99	99.99	999.99	0.	341.
15.000	99.999	99.999	999.99	203.58	2.49	.02	999.99	99.99	999.99	0.	340.
16.000	99.999	99.999	999.99	200.33	2.53	.45	999.99	99.99	999.99	0.	338.
17.000	99.999	99.999	999.99	199.12	2.72	.32	999.99	99.99	999.99	0.	338.
18.000	99.999	99.999	999.99	200.66	2.97	.38	999.99	99.99	999.99	0.	337.
19.000	99.999	99.999	999.99	204.67	2.55	.26	999.99	99.99	999.99	0.	332.
20.000	99.999	99.999	999.99	203.62	2.05	.04	999.99	99.99	999.99	0.	327.
21.000	99.999	99.999	999.99	211.63	1.88	.03	999.99	99.99	999.99	0.	320.
22.000	99.999	99.999	999.99	214.31	1.92	.07	999.99	99.99	999.99	0.	318.
23.000	99.999	99.999	999.99	216.77	1.93	-.08	999.99	99.99	999.99	0.	309.
24.000	99.999	99.999	999.99	219.01	2.17	-.09	999.99	99.99	999.99	0.	304.
25.000	99.999	99.999	999.99	210.82	2.20	-.23	999.99	99.99	999.99	0.	294.
26.000	99.999	99.999	999.99	222.63	2.29	.05	999.99	99.99	999.99	0.	278.
27.000	99.999	99.999	999.99	224.45	2.46	.20	999.99	99.99	999.99	0.	255.
28.000	99.999	99.999	999.99	226.32	2.68	.00	999.99	99.99	999.99	0.	250.
29.000	99.999	99.999	999.99	227.92	2.73	.09	999.99	99.99	999.99	0.	197.
30.000	99.999	99.999	999.99	229.31	2.78	.08	999.99	99.99	999.99	0.	166.

TABLE III-12. MOISTURE RELATED STATISTICAL PARAMETERS

DECEMBER

STATION Z	BARKING SANDS, HI		TV MEAN DEG K	TV S.D. DEG K	SKEW TV	DEWPT T		S.D. DPT DEG K	SKEW DPT	NOBS T+P	NOBS TV
	VAPOR P MEAN MB	S.D. VP MB				MEAN DEG K	MEAN DEG K				
.000	19.074	3.356	.15	295.22	2.37	.00	289.53	2.82	-.25	293.	273.
.025	18.934	3.334	.20	293.11	2.41	-.06	289.57	2.81	-.19	317.	317.
1.000	13.258	2.527	-.15	290.70	1.66	-.23	294.04	3.07	-.91	317.	317.
2.000	6.446	3.702	-.01	285.65	2.34	-.69	270.37	12.32	-1.41	273.	317.
3.000	2.560	2.271	1.11	231.27	2.17	-.41	235.23	13.63	-.53	276.	317.
4.000	1.386	1.385	1.56	275.91	2.40	-.27	248.71	13.04	-.30	257.	317.
5.000	.777	.808	1.74	270.00	2.67	-.56	242.32	12.34	-.21	248.	317.
6.000	.458	.497	2.23	263.51	2.89	-.71	237.10	11.44	-.23	250.	317.
7.000	.290	.299	1.94	255.32	2.95	-.76	232.90	10.76	-.28	253.	317.
8.000	.170	.175	1.74	249.02	2.97	-.78	227.62	10.23	-.23	245.	316.
9.000	.089	.083	1.73	241.61	3.01	-.64	222.78	9.09	-.45	209.	315.
10.000	.041	.037	1.67	234.19	3.03	-.30	216.57	8.41	-.52	70.	315.
11.000	.020	.009	1.39	227.02	2.93	-.04	213.45	3.51	-.12	25.	315.
12.000	.008	.003	.54	220.61	2.82	-.19	207.19	2.80	-.10	25.	315.
13.000	99.999	99.999	999.99	214.64	2.69	-.13	999.99	99.99	999.99	3.	315.
14.000	99.999	99.999	999.99	209.19	2.49	.00	999.99	99.99	999.99	0.	314.
15.000	99.999	99.999	999.99	204.36	2.54	.20	999.99	99.99	999.99	0.	314.
16.000	99.999	99.999	999.99	200.62	2.67	.47	999.99	99.99	999.99	0.	314.
17.000	99.999	99.999	999.99	193.67	2.95	.38	999.99	99.99	999.99	0.	314.
18.000	99.999	99.999	999.99	189.42	3.24	.40	999.99	99.99	999.99	0.	314.
19.000	99.999	99.999	999.99	184.20	2.93	.16	999.99	99.99	999.99	0.	311.
20.000	99.999	99.999	999.99	207.45	2.52	.17	999.99	99.99	999.99	0.	307.
21.000	99.999	99.999	999.99	210.78	2.17	.18	999.99	99.99	999.99	0.	303.
22.000	99.999	99.999	999.99	213.07	2.07	.68	999.99	99.99	999.99	0.	298.
23.000	99.999	99.999	999.99	216.07	1.88	.17	999.99	99.99	999.99	0.	287.
24.000	99.999	99.999	999.99	218.43	2.39	.18	999.99	99.99	999.99	0.	283.
25.000	99.999	99.999	999.99	220.51	2.58	.17	999.99	99.99	999.99	0.	279.
26.000	99.999	99.999	999.99	222.28	2.53	.11	999.99	99.99	999.99	0.	250.
27.000	99.999	99.999	999.99	223.90	2.55	.29	999.99	99.99	999.99	0.	224.
28.000	99.999	99.999	999.99	225.31	2.71	.20	999.99	99.99	999.99	0.	218.
29.000	99.999	99.999	999.99	226.69	2.97	-.16	999.99	99.99	999.99	0.	178.
30.000	99.999	99.999	999.99	228.08	3.36	-.11	999.99	99.99	999.99	0.	161.

TABLE III-13. MOISTURE RELATED STATISTICAL PARAMETERS

ANNUAL

STATION = 911620		BARKING SANDS, MI		TV		TV		DEWPT T		NOBS T+P		NOBS TV	
Z	VAPOR P	S.D. VP	SKEW VP	TV	TV	SKEW TV	SKEW TV	S.D. DPT	SKEW DPT	NOBS T+P	NOBS TV	NOBS T+P	NOBS TV
	MEAN			MEAN	S.D.		MEAN	S.D. DPT	SKEW DPT				
KH	MB	MB		DEC K	DEC K		DEC K	DEC K					
.000	20.502	3.297	-.12	299.26	3.04	-.51	290.92	2.65	-.59	4124.	4124.	4124.	4124.
.005	20.444	3.328	-.12	299.16	3.10	-.54	290.81	2.69	-.58	4337.	4337.	4337.	4337.
1.000	13.678	2.423	-.08	291.50	2.05	-.58	284.55	2.82	-.78	4337.	4337.	4337.	4337.
2.000	7.137	3.575	-.18	288.14	2.39	-.38	272.75	10.35	-1.56	4124.	4124.	4124.	4124.
3.000	2.779	2.322	.99	281.81	2.41	-.22	257.77	13.23	-.66	3090.	3090.	3090.	3090.
4.000	1.475	1.415	1.51	276.51	2.59	-.29	249.78	12.79	-.41	3513.	3513.	3513.	3513.
5.000	.883	.888	1.76	270.53	2.78	-.44	243.93	12.36	-.37	3473.	3473.	3473.	3473.
6.000	.545	.556	1.85	264.04	2.96	-.46	238.92	11.78	-.37	3472.	3472.	3472.	3472.
7.000	.326	.330	1.89	257.00	3.11	-.48	233.95	11.15	-.40	3461.	3461.	3461.	3461.
8.000	.187	.179	1.72	249.67	3.20	-.49	229.03	10.28	-.48	3356.	3356.	3356.	3356.
9.000	.099	.087	1.62	242.24	3.23	-.35	223.93	9.02	-.59	2658.	2658.	2658.	2658.
10.000	.045	.041	1.75	234.79	3.23	-.16	217.97	8.02	-.42	925.	925.	925.	925.
11.000	.016	.009	1.00	227.42	3.01	-.11	211.19	4.51	-.07	475.	475.	475.	475.
12.000	.007	.004	1.03	220.60	2.87	-.11	205.35	3.63	-.06	472.	472.	472.	472.
13.000	.004	.002	6.47	214.37	2.73	.04	200.69	3.32	.04	122.	122.	122.	122.
14.000	99.999	99.999	999.99	203.16	2.66	.06	999.99	99.99	999.99	19.	19.	19.	19.
15.000	99.999	99.999	999.99	205.12	2.76	.08	999.99	99.99	999.99	0.	0.	0.	0.
16.000	99.999	99.999	999.99	202.53	3.17	.03	999.99	99.99	999.99	0.	0.	0.	0.
17.000	99.999	99.999	999.99	201.69	3.83	-.29	999.99	99.99	999.99	0.	0.	0.	0.
18.000	99.999	99.999	999.99	202.97	4.23	-.51	999.99	99.99	999.99	0.	0.	0.	0.
19.000	99.999	99.999	999.99	205.09	3.62	-.69	999.99	99.99	999.99	0.	0.	0.	0.
20.000	99.999	99.999	999.99	209.47	2.89	-.62	999.99	99.99	999.99	0.	0.	0.	0.
21.000	99.999	99.999	999.99	212.81	2.91	-.46	999.99	99.99	999.99	0.	0.	0.	0.
22.000	99.999	99.999	999.99	214.97	2.40	-.48	999.99	99.99	999.99	0.	0.	0.	0.
23.000	99.999	99.999	999.99	217.30	2.38	-.53	999.99	99.99	999.99	0.	0.	0.	0.
24.000	99.999	99.999	999.99	219.55	2.55	-.54	999.99	99.99	999.99	0.	0.	0.	0.
25.000	99.999	99.999	999.99	221.62	2.62	-.60	999.99	99.99	999.99	0.	0.	0.	0.
26.000	99.999	99.999	999.99	222.62	2.61	-.51	999.99	99.99	999.99	0.	0.	0.	0.
27.000	99.999	99.999	999.99	225.53	2.67	-.43	999.99	99.99	999.99	0.	0.	0.	0.
28.000	99.999	99.999	999.99	227.40	2.70	-.49	999.99	99.99	999.99	0.	0.	0.	0.
29.000	99.999	99.999	999.99	229.12	2.83	-.41	999.99	99.99	999.99	0.	0.	0.	0.
30.000	99.999	99.999	999.99	230.71	2.91	-.47	999.99	99.99	999.99	0.	0.	0.	0.

TABLE IV-1. HYDROSTATIC MODEL ATMOSPHERE

JANUARY

STATION • 911620		BARKING SANDS, HI		
Z	GEO. HT.	P	D	T
KM	KM	MB	G/M ³	DEG K
.000	.000	1014.8000	1195.0000	295.77
.005	.005	1014.2000	1195.0000	295.59
1.000	.998	903.2100	1086.0000	283.87
2.000	1.995	802.1300	981.8000	274.62
3.000	2.993	711.0100	893.2000	267.44
4.000	3.990	628.9400	816.0000	274.97
5.000	4.985	554.9300	748.8000	283.55
6.000	5.983	488.2100	698.0000	292.45
7.000	6.979	428.1000	653.6000	298.53
8.000	7.974	374.0500	614.3000	304.55
9.000	8.970	325.6200	580.0000	311.92
10.000	9.965	282.4000	550.7000	319.50
11.000	10.960	243.9500	526.3000	328.60
12.000	11.954	209.8600	506.8000	338.54
13.000	12.948	179.7500	492.0000	349.10
14.000	13.942	153.2800	481.2000	360.29
15.000	14.936	130.1300	473.0000	372.48
16.000	15.929	110.0400	467.0000	385.21
17.000	16.922	92.7970	463.0000	398.00
18.000	17.914	78.1920	460.0000	411.12
19.000	18.906	65.9700	458.0000	424.79
20.000	19.899	55.8390	457.0000	439.78
21.000	20.890	47.4580	456.0000	455.78
22.000	21.881	40.4580	456.0000	472.43
23.000	22.872	34.5260	456.0000	489.61
24.000	23.863	29.5100	456.0000	507.55
25.000	24.853	25.2580	456.0000	526.41
26.000	25.844	21.6490	456.0000	546.36
27.000	26.833	18.5820	456.0000	567.33
28.000	27.823	15.9740	456.0000	589.61
29.000	28.812	13.7500	456.0000	613.33
30.000	29.801	11.8497	456.0000	638.97
32.000	31.777	8.8389	456.0000	682.59
34.000	33.752	6.6298	456.0000	735.29
36.000	35.726	4.9997	456.0000	798.81
38.000	37.699	3.7964	456.0000	874.79
40.000	39.671	2.9025	456.0000	964.09
42.000	41.641	2.2541	456.0000	1067.11
44.000	43.611	1.7233	456.0000	1184.43
46.000	45.579	1.3446	456.0000	1316.63
48.000	47.545	1.0472	456.0000	1464.38
50.000	49.511	.8146	456.0000	1628.45
52.000	51.475	.6326	456.0000	1809.33
54.000	53.438	.4908	456.0000	2007.90
56.000	55.400	.3804	456.0000	2224.33
58.000	57.361	.2944	456.0000	2458.17
60.000	59.320	.2271	456.0000	2710.01
62.000	61.279	.1744	456.0000	2980.52
64.000	63.236	.1329	456.0000	3270.34
66.000	65.191	.1003	456.0000	3580.44
68.000	67.146	.0748	456.0000	3911.83
70.000	69.099	.0553	456.0000	4274.66

TABLE IV-2. HYDROSTATIC MODEL ATMOSPHERE

FEBRUARY

STATION = 911620		BARKING SANDS, HI		TV
Z	GEO. HT.	P	D	DEG K
KM	KM	MB	G/M3	
.000	.000	1016.3000	1197.0000	295.06
.005	.005	1015.8000	1197.0000	295.70
1.000	.998	904.5700	1089.0000	289.47
2.000	1.995	803.2500	994.3000	284.29
3.000	2.993	711.8900	895.5000	280.05
4.000	3.990	629.6300	798.3000	274.76
5.000	4.986	555.5000	719.8000	268.65
6.000	5.983	488.6900	648.8000	262.33
7.000	6.979	428.5200	584.2000	255.54
8.000	7.974	374.4100	524.9000	248.48
9.000	8.970	325.9000	469.9000	241.63
10.000	9.965	282.5800	418.7000	235.11
11.000	10.960	244.0500	371.8000	228.65
12.000	11.954	209.9300	328.9000	222.36
13.000	12.948	179.8100	289.6000	216.26
14.000	13.942	153.3400	254.1000	210.25
15.000	14.936	130.2100	221.5000	204.78
16.000	15.929	110.1400	191.2000	200.06
17.000	16.922	92.9160	163.2000	198.29
18.000	17.914	78.3200	137.4000	198.68
19.000	18.906	66.1300	114.0000	202.17
20.000	19.899	56.0200	94.5000	206.53
21.000	20.890	47.6110	79.0500	209.81
22.000	21.881	40.5980	66.4300	212.70
23.000	22.872	34.6200	56.1000	214.98
24.000	23.863	29.5500	47.5000	217.07
25.000	24.853	25.3400	40.2900	219.16
26.000	25.844	21.7370	34.2200	221.30
27.000	26.833	18.6700	29.1200	223.35
28.000	27.823	16.0600	24.8100	225.51
29.000	28.812	13.8340	21.1900	227.41
30.000	29.801	11.9316	18.1200	229.34
32.000	31.777	8.9223	13.1400	235.19
34.000	33.752	6.7186	9.6750	240.50
36.000	35.726	5.0823	7.1950	244.95
38.000	37.699	3.8757	5.3680	250.04
40.000	39.671	2.9695	4.0200	255.84
42.000	41.641	2.2800	3.0320	261.34
44.000	43.611	1.7724	2.3170	264.89
46.000	45.579	1.3768	1.7830	267.39
48.000	47.545	1.0710	1.3850	267.56
50.000	49.511	.8332	1.0790	267.30
52.000	51.475	.6480	.8416	266.66
54.000	53.438	.5034	.6597	264.21
56.000	55.400	.3901	.5161	261.78
58.000	57.361	.3017	.4026	259.52
60.000	59.320	.2328	.3143	256.43
62.000	61.279	.1787	.2461	251.72
64.000	63.236	.1345	.1943	243.30
66.000	65.191	.1033	.1522	234.99
68.000	67.146	.0770	.1215	219.40
70.000	69.099	.0565	.0910	215.40

TABLE IV-3. HYDROSTATIC MODEL ATMOSPHERE

MARCH

STATION # 911620		BARKING SANDS, HI		TV
Z	GEO. HT.	P	D	DEG K
KM	KM	MB	G/M3	
.000	.000	1017.6000	1195.0000	236.79
.005	.005	1017.0000	1194.0000	236.67
1.000	.938	905.6300	1030.0000	239.51
2.000	1.935	804.4700	985.3000	239.44
3.000	2.993	713.0000	986.0000	239.09
4.000	3.930	630.6000	900.0000	274.59
5.000	4.986	556.2000	722.2000	258.33
6.000	5.983	489.2000	551.5000	251.57
7.000	6.979	428.7400	587.3000	254.23
8.000	7.974	374.3200	528.1000	246.92
9.000	8.970	325.5000	473.0000	239.71
10.000	9.965	281.0970	421.6000	232.94
11.000	10.960	243.1400	373.6000	226.70
12.000	11.954	209.9100	329.2000	221.10
13.000	12.948	178.8400	289.6000	215.89
14.000	13.942	152.5200	252.1000	210.79
15.000	14.936	129.5900	219.3000	205.87
16.000	15.929	109.7300	189.2000	202.04
17.000	16.922	92.6930	161.5000	199.98
18.000	17.914	78.2560	135.9000	200.57
19.000	18.906	66.1770	113.1000	203.84
20.000	19.898	56.1260	94.1900	207.59
21.000	20.890	47.7350	78.6900	210.82
22.000	21.881	40.6960	66.3300	213.74
23.000	22.872	34.7640	56.0500	216.06
24.000	23.853	29.7470	47.4600	218.27
25.000	24.853	25.4950	40.3000	220.41
26.000	25.844	21.6850	34.2500	222.62
27.000	26.833	18.8160	29.1400	224.96
28.000	27.823	16.2030	24.8300	227.32
29.000	28.812	13.9740	21.2400	229.21
30.000	29.801	12.0655	18.2000	230.95
32.000	31.777	9.0417	13.2100	237.00
34.000	33.752	6.8201	9.7740	241.50
36.000	35.725	5.1708	7.2600	245.62
38.000	37.679	3.9402	5.4480	250.35
40.000	39.671	3.0180	4.0920	255.35
42.000	41.641	2.3243	3.0990	259.63
44.000	43.611	1.7968	2.3630	263.22
46.000	45.579	1.3930	1.8200	264.97
48.000	47.545	1.0817	1.4070	266.19
50.000	49.511	.8407	1.0910	266.72
52.000	51.475	.6535	.8505	265.96
54.000	53.438	.5075	.6642	264.46
56.000	55.400	.3935	.5190	262.43
58.000	57.361	.3044	.4065	259.17
60.000	59.320	.2347	.3176	255.76
62.000	61.279	.1802	.2483	251.22
64.000	63.236	.1374	.1968	241.69
66.000	65.191	.1037	.1540	233.05
68.000	67.146	.0772	.1218	219.45
70.000	69.093	.0567	.0918	213.92

TABLE IV-4. HYDROSTATIC MODEL ATMOSPHERE

APRIL

STATION = 911620		BARKING SANDS, HI		TV
Z	GEO. HT.	P	D	
KM	KM	MB	G/M3	CEG K
.000	.000	1017.8000	1197.0000	299.83
.005	.005	1017.2000	1186.0000	299.77
1.000	.978	905.5600	1089.0000	293.24
2.000	1.995	805.2100	995.3000	284.68
3.000	2.993	713.7300	907.0000	280.31
4.000	3.990	631.3200	830.1000	274.83
5.000	4.996	557.0100	761.6000	268.90
6.000	5.993	490.0000	691.2000	262.14
7.000	6.979	429.5700	629.9000	254.96
8.000	7.974	375.1700	576.1000	247.48
9.000	8.970	326.3100	529.9000	239.88
10.000	9.965	282.5300	484.0000	232.12
11.000	10.960	243.4600	437.3000	224.83
12.000	11.954	208.8900	392.9000	218.59
13.000	12.948	178.5000	351.3000	213.49
14.000	13.942	152.0300	312.0000	209.51
15.000	14.935	129.1200	275.2000	206.11
16.000	15.929	109.4000	240.4000	203.34
17.000	16.922	92.5420	207.6000	202.03
18.000	17.914	78.2740	177.3000	202.99
19.000	18.906	66.3270	149.0000	206.37
20.000	19.898	56.3610	123.5000	209.90
21.000	20.890	48.0100	100.6700	212.60
22.000	21.881	40.9780	79.3800	215.06
23.000	22.872	35.0410	60.1100	217.57
24.000	23.863	30.0200	42.5100	220.12
25.000	24.853	25.7640	26.3500	222.46
26.000	25.844	22.1460	11.3400	224.70
27.000	26.833	19.0660	29.2800	226.68
28.000	27.823	16.4390	25.0000	229.07
29.000	28.812	14.1930	21.4100	230.94
30.000	29.801	12.2684	18.3600	232.77
32.000	31.777	9.2104	13.4300	238.14
34.000	33.752	6.9352	9.9650	242.35
36.000	35.726	5.2724	7.4340	246.55
38.000	37.699	4.0258	5.5090	251.04
40.000	39.671	3.0868	4.1830	253.27
42.000	41.641	2.3725	3.1660	260.97
44.000	43.611	1.8423	2.4140	265.00
46.000	45.579	1.4309	1.8600	267.13
48.000	47.545	1.1134	1.4410	268.29
50.000	49.511	.8667	1.1230	267.68
52.000	51.475	.6744	.8770	267.00
54.000	53.438	.5240	.6893	264.31
56.000	55.400	.4059	.5405	260.72
58.000	57.361	.3133	.4234	256.92
60.000	59.320	.2409	.3318	252.02
62.000	61.279	.1840	.2609	245.01
64.000	63.236	.1393	.2056	235.28
66.000	65.191	.1045	.1579	229.87
68.000	67.146	.0776	.1230	219.72
70.000	69.099	.0570	.0929	213.16

TABLE IV-5. HYDROSTATIC MODEL ATMOSPHERE

MAY

STATION = 911620		BARKING SANDS, HI		TV DEG K
Z KM	GEO. HT. KM	P MB	D G/M3	
.000	.000	1017.4000	1179.0000	300.49
.005	.005	1016.8000	1179.0000	300.46
1.000	.998	906.6400	1084.0000	291.29
2.000	1.995	805.6100	992.5000	283.84
3.000	2.993	714.4000	894.3000	281.45
4.000	3.990	632.3000	796.6000	276.51
5.000	4.986	559.2900	718.8000	270.57
6.000	5.983	491.5400	648.6000	264.01
7.000	6.979	431.3600	594.6000	257.03
8.000	7.974	377.1600	526.3000	249.85
9.000	8.970	328.4200	472.9000	241.92
10.000	9.955	284.7100	423.7000	234.12
11.000	10.950	245.6400	378.0000	226.37
12.000	11.954	210.9000	335.2000	219.16
13.000	12.948	180.2000	295.1000	212.71
14.000	13.942	153.3400	257.0000	207.89
15.000	14.936	130.0800	221.2000	204.89
16.000	15.929	110.1600	189.7000	203.36
17.000	16.922	93.2370	159.7000	203.34
18.000	17.914	78.9720	134.1000	205.08
19.000	18.906	67.0140	112.3000	207.83
20.000	19.898	56.9960	94.2300	210.74
21.000	20.890	48.5830	79.2700	213.50
22.000	21.881	41.4950	66.9000	216.66
23.000	22.872	35.5100	56.5800	218.84
24.000	23.863	30.4430	47.9800	221.05
25.000	24.853	26.1430	40.7800	223.35
26.000	25.844	22.4860	34.7200	225.61
27.000	26.833	19.3700	29.6300	227.75
28.000	27.823	16.7090	25.3500	229.63
29.000	28.812	14.4310	21.7200	231.43
30.000	29.801	12.4770	18.6500	233.00
32.000	31.777	9.3600	13.7100	236.70
34.000	33.752	7.0562	10.1600	240.90
36.000	35.726	5.3461	7.5640	243.68
38.000	37.699	4.0706	5.6570	249.47
40.000	39.671	3.1169	4.2340	255.26
42.000	41.641	2.4011	3.1940	260.64
44.000	43.611	1.8587	2.4320	264.96
46.000	45.579	1.4438	1.8720	267.38
48.000	47.545	1.1236	1.4520	269.30
50.000	49.511	.8745	1.1330	267.60
52.000	51.475	.6800	.8869	265.80
54.000	53.438	.5276	.6916	262.97
56.000	55.400	.4084	.5434	260.50
58.000	57.361	.3152	.4257	256.69
60.000	59.320	.2422	.3345	251.01
62.000	61.279	.1848	.2626	244.02
64.000	63.236	.1398	.2065	234.66
66.000	65.191	.1046	.1598	226.95
68.000	67.146	.0772	.1257	218.99
70.000	69.099	.0562	.0939	207.66

TABLE IV-6. HYDROSTATIC MODEL ATMOSPHERE

JUNE

STATION = 911620		BARKING SANDS, MI		TV
Z	Geo. HT.	P	D	DEG K
KM	KM	MB	G/M3	
.000	.000	1017.3000	1176.0000	301.39
.005	.005	1016.7000	1175.0000	301.37
1.000	.998	906.8800	1081.0000	292.15
2.000	1.995	806.2100	978.2000	287.12
3.000	2.993	715.4100	870.1000	283.17
4.000	3.990	633.6100	774.4000	277.88
5.000	4.986	559.7900	717.3000	271.87
6.000	5.983	493.1600	647.7000	265.24
7.000	6.979	433.0100	594.6000	258.04
8.000	7.974	378.8100	526.4000	250.68
9.000	8.970	330.0700	473.0000	243.08
10.000	9.965	286.3400	424.0000	235.28
11.000	10.960	247.2200	379.6000	227.48
12.000	11.954	212.3900	346.3000	220.00
13.000	12.948	181.5300	295.5000	213.32
14.000	13.942	154.5700	256.4000	208.38
15.000	14.936	131.1900	222.4000	205.50
16.000	15.929	111.1600	189.7000	204.19
17.000	16.922	94.1560	160.5000	204.33
18.000	17.914	79.8100	135.0000	205.93
19.000	18.906	67.7670	113.2000	208.55
20.000	19.898	57.6660	95.0400	211.39
21.000	20.890	49.1780	80.0100	214.12
22.000	21.881	42.0230	67.5000	216.70
23.000	22.872	35.9760	57.1900	219.14
24.000	23.863	30.8530	48.5200	221.52
25.000	24.853	26.5030	41.2800	223.68
26.000	25.844	22.8000	35.1800	225.80
27.000	26.833	19.6410	30.0500	227.71
28.000	27.823	16.9410	25.7300	229.38
29.000	28.812	14.6230	22.0000	230.99
30.000	29.801	12.6431	18.9500	232.38
32.000	31.777	9.4740	13.9000	235.50
34.000	33.752	7.1305	10.3000	239.35
36.000	35.726	5.3944	7.6400	244.04
38.000	37.699	4.1035	5.7000	248.79
40.000	39.671	3.1402	4.2500	254.80
42.000	41.641	2.4184	3.2080	260.53
44.000	43.611	1.8720	2.4410	265.00
46.000	45.579	1.4535	1.8910	268.66
48.000	47.545	1.1305	1.4500	267.52
50.000	49.511	.8792	1.1390	266.76
52.000	51.475	.6832	.8999	265.29
54.000	53.438	.5299	.6971	262.67
56.000	55.400	.4097	.5482	259.26
58.000	57.361	.3153	.4304	253.13
60.000	59.320	.2414	.3359	248.37
62.000	61.279	.1840	.2598	244.04
64.000	63.236	.1391	.2063	233.93
66.000	65.191	.1040	.1586	226.70
68.000	67.143	.0768	.1242	213.70
70.000	69.099	.0560	.0946	202.08

TABLE IV-7. HYDROSTATIC MODEL ATMOSPHERE

JULY

STATION # 911620		BARKING SANDS, HI		TV
Z	GEO. HT.	P	D	DEG K
KM	KM	MB	G/M ³	
.000	.000	1016.9000	1174.0000	301.60
.005	.005	1016.4000	1173.0000	301.05
1.000	.999	926.7000	1070.0000	292.78
2.000	1.995	806.2000	970.0000	287.52
3.000	2.993	715.4000	891.5000	282.75
4.000	3.990	633.0000	795.0000	277.43
5.000	4.980	550.0000	717.5000	271.74
6.000	5.965	463.0000	647.4000	265.37
7.000	6.979	432.0000	583.0000	258.31
8.000	7.974	378.3100	520.0000	250.50
9.000	8.970	330.1000	472.7000	243.20
10.000	9.965	286.4000	423.6000	235.45
11.000	10.950	247.3000	378.5000	227.63
12.000	11.954	212.4000	336.1000	220.27
13.000	12.948	181.7200	296.0000	213.65
14.000	13.942	154.7700	257.7000	209.19
15.000	14.926	131.4400	221.2000	205.38
16.000	15.929	111.4700	188.2000	205.27
17.000	16.922	94.5000	160.1000	205.63
18.000	17.914	80.1810	134.8000	207.05
19.000	18.906	68.1310	113.4000	209.27
20.000	19.898	58.0020	95.4000	211.79
21.000	20.890	49.4780	80.3500	214.48
22.000	21.881	42.2050	67.9700	216.74
23.000	22.872	36.1900	57.6100	216.90
24.000	23.863	31.0370	48.9100	221.07
25.000	24.853	26.6310	41.6100	223.11
26.000	25.844	22.9160	35.4200	224.91
27.000	26.833	19.7280	30.3200	226.64
28.000	27.823	17.0040	25.9400	228.38
29.000	28.812	14.6740	22.2200	230.04
30.000	29.801	12.6740	19.0000	231.33
32.000	31.777	9.4000	14.0000	233.95
34.000	33.752	7.1233	10.2000	237.71
35.000	35.726	5.3787	7.6720	242.40
33.000	37.699	4.0037	5.7179	246.99
40.000	39.671	3.1181	4.2710	250.43
42.000	41.641	2.3160	3.2040	253.57
44.000	43.611	1.6700	2.4400	257.01
46.000	45.579	1.4320	1.8750	254.29
48.000	47.545	1.1121	1.4480	255.61
50.000	49.511	.6032	1.1280	254.40
52.000	51.475	.5009	.6010	251.72
54.000	53.439	.5171	.6602	253.39
56.000	55.400	.3709	.5263	257.15
58.000	57.361	.3009	.4177	254.03
60.000	59.320	.2352	.3266	248.99
62.000	61.279	.1790	.2569	240.89
64.000	63.236	.1348	.2015	231.38
66.000	65.191	.1006	.1547	224.87
68.000	67.146	.0742	.1197	214.10
70.000	69.099	.0541	.0826	208.81

TABLE IV-8. HYDROSTATIC MODEL ATMOSPHERE

AUGUST

STATION - 911620		BARKING SANDS, HI		TV
Z	GEOM. HT.	P	D	DEG K
KM	KM	MB	G/M3	
.000	.000	1016.1000	1172.0000	301.95
.005	.005	1015.5000	1172.0000	301.89
1.000	.993	906.1300	1070.0000	293.26
2.000	1.995	805.8200	975.6000	287.69
3.000	2.993	715.1300	880.2000	283.04
4.000	3.990	633.3500	793.9000	277.93
5.000	4.986	559.6400	715.9000	272.33
6.000	5.983	493.1600	645.6000	266.01
7.000	6.979	433.2200	582.4000	259.13
8.000	7.974	379.2100	524.7000	251.77
9.000	8.970	330.6100	471.7000	244.18
10.000	9.965	287.0000	422.6000	236.47
11.000	10.960	247.9700	378.1000	228.50
12.000	11.954	213.1800	336.0000	221.03
13.000	12.948	182.3300	296.6000	214.22
14.000	13.942	155.3300	259.1000	208.81
15.000	14.936	131.8700	223.4000	203.65
16.000	15.929	111.7600	189.3000	198.60
17.000	16.922	94.7000	160.9000	193.10
18.000	17.914	80.3300	135.3000	186.91
19.000	18.906	68.2550	113.7000	180.16
20.000	19.898	58.1000	95.0500	171.60
21.000	20.890	49.5500	80.6400	161.07
22.000	21.881	42.3350	69.1900	149.29
23.000	22.872	35.2280	57.7900	135.39
24.000	23.863	31.0490	49.0700	120.44
25.000	24.853	26.6510	41.7200	102.55
26.000	25.844	22.9080	35.5200	82.47
27.000	26.833	19.7160	30.3700	60.15
28.000	27.823	16.9870	25.9000	37.75
29.000	28.812	14.6520	22.2600	15.31
30.000	29.801	12.6509	19.1000	2.81
32.000	31.777	9.4536	13.9500	233.64
34.000	33.752	7.1048	10.3100	237.75
36.000	35.726	5.3637	7.6400	242.02
38.000	37.699	4.0704	5.6000	246.54
40.000	39.671	3.1067	4.2500	252.14
42.000	41.641	2.3862	3.1900	257.95
44.000	43.611	1.8410	2.4300	260.98
46.000	45.579	1.4248	1.8500	263.73
48.000	47.545	1.1052	1.4390	264.97
50.000	49.511	.8577	1.1170	265.05
52.000	51.475	.6657	.8691	264.33
54.000	53.438	.5150	.6790	261.00
56.000	55.400	.3989	.5308	257.36
58.000	57.361	.3077	.4139	252.55
60.000	59.320	.2366	.3229	252.96
62.000	61.279	.1808	.2502	244.53
64.000	63.236	.1371	.1982	238.66
66.000	65.191	.1030	.1551	229.21
68.000	67.146	.0764	.1214	217.21
70.000	69.099	.0559	.0914	211.21

TABLE IV-9. HYDROSTATIC MODEL ATMOSPHERE

SEPTEMBER

STATION = 911620		BARKING SANDS, HI		TV
Z	GEO. HT.	P	D	CEG K
KM	KM	MB	G/M3	
.000	.000	1015.5000	1173.0000	301.48
.025	.005	1014.9000	1173.0000	301.43
1.000	.909	905.5000	1075.0000	293.45
2.000	1.835	805.2600	975.5000	287.57
3.000	2.933	714.6300	878.5000	283.40
4.000	3.930	633.0500	782.5000	279.28
5.000	4.925	559.4200	715.3000	272.44
6.000	5.933	492.9700	645.0000	265.94
7.000	6.979	433.0200	582.8000	259.85
8.000	7.974	378.9700	525.1000	251.42
9.000	8.970	330.3300	472.1000	243.76
10.000	9.965	285.6300	423.2000	236.02
11.000	10.960	247.6400	378.1000	229.13
12.000	11.954	212.8000	335.7000	223.83
13.000	12.948	182.1000	295.1000	219.26
14.000	13.942	155.1000	258.7000	209.87
15.000	14.935	131.0500	223.4000	205.31
16.000	15.929	111.5100	190.2000	203.47
17.000	16.922	94.3960	161.5000	203.51
18.000	17.914	79.9970	135.4000	205.34
19.000	18.910	67.9100	113.5000	209.35
20.000	19.913	57.7750	95.5700	211.34
21.000	20.930	49.2530	80.3700	213.00
22.000	21.891	42.0000	67.8700	215.90
23.000	22.872	35.9900	57.4600	218.18
24.000	23.863	30.8420	48.7700	220.32
25.000	24.853	26.4700	41.4600	222.32
26.000	25.944	22.7480	35.3500	224.20
27.000	26.833	19.5750	30.1800	225.97
28.000	27.803	16.8650	25.8000	227.70
29.000	28.812	14.5470	22.0500	229.44
30.000	29.801	12.5619	18.9400	231.12
32.000	31.777	9.3980	13.8700	234.15
34.000	33.752	7.0532	10.2400	238.34
36.000	35.726	5.3353	7.5080	242.38
39.000	37.699	4.0505	5.6590	246.93
40.000	39.671	3.0921	4.2370	252.08
42.000	41.641	2.3752	3.1790	259.22
44.000	43.611	1.8345	2.4120	268.98
46.000	45.579	1.4230	1.8460	265.47
48.000	47.545	1.1066	1.4280	267.77
50.000	49.511	.8609	1.1130	257.22
52.000	51.475	.6694	.8693	206.14
54.000	53.438	.5199	.6799	264.23
56.000	55.400	.4027	.5334	260.92
58.000	57.351	.3110	.4174	257.46
60.000	59.320	.2373	.3262	255.53
62.000	61.279	.1831	.2574	245.75
64.000	63.230	.1369	.2019	237.69
66.000	65.191	.1043	.1567	230.16
68.000	67.146	.0773	.1243	214.67
70.000	69.099	.0565	.0930	209.00

TABLE IV-10. HYDROSTATIC MODEL ATMOSPHERE

OCTOBER

STATION # 9:1620		BARKING SANDS, HI		TV
Z	GEO. HT.	P	D	DEG K
KM	KM	MB	G/M3	
.000	.000	1015.6000	1177.0000	300.66
.005	.005	1015.0000	1176.0000	300.63
1.000	.933	965.4000	1076.0000	297.09
2.000	1.975	805.1000	775.7000	297.45
3.000	2.933	714.4700	879.0000	283.15
4.000	3.930	632.7700	793.6000	277.77
5.000	4.996	559.0200	716.7000	271.73
6.000	5.983	492.4500	646.8000	265.24
7.000	6.979	432.4200	583.4000	258.21
8.000	7.974	378.3200	521.4000	250.82
9.000	8.970	329.6700	472.1000	243.28
10.000	9.965	286.0300	423.0000	235.57
11.000	10.960	247.0200	377.6000	227.88
12.000	11.954	212.2900	335.1000	220.69
13.000	12.948	181.5900	295.5000	214.08
14.000	13.942	154.6400	258.2000	203.64
15.000	14.936	131.2000	223.7000	204.30
16.000	15.929	111.0000	191.7000	201.69
17.000	16.922	93.8070	162.3000	201.35
18.000	17.914	79.3360	135.9000	203.42
19.000	18.906	67.2500	113.3000	206.81
20.000	19.898	57.1570	94.8400	209.95
21.000	20.890	48.6920	79.7200	212.78
22.000	21.881	41.5680	67.2200	215.43
23.000	22.872	35.5530	56.8800	217.74
24.000	23.863	30.4580	48.7500	219.88
25.000	24.853	26.1310	41.0500	221.75
26.000	25.844	22.4490	34.9600	223.73
27.000	26.833	19.3130	29.8100	225.67
28.000	27.823	16.6360	25.4900	227.35
29.000	28.812	14.3470	21.0000	229.29
30.000	29.801	12.3297	18.6700	231.16
32.000	31.777	9.2717	13.6700	234.67
34.000	33.752	6.9669	10.1500	237.49
36.000	35.726	5.2577	7.5240	241.67
38.000	37.699	3.9930	5.5970	246.46
40.000	39.671	3.0450	4.1710	252.49
42.000	41.641	2.3235	3.1330	259.27
44.000	43.611	1.8077	2.3720	263.62
46.000	45.579	1.4029	1.8200	255.60
48.000	47.545	1.0911	1.4060	209.01
50.000	49.511	.8490	1.0980	267.31
52.000	51.475	.6693	.8600	283.16
54.000	53.438	.5170	.6721	263.44
56.000	55.400	.3964	.5205	250.35
58.000	57.361	.3058	.4131	255.01
60.000	59.320	.2349	.3226	251.85
62.000	61.279	.1796	.2503	245.13
64.000	63.236	.1362	.1900	237.27
66.000	65.191	.1022	.1451	227.83
68.000	67.146	.0755	.1119	214.27
70.000	69.099	.0551	.0900	209.70

TABLE IV-11. HYDROSTATIC MODEL ATMOSPHERE

NOVEMBER

STATION # 911620		BARKING SANDS, HI		TV DEG K
Z KM	GEO. HT. KM	P MB	D G/M3	
.000	.000	1015.9000	1185.0000	293.04
.005	.005	1015.3000	1183.0000	293.50
1.000	.938	905.1200	1080.0000	282.05
2.000	1.995	804.5600	977.0000	265.72
3.000	2.993	713.8000	890.0000	262.57
4.000	3.990	632.0100	814.4000	277.16
5.000	4.985	558.2100	747.0000	271.22
6.000	5.993	491.5100	687.1000	264.68
7.000	6.970	431.5700	633.3000	257.74
8.000	7.974	377.4900	585.2000	250.37
9.000	8.970	328.5500	542.0000	242.72
10.000	9.955	285.2200	502.6000	234.99
11.000	10.960	246.2300	377.3000	227.35
12.000	11.954	211.5600	334.5000	220.32
13.000	12.948	180.3200	294.7000	213.89
14.000	13.942	154.0400	257.5000	208.37
15.000	14.936	130.6400	223.6000	203.59
16.000	15.929	110.4400	192.0000	200.33
17.000	16.922	93.1870	163.0000	199.12
18.000	17.914	78.6470	135.5000	200.66
19.000	18.906	65.5330	113.2000	204.67
20.000	19.898	56.4700	94.3000	208.62
21.000	20.890	48.0620	79.1100	211.63
22.000	21.881	40.9960	66.6400	214.31
23.000	22.872	35.0360	56.3100	216.77
24.000	23.853	29.9960	47.7100	219.01
25.000	24.853	25.7190	40.5800	220.92
26.000	25.844	22.0810	34.5500	222.63
27.000	26.833	18.9310	29.4600	224.45
28.000	27.823	16.3380	25.1500	225.32
29.000	28.812	14.0790	21.5200	227.92
30.000	29.801	12.1448	18.4500	229.31
32.000	31.777	9.0709	13.4800	233.32
34.000	33.752	6.6090	9.9630	235.91
36.000	35.726	5.1332	7.2930	240.71
38.000	37.699	3.8305	5.4910	245.62
40.000	39.671	2.9667	4.0920	251.37
42.000	41.641	2.2747	3.0790	256.28
44.000	43.611	1.7550	2.3190	261.74
46.000	45.579	1.3601	1.7750	265.70
48.000	47.545	1.0572	1.3700	267.51
50.000	49.511	.8224	1.0660	267.32
52.000	51.475	.6393	.8343	265.67
54.000	53.438	.4963	.6516	264.07
56.000	55.400	.3847	.5032	261.85
58.000	57.361	.2973	.3993	258.08
60.000	59.320	.2291	.3110	255.29
62.000	61.279	.1758	.2437	249.99
64.000	63.236	.1338	.1934	239.78
66.000	65.191	.1008	.1500	233.08
68.000	67.146	.0750	.1119	217.73
70.000	69.099	.0549	.0805	210.33

TABLE IV-12. HYDROSTATIC MODEL ATMOSPHERE

DECEMBER

STATION - 911620		BARKING SANDS, HI		TV
Z	GEO. HT.	P	D	DEG K
KM	KM	MB	G/MB	
.000	.000	1016.1000	1195.0000	235.22
.005	.005	1015.5000	1195.0000	233.11
1.000	.908	904.6700	1084.5000	200.70
2.000	1.995	803.8000	979.0000	200.65
3.000	2.993	712.8000	882.9000	201.27
4.000	3.990	630.7700	795.4000	205.91
5.000	4.985	556.8000	718.4000	210.00
6.000	5.983	490.1000	647.9000	213.51
7.000	6.979	429.7500	584.4000	216.32
8.000	7.974	375.8000	525.7000	219.02
9.000	8.970	327.1600	471.7000	221.61
10.000	9.965	283.5900	421.6000	224.19
11.000	10.960	244.7300	375.5000	227.02
12.000	11.954	210.2700	332.6000	229.61
13.000	12.948	179.8300	292.0000	214.64
14.000	13.942	153.2600	255.2000	209.19
15.000	14.936	130.6500	221.7000	204.36
16.000	15.929	109.5300	191.0000	200.62
17.000	16.922	92.8040	162.7000	199.67
18.000	17.914	78.2670	136.7000	199.42
19.000	18.906	66.1370	113.4000	203.20
20.000	19.899	56.0750	94.1700	207.45
21.000	20.890	47.6880	78.8200	210.78
22.000	21.881	40.6540	66.2800	213.67
23.000	22.872	34.7270	55.9000	216.07
24.000	23.863	29.7180	47.4000	218.43
25.000	24.853	25.4720	40.2400	220.51
26.000	25.844	21.6630	34.2600	222.58
27.000	26.833	18.7880	29.2300	223.90
28.000	27.823	16.1630	24.9900	225.31
29.000	28.812	13.9180	21.3500	226.69
30.000	29.801	11.9263	18.3200	228.08
32.000	31.777	8.9480	13.4100	232.09
34.000	33.752	6.7019	9.2100	235.13
36.000	35.725	5.0437	7.3310	238.23
38.000	37.693	3.8225	5.3510	246.23
40.000	39.671	2.9803	4.0070	253.62
42.000	41.641	2.2459	3.0160	259.05
44.000	43.611	1.7372	2.2800	255.01
46.000	45.579	1.3498	1.7550	257.88
48.000	47.545	1.0506	1.3520	263.28
50.000	49.511	.8179	1.0610	269.22
52.000	51.475	.6357	.8521	267.45
54.000	53.438	.4950	.6893	265.48
56.000	55.400	.3942	.5670	262.62
58.000	57.361	.2979	.4595	262.60
60.000	59.320	.2304	.3700	256.47
62.000	61.279	.1771	.2953	250.59
64.000	63.235	.1352	.1927	243.97
66.000	65.191	.1020	.1535	231.08
68.000	67.146	.0759	.1103	220.41
70.000	69.099	.0559	.0835	217.08

TABLE IV-13. HYDROSTATIC MODEL ATMOSPHERE

ANNUAL

STATION # 911620		BARKING SANDS, HI		TV
Z	Geo. Ht.	P	D	CEG K
km	km	mb	G M3	
.000	.000	1016.5000	1183.0000	293.26
.005	.005	1015.5000	1183.0000	293.16
1.000	.938	925.6500	1082.0000	291.50
2.000	1.995	804.8500	979.9000	286.14
3.000	2.993	713.8500	892.4000	281.81
4.000	3.990	631.8600	796.1000	276.51
5.000	4.986	557.9100	718.3000	270.59
6.000	5.983	491.2100	648.1000	264.04
7.000	6.979	431.0700	584.3000	257.00
8.000	7.974	376.9000	525.9000	249.67
9.000	8.970	329.2300	472.0000	242.24
10.000	9.965	284.6300	422.3000	234.79
11.000	10.960	245.7100	376.4000	227.42
12.000	11.954	211.1300	333.4000	220.60
13.000	12.948	180.6100	293.5000	214.37
14.000	13.942	153.8500	256.3000	209.16
15.000	14.936	130.6000	221.8000	205.12
16.000	15.929	110.5700	190.2000	202.53
17.000	16.922	93.4890	161.5000	201.69
18.000	17.914	79.0640	135.7000	202.97
19.000	18.905	66.9580	113.2000	206.08
20.000	19.898	56.9070	94.6400	209.47
21.000	20.890	48.4630	79.4900	212.37
22.000	21.881	41.3600	67.0200	214.97
23.000	22.872	35.3630	56.6900	217.30
24.000	23.863	30.2870	48.0000	219.55
25.000	24.853	25.9900	40.8400	221.62
26.000	25.844	22.3160	34.7700	223.62
27.000	26.833	19.1980	29.6500	225.53
28.000	27.823	16.5360	25.3300	227.40
29.000	28.812	14.2610	21.6900	229.12
30.000	29.801	12.3120	18.5900	230.71
32.000	31.777	9.2127	13.6000	234.85
34.000	33.752	6.9289	10.0600	239.82
36.000	35.726	5.2377	7.4000	243.18
38.000	37.699	3.9810	5.5600	248.16
40.000	39.671	3.0439	4.1500	253.86
42.000	41.641	2.3417	3.1200	259.38
44.000	43.611	1.8105	2.3790	263.74
46.000	45.579	1.4049	1.8200	266.38
48.000	47.545	1.0923	1.4100	267.30
50.000	49.511	.8194	1.1030	265.80
52.000	51.475	.6601	.8619	265.41
54.000	53.433	.5122	.6740	263.36
56.000	55.400	.3906	.5271	260.73
58.000	57.361	.3063	.4121	257.50
60.000	59.320	.2357	.3222	253.49
62.000	61.279	.1804	.2530	247.12
64.000	63.235	.1370	.1902	238.27
66.000	65.191	.1030	.1551	230.07
68.000	67.145	.0754	.1219	217.08
70.000	69.099	.0660	.0915	211.95

APPENDIX A

EXAMPLES OF WIND STATISTICS FOR BARKING SANDS, HAWAII

Appendix A gives some examples of graphical displays of wind statistics that can be derived from the statistical parameters presented in table I. These illustrations should aid the user of the RRA to understand the functional relationships of the probability wind models and, thus, to develop an appreciation of the powerful properties of the bivariate normal probability distribution function.

All illustrations for this appendix are derived from the five wind component statistical parameters from table I.1 for January and table I.7 for July for eight selected altitudes. These selected altitudes are 4, 12, 20, 30, 40, 50, 60, and 70 km.

1. Frequency of Wind Direction (Figures A-1 through A-16)

The derived frequencies for wind direction shown in figures A-1 through A-16 were obtained using the five wind component parameters from tables I.1 and I.7 as input values in equation (35). The limits of integration (performed numerically) are over the 22.5-degree interval for each of the 16 compass points. These graphs give the percentage frequency that the wind will blow from the direction intervals.

2. Mean Wind Components and 80th Interpercentile Range of Wind Components (Figures A-17 through A-32)

The wind component means with respect to any orthogonal axes are obtained by using the zonal and meridional mean wind components in equations (44) and (45). These component means form the circles shown in figures A-17 through A-32. Further, the zonal and meridional wind component variances and correlation coefficients are used in equations (46) and (47) to obtain the variances with respect to any orthogonal axes. These rotated component variances and the rotated component means are used in equation (8) to obtain the 80th interpercentile range of wind components and are then illustrated in figures A-17 through A-32.

3. Probability Ellipses (Figures A-33 through A-48)

Using the five wind component parameters from tables I.1 and I.7 and $p = 0.50$, $p = 0.95$, and $p = 0.99$ as input values to equation (13), the wind probability ellipses shown in figures A-33 through A-48 were obtained by computer graphics. The statistical inferences are, for example, that 50 percent of the wind vectors lie within the smaller ellipse and 99 percent of the wind vectors lie within the outer ellipse. These probability ellipses are illustrated using the standard meteorological coordinate system explained in section I.B.1.

4. Conditional Windspeed Given the Wind Direction (Figures A-49 through A-64)

The five wind component parameters from table I.1 and table I.7 are used to evaluate the conditional probability distribution function, equation (41). Figures A-49 through A-64 show interpolations of the conditional function made to

obtain the 5th, 15th, 50th (median), 85th, 95th, and 99th conditional percentile values of windspeed, given the wind directions. The conditional mean windspeed, given the wind direction, is obtained from equation (40). The conditional mode (most probable) windspeed, given the wind direction, is obtained from equation (38). The conditional mean windspeed and the conditional windspeed modal value, given the wind direction, are also shown in these figures. For some figures, the conditional windspeed values are invalid for the given wind direction near 270° (from the west). This is caused by the lack of computational precision in evaluating equations (40) and (41) when the arguments for the Gaussian probability distribution have large negative values, i.e., when the coefficients (b/a) become less than -4 in these equations.

This appendix contains only a few of the many options in presenting wind statistics illustrations.

STATION=BARKINGSANDS MONTH=JAN ALT= 4KM

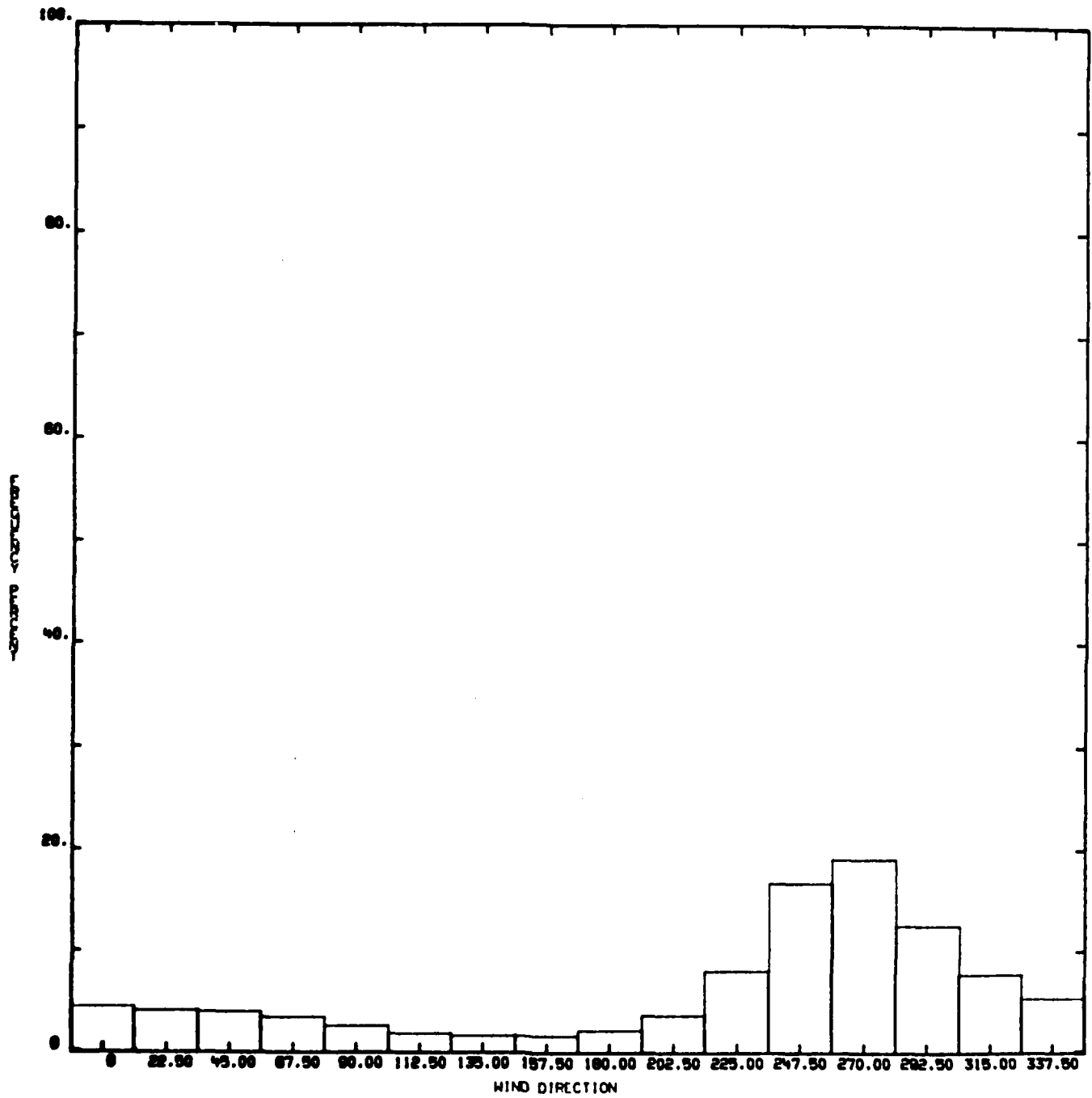

Figure A-1.

STATION=BARKINGSANDS MONTH=JAN ALT=12KM

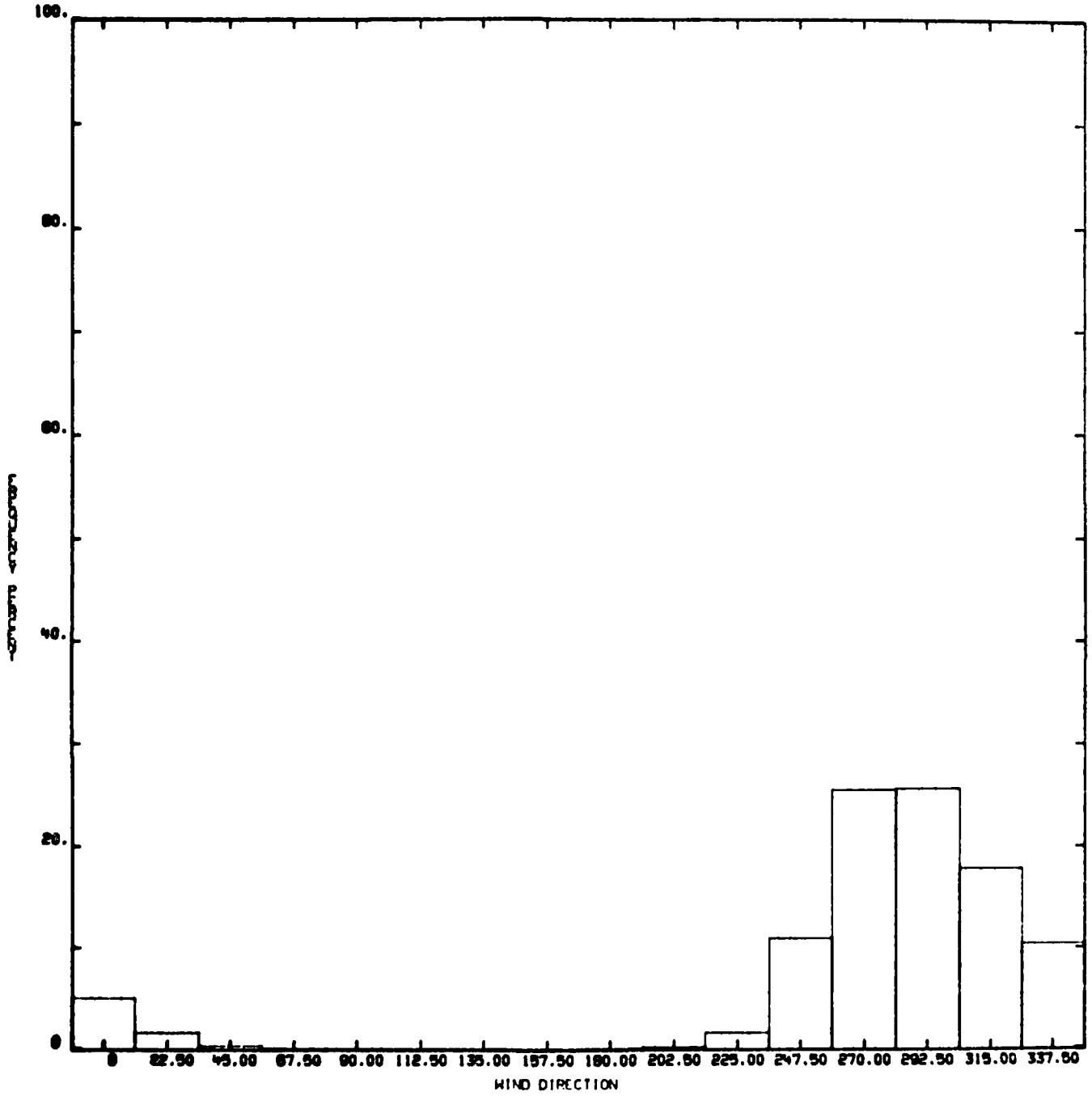

Figure A-2.

STATION=BARKINGSANDS MONTH=JAN ALT=20KM

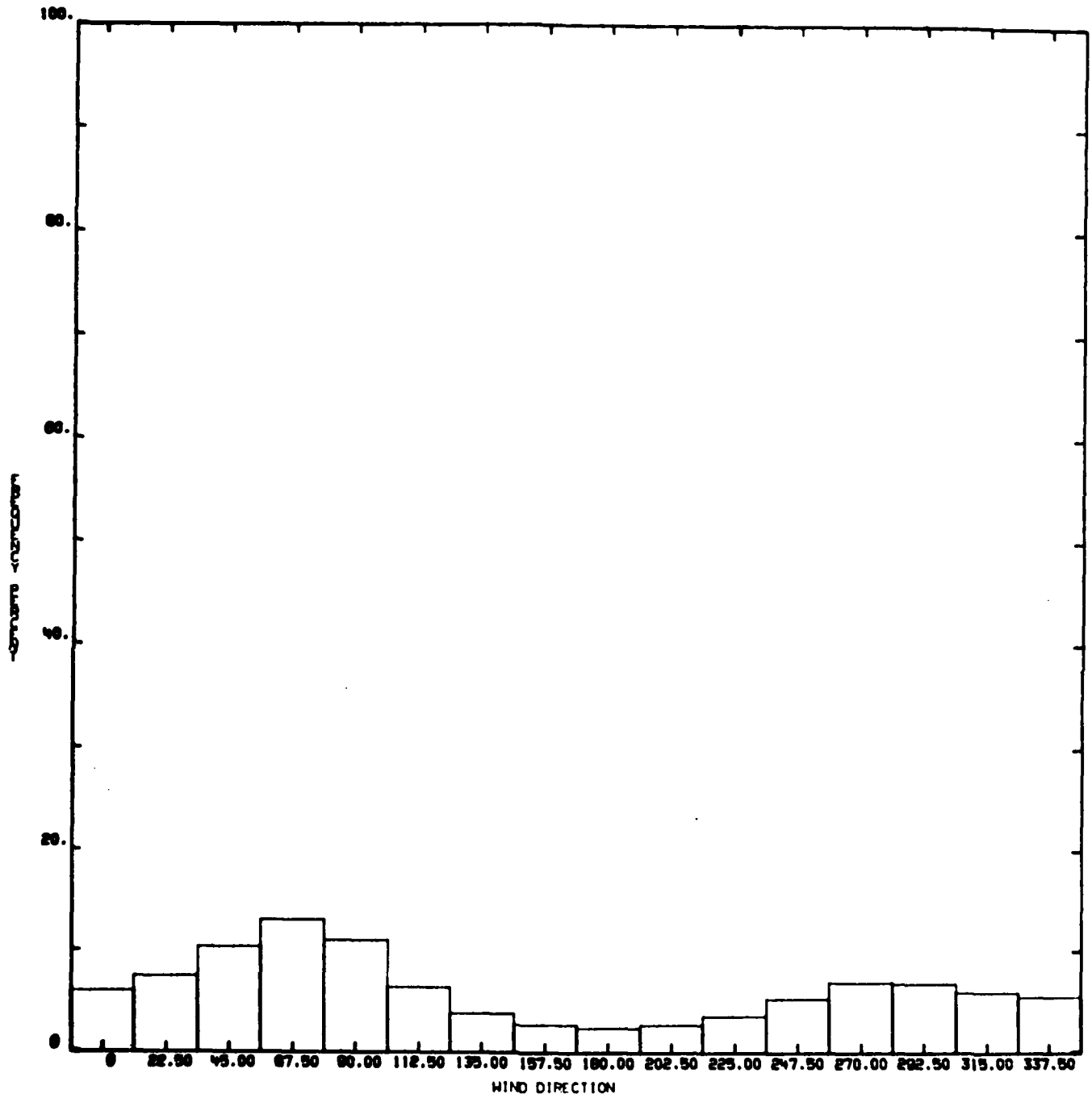

Figure A-3.

STATION=BARKINGSANDS MONTH=JAN ALT=30KM

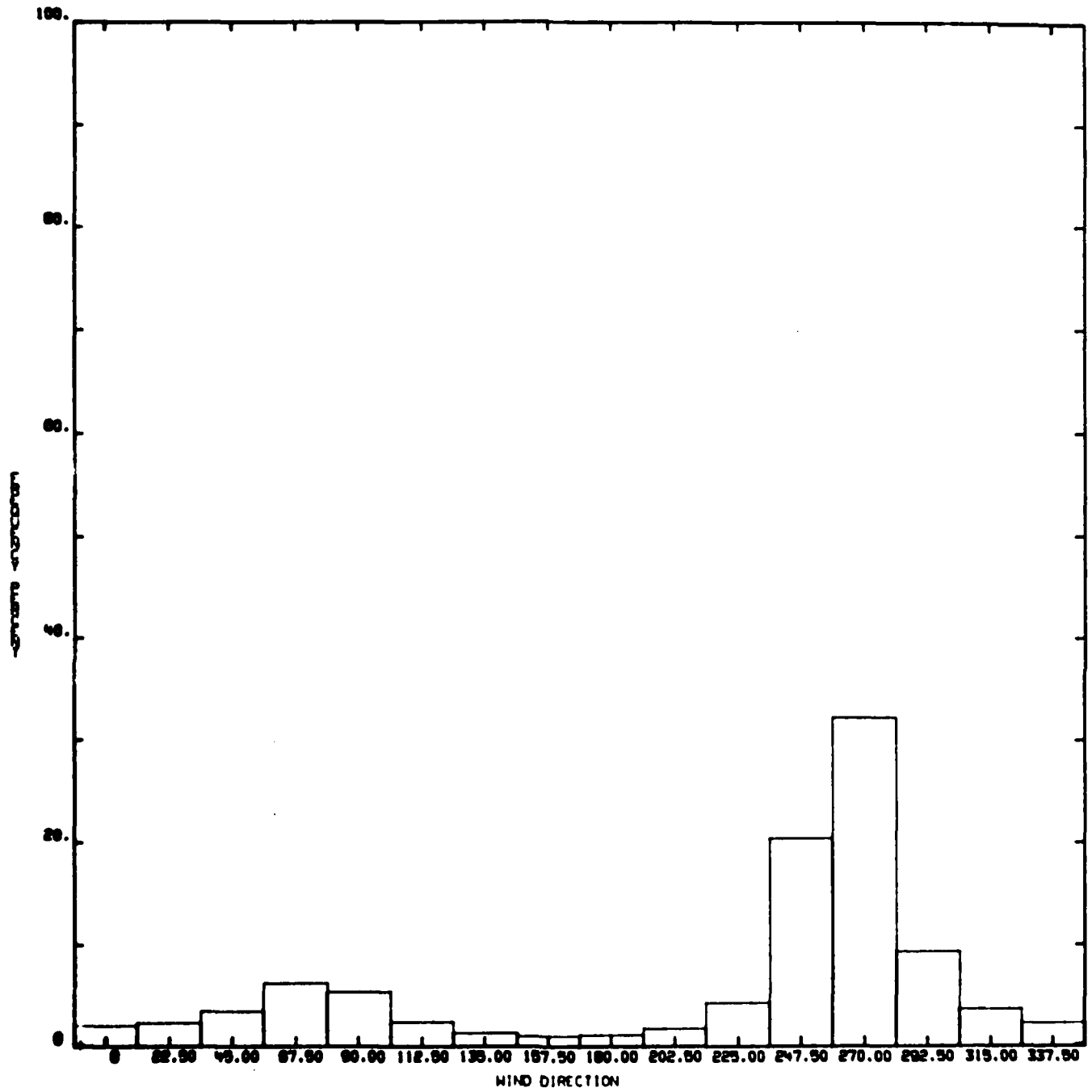

Figure A-4.

STATION=BARKINGSANDS MONTH=JAN ALT=40KM

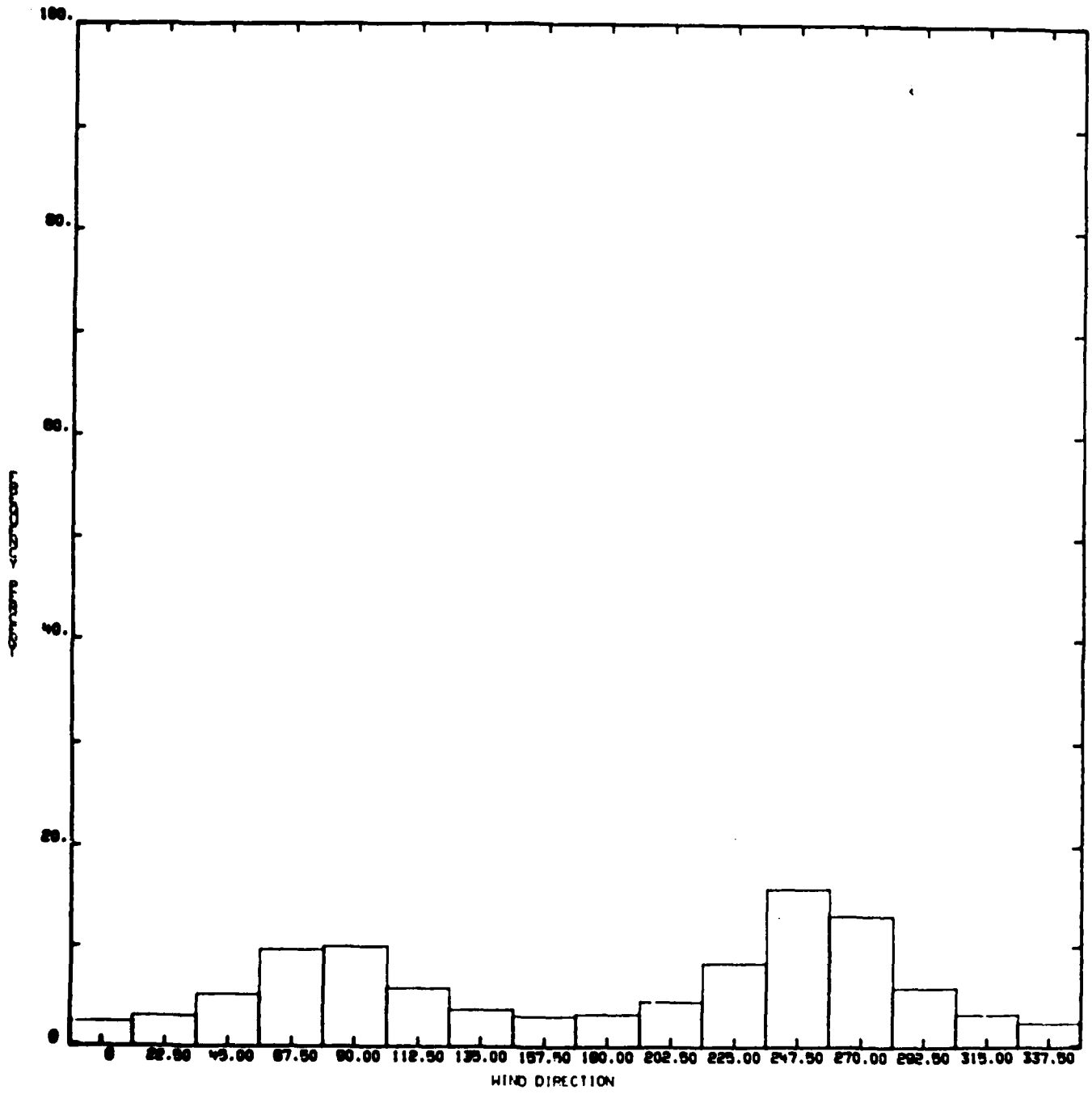

Figure A-5.

STATION=BARKINOSANDS MON. JAN ALT=50KM

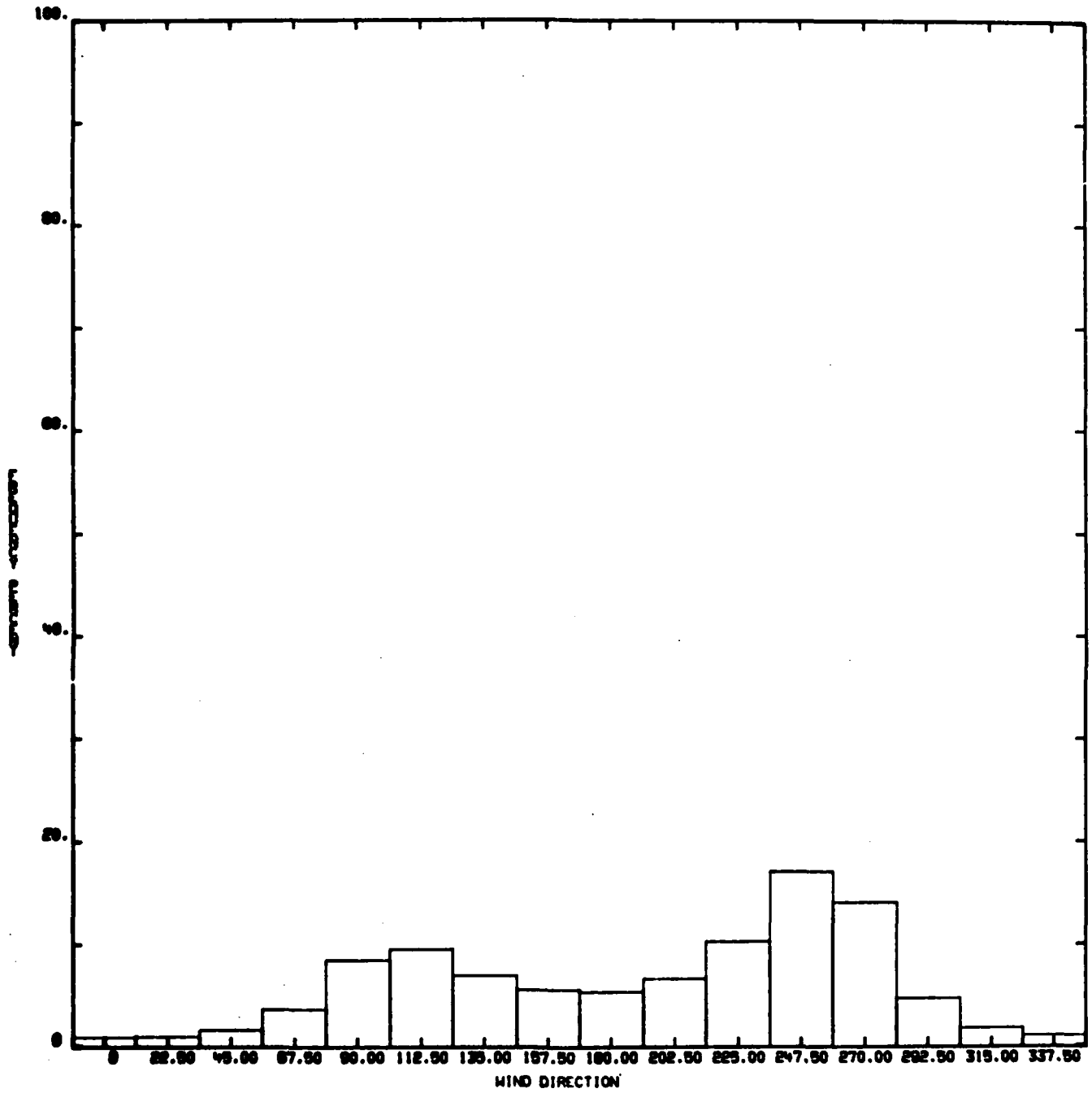

Figure A-6.

STATION=BARKINGSANDS MON. -JAN ALT=60KM

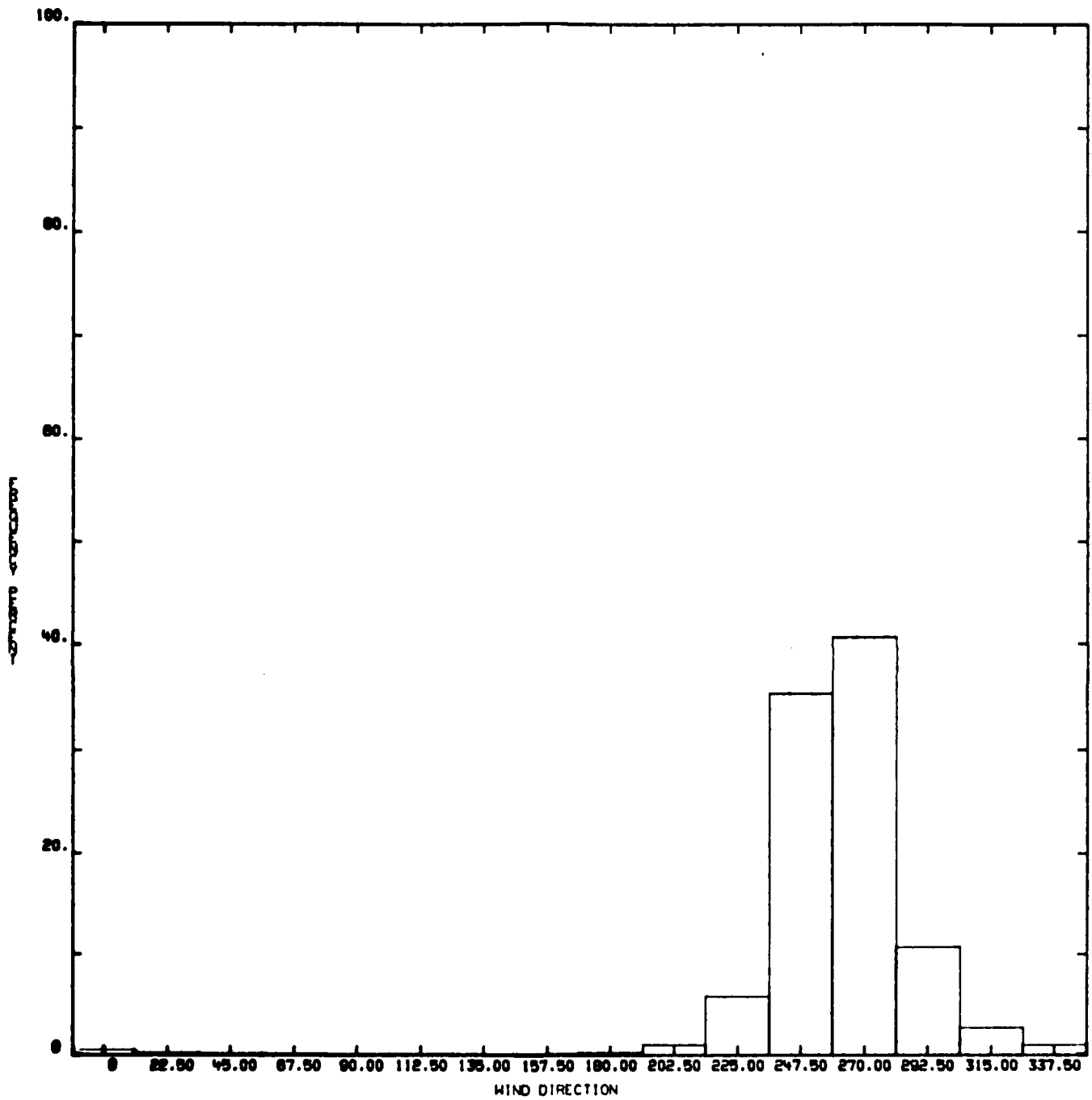

Figure A-7.

STATION=BARKINGSANDS MONTH=JAN ALT=70KM

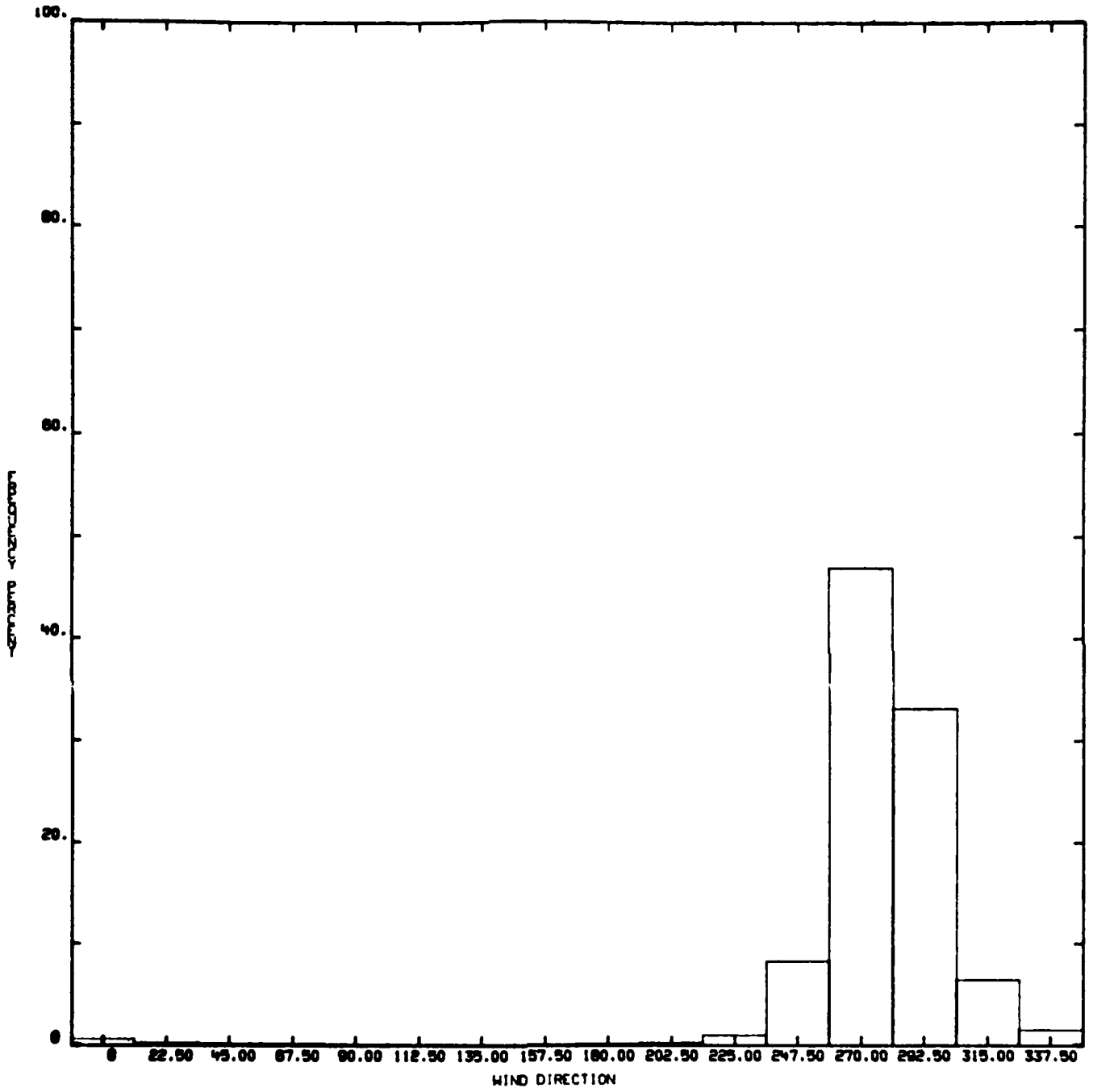

Figure A-8.

STATION=BARKINGSANDS MONTH=JUL ALT= 4KM

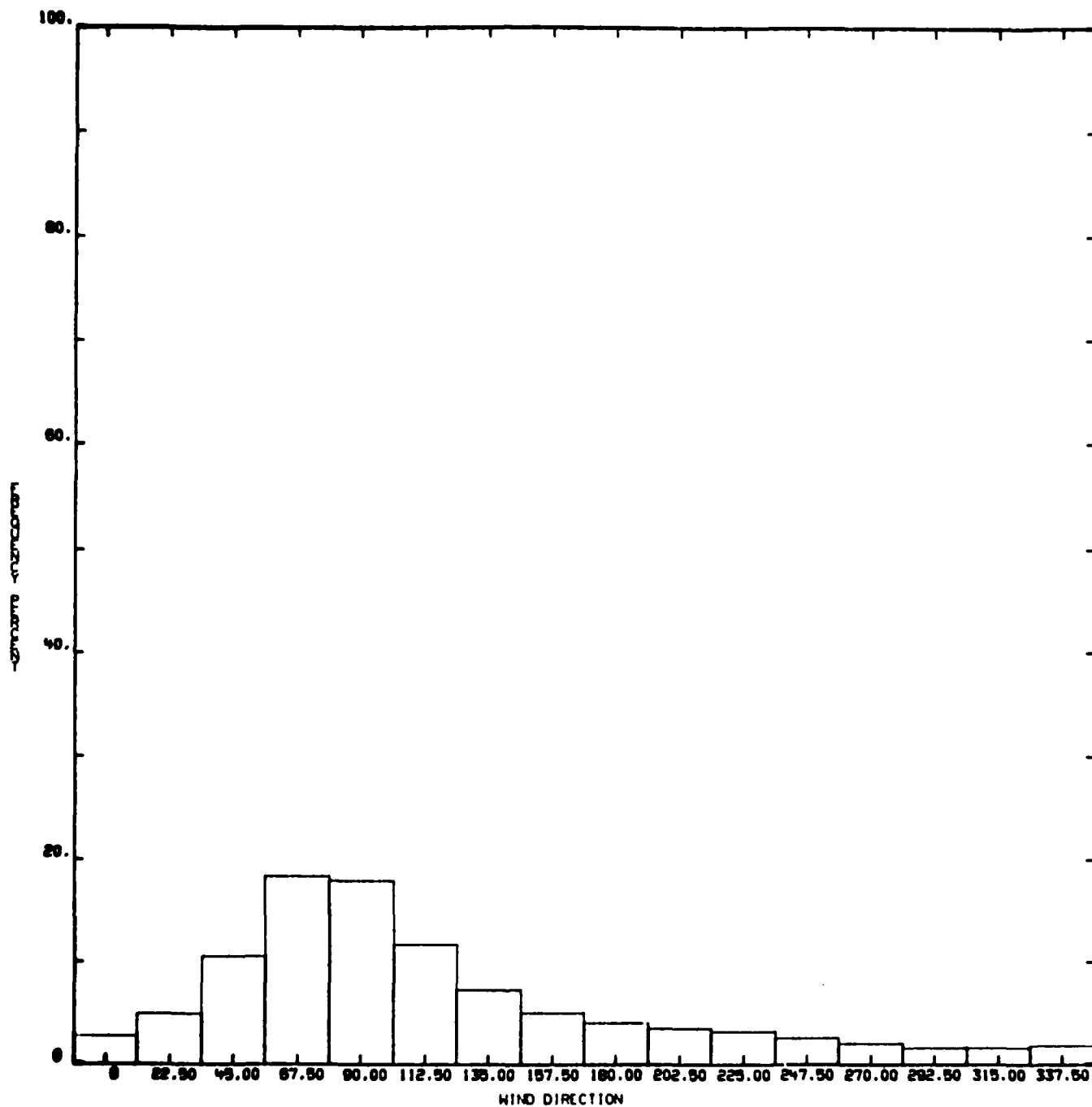

Figure A-9.

STATION=BARKINOSANDS MONTH=JUL ALT=120M

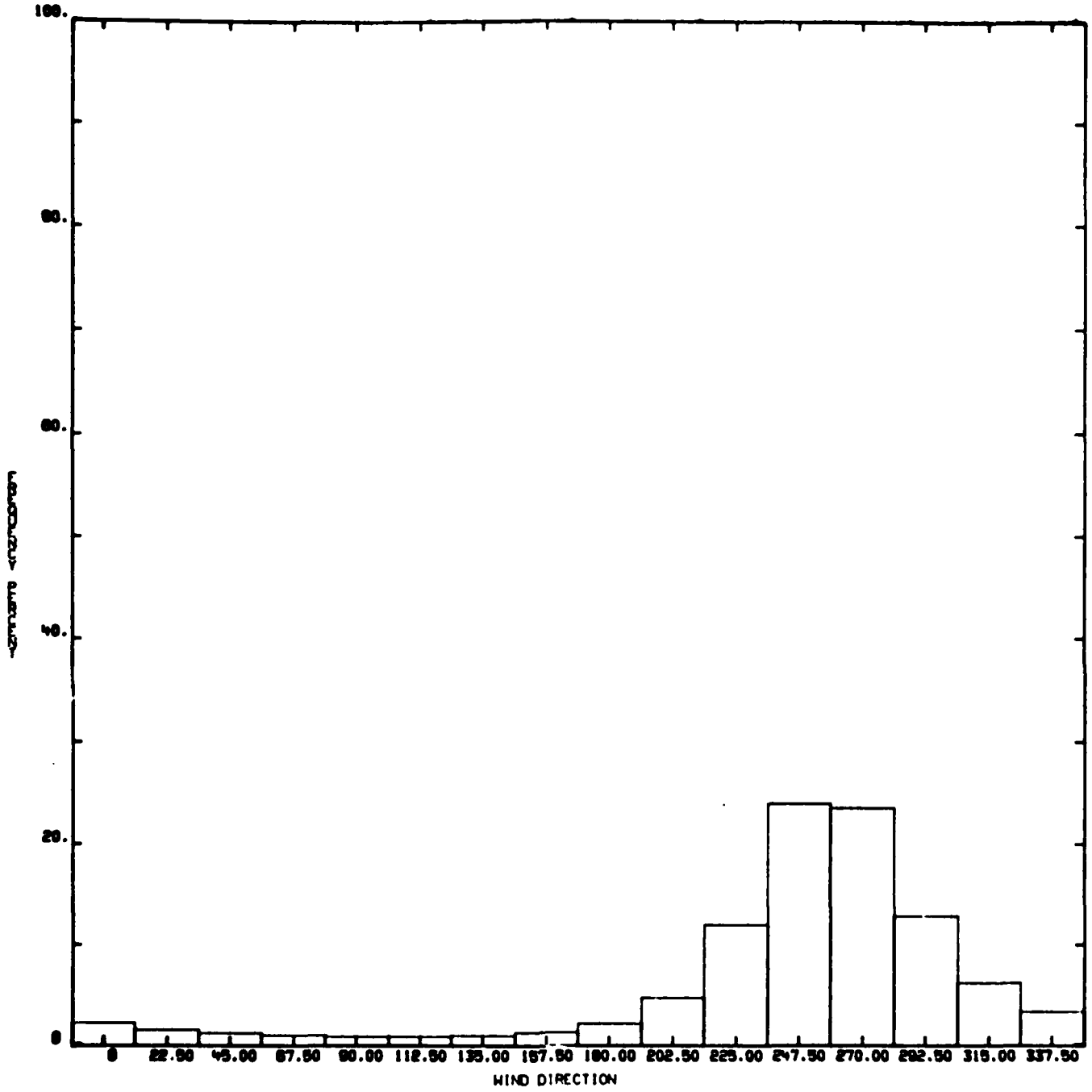

Figure A-10.

STATION=BARKINGSANDS MONTH=JUL ALT=20KM

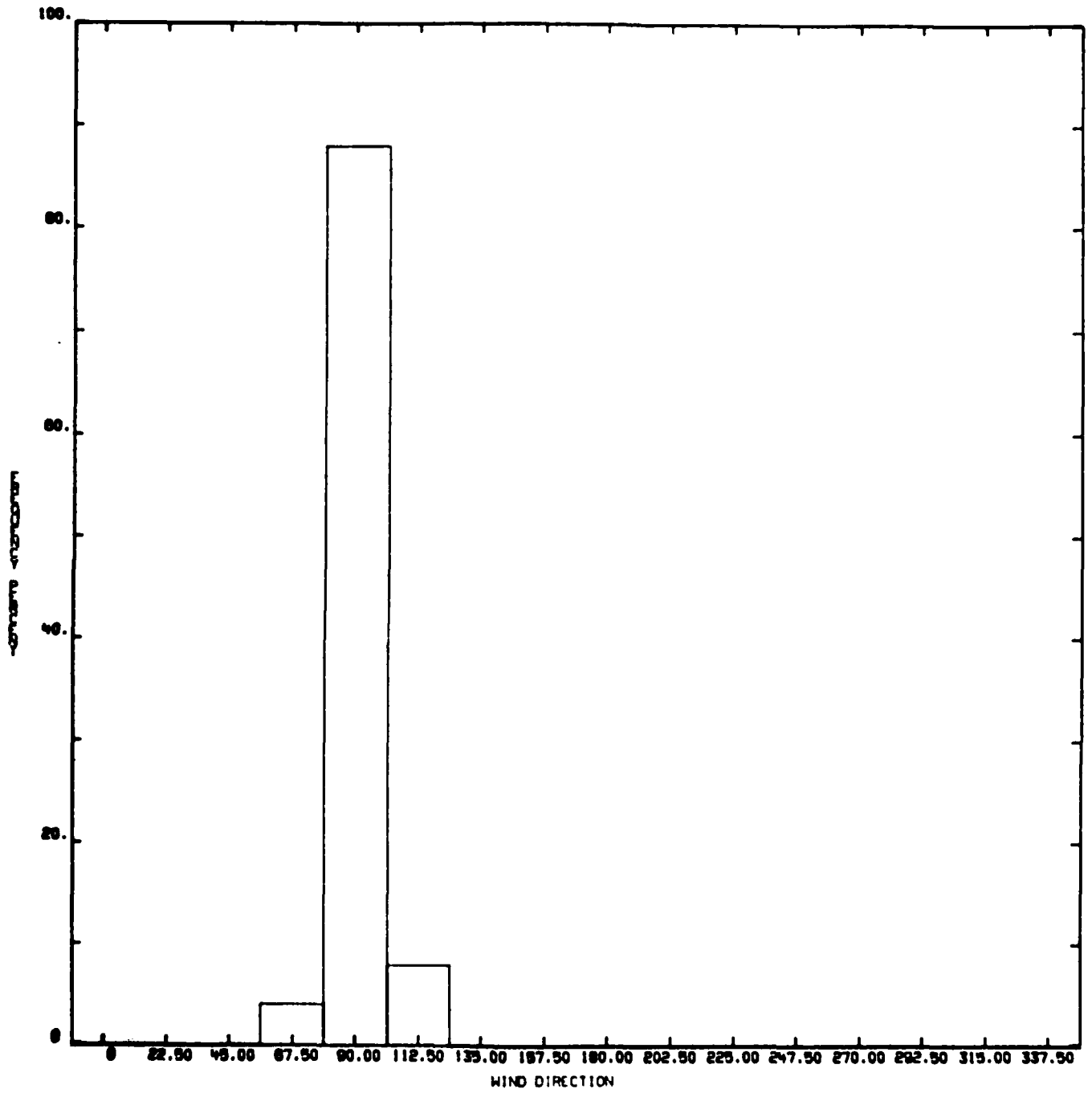

Figure A-11.

STATION=BARKINGSANDS MONTH=JUL ALT=30KM

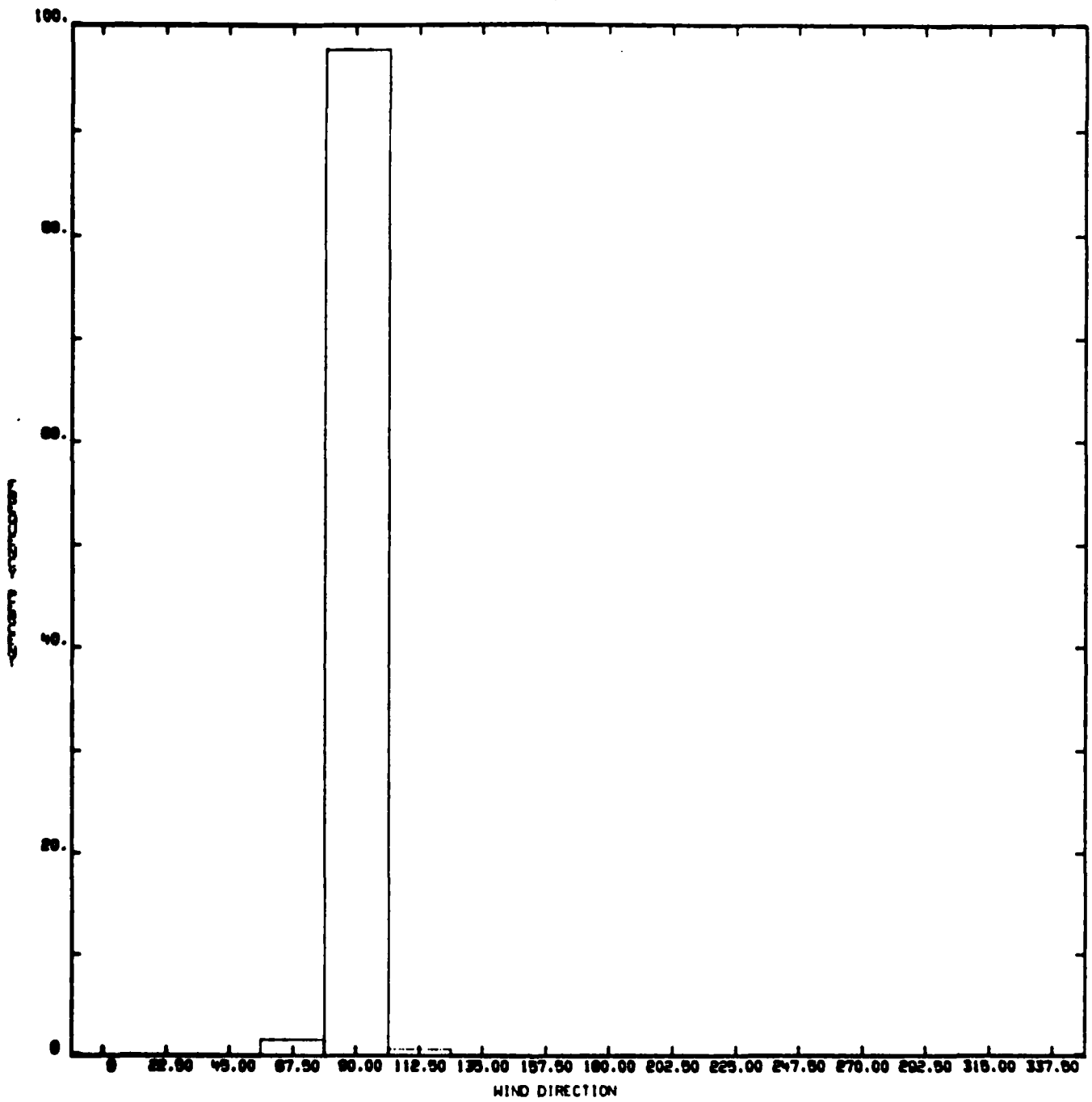

Figure A-12.

STATION=BARKINGSANDS MONTH=JUL ALT=40KM

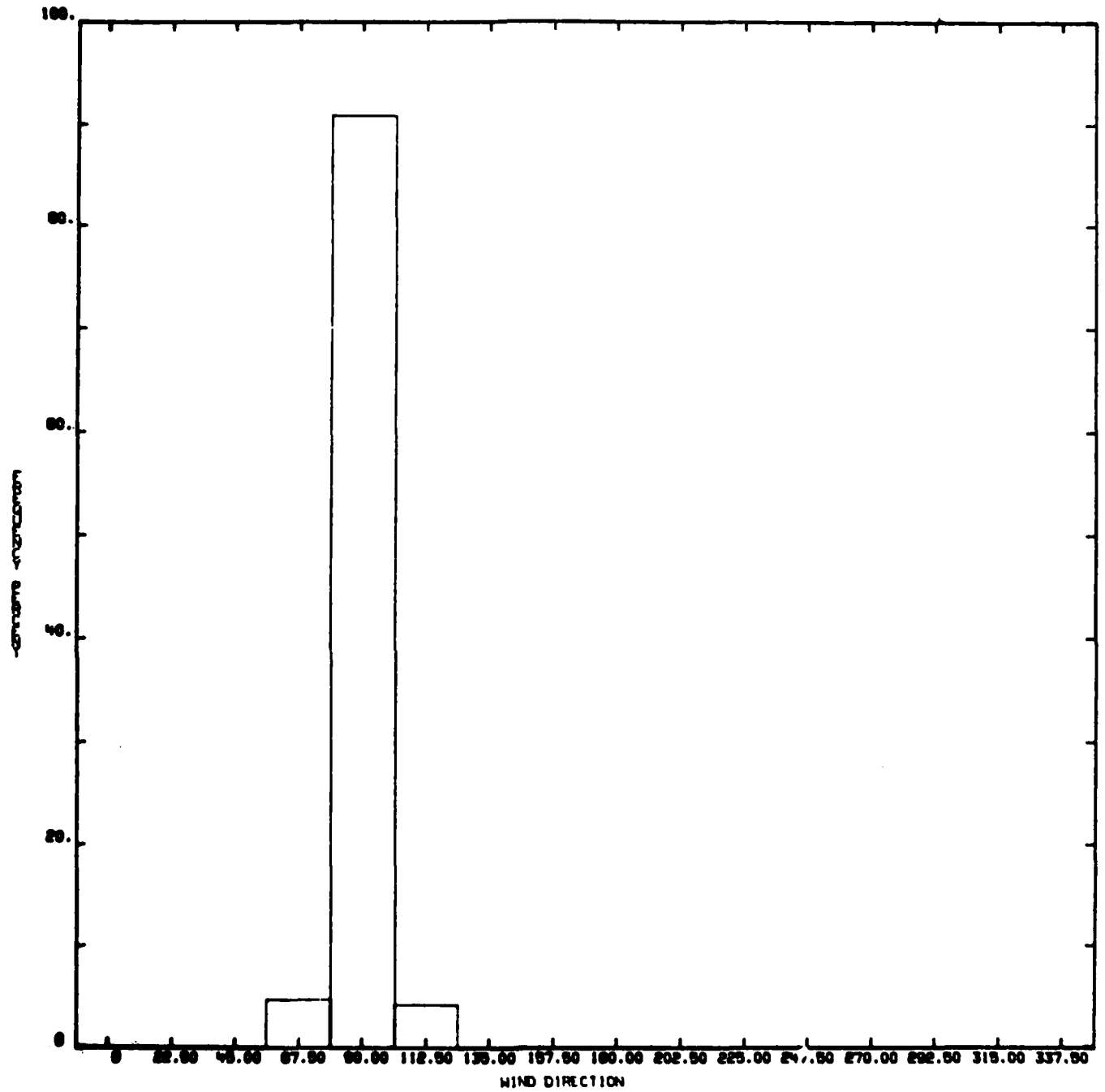

Figure A-13.

STATION=BARKINGSANDS MON17=JUL ALT=50KM

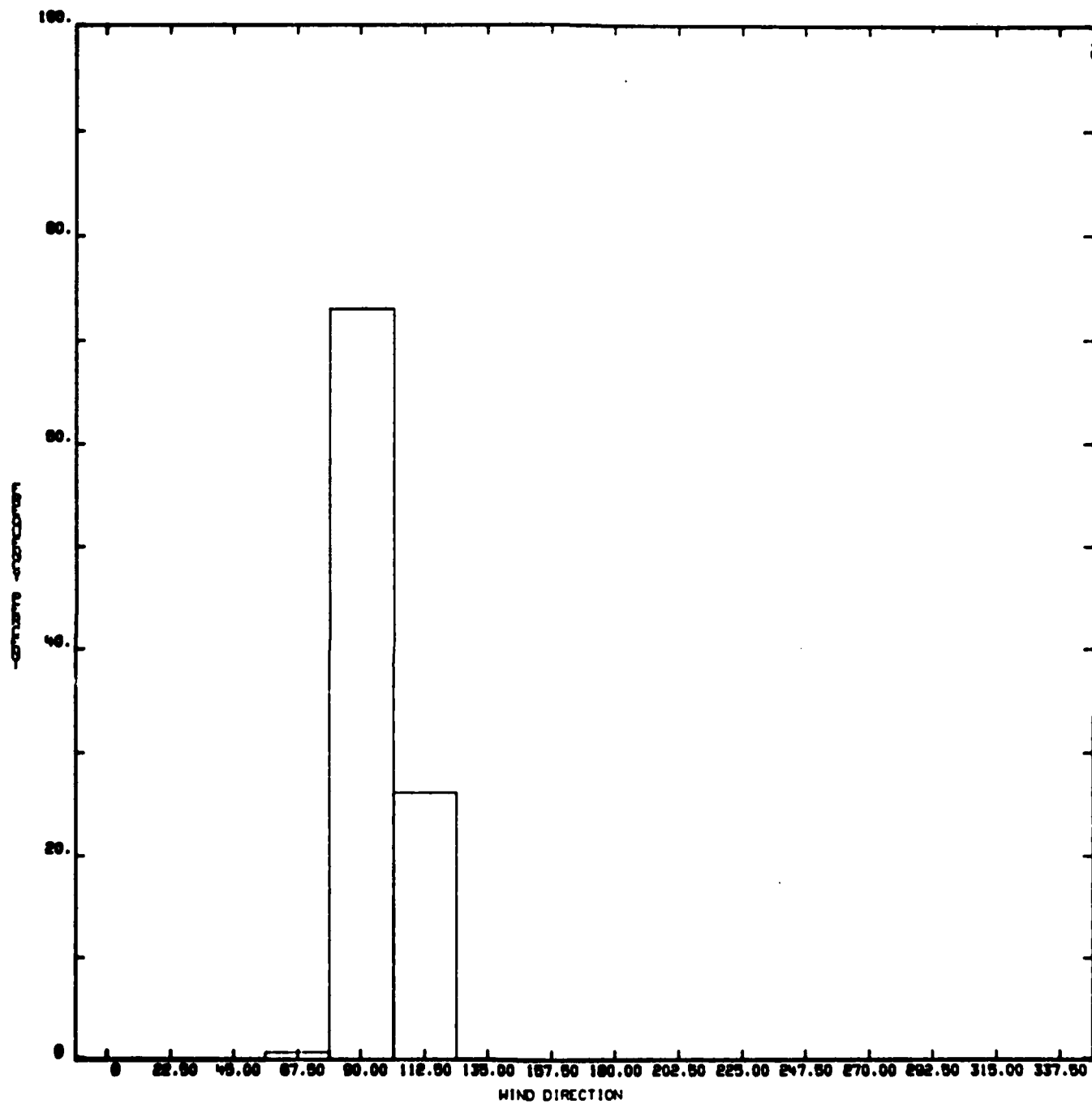

Figure A-14.

STATION=BARKINGSANDS MONTH=JUL ALT=60KM

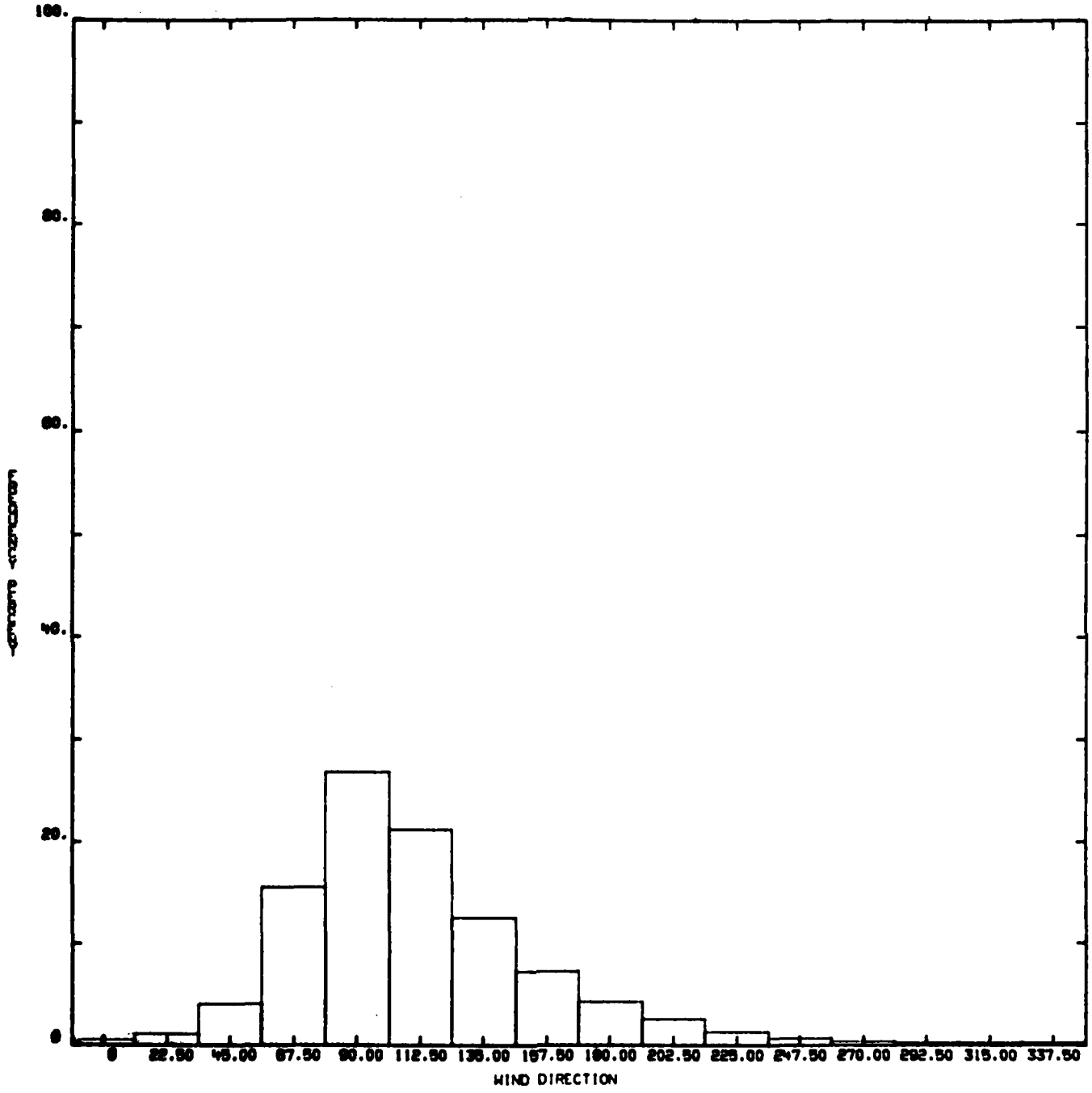

Figure A-15.

STATION=BARKINGSANDS MONTH=JUL ALT=70KM

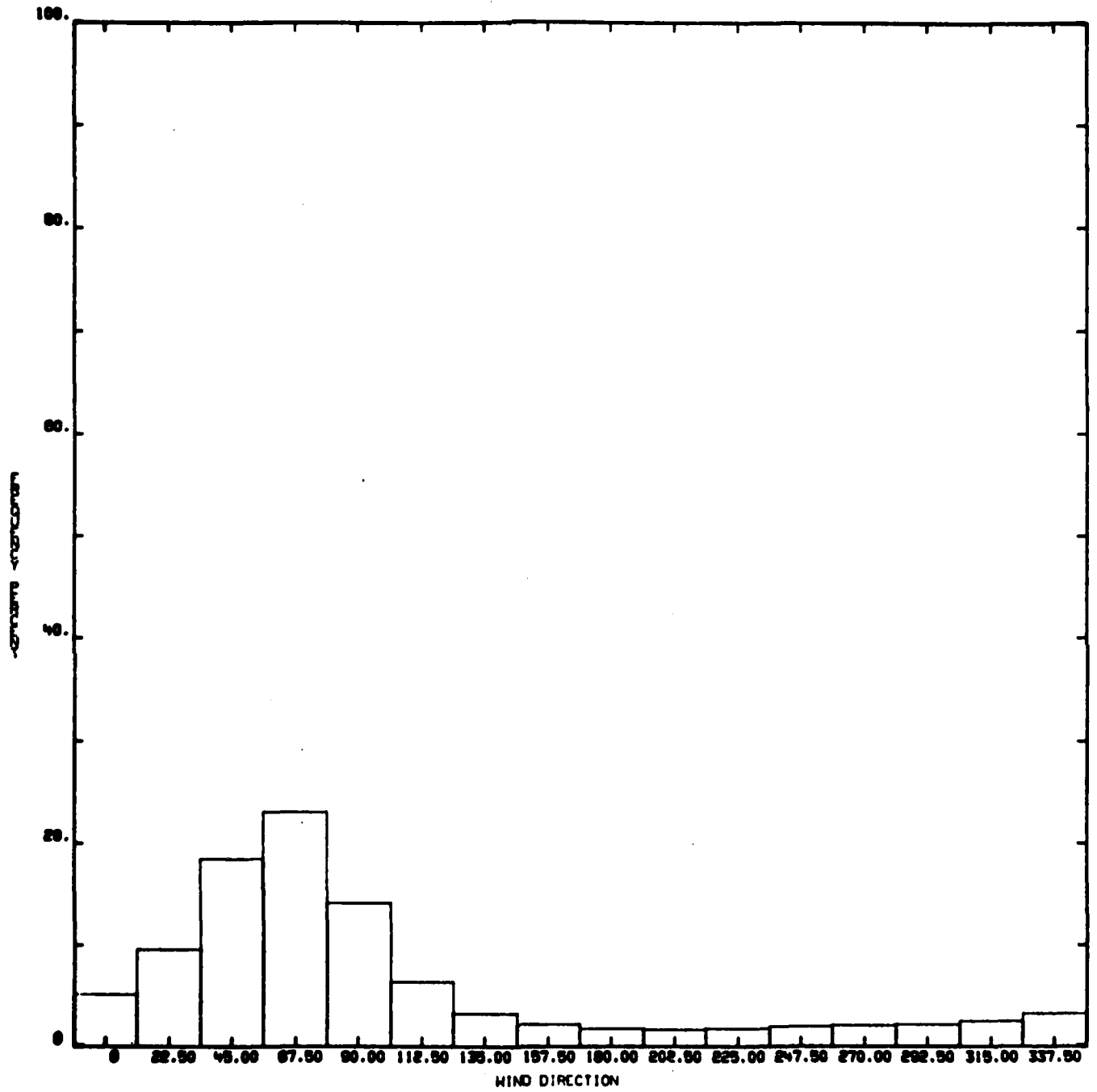

Figure A-16.

XBAR= 6.97 SIGMAX= 9.44 RHO= .2794 YBAR= -.43 SIGMAY= 6.62 PERCENT=****

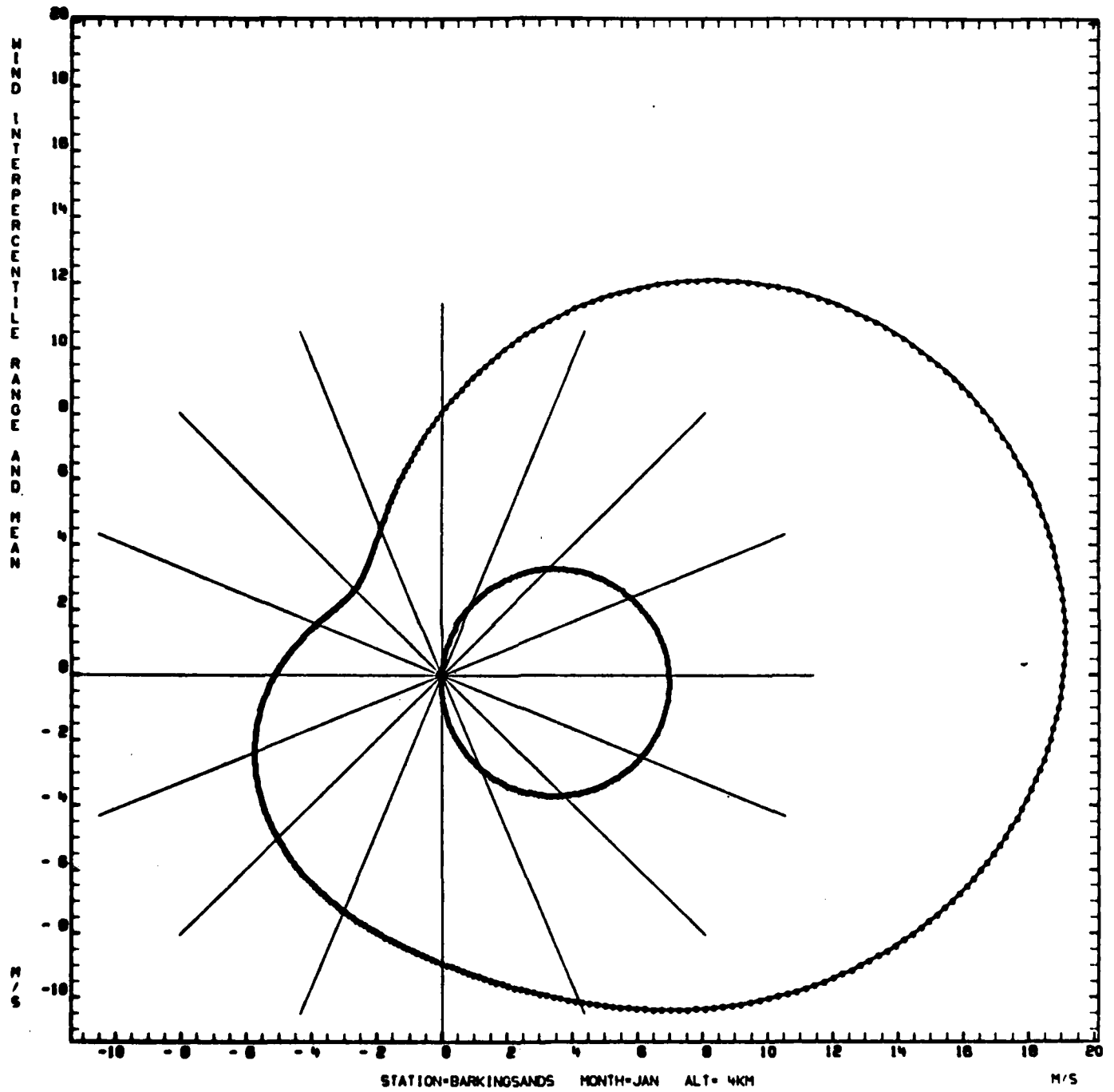

Figure A-17.

XBAR= 29.62 SIGMAX= 17.41 RHO= .4202 YBAR=-11.09 SIGMAY= 16.38 PERCENT=*****

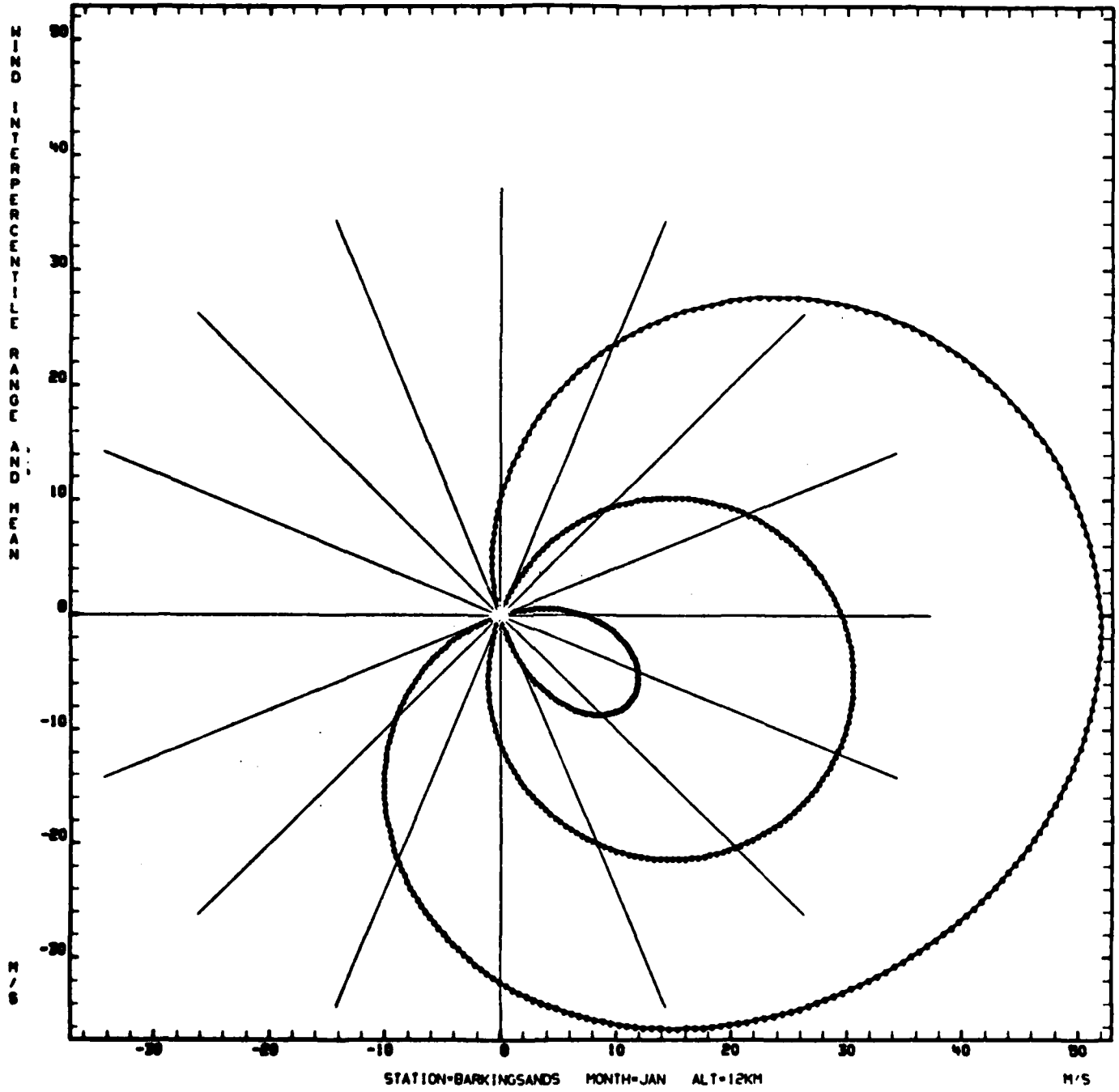

Figure A-18.

XBAR= -1.01 SIGMAX= 4.42 RHO= .1235 YBAR= -1.08 SIGMAY= 2.89 PERCENT=*****

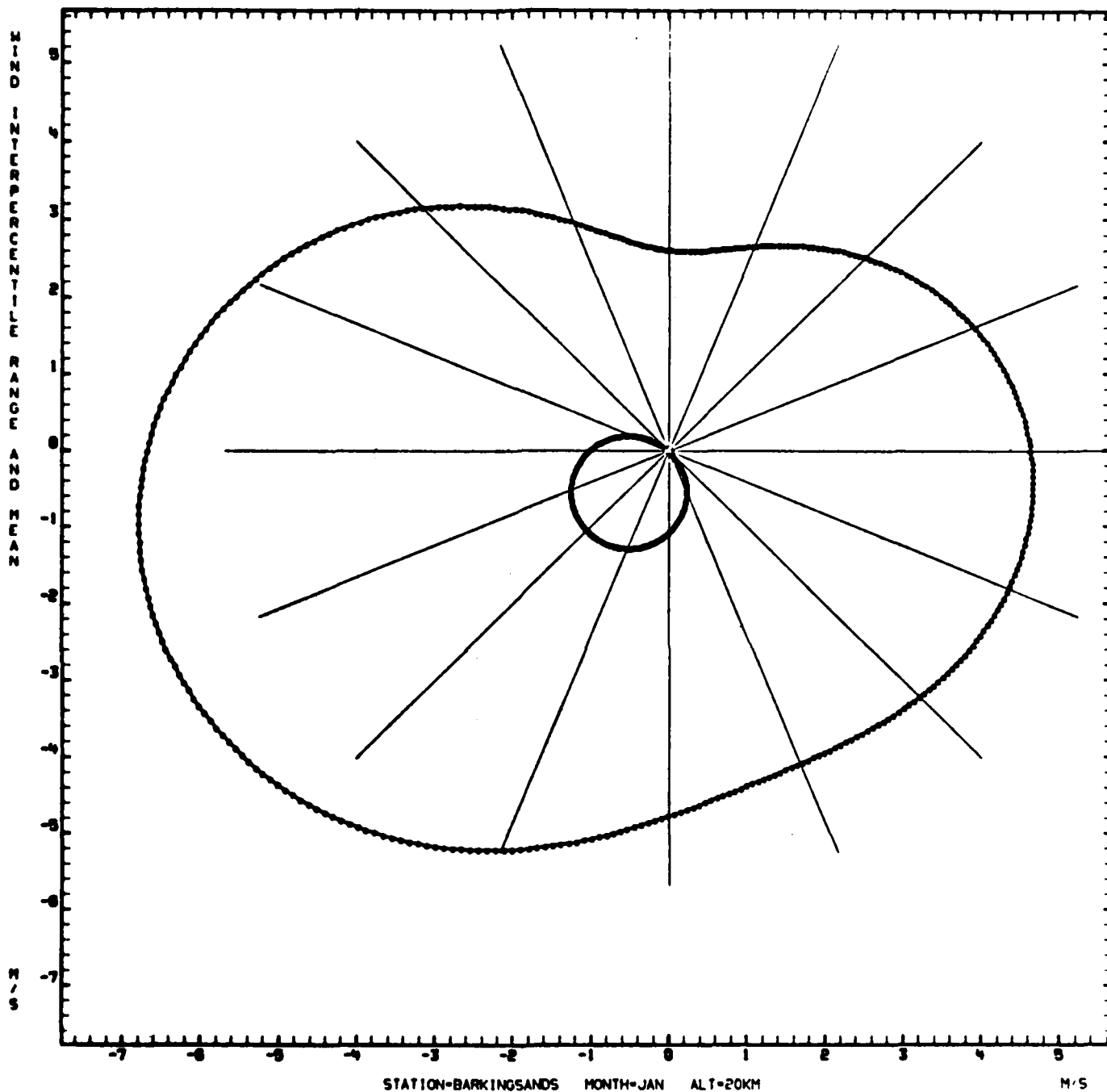

Figure A-19.

XBAR= 8.70 SIGMAX= 12.41 RHO= .4313 YBAR= .52 SIGMAY= 4.39 PERCENT=****

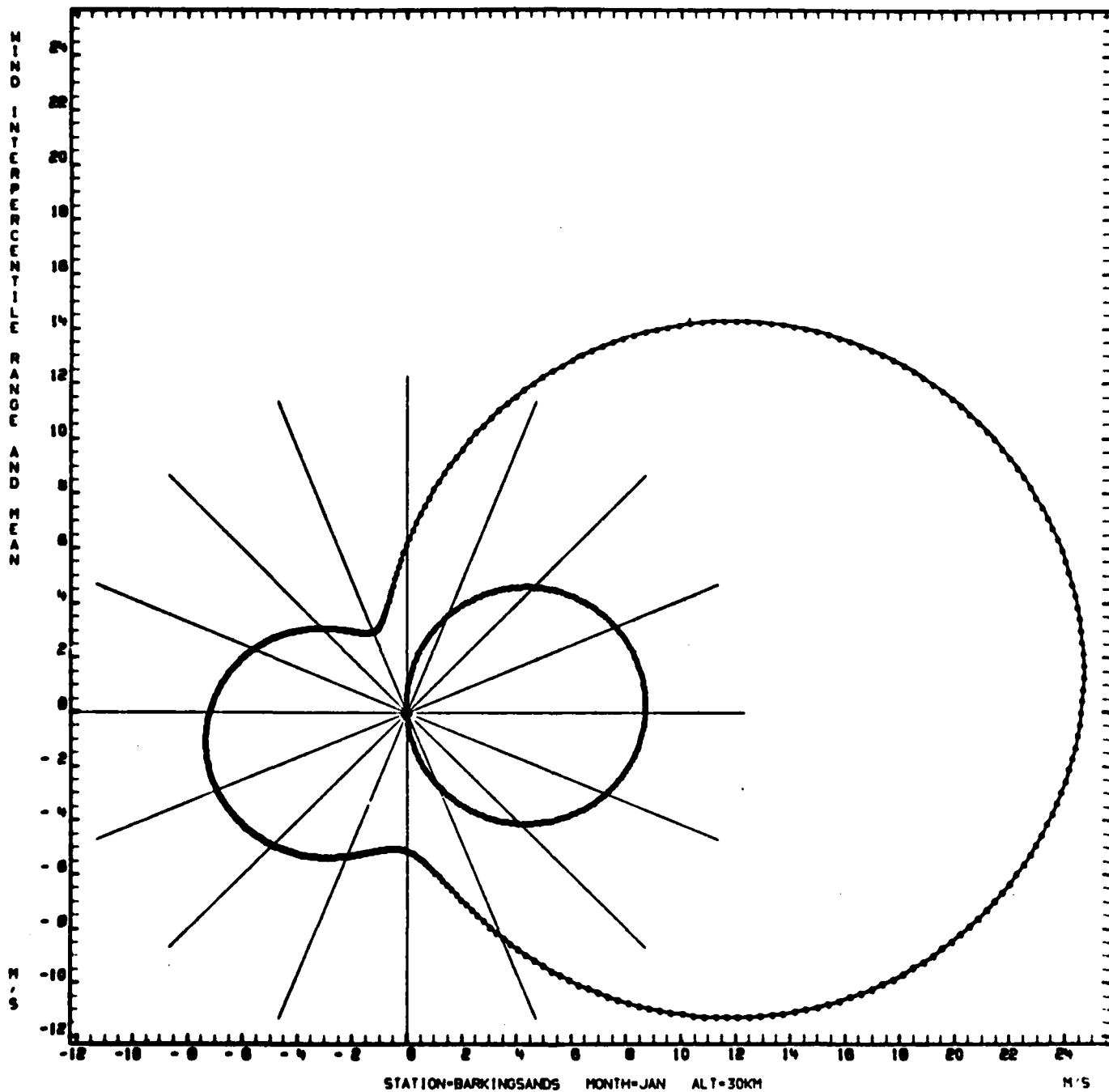

Figure A-20.

XBAR= 2.59 SIGMAX= 16.22 RHO= .3803 YBAR= 1.40 SIGMAY= 7.94 PERCENT=*****

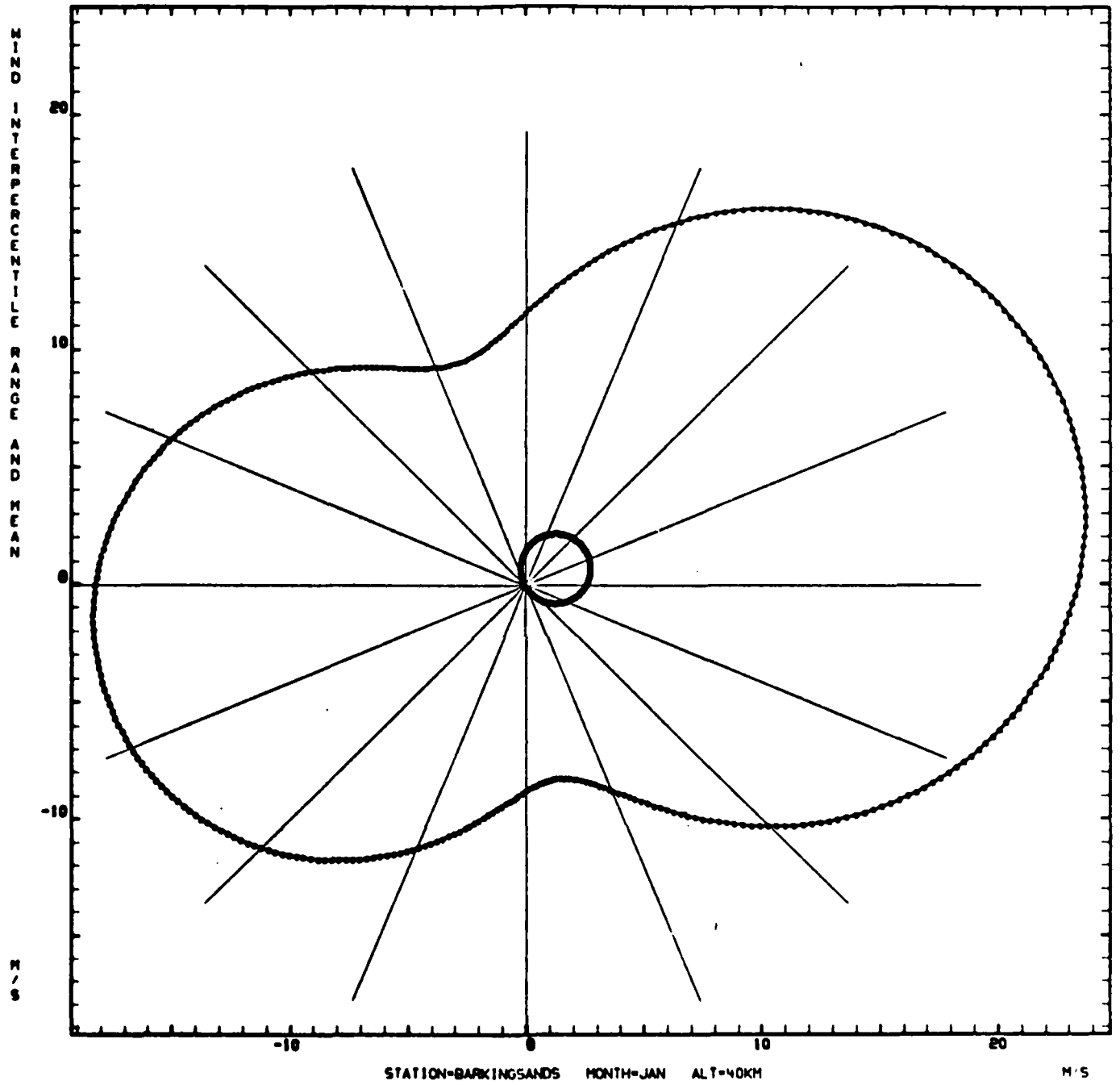

Figure A-21.

XBAR= 9.97 SIGMAX= 25.11 RHO= .0579 YBAR= 7.50 SIGMAY= 10.90 * PERCENT=*****

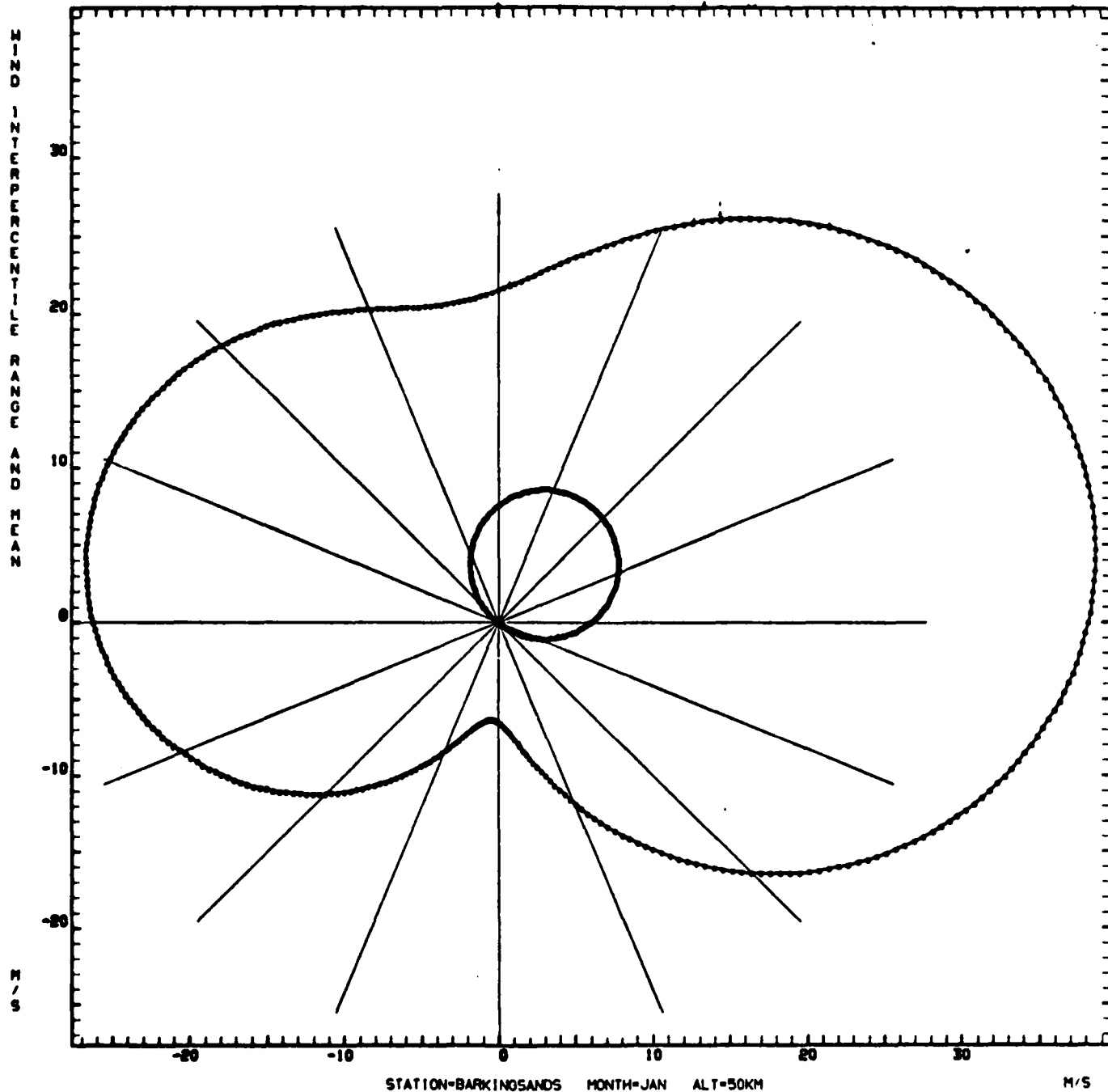

Figure A-22.

XBAR= 52.01 SIGMAX= 24.99 RHO= .3074 YBAR= 7.77 SIGMAY= 16.09 PERCENT=****

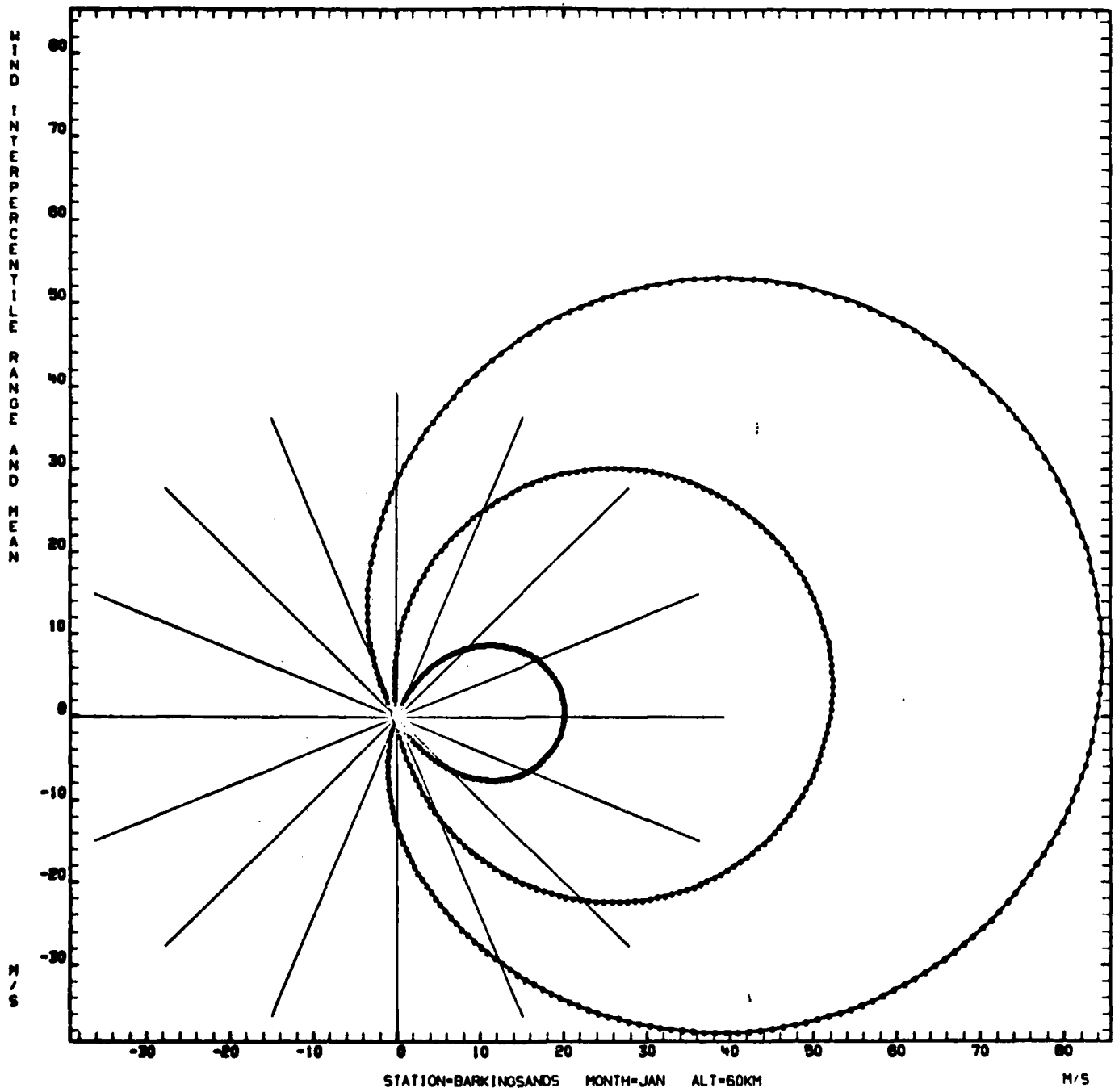

Figure A-23.

XBAR= 58.89 SIGMAX= 27.37 RHO= -.0213 YBAR= -8.80 SIGMAY= 15.24 PERCENT=*****

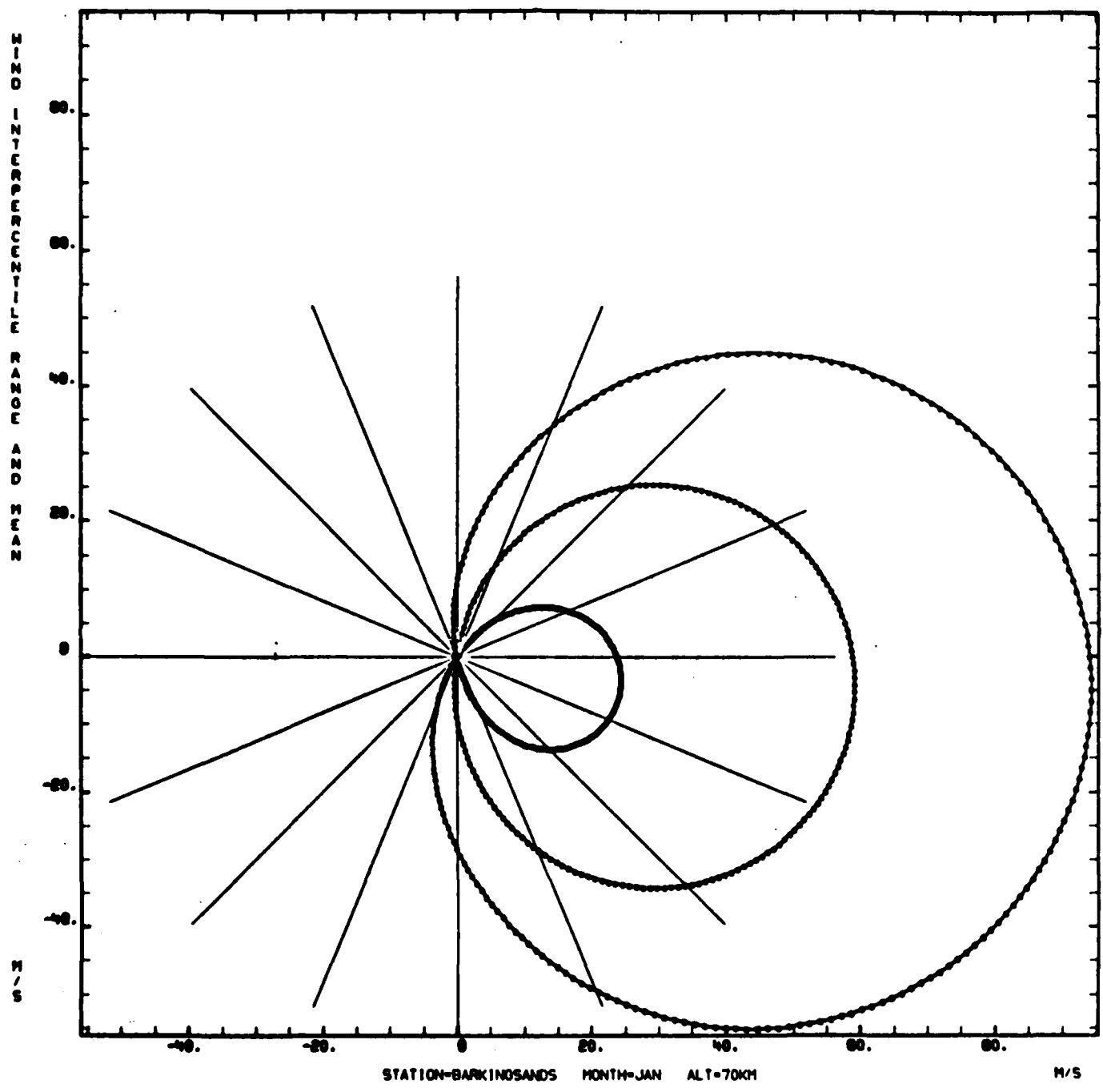

Figure A-24.

XBAR= -3.57 SIGMAX= 4.28 RHO= .2759 YBAR= -.22 SIGMAY= 3.39 PERCENT=*****

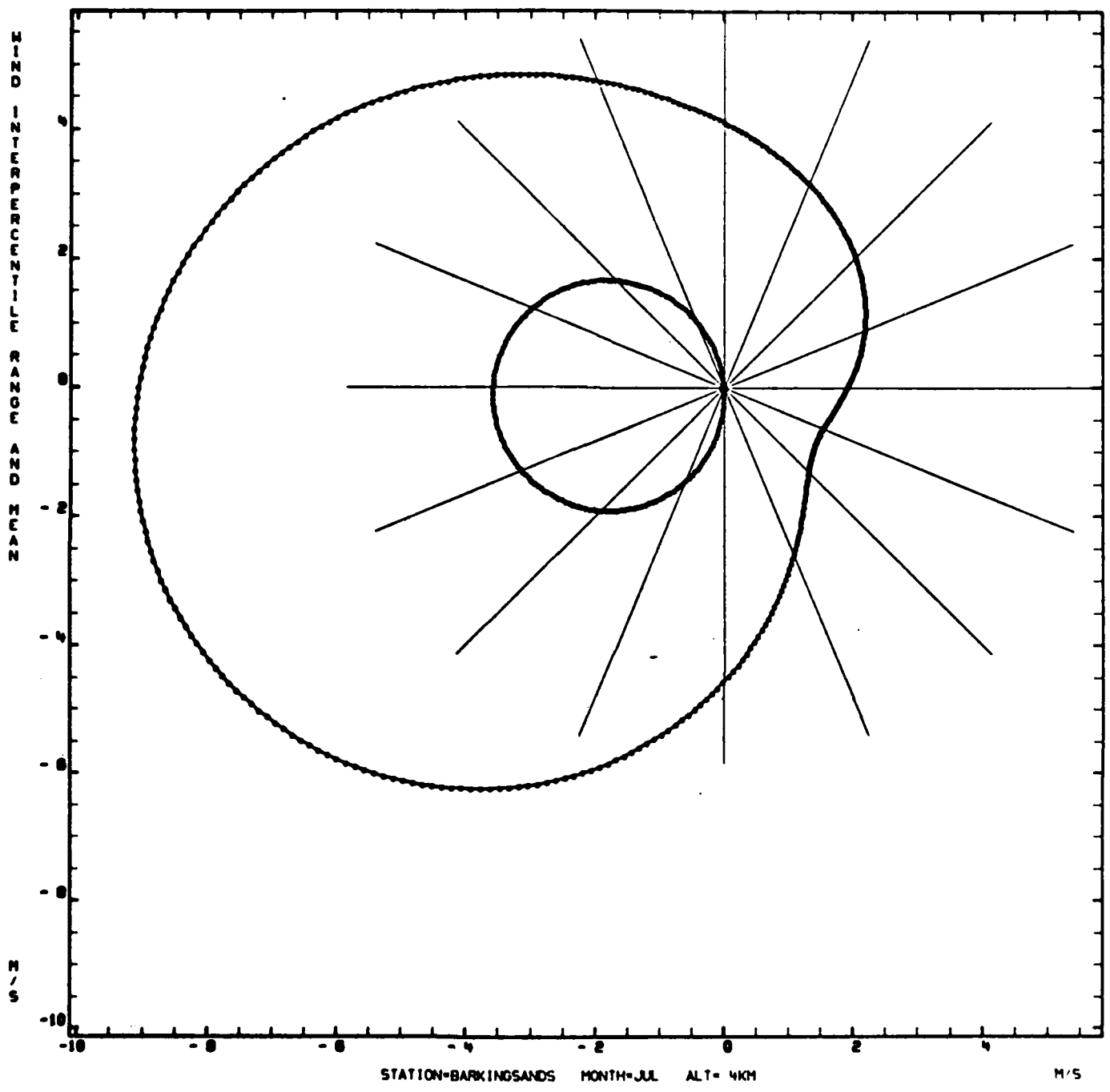

Figure A-25.

XBAR= 18.38 SIGMAX= 12.99 RHO= .2010 YBAR= 2.61 SIGMAY= 10.32 PERCENT=****

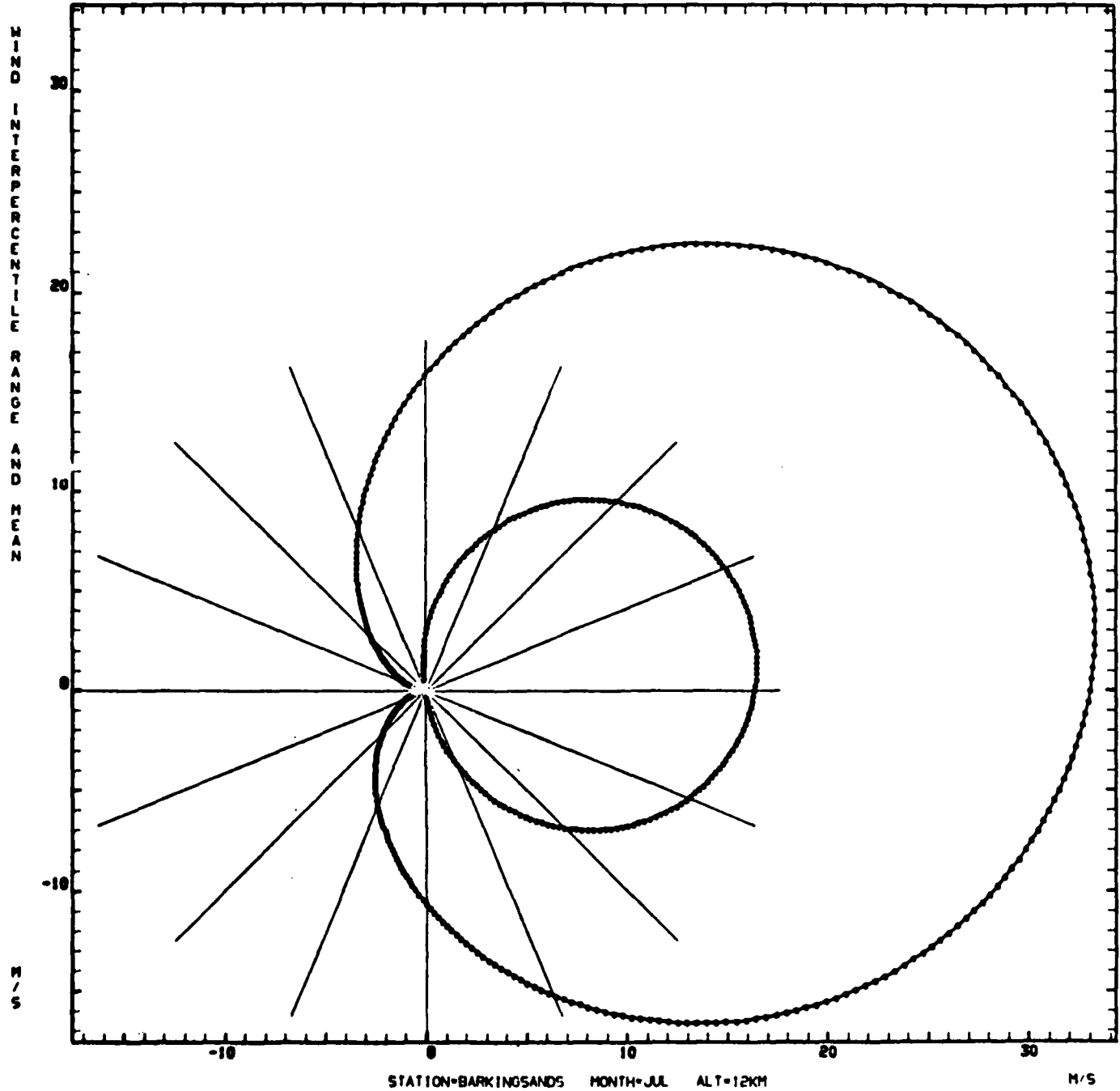

Figure A-26.

XBAR=-15.53 SIGMAX= 2.75 RHO= .0061 YBAR= .32 SIGMAY= 1.88 PERCENT=****

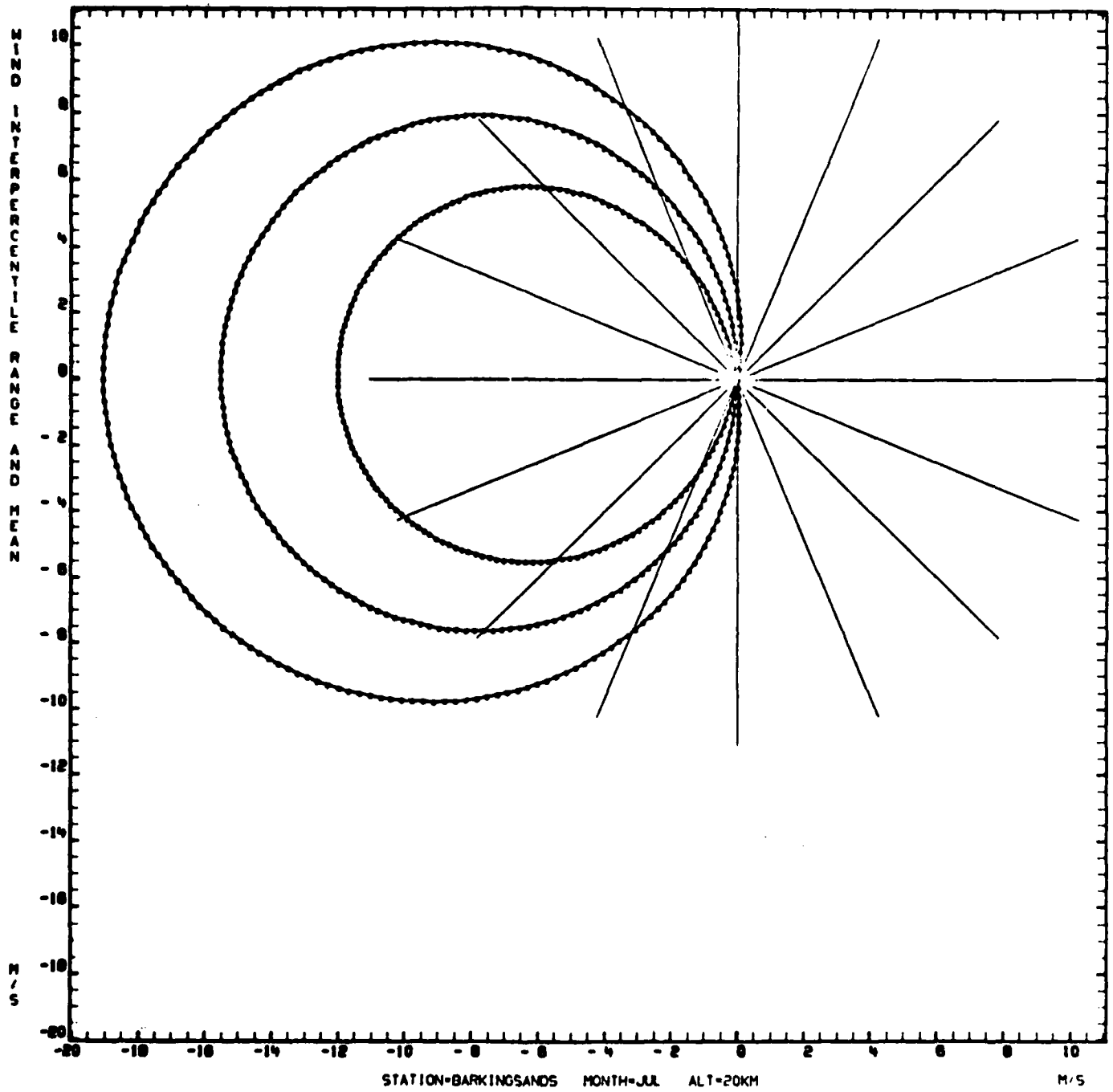

Figure A-27.

XBAR=-26.44 SIGMAX= 3.34 RHO= .1130 YBAR= -.52 SIGMAY= 2.17 PERCENT=****

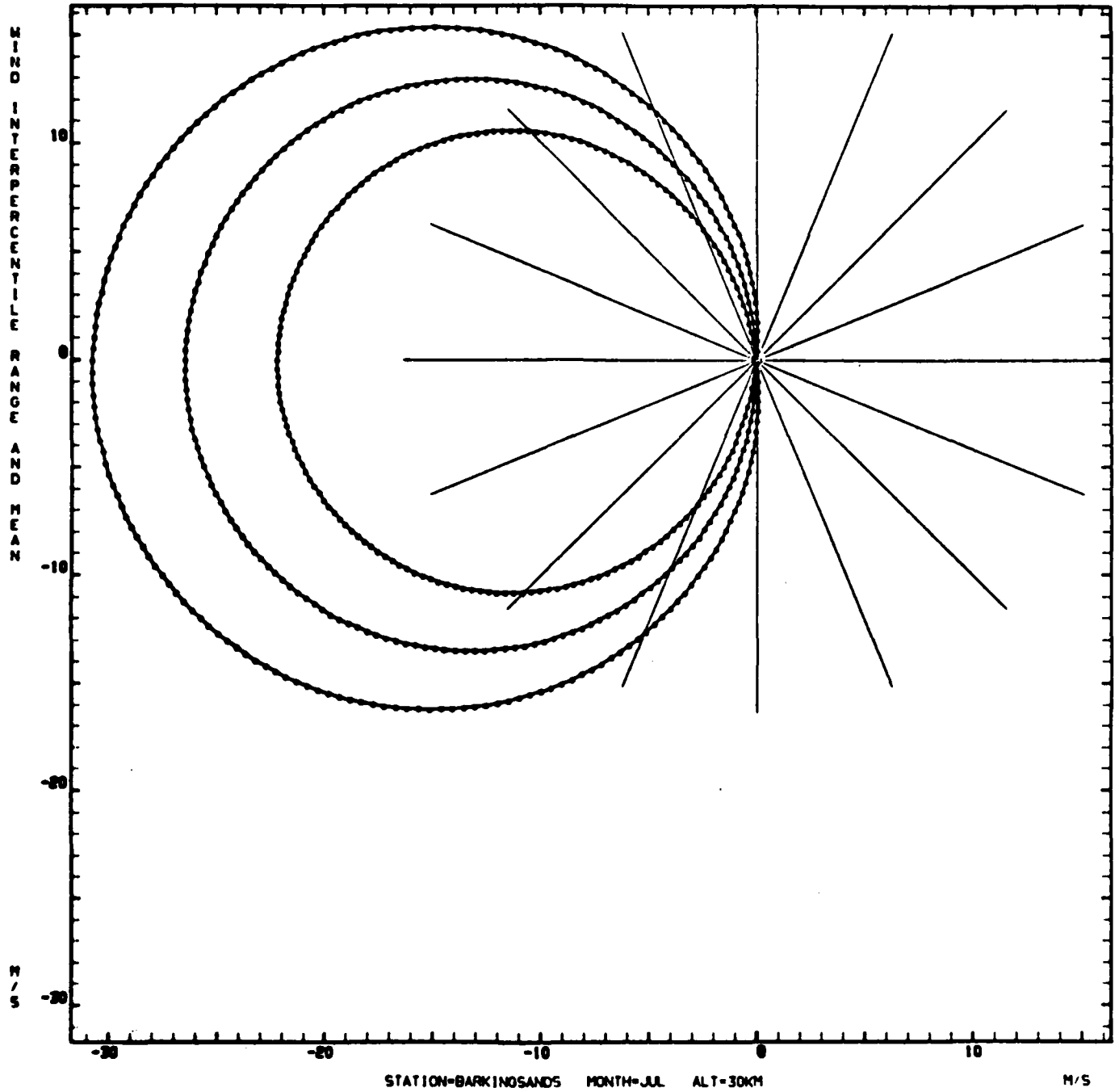

Figure A-28.

XBAR=-39.53 SIGMAX= 6.15 RHO= -.040% YBAR= -.07 SIGMAY= 4.48 PERCENT=*****

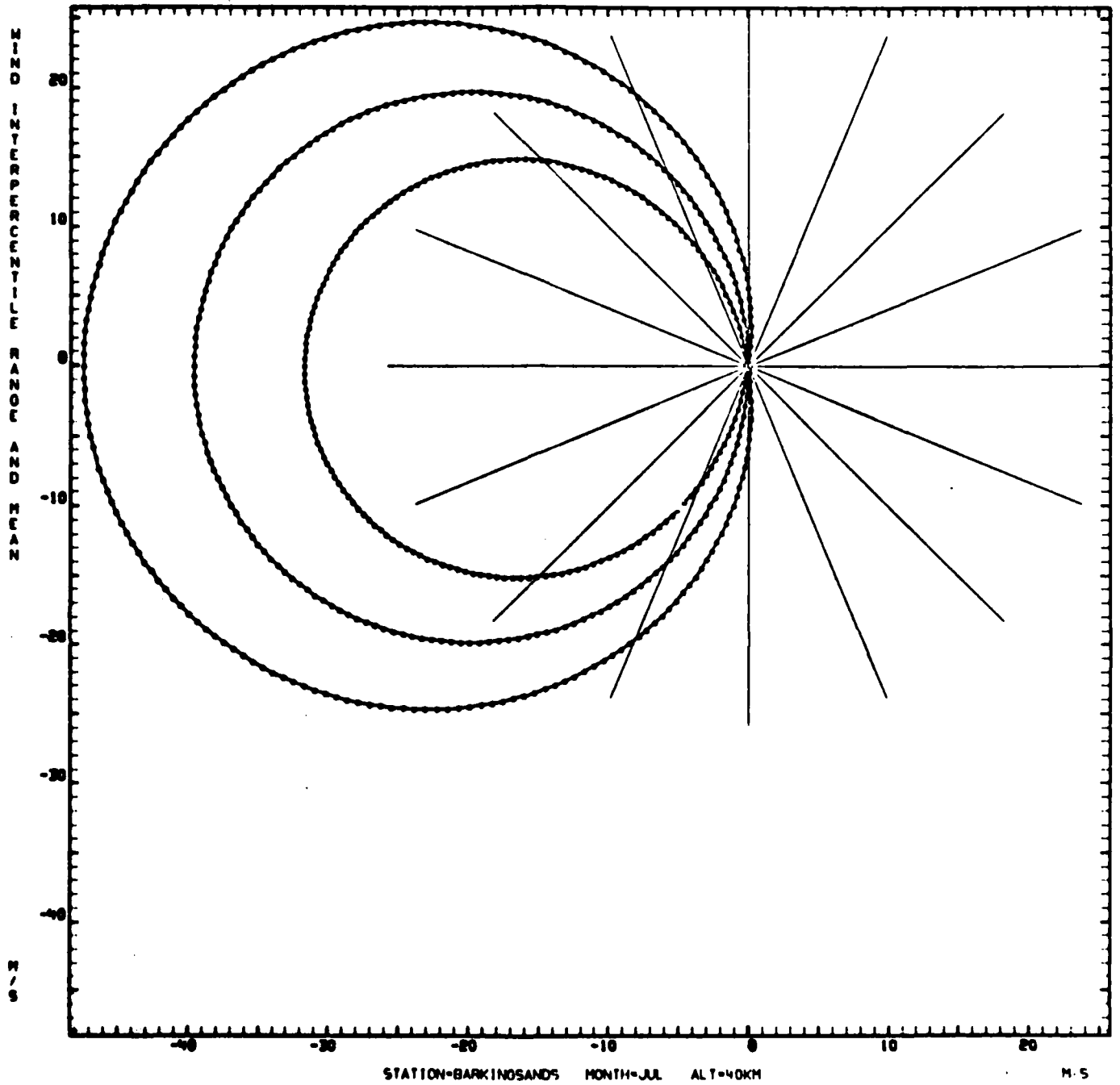

Figure A-29.

XBAR=-50.76 SIGMAX= 9.17 RHO= -.0594 YBAR= 6.02 SIGMAY= 6.23 PERCENT=*****

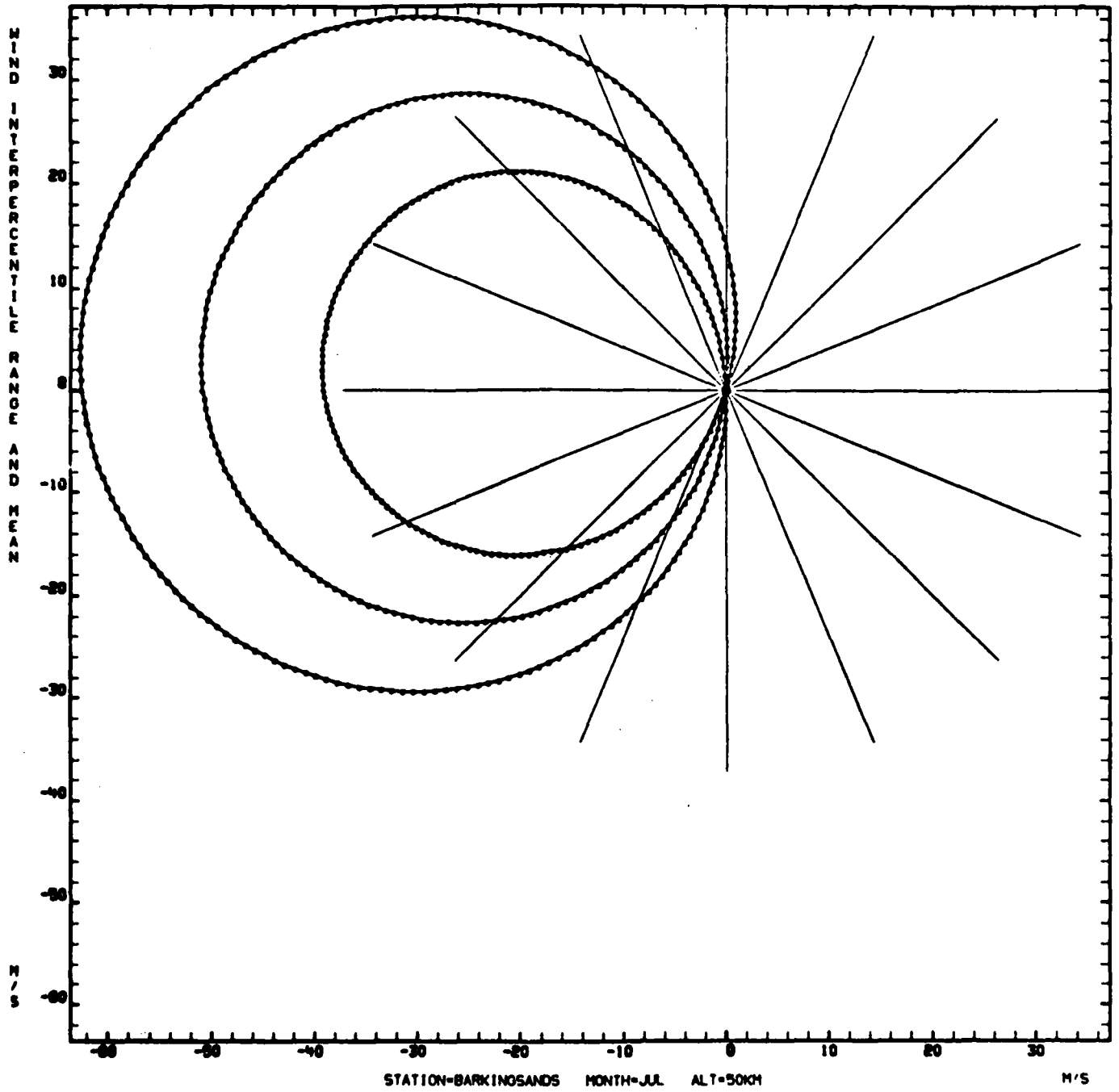

Figure A-30.

XBAR=-23.98 SIGMAX= 17.25 RHO= .3221 YBAR= 5.06 SIGMAY= 13.87 PERCENT*****

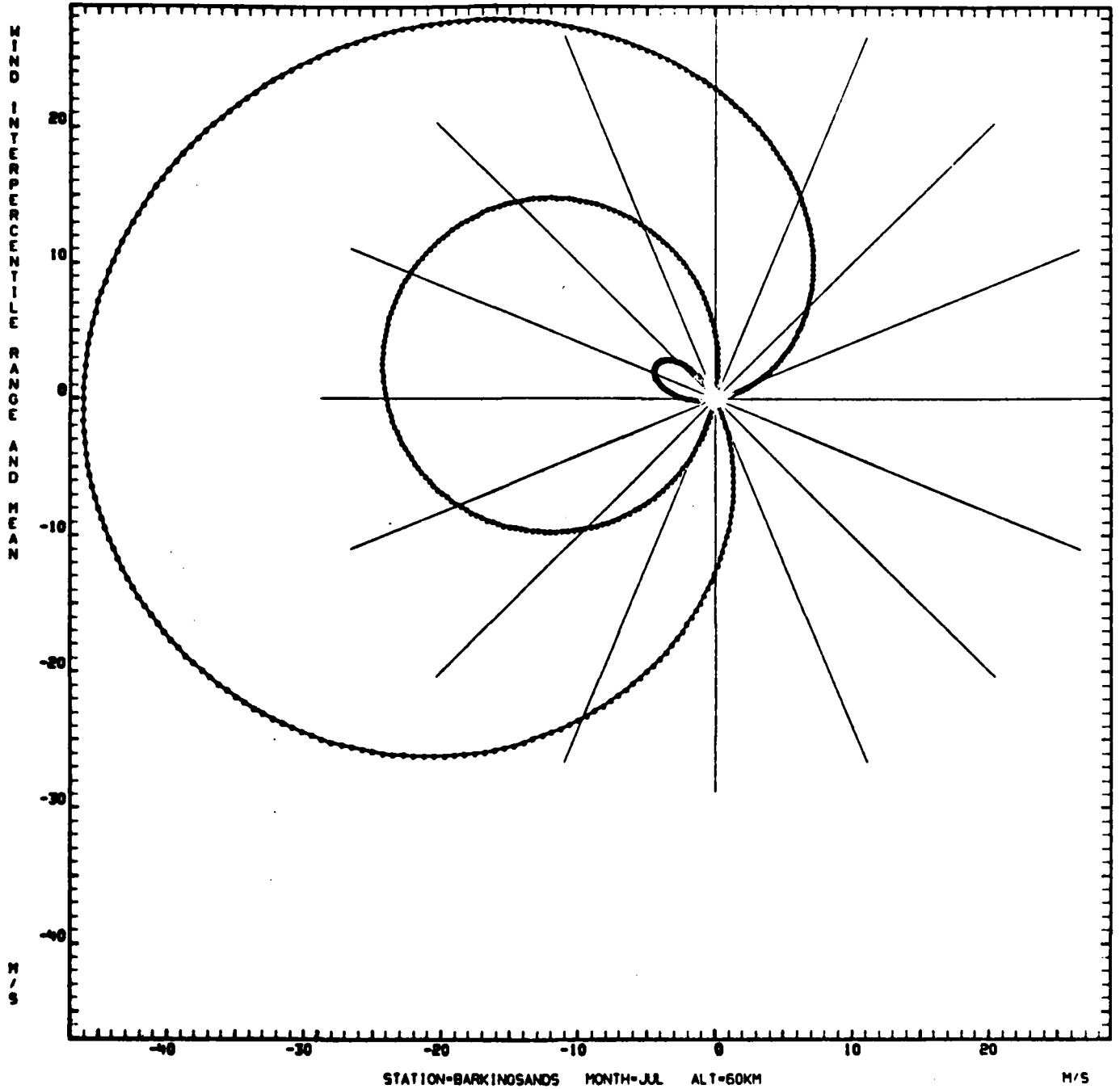

Figure A-31.

XBAR=-19.04 SIGMAX= 21.60 RHO= .2679 YBAR=-10.59 SIGMAY= 16.57 PERCENT=*****

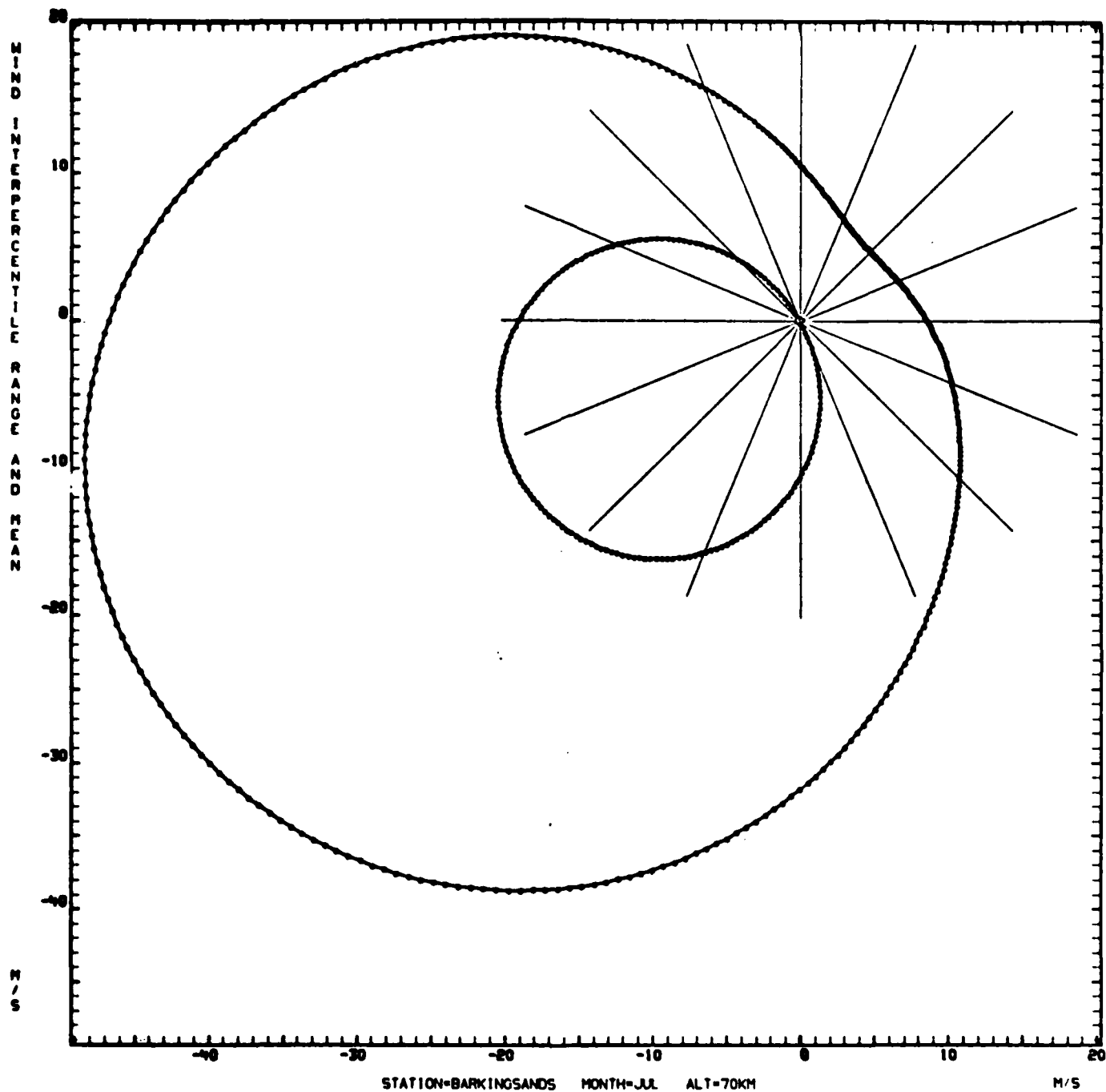

Figure A-32.

WIND PROBABILITY ELLIPSES

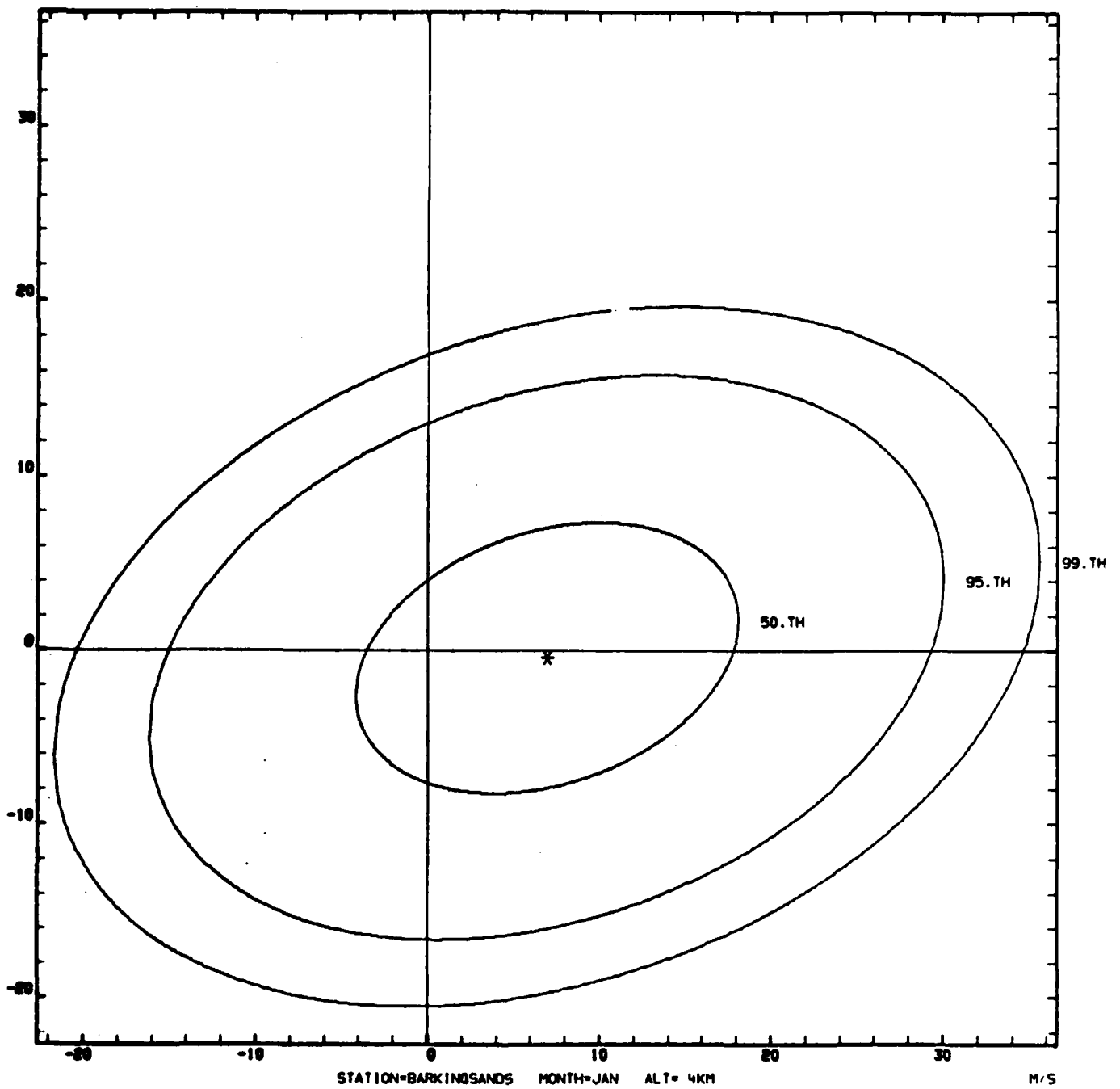

Figure A-33.

WIND PROBABILITY ELLIPSES

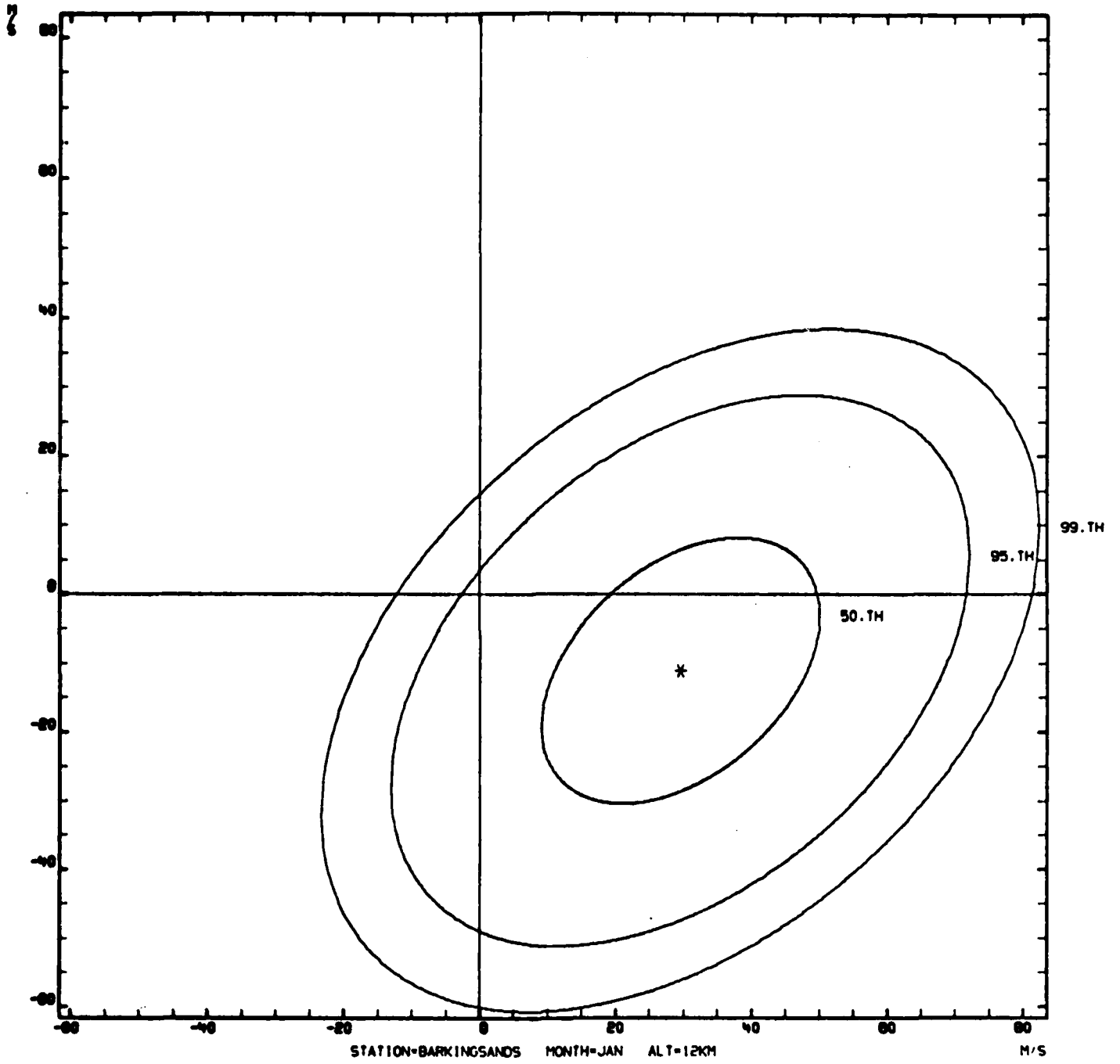

Figure A-34.

WIND PROBABILITY ELLIPSES

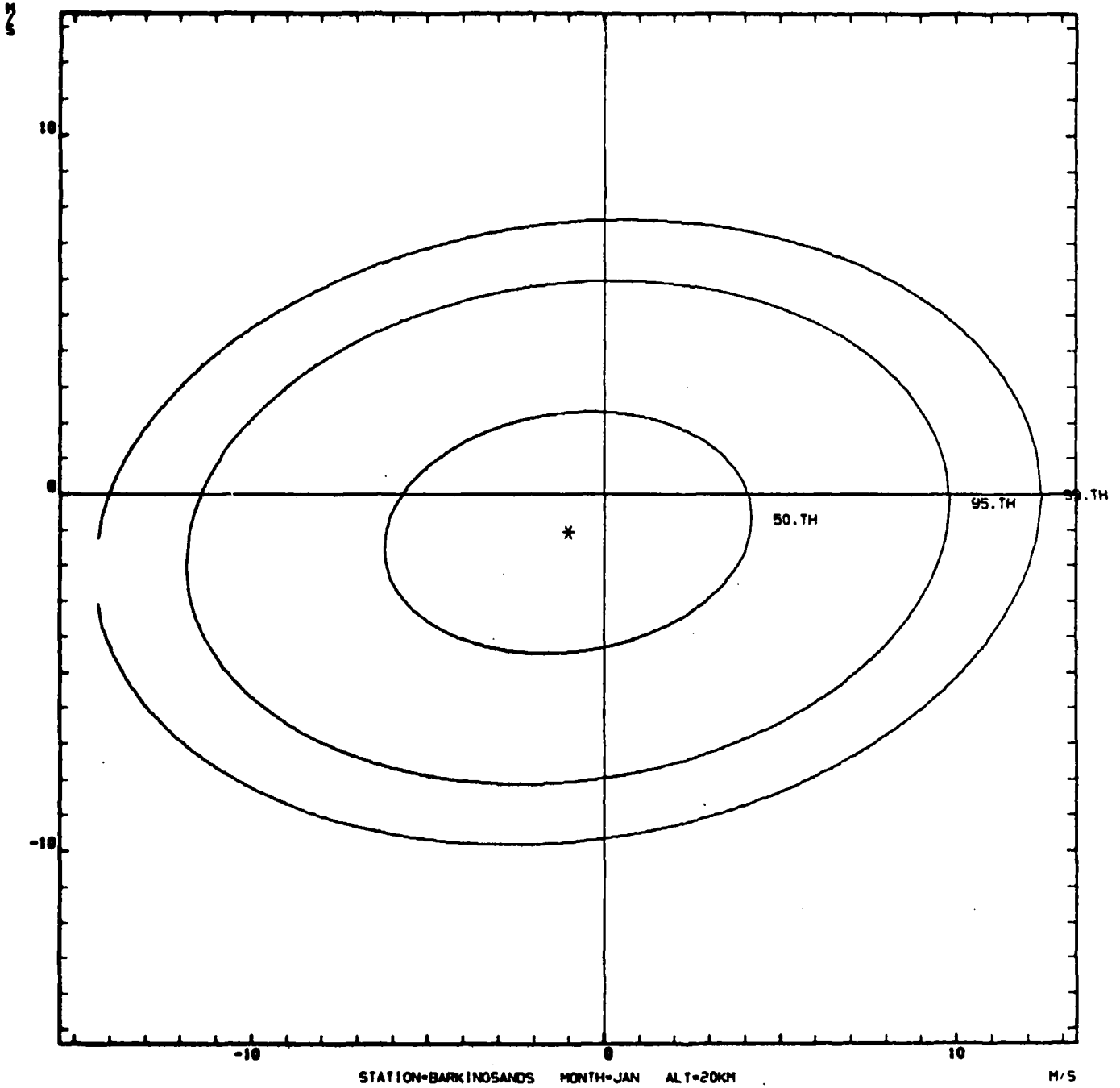

Figure A-35.

WIND PROBABILITY ELLIPSES

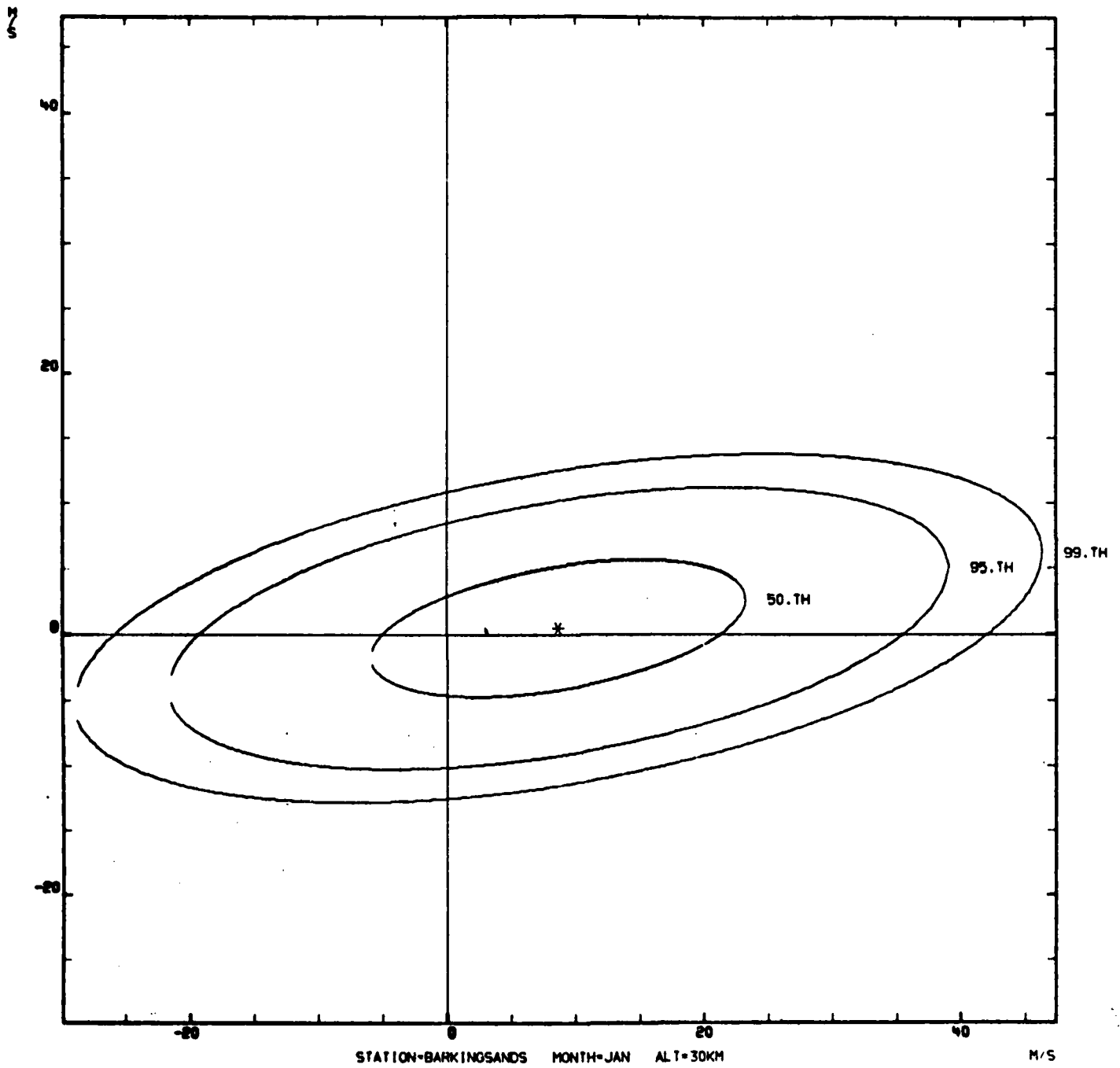

Figure A-36.

WIND PROBABILITY ELLIPSES

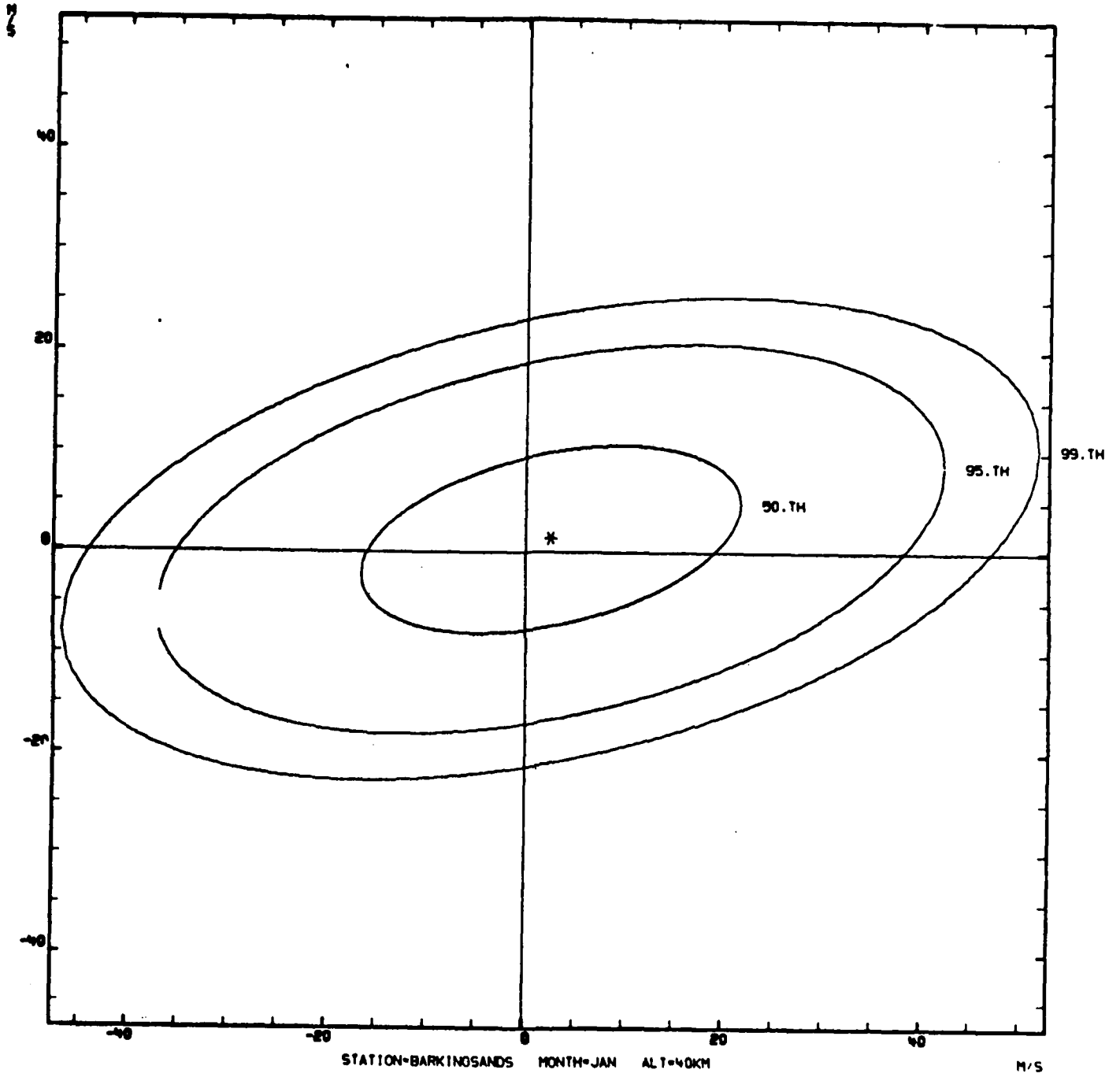

Figure A-37.

WIND PROBABILITY ELLIPSES

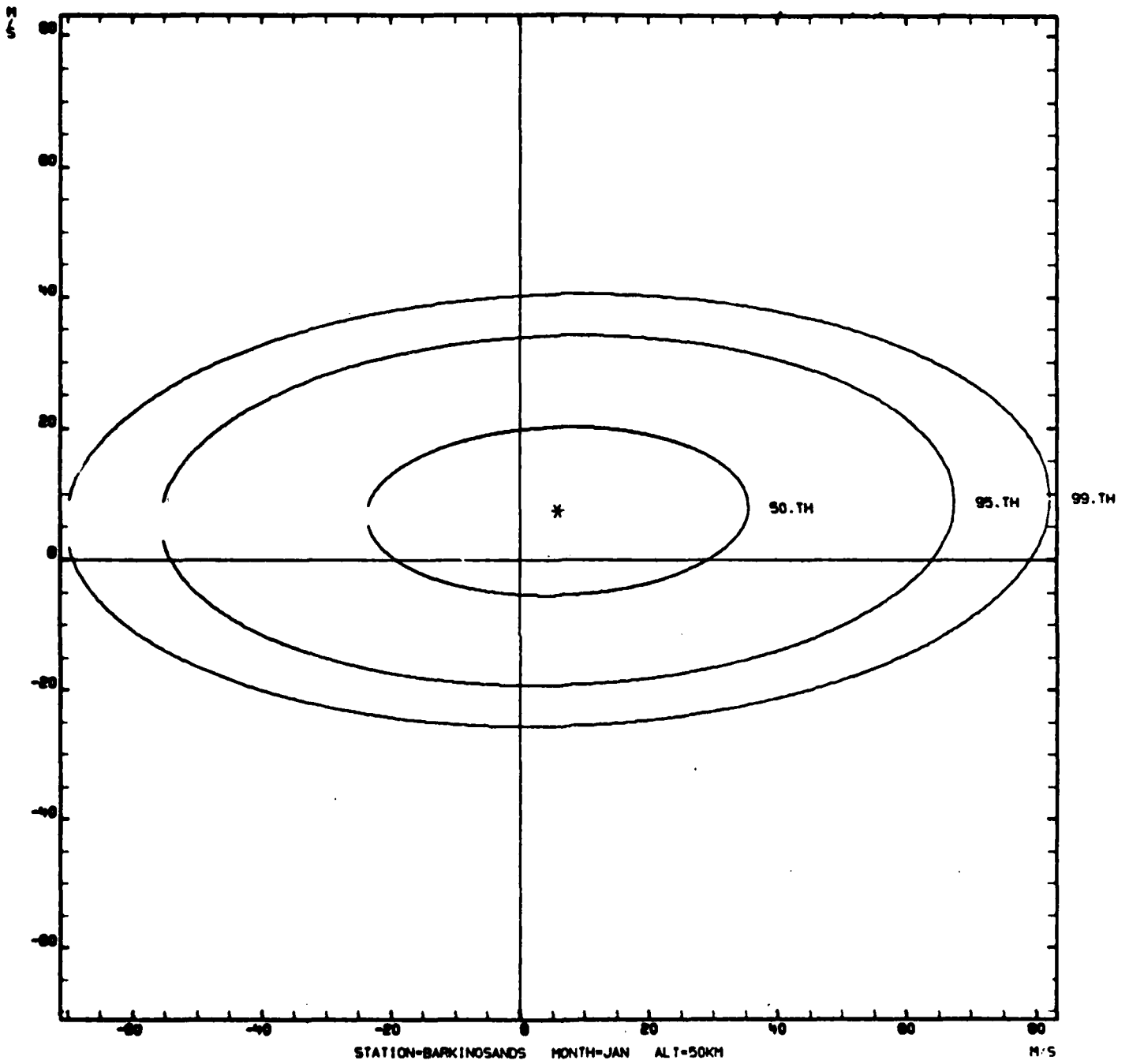

Figure A-38.

WIND PROBABILITY ELLIPSES

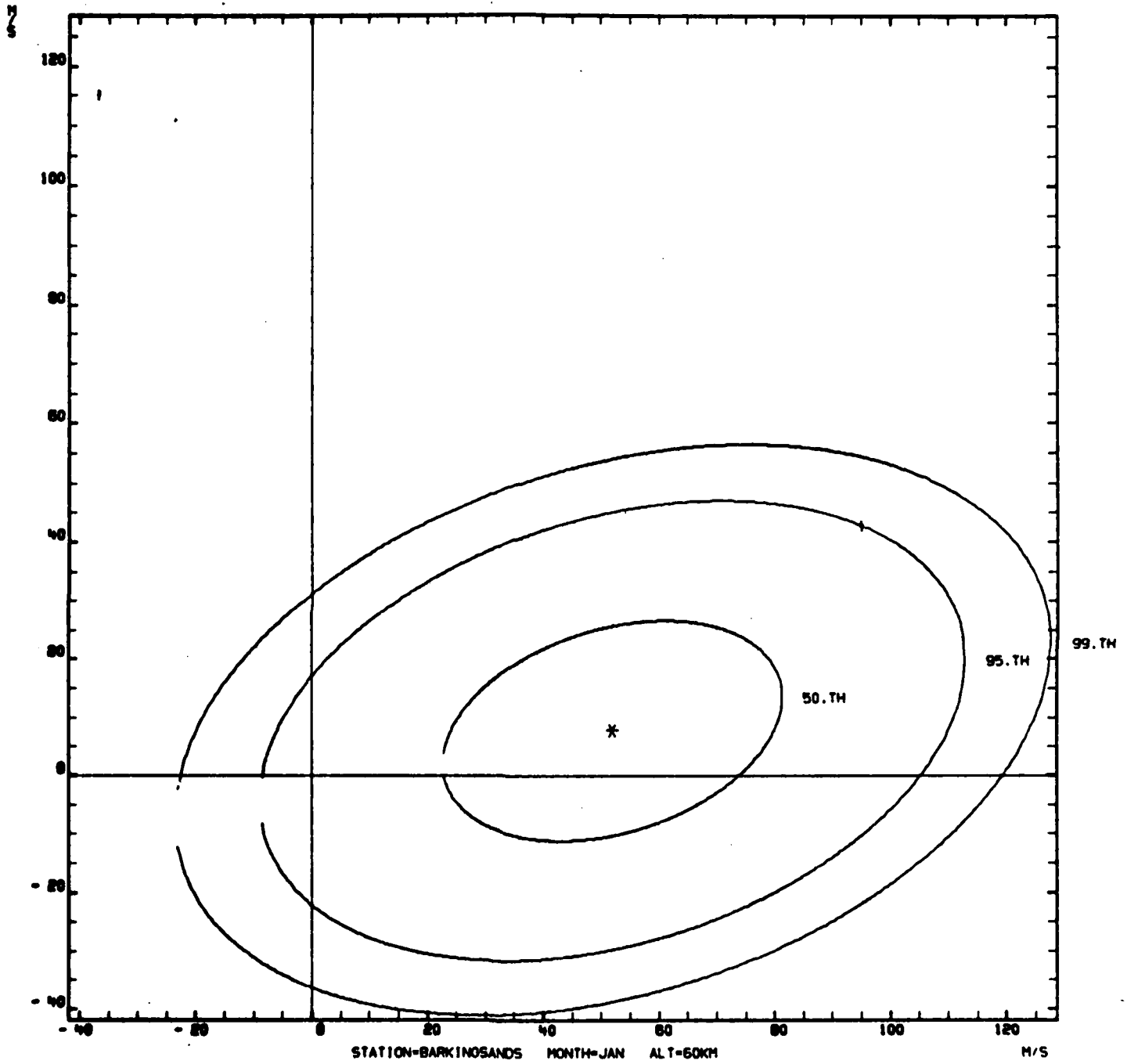

Figure A-39.

MIND PROBABILITY ELLIPSES

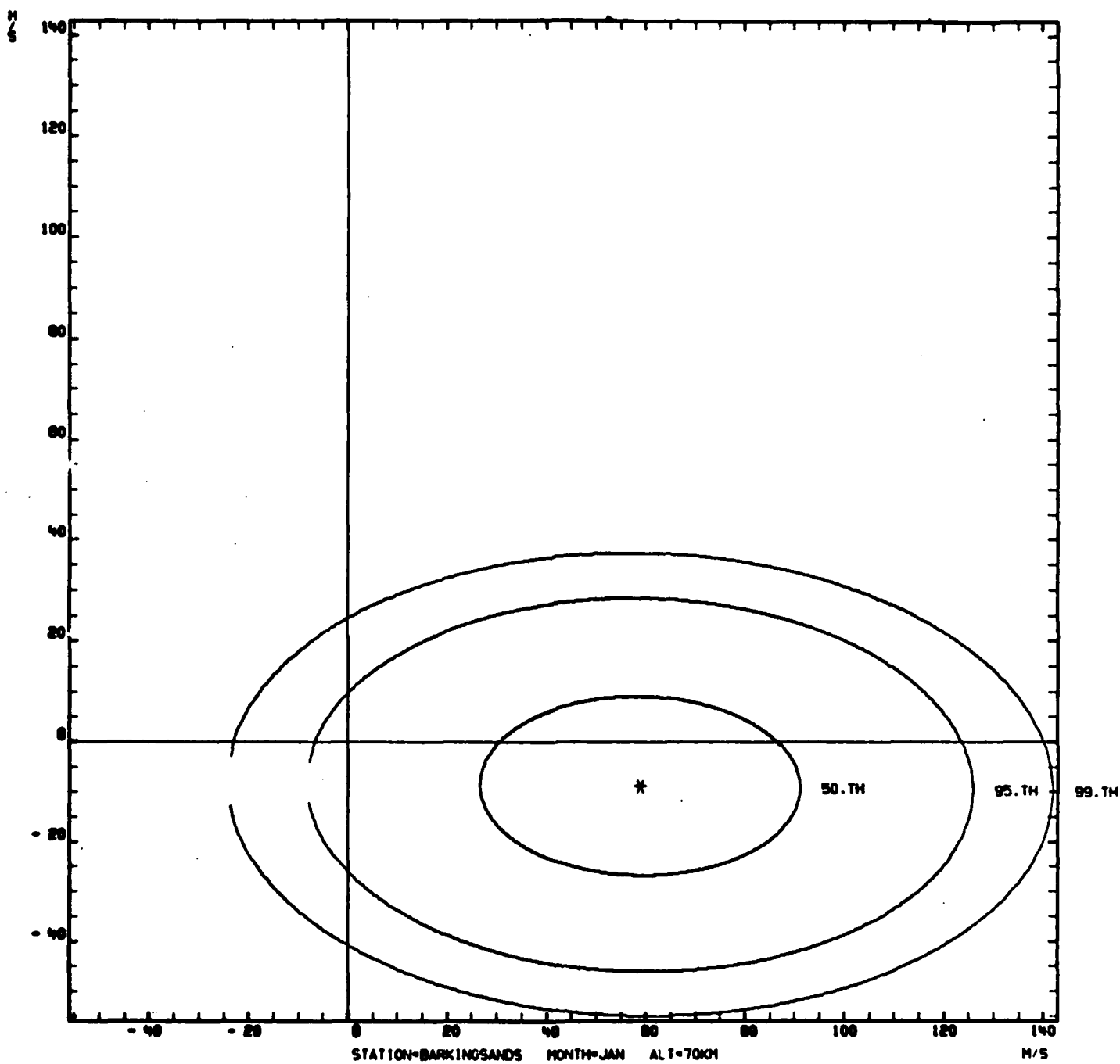

Figure A-40.

WIND PROBABILITY ELLIPSES

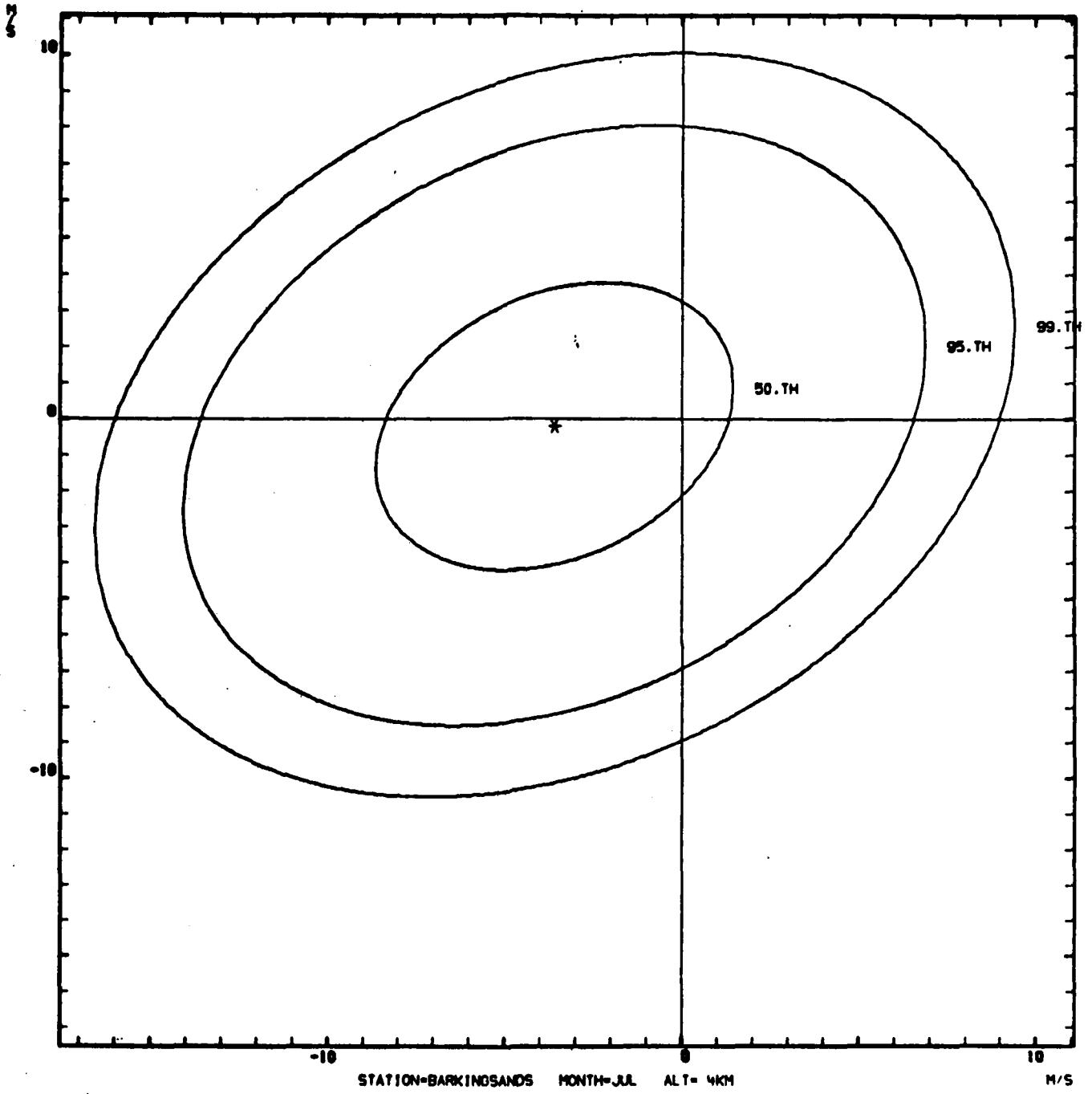

Figure A-41.

WIND PROBABILITY ELLIPSES

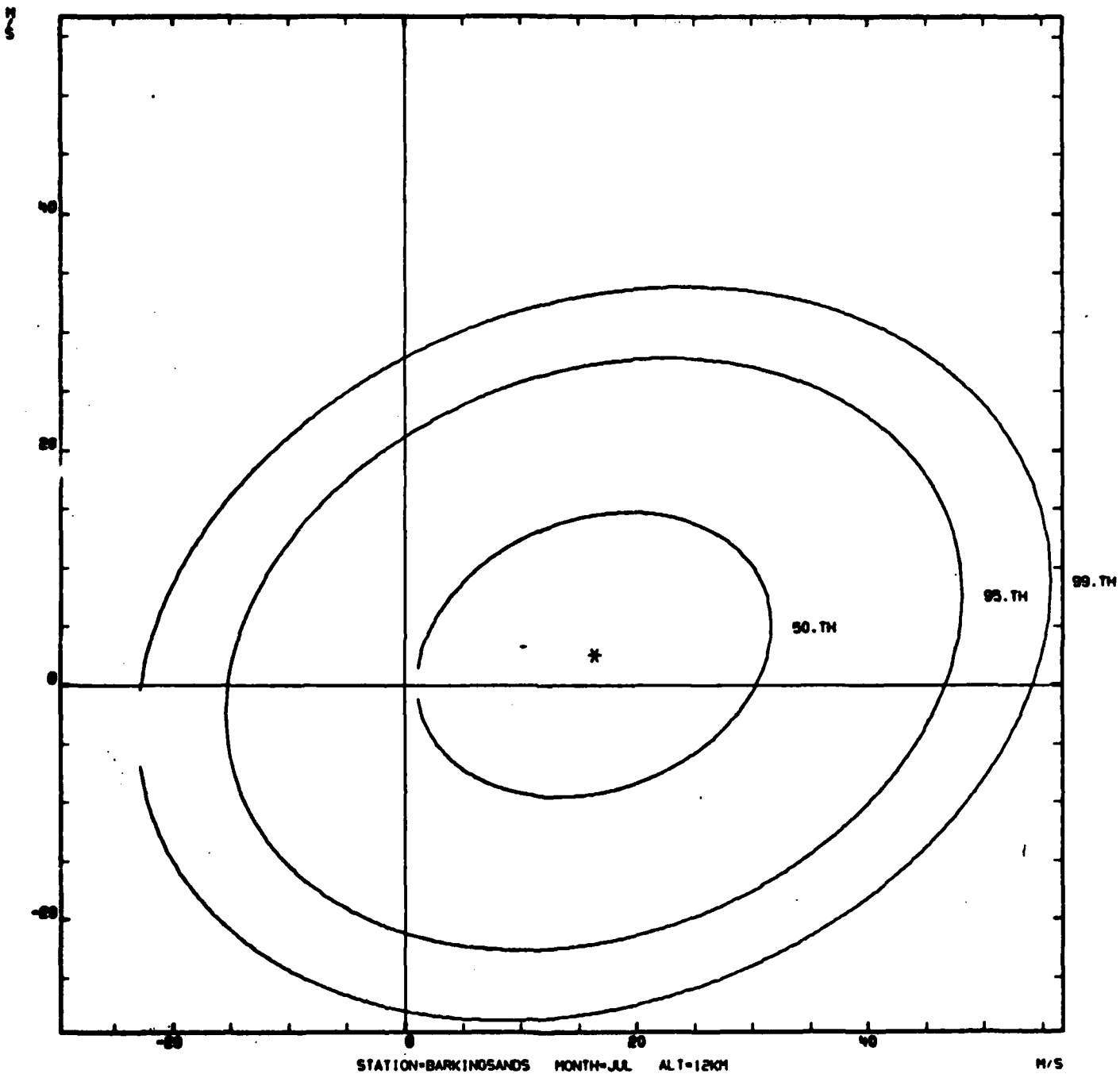

Figure A-42.

WIND PROBABILITY ELLIPSES

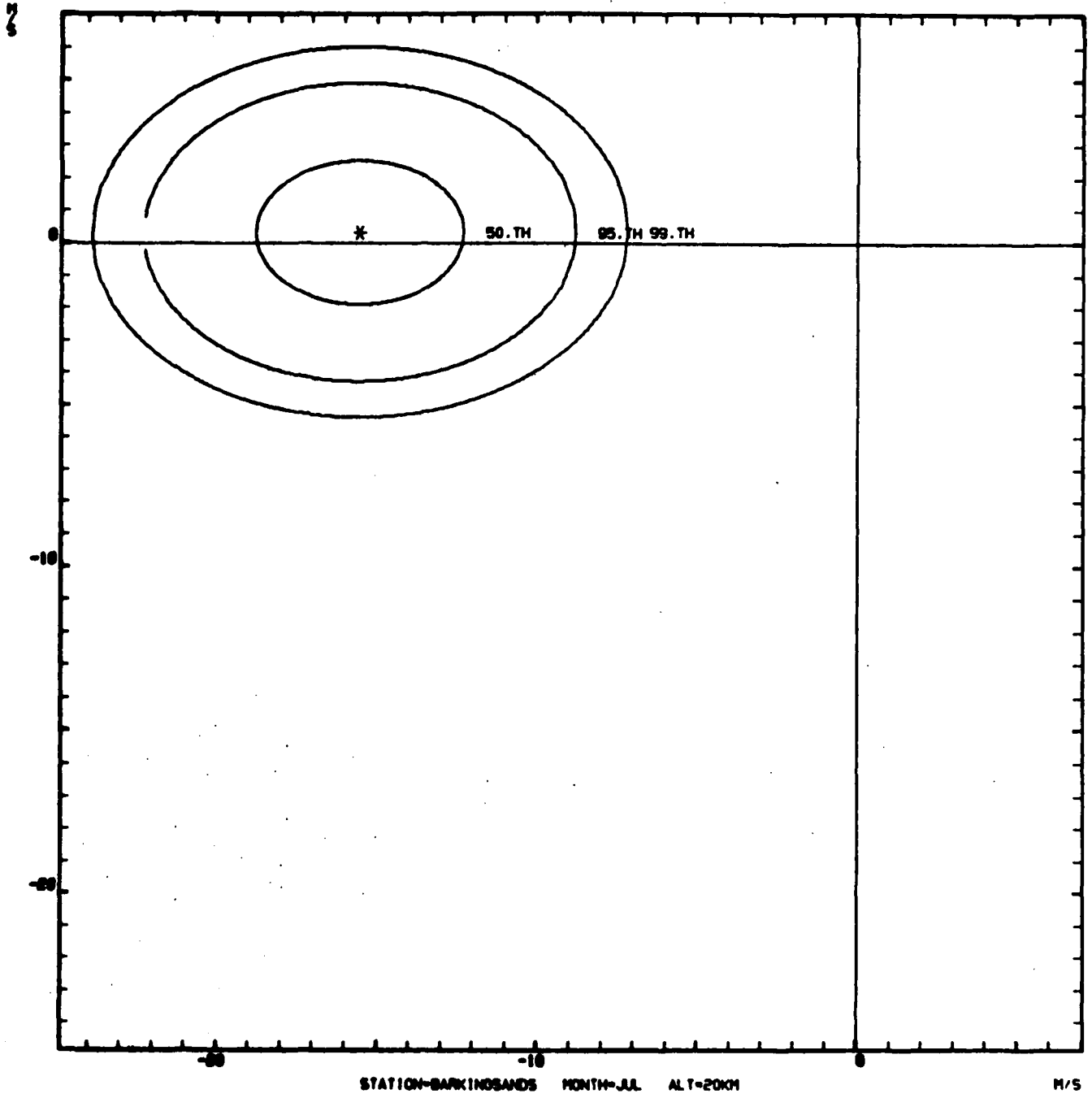

Figure A-43.

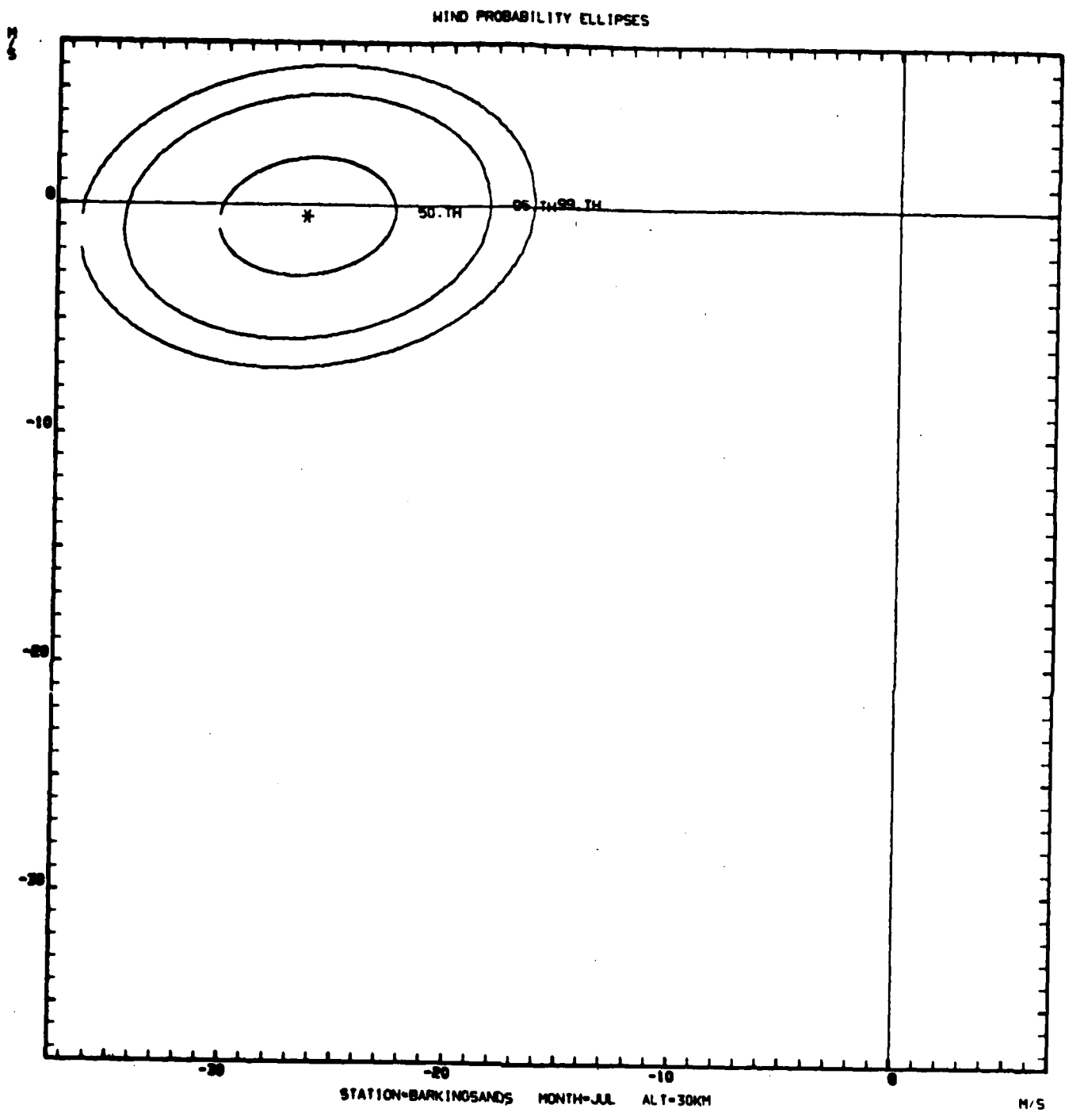

Figure A-44.

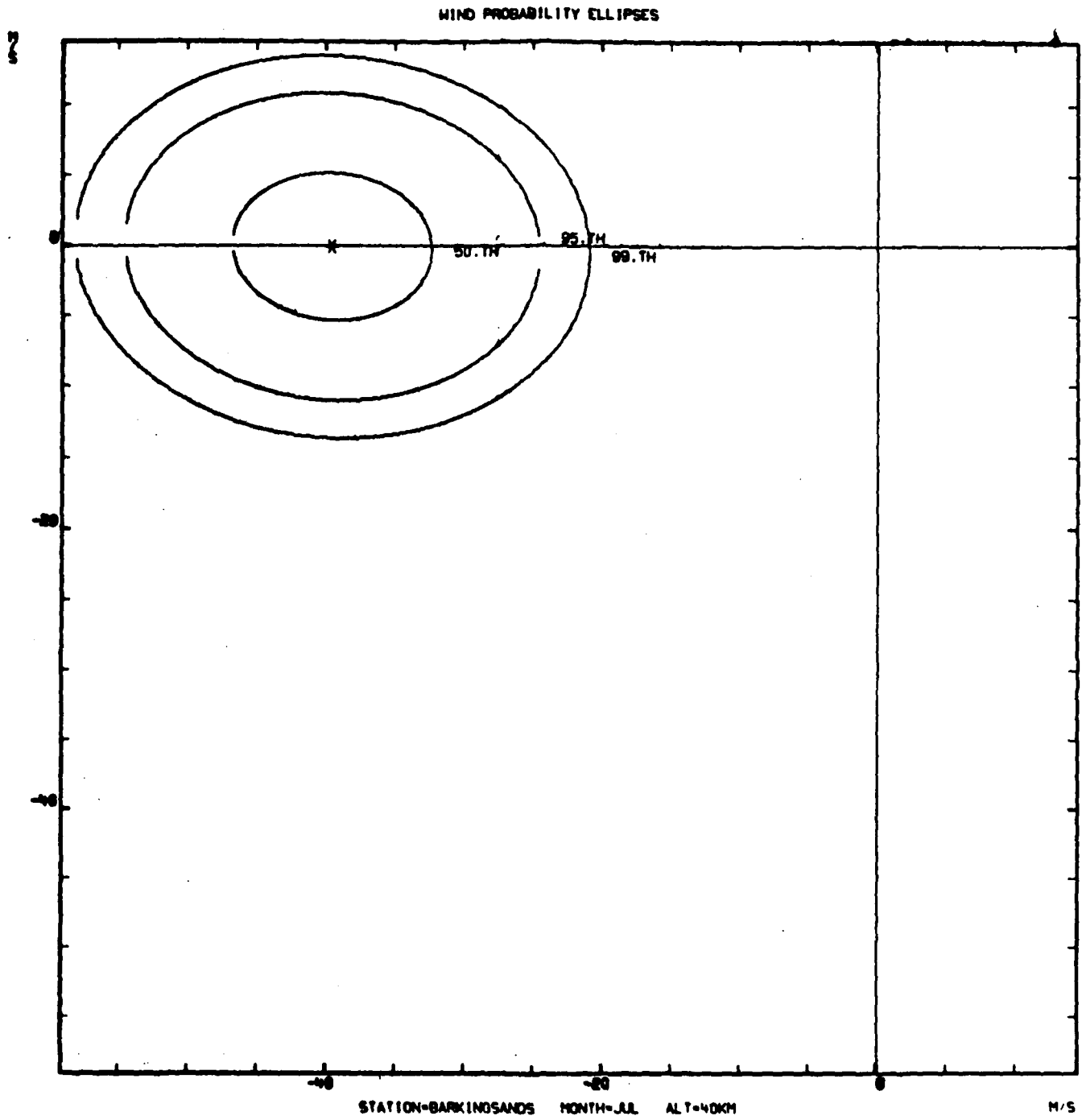

Figure A-45.

WIND PROBABILITY ELLIPSES

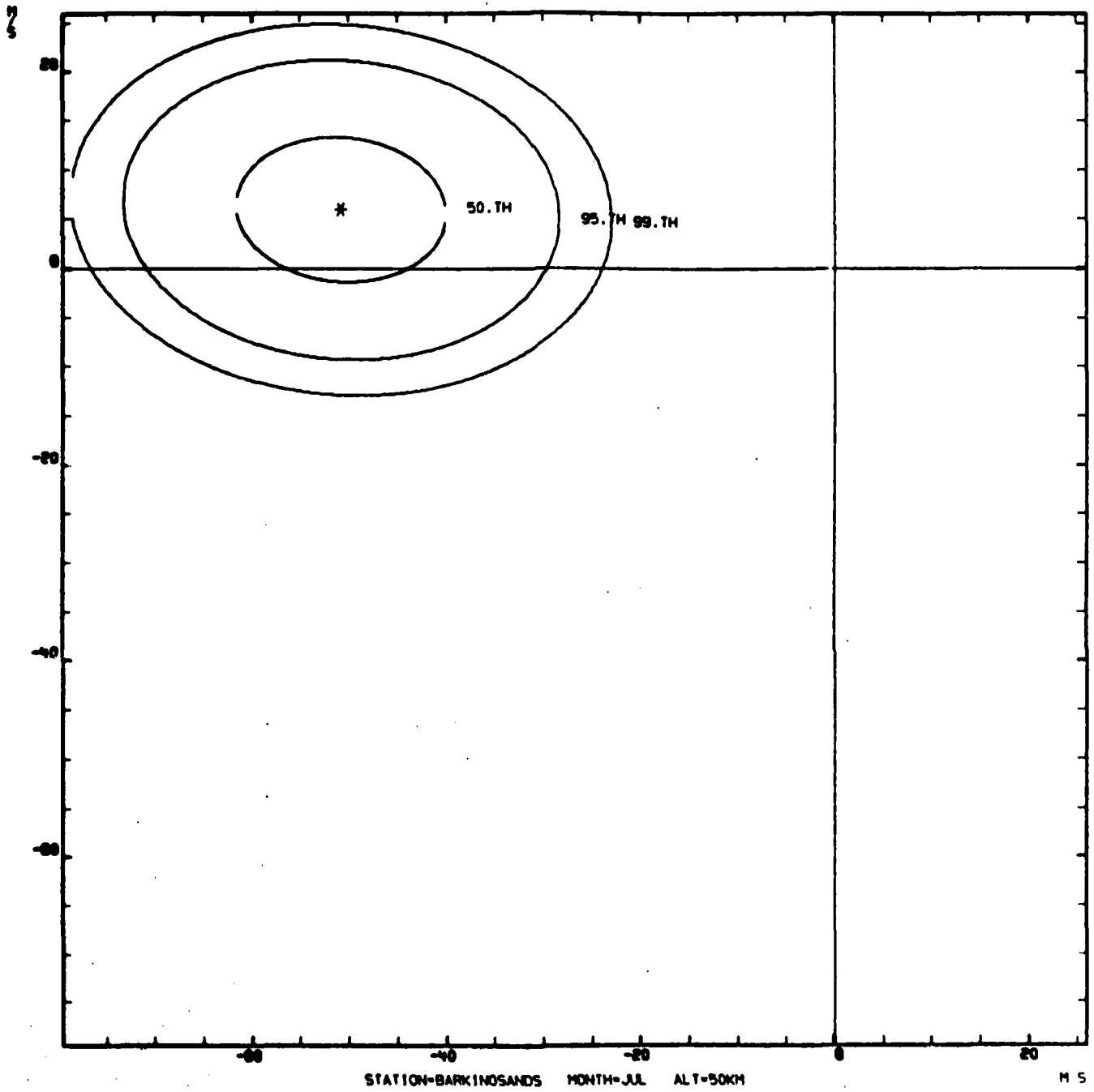

Figure A-46.

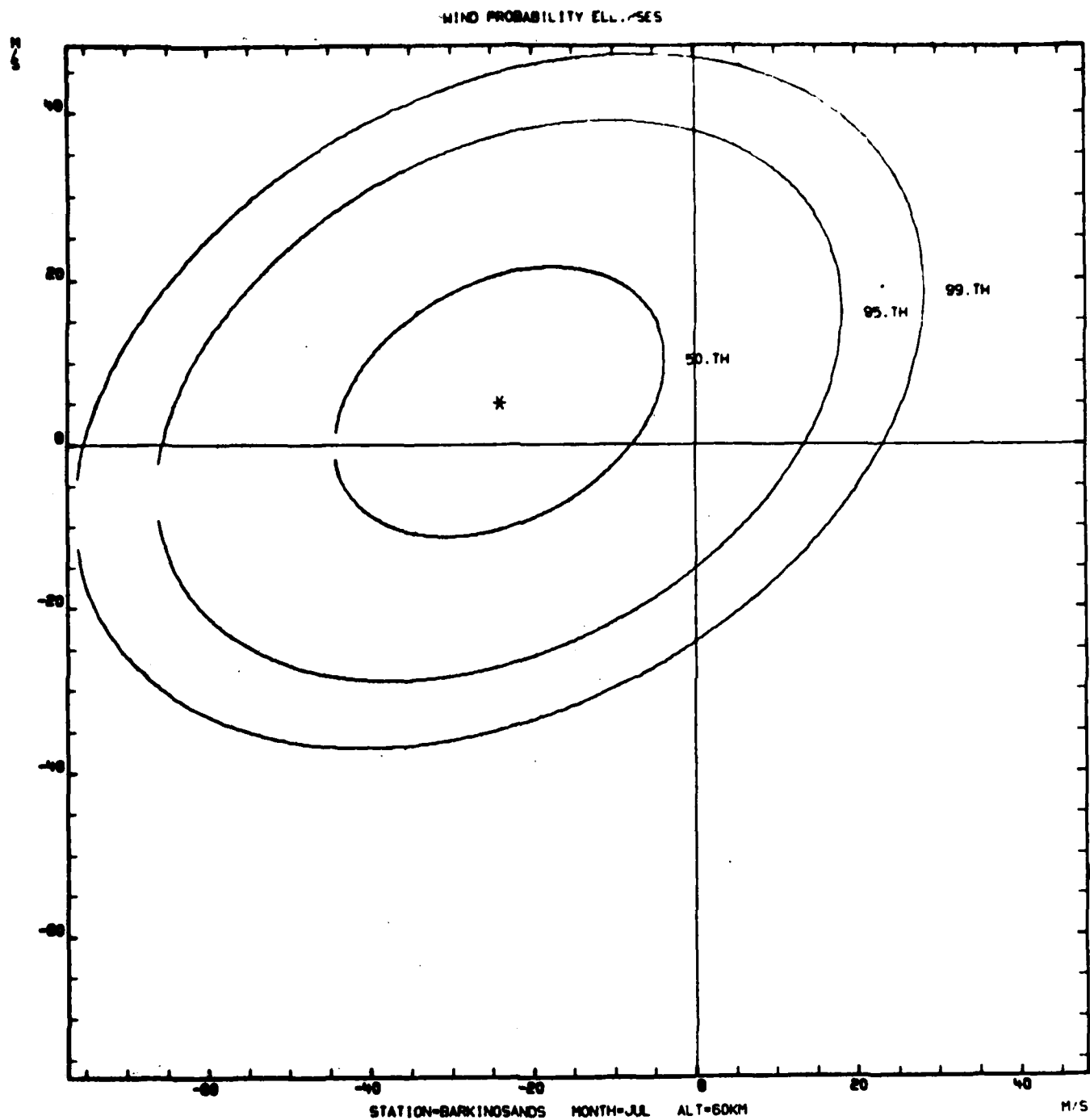

Figure A-47.

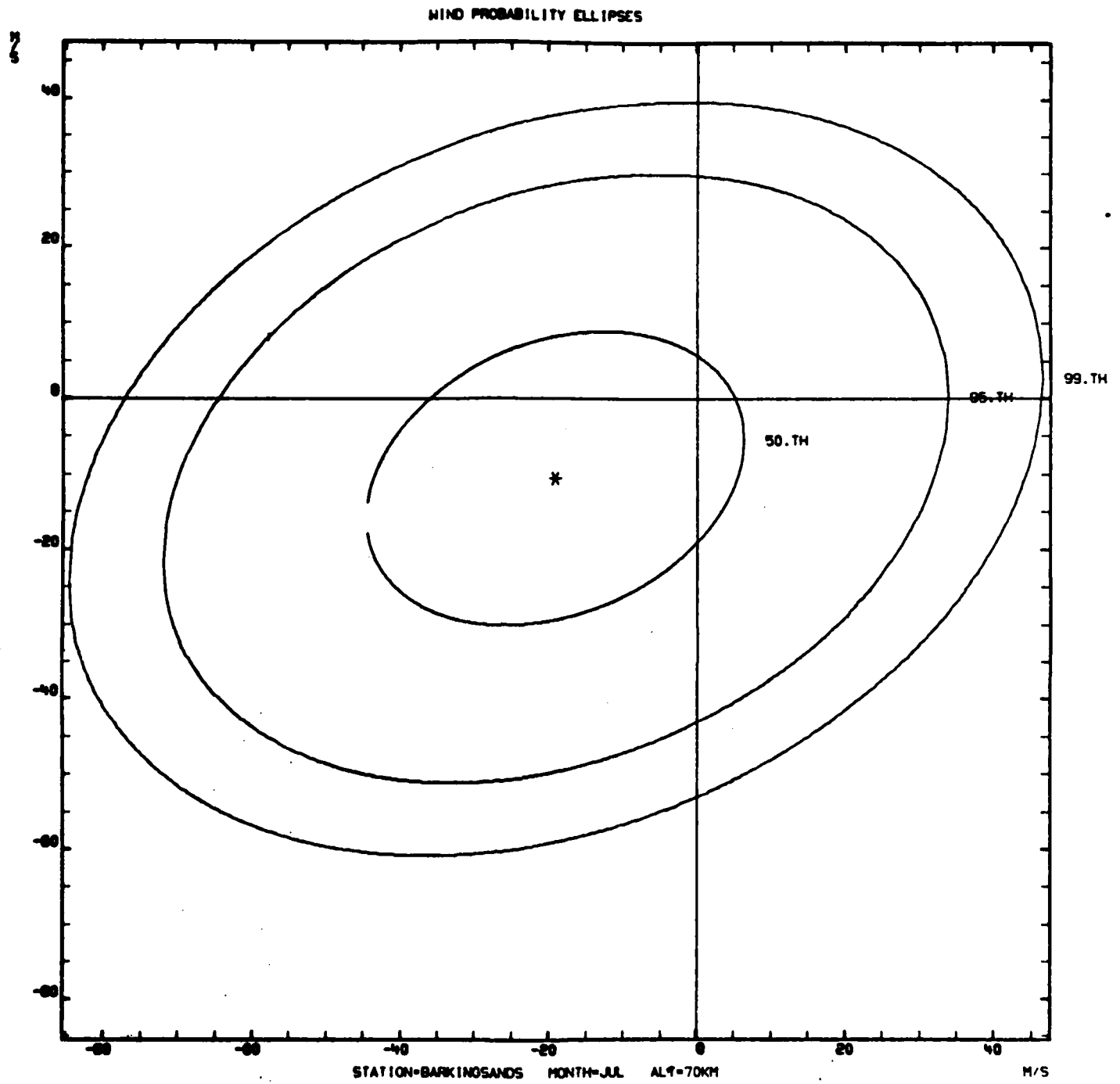
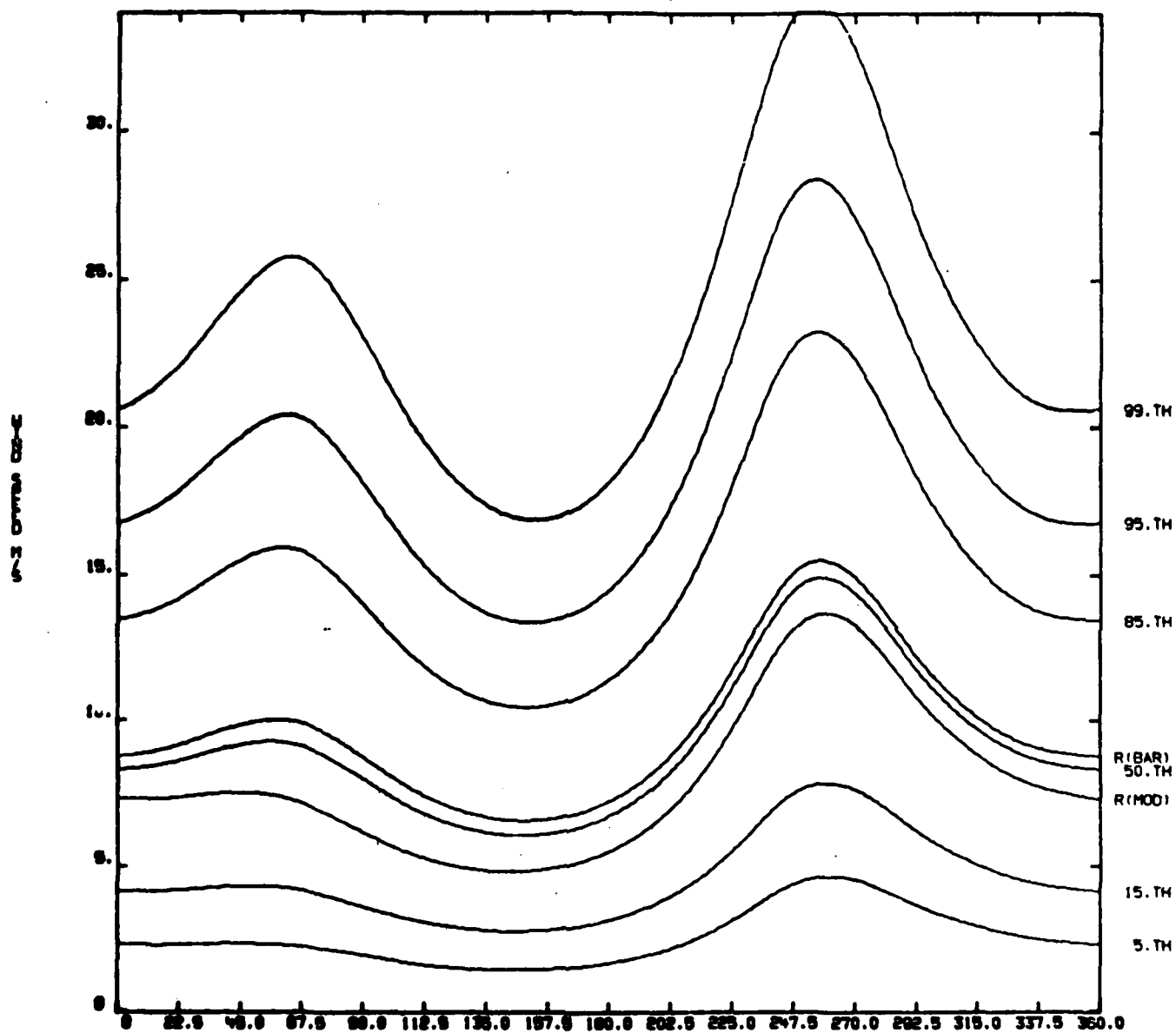

Figure A-48.

STATION=BARKINGSANDS MONTH=JAN ALT= 4KM



CONDITIONAL WIND SPEED GIVEN WIND DIRECTION

Figure A-49.

STATION=BARKINGSANDS MONTH=JAN ALT=12101

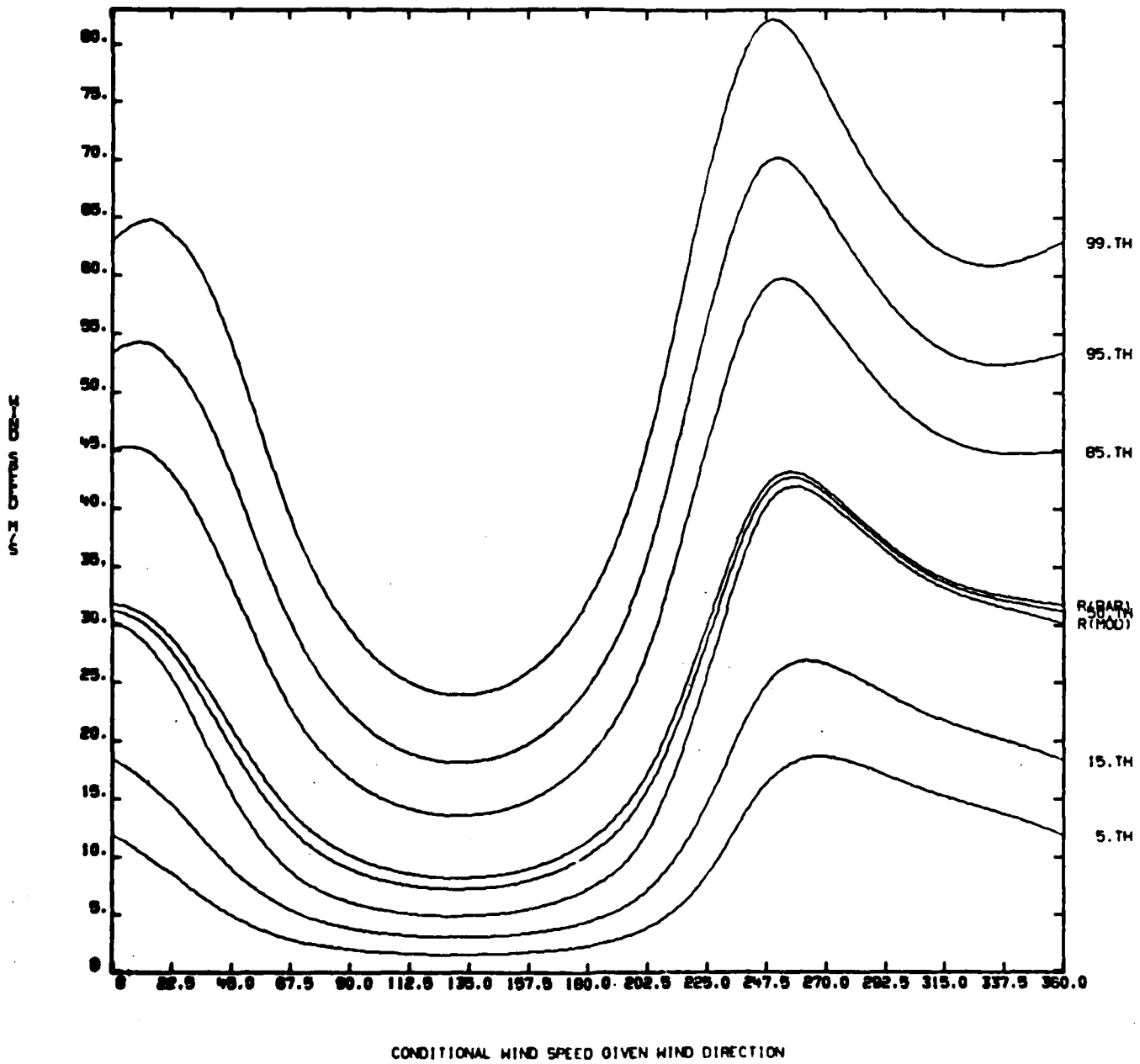
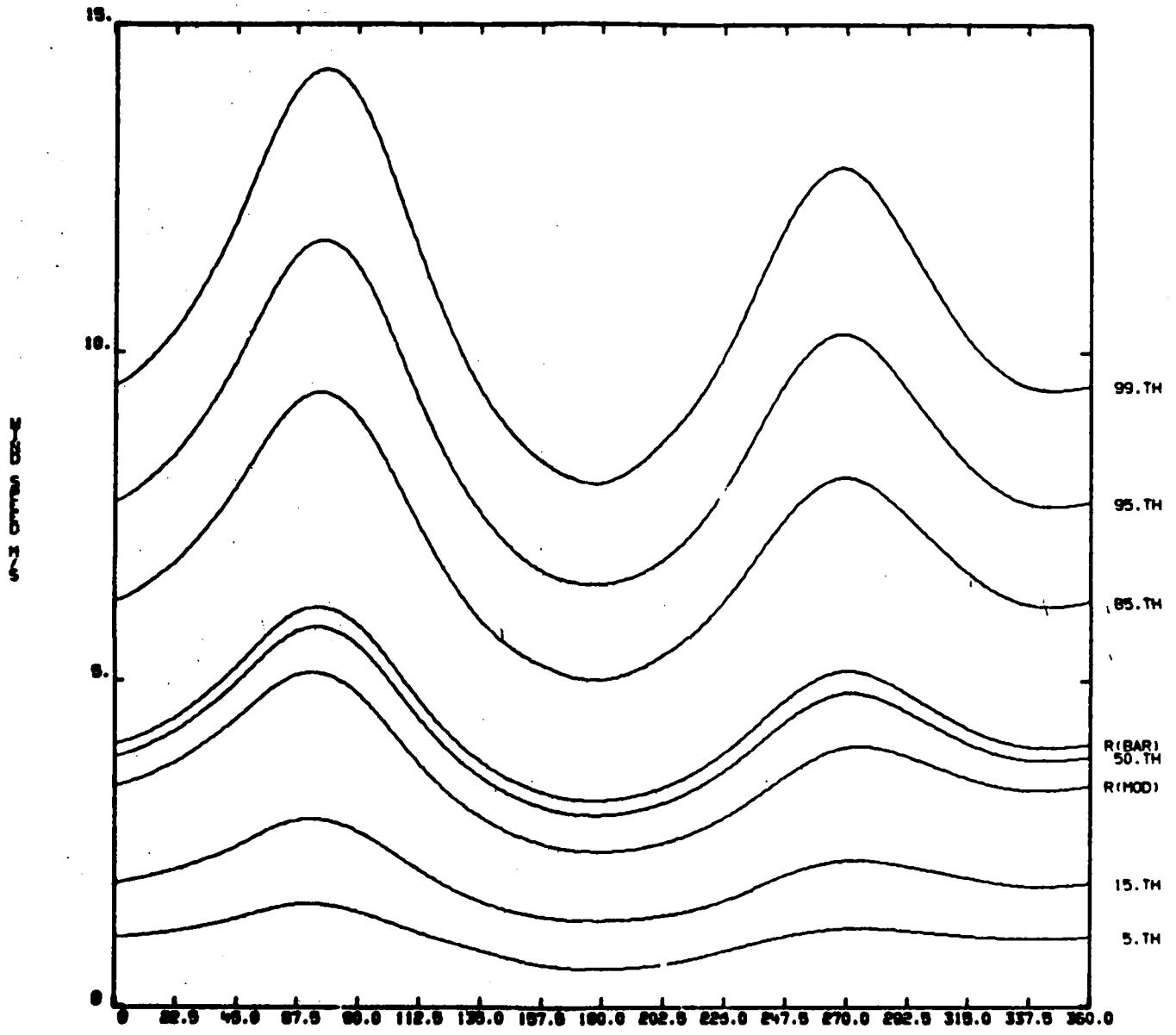

Figure A-50.

STATION-BARKINGSANDS MONTH-JAN ALT=20KM



CONDITIONAL WIND SPEED GIVEN WIND DIRECTION

Figure A-51.

STATION=BARKINGSANDS MONTH=JAN ALT=30KM

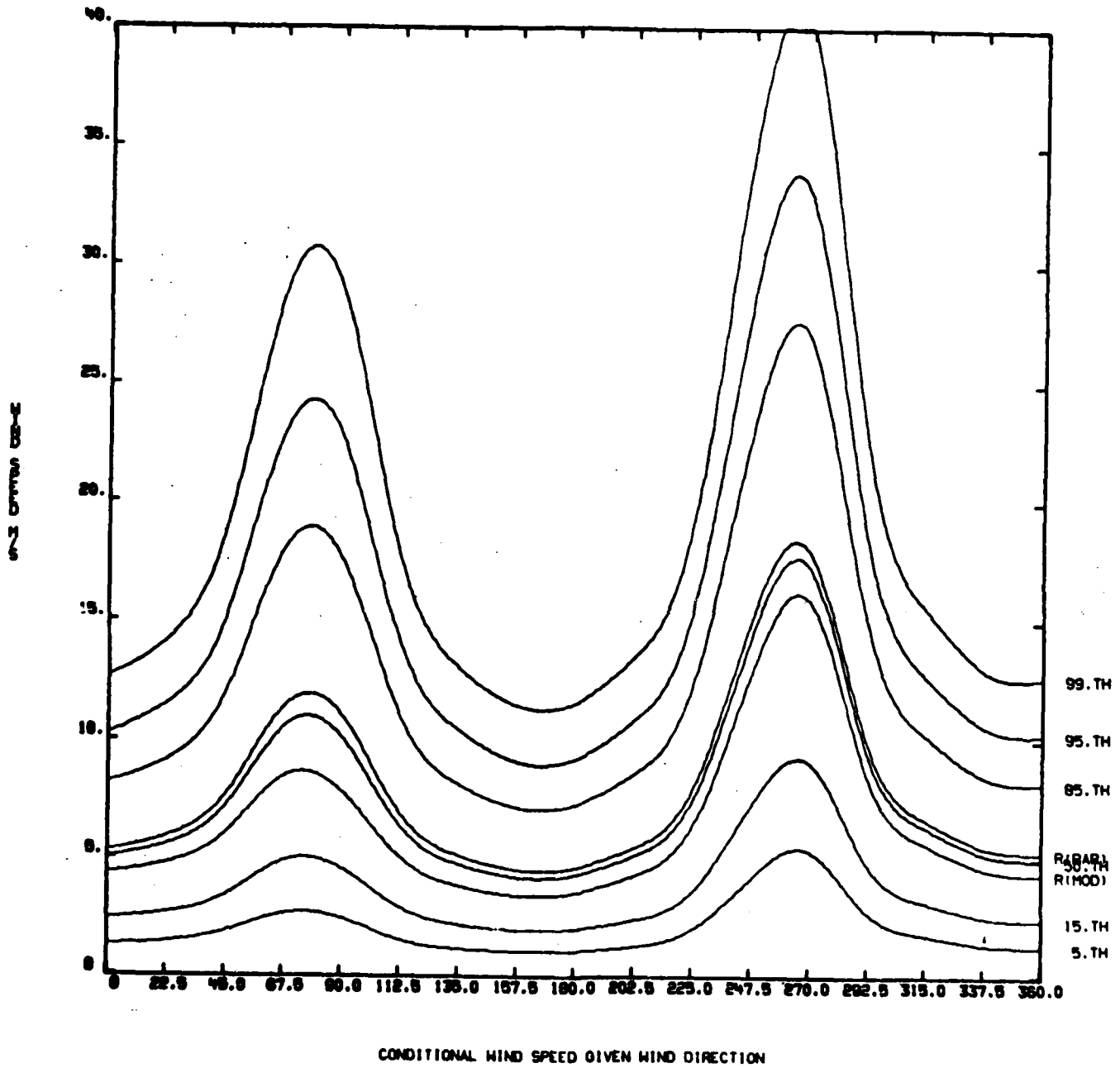

Figure A-52.

STATION=BARKINGSANDS MONTH=JAN ALT=401M

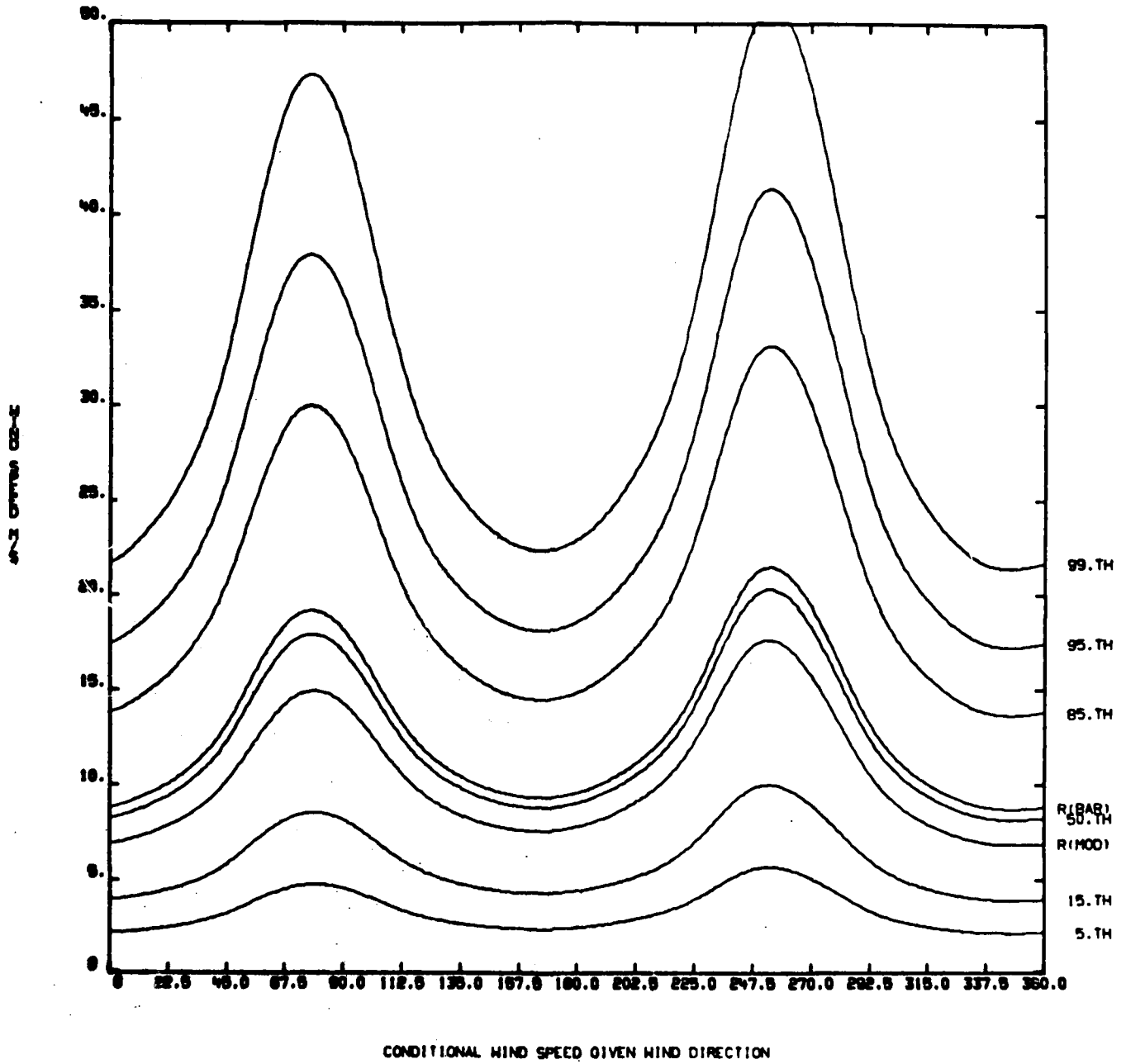

Figure A-53.

STATION=BARKINGSANDS MONTH=JAN ALT=50KM

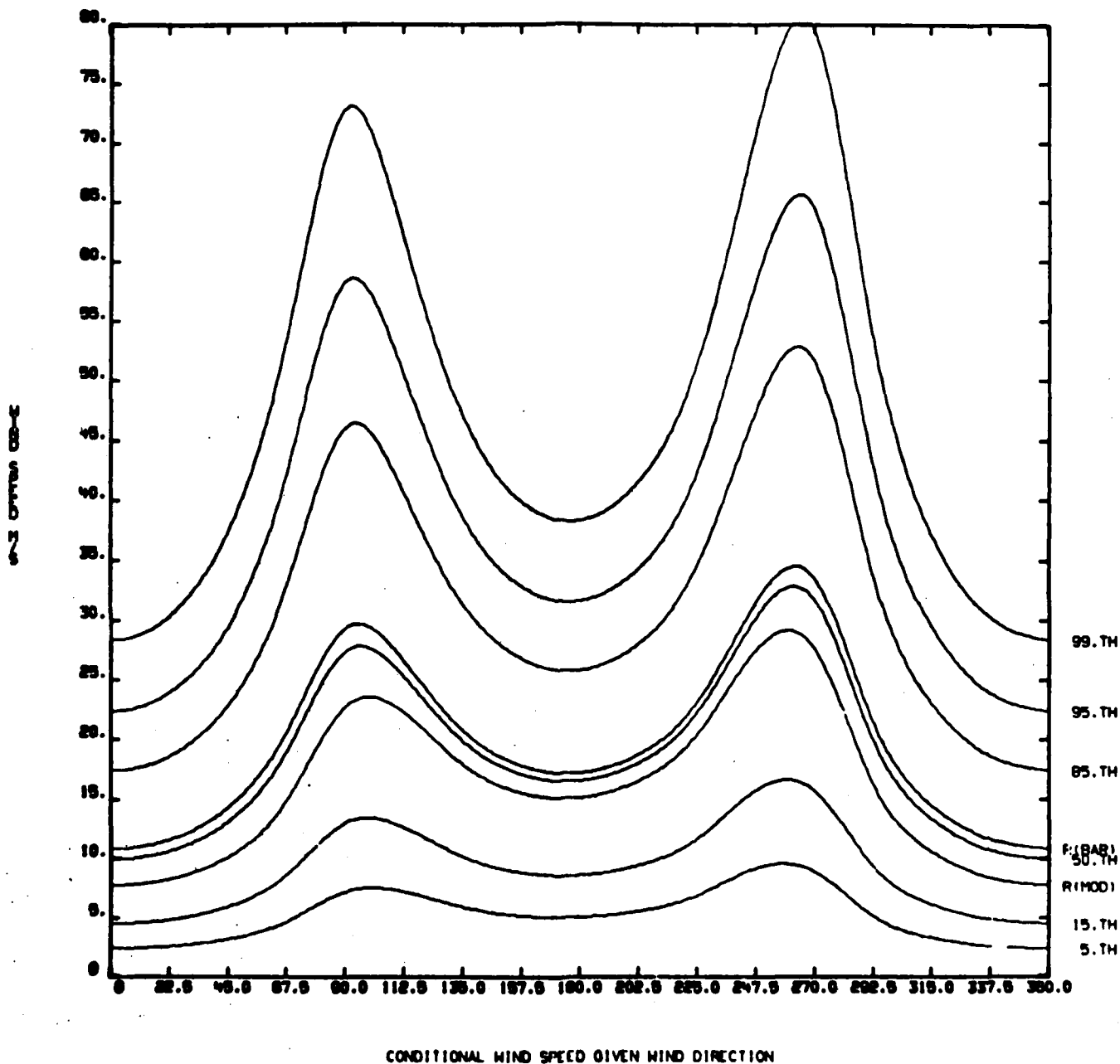

Figure A-54.

STATION=BARKINGSANDS MONTH=JAN ALT=6CKM

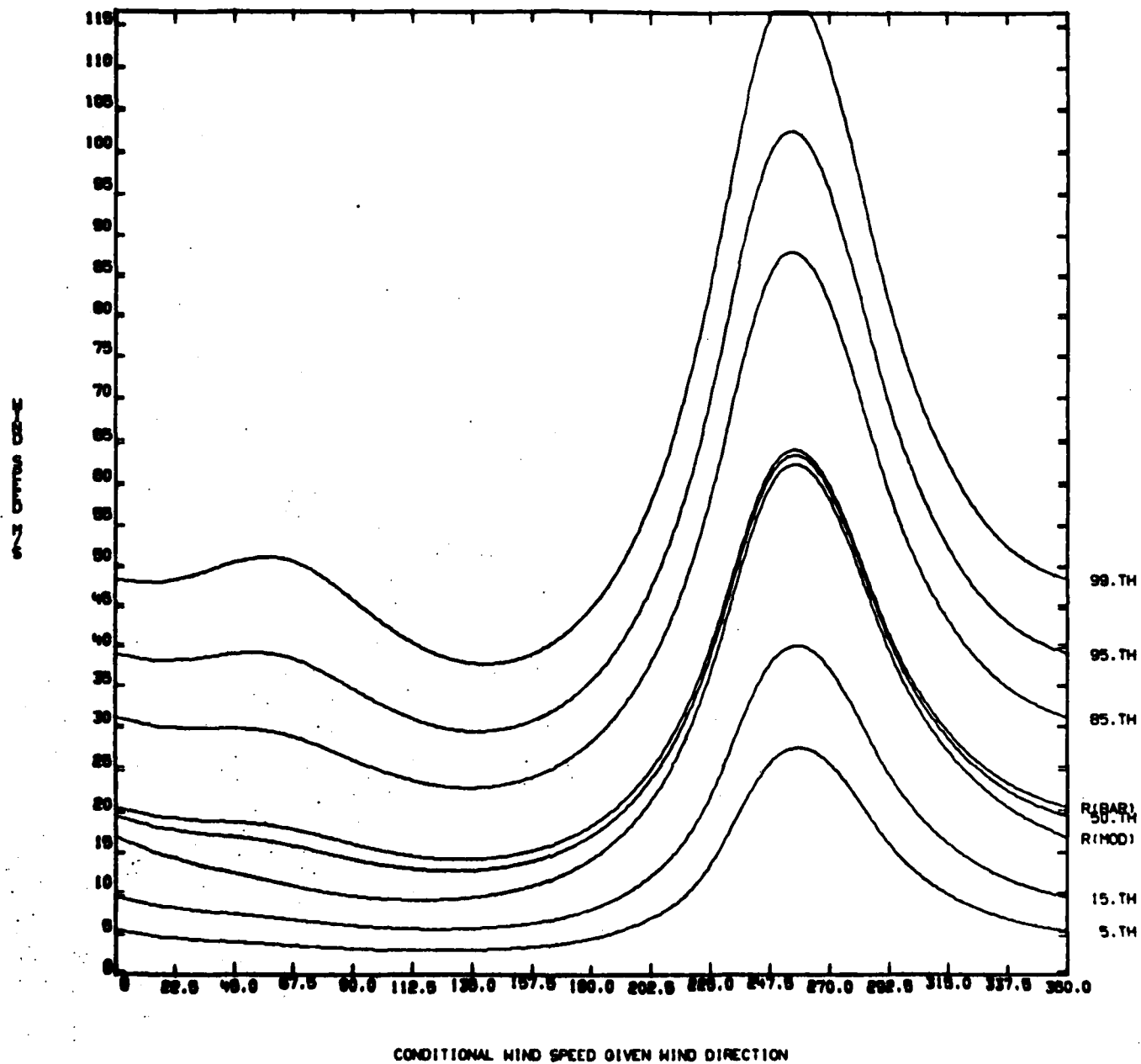

Figure A-55.

STATION=BARKINGSANDS MONTH=JAN ALT=701M

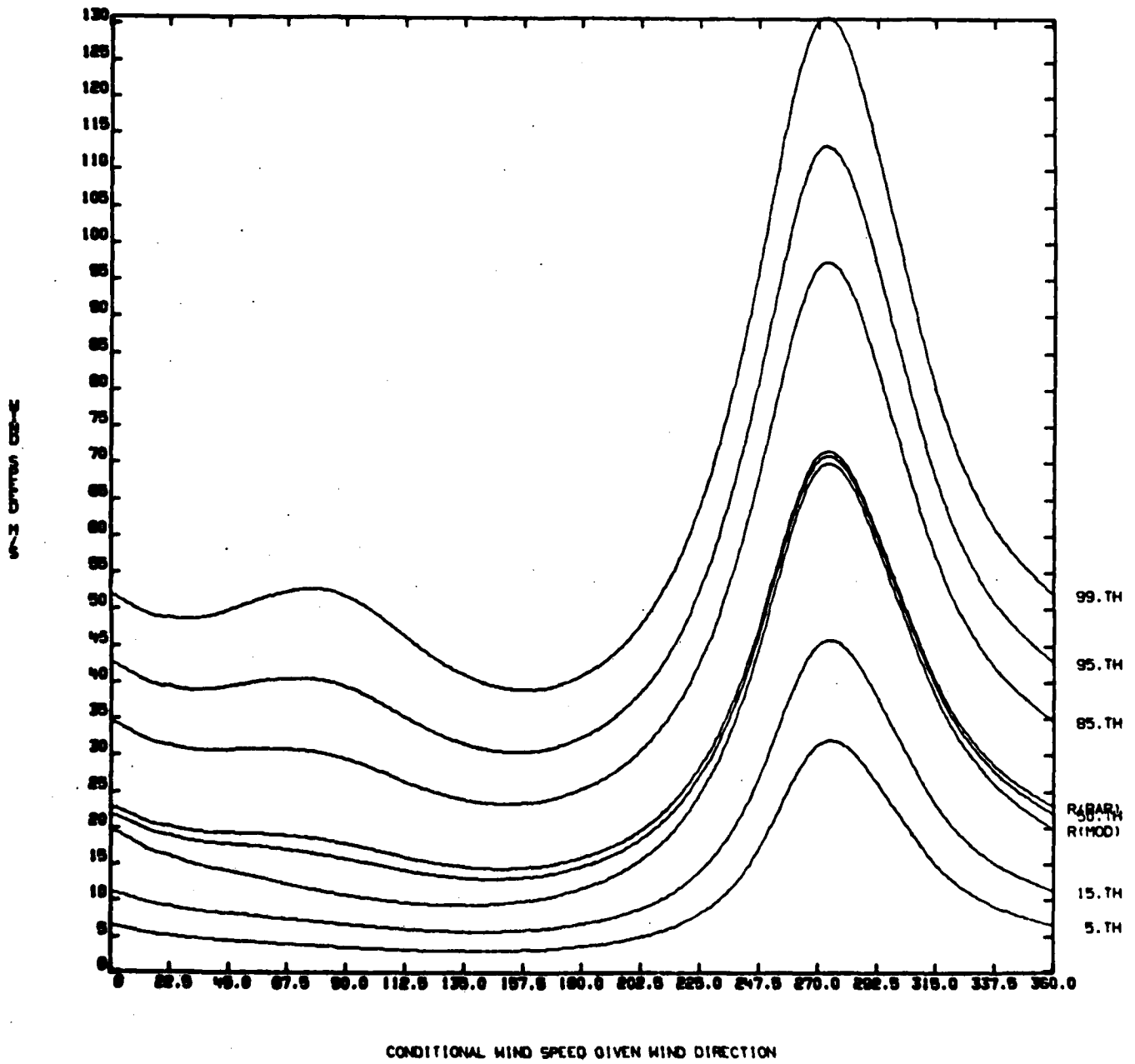

Figure A-56.

STATION-BARKINGSANDS MONTH-JUL ALT= 4KM

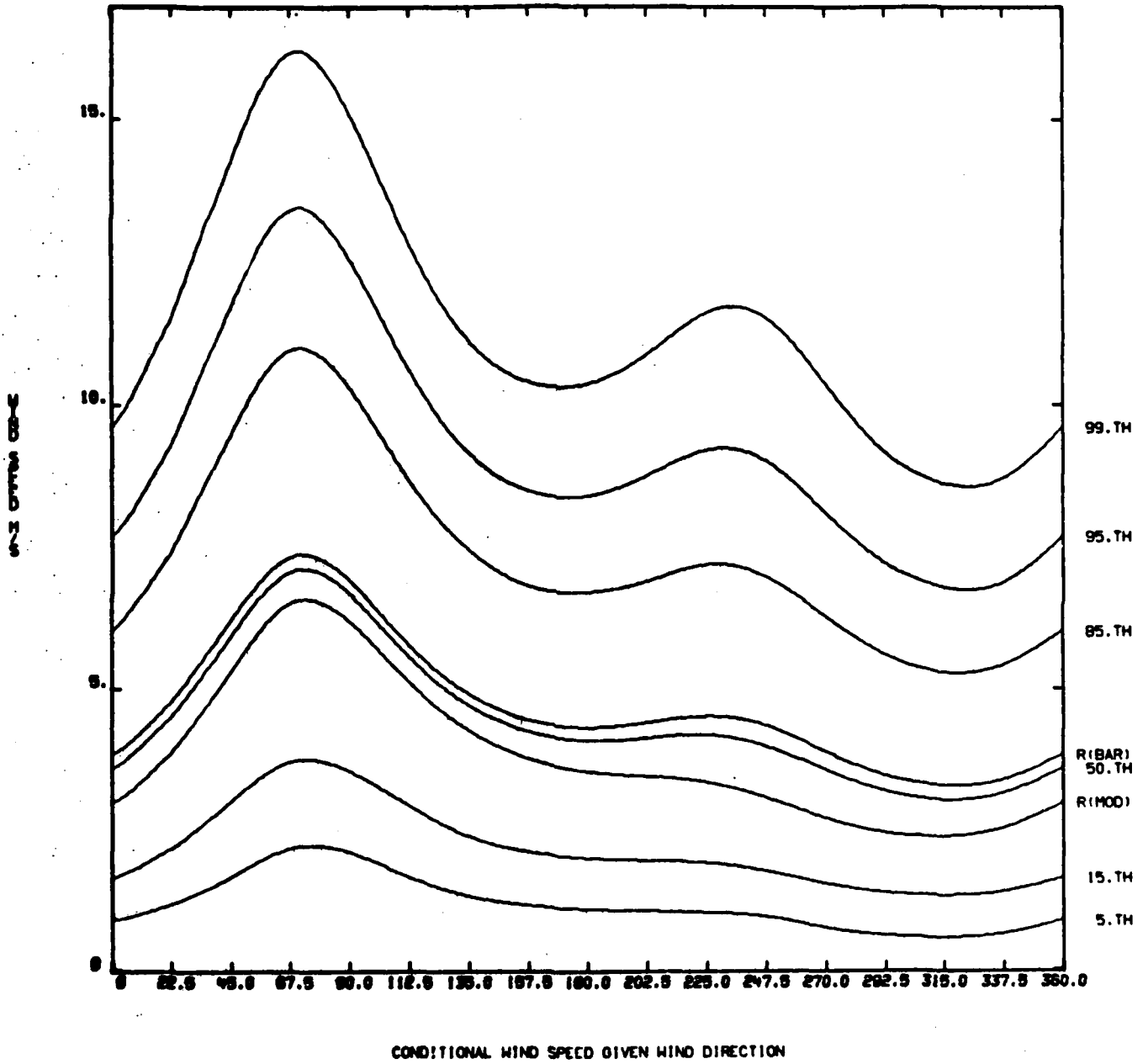

Figure A-57.

STATION=BARKINGSANDS MONTH=JUL ALT=12K01

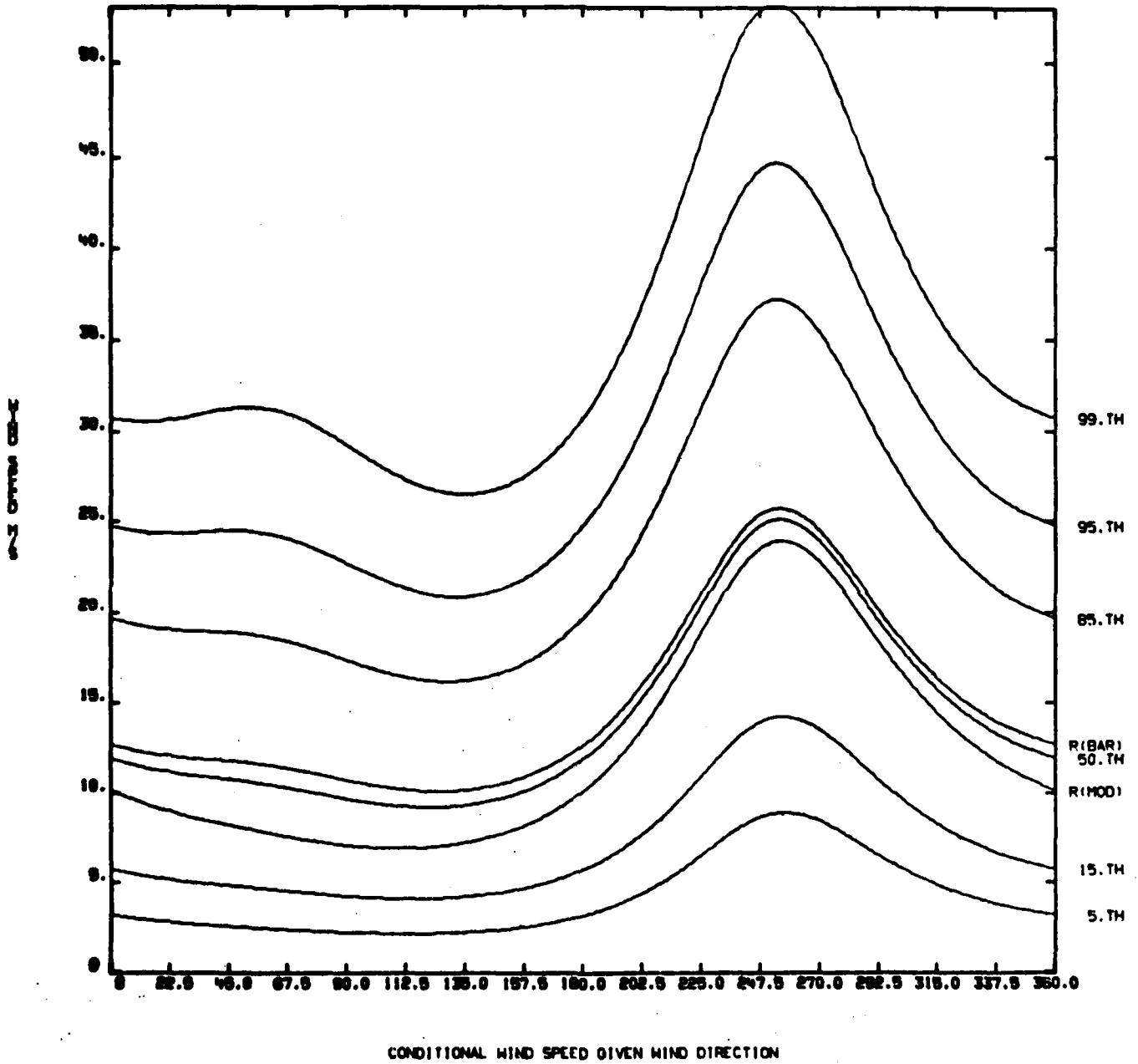

Figure A-58.

STATION-BARKINGSANDS MONTH-JUL ALT-20KM

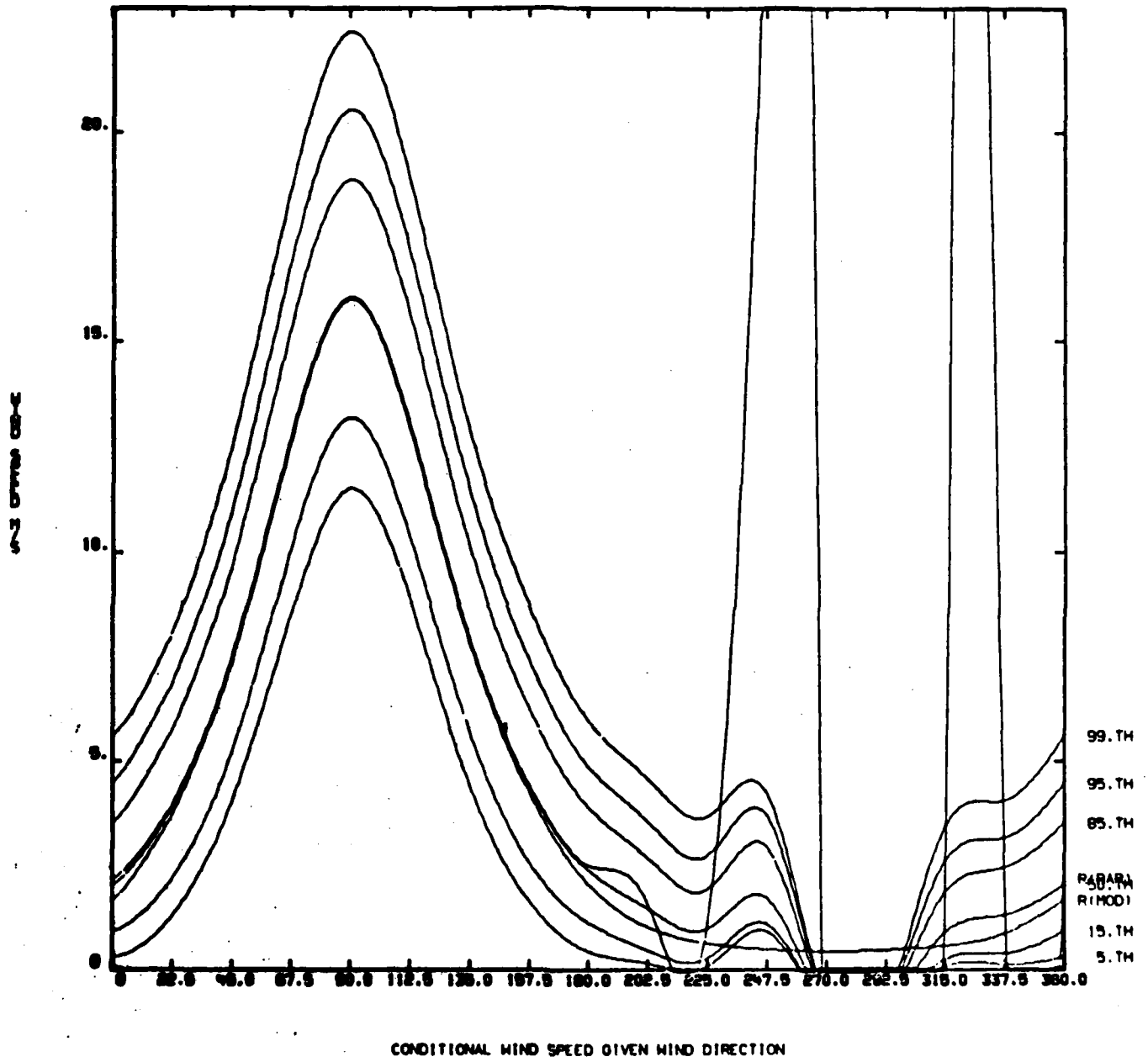

Figure A-59.

STATION=BARKINGSANDS MONTH=JUL ALT=30KM

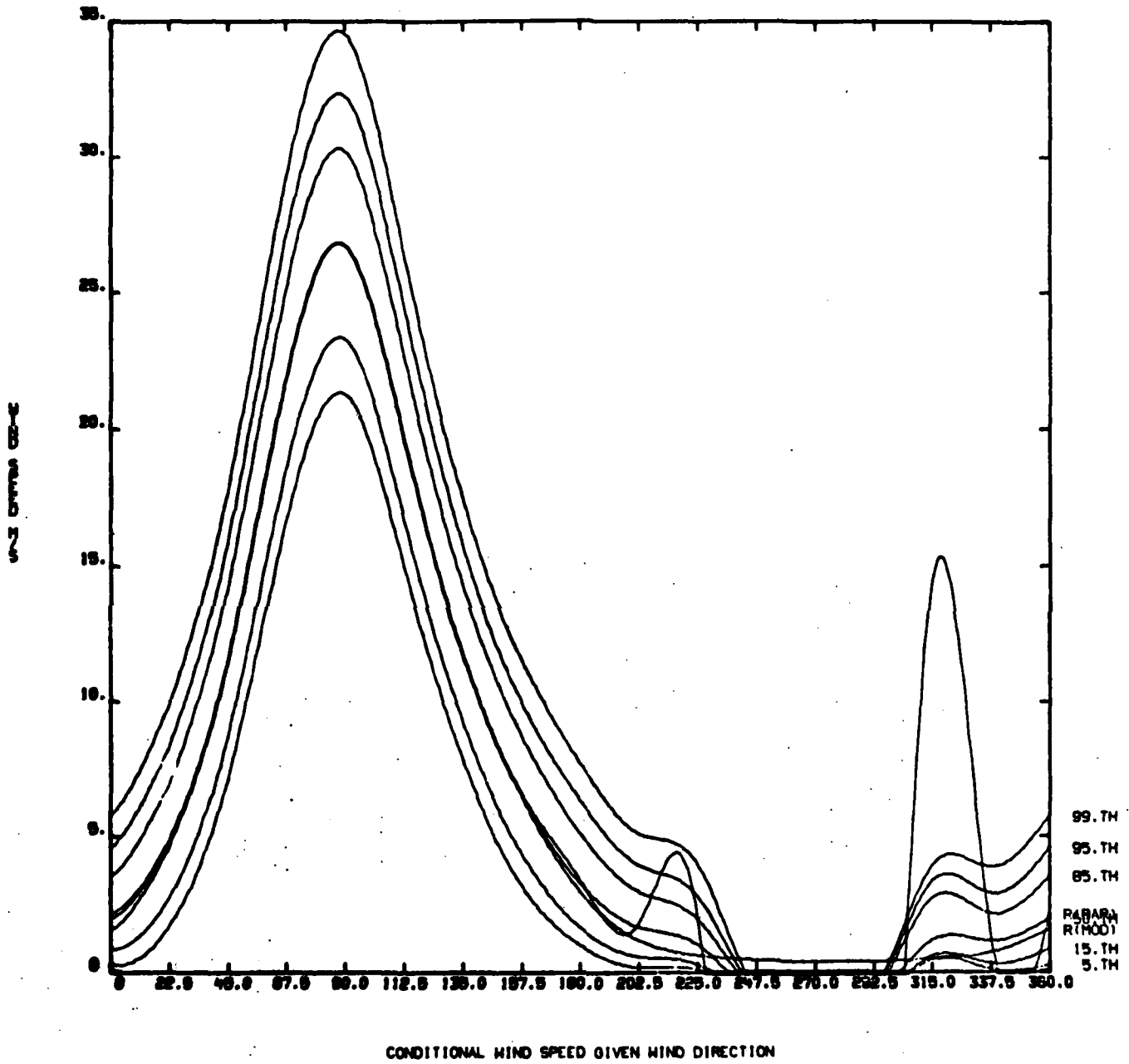

Figure A-60.

STATION-BARKINGSANDS MONTH-JUL ALT=40001

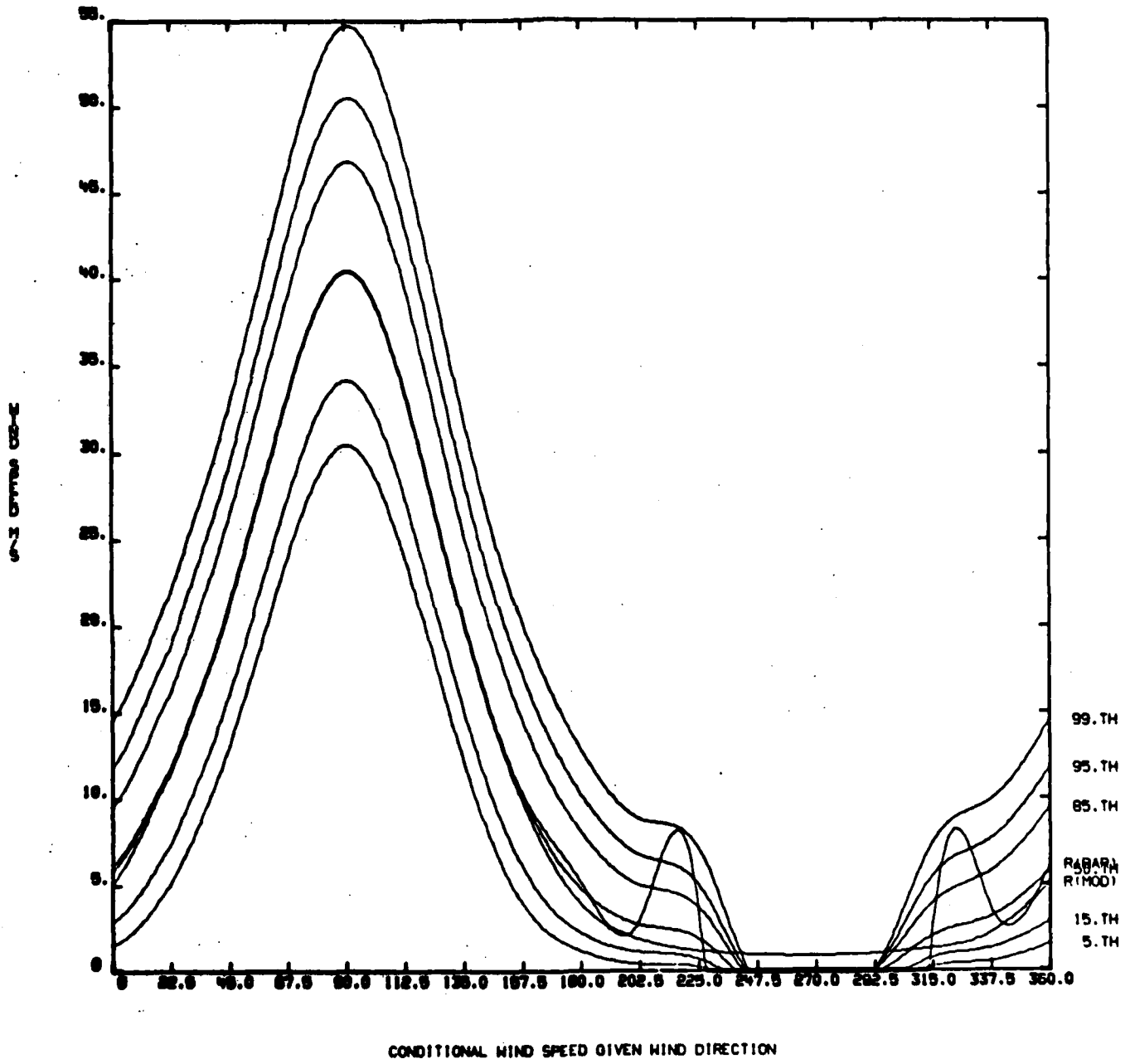

Figure A-61.

STATION-BARKINOSANDS MONTH-JUL ALT-50M

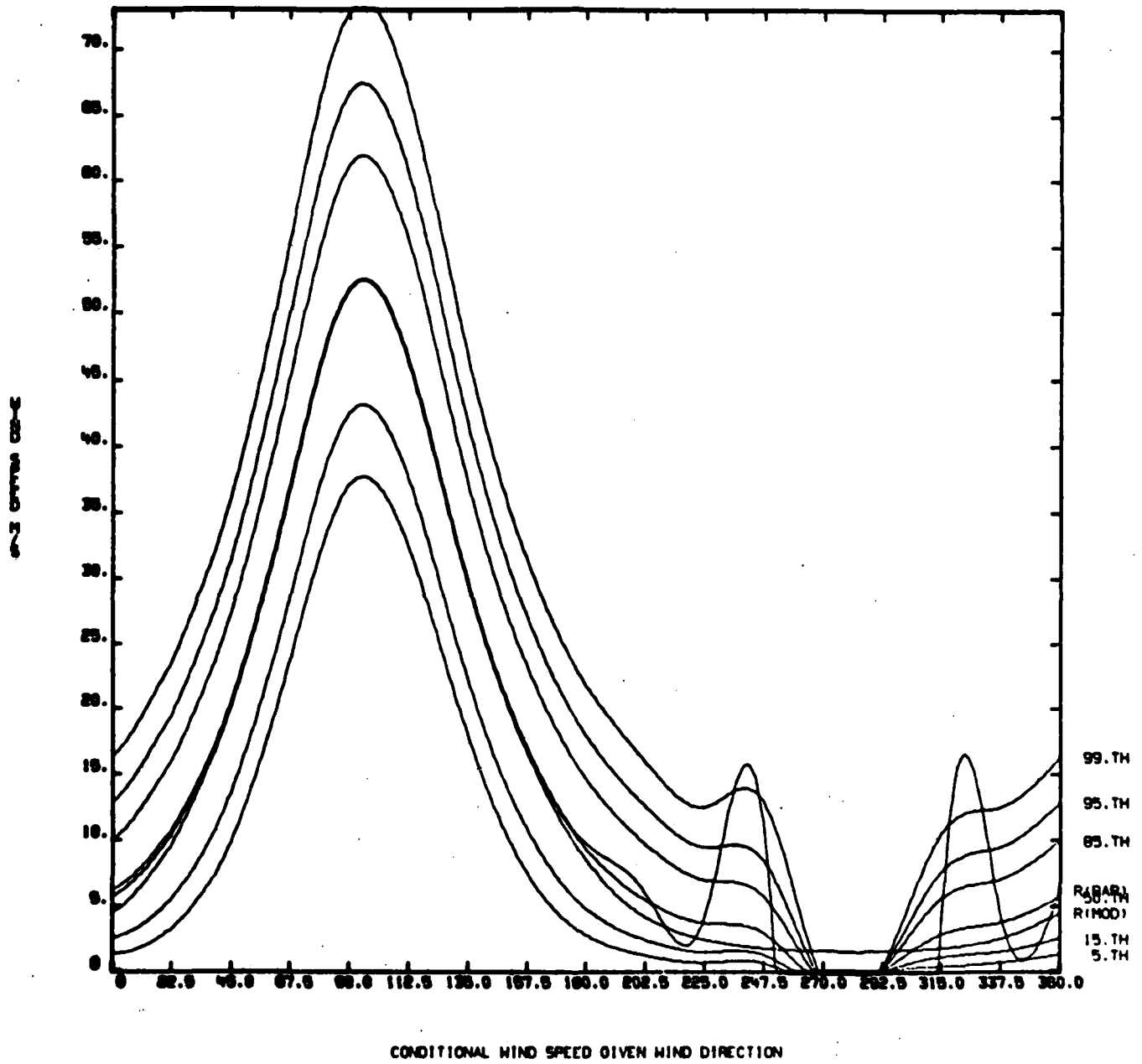

Figure A-62.

STATION=BARKINGSANDS MONTH=JUL ALT=60CM

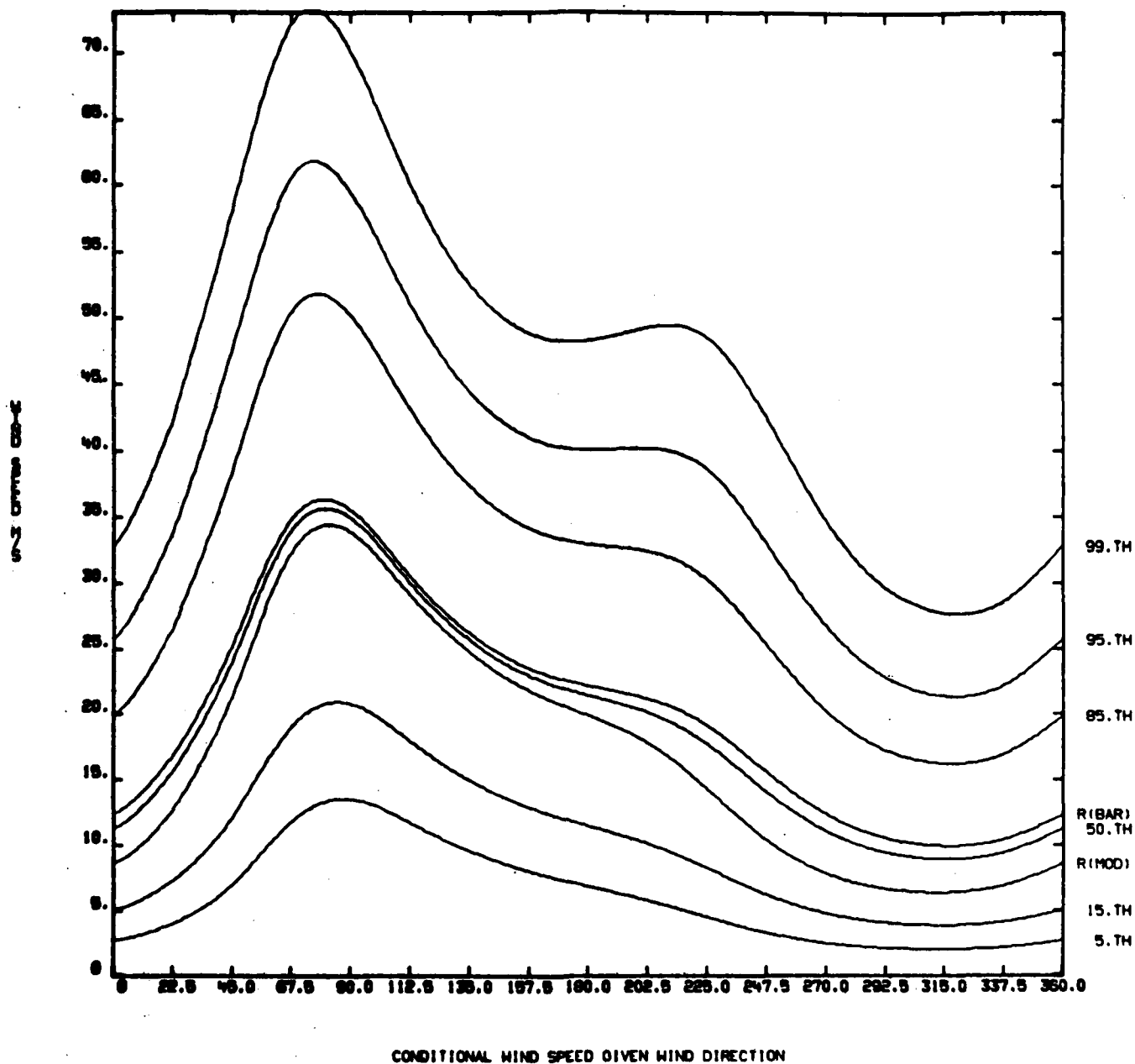

Figure A-63.

STATION=BARKINOSANDS MONTH=JUL ALT=70KM

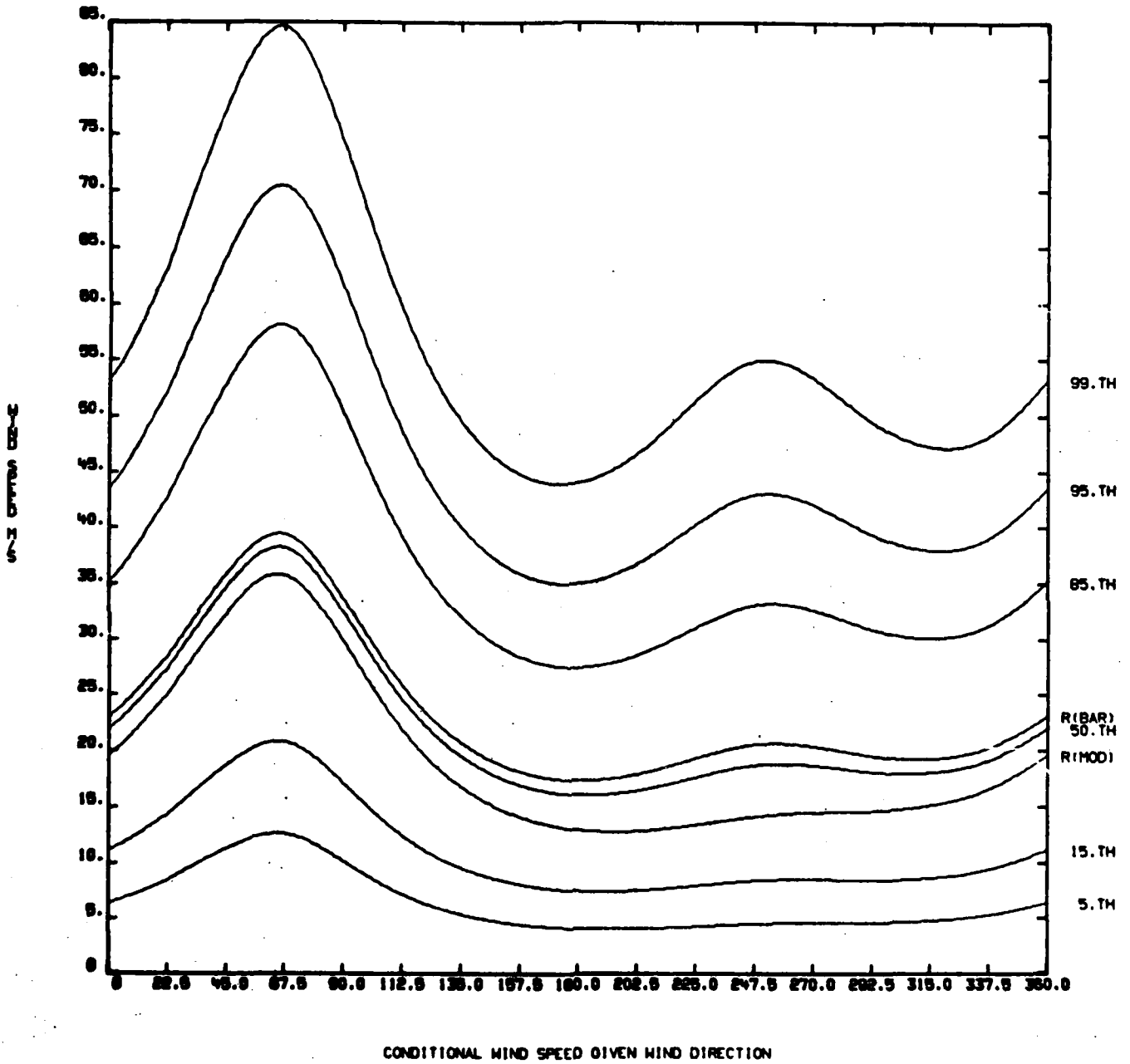

Figure A-64.

APPENDIX B

RANGE SPECIFIC INFORMATION AND THERMODYNAMIC QUANTITIES
FOR BARKING SANDS, HAWAII

1. Range Specific Information

To prevent further character size reductions for tables I through IV, certain range-specific information has been omitted. This important information is given in table B-1.

TABLE B-1

<u>Header Record 0-30 Km</u>	<u>Header Record 32-70 Km</u>
Table Number-----0	Table Number-----0
Data Source (1=DATSAV, 2=WDC-A)----1	Data Source (1=DATSAV, 2=WDC-A)----2
Call Letters-----BKH	Call Letters-----BKH
WMO Number-----91162	WMO Number-----91162
Latitude-----22.02	Latitude-----22.02
Direction (N or S)-----N	Direction (N or S)-----N
Longitude-----159.47	Longitude-----159.47
Direction (E or W)-----W	Direction (E or W)-----W
Elevation in Meters-----5	Elevation in Meters-----5
Start Period of Record (Mo-Yr)----863	Start Period of Record (Mo-Yr)----169
End Period of Record (Mo-Yr)----1282	End Period of Record (Mo-Yr)----1179
No. of Time Windows (0, 1 or 2)----1	No. of Time Windows (0, 1 or 2)----1
Start Time Window No. 1 (Hr-MNZ)-1700	Start Time Window No. 1 (Hr-MNZ)-1700
End Time Window No. 1-----100	End Time Window No. 1-----100
Start Time Window No. 2-----0	Start Time Window No. 2-----0
End Time Window No. 2-----0	End Time Window No. 2-----0
Date of RRA-----683	Date of RRA-----683
Altitude Range of RRA	Altitude Range of RRA
Low Level (km)-----0	Low Level (km)-----30
Altitude Range of RRA	Altitude Range of RRA
High Level (km)-----30	High Level (km)-----70
Standard Deviation of Thermo-	Standard Deviation of Thermo-
dynamic Limits-----6.0	dynamic Limits-----6.0
Wind Limits-----6.0	Wind Limits-----6.0

2. Thermodynamic Quantities

This section presents examples of further computations and graphical displays of pressure, density, and virtual temperature statistics that can be derived from the data given in tables II, III, and IV. No attempt is made to present complete nor exhaustive illustrations that can be made to aid in visualizing the relationships that can be made from the data in tables II and IV. The choices are those that aided the committee to verify the reasonableness of the tabulations.

2.1 Monthly Mean from the Annual Mean

The hydrostatic model values in table IV are used to compute (1) the monthly mean differences relative to the annual mean values of pressure, density, and

virtual temperature expressed in percent and (2) the monthly mean difference in virtual temperature for the annual mean virtual temperature expressed in degrees Kelvin. Examples of these four statistics are given in table B-2 for January and table B-3 for July. Graphical displays of the four statistics contained in tables B-2 and B-3 are shown in figures B-1 through B-8. Also, the relative differences between the monthly mean values from table IV-1 through IV-12 for all months from the annual mean values (table IV-13) are illustrated in figure B-9 for pressure, in figure B-10 for density, and in figure B-11 for virtual temperature. The monthly mean virtual temperature differences from the annual mean virtual temperature for all months are given in figure B-12. The simple sum of the monthly mean differences from the annual mean values of these quantities is not zero. This is because the annual mean statistical parameters are computed (see section III.C.3 of text) by weighting the monthly means by the number of observations in each month.

2.2 Coefficients of Variation and Derived Correlation Coefficients

The coefficient of variation, C_V , is defined by the standard deviation with respect to the mean divided by the mean. The coefficients of variation for pressure, C_{VP} , and density, C_{VD} , were computed using the standard deviations from table II and the hydrostatic mean values from table IV. The coefficient of variation for temperature uses the standard deviations of virtual temperature from table III to the altitude where virtual temperature exists. Above this altitude, the standard deviations of temperature are from table II. The mean values for temperature (virtual temperature to the altitude where it exists) are taken from table IV. No distinction is made in the table headings in table B-4 (January) and table B-5 (July) and all related figures between virtual temperature and temperature.

From the coefficients of variation for pressure, density, and temperature (virtual temperature to the altitude where it exists), the correlation coefficients between these quantities are derived using Buell's method (see reference in text). The equations for these derived correlation coefficients are

$$r(P,T) = \frac{(C_{VT})^2 + (C_{VP})^2 - (C_{VD})^2}{2 [C_{VT} \cdot C_{VP}]} \quad (B-1)$$

$$r(P,D) = \frac{(C_{VD})^2 - (C_{VT})^2 + (C_{VP})^2}{2 [C_{VP} \cdot C_{VD}]} \quad (B-2)$$

$$r(T,D) = \frac{(C_{VP})^2 - (C_{VD})^2 - (C_{VT})^2}{2 [C_{VT} \cdot C_{VD}]} \quad (B-3)$$

The correlation coefficients in tables B-4 and B-5 are derived from the above equations.

A test for the validity of the derived correlation coefficients is that all three of the following inequalities be satisfied.

$$C_{VP} - [C_{VD} + C_{VT}] < 0$$

$$C_{VD} - [C_{VT} + C_{VP}] < 0 \quad (B-4)$$

$$C_{VT} - [C_{VP} + C_{VD}] < 0$$

In these examples (tables B-4 and B-5) the numerical values from equation (B-4) are all negative; hence, the derived correlation test is considered valid. The rare exceptions to this test for several RRAs occur at the extreme highest altitudes, where samples sizes for the statistical sample are small.

The statistical parameters from table B-4 (January) and table B-5 (July) are illustrated in figures B-13 through B-16.

For all months the C_{VP} values are shown in figure B-17, the C_{VD} values are shown in figure B-18, and C_{VT} values are shown in figure B-19. If the abscissa on the figures for the coefficient of variation were multiplied by 100, these figures would show the percentage of the random dispersion of these quantities over the month with respect to the monthly mean for these thermodynamic quantities.

The derived correlation coefficients for all months are illustrated in the following figures:

- a) Figure B-20 gives $r(P,D)$.
- b) Figure B-21 gives $r(P,T)$.
- c) Figure B-22 gives $r(T,D)$.

TABLE B-2.

STATION 911620 MONTH 1
 DELTAS IN PERCENT RELATIVE TO ANNUAL

LEVEL	PRESSURE	DENSITY	TEMP.	TMO-TAPN(CEG.K)
.000	-.17	1.01	-1.17	-3.49
.005	-.17	1.01	-1.16	-3.47
1.000	-.27	.37	-.63	-1.83
2.000	-.34	.19	-.53	-1.52
3.000	-.40	.09	-.49	-1.37
4.000	-.46	.09	-.56	-1.54
5.000	-.53	.07	-.60	-1.63
6.000	-.61	-.02	-.60	-1.79
7.000	-.69	-.12	-.57	-1.47
8.000	-.76	-.30	-.45	-1.12
9.000	-.80	-.06	-.13	-.32
10.000	-.78	-1.09	.30	.71
11.000	-.72	-1.35	.63	1.44
12.000	-.60	-1.47	.88	1.94
13.000	-.48	-1.26	.81	1.73
14.000	-.37	-.82	.44	.93
15.000	-.36	-.05	-.31	-.64
16.000	-.48	.68	-1.15	-2.32
17.000	-.74	1.11	-1.88	-3.79
18.000	-1.10	1.33	-2.39	-4.85
19.000	-1.48	.62	-2.03	-4.29
20.000	-1.77	-.25	-1.52	-3.19
21.000	-1.99	-.77	-1.22	-2.60
22.000	-2.18	-1.00	-1.18	-2.54
23.000	-2.37	-1.13	-1.24	-2.69
24.000	-2.57	-1.23	-1.36	-2.99
25.000	-2.78	-1.35	-1.45	-3.21
26.000	-3.00	-1.55	-1.46	-3.20
27.000	-3.21	-1.79	-1.42	-3.20
28.000	-3.40	-2.21	-1.23	-2.79
29.000	-3.58	-2.40	-1.22	-2.79
30.000	-3.76	-2.58	-1.19	-2.74
32.000	-4.06	-2.79	-.96	-2.26
34.000	-4.33	-3.03	-1.02	-2.44
35.000	-4.54	-3.66	-.56	-1.37
38.000	-4.64	-4.15	-.15	-.37
40.000	-4.64	-4.38	.09	.23
42.000	-4.60	-4.54	.28	.73
44.000	-4.48	-4.75	.66	1.74
46.000	-4.29	-4.87	.94	2.51
48.000	-4.13	-4.17	.40	1.68
50.000	-4.10	-3.63	-.13	-.34
52.000	-4.16	-3.42	-.41	-1.08
54.000	-4.18	-4.04	.21	.54
56.000	-4.09	-4.31	.61	1.60
58.000	-3.88	-4.49	1.02	2.62
60.000	-3.63	-4.22	.99	2.52
62.000	-3.33	-4.31	1.38	3.40
64.000	-2.98	-3.87	1.29	3.07
66.000	-2.60	-3.68	1.46	3.27
68.000	-2.02	-4.18	2.65	5.75
70.000	-1.16	-3.84	3.17	6.71

TABLE B-3.

STATION 9:1620 MONTH 7
 DELTAS IN PERCENT RELATIVE TO ANNUAL

LEVEL	PRESSURE	DENSITY	TEMP.	THO-TANN(DEG.K)
.000	.04	-.76	.89	2.62
.005	.05	-.85	.90	2.69
1.000	.12	-.28	.44	1.28
2.000	.18	-.31	.48	1.38
3.000	.23	-.10	.33	.94
4.000	.27	-.06	.33	.92
5.000	.32	-.11	.42	1.15
6.000	.37	-.11	.48	1.28
7.000	.44	-.07	.51	1.31
8.000	.51	.02	.49	1.23
9.000	.57	.15	.43	1.04
10.000	.62	.36	.28	.65
11.000	.65	.56	.09	.21
12.000	.64	.81	-.15	-.33
13.000	.61	.85	-.24	-.52
14.000	.60	.55	.01	.03
15.000	.64	.05	.61	1.26
16.000	.81	-.53	1.35	2.74
17.000	1.08	-.87	1.95	3.94
18.000	1.41	-.59	2.01	4.08
19.000	1.71	.16	1.55	3.19
20.000	1.92	.80	1.11	2.32
21.000	2.09	1.09	.99	2.10
22.000	2.24	1.42	.82	1.77
23.000	2.36	1.62	.74	1.60
24.000	2.48	1.77	.69	1.52
25.000	2.58	1.89	.67	1.49
26.000	2.68	2.07	.58	1.29
27.000	2.76	2.26	.49	1.11
28.000	2.83	2.41	.43	.98
29.000	2.90	2.49	.40	.92
30.000	2.95	2.69	.27	.62
32.000	2.93	3.09	-.38	-.89
34.000	2.80	2.98	-.46	-1.11
36.000	2.69	2.77	-.32	-.78
38.000	2.58	2.82	-.47	-1.17
40.000	2.44	2.77	-.56	-1.43
42.000	2.32	2.40	-.33	-.86
44.000	2.19	2.65	-.66	-1.73
46.000	2.00	2.57	-.78	-2.09
48.000	1.81	2.16	-.63	-1.69
50.000	1.62	2.27	-.87	-2.31
52.000	1.33	2.52	-1.39	-3.69
54.000	.93	2.26	-1.51	-3.07
56.000	.58	1.75	-1.37	-3.59
58.000	.22	1.36	-1.35	-3.47
60.000	-.20	1.37	-1.78	-4.50
62.000	-.78	1.54	-2.52	-6.23
64.000	-1.54	1.15	-2.89	-6.89
66.000	-2.28	-.26	-2.26	-5.20
68.000	-2.82	-1.64	-1.57	-2.98
70.000	-3.26	-2.02	-1.48	-3.14

STATION = 911620 MONTH = 1

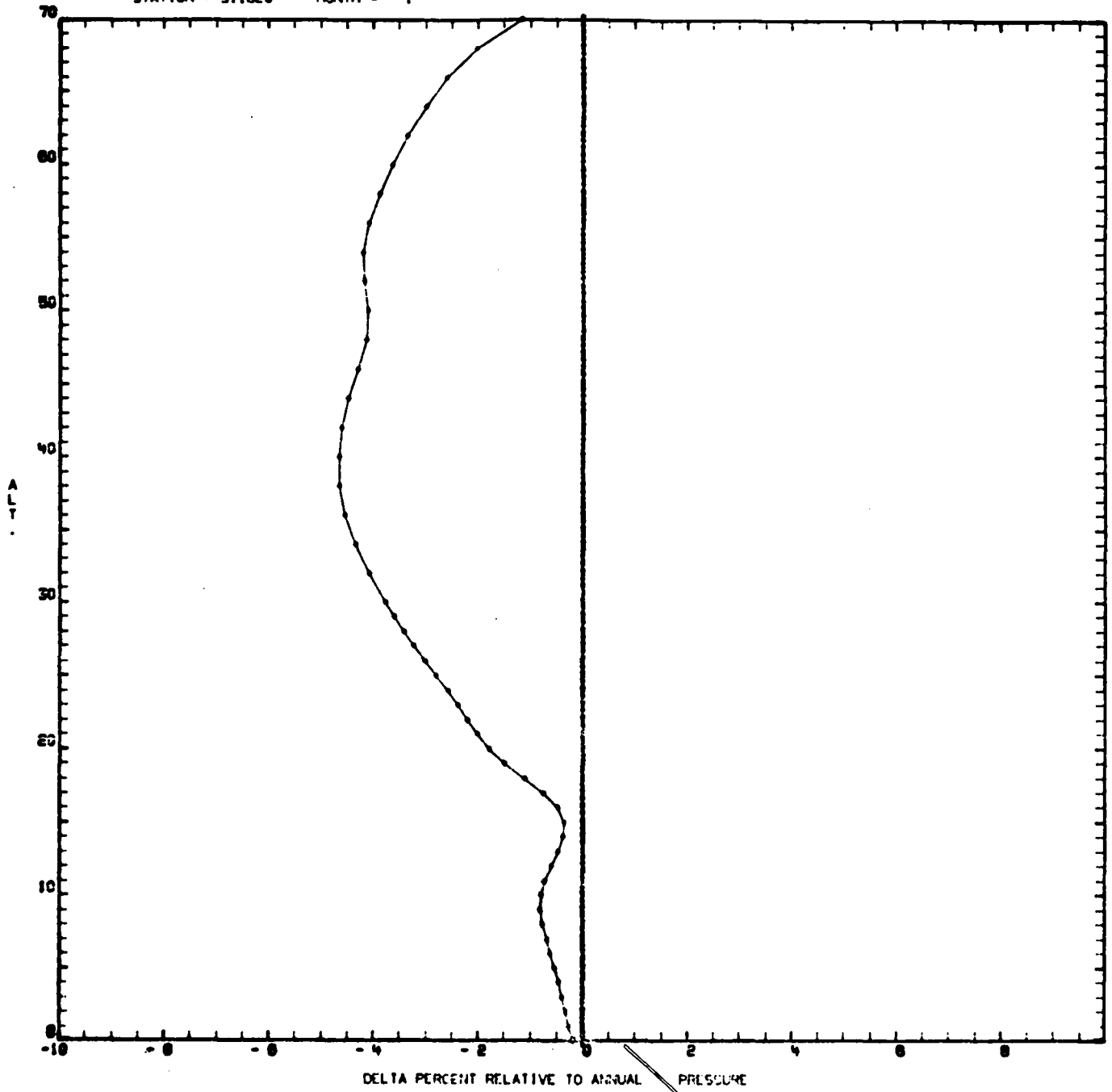

Figure B-1.

STATION - 911620 MONTH - 1

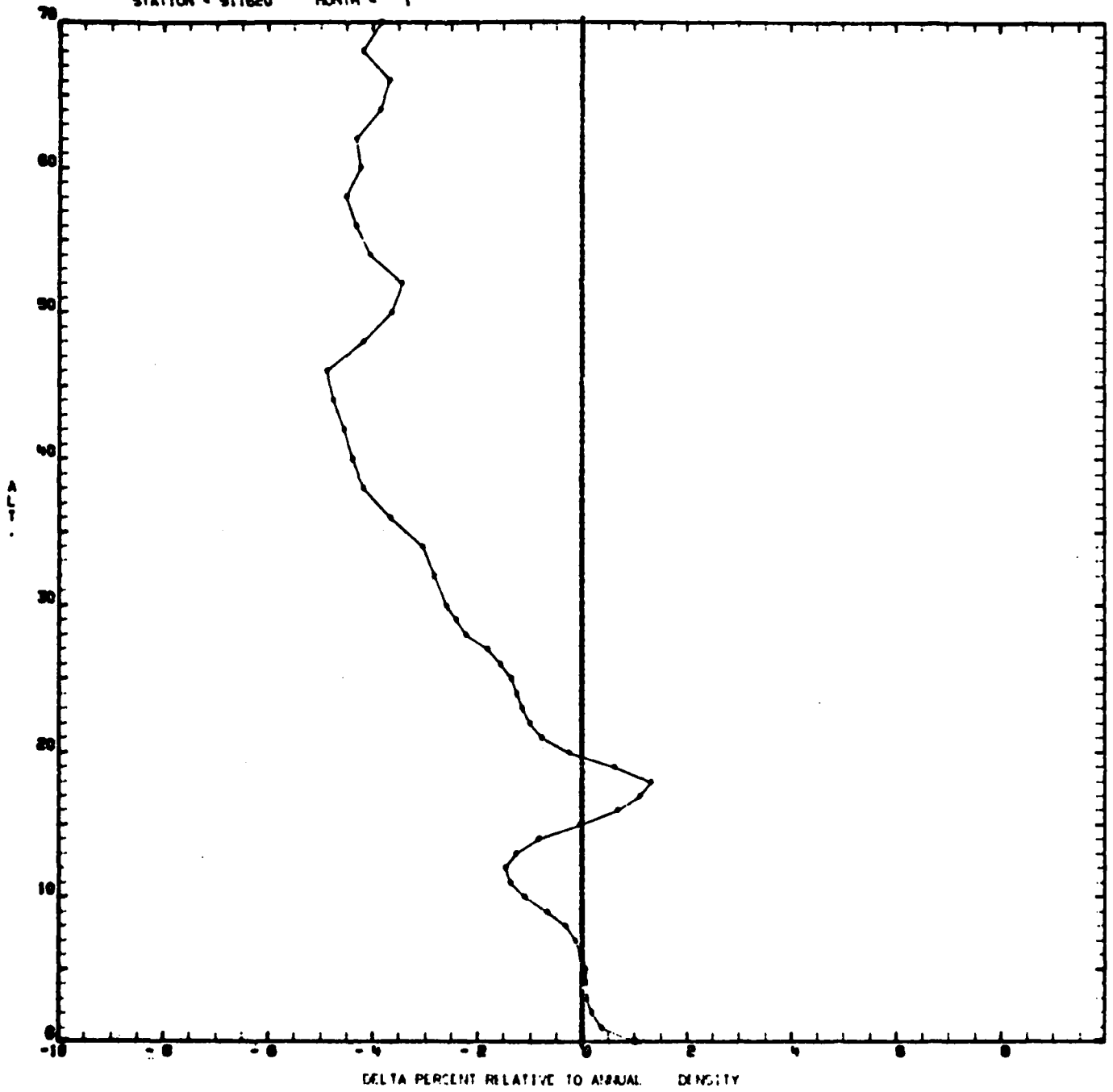

Figure B-2.

STATION • 911620 MONTH • 1

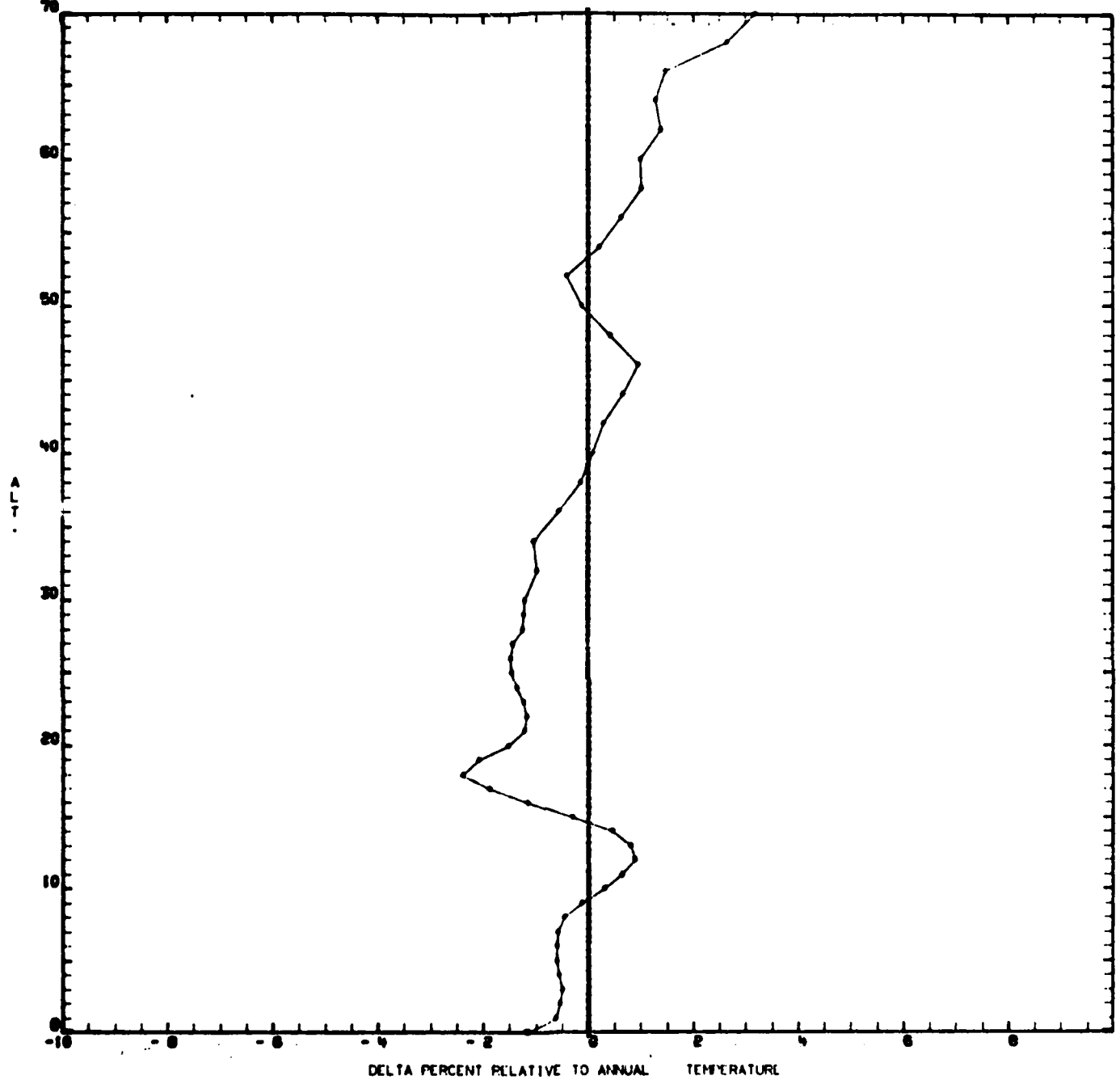

Figure B-3.

STATION = 911620 MONTH = 1

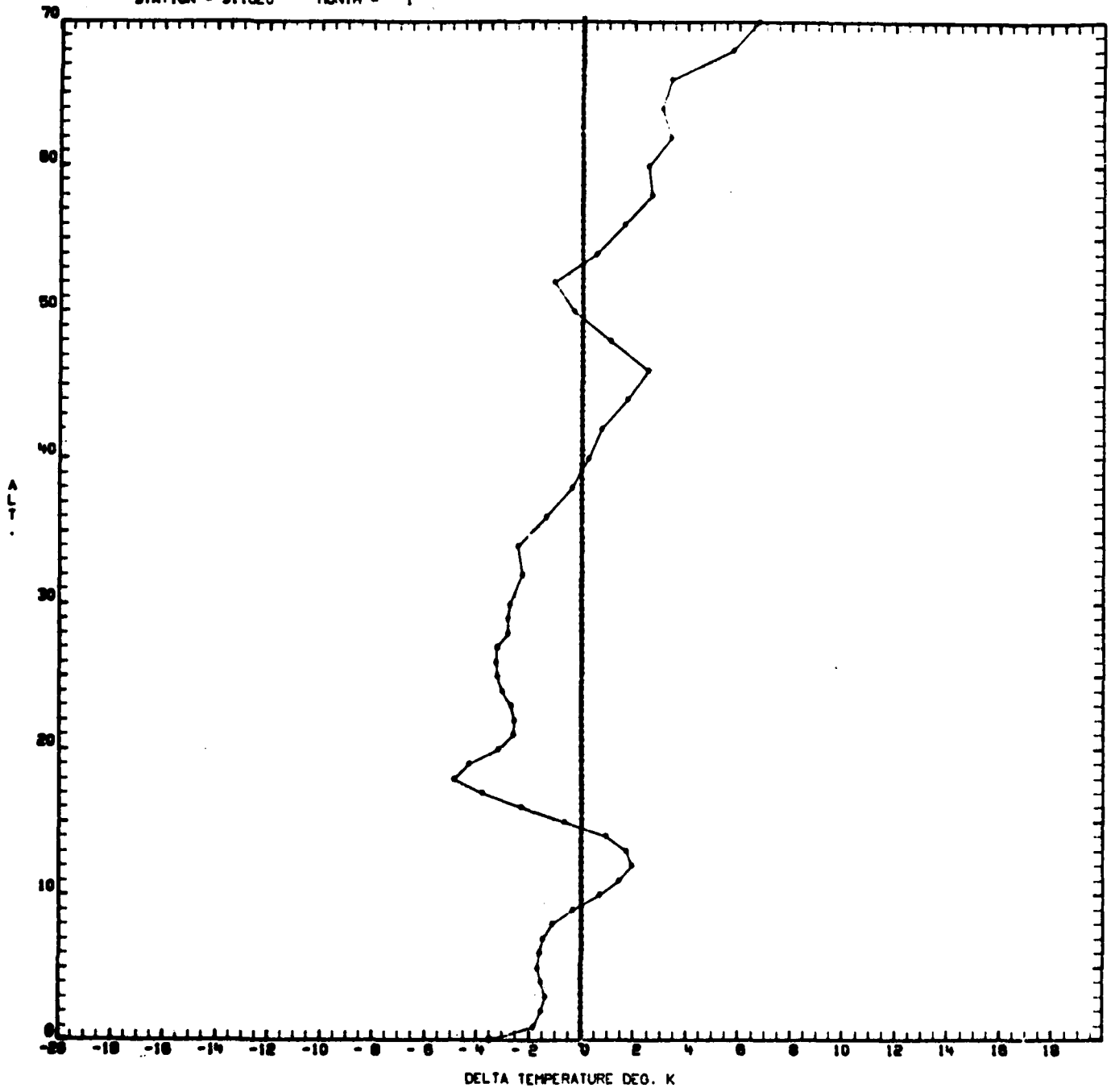

Figure B-4.

STATION - 911620 MONTH - 7

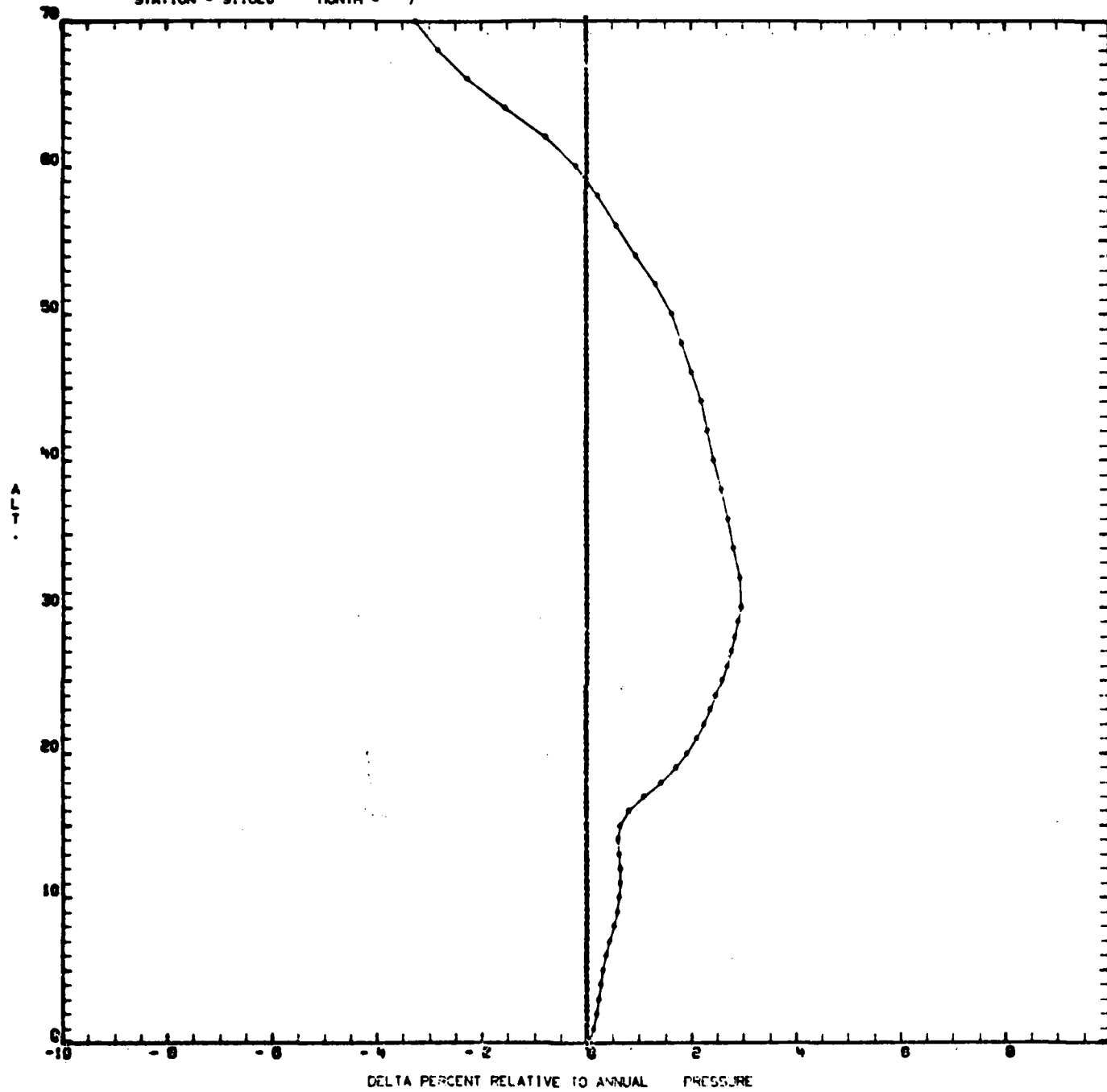

Figure B-5.

STATION - 911620 MONTH - 7

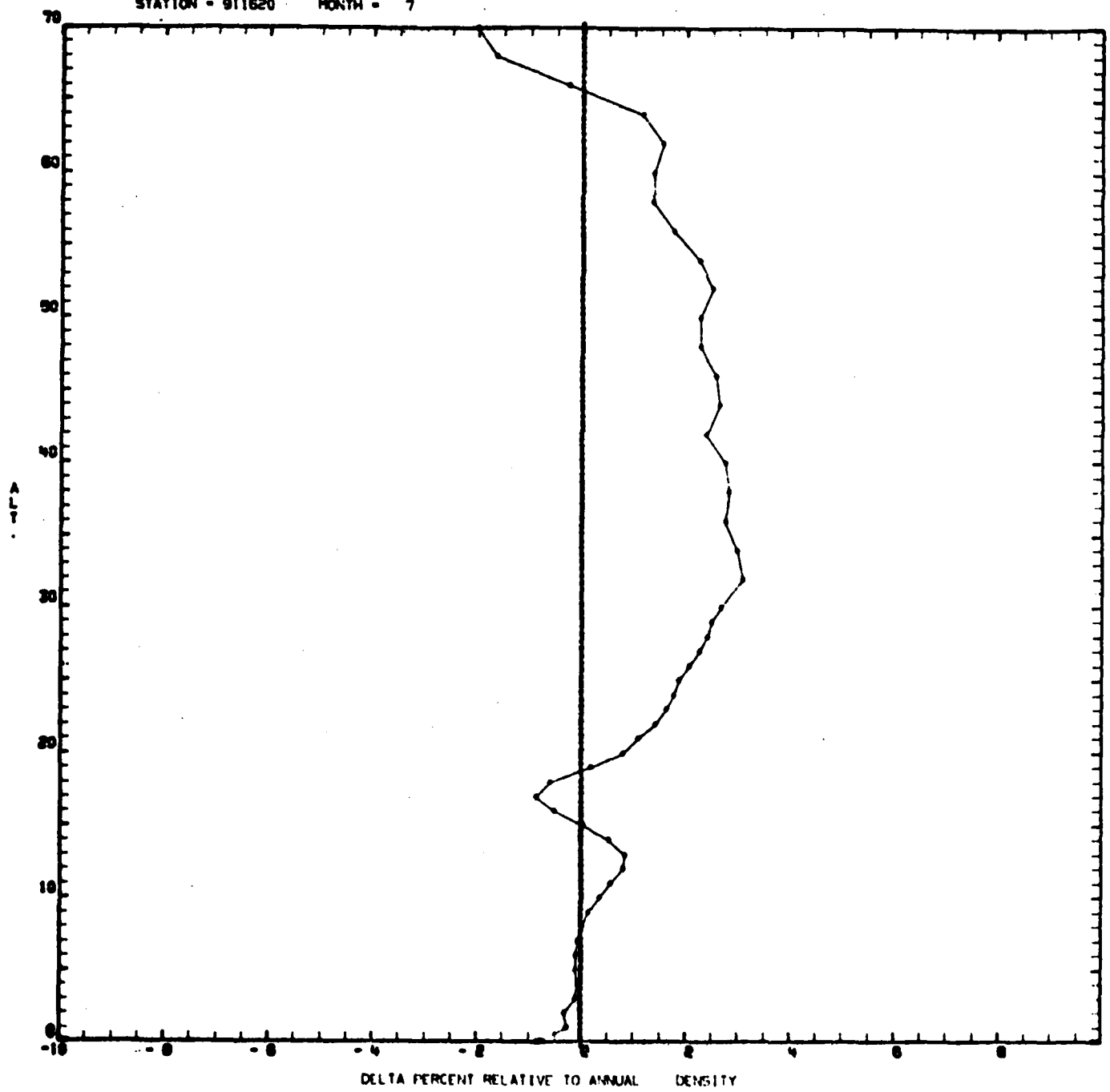

Figure B-6.

STATION - 911620 MONTH - 7

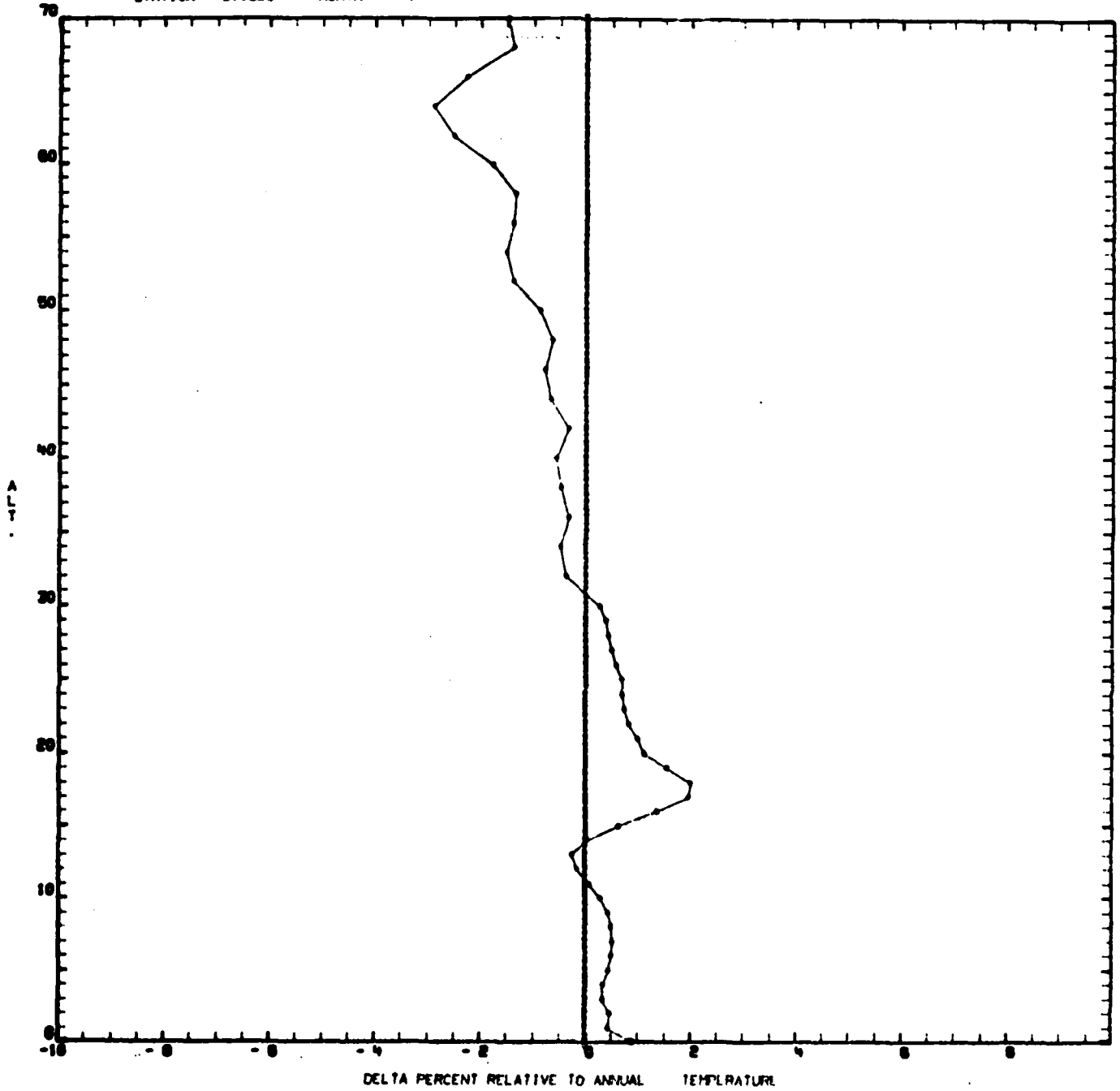

Figure B-7.

STATION = 911620 MONTH = 7

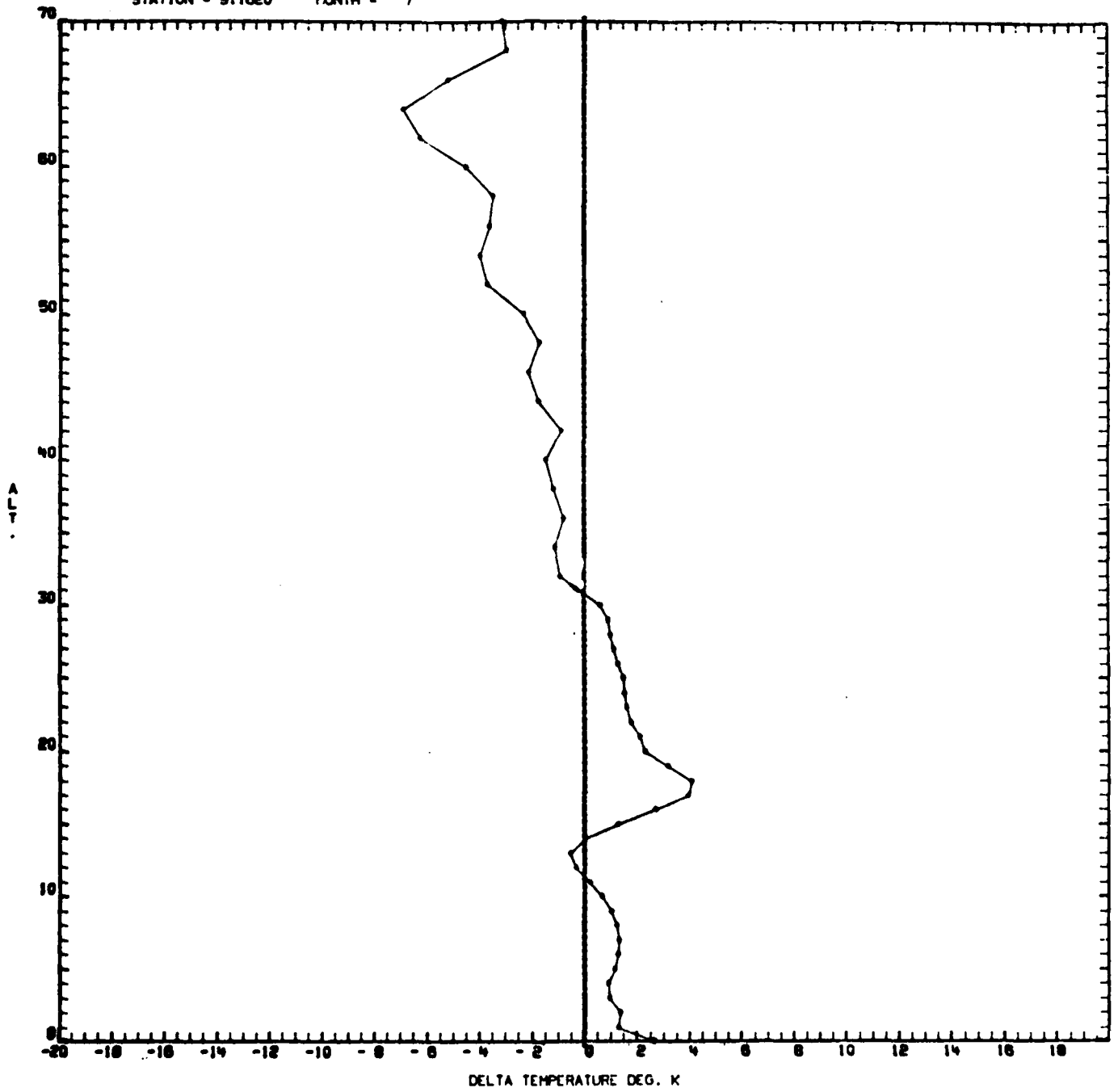

Figure B-8.

STATION - 911620 ALL MONTHS

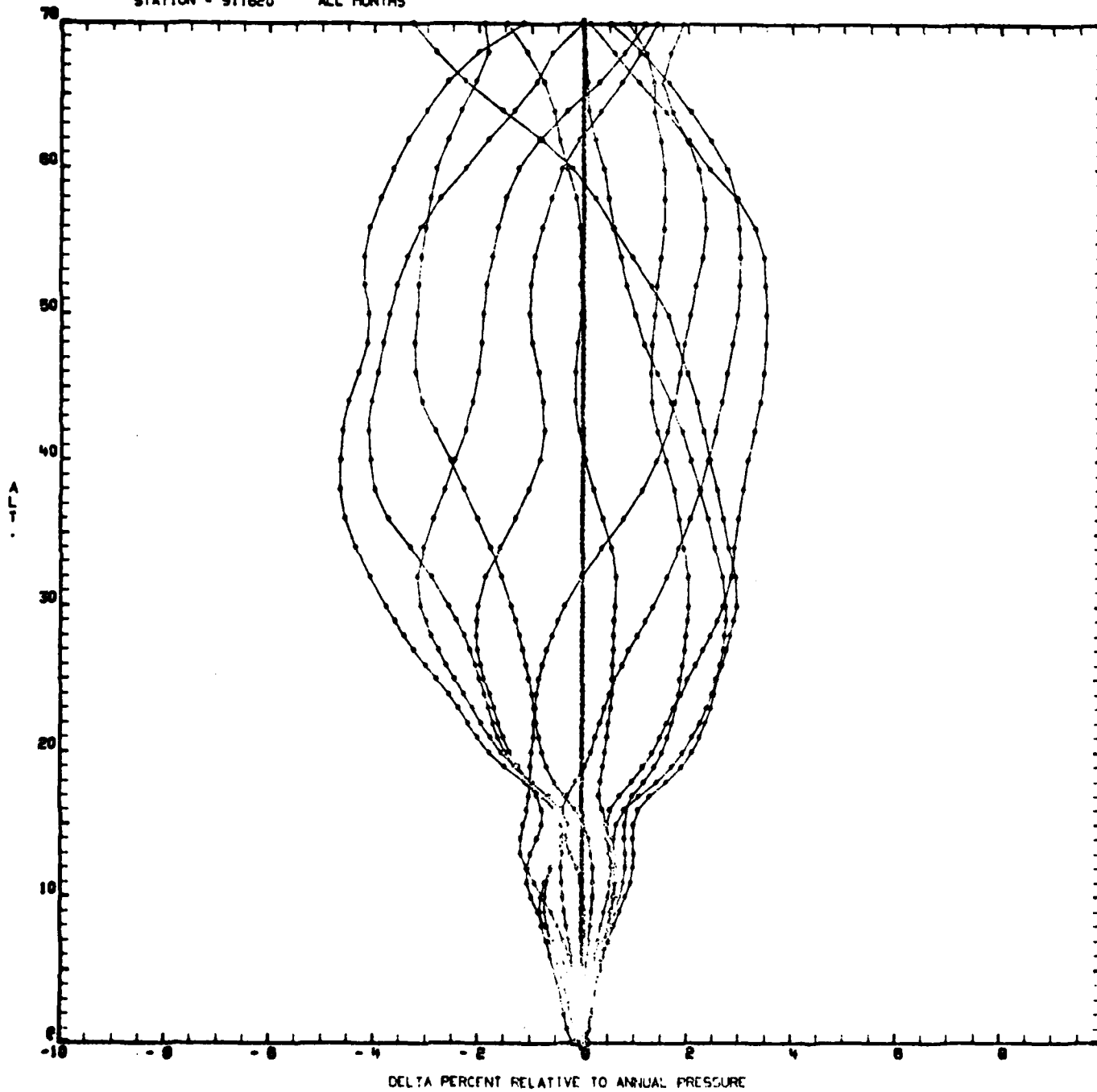

Figure B-9.

STATION - 911620 ALL MONTHS

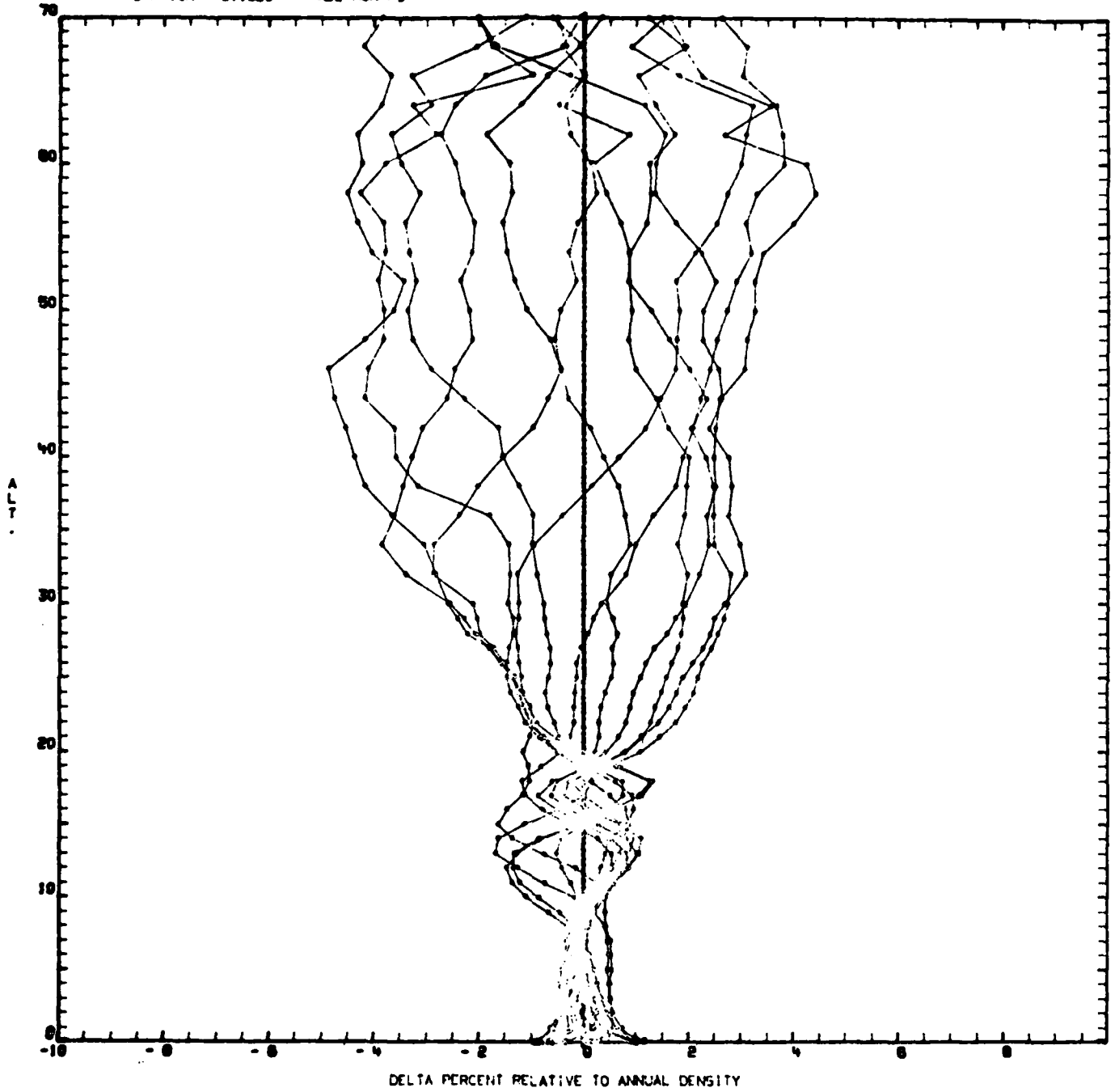

Figure B-10.

STATION - 911620 ALL MONTHS

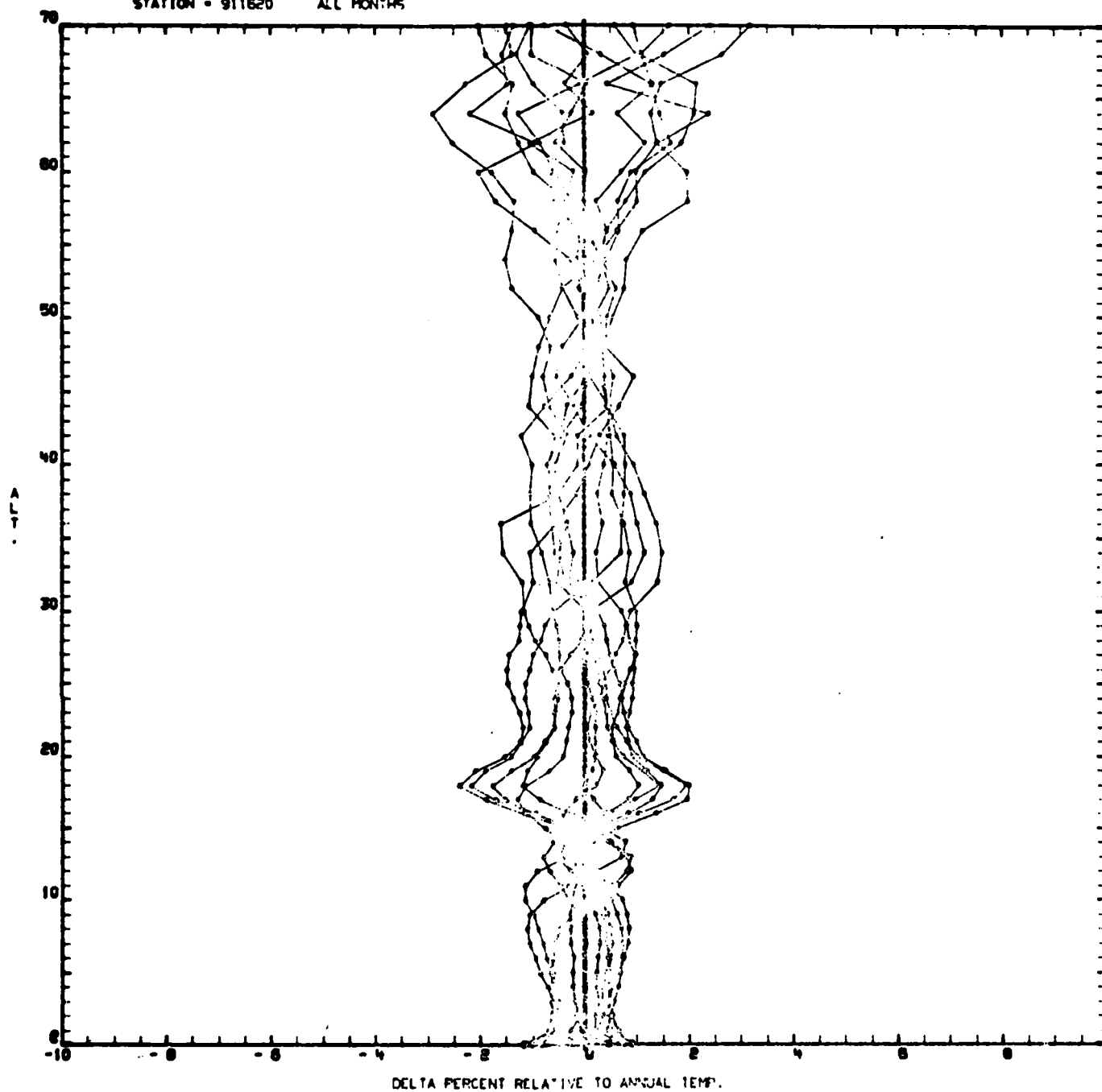

Figure B-11.

STATION = 911620 ALL MONTHS

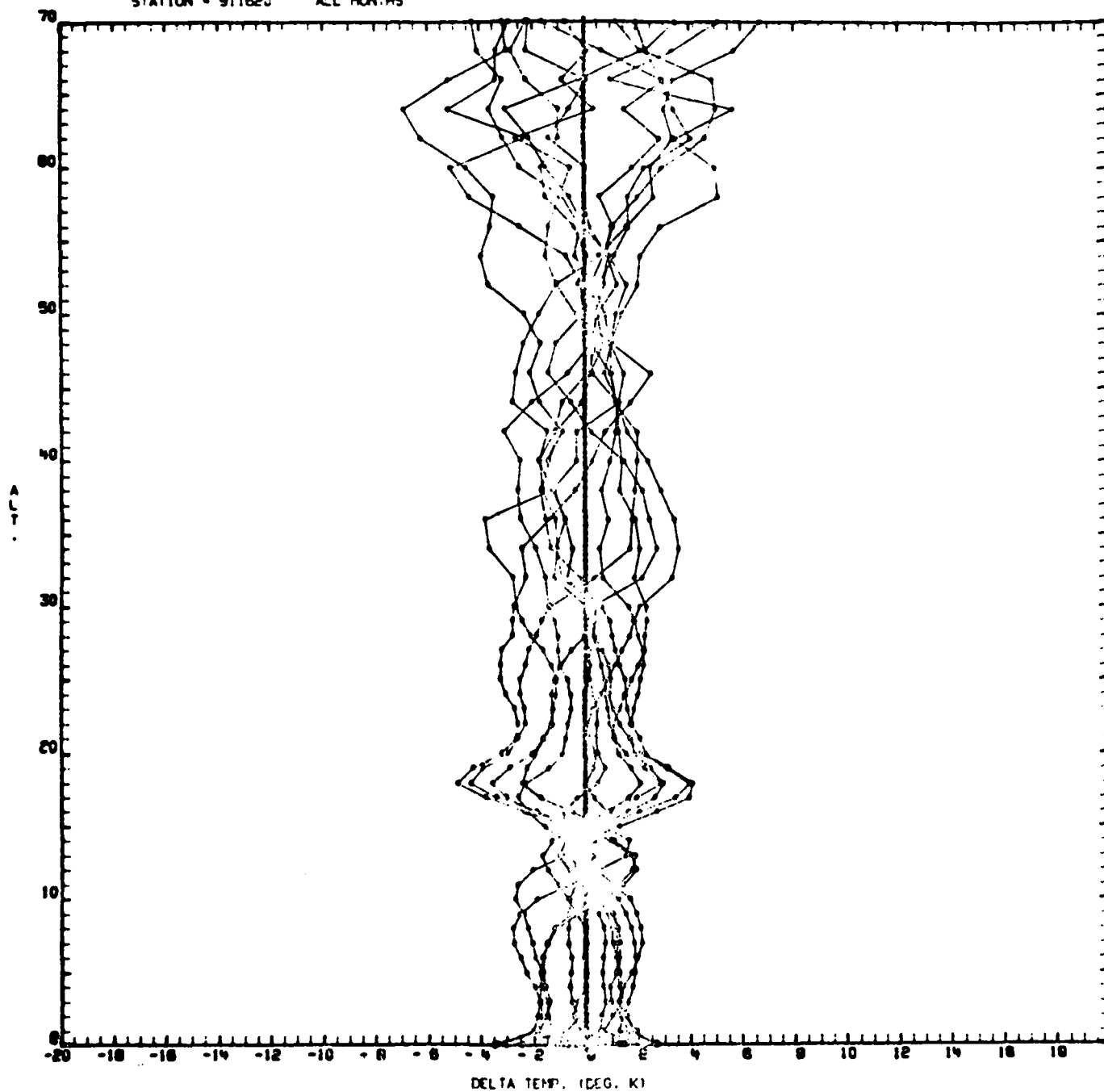

Figure B-12.

TABLE B-4.

STATION 91162C LEVEL	MONTH CVP	I CVO	CVT	RIP,T1	RIP,O1	R:T,O1	OCVP	OCVO	OCVT
.000	.0036	.0107	.0189	-.3156	.6262	-.9491	-.0159	-.0018	-.0054
.005	.0037	.0110	.0191	-.3627	.6322	-.9489	-.0163	-.0018	-.0056
1.000	.0037	.0077	.0071	.0601	.4059	-.8785	-.0111	-.0031	-.0043
2.000	.0046	.0082	.0050	.4165	.0252	-.8934	-.0132	-.0048	-.0031
3.000	.0045	.0082	.0034	.4880	-.0095	-.8774	-.0132	-.0057	-.0023
4.000	.0052	.0031	.0039	.5753	-.0618	-.8515	-.0128	-.0070	-.0034
5.000	.0050	.0055	.0109	.6390	-.1220	-.8414	-.0134	-.0064	-.0035
6.000	.0070	.0033	.0126	.6502	-.1622	-.8337	-.0149	-.0103	-.0039
7.000	.0022	.0100	.0140	.7131	-.1784	-.8170	-.0158	-.0123	-.0042
8.000	.0097	.0114	.0157	.6901	-.0992	-.7956	-.0174	-.0139	-.0054
9.000	.0112	.0128	.0169	.6560	.0217	-.7457	-.0184	-.0153	-.0072
10.000	.0127	.0141	.0173	.5999	.1637	-.6911	-.0187	-.0160	-.0094
11.000	.0140	.0142	.0156	.5446	.3228	-.5554	-.0199	-.0154	-.0125
12.000	.0149	.0149	.0146	.4239	.5222	-.4097	-.0146	-.0146	-.0152
13.000	.0159	.0165	.0140	.3935	.6255	-.4652	-.0146	-.0135	-.0184
14.000	.0166	.0193	.0141	.2150	.7028	-.5435	-.0168	-.0114	-.0219
15.000	.0169	.0215	.0137	.0275	.7685	-.6184	-.0133	-.0092	-.0146
16.000	.0167	.0234	.0134	-.1959	.8287	-.7138	-.0201	-.0067	-.0267
17.000	.0159	.0269	.0158	-.4333	.8497	-.8471	-.0202	-.0049	-.0271
18.000	.0145	.0230	.0197	-.5139	.8322	-.9033	-.0132	-.0042	-.0247
19.000	.0127	.0259	.0174	-.4618	.8029	-.8335	-.0325	-.0043	-.0212
20.000	.0117	.0203	.0134	-.3117	.7803	-.8375	-.0220	-.0047	-.0186
21.000	.0113	.0170	.0119	-.0710	.7134	-.7435	-.0176	-.0067	-.0163
22.000	.0115	.0147	.0117	.1920	.6280	-.6437	-.0149	-.0084	-.0145
23.000	.0118	.0132	.0112	.3245	.6057	-.5472	-.0127	-.0097	-.0138
24.000	.0123	.0133	.0119	.4000	.5493	-.5063	-.0120	-.0110	-.0137
25.000	.0132	.0136	.0115	.4460	.5636	-.4911	-.0129	-.0127	-.0142
26.000	.0142	.0141	.0119	.4302	.6458	-.4114	-.0118	-.0120	-.0164
27.000	.0144	.0153	.0119	.3317	.6793	-.4670	-.0129	-.0110	-.0178
28.000	.0149	.0166	.0127	.2622	.6785	-.5132	-.0145	-.0110	-.0188
29.000	.0155	.0170	.0129	.2956	.6991	-.4949	-.0145	-.0113	-.0196
30.000	.0163	.0170	.0136	.3697	.6654	-.4477	-.0143	-.0130	-.0197
32.000	.0216	.0231	.0155	.3412	.6503	-.4907	-.0200	-.0169	-.0262
34.000	.0233	.0232	.0220	.1691	.6704	-.6159	-.0279	-.0161	-.0305
36.000	.0233	.0287	.0207	.1754	.7038	-.5759	-.0215	-.0152	-.0318
38.000	.0254	.0301	.0197	.1262	.7604	-.5483	-.0144	-.0150	-.0357
40.000	.0269	.0303	.0255	.3350	.6066	-.5458	-.0299	-.0222	-.0316
42.000	.0288	.0326	.0237	.2395	.7095	-.5142	-.0275	-.0199	-.0378
44.000	.0309	.0322	.0237	.3628	.6705	-.4481	-.0270	-.0243	-.0375
46.000	.0333	.0318	.0246	.4302	.7153	-.3232	-.0230	-.0261	-.0405
48.000	.0363	.0325	.0237	.4792	.7693	-.1921	-.0198	-.0275	-.0452
50.000	.0395	.0314	.0243	.6285	.7885	-.0027	-.0152	-.0325	-.0465
52.000	.0418	.0301	.0241	.5082	.8177	-.0702	-.0184	-.0249	-.0538
54.000	.0452	.0402	.0244	.3886	.8464	-.1617	-.0214	-.0274	-.0630
56.000	.0475	.0419	.0253	.4794	.8339	-.0247	-.0207	-.0320	-.0631
58.000	.0488	.0410	.0260	.5420	.8457	.0098	-.0182	-.0328	-.0637
60.000	.0463	.0405	.0239	.4853	.8562	-.0355	-.0181	-.0399	-.0627
62.000	.0548	.0387	.0313	.7259	.8312	.2211	-.0151	-.0474	-.0622
64.000	.0402	.0376	.0327	.4832	.6498	-.3515	-.0300	-.0353	-.0452
66.000	.0430	.0406	.0386	.4127	.7691	-.2653	-.0260	-.0309	-.0561
68.000	.0465	.0441	.0247	.3766	.8275	-.2084	-.0242	-.0342	-.0639
70.000	.0467	.0510	.0267	.1196	.8545	-.4136	-.0203	-.0374	-.0710

TABLE B-5.

STATION 911828 LEVEL	MONTH CVP	7 CVD	CVT	RIP,T)	RIP,D)	RIT,D)	DCVP	DCVD	DCVT
.000	.0014	.0049	.0046	-.0822	.3598	-.9594	-.0081	-.0011	-.0017
.005	.0014	.0049	.0046	-.0702	.3491	-.9533	-.0061	-.0011	-.0017
1.000	.0013	.0029	.0036	-.0340	.3618	-.9440	-.0002	-.0010	-.0015
2.000	.0014	.0060	.0062	.2801	-.0066	-.9743	-.0107	-.0016	-.0012
3.000	.0016	.0058	.0052	.3876	-.1324	-.9050	-.0103	-.0021	-.0012
4.000	.0020	.0067	.0071	.3609	-.0856	-.9501	-.0118	-.0025	-.0015
5.000	.0024	.0056	.0077	.5588	-.2811	-.9529	-.0119	-.0035	-.0014
6.000	.0031	.0066	.0083	.6813	-.4038	-.9402	-.0118	-.0049	-.0014
7.000	.0039	.0062	.0087	.7698	-.4519	-.9172	-.0110	-.0063	-.0014
8.000	.0048	.0060	.0090	.7851	-.3781	-.8592	-.0102	-.0076	-.0018
9.000	.0059	.0058	.0092	.7917	-.2468	-.7875	-.0092	-.0093	-.0025
10.000	.0069	.0058	.0095	.7914	-.0932	-.6868	-.0084	-.0106	-.0033
11.000	.0060	.0056	.0088	.7850	.1959	-.4522	-.0064	-.0113	-.0048
12.000	.0069	.0069	.0080	.6742	.4919	-.3114	-.0061	-.0100	-.0076
13.000	.0096	.0102	.0081	.3440	.6622	-.4759	-.0098	-.0175	-.0116
14.000	.0096	.0159	.0111	-.1737	.7268	-.8026	-.0174	-.0048	-.0144
15.000	.0090	.0185	.0133	-.3498	.7403	-.8388	-.0227	-.0038	-.0143
16.000	.0082	.0184	.0134	-.4176	.7505	-.9139	-.0236	-.0032	-.0133
17.000	.0075	.0150	.0107	-.3305	.7355	-.8918	-.0183	-.0032	-.0117
18.000	.0072	.0121	.0084	-.2115	.7385	-.8152	-.0133	-.0034	-.0109
19.000	.0069	.0104	.0066	-.1904	.7812	-.7535	-.0101	-.0031	-.0108
20.000	.0068	.0093	.0064	-.1463	.7733	-.7404	-.0096	-.0032	-.0103
21.000	.0067	.0091	.0064	.0414	.7074	-.6770	-.0084	-.0040	-.0094
22.000	.0069	.0094	.0060	.1570	.7112	-.5827	-.0074	-.0045	-.0093
23.000	.0071	.0083	.0059	.1894	.7178	-.5477	-.0071	-.0047	-.0095
24.000	.0074	.0092	.0068	.1613	.6835	-.6101	-.0096	-.0050	-.0098
25.000	.0076	.0032	.0070	.2079	.6061	-.5910	-.0087	-.0054	-.0098
26.000	.0079	.0091	.0070	.2640	.6048	-.5451	-.0082	-.0058	-.0099
27.000	.0082	.0095	.0075	.2780	.6408	-.5495	-.0087	-.0063	-.0102
28.000	.0085	.0093	.0072	.3181	.6729	-.4872	-.0080	-.0065	-.0106
29.000	.0082	.0093	.0080	.4184	.6221	-.4498	-.0082	-.0079	-.0105
30.000	.0082	.0089	.0074	.4429	.6655	-.3745	-.0071	-.0077	-.0107
32.000	.0126	.0130	.0121	.4521	.5509	-.4953	-.0125	-.0118	-.0135
34.000	.0139	.0158	.0140	.3576	.5623	-.5711	-.0159	-.0121	-.0157
36.000	.0166	.0200	.0165	.2760	.6004	-.6030	-.0200	-.0132	-.0199
38.000	.0178	.0150	.0150	.5855	.5300	-.3030	-.0124	-.0176	-.0177
40.000	.0200	.0193	.0168	.4589	.6351	-.3943	-.0161	-.0175	-.0225
42.000	.0218	.0216	.0161	.3844	.7234	-.3593	-.0159	-.0164	-.0272
44.000	.0235	.0232	.0139	.3171	.8235	-.2768	-.0136	-.0142	-.0329
46.000	.0249	.0240	.0152	.3662	.8055	-.2548	-.0143	-.0162	-.0337
48.000	.0264	.0247	.0143	.3946	.8457	-.1674	-.0126	-.0160	-.0369
50.000	.0285	.0259	.0155	.3755	.8445	-.1794	-.0139	-.0172	-.0399
52.000	.0307	.0288	.0186	.4965	.7976	-.1273	-.0148	-.0225	-.0389
54.000	.0325	.0290	.0205	.4769	.7827	-.1733	-.0171	-.0240	-.0410
56.000	.0352	.0309	.0231	.5047	.7644	-.1708	-.0187	-.0274	-.0431
58.000	.0389	.0357	.0277	.4338	.7334	-.2944	-.0254	-.0299	-.0479
60.000	.0389	.0339	.0363	.5959	.5093	-.3847	-.0314	-.0413	-.0384
62.000	.0382	.0398	.0450	.5533	.3849	-.5335	-.0406	-.0434	-.0330
64.000	.0394	.0325	.0308	.4887	.5651	-.4426	-.0293	-.0317	-.0352
66.000	.0350	.0480	.0277	-.1587	.8206	-.6930	-.0407	-.0148	-.0552
68.000	.0324	.0521	.0371	-.1203	.7078	-.7884	-.0568	-.0174	-.0475
70.000	.0276	.0574	.0419	-.3365	.7267	-.8915	-.0717	-.0121	-.0432

STATION = 911620 MONTH = 1

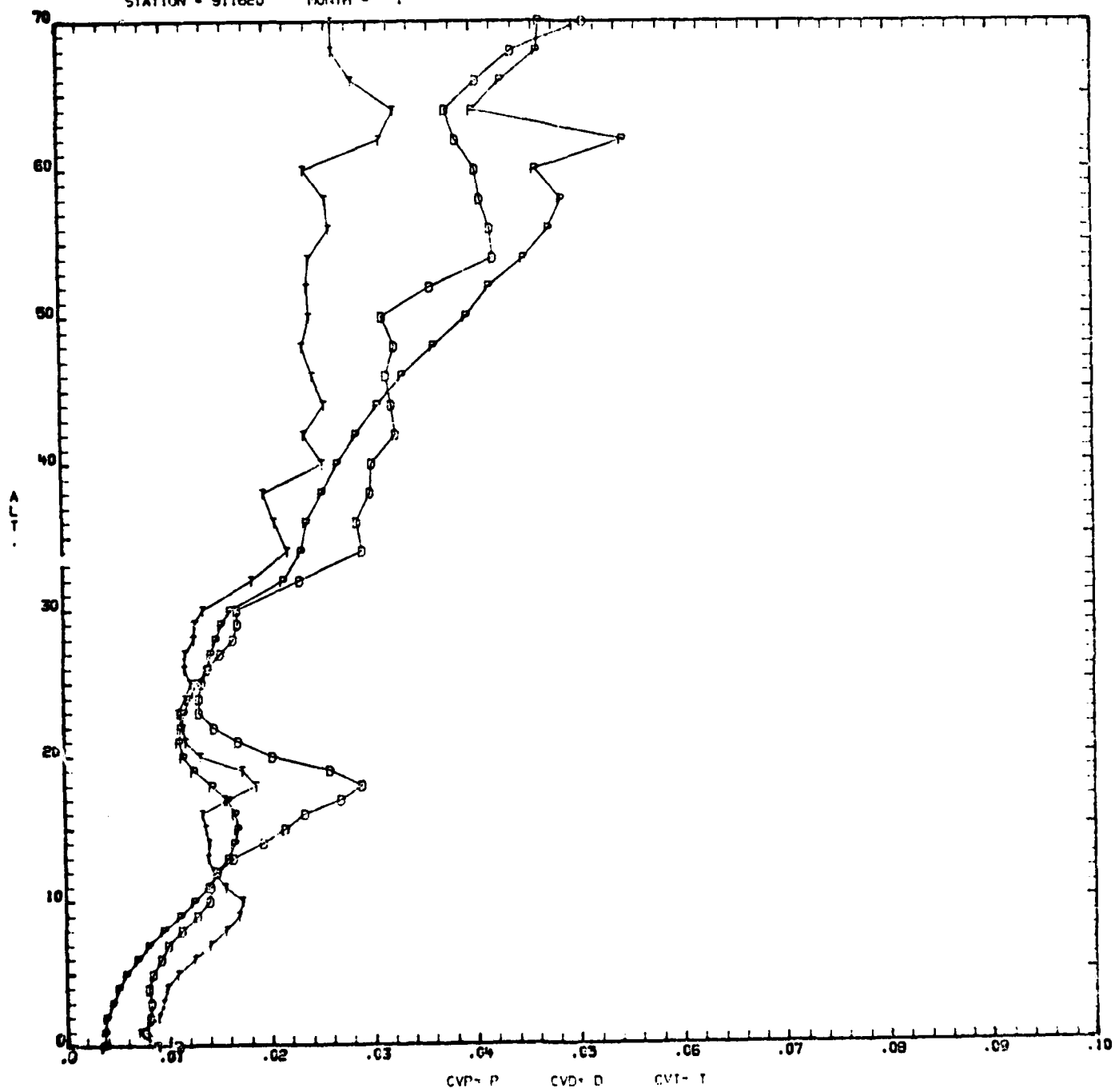

Figure B-13.

STATION = 911620 MONTH = 1

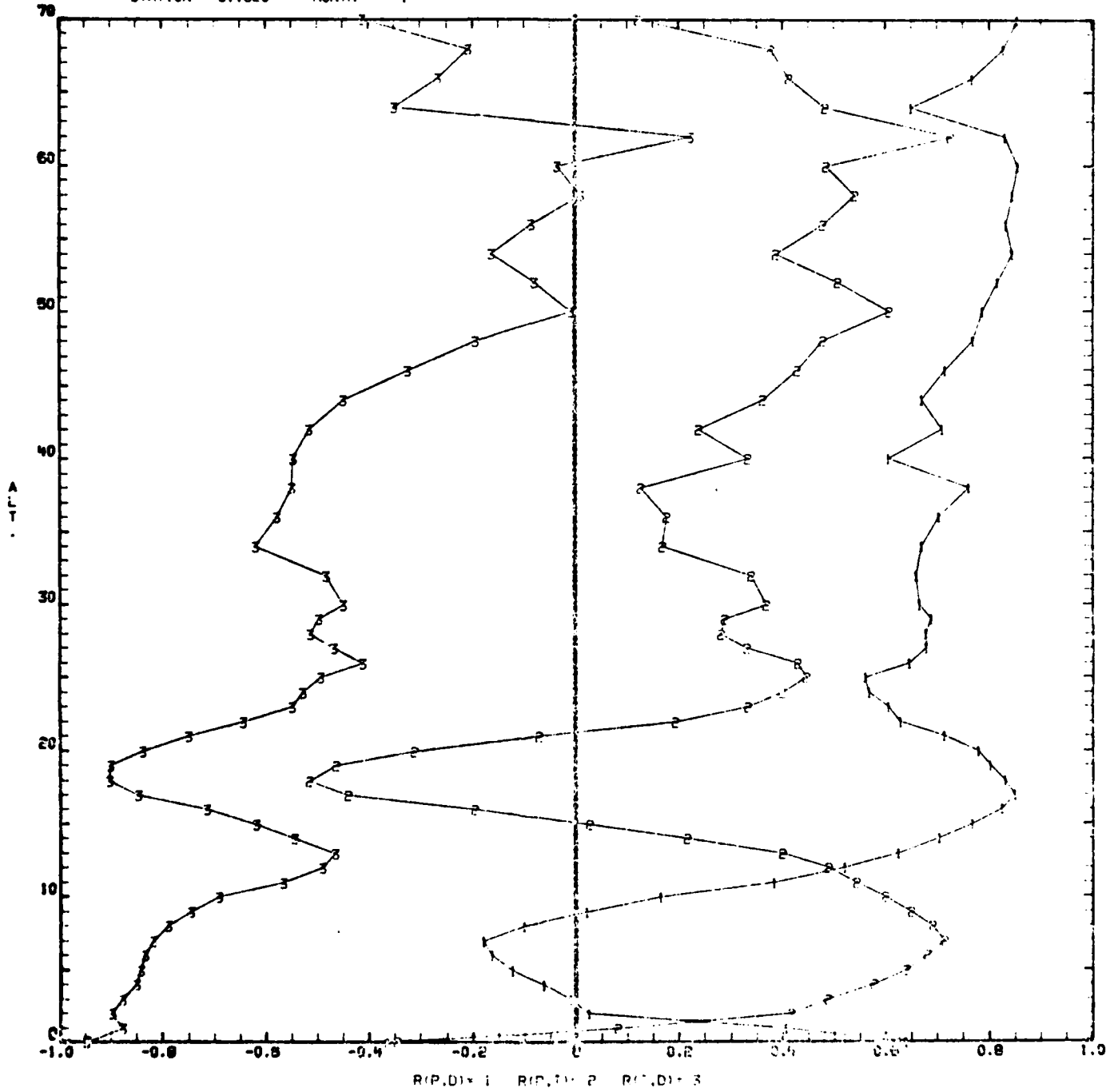

Figure B-14.

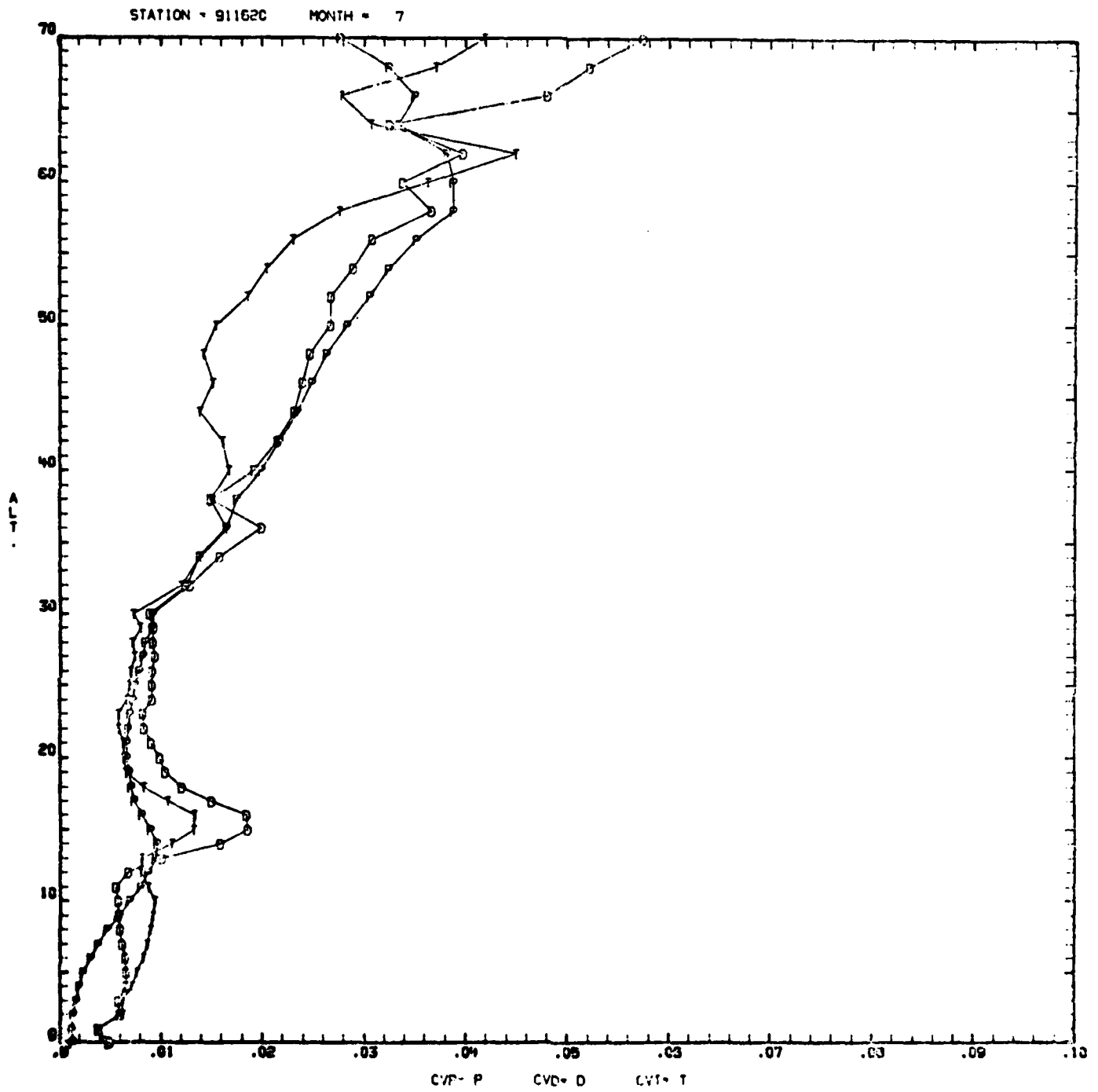

Figure B-15.

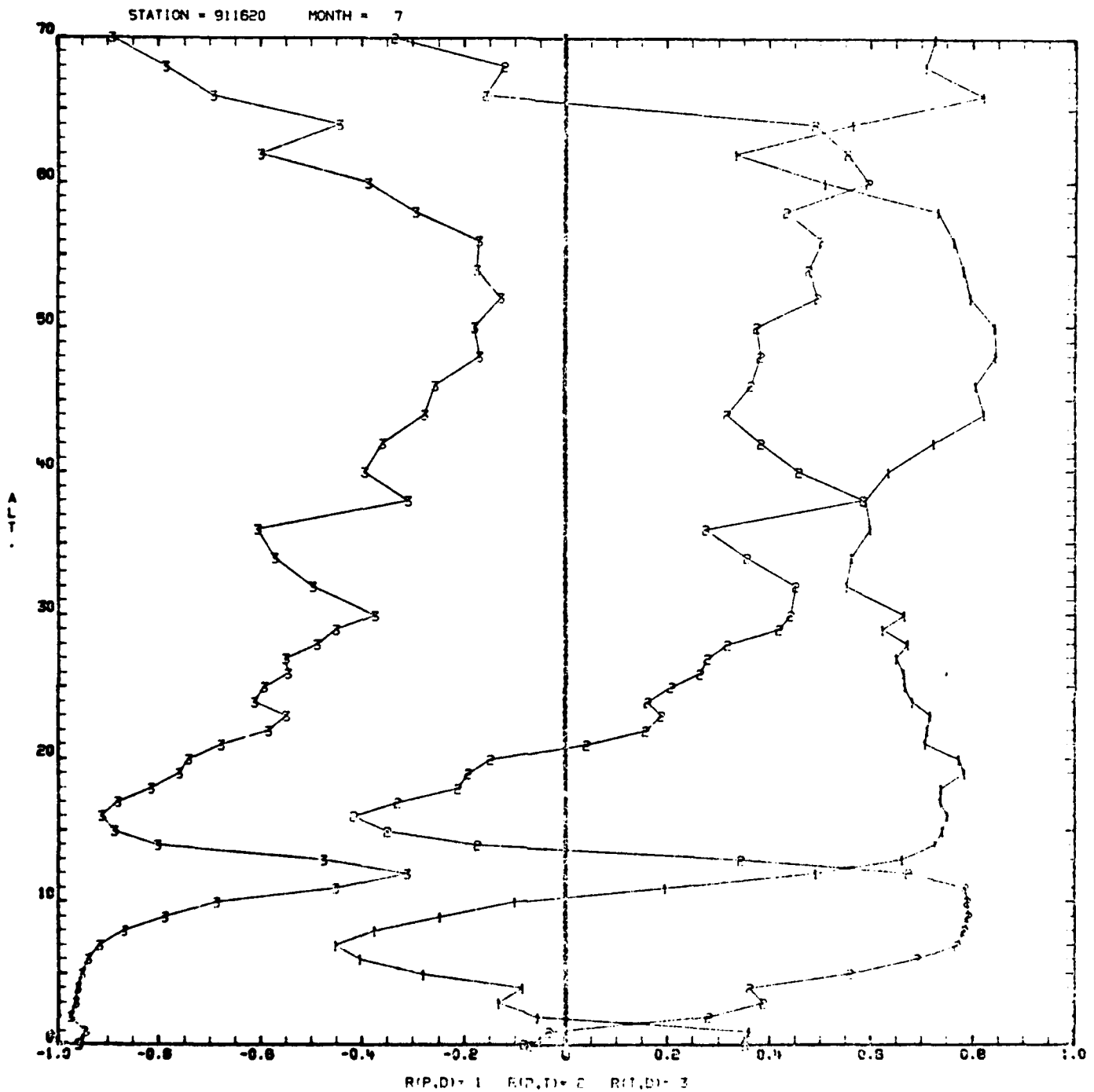

Figure B-16.

STATION = 911620 ALL MONTHS

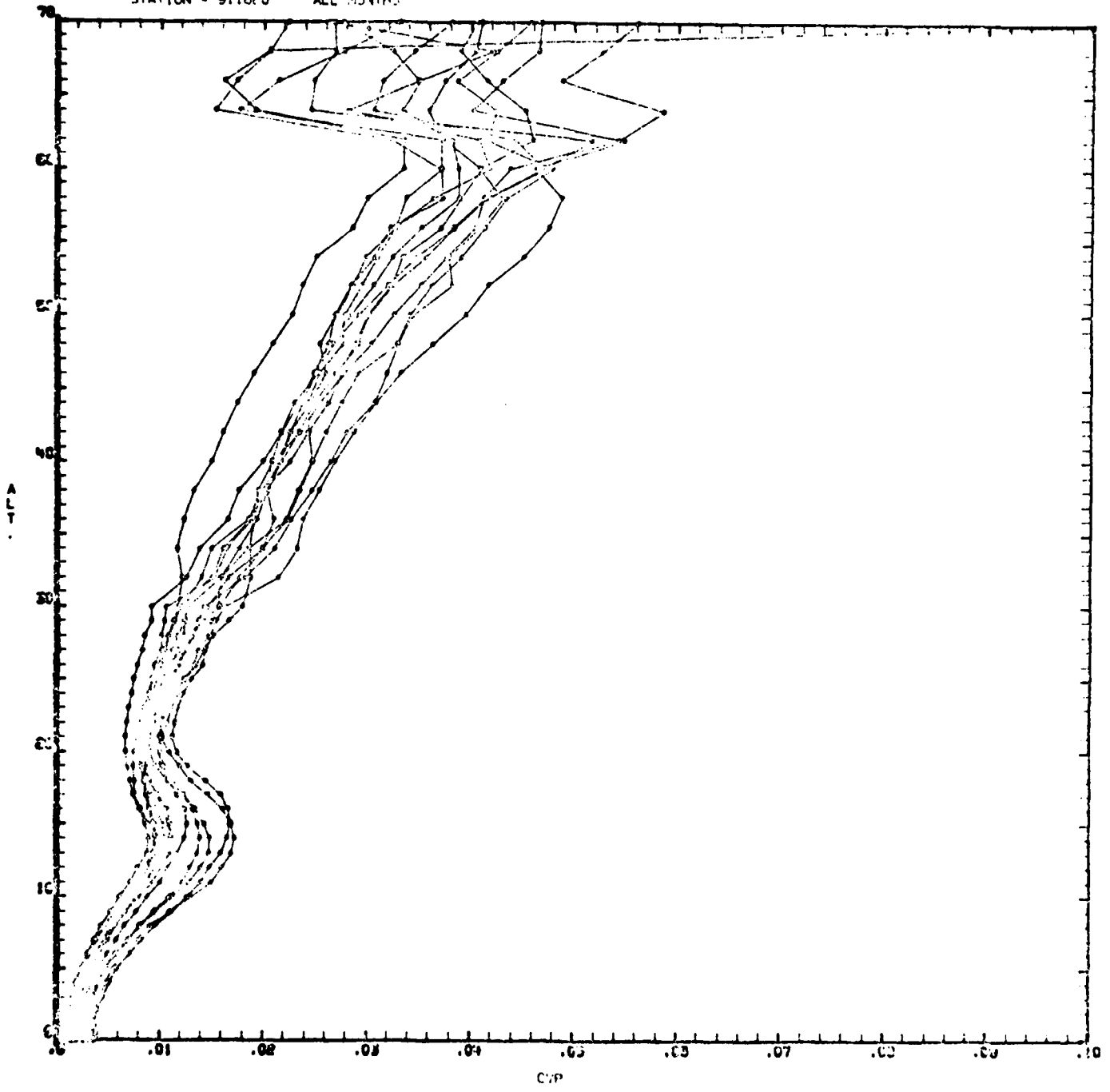

Figure B-17.

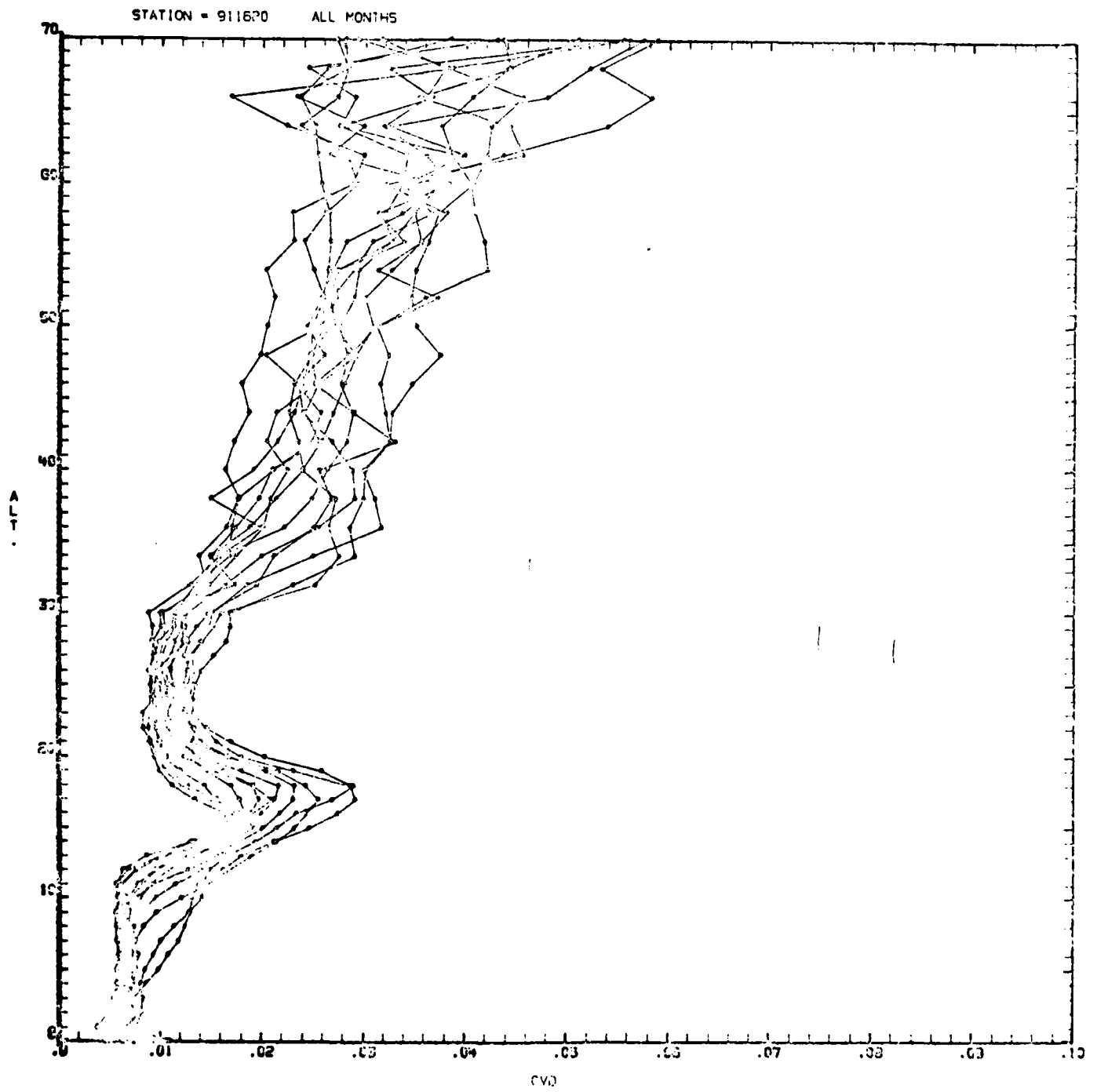

Figure B-18.

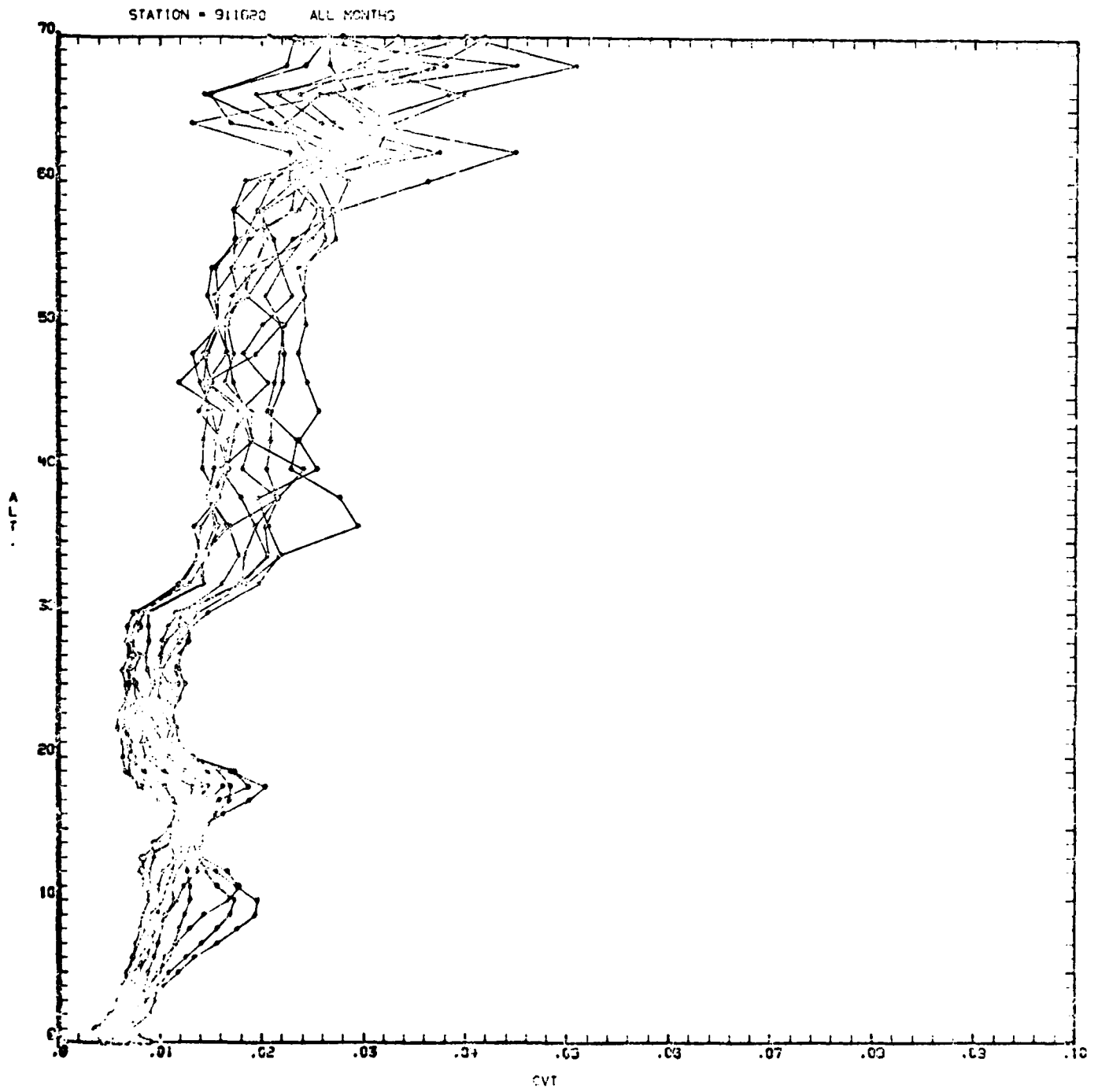

Figure B-19.

STATION - 911620 ALL MONTHS

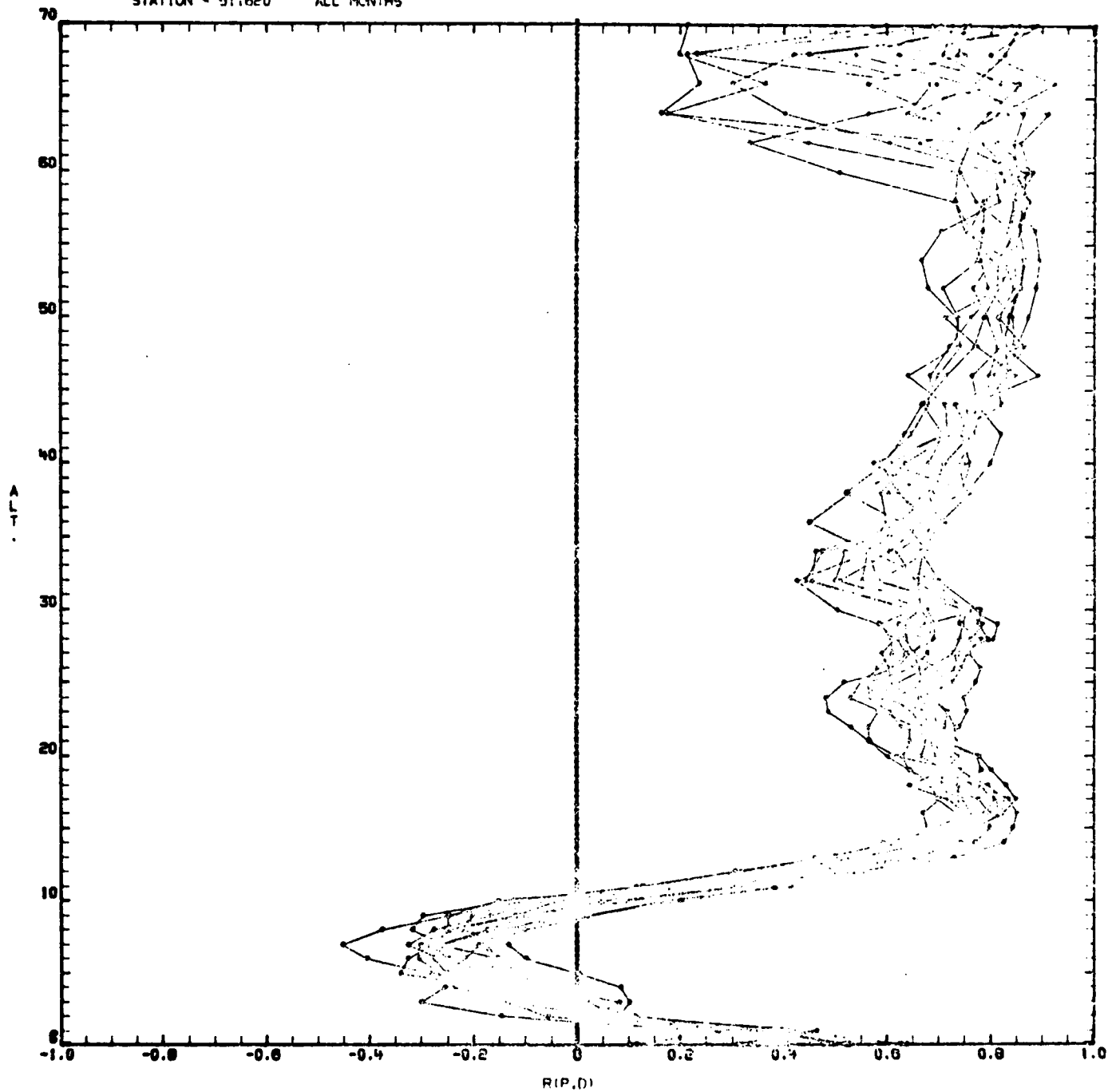

Figure B-20.

STATION = 911620 ALL MONTHS

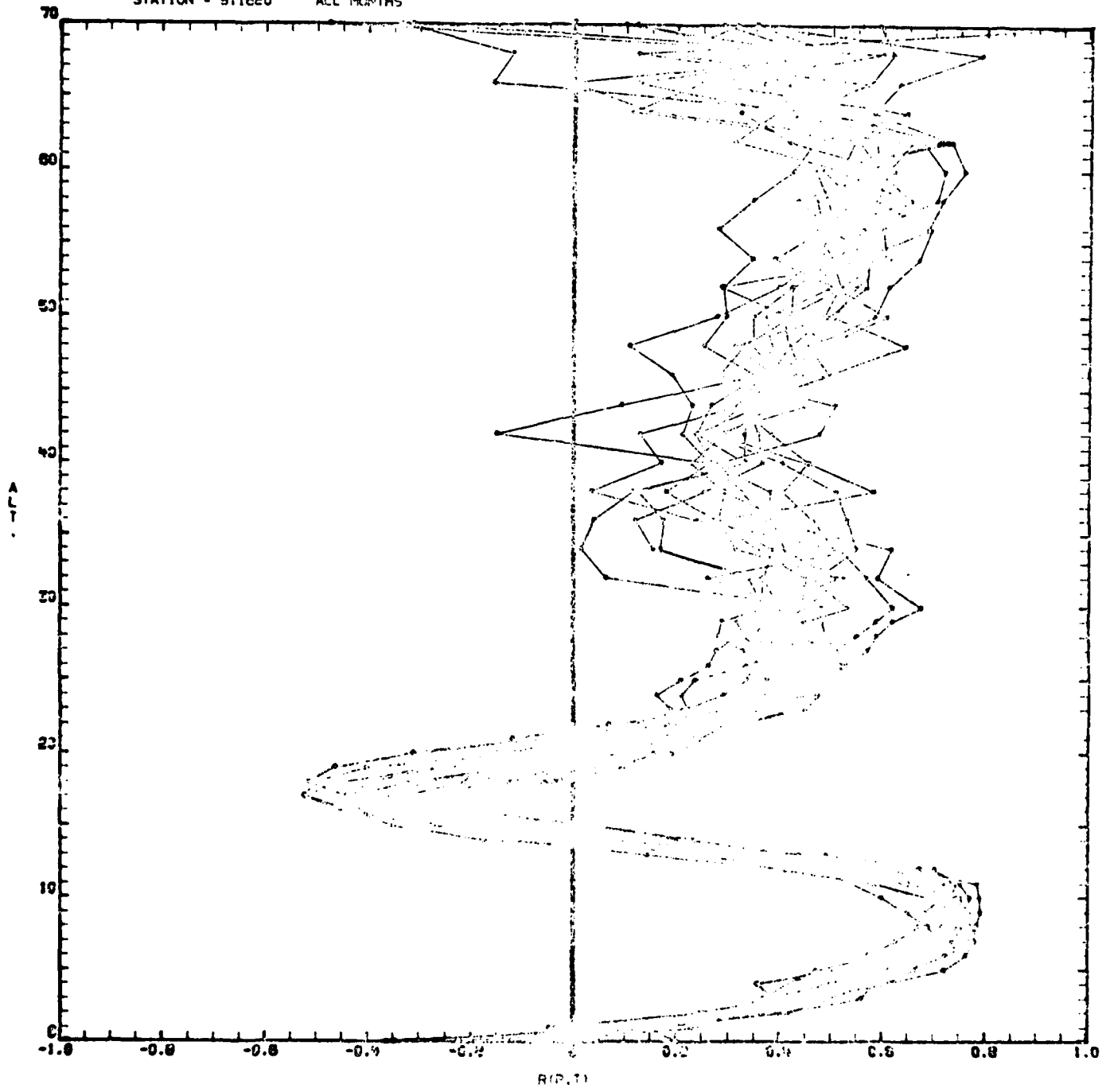

Figure B-21.

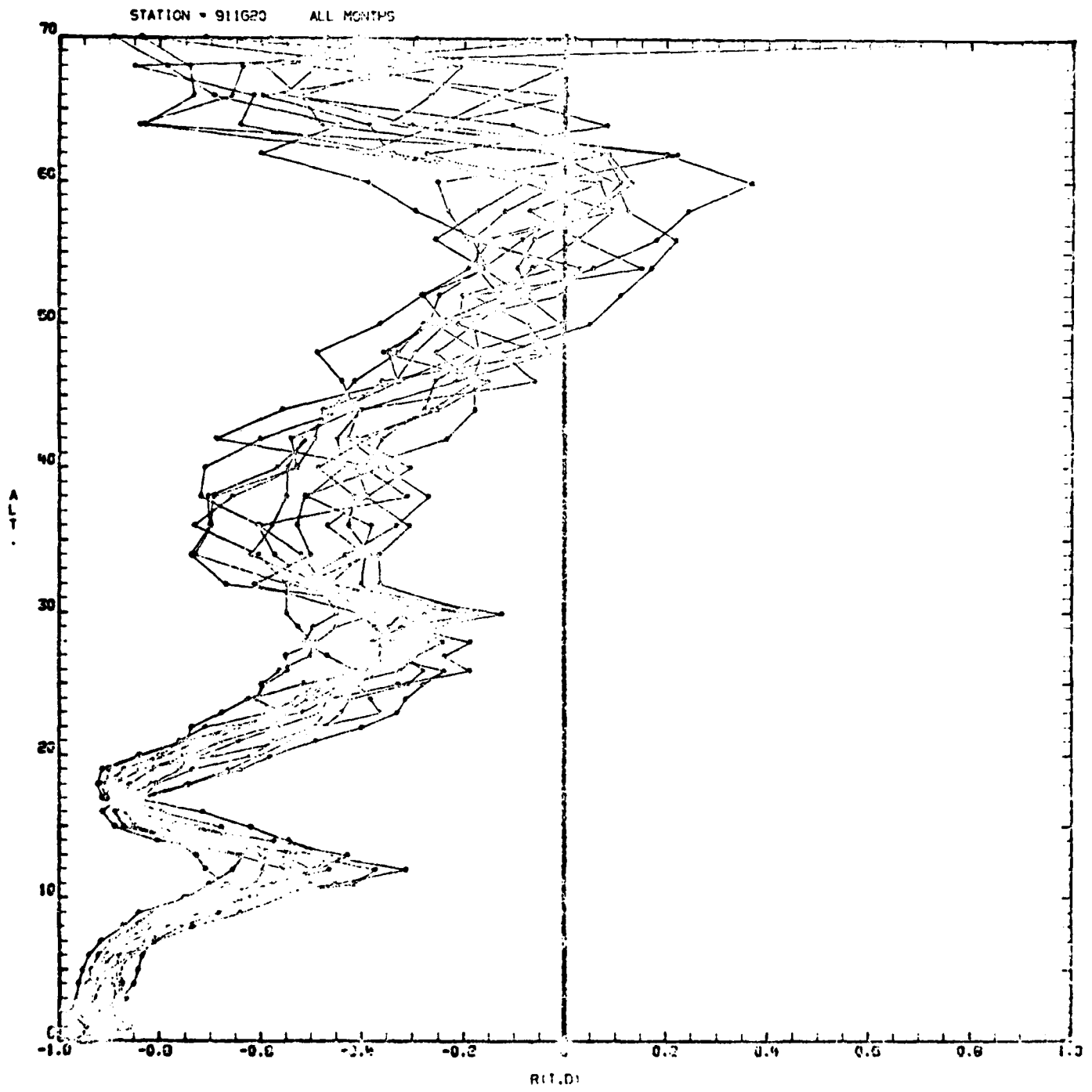

Figure B-22.